

ND129M TRITON ACER TENDL-2023 LIBRARY; T=0.K

Principal cross sections

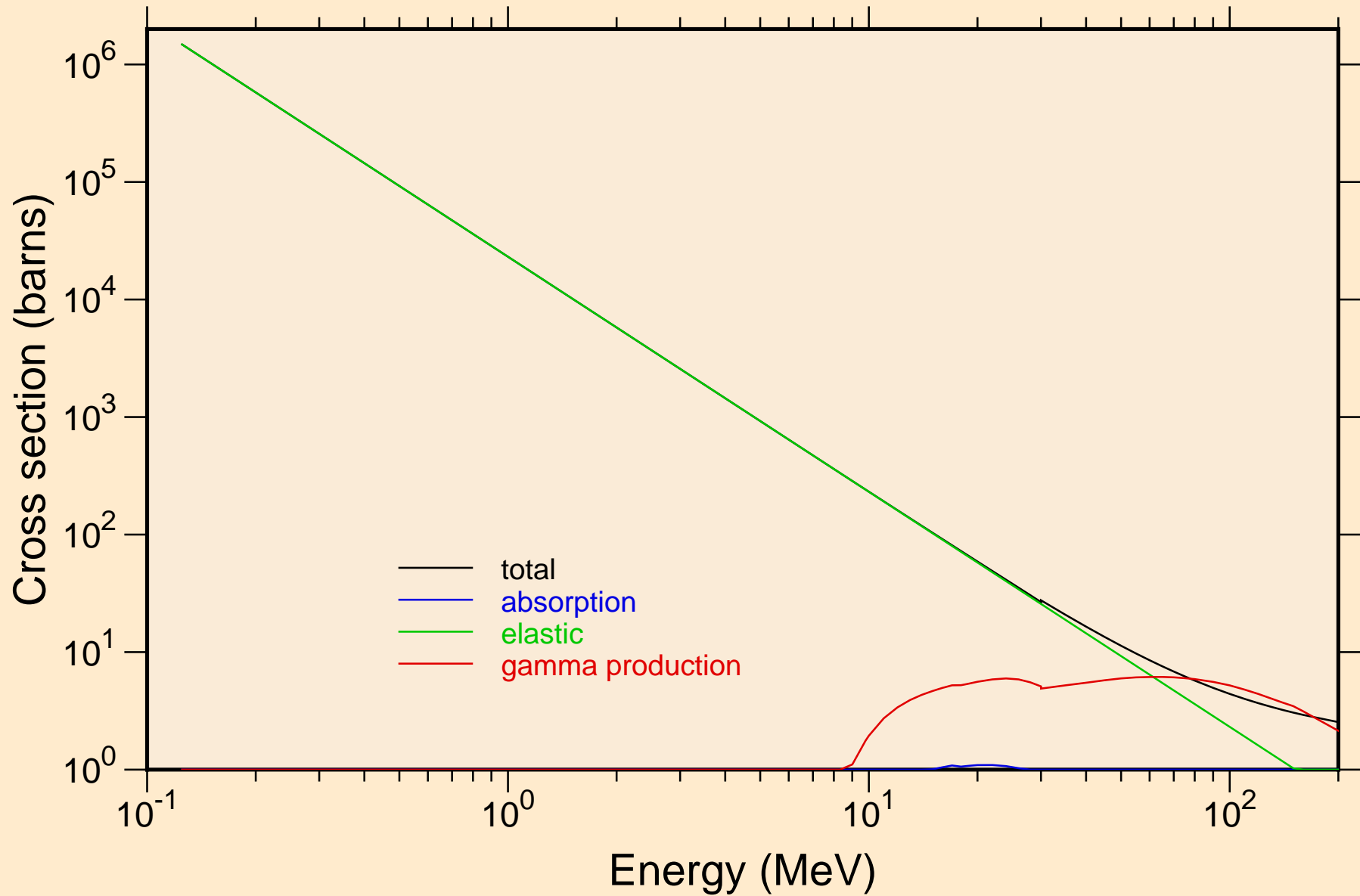

ND129M TRITON ACER TENDL-2023 LIBRARY; T=0.K

Heating

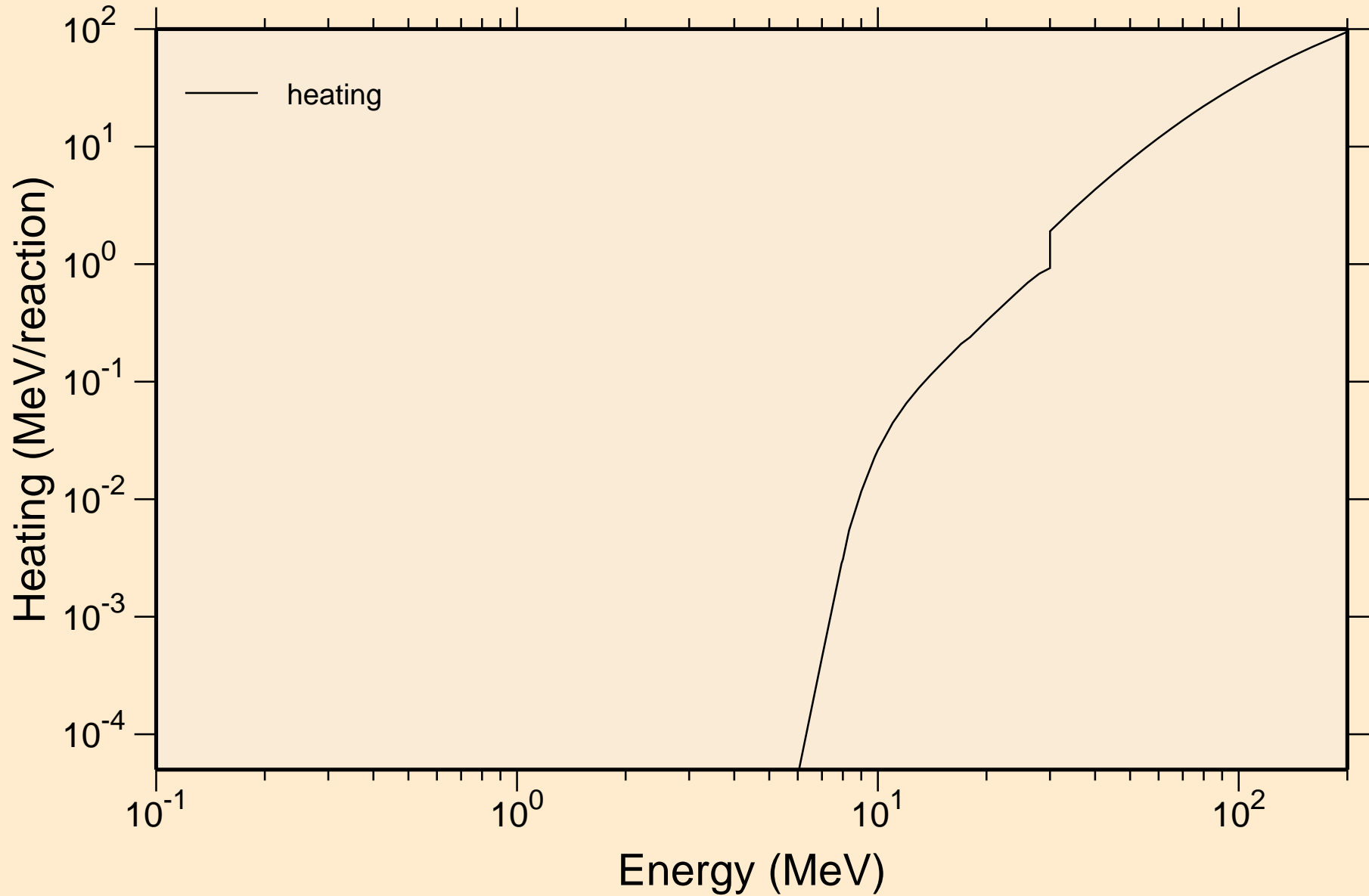

ND129M TRITON ACER TENDL-2023 LIBRARY; T=0.K

Principal cross sections

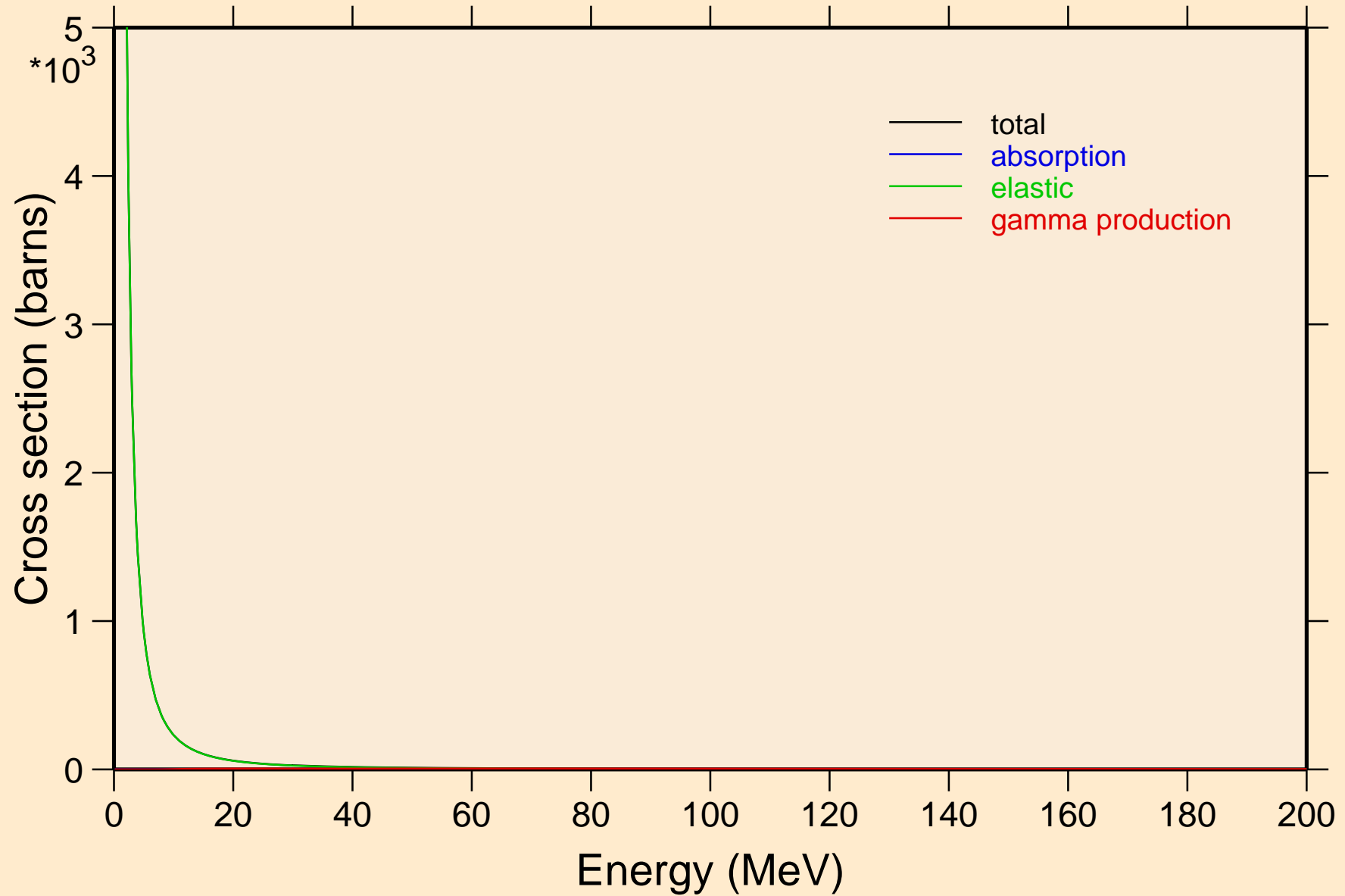

ND129M TRITON ACER TENDL-2023 LIBRARY; T=0.K

Heating

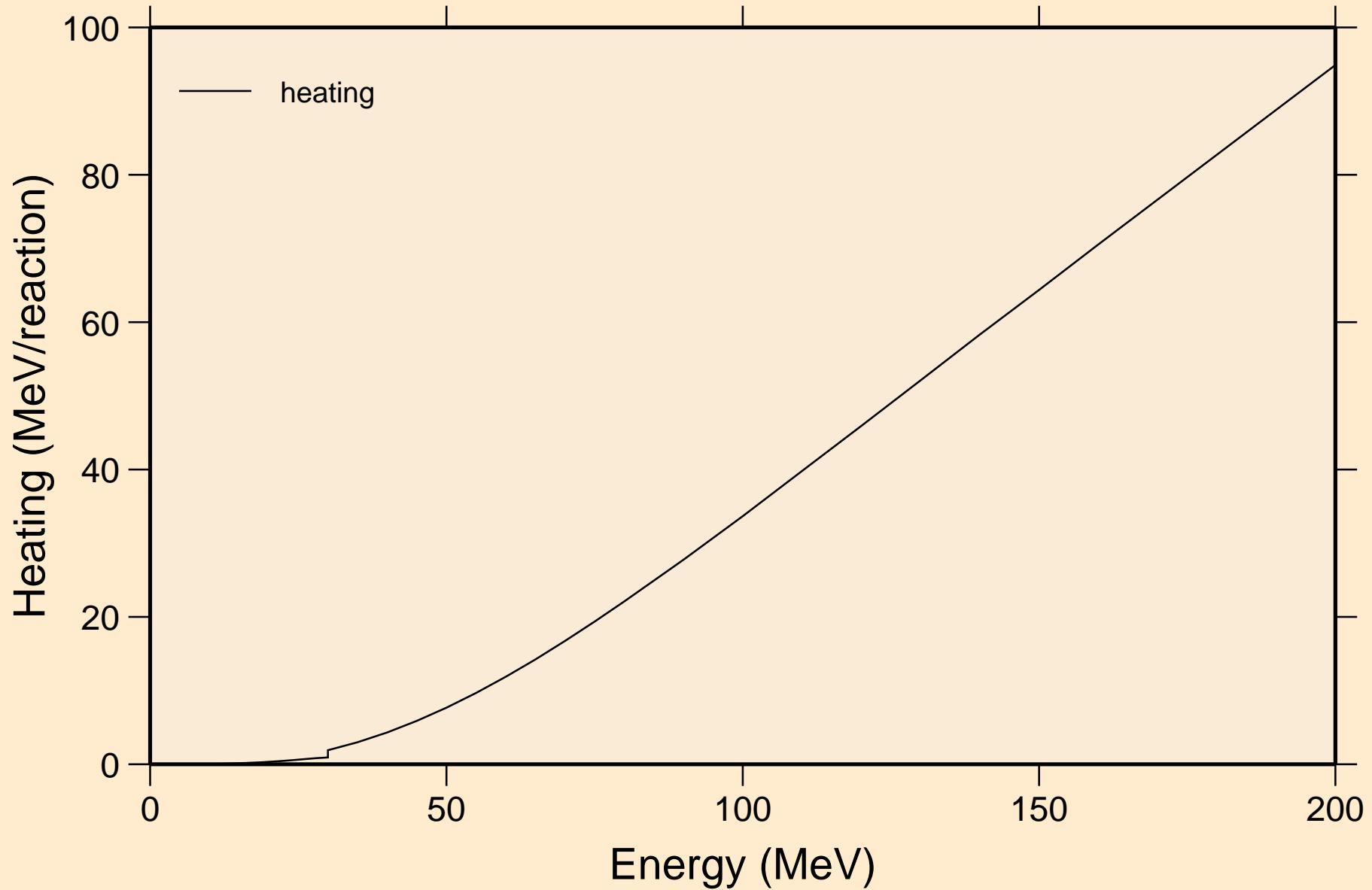

ND129M TRITON ACER TENDL-2023 LIBRARY; T=0.K
Threshold reactions

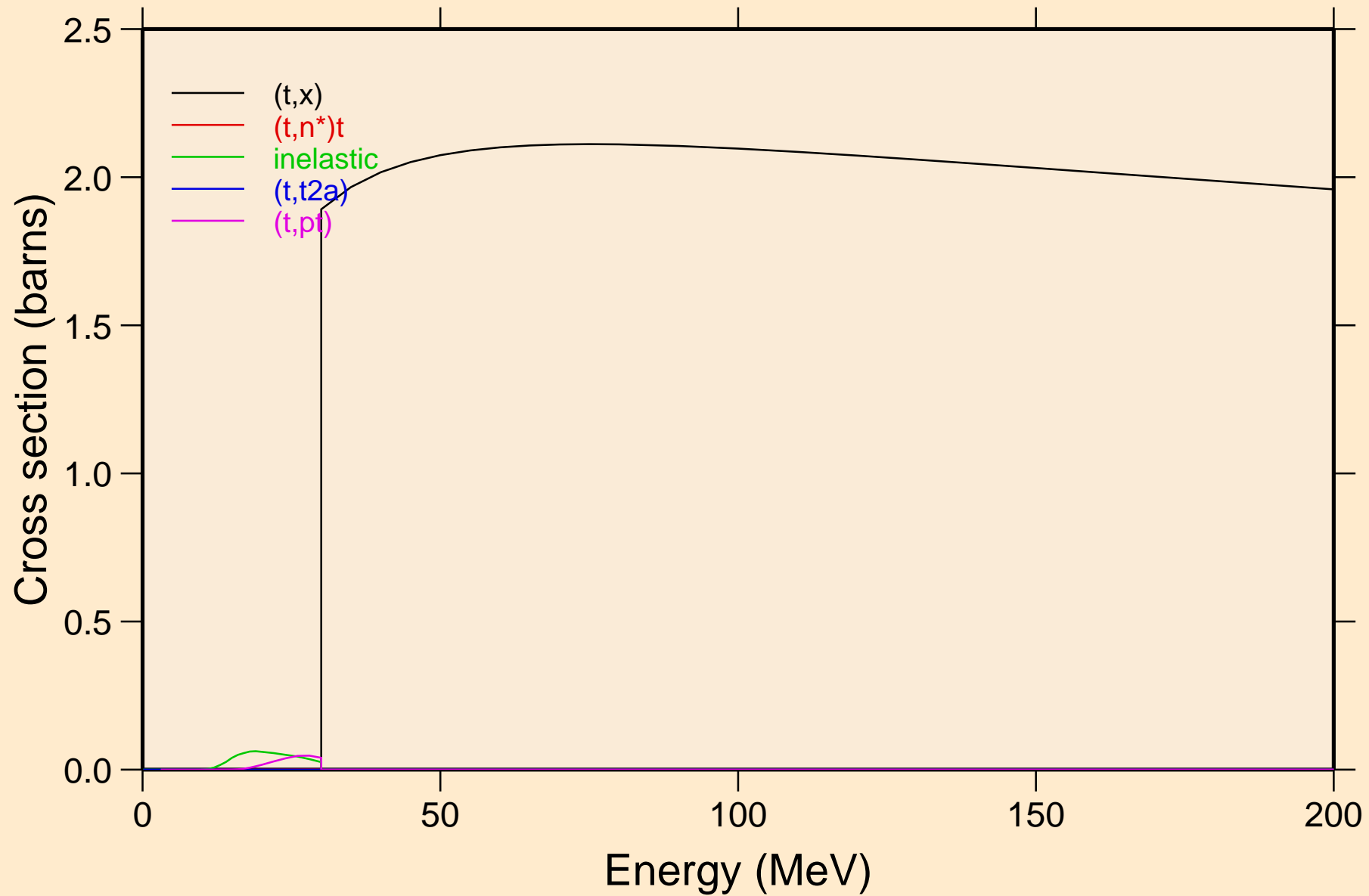

ND129M TRITON ACER TENDL-2023 LIBRARY; T=0.K
Threshold reactions

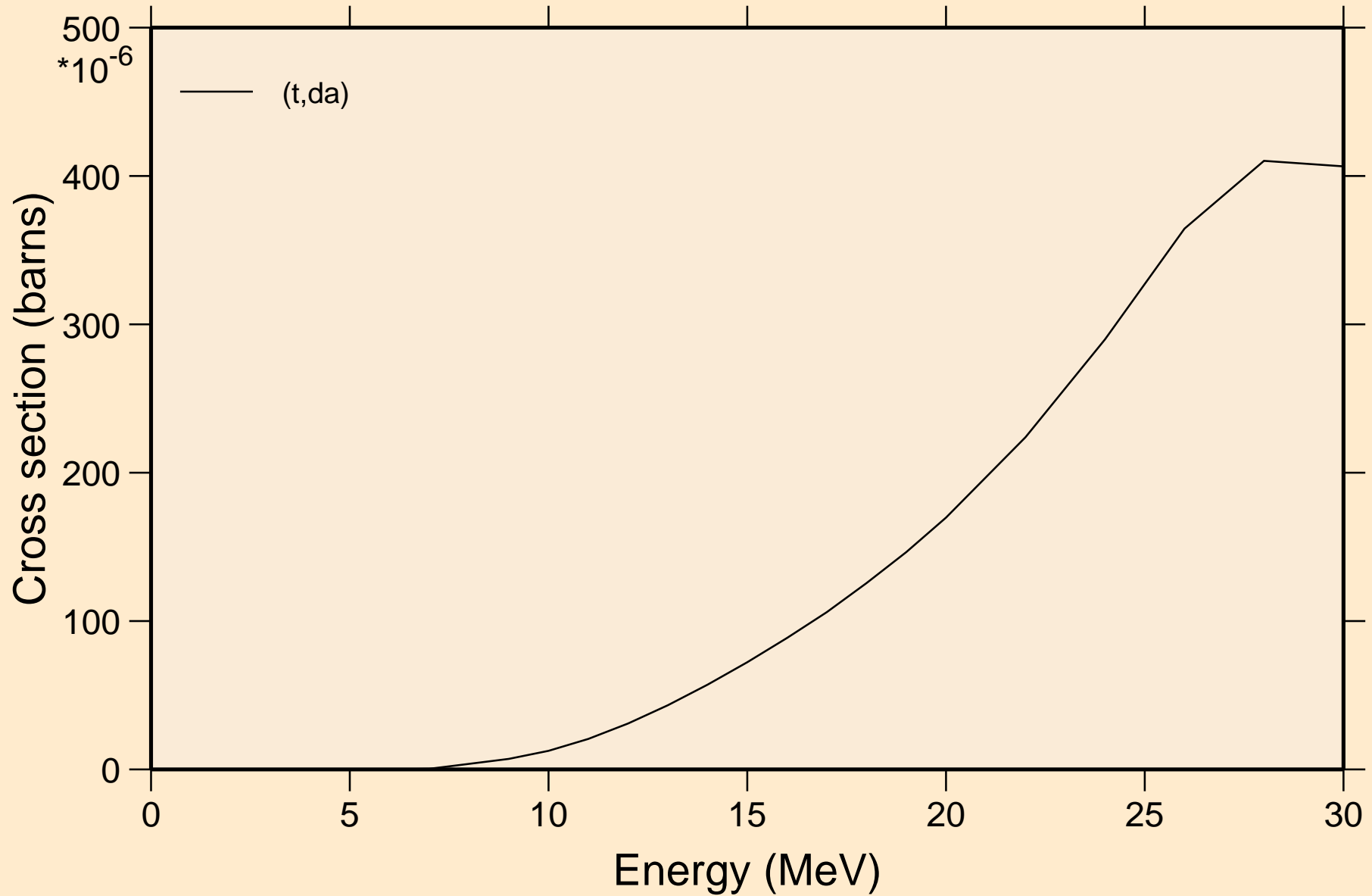

ND129M TRITON ACER TENDL-2023 LIBRARY; T=0.K
angular distribution for elastic

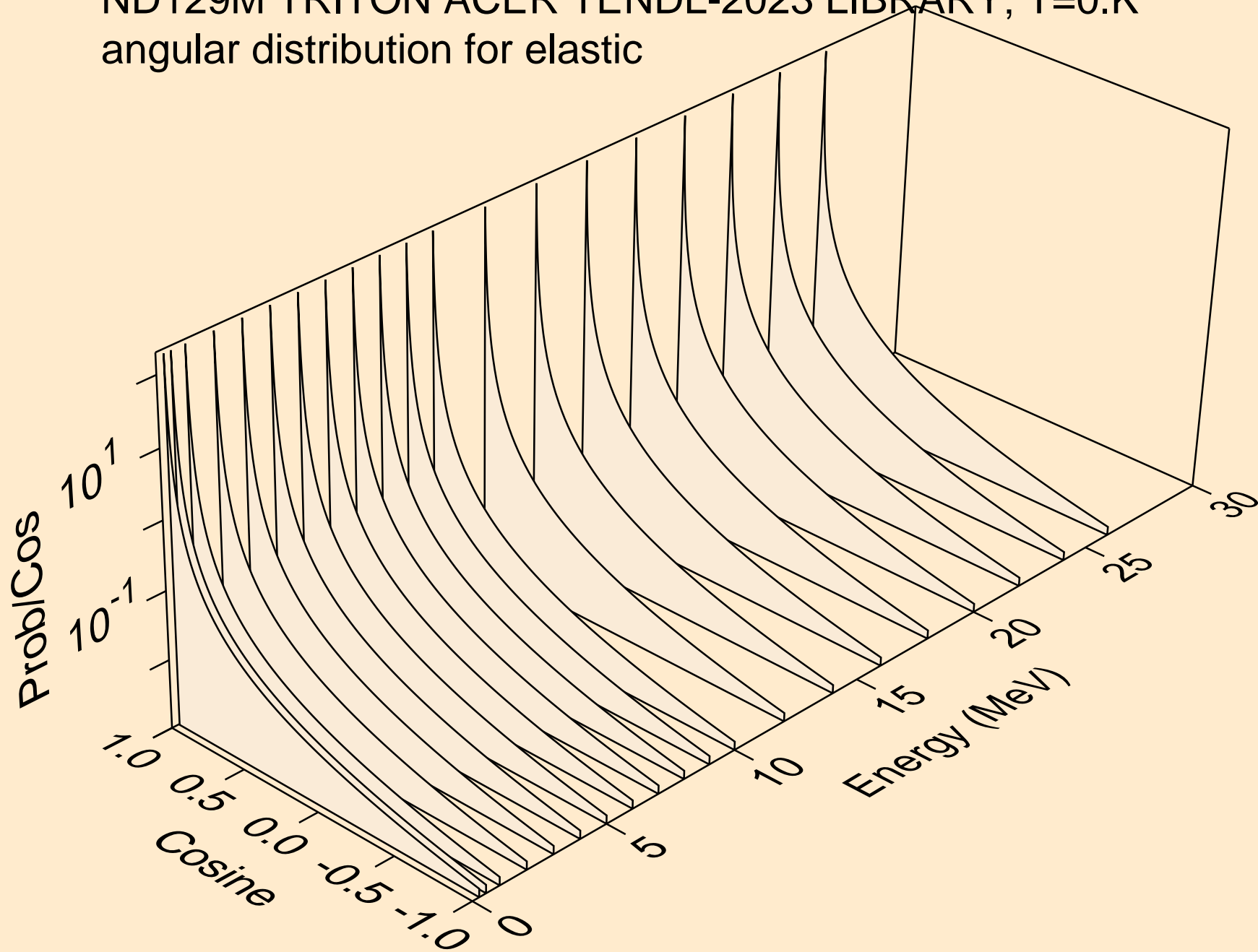

ND129M TRITON ACER TENDL-2023 LIBRARY; T=0.K
Triton emission for (t,x)

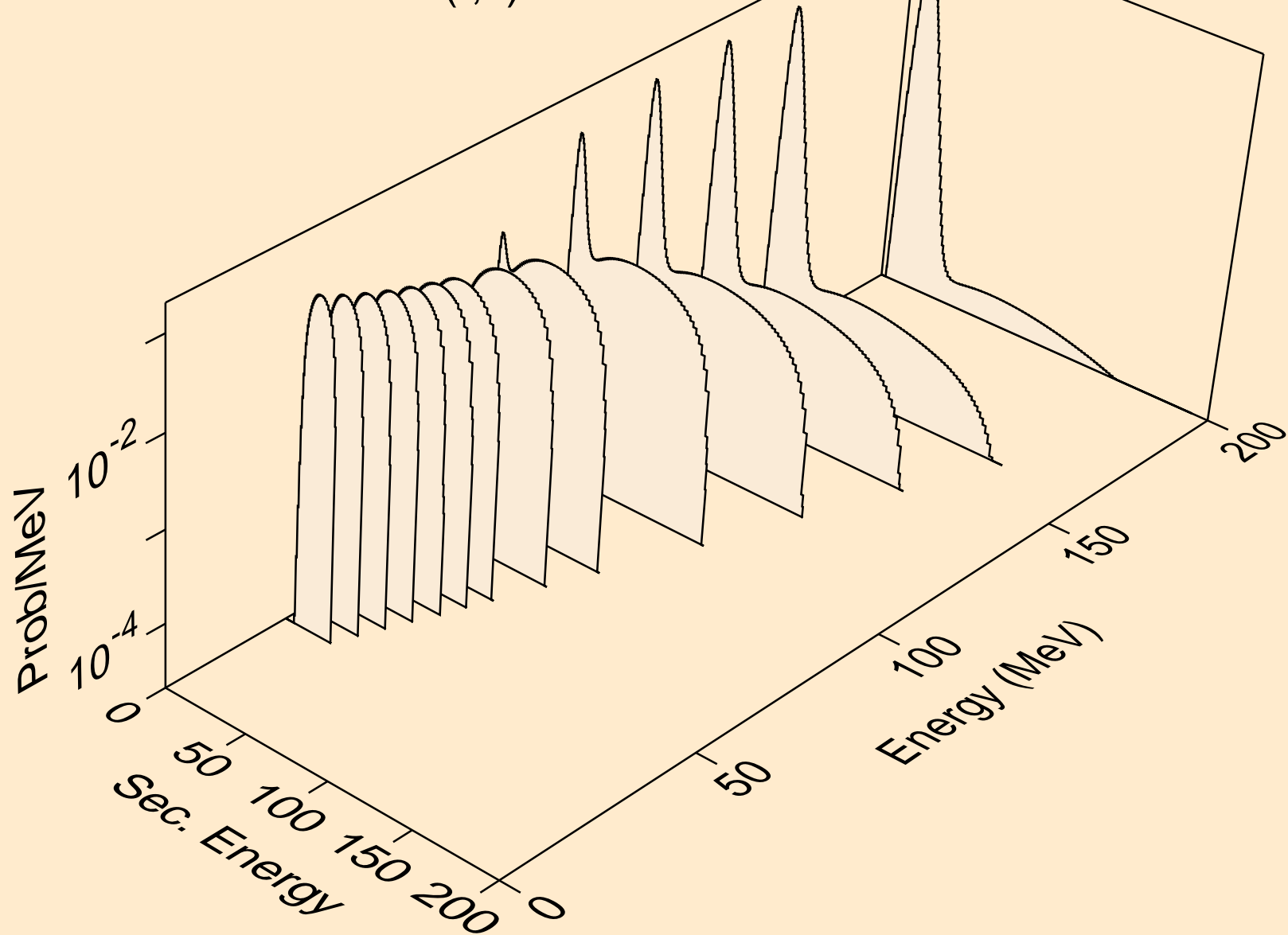

ND129M TRITON ACER TENDL-2023 LIBRARY; T=0.K
Triton emission for (t,n*)t

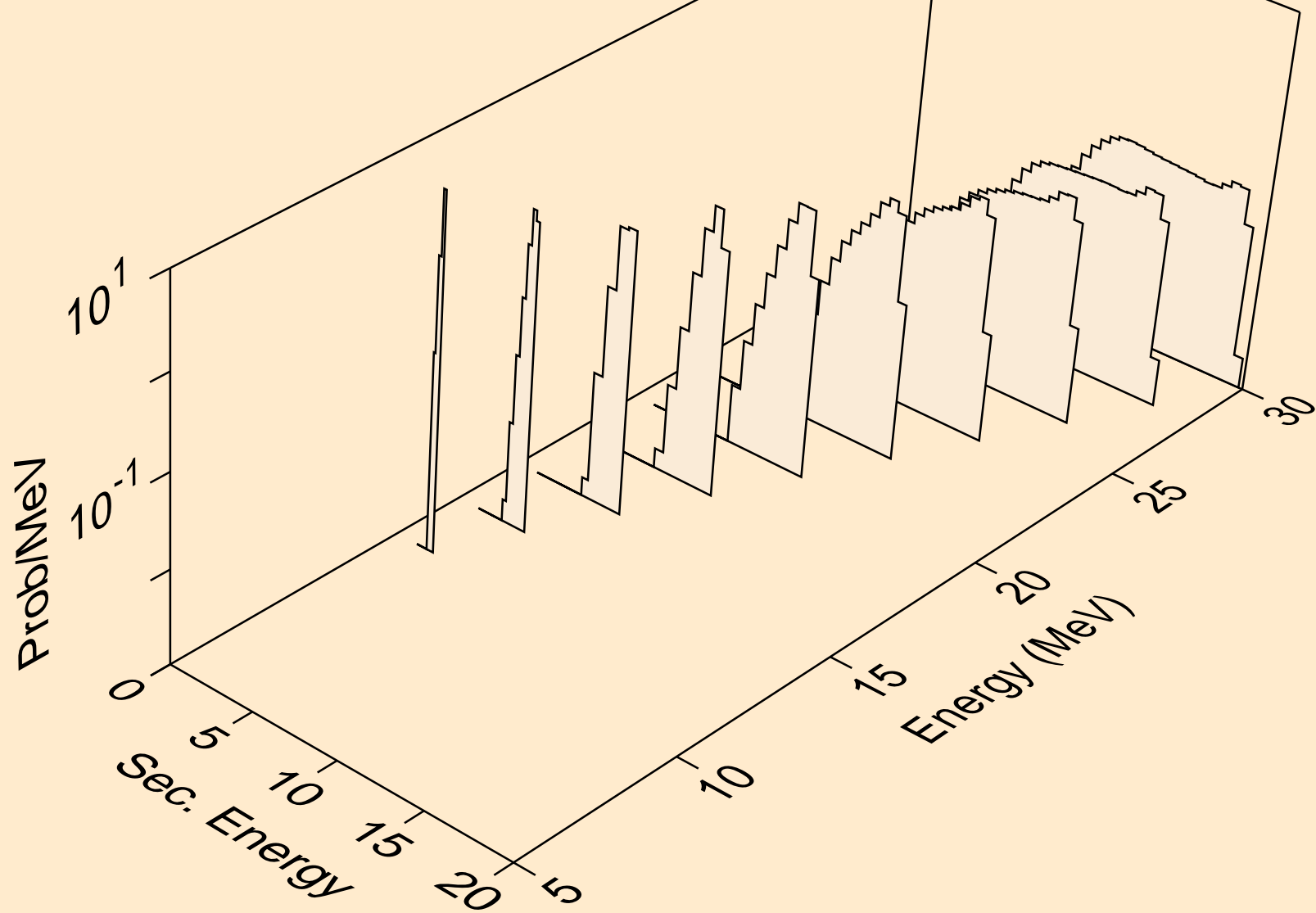

ND129M TRITON ACER TENDL-2023 LIBRARY; T=0.K
Triton emission for inelastic

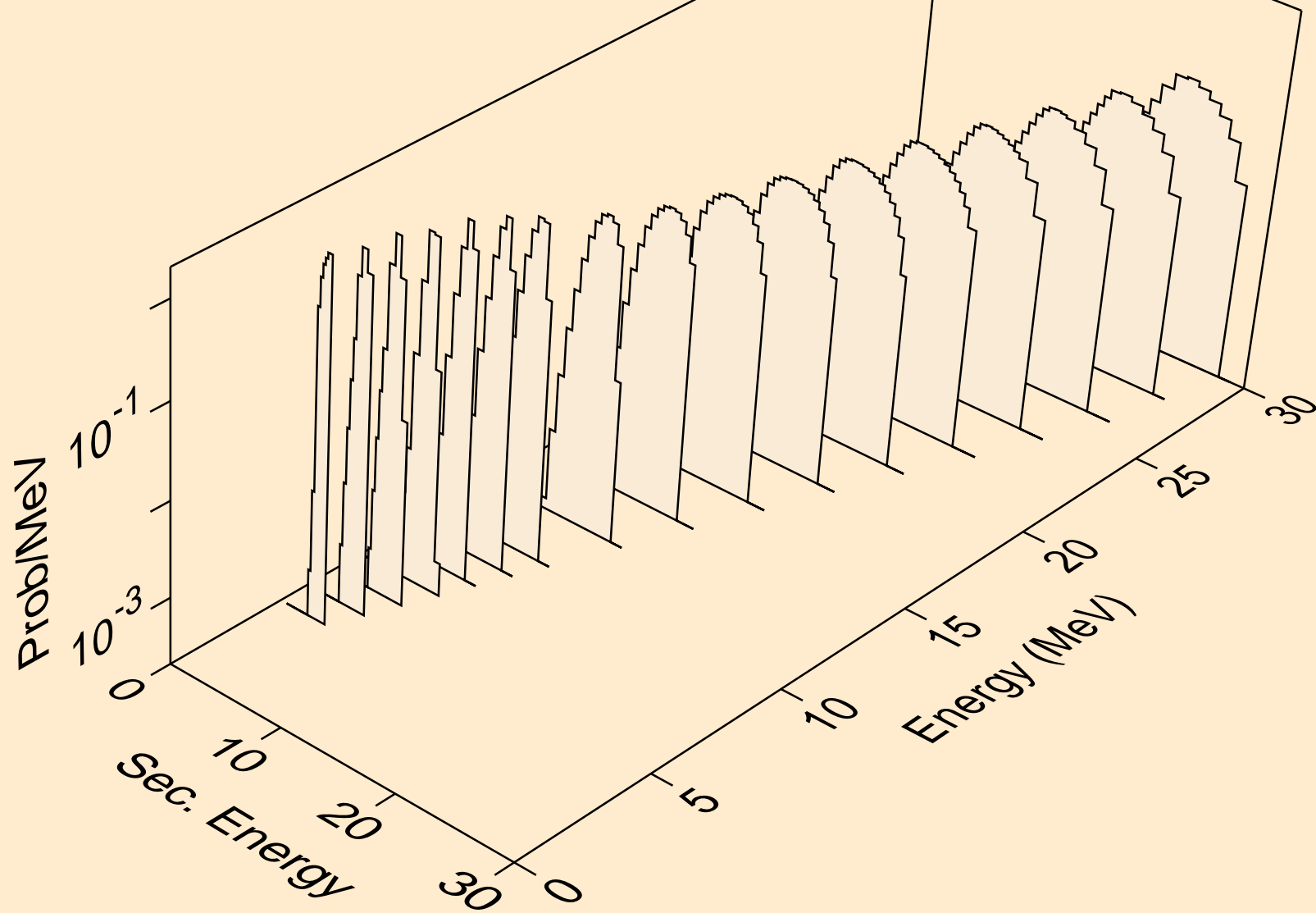

ND129M TRITON ACER TENDL-2023 LIBRARY; T=0.K
Triton emission for (t,t2a)

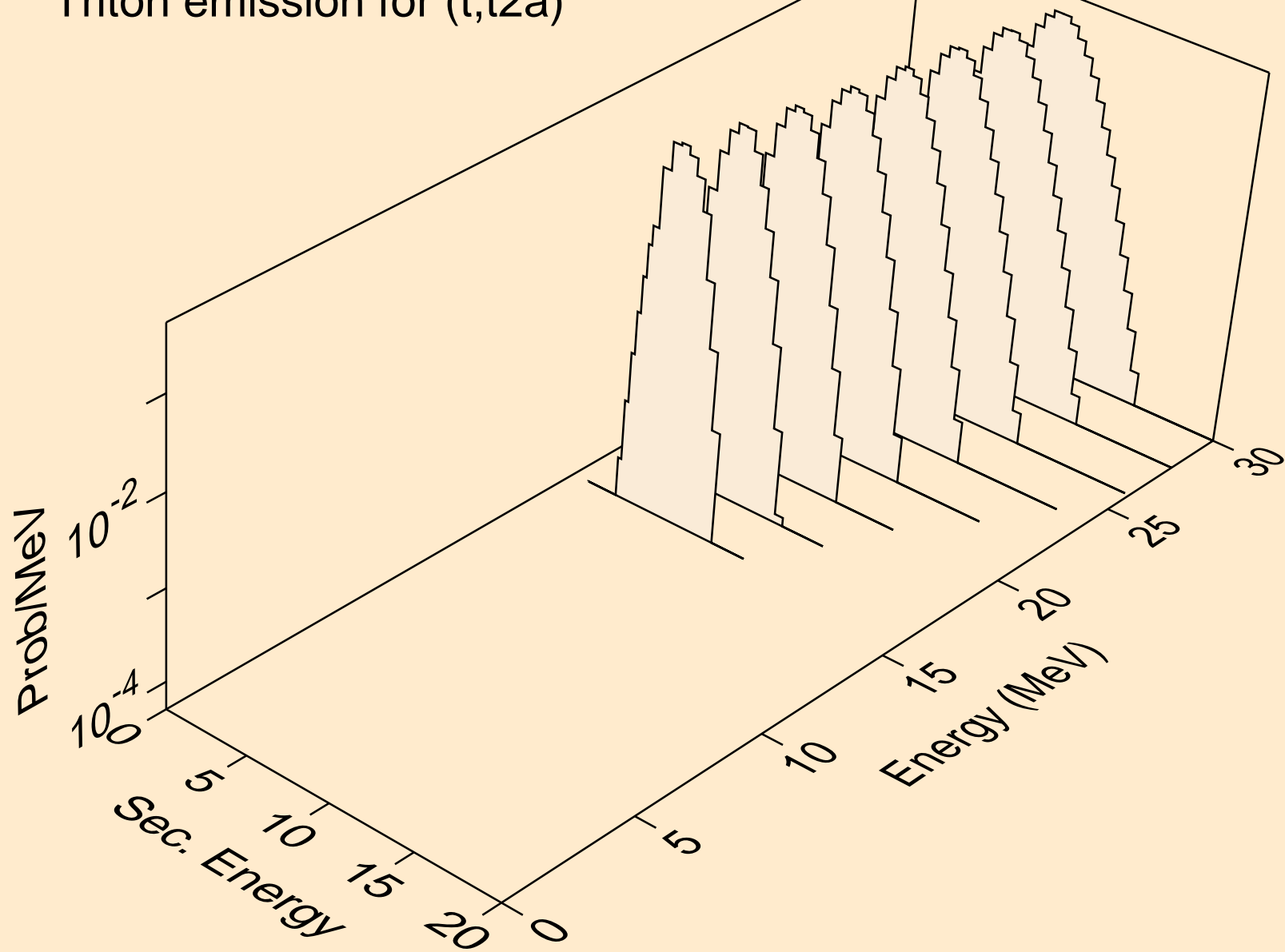

ND129M TRITON ACER TENDL-2023 LIBRARY; T=0.K
Triton emission for (t,pt)

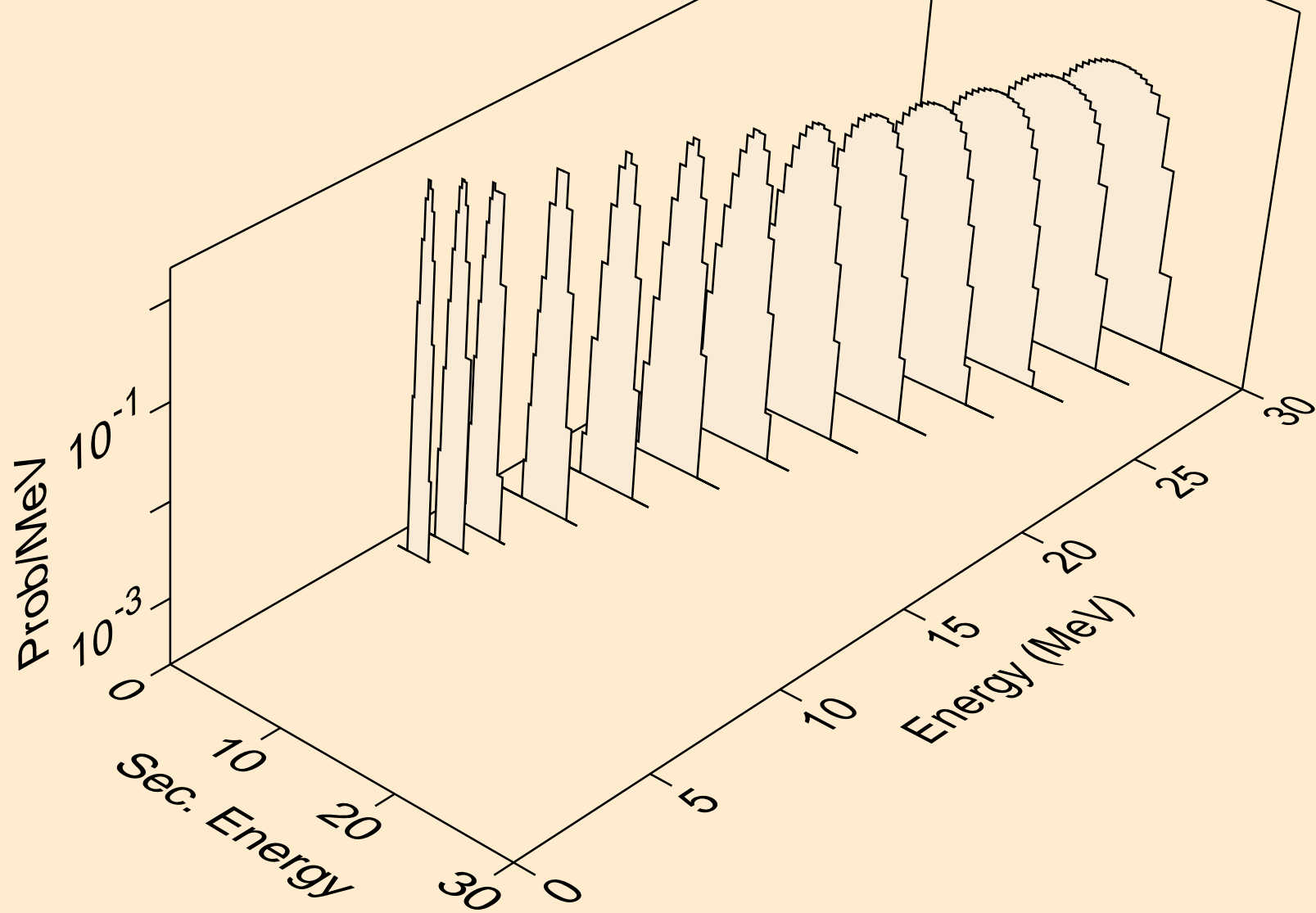

ND129M TRITON ACER TENDL-2023 LIBRARY; T=0.K
Photon emission for (z,n)

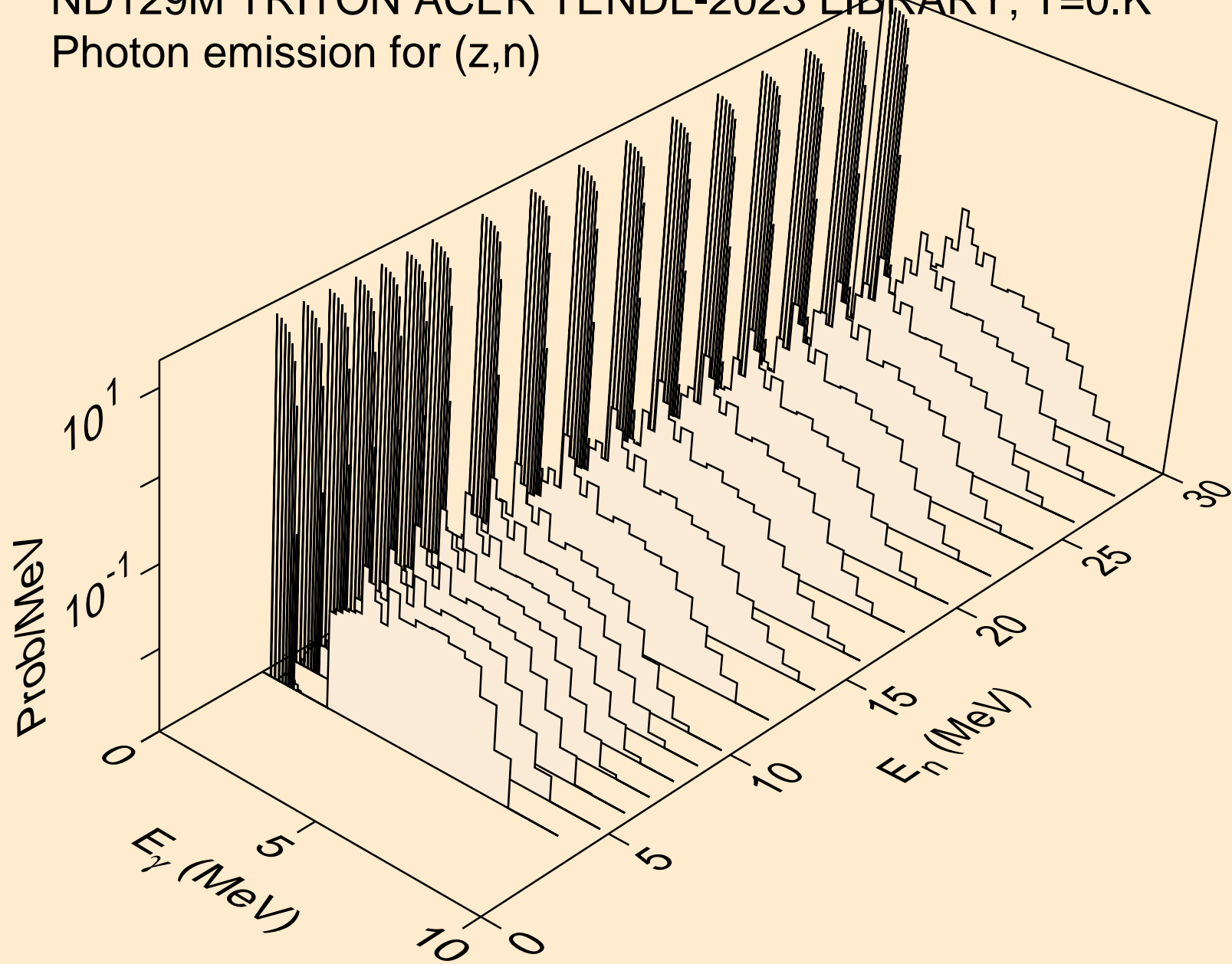

ND129M TRITON ACER TENDL-2023 LIBRARY; T=0.K
Photon emission for (z,x)

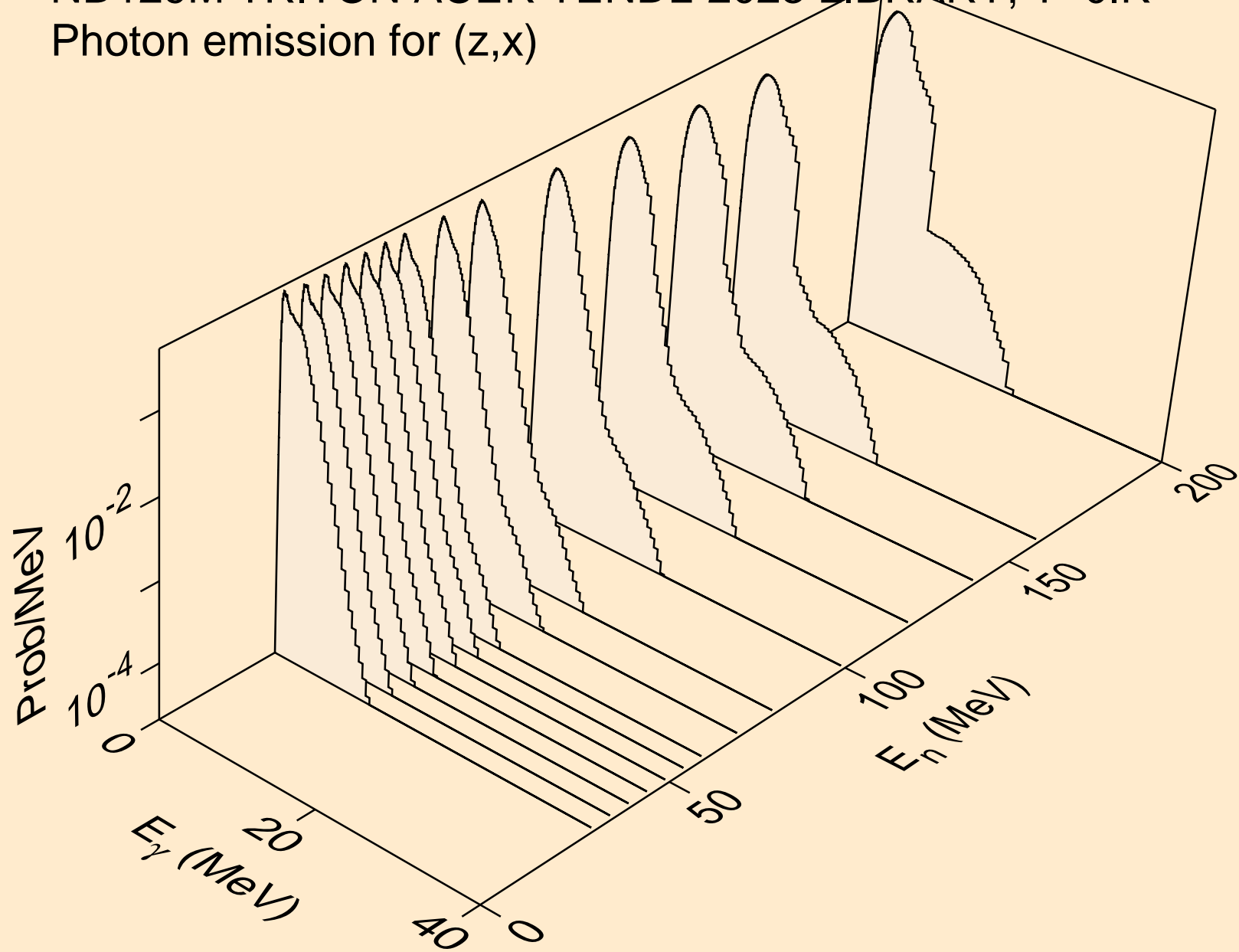

ND129M TRITON ACER TENDL-2023 LIBRARY; T=0.K
Photon emission for (n,2nd)

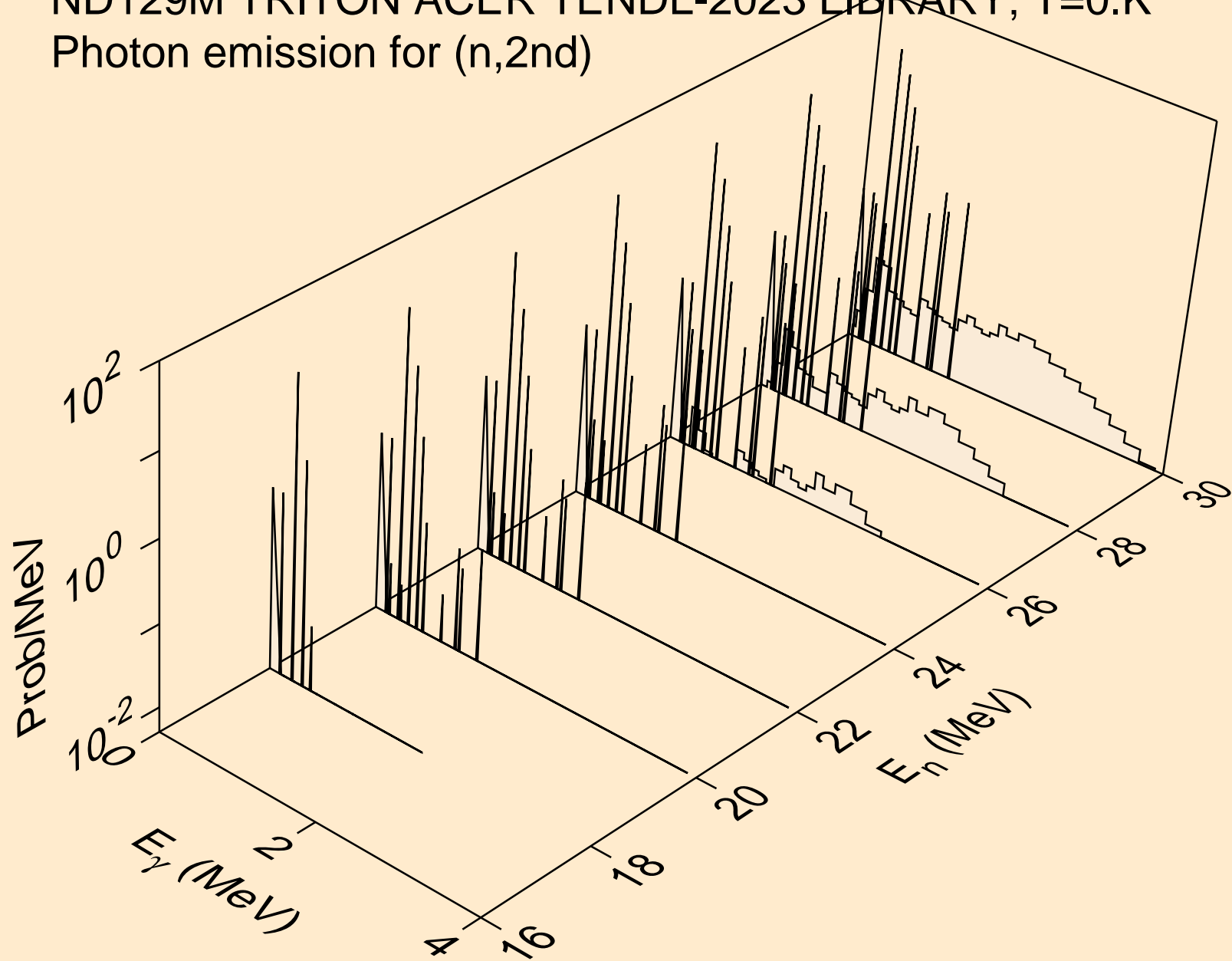

ND129M TRITON ACER TENDL-2023 LIBRARY; T=0.K
Photon emission for (n,2n)

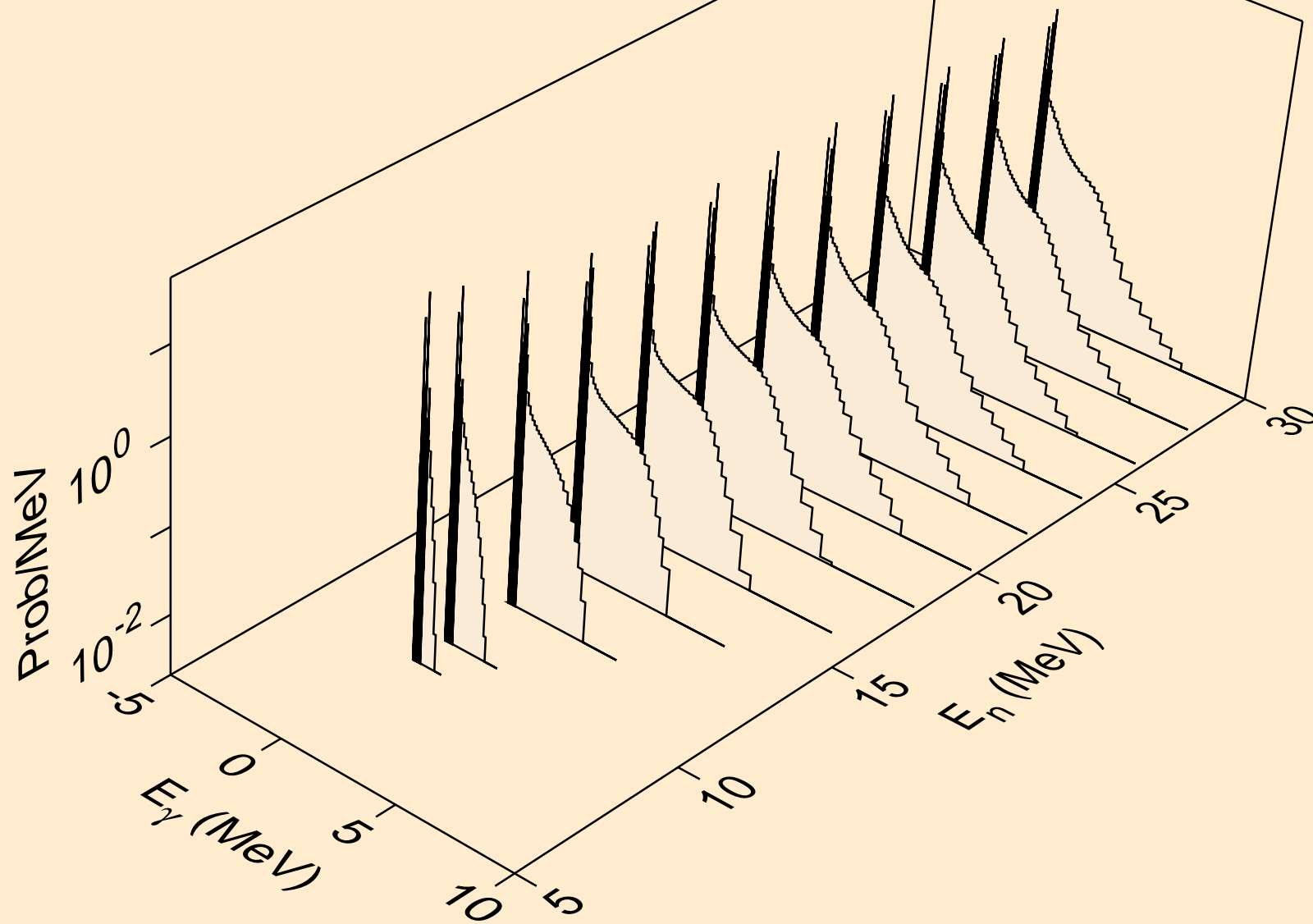

ND129M TRITON ACER TENDL-2023 LIBRARY; T=0.K
Photon emission for (n,3n)

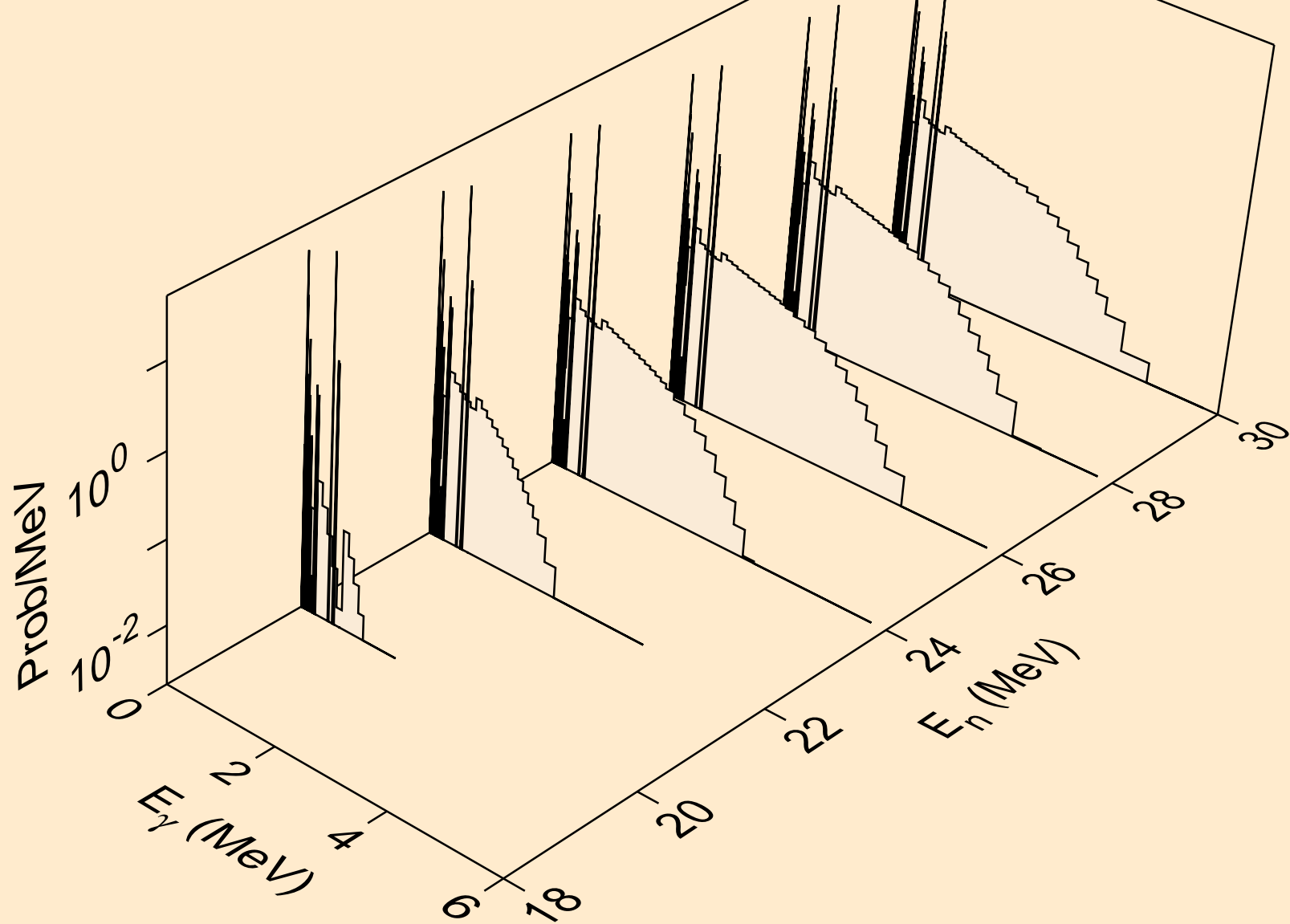

ND129M TRITON ACER TENDL-2023 LIBRARY; T=0.K
Photon emission for (n,n*)a

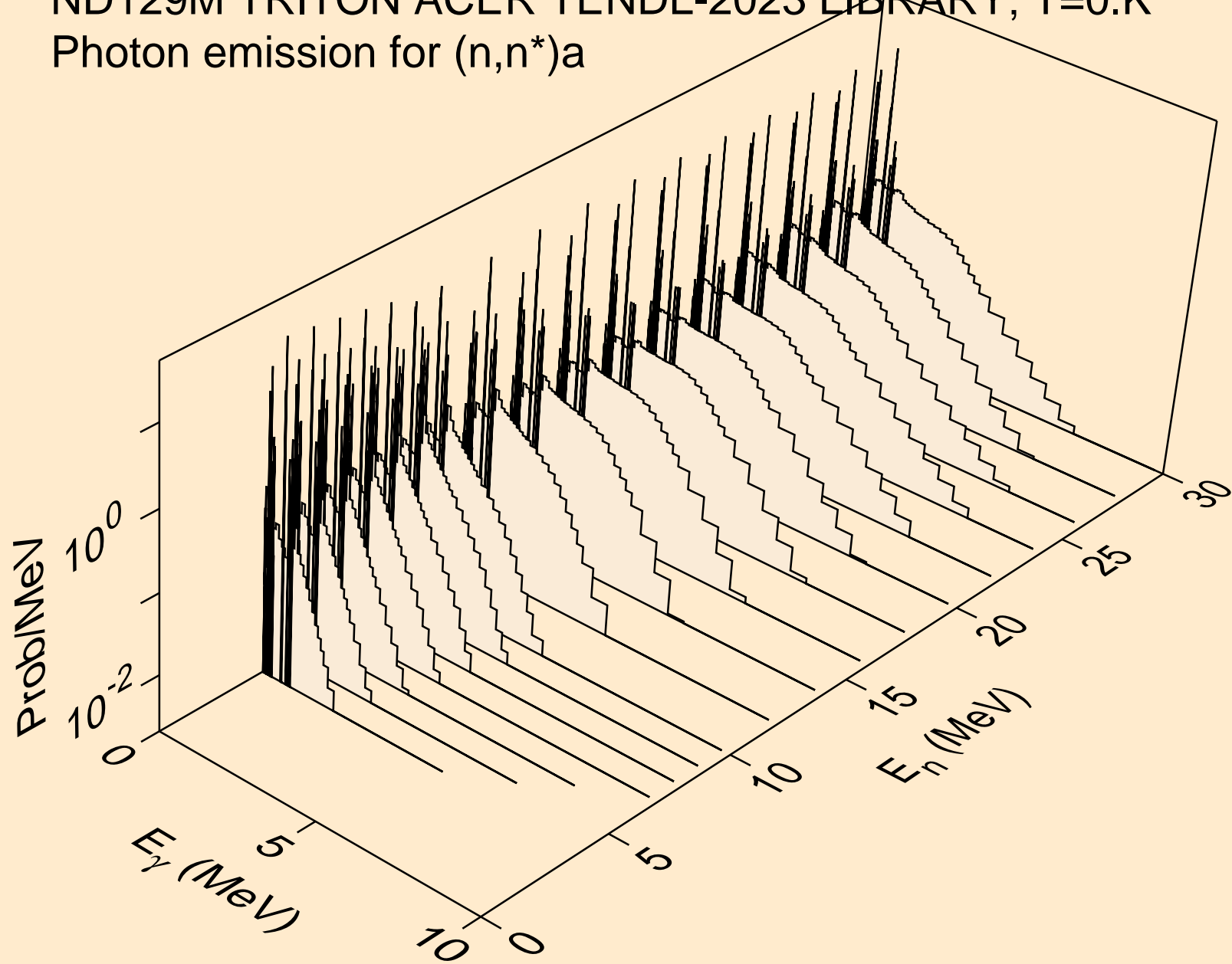

ND129M TRITON ACER TENDL-2023 LIBRARY; T=0.K
Photon emission for (n,2n)a

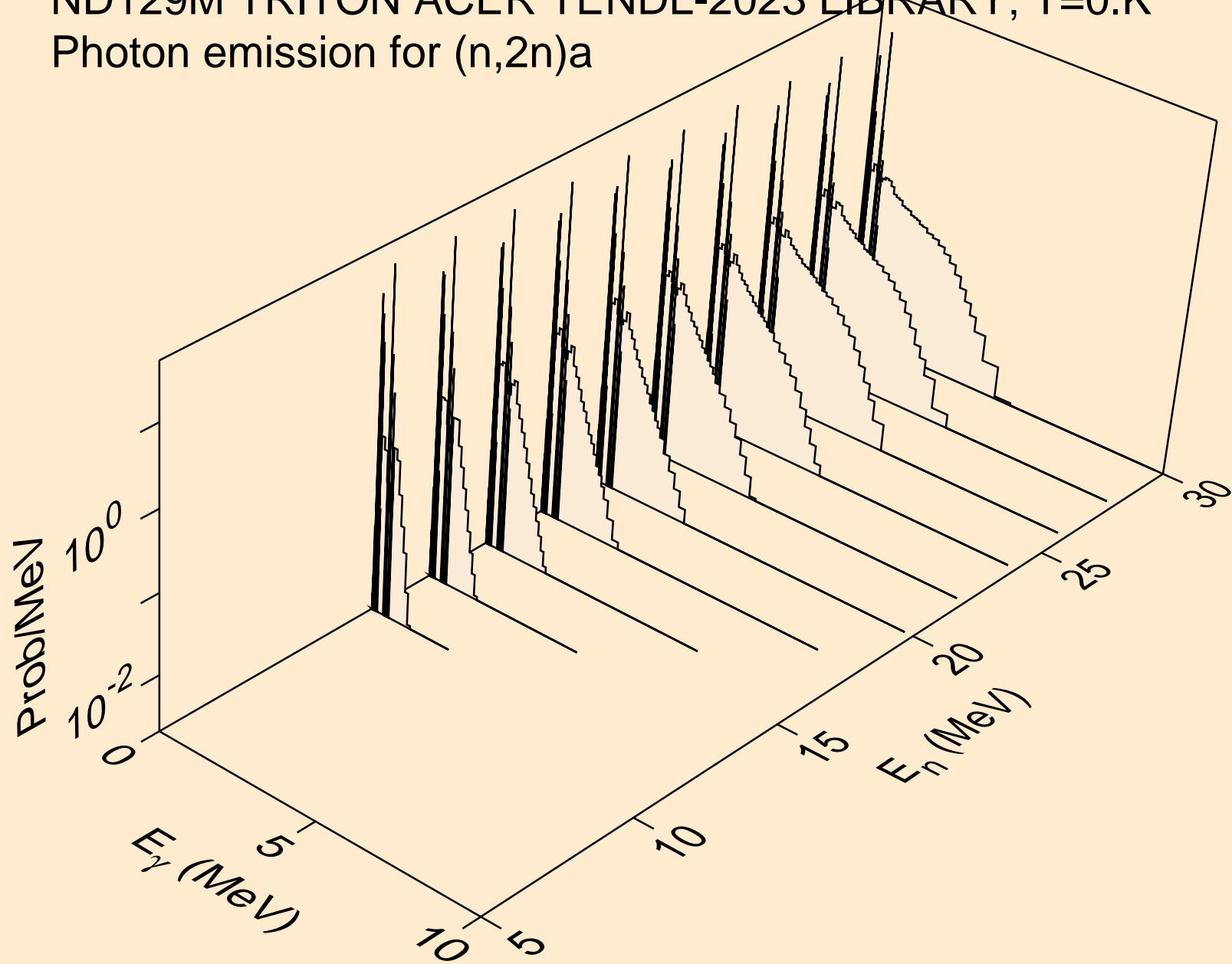

ND129M TRITON ACER TENDL-2023 LIBRARY; T=0.K
Photon emission for (n,n*)p

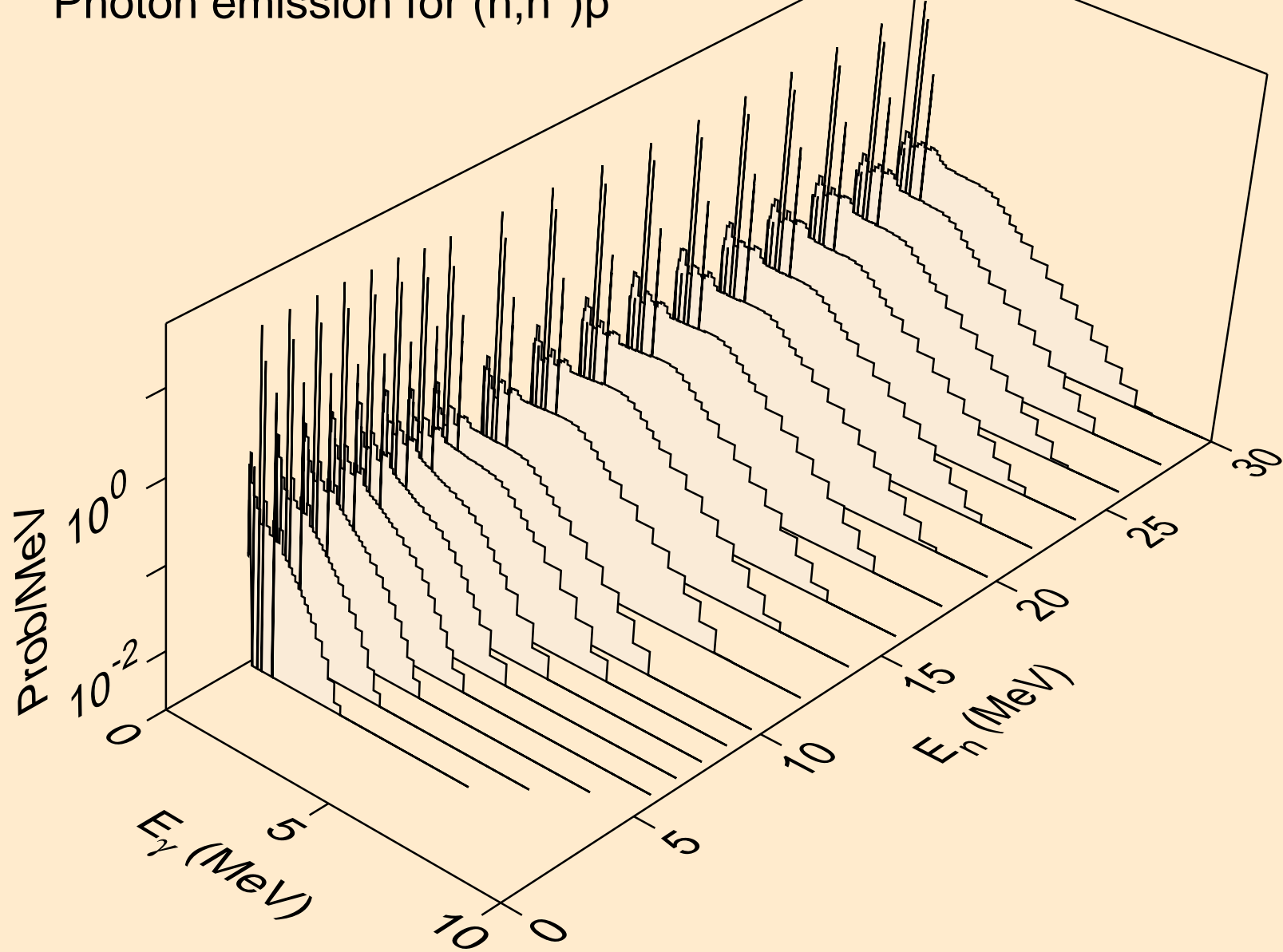

ND129M TRITON ACER TENDL-2023 LIBRARY; T=0.K
Photon emission for (n,n*)2a

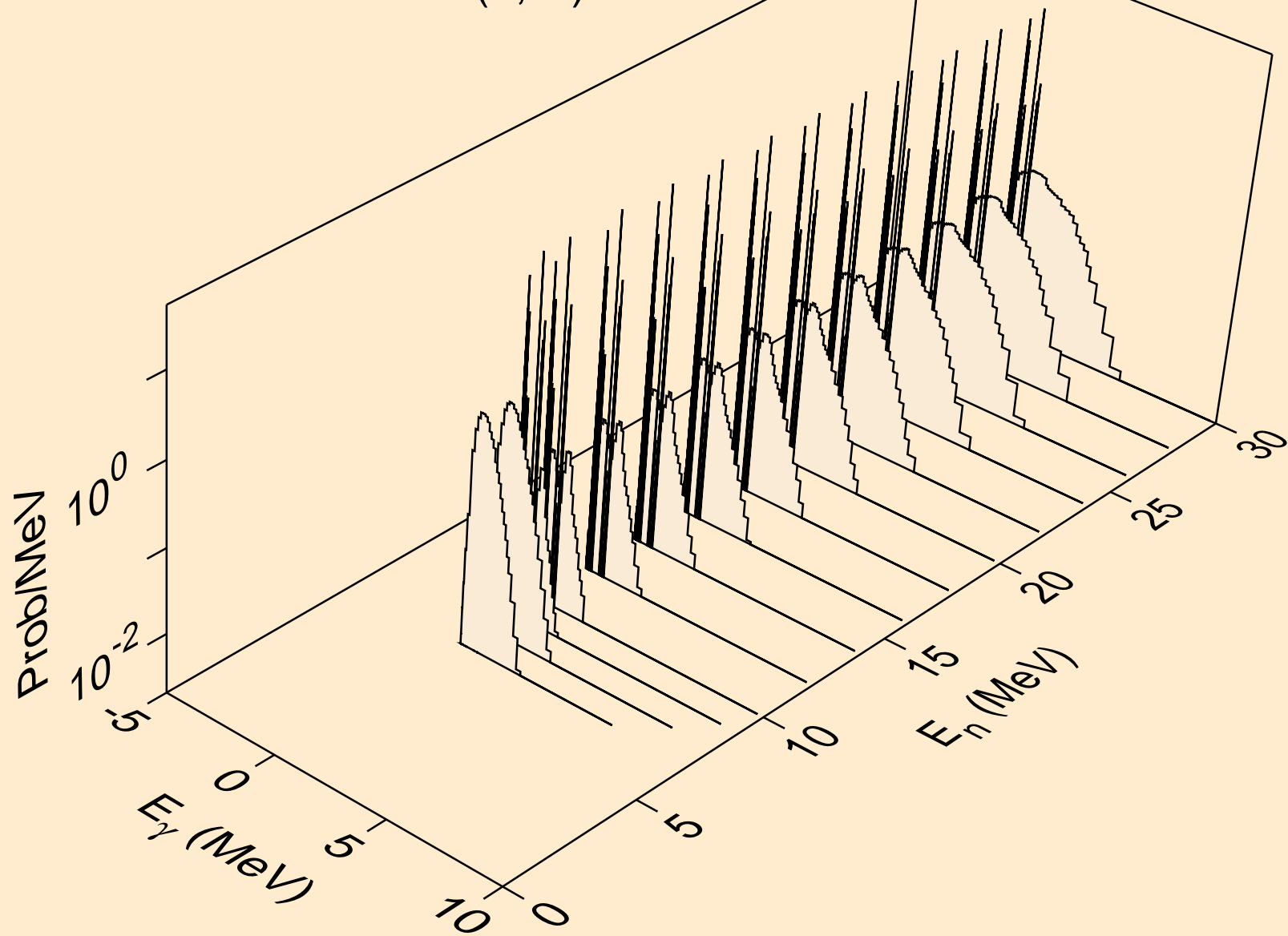

ND129M TRITON ACER TENDL-2023 LIBRARY; T=0.K
Photon emission for (n,n*)d

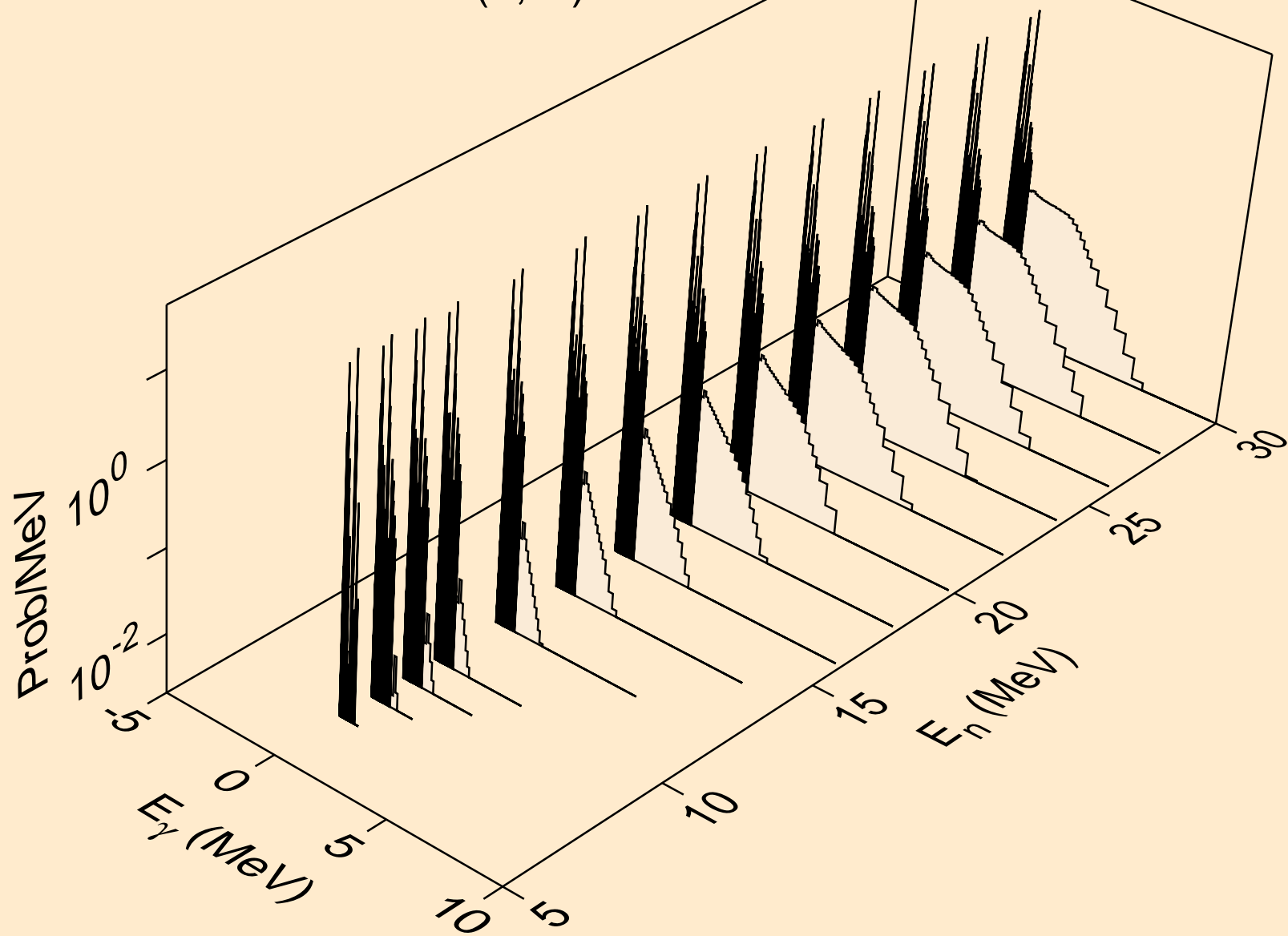

ND129M TRITON ACER TENDL-2023 LIBRARY; T=0.K
Photon emission for (n,n*)t

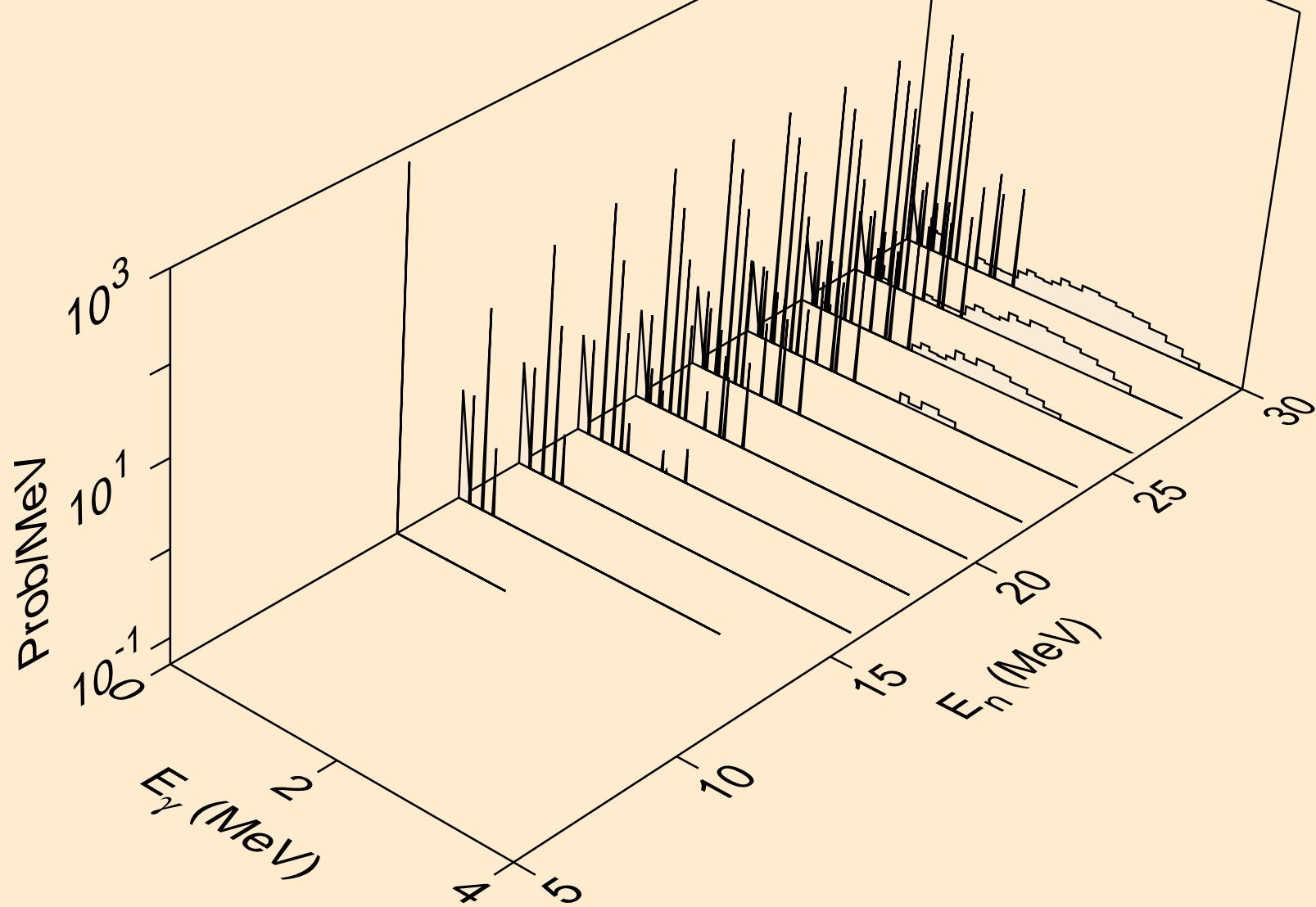

ND129M TRITON ACER TENDL-2023 LIBRARY; T=0.K
Photon emission for (n,n*)he3

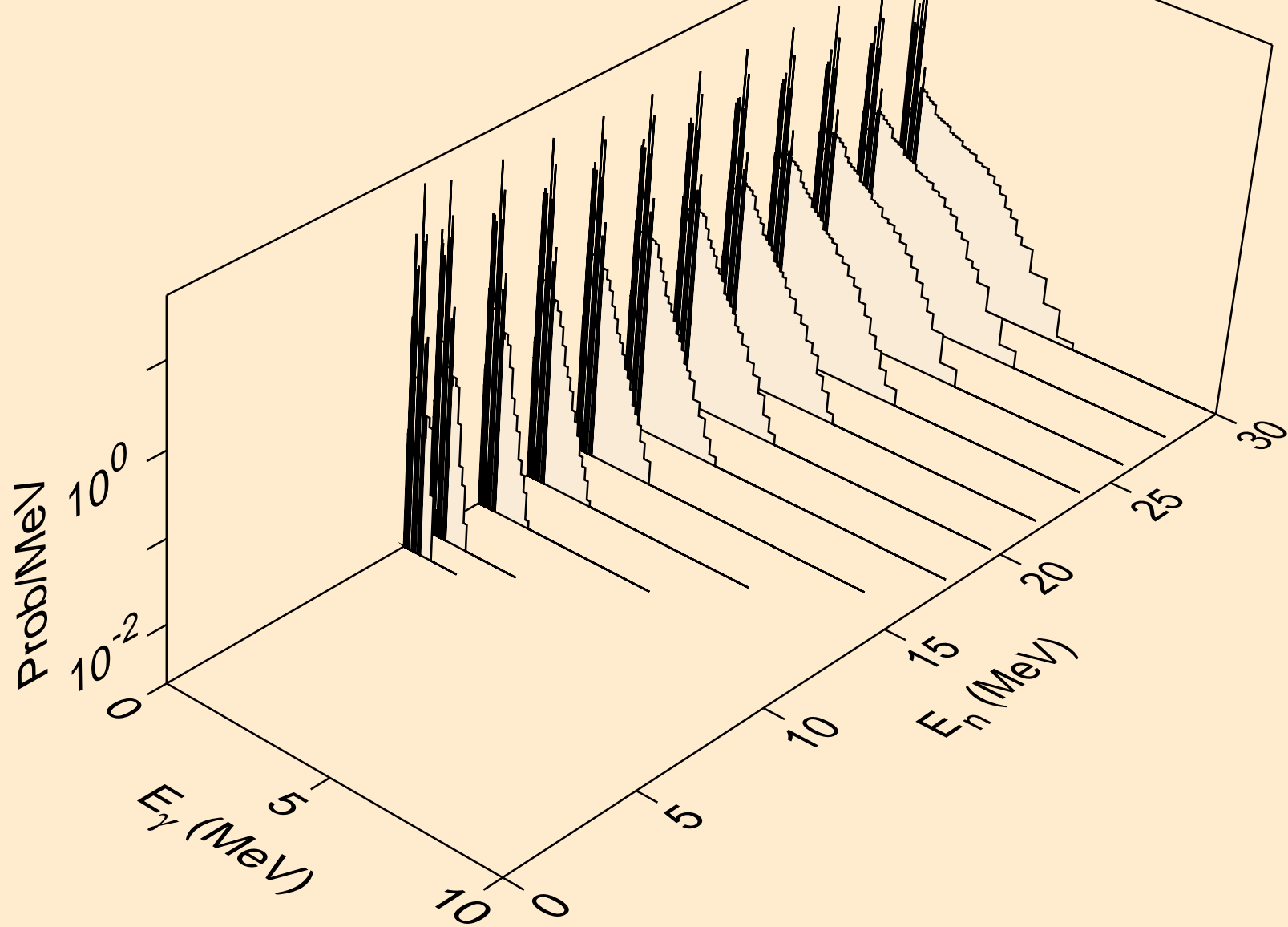

ND129M TRITON ACER TENDL-2023 LIBRARY; T=0.K
Photon emission for (n,2np)

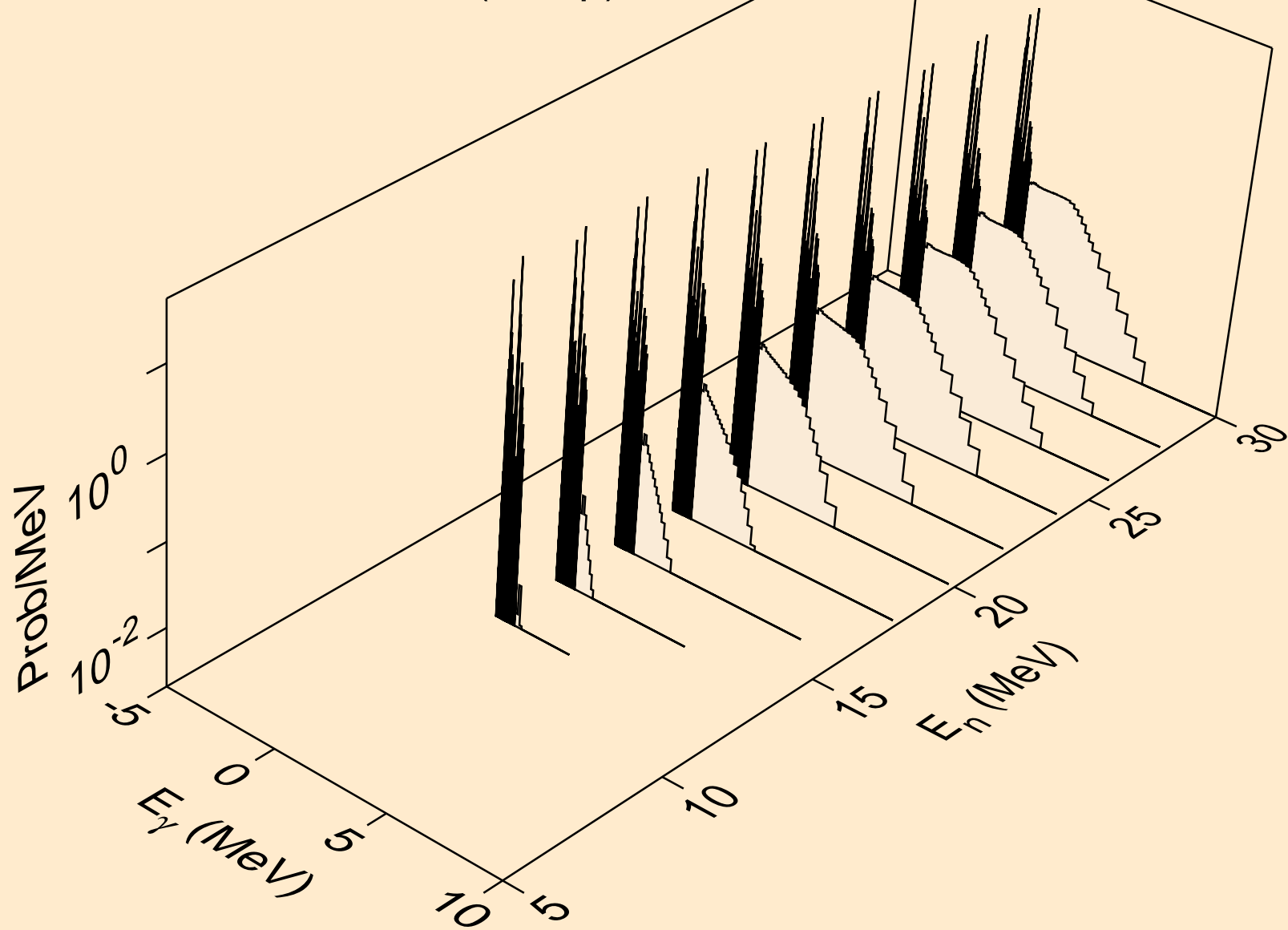

ND129M TRITON ACER TENDL-2023 LIBRARY; T=0.K
Photon emission for (n,3np)

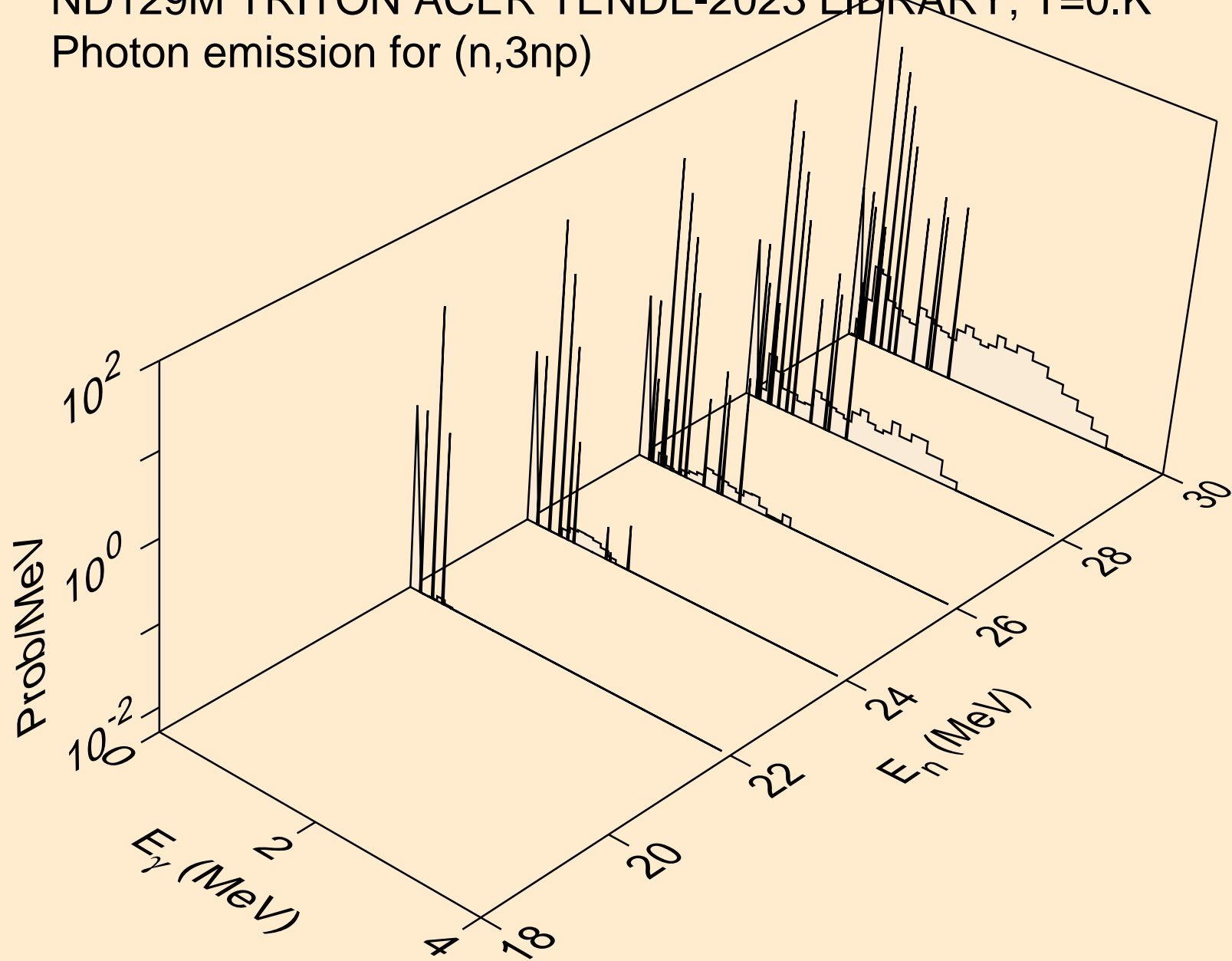

ND129M TRITON ACER TENDL-2023 LIBRARY; T=0.K
Photon emission for (n,n2p)

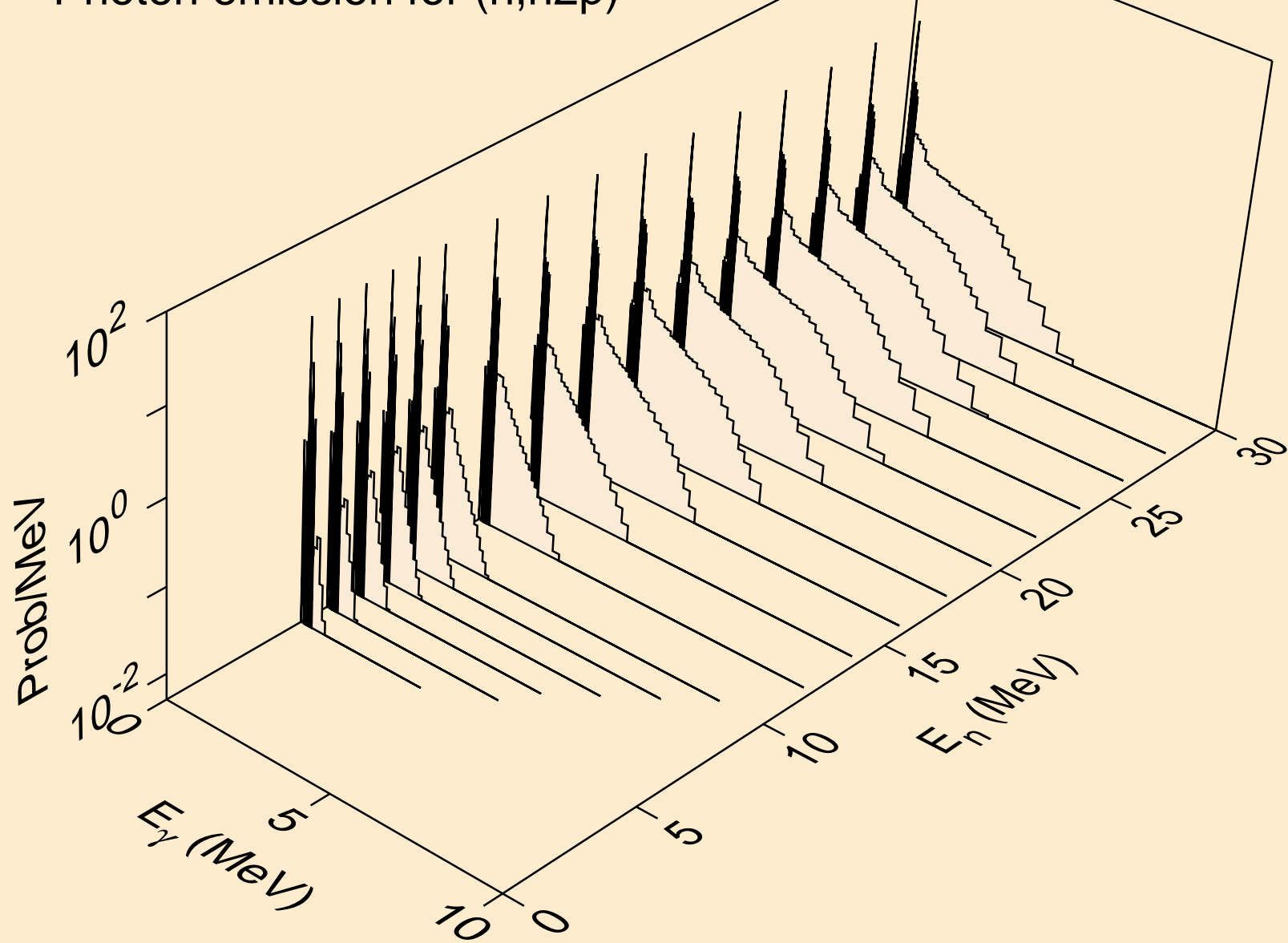

ND129M TRITON ACER TENDL-2023 LIBRARY; T=0.K
Photon emission for (n,npa)

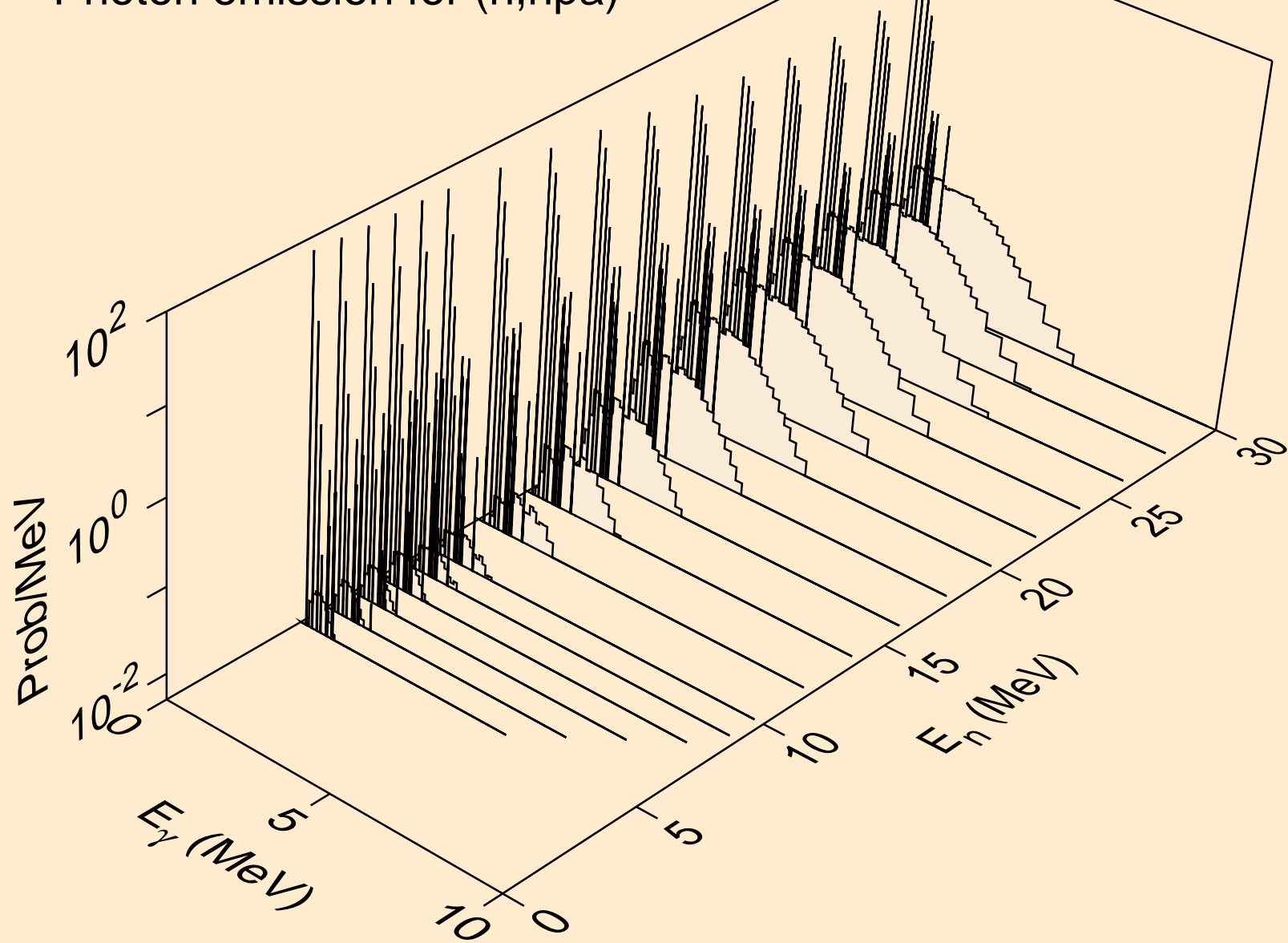

ND129M TRITON ACER TENDL-2023 LIBRARY; T=0.K
Photon emission for (n,gma)

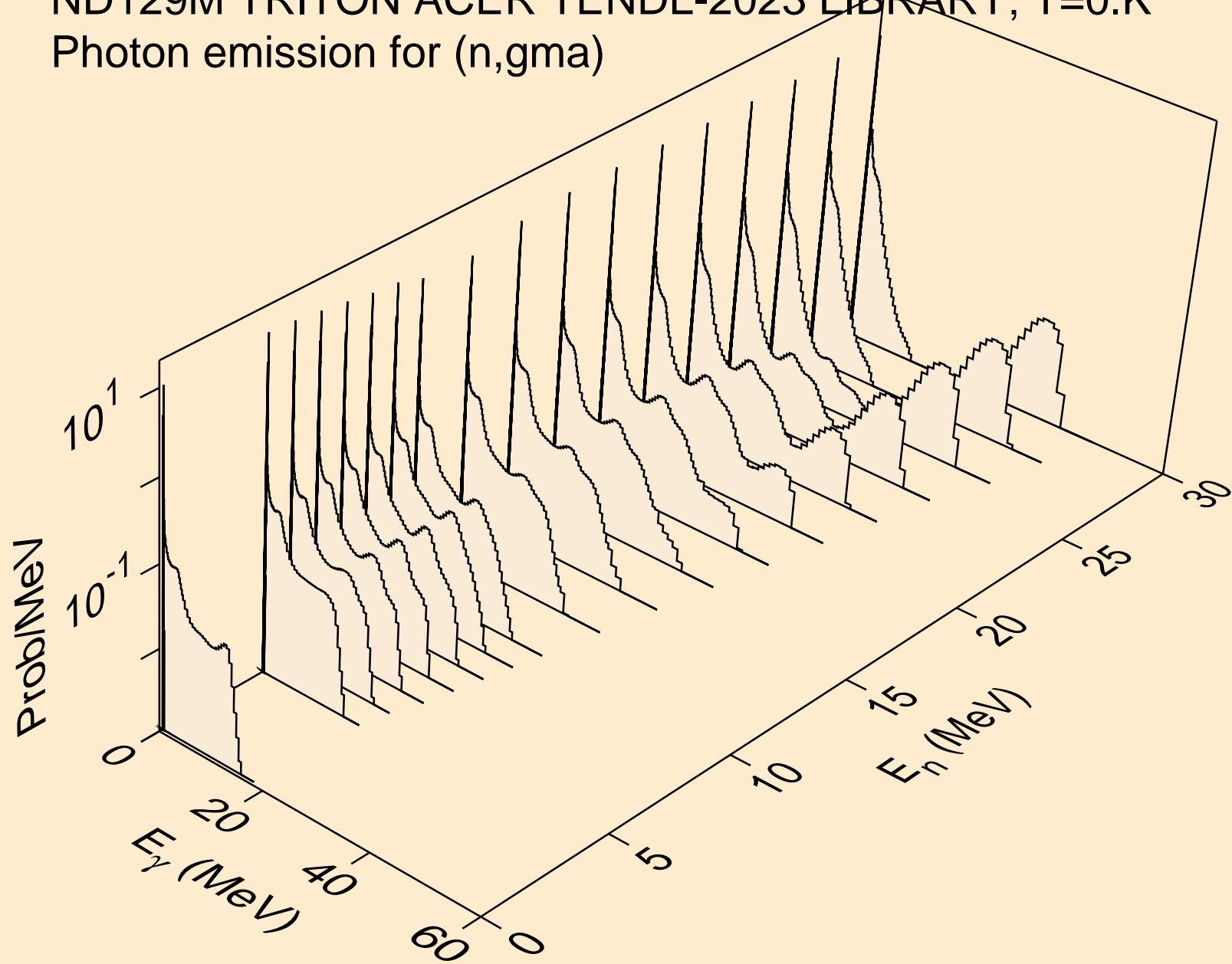

ND129M TRITON ACER TENDL-2023 LIBRARY; T=0.K
Photon emission for (n,p)

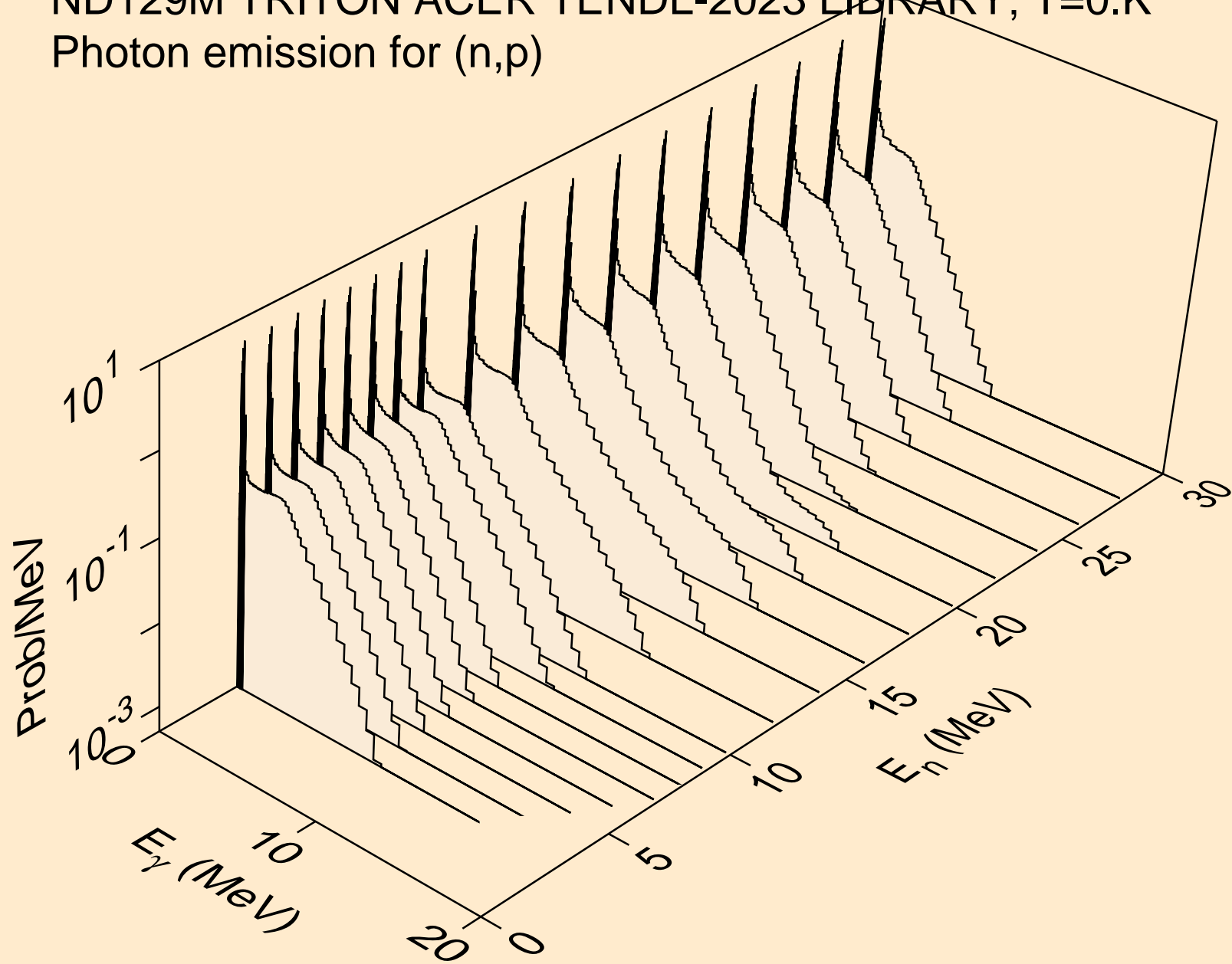

ND129M TRITON ACER TENDL-2023 LIBRARY; T=0.K
Photon emission for (n,d)

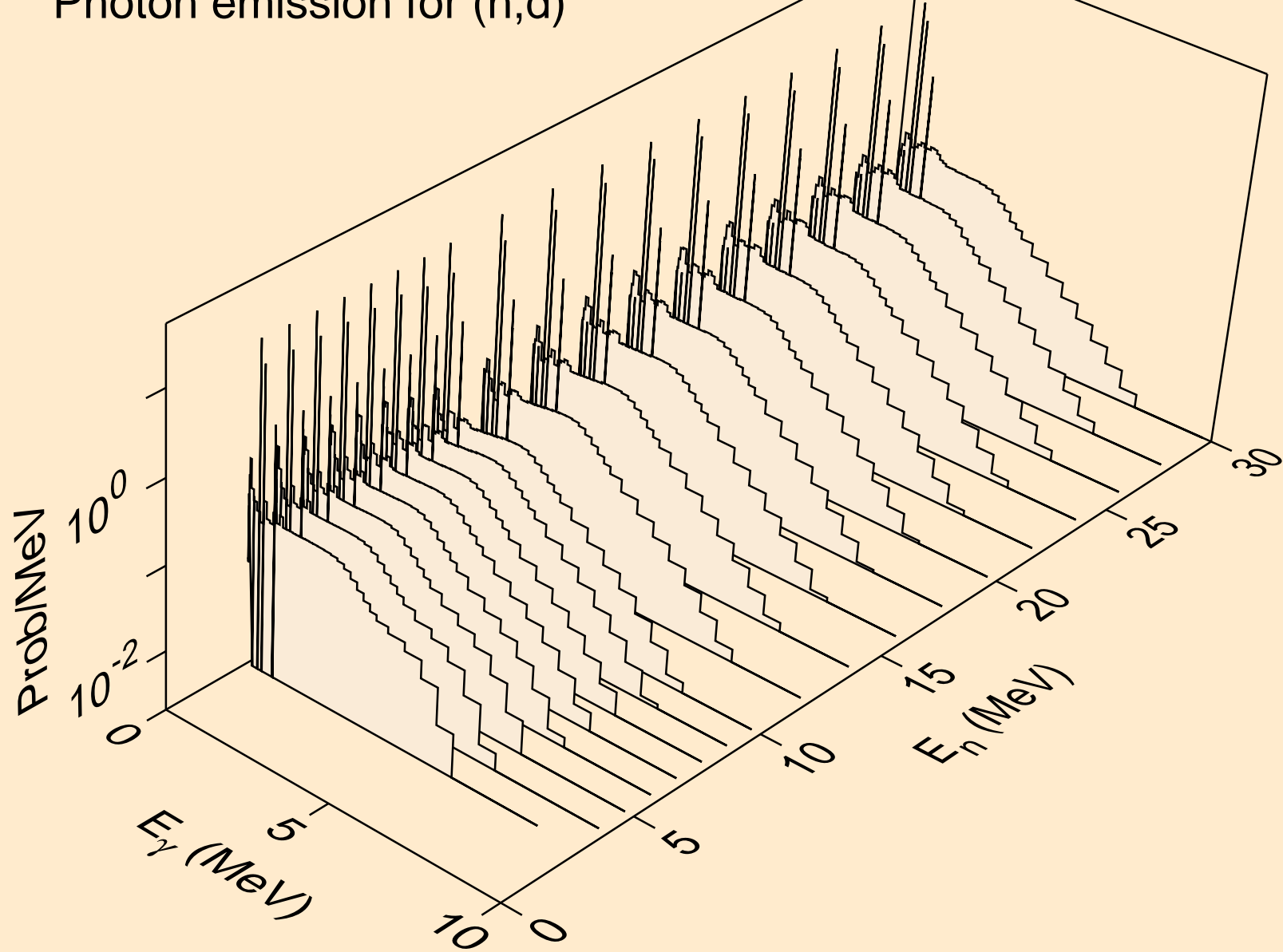

ND129M TRITON ACER TENDL-2023 LIBRARY; T=0.K
Photon emission for inelastic

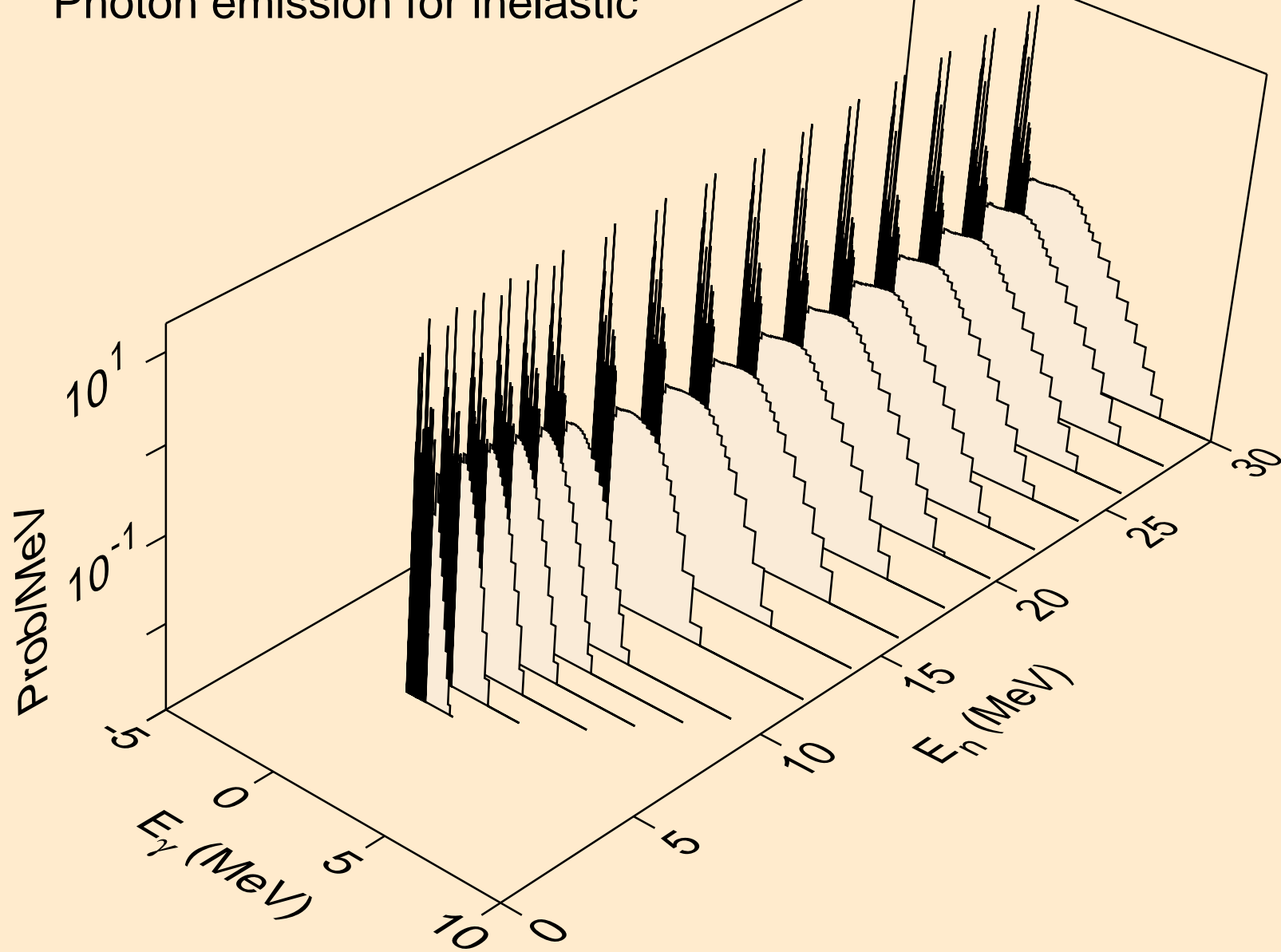

ND129M TRITON ACER TENDL-2023 LIBRARY; T=0.K
Photon emission for (n,he3)

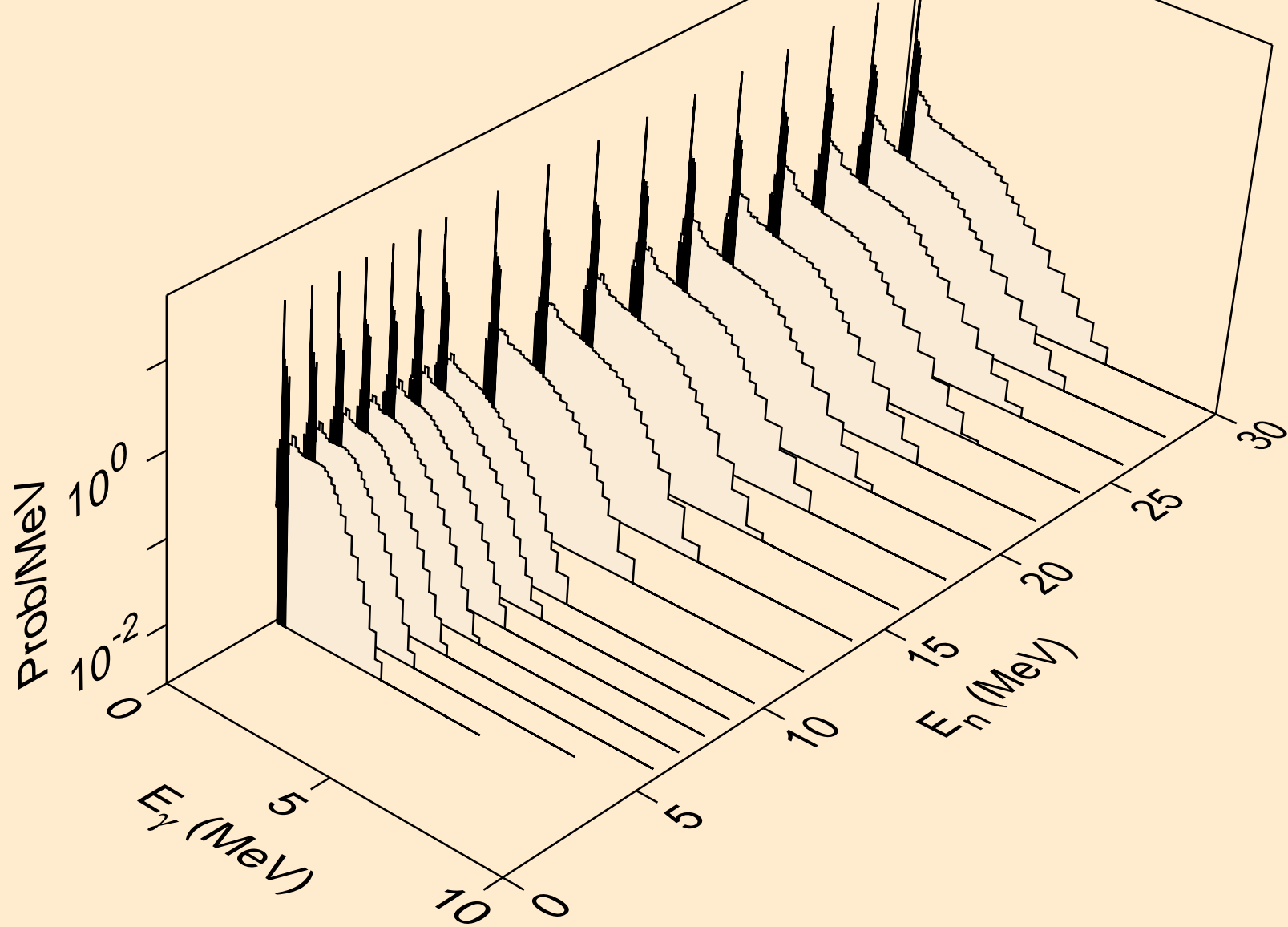

ND129M TRITON ACER TENDL-2023 LIBRARY; T=0.K
Photon emission for (n,a)

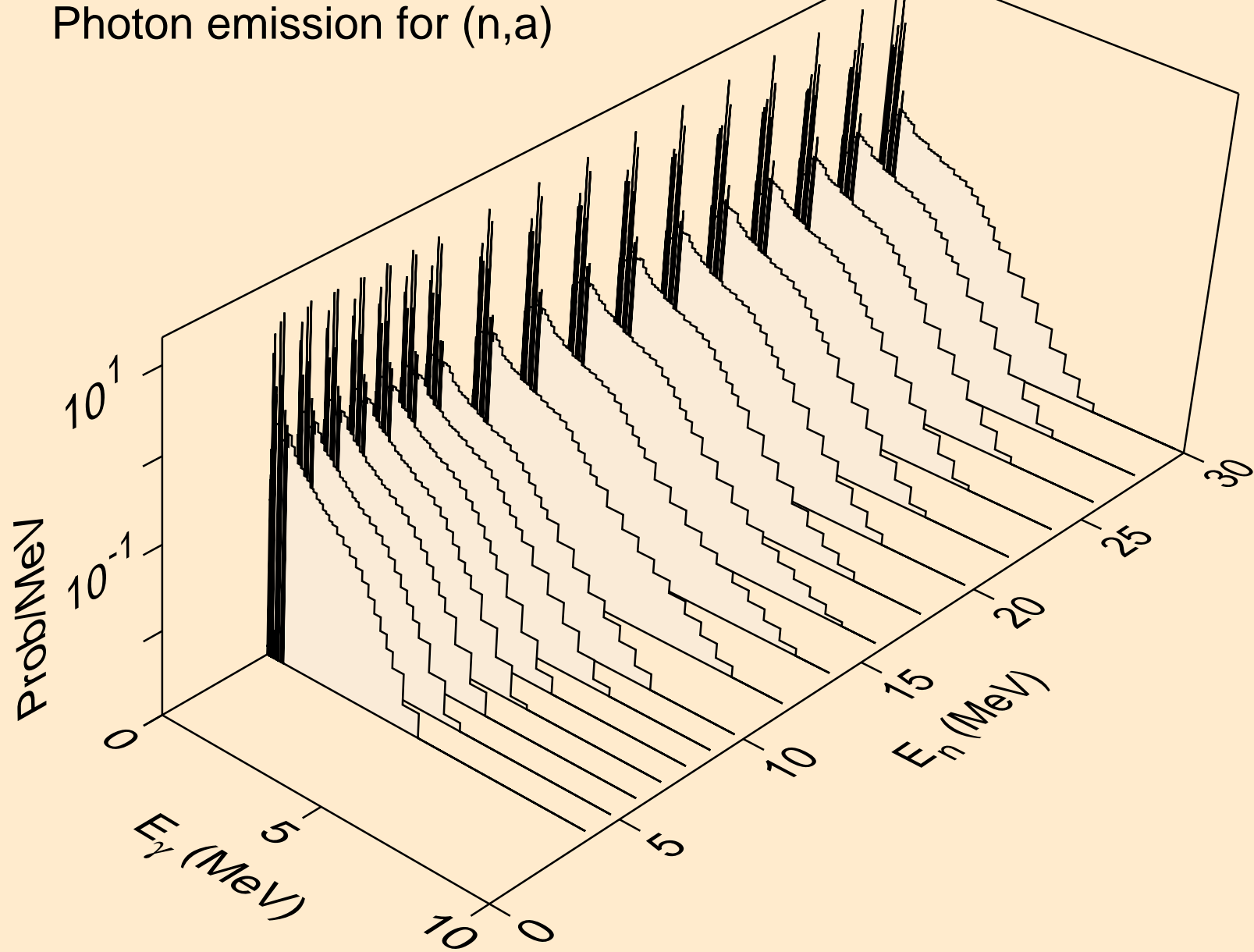

ND129M TRITON ACER TENDL-2023 LIBRARY; T=0.K
Photon emission for (n,2a)

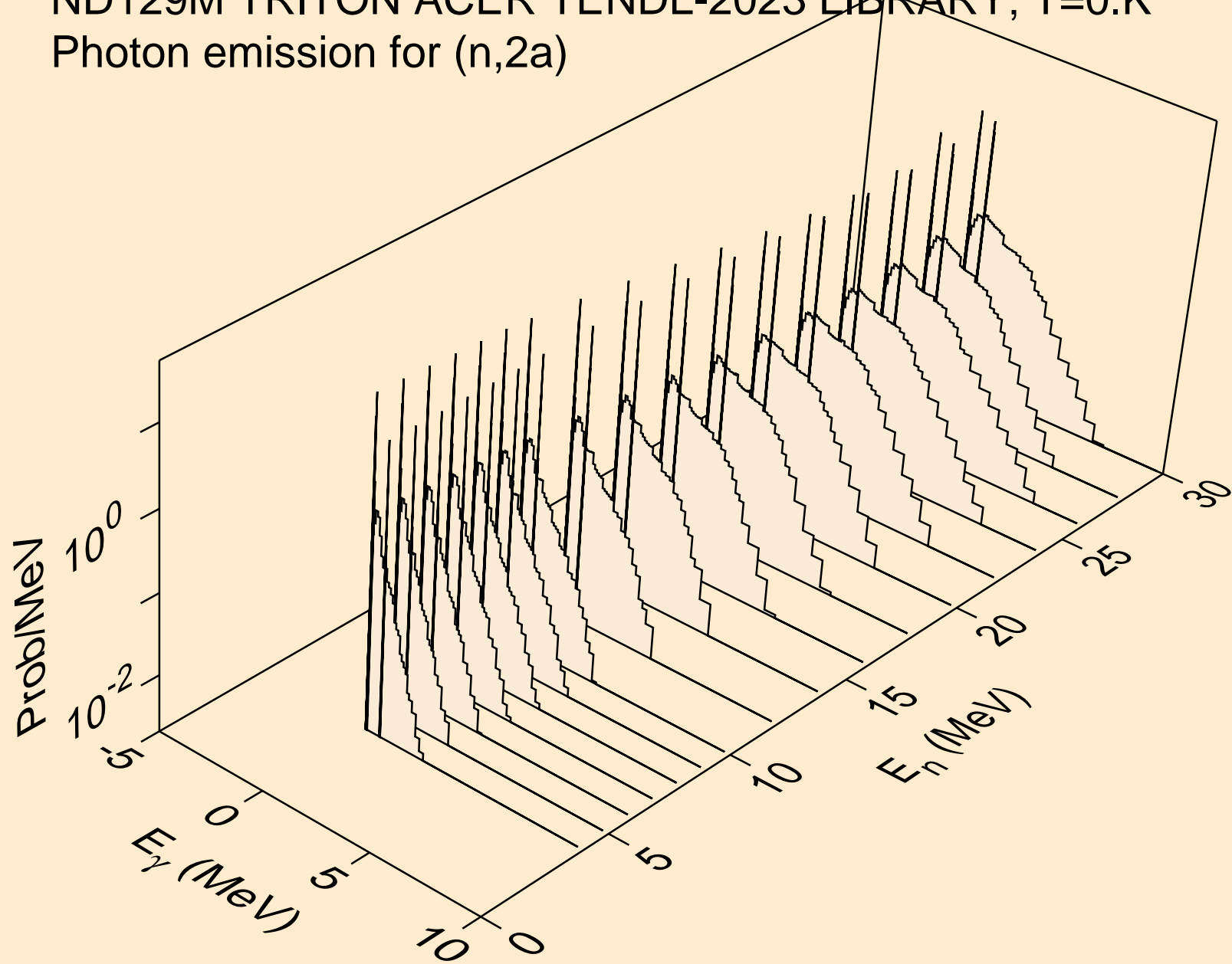

ND129M TRITON ACER TENDL-2023 LIBRARY; T=0.K
Photon emission for (n,3a)

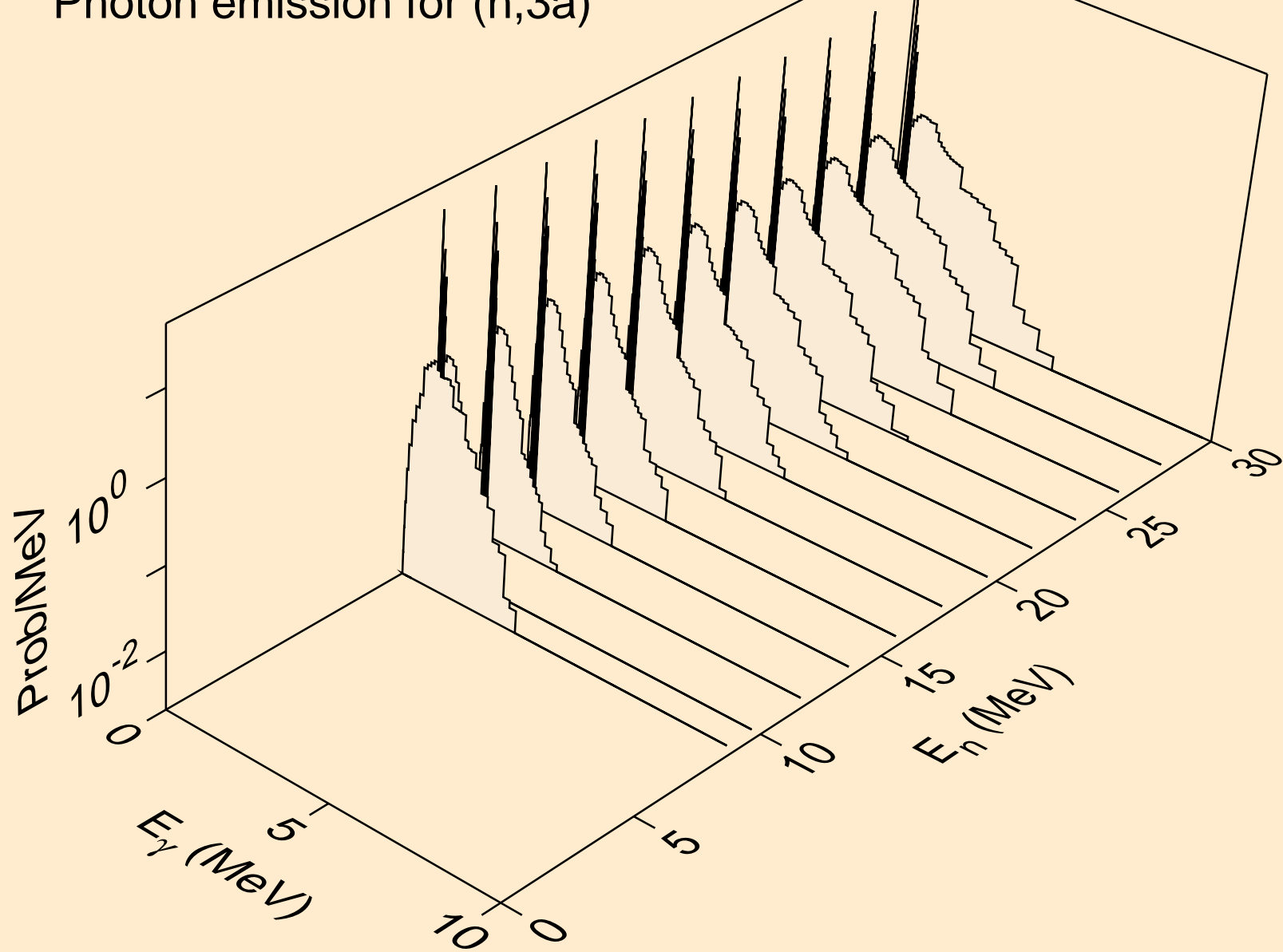

ND129M TRITON ACER TENDL-2023 LIBRARY; T=0.K
Photon emission for (n,2p)

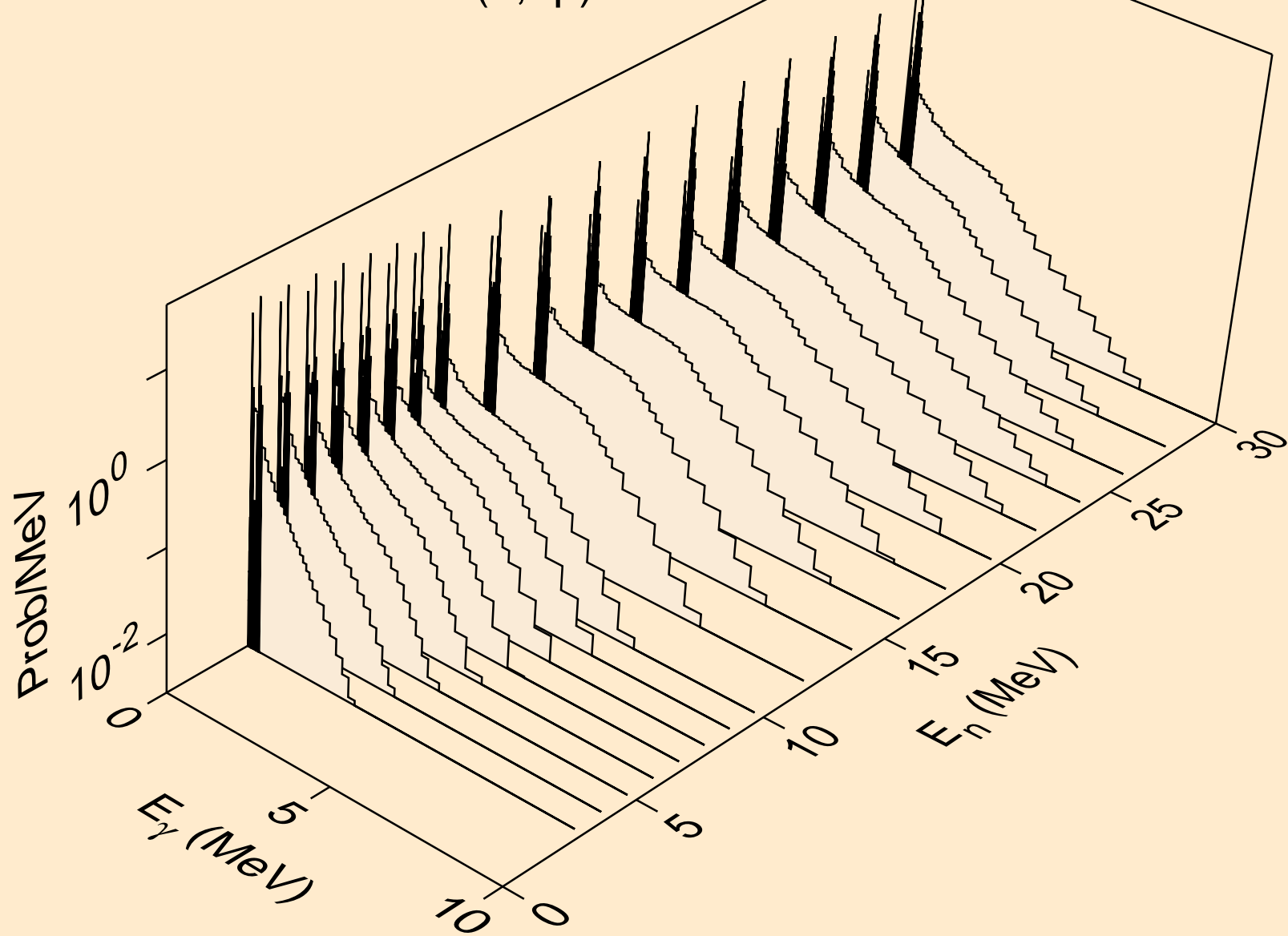

ND129M TRITON ACER TENDL-2023 LIBRARY; T=0.K
Photon emission for (n,pa)

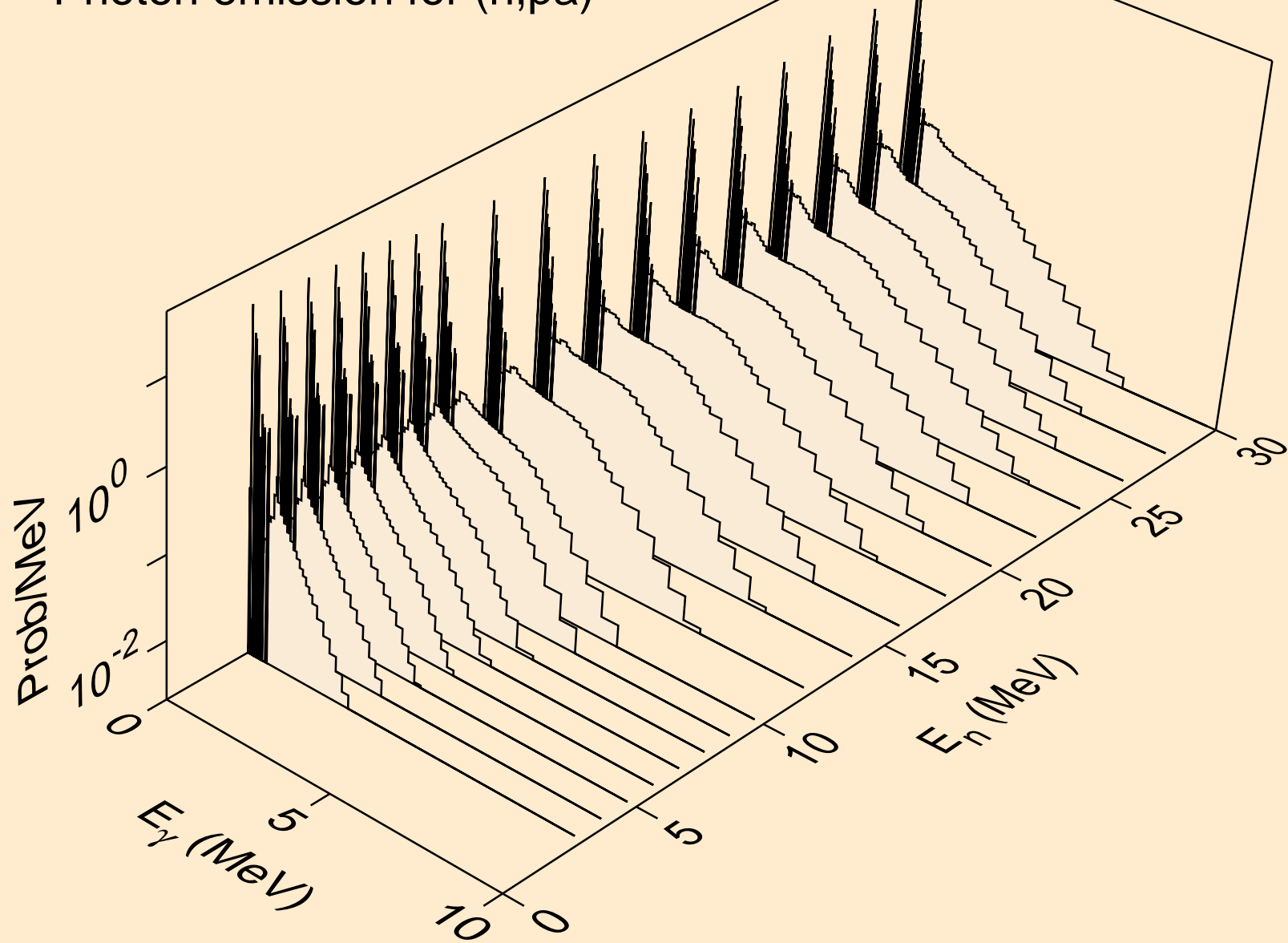

ND129M TRITON ACER TENDL-2023 LIBRARY; T=0.K
Photon emission for (n,t2a)

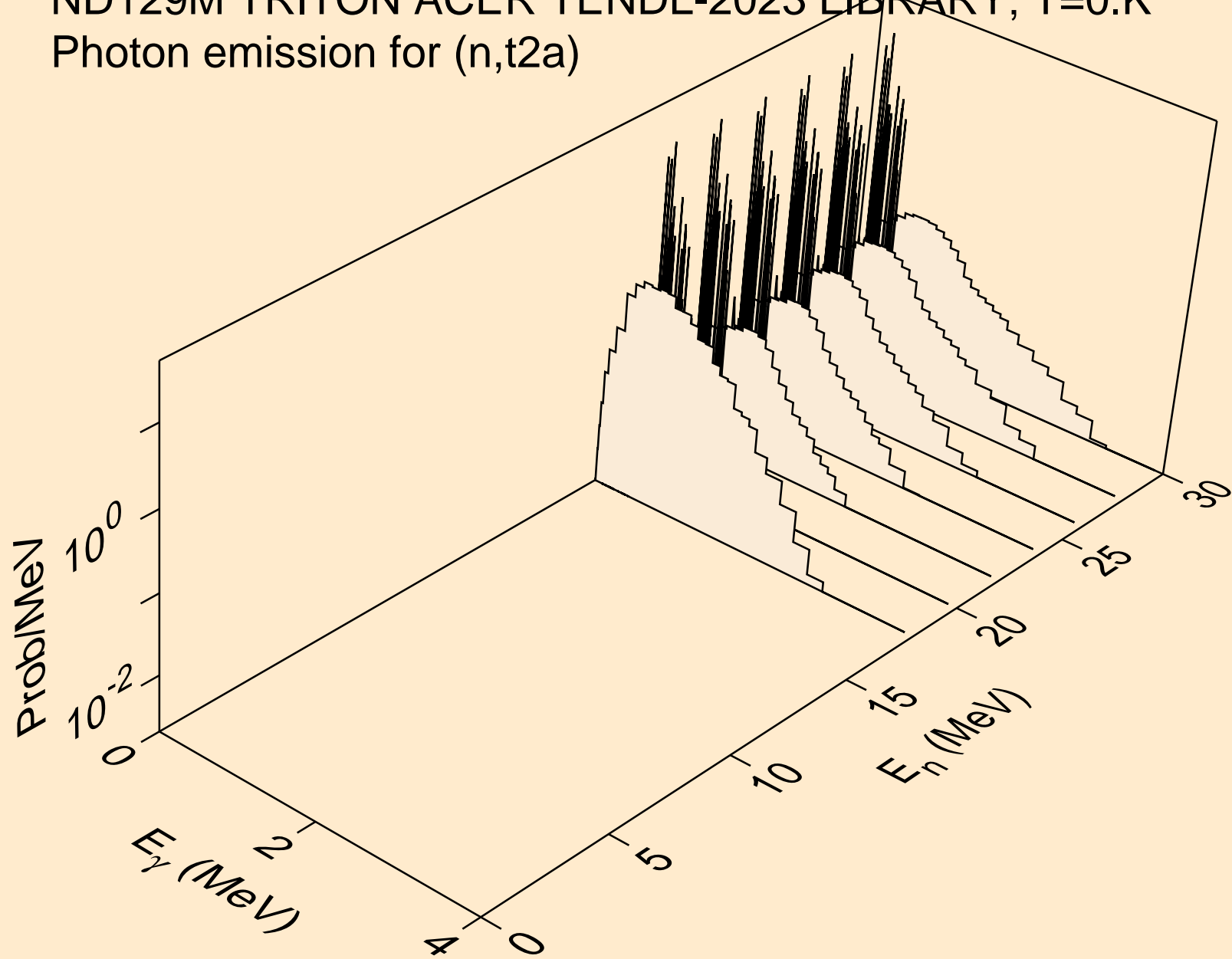

ND129M TRITON ACER TENDL-2023 LIBRARY; T=0.K
Photon emission for (n,d2a)

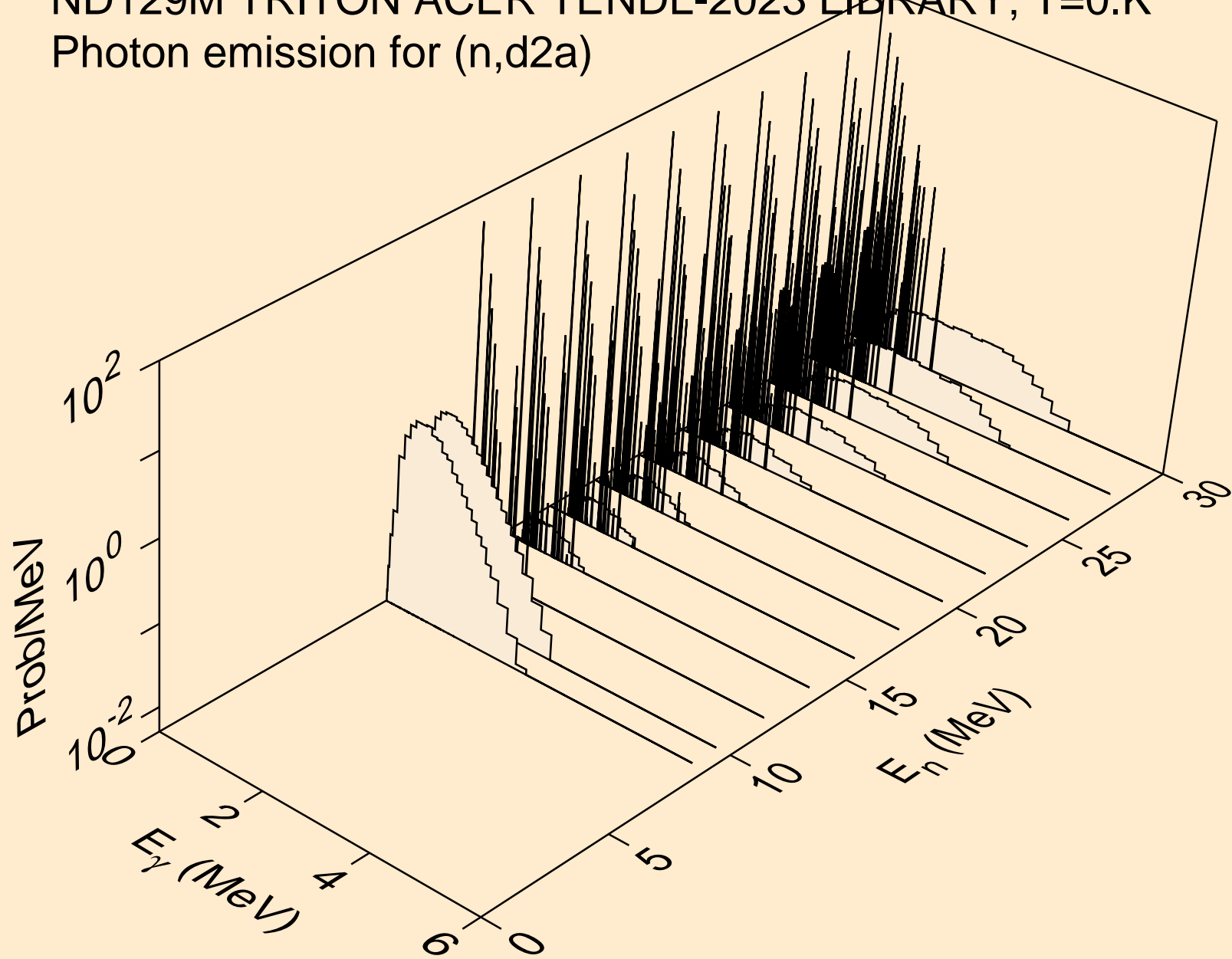

ND129M TRITON ACER TENDL-2023 LIBRARY; T=0.K
Photon emission for (n,pd)

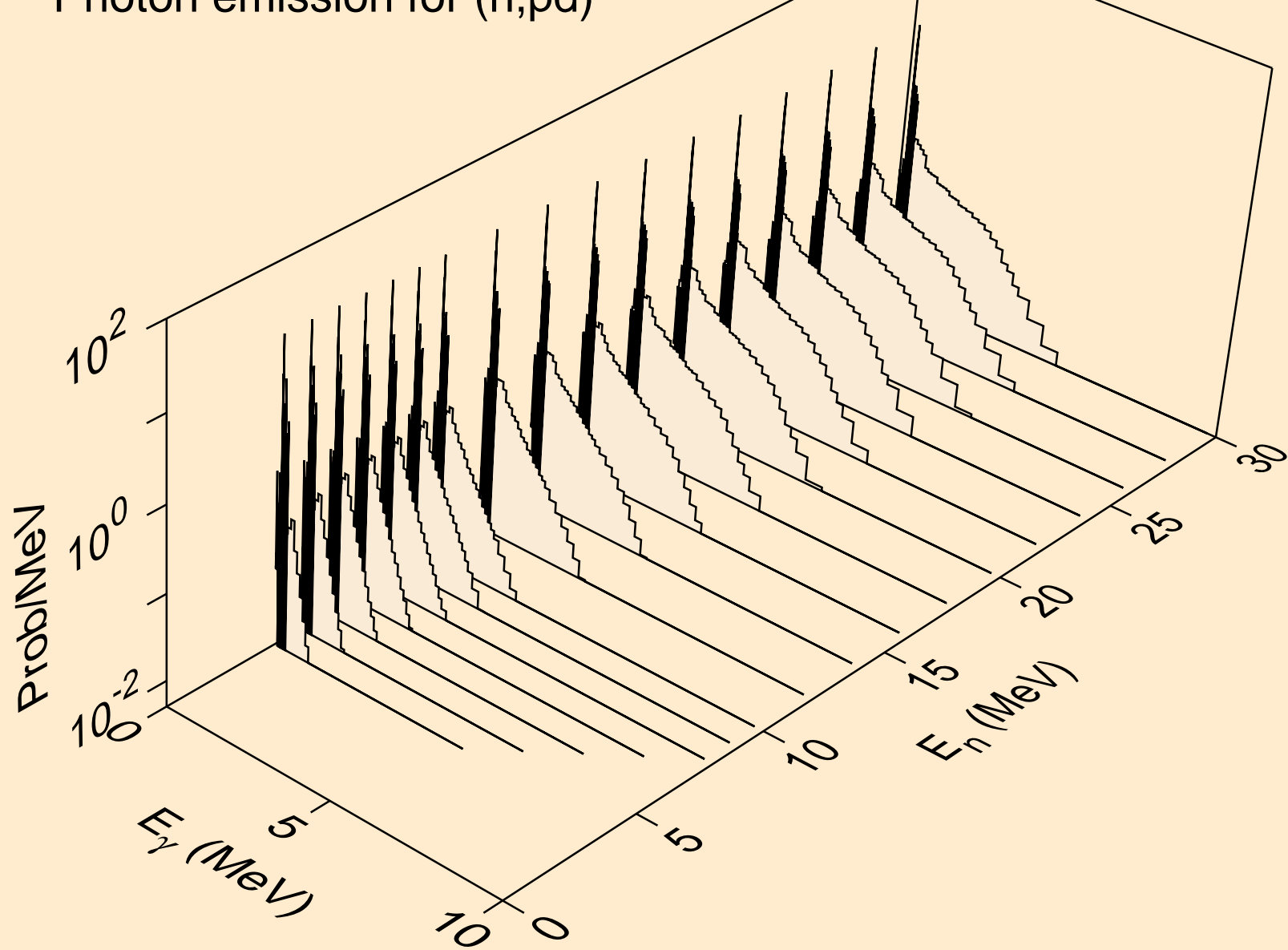

ND129M TRITON ACER TENDL-2023 LIBRARY; T=0.K
Photon emission for (n,pt)

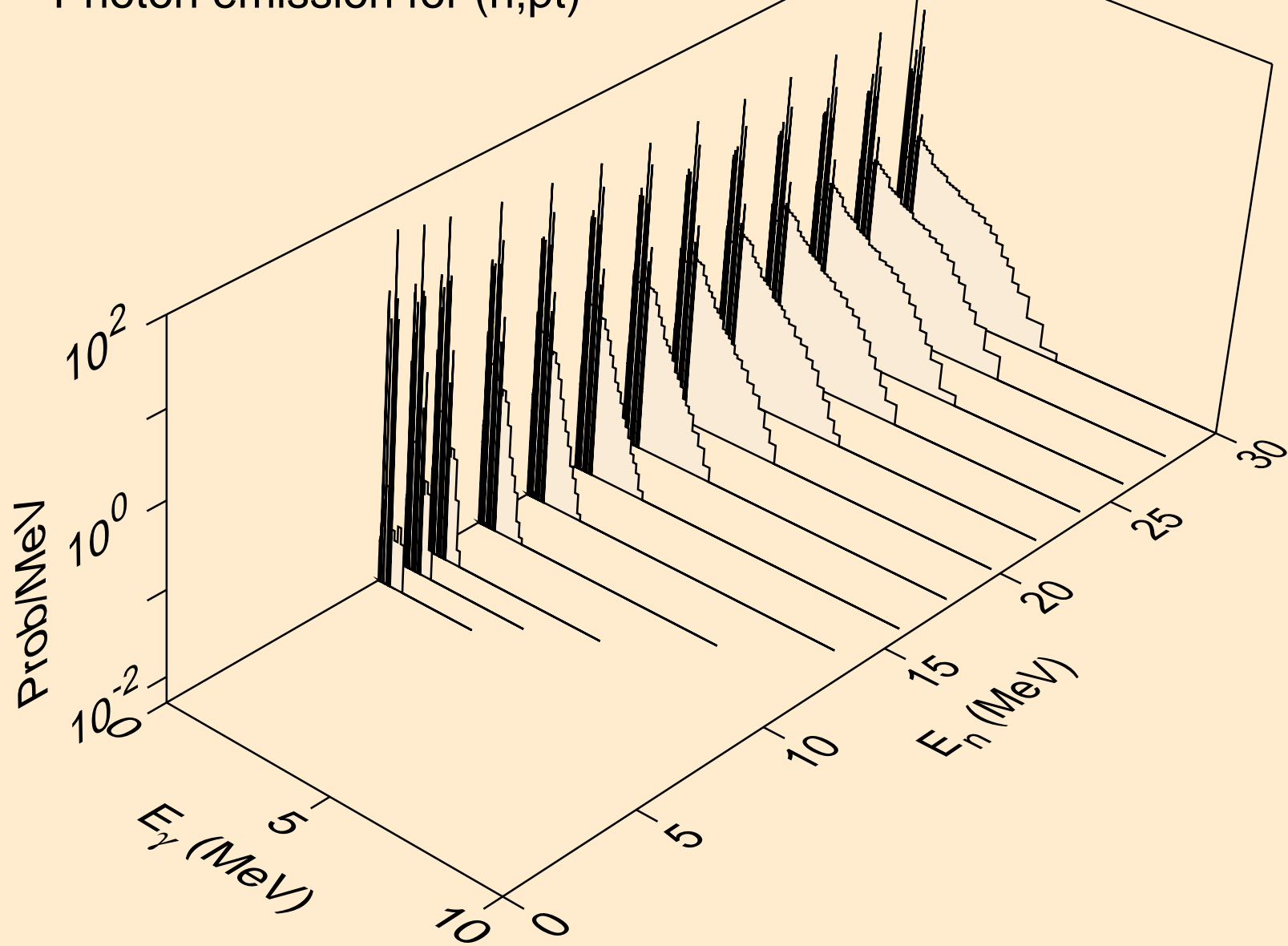

ND129M TRITON ACER TENDL-2023 LIBRARY; T=0.K
Photon emission for (n,da)

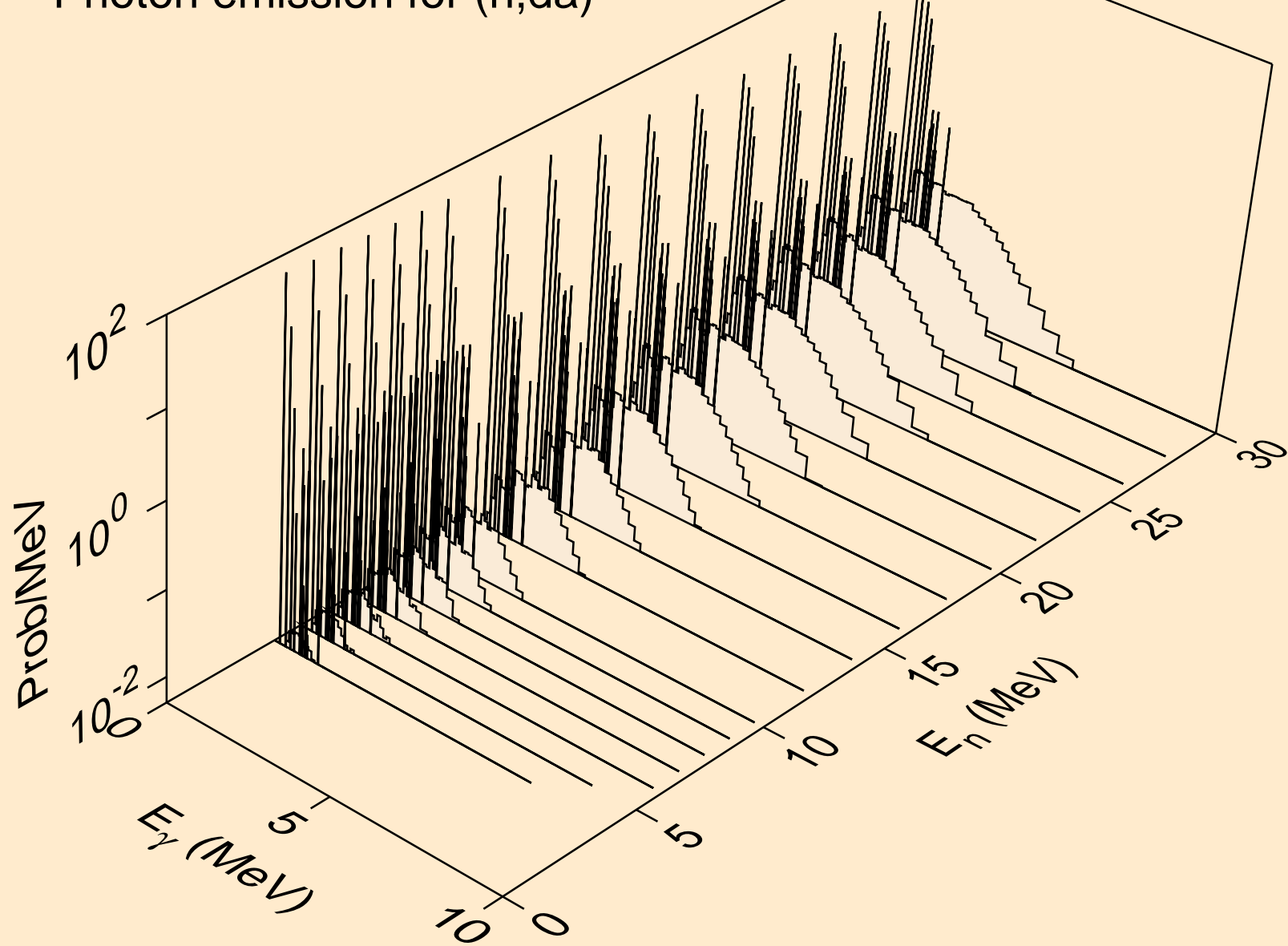

ND129M TRITON ACER TENDL-2023 LIBRARY; T=0.K

Particle heating contributions

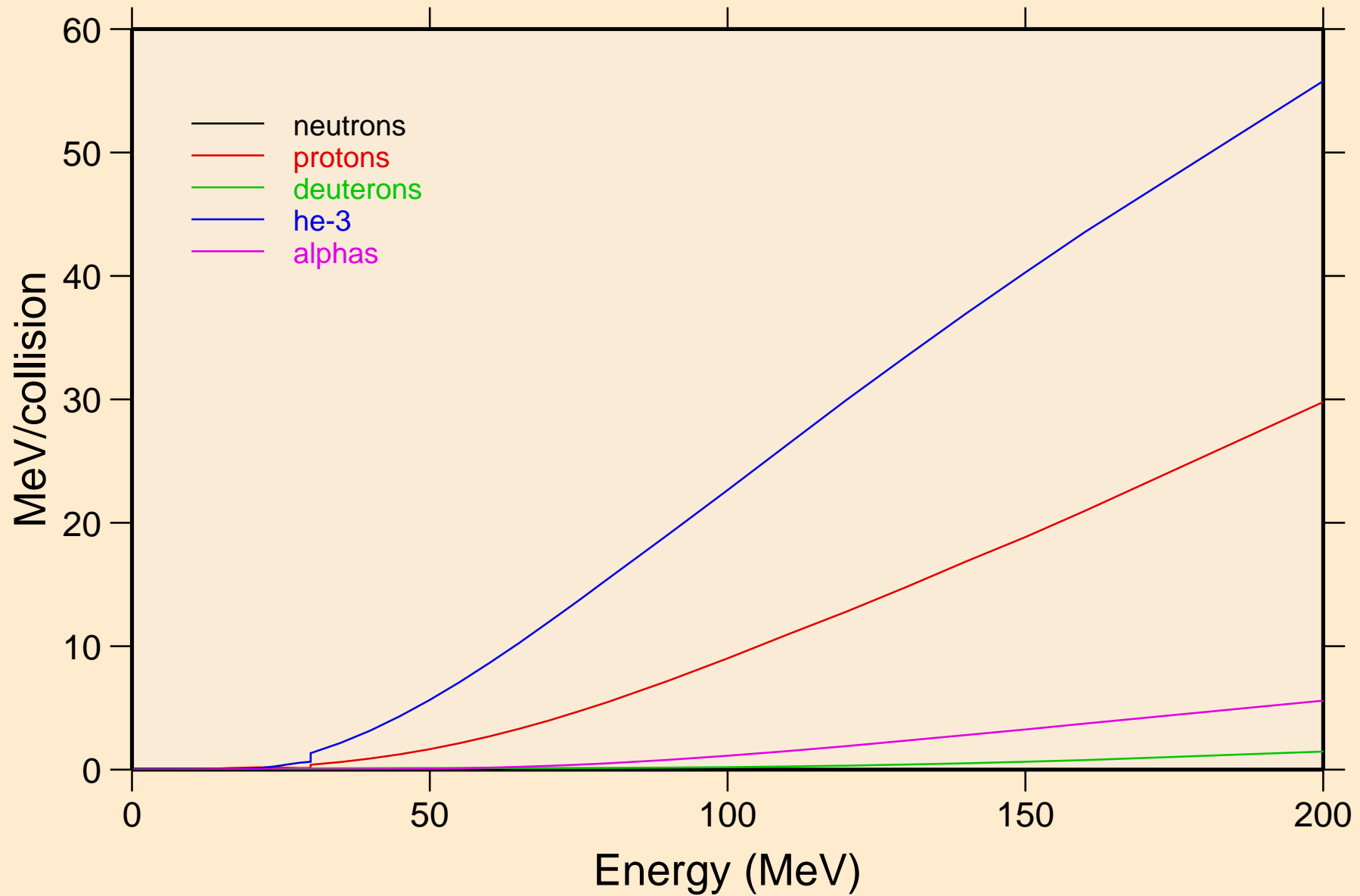

ND129M TRITON ACER TENDL-2023 LIBRARY; T=0.K
Recoil Heating

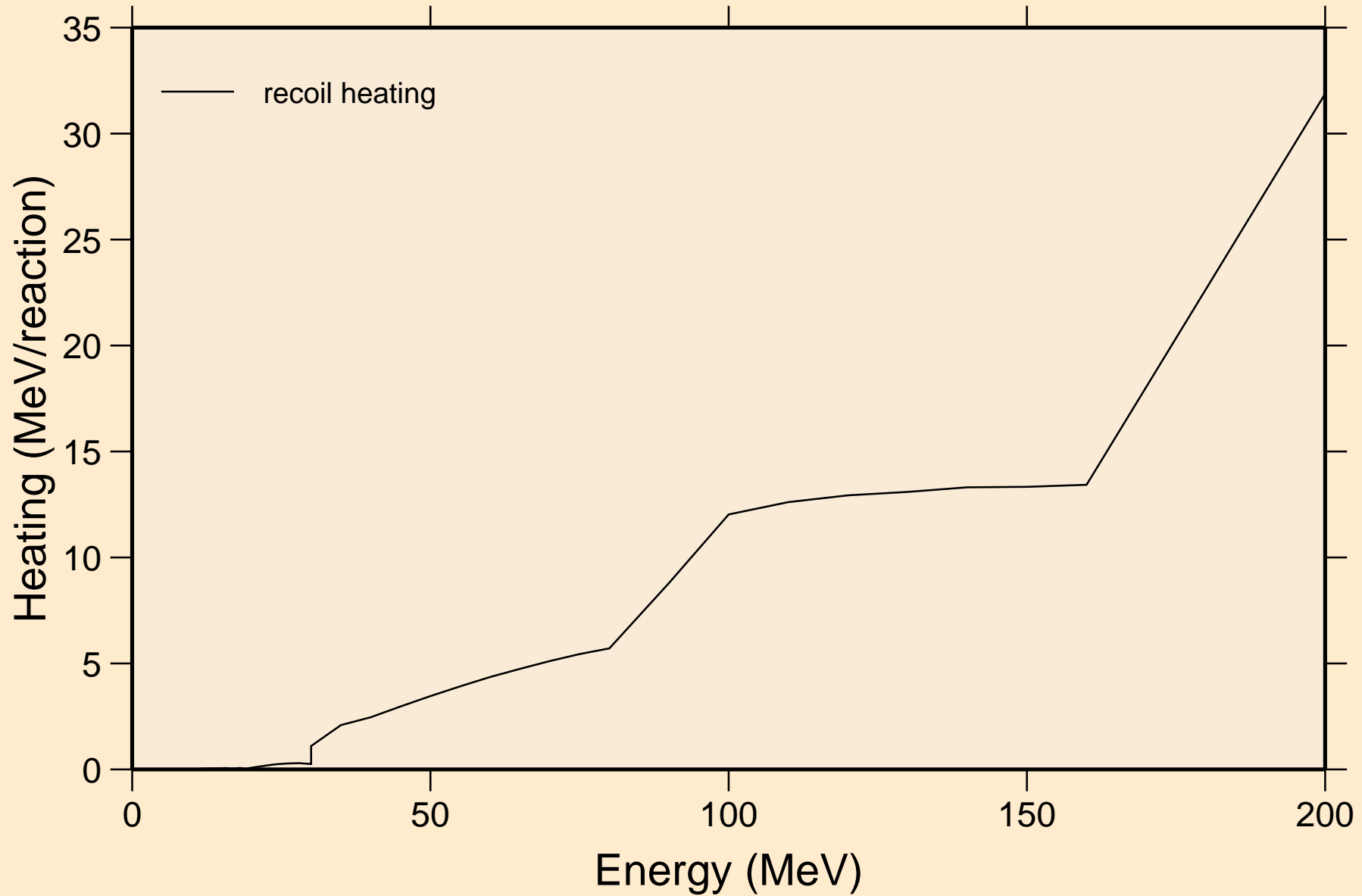

ND129M TRITON ACER TENDL-2023 LIBRARY; T=0.K
Particle production cross sections

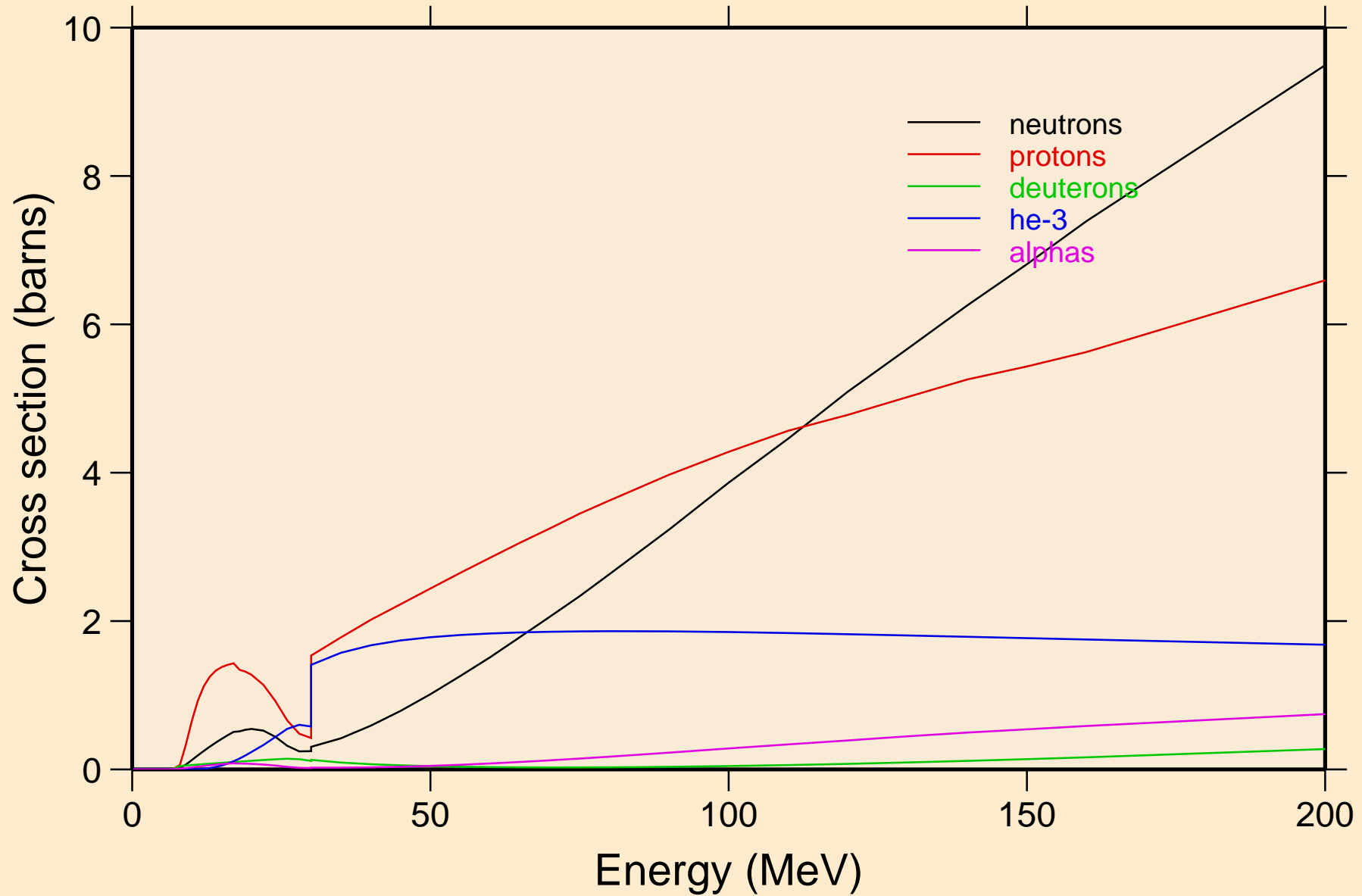

ND129M TRITON ACER TENDL-2023 LIBRARY; T=0.K
neutrons from (t,n)

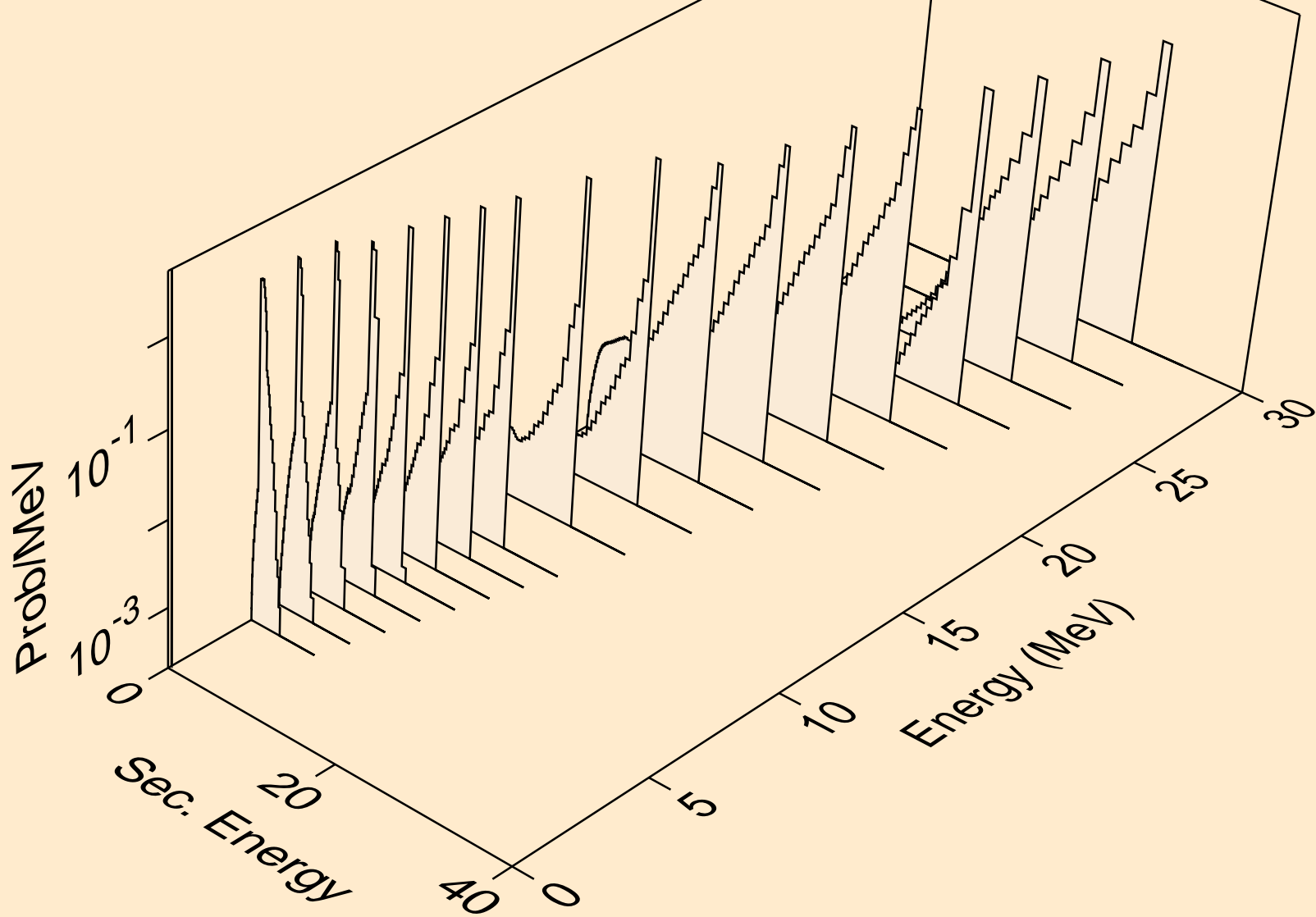

ND129M TRITON ACER TENDL-2023 LIBRARY; T=0.K
neutrons from (t,x)

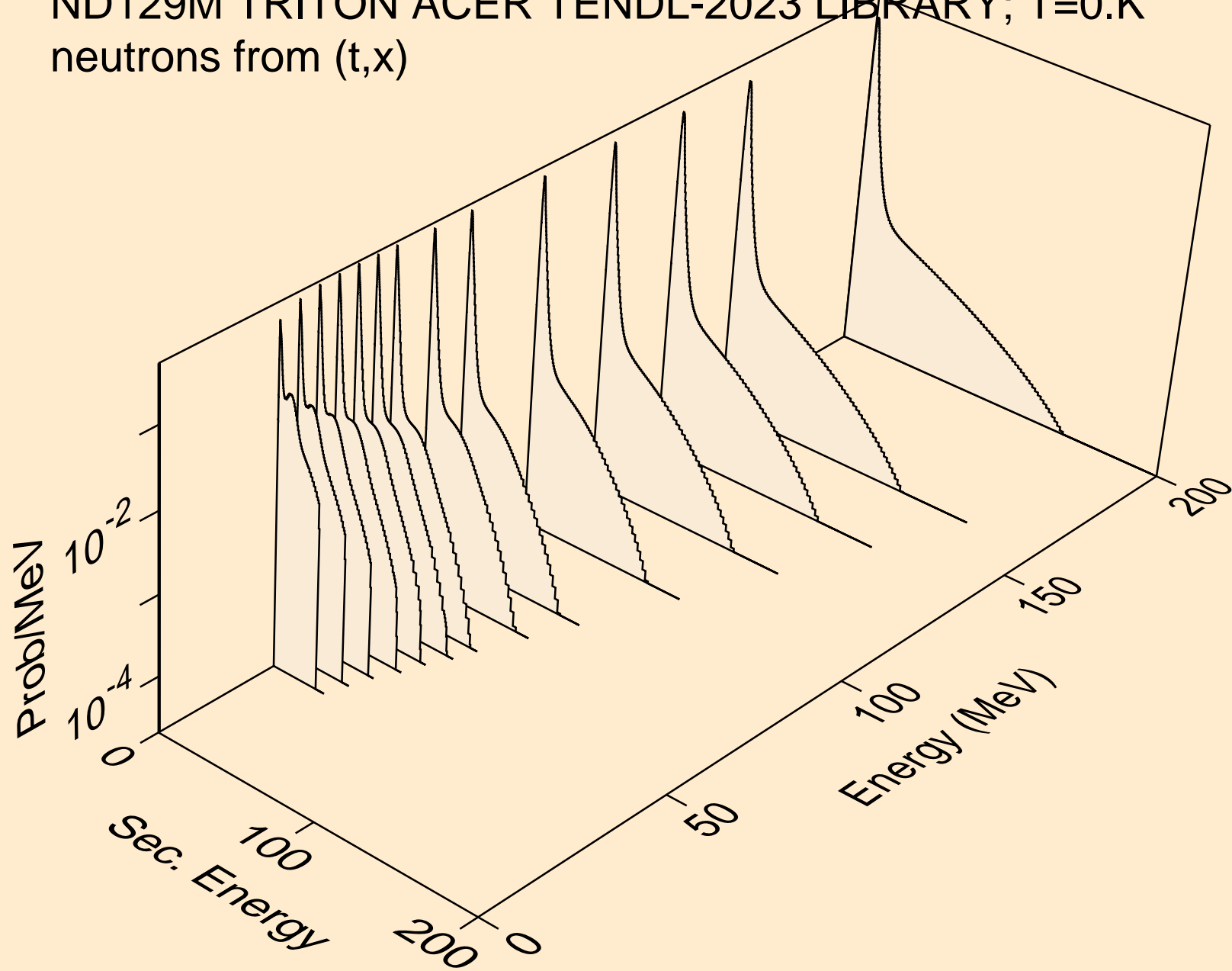

ND129M TRITON ACER TENDL-2023 LIBRARY; T=0.K
neutrons from (t,2nd)

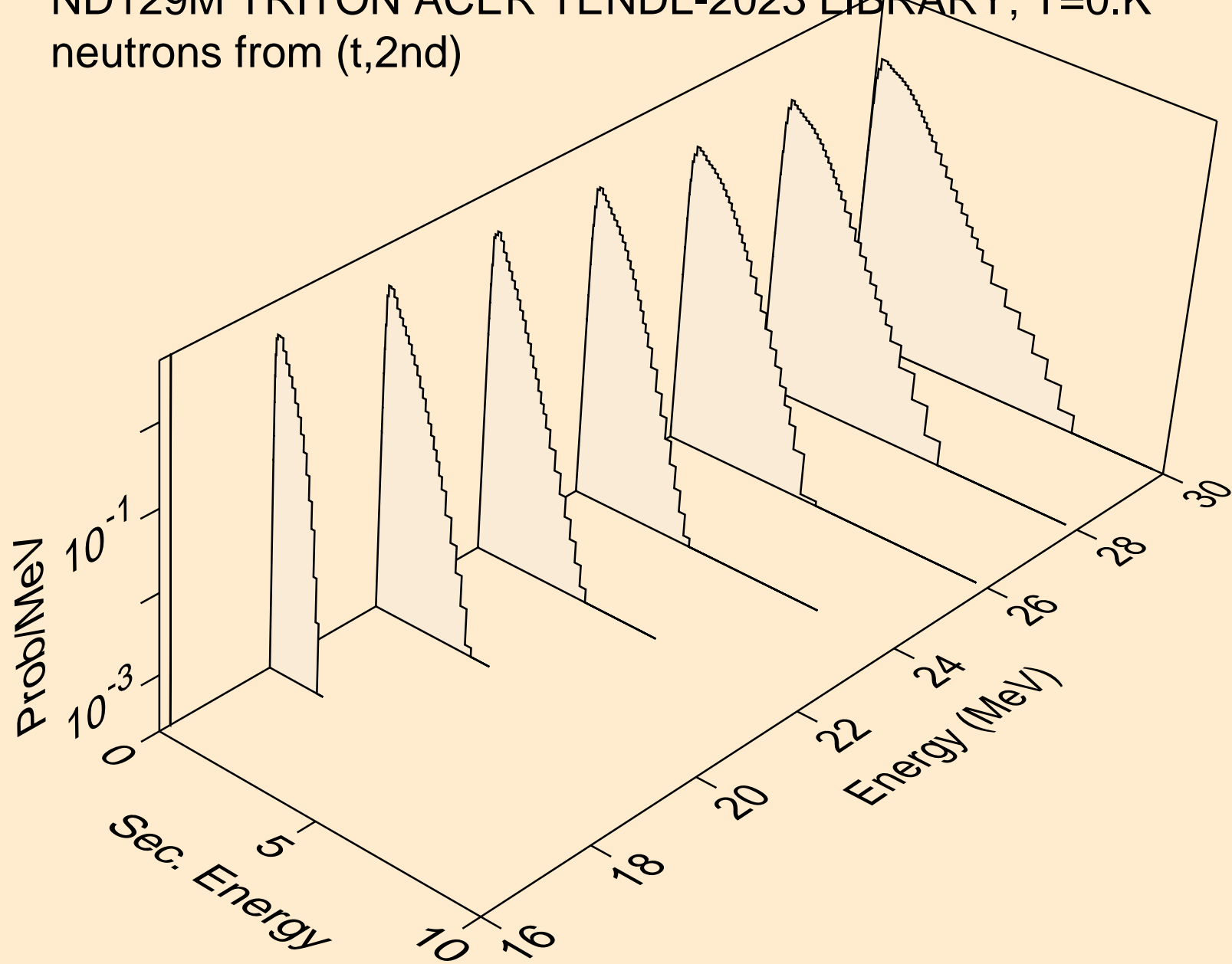

ND129M TRITON ACER TENDL-2023 LIBRARY; T=0.K
neutrons from (t,2n)

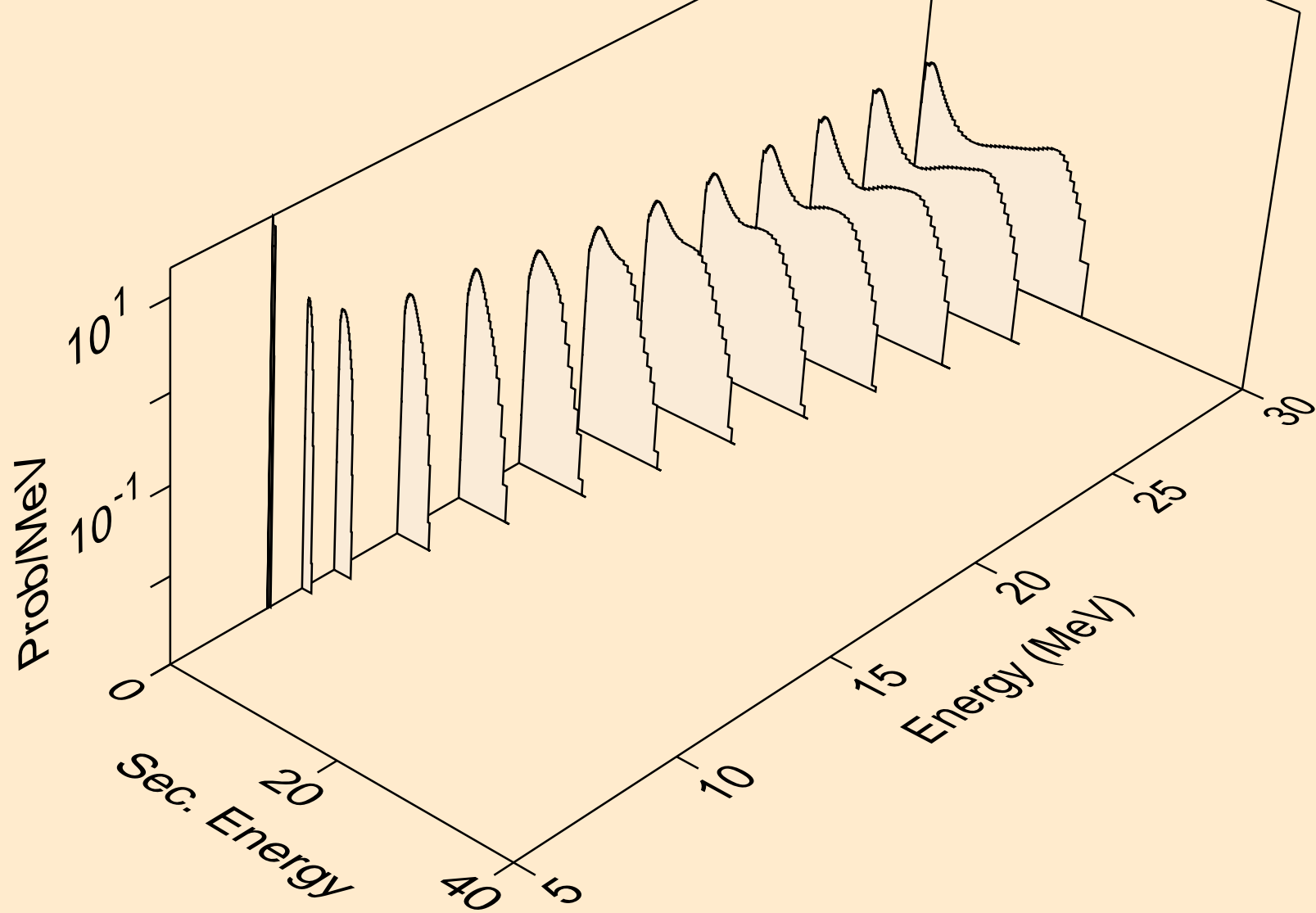

ND129M TRITON ACER TENDL-2023 LIBRARY; T=0.K
neutrons from (t,3n)

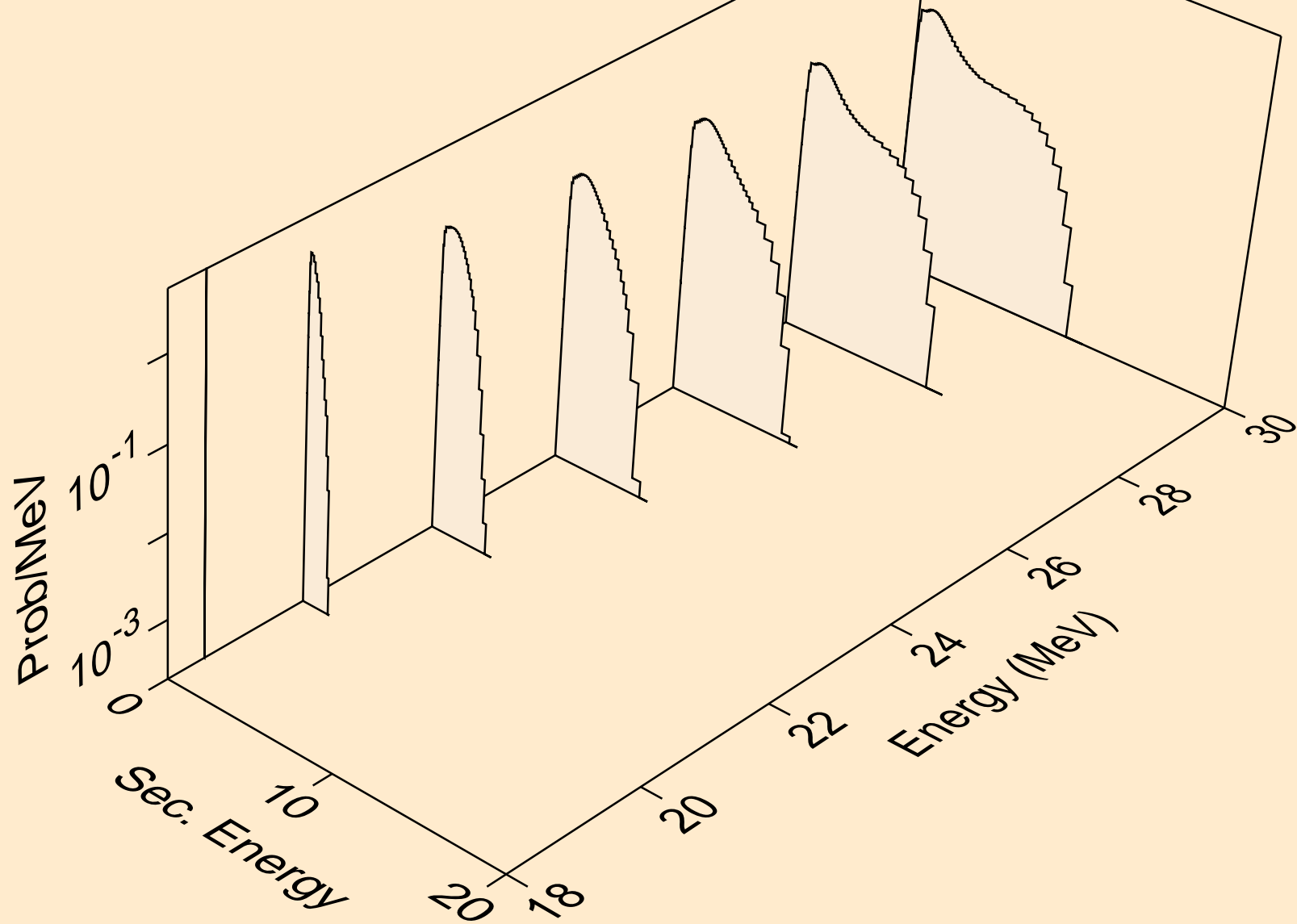

ND129M TRITON ACER TENDL-2023 LIBRARY; T=0.K
neutrons from (t,n*)a

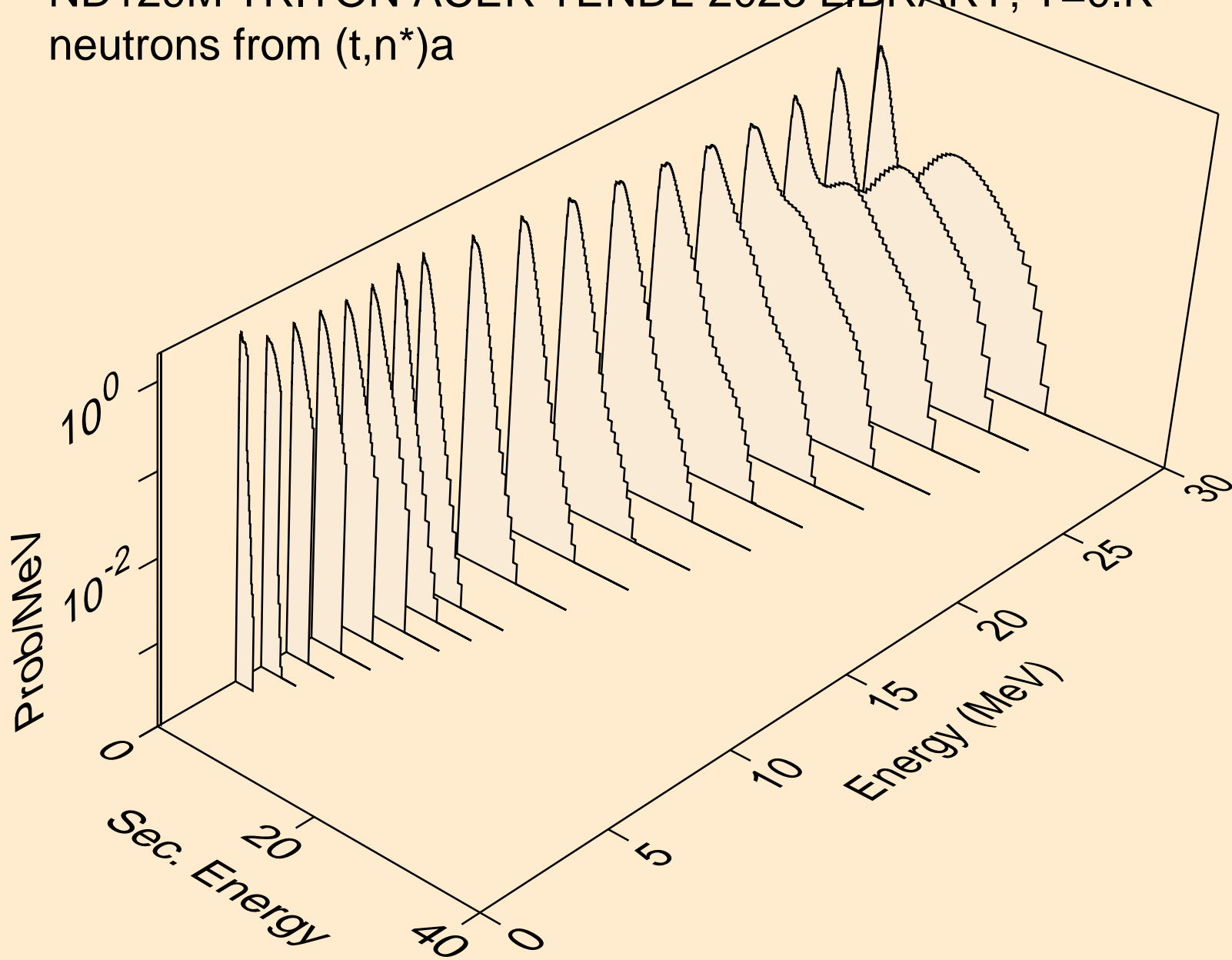

ND129M TRITON ACER TENDL-2023 LIBRARY; T=0.K
neutrons from (t,2n)a

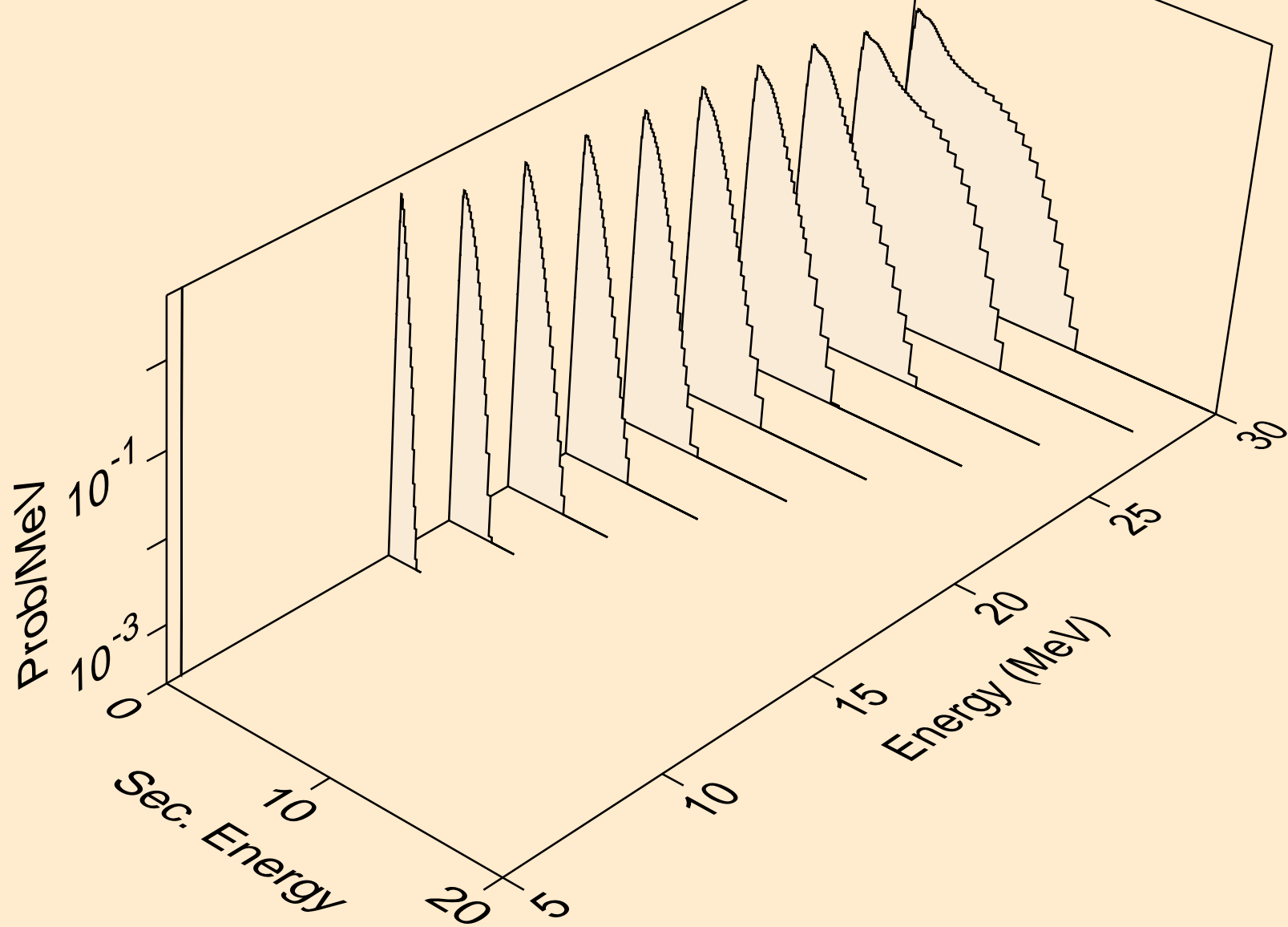

ND129M TRITON ACER TENDL-2023 LIBRARY; T=0.K
neutrons from (t,n*)p

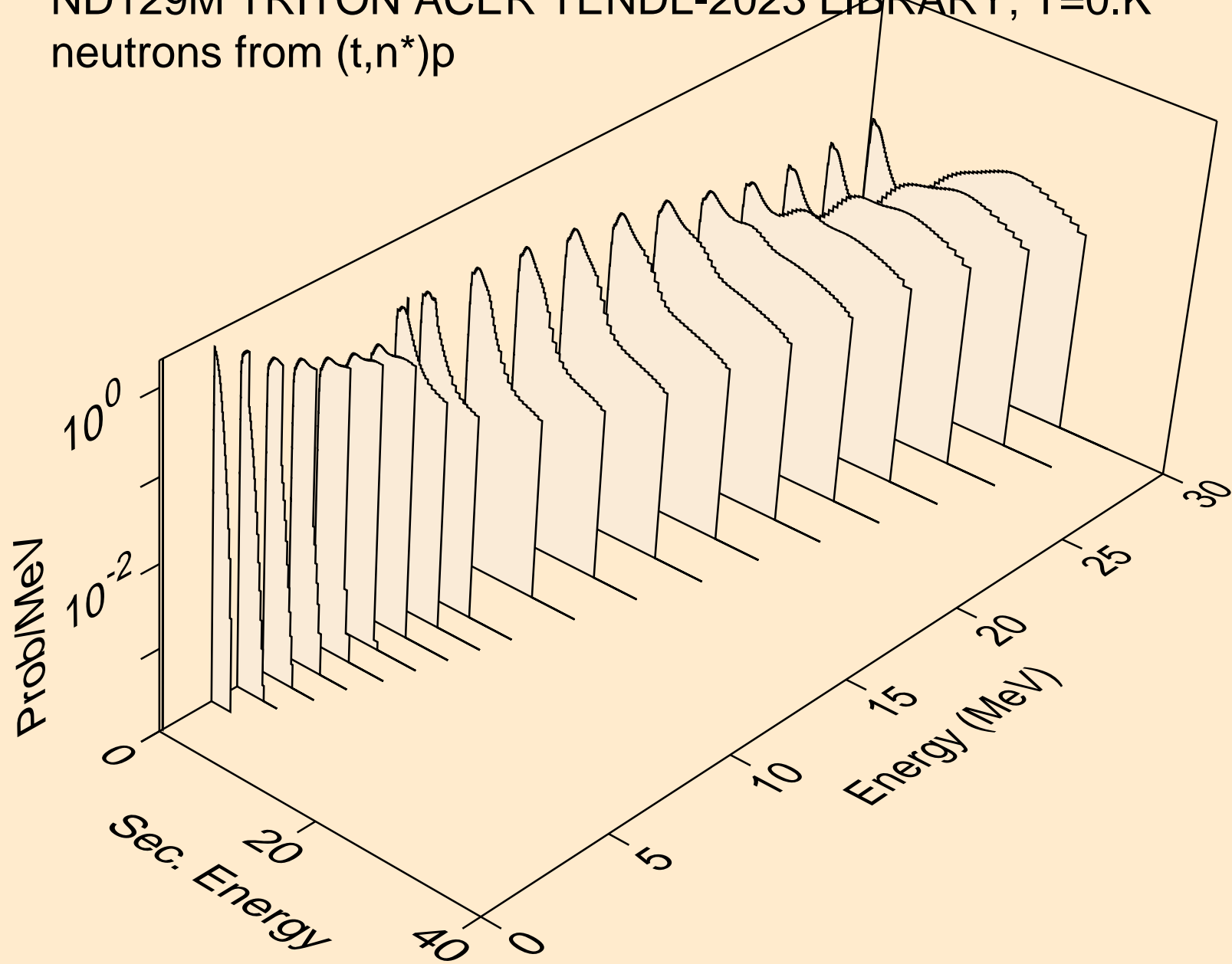

ND129M TRITON ACER TENDL-2023 LIBRARY; T=0.K
neutrons from (t,n*)2a

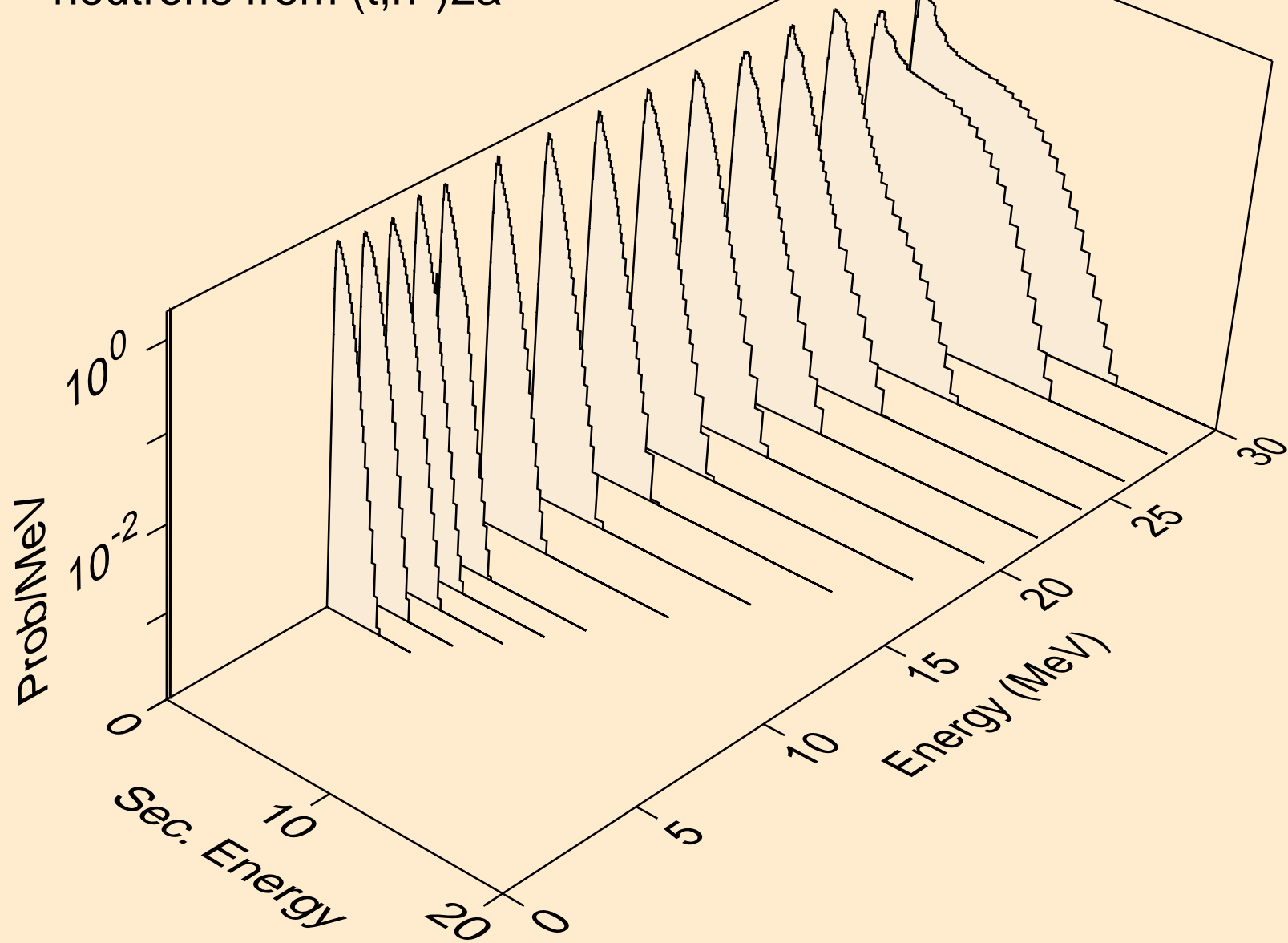

ND129M TRITON ACER TENDL-2023 LIBRARY; T=0.K
neutrons from (t,n*)d

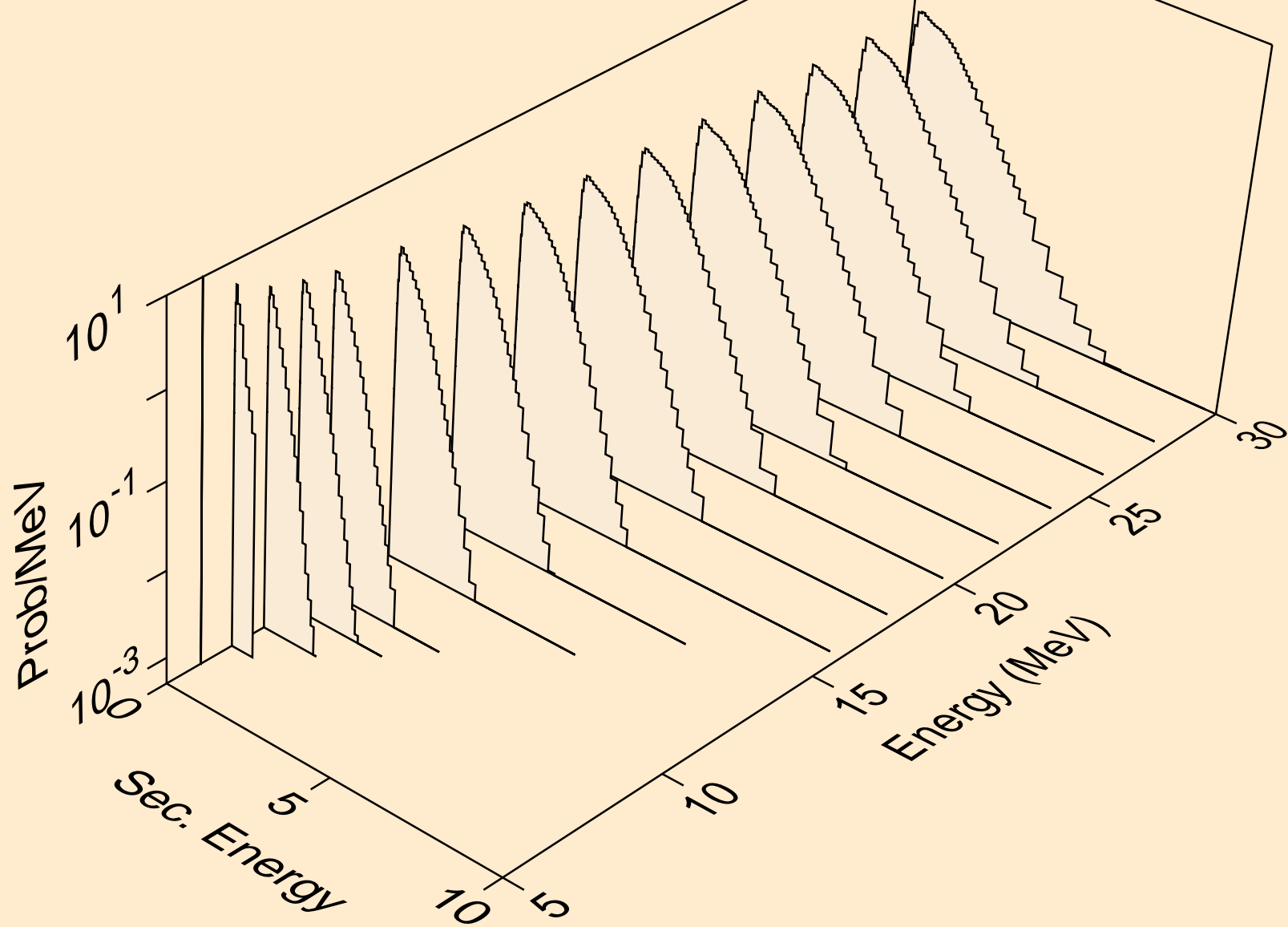

ND129M TRITON ACER TENDL-2023 LIBRARY; T=0.K
neutrons from (t,n*)t

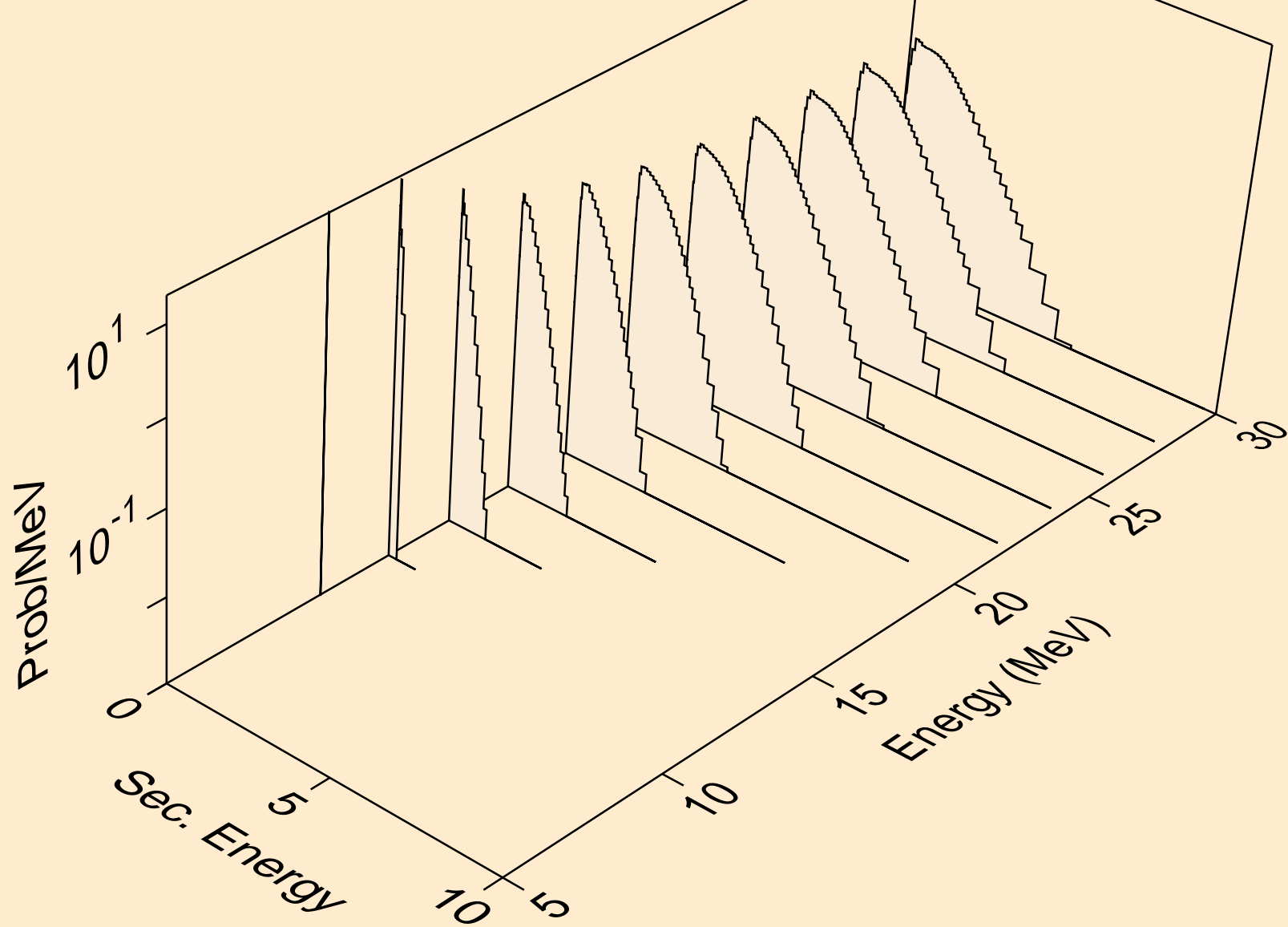

ND129M TRITON ACER TENDL-2023 LIBRARY; T=0.K
neutrons from (t,n*)he3

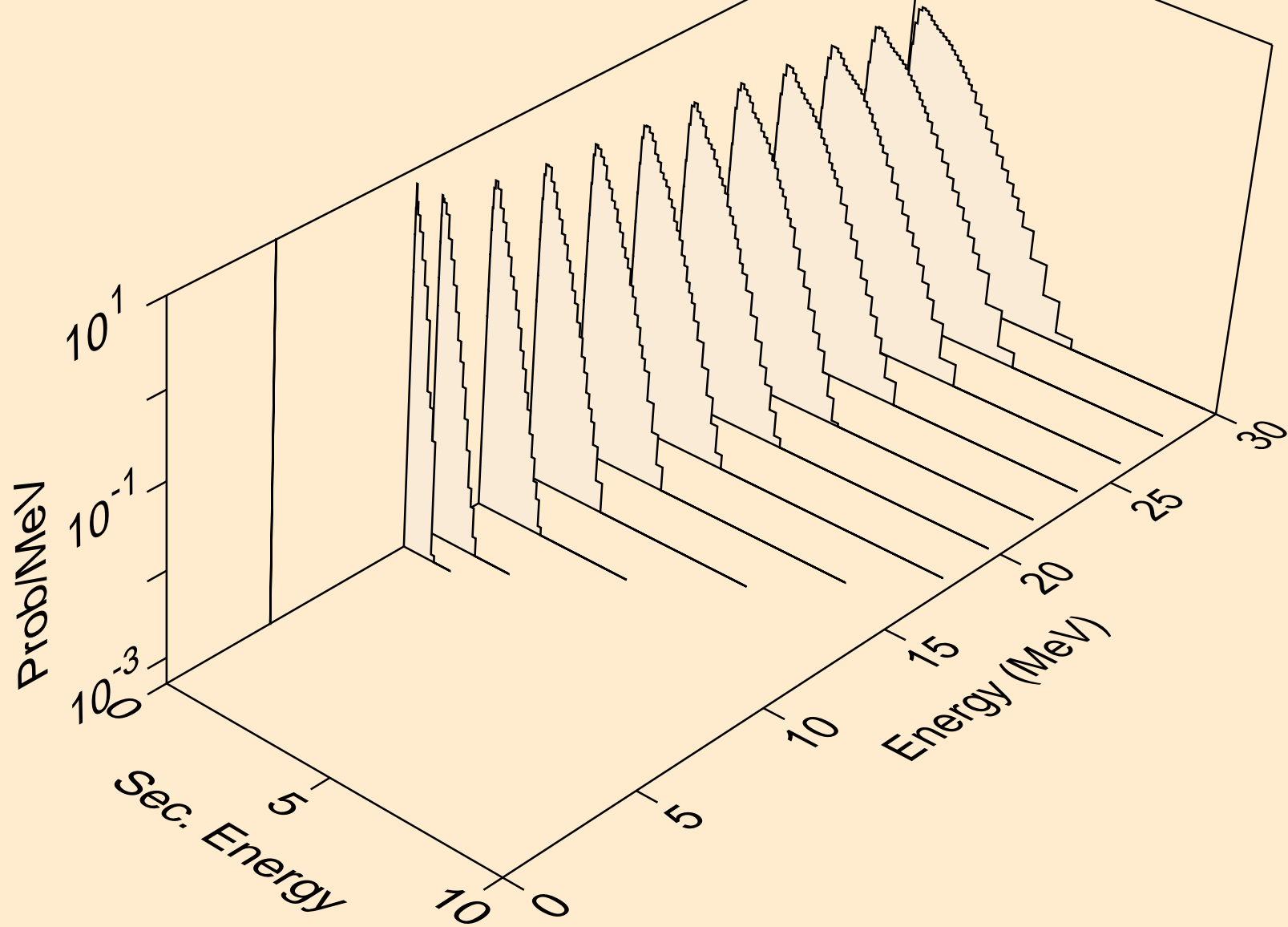

ND129M TRITON ACER TENDL-2023 LIBRARY; T=0.K
neutrons from (t,2np)

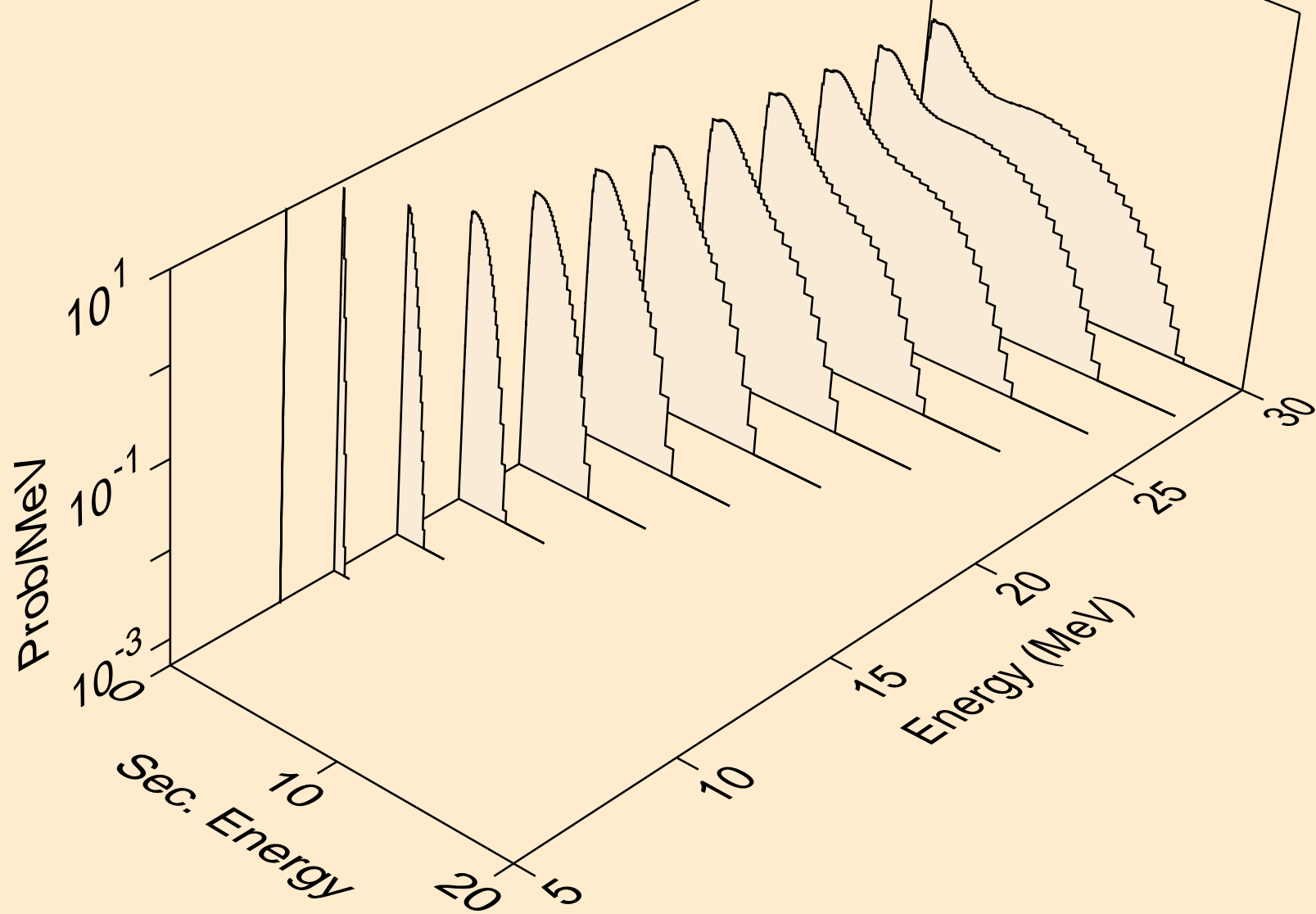

ND129M TRITON ACER TENDL-2023 LIBRARY; T=0.K
neutrons from (t,3np)

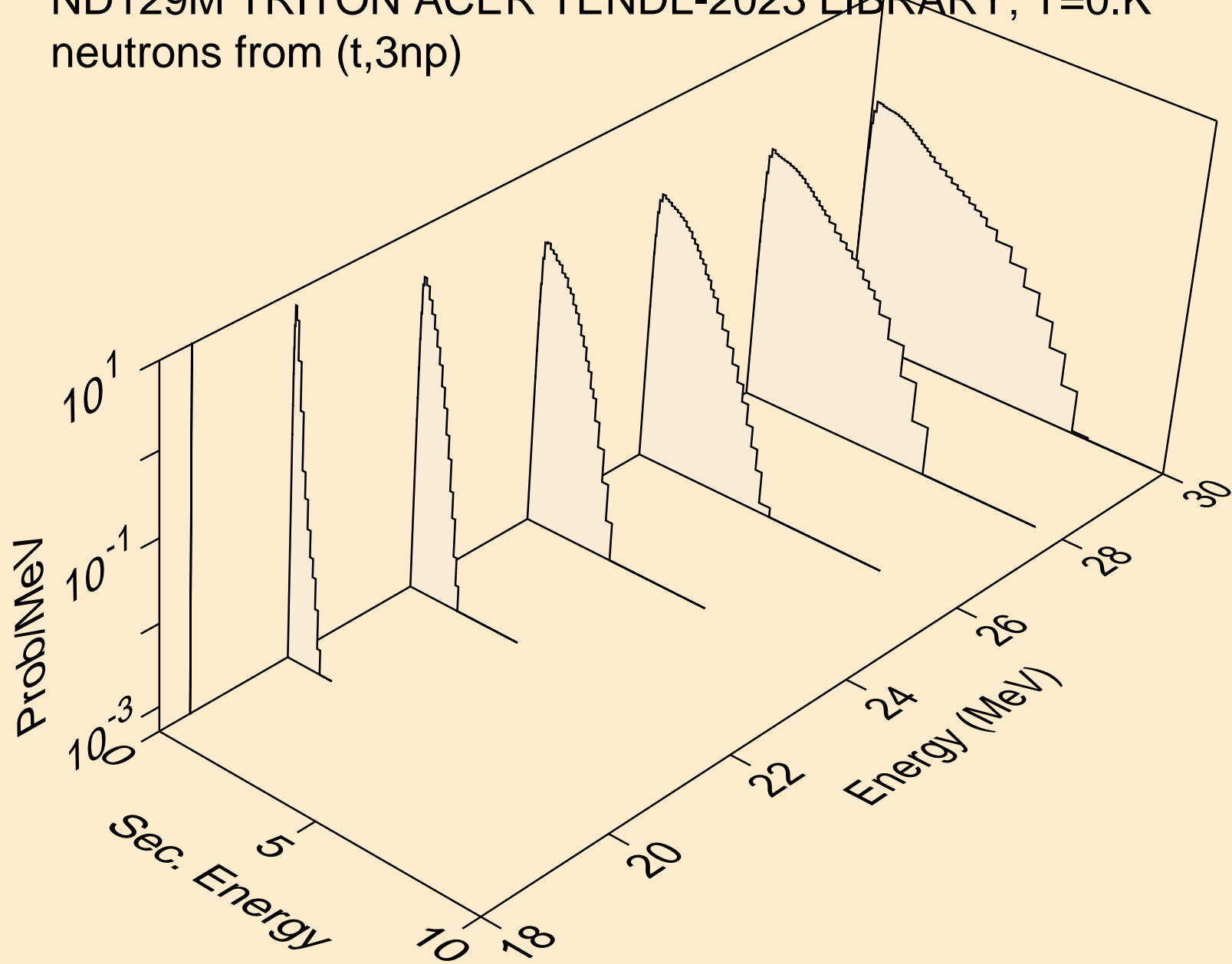

ND129M TRITON ACER TENDL-2023 LIBRARY; T=0.K
neutrons from (t,n2p)

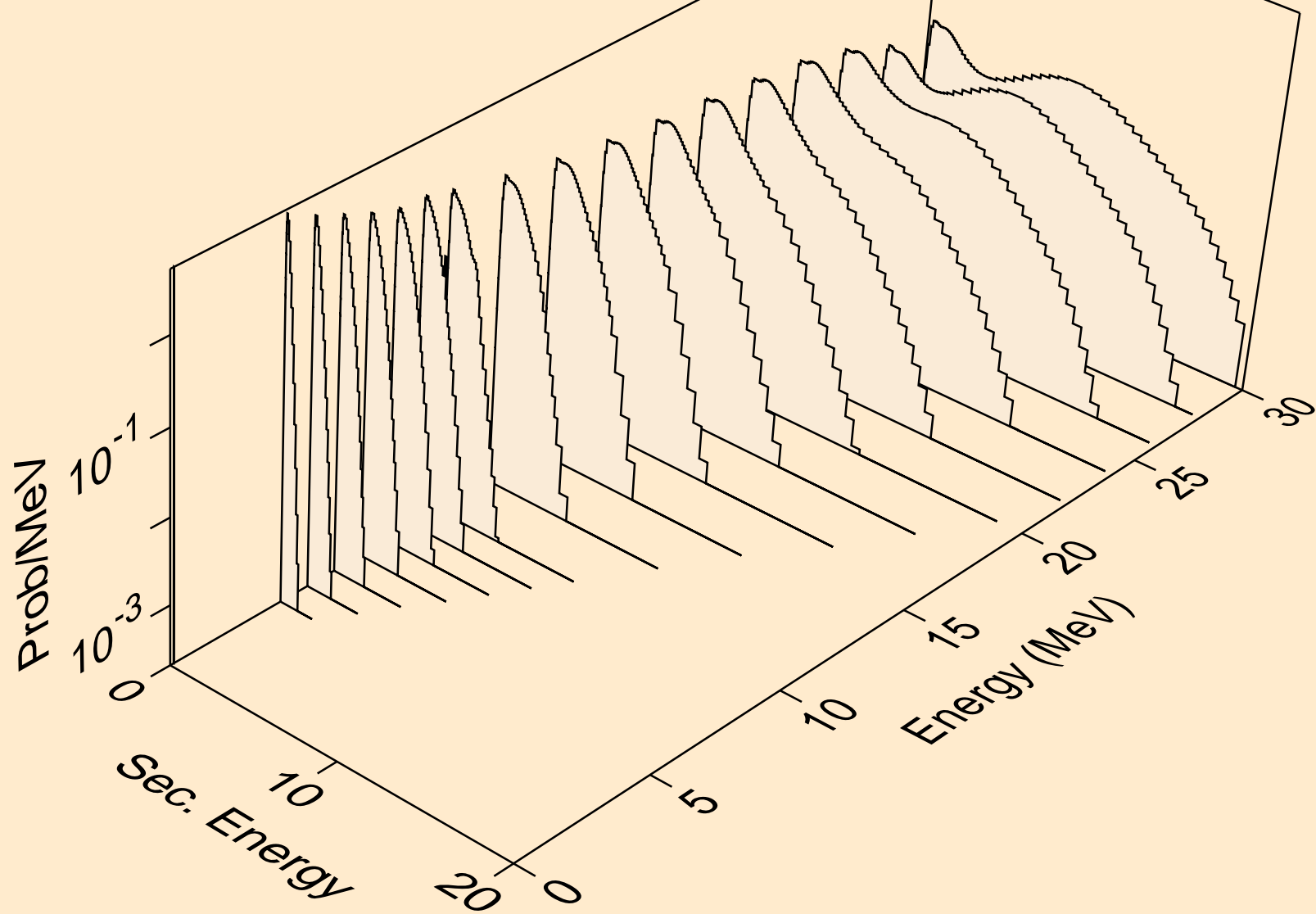

ND129M TRITON ACER TENDL-2023 LIBRARY; T=0.K
neutrons from (t,npa)

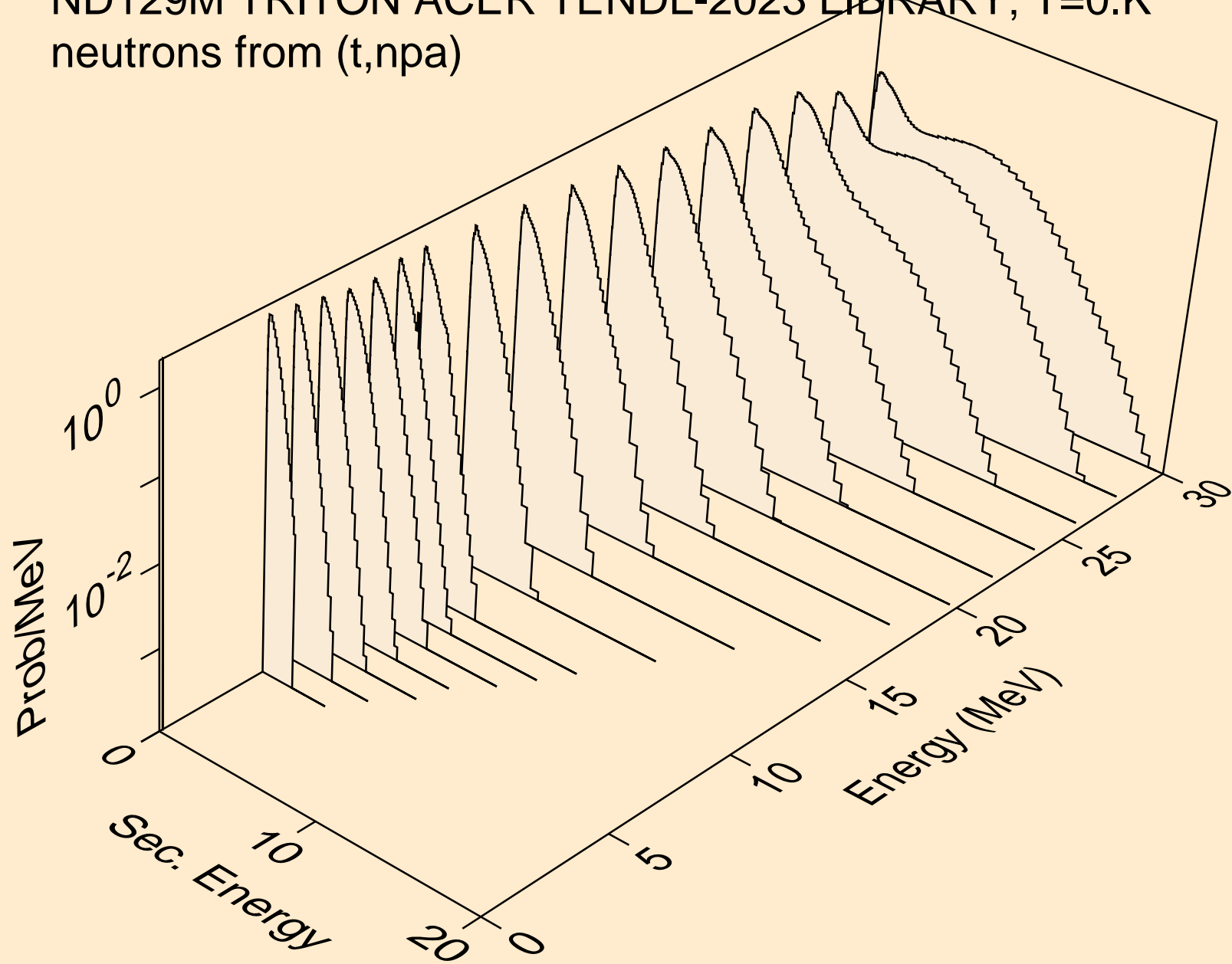

ND129M TRITON ACER TENDL-2023 LIBRARY; T=0.K
protons from (t,x)

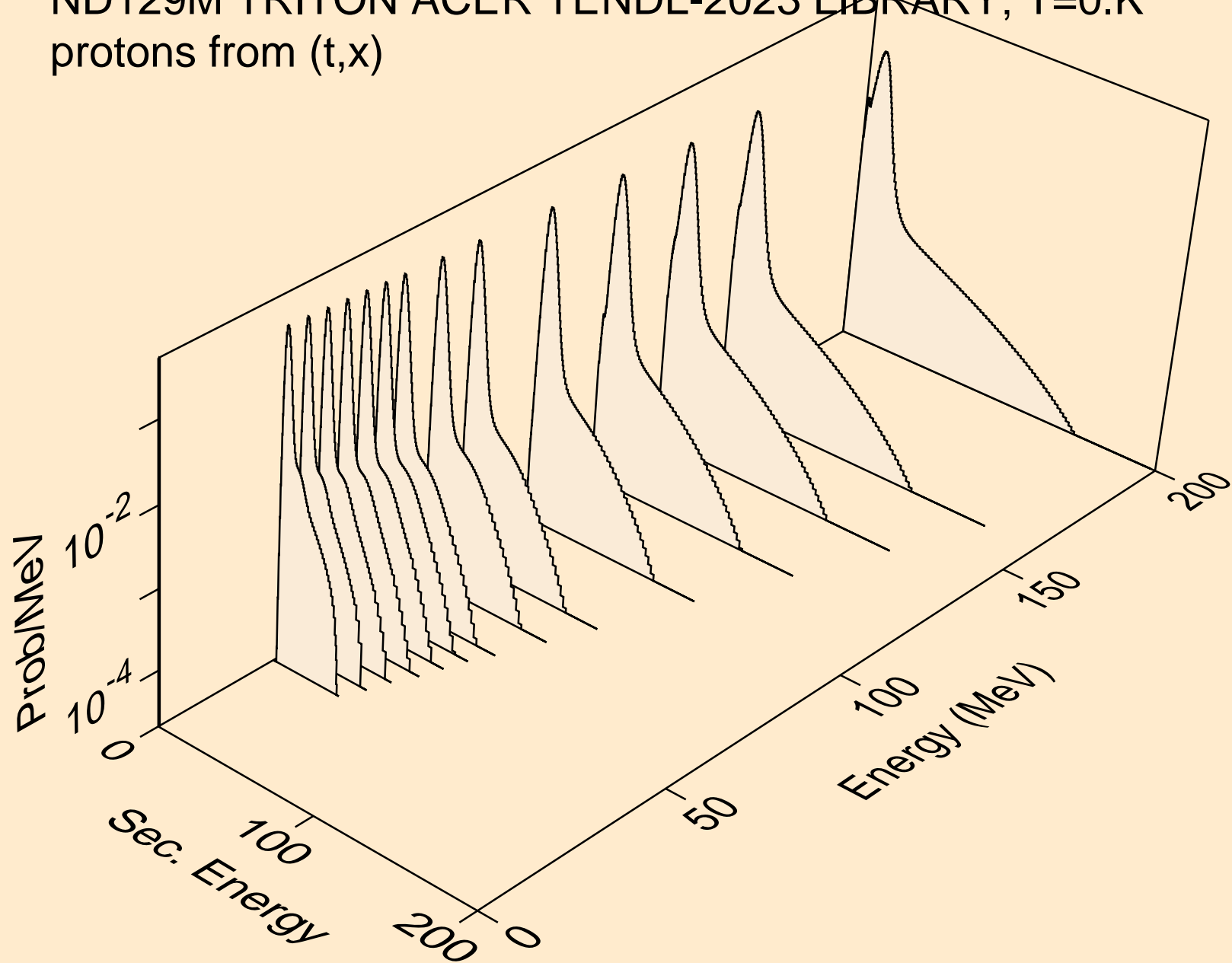

ND129M TRITON ACER TENDL-2023 LIBRARY; T=0.K
protons from (t,n*)p

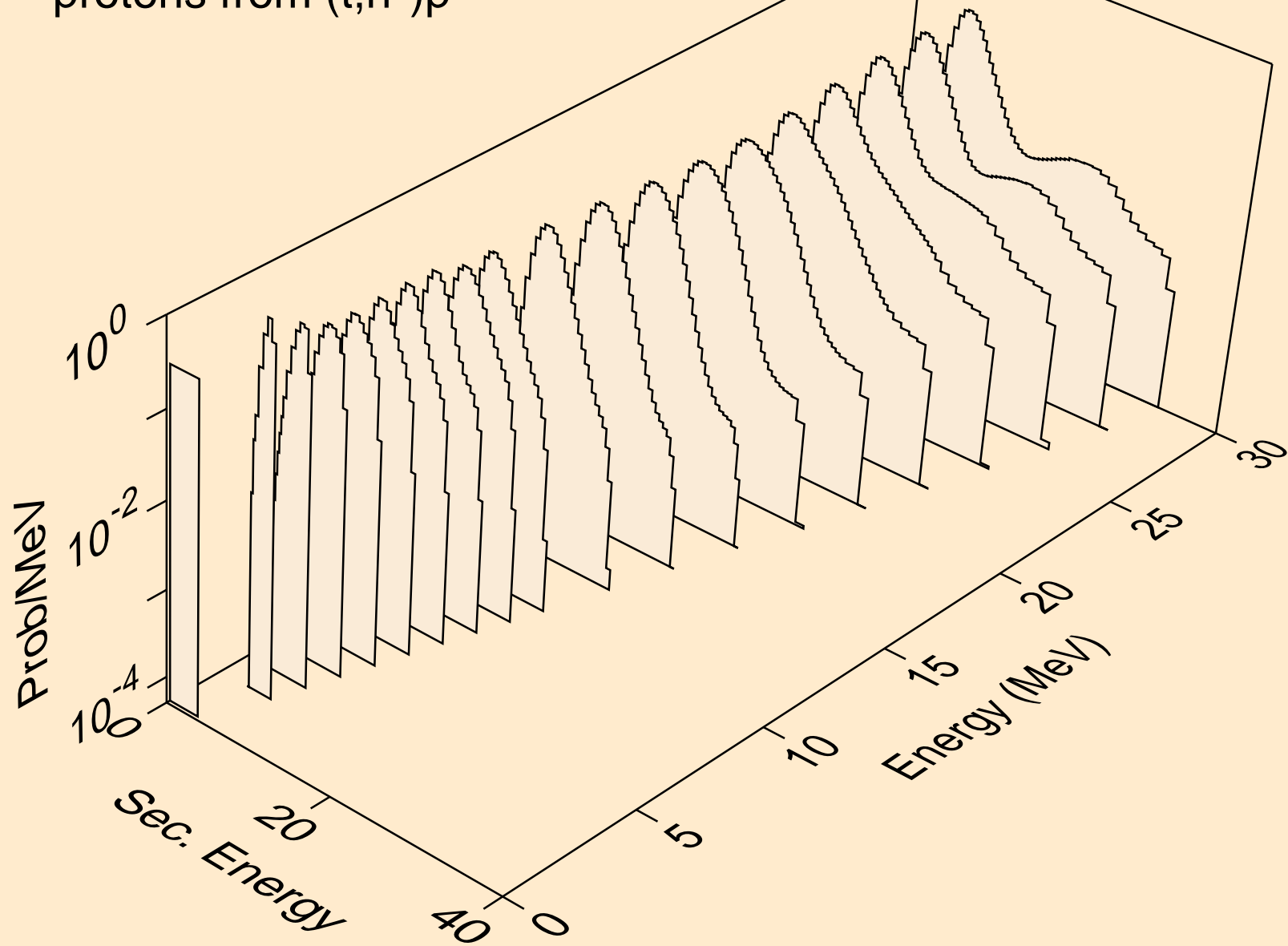

ND129M TRITON ACER TENDL-2023 LIBRARY; T=0.K
protons from (t,2np)

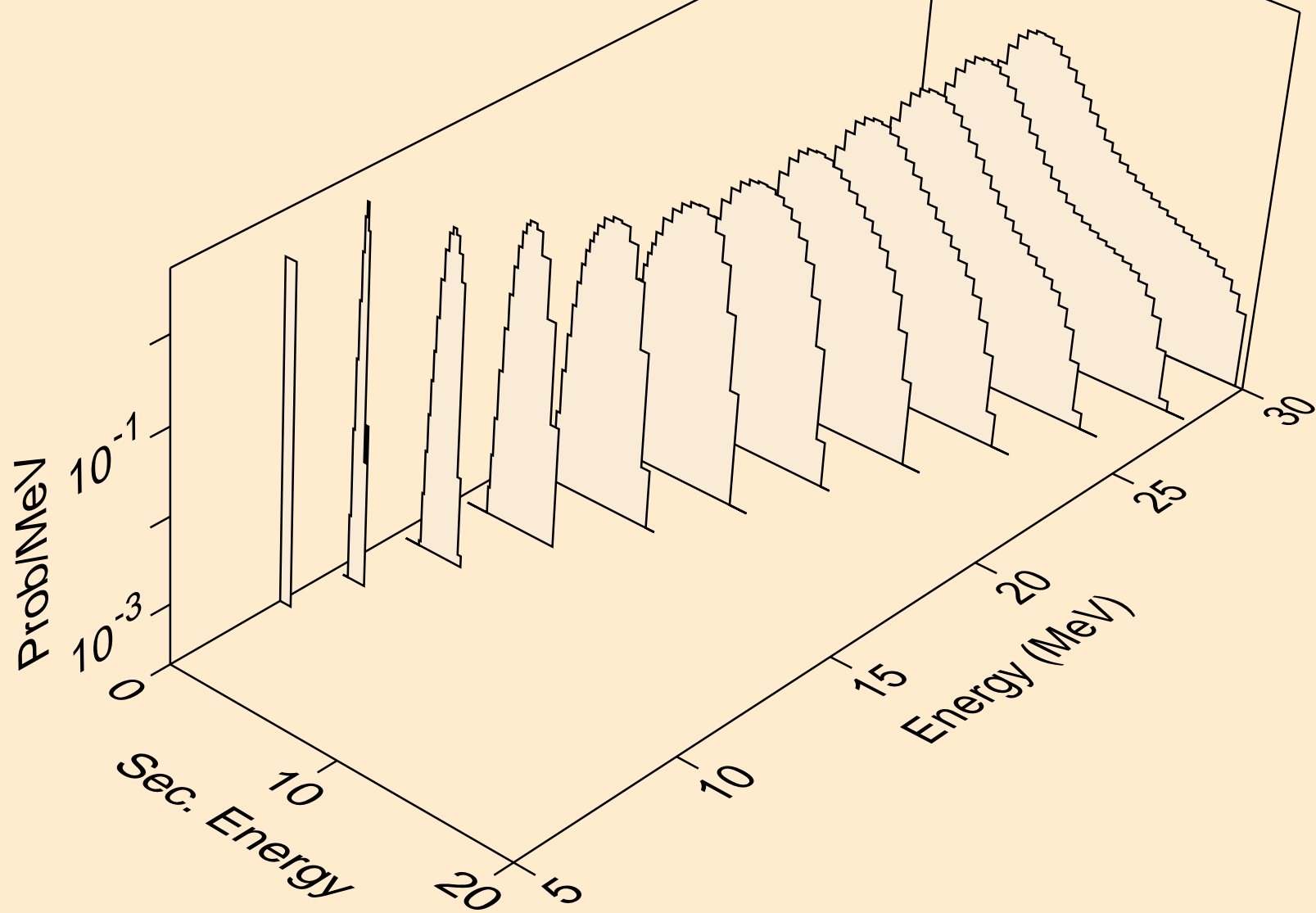

ND129M TRITON ACER TENDL-2023 LIBRARY; T=0.K
protons from (t,3np)

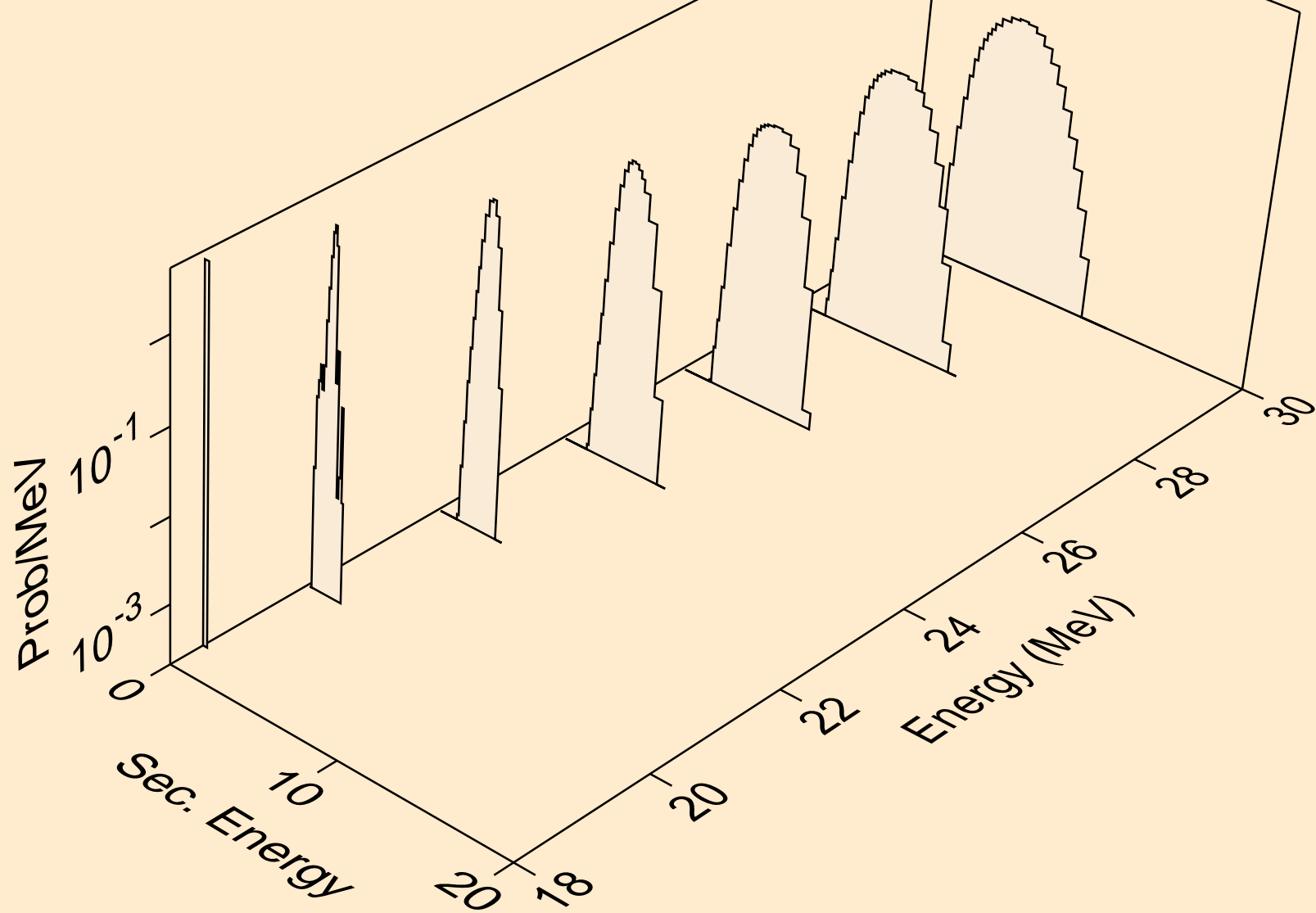

ND129M TRITON ACER TENDL-2023 LIBRARY; T=0.K
protons from (t,n2p)

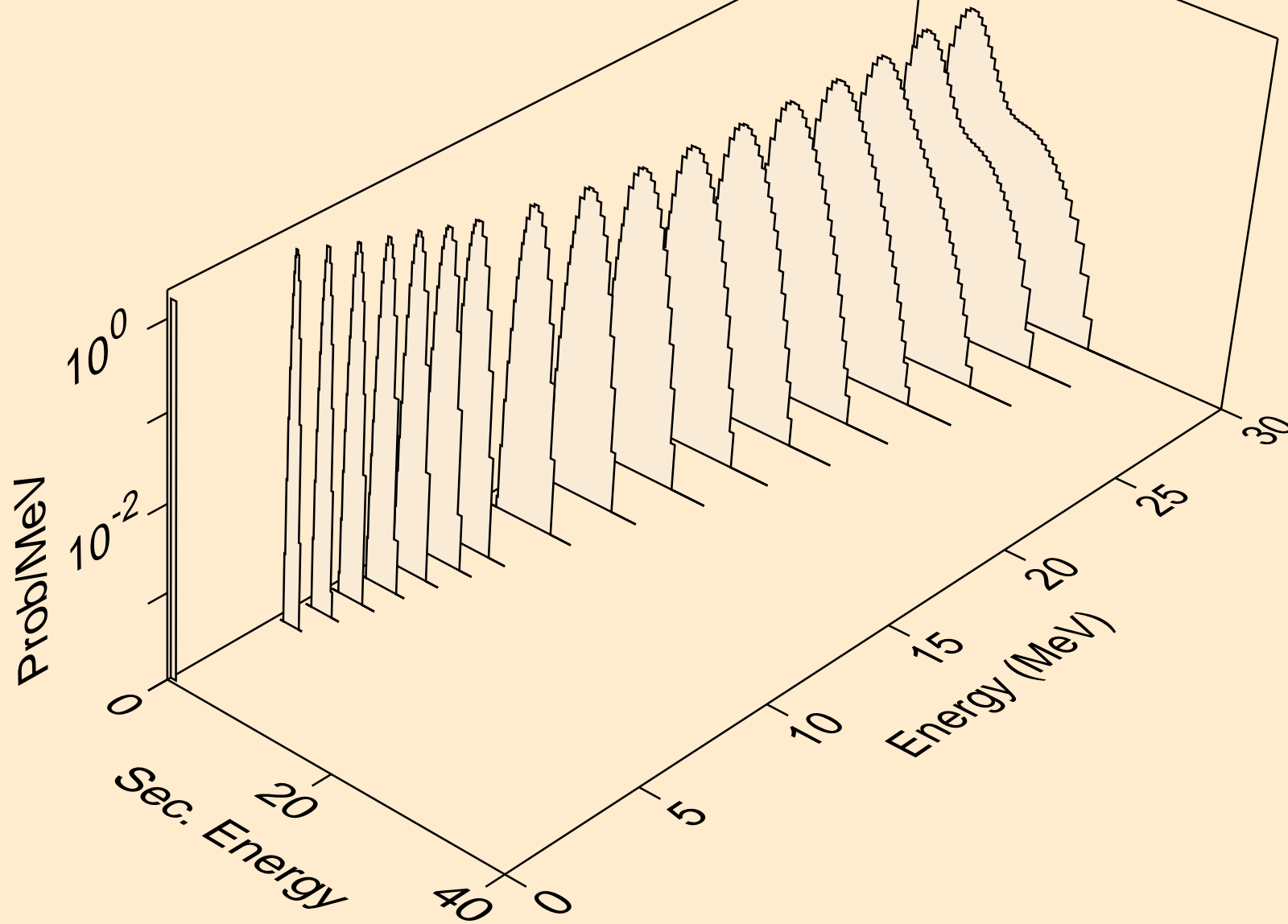

ND129M TRITON ACER TENDL-2023 LIBRARY; T=0.K
protons from (t,npa)

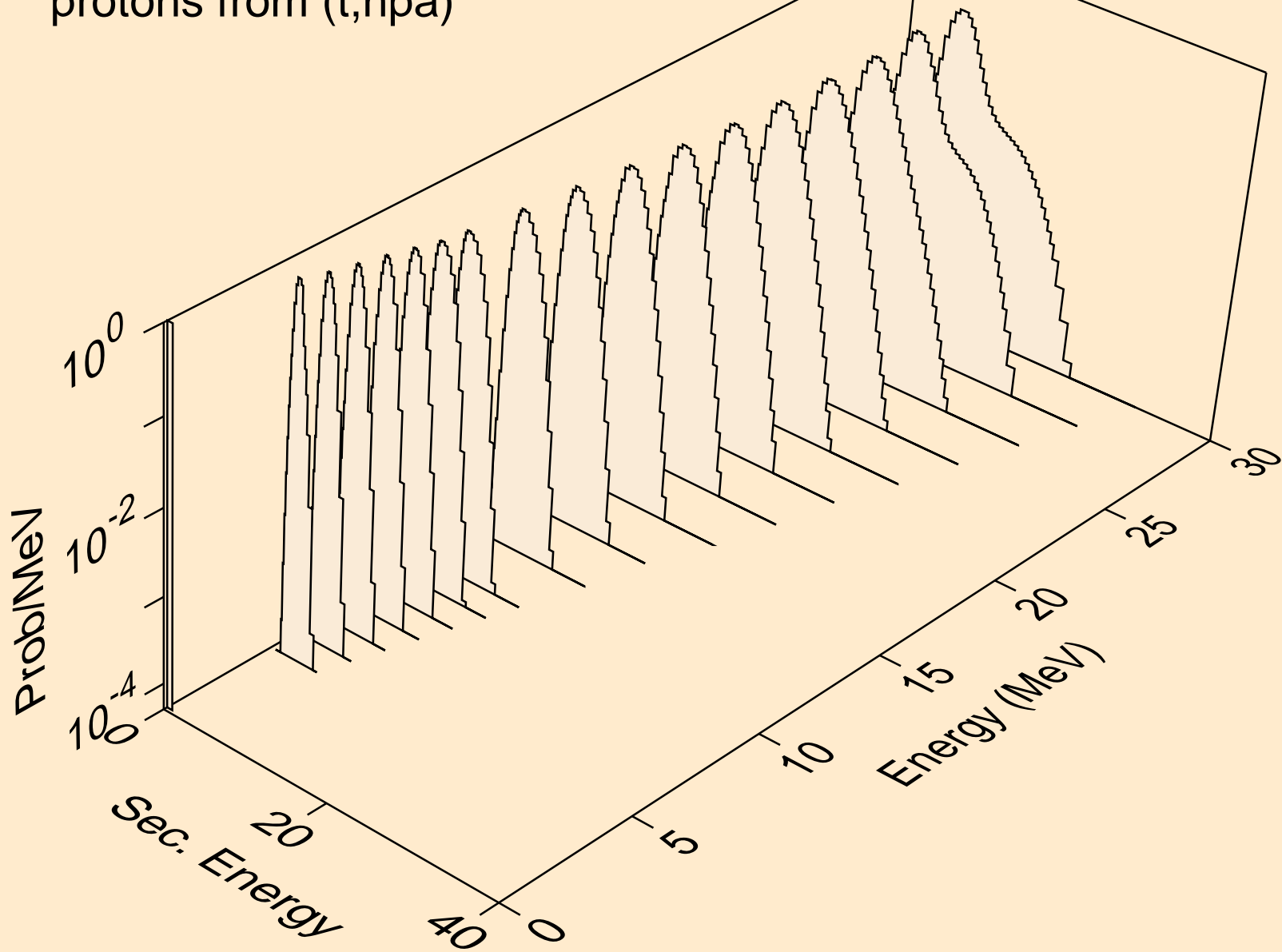

ND129M TRITON ACER TENDL-2023 LIBRARY; T=0.K
protons from (t,p)

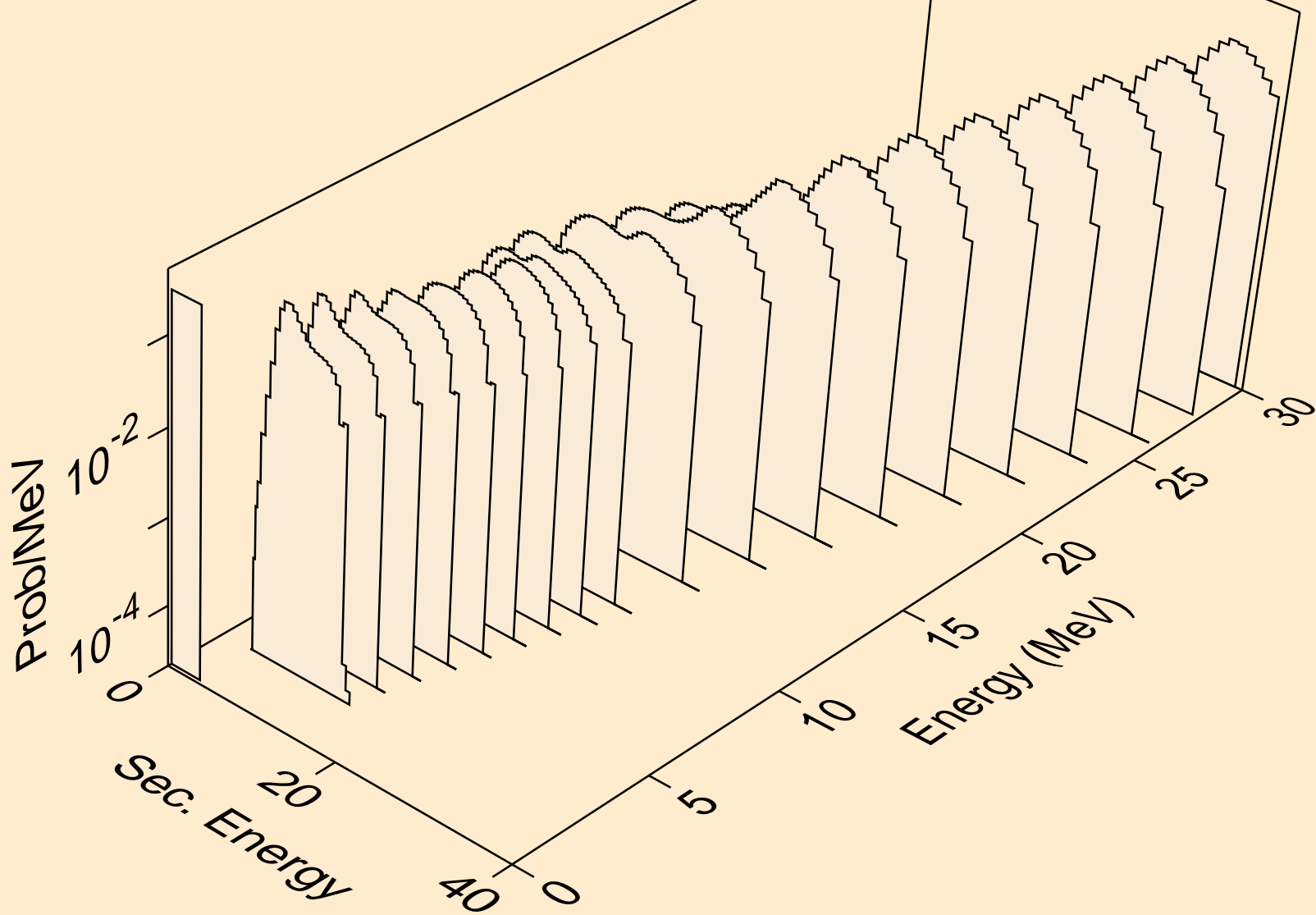

ND129M TRITON ACER TENDL-2023 LIBRARY; T=0.K
protons from (t,2p)

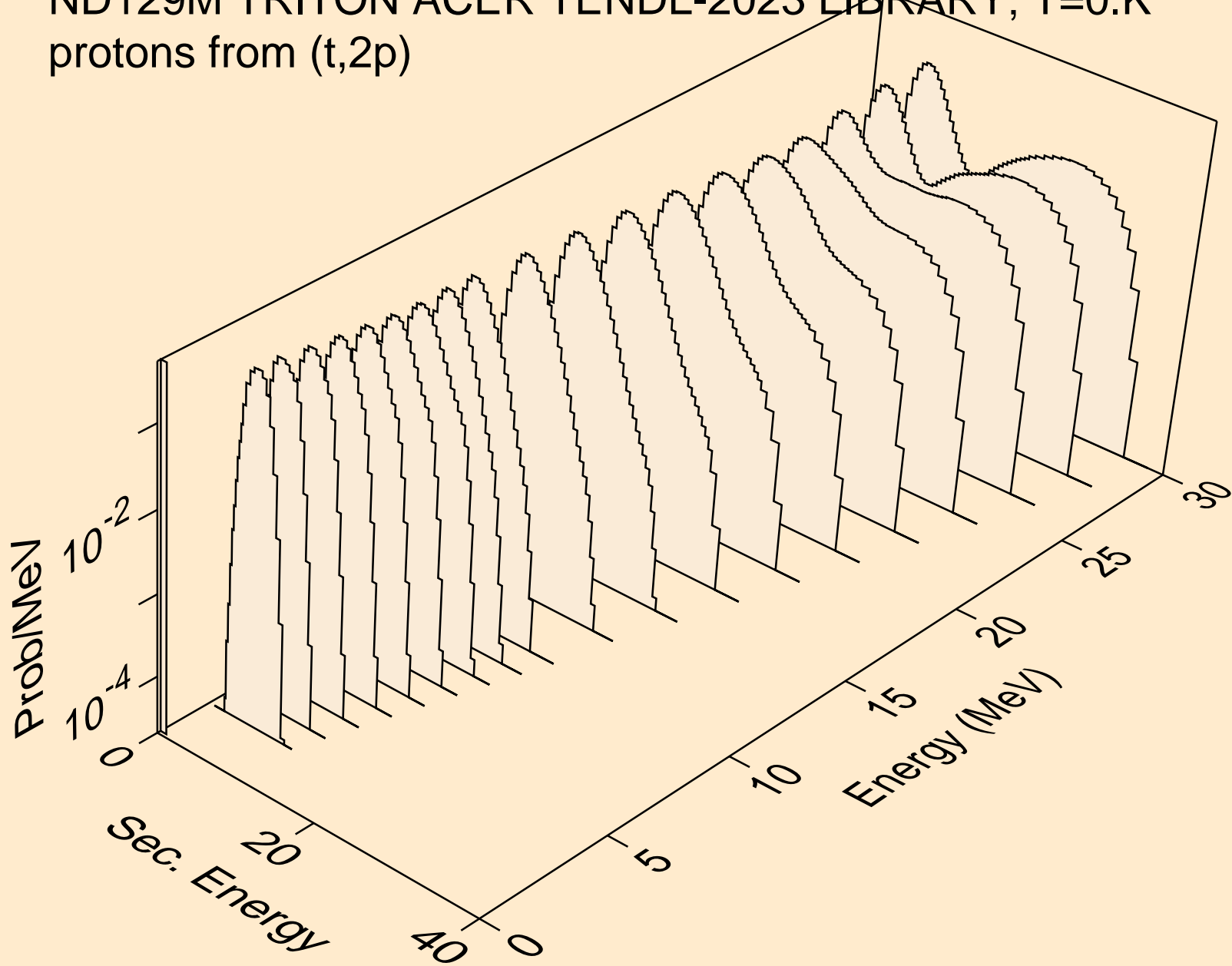

ND129M TRITON ACER TENDL-2023 LIBRARY; T=0.K
protons from (t,pa)

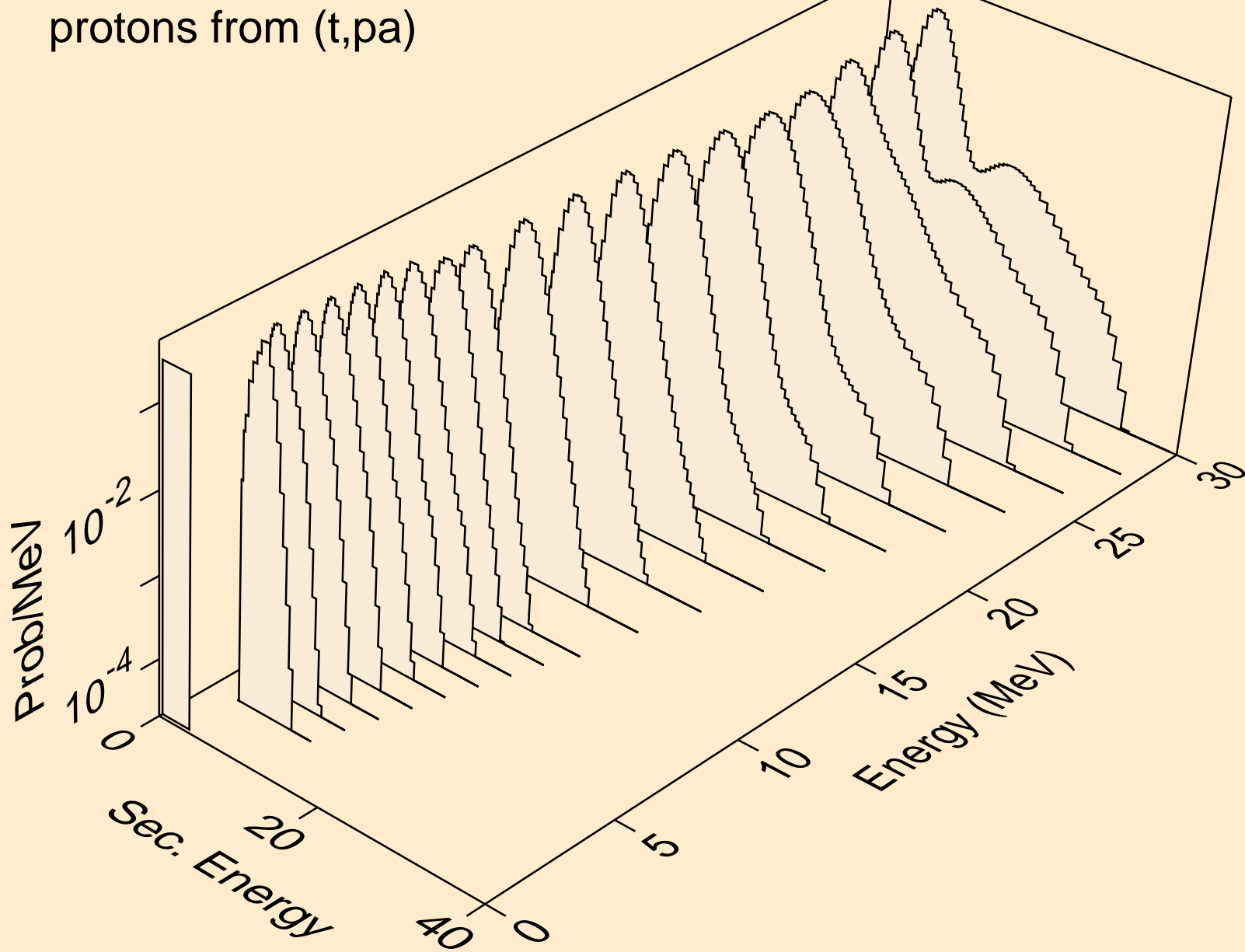

ND129M TRITON ACER TENDL-2023 LIBRARY; T=0.K
protons from (t,pd)

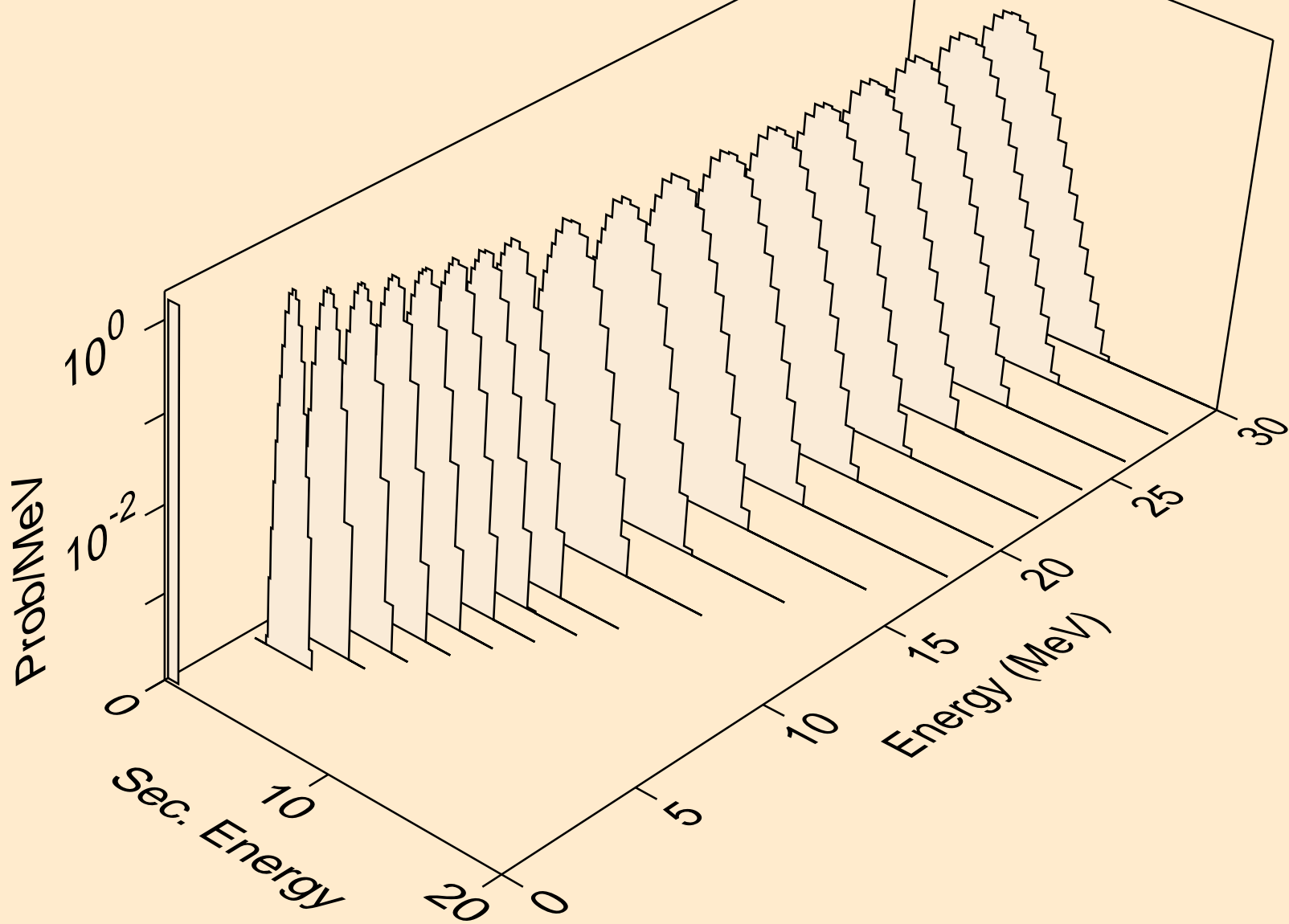

ND129M TRITON ACER TENDL-2023 LIBRARY; T=0.K
protons from (t,pt)

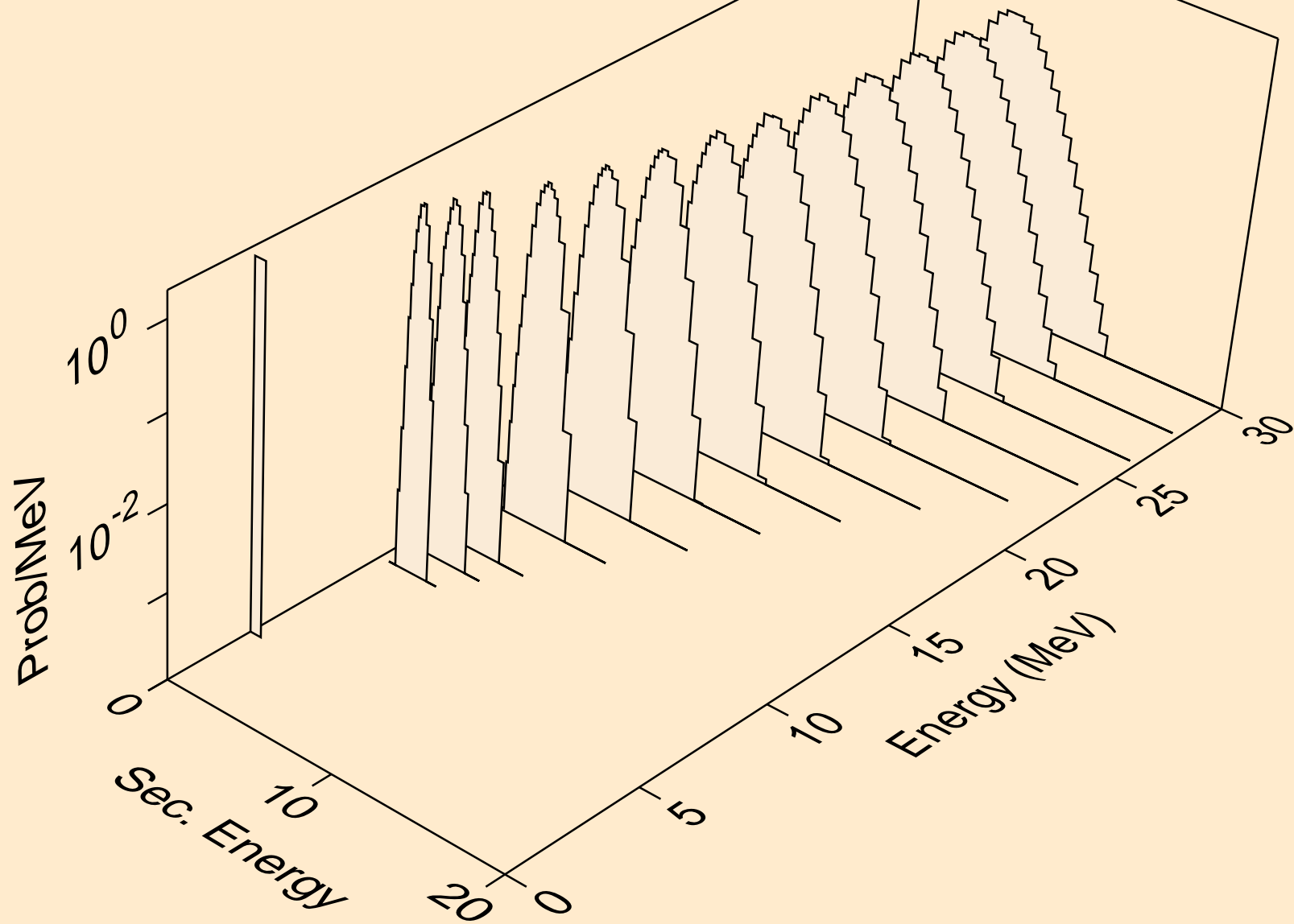

ND129M TRITON ACER TENDL-2023 LIBRARY; T=0.K
deuterons from (t,x)

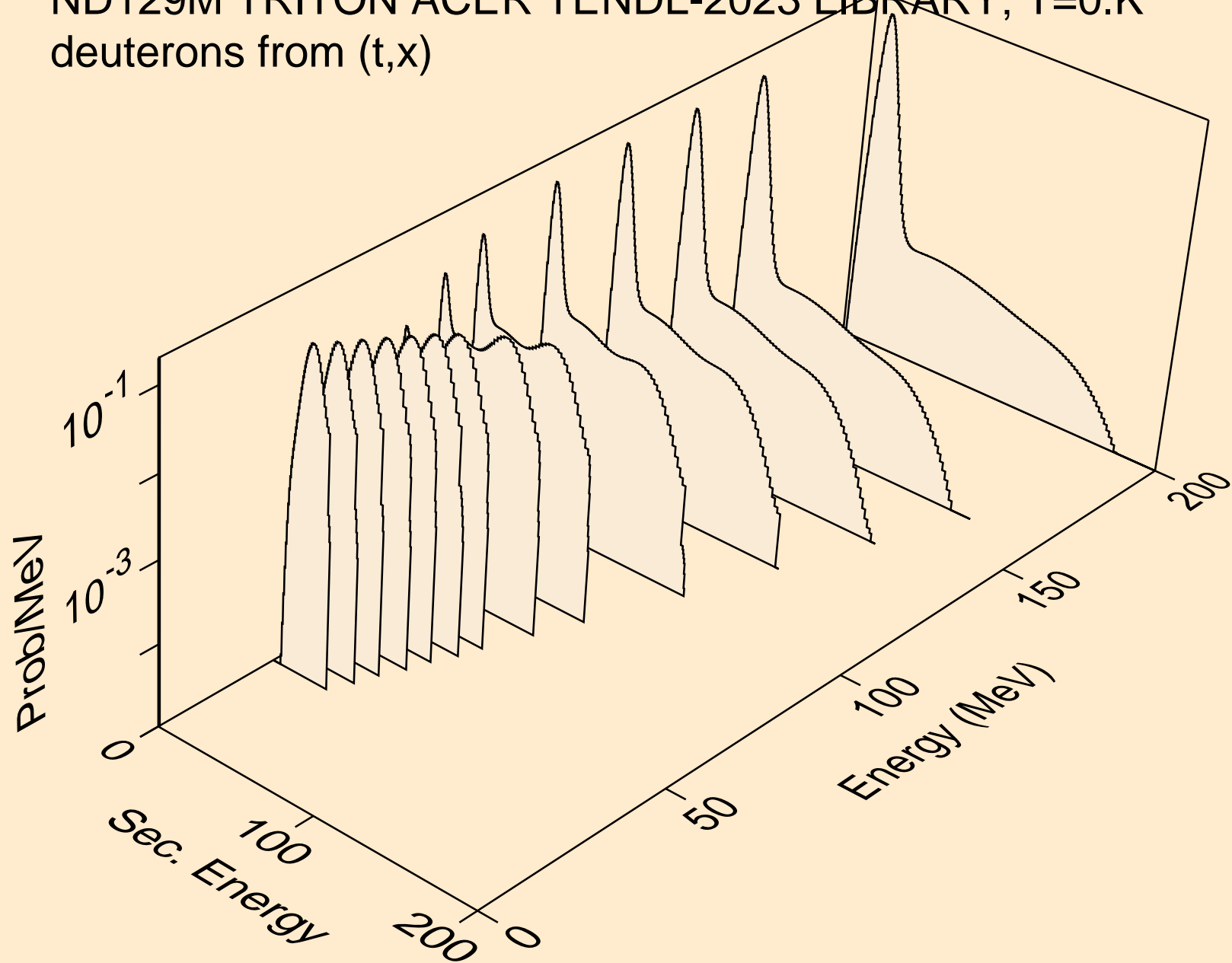

ND129M TRITON ACER TENDL-2023 LIBRARY; T=0.K
deuterons from (t,2nd)

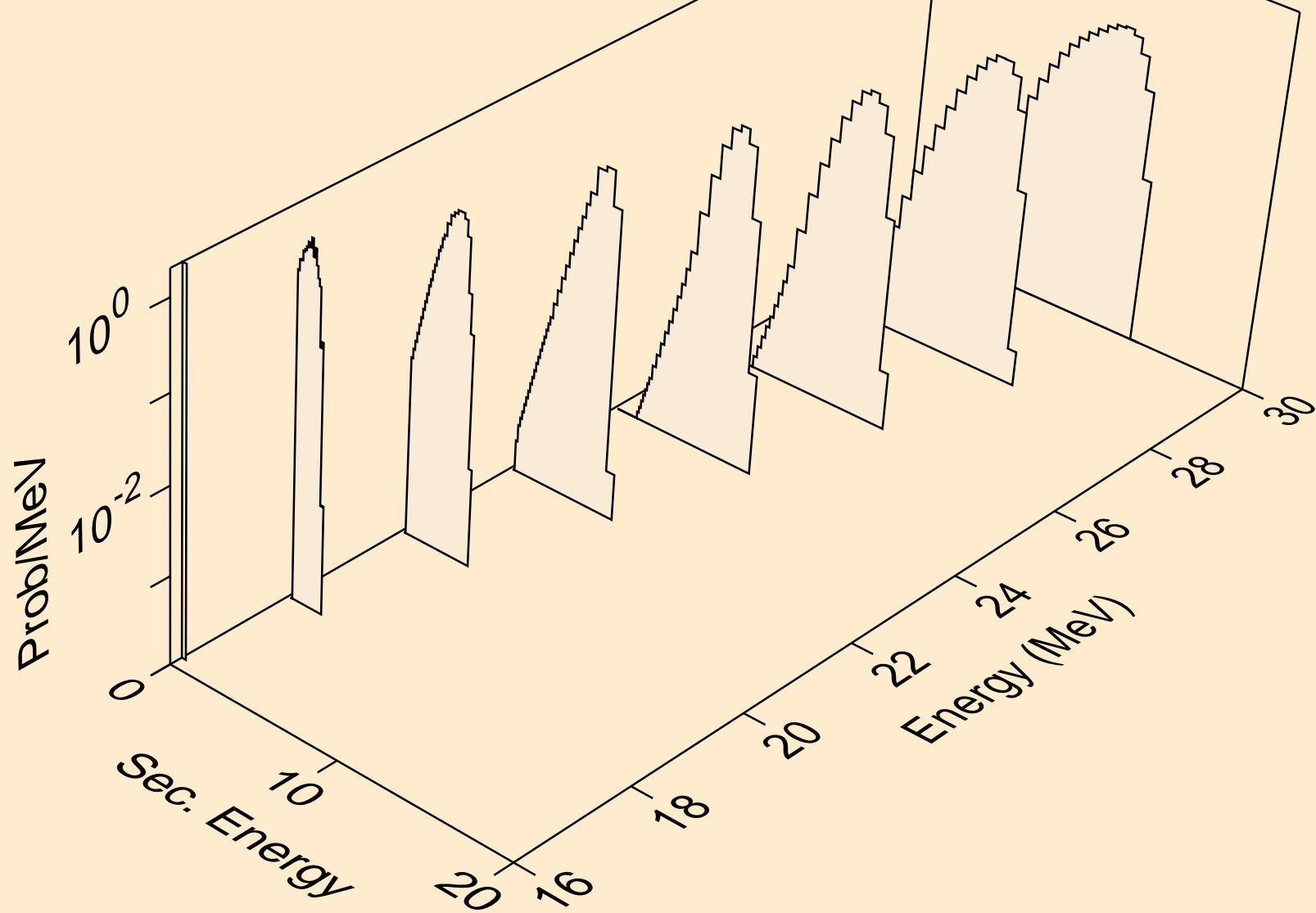

ND129M TRITON ACER TENDL-2023 LIBRARY; T=0.K
deuterons from (t,n*)d

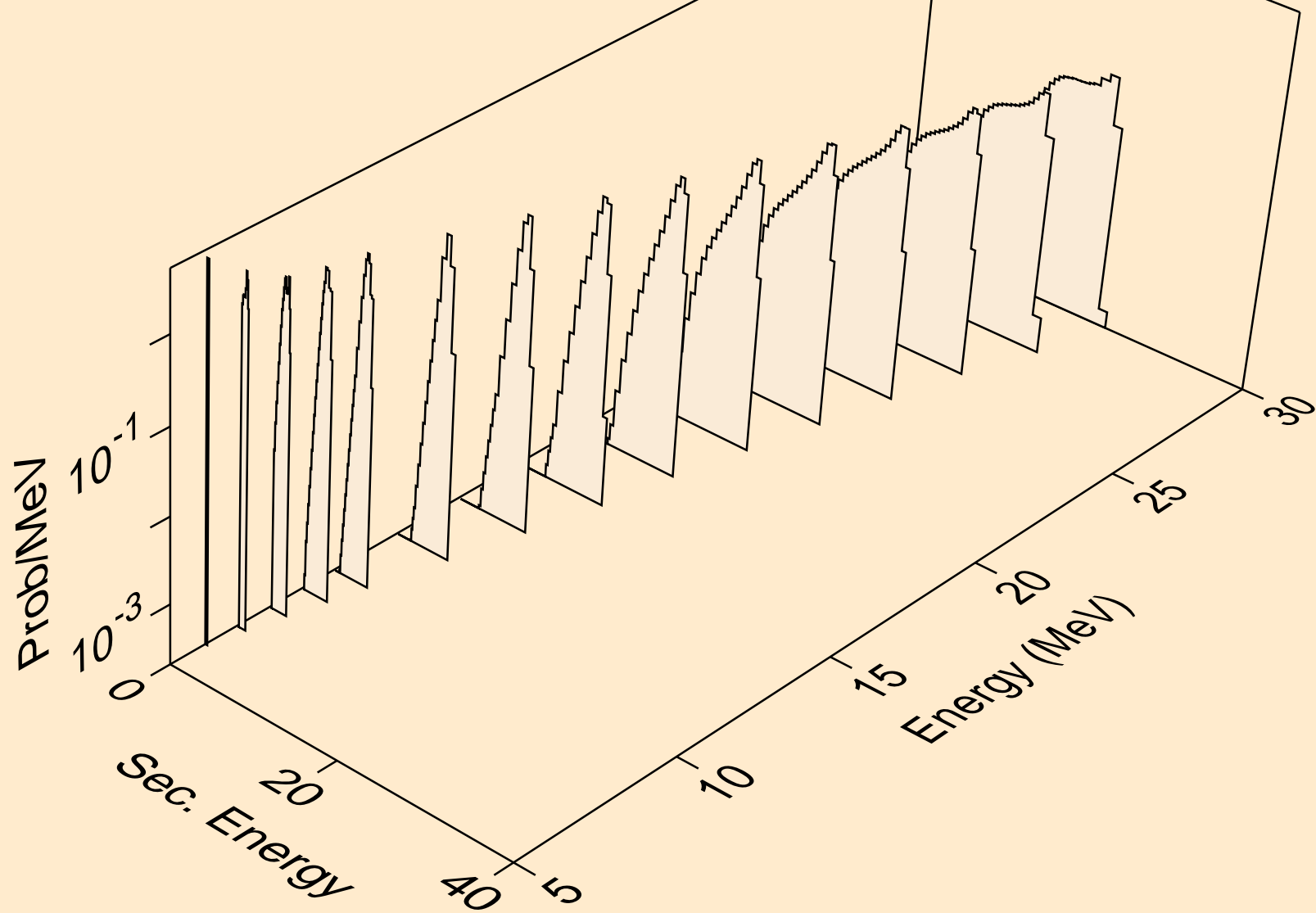

ND129M TRITON ACER TENDL-2023 LIBRARY; T=0.K
deuterons from (t,d)

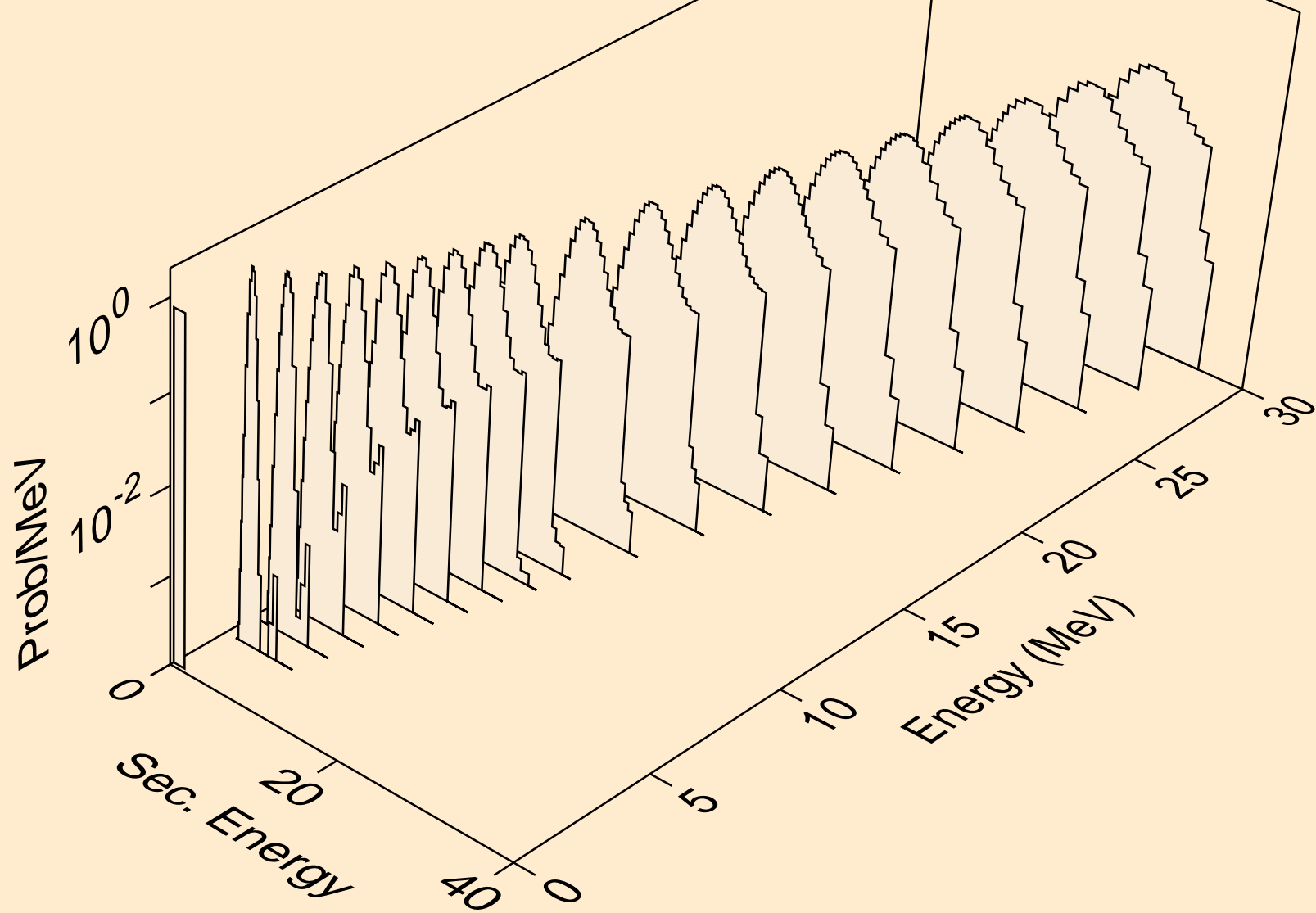

ND129M TRITON ACER TENDL-2023 LIBRARY; T=0.K
deuterons from (t,d2a)

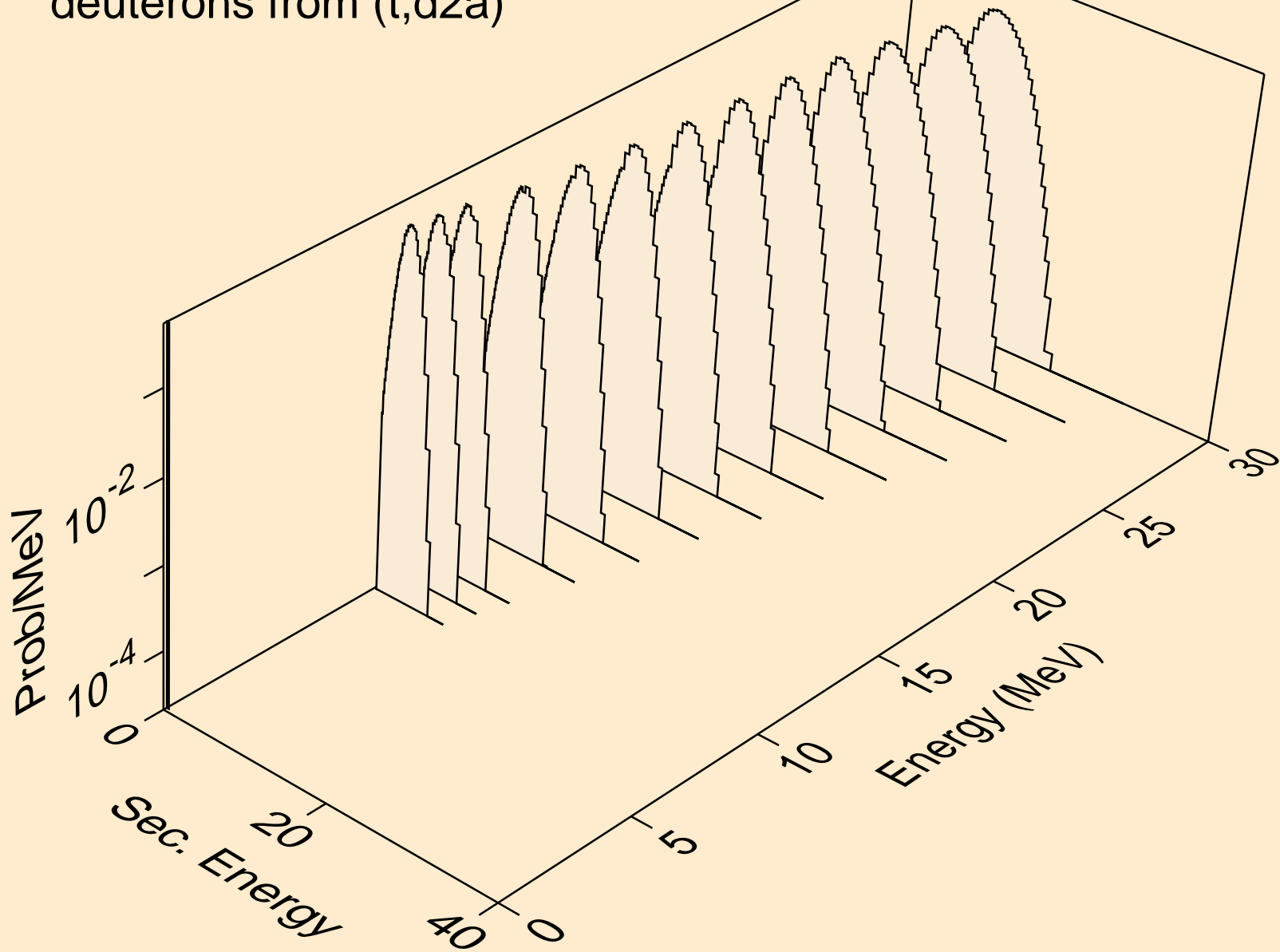

ND129M TRITON ACER TENDL-2023 LIBRARY; T=0.K
deuterons from (t,pd)

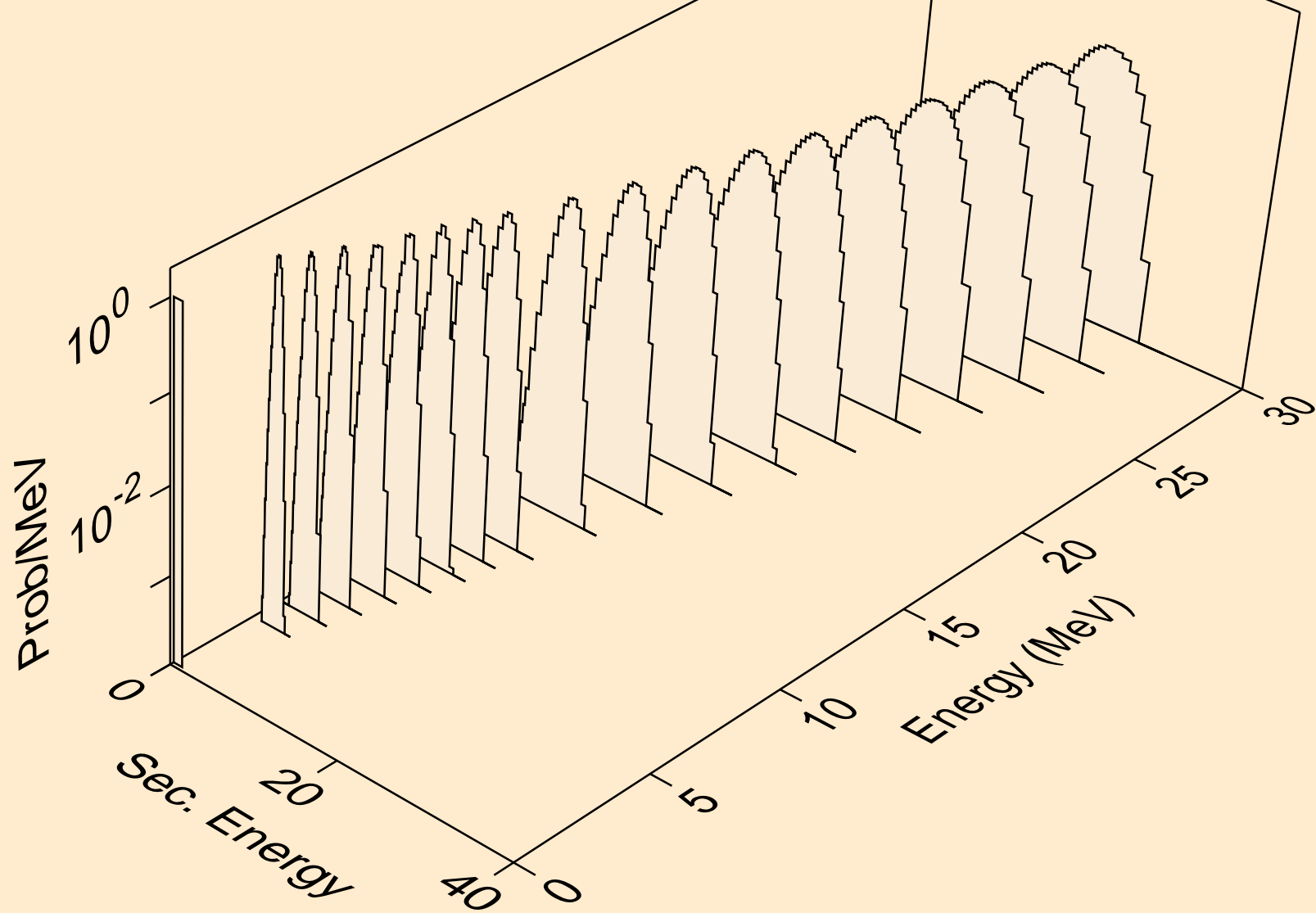

ND129M TRITON ACER TENDL-2023 LIBRARY; T=0.K
deuterons from (t,da)

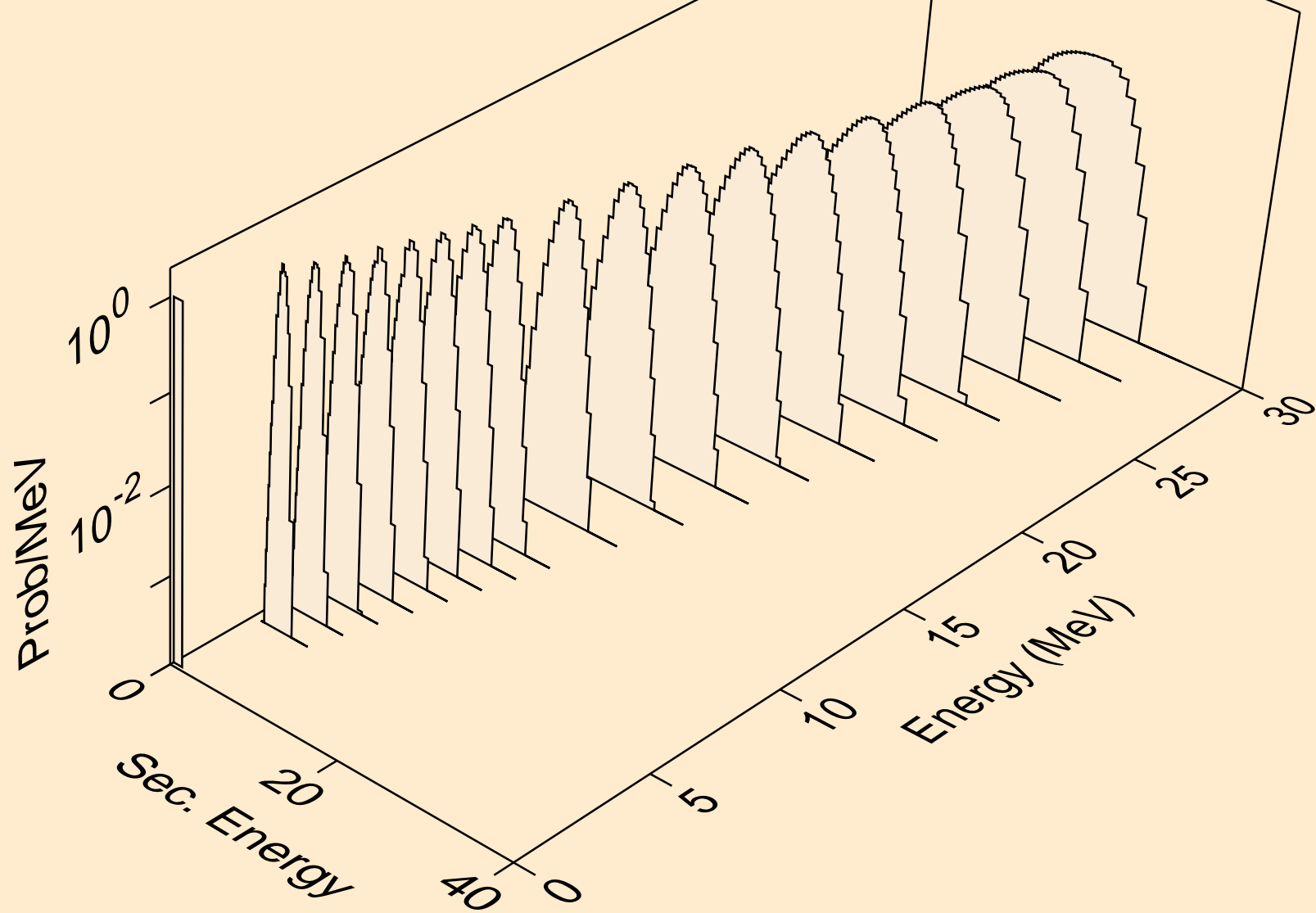

ND129M TRITON ACER TENDL-2023 LIBRARY; T=0.K
he3s from (t,x)

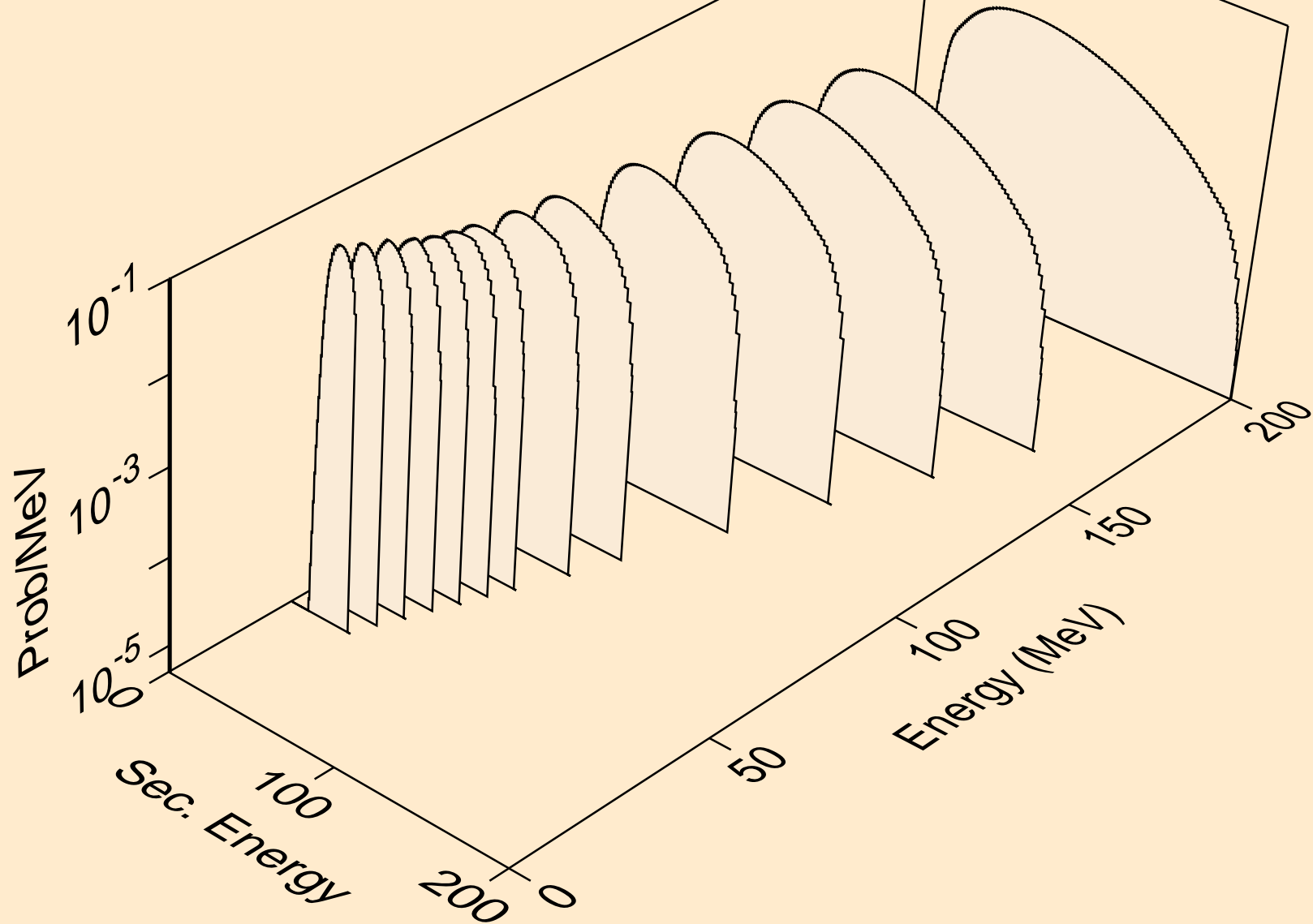

ND129M TRITON ACER TENDL-2023 LIBRARY; T=0.K
he3s from (t,n*)he3

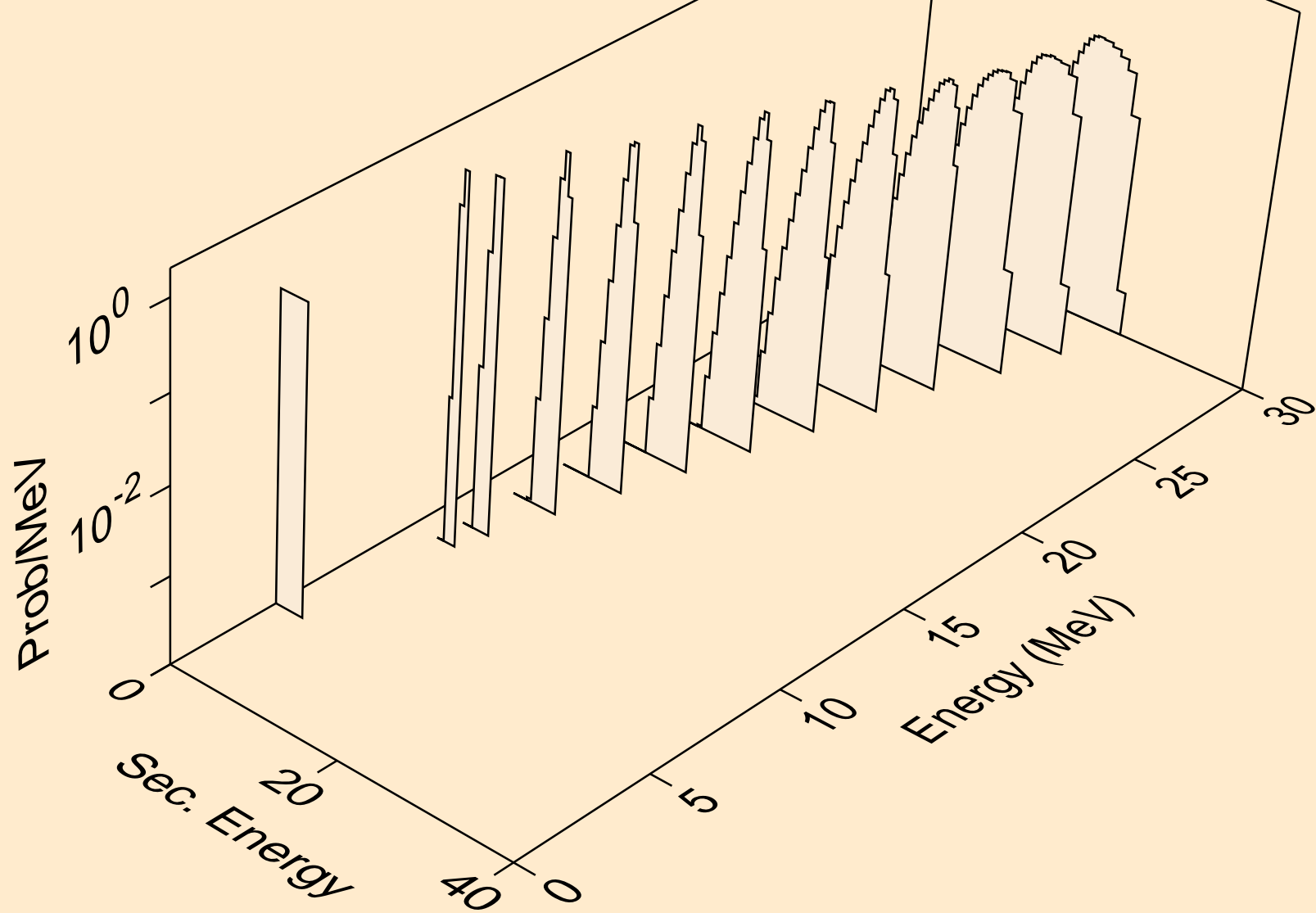

ND129M TRITON ACER TENDL-2023 LIBRARY; T=0.K
he3s from (t,he3)

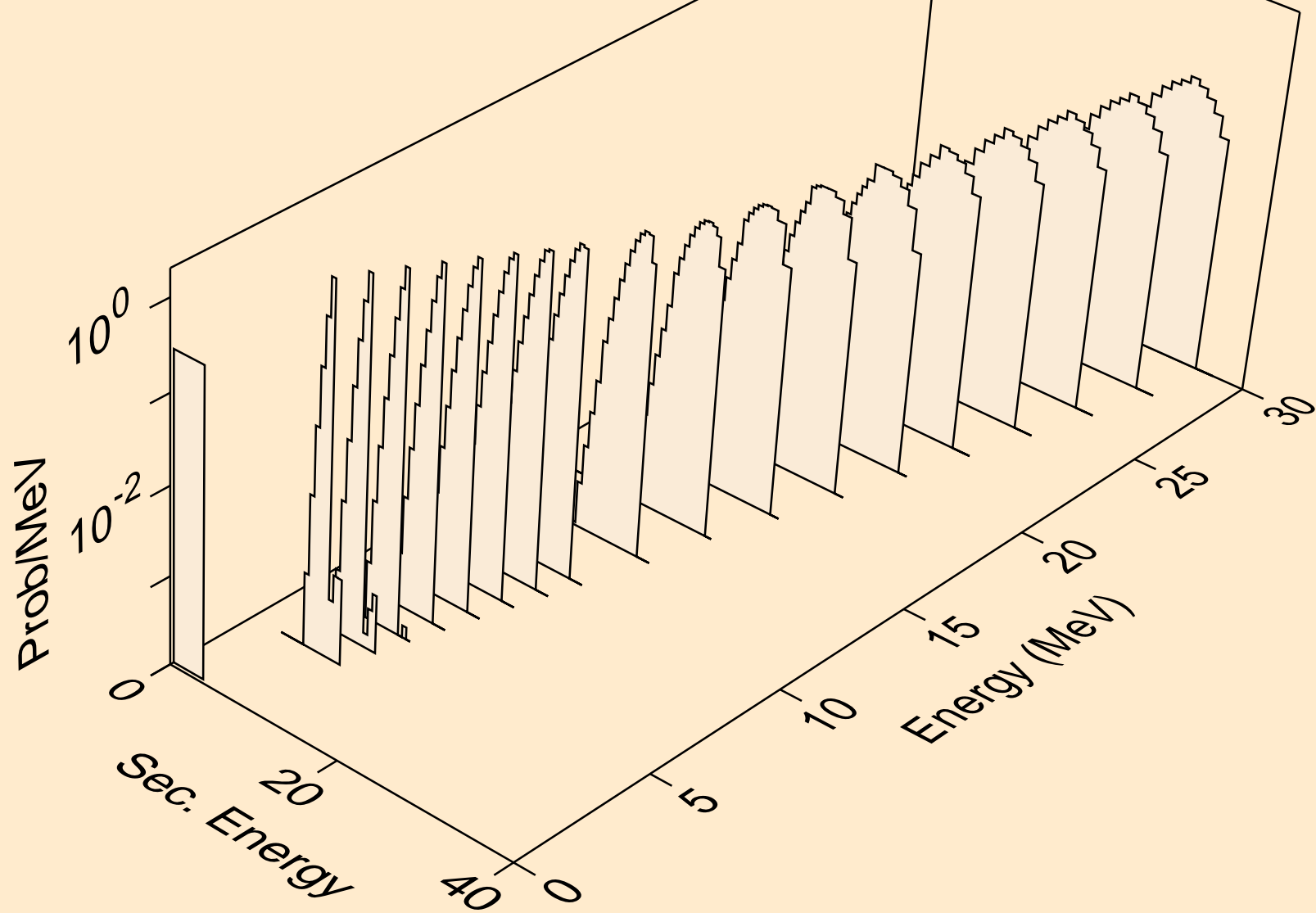

ND129M TRITON ACER TENDL-2023 LIBRARY; T=0.K
alphas from (t,x)

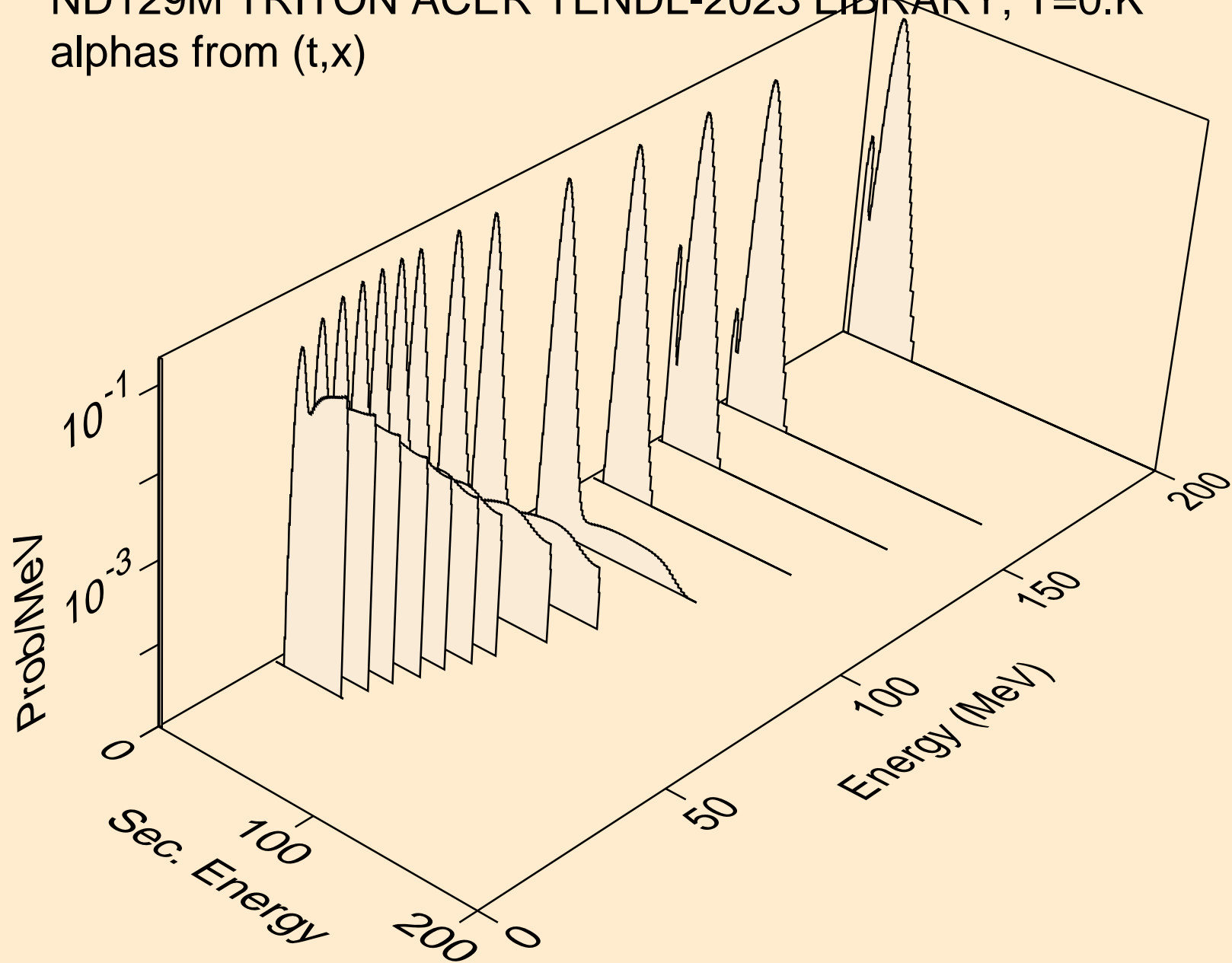

ND129M TRITON ACER TENDL-2023 LIBRARY; T=0.K
alphas from (t,n*)a

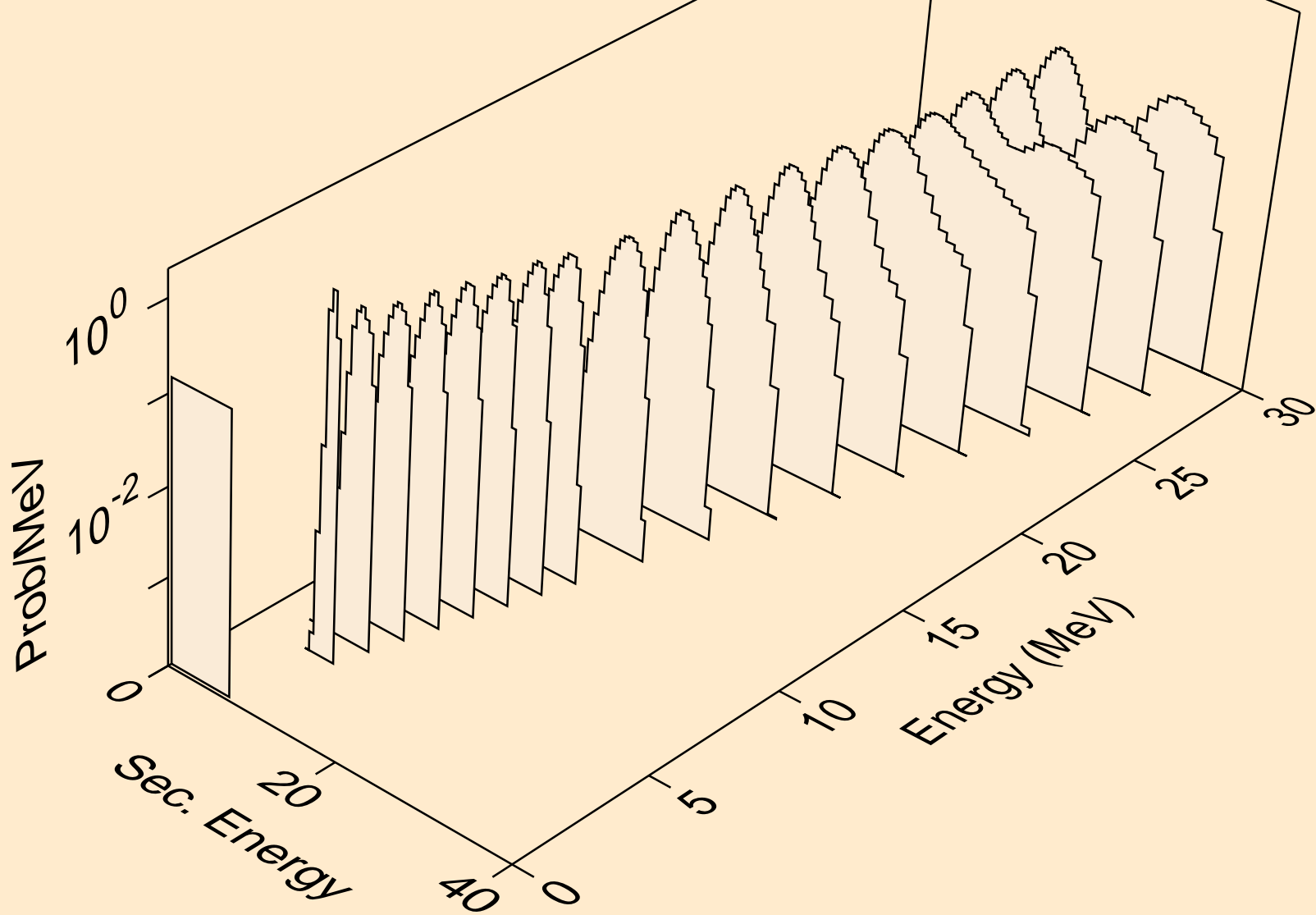

ND129M TRITON ACER TENDL-2023 LIBRARY; T=0.K
alphas from (t,2n)a

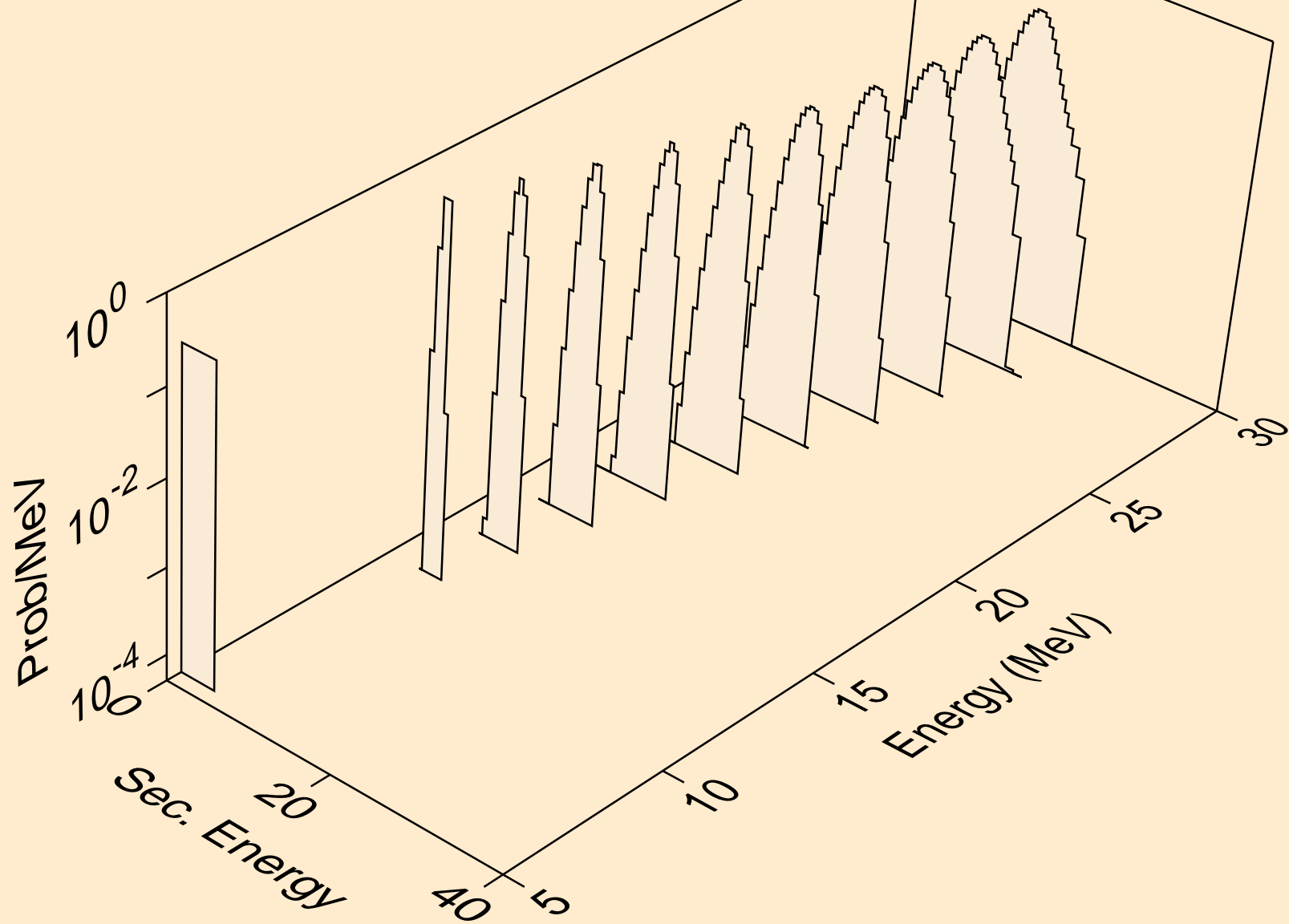

ND129M TRITON ACER TENDL-2023 LIBRARY; T=0.K
alphas from (t,n*)2a

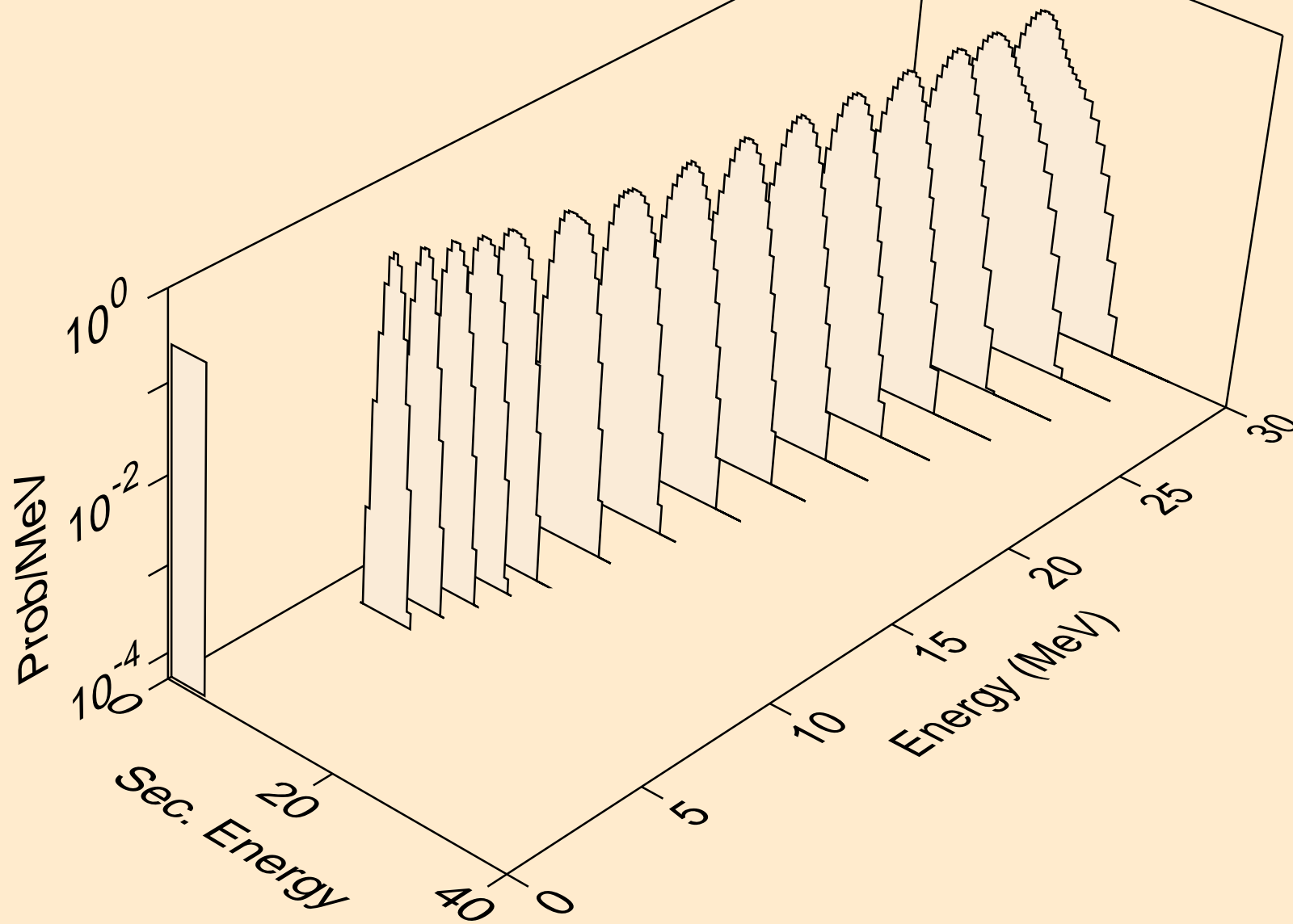

ND129M TRITON ACER TENDL-2023 LIBRARY; T=0.K
alphas from (t,npa)

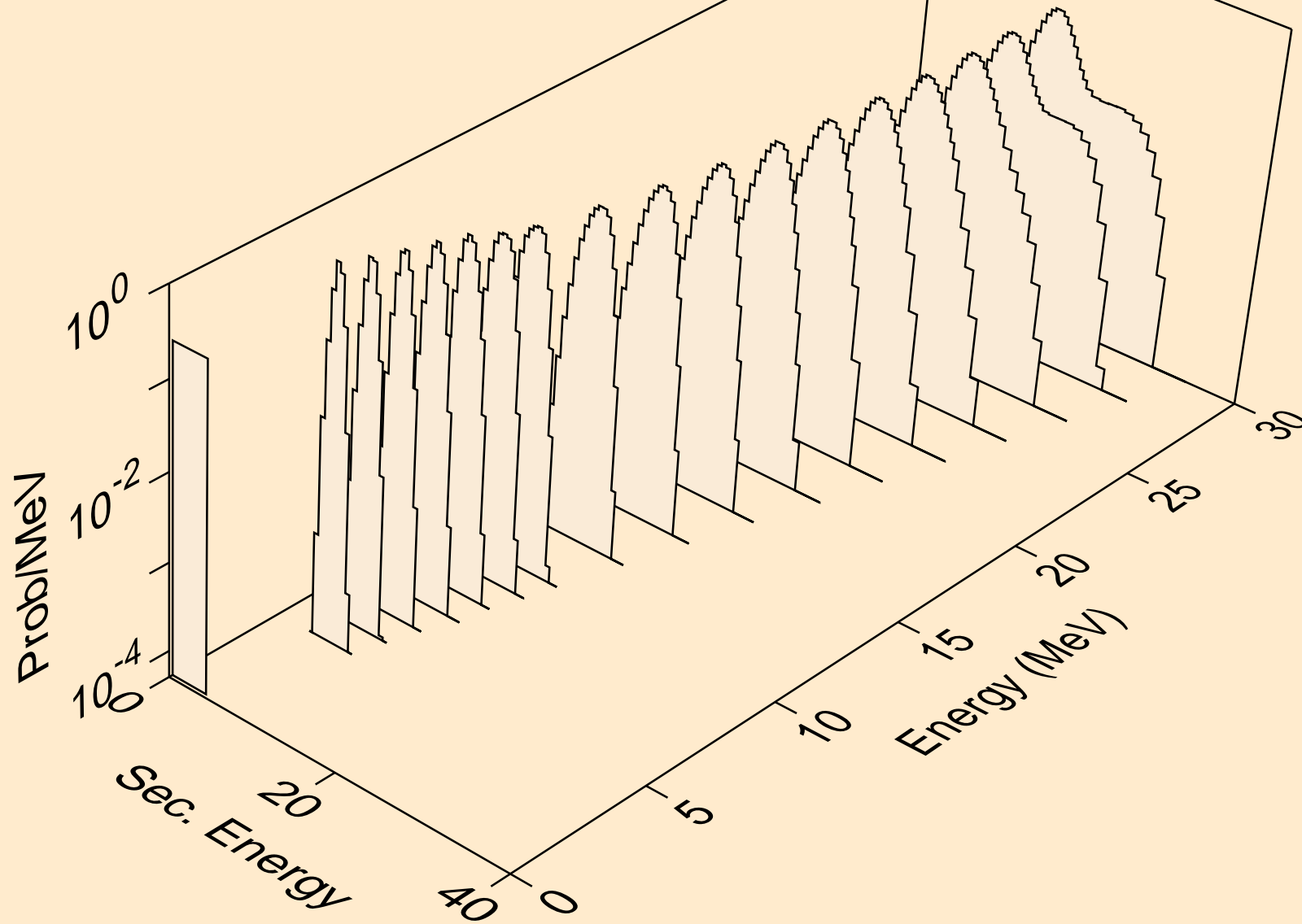

ND129M TRITON ACER TENDL-2023 LIBRARY; T=0.K
alphas from (t,a)

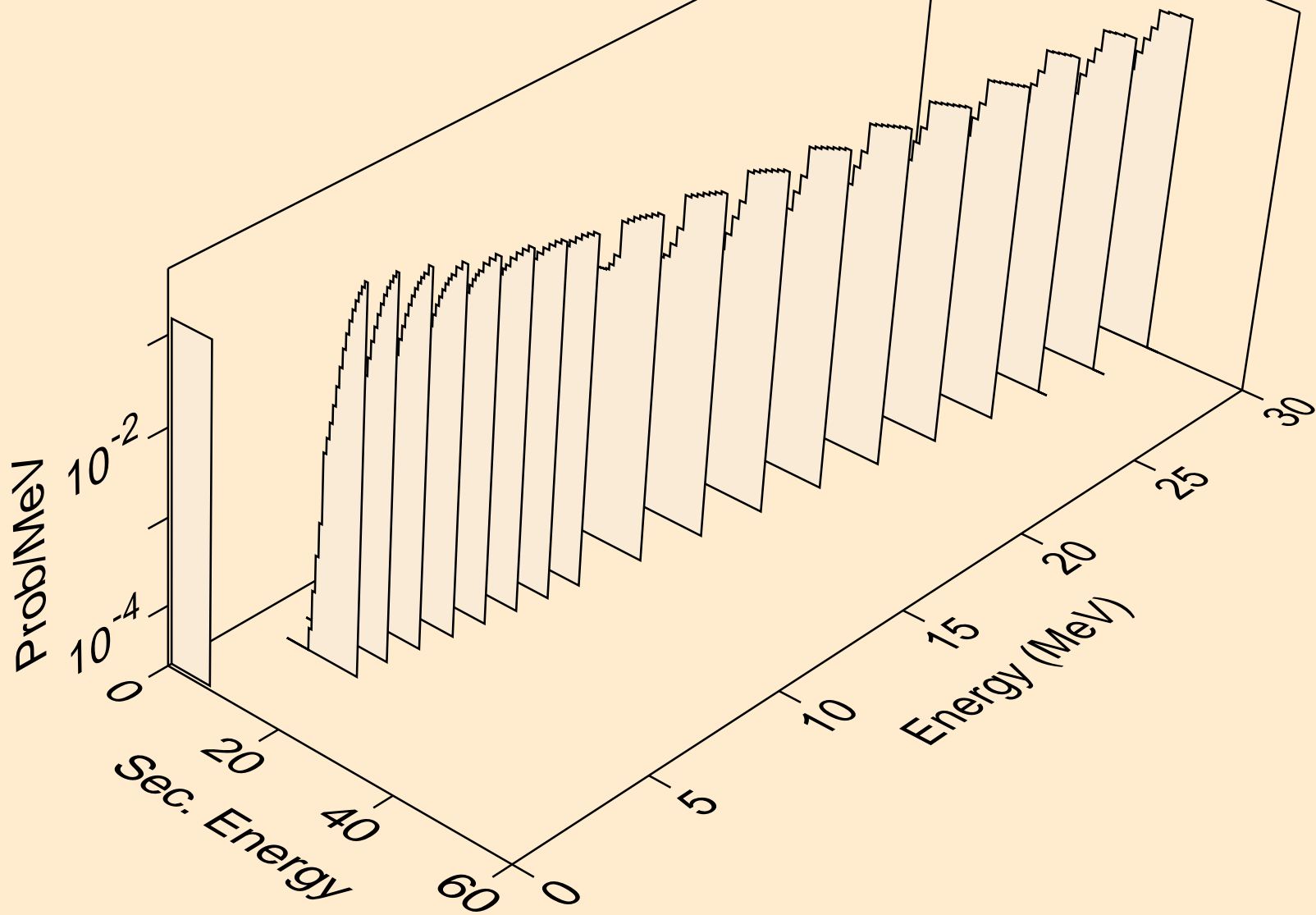

ND129M TRITON ACER TENDL-2023 LIBRARY; T=0.K
alphas from (t,2a)

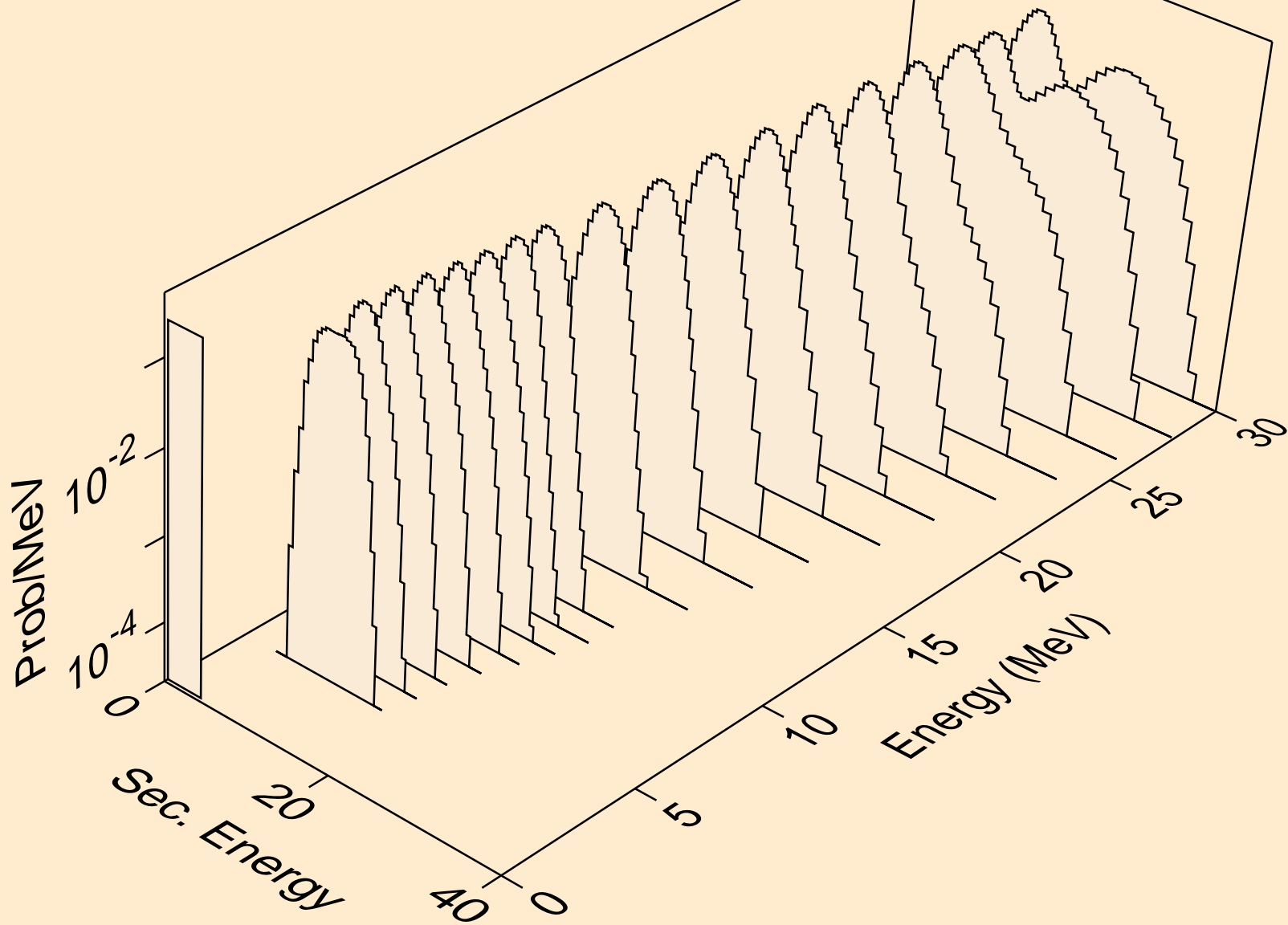

ND129M TRITON ACER TENDL-2023 LIBRARY; T=0.K
alphas from (t,3a)

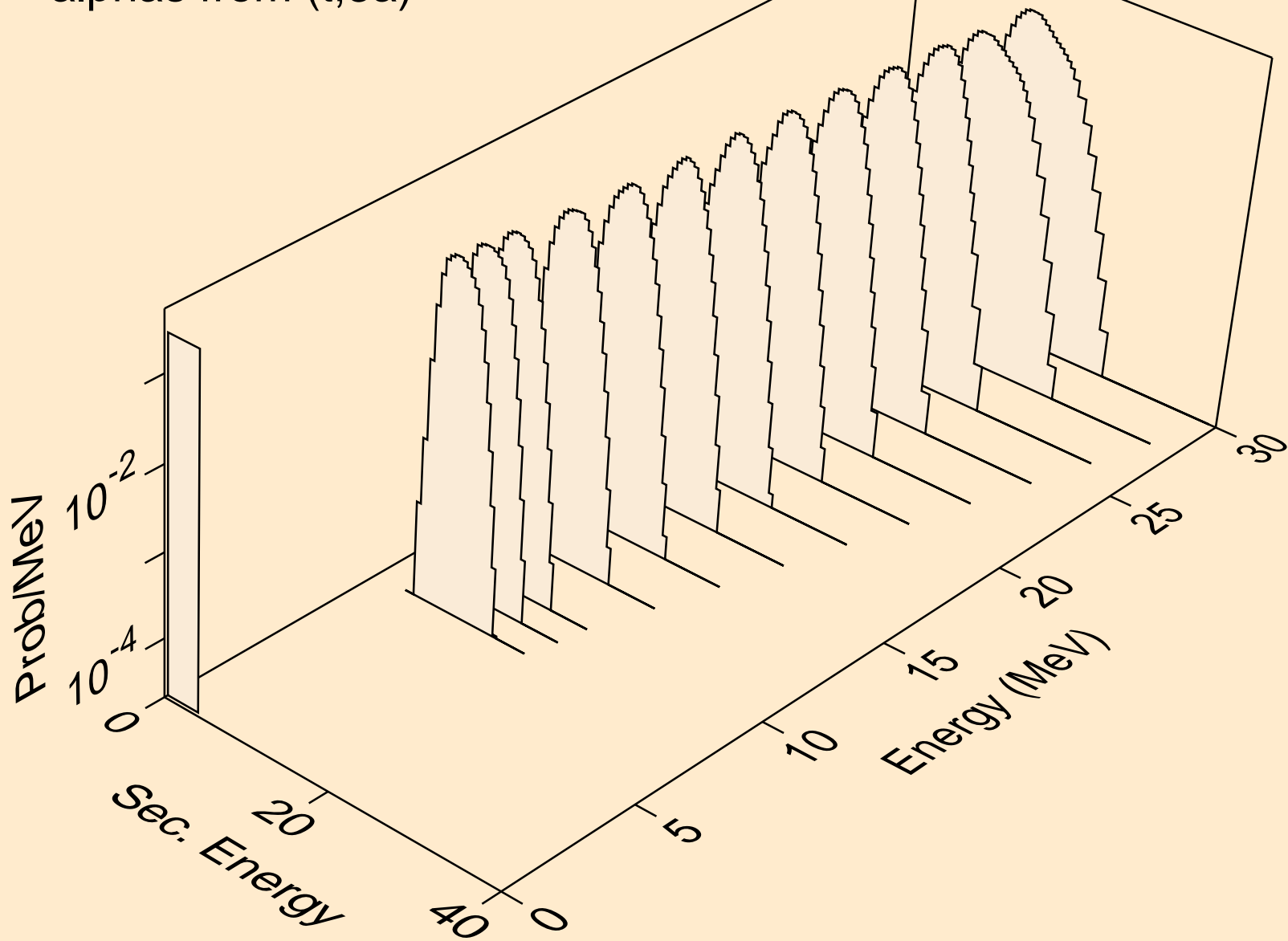

ND129M TRITON ACER TENDL-2023 LIBRARY; T=0.K
alphas from (t,pa)

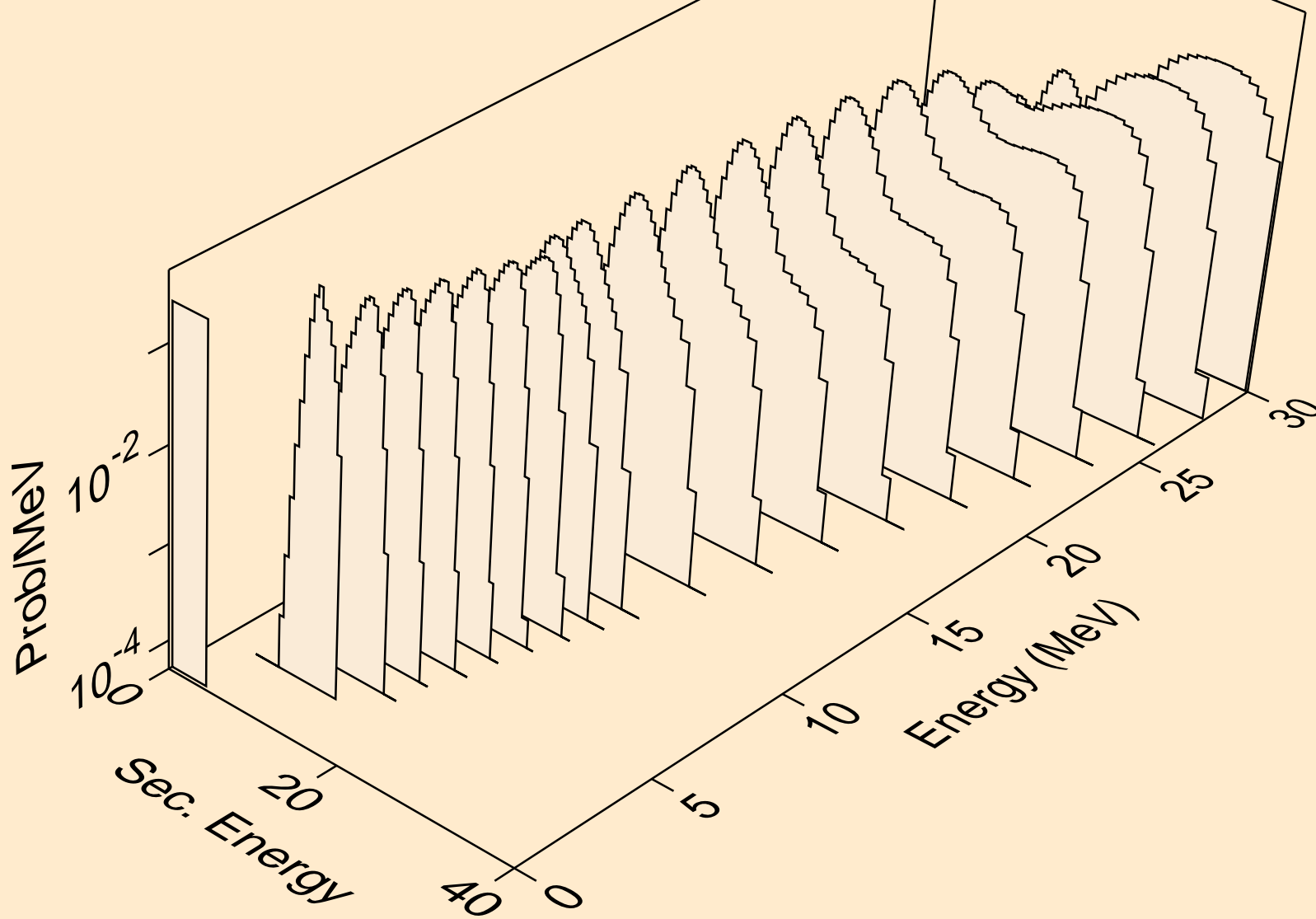

ND129M TRITON ACER TENDL-2023 LIBRARY; T=0.K
alphas from (t,t2a)

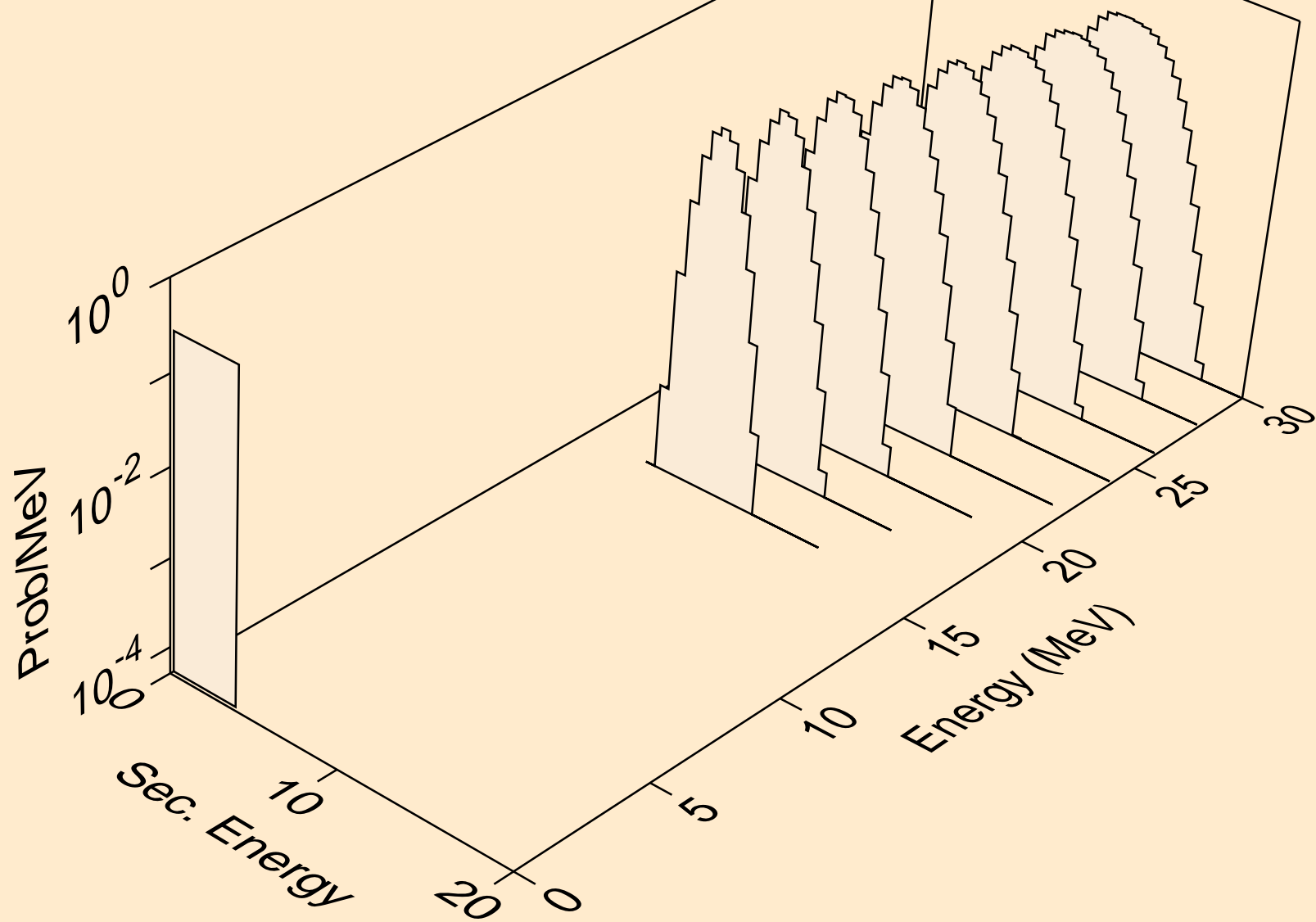

ND129M TRITON ACER TENDL-2023 LIBRARY; T=0.K
alphas from (t,d2a)

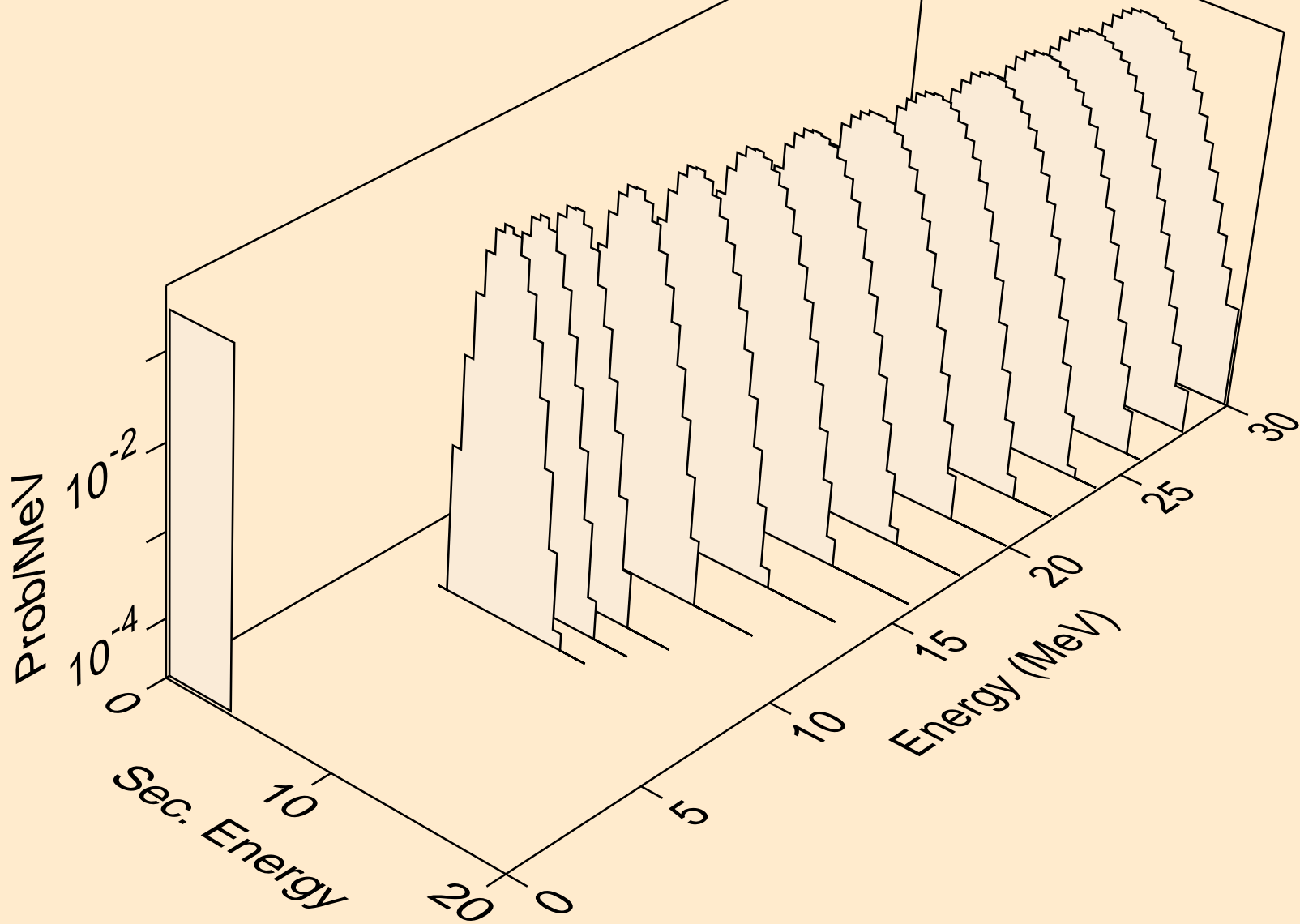

ND129M TRITON ACER TENDL-2023 LIBRARY; T=0.K
alphas from (t,da)

