

# RN205M TRITON ACER TENDL-2023 LIBRARY; T=0.K

## Principal cross sections

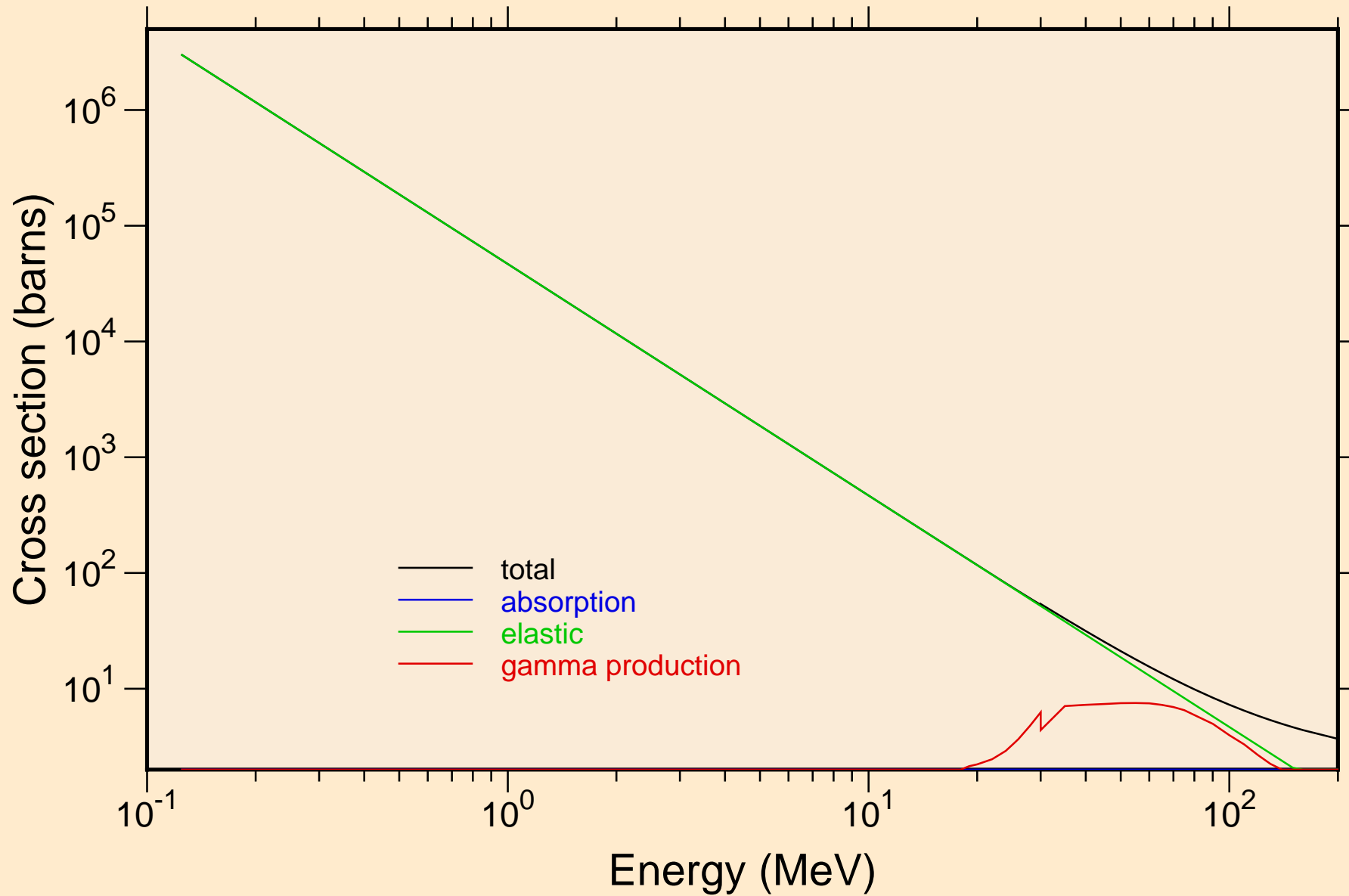

RN205M TRITON ACER TENDL-2023 LIBRARY; T=0.K

Heating

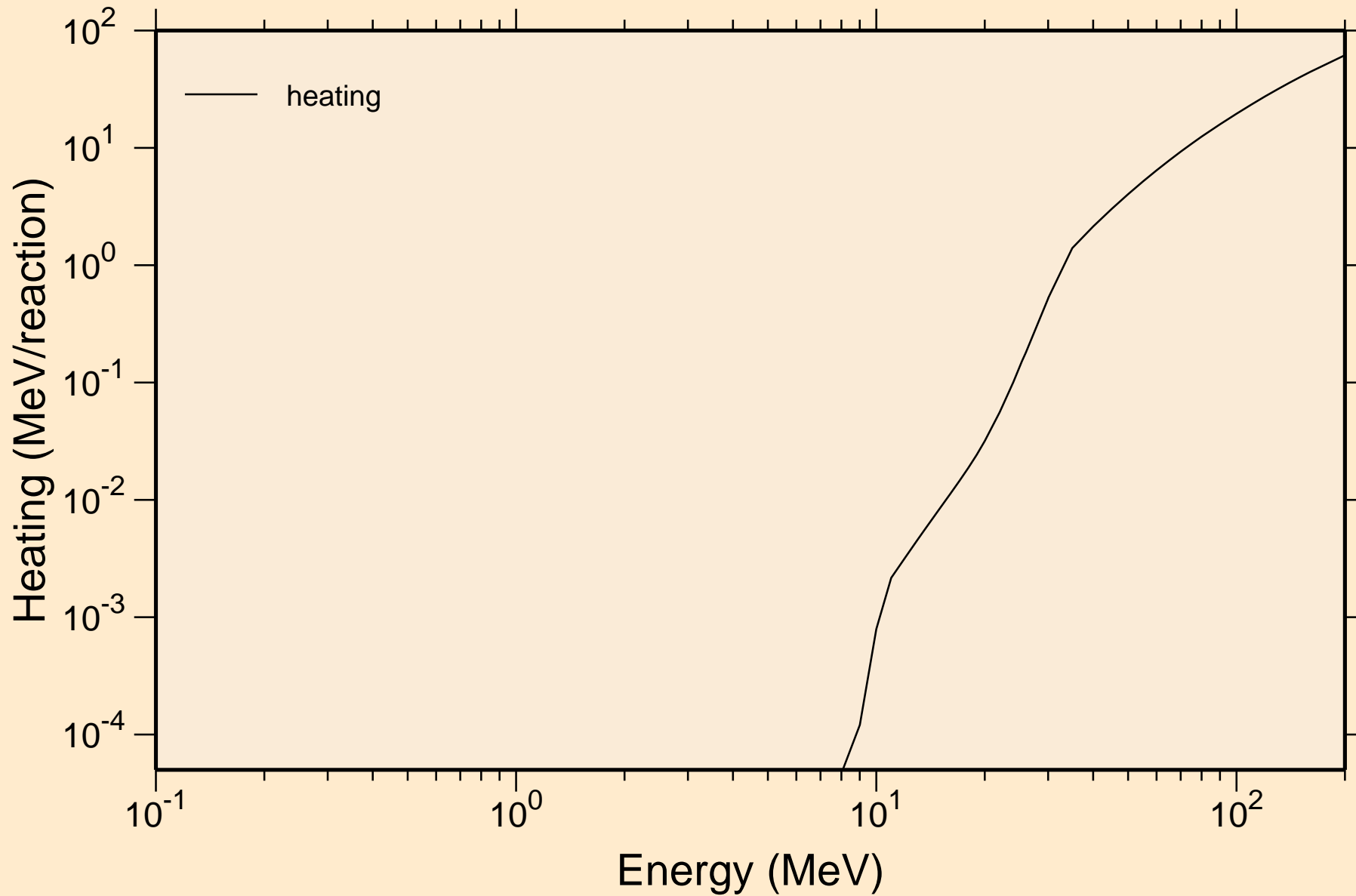

# RN205M TRITON ACER TENDL-2023 LIBRARY; T=0.K

## Principal cross sections

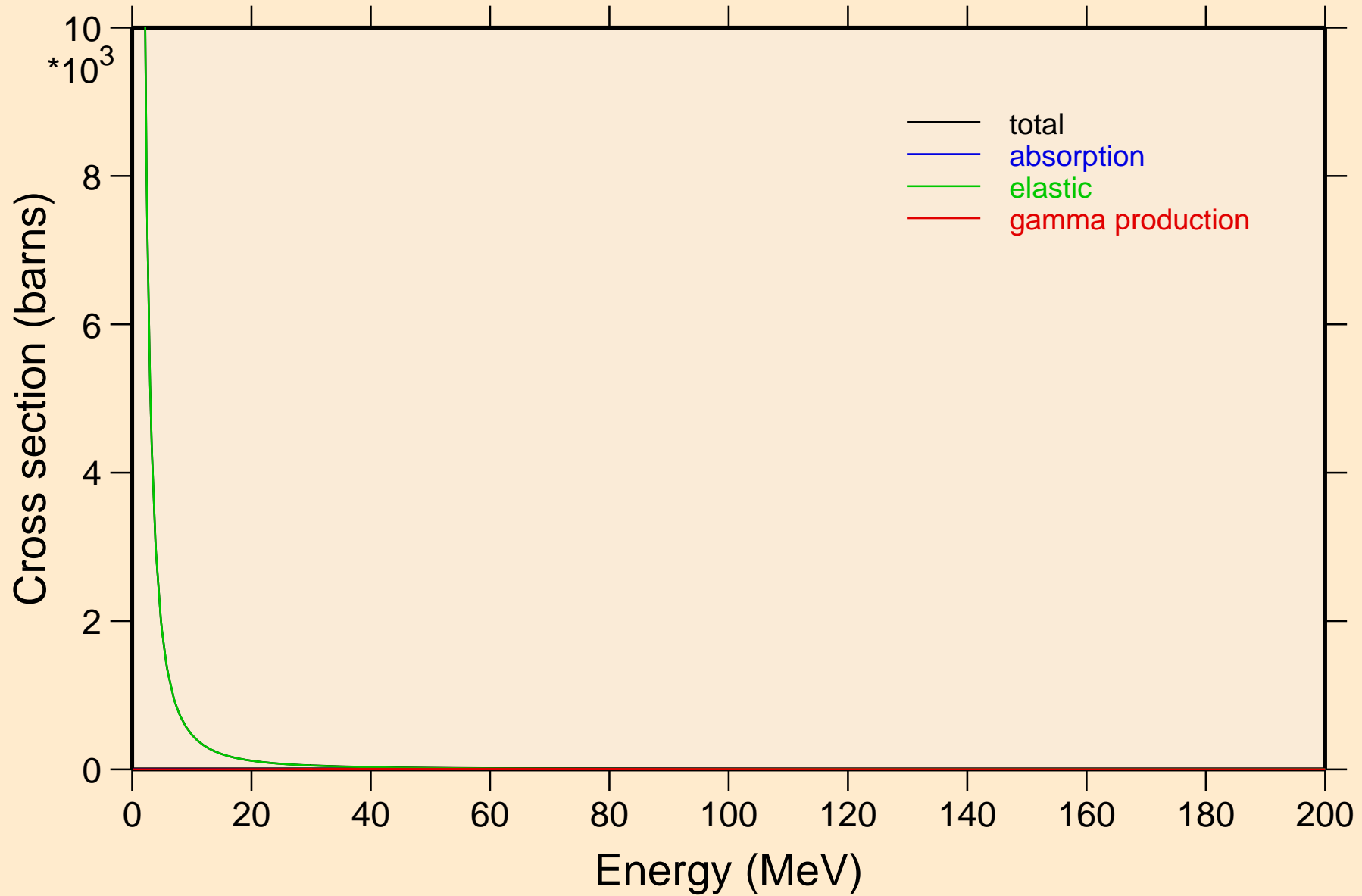

RN205M TRITON ACER TENDL-2023 LIBRARY; T=0.K

Heating

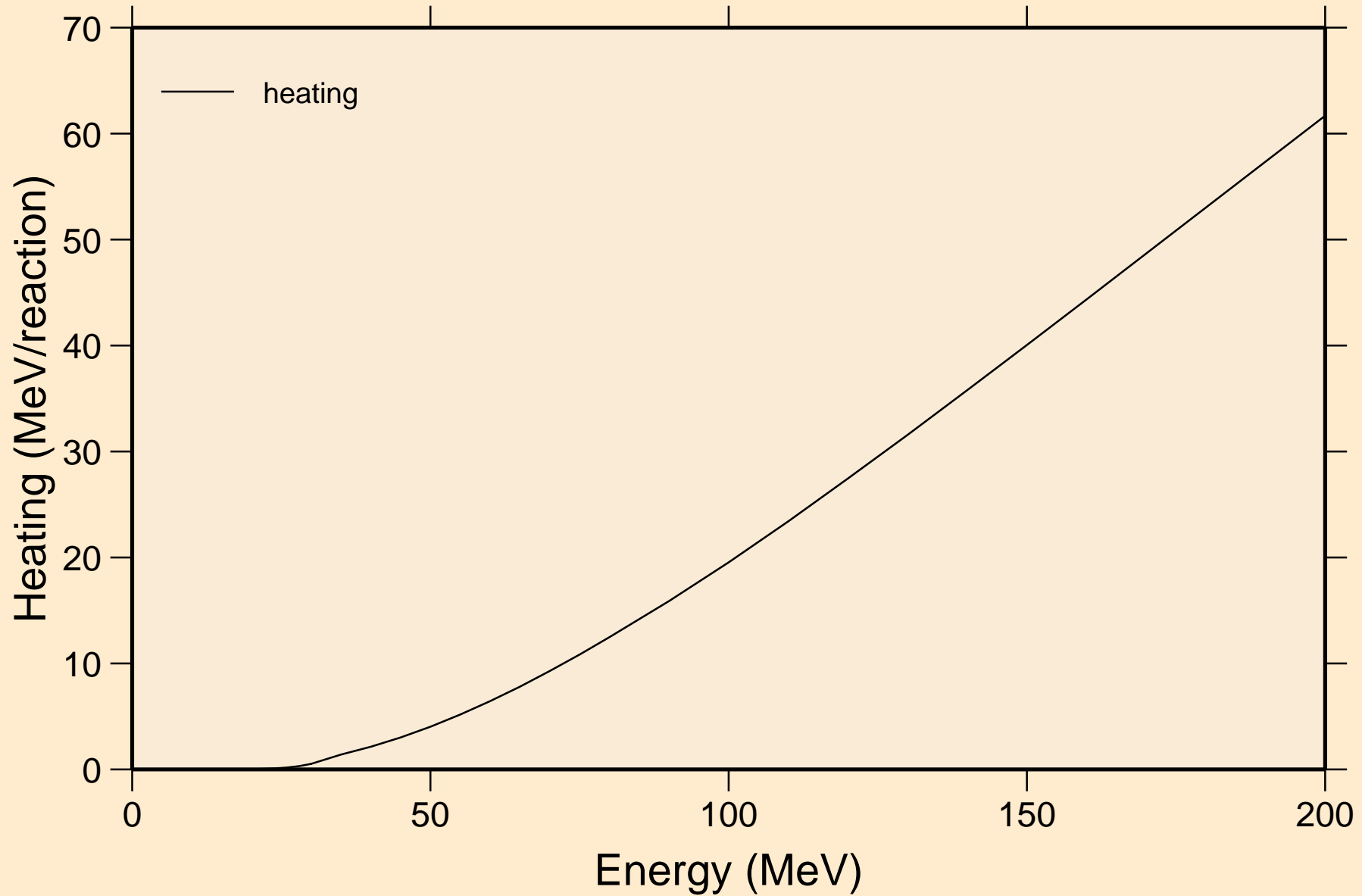

RN205M TRITON ACER TENDL-2023 LIBRARY; T=0.K  
Threshold reactions

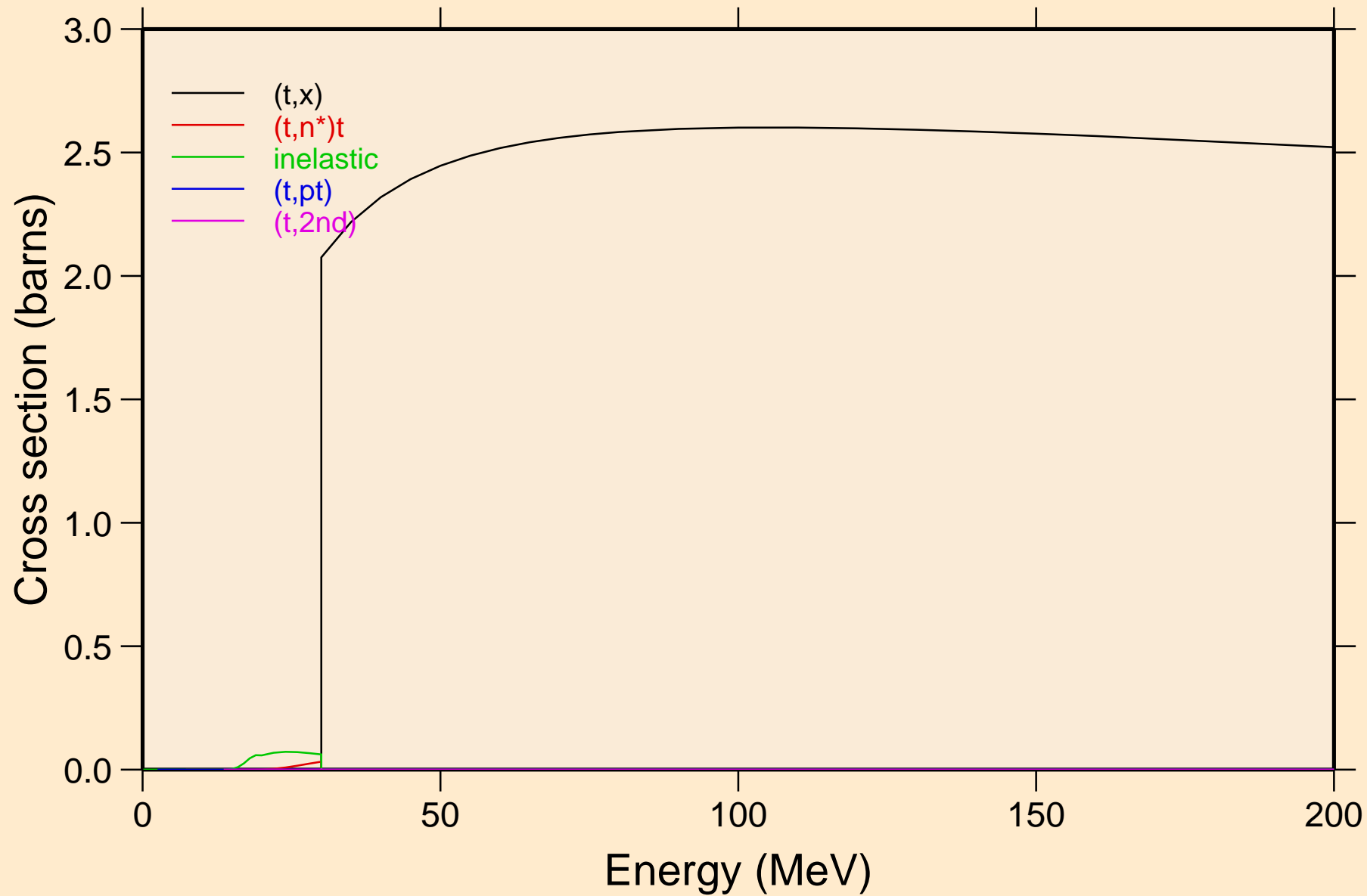

# RN205M TRITON ACER TENDL-2023 LIBRARY; T=0.K

## Threshold reactions

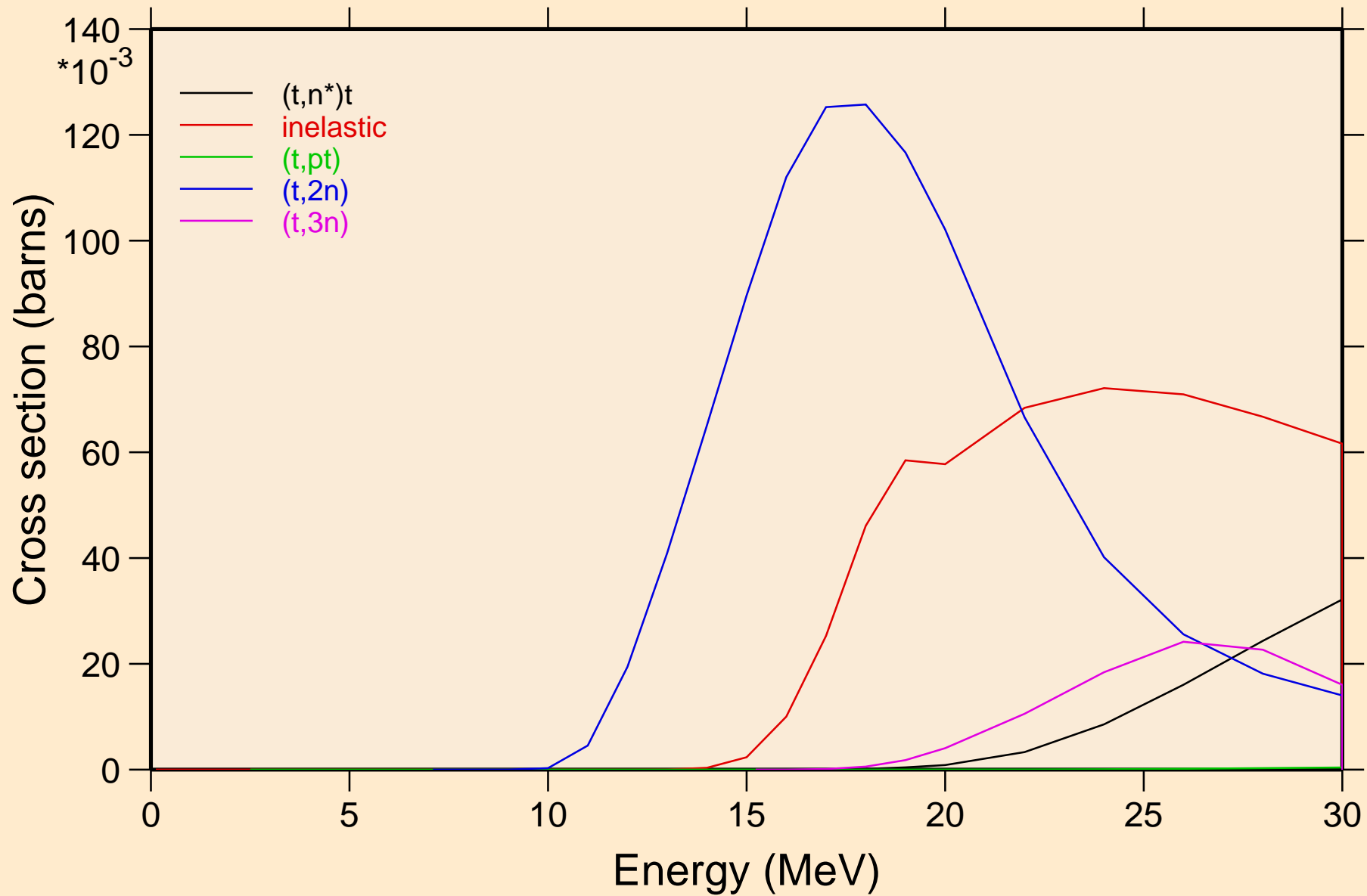

RN205M TRITON ACER TENDL-2023 LIBRARY; T=0.K  
Threshold reactions

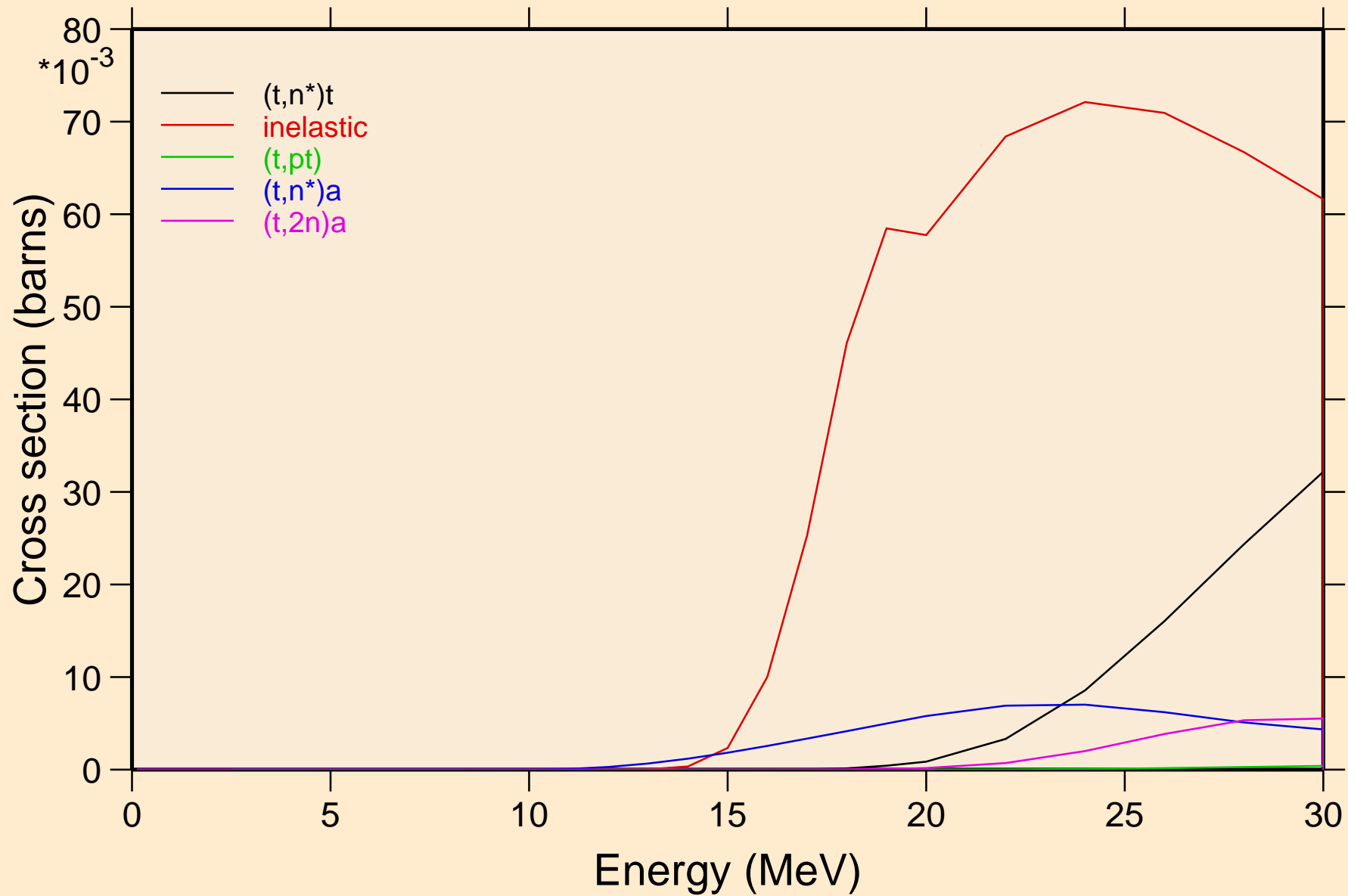

RN205M TRITON ACER TENDL-2023 LIBRARY; T=0.K  
Threshold reactions

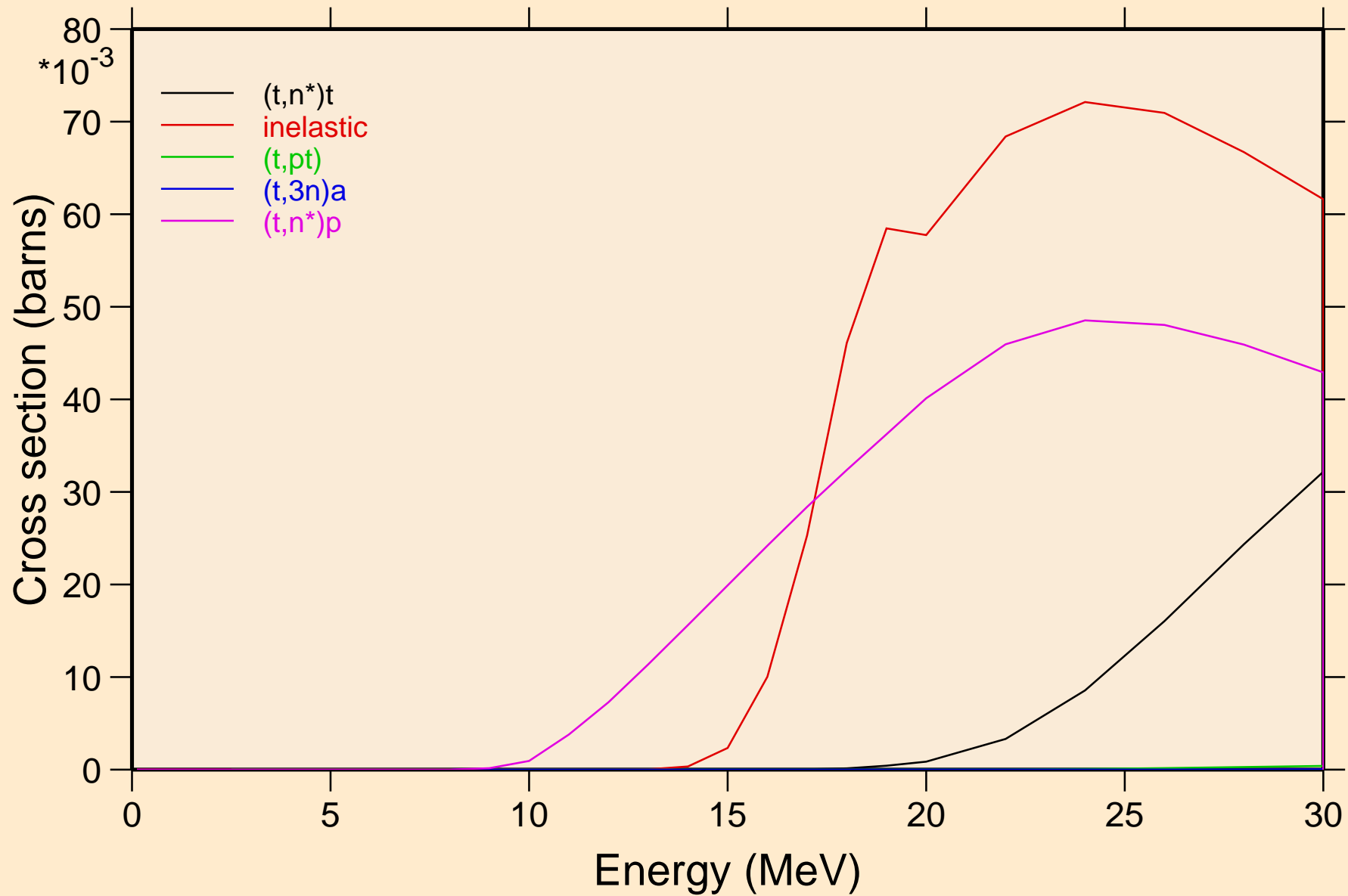

RN205M TRITON ACER TENDL-2023 LIBRARY; T=0.K  
Threshold reactions

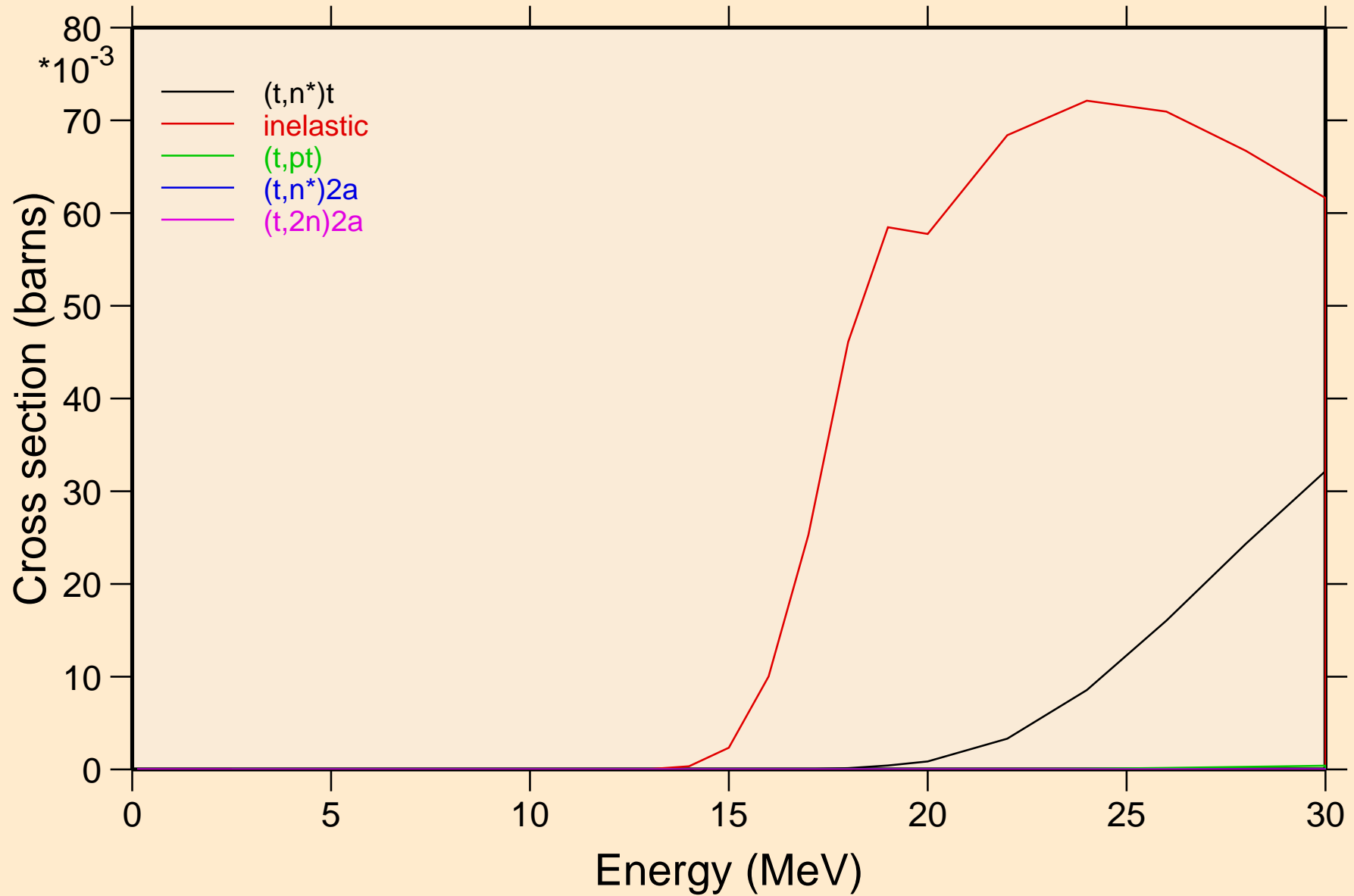

# RN205M TRITON ACER TENDL-2023 LIBRARY; T=0.K

## Threshold reactions

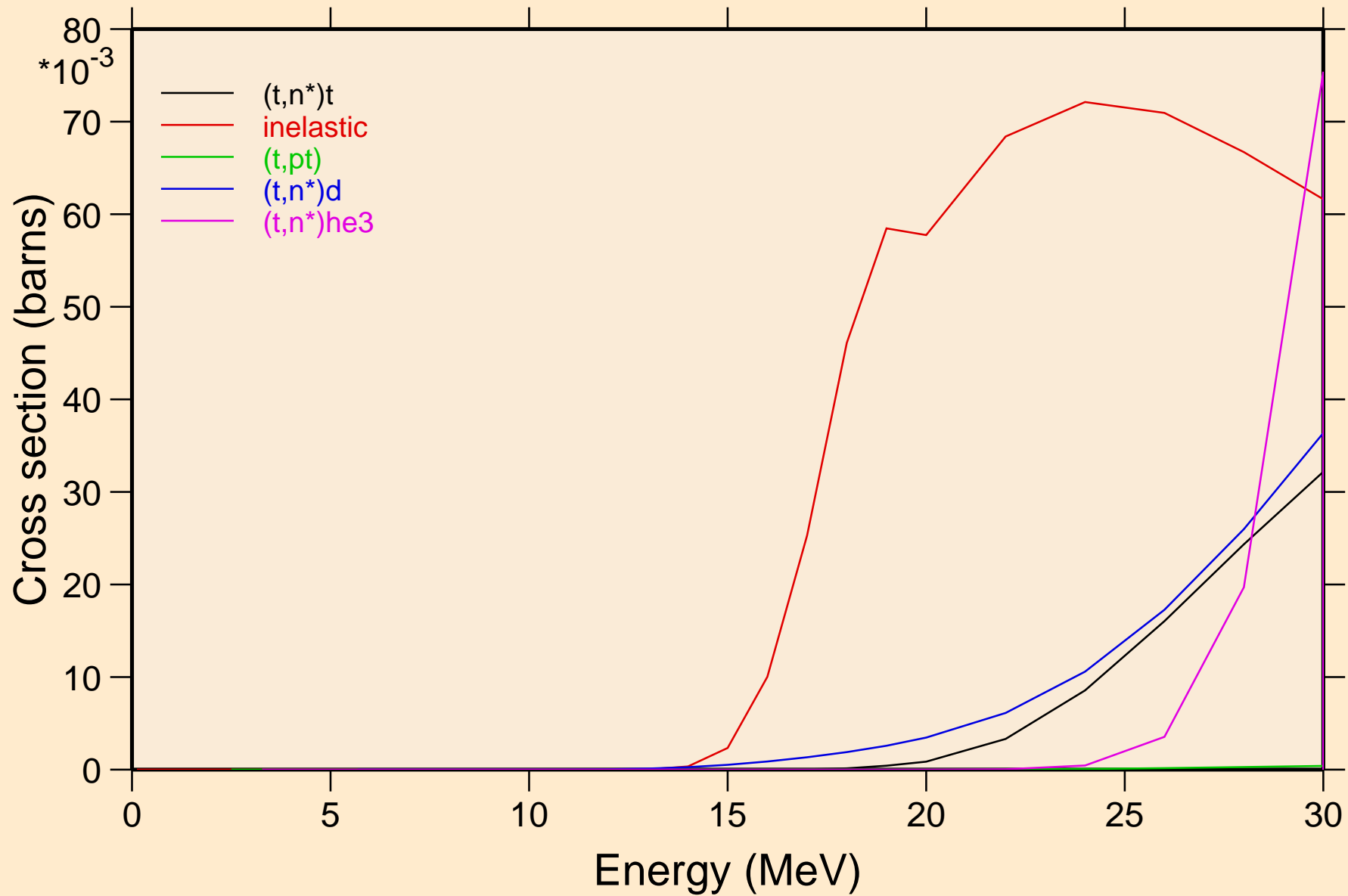

# RN205M TRITON ACER TENDL-2023 LIBRARY; T=0.K

## Threshold reactions

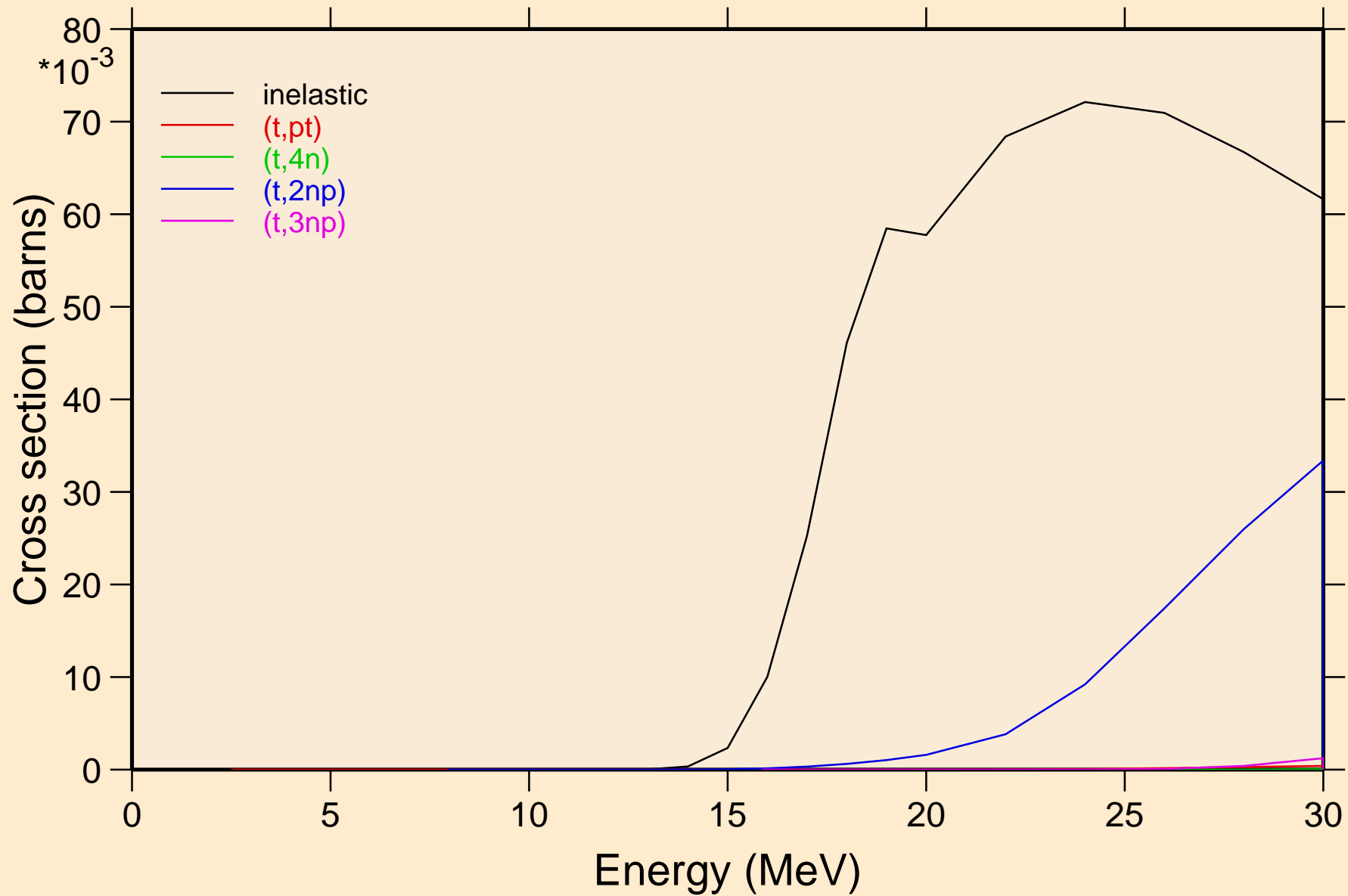

RN205M TRITON ACER TENDL-2023 LIBRARY; T=0.K  
Threshold reactions

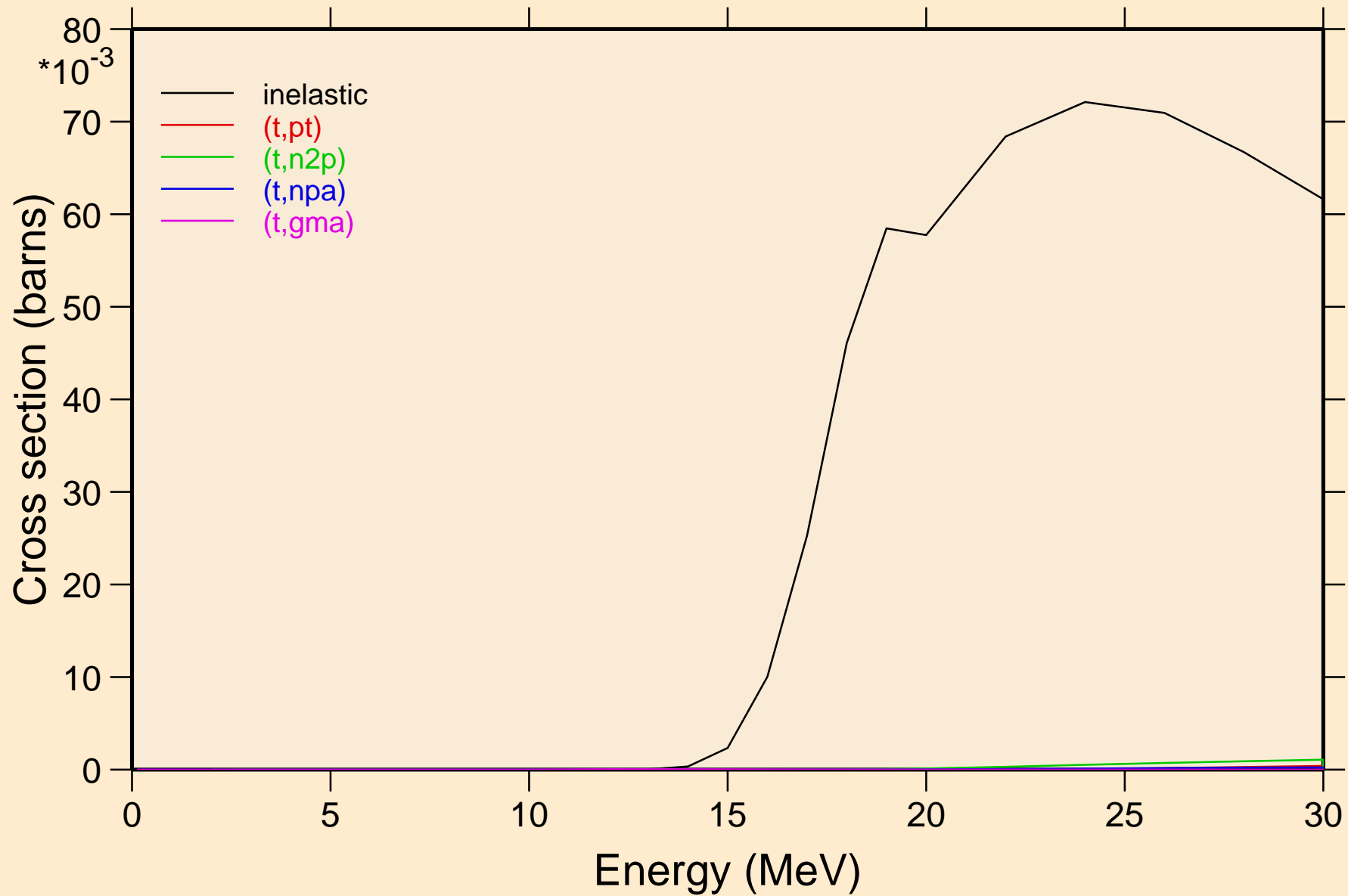

RN205M TRITON ACER TENDL-2023 LIBRARY; T=0.K  
Threshold reactions

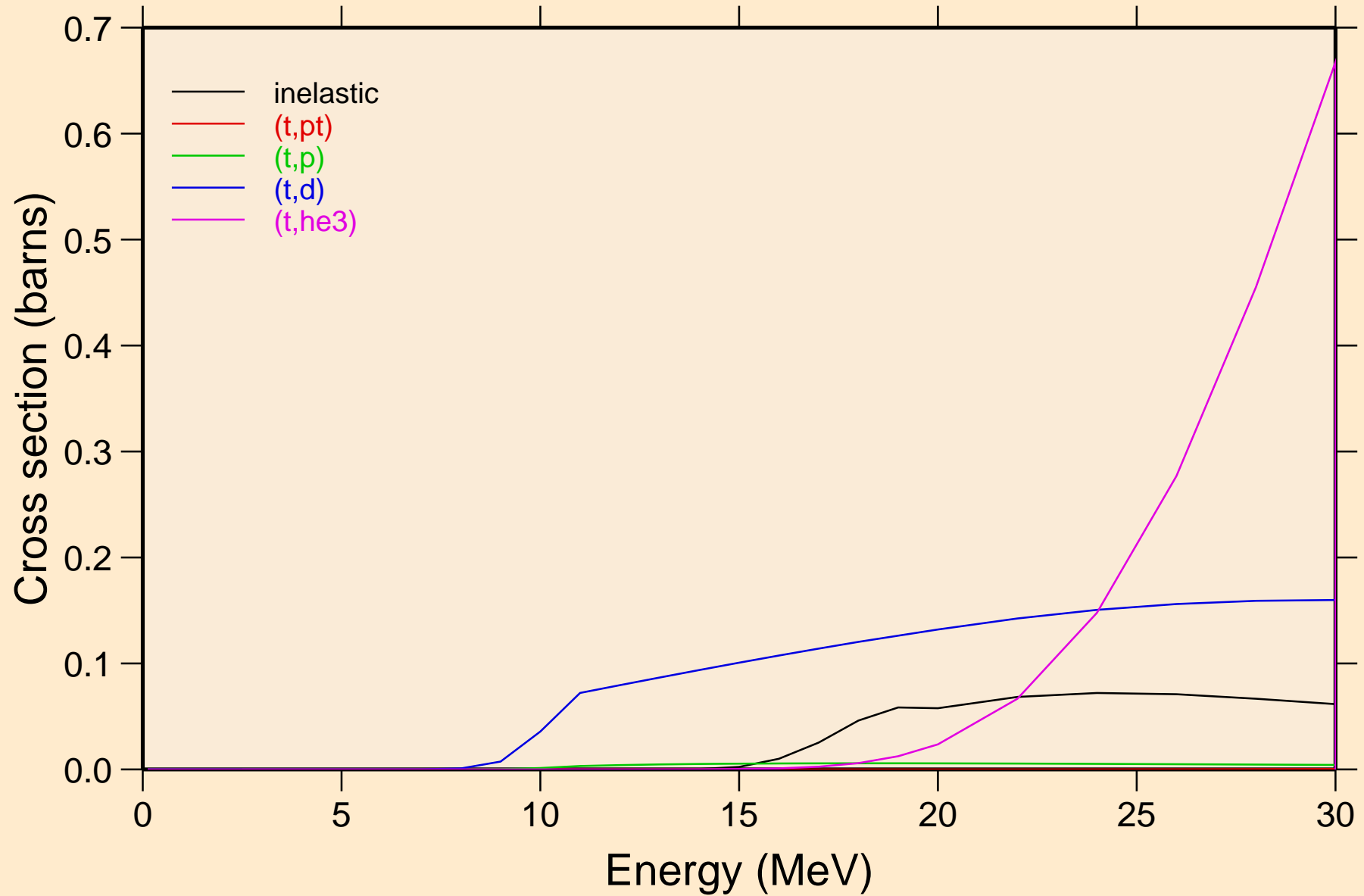

RN205M TRITON ACER TENDL-2023 LIBRARY; T=0.K  
Threshold reactions

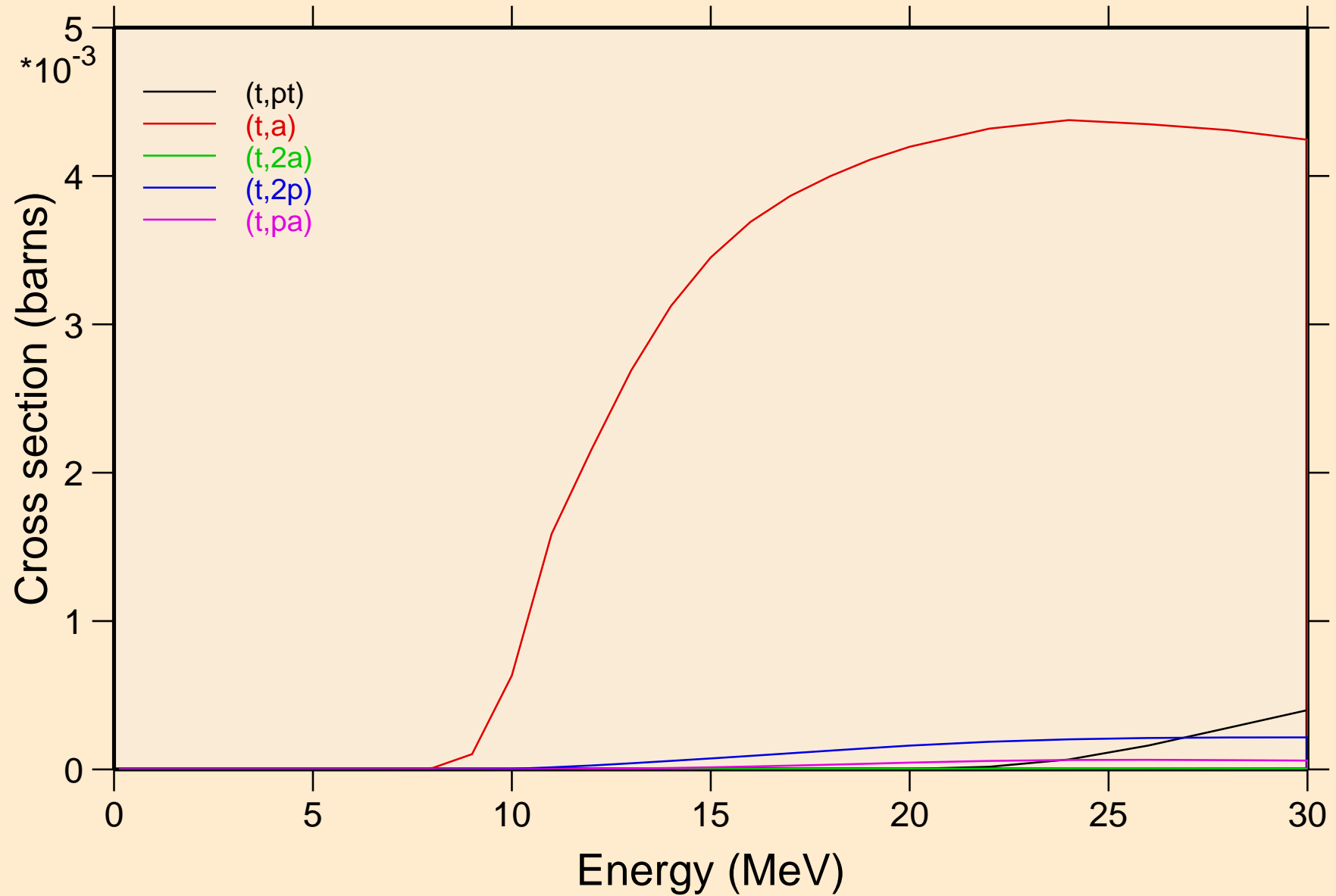

RN205M TRITON ACER TENDL-2023 LIBRARY; T=0.K  
Threshold reactions

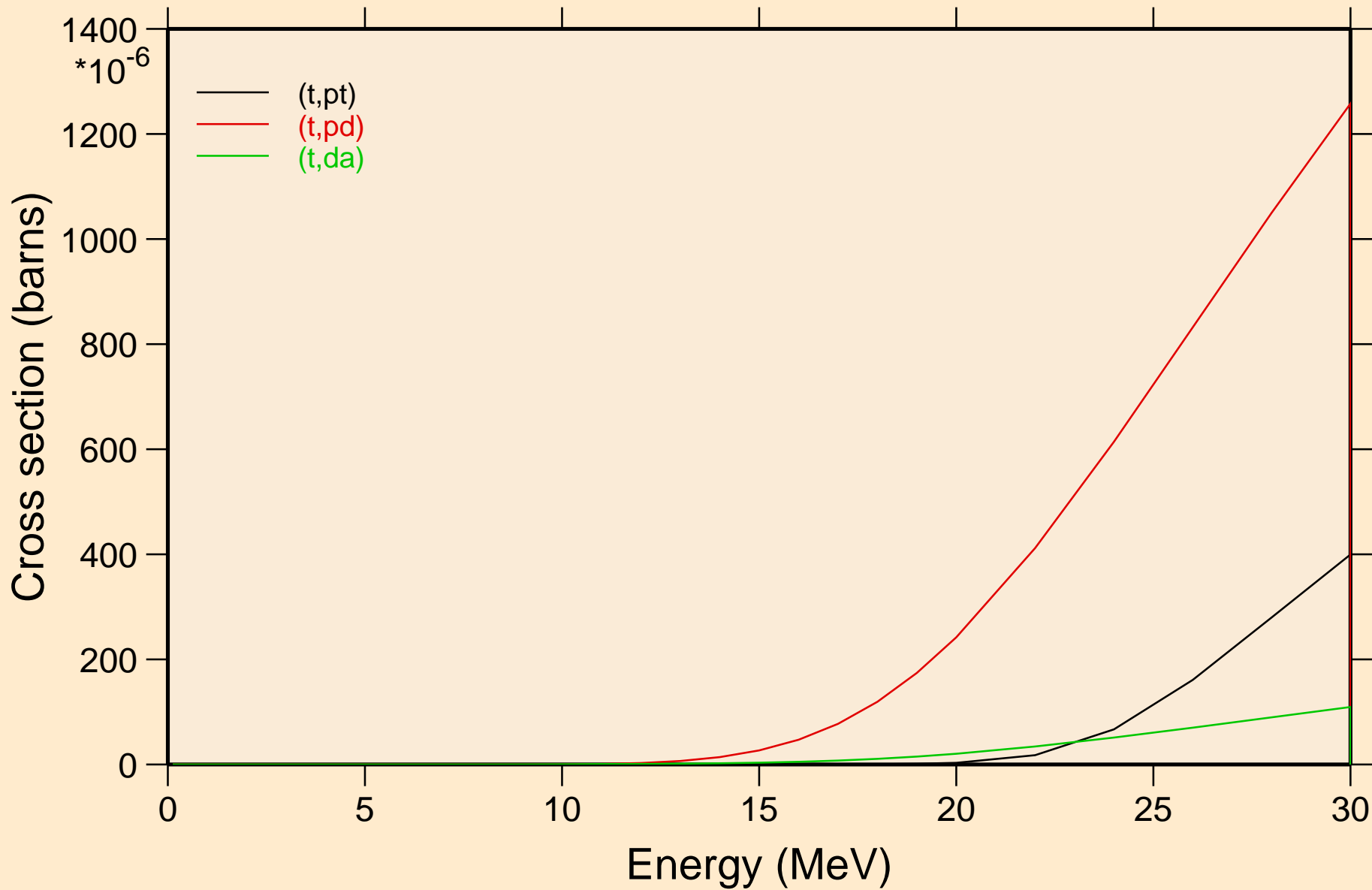

RN205M TRITON ACER TENDL-2023 LIBRARY; T=0.K  
angular distribution for elastic

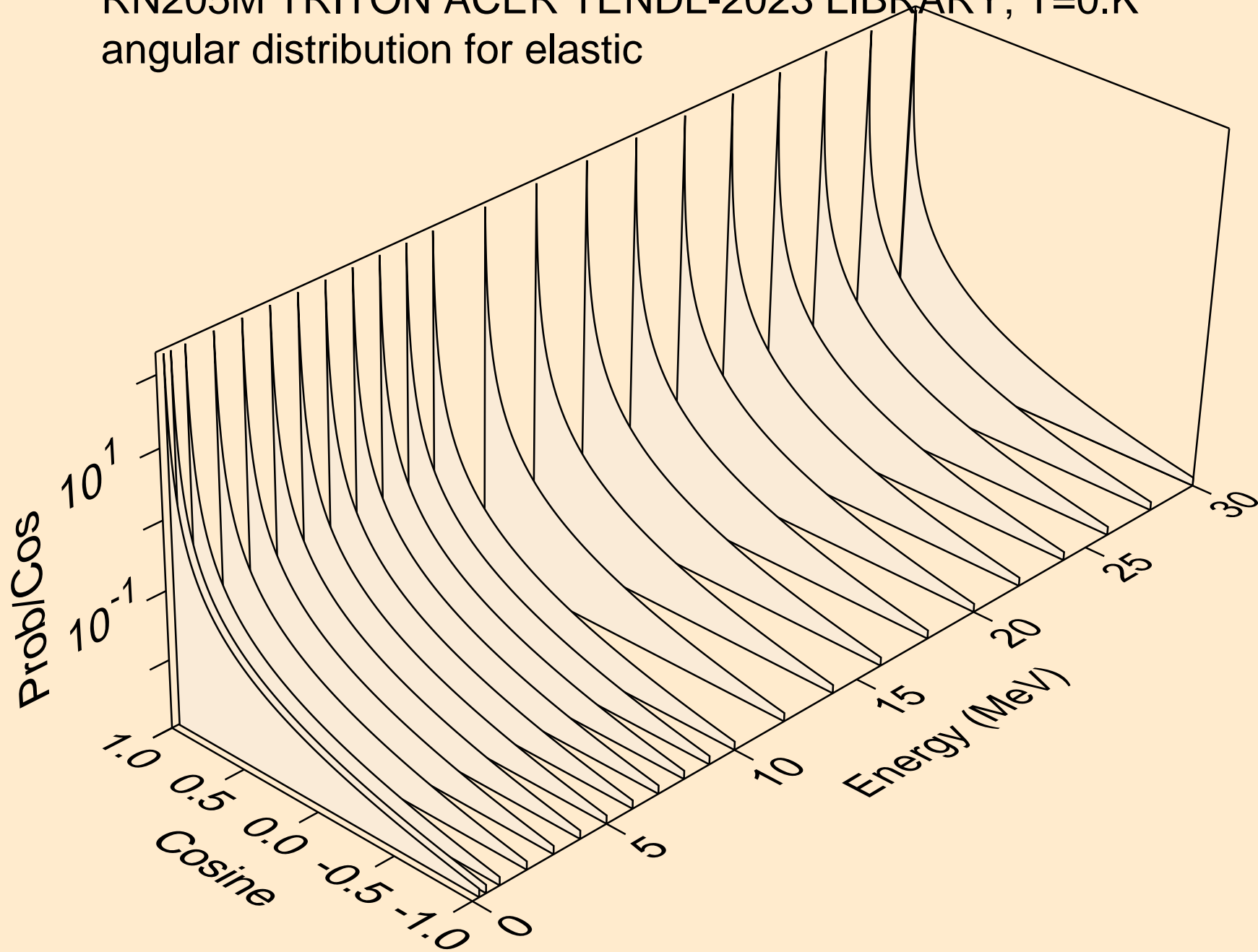

RN205M TRITON ACER TENDL-2023 LIBRARY; T=0.K  
Triton emission for (t,x)

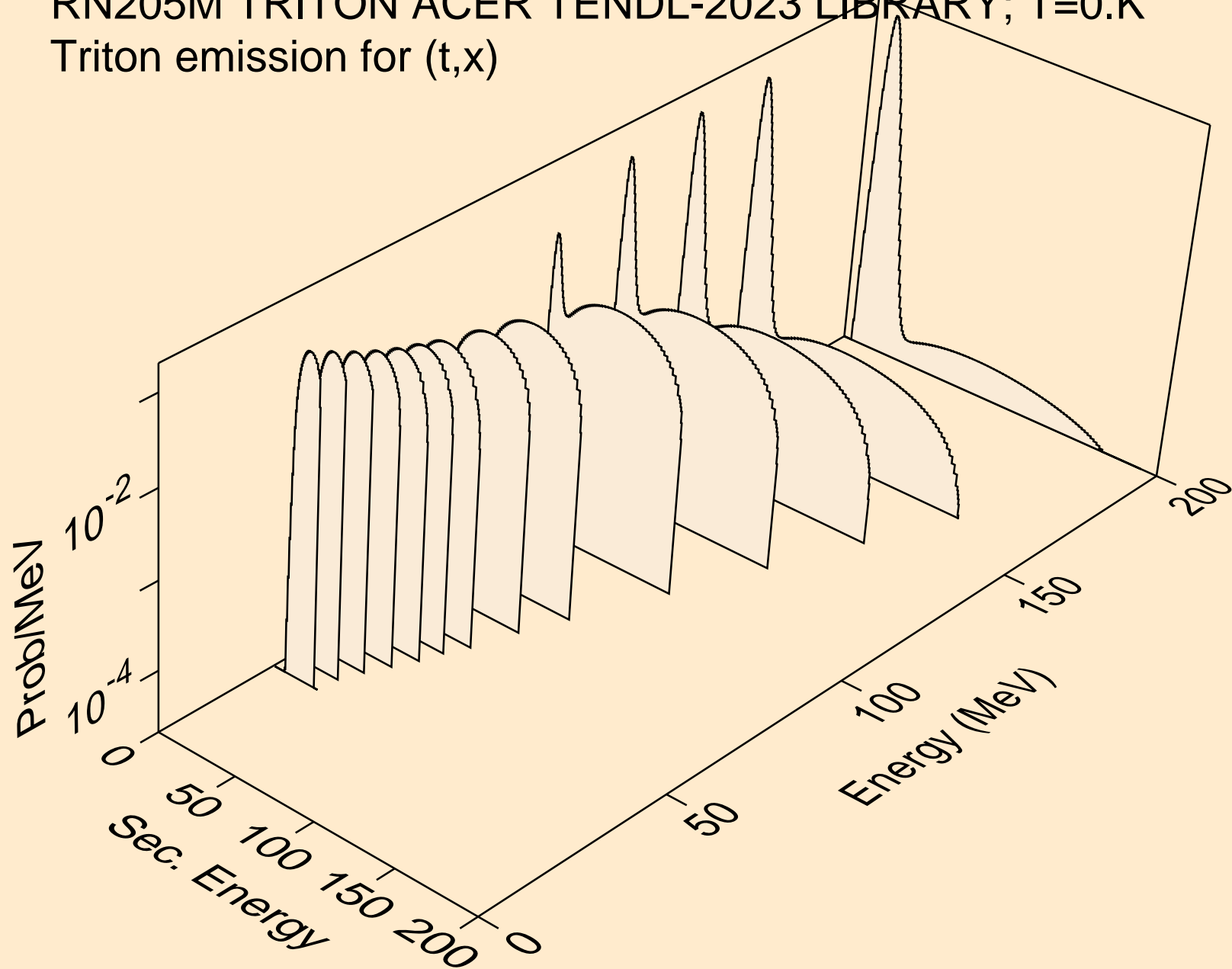

RN205M TRITON ACER TENDL-2023 LIBRARY; T=0.K  
Triton emission for (t,n\*)t

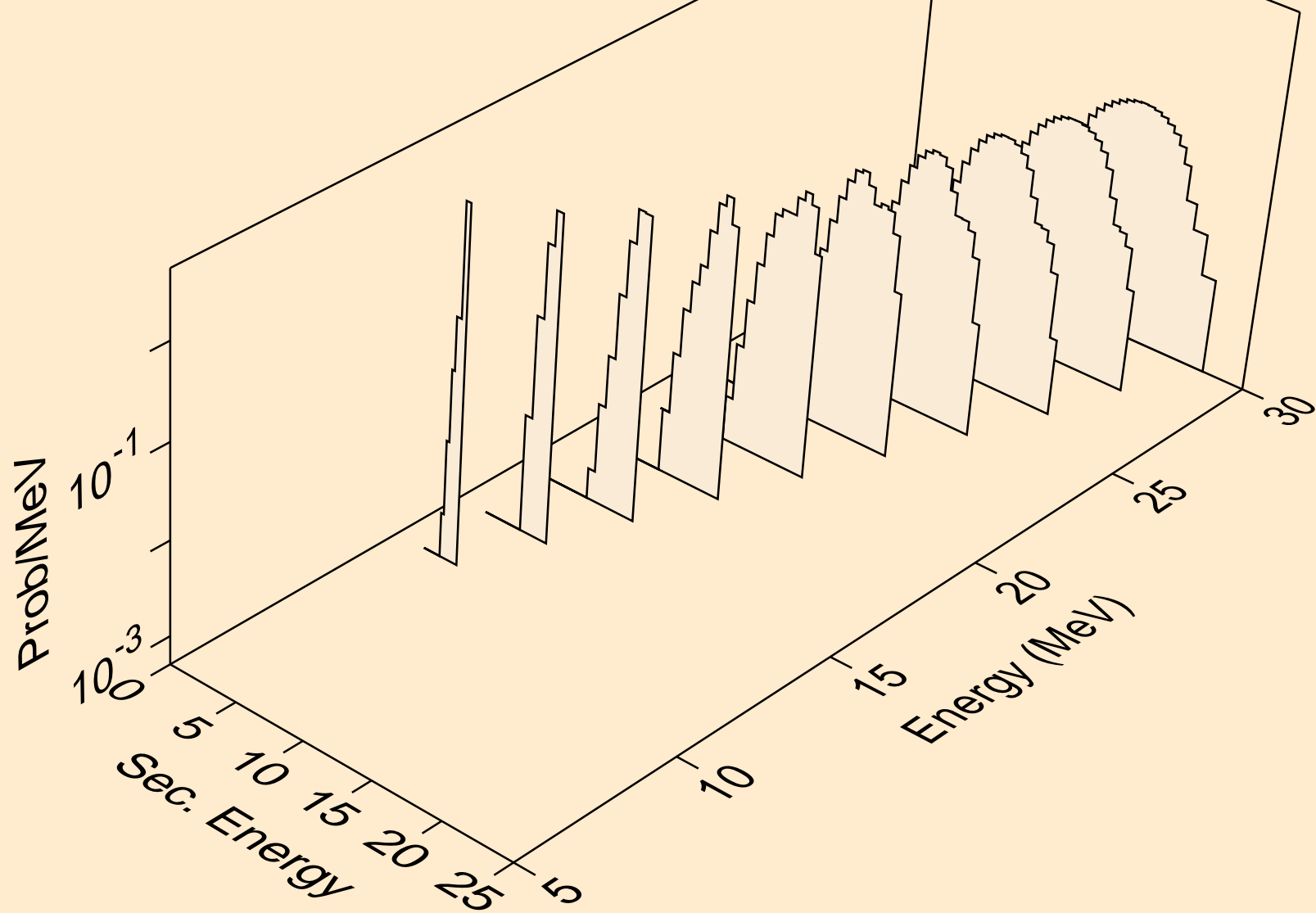

RN205M TRITON ACER TENDL-2023 LIBRARY; T=0.K  
Triton emission for inelastic

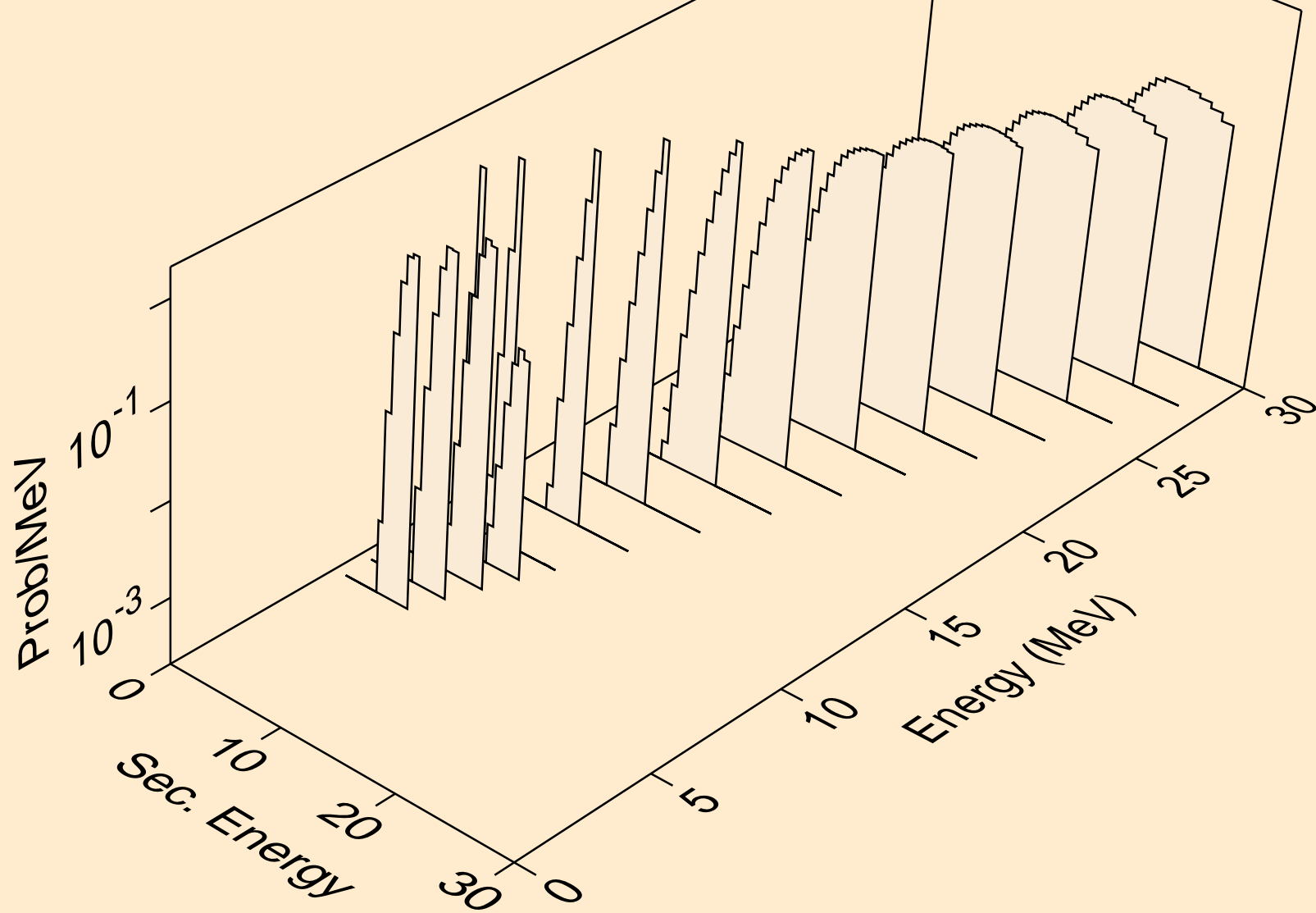

RN205M TRITON ACER TENDL-2023 LIBRARY; T=0.K  
Triton emission for (t,pt)

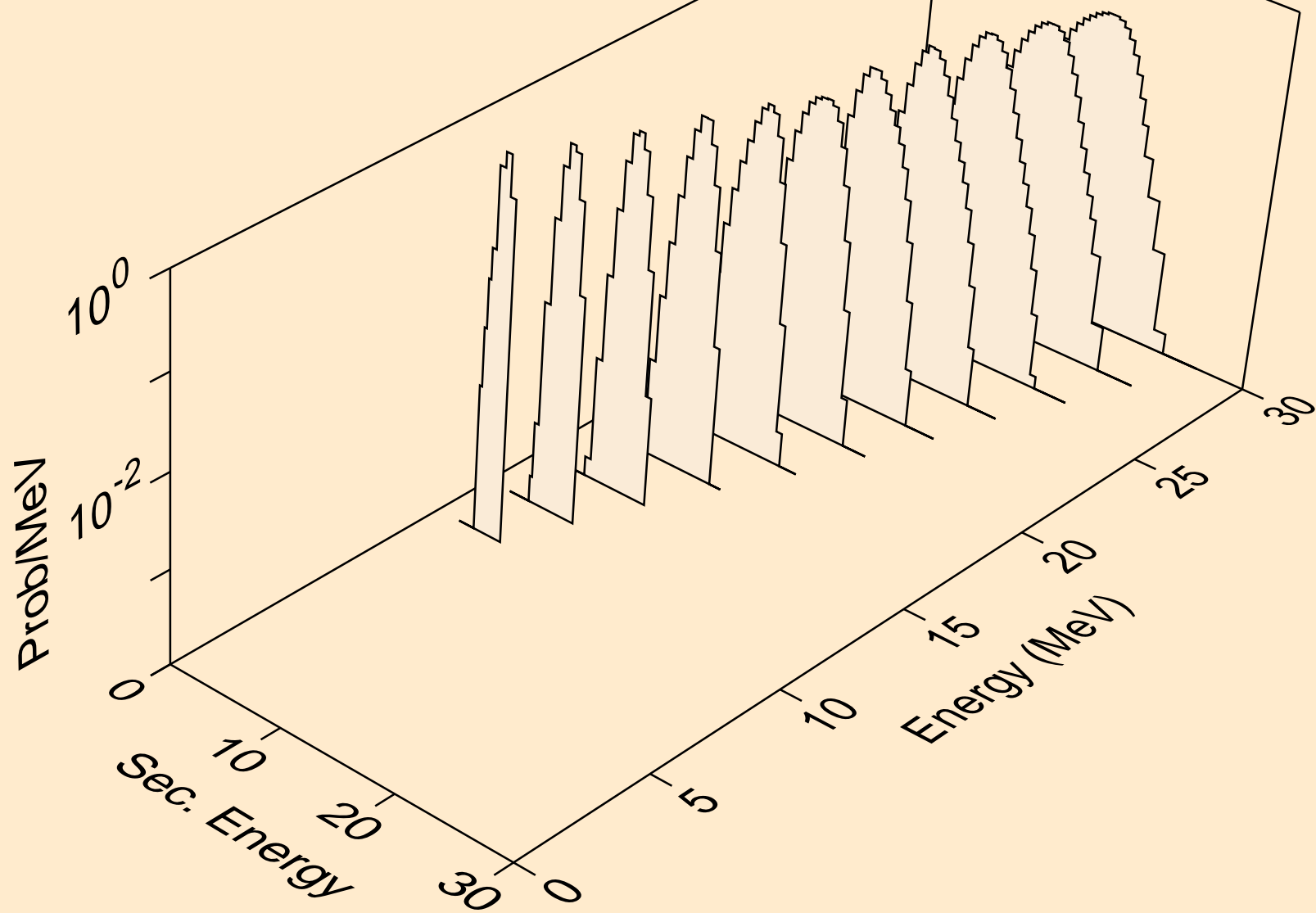

RN205M TRITON ACER TENDL-2023 LIBRARY; T=0.K  
Photon emission for (z,n)

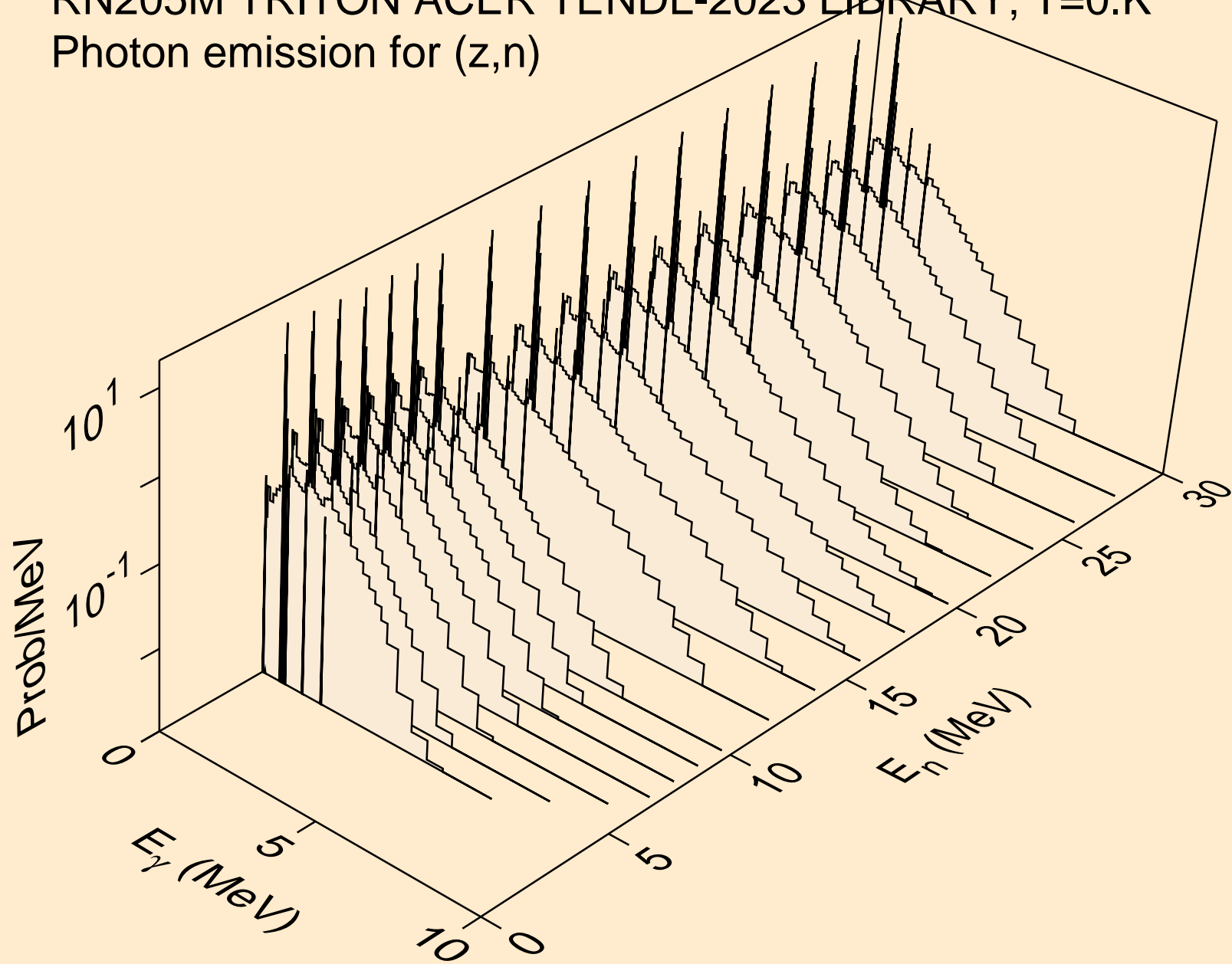

RN205M TRITON ACER TENDL-2023 LIBRARY; T=0.K  
Photon emission for (z,x)

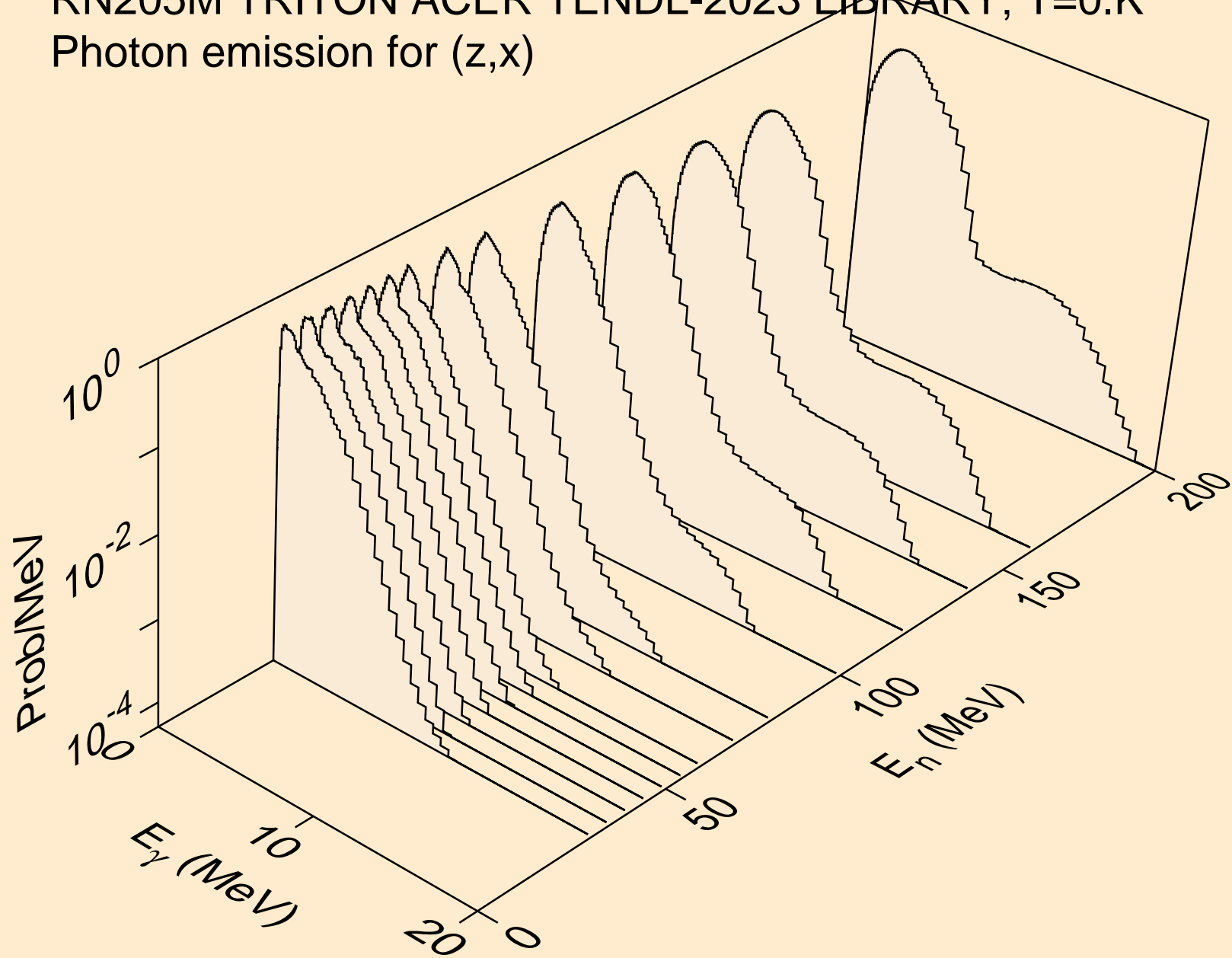

RN205M TRITON ACER TENDL-2023 LIBRARY; T=0.K  
Photon emission for (n,2nd)

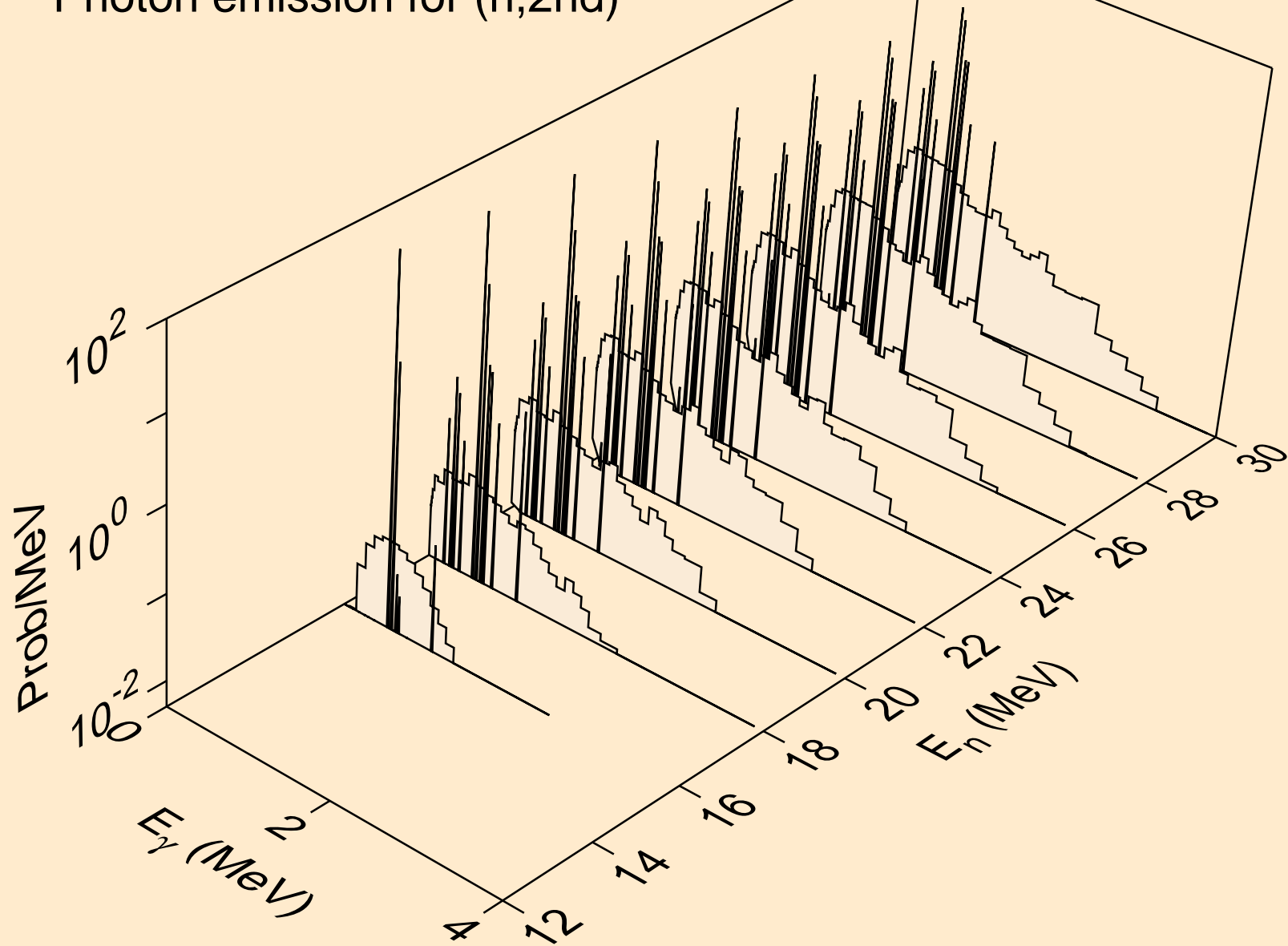

RN205M TRITON ACER TENDL-2023 LIBRARY; T=0.K  
Photon emission for (n,2n)

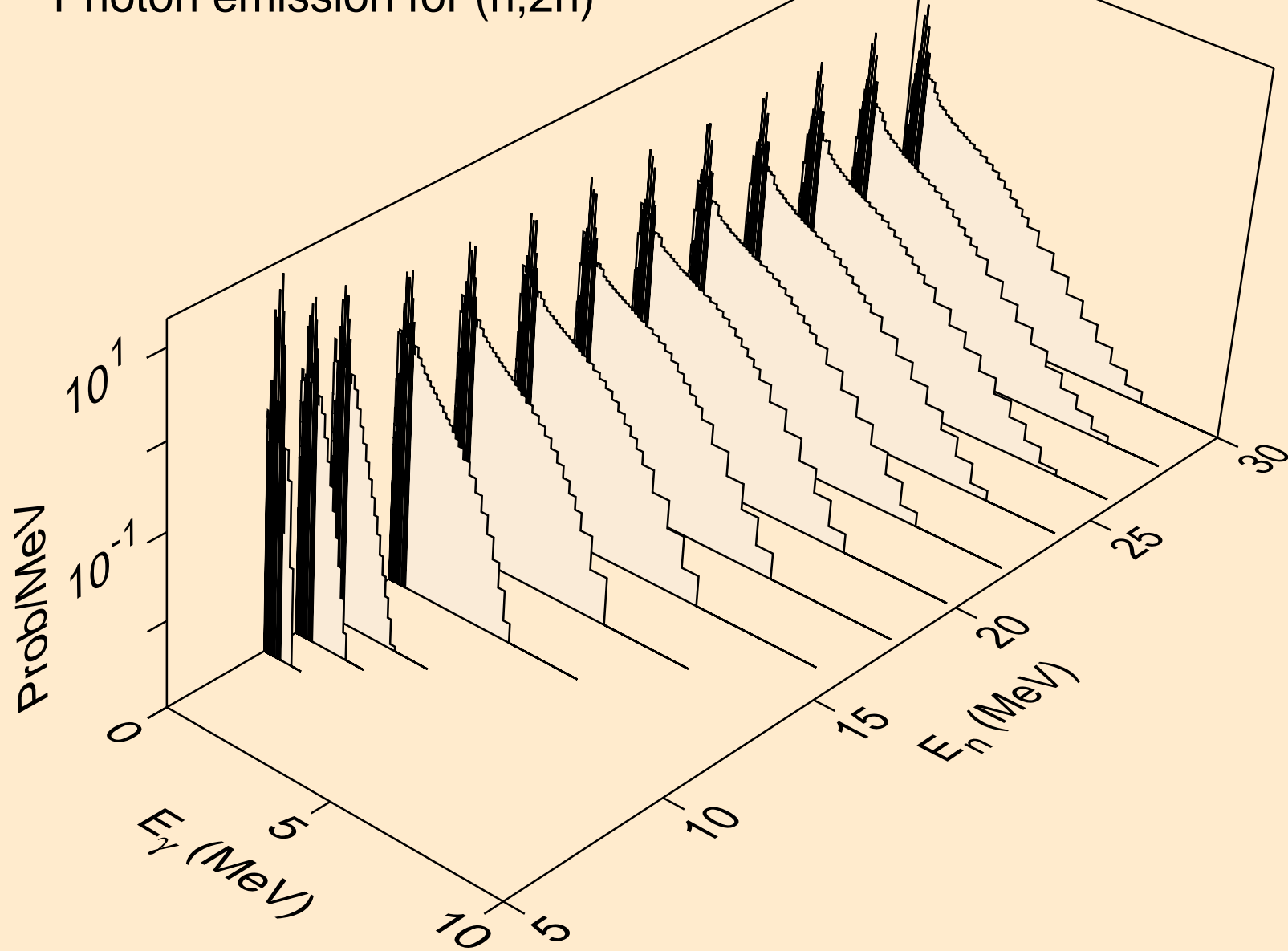

RN205M TRITON ACER TENDL-2023 LIBRARY; T=0.K  
Photon emission for (n,3n)

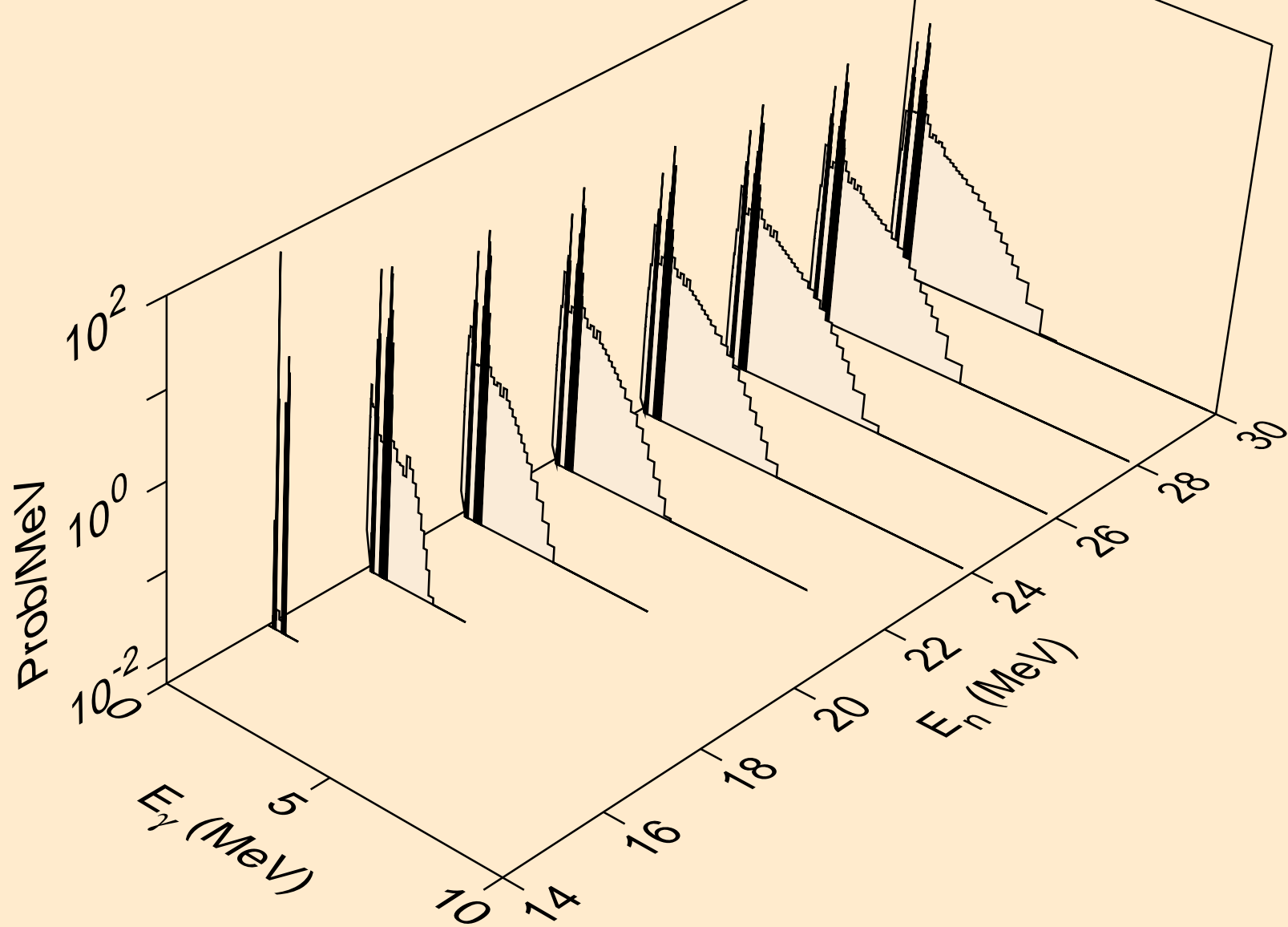

RN205M TRITON ACER TENDL-2023 LIBRARY; T=0.K  
Photon emission for (n,n\*)a

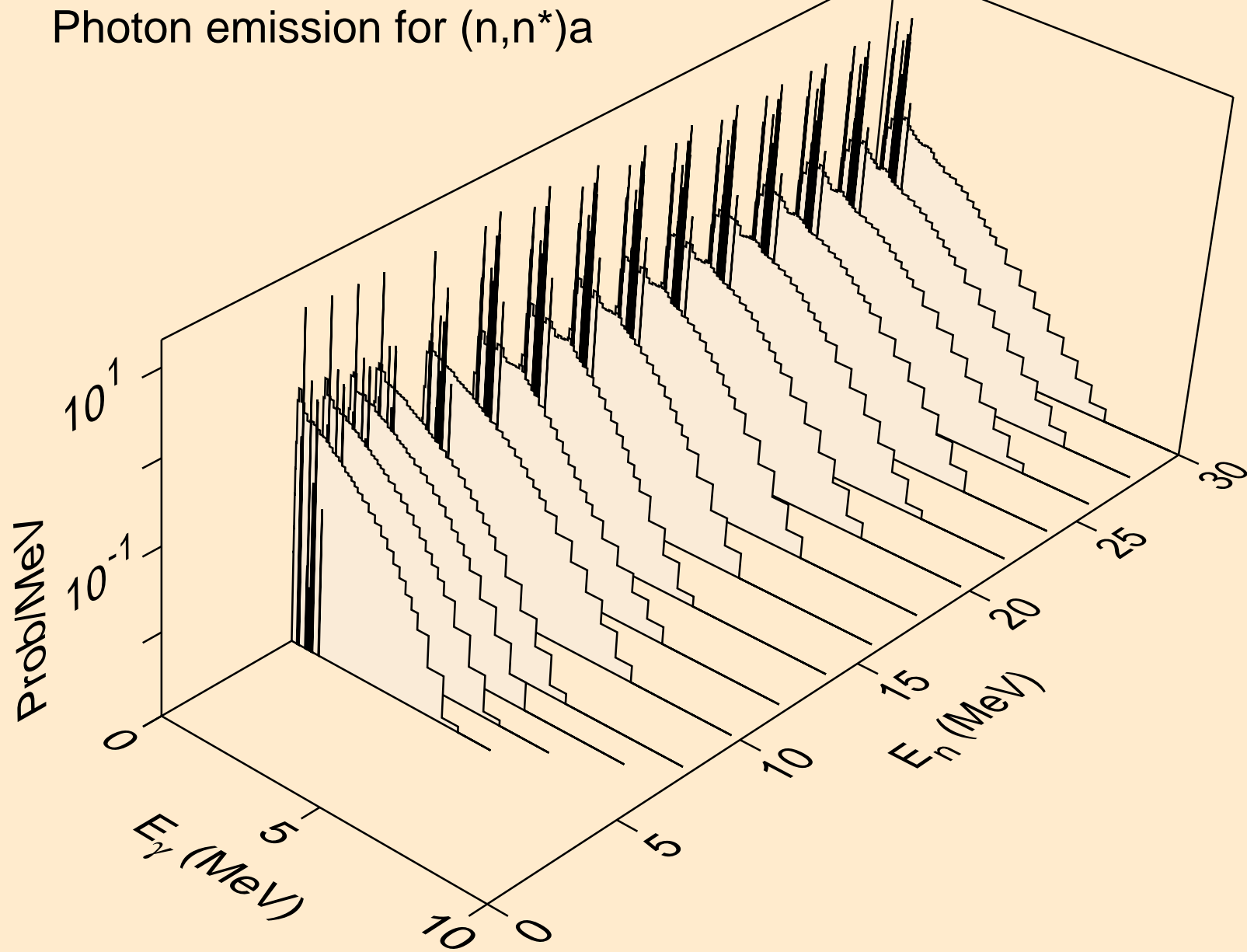

RN205M TRITON ACER TENDL-2023 LIBRARY; T=0.K  
Photon emission for (n,2n)a

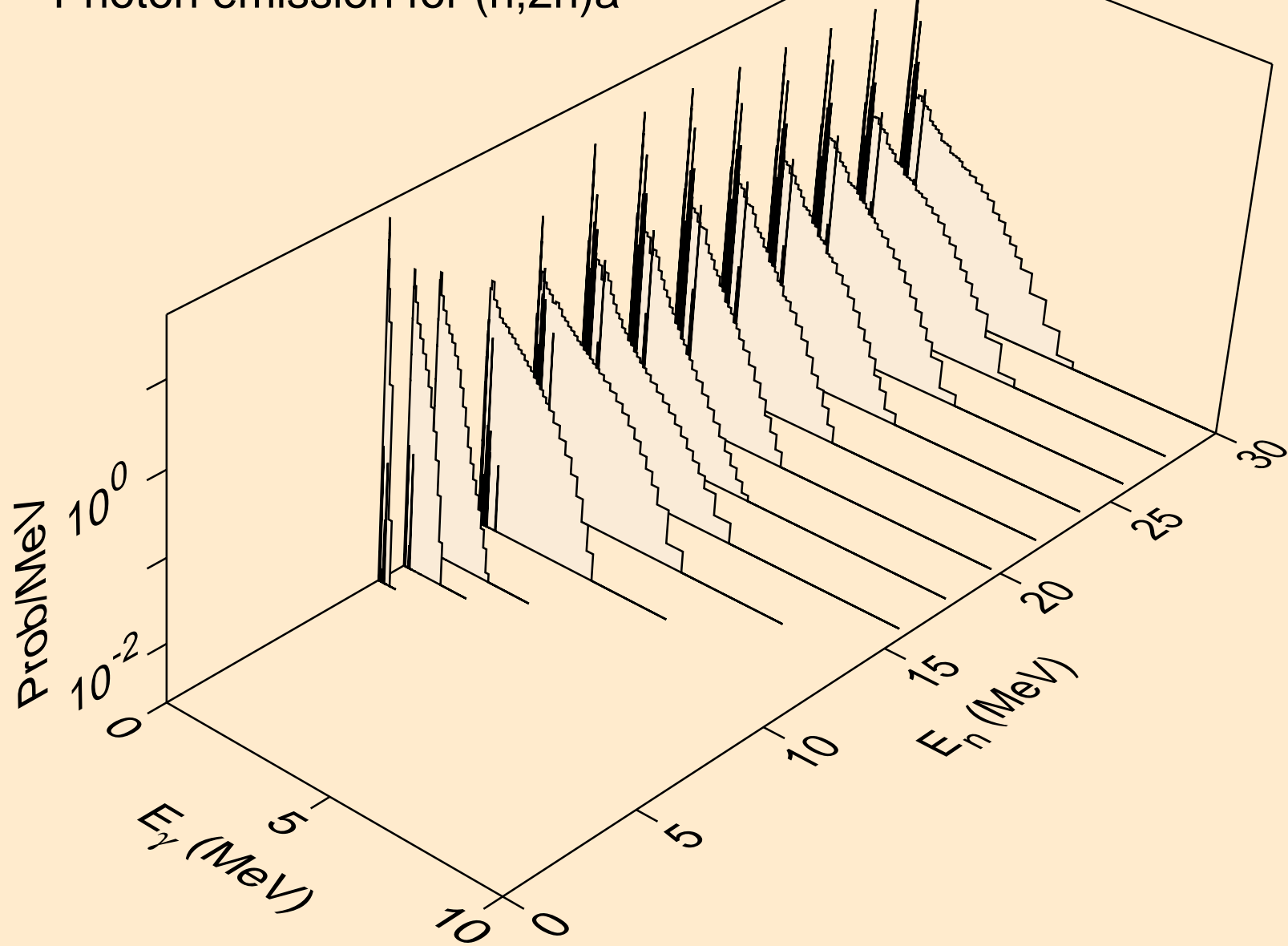

RN205M TRITON ACER TENDL-2023 LIBRARY; T=0.K  
Photon emission for (n,3n)a

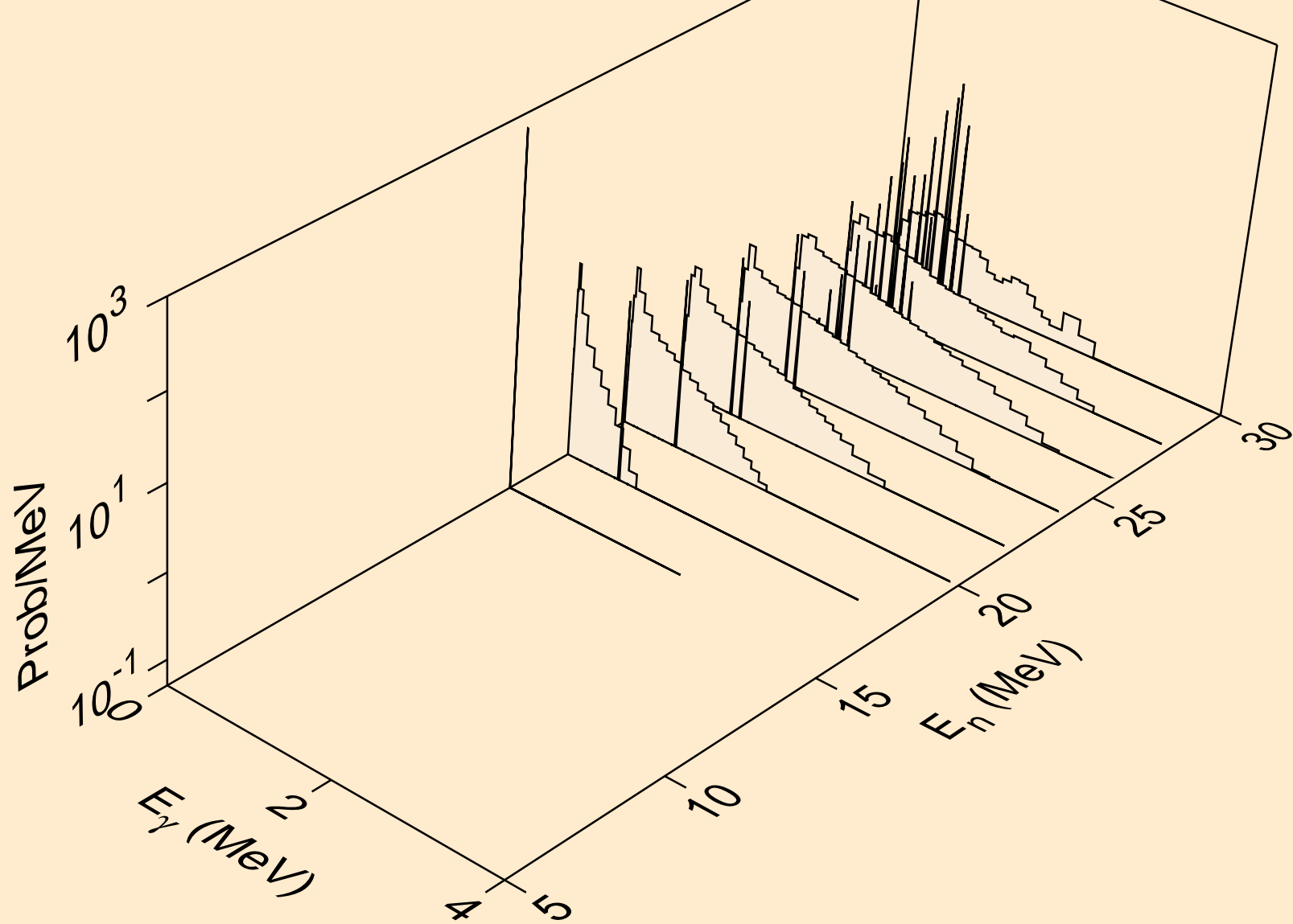

RN205M TRITON ACER TENDL-2023 LIBRARY; T=0.K  
Photon emission for (n,n\*)p

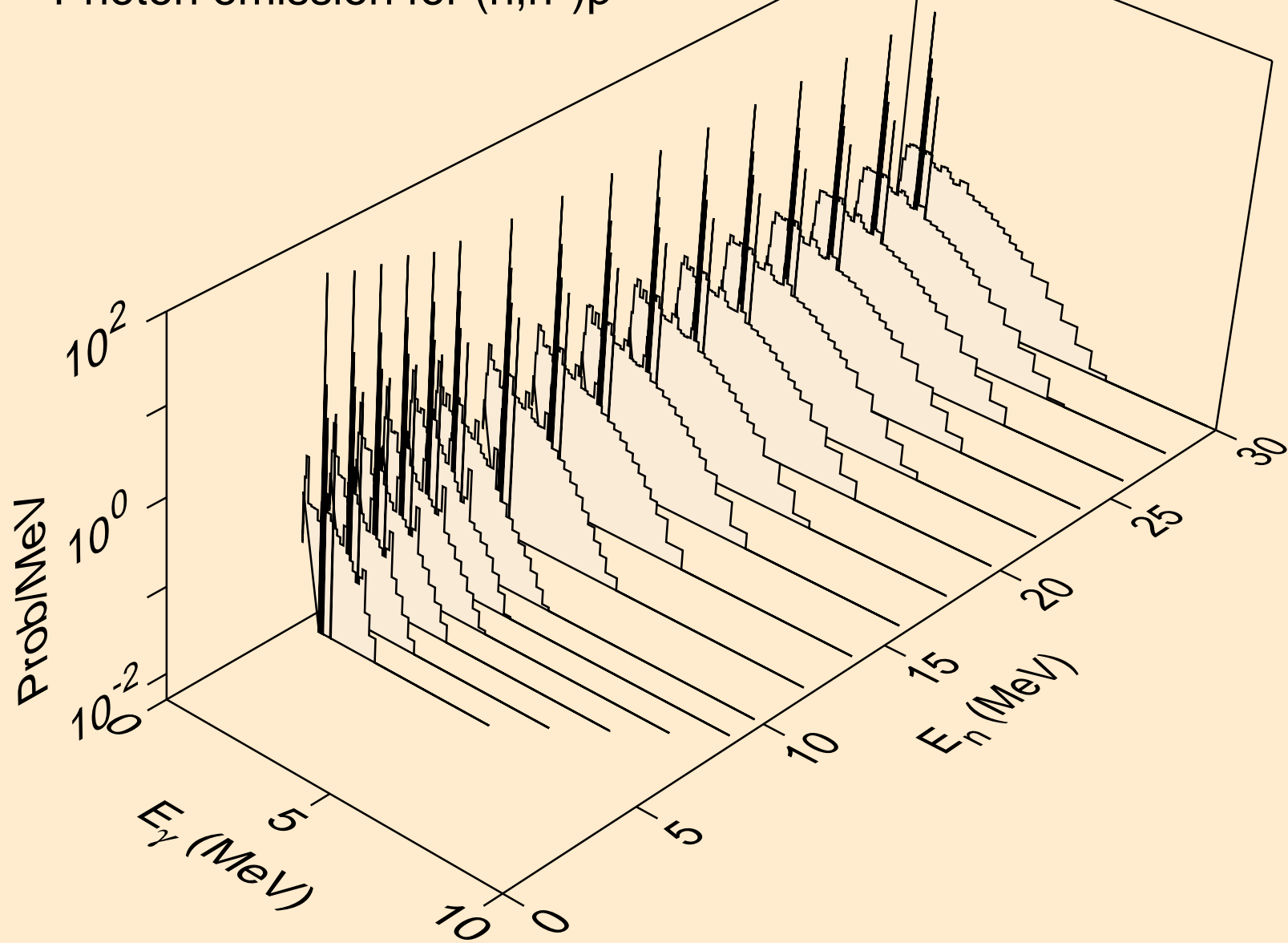

RN205M TRITON ACER TENDL-2023 LIBRARY; T=0.K  
Photon emission for (n,n\*)2a

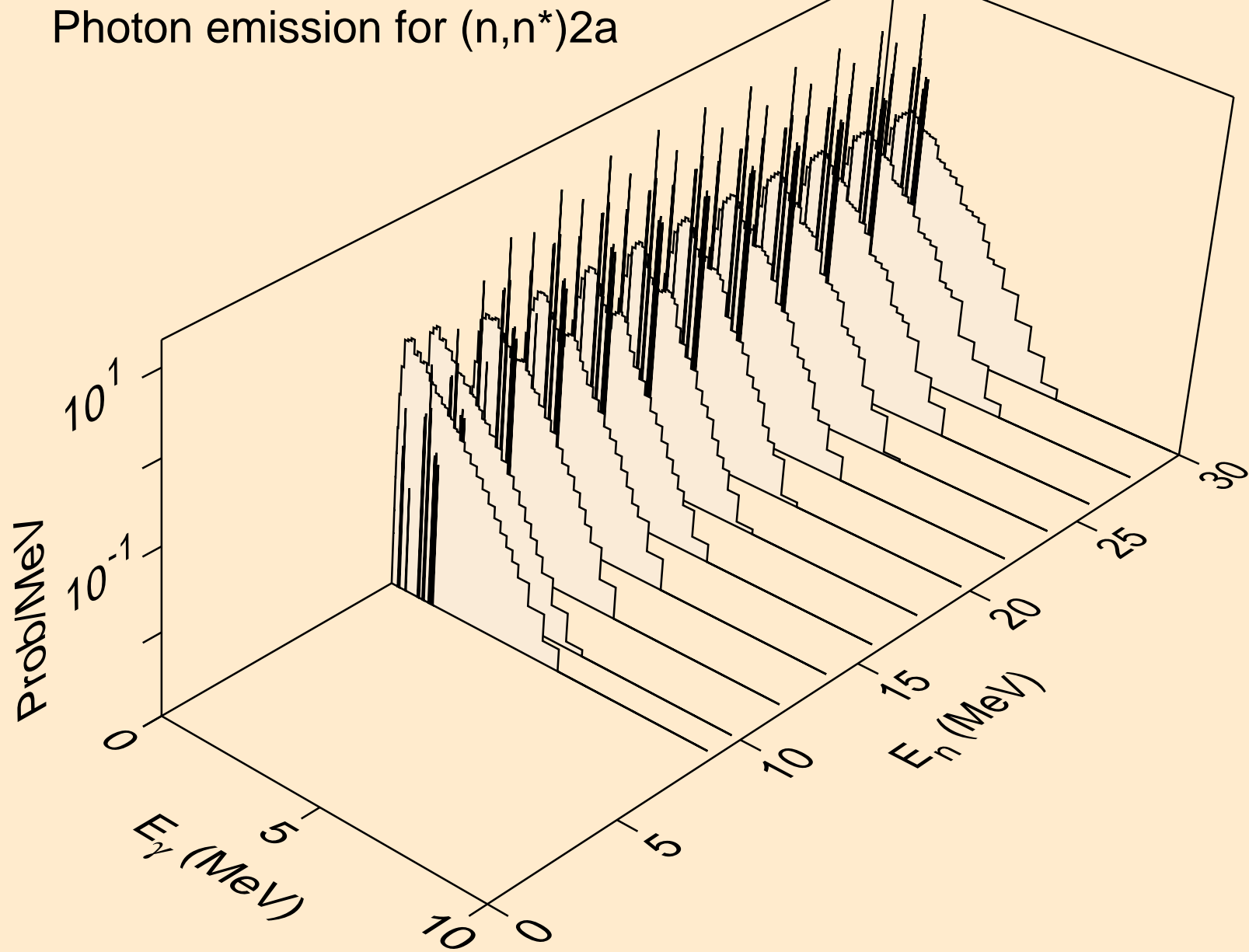

RN205M TRITON ACER TENDL-2023 LIBRARY; T=0.K  
Photon emission for (n,2n)2a

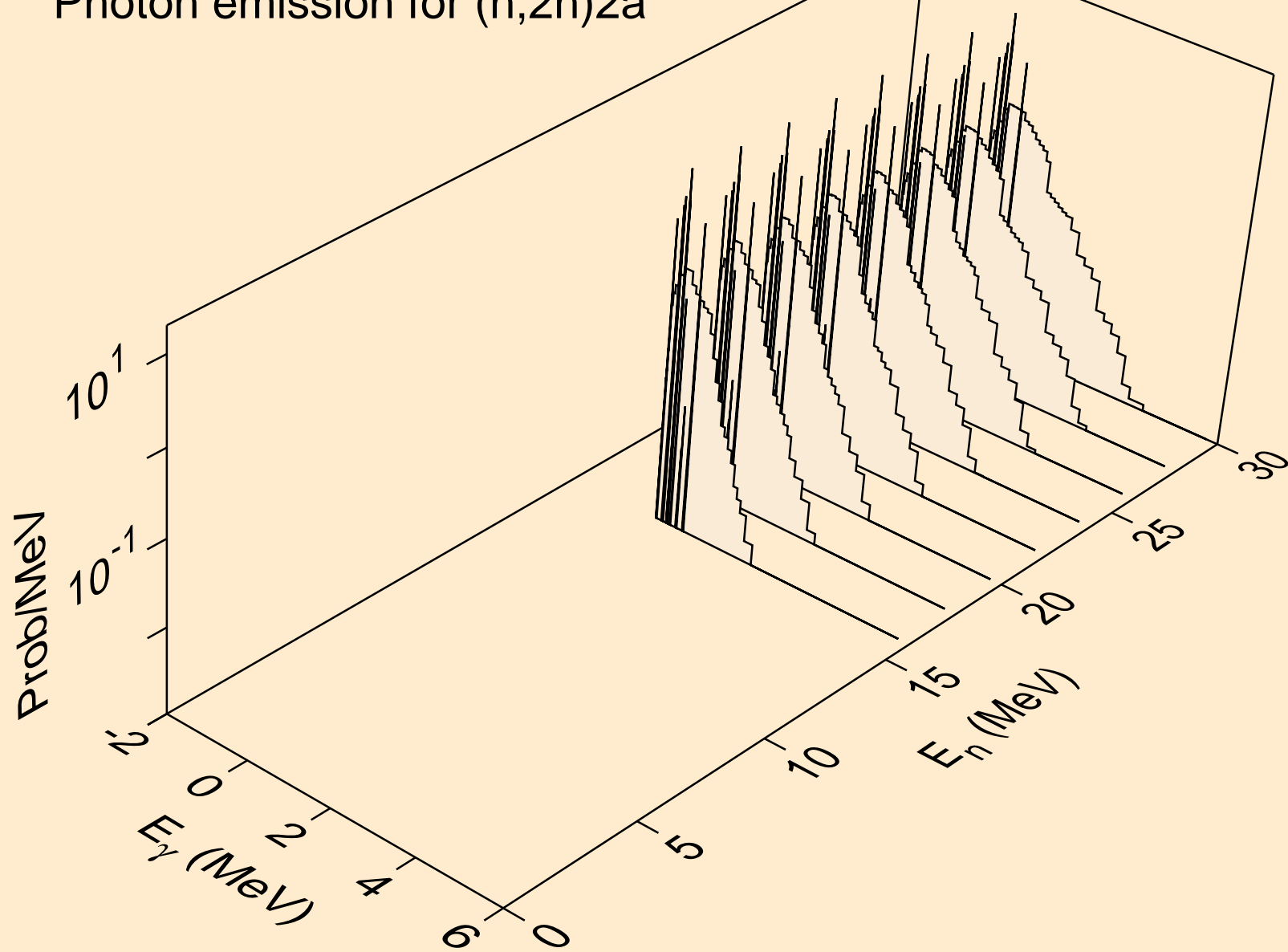

RN205M TRITON ACER TENDL-2023 LIBRARY; T=0.K  
Photon emission for (n,n\*)d

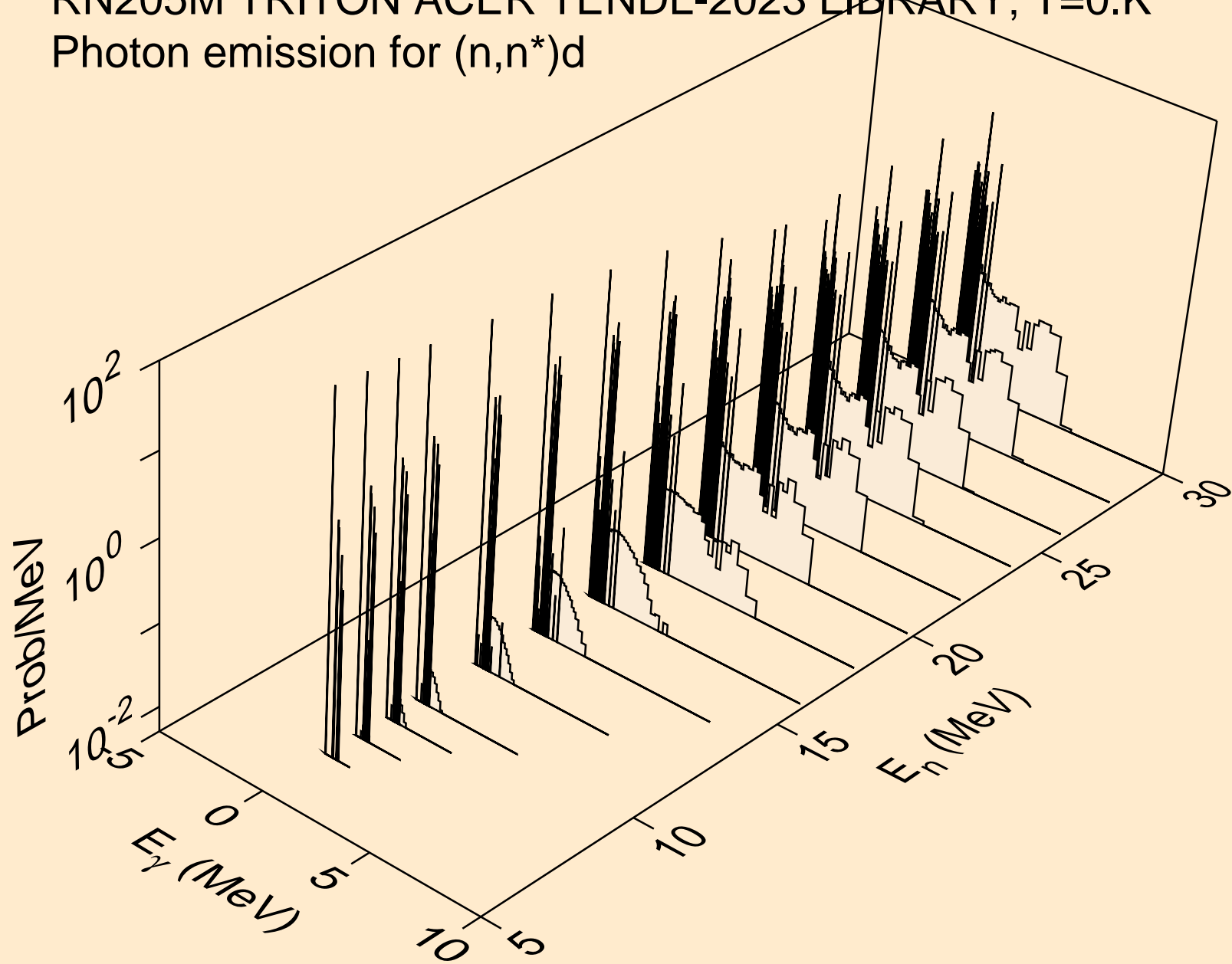

RN205M TRITON ACER TENDL-2023 LIBRARY; T=0.K  
Photon emission for (n,n\*)t

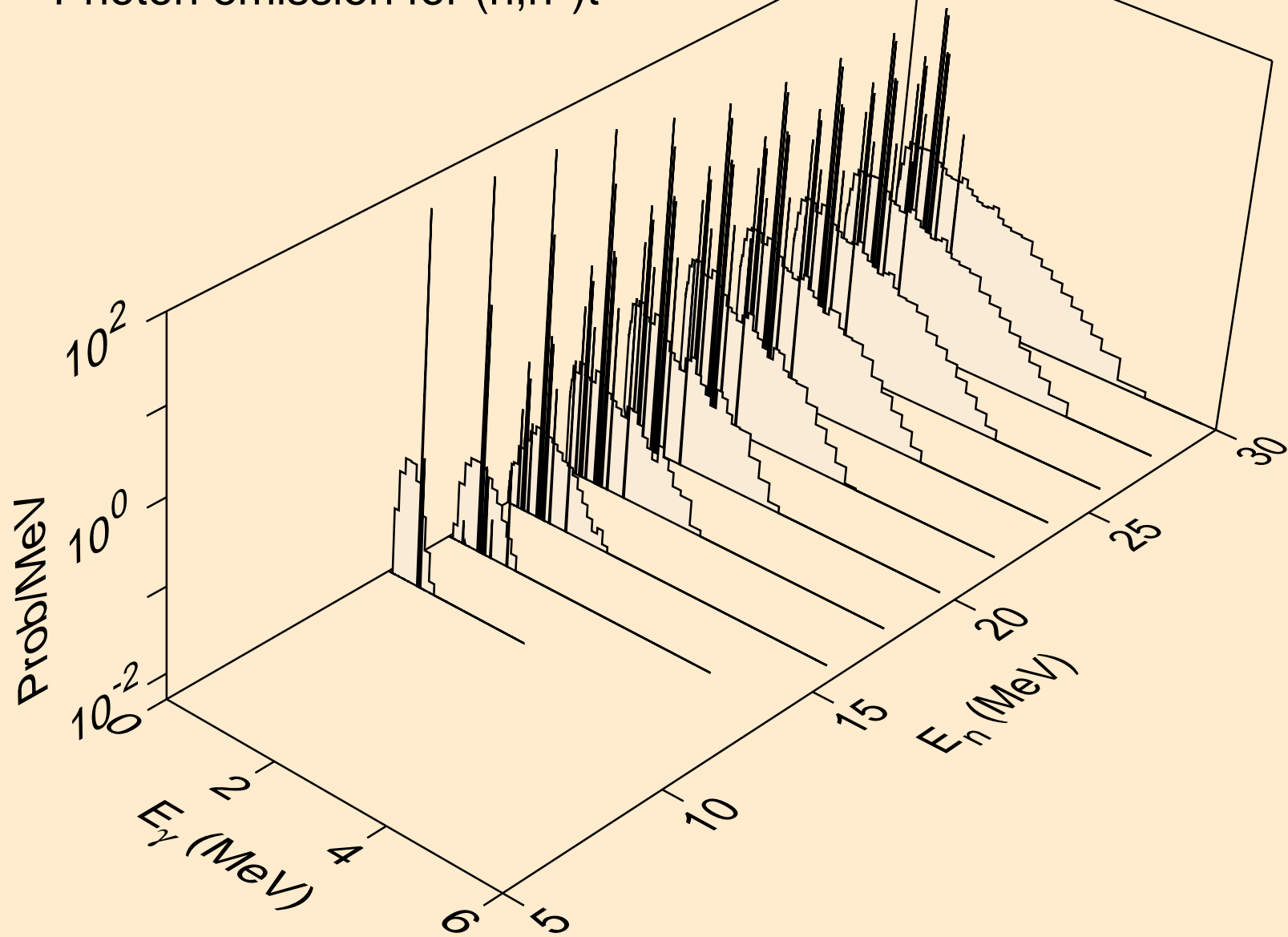

RN205M TRITON ACER TENDL-2023 LIBRARY; T=0.K  
Photon emission for (n,n\*)he3

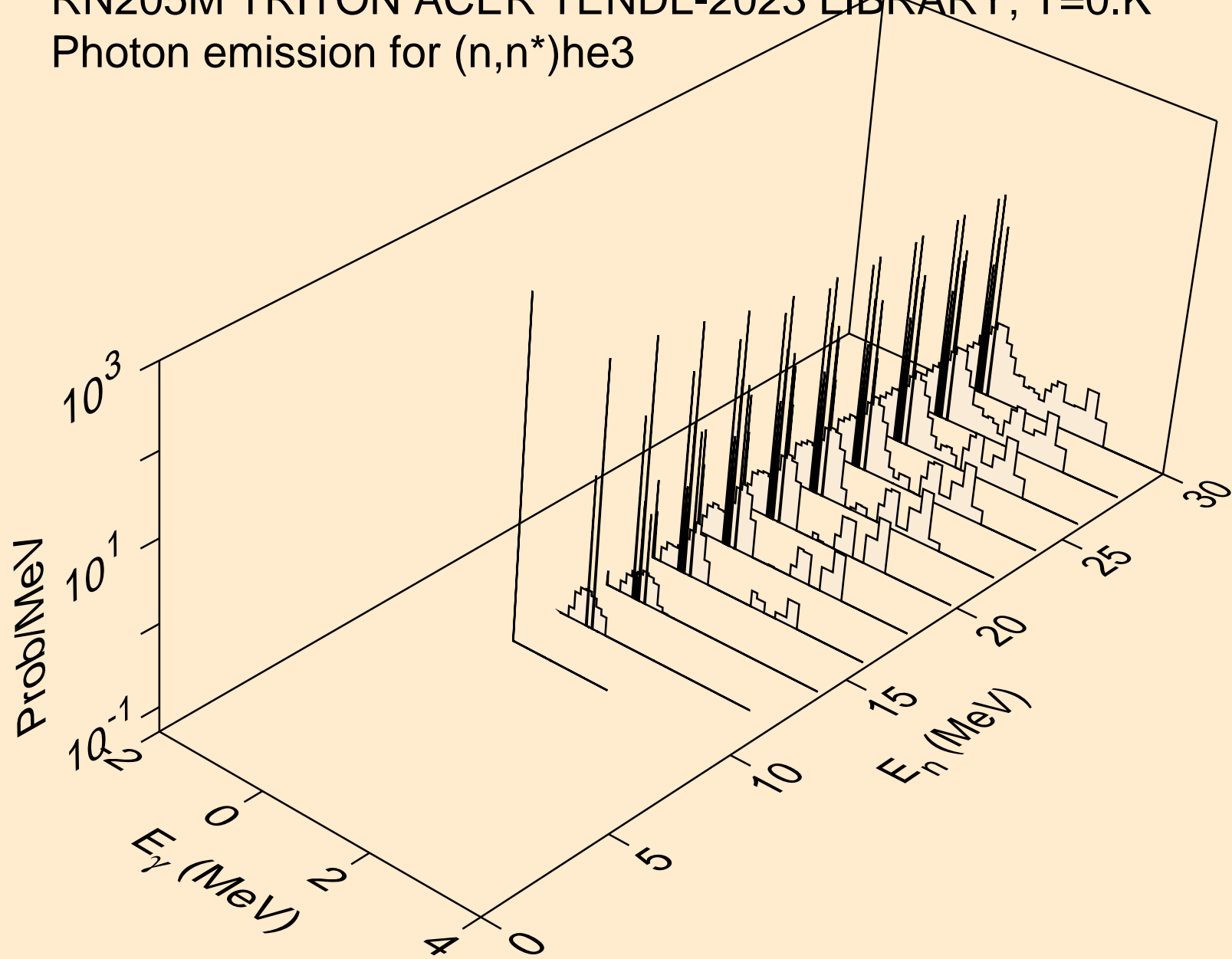

RN205M TRITON ACER TENDL-2023 LIBRARY; T=0.K  
Photon emission for (n,4n)

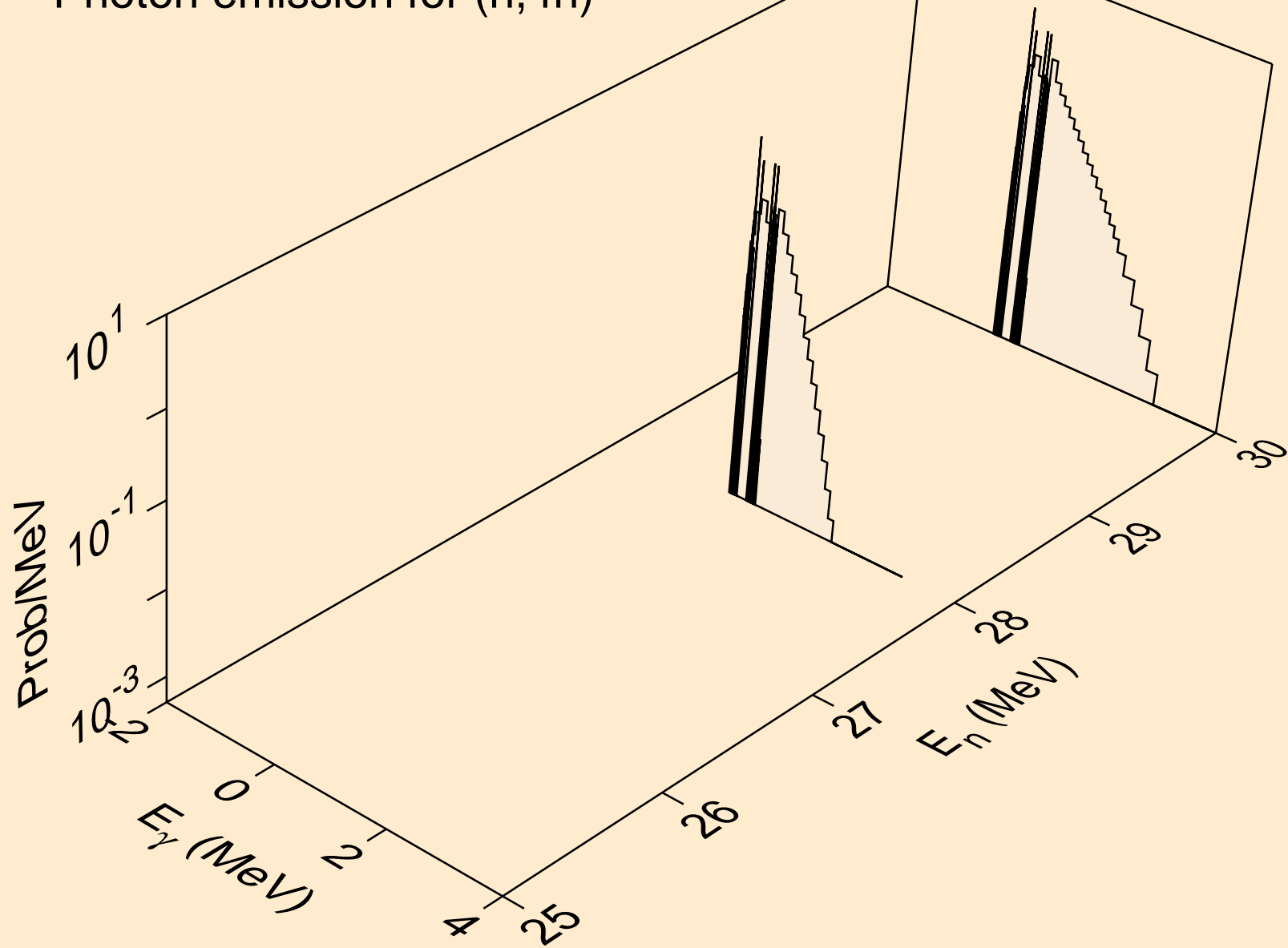

RN205M TRITON ACER TENDL-2023 LIBRARY; T=0.K  
Photon emission for (n,2np)

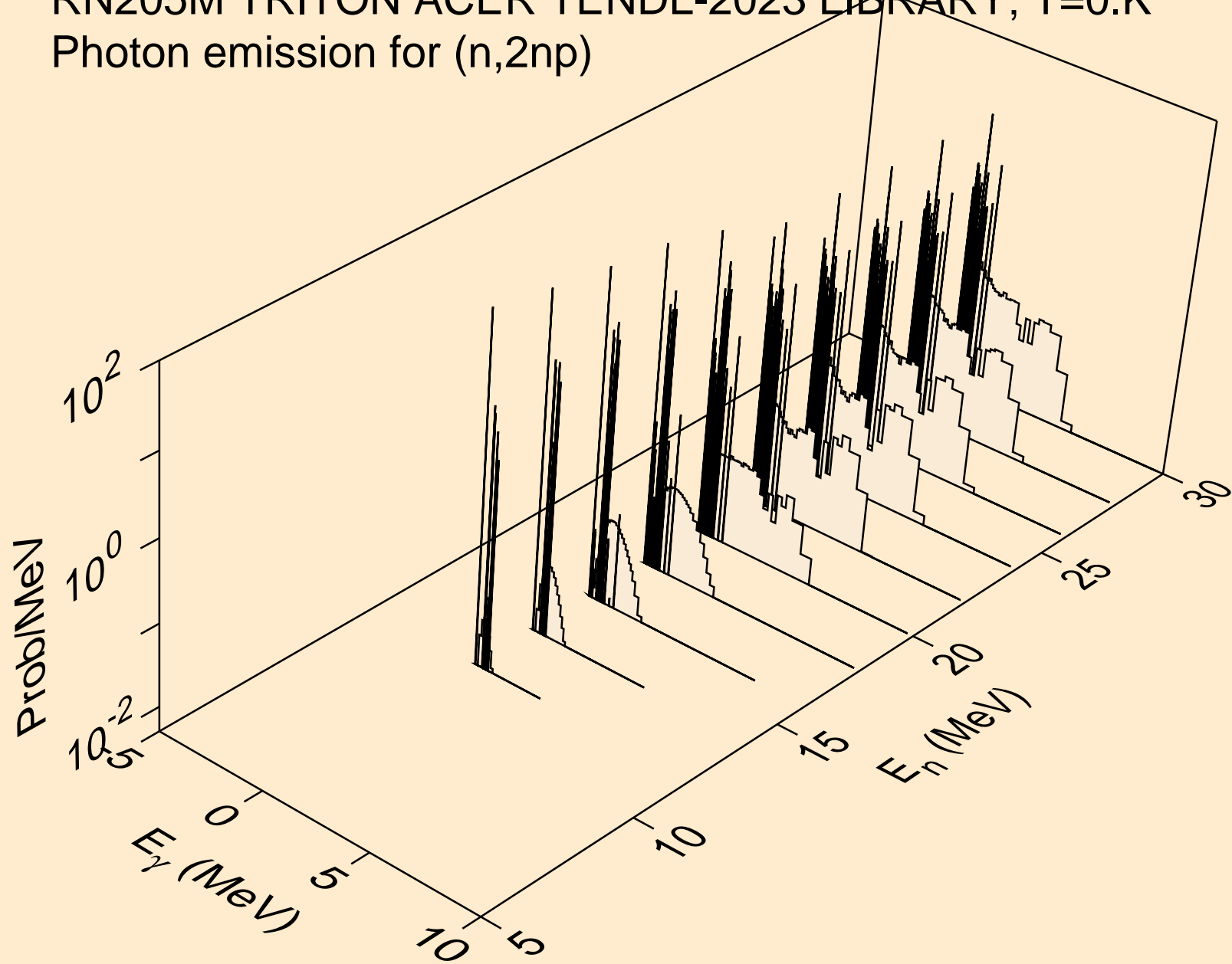

RN205M TRITON ACER TENDL-2023 LIBRARY; T=0.K  
Photon emission for (n,3np)

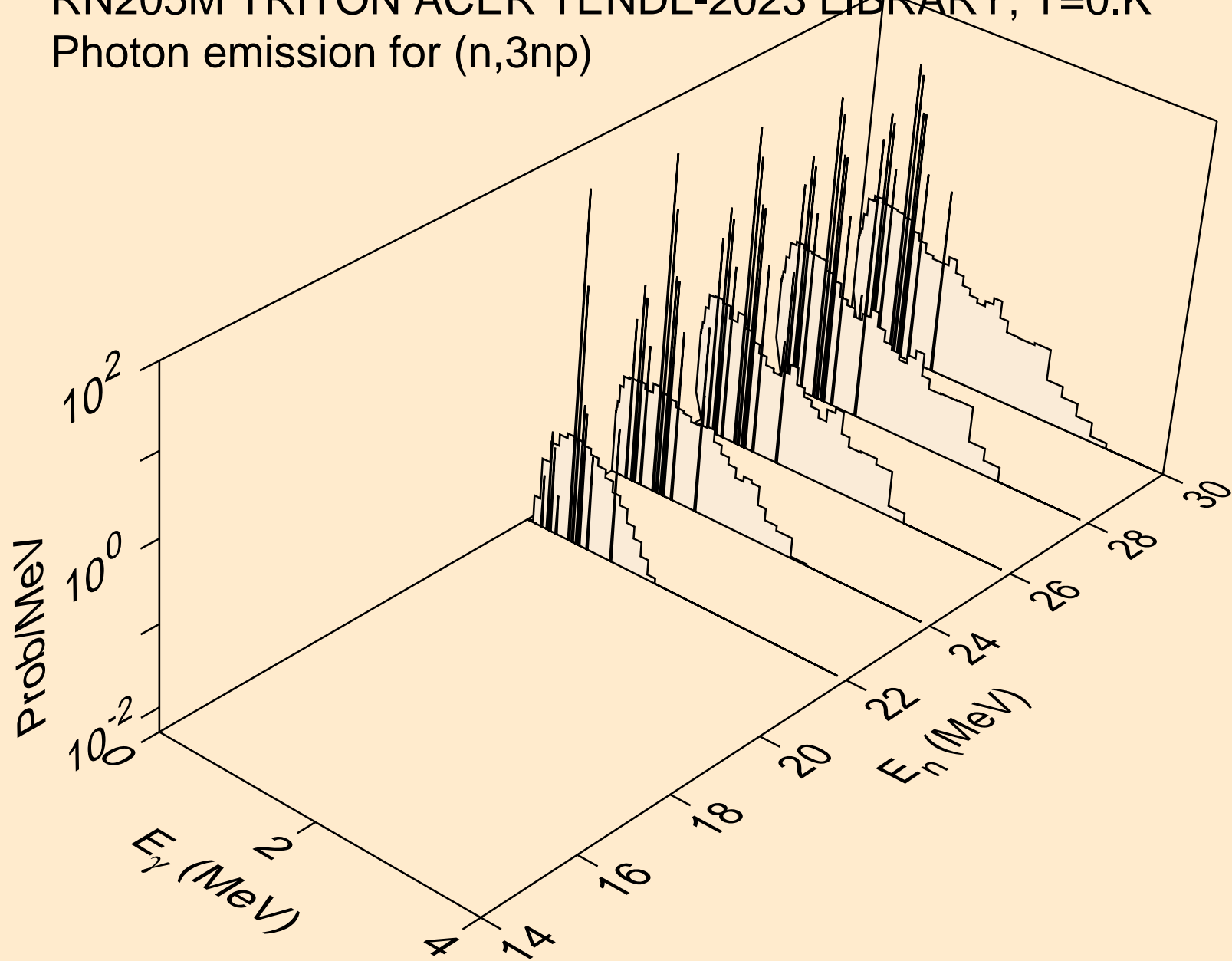

RN205M TRITON ACER TENDL-2023 LIBRARY; T=0.K  
Photon emission for (n,n2p)

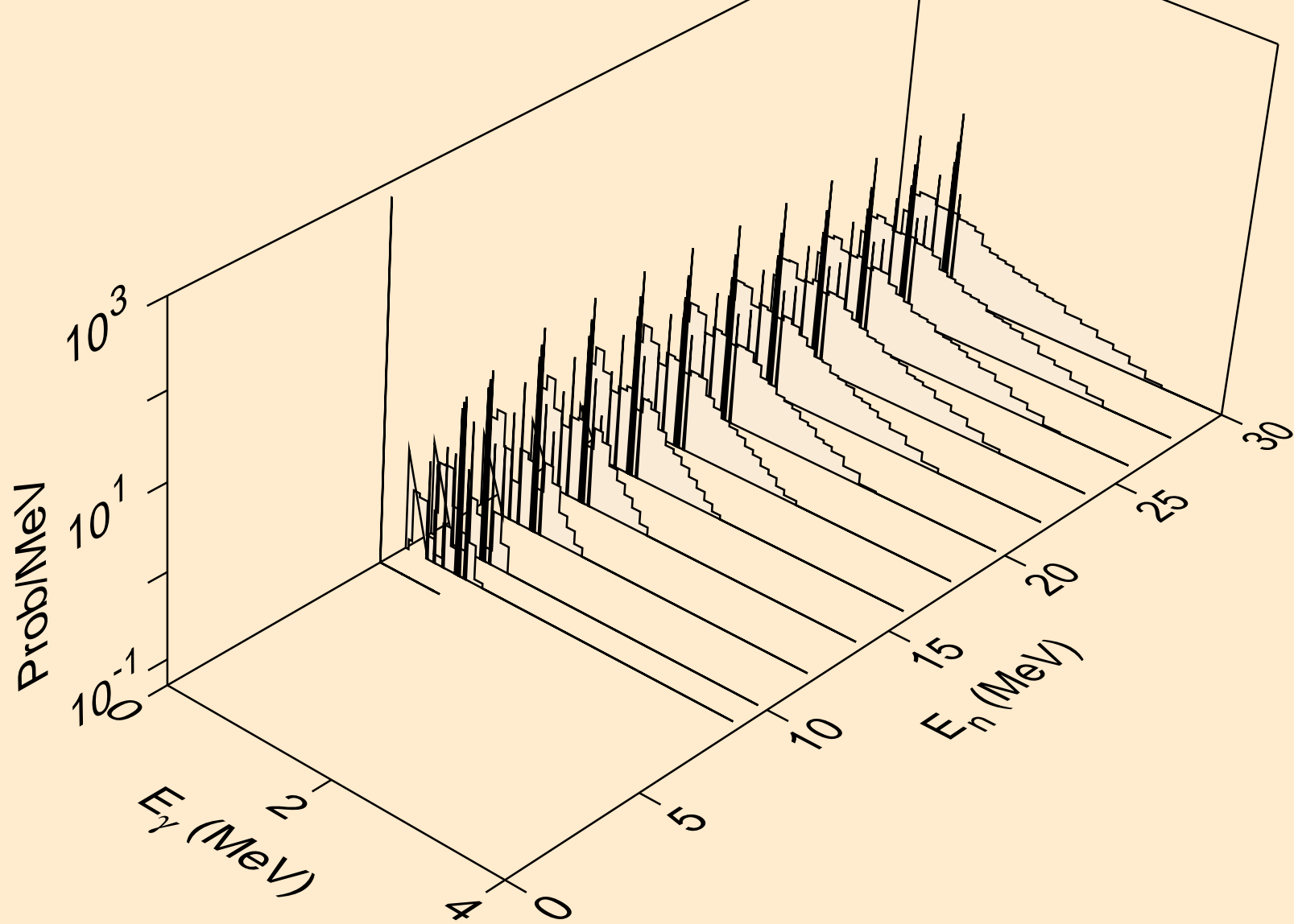

RN205M TRITON ACER TENDL-2023 LIBRARY; T=0.K  
Photon emission for (n,npa)

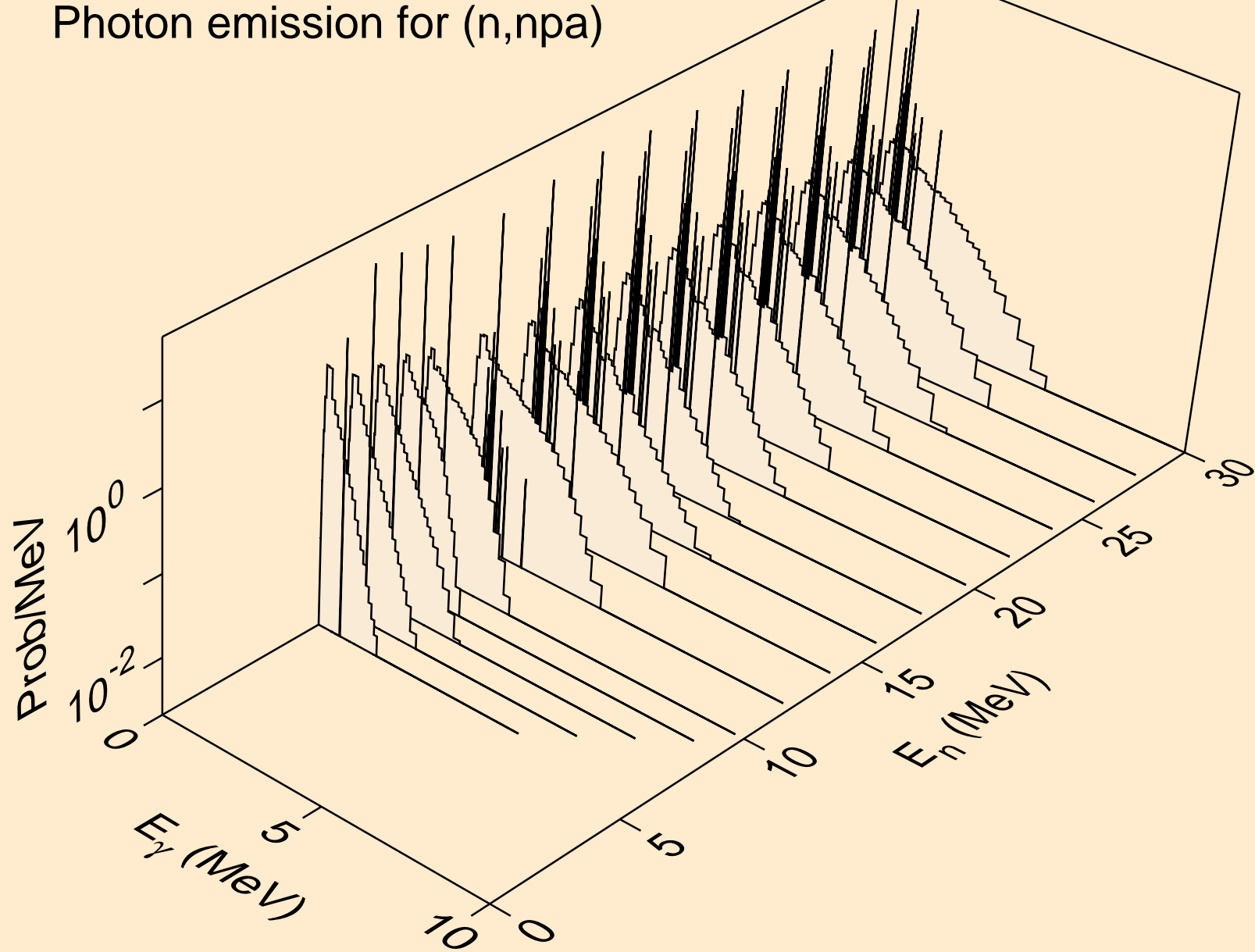

RN205M TRITON ACER TENDL-2023 LIBRARY; T=0.K  
Photon emission for (n,gma)

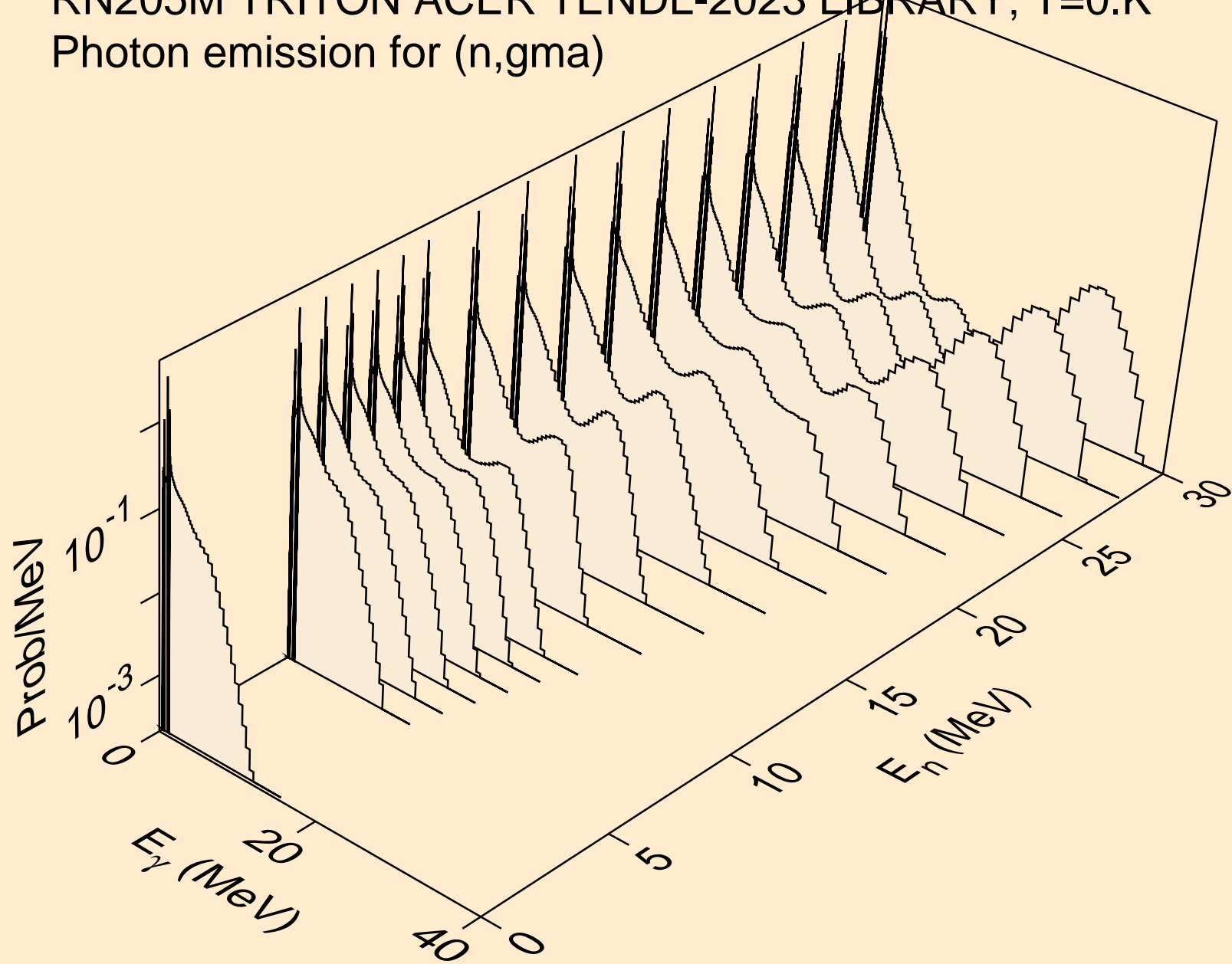

RN205M TRITON ACER TENDL-2023 LIBRARY; T=0.K  
Photon emission for (n,p)

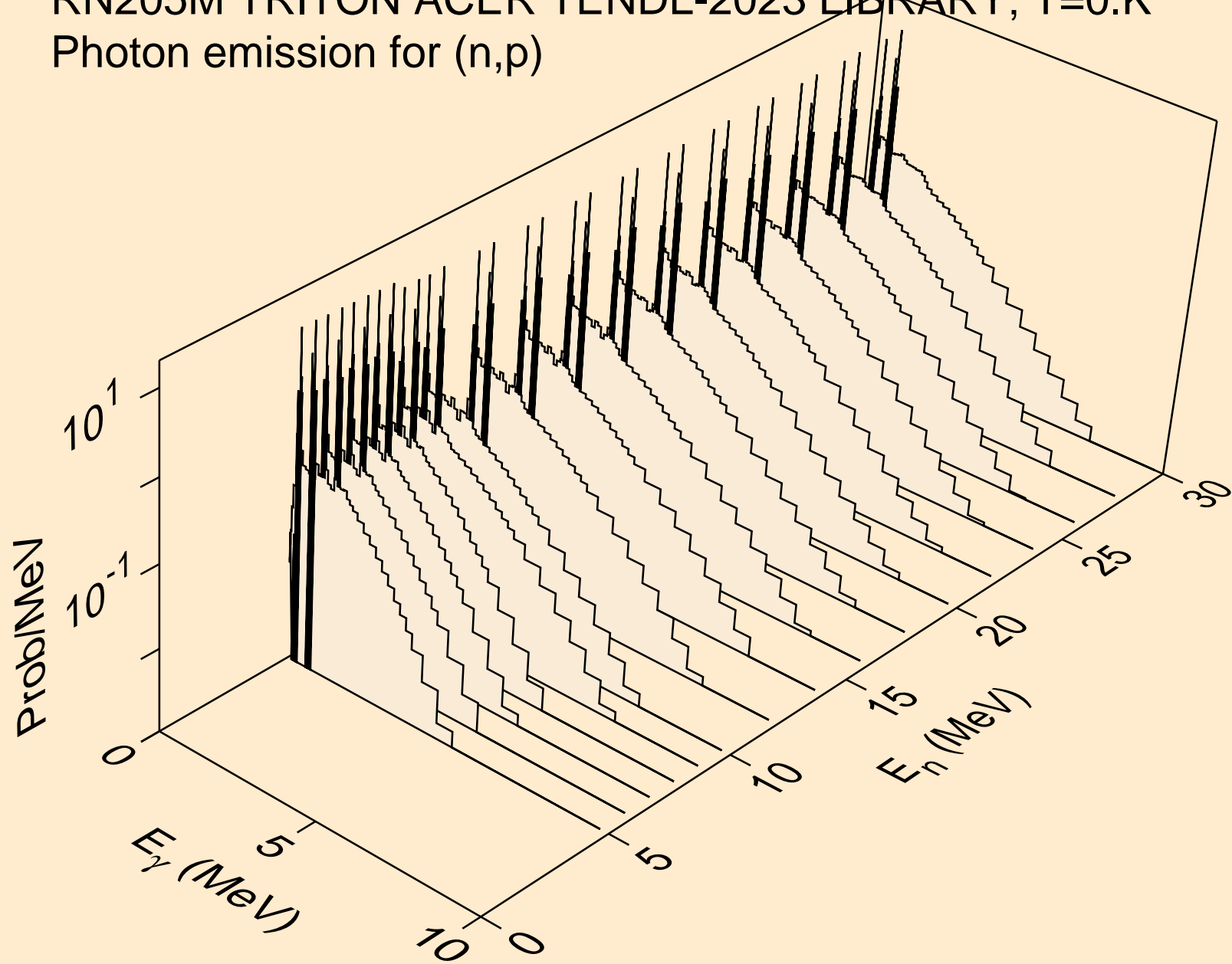

RN205M TRITON ACER TENDL-2023 LIBRARY; T=0.K  
Photon emission for (n,d)

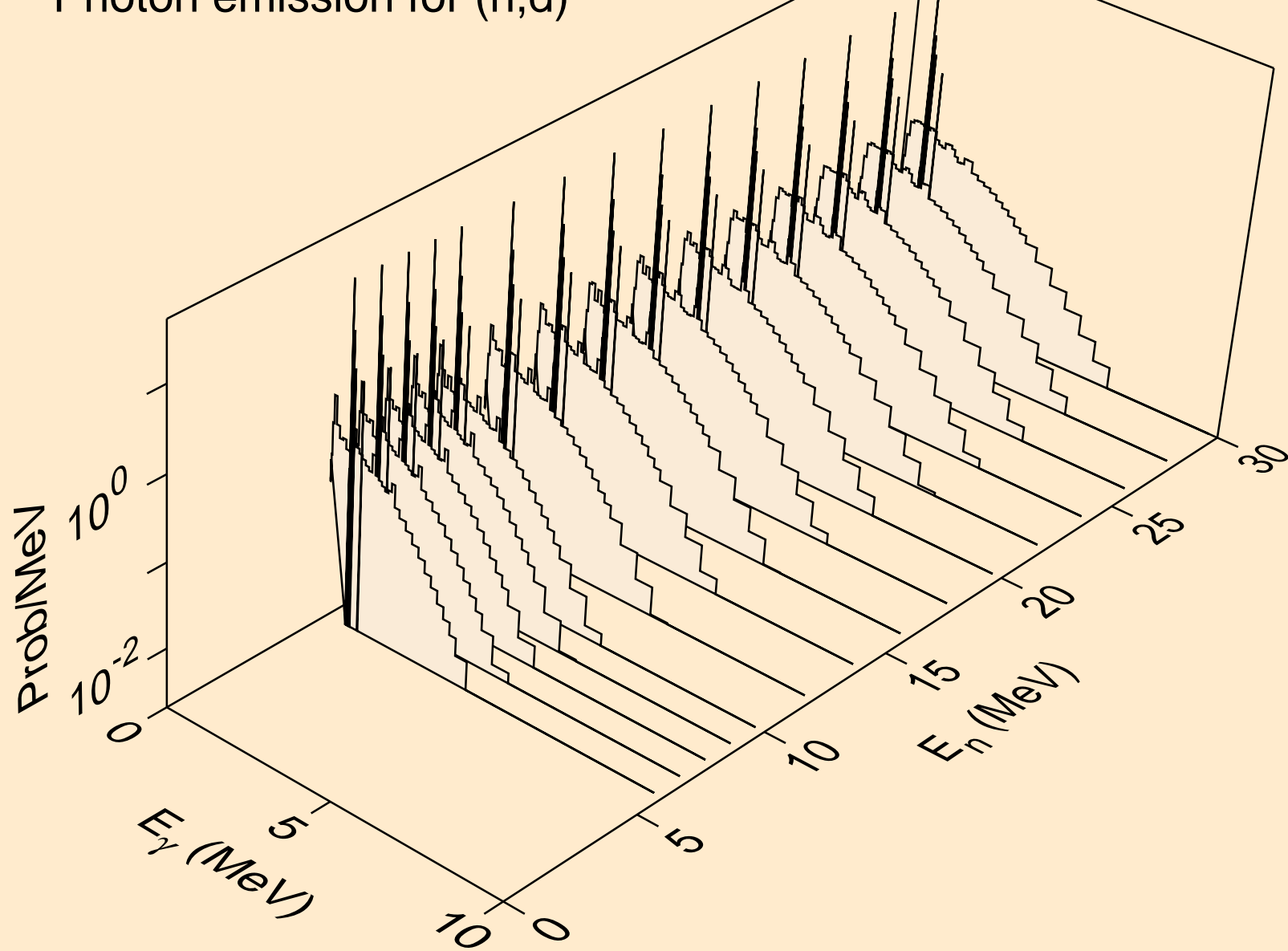

RN205M TRITON ACER TENDL-2023 LIBRARY; T=0.K  
Photon emission for inelastic

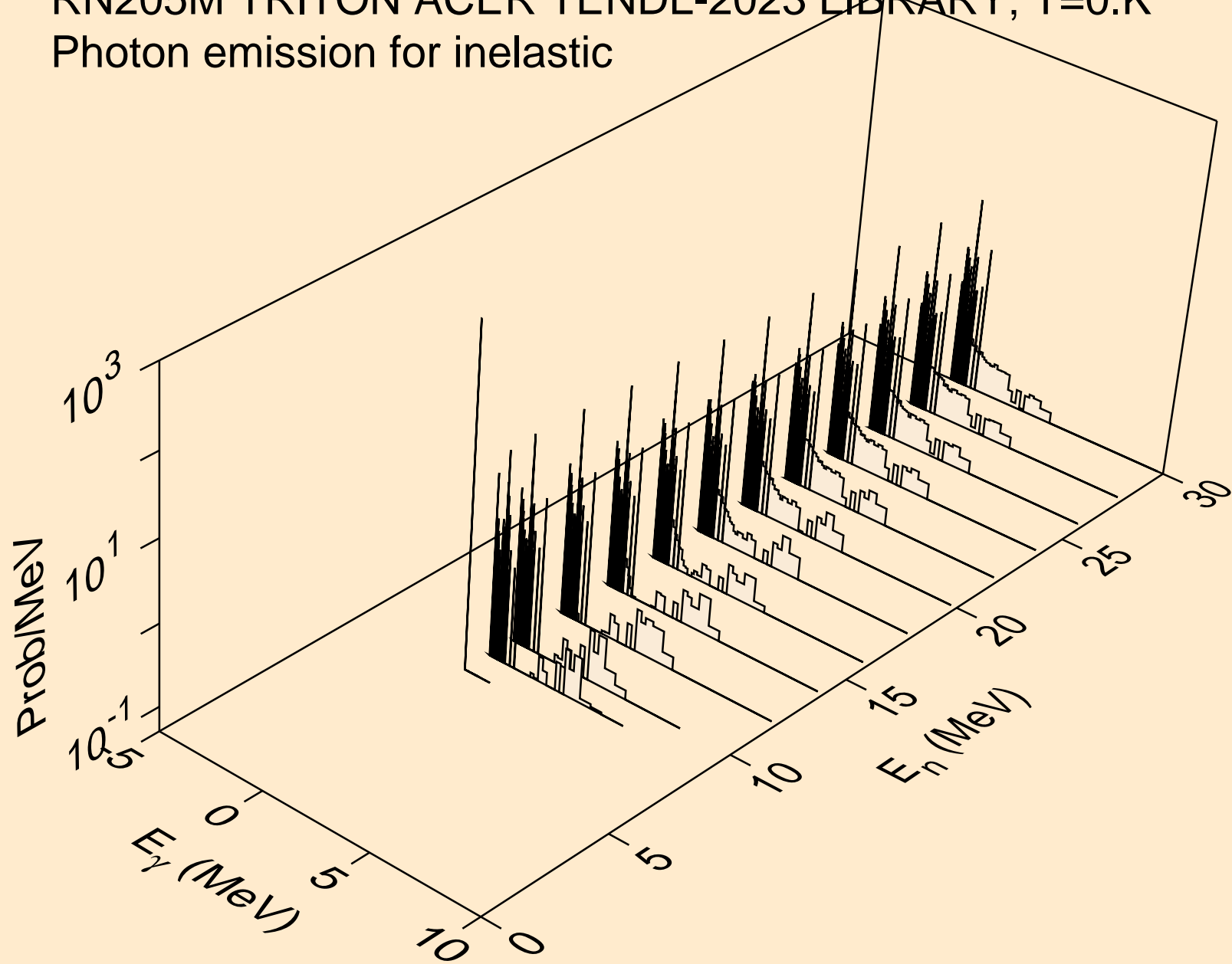

RN205M TRITON ACER TENDL-2023 LIBRARY; T=0.K  
Photon emission for (n,he3)

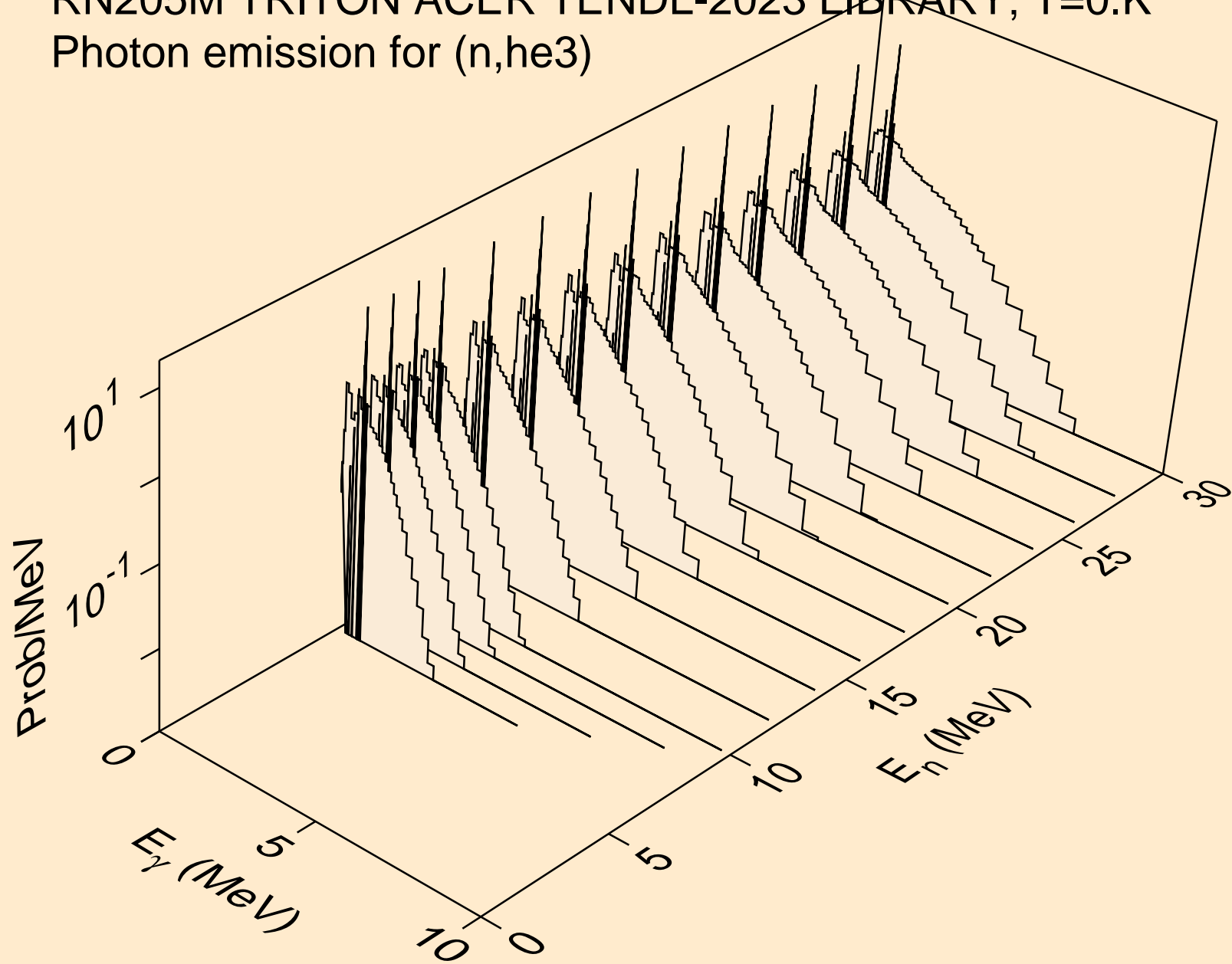

RN205M TRITON ACER TENDL-2023 LIBRARY; T=0.K  
Photon emission for (n,a)

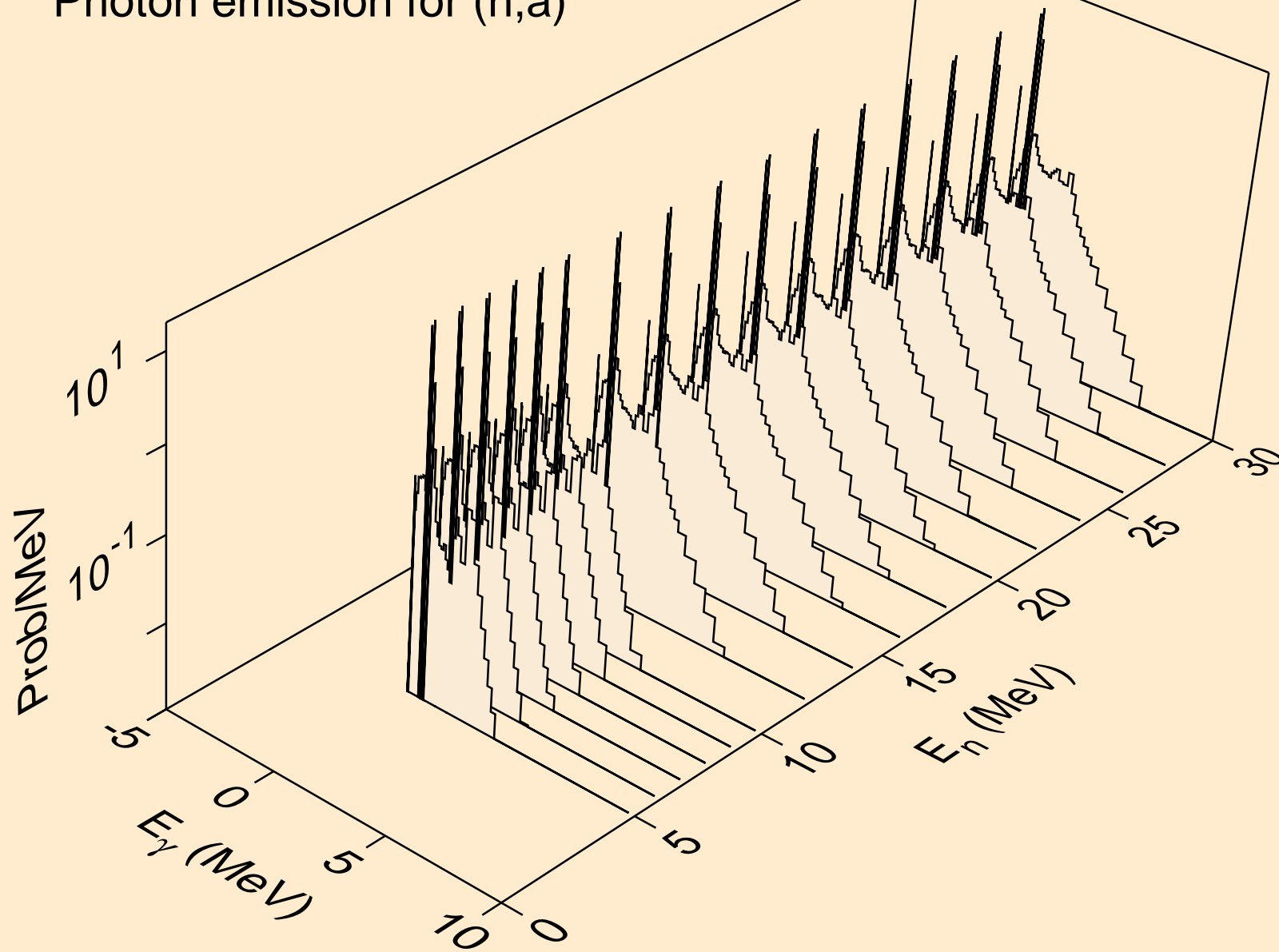

RN205M TRITON ACER TENDL-2023 LIBRARY; T=0.K  
Photon emission for (n,2a)

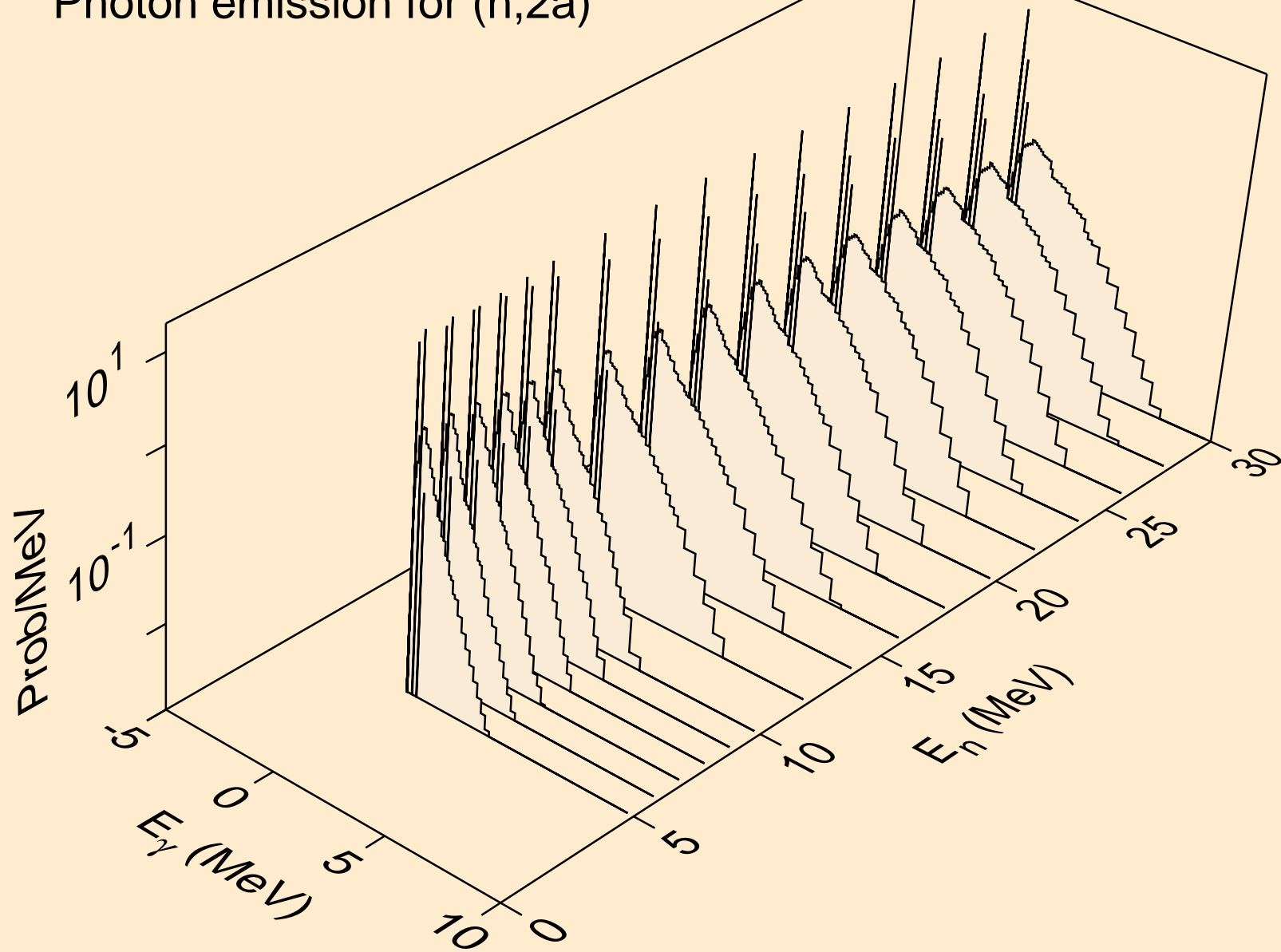

RN205M TRITON ACER TENDL-2023 LIBRARY; T=0.K  
Photon emission for (n,2p)

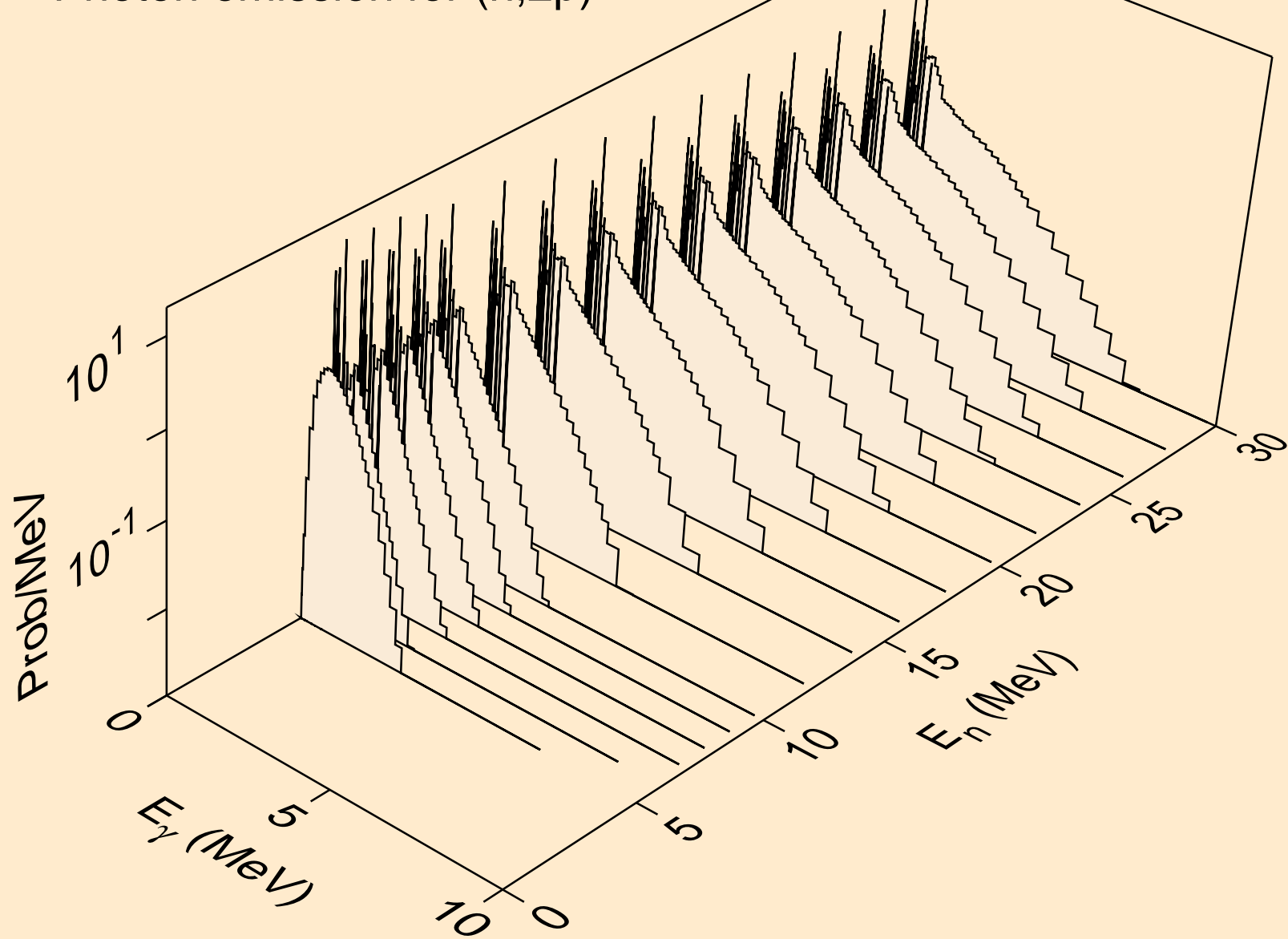

RN205M TRITON ACER TENDL-2023 LIBRARY; T=0.K  
Photon emission for (n,pa)

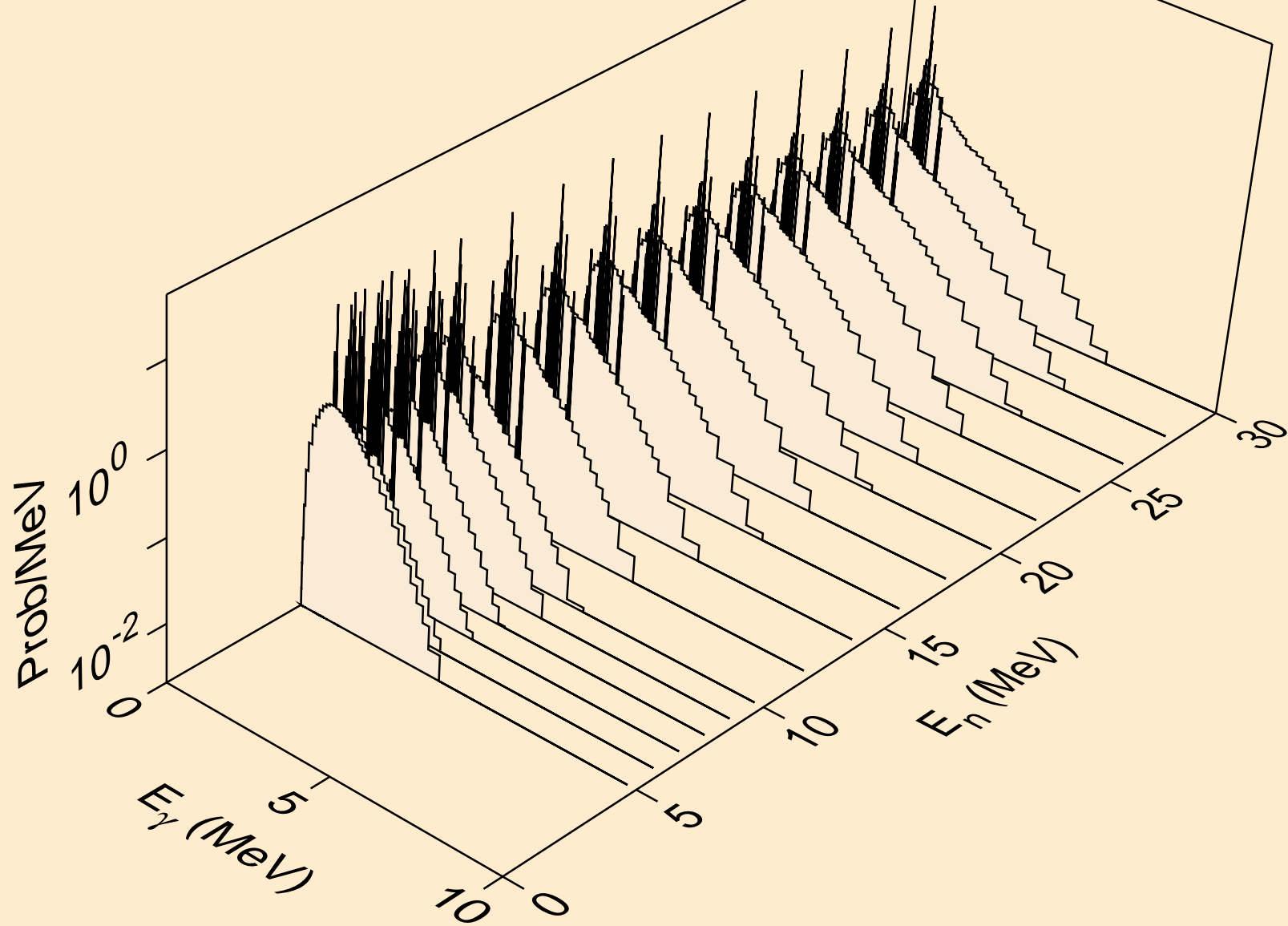

RN205M TRITON ACER TENDL-2023 LIBRARY; T=0.K  
Photon emission for (n,pd)

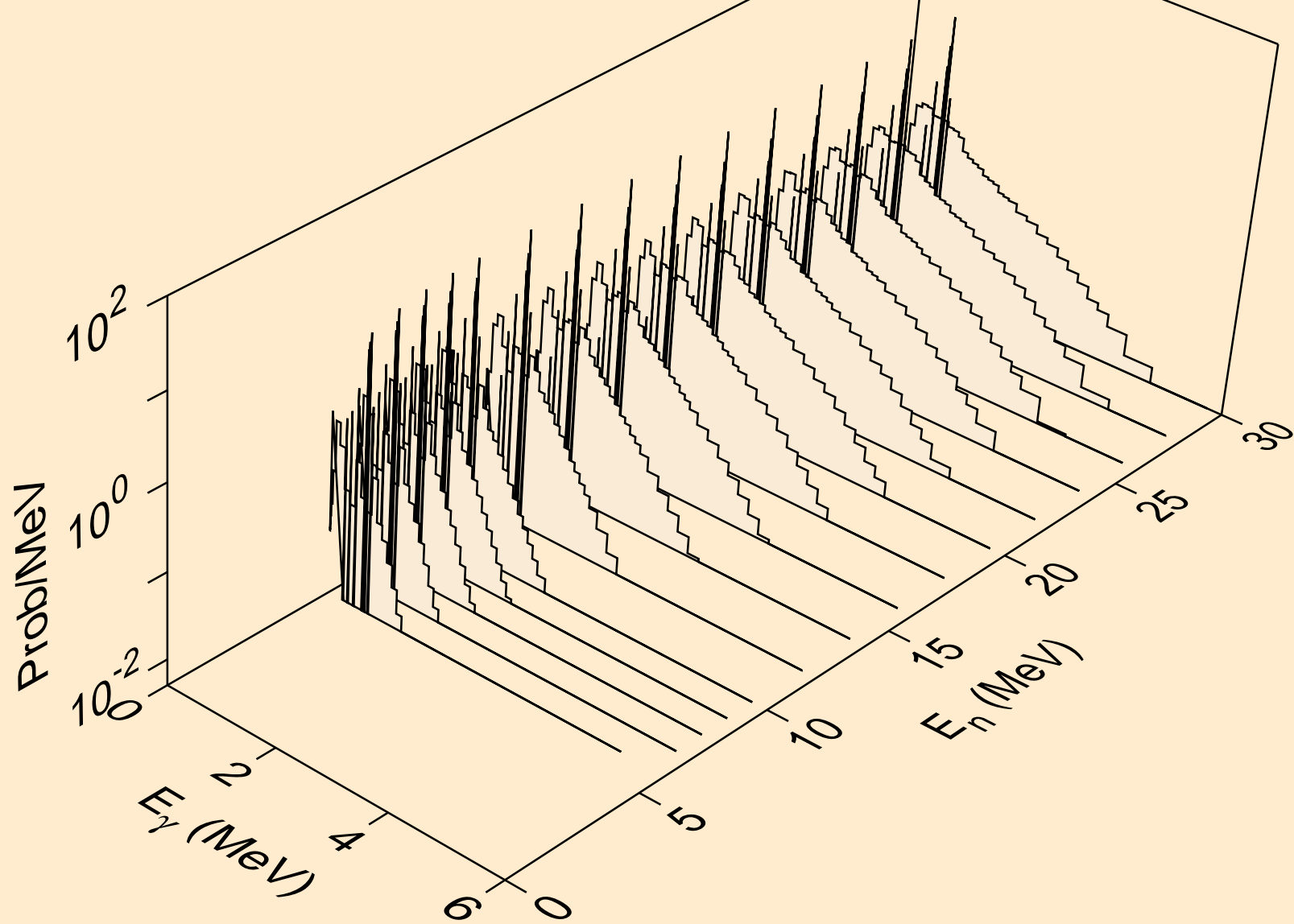

RN205M TRITON ACER TENDL-2023 LIBRARY; T=0.K  
Photon emission for (n,pt)

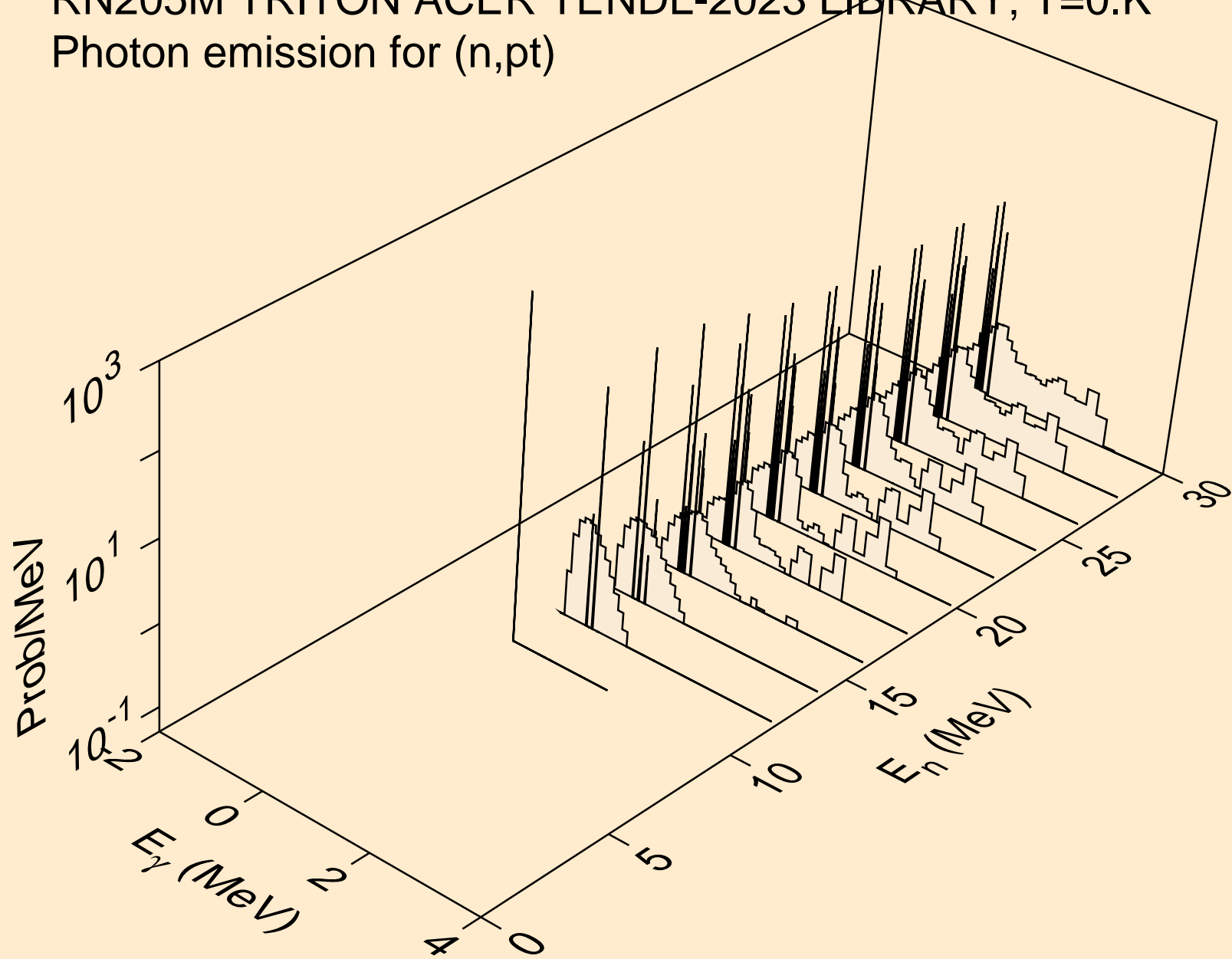

RN205M TRITON ACER TENDL-2023 LIBRARY; T=0.K  
Photon emission for (n,da)

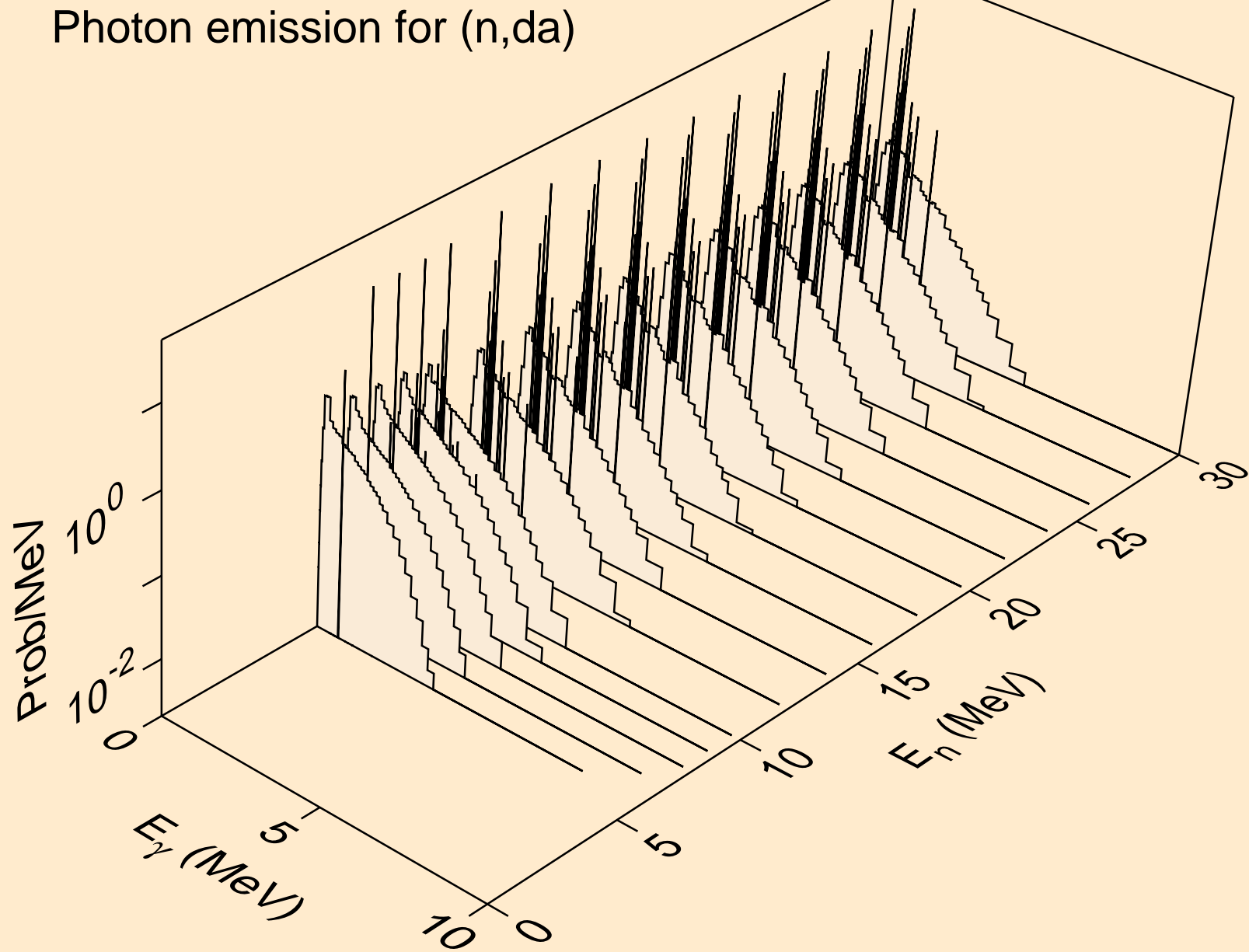

RN205M TRITON ACER TENDL-2023 LIBRARY; T=0.K  
Particle heating contributions

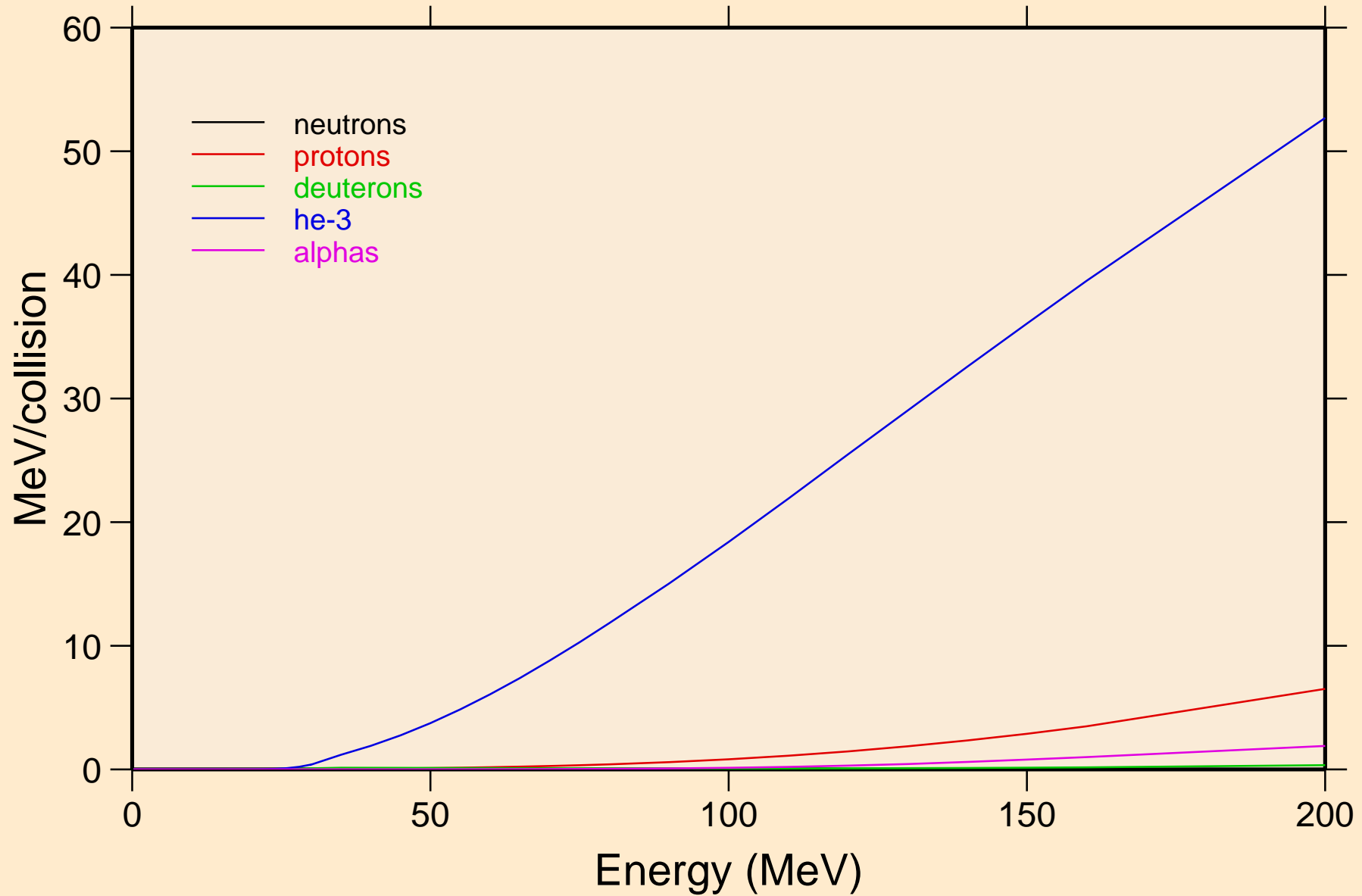

RN205M TRITON ACER TENDL-2023 LIBRARY; T=0.K  
Recoil Heating

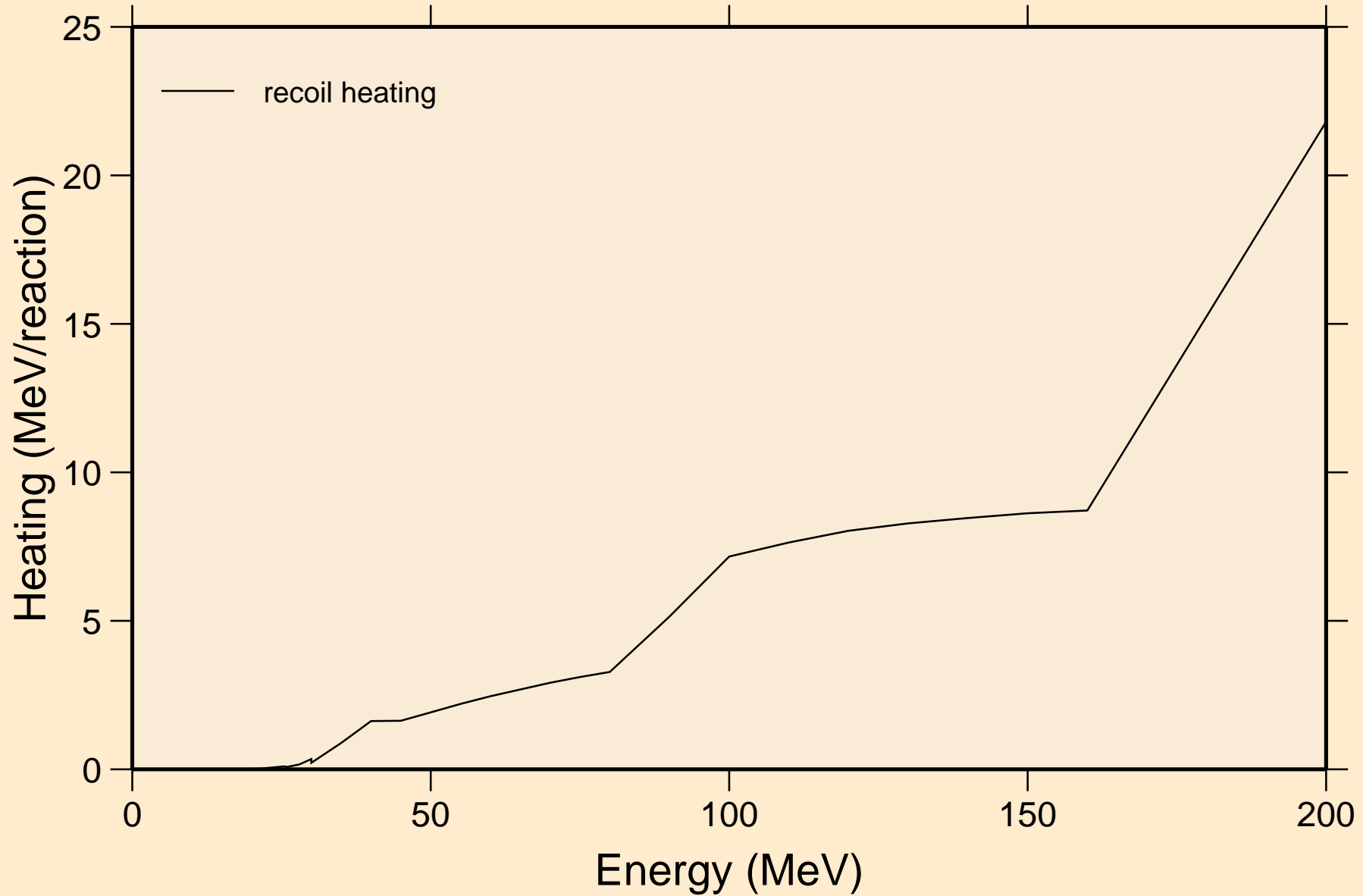

RN205M TRITON ACER TENDL-2023 LIBRARY; T=0.K  
Particle production cross sections

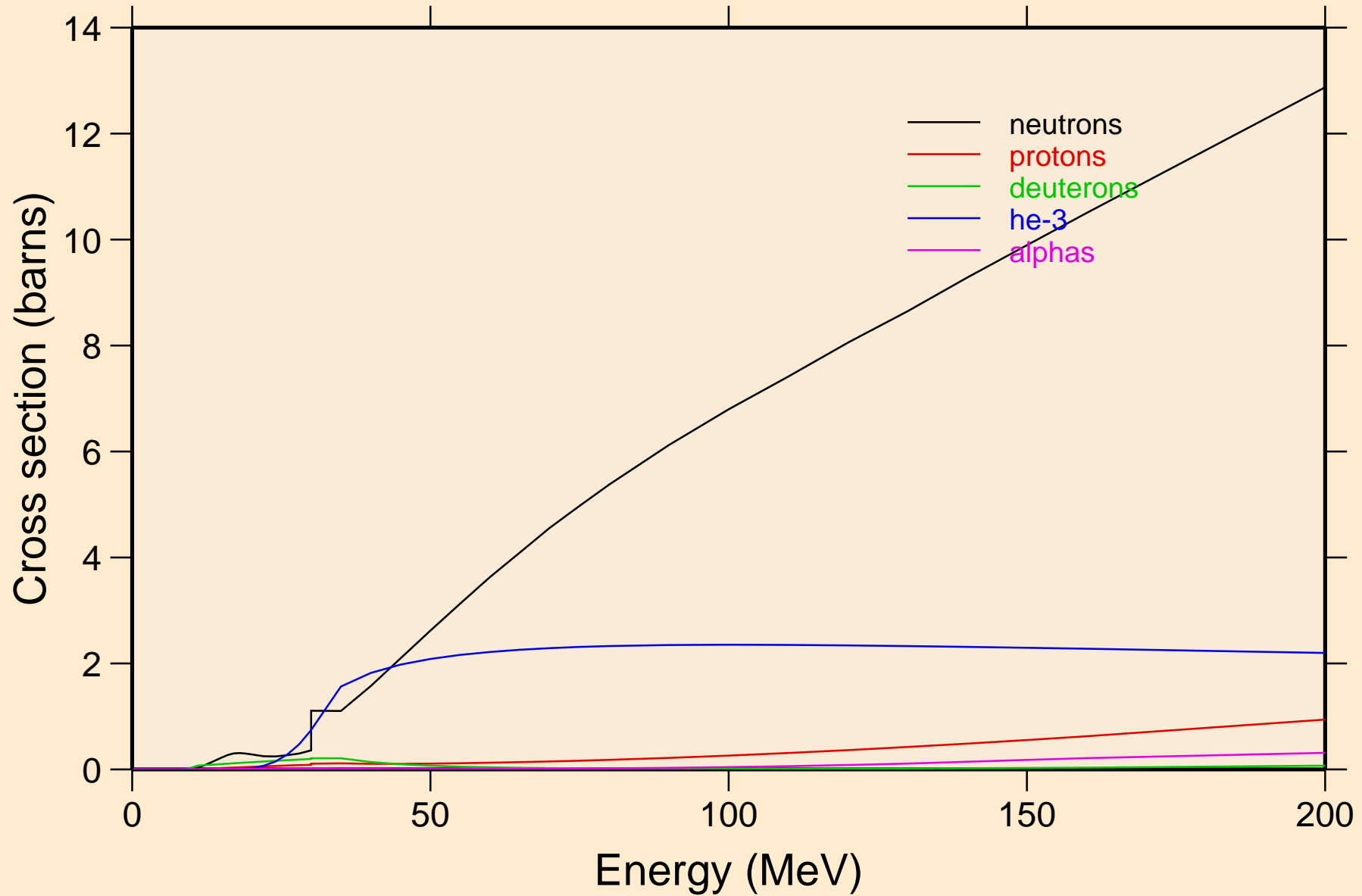

RN205M TRITON ACER TENDL-2023 LIBRARY; T=0.K  
neutrons from (t,n)

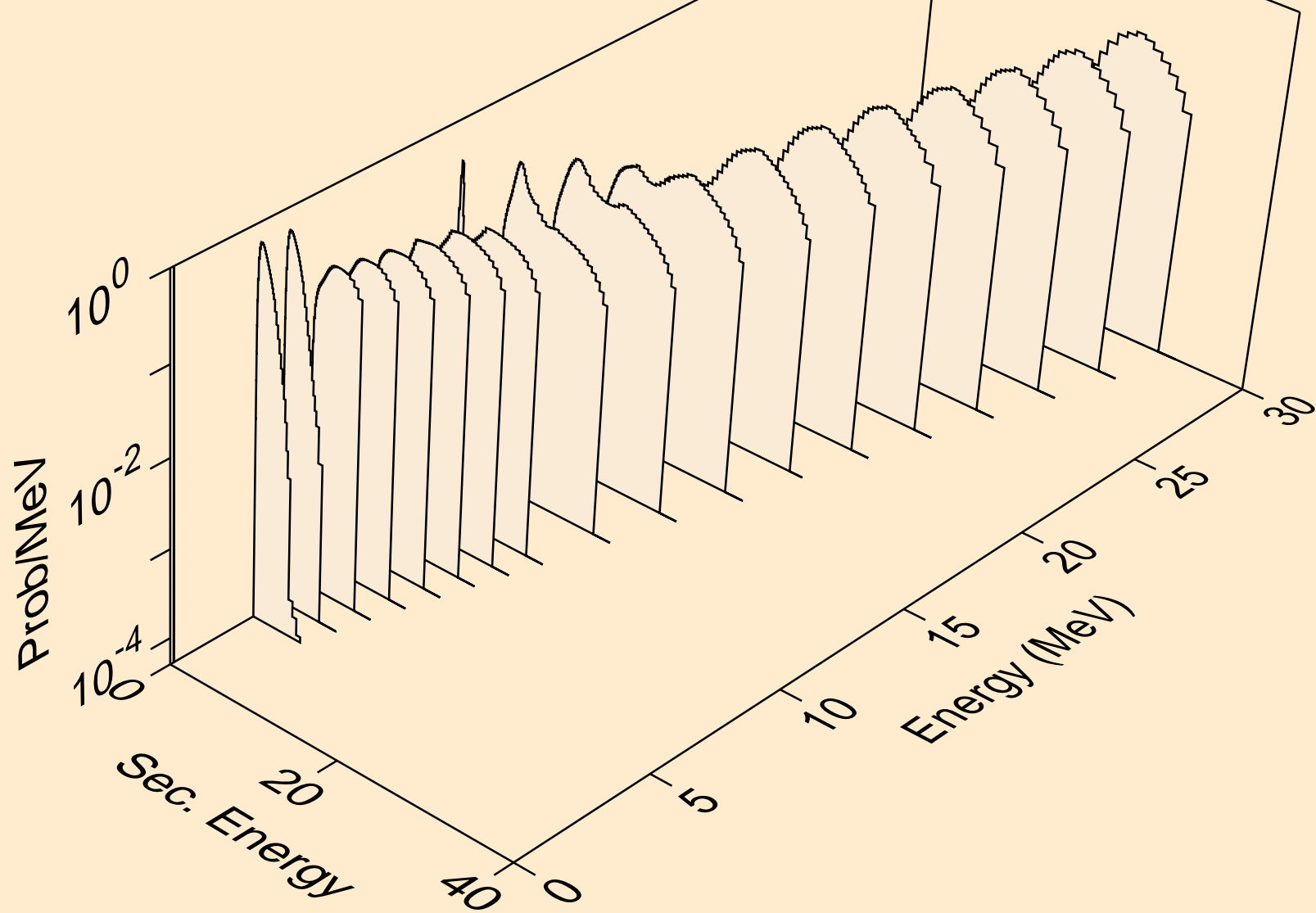

RN205M TRITON ACER TENDL-2023 LIBRARY; T=0.K  
neutrons from (t,x)

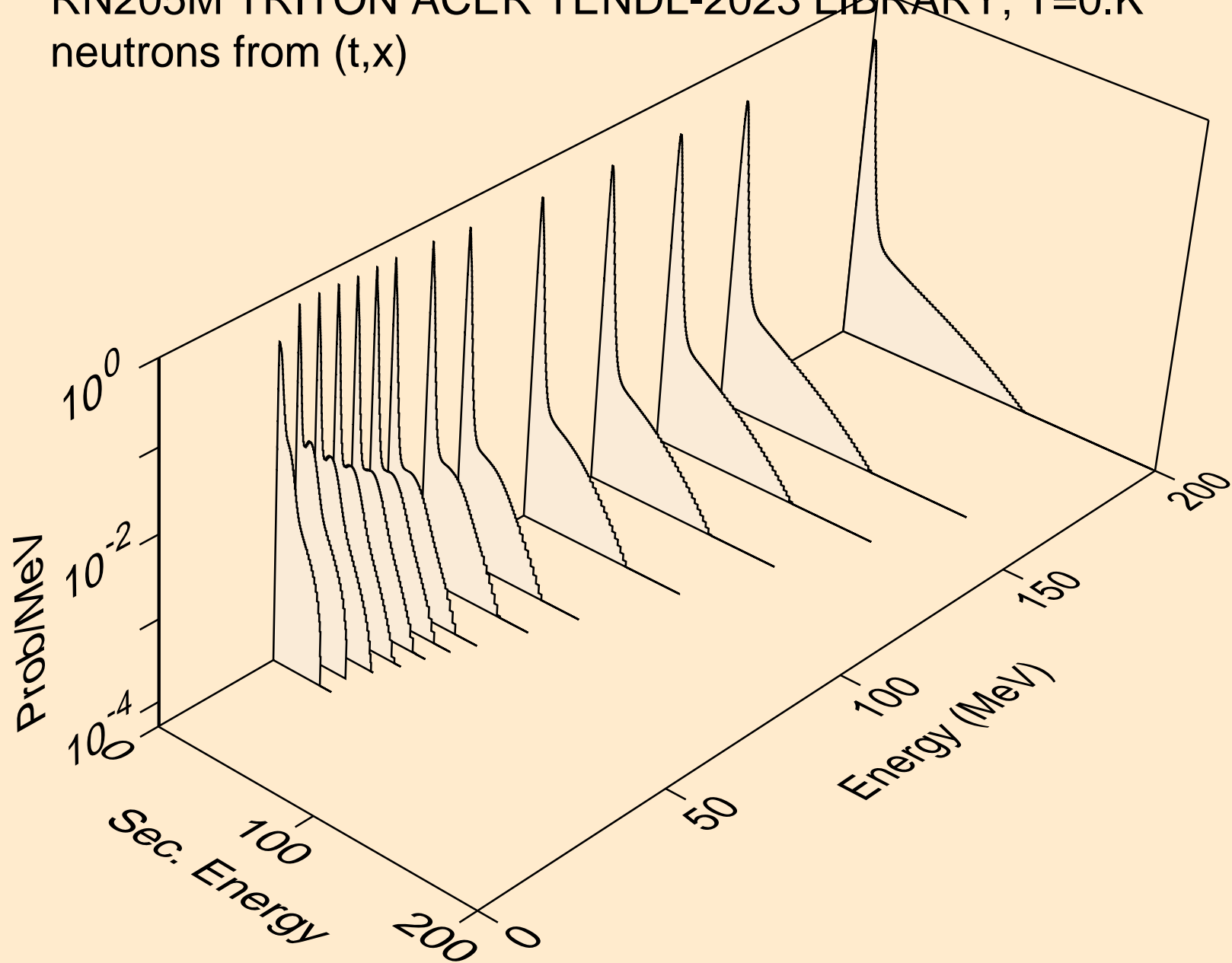

RN205M TRITON ACER TENDL-2023 LIBRARY; T=0.K  
neutrons from (t,2nd)

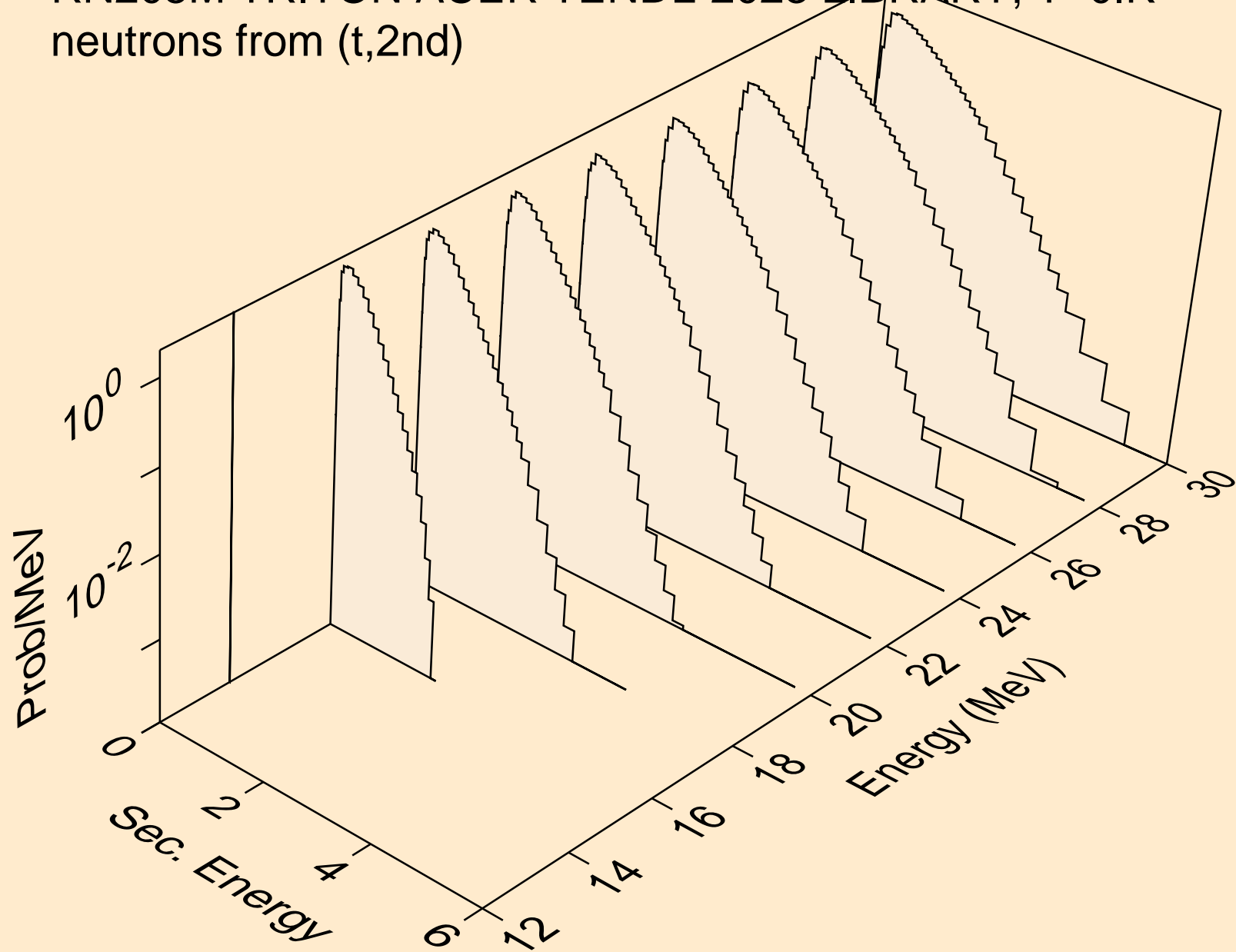

RN205M TRITON ACER TENDL-2023 LIBRARY; T=0.K  
neutrons from (t,2n)

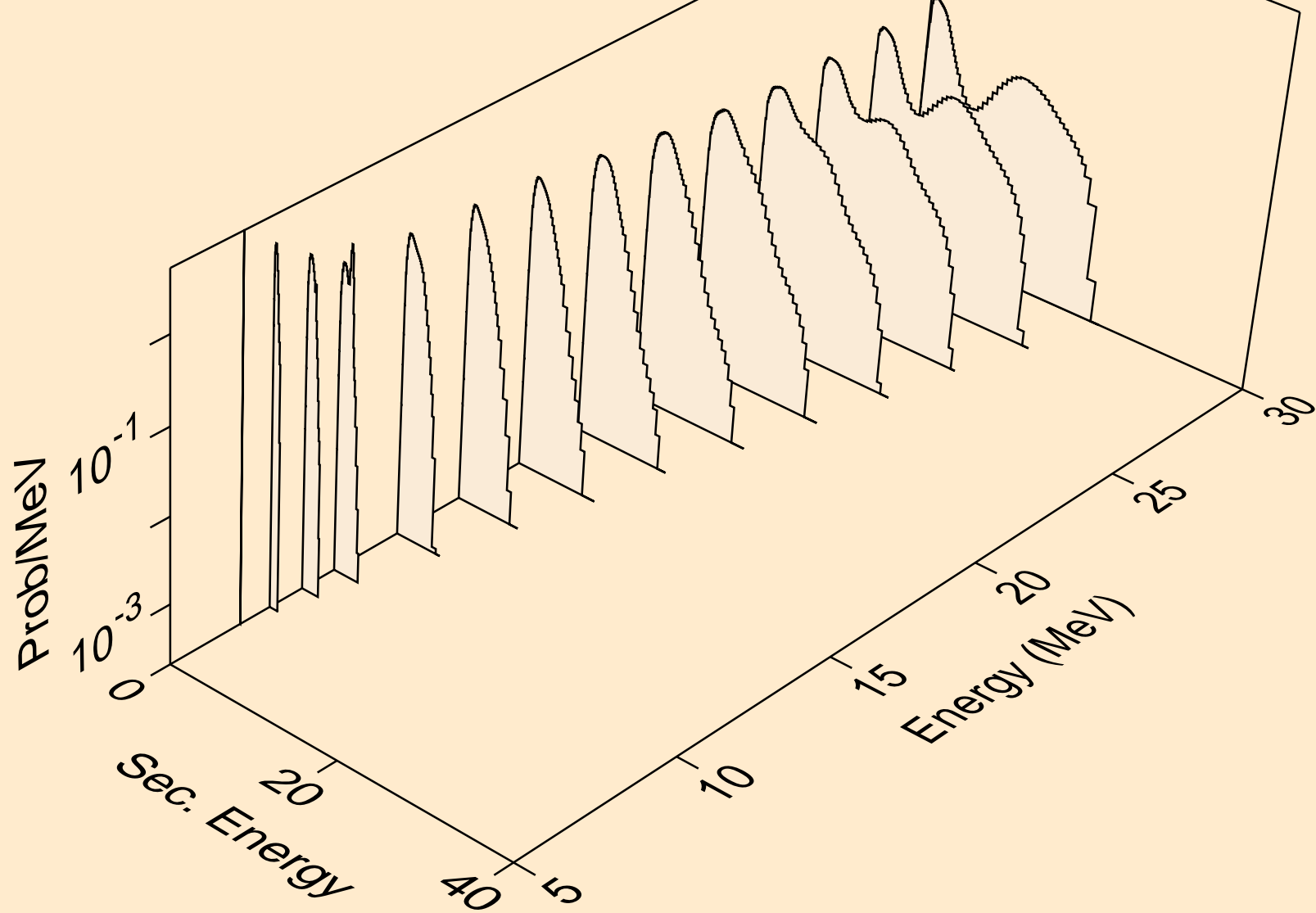

RN205M TRITON ACER TENDL-2023 LIBRARY; T=0.K  
neutrons from (t,3n)

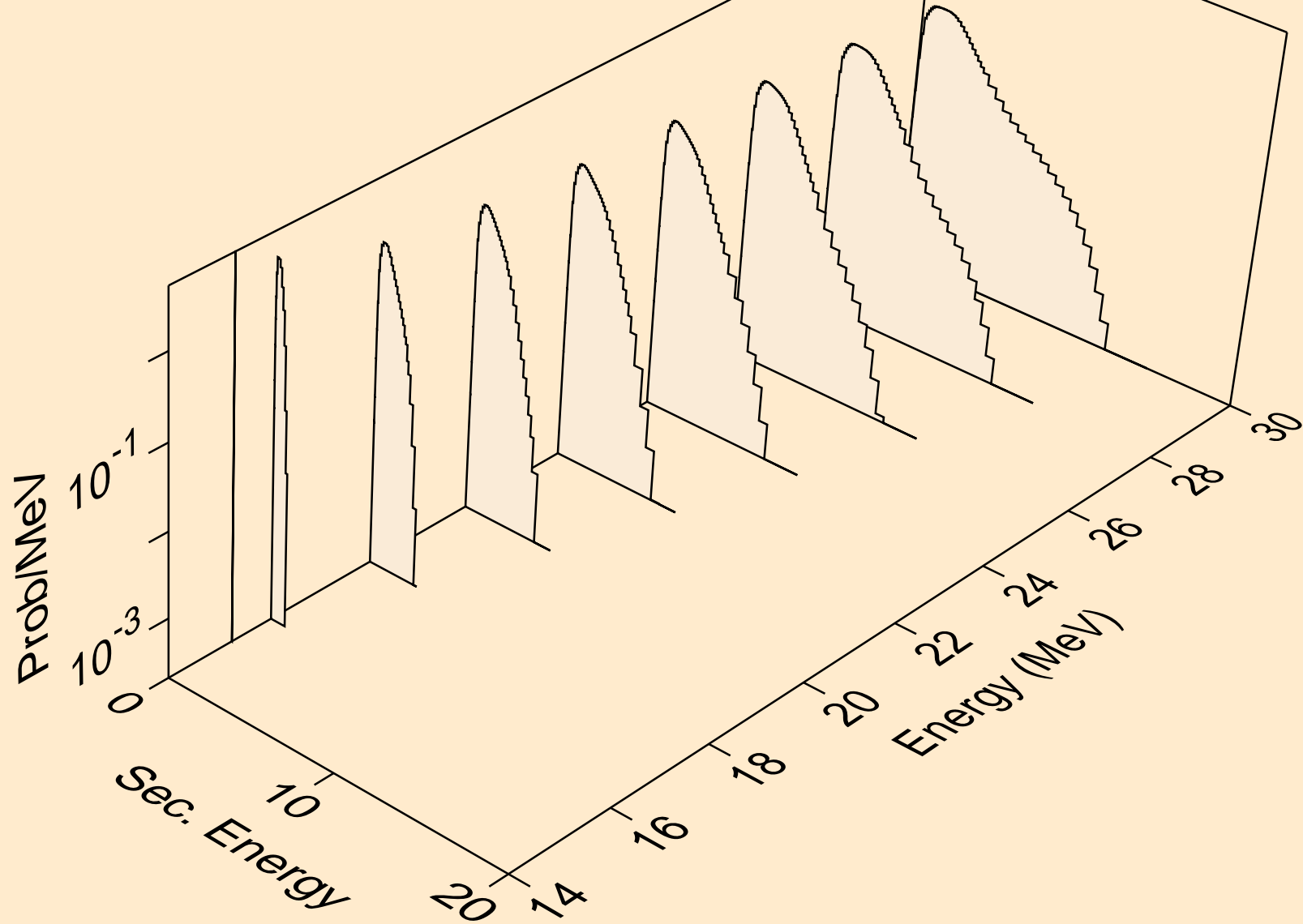

RN205M TRITON ACER TENDL-2023 LIBRARY; T=0.K  
neutrons from (t,n\*)a

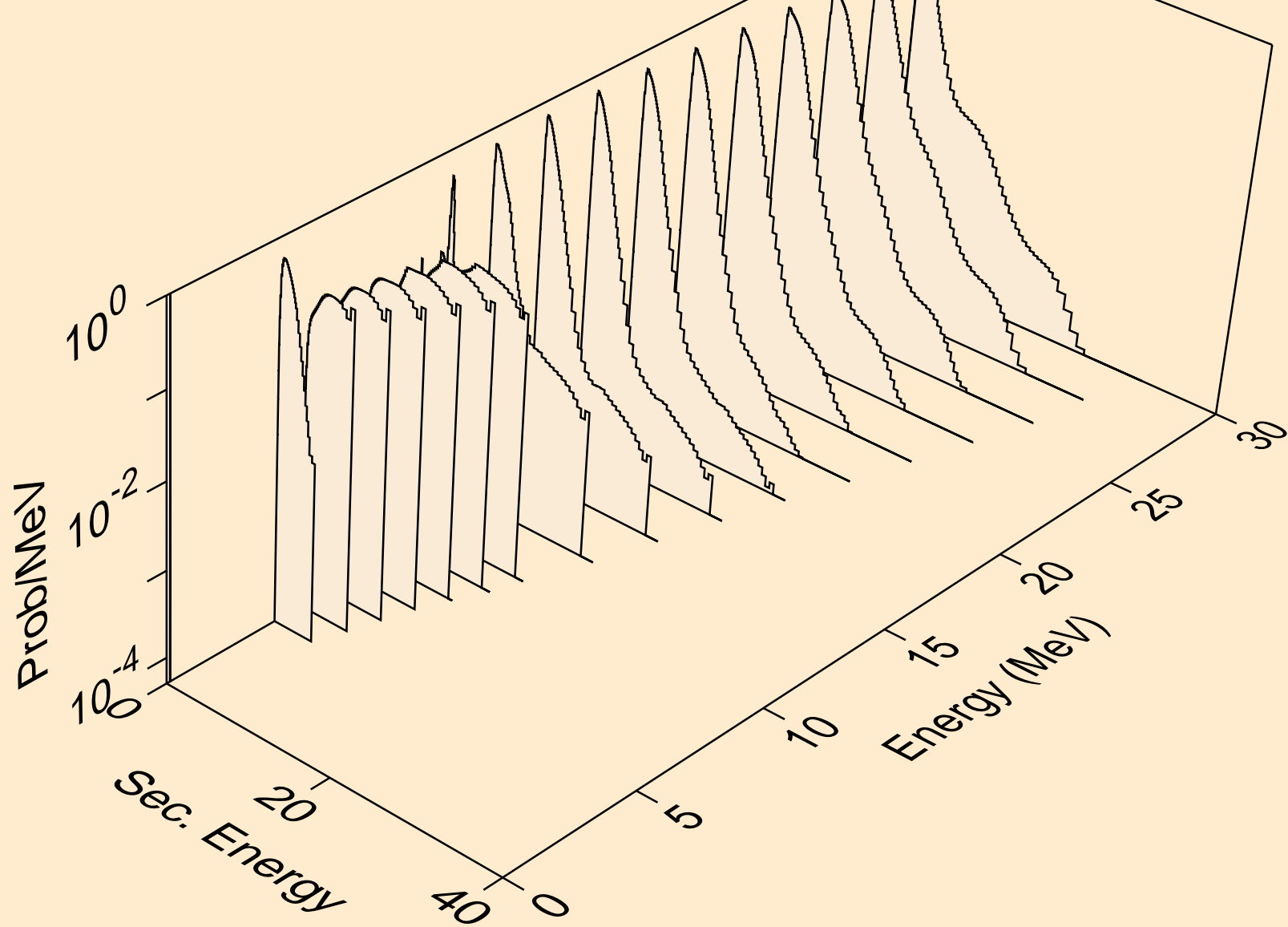

RN205M TRITON ACER TENDL-2023 LIBRARY; T=0.K  
neutrons from (t,2n)a

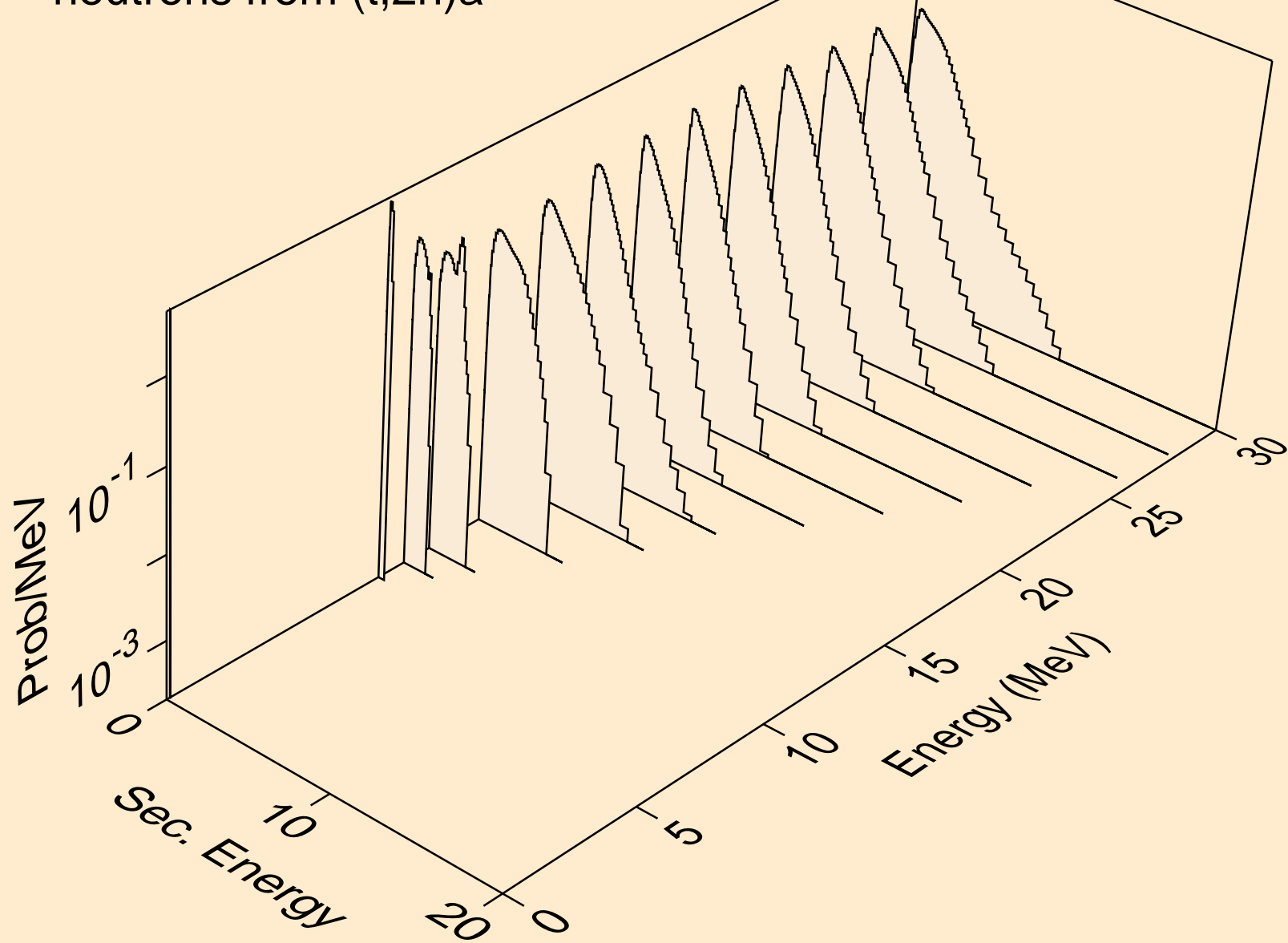

RN205M TRITON ACER TENDL-2023 LIBRARY; T=0.K  
neutrons from (t,3n)a

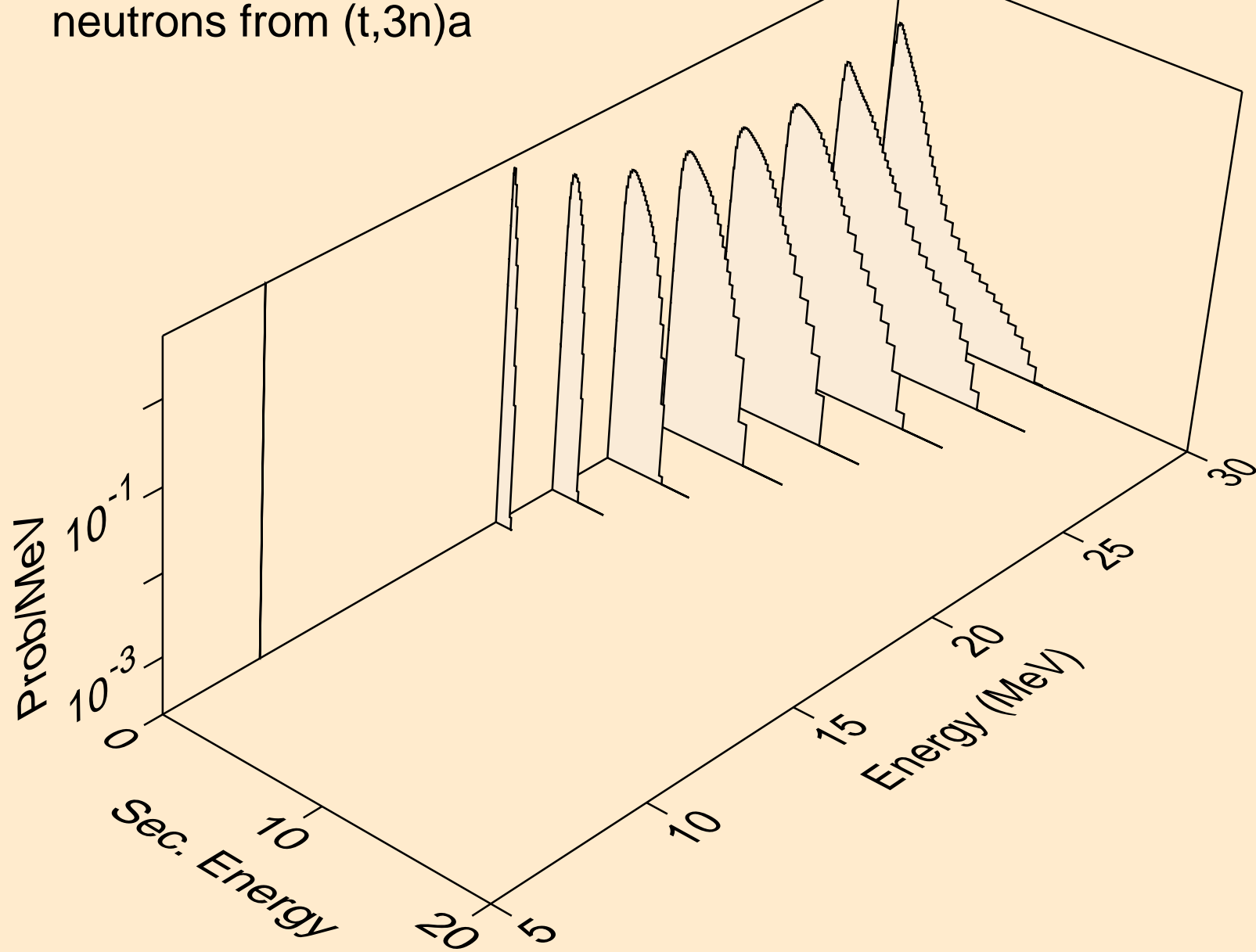

RN205M TRITON ACER TENDL-2023 LIBRARY; T=0.K  
neutrons from (t,n\*)p

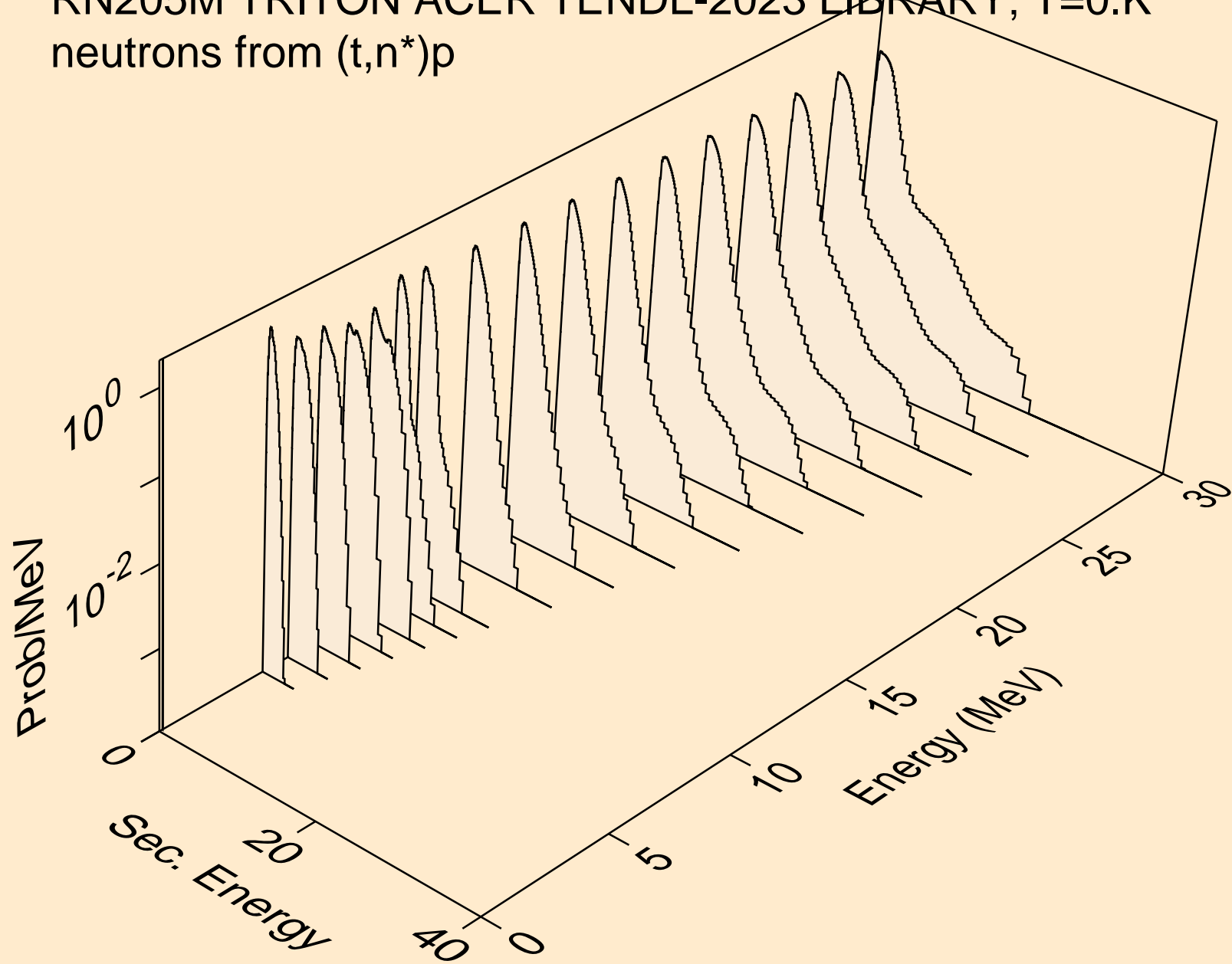

RN205M TRITON ACER TENDL-2023 LIBRARY; T=0.K  
neutrons from (t,n\*)2a

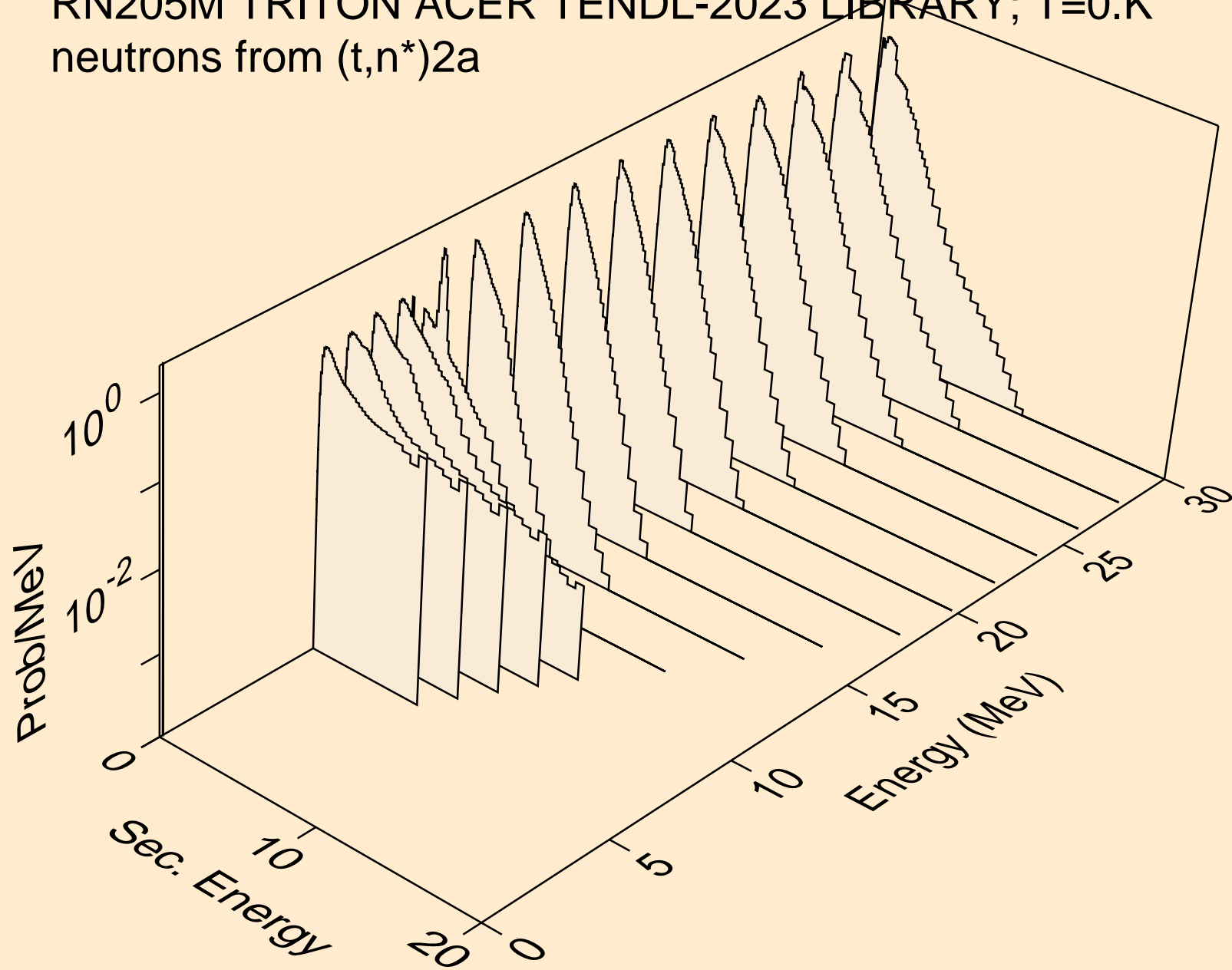

RN205M TRITON ACER TENDL-2023 LIBRARY; T=0.K  
neutrons from (t,2n)2a

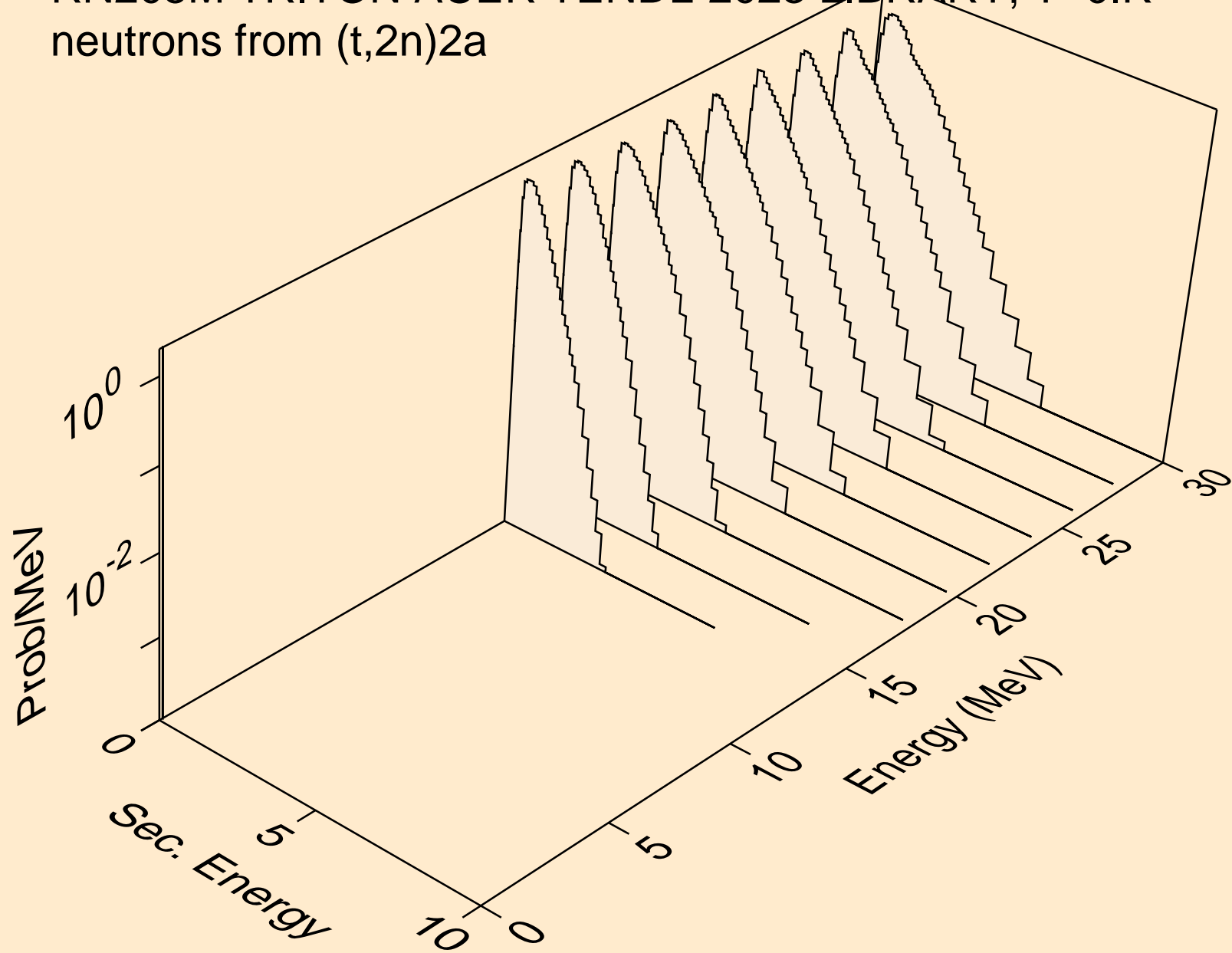

RN205M TRITON ACER TENDL-2023 LIBRARY; T=0.K  
neutrons from (t,n\*)d

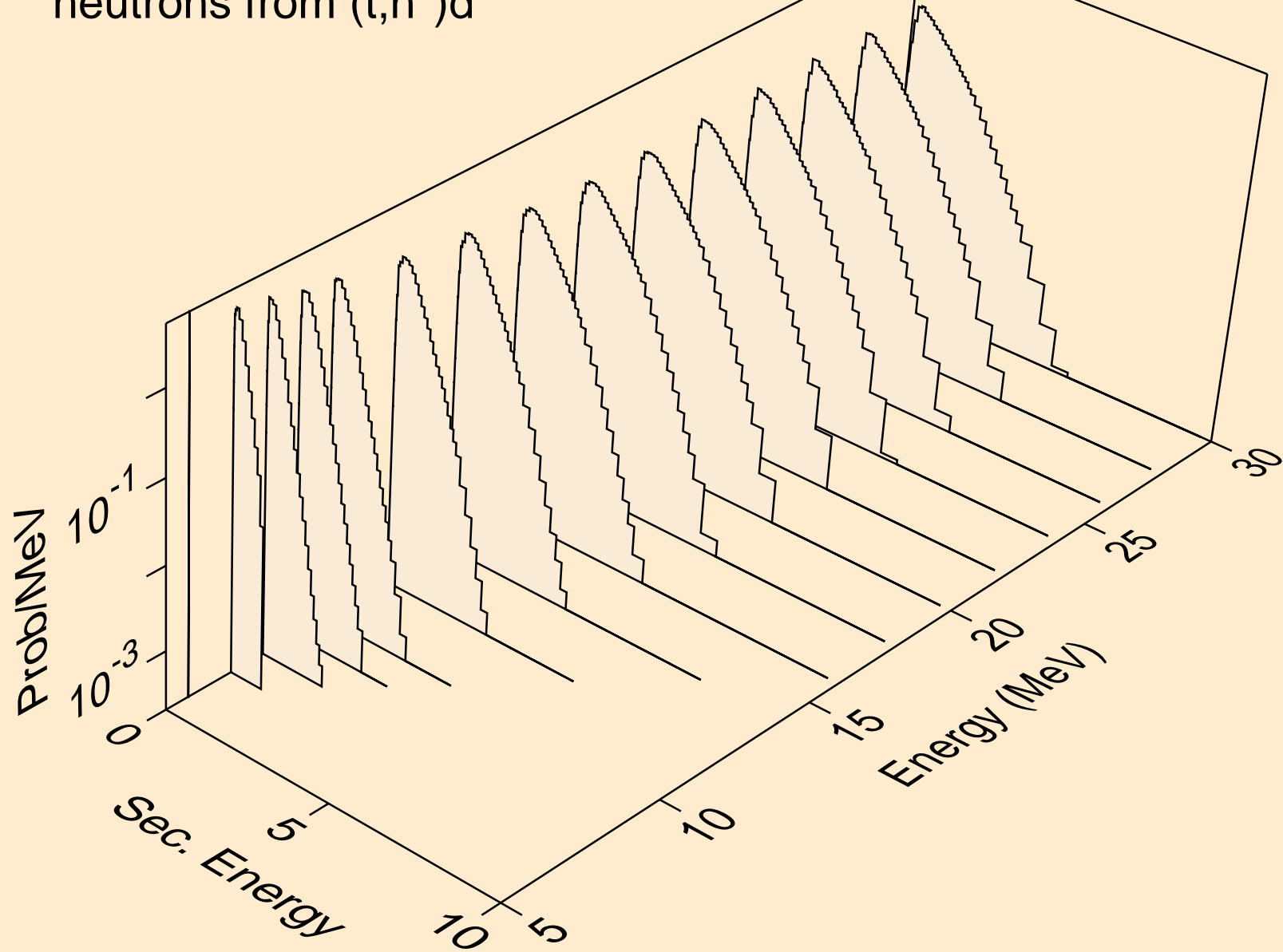

RN205M TRITON ACER TENDL-2023 LIBRARY; T=0.K  
neutrons from (t,n\*)t

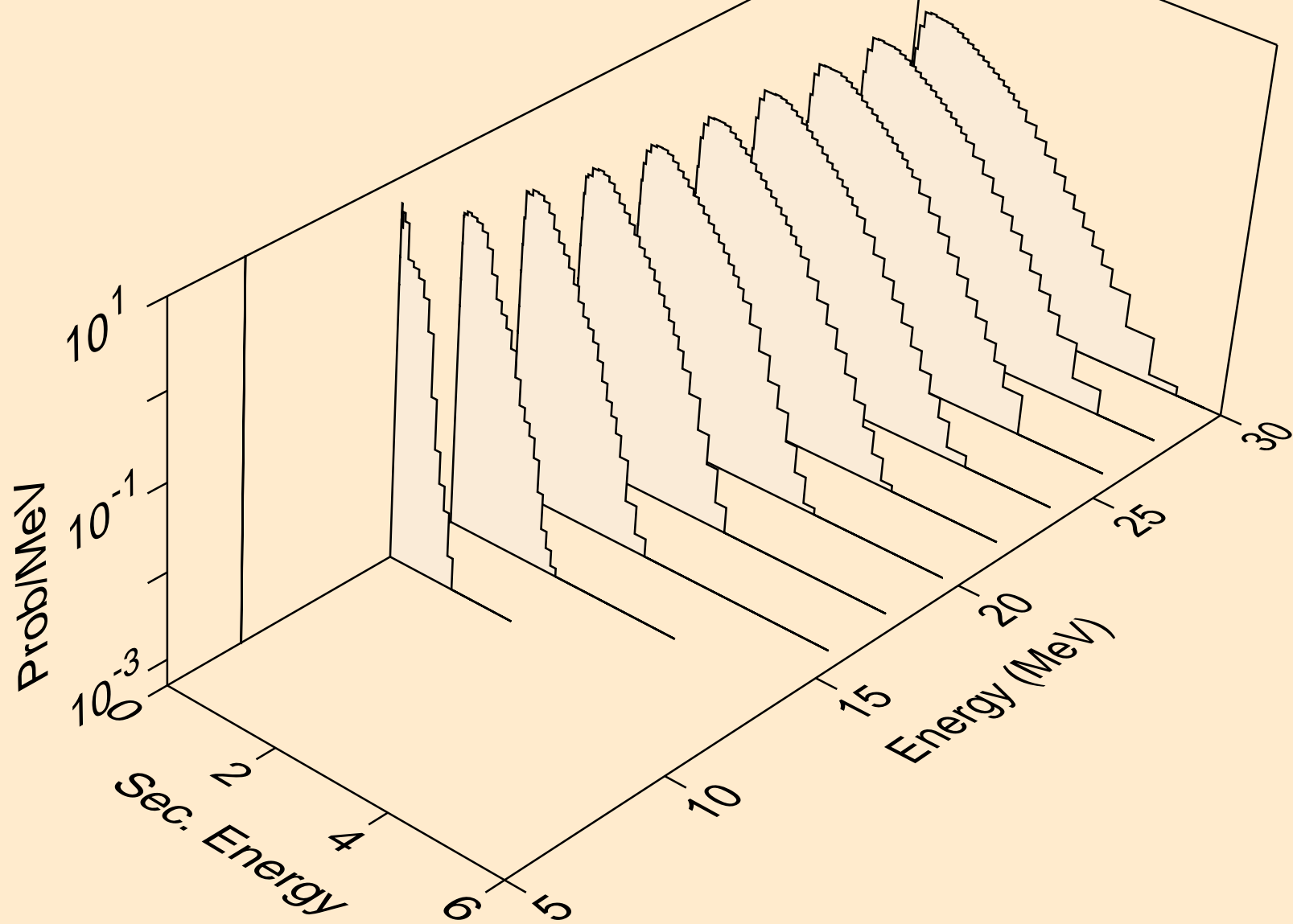

RN205M TRITON ACER TENDL-2023 LIBRARY; T=0.K  
neutrons from (t,n\*)he3

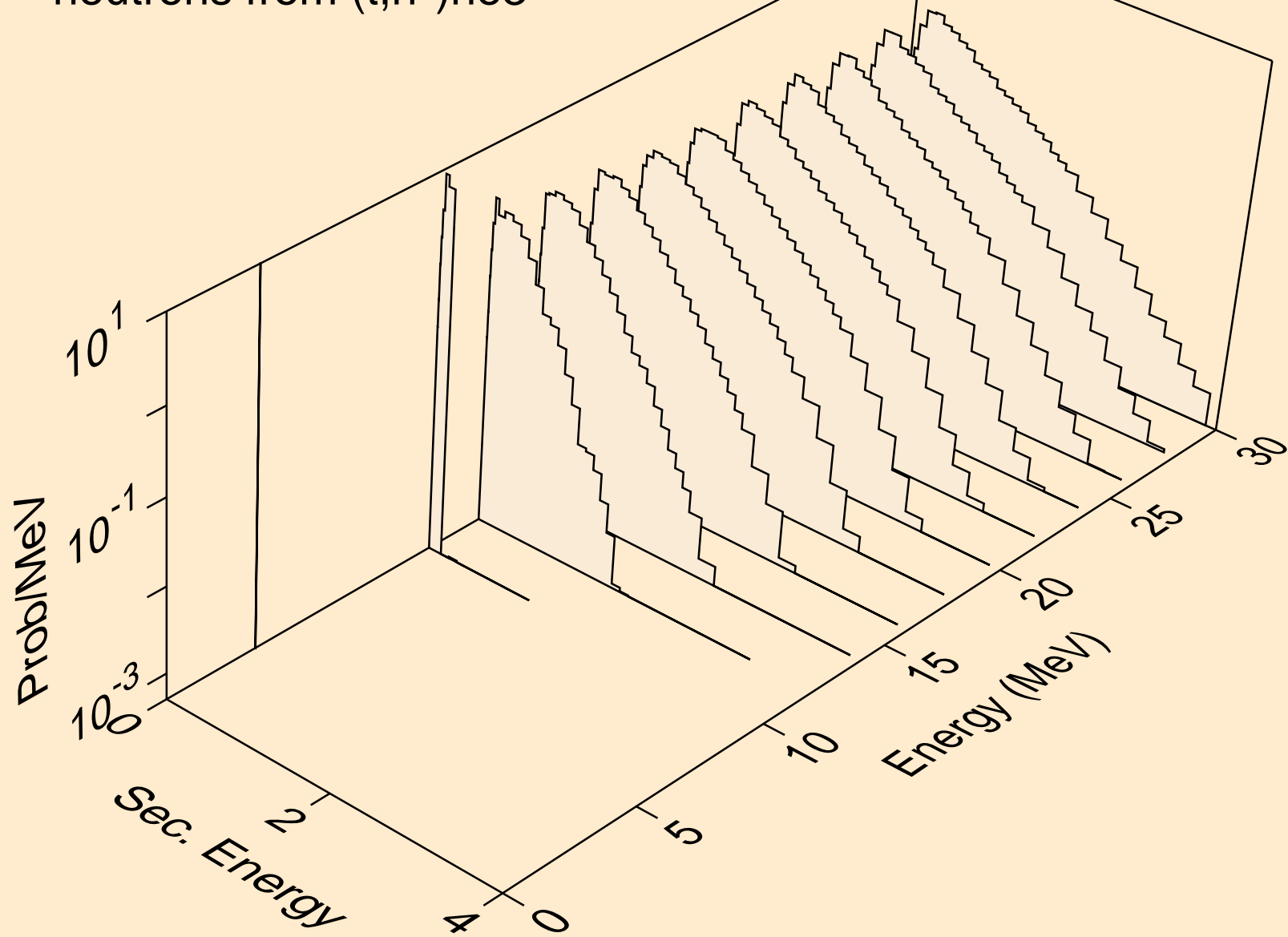

RN205M TRITON ACER TENDL-2023 LIBRARY; T=0.K  
neutrons from (t,4n)

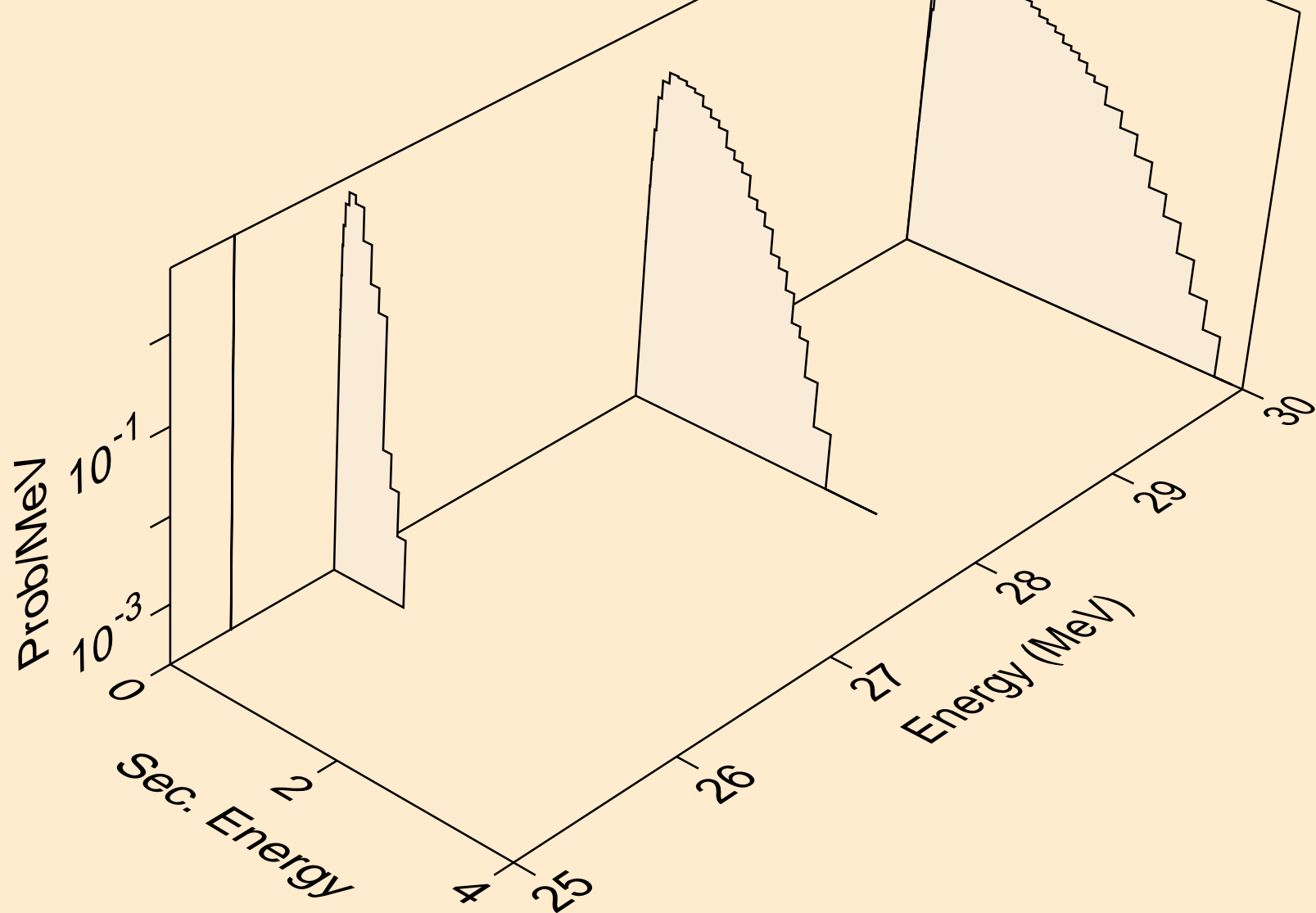

RN205M TRITON ACER TENDL-2023 LIBRARY; T=0.K  
neutrons from (t,2np)

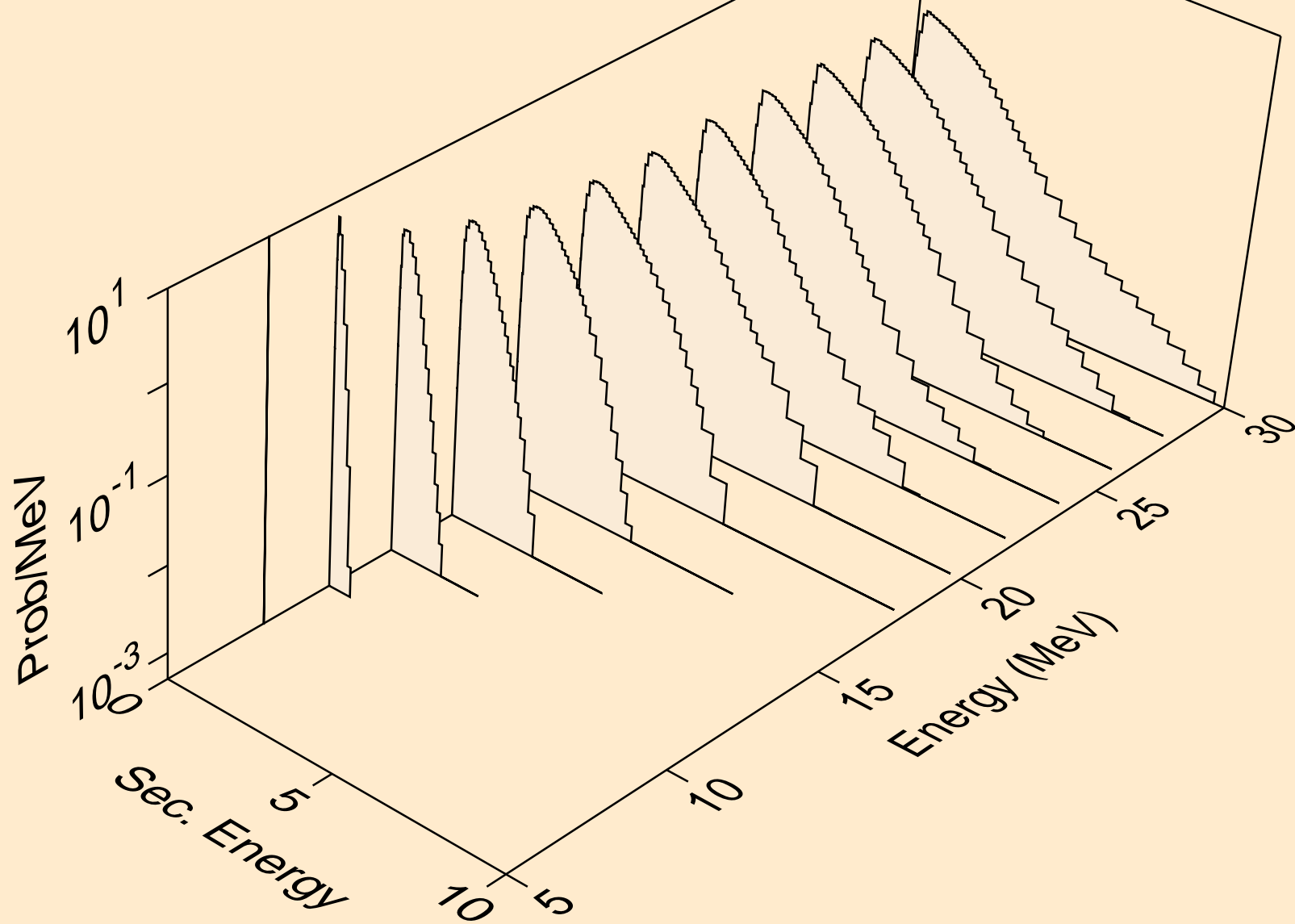

RN205M TRITON ACER TENDL-2023 LIBRARY; T=0.K  
neutrons from (t,3np)

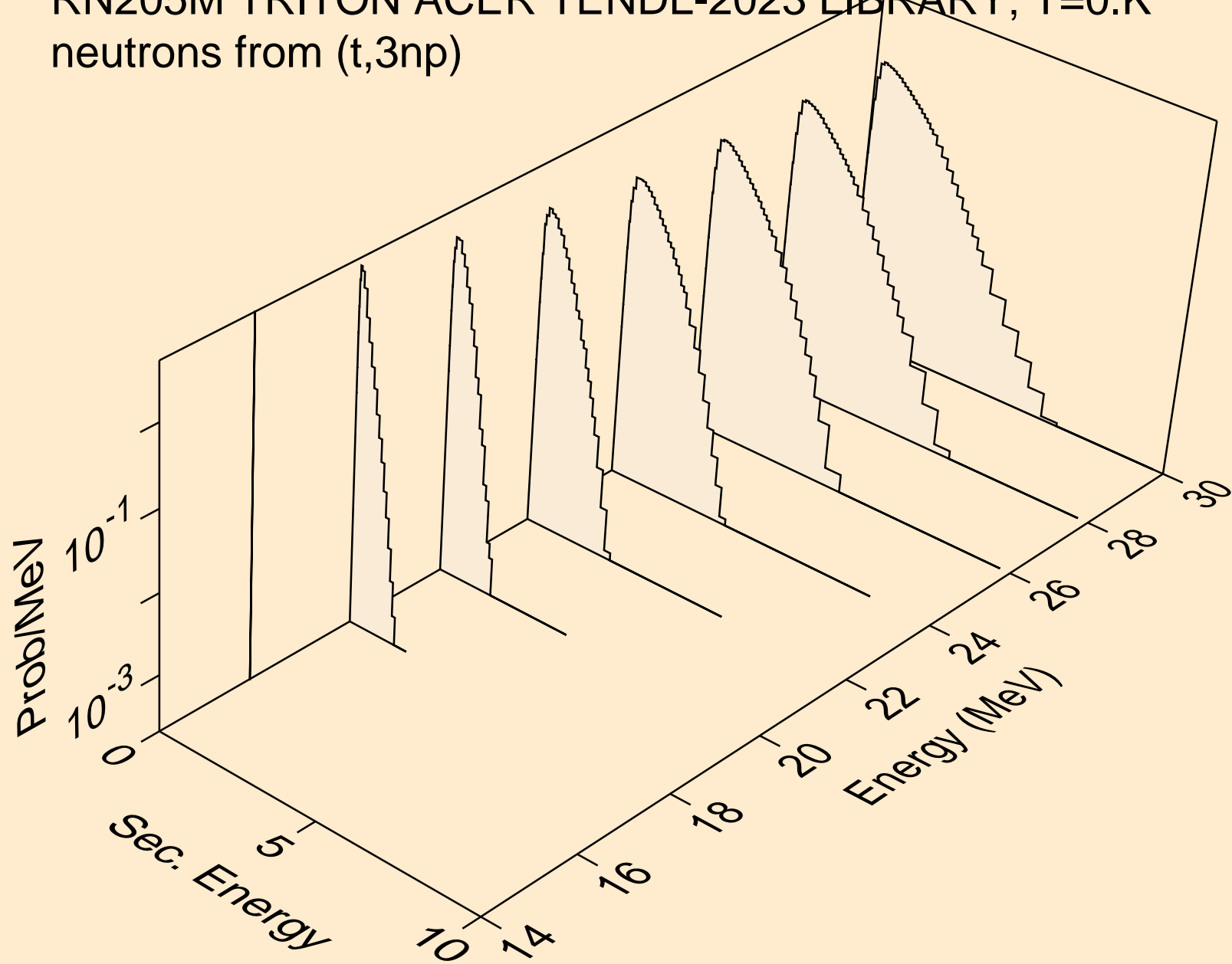

RN205M TRITON ACER TENDL-2023 LIBRARY; T=0.K  
neutrons from (t,n2p)

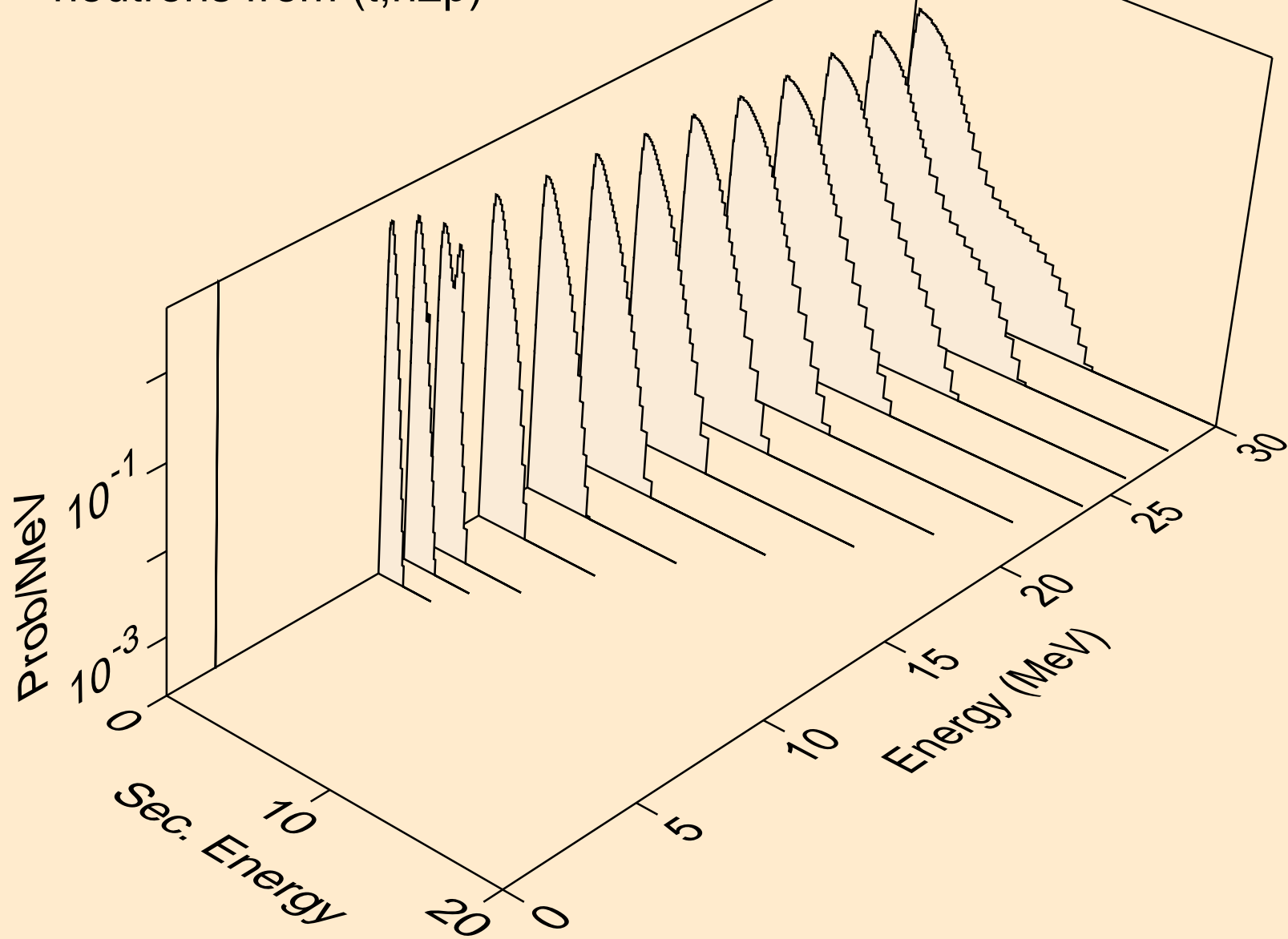

RN205M TRITON ACER TENDL-2023 LIBRARY; T=0.K  
neutrons from (t,npa)

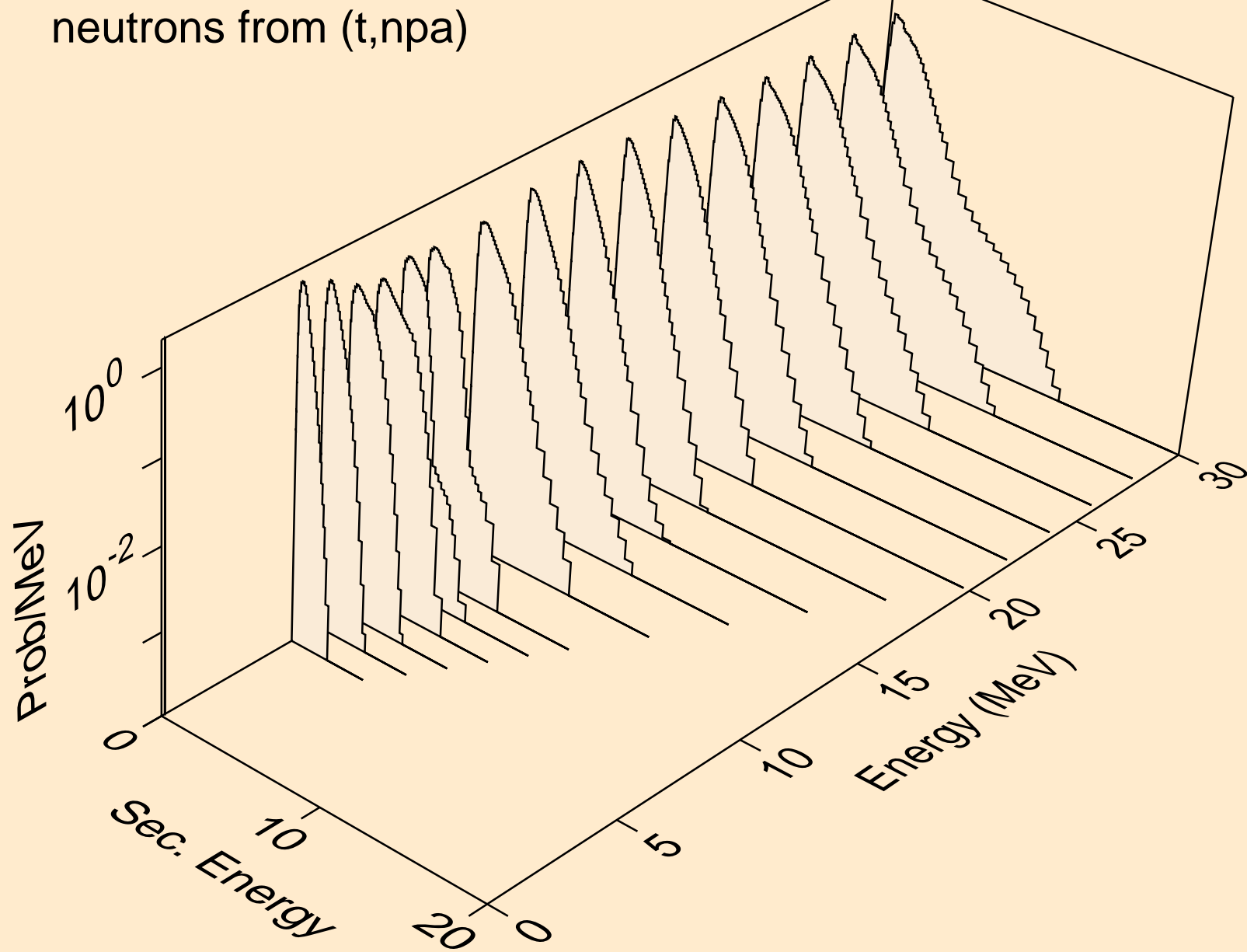

RN205M TRITON ACER TENDL-2023 LIBRARY; T=0.K  
protons from (t,x)

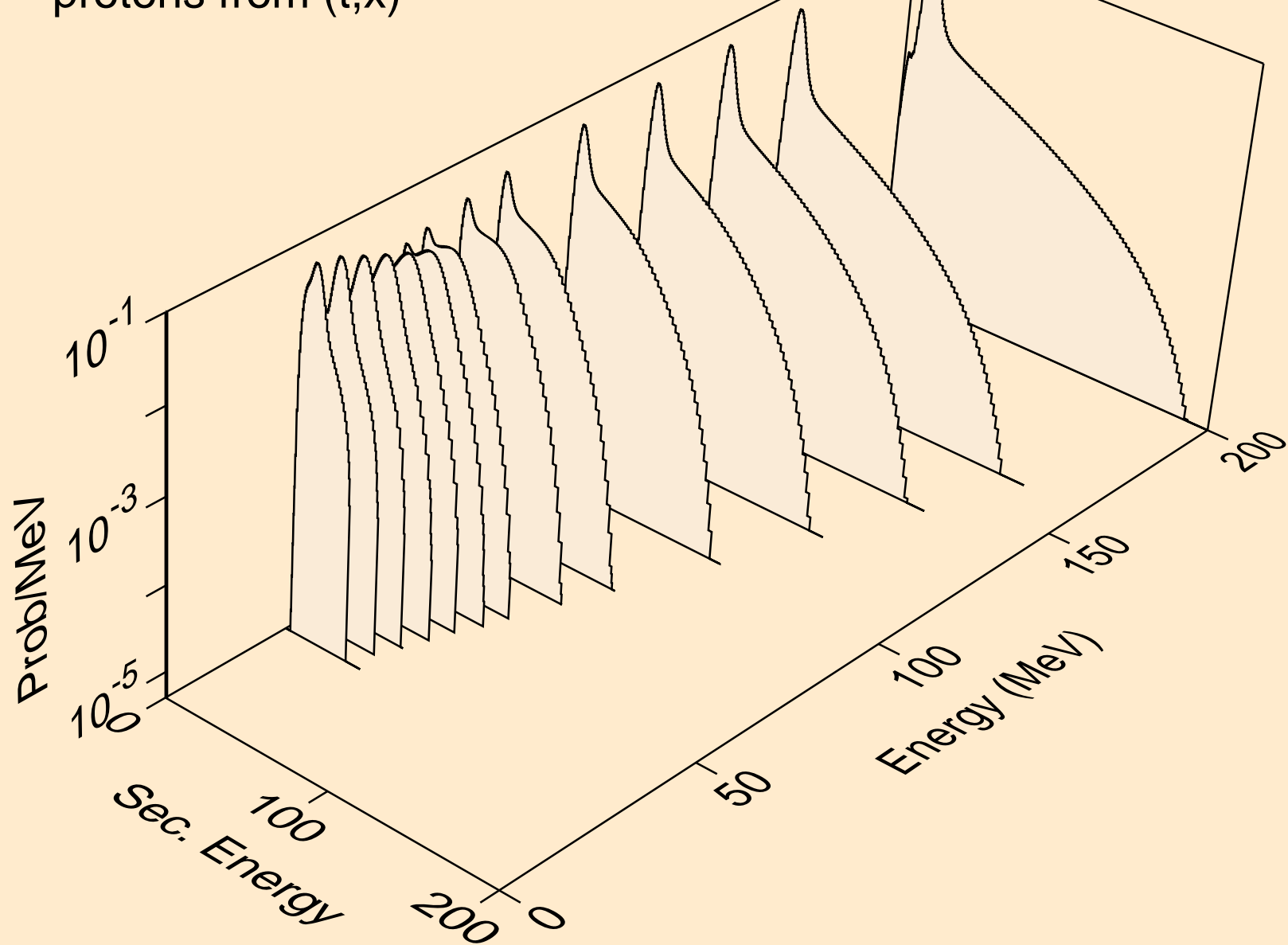

RN205M TRITON ACER TENDL-2023 LIBRARY; T=0.K  
protons from (t,n\*)p

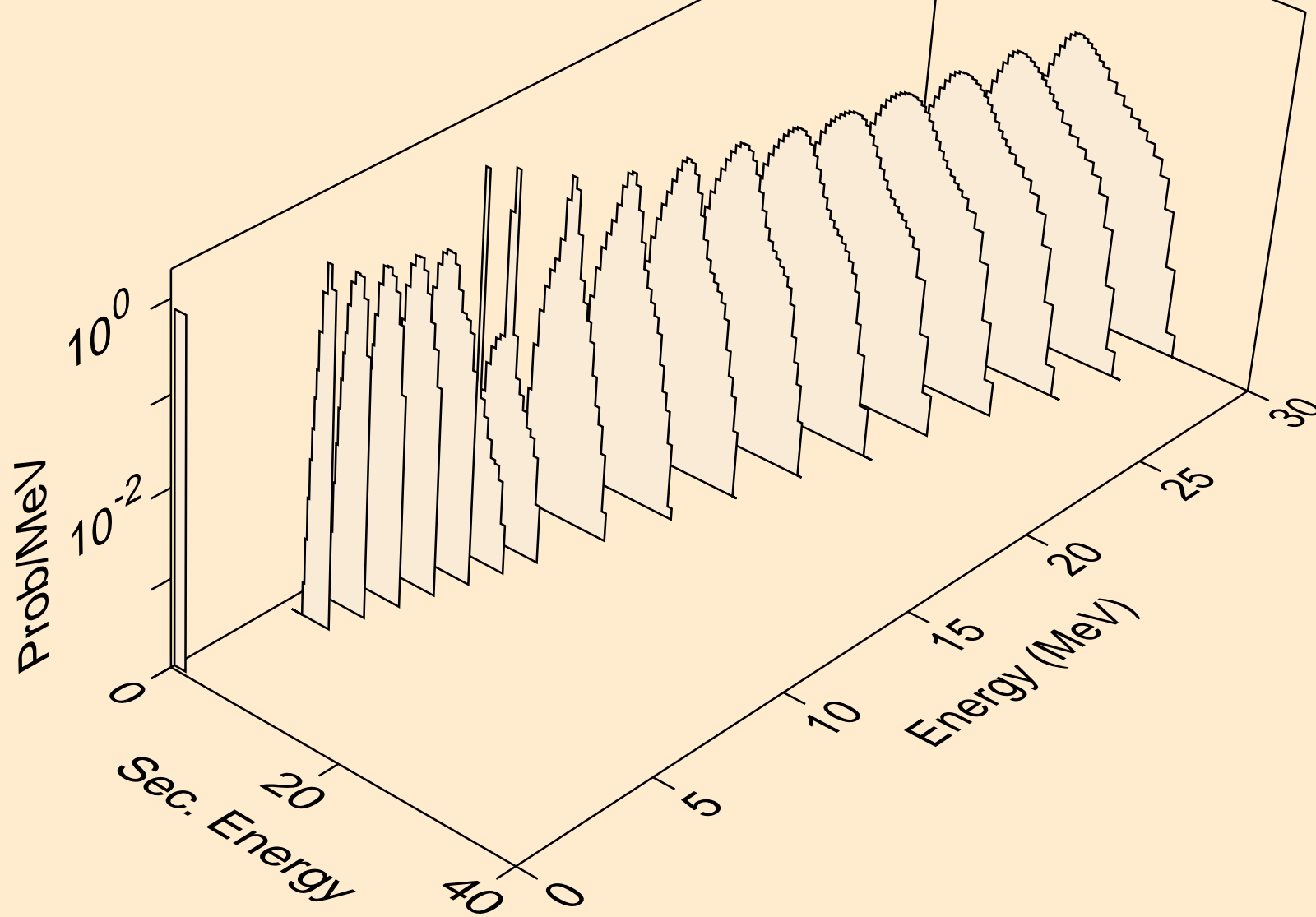

RN205M TRITON ACER TENDL-2023 LIBRARY; T=0.K  
protons from (t,2np)

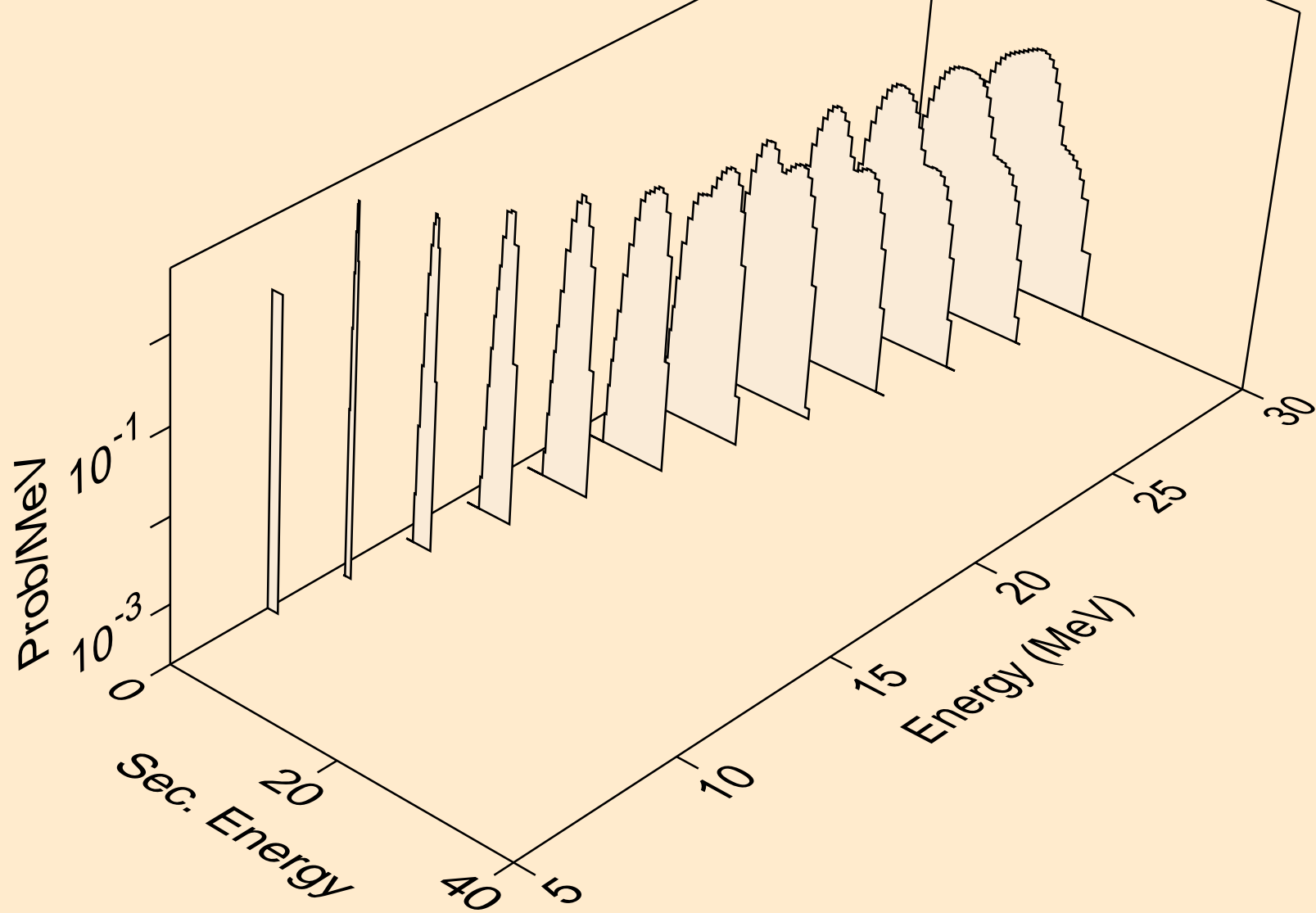

RN205M TRITON ACER TENDL-2023 LIBRARY; T=0.K  
protons from (t,3np)

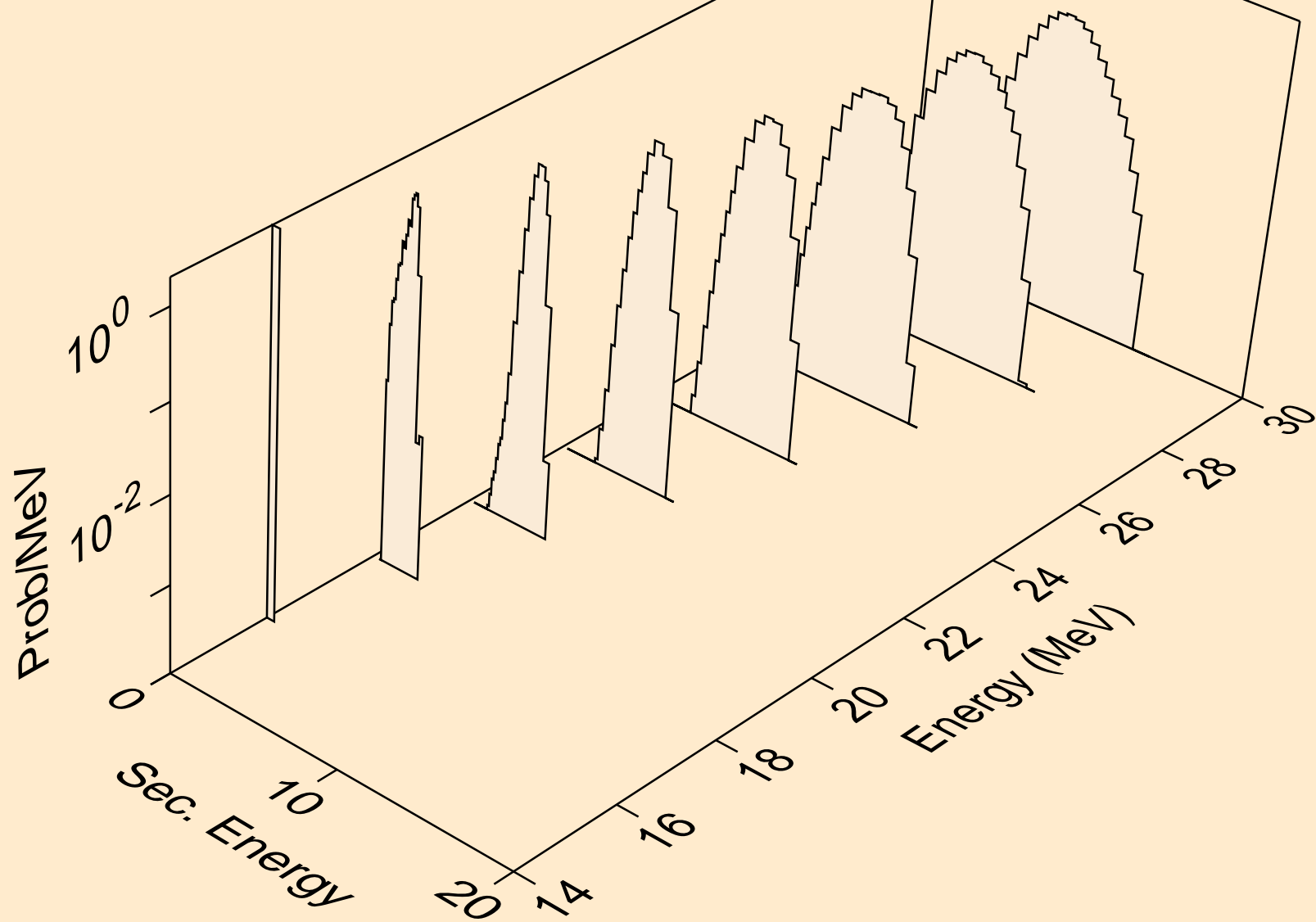

RN205M TRITON ACER TENDL-2023 LIBRARY; T=0.K  
protons from (t,n2p)

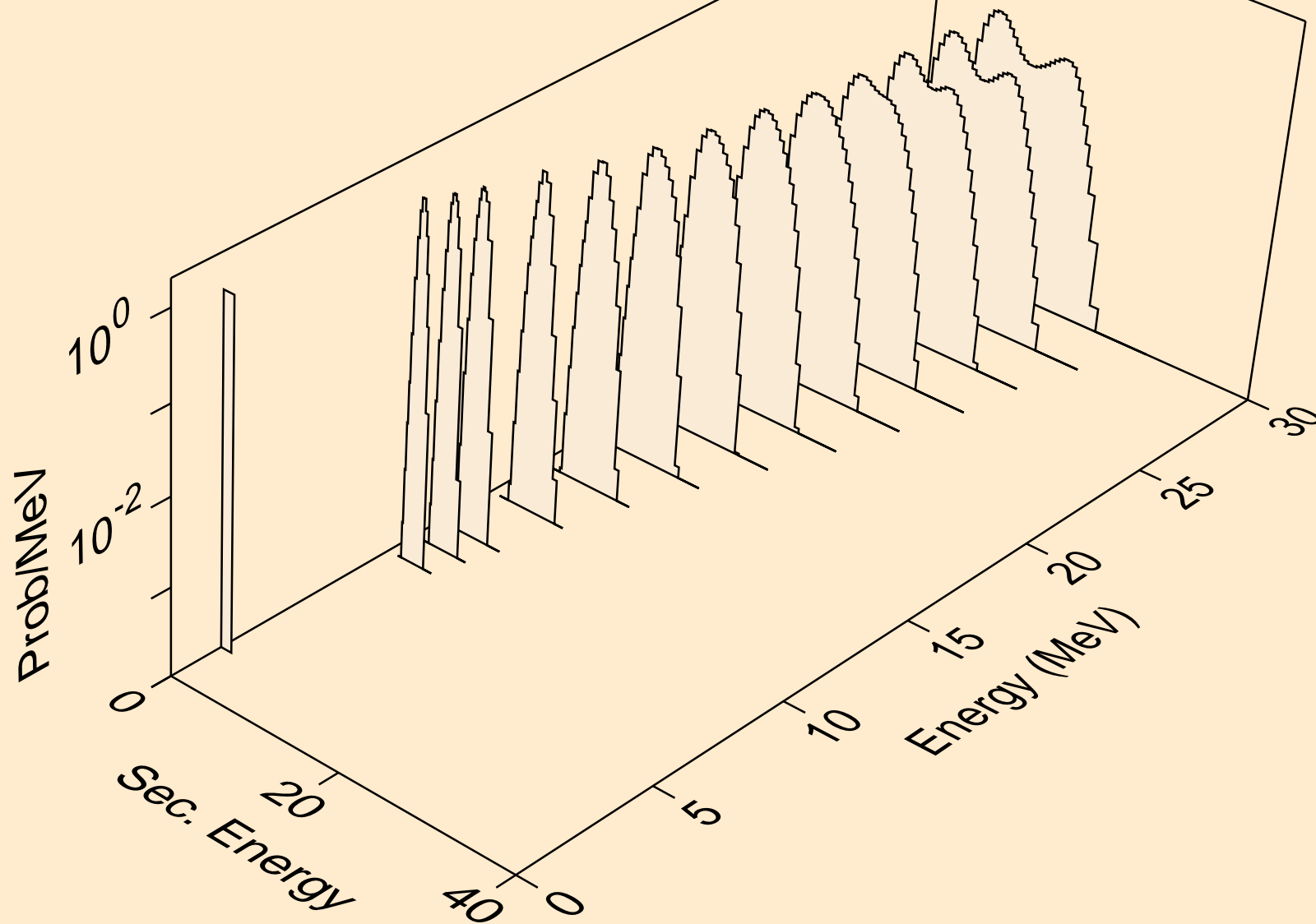

RN205M TRITON ACER TENDL-2023 LIBRARY; T=0.K  
protons from (t,npa)

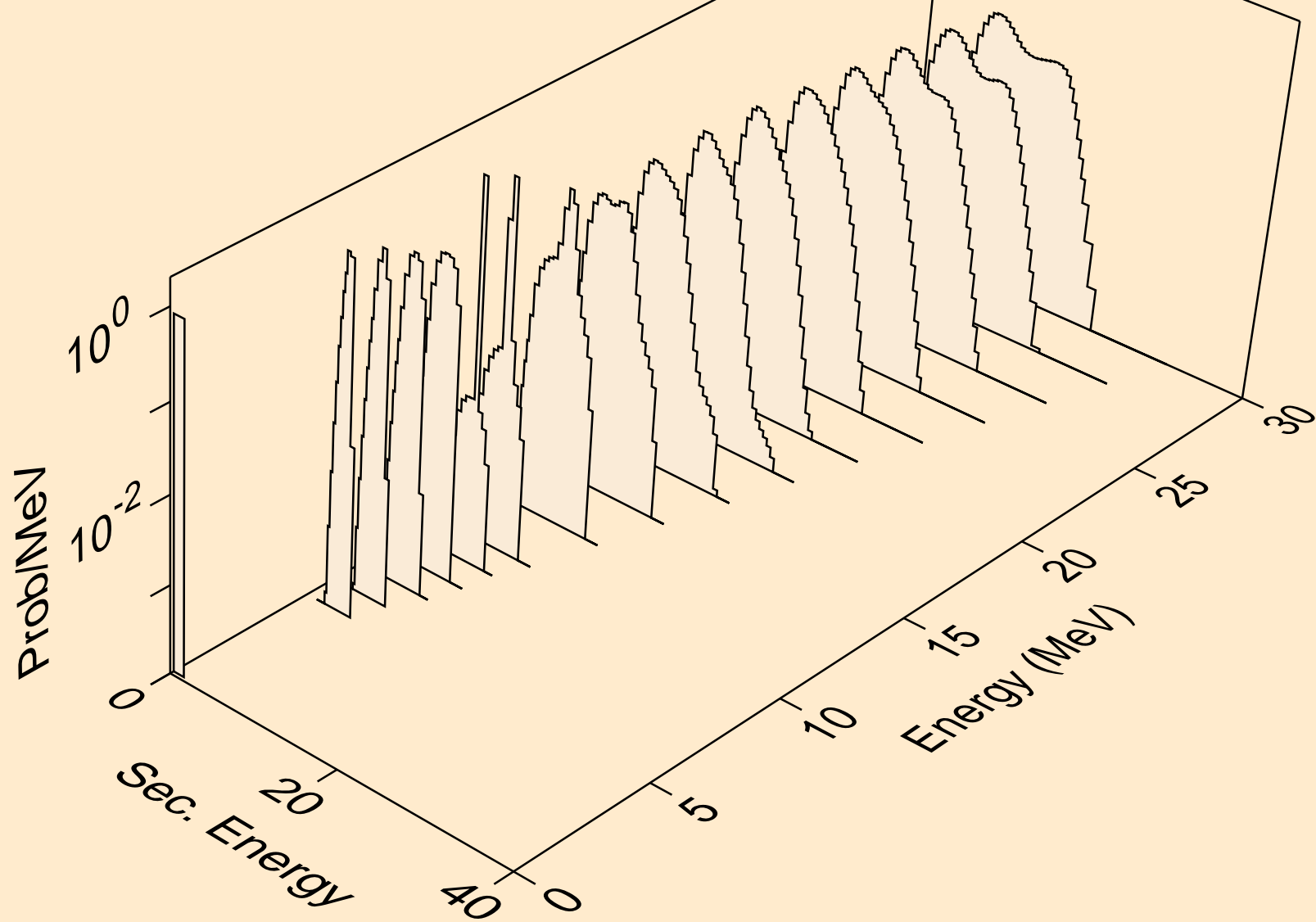

RN205M TRITON ACER TENDL-2023 LIBRARY; T=0.K  
protons from (t,p)

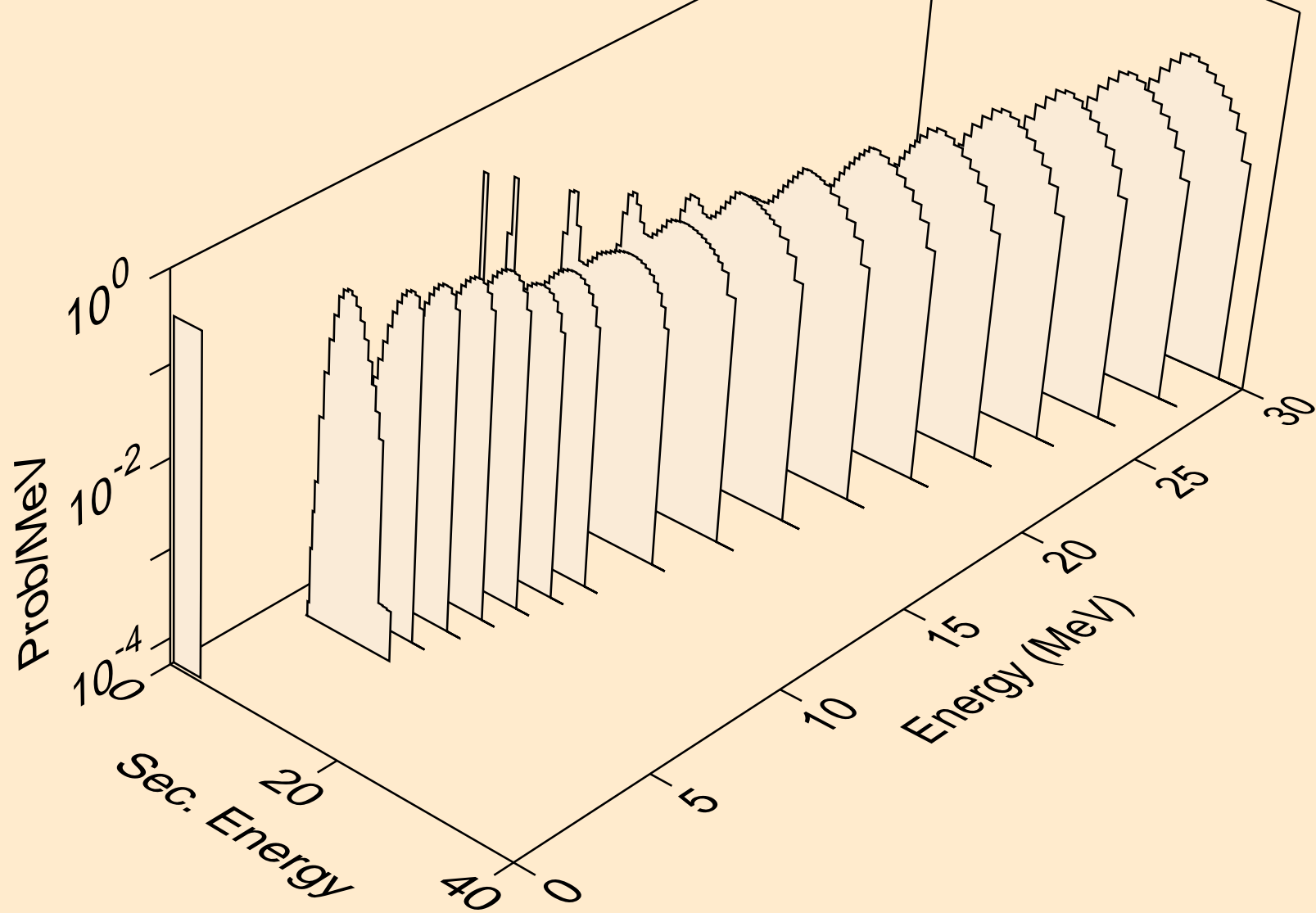

RN205M TRITON ACER TENDL-2023 LIBRARY; T=0.K  
protons from (t,2p)

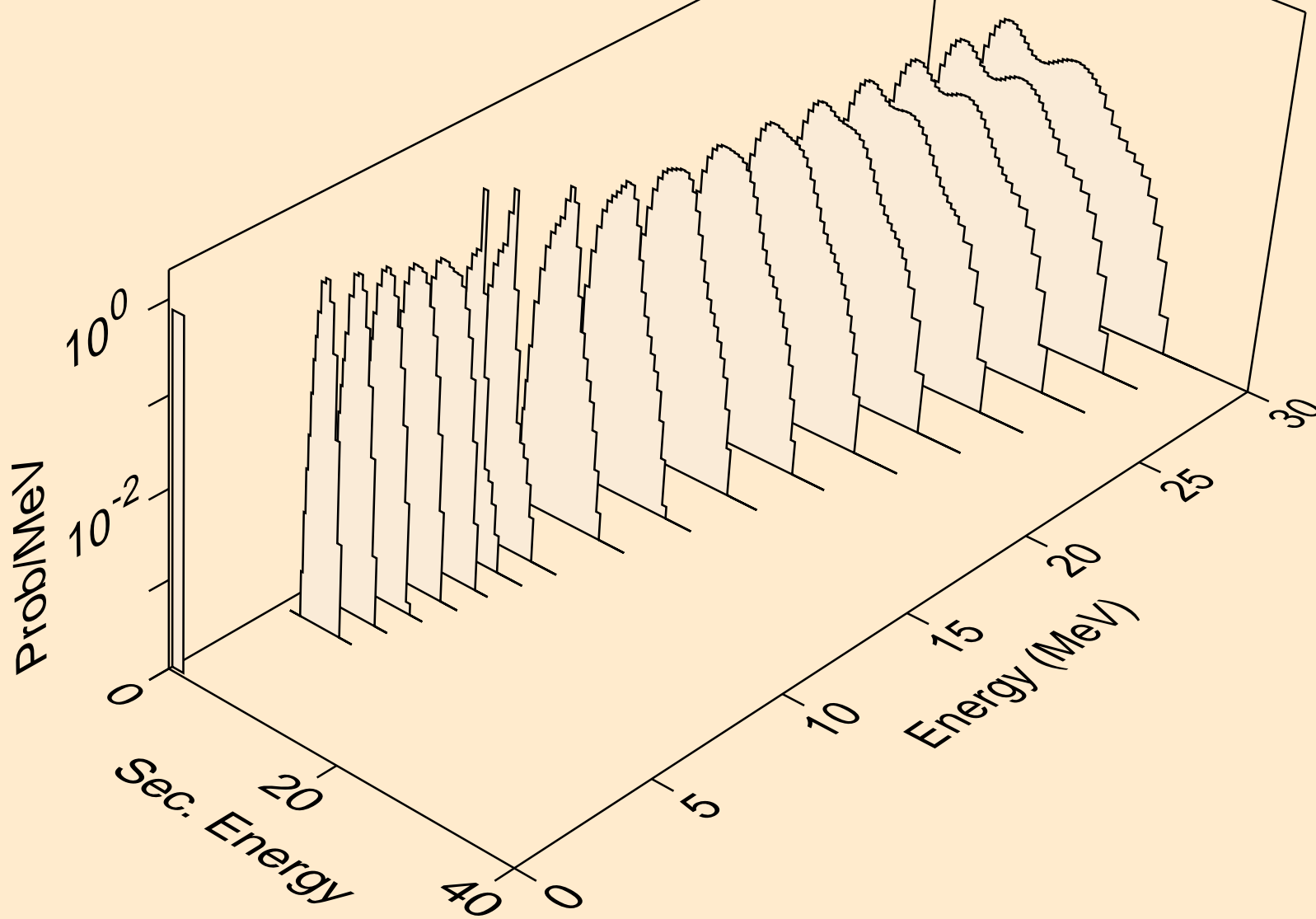

RN205M TRITON ACER TENDL-2023 LIBRARY; T=0.K  
protons from (t,pa)

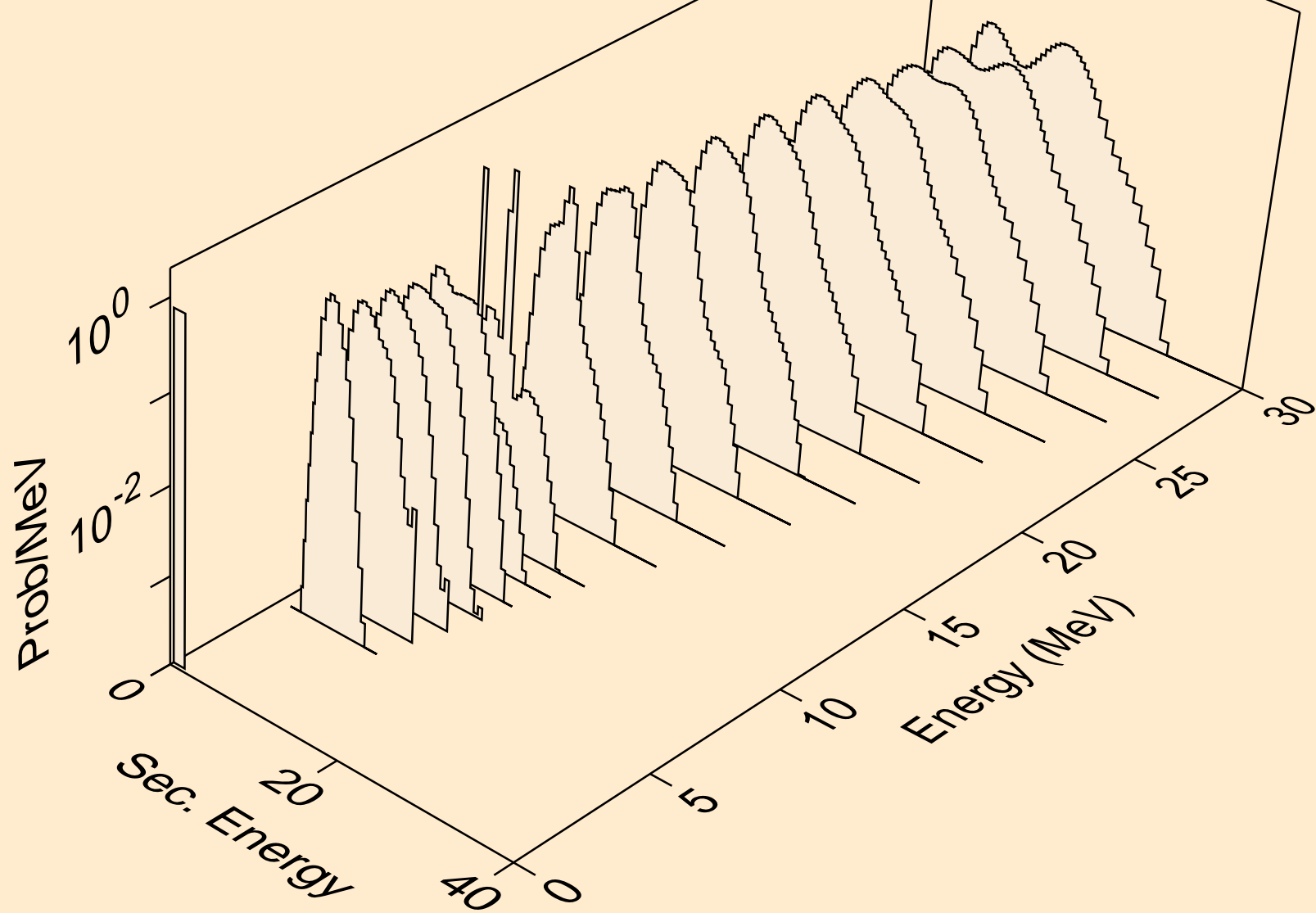

RN205M TRITON ACER TENDL-2023 LIBRARY; T=0.K  
protons from (t,pd)

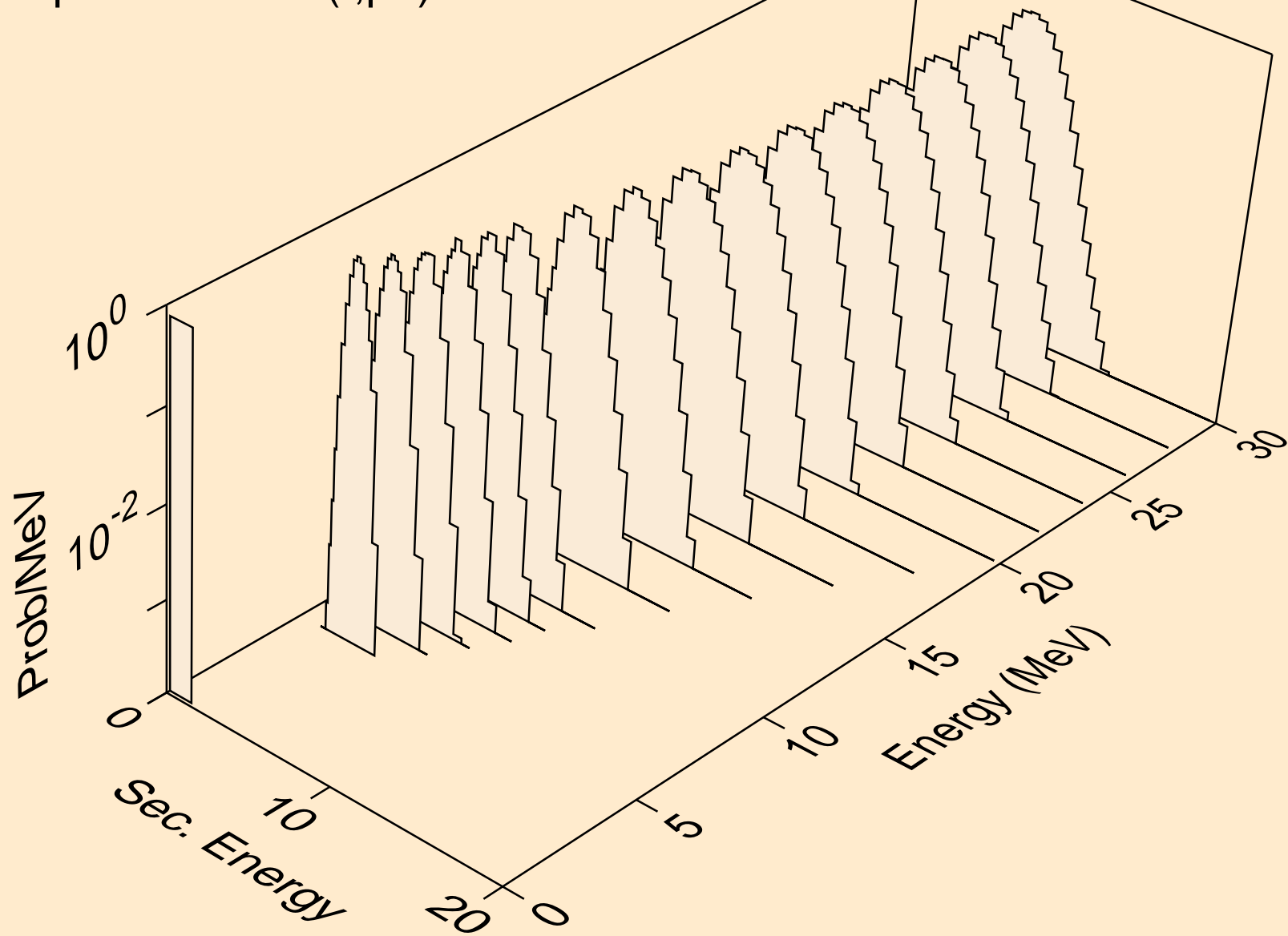

RN205M TRITON ACER TENDL-2023 LIBRARY; T=0.K  
protons from (t,pt)

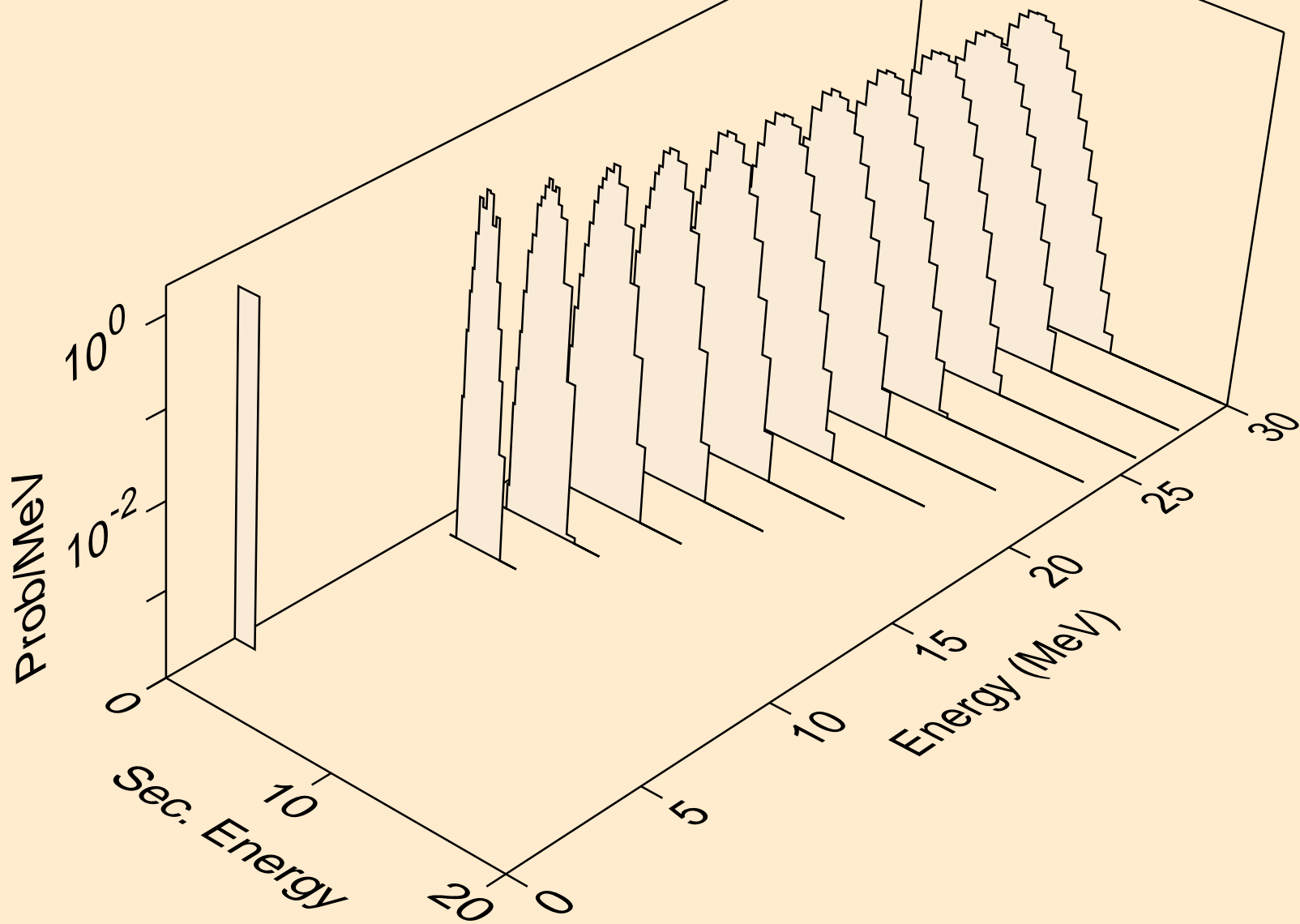

RN205M TRITON ACER TENDL-2023 LIBRARY; T=0.K  
deuterons from (t,x)

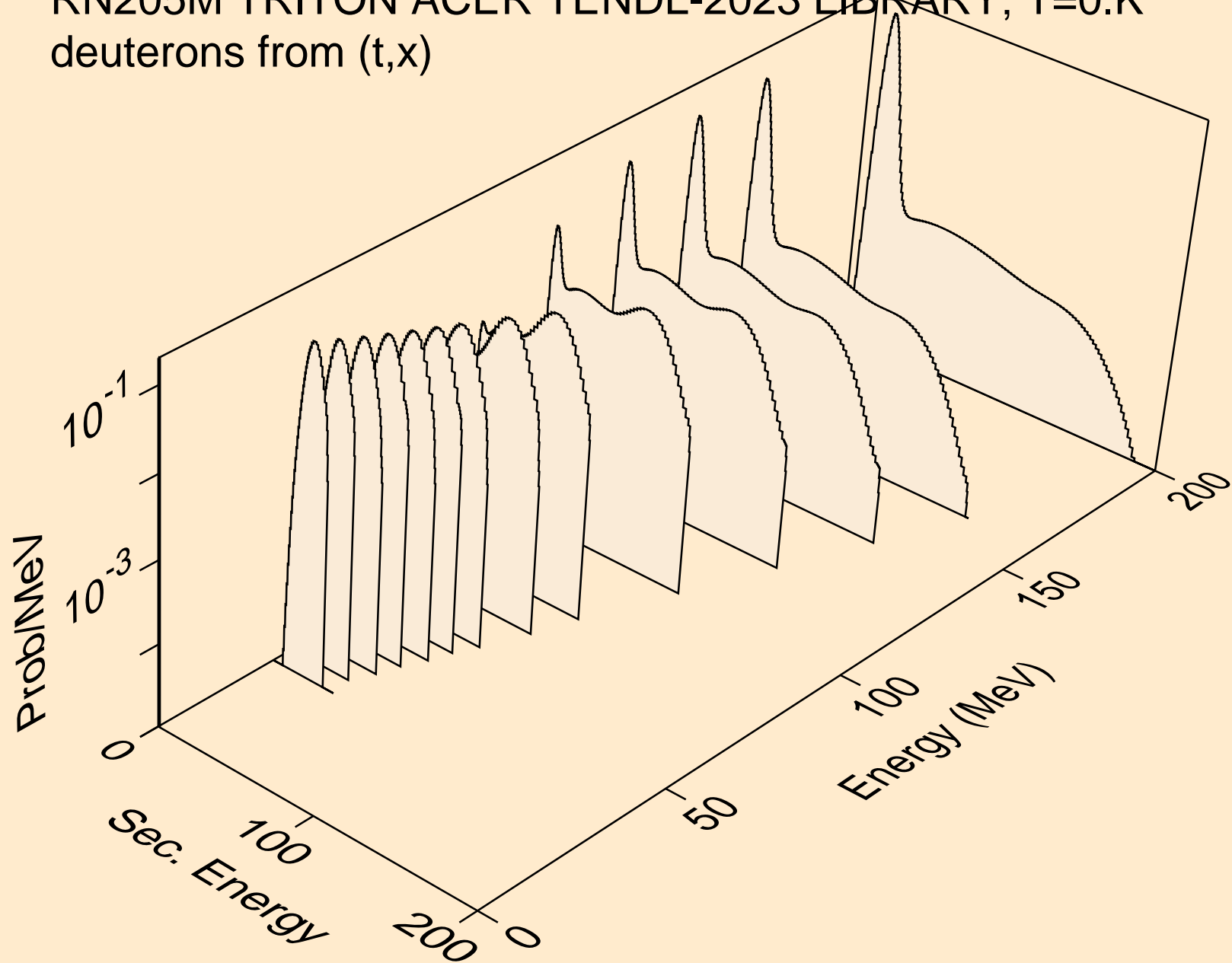

RN205M TRITON ACER TENDL-2023 LIBRARY; T=0.K  
deuterons from (t,2nd)

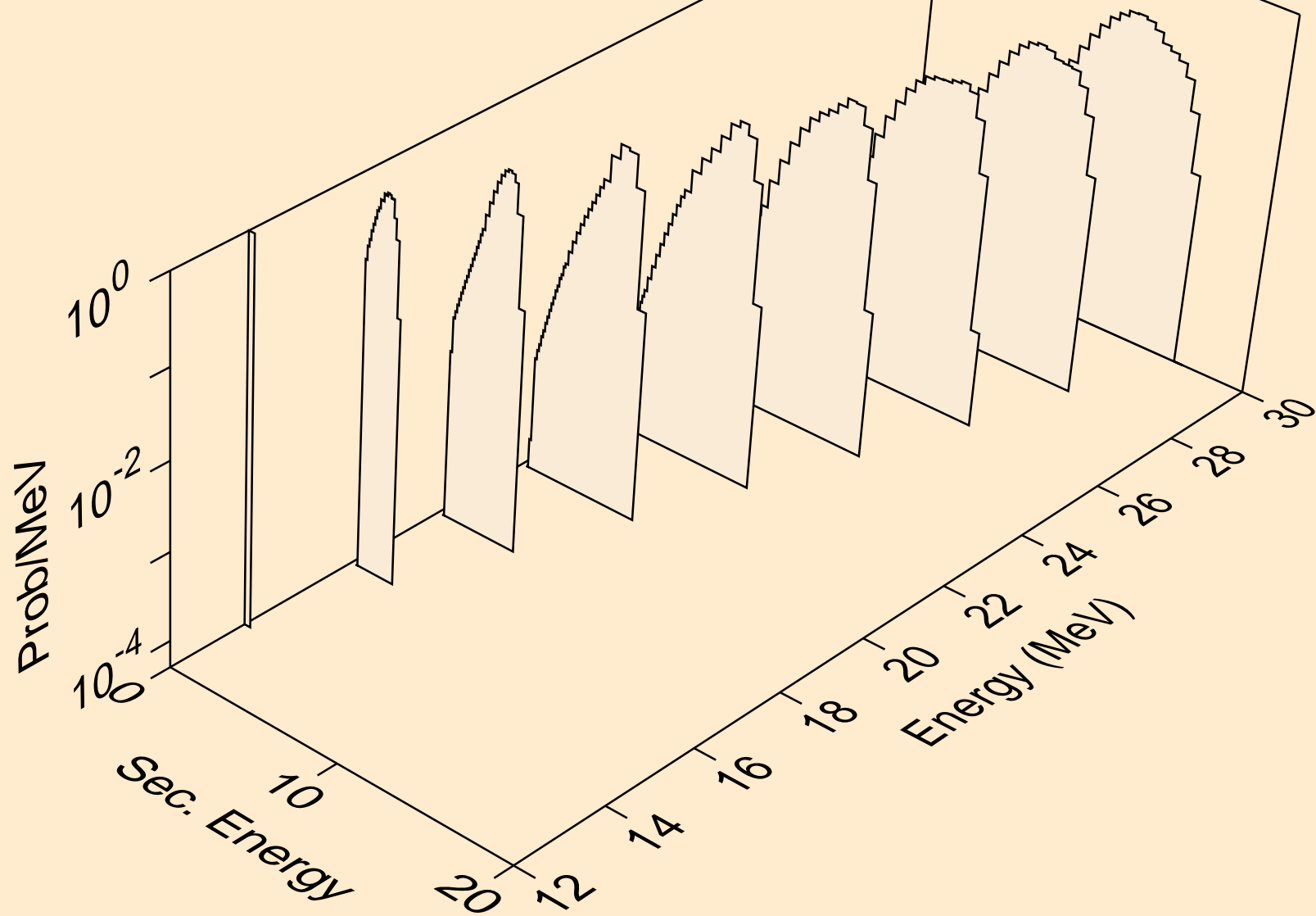

RN205M TRITON ACER TENDL-2023 LIBRARY; T=0.K  
deuterons from (t,n\*)d

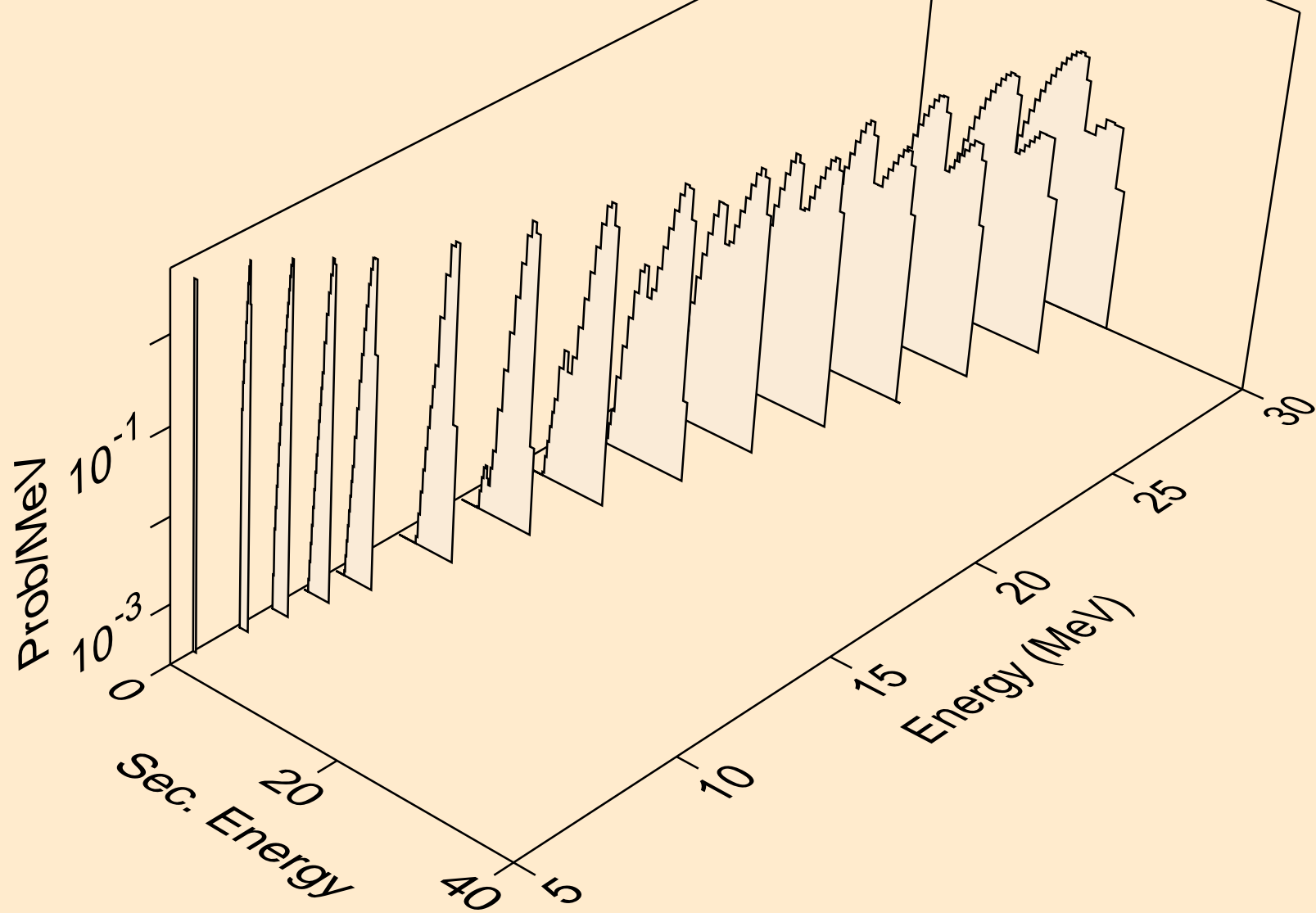

RN205M TRITON ACER TENDL-2023 LIBRARY; T=0.K  
deuterons from (t,d)

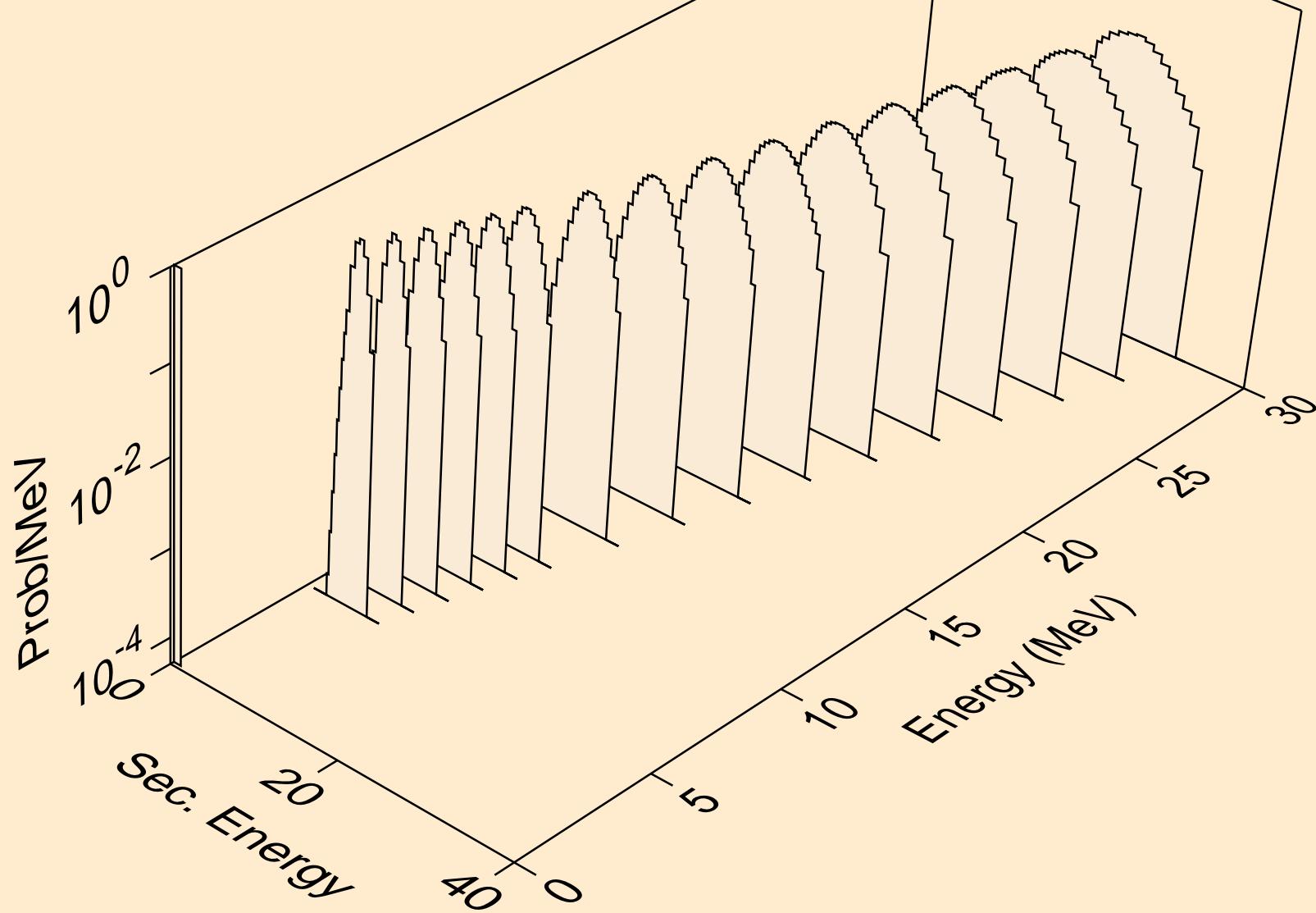

RN205M TRITON ACER TENDL-2023 LIBRARY; T=0.K  
deuterons from (t,pd)

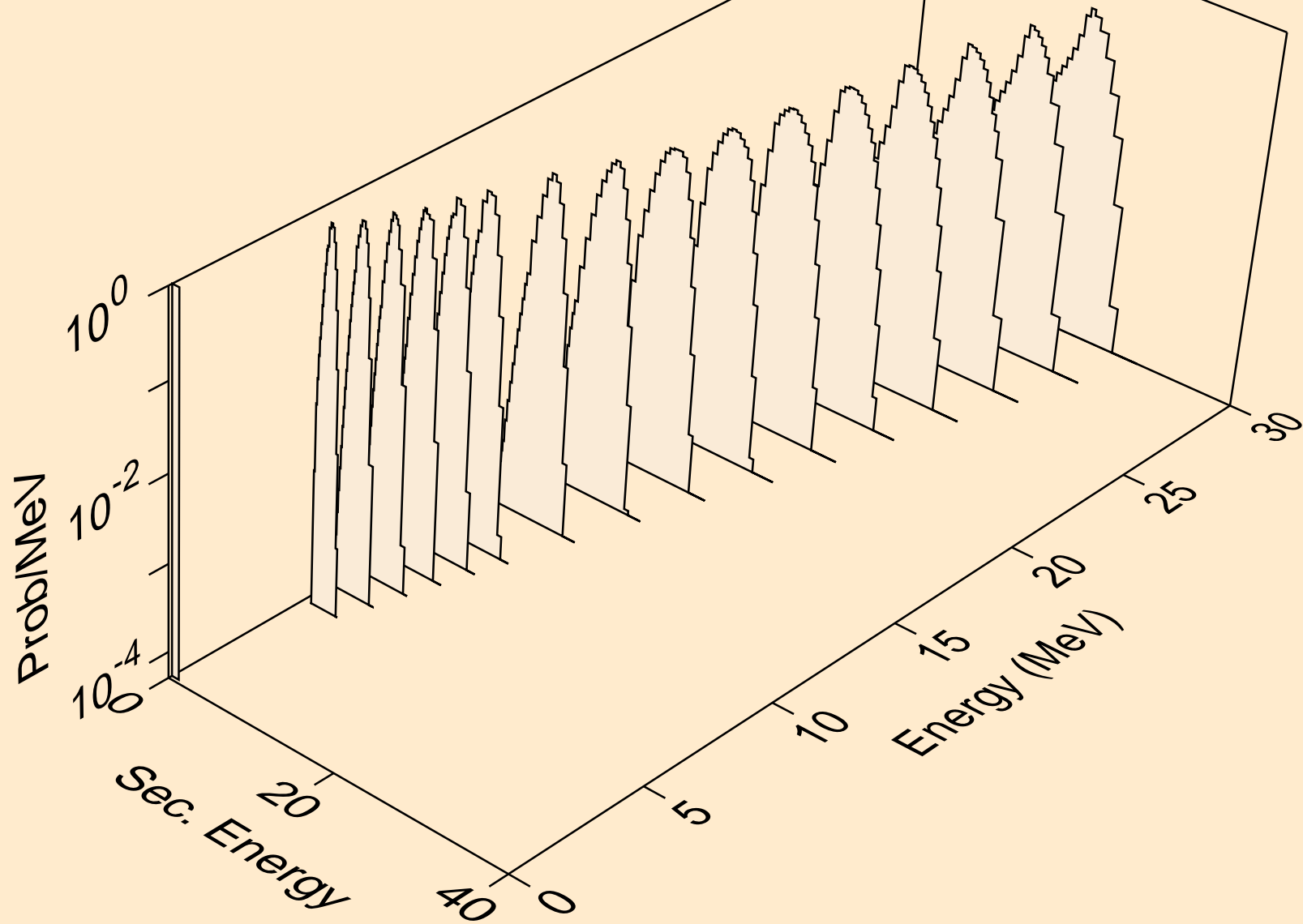

RN205M TRITON ACER TENDL-2023 LIBRARY; T=0.K  
deuterons from (t,da)

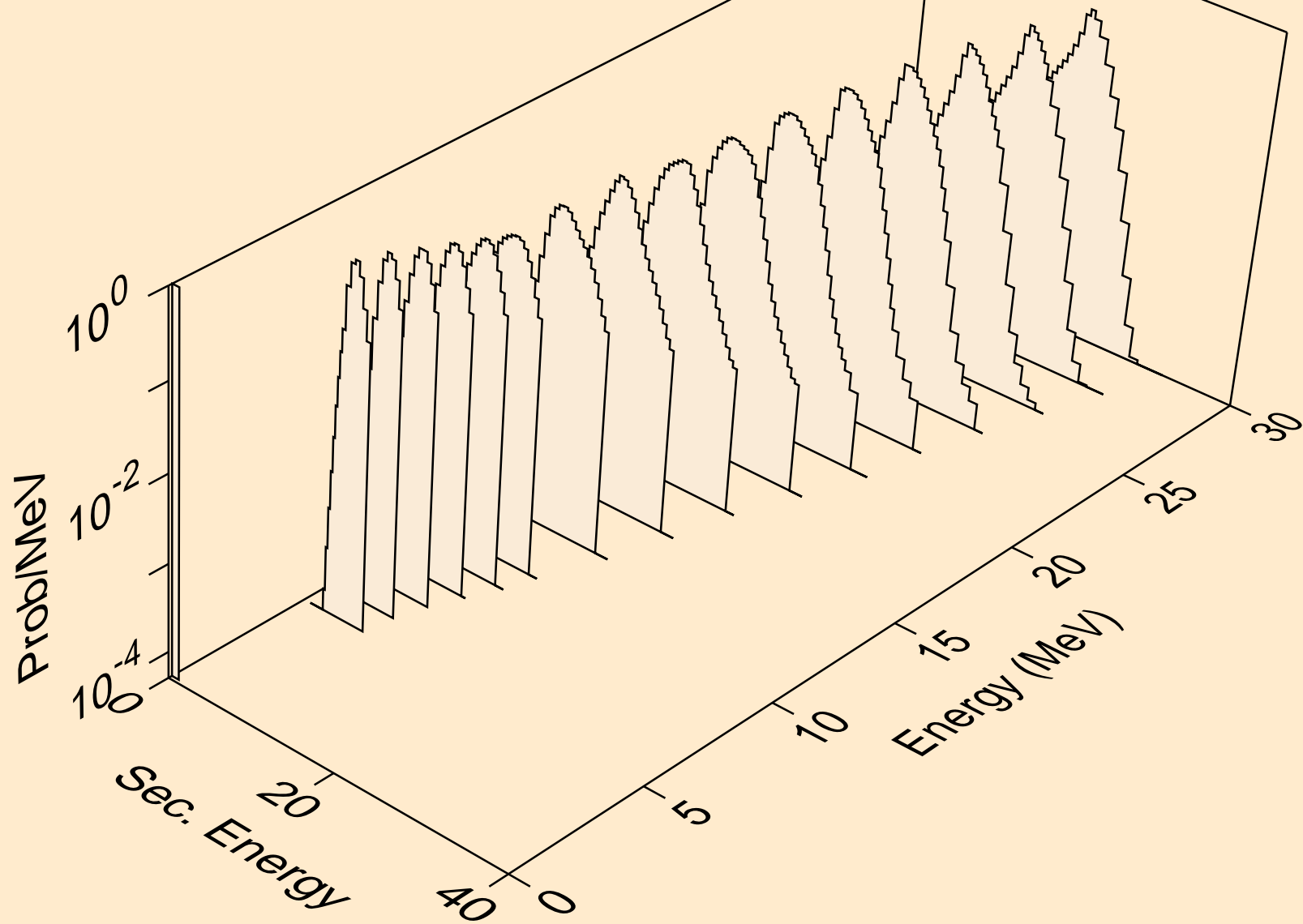

RN205M TRITON ACER TENDL-2023 LIBRARY; T=0.K  
he3s from (t,x)

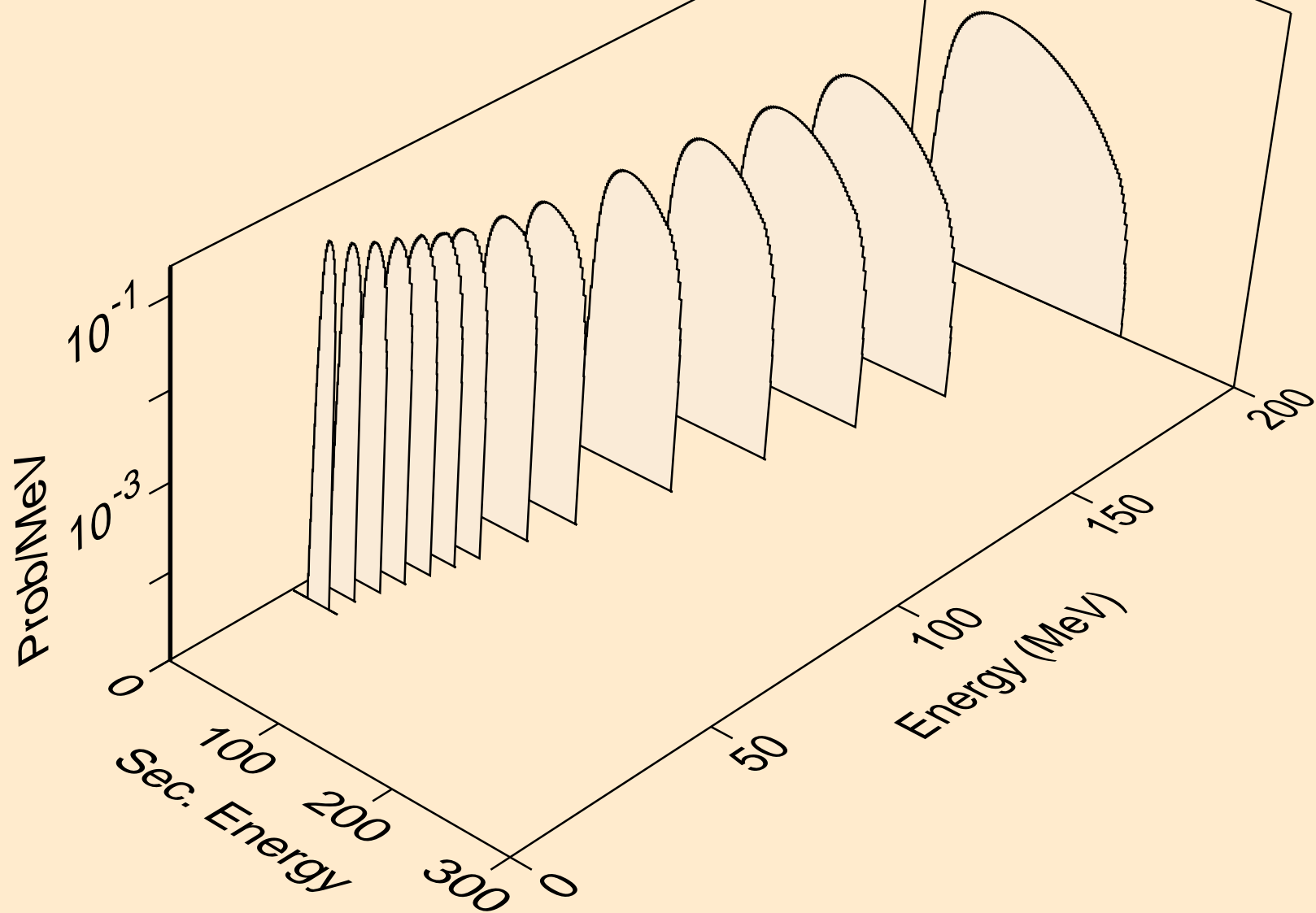

RN205M TRITON ACER TENDL-2023 LIBRARY; T=0.K  
he3s from (t,n\*)he3

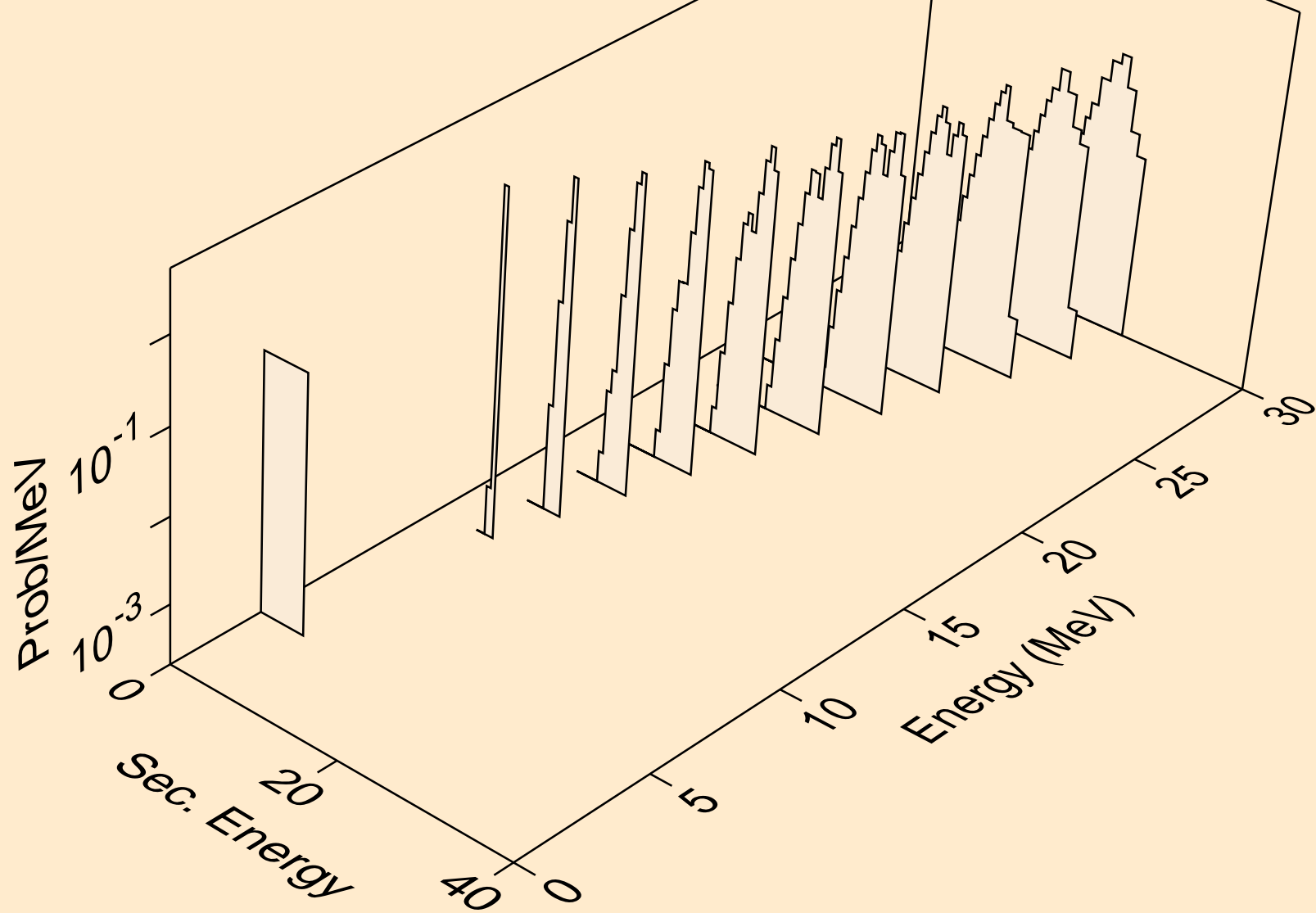

RN205M TRITON ACER TENDL-2023 LIBRARY; T=0.K  
he3s from (t,he3)

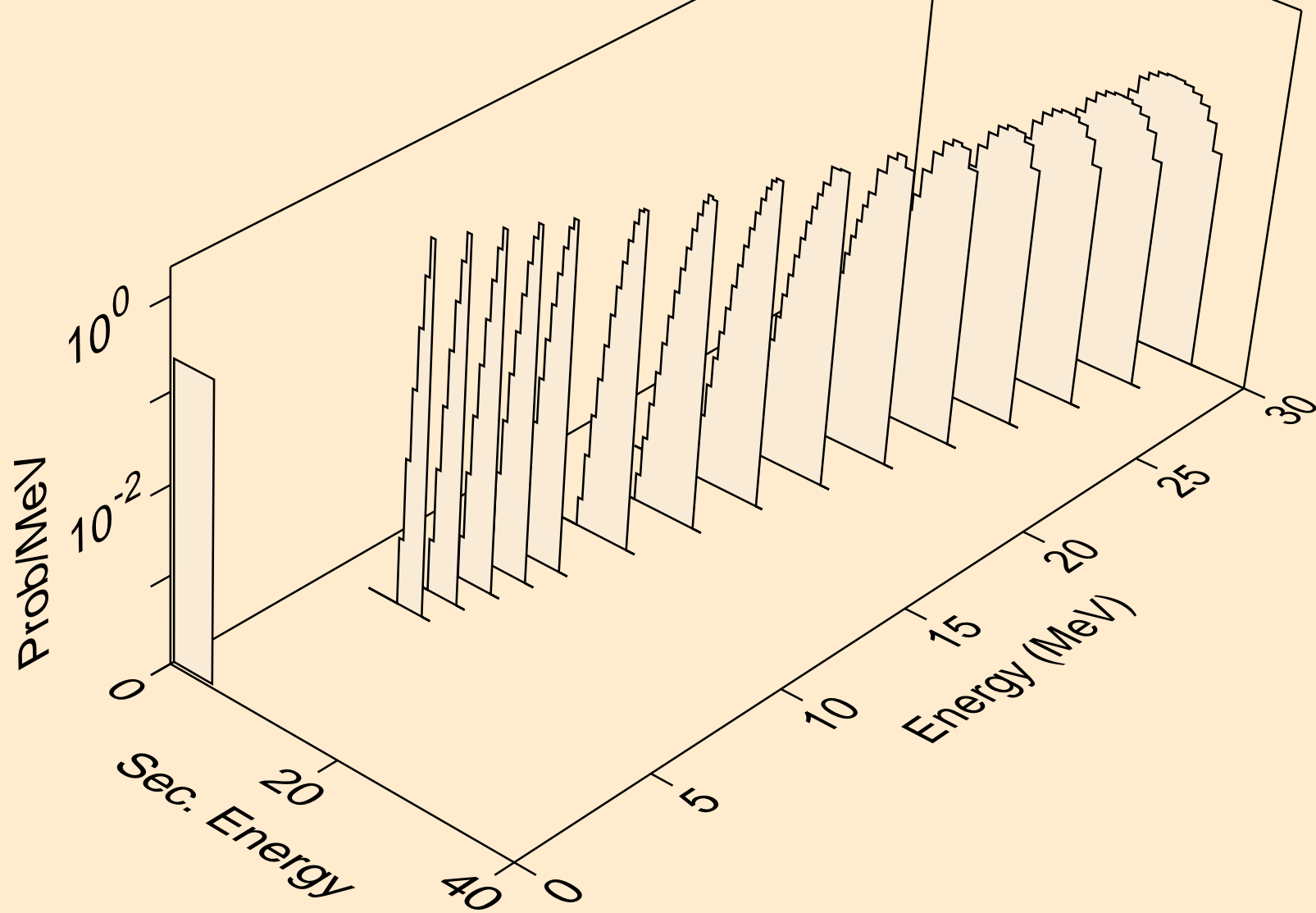

RN205M TRITON ACER TENDL-2023 LIBRARY; T=0.K  
alphas from (t,x)

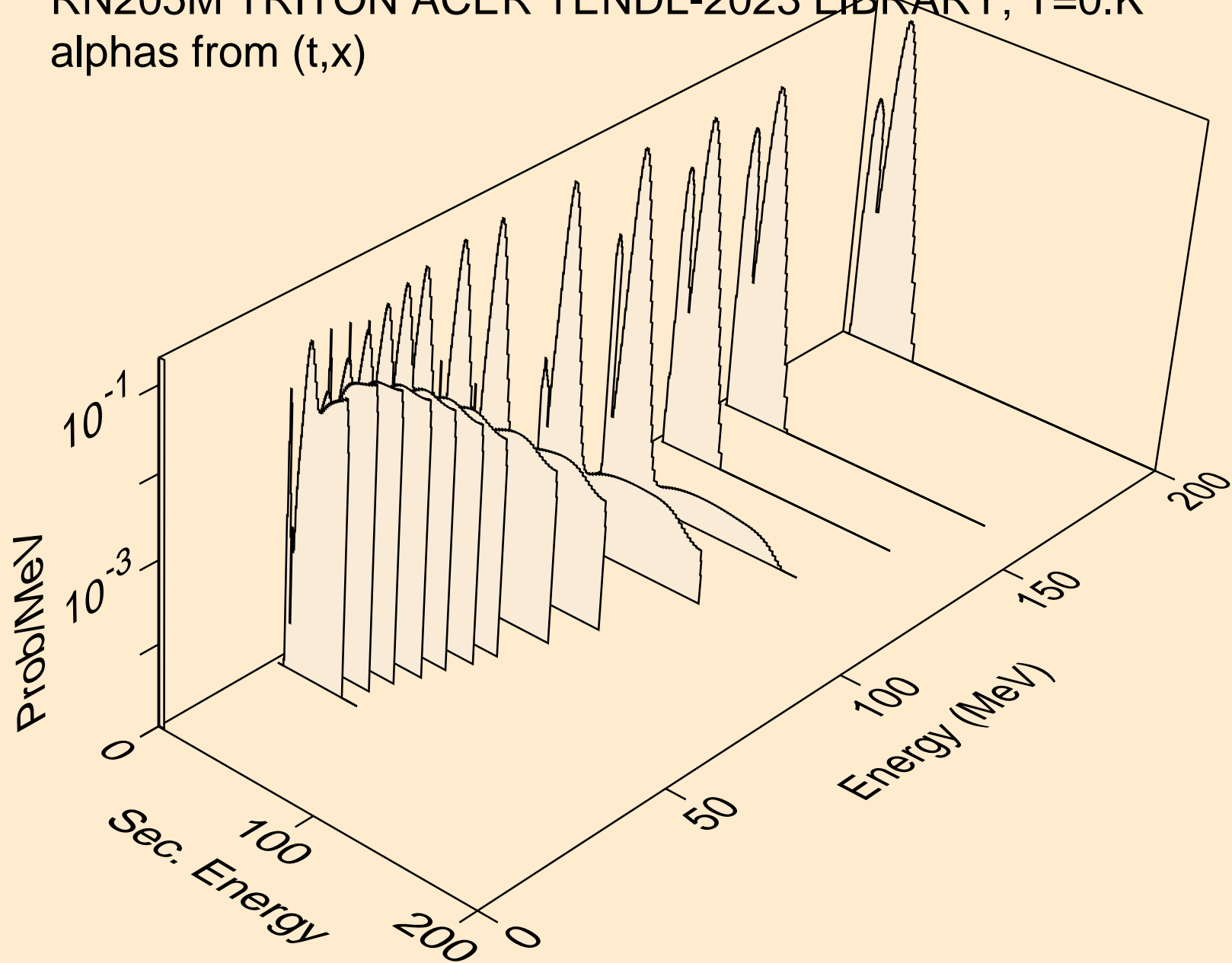

RN205M TRITON ACER TENDL-2023 LIBRARY; T=0.K  
alphas from (t,n\*)a

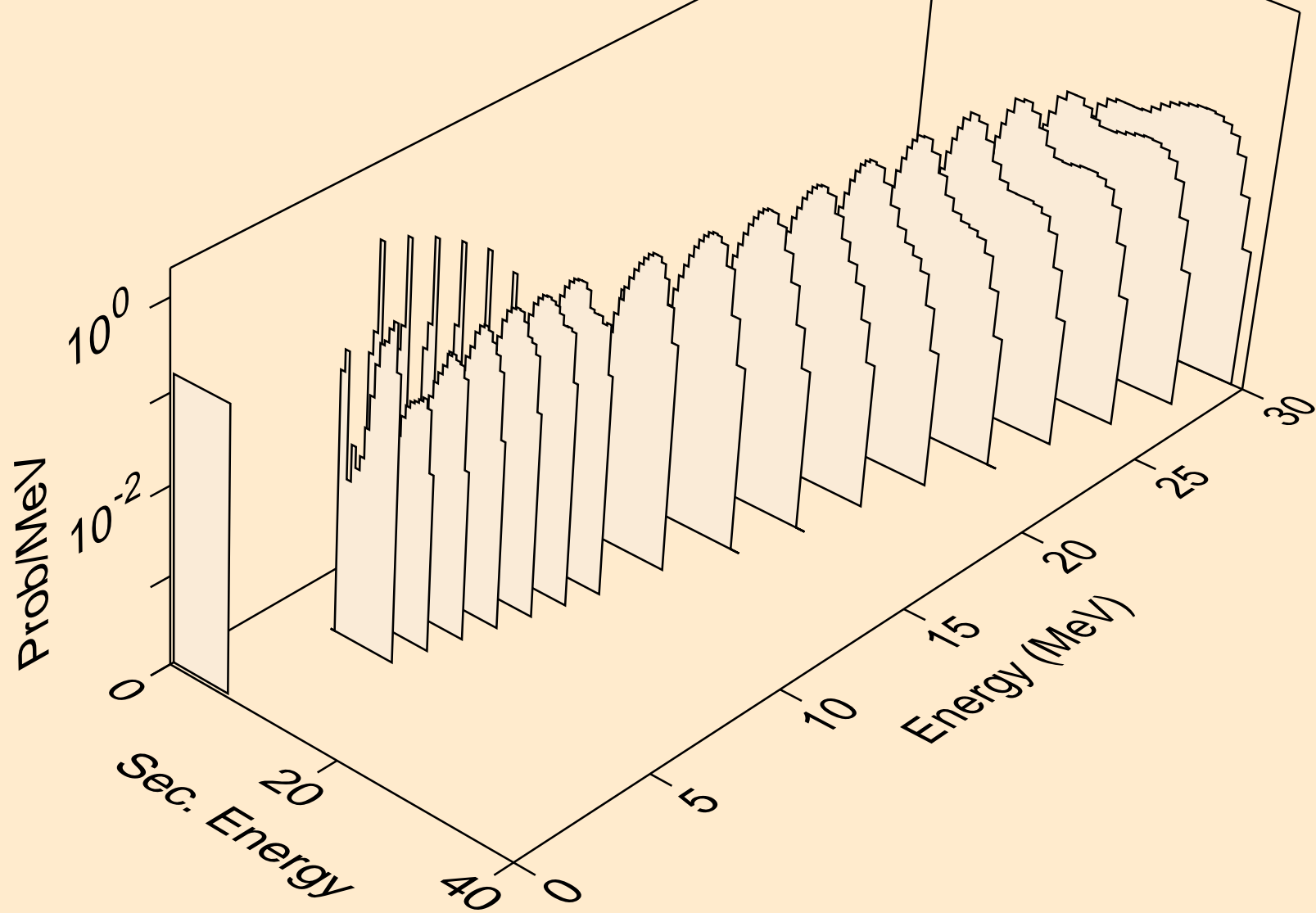

RN205M TRITON ACER TENDL-2023 LIBRARY; T=0.K  
alphas from (t,2n)a

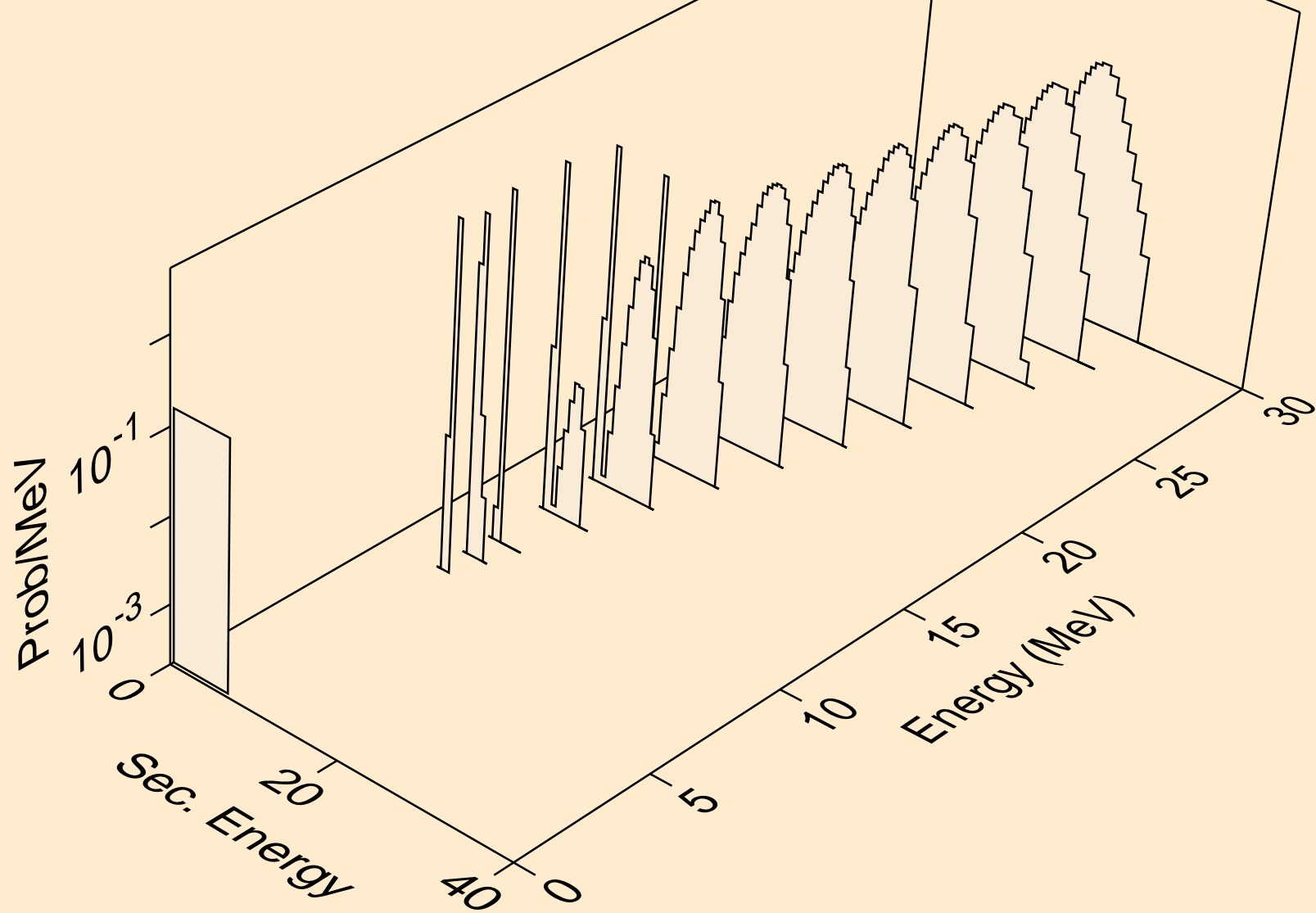

RN205M TRITON ACER TENDL-2023 LIBRARY; T=0.K  
alphas from (t,3n)a

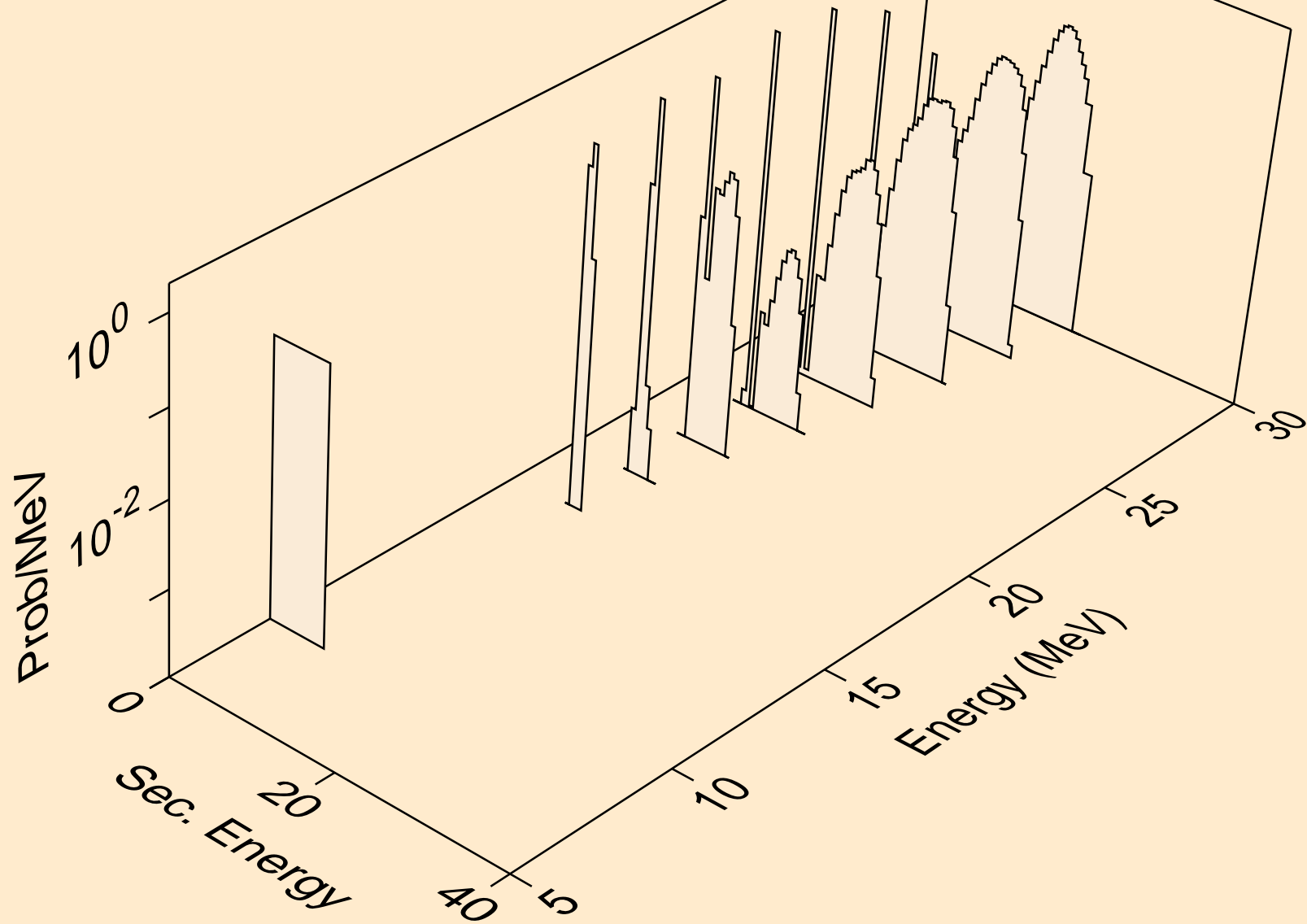

RN205M TRITON ACER TENDL-2023 LIBRARY; T=0.K  
alphas from (t,n\*)2a

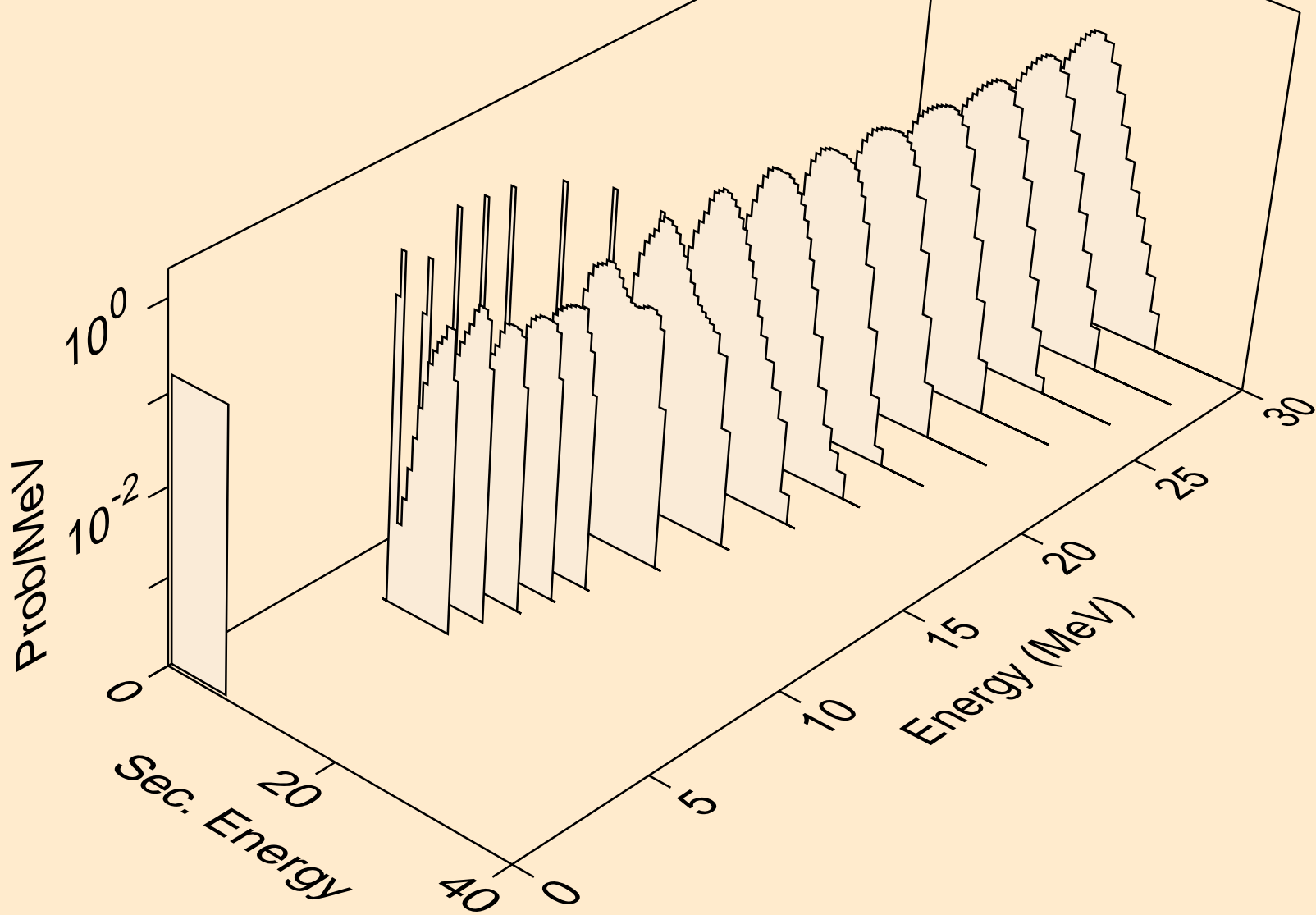

RN205M TRITON ACER TENDL-2023 LIBRARY; T=0.K  
alphas from (t,2n)2a

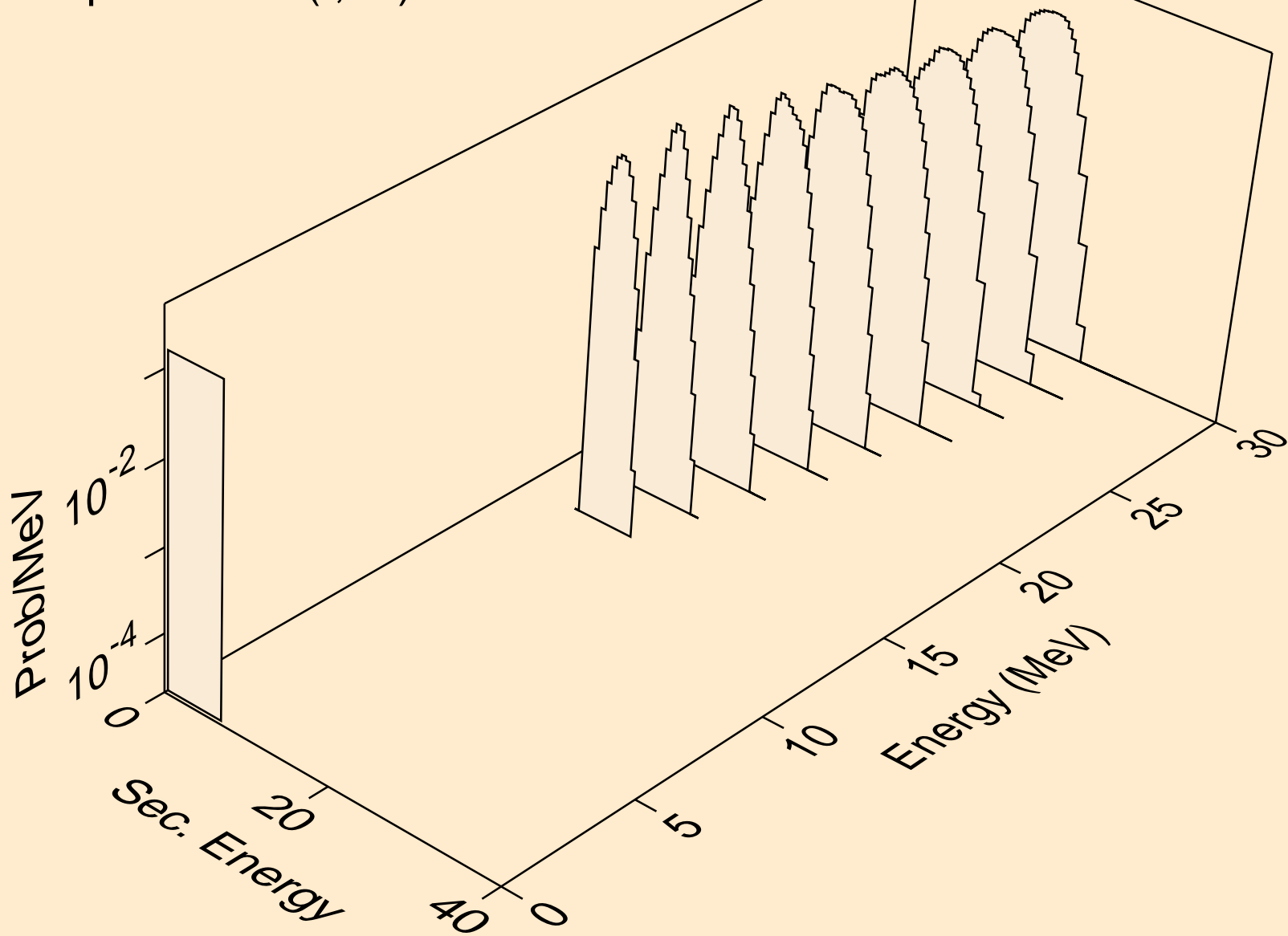

RN205M TRITON ACER TENDL-2023 LIBRARY; T=0.K  
alphas from (t,npa)

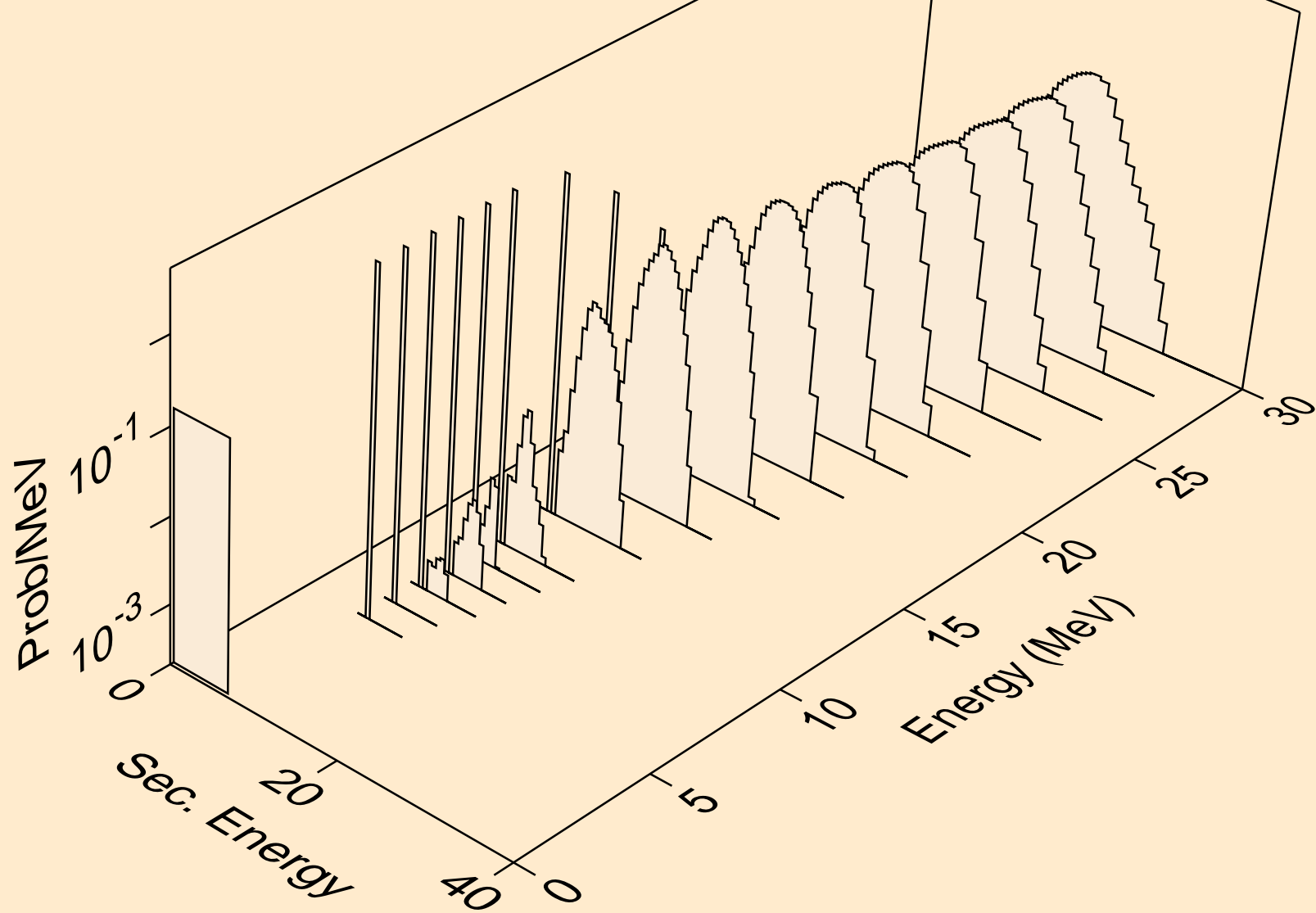

RN205M TRITON ACER TENDL-2023 LIBRARY; T=0.K  
alphas from (t,a)

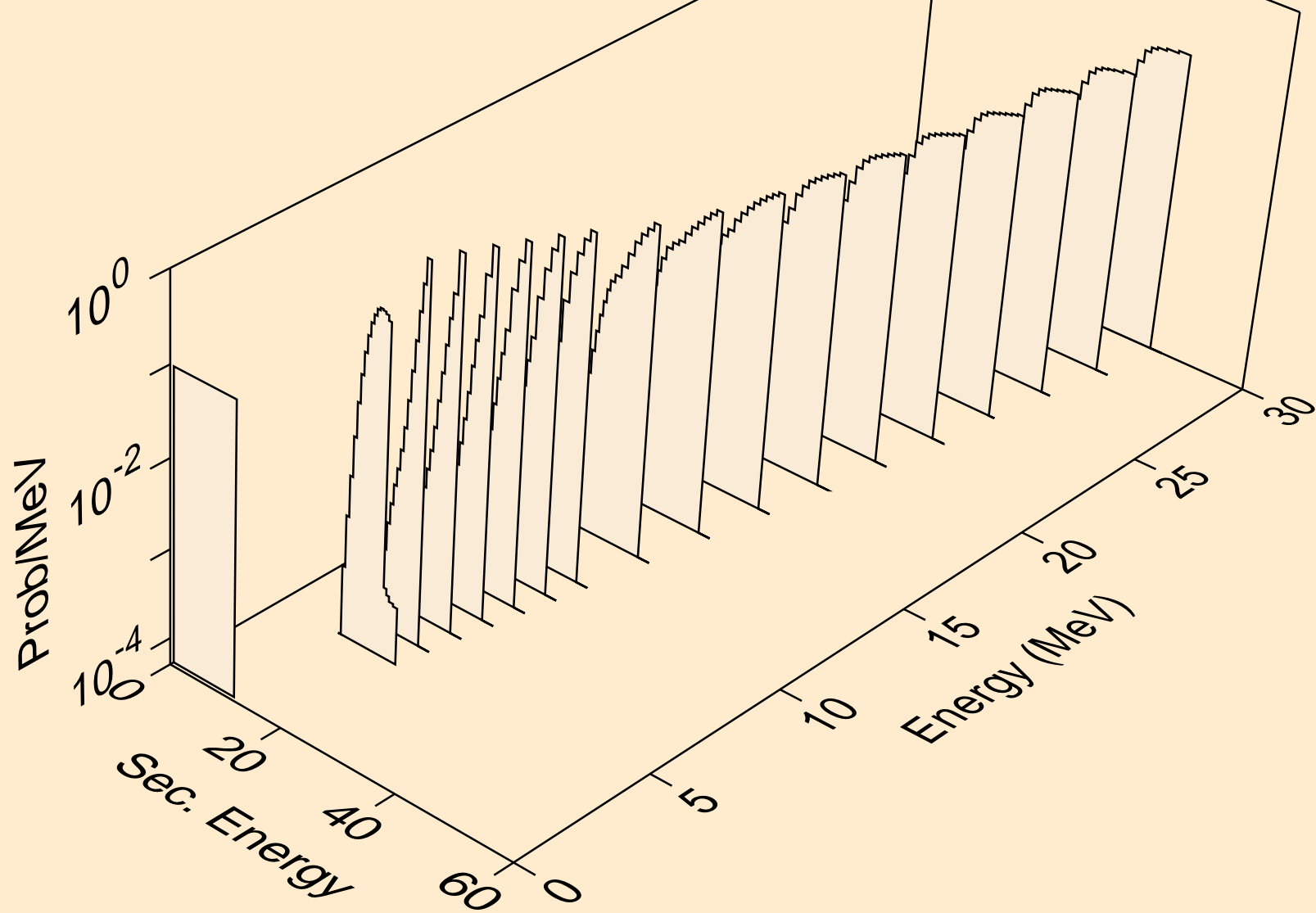

RN205M TRITON ACER TENDL-2023 LIBRARY; T=0.K  
alphas from (t,2a)

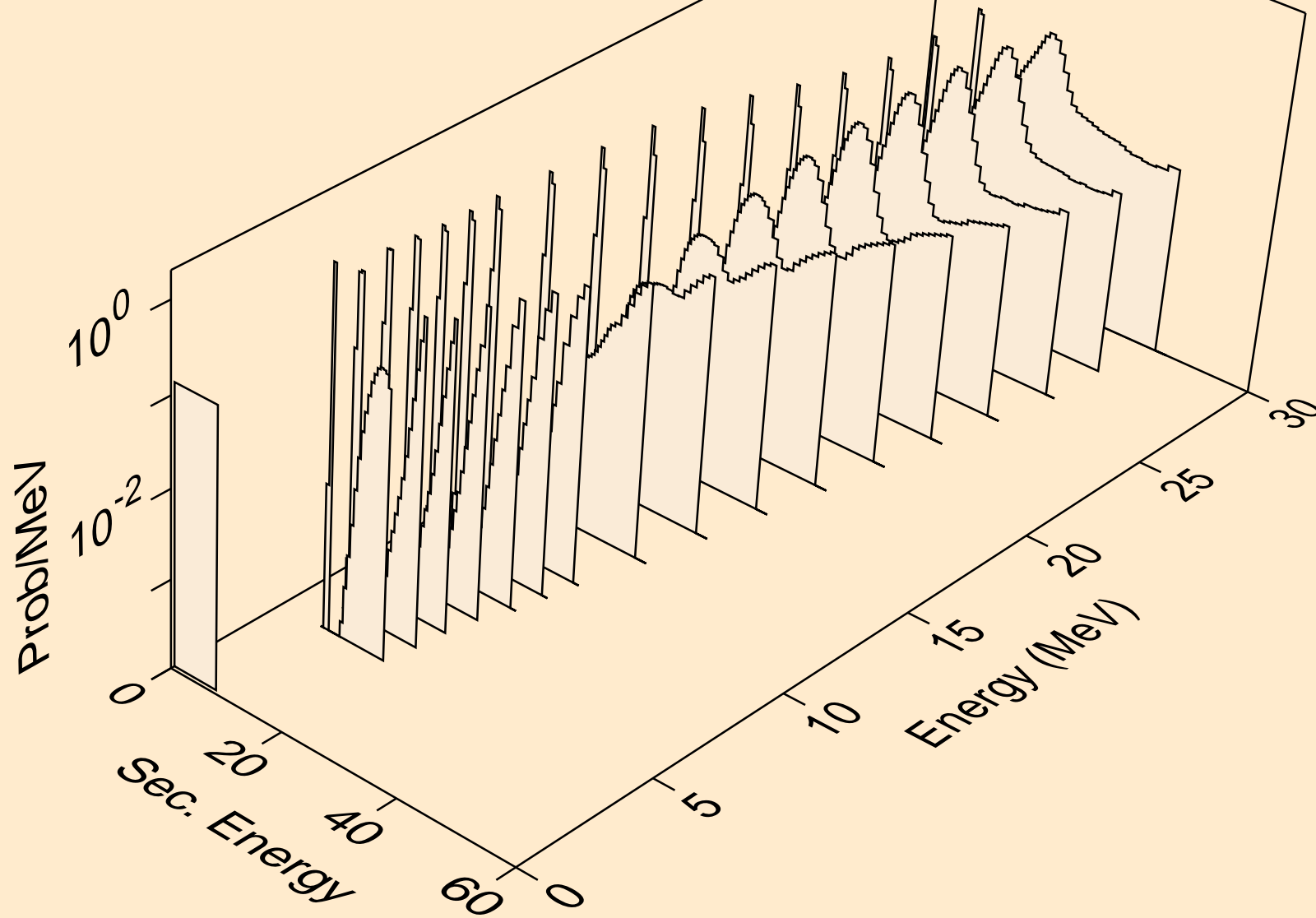

RN205M TRITON ACER TENDL-2023 LIBRARY; T=0.K  
alphas from (t,pa)

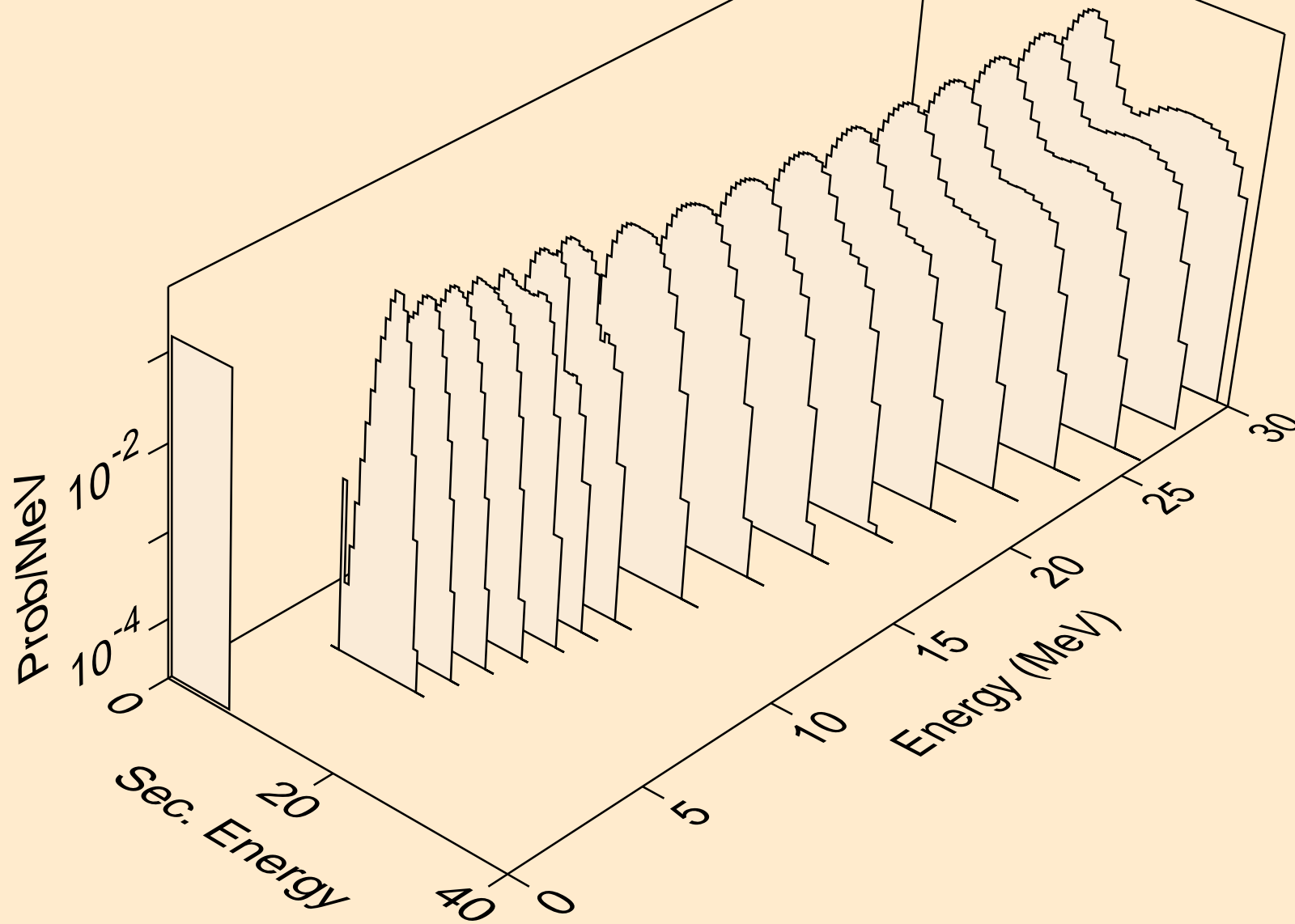

RN205M TRITON ACER TENDL-2023 LIBRARY; T=0.K  
alphas from (t,da)

