

AS078 ALPHA ACER TENDL-2024 LIBRARY; T=0.K  
Principal cross sections

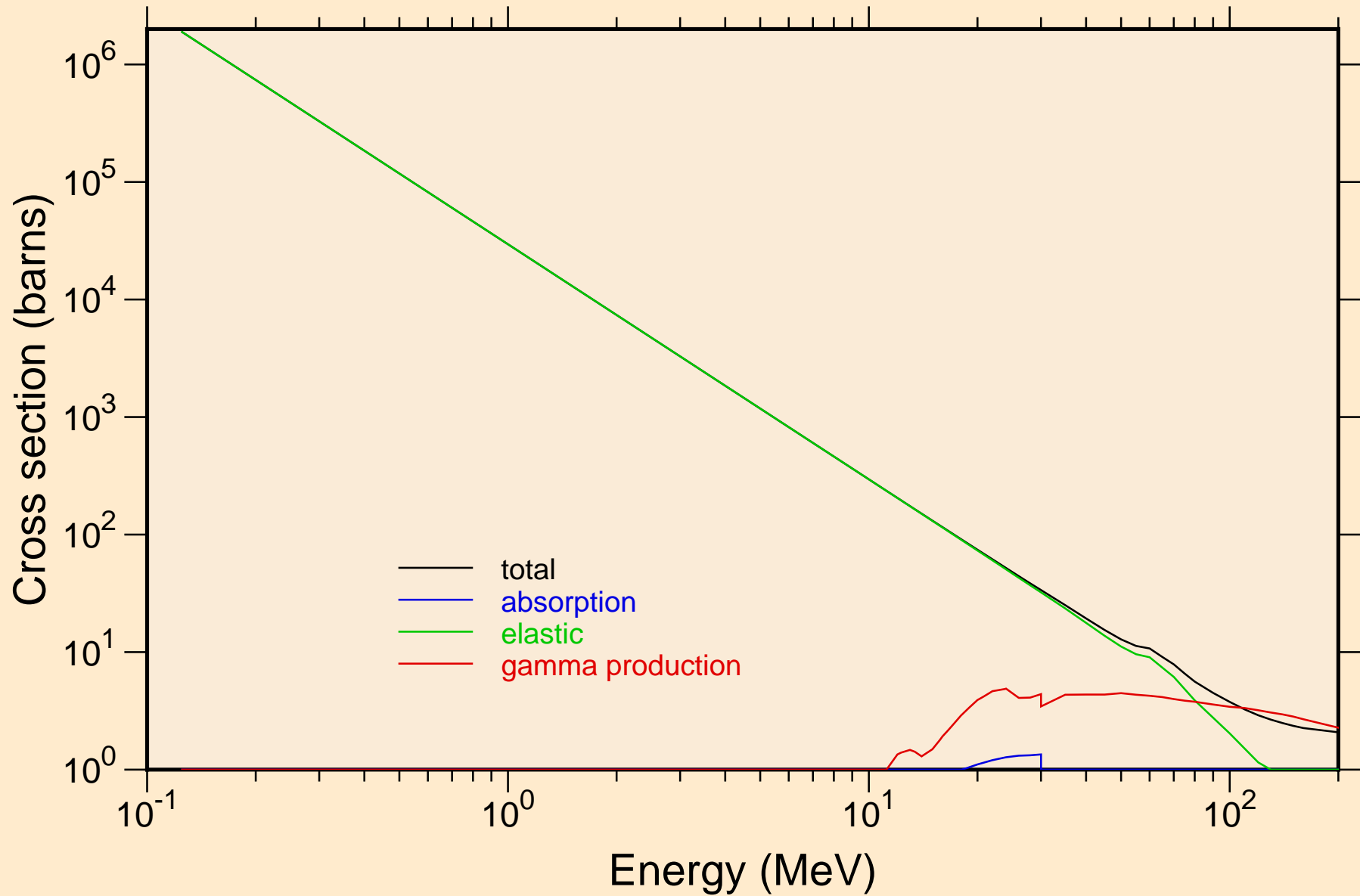

# AS078 ALPHA ACER TENDL-2024 LIBRARY; T=0.K

## Heating

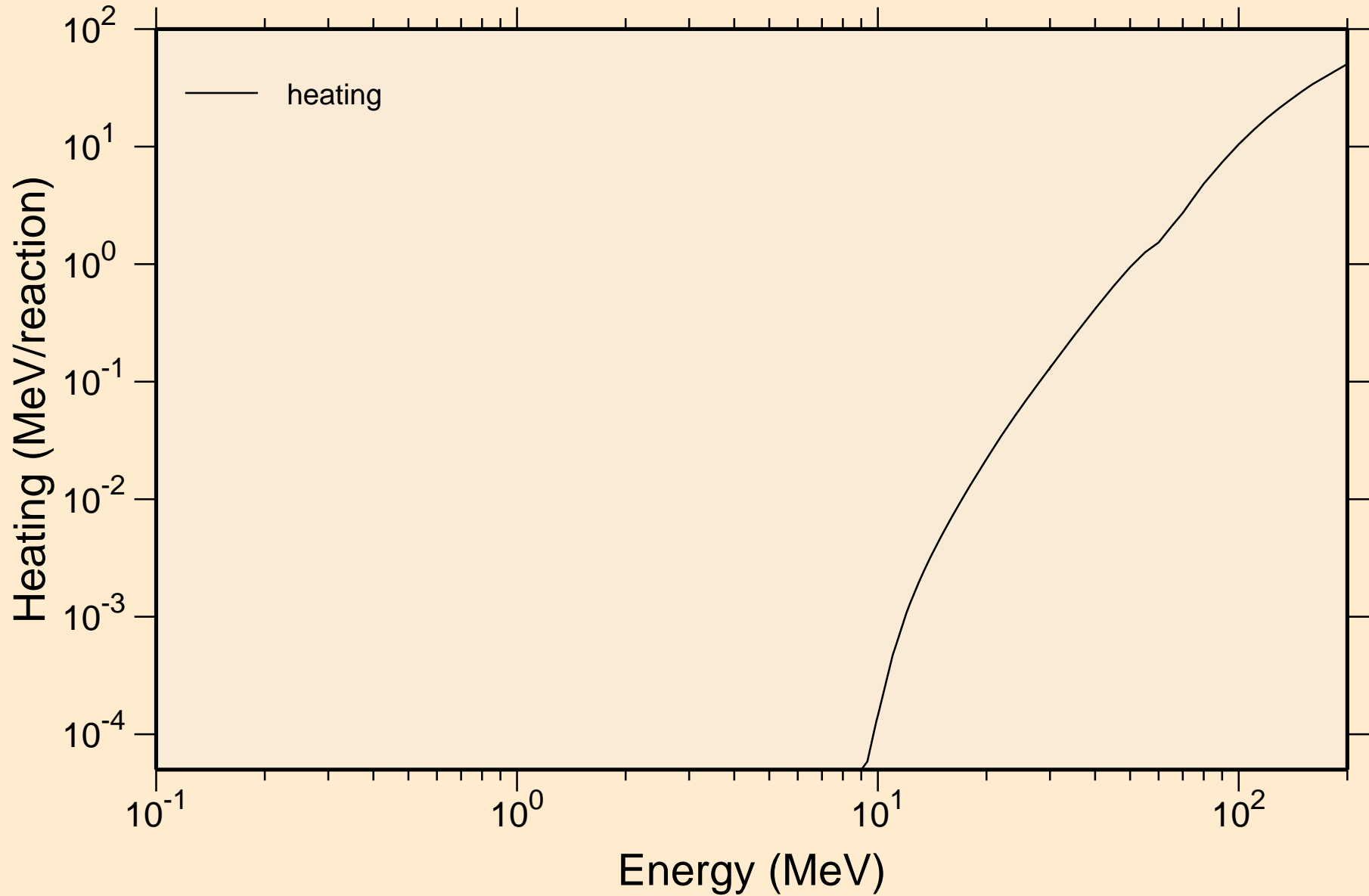

# AS078 ALPHA ACER TENDL-2024 LIBRARY; T=0.K

## Principal cross sections

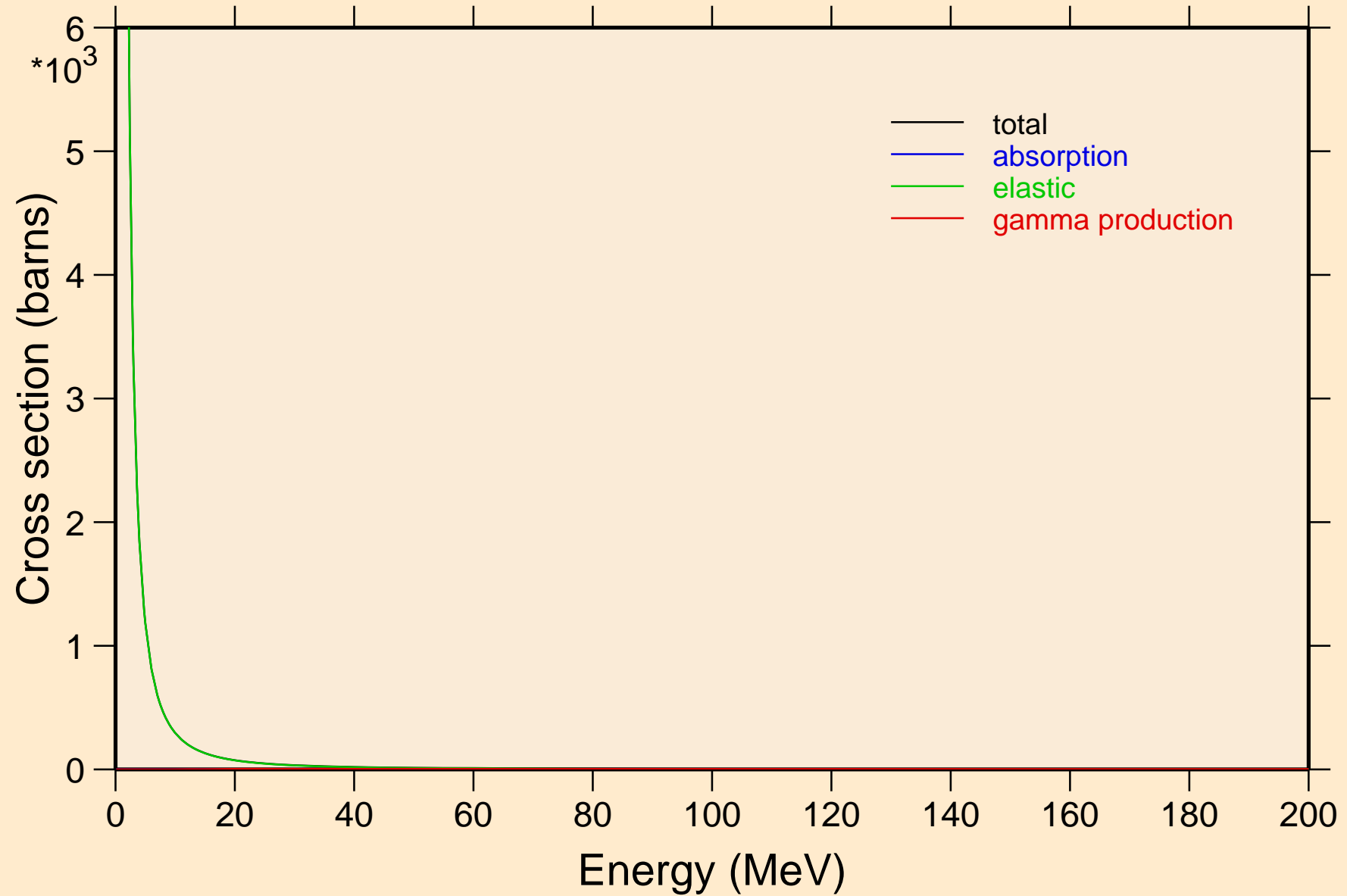

AS078 ALPHA ACER TENDL-2024 LIBRARY; T=0.K

Heating

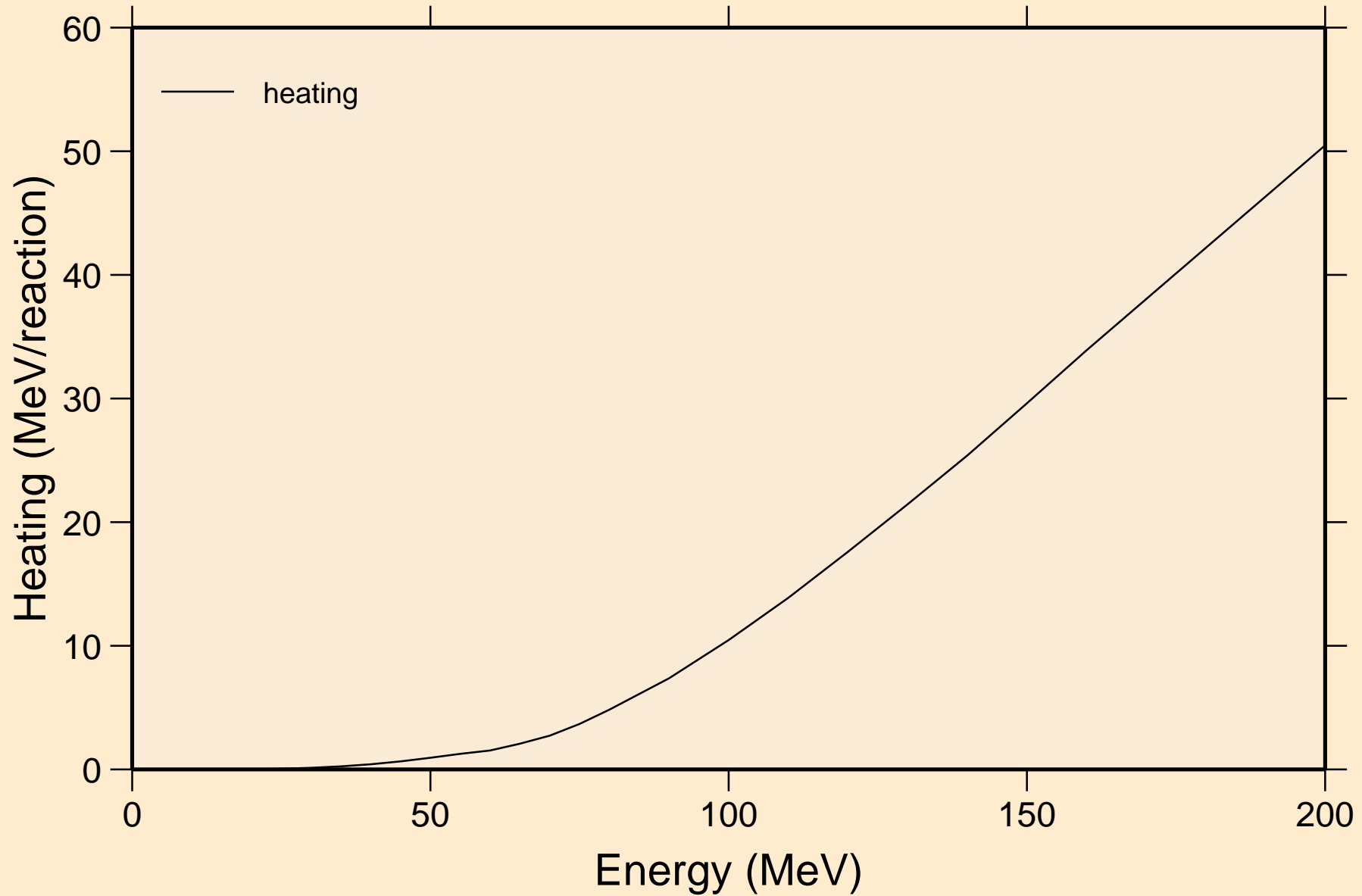

# AS078 ALPHA ACER TENDL-2024 LIBRARY; T=0.K

## Threshold reactions

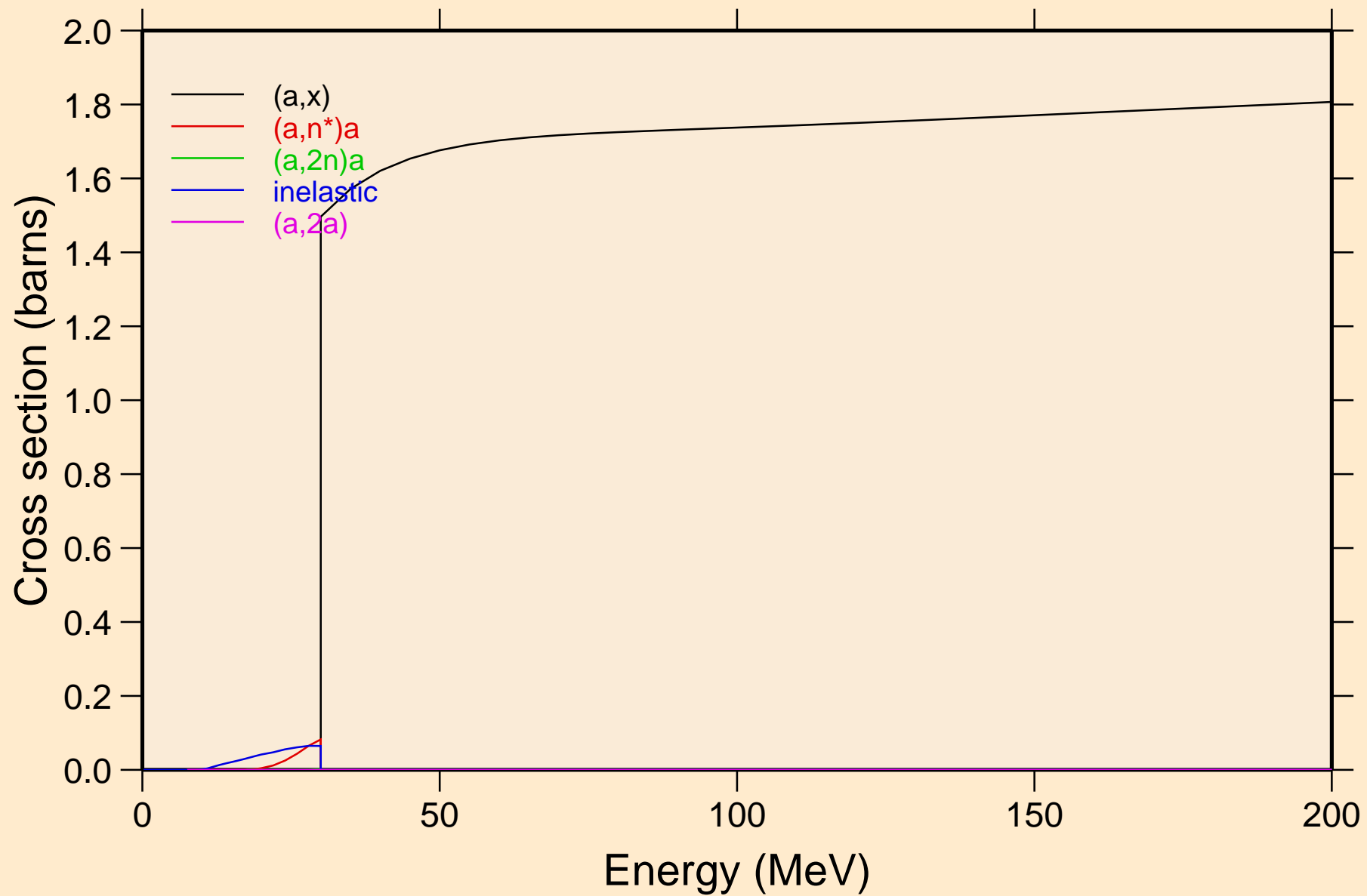

AS078 ALPHA ACER TENDL-2024 LIBRARY; T=0.K  
Threshold reactions

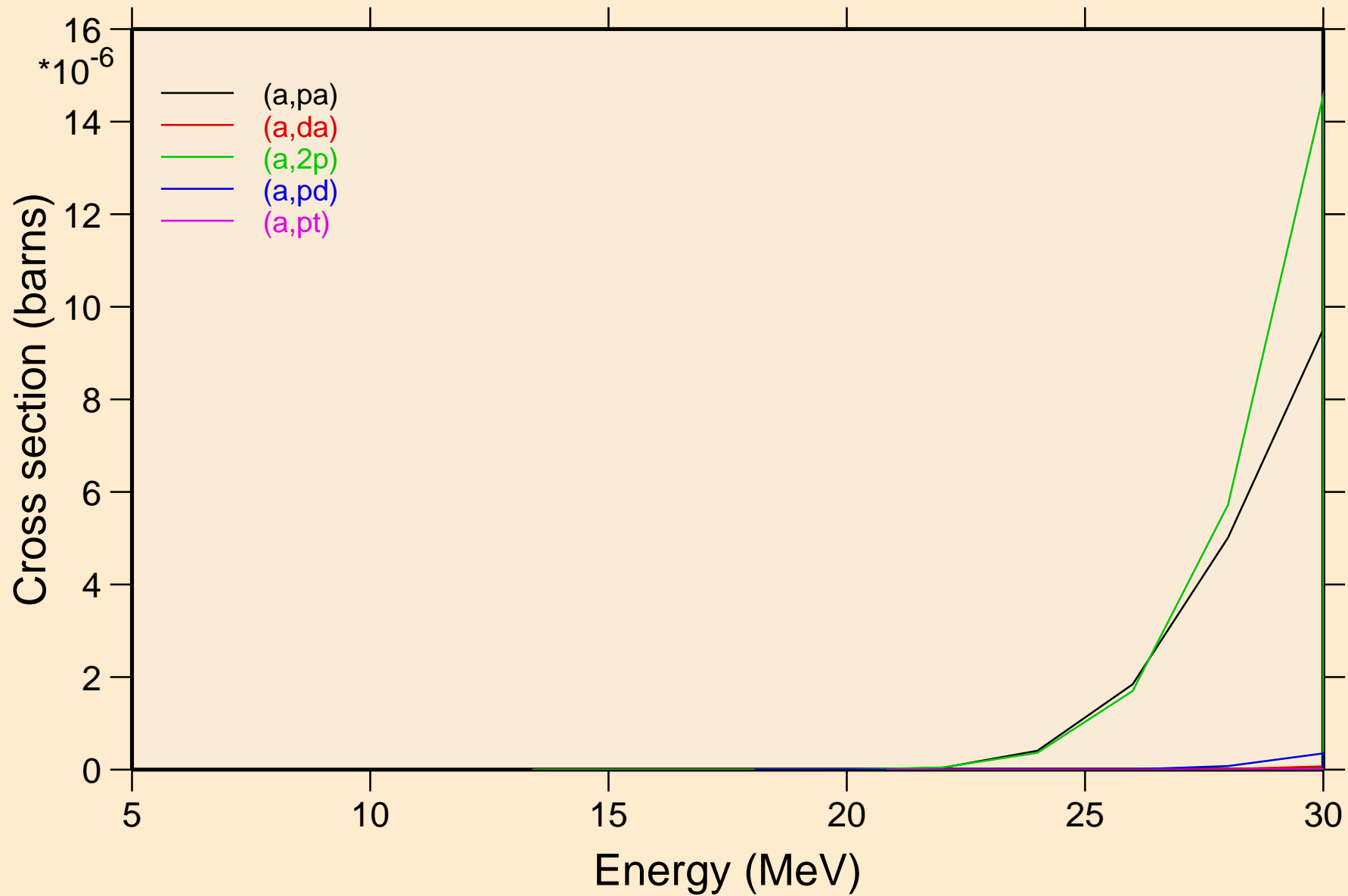

AS078 ALPHA ACER TENDL-2024 LIBRARY; T=0.K  
Threshold reactions

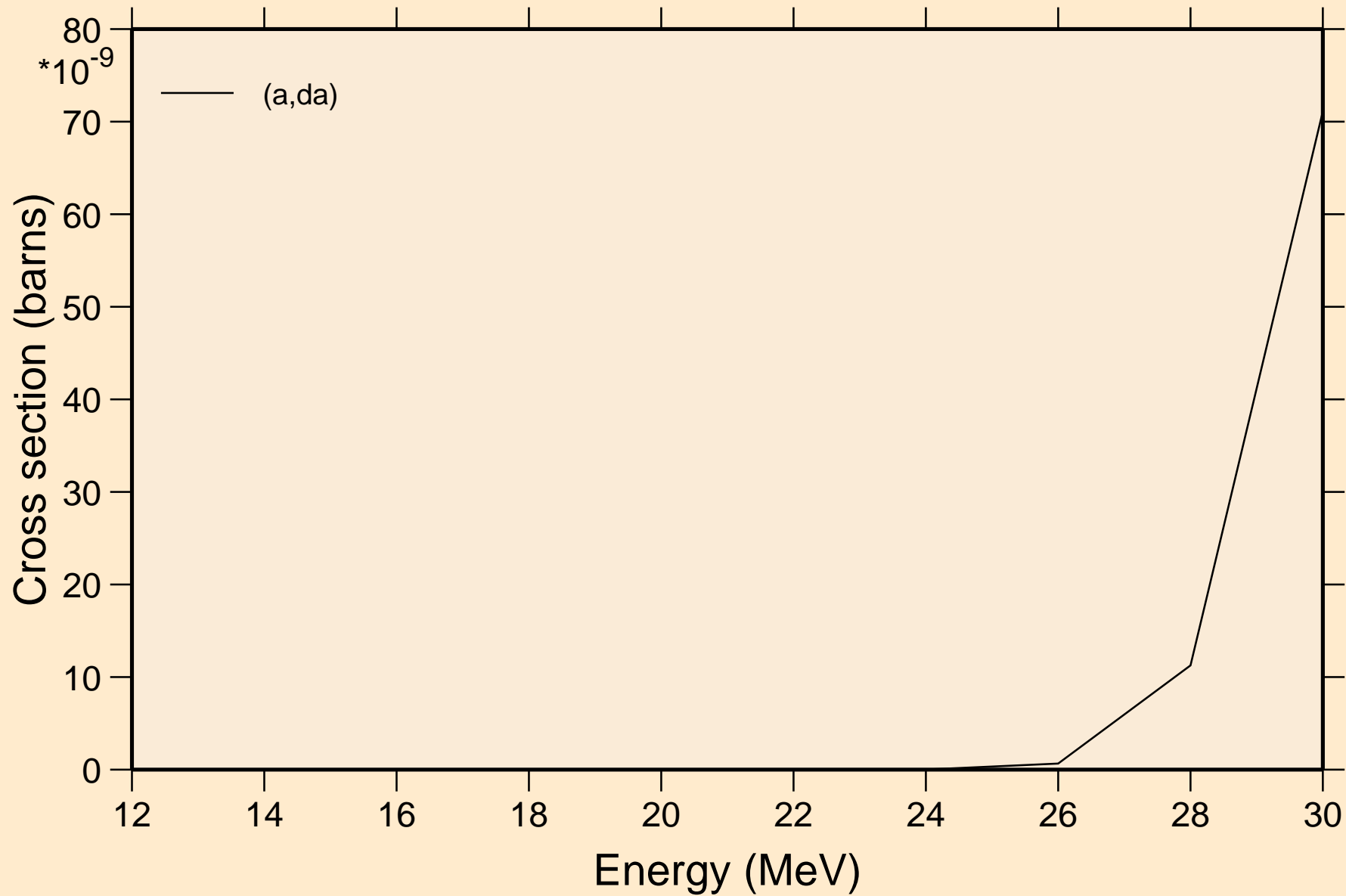

AS078 ALPHA ACER TENDL-2024 LIBRARY; T=0.K  
angular distribution for elastic

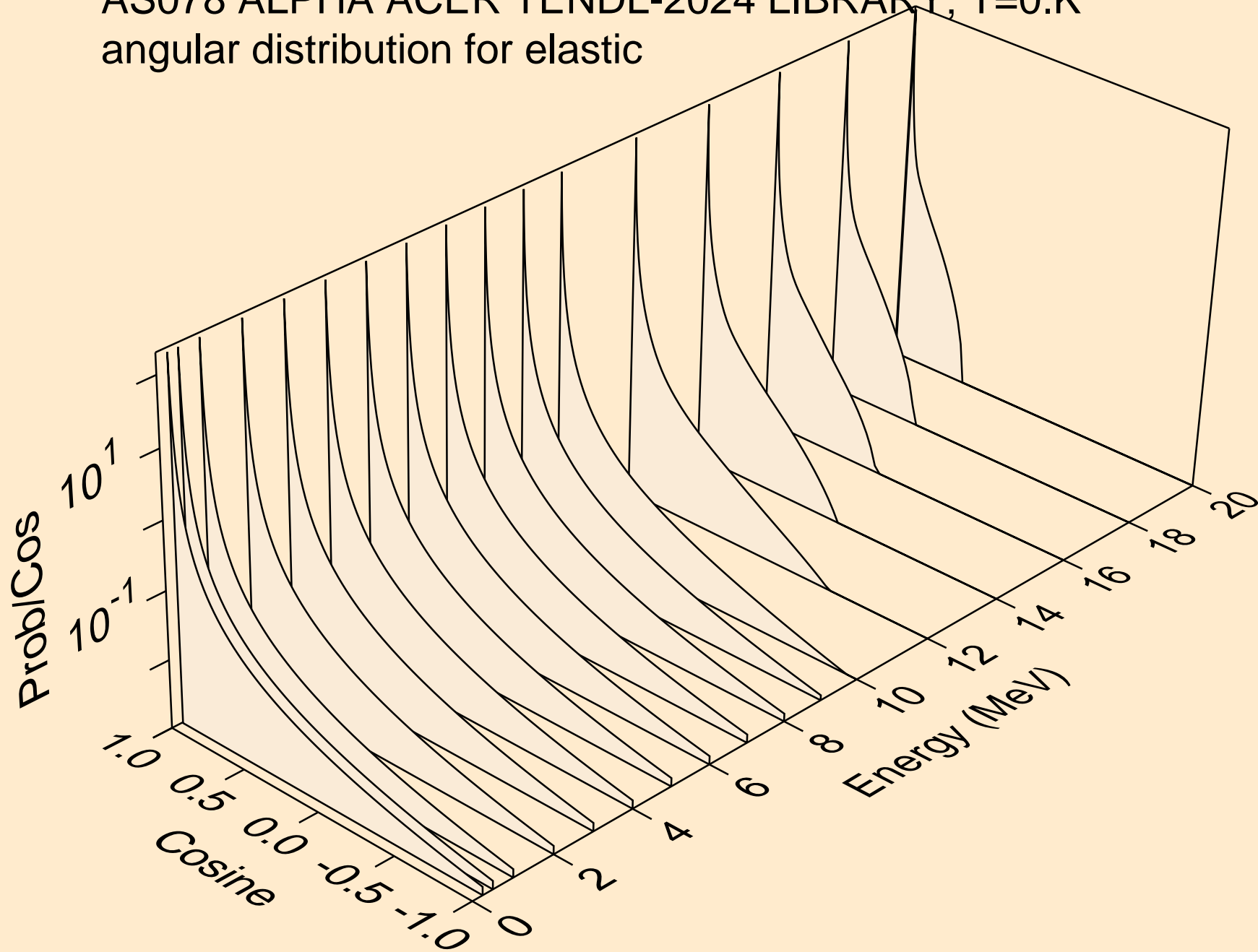

AS078 ALPHA ACER TENDL-2024 LIBRARY; T=0.K  
angular distribution for elastic

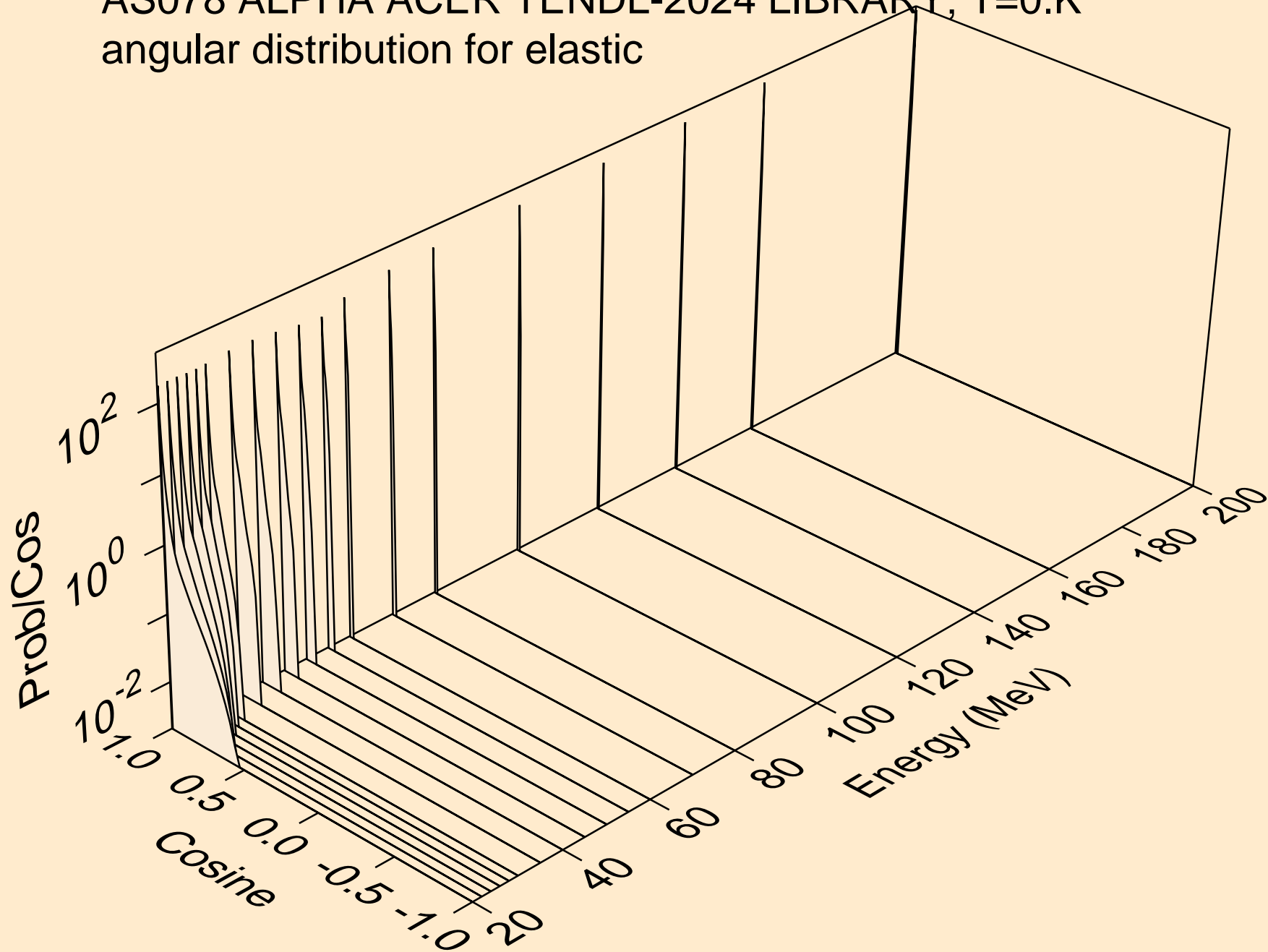

AS078 ALPHA ACER TENDL-2024 LIBRARY; T=0.K  
Alpha emission for (a,x)

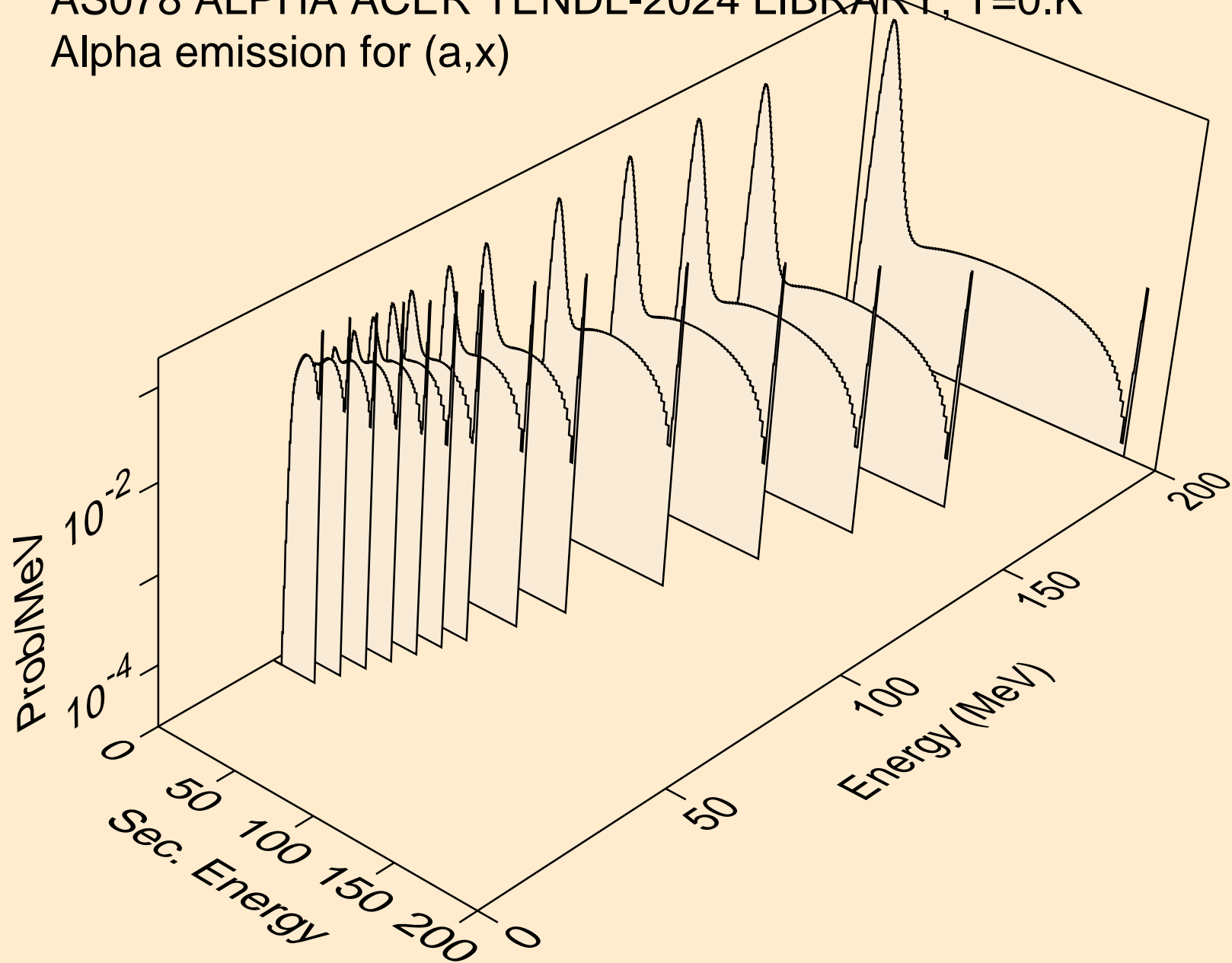

AS078 ALPHA ACER TENDL-2024 LIBRARY; T=0.K  
Alpha emission for (a,n\*)a

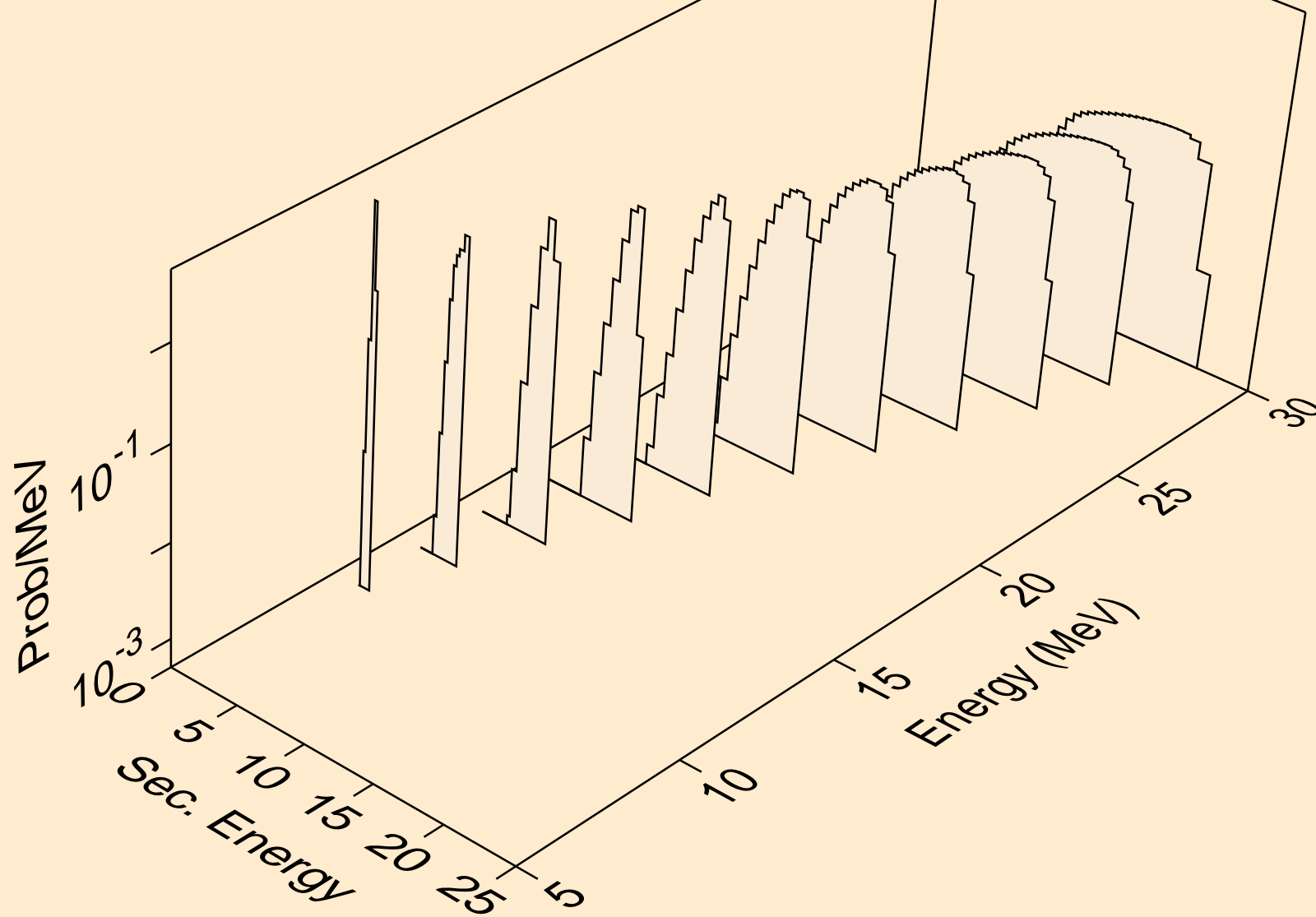

AS078 ALPHA ACER TENDL-2024 LIBRARY; T=0.K  
Alpha emission for (a,2n)a

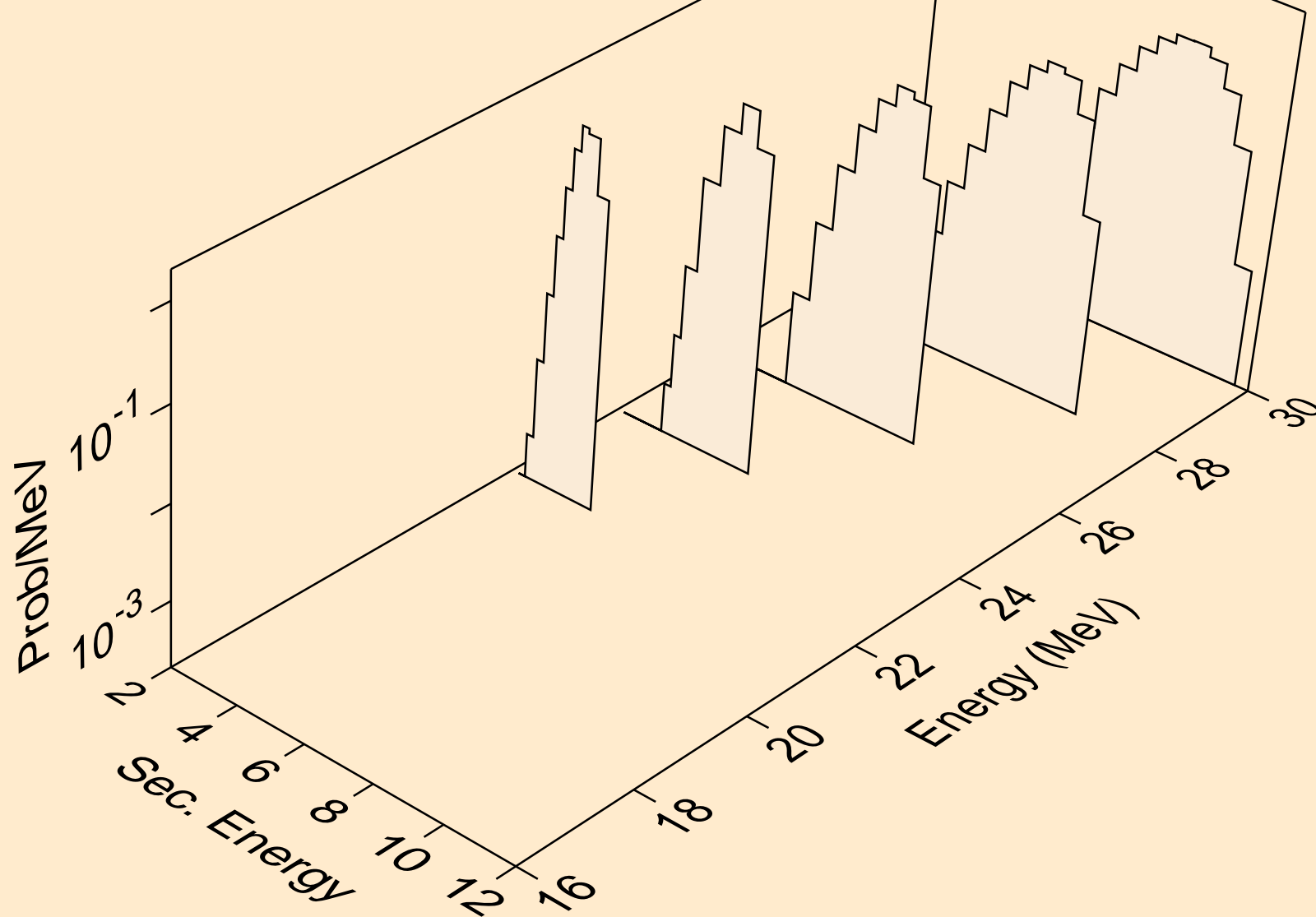

AS078 ALPHA ACER TENDL-2024 LIBRARY; T=0.K  
Alpha emission for inelastic

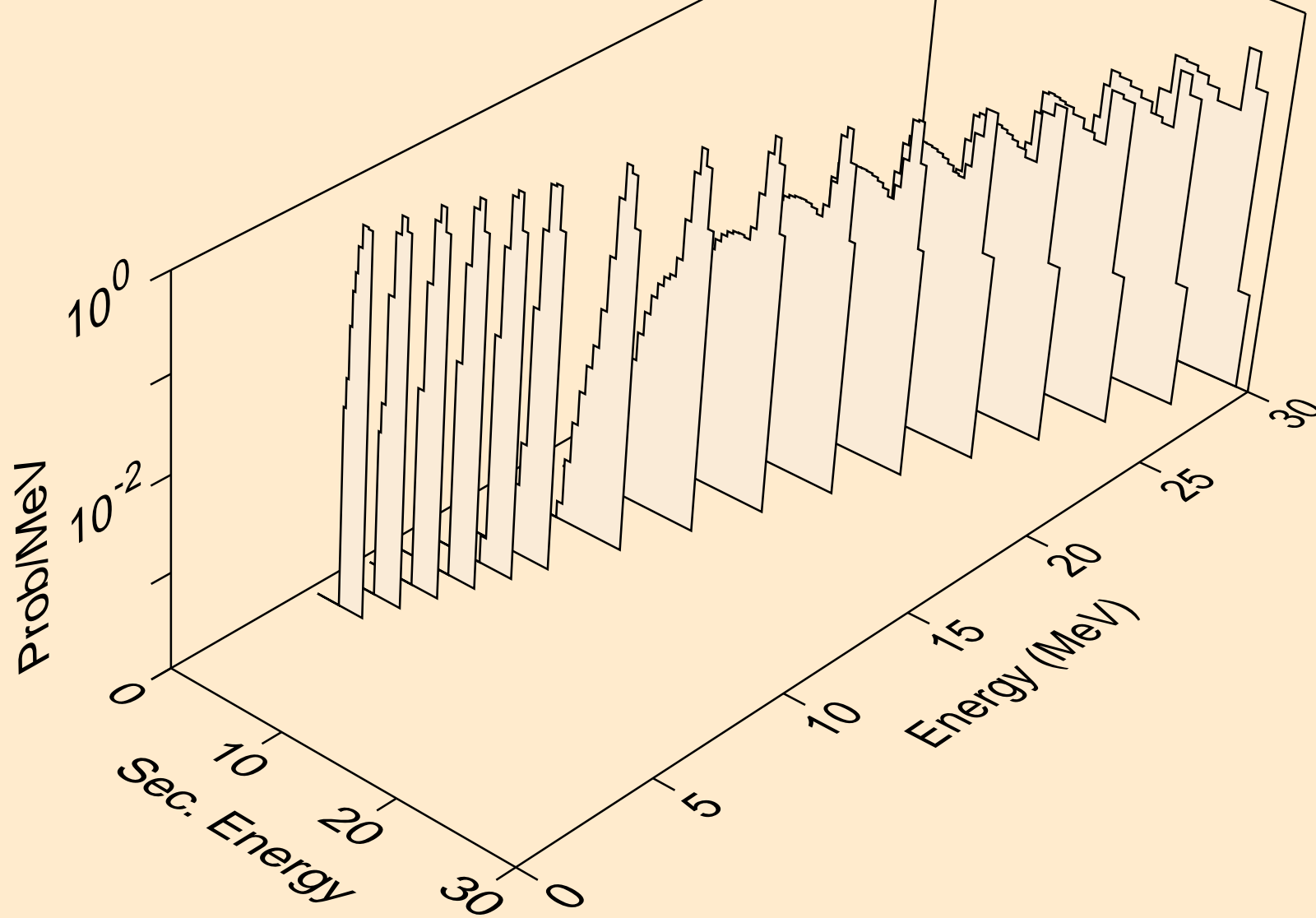

AS078 ALPHA ACER TENDL-2024 LIBRARY; T=0.K  
Alpha emission for (a,2a)

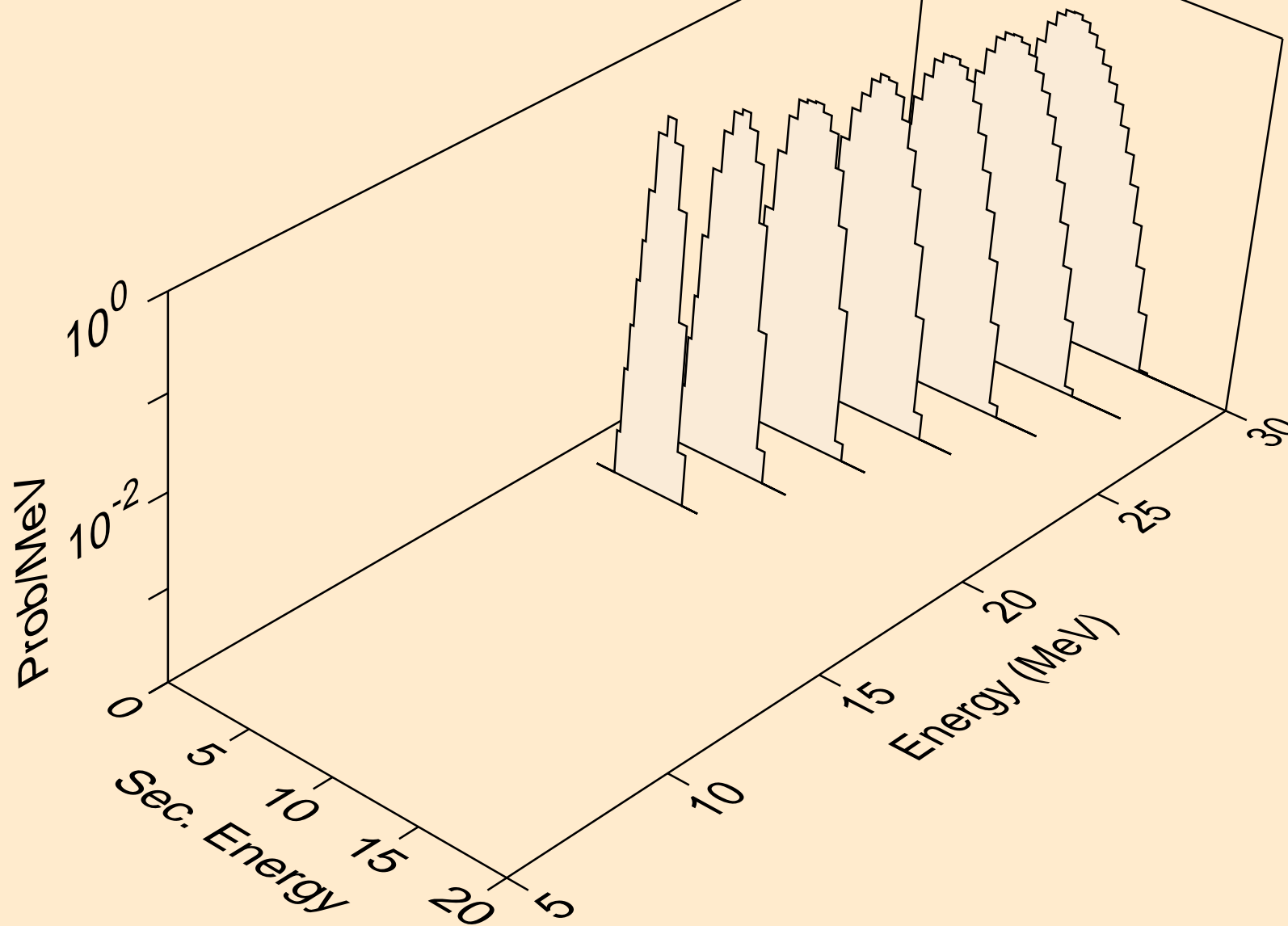

AS078 ALPHA ACER TENDL-2024 LIBRARY; T=0.K  
Alpha emission for (a,pa)

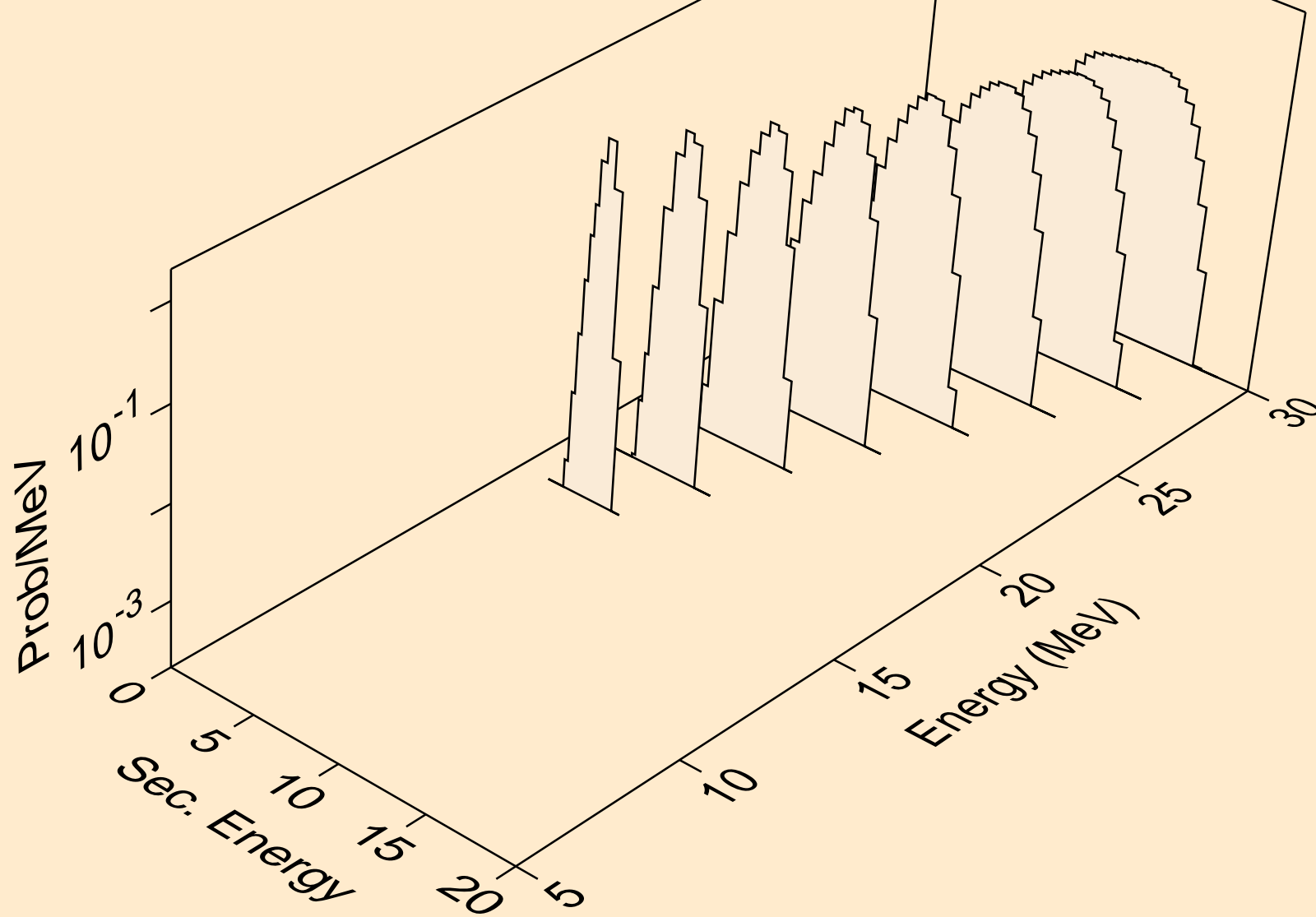

AS078 ALPHA ACER TENDL-2024 LIBRARY; T=0.K  
Alpha emission for (a,da)

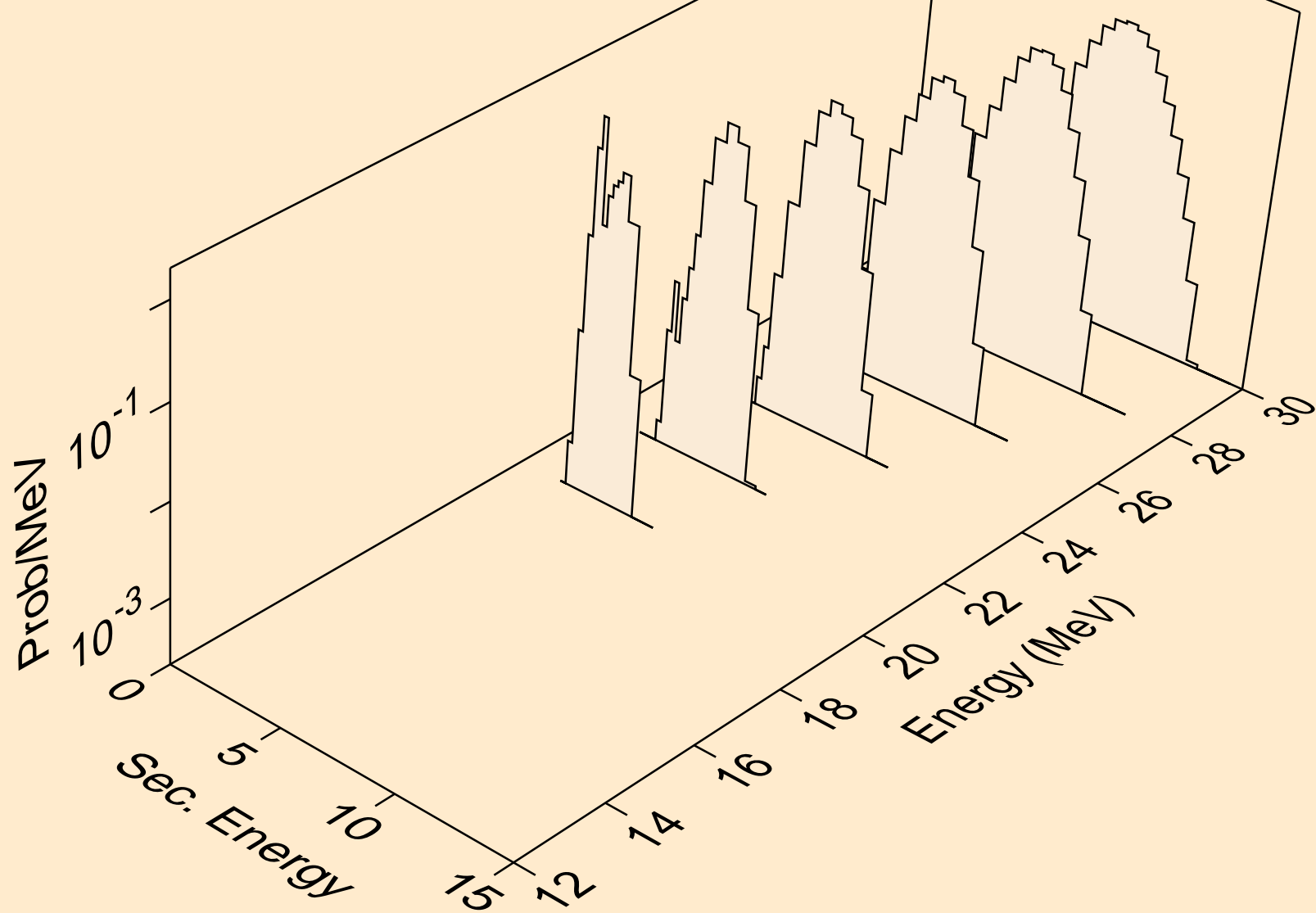

AS078 ALPHA ACER TENDL-2024 LIBRARY; T=0.K  
Photon emission for (z,n)

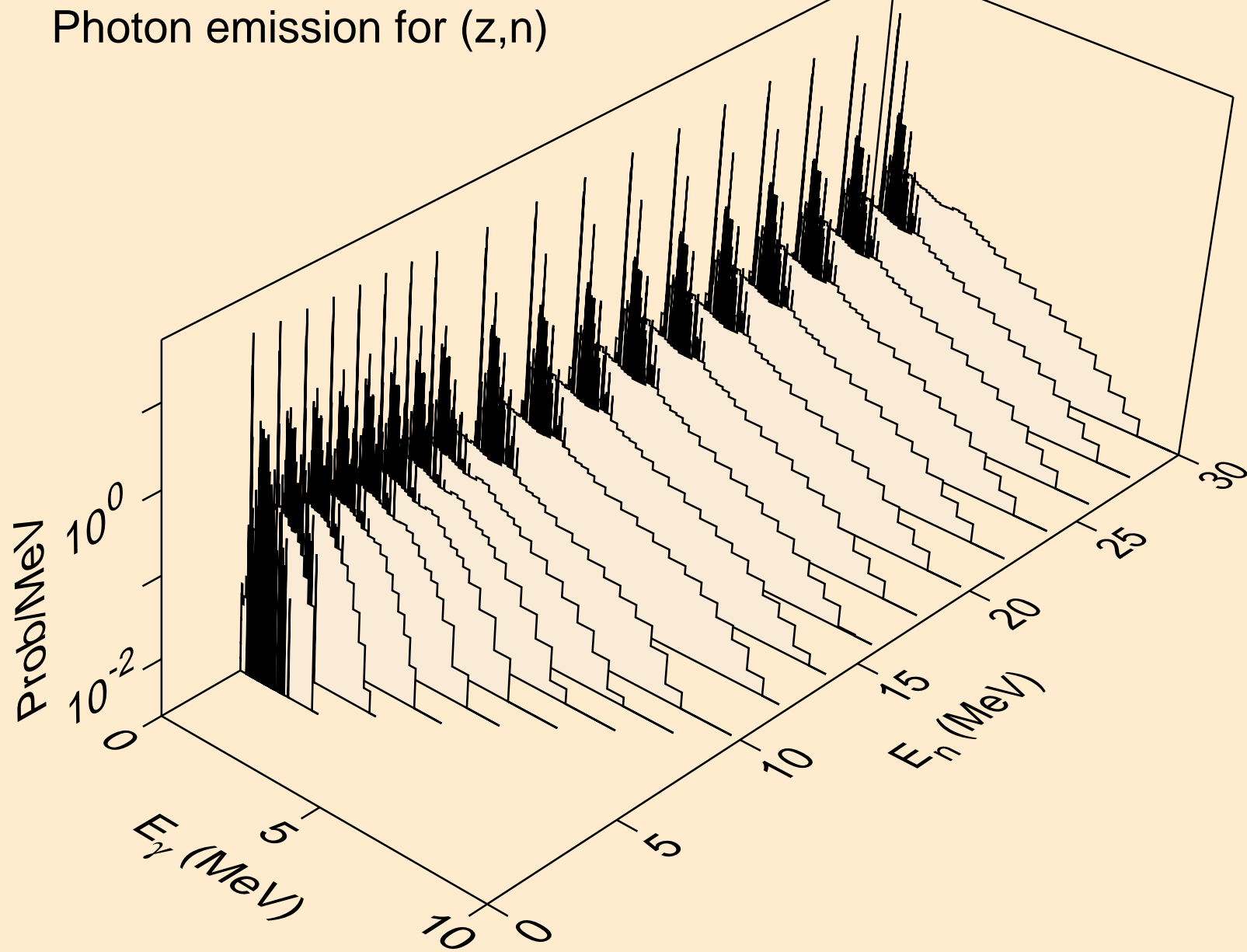

AS078 ALPHA ACER TENDL-2024 LIBRARY; T=0.K  
Photon emission for (z,x)

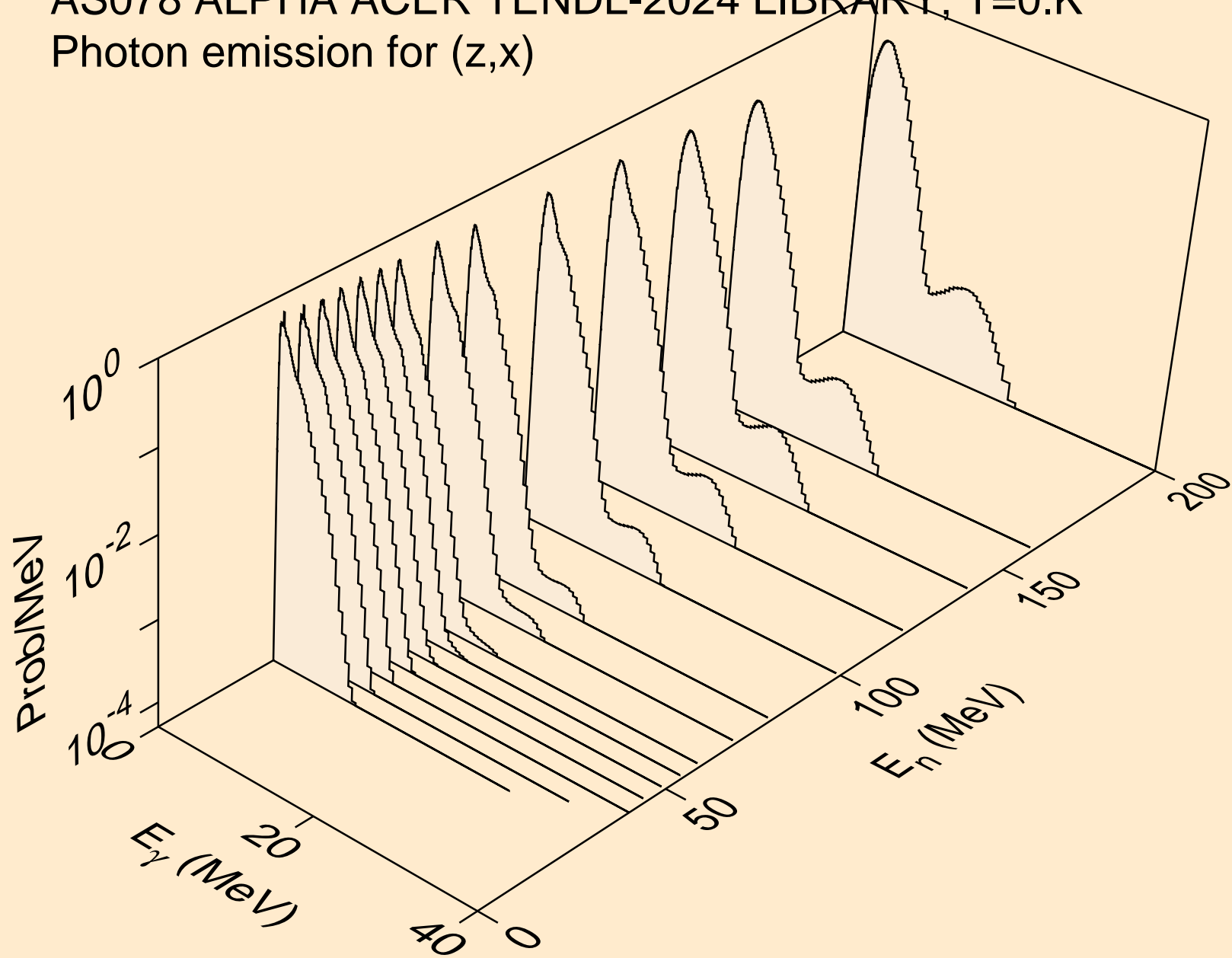

AS078 ALPHA ACER TENDL-2024 LIBRARY; T=0.K  
Photon emission for (n,2nd)

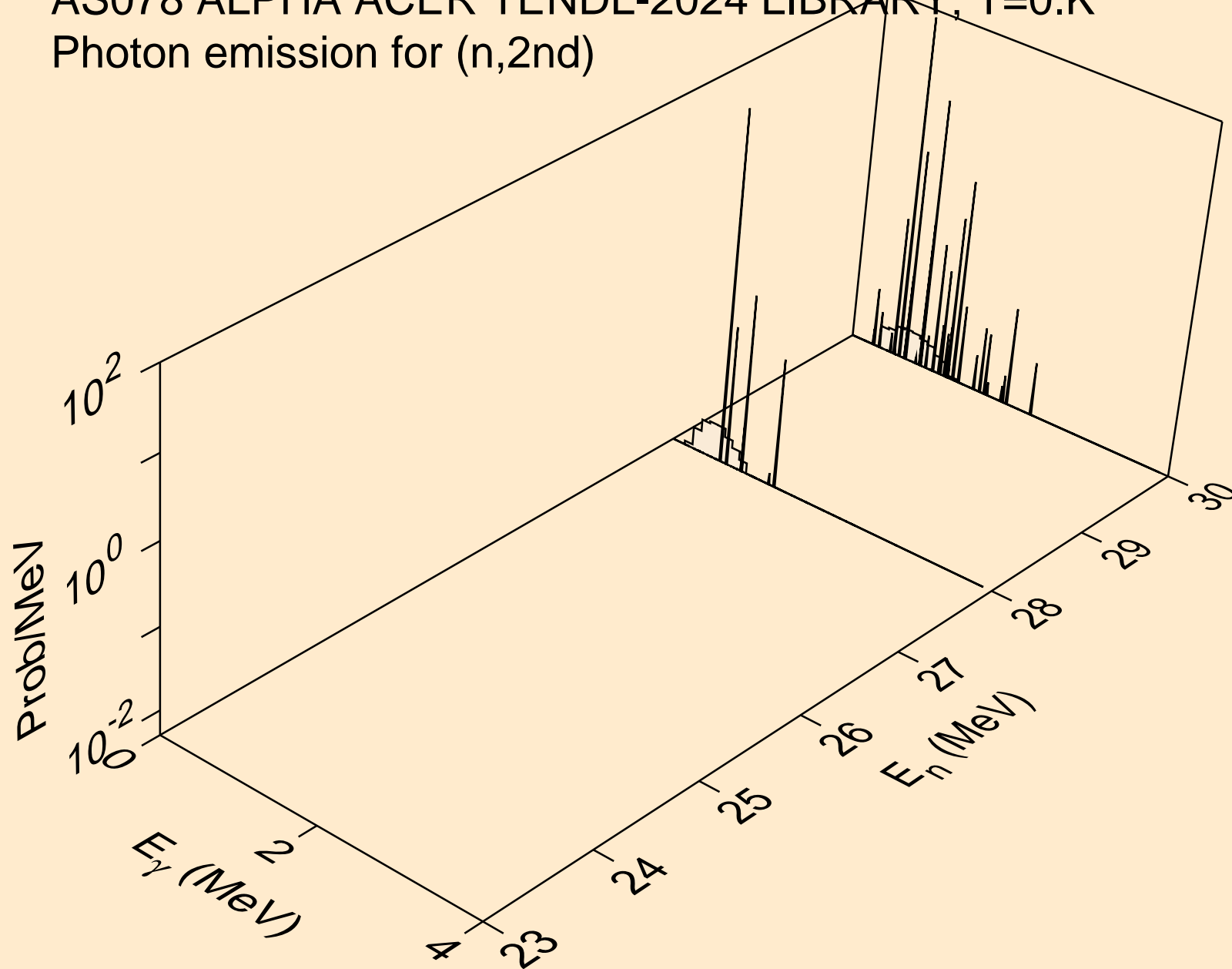

AS078 ALPHA ACER TENDL-2024 LIBRARY; T=0.K  
Photon emission for (n,2n)

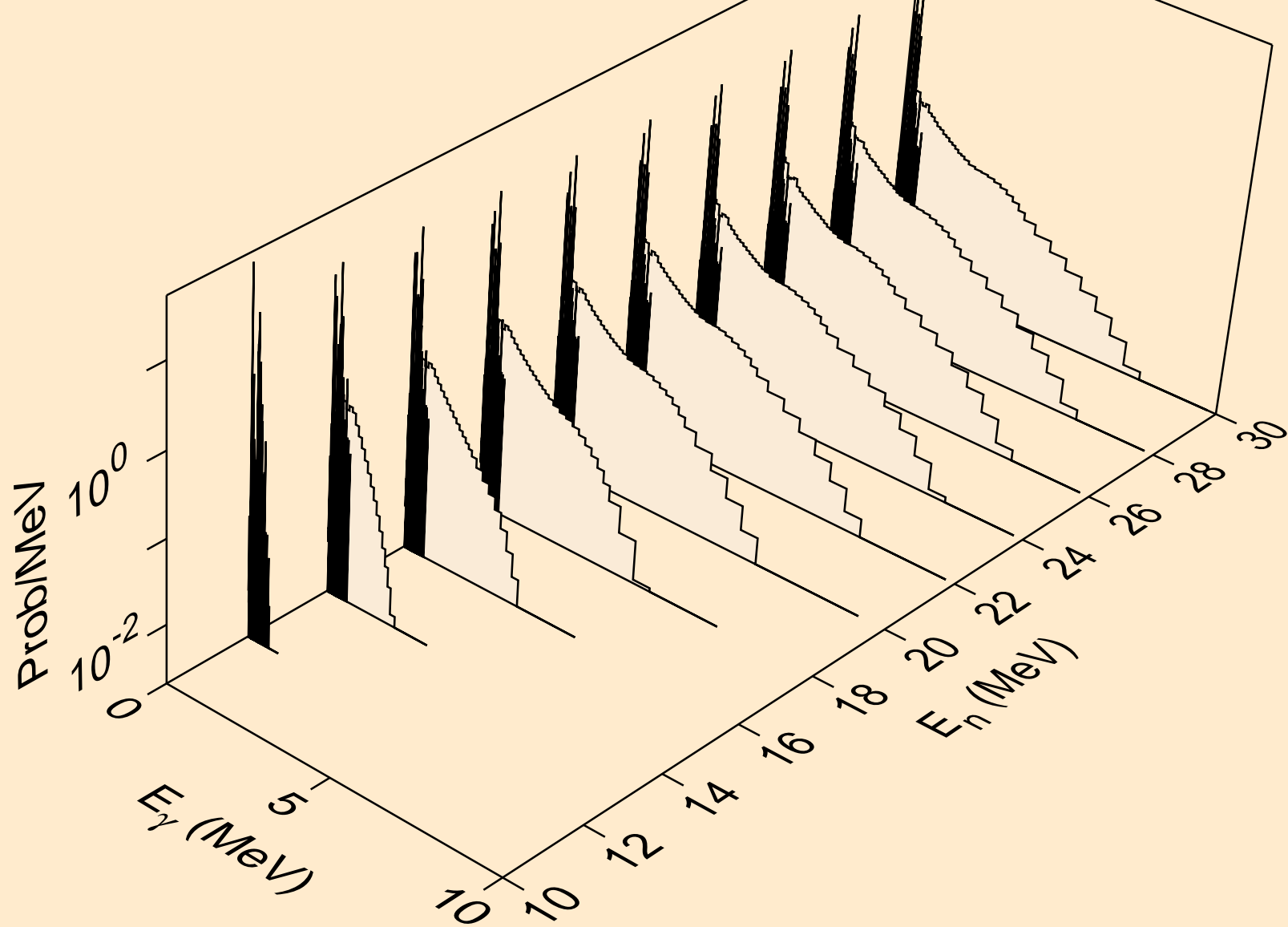

AS078 ALPHA ACER TENDL-2024 LIBRARY; T=0.K  
Photon emission for (n,3n)

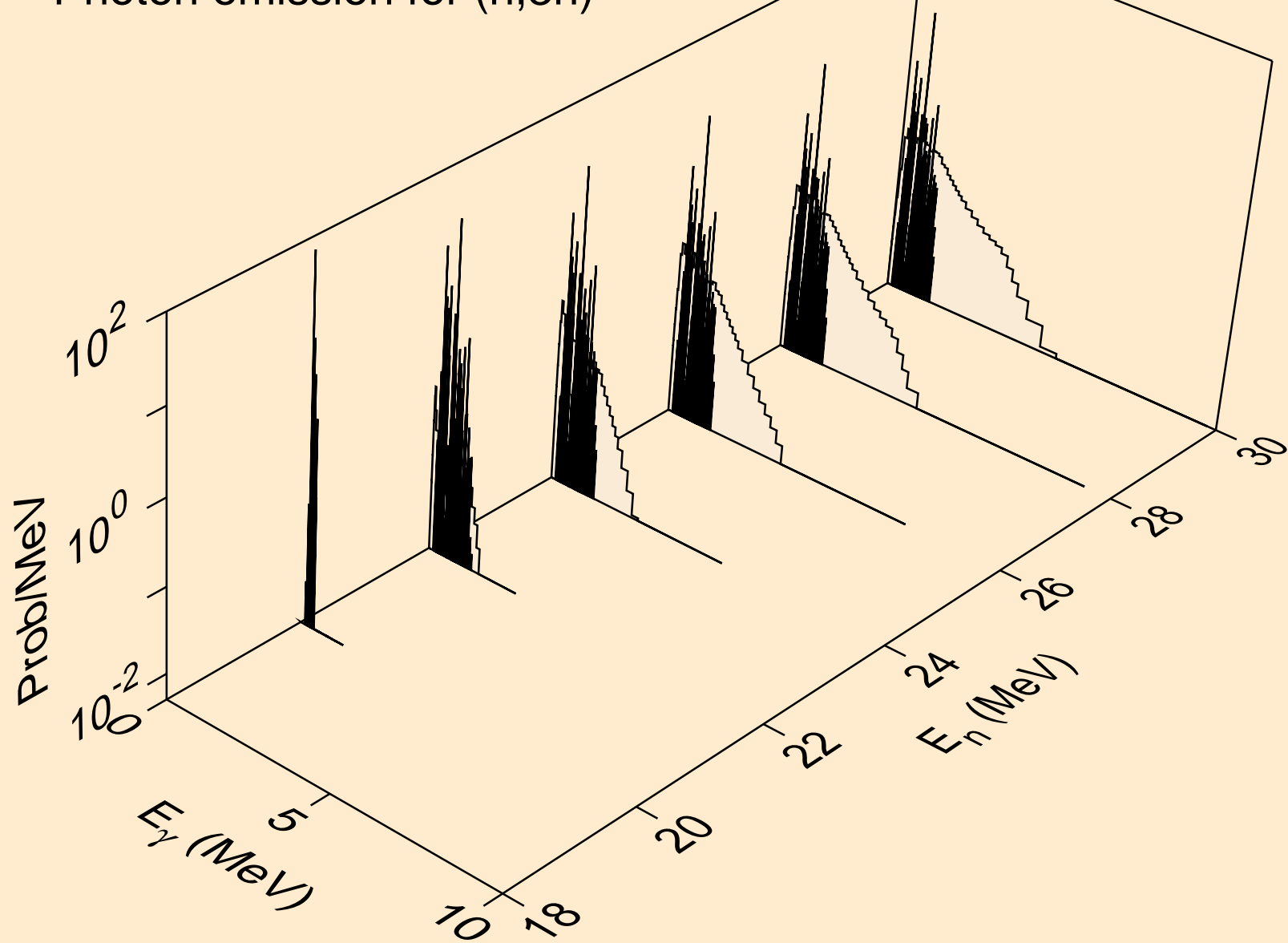

AS078 ALPHA ACER TENDL-2024 LIBRARY; T=0.K  
Photon emission for (n,n\*)a

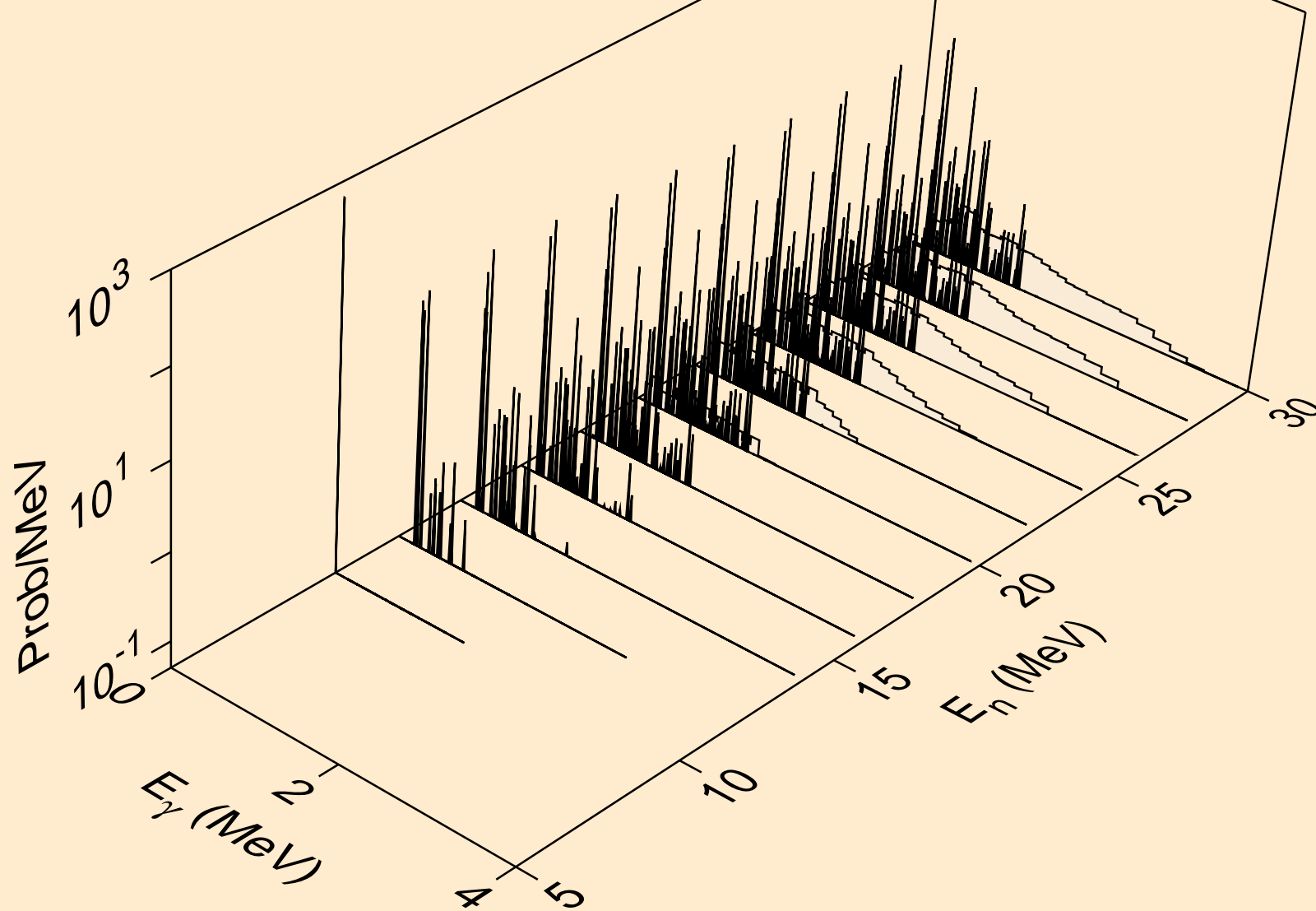

AS078 ALPHA ACER TENDL-2024 LIBRARY; T=0.K  
Photon emission for (n,2n)a

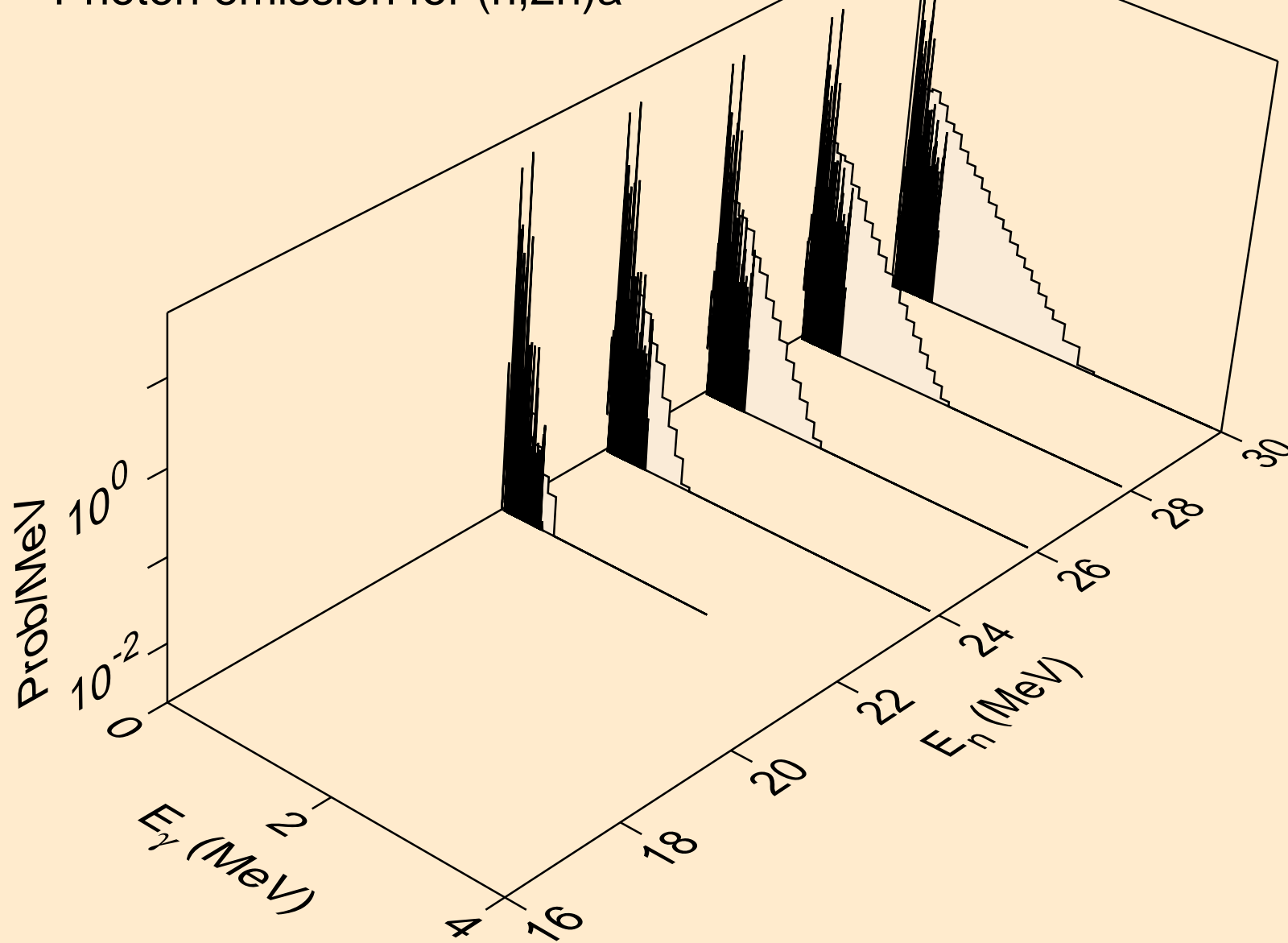

AS078 ALPHA ACER TENDL-2024 LIBRARY; T=0.K  
Photon emission for (n,n\*)p

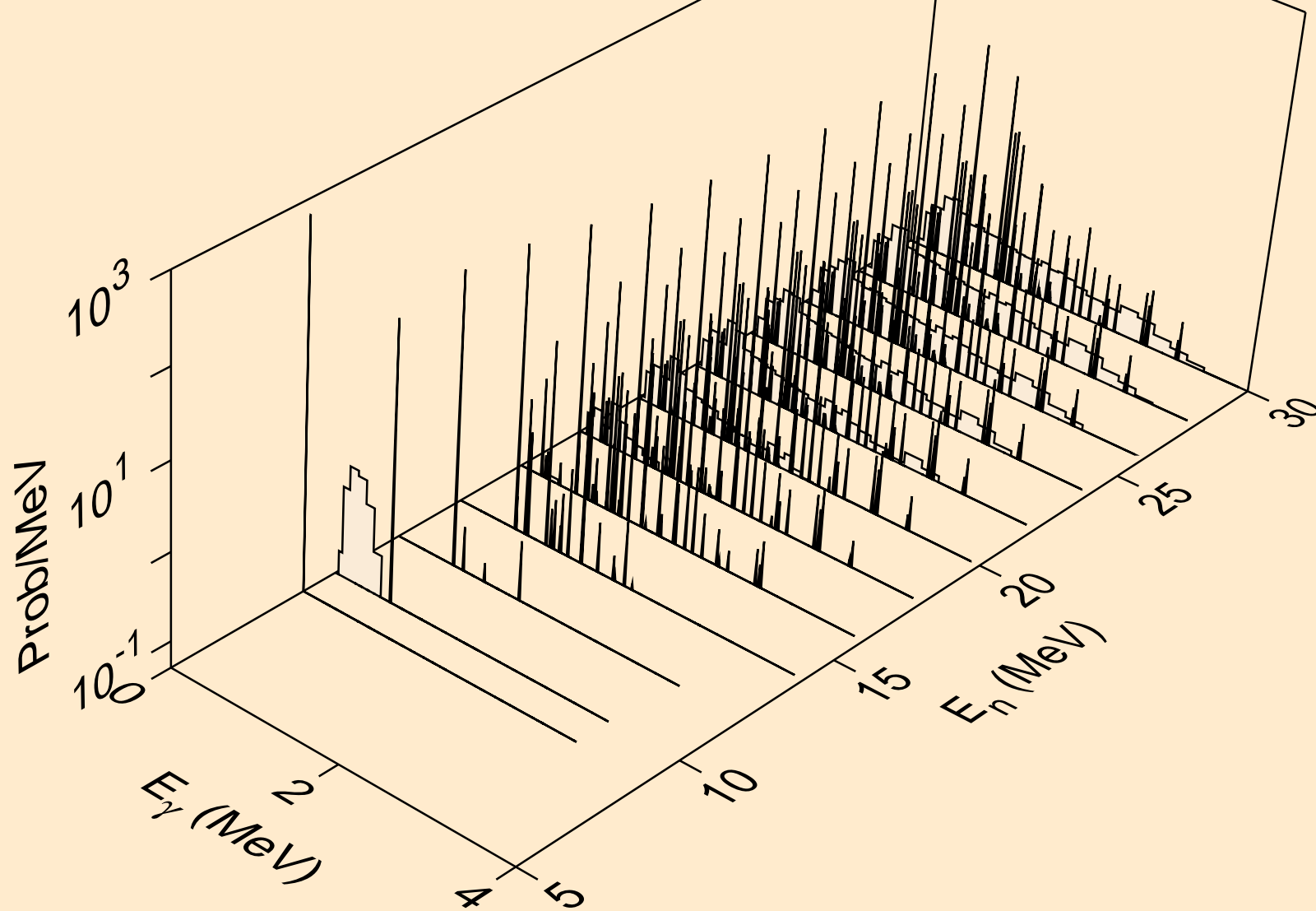

AS078 ALPHA ACER TENDL-2024 LIBRARY; T=0.K  
Photon emission for (n,n\*)d

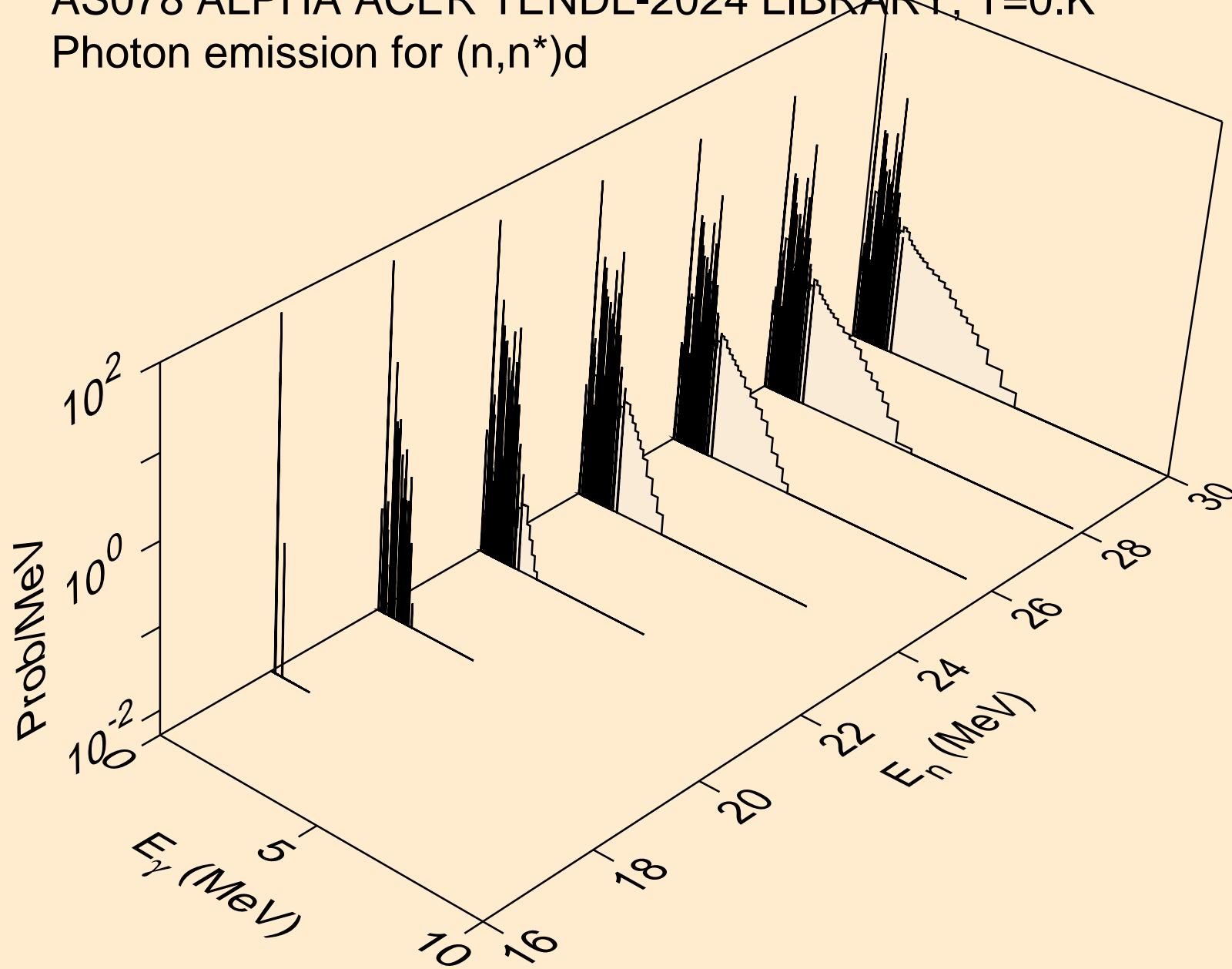

AS078 ALPHA ACER TENDL-2024 LIBRARY; T=0.K  
Photon emission for (n,n\*)t

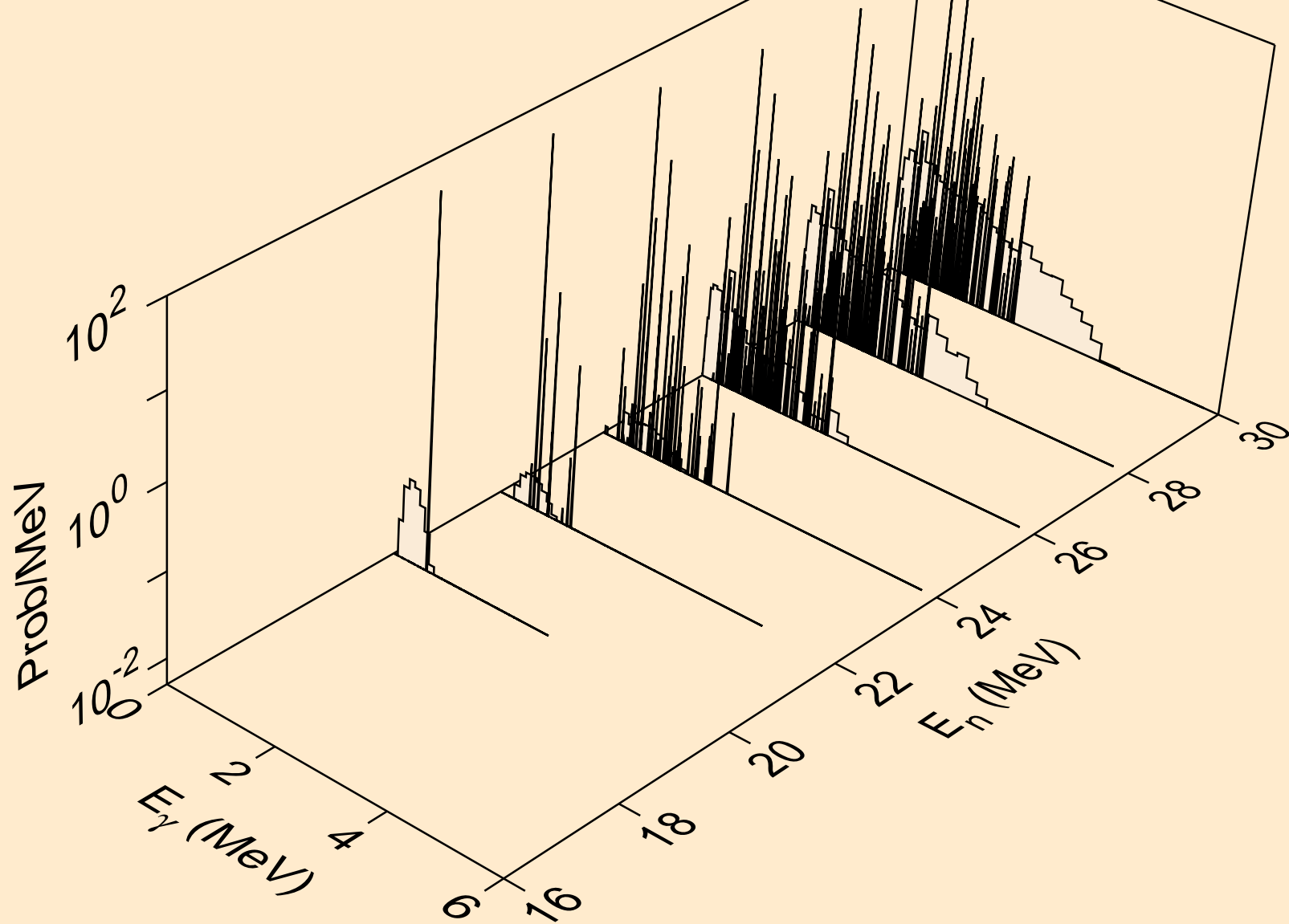

AS078 ALPHA ACER TENDL-2024 LIBRARY; T=0.K  
Photon emission for (n,n\*)he3

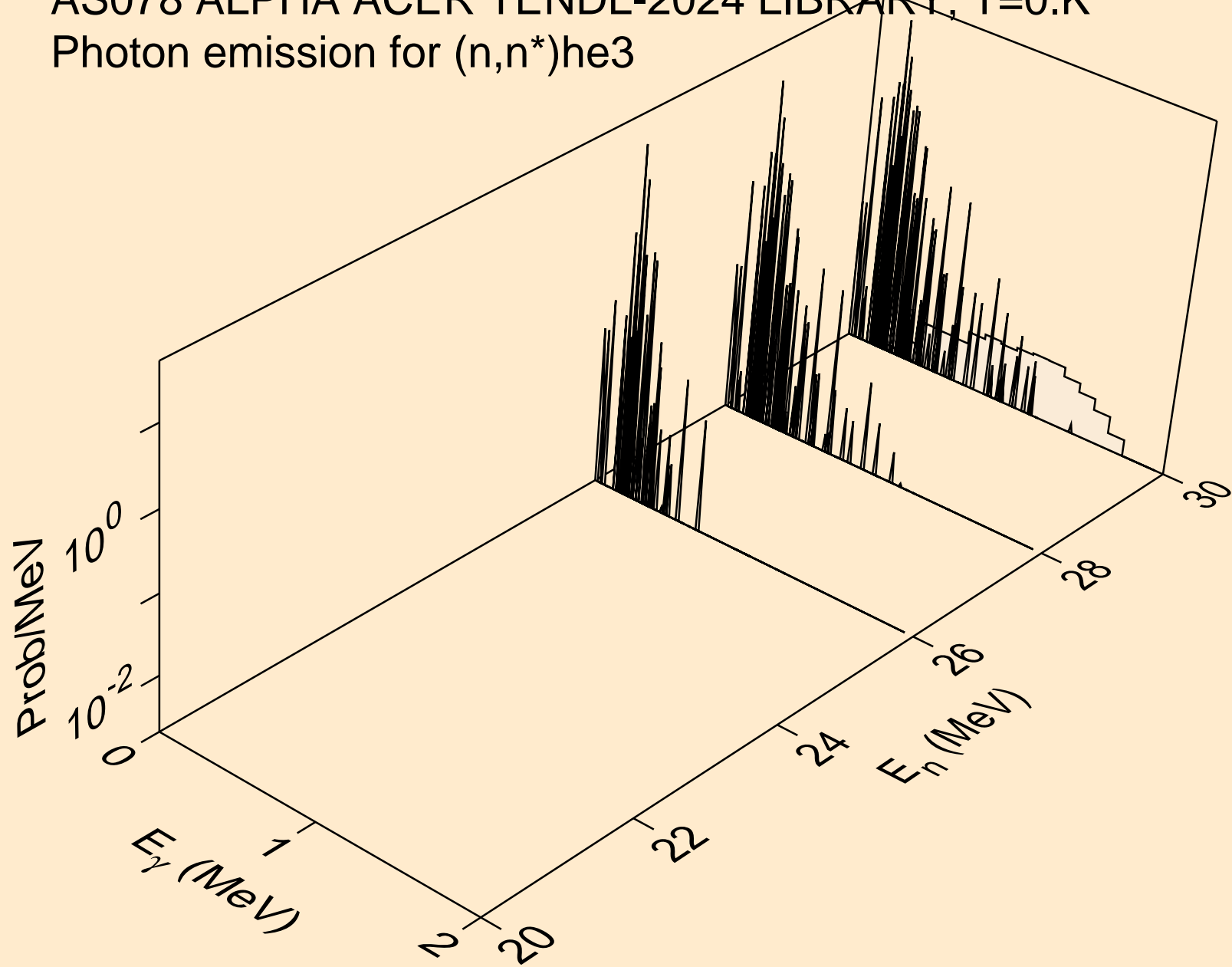

AS078 ALPHA ACER TENDL-2024 LIBRARY; T=0.K  
Photon emission for (n,2np)

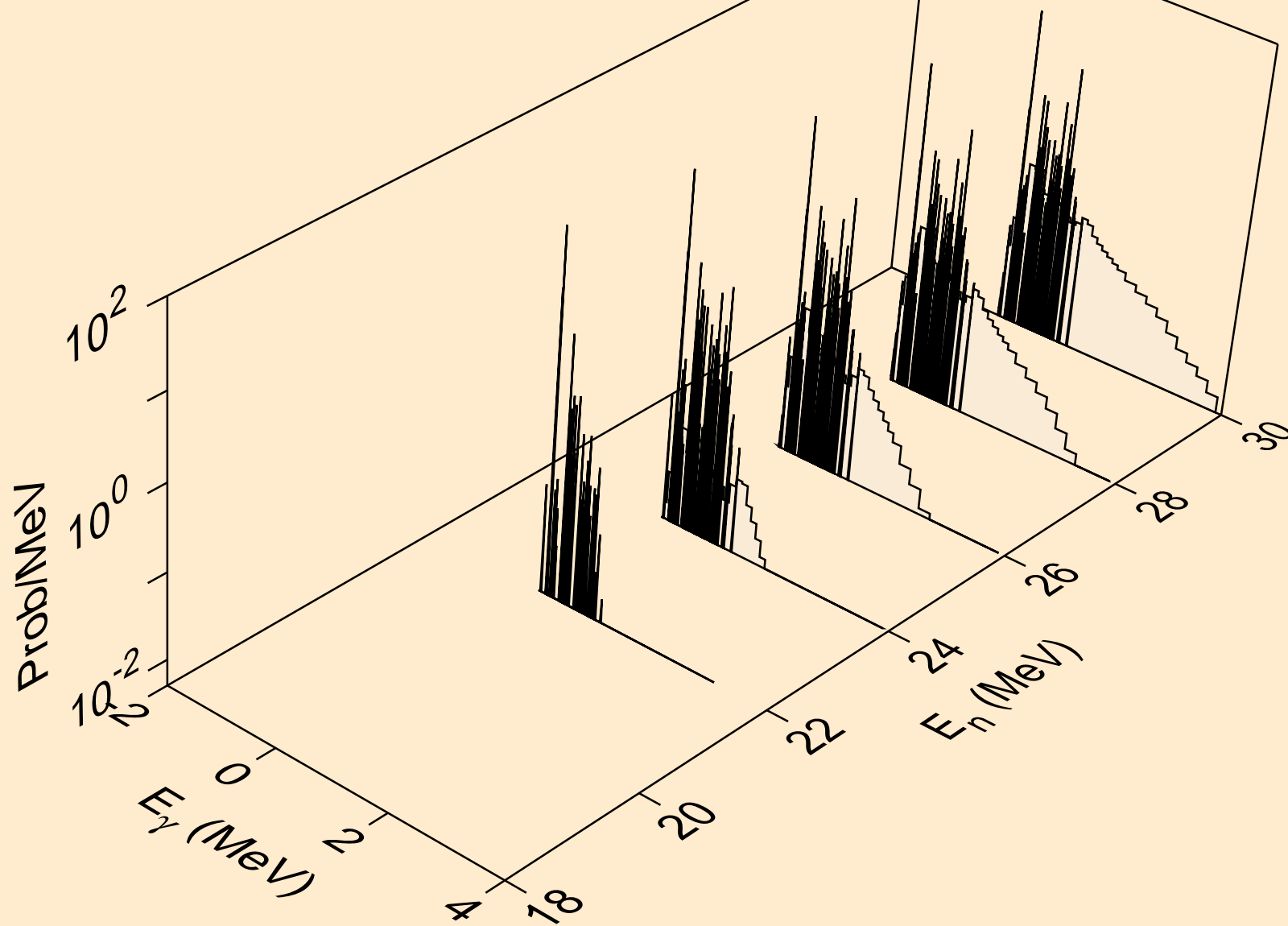

AS078 ALPHA ACER TENDL-2024 LIBRARY; T=0.K  
Photon emission for (n,3np)

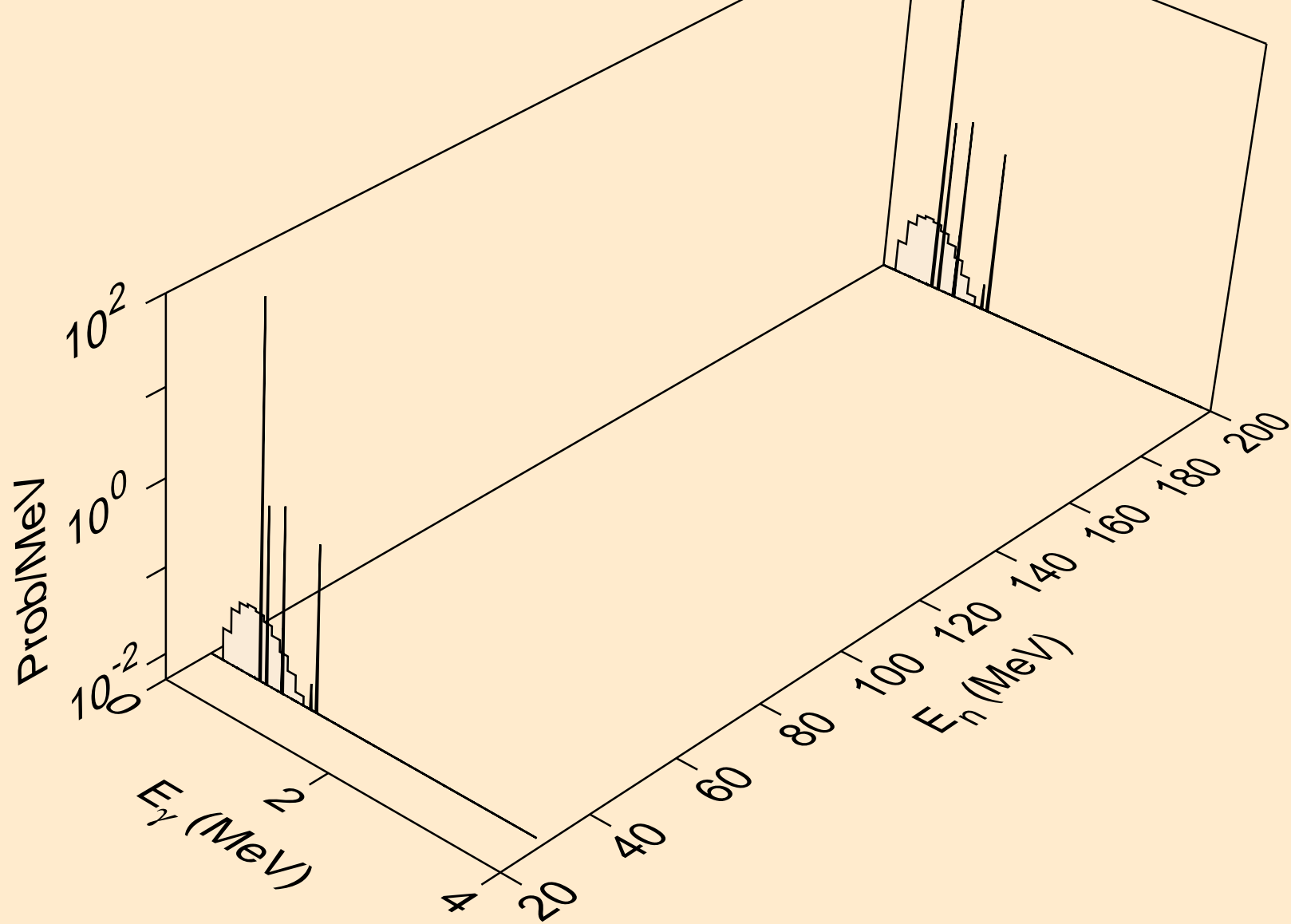

AS078 ALPHA ACER TENDL-2024 LIBRARY; T=0.K  
Photon emission for (n,n2p)

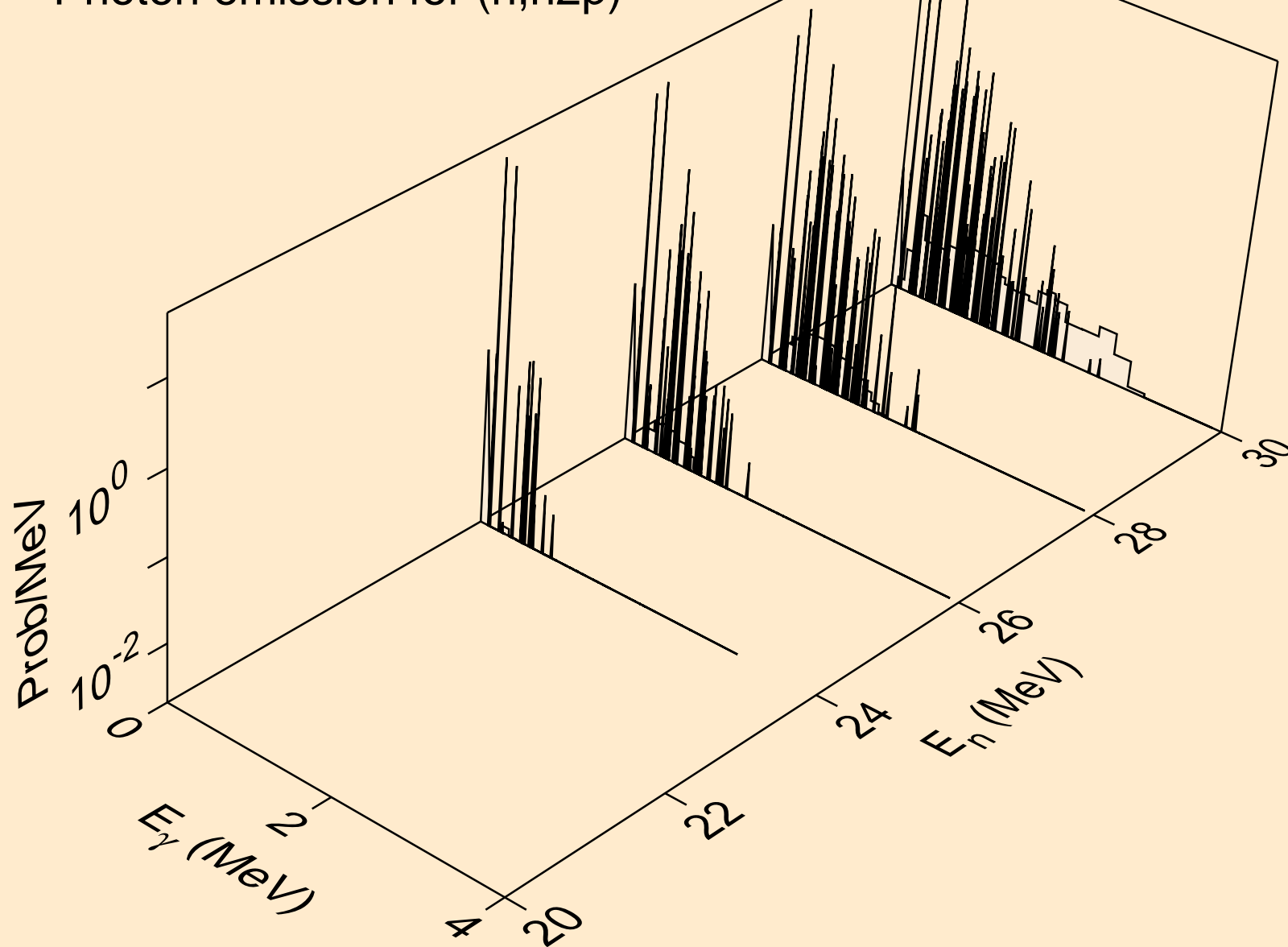

AS078 ALPHA ACER TENDL-2024 LIBRARY; T=0.K  
Photon emission for (n,npa)

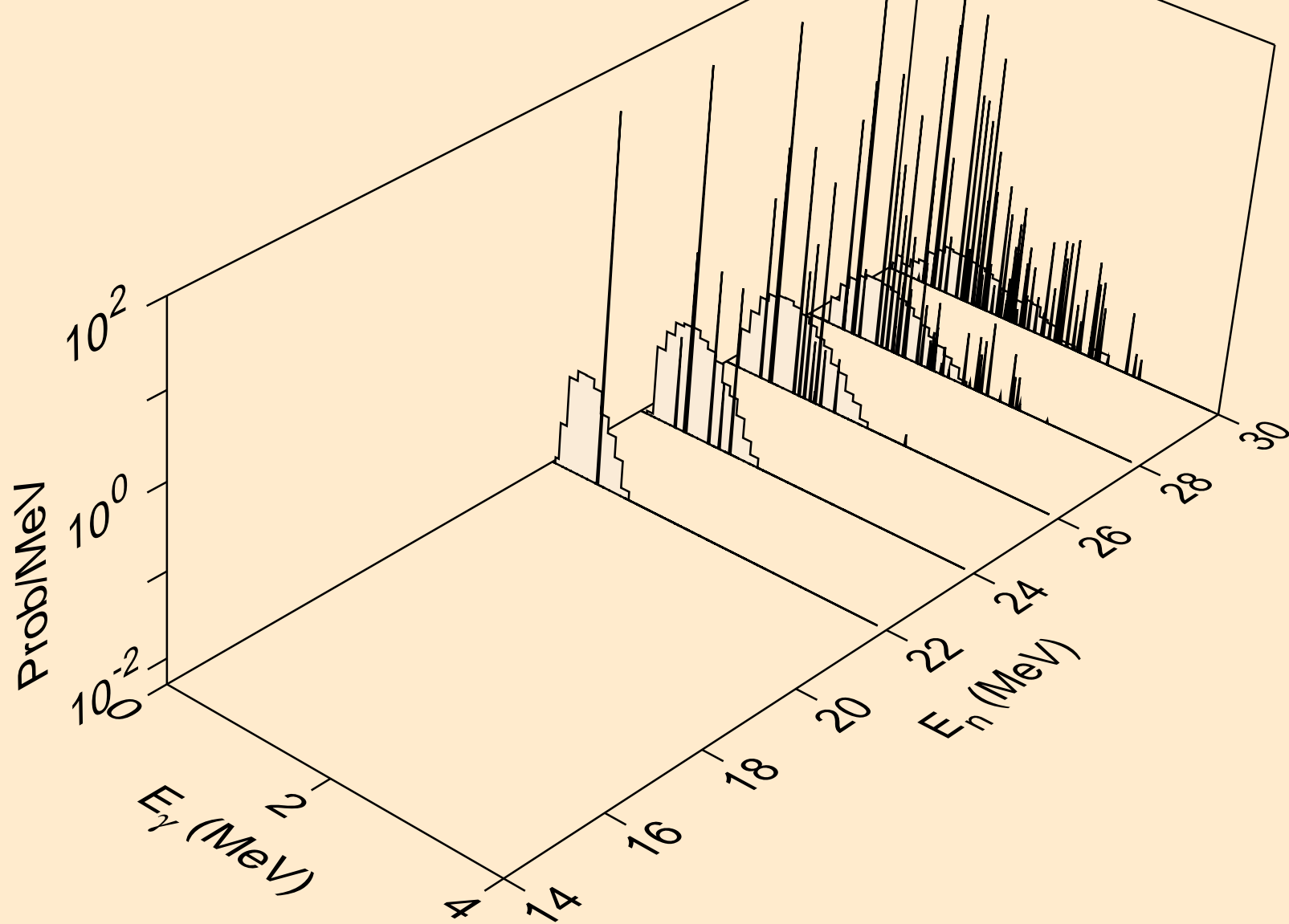

AS078 ALPHA ACER TENDL-2024 LIBRARY; T=0.K  
Photon emission for (n,gma)

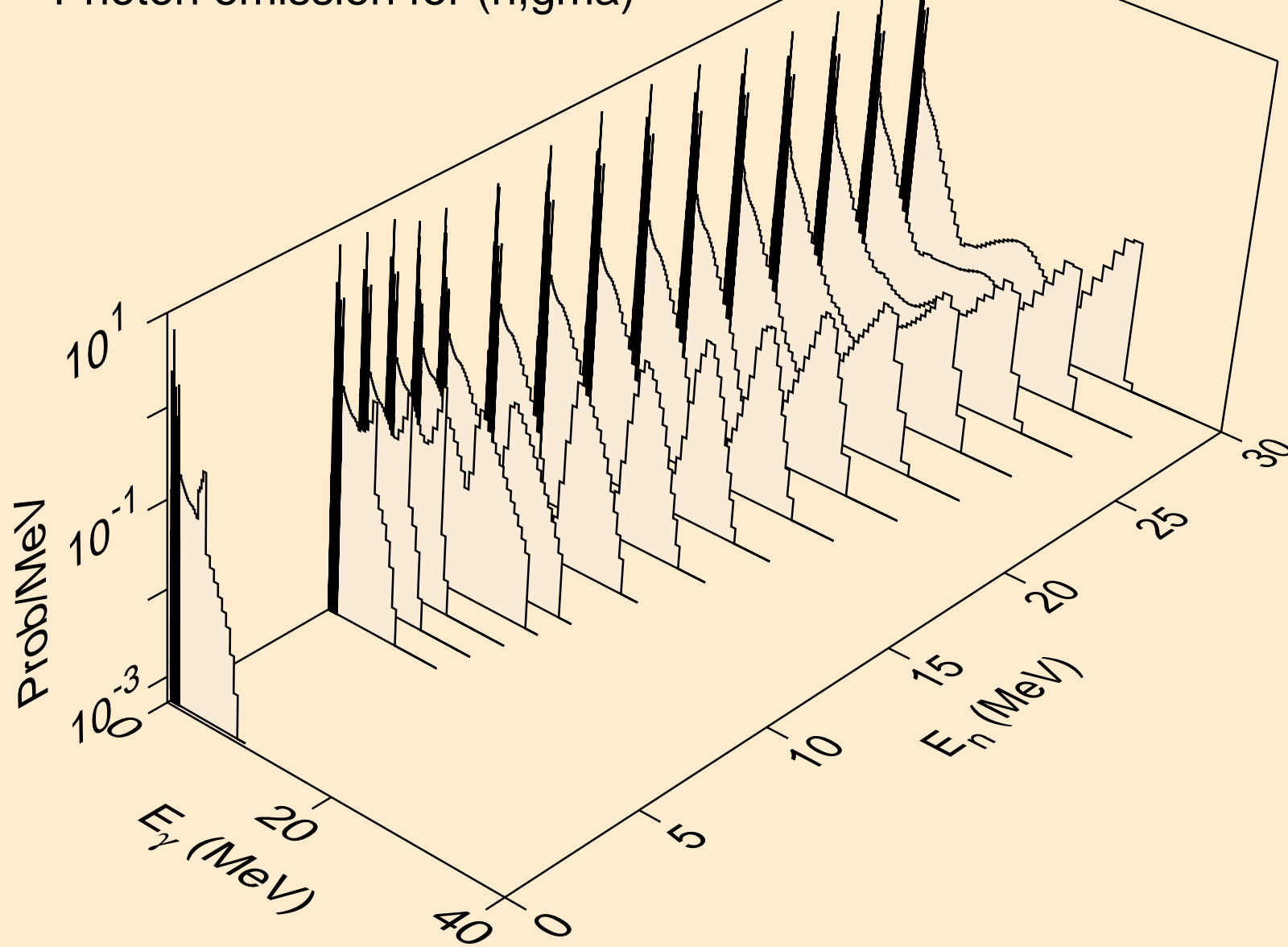

AS078 ALPHA ACER TENDL-2024 LIBRARY; T=0.K  
Photon emission for (n,p)

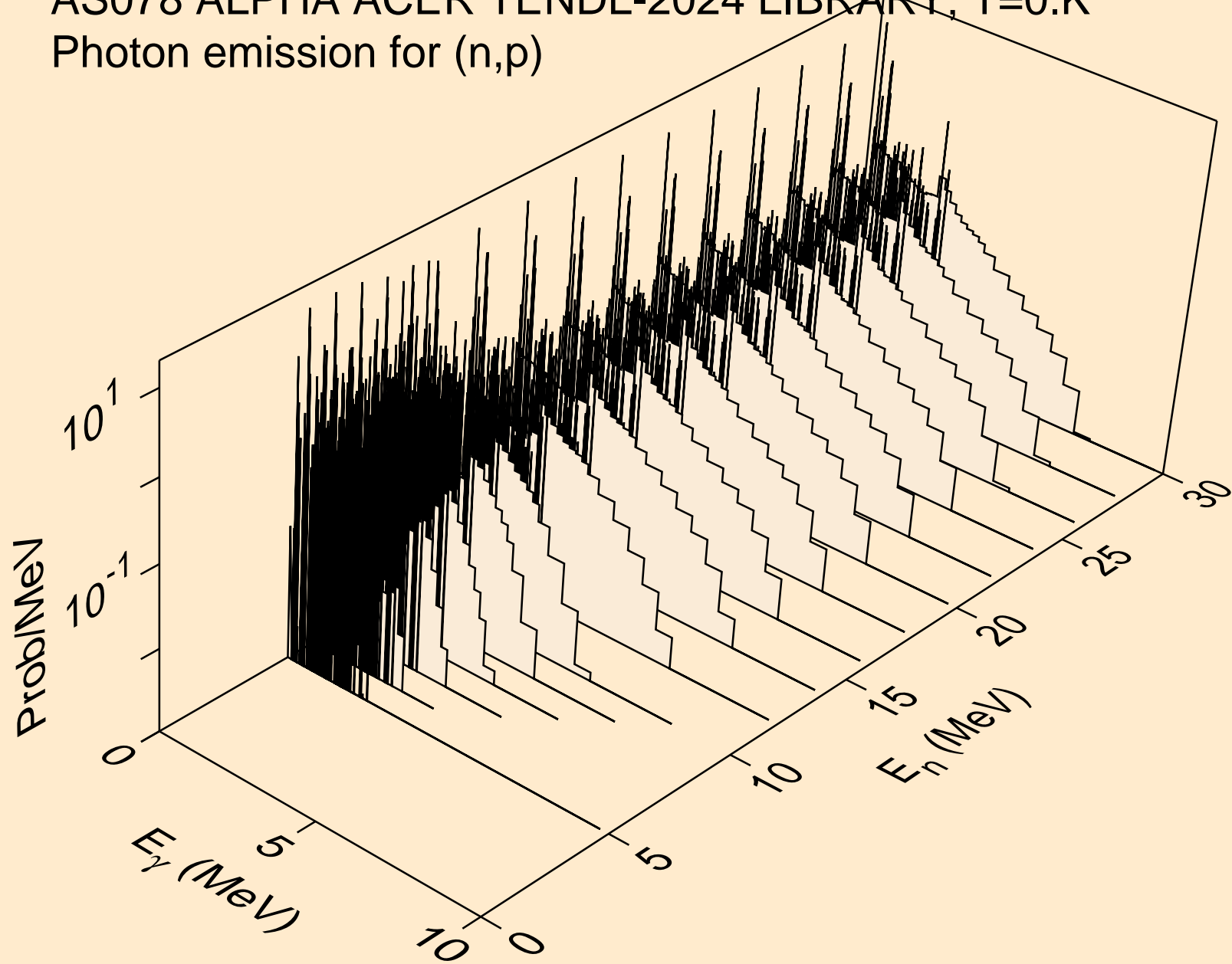

AS078 ALPHA ACER TENDL-2024 LIBRARY; T=0.K  
Photon emission for (n,d)

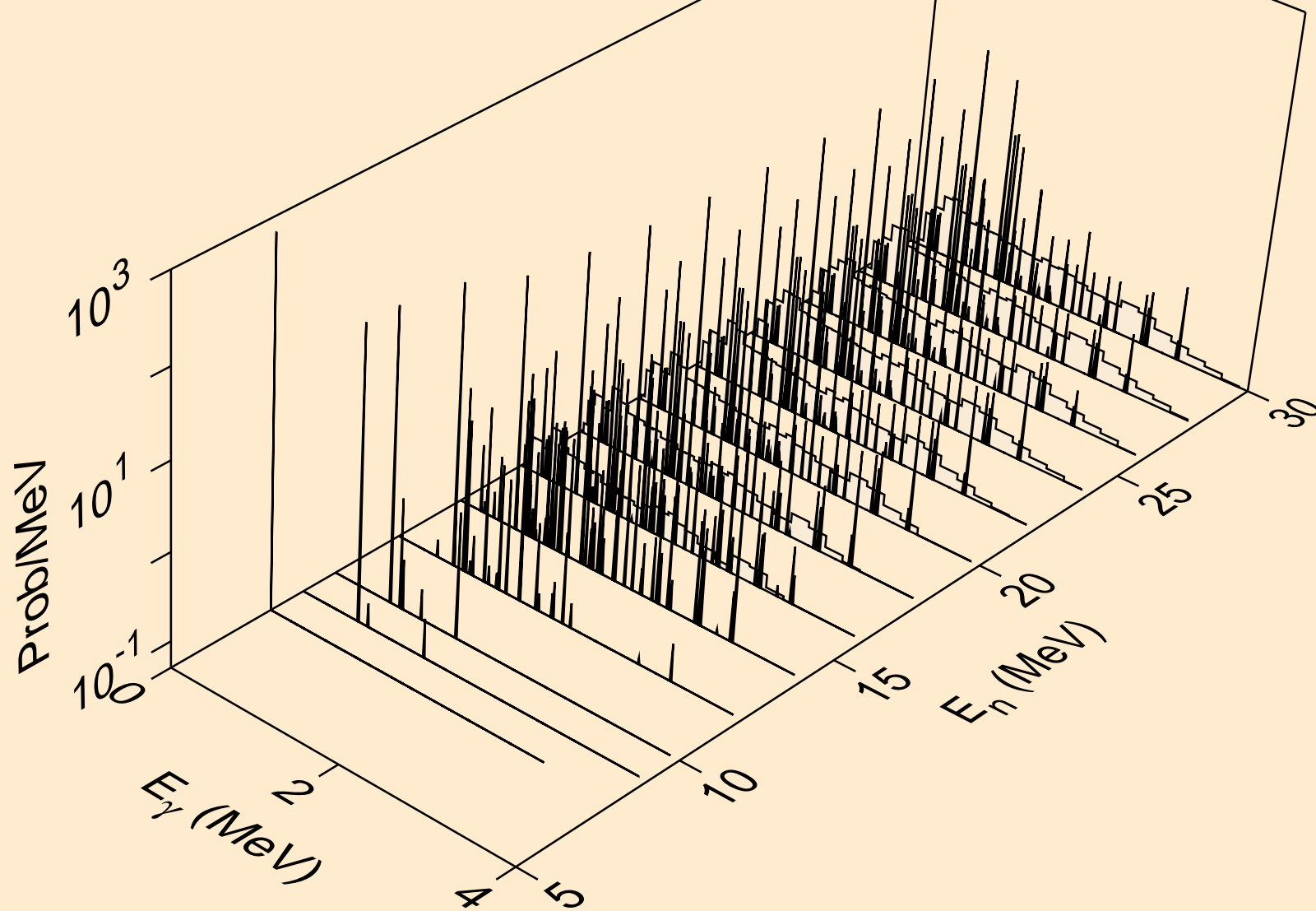

AS078 ALPHA ACER TENDL-2024 LIBRARY; T=0.K  
Photon emission for (n,t)

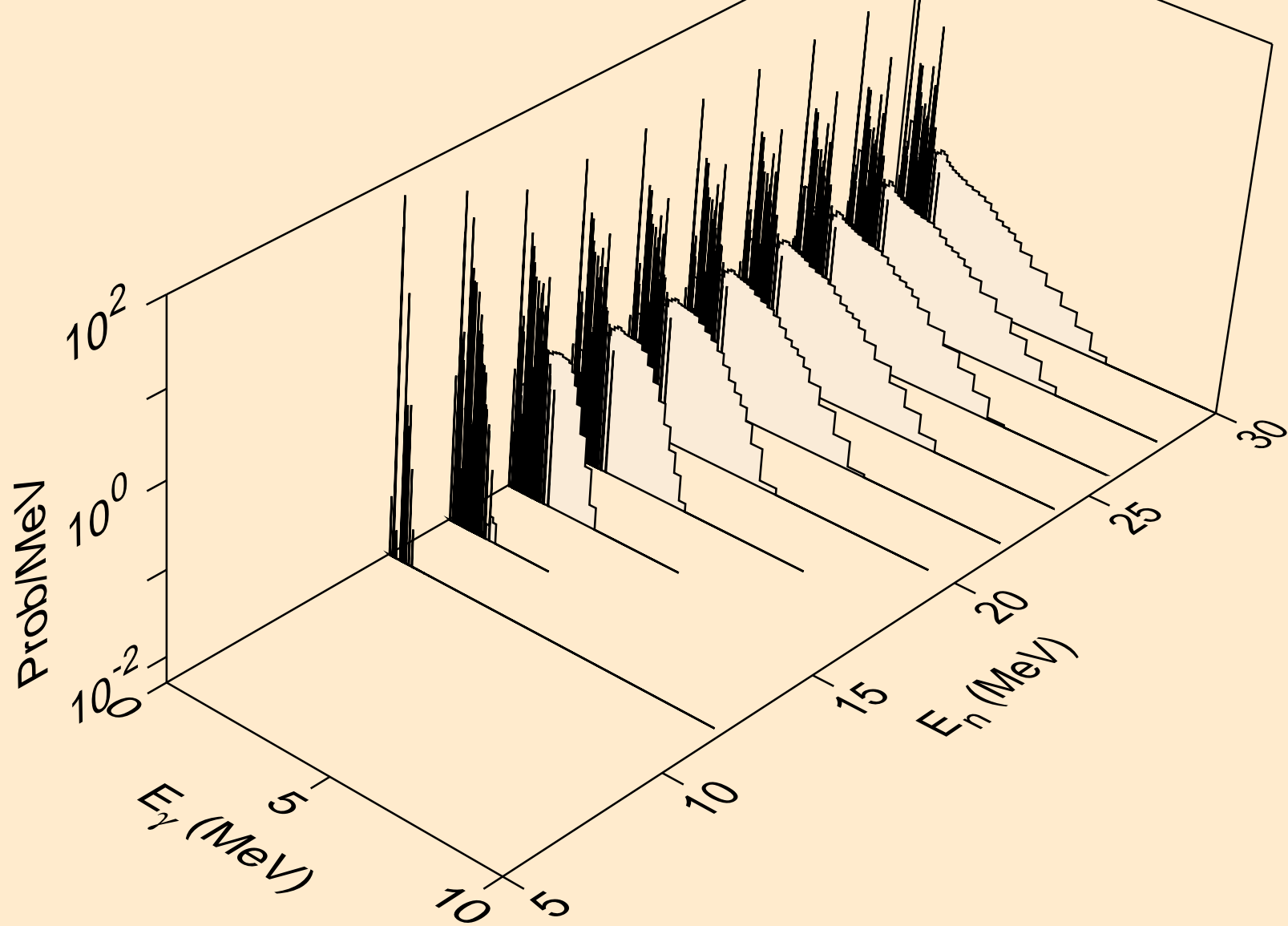

AS078 ALPHA ACER TENDL-2024 LIBRARY; T=0.K  
Photon emission for (n,he3)

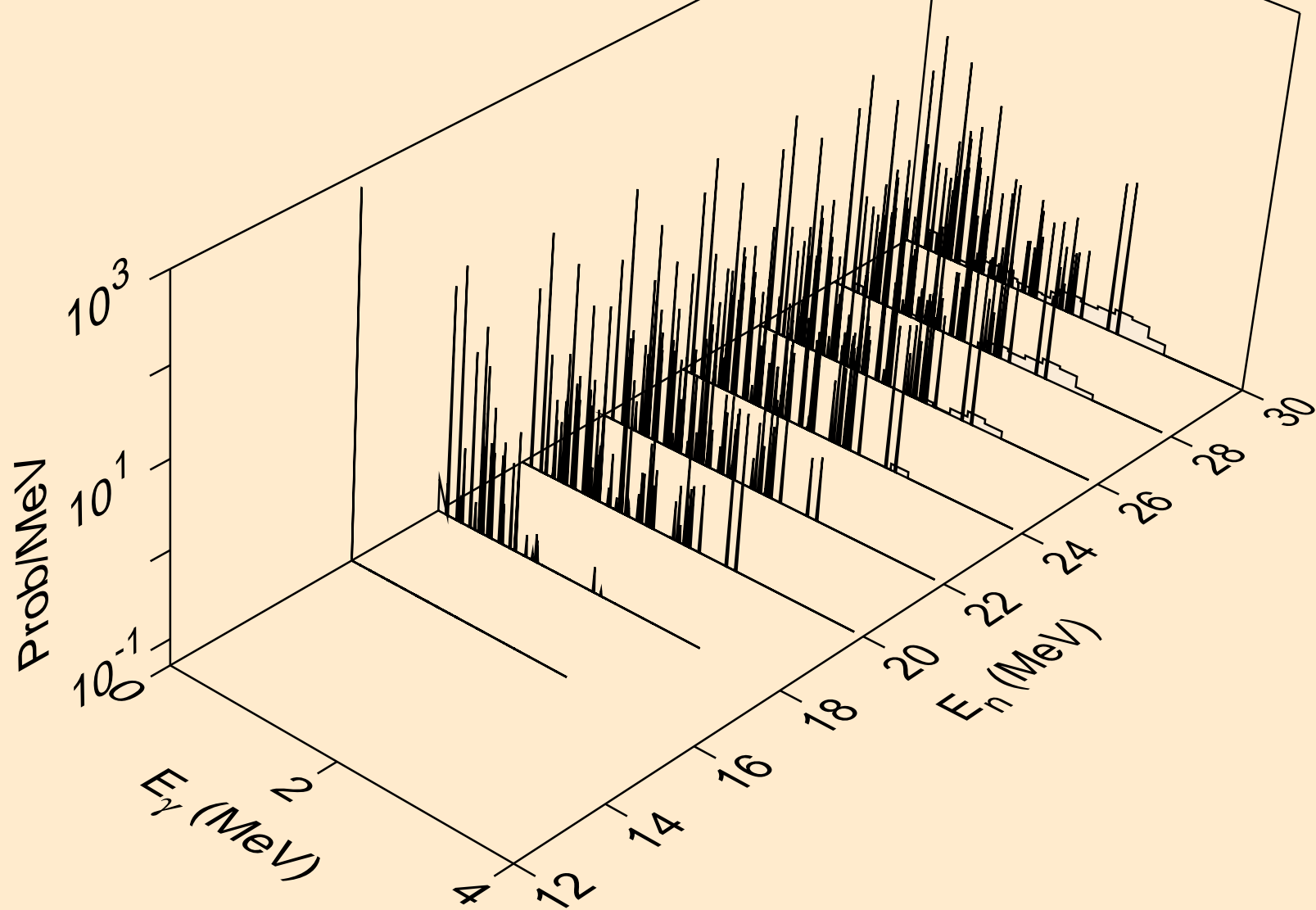

AS078 ALPHA ACER TENDL-2024 LIBRARY; T=0.K  
Photon emission for inelastic

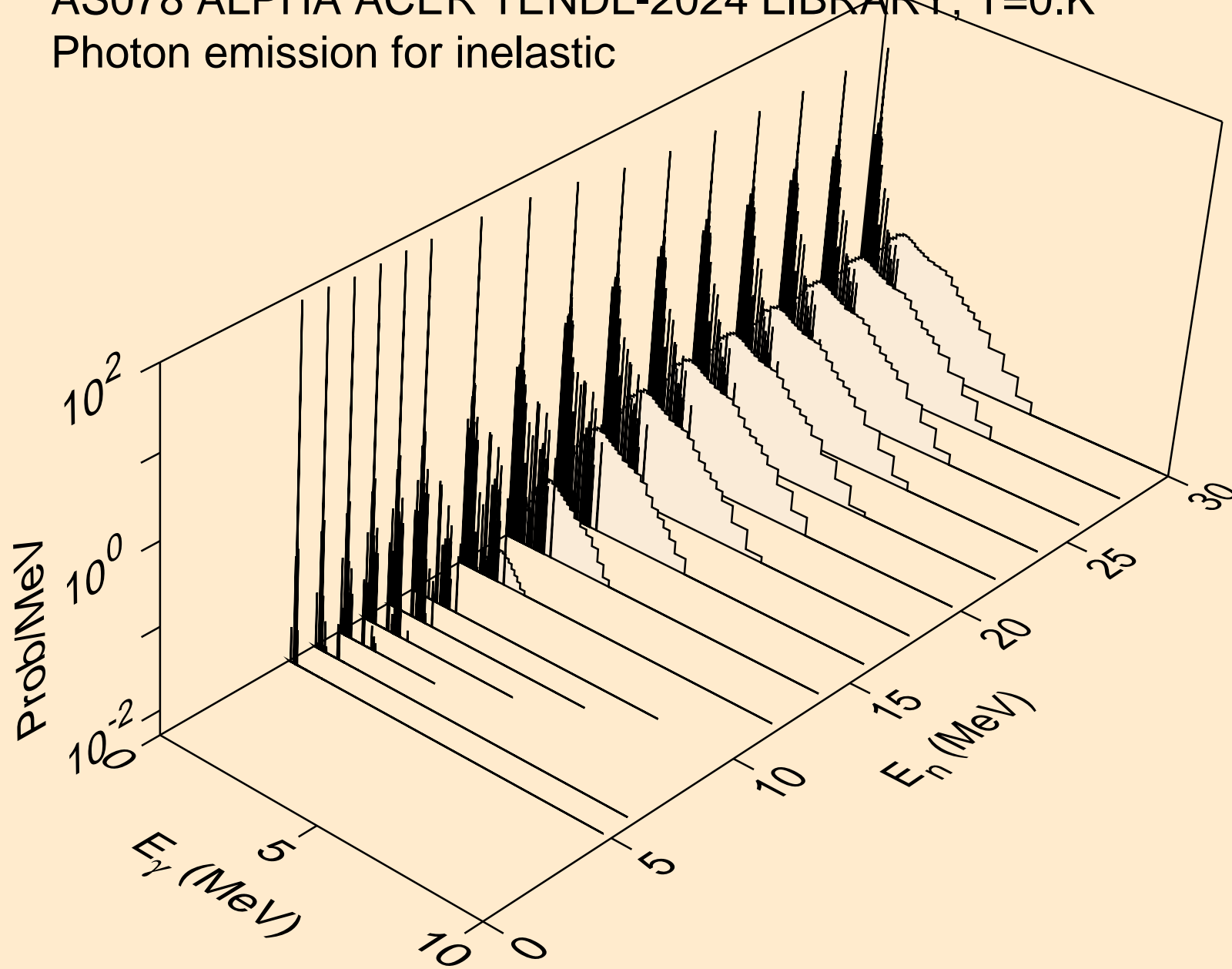

AS078 ALPHA ACER TENDL-2024 LIBRARY; T=0.K  
Photon emission for (n,2a)

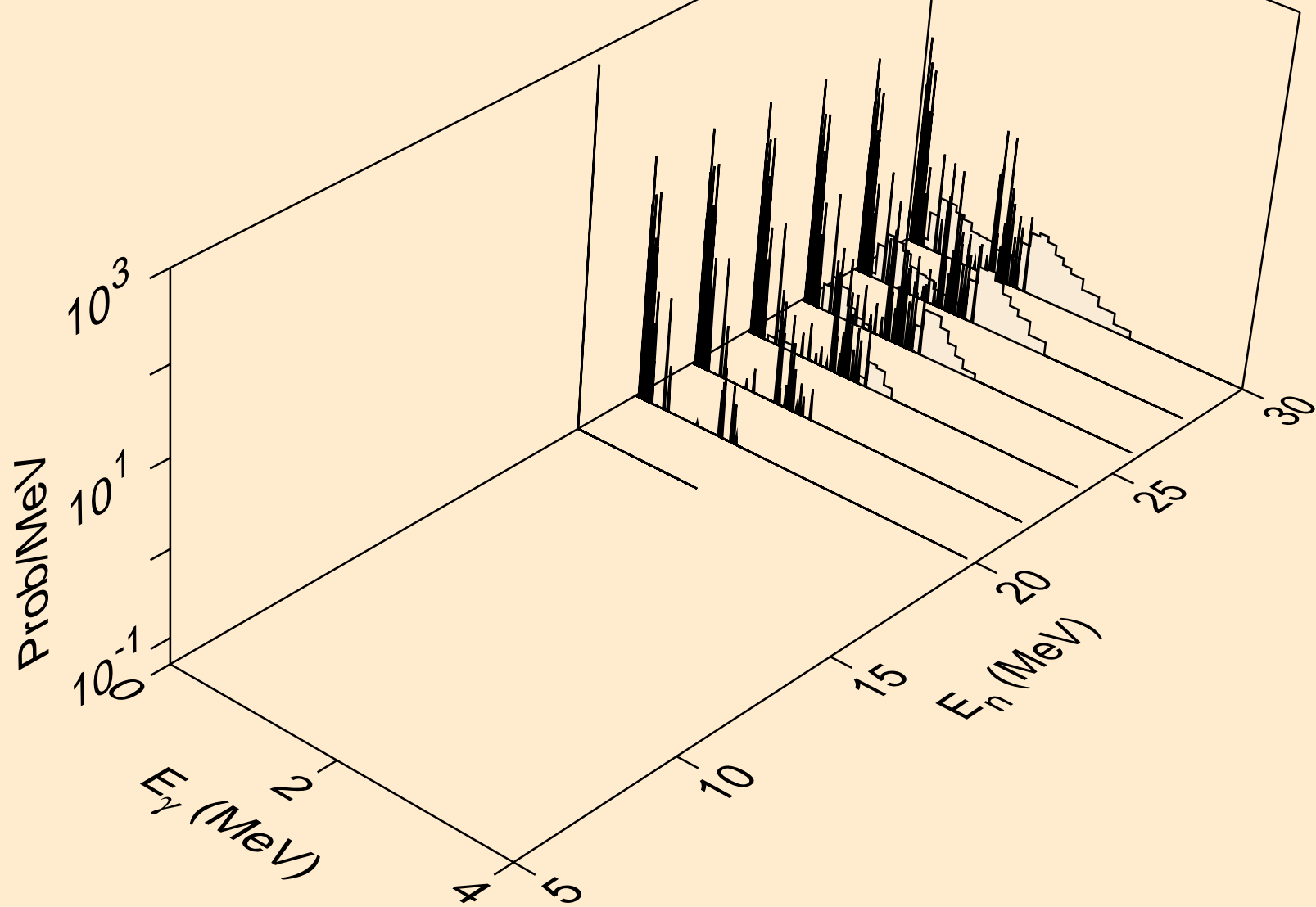

AS078 ALPHA ACER TENDL-2024 LIBRARY; T=0.K  
Photon emission for (n,2p)

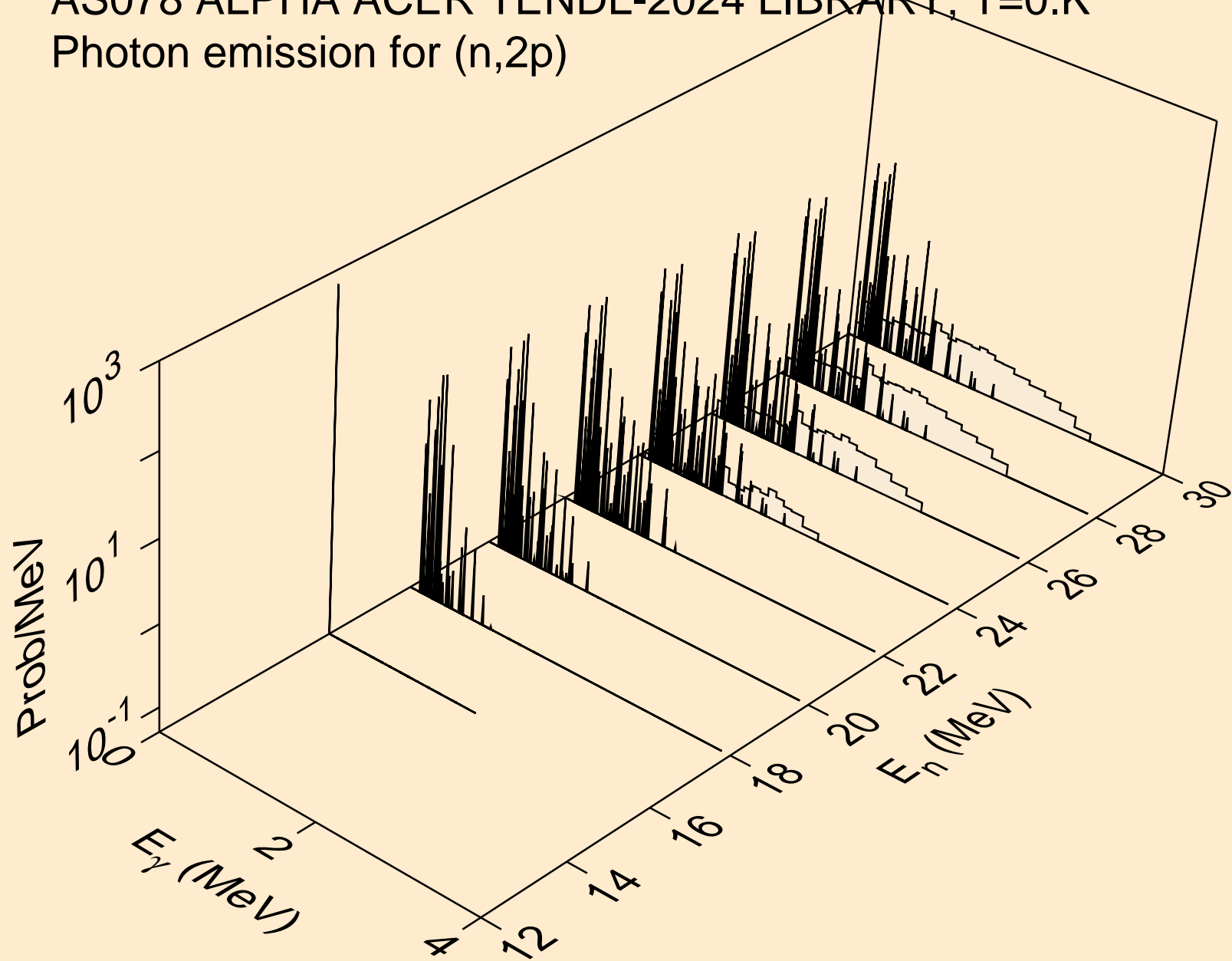

AS078 ALPHA ACER TENDL-2024 LIBRARY; T=0.K  
Photon emission for (n,pa)

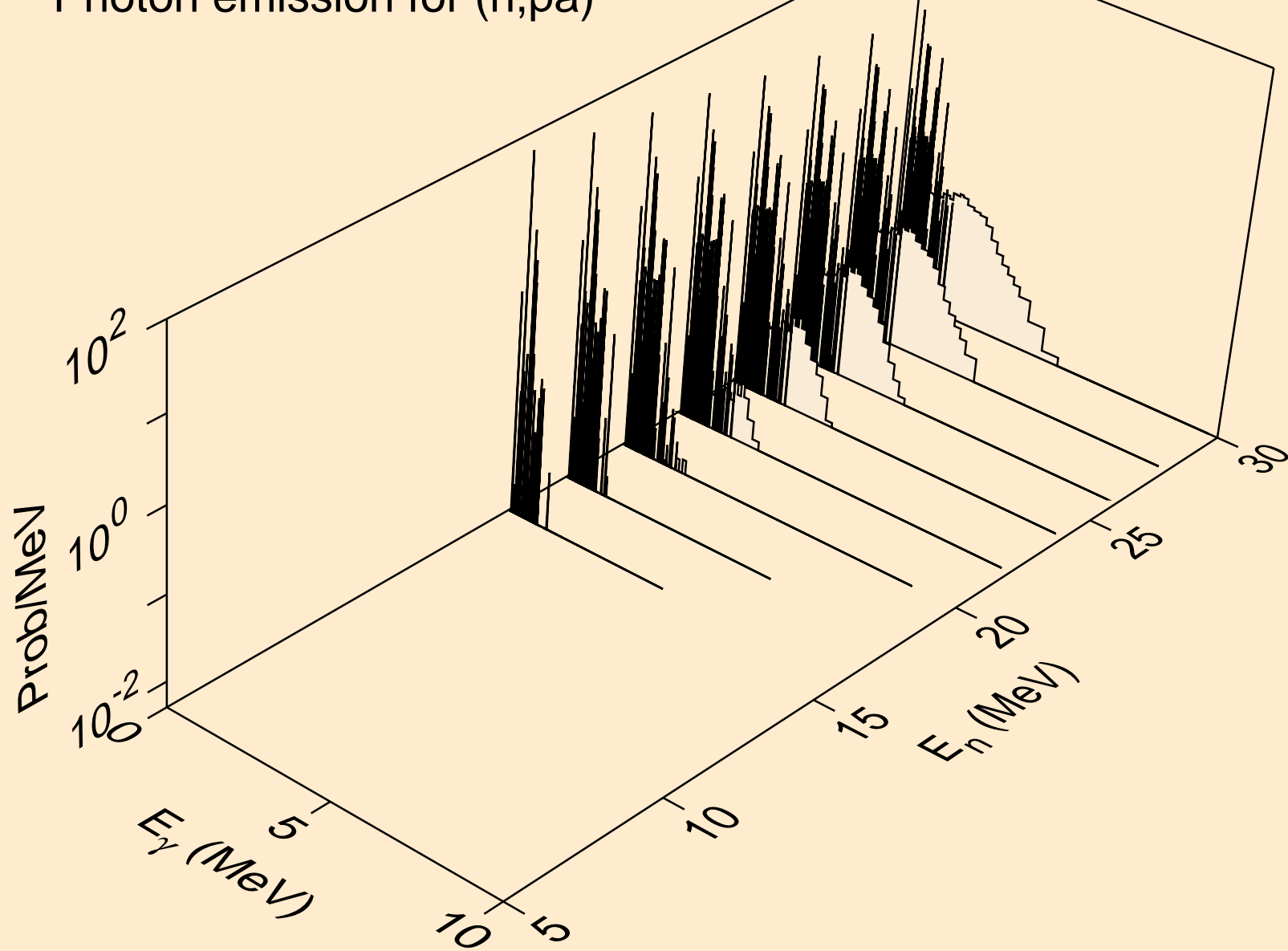

AS078 ALPHA ACER TENDL-2024 LIBRARY; T=0.K  
Photon emission for (n,pd)

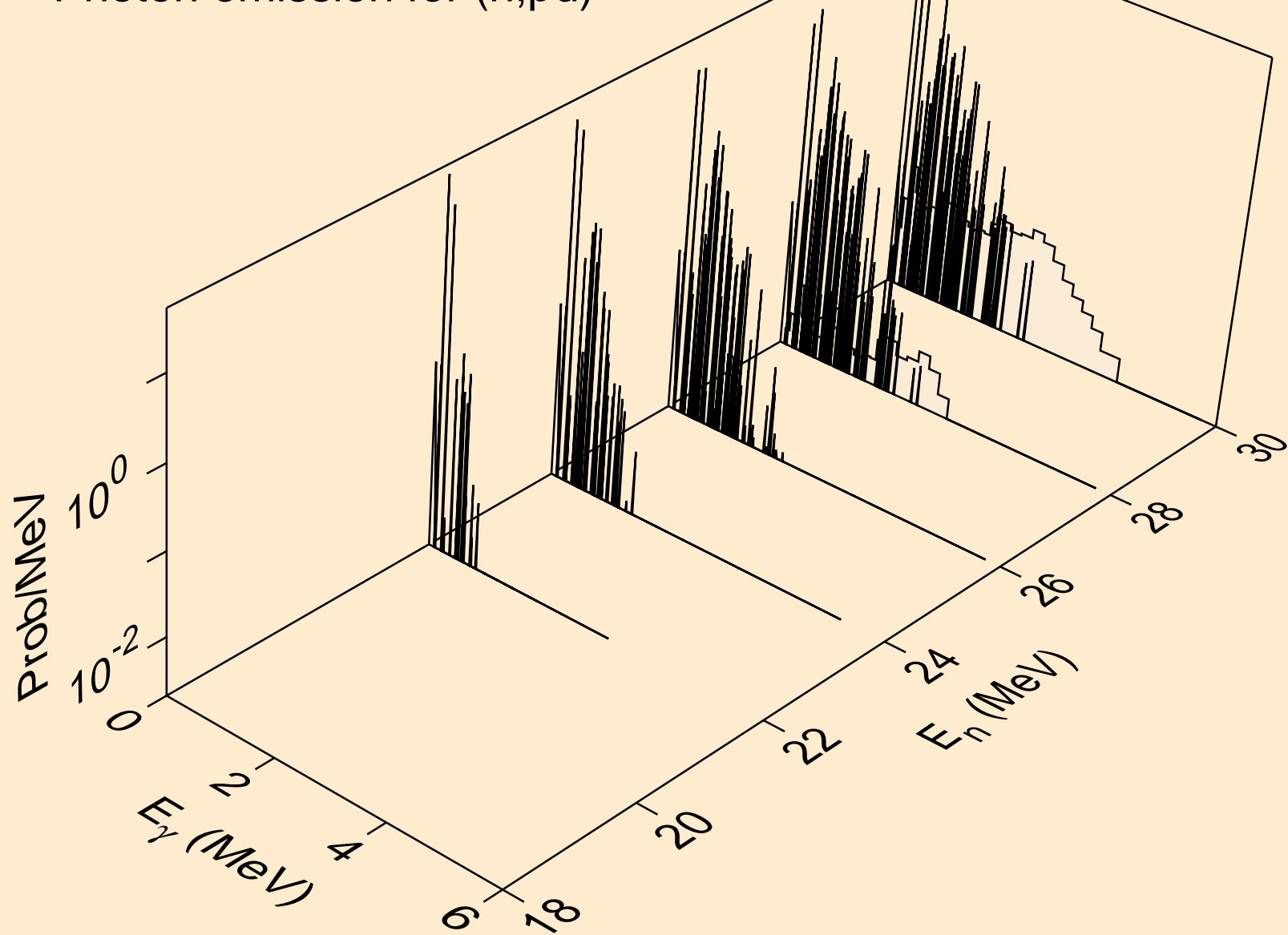

AS078 ALPHA ACER TENDL-2024 LIBRARY; T=0.K  
Photon emission for (n,pt)

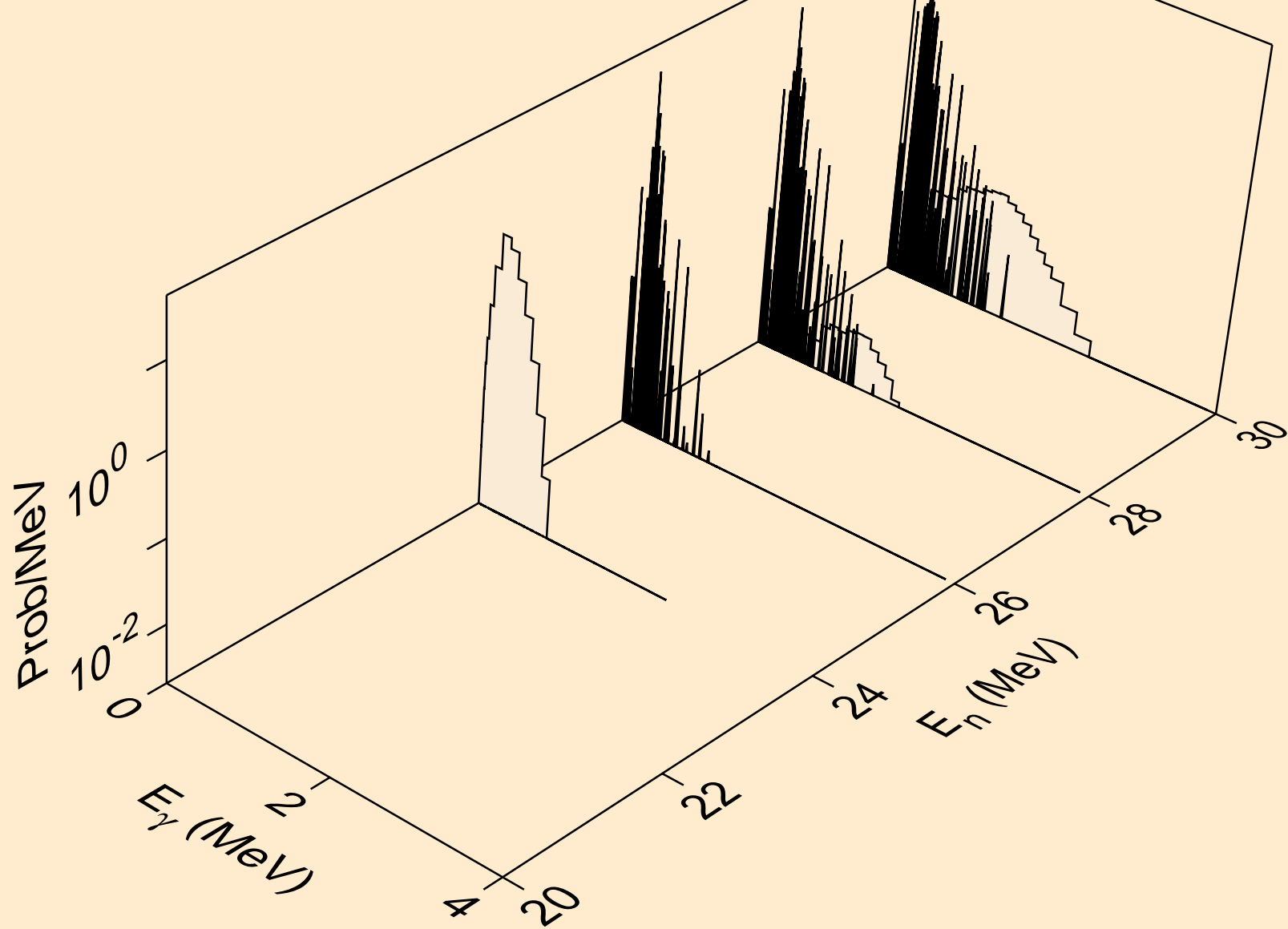

AS078 ALPHA ACER TENDL-2024 LIBRARY; T=0.K  
Photon emission for (n,da)

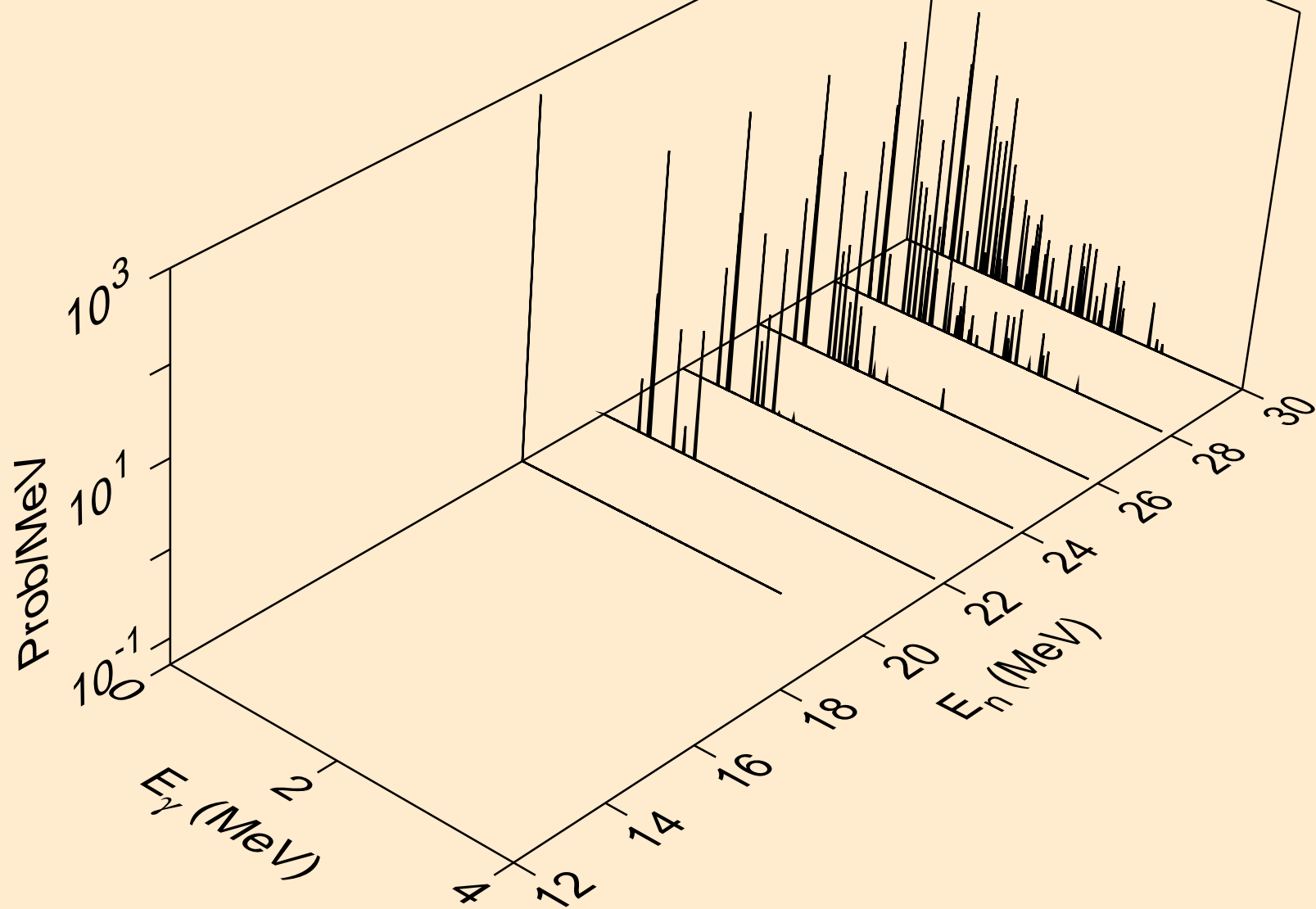

AS078 ALPHA ACER TENDL-2024 LIBRARY; T=0.K  
Particle heating contributions

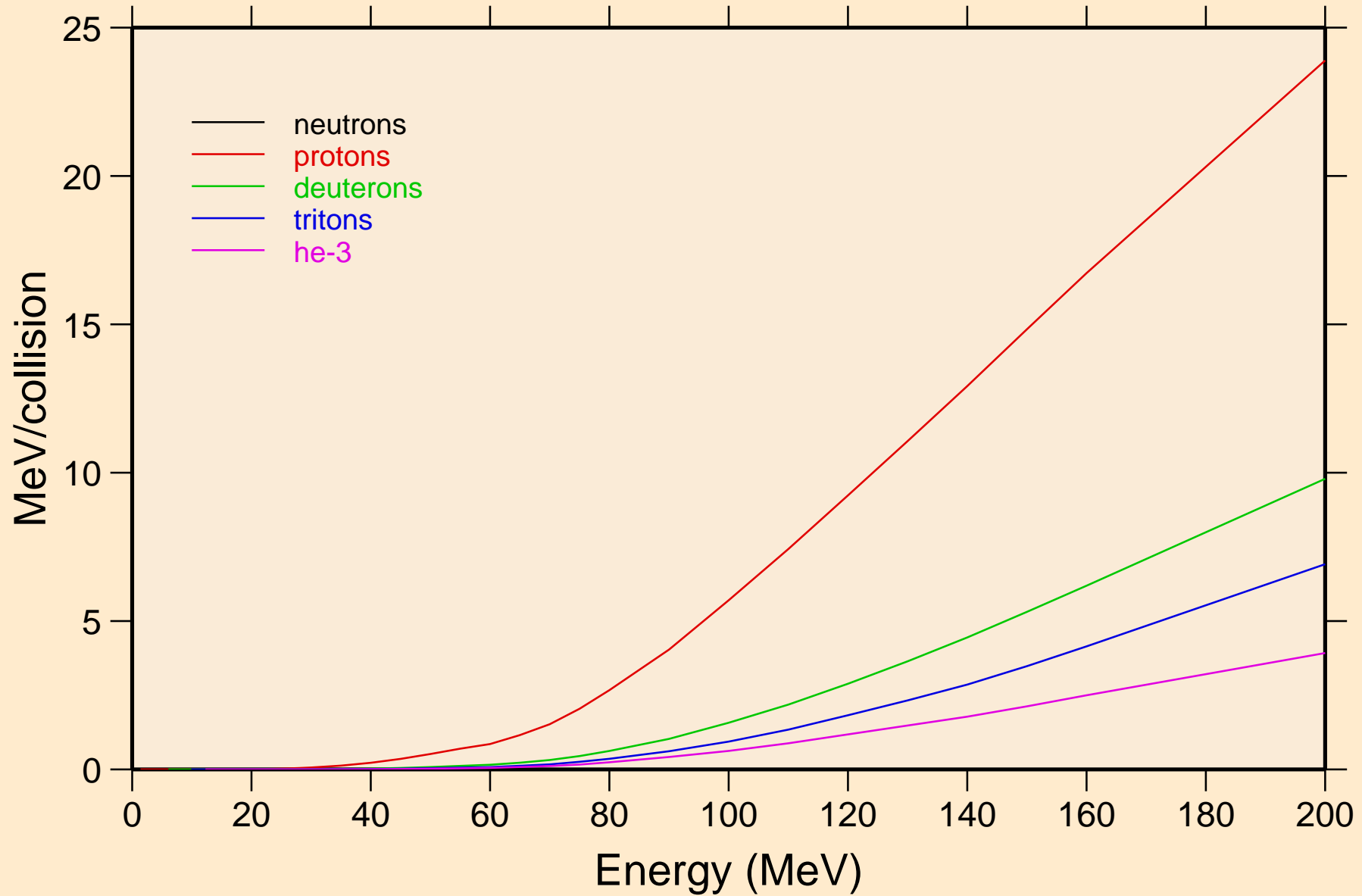

AS078 ALPHA ACER TENDL-2024 LIBRARY; T=0.K  
Recoil Heating

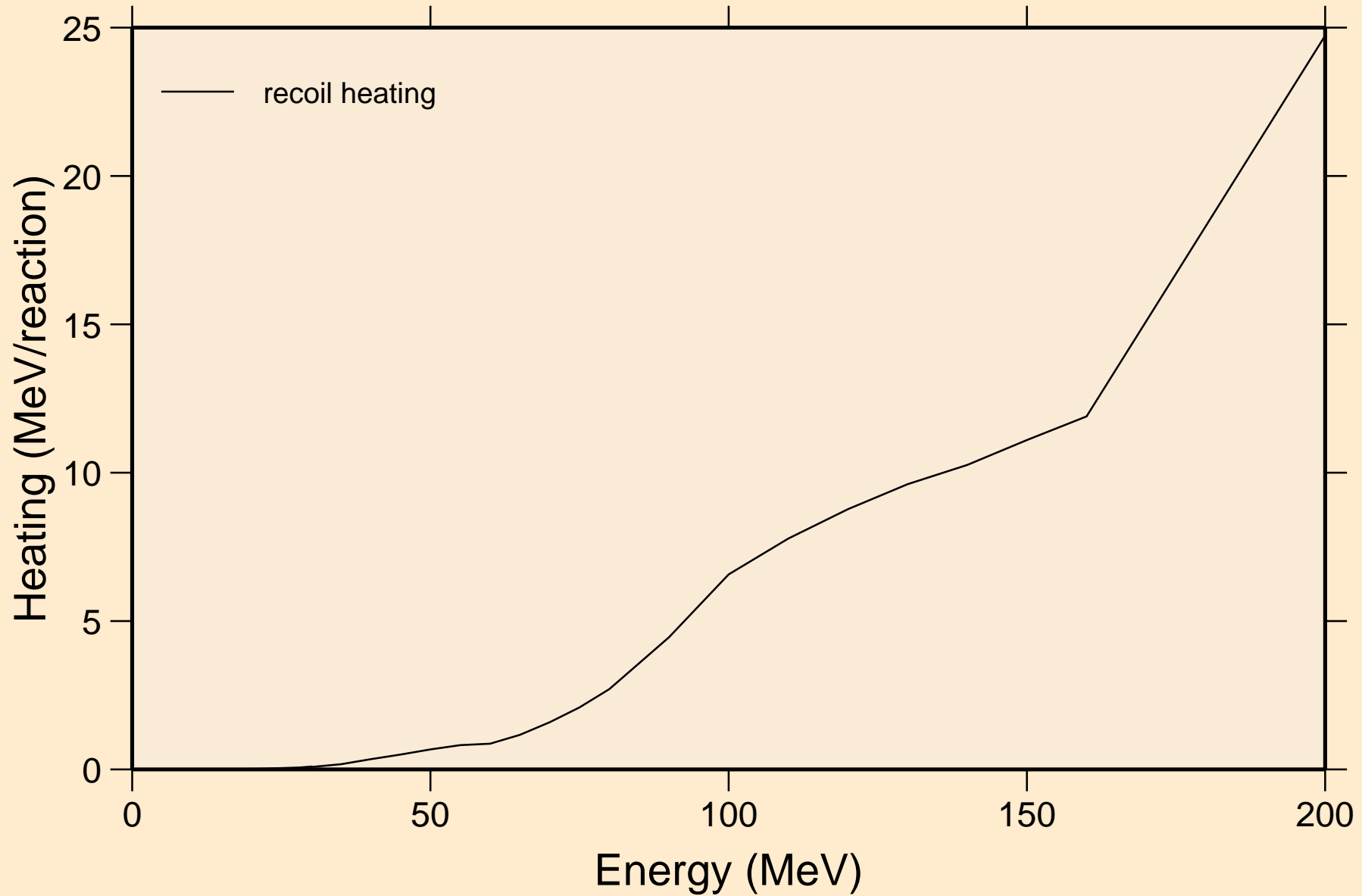

AS078 ALPHA ACER TENDL-2024 LIBRARY; T=0.K  
Particle production cross sections

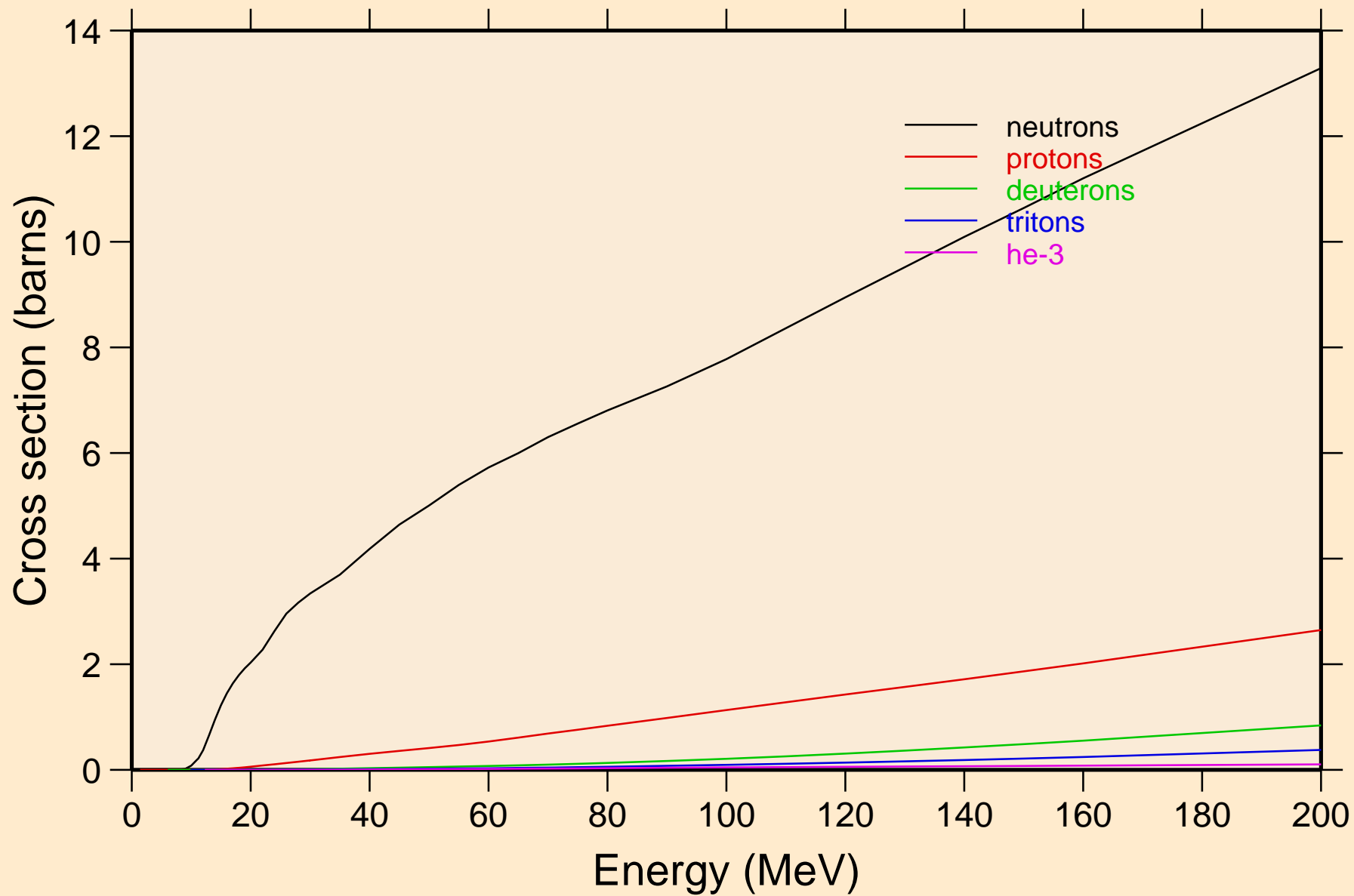

AS078 ALPHA ACER TENDL-2024 LIBRARY; T=0.K  
neutrons from (a,n)

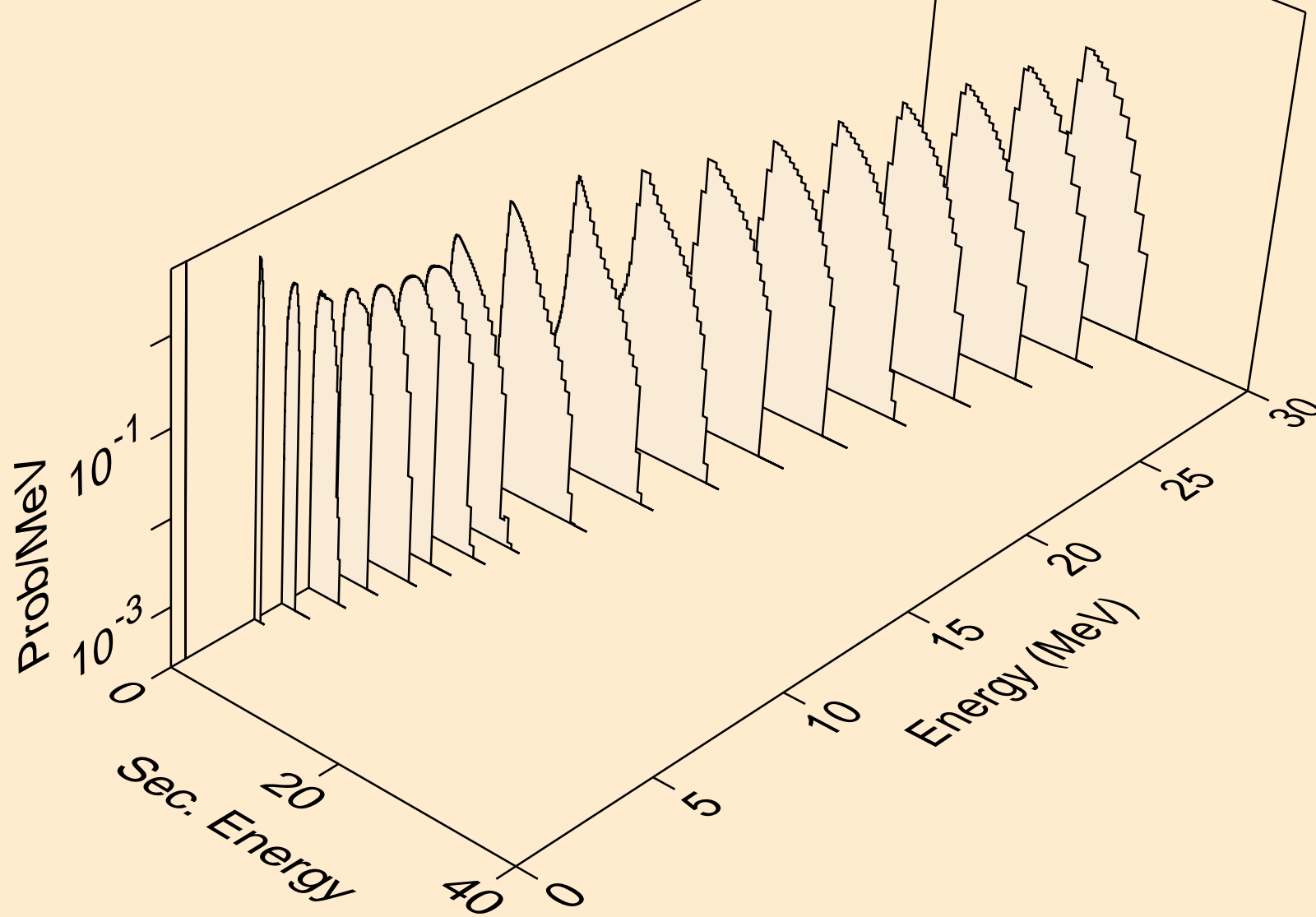

AS078 ALPHA ACER TENDL-2024 LIBRARY; T=0.K  
neutrons from (a,x)

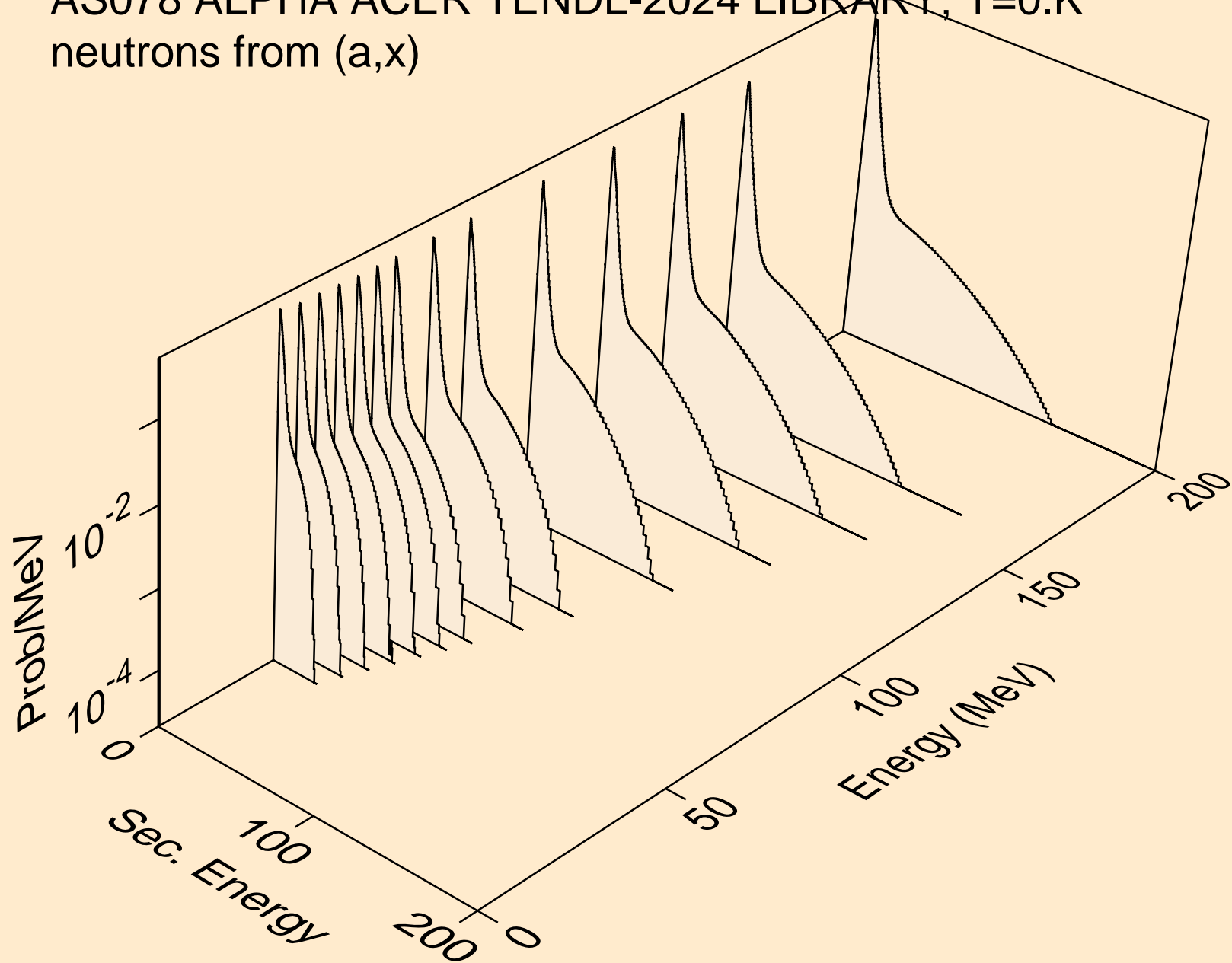

AS078 ALPHA ACER TENDL-2024 LIBRARY; T=0.K  
neutrons from (a,2nd)

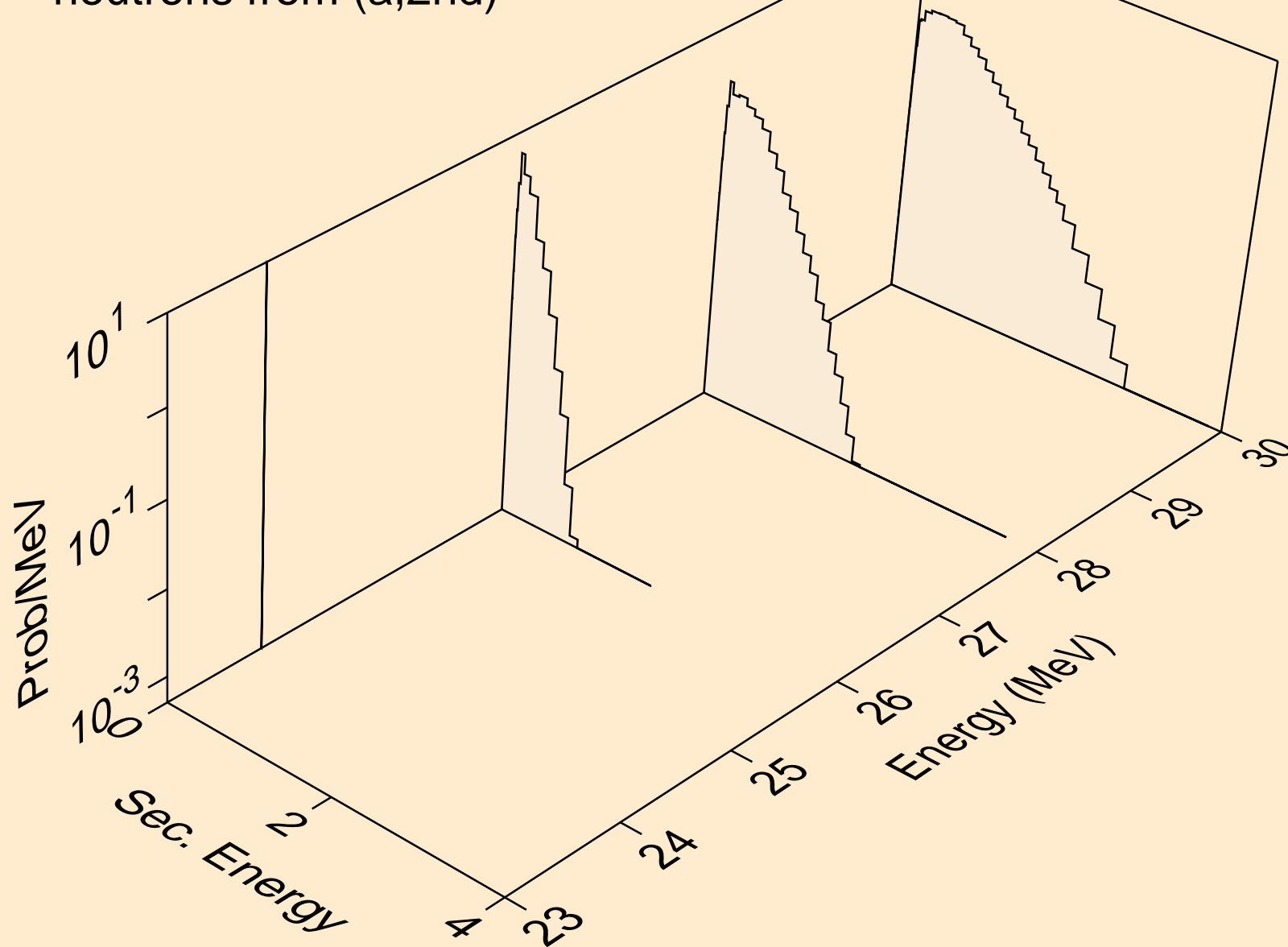

AS078 ALPHA ACER TENDL-2024 LIBRARY; T=0.K  
neutrons from (a,2n)

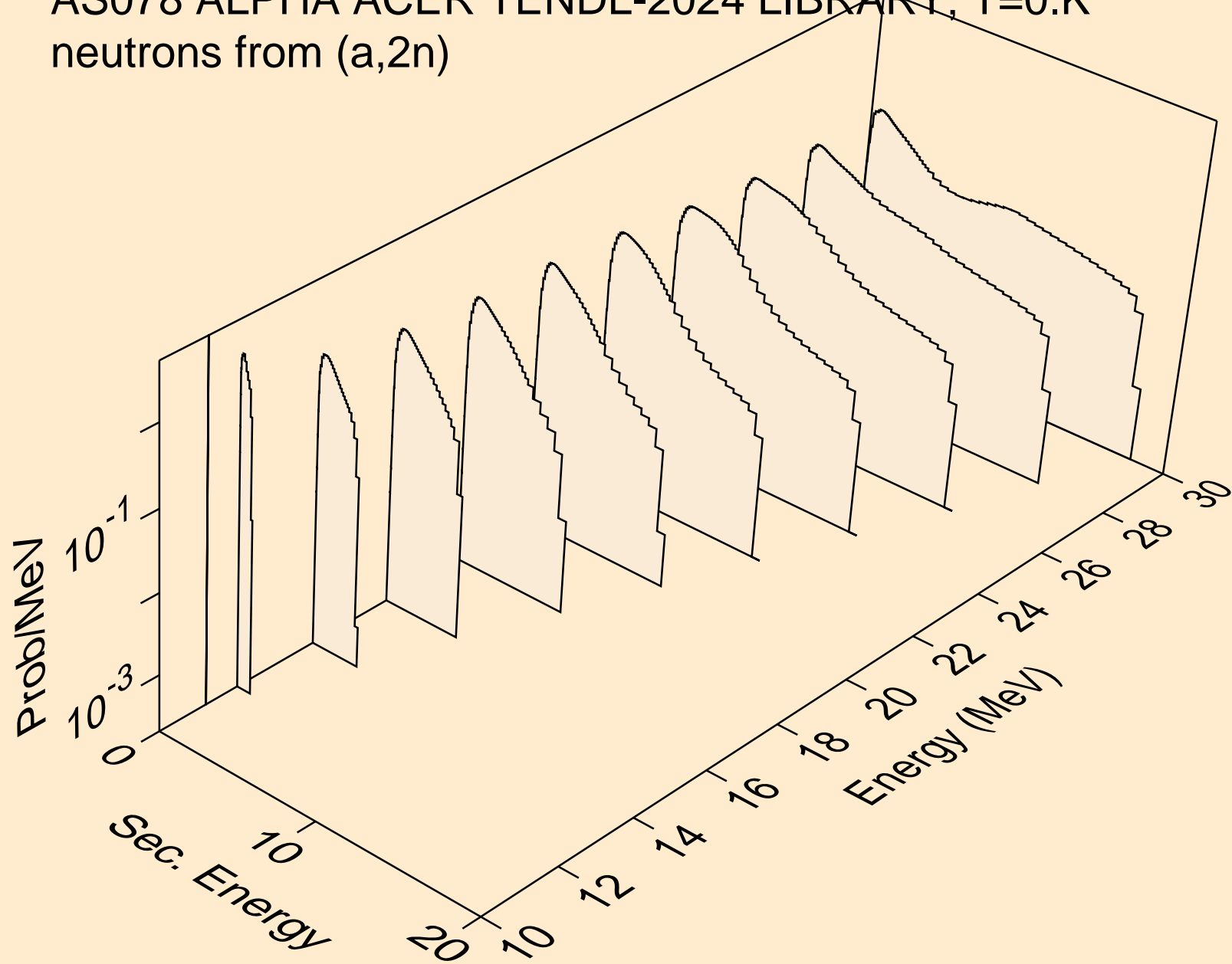

AS078 ALPHA ACER TENDL-2024 LIBRARY; T=0.K  
neutrons from (a,3n)

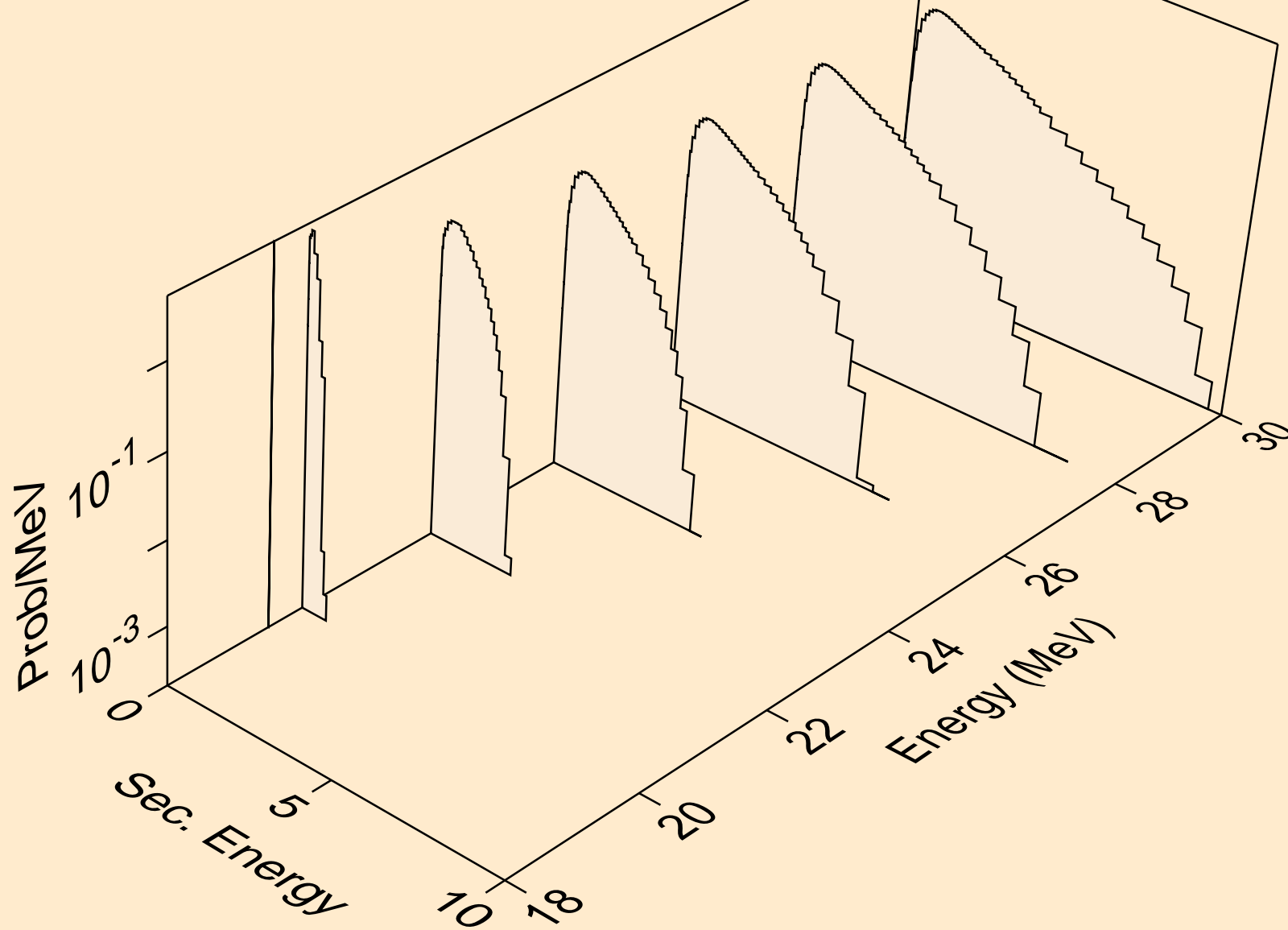

AS078 ALPHA ACER TENDL-2024 LIBRARY; T=0.K  
neutrons from (a,n\*)a

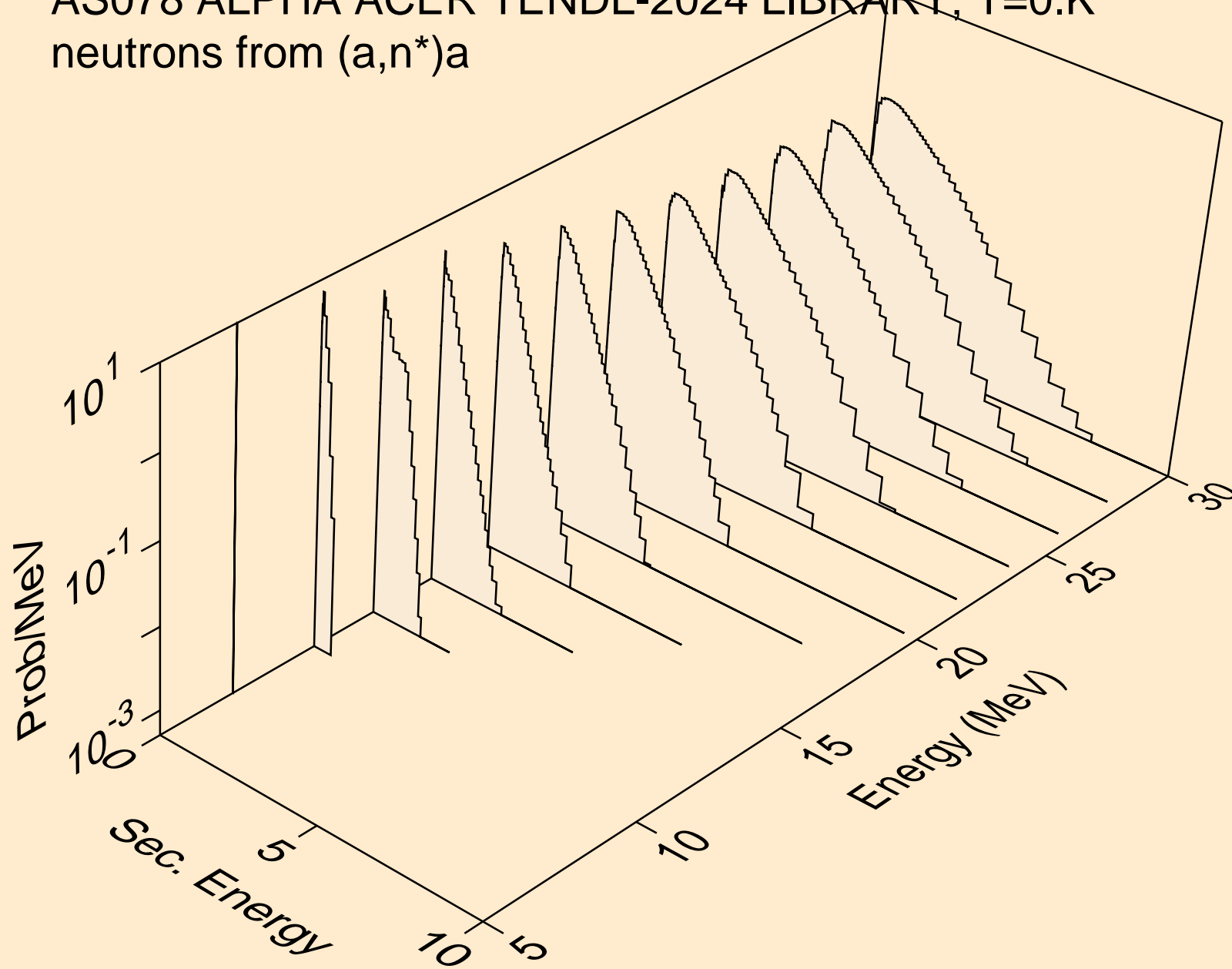

AS078 ALPHA ACER TENDL-2024 LIBRARY; T=0.K  
neutrons from (a,2n)a

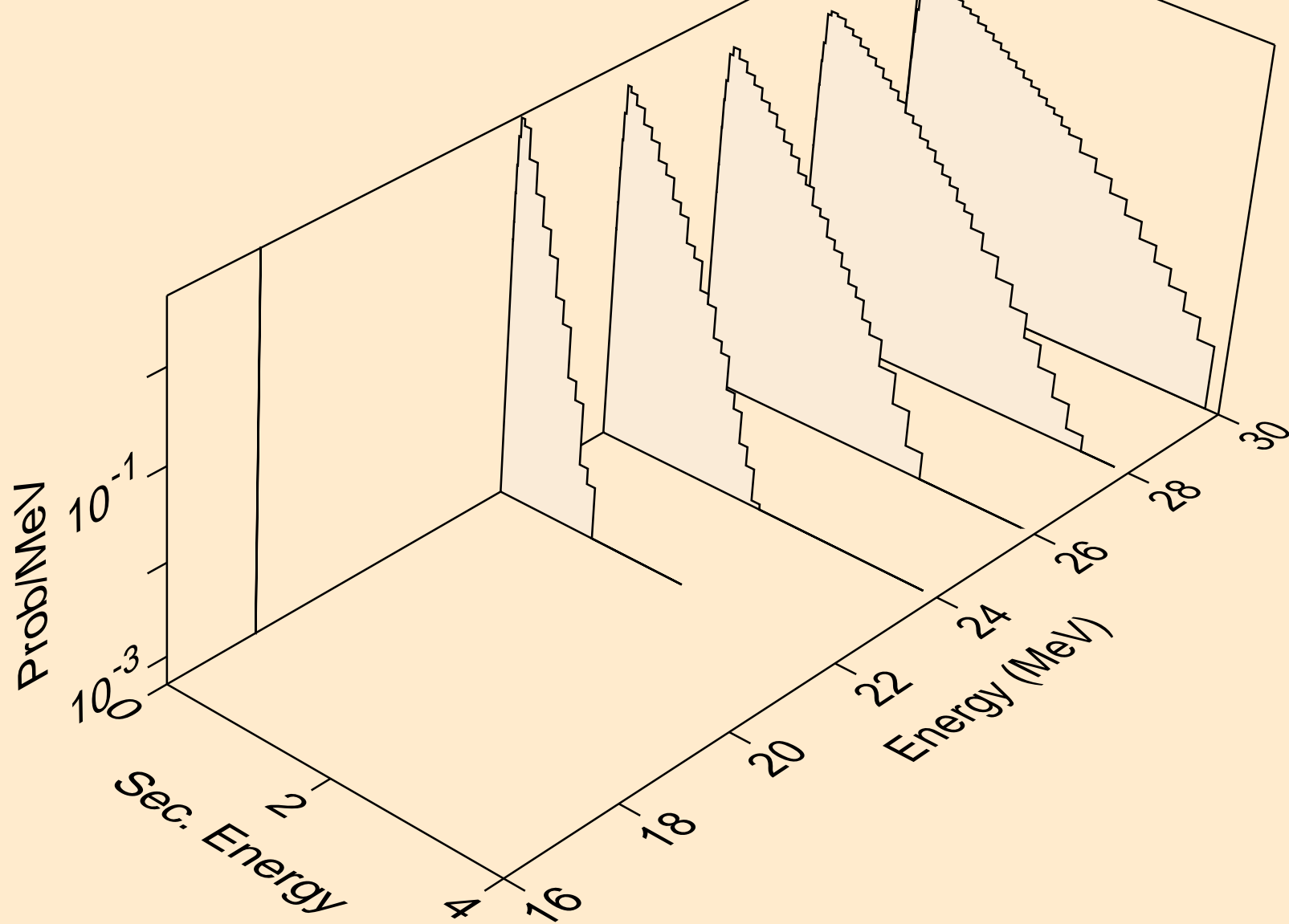

AS078 ALPHA ACER TENDL-2024 LIBRARY; T=0.K  
neutrons from (a,n\*)p

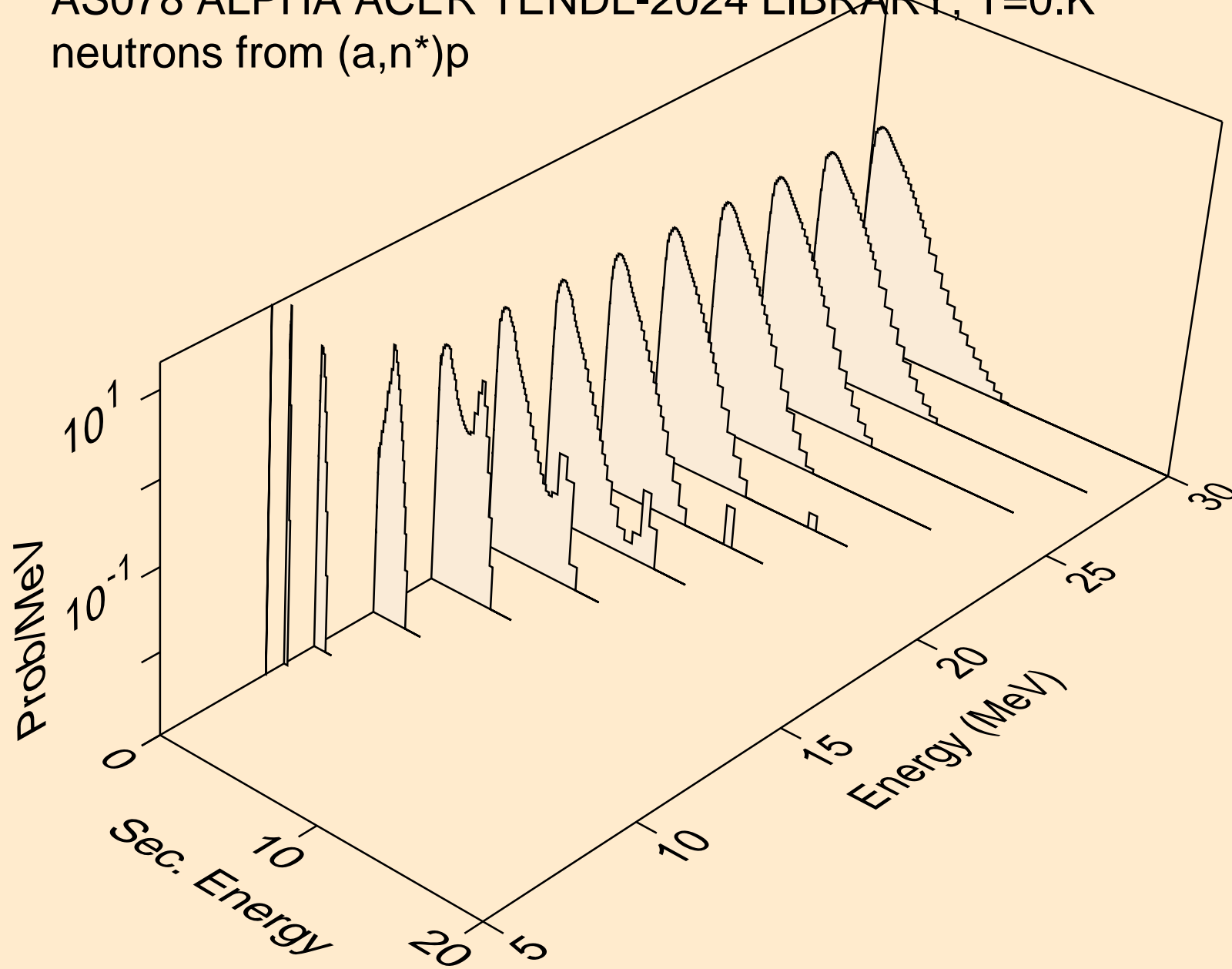

AS078 ALPHA ACER TENDL-2024 LIBRARY; T=0.K  
neutrons from (a,n\*)d

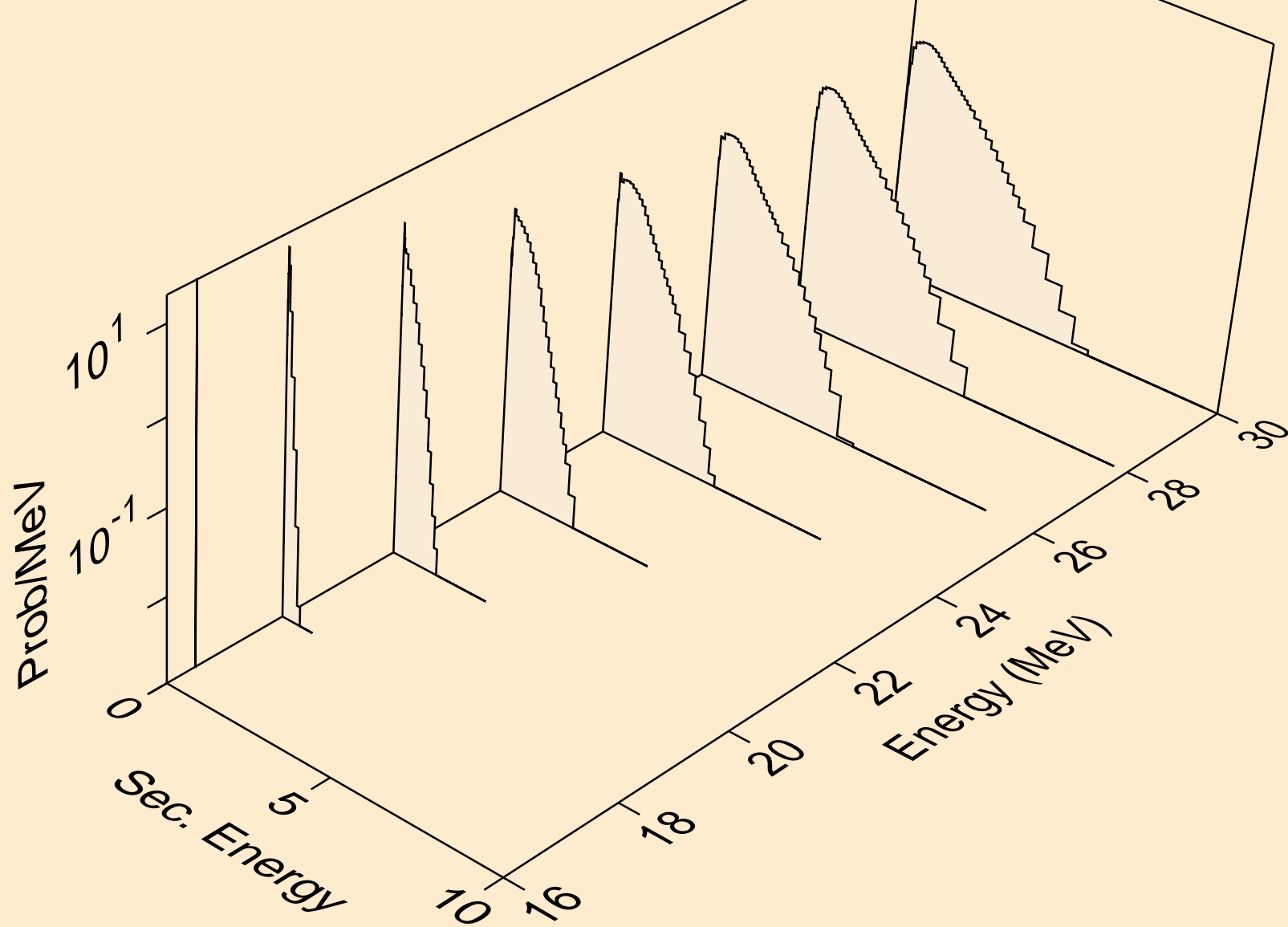

AS078 ALPHA ACER TENDL-2024 LIBRARY; T=0.K  
neutrons from (a,n\*)t

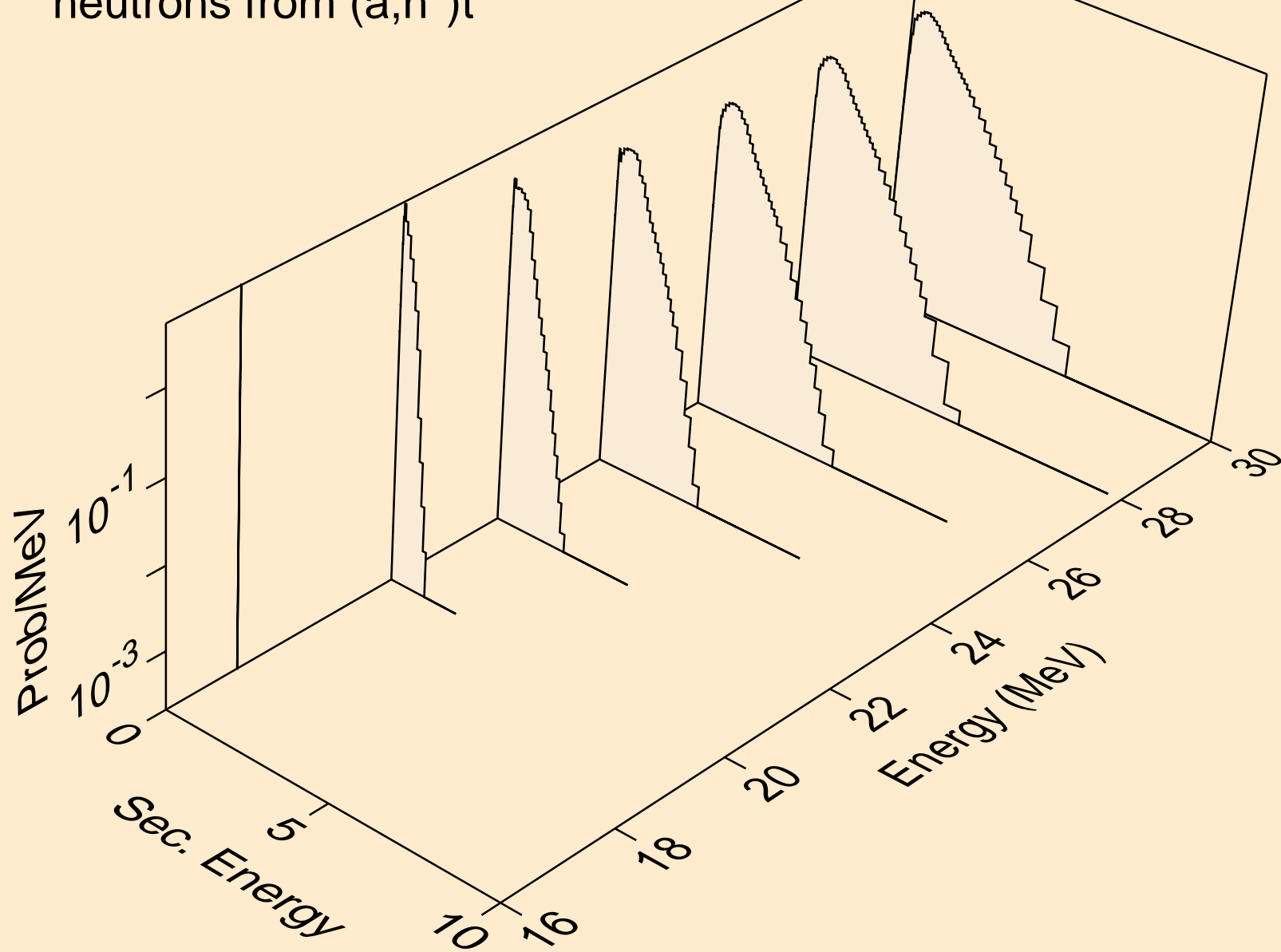

AS078 ALPHA ACER TENDL-2024 LIBRARY; T=0.K  
neutrons from (a,n\*)he3

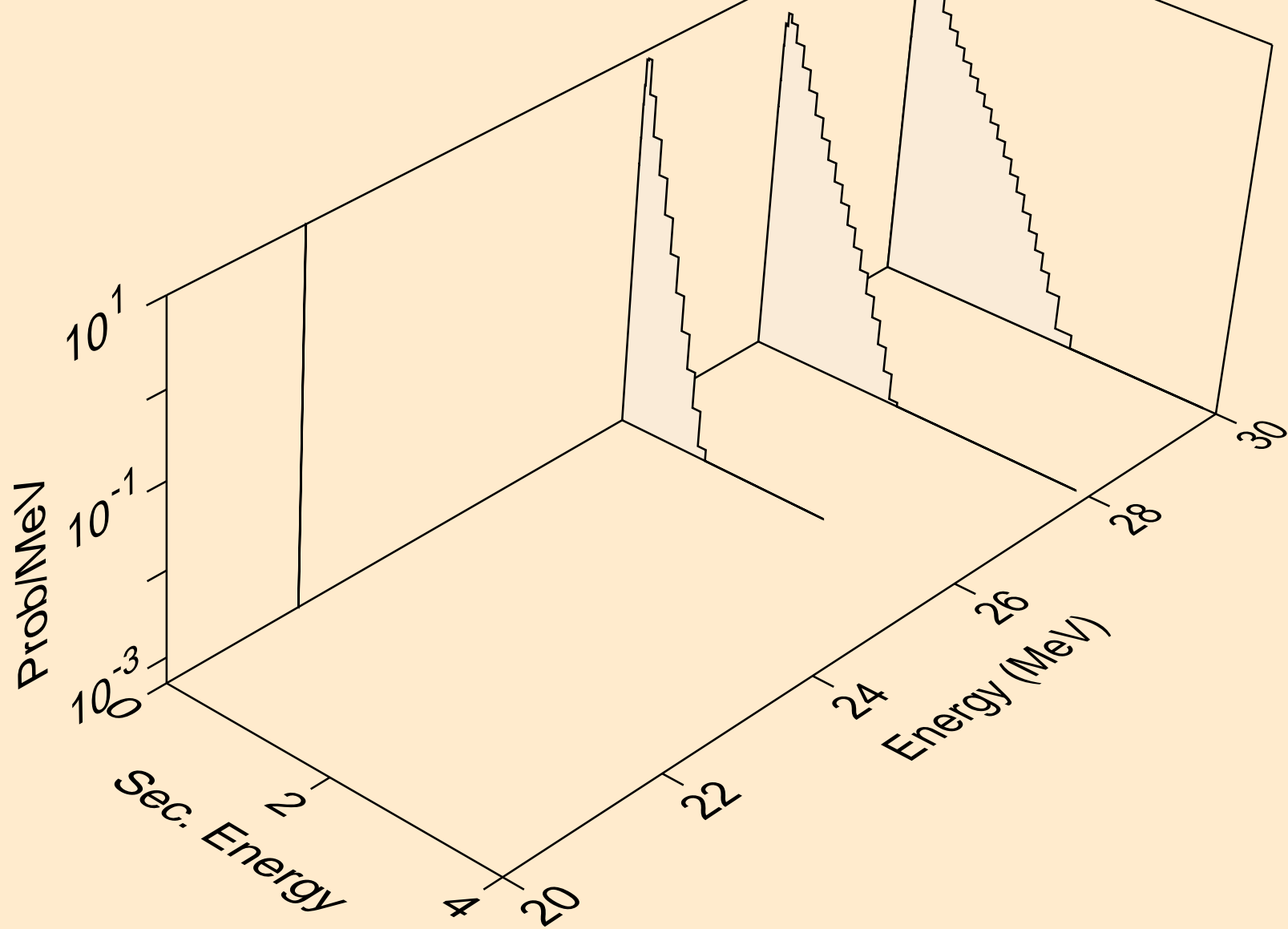

AS078 ALPHA ACER TENDL-2024 LIBRARY; T=0.K  
neutrons from (a,2np)

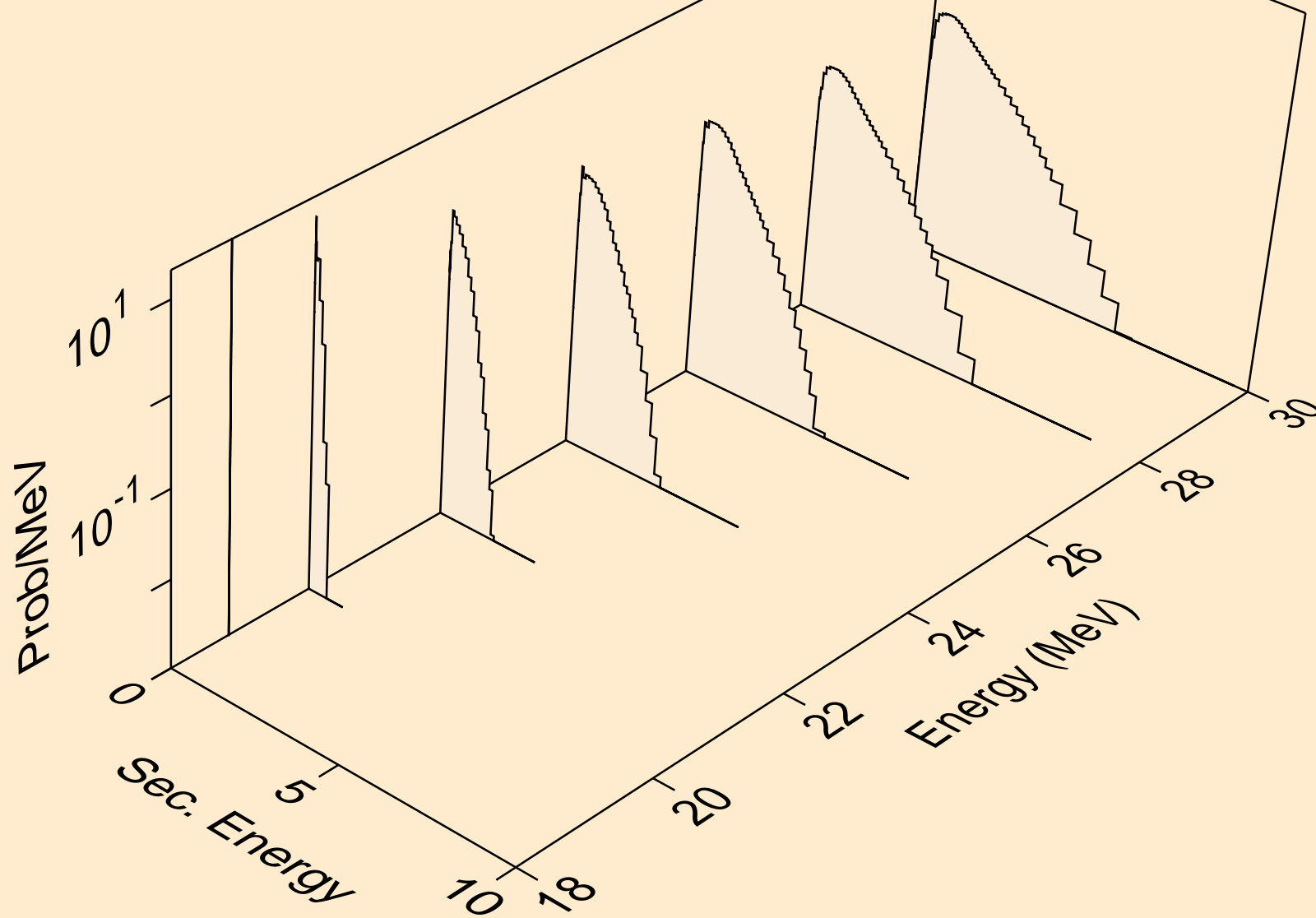

AS078 ALPHA ACER TENDL-2024 LIBRARY; T=0.K  
neutrons from (a,3np)

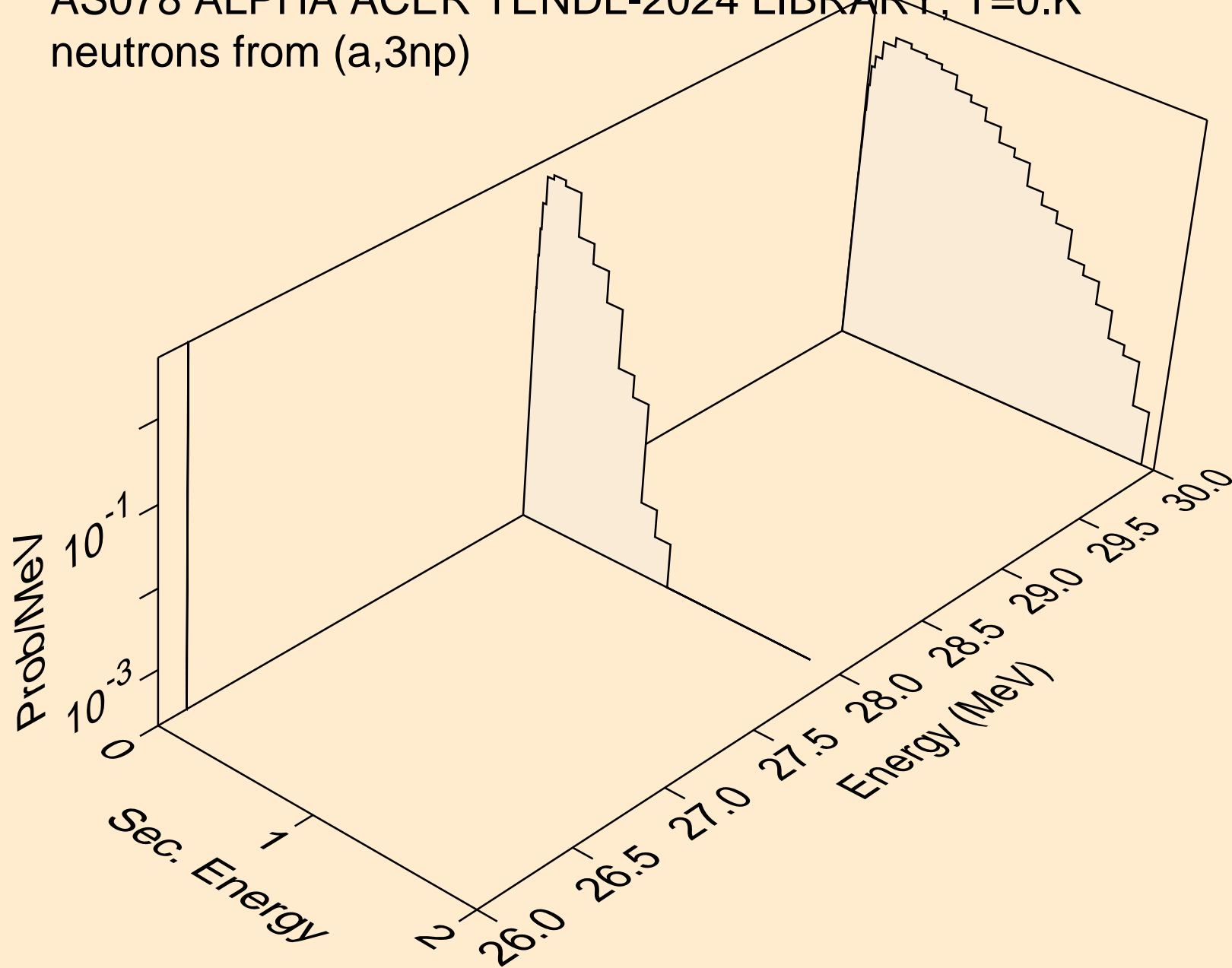

AS078 ALPHA ACER TENDL-2024 LIBRARY; T=0.K  
neutrons from (a,n2p)

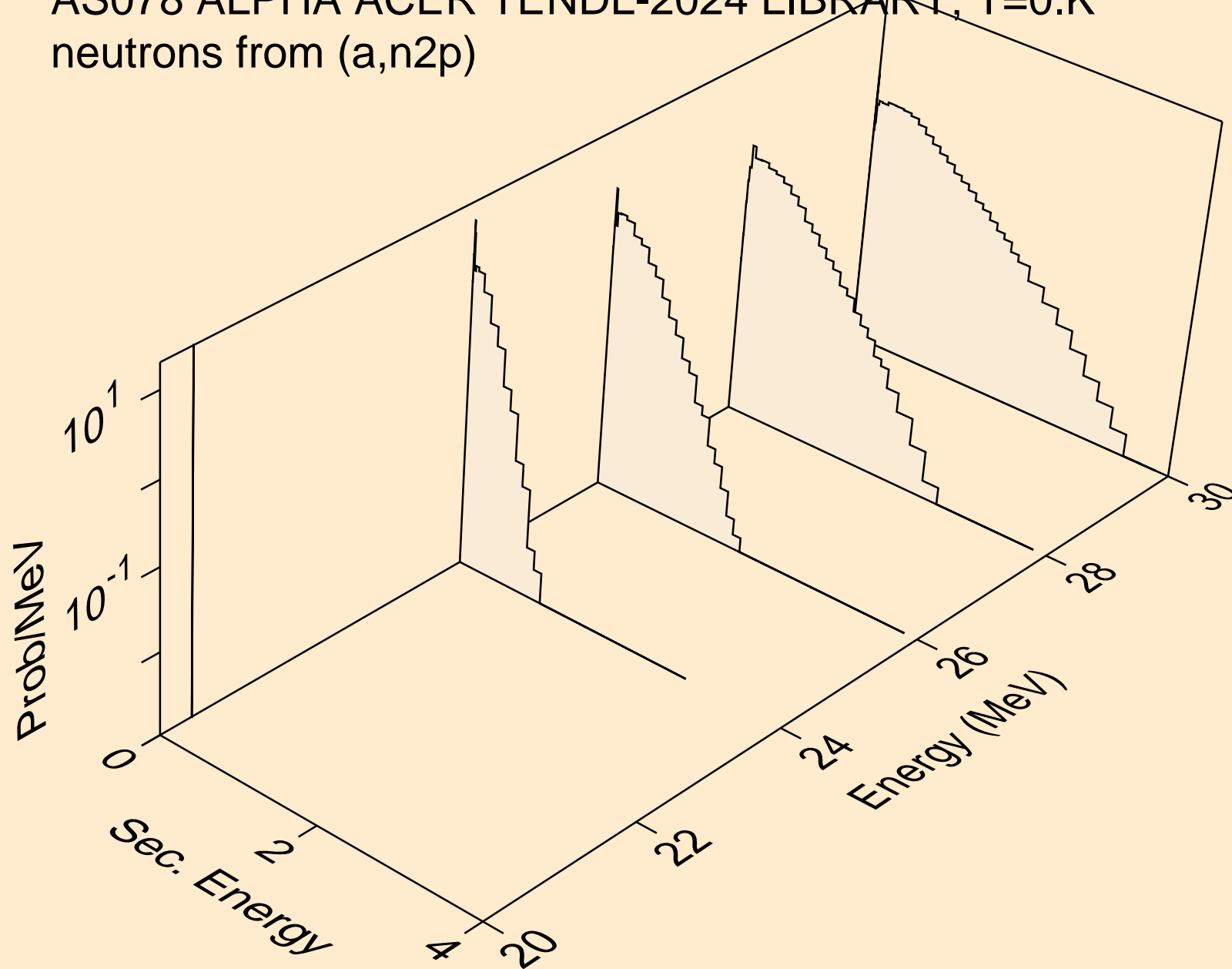

AS078 ALPHA ACER TENDL-2024 LIBRARY; T=0.K  
neutrons from (a,npa)

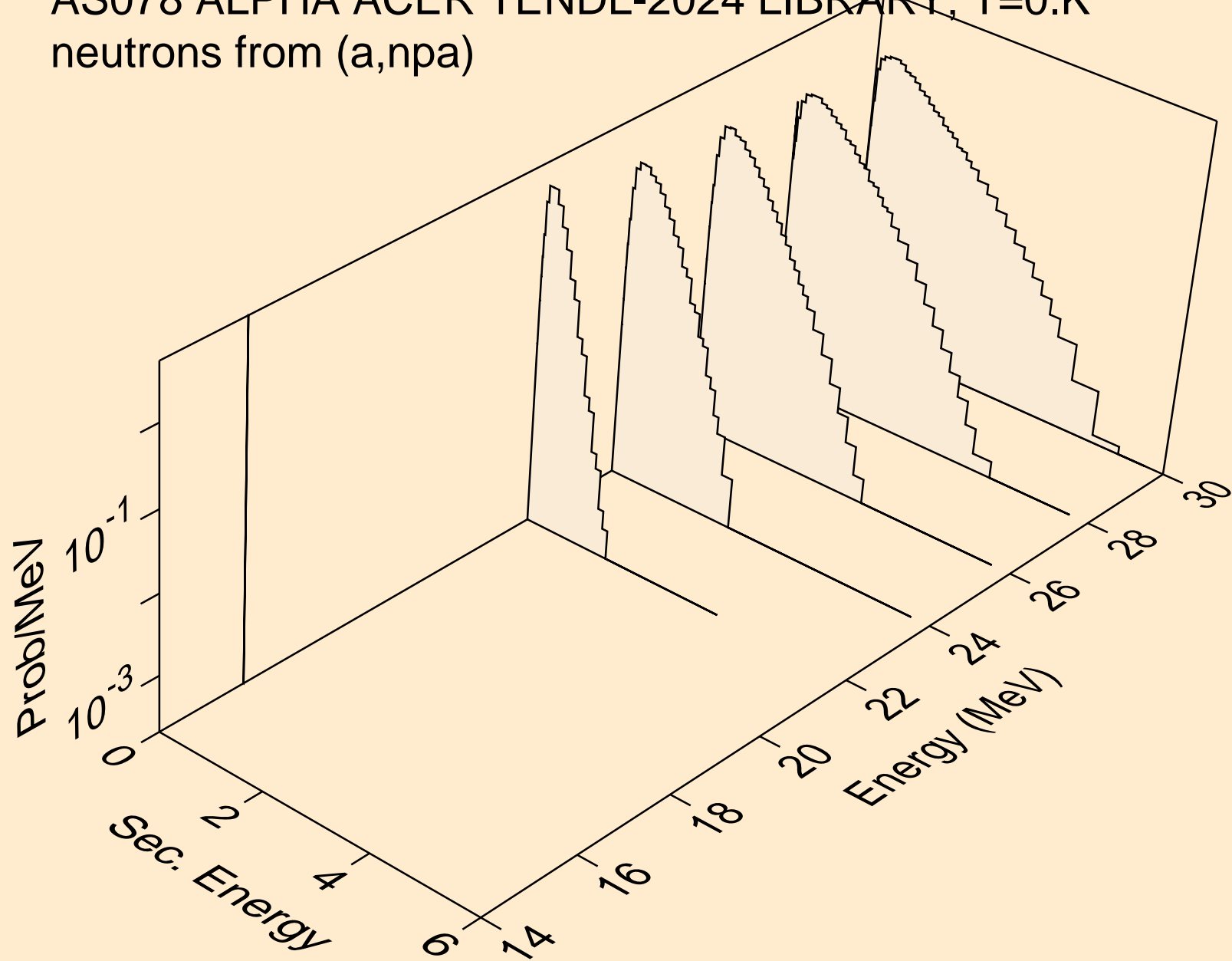

AS078 ALPHA ACER TENDL-2024 LIBRARY; T=0.K  
protons from (a,x)

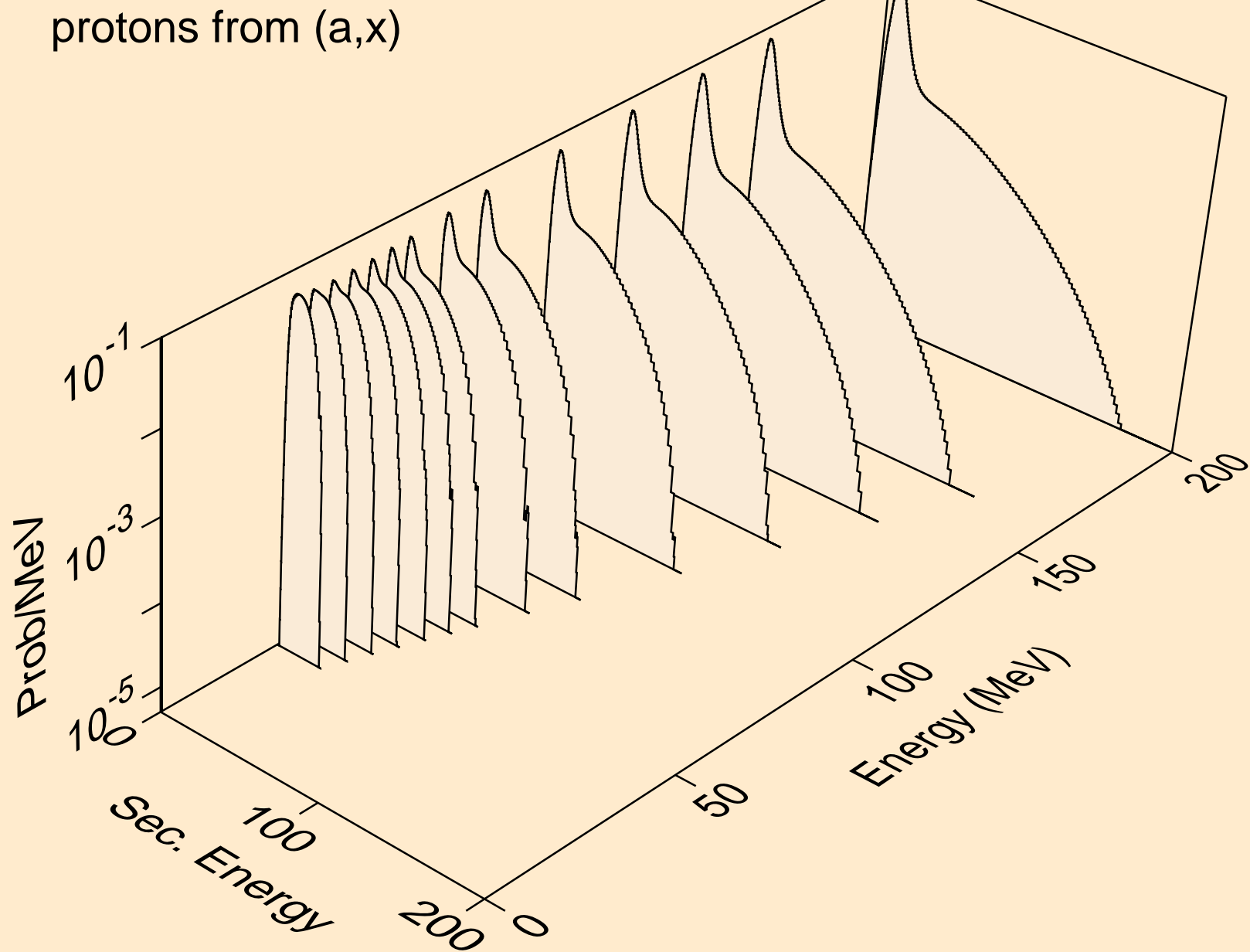

AS078 ALPHA ACER TENDL-2024 LIBRARY; T=0.K  
protons from (a,n\*)p

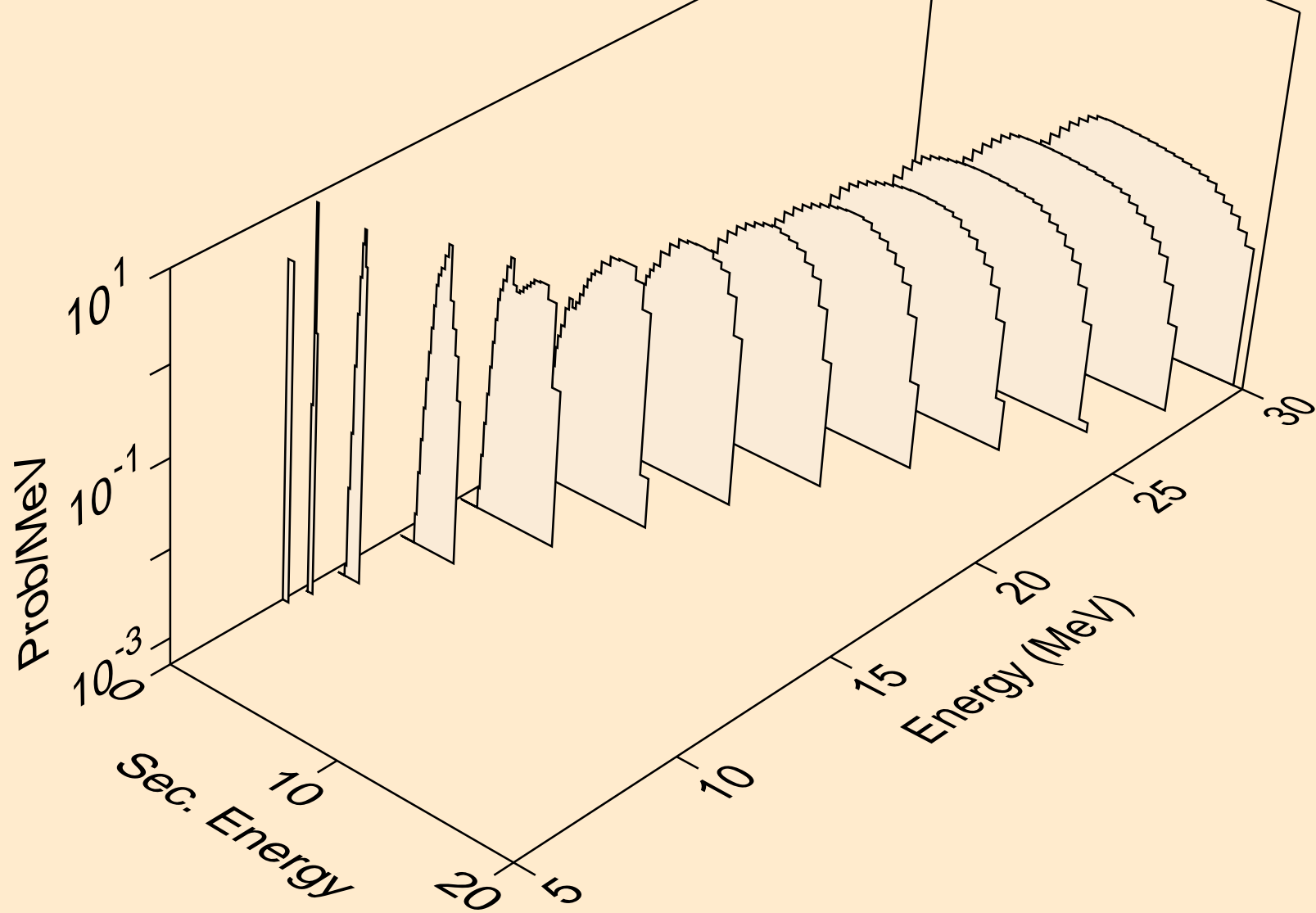

AS078 ALPHA ACER TENDL-2024 LIBRARY; T=0.K  
protons from (a,2np)

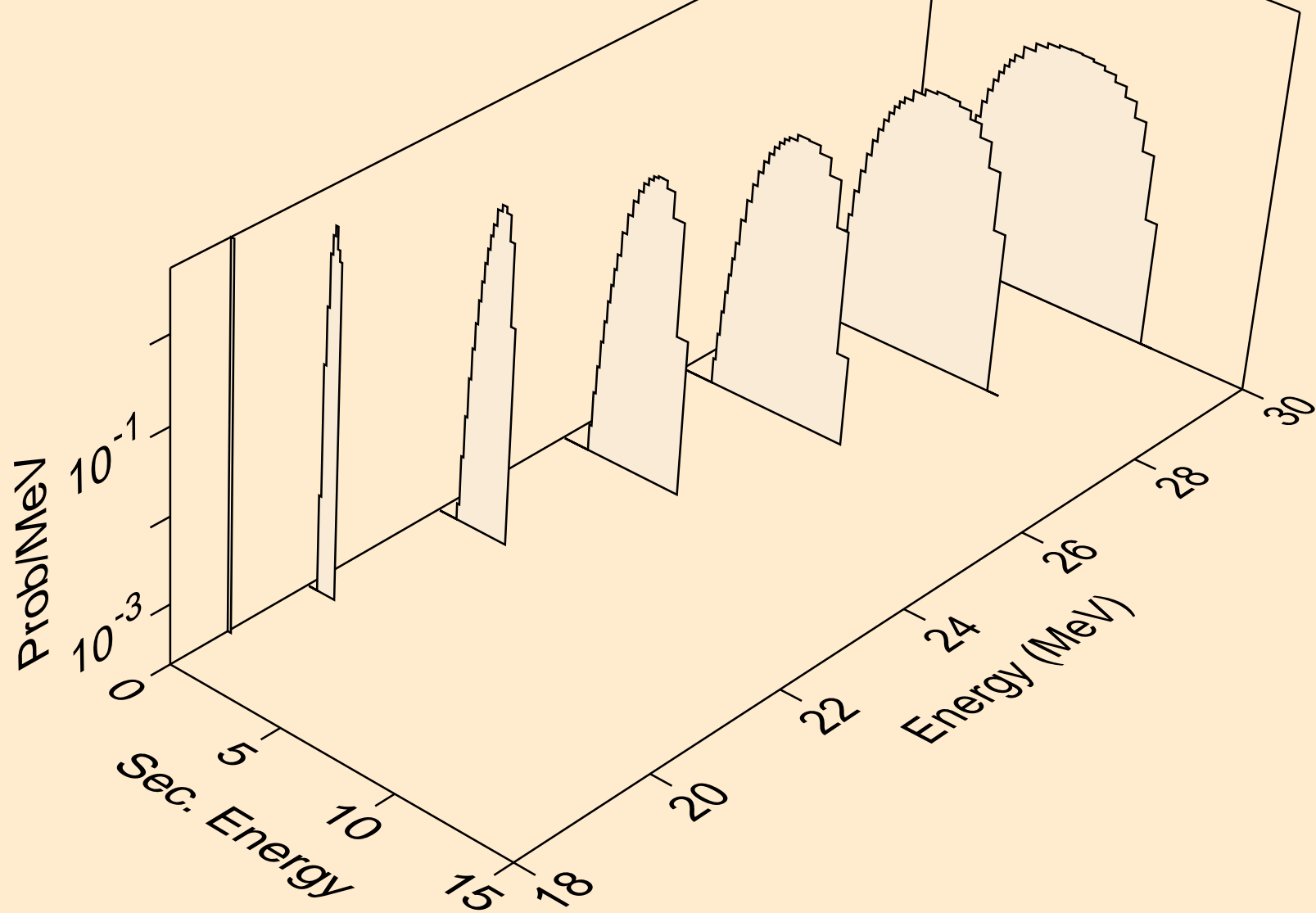

AS078 ALPHA ACER TENDL-2024 LIBRARY; T=0.K  
protons from (a,3np)

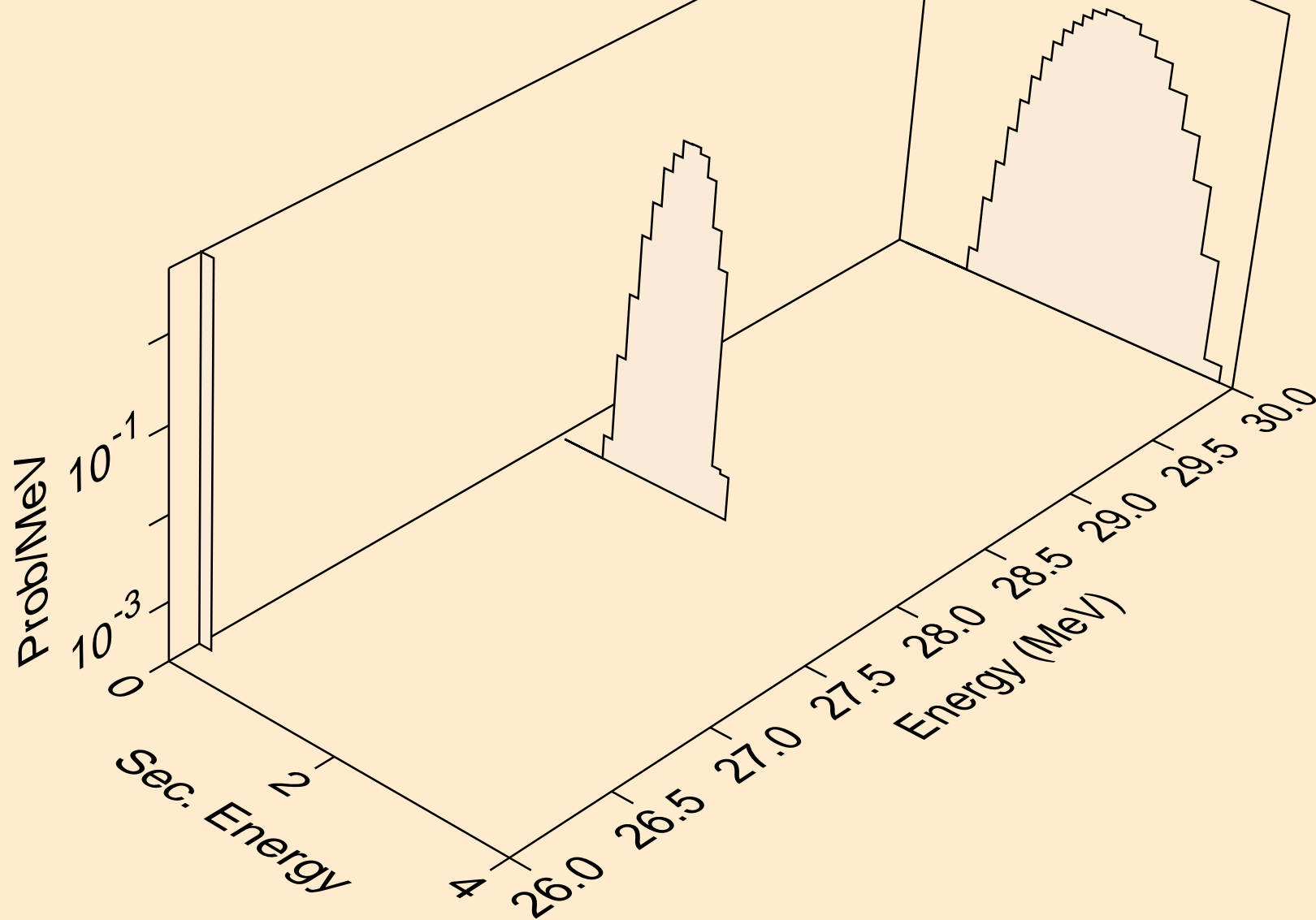

AS078 ALPHA ACER TENDL-2024 LIBRARY; T=0.K  
protons from (a,n2p)

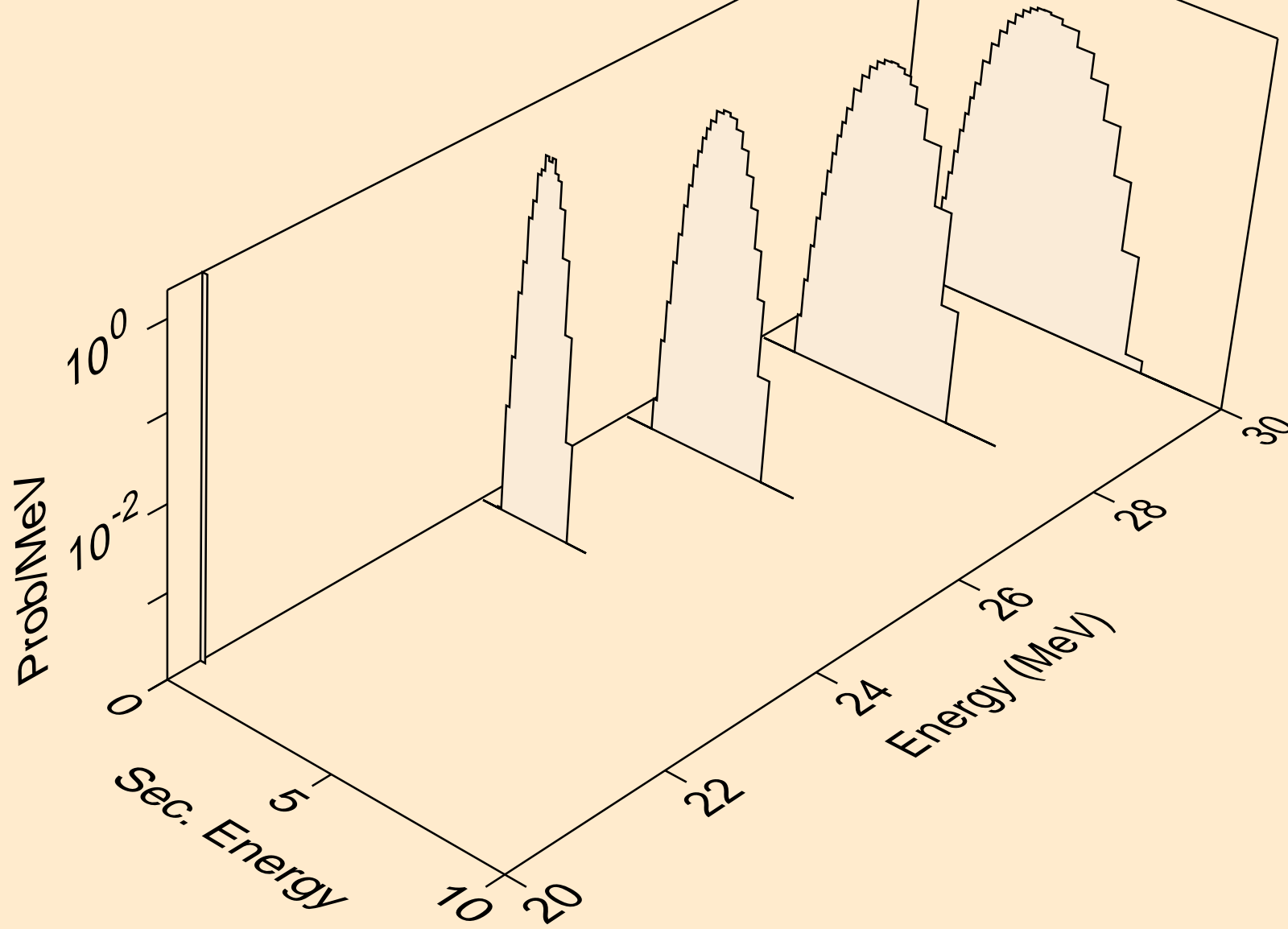

AS078 ALPHA ACER TENDL-2024 LIBRARY; T=0.K  
protons from (a,npa)

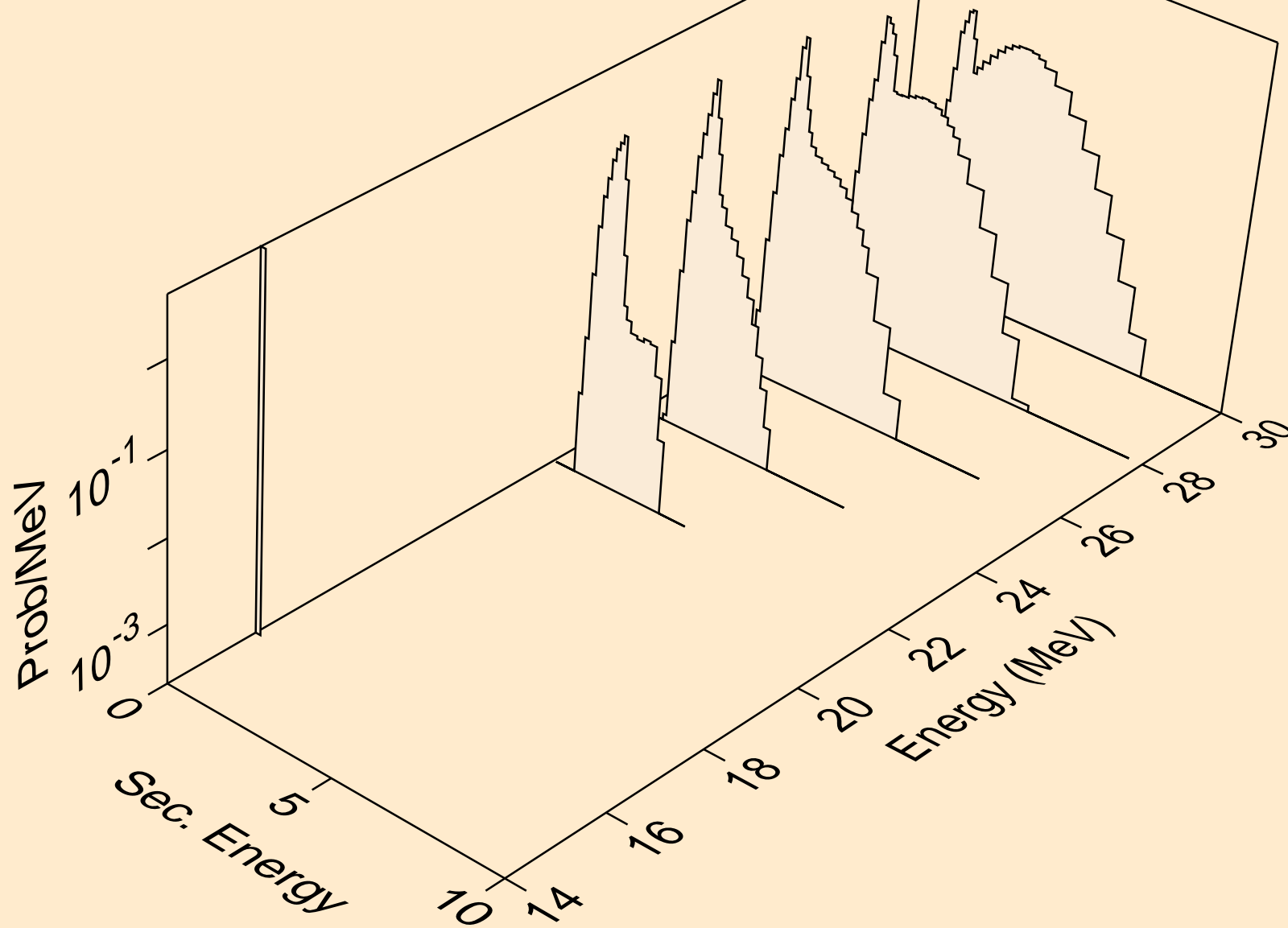

AS078 ALPHA ACER TENDL-2024 LIBRARY; T=0.K  
protons from (a,p)

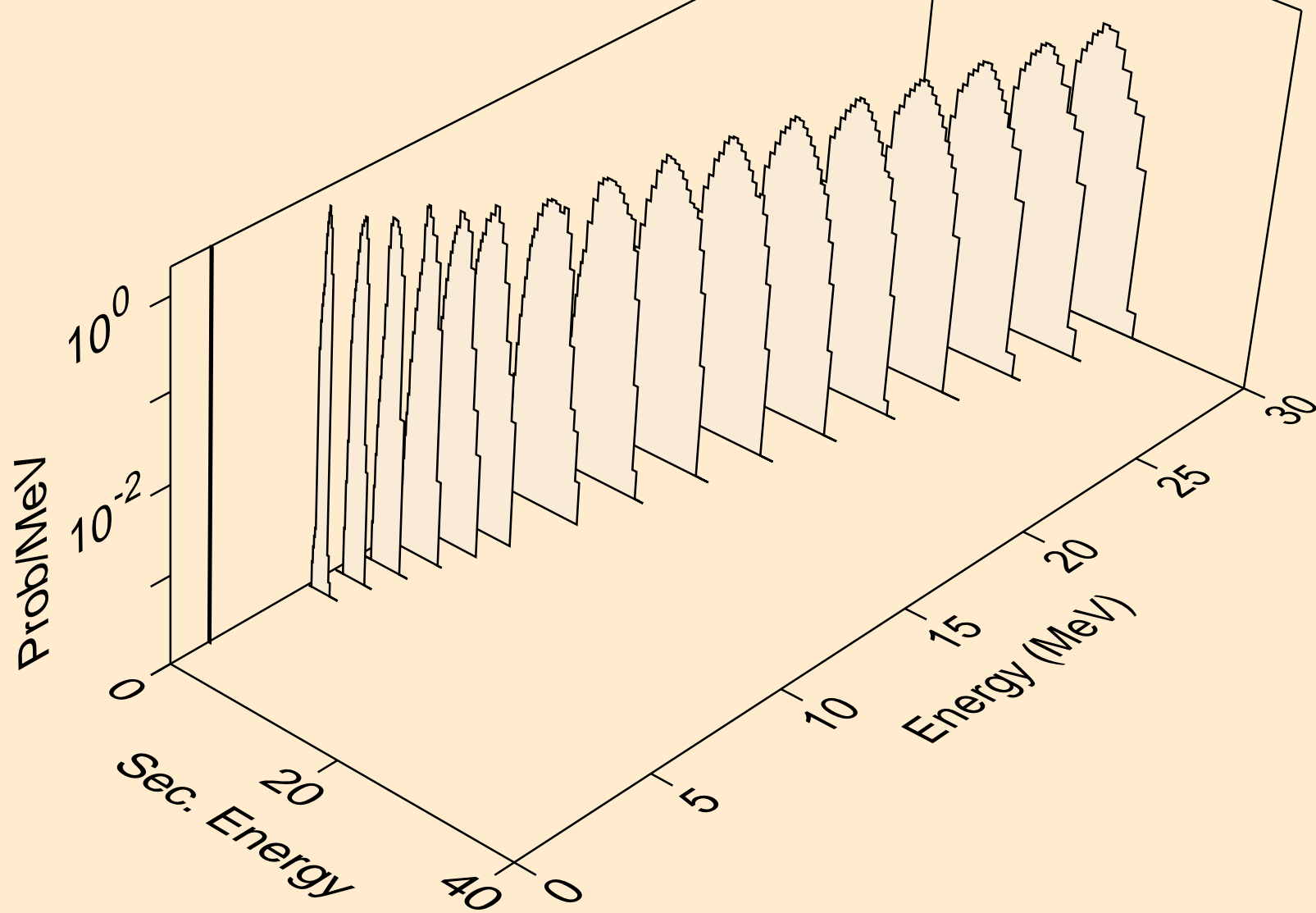

AS078 ALPHA ACER TENDL-2024 LIBRARY; T=0.K  
protons from (a,2p)

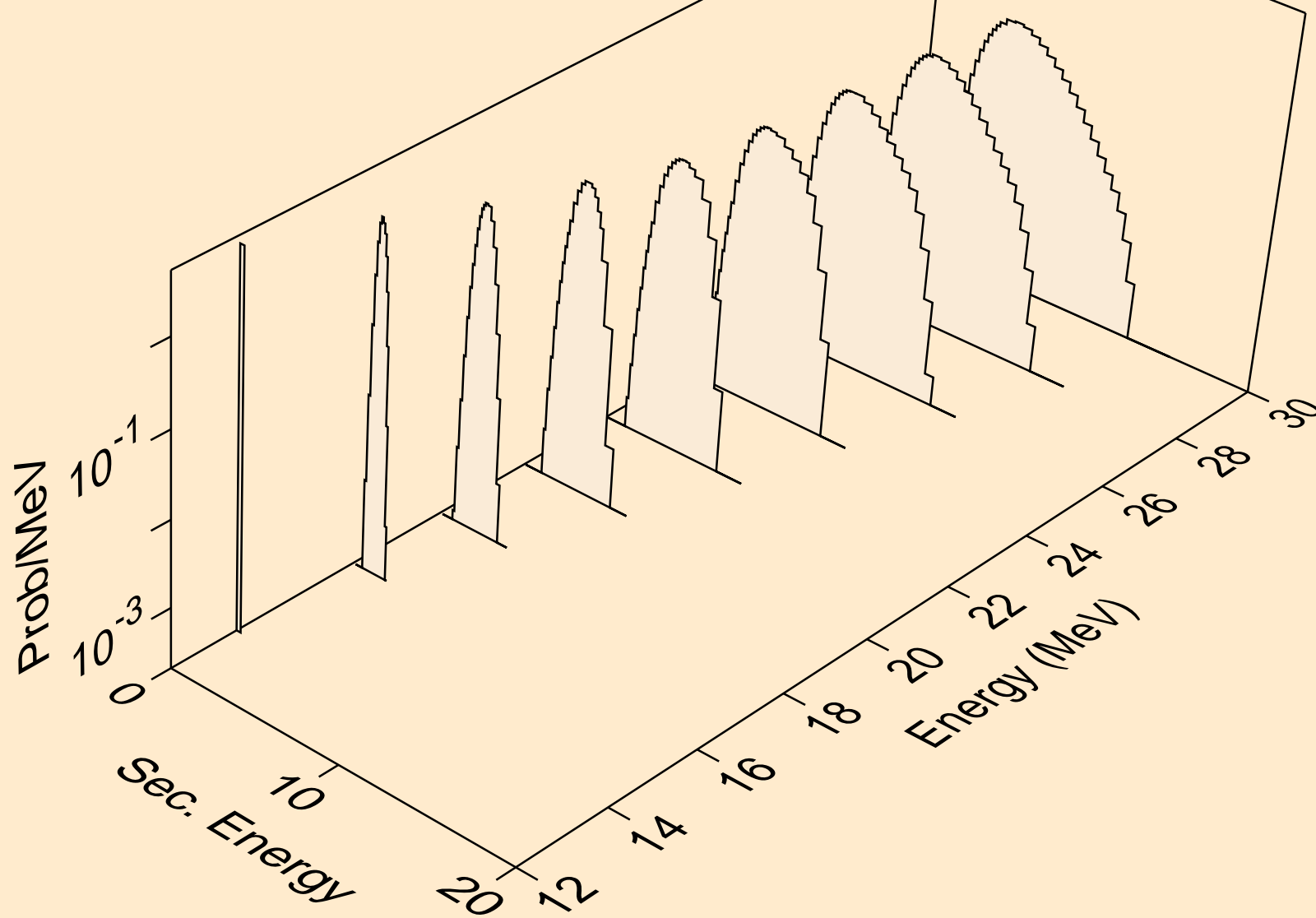

AS078 ALPHA ACER TENDL-2024 LIBRARY; T=0.K  
protons from (a,pa)

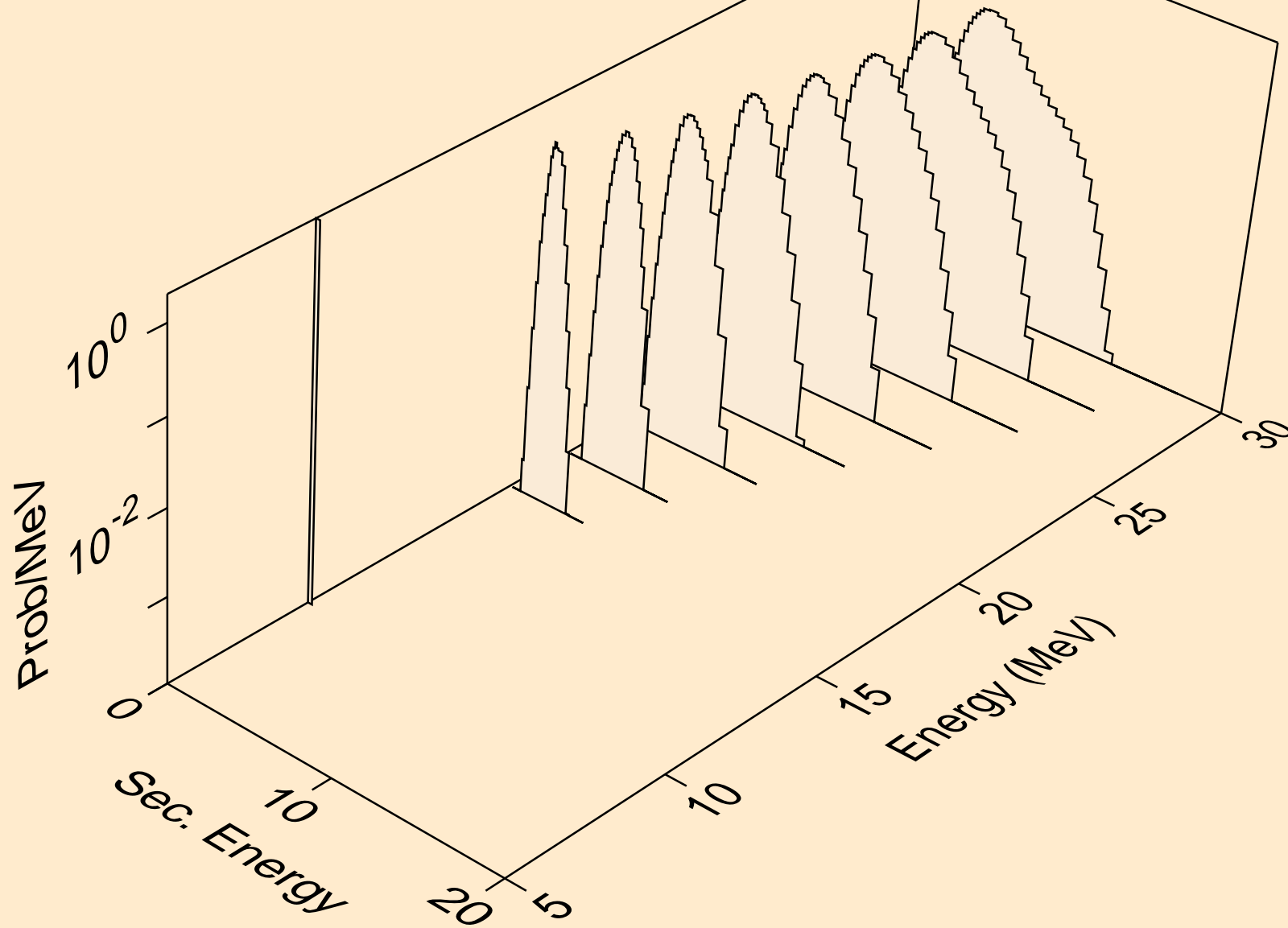

AS078 ALPHA ACER TENDL-2024 LIBRARY; T=0.K  
protons from (a,pd)

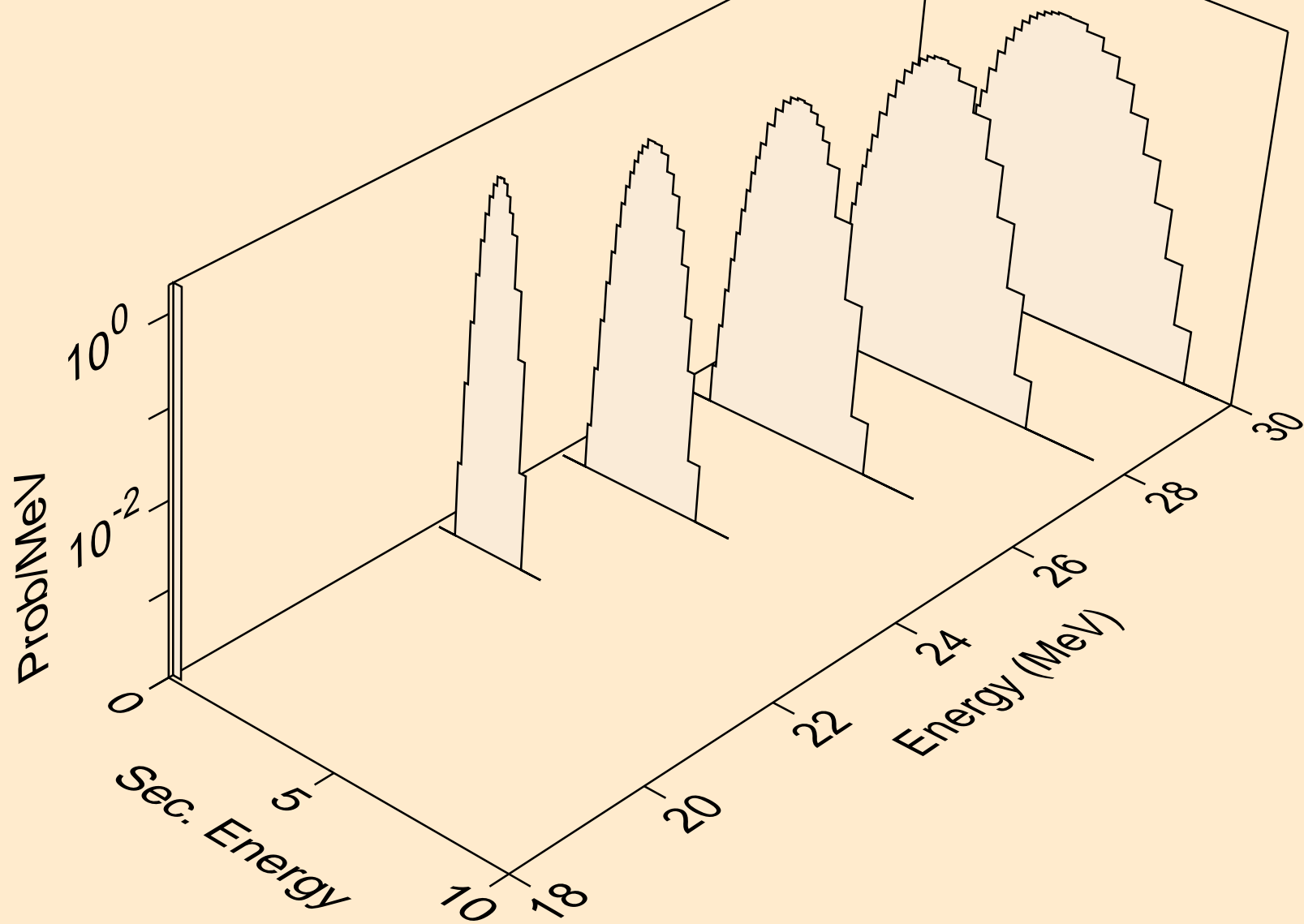

AS078 ALPHA ACER TENDL-2024 LIBRARY; T=0.K  
protons from (a,pt)

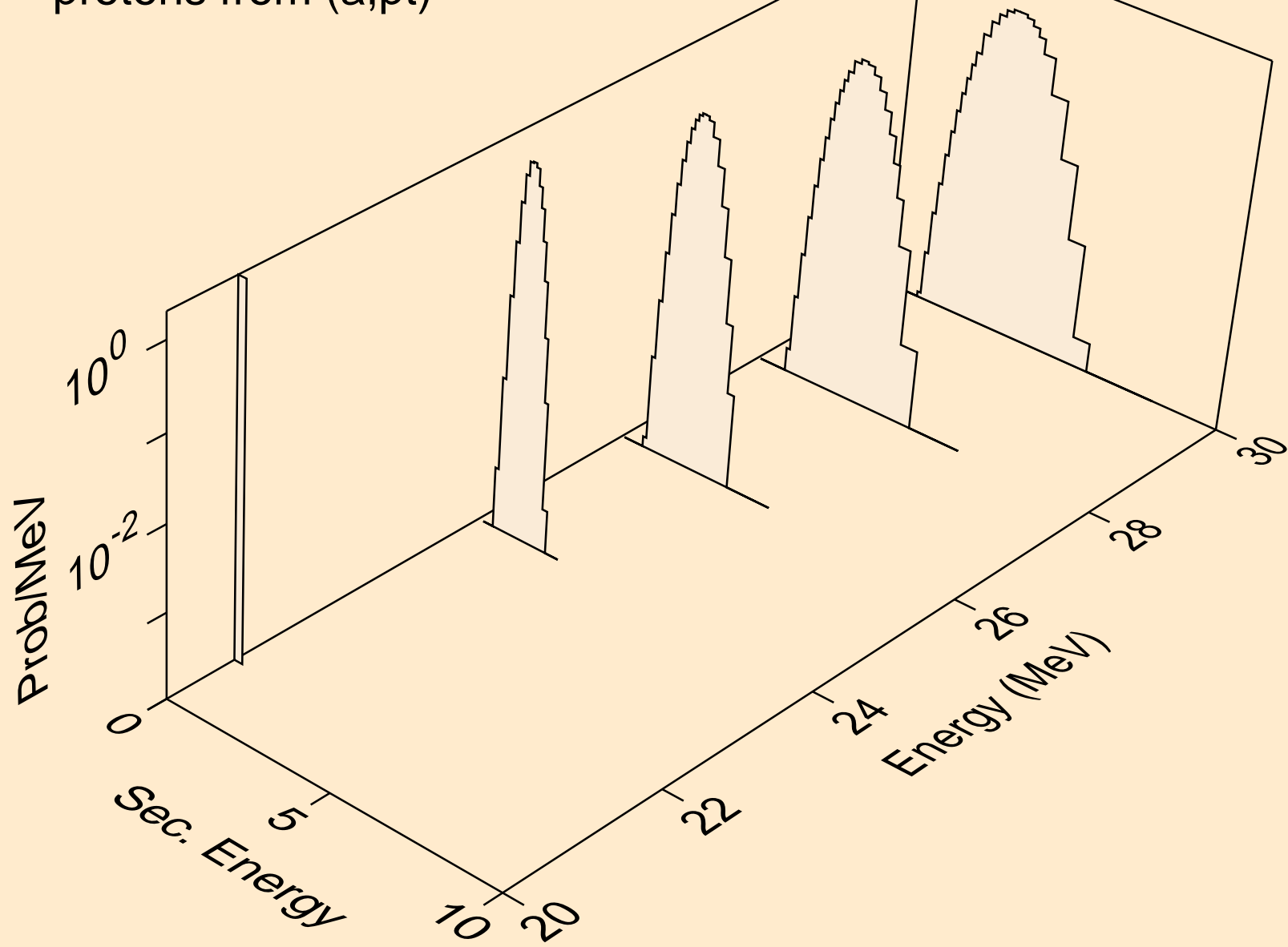

AS078 ALPHA ACER TENDL-2024 LIBRARY; T=0.K  
deuterons from (a,x)

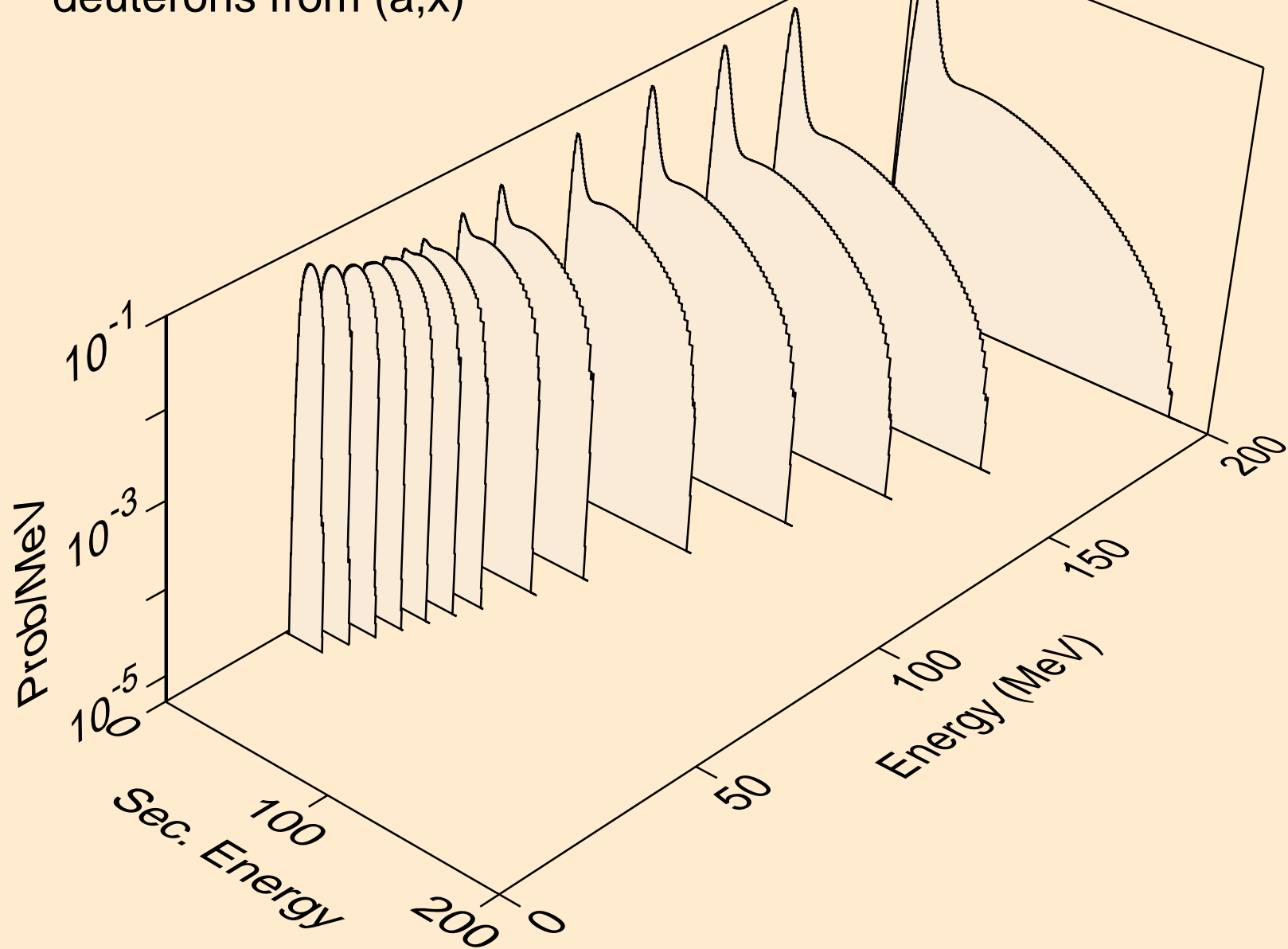

AS078 ALPHA ACER TENDL-2024 LIBRARY; T=0.K  
deuterons from (a,2nd)

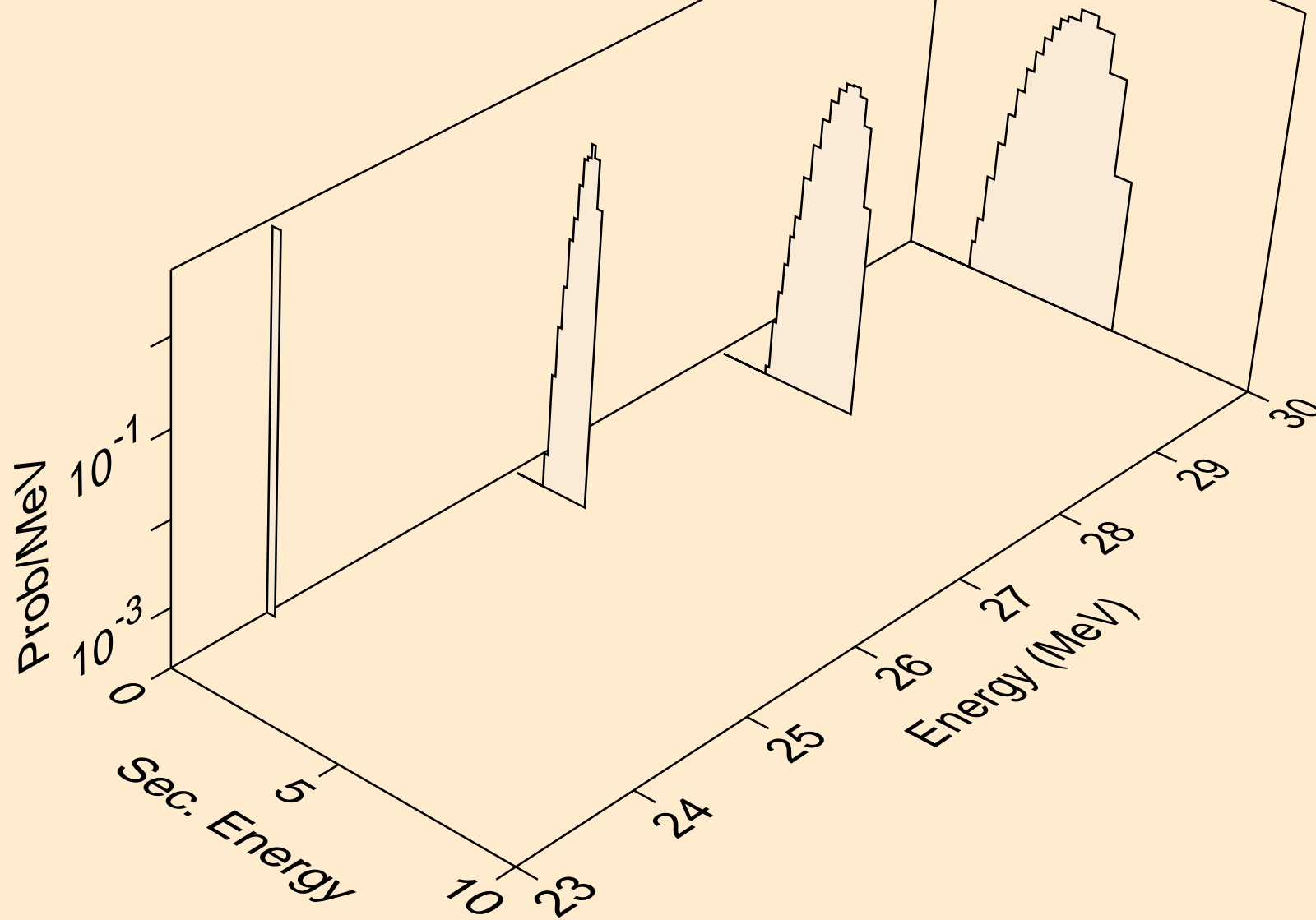

AS078 ALPHA ACER TENDL-2024 LIBRARY; T=0.K  
deuterons from (a,n\*)d

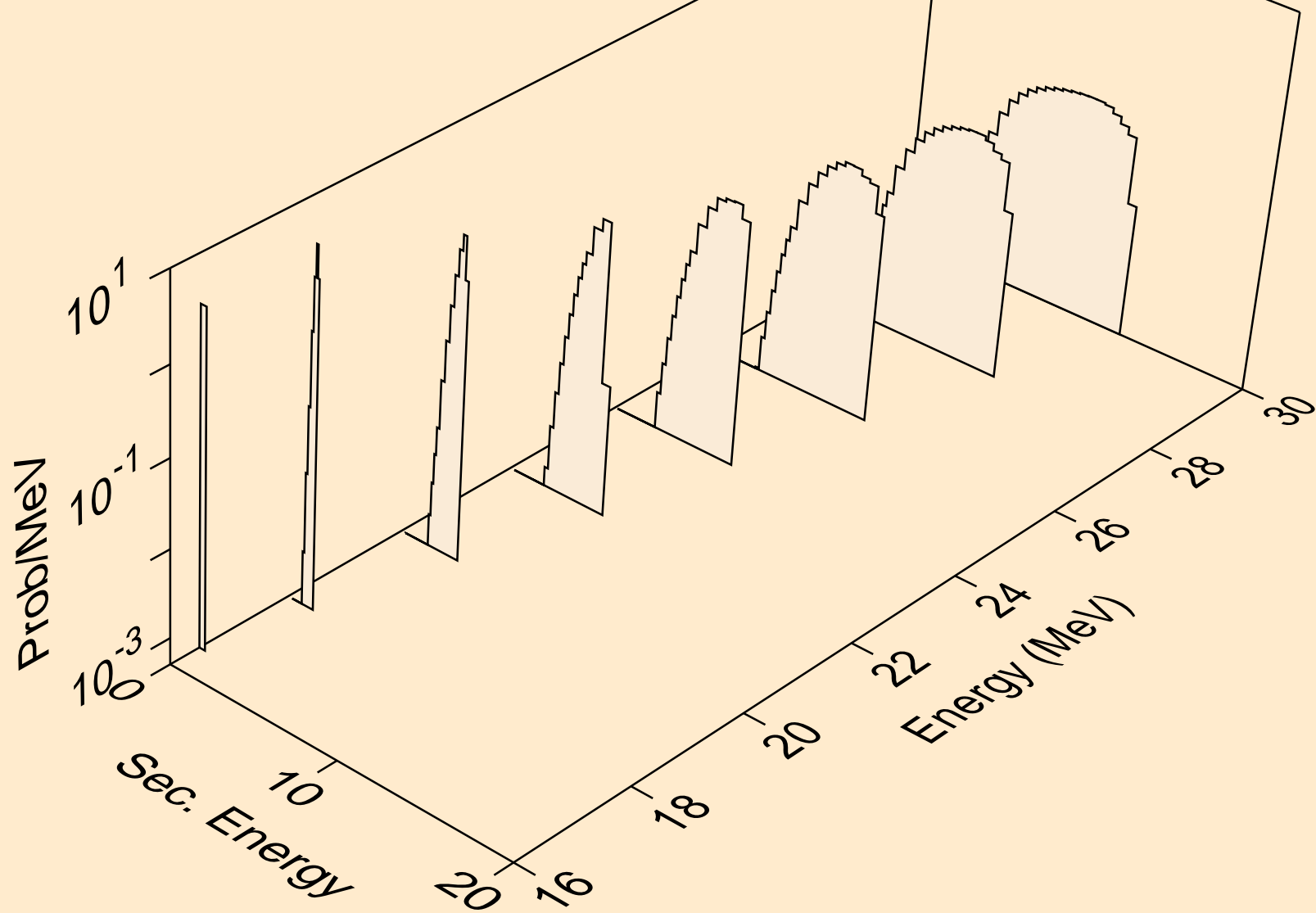

AS078 ALPHA ACER TENDL-2024 LIBRARY; T=0.K  
deuterons from (a,d)

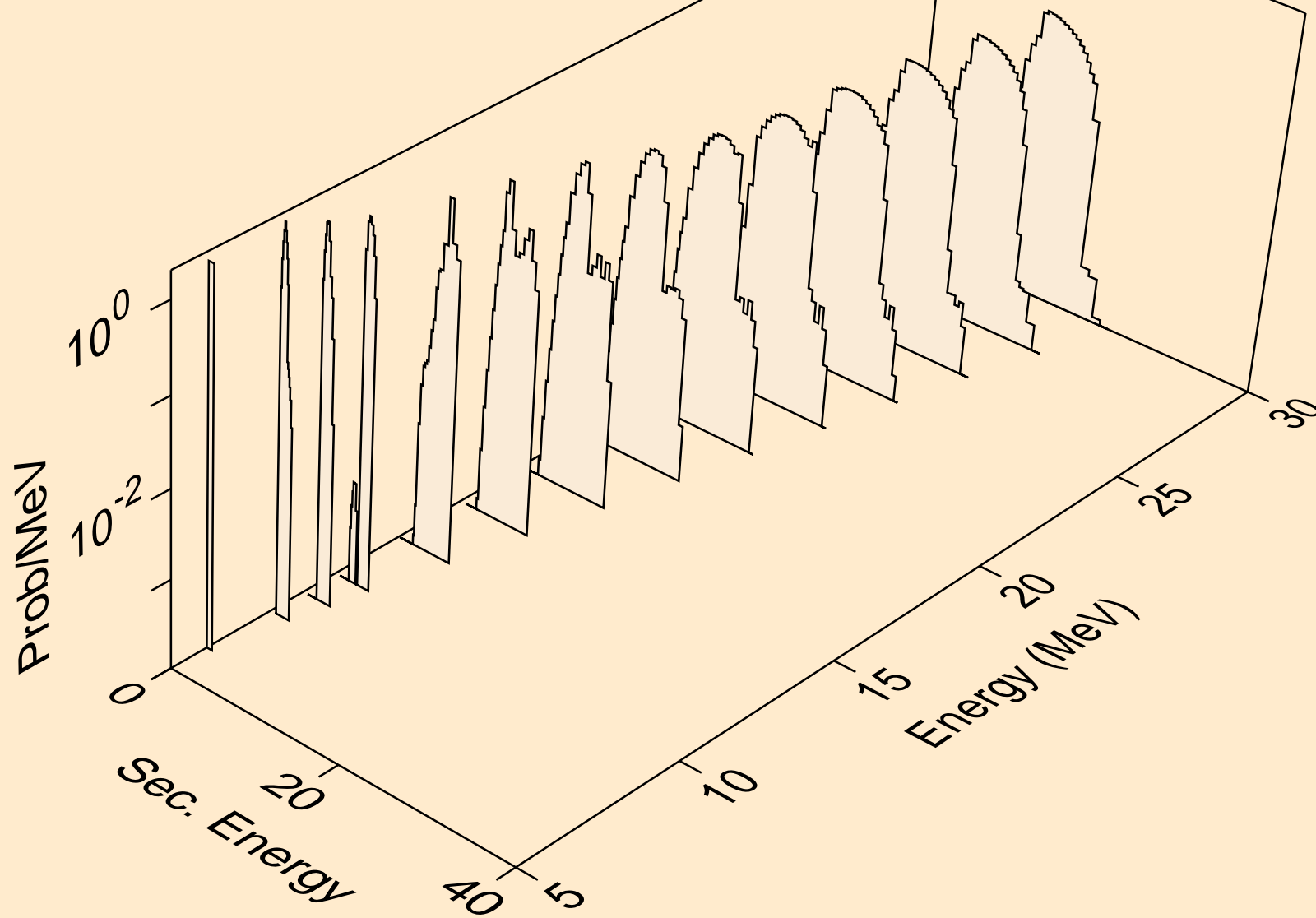

AS078 ALPHA ACER TENDL-2024 LIBRARY; T=0.K  
deuterons from (a,pd)

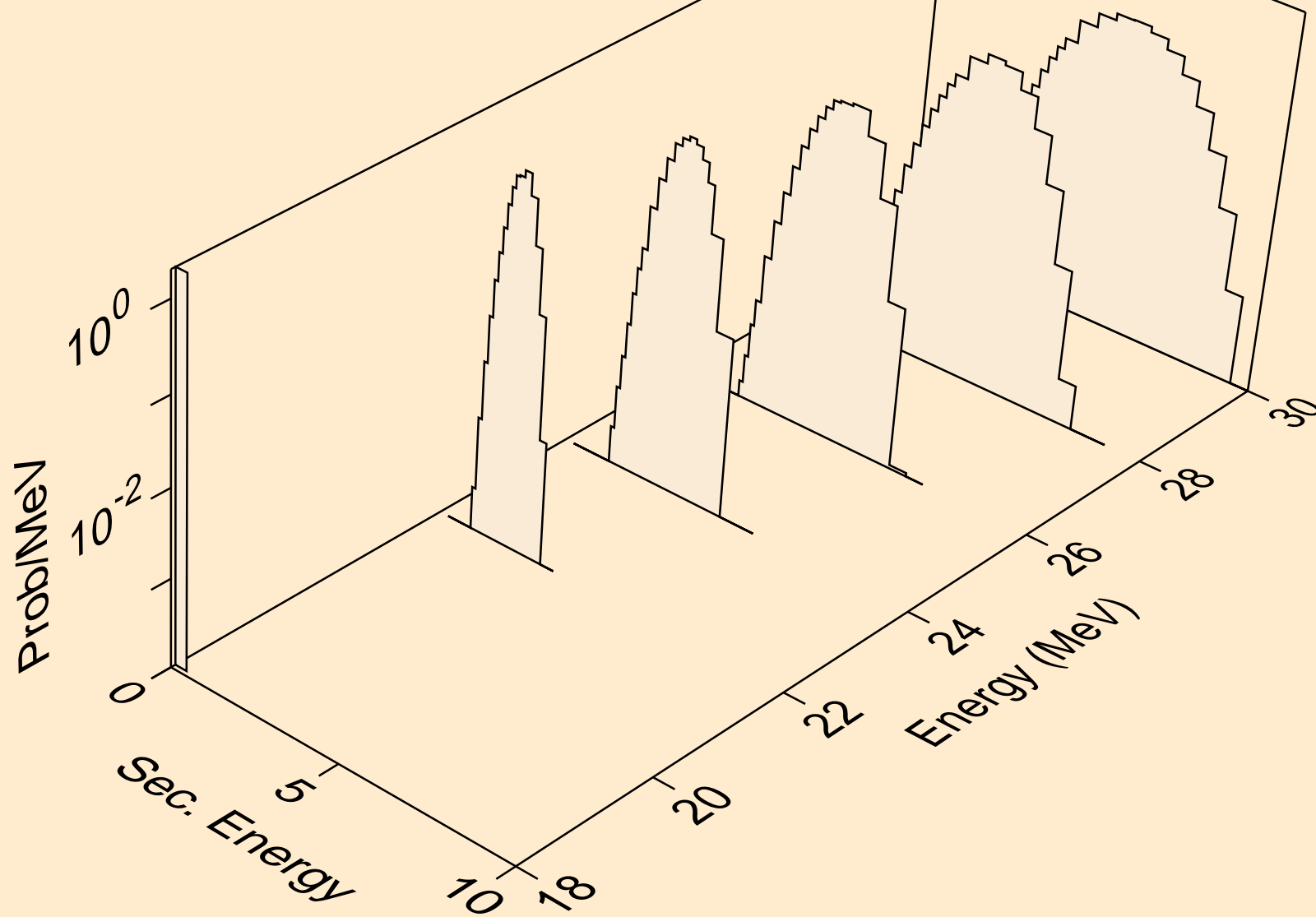

AS078 ALPHA ACER TENDL-2024 LIBRARY; T=0.K  
deuterons from (a,da)

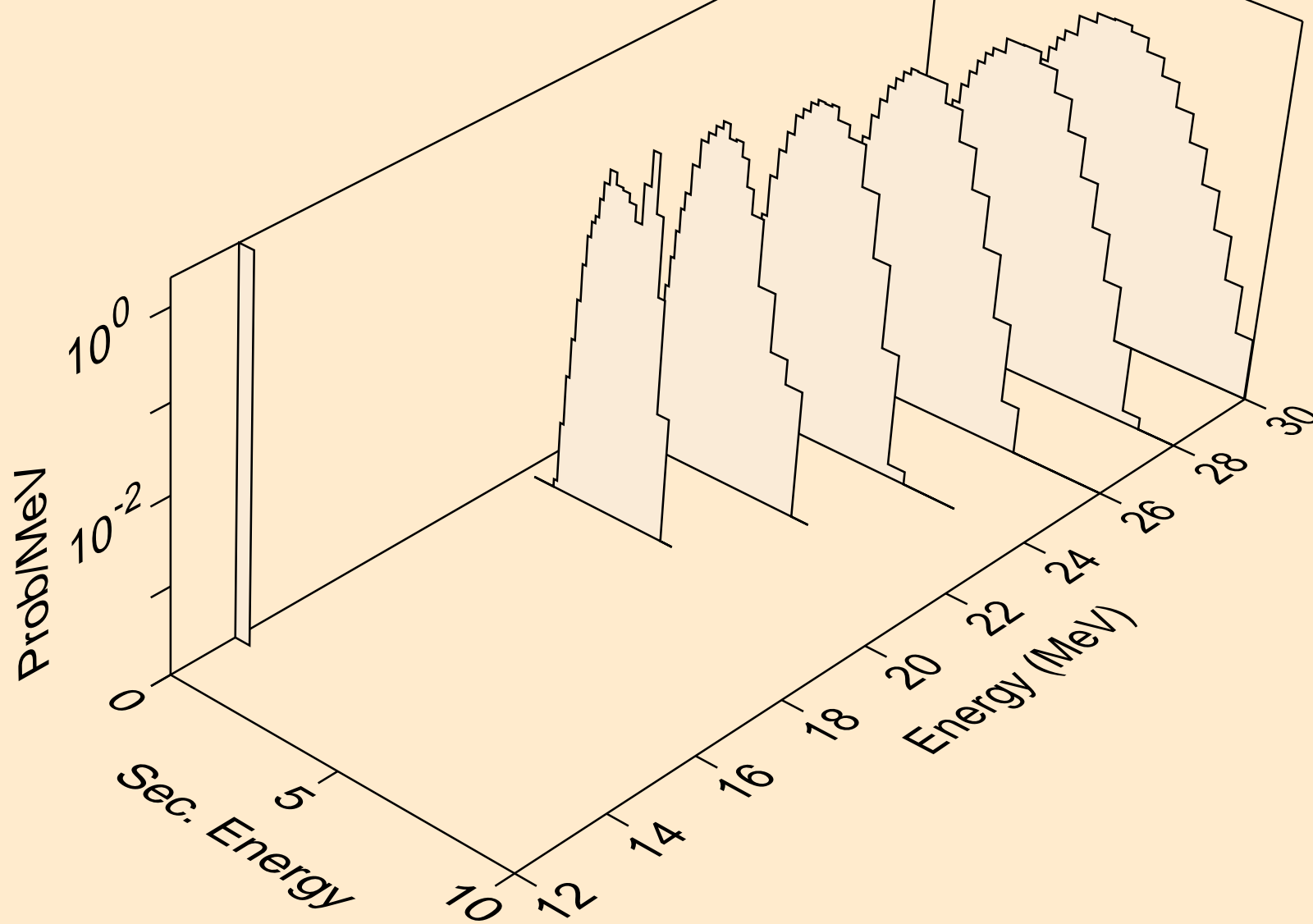

AS078 ALPHA ACER TENDL-2024 LIBRARY; T=0.K  
tritons from (a,x)

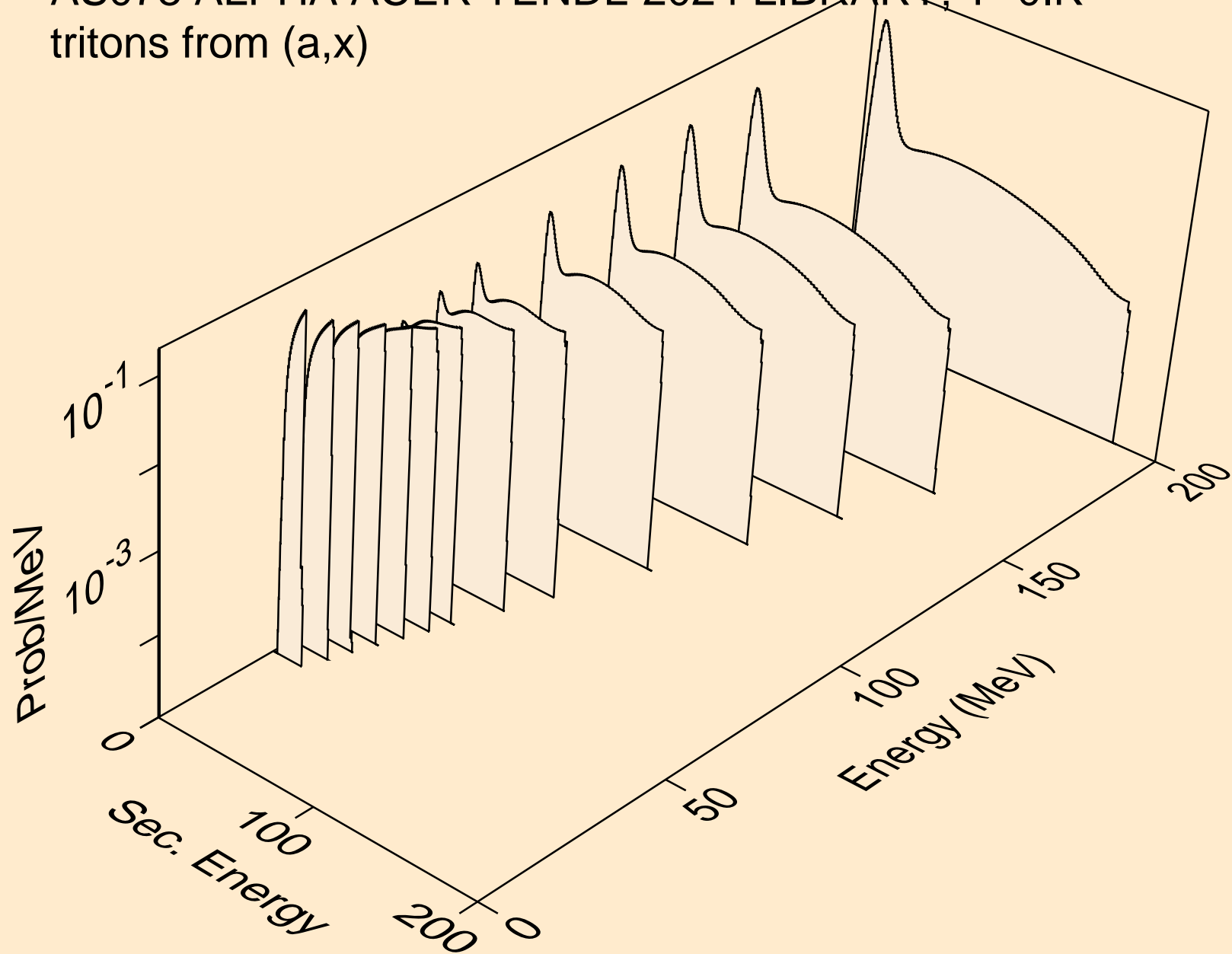

AS078 ALPHA ACER TENDL-2024 LIBRARY; T=0.K  
tritons from (a,n\*)t

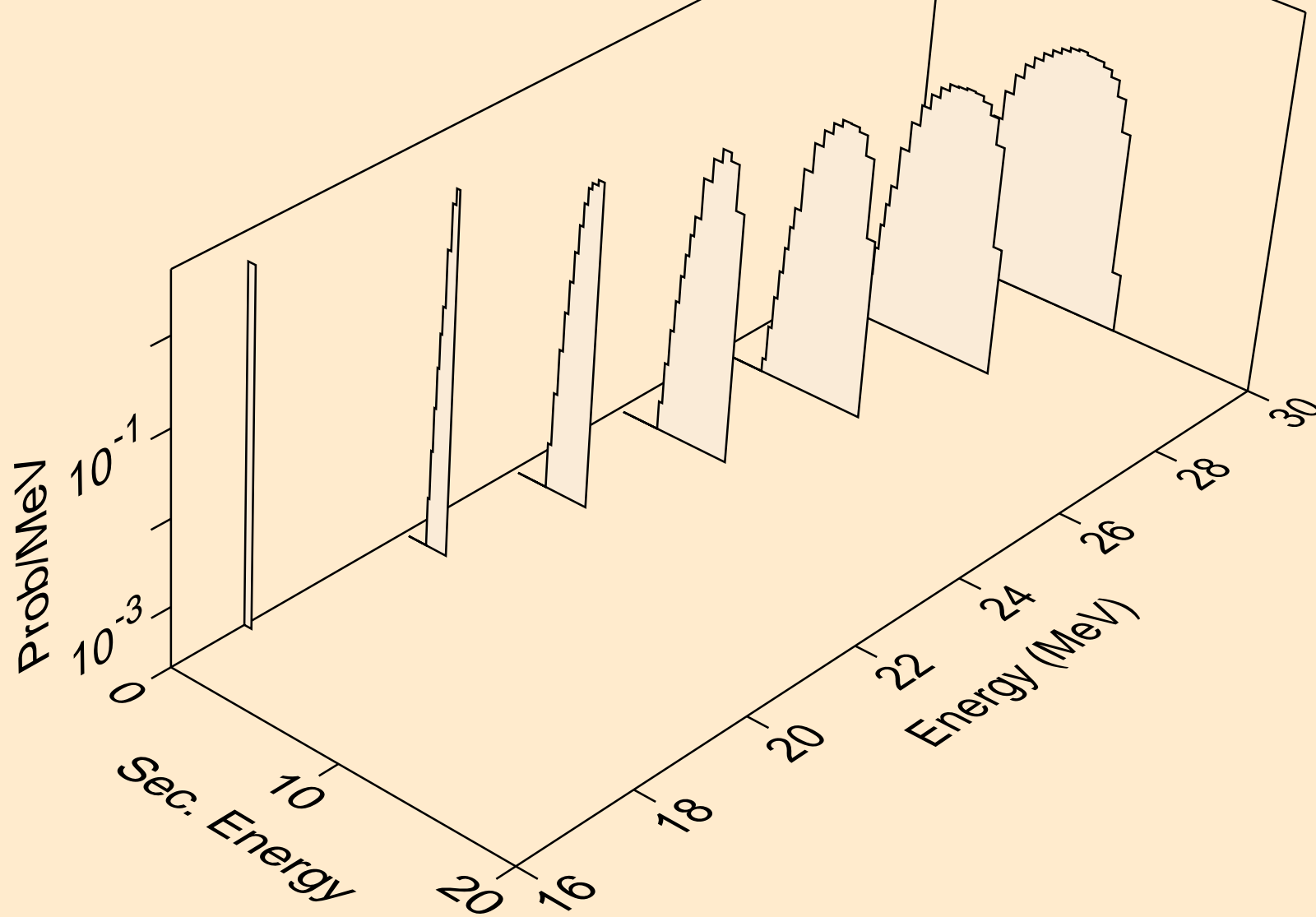

AS078 ALPHA ACER TENDL-2024 LIBRARY; T=0.K  
tritons from (a,t)

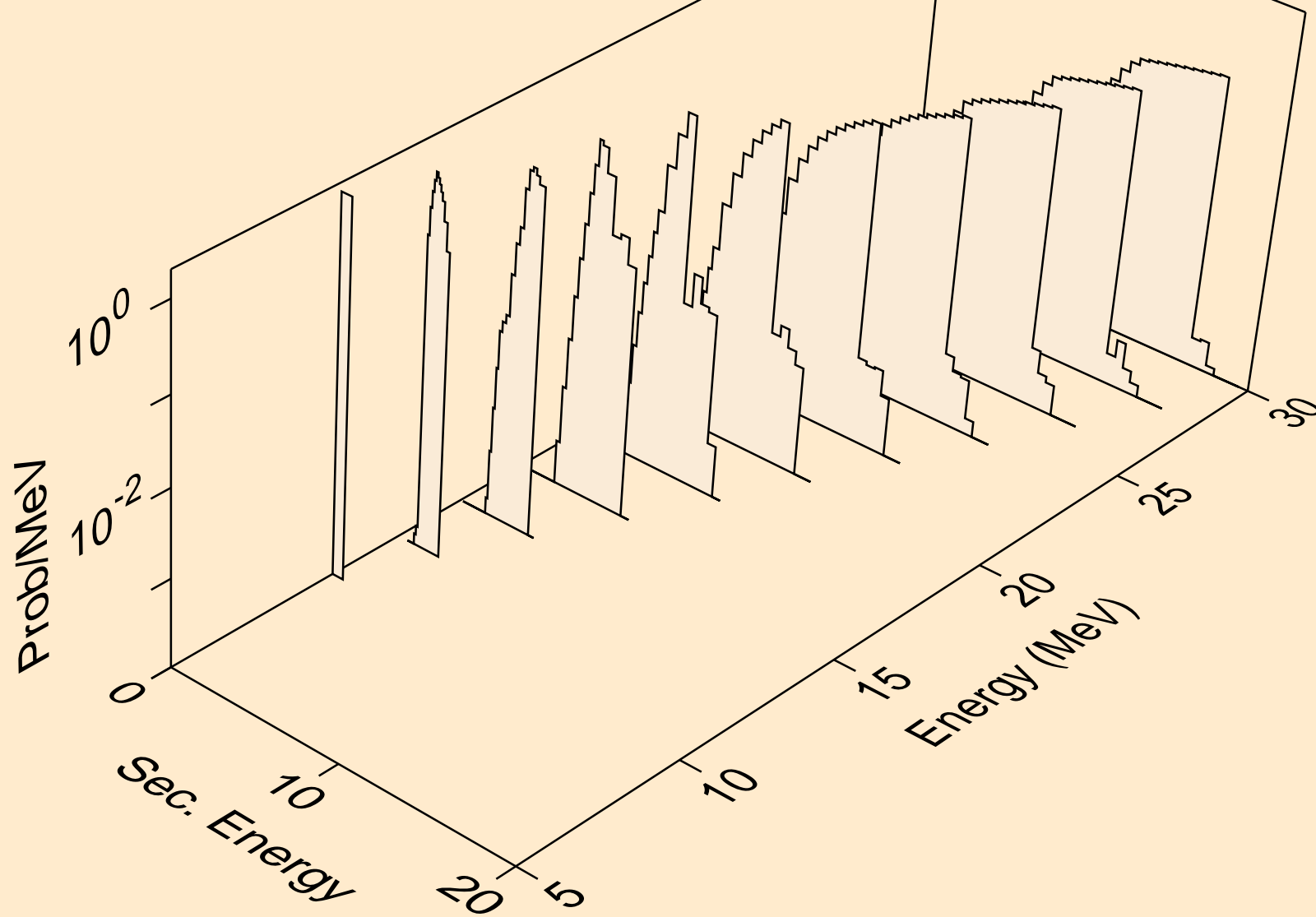

AS078 ALPHA ACER TENDL-2024 LIBRARY; T=0.K  
tritons from (a,pt)

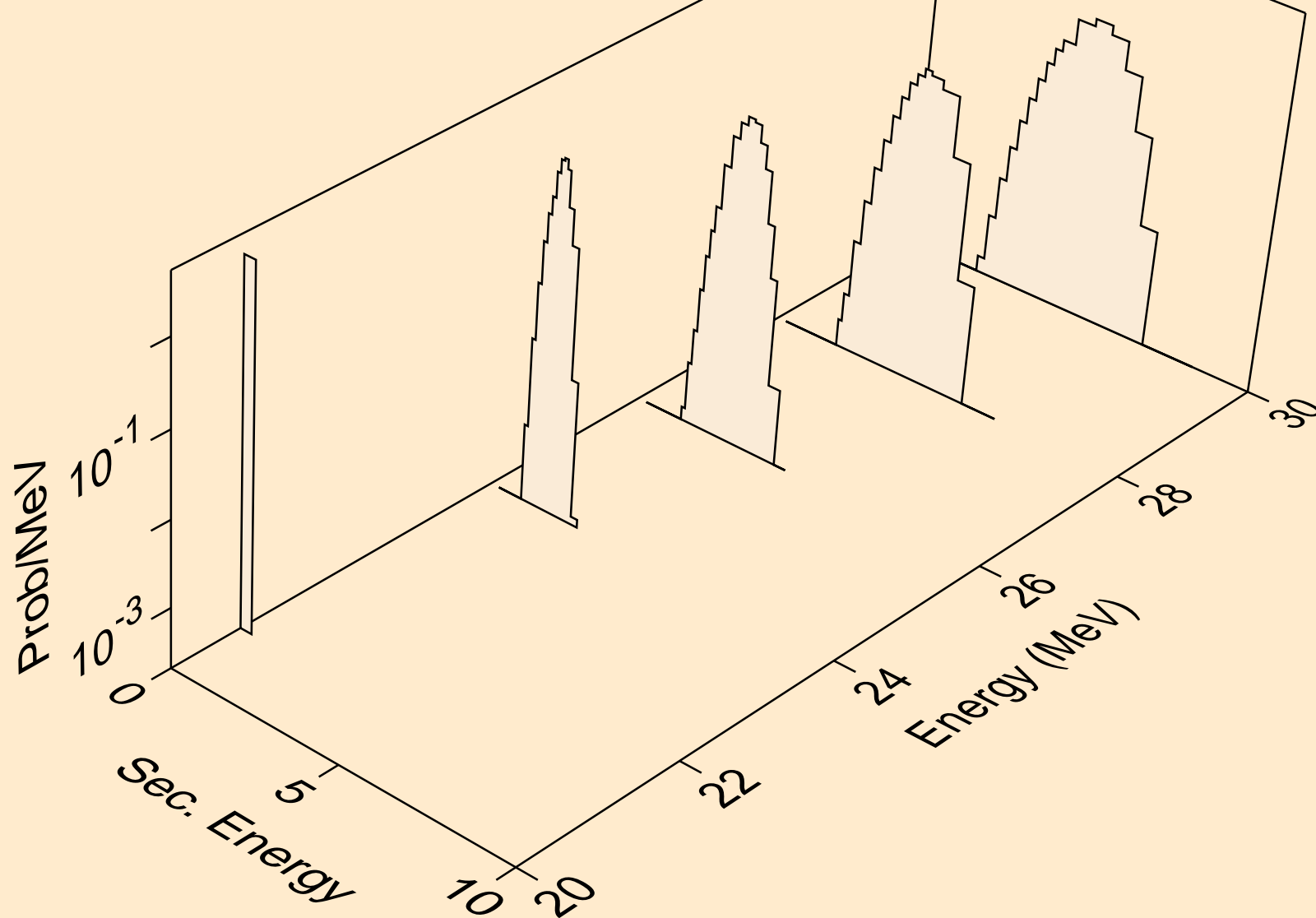

AS078 ALPHA ACER TENDL-2024 LIBRARY; T=0.K  
he3s from (a,x)

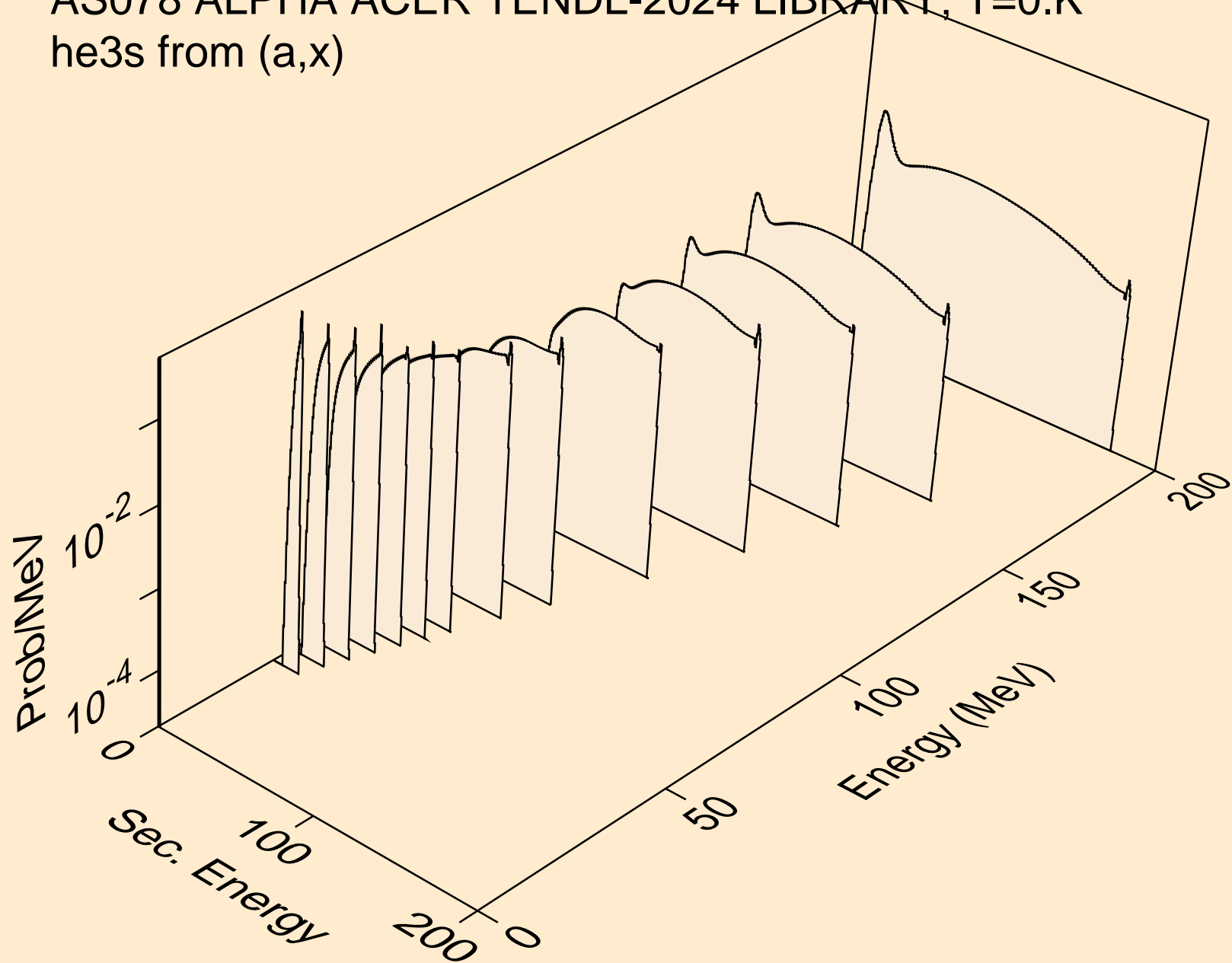

AS078 ALPHA ACER TENDL-2024 LIBRARY; T=0.K  
he3s from (a,n\*)he3

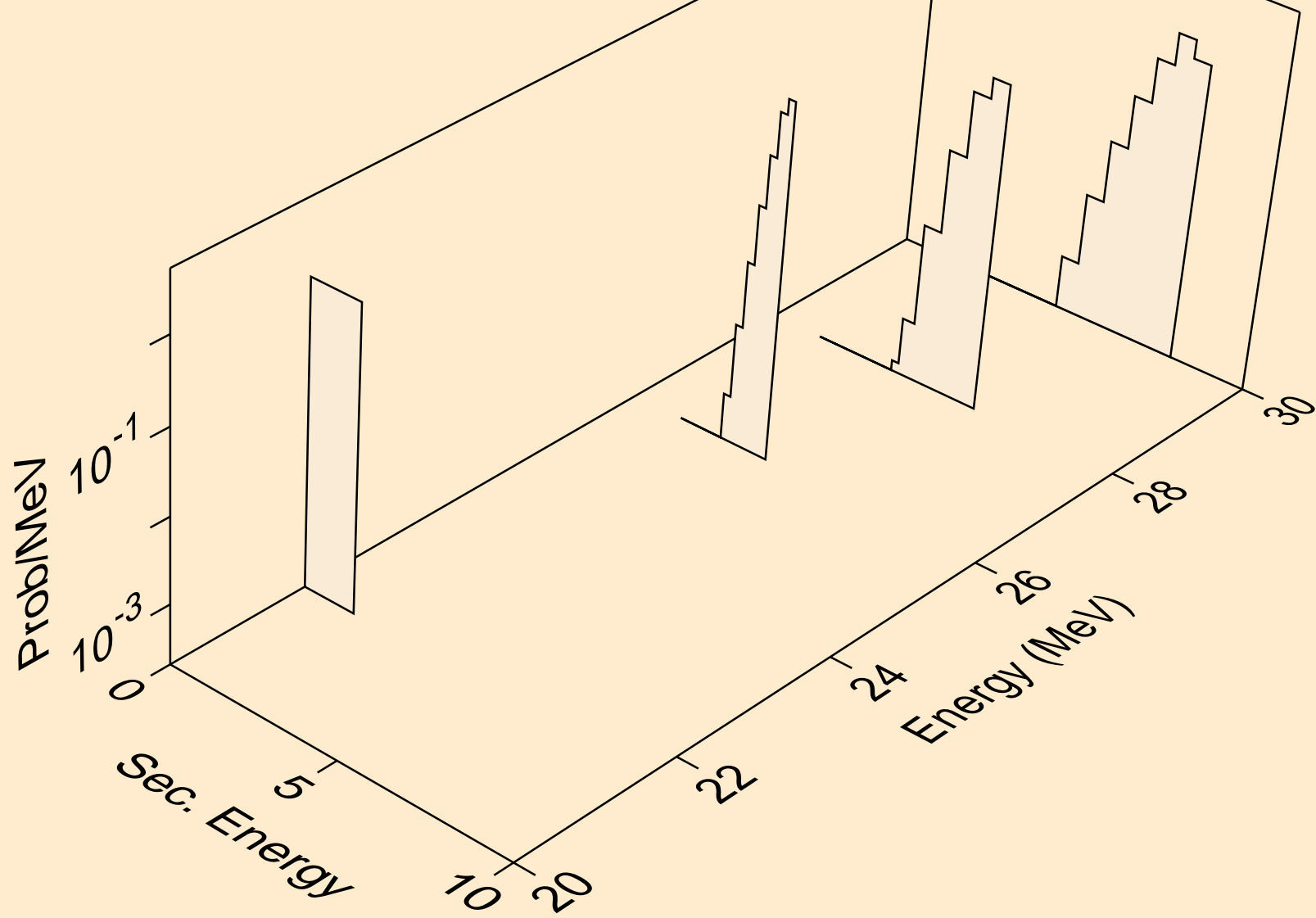

AS078 ALPHA ACER TENDL-2024 LIBRARY; T=0.K  
he3s from (a,he3)

