

BE011 ALPHA ACER TENDL-2024 LIBRARY; T=0.K
Principal cross sections

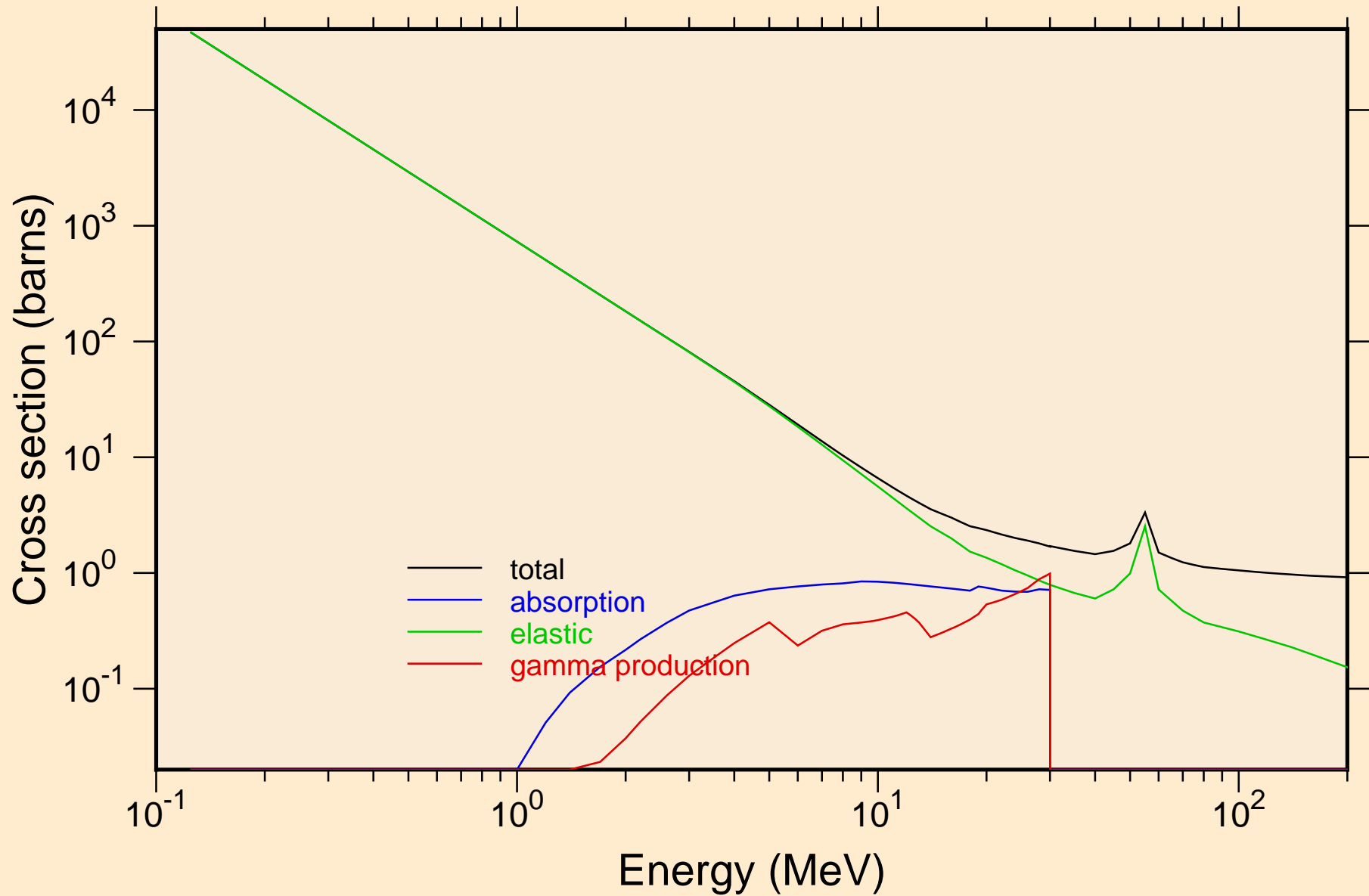

BE011 ALPHA ACER TENDL-2024 LIBRARY; T=0.K

Heating

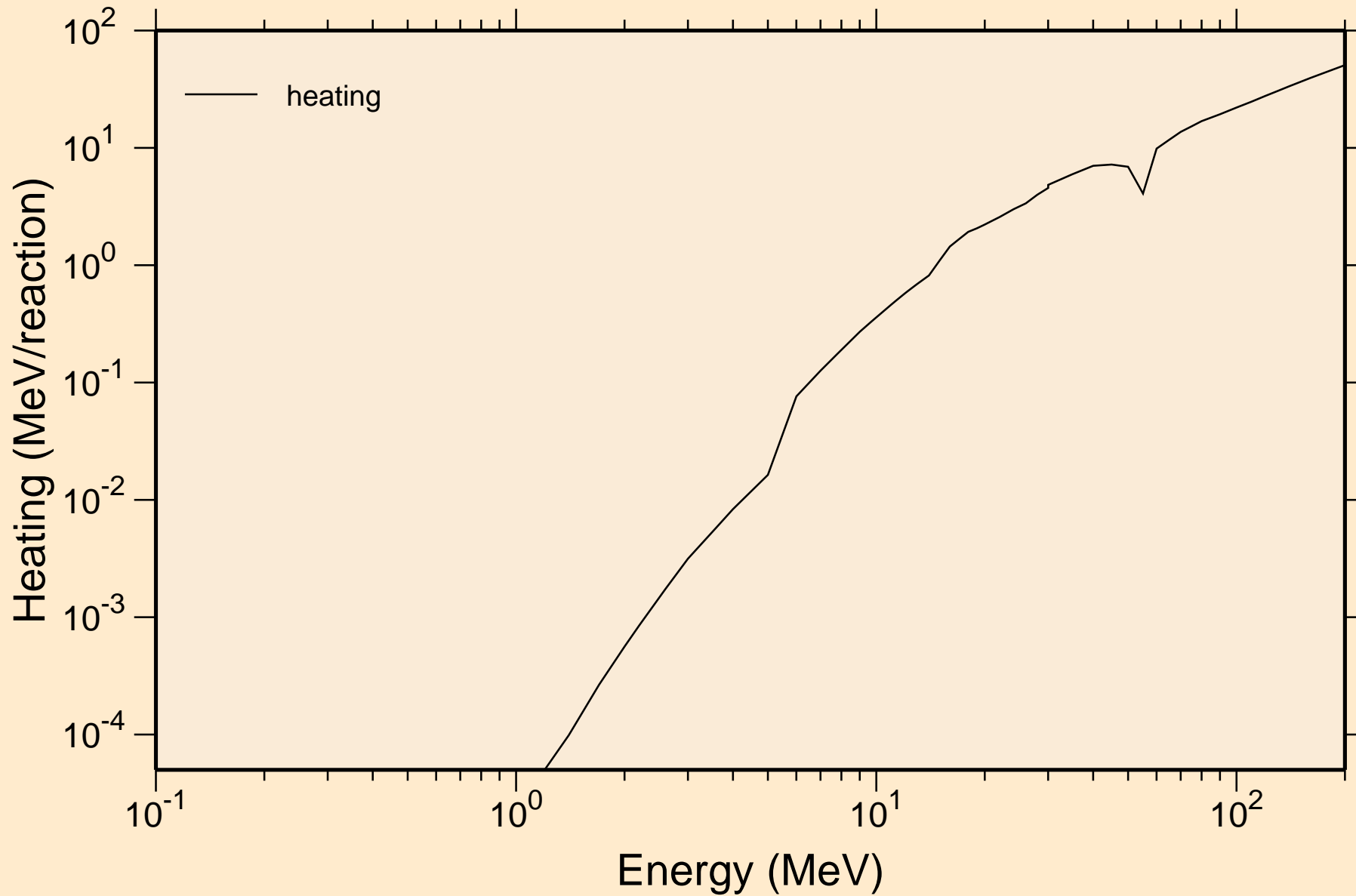

BE011 ALPHA ACER TENDL-2024 LIBRARY; T=0.K

Principal cross sections

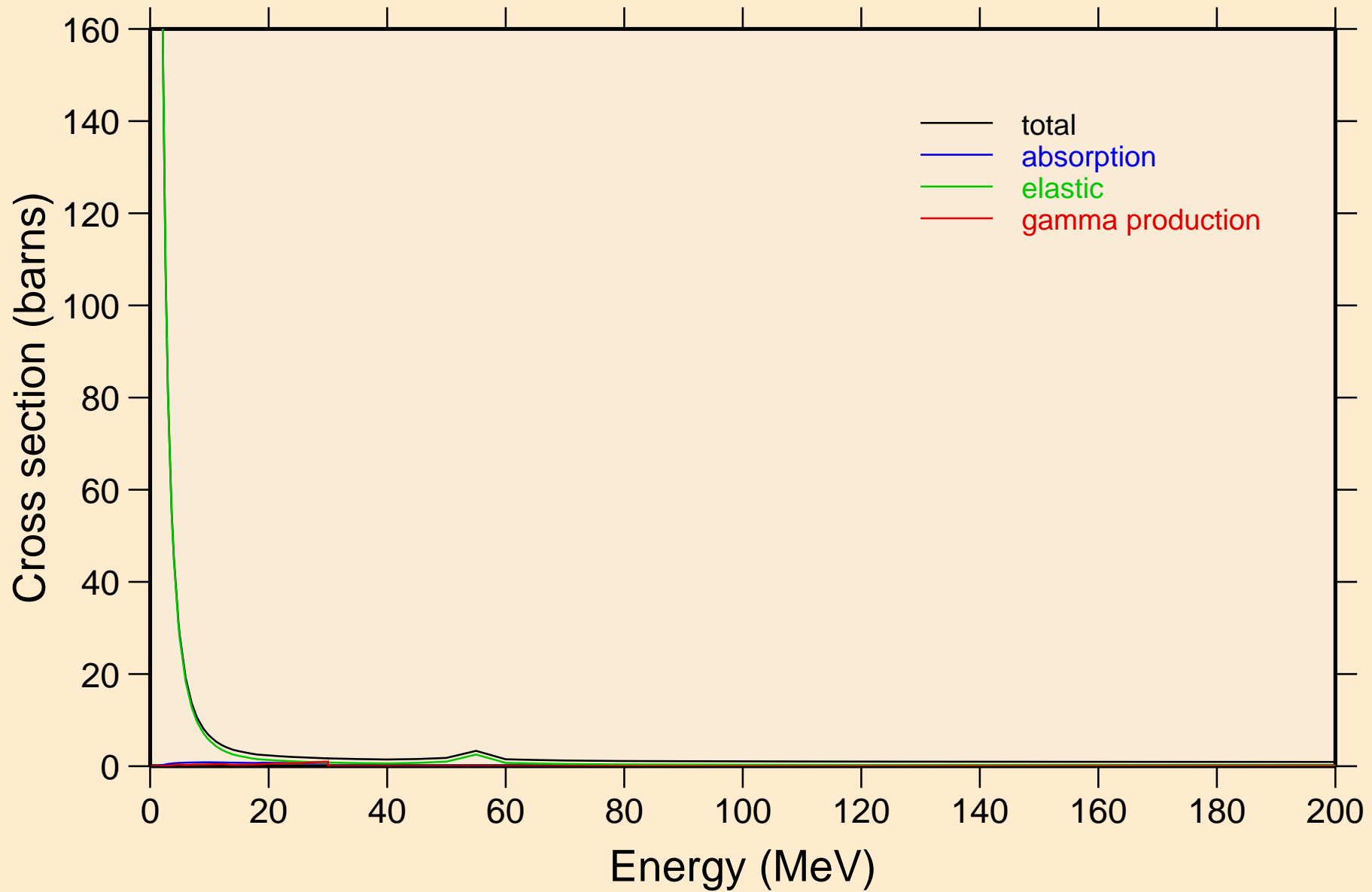

BE011 ALPHA ACER TENDL-2024 LIBRARY; T=0.K

Heating

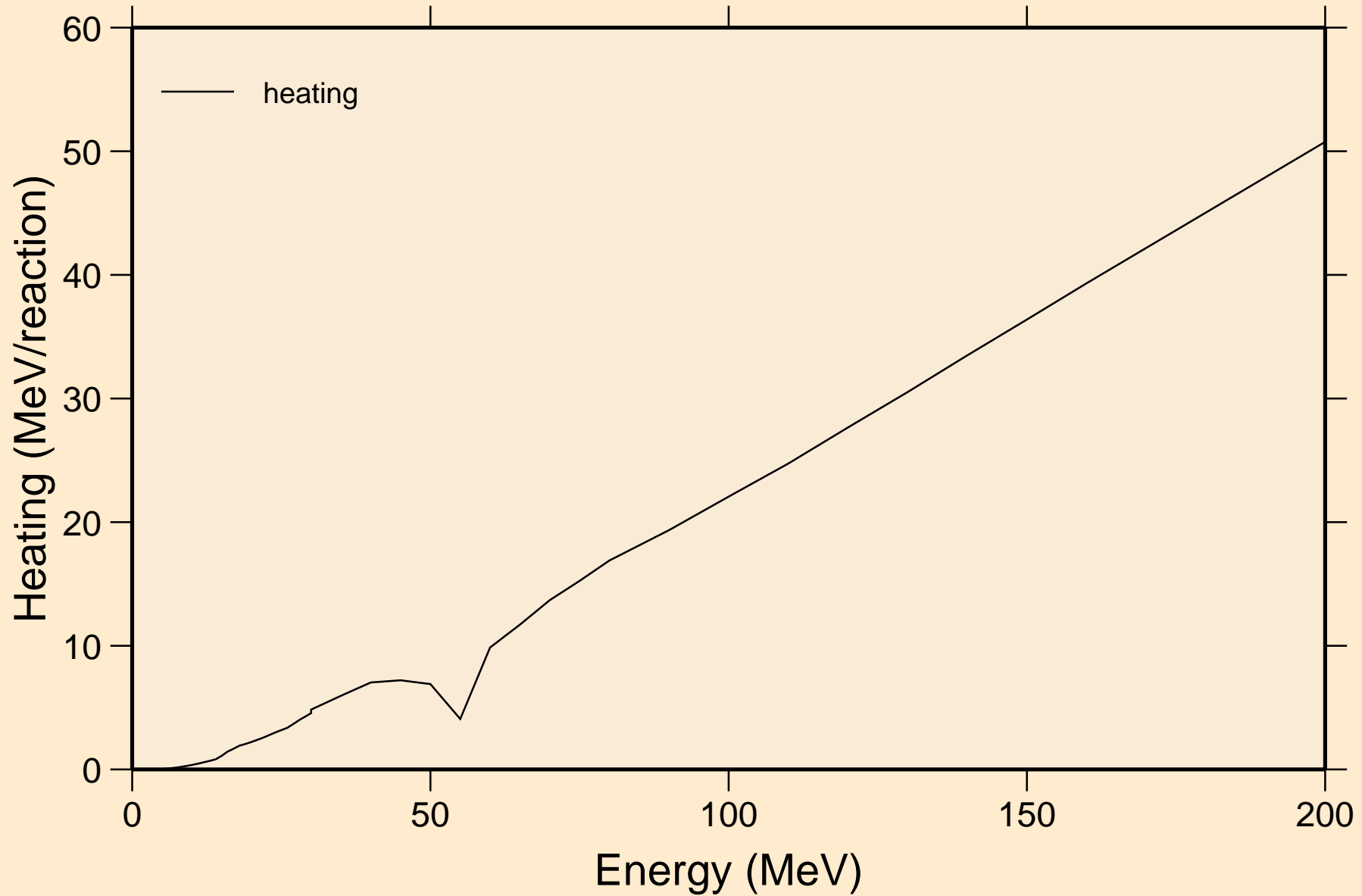

BE011 ALPHA ACER TENDL-2024 LIBRARY; T=0.K
Threshold reactions

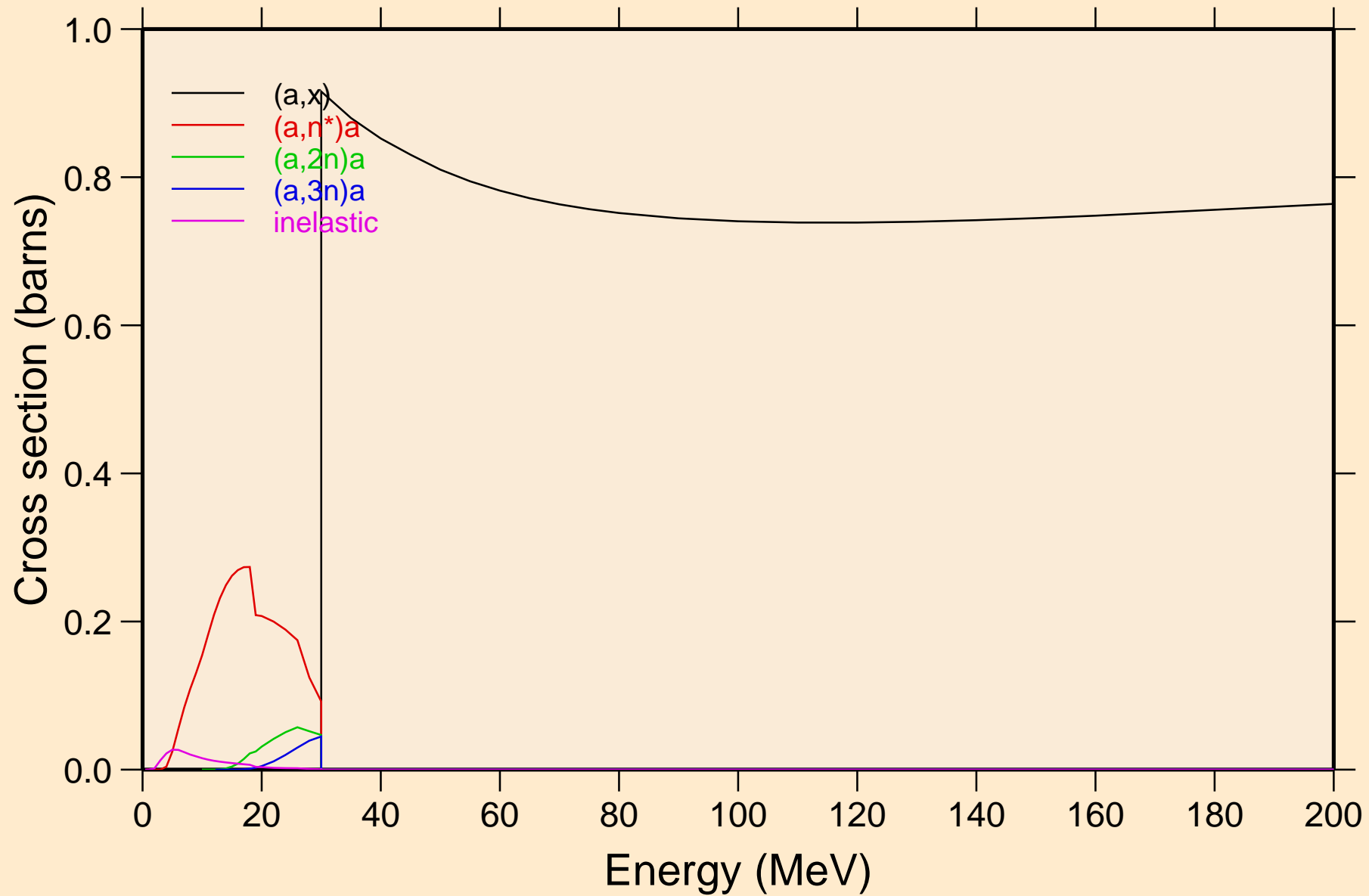

BE011 ALPHA ACER TENDL-2024 LIBRARY; T=0.K
Threshold reactions

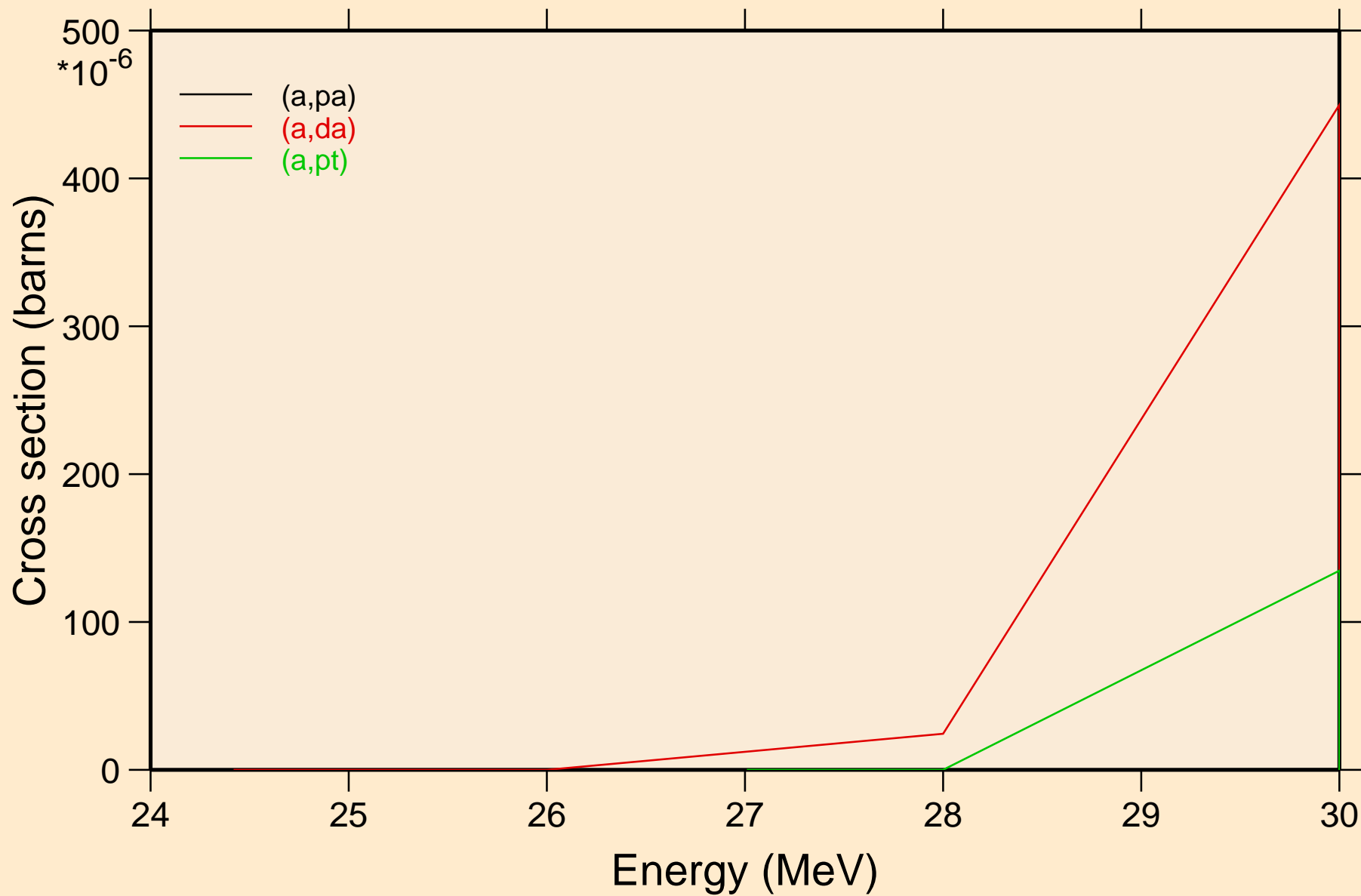

BE011 ALPHA ACER TENDL-2024 LIBRARY; T=0.K
Threshold reactions

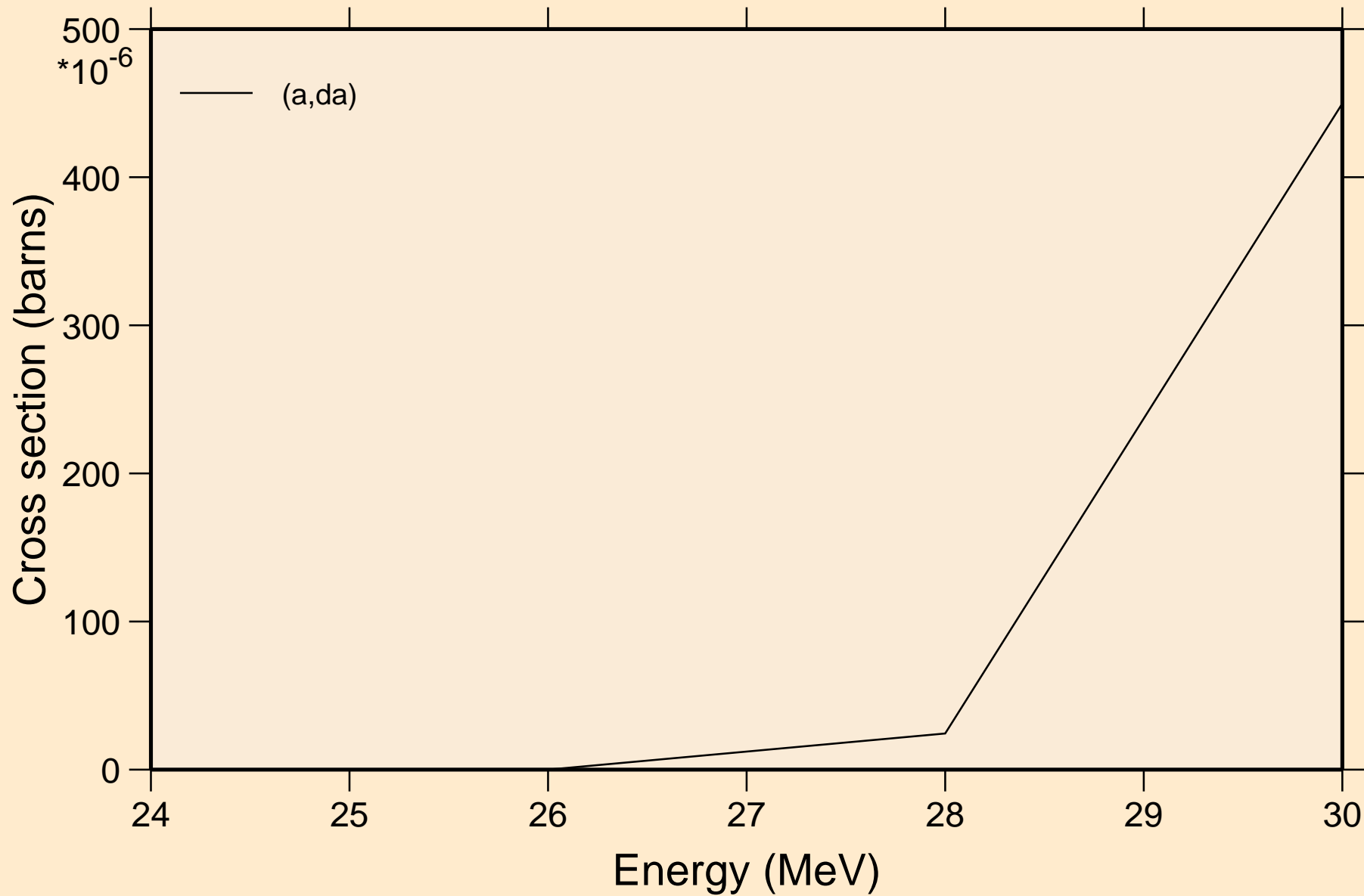

BE011 ALPHA ACER TENDL-2024 LIBRARY; T=0.K
angular distribution for elastic

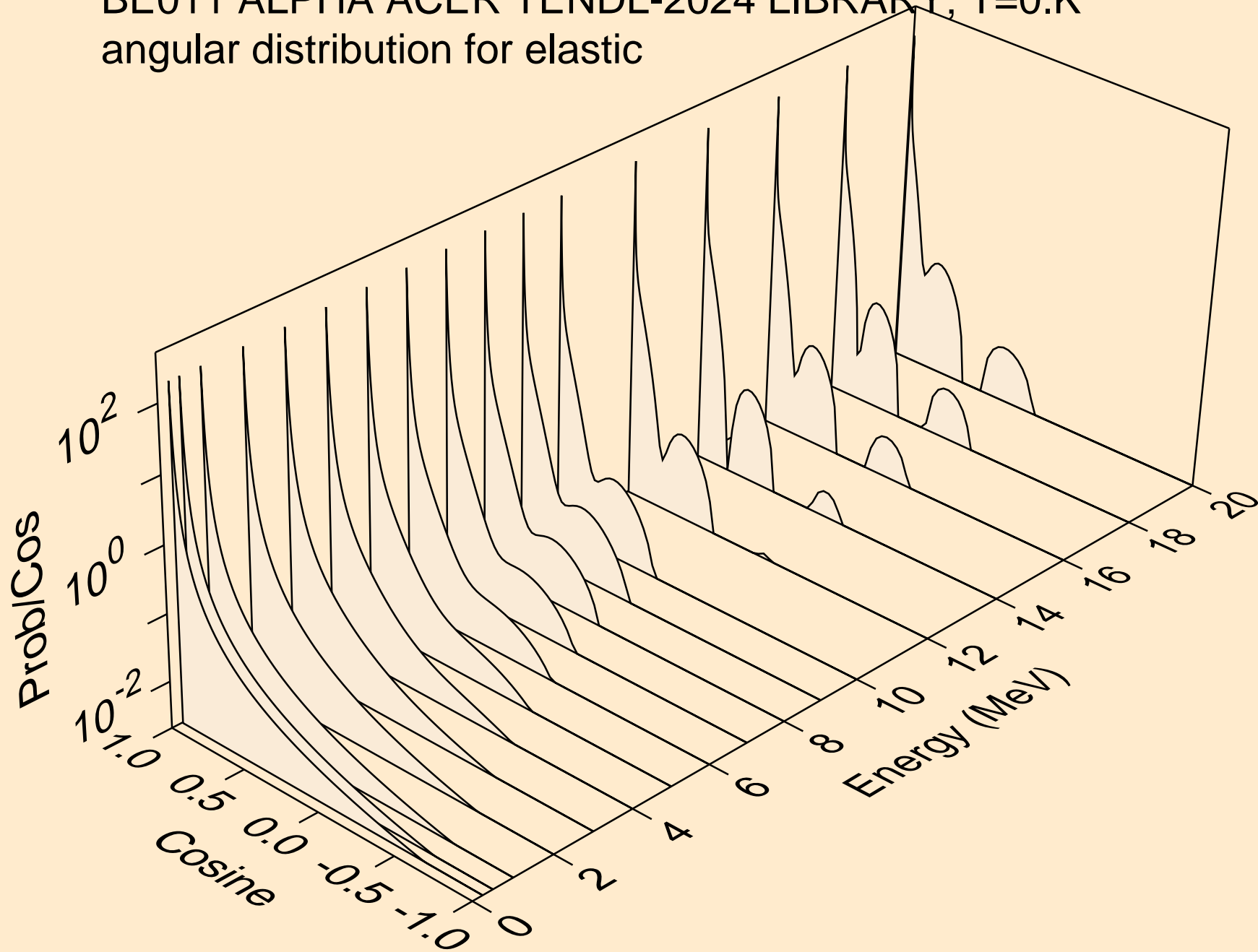

BE011 ALPHA ACER TENDL-2024 LIBRARY; T=0.K
angular distribution for elastic

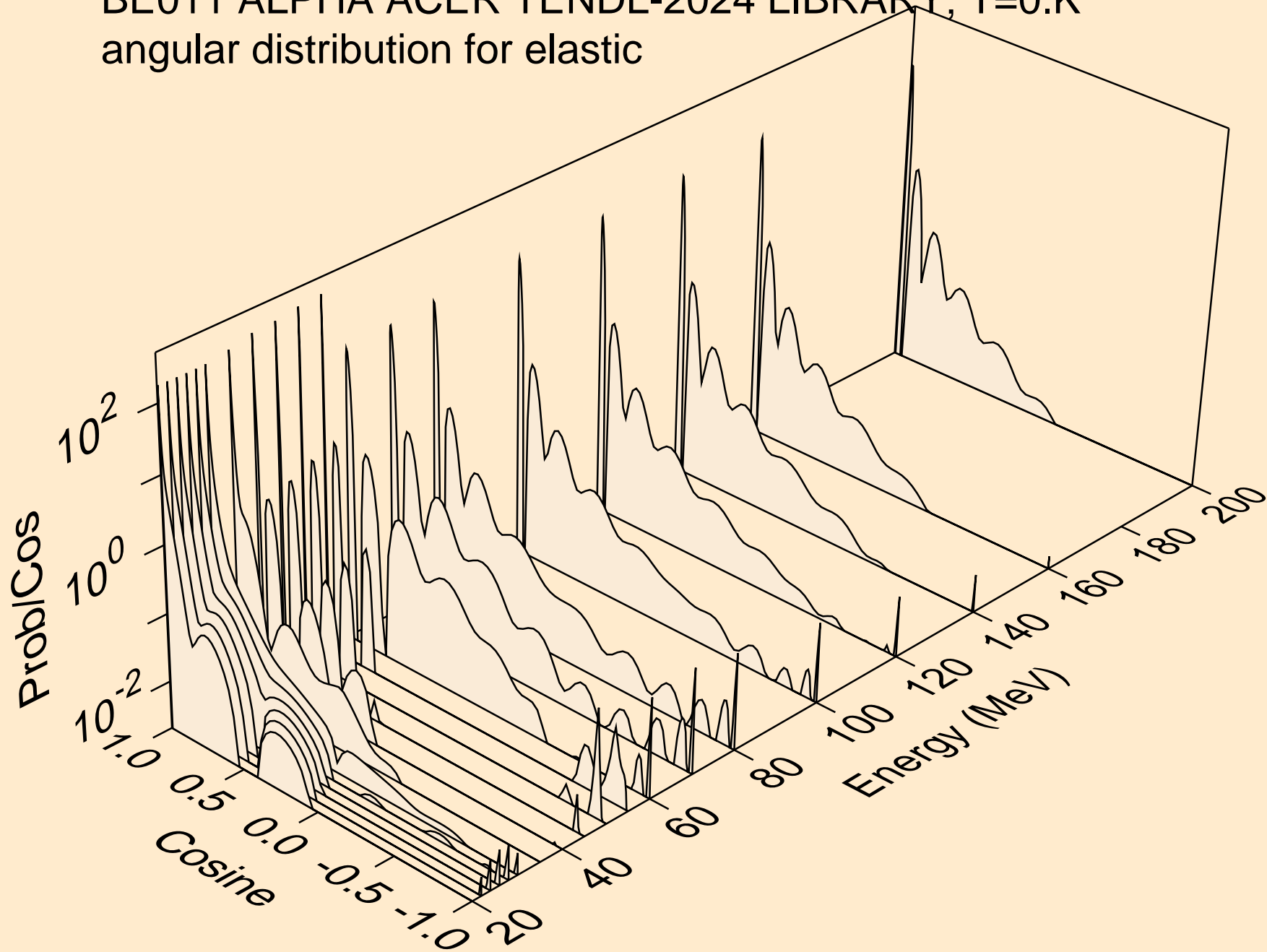

BE011 ALPHA ACER TENDL-2024 LIBRARY; T=0.K
Alpha emission for (a,x)

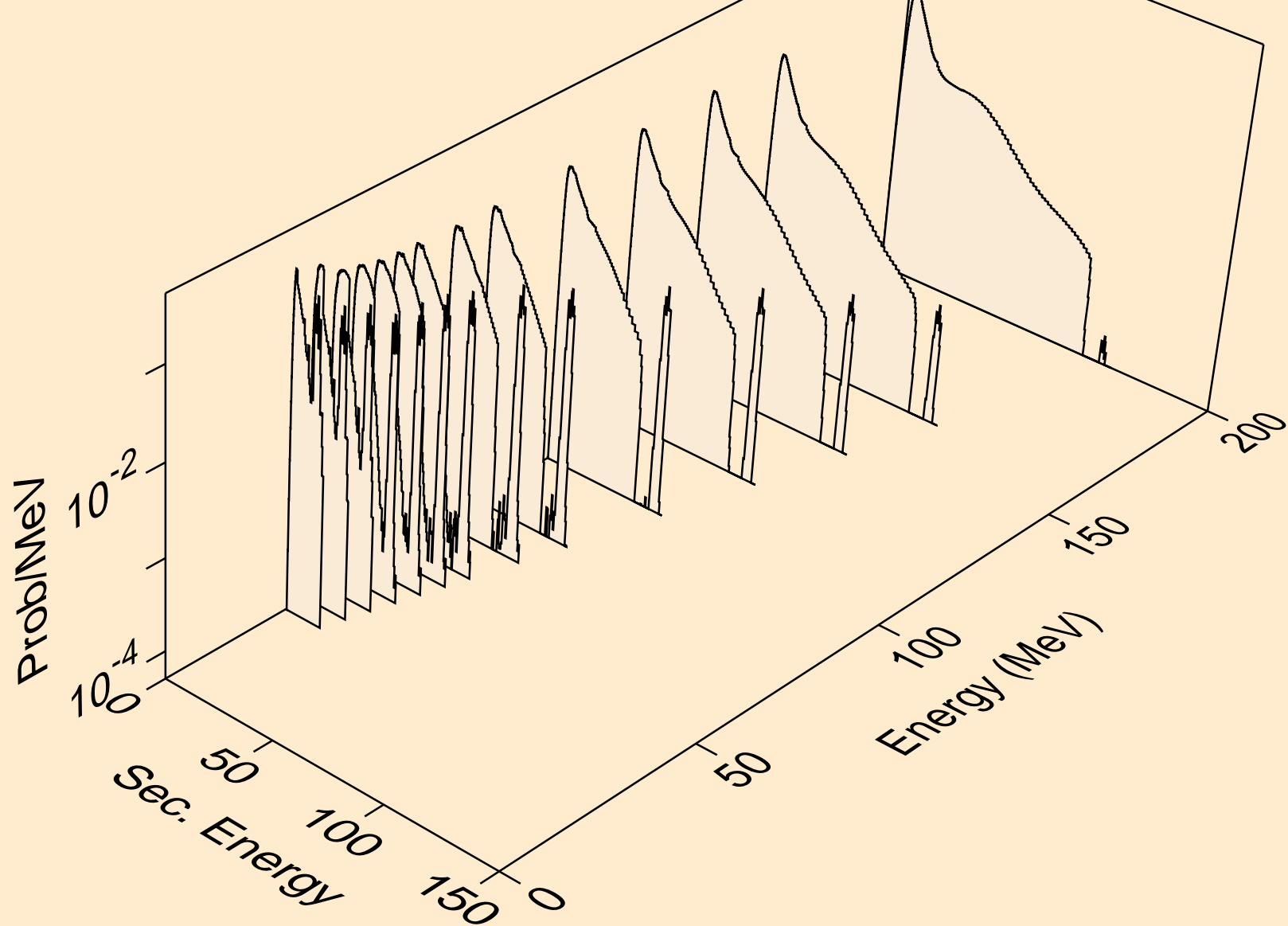

BE011 ALPHA ACER TENDL-2024 LIBRARY; T=0.K
Alpha emission for (a,n*)a

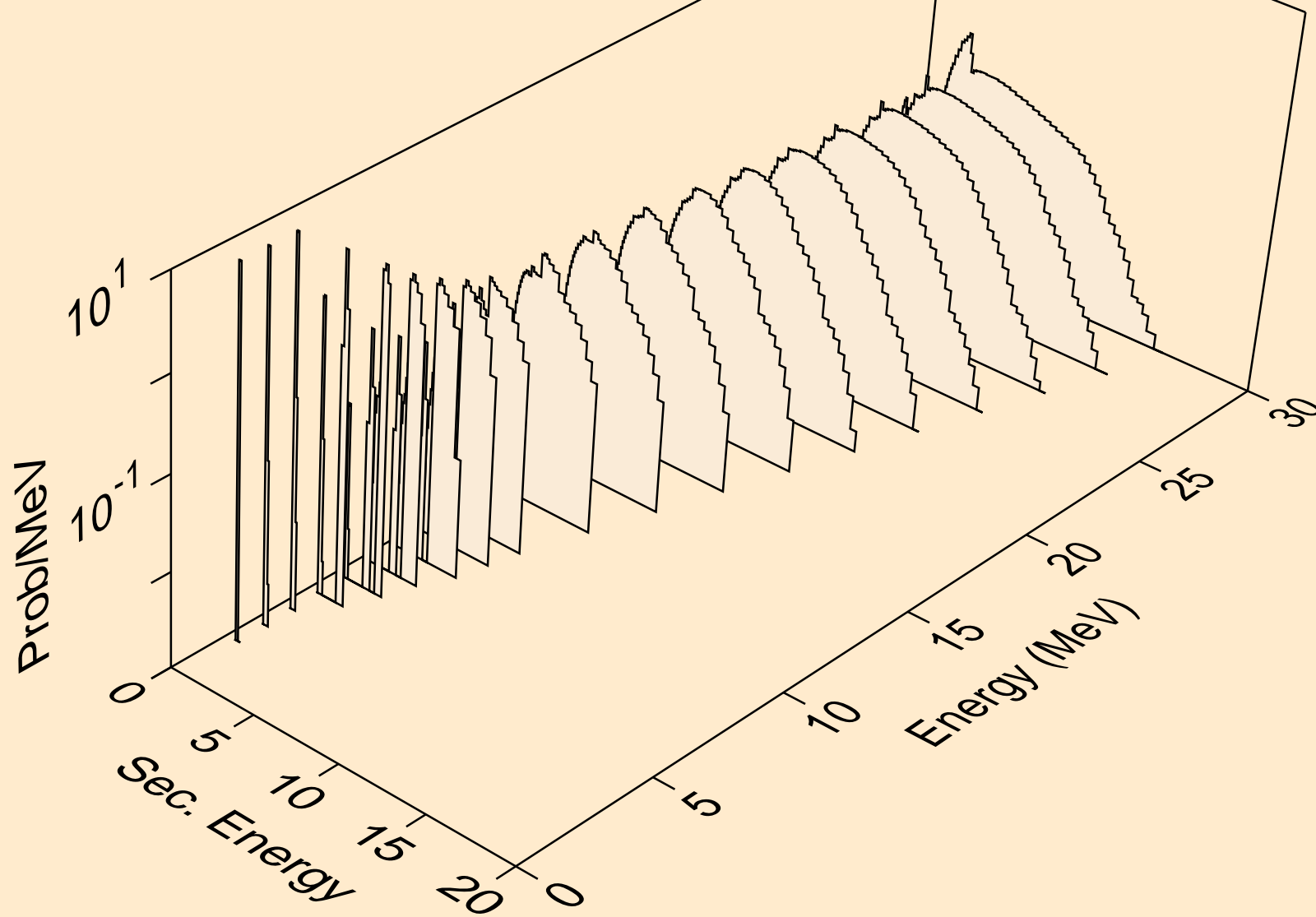

BE011 ALPHA ACER TENDL-2024 LIBRARY; T=0.K
Alpha emission for (a,2n)a

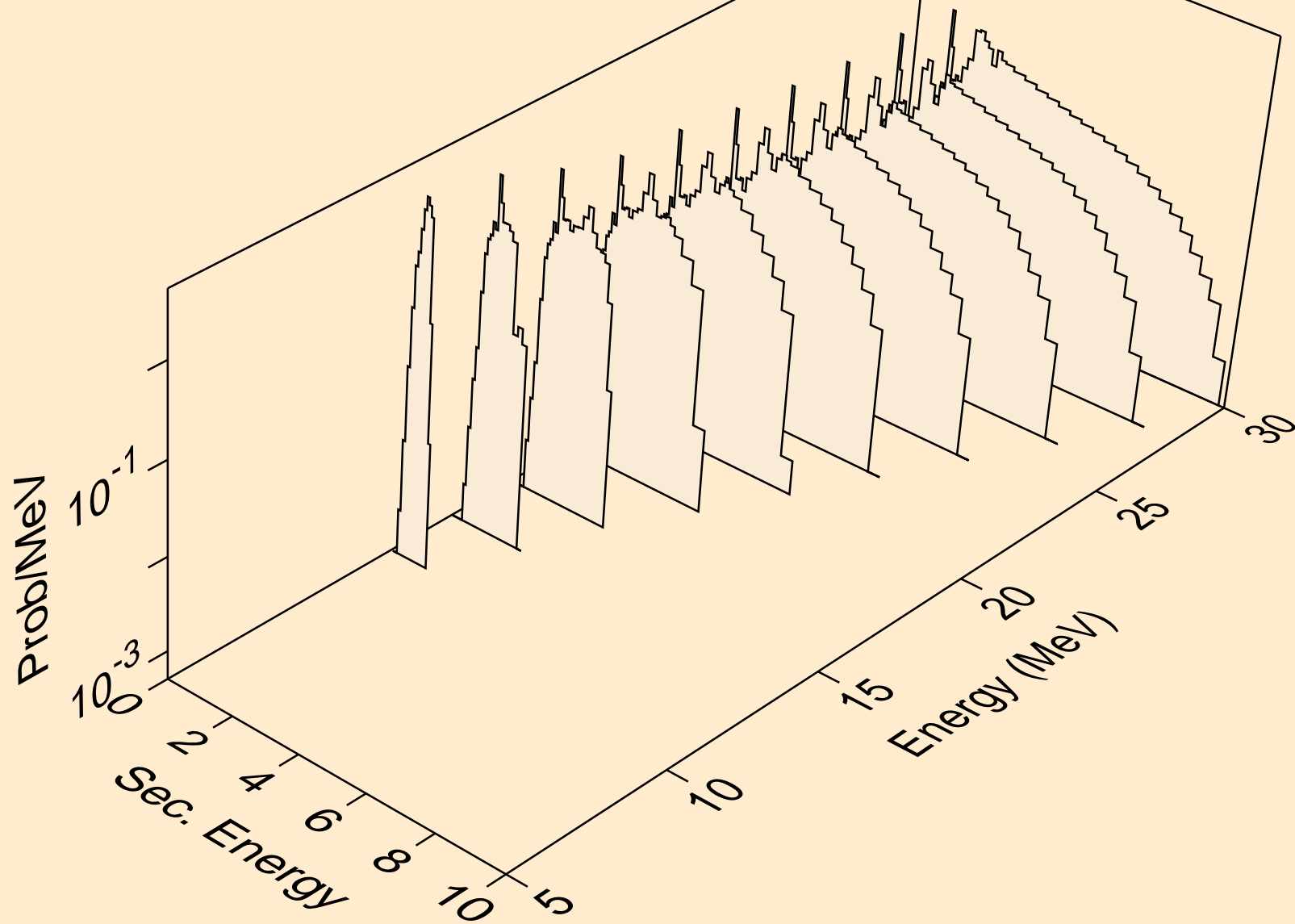

BE011 ALPHA ACER TENDL-2024 LIBRARY; T=0.K
Alpha emission for (a,3n)a

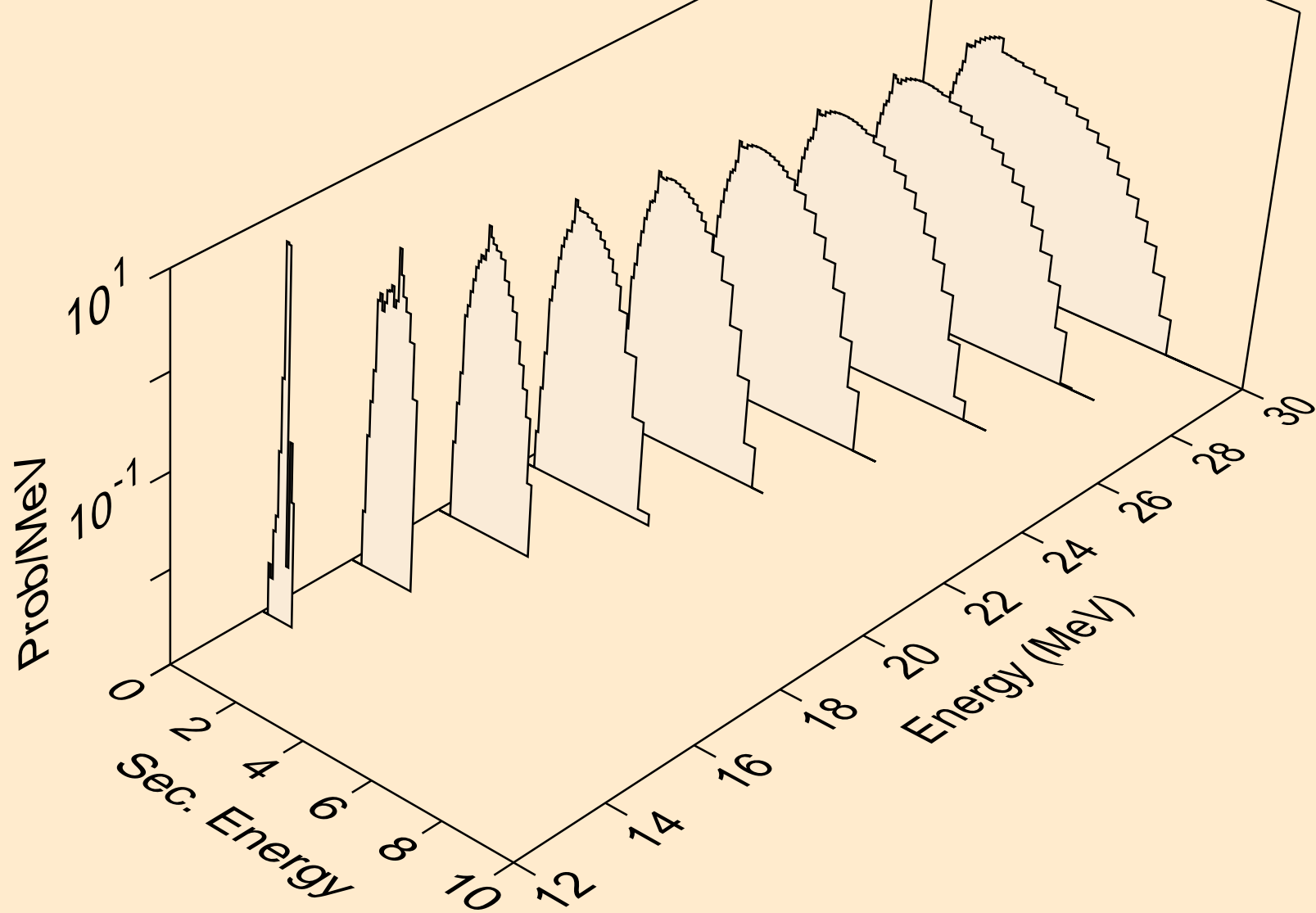

BE011 ALPHA ACER TENDL-2024 LIBRARY; T=0.K
Alpha emission for inelastic

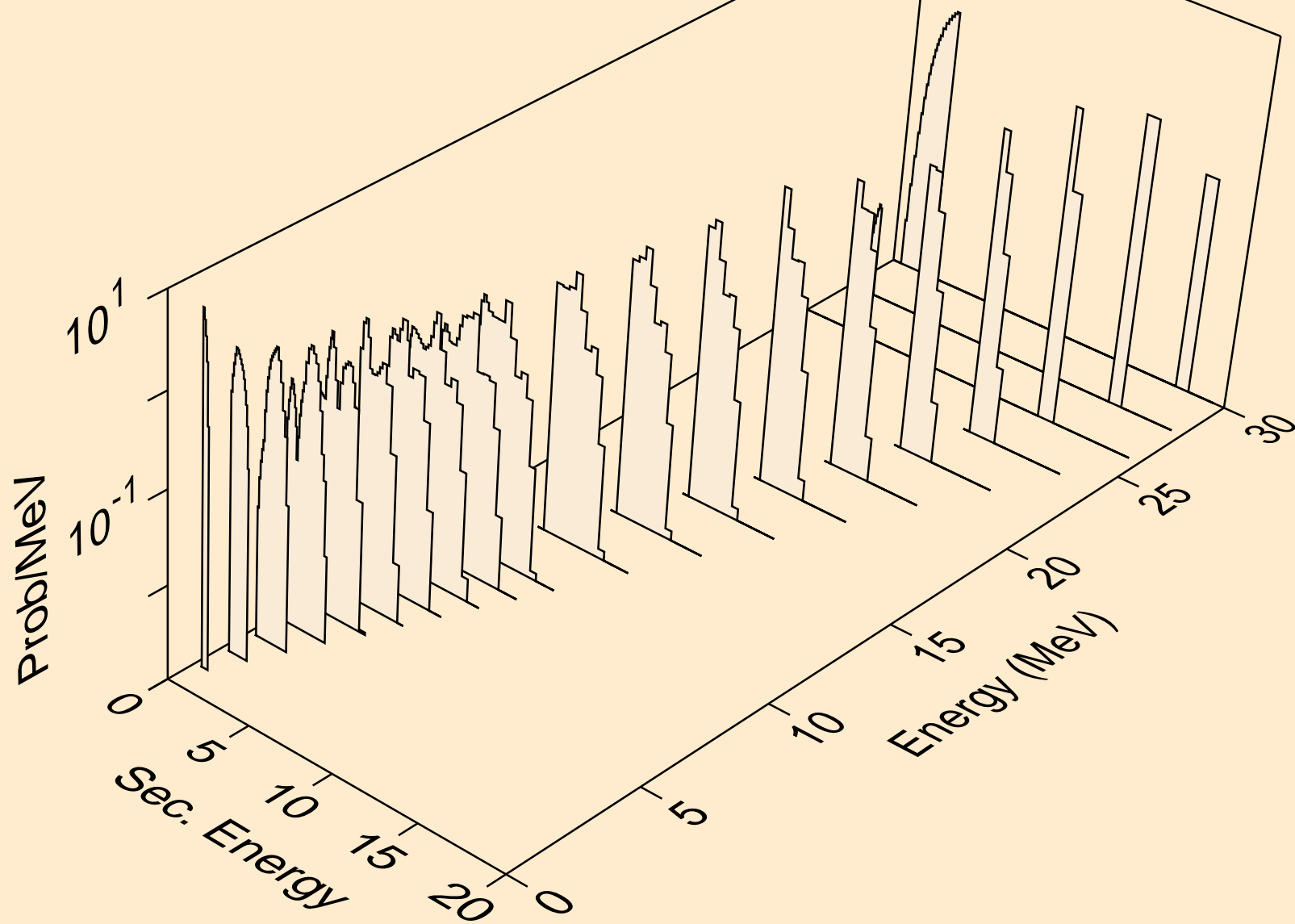

BE011 ALPHA ACER TENDL-2024 LIBRARY; T=0.K

Alpha emission for (a,pa)

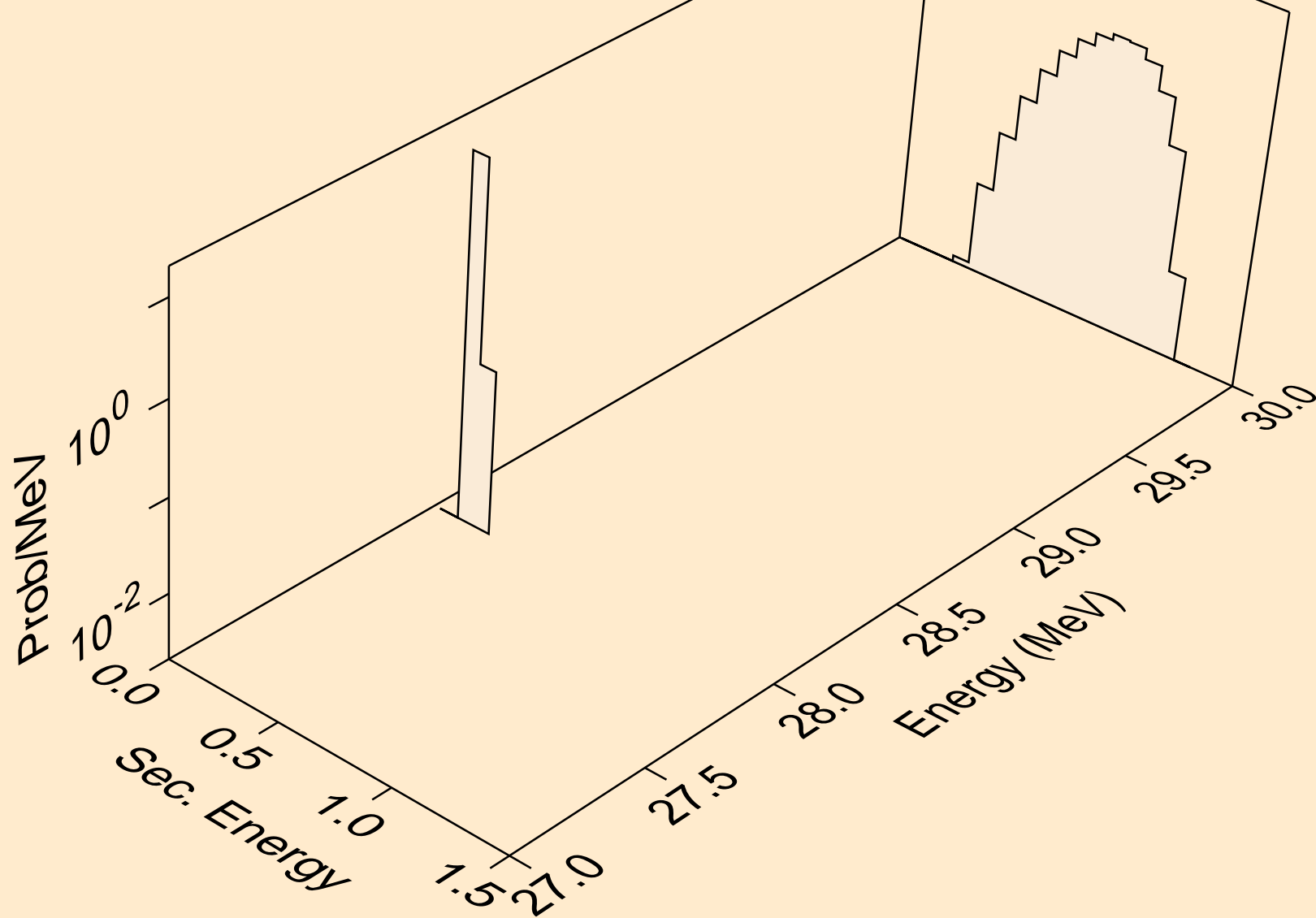

BE011 ALPHA ACER TENDL-2024 LIBRARY; T=0.K
Alpha emission for (a,da)

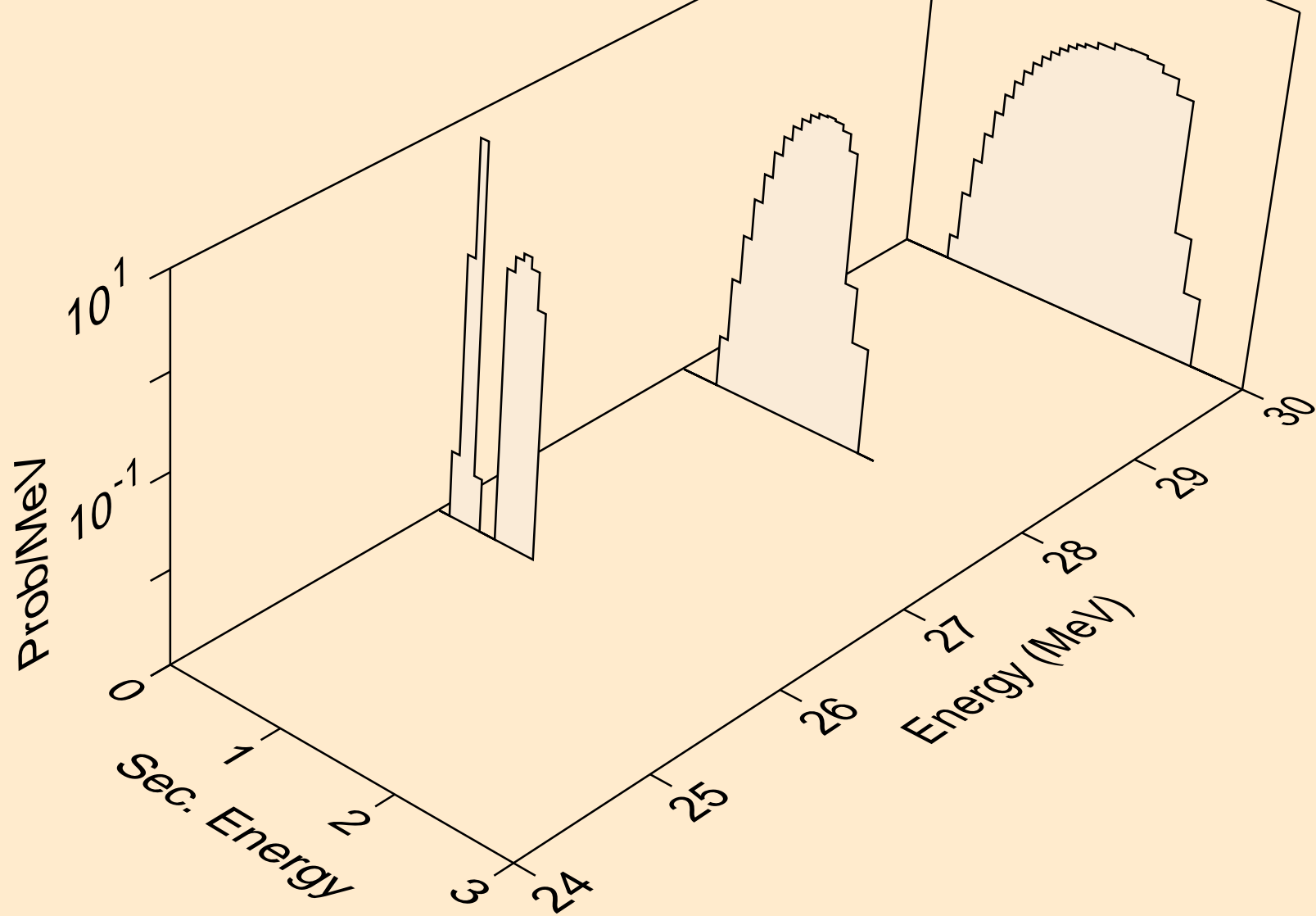

BE011 ALPHA ACER TENDL-2024 LIBRARY; T=0.K
Photon emission for (z,n)

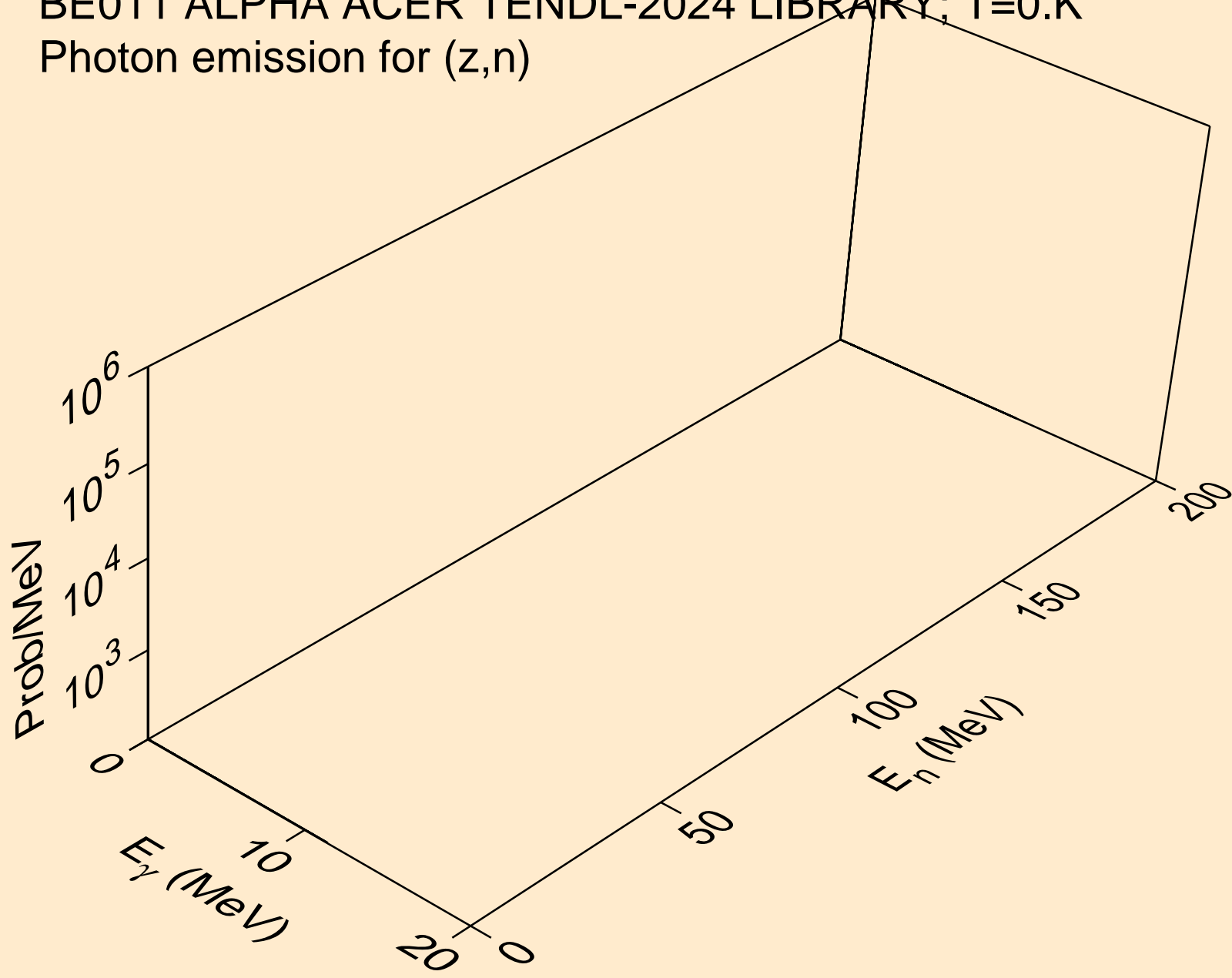

BE011 ALPHA ACER TENDL-2024 LIBRARY; T=0.K
Photon emission for (z,x)

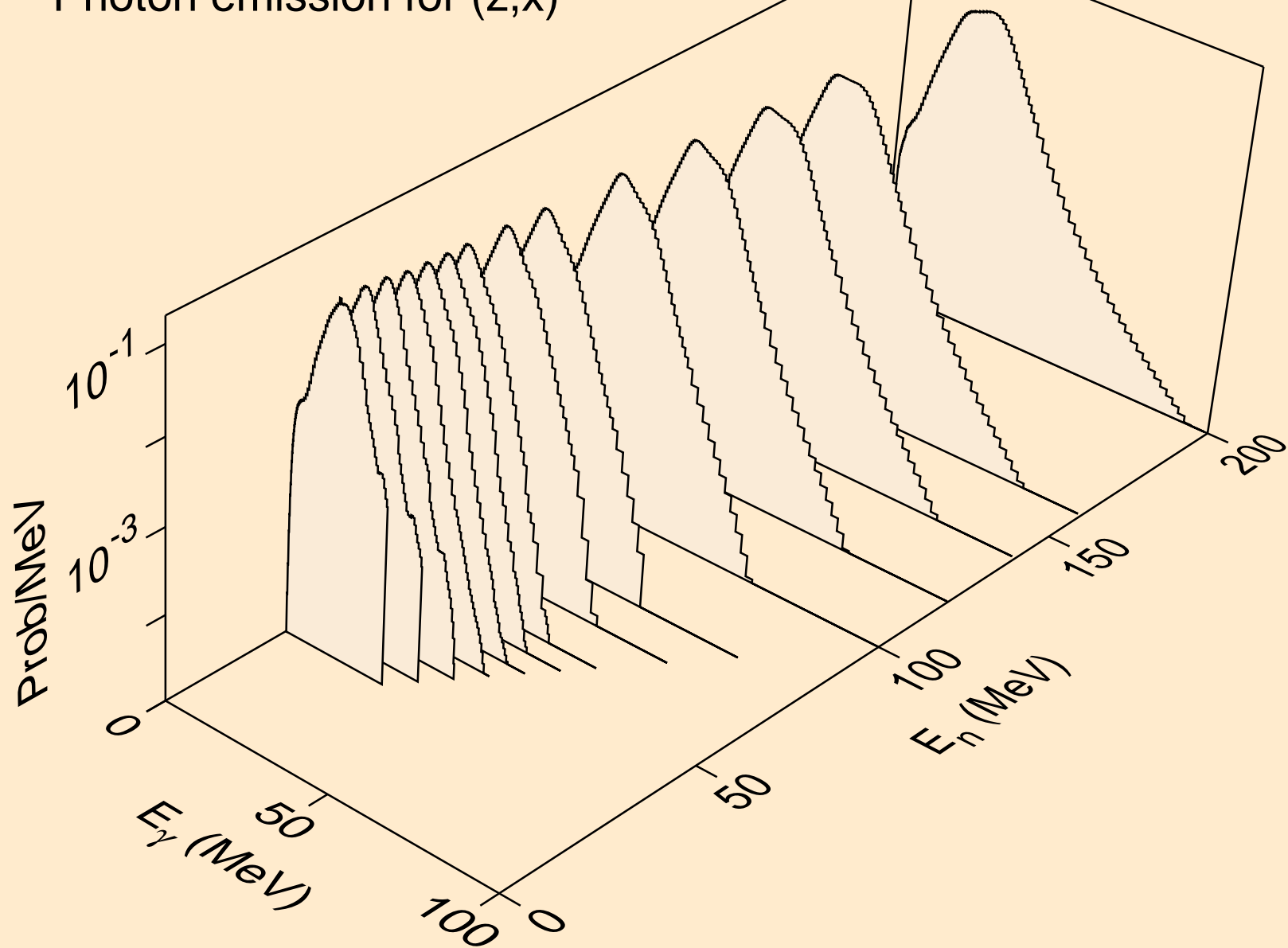

BE011 ALPHA ACER TENDL-2024 LIBRARY; T=0.K
Photon emission for (n,2nd)

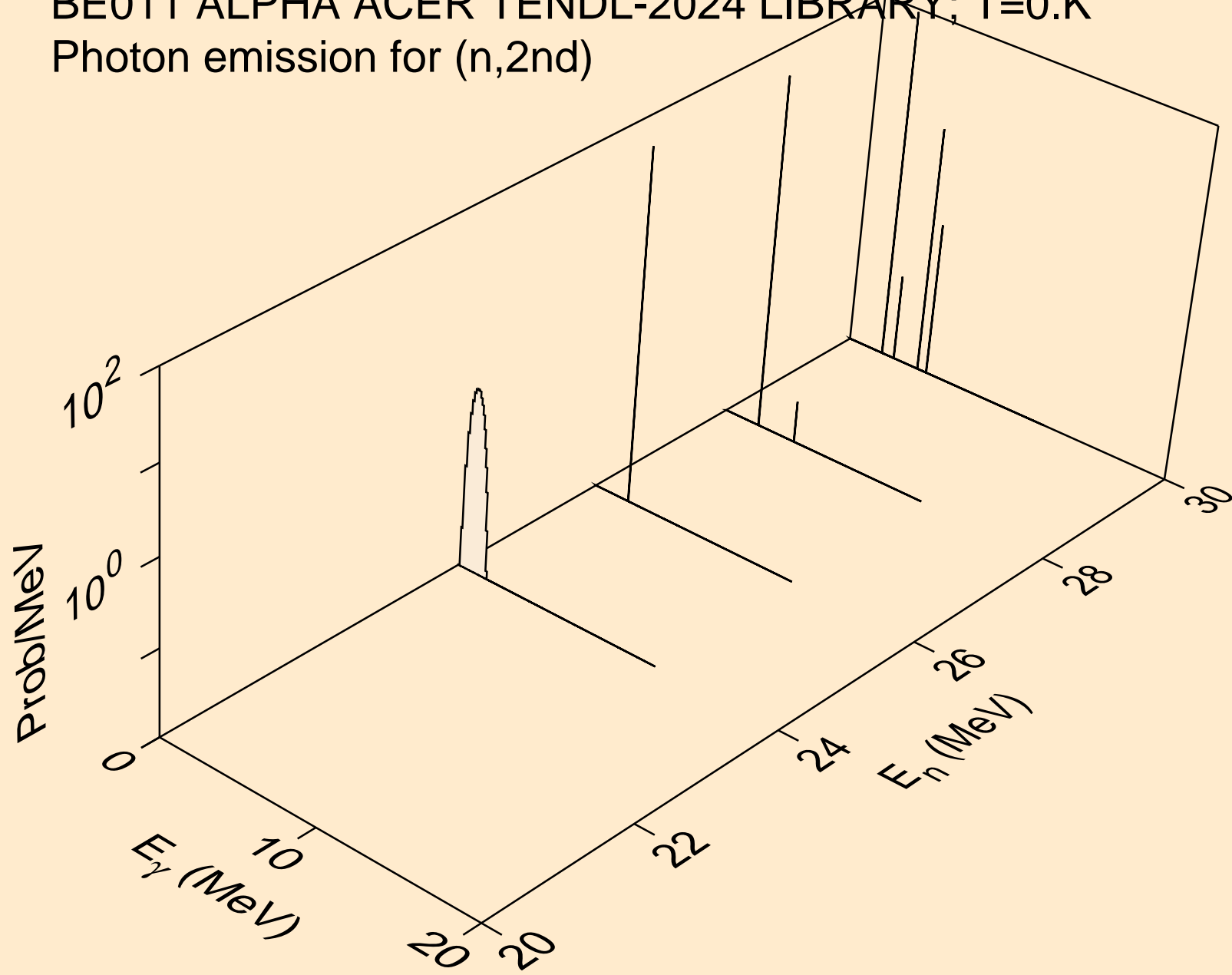

BE011 ALPHA ACER TENDL-2024 LIBRARY; T=0.K
Photon emission for (n,2n)

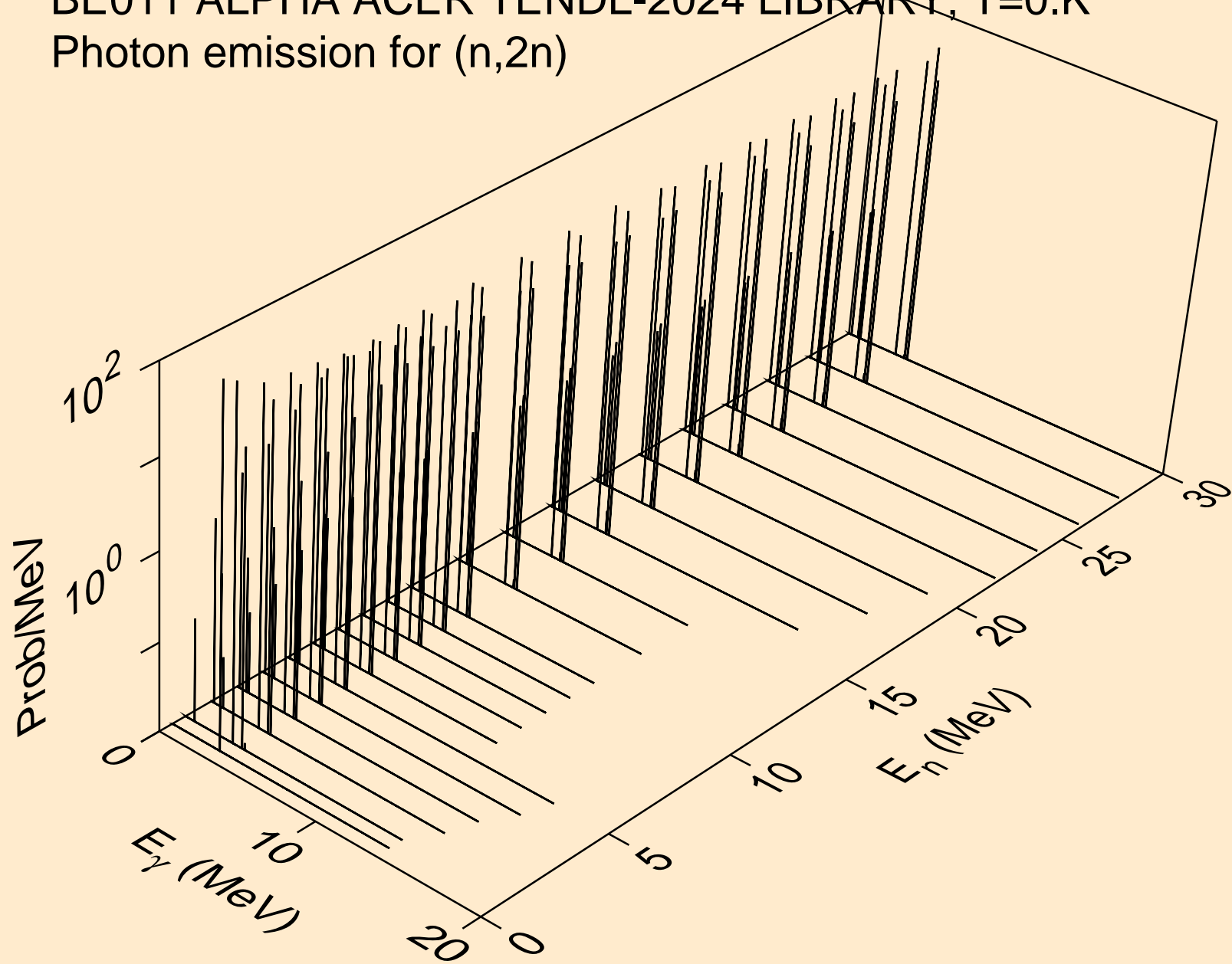

BE011 ALPHA ACER TENDL-2024 LIBRARY; T=0.K
Photon emission for (n,3n)

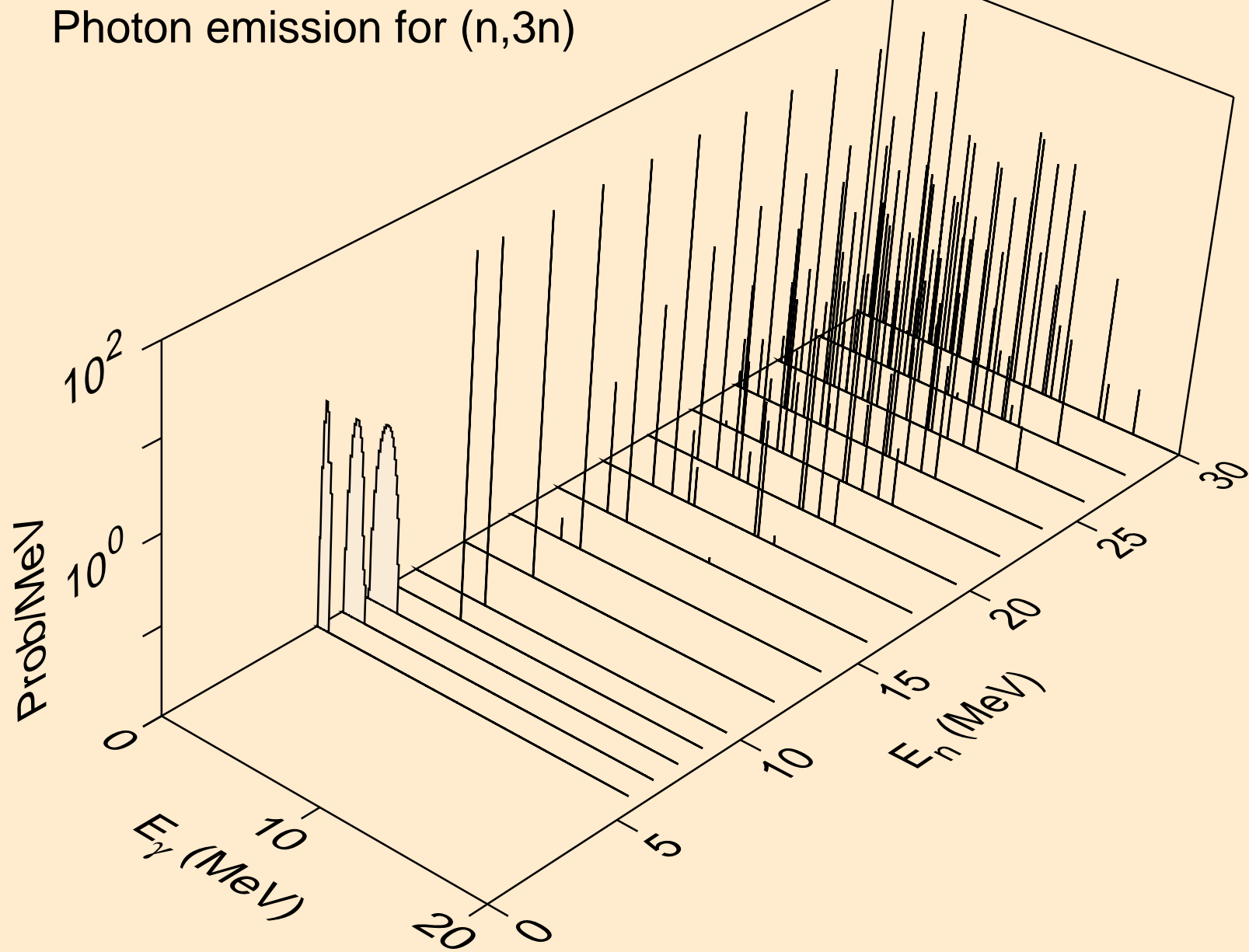

BE011 ALPHA ACER TENDL-2024 LIBRARY; T=0.K
Photon emission for (n,n*)a

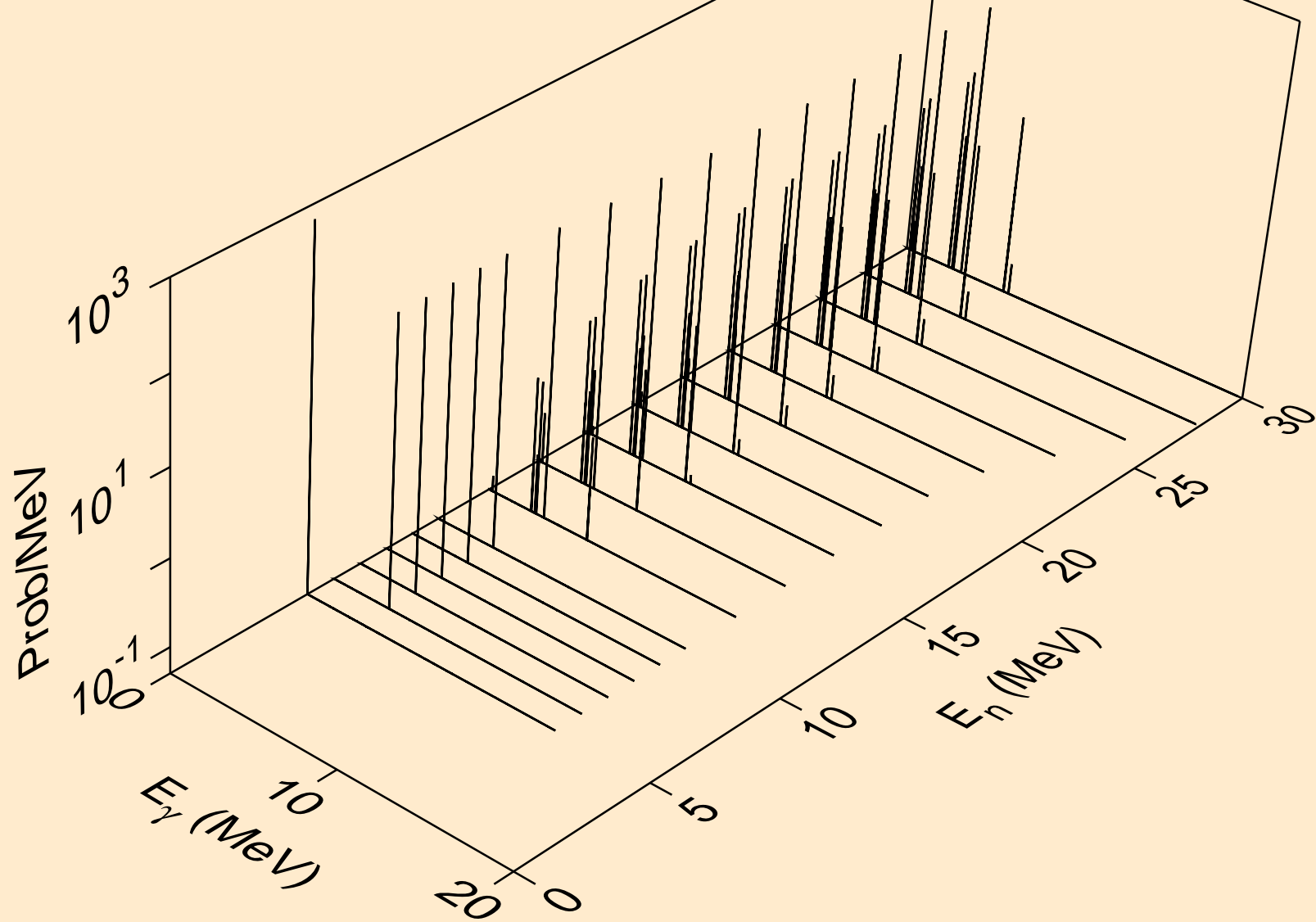

BE011 ALPHA ACER TENDL-2024 LIBRARY; T=0.K
Photon emission for (n,2n)a

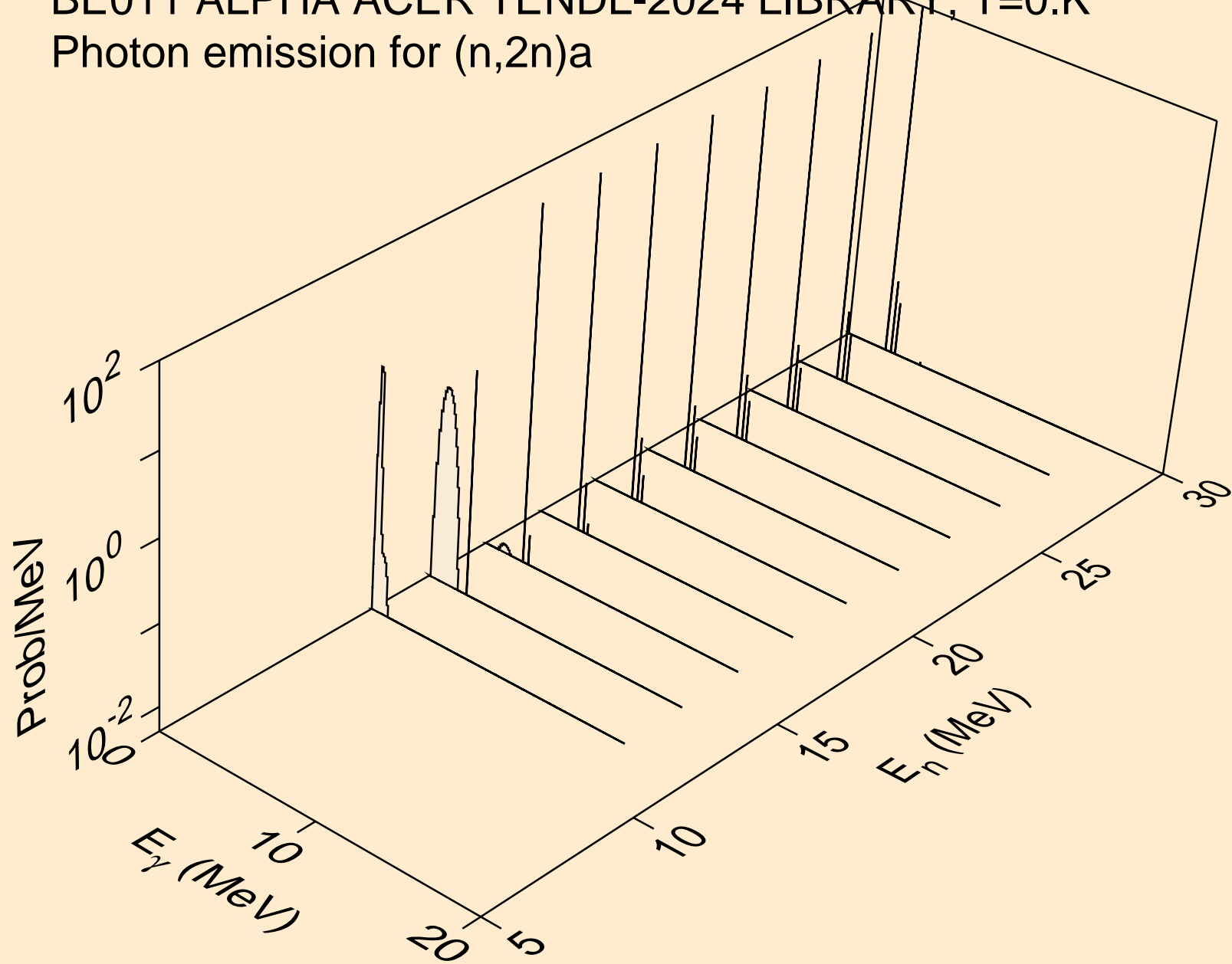

BE011 ALPHA ACER TENDL-2024 LIBRARY; T=0.K
Photon emission for (n,3n)a

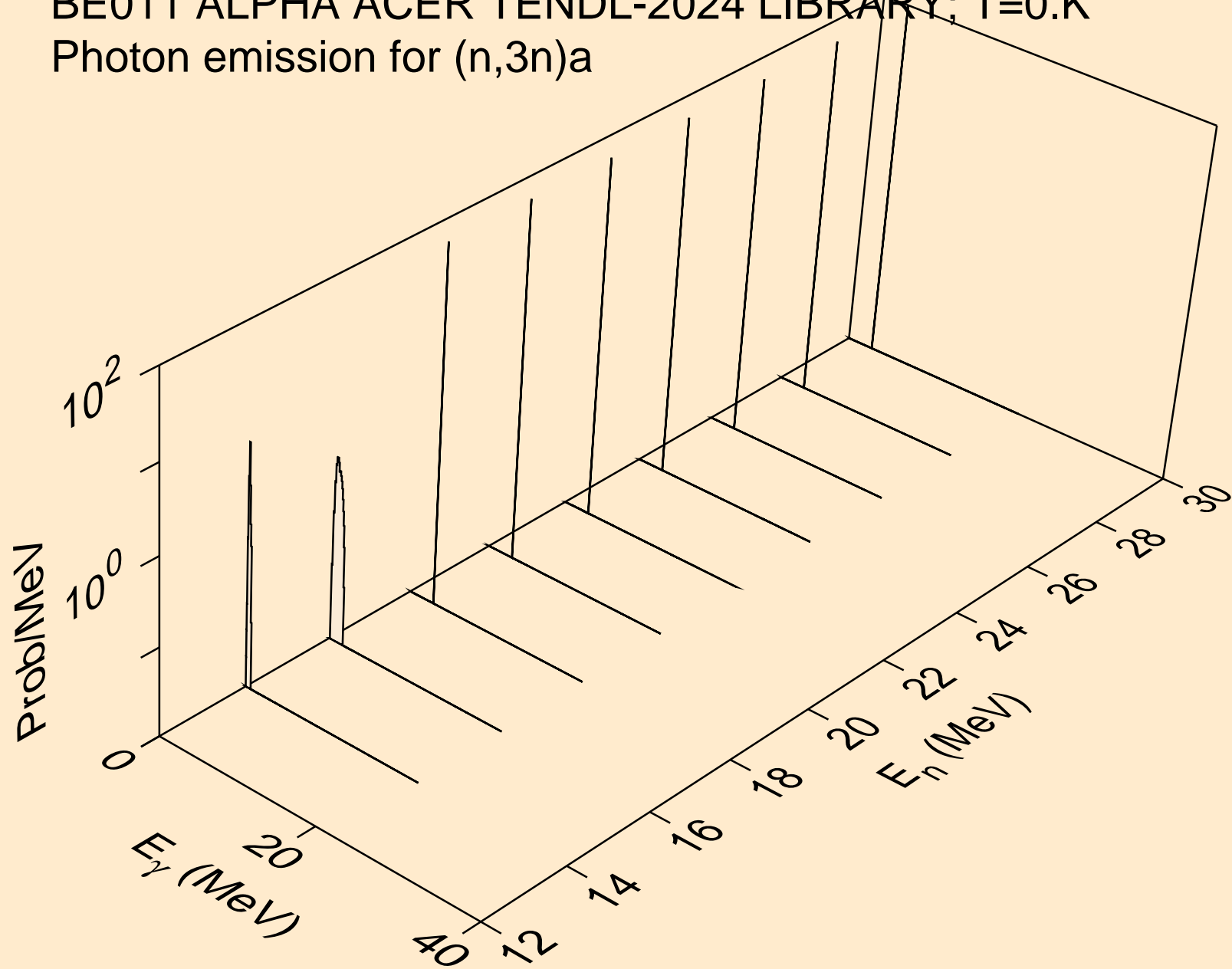

BE011 ALPHA ACER TENDL-2024 LIBRARY; T=0.K
Photon emission for (n,n*)p

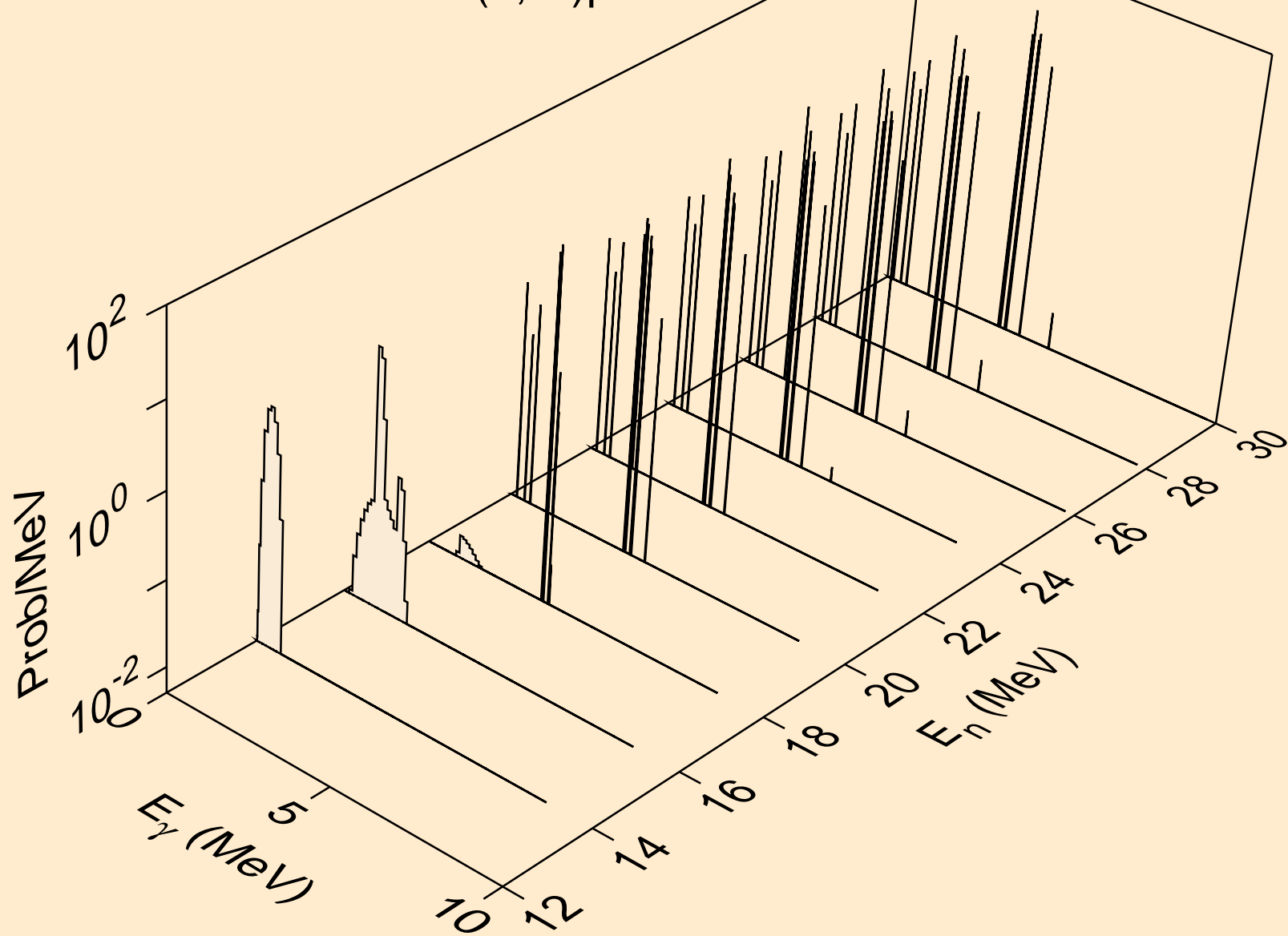

BE011 ALPHA ACER TENDL-2024 LIBRARY; T=0.K
Photon emission for (n,n*)d

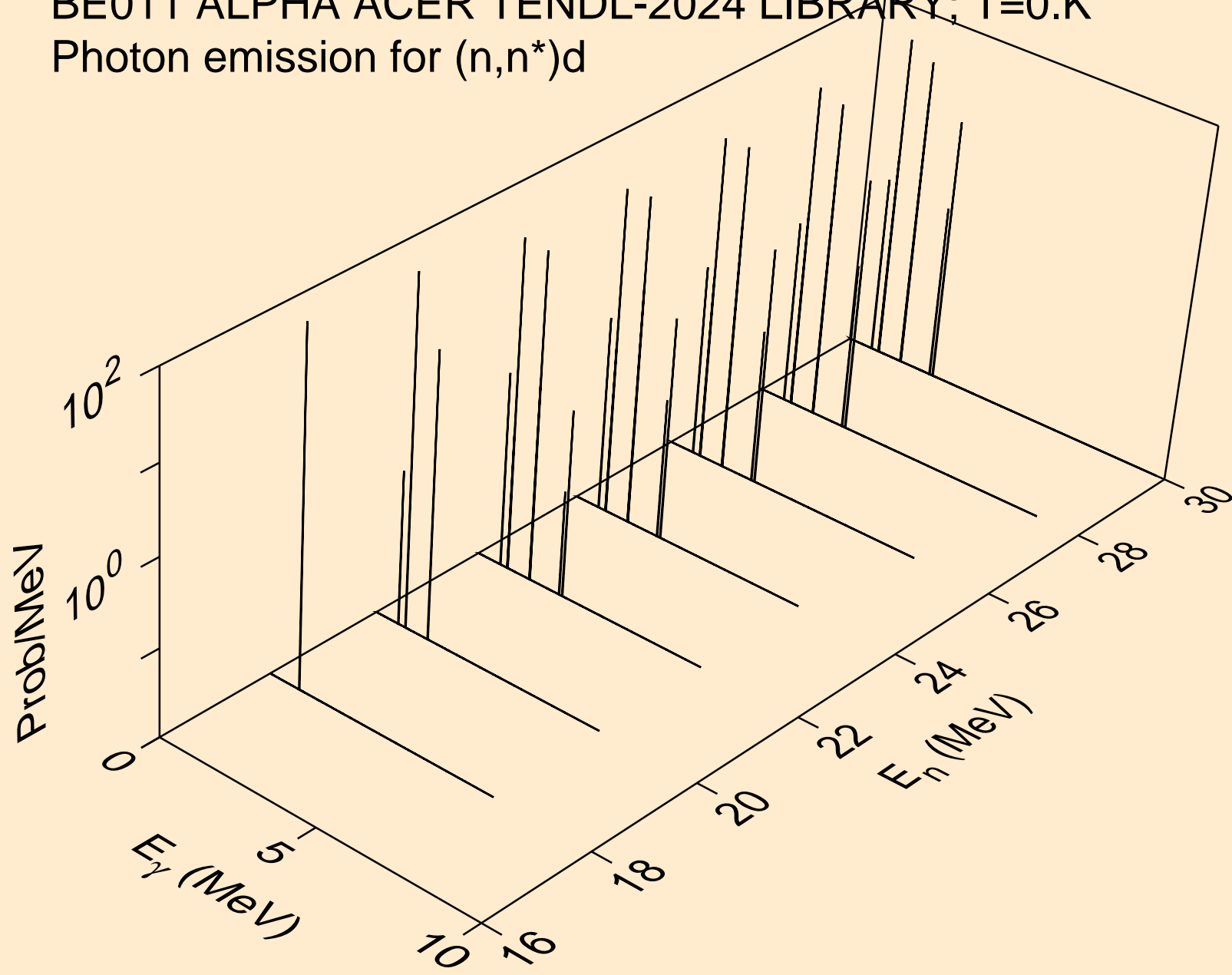

BE011 ALPHA ACER TENDL-2024 LIBRARY; T=0.K
Photon emission for (n,n*)t

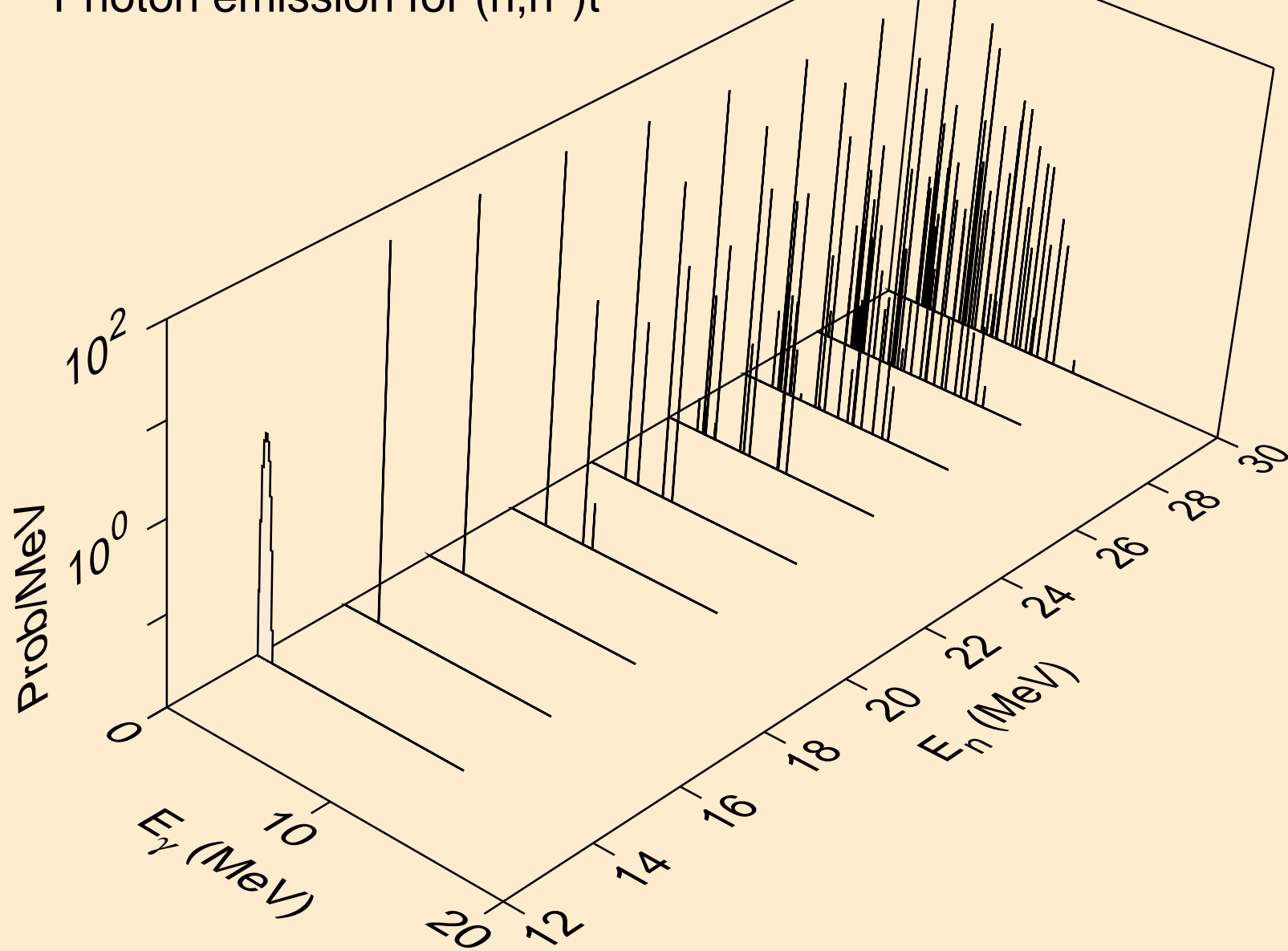

BE011 ALPHA ACER TENDL-2024 LIBRARY; T=0.K
Photon emission for (n,4n)

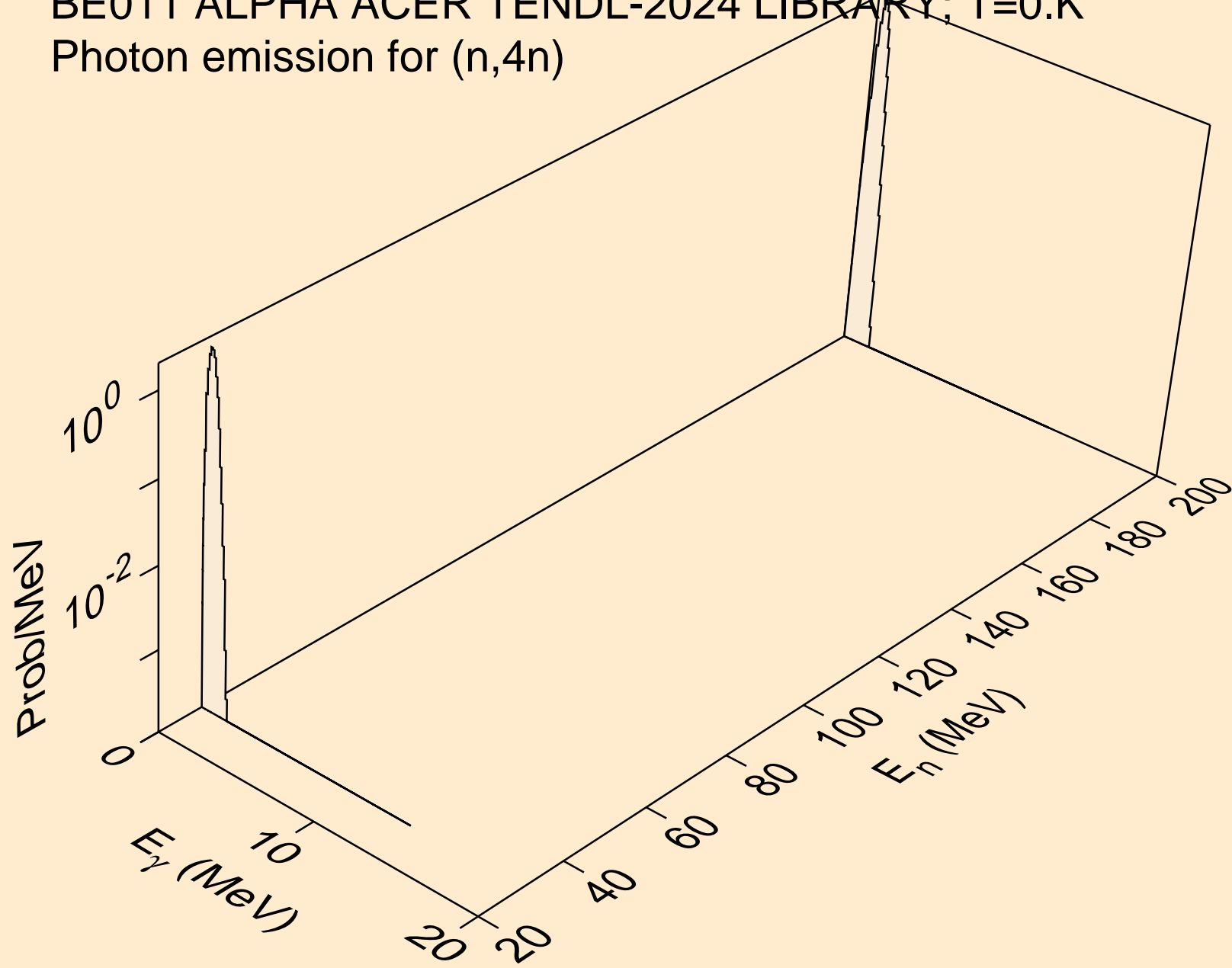

BE011 ALPHA ACER TENDL-2024 LIBRARY; T=0.K
Photon emission for (n,2np)

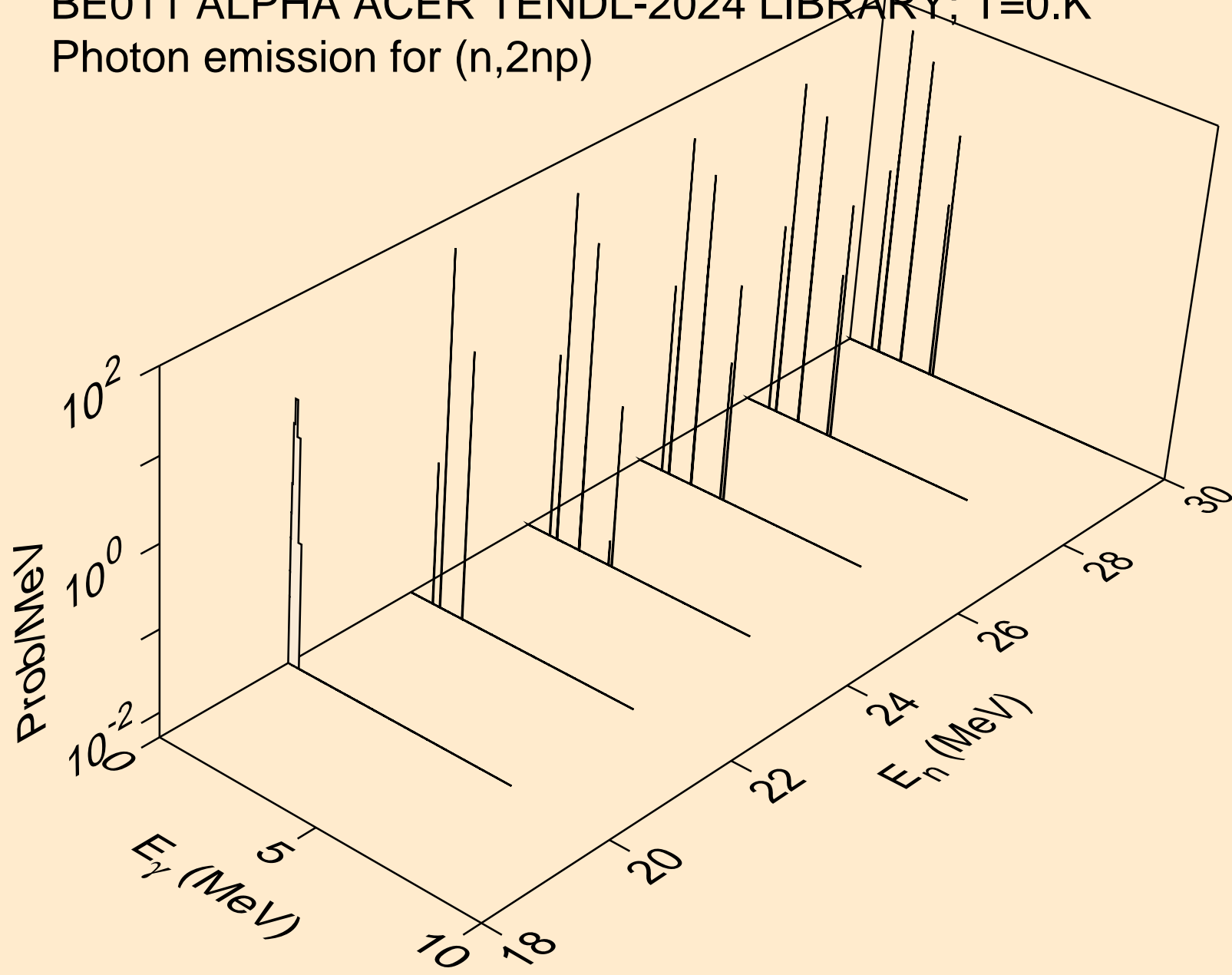

BE011 ALPHA ACER TENDL-2024 LIBRARY; T=0.K
Photon emission for (n,3np)

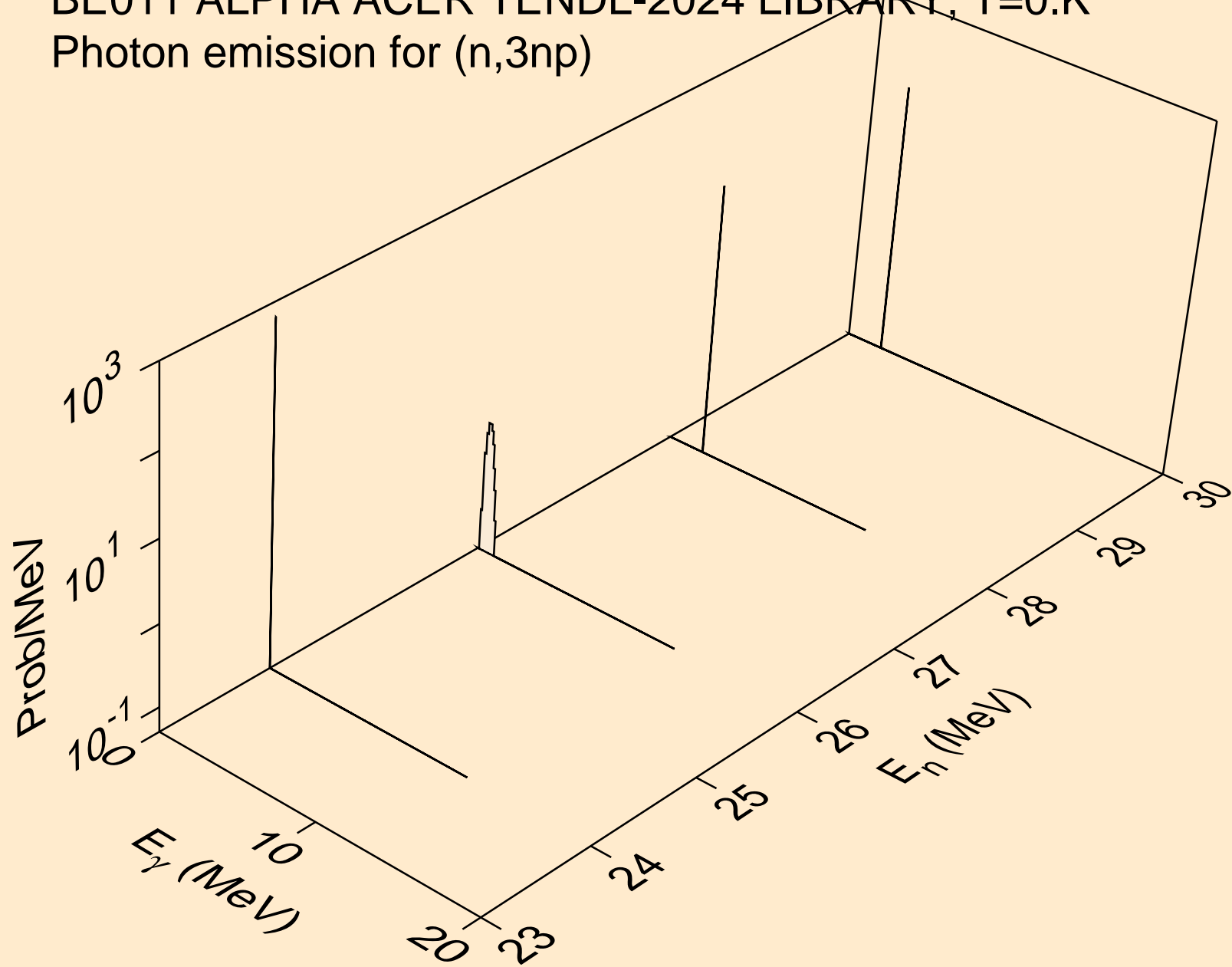

BE011 ALPHA ACER TENDL-2024 LIBRARY; T=0.K
Photon emission for (n,npa)

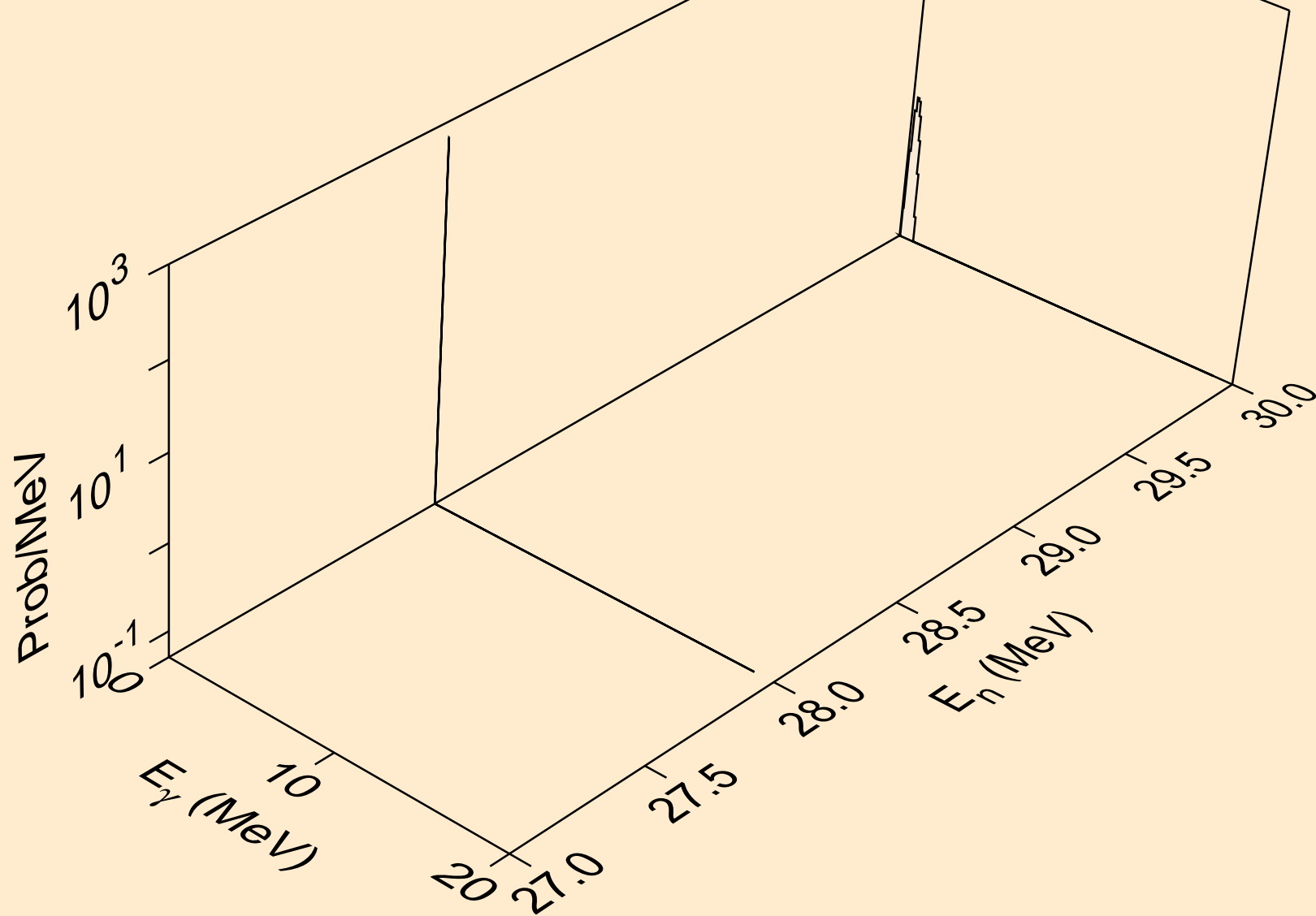

BE011 ALPHA ACER TENDL-2024 LIBRARY; T=0.K
Photon emission for (n,gma)

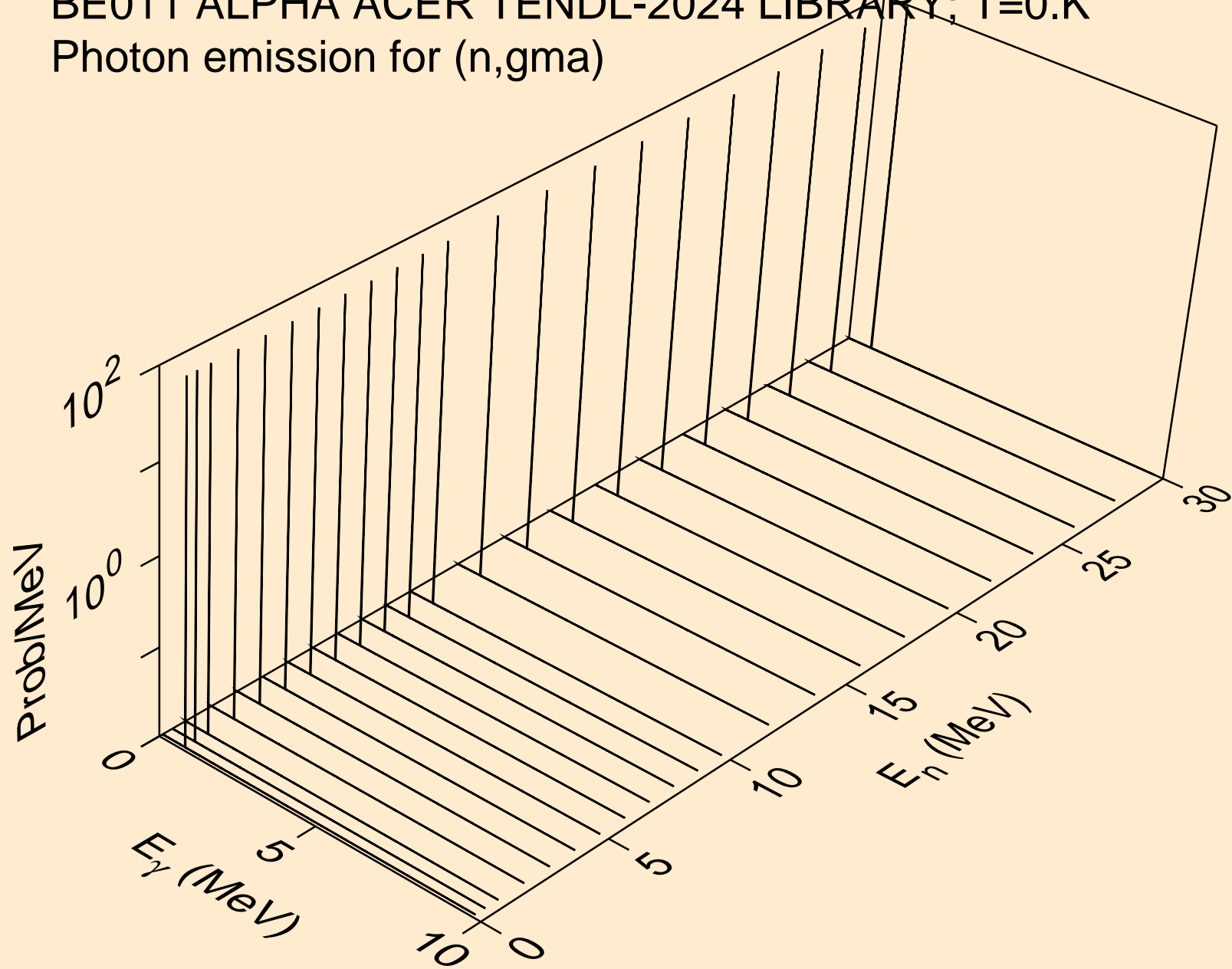

BE011 ALPHA ACER TENDL-2024 LIBRARY; T=0.K
Photon emission for (n,p)

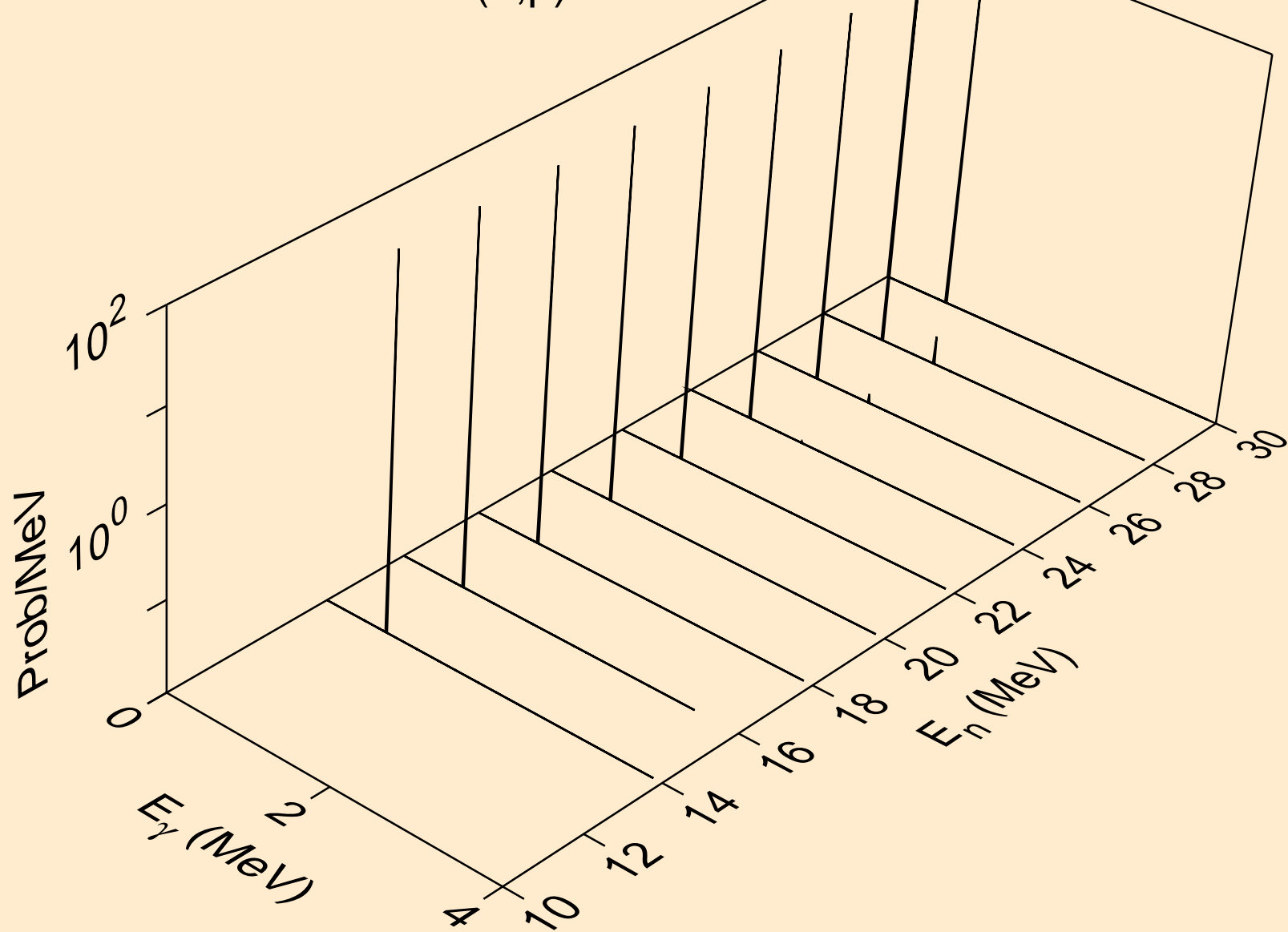

BE011 ALPHA ACER TENDL-2024 LIBRARY; T=0.K
Photon emission for (n,d)

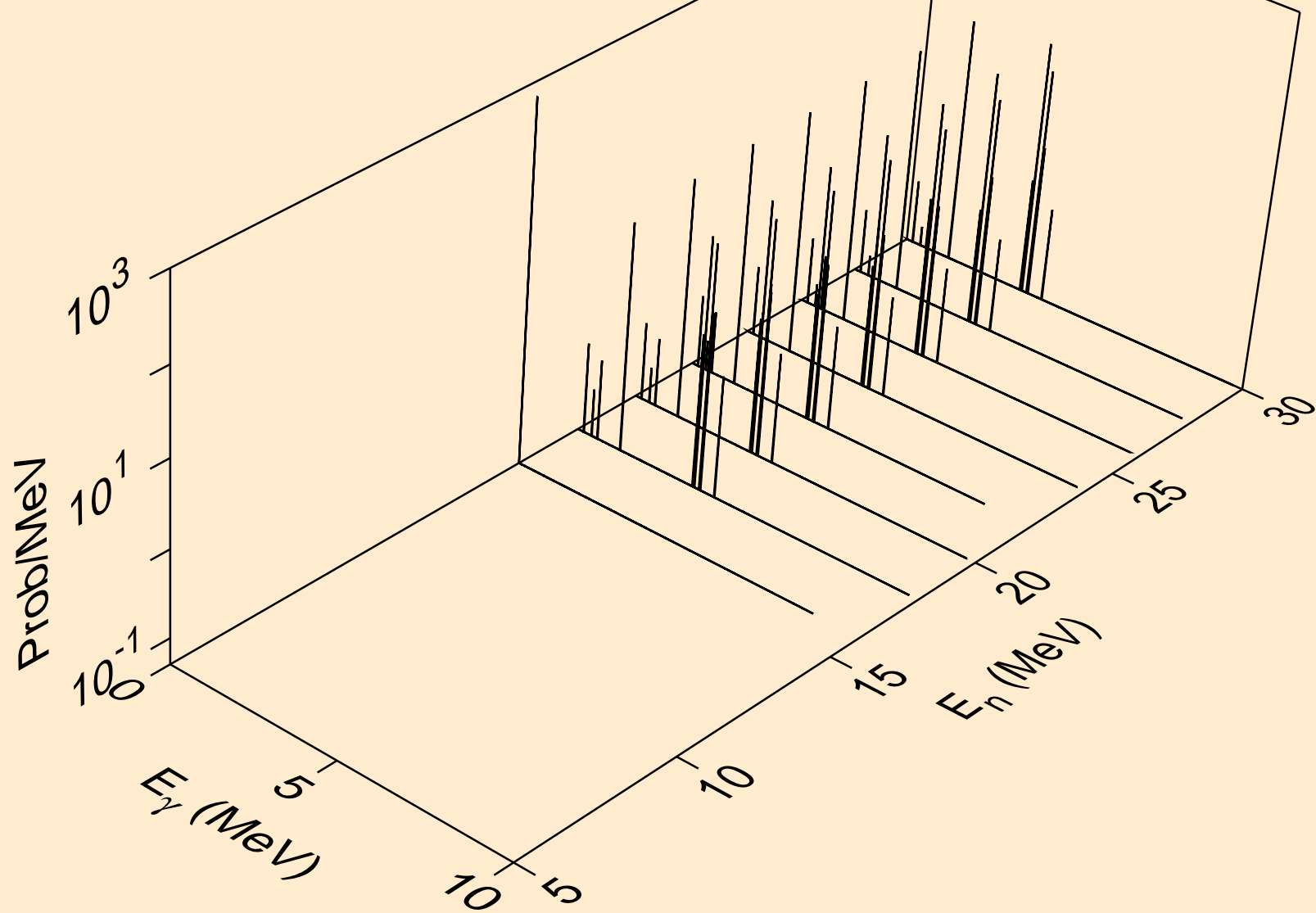

BE011 ALPHA ACER TENDL-2024 LIBRARY; T=0.K
Photon emission for (n,t)

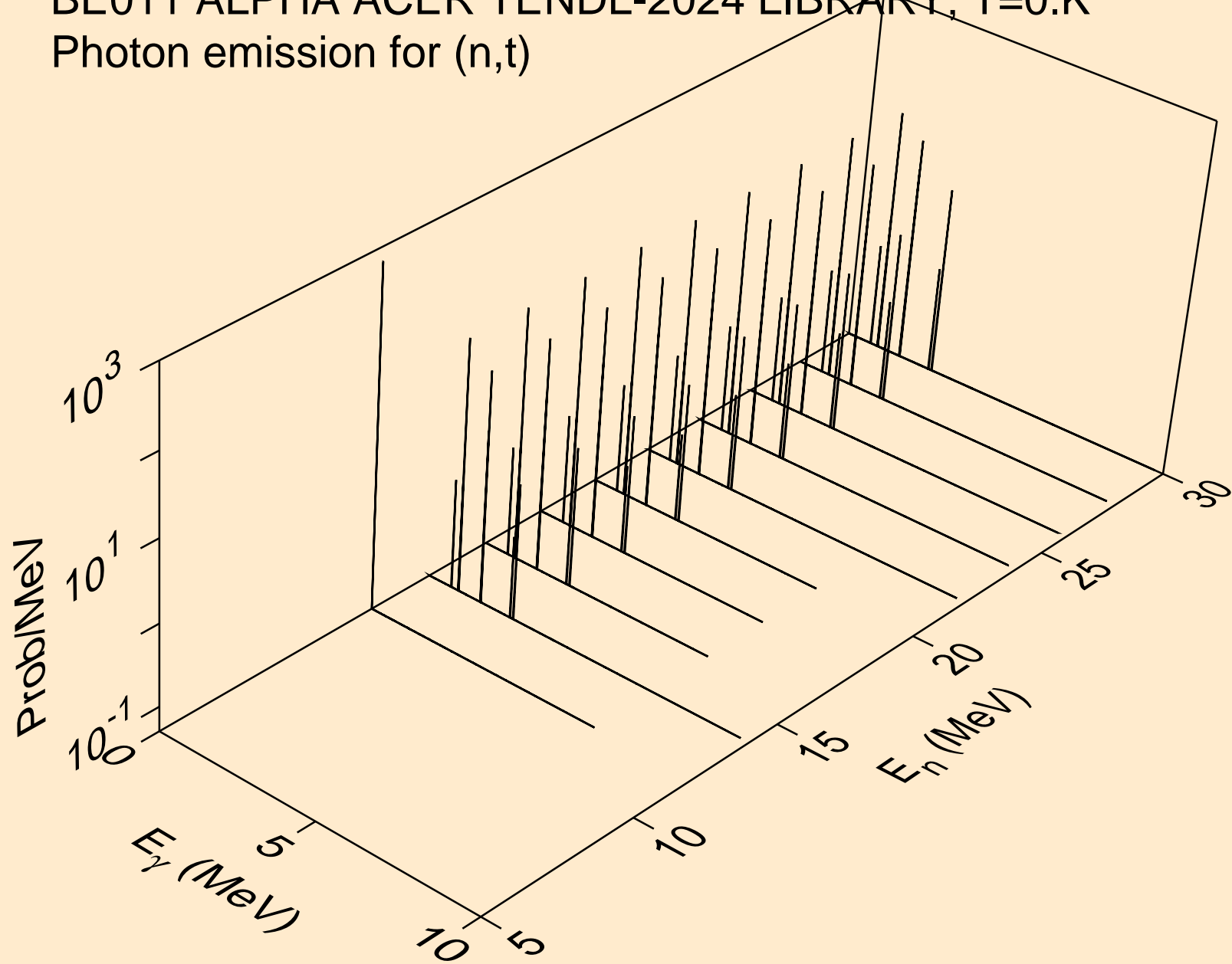

BE011 ALPHA ACER TENDL-2024 LIBRARY; T=0.K
Photon emission for (n,he3)

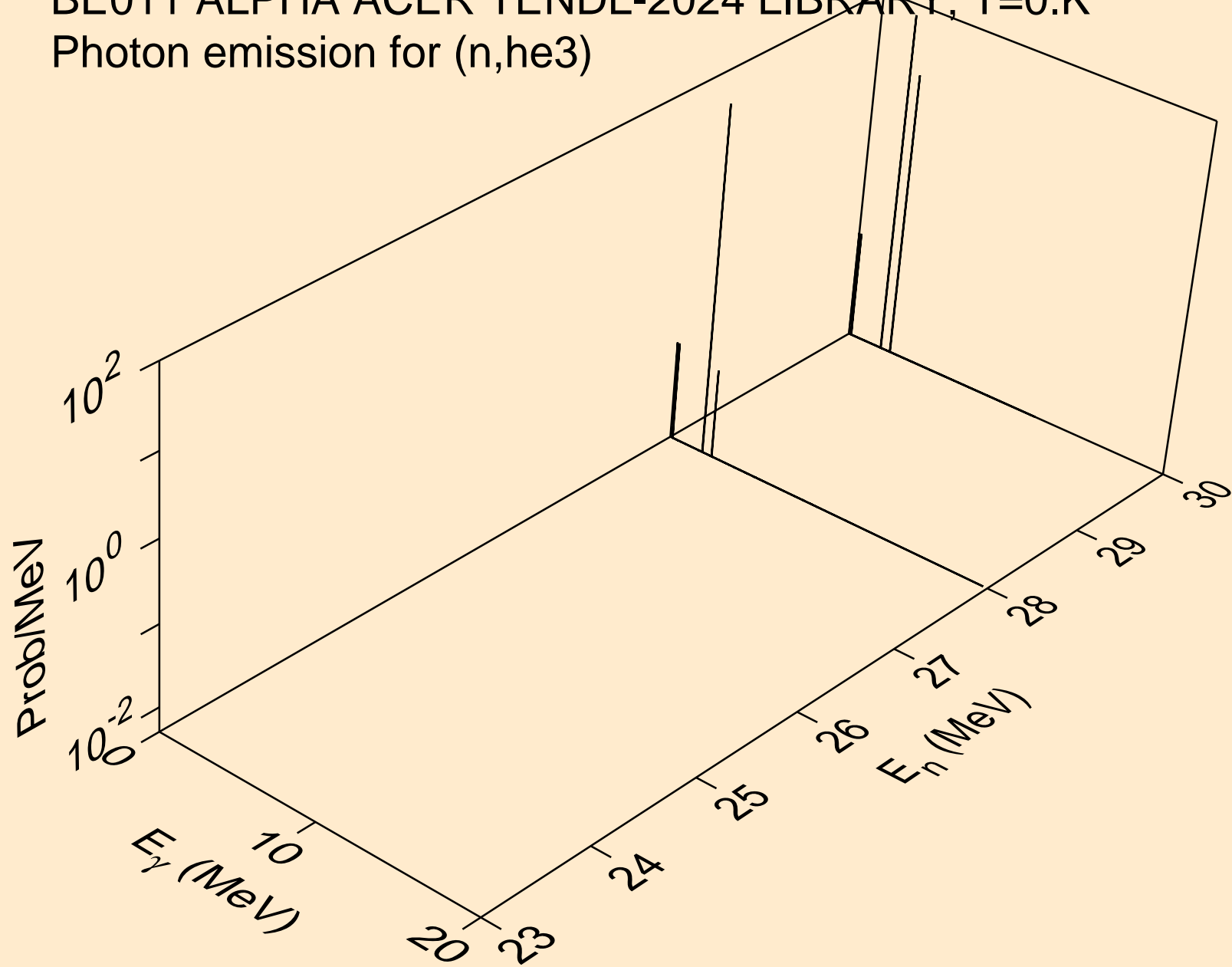

BE011 ALPHA ACER TENDL-2024 LIBRARY; T=0.K
Photon emission for inelastic

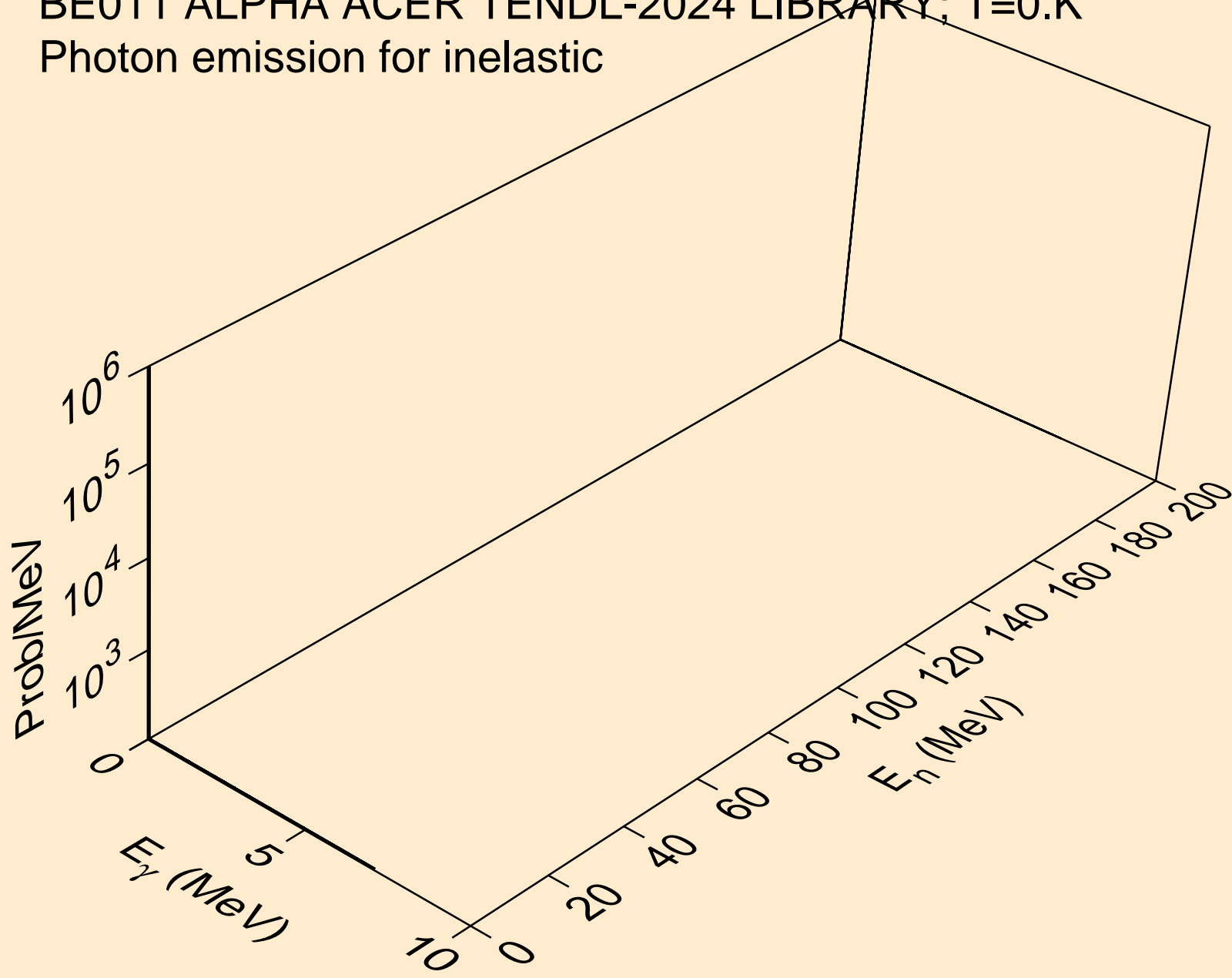

BE011 ALPHA ACER TENDL-2024 LIBRARY; T=0.K
Photon emission for (n,pa)

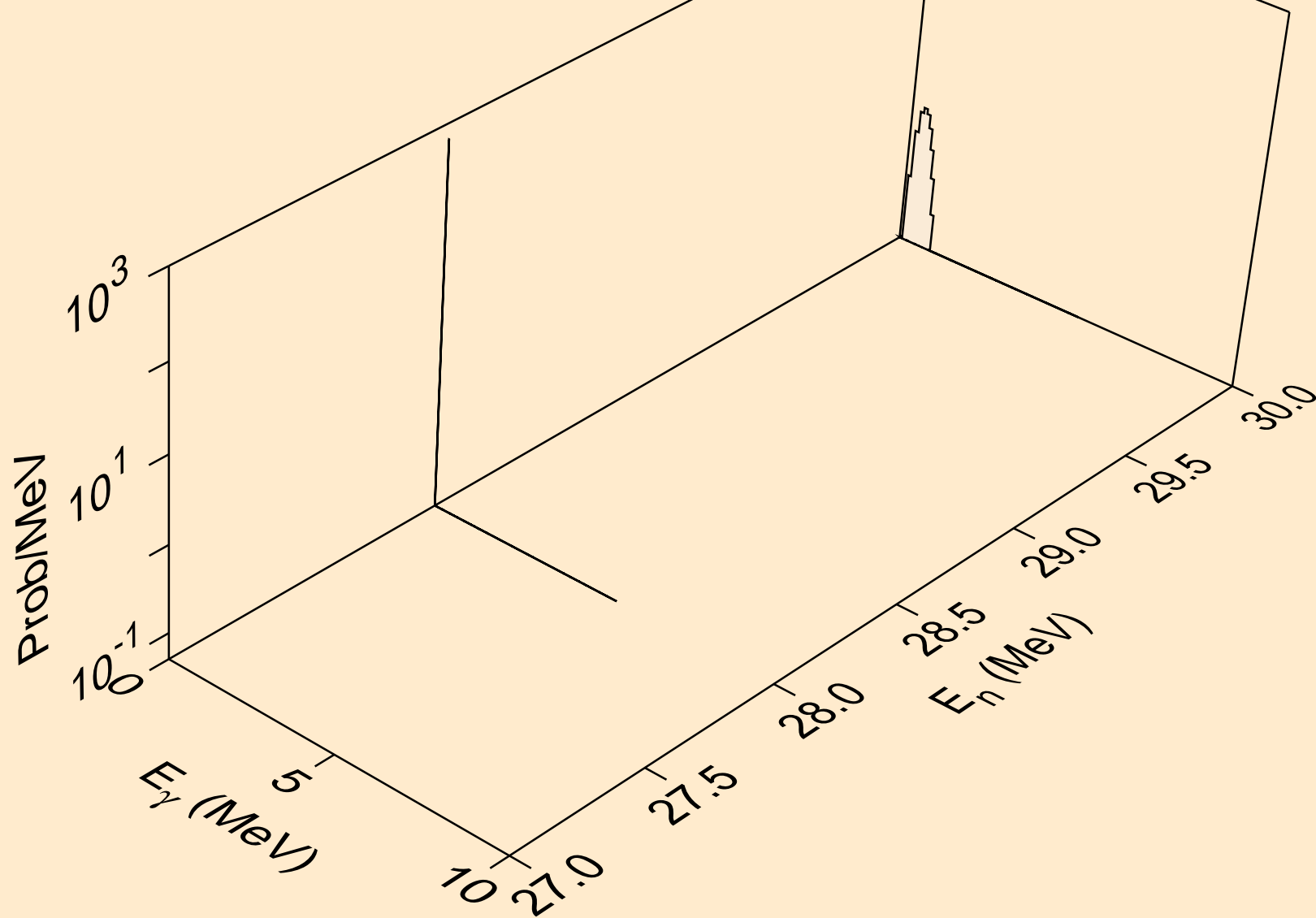

BE011 ALPHA ACER TENDL-2024 LIBRARY; T=0.K
Photon emission for (n,pt)

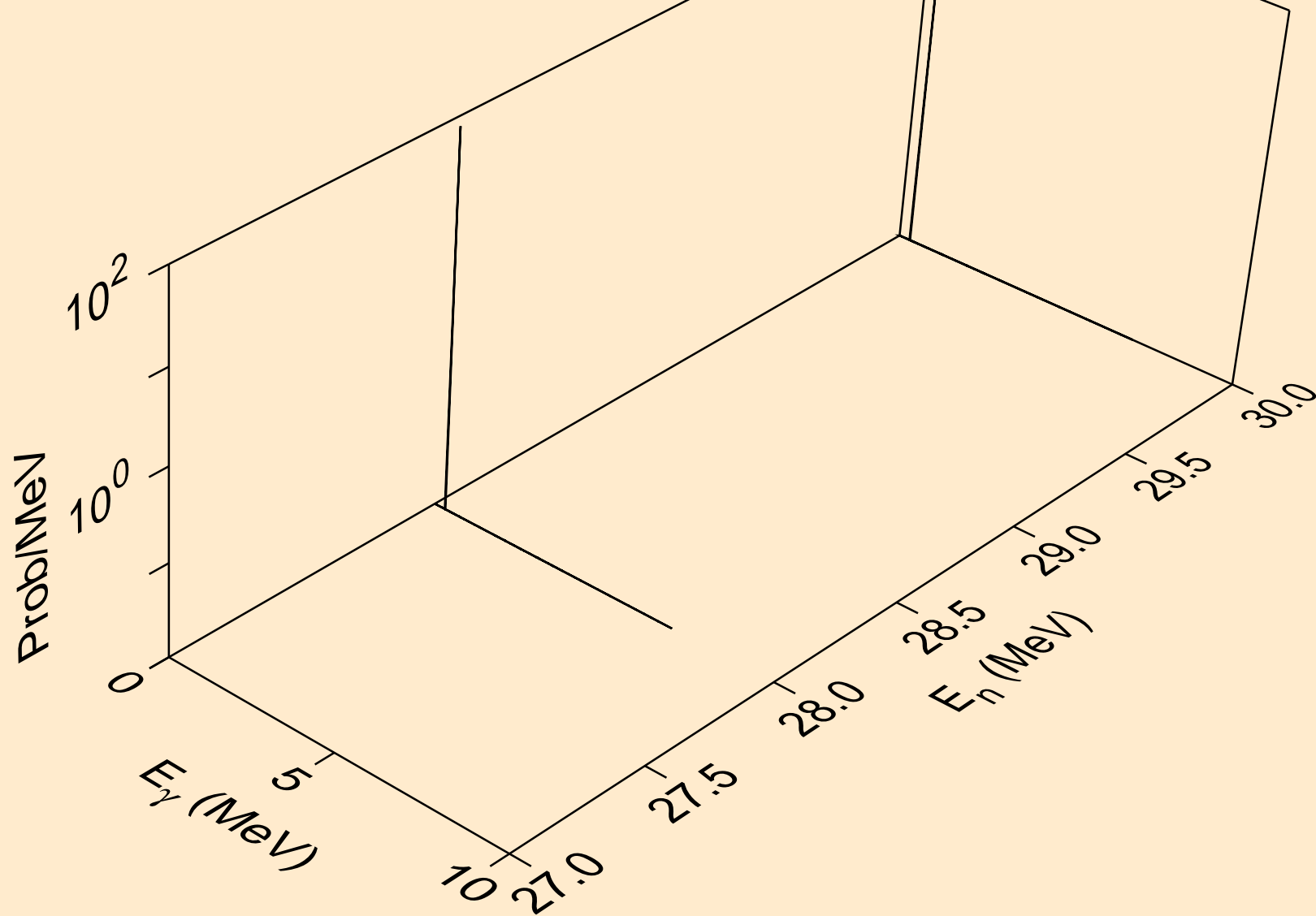

BE011 ALPHA ACER TENDL-2024 LIBRARY; T=0.K
Photon emission for (n,da)

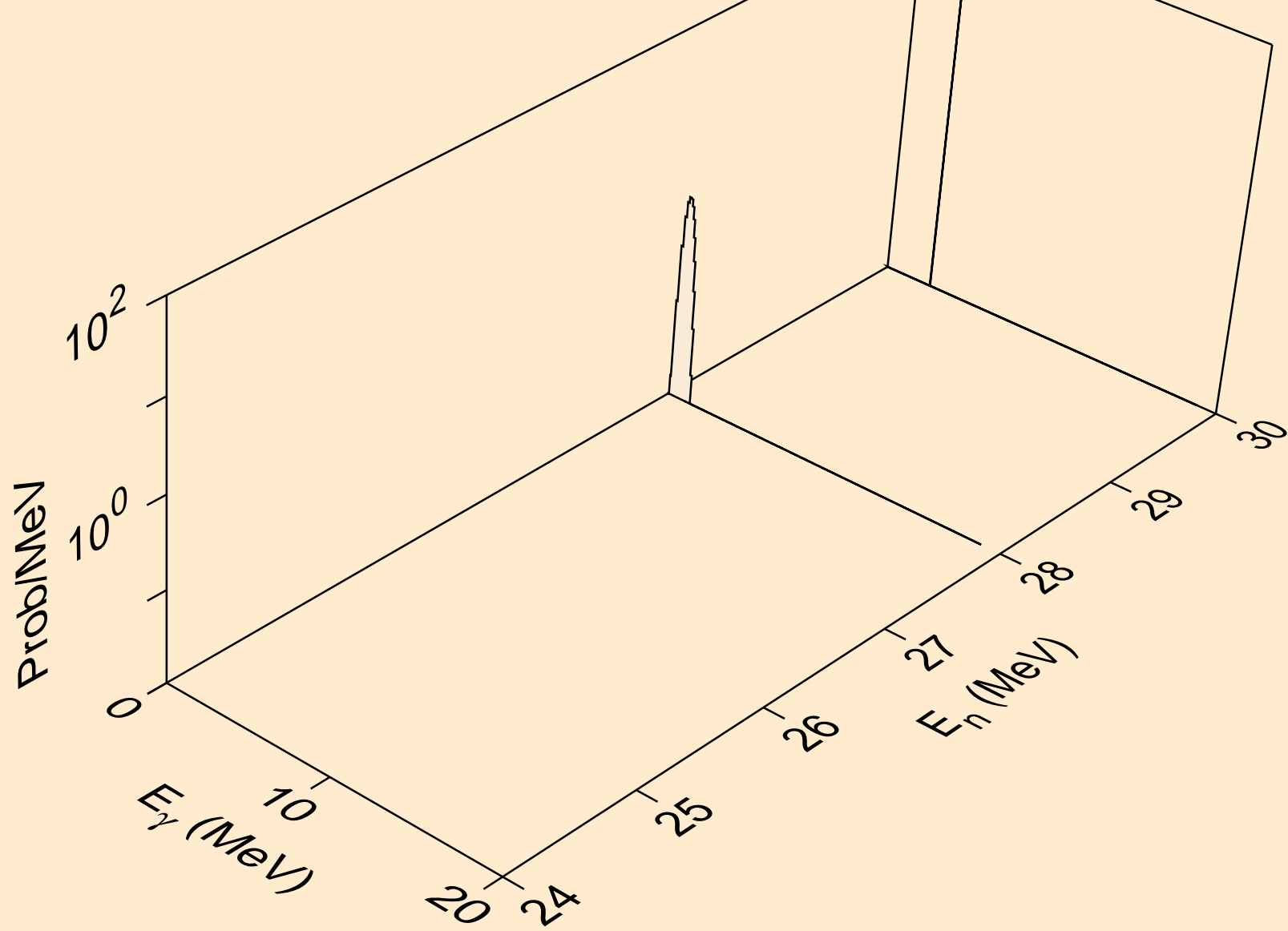

BE011 ALPHA ACER TENDL-2024 LIBRARY; T=0.K

Particle heating contributions

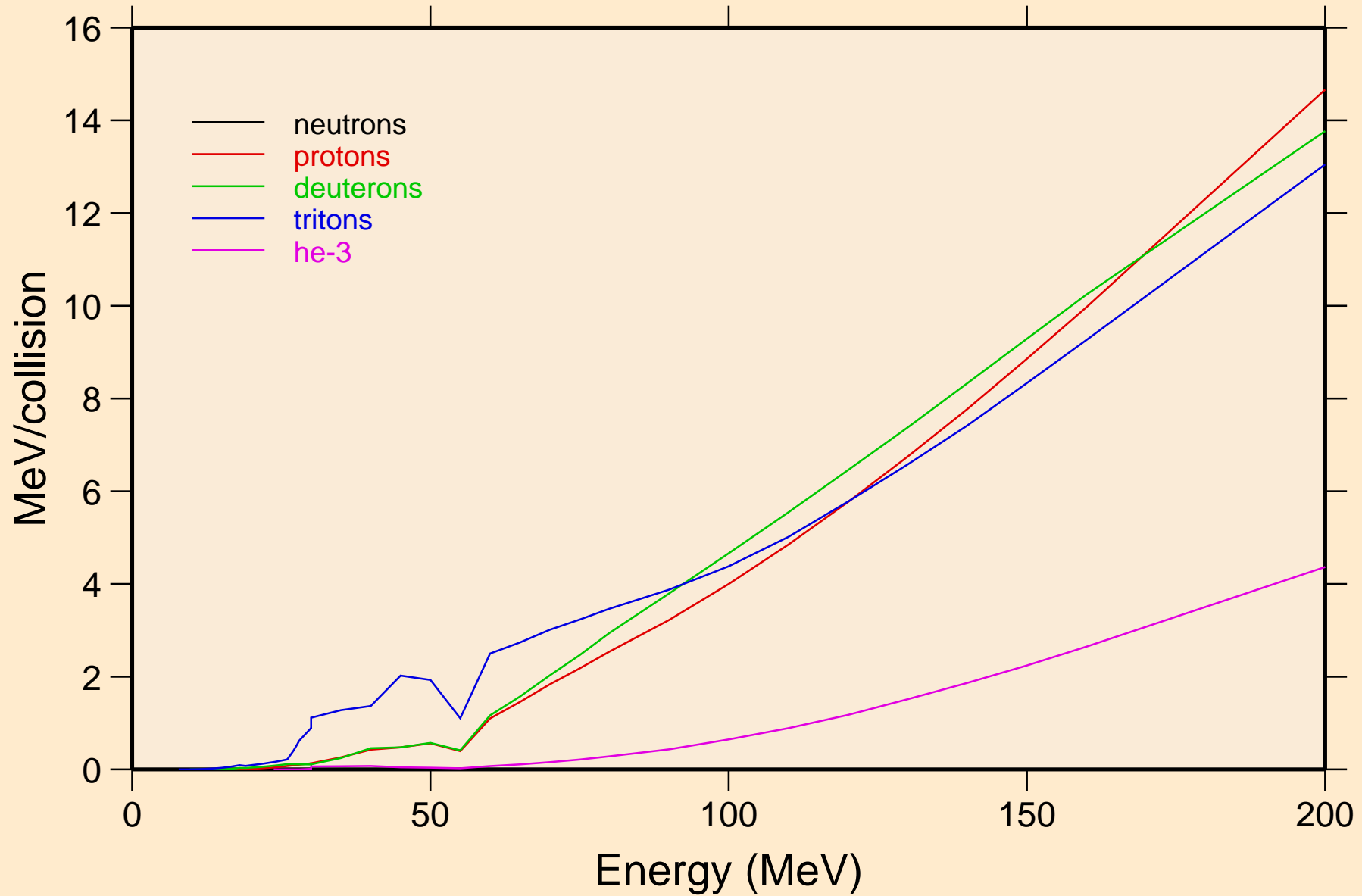

BE011 ALPHA ACER TENDL-2024 LIBRARY; T=0.K
Recoil Heating

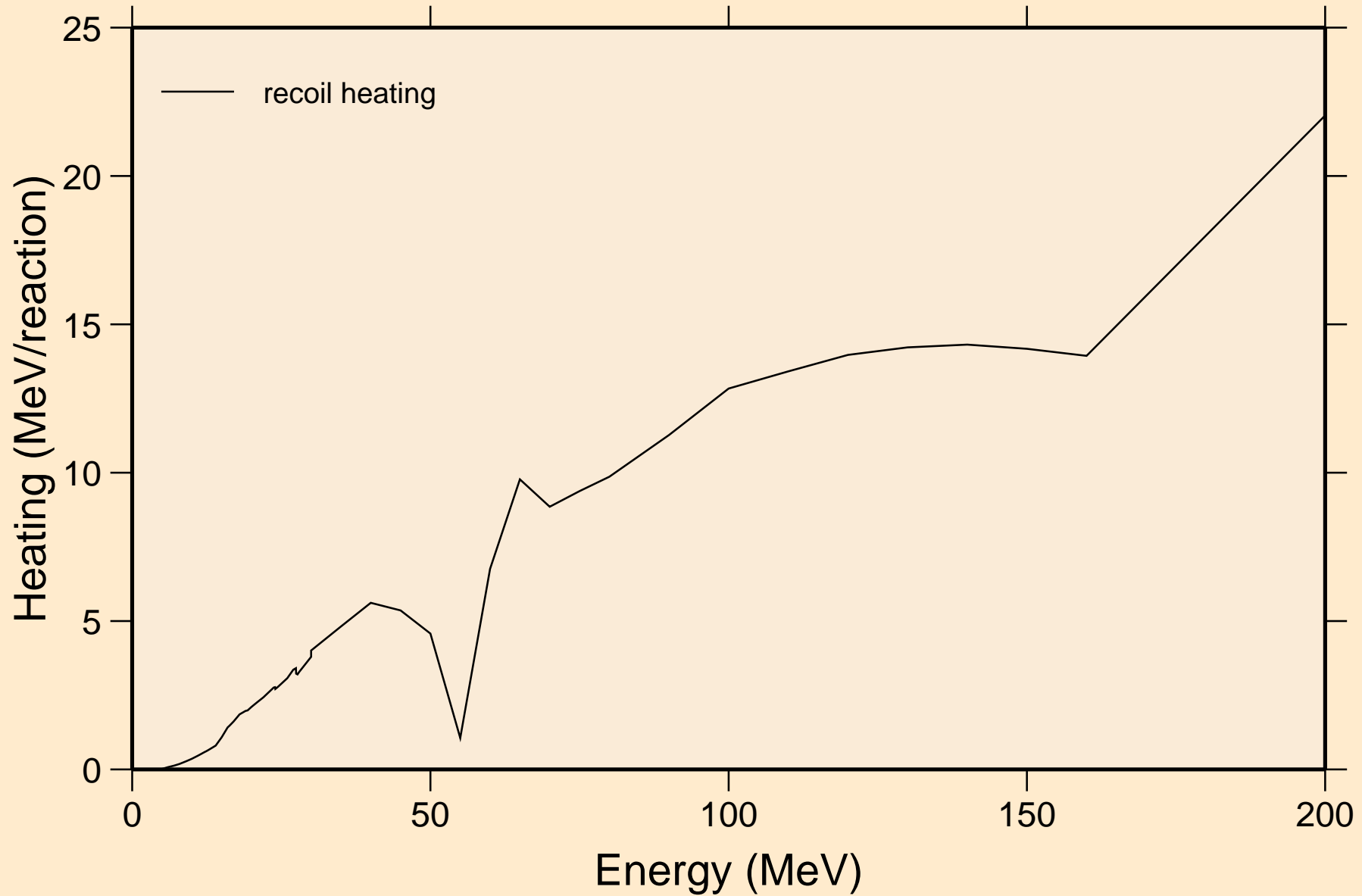

BE011 ALPHA ACER TENDL-2024 LIBRARY; T=0.K
Particle production cross sections

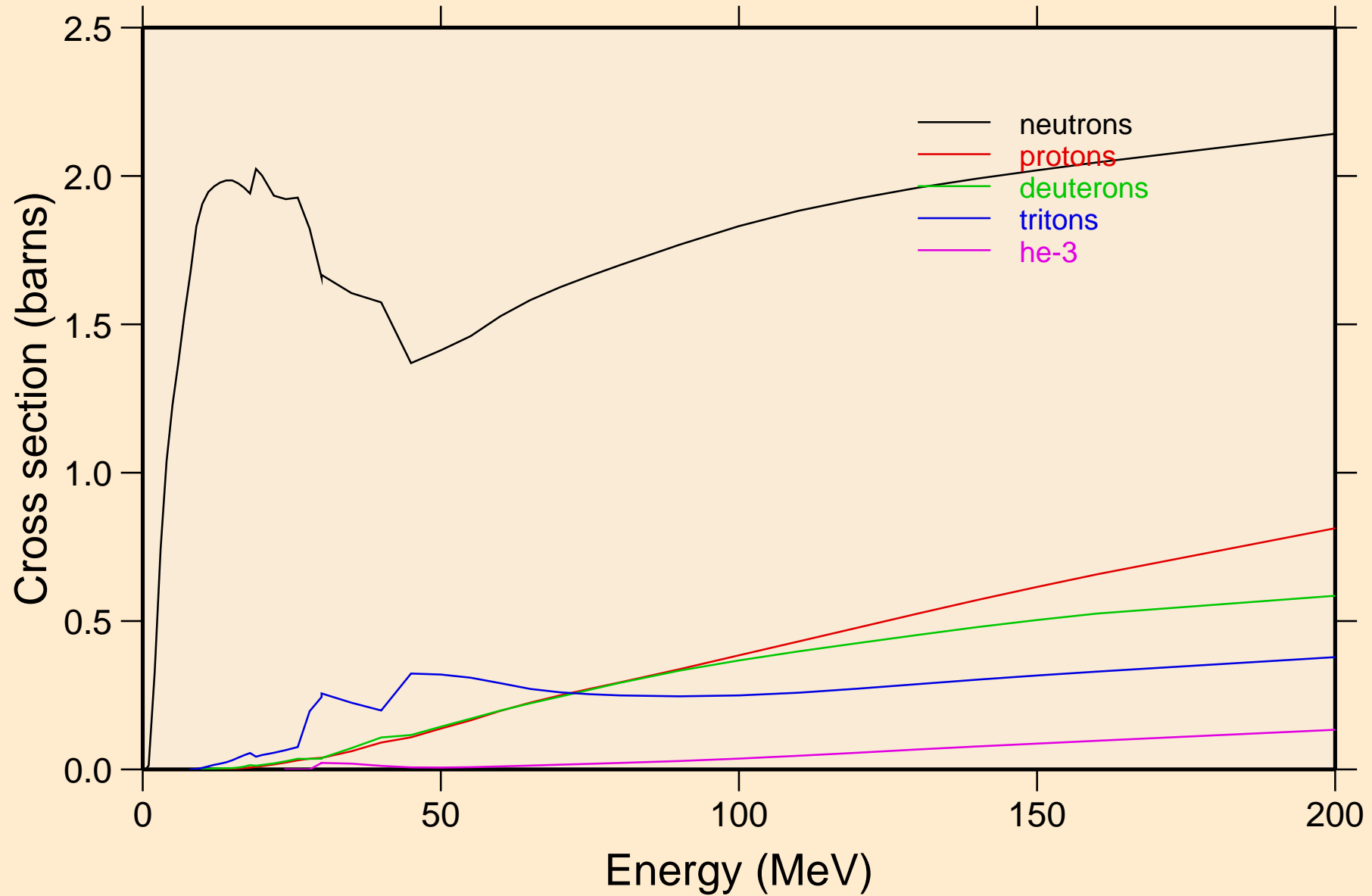

BE011 ALPHA ACER TENDL-2024 LIBRARY; T=0.K
neutrons from (a,n)

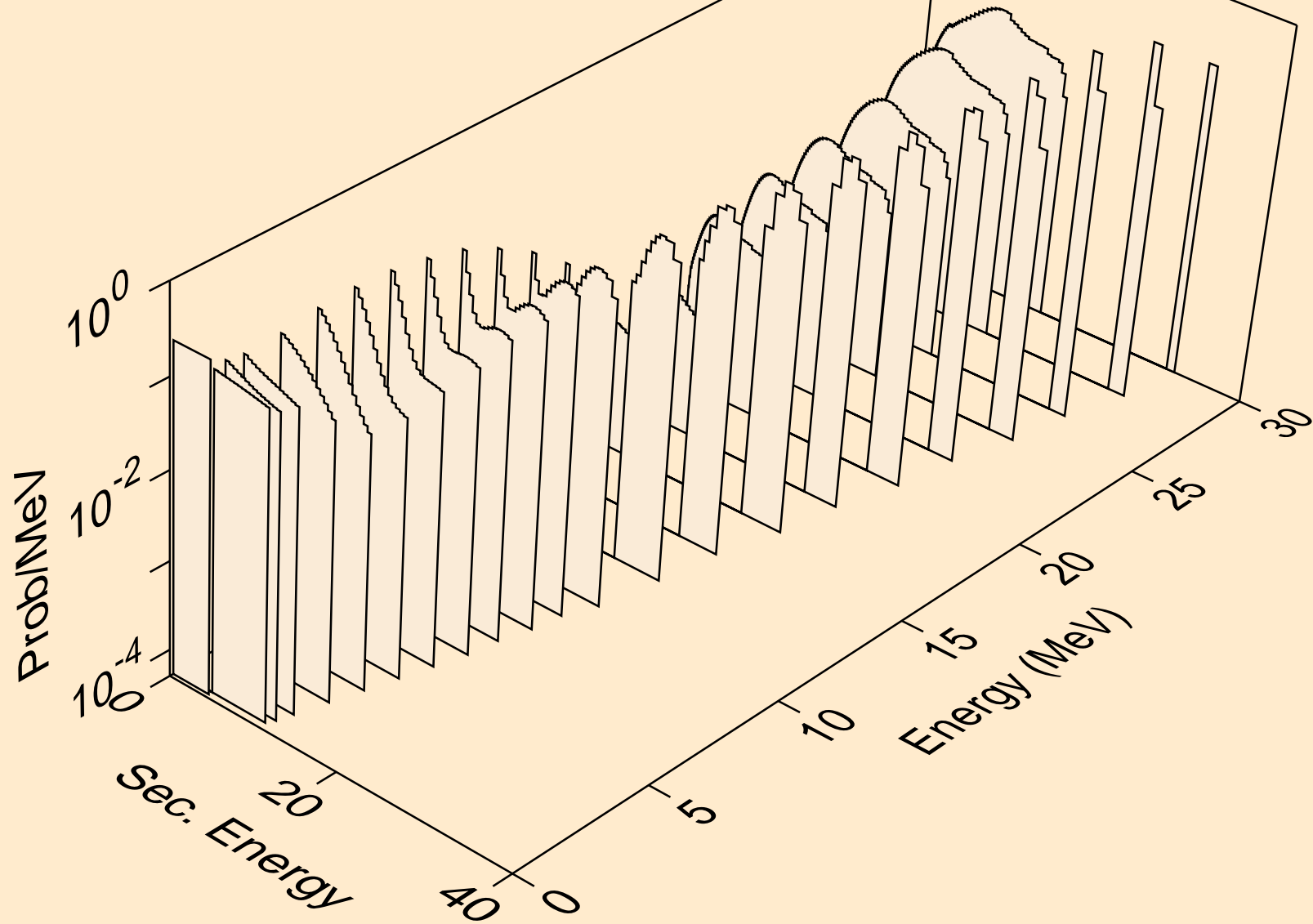

BE011 ALPHA ACER TENDL-2024 LIBRARY; T=0.K
neutrons from (a,x)

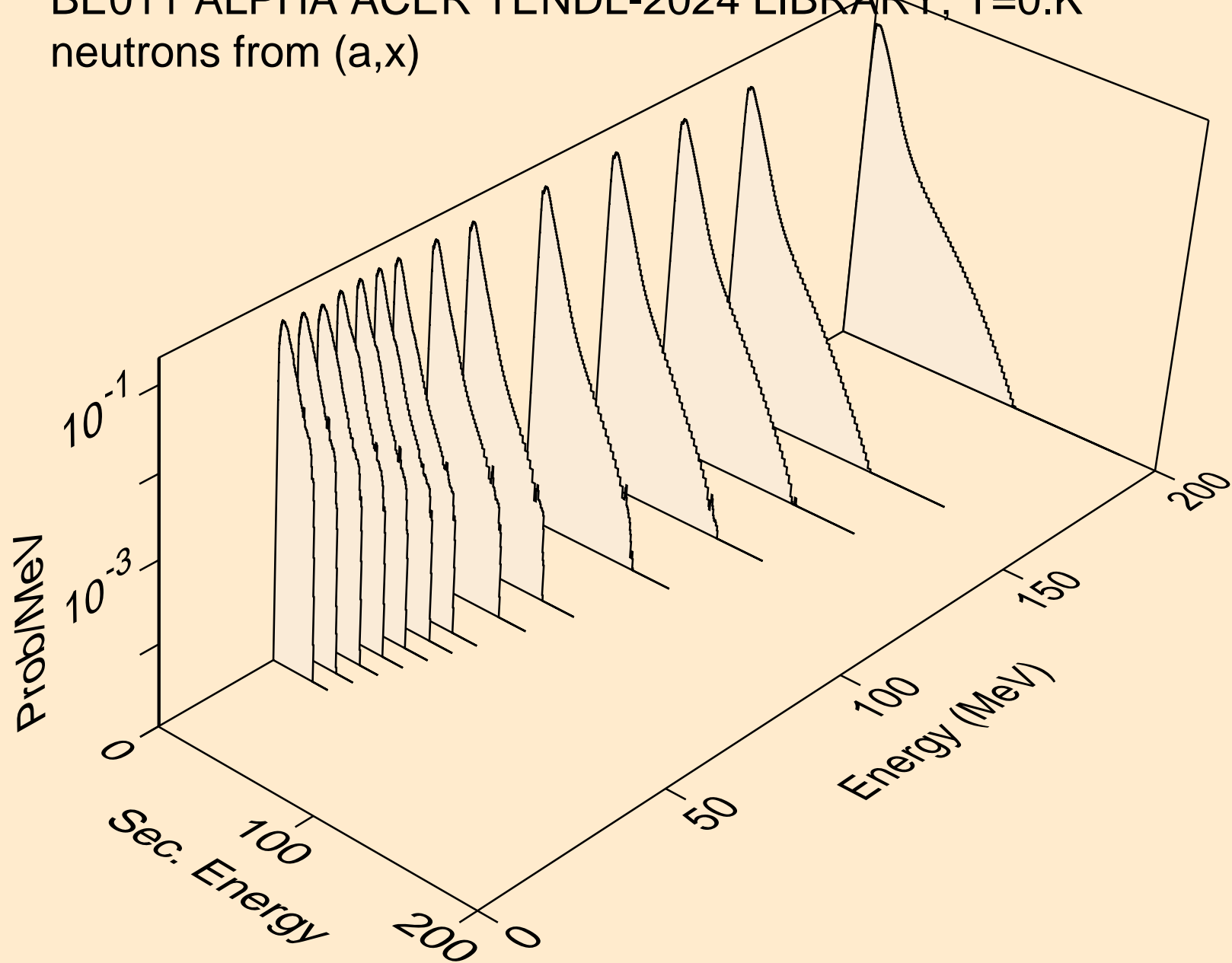

BE011 ALPHA ACER TENDL-2024 LIBRARY; T=0.K
neutrons from (a,2nd)

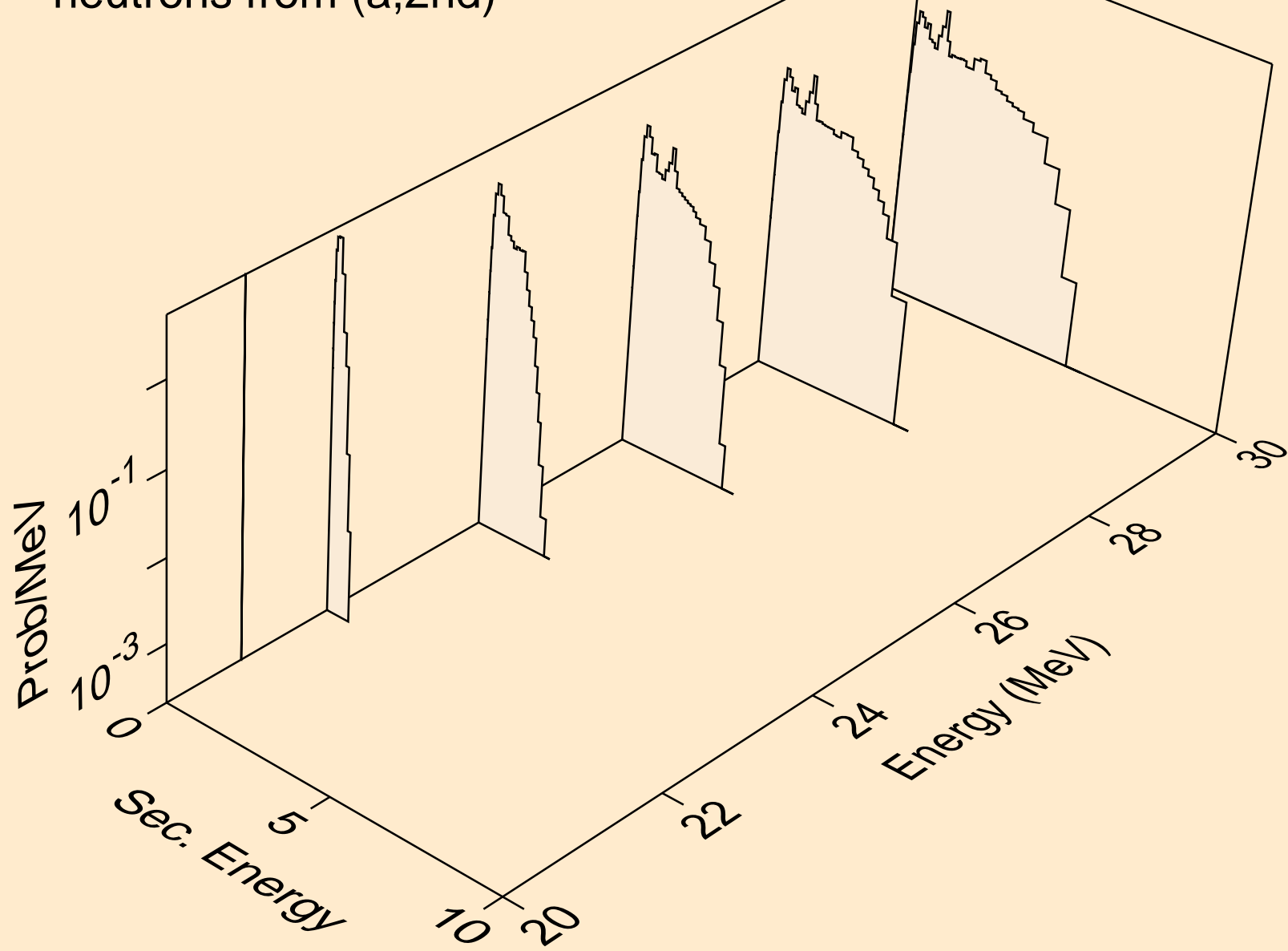

BE011 ALPHA ACER TENDL-2024 LIBRARY; T=0.K
neutrons from (a,2n)

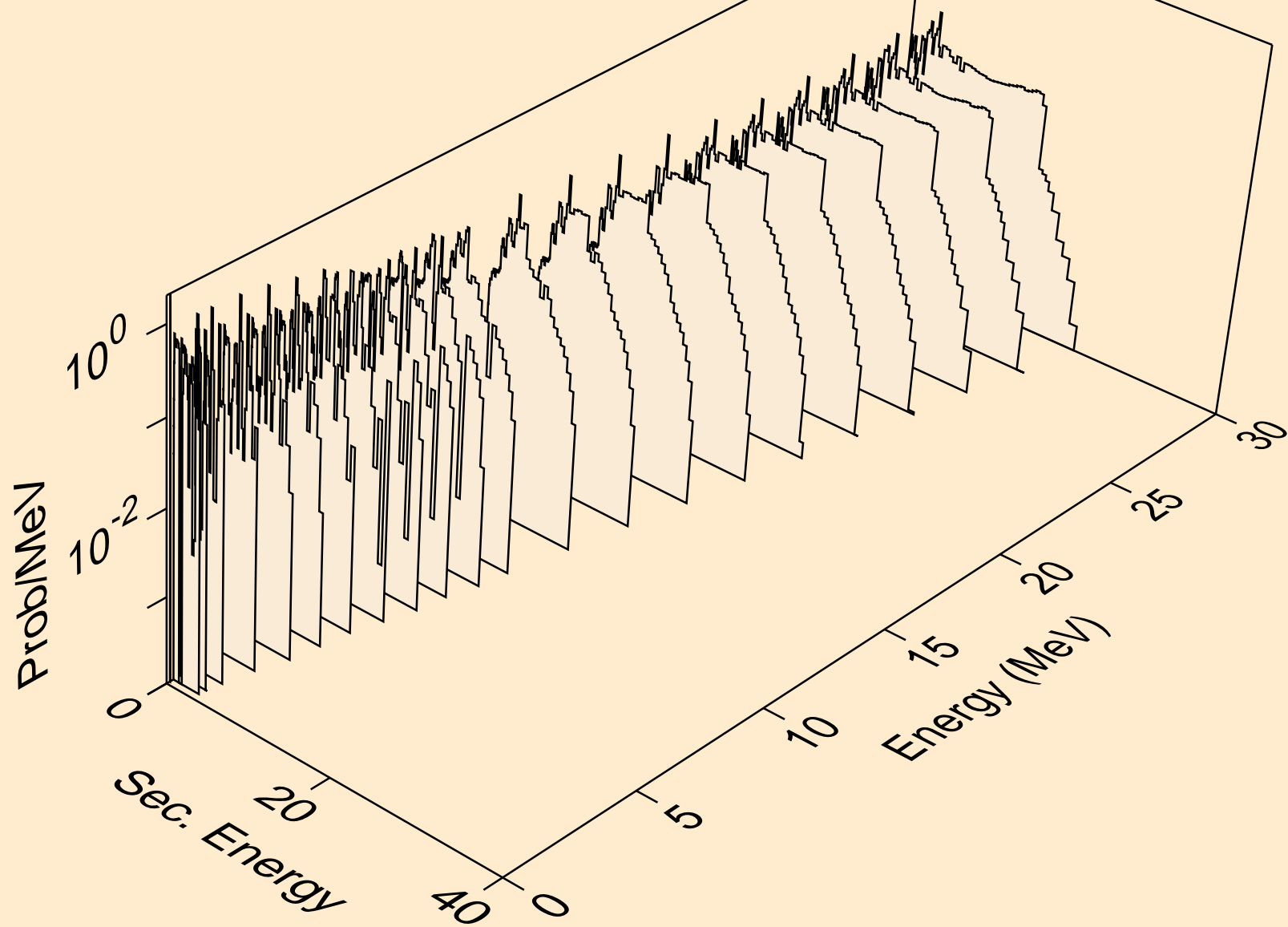

BE011 ALPHA ACER TENDL-2024 LIBRARY; T=0.K
neutrons from (a,3n)

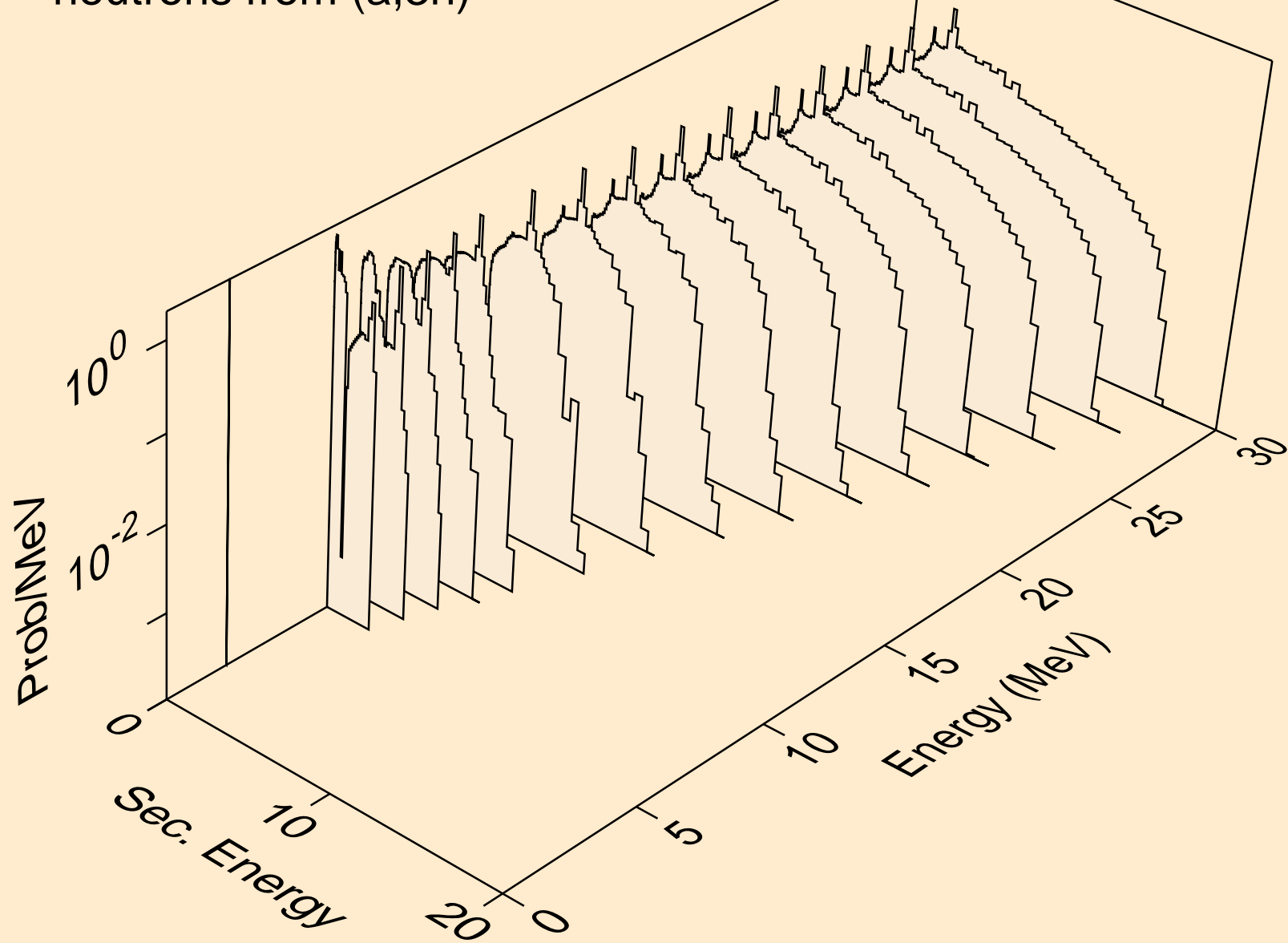

BE011 ALPHA ACER TENDL-2024 LIBRARY; T=0.K
neutrons from (a,n*)a

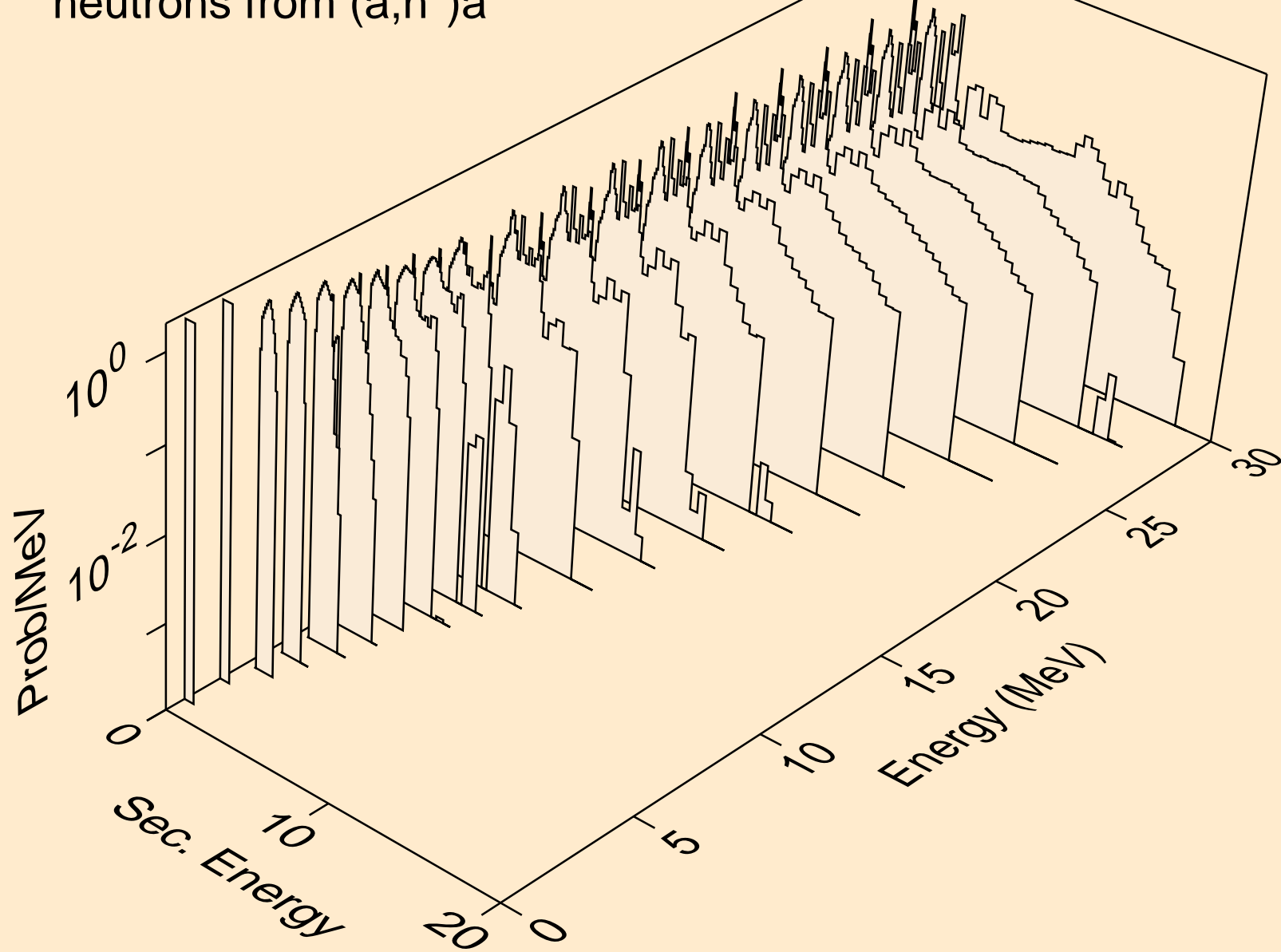

BE011 ALPHA ACER TENDL-2024 LIBRARY; T=0.K
neutrons from (a,2n)a

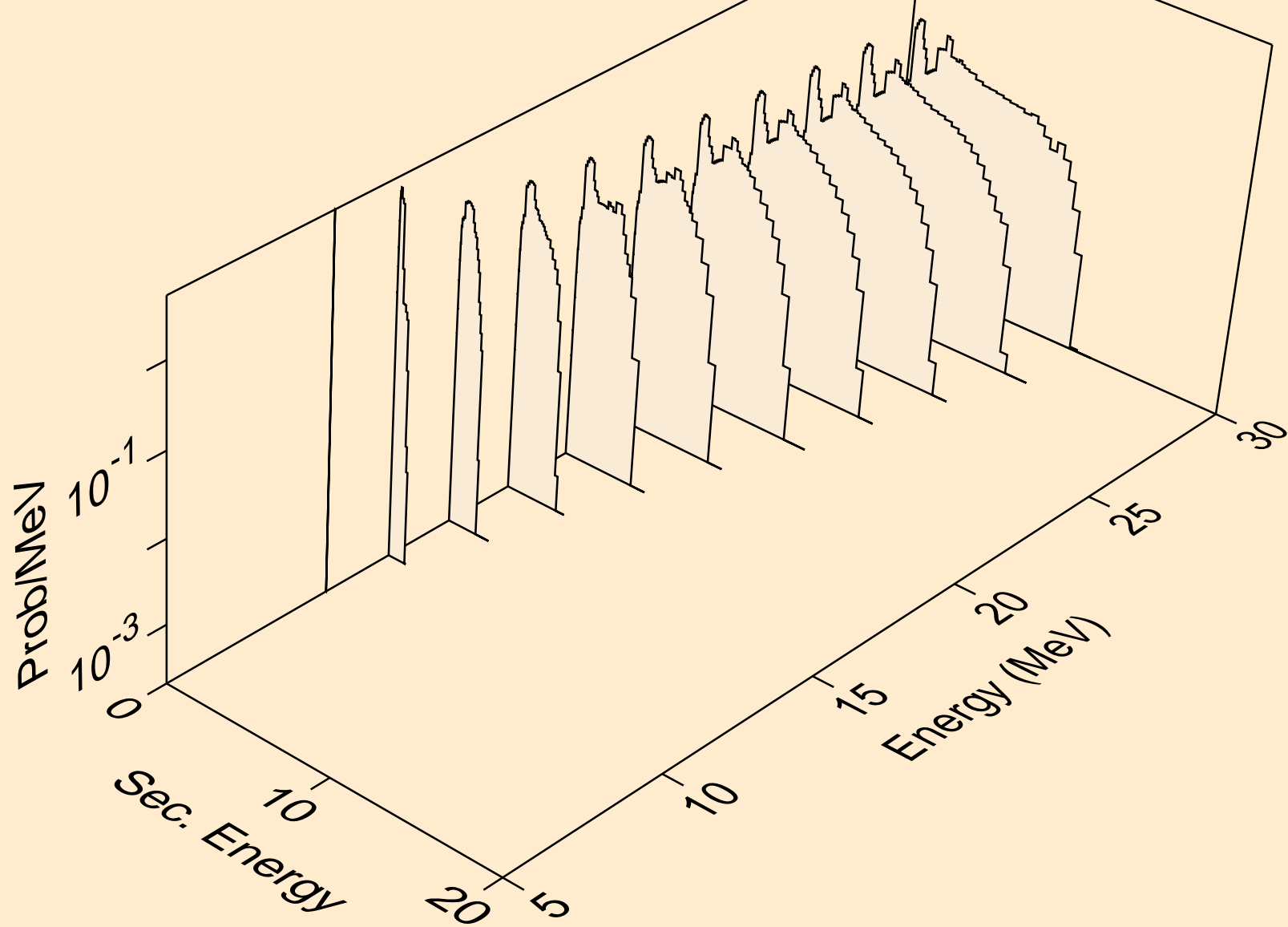

BE011 ALPHA ACER TENDL-2024 LIBRARY; T=0.K
neutrons from (a,3n)a

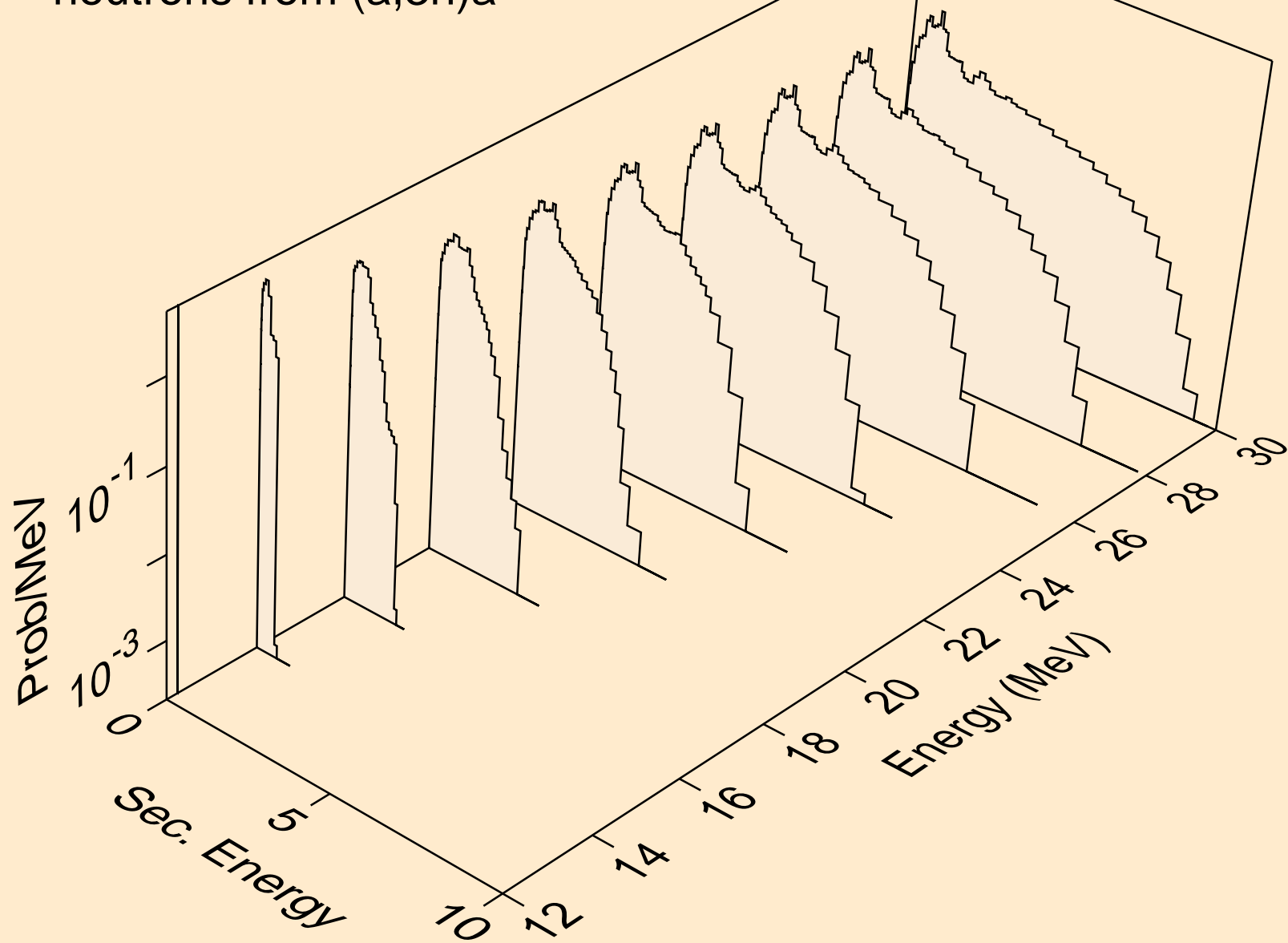

BE011 ALPHA ACER TENDL-2024 LIBRARY; T=0.K
neutrons from (a,n*)p

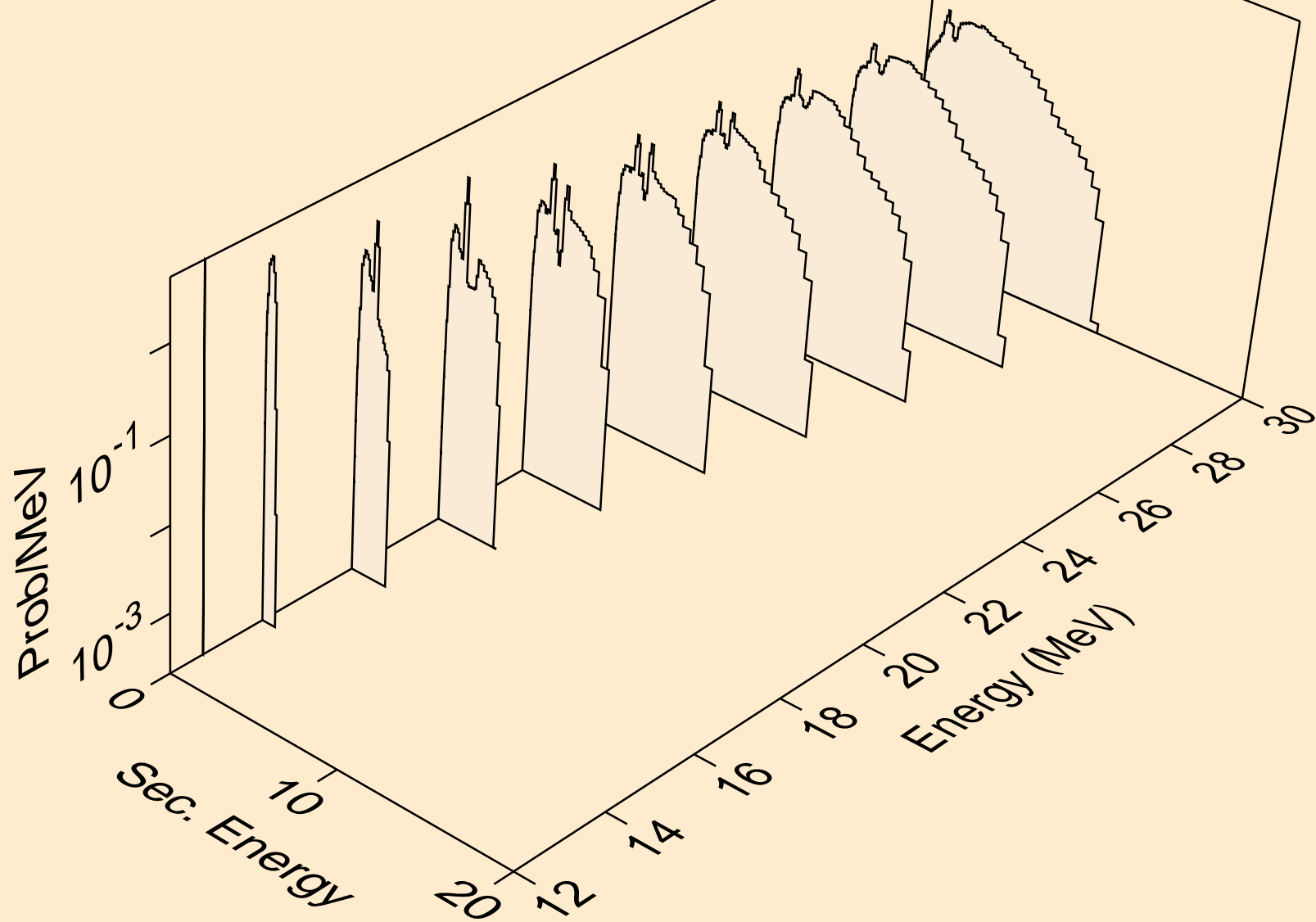

BE011 ALPHA ACER TENDL-2024 LIBRARY; T=0.K
neutrons from (a,n*)d

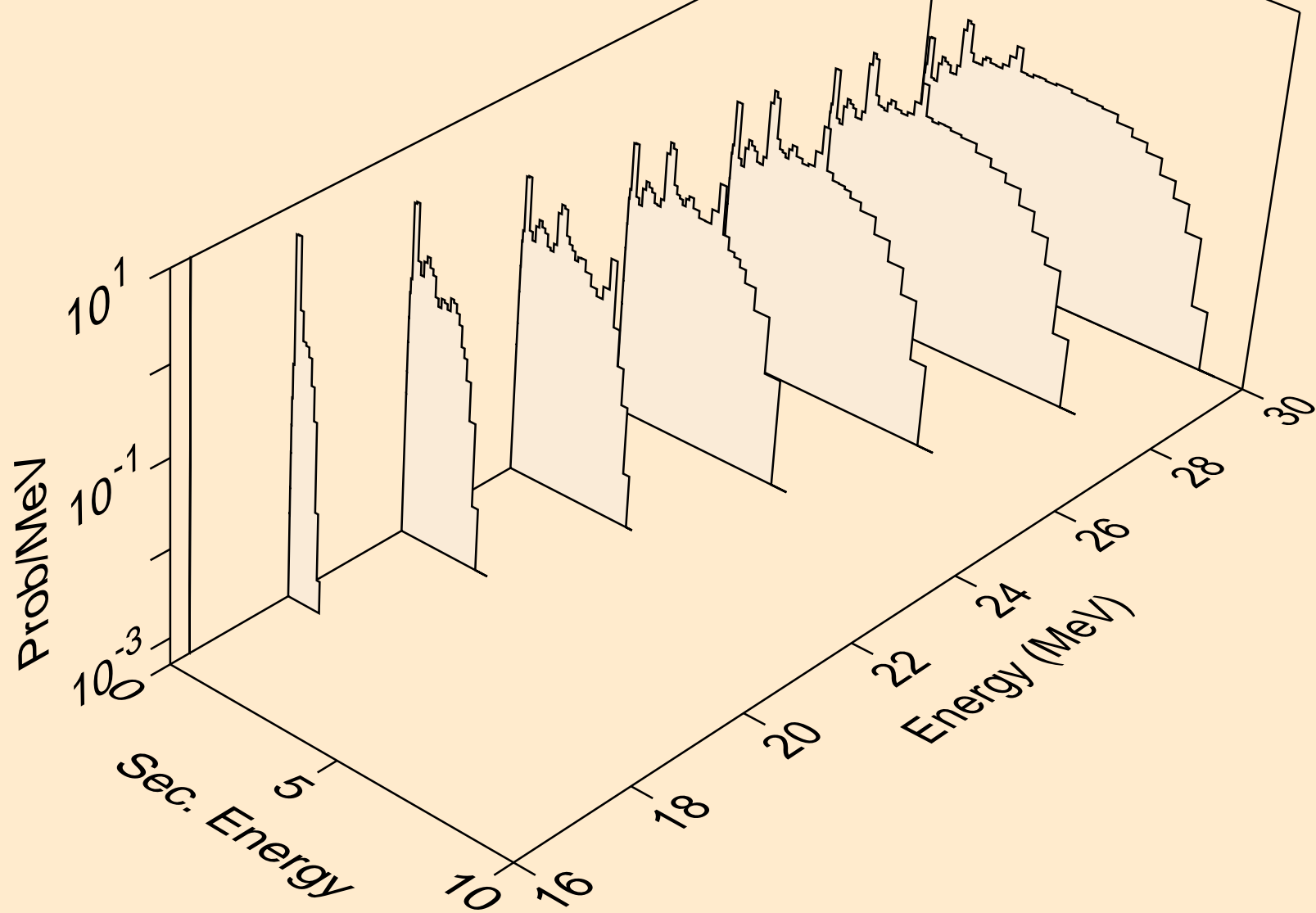

BE011 ALPHA ACER TENDL-2024 LIBRARY; T=0.K
neutrons from (a,n*)t

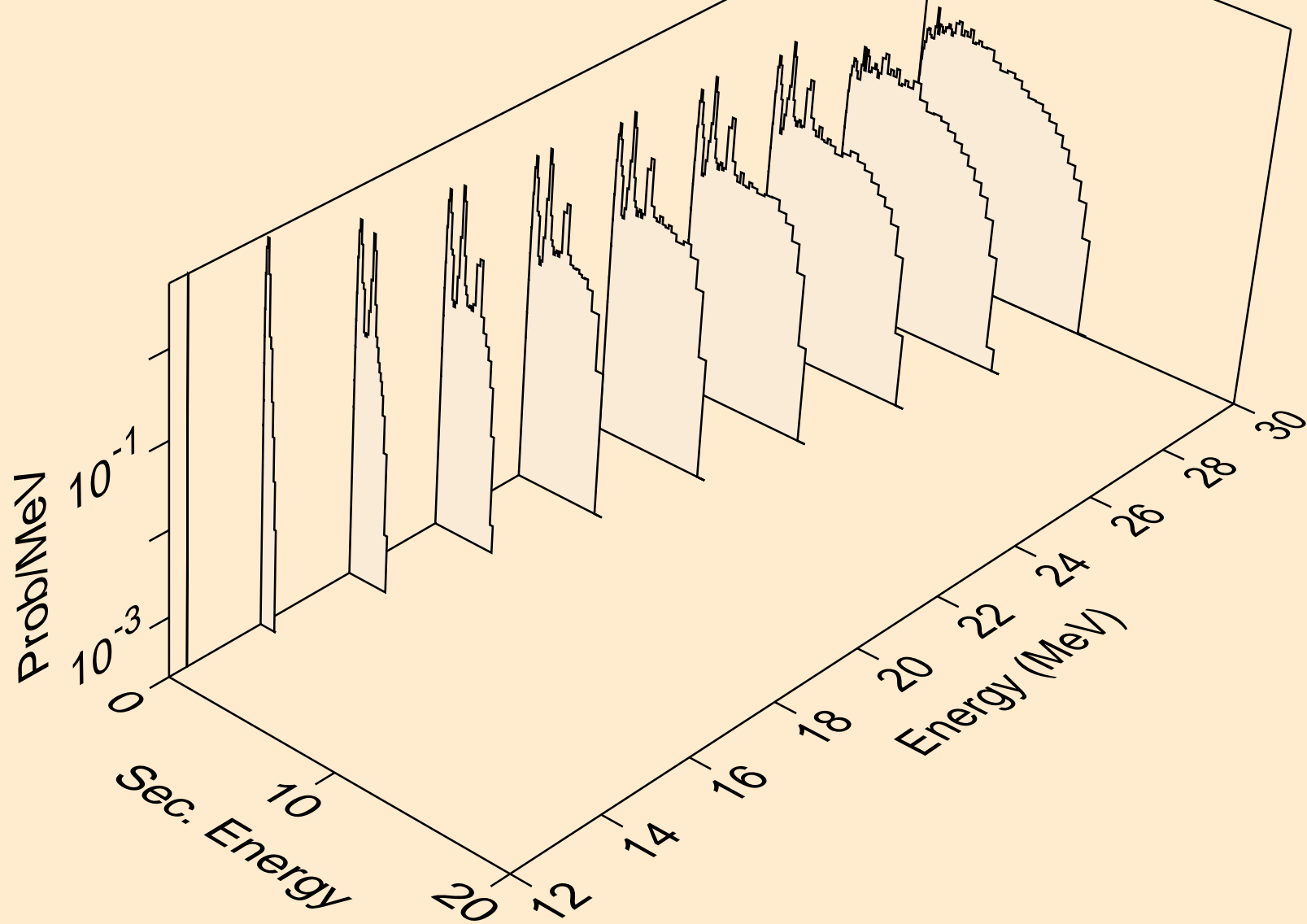

BE011 ALPHA ACER TENDL-2024 LIBRARY; T=0.K
neutrons from (a,4n)

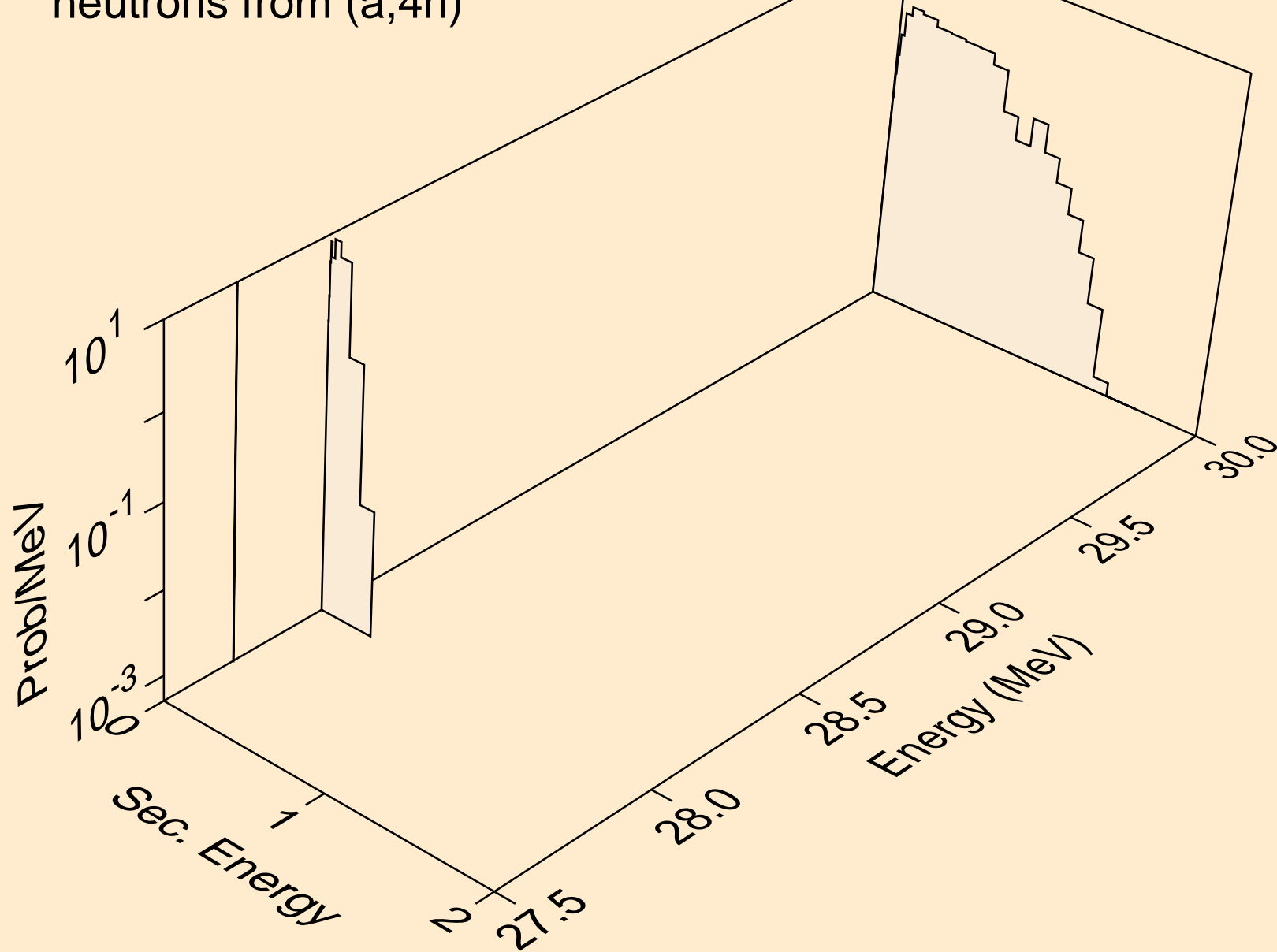

BE011 ALPHA ACER TENDL-2024 LIBRARY; T=0.K
neutrons from (a,2np)

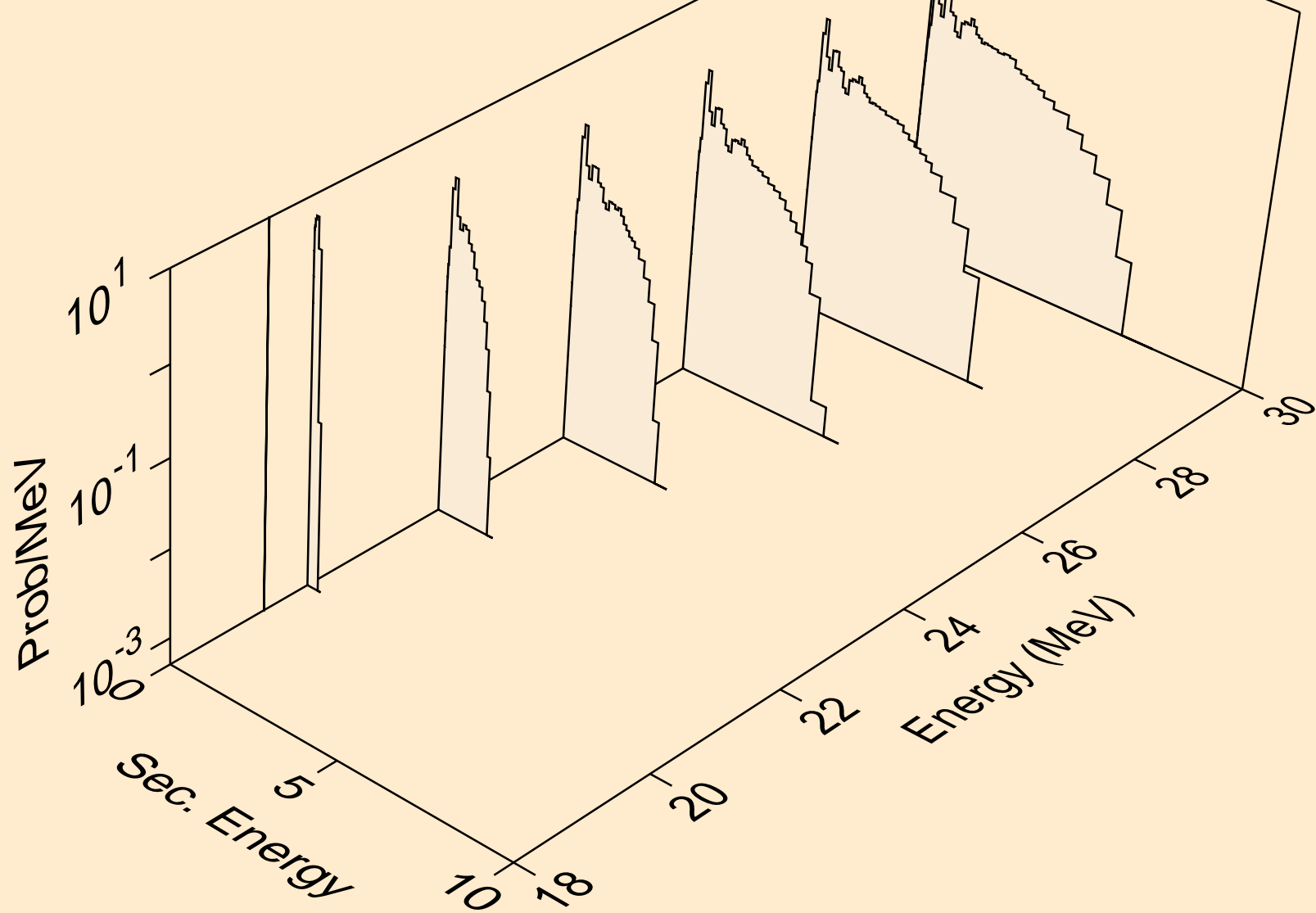

BE011 ALPHA ACER TENDL-2024 LIBRARY; T=0.K
neutrons from (a,3np)

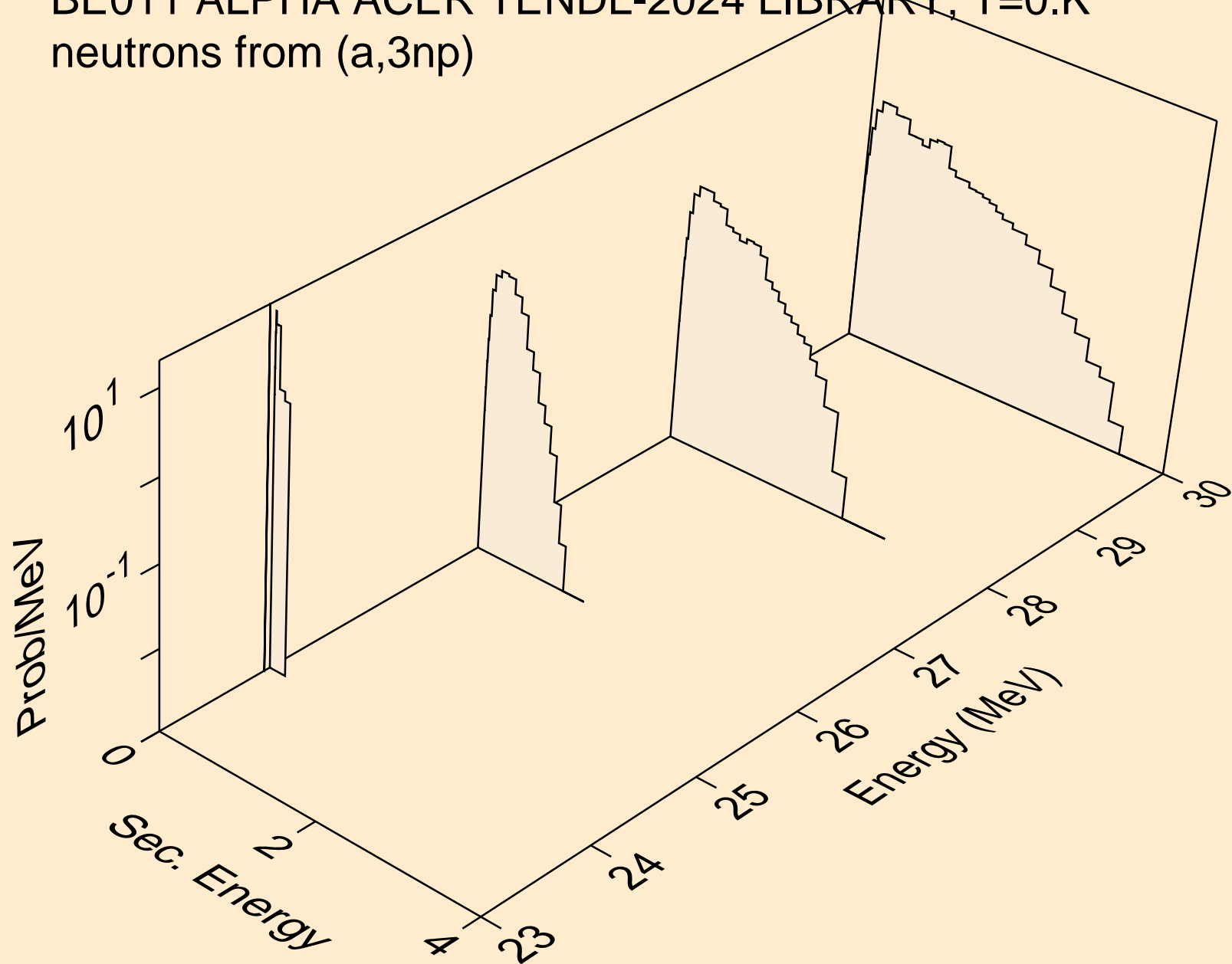

BE011 ALPHA ACER TENDL-2024 LIBRARY; T=0.K
neutrons from (a,npa)

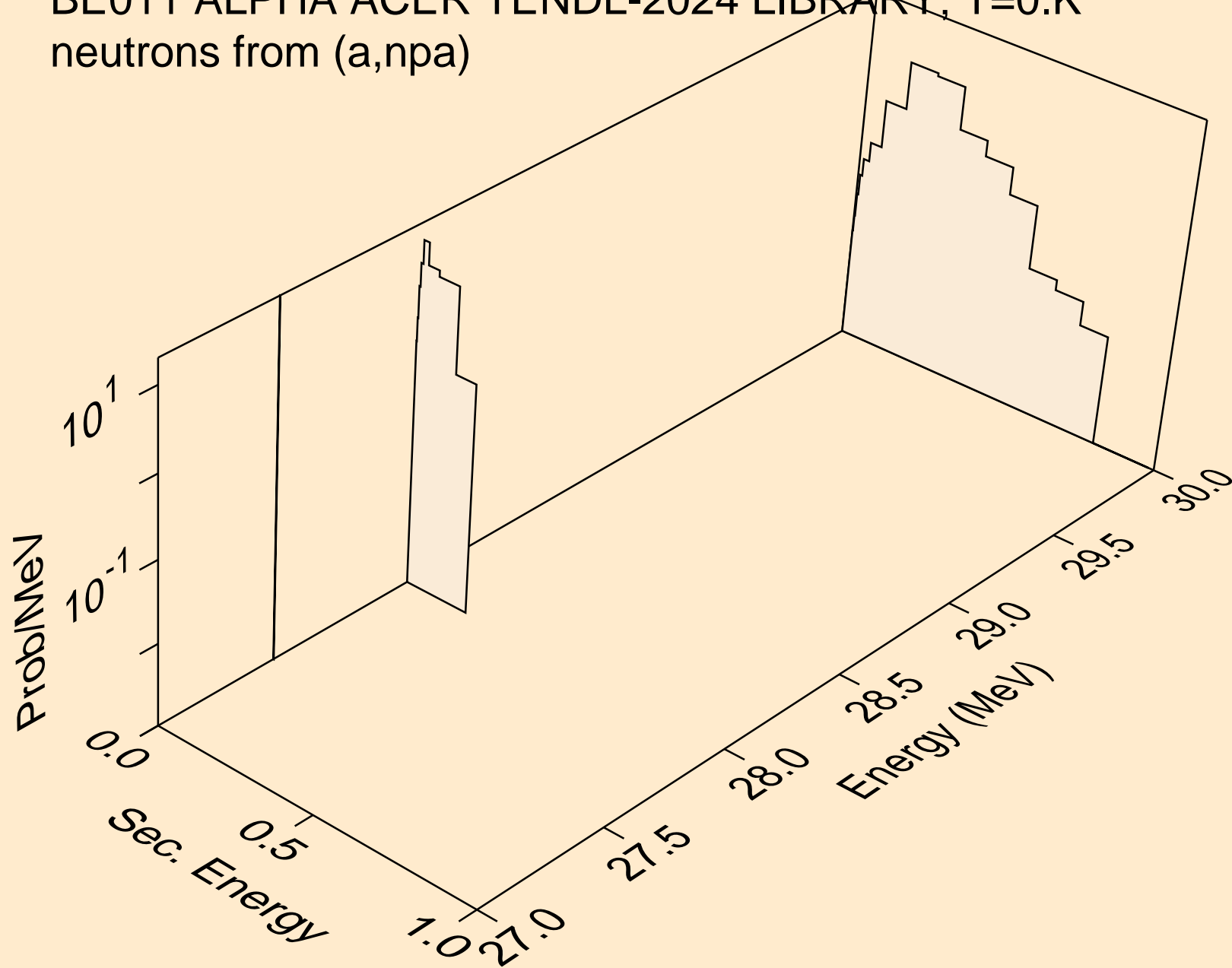

BE011 ALPHA ACER TENDL-2024 LIBRARY; T=0.K
protons from (a,x)

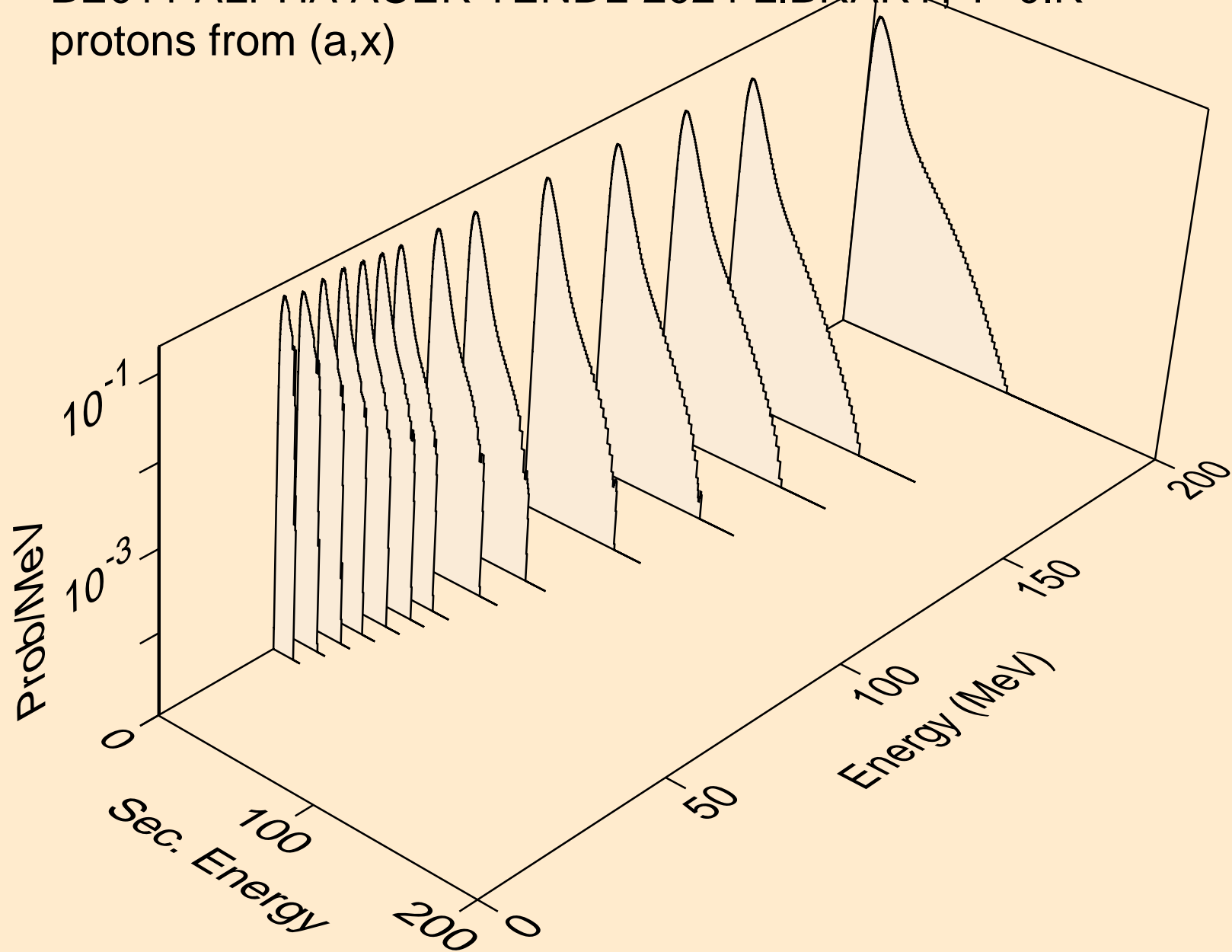

BE011 ALPHA ACER TENDL-2024 LIBRARY; T=0.K
protons from (a,n*)p

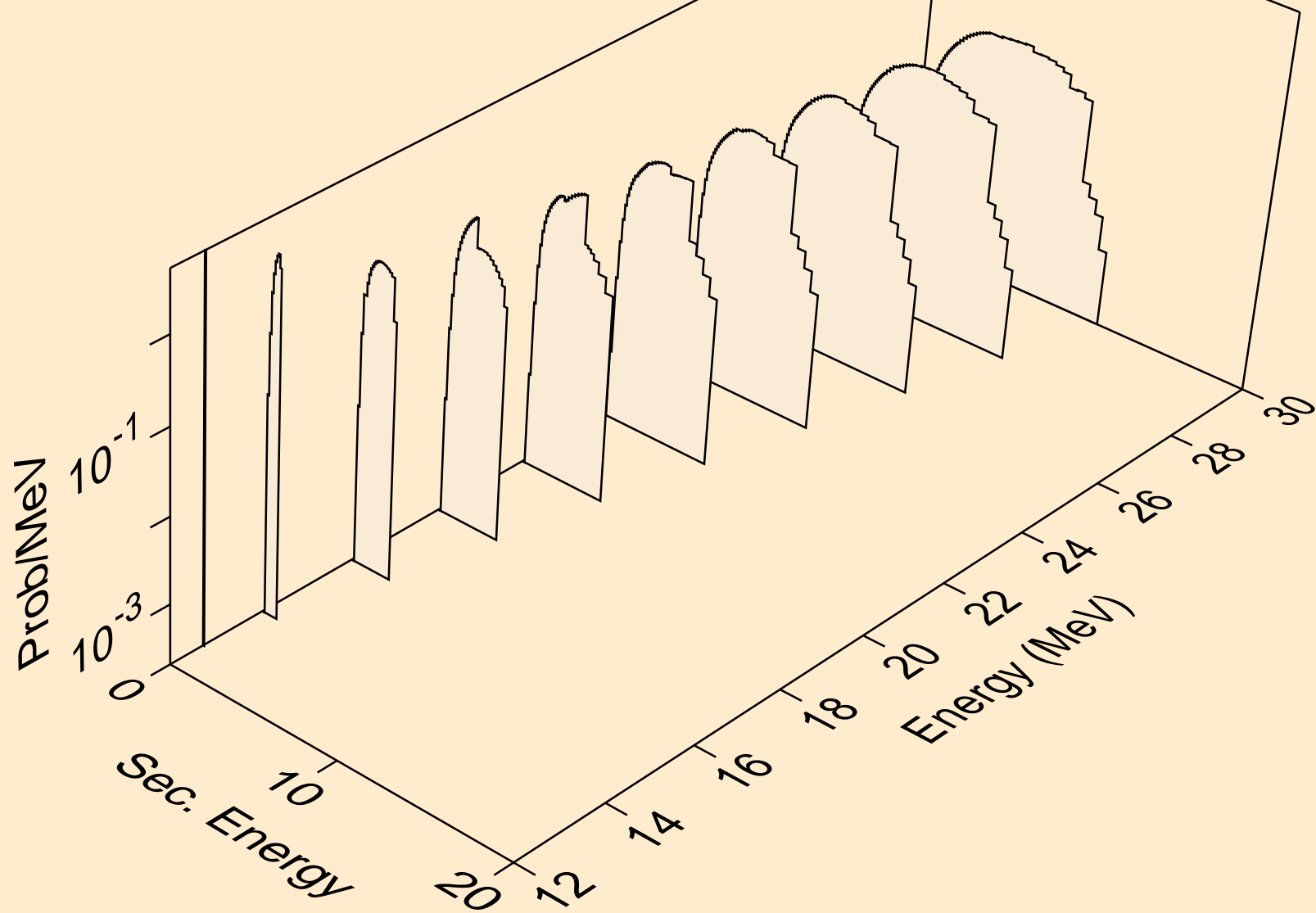

BE011 ALPHA ACER TENDL-2024 LIBRARY; T=0.K
protons from (a,2np)

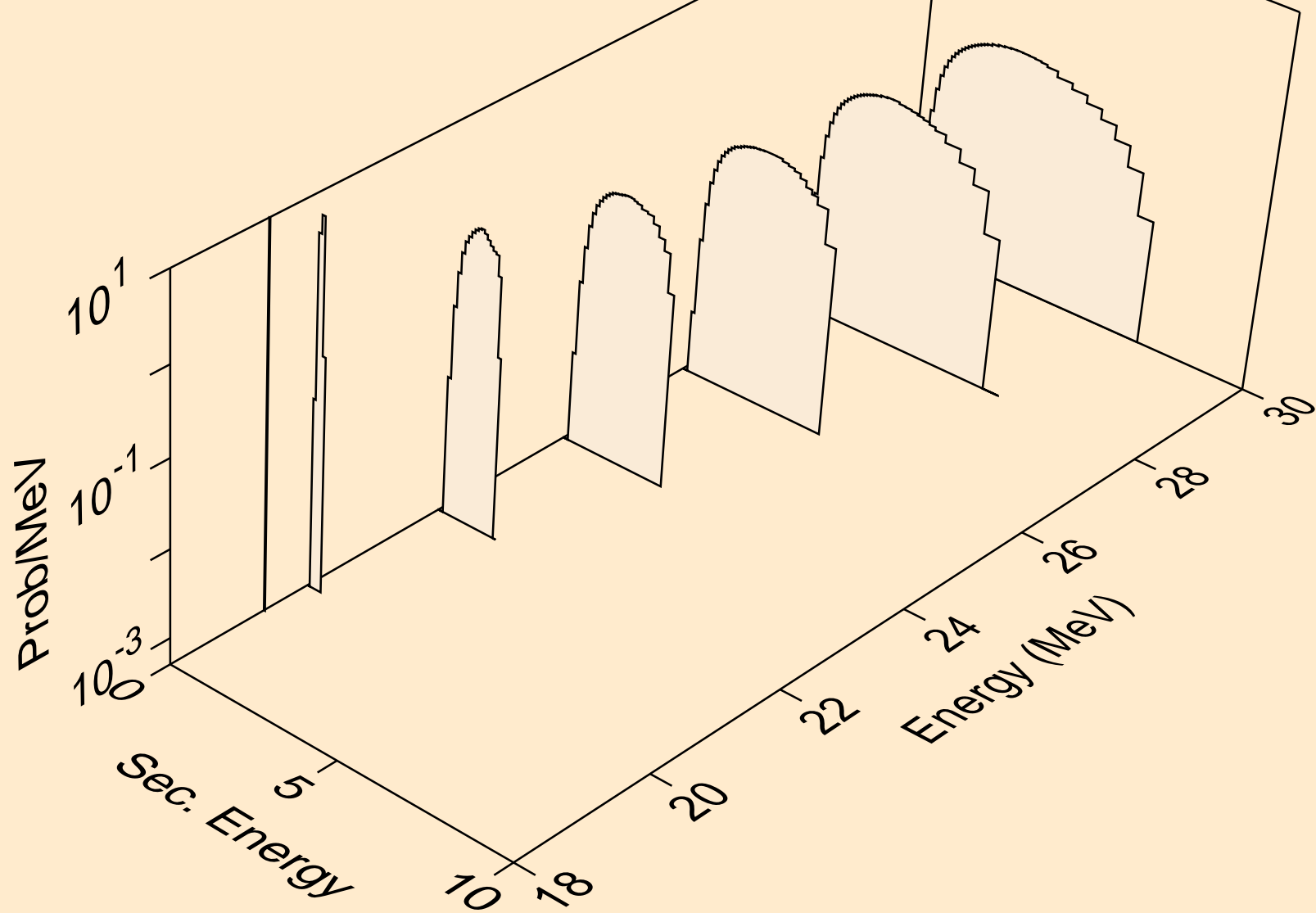

BE011 ALPHA ACER TENDL-2024 LIBRARY; T=0.K
protons from (a,3np)

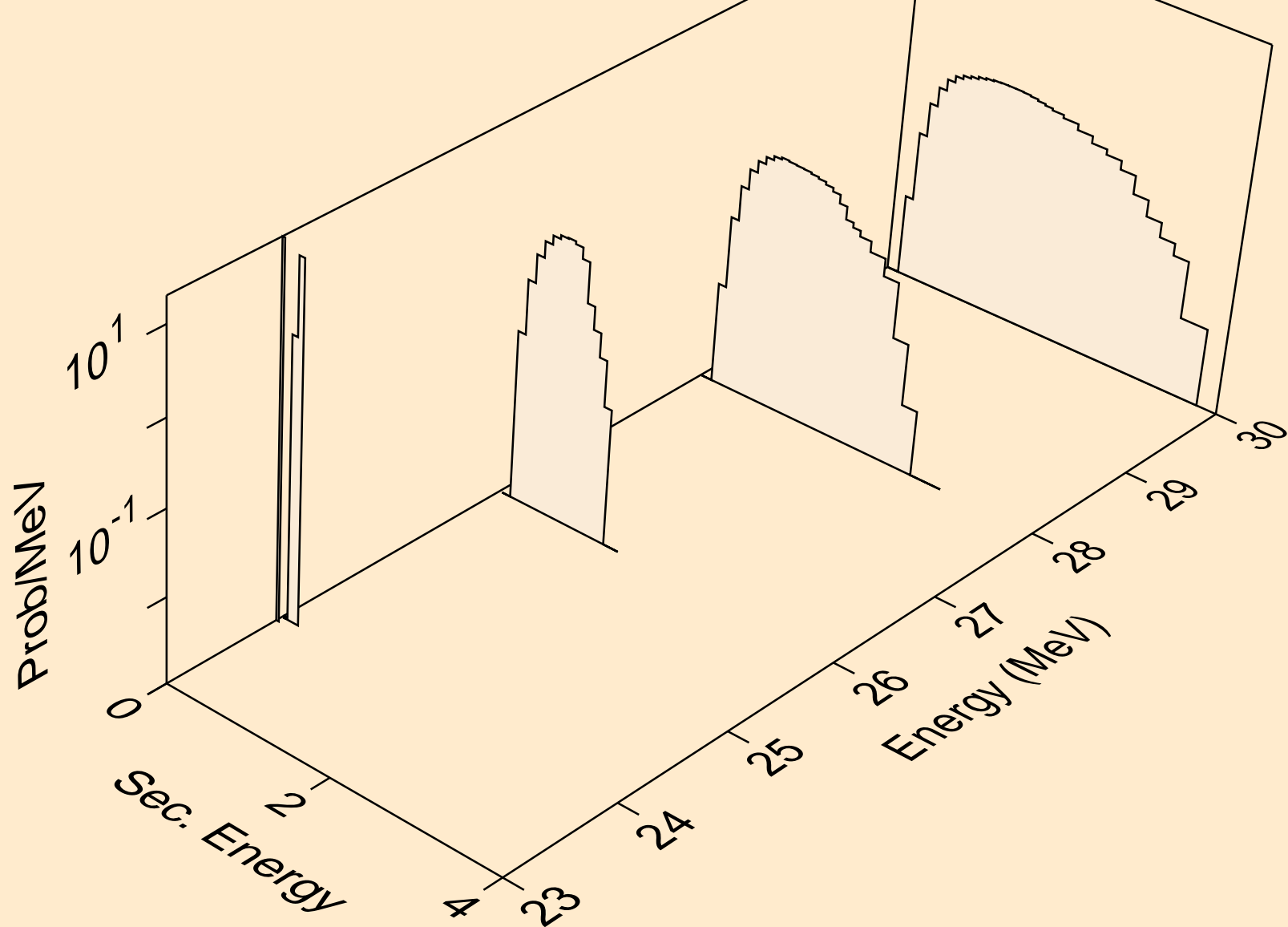

BE011 ALPHA ACER TENDL-2024 LIBRARY; T=0.K
protons from (a,npa)

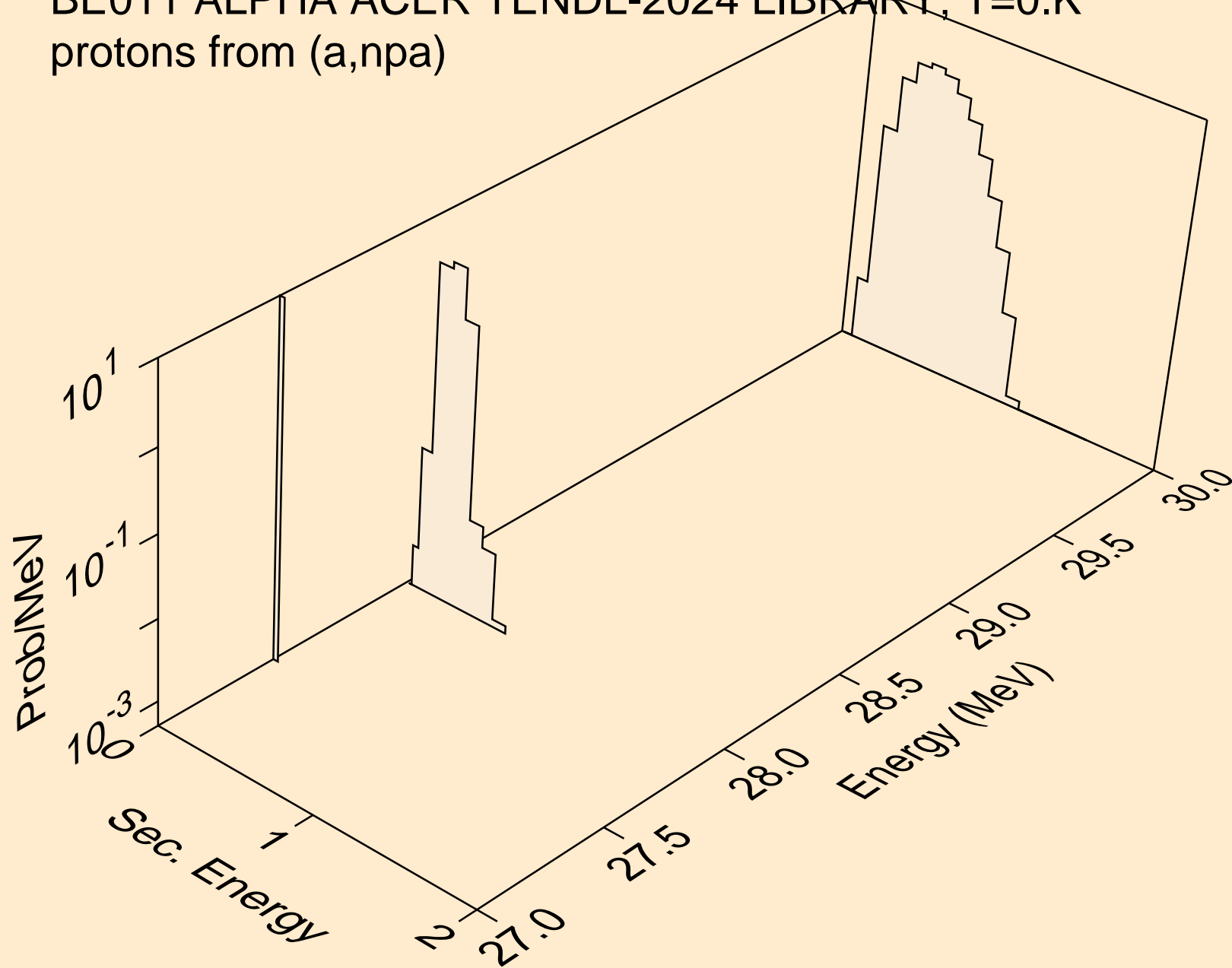

BE011 ALPHA ACER TENDL-2024 LIBRARY; T=0.K
protons from (a,p)

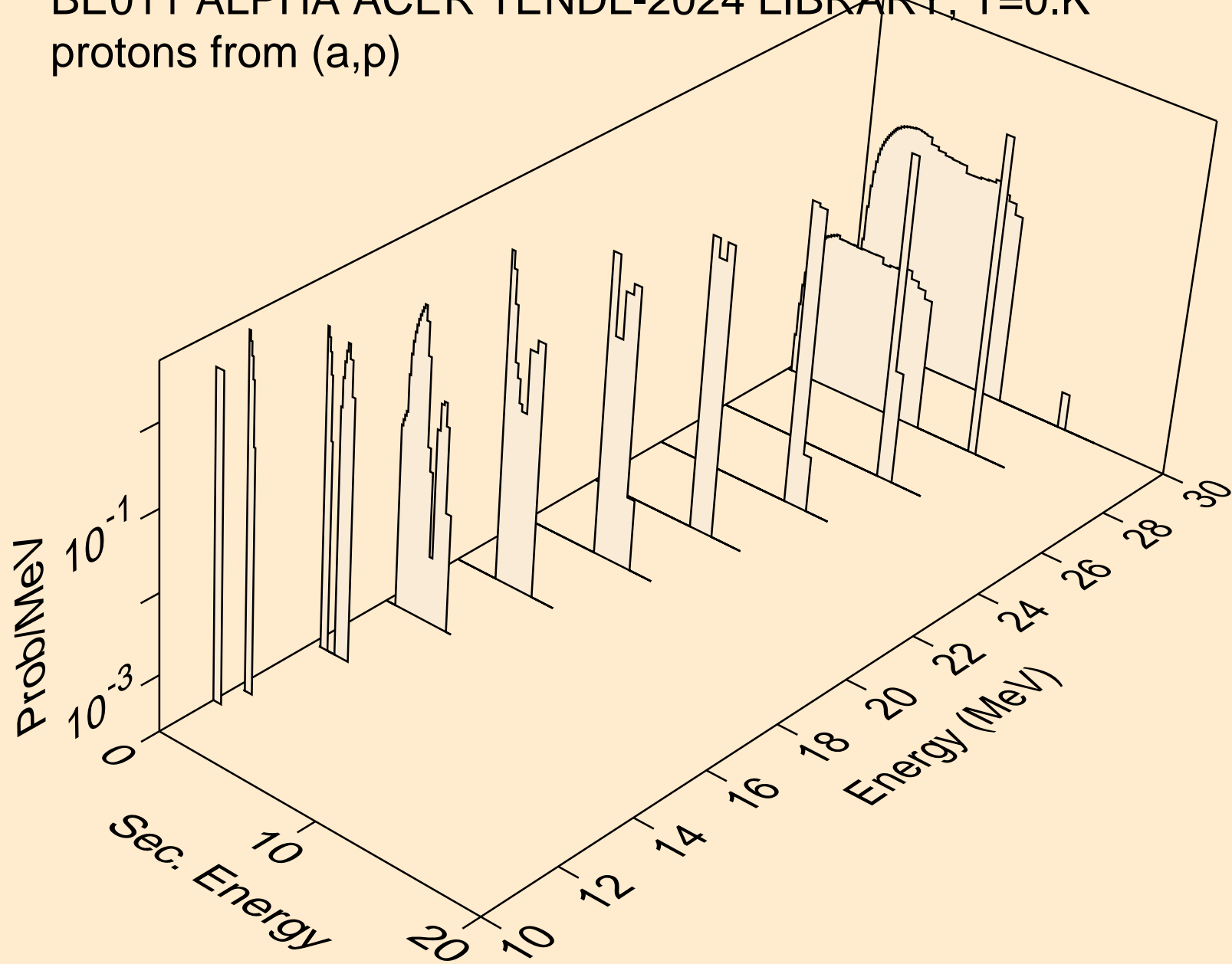

BE011 ALPHA ACER TENDL-2024 LIBRARY; T=0.K
protons from (a,pa)

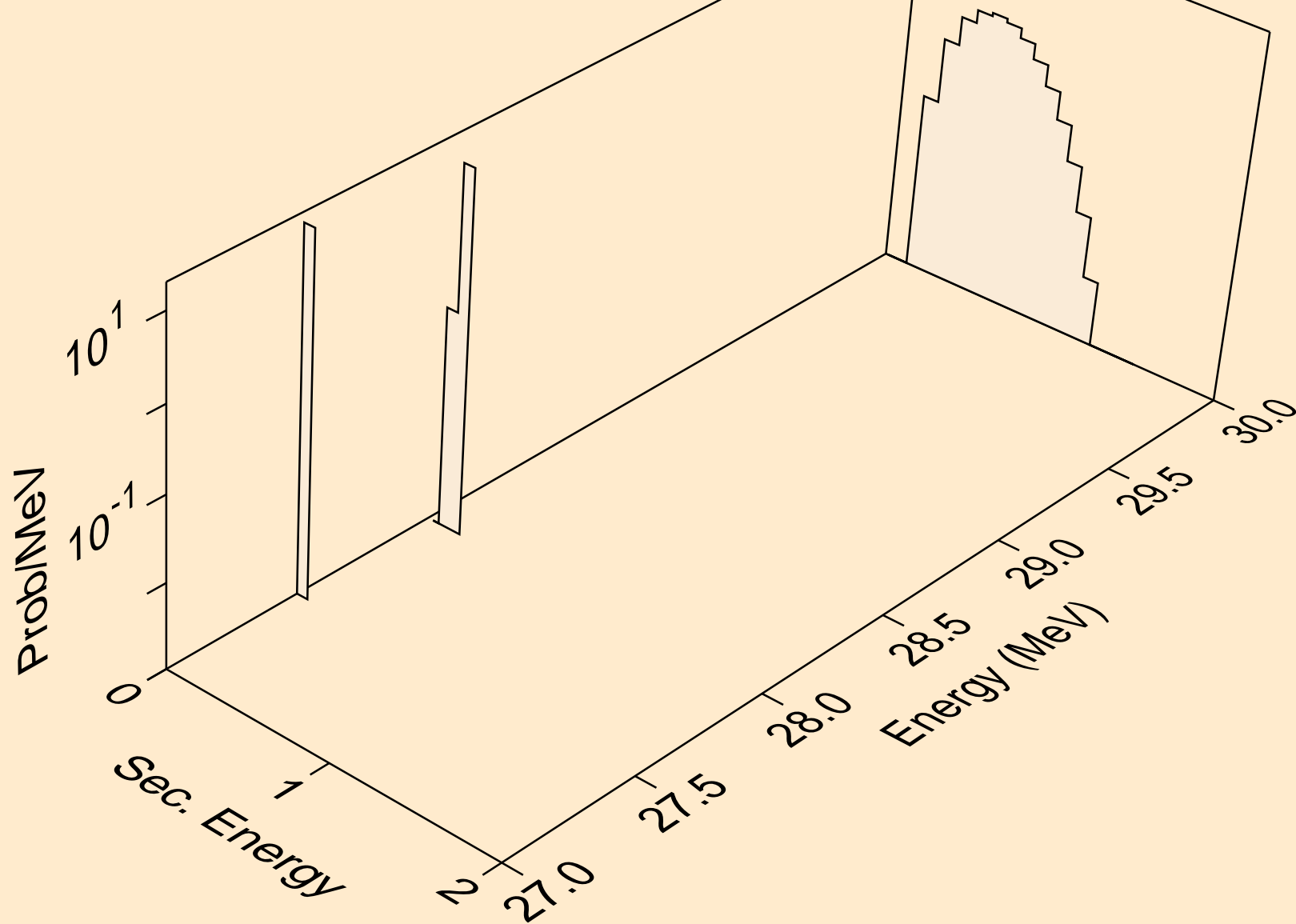

BE011 ALPHA ACER TENDL-2024 LIBRARY; T=0.K
protons from (a,pt)

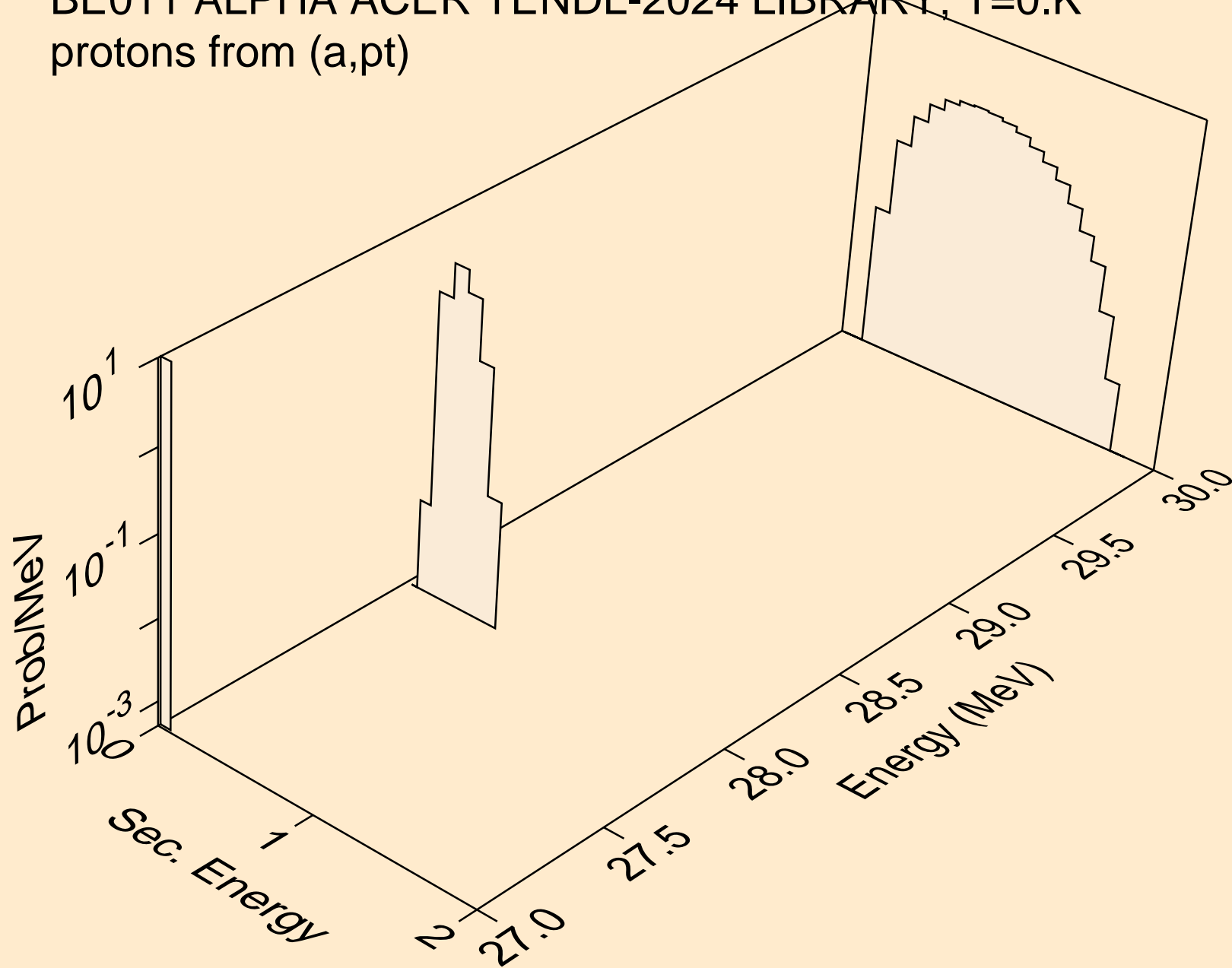

BE011 ALPHA ACER TENDL-2024 LIBRARY; T=0.K
deuterons from (a,x)

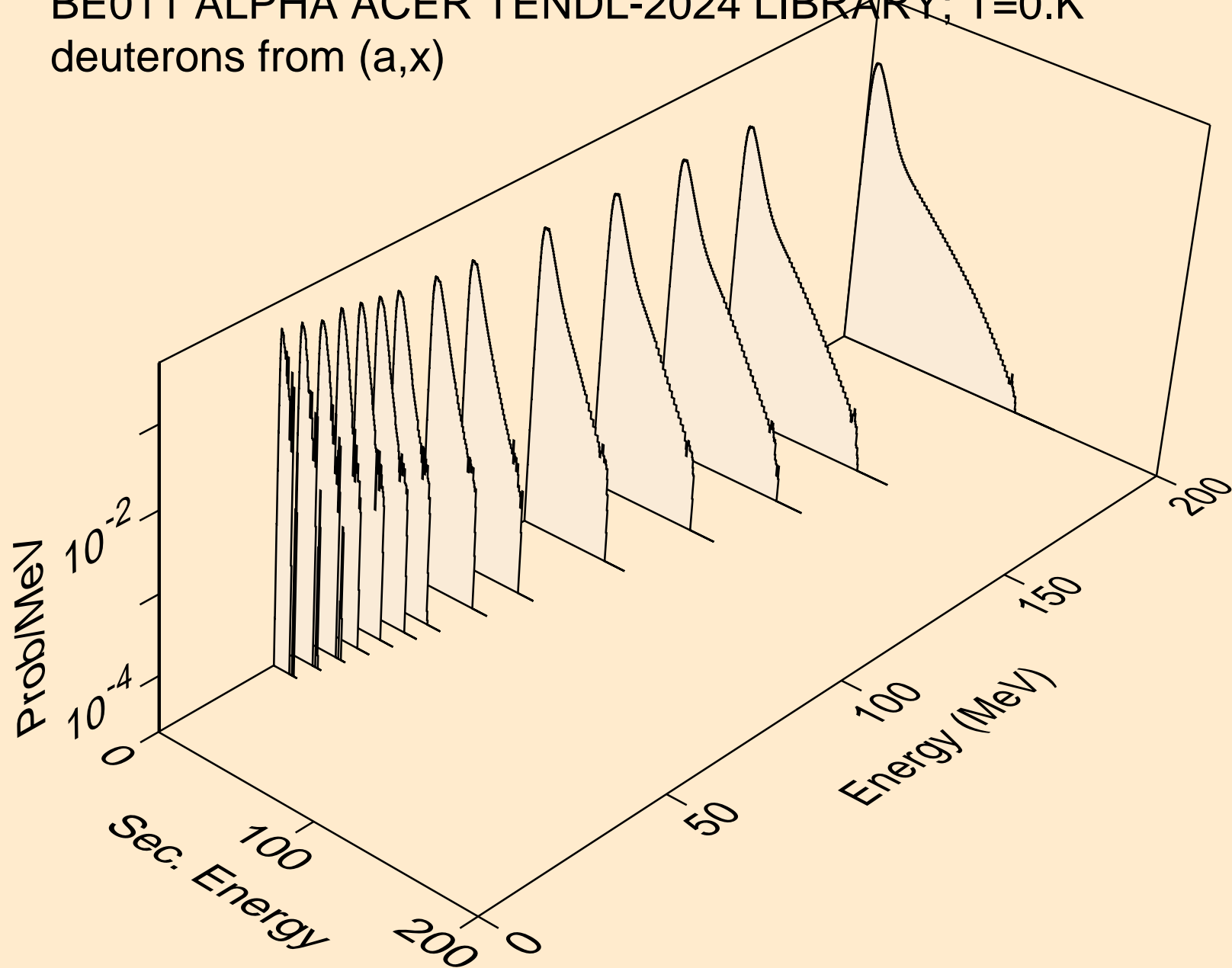

BE011 ALPHA ACER TENDL-2024 LIBRARY; T=0.K
deuterons from (a,2nd)

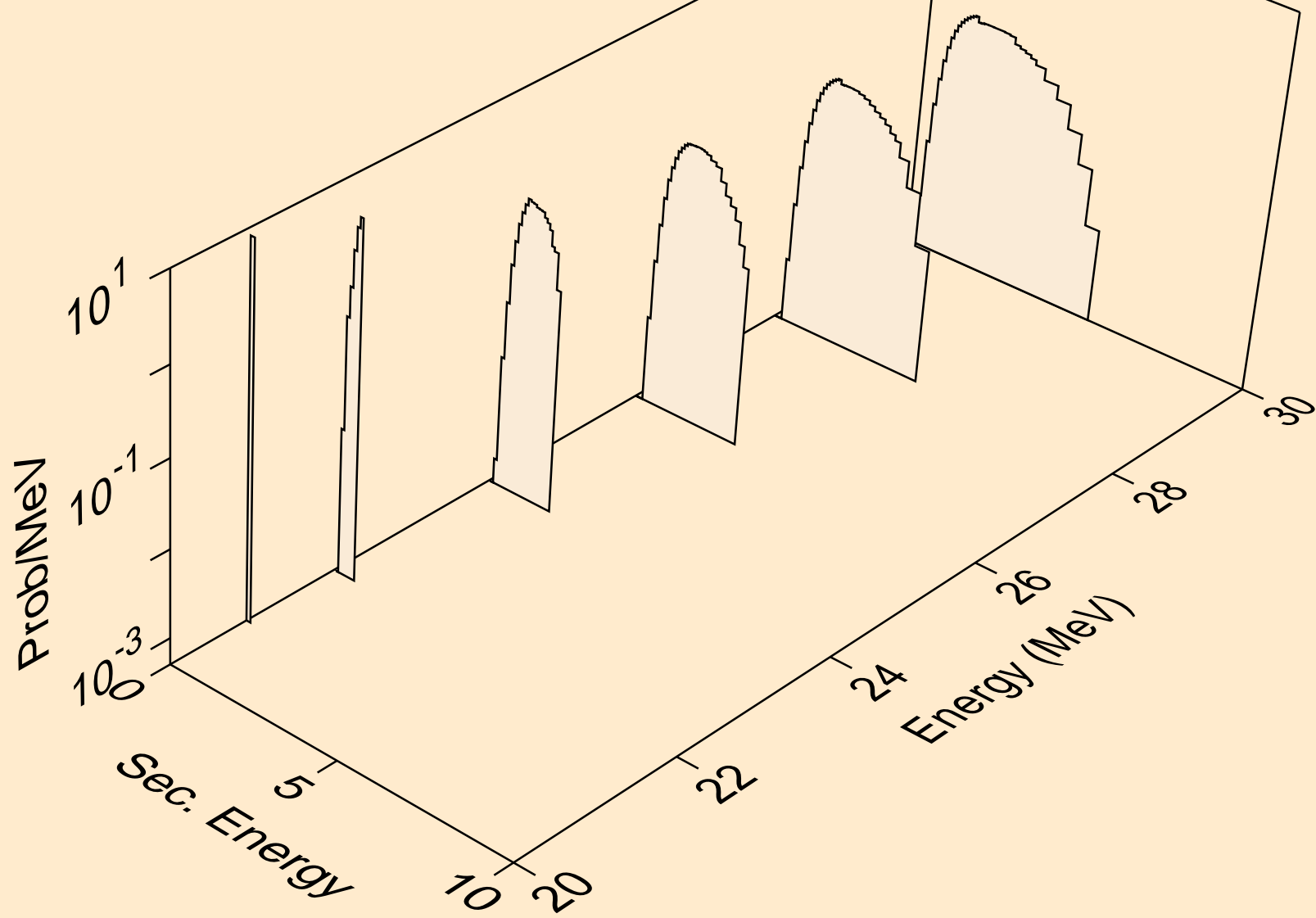

BE011 ALPHA ACER TENDL-2024 LIBRARY; T=0.K
deuterons from (a,n*)d

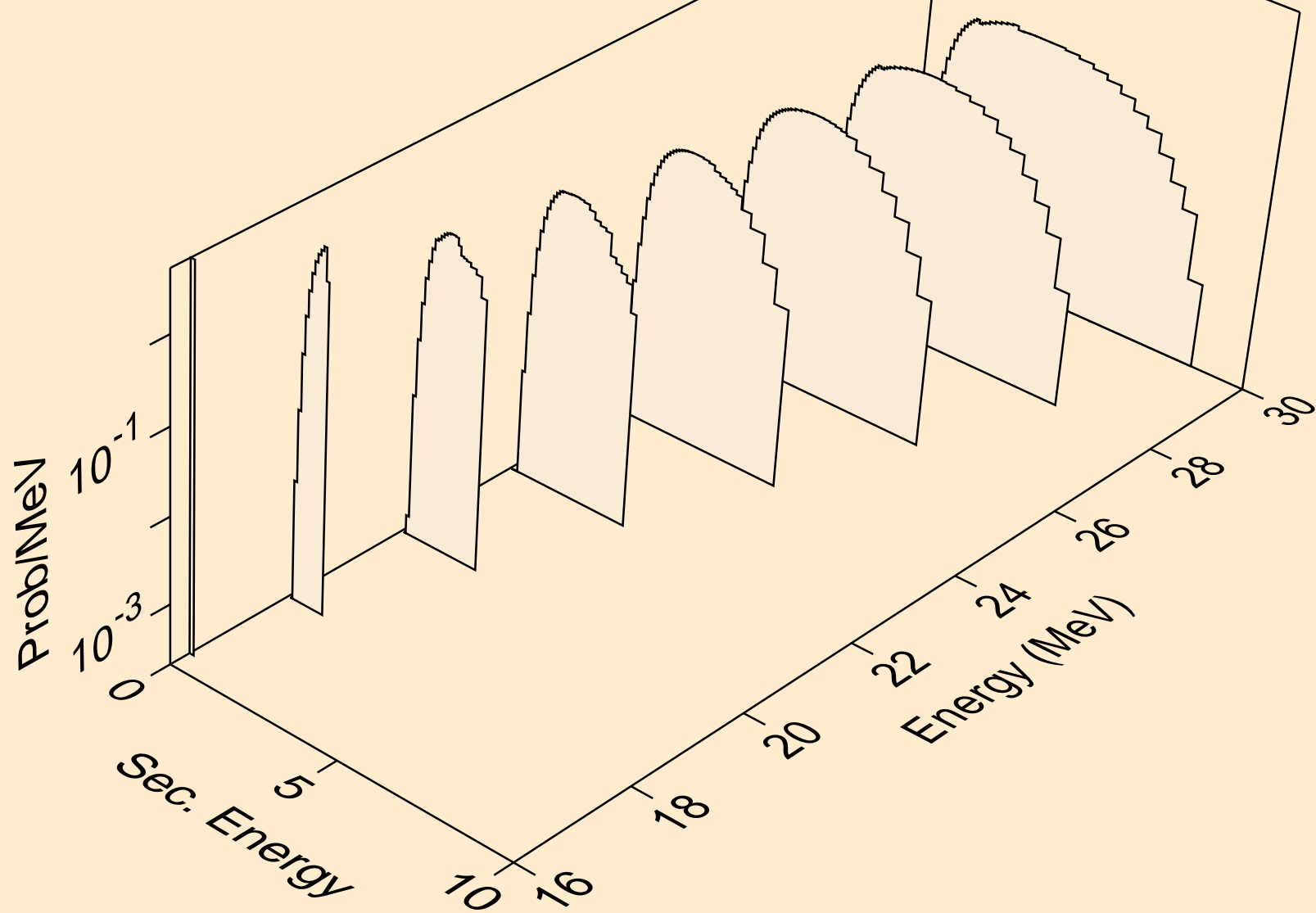

BE011 ALPHA ACER TENDL-2024 LIBRARY; T=0.K
deuterons from (a,d)

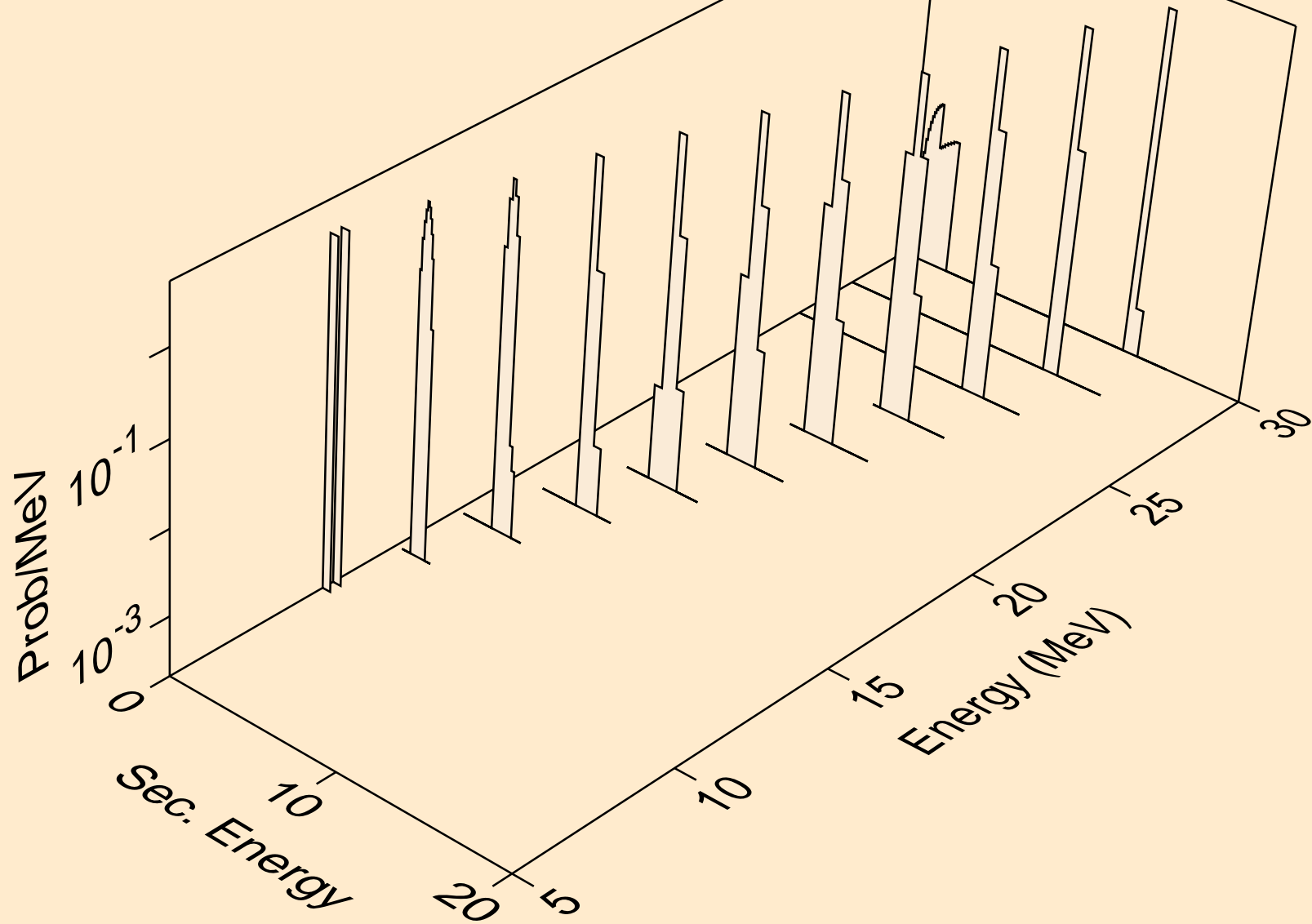

BE011 ALPHA ACER TENDL-2024 LIBRARY; T=0.K
deuterons from (a,da)

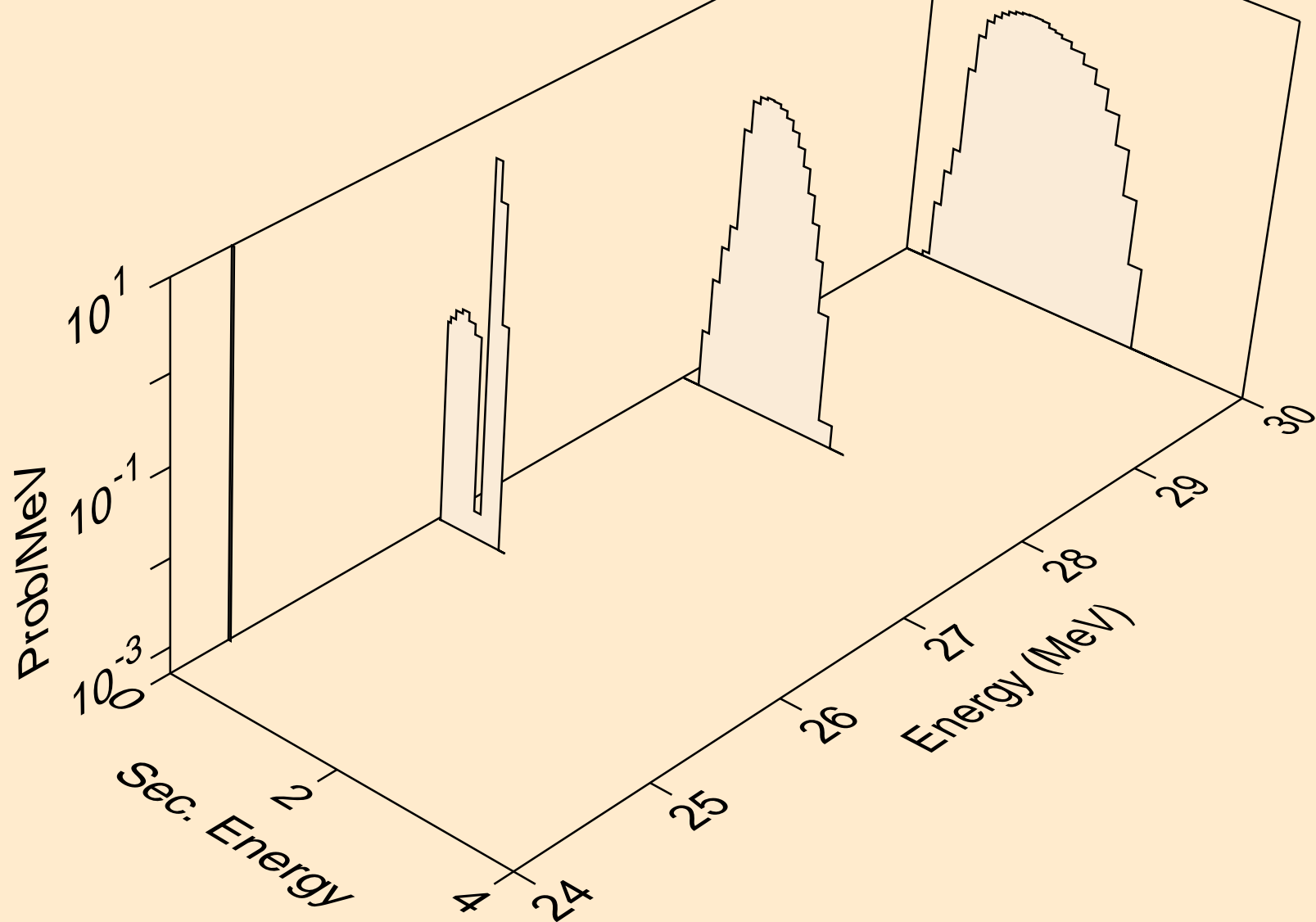

BE011 ALPHA ACER TENDL-2024 LIBRARY; T=0.K
tritons from (a,x)

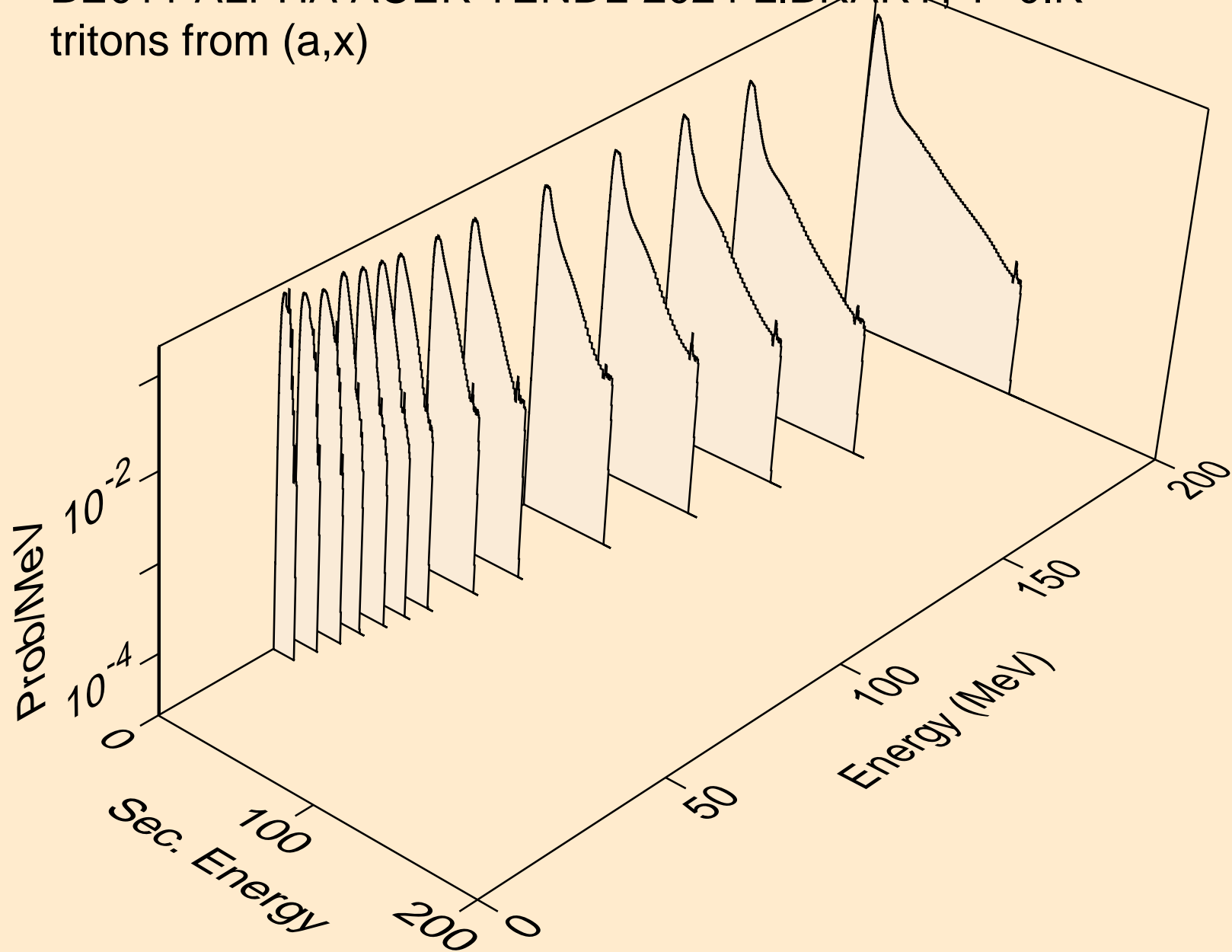

BE011 ALPHA ACER TENDL-2024 LIBRARY; T=0.K
tritons from (a,n*)t

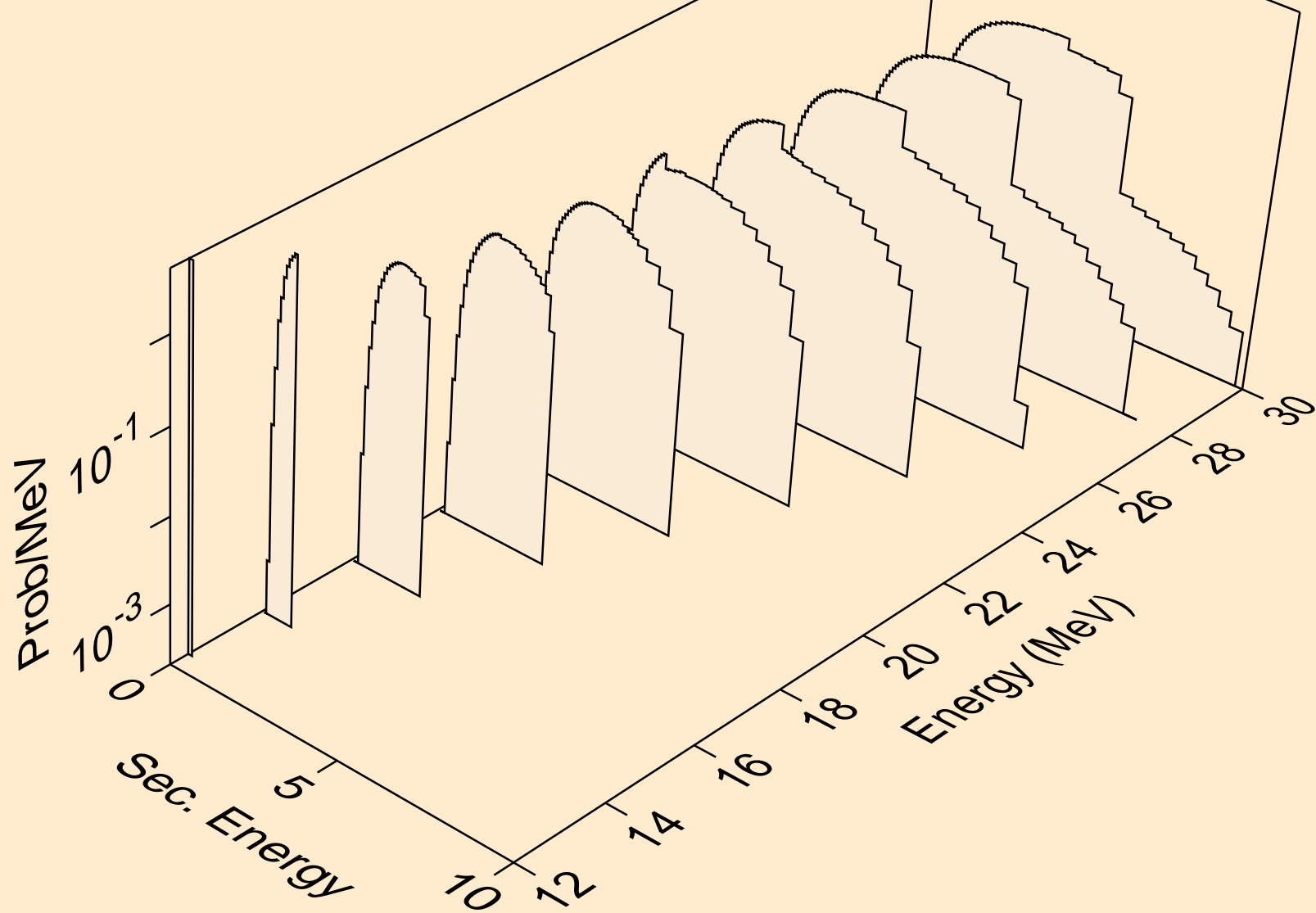

BE011 ALPHA ACER TENDL-2024 LIBRARY; T=0.K
tritons from (a,t)

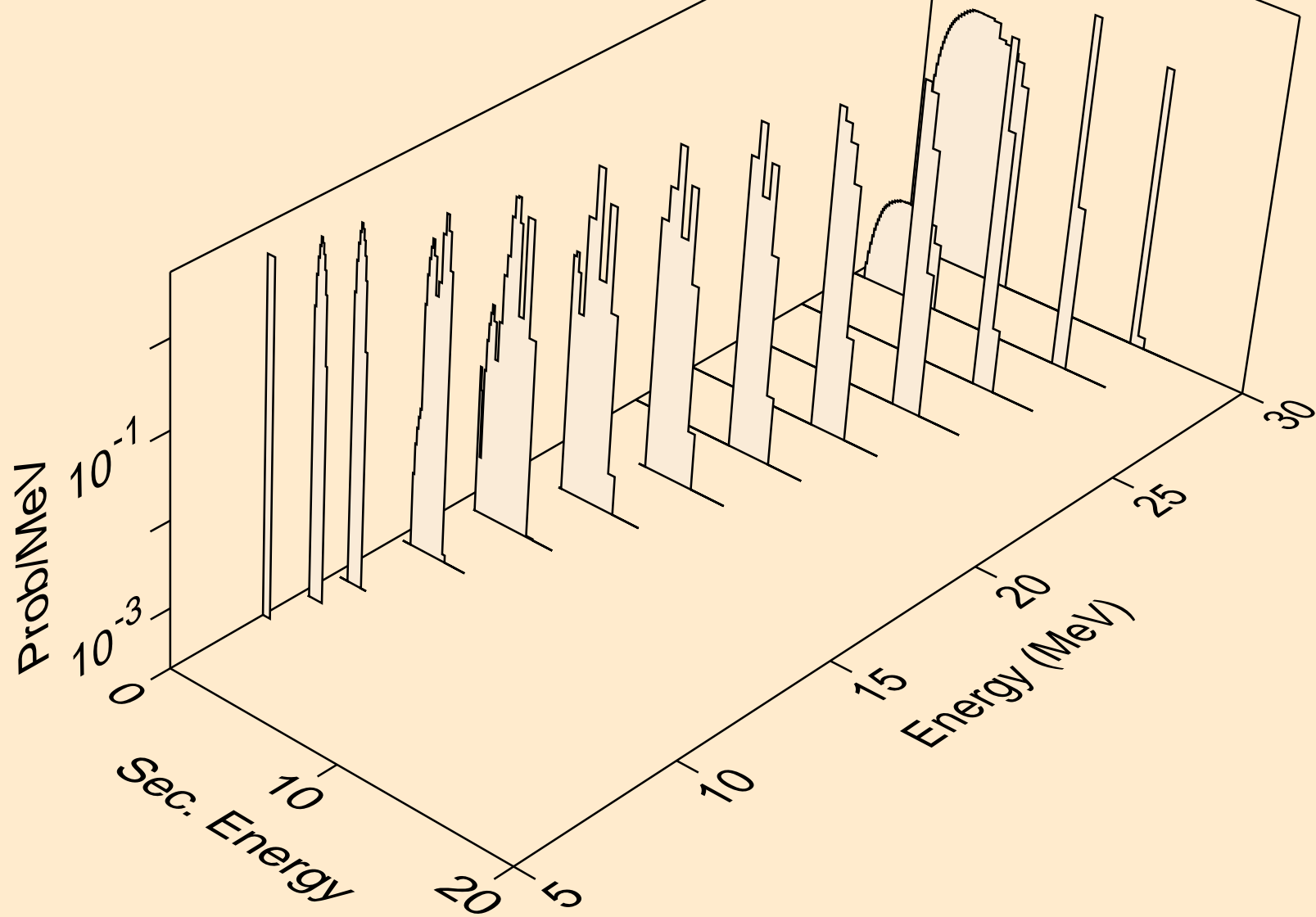

BE011 ALPHA ACER TENDL-2024 LIBRARY; T=0.K
tritons from (a,pt)

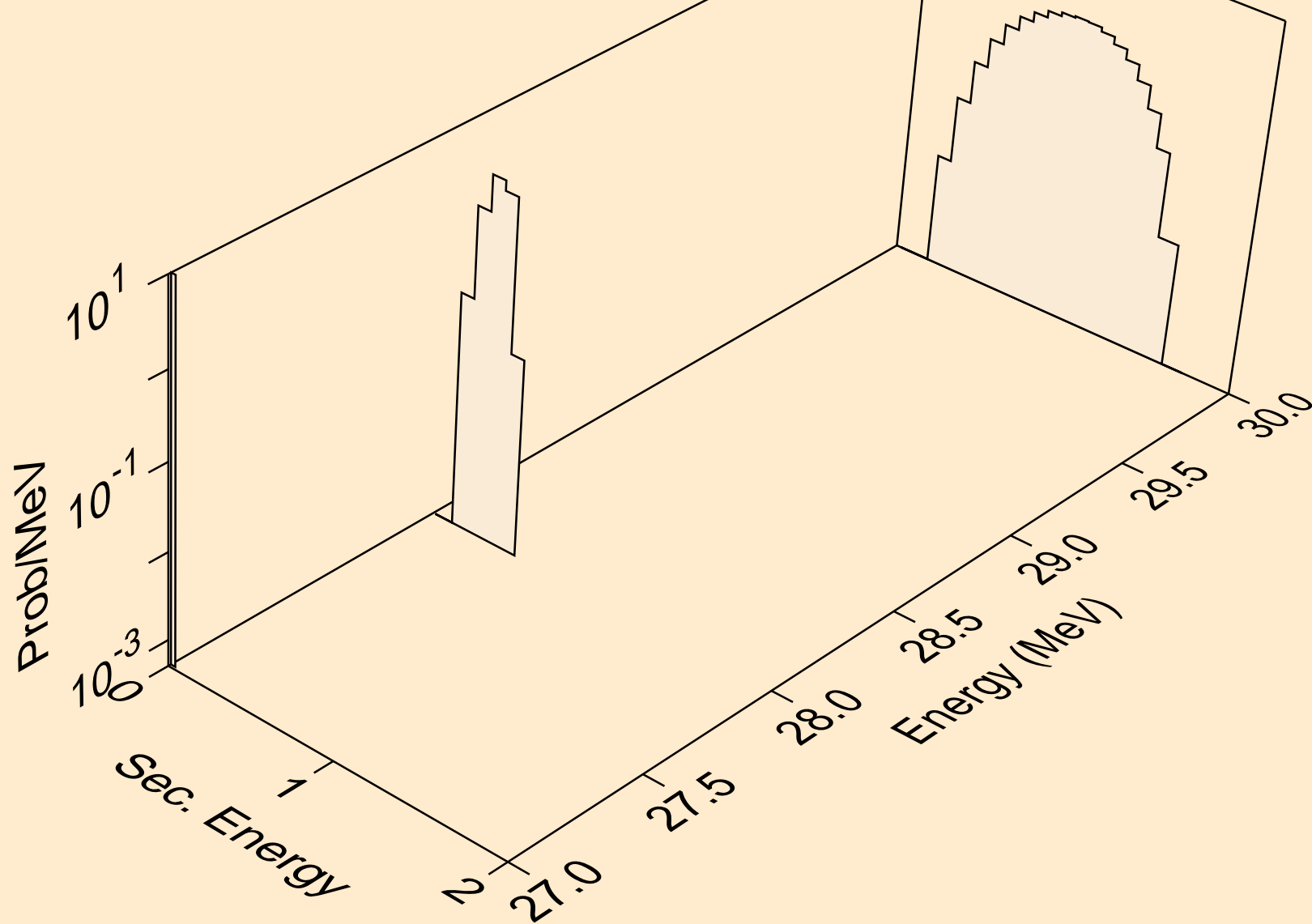

BE011 ALPHA ACER TENDL-2024 LIBRARY; T=0.K
he3s from (a,x)

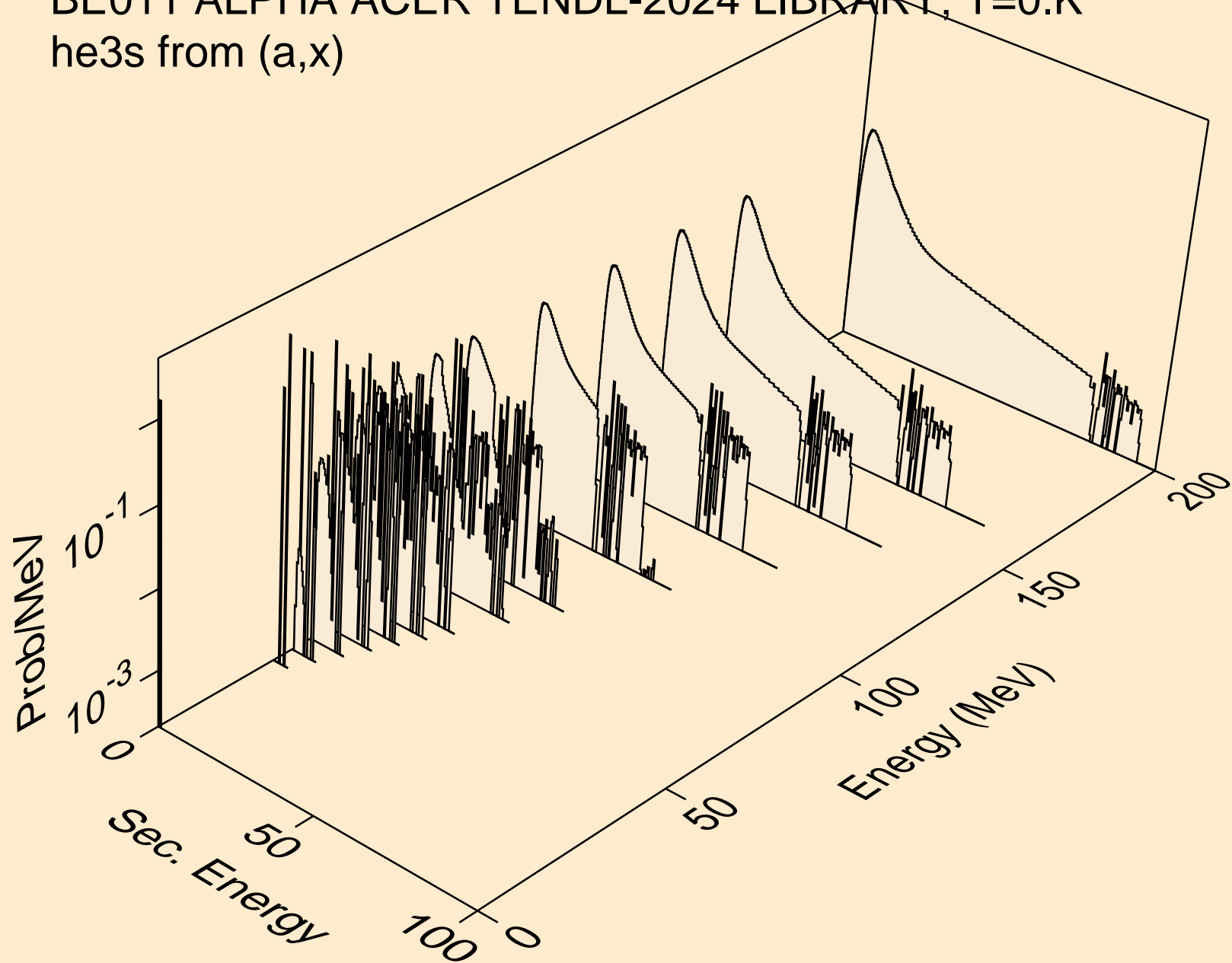

BE011 ALPHA ACER TENDL-2024 LIBRARY; T=0.K
he3s from (a,he3)

