

BR088 ALPHA ACER TENDL-2024 LIBRARY; T=0.K
Principal cross sections

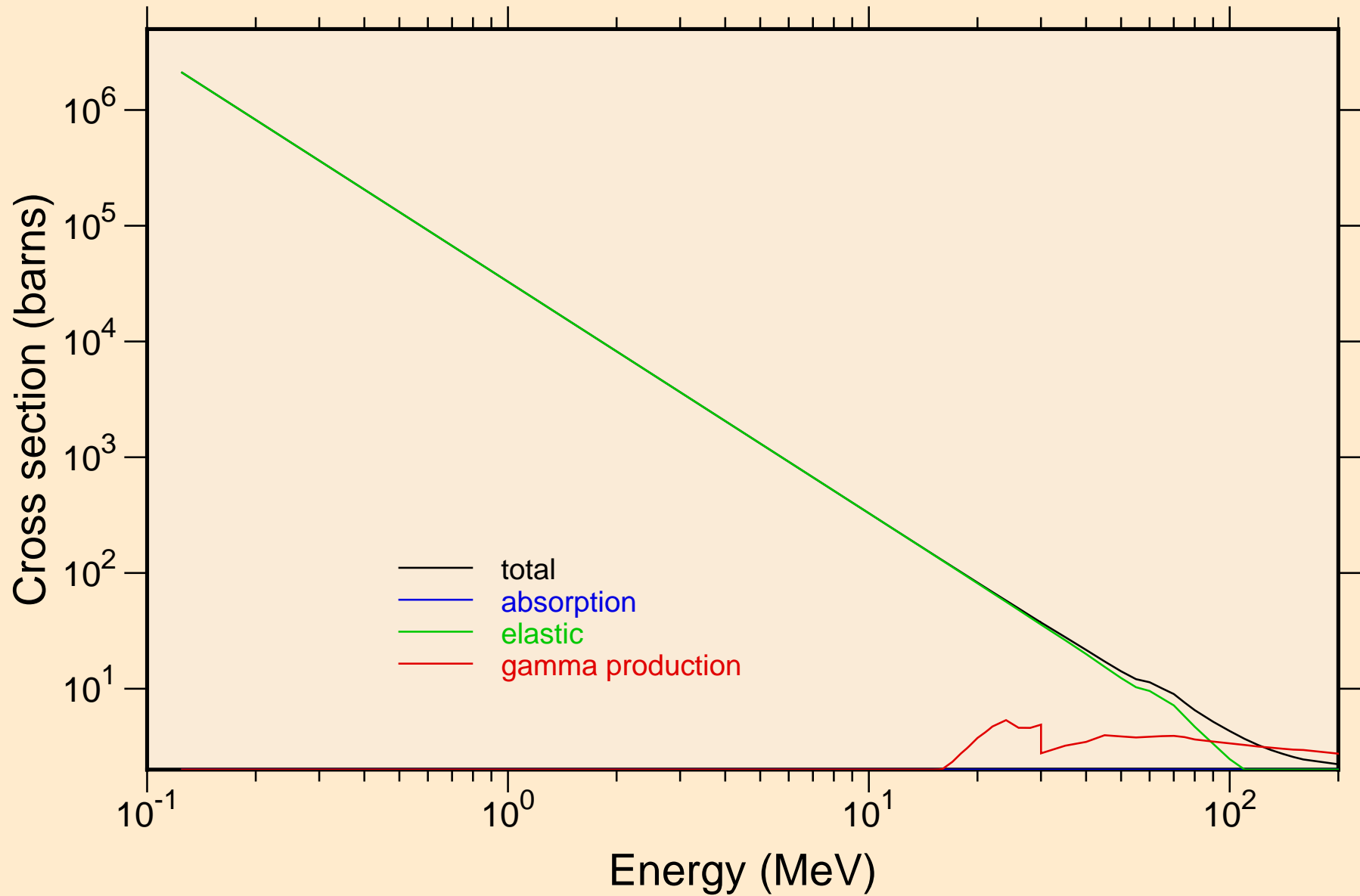

BR088 ALPHA ACER TENDL-2024 LIBRARY; T=0.K
Heating

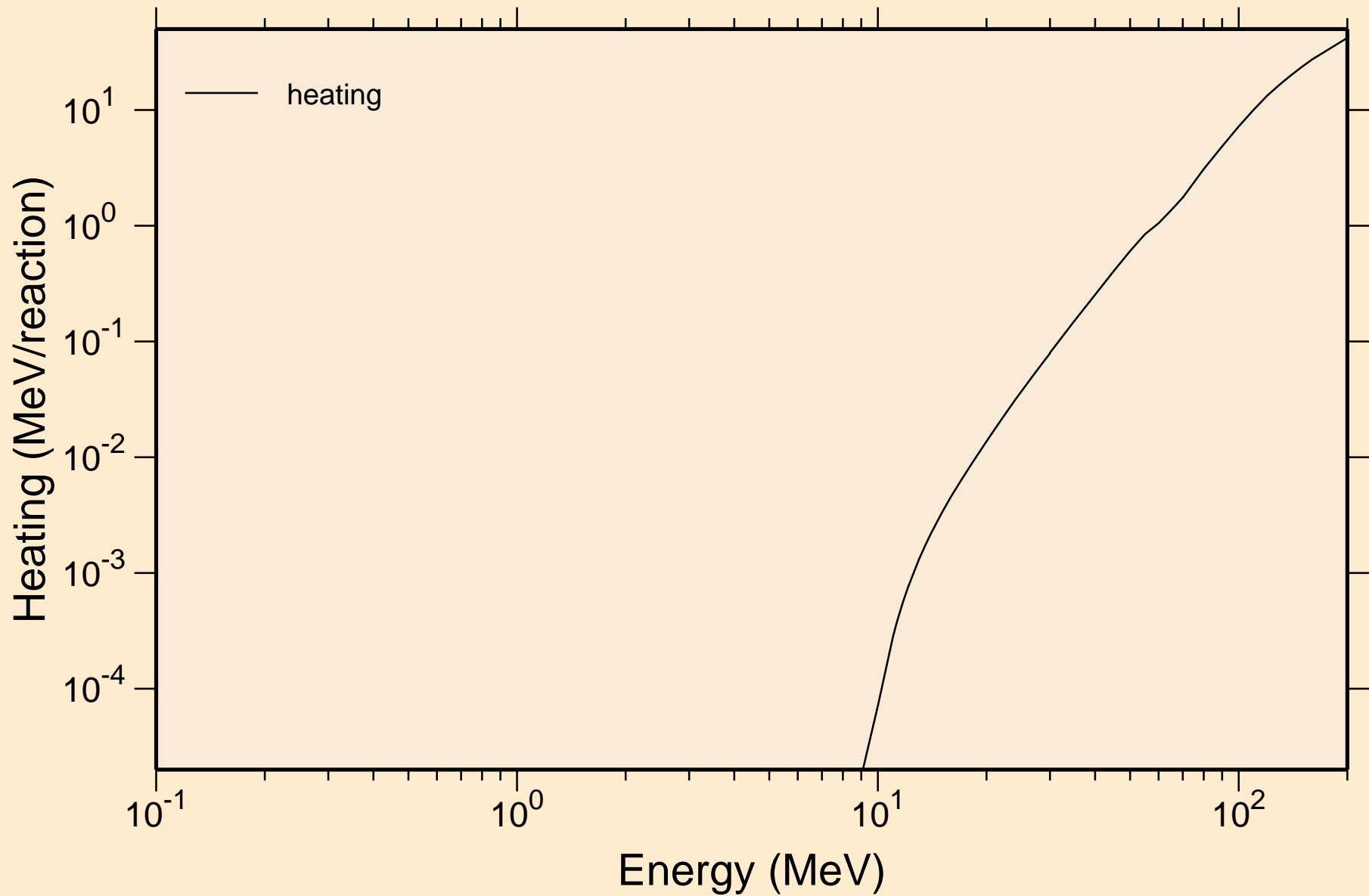

BR088 ALPHA ACER TENDL-2024 LIBRARY; T=0.K

Principal cross sections

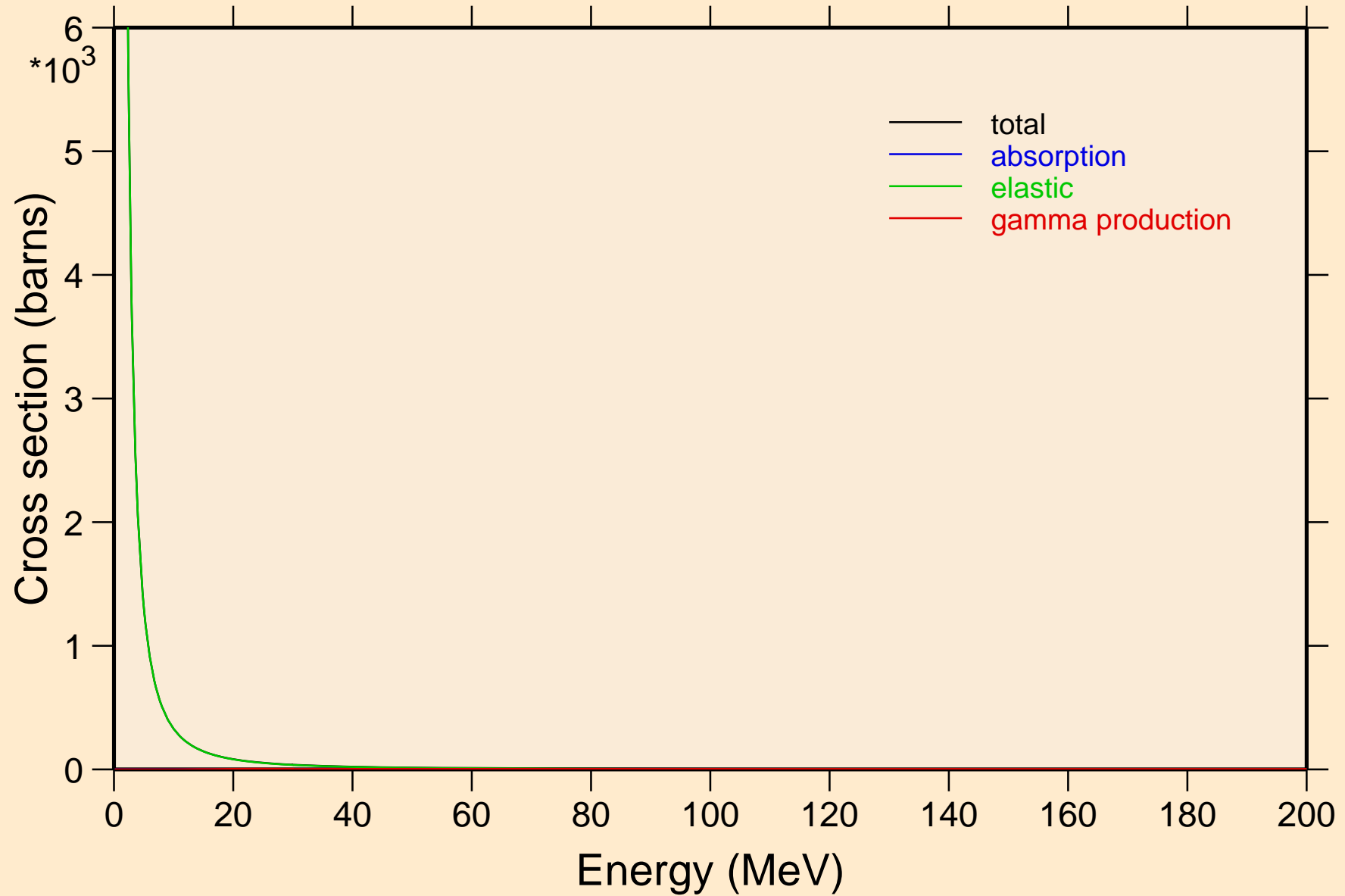

BR088 ALPHA ACER TENDL-2024 LIBRARY; T=0.K

Heating

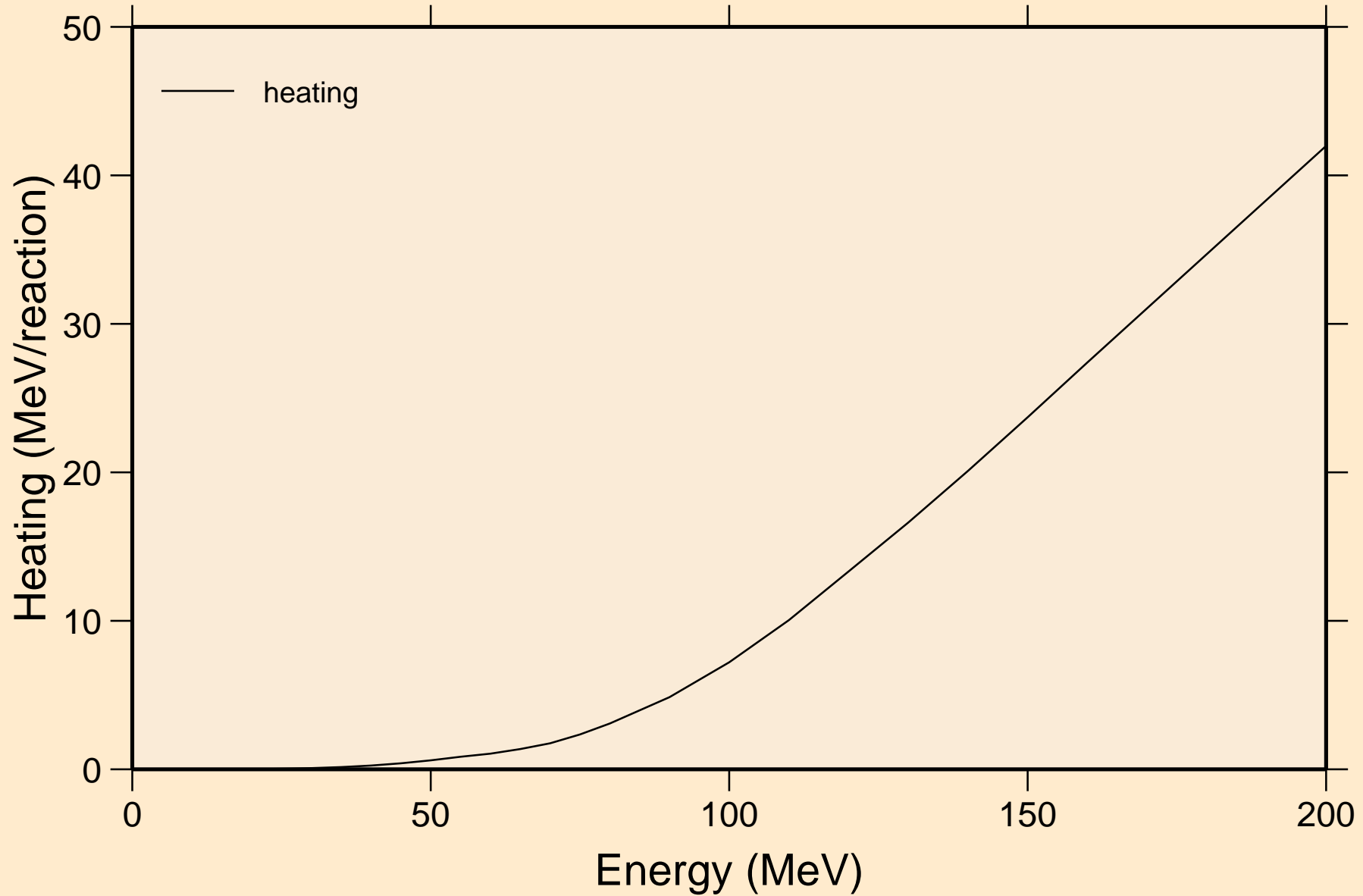

BR088 ALPHA ACER TENDL-2024 LIBRARY; T=0.K
Threshold reactions

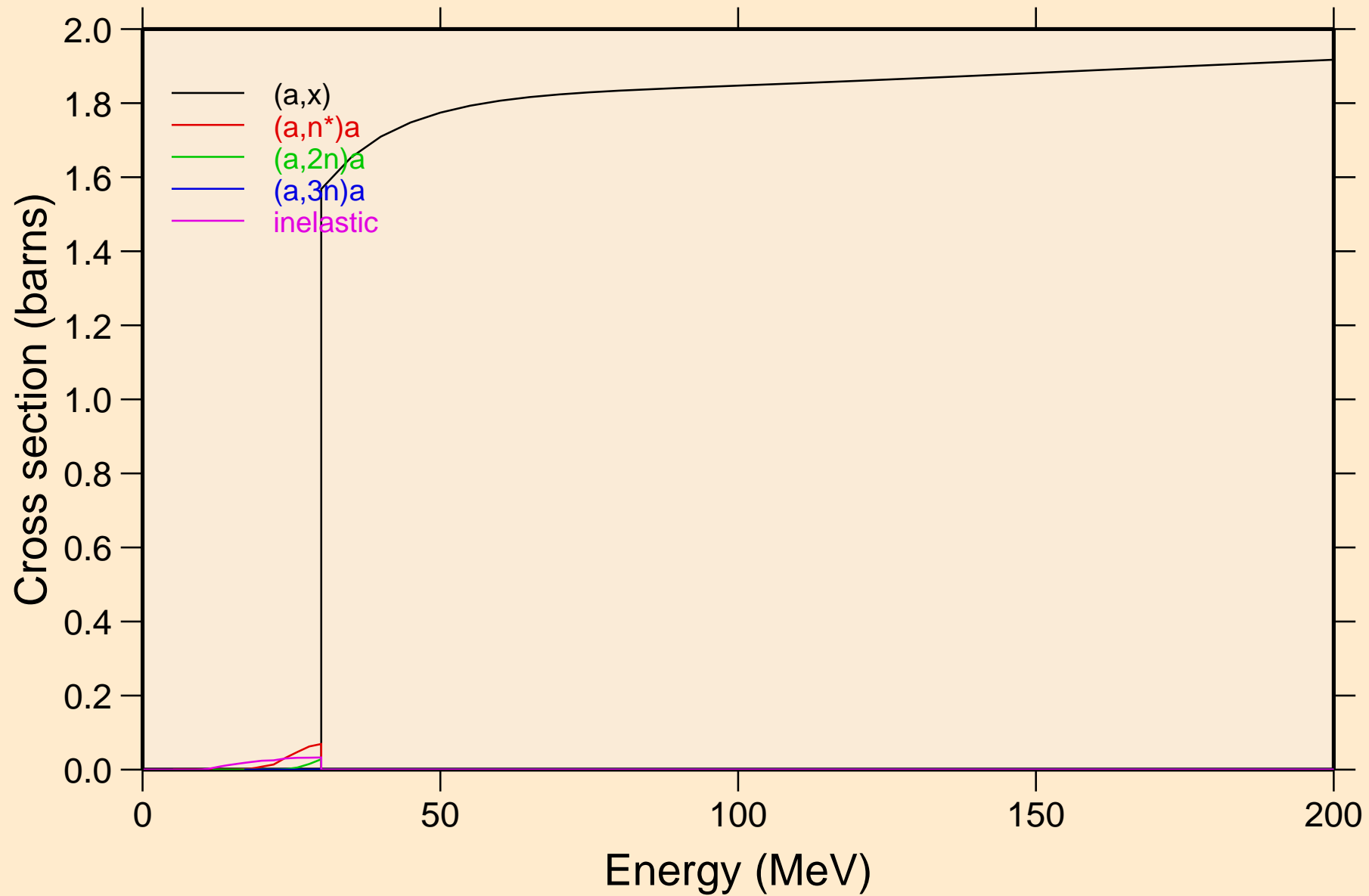

BR088 ALPHA ACER TENDL-2024 LIBRARY; T=0.K
Threshold reactions

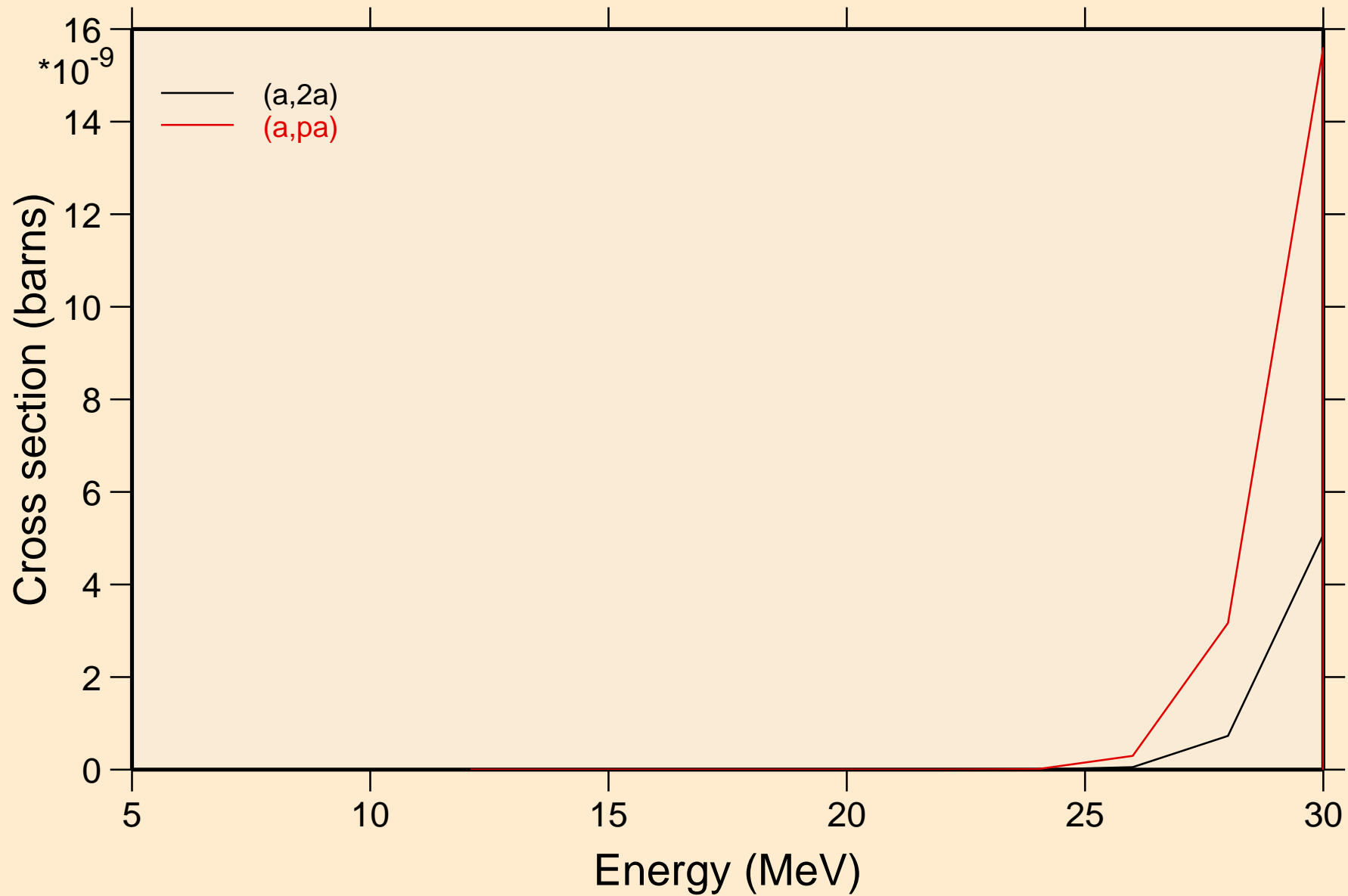

BR088 ALPHA ACER TENDL-2024 LIBRARY; T=0.K
angular distribution for elastic

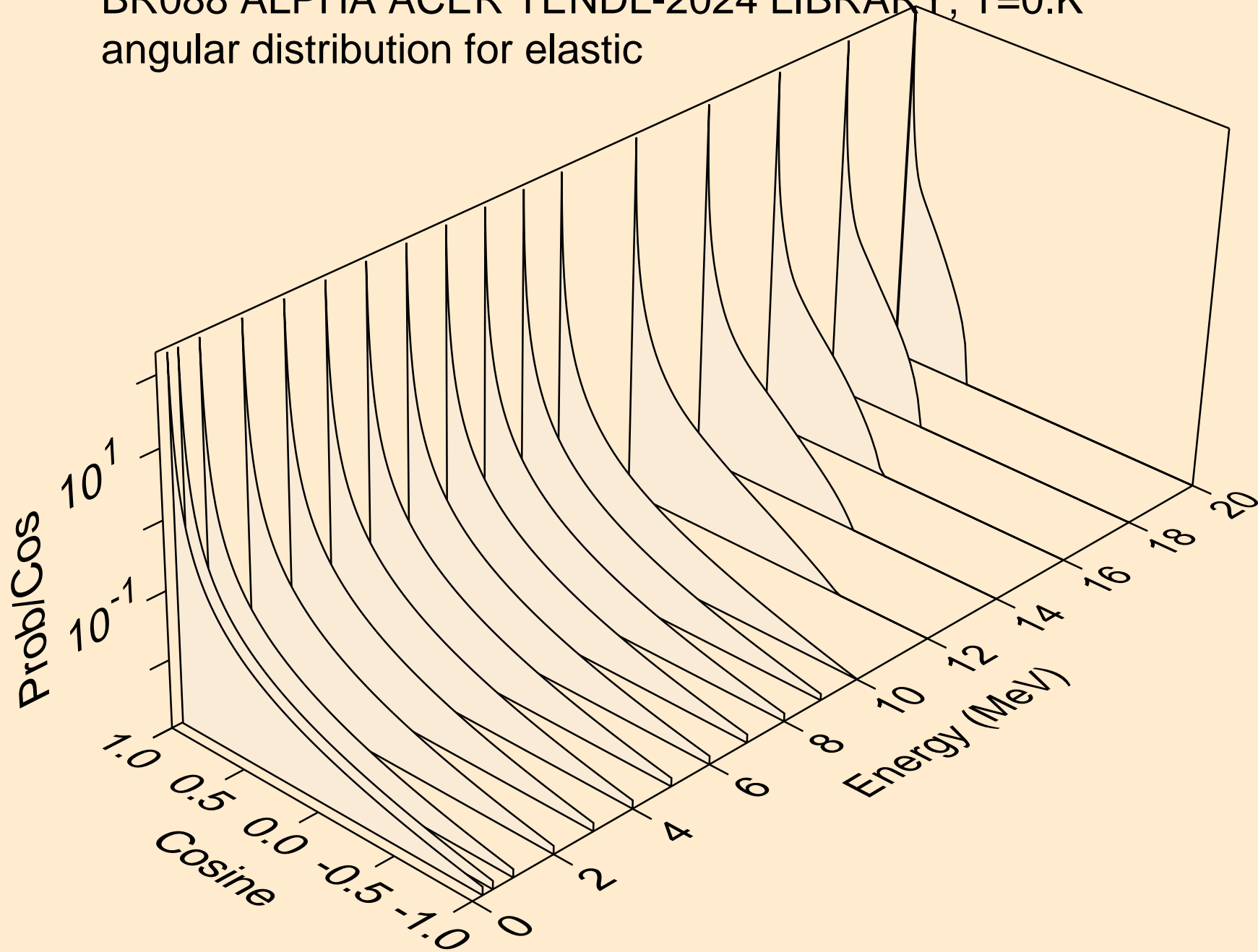

BR088 ALPHA ACER TENDL-2024 LIBRARY; T=0.K
angular distribution for elastic

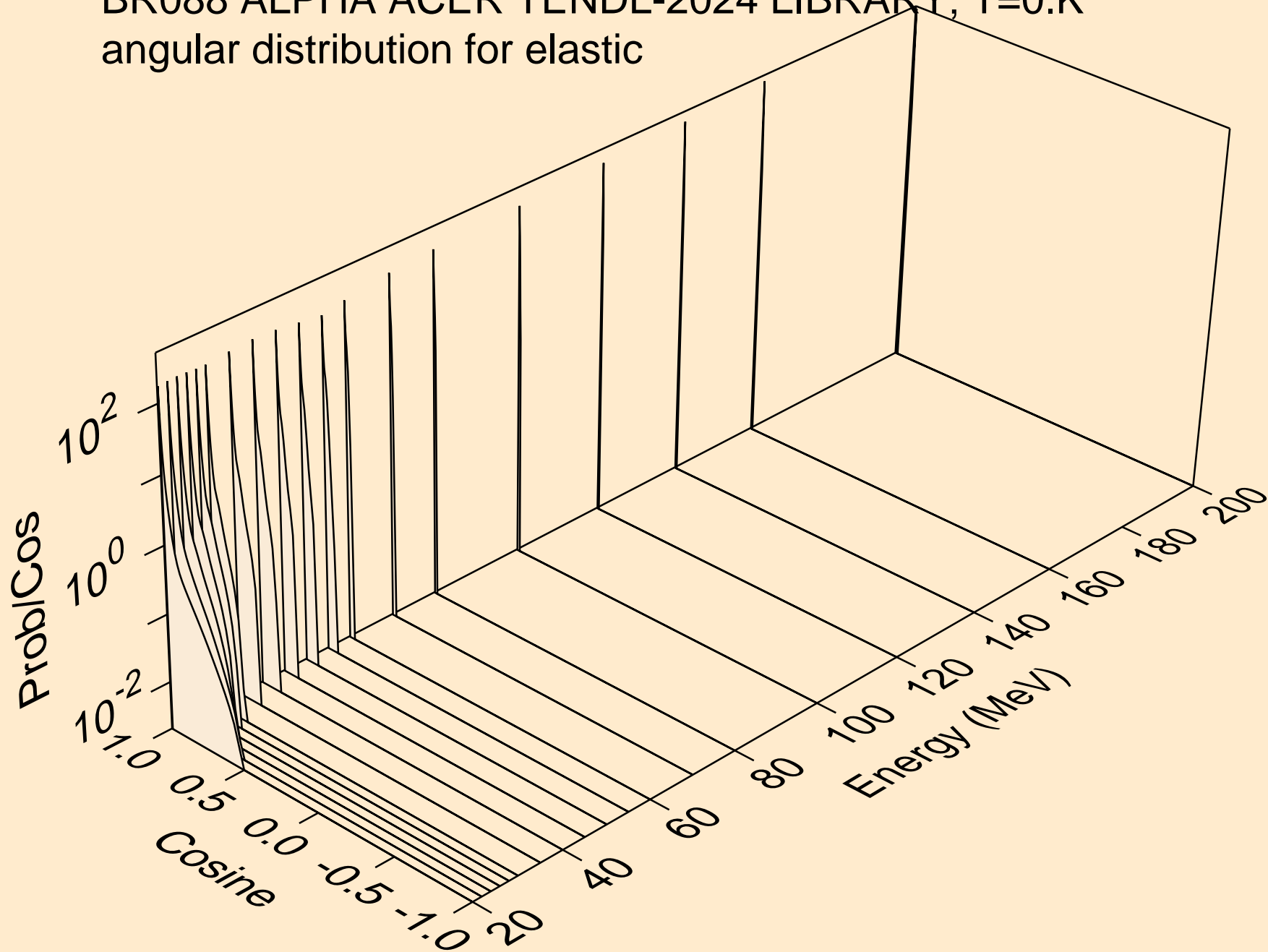

BR088 ALPHA ACER TENDL-2024 LIBRARY; T=0.K
Alpha emission for (a,x)

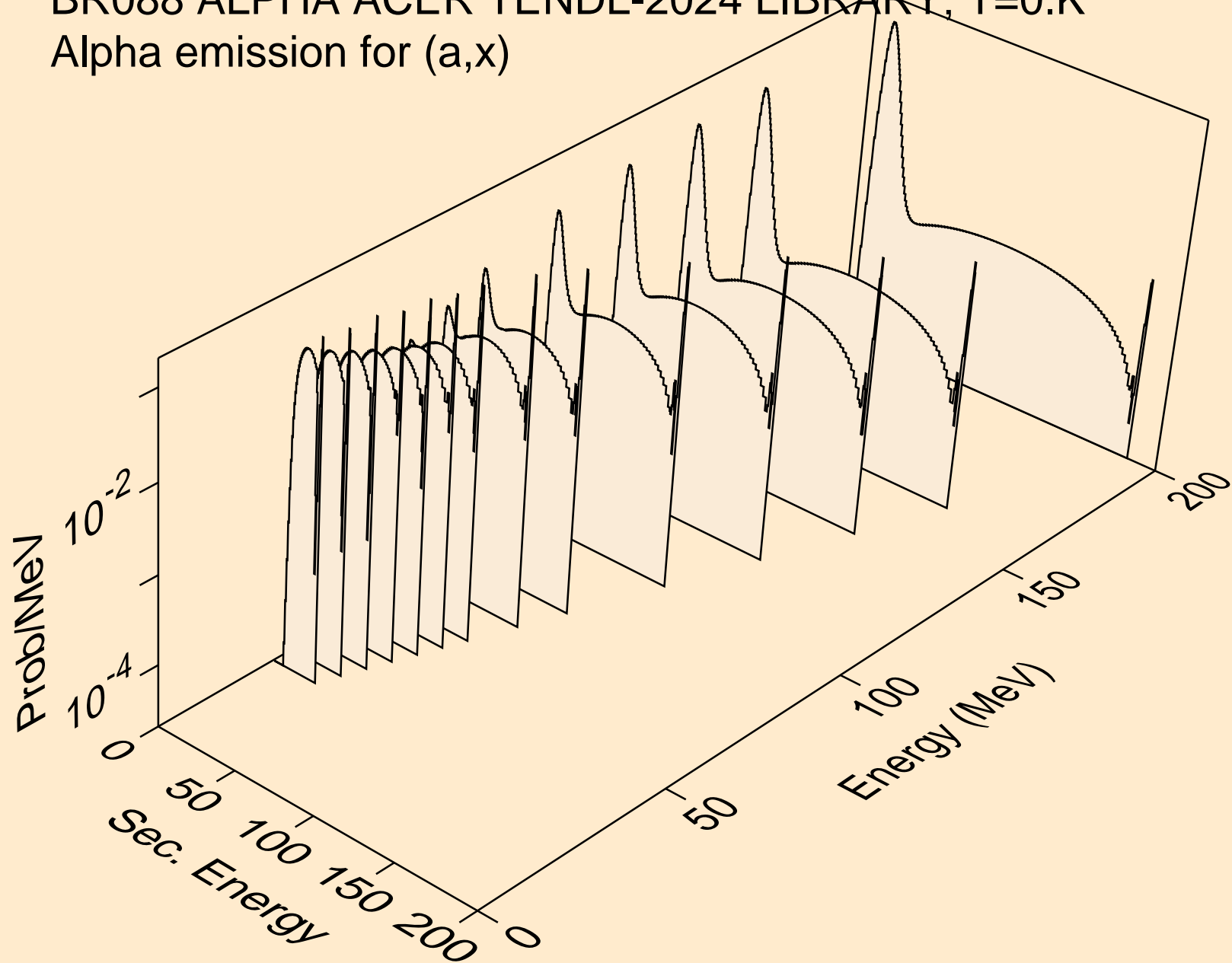

BR088 ALPHA ACER TENDL-2024 LIBRARY; T=0.K
Alpha emission for (a,n*)a

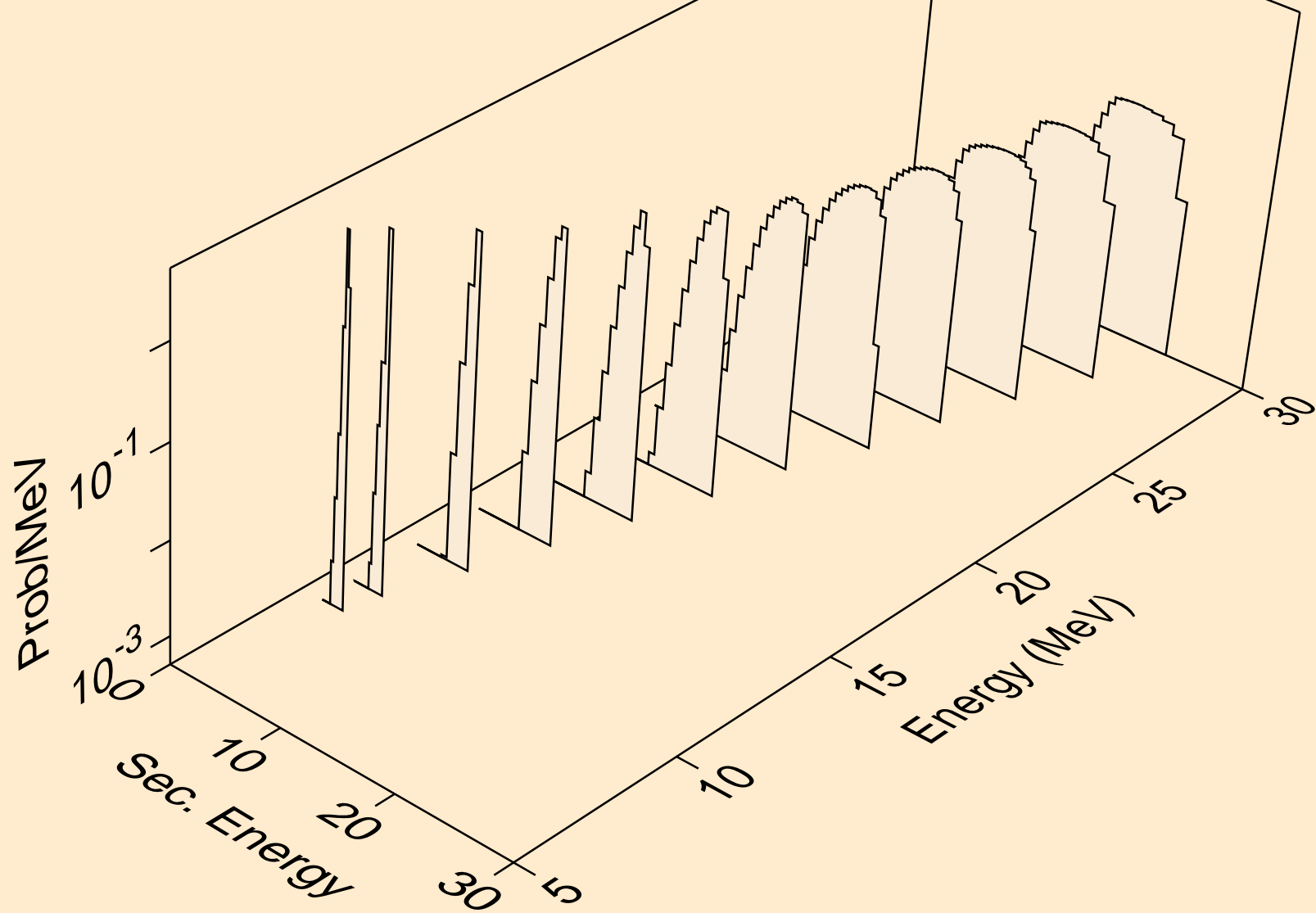

BR088 ALPHA ACER TENDL-2024 LIBRARY; T=0.K
Alpha emission for (a,2n)a

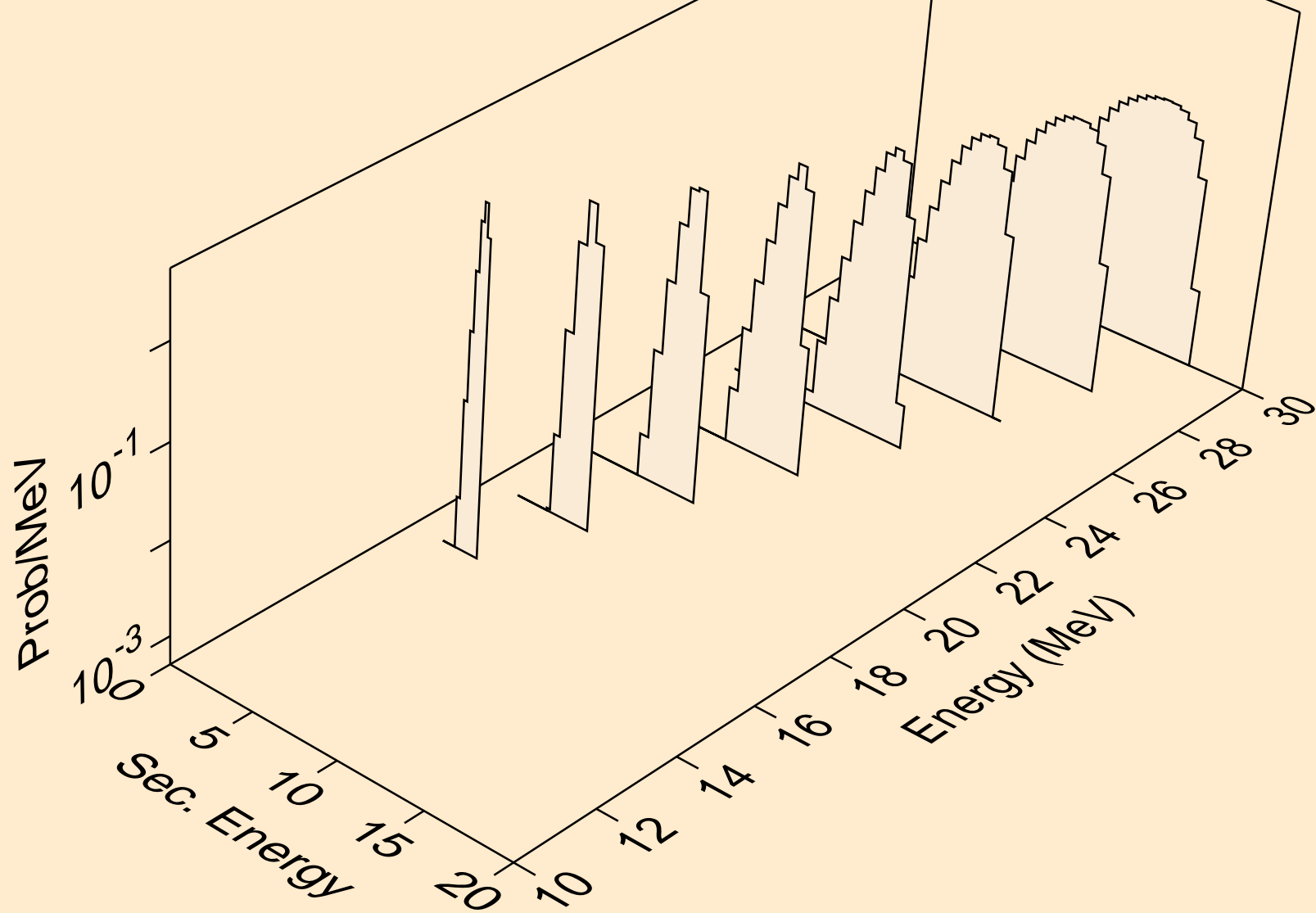

BR088 ALPHA ACER TENDL-2024 LIBRARY; T=0.K
Alpha emission for (a,3n)a

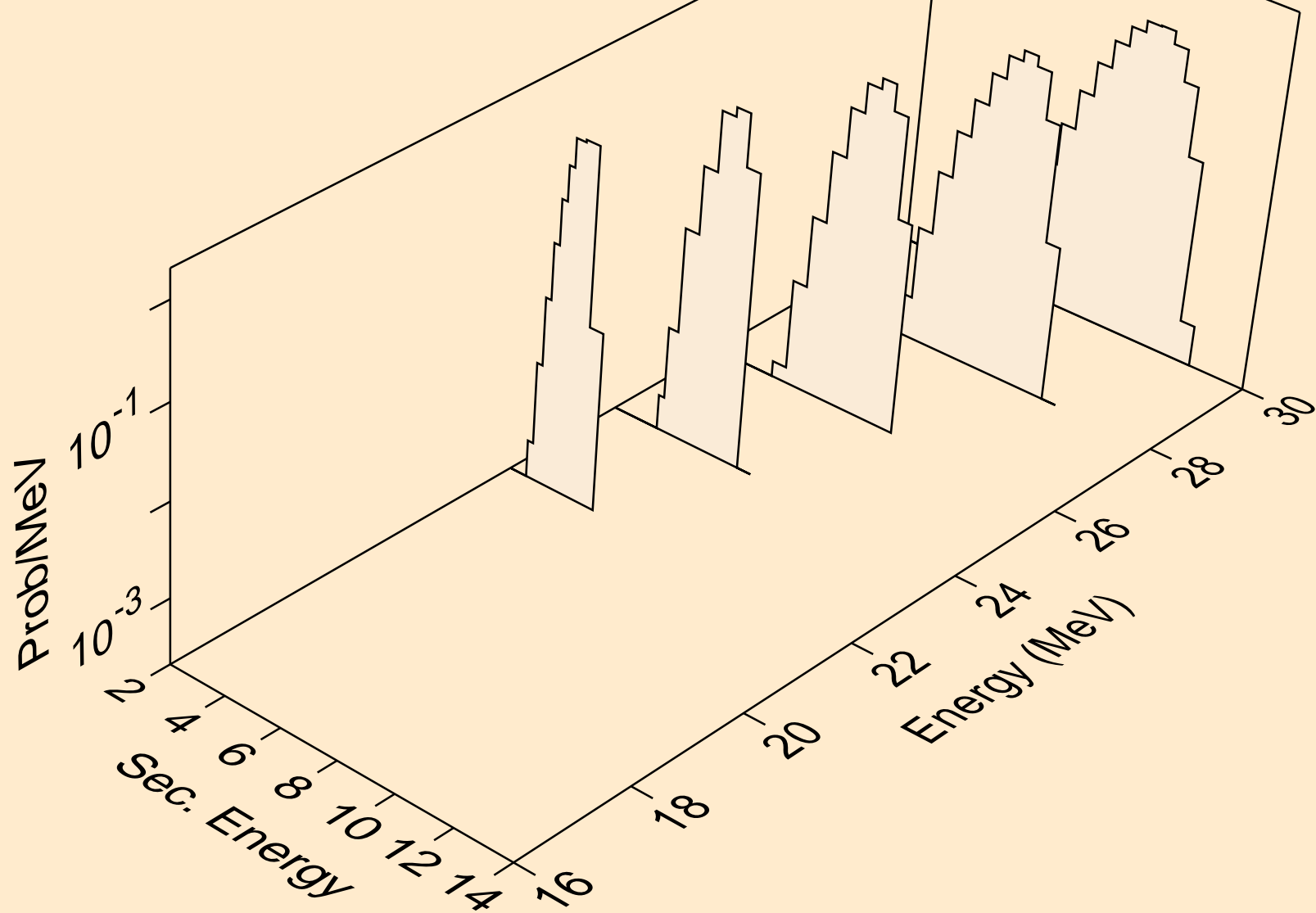

BR088 ALPHA ACER TENDL-2024 LIBRARY; T=0.K
Alpha emission for inelastic

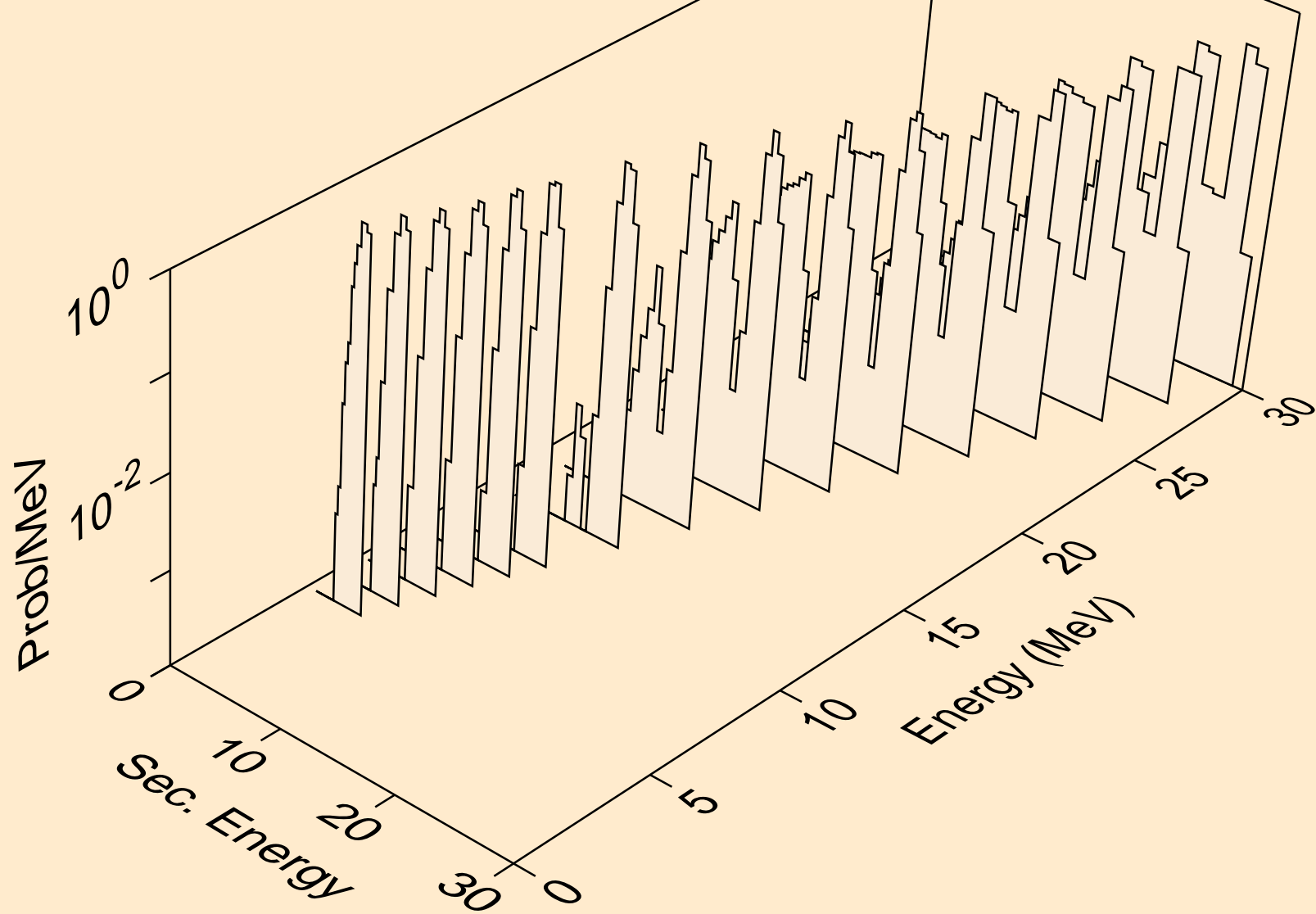

BR088 ALPHA ACER TENDL-2024 LIBRARY; T=0.K
Alpha emission for (a,2a)

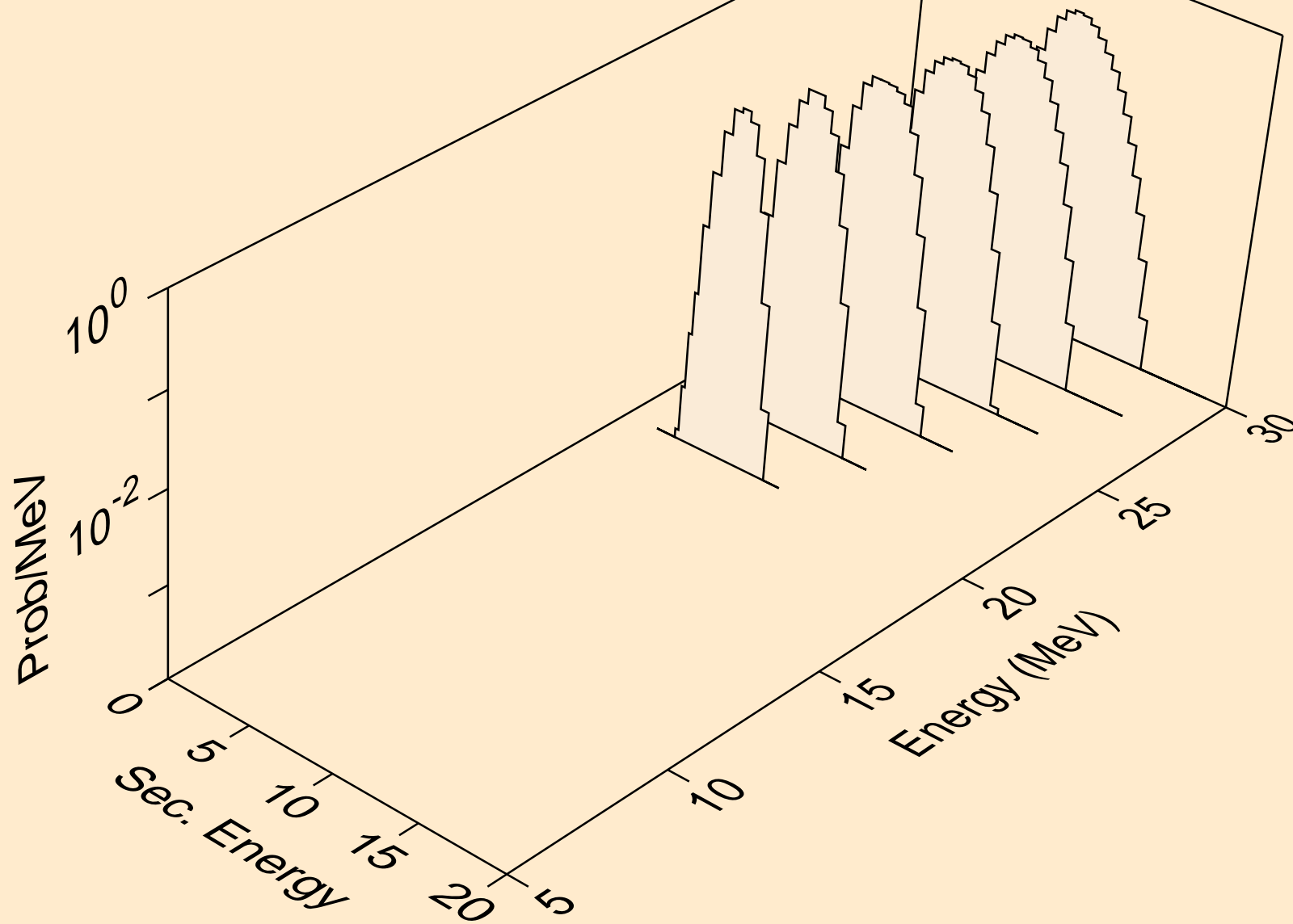

BR088 ALPHA ACER TENDL-2024 LIBRARY; T=0.K
Alpha emission for (a,pa)

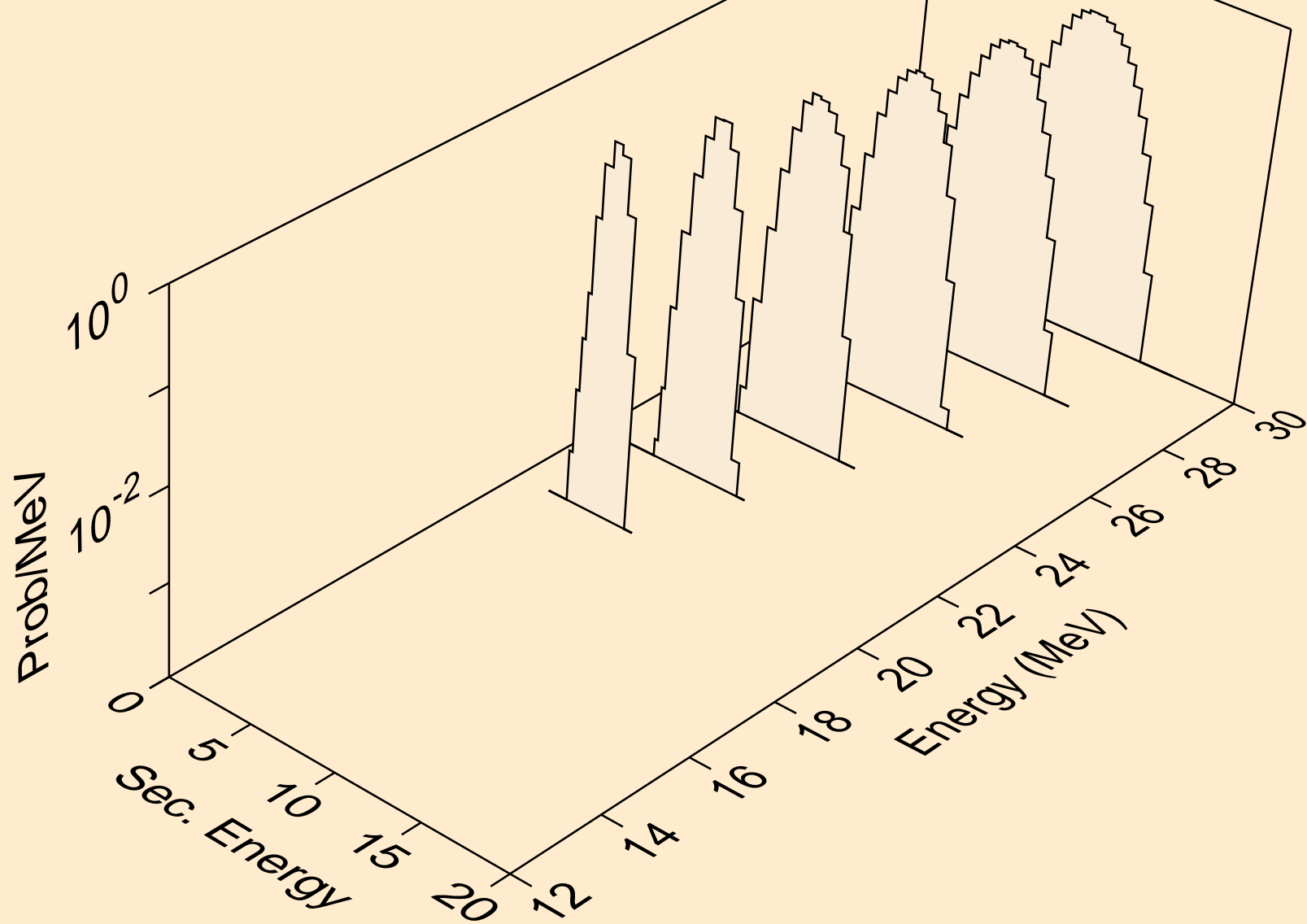

BR088 ALPHA ACER TENDL-2024 LIBRARY; T=0.K
Photon emission for (z,n)

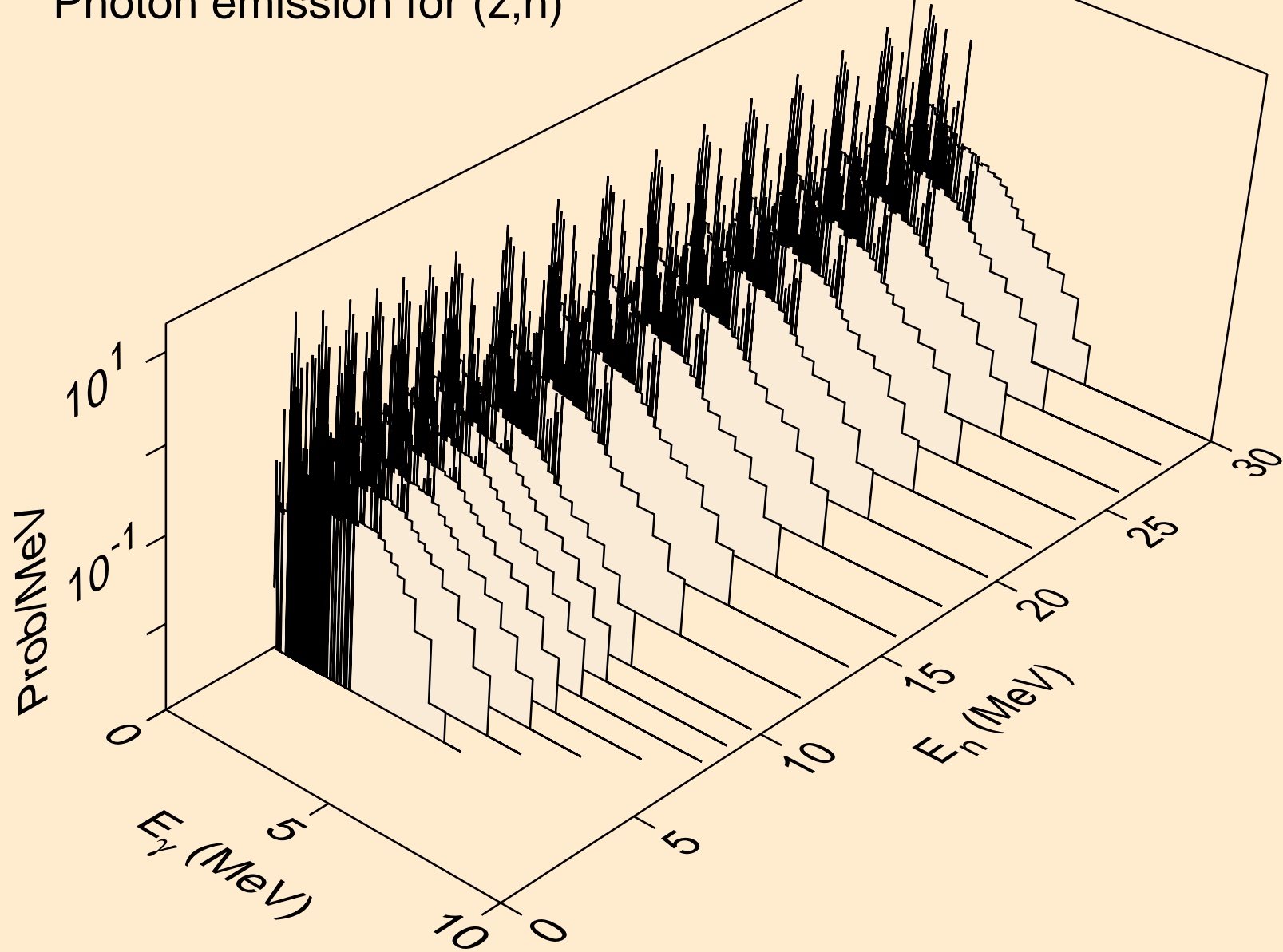

BR088 ALPHA ACER TENDL-2024 LIBRARY; T=0.K
Photon emission for (z,x)

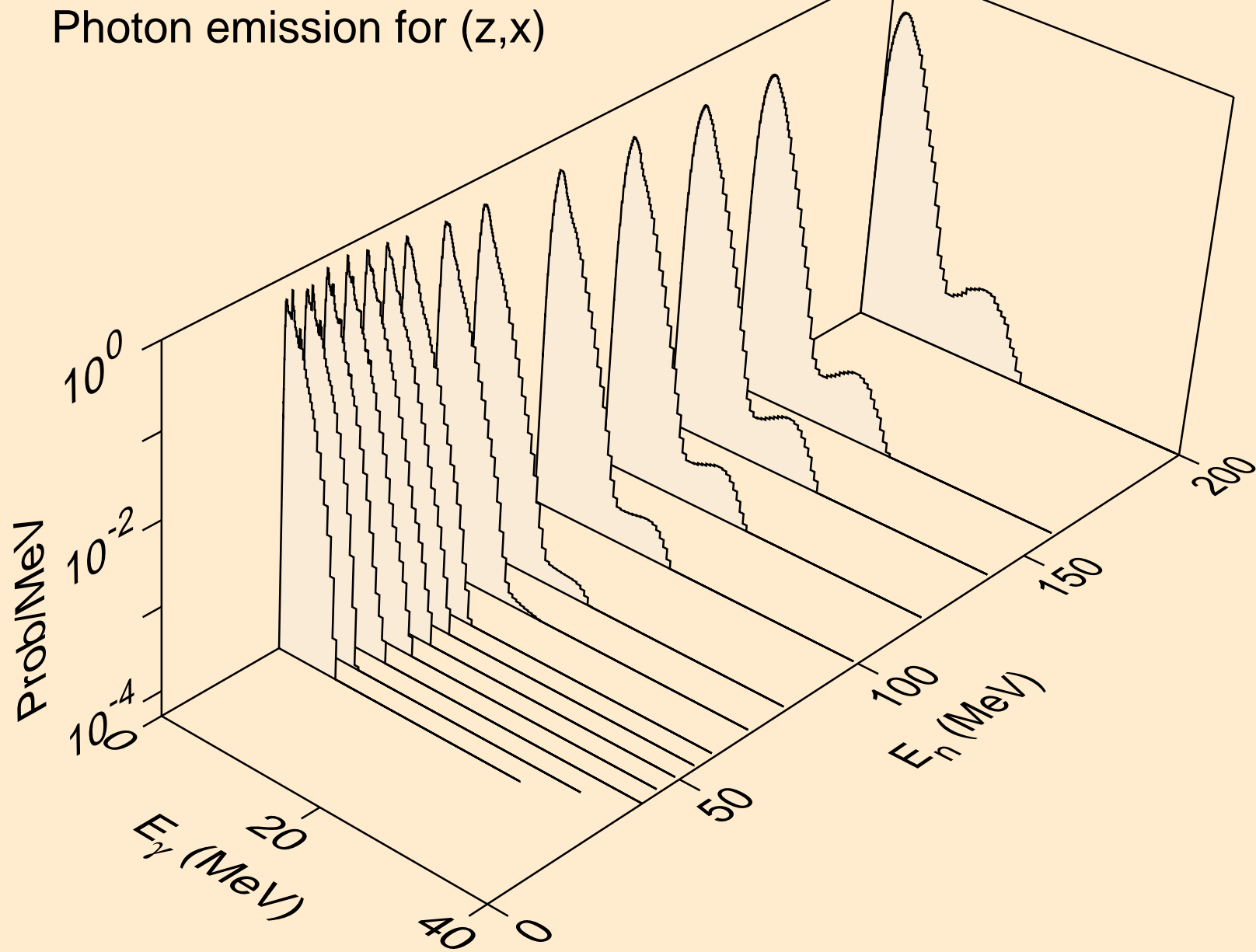

BR088 ALPHA ACER TENDL-2024 LIBRARY; T=0.K
Photon emission for (n,2nd)

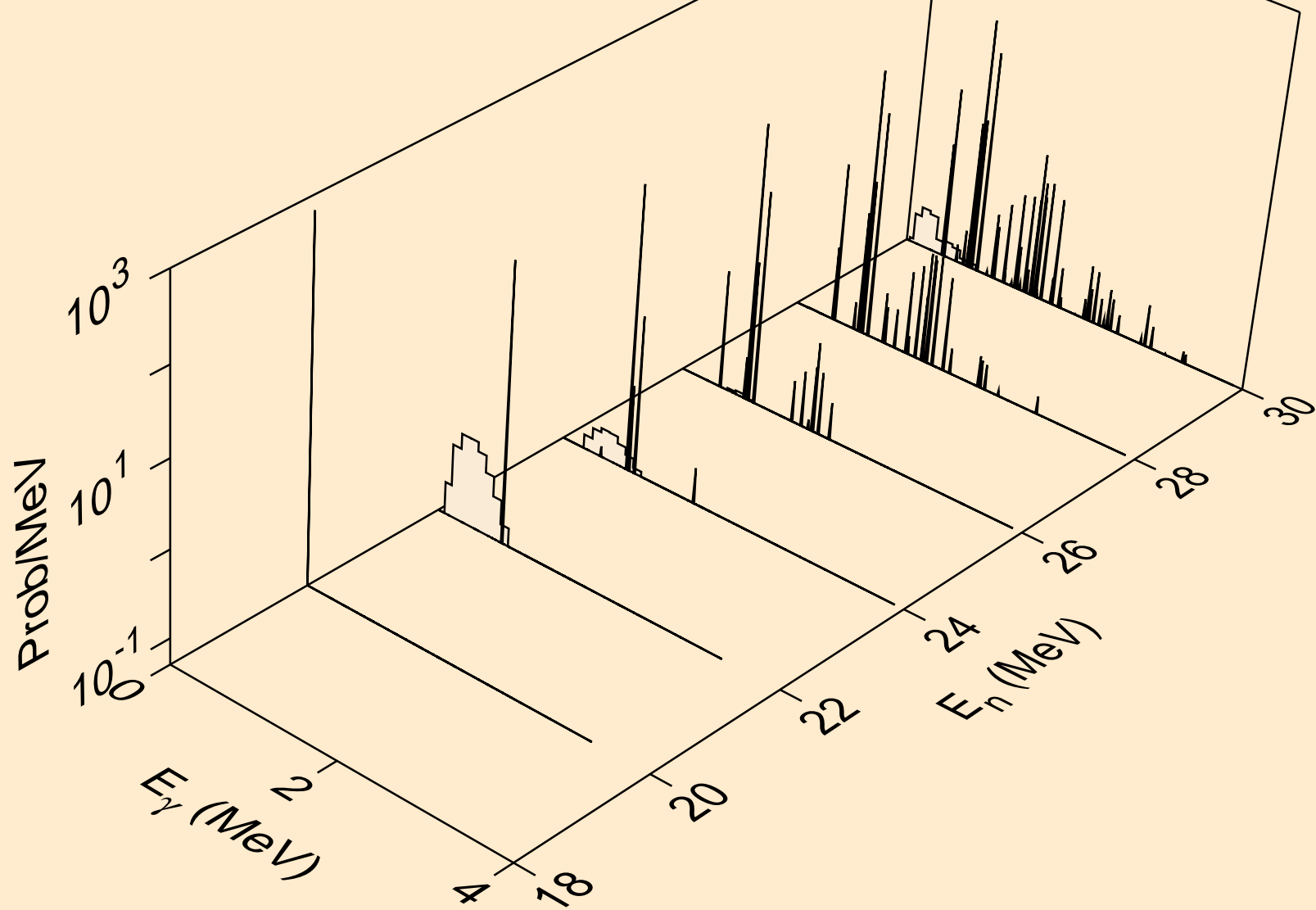

BR088 ALPHA ACER TENDL-2024 LIBRARY; T=0.K
Photon emission for (n,2n)

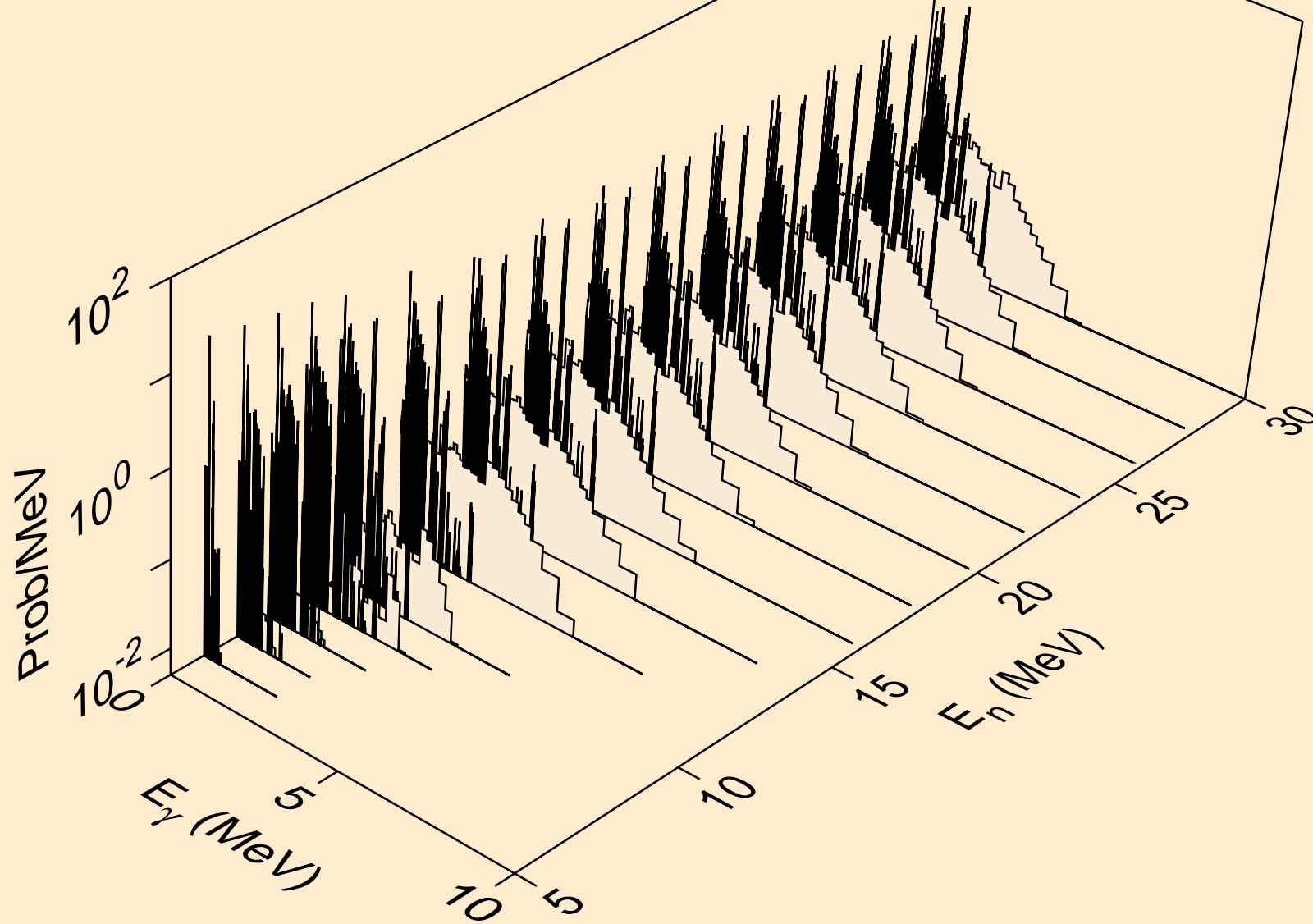

BR088 ALPHA ACER TENDL-2024 LIBRARY; T=0.K
Photon emission for (n,3n)

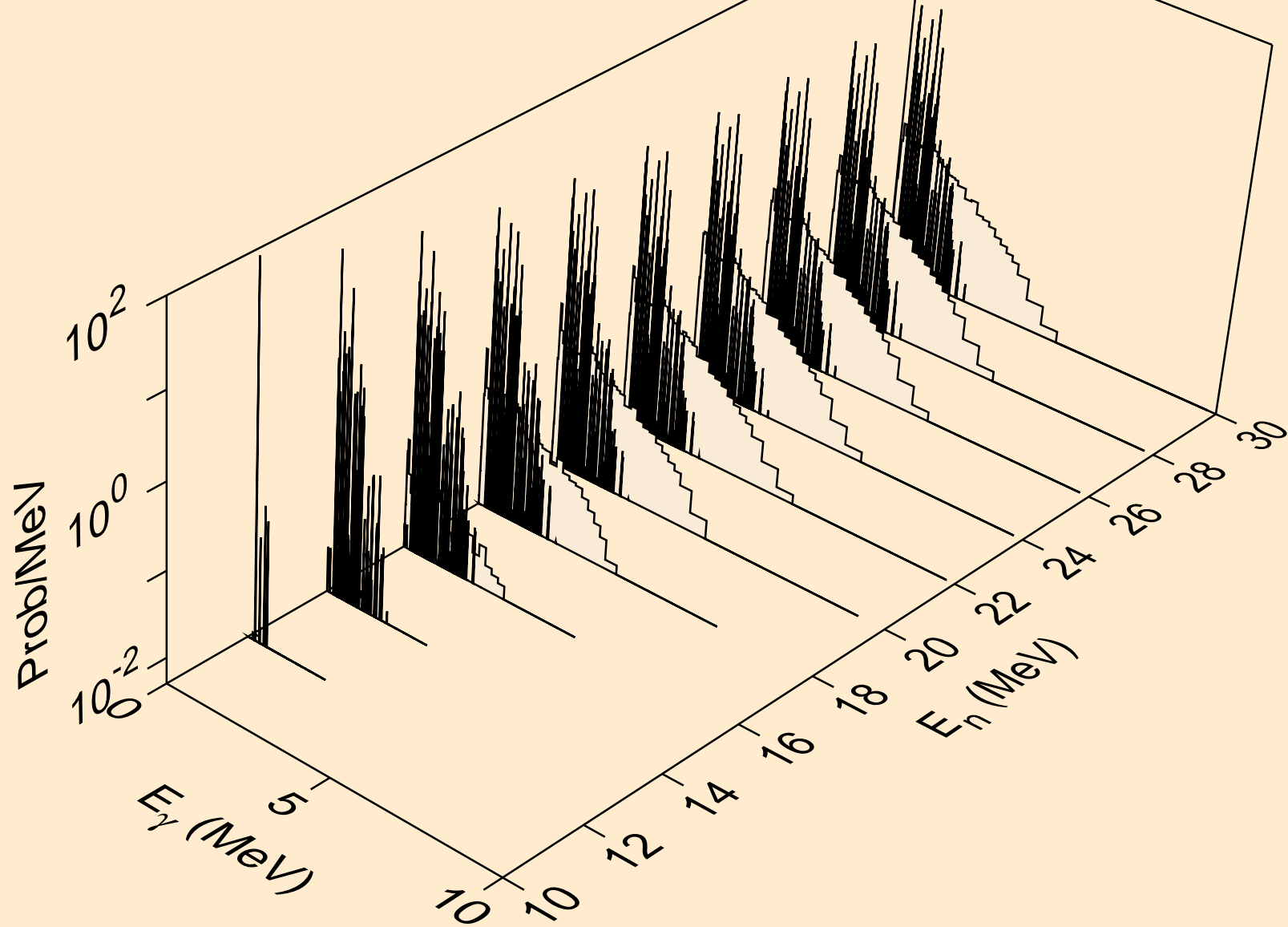

BR088 ALPHA ACER TENDL-2024 LIBRARY; T=0.K
Photon emission for (n,n*)a

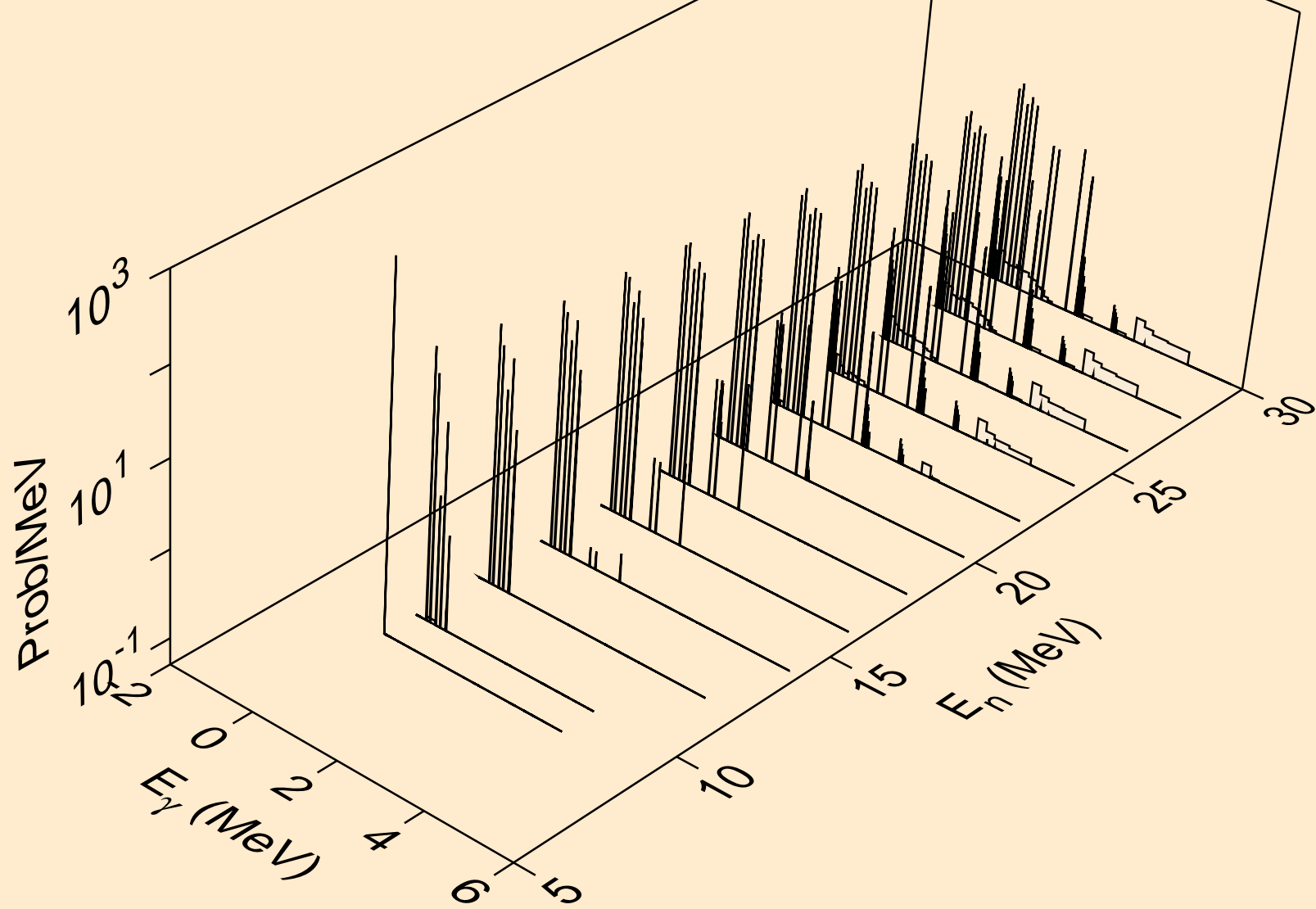

BR088 ALPHA ACER TENDL-2024 LIBRARY; T=0.K
Photon emission for (n,2n)a

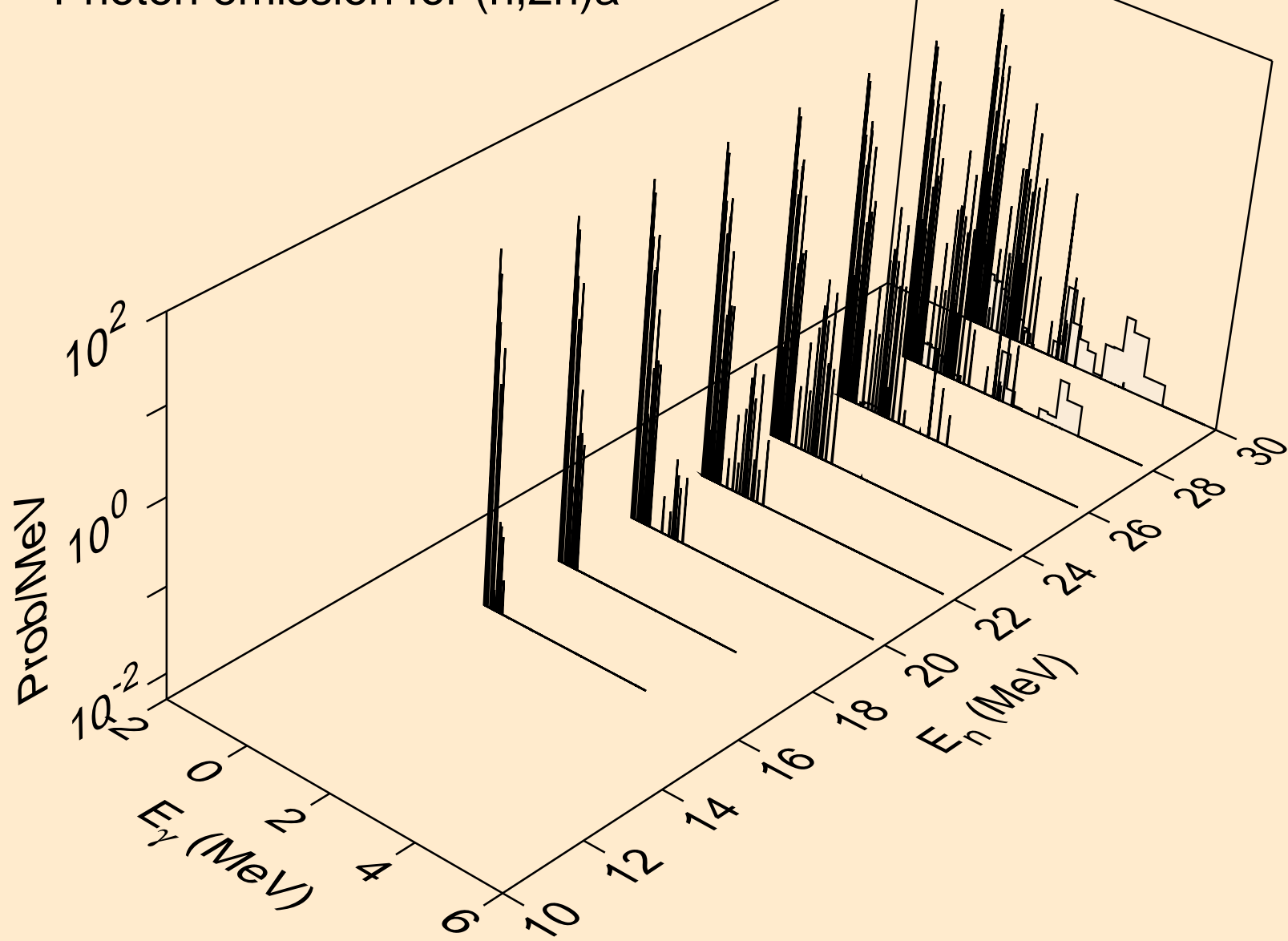

BR088 ALPHA ACER TENDL-2024 LIBRARY; T=0.K
Photon emission for (n,3n)a

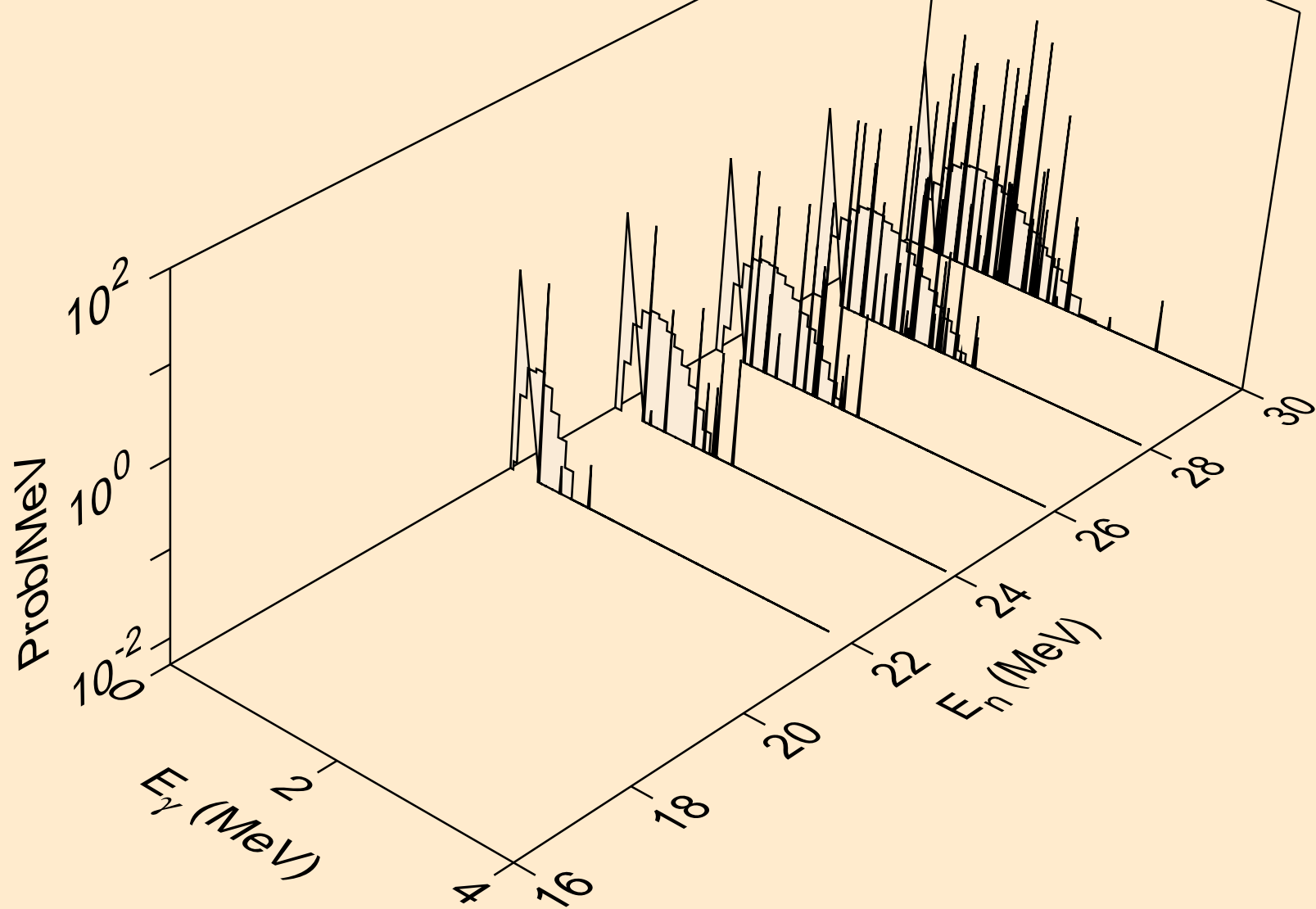

BR088 ALPHA ACER TENDL-2024 LIBRARY; T=0.K
Photon emission for (n,n*)p

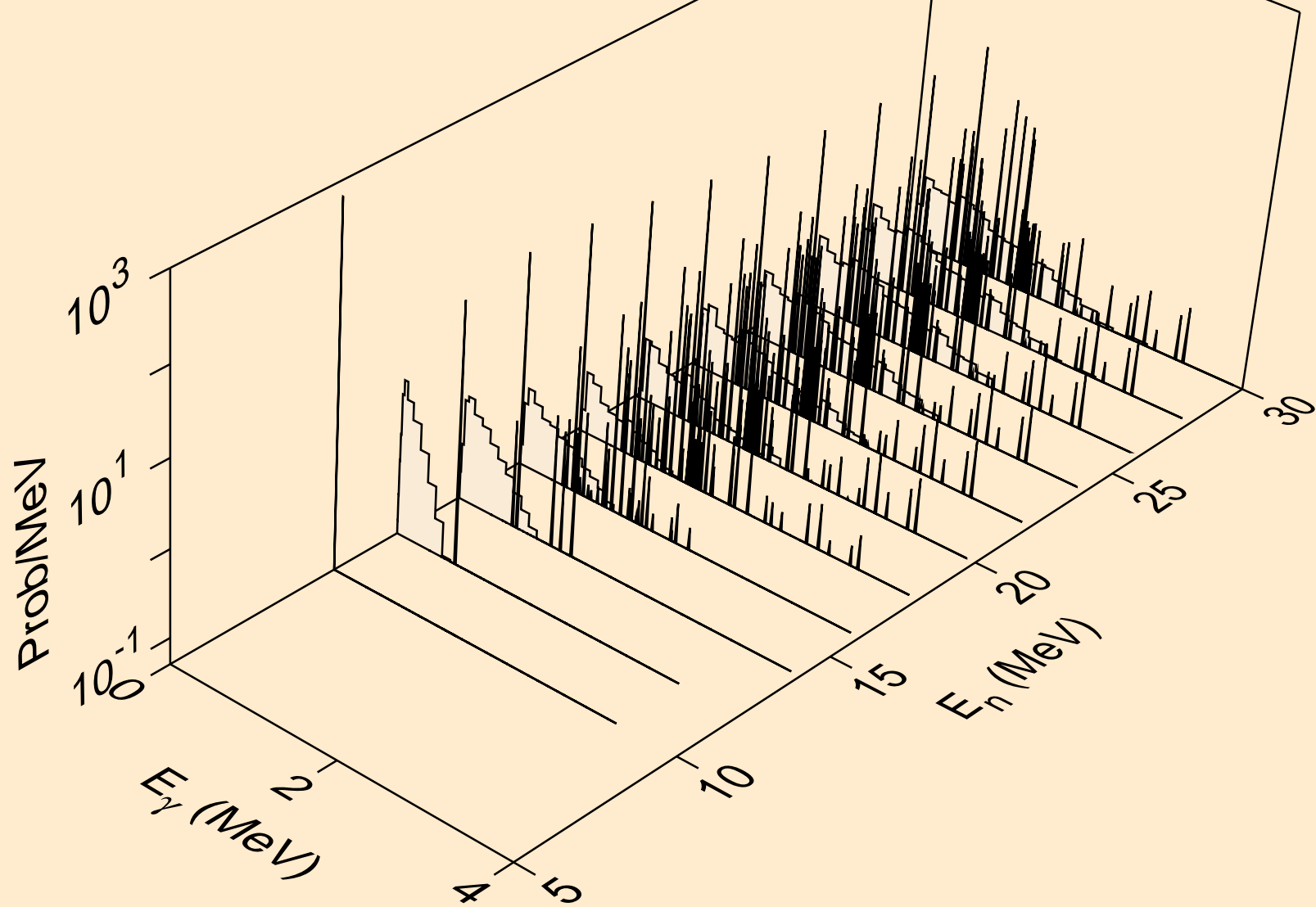

BR088 ALPHA ACER TENDL-2024 LIBRARY; T=0.K
Photon emission for (n,n*)d

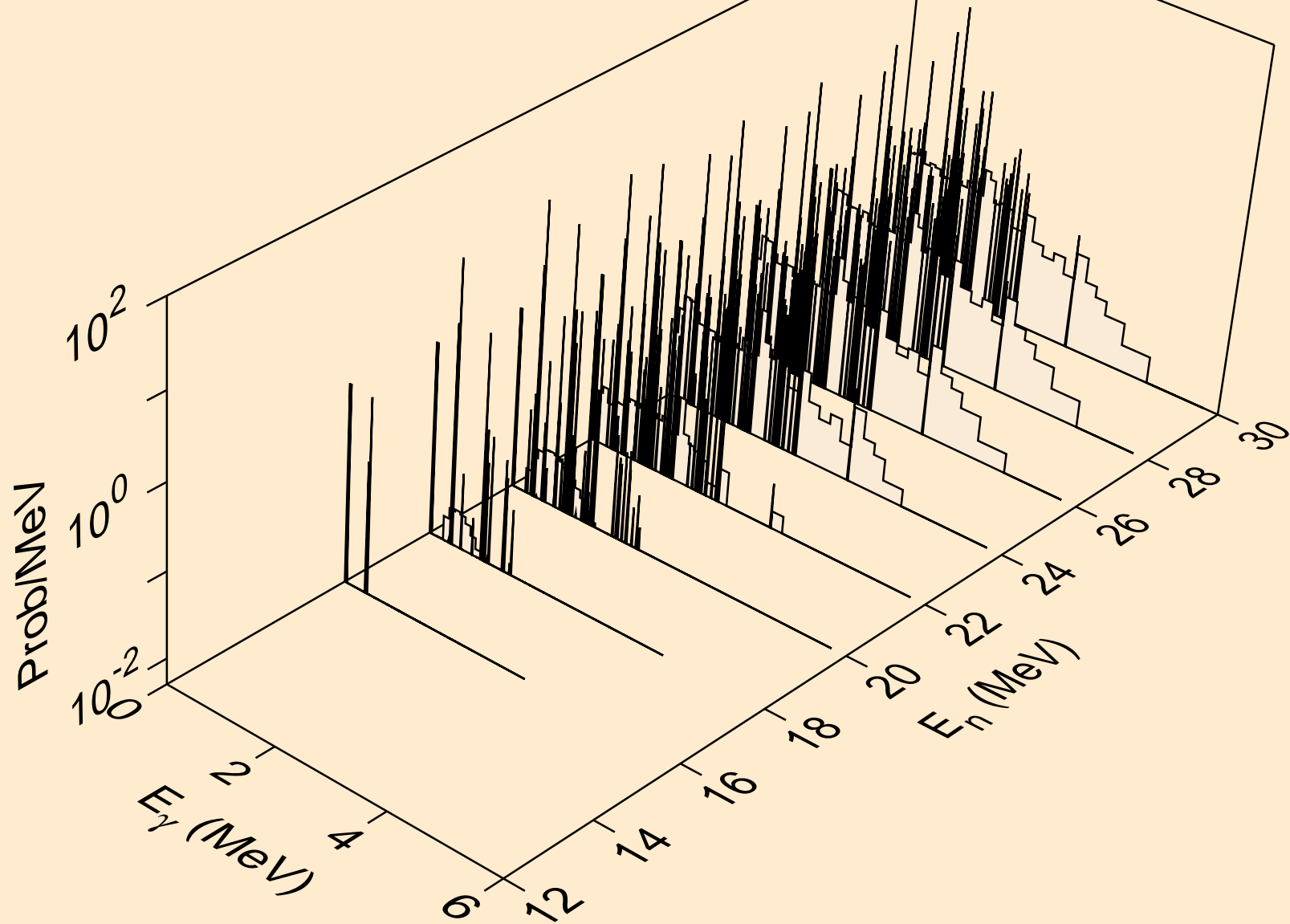

BR088 ALPHA ACER TENDL-2024 LIBRARY; T=0.K
Photon emission for (n,n*)t

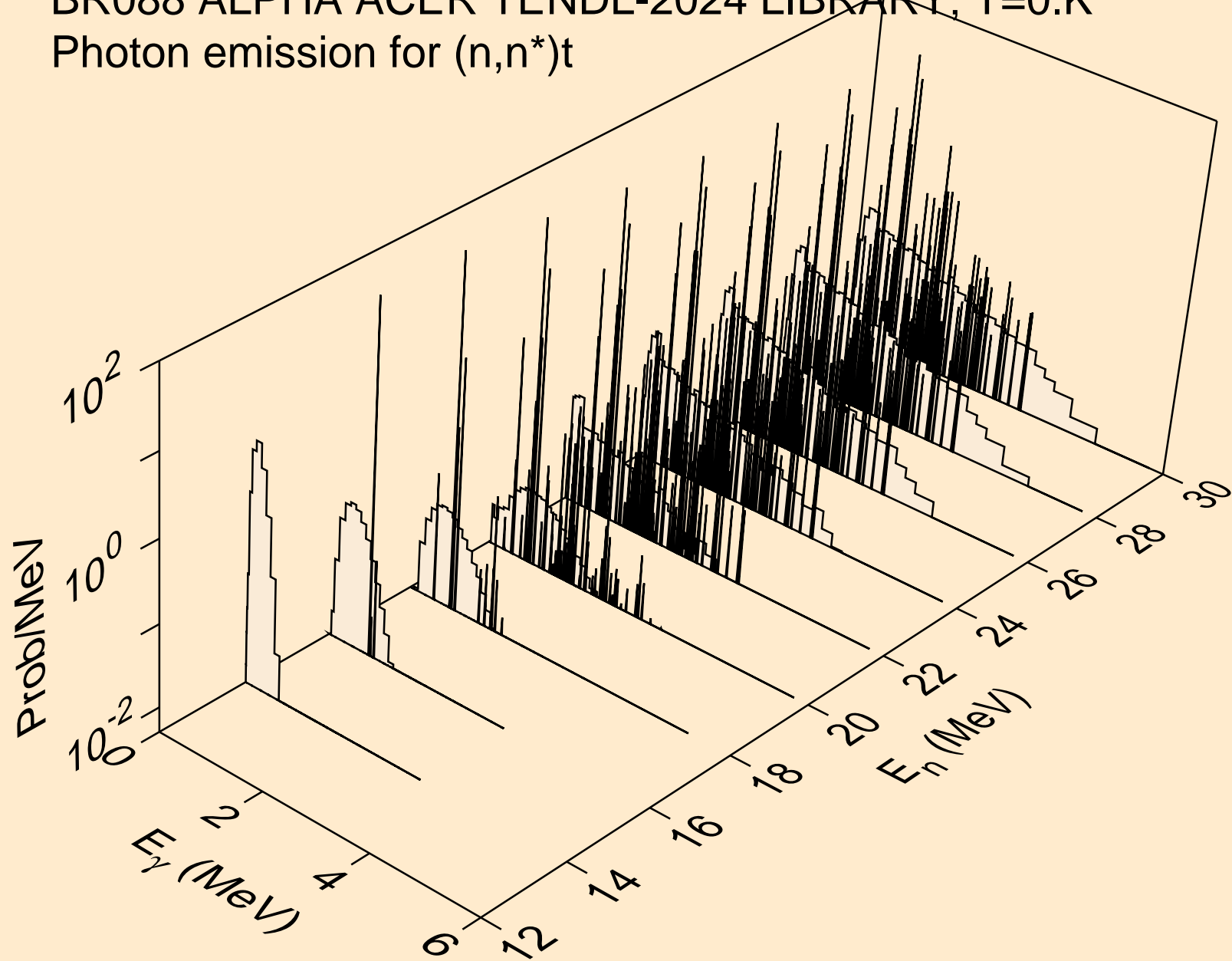

BR088 ALPHA ACER TENDL-2024 LIBRARY; T=0.K
Photon emission for (n,n*)he3

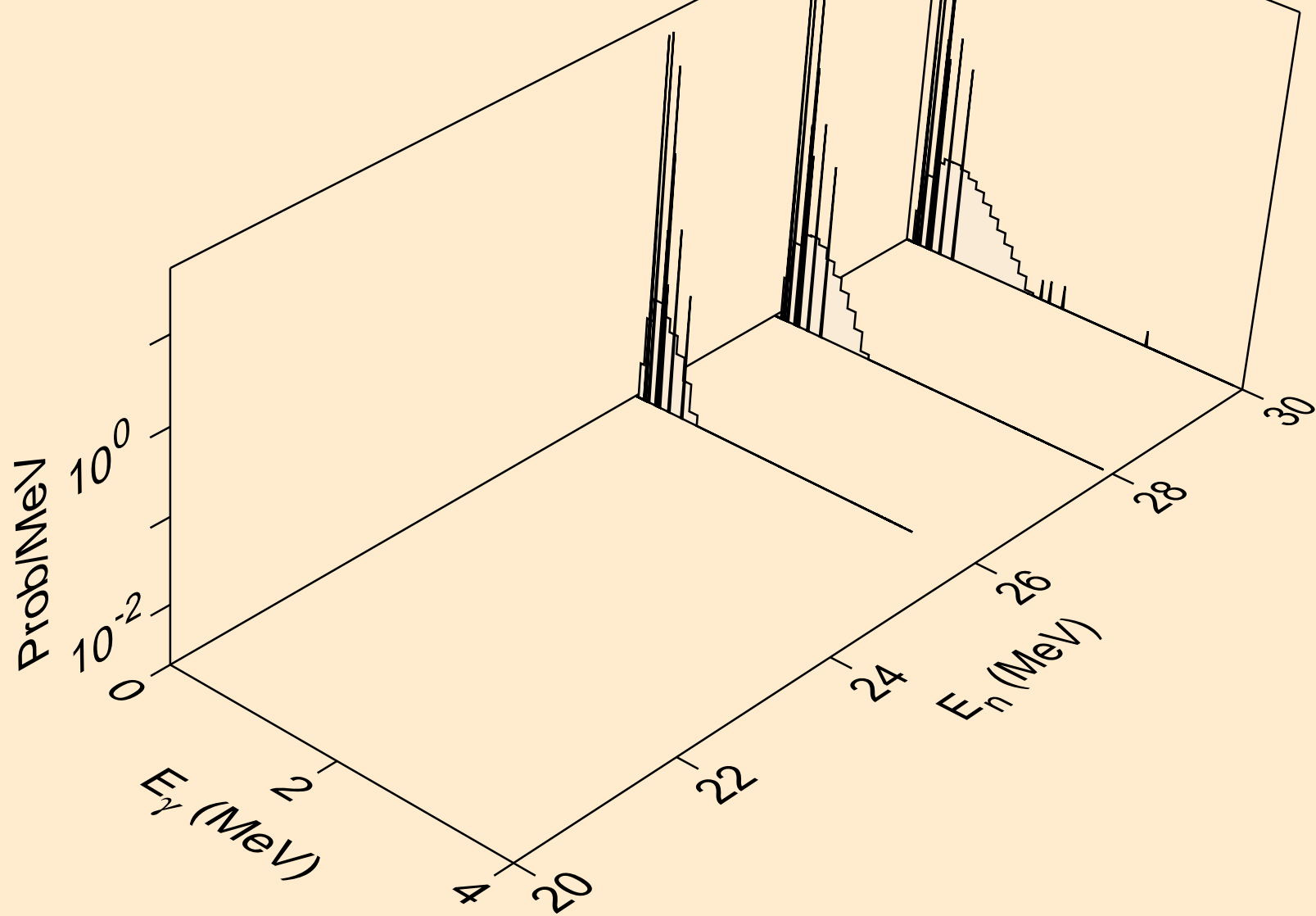

BR088 ALPHA ACER TENDL-2024 LIBRARY; T=0.K
Photon emission for (n,4n)

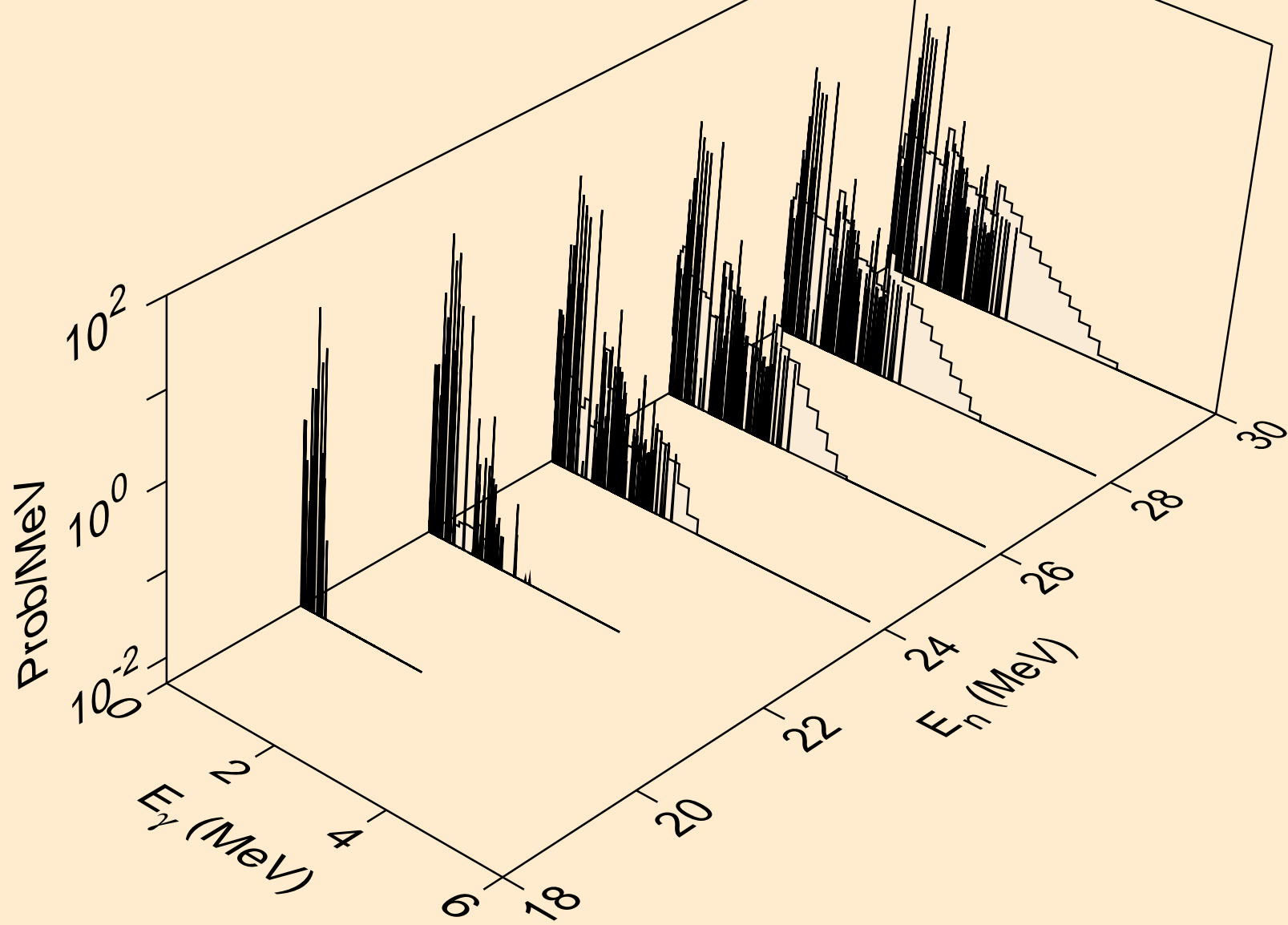

BR088 ALPHA ACER TENDL-2024 LIBRARY; T=0.K
Photon emission for (n,2np)

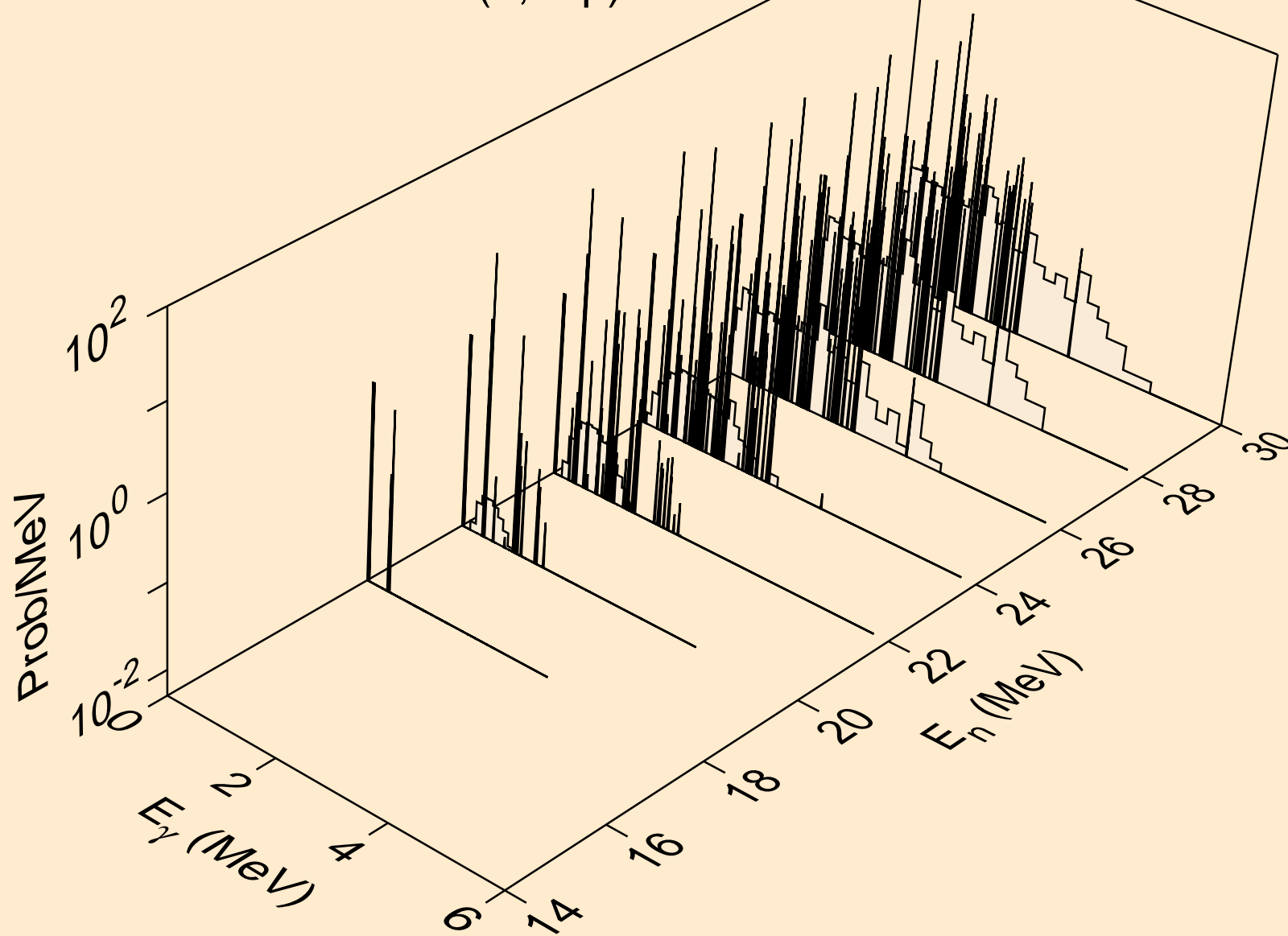

BR088 ALPHA ACER TENDL-2024 LIBRARY; T=0.K
Photon emission for (n,3np)

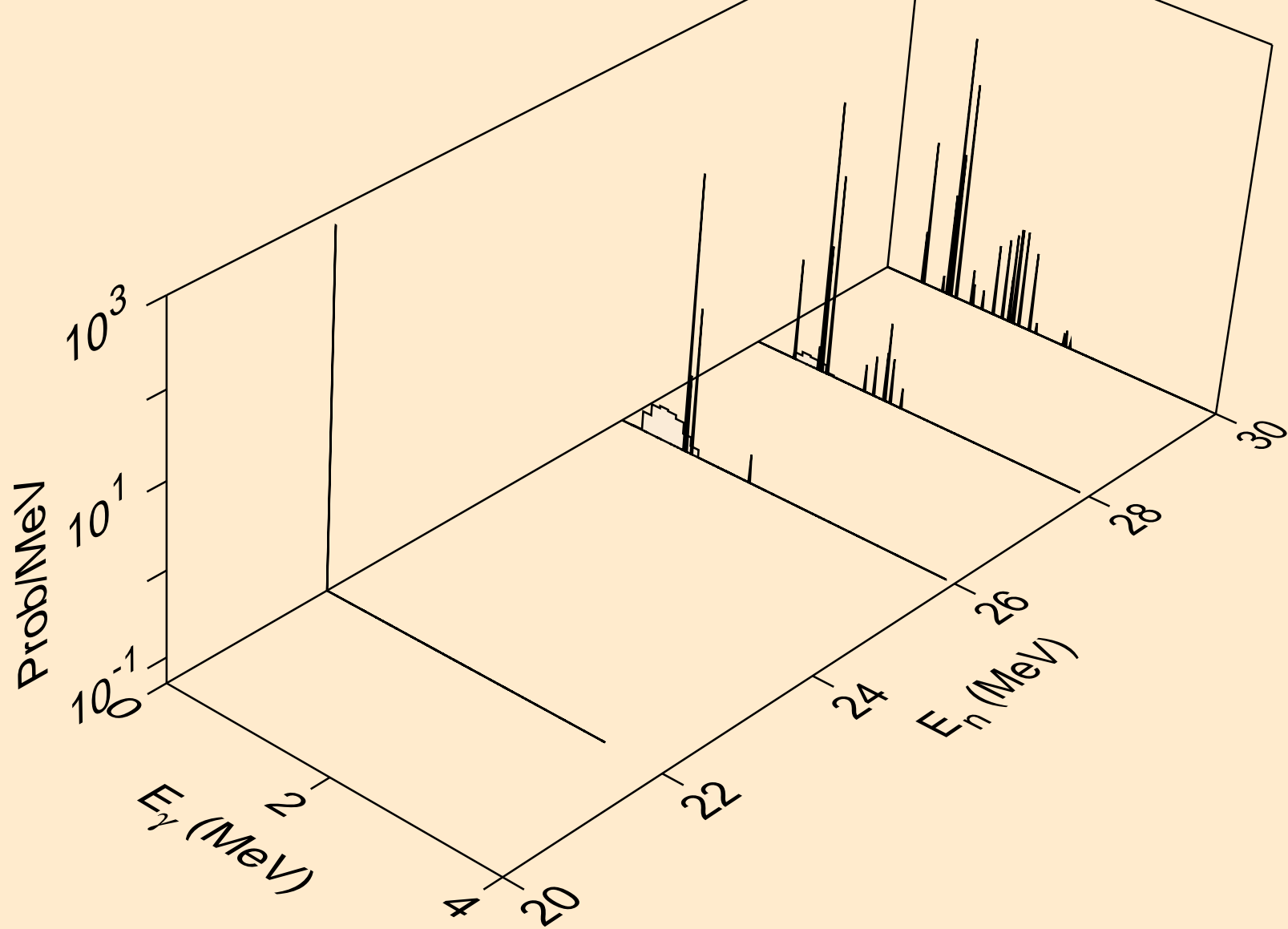

BR088 ALPHA ACER TENDL-2024 LIBRARY; T=0.K
Photon emission for (n,gma)

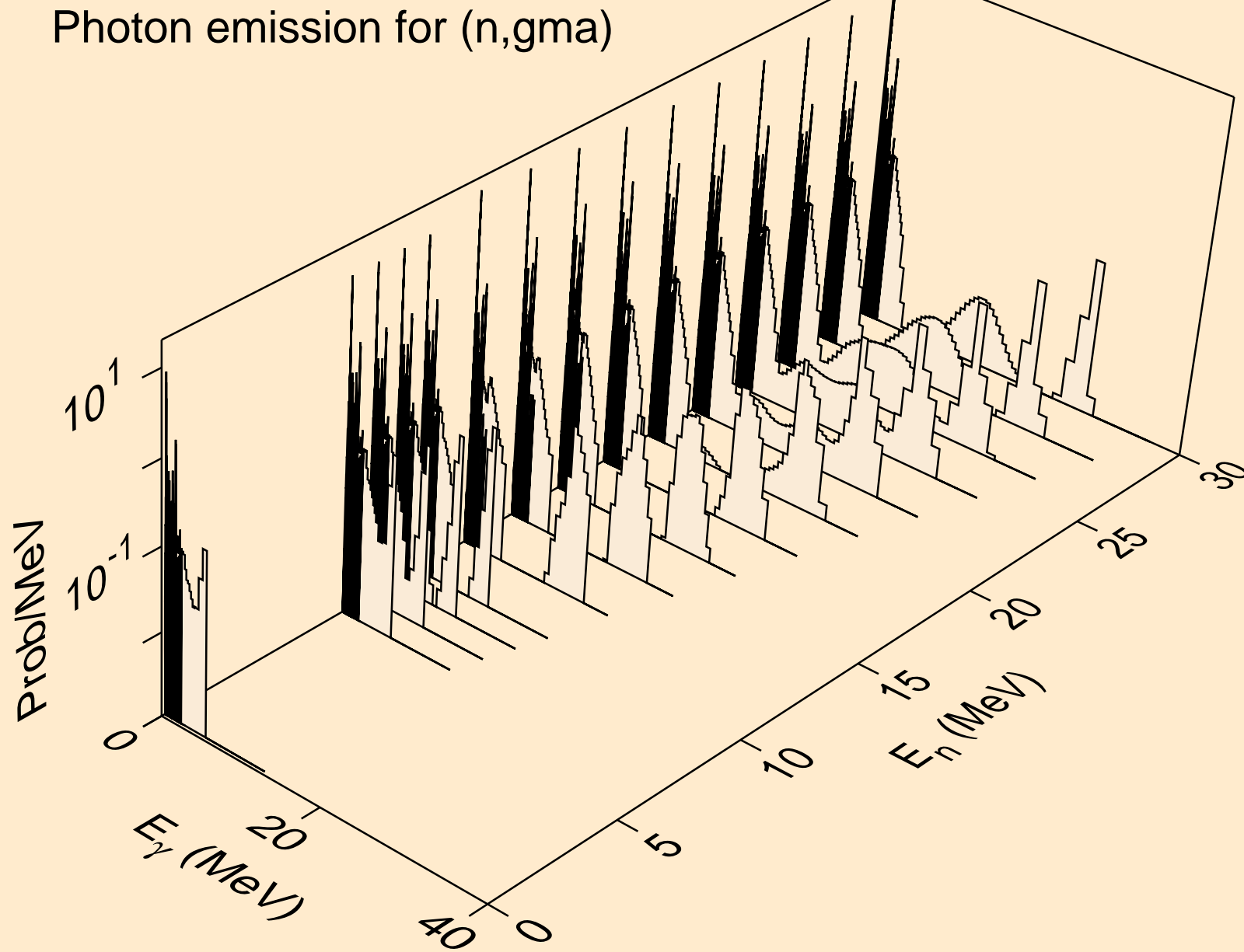

BR088 ALPHA ACER TENDL-2024 LIBRARY; T=0.K
Photon emission for (n,p)

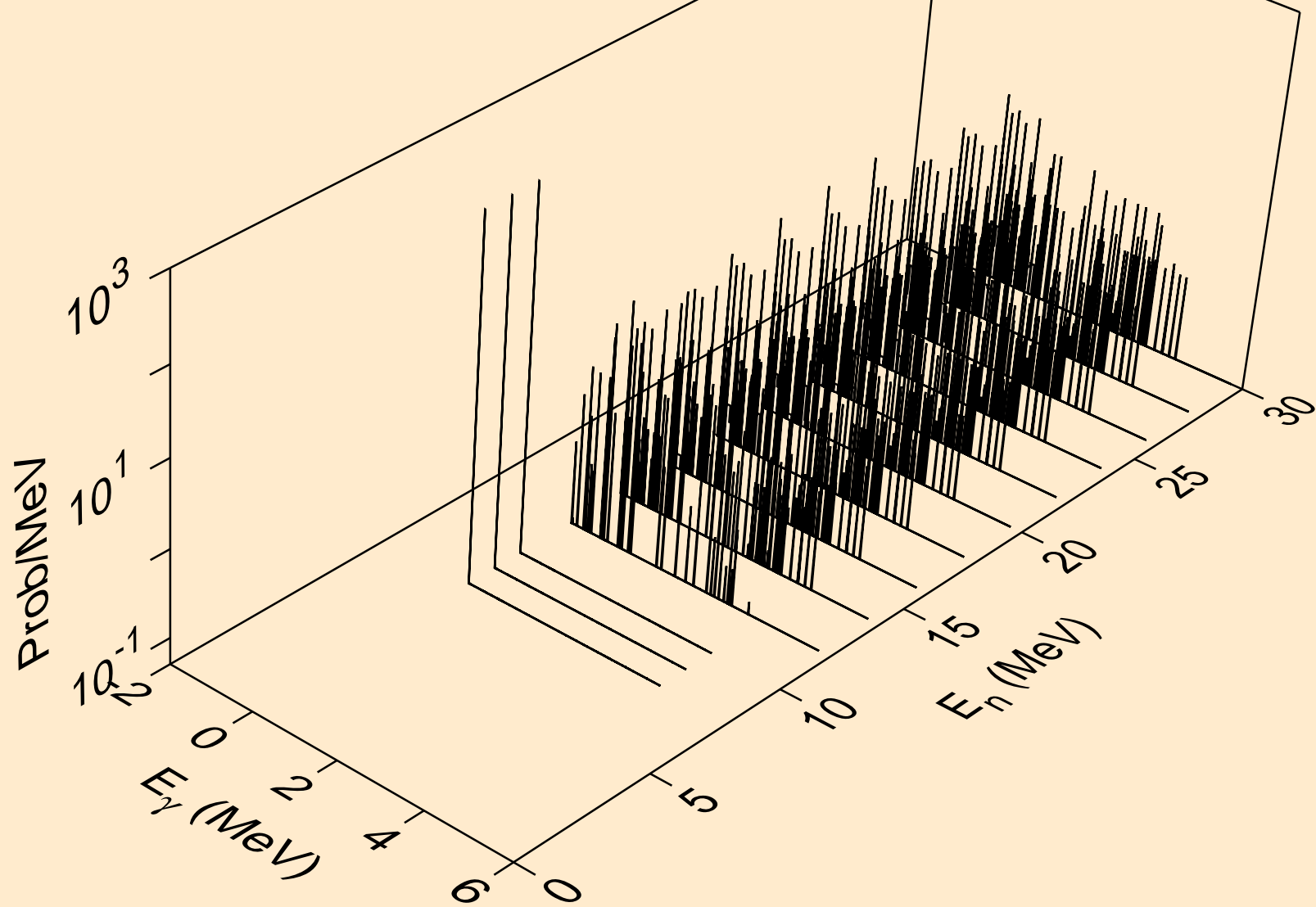

BR088 ALPHA ACER TENDL-2024 LIBRARY; T=0.K
Photon emission for (n,d)

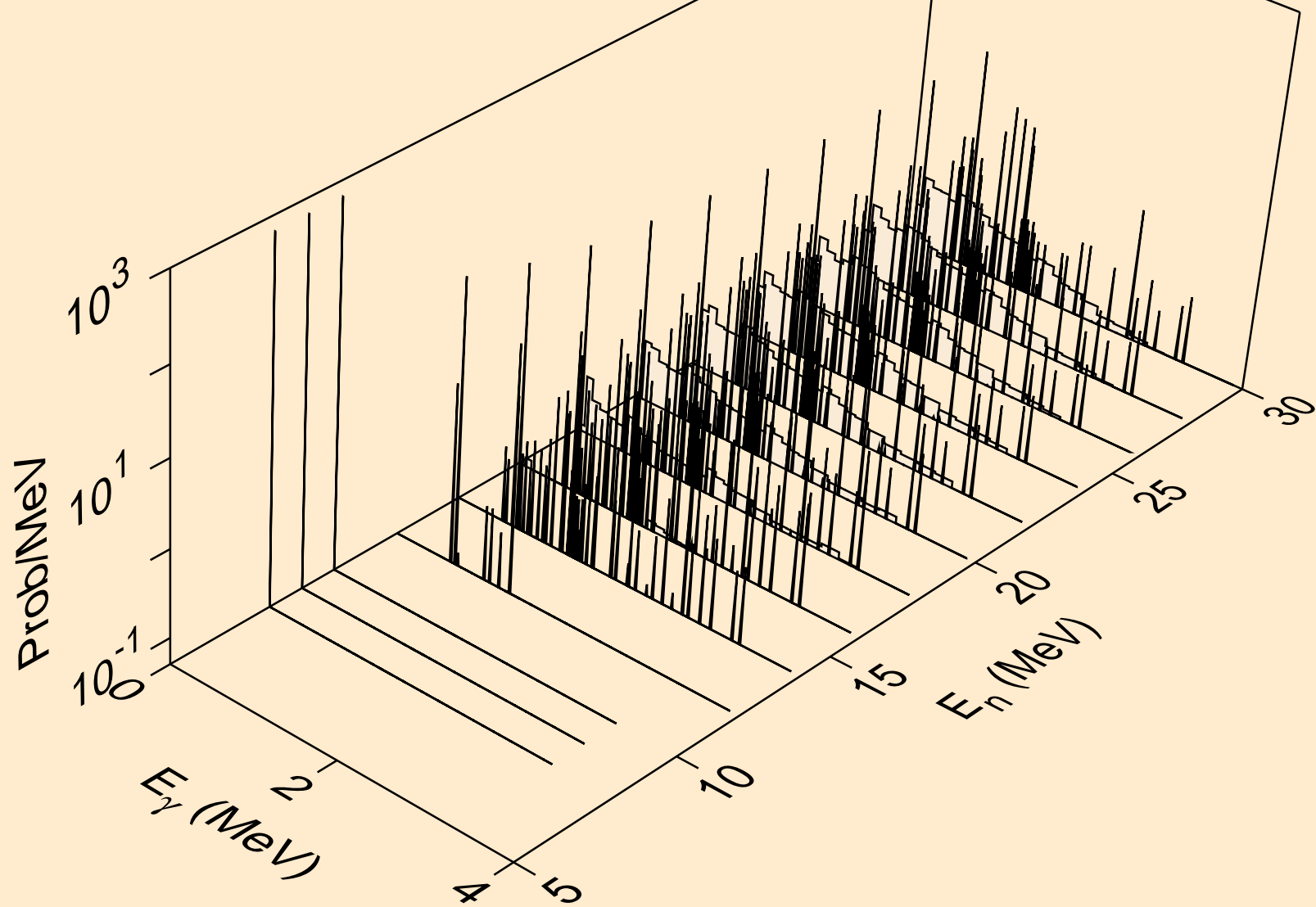

BR088 ALPHA ACER TENDL-2024 LIBRARY; T=0.K
Photon emission for (n,t)

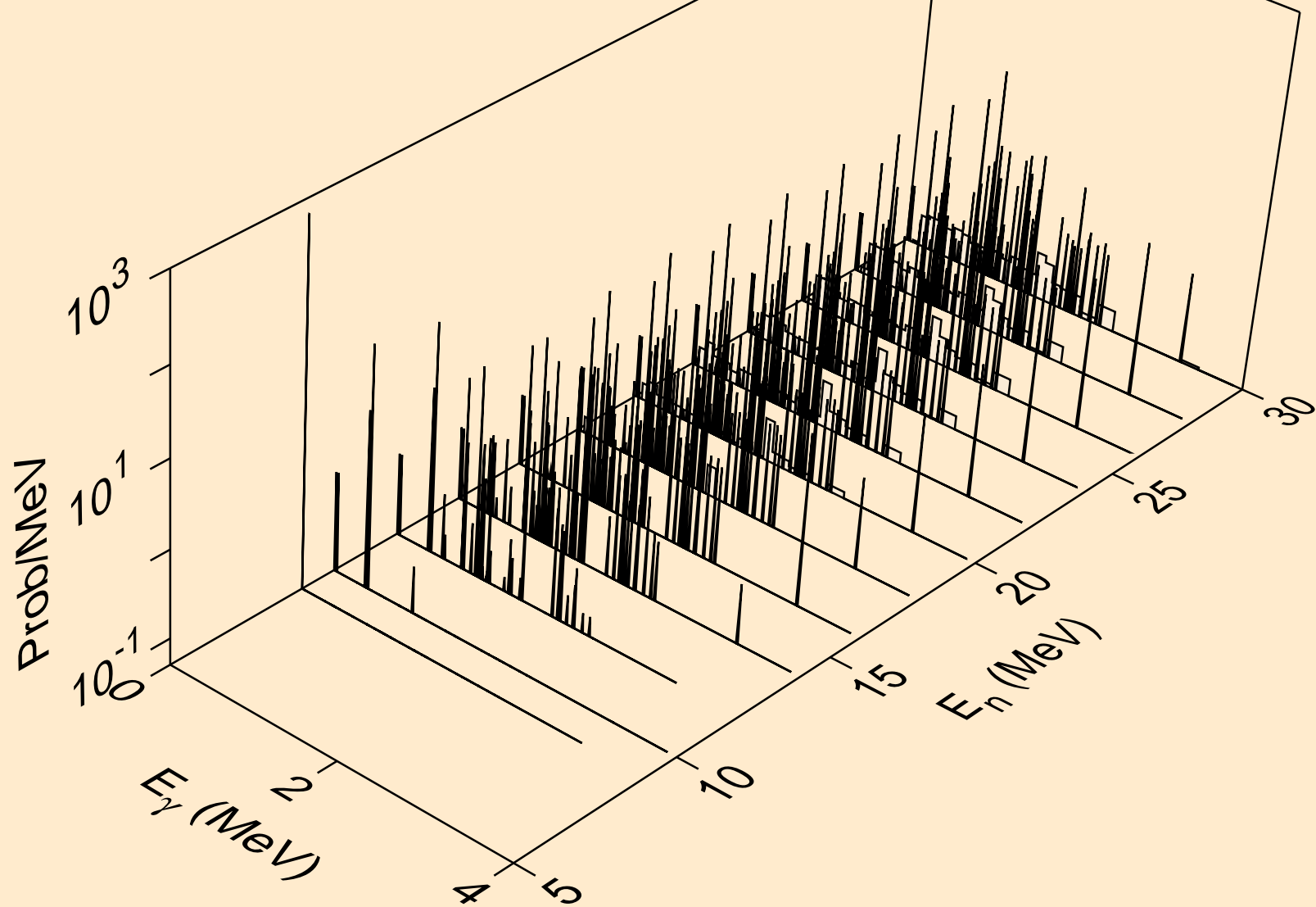

BR088 ALPHA ACER TENDL-2024 LIBRARY; T=0.K
Photon emission for (n,he3)

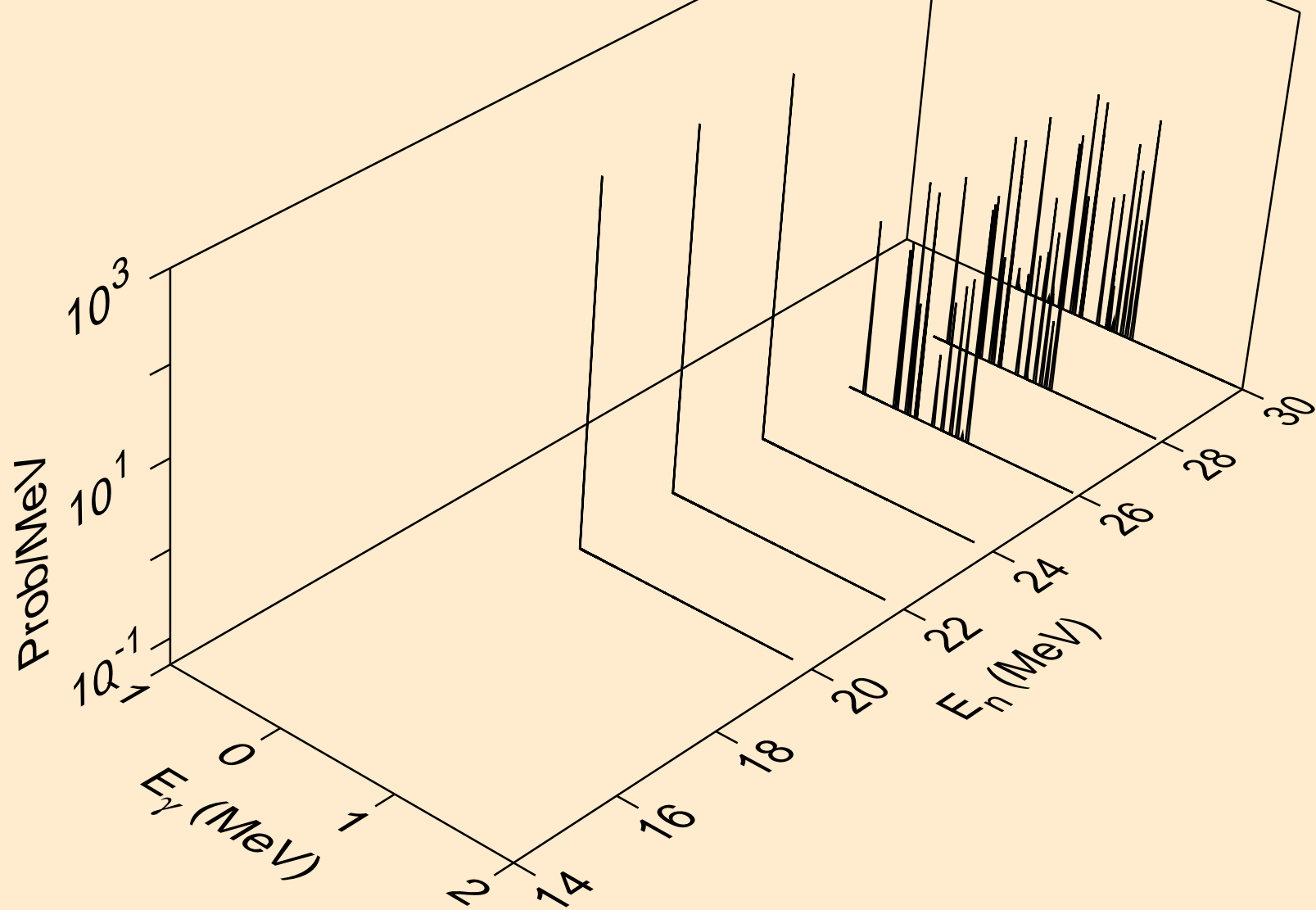

BR088 ALPHA ACER TENDL-2024 LIBRARY; T=0.K
Photon emission for inelastic

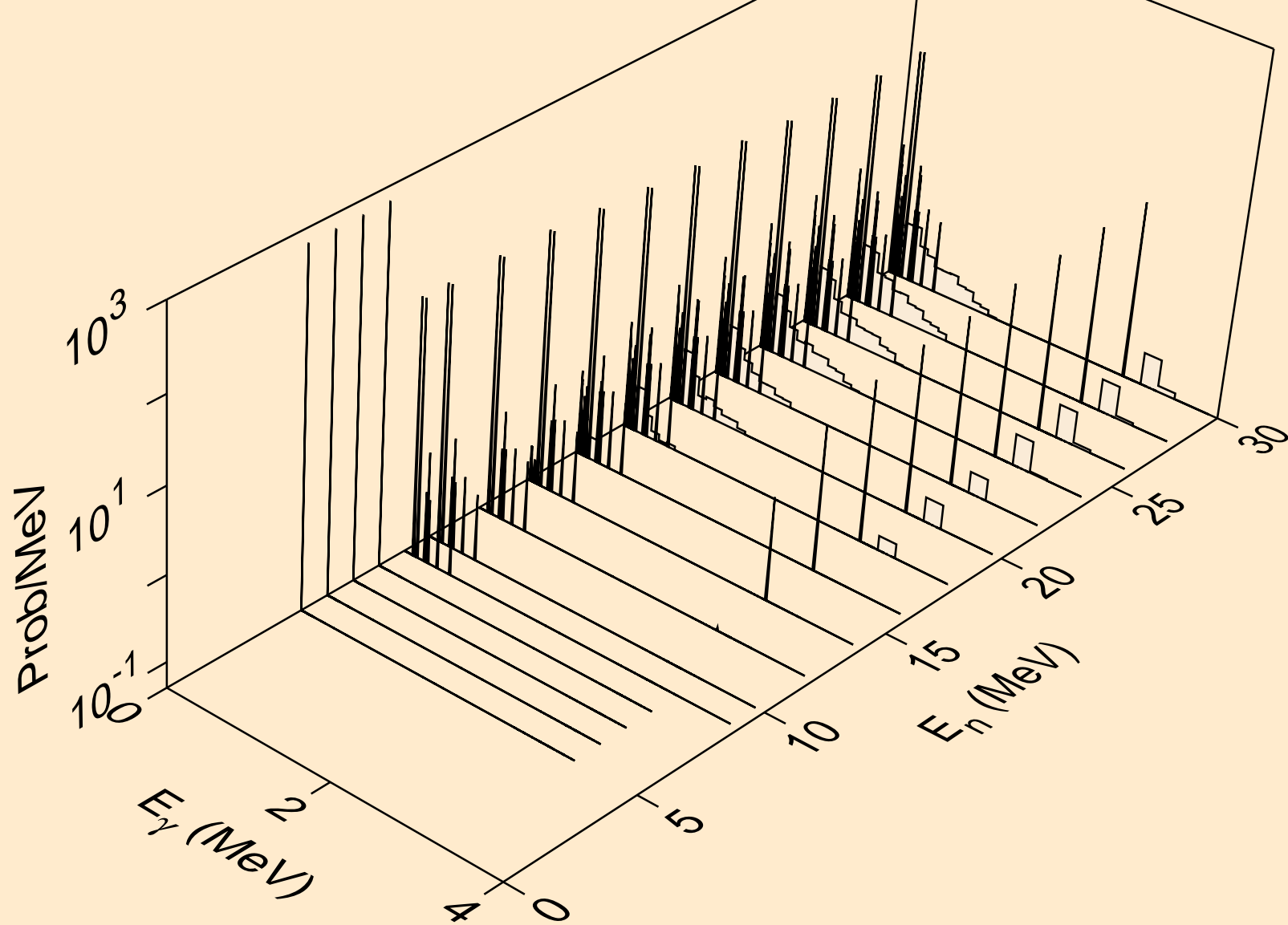

BR088 ALPHA ACER TENDL-2024 LIBRARY; T=0.K
Photon emission for (n,2a)

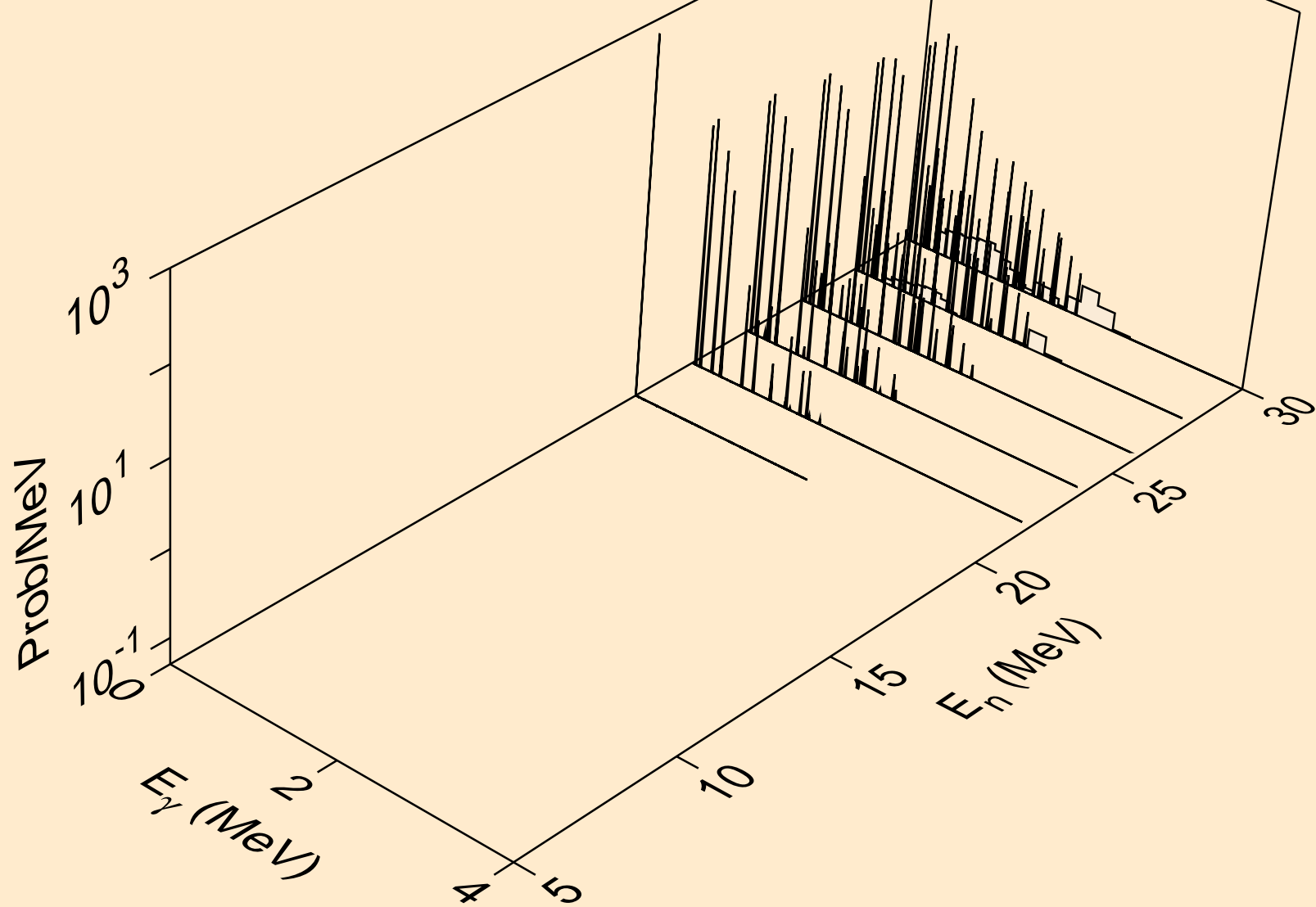

BR088 ALPHA ACER TENDL-2024 LIBRARY; T=0.K
Photon emission for (n,pa)

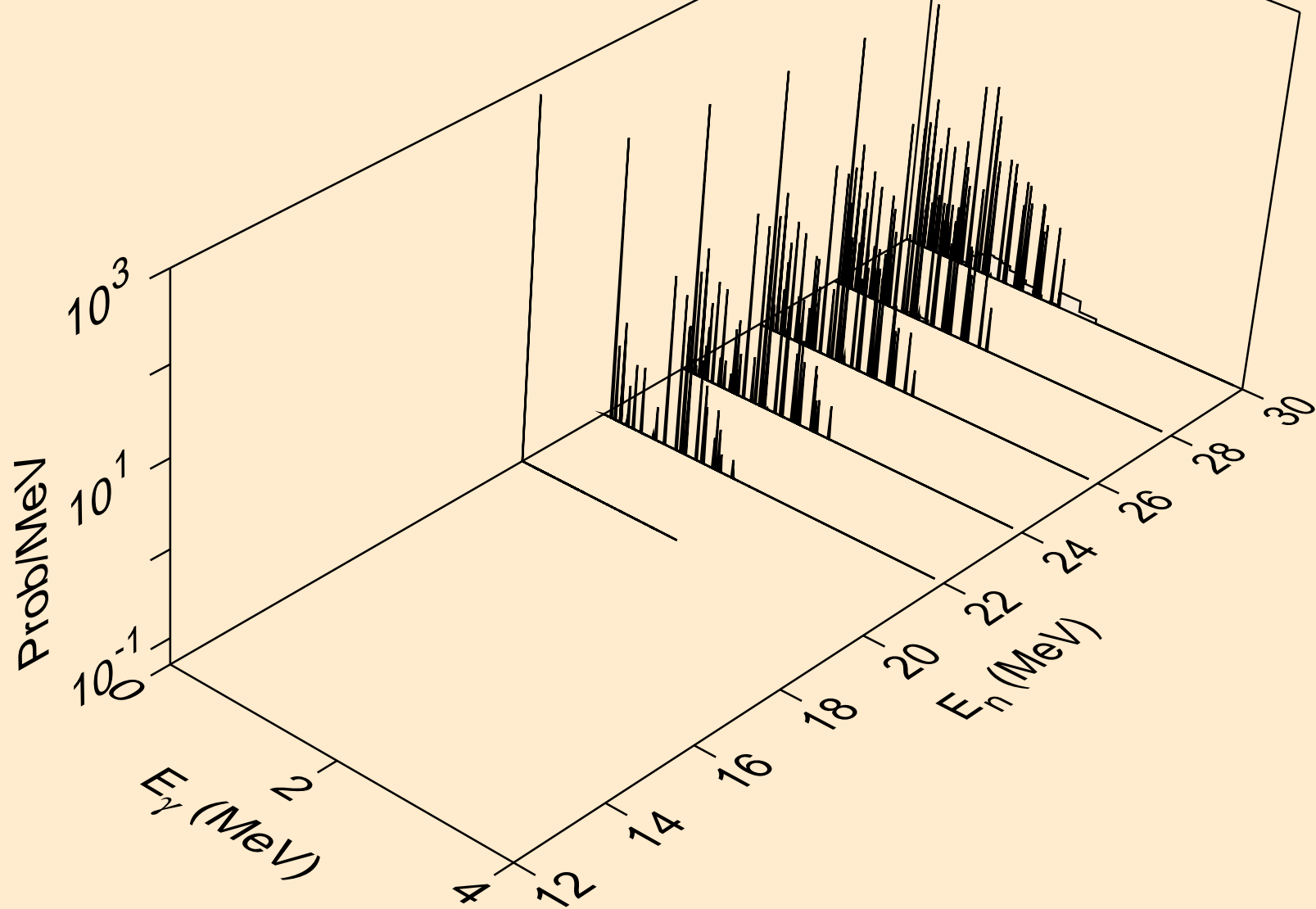

BR088 ALPHA ACER TENDL-2024 LIBRARY; T=0.K
Particle heating contributions

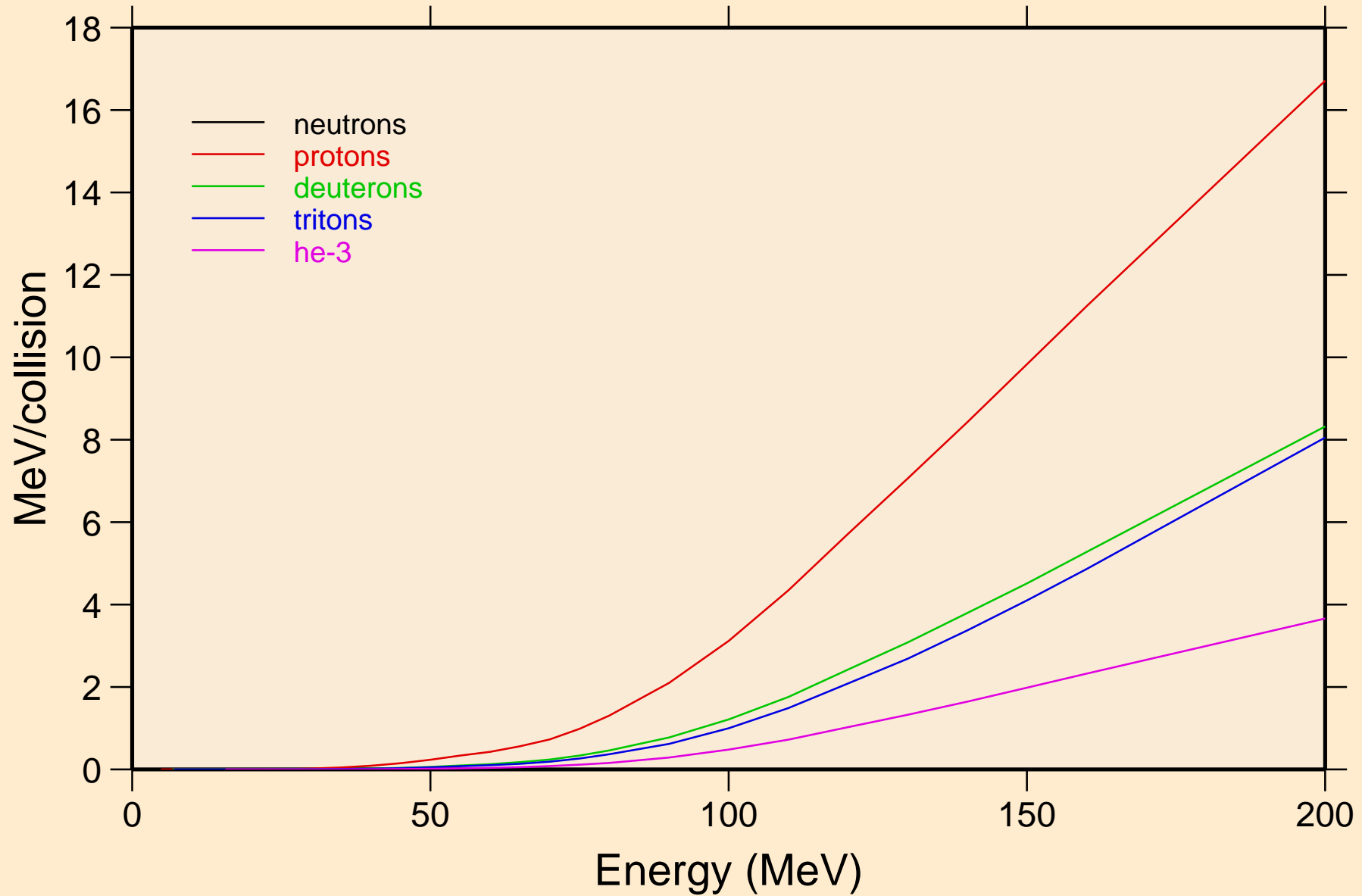

BR088 ALPHA ACER TENDL-2024 LIBRARY; T=0.K
Recoil Heating

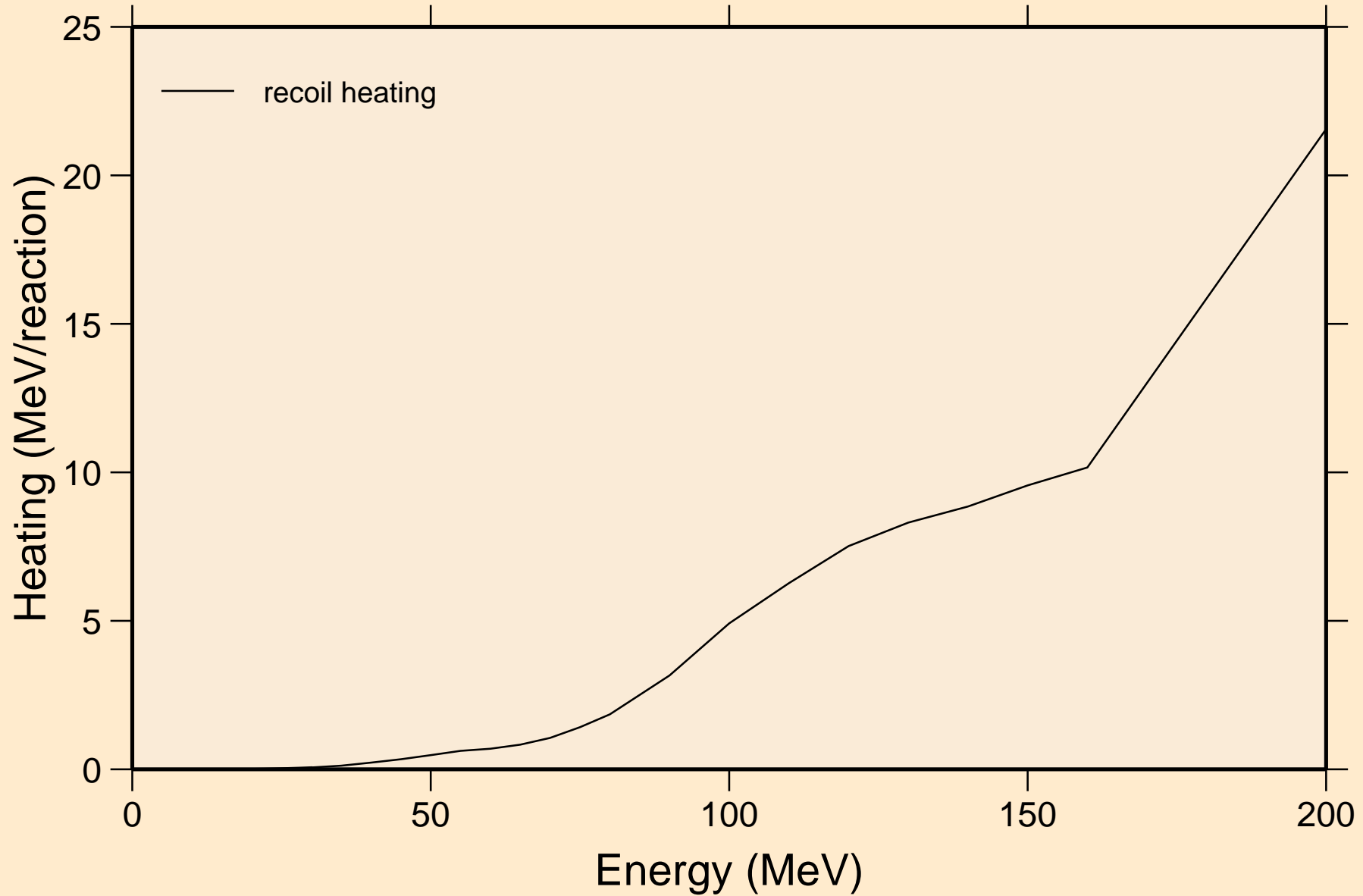

BR088 ALPHA ACER TENDL-2024 LIBRARY; T=0.K
Particle production cross sections

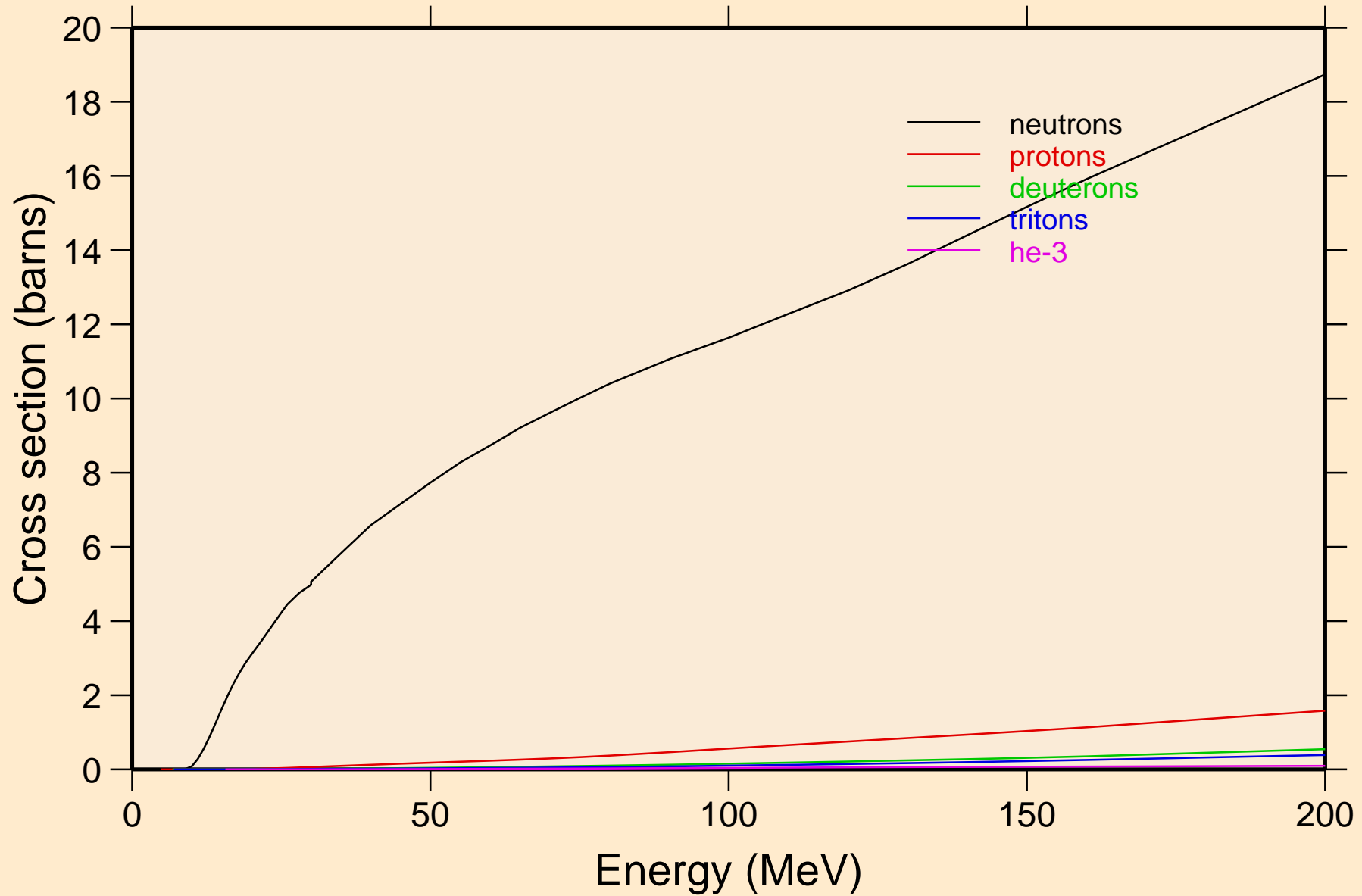

BR088 ALPHA ACER TENDL-2024 LIBRARY; T=0.K
neutrons from (a,n)

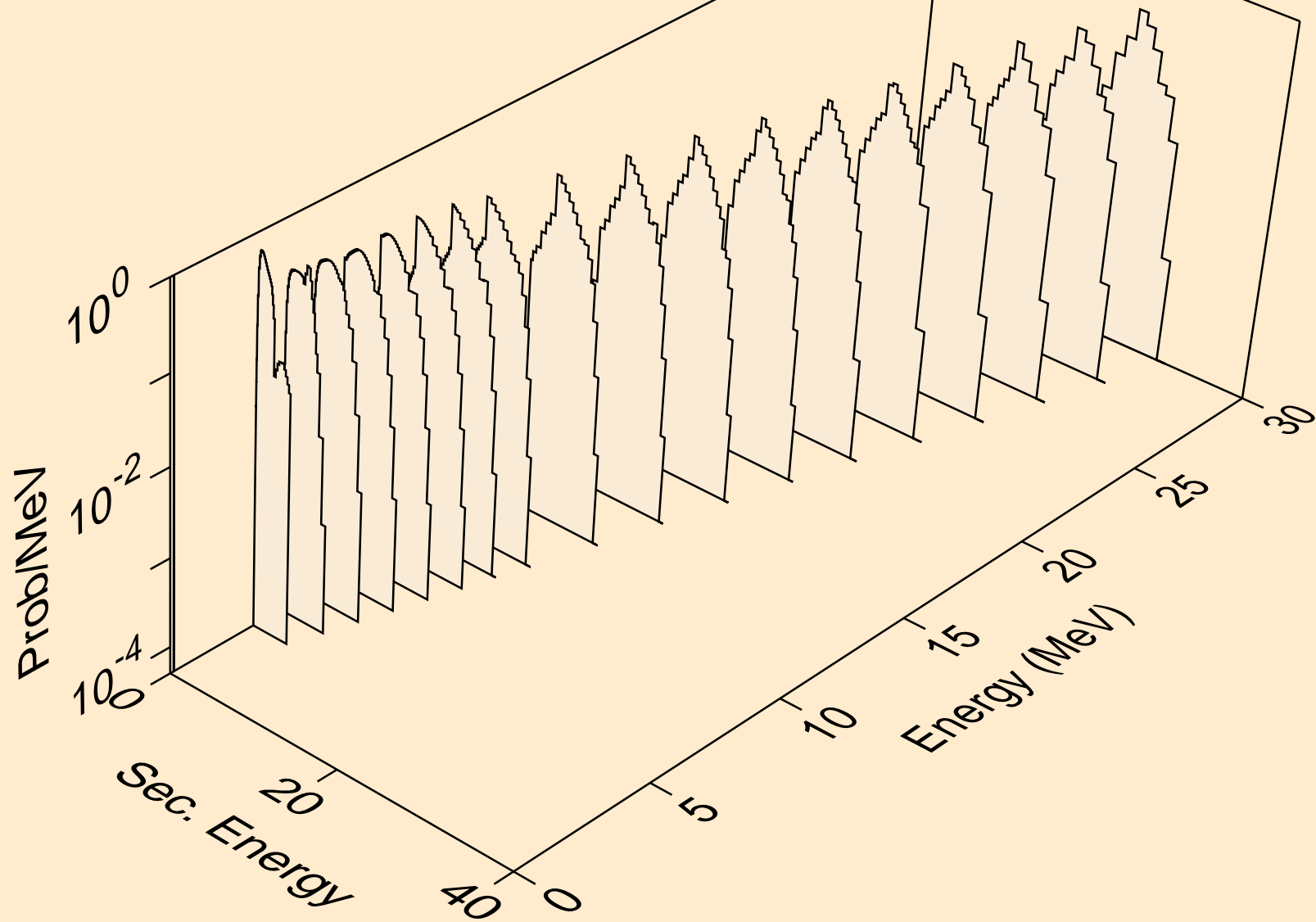

BR088 ALPHA ACER TENDL-2024 LIBRARY; T=0.K
neutrons from (a,x)

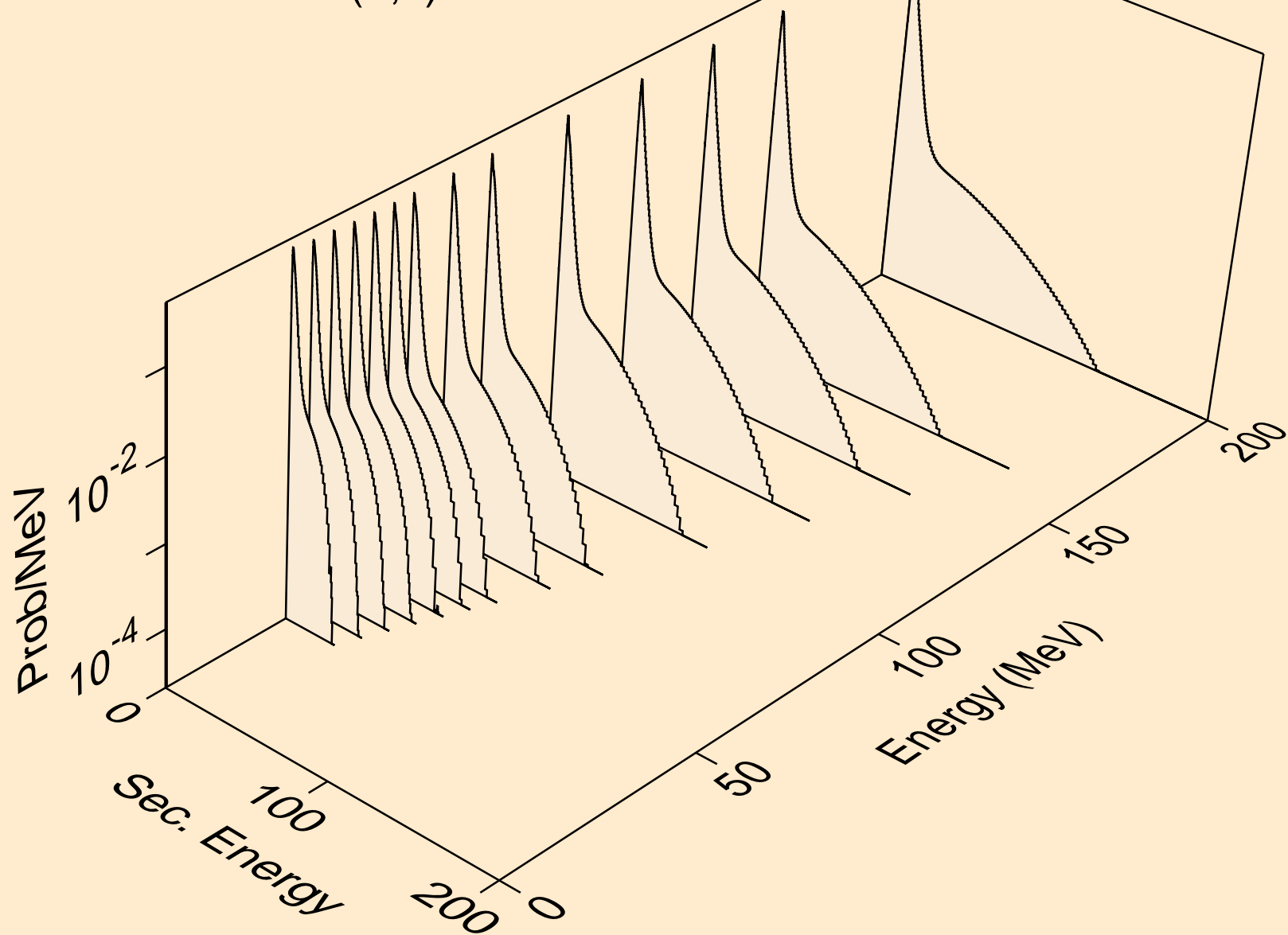

BR088 ALPHA ACER TENDL-2024 LIBRARY; T=0.K
neutrons from (a,2nd)

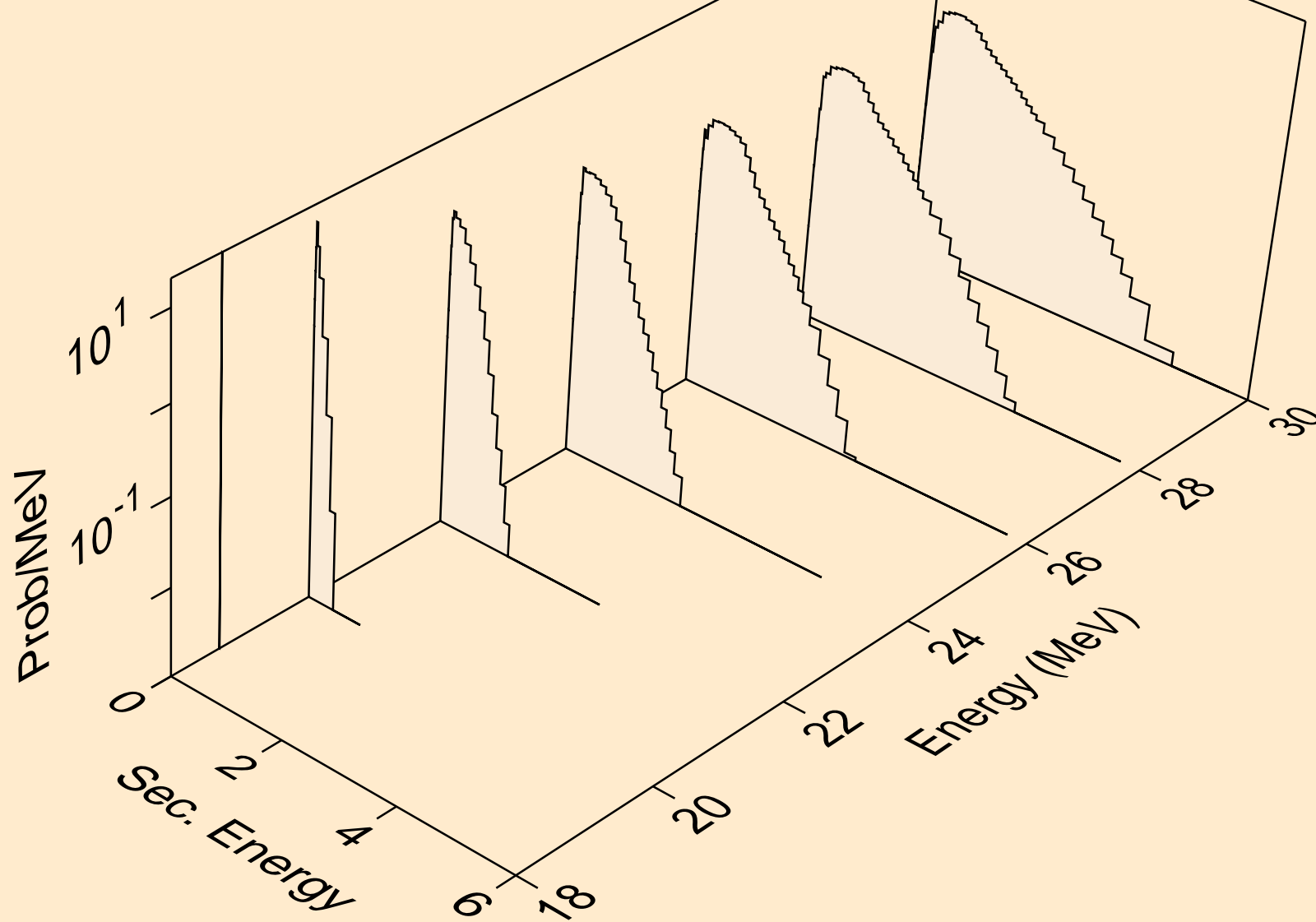

BR088 ALPHA ACER TENDL-2024 LIBRARY; T=0.K
neutrons from (a,2n)

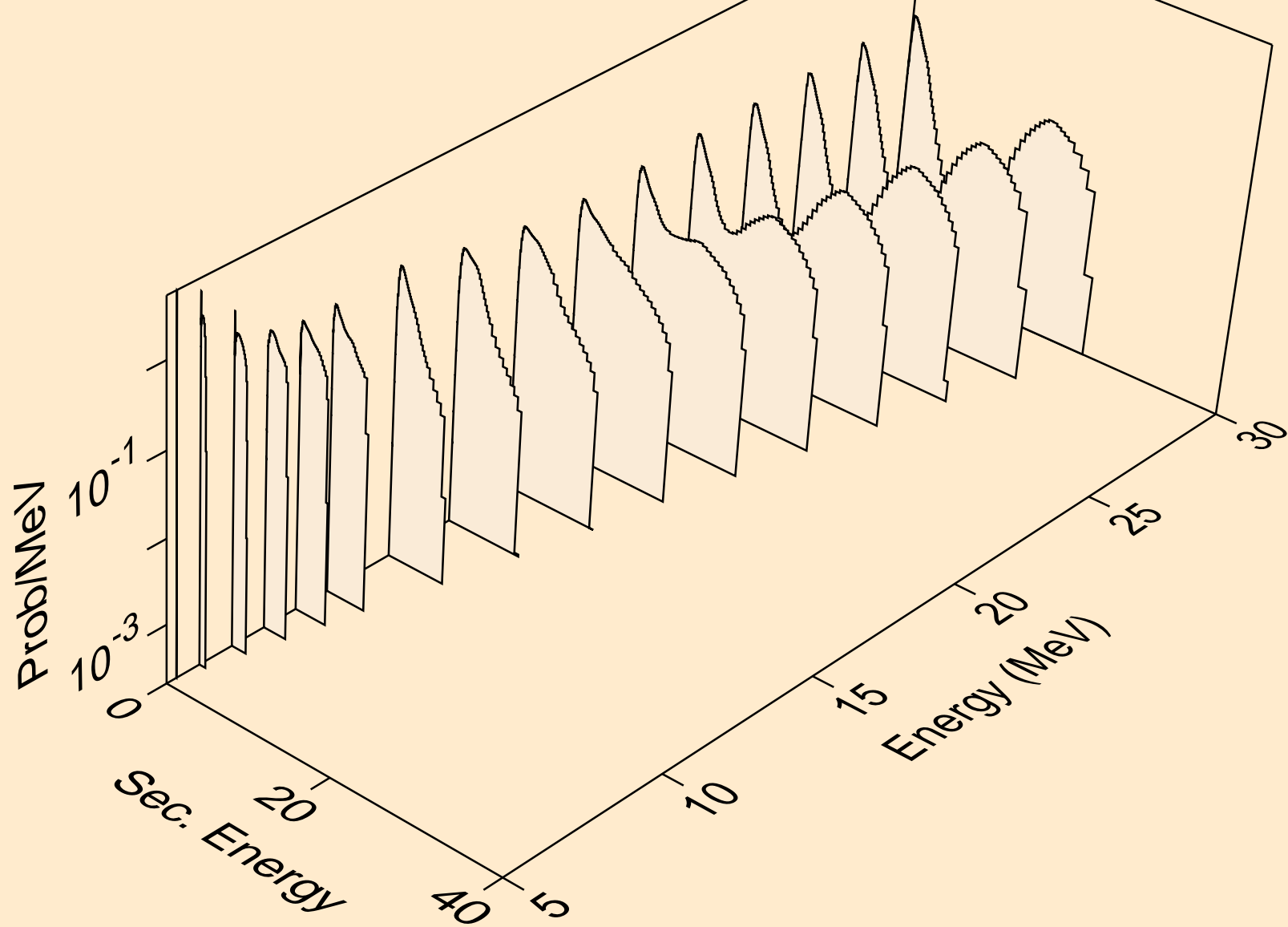

BR088 ALPHA ACER TENDL-2024 LIBRARY; T=0.K
neutrons from (a,3n)

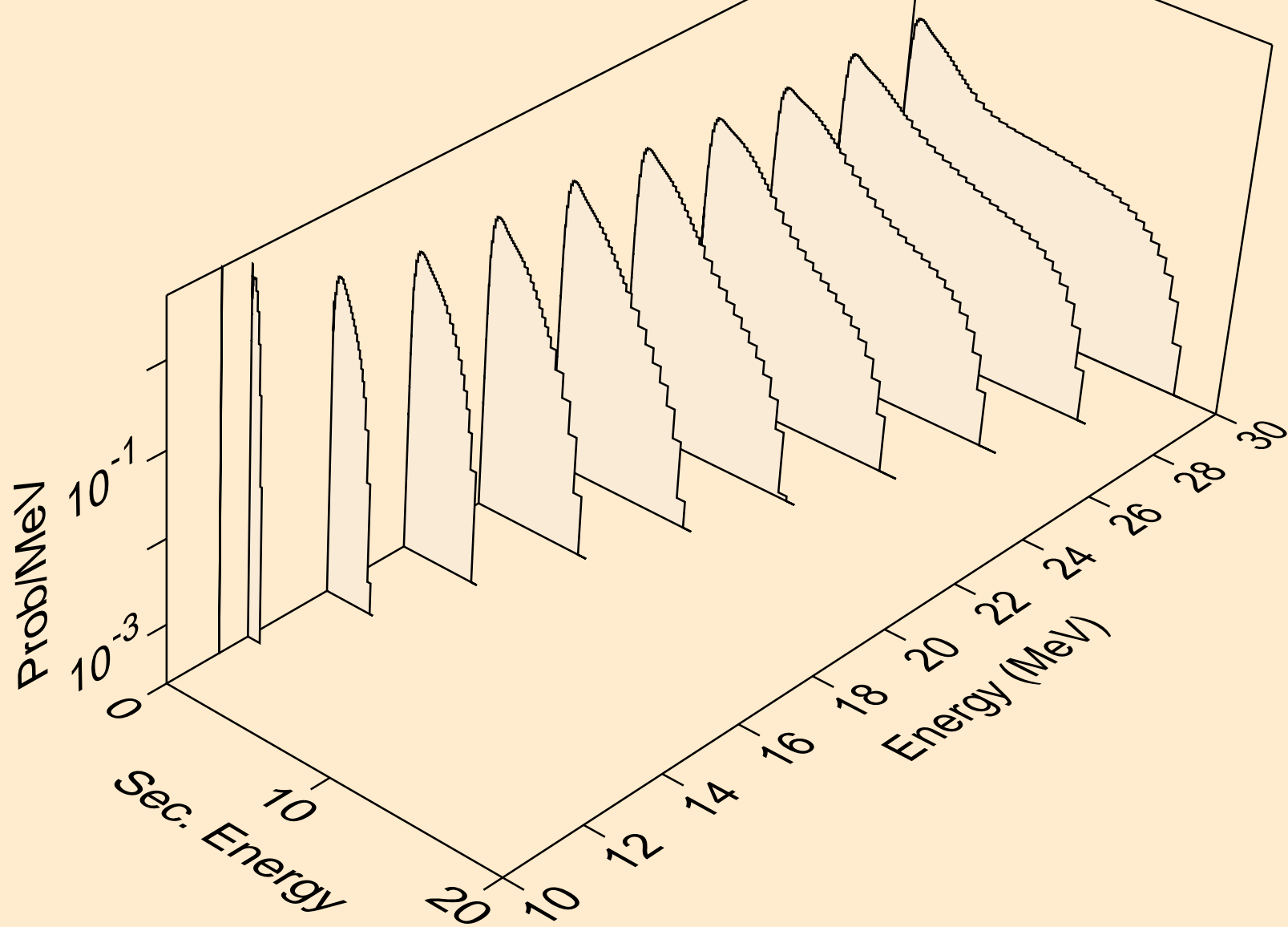

BR088 ALPHA ACER TENDL-2024 LIBRARY; T=0.K
neutrons from (a,n*)a

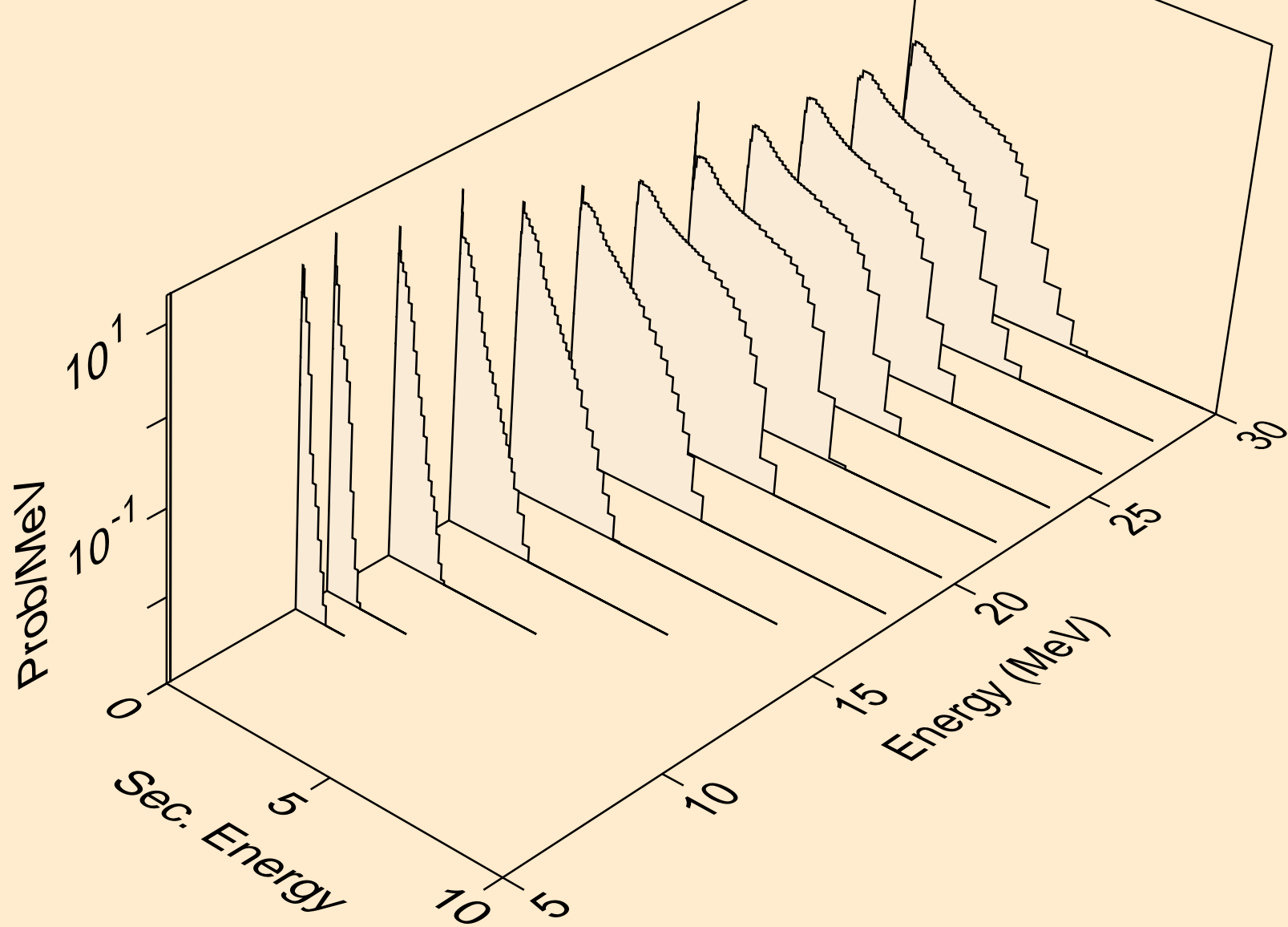

BR088 ALPHA ACER TENDL-2024 LIBRARY; T=0.K
neutrons from (a,2n)a

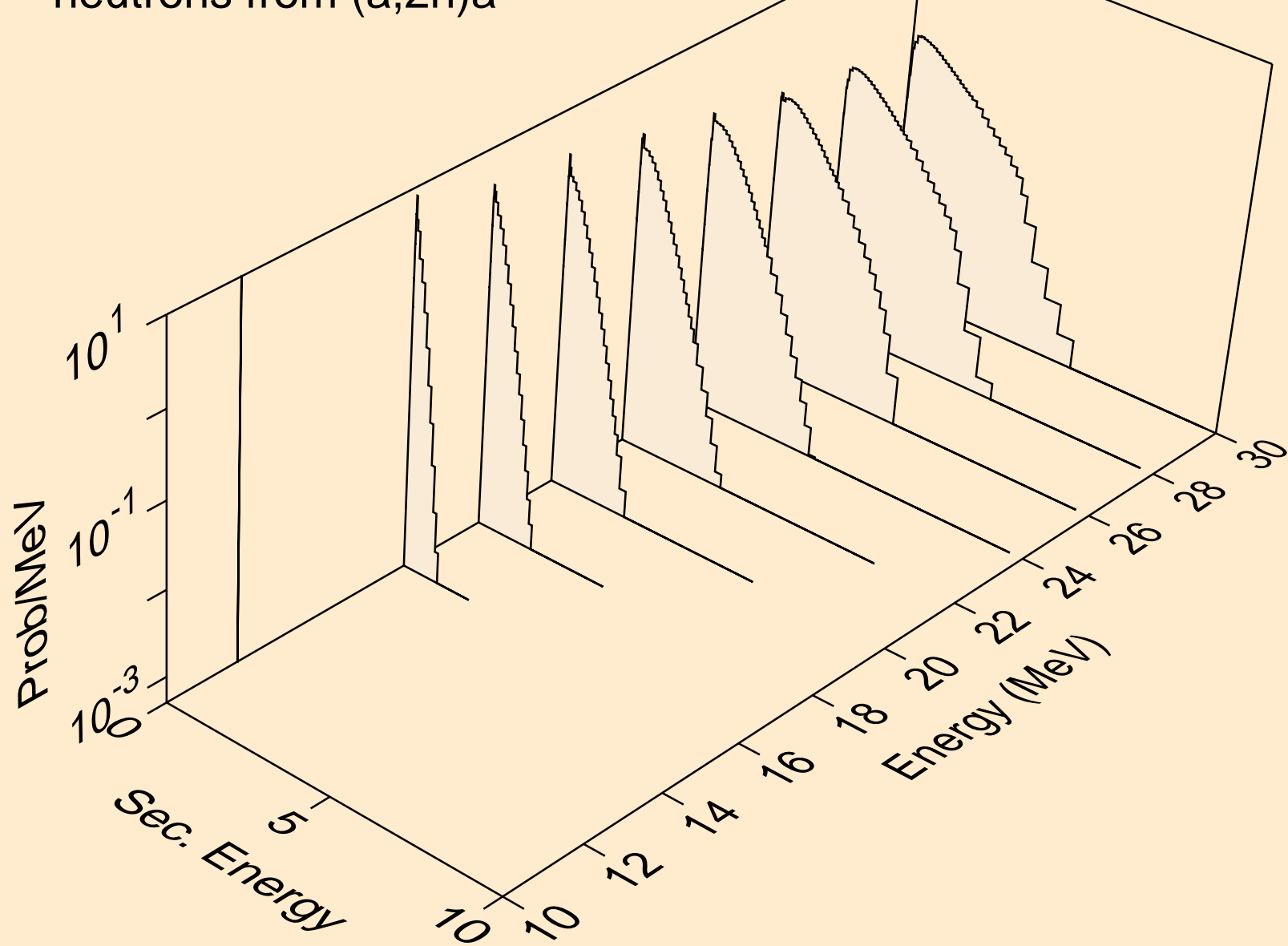

BR088 ALPHA ACER TENDL-2024 LIBRARY; T=0.K
neutrons from (a,3n)a

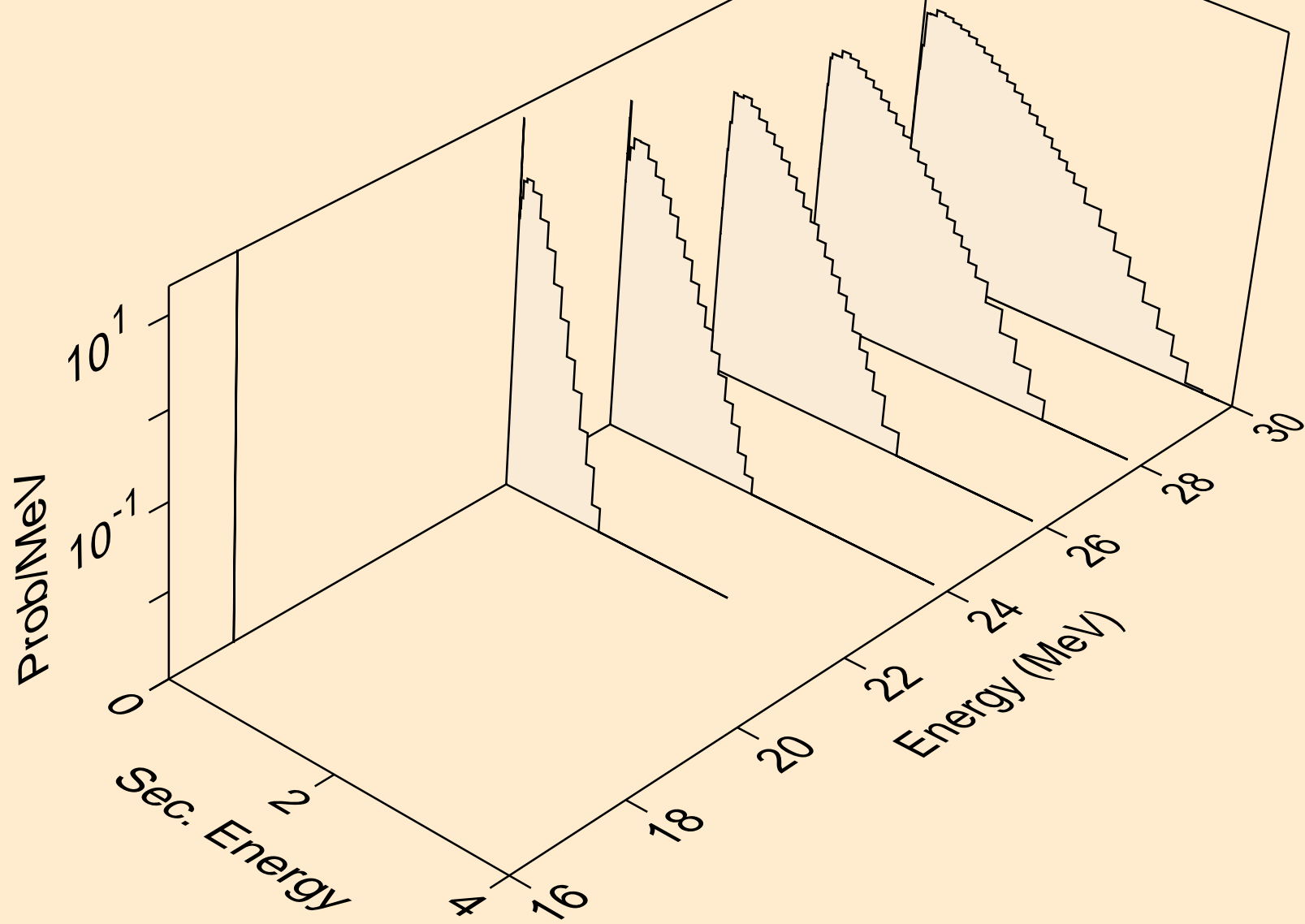

BR088 ALPHA ACER TENDL-2024 LIBRARY; T=0.K
neutrons from (a,n*)p

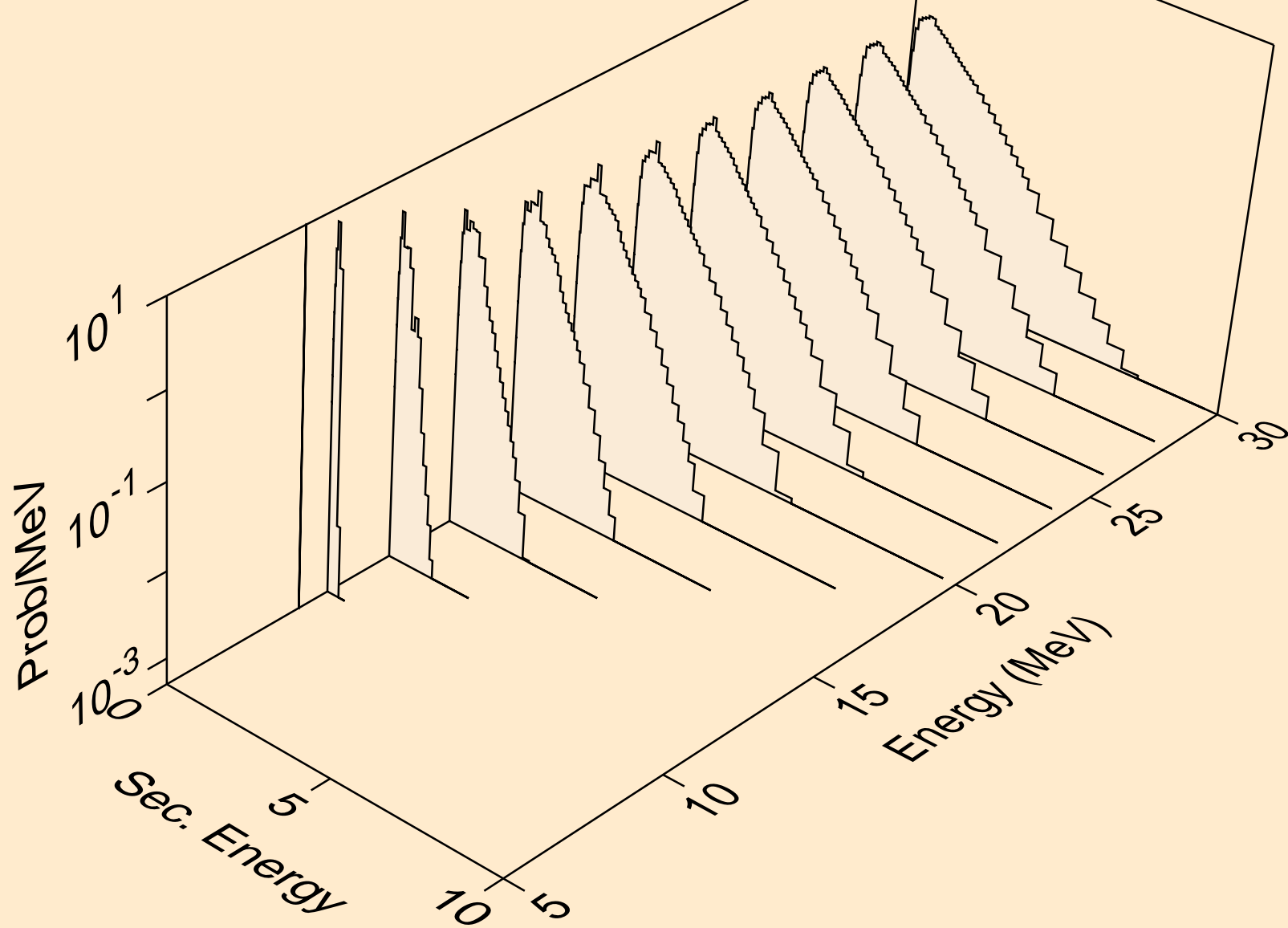

BR088 ALPHA ACER TENDL-2024 LIBRARY; T=0.K
neutrons from (a,n*)d

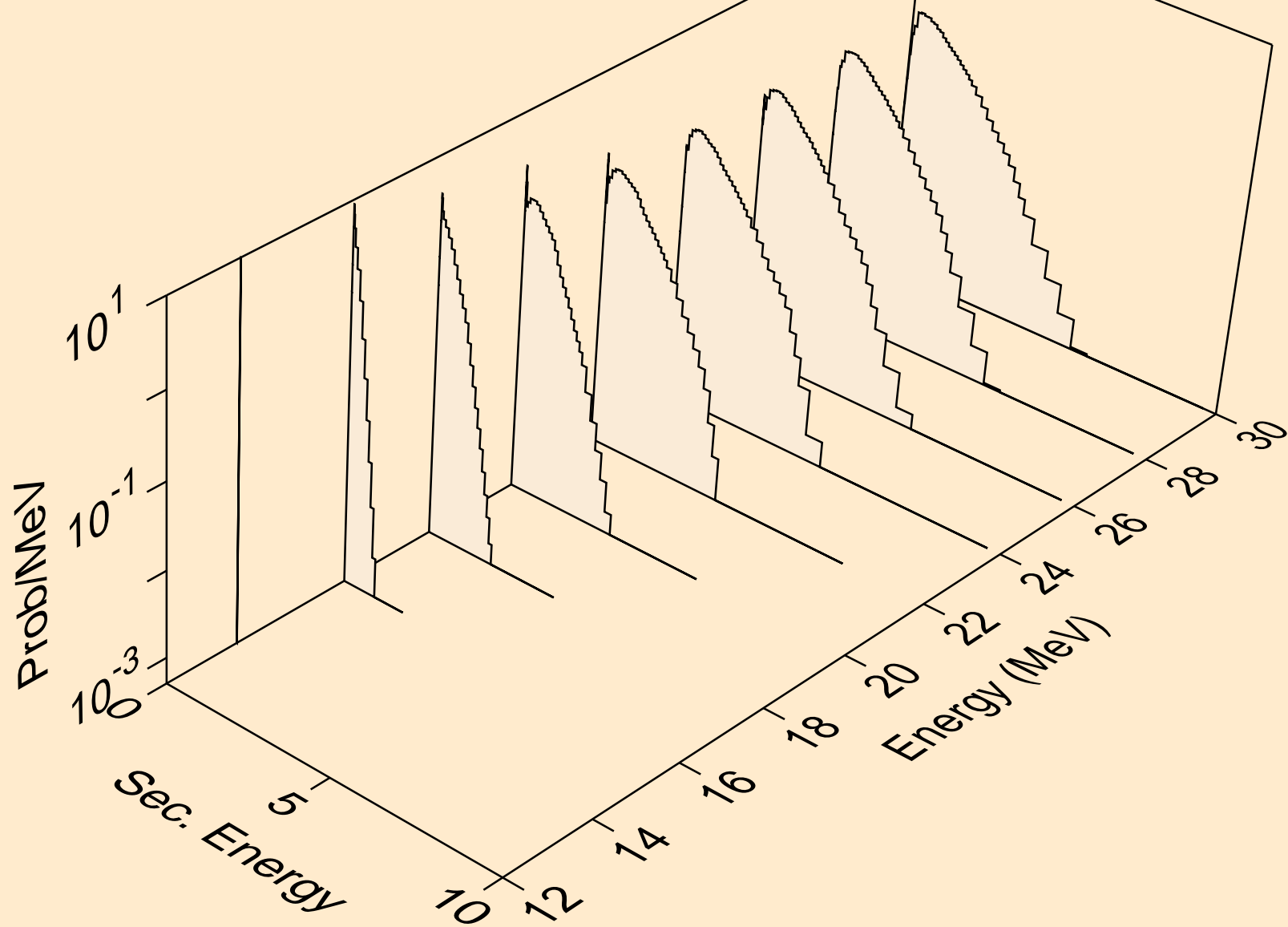

BR088 ALPHA ACER TENDL-2024 LIBRARY; T=0.K
neutrons from (a,n*)t

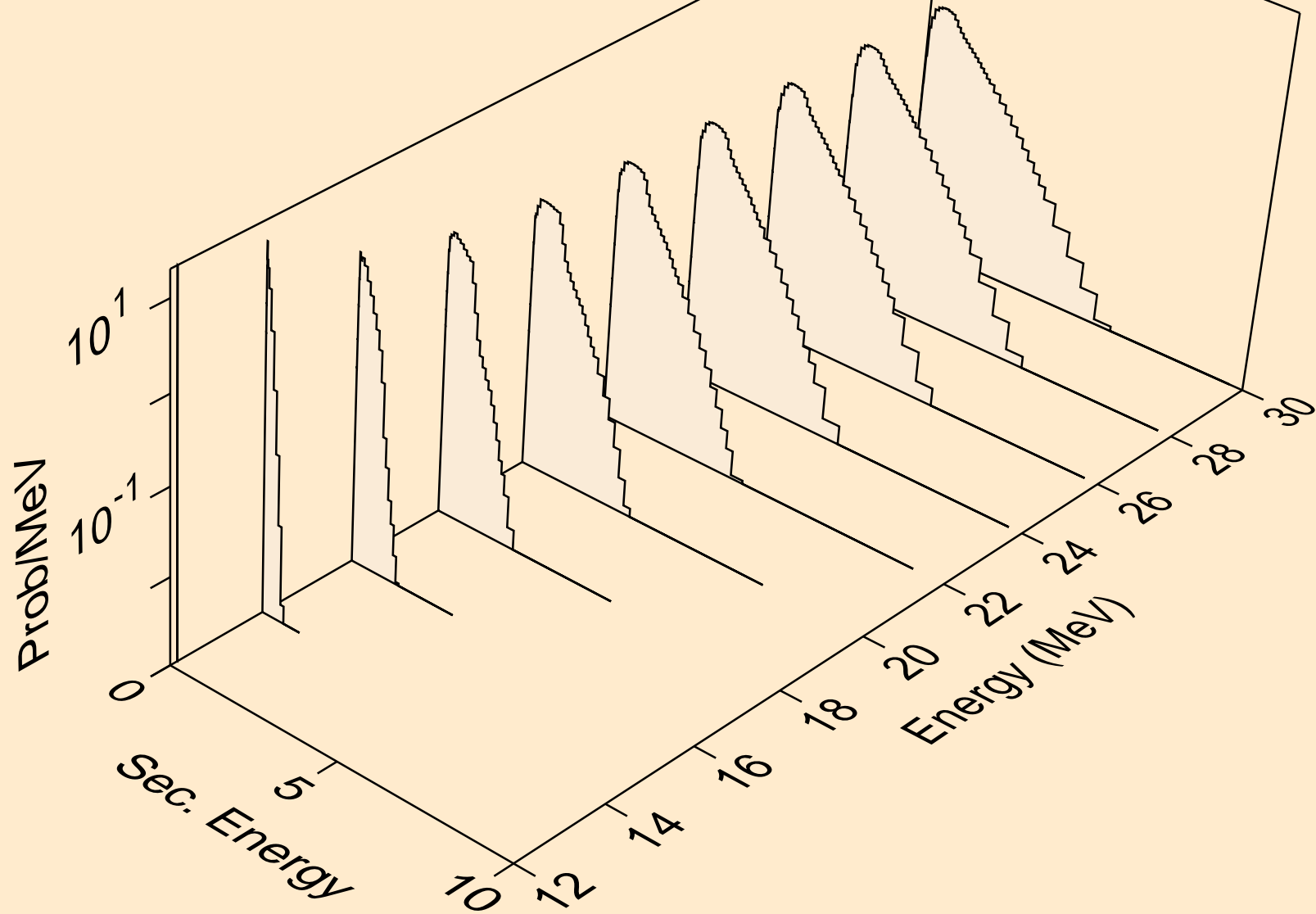

BR088 ALPHA ACER TENDL-2024 LIBRARY; T=0.K
neutrons from (a,n*)he3

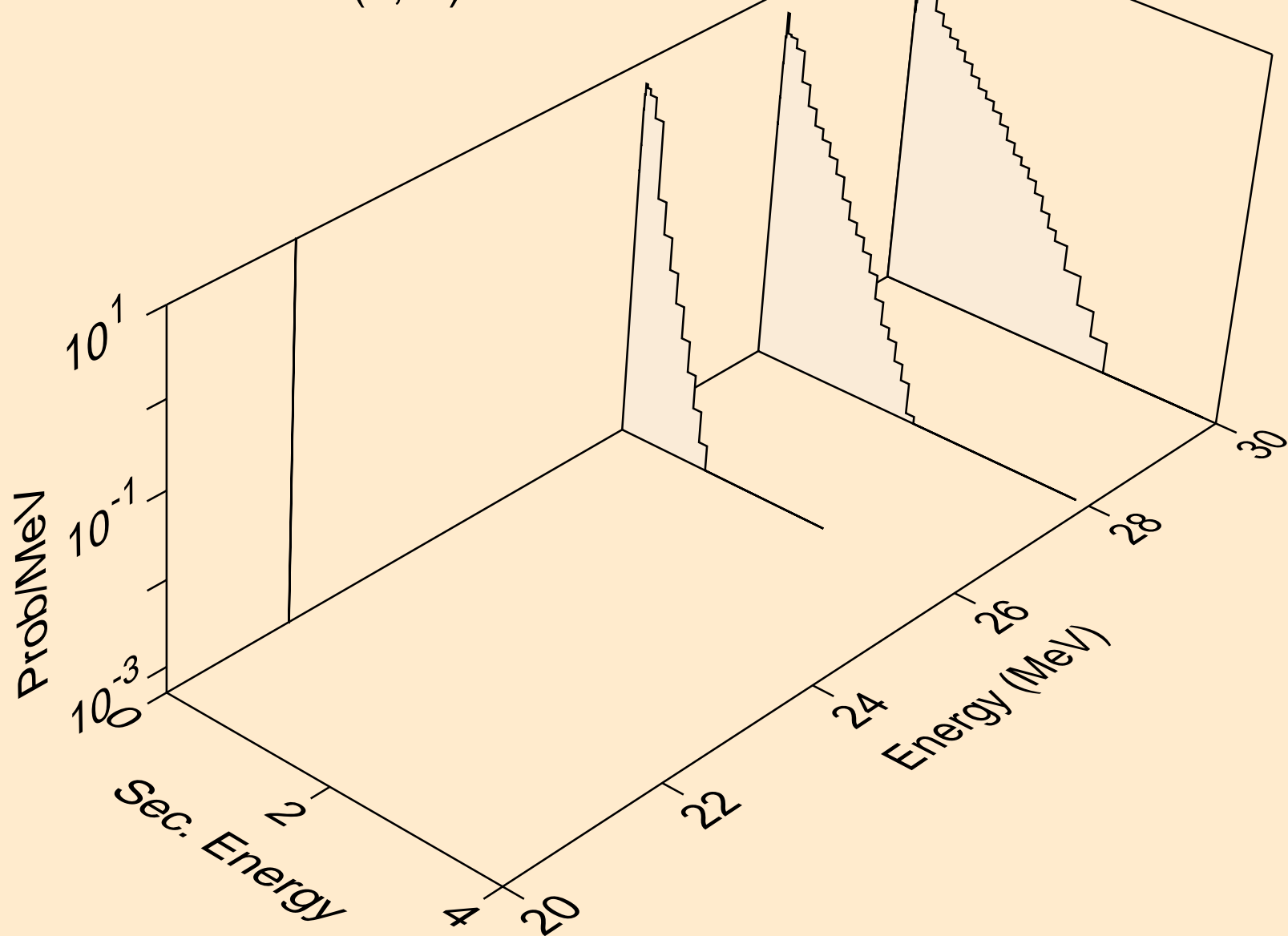

BR088 ALPHA ACER TENDL-2024 LIBRARY; T=0.K
neutrons from (a,4n)

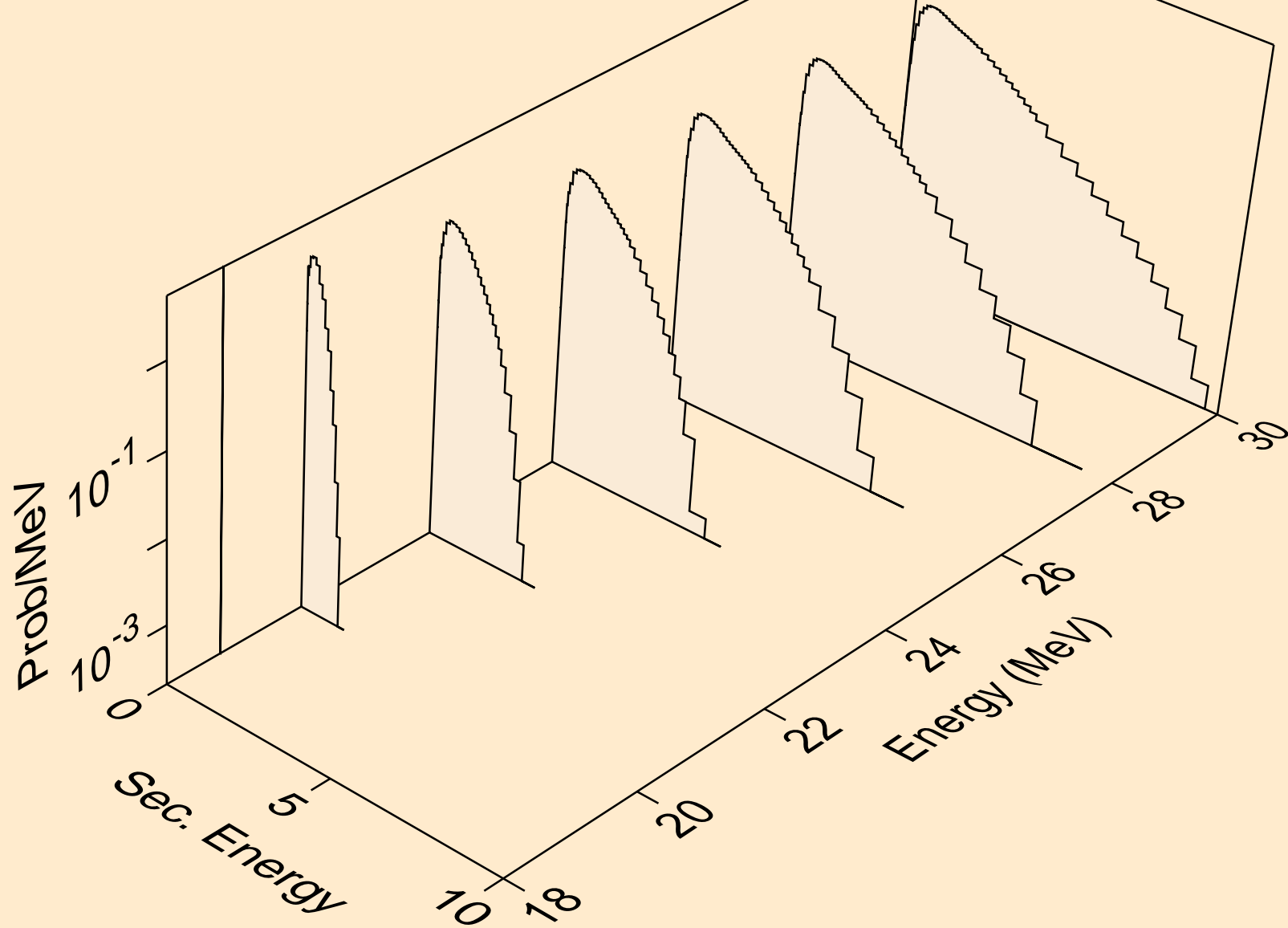

BR088 ALPHA ACER TENDL-2024 LIBRARY; T=0.K
neutrons from (a,2np)

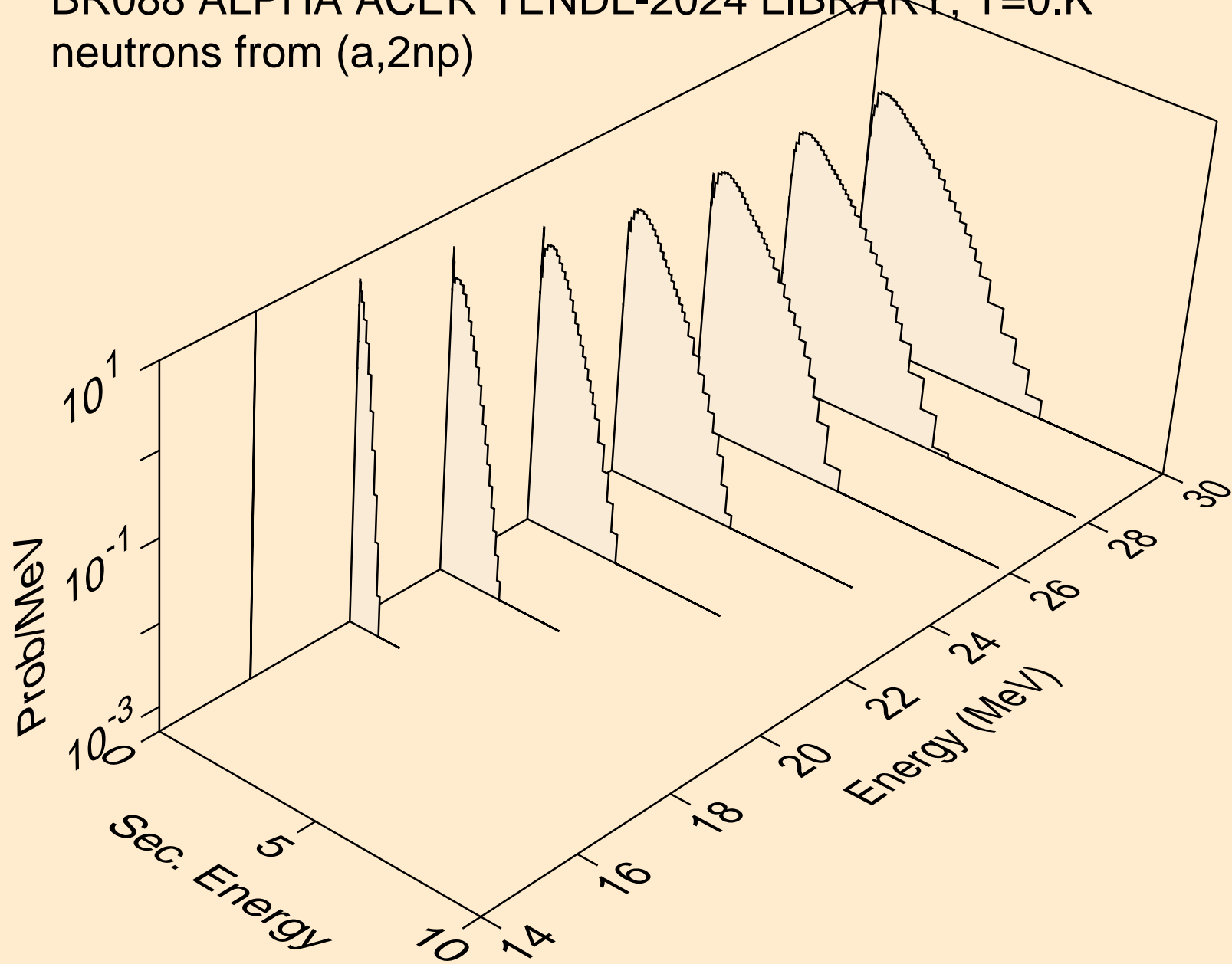

BR088 ALPHA ACER TENDL-2024 LIBRARY; T=0.K
neutrons from (a,3np)

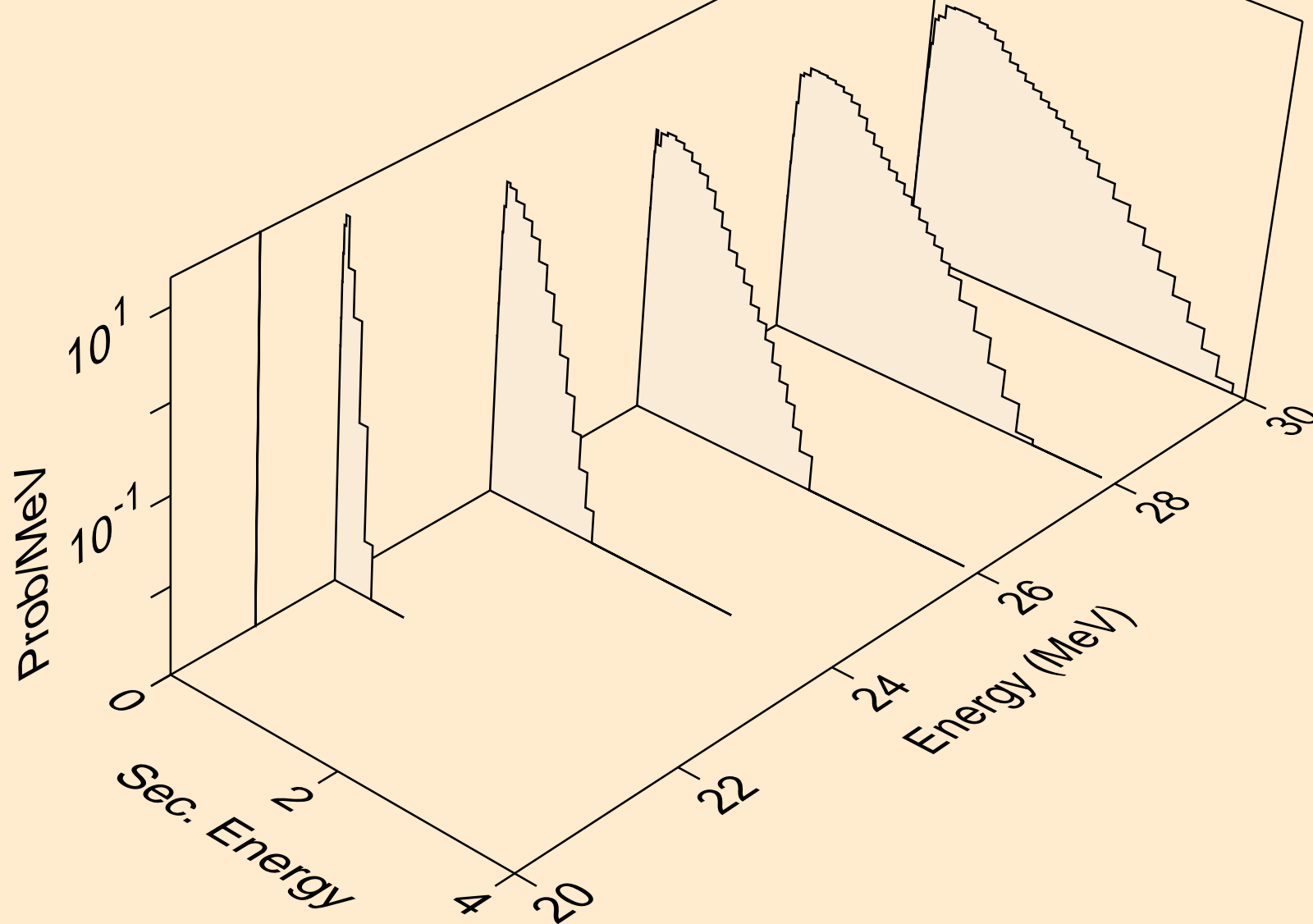

BR088 ALPHA ACER TENDL-2024 LIBRARY; T=0.K
protons from (a,x)

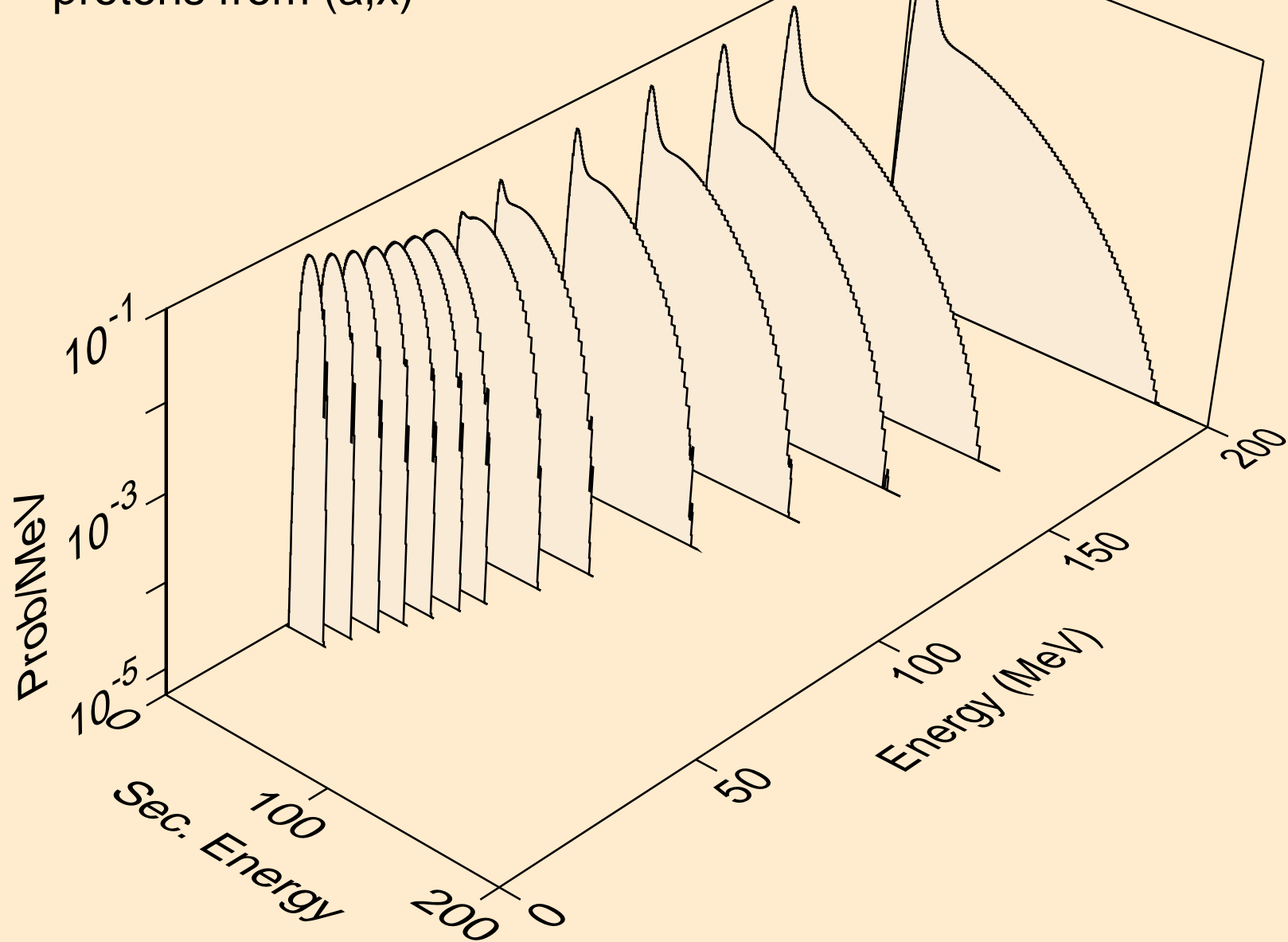

BR088 ALPHA ACER TENDL-2024 LIBRARY; T=0.K
protons from (a,n*)p

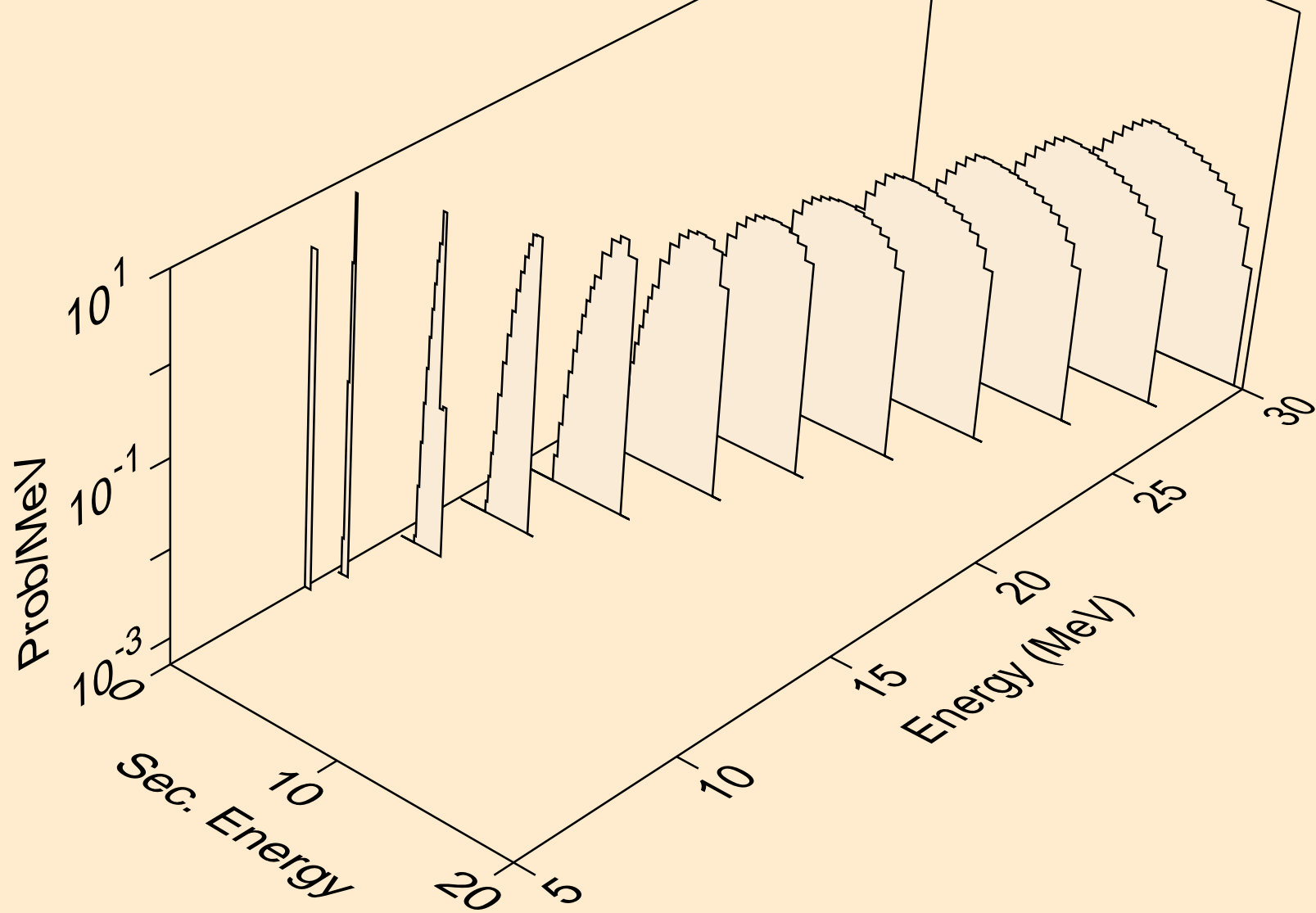

BR088 ALPHA ACER TENDL-2024 LIBRARY; T=0.K
protons from (a,2np)

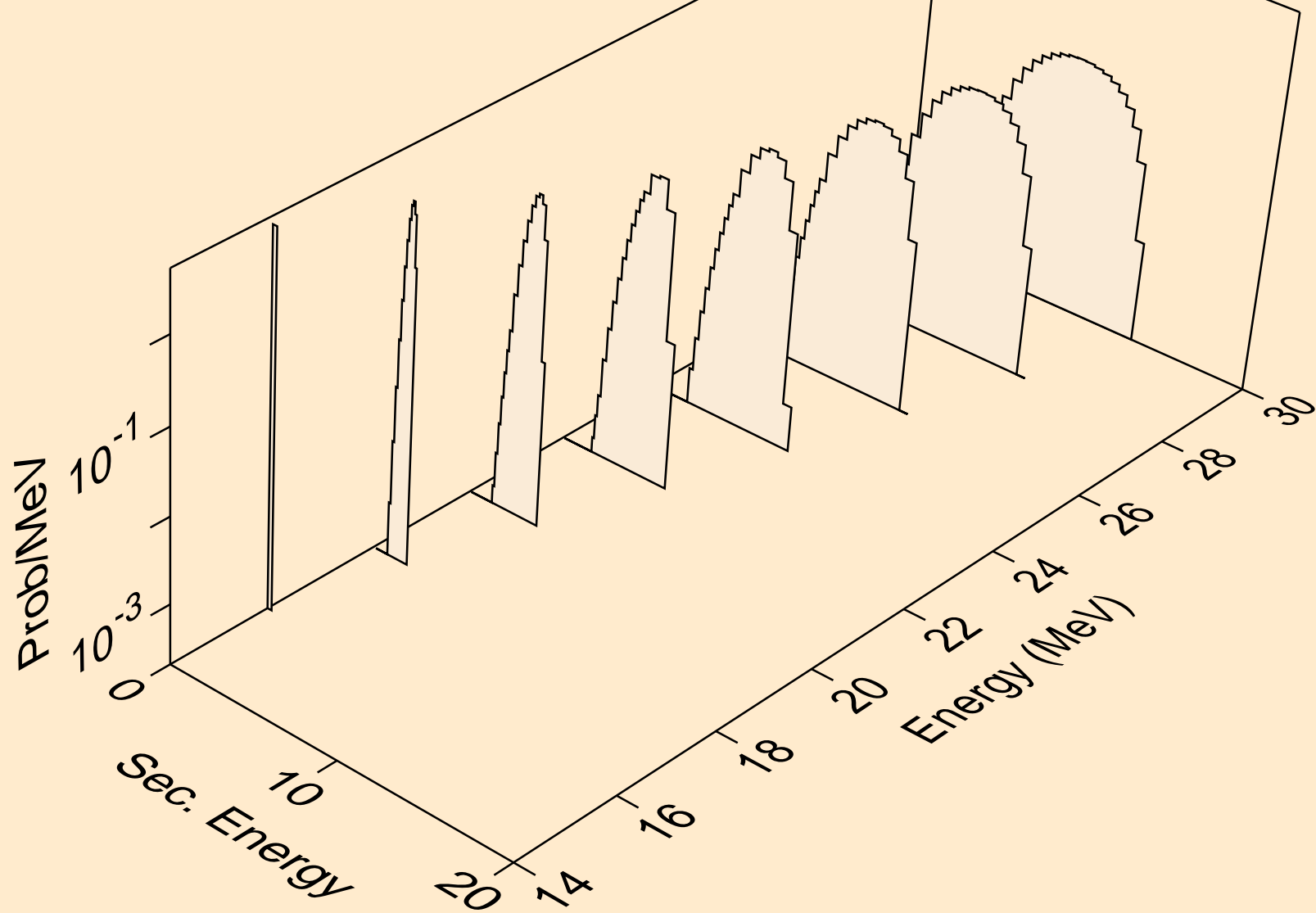

BR088 ALPHA ACER TENDL-2024 LIBRARY; T=0.K
protons from (a,3np)

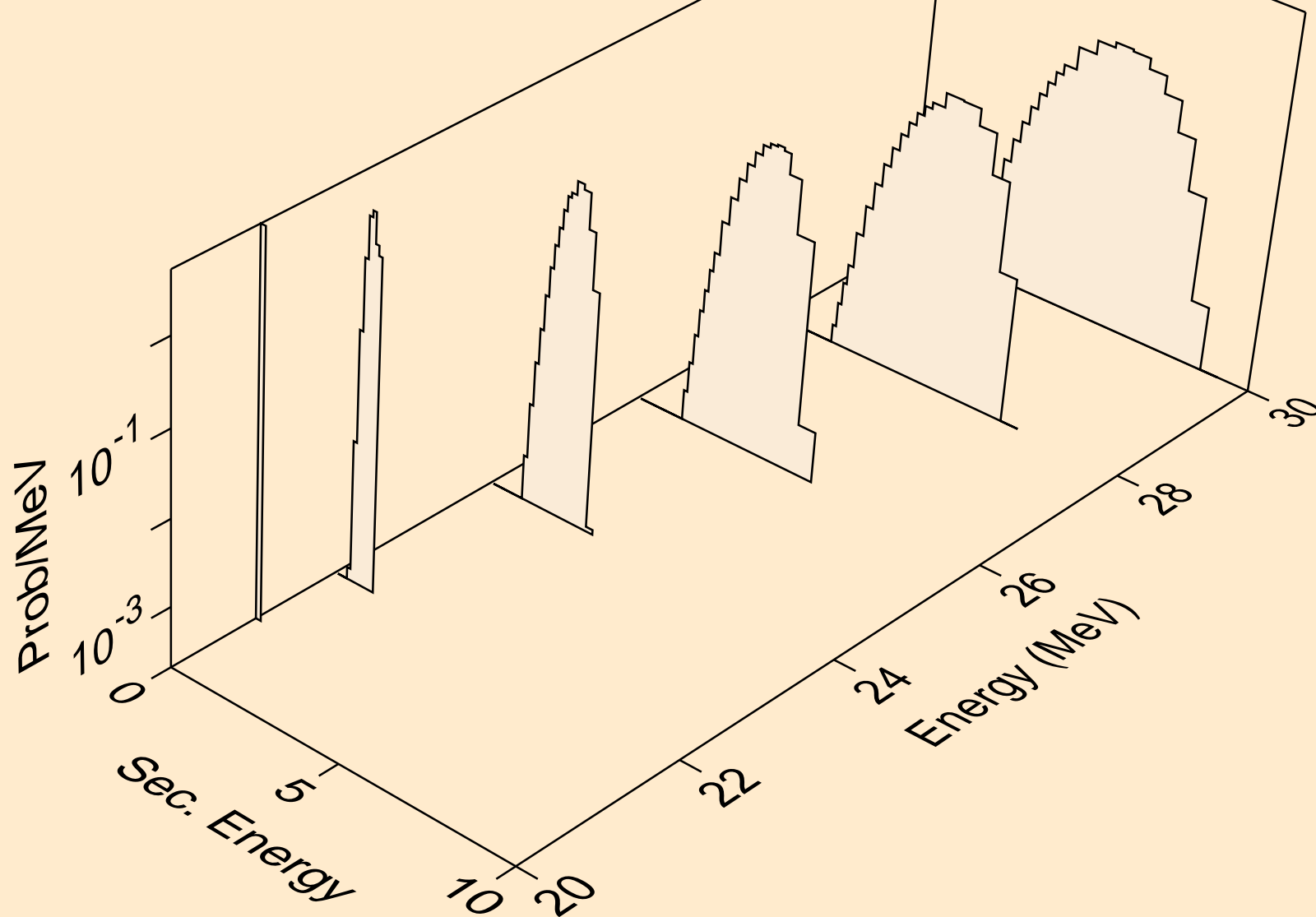

BR088 ALPHA ACER TENDL-2024 LIBRARY; T=0.K
protons from (a,p)

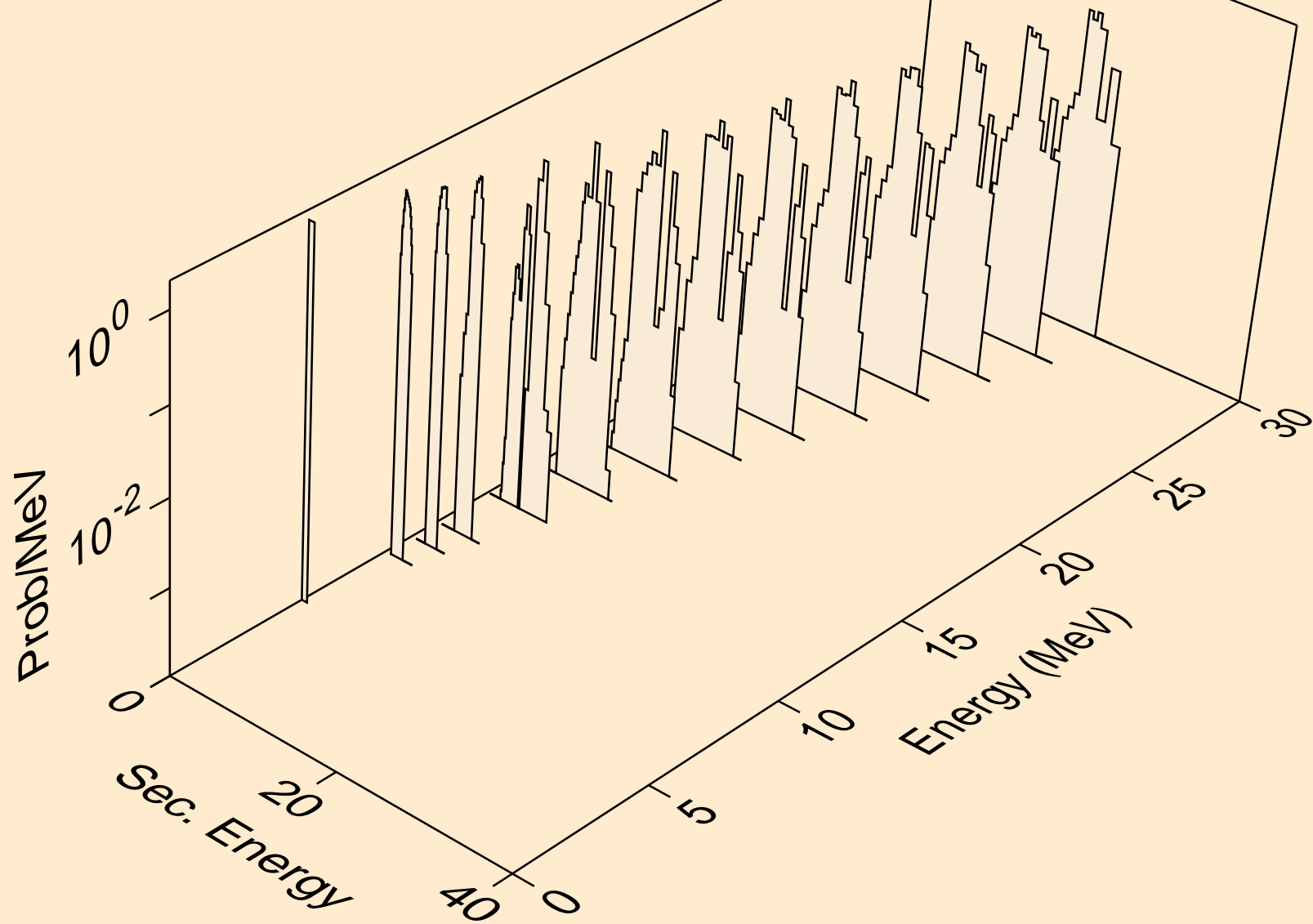

BR088 ALPHA ACER TENDL-2024 LIBRARY; T=0.K
protons from (a,pa)

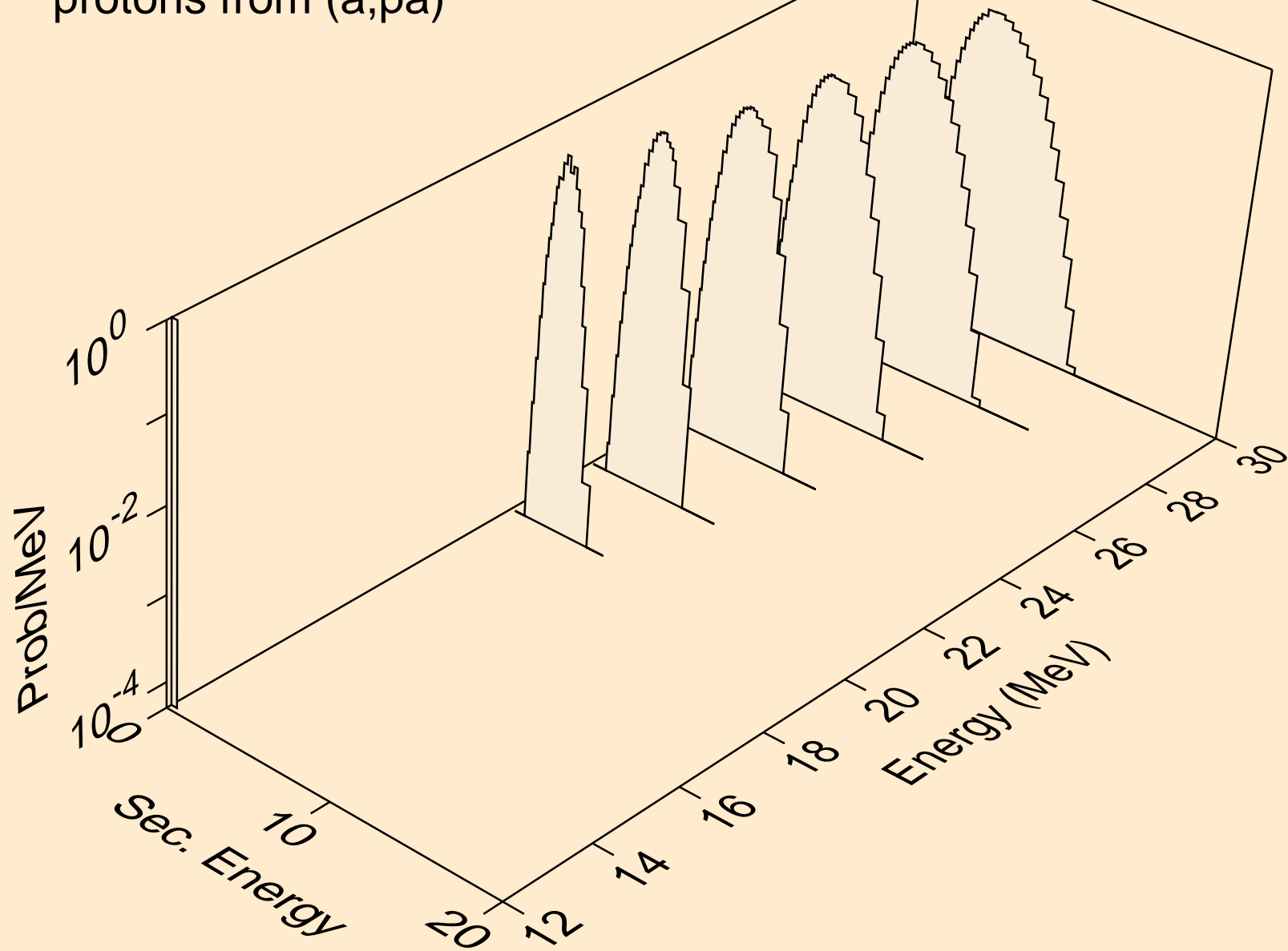

BR088 ALPHA ACER TENDL-2024 LIBRARY; T=0.K
deuterons from (a,x)

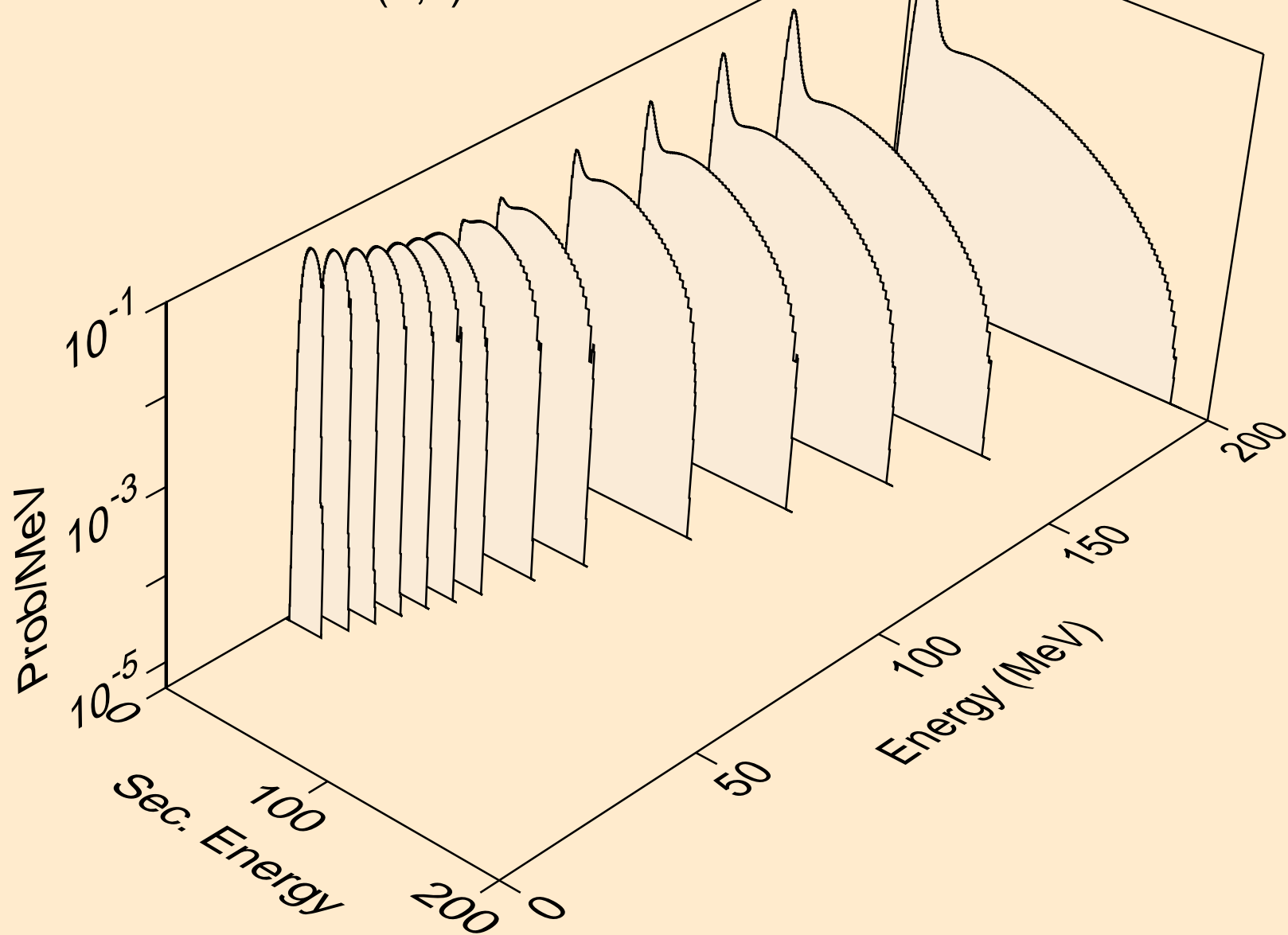

BR088 ALPHA ACER TENDL-2024 LIBRARY; T=0.K
deuterons from (a,2nd)

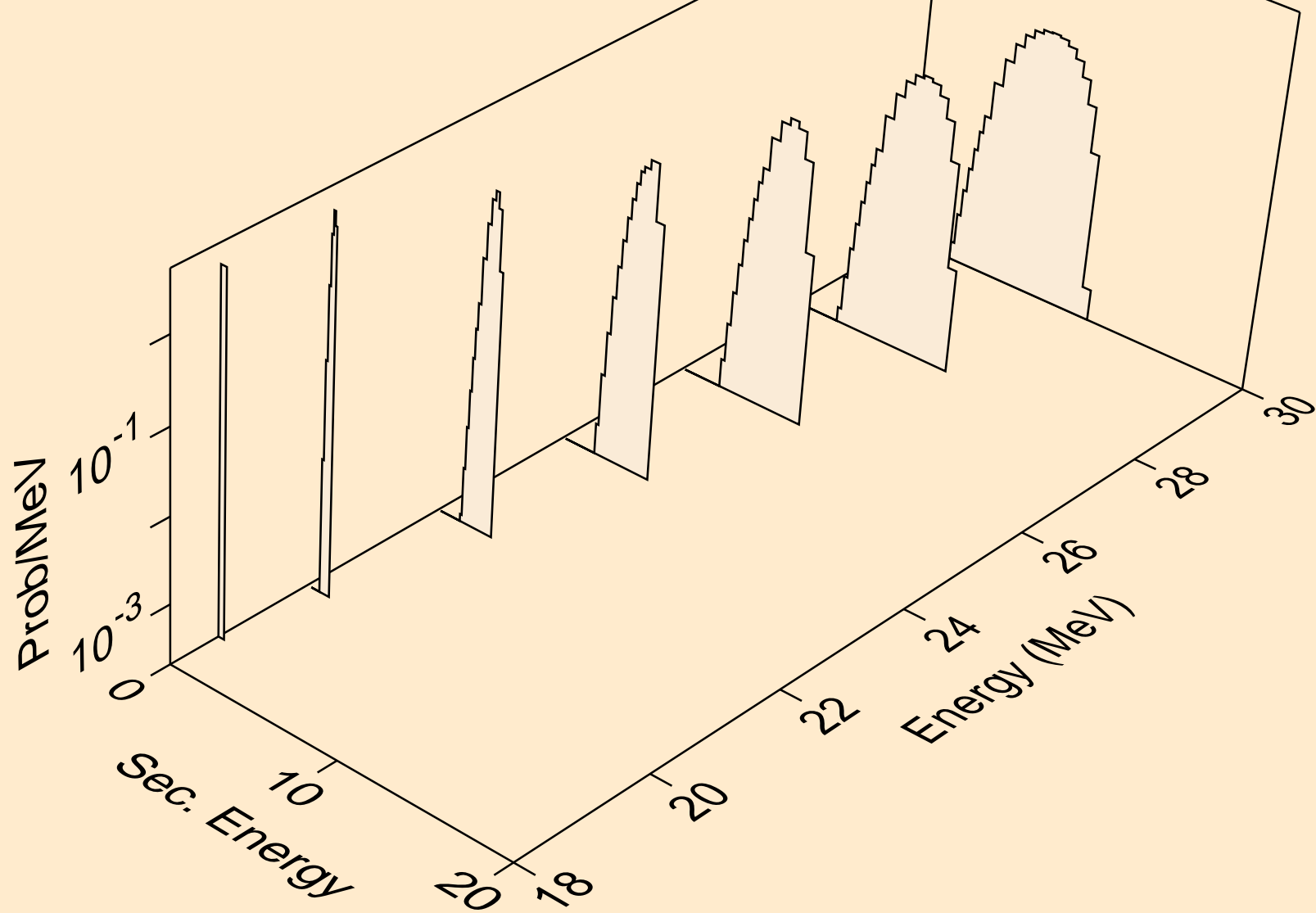

BR088 ALPHA ACER TENDL-2024 LIBRARY; T=0.K
deuterons from (a,n*)d

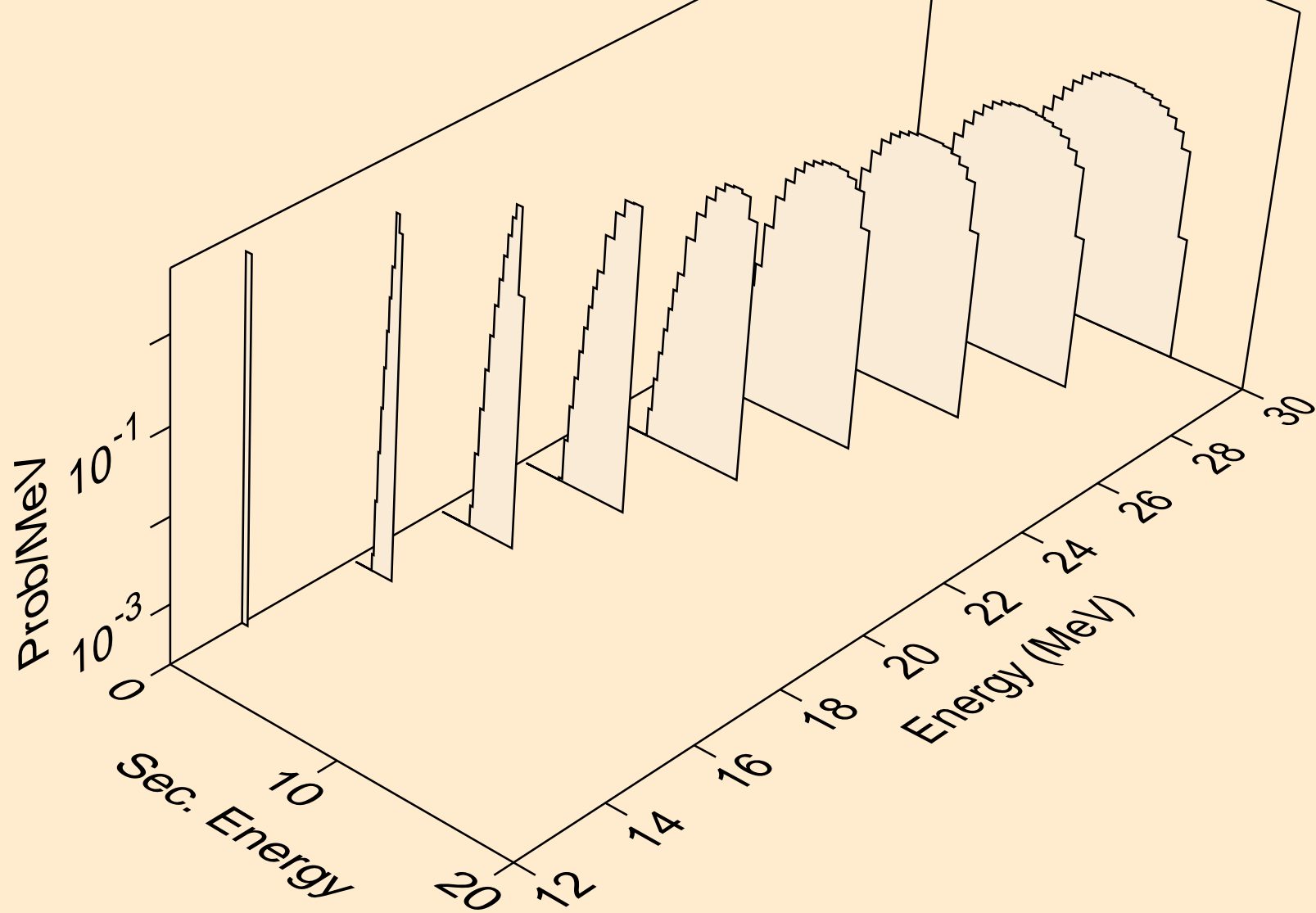

BR088 ALPHA ACER TENDL-2024 LIBRARY; T=0.K
deuterons from (a,d)

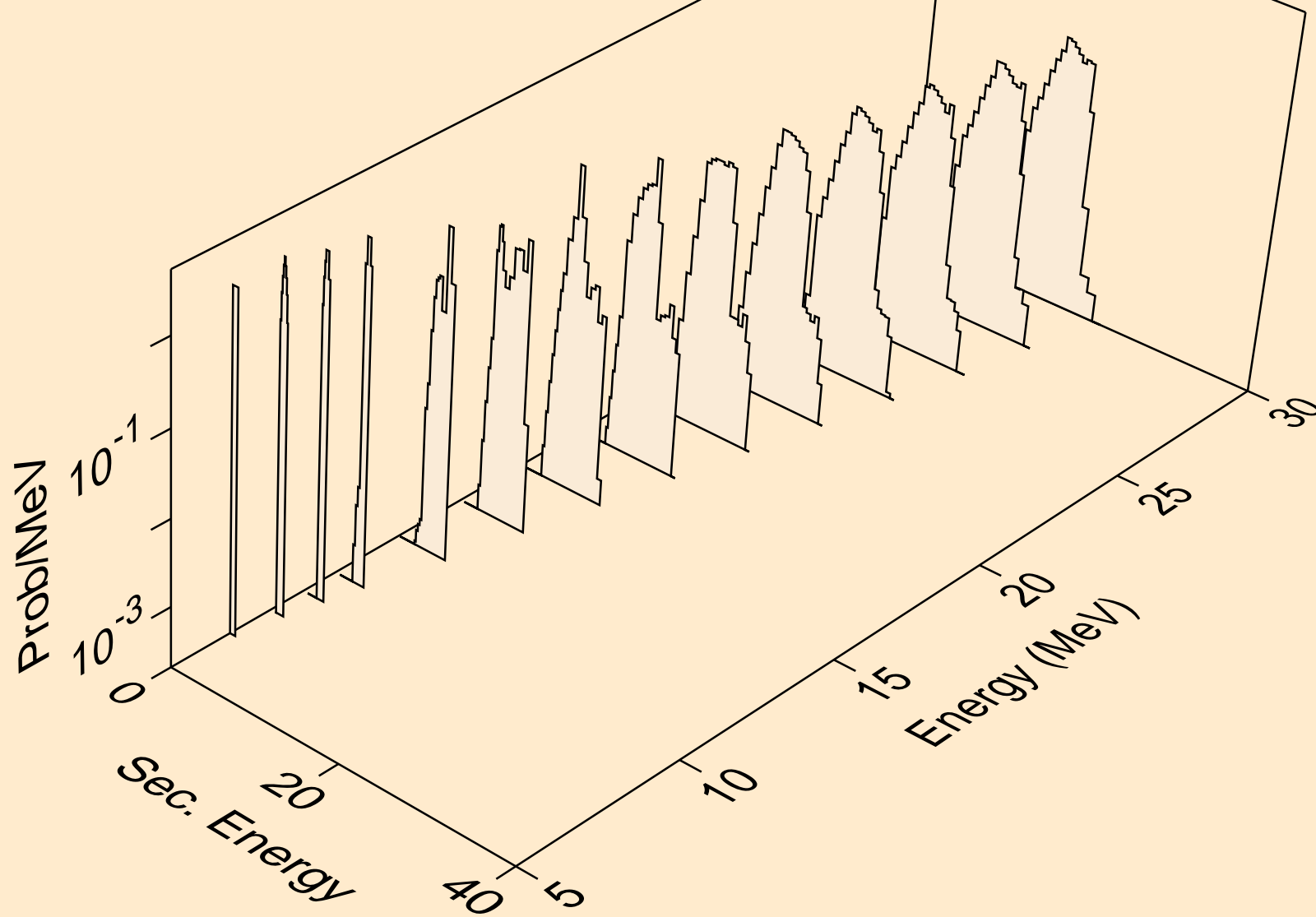

BR088 ALPHA ACER TENDL-2024 LIBRARY; T=0.K
tritons from (a,x)

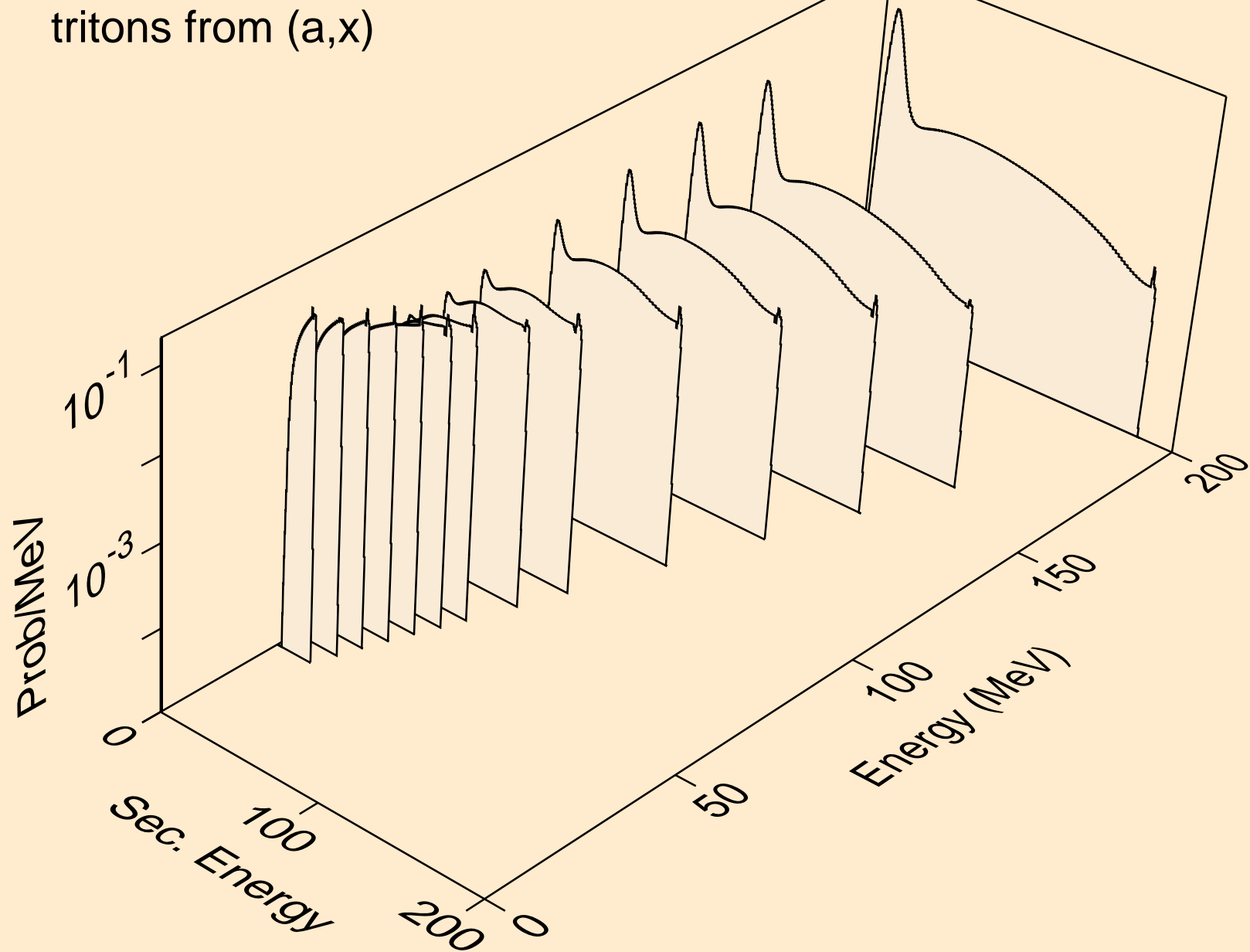

BR088 ALPHA ACER TENDL-2024 LIBRARY; T=0.K
tritons from (a,n*)t

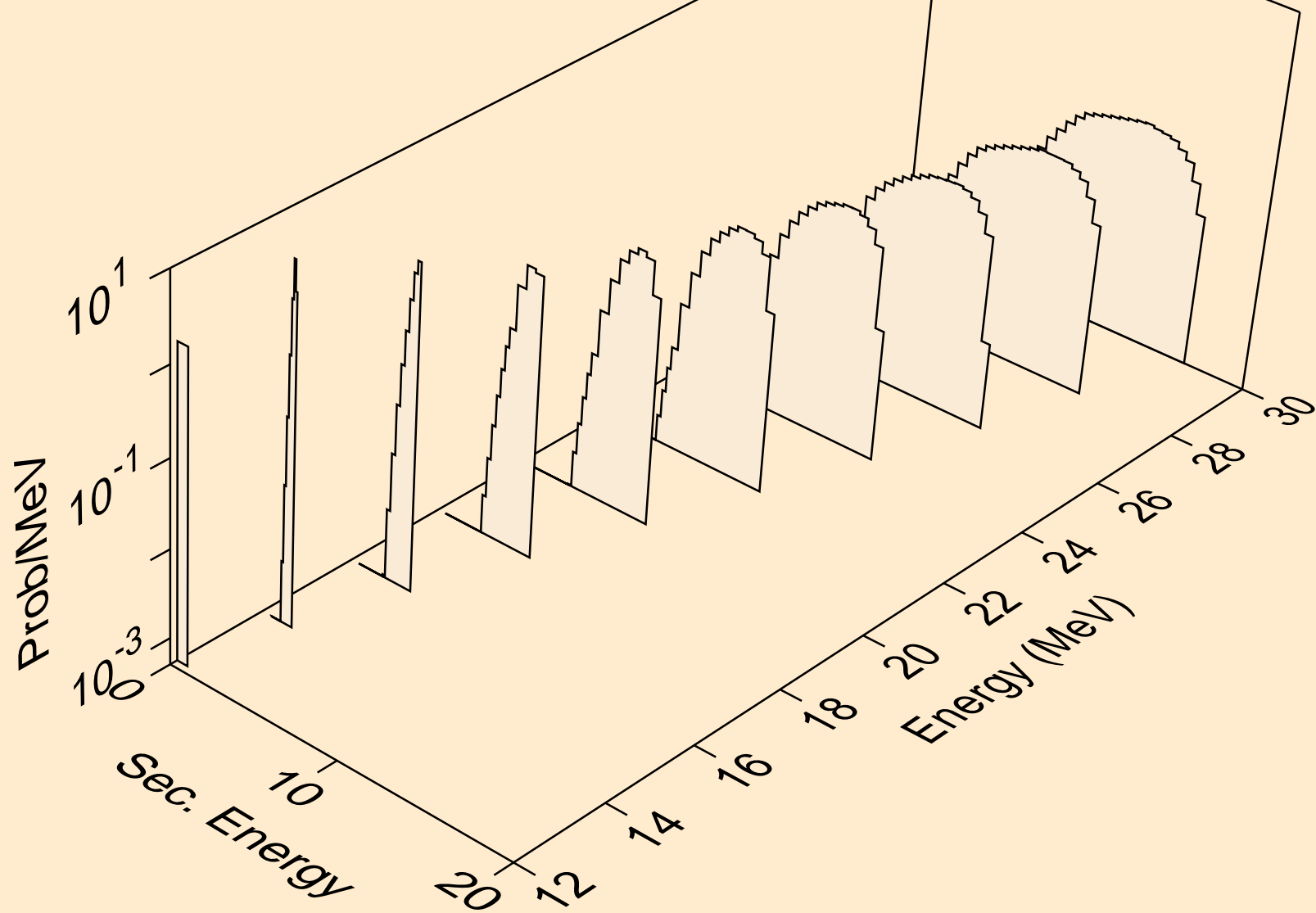

BR088 ALPHA ACER TENDL-2024 LIBRARY; T=0.K
tritons from (a,t)

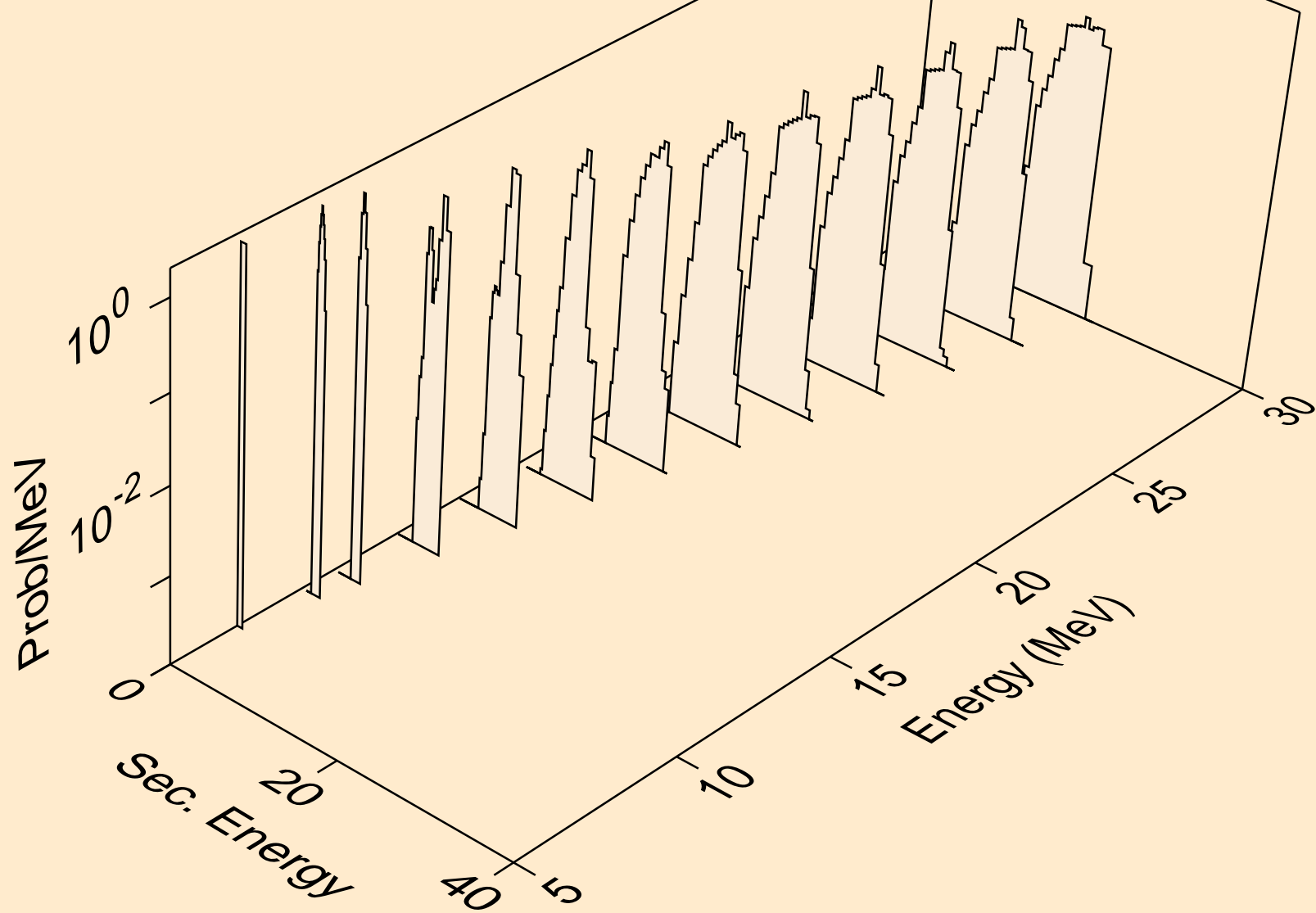

BR088 ALPHA ACER TENDL-2024 LIBRARY; T=0.K
he3s from (a,x)

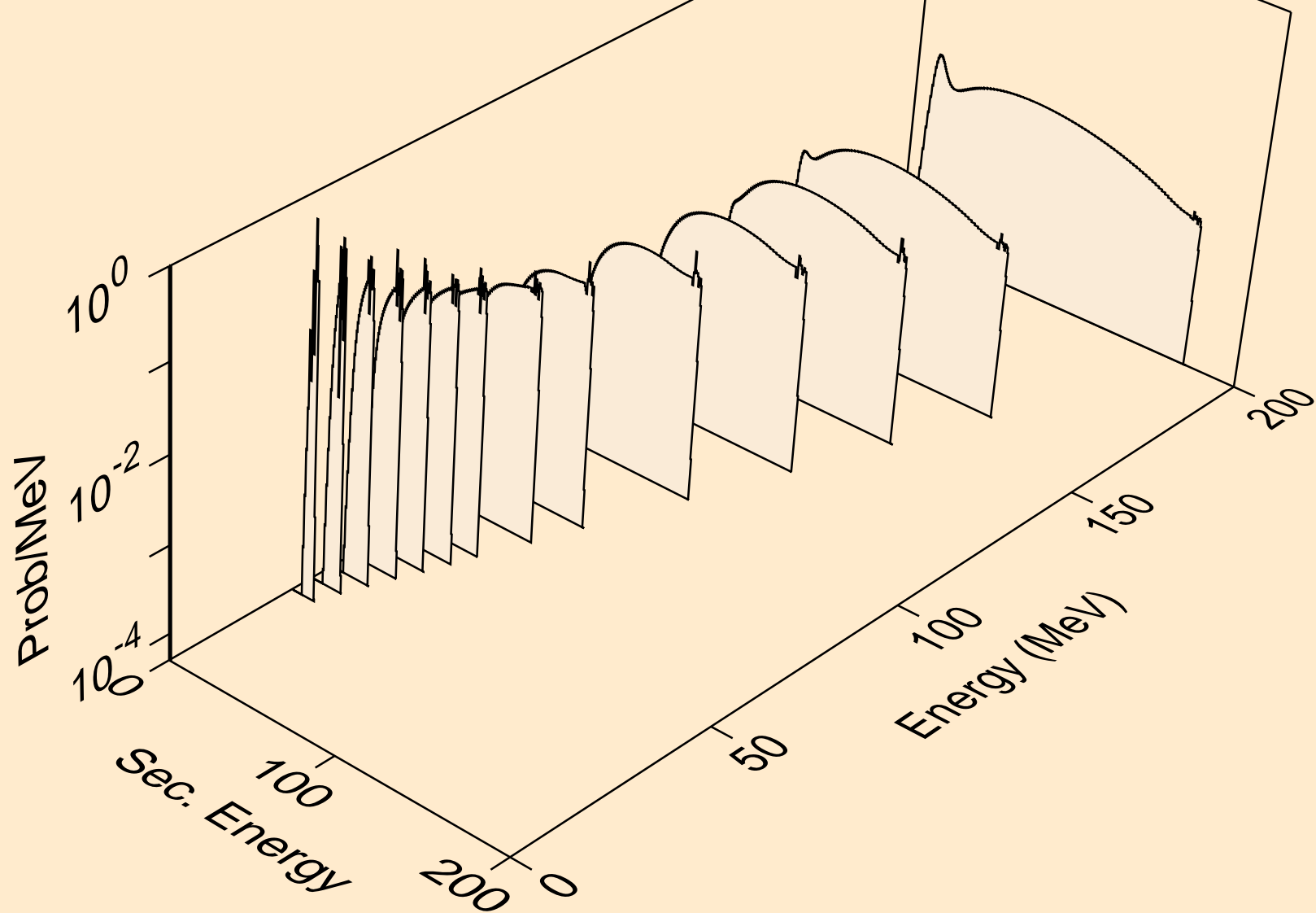

BR088 ALPHA ACER TENDL-2024 LIBRARY; T=0.K
he3s from (a,n*)he3

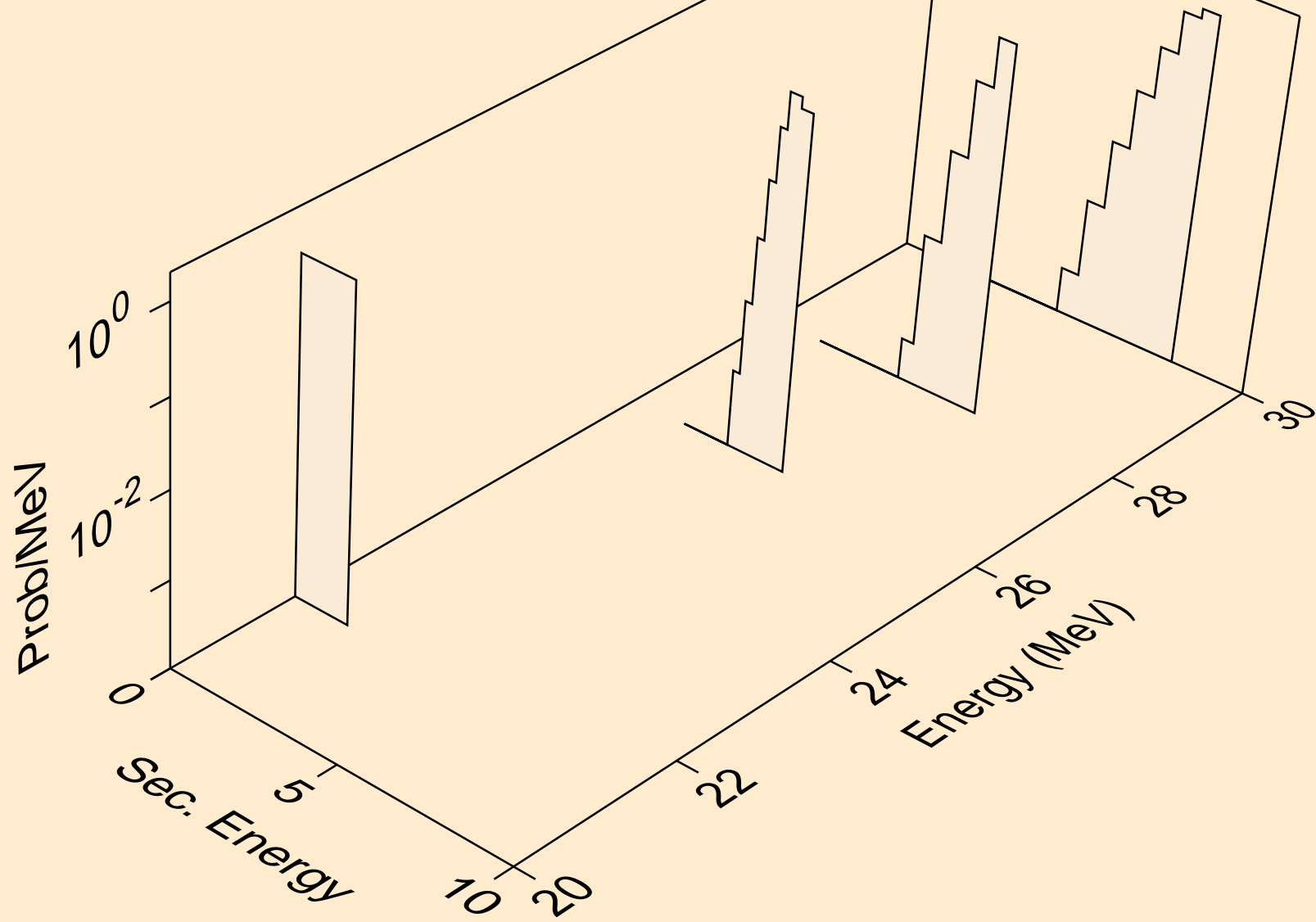

BR088 ALPHA ACER TENDL-2024 LIBRARY; T=0.K
he3s from (a,he3)

