

CU062 ALPHA ACER TENDL-2024 LIBRARY; T=0.K

Principal cross sections

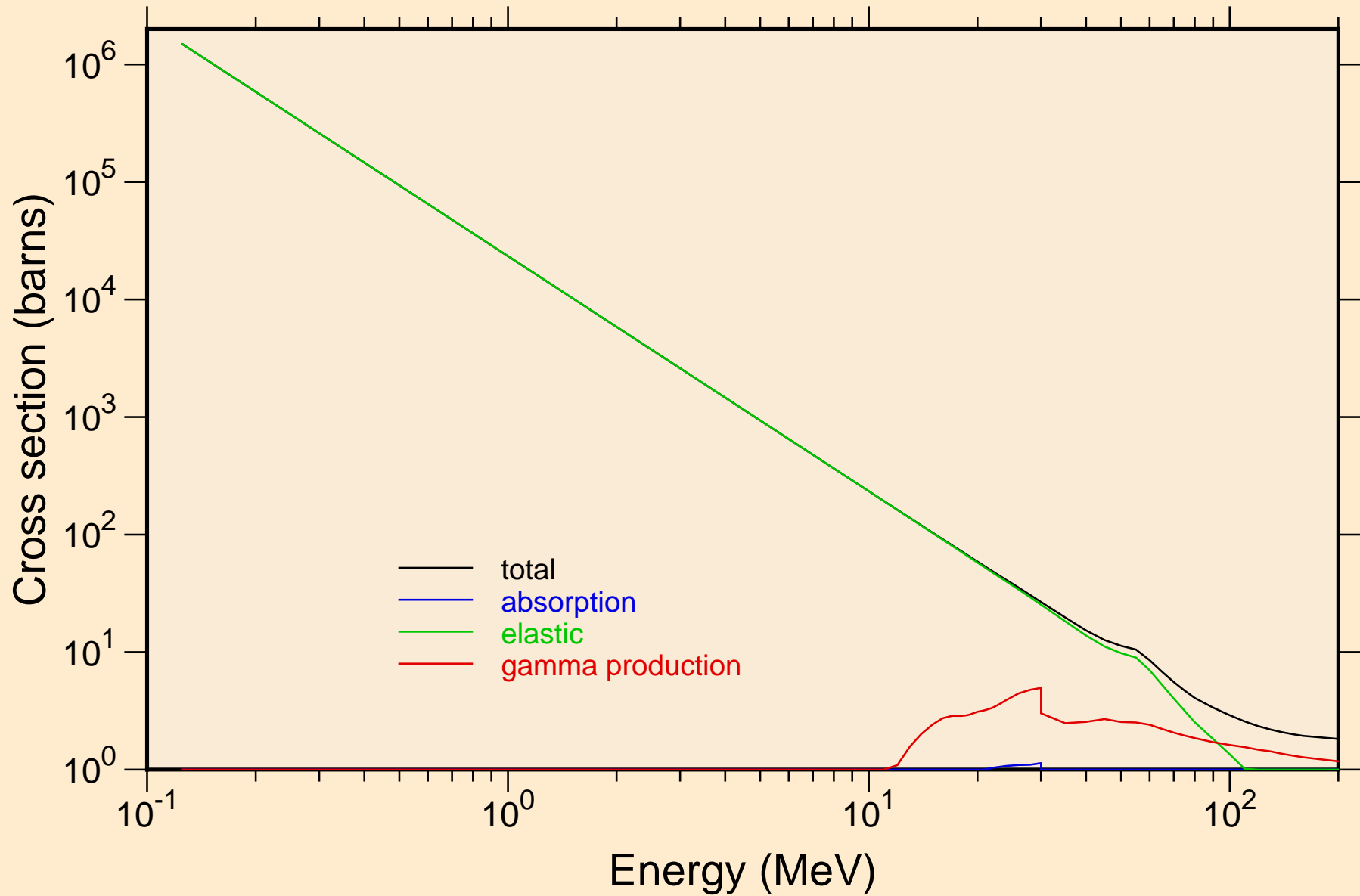

CU062 ALPHA ACER TENDL-2024 LIBRARY; T=0.K

Heating

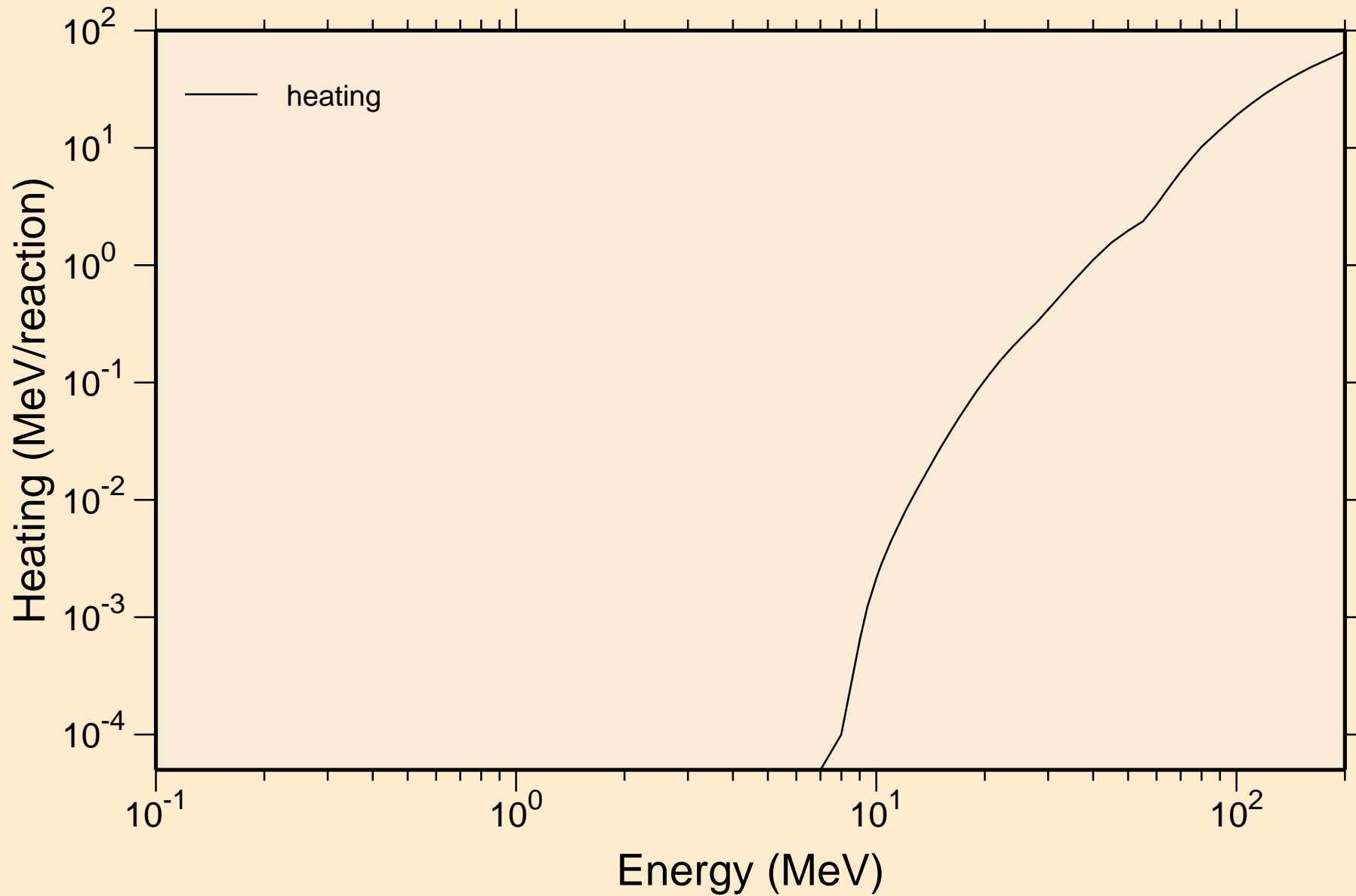

CU062 ALPHA ACER TENDL-2024 LIBRARY; T=0.K

Principal cross sections

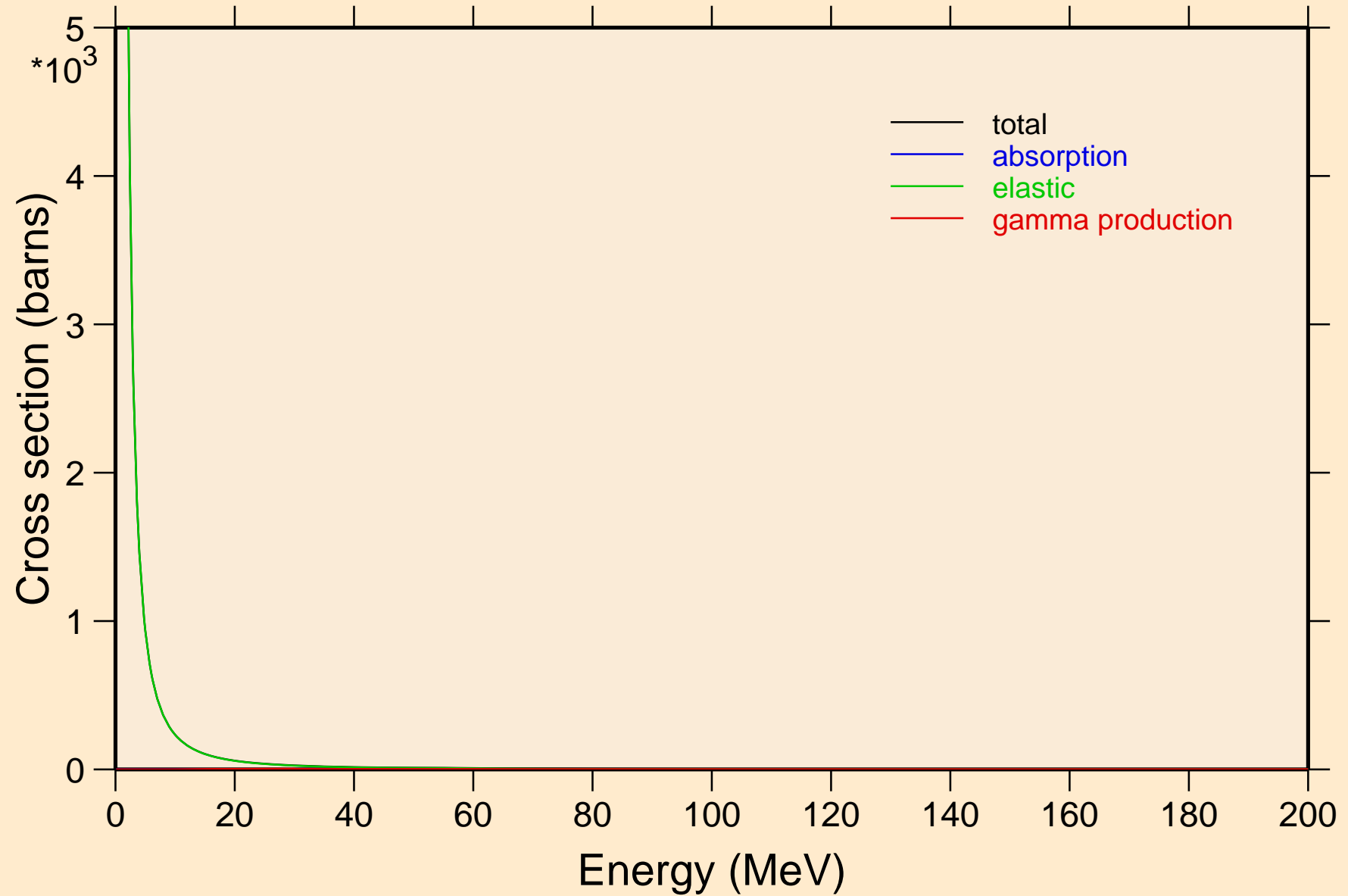

CU062 ALPHA ACER TENDL-2024 LIBRARY; T=0.K

Heating

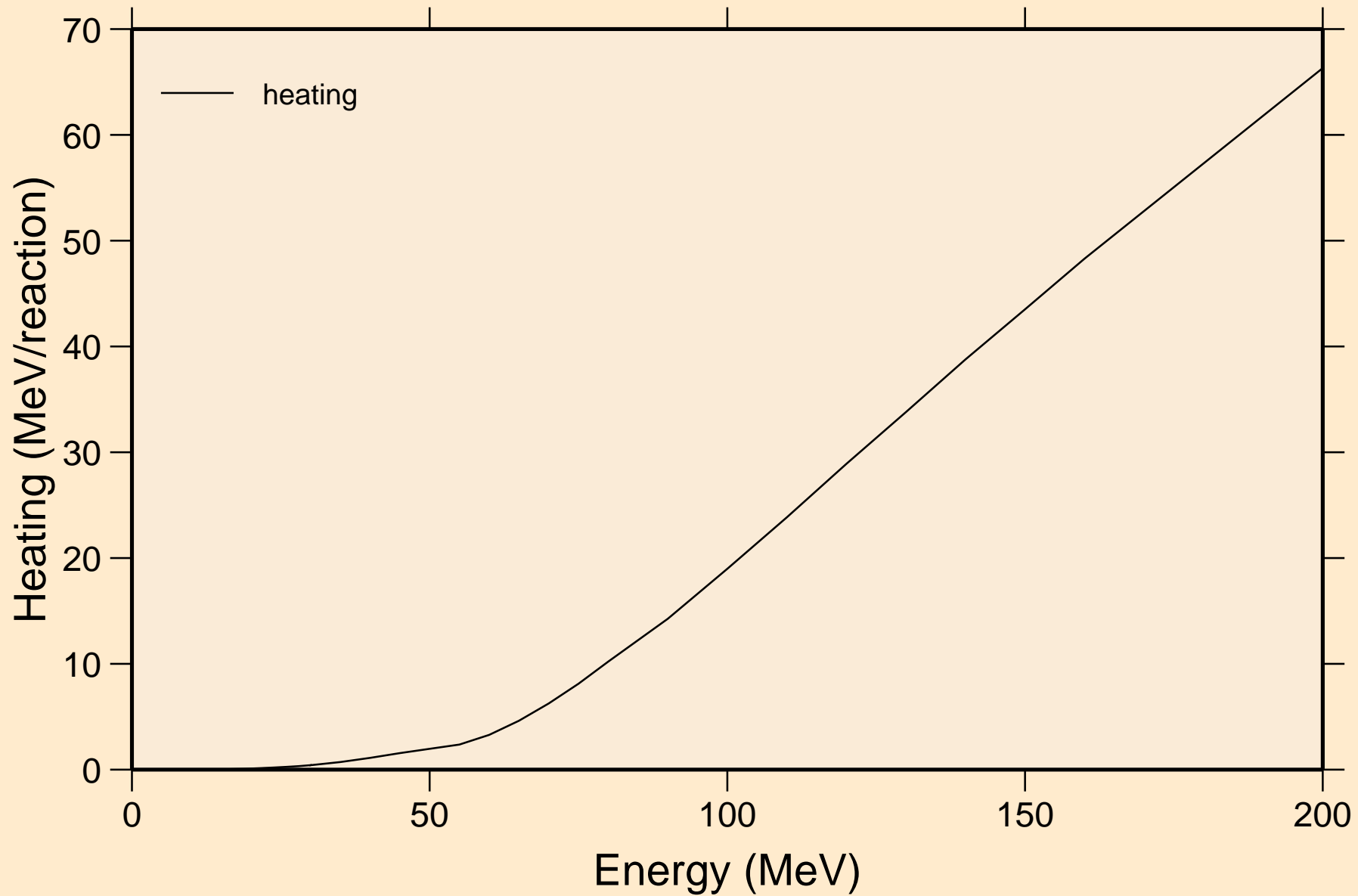

CU062 ALPHA ACER TENDL-2024 LIBRARY; T=0.K
Threshold reactions

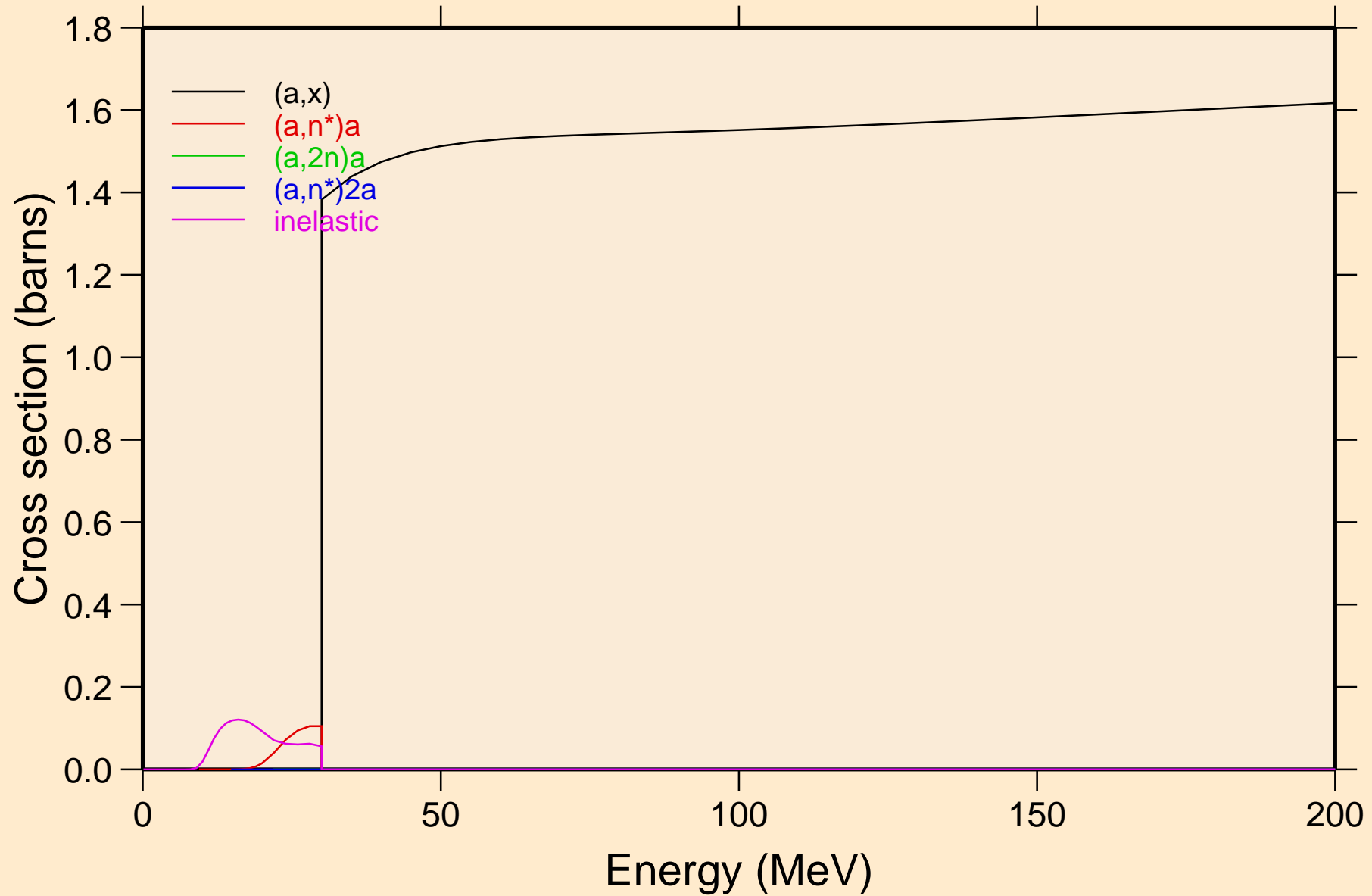

CU062 ALPHA ACER TENDL-2024 LIBRARY; T=0.K
Threshold reactions

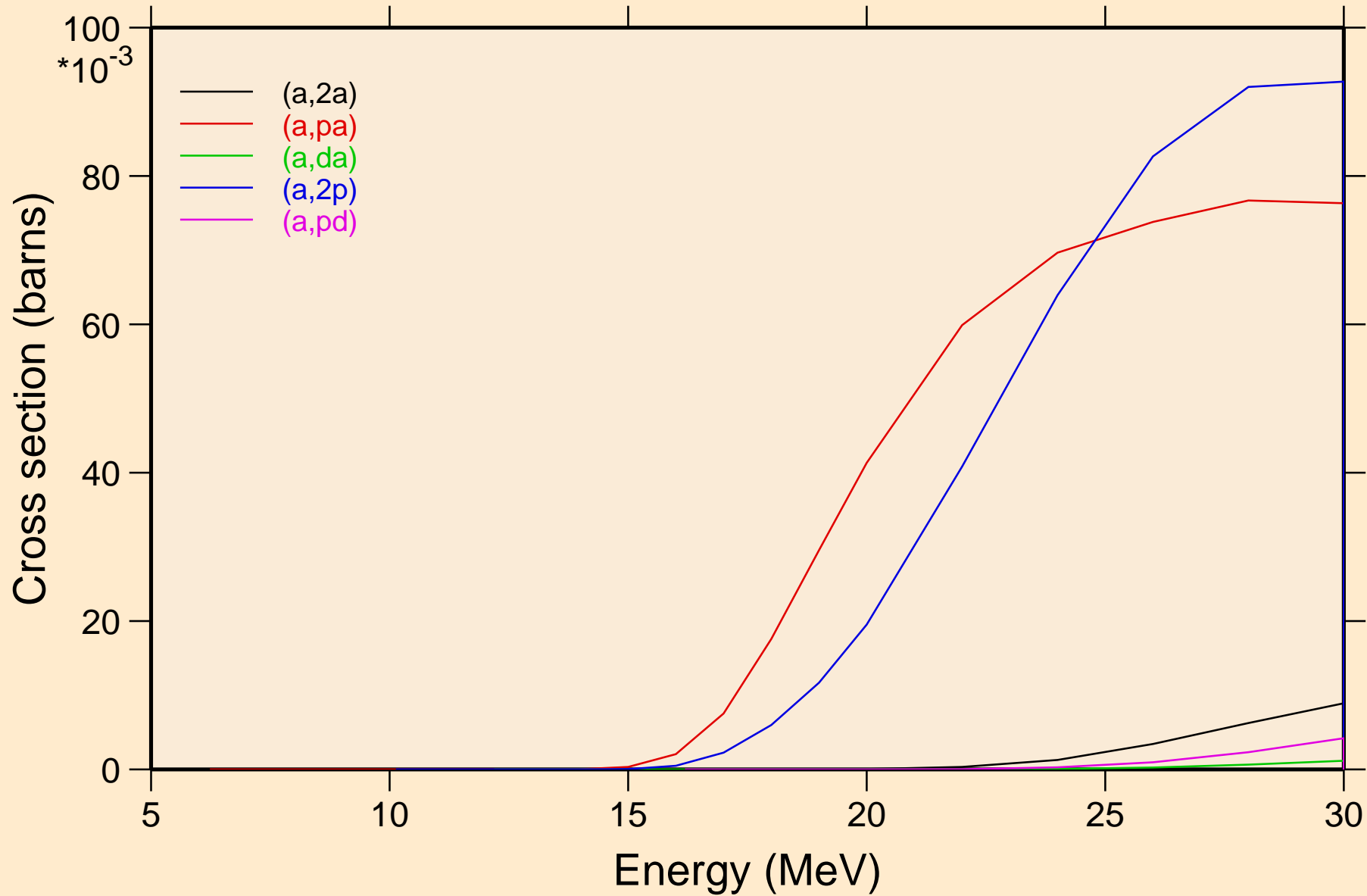

CU062 ALPHA ACER TENDL-2024 LIBRARY; T=0.K
Threshold reactions

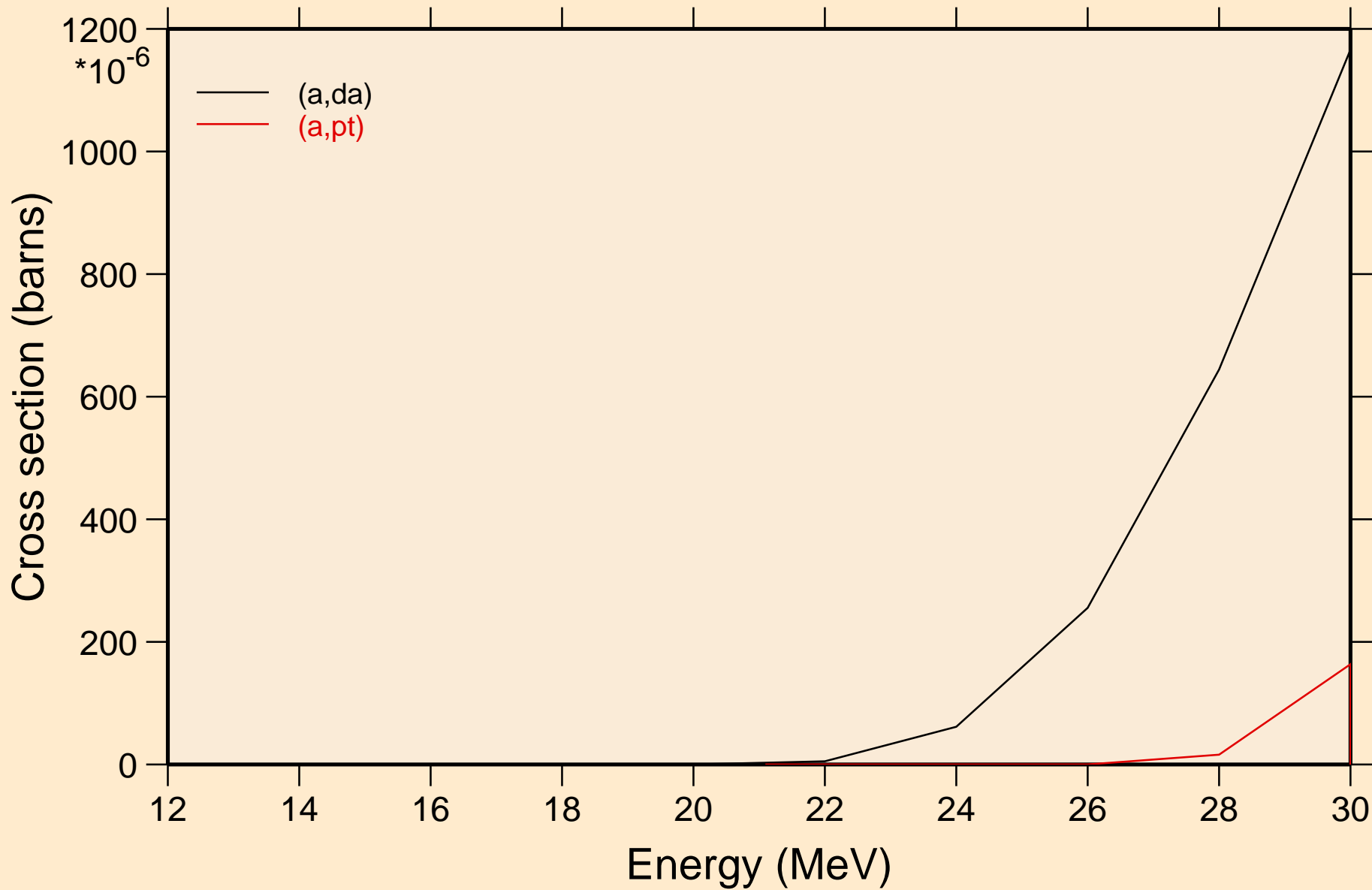

CU062 ALPHA ACER TENDL-2024 LIBRARY; T=0.K
Threshold reactions

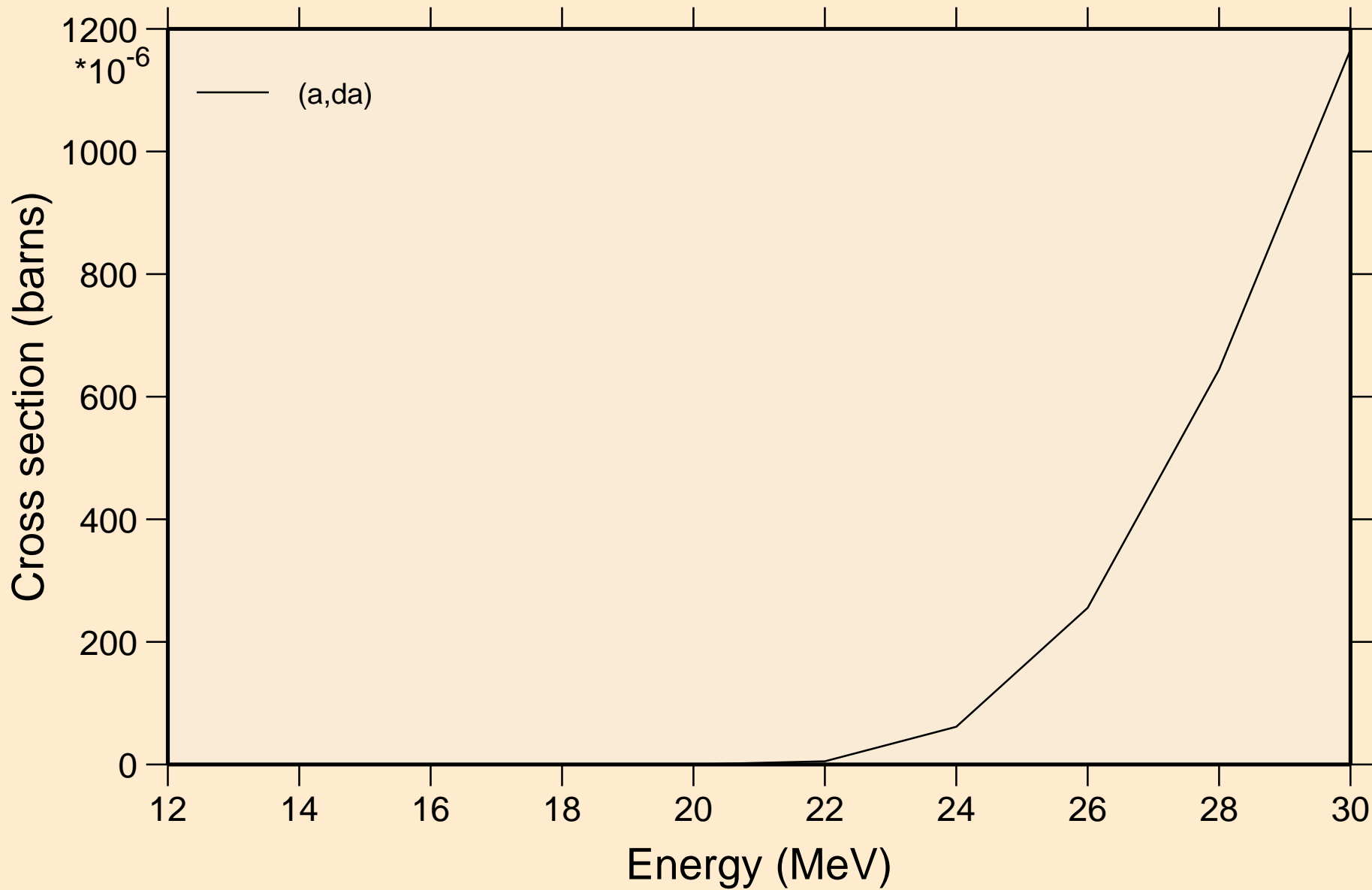

CU062 ALPHA ACER TENDL-2024 LIBRARY; T=0.K
angular distribution for elastic

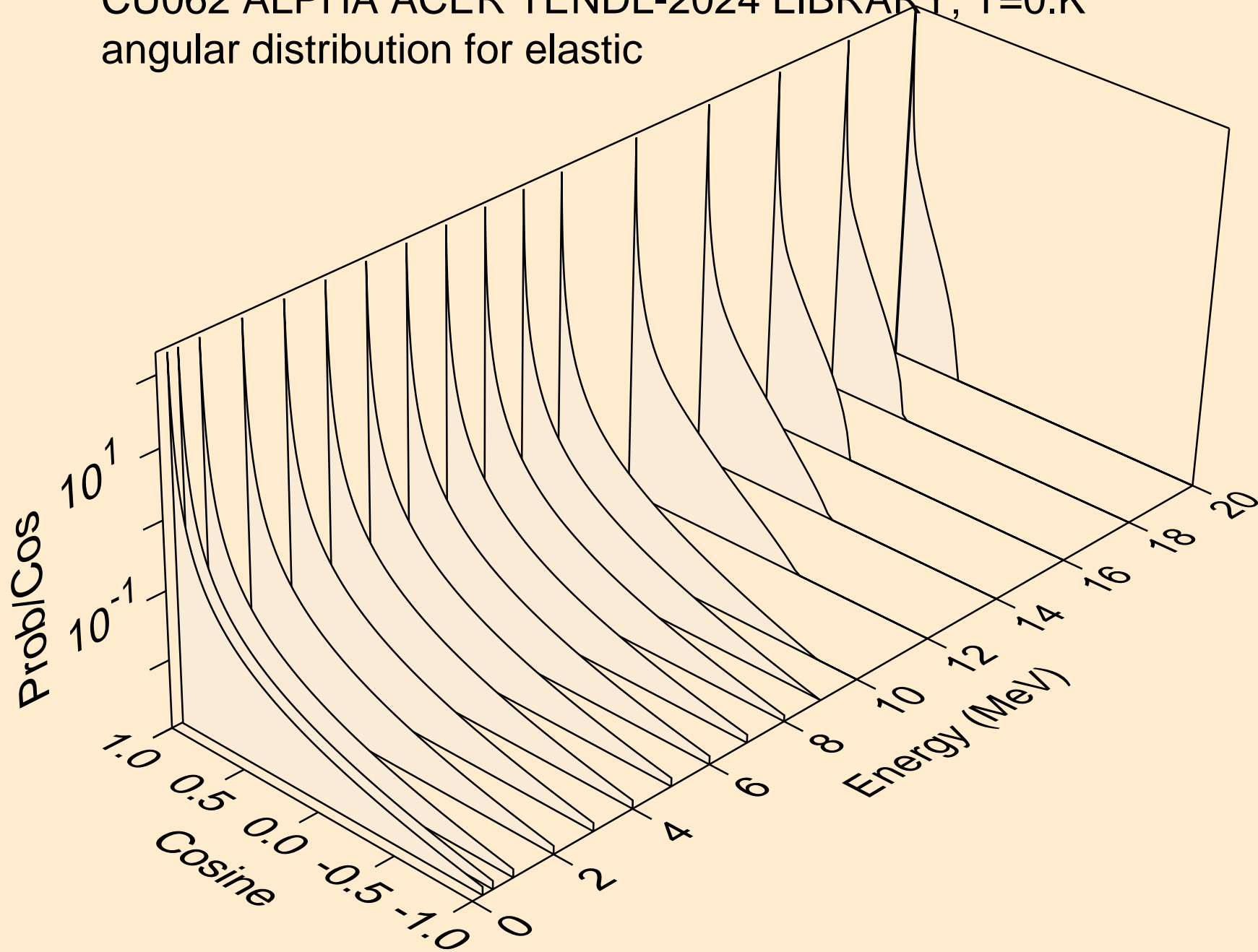

CU062 ALPHA ACER TENDL-2024 LIBRARY; T=0.K
angular distribution for elastic

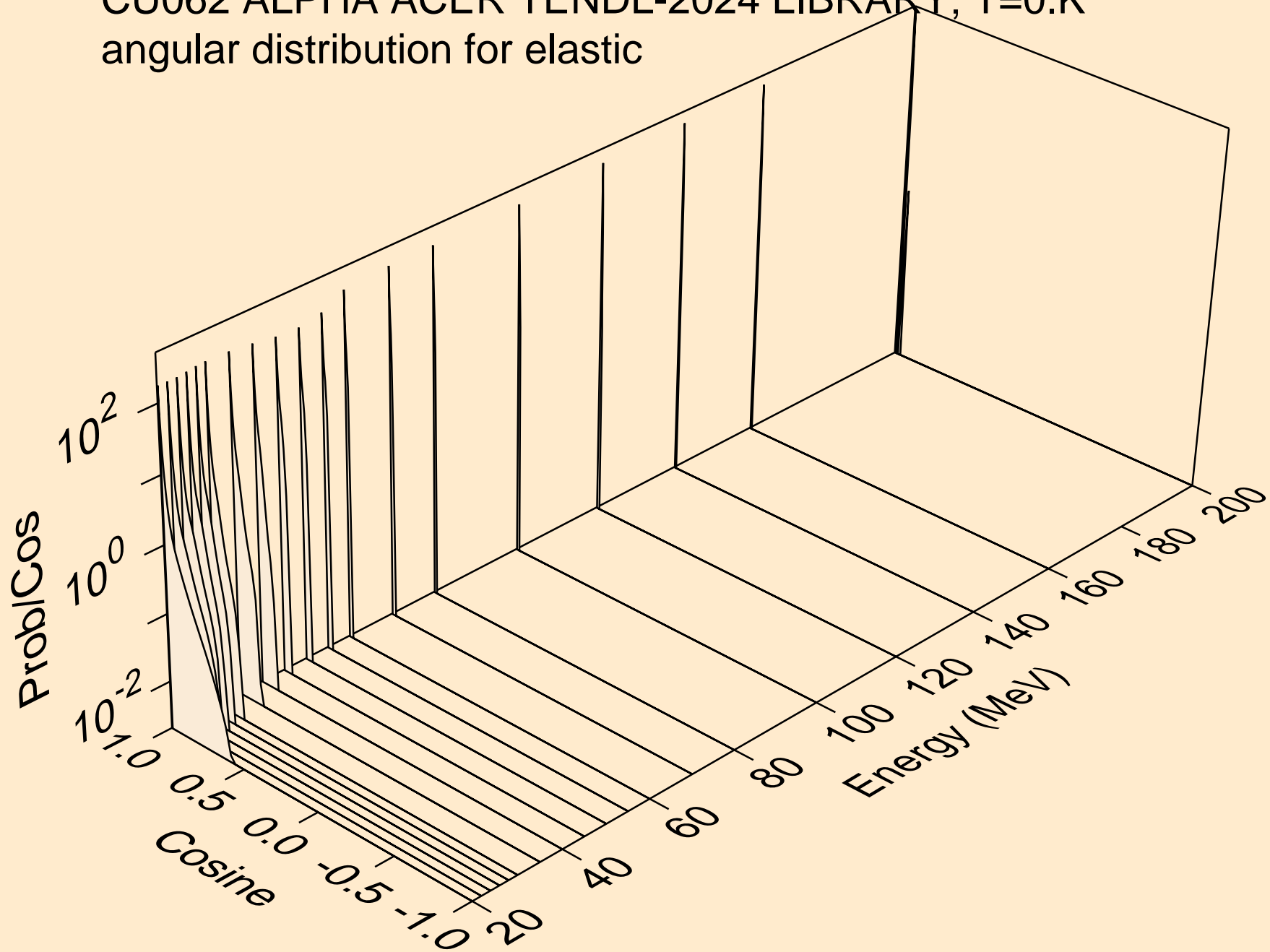

CU062 ALPHA ACER TENDL-2024 LIBRARY; T=0.K
Alpha emission for (a,x)

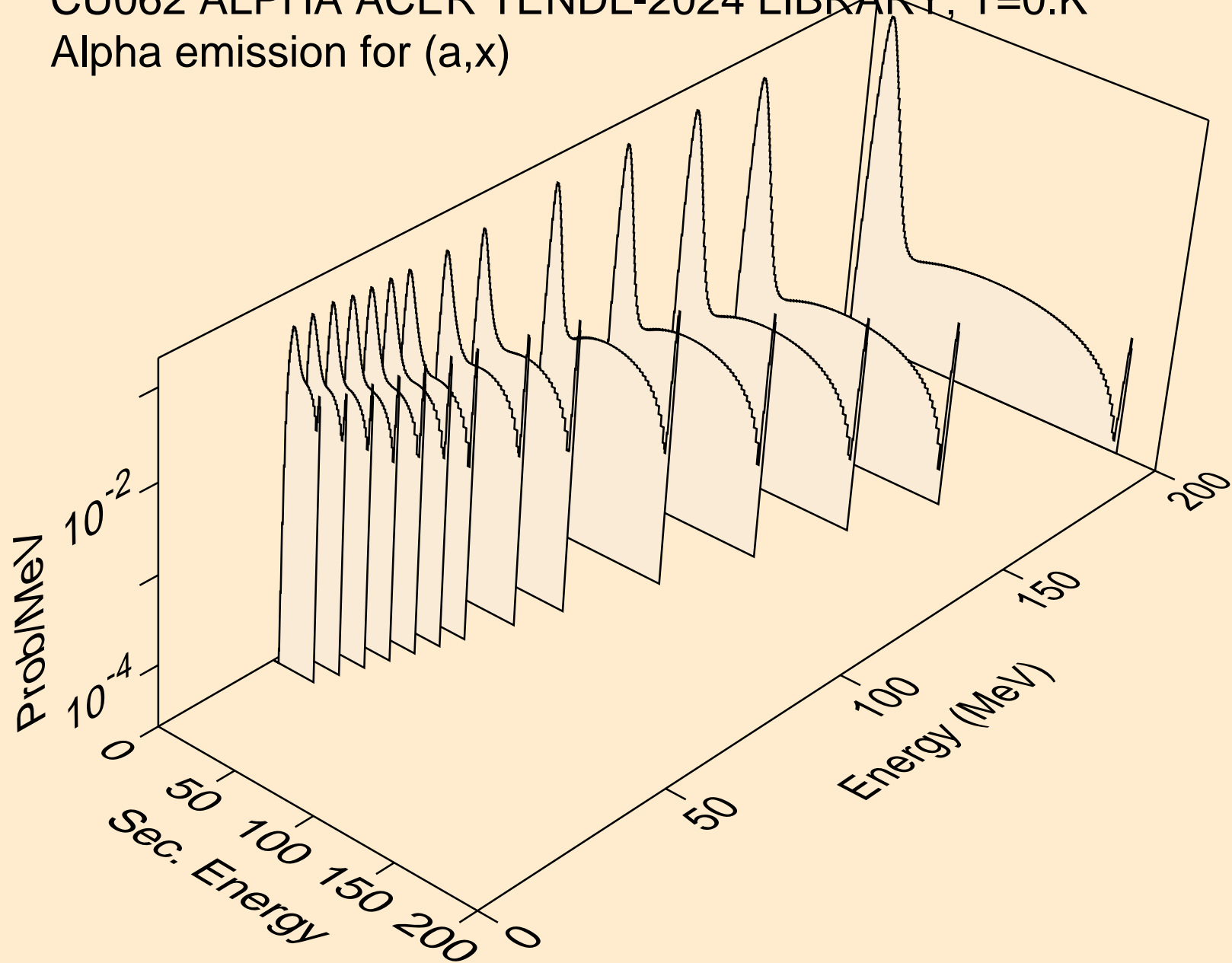

CU062 ALPHA ACER TENDL-2024 LIBRARY; T=0.K
Alpha emission for (a,n*)a

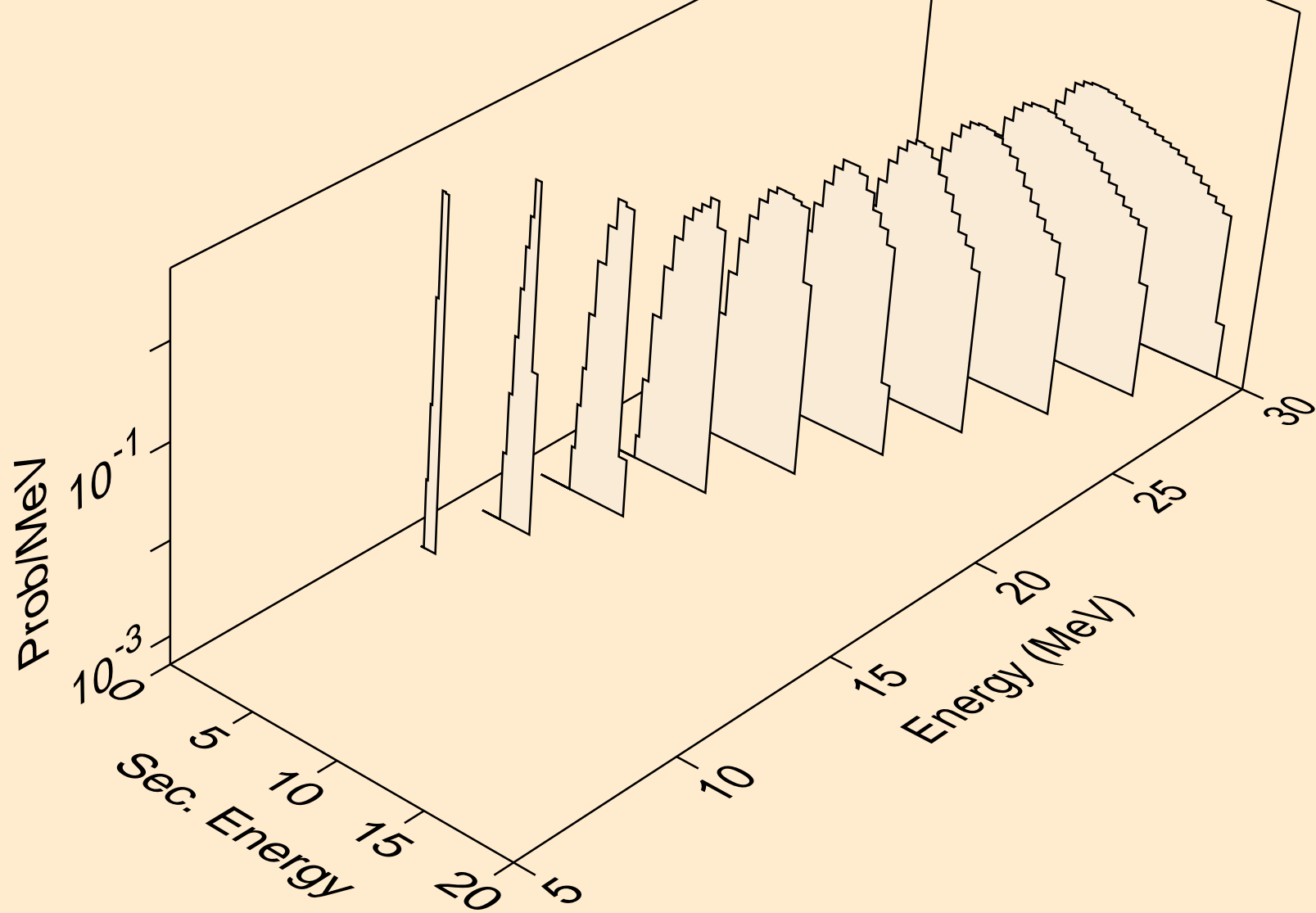

CU062 ALPHA ACER TENDL-2024 LIBRARY; T=0.K
Alpha emission for (a,2n)a

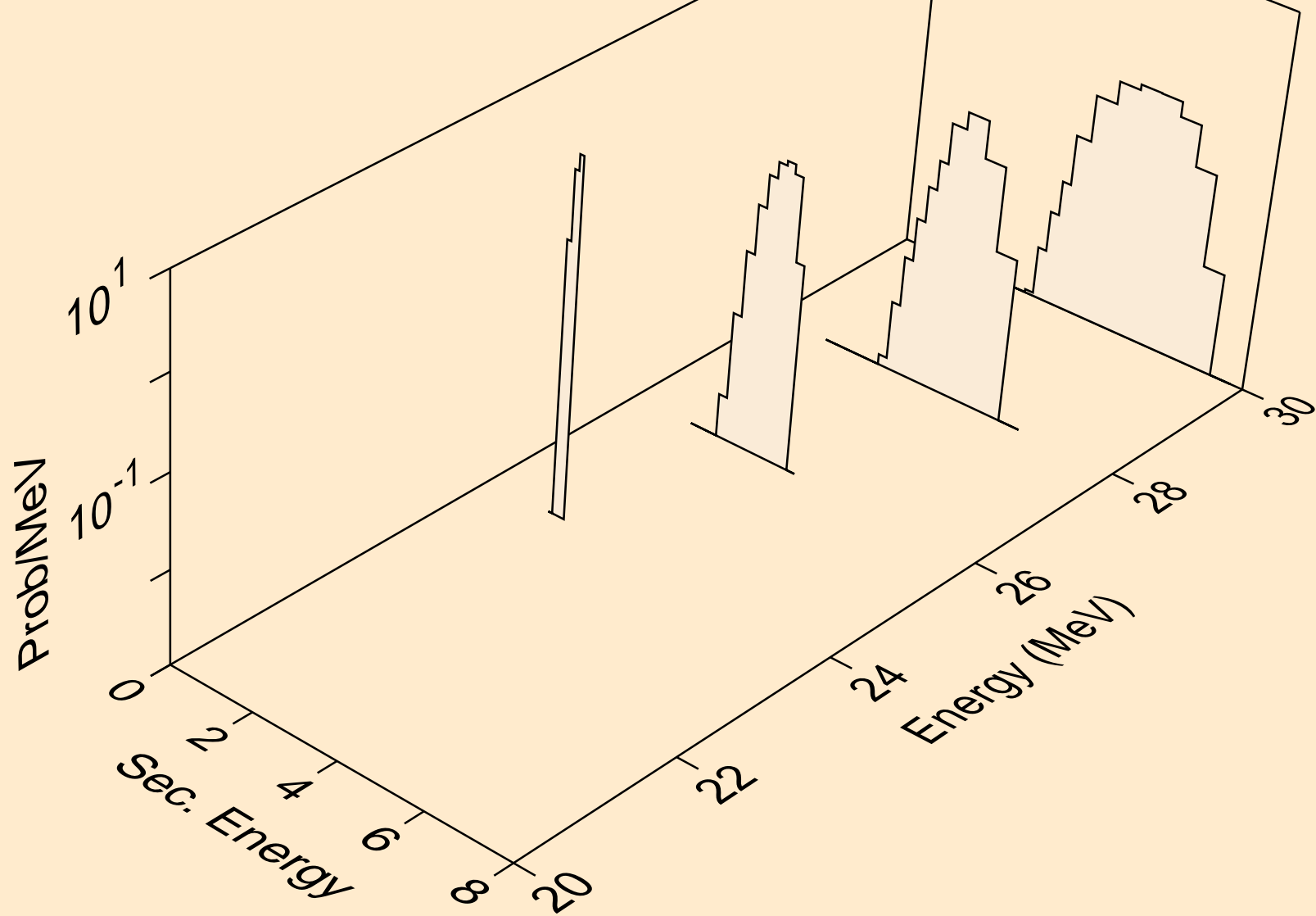

CU062 ALPHA ACER TENDL-2024 LIBRARY; T=0.K
Alpha emission for (a,n*)2a

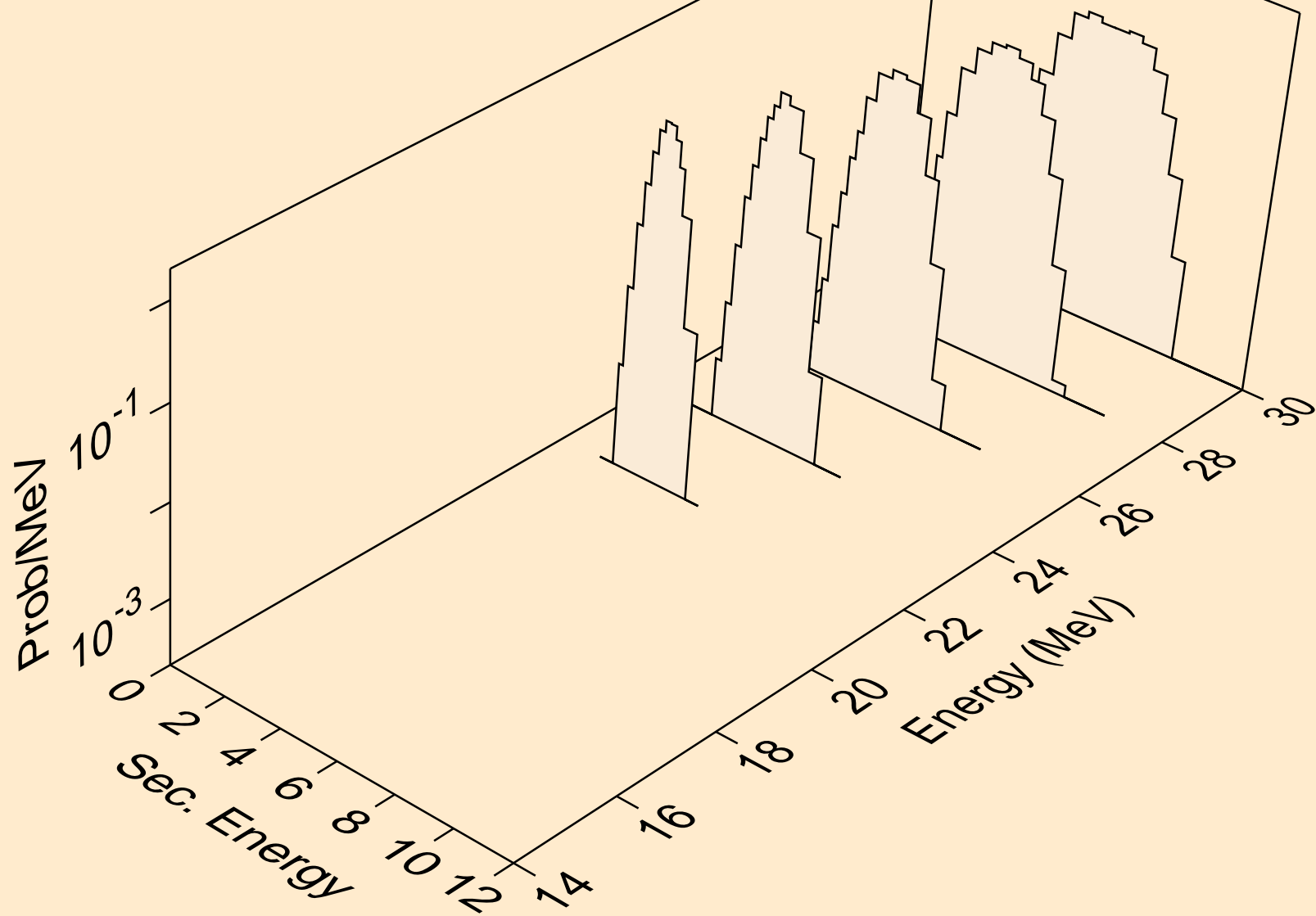

CU062 ALPHA ACER TENDL-2024 LIBRARY; T=0.K
Alpha emission for inelastic

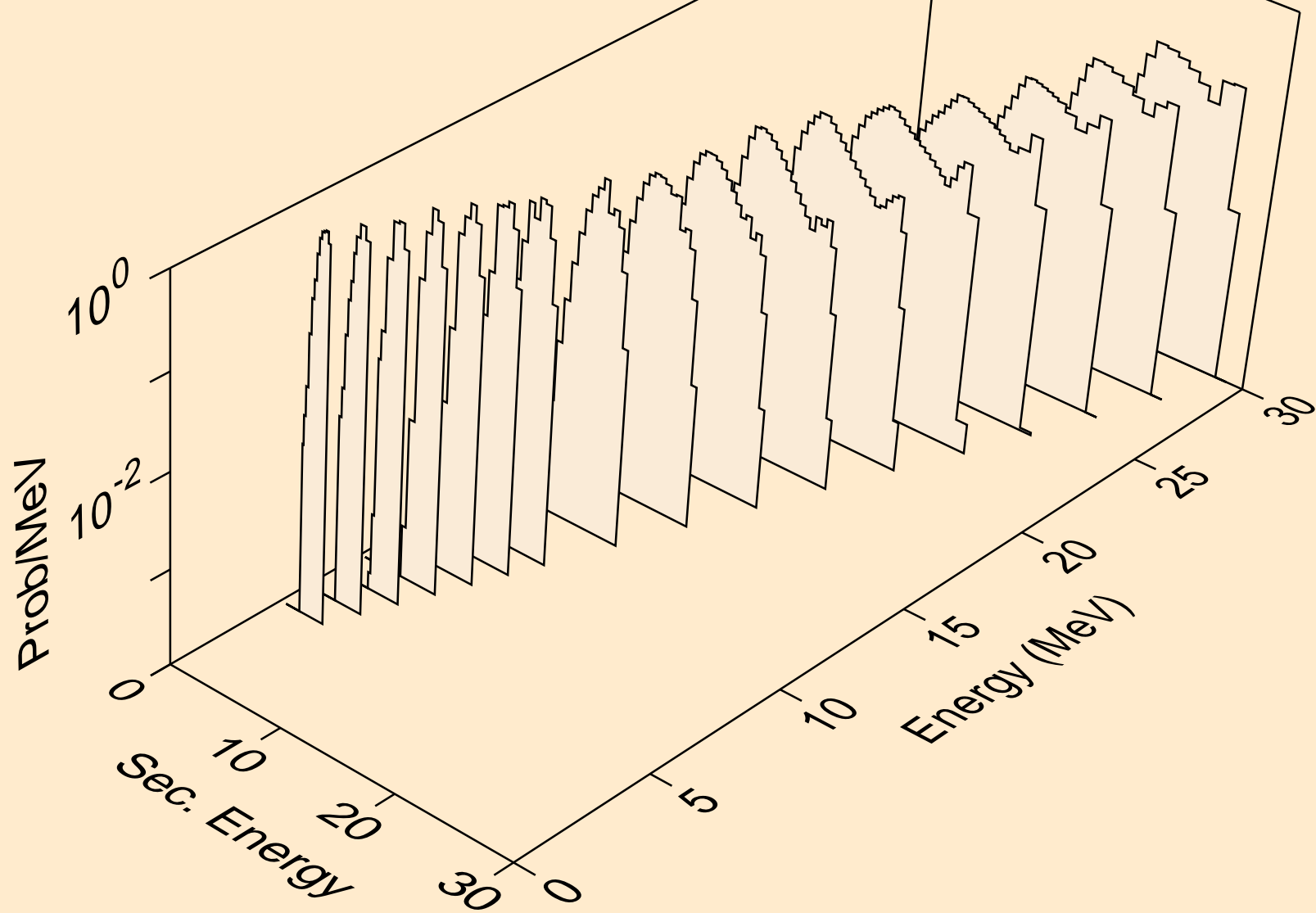

CU062 ALPHA ACER TENDL-2024 LIBRARY; T=0.K
Alpha emission for (a,2a)

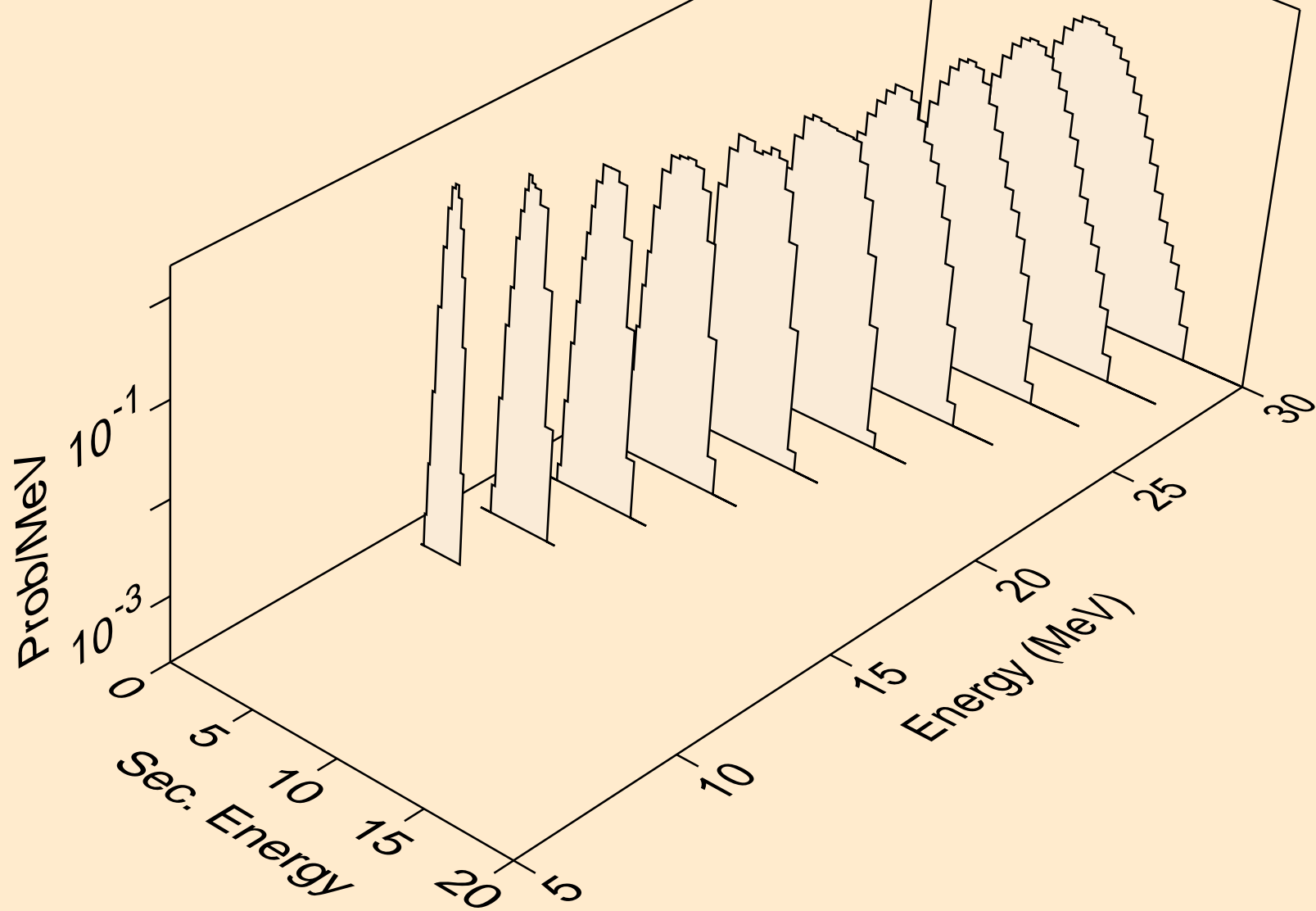

CU062 ALPHA ACER TENDL-2024 LIBRARY; T=0.K
Alpha emission for (a,pa)

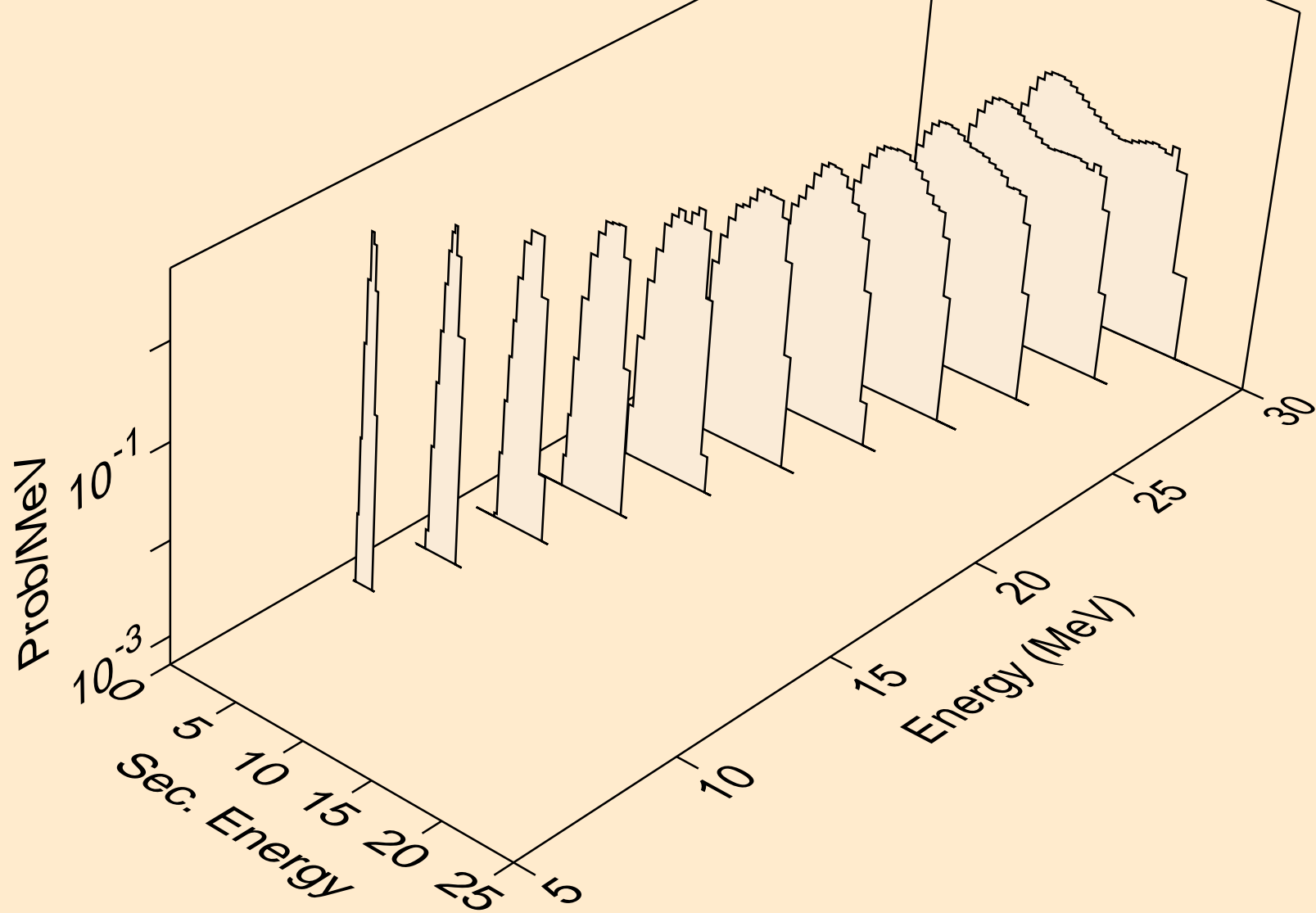

CU062 ALPHA ACER TENDL-2024 LIBRARY; T=0.K
Alpha emission for (a,da)

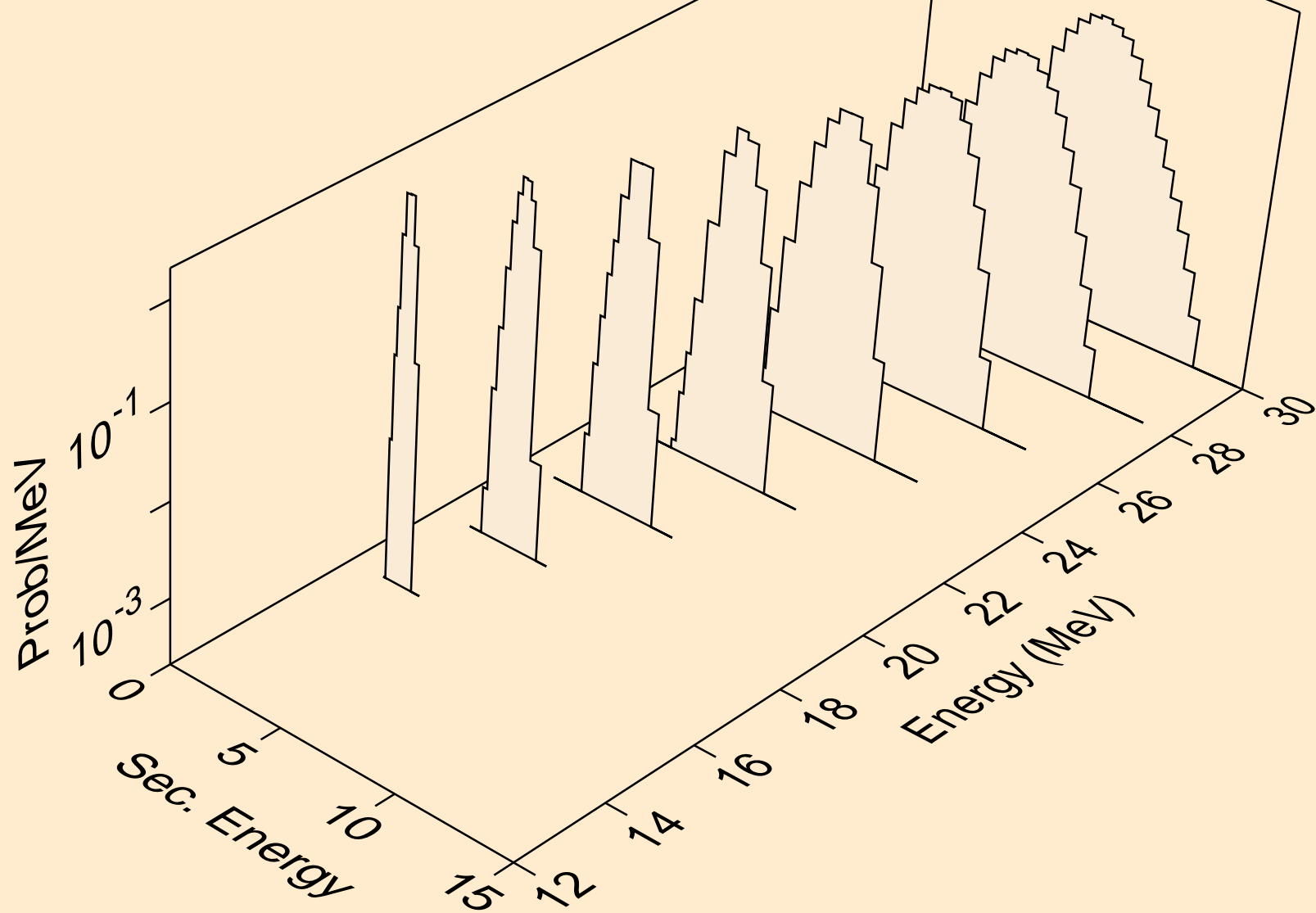

CU062 ALPHA ACER TENDL-2024 LIBRARY; T=0.K
Photon emission for (z,n)

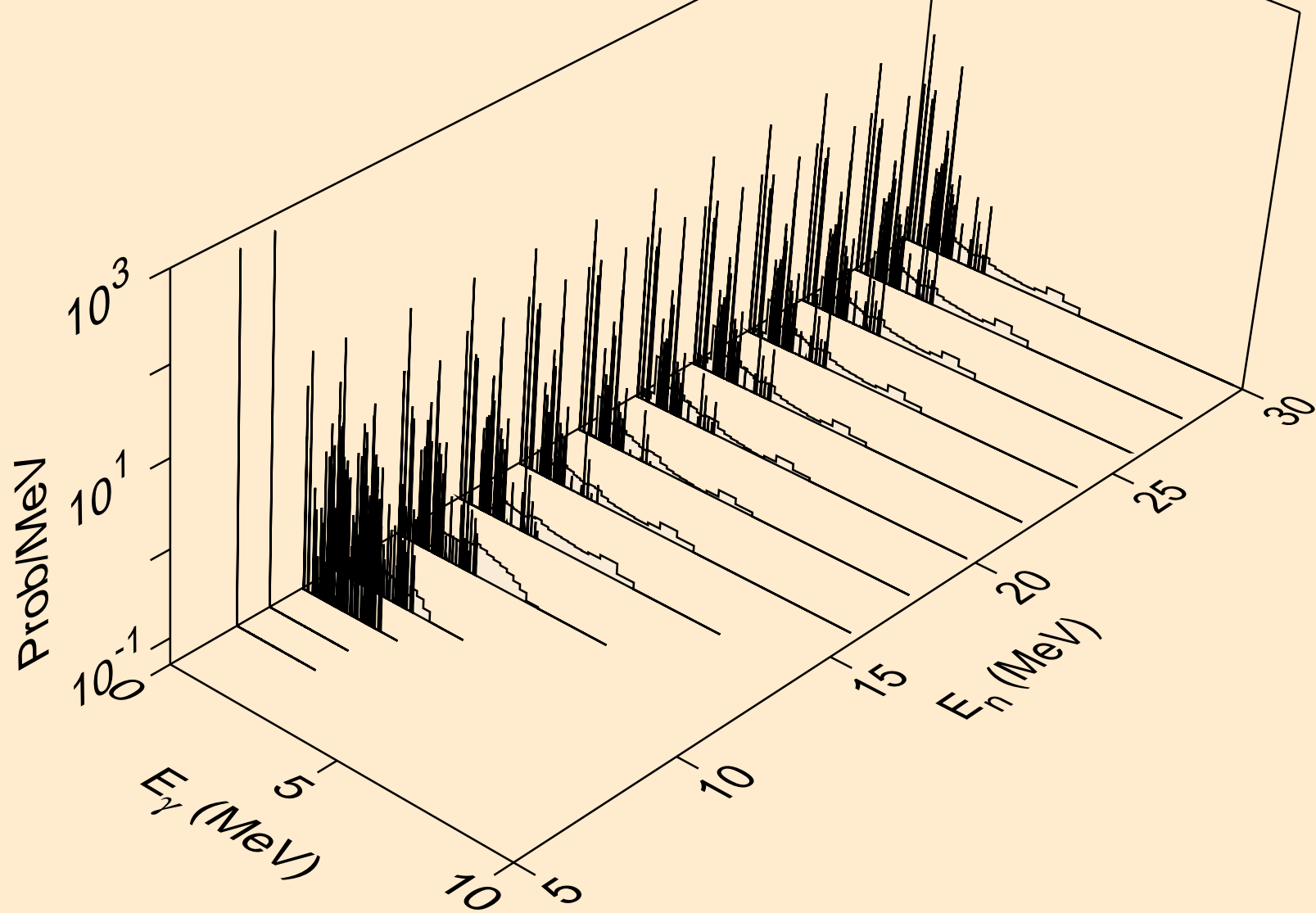

CU062 ALPHA ACER TENDL-2024 LIBRARY; T=0.K
Photon emission for (z,x)

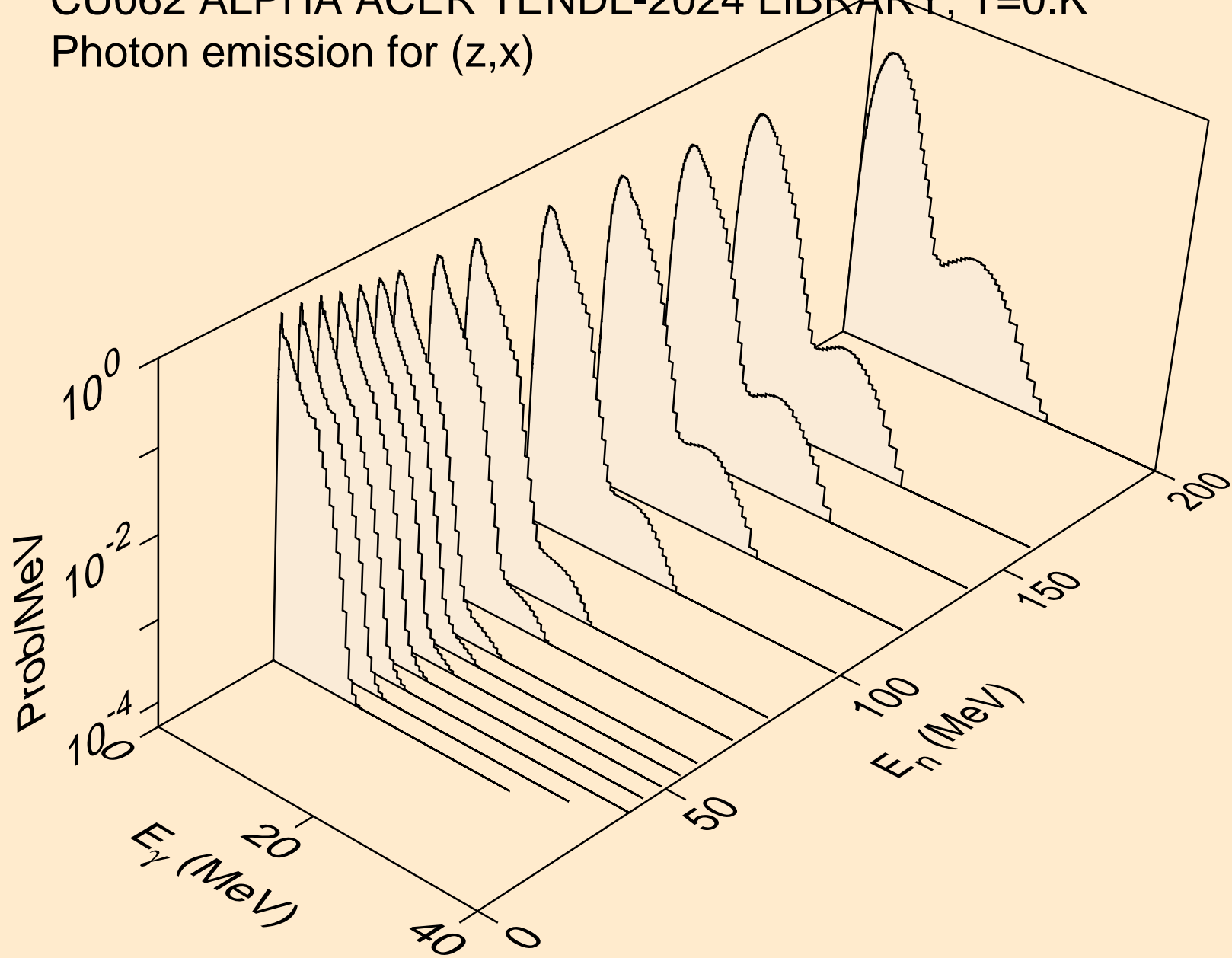

CU062 ALPHA ACER TENDL-2024 LIBRARY; T=0.K
Photon emission for (n,2n)

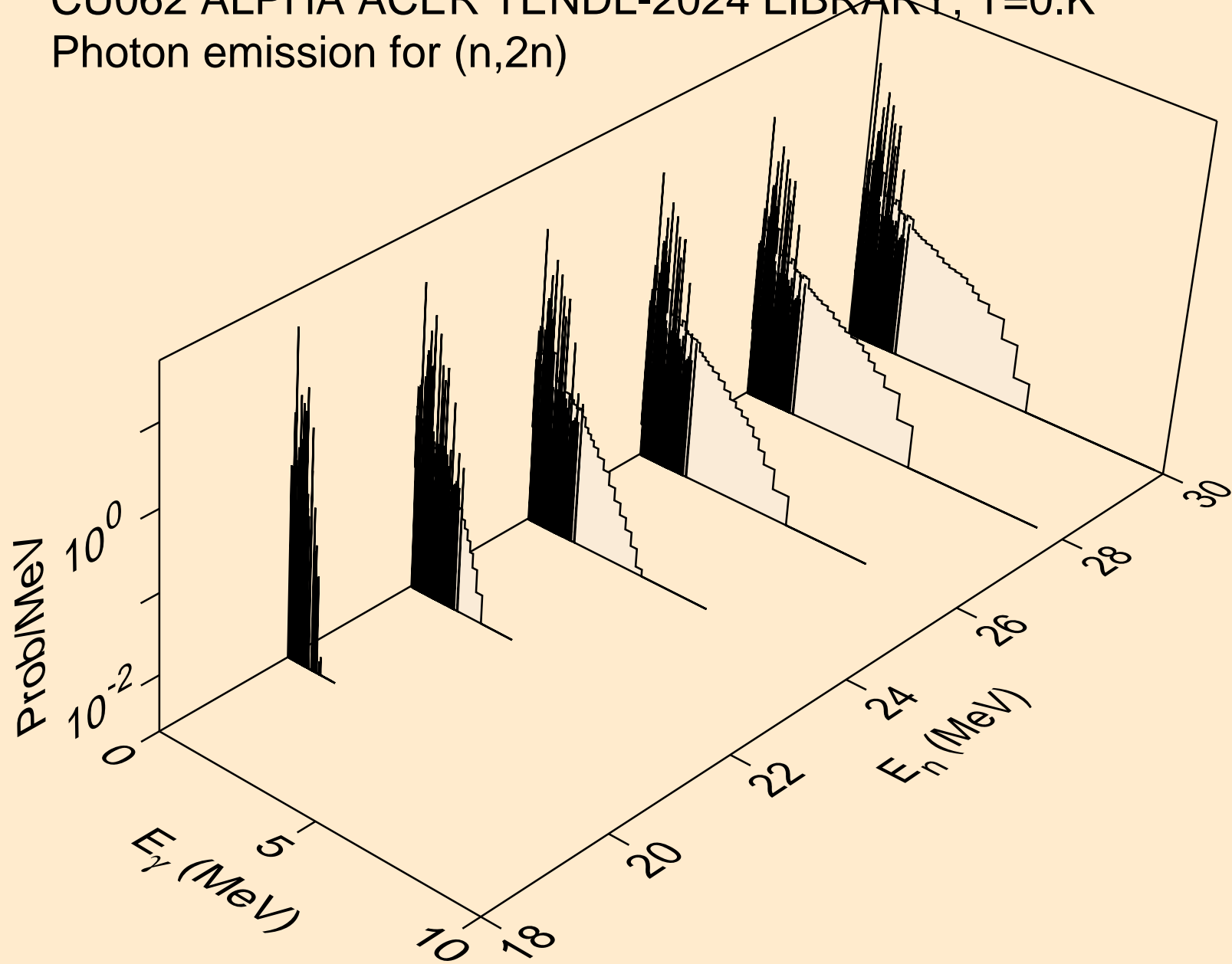

CU062 ALPHA ACER TENDL-2024 LIBRARY; T=0.K
Photon emission for (n,n*)a

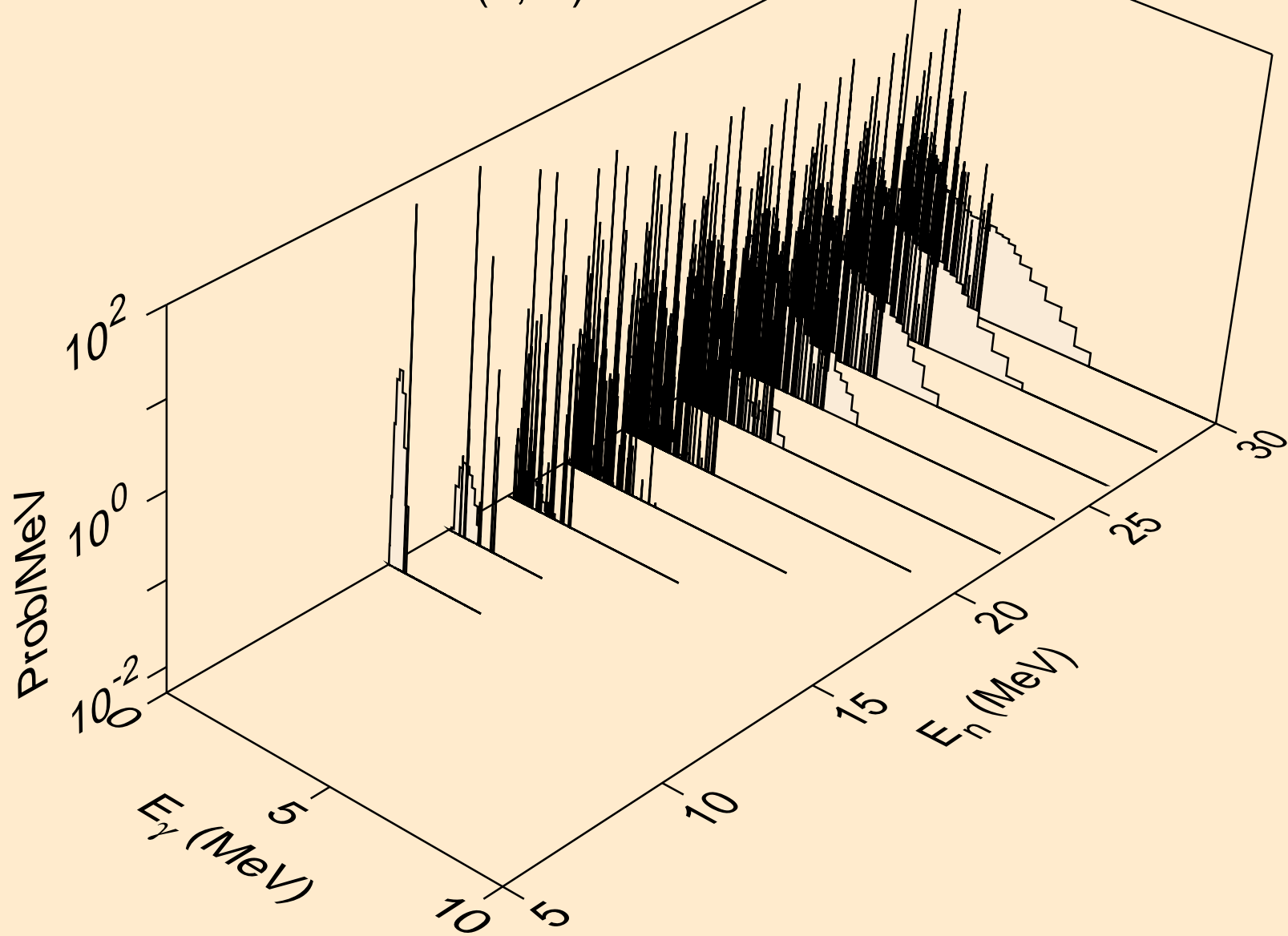

CU062 ALPHA ACER TENDL-2024 LIBRARY; T=0.K
Photon emission for (n,2n)a

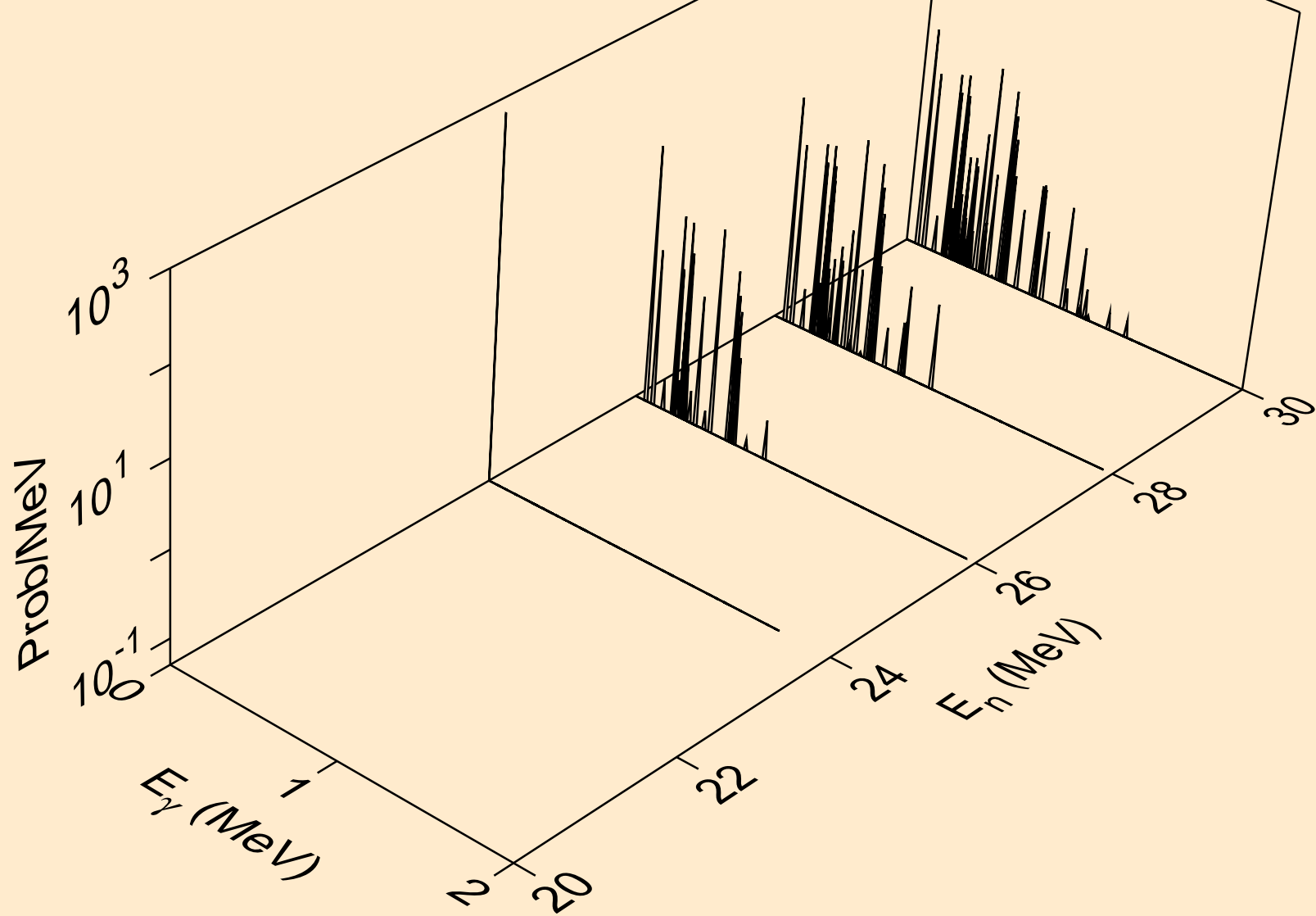

CU062 ALPHA ACER TENDL-2024 LIBRARY; T=0.K
Photon emission for (n,n*)p

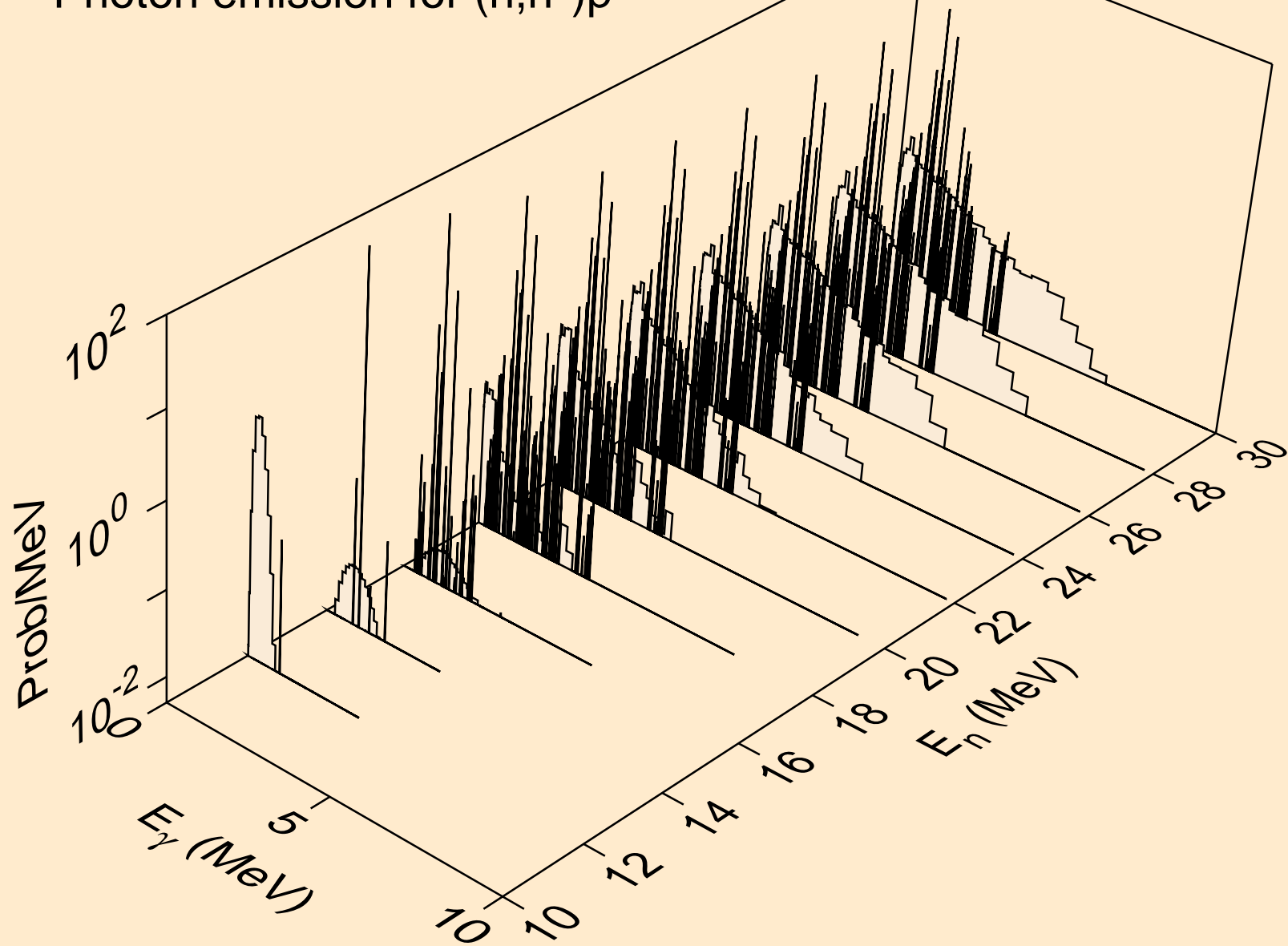

CU062 ALPHA ACER TENDL-2024 LIBRARY; T=0.K
Photon emission for (n,n*)2a

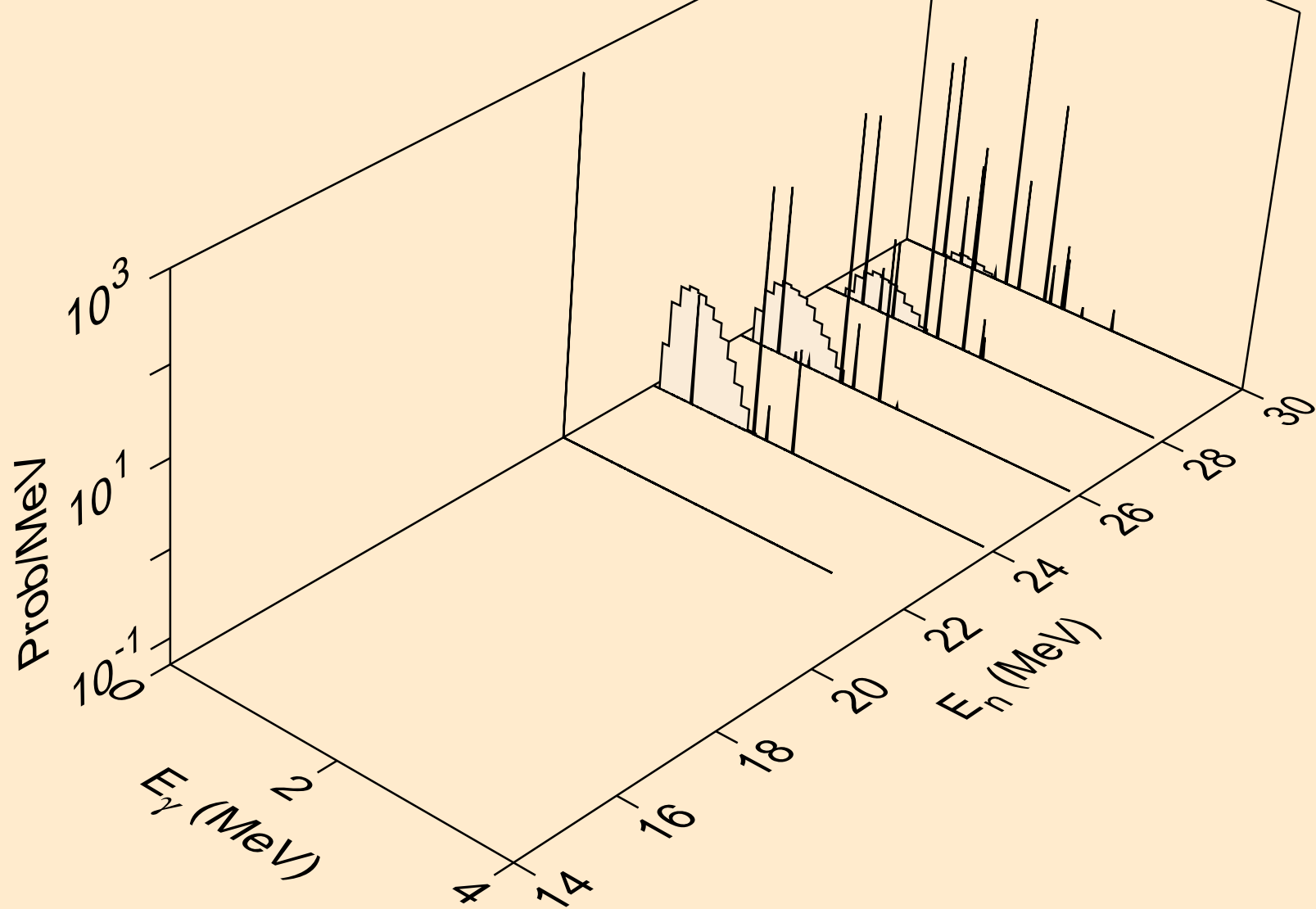

CU062 ALPHA ACER TENDL-2024 LIBRARY; T=0.K
Photon emission for (n,n*)d

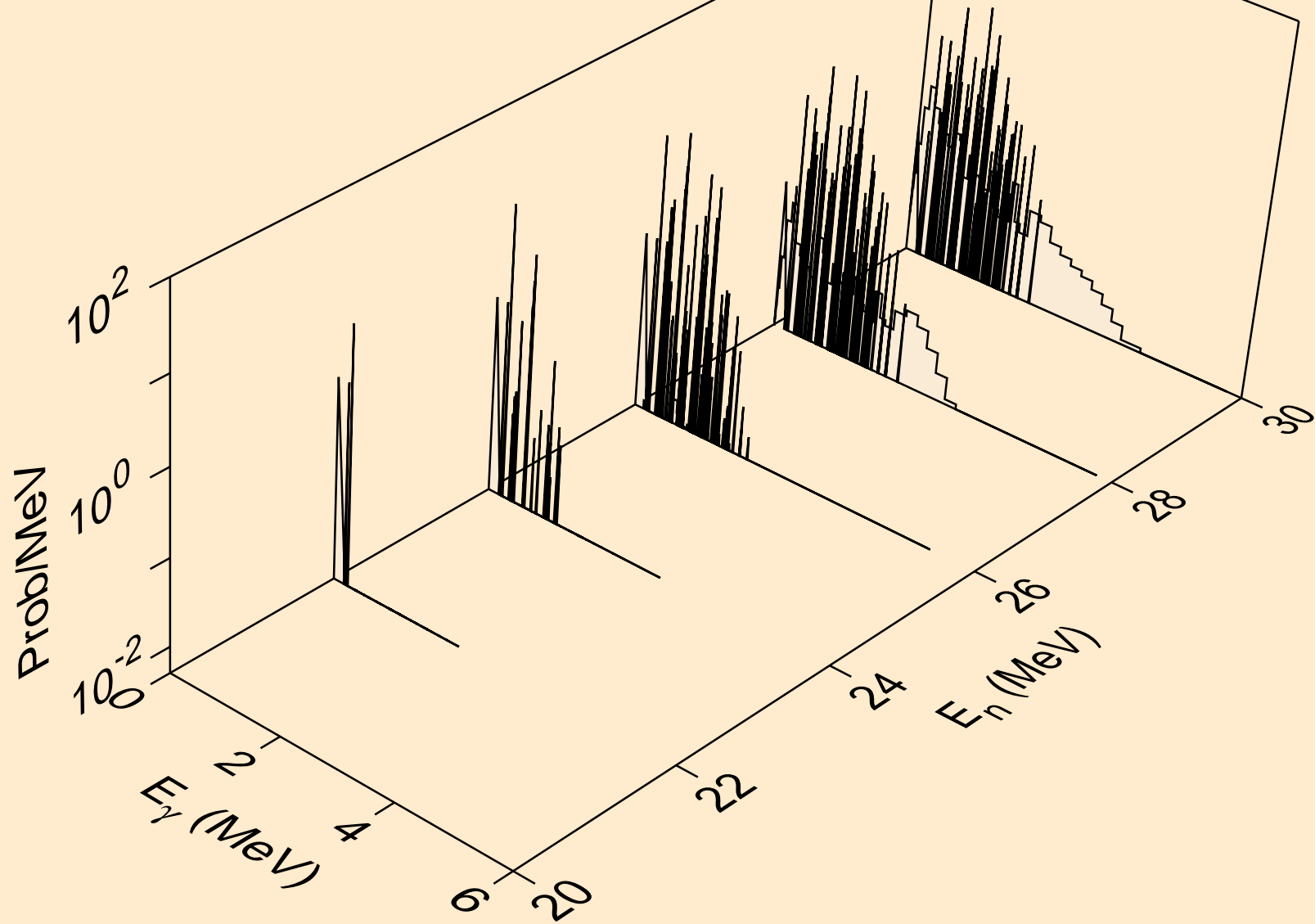

CU062 ALPHA ACER TENDL-2024 LIBRARY; T=0.K
Photon emission for (n,n*)t

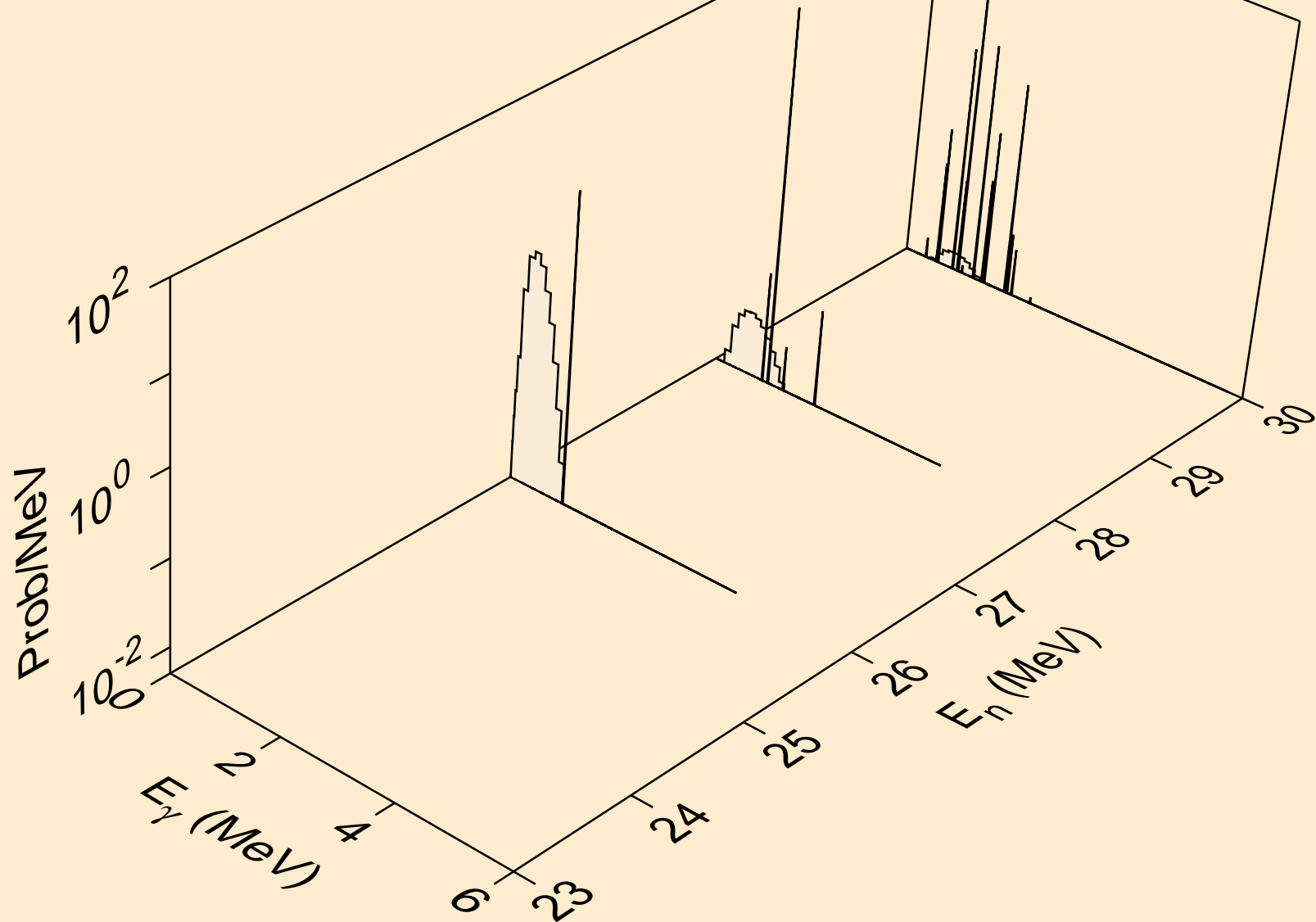

CU062 ALPHA ACER TENDL-2024 LIBRARY; T=0.K
Photon emission for (n,n*)he3

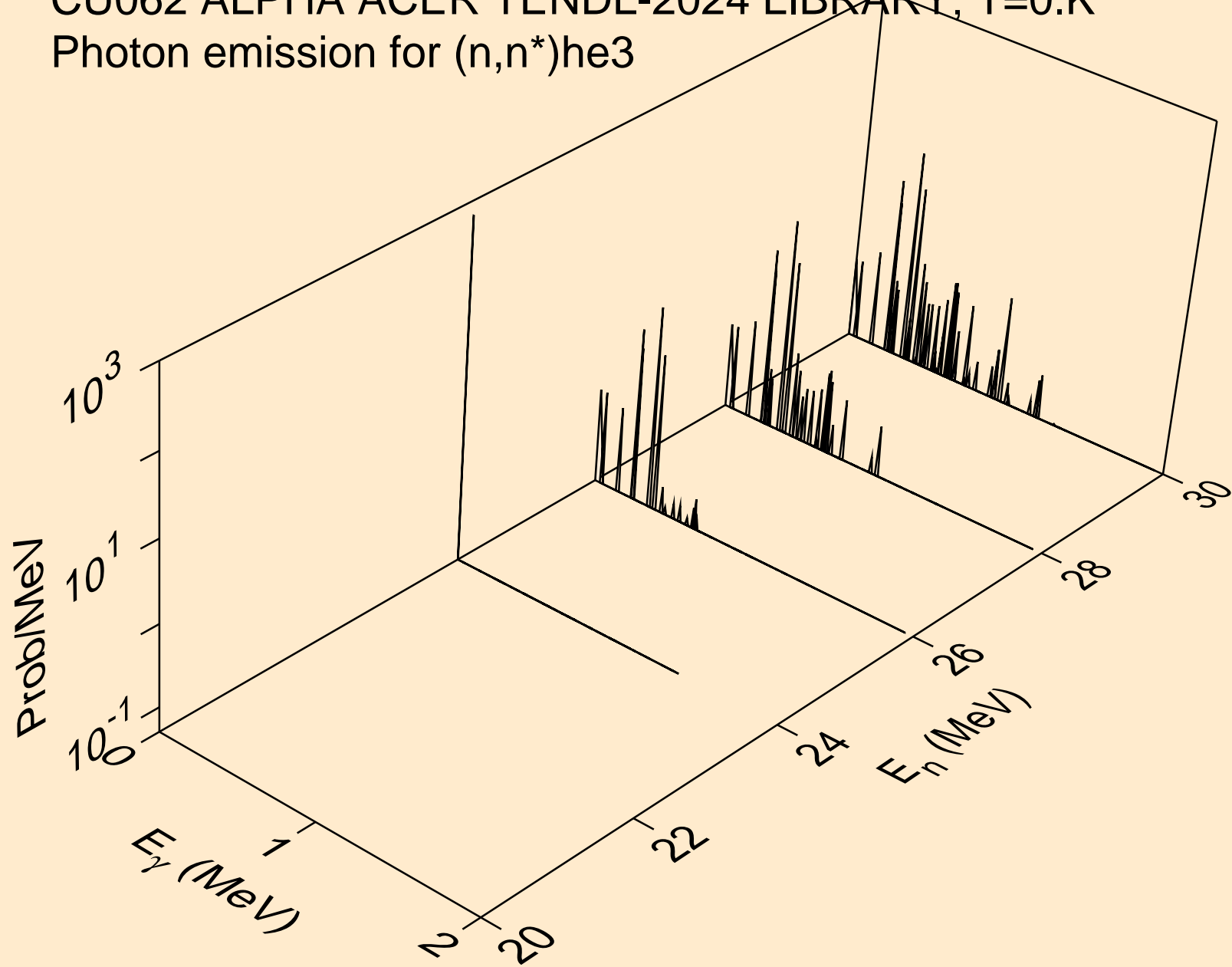

CU062 ALPHA ACER TENDL-2024 LIBRARY; T=0.K
Photon emission for (n,2np)

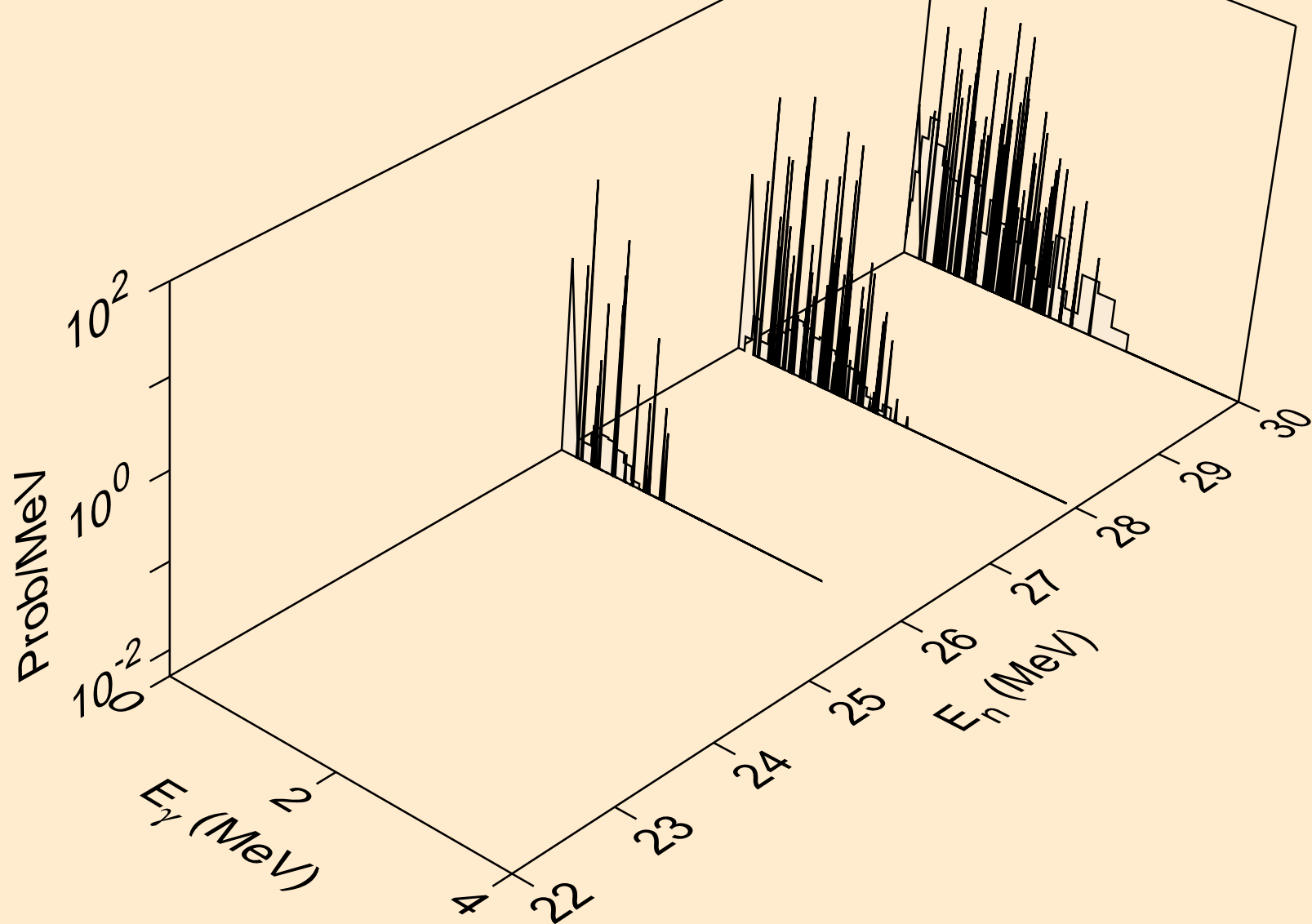

CU062 ALPHA ACER TENDL-2024 LIBRARY; T=0.K
Photon emission for (n,n2p)

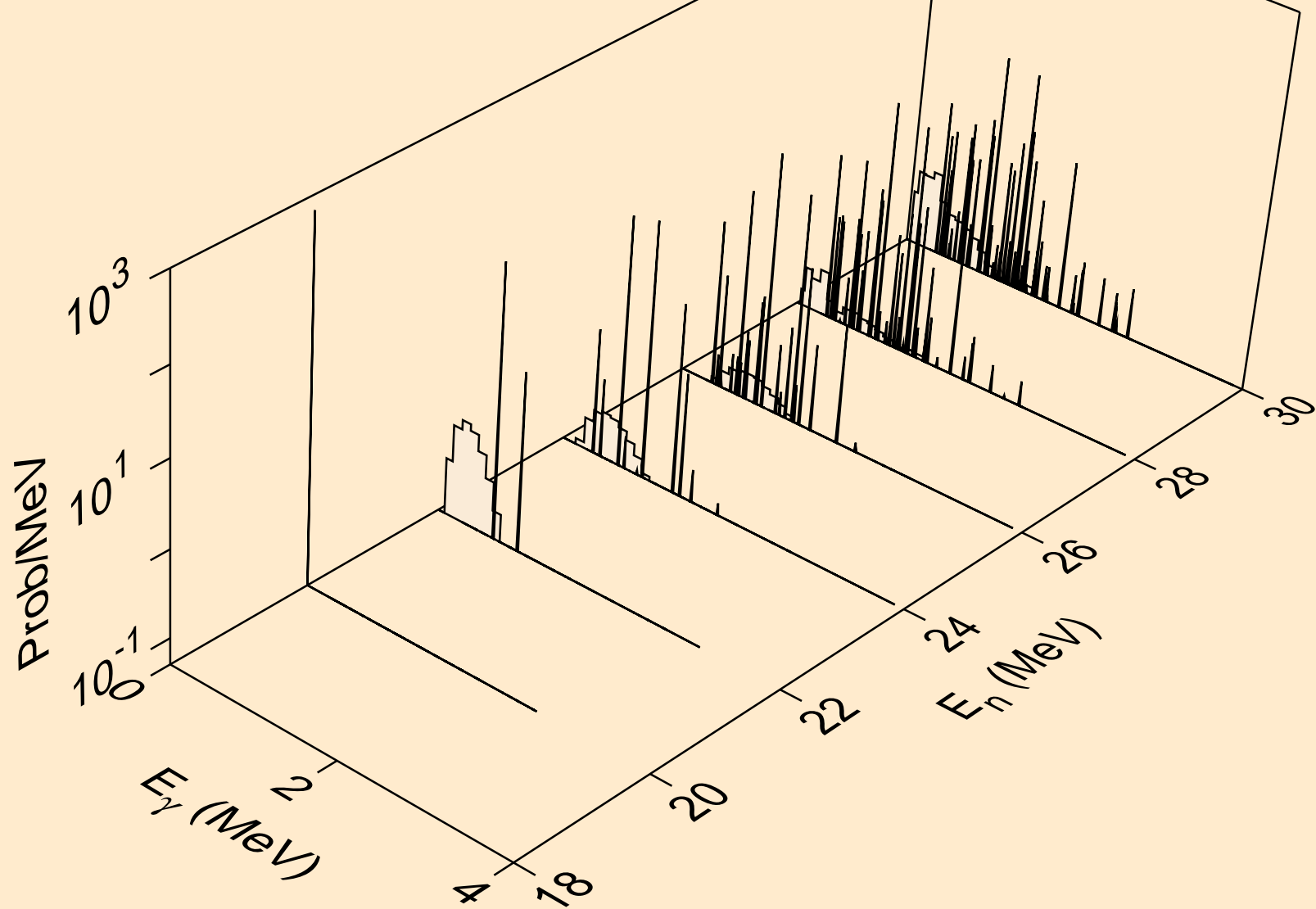

CU062 ALPHA ACER TENDL-2024 LIBRARY; T=0.K
Photon emission for (n,npa)

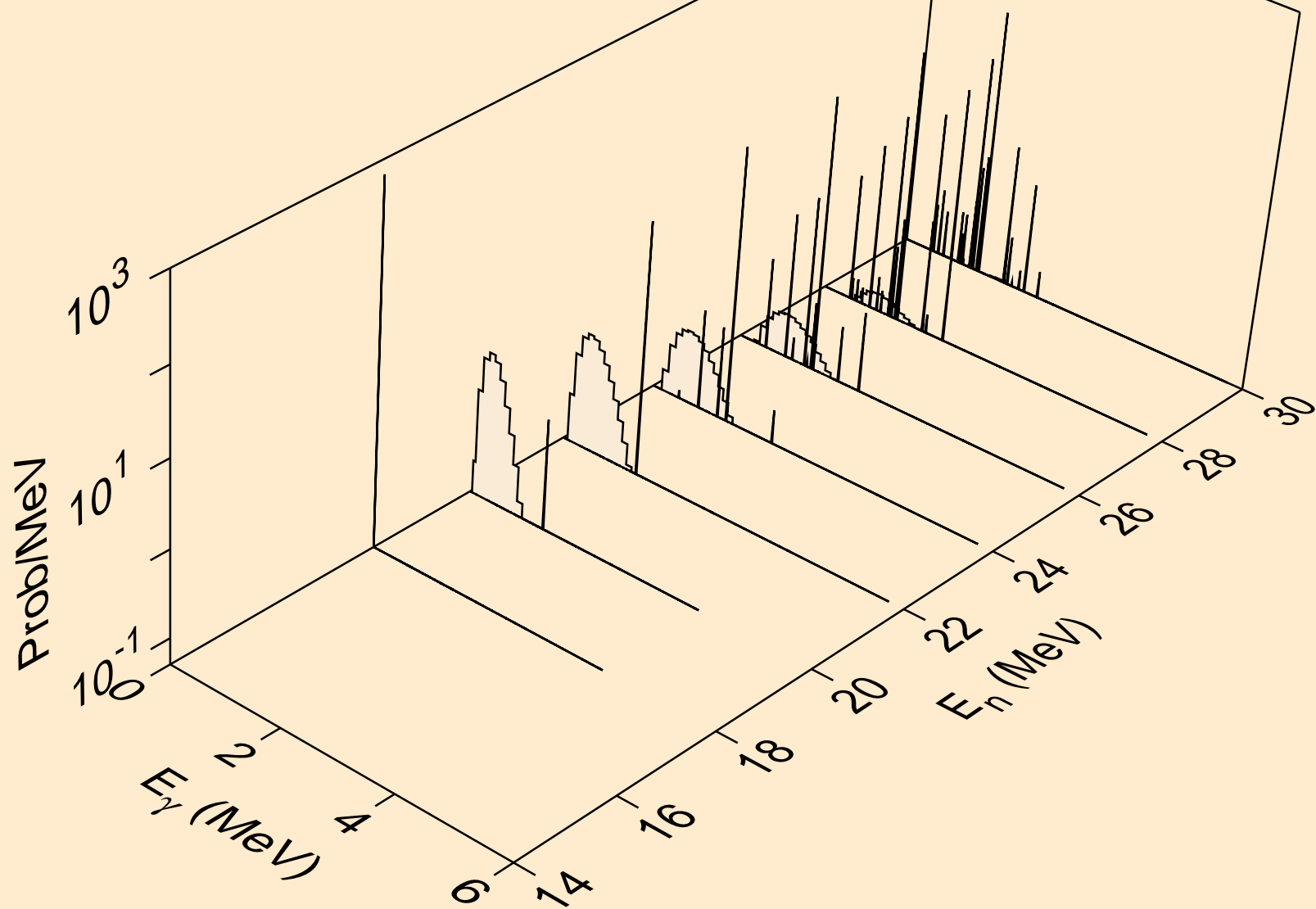

CU062 ALPHA ACER TENDL-2024 LIBRARY; T=0.K
Photon emission for (n,gma)

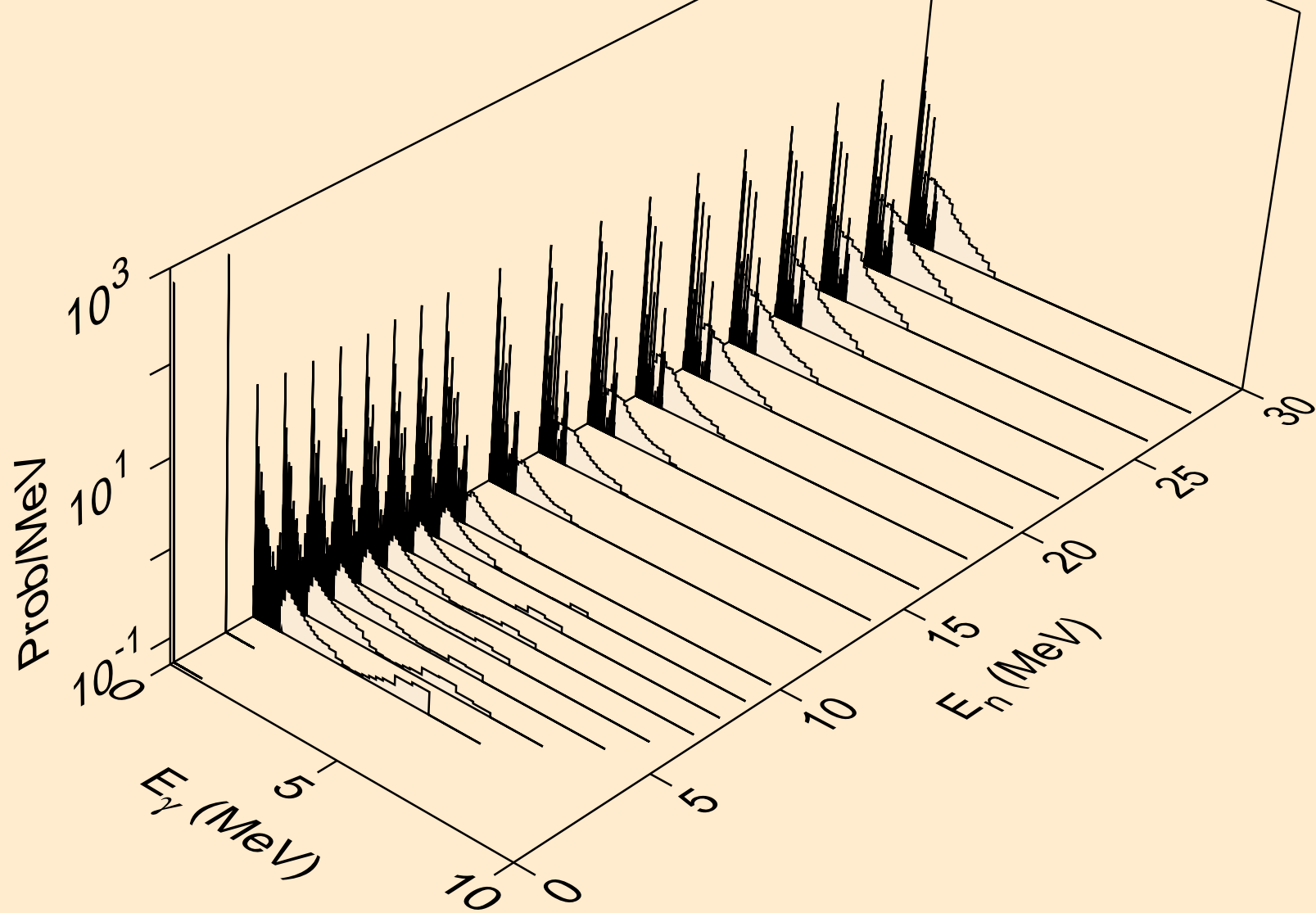

CU062 ALPHA ACER TENDL-2024 LIBRARY; T=0.K
Photon emission for (n,p)

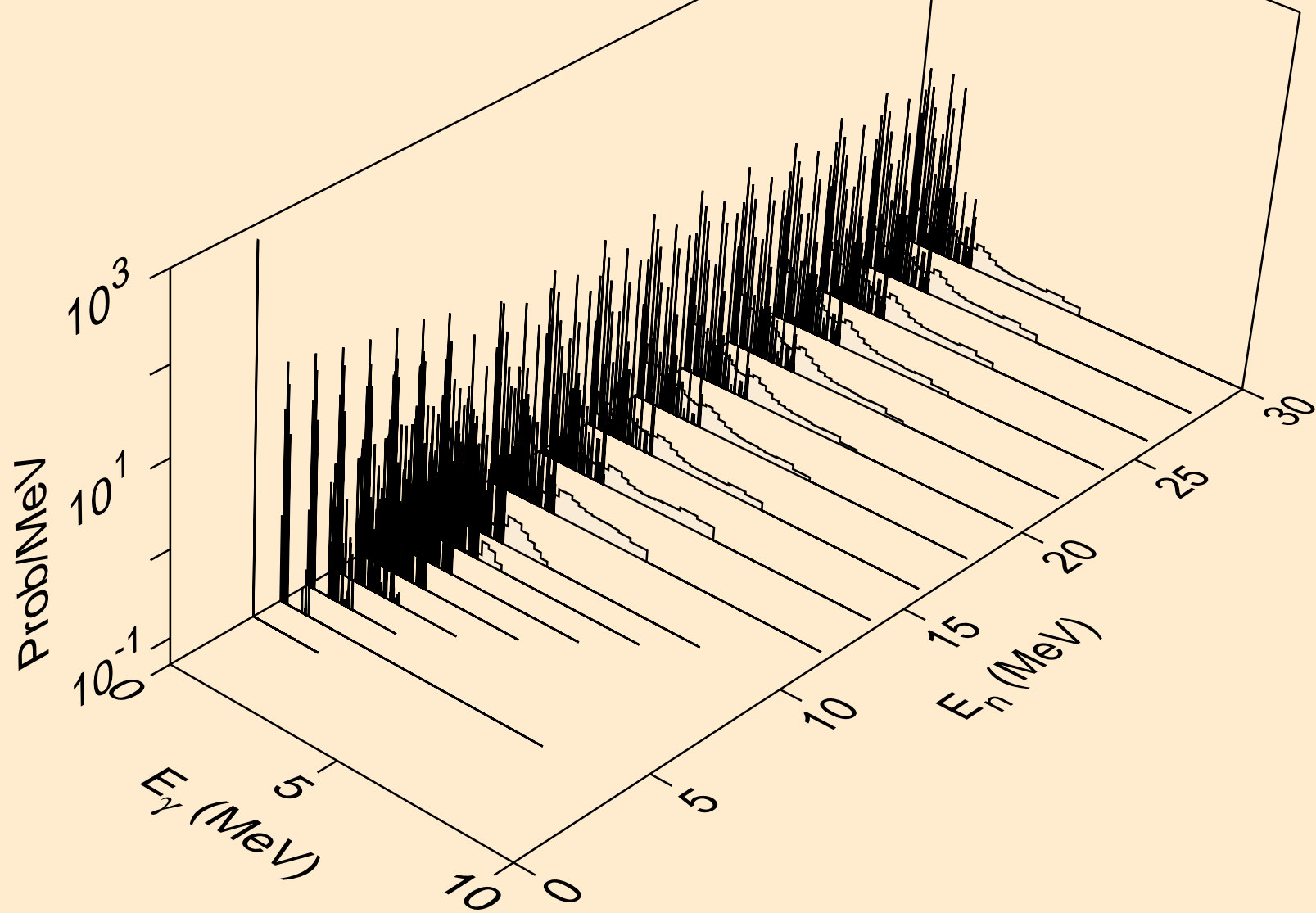

CU062 ALPHA ACER TENDL-2024 LIBRARY; T=0.K
Photon emission for (n,d)

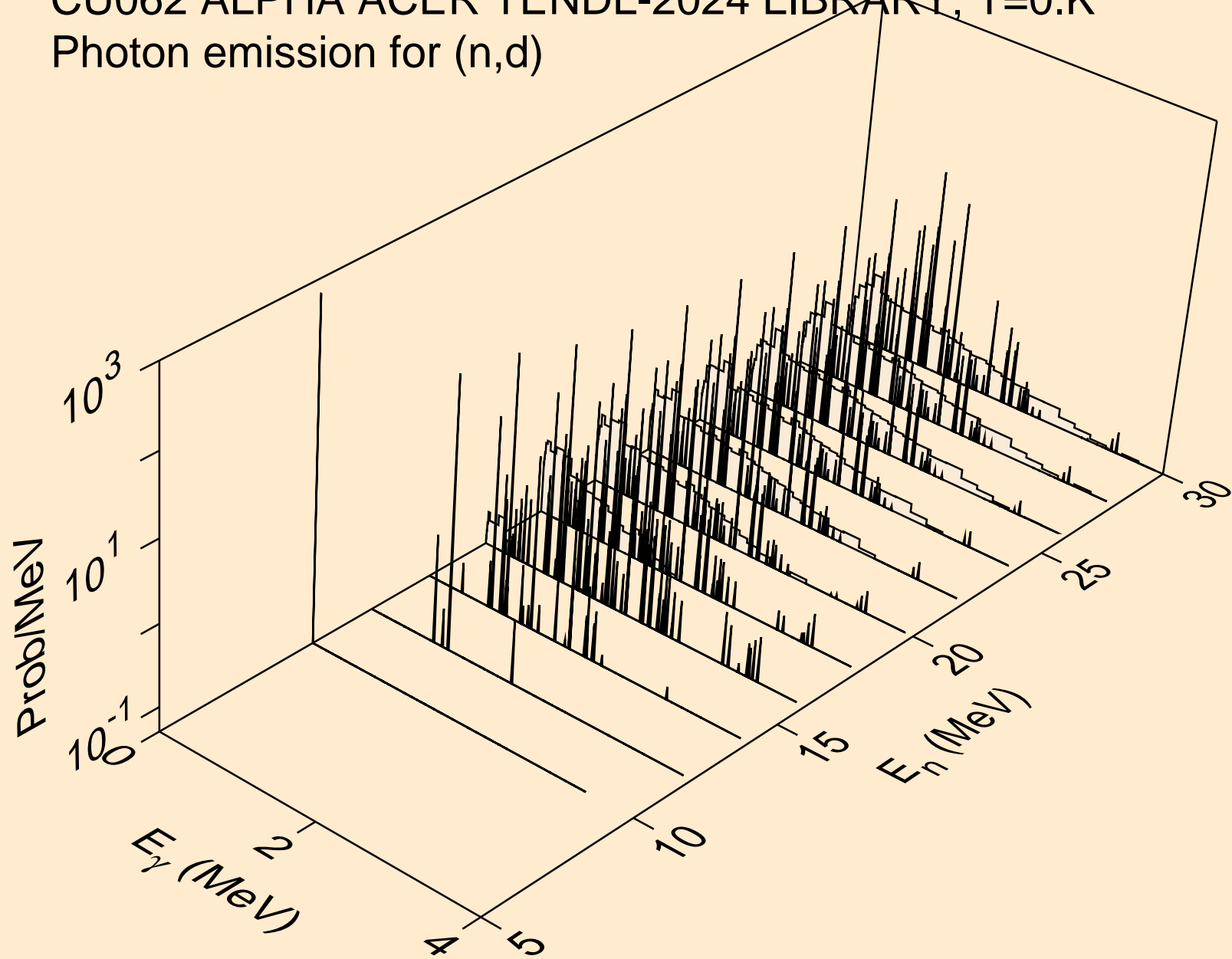

CU062 ALPHA ACER TENDL-2024 LIBRARY; T=0.K
Photon emission for (n,t)

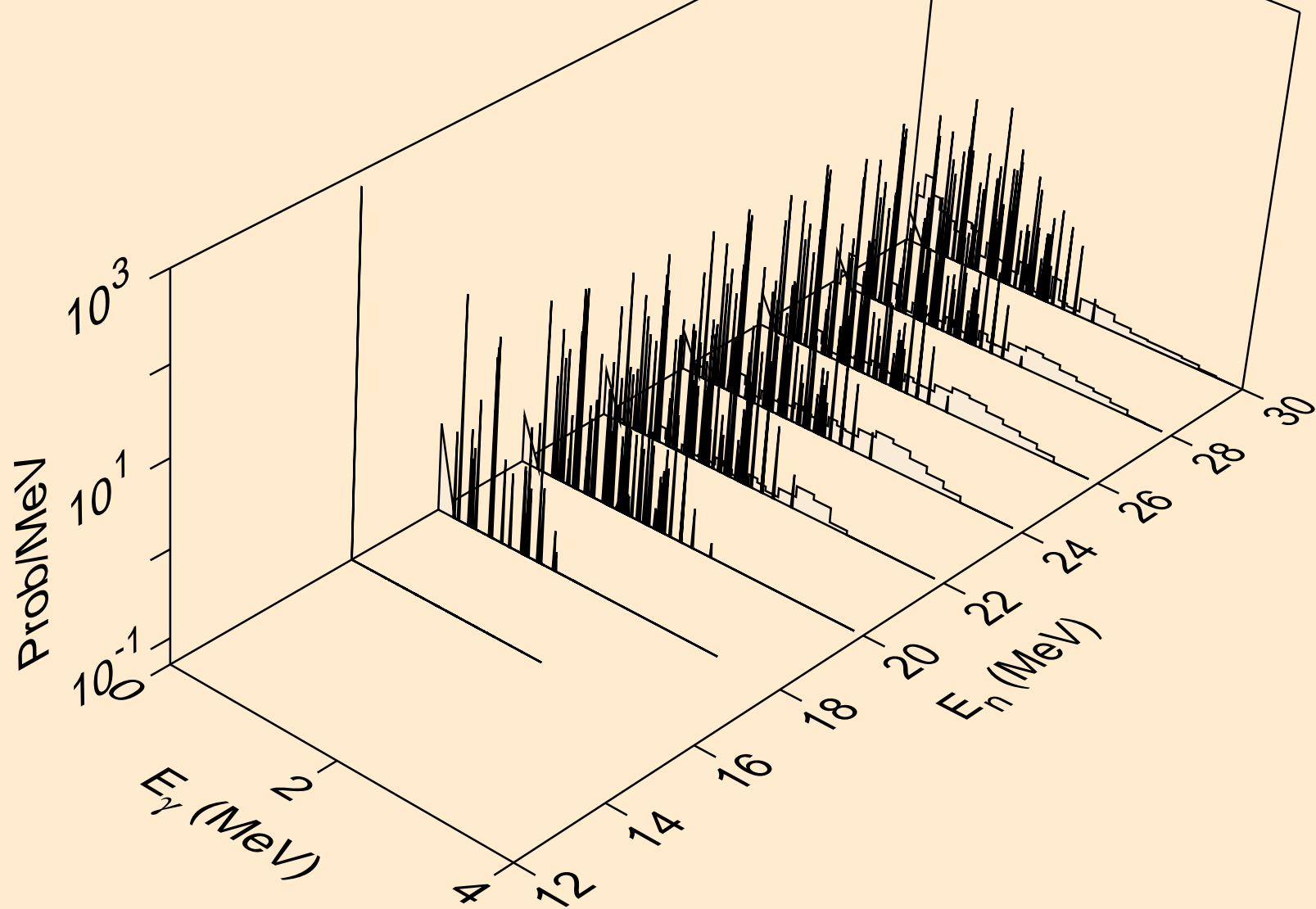

CU062 ALPHA ACER TENDL-2024 LIBRARY; T=0.K
Photon emission for (n,he3)

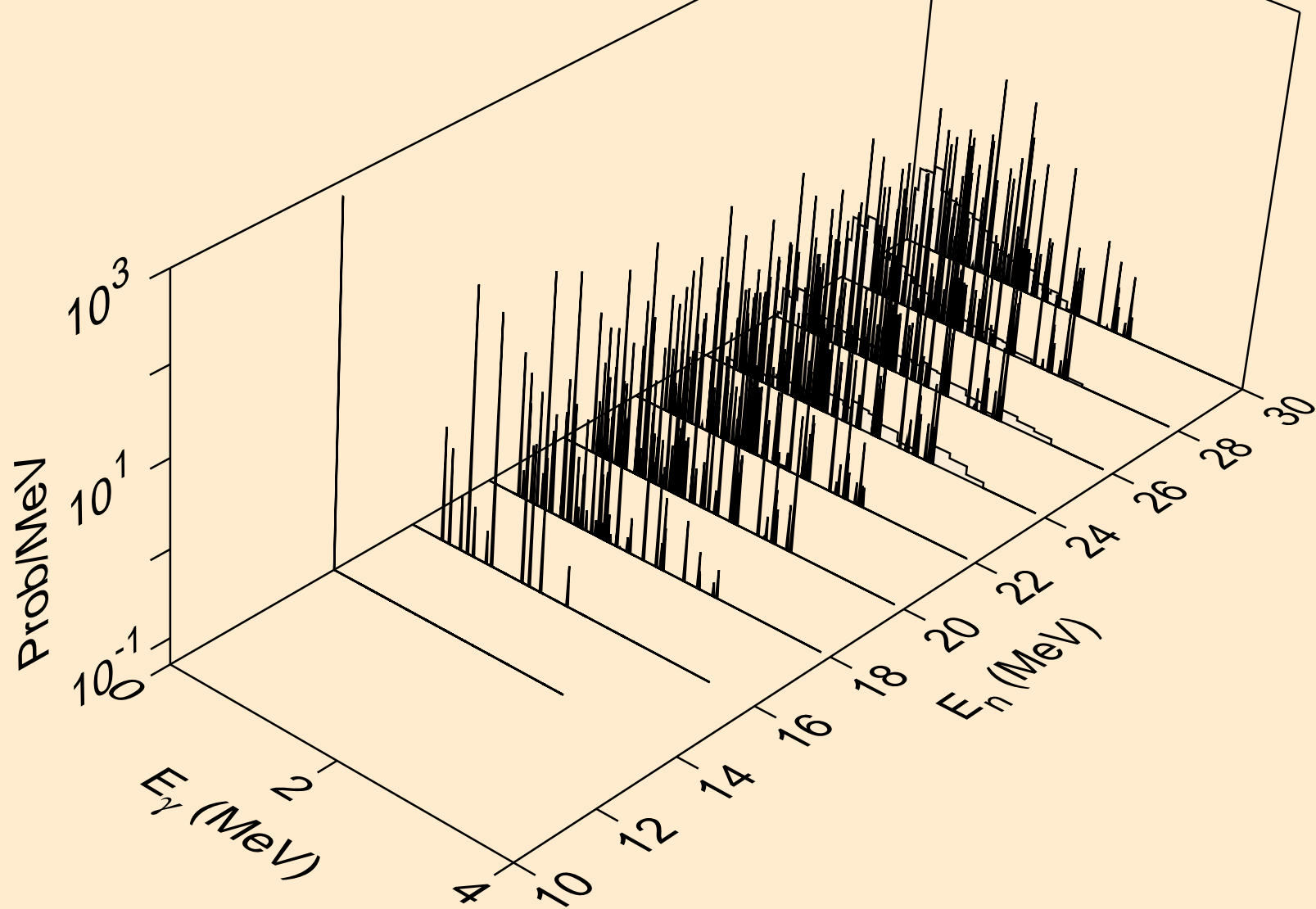

CU062 ALPHA ACER TENDL-2024 LIBRARY; T=0.K
Photon emission for inelastic

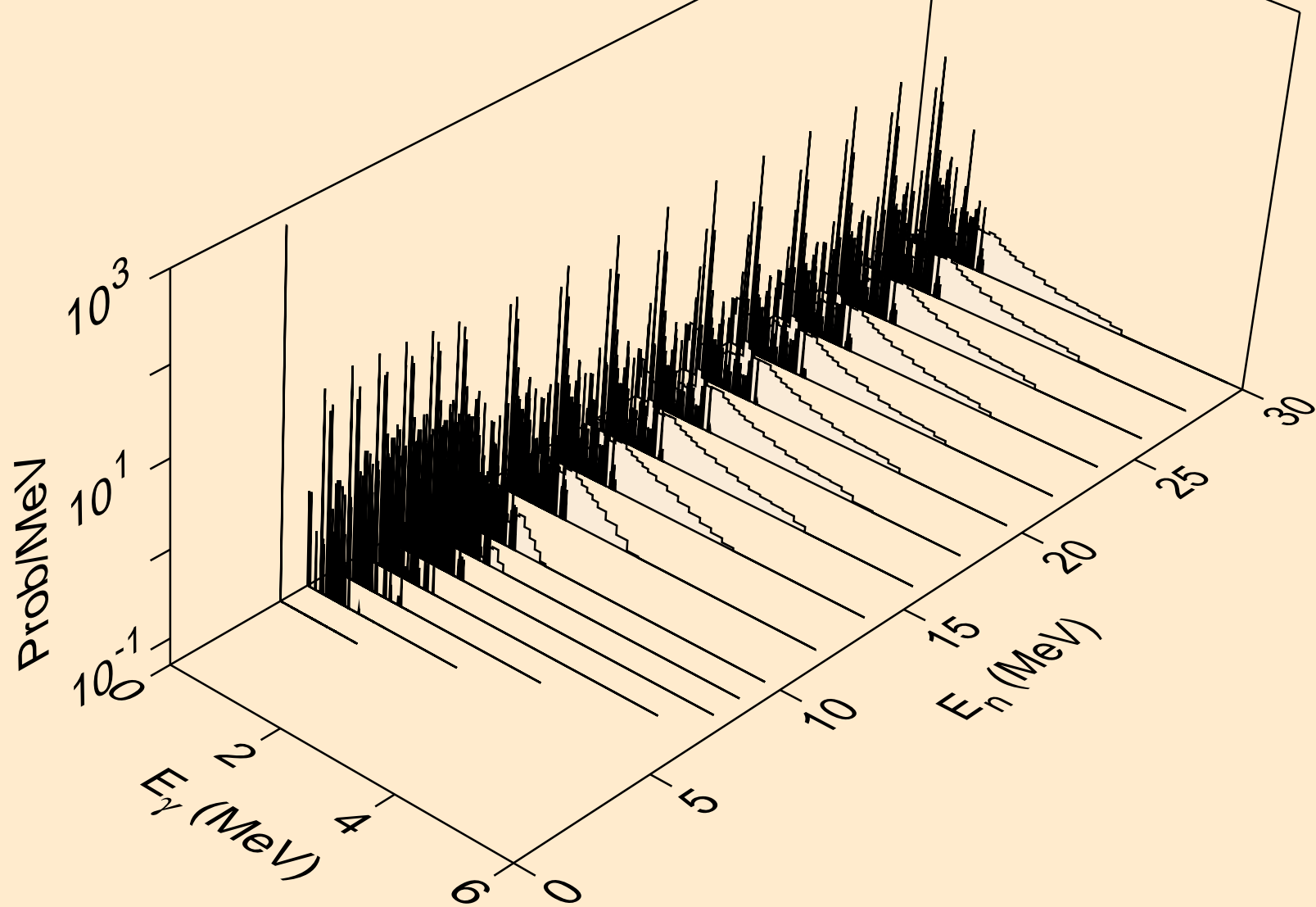

CU062 ALPHA ACER TENDL-2024 LIBRARY; T=0.K
Photon emission for (n,2a)

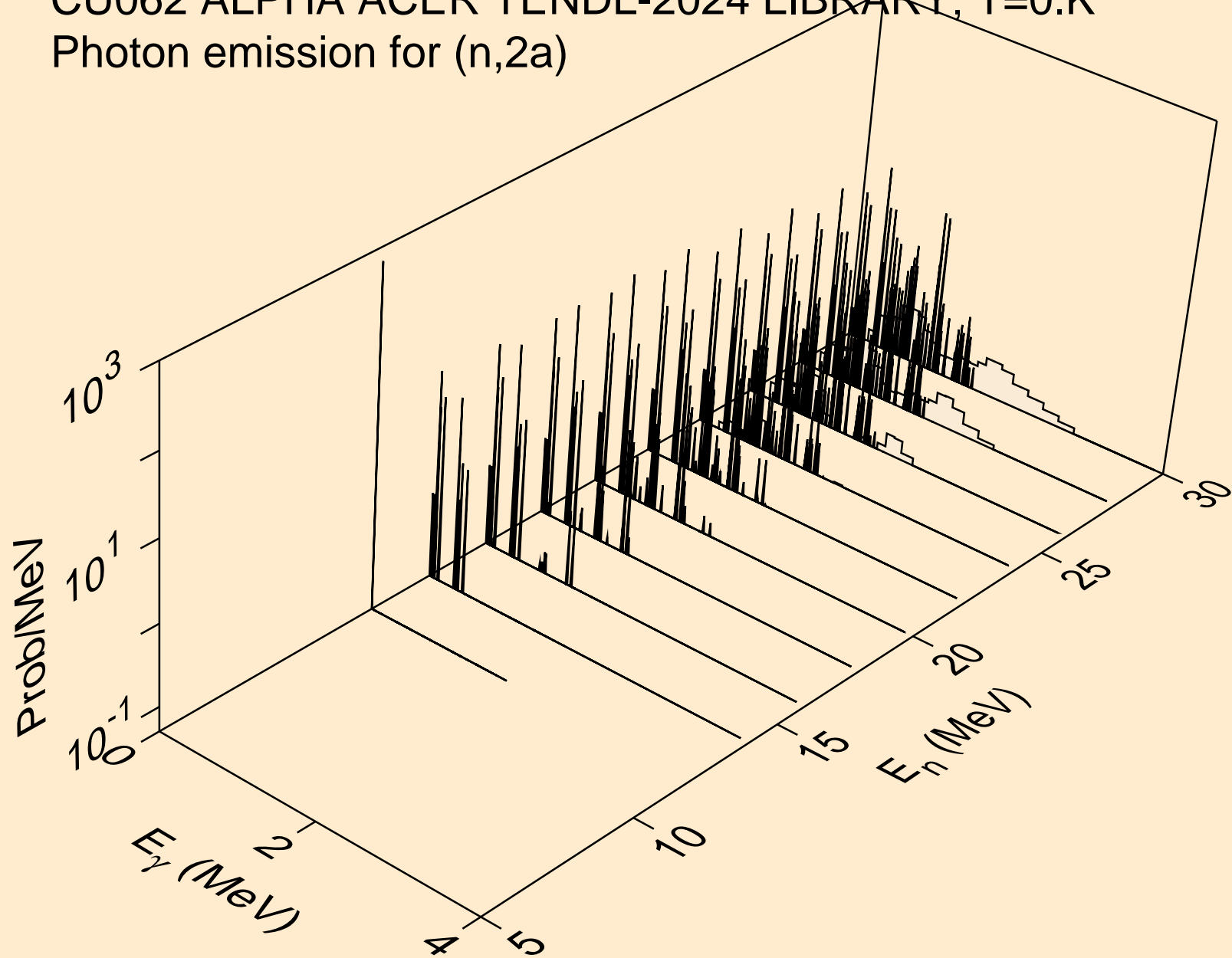

CU062 ALPHA ACER TENDL-2024 LIBRARY; T=0.K
Photon emission for (n,2p)

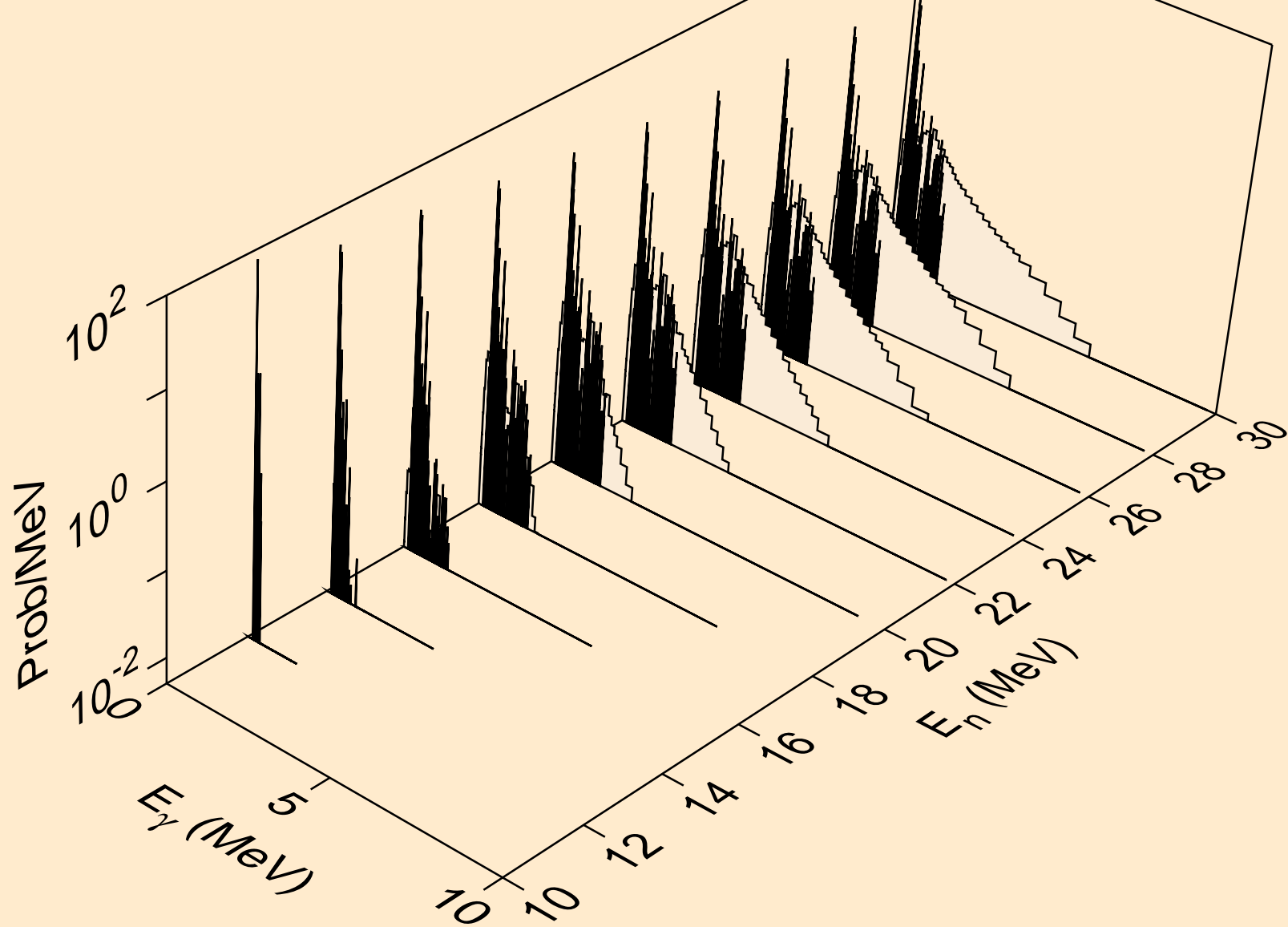

CU062 ALPHA ACER TENDL-2024 LIBRARY; T=0.K
Photon emission for (n,pa)

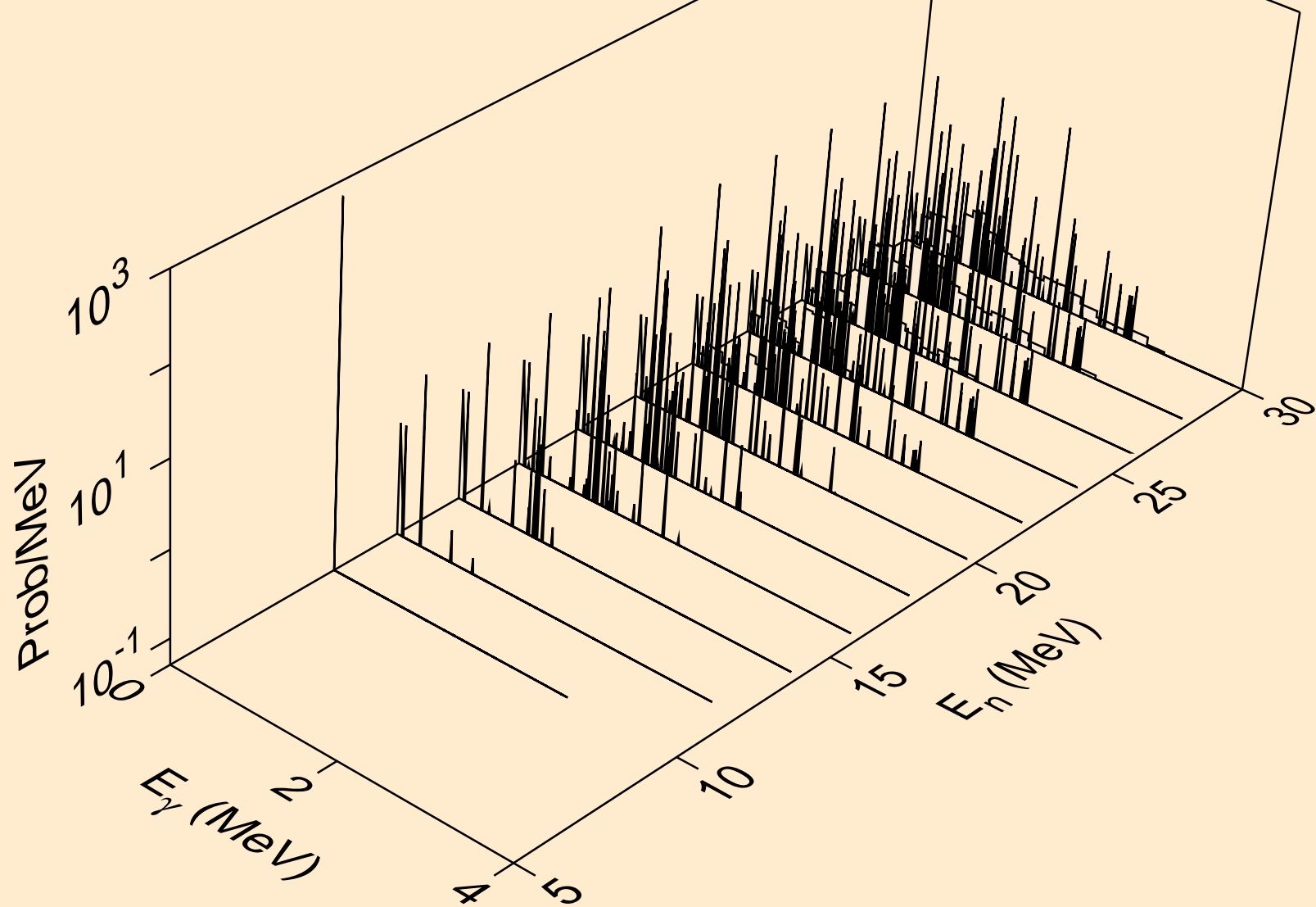

CU062 ALPHA ACER TENDL-2024 LIBRARY; T=0.K
Photon emission for (n,pd)

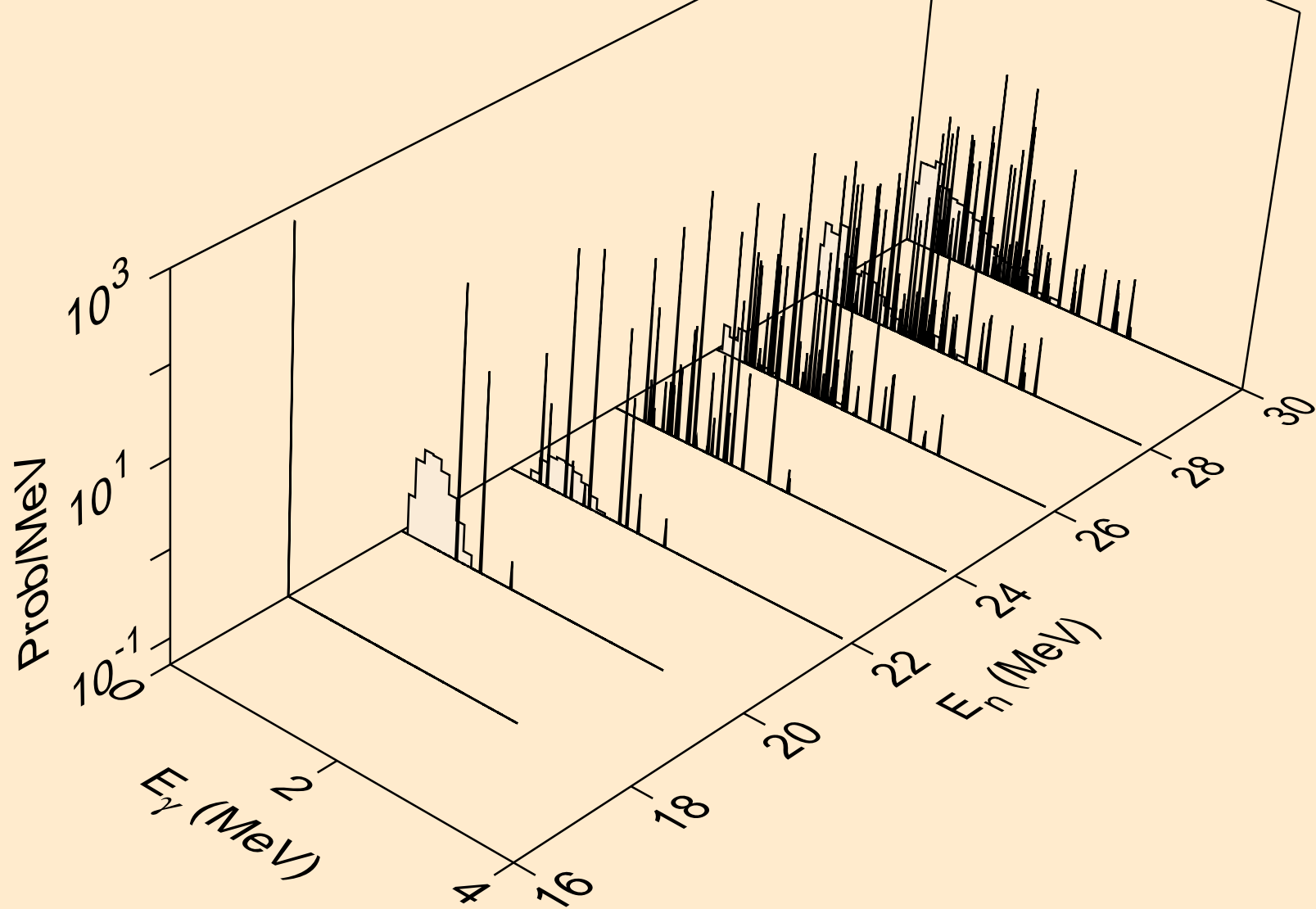

CU062 ALPHA ACER TENDL-2024 LIBRARY; T=0.K
Photon emission for (n,pt)

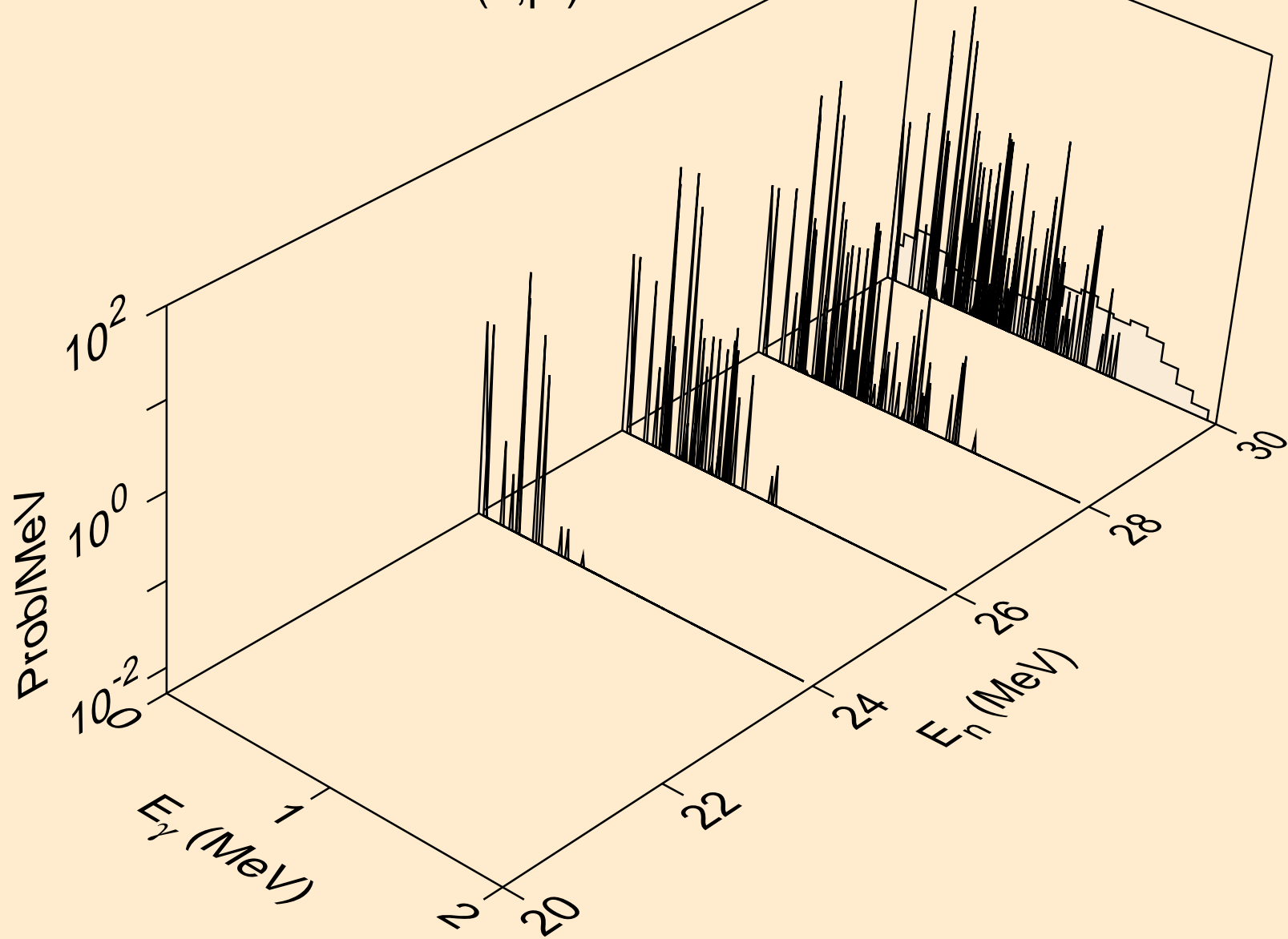

CU062 ALPHA ACER TENDL-2024 LIBRARY; T=0.K
Photon emission for (n,da)

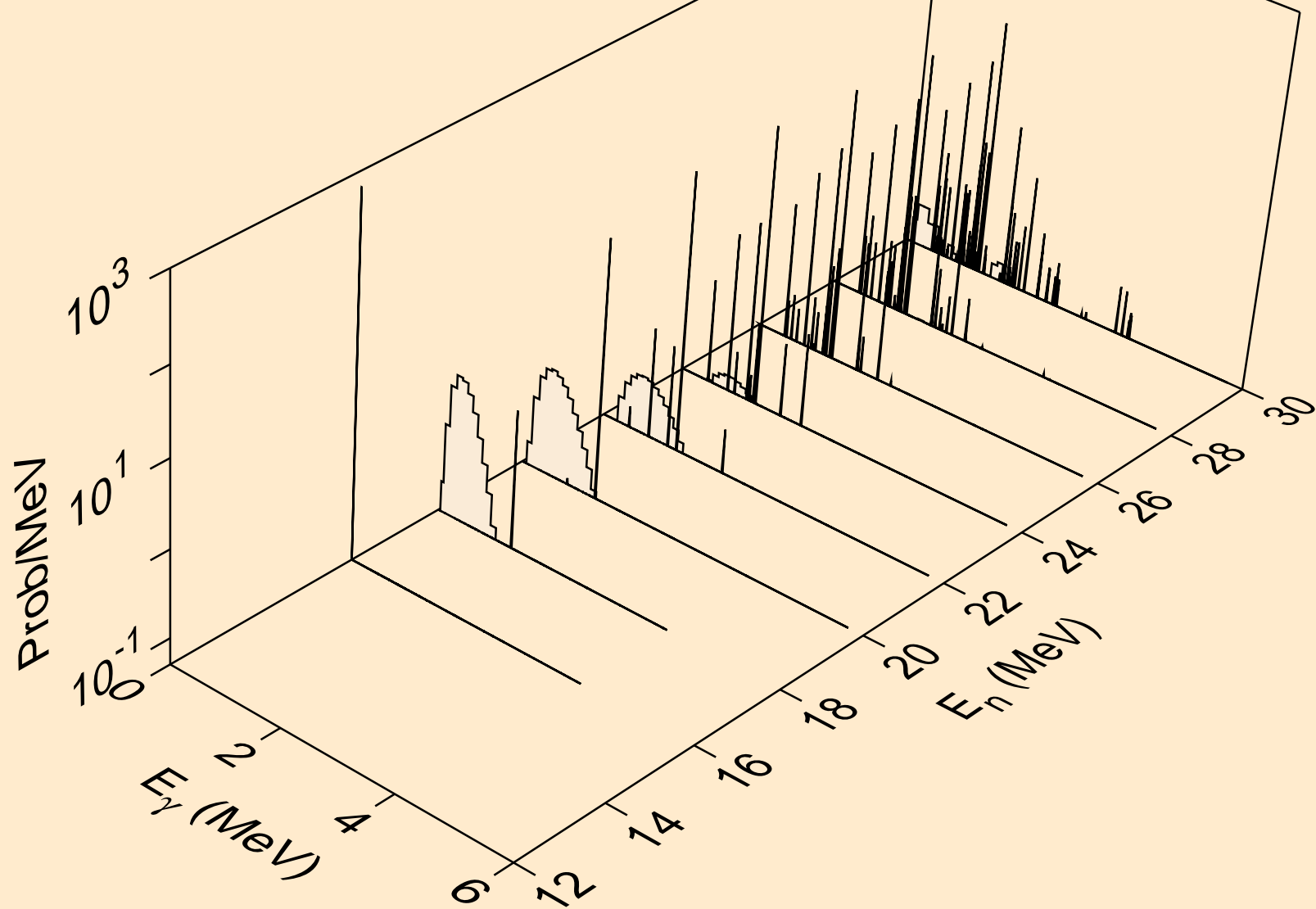

CU062 ALPHA ACER TENDL-2024 LIBRARY; T=0.K

Particle heating contributions

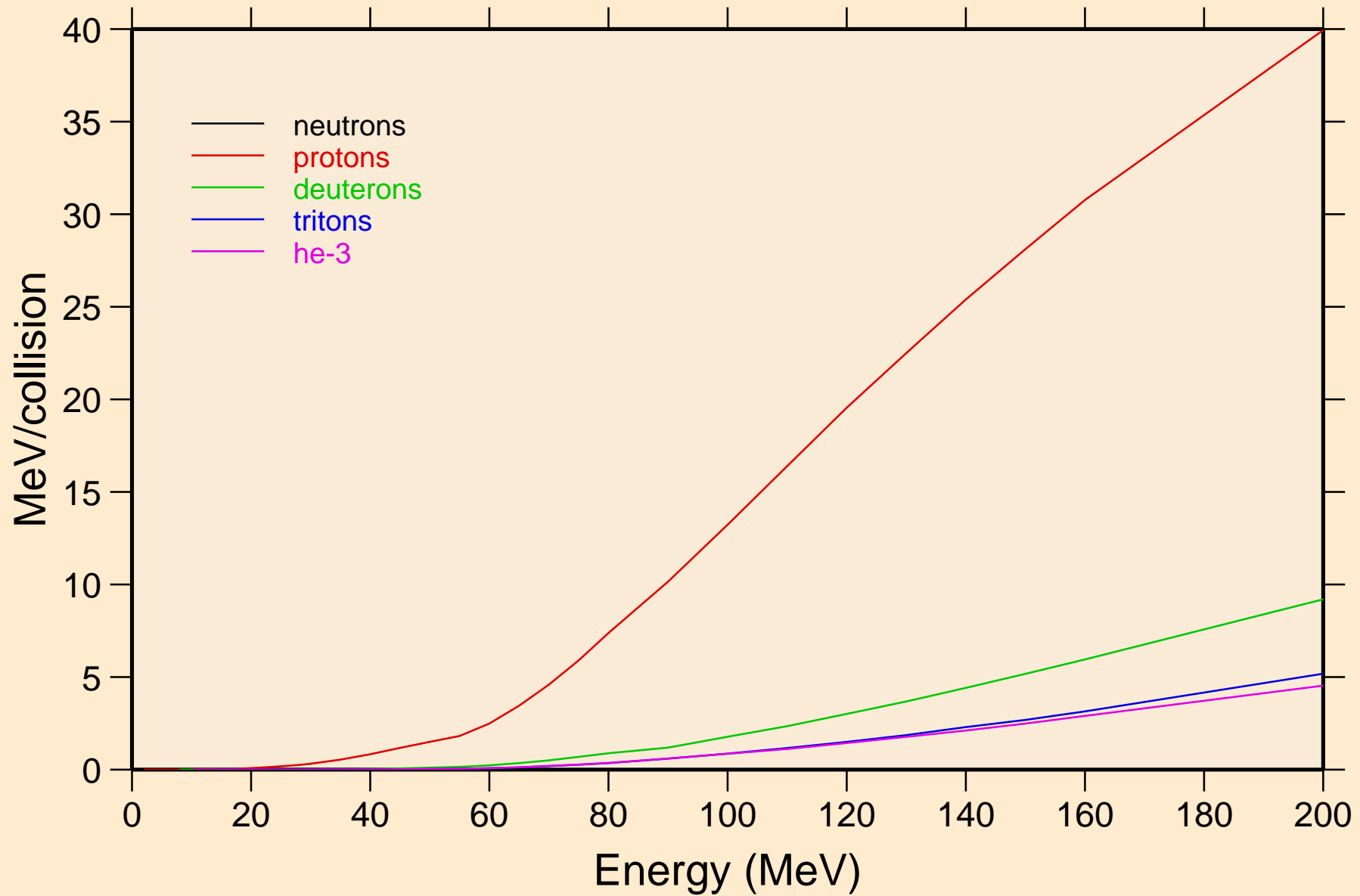

CU062 ALPHA ACER TENDL-2024 LIBRARY; T=0.K
Recoil Heating

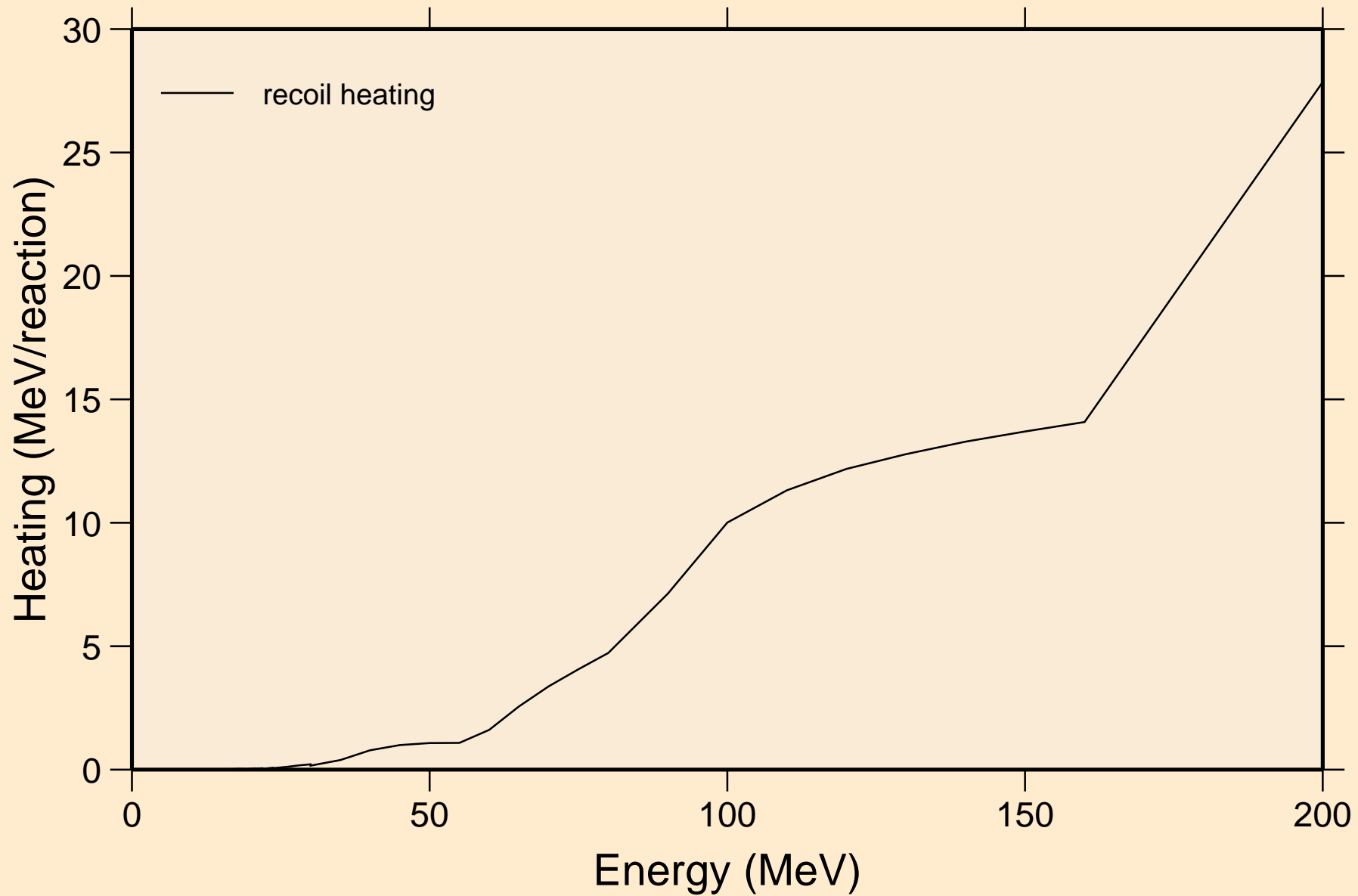

CU062 ALPHA ACER TENDL-2024 LIBRARY; T=0.K
Particle production cross sections

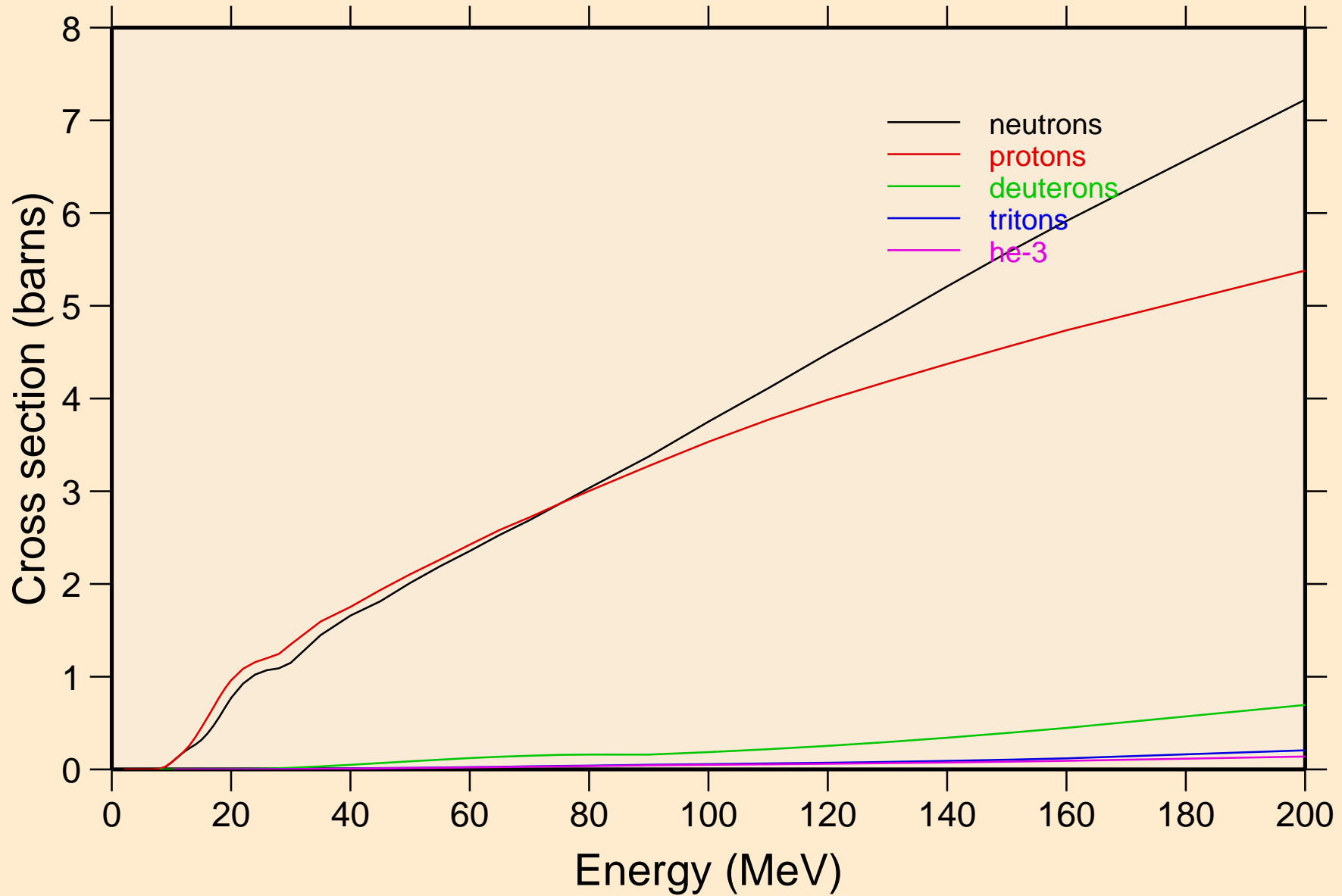

CU062 ALPHA ACER TENDL-2024 LIBRARY; T=0.K
neutrons from (a,n)

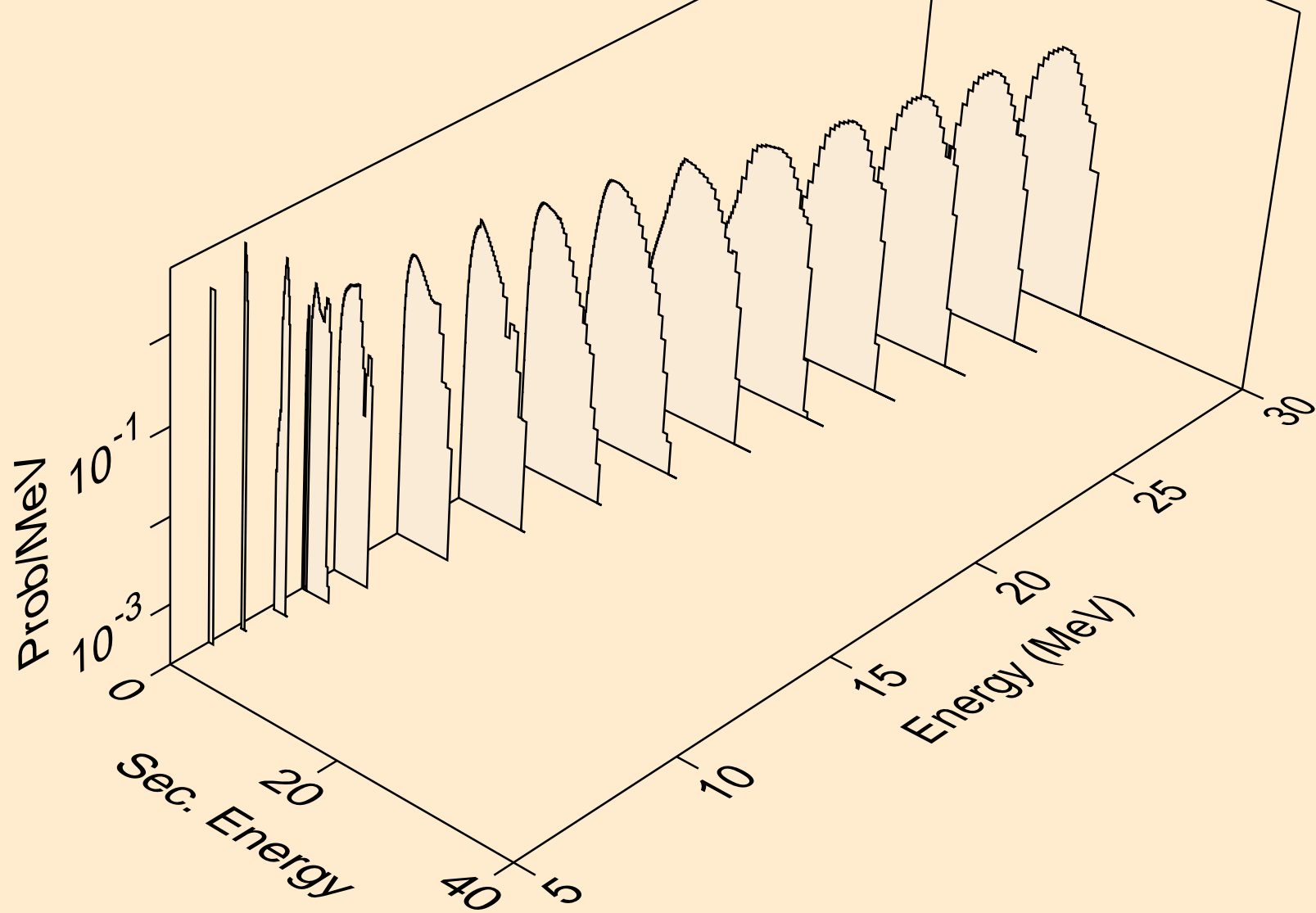

CU062 ALPHA ACER TENDL-2024 LIBRARY; T=0.K
neutrons from (a,x)

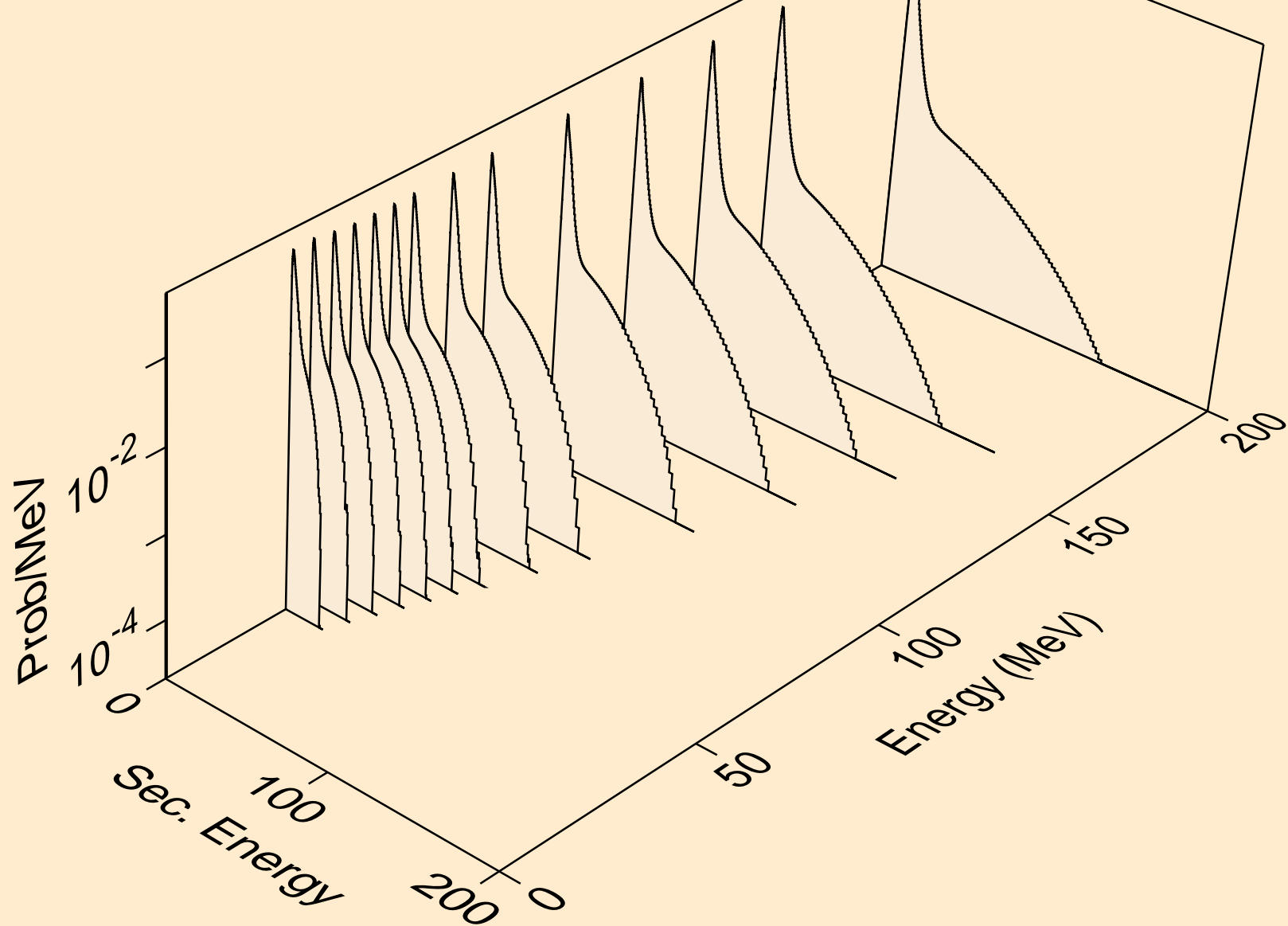

CU062 ALPHA ACER TENDL-2024 LIBRARY; T=0.K
neutrons from (a,2n)

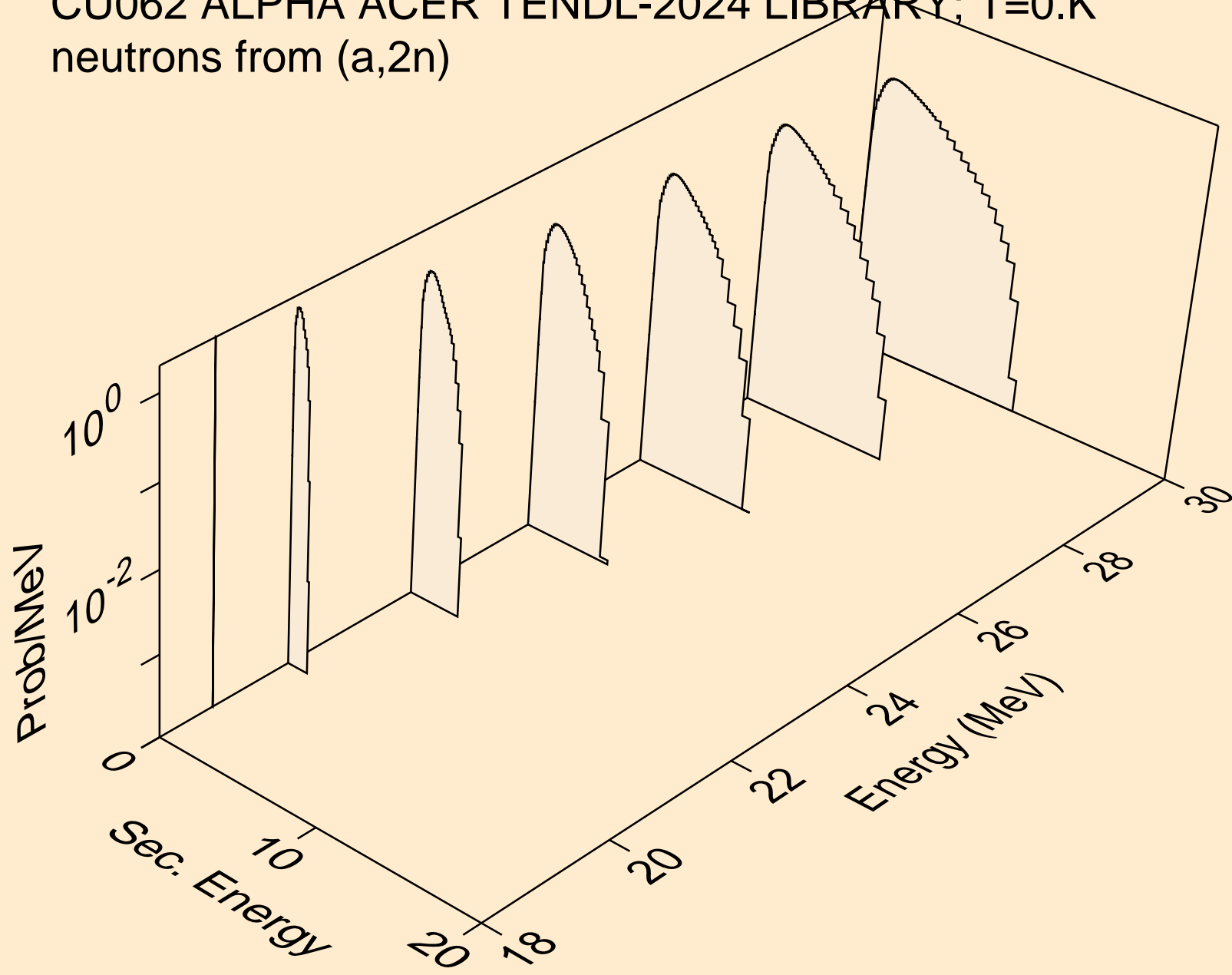

CU062 ALPHA ACER TENDL-2024 LIBRARY; T=0.K
neutrons from (a,n*)a

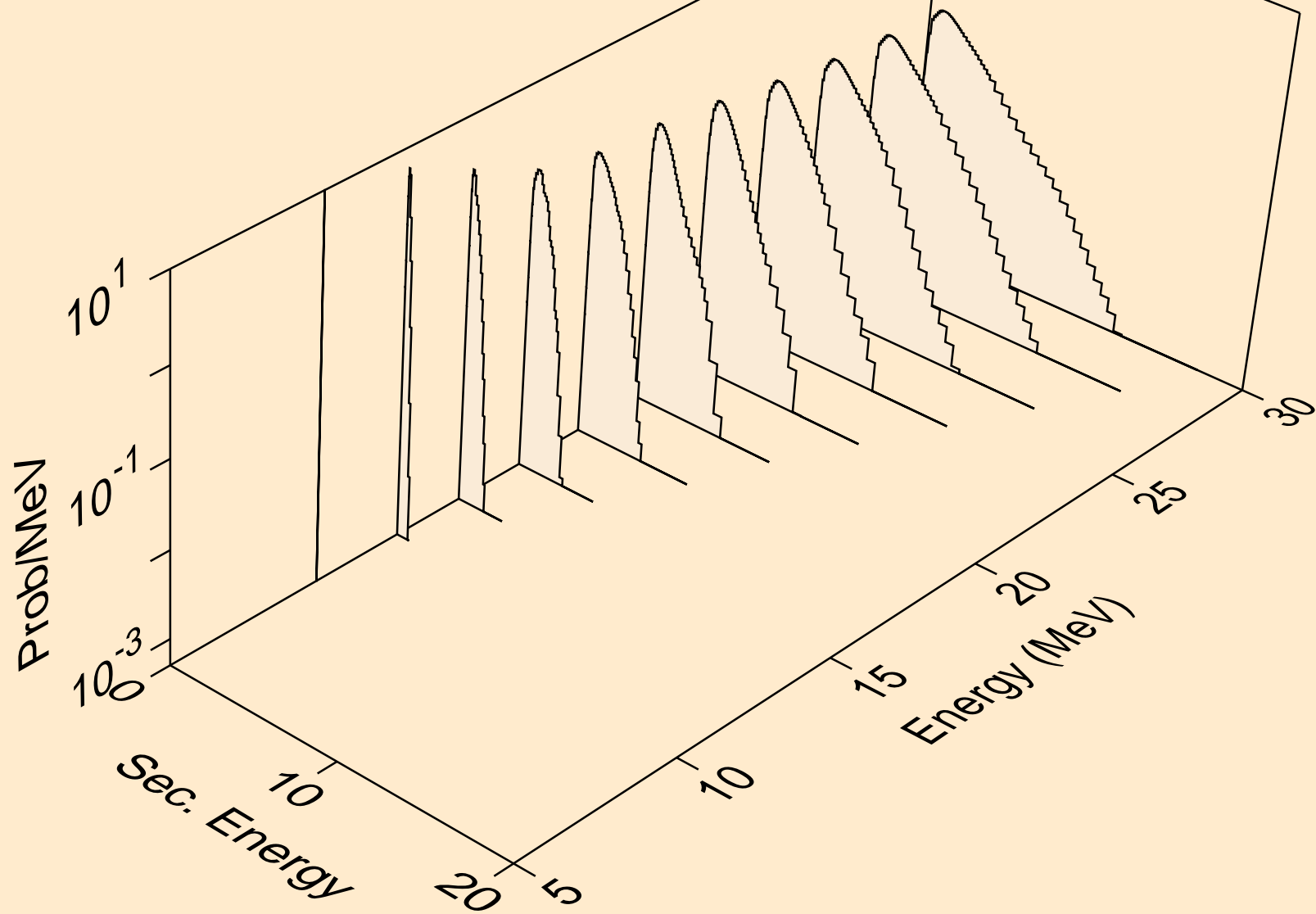

CU062 ALPHA ACER TENDL-2024 LIBRARY; T=0.K
neutrons from (a,2n)a

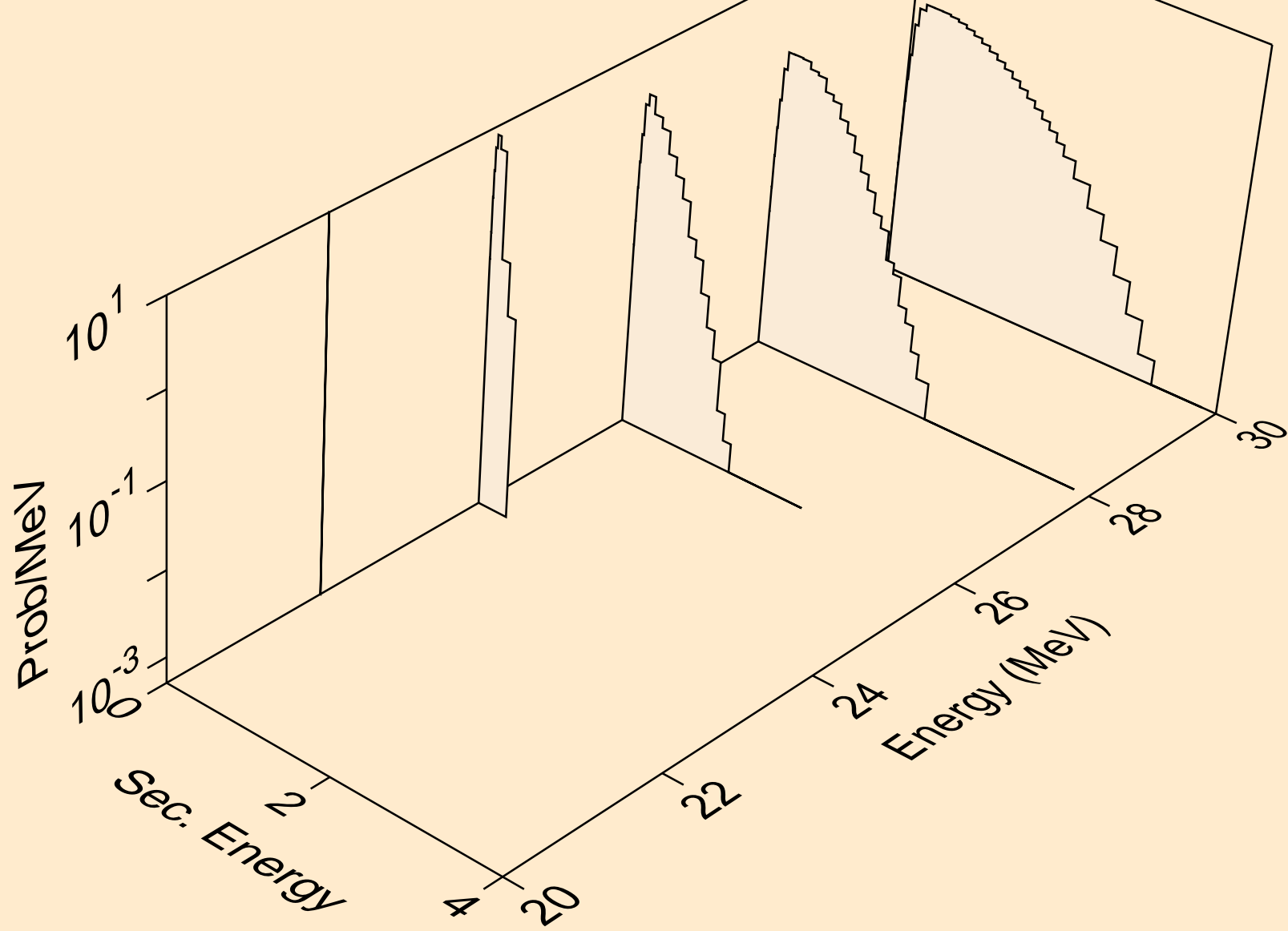

CU062 ALPHA ACER TENDL-2024 LIBRARY; T=0.K
neutrons from (a,n*)p

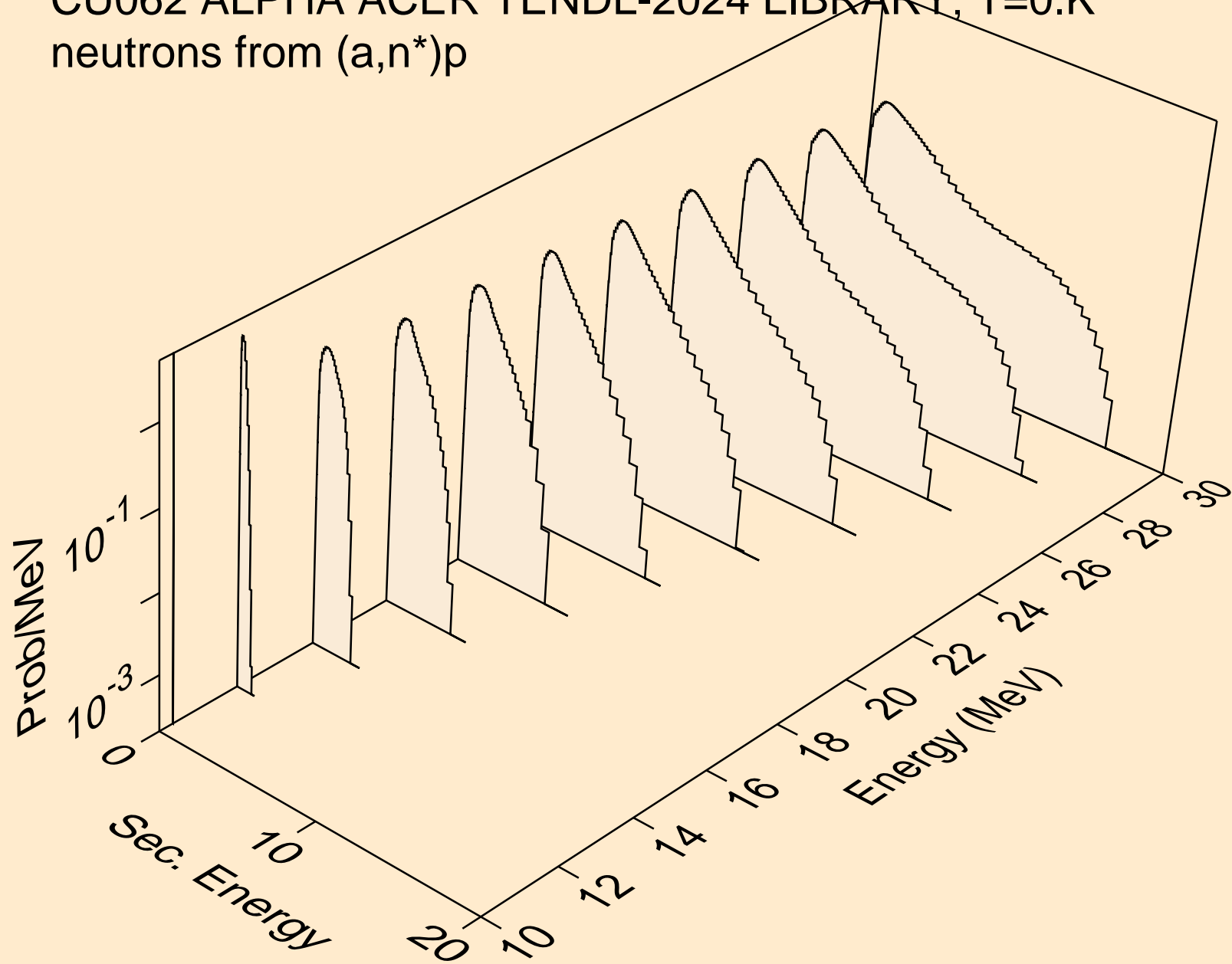

CU062 ALPHA ACER TENDL-2024 LIBRARY; T=0.K
neutrons from (a,n*)2a

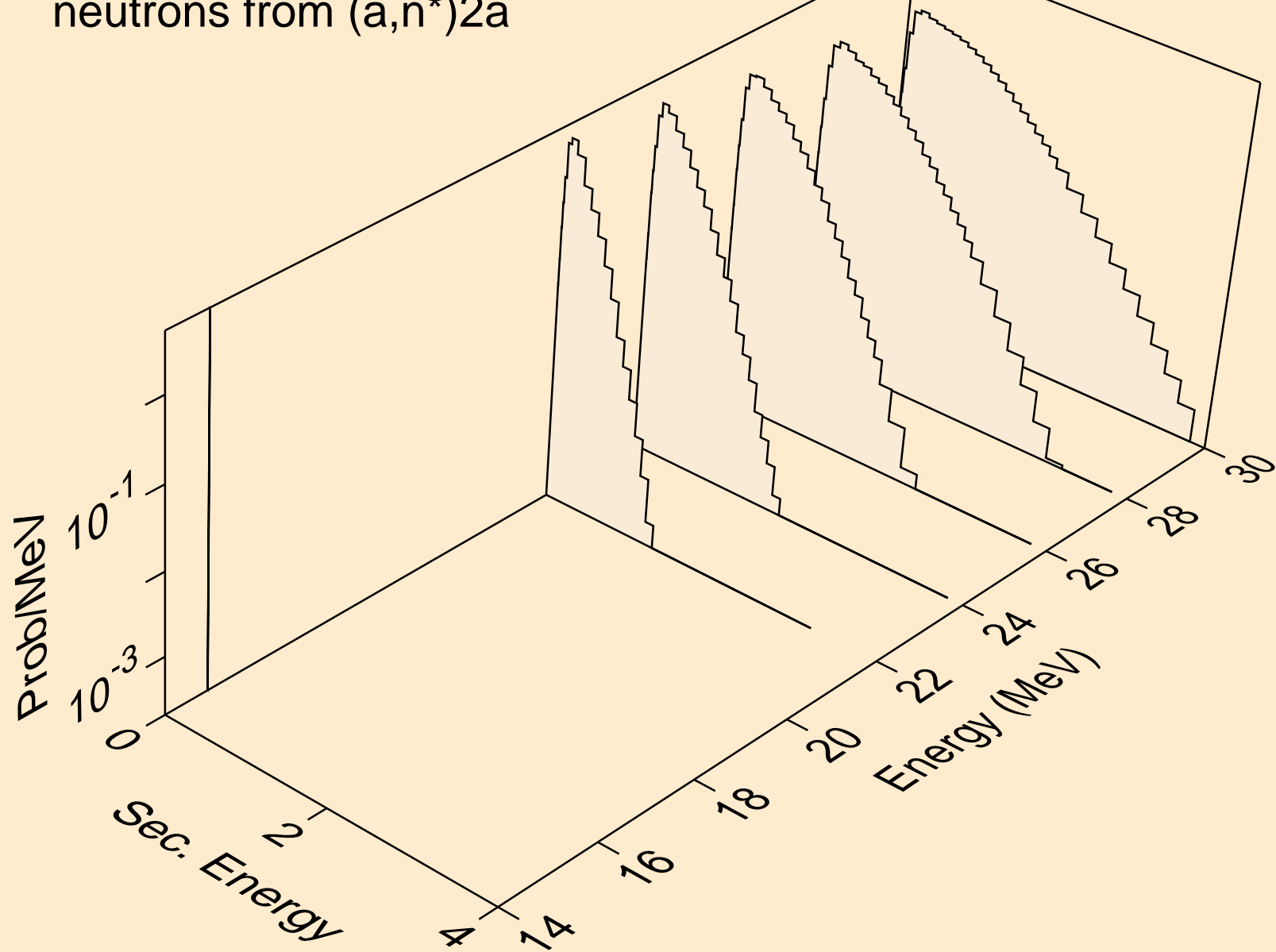

CU062 ALPHA ACER TENDL-2024 LIBRARY; T=0.K
neutrons from (a,n*)d

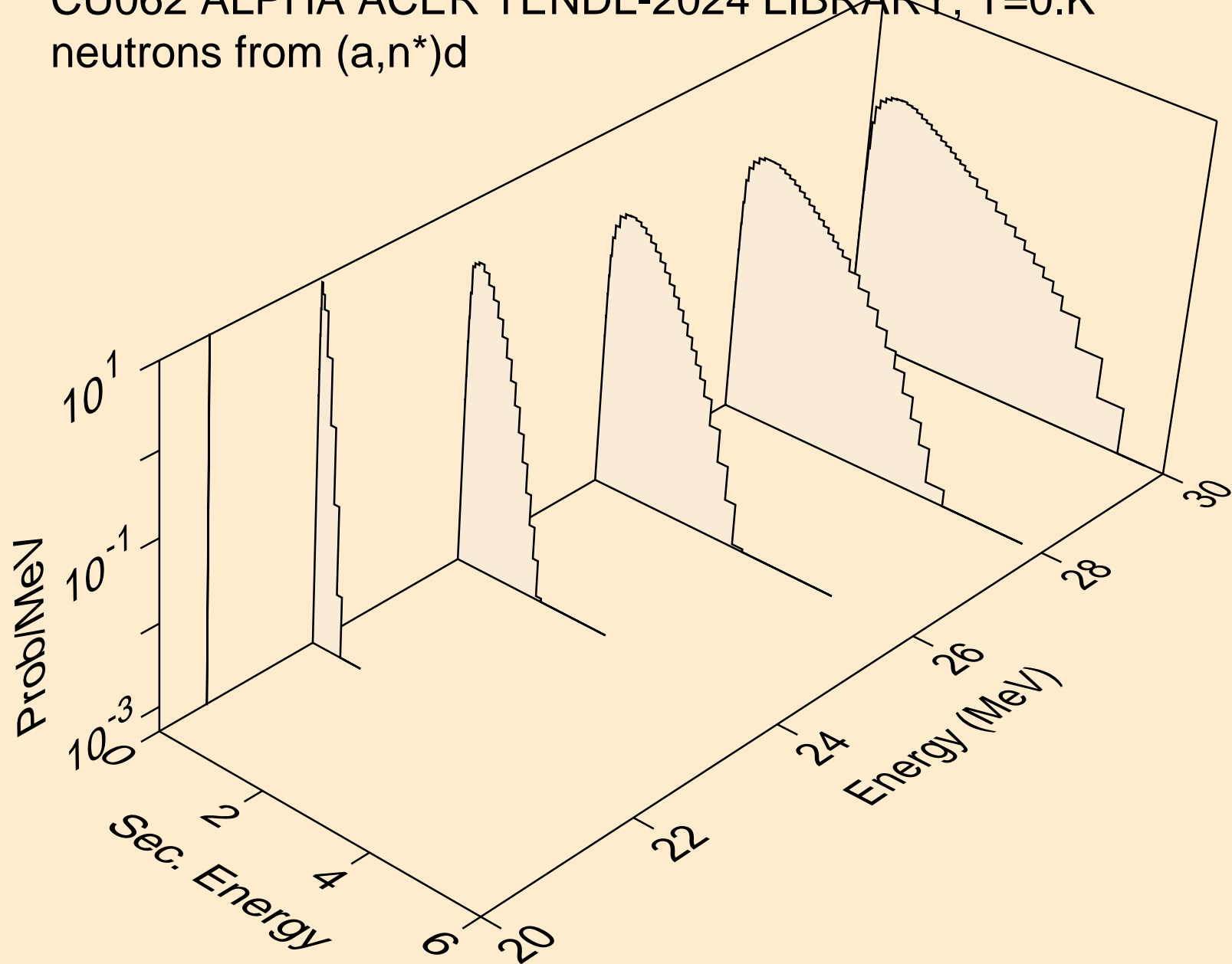

CU062 ALPHA ACER TENDL-2024 LIBRARY; T=0.K
neutrons from (a,n*)t

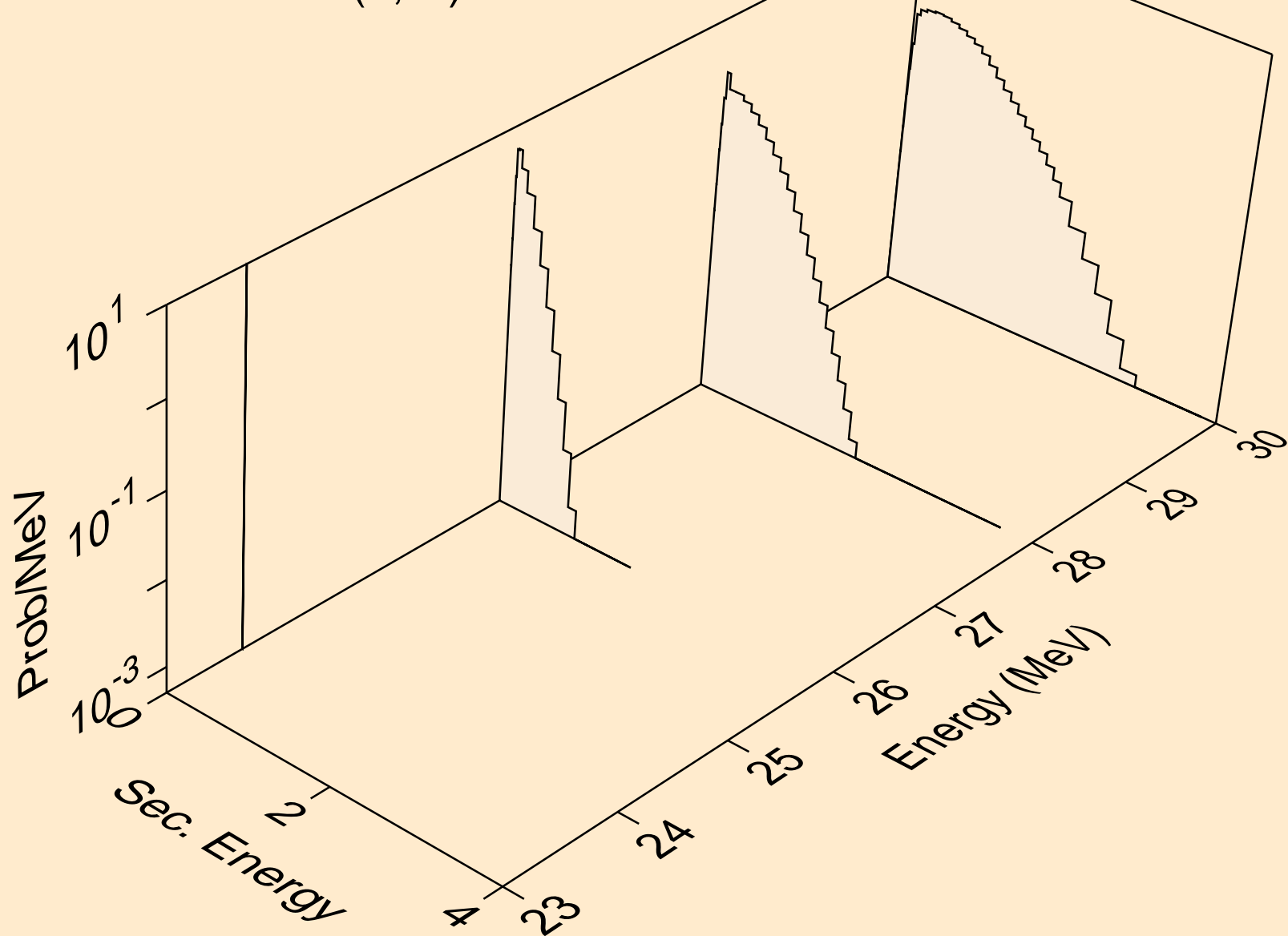

CU062 ALPHA ACER TENDL-2024 LIBRARY; T=0.K
neutrons from (a,n*)he3

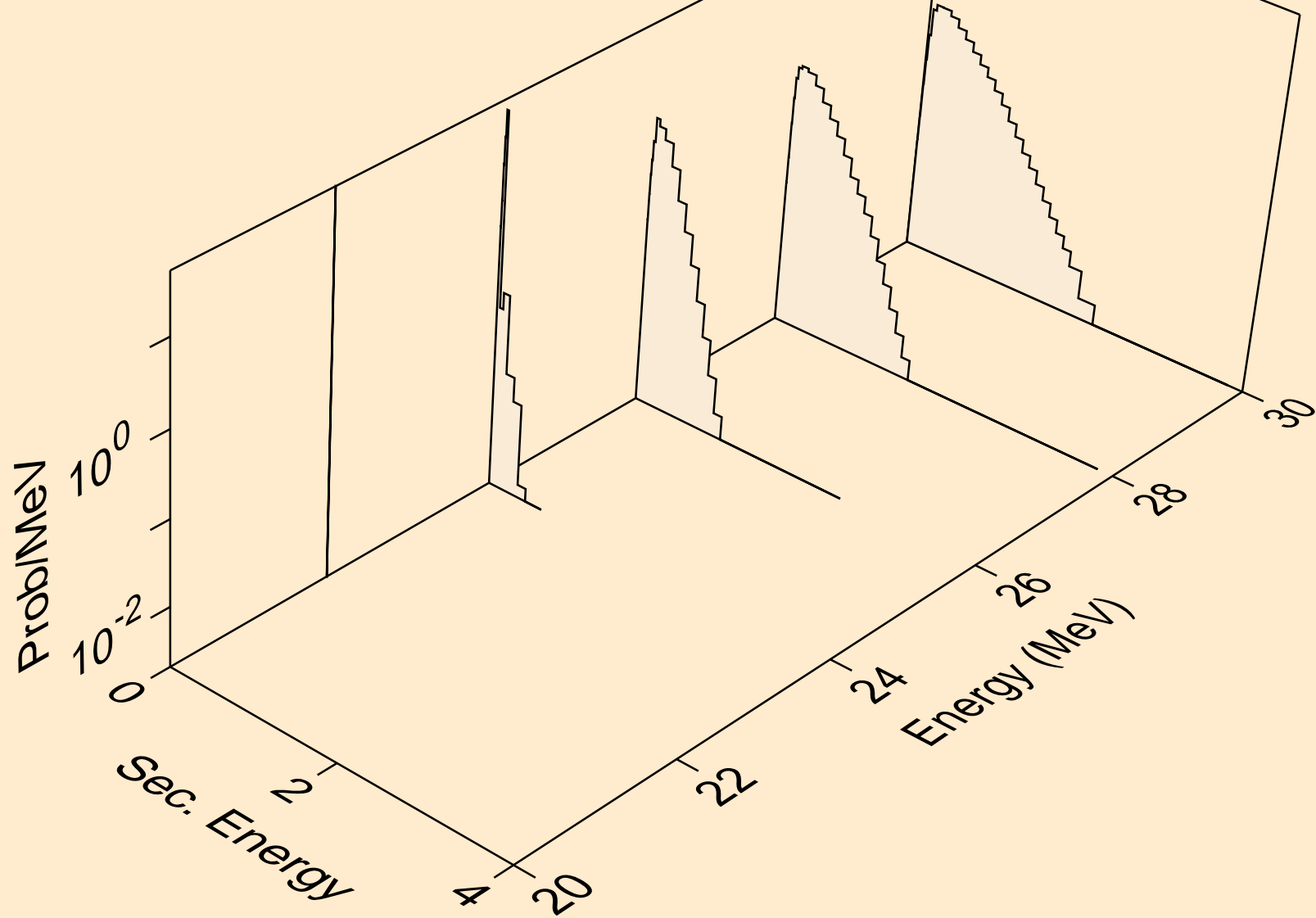

CU062 ALPHA ACER TENDL-2024 LIBRARY; T=0.K
neutrons from (a,2np)

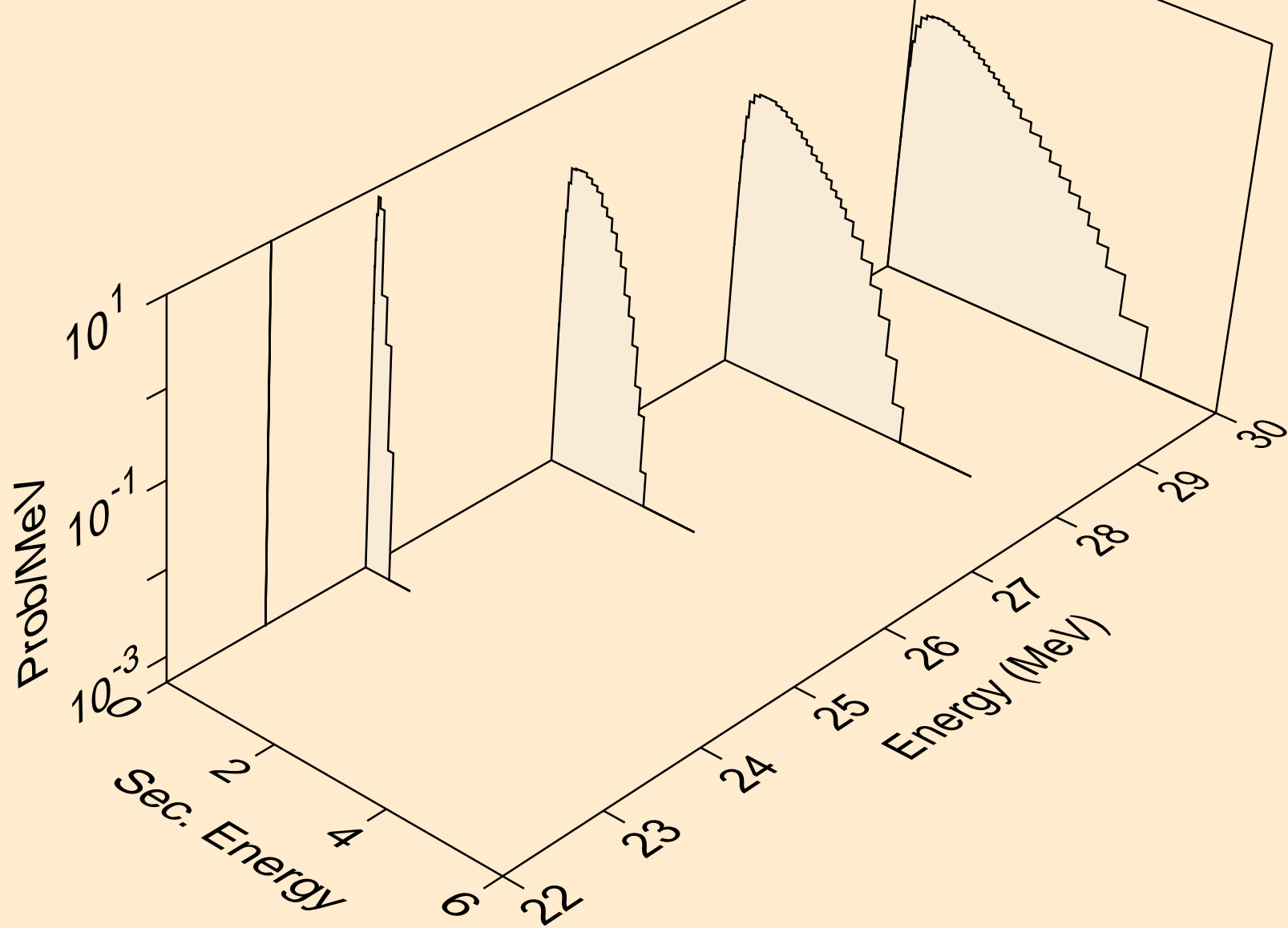

CU062 ALPHA ACER TENDL-2024 LIBRARY; T=0.K
neutrons from (a,n2p)

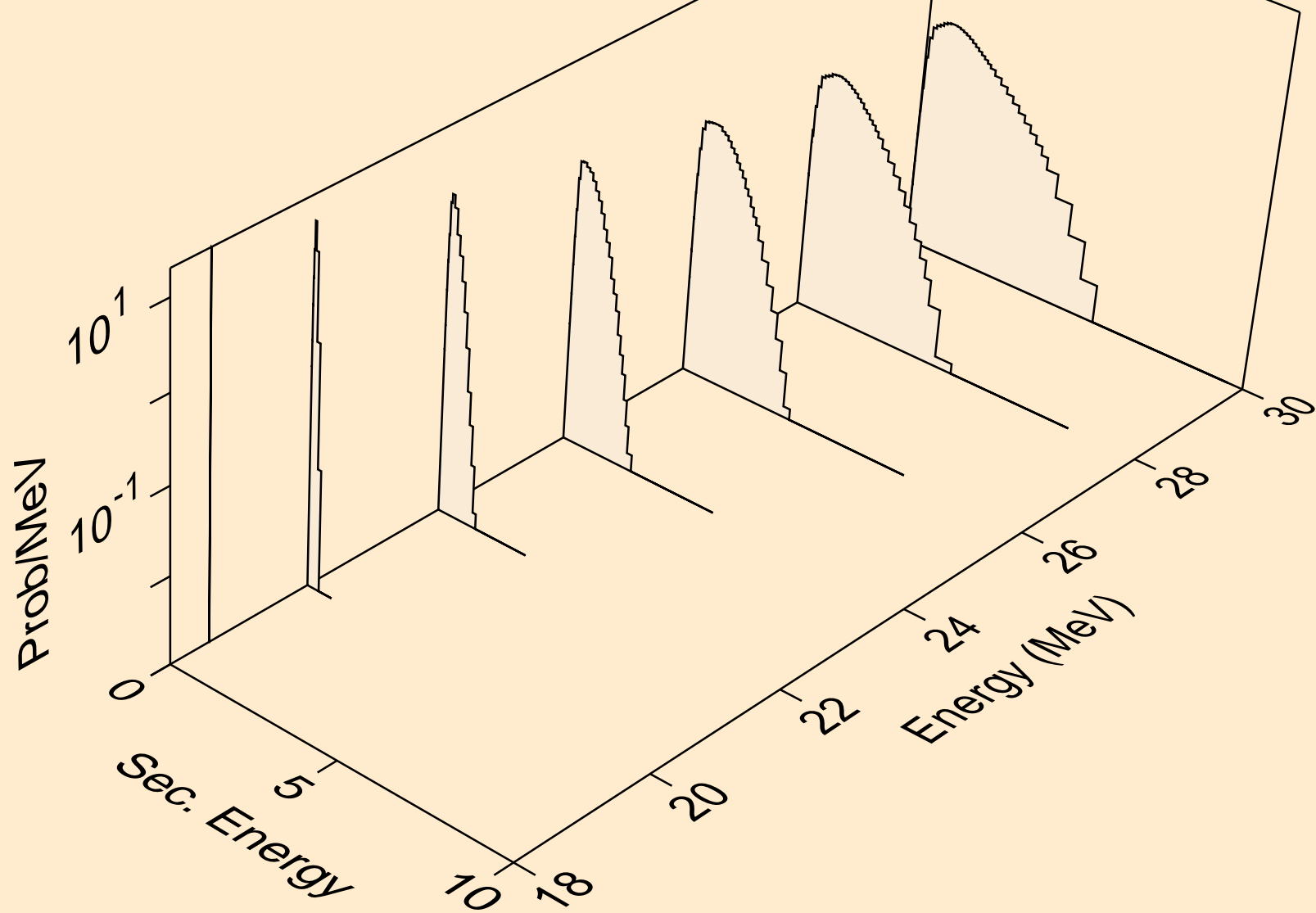

CU062 ALPHA ACER TENDL-2024 LIBRARY; T=0.K
neutrons from (a,npa)

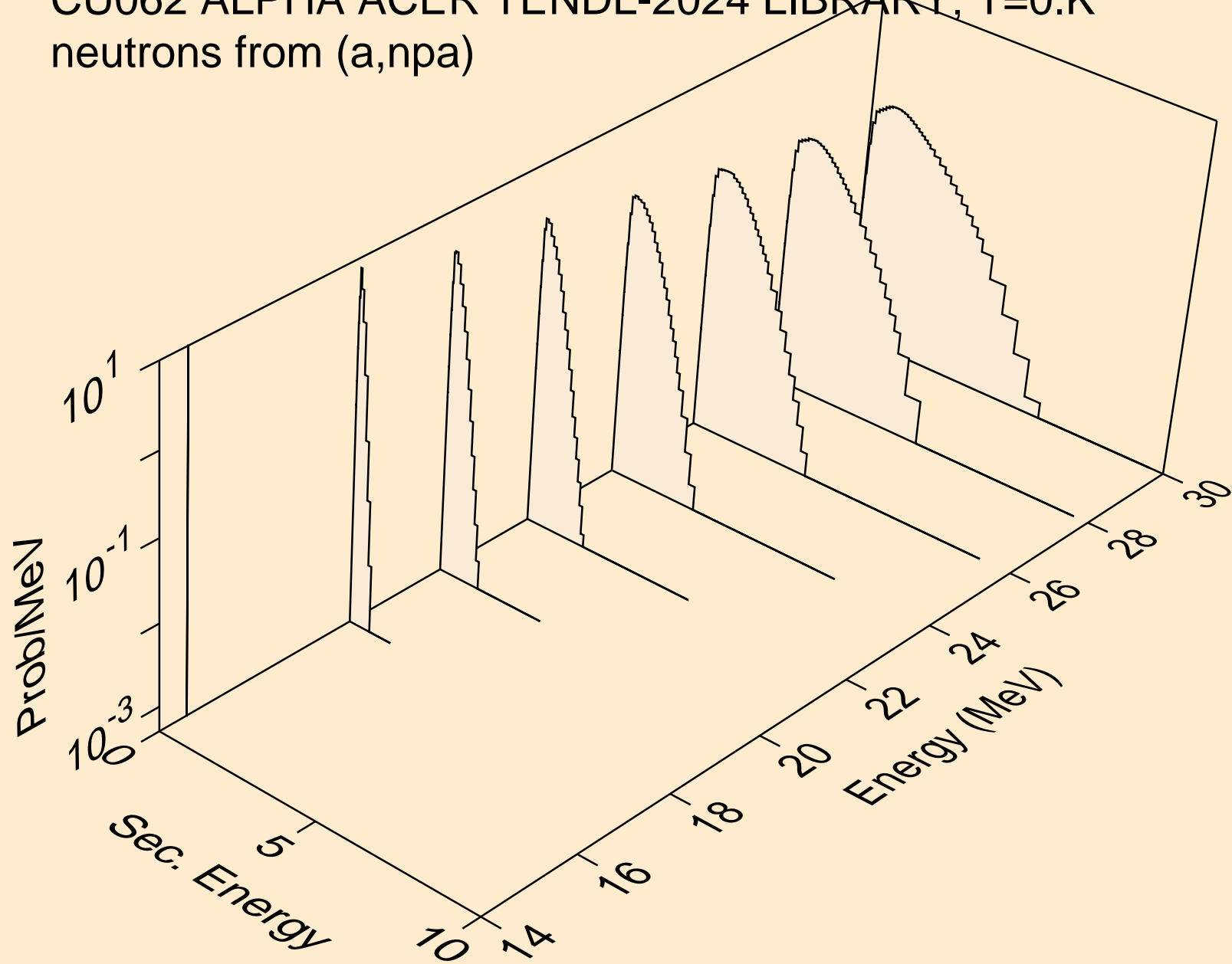

CU062 ALPHA ACER TENDL-2024 LIBRARY; T=0.K
protons from (a,x)

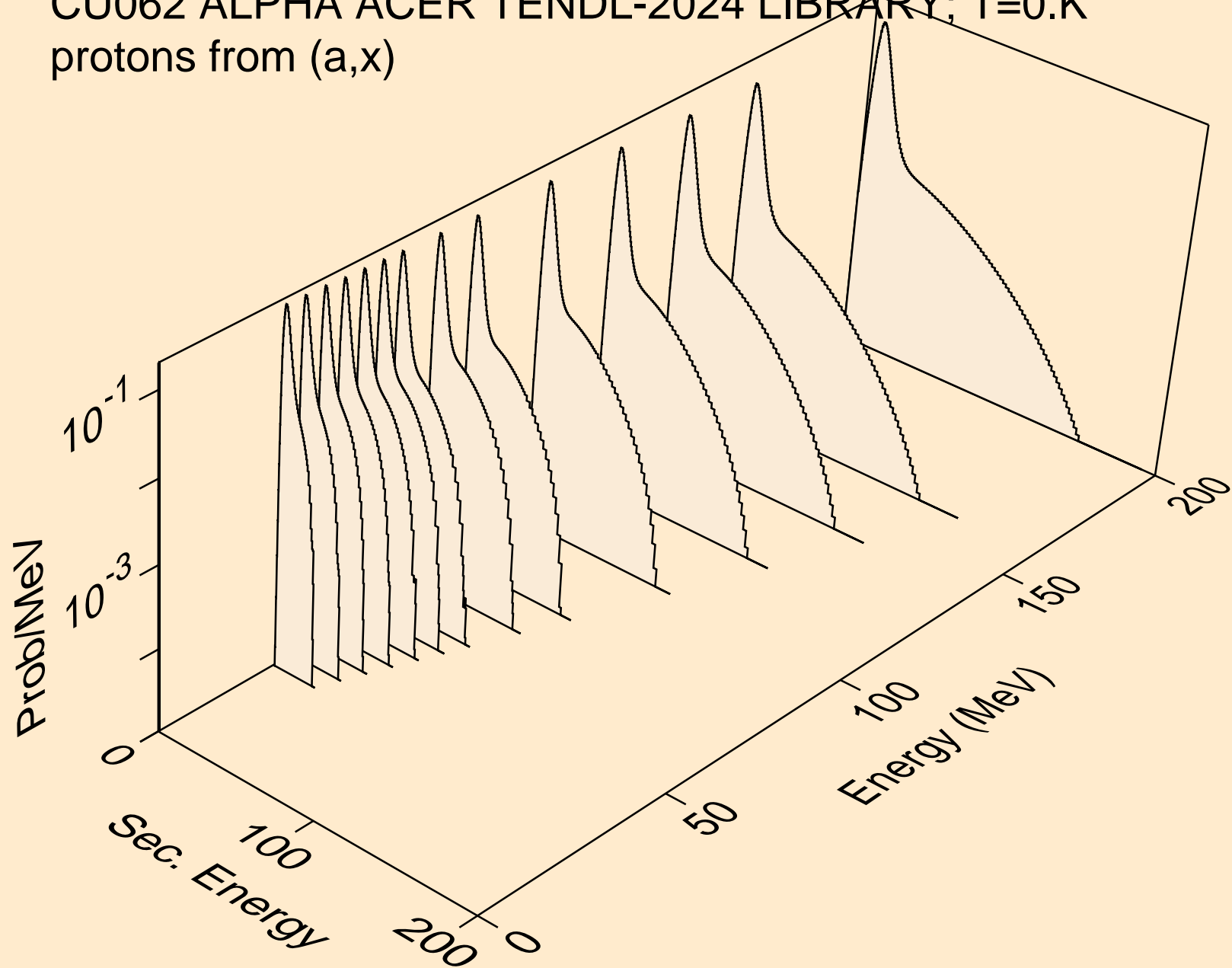

CU062 ALPHA ACER TENDL-2024 LIBRARY; T=0.K
protons from (a,n*)p

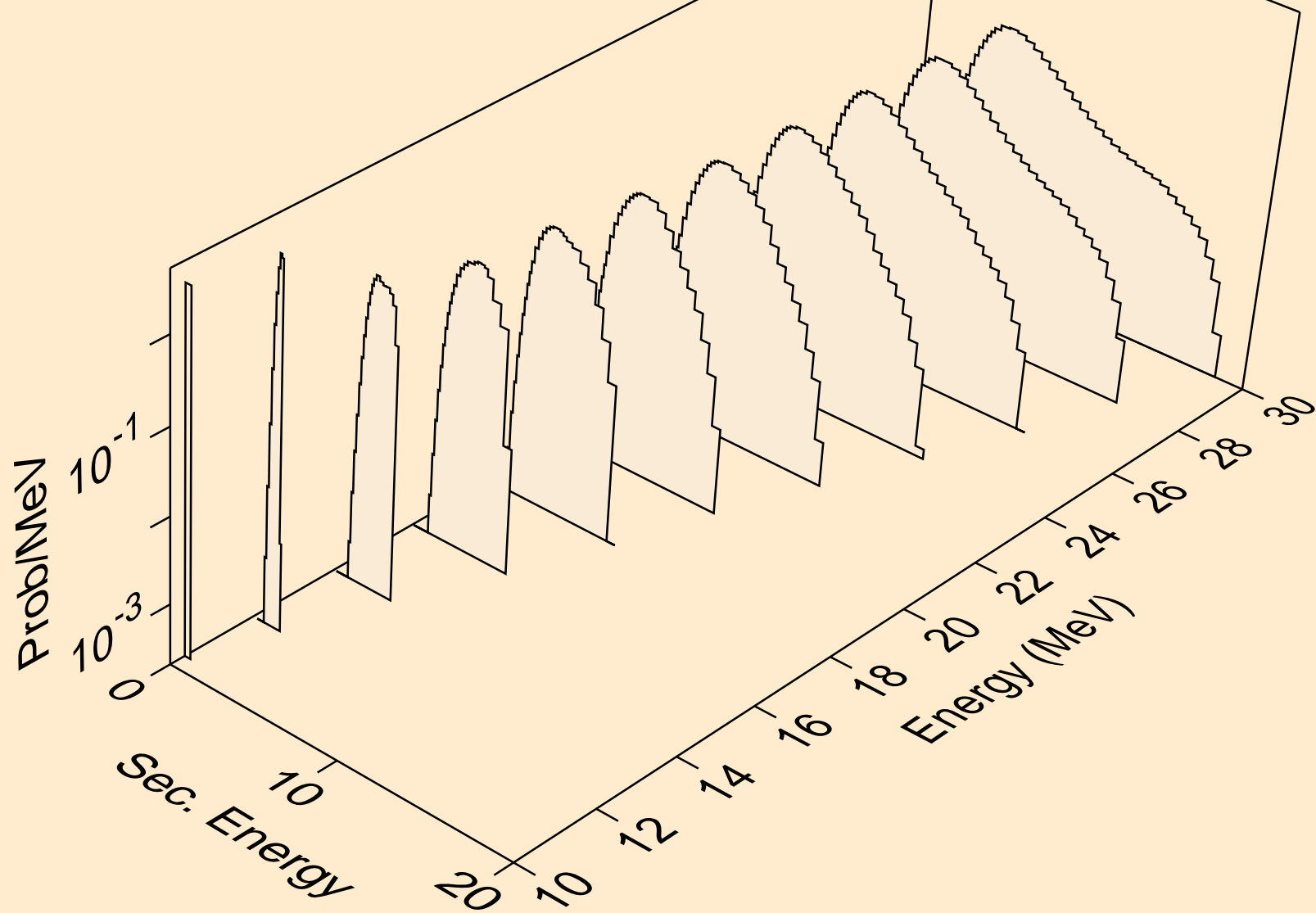

CU062 ALPHA ACER TENDL-2024 LIBRARY; T=0.K
protons from (a,2np)

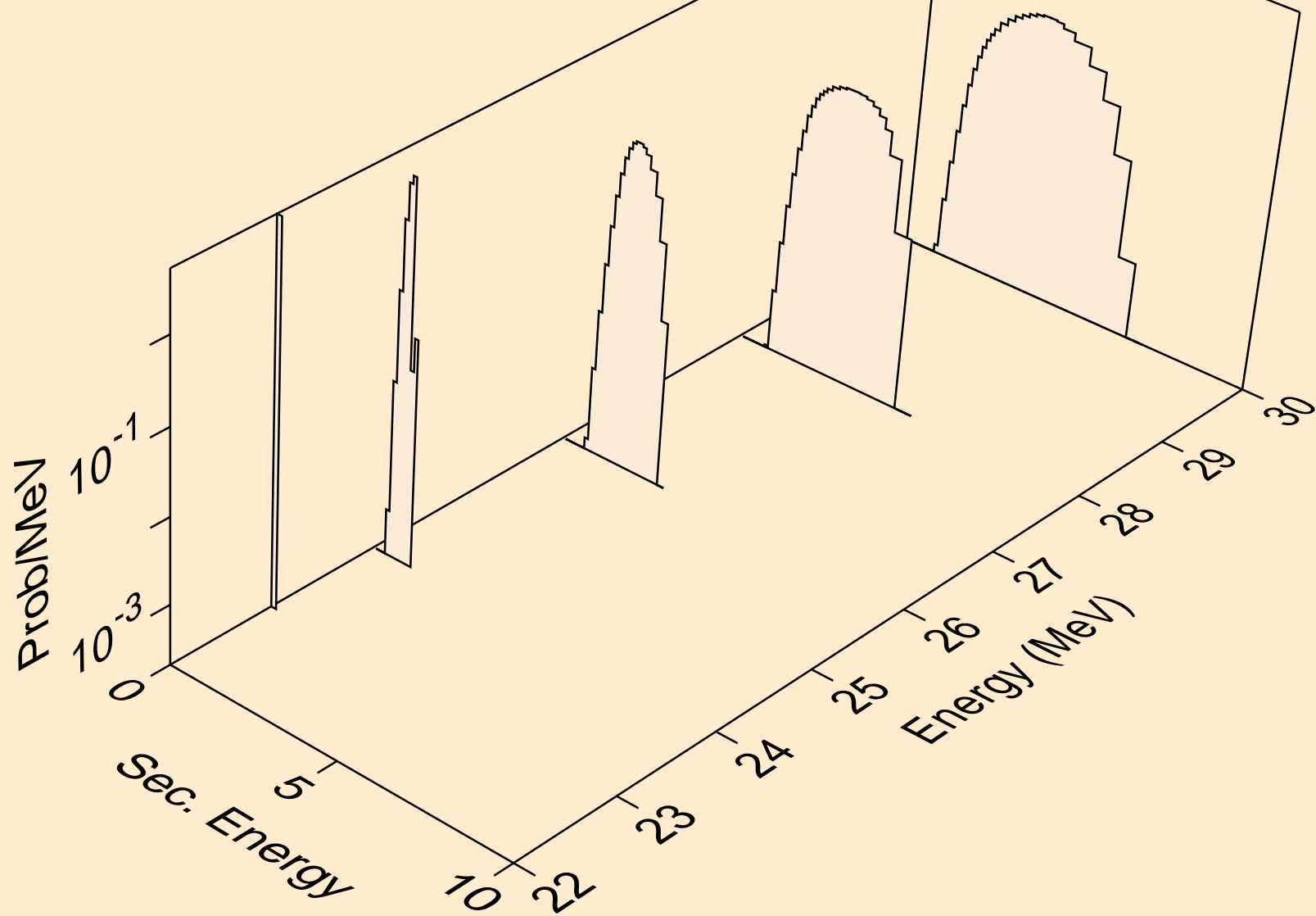

CU062 ALPHA ACER TENDL-2024 LIBRARY; T=0.K
protons from (a,n2p)

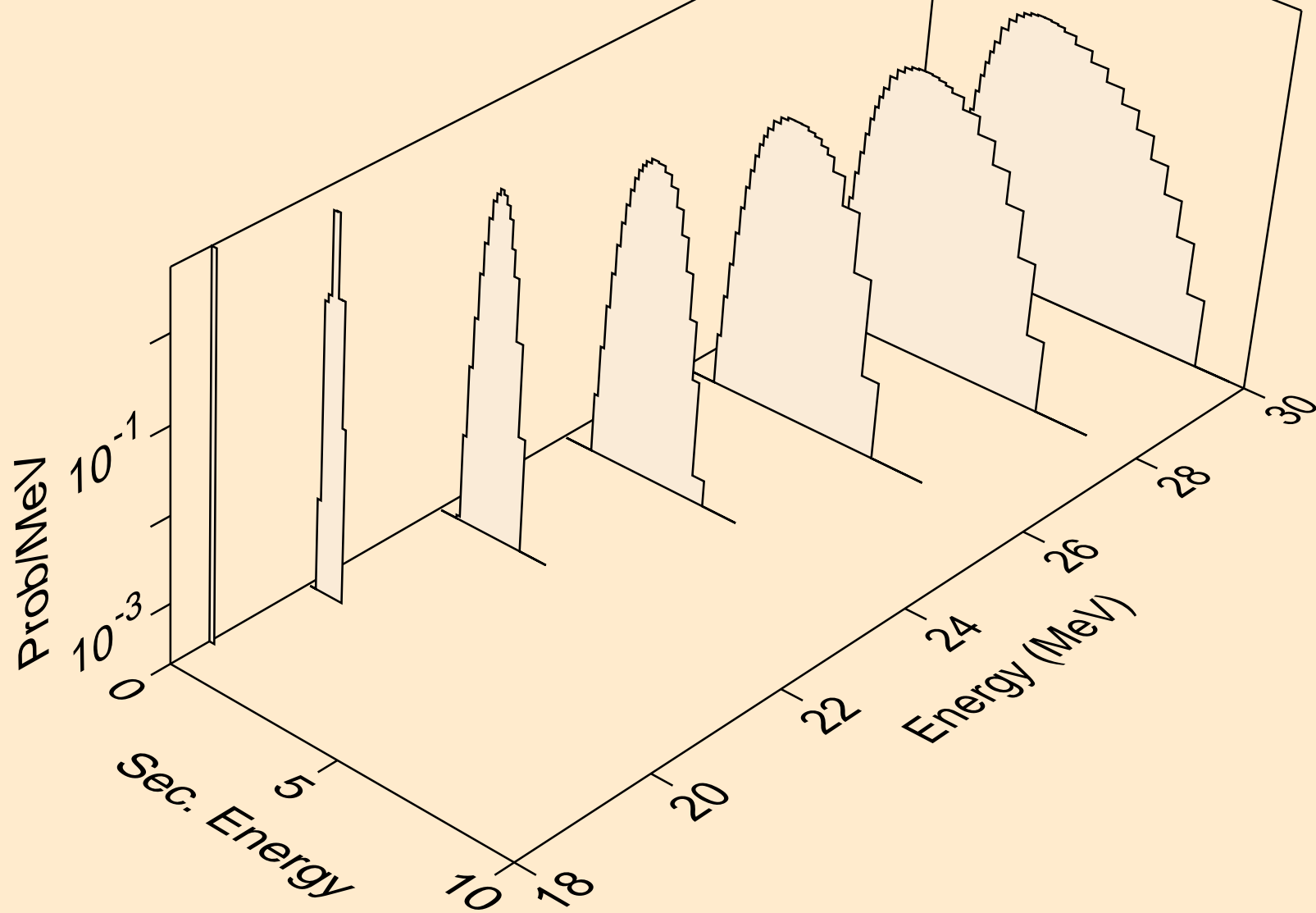

CU062 ALPHA ACER TENDL-2024 LIBRARY; T=0.K
protons from (a,npa)

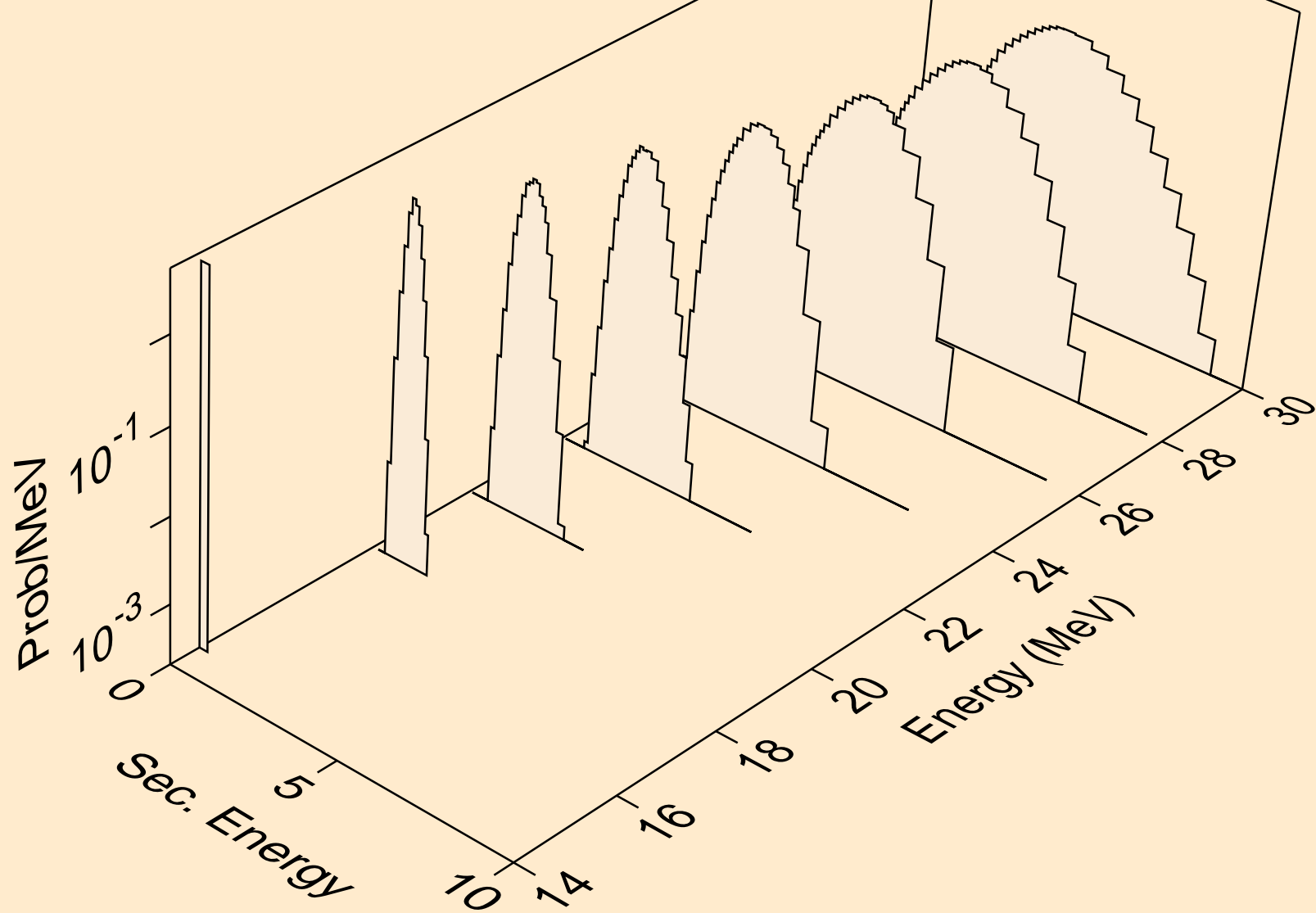

CU062 ALPHA ACER TENDL-2024 LIBRARY; T=0.K
protons from (a,p)

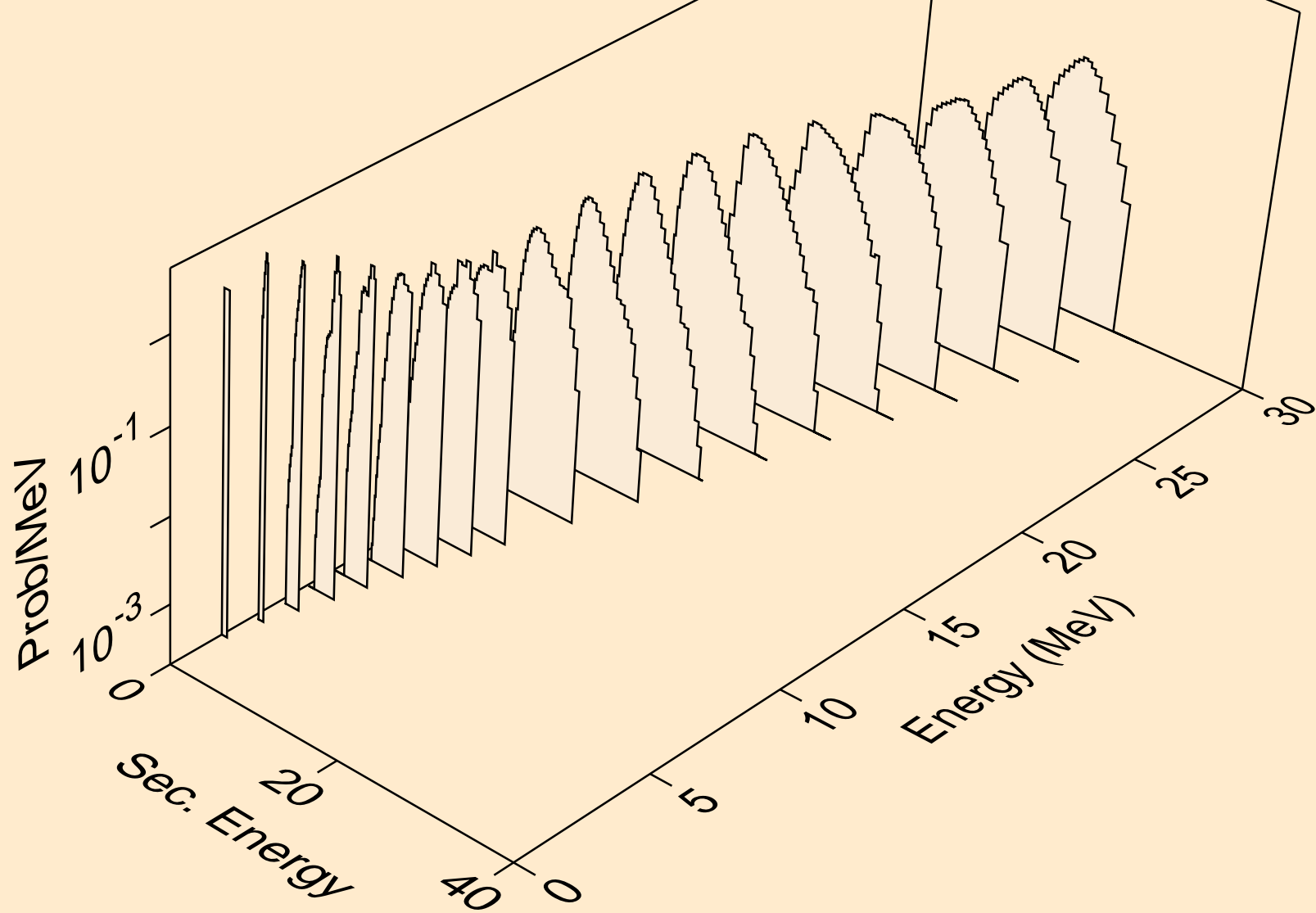

CU062 ALPHA ACER TENDL-2024 LIBRARY; T=0.K
protons from (a,2p)

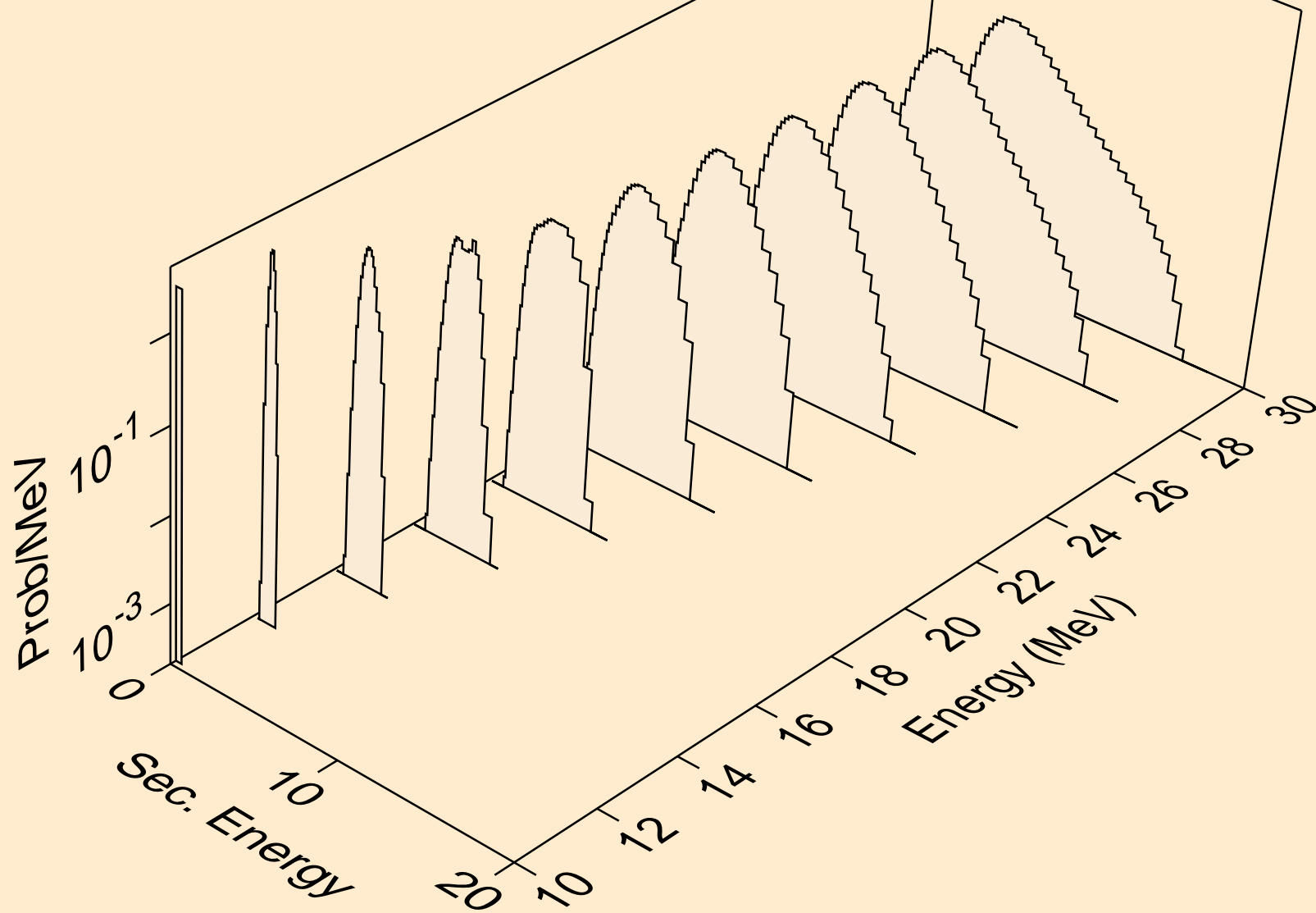

CU062 ALPHA ACER TENDL-2024 LIBRARY; T=0.K
protons from (a,pa)

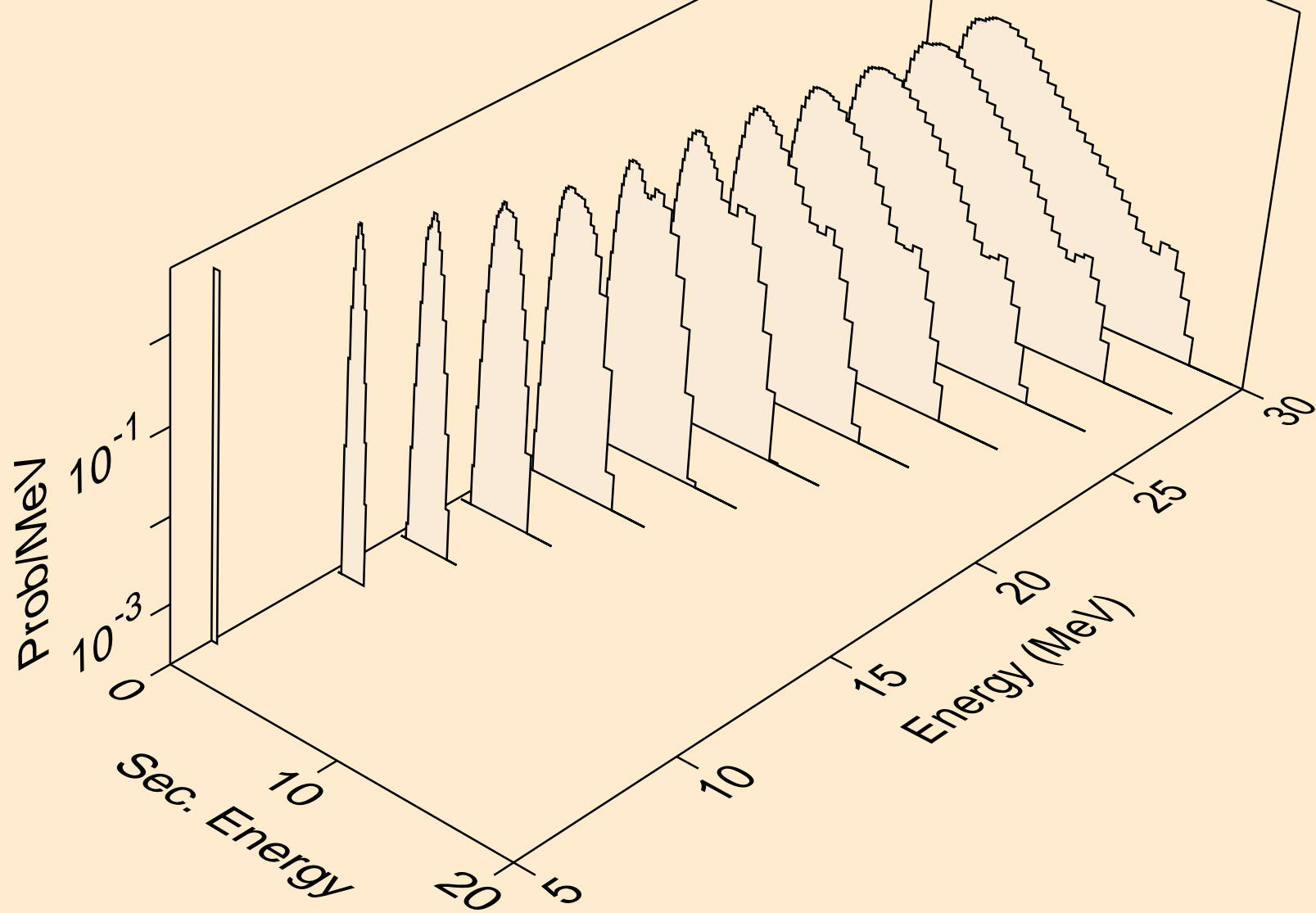

CU062 ALPHA ACER TENDL-2024 LIBRARY; T=0.K
protons from (a,pd)

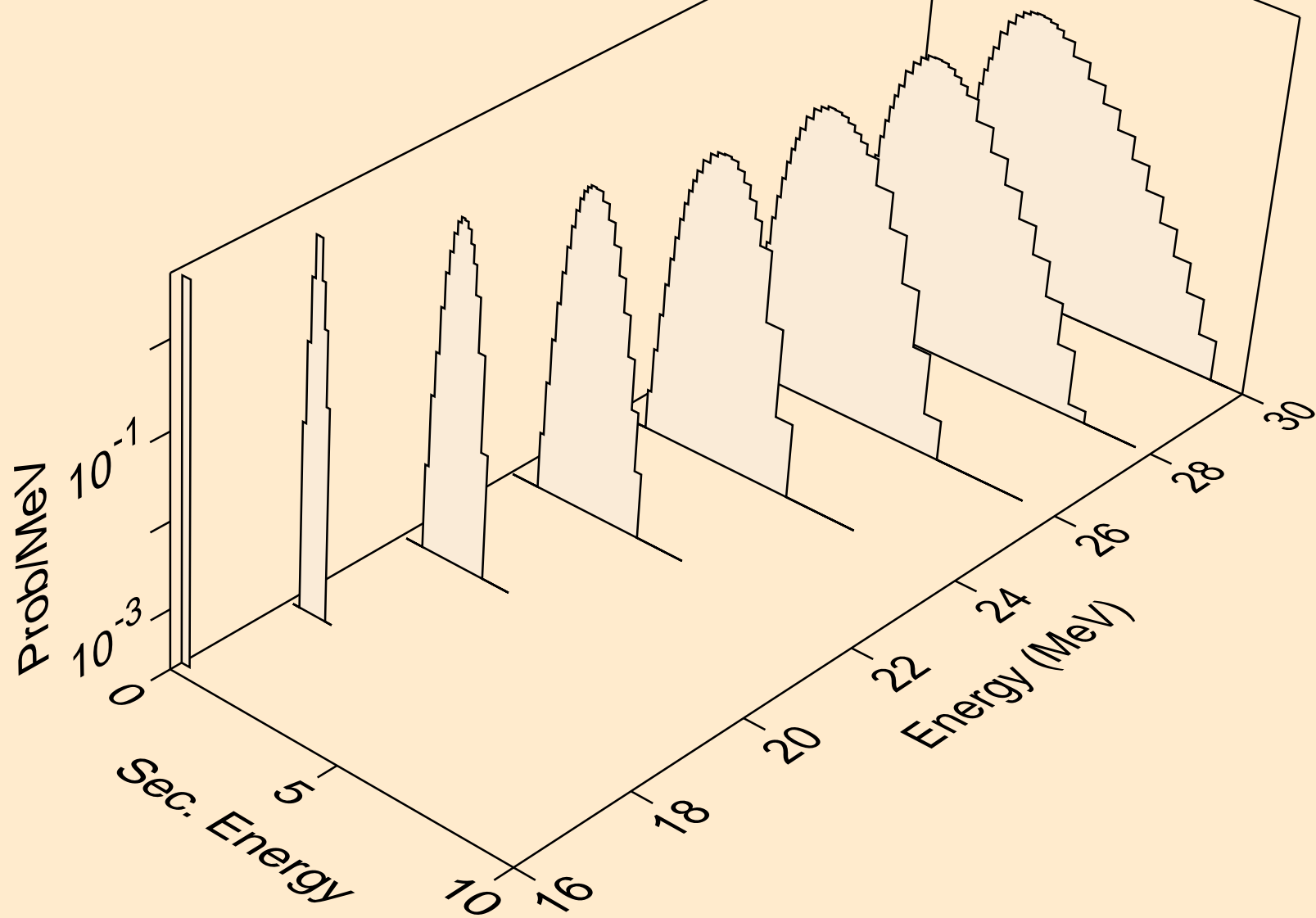

CU062 ALPHA ACER TENDL-2024 LIBRARY; T=0.K
protons from (a,pt)

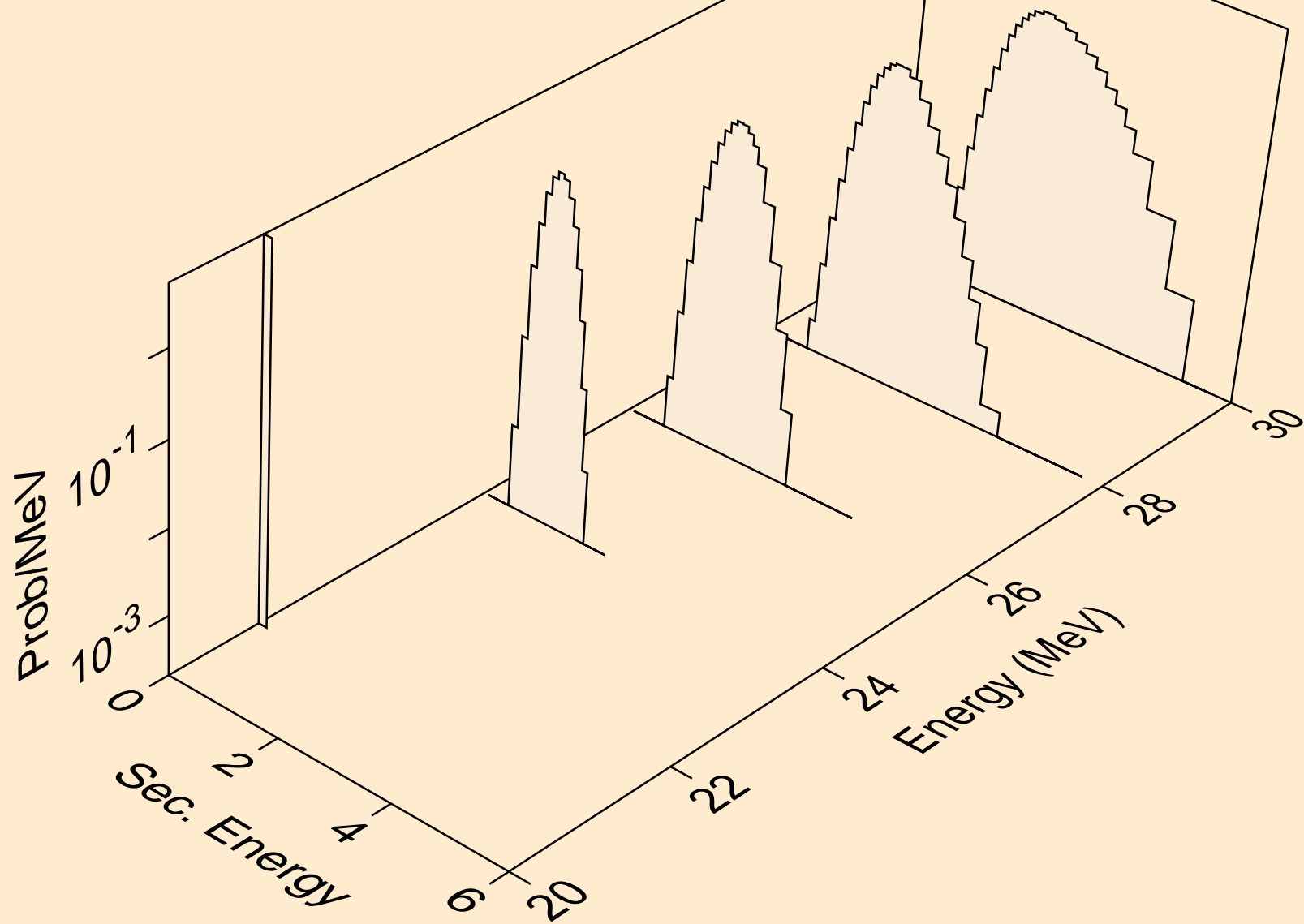

CU062 ALPHA ACER TENDL-2024 LIBRARY; T=0.K
deuterons from (a,x)

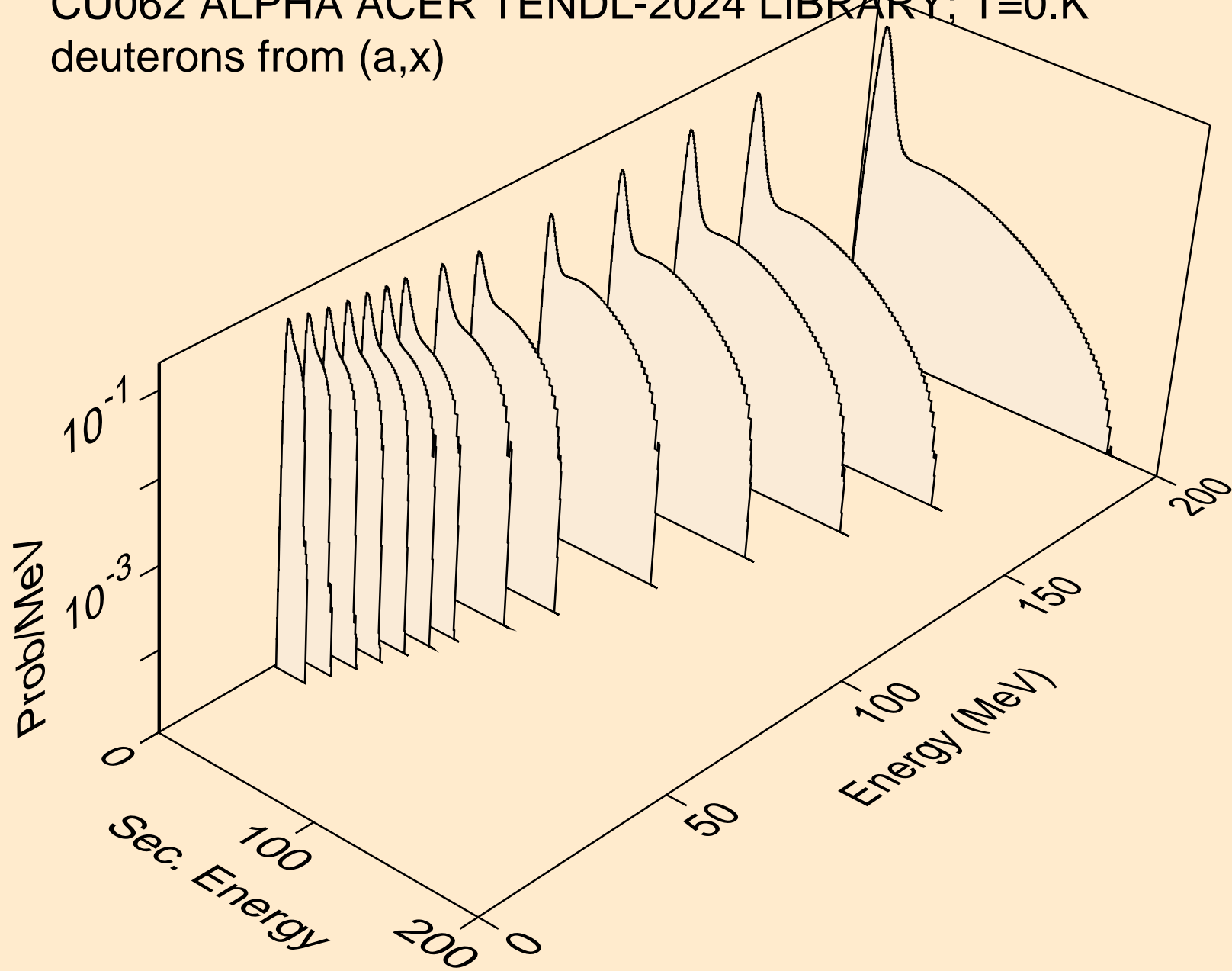

CU062 ALPHA ACER TENDL-2024 LIBRARY; T=0.K
deuterons from (a,n*)d

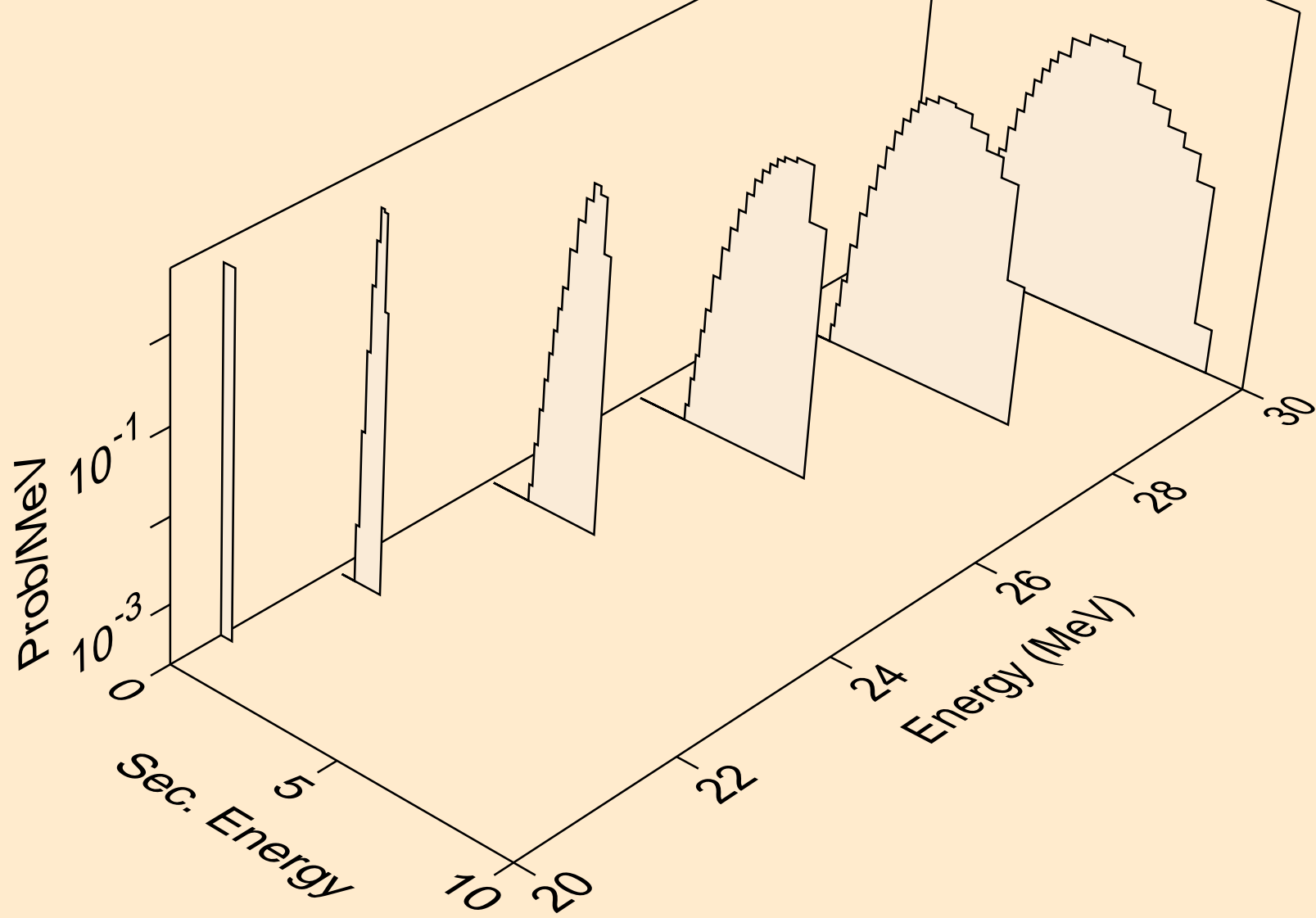

CU062 ALPHA ACER TENDL-2024 LIBRARY; T=0.K
deuterons from (a,d)

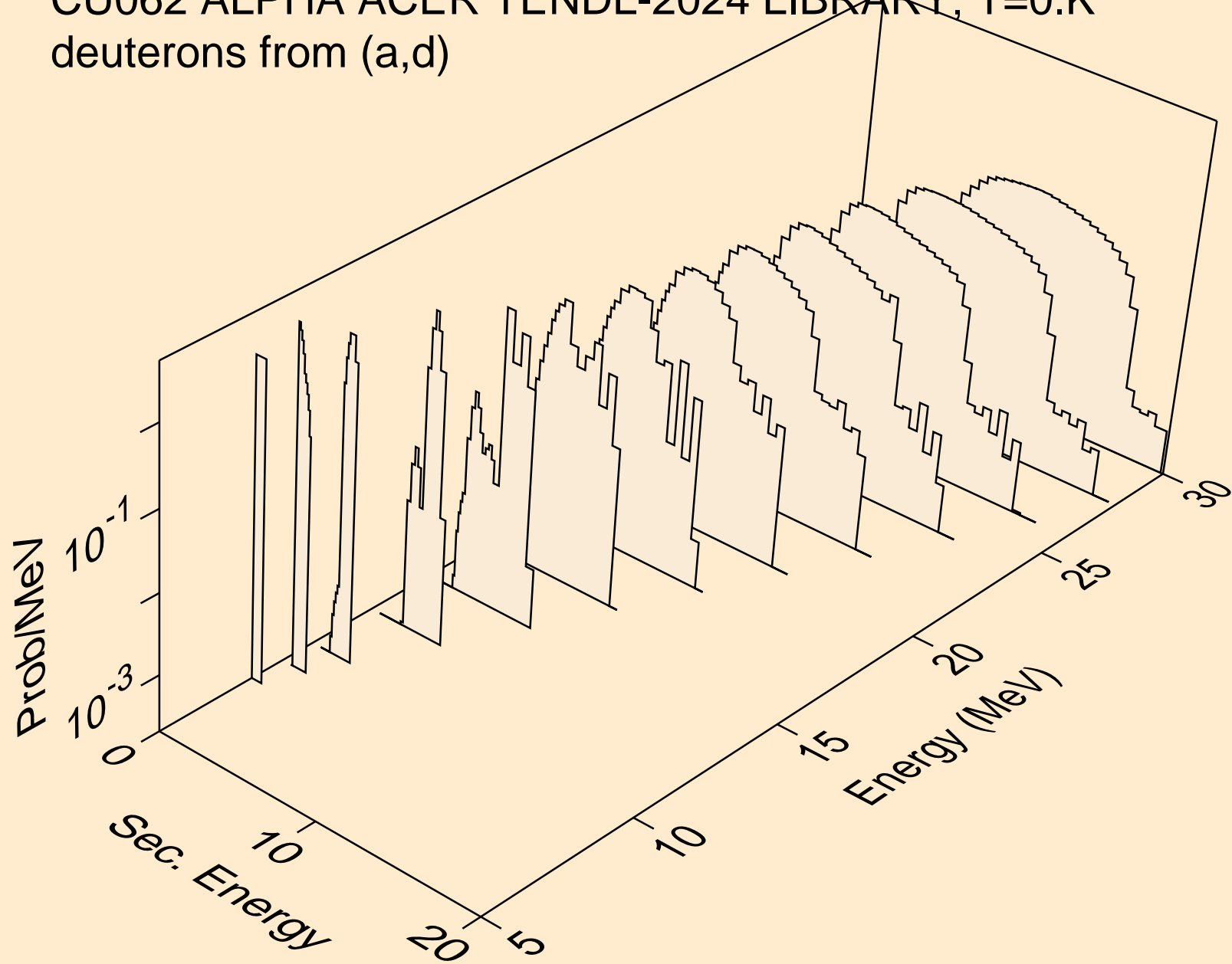

CU062 ALPHA ACER TENDL-2024 LIBRARY; T=0.K
deuterons from (a,pd)

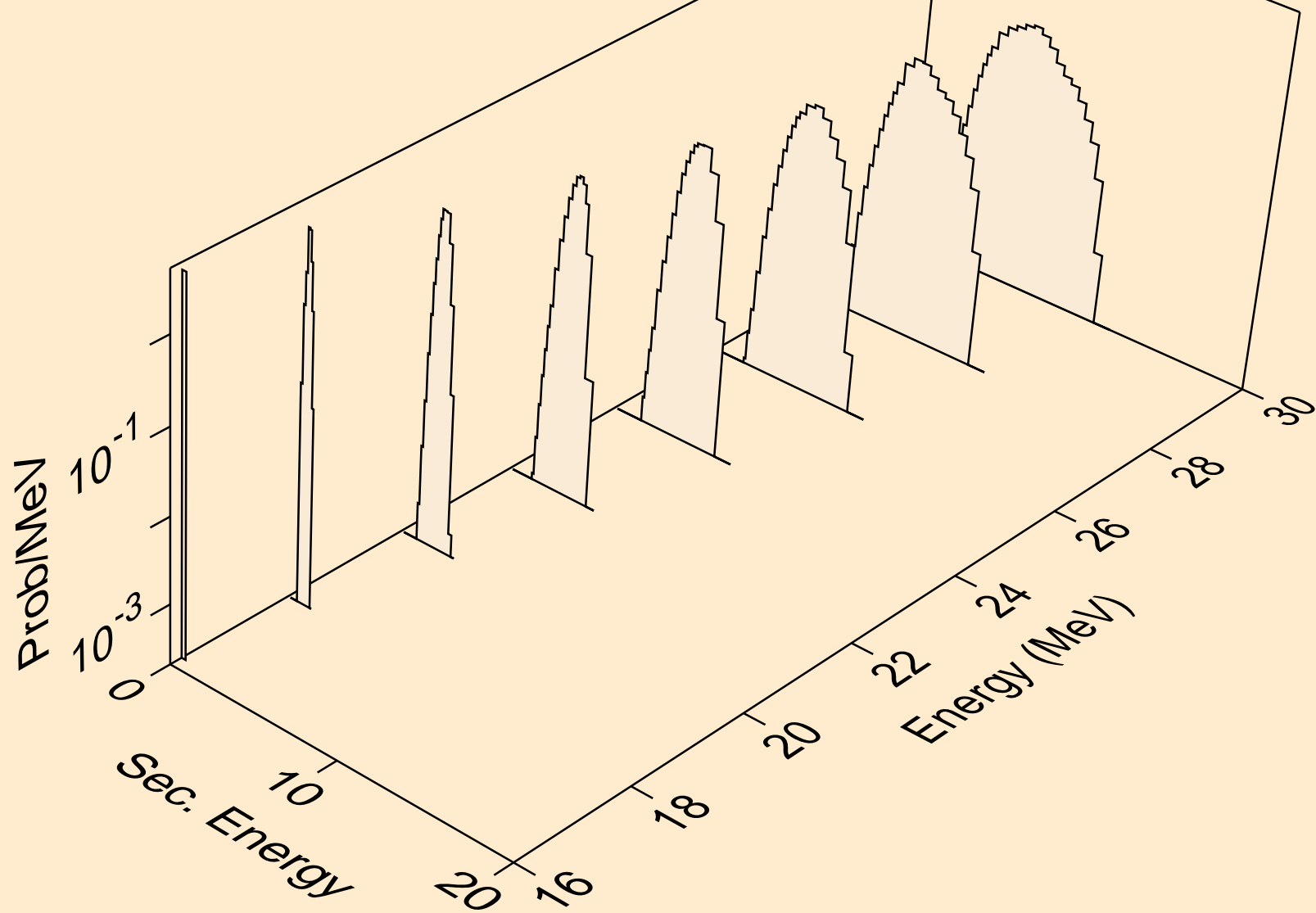

CU062 ALPHA ACER TENDL-2024 LIBRARY; T=0.K
deuterons from (a,da)

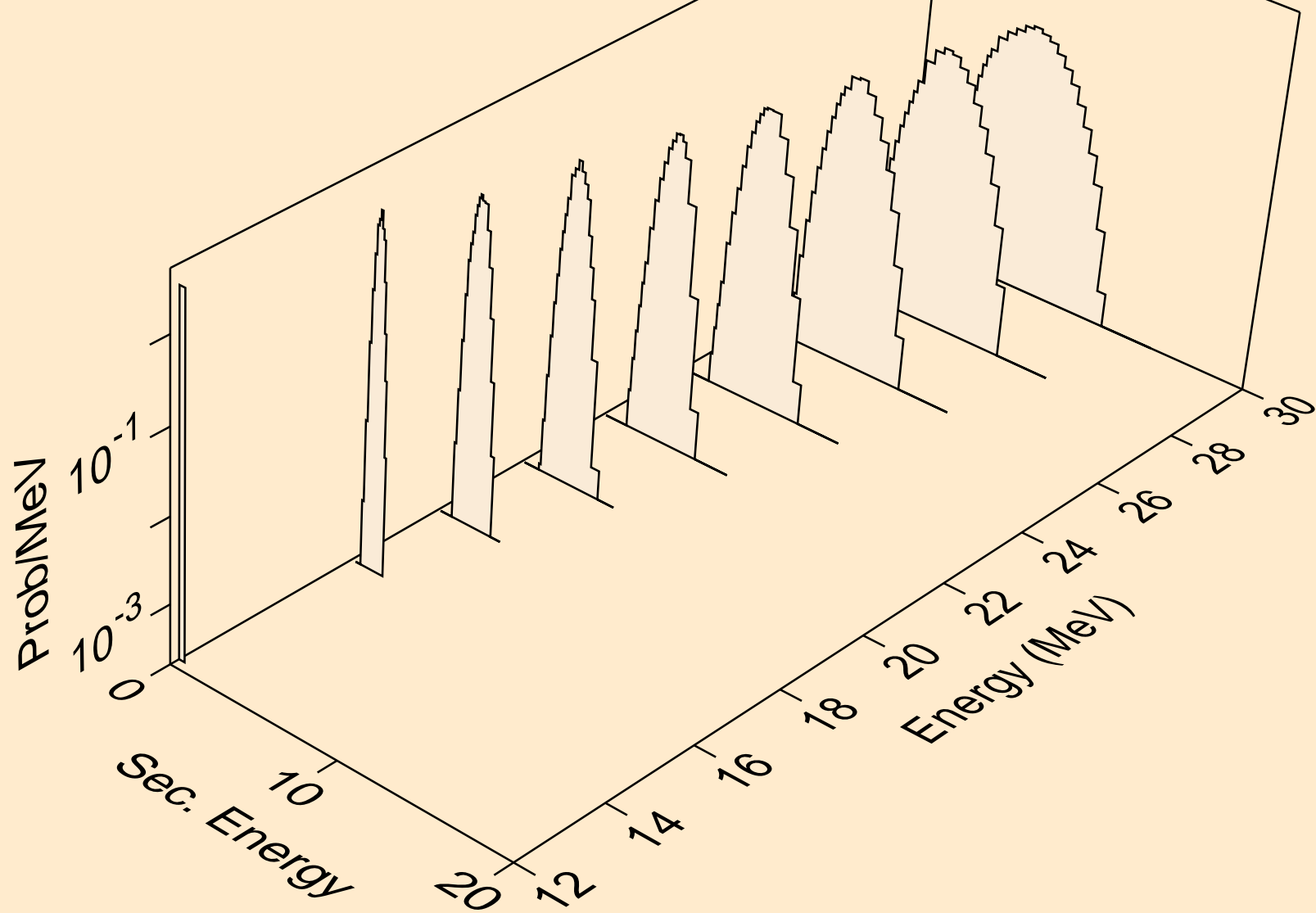

CU062 ALPHA ACER TENDL-2024 LIBRARY; T=0.K
tritons from (a,x)

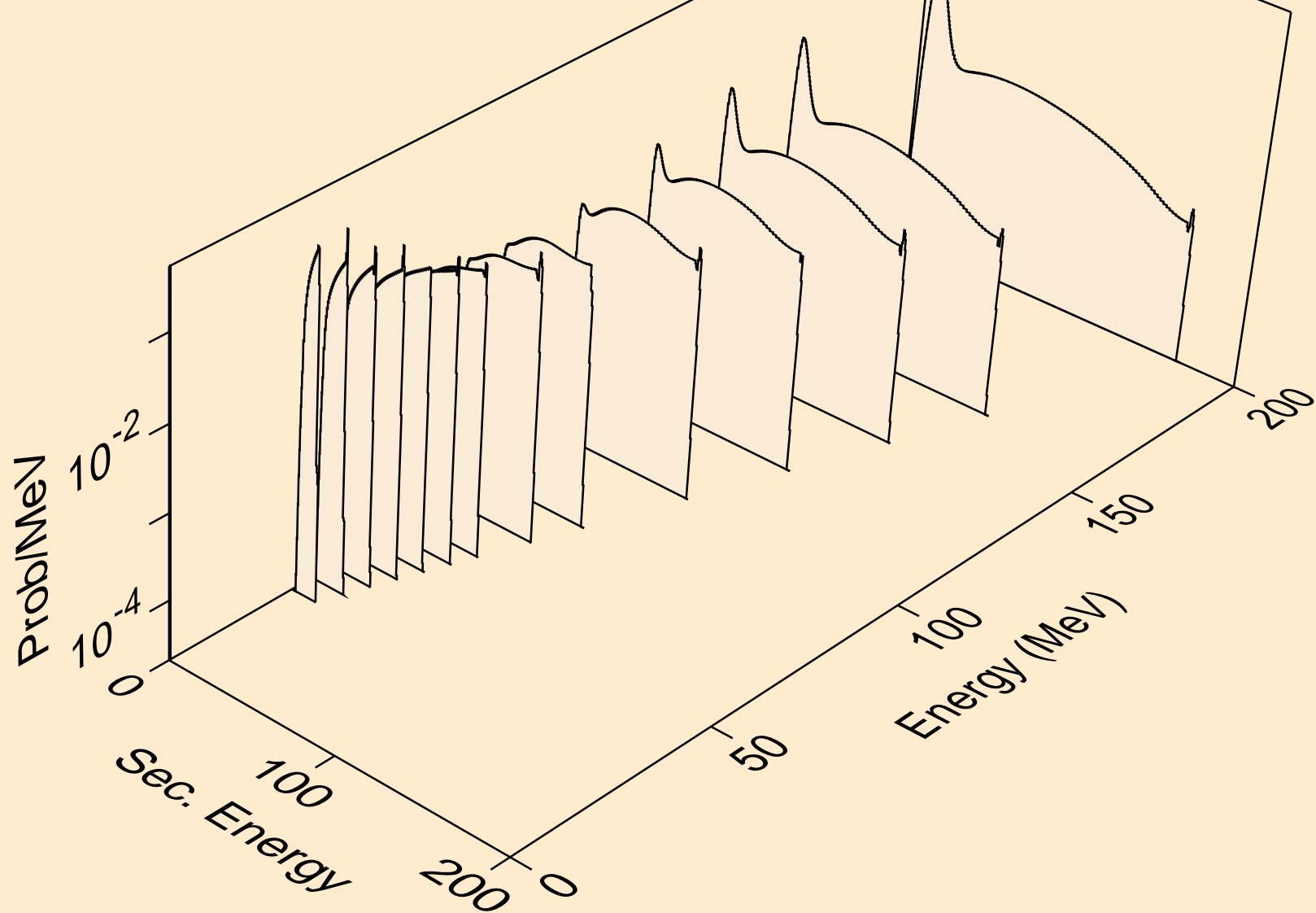

CU062 ALPHA ACER TENDL-2024 LIBRARY; T=0.K
tritons from (a,n*)t

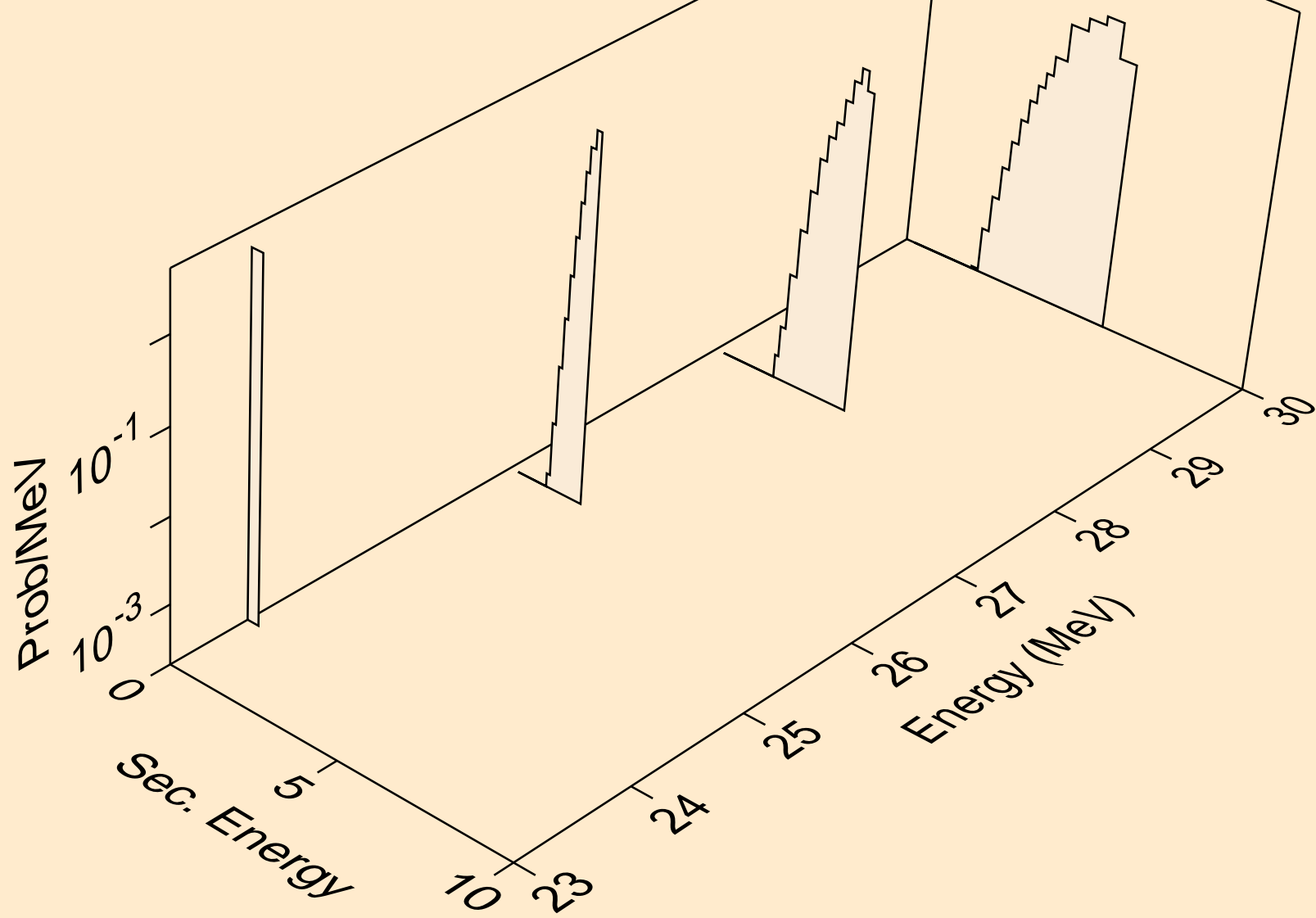

CU062 ALPHA ACER TENDL-2024 LIBRARY; T=0.K
tritons from (a,t)

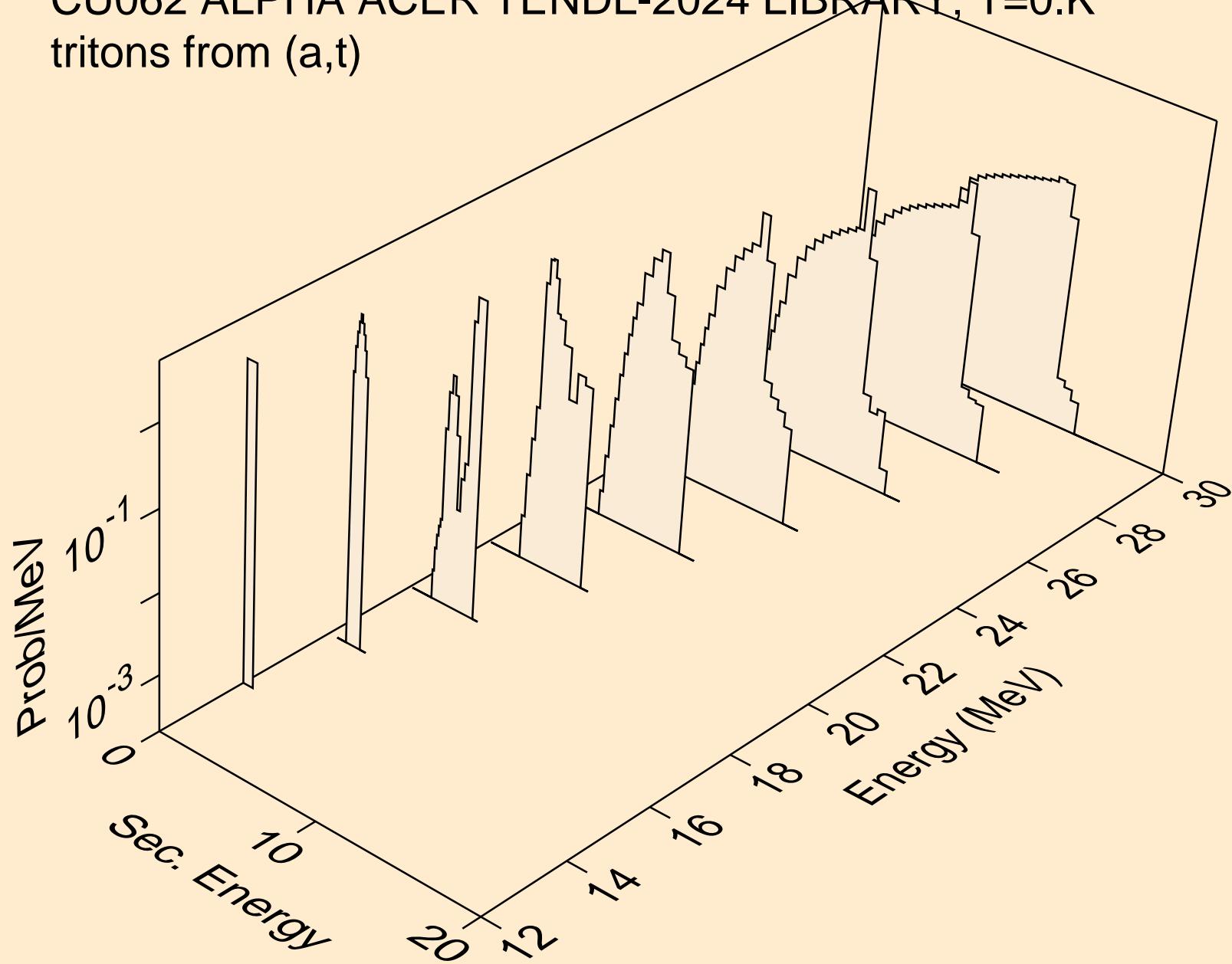

CU062 ALPHA ACER TENDL-2024 LIBRARY; T=0.K
tritons from (a,pt)

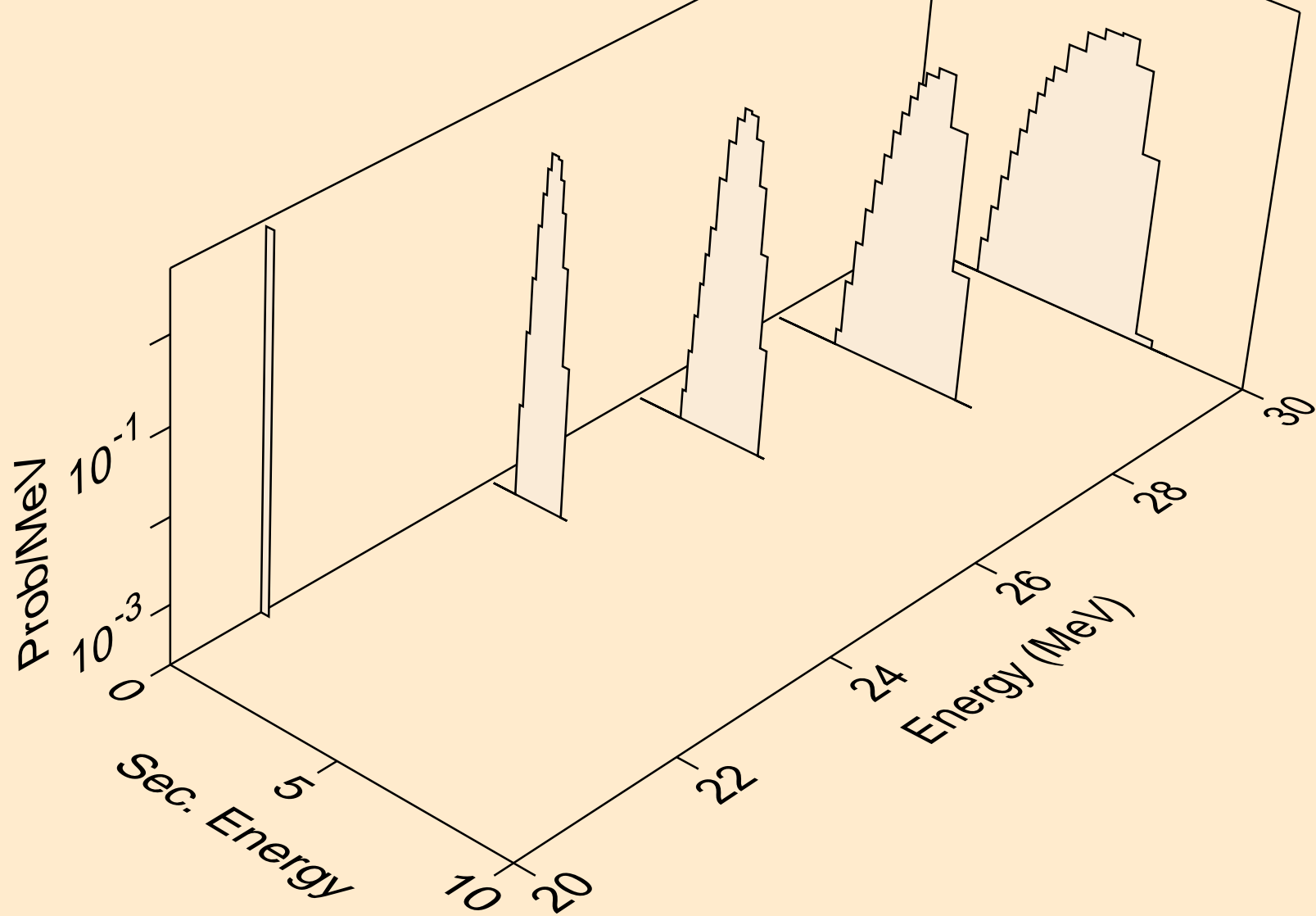

CU062 ALPHA ACER TENDL-2024 LIBRARY; T=0.K
he3s from (a,x)

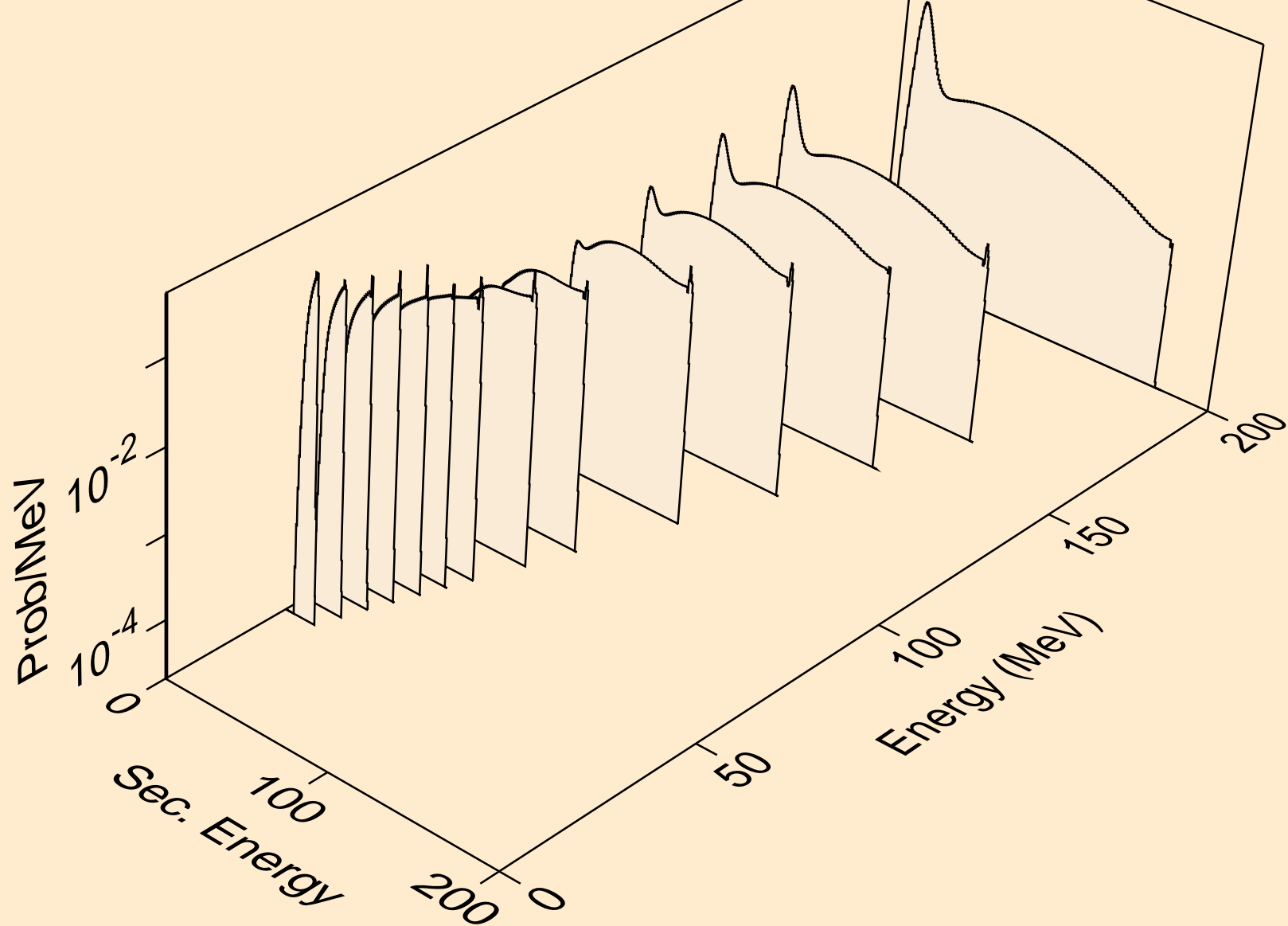

CU062 ALPHA ACER TENDL-2024 LIBRARY; T=0.K
he3s from (a,n*)he3

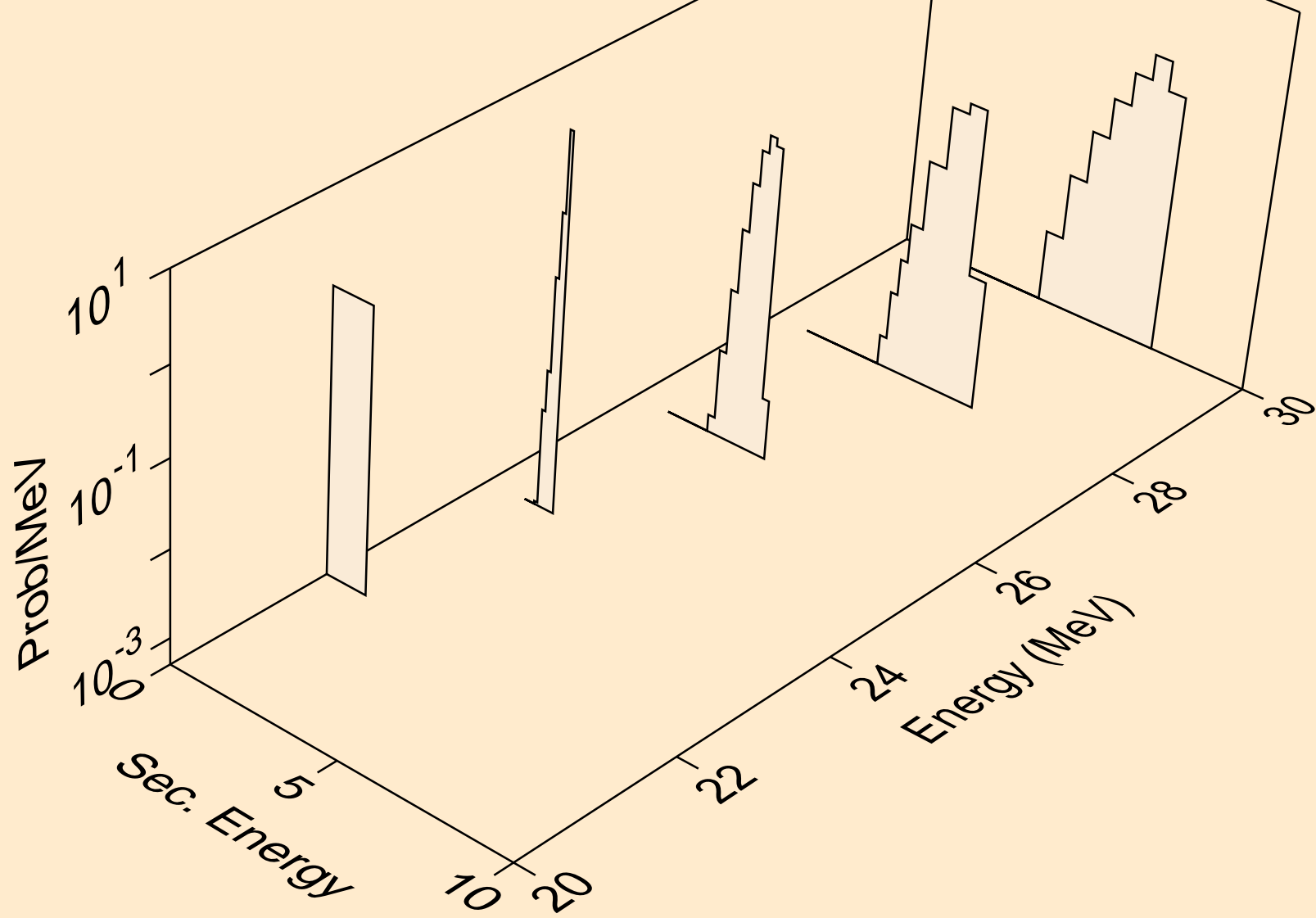

CU062 ALPHA ACER TENDL-2024 LIBRARY; T=0.K
he3s from (a,he3)

