

O018 ALPHA ACER TENDL-2024 LIBRARY; T=0.K
Principal cross sections

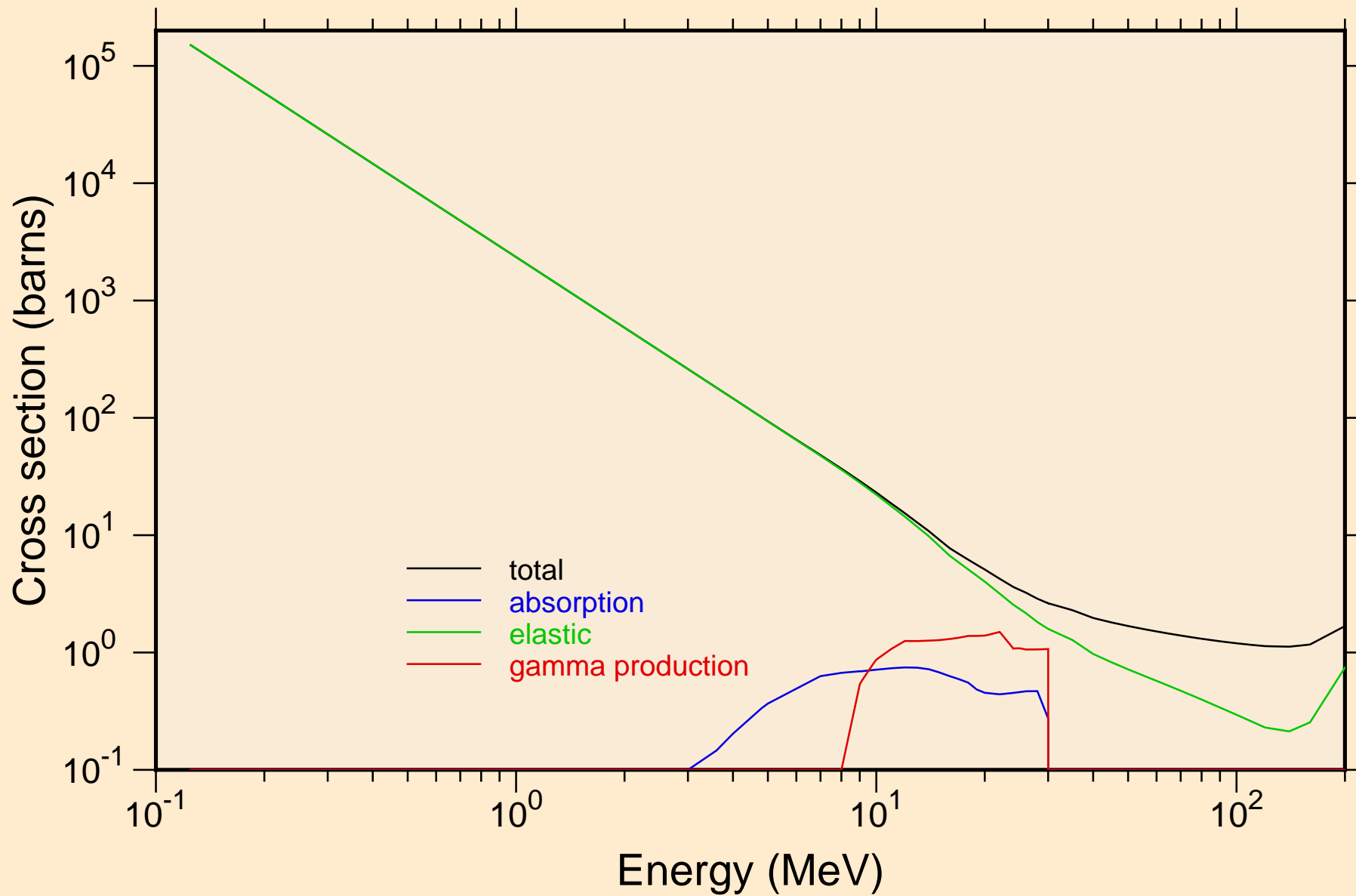

O018 ALPHA ACER TENDL-2024 LIBRARY; T=0.K
Heating

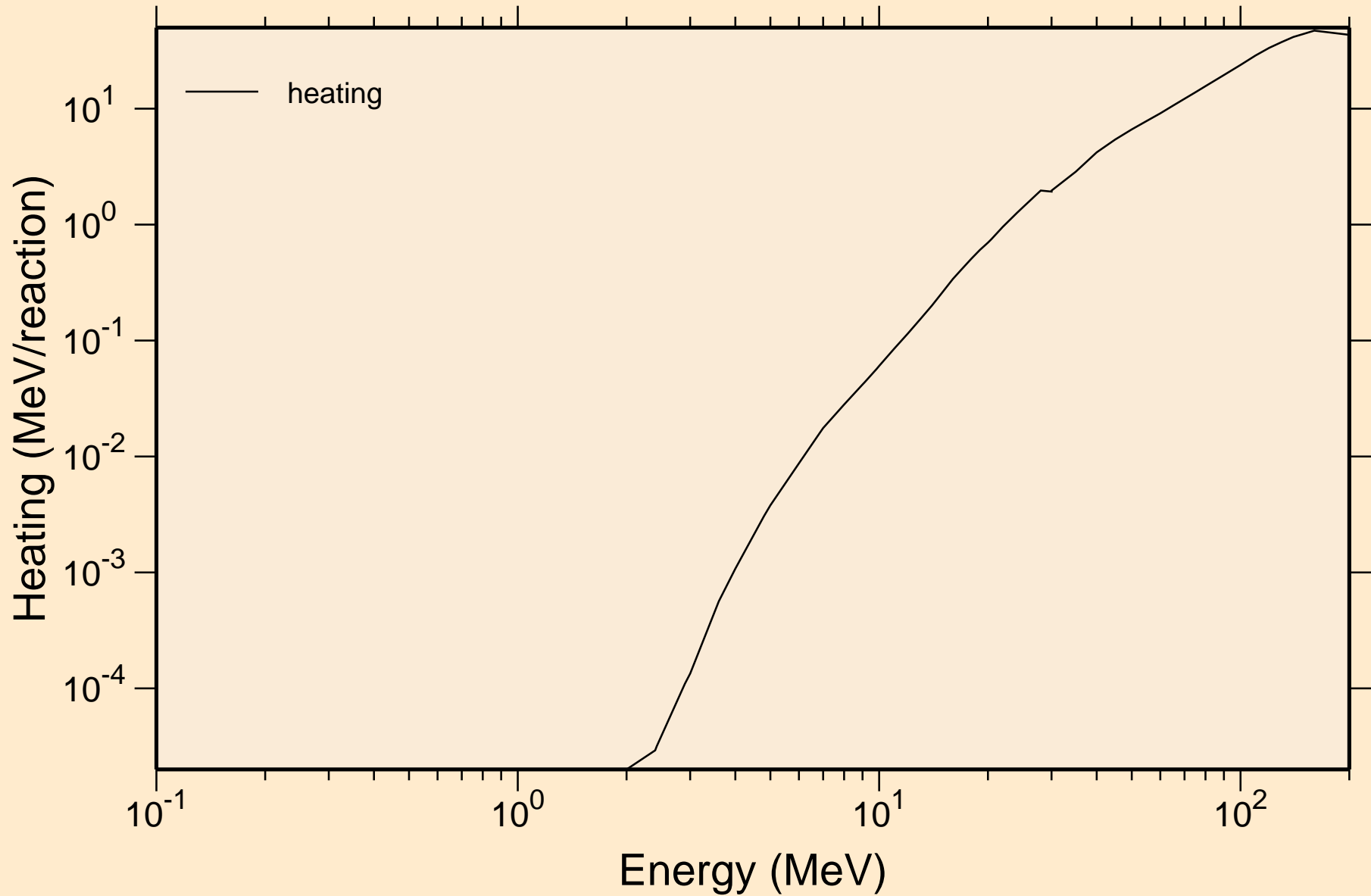

O018 ALPHA ACER TENDL-2024 LIBRARY; T=0.K

Principal cross sections

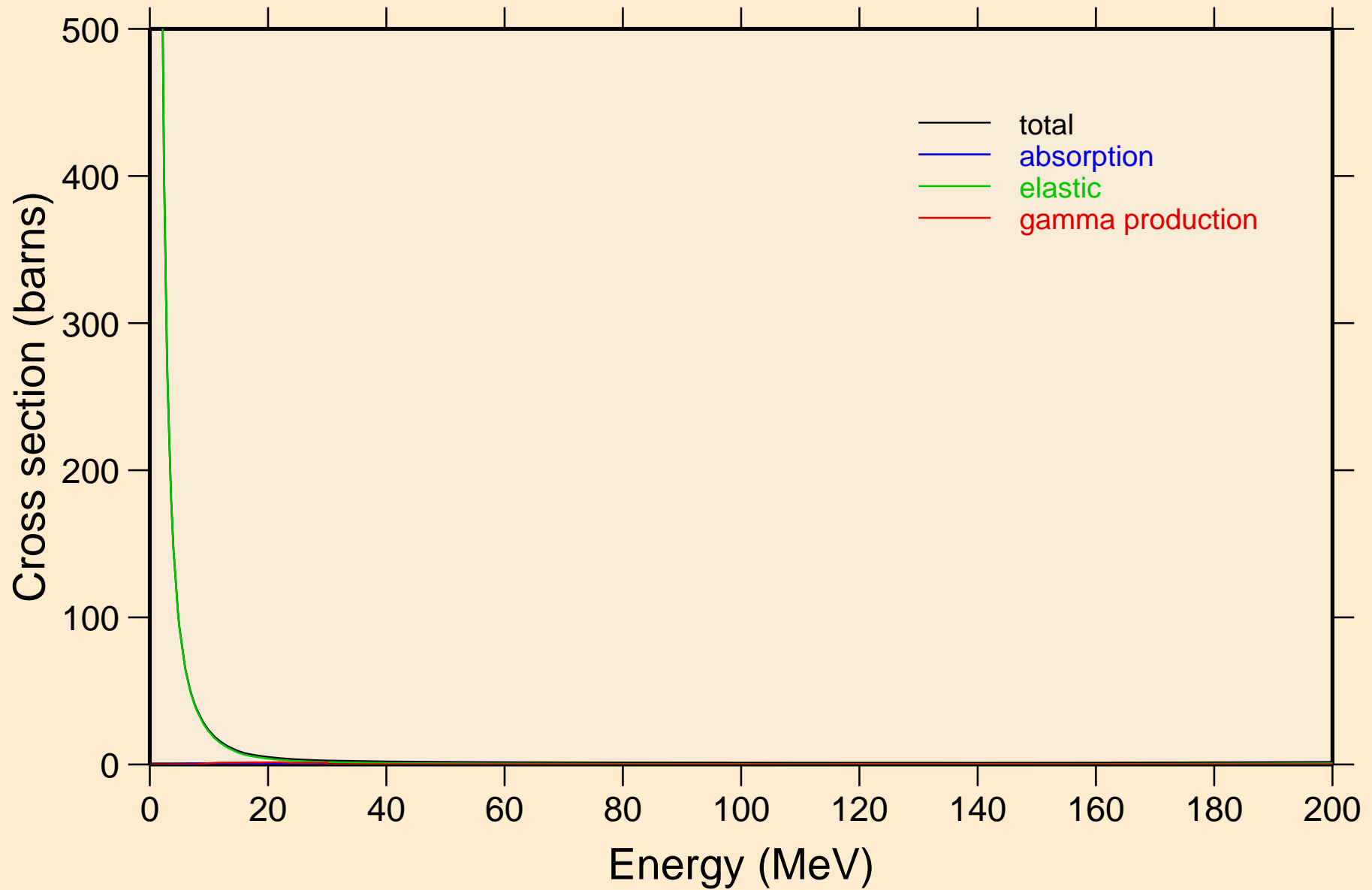

O018 ALPHA ACER TENDL-2024 LIBRARY; T=0.K

Heating

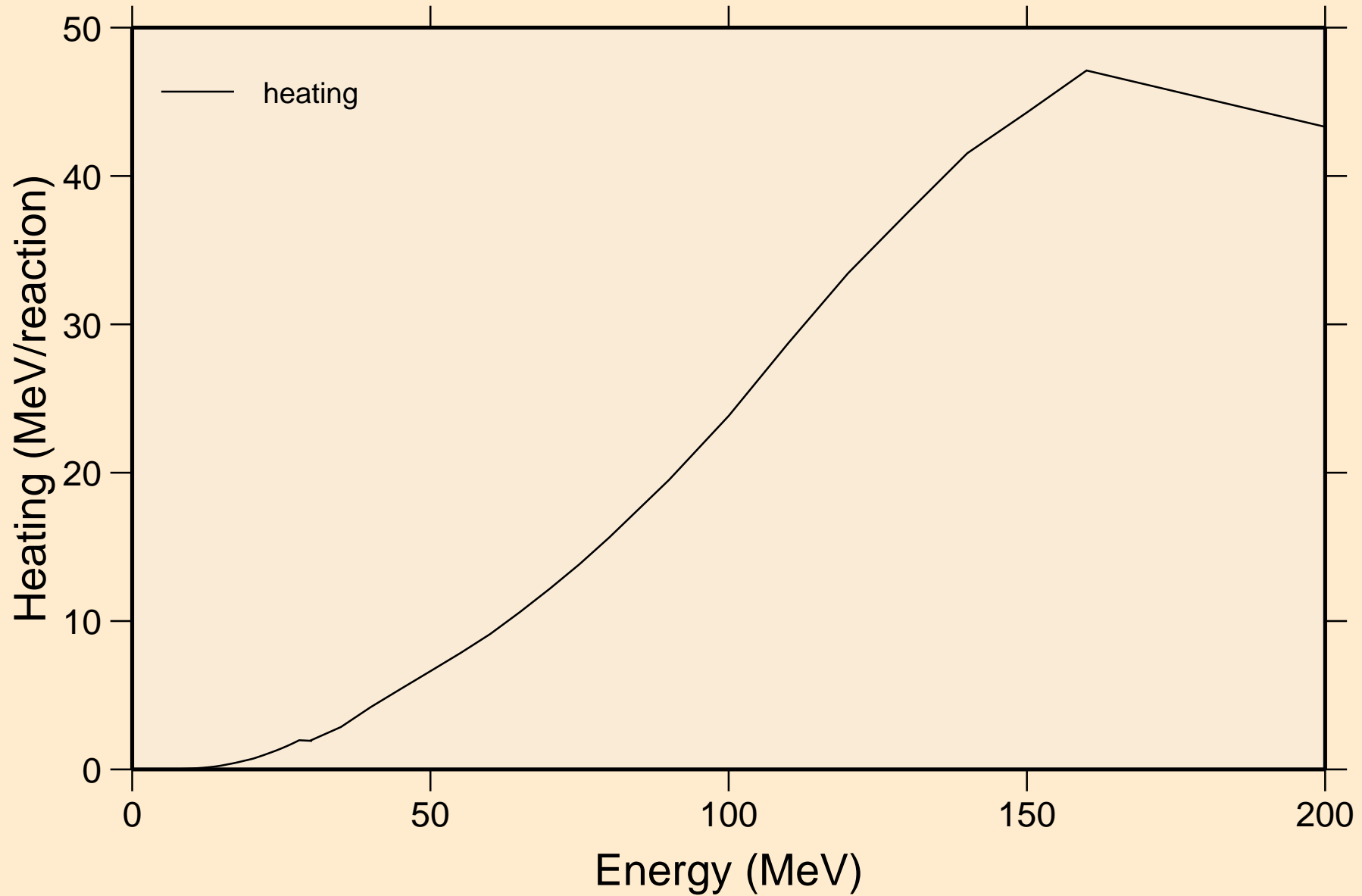

O018 ALPHA ACER TENDL-2024 LIBRARY; T=0.K

Threshold reactions

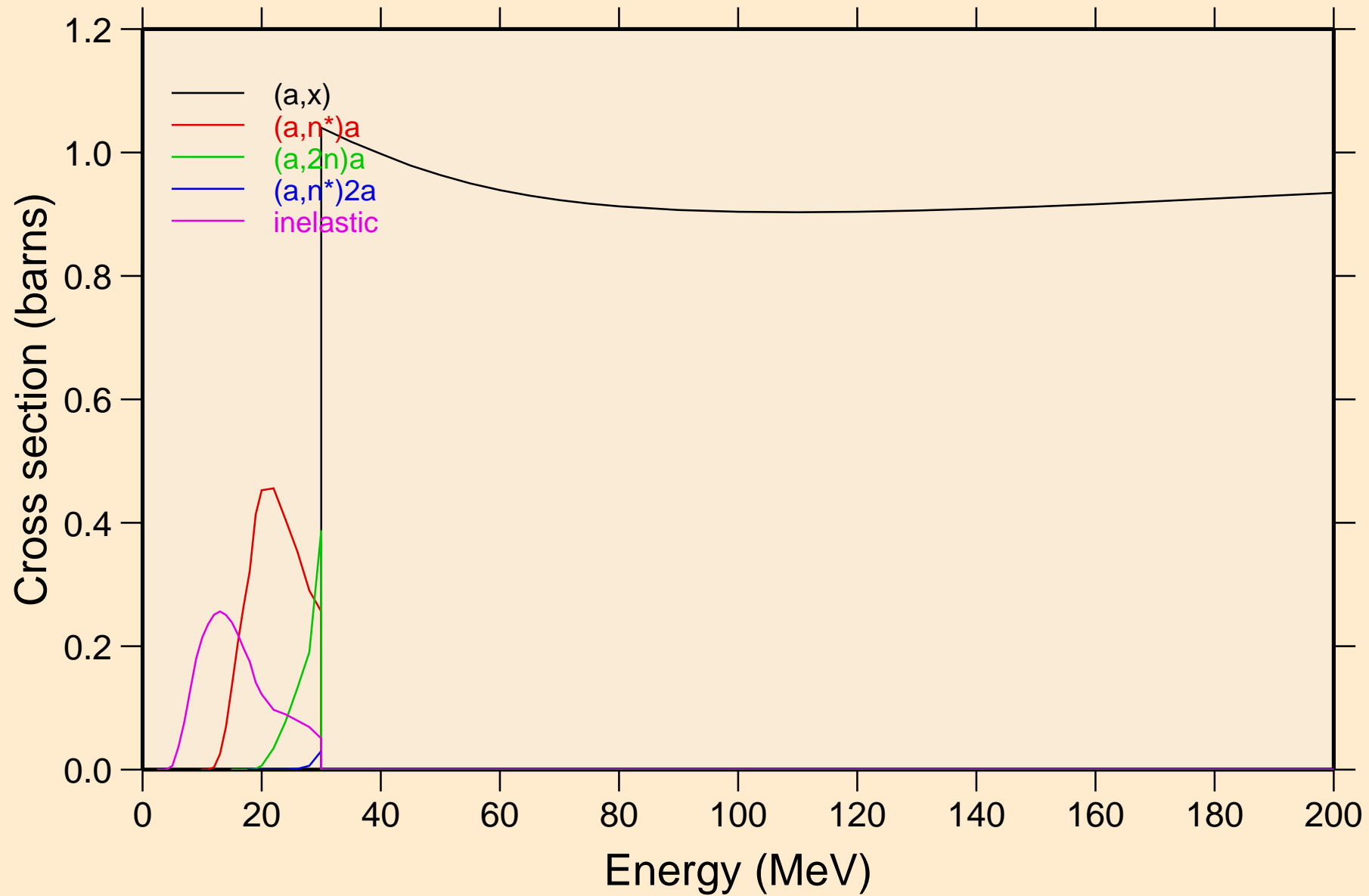

O018 ALPHA ACER TENDL-2024 LIBRARY; T=0.K
Threshold reactions

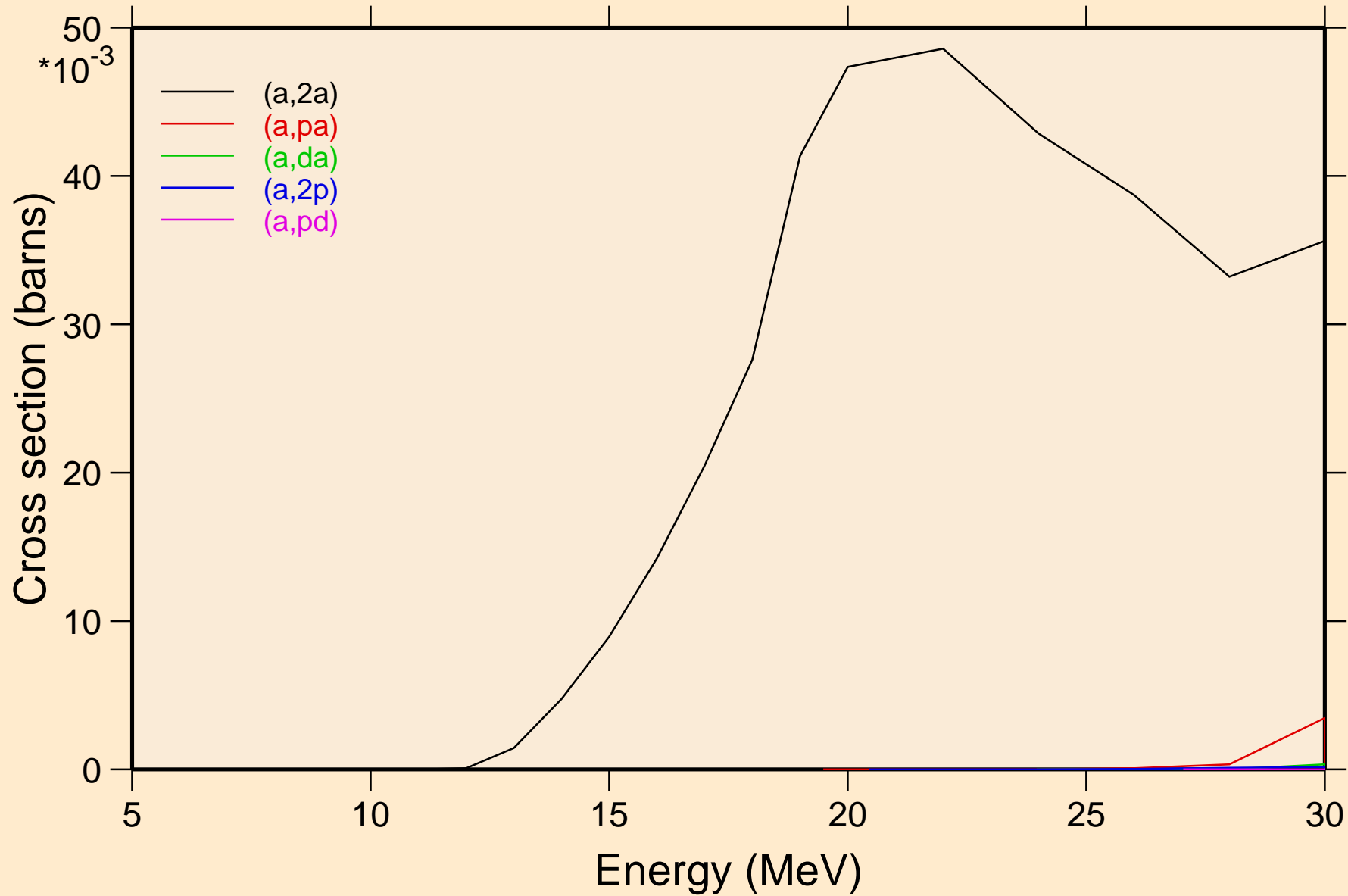

O018 ALPHA ACER TENDL-2024 LIBRARY; T=0.K
Threshold reactions

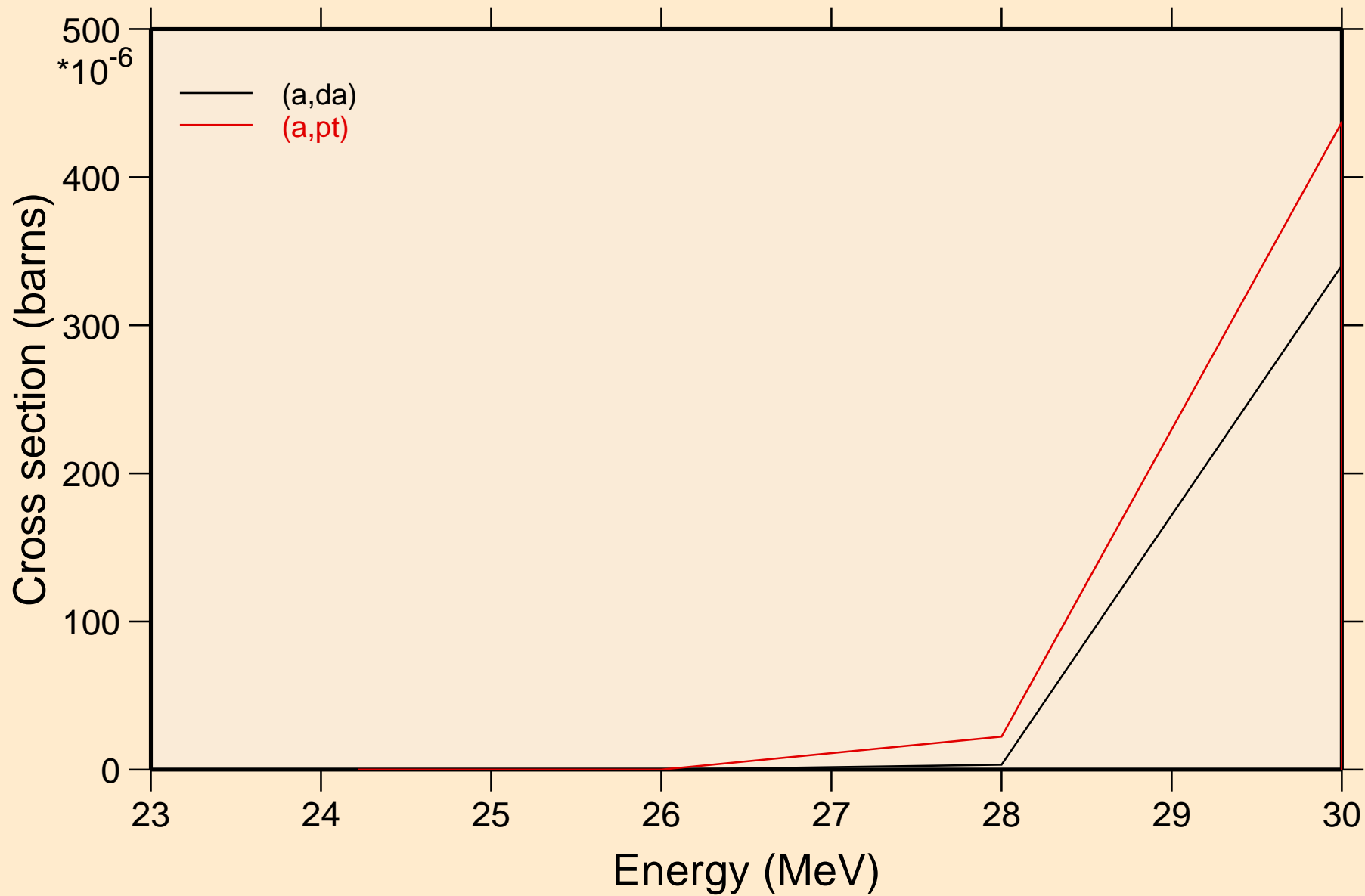

O018 ALPHA ACER TENDL-2024 LIBRARY; T=0.K
Threshold reactions

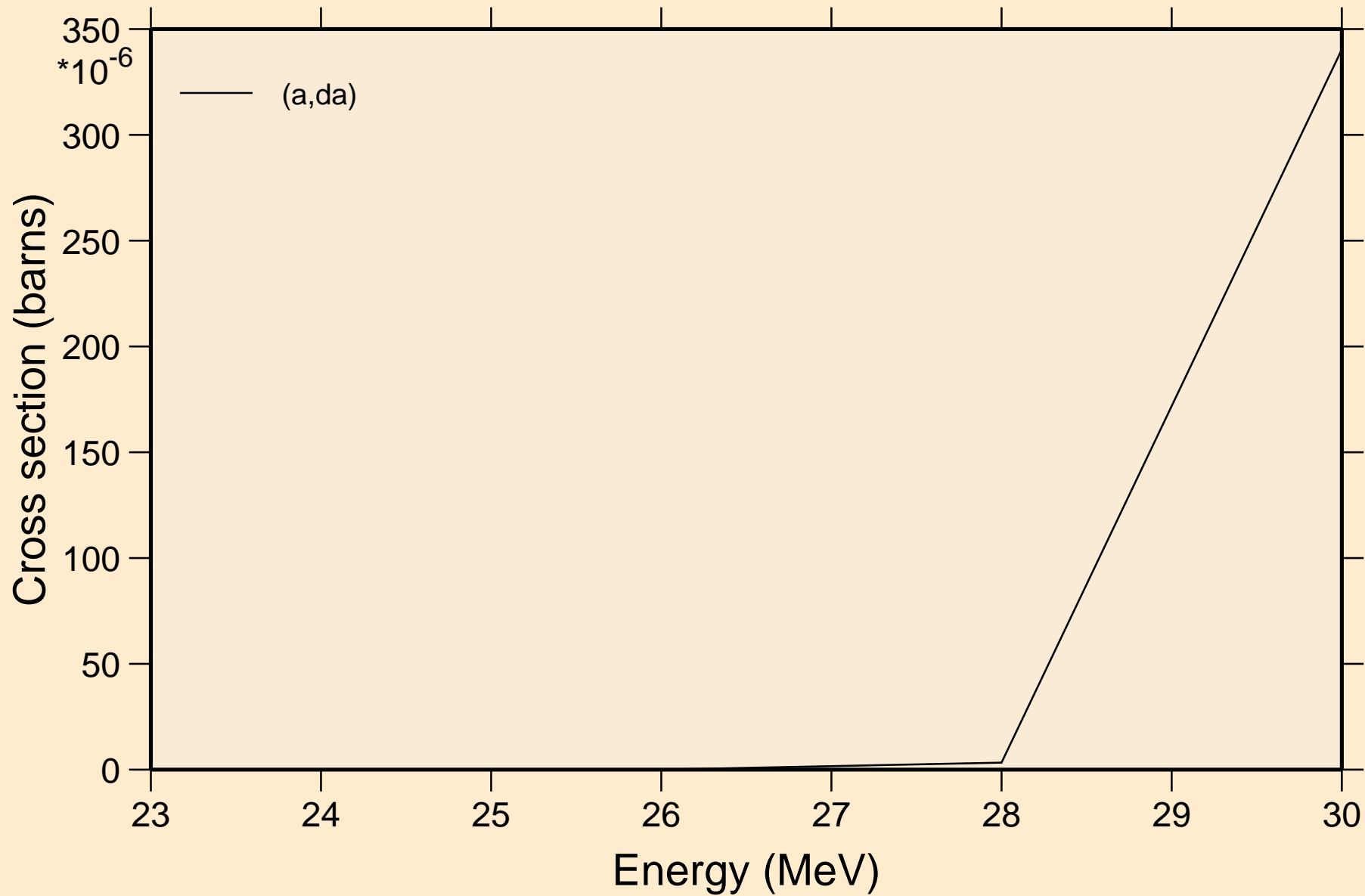

O018 ALPHA ACER TENDL-2024 LIBRARY; T=0.K
angular distribution for elastic

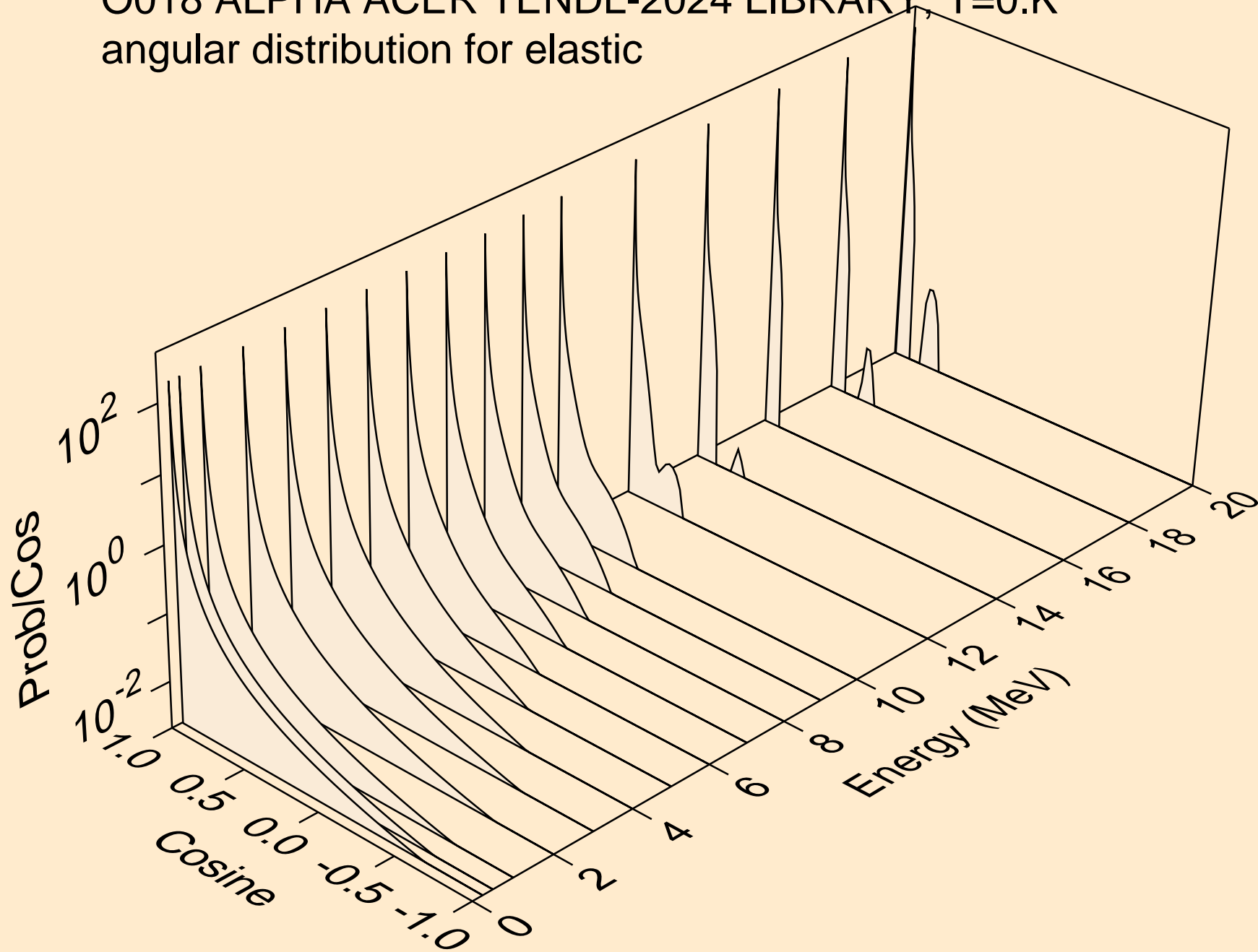

O018 ALPHA ACER TENDL-2024 LIBRARY; T=0.K
angular distribution for elastic

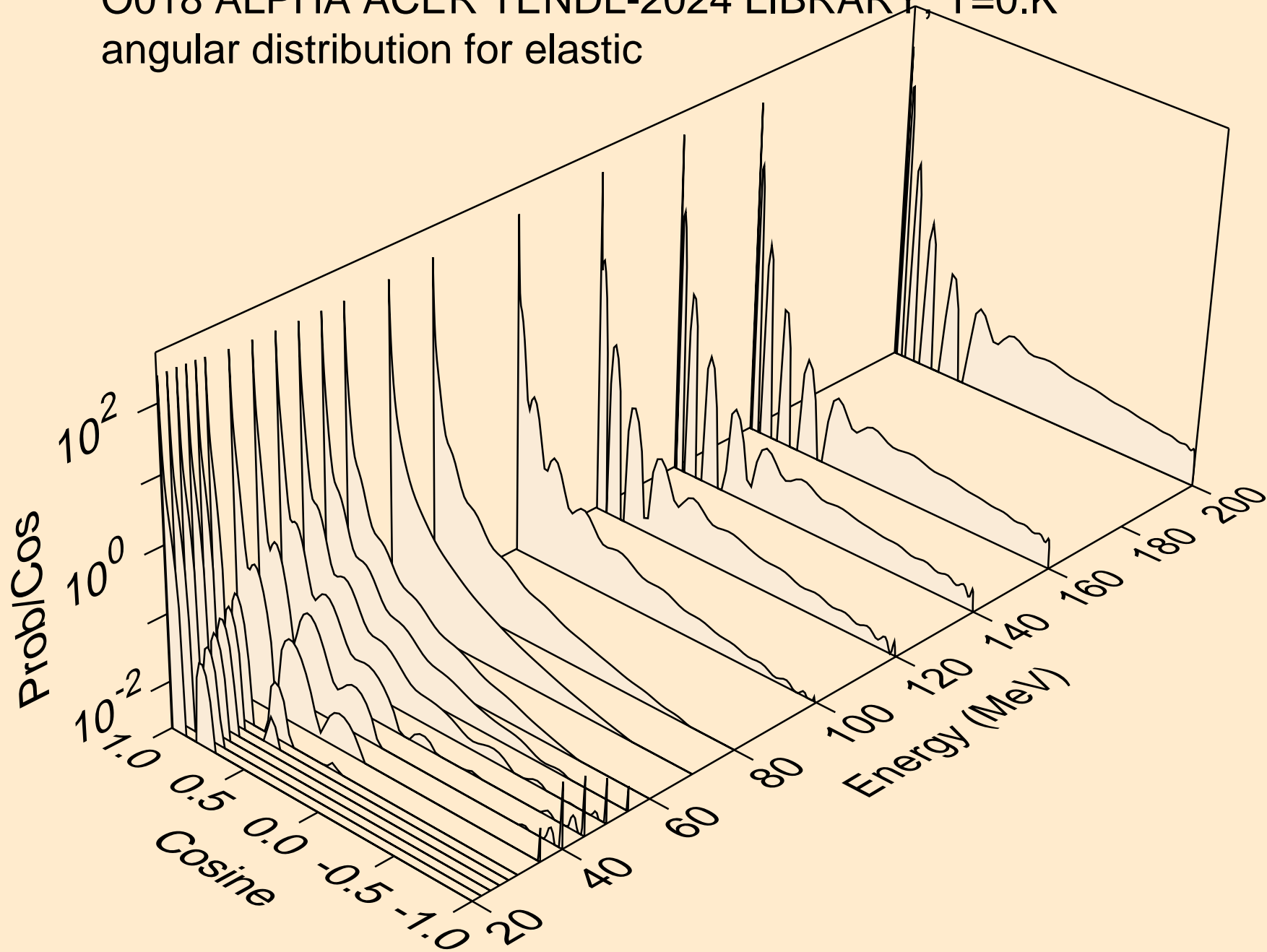

O018 ALPHA ACER TENDL-2024 LIBRARY; T=0.K
Alpha emission for (a,x)

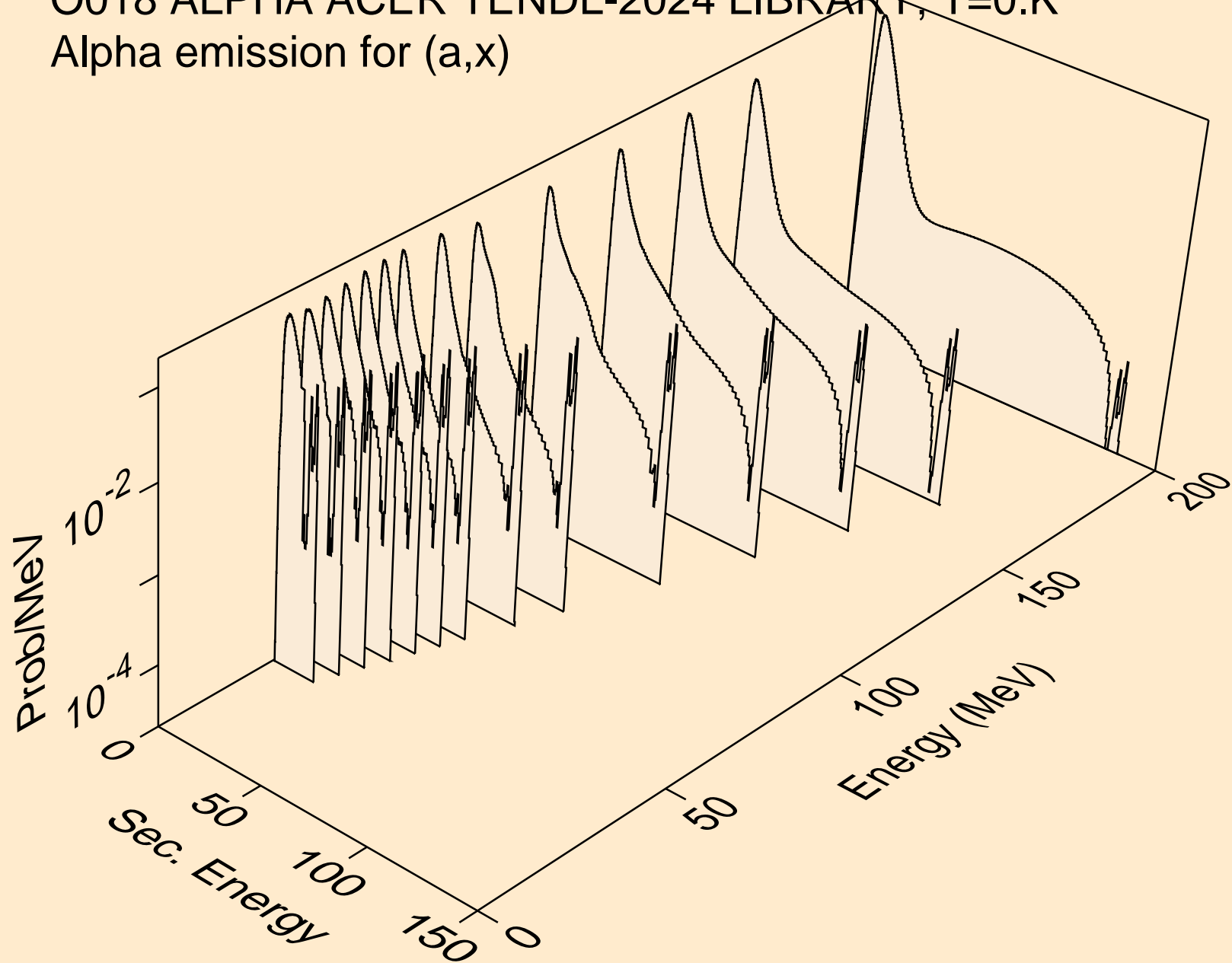

O018 ALPHA ACER TENDL-2024 LIBRARY; T=0.K
Alpha emission for (a,n*)a

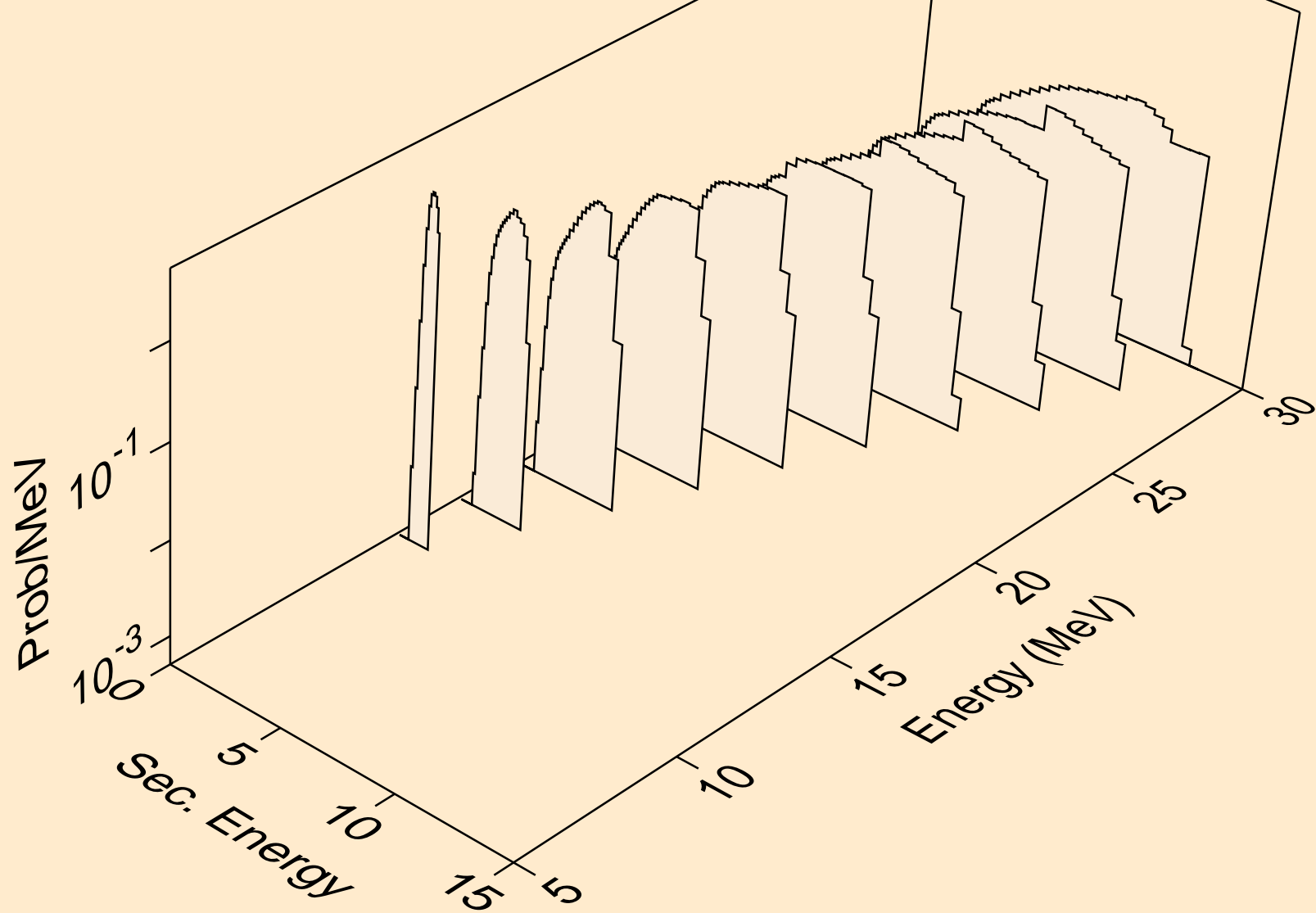

O018 ALPHA ACER TENDL-2024 LIBRARY; T=0.K
Alpha emission for (a,2n)a

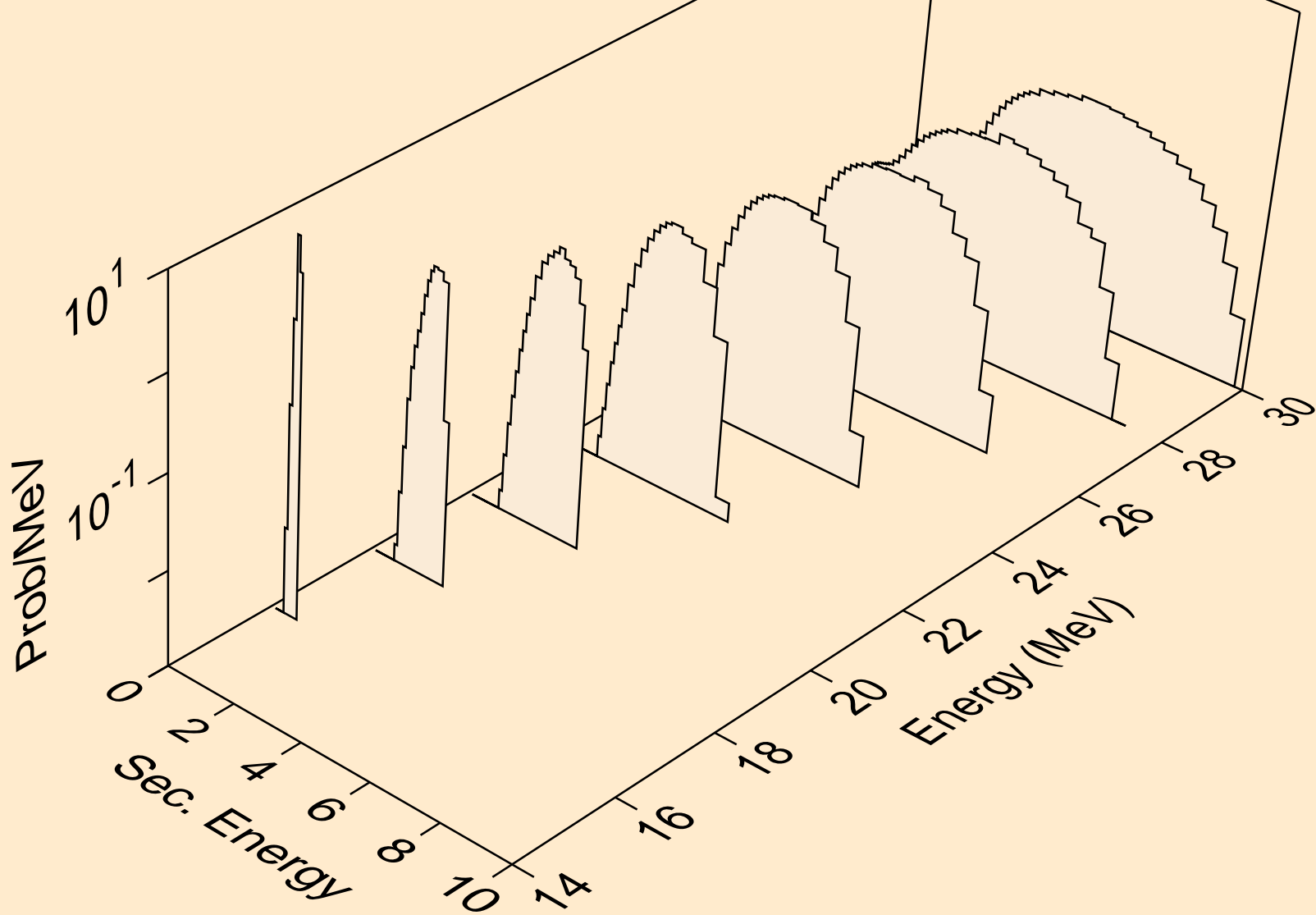

O018 ALPHA ACER TENDL-2024 LIBRARY; T=0.K
Alpha emission for (a,n*)2a

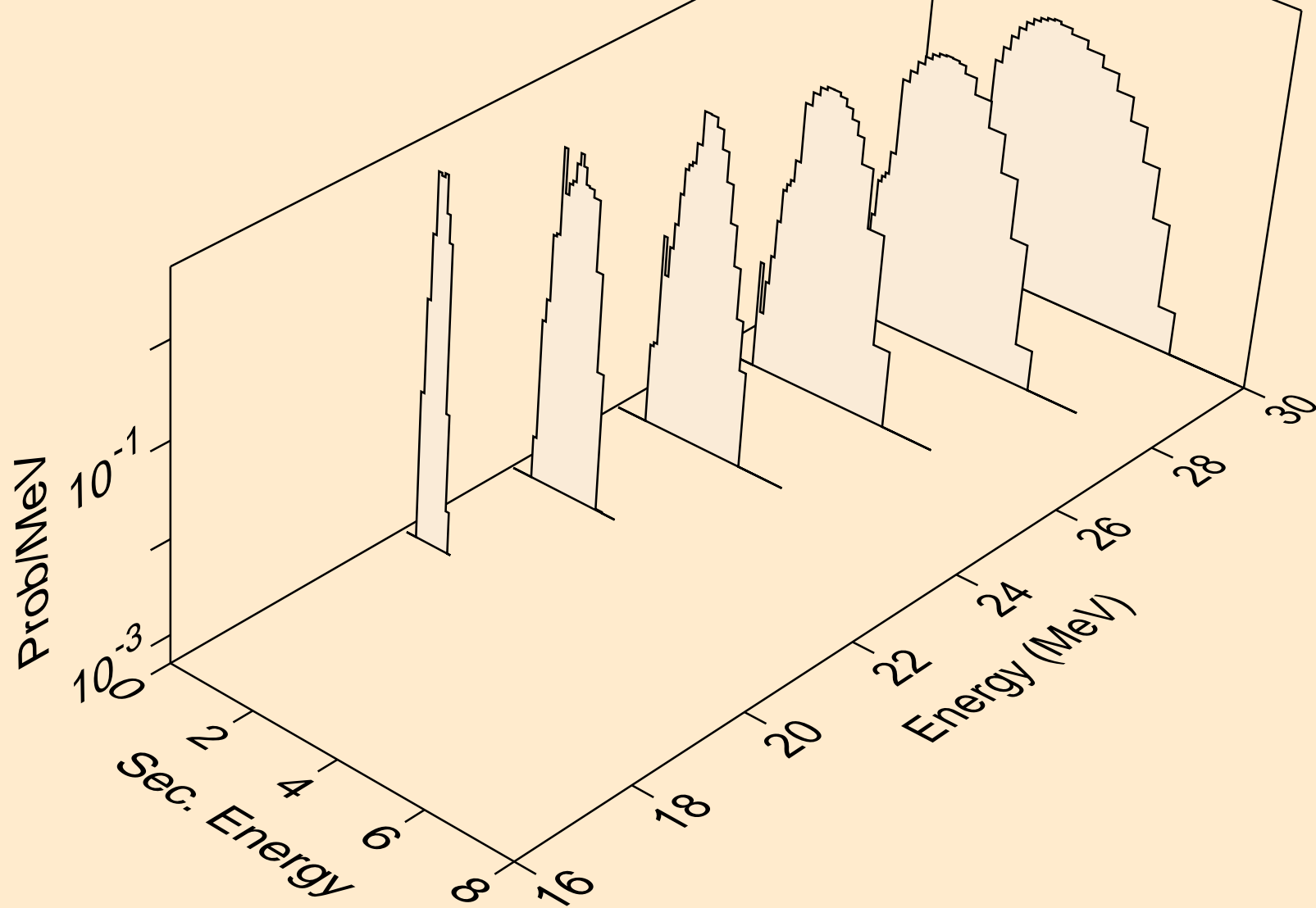

O018 ALPHA ACER TENDL-2024 LIBRARY; T=0.K
Alpha emission for inelastic

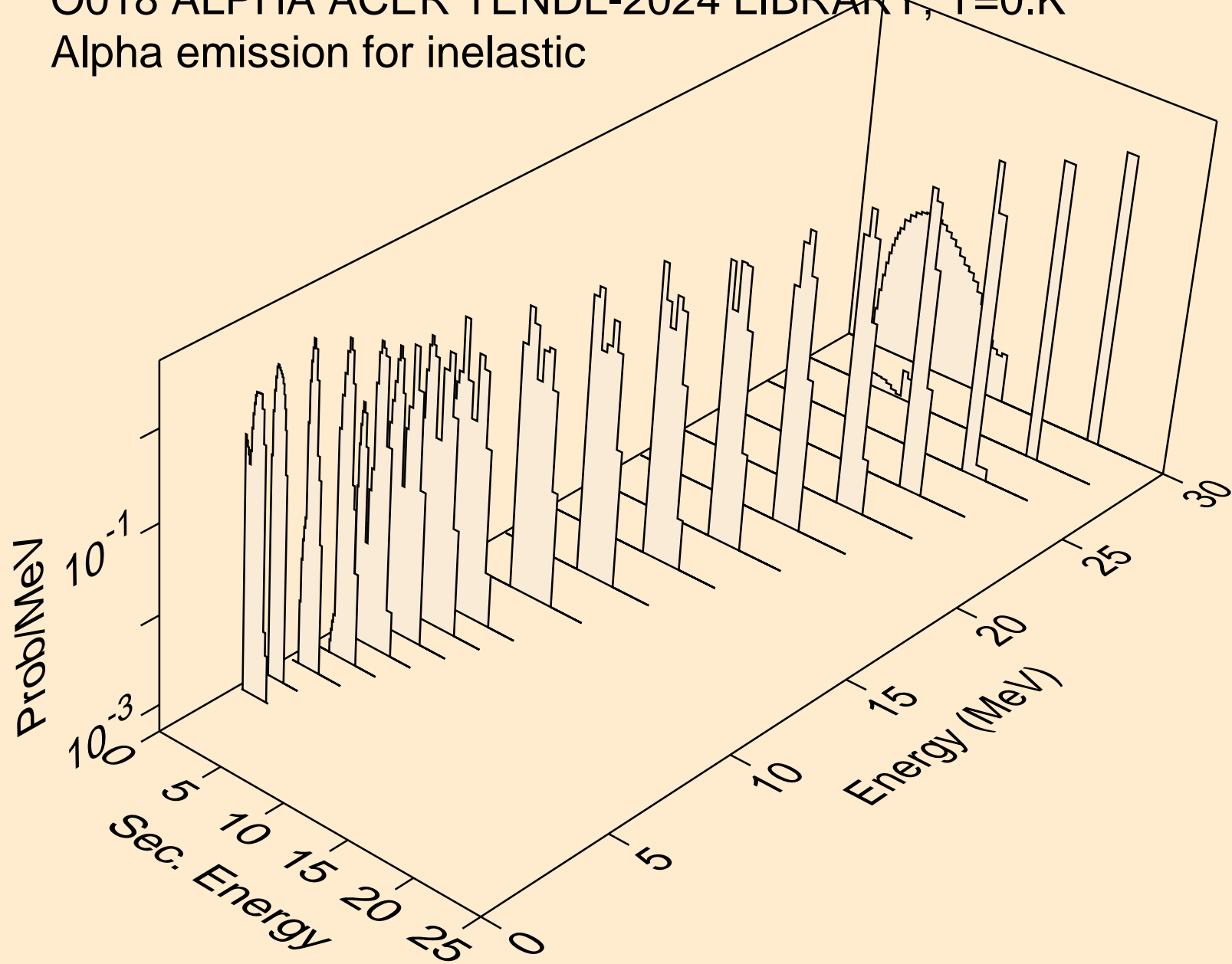

O018 ALPHA ACER TENDL-2024 LIBRARY; T=0.K
Alpha emission for (a,2a)

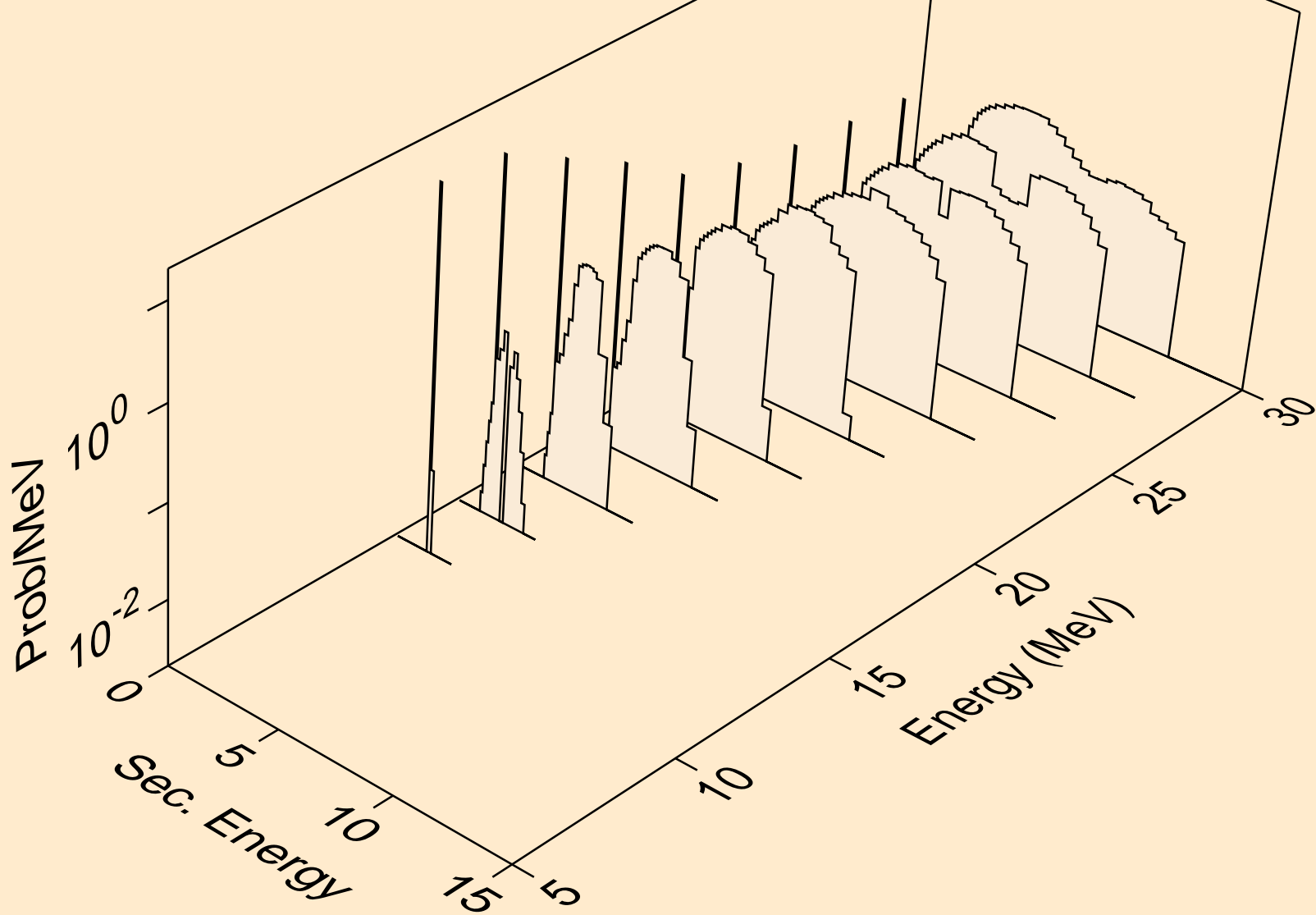

O018 ALPHA ACER TENDL-2024 LIBRARY; T=0.K
Alpha emission for (a,pa)

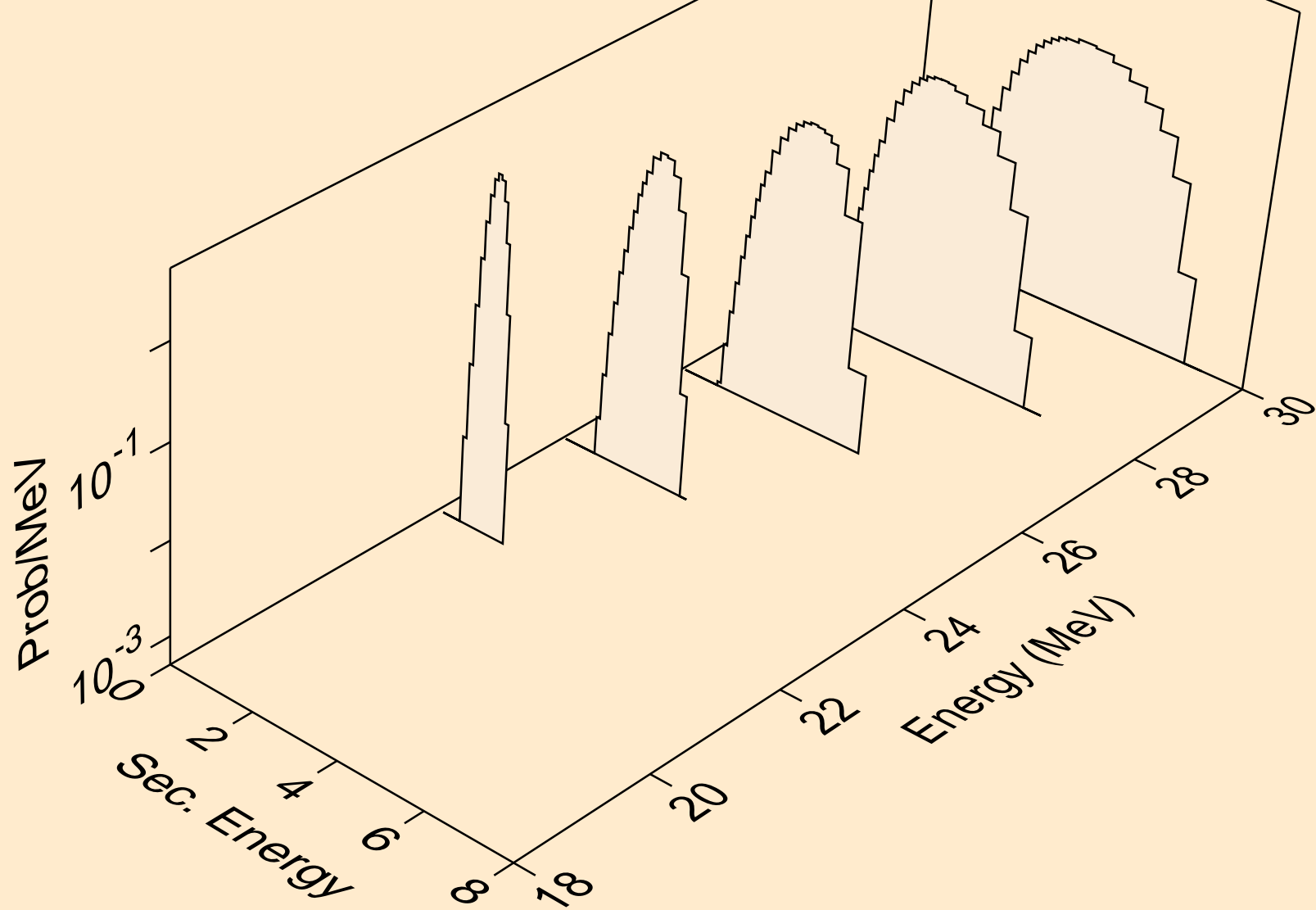

O018 ALPHA ACER TENDL-2024 LIBRARY; T=0.K
Alpha emission for (a,da)

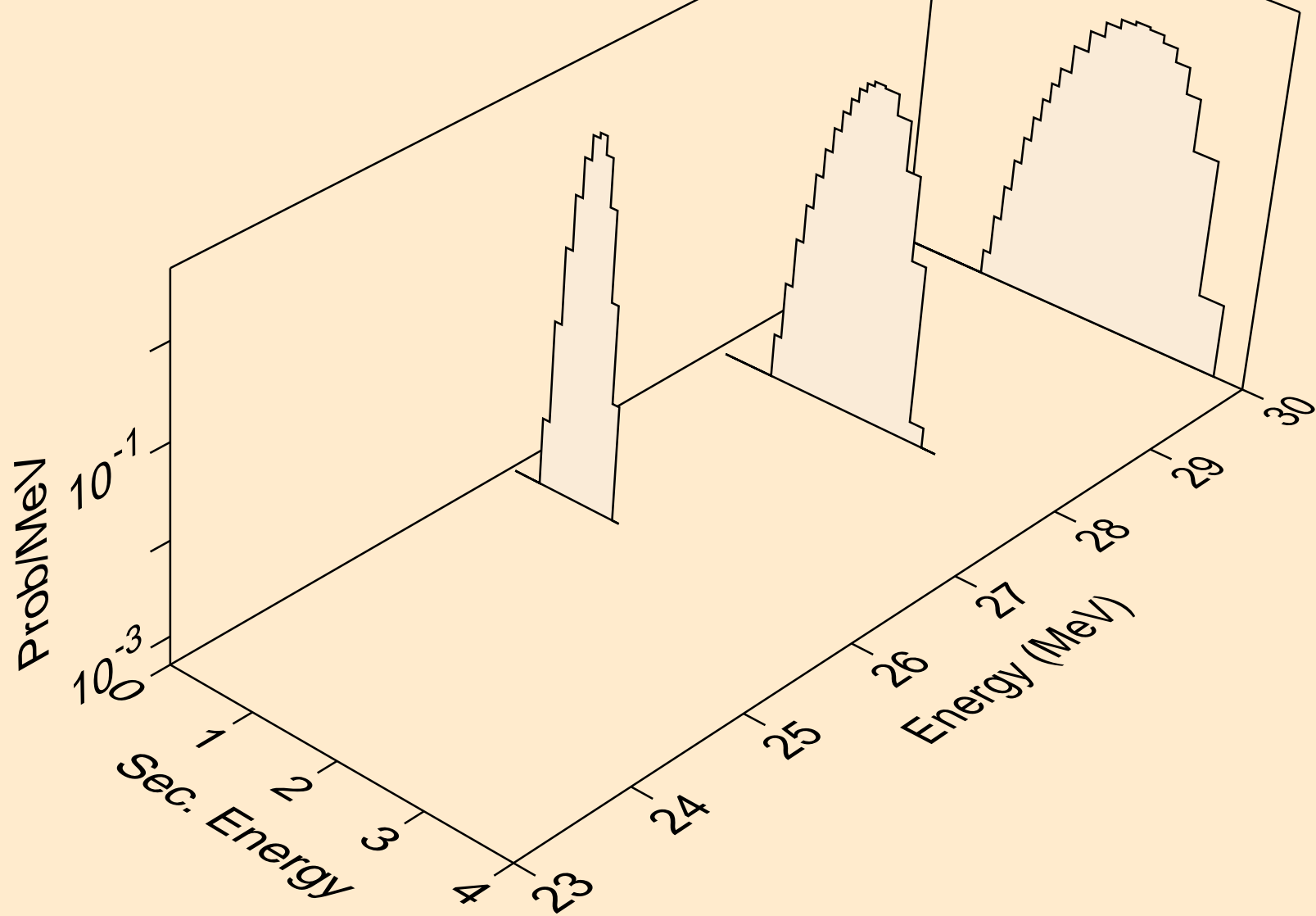

O018 ALPHA ACER TENDL-2024 LIBRARY; T=0.K
Photon emission for (z,n)

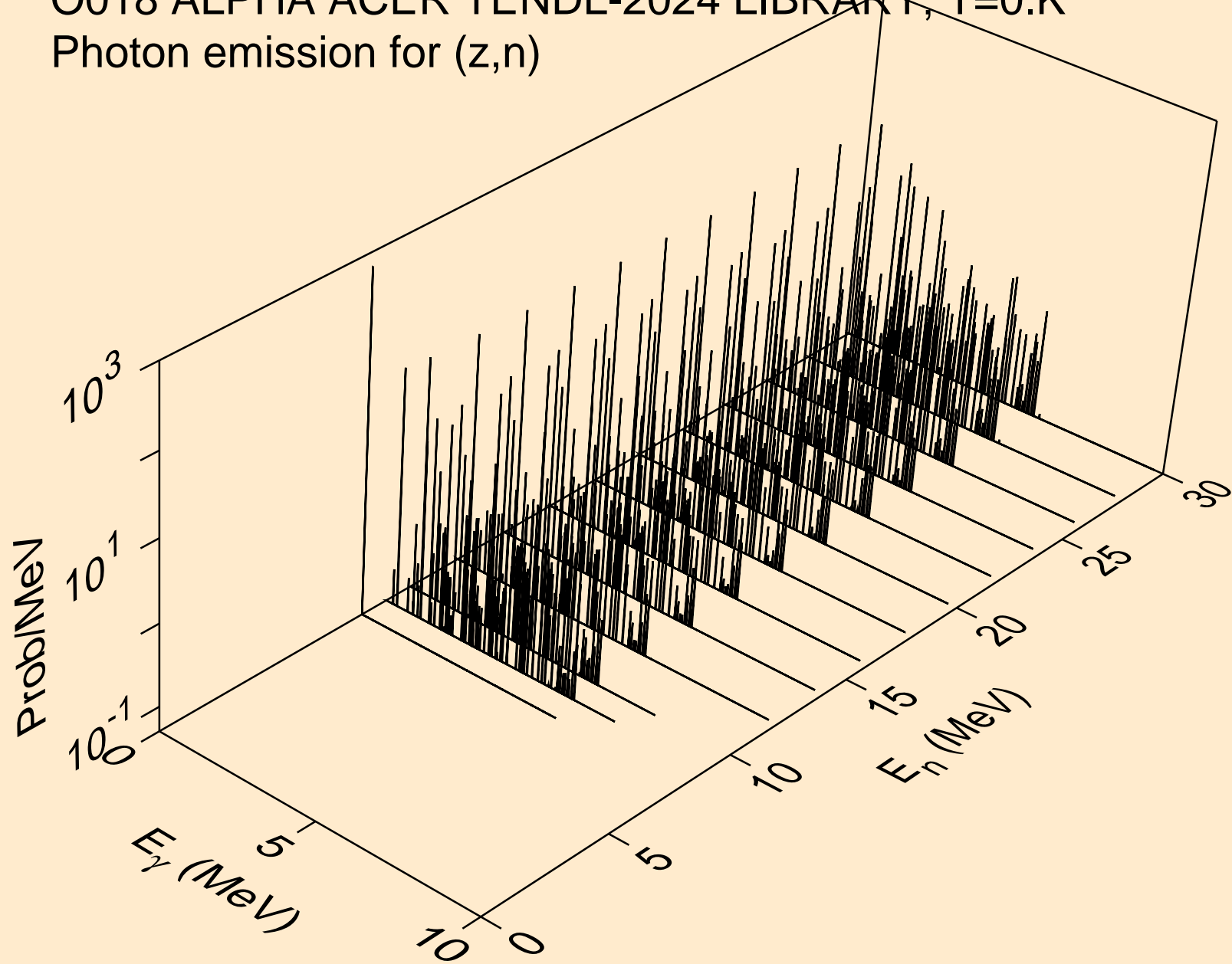

O018 ALPHA ACER TENDL-2024 LIBRARY; T=0.K
Photon emission for (z,x)

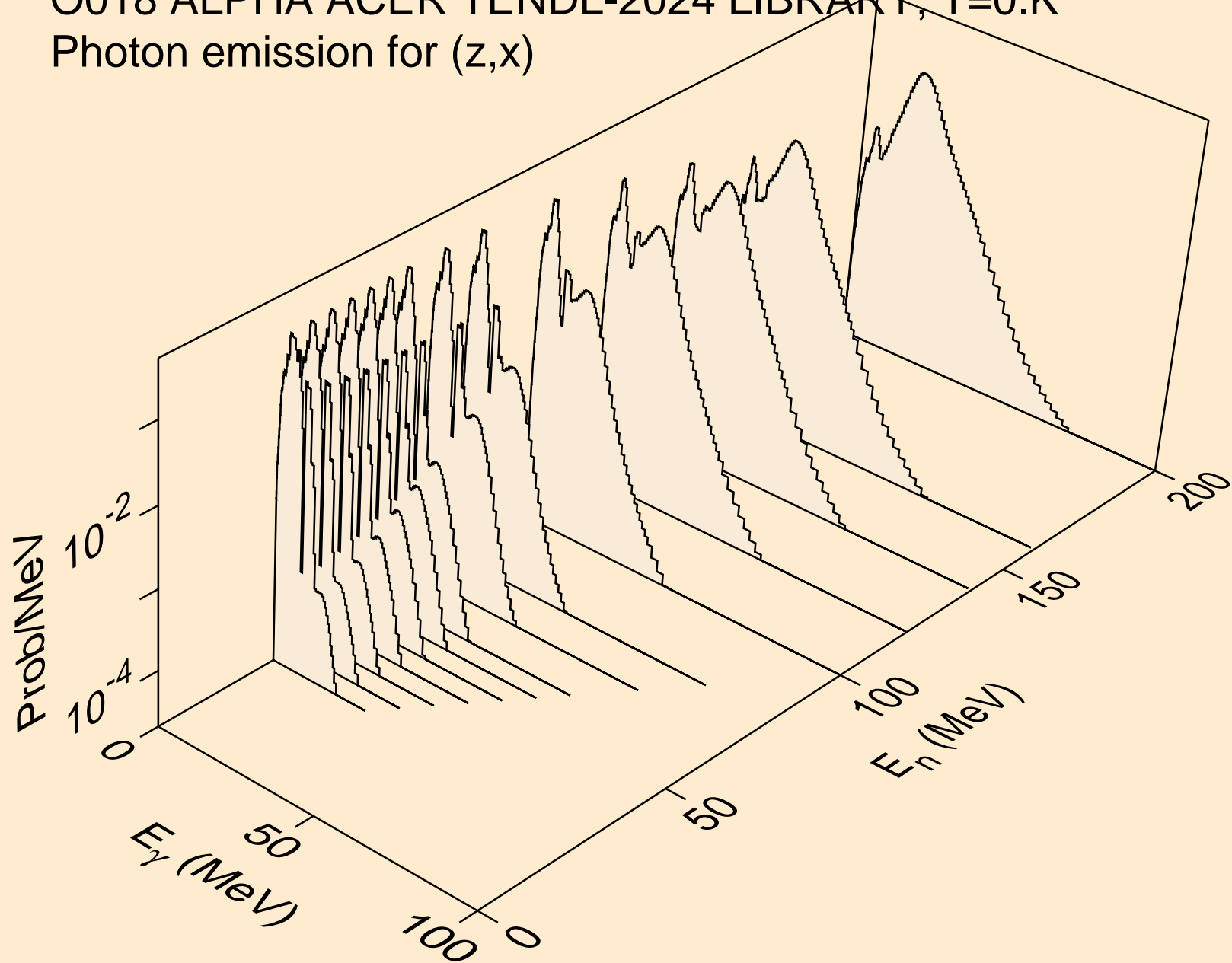

O018 ALPHA ACER TENDL-2024 LIBRARY; T=0.K
Photon emission for (n,2n)

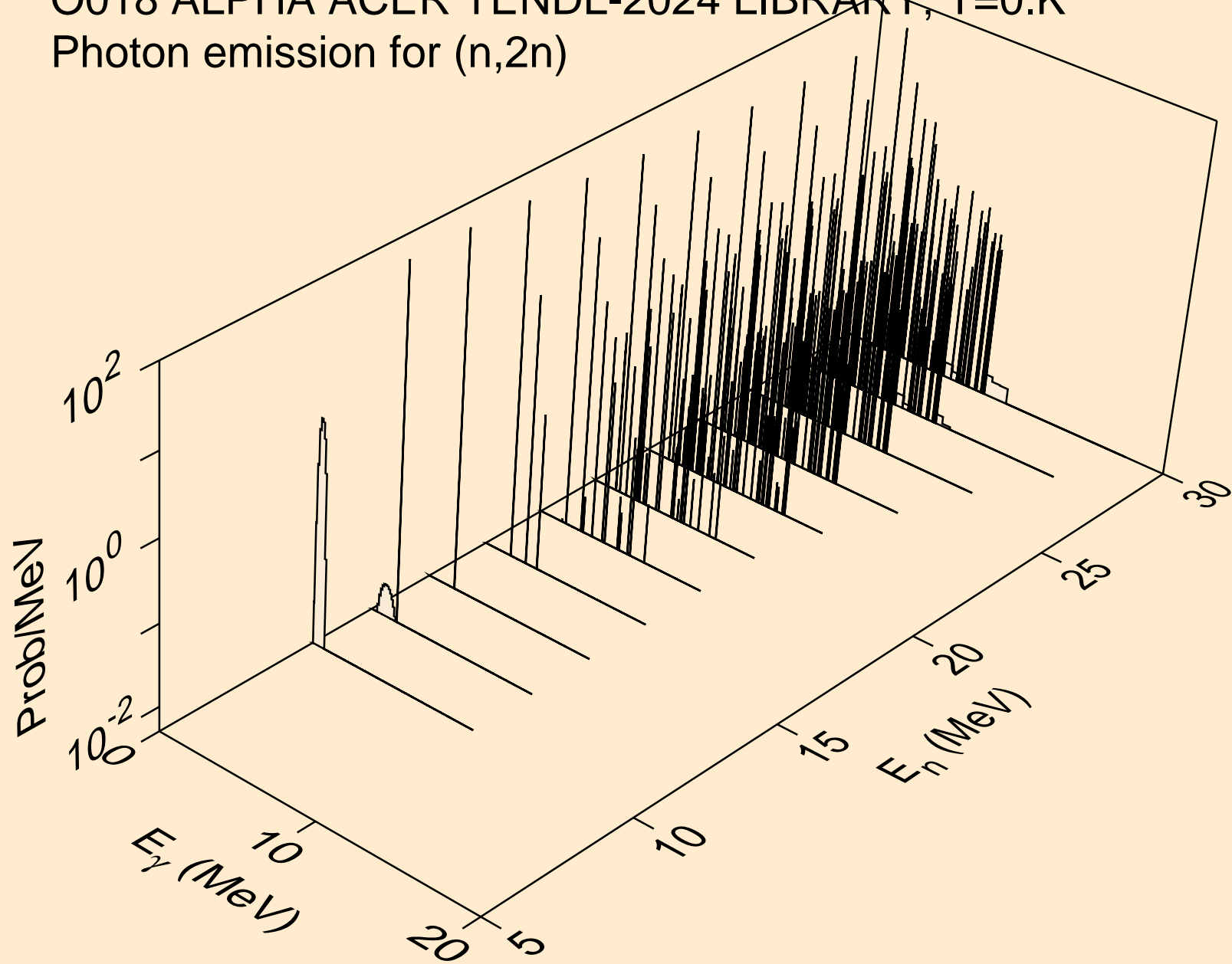

O018 ALPHA ACER TENDL-2024 LIBRARY; T=0.K
Photon emission for (n,n*)a

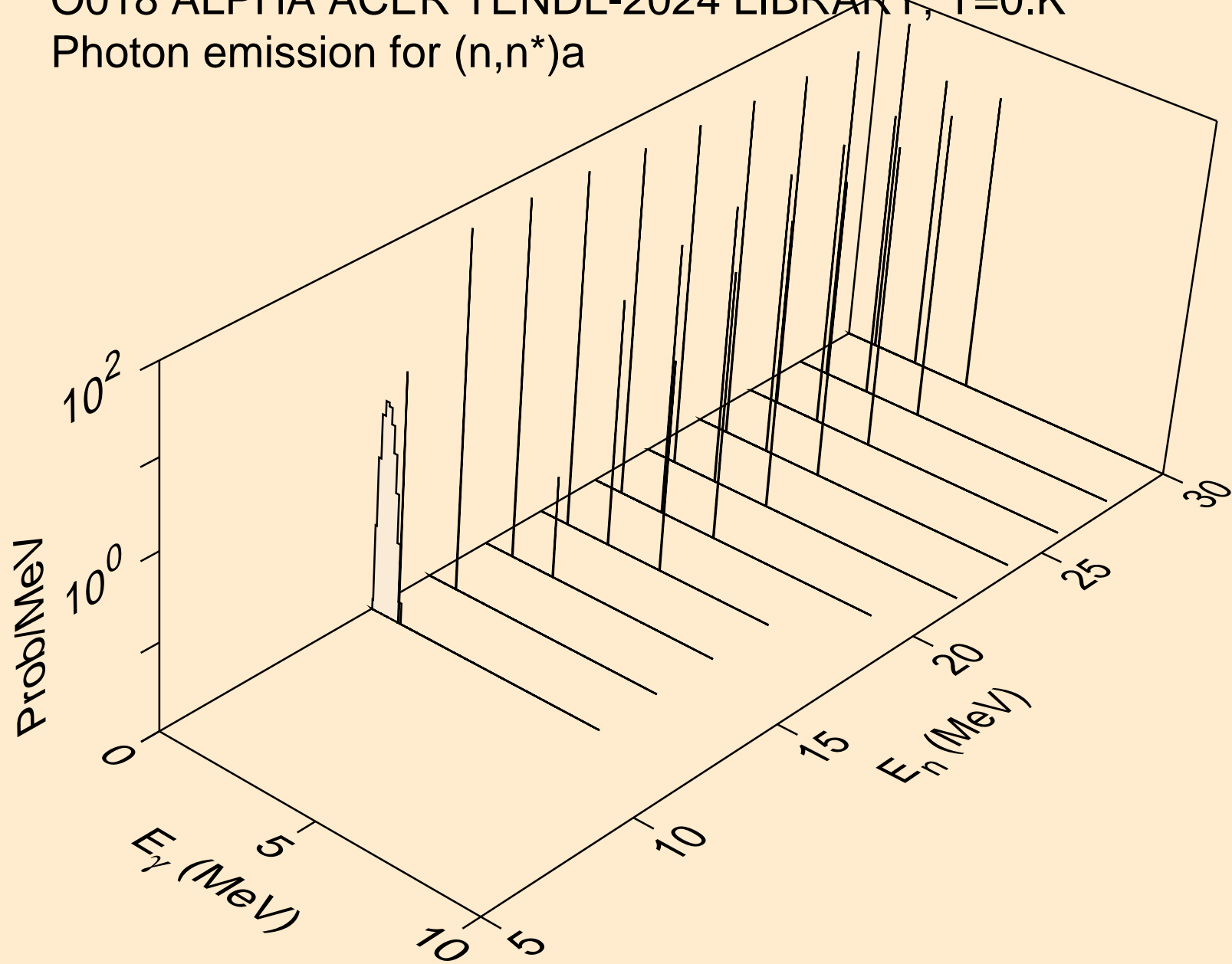

O018 ALPHA ACER TENDL-2024 LIBRARY; T=0.K
Photon emission for (n,2n)a

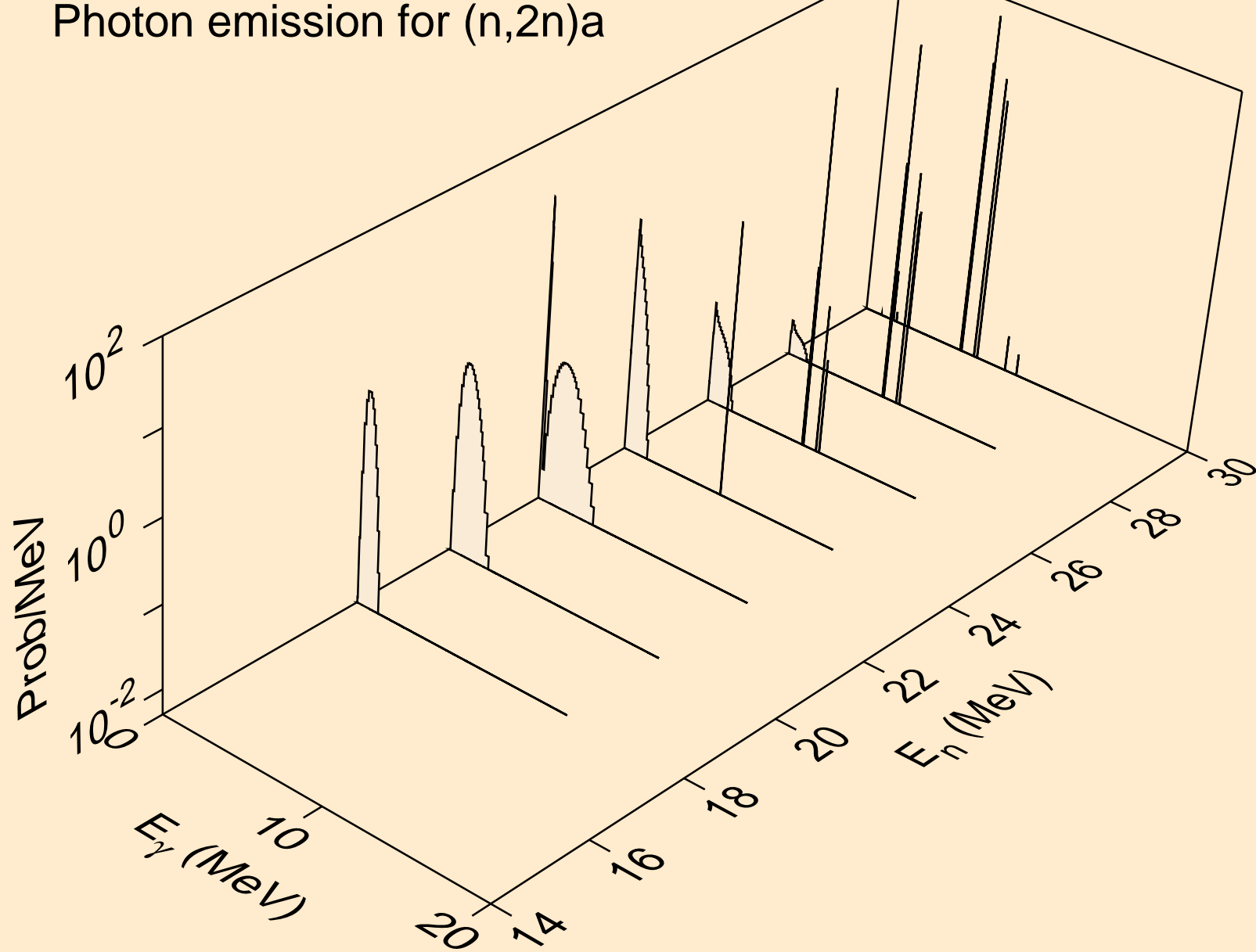

O018 ALPHA ACER TENDL-2024 LIBRARY; T=0.K
Photon emission for (n,n*)p

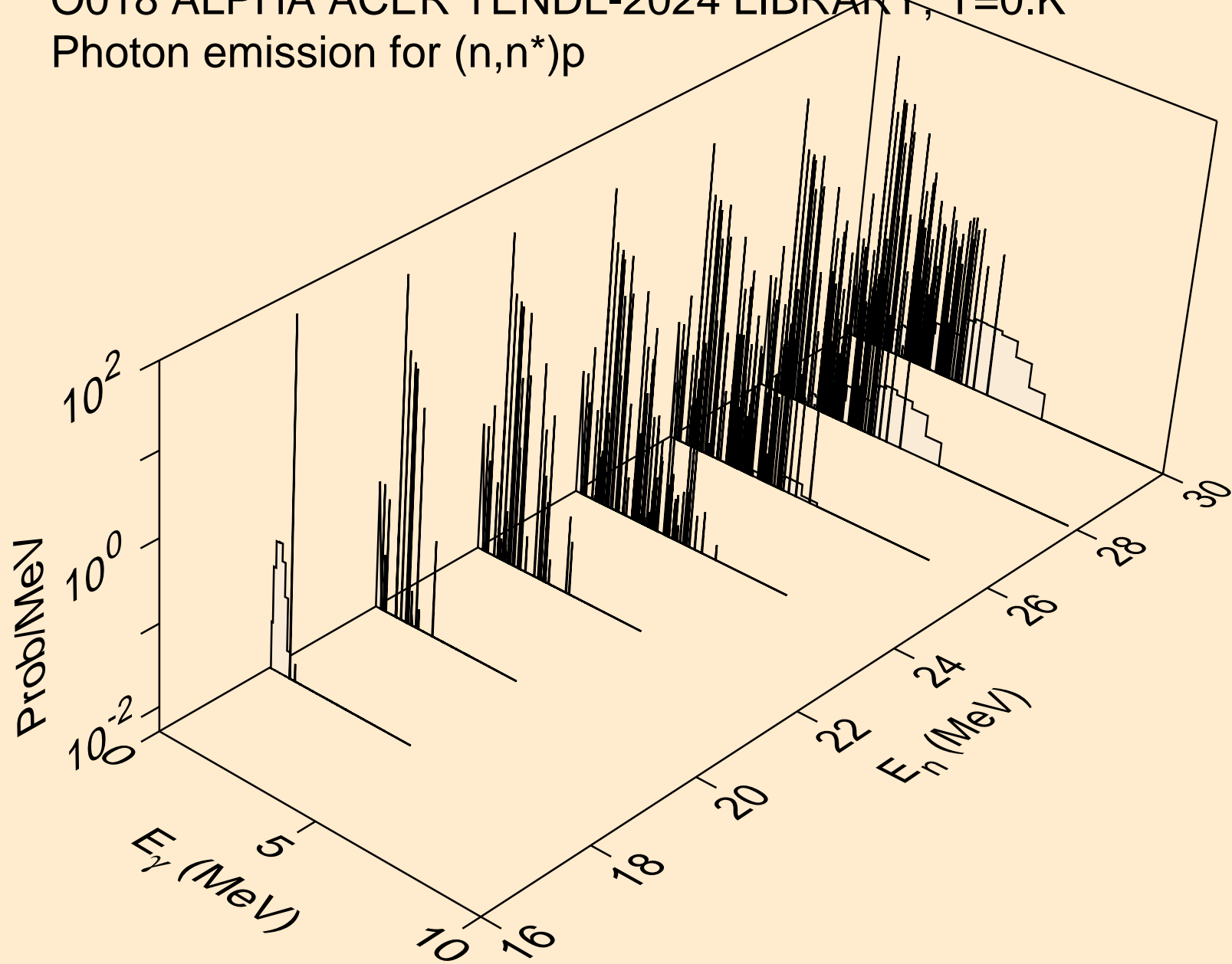

O018 ALPHA ACER TENDL-2024 LIBRARY; T=0.K
Photon emission for (n,n*)2a

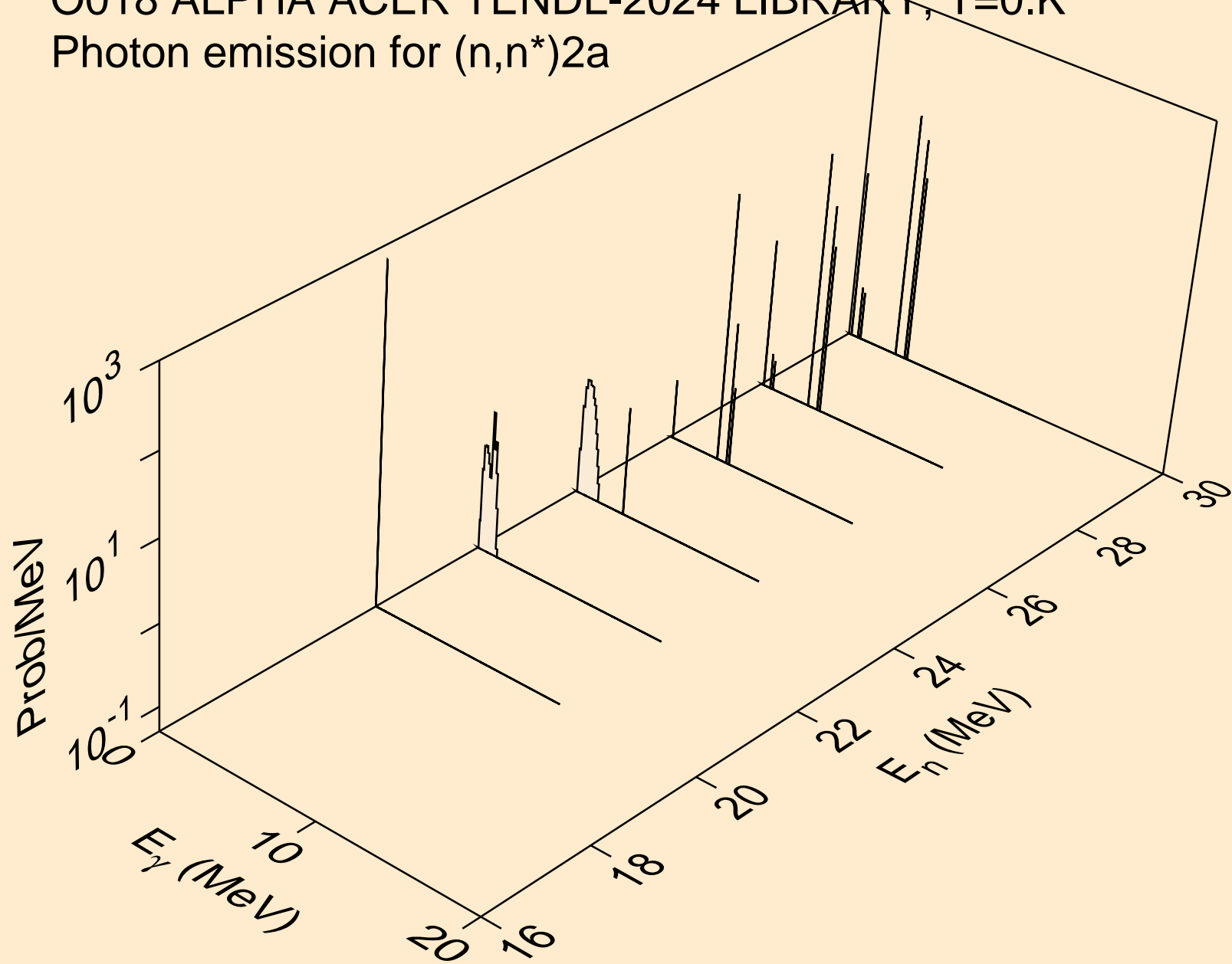

O018 ALPHA ACER TENDL-2024 LIBRARY; T=0.K
Photon emission for (n,n*)d

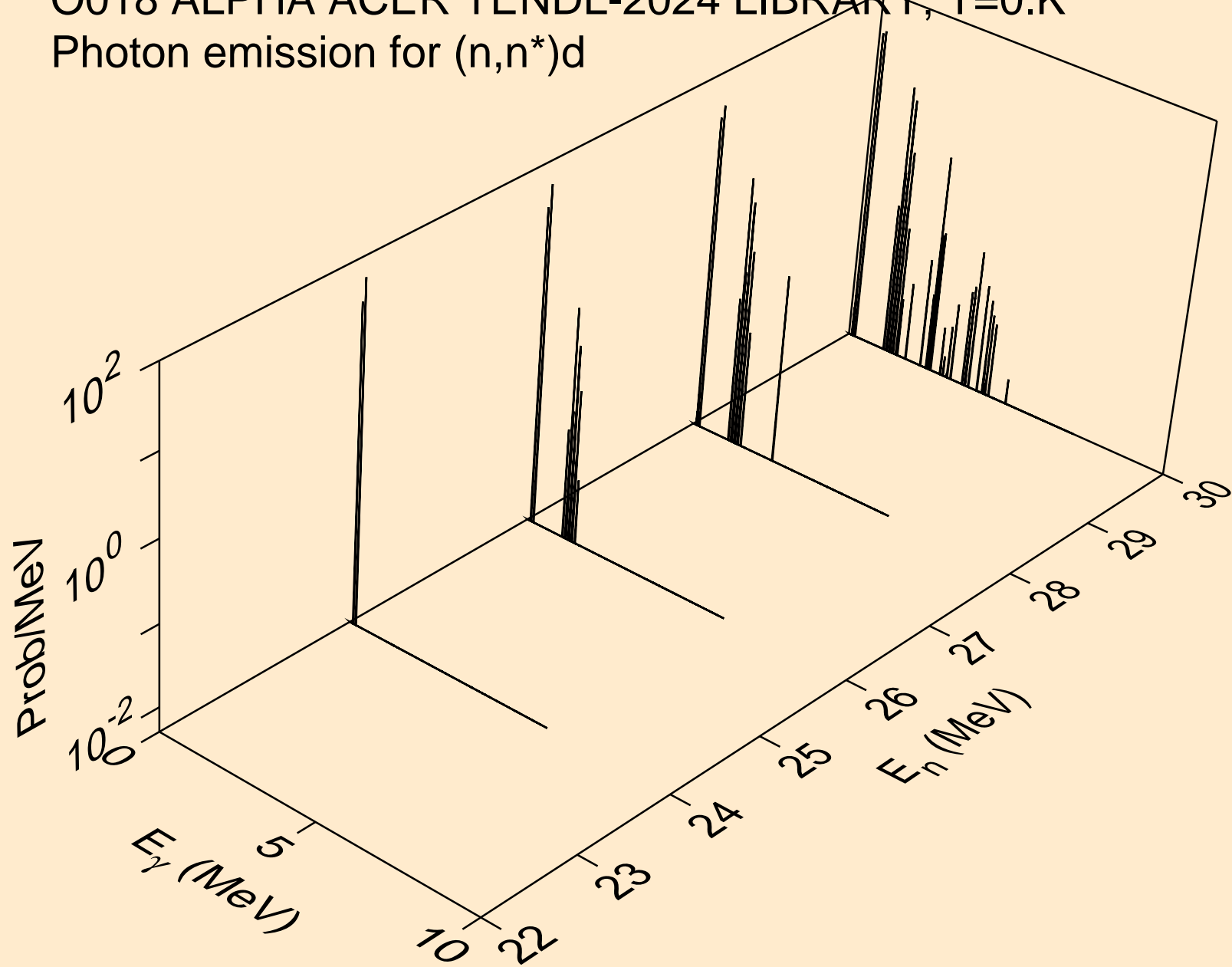

O018 ALPHA ACER TENDL-2024 LIBRARY; T=0.K
Photon emission for (n,n*)t

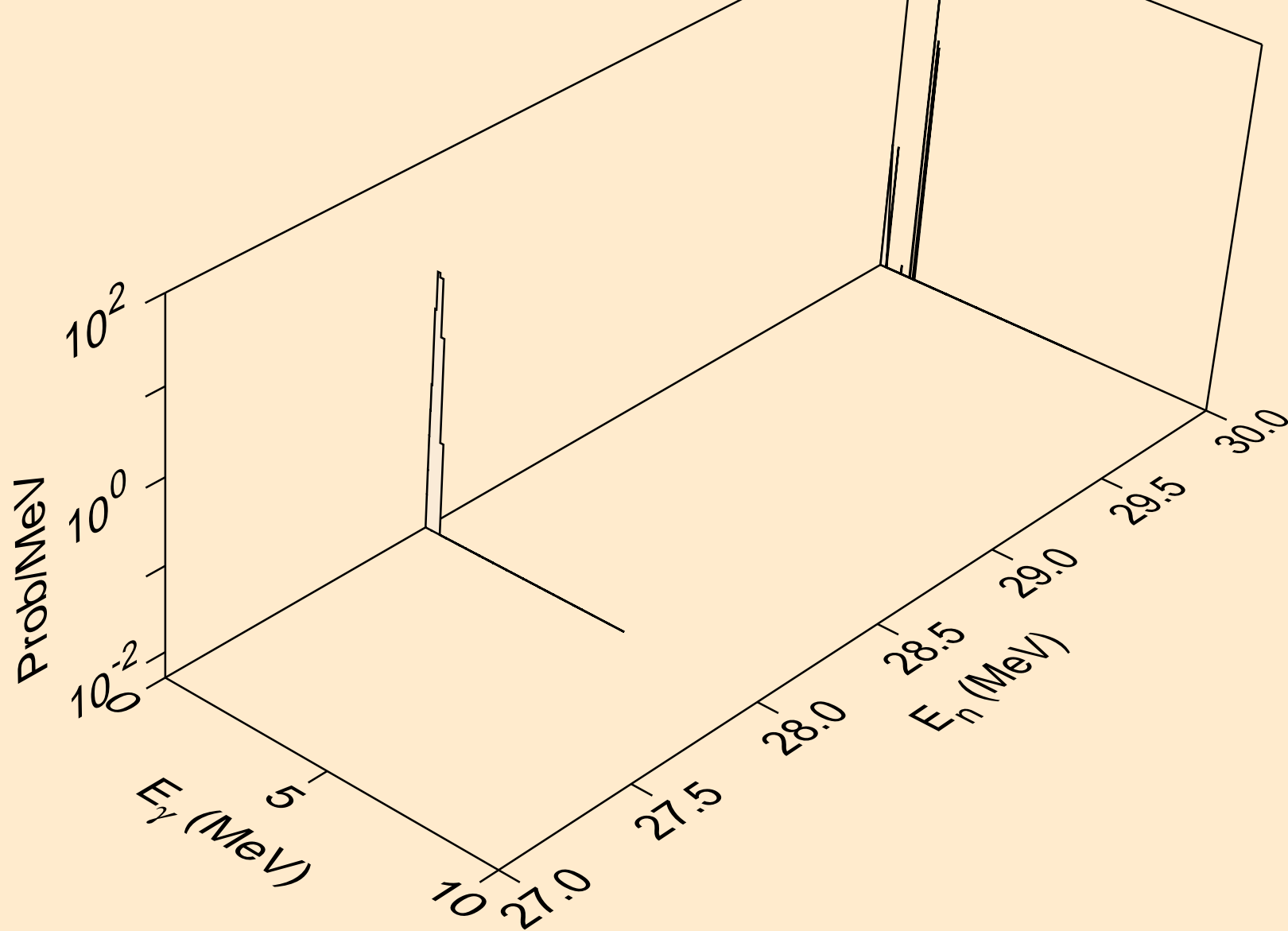

O018 ALPHA ACER TENDL-2024 LIBRARY; T=0.K
Photon emission for (n,n*)he3

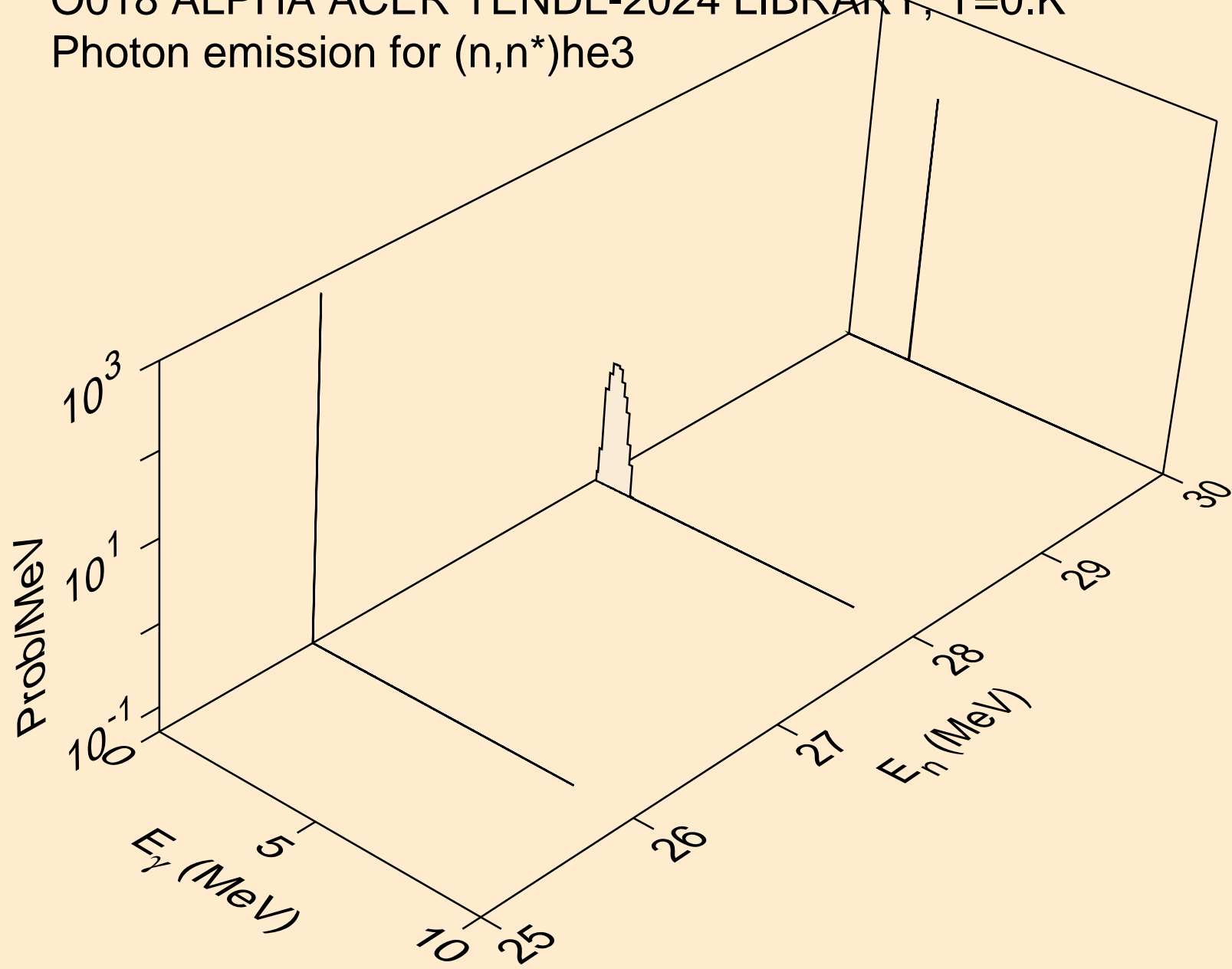

O018 ALPHA ACER TENDL-2024 LIBRARY; T=0.K
Photon emission for (n,2np)

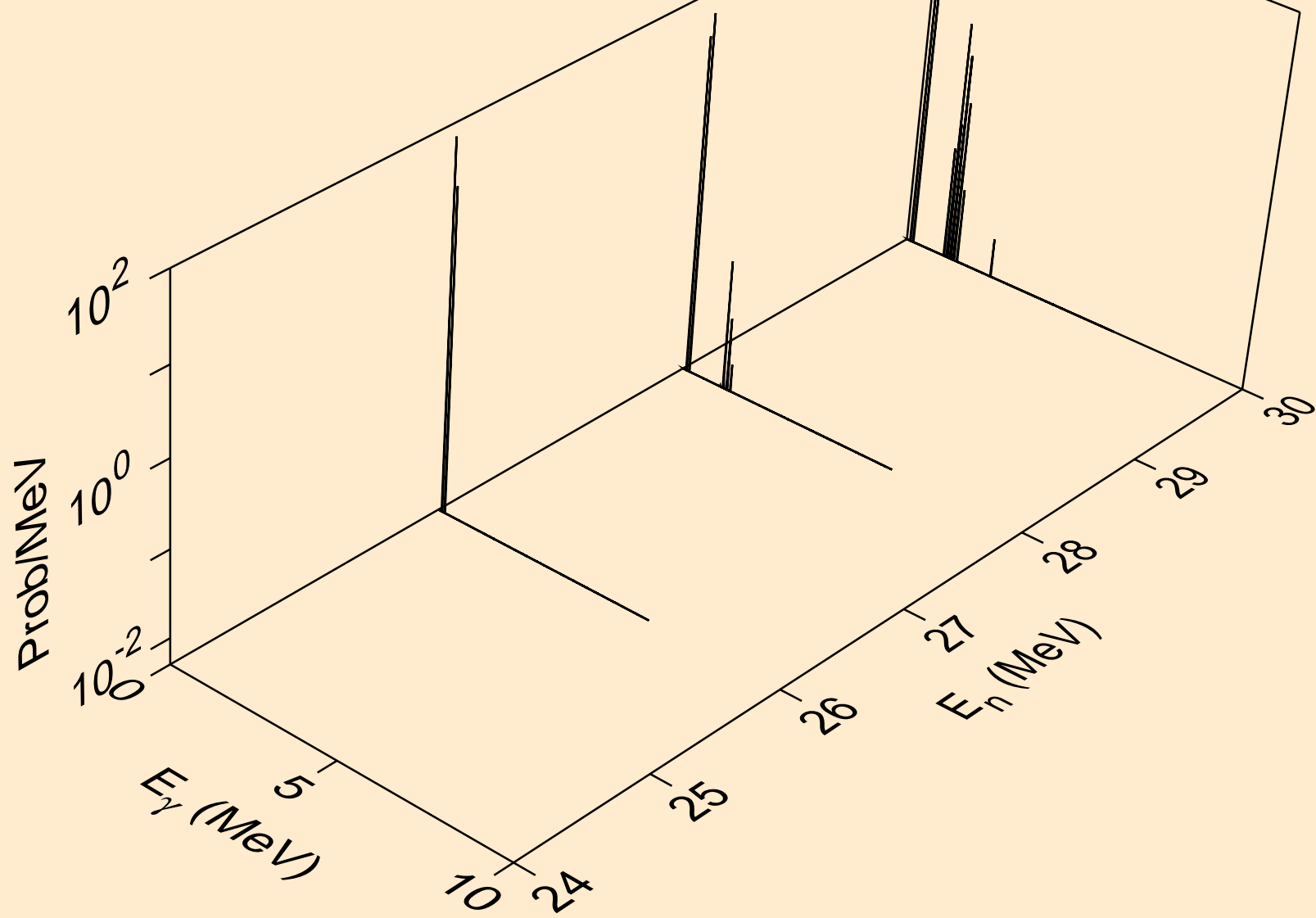

O018 ALPHA ACER TENDL-2024 LIBRARY; T=0.K
Photon emission for (n,npa)

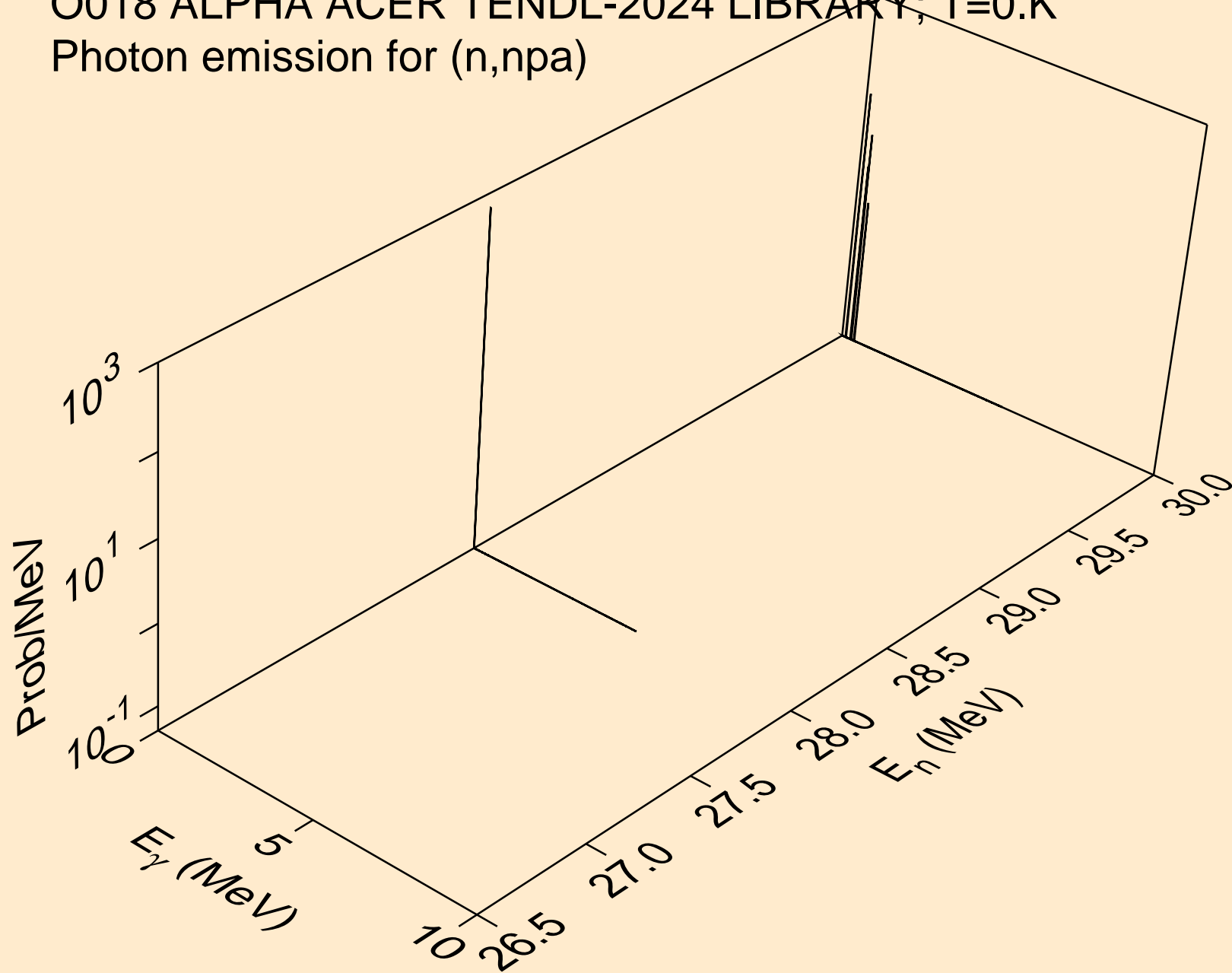

O018 ALPHA ACER TENDL-2024 LIBRARY; T=0.K
Photon emission for (n,gma)

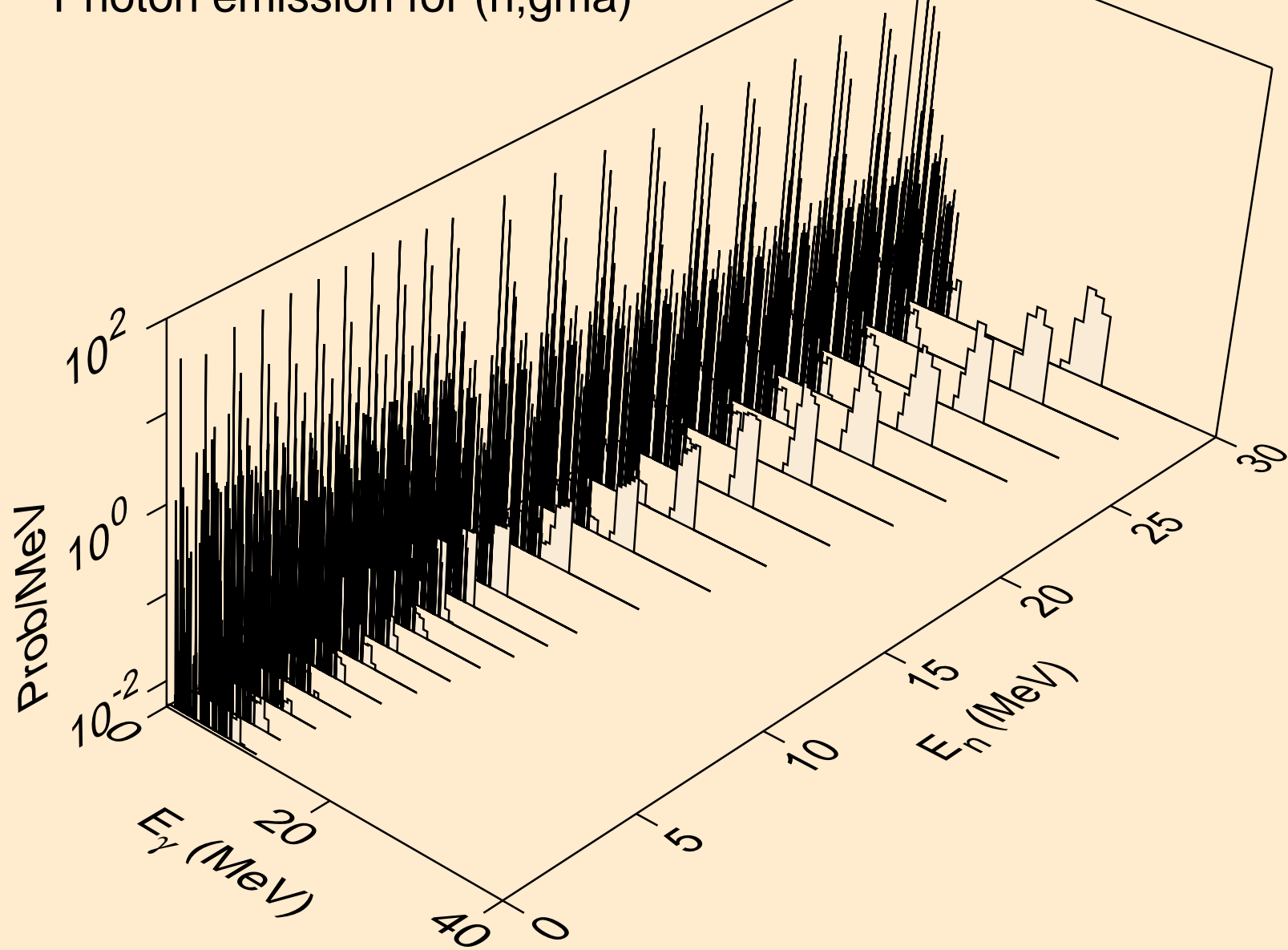

O018 ALPHA ACER TENDL-2024 LIBRARY; T=0.K
Photon emission for (n,p)

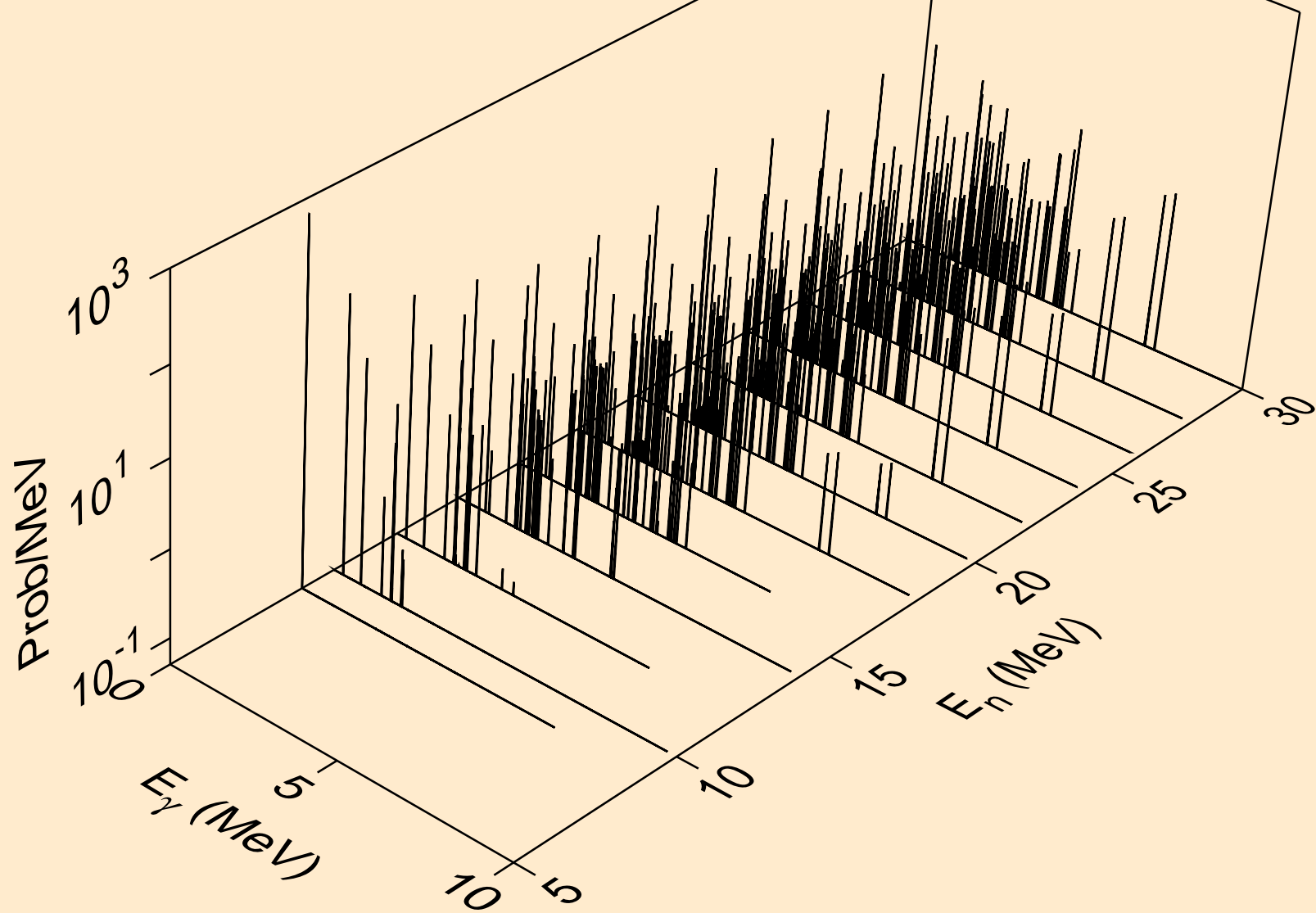

O018 ALPHA ACER TENDL-2024 LIBRARY; T=0.K
Photon emission for (n,d)

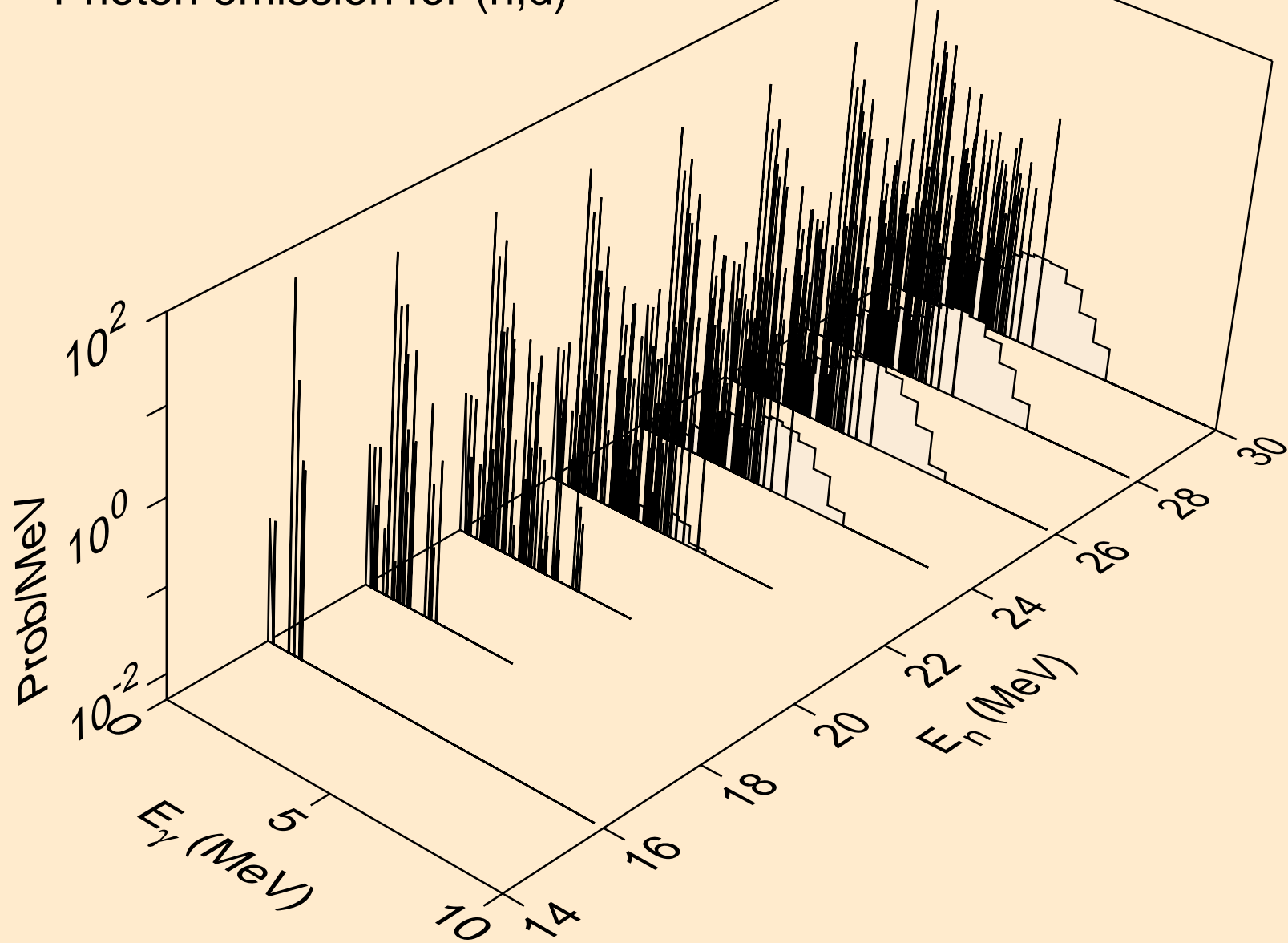

O018 ALPHA ACER TENDL-2024 LIBRARY; T=0.K
Photon emission for (n,t)

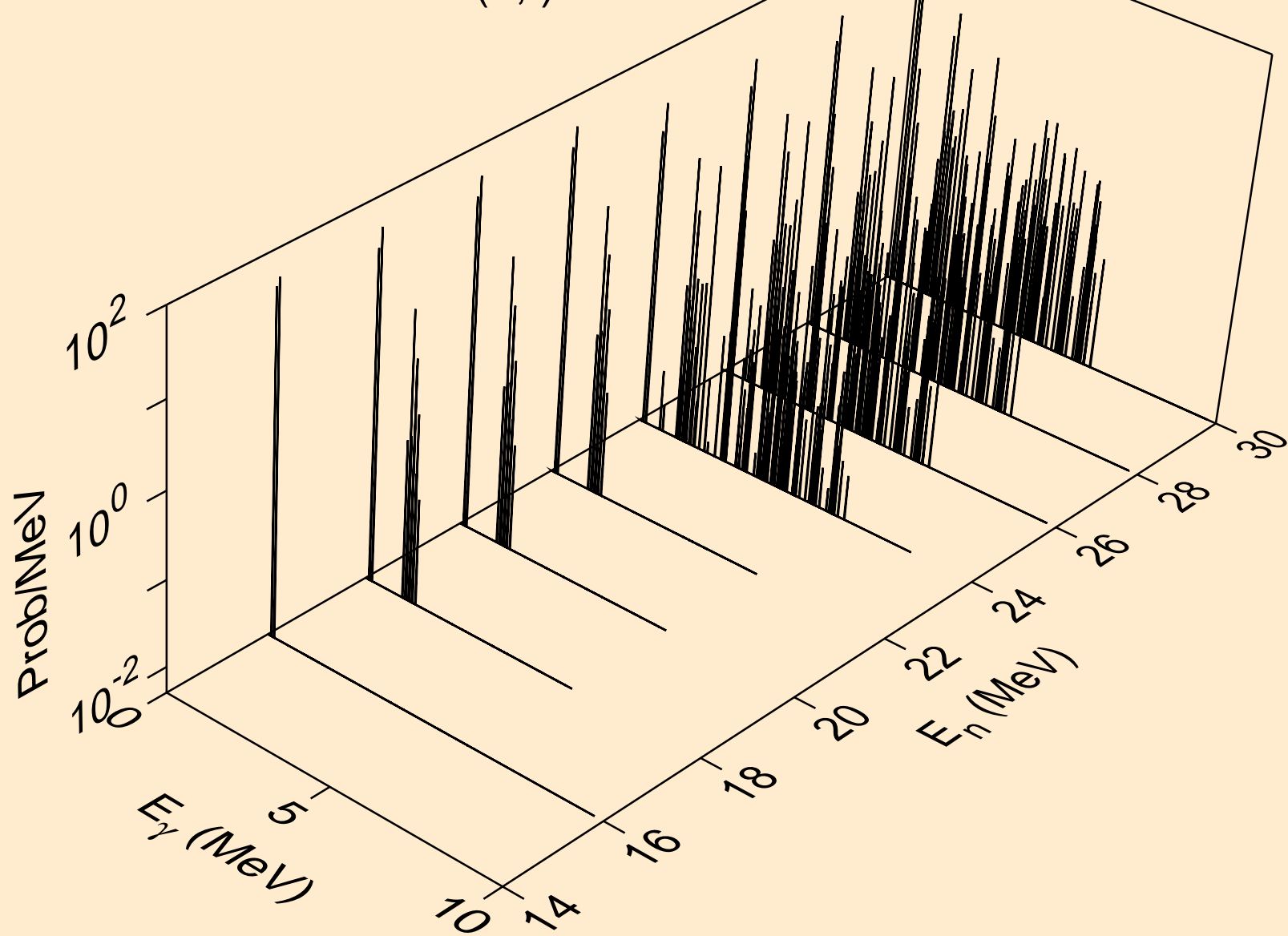

O018 ALPHA ACER TENDL-2024 LIBRARY; T=0.K
Photon emission for (n,he3)

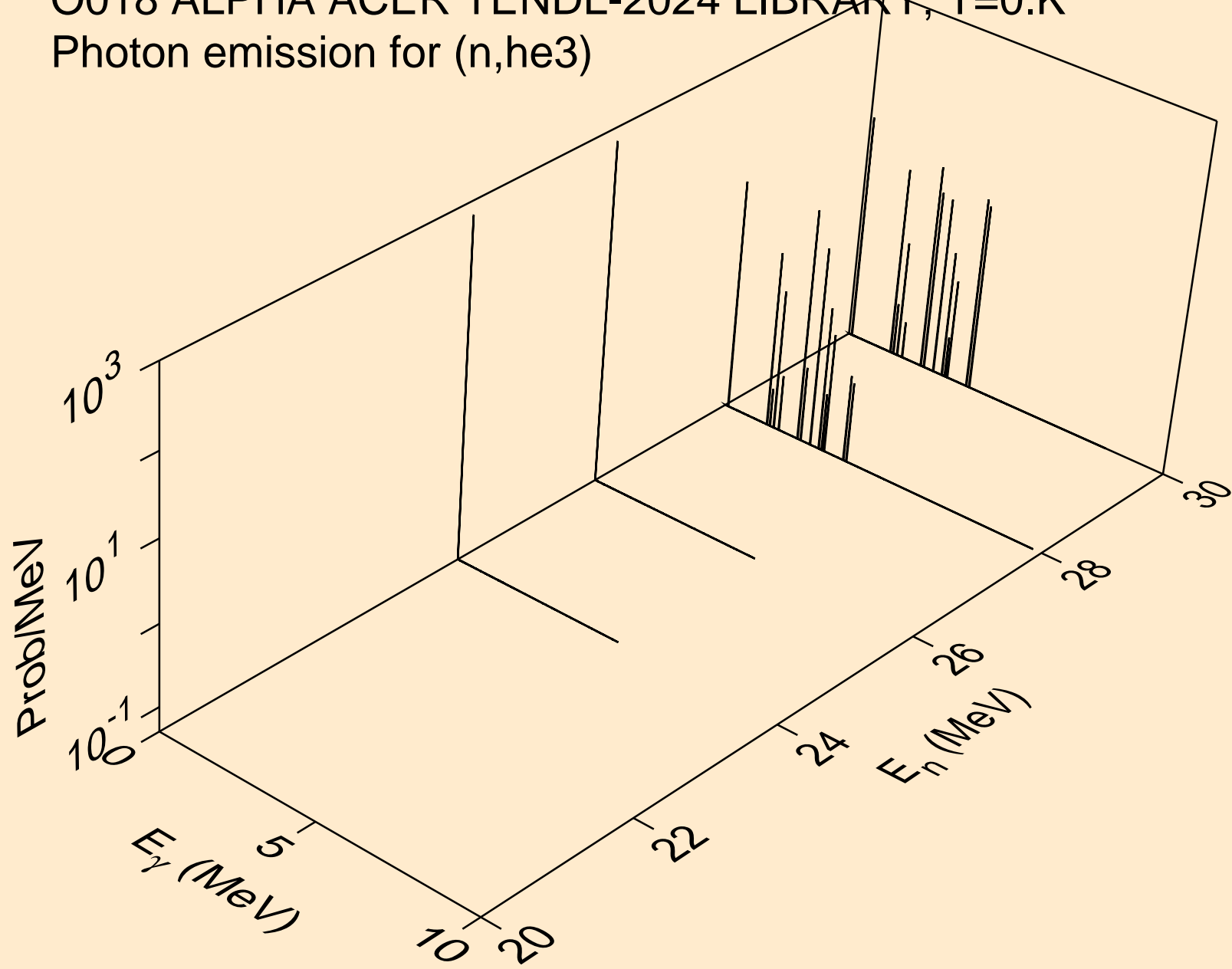

O018 ALPHA ACER TENDL-2024 LIBRARY; T=0.K
Photon emission for inelastic

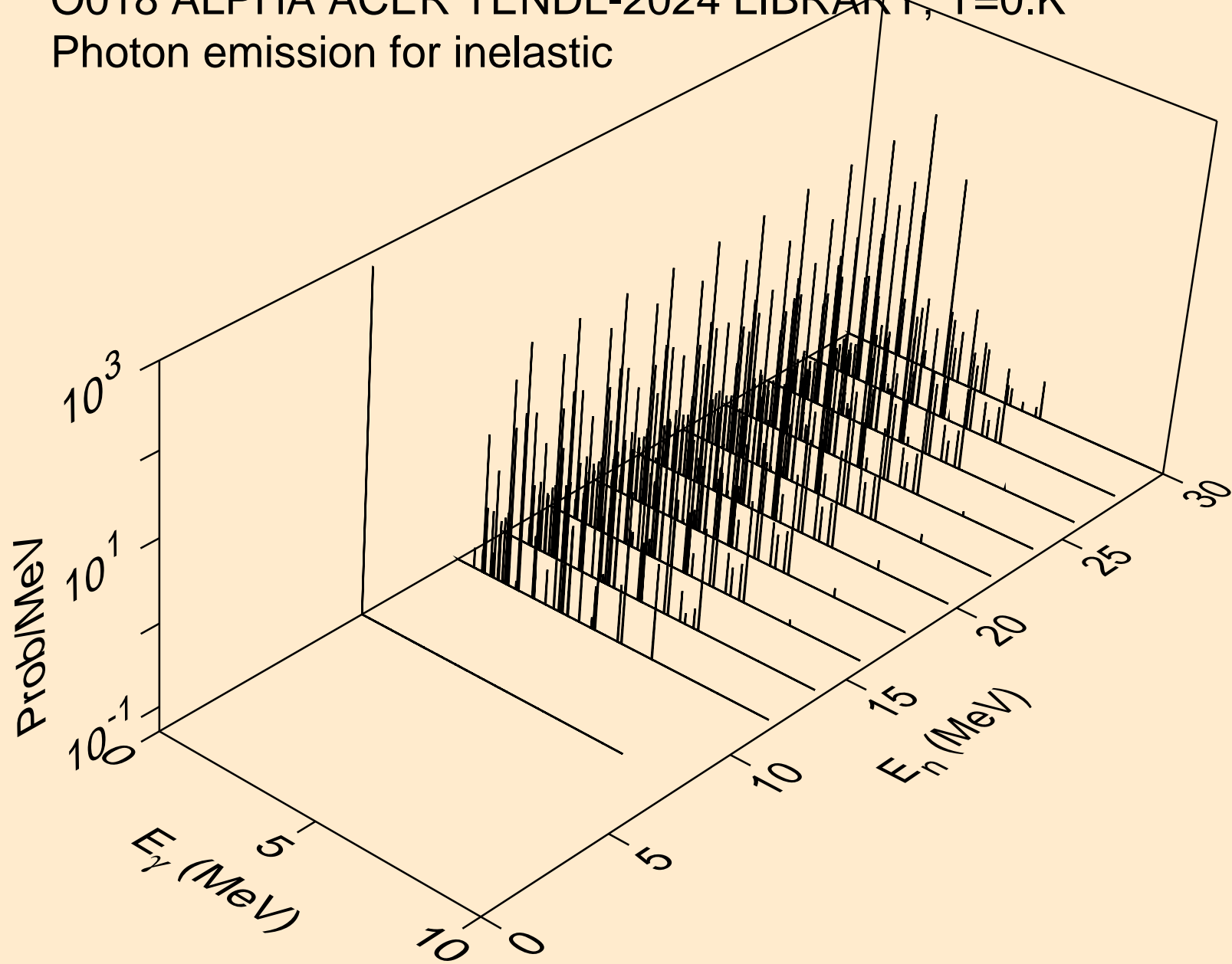

O018 ALPHA ACER TENDL-2024 LIBRARY; T=0.K
Photon emission for (n,2a)

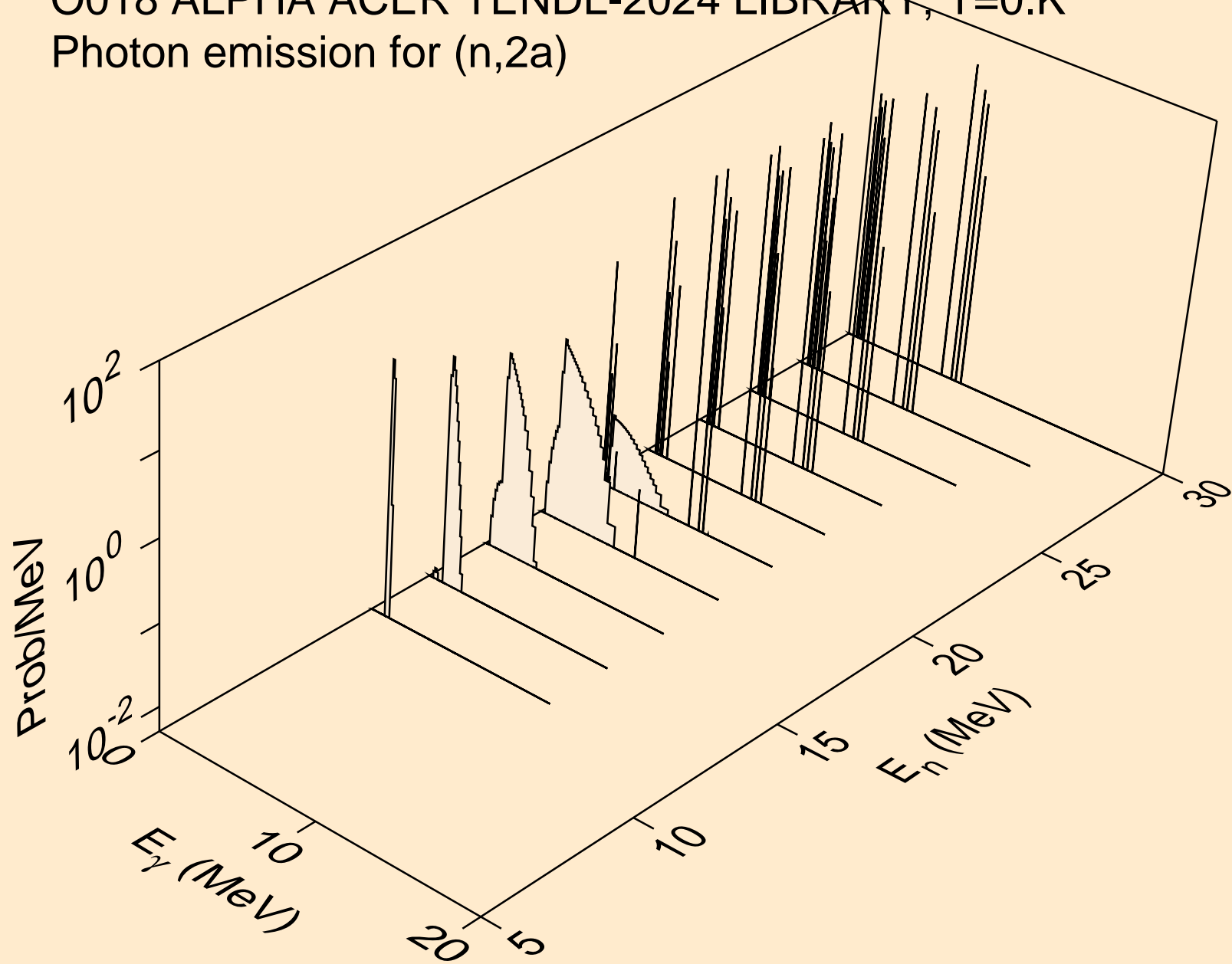

O018 ALPHA ACER TENDL-2024 LIBRARY; T=0.K
Photon emission for (n,2p)

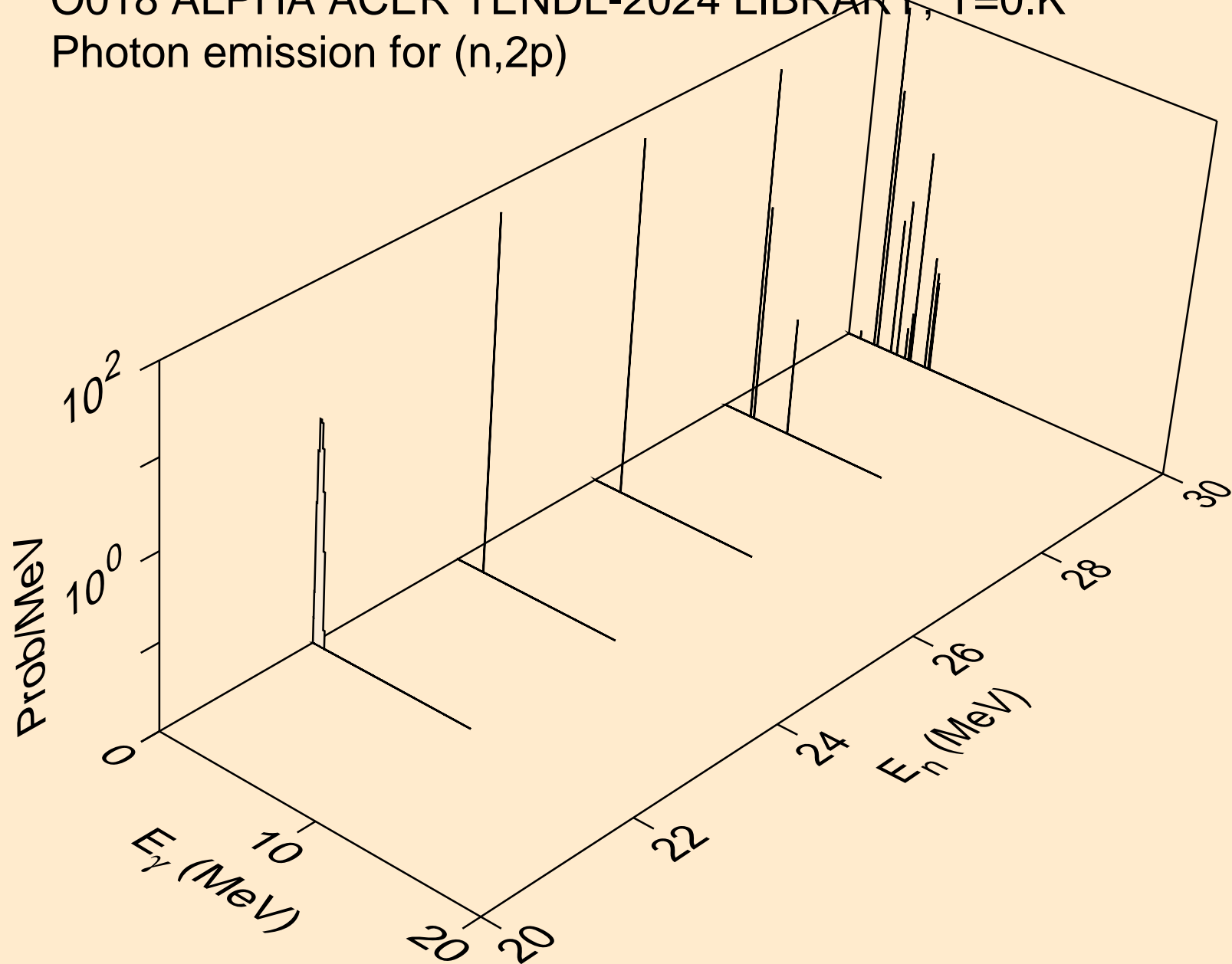

O018 ALPHA ACER TENDL-2024 LIBRARY; T=0.K
Photon emission for (n,pa)

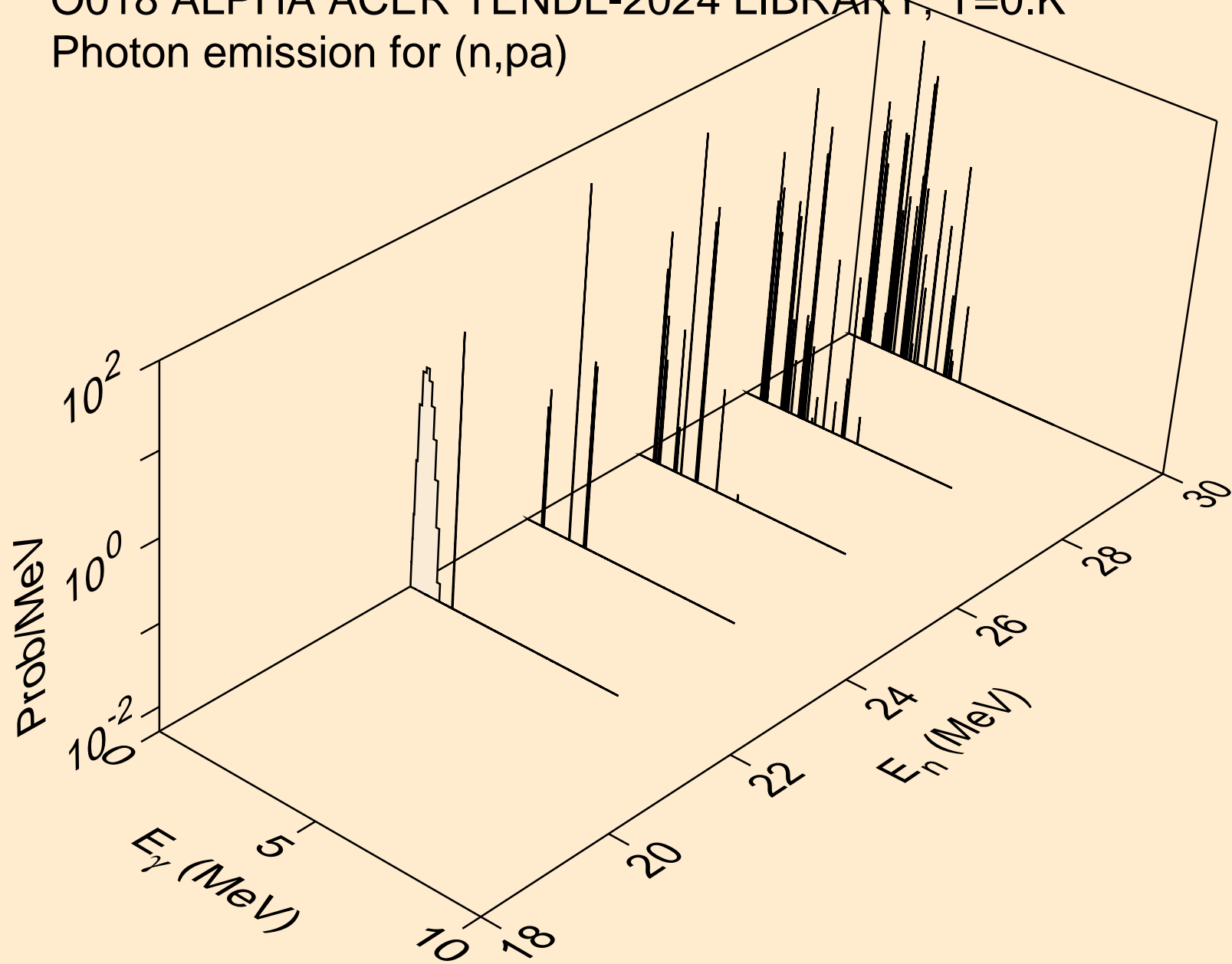

O018 ALPHA ACER TENDL-2024 LIBRARY; T=0.K
Photon emission for (n,pd)

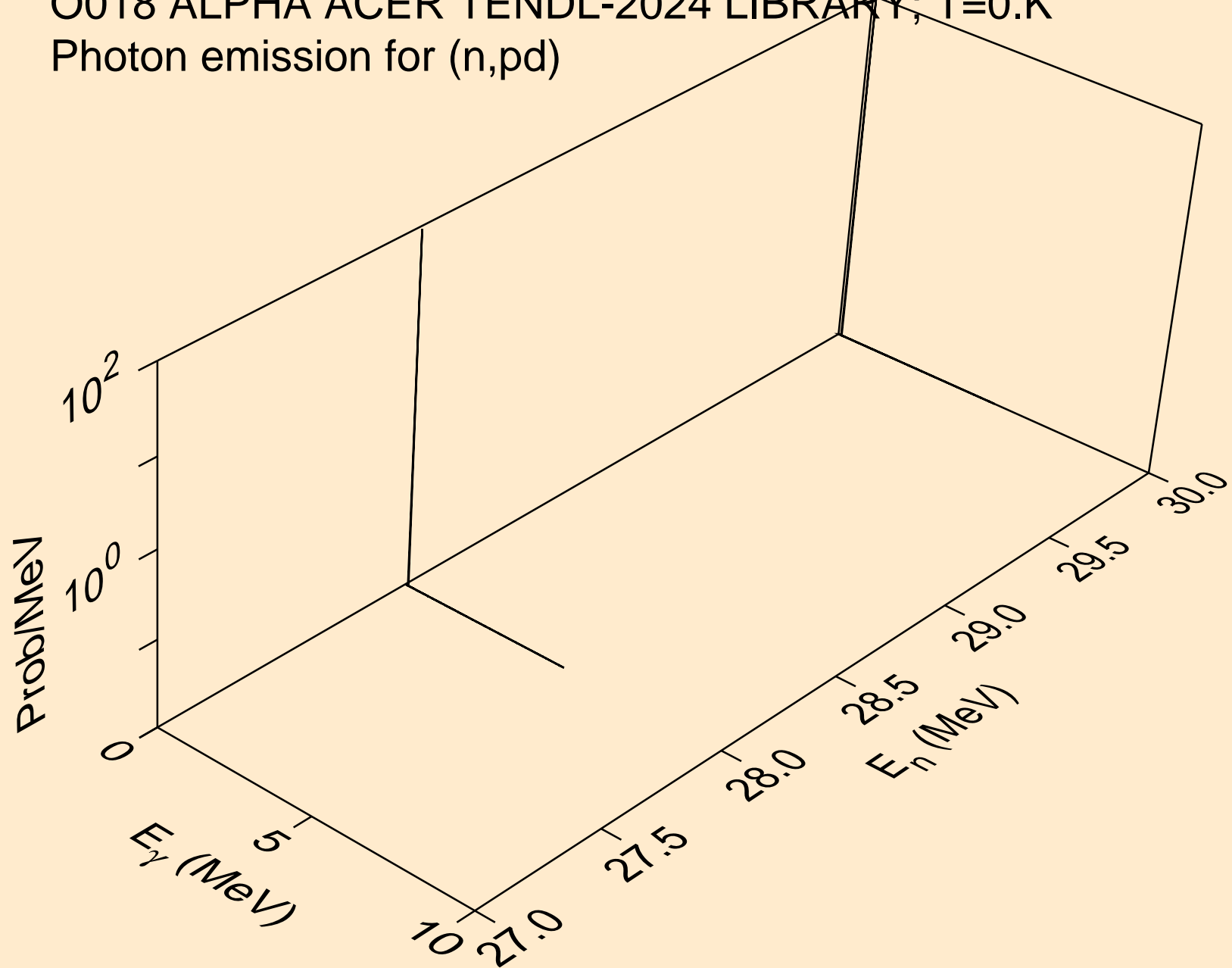

O018 ALPHA ACER TENDL-2024 LIBRARY; T=0.K
Photon emission for (n,pt)

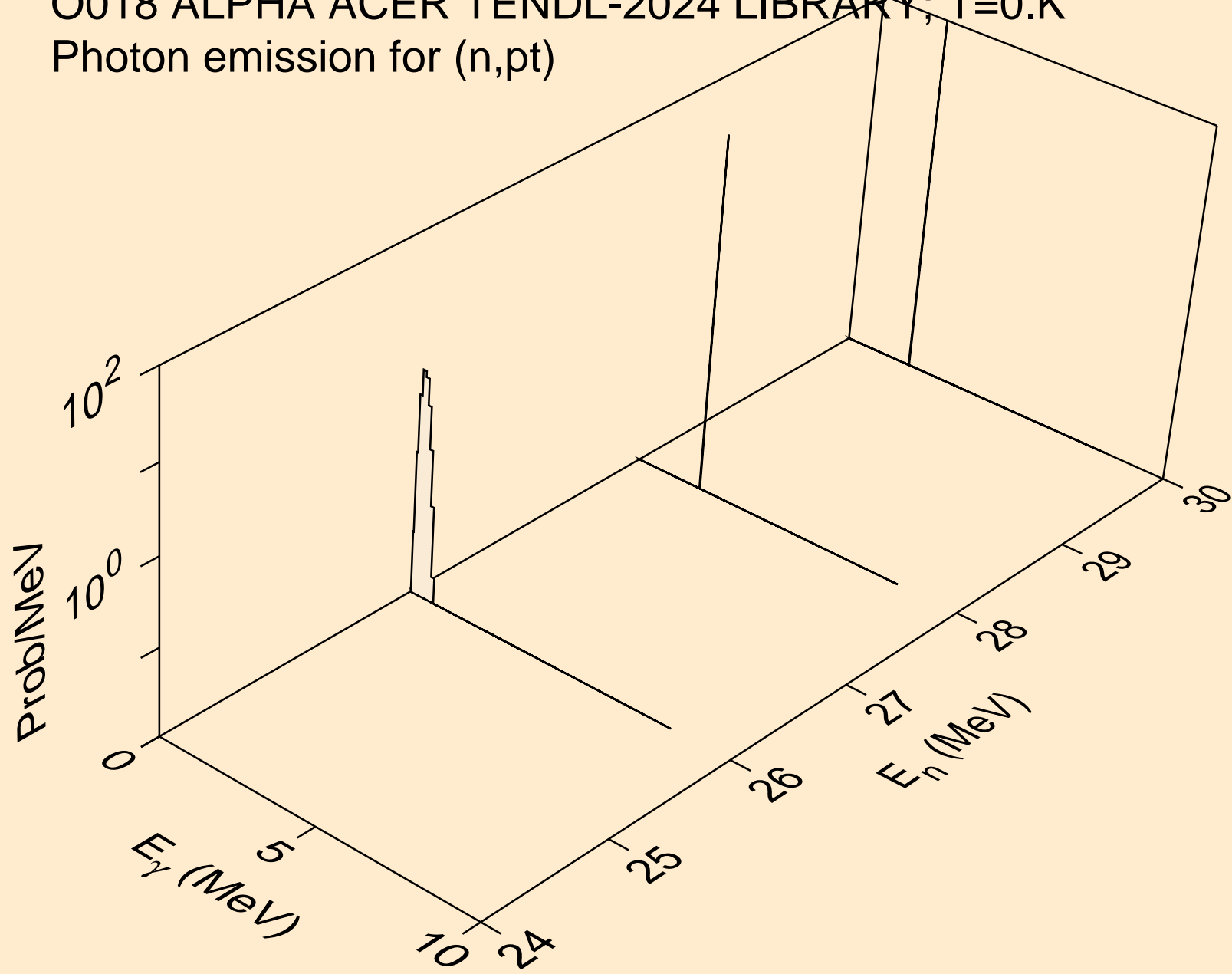

O018 ALPHA ACER TENDL-2024 LIBRARY; T=0.K
Photon emission for (n,da)

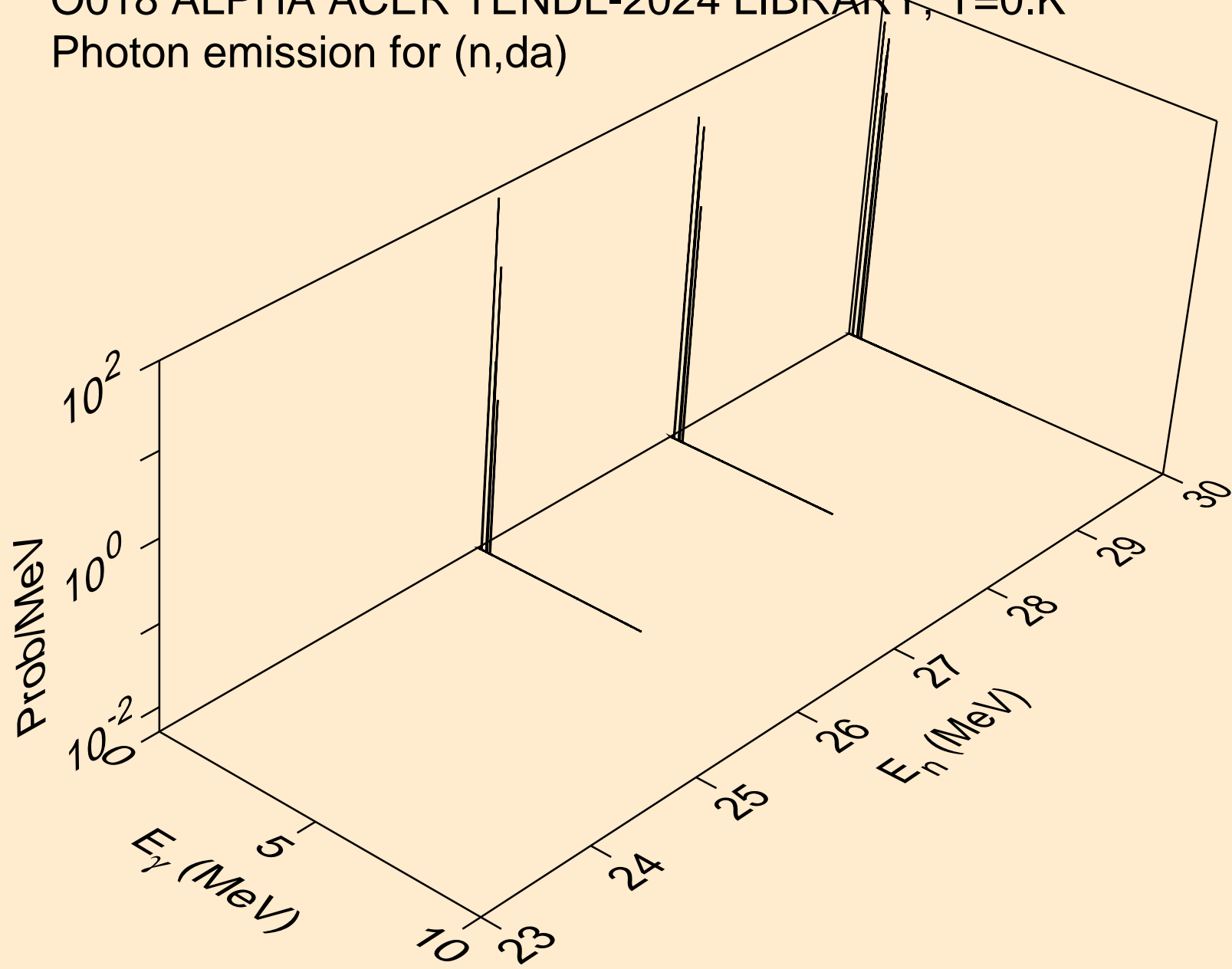

O018 ALPHA ACER TENDL-2024 LIBRARY; T=0.K
Particle heating contributions

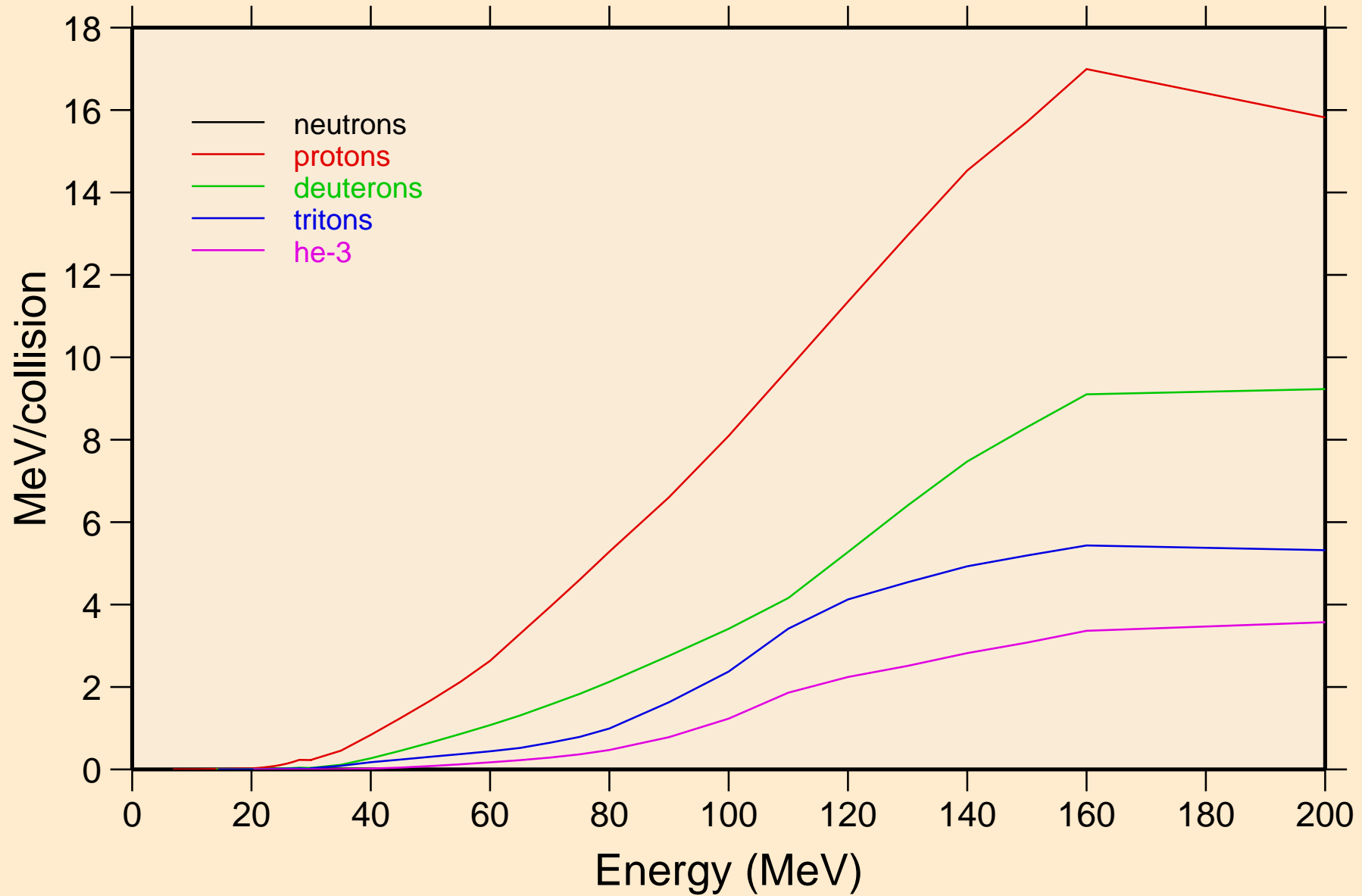

O018 ALPHA ACER TENDL-2024 LIBRARY; T=0.K
Recoil Heating

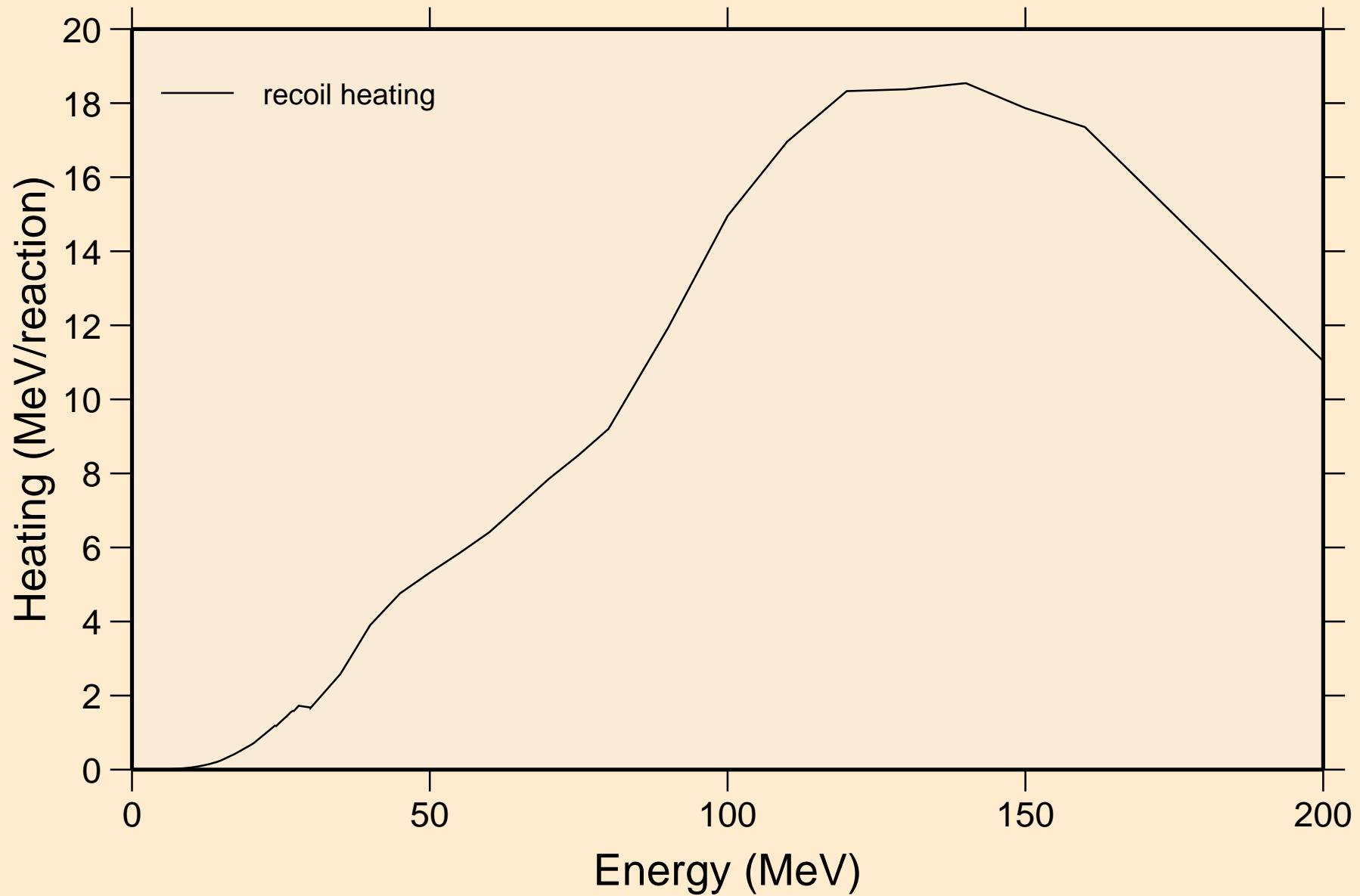

O018 ALPHA ACER TENDL-2024 LIBRARY; T=0.K
Particle production cross sections

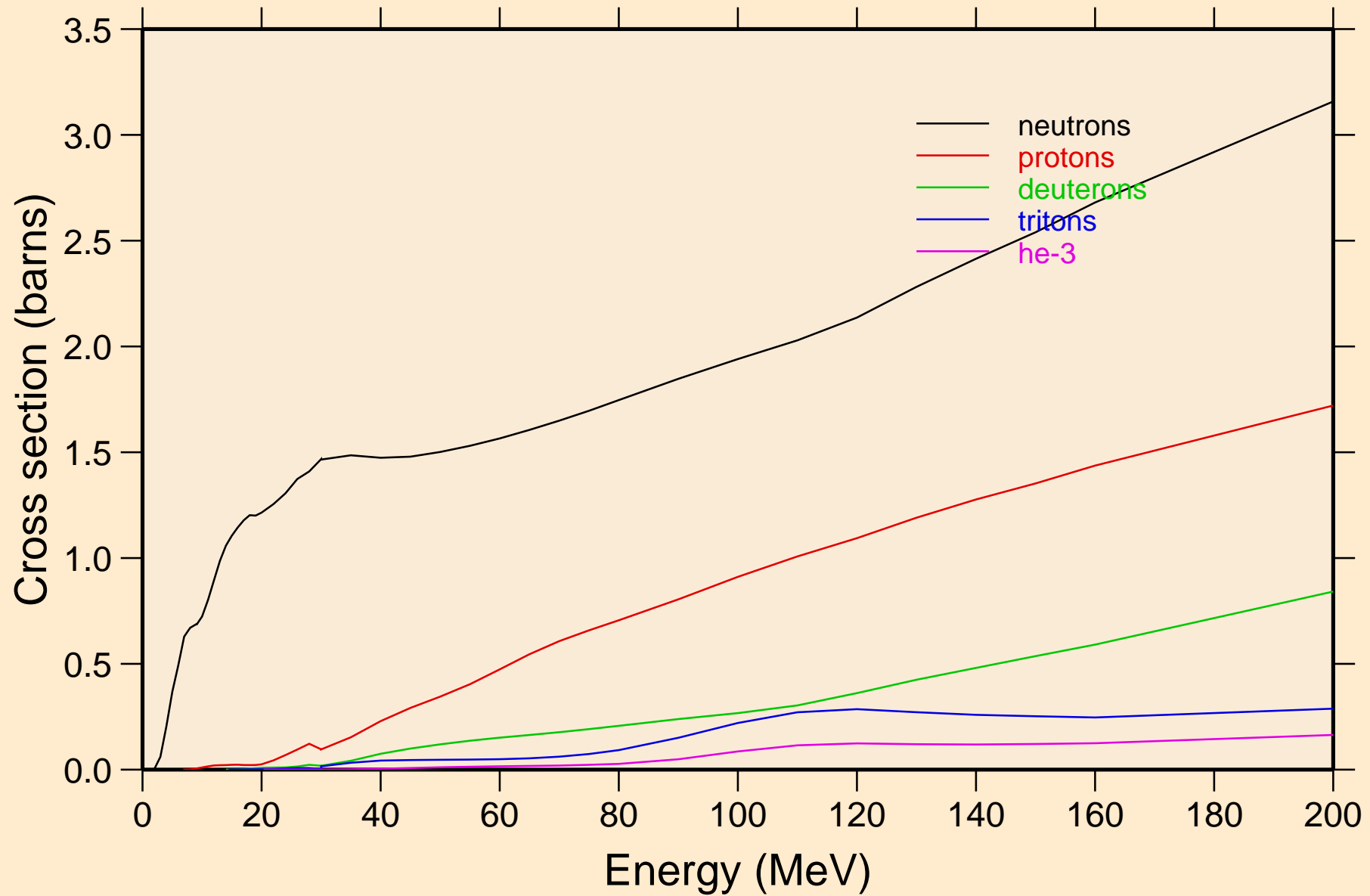

O018 ALPHA ACER TENDL-2024 LIBRARY; T=0.K
neutrons from (a,n)

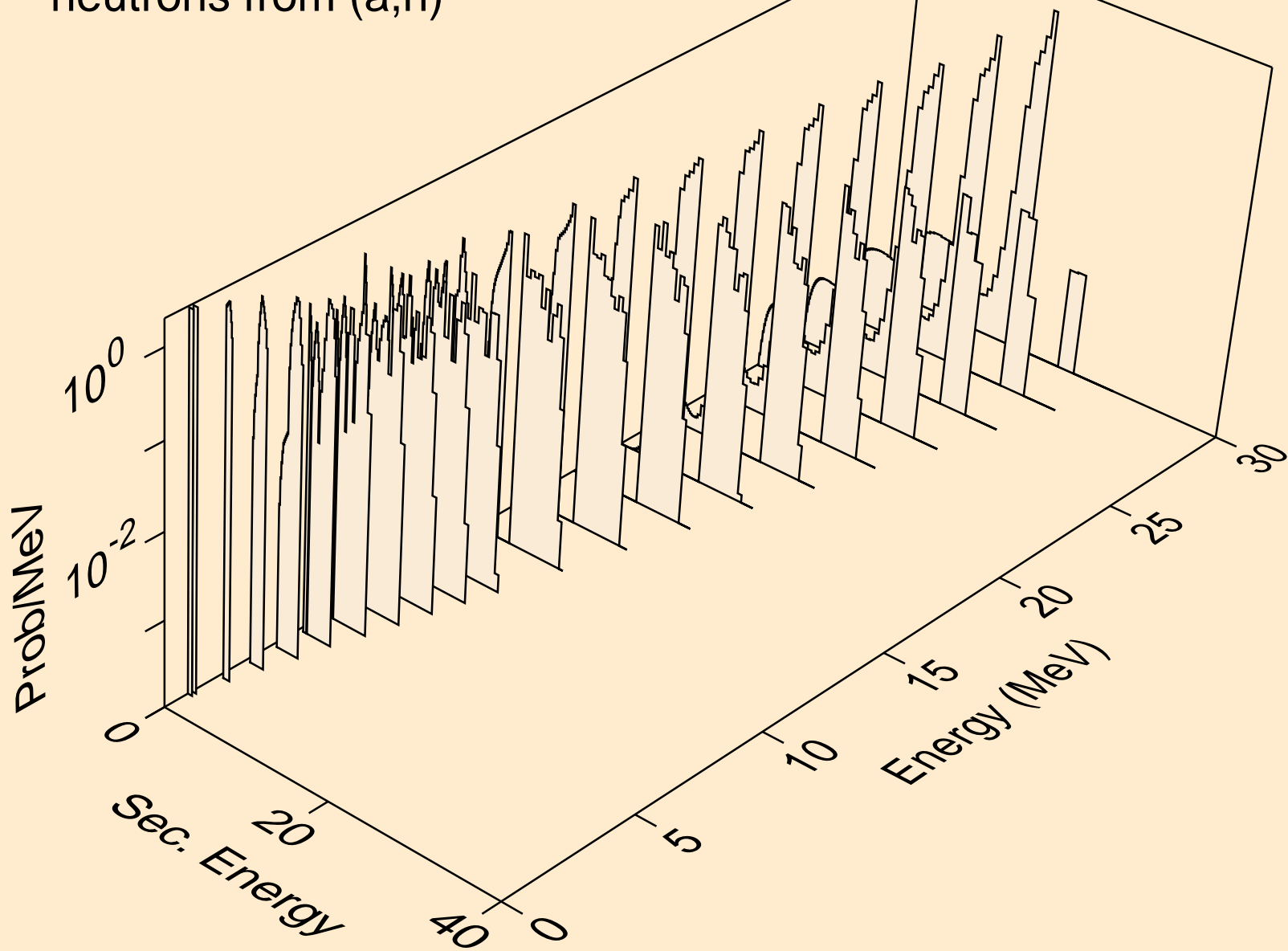

O018 ALPHA ACER TENDL-2024 LIBRARY; T=0.K
neutrons from (a,x)

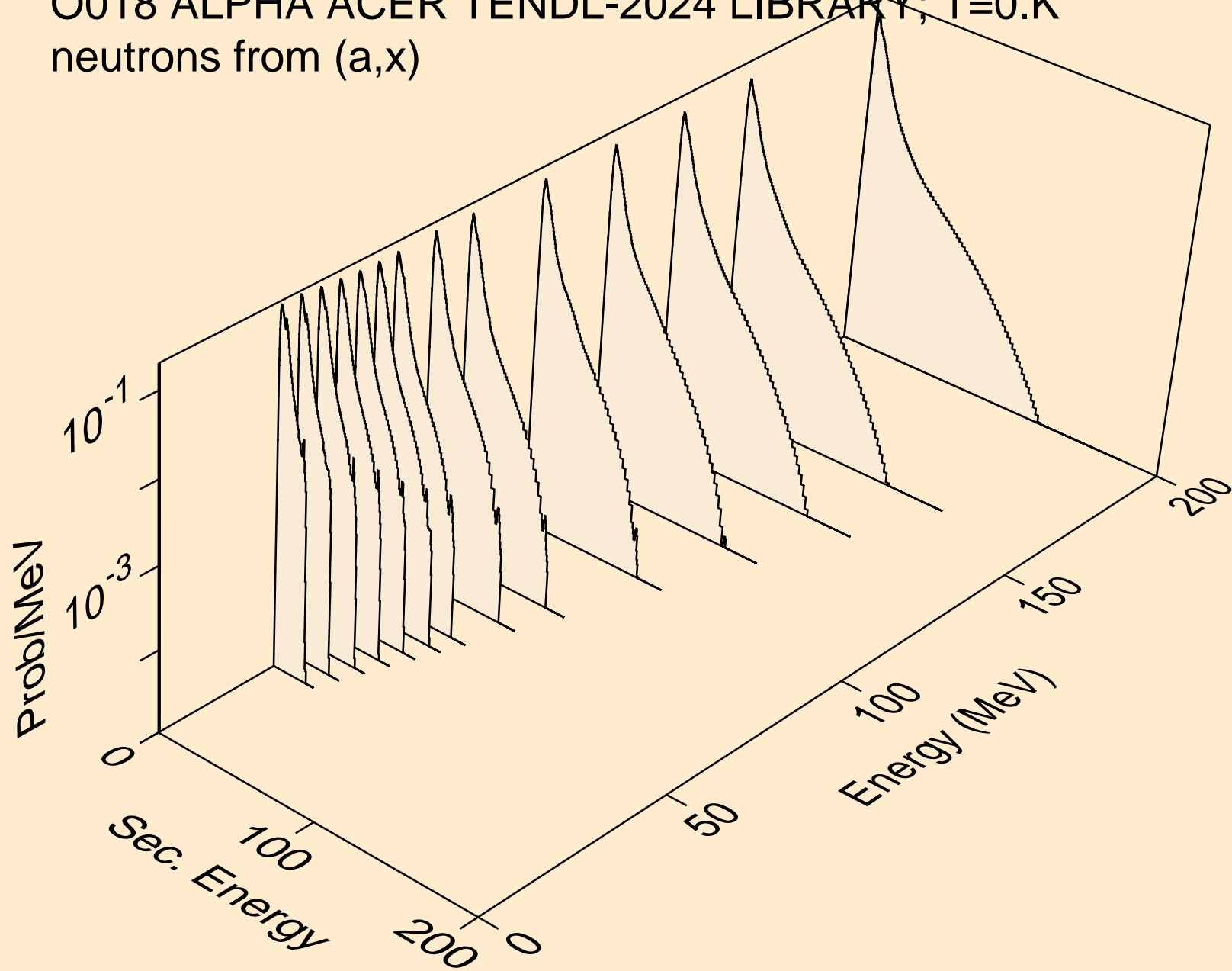

O018 ALPHA ACER TENDL-2024 LIBRARY; T=0.K
neutrons from (a,2n)

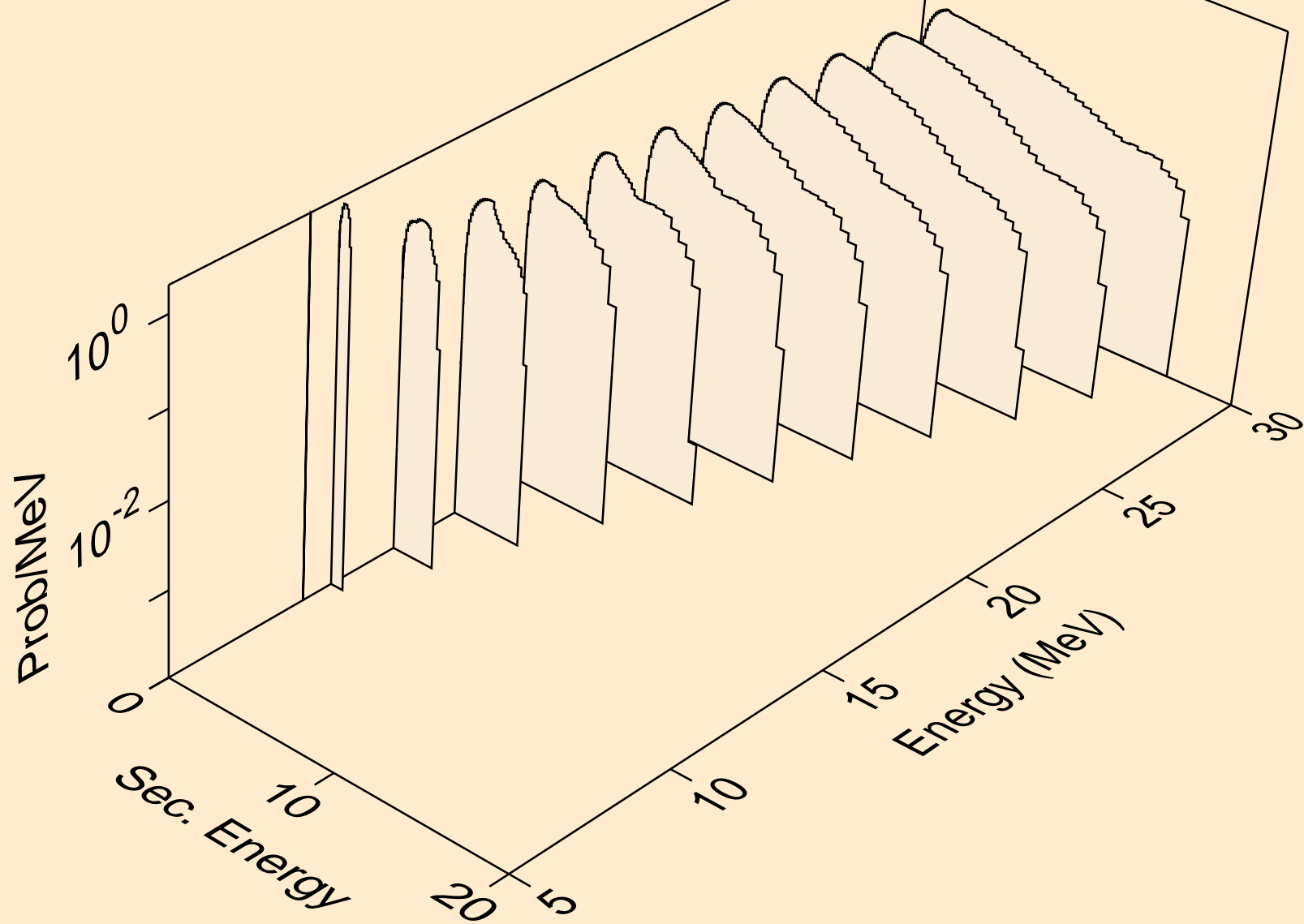

O018 ALPHA ACER TENDL-2024 LIBRARY; T=0.K
neutrons from (a,n*)a

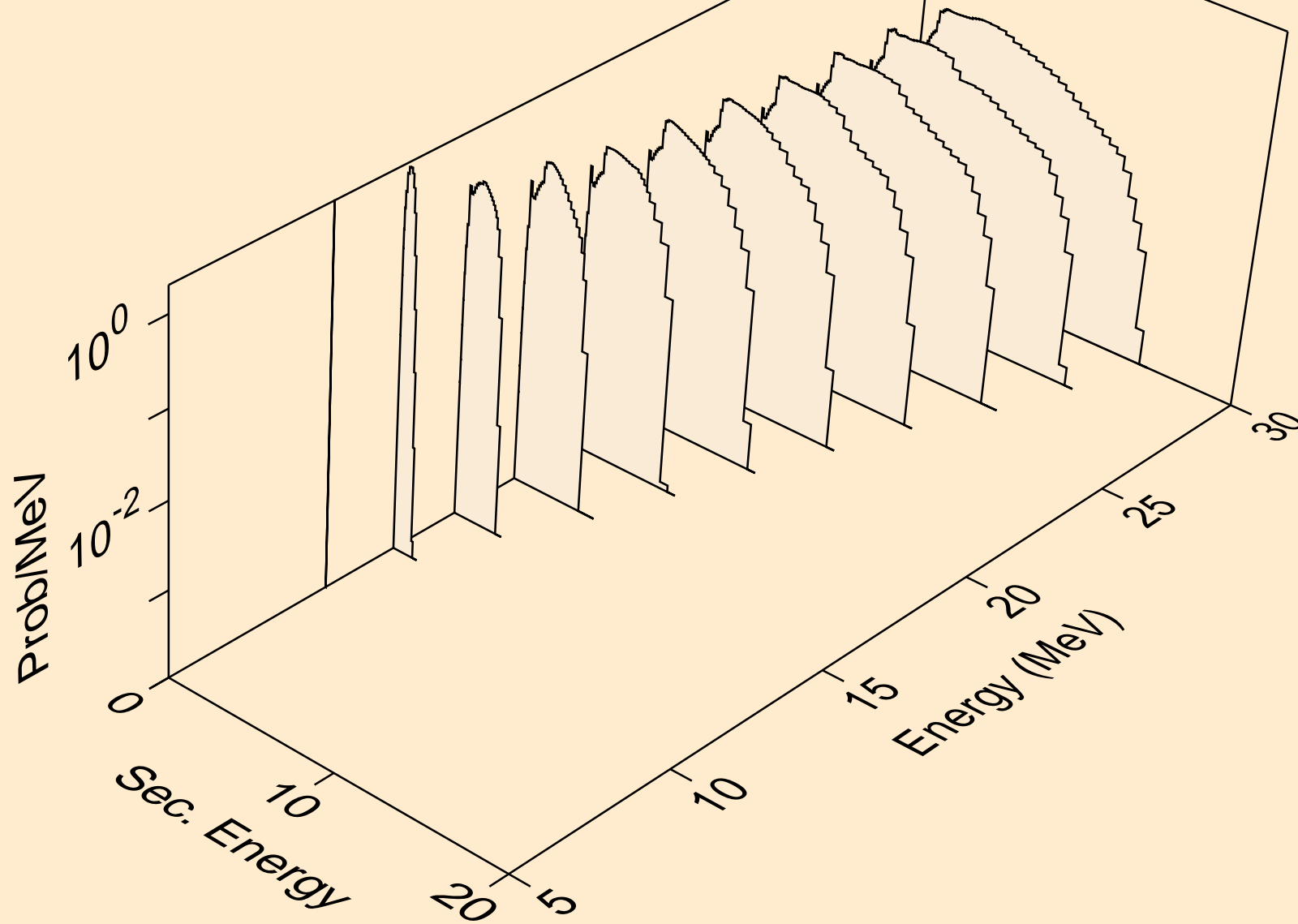

O018 ALPHA ACER TENDL-2024 LIBRARY; T=0.K
neutrons from (a,2n)a

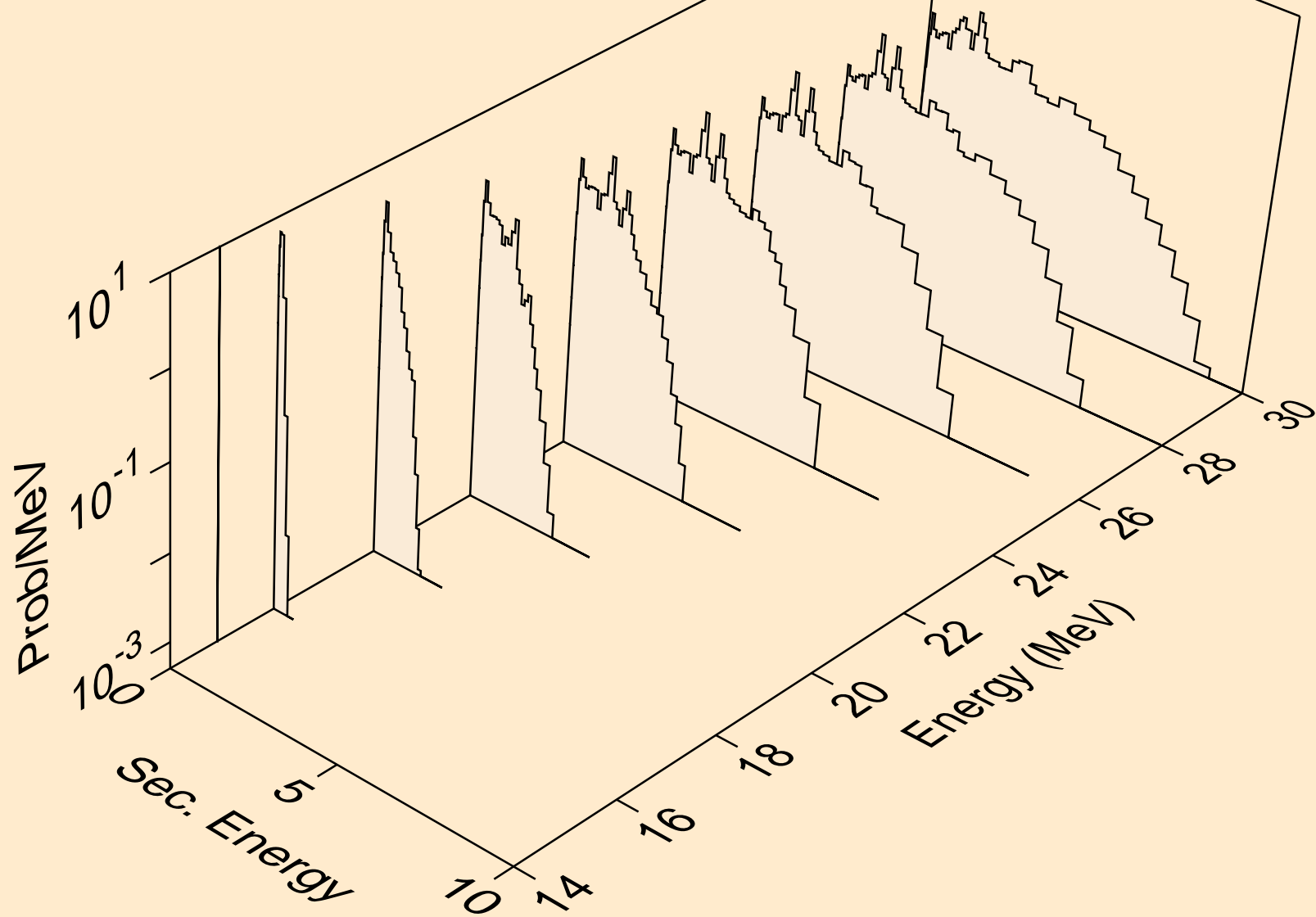

O018 ALPHA ACER TENDL-2024 LIBRARY; T=0.K
neutrons from (a,n*)p

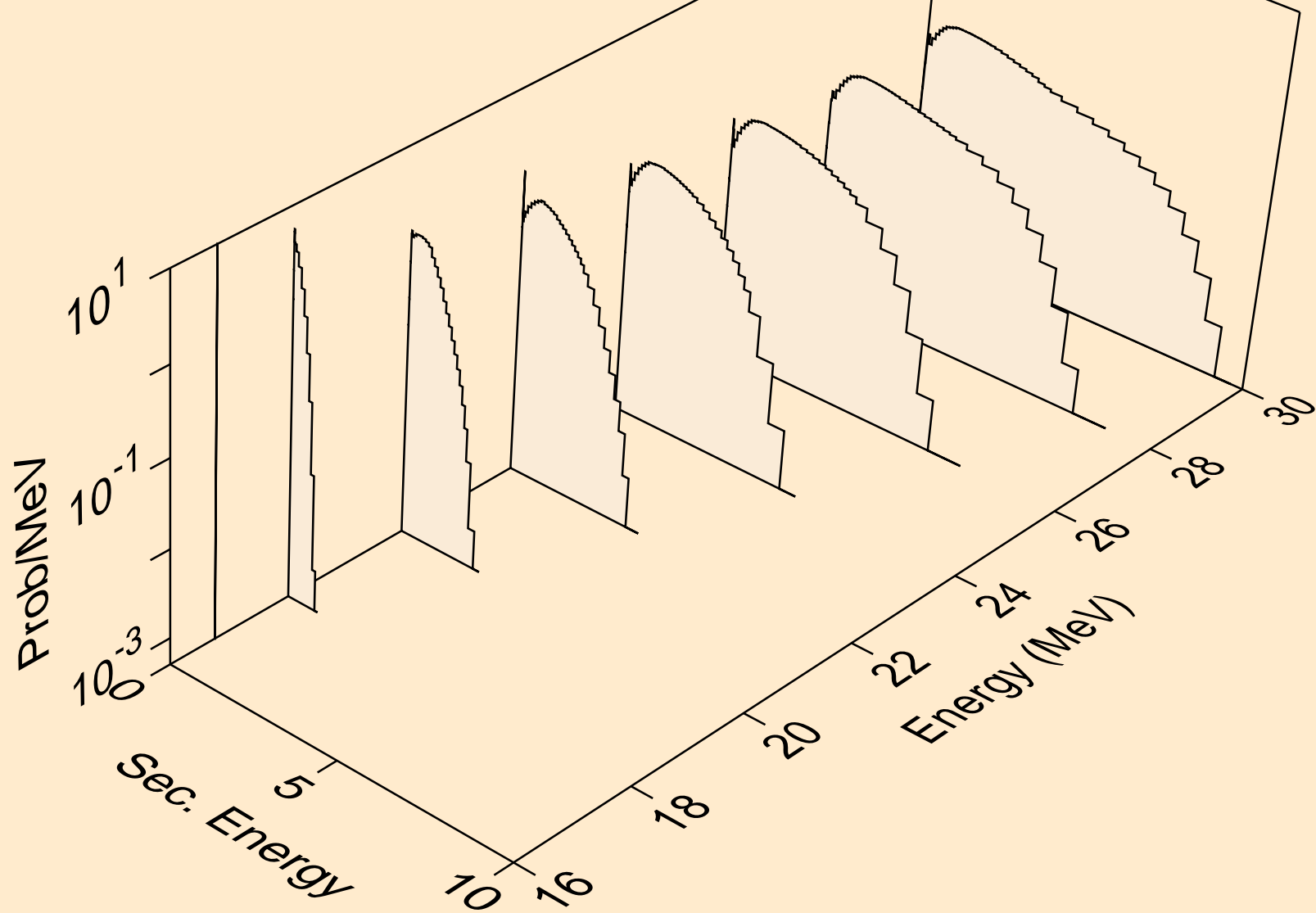

O018 ALPHA ACER TENDL-2024 LIBRARY; T=0.K
neutrons from (a,n*)2a

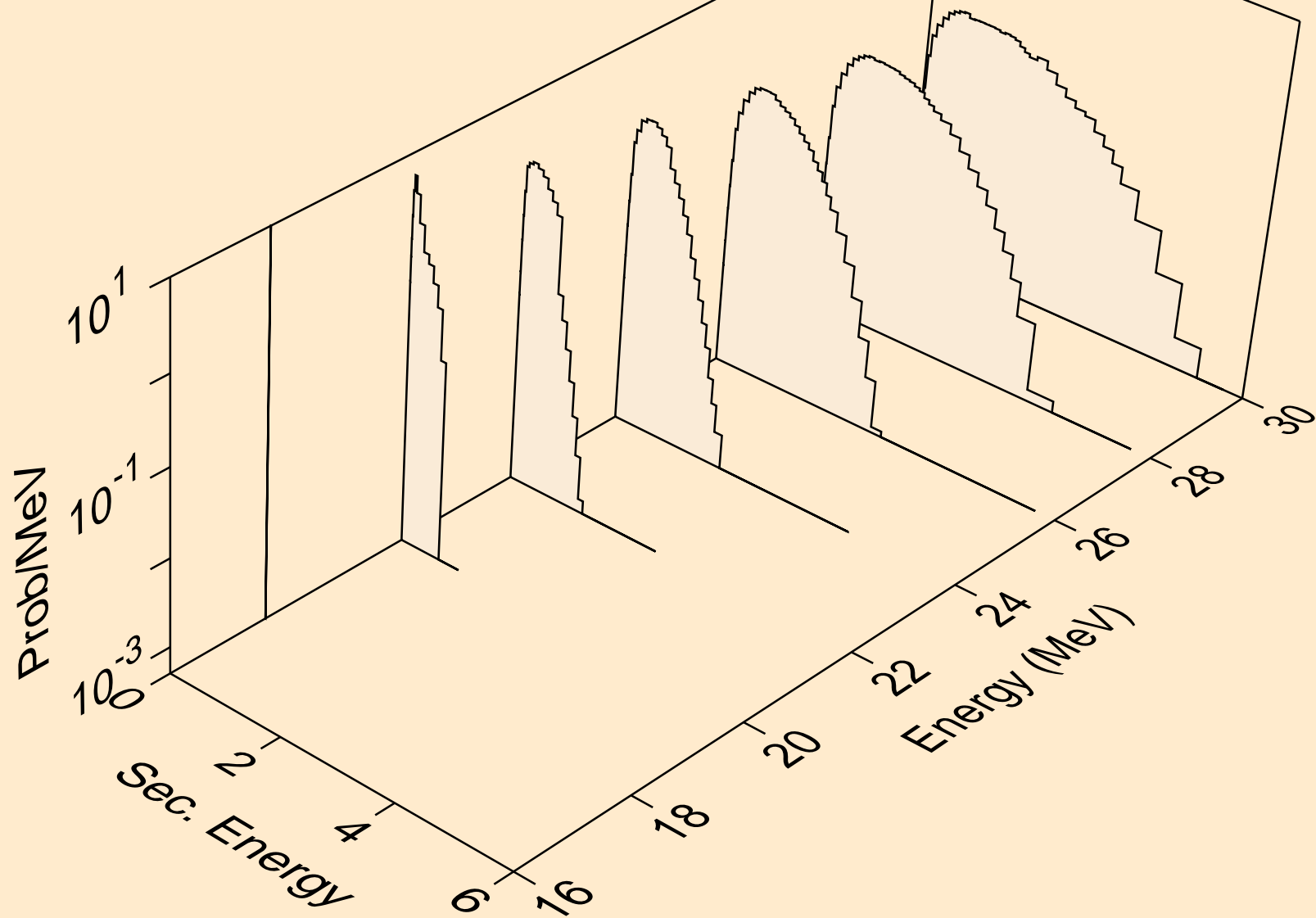

O018 ALPHA ACER TENDL-2024 LIBRARY; T=0.K
neutrons from (a,n*)d

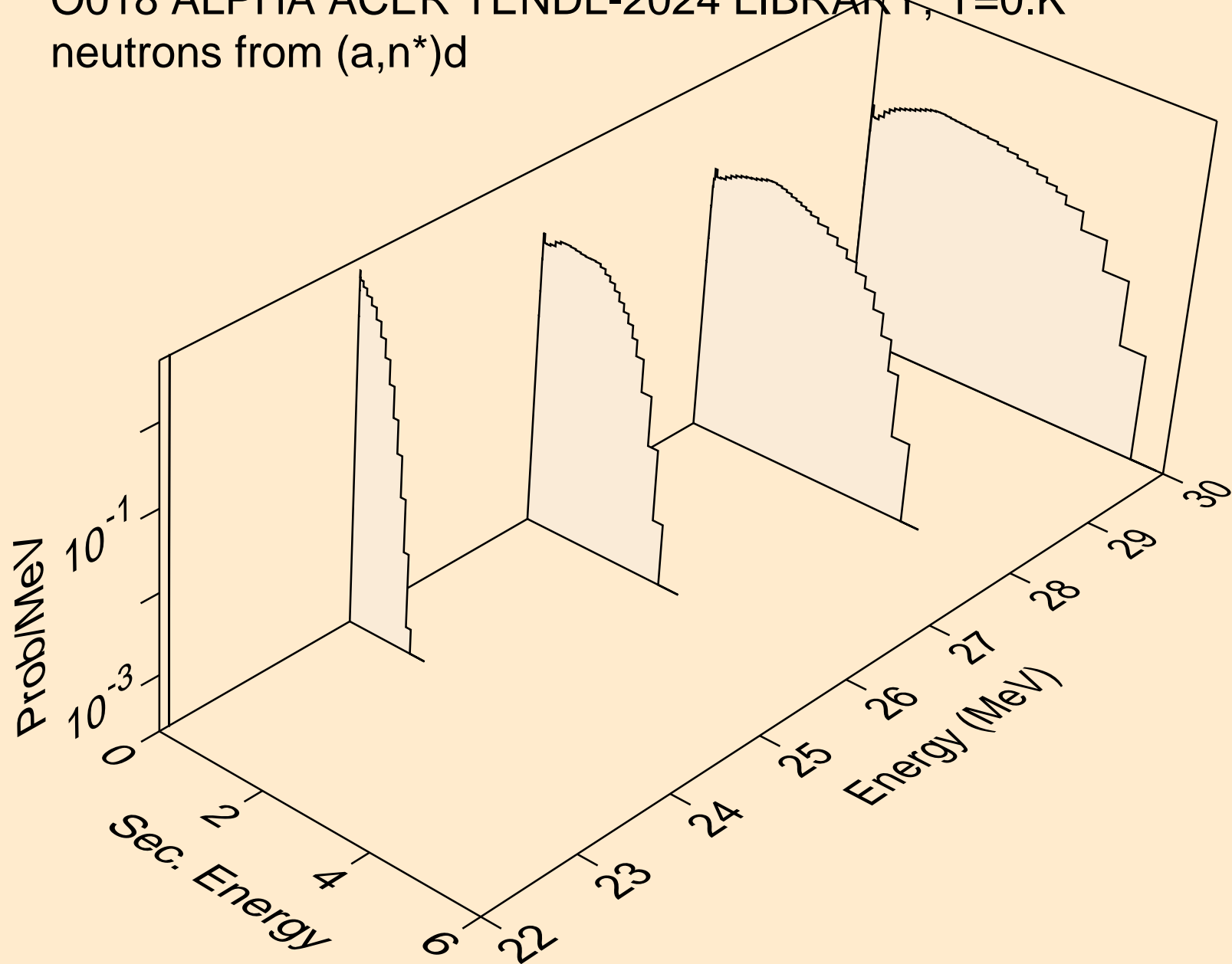

O018 ALPHA ACER TENDL-2024 LIBRARY; T=0.K
neutrons from (a,n*)t

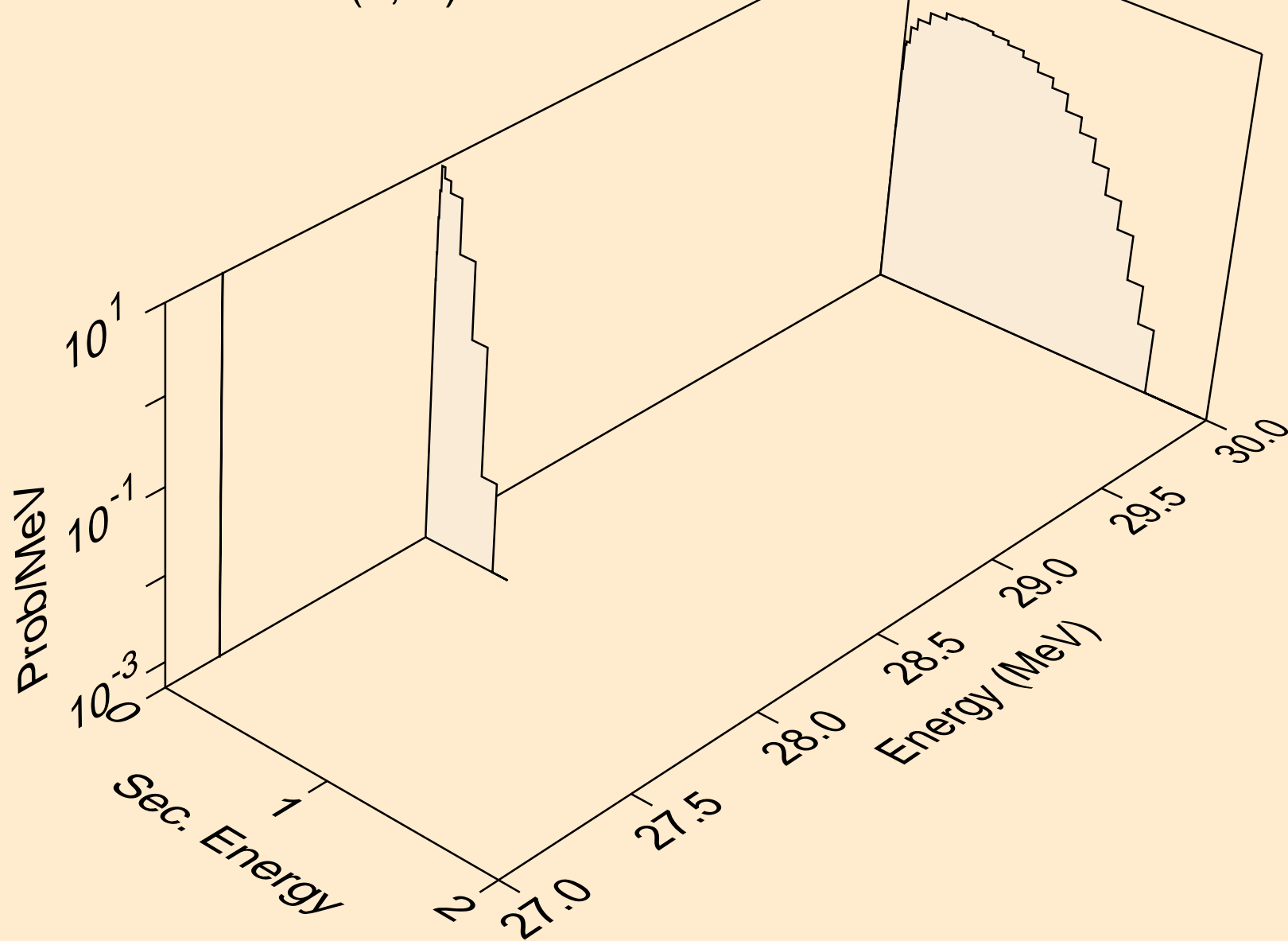

O018 ALPHA ACER TENDL-2024 LIBRARY; T=0.K
neutrons from (a,n*)he3

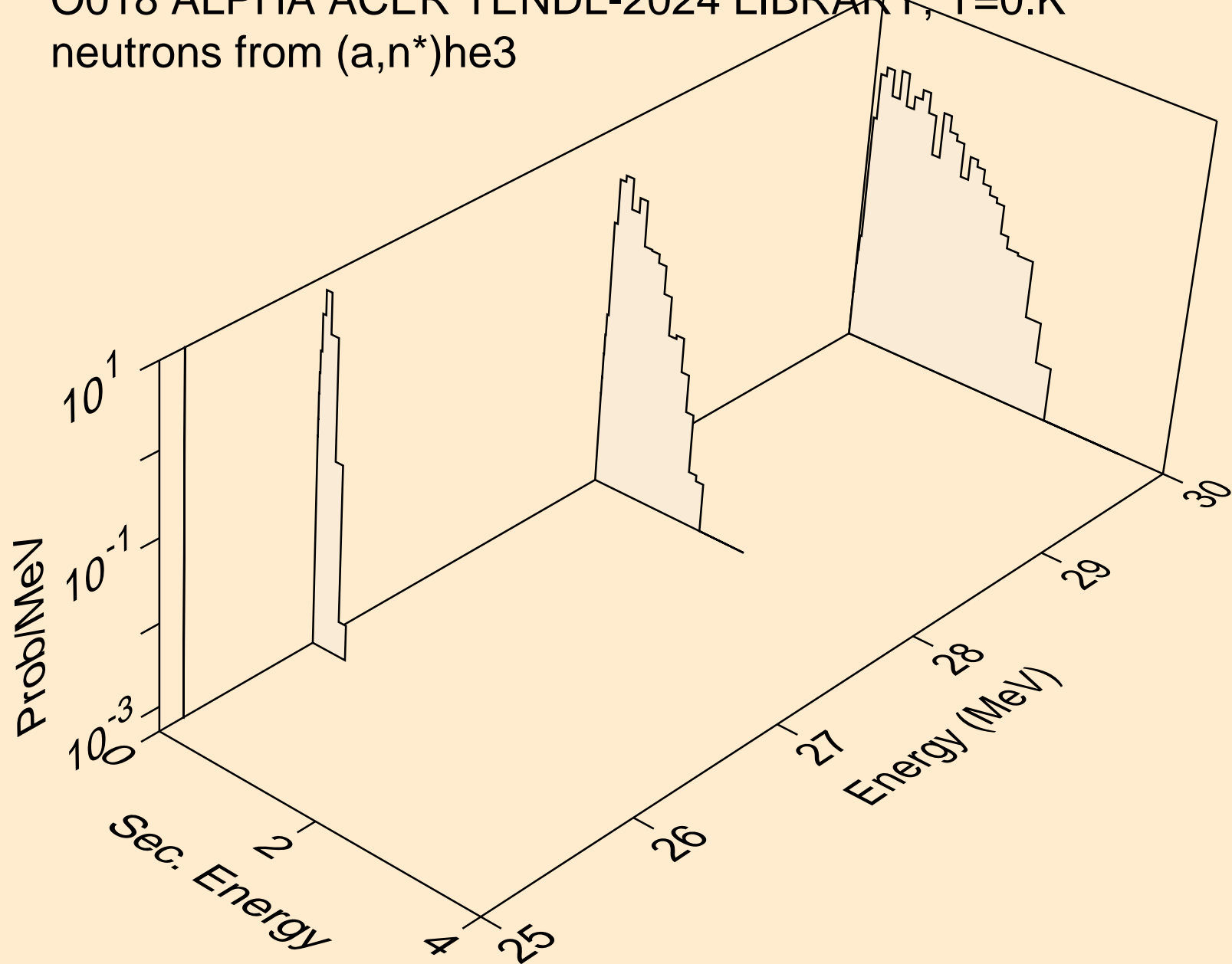

O018 ALPHA ACER TENDL-2024 LIBRARY; T=0.K
neutrons from (a,2np)

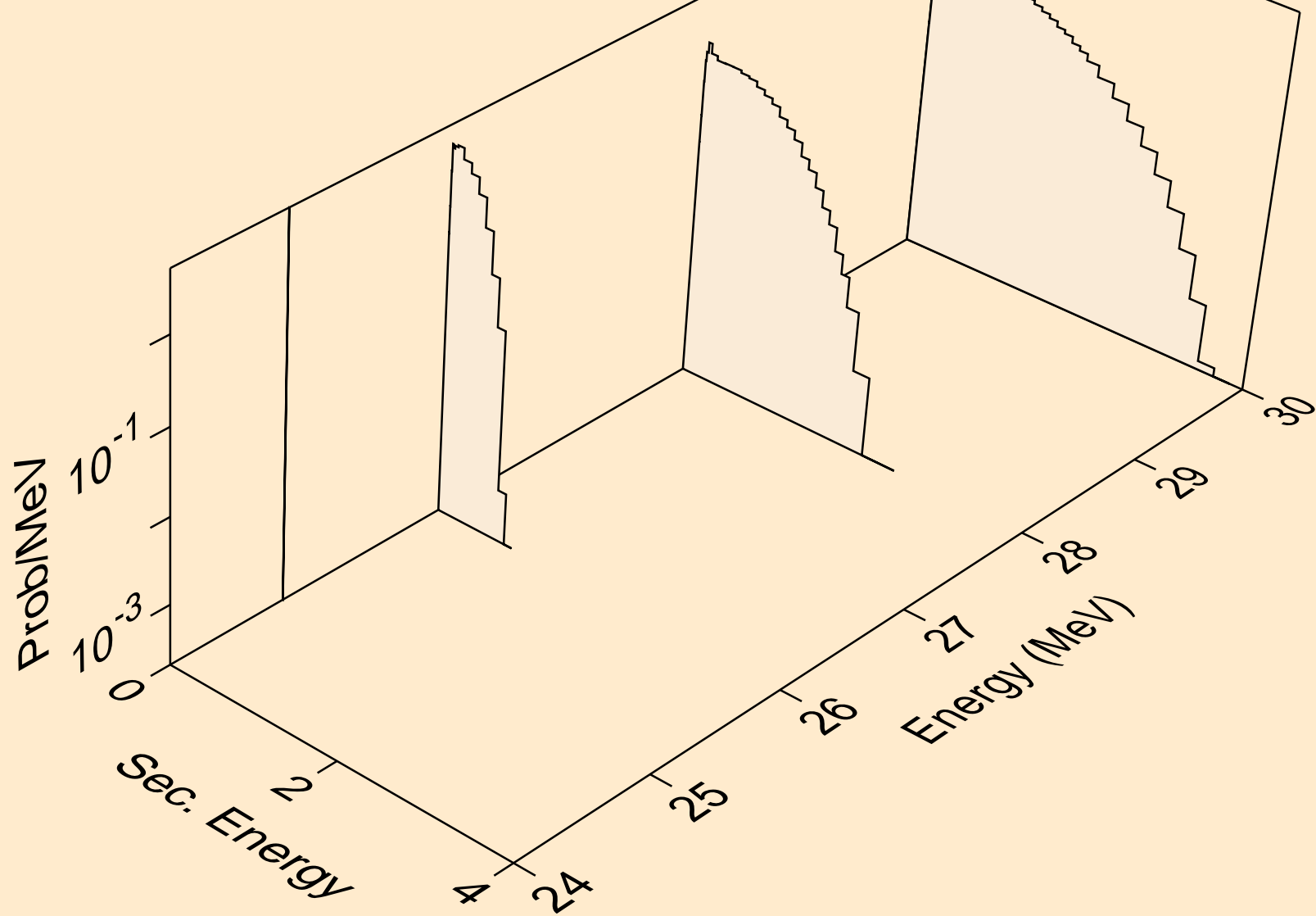

O018 ALPHA ACER TENDL-2024 LIBRARY; T=0.K
neutrons from (a,npa)

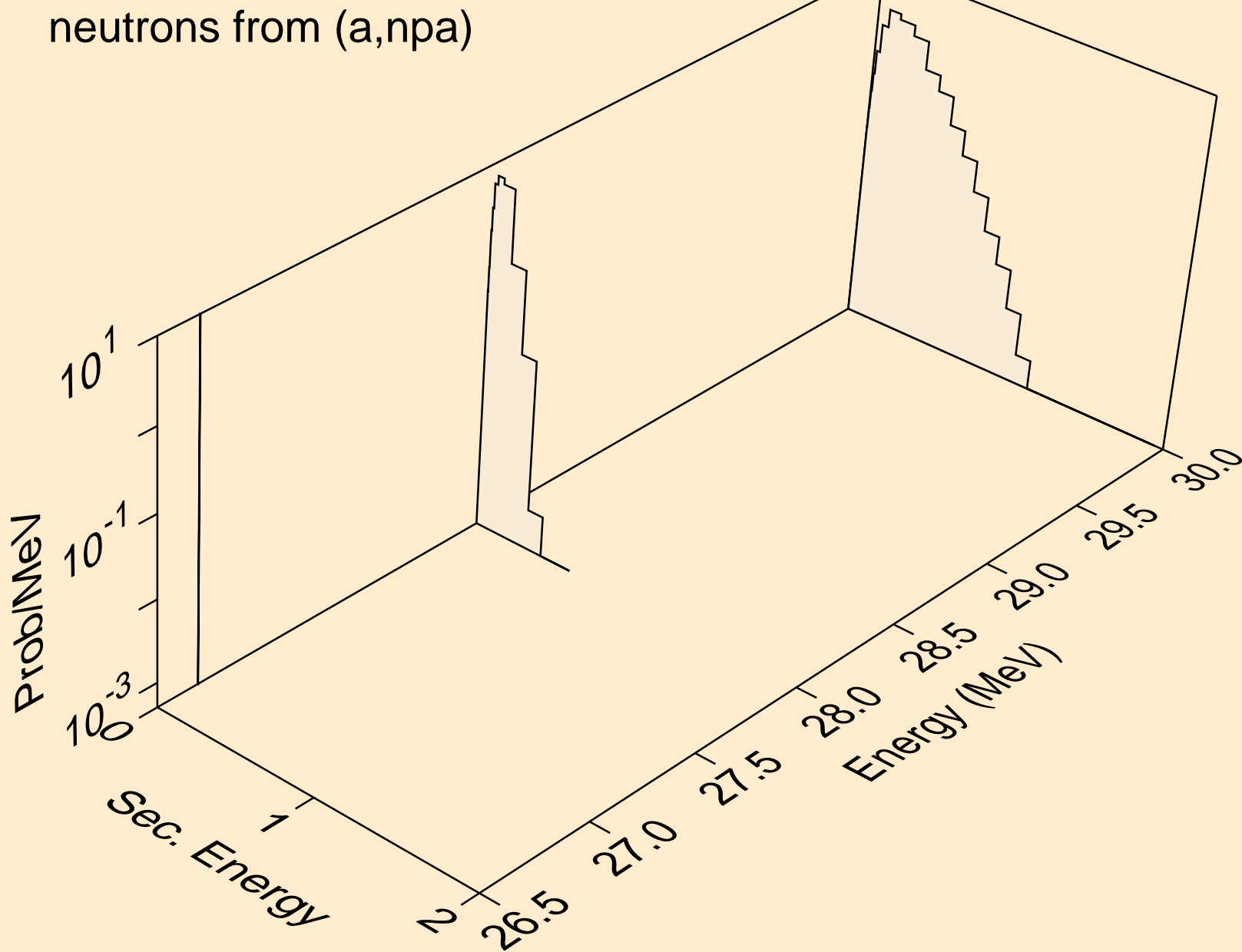

O018 ALPHA ACER TENDL-2024 LIBRARY; T=0.K
protons from (a,x)

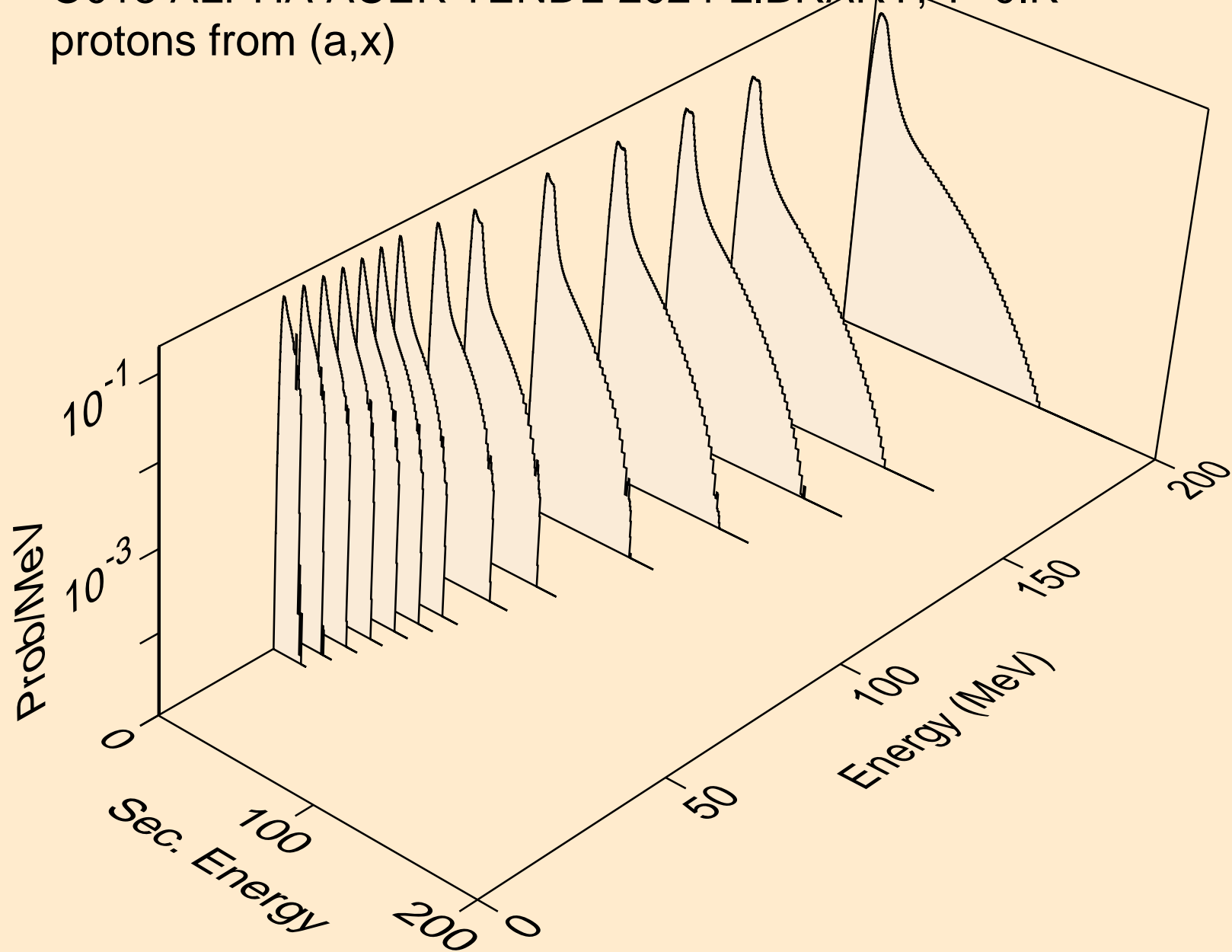

O018 ALPHA ACER TENDL-2024 LIBRARY; T=0.K
protons from (a,n*)p

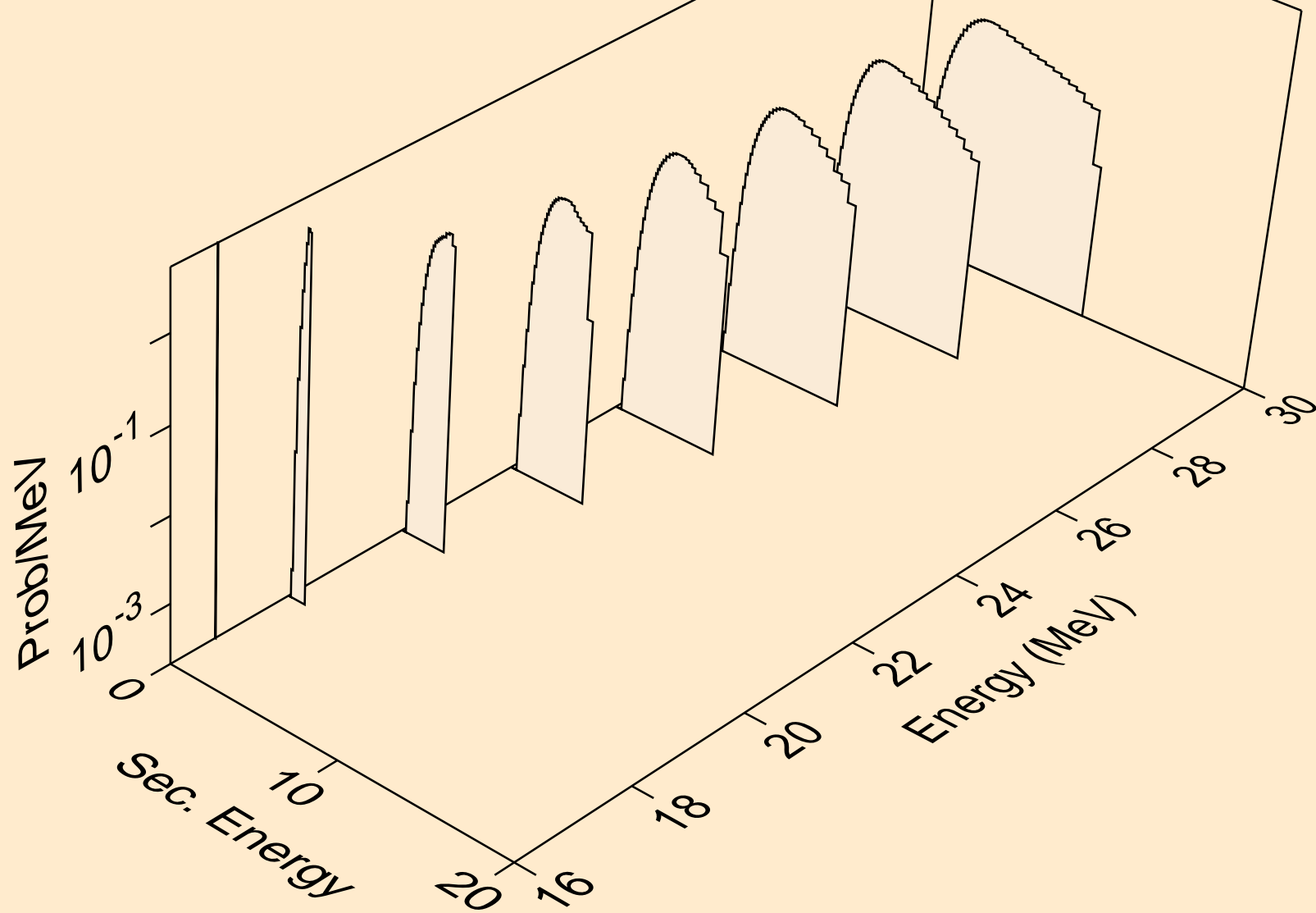

O018 ALPHA ACER TENDL-2024 LIBRARY; T=0.K
protons from (a,2np)

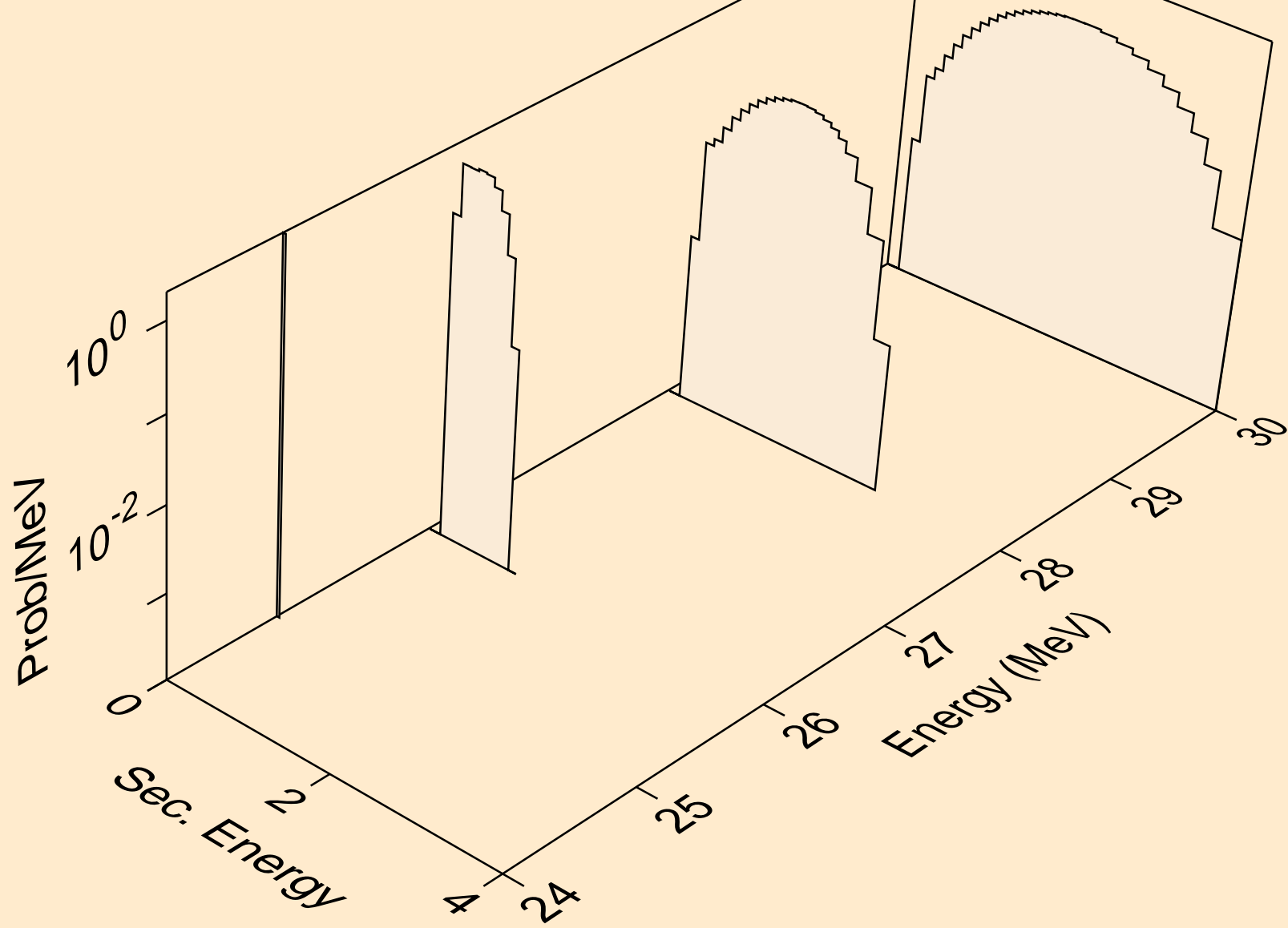

O018 ALPHA ACER TENDL-2024 LIBRARY; T=0.K
protons from (a,npa)

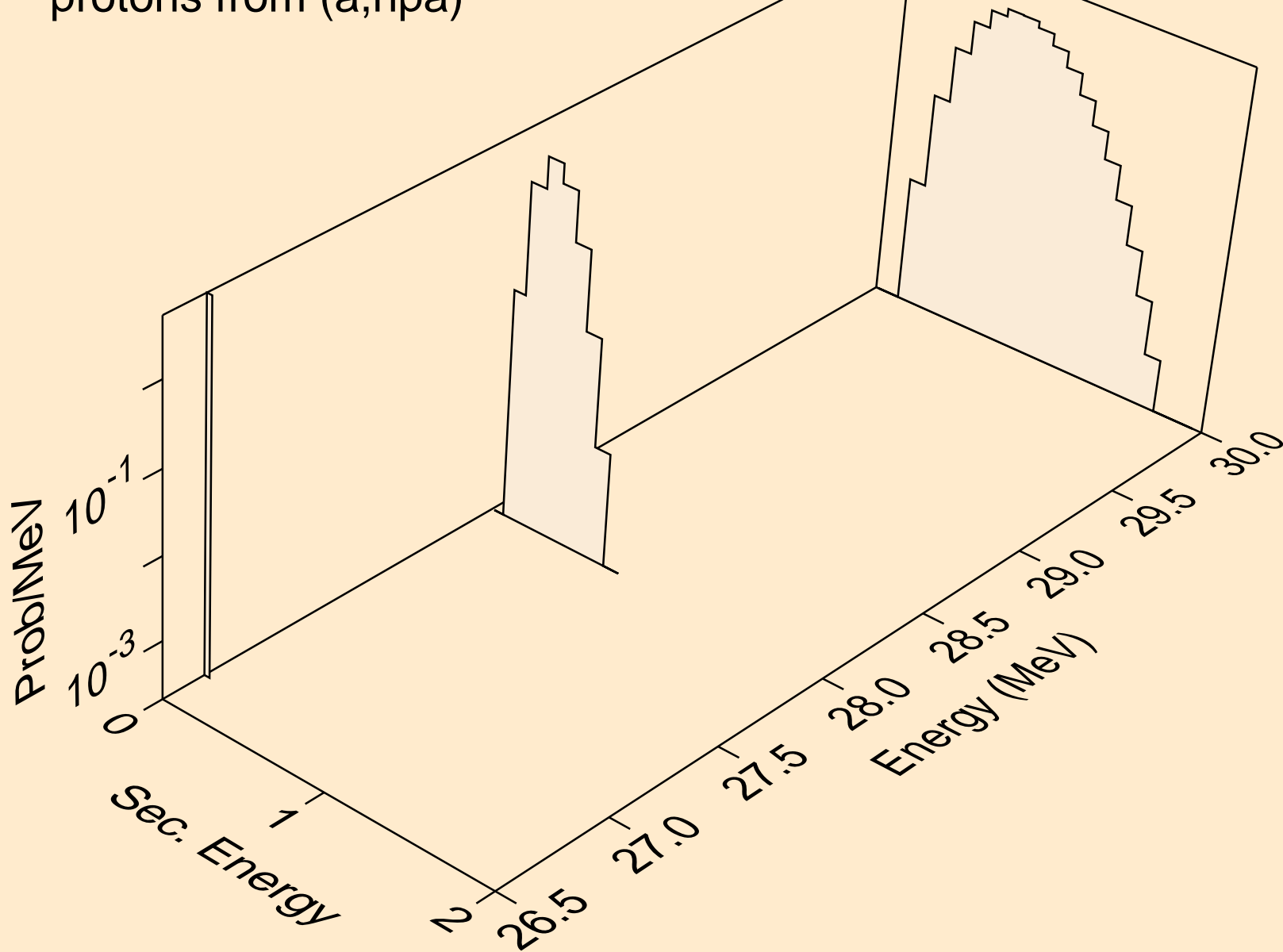

O018 ALPHA ACER TENDL-2024 LIBRARY; T=0.K
protons from (a,p)

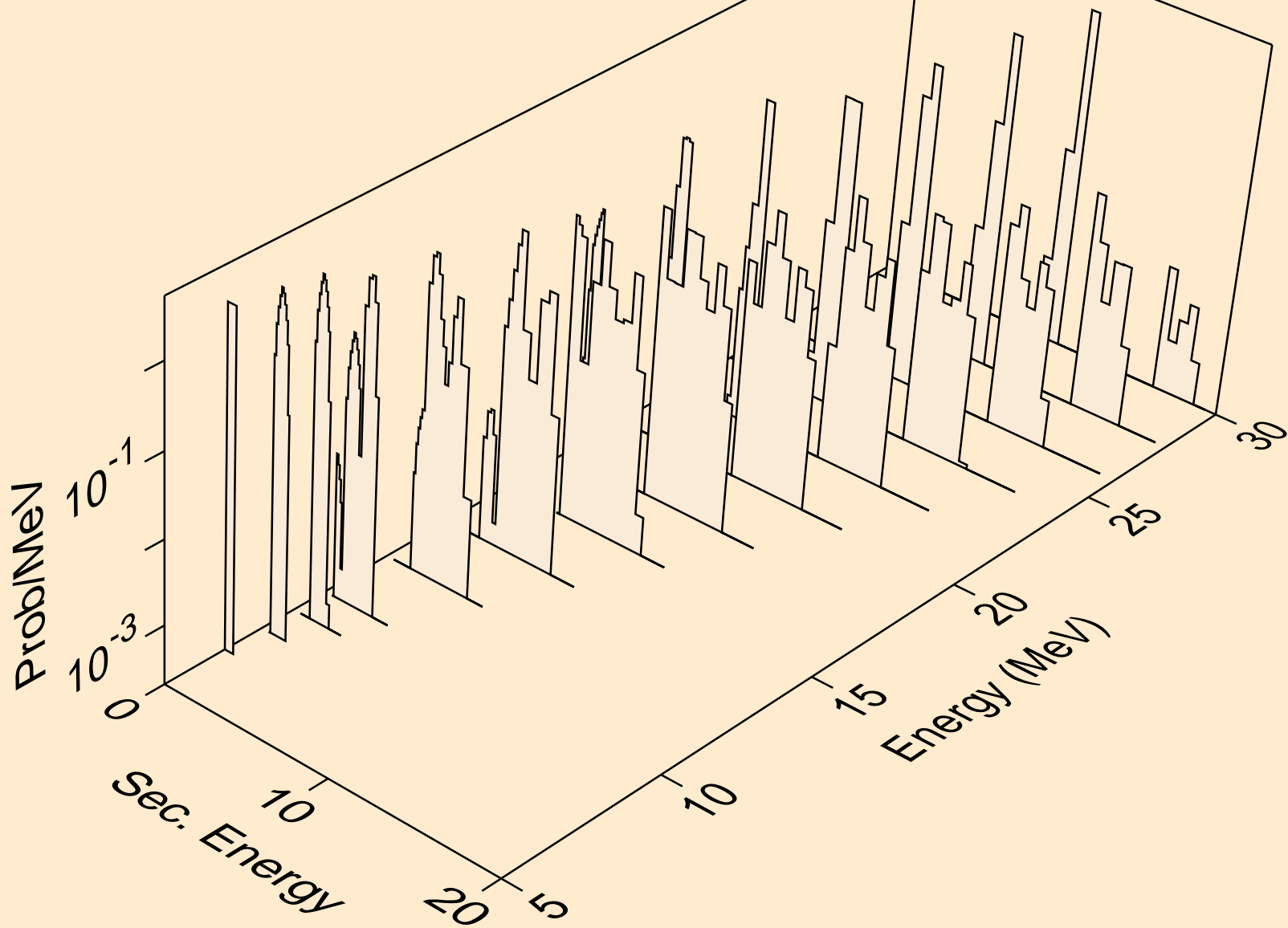

O018 ALPHA ACER TENDL-2024 LIBRARY; T=0.K
protons from (a,2p)

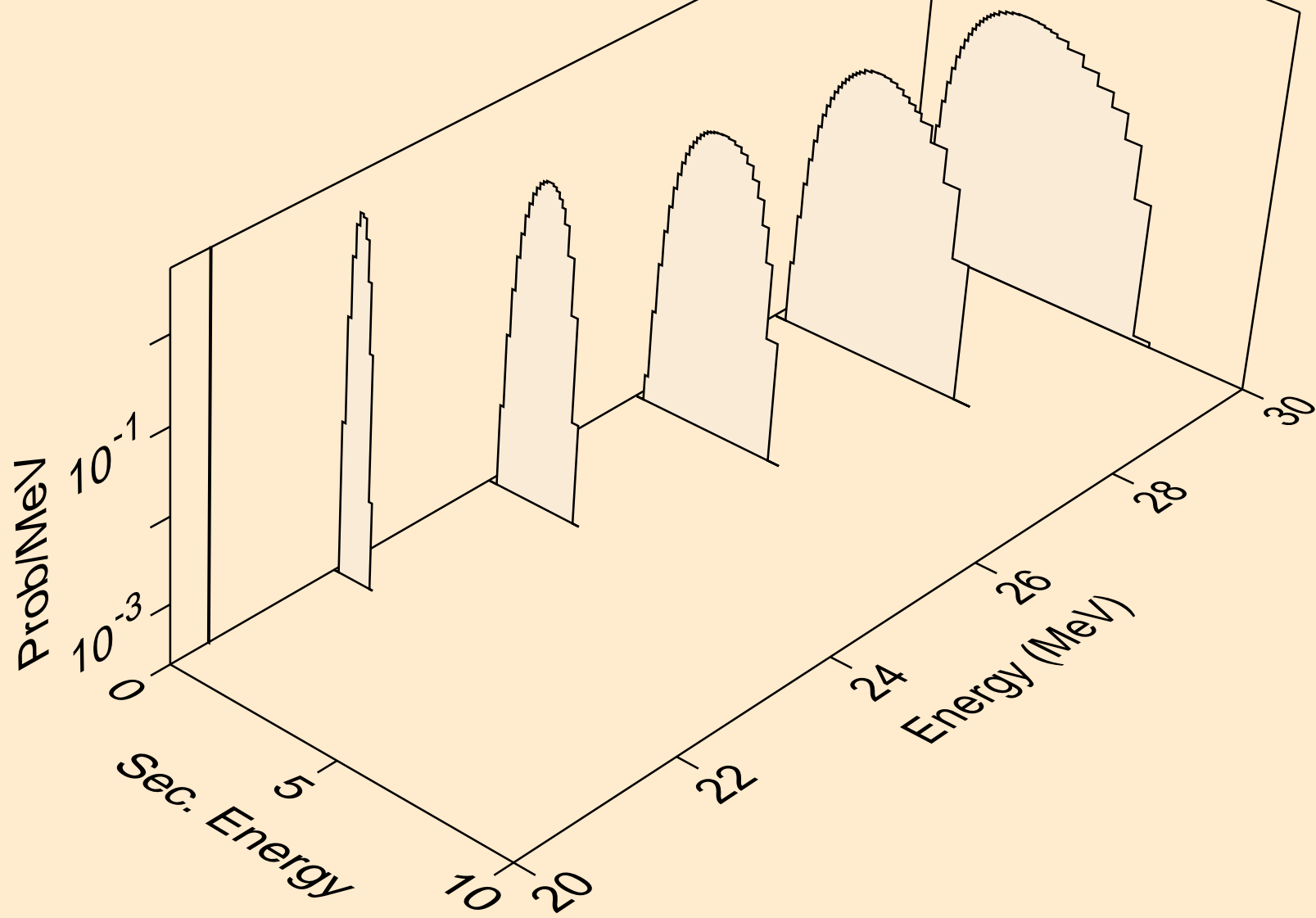

O018 ALPHA ACER TENDL-2024 LIBRARY; T=0.K
protons from (a,pa)

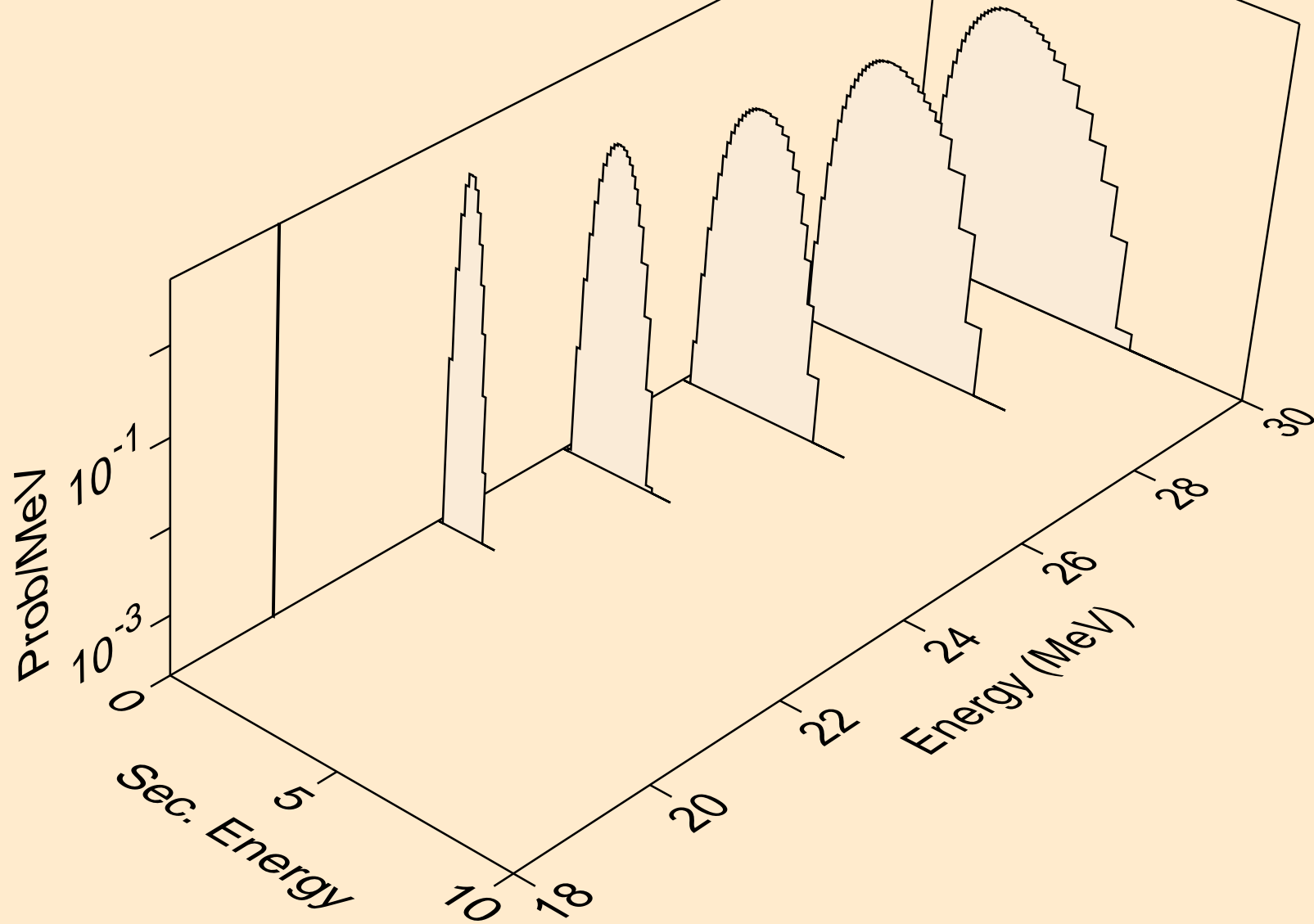

O018 ALPHA ACER TENDL-2024 LIBRARY; T=0.K
protons from (a,pd)

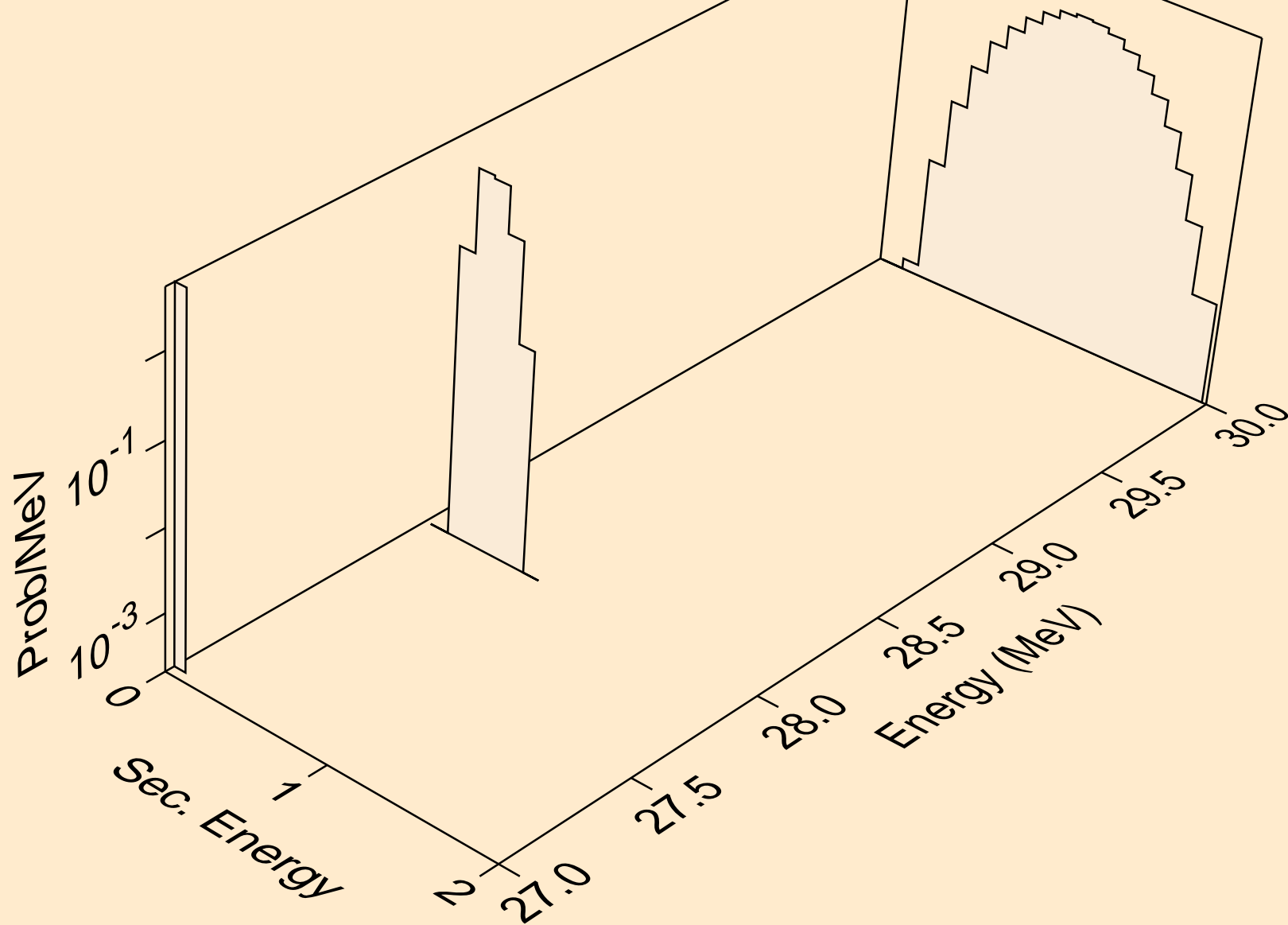

O018 ALPHA ACER TENDL-2024 LIBRARY; T=0.K
protons from (a,pt)

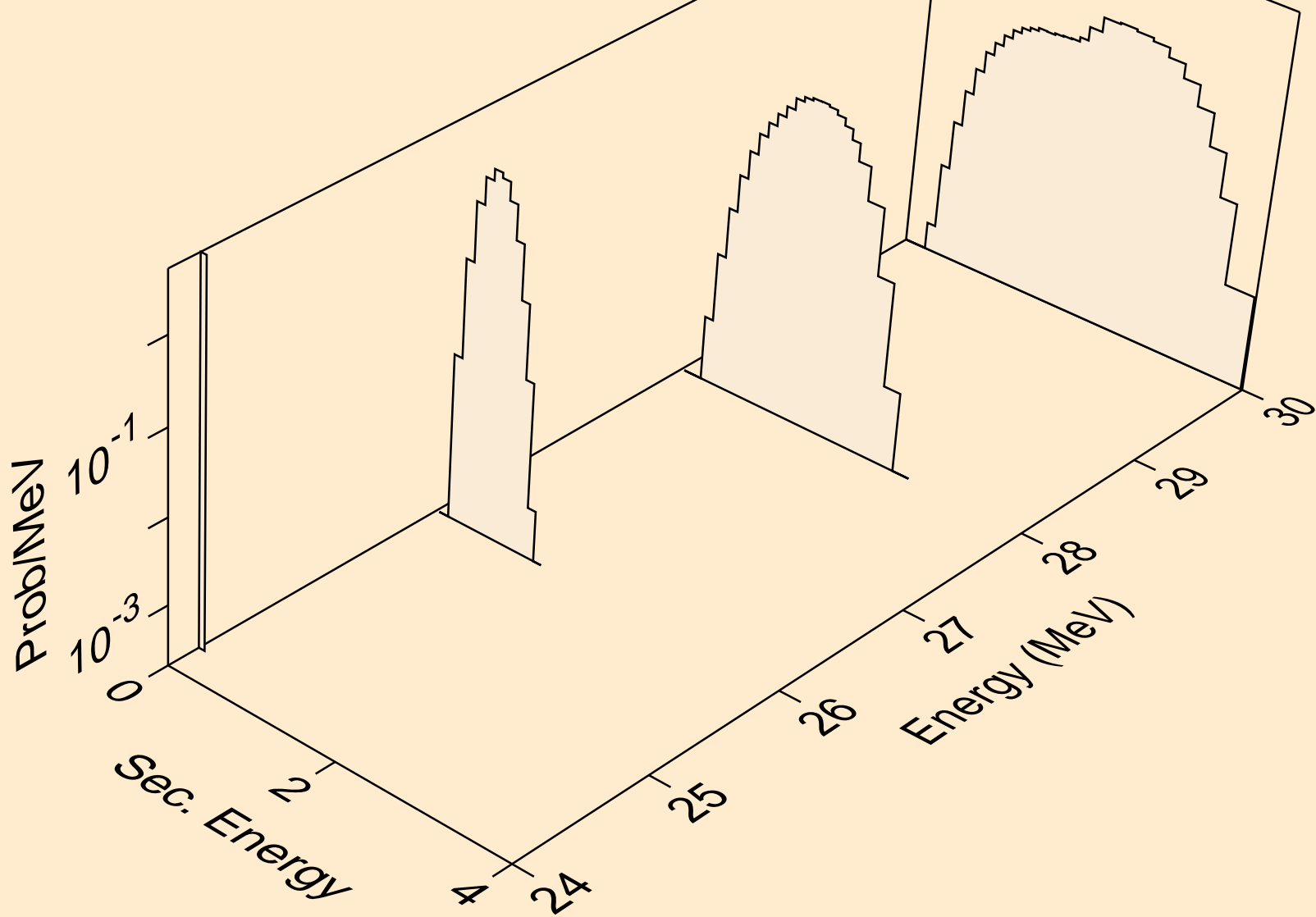

O018 ALPHA ACER TENDL-2024 LIBRARY; T=0.K
deuterons from (a,x)

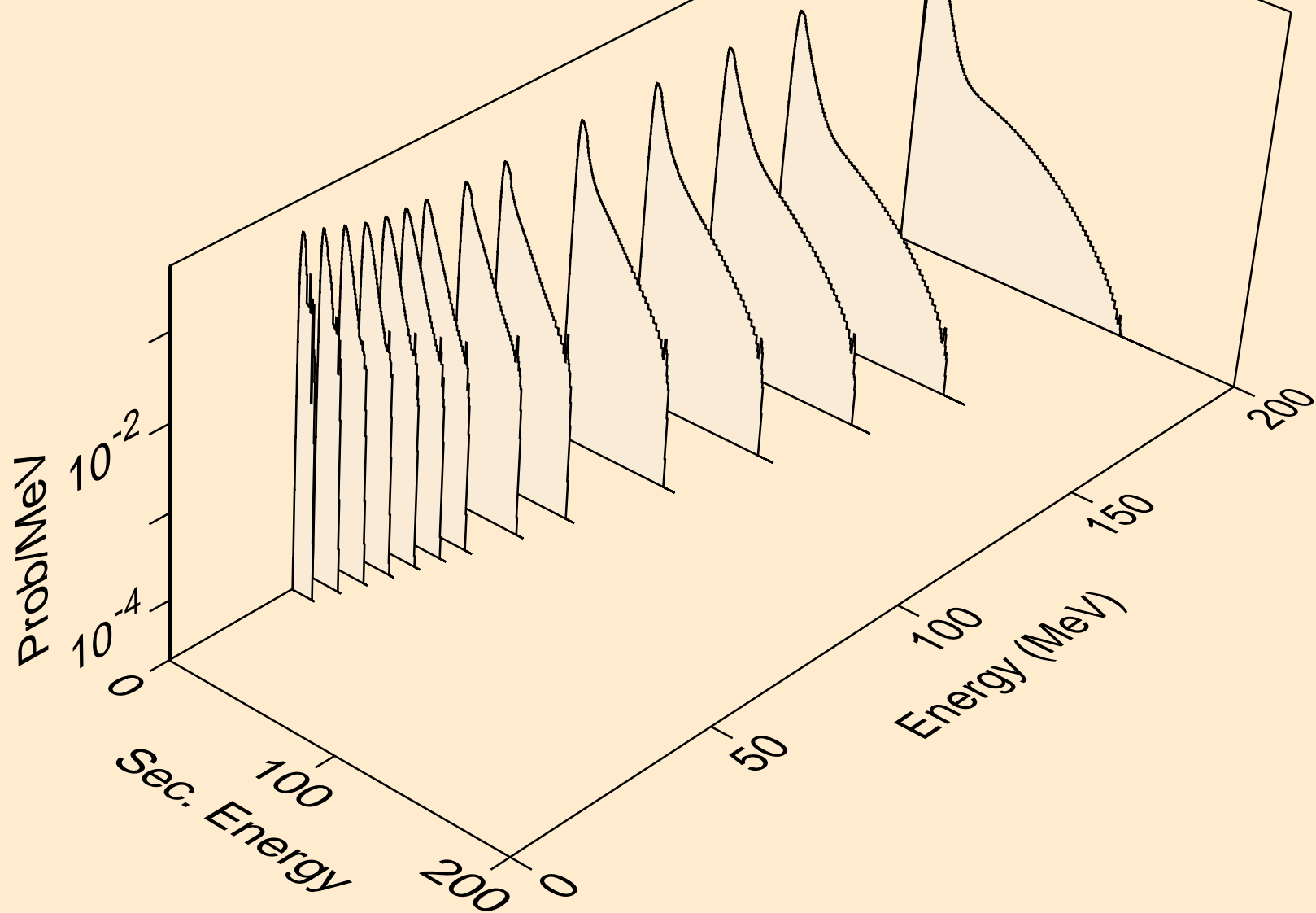

O018 ALPHA ACER TENDL-2024 LIBRARY; T=0.K
deuterons from (a,n*)d

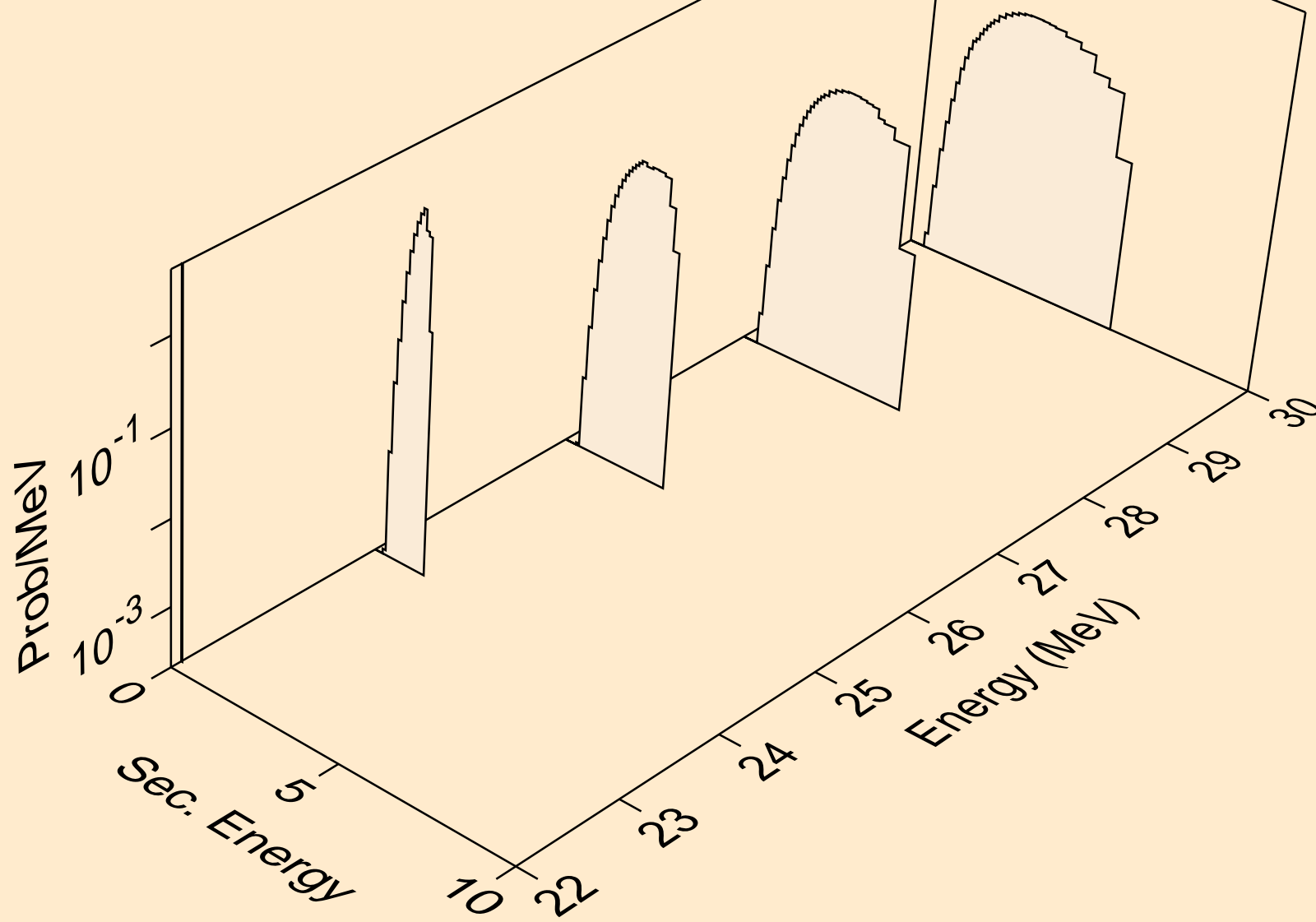

O018 ALPHA ACER TENDL-2024 LIBRARY; T=0.K
deuterons from (a,d)

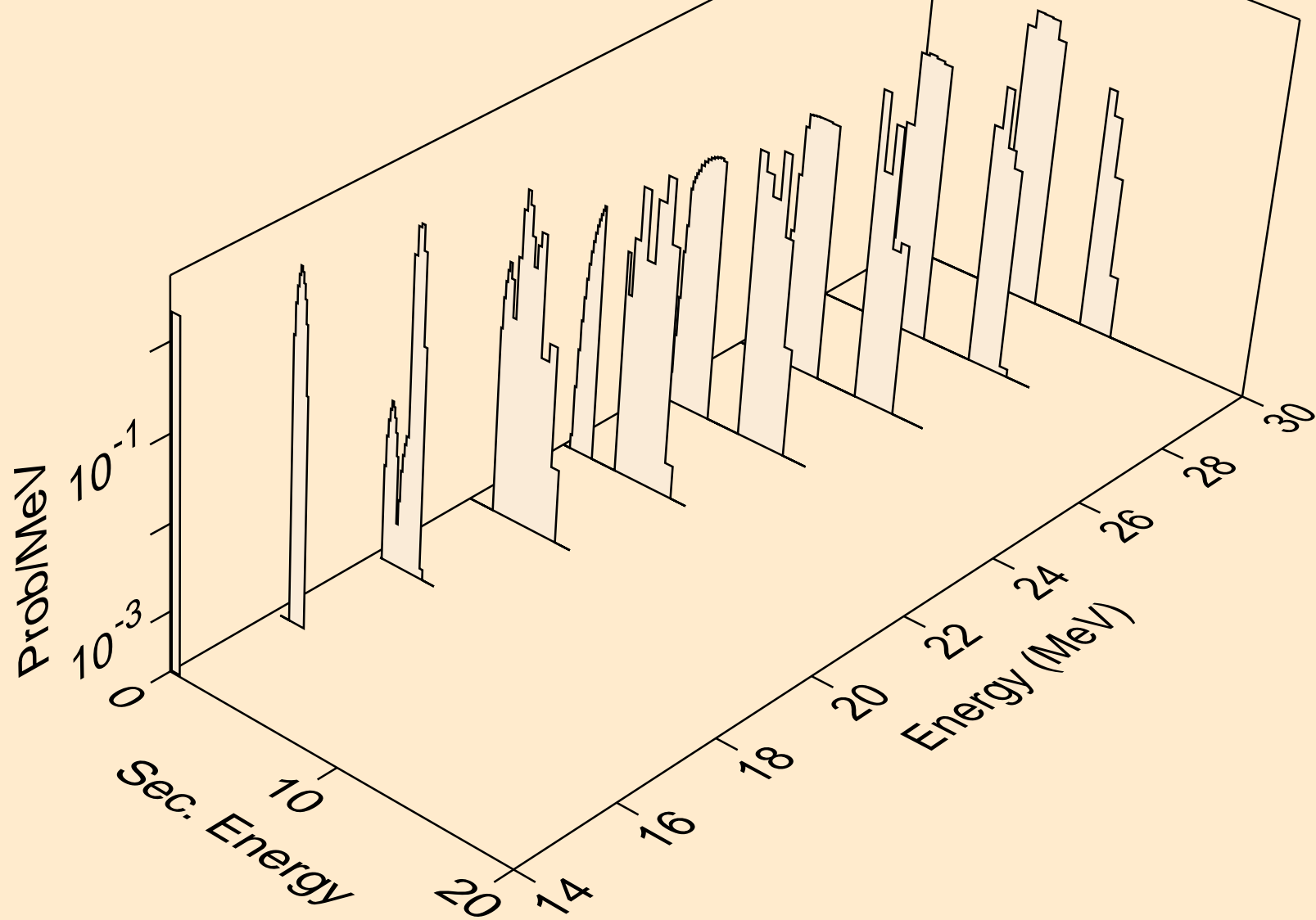

O018 ALPHA ACER TENDL-2024 LIBRARY; T=0.K
deuterons from (a,pd)

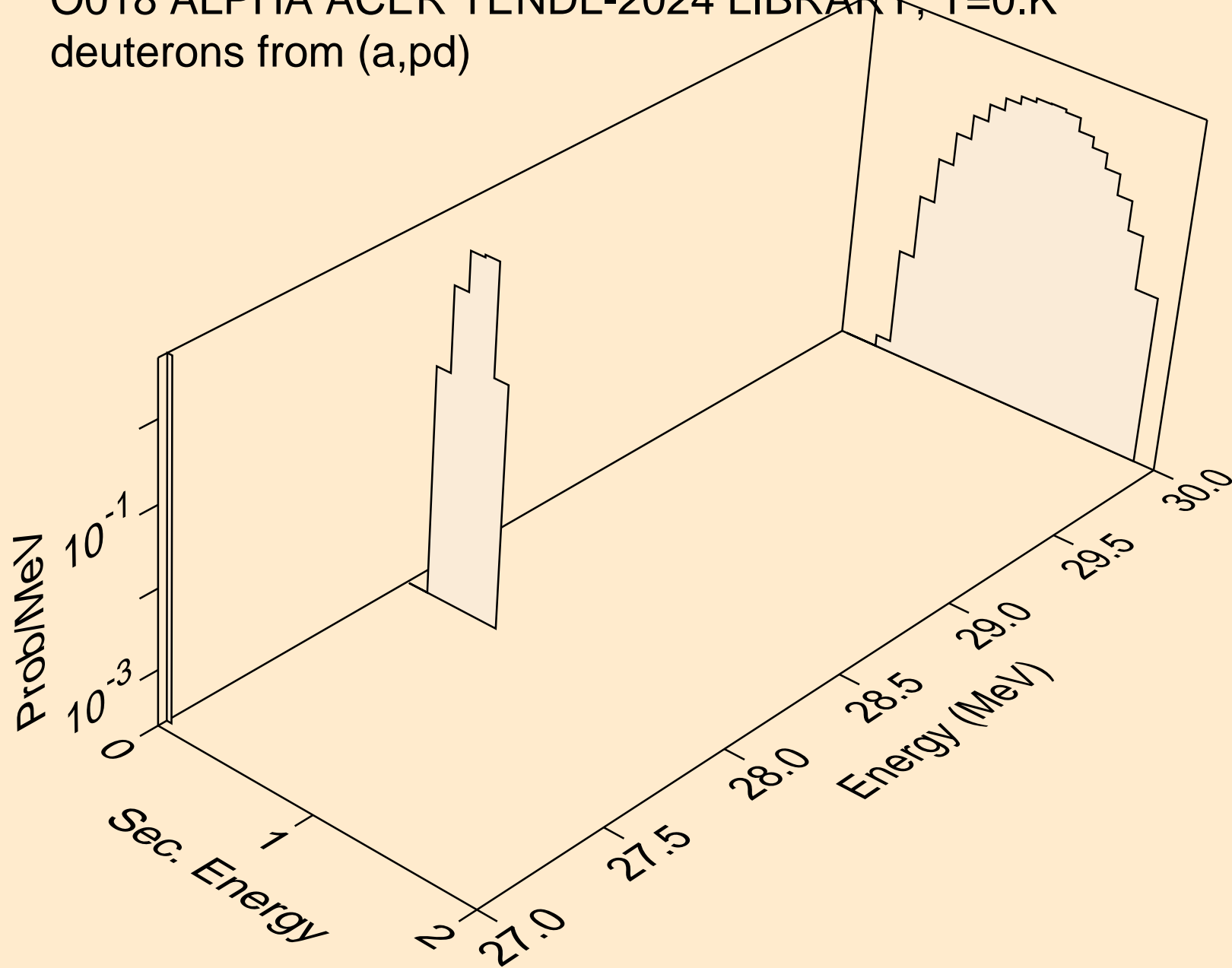

O018 ALPHA ACER TENDL-2024 LIBRARY; T=0.K
deuterons from (a,da)

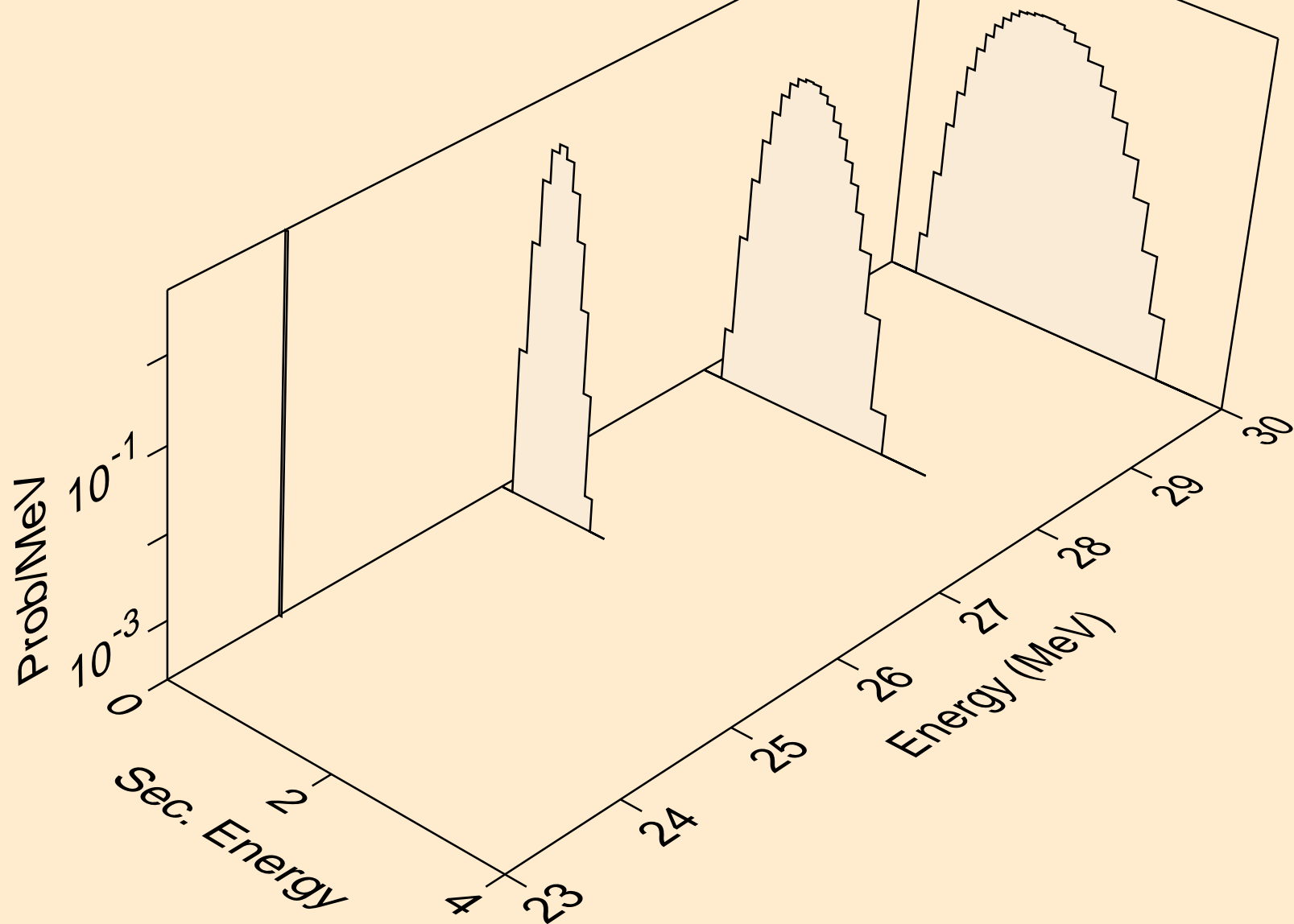

O018 ALPHA ACER TENDL-2024 LIBRARY; T=0.K
tritons from (a,x)

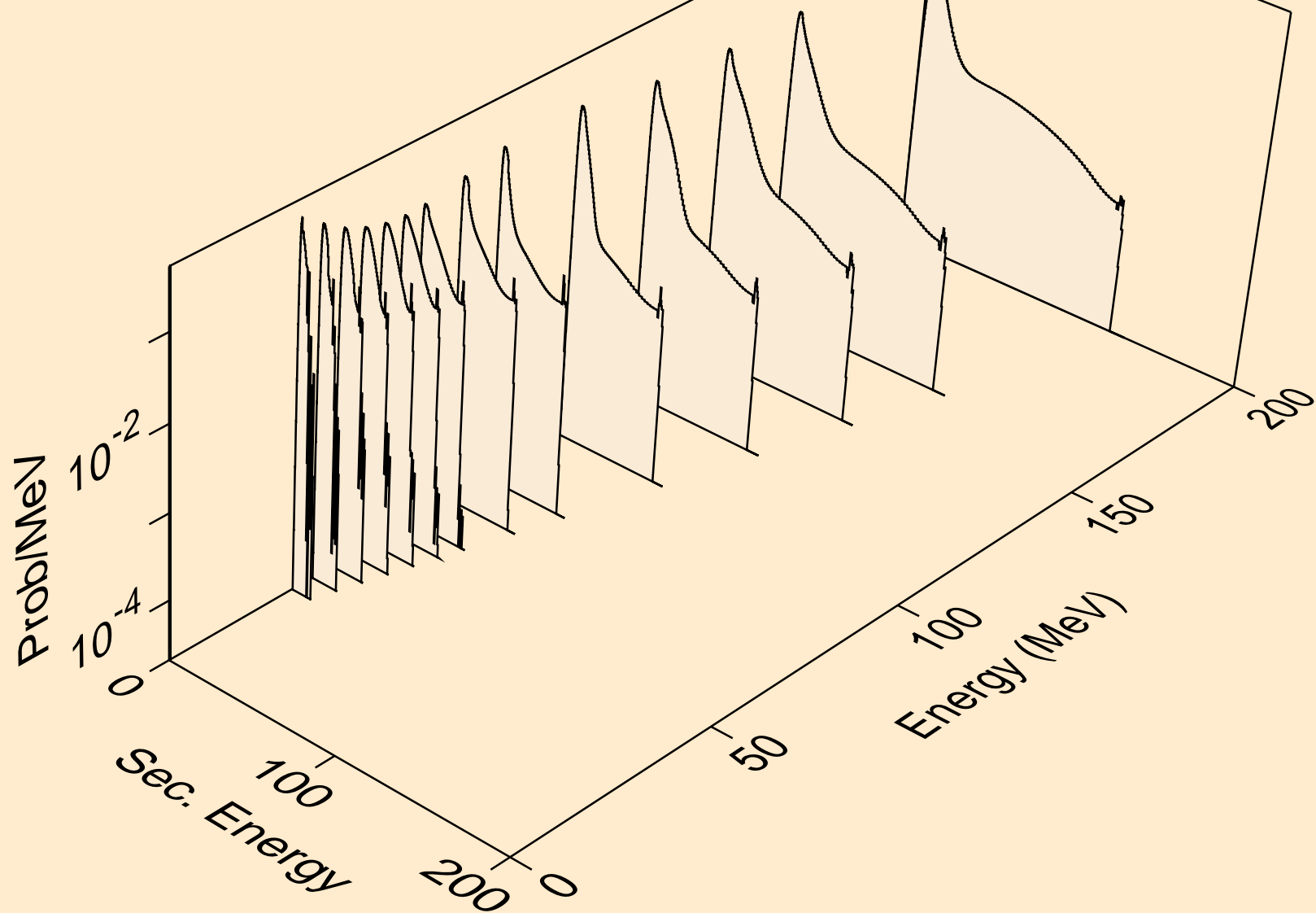

O018 ALPHA ACER TENDL-2024 LIBRARY; T=0.K
tritons from (a,n*)t

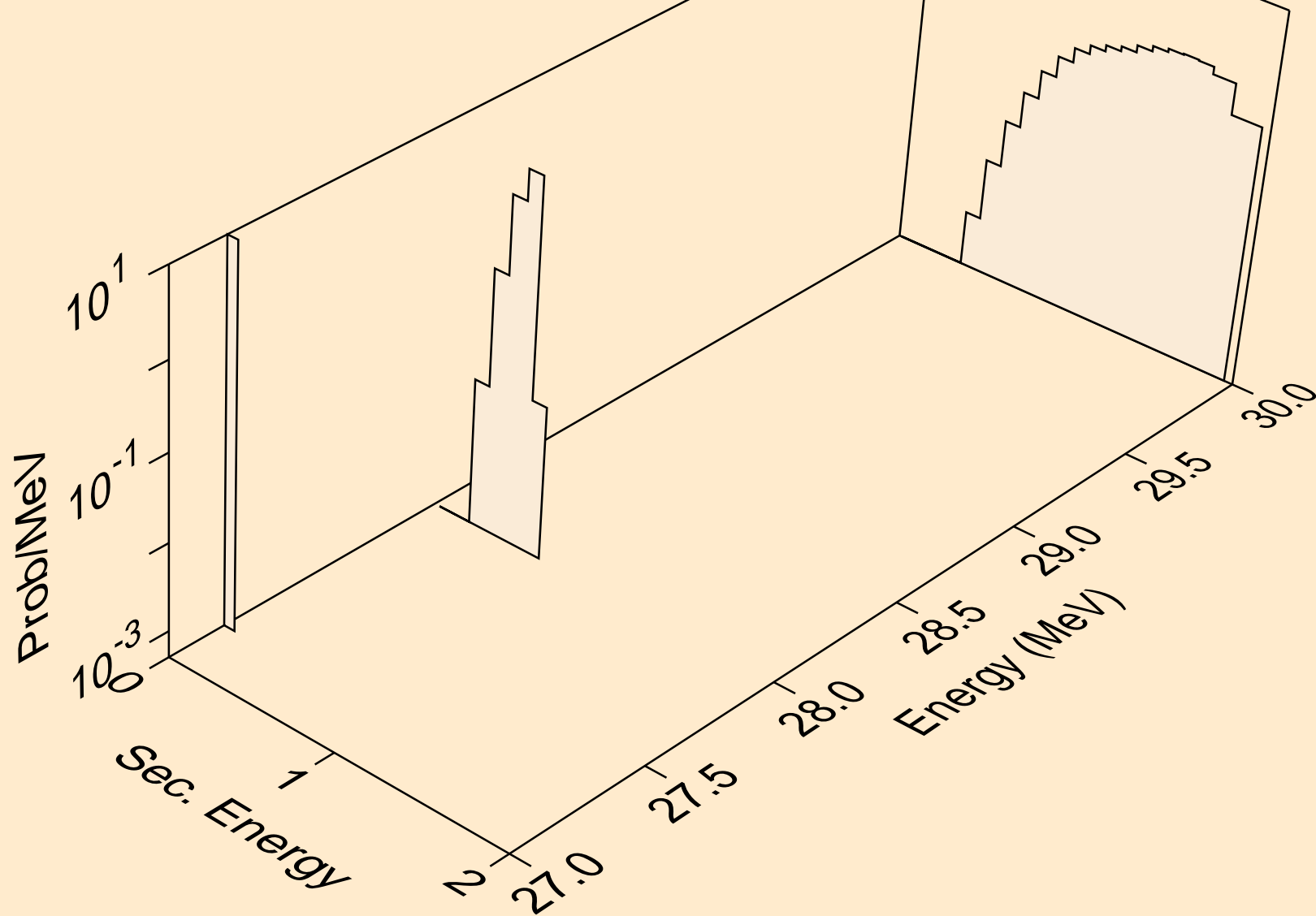

O018 ALPHA ACER TENDL-2024 LIBRARY; T=0.K
tritons from (a,t)

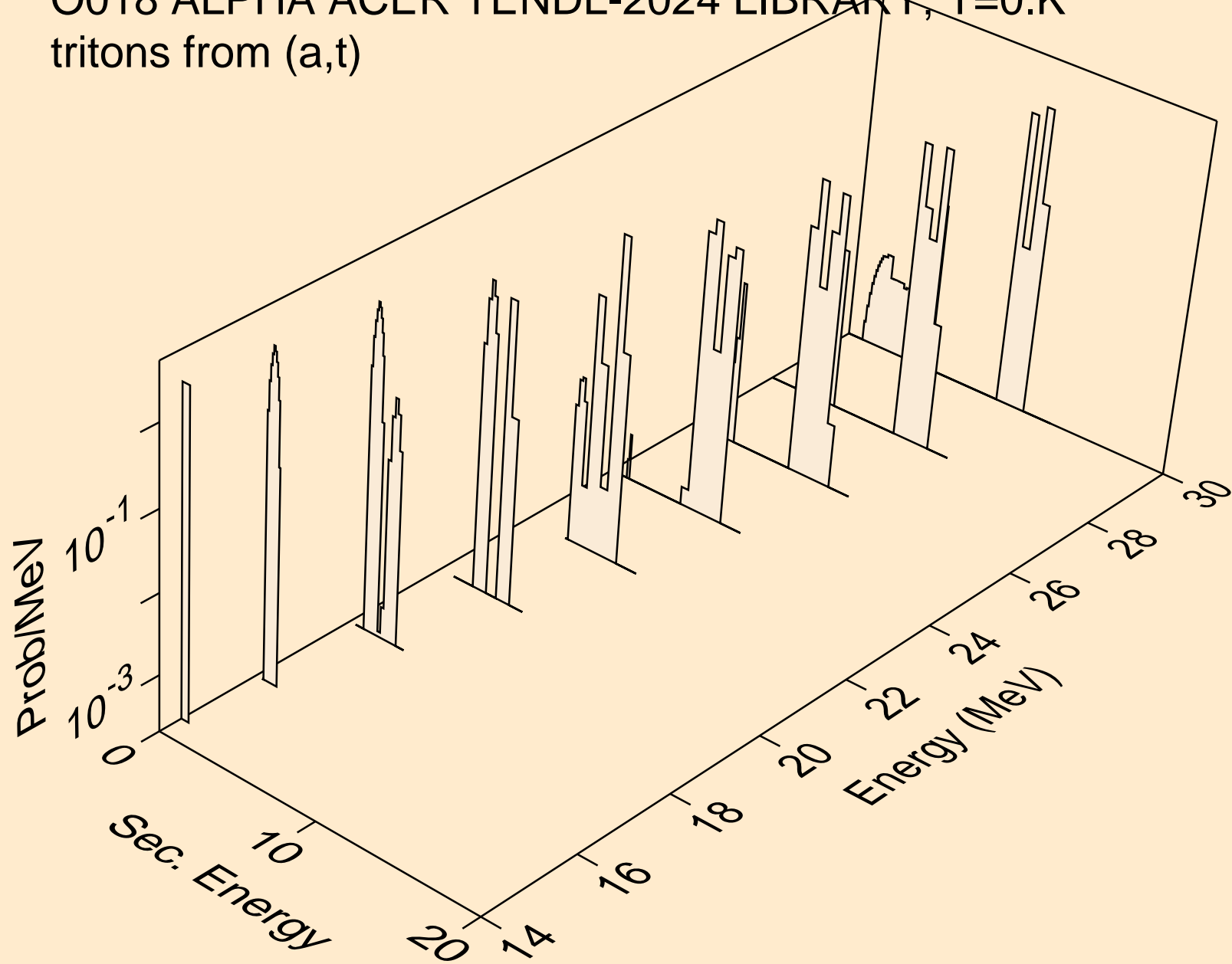

O018 ALPHA ACER TENDL-2024 LIBRARY; T=0.K
tritons from (a,pt)

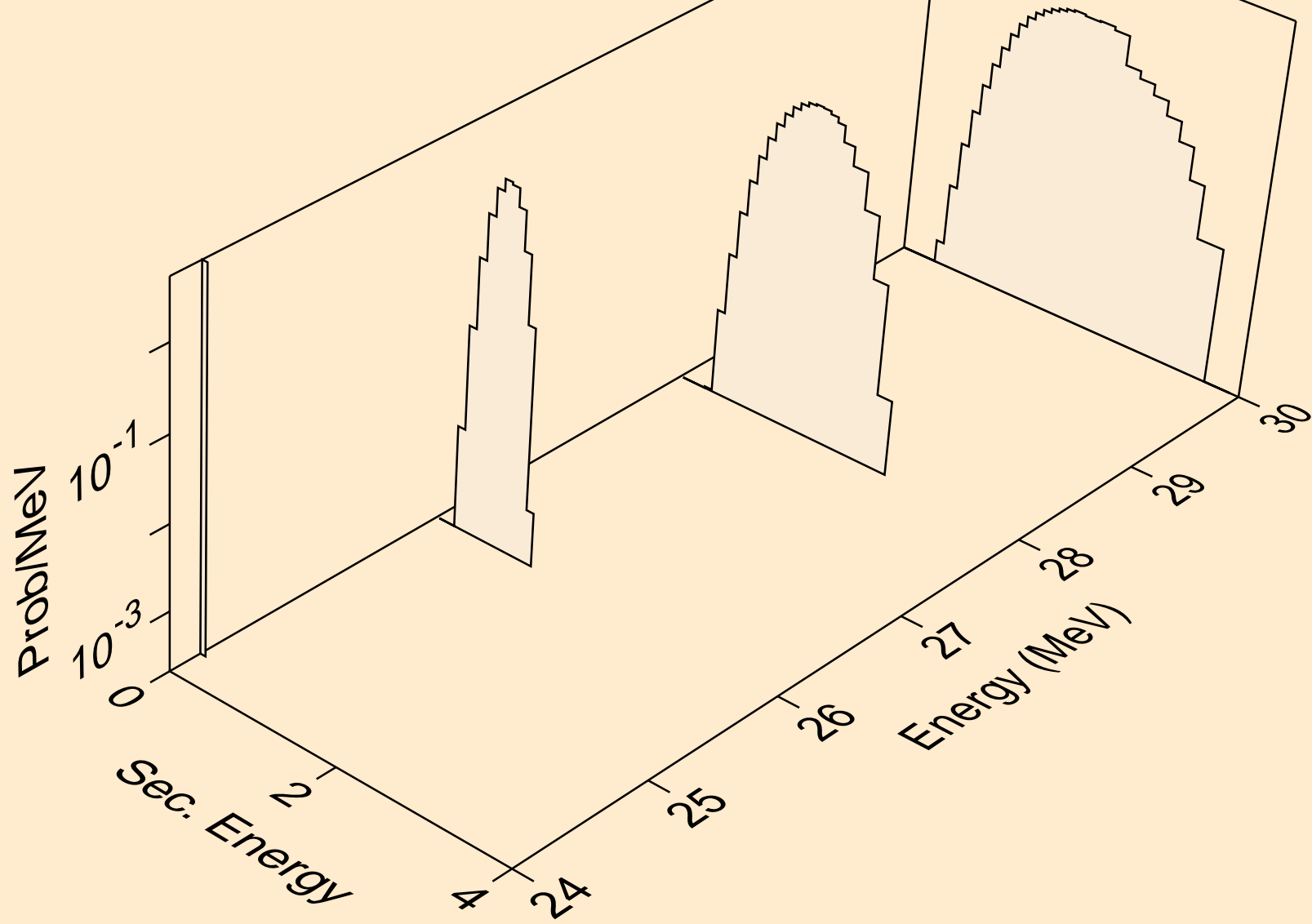

O018 ALPHA ACER TENDL-2024 LIBRARY; T=0.K
he3s from (a,x)

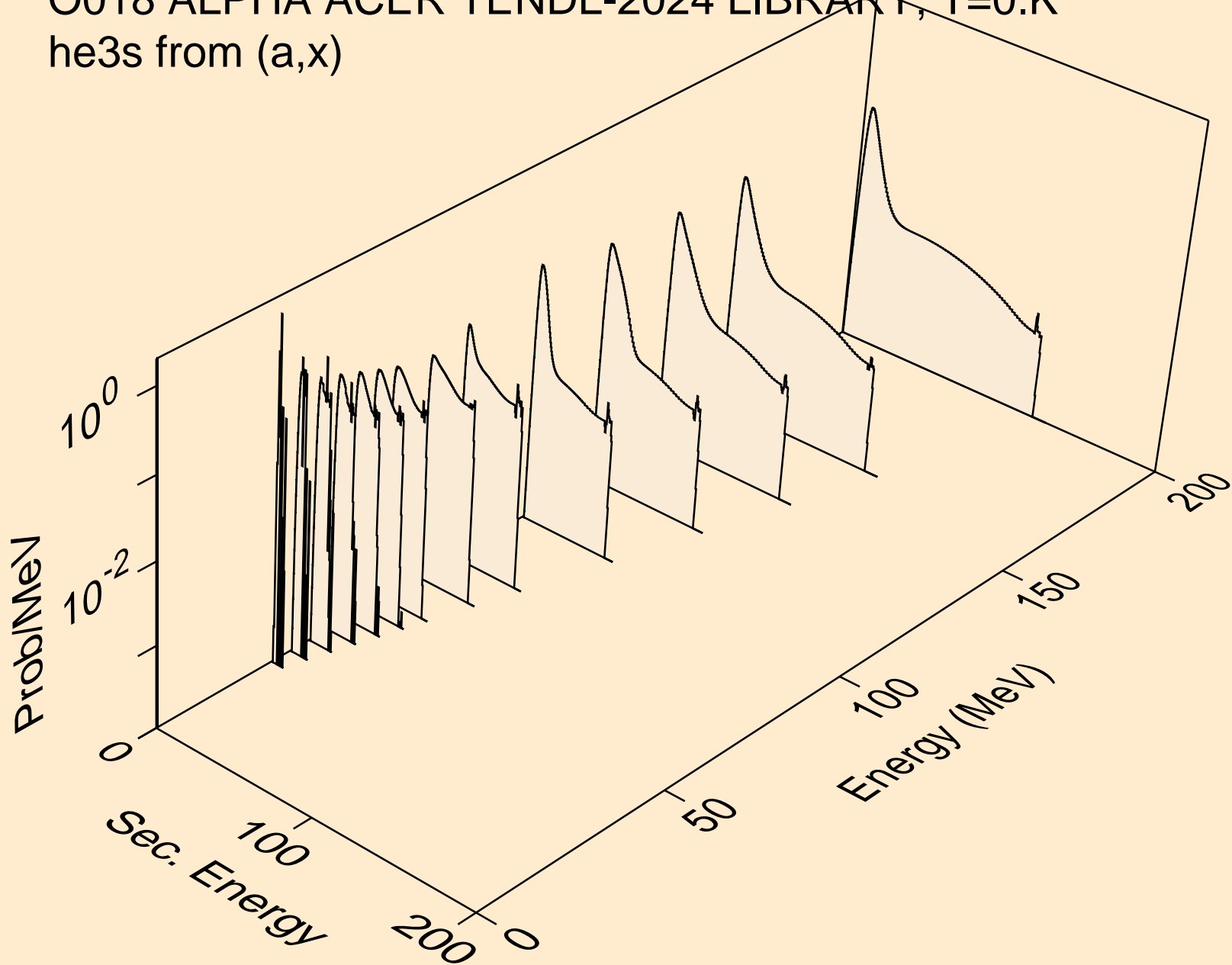

O018 ALPHA ACER TENDL-2024 LIBRARY; T=0.K
he3s from (a,n*)he3

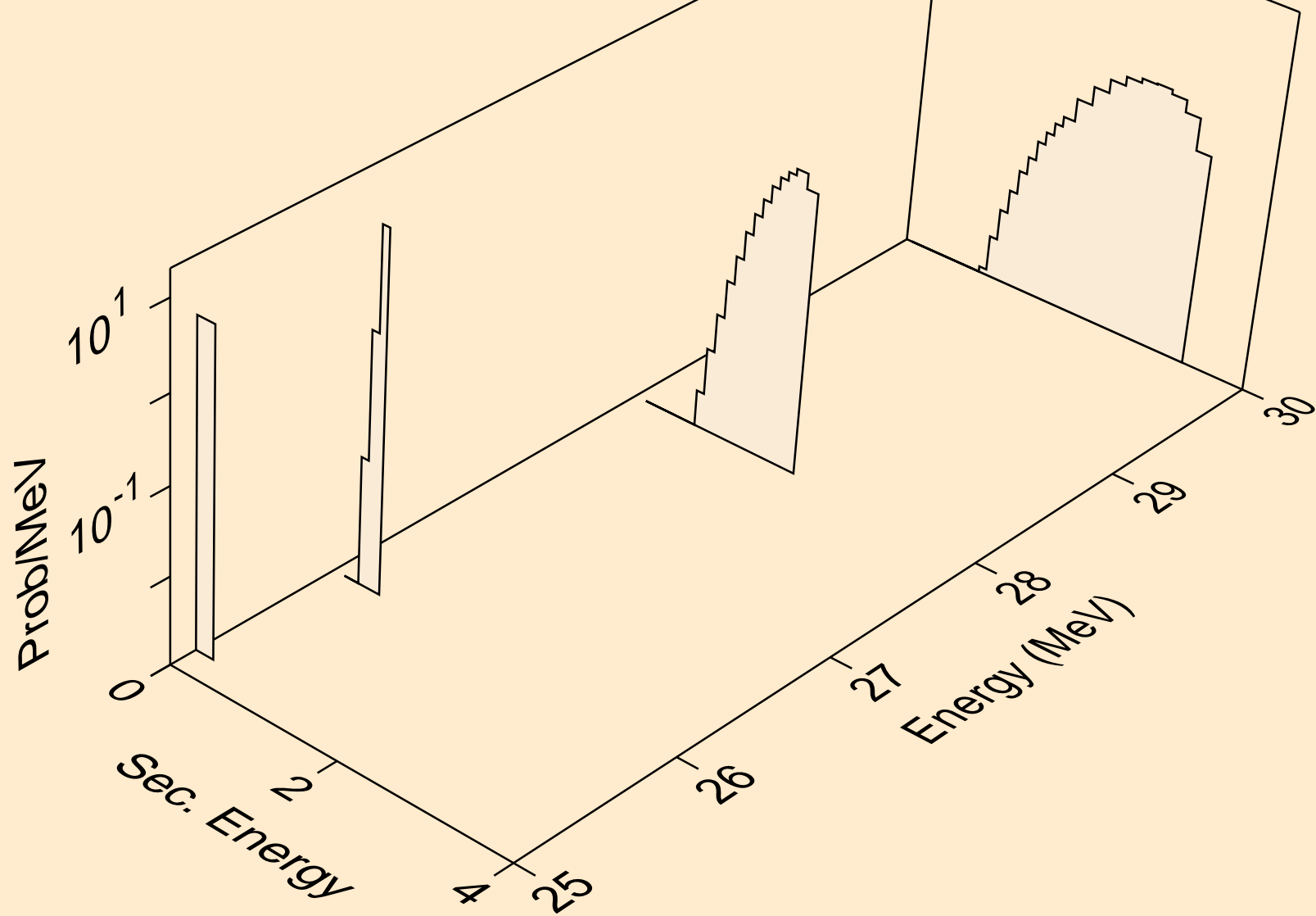

O018 ALPHA ACER TENDL-2024 LIBRARY; T=0.K
he3s from (a,he3)

