

RU090 ALPHA ACER TENDL-2024 LIBRARY; T=0.K
Principal cross sections

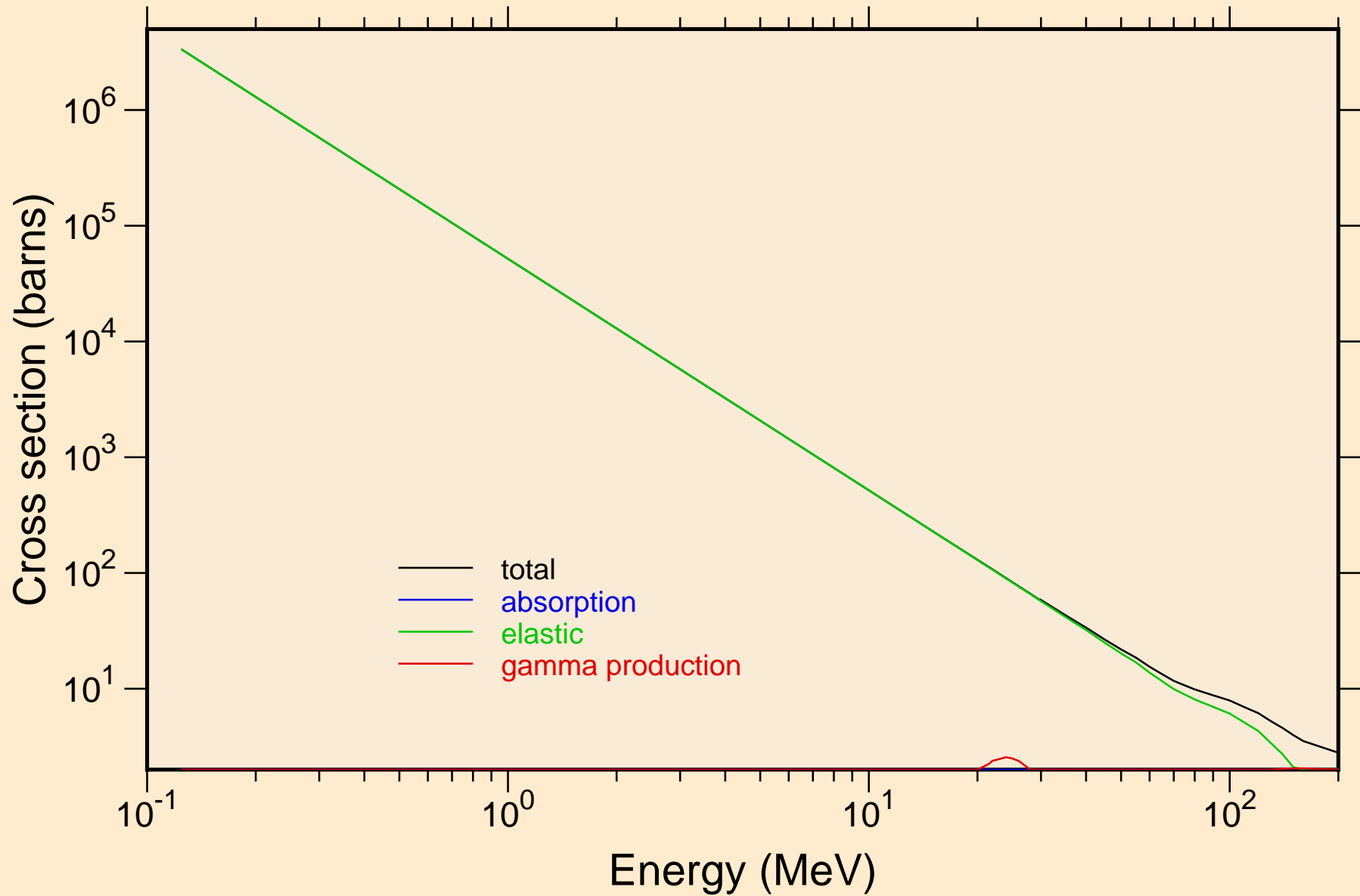

RU090 ALPHA ACER TENDL-2024 LIBRARY; T=0.K

Heating

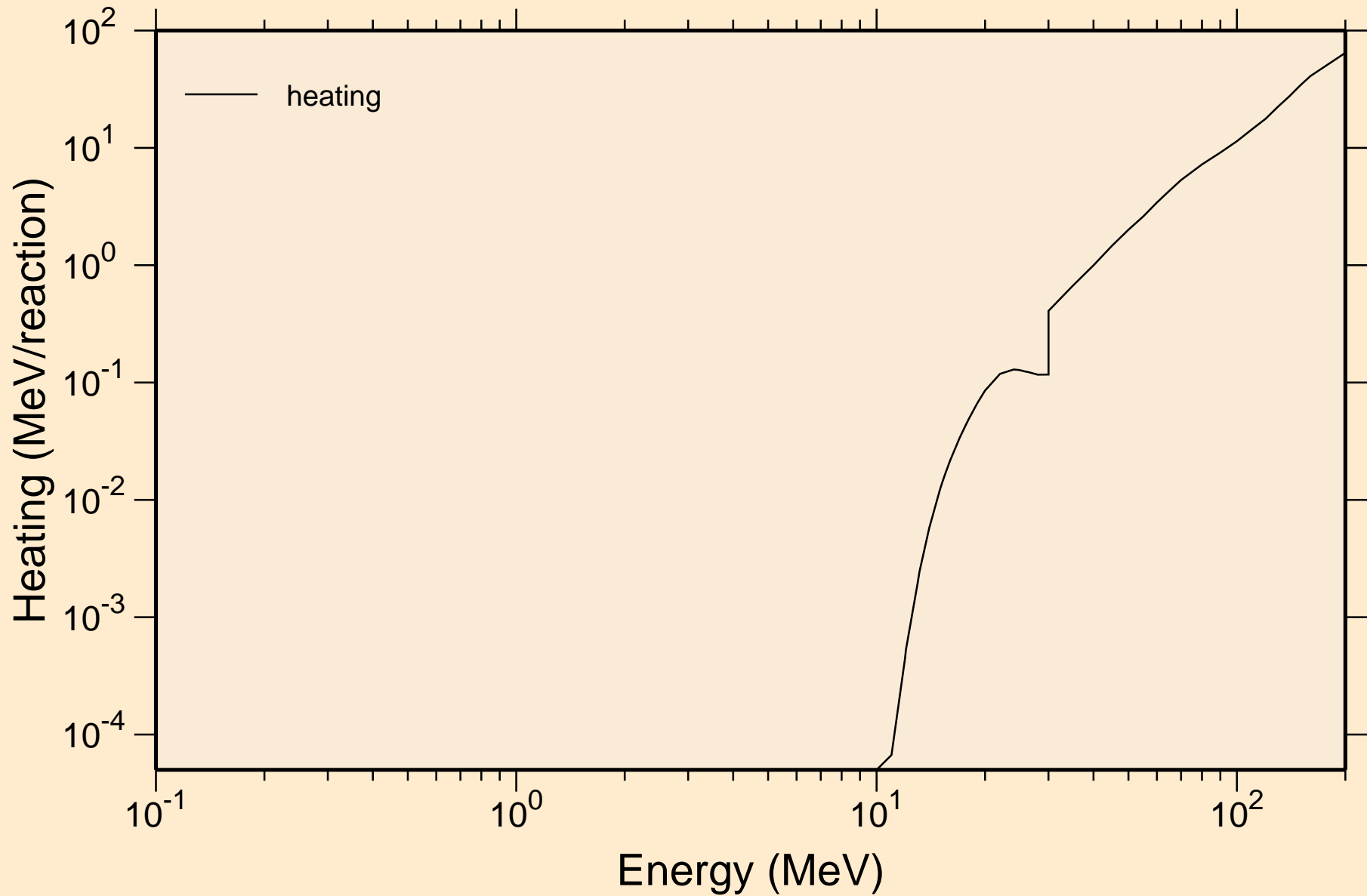

RU090 ALPHA ACER TENDL-2024 LIBRARY; T=0.K

Principal cross sections

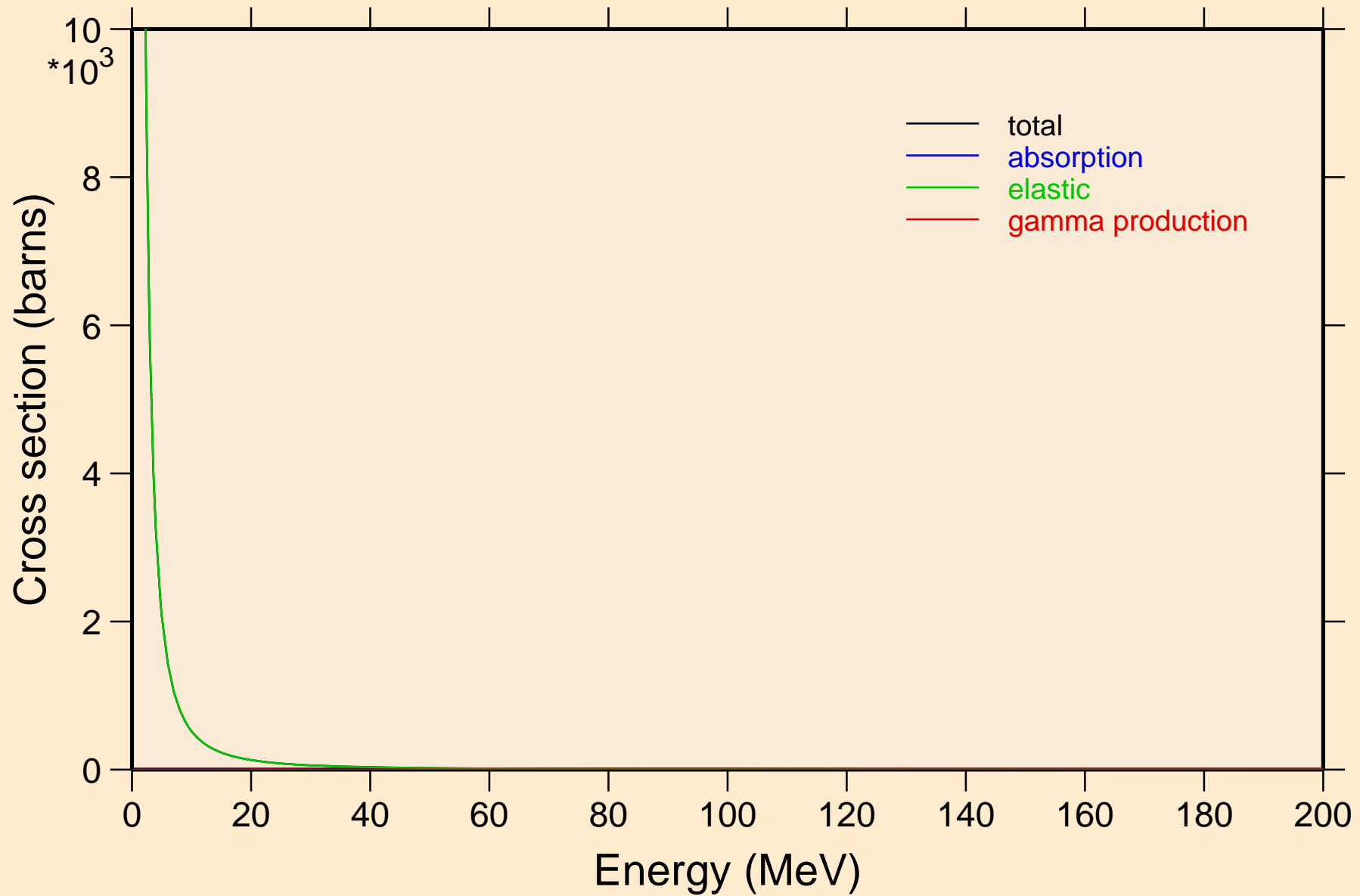

RU090 ALPHA ACER TENDL-2024 LIBRARY; T=0.K

Heating

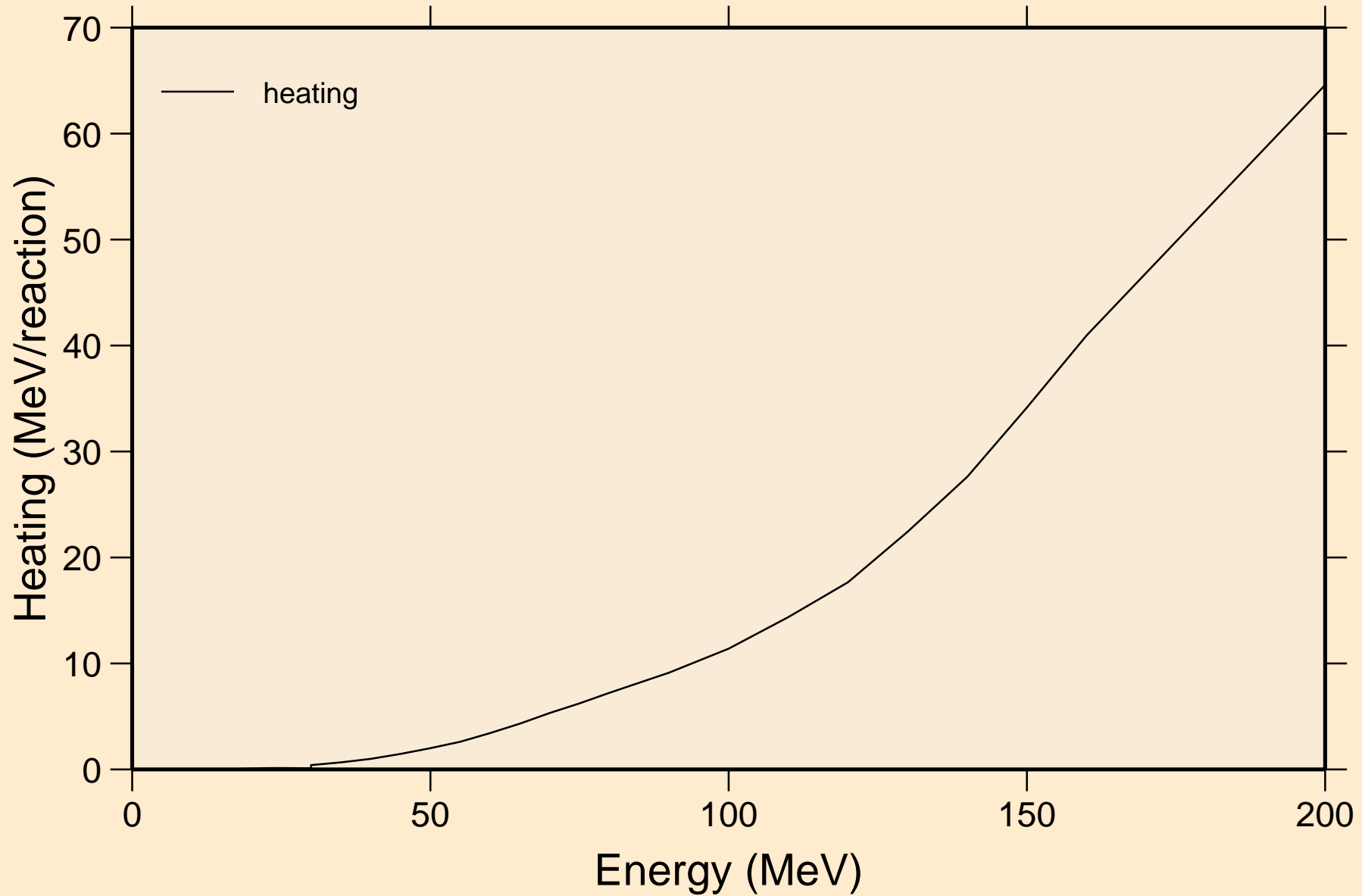

RU090 ALPHA ACER TENDL-2024 LIBRARY; T=0.K
Threshold reactions

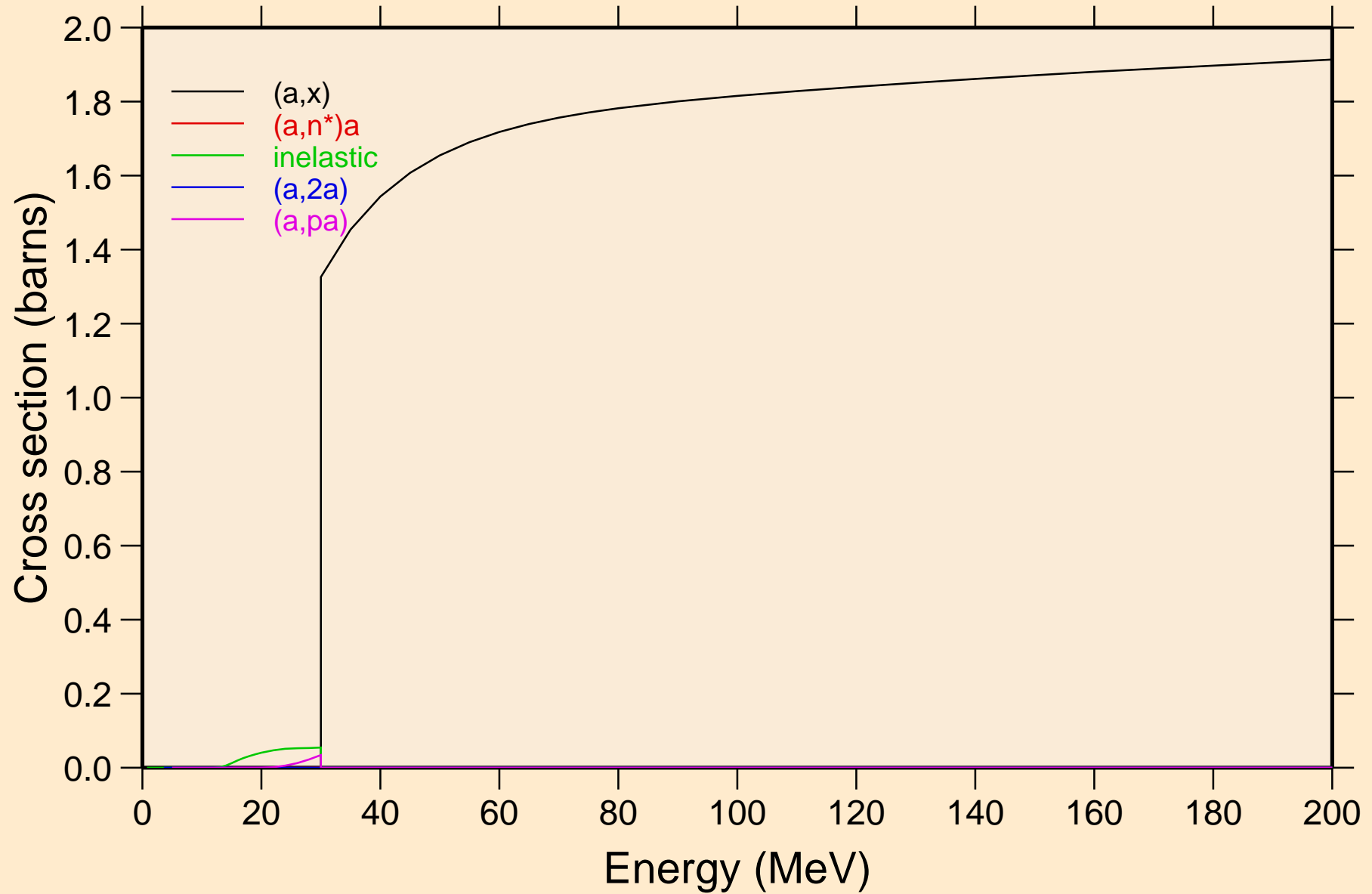

RU090 ALPHA ACER TENDL-2024 LIBRARY; T=0.K
Threshold reactions

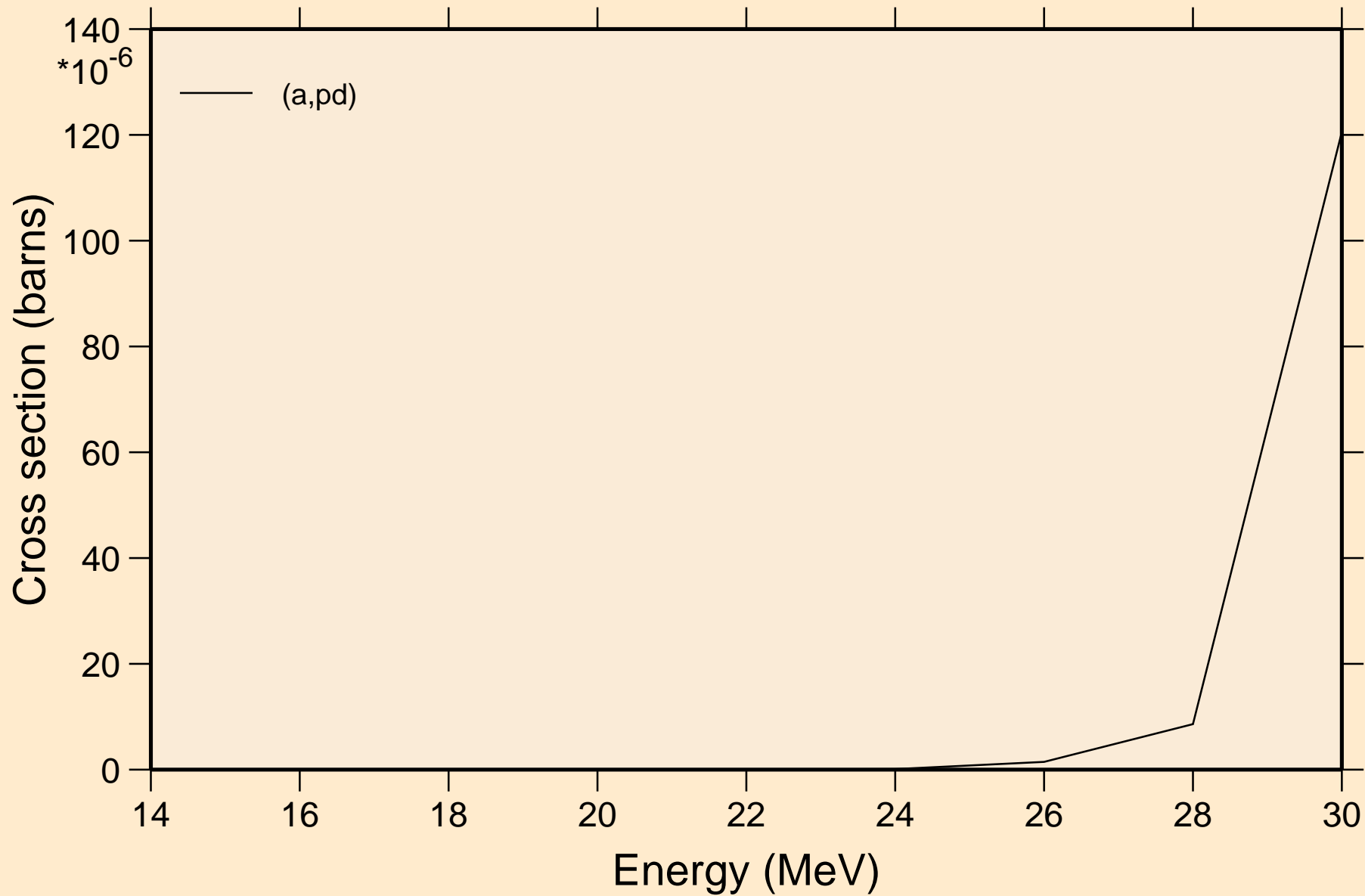

RU090 ALPHA ACER TENDL-2024 LIBRARY; T=0.K
angular distribution for elastic

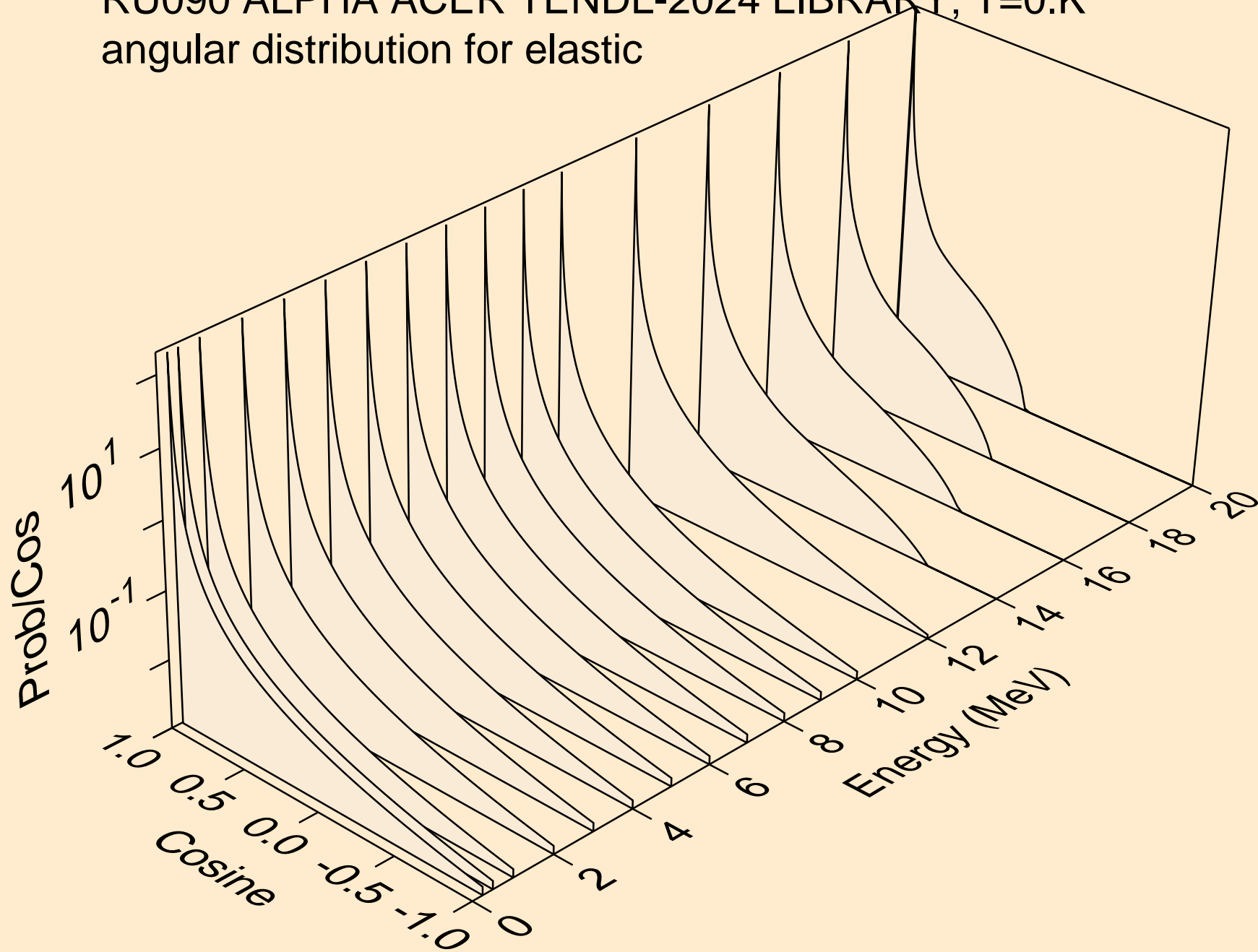

RU090 ALPHA ACER TENDL-2024 LIBRARY; T=0.K
angular distribution for elastic

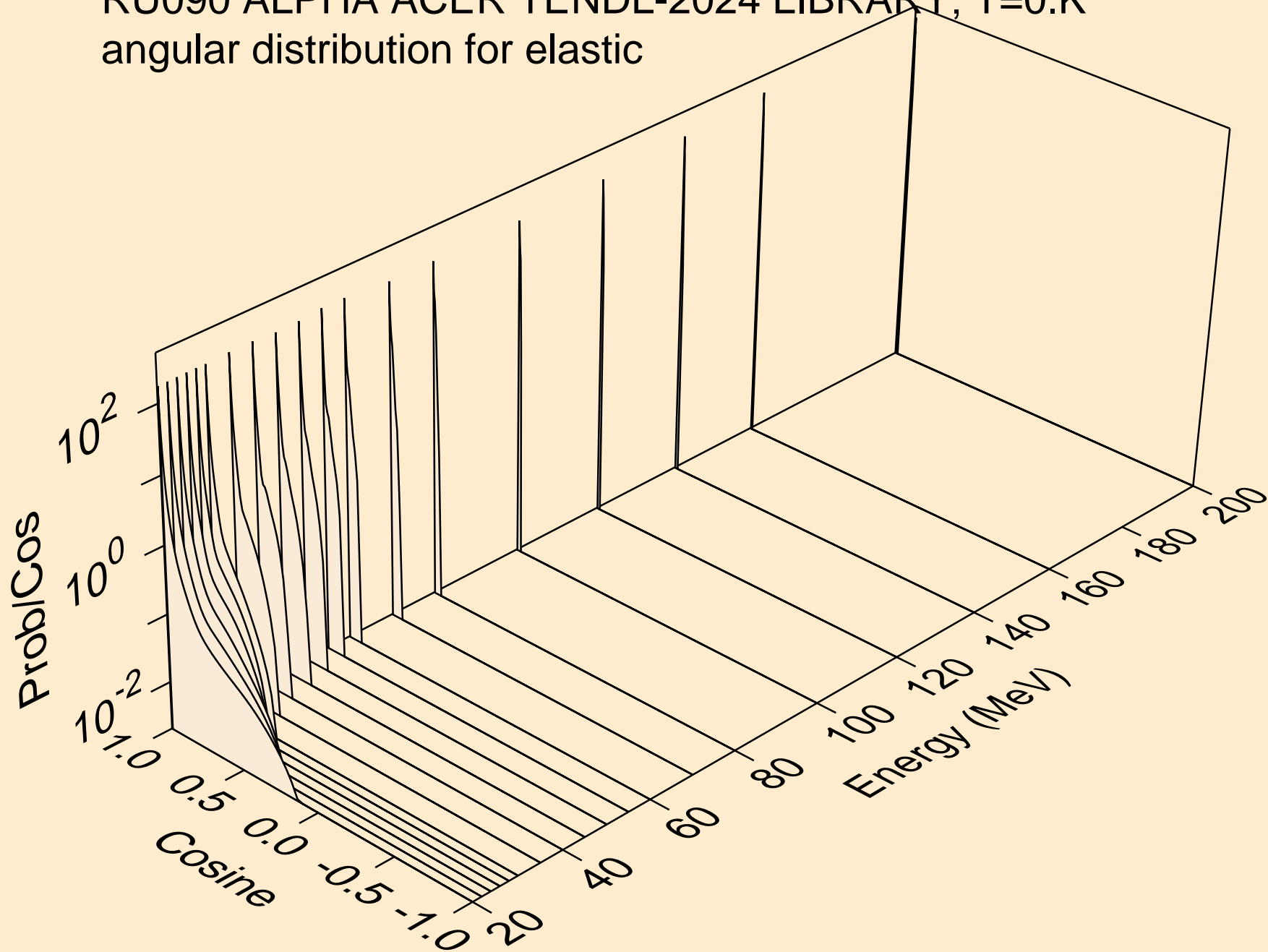

RU090 ALPHA ACER TENDL-2024 LIBRARY; T=0.K
Alpha emission for (a,x)

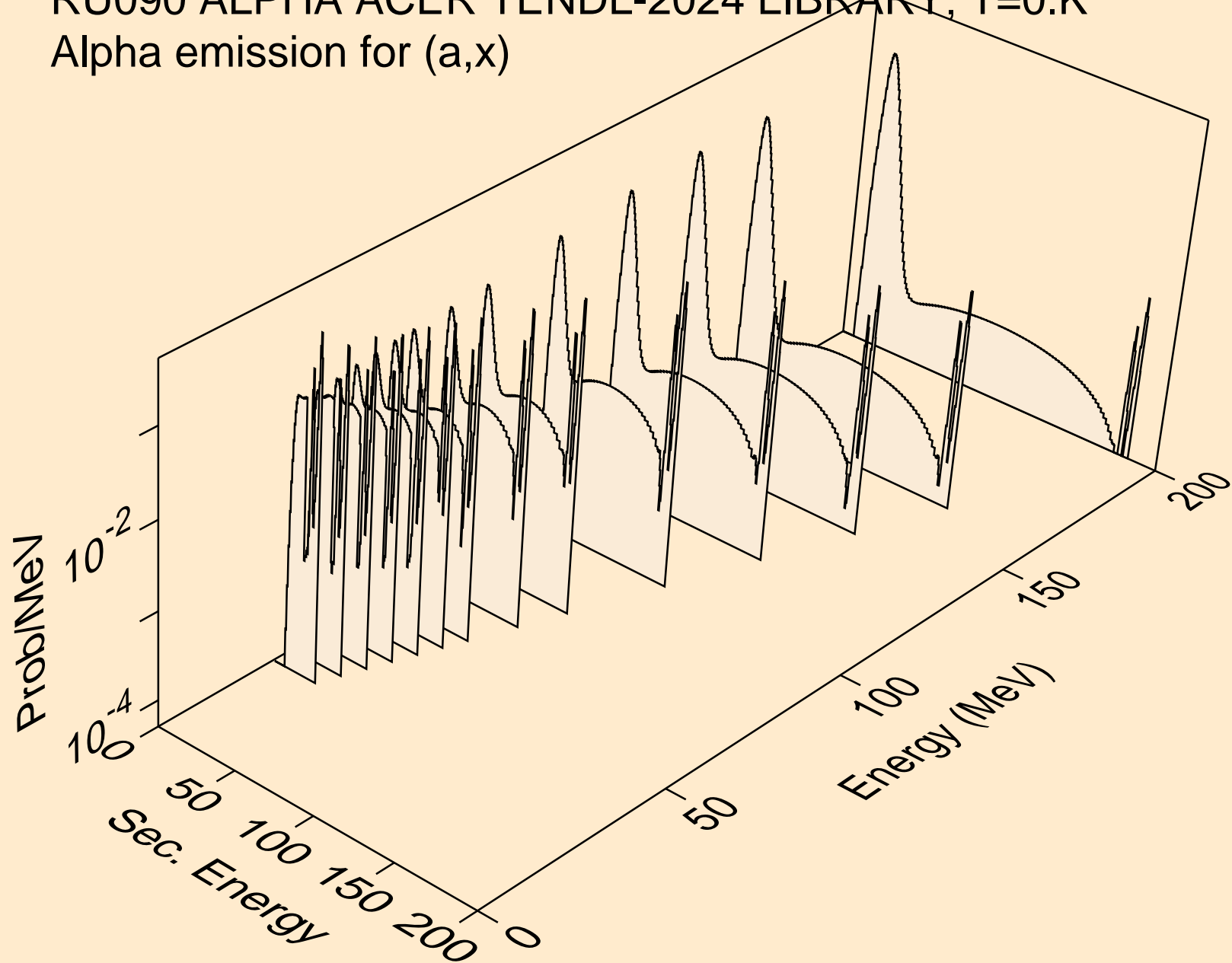

RU090 ALPHA ACER TENDL-2024 LIBRARY; T=0.K
Alpha emission for (a,n*)a

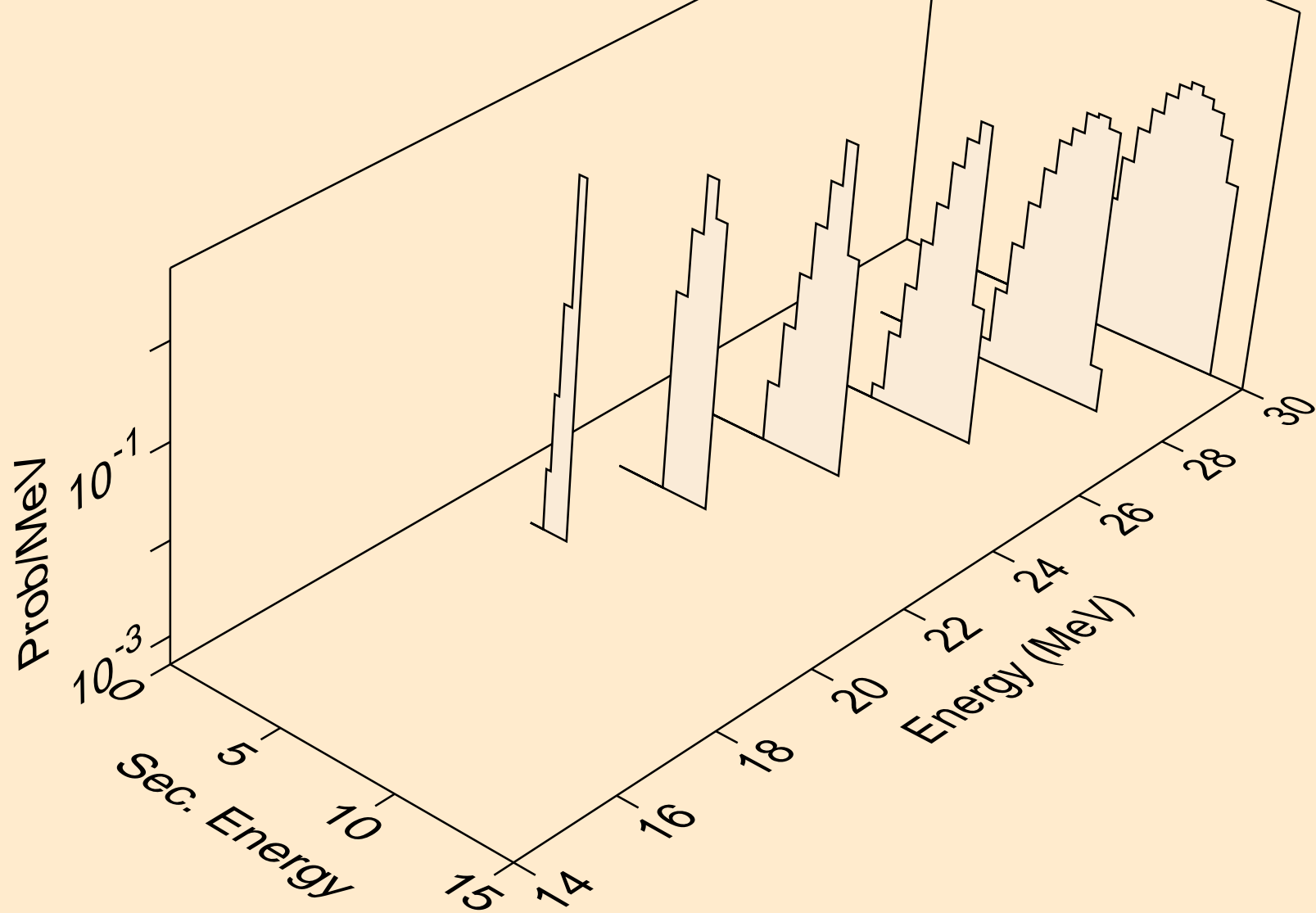

RU090 ALPHA ACER TENDL-2024 LIBRARY; T=0.K
Alpha emission for inelastic

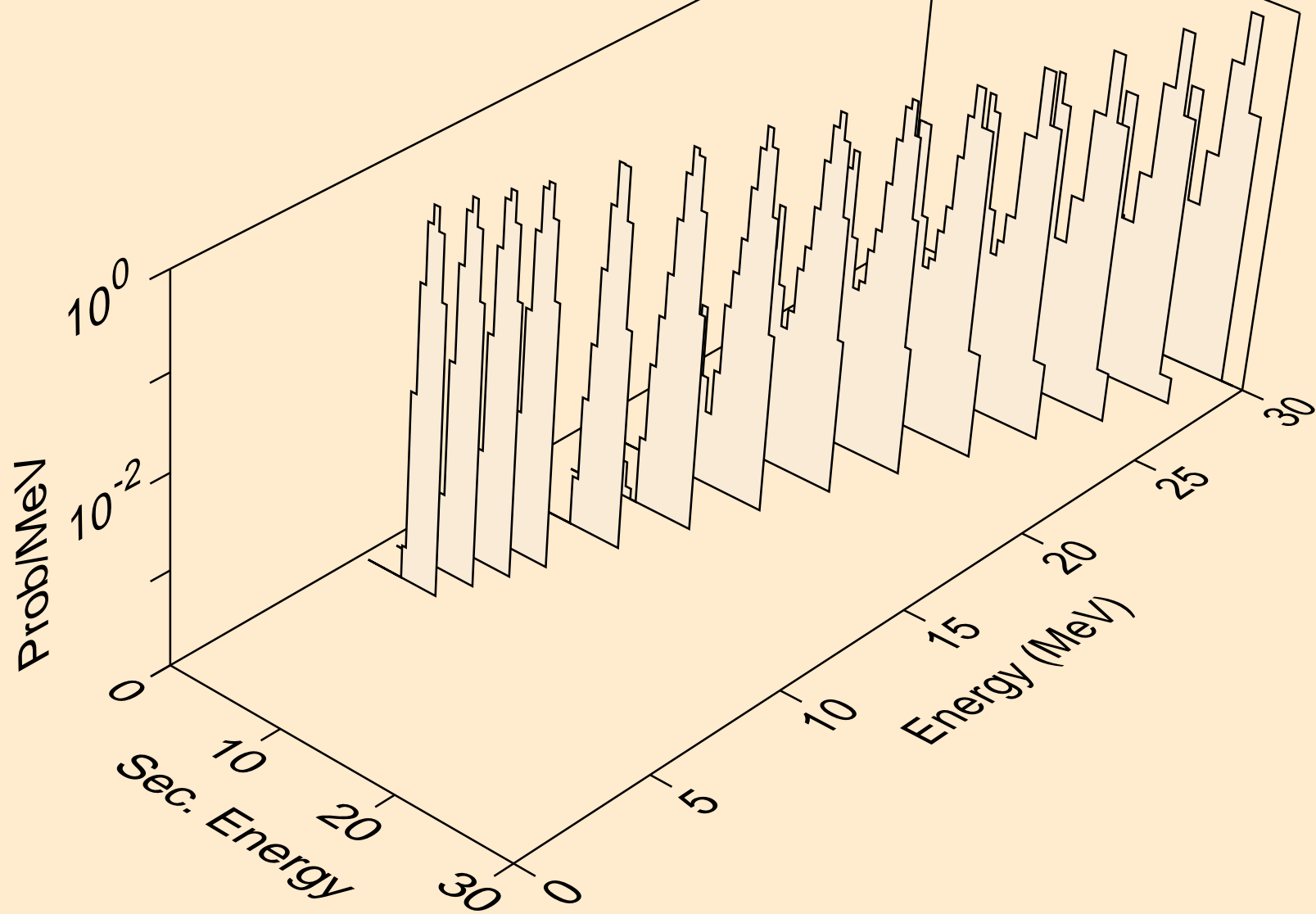

RU090 ALPHA ACER TENDL-2024 LIBRARY; T=0.K
Alpha emission for (a,2a)

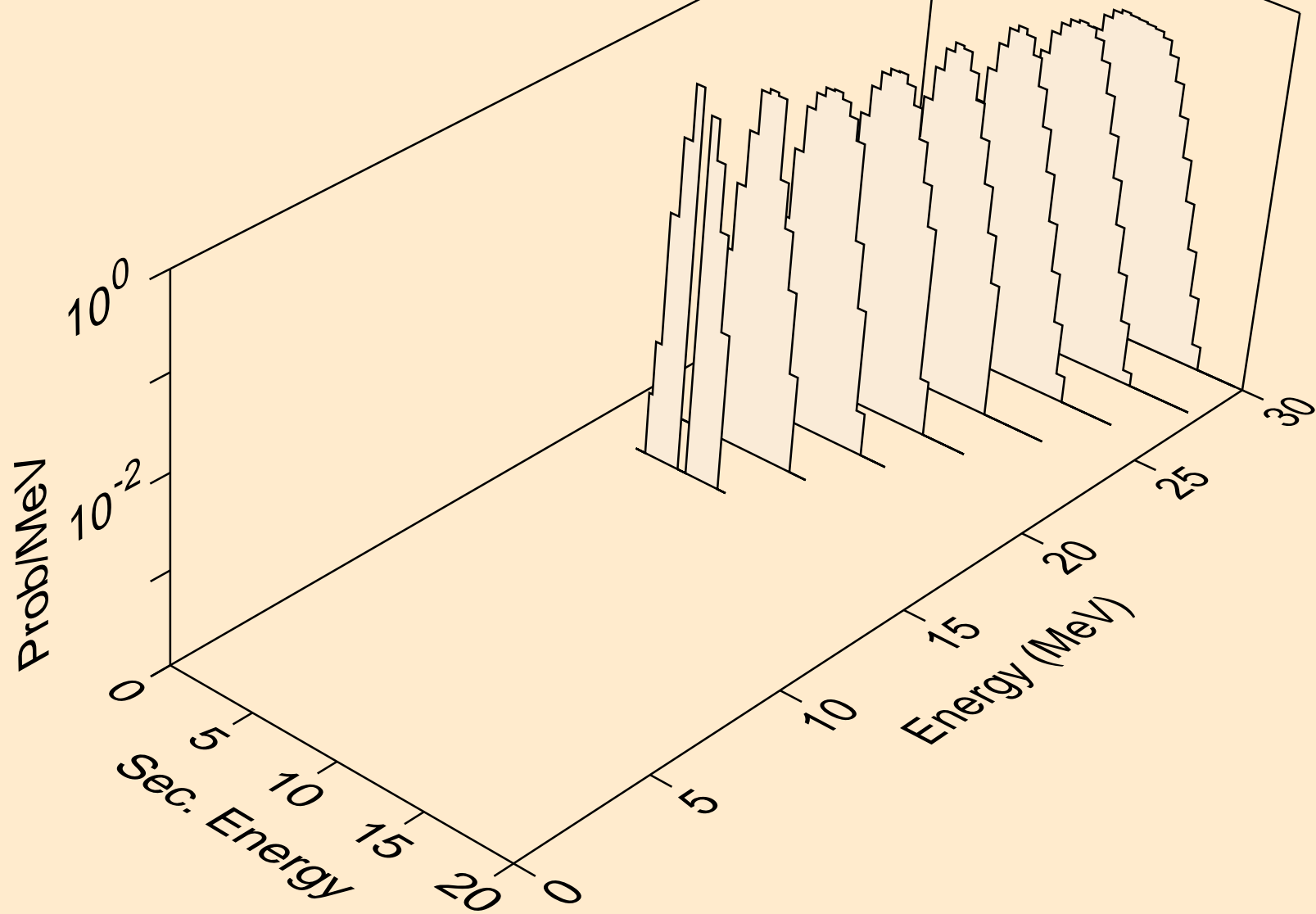

RU090 ALPHA ACER TENDL-2024 LIBRARY; T=0.K
Alpha emission for (a,pa)

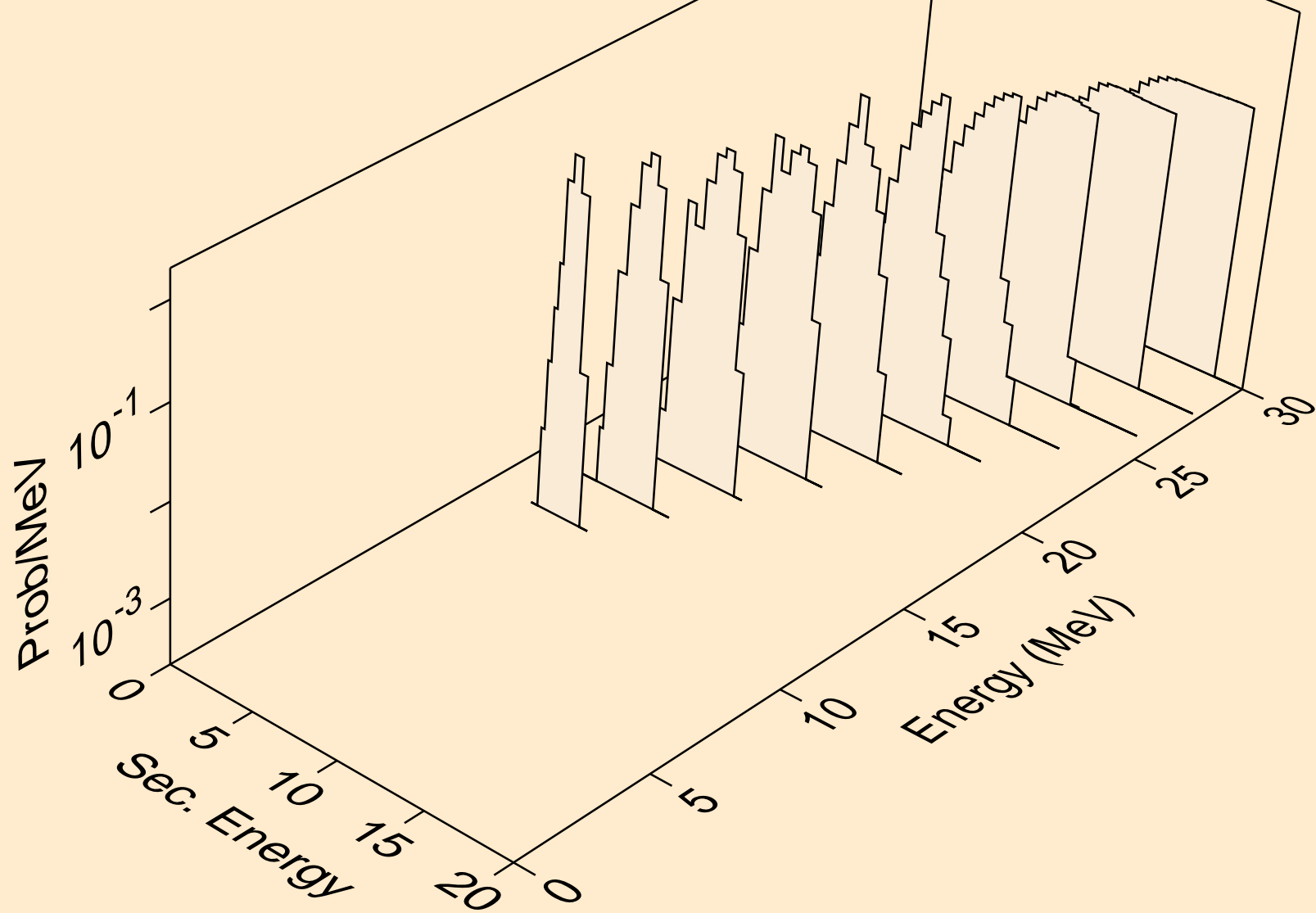

RU090 ALPHA ACER TENDL-2024 LIBRARY; T=0.K
Photon emission for (z,n)

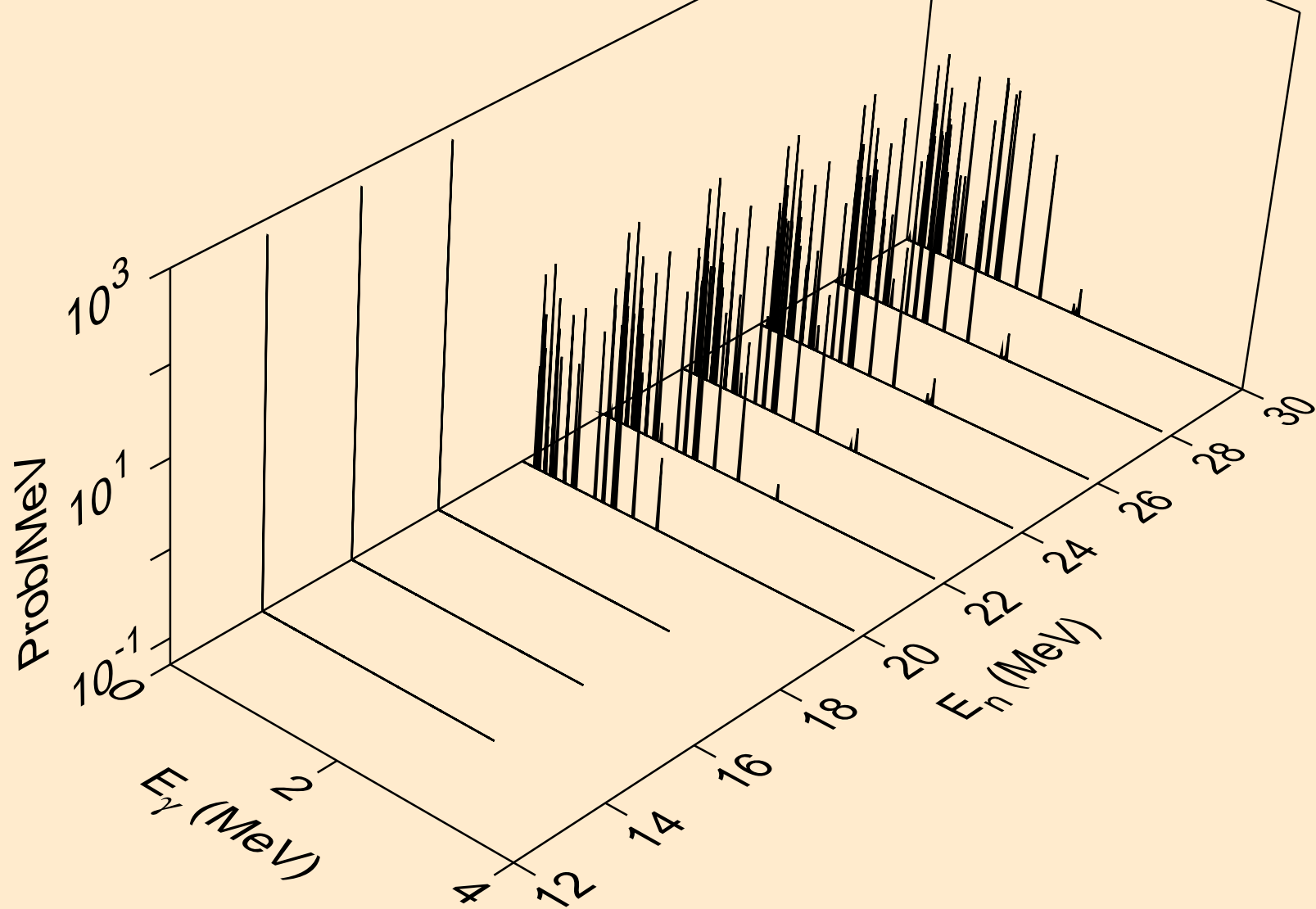

RU090 ALPHA ACER TENDL-2024 LIBRARY; T=0.K
Photon emission for (z,x)

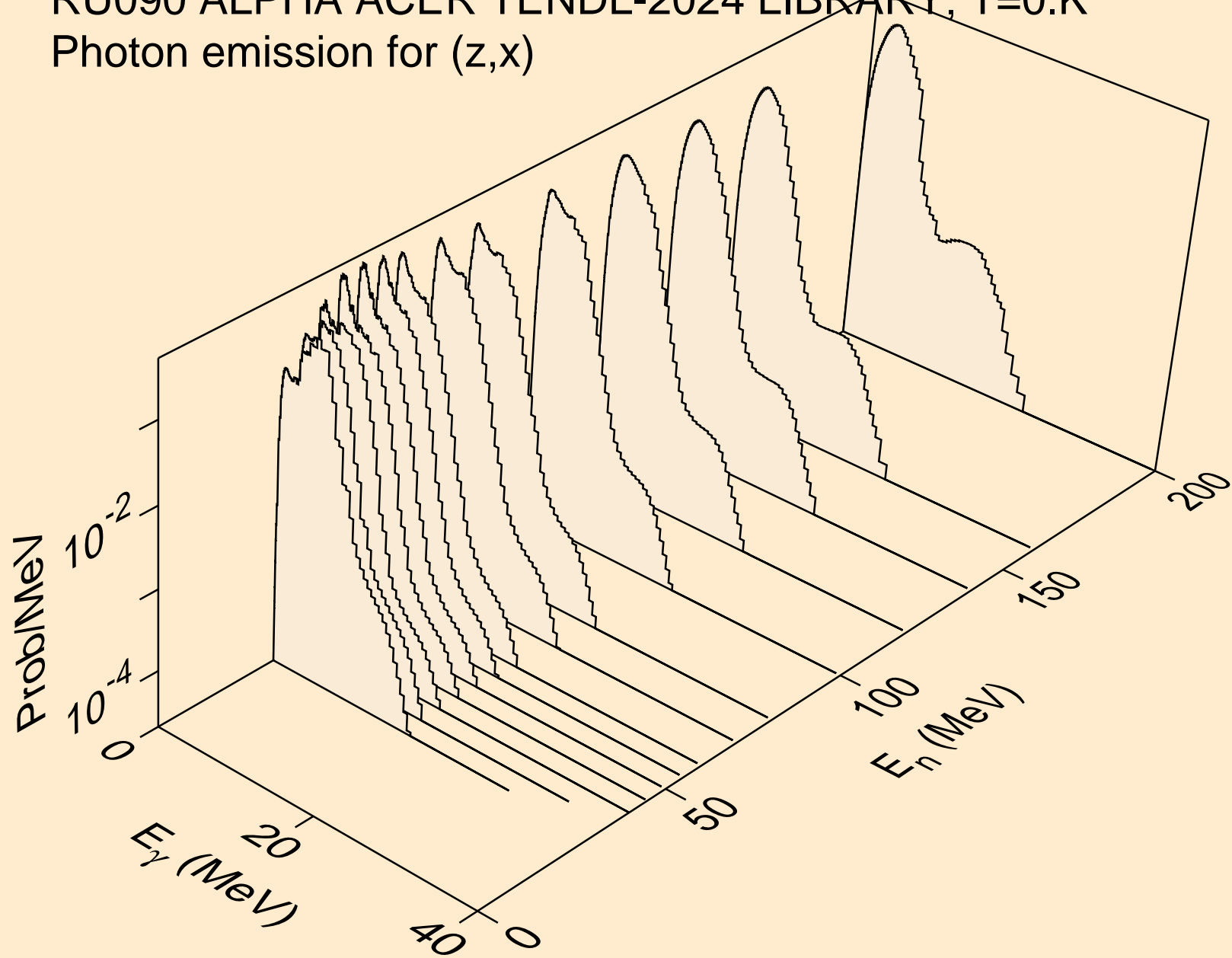

RU090 ALPHA ACER TENDL-2024 LIBRARY; T=0.K
Photon emission for (n,2n)

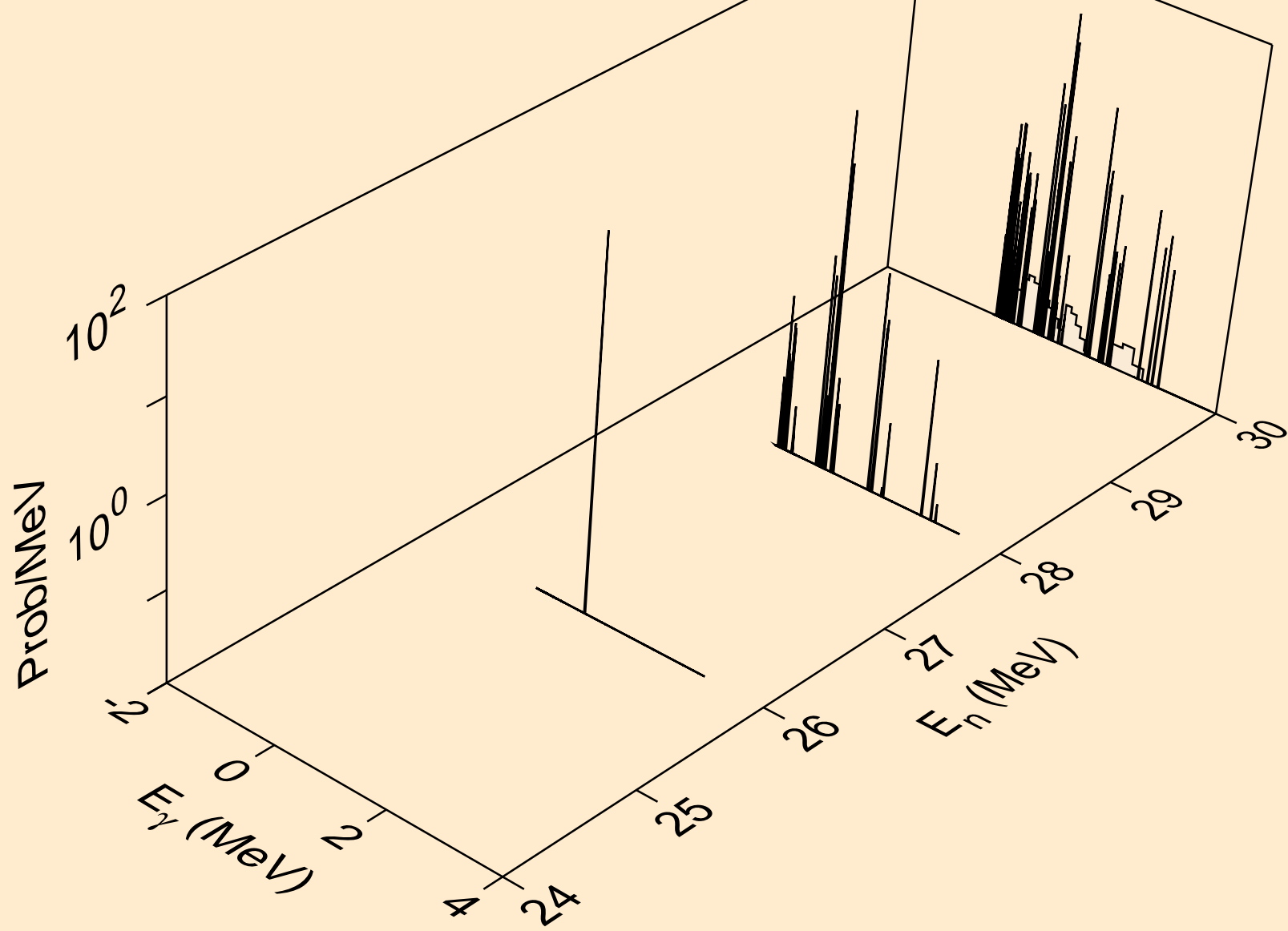

RU090 ALPHA ACER TENDL-2024 LIBRARY; T=0.K
Photon emission for (n,n*)a

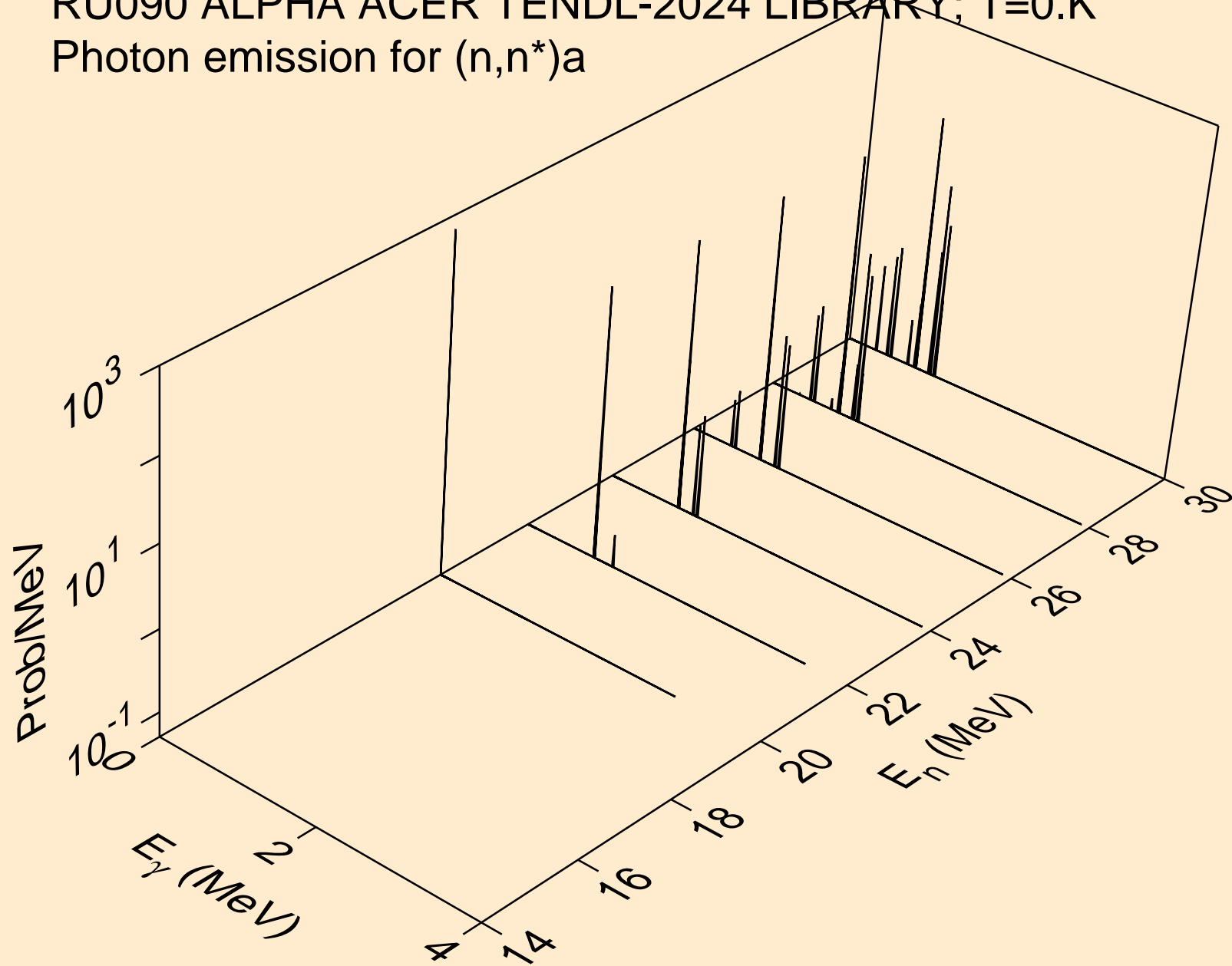

RU090 ALPHA ACER TENDL-2024 LIBRARY; T=0.K
Photon emission for (n,n*)p

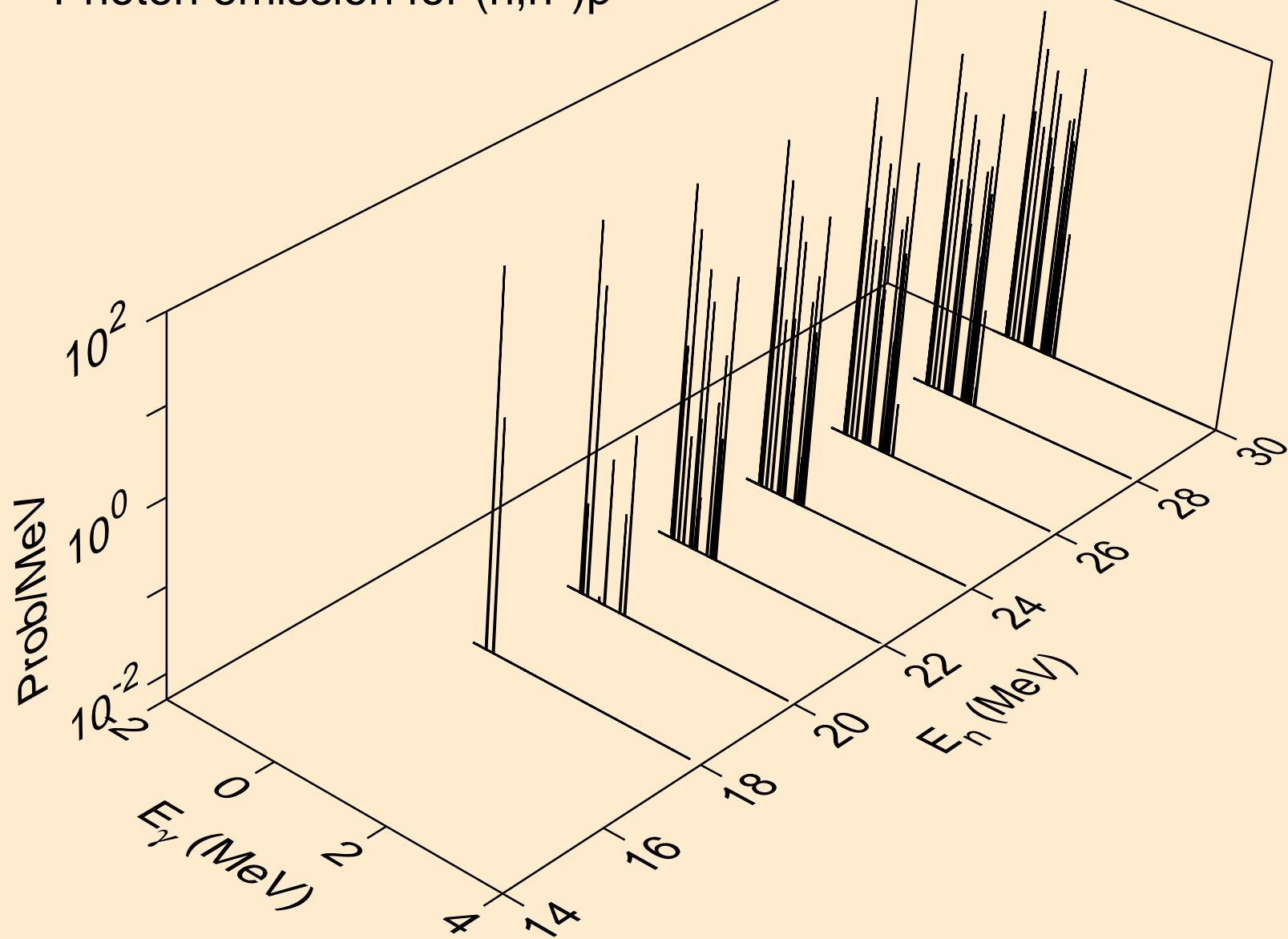

RU090 ALPHA ACER TENDL-2024 LIBRARY; T=0.K
Photon emission for (n,n*)d

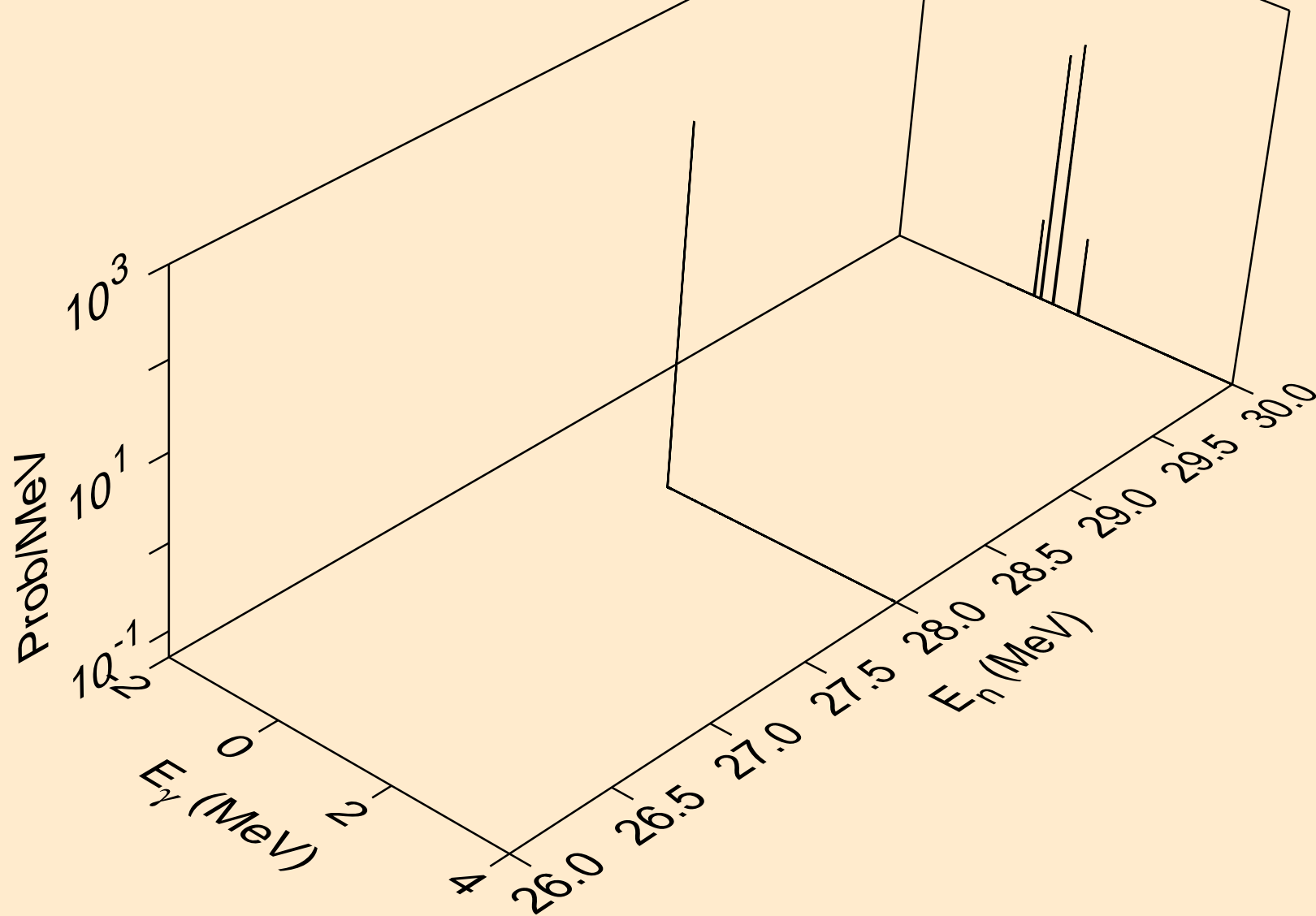

RU090 ALPHA ACER TENDL-2024 LIBRARY; T=0.K
Photon emission for (n,n*)he3

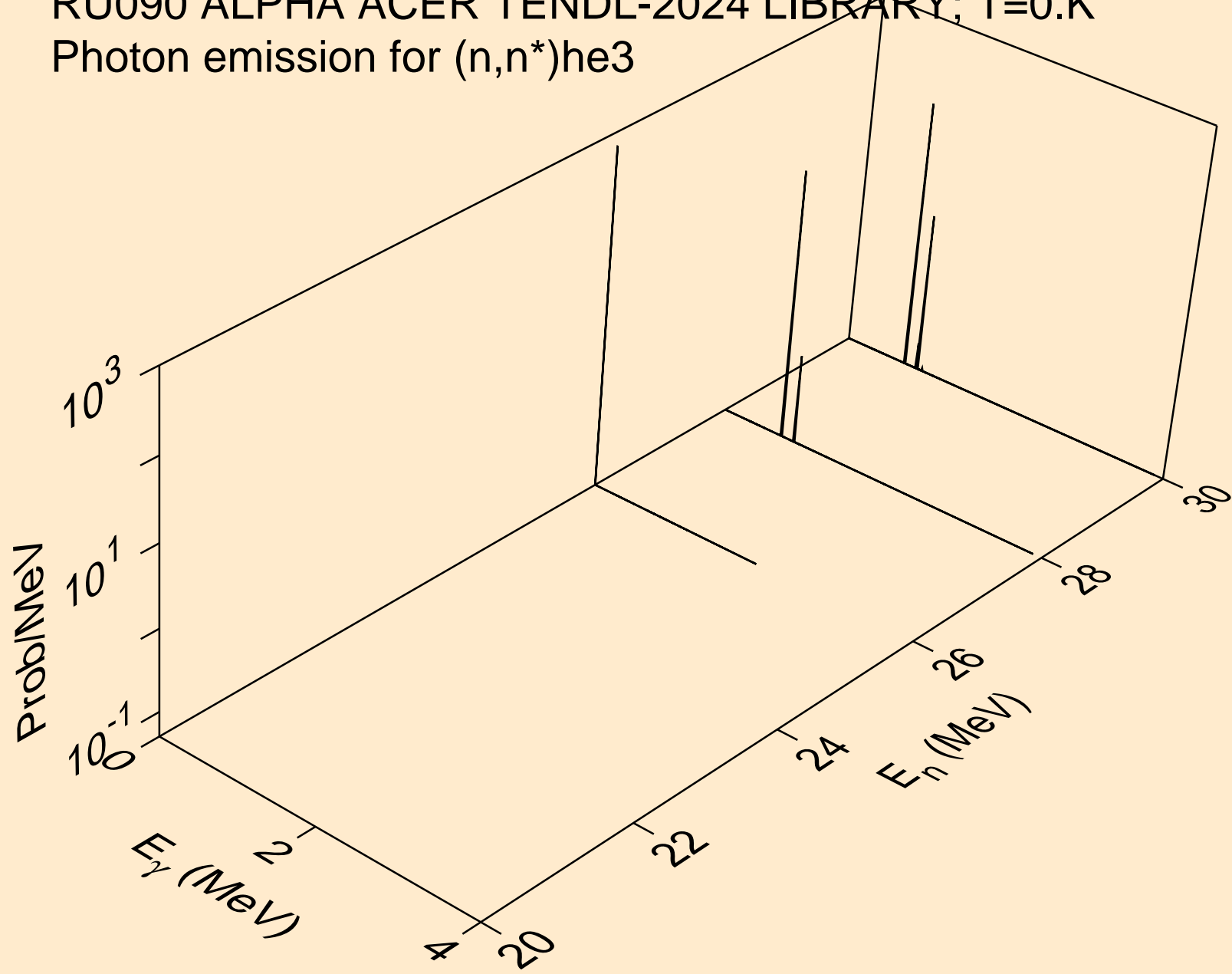

RU090 ALPHA ACER TENDL-2024 LIBRARY; T=0.K
Photon emission for (n,n2p)

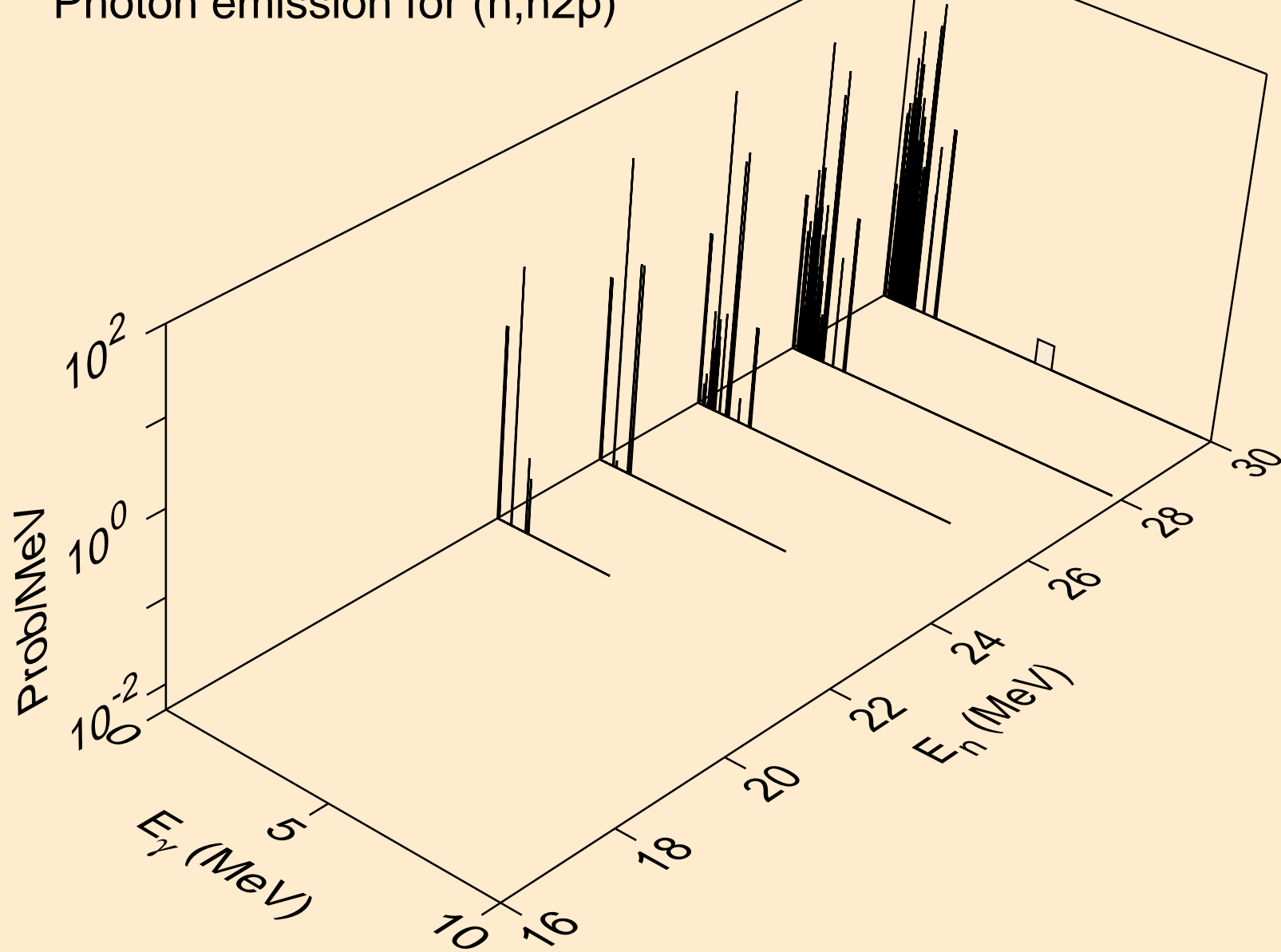

RU090 ALPHA ACER TENDL-2024 LIBRARY; T=0.K
Photon emission for (n,npa)

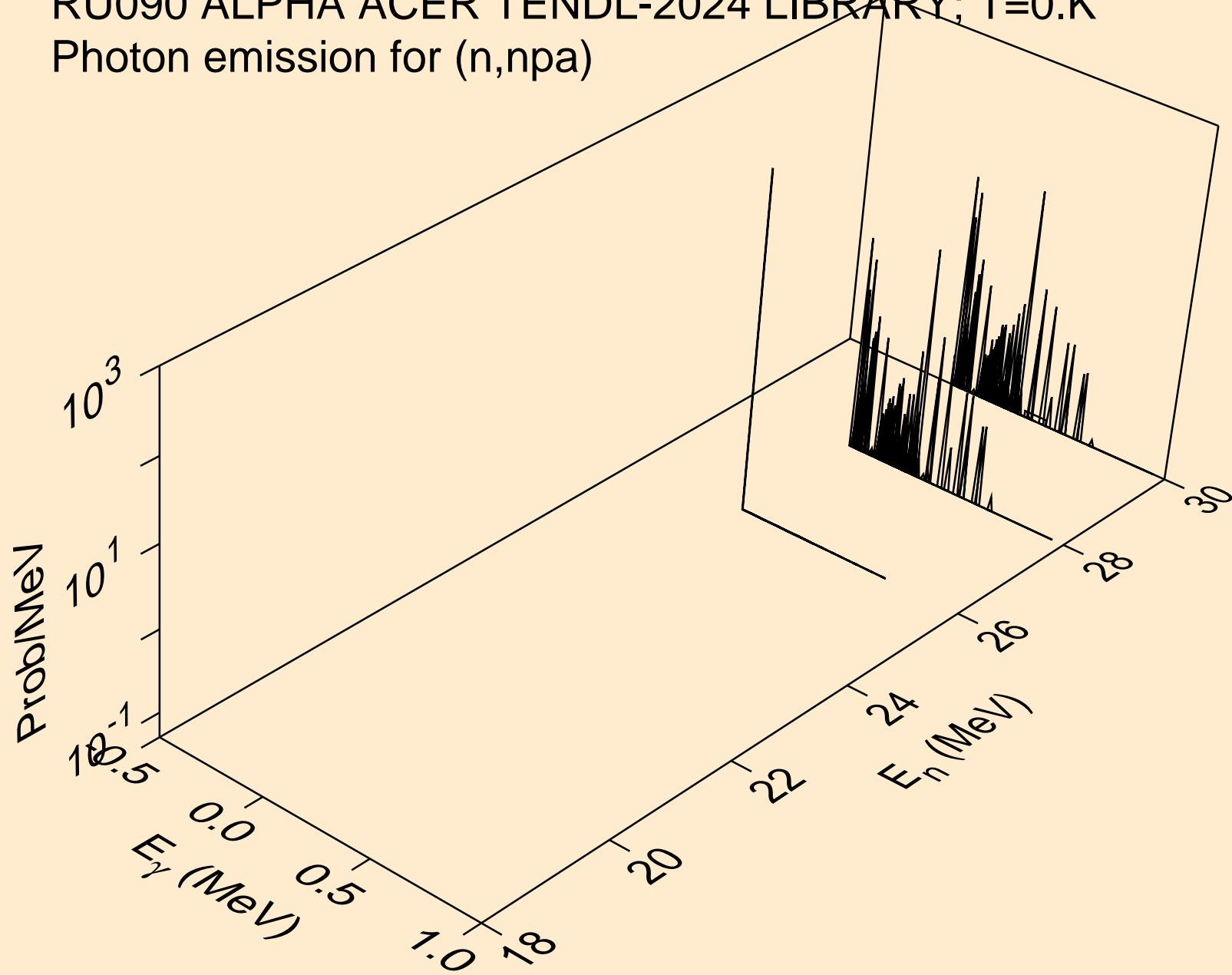

RU090 ALPHA ACER TENDL-2024 LIBRARY; T=0.K
Photon emission for (n,gma)

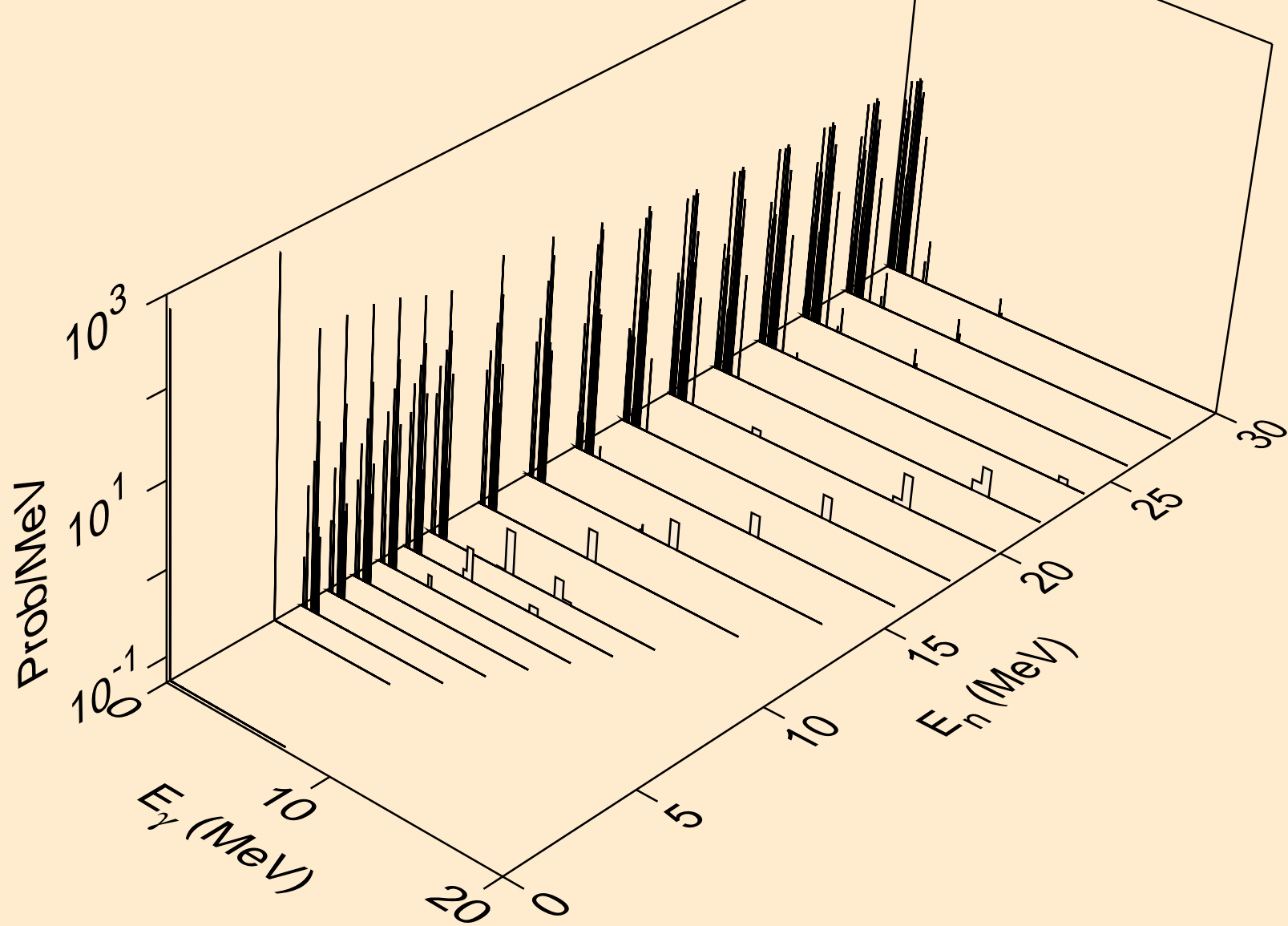

RU090 ALPHA ACER TENDL-2024 LIBRARY; T=0.K
Photon emission for (n,p)

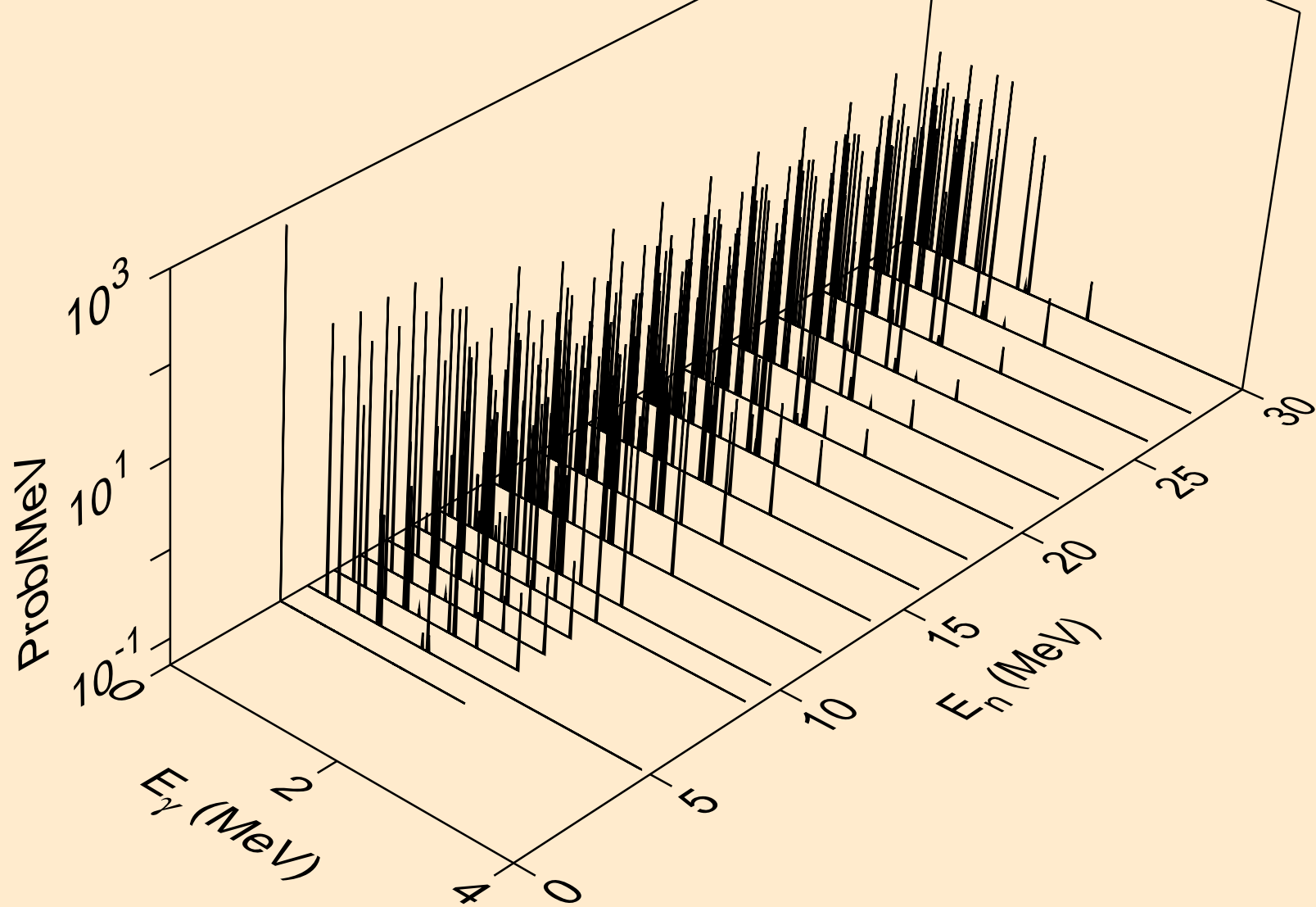

RU090 ALPHA ACER TENDL-2024 LIBRARY; T=0.K
Photon emission for (n,d)

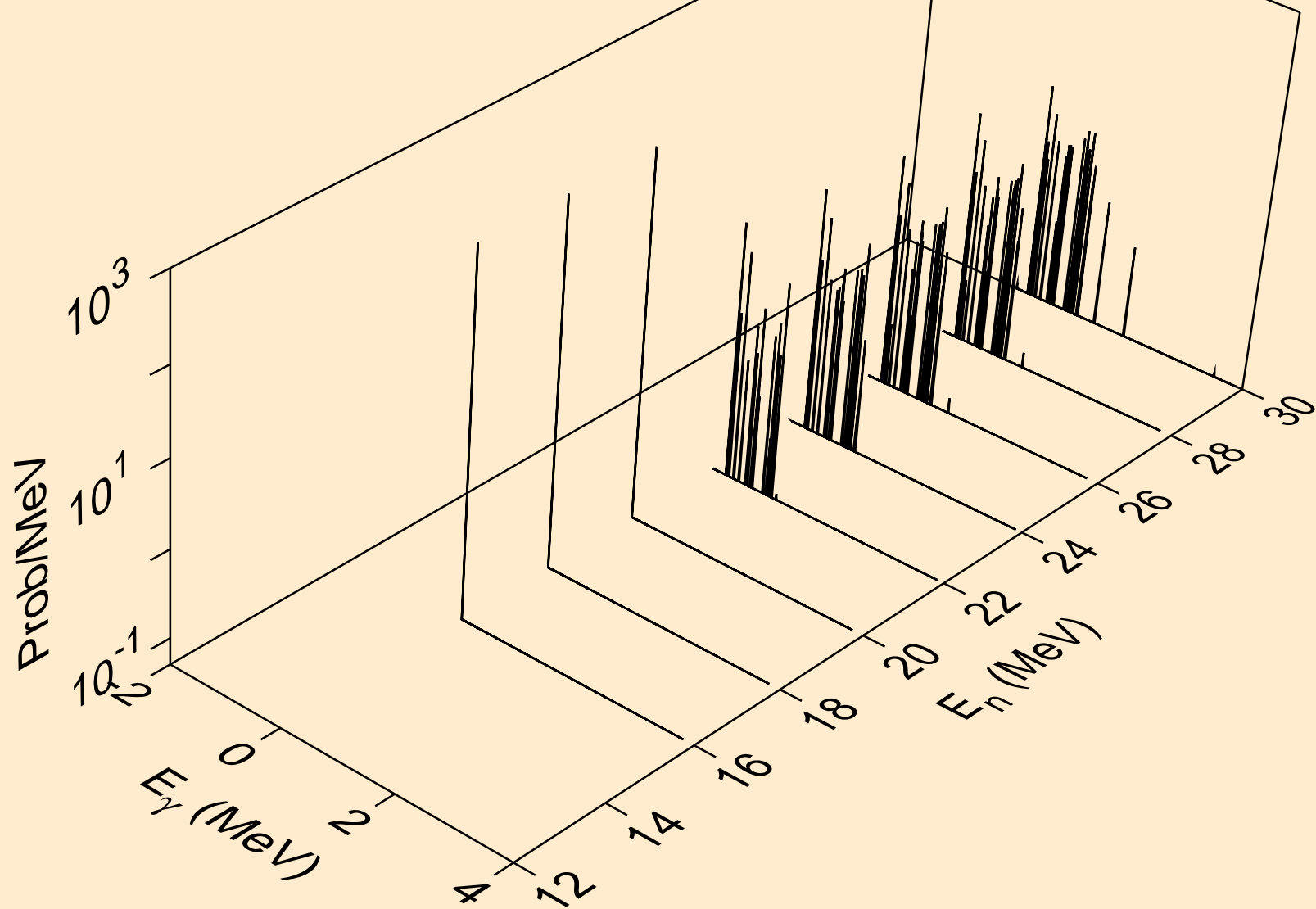

RU090 ALPHA ACER TENDL-2024 LIBRARY; T=0.K
Photon emission for (n,t)

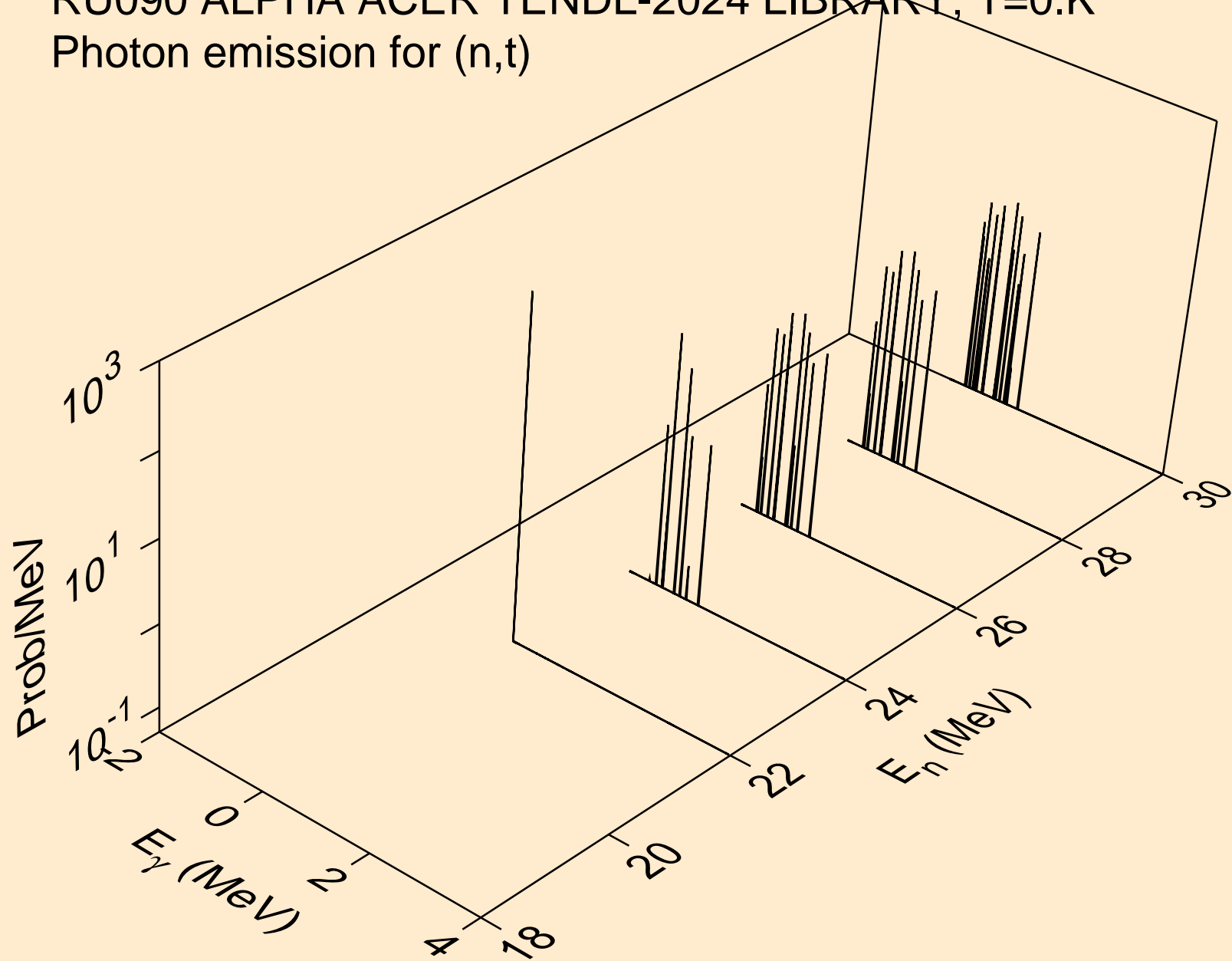

RU090 ALPHA ACER TENDL-2024 LIBRARY; T=0.K
Photon emission for (n,he3)

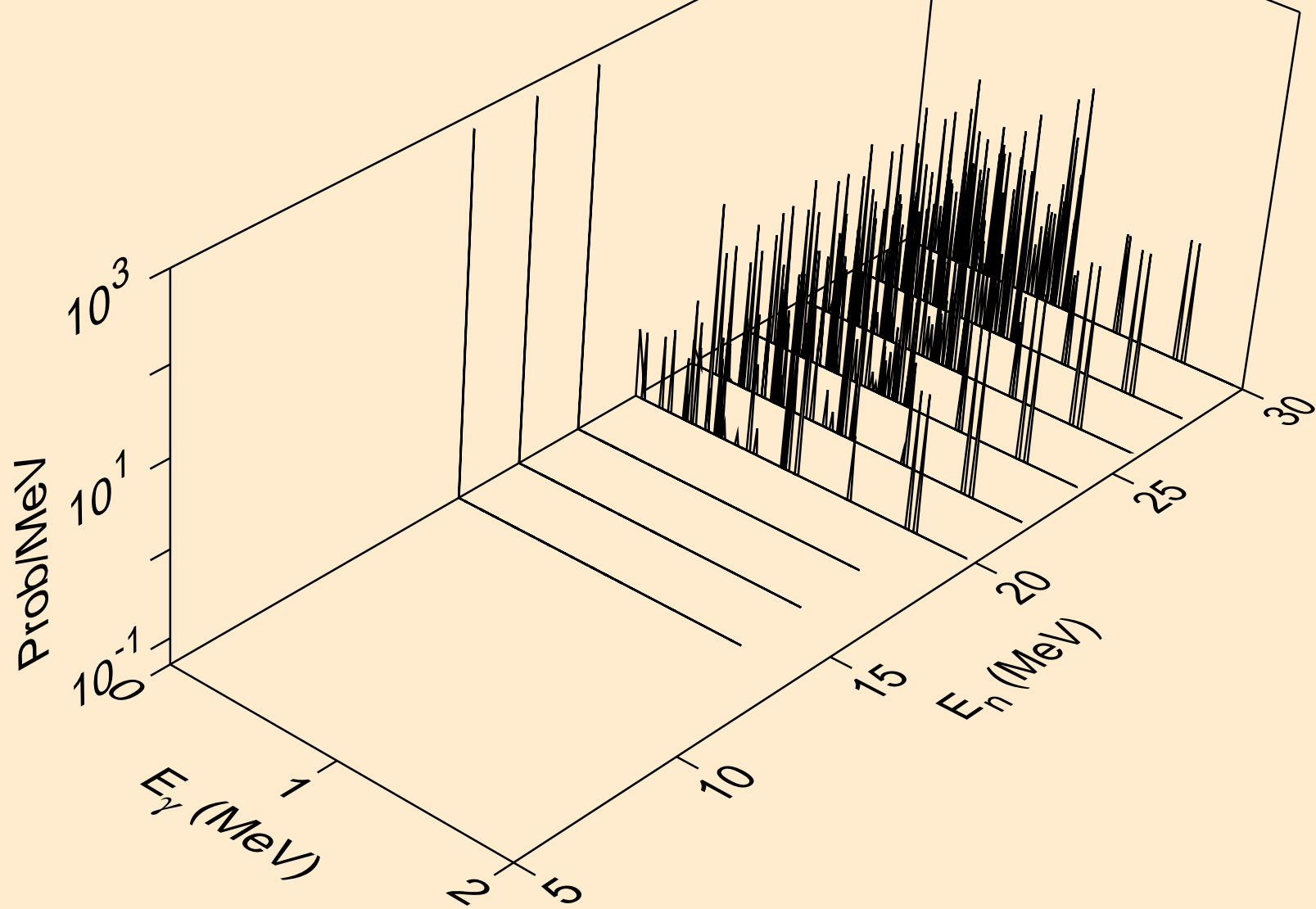

RU090 ALPHA ACER TENDL-2024 LIBRARY; T=0.K
Photon emission for inelastic

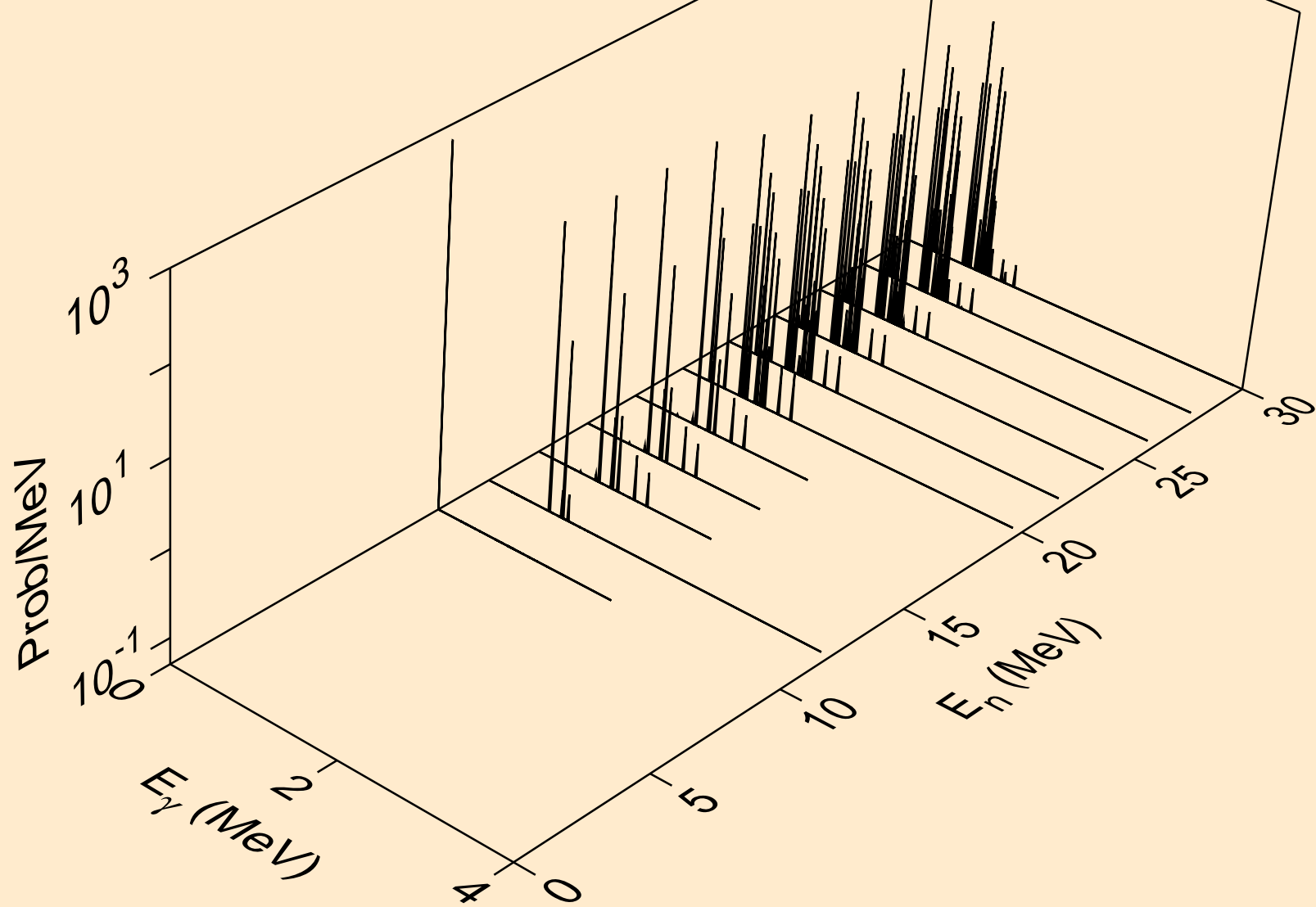

RU090 ALPHA ACER TENDL-2024 LIBRARY; T=0.K
Photon emission for (n,2a)

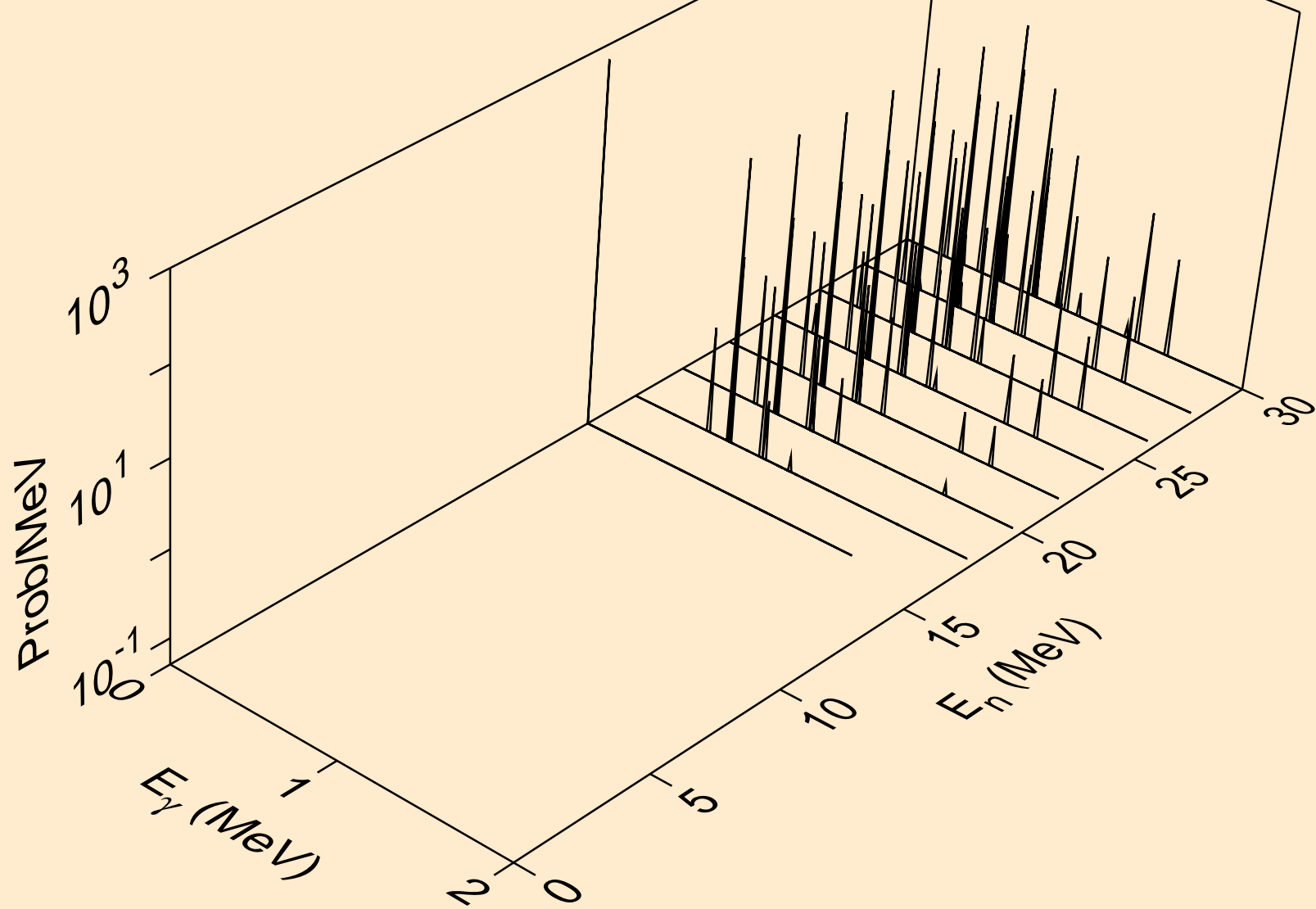

RU090 ALPHA ACER TENDL-2024 LIBRARY; T=0.K
Photon emission for (n,2p)

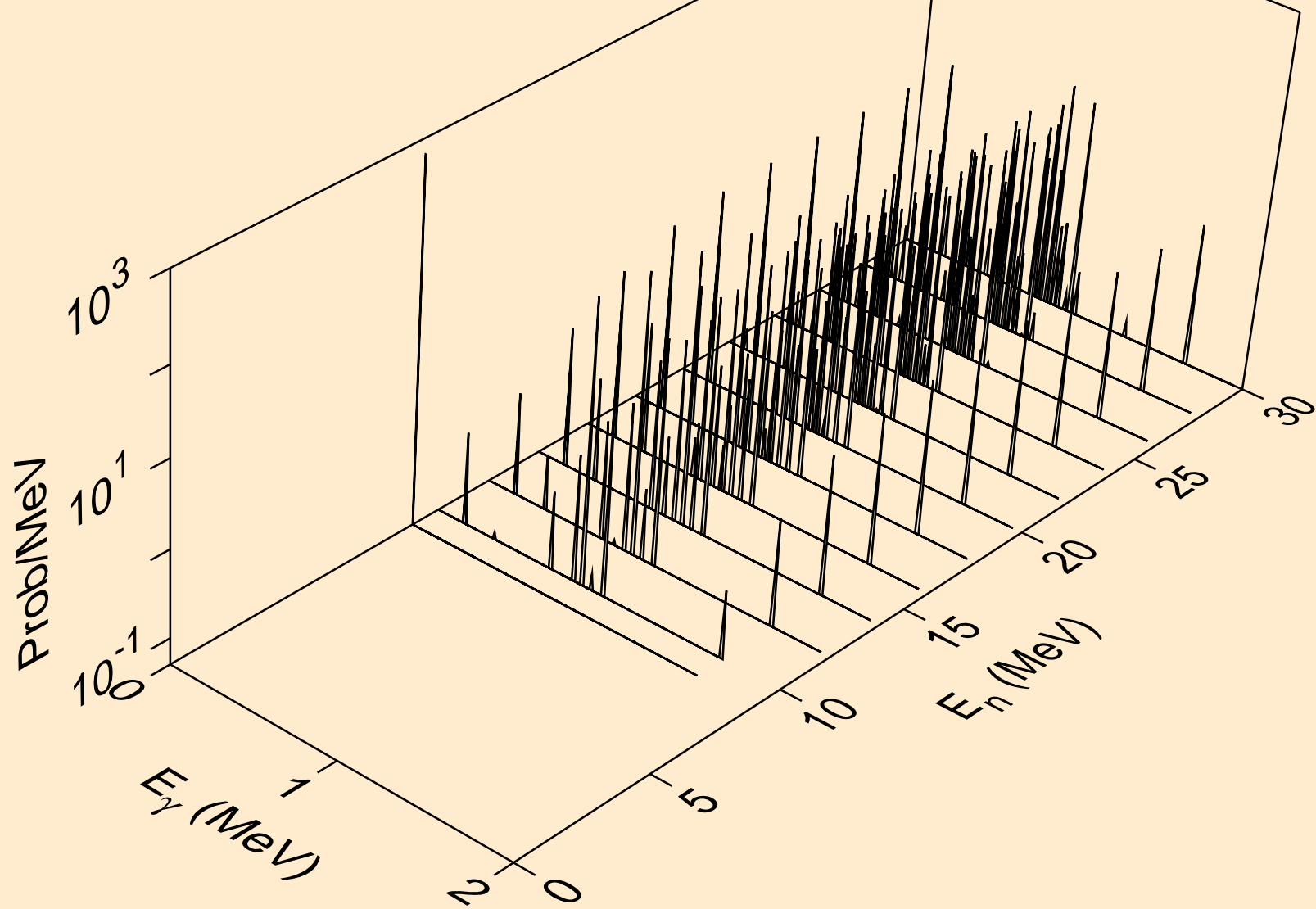

RU090 ALPHA ACER TENDL-2024 LIBRARY; T=0.K
Photon emission for (n,pa)

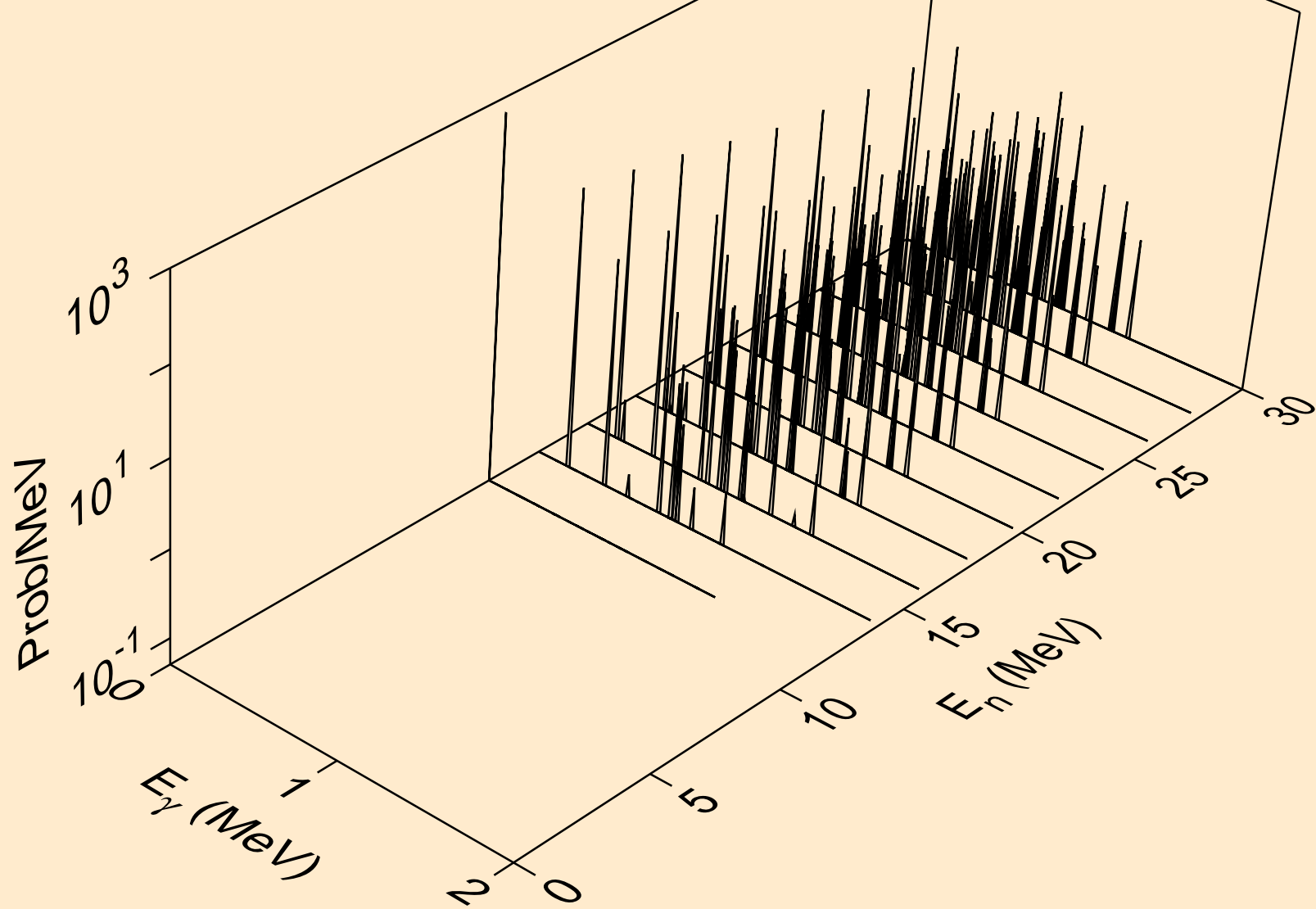

RU090 ALPHA ACER TENDL-2024 LIBRARY; T=0.K
Photon emission for (n,pd)

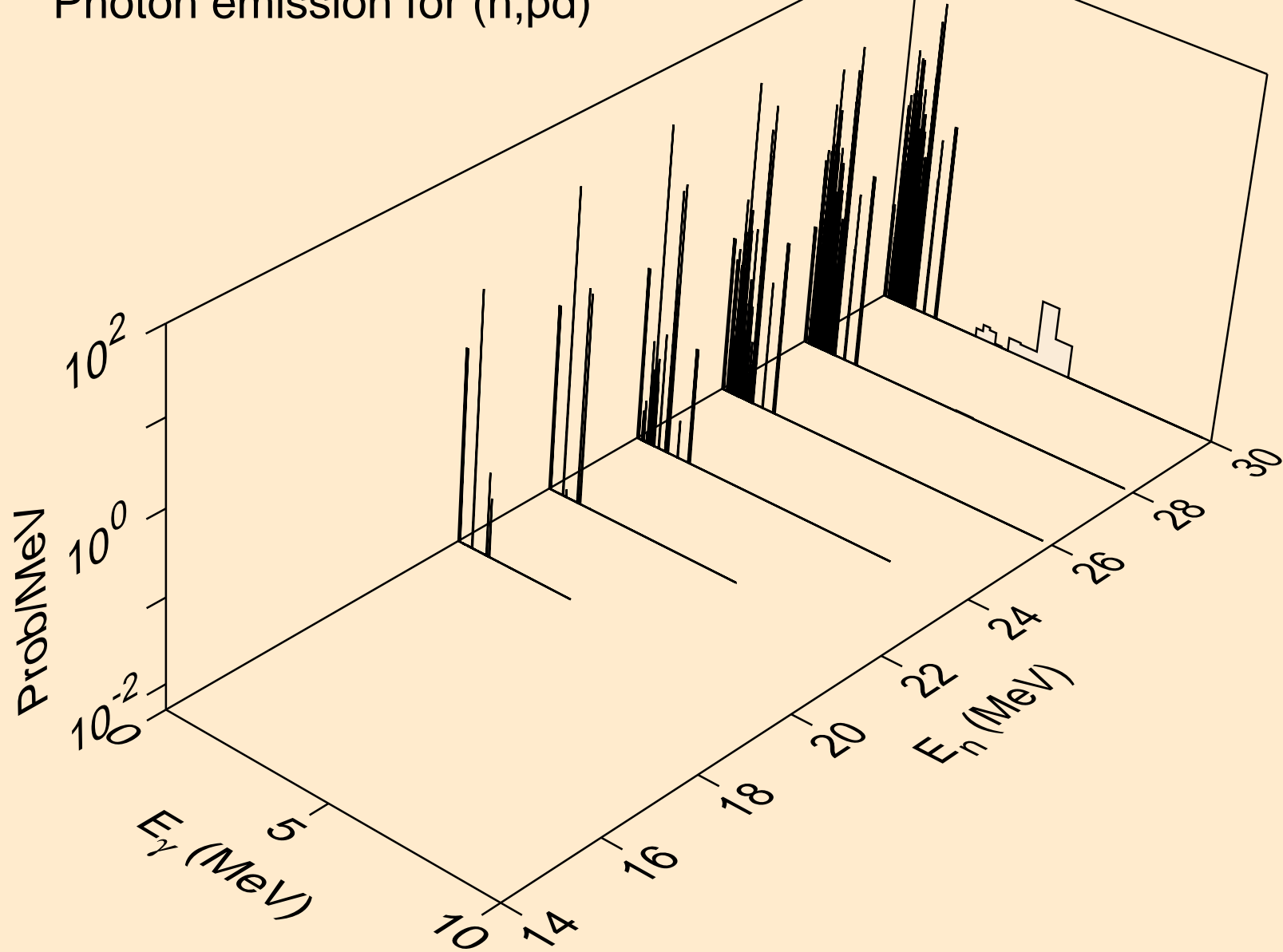

RU090 ALPHA ACER TENDL-2024 LIBRARY; T=0.K
Particle heating contributions

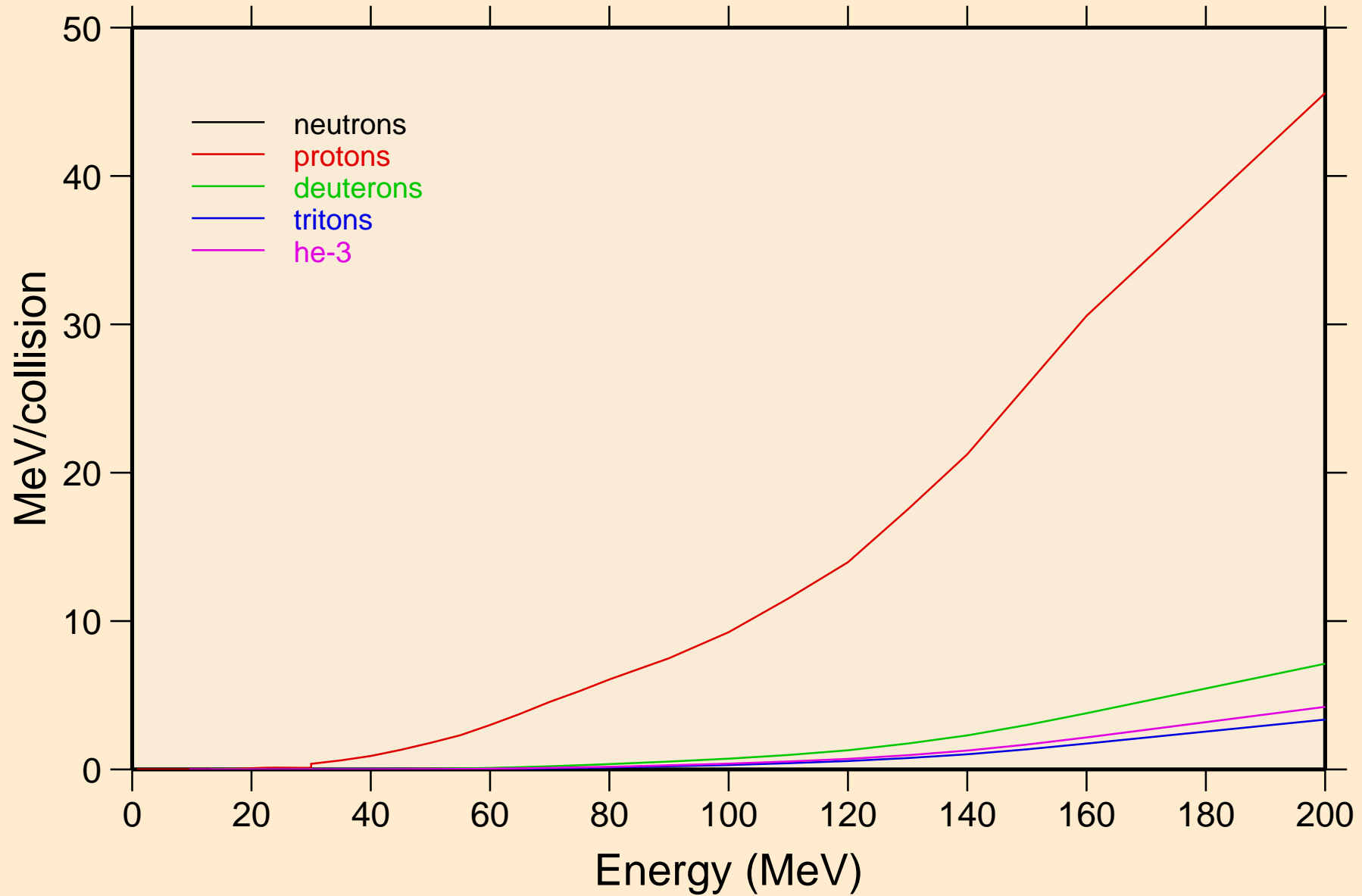

RU090 ALPHA ACER TENDL-2024 LIBRARY; T=0.K
Recoil Heating

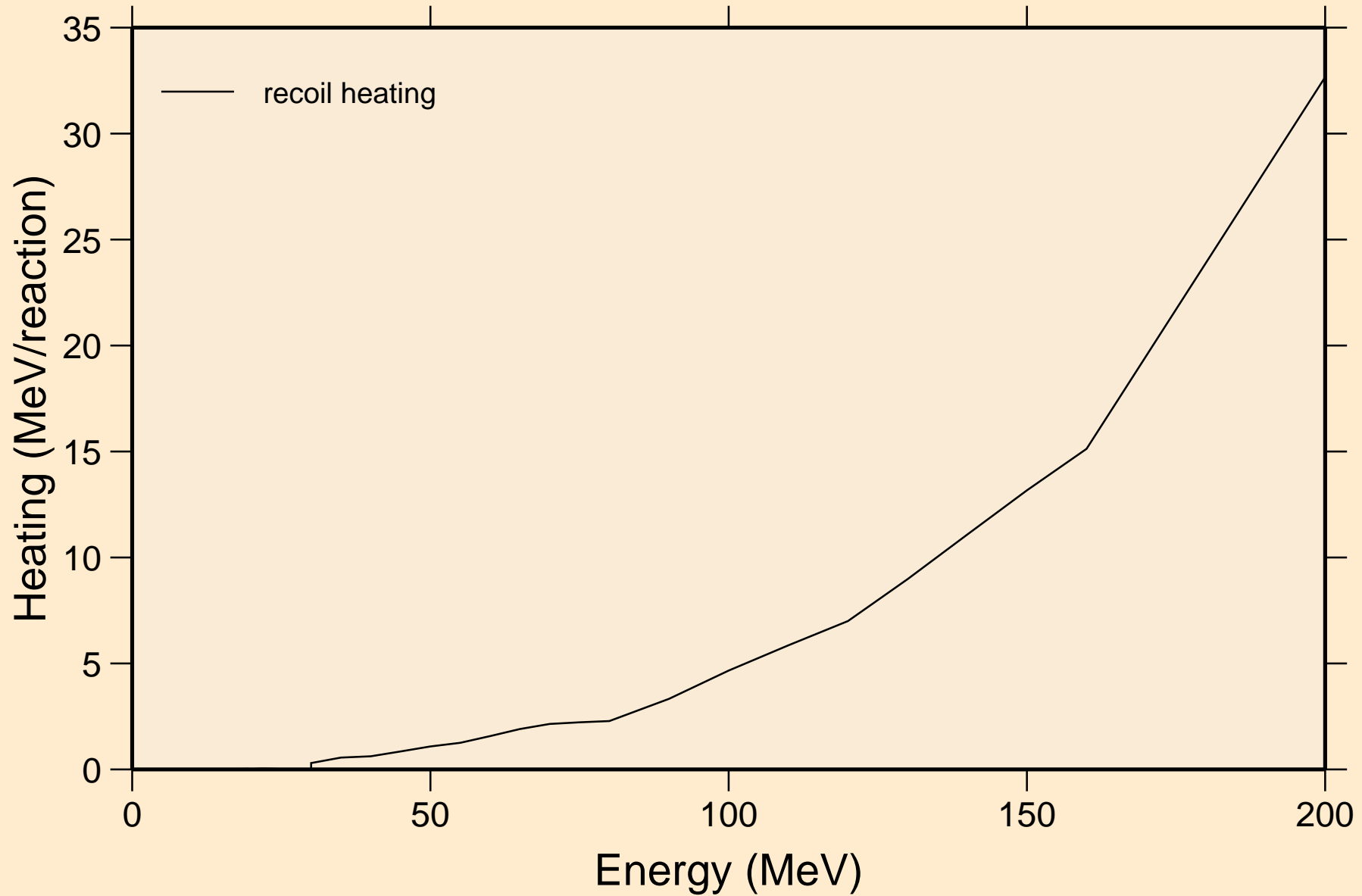

RU090 ALPHA ACER TENDL-2024 LIBRARY; T=0.K
Particle production cross sections

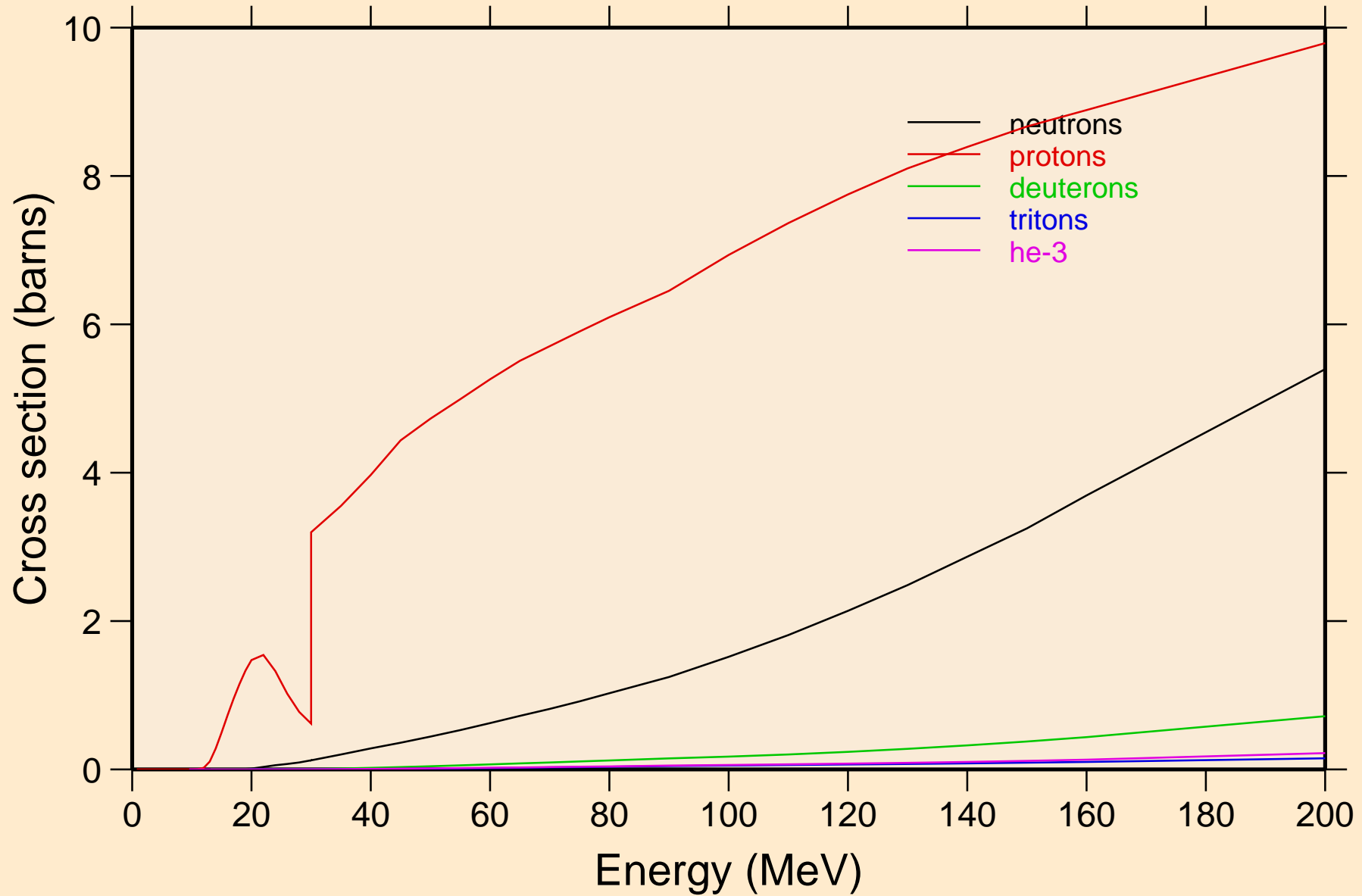

RU090 ALPHA ACER TENDL-2024 LIBRARY; T=0.K
neutrons from (a,n)

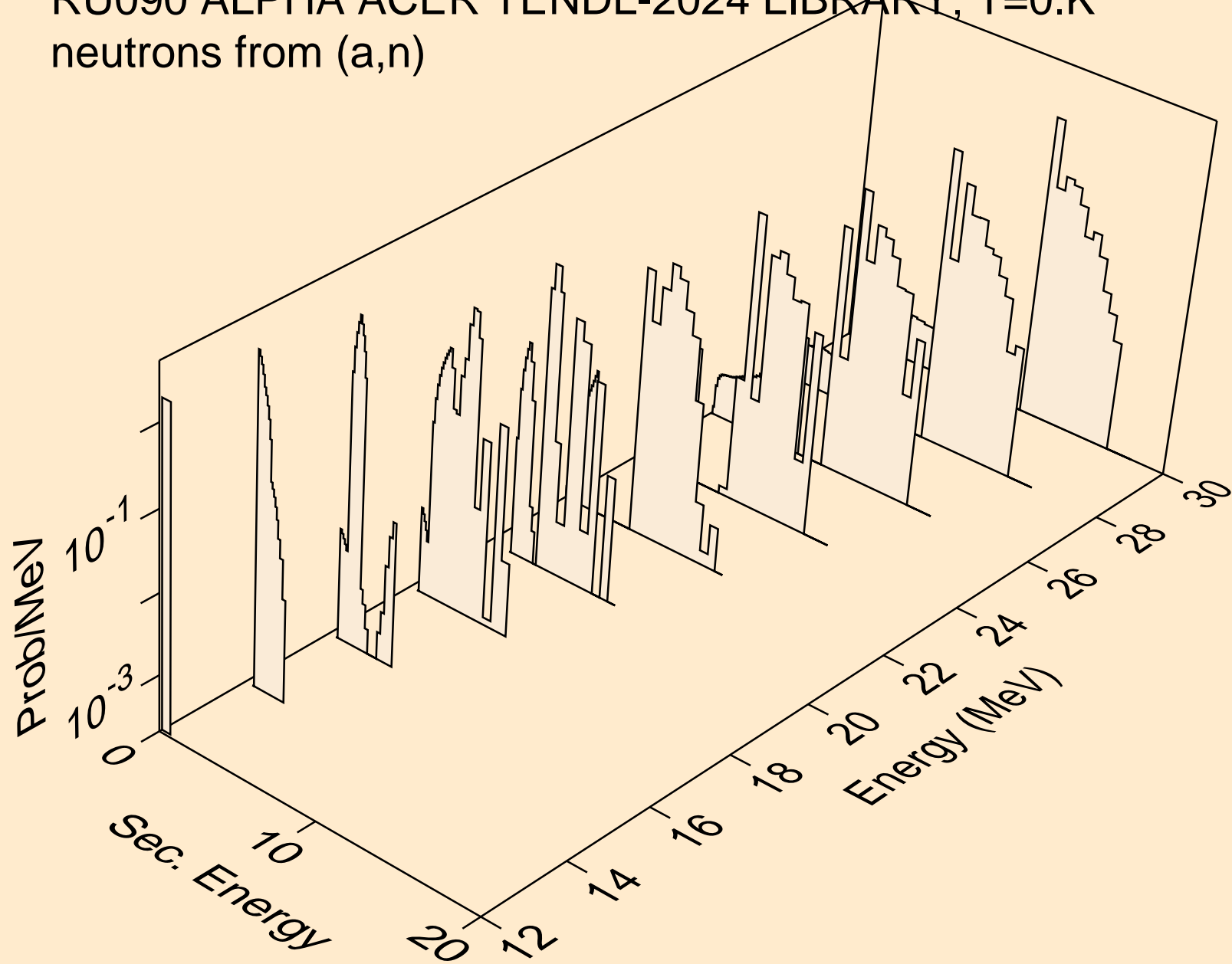

RU090 ALPHA ACER TENDL-2024 LIBRARY; T=0.K
neutrons from (a,x)

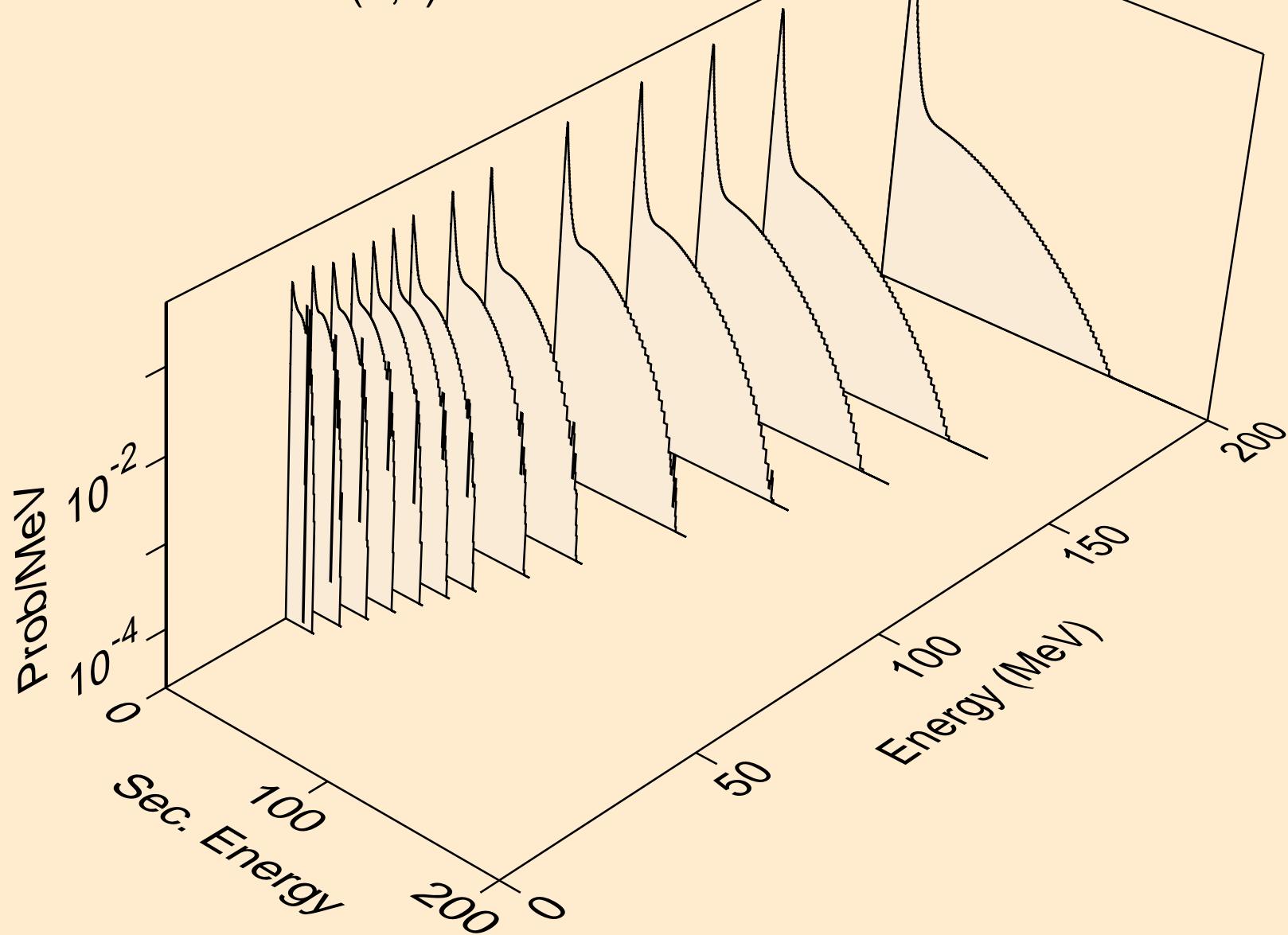

RU090 ALPHA ACER TENDL-2024 LIBRARY; T=0.K
neutrons from (a,2n)

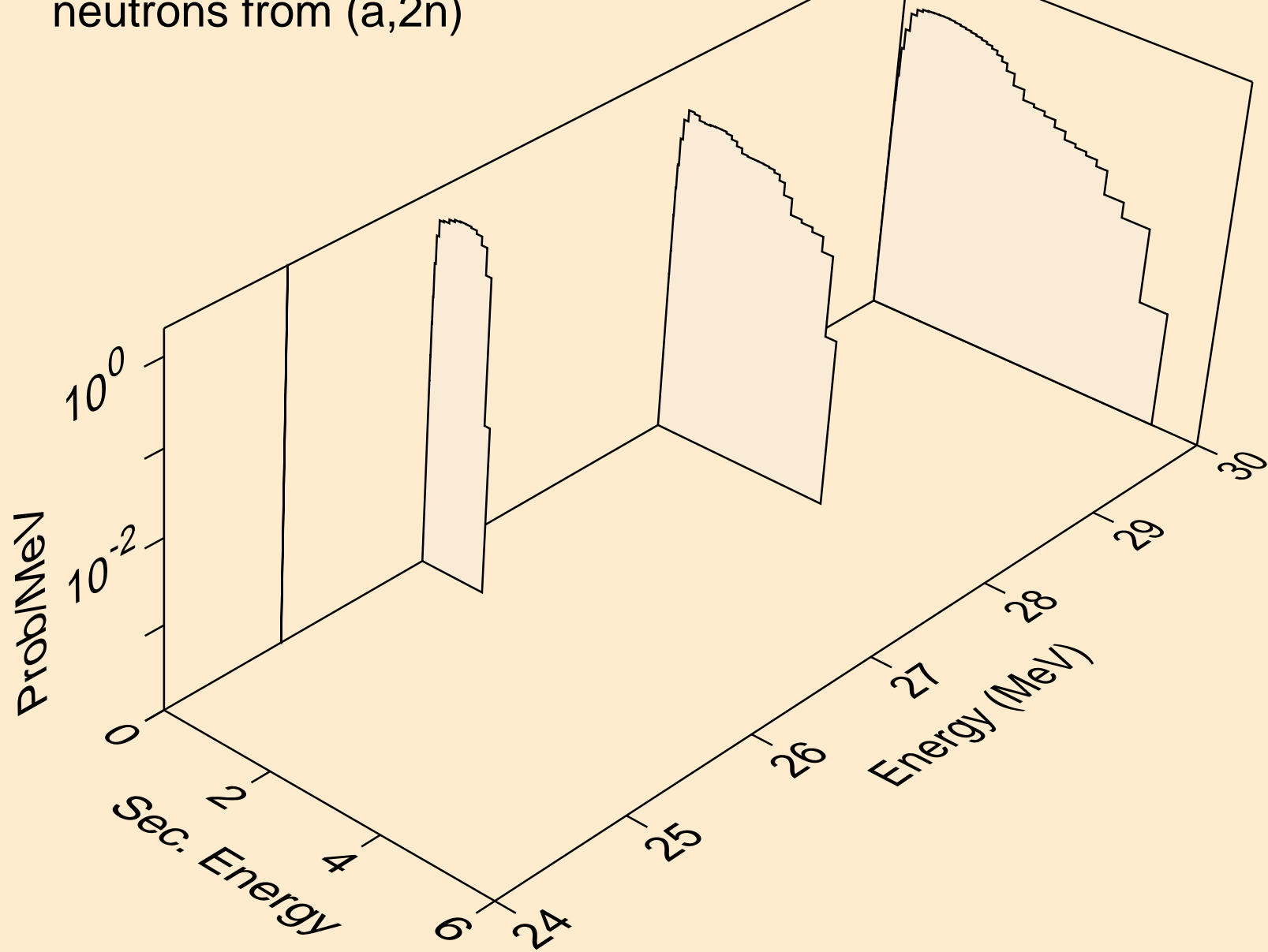

RU090 ALPHA ACER TENDL-2024 LIBRARY; T=0.K
neutrons from (a,n*)a

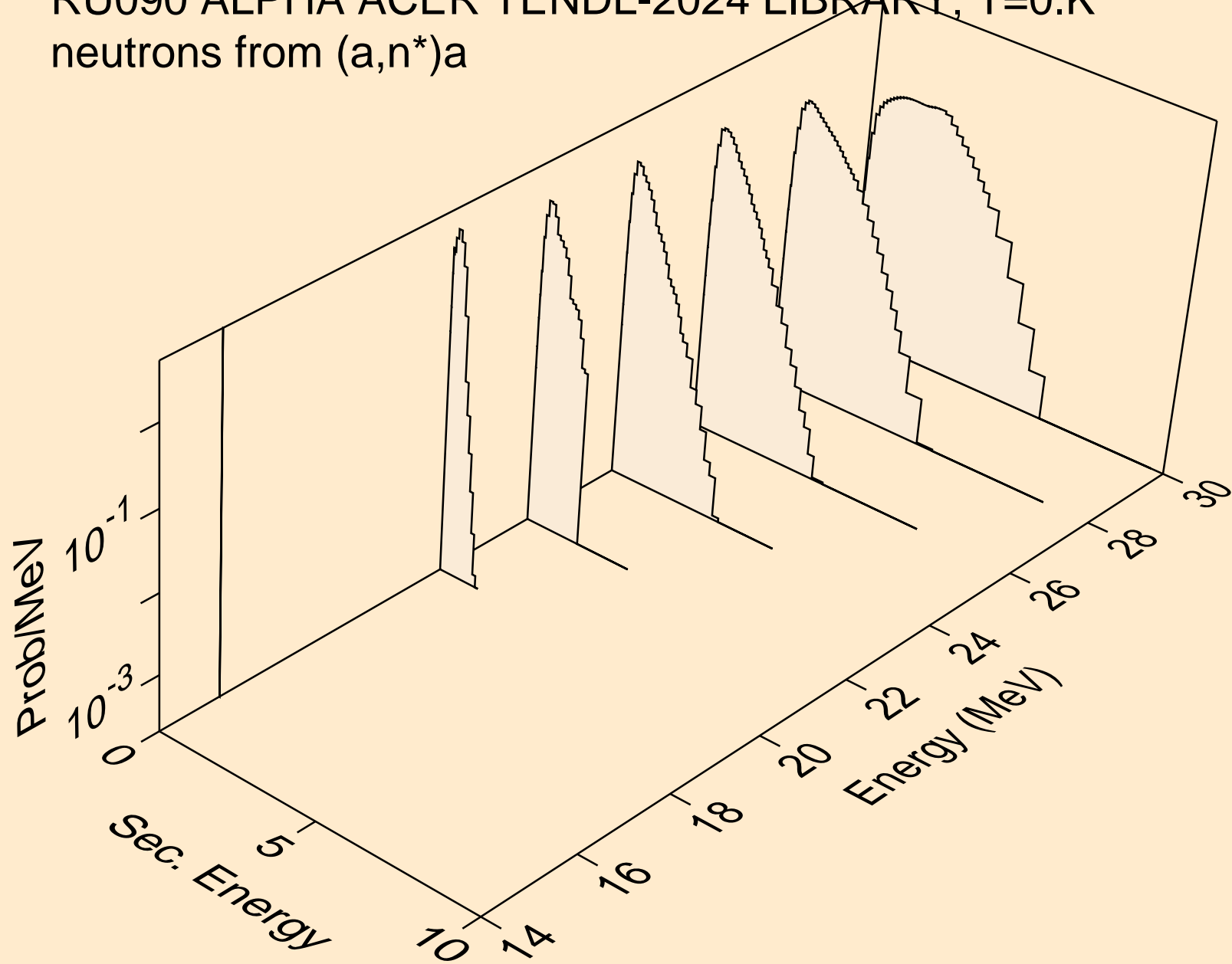

RU090 ALPHA ACER TENDL-2024 LIBRARY; T=0.K
neutrons from (a,n*)p

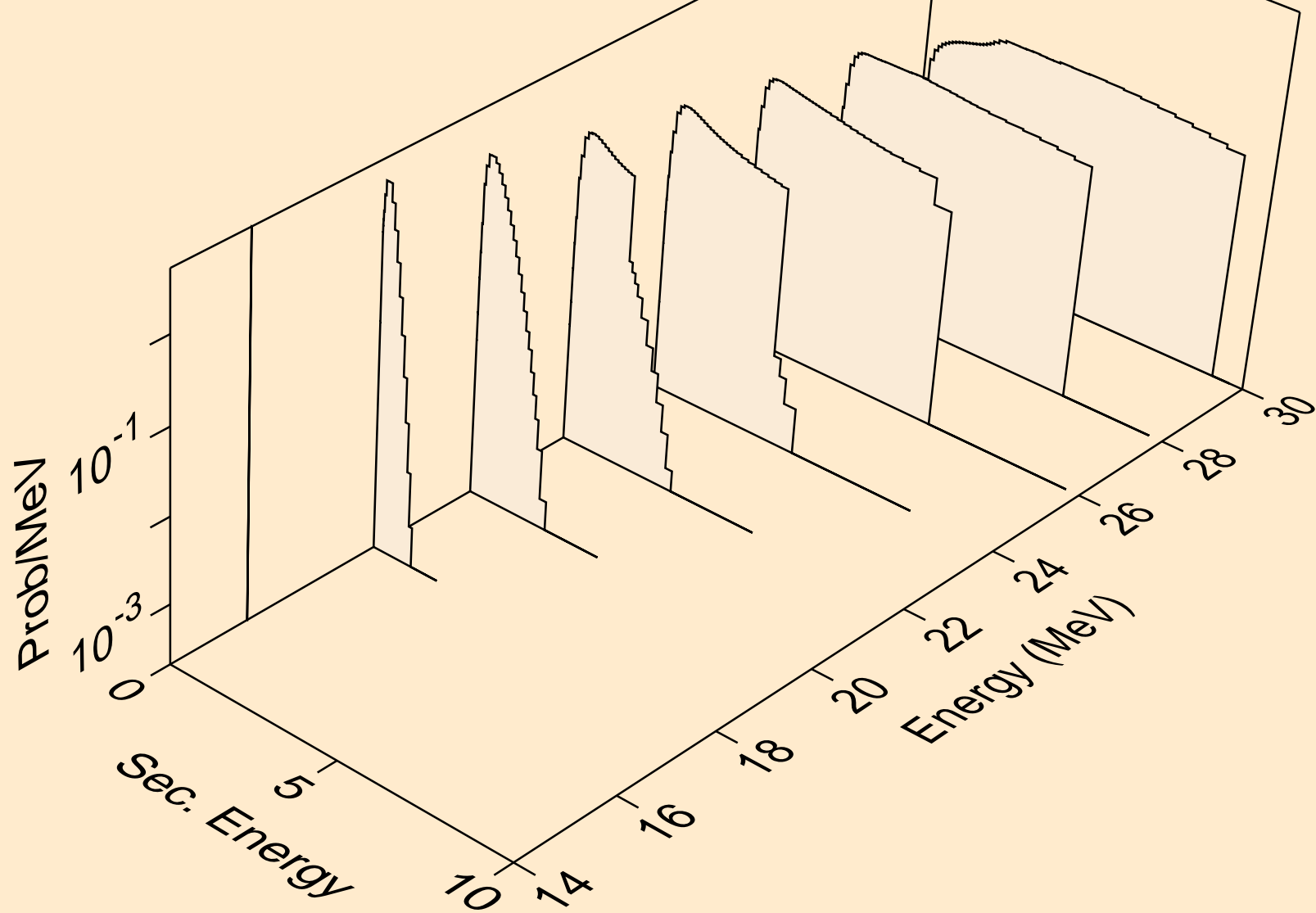

RU090 ALPHA ACER TENDL-2024 LIBRARY; T=0.K
neutrons from (a,n*)d

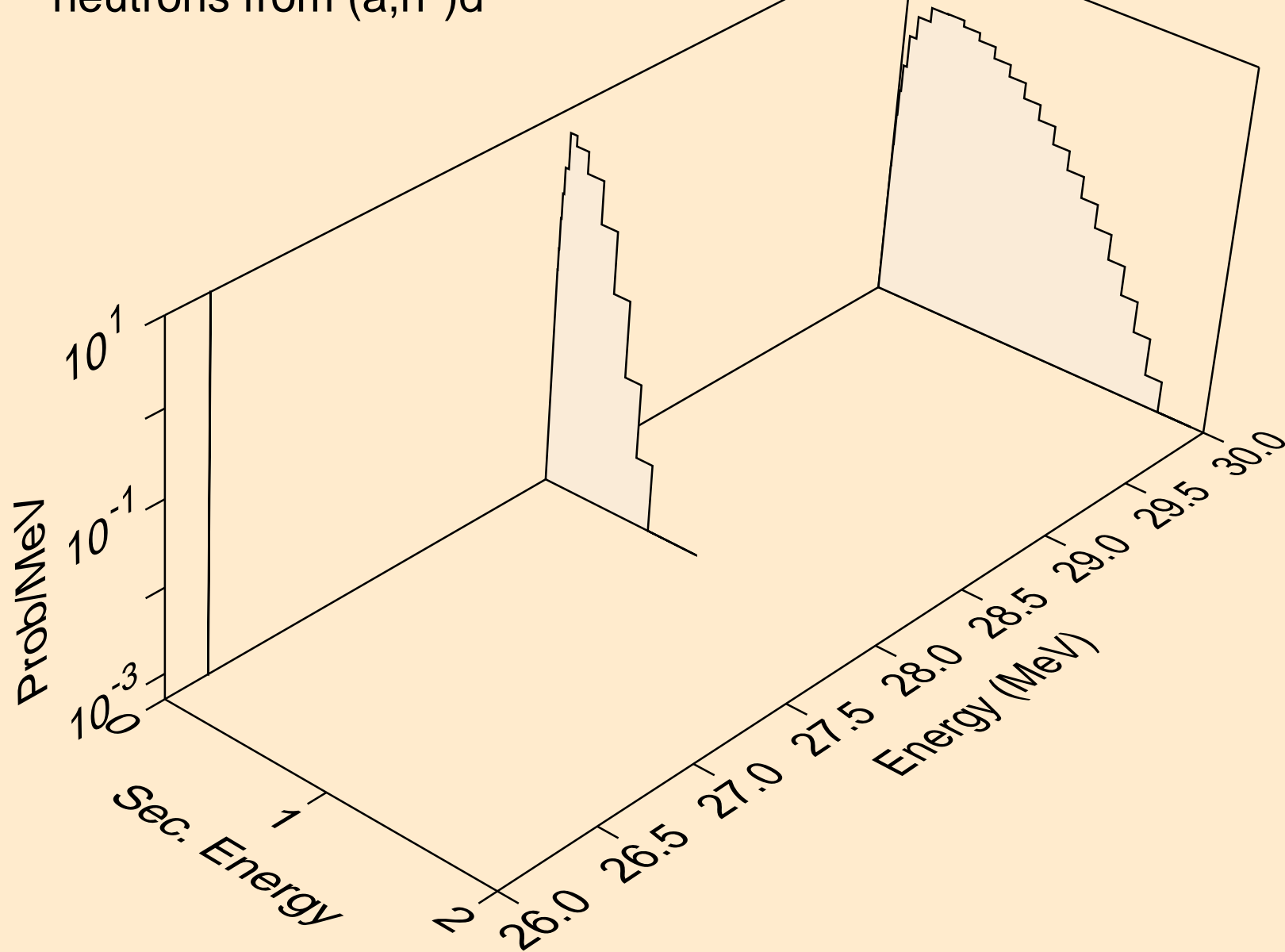

RU090 ALPHA ACER TENDL-2024 LIBRARY; T=0.K
neutrons from (a,n*)he3

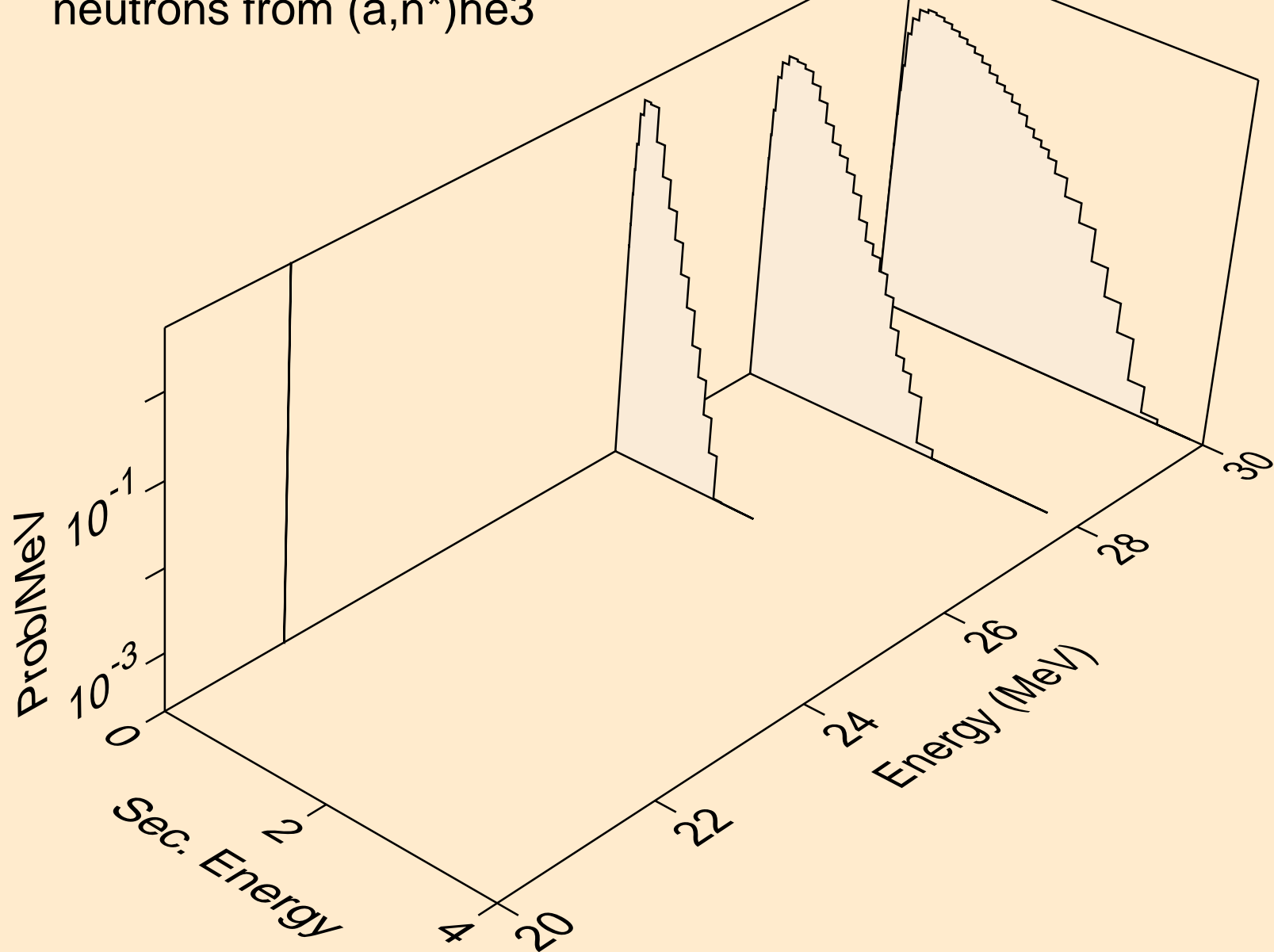

RU090 ALPHA ACER TENDL-2024 LIBRARY; T=0.K
neutrons from (a,n2p)

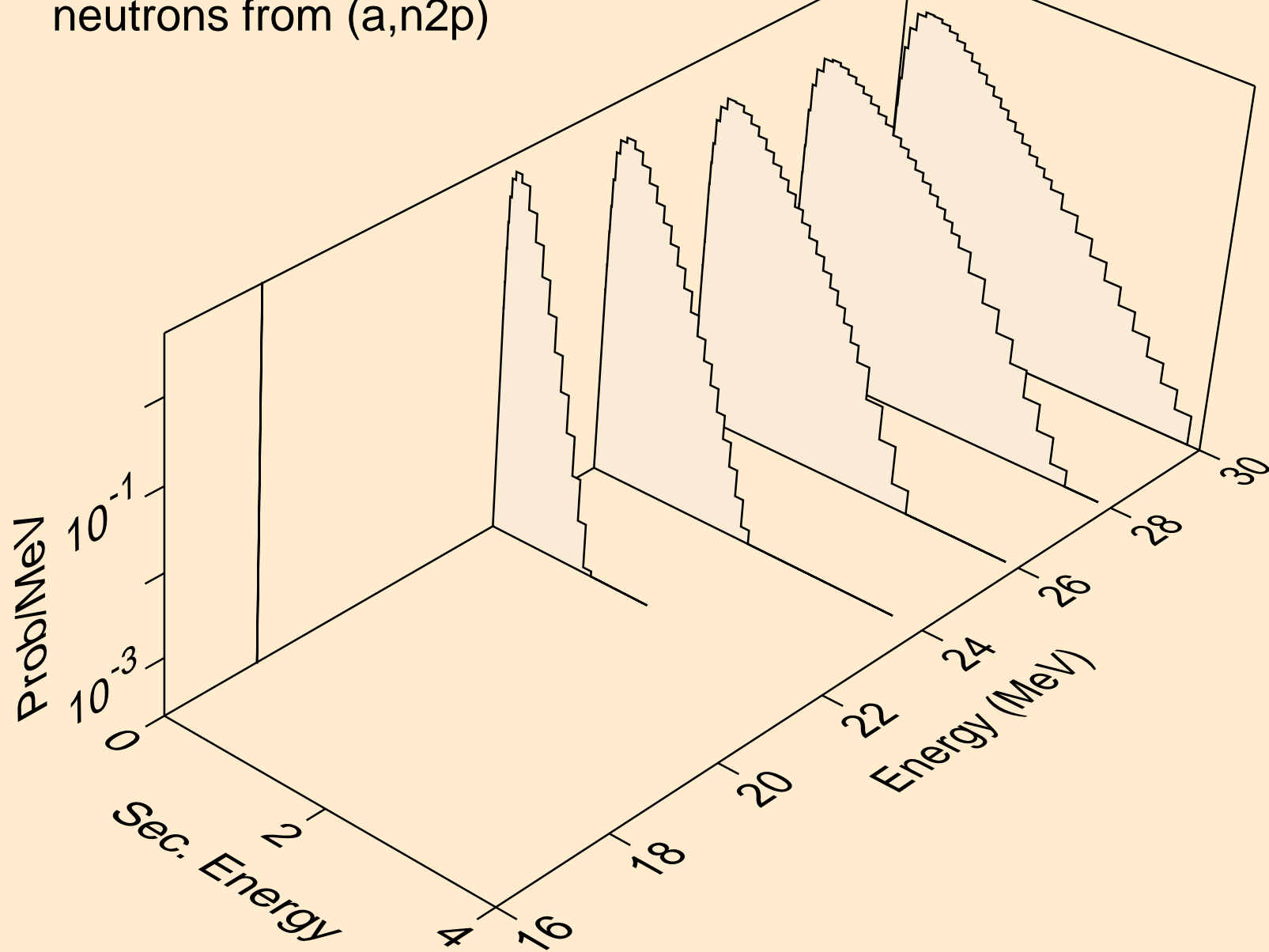

RU090 ALPHA ACER TENDL-2024 LIBRARY; T=0.K
neutrons from (a,npa)

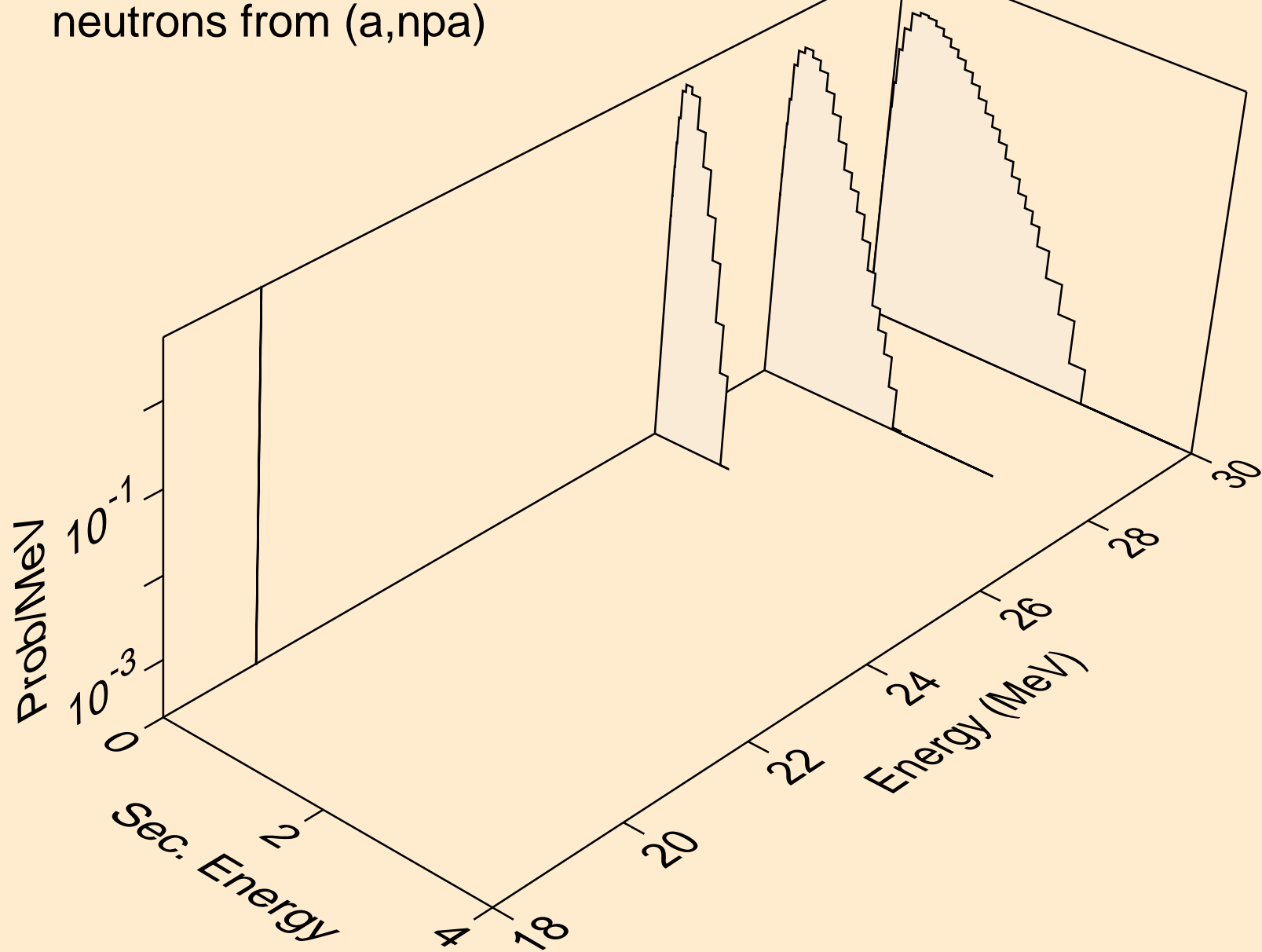

RU090 ALPHA ACER TENDL-2024 LIBRARY; T=0.K
protons from (a,x)

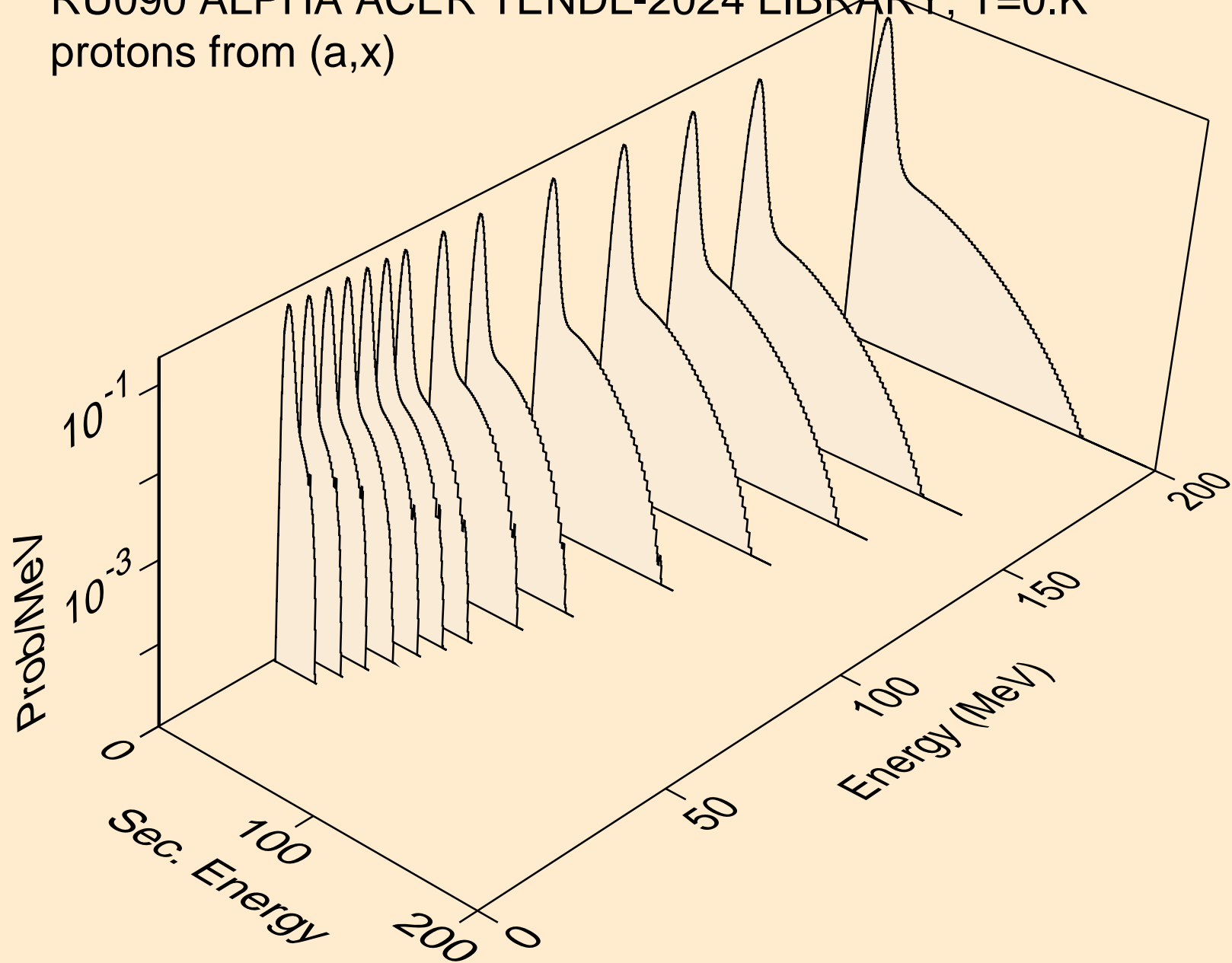

RU090 ALPHA ACER TENDL-2024 LIBRARY; T=0.K
protons from (a,n*)p

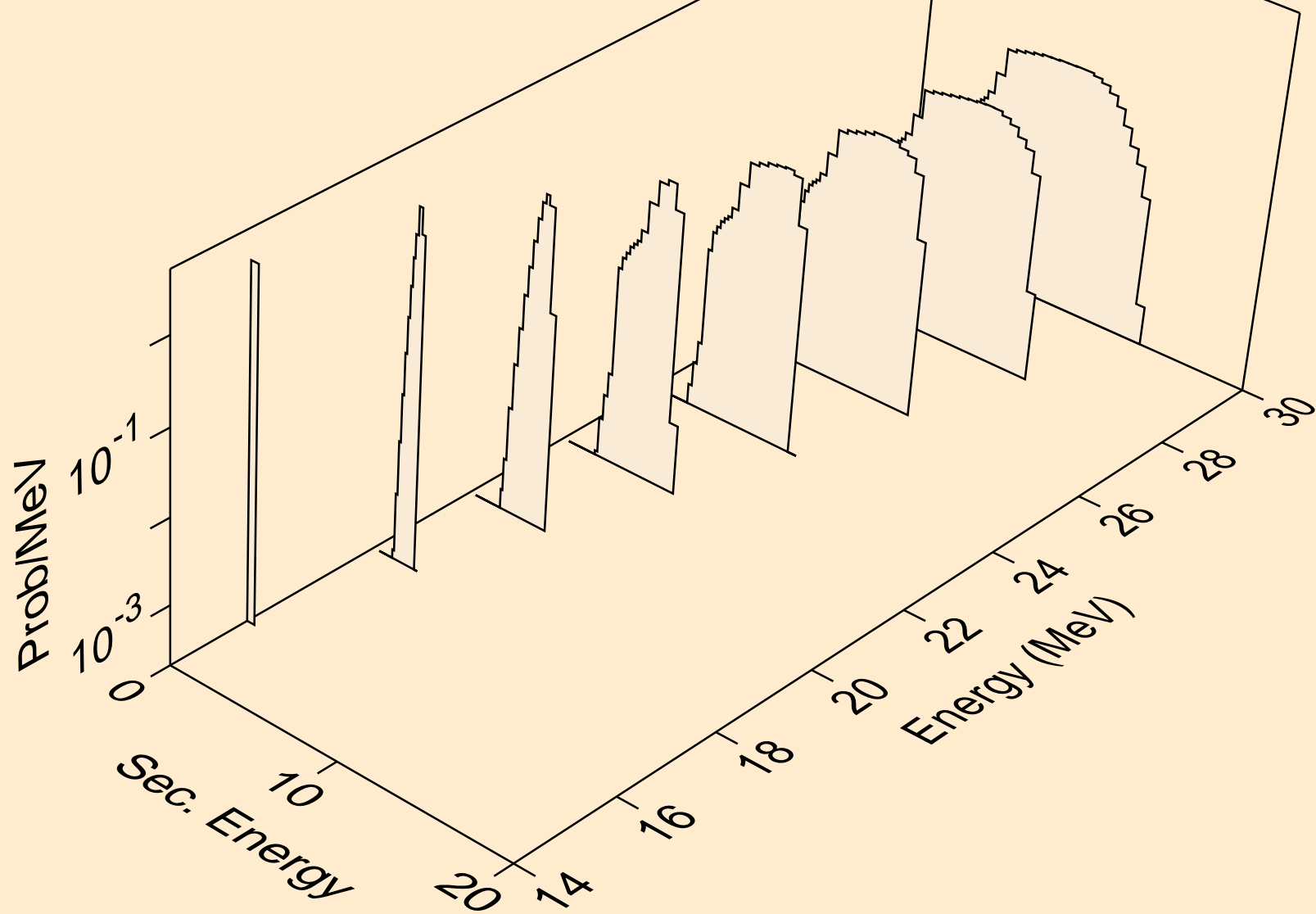

RU090 ALPHA ACER TENDL-2024 LIBRARY; T=0.K
protons from (a,n2p)

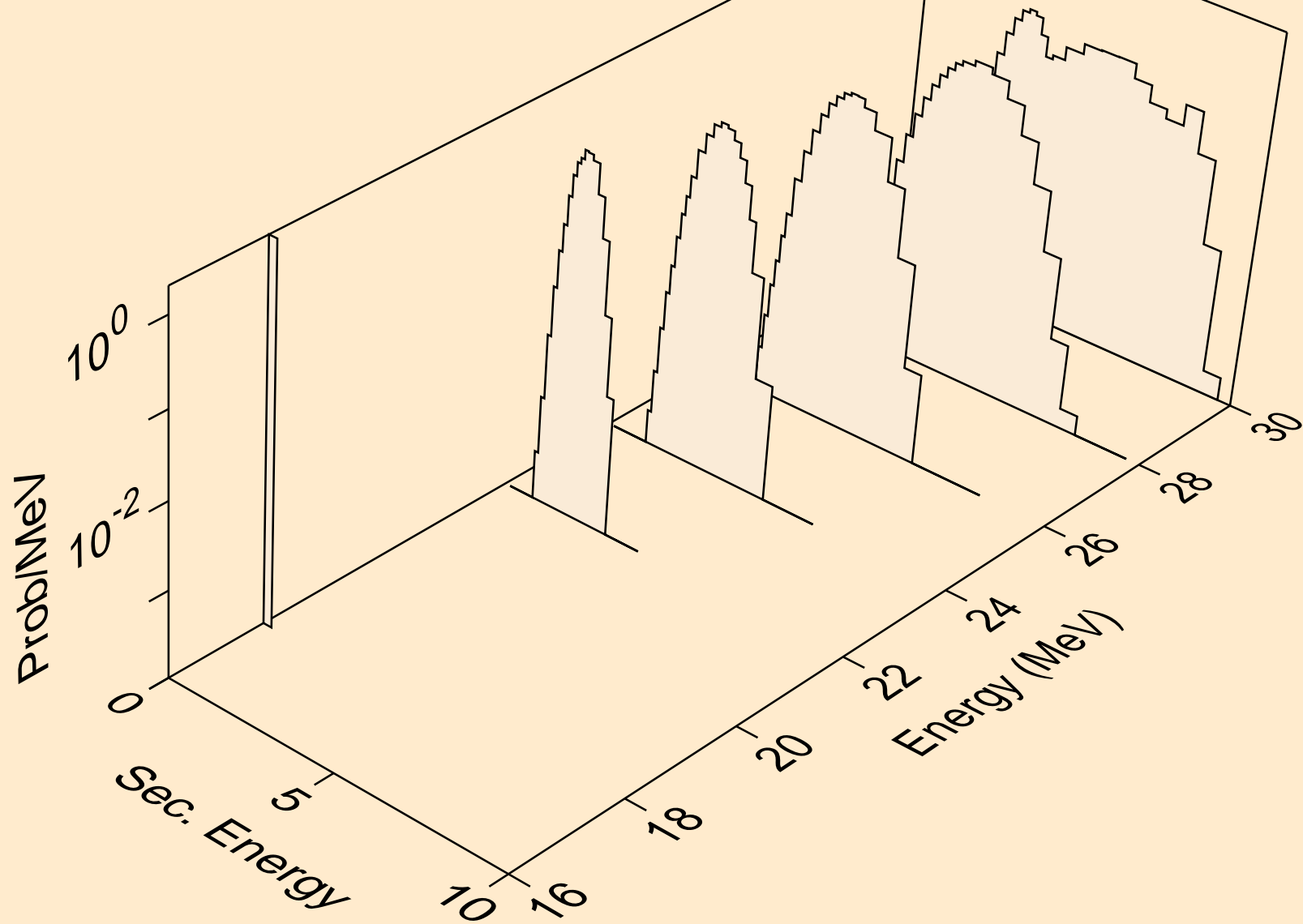

RU090 ALPHA ACER TENDL-2024 LIBRARY; T=0.K
protons from (a,npa)

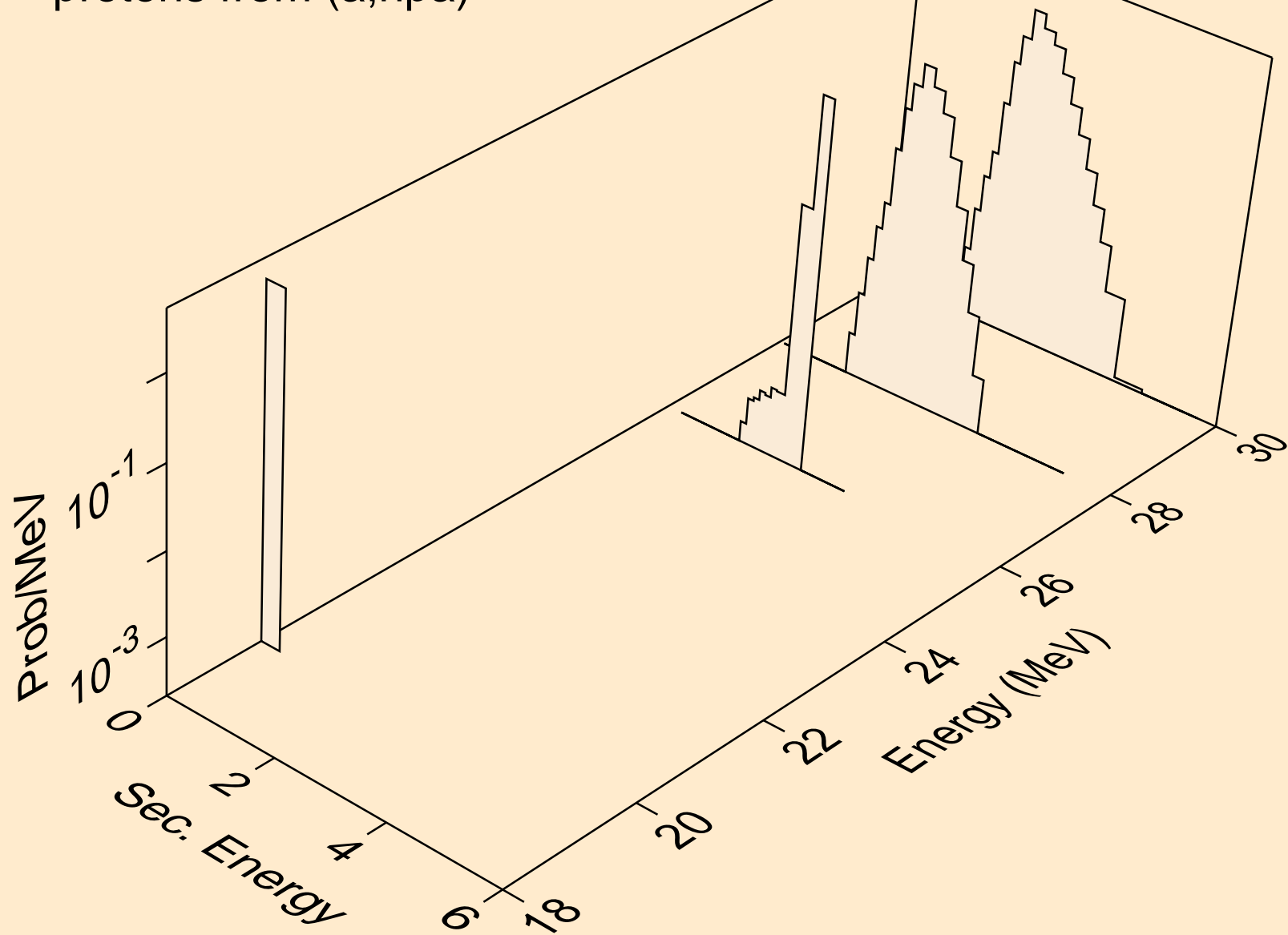

RU090 ALPHA ACER TENDL-2024 LIBRARY; T=0.K
protons from (a,p)

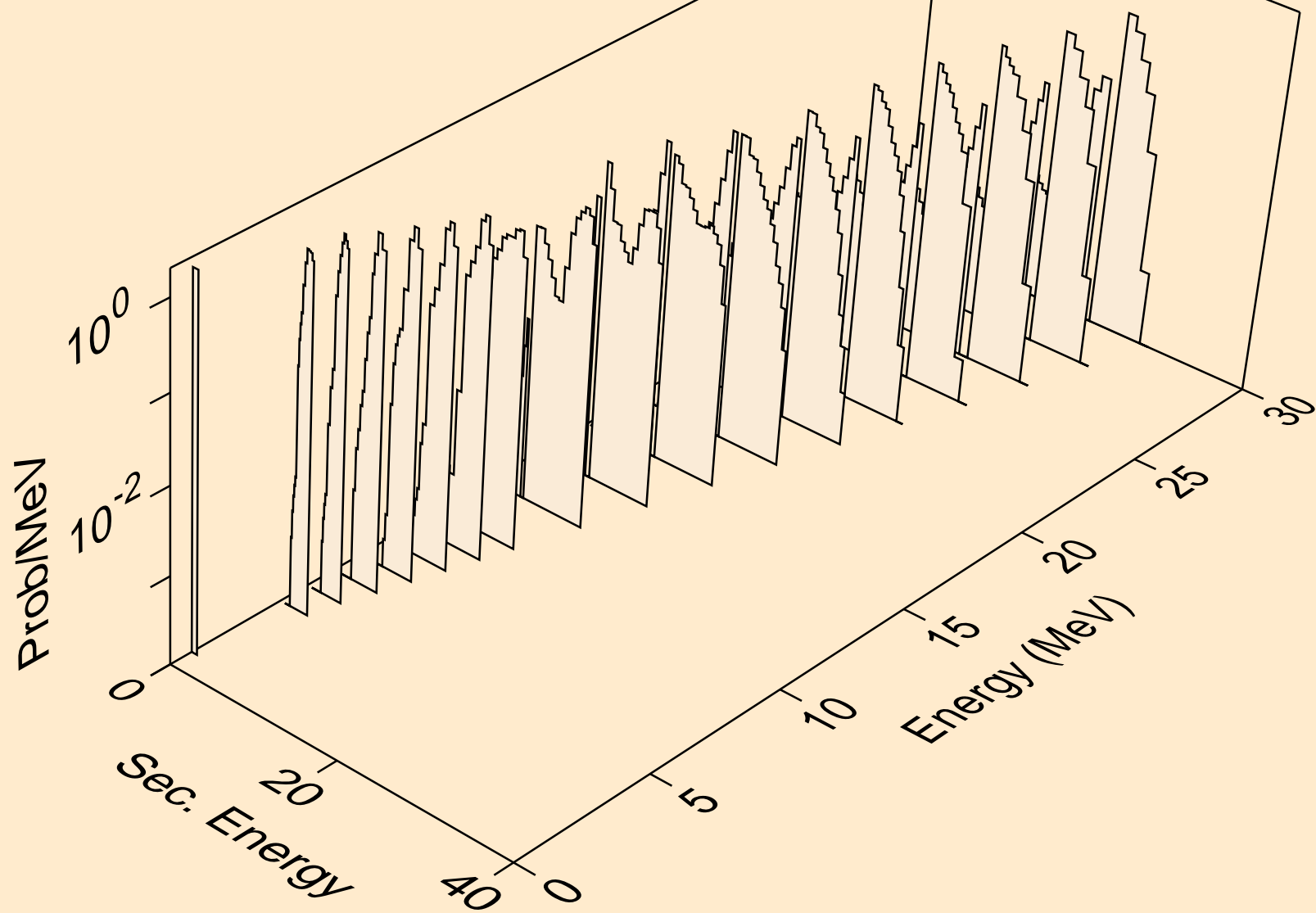

RU090 ALPHA ACER TENDL-2024 LIBRARY; T=0.K
protons from (a,2p)

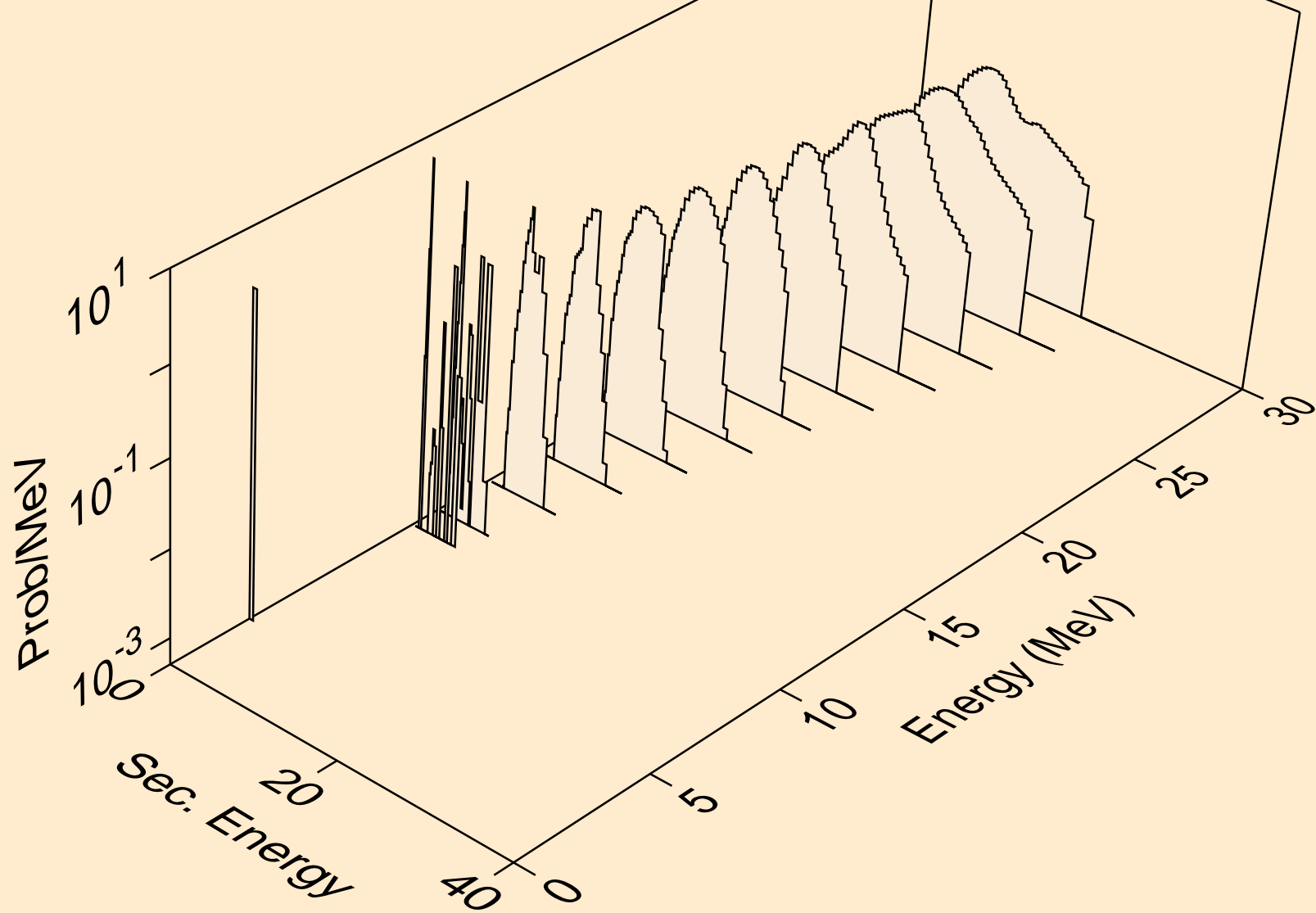

RU090 ALPHA ACER TENDL-2024 LIBRARY; T=0.K
protons from (a,pa)

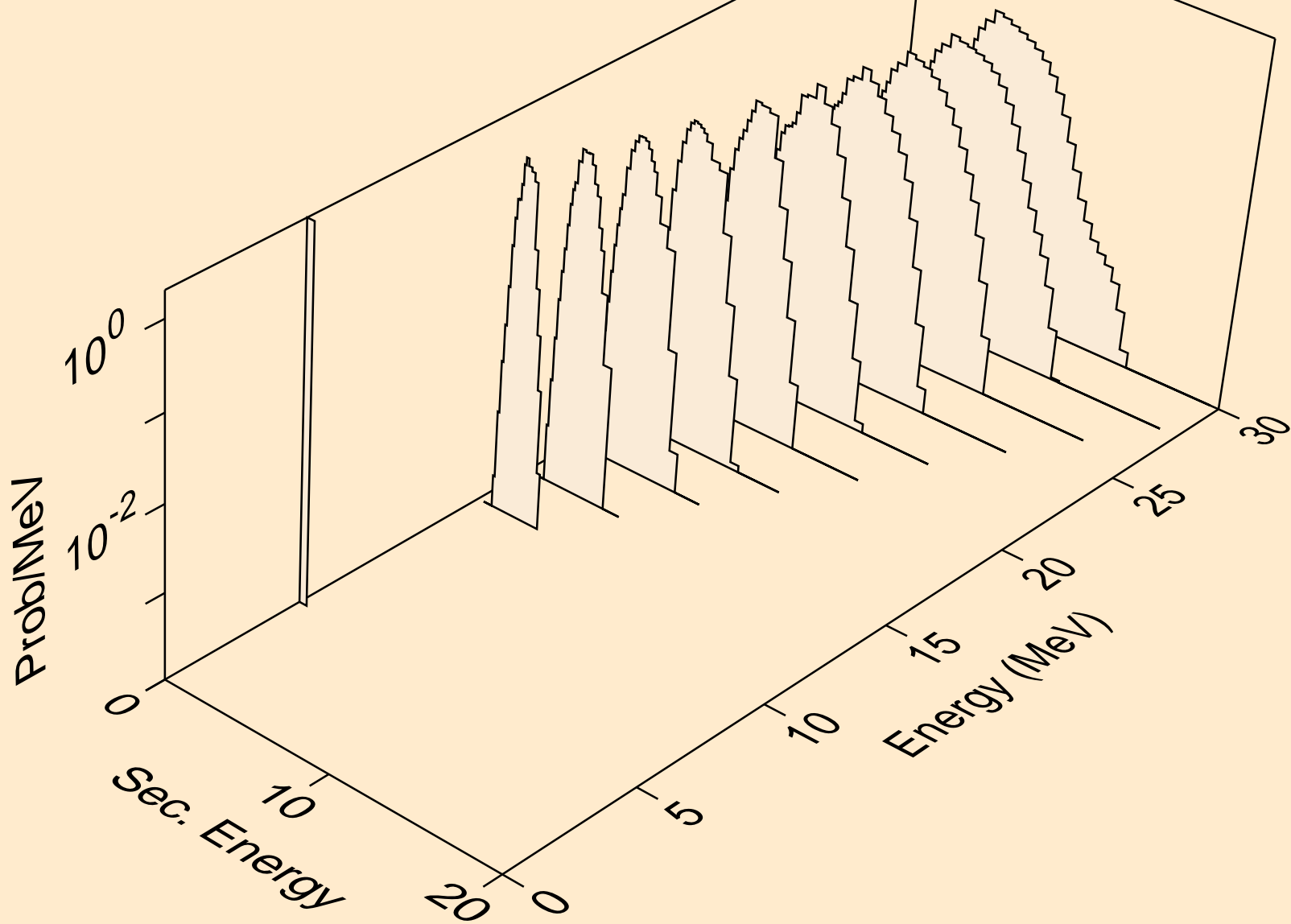

RU090 ALPHA ACER TENDL-2024 LIBRARY; T=0.K
protons from (a,pd)

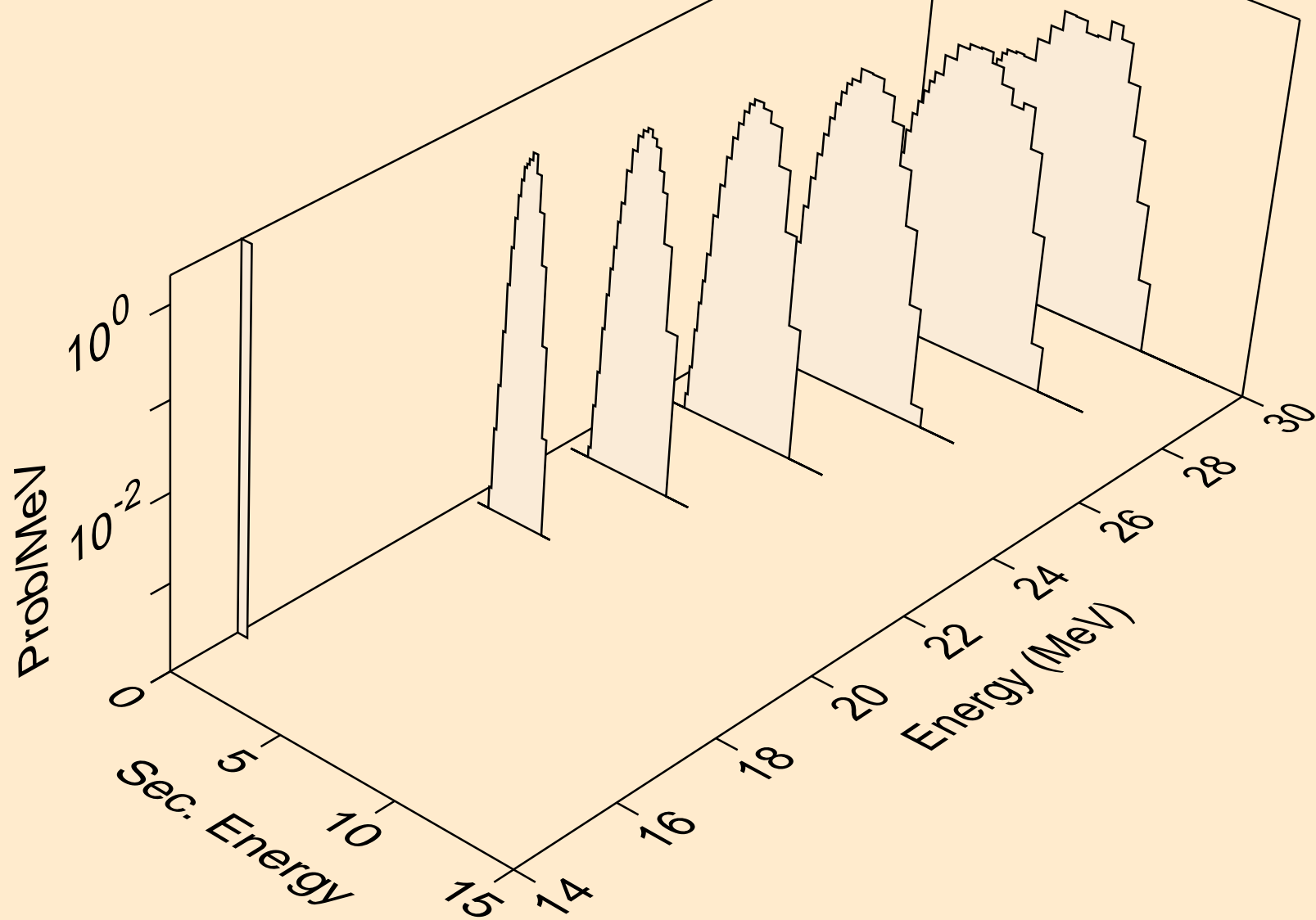

RU090 ALPHA ACER TENDL-2024 LIBRARY; T=0.K
deuterons from (a,x)

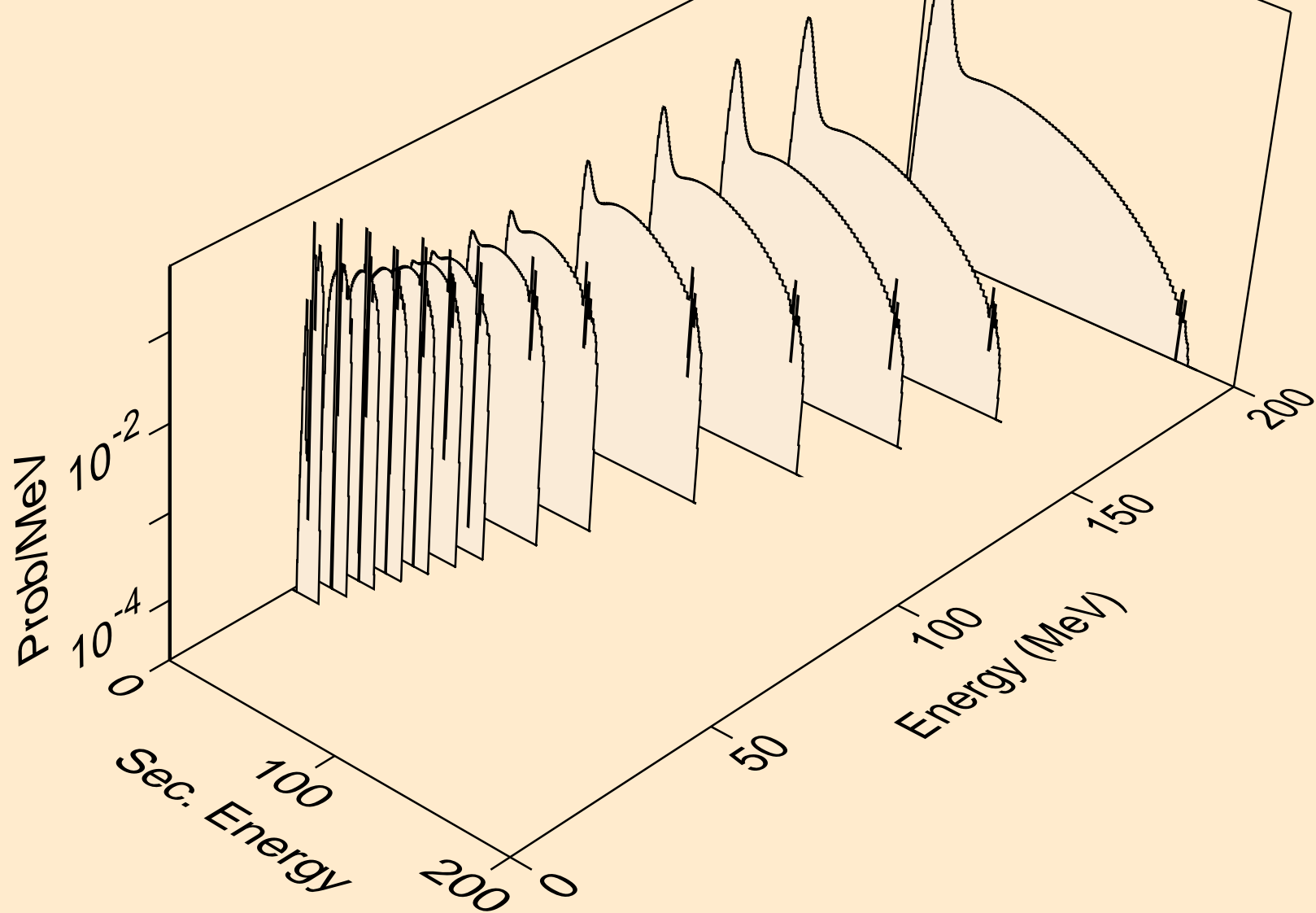

RU090 ALPHA ACER TENDL-2024 LIBRARY; T=0.K
deuterons from (a,n*)d

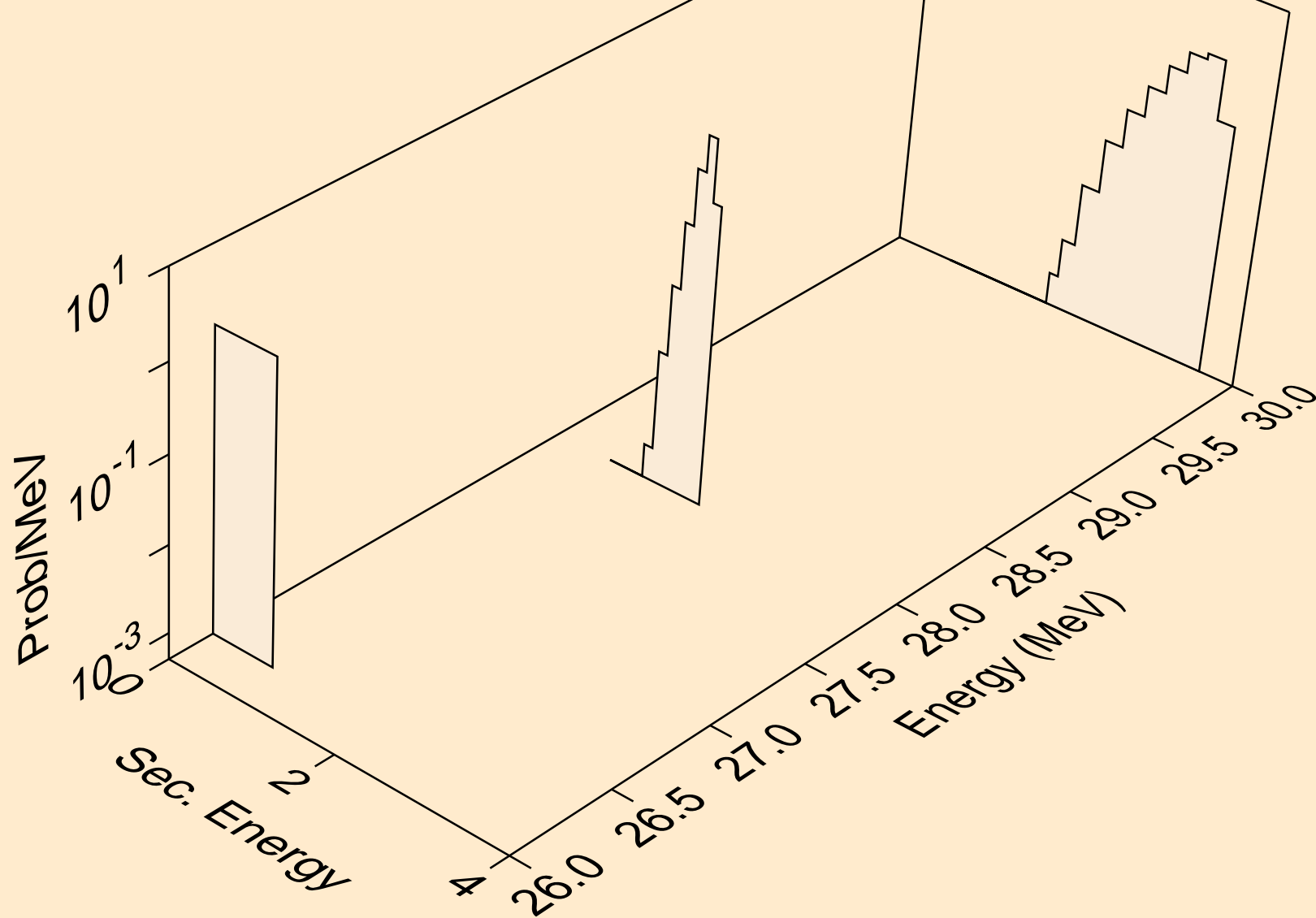

RU090 ALPHA ACER TENDL-2024 LIBRARY; T=0.K
deuterons from (a,d)

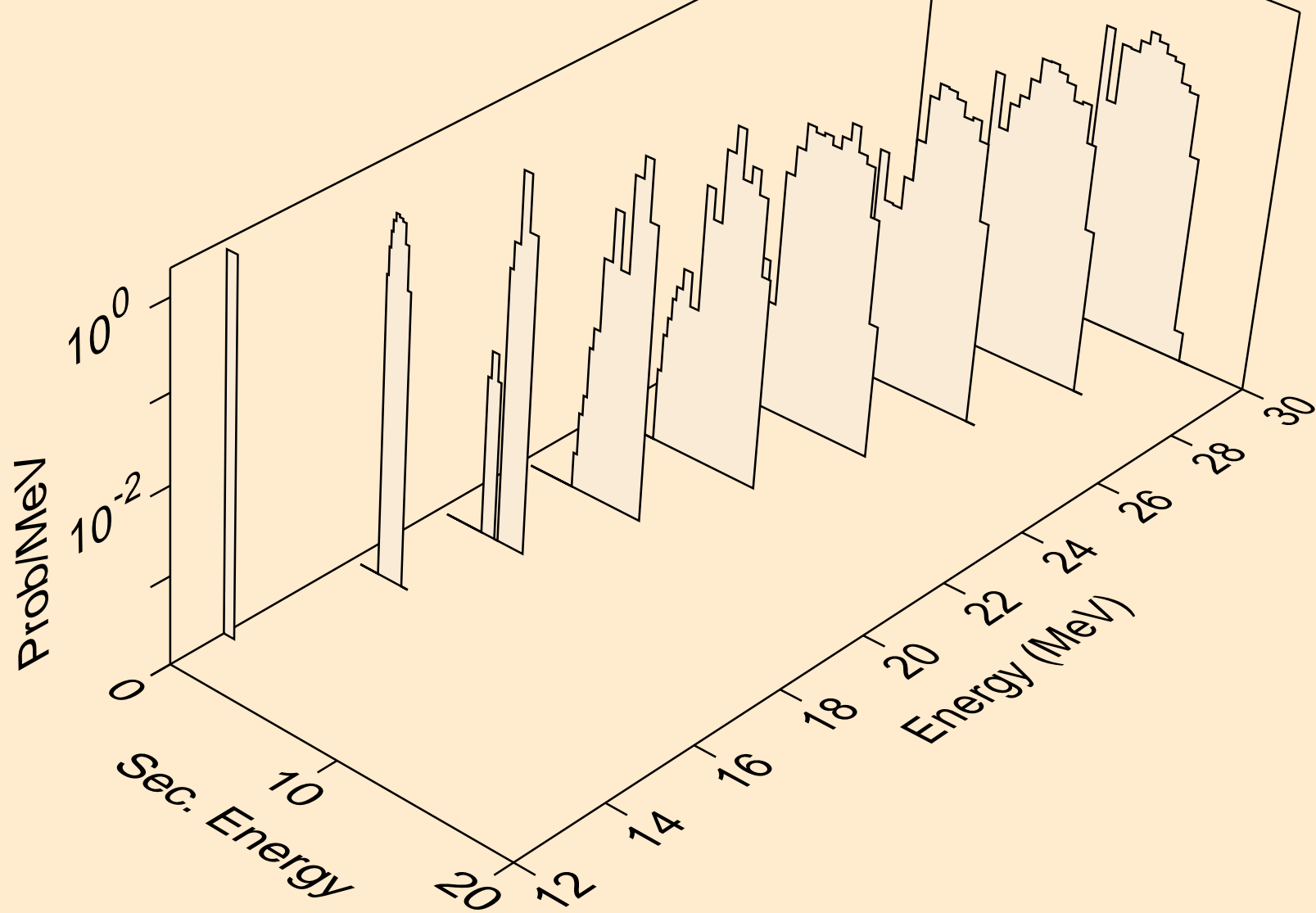

RU090 ALPHA ACER TENDL-2024 LIBRARY; T=0.K
deuterons from (a,pd)

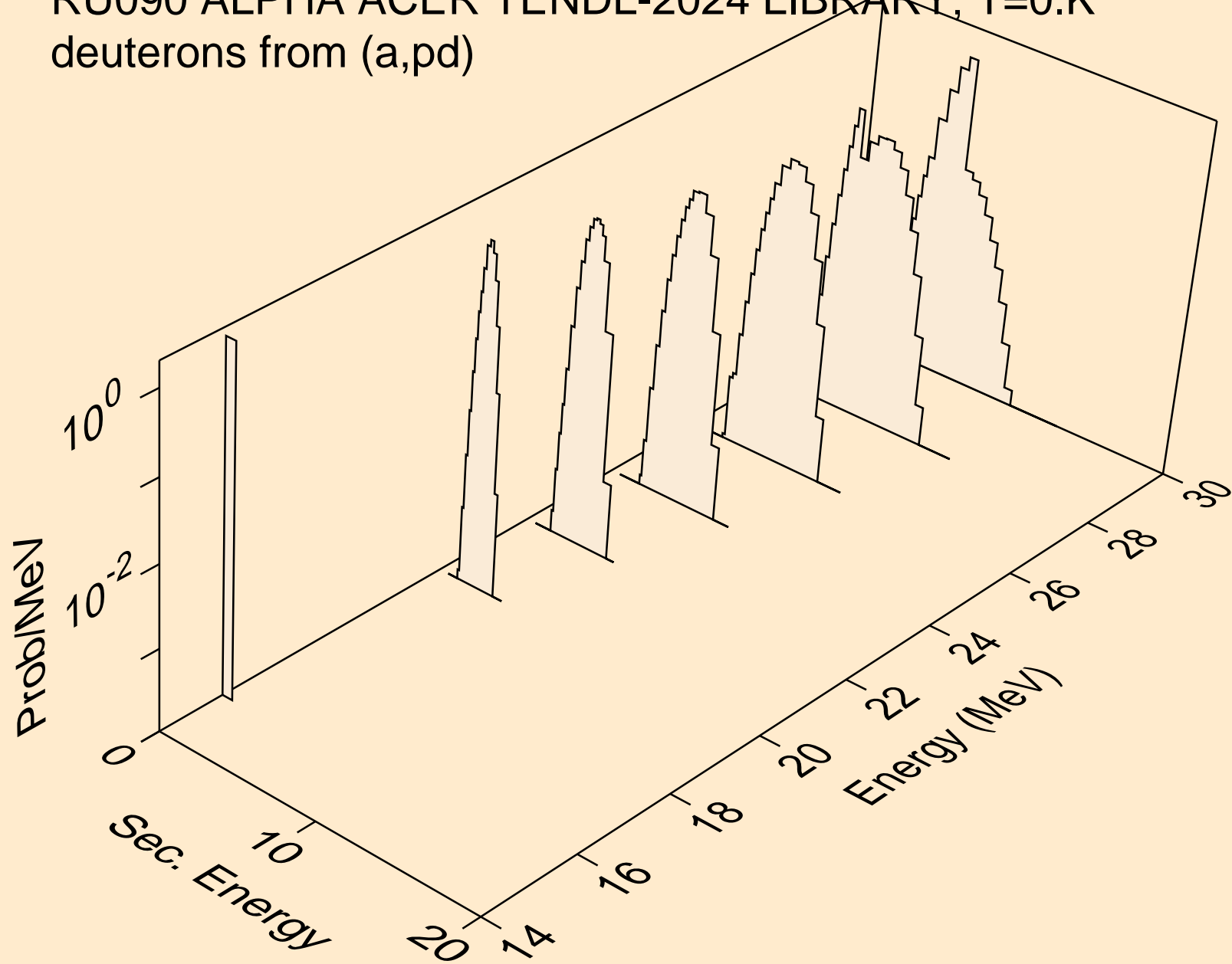

RU090 ALPHA ACER TENDL-2024 LIBRARY; T=0.K
tritons from (a,x)

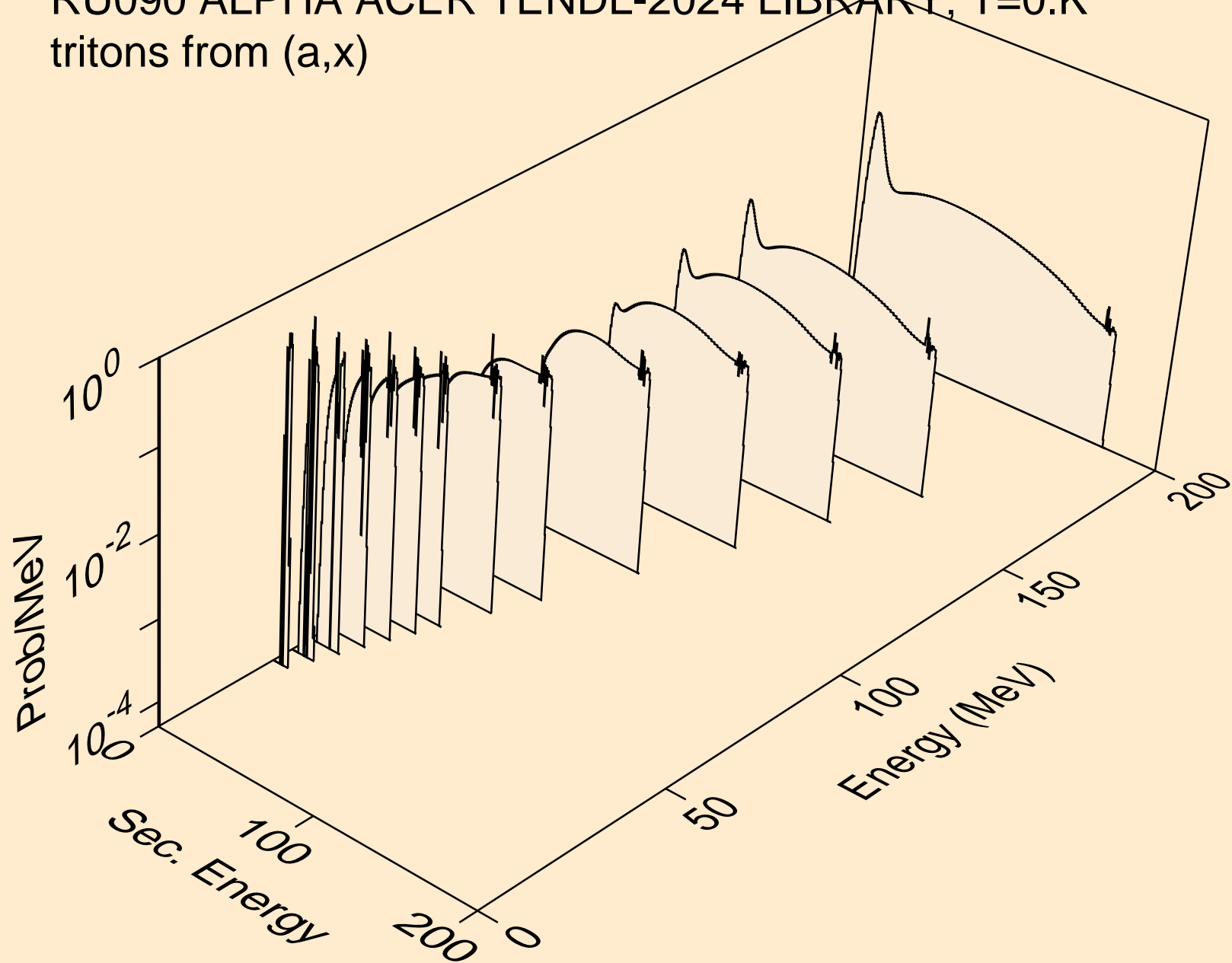

RU090 ALPHA ACER TENDL-2024 LIBRARY; T=0.K
tritons from (a,t)

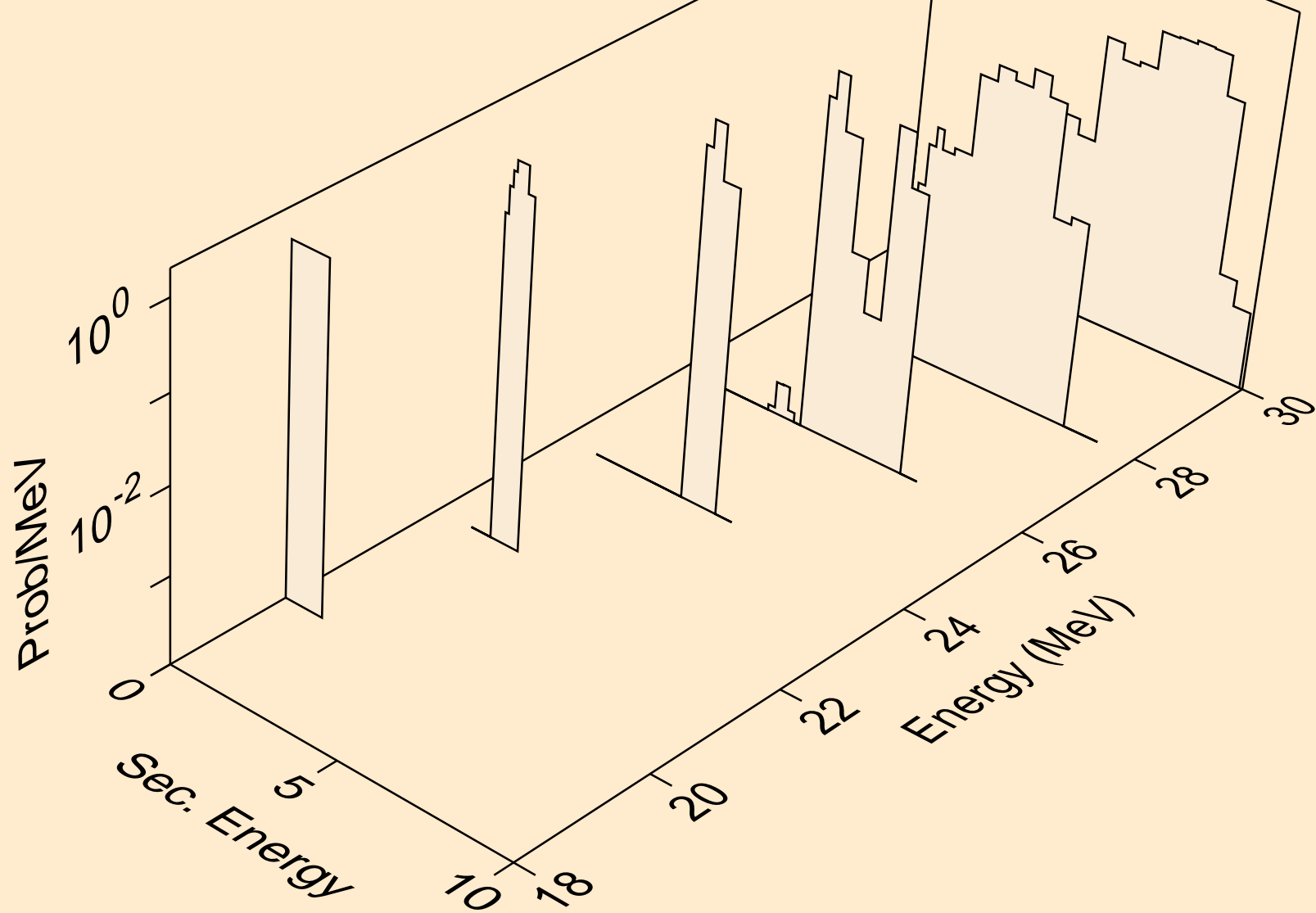

RU090 ALPHA ACER TENDL-2024 LIBRARY; T=0.K
he3s from (a,x)

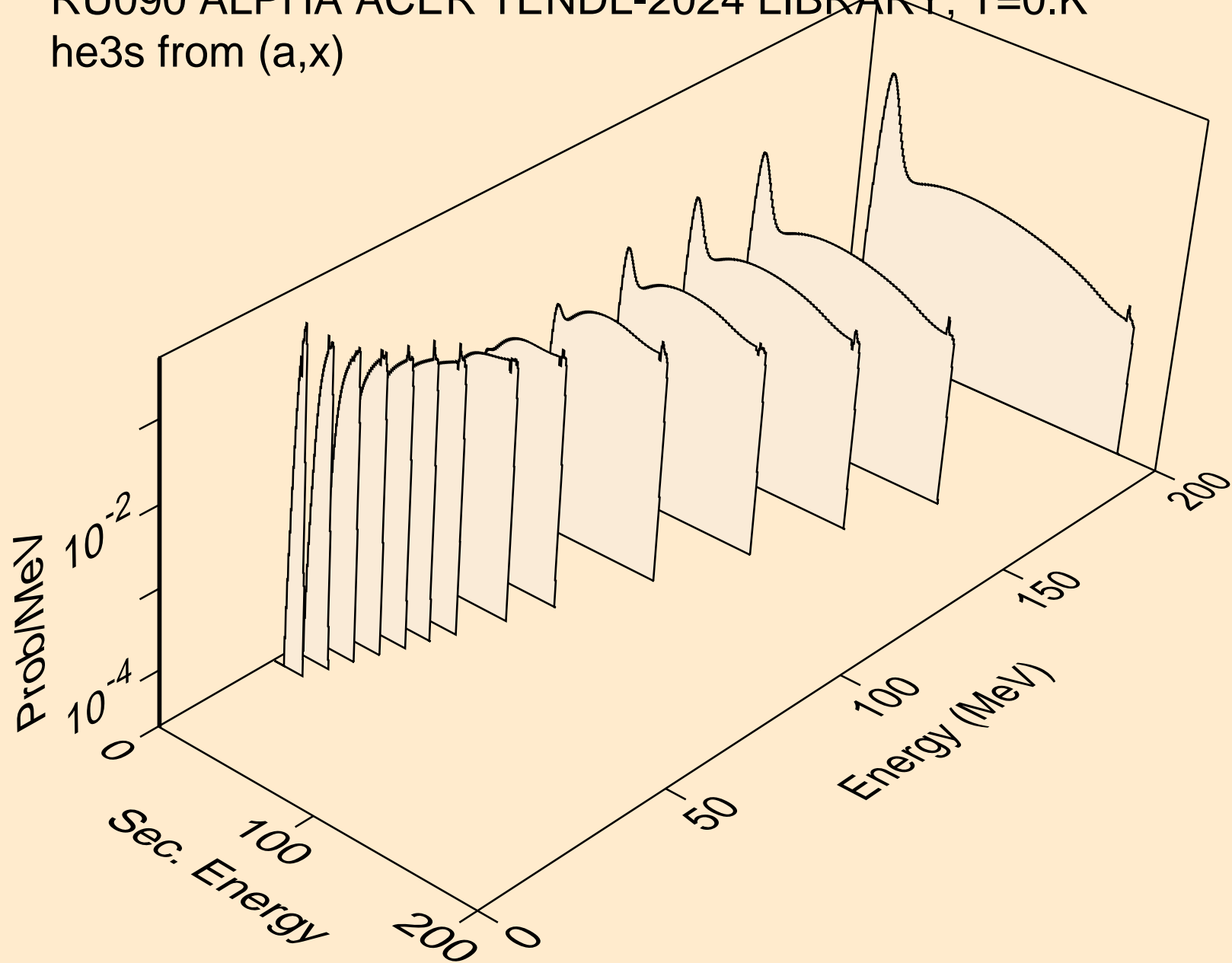

RU090 ALPHA ACER TENDL-2024 LIBRARY; T=0.K
he3s from (a,n*)he3

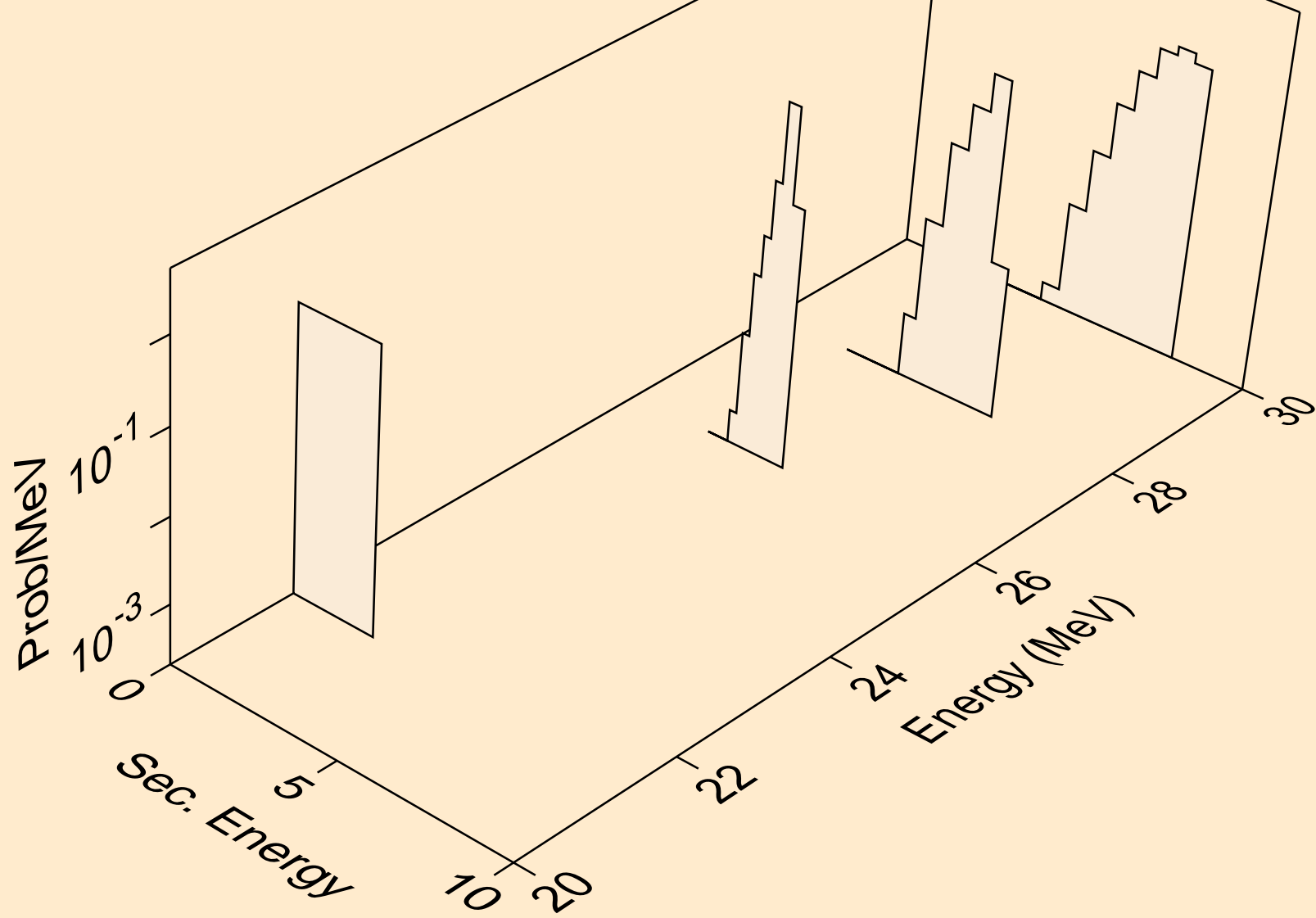

RU090 ALPHA ACER TENDL-2024 LIBRARY; T=0.K
he3s from (a,he3)

