

SC050 ALPHA ACER TENDL-2024 LIBRARY; T=0.K

Principal cross sections

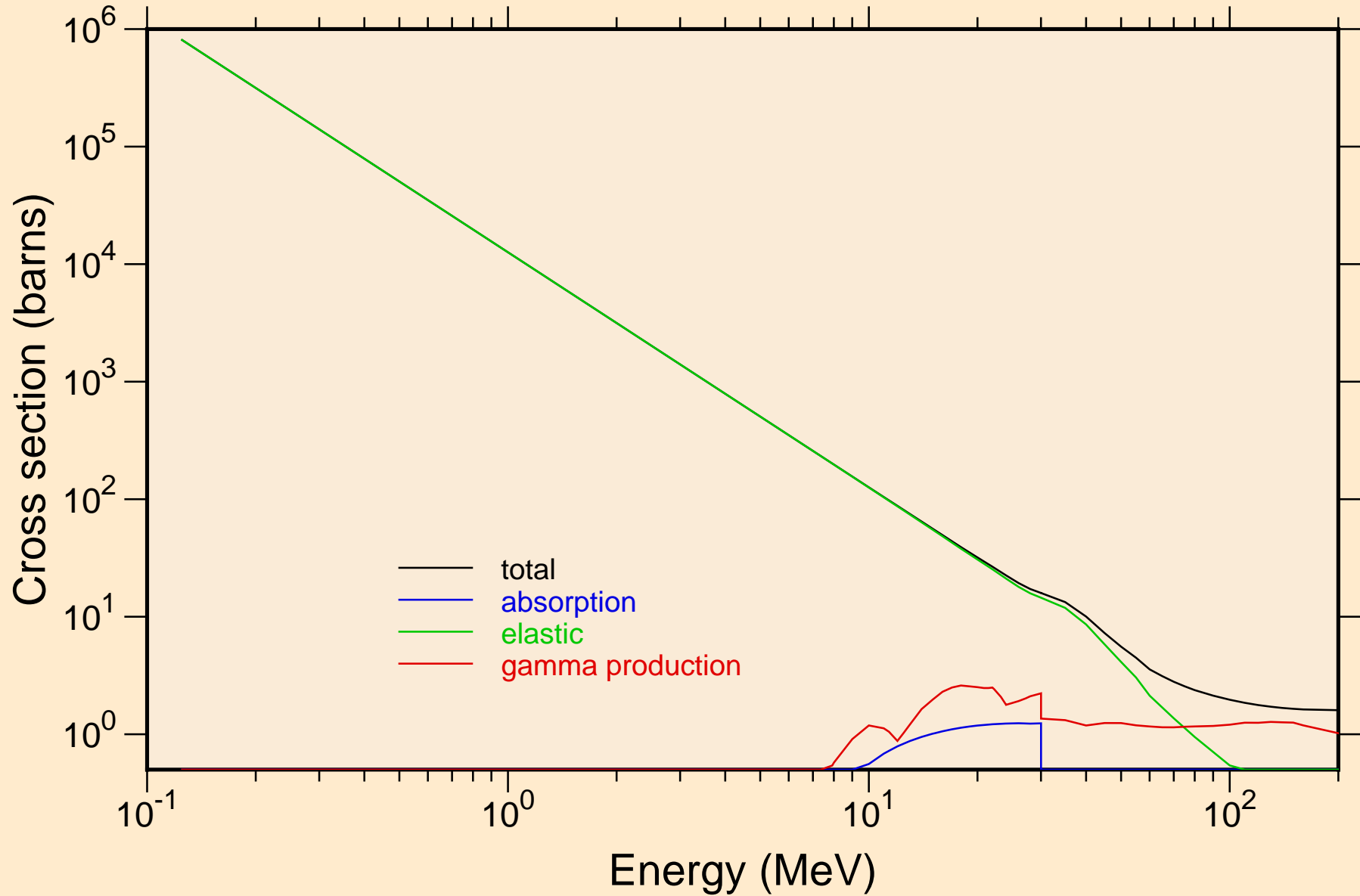

SC050 ALPHA ACER TENDL-2024 LIBRARY; T=0.K

Heating

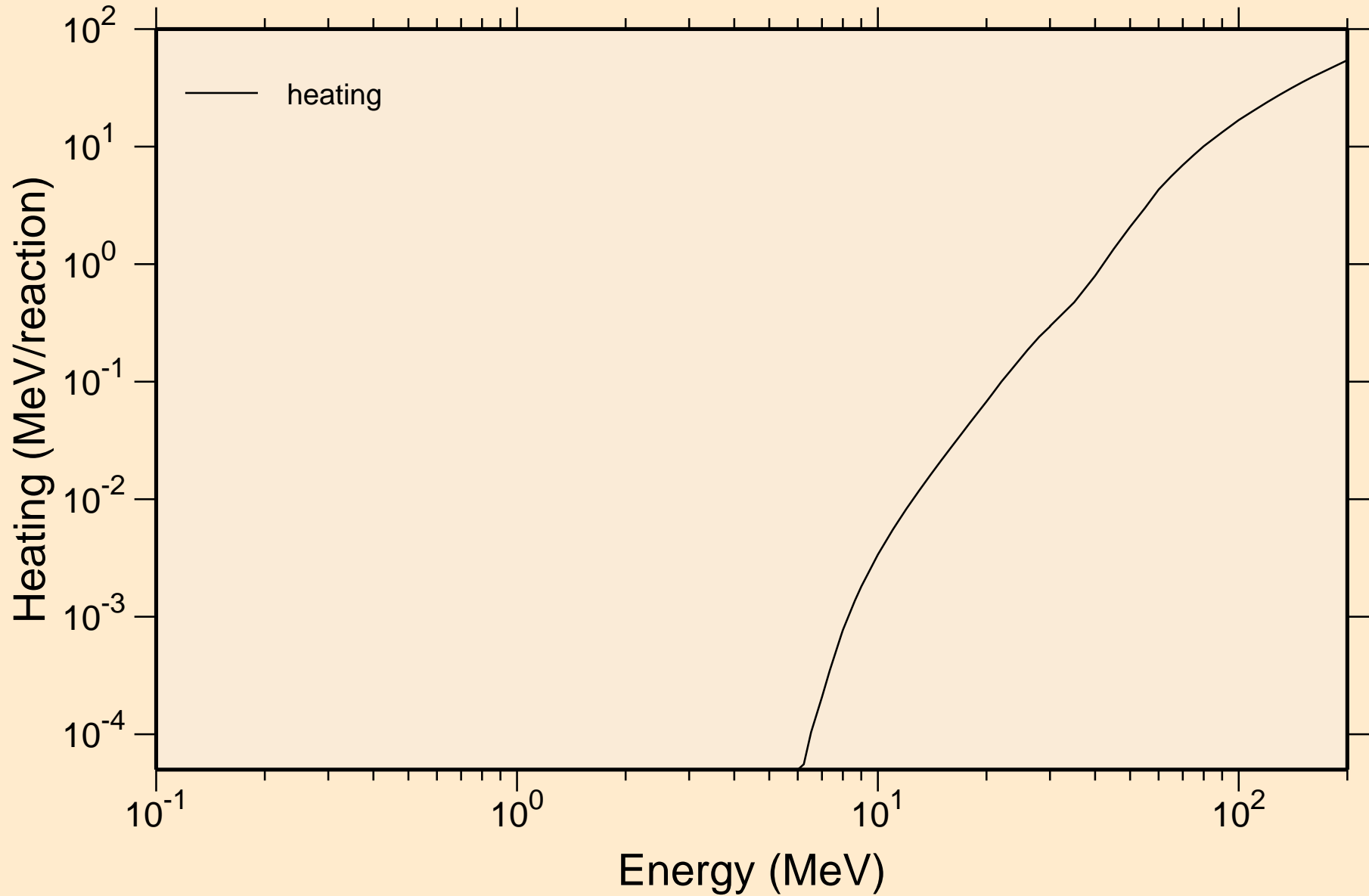

SC050 ALPHA ACER TENDL-2024 LIBRARY; T=0.K

Principal cross sections

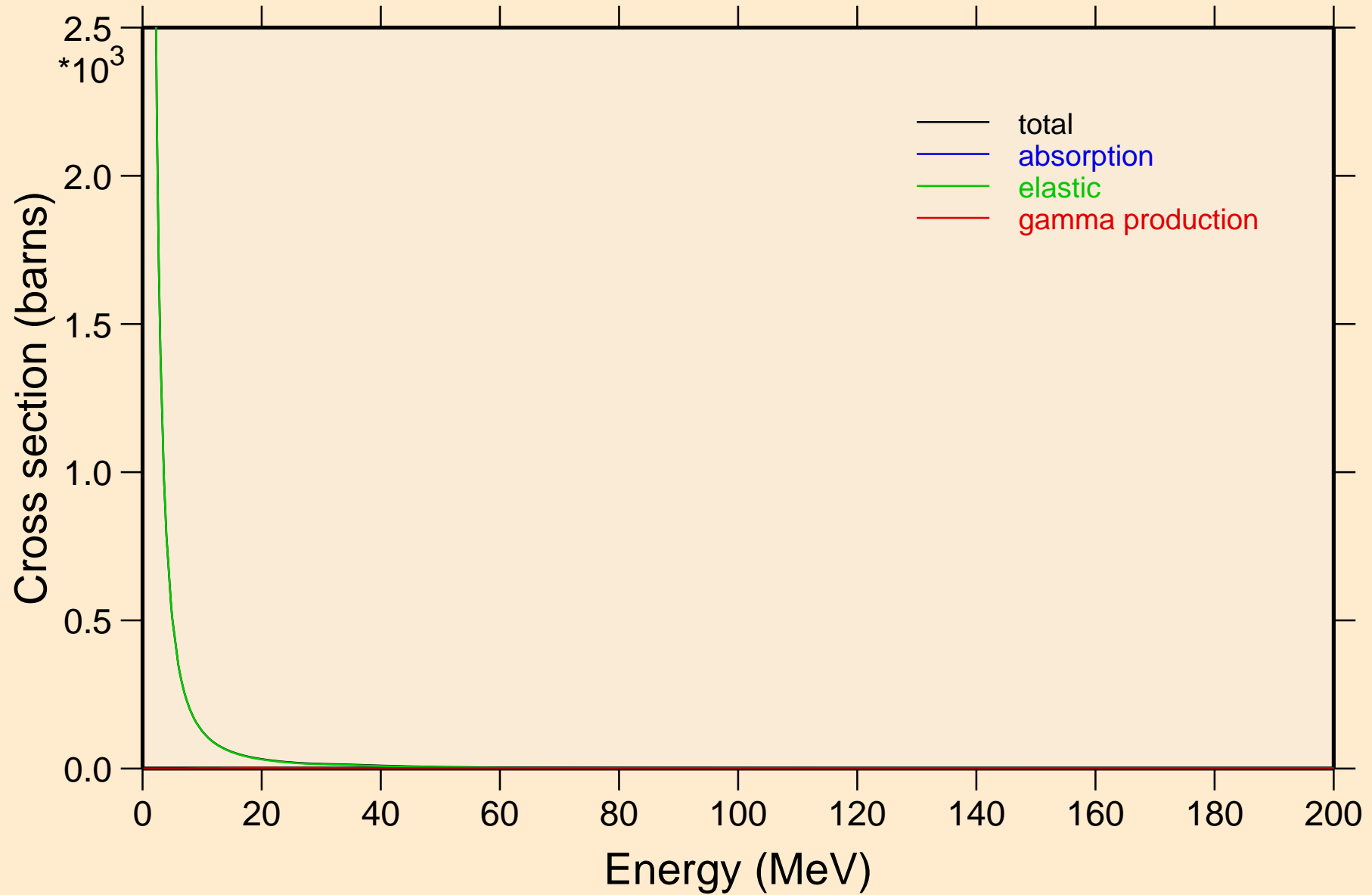

SC050 ALPHA ACER TENDL-2024 LIBRARY; T=0.K

Heating

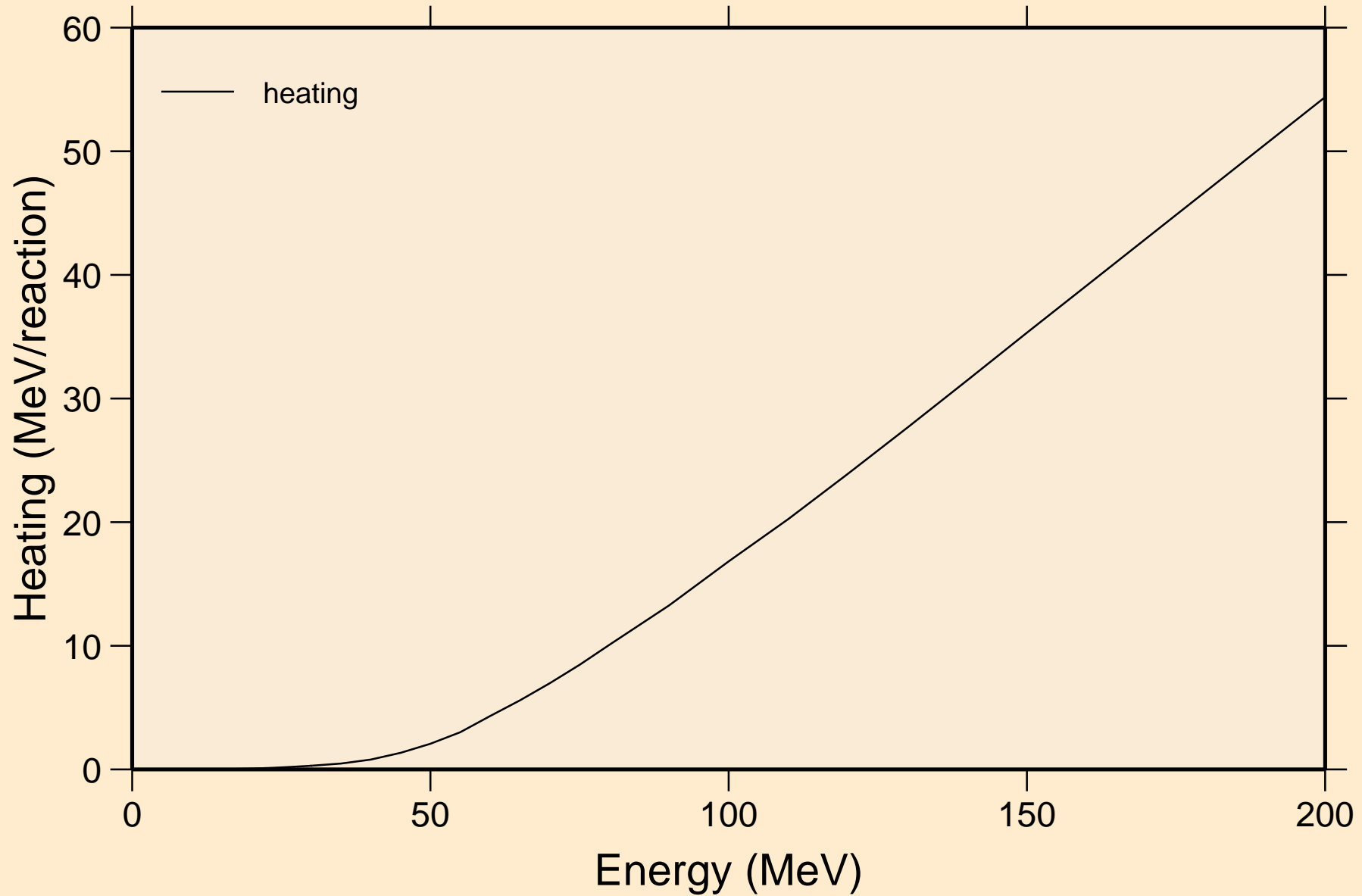

SC050 ALPHA ACER TENDL-2024 LIBRARY; T=0.K
Threshold reactions

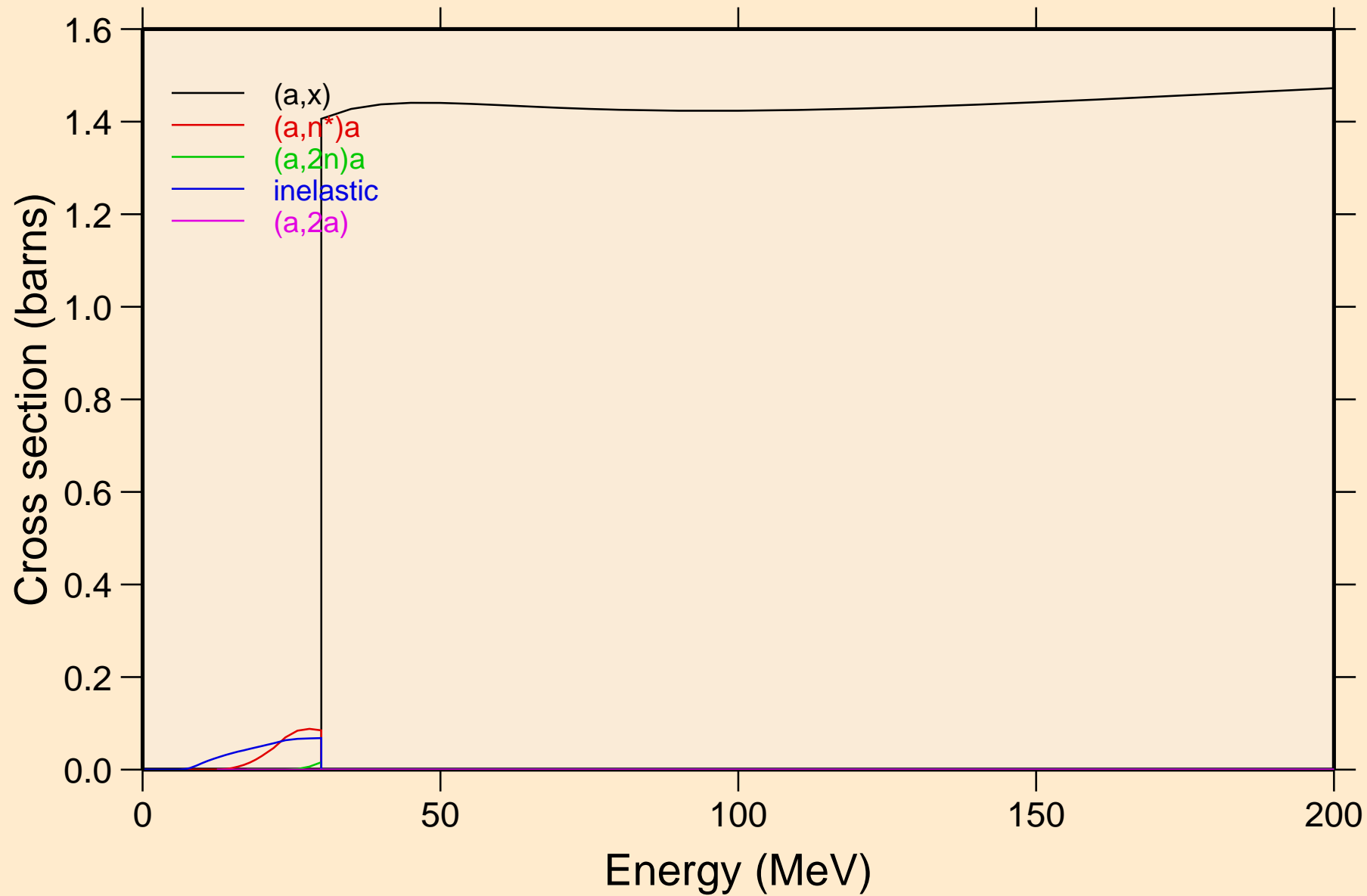

SC050 ALPHA ACER TENDL-2024 LIBRARY; T=0.K
Threshold reactions

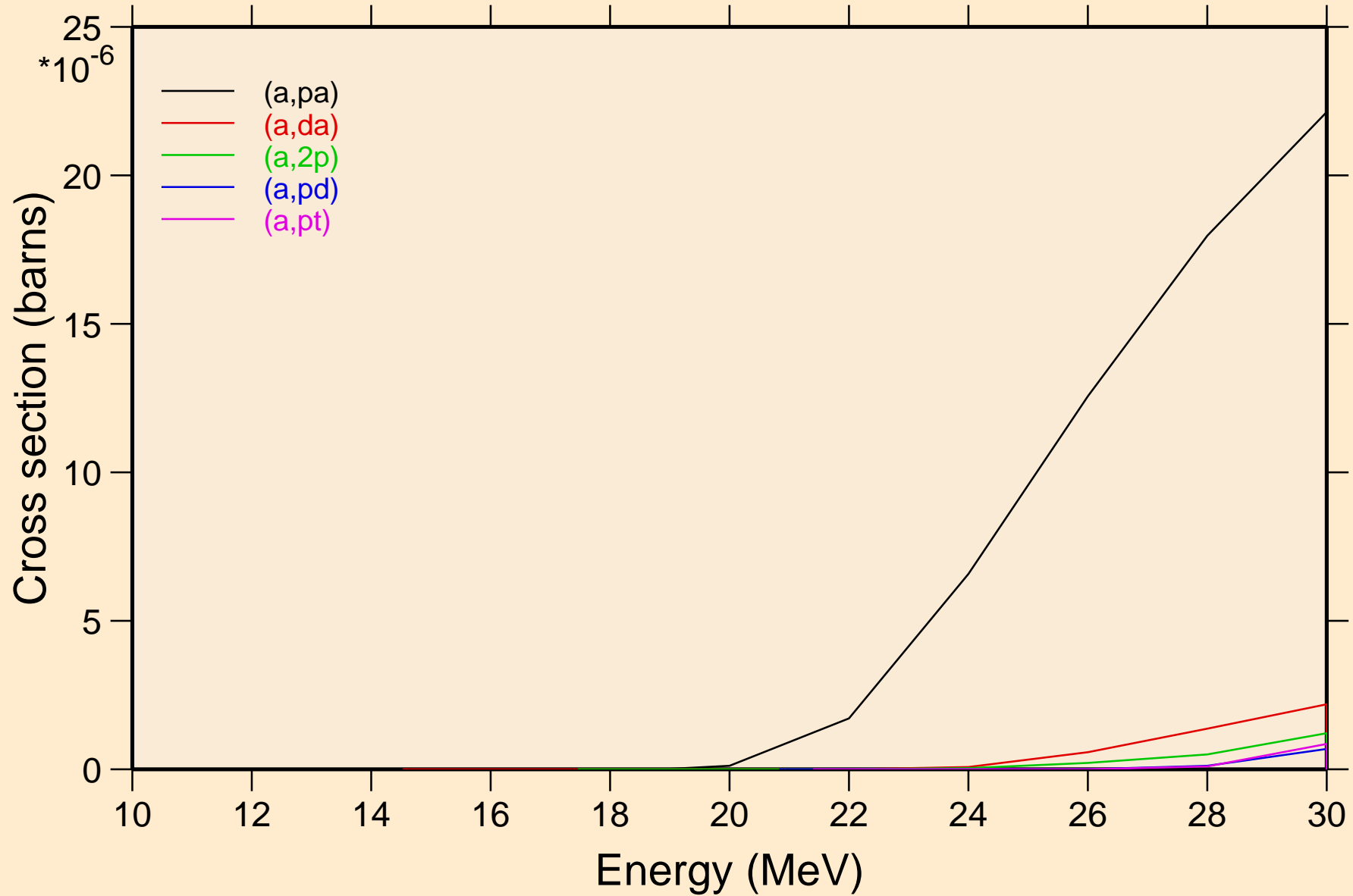

SC050 ALPHA ACER TENDL-2024 LIBRARY; T=0.K
Threshold reactions

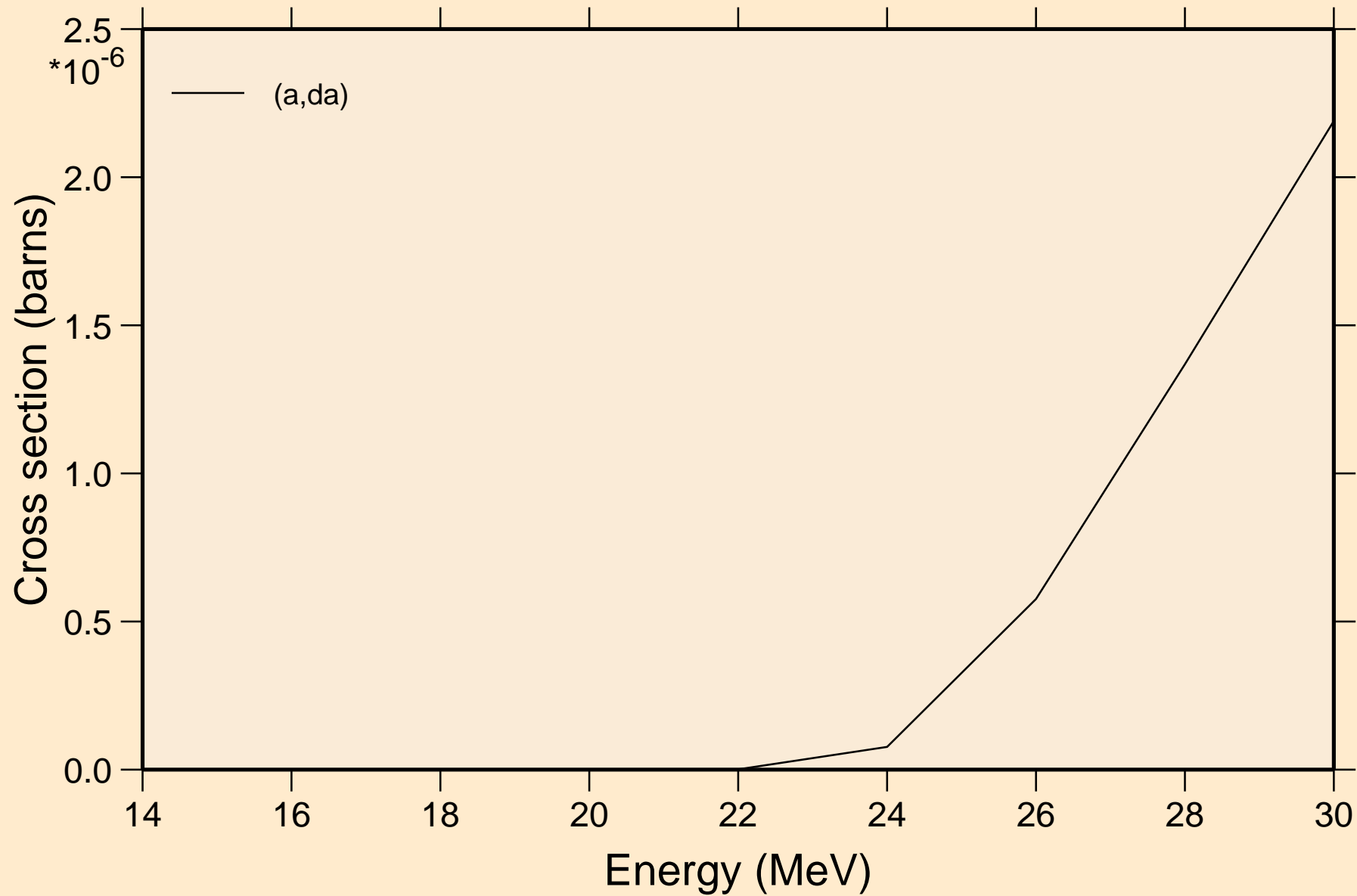

SC050 ALPHA ACER TENDL-2024 LIBRARY; T=0.K
angular distribution for elastic

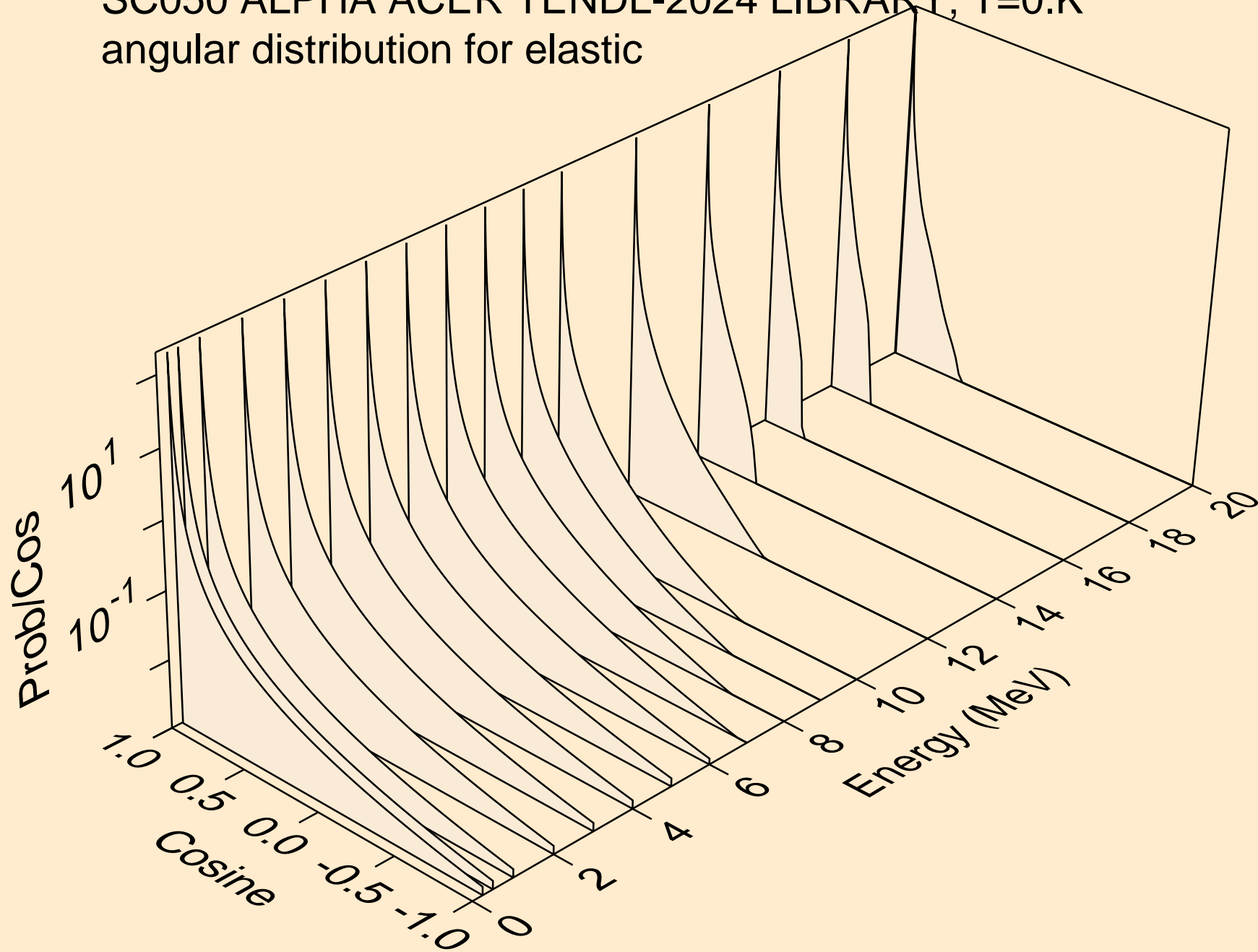

SC050 ALPHA ACER TENDL-2024 LIBRARY; T=0.K
angular distribution for elastic

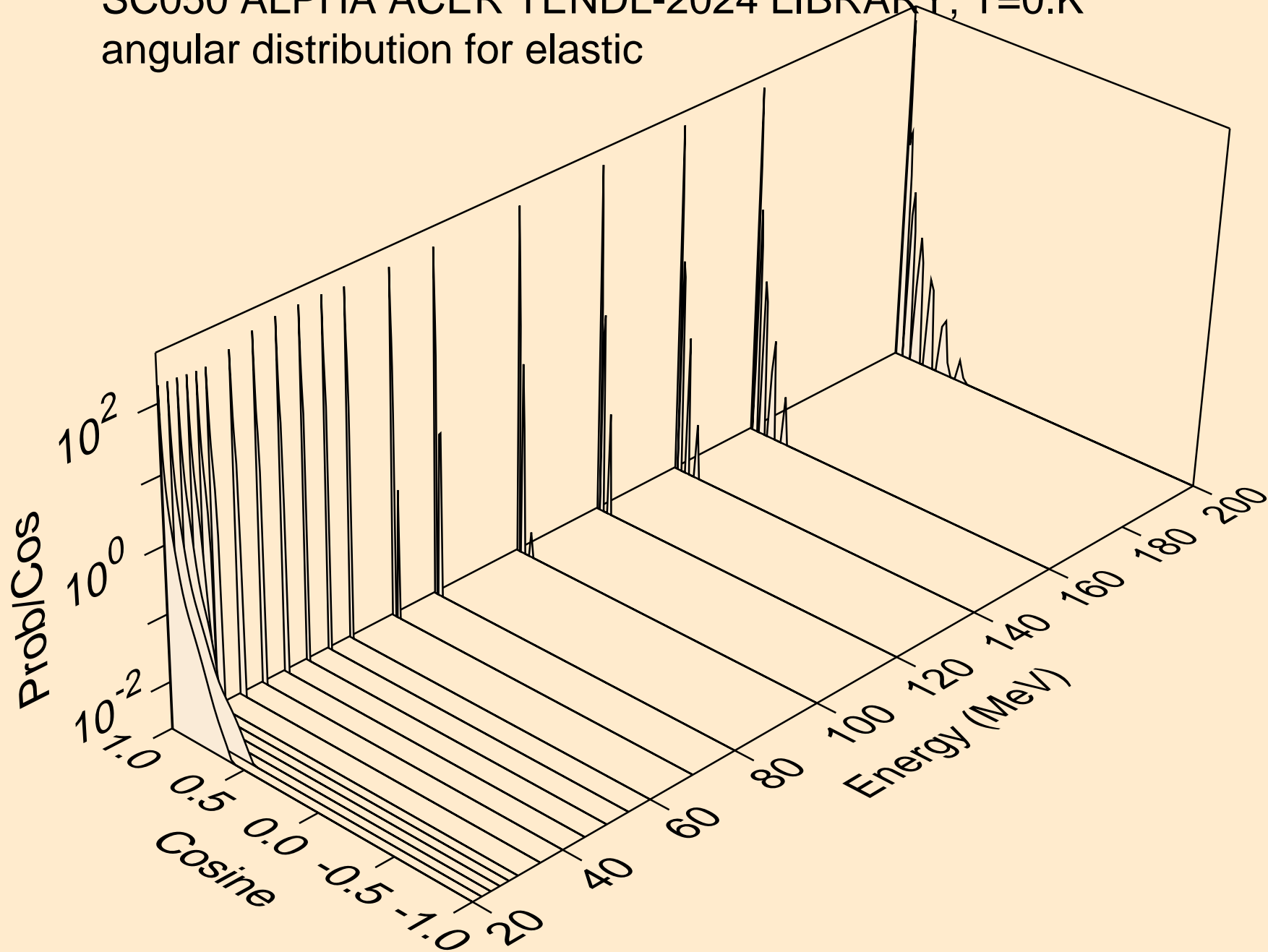

SC050 ALPHA ACER TENDL-2024 LIBRARY; T=0.K
Alpha emission for (a,x)

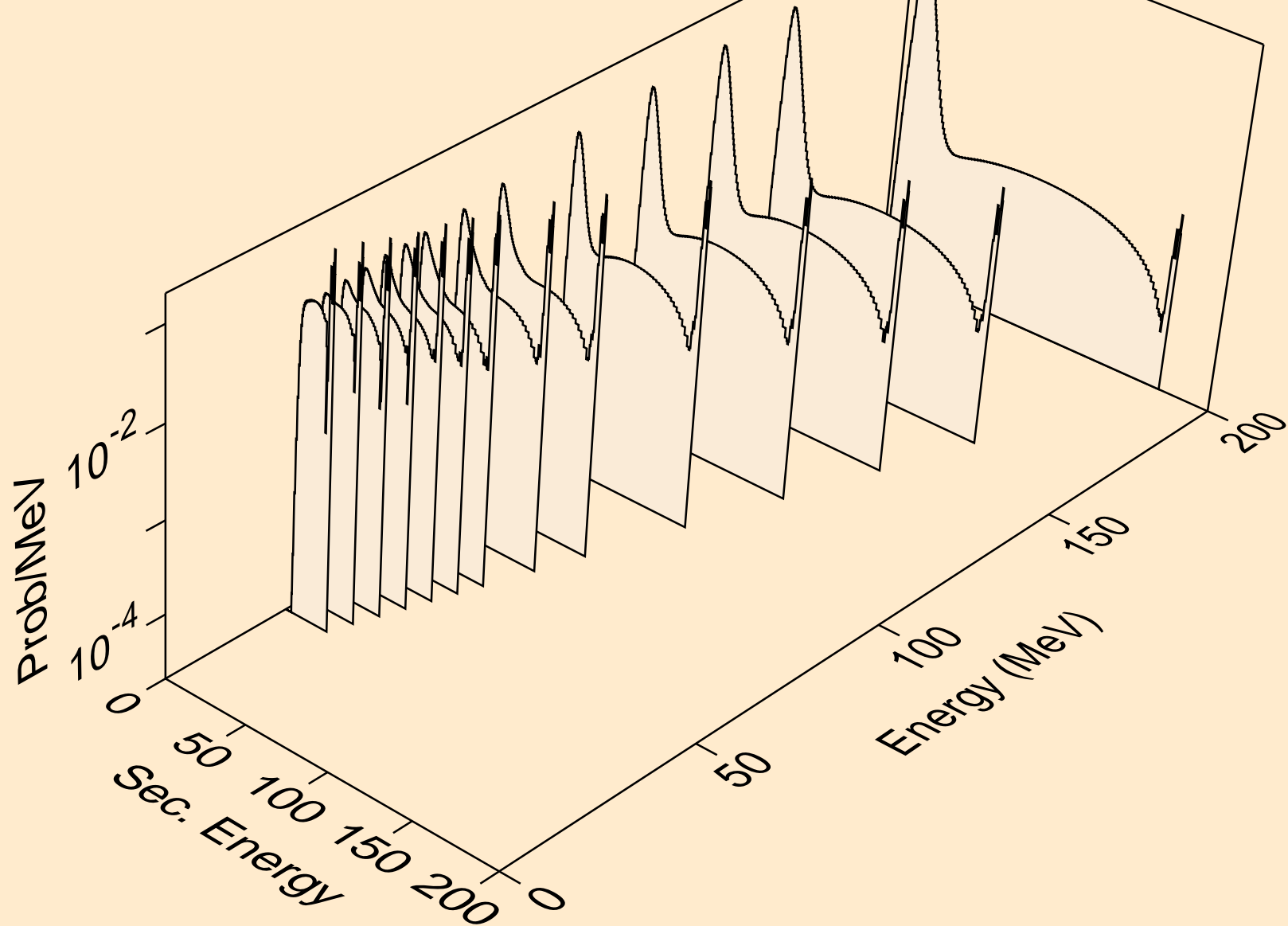

SC050 ALPHA ACER TENDL-2024 LIBRARY; T=0.K
Alpha emission for (a,n*)a

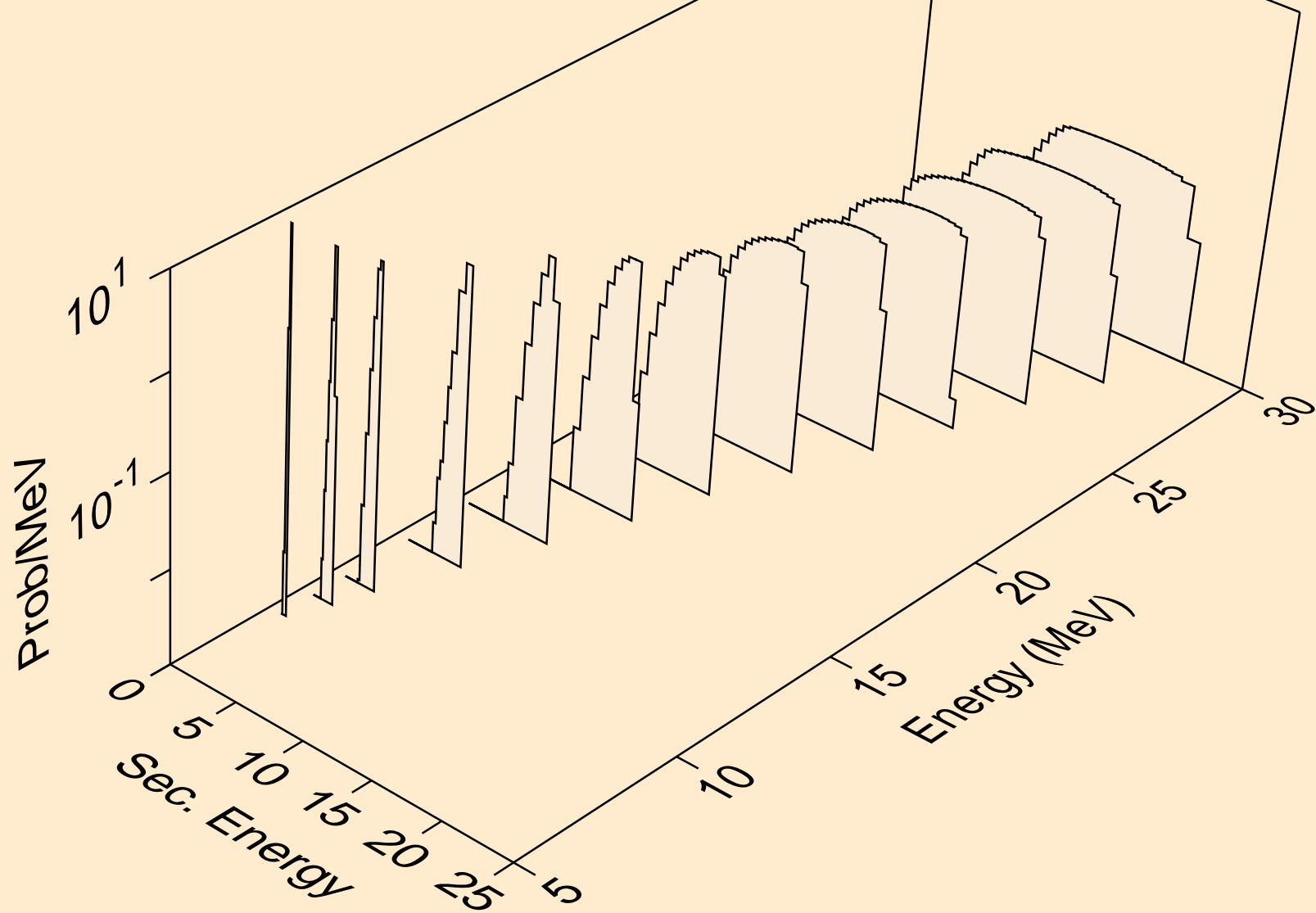

SC050 ALPHA ACER TENDL-2024 LIBRARY; T=0.K
Alpha emission for (a,2n)a

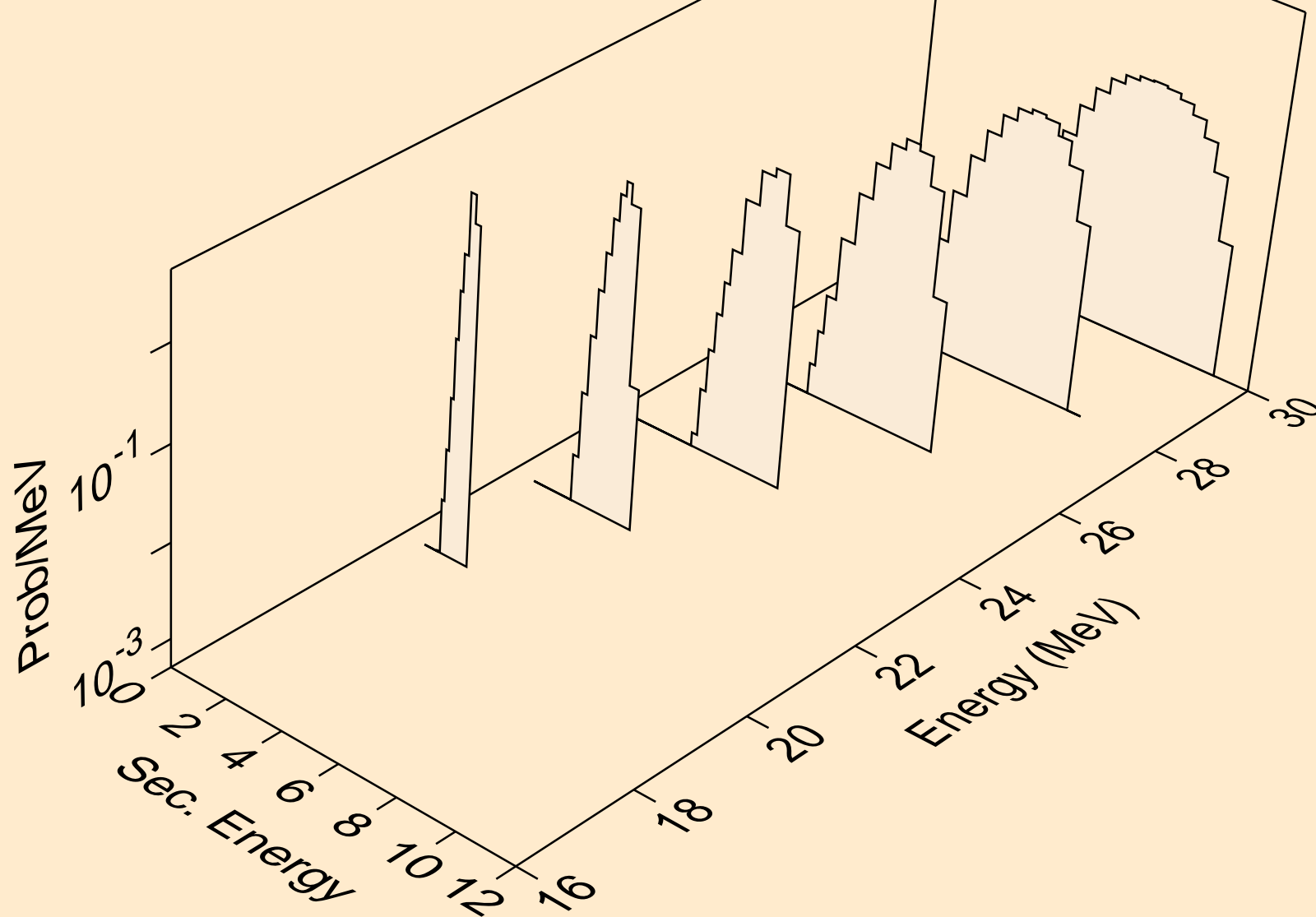

SC050 ALPHA ACER TENDL-2024 LIBRARY; T=0.K
Alpha emission for inelastic

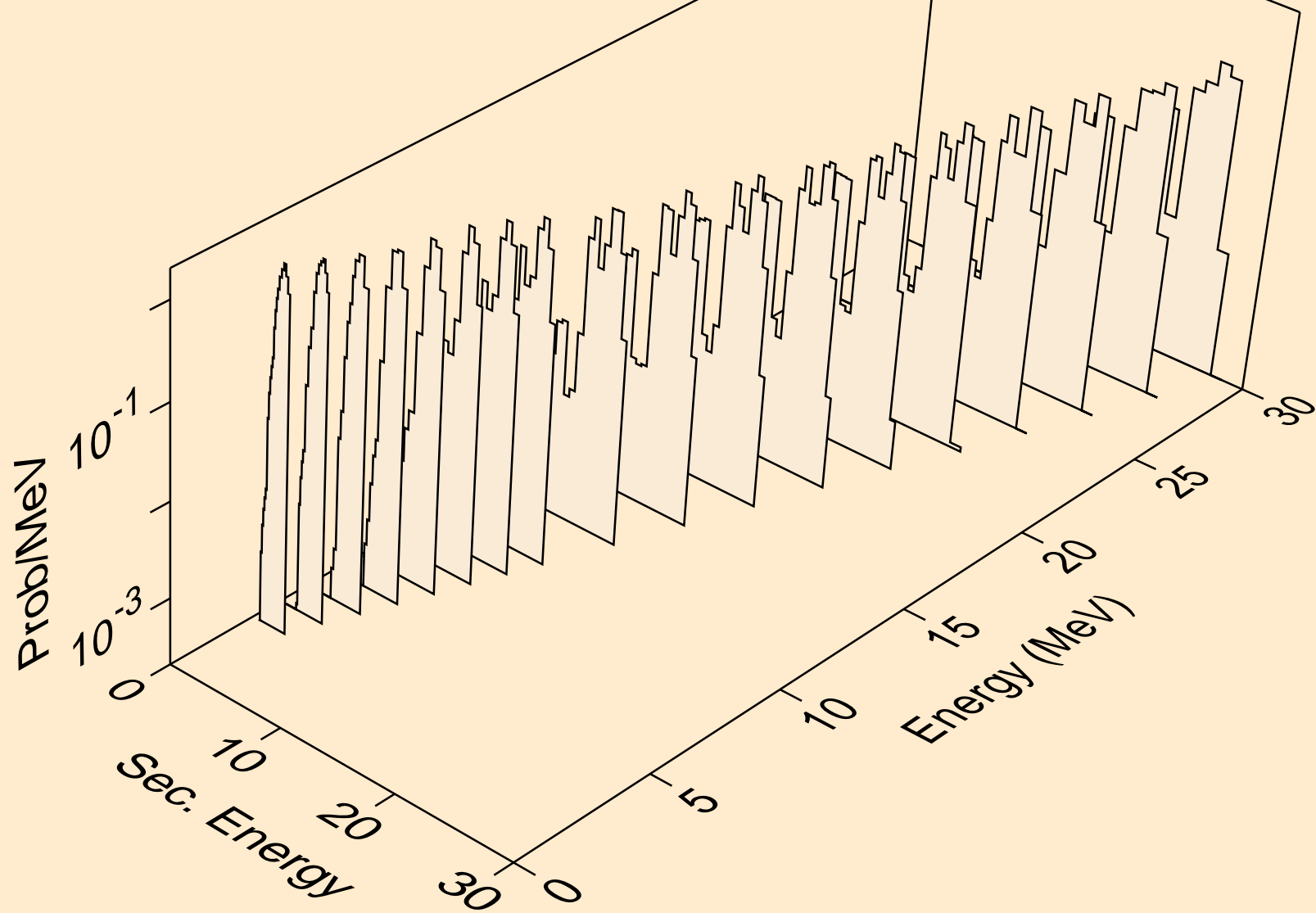

SC050 ALPHA ACER TENDL-2024 LIBRARY; T=0.K
Alpha emission for (a,2a)

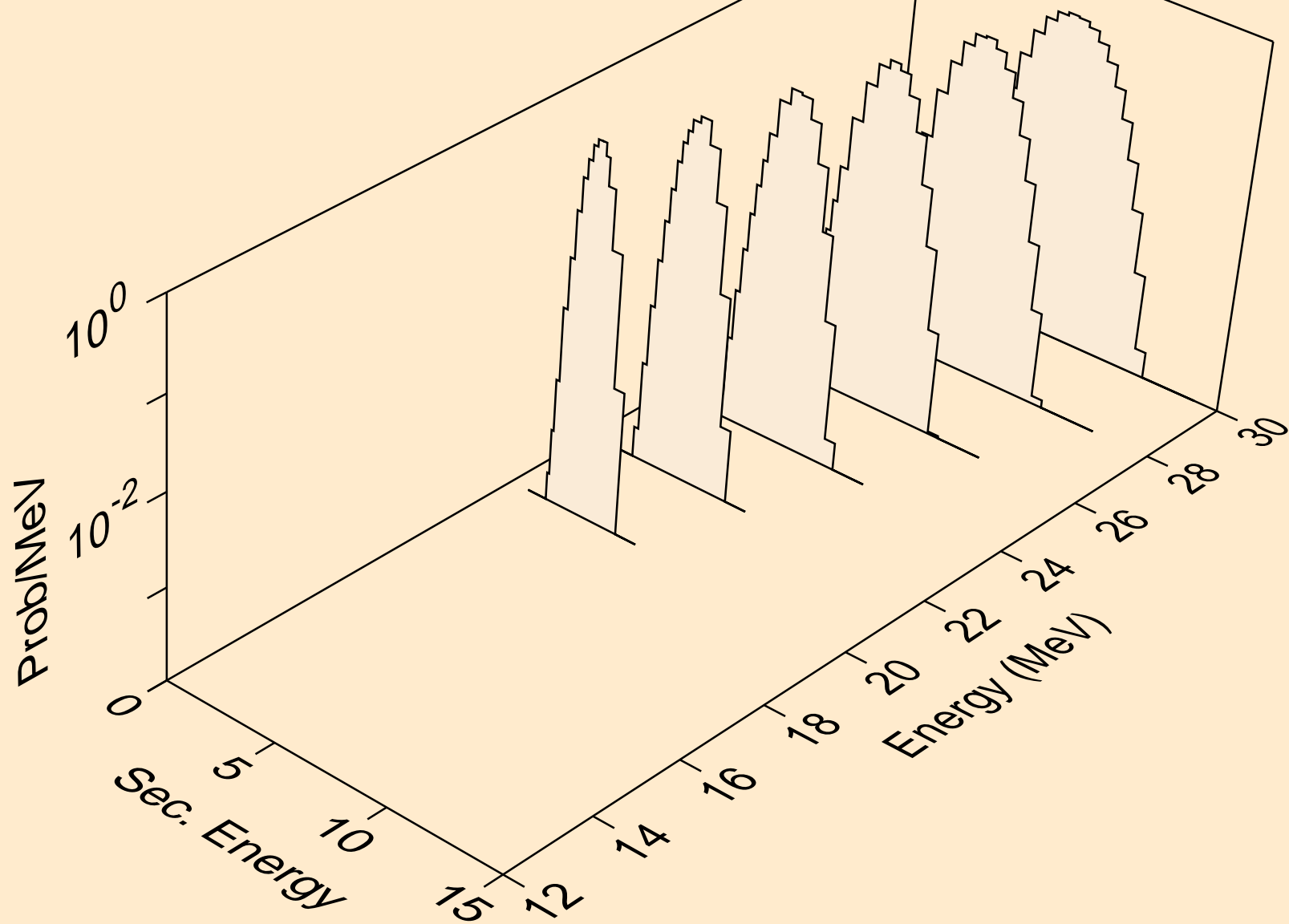

SC050 ALPHA ACER TENDL-2024 LIBRARY; T=0.K
Alpha emission for (a,pa)

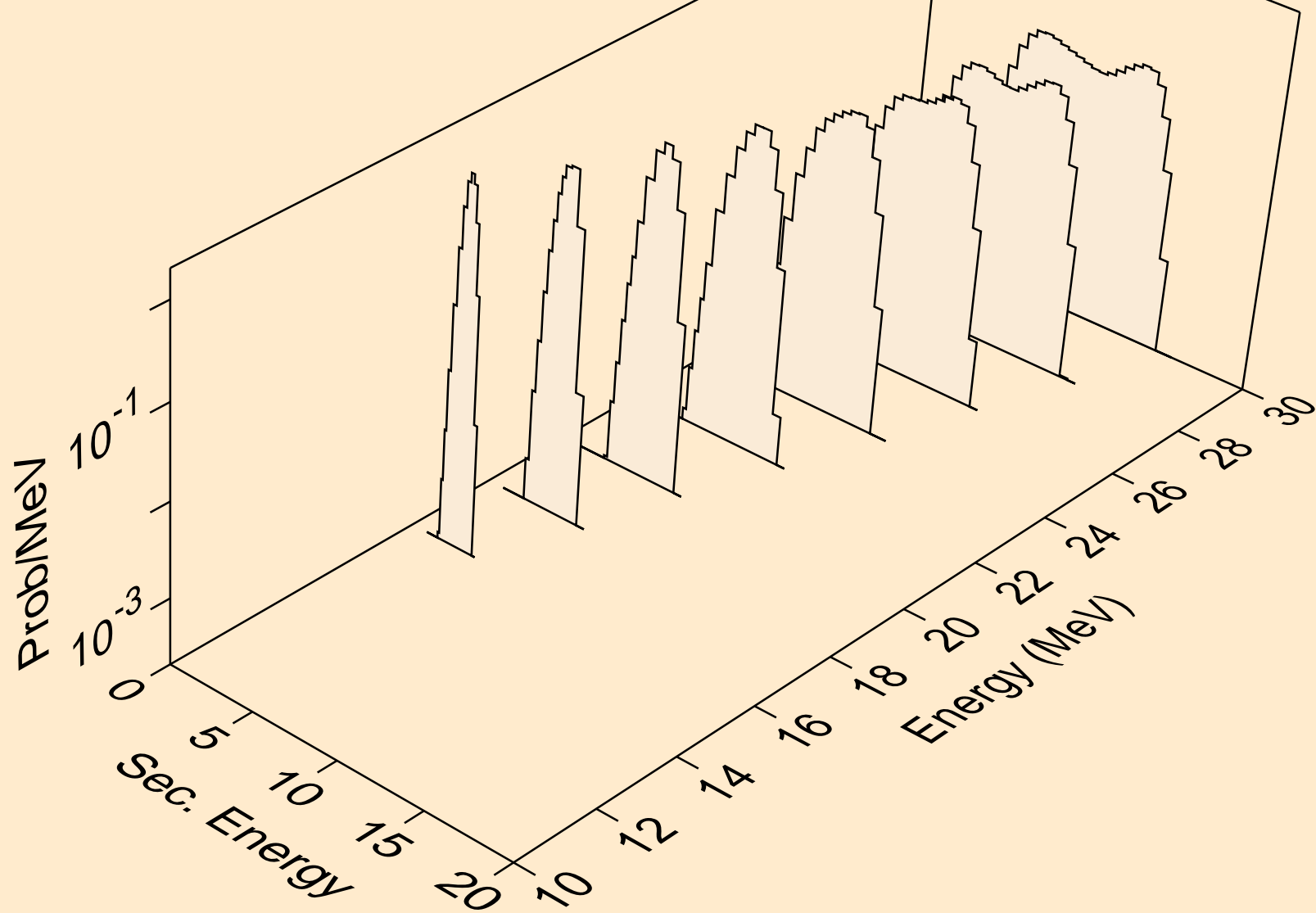

SC050 ALPHA ACER TENDL-2024 LIBRARY; T=0.K
Alpha emission for (a,da)

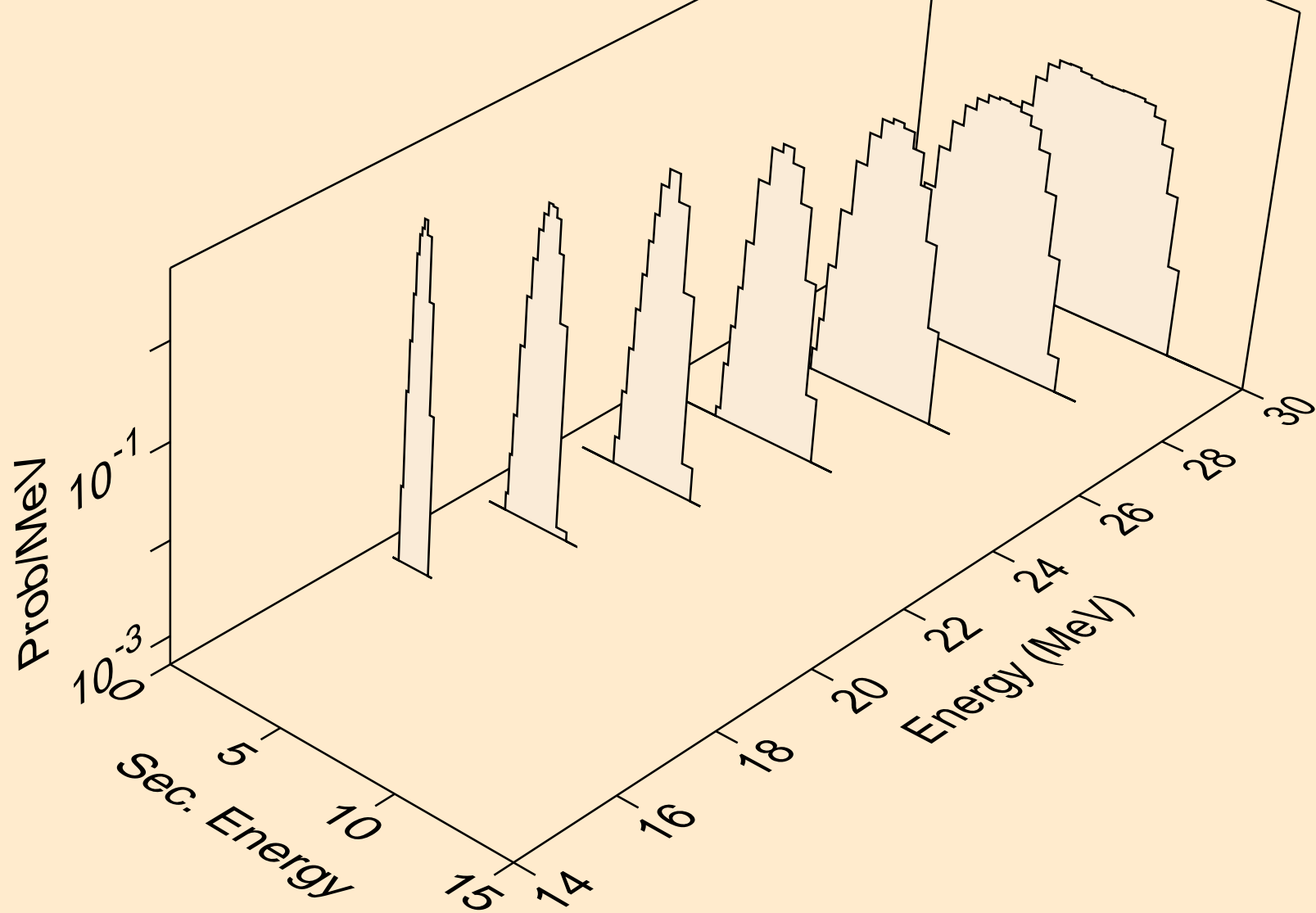

SC050 ALPHA ACER TENDL-2024 LIBRARY; T=0.K
Photon emission for (z,n)

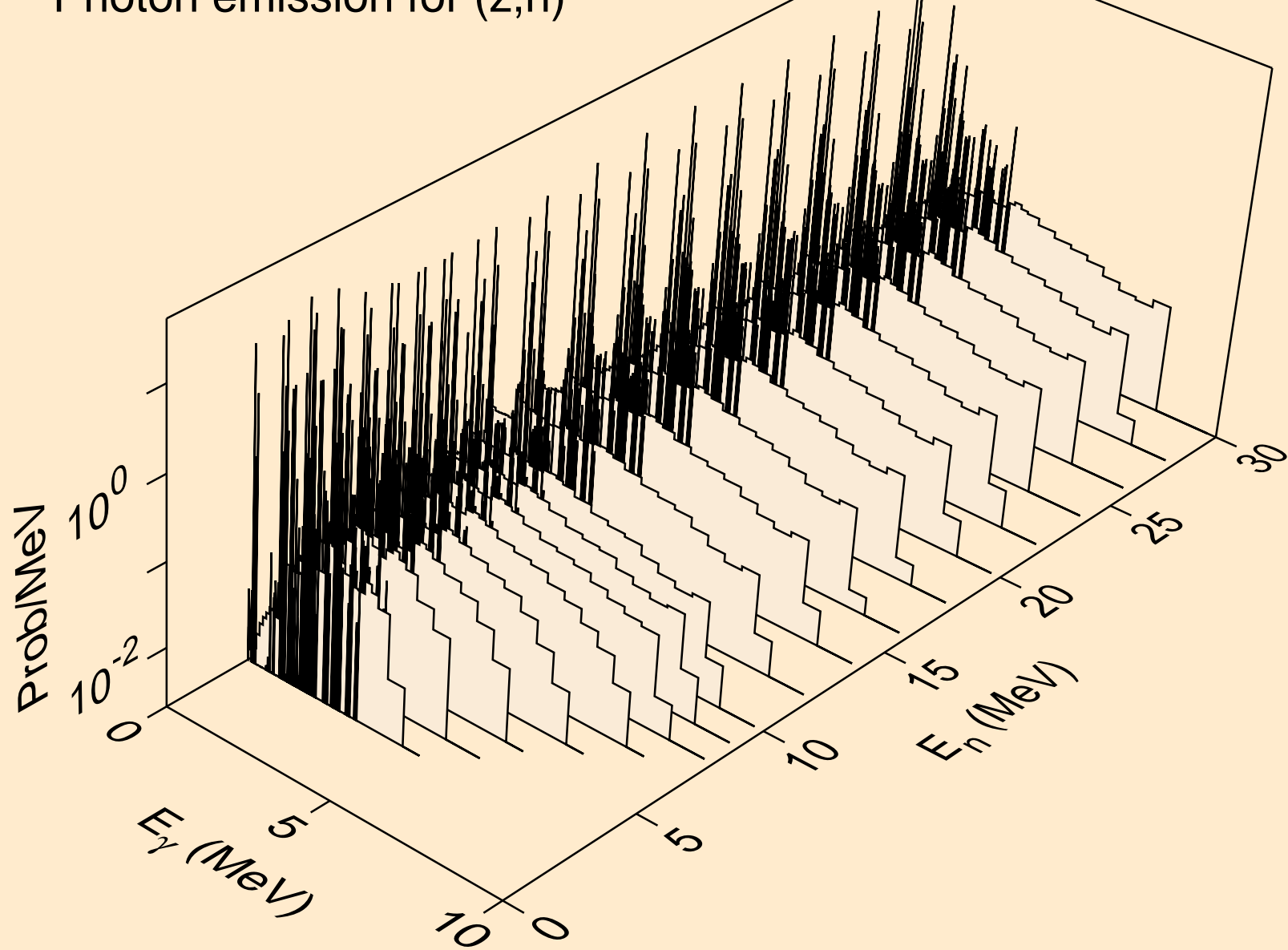

SC050 ALPHA ACER TENDL-2024 LIBRARY; T=0.K
Photon emission for (z,x)

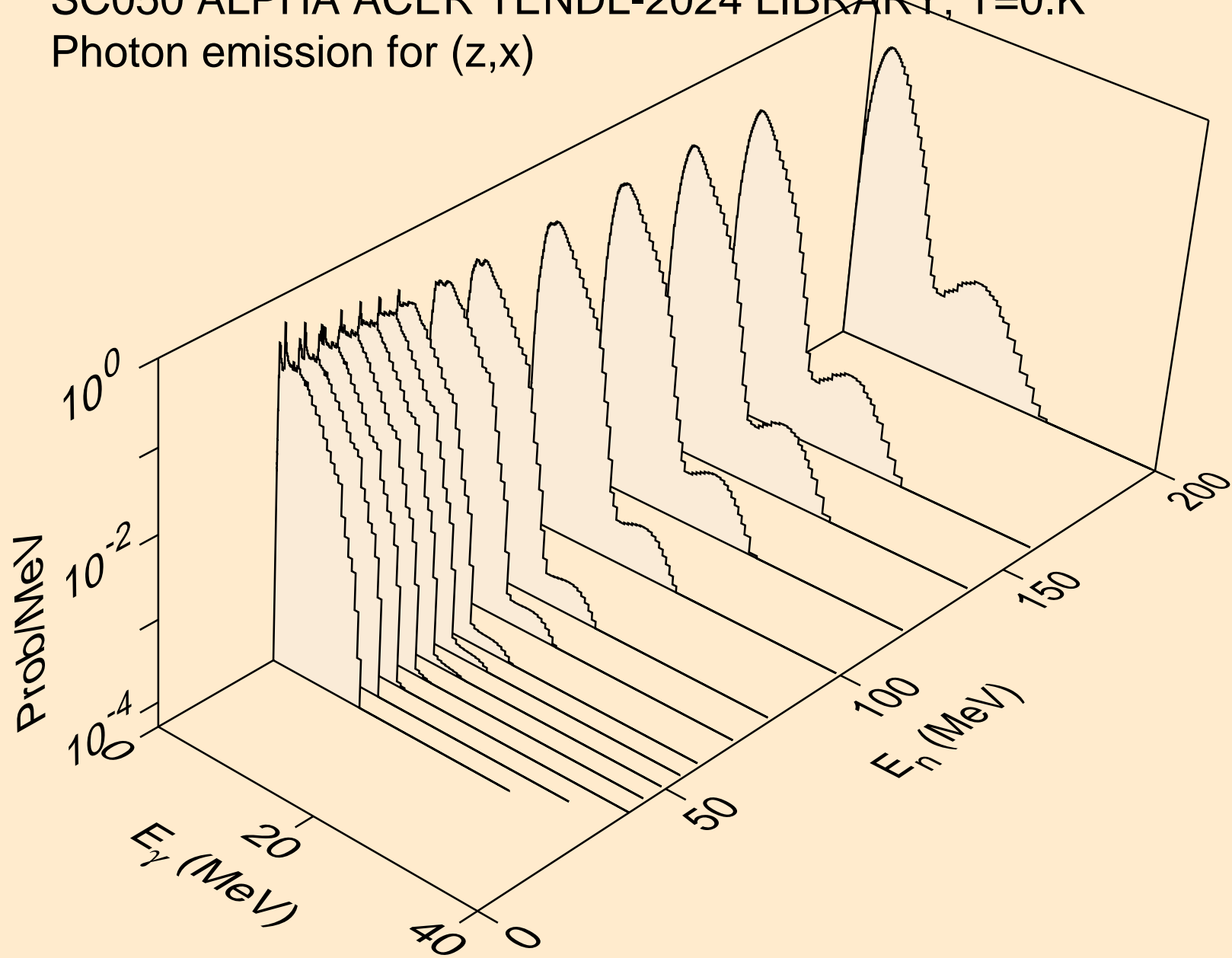

SC050 ALPHA ACER TENDL-2024 LIBRARY; T=0.K
Photon emission for (n,2nd)

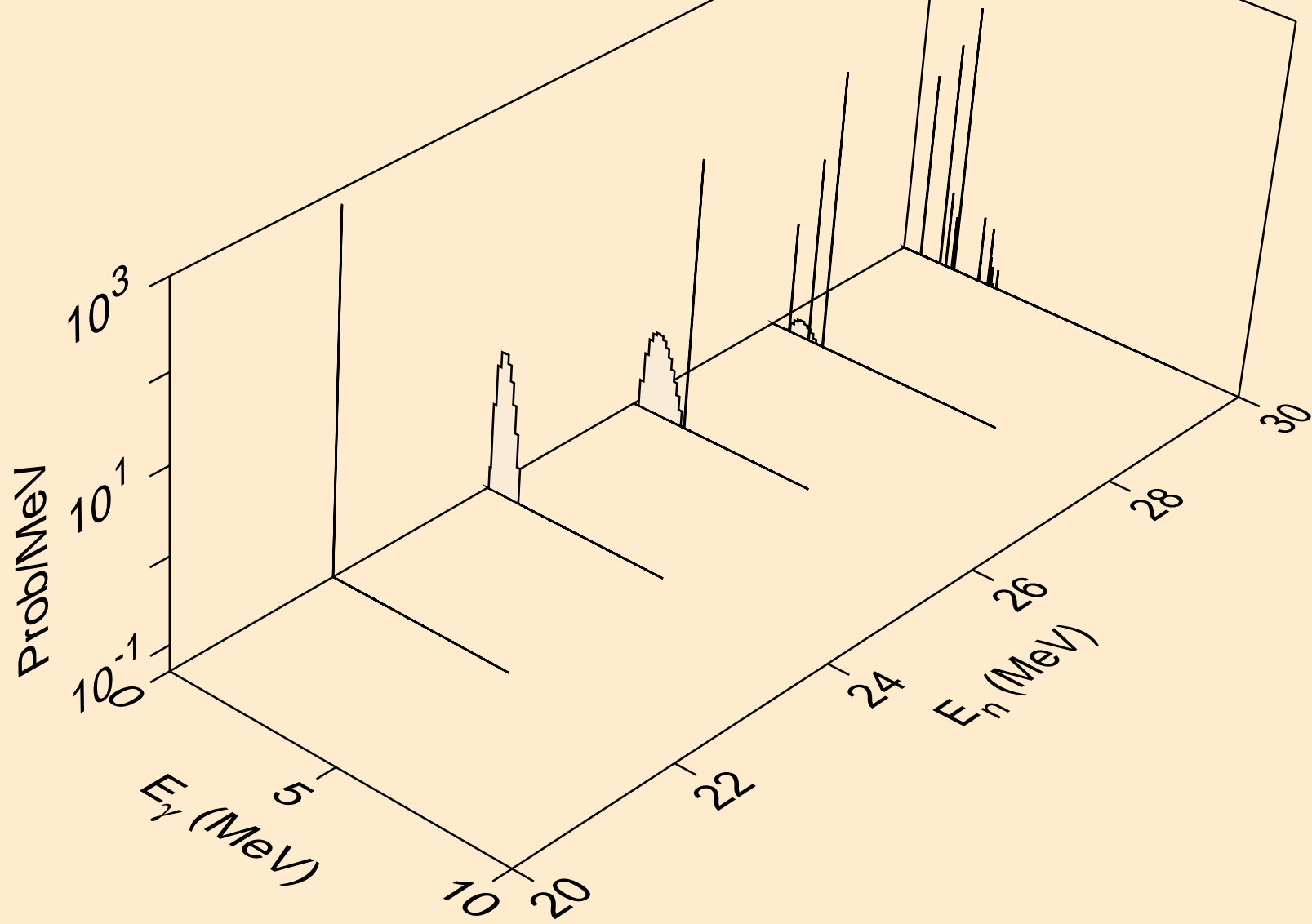

SC050 ALPHA ACER TENDL-2024 LIBRARY; T=0.K
Photon emission for (n,2n)

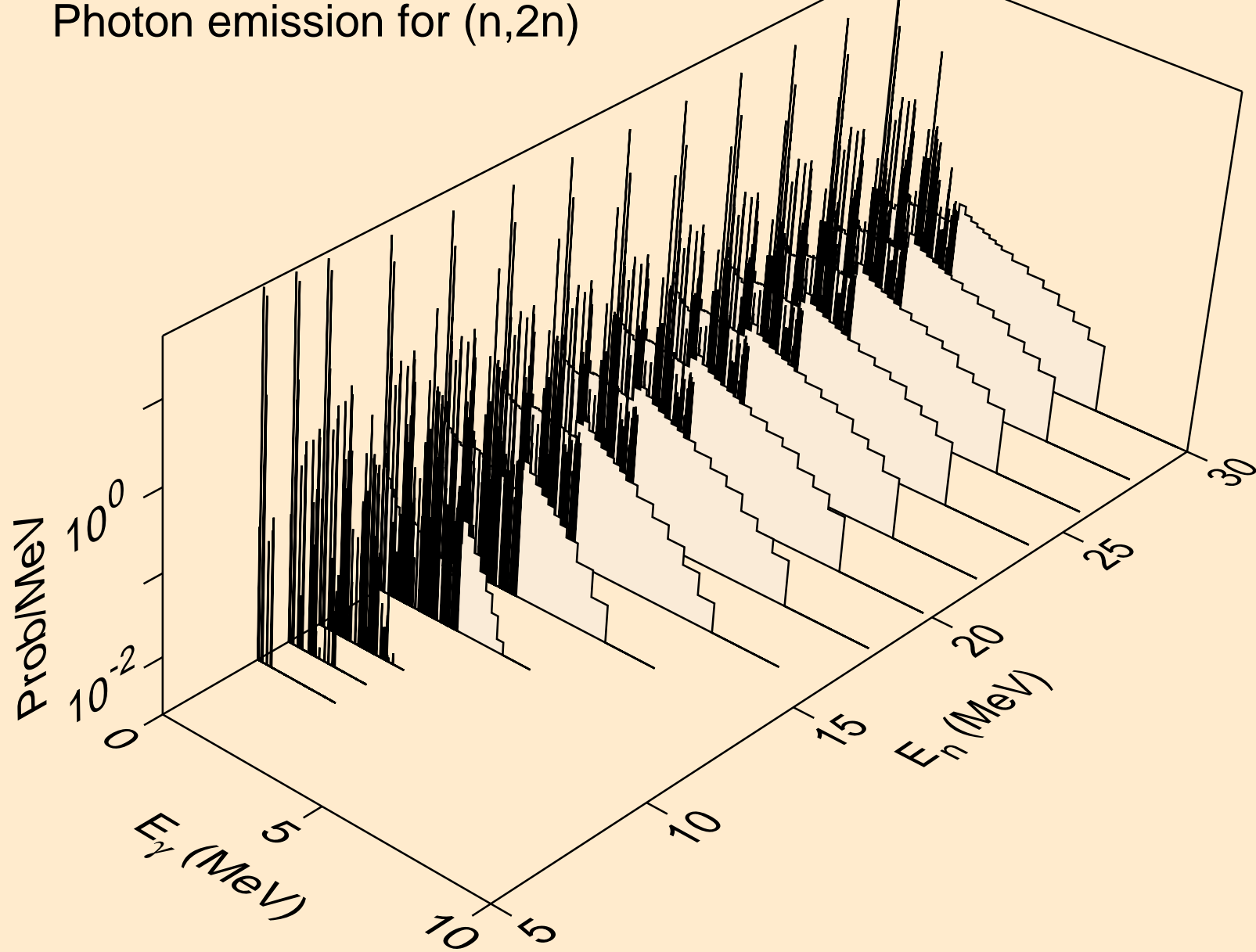

SC050 ALPHA ACER TENDL-2024 LIBRARY; T=0.K
Photon emission for (n,3n)

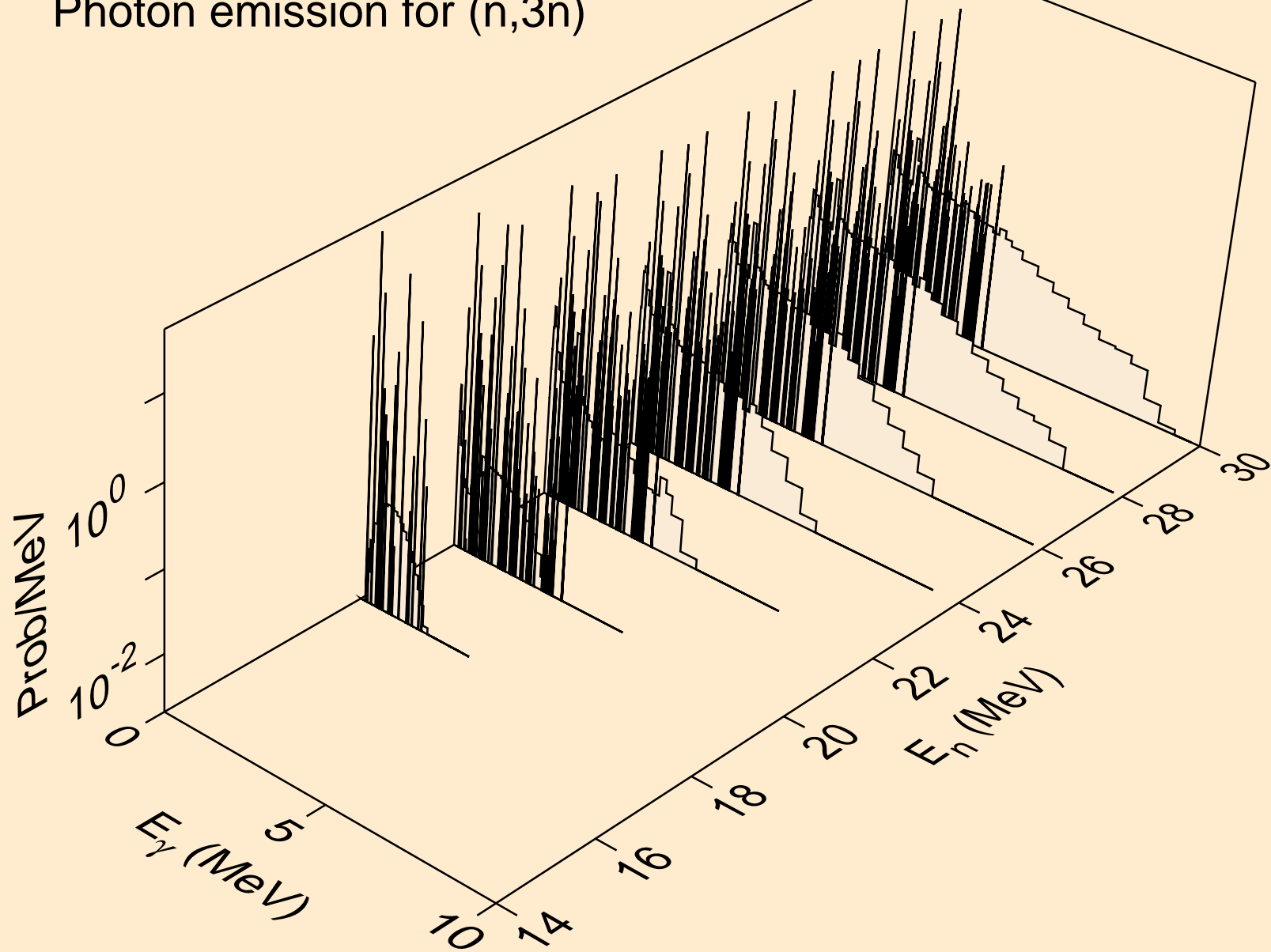

SC050 ALPHA ACER TENDL-2024 LIBRARY; T=0.K
Photon emission for (n,n*)a

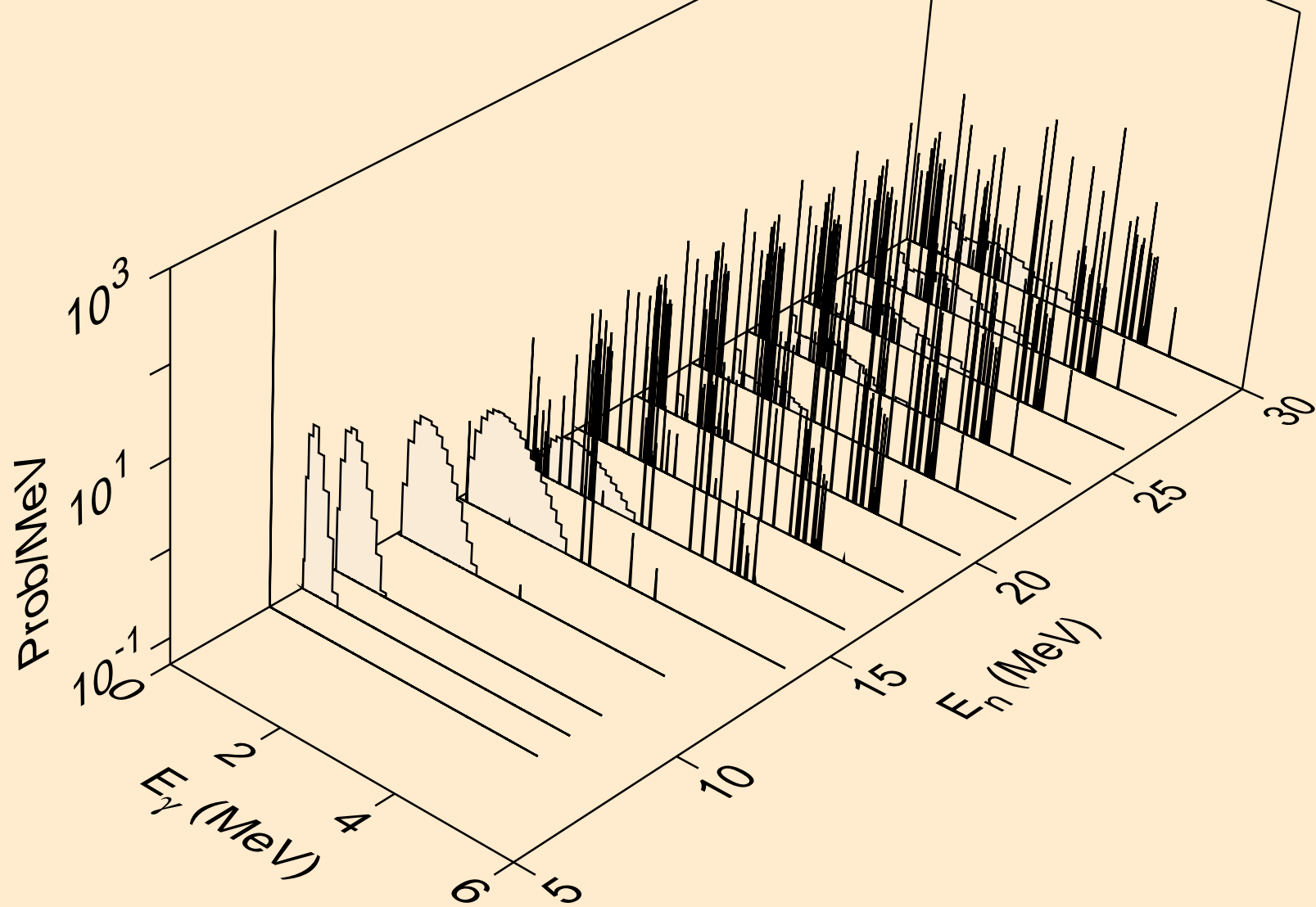

SC050 ALPHA ACER TENDL-2024 LIBRARY; T=0.K
Photon emission for (n,2n)a

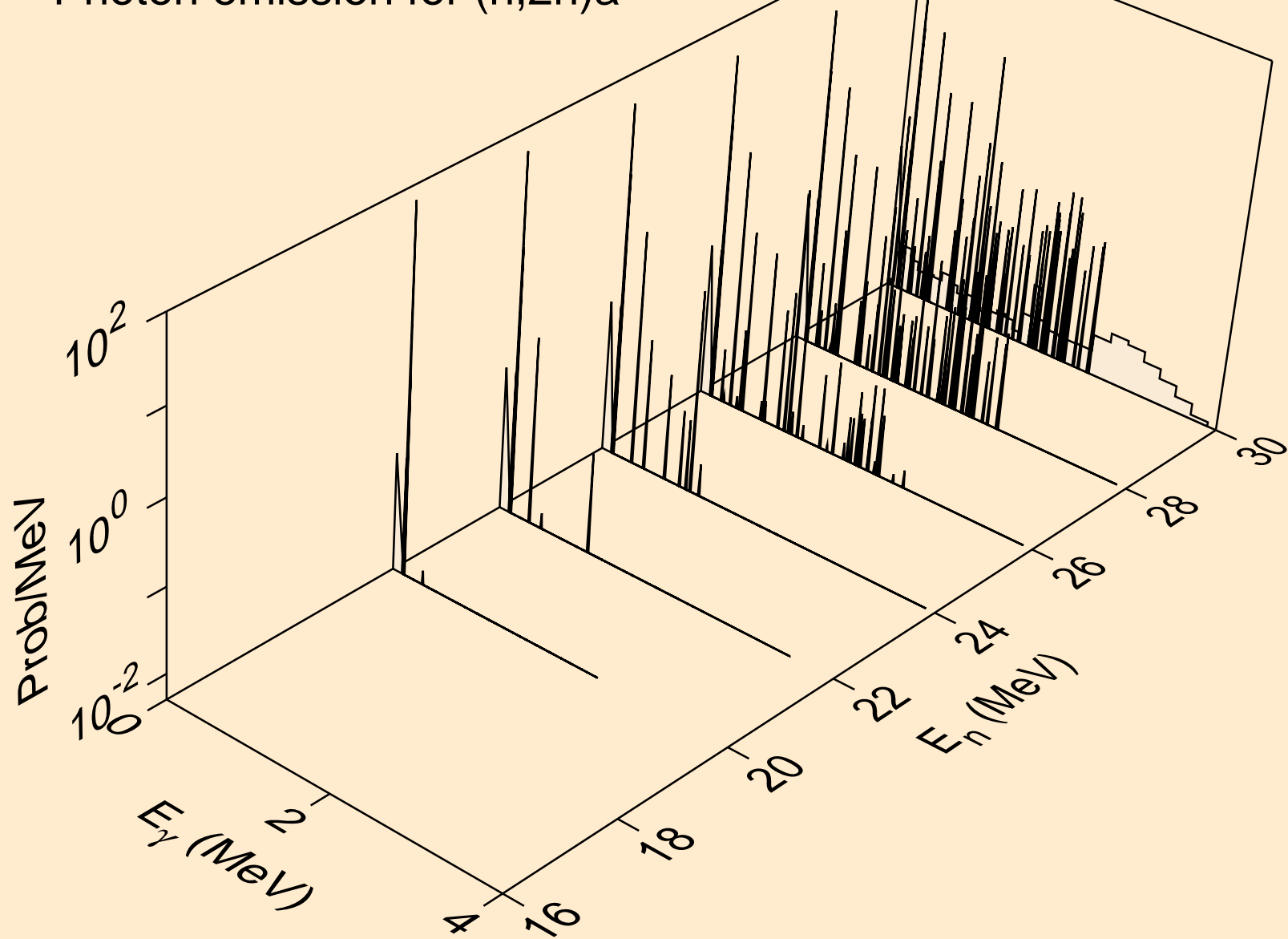

SC050 ALPHA ACER TENDL-2024 LIBRARY; T=0.K
Photon emission for (n,n*)p

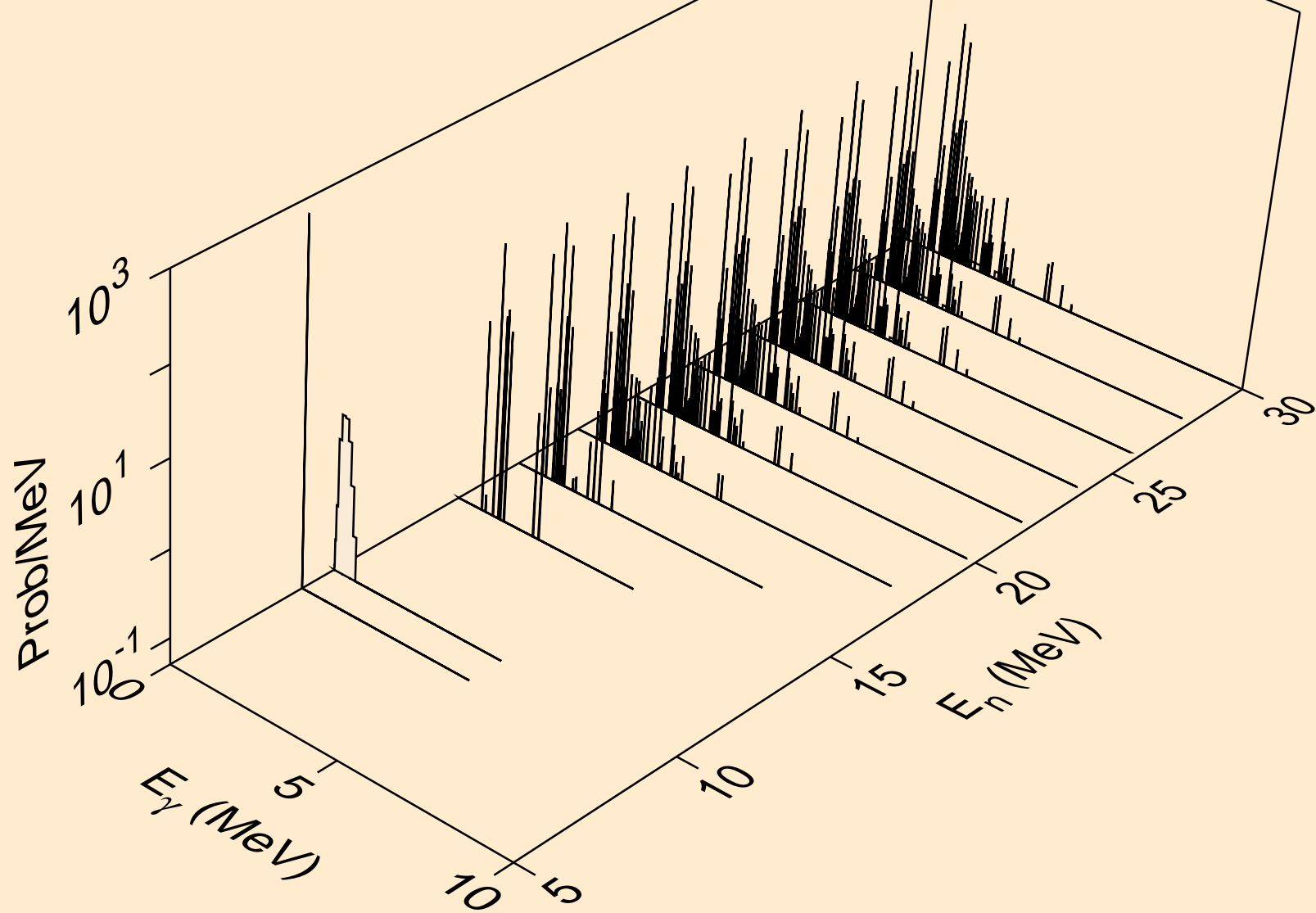

SC050 ALPHA ACER TENDL-2024 LIBRARY; T=0.K
Photon emission for (n,n*)d

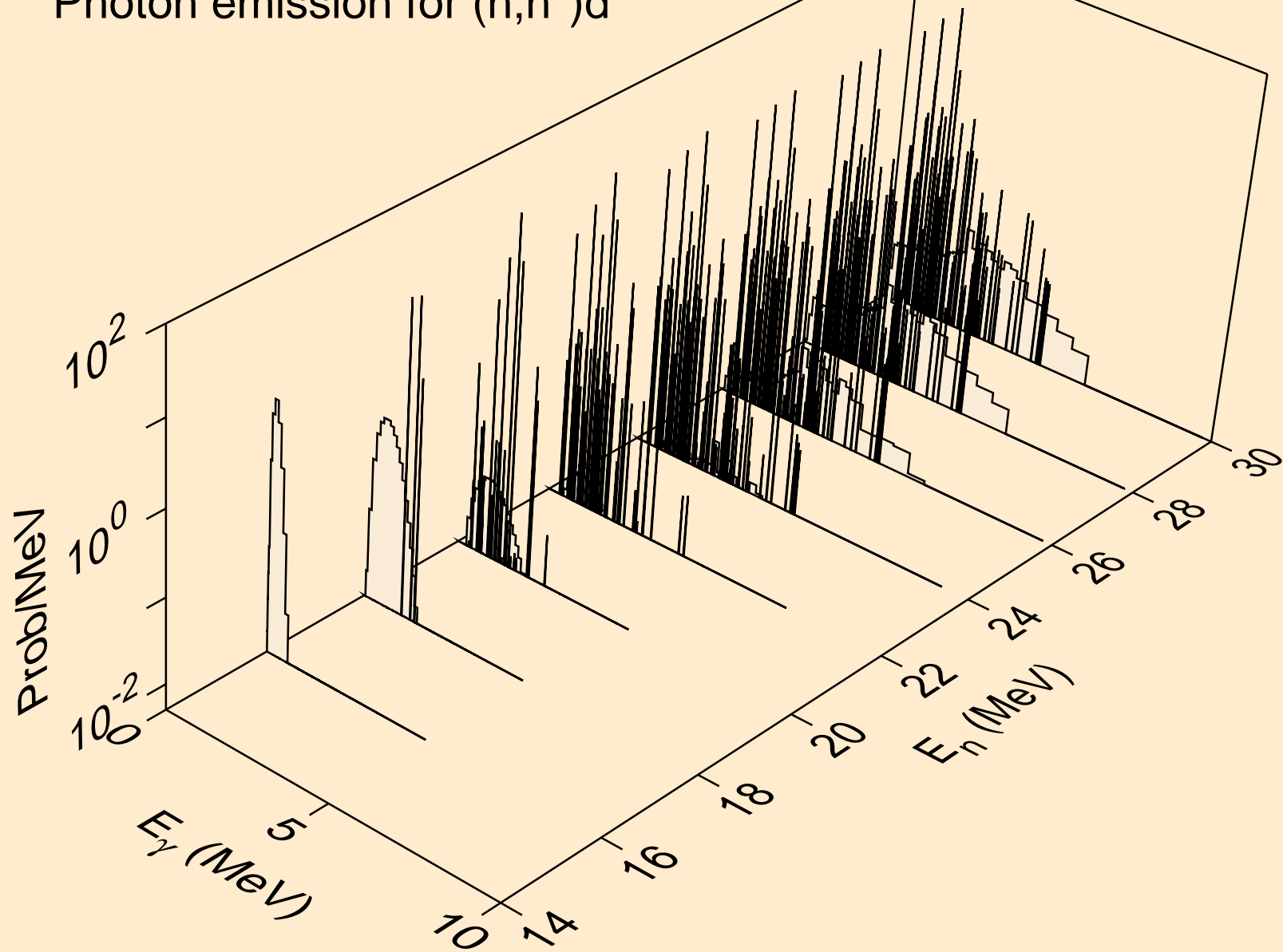

SC050 ALPHA ACER TENDL-2024 LIBRARY; T=0.K
Photon emission for (n,n*)t

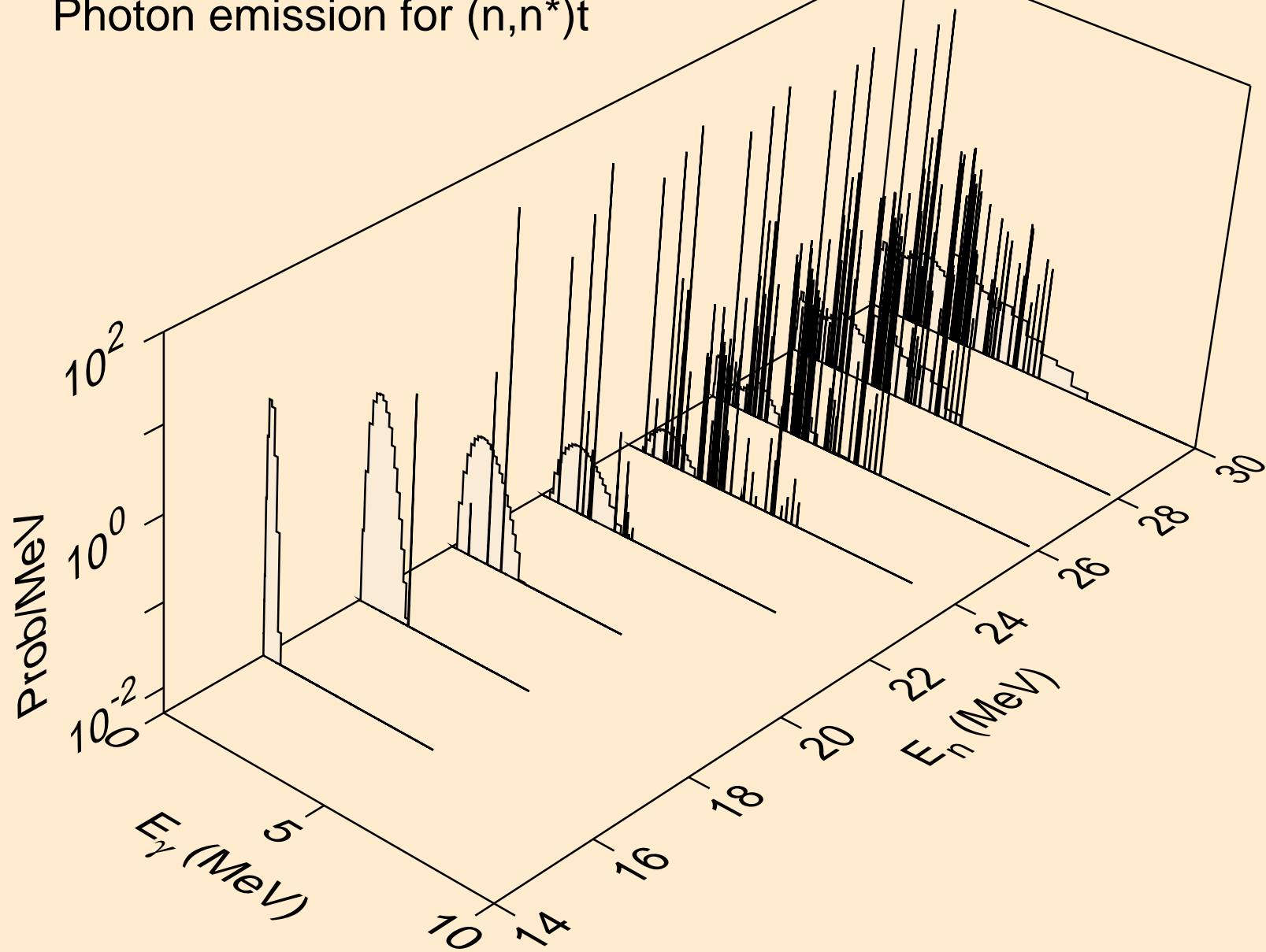

SC050 ALPHA ACER TENDL-2024 LIBRARY; T=0.K
Photon emission for (n,n*)he3

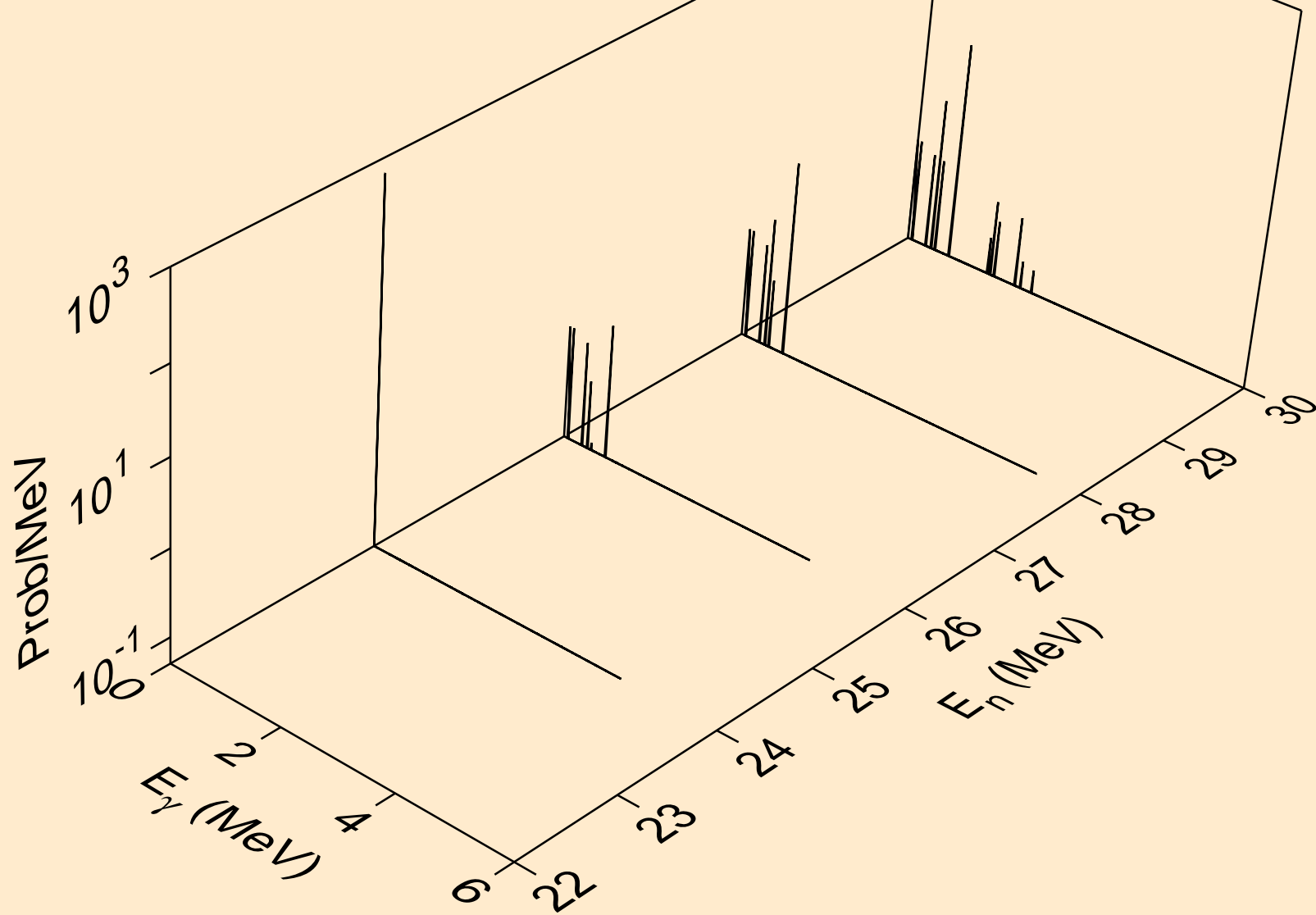

SC050 ALPHA ACER TENDL-2024 LIBRARY; T=0.K
Photon emission for (n,4n)

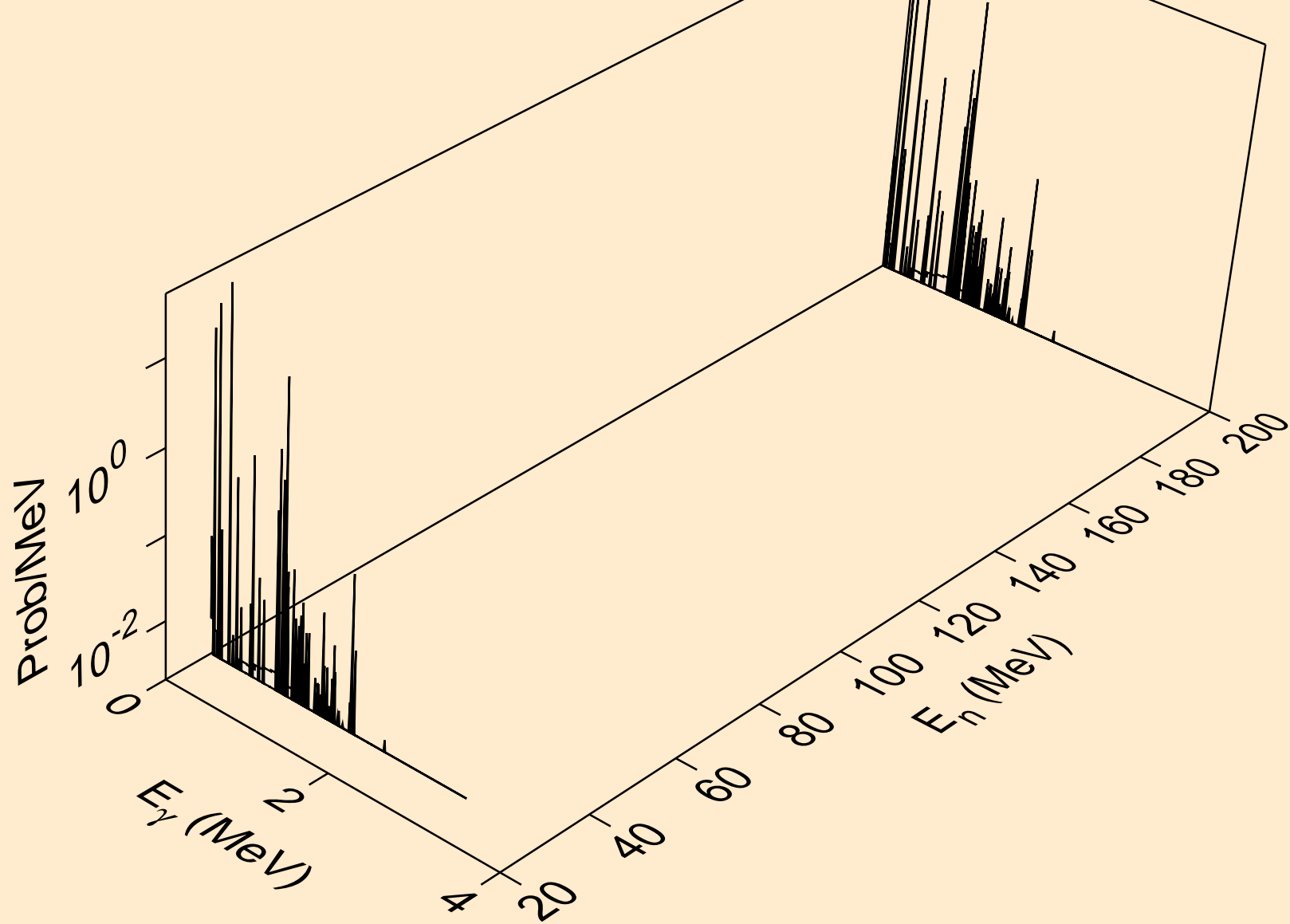

SC050 ALPHA ACER TENDL-2024 LIBRARY; T=0.K
Photon emission for (n,2np)

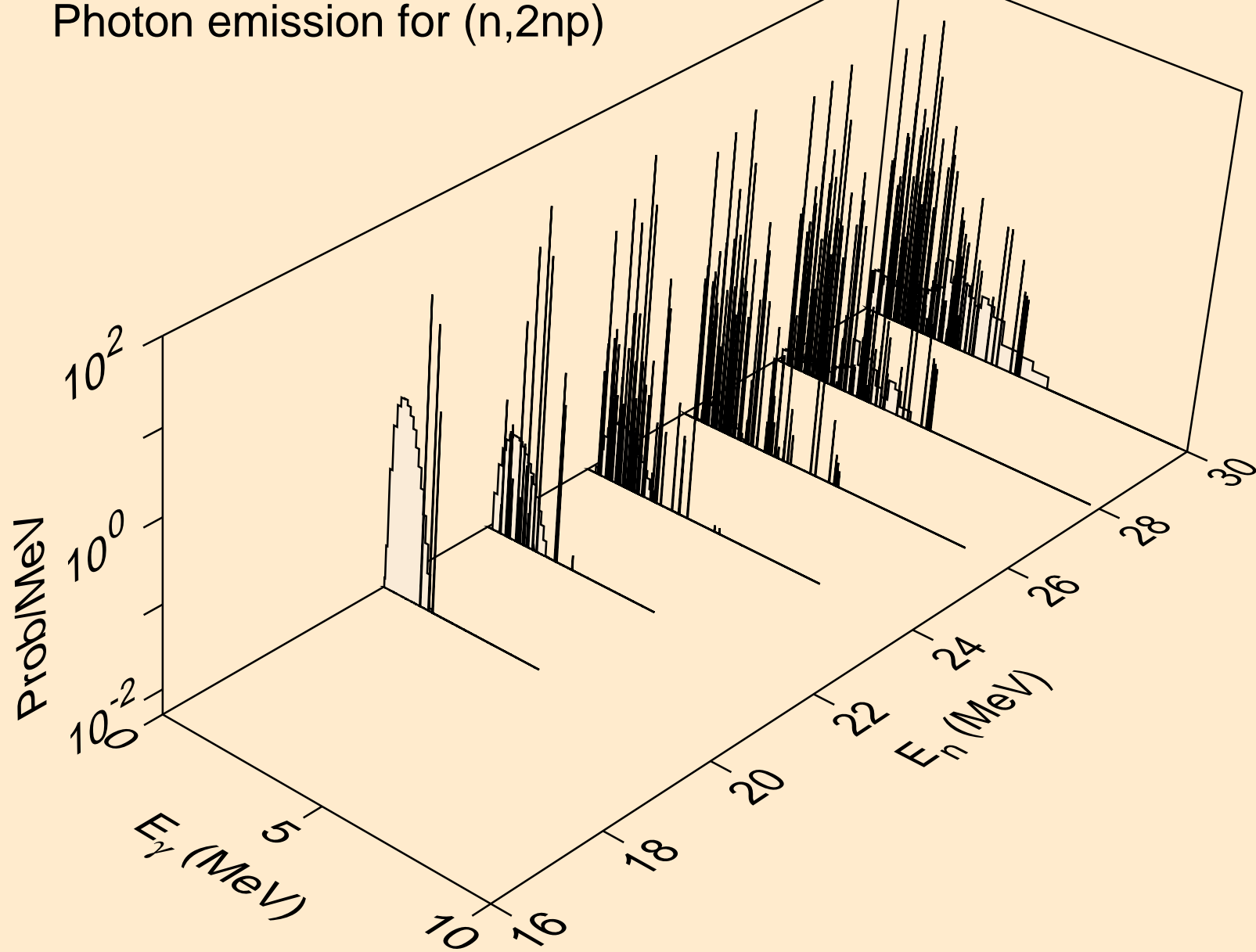

SC050 ALPHA ACER TENDL-2024 LIBRARY; T=0.K
Photon emission for (n,3np)

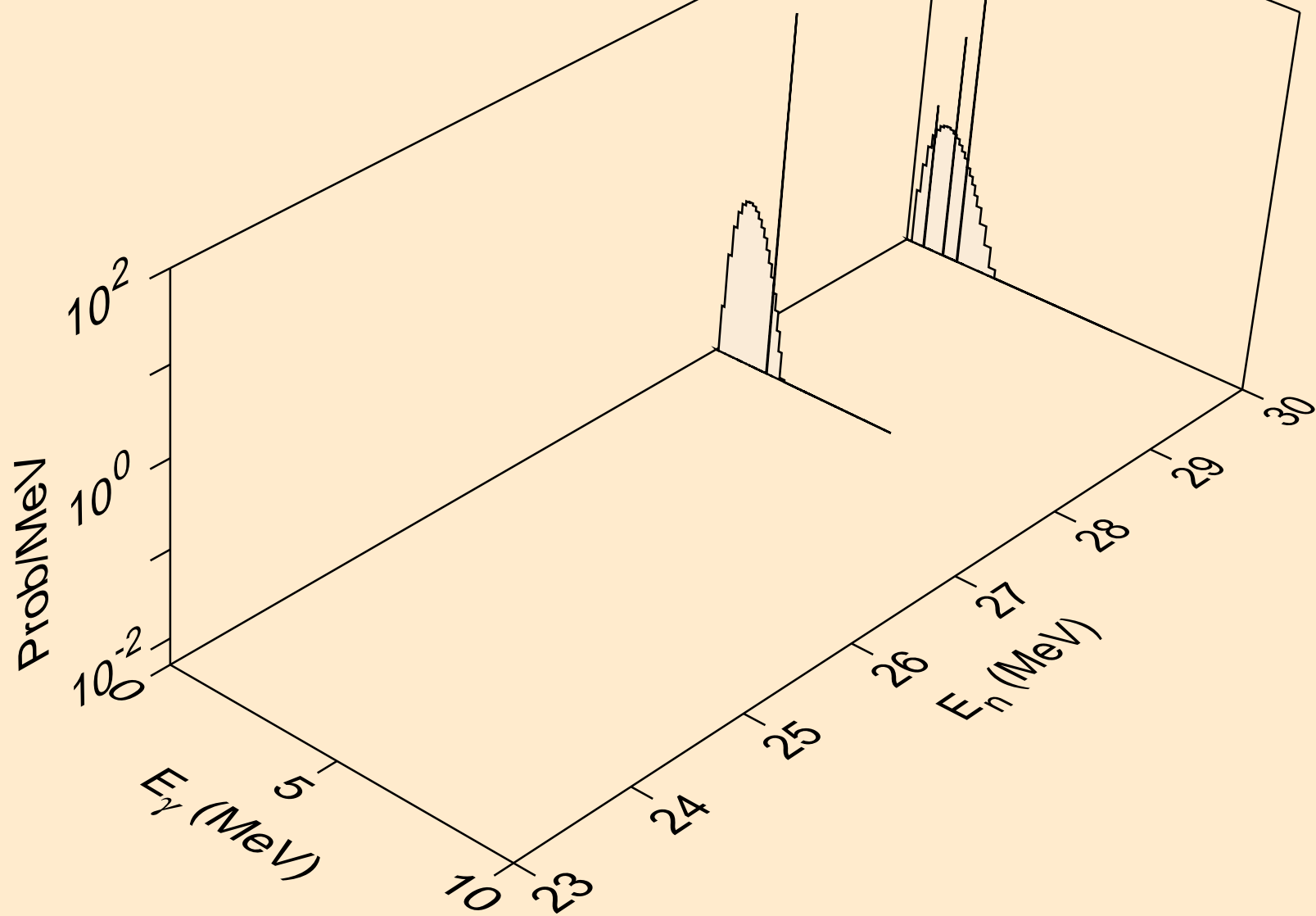

SC050 ALPHA ACER TENDL-2024 LIBRARY; T=0.K
Photon emission for (n,n2p)

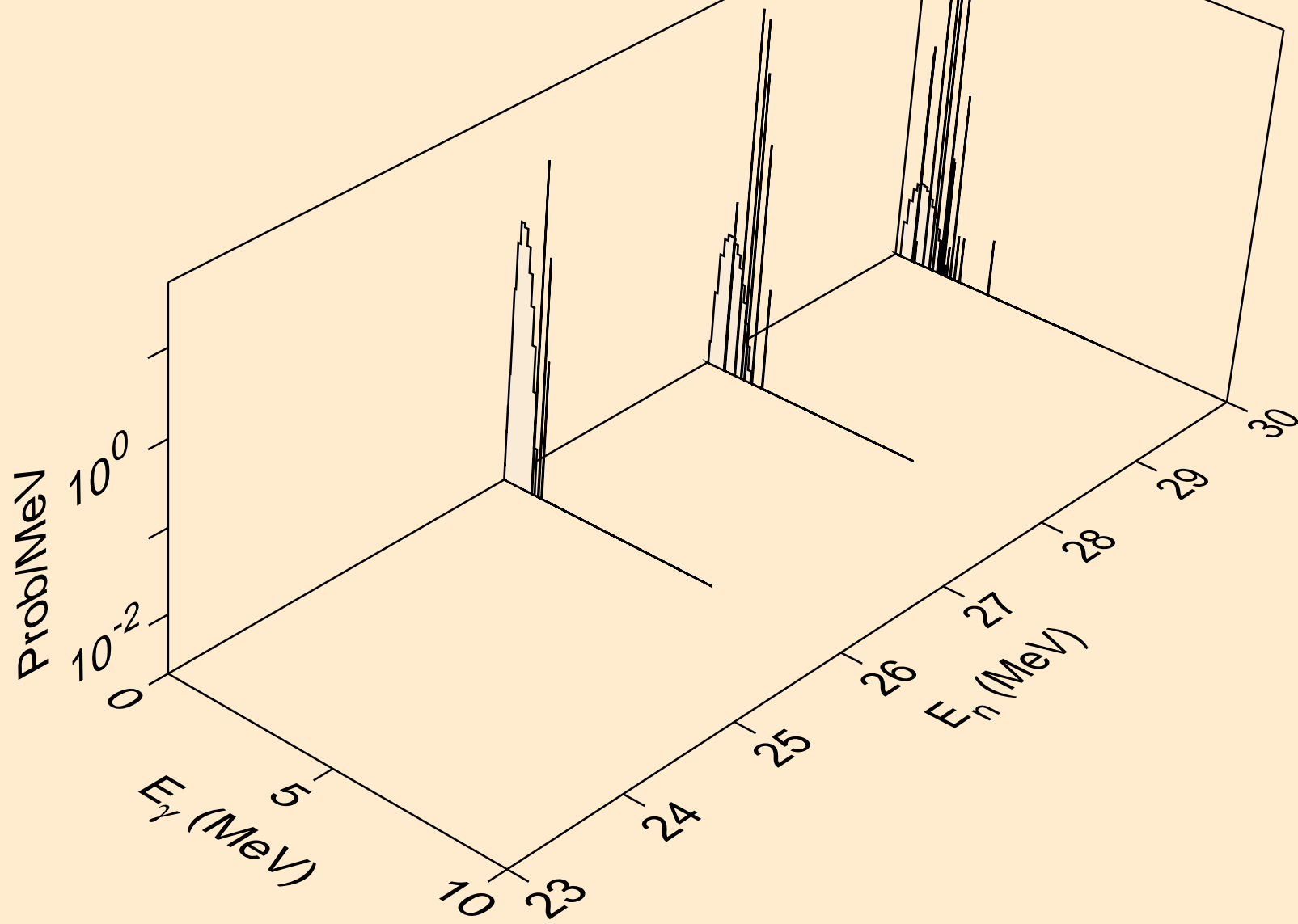

SC050 ALPHA ACER TENDL-2024 LIBRARY; T=0.K
Photon emission for (n,npa)

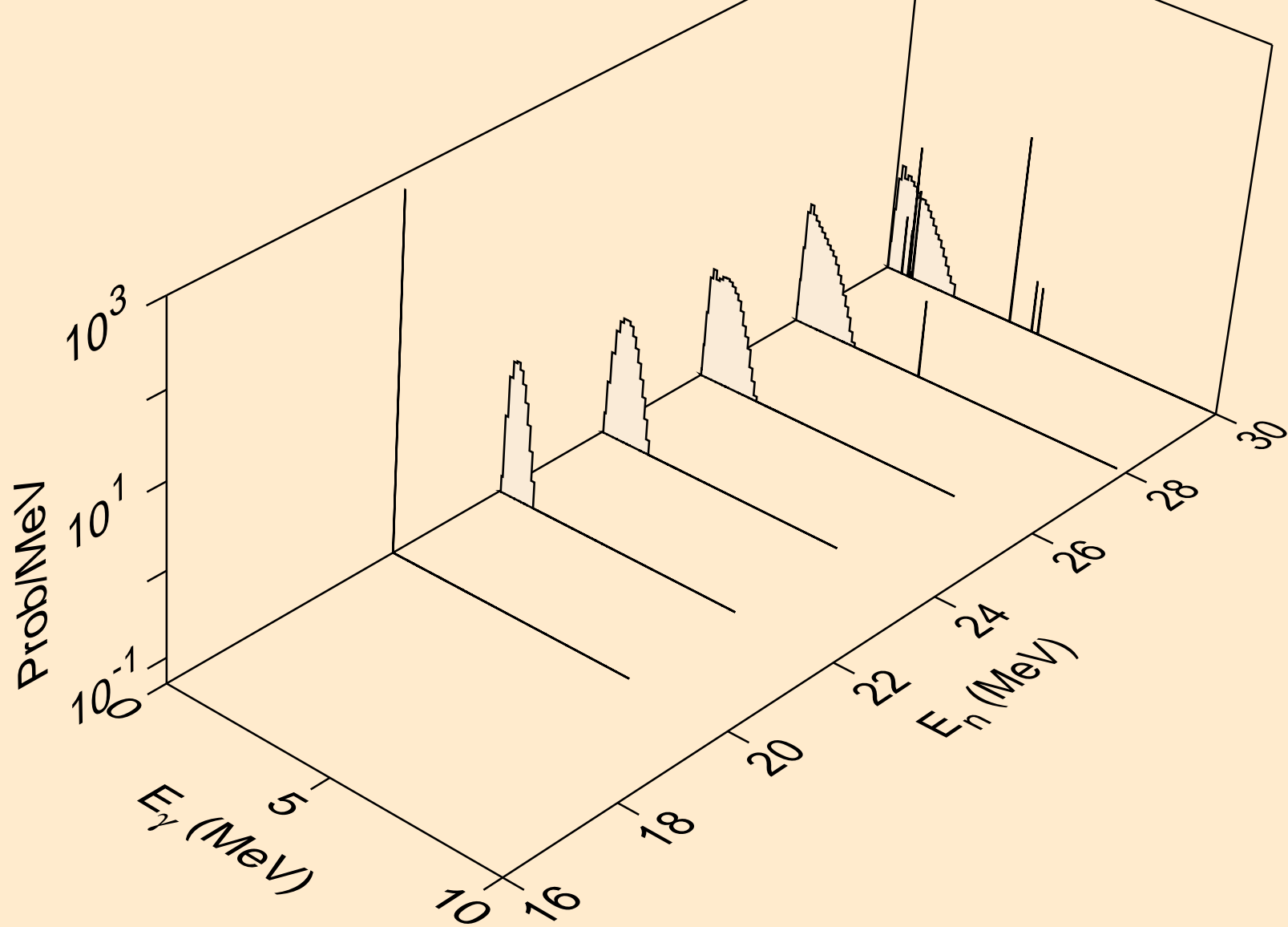

SC050 ALPHA ACER TENDL-2024 LIBRARY; T=0.K
Photon emission for (n,gma)

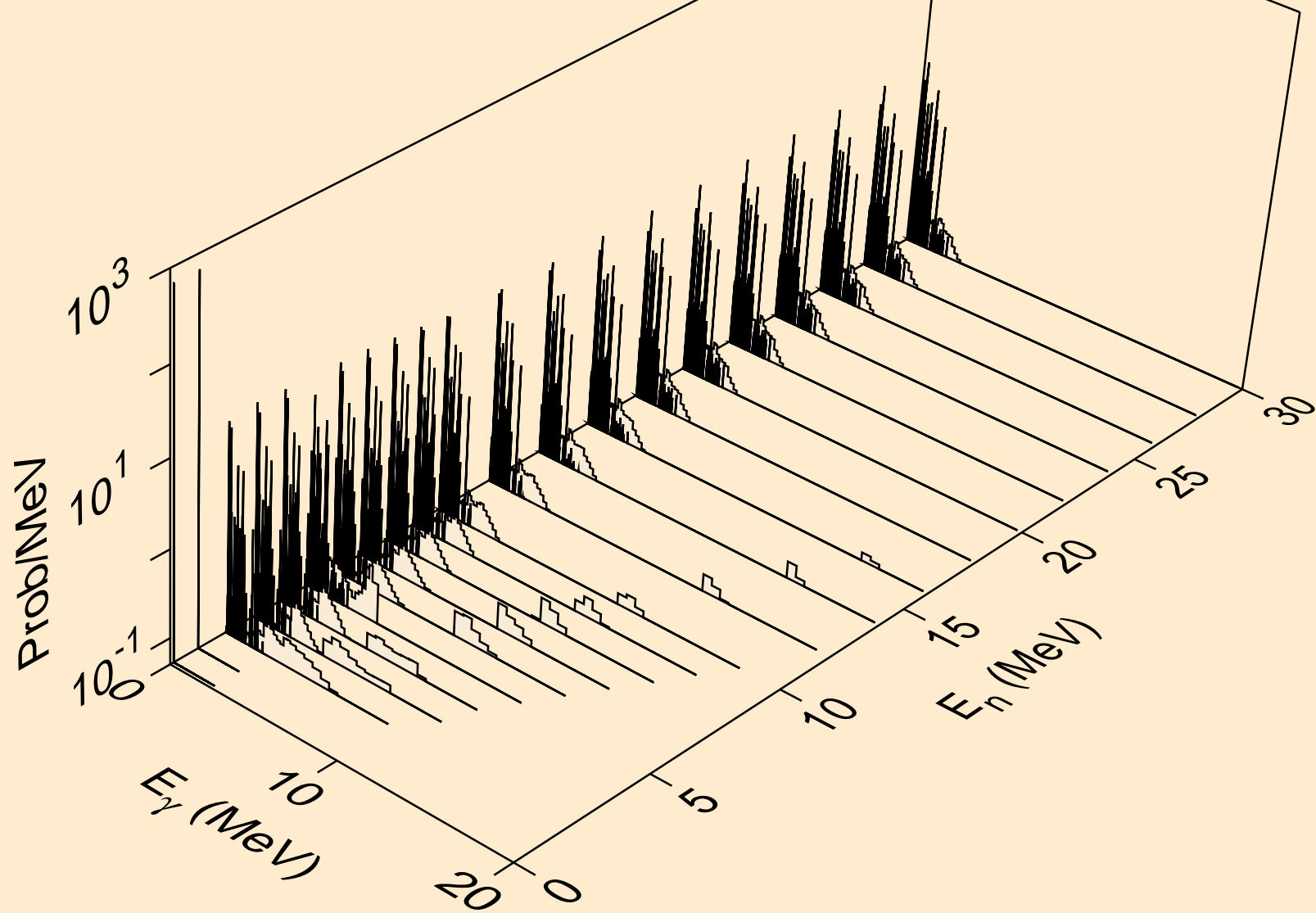

SC050 ALPHA ACER TENDL-2024 LIBRARY; T=0.K
Photon emission for (n,p)

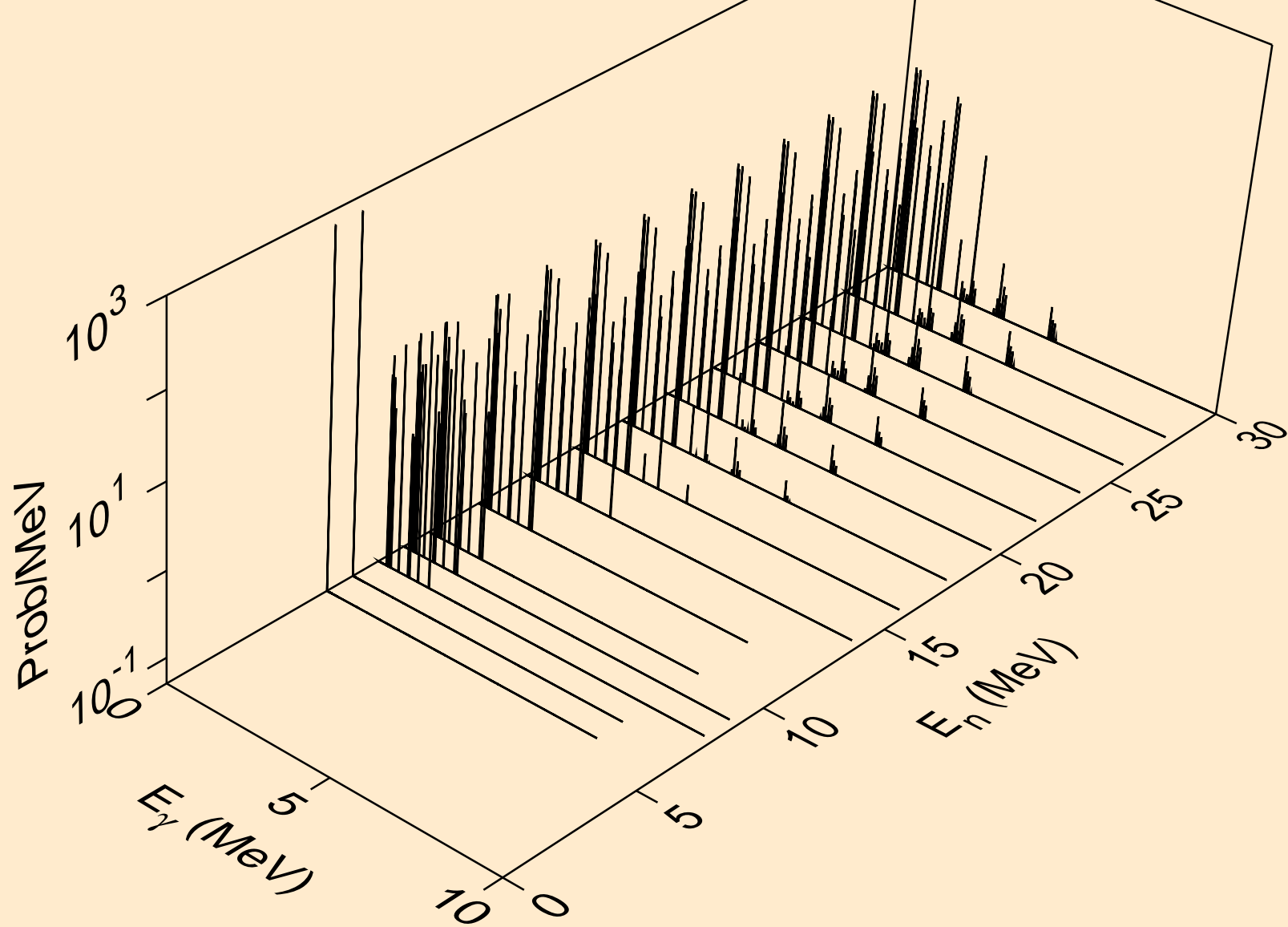

SC050 ALPHA ACER TENDL-2024 LIBRARY; T=0.K
Photon emission for (n,d)

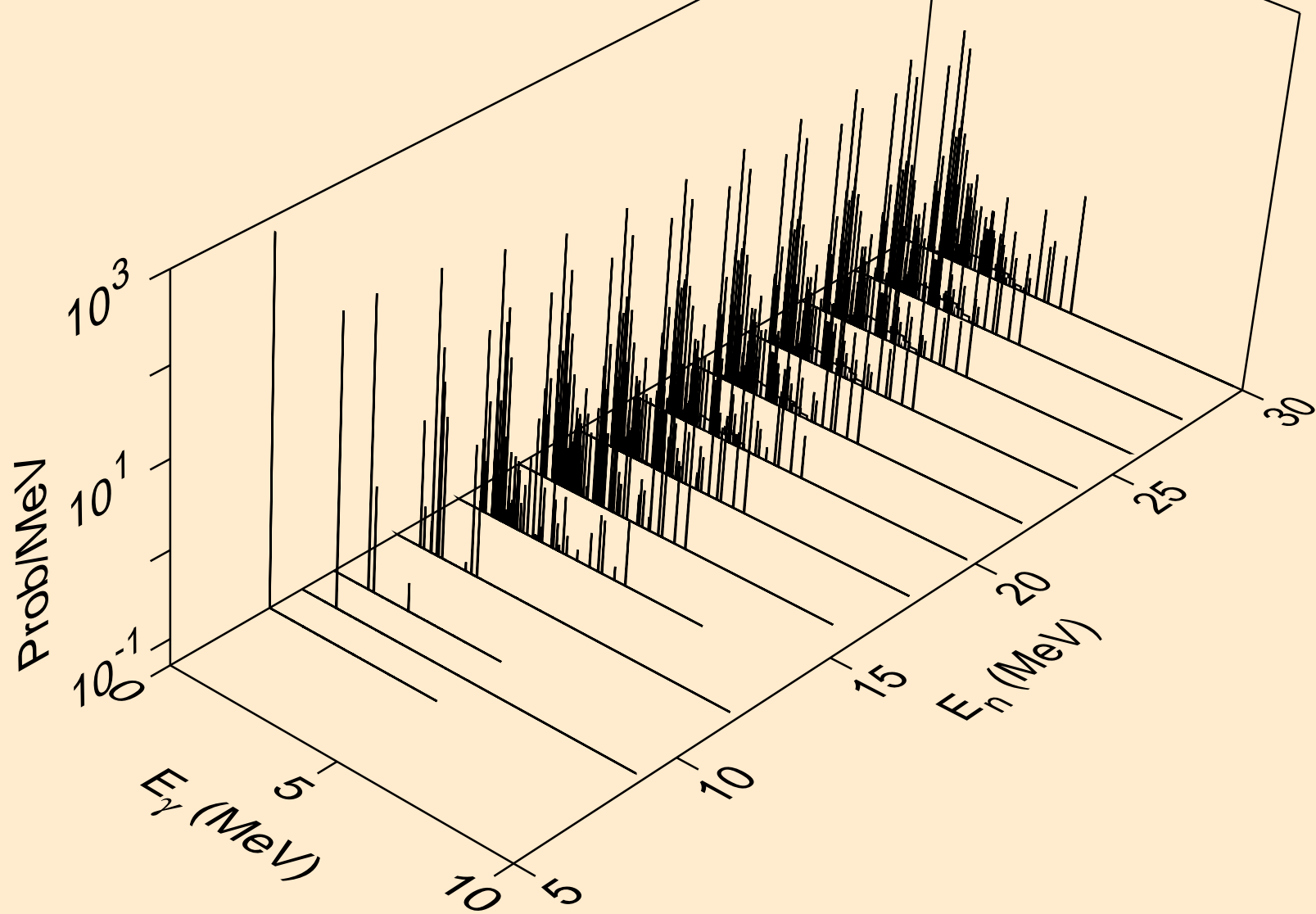

SC050 ALPHA ACER TENDL-2024 LIBRARY; T=0.K
Photon emission for (n,t)

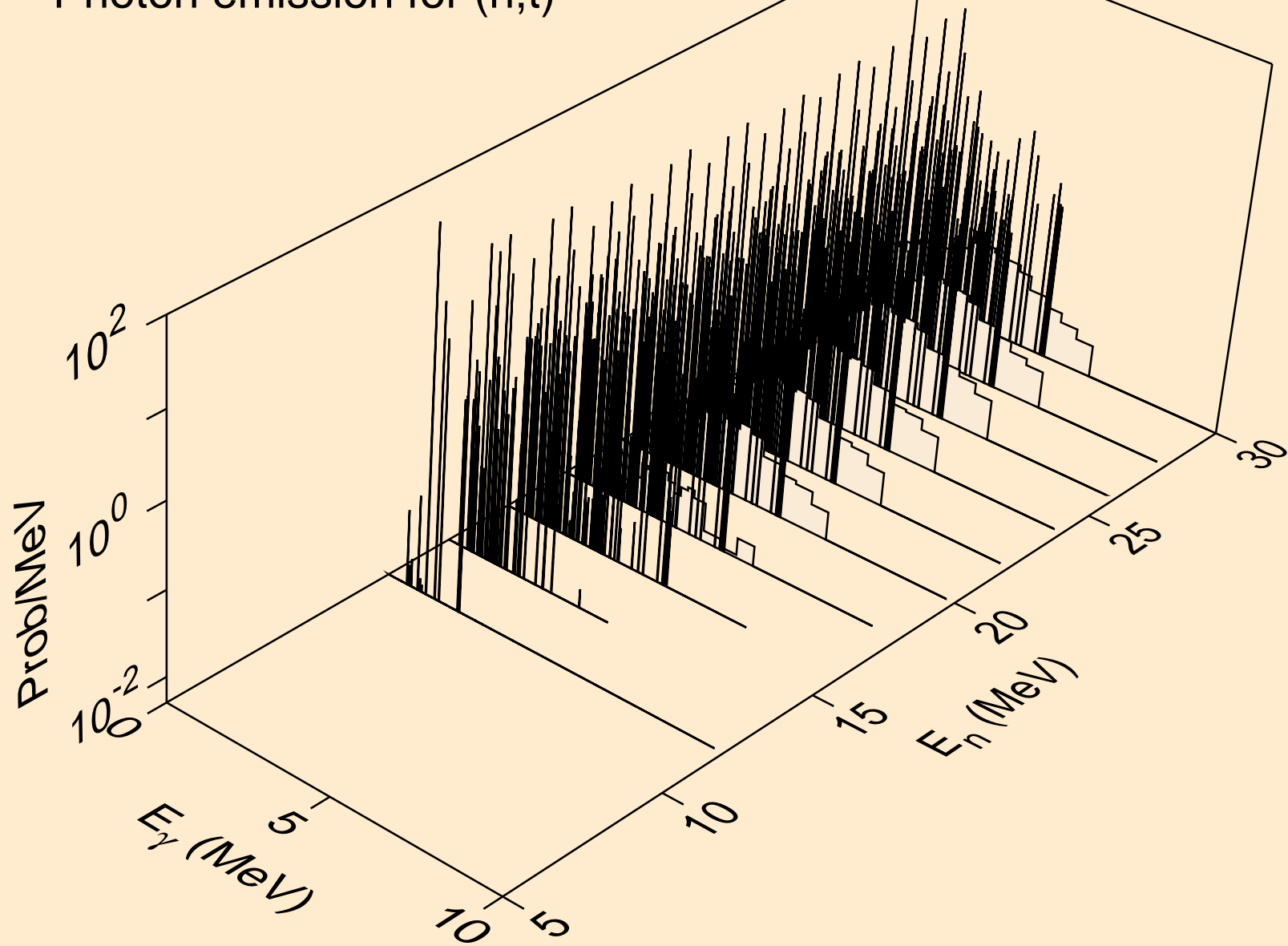

SC050 ALPHA ACER TENDL-2024 LIBRARY; T=0.K
Photon emission for (n,he3)

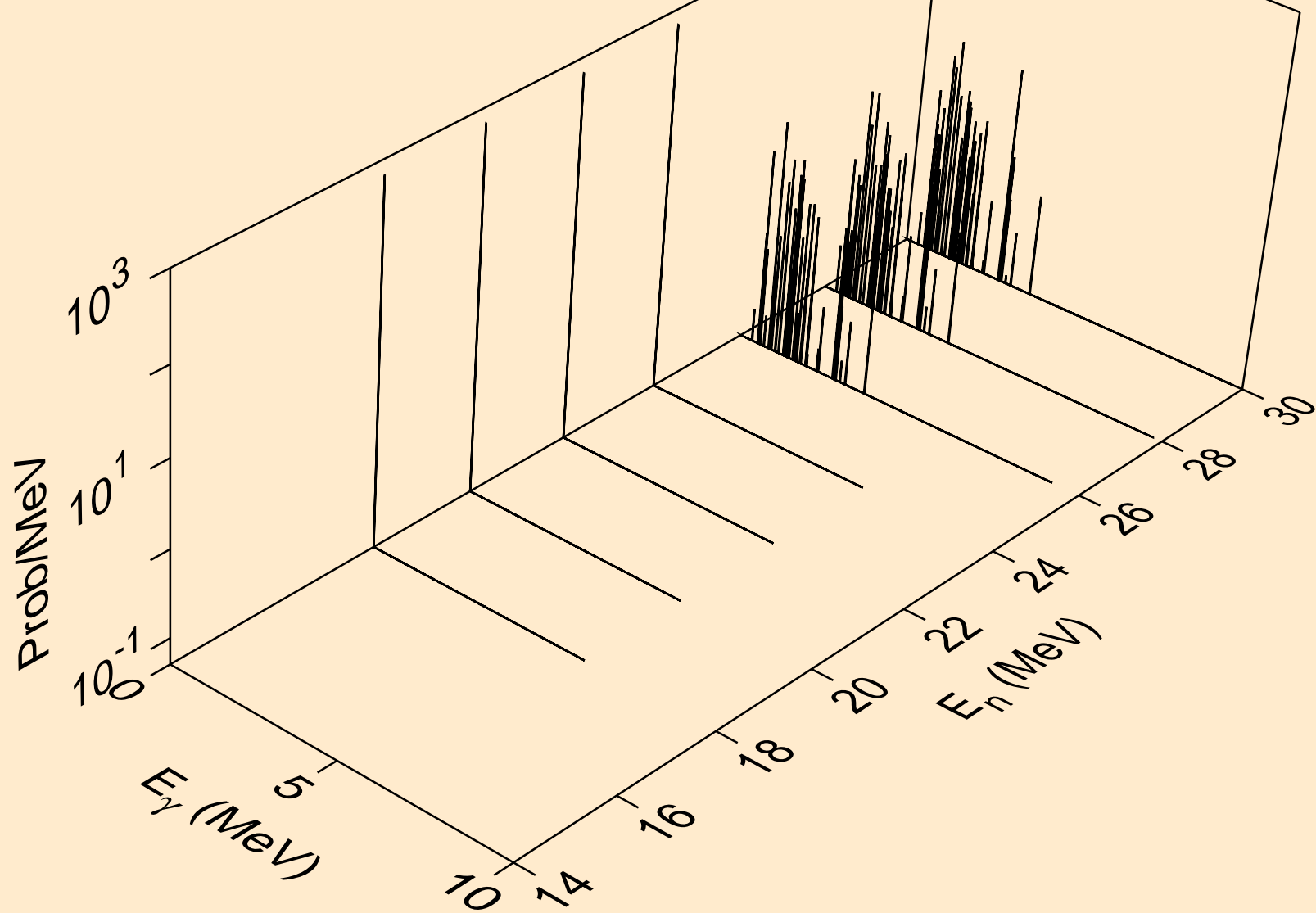

SC050 ALPHA ACER TENDL-2024 LIBRARY; T=0.K
Photon emission for inelastic

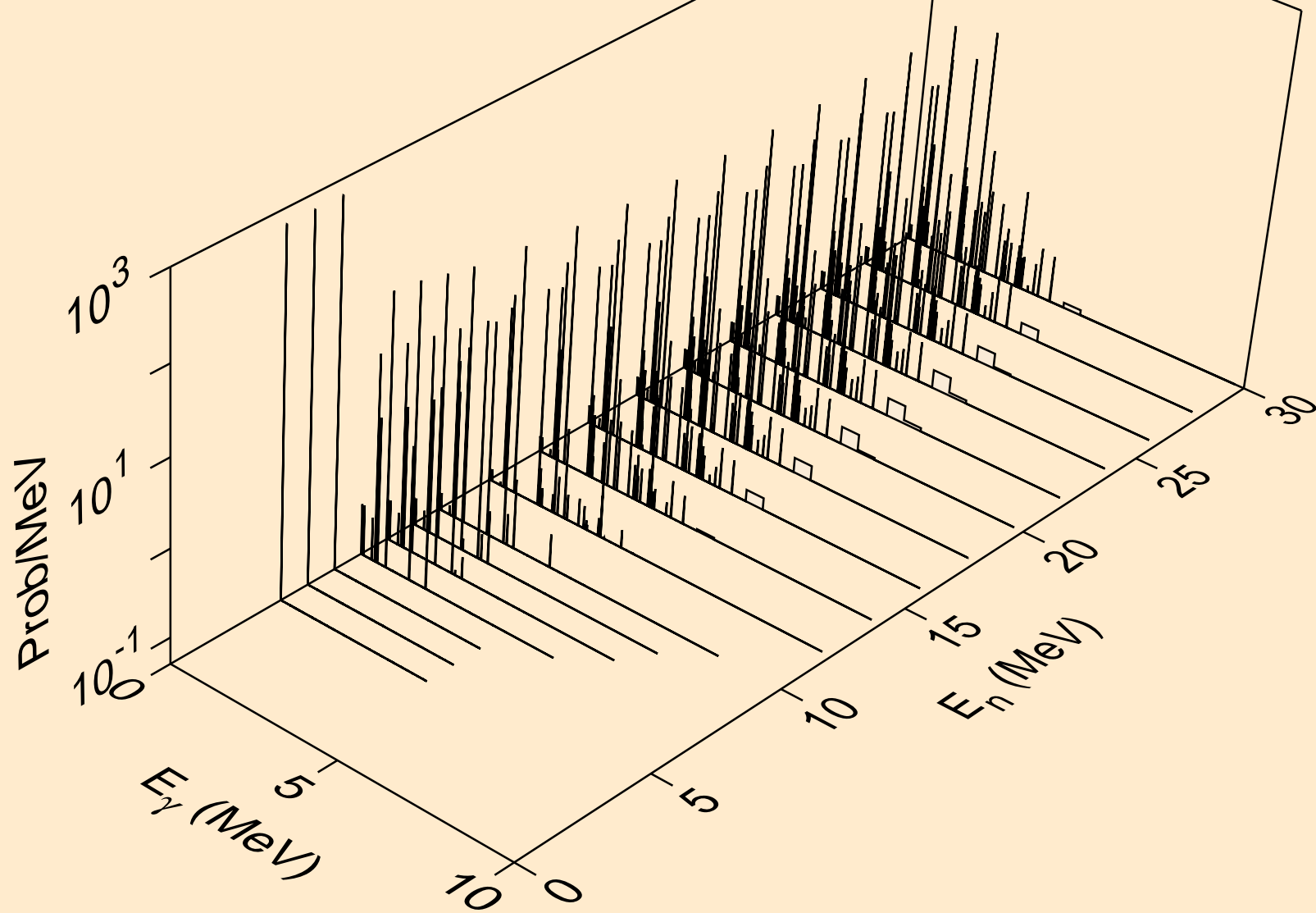

SC050 ALPHA ACER TENDL-2024 LIBRARY; T=0.K
Photon emission for (n,2a)

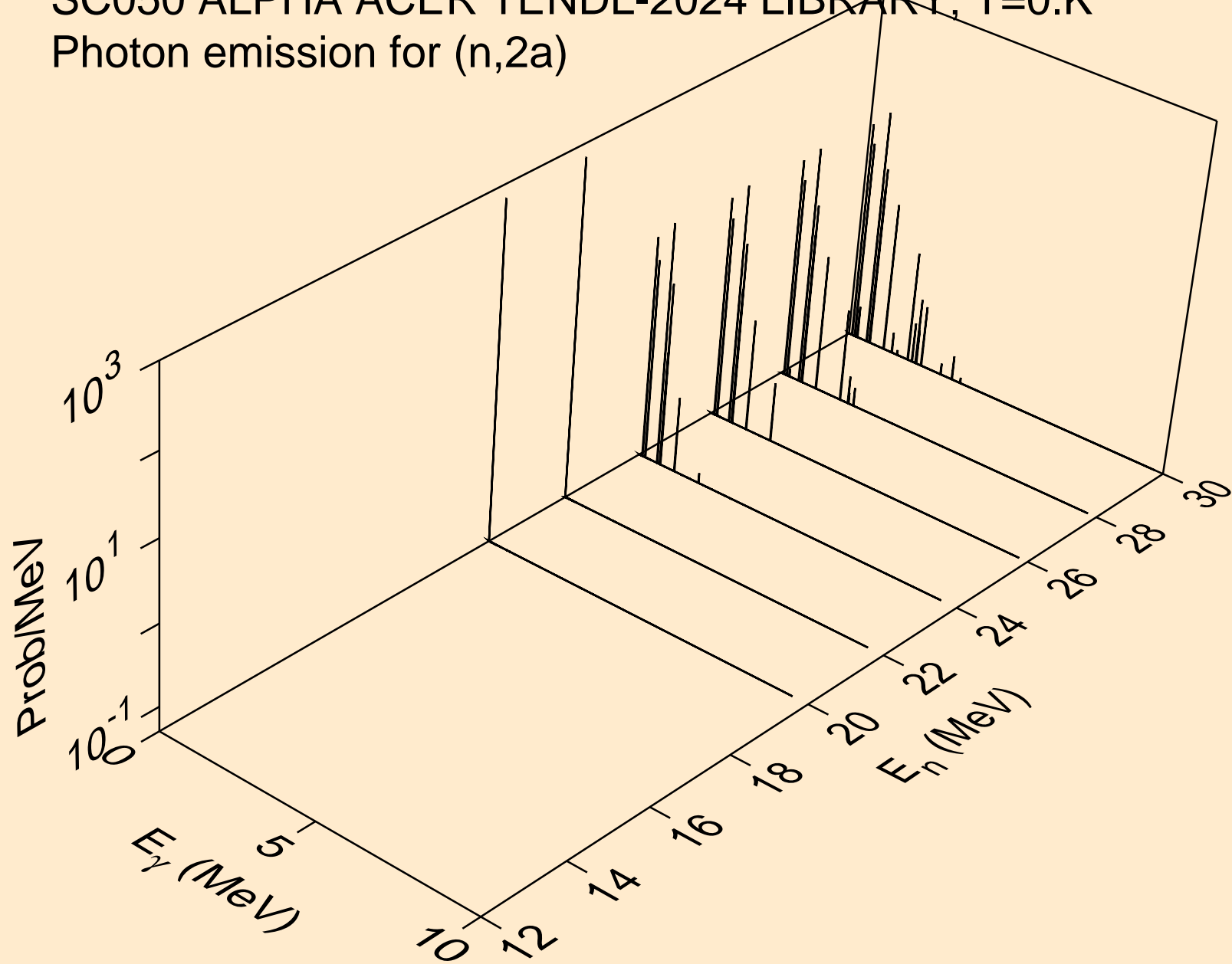

SC050 ALPHA ACER TENDL-2024 LIBRARY; T=0.K
Photon emission for (n,2p)

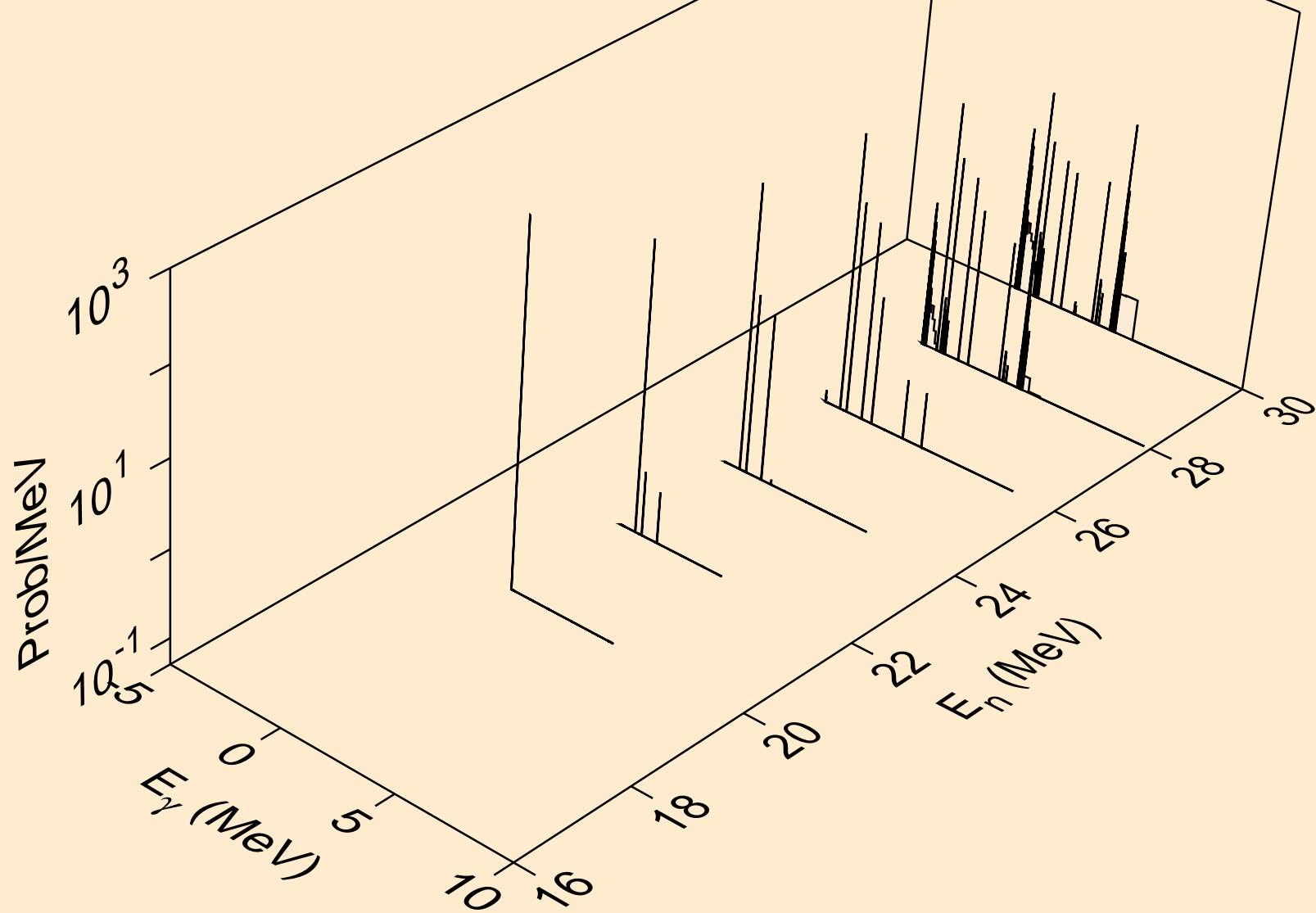

SC050 ALPHA ACER TENDL-2024 LIBRARY; T=0.K
Photon emission for (n,pa)

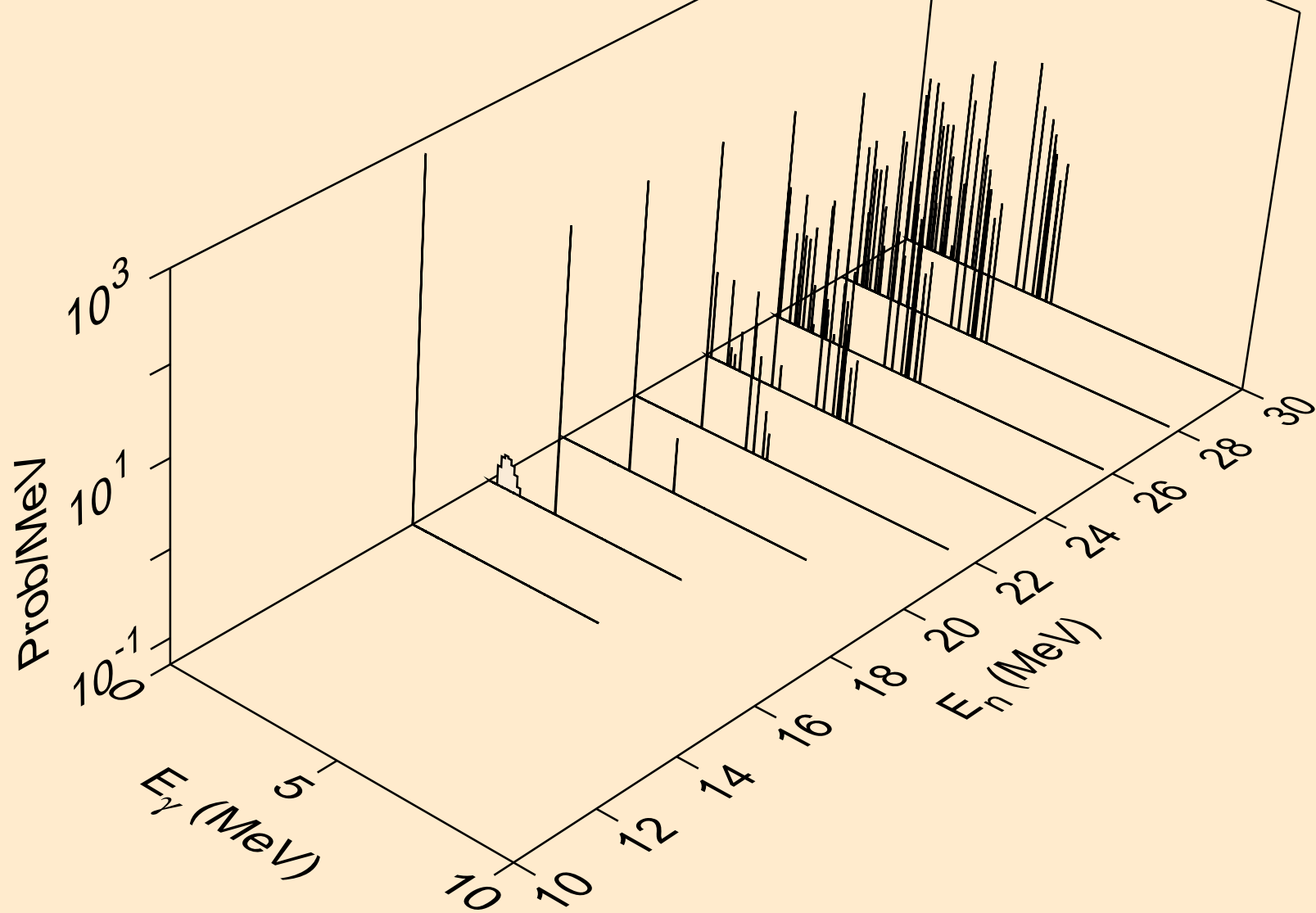

SC050 ALPHA ACER TENDL-2024 LIBRARY; T=0.K
Photon emission for (n,pd)

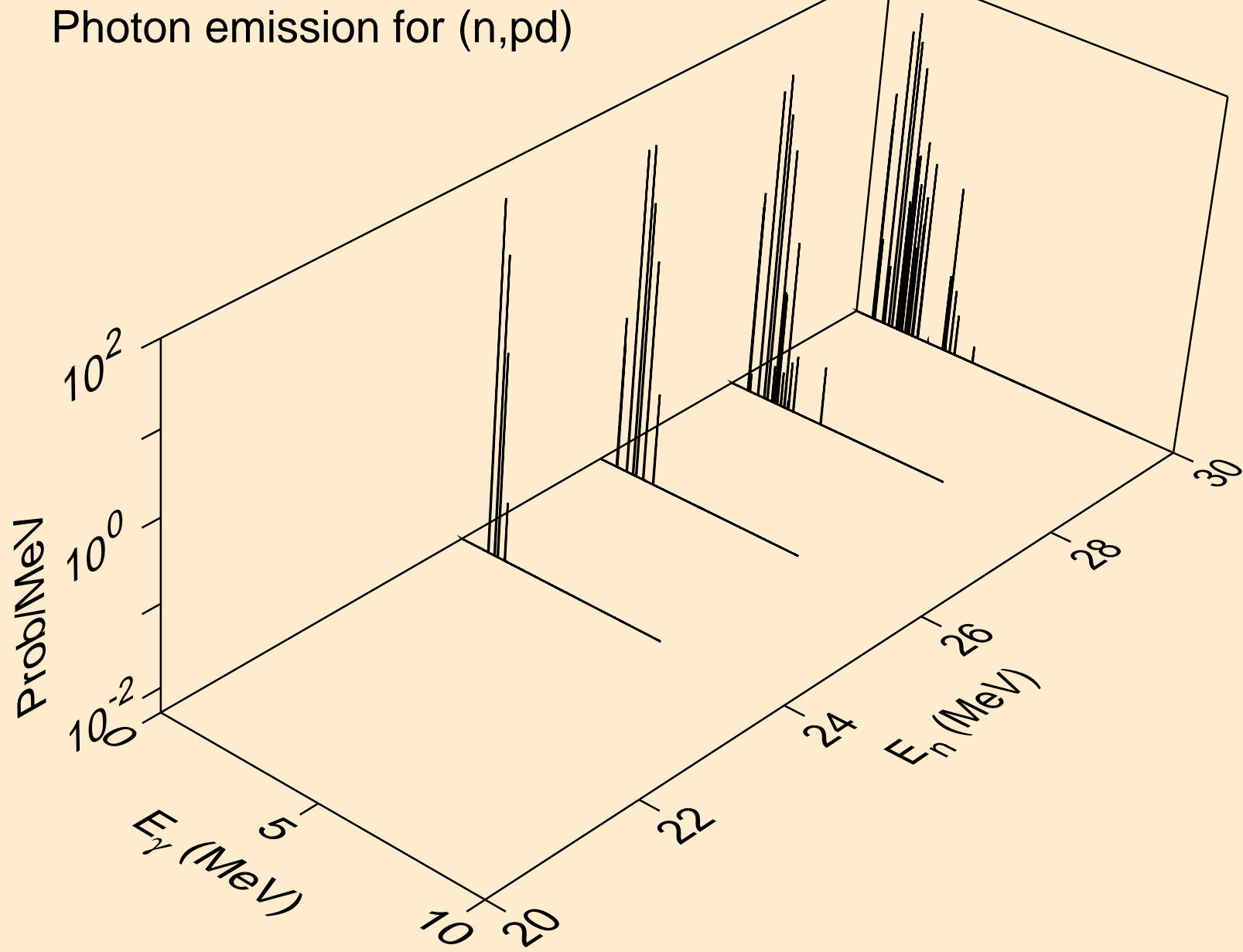

SC050 ALPHA ACER TENDL-2024 LIBRARY; T=0.K
Photon emission for (n,pt)

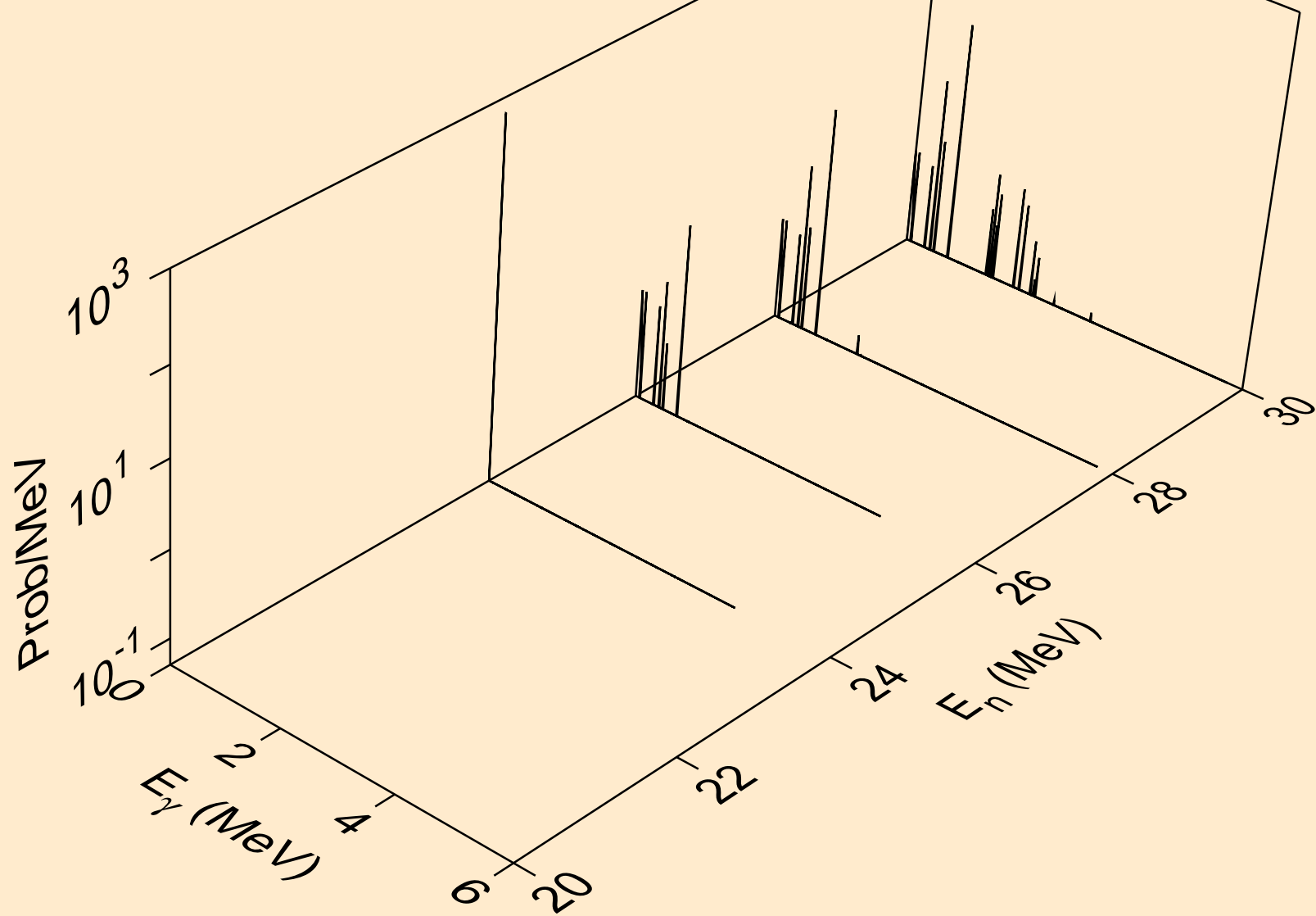

SC050 ALPHA ACER TENDL-2024 LIBRARY; T=0.K
Photon emission for (n,da)

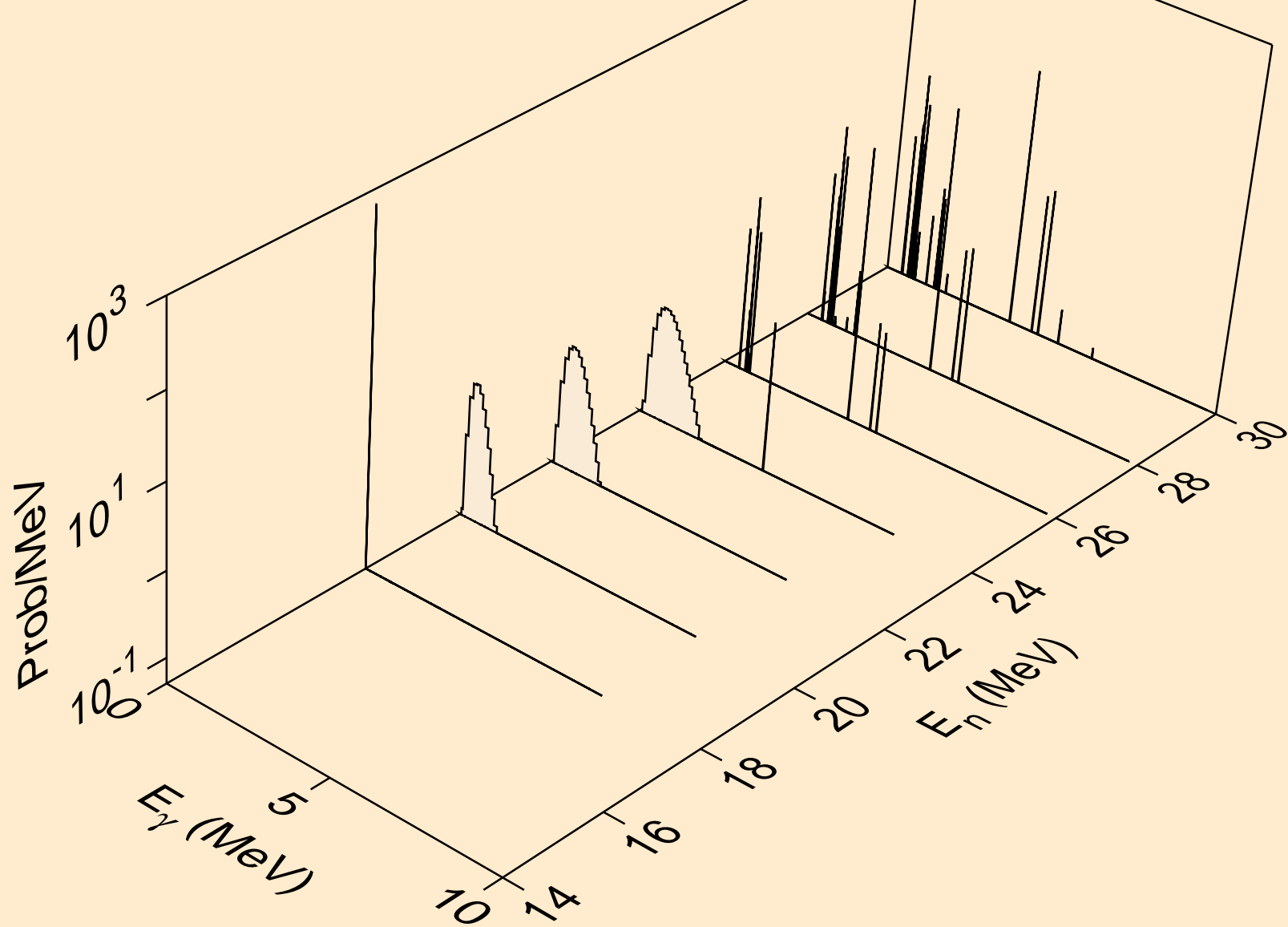

SC050 ALPHA ACER TENDL-2024 LIBRARY; T=0.K
Particle heating contributions

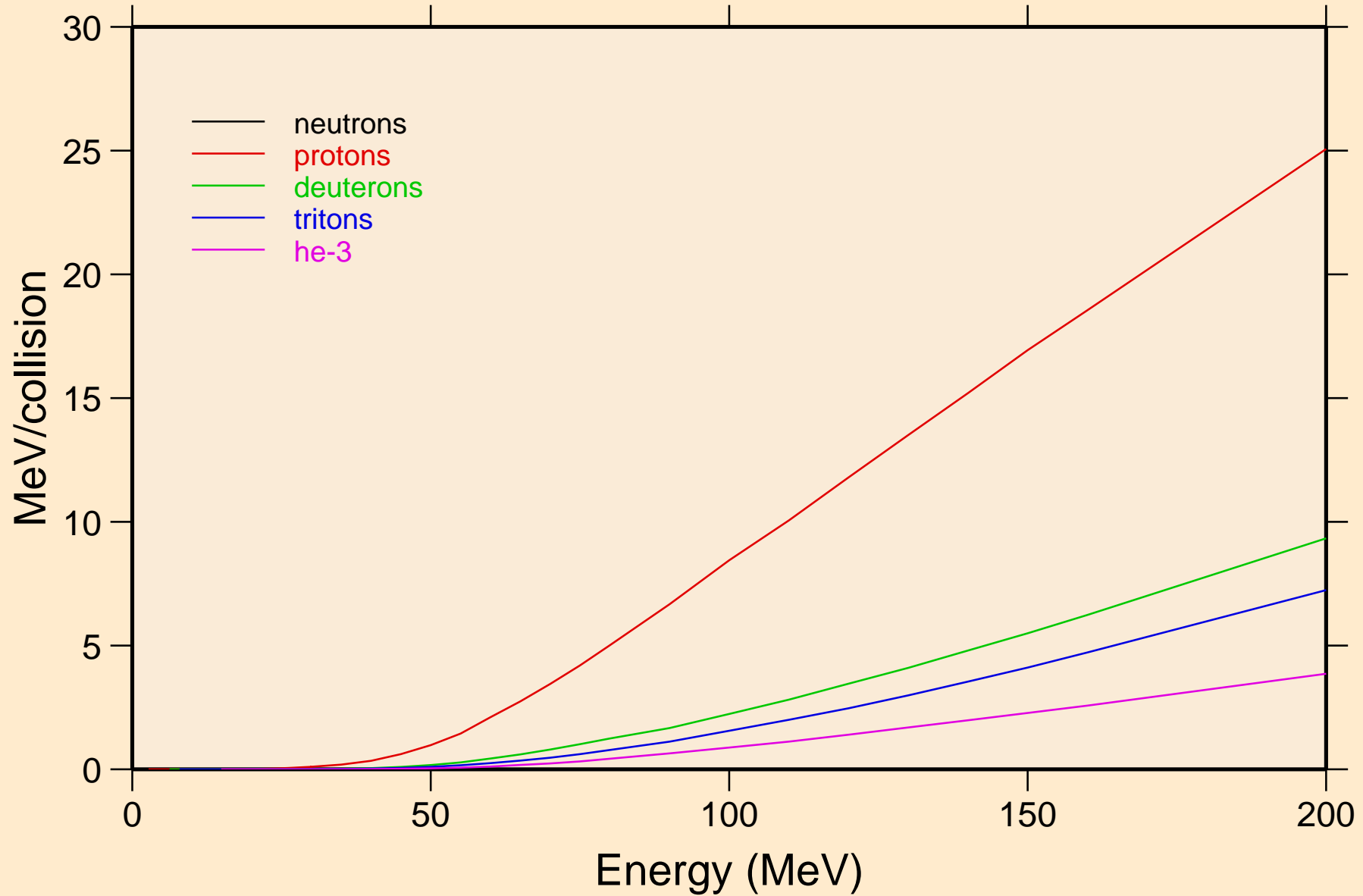

SC050 ALPHA ACER TENDL-2024 LIBRARY; T=0.K
Recoil Heating

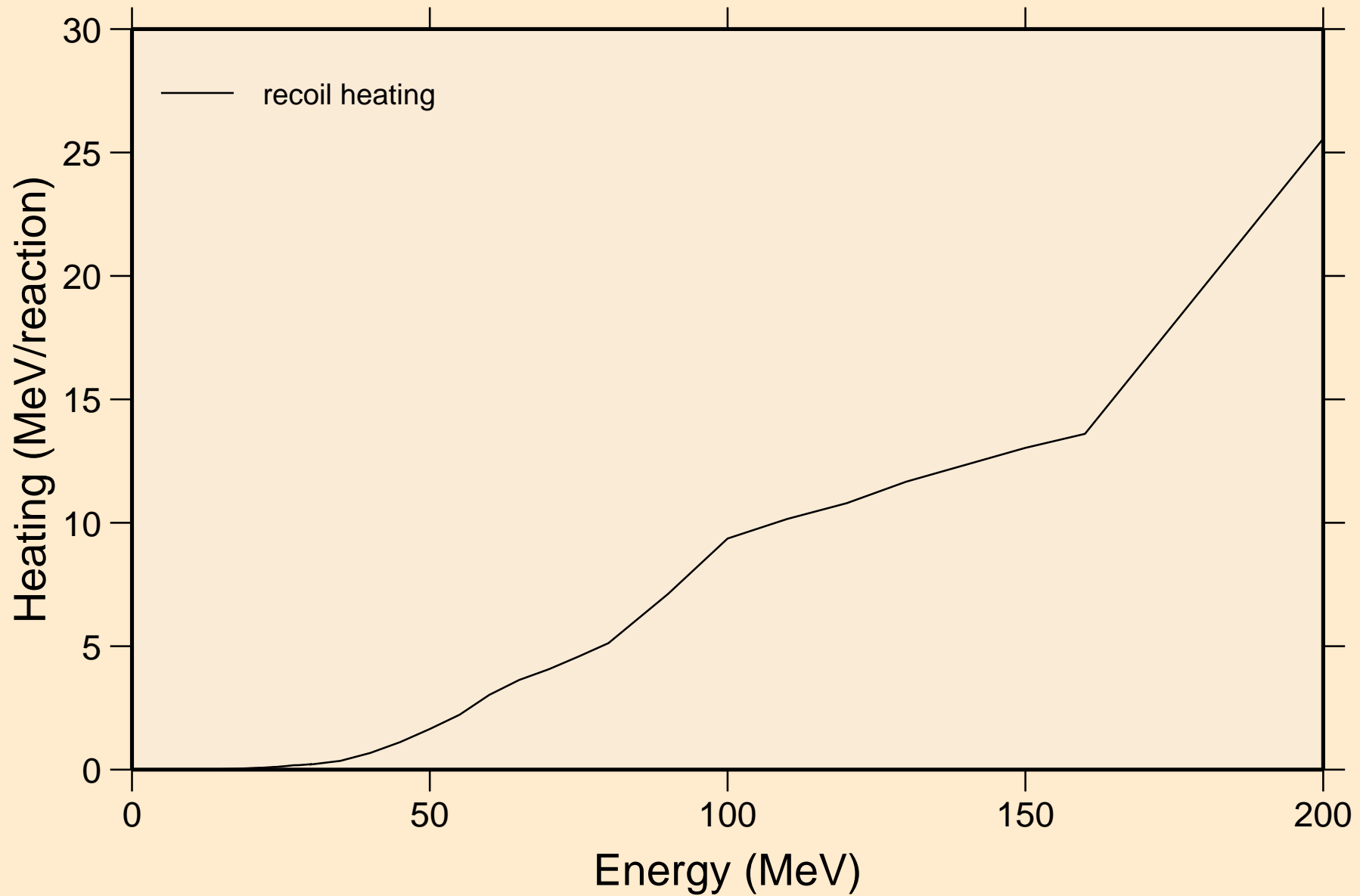

SC050 ALPHA ACER TENDL-2024 LIBRARY; T=0.K
Particle production cross sections

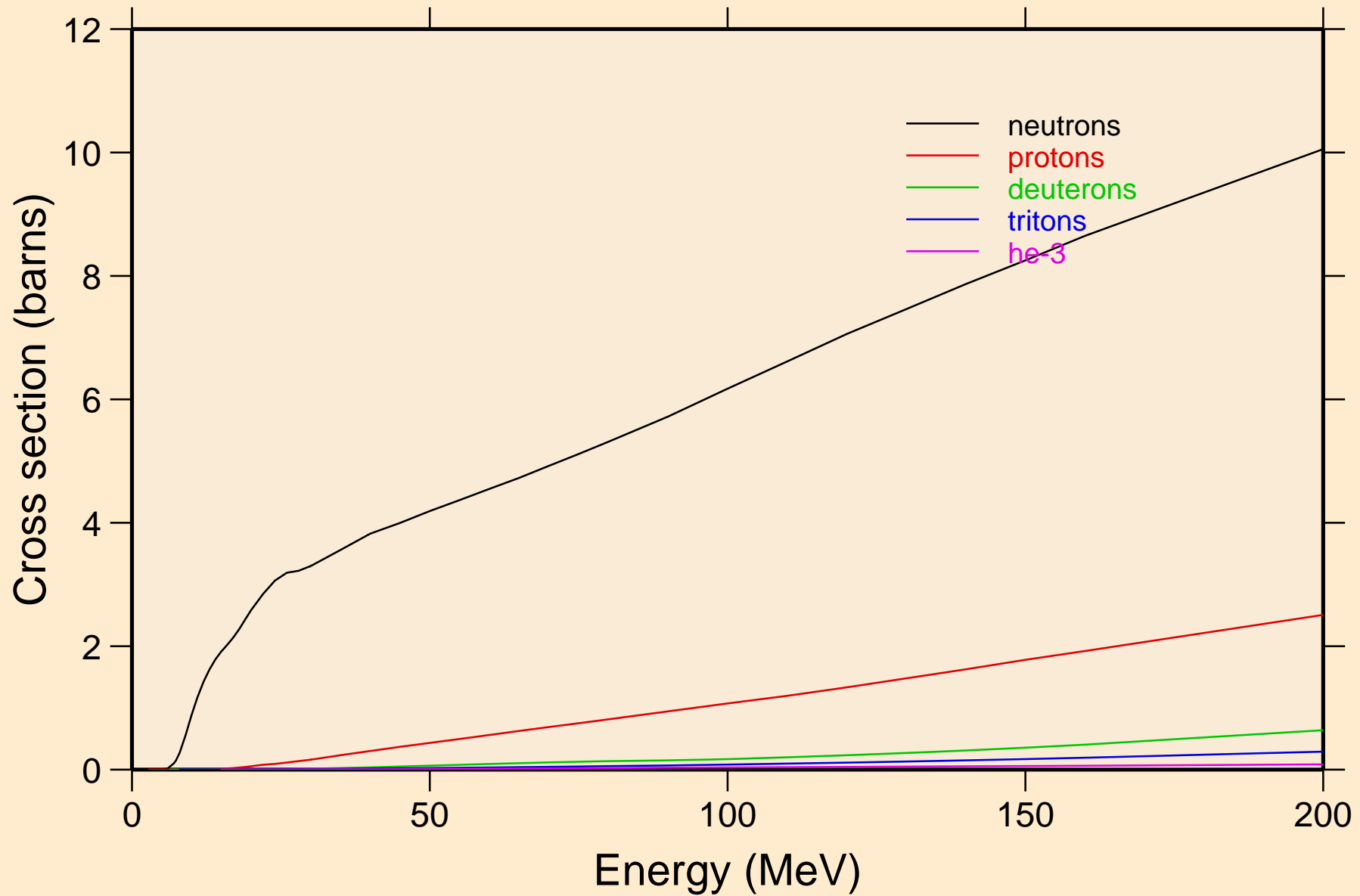

SC050 ALPHA ACER TENDL-2024 LIBRARY; T=0.K
neutrons from (a,n)

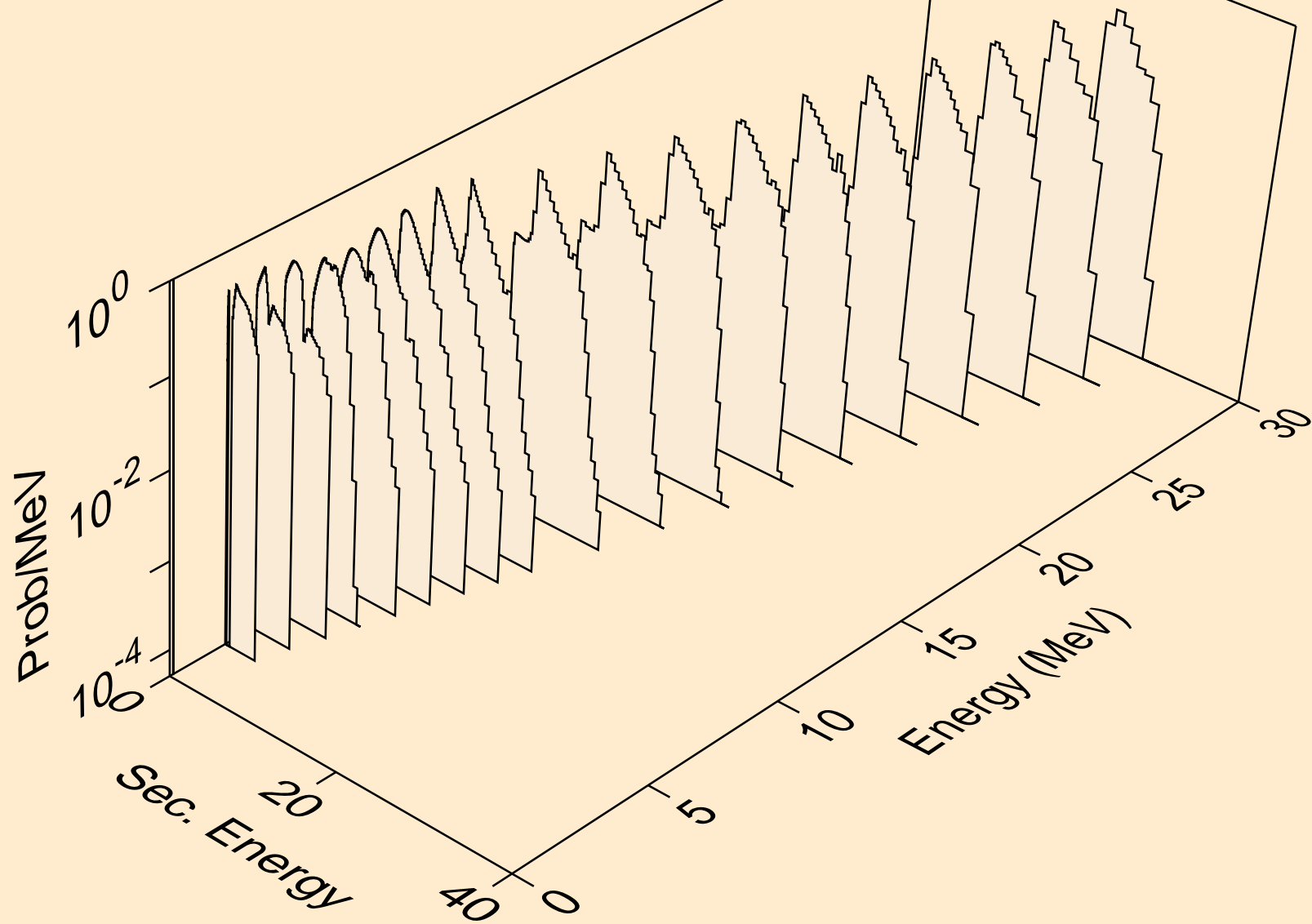

SC050 ALPHA ACER TENDL-2024 LIBRARY; T=0.K
neutrons from (a,x)

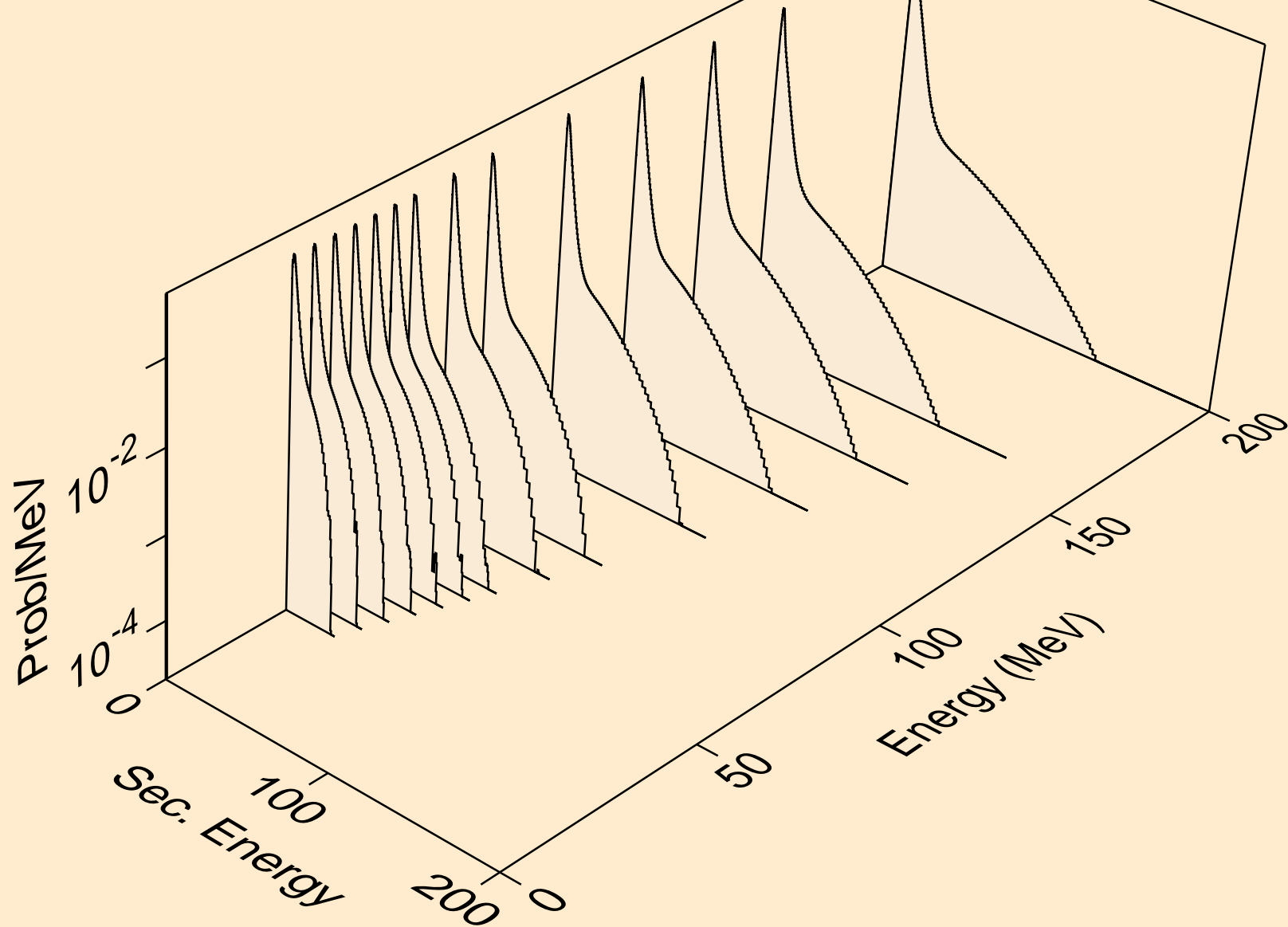

SC050 ALPHA ACER TENDL-2024 LIBRARY; T=0.K
neutrons from (a,2nd)

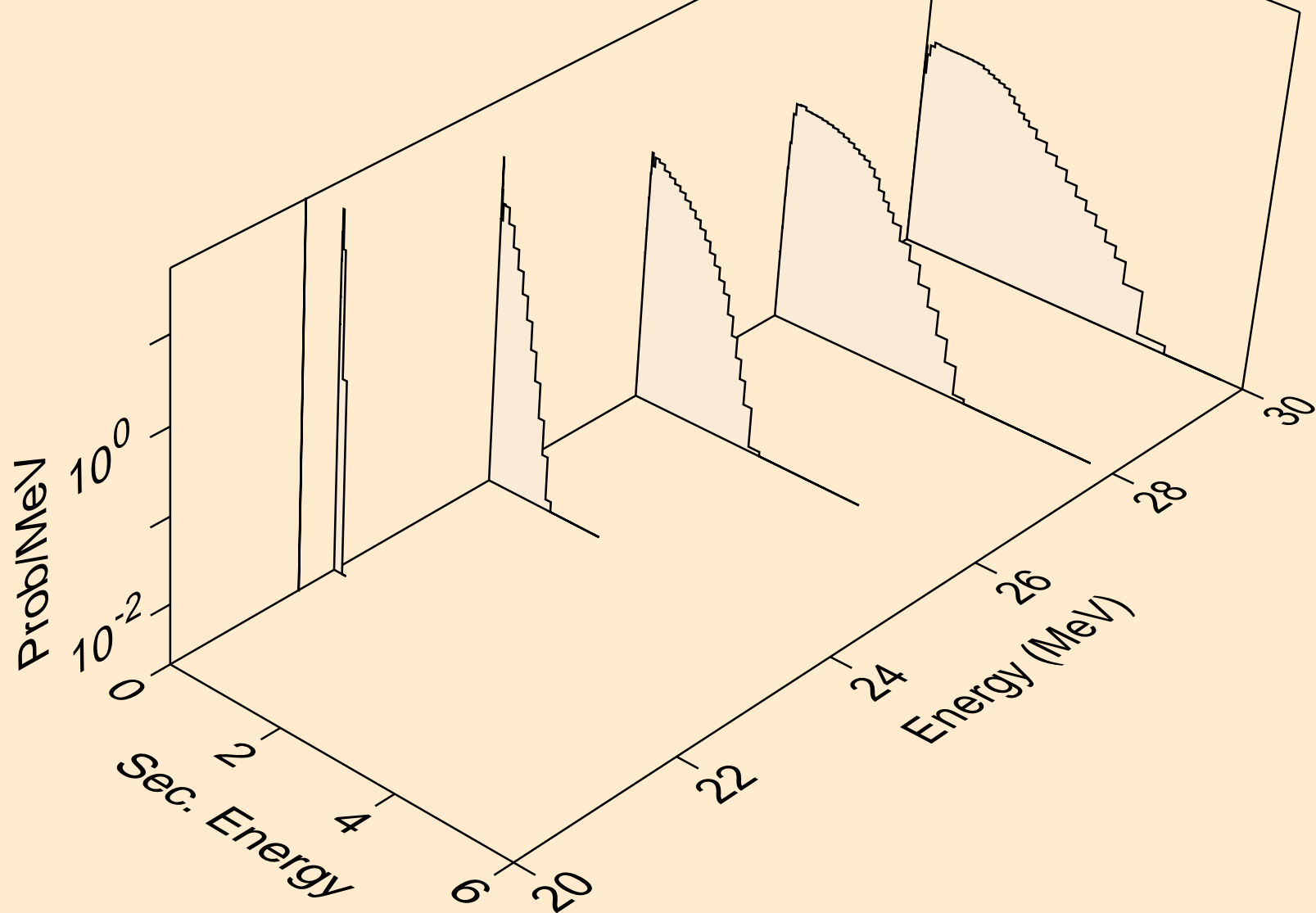

SC050 ALPHA ACER TENDL-2024 LIBRARY; T=0.K
neutrons from (a,2n)

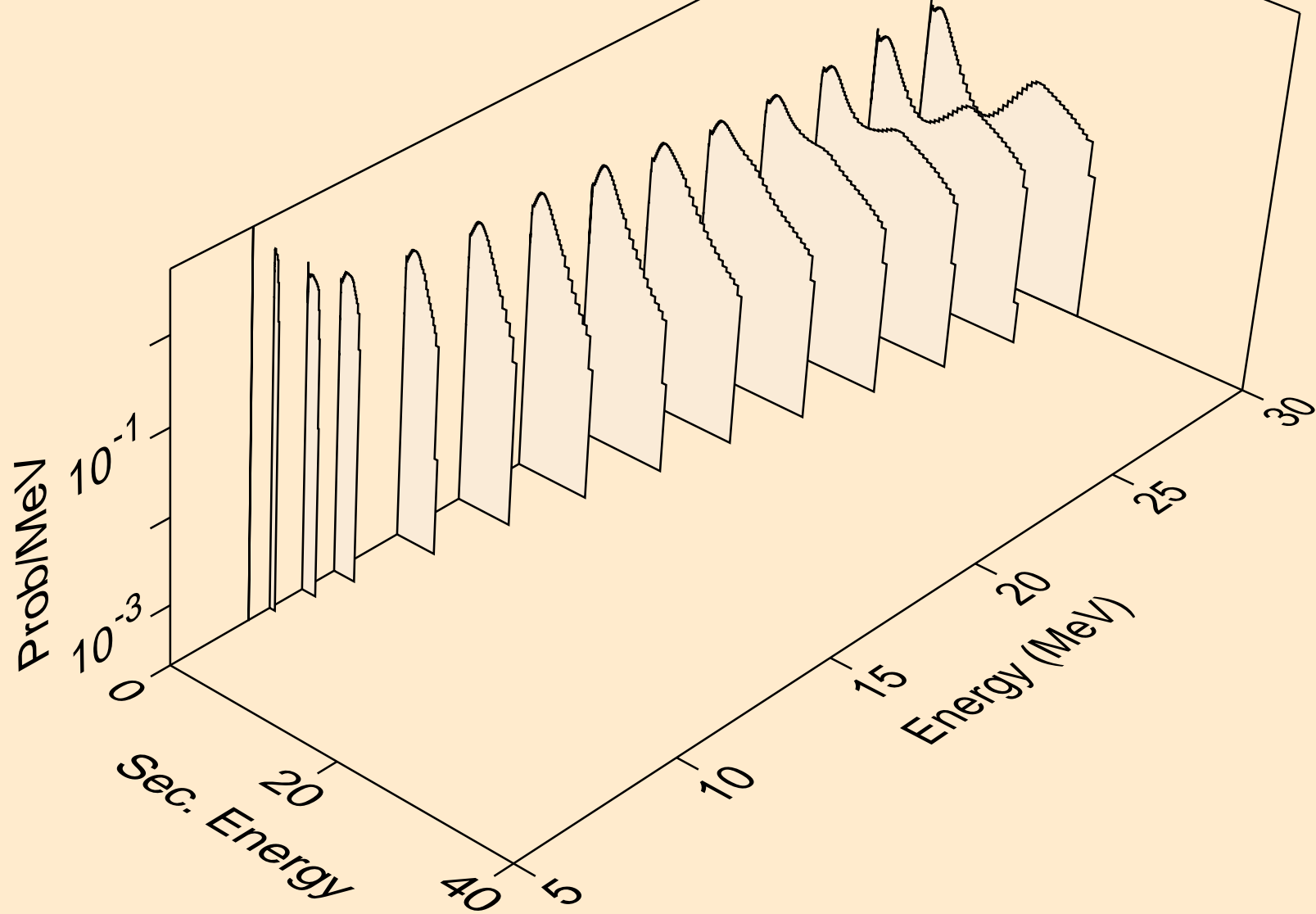

SC050 ALPHA ACER TENDL-2024 LIBRARY; T=0.K
neutrons from (a,3n)

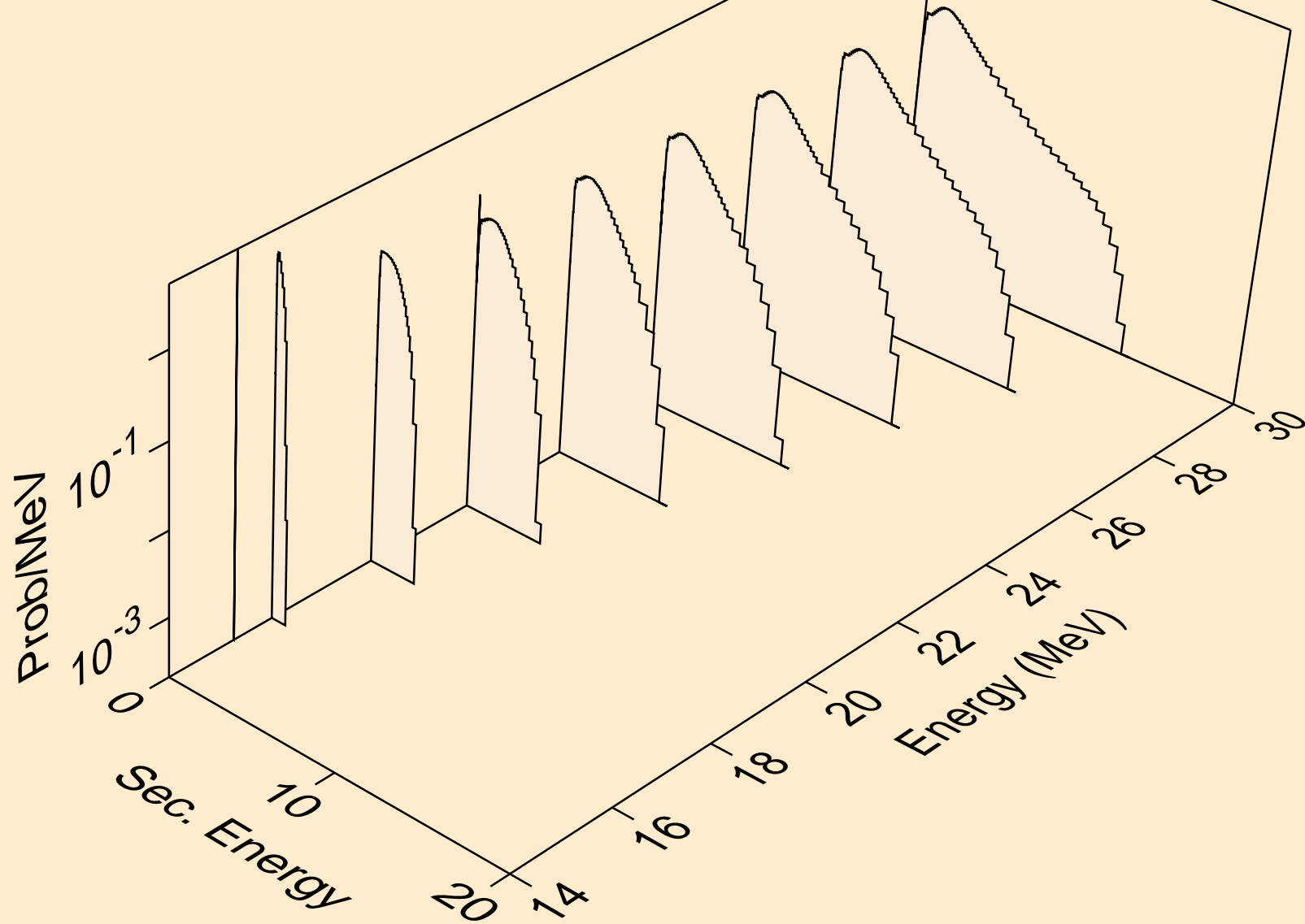

SC050 ALPHA ACER TENDL-2024 LIBRARY; T=0.K
neutrons from (a,n*)a

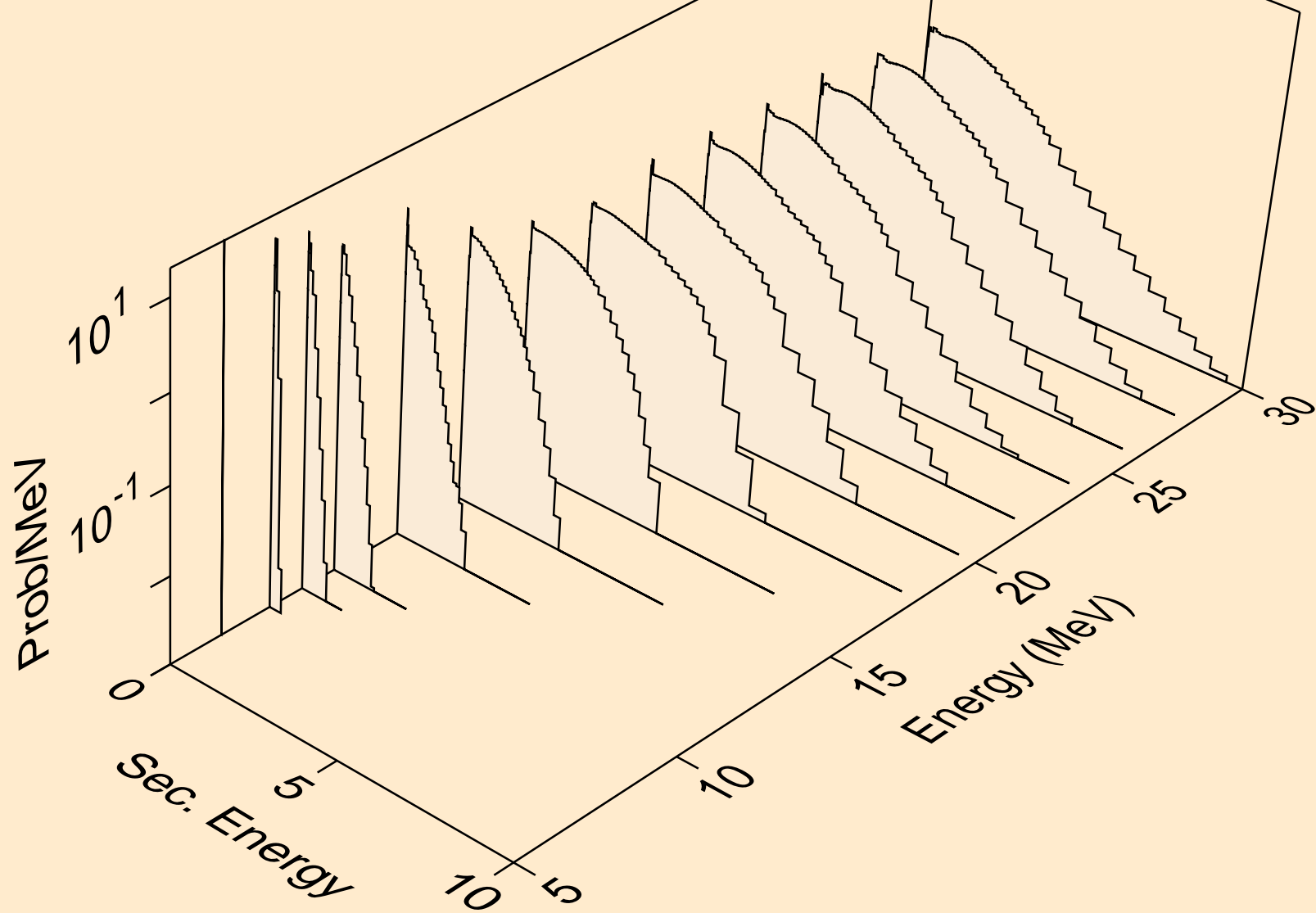

SC050 ALPHA ACER TENDL-2024 LIBRARY; T=0.K
neutrons from (a,2n)a

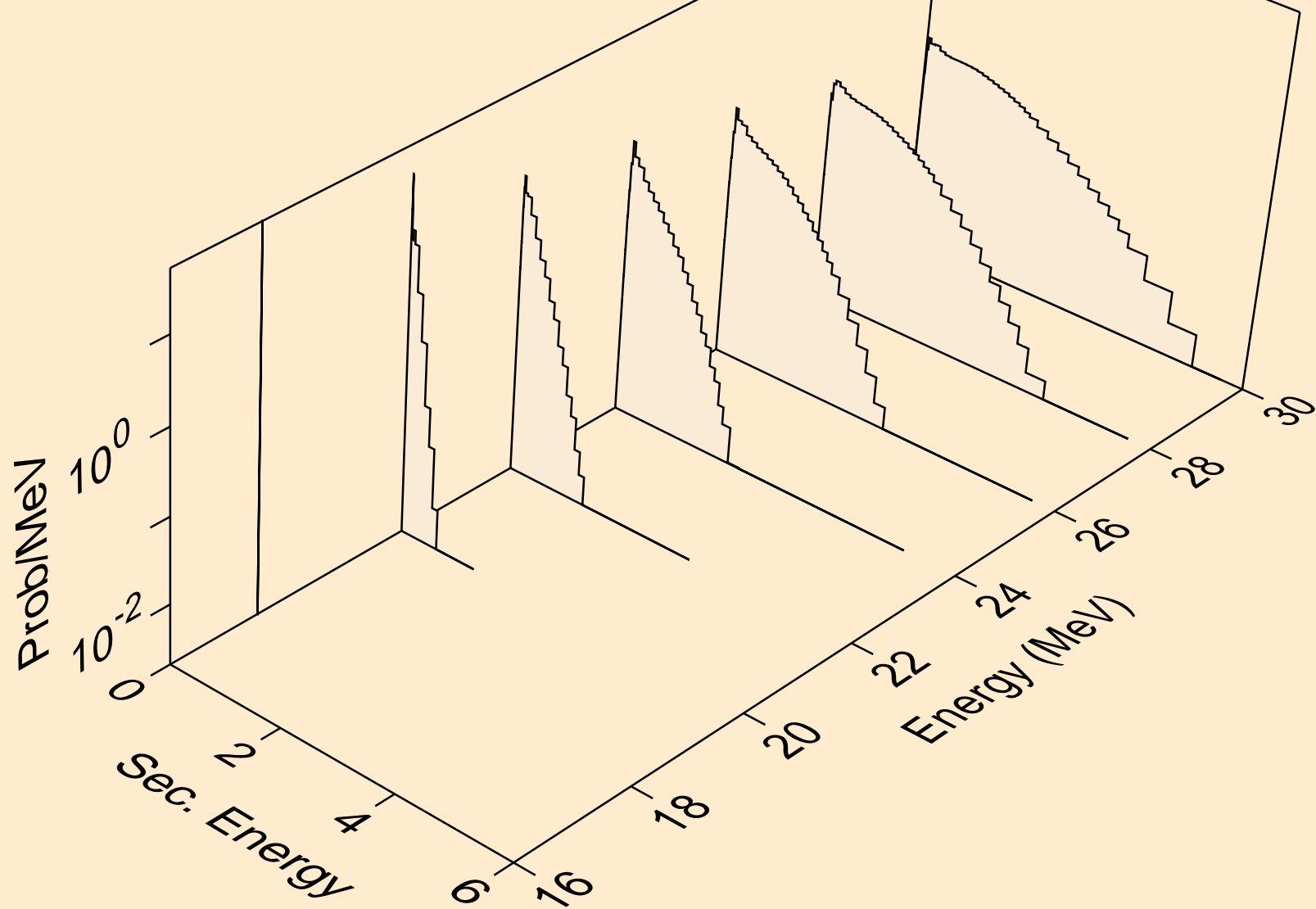

SC050 ALPHA ACER TENDL-2024 LIBRARY; T=0.K
neutrons from (a,n*)p

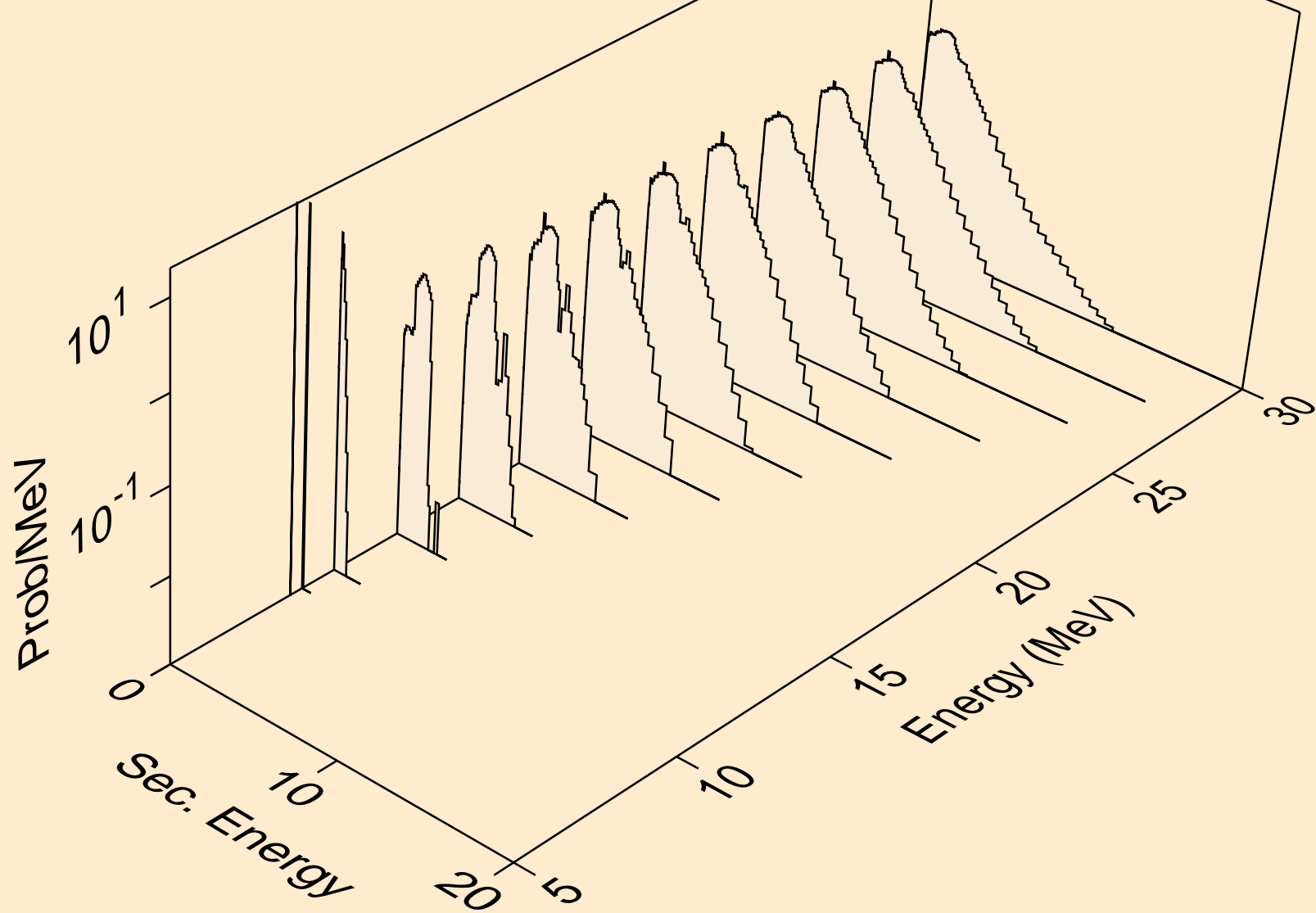

SC050 ALPHA ACER TENDL-2024 LIBRARY; T=0.K
neutrons from (a,n*)d

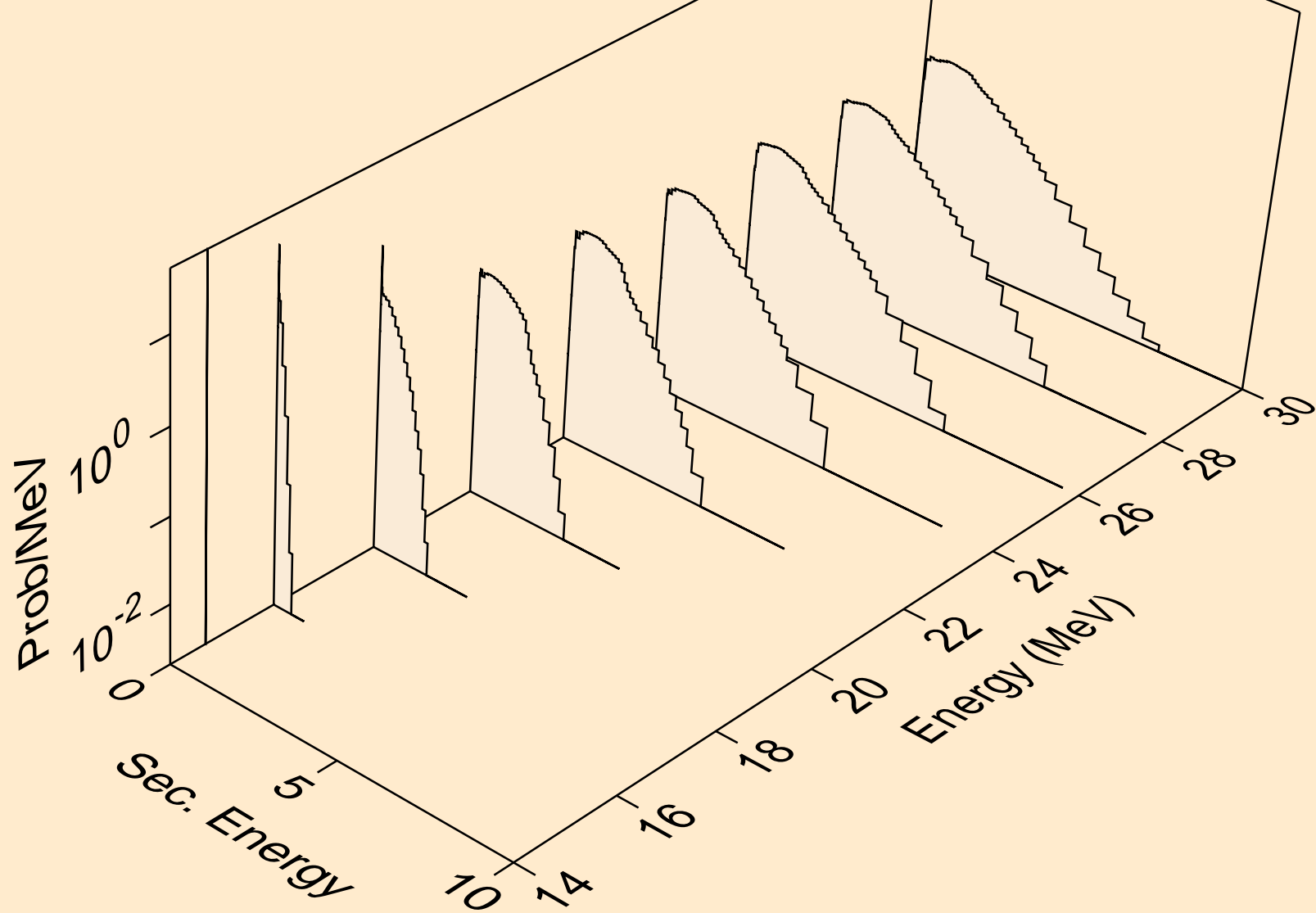

SC050 ALPHA ACER TENDL-2024 LIBRARY; T=0.K
neutrons from (a,n*)t

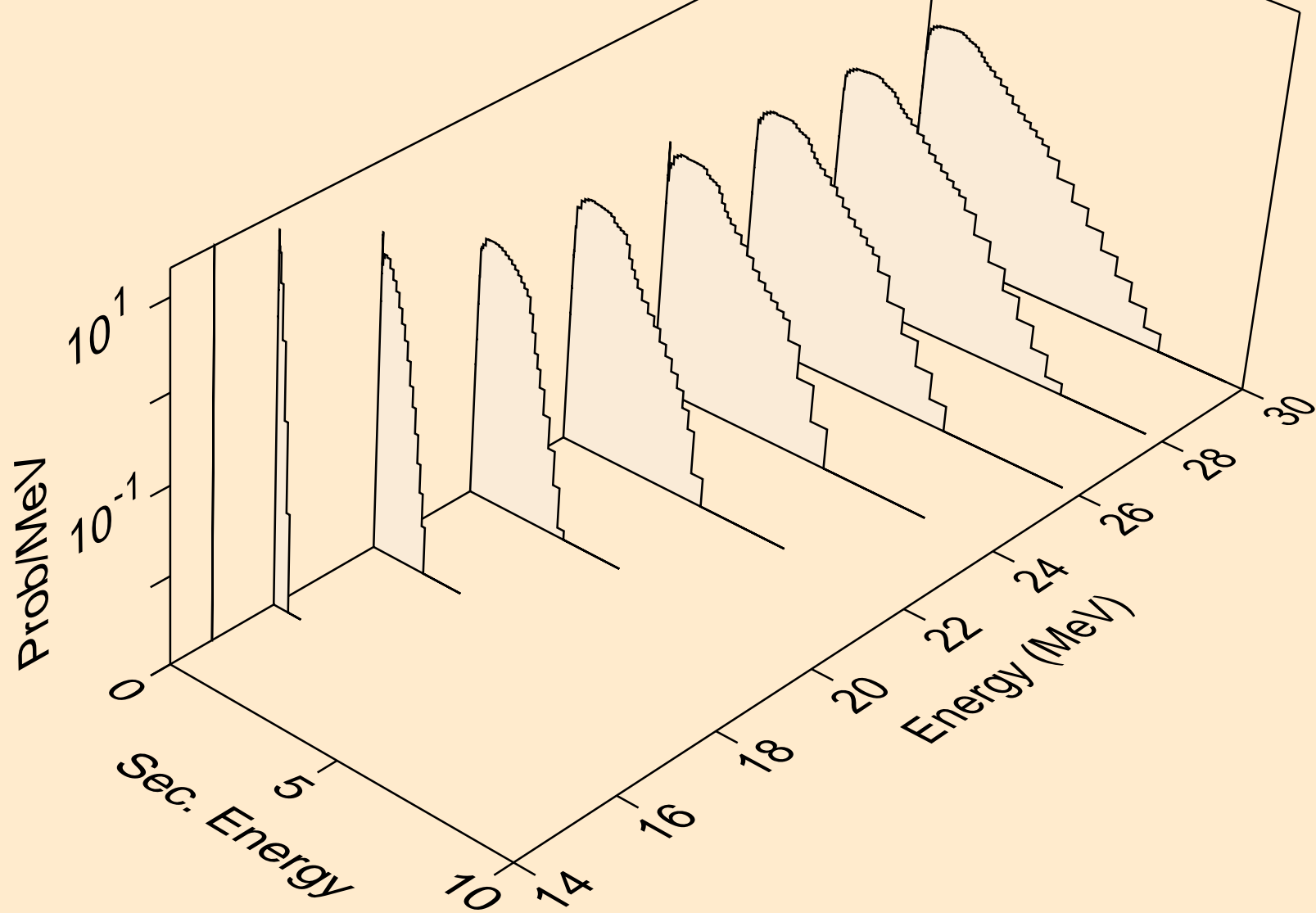

SC050 ALPHA ACER TENDL-2024 LIBRARY; T=0.K
neutrons from (a,n*)he3

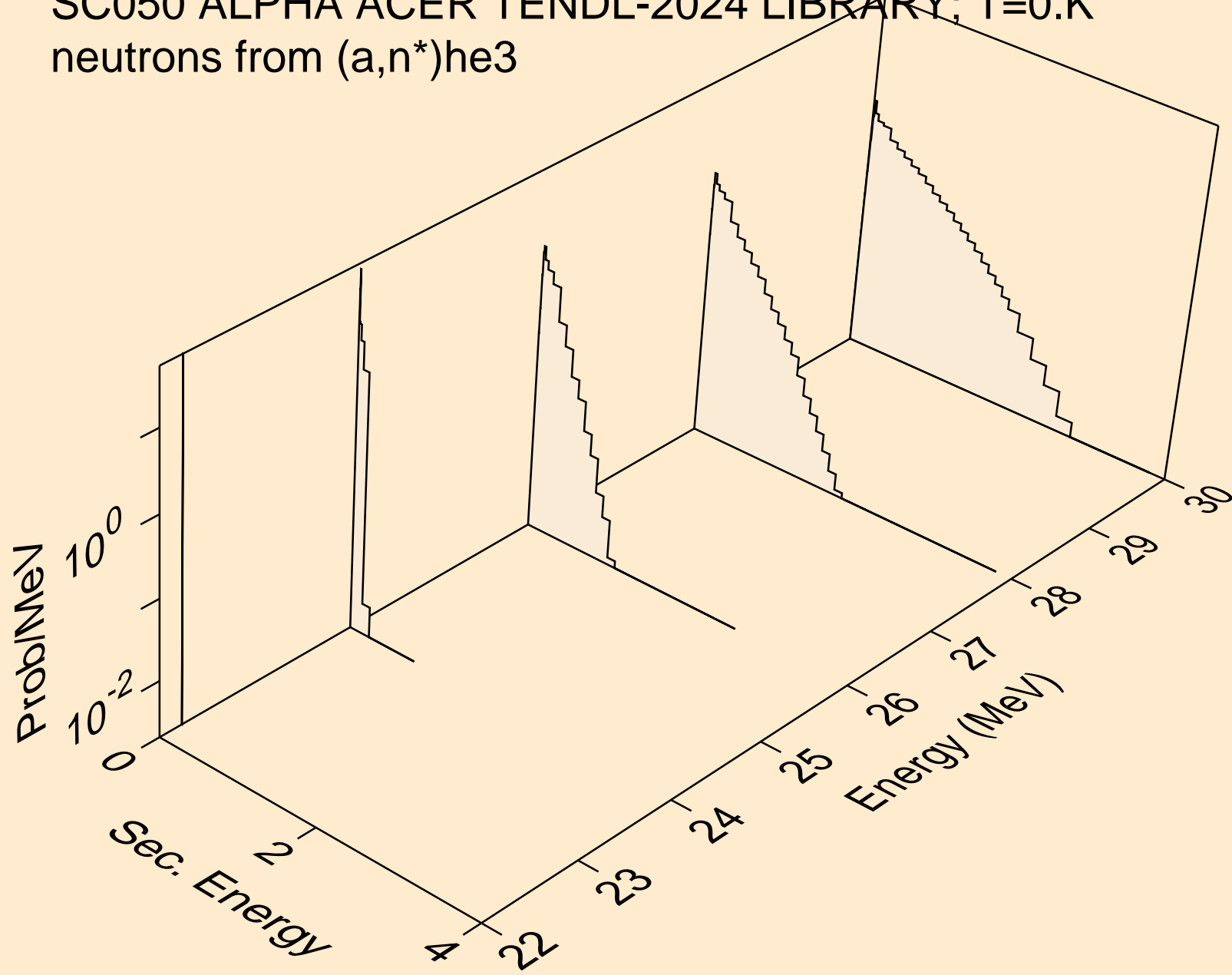

SC050 ALPHA ACER TENDL-2024 LIBRARY; T=0.K
neutrons from (a,4n)

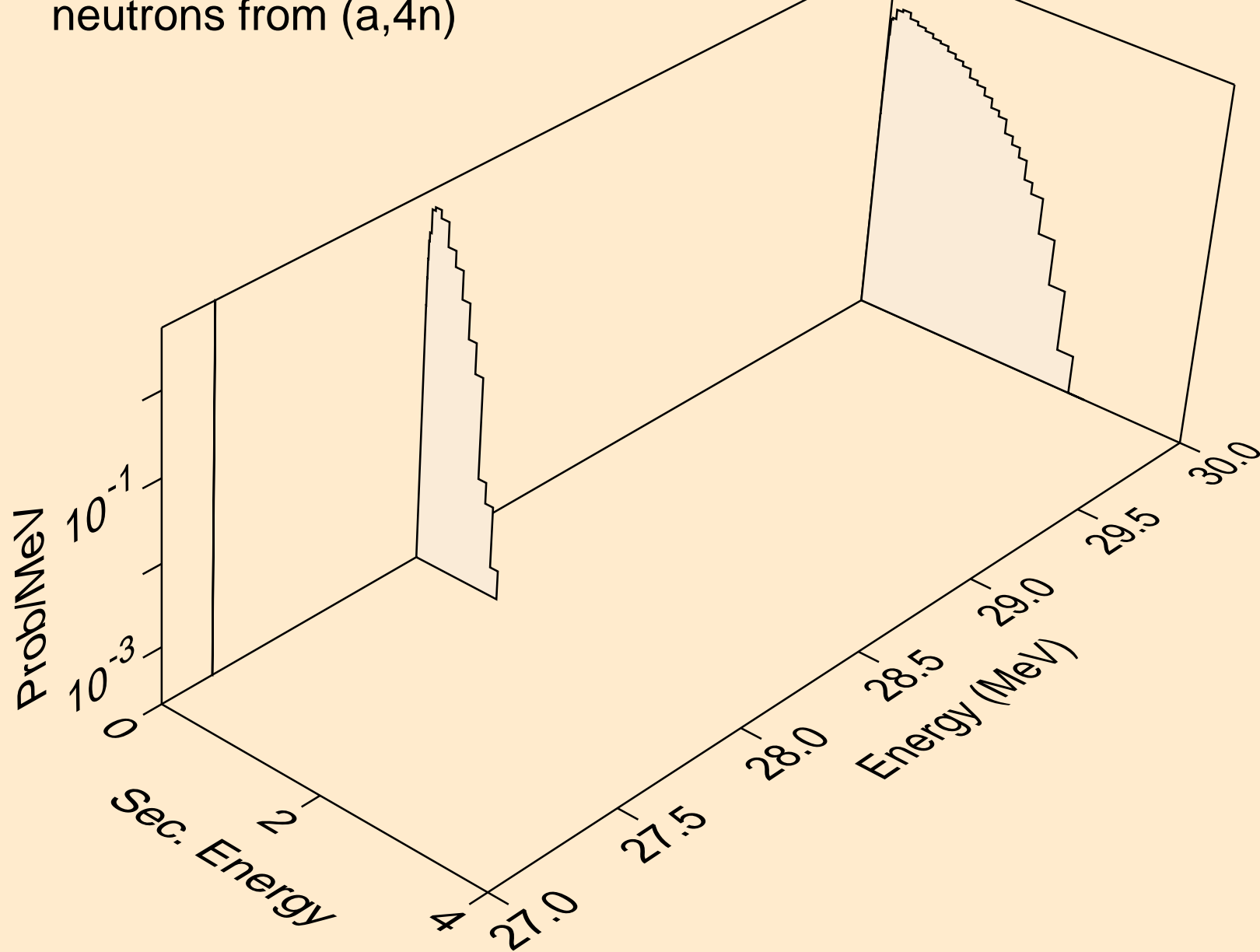

SC050 ALPHA ACER TENDL-2024 LIBRARY; T=0.K
neutrons from (a,2np)

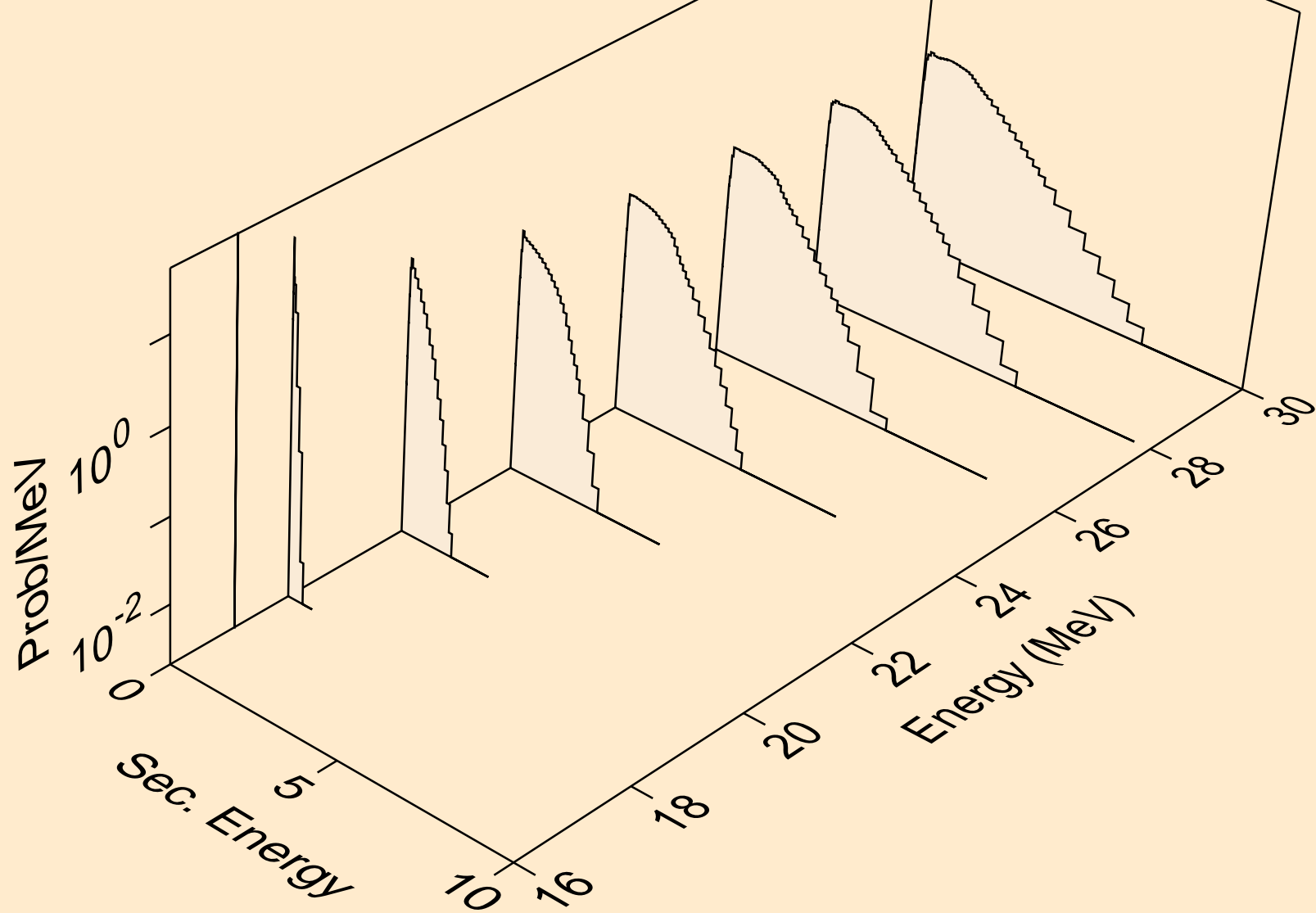

SC050 ALPHA ACER TENDL-2024 LIBRARY; T=0.K
neutrons from (a,3np)

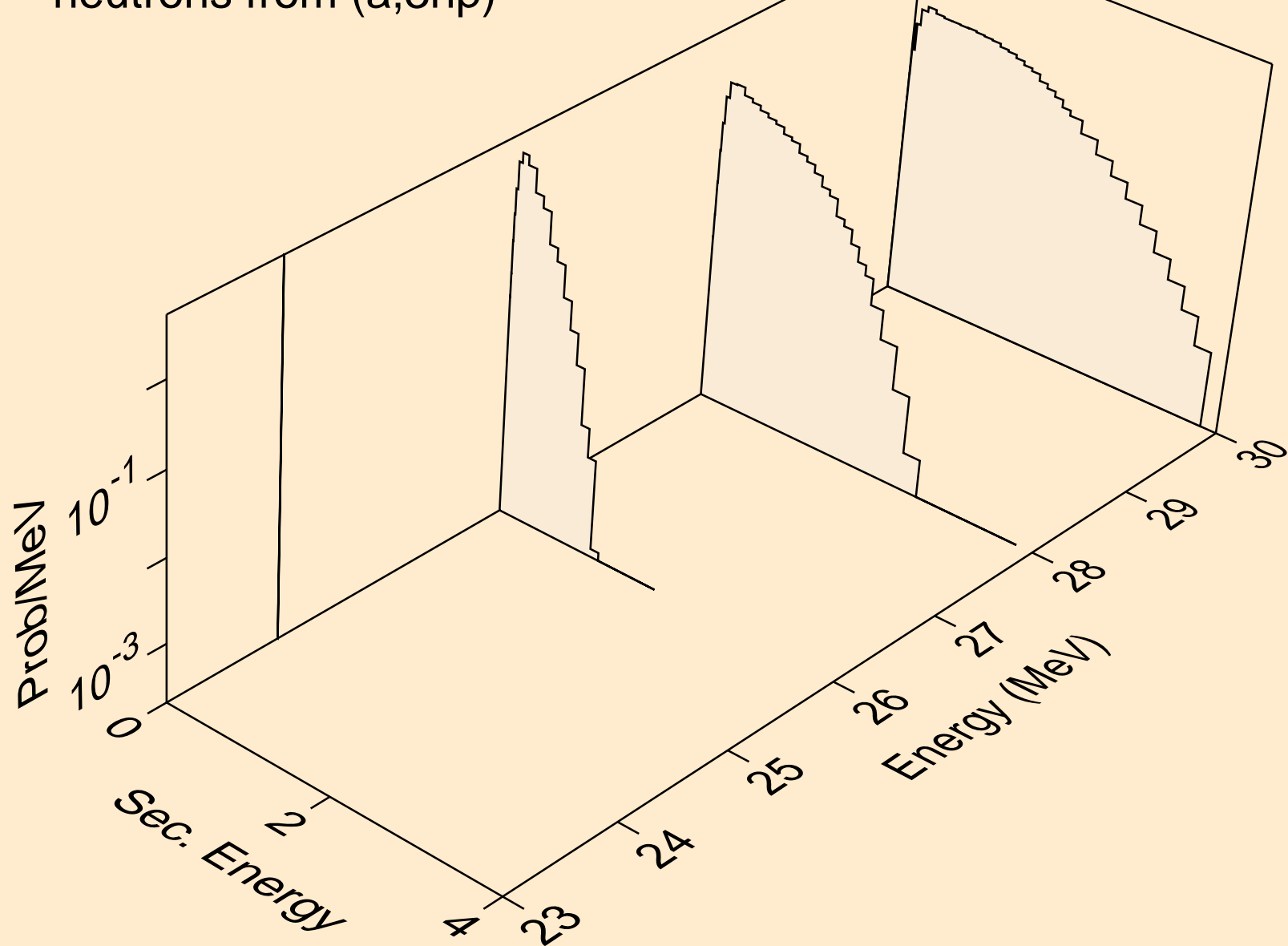

SC050 ALPHA ACER TENDL-2024 LIBRARY; T=0.K
neutrons from (a,n2p)

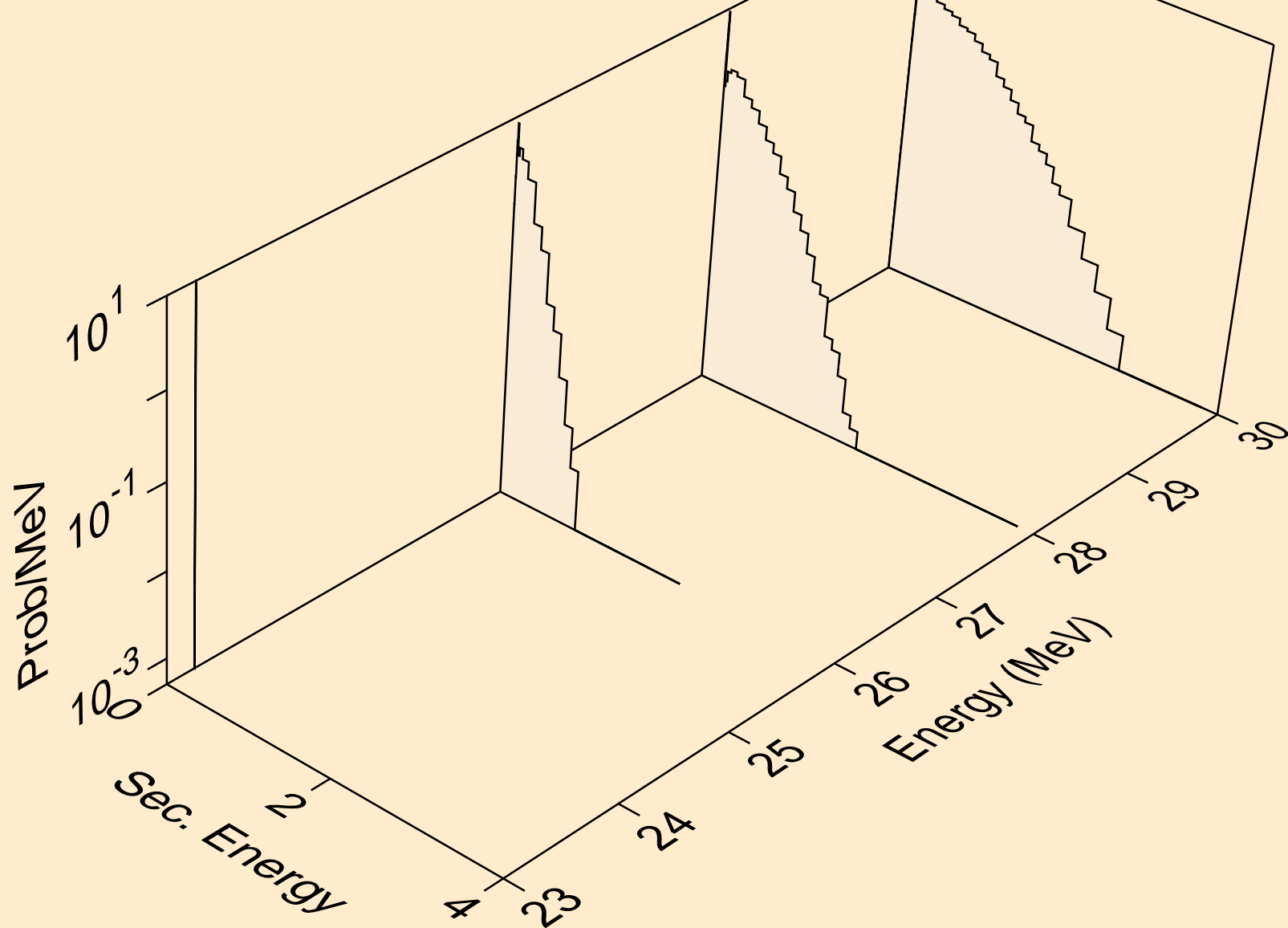

SC050 ALPHA ACER TENDL-2024 LIBRARY; T=0.K
neutrons from (a,npa)

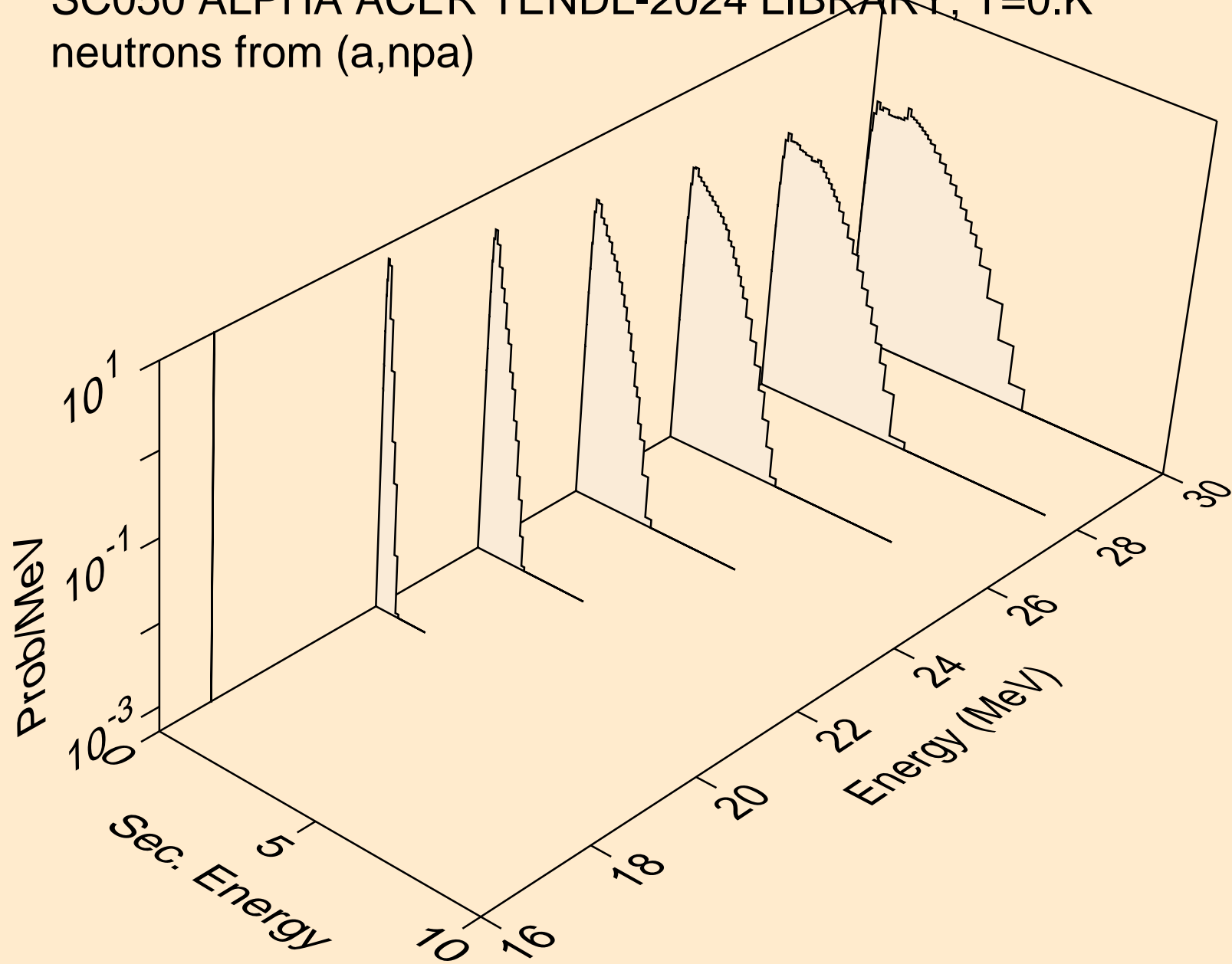

SC050 ALPHA ACER TENDL-2024 LIBRARY; T=0.K
protons from (a,x)

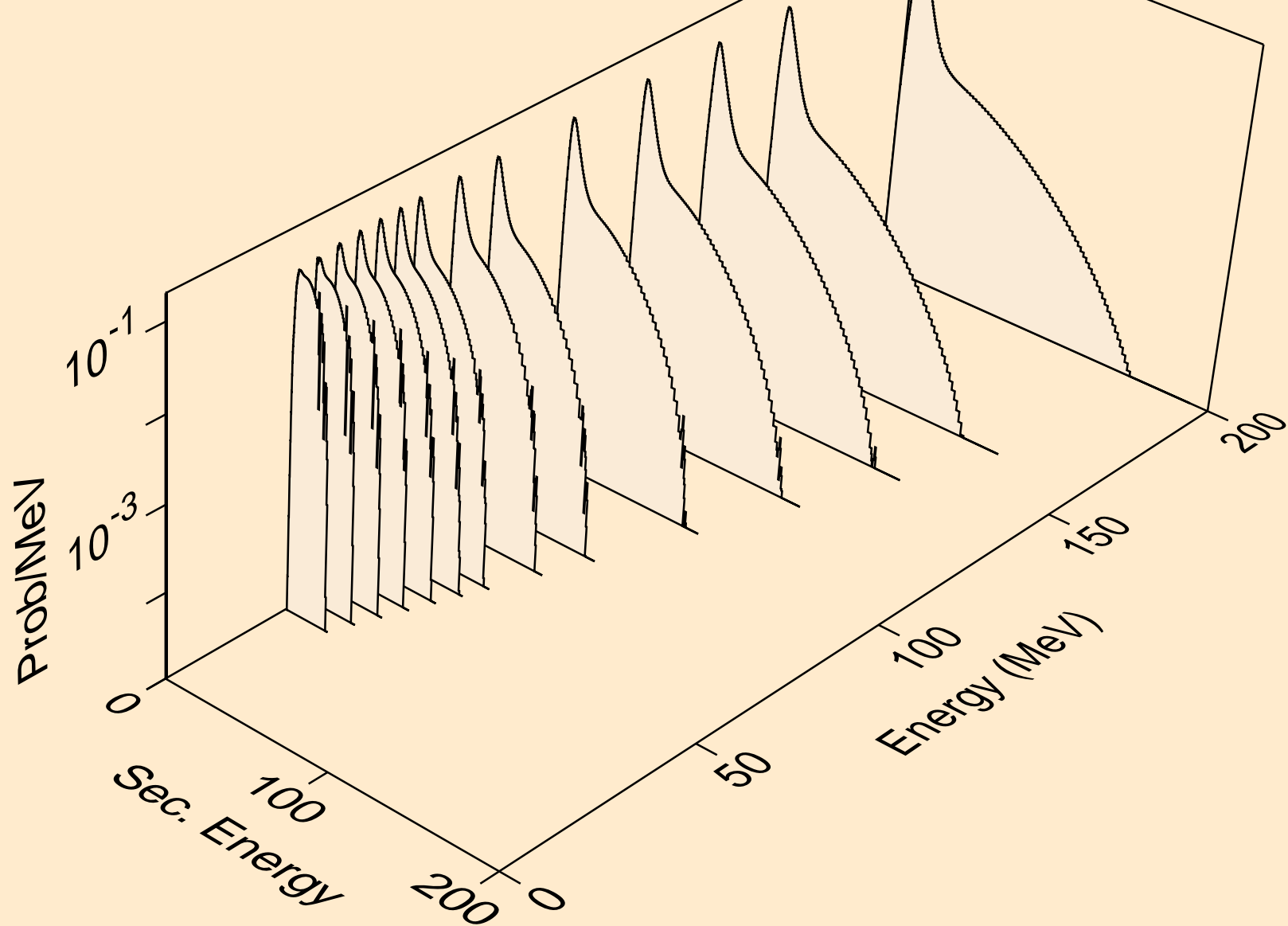

SC050 ALPHA ACER TENDL-2024 LIBRARY; T=0.K
protons from (a,n*)p

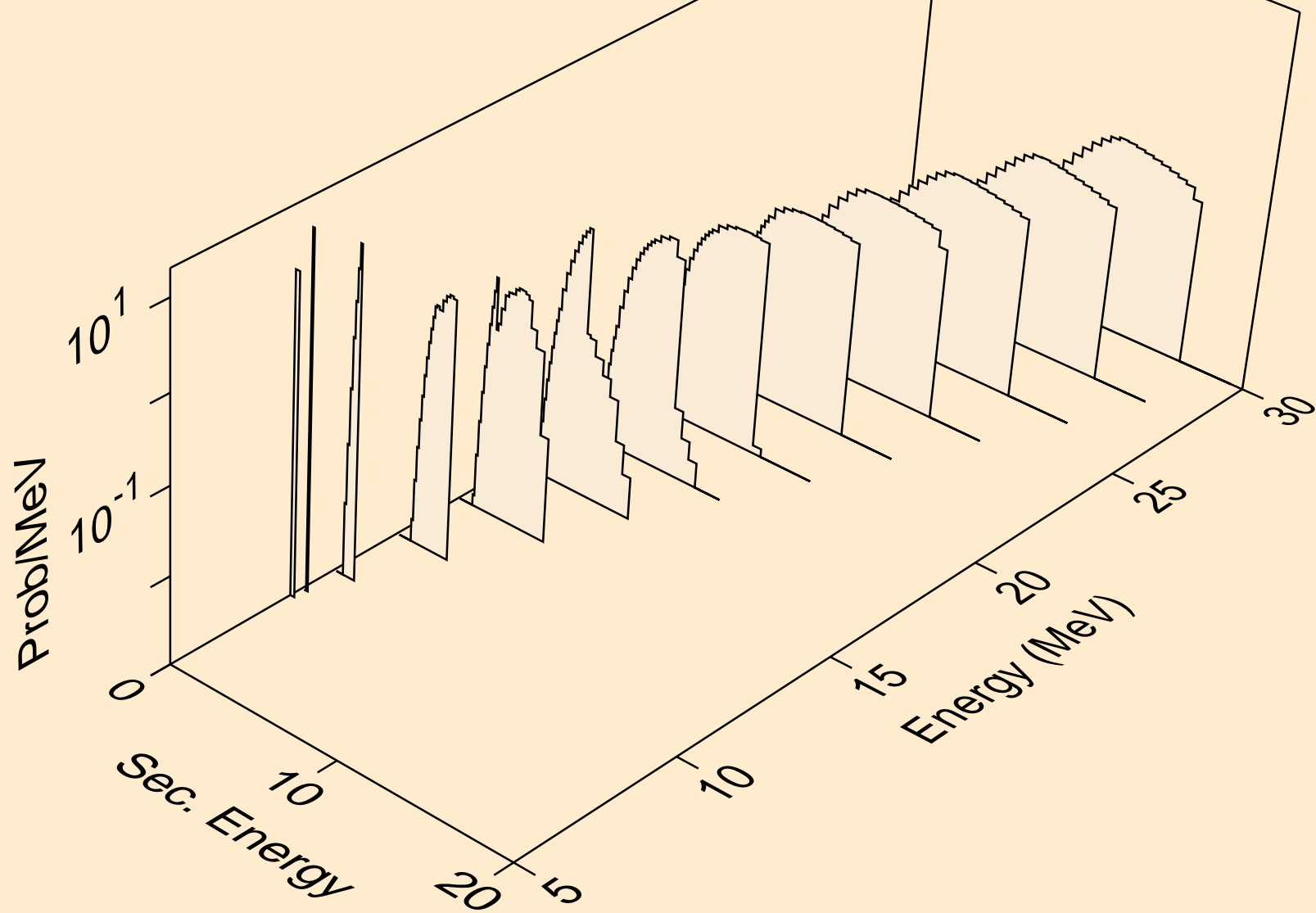

SC050 ALPHA ACER TENDL-2024 LIBRARY; T=0.K
protons from (a,2np)

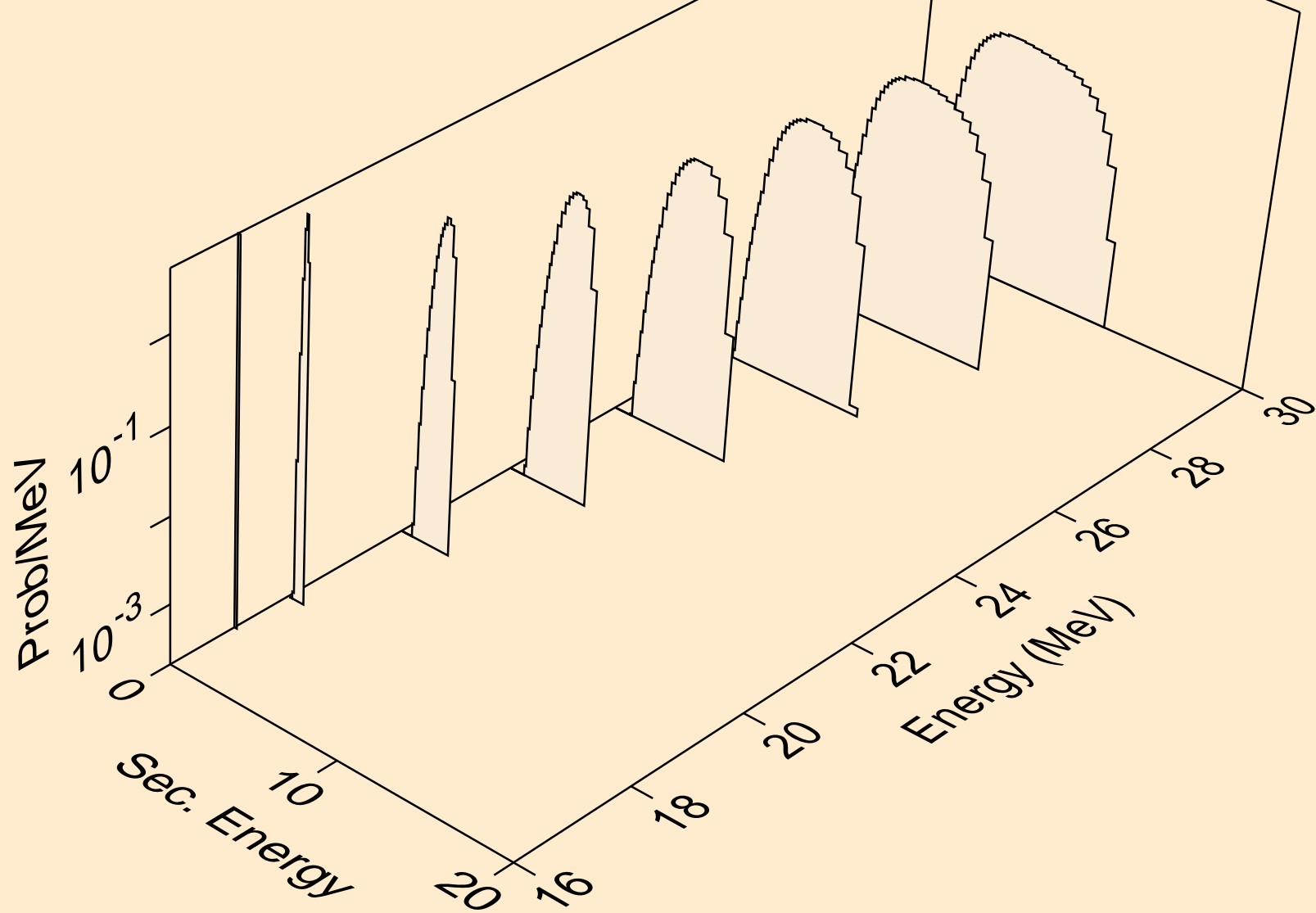

SC050 ALPHA ACER TENDL-2024 LIBRARY; T=0.K
protons from (a,3np)

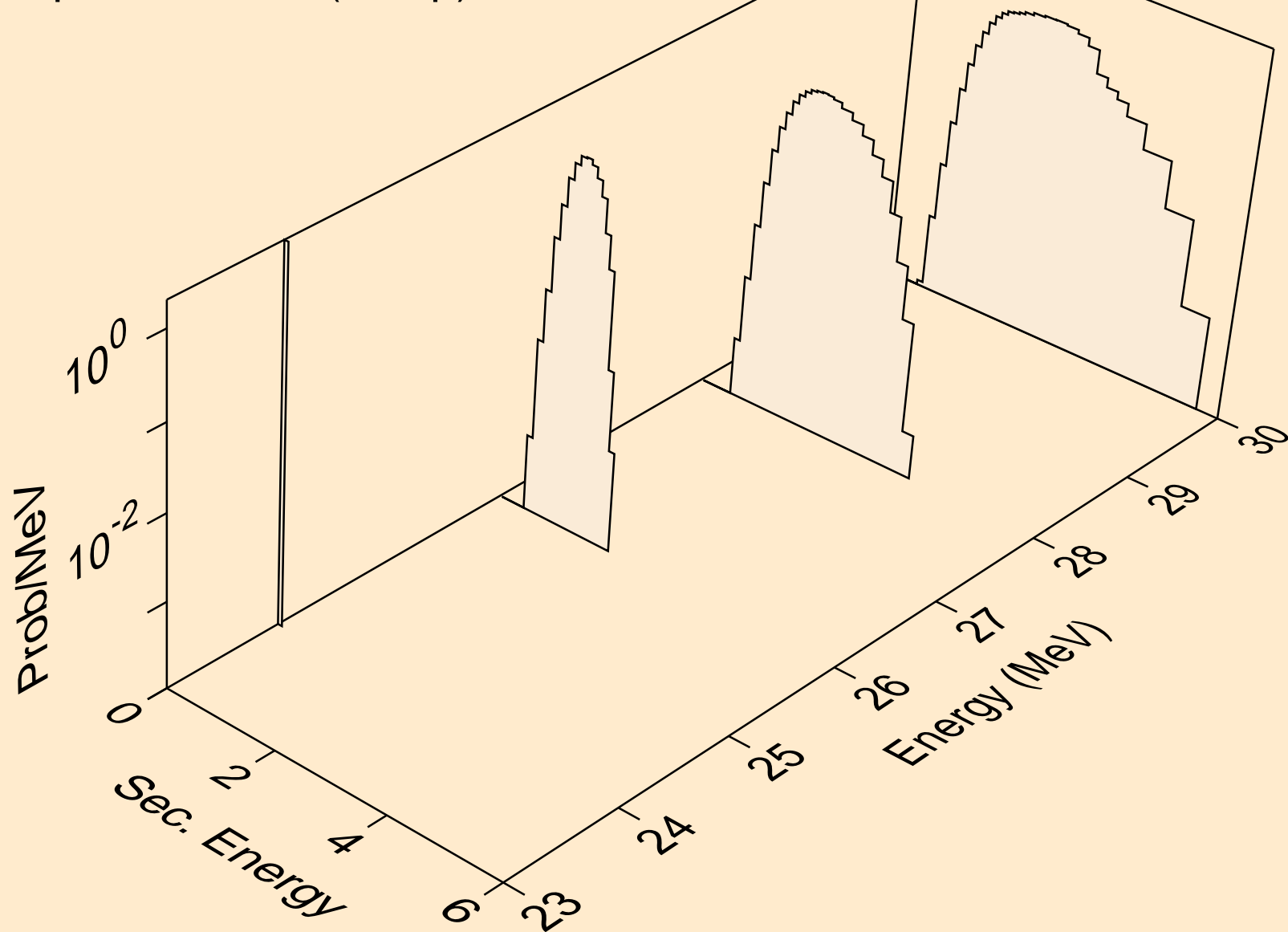

SC050 ALPHA ACER TENDL-2024 LIBRARY; T=0.K
protons from (a,n2p)

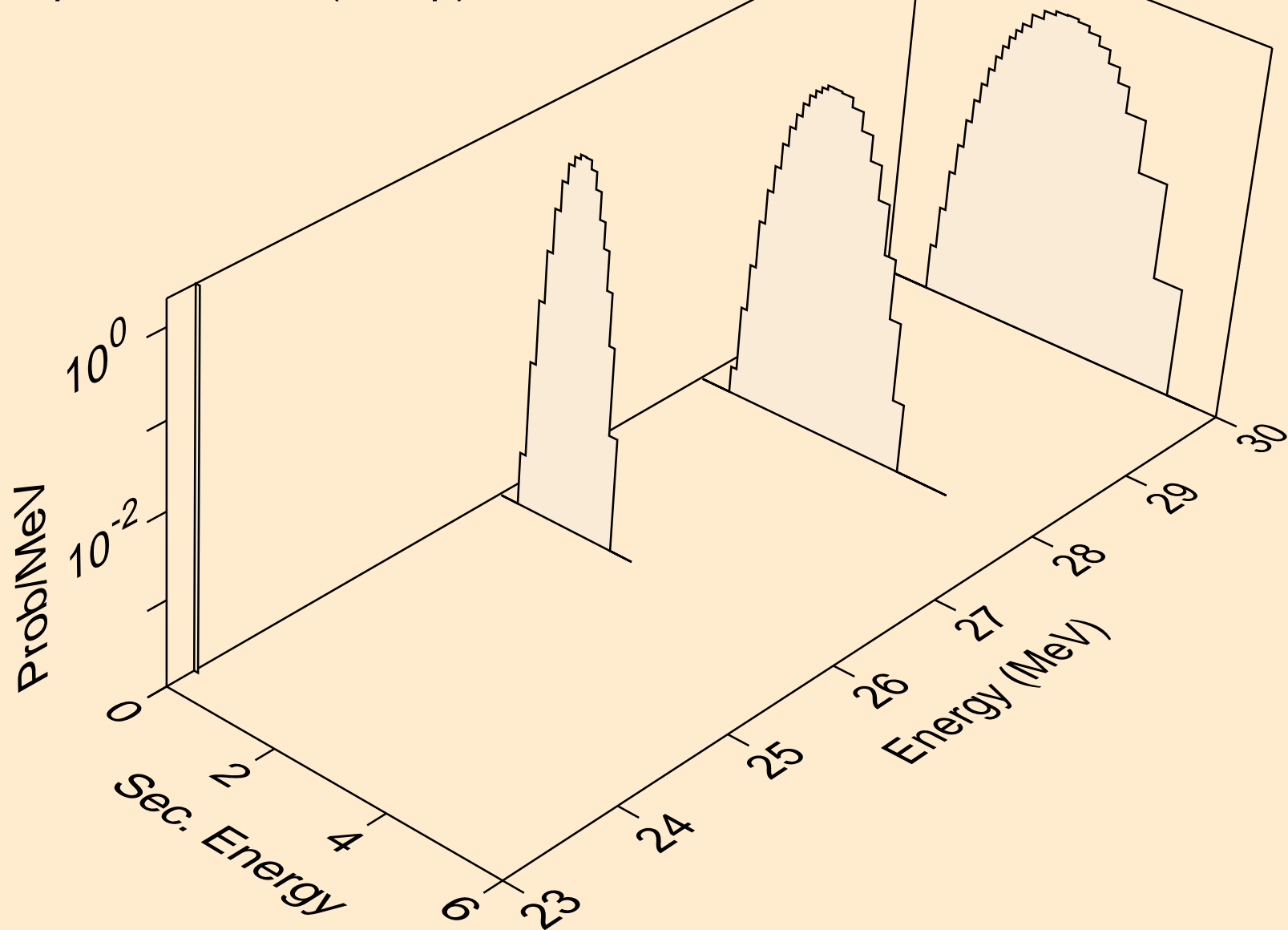

SC050 ALPHA ACER TENDL-2024 LIBRARY; T=0.K
protons from (a,npa)

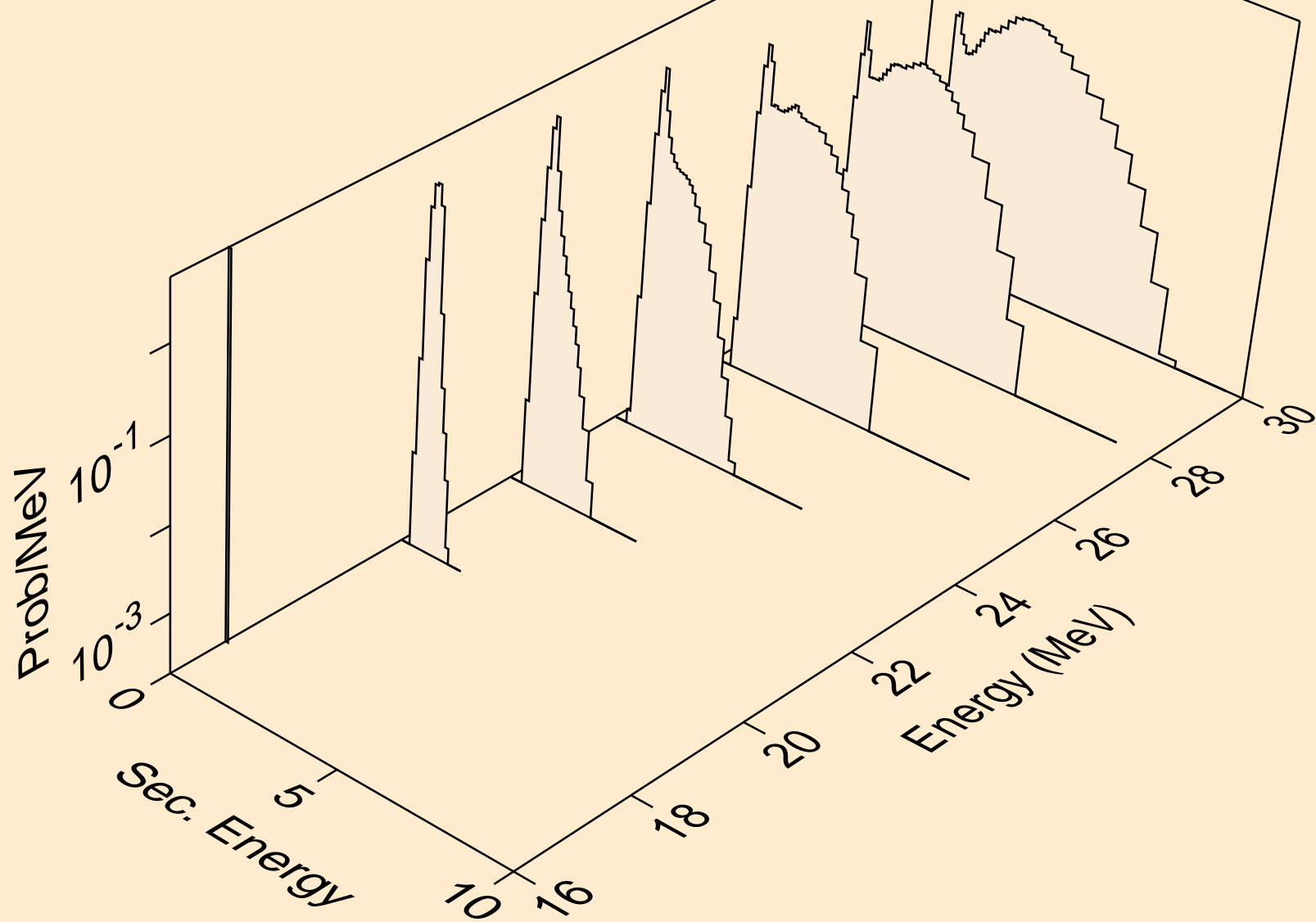

SC050 ALPHA ACER TENDL-2024 LIBRARY; T=0.K
protons from (a,p)

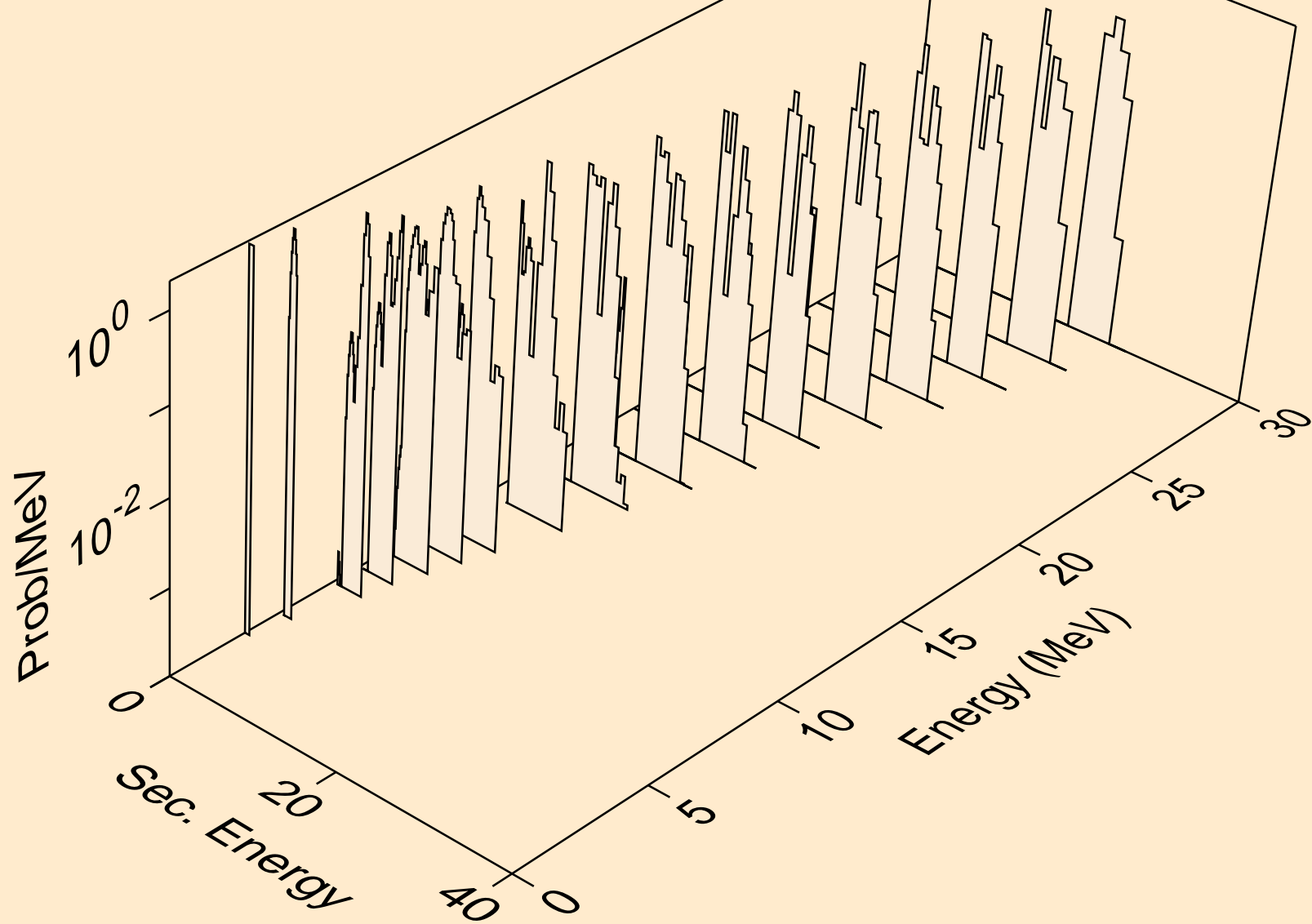

SC050 ALPHA ACER TENDL-2024 LIBRARY; T=0.K
protons from (a,2p)

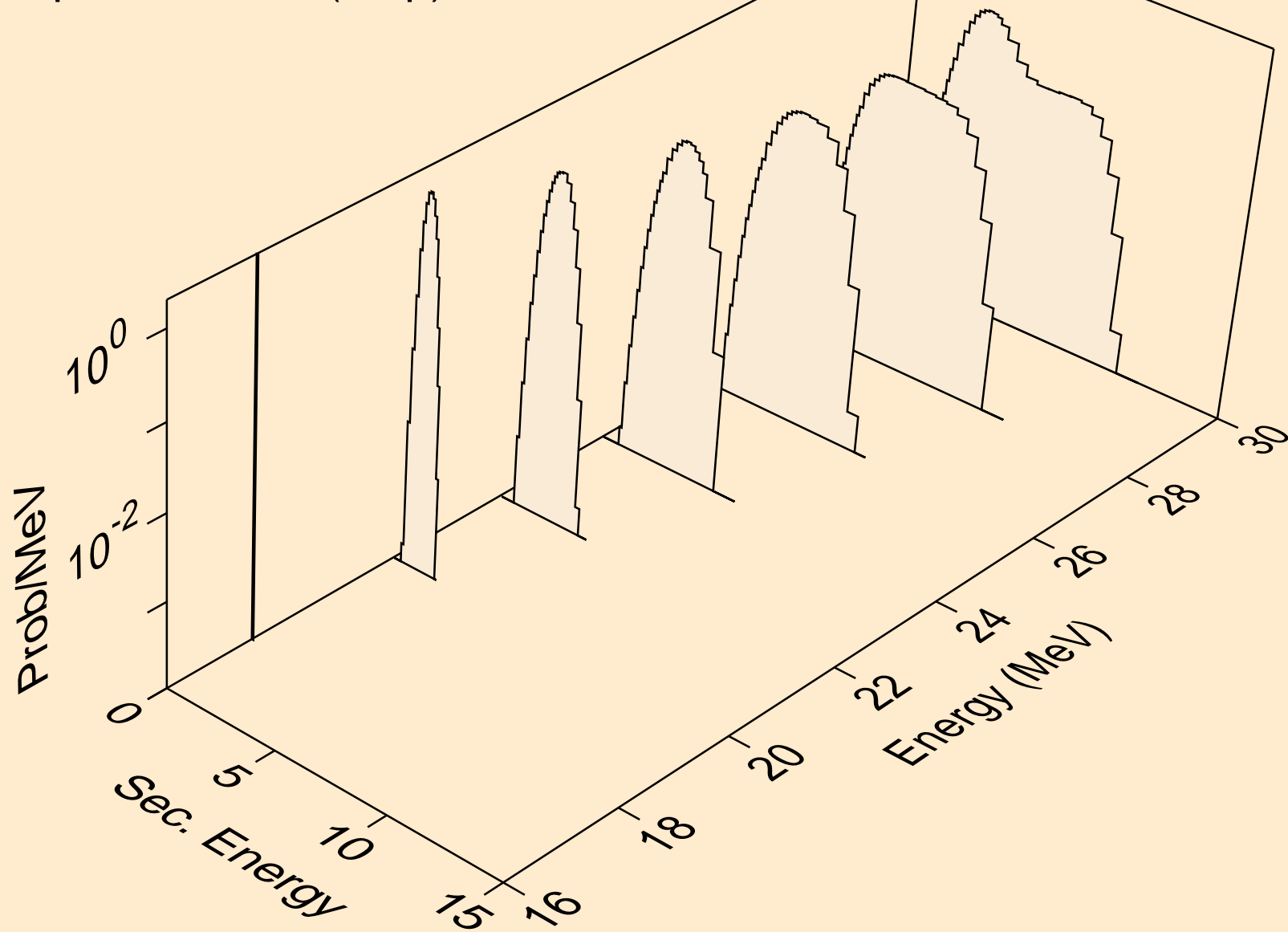

SC050 ALPHA ACER TENDL-2024 LIBRARY; T=0.K
protons from (a,pa)

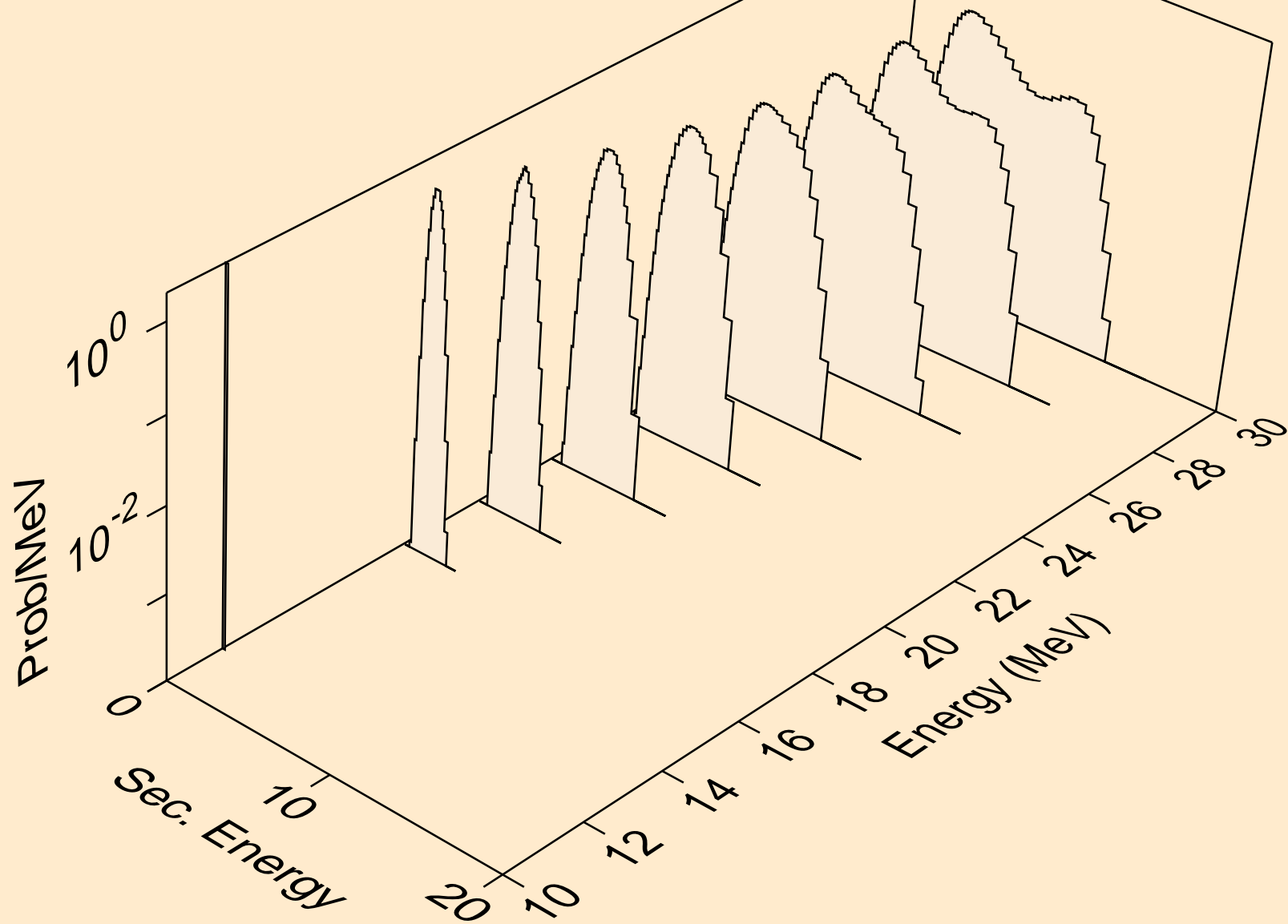

SC050 ALPHA ACER TENDL-2024 LIBRARY; T=0.K
protons from (a,pd)

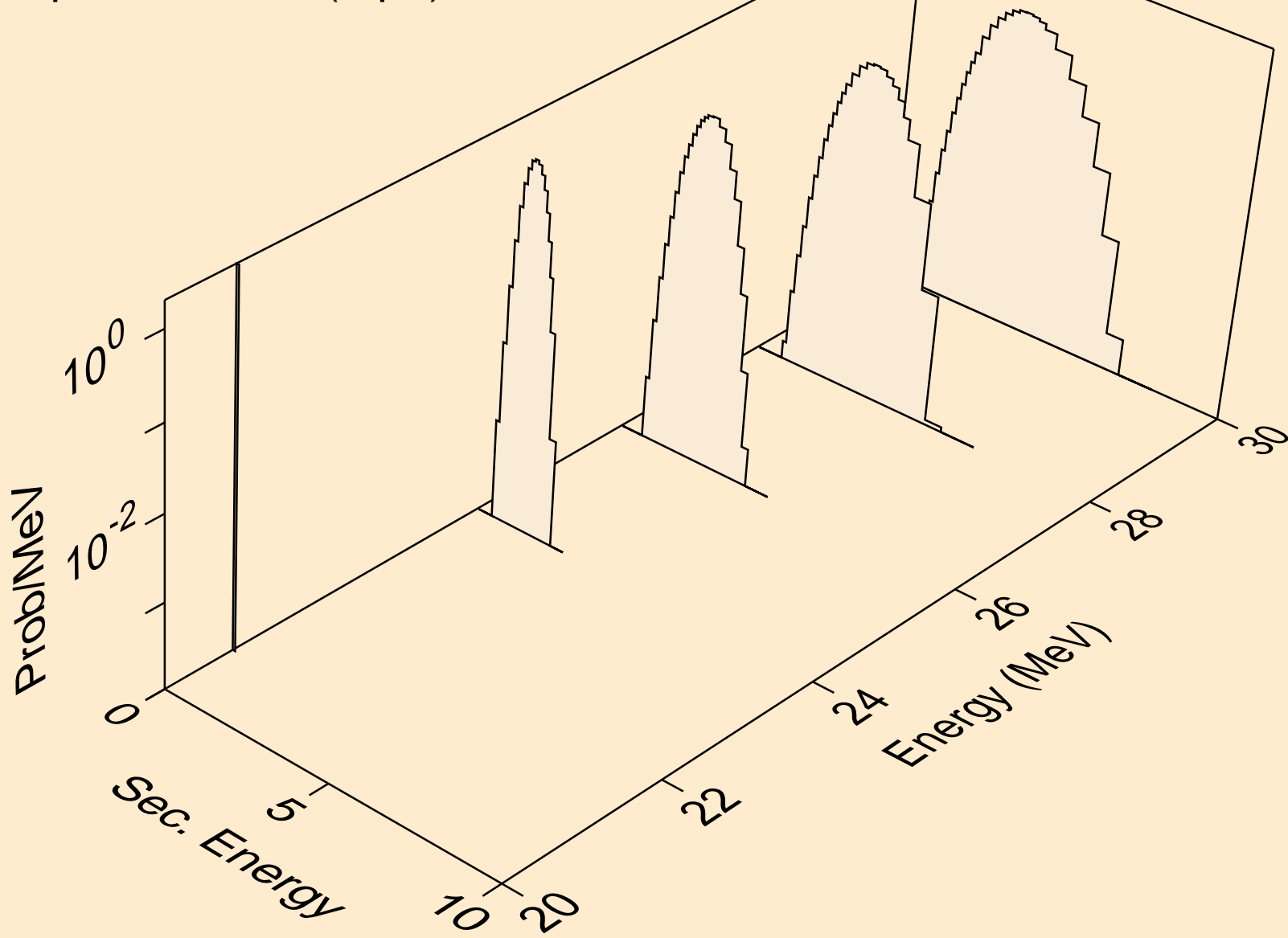

SC050 ALPHA ACER TENDL-2024 LIBRARY; T=0.K
protons from (a,pt)

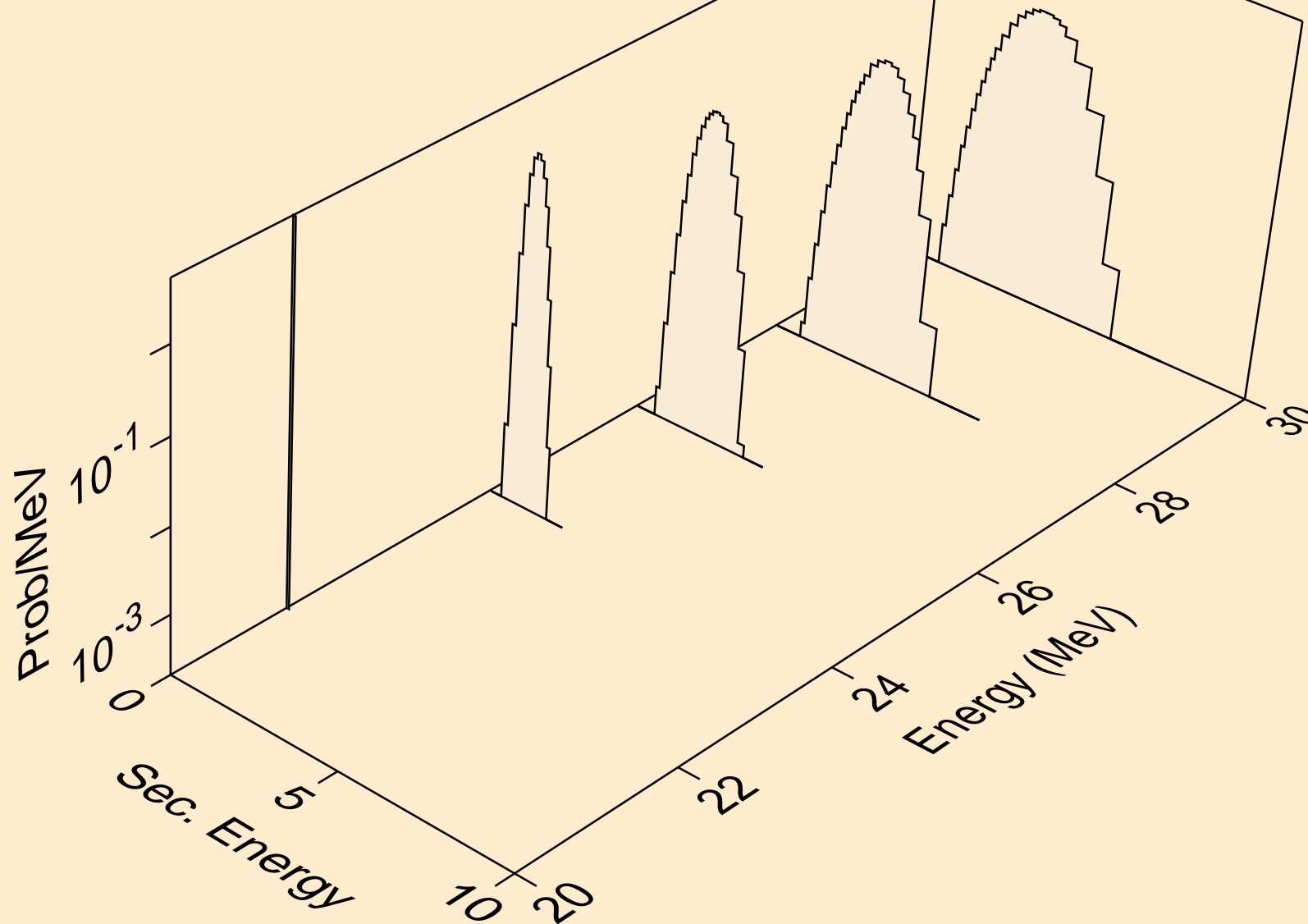

SC050 ALPHA ACER TENDL-2024 LIBRARY; T=0.K
deuterons from (a,x)

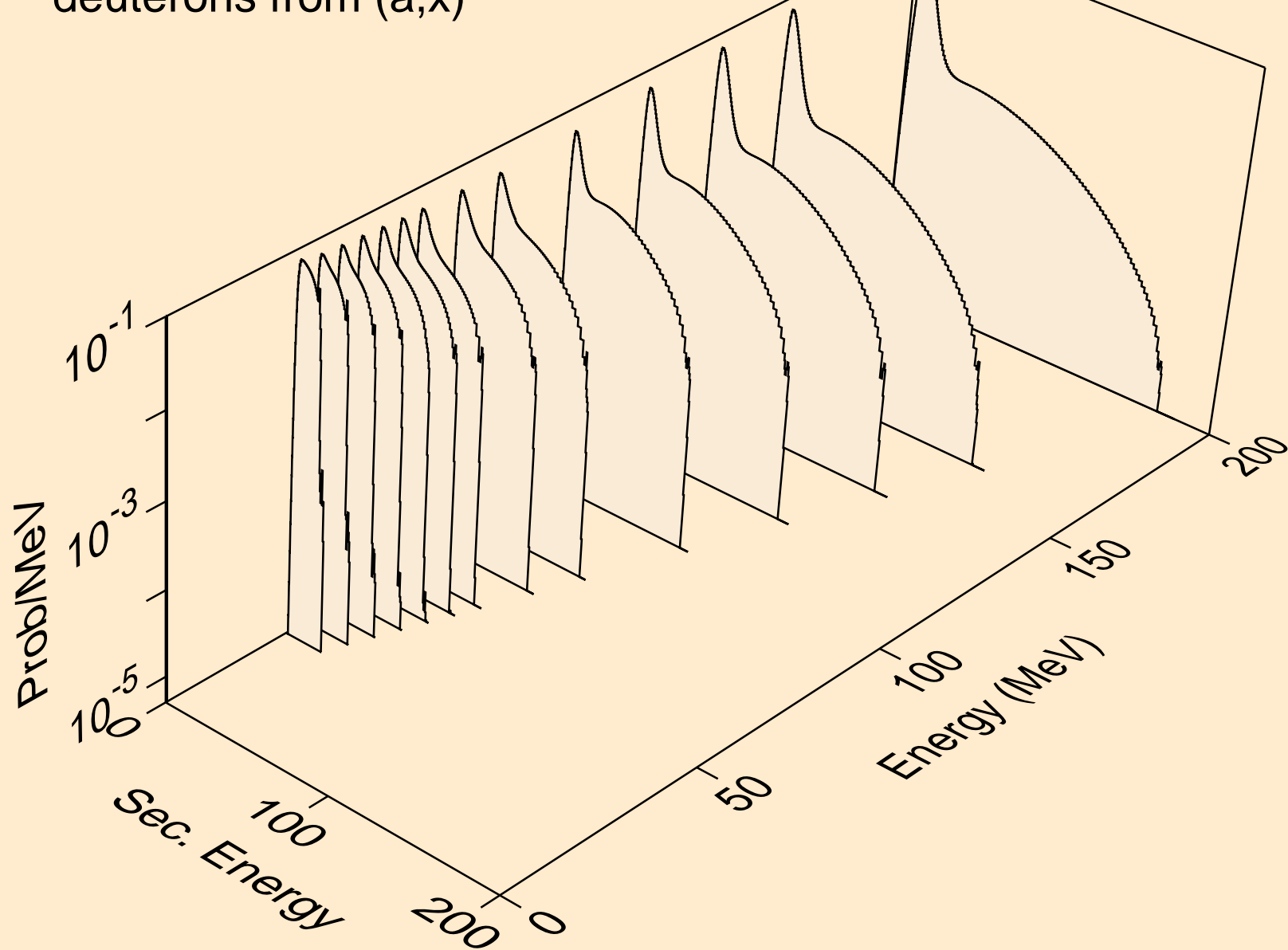

SC050 ALPHA ACER TENDL-2024 LIBRARY; T=0.K
deuterons from (a,2nd)

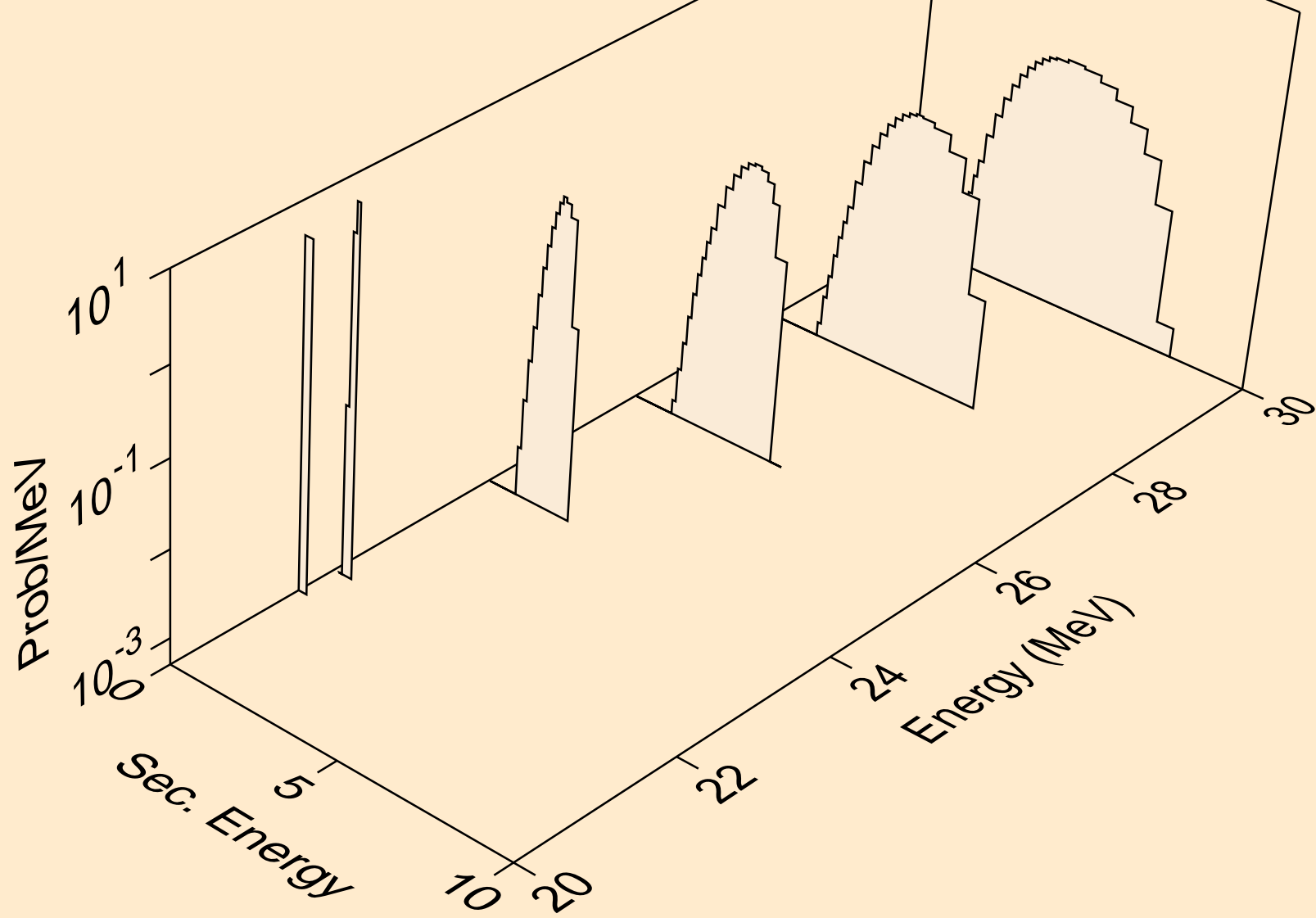

SC050 ALPHA ACER TENDL-2024 LIBRARY; T=0.K
deuterons from (a,n*)d

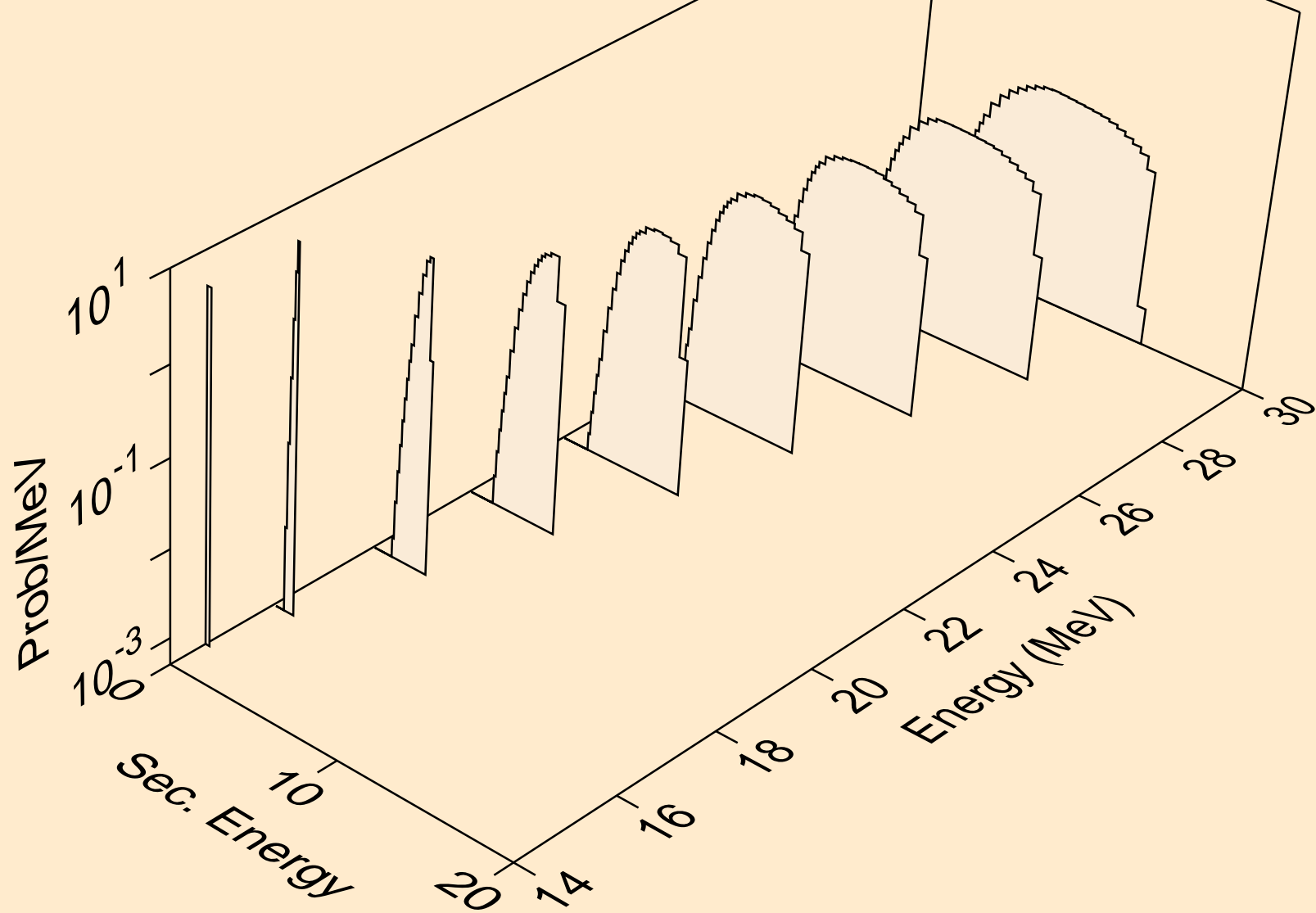

SC050 ALPHA ACER TENDL-2024 LIBRARY; T=0.K
deuterons from (a,d)

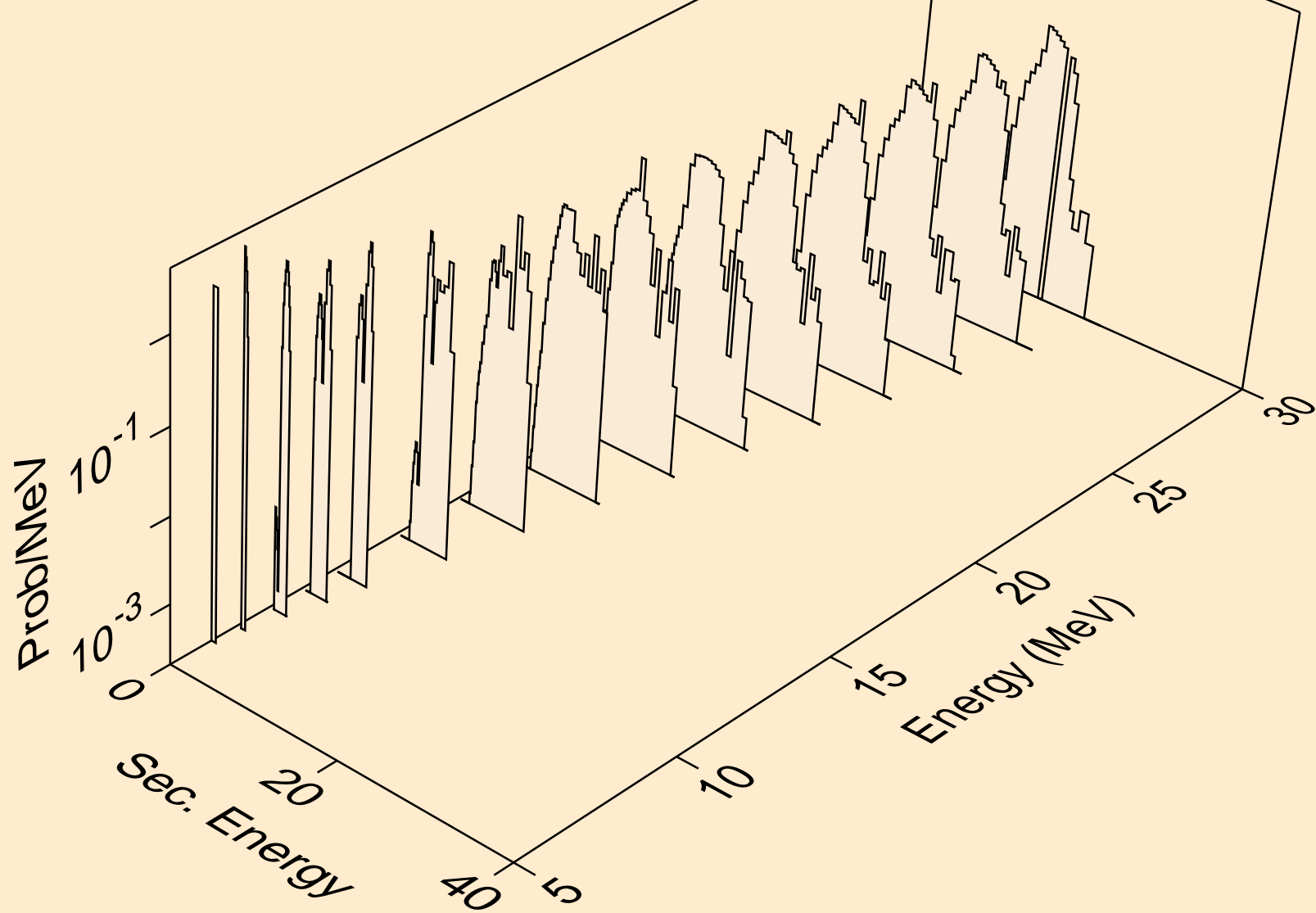

SC050 ALPHA ACER TENDL-2024 LIBRARY; T=0.K
deuterons from (a,pd)

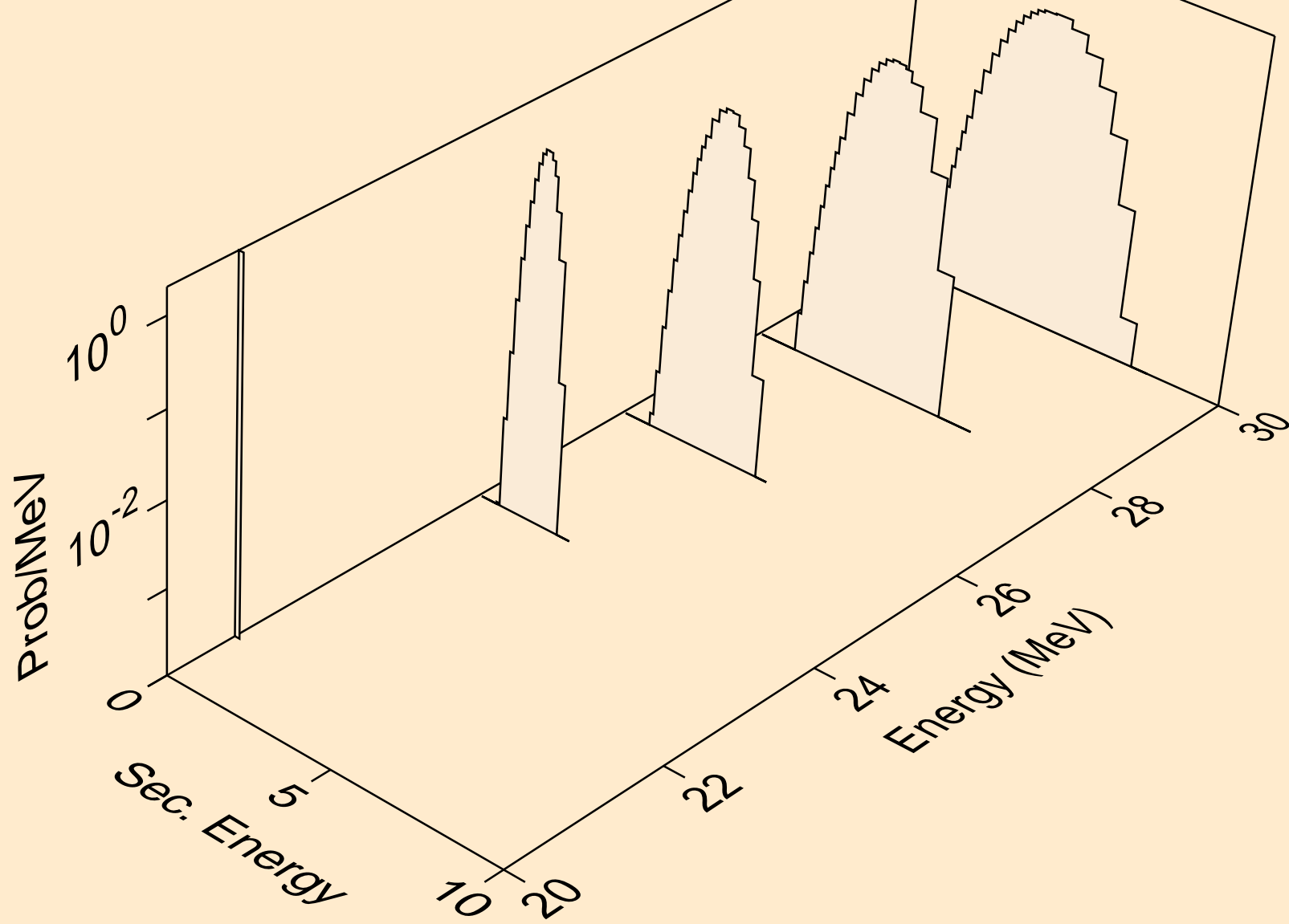

SC050 ALPHA ACER TENDL-2024 LIBRARY; T=0.K
deuterons from (a,da)

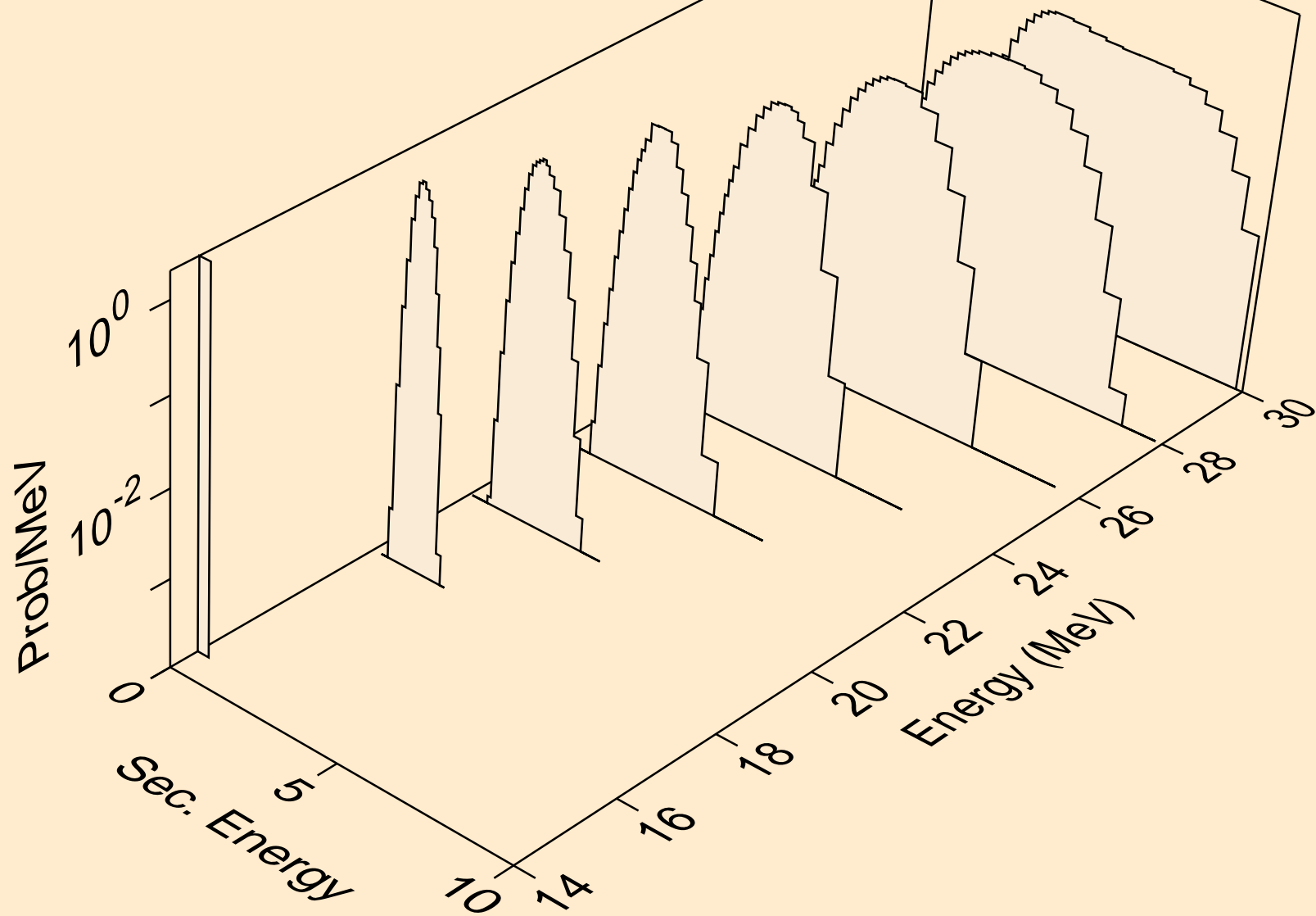

SC050 ALPHA ACER TENDL-2024 LIBRARY; T=0.K
tritons from (a,x)

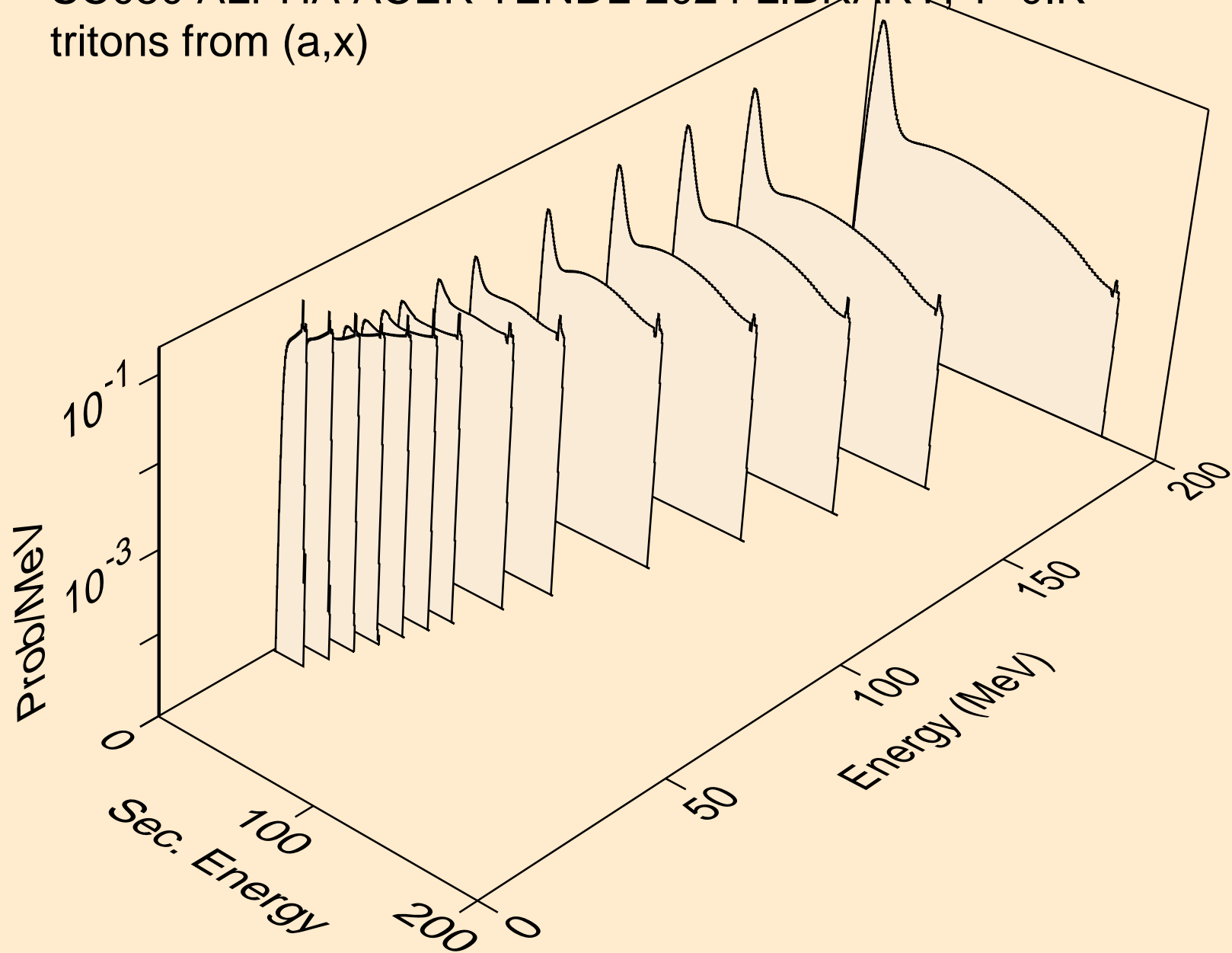

SC050 ALPHA ACER TENDL-2024 LIBRARY; T=0.K
tritons from (a,n*)t

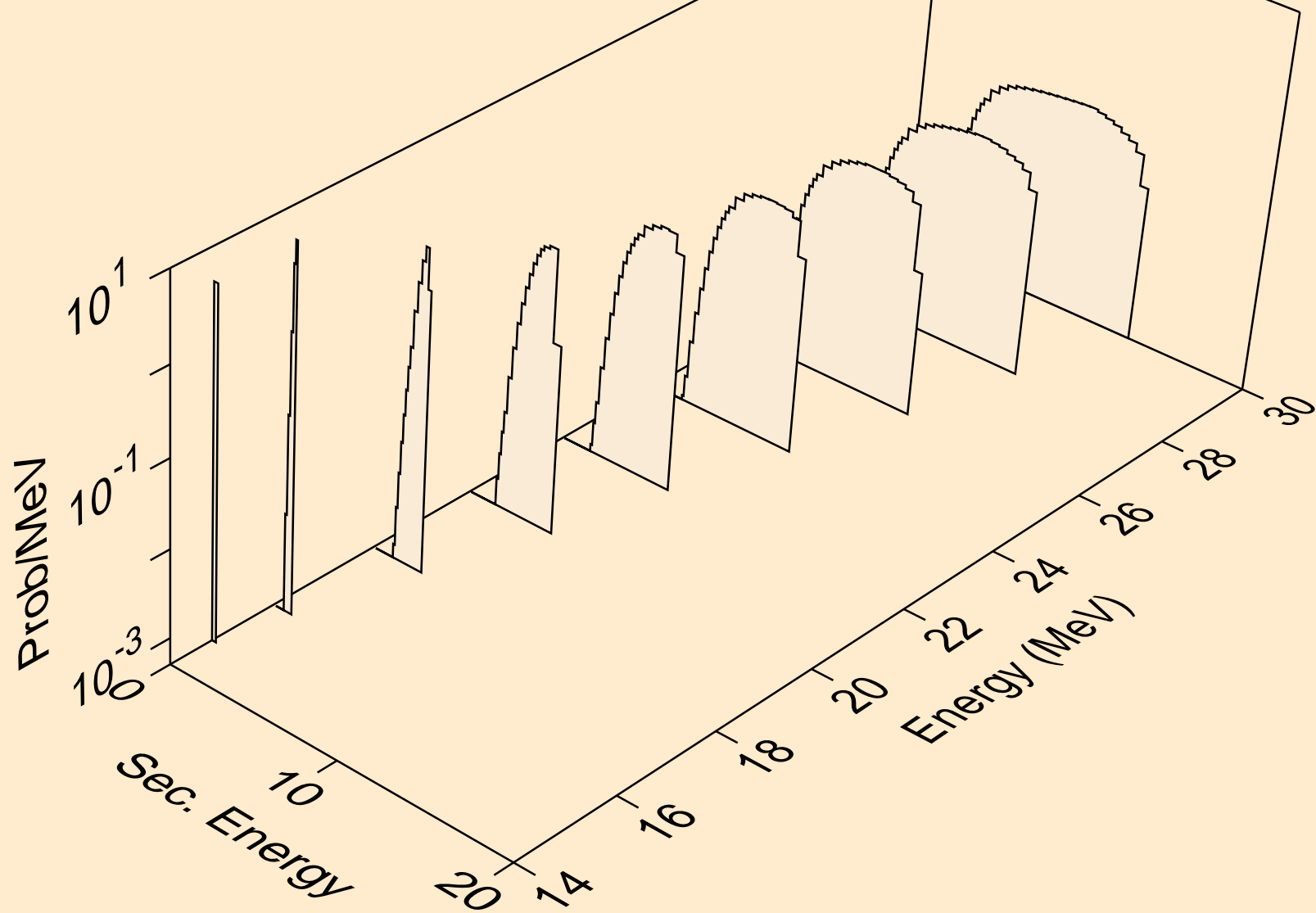

SC050 ALPHA ACER TENDL-2024 LIBRARY; T=0.K
tritons from (a,t)

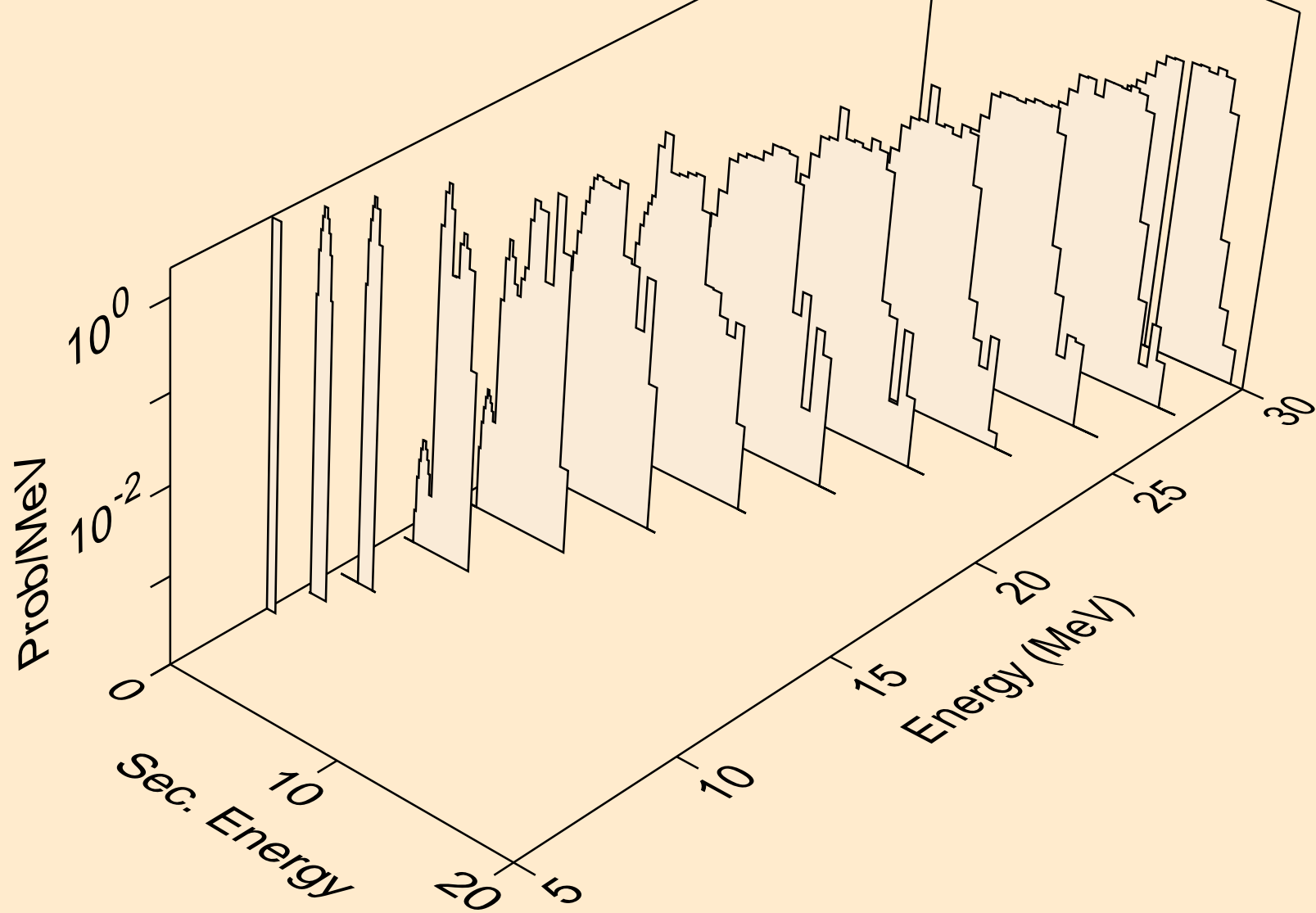

SC050 ALPHA ACER TENDL-2024 LIBRARY; T=0.K
tritons from (a,pt)

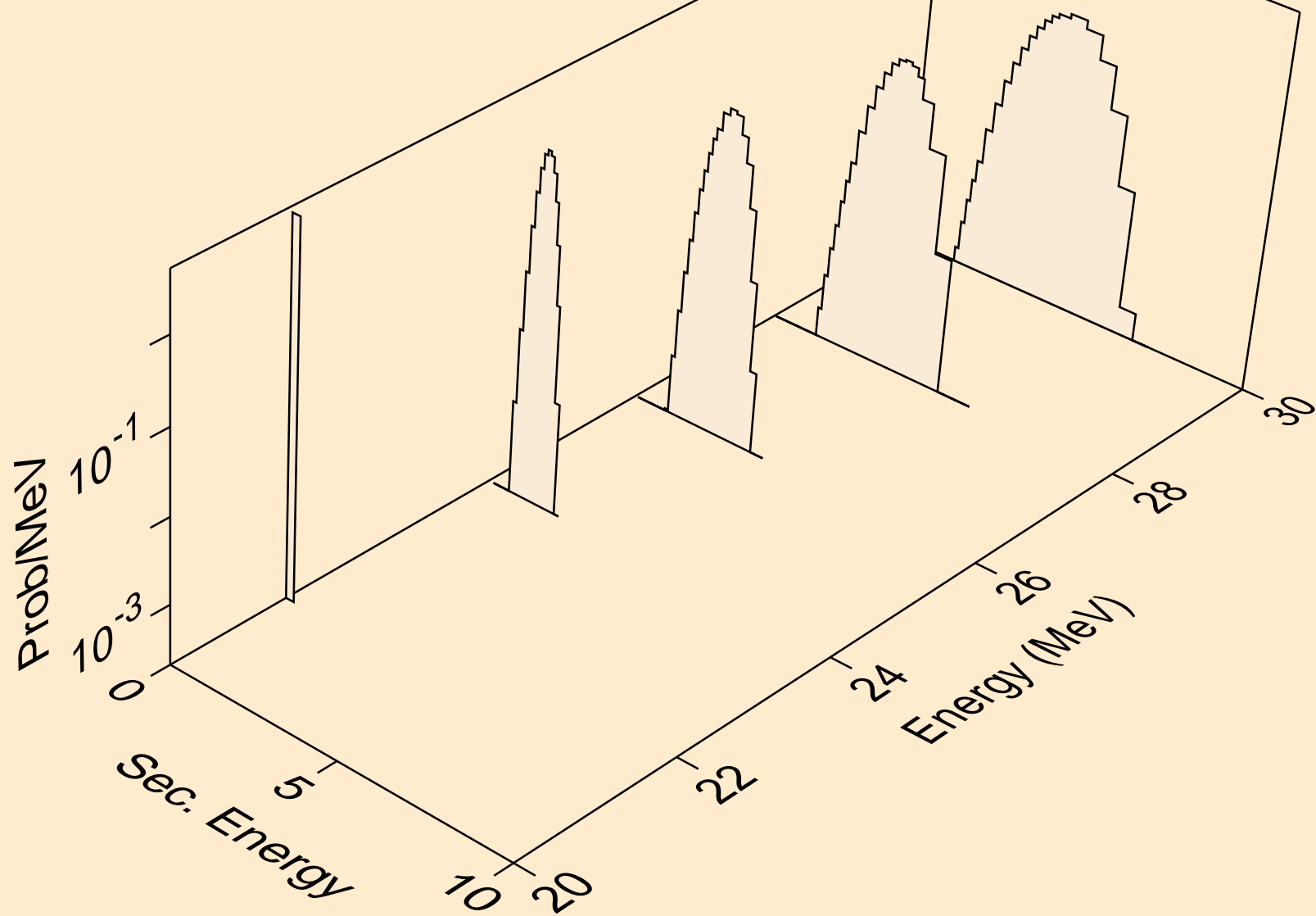

SC050 ALPHA ACER TENDL-2024 LIBRARY; T=0.K
he3s from (a,x)

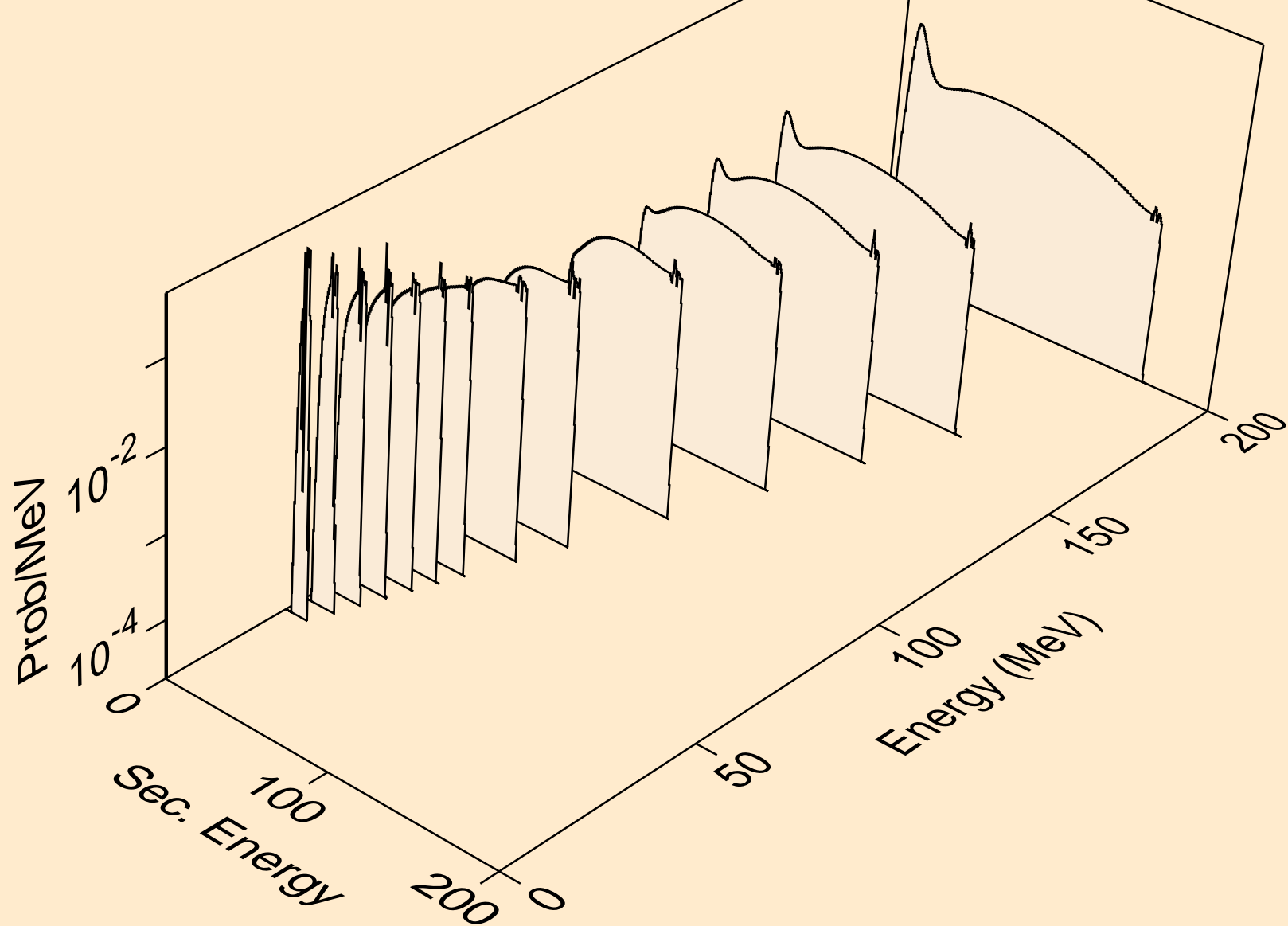

SC050 ALPHA ACER TENDL-2024 LIBRARY; T=0.K
he3s from (a,n*)he3

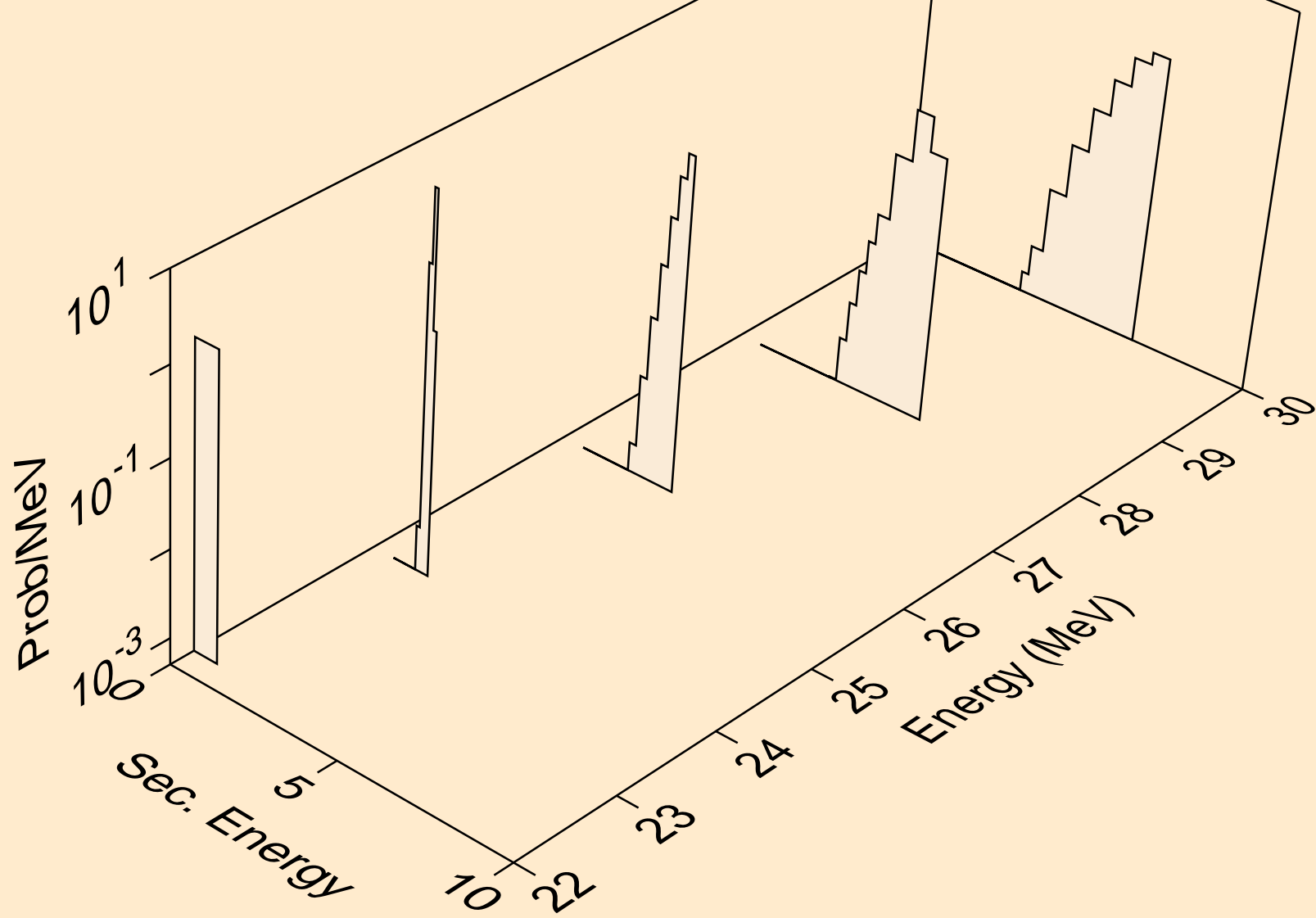

SC050 ALPHA ACER TENDL-2024 LIBRARY; T=0.K
he3s from (a,he3)

