

W176 ALPHA ACER TENDL-2024 LIBRARY; T=0.K
Principal cross sections

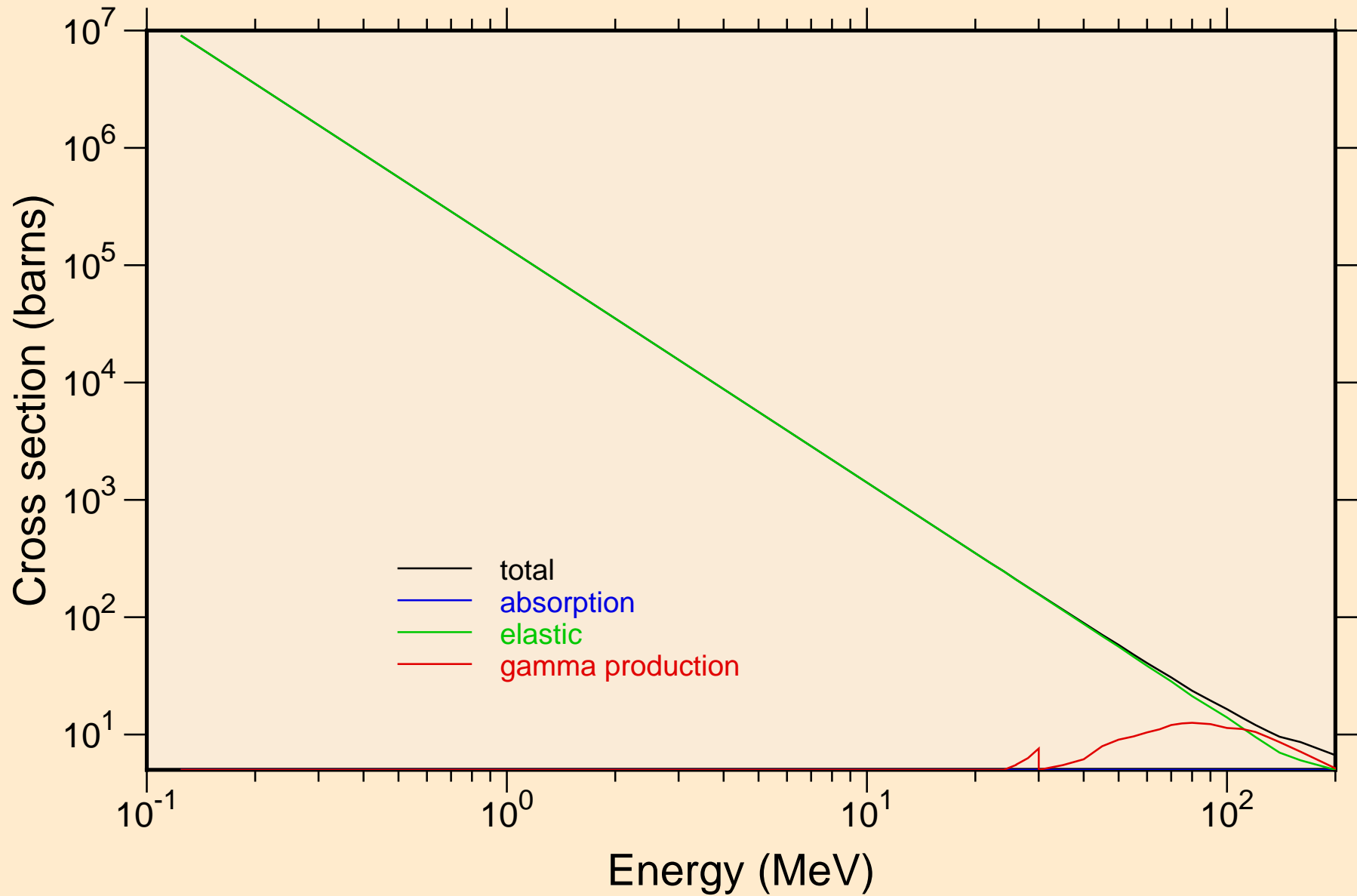

W176 ALPHA ACER TENDL-2024 LIBRARY; T=0.K

Heating

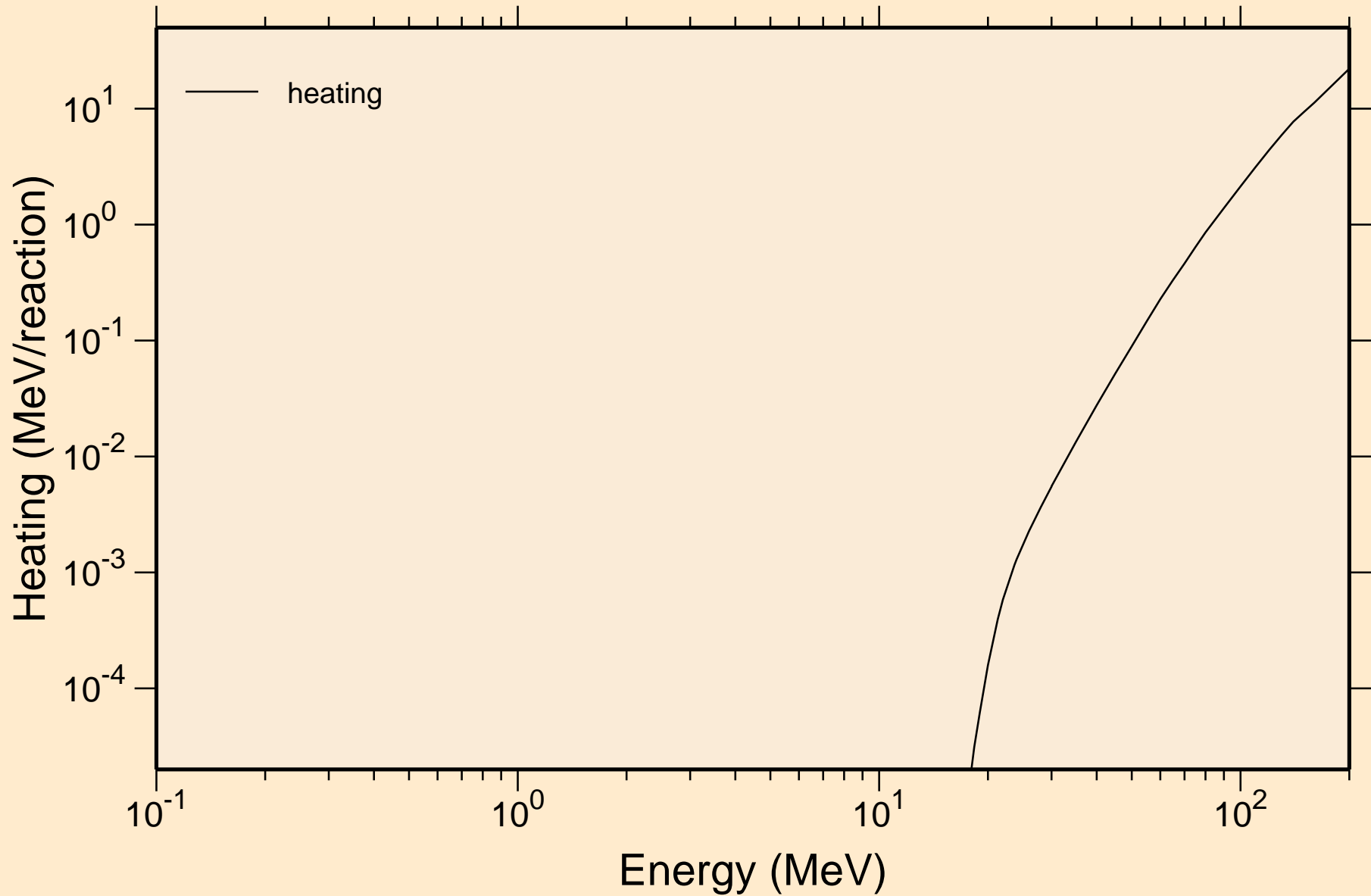

W176 ALPHA ACER TENDL-2024 LIBRARY; T=0.K

Principal cross sections

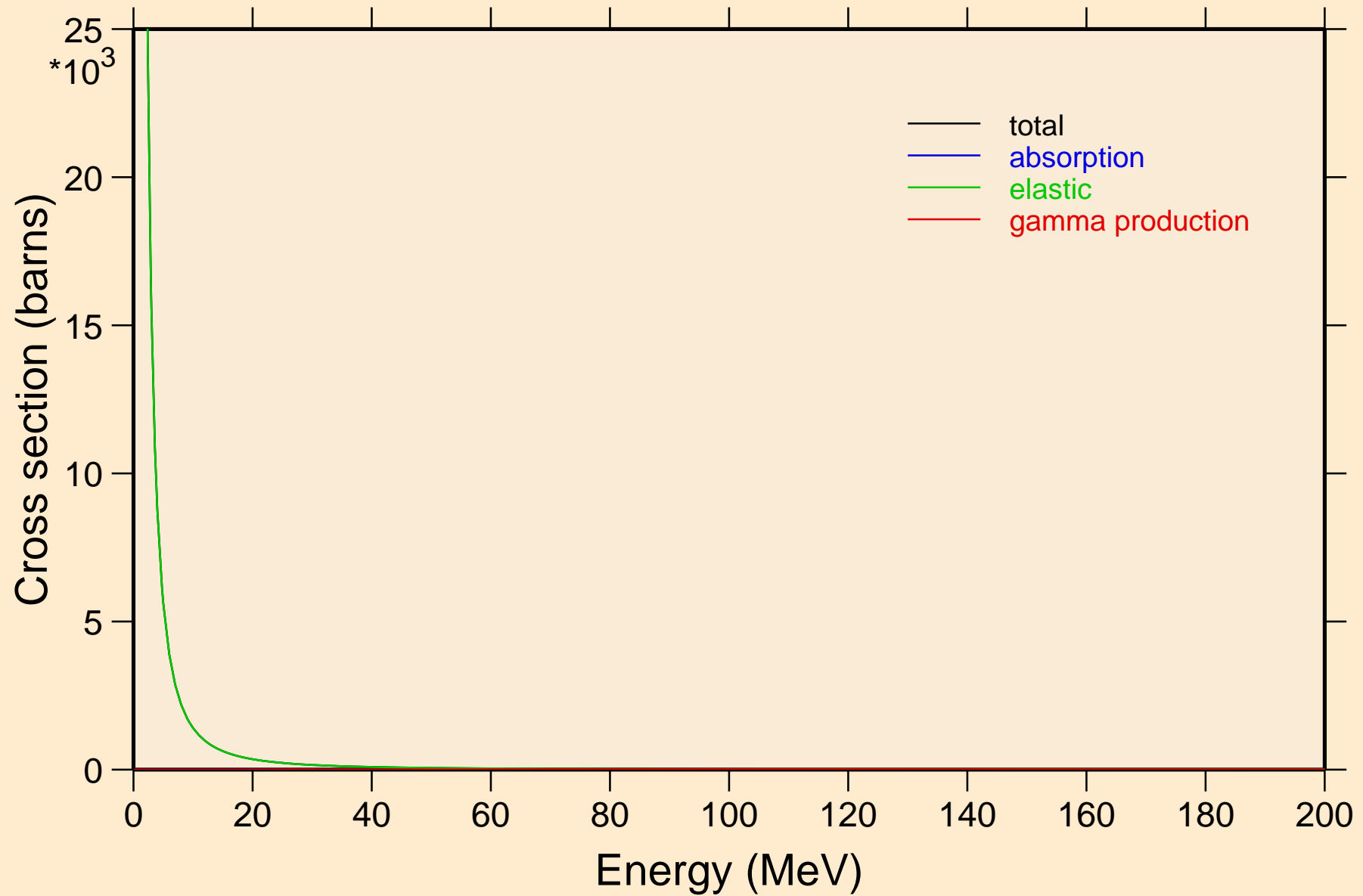

W176 ALPHA ACER TENDL-2024 LIBRARY; T=0.K

Heating

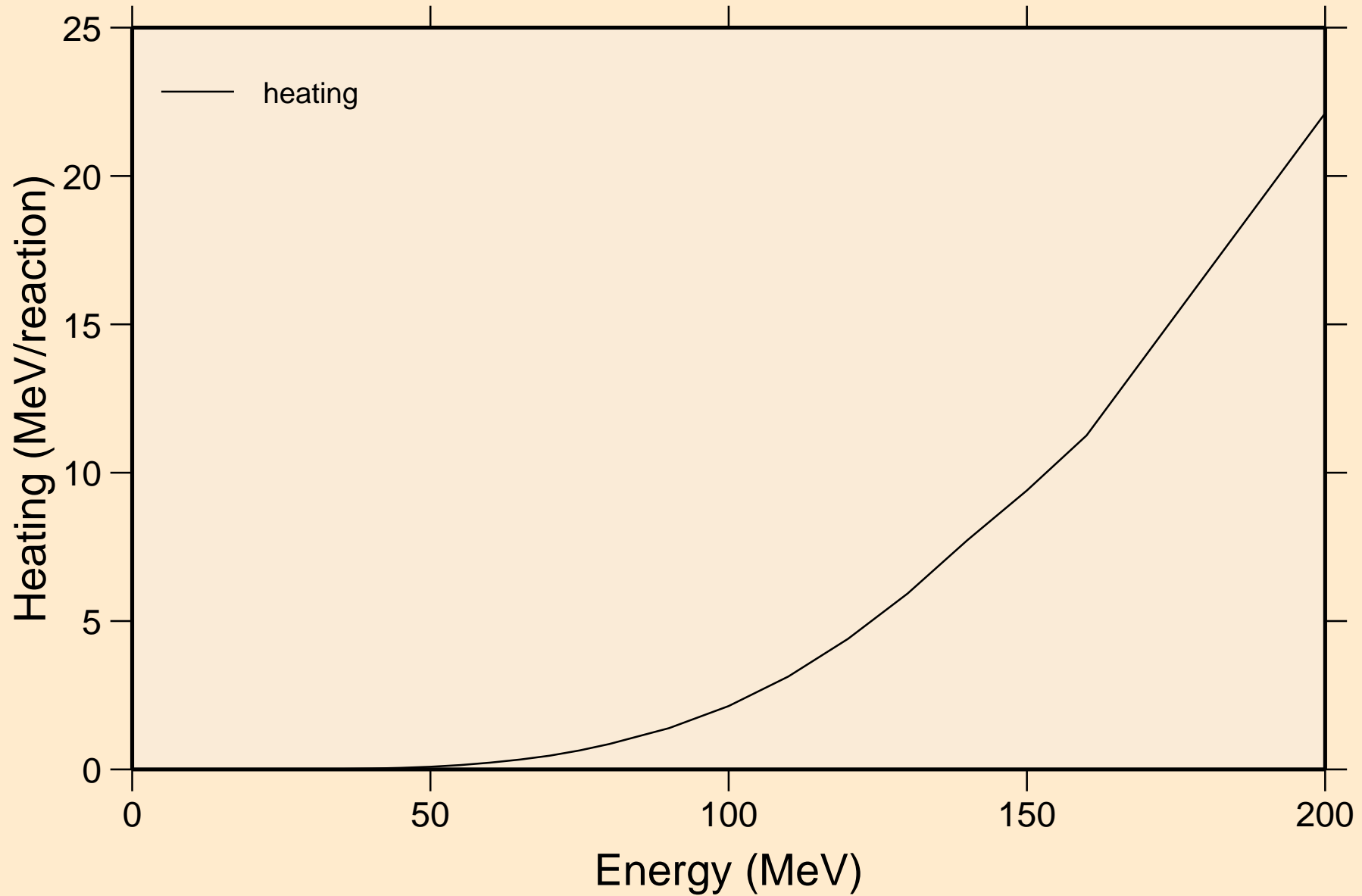

W176 ALPHA ACER TENDL-2024 LIBRARY; T=0.K
Threshold reactions

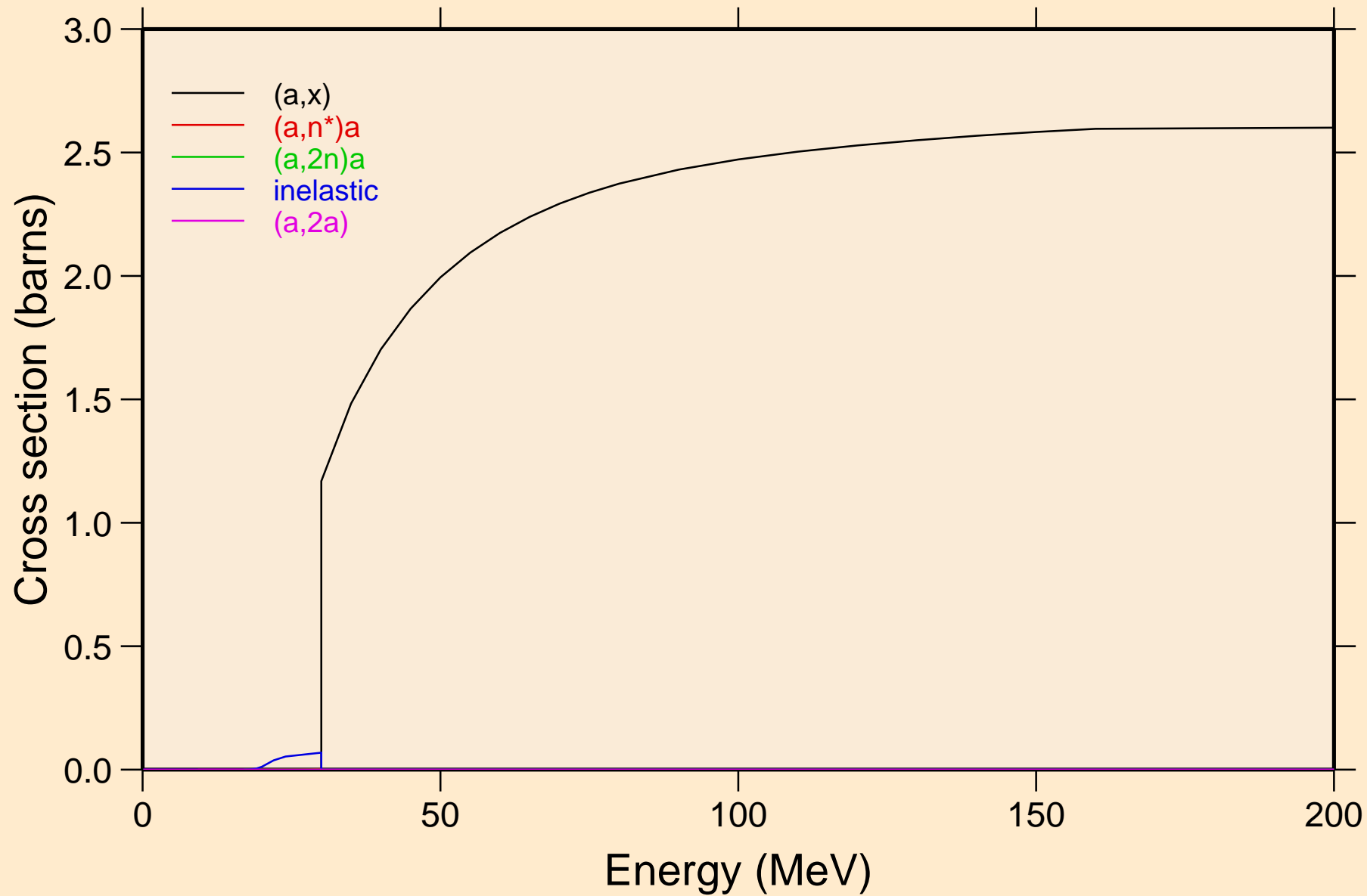

W176 ALPHA ACER TENDL-2024 LIBRARY; T=0.K
Threshold reactions

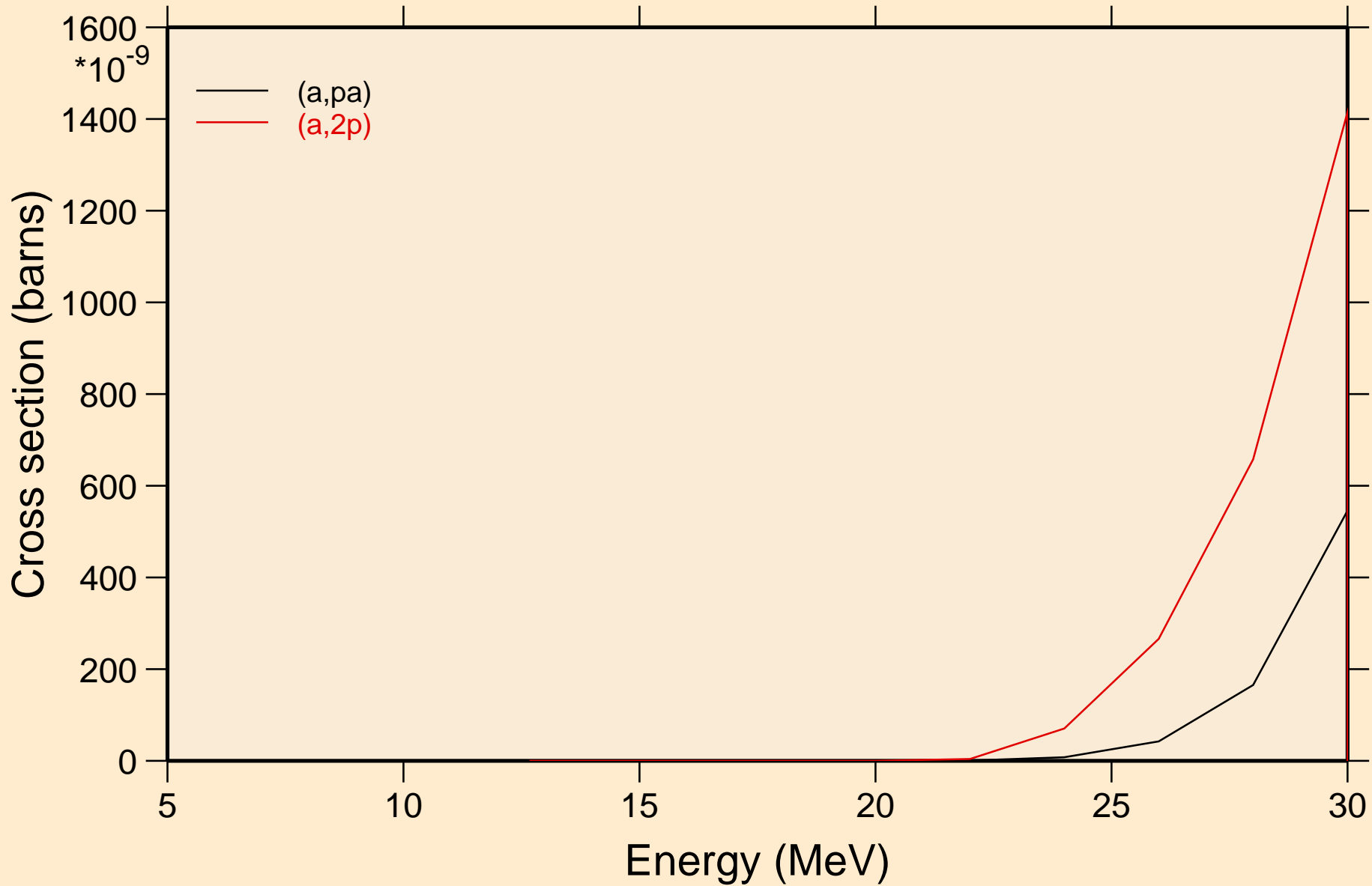

W176 ALPHA ACER TENDL-2024 LIBRARY; T=0.K
Threshold reactions

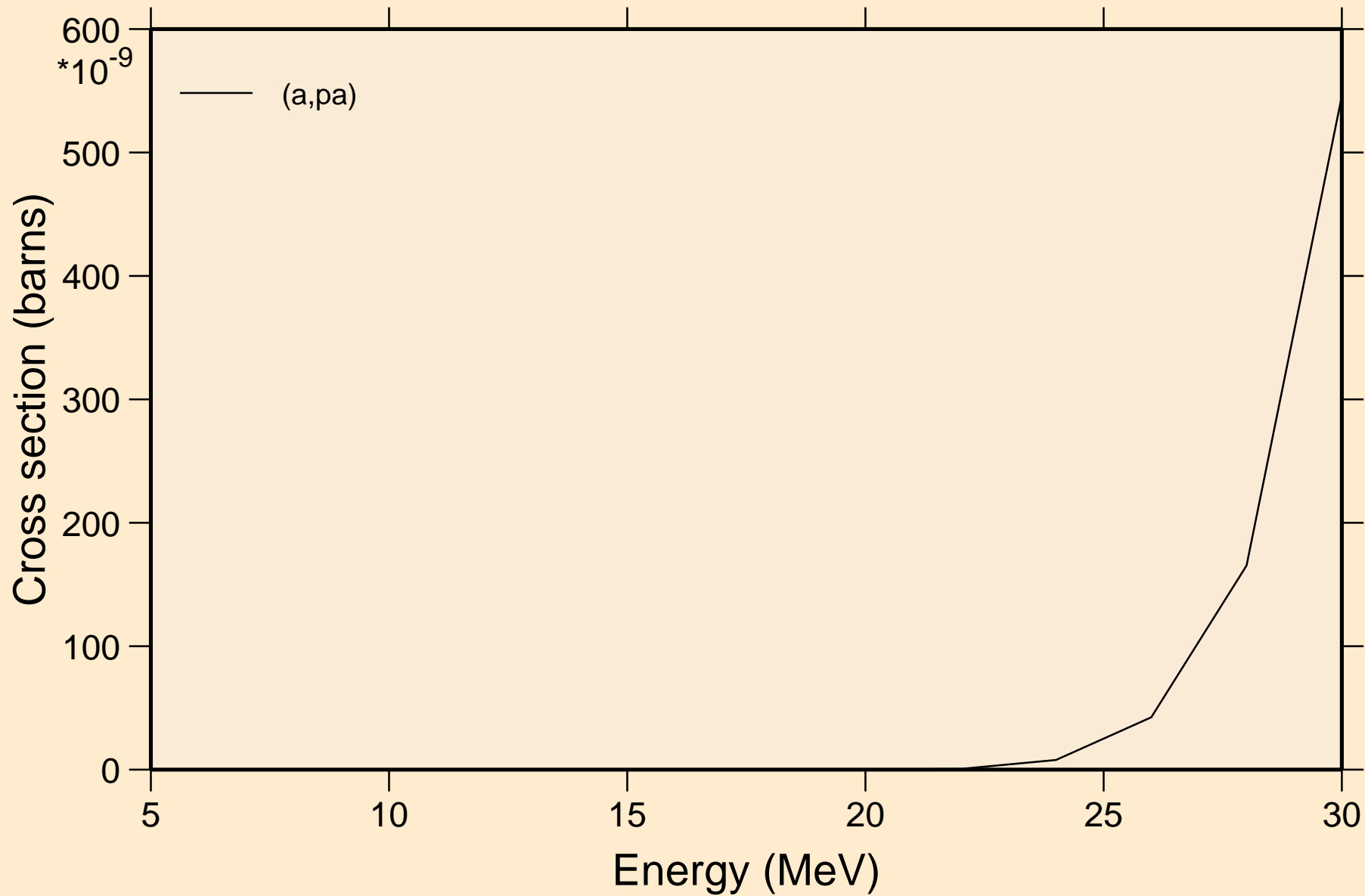

W176 ALPHA ACER TENDL-2024 LIBRARY; T=0.K
angular distribution for elastic

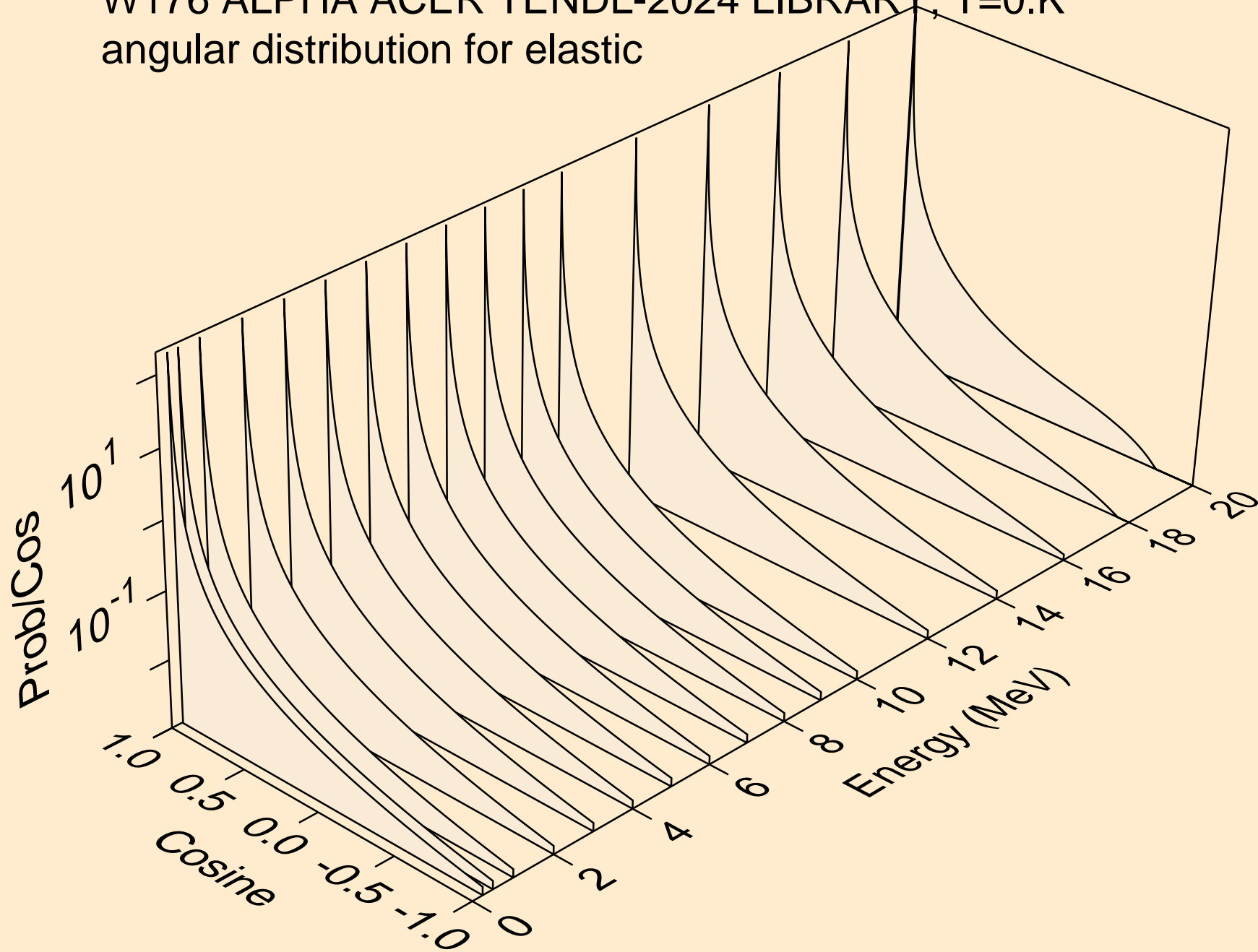

W176 ALPHA ACER TENDL-2024 LIBRARY; T=0.K
angular distribution for elastic

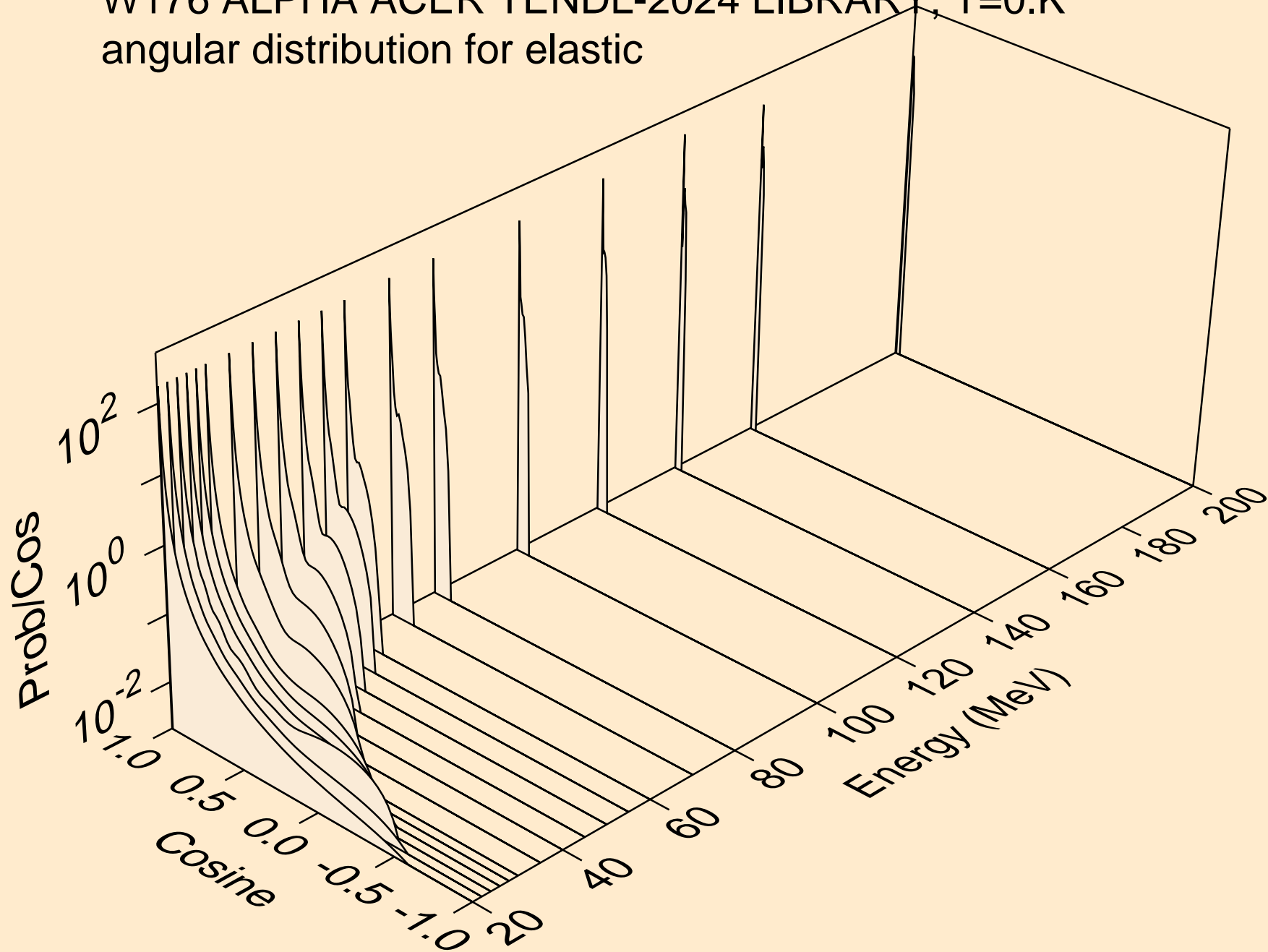

W176 ALPHA ACER TENDL-2024 LIBRARY; T=0.K
Alpha emission for (a,x)

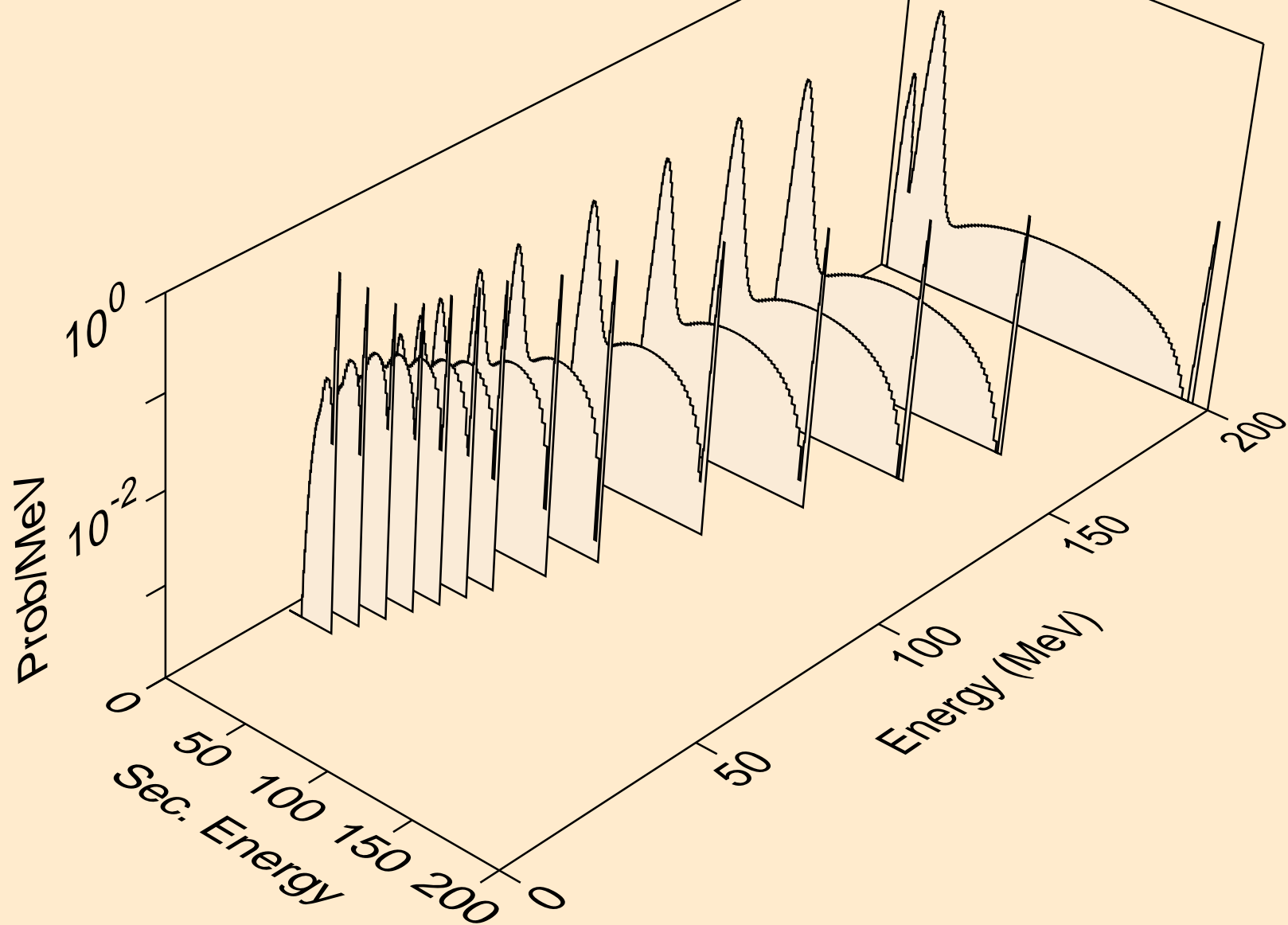

W176 ALPHA ACER TENDL-2024 LIBRARY; T=0.K
Alpha emission for (a,n*)a

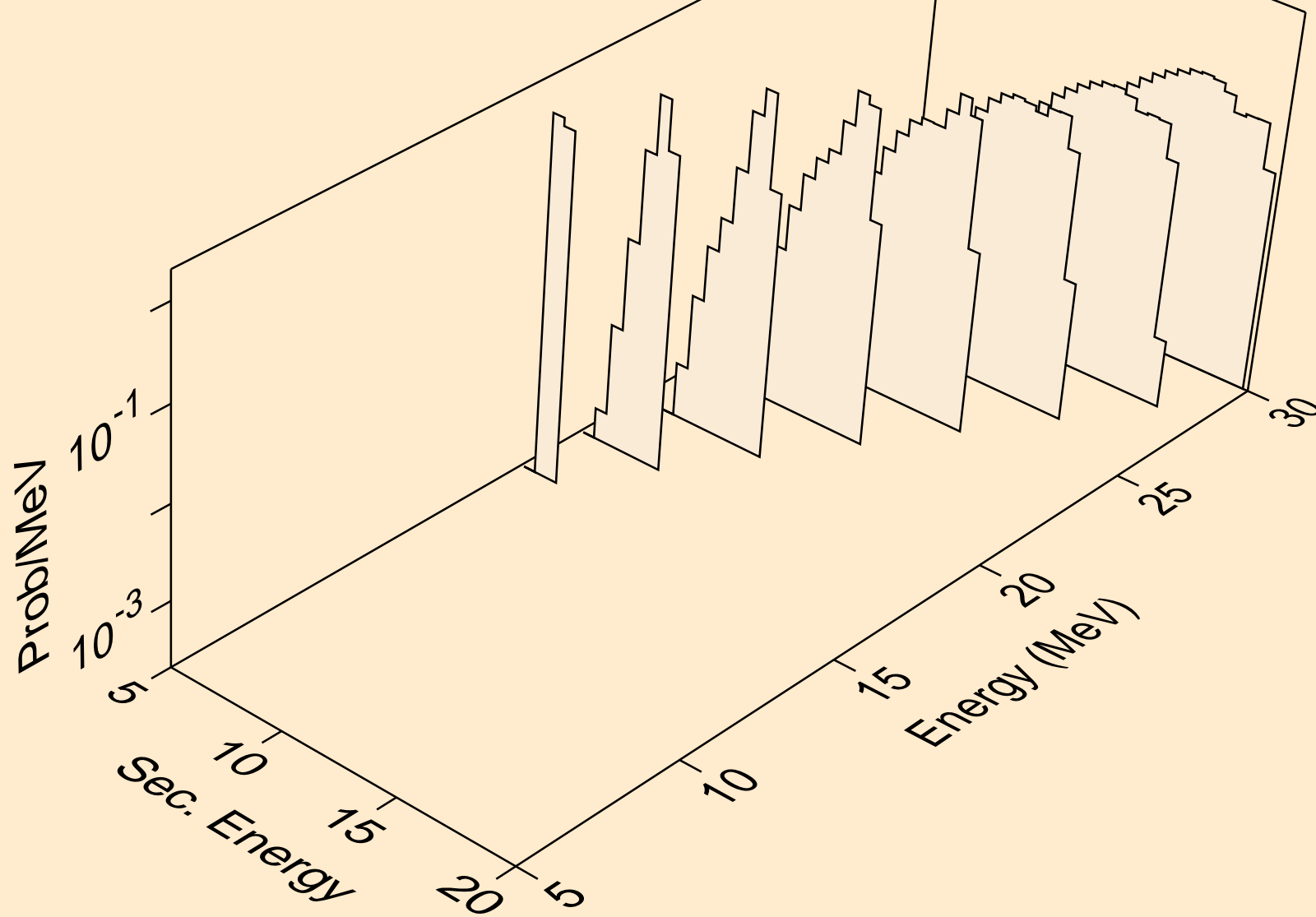

W176 ALPHA ACER TENDL-2024 LIBRARY; T=0.K
Alpha emission for (a,2n)a

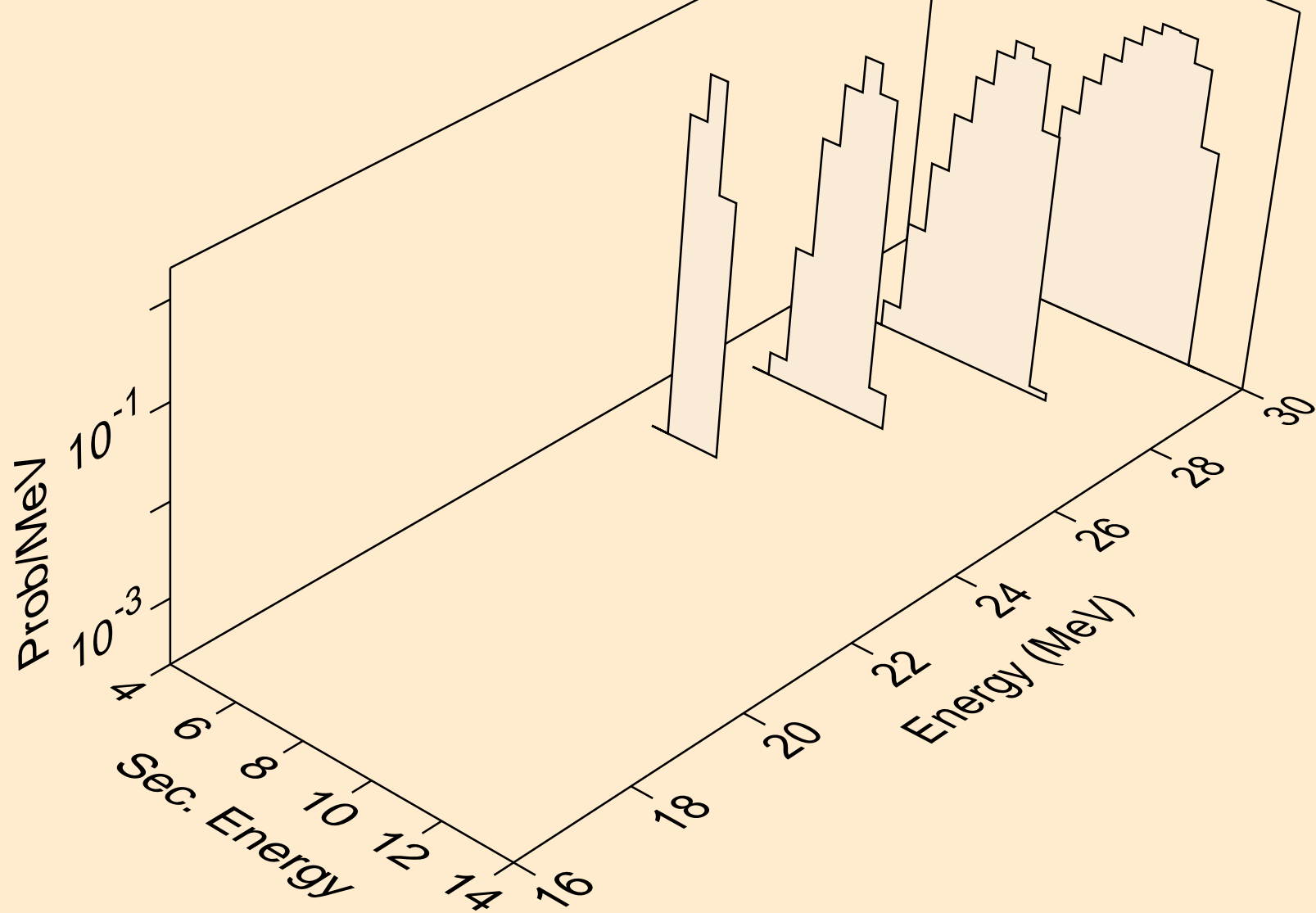

W176 ALPHA ACER TENDL-2024 LIBRARY; T=0.K
Alpha emission for inelastic

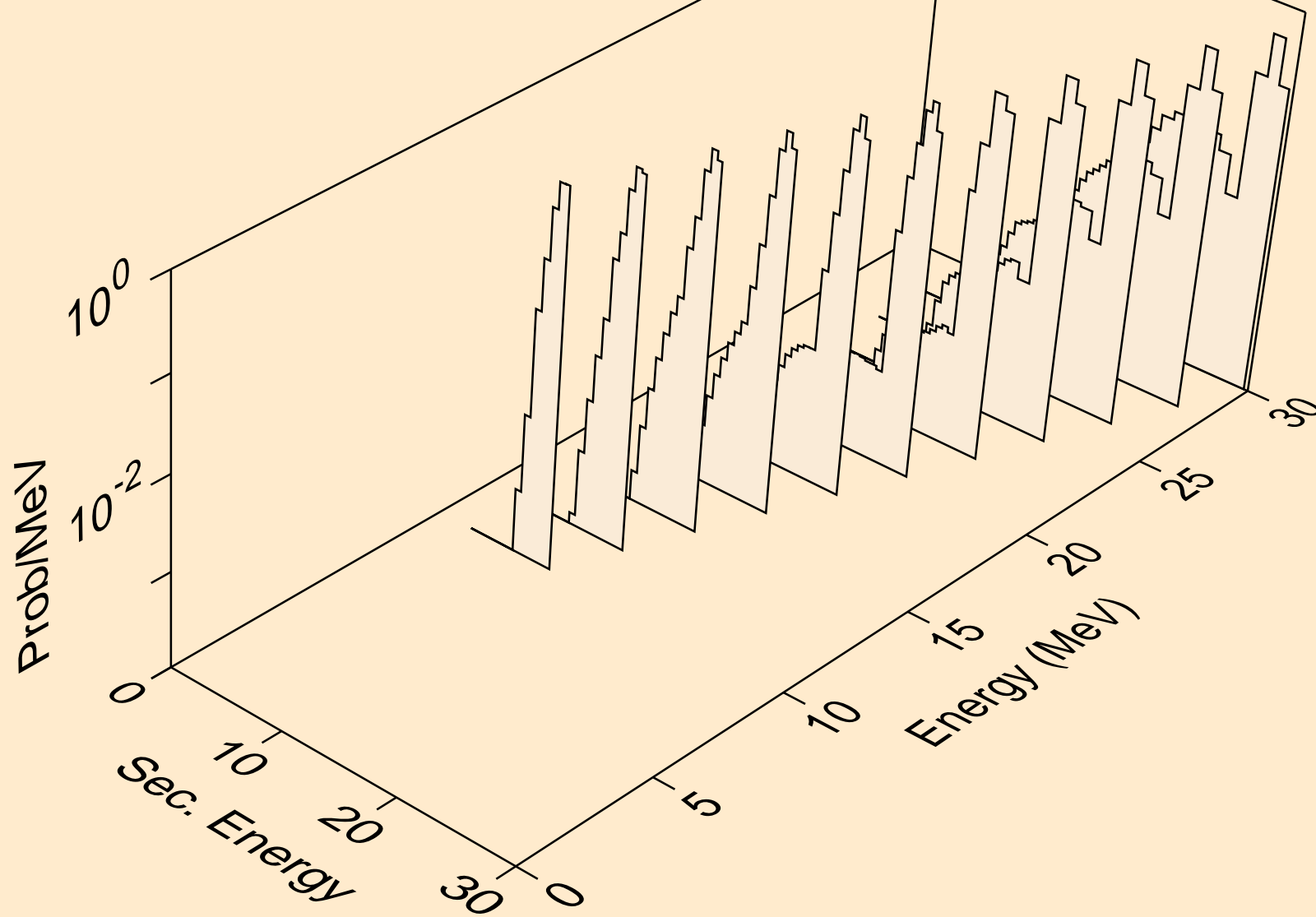

W176 ALPHA ACER TENDL-2024 LIBRARY; T=0.K
Alpha emission for (a,2a)

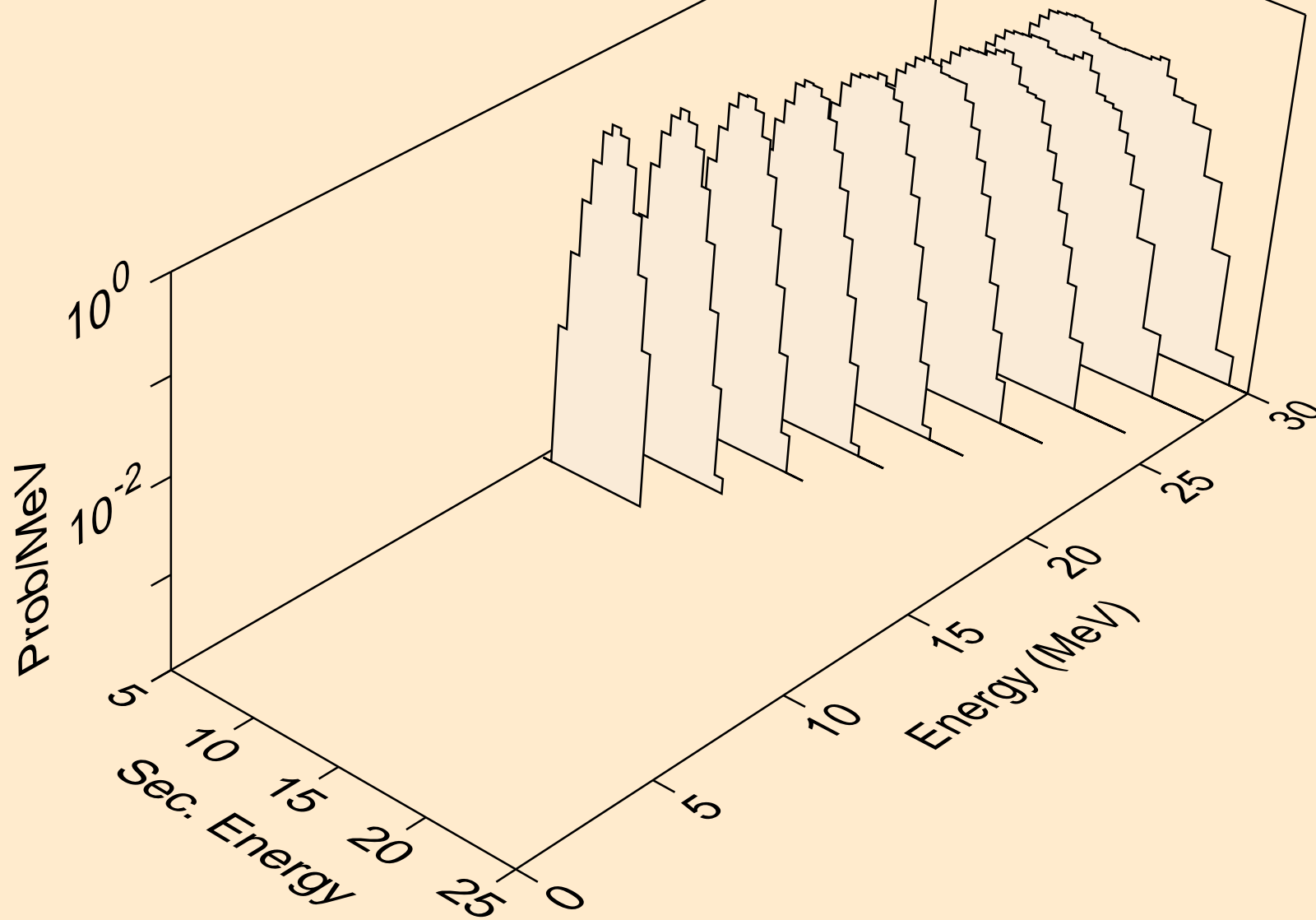

W176 ALPHA ACER TENDL-2024 LIBRARY; T=0.K
Alpha emission for (a,pa)

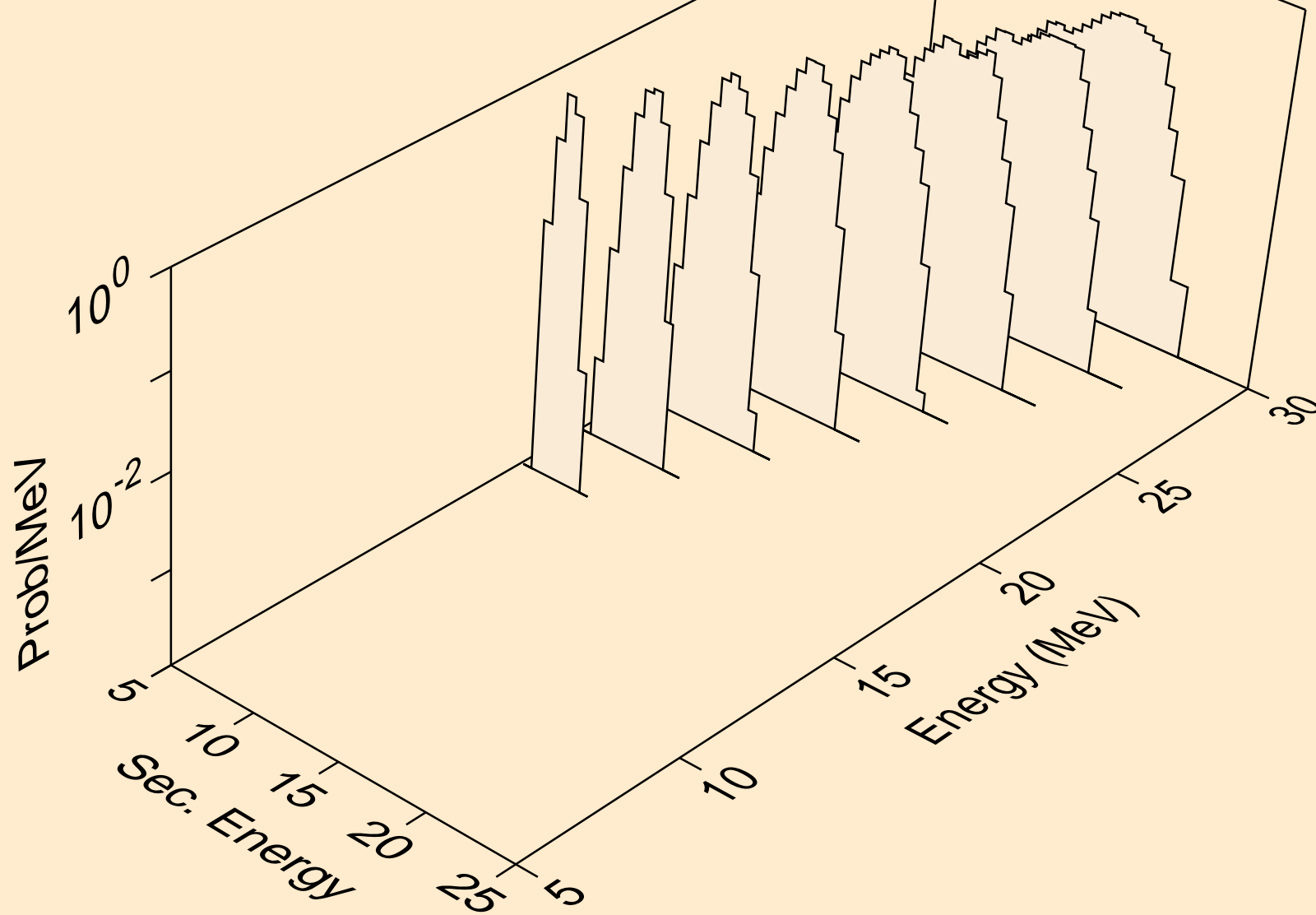

W176 ALPHA ACER TENDL-2024 LIBRARY; T=0.K
Photon emission for (z,n)

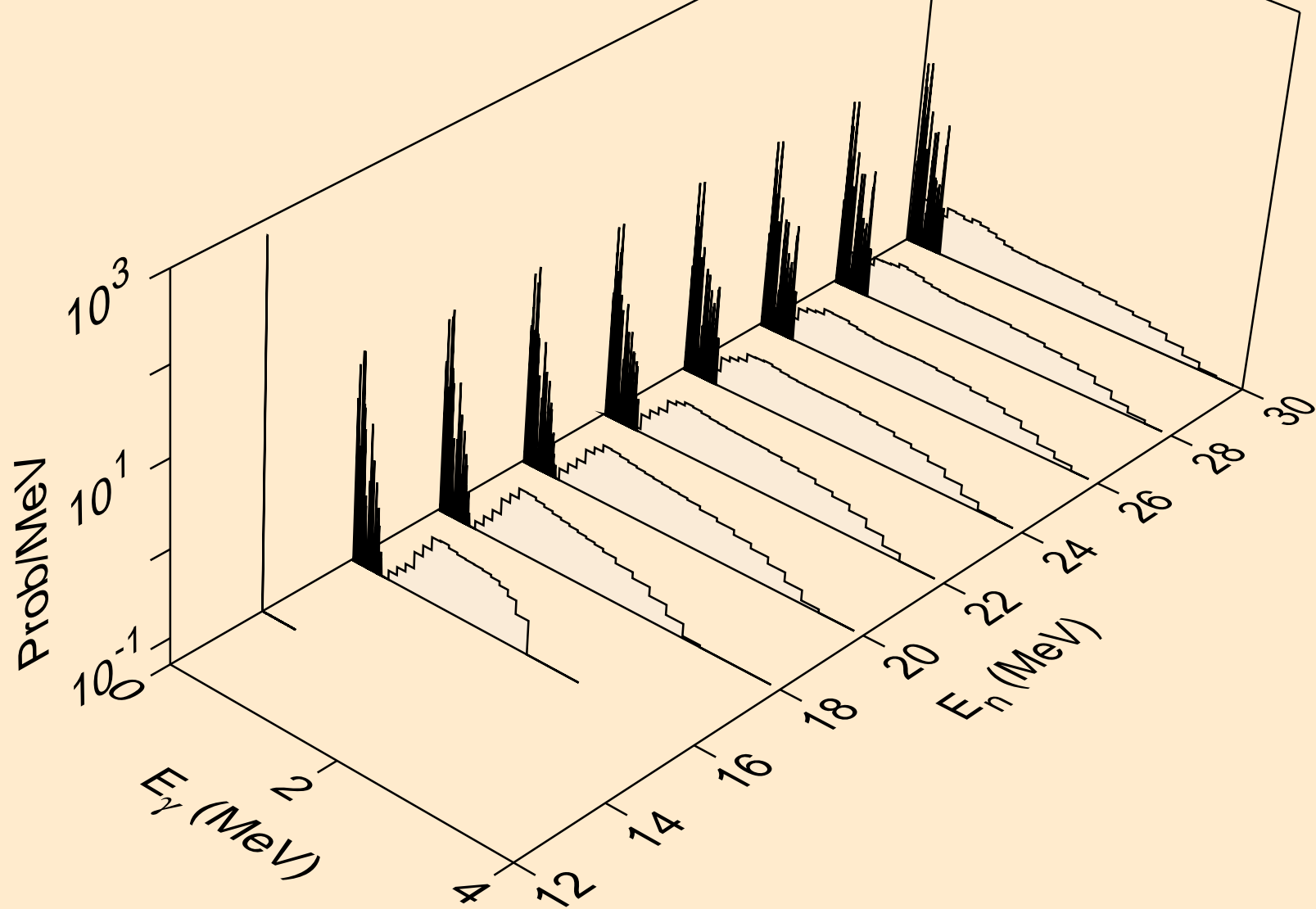

W176 ALPHA ACER TENDL-2024 LIBRARY; T=0.K

Photon emission for (z,x)

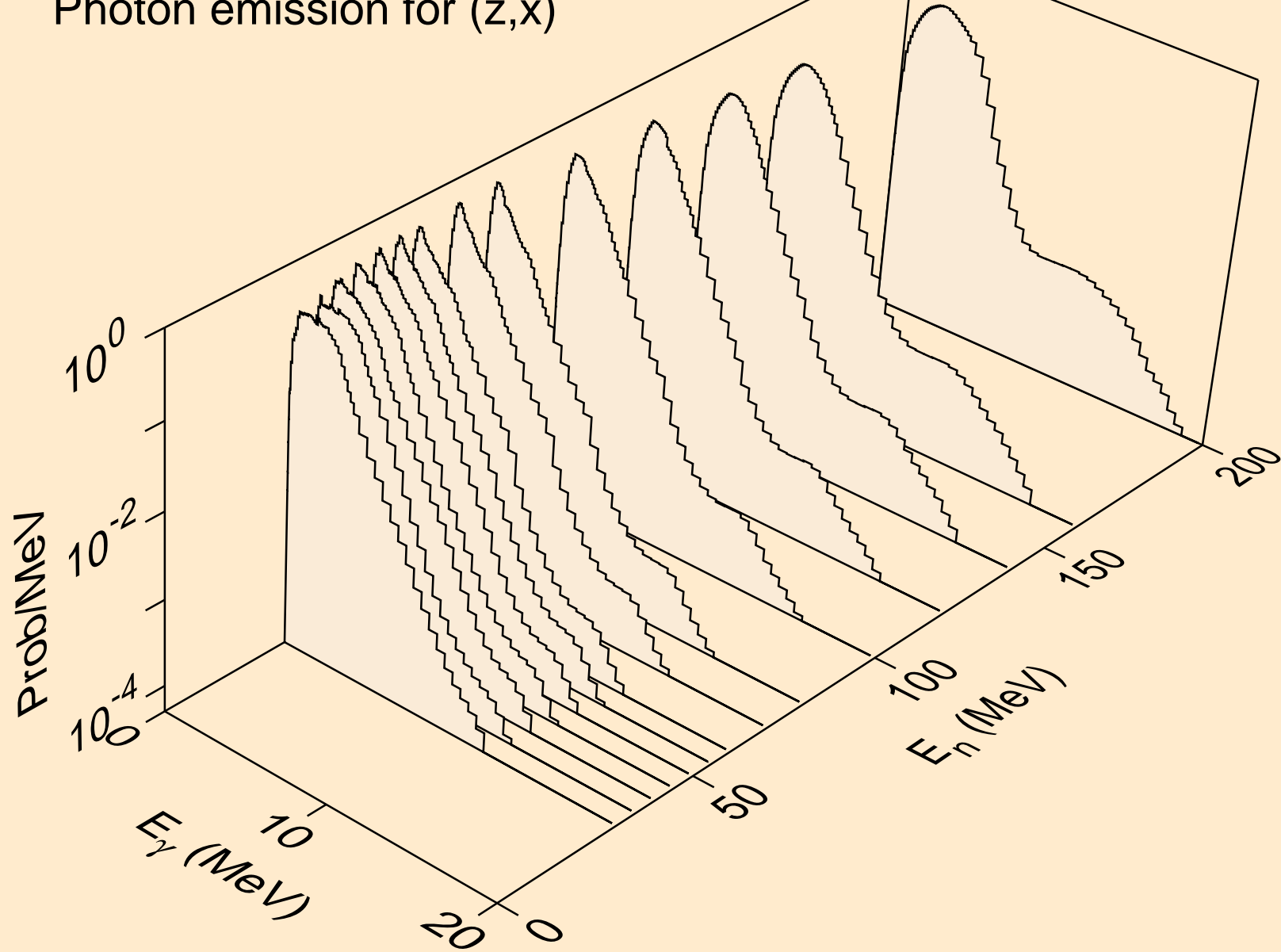

W176 ALPHA ACER TENDL-2024 LIBRARY; T=0.K
Photon emission for (n,2n)

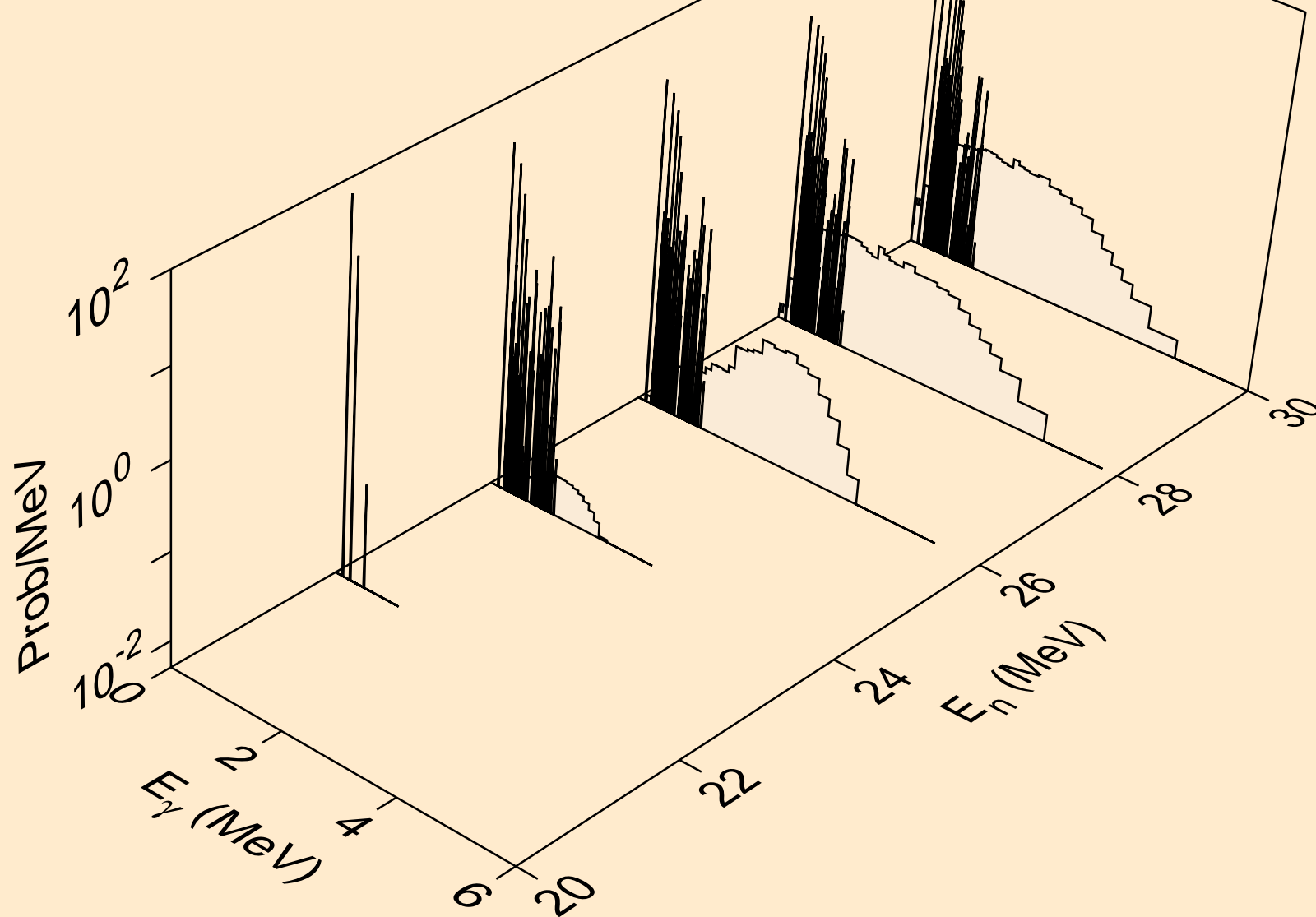

W176 ALPHA ACER TENDL-2024 LIBRARY; T=0.K
Photon emission for (n,n*)a

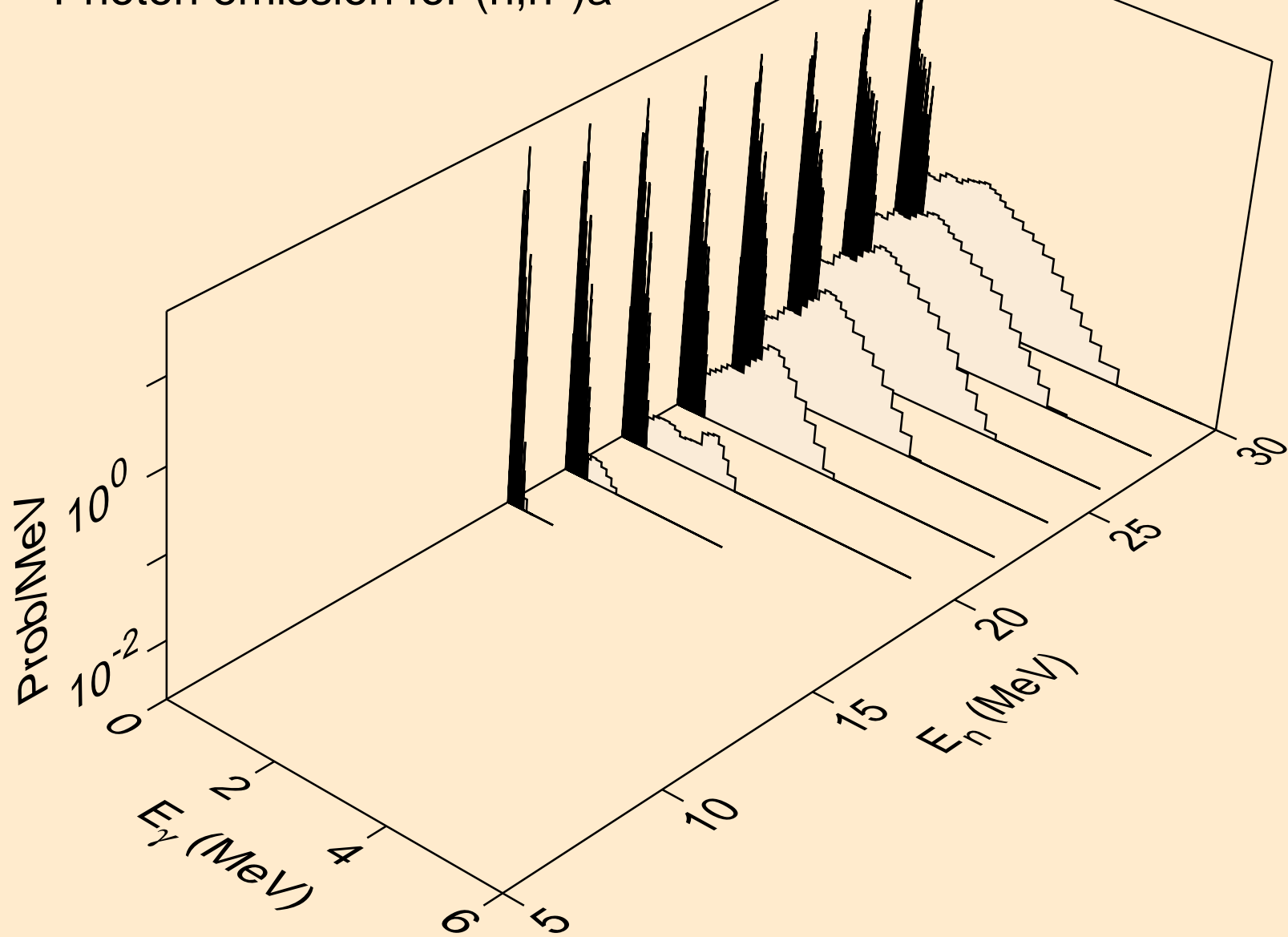

W176 ALPHA ACER TENDL-2024 LIBRARY; T=0.K
Photon emission for (n,2n)a

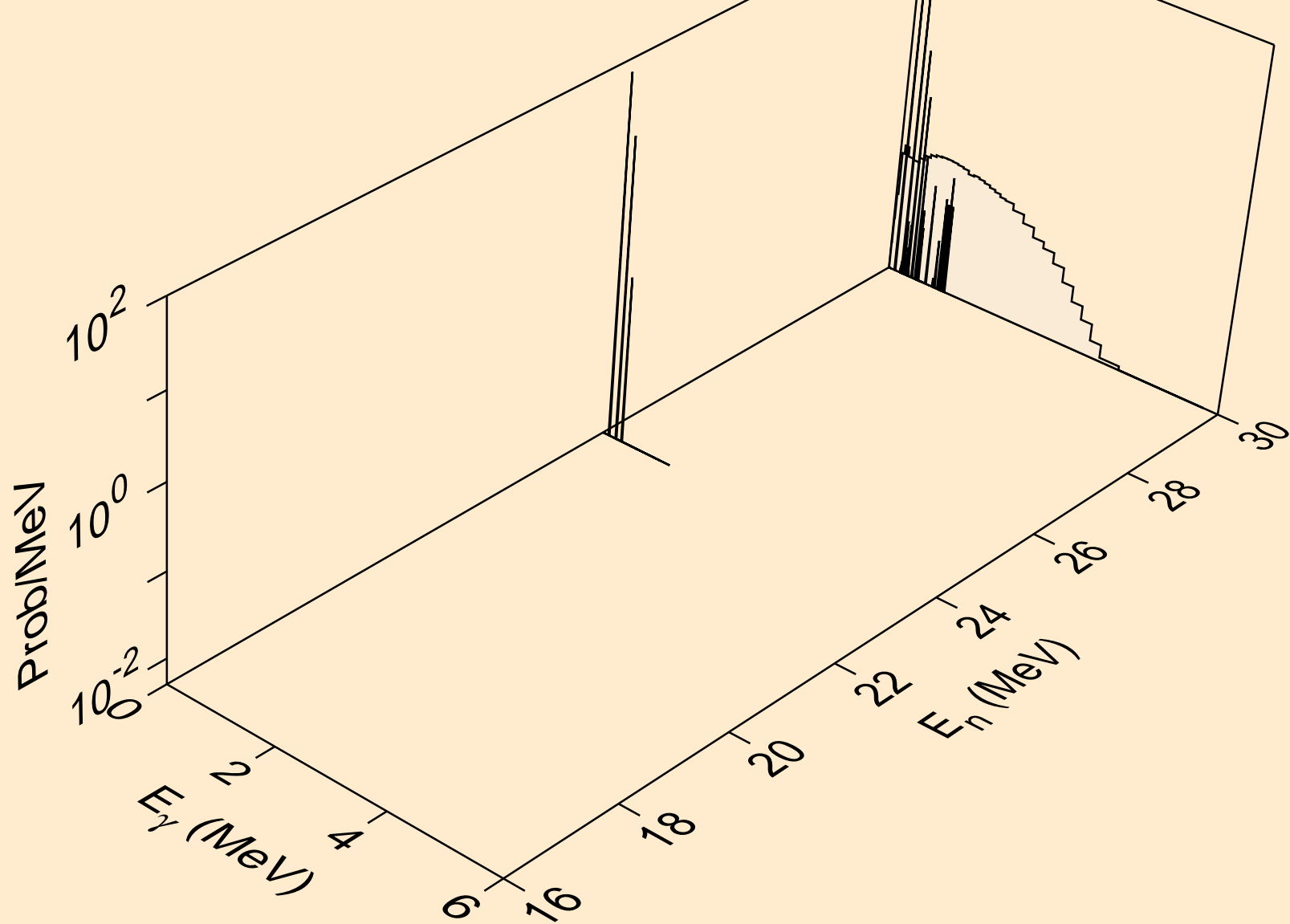

W176 ALPHA ACER TENDL-2024 LIBRARY; T=0.K

Photon emission for (n,n*)p

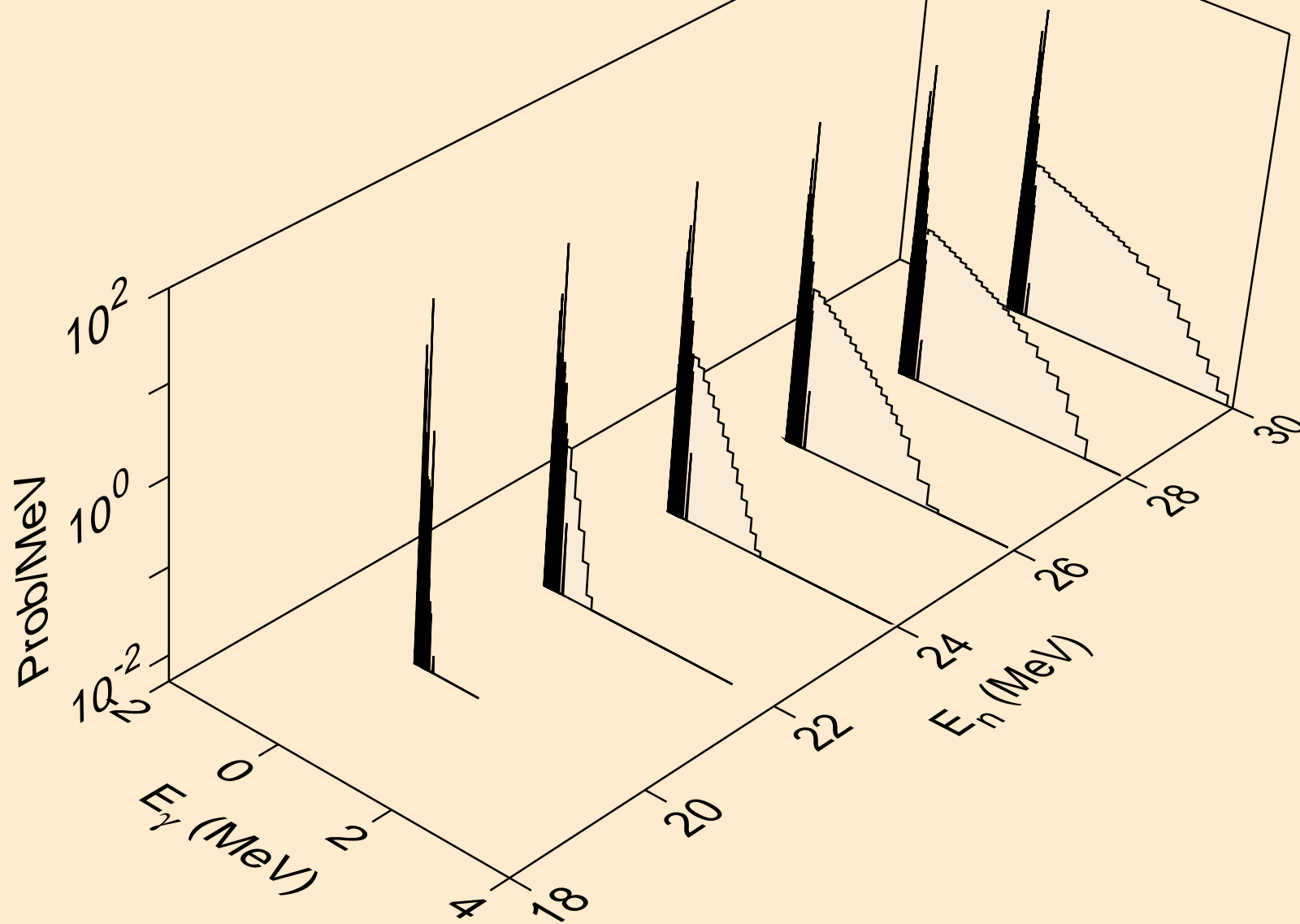

W176 ALPHA ACER TENDL-2024 LIBRARY; T=0.K
Photon emission for (n,n*)d

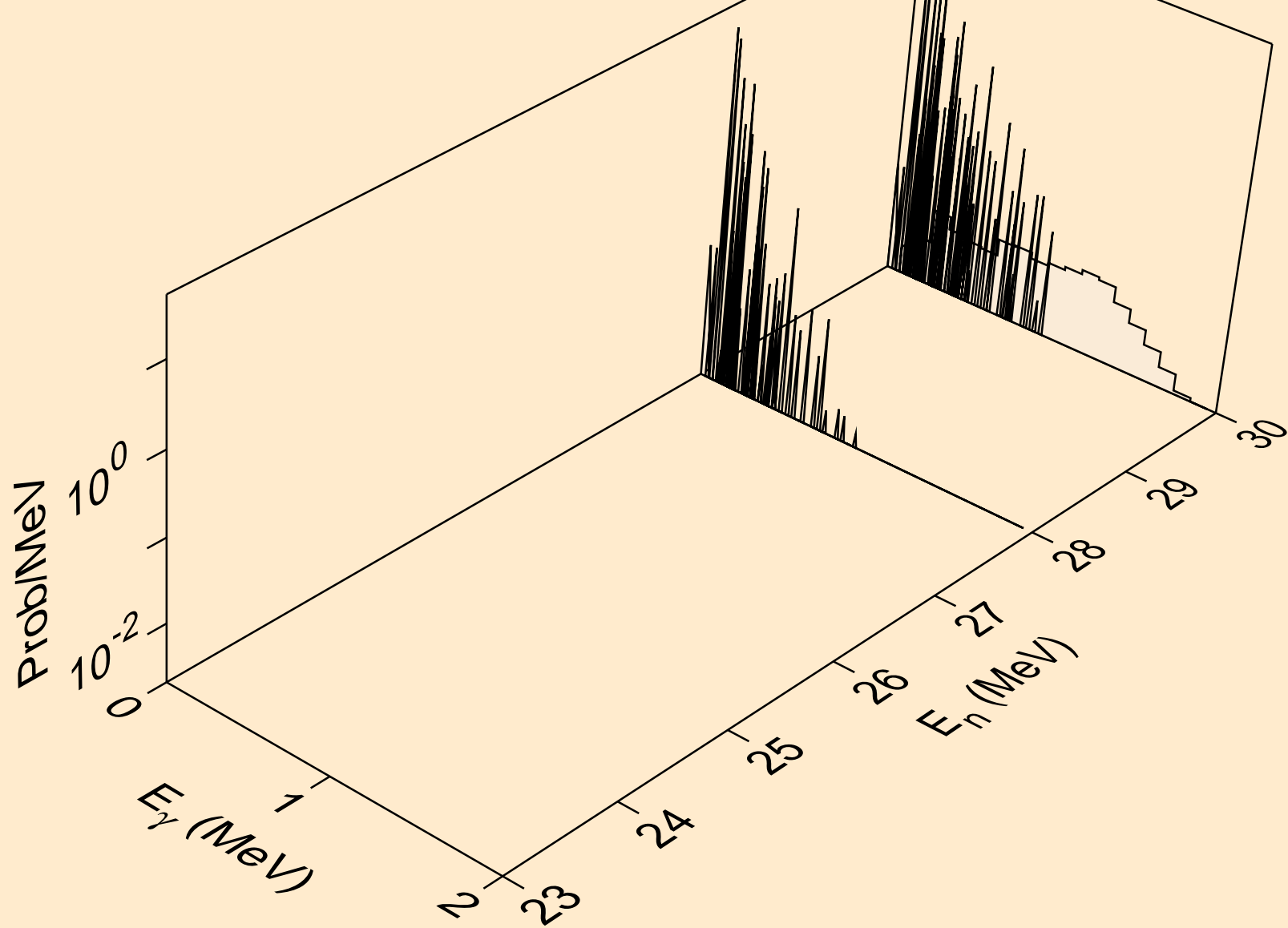

W176 ALPHA ACER TENDL-2024 LIBRARY; T=0.K
Photon emission for (n,2np)

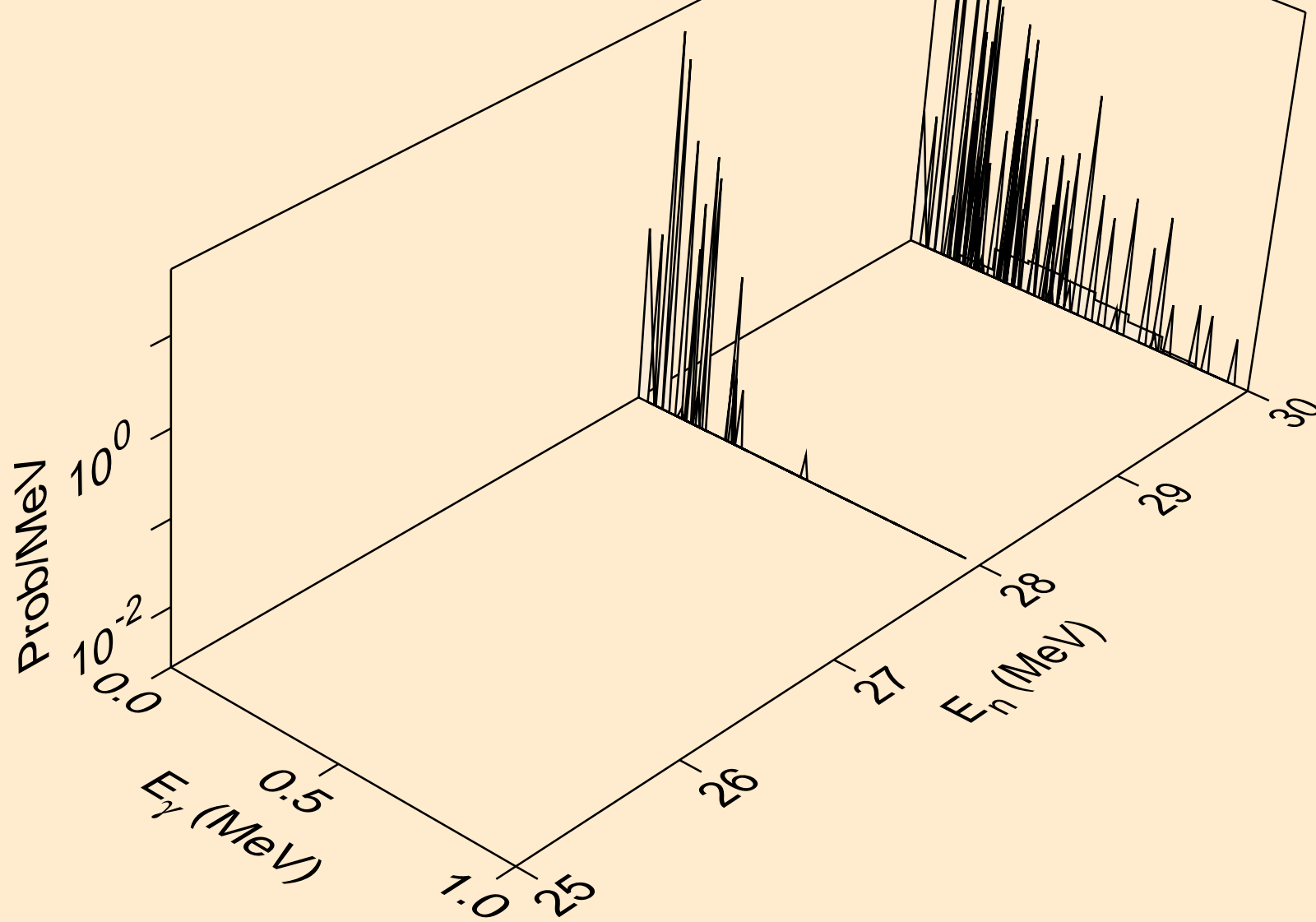

W176 ALPHA ACER TENDL-2024 LIBRARY; T=0.K
Photon emission for (n,gma)

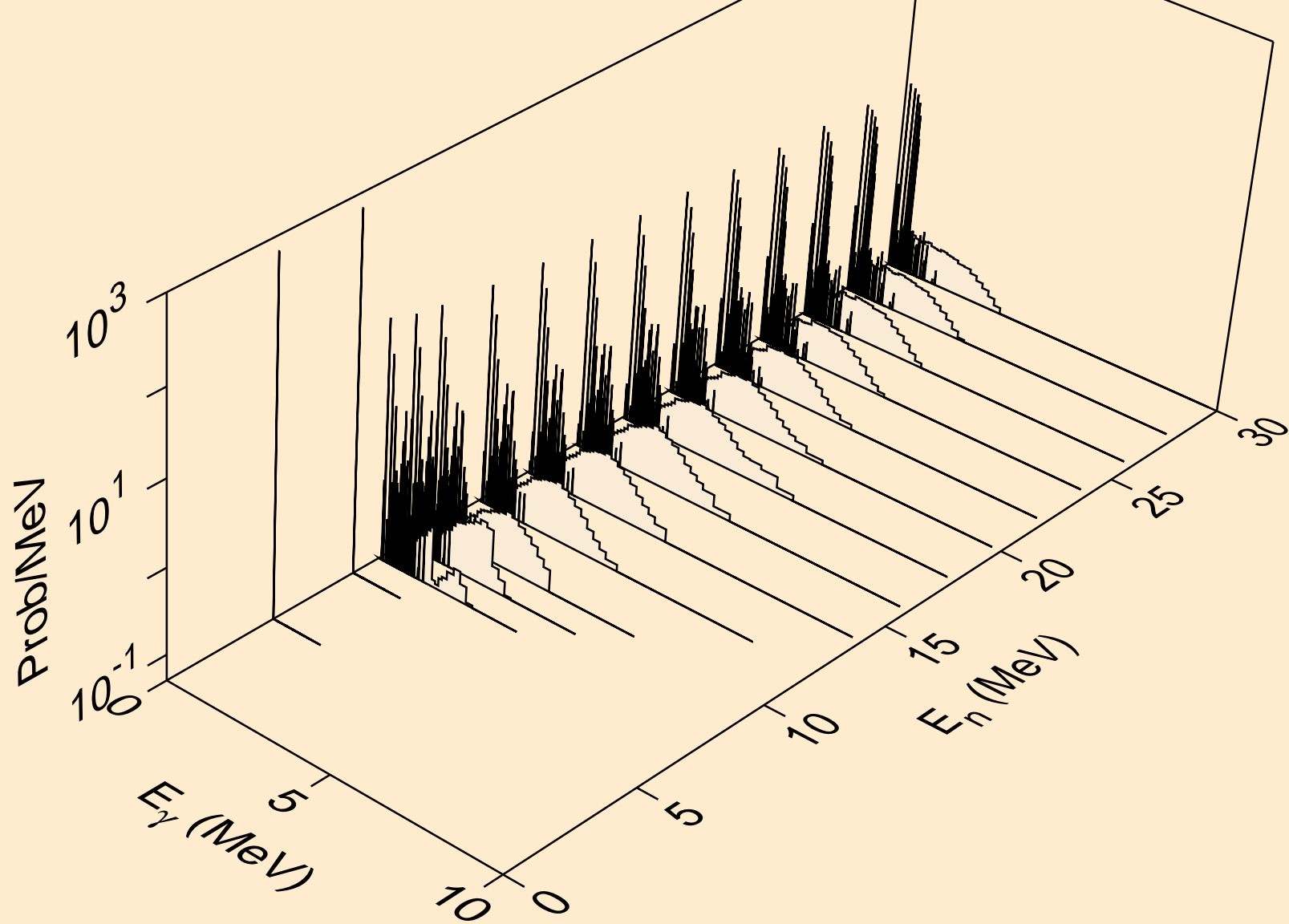

W176 ALPHA ACER TENDL-2024 LIBRARY; T=0.K
Photon emission for (n,p)

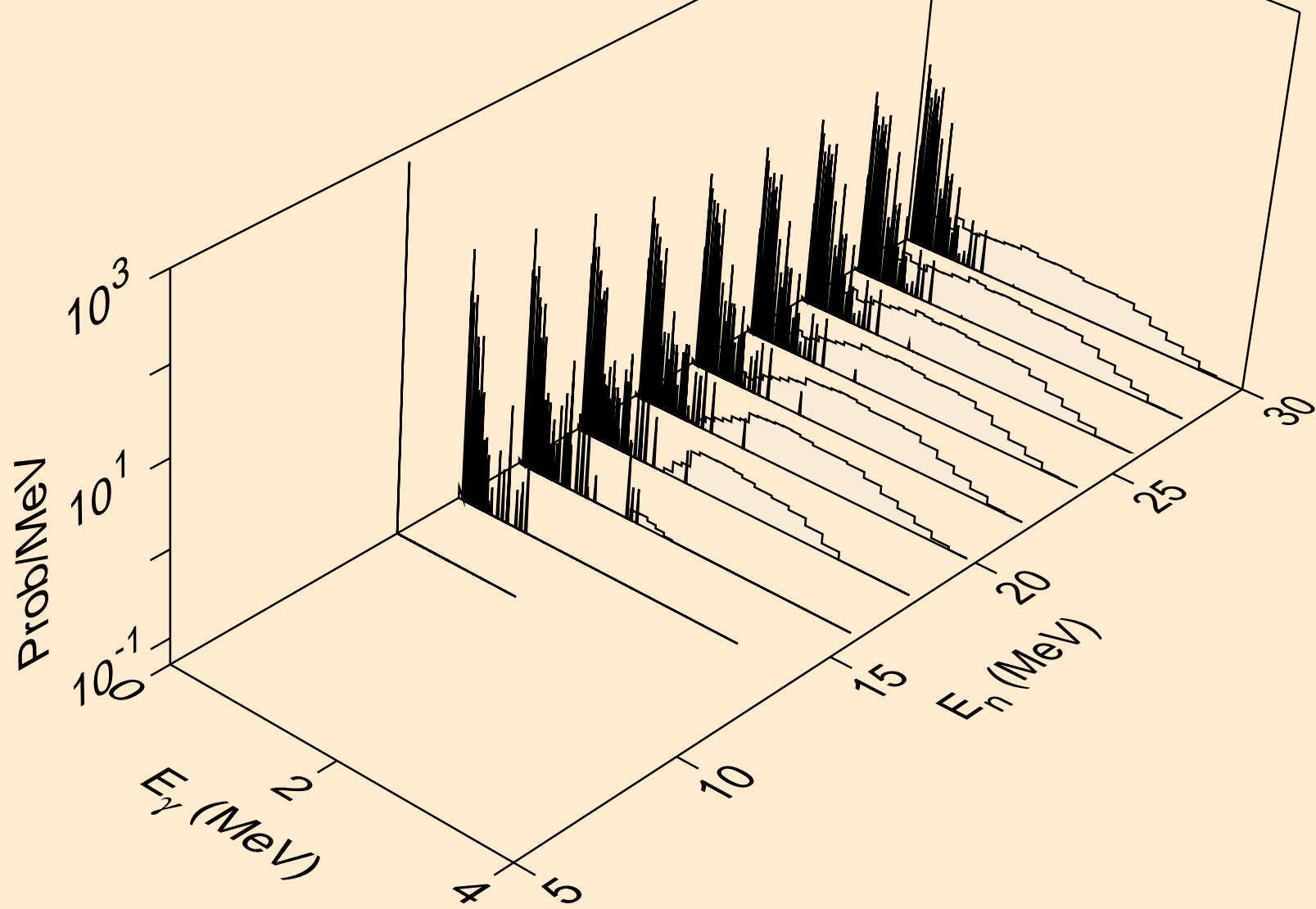

W176 ALPHA ACER TENDL-2024 LIBRARY; T=0.K

Photon emission for (n,d)

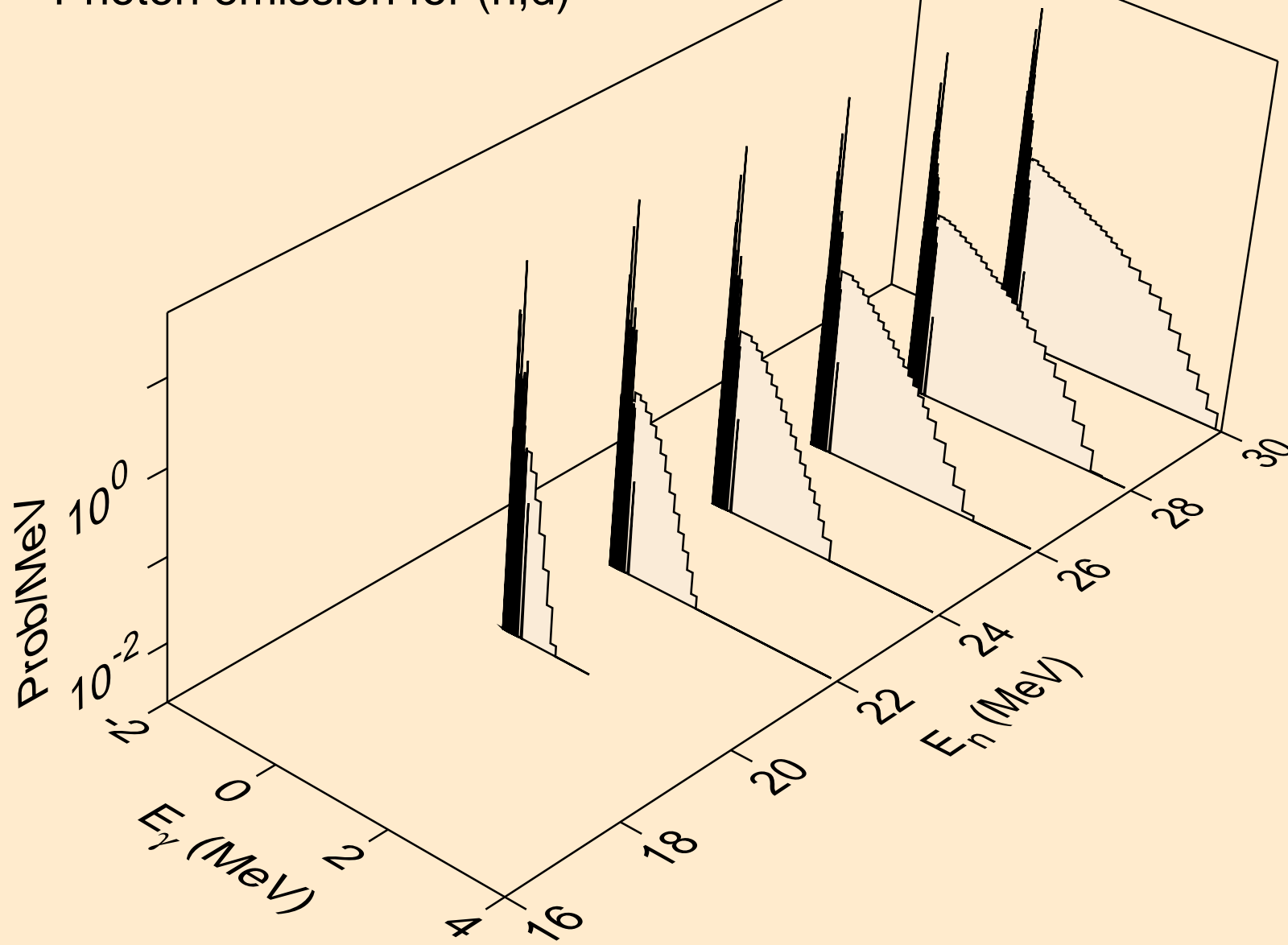

W176 ALPHA ACER TENDL-2024 LIBRARY; T=0.K
Photon emission for (n,t)

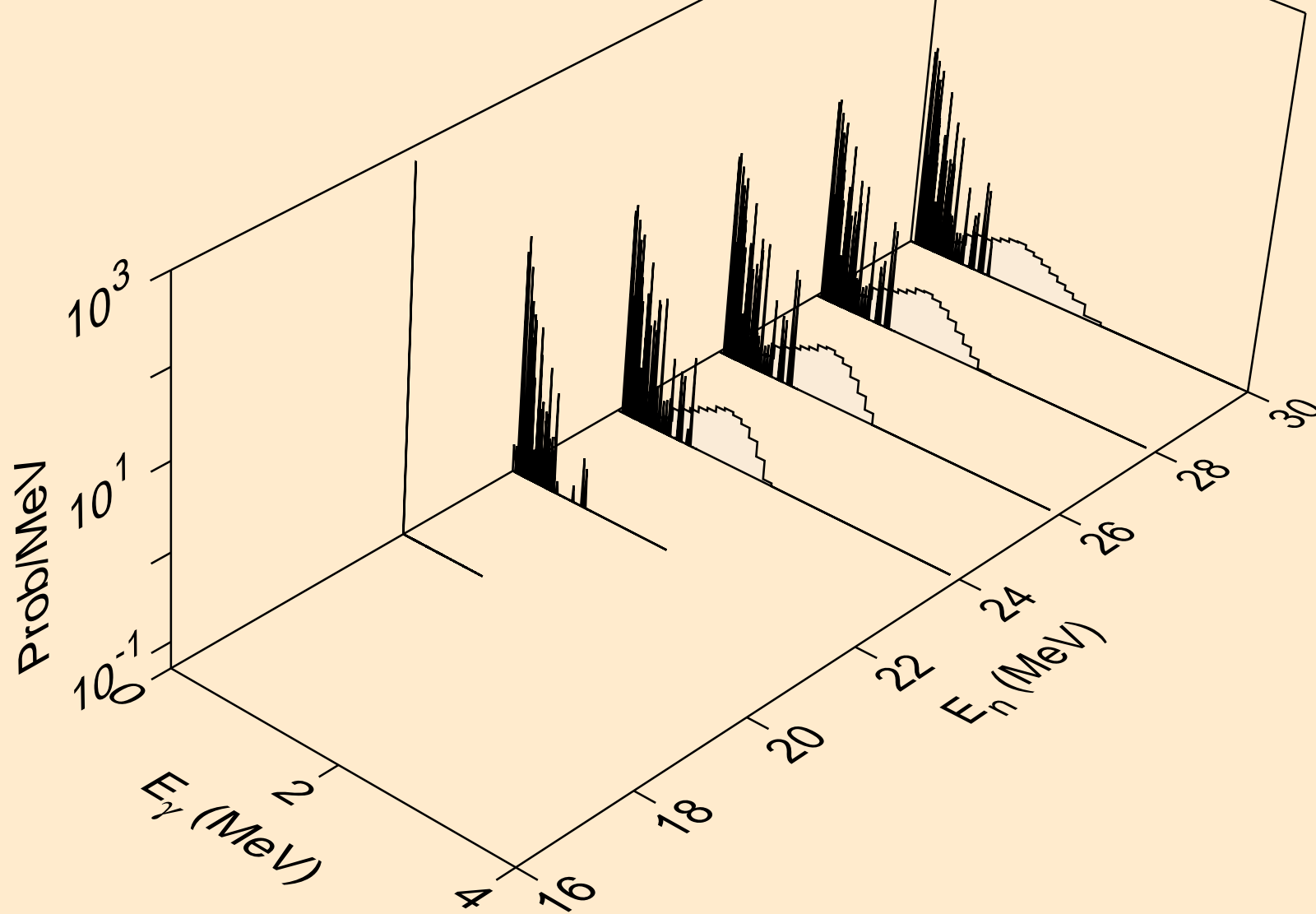

W176 ALPHA ACER TENDL-2024 LIBRARY; T=0.K
Photon emission for (n,he3)

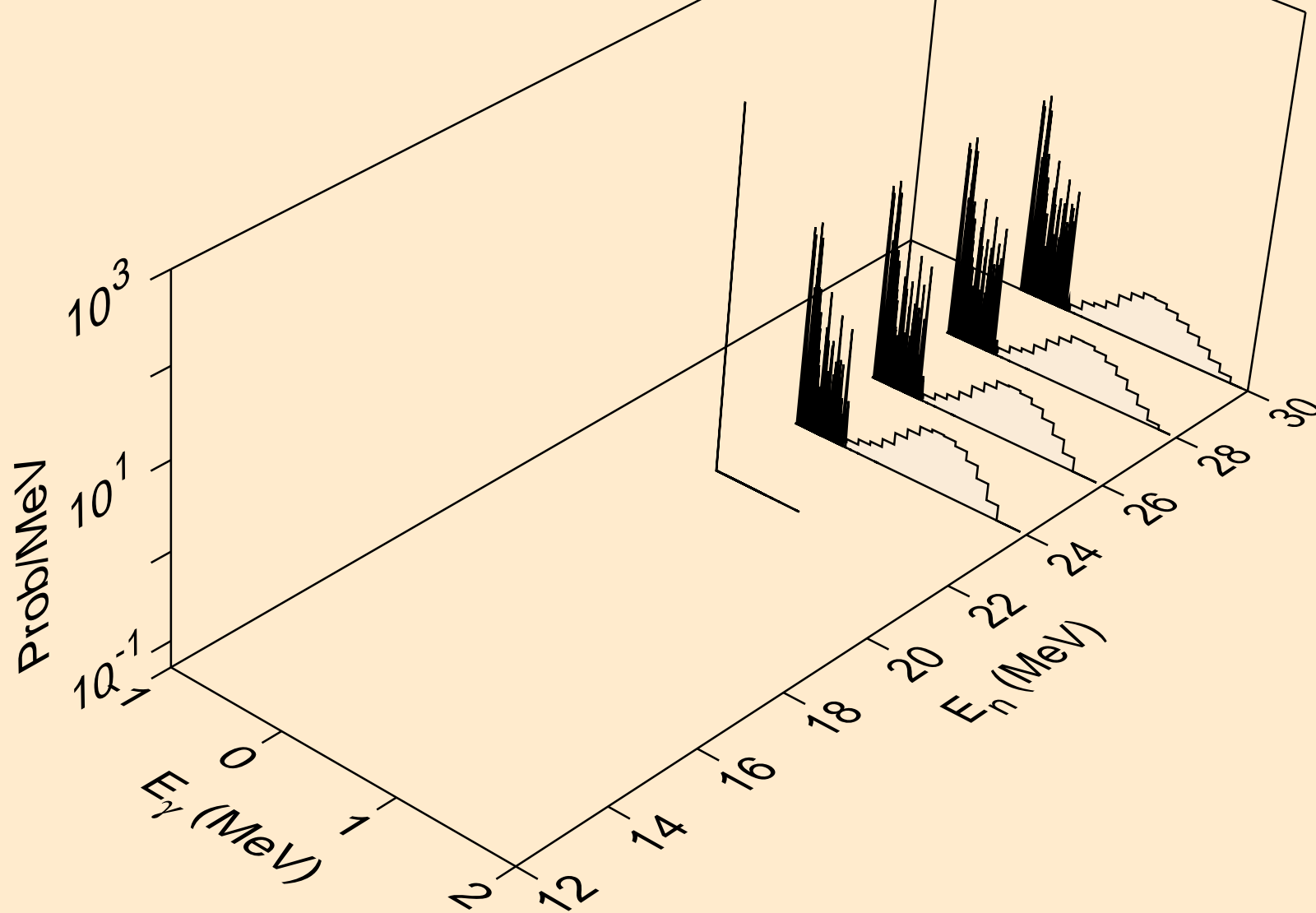

W176 ALPHA ACER TENDL-2024 LIBRARY; T=0.K
Photon emission for inelastic

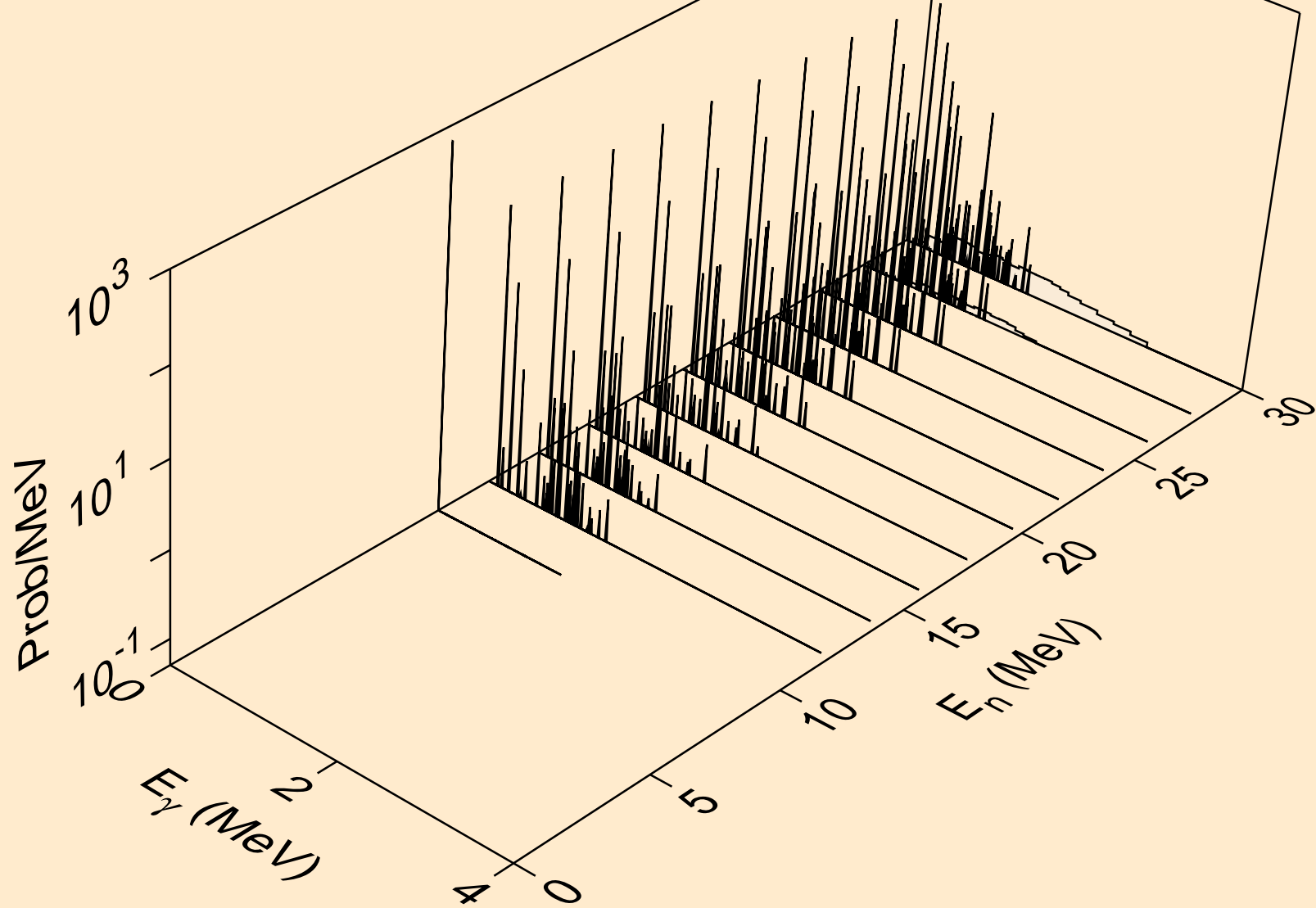

W176 ALPHA ACER TENDL-2024 LIBRARY; T=0.K
Photon emission for (n,2a)

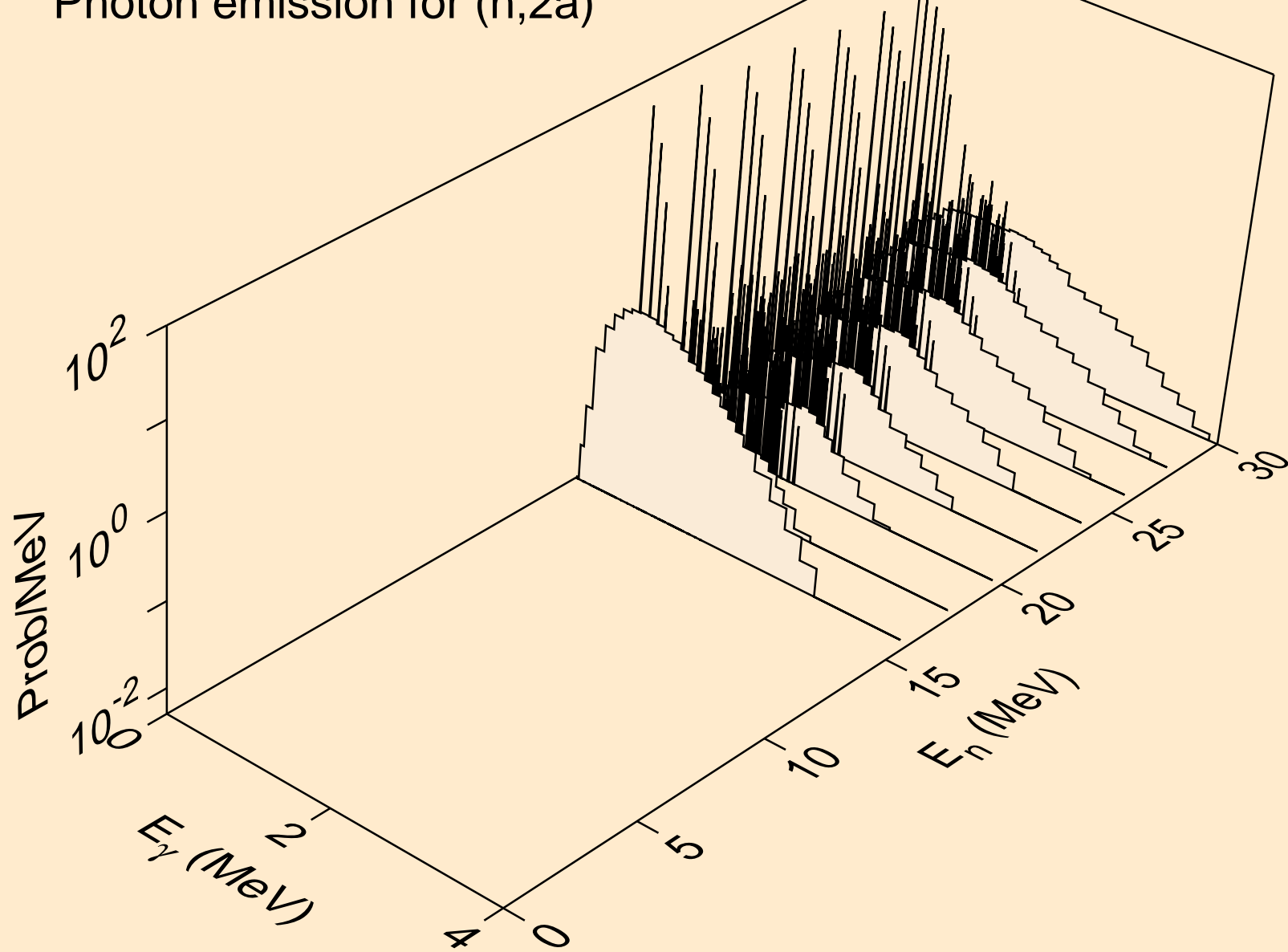

W176 ALPHA ACER TENDL-2024 LIBRARY; T=0.K
Photon emission for (n,2p)

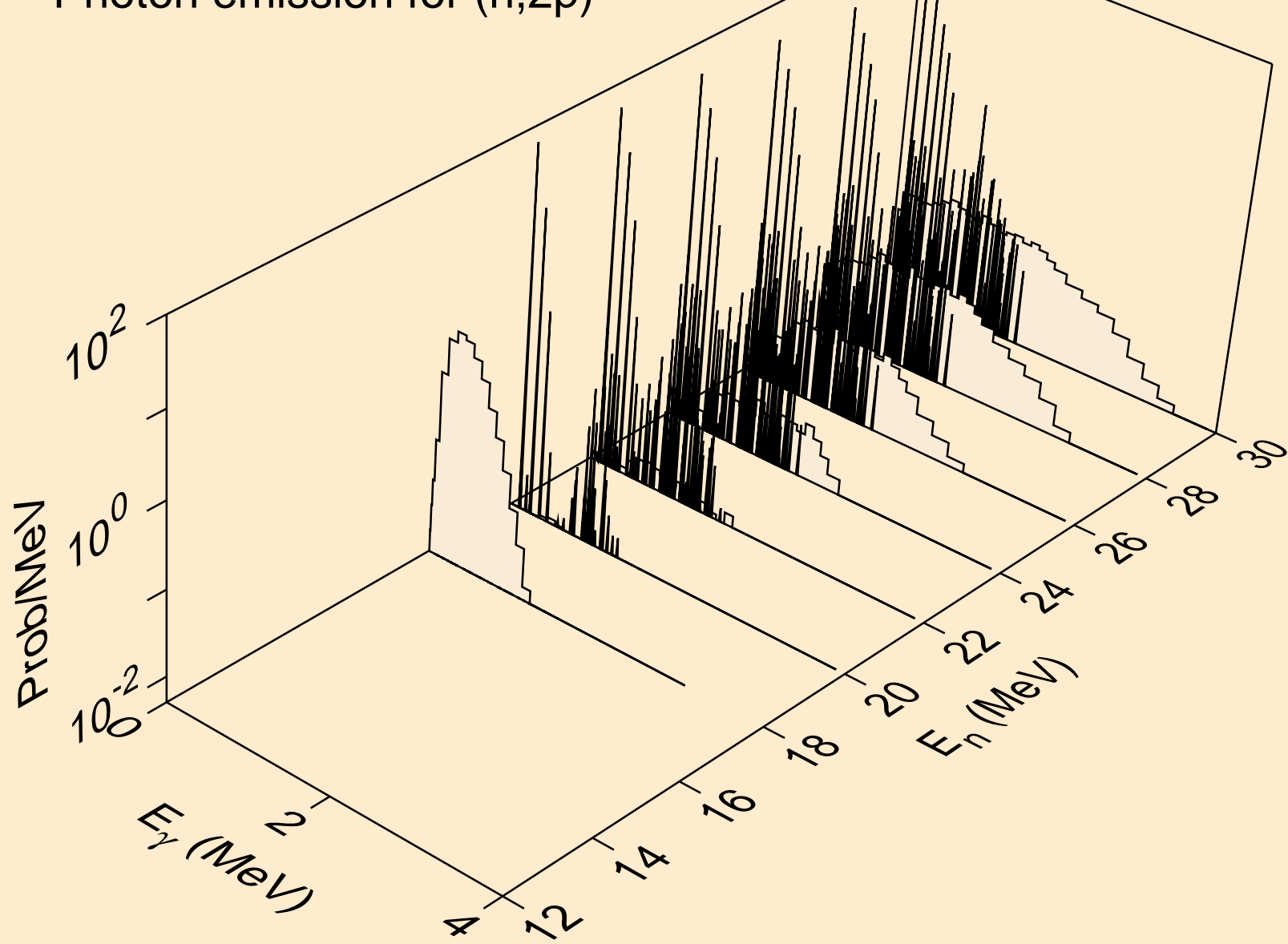

W176 ALPHA ACER TENDL-2024 LIBRARY; T=0.K
Photon emission for (n,pa)

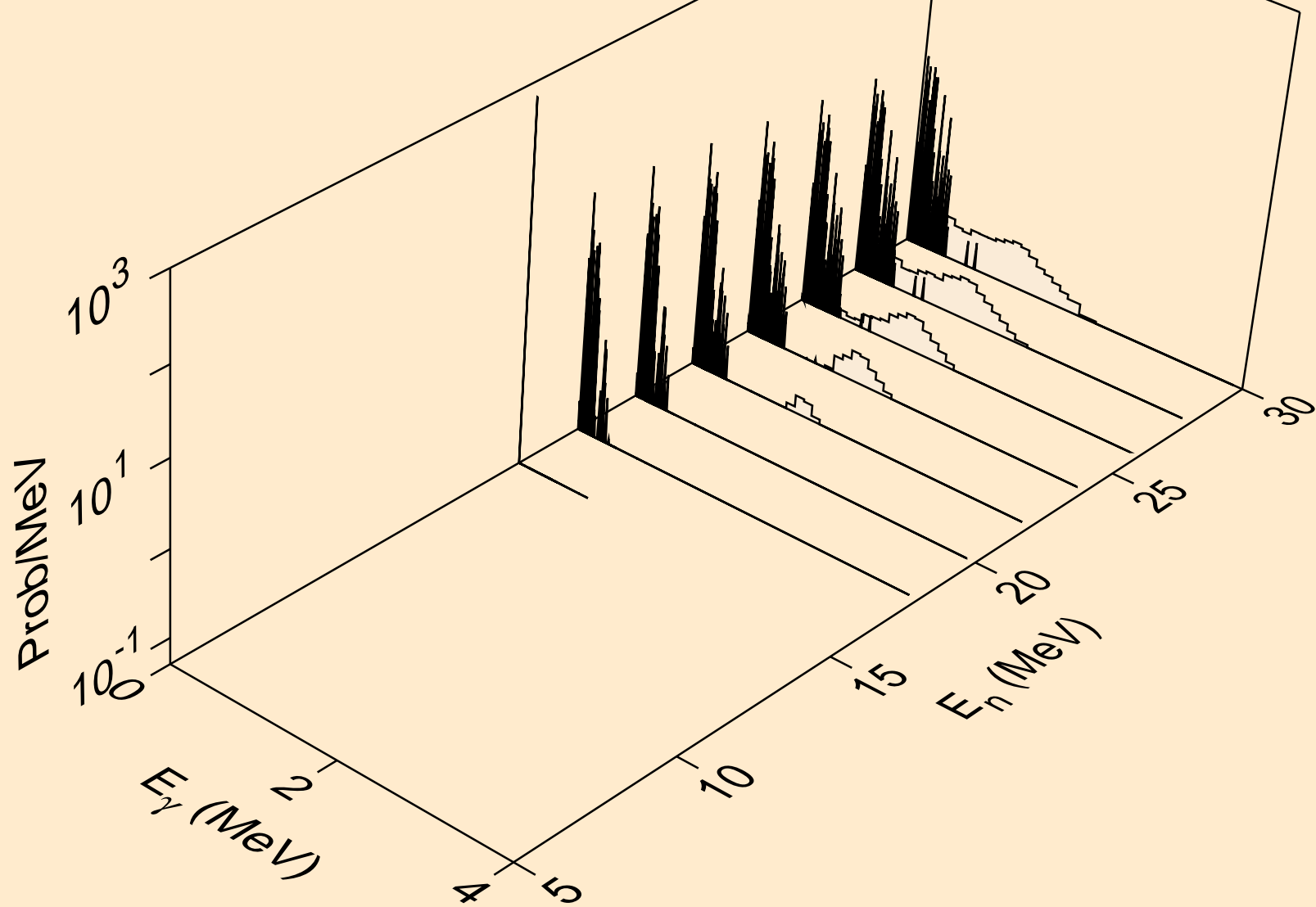

W176 ALPHA ACER TENDL-2024 LIBRARY; T=0.K
Particle heating contributions

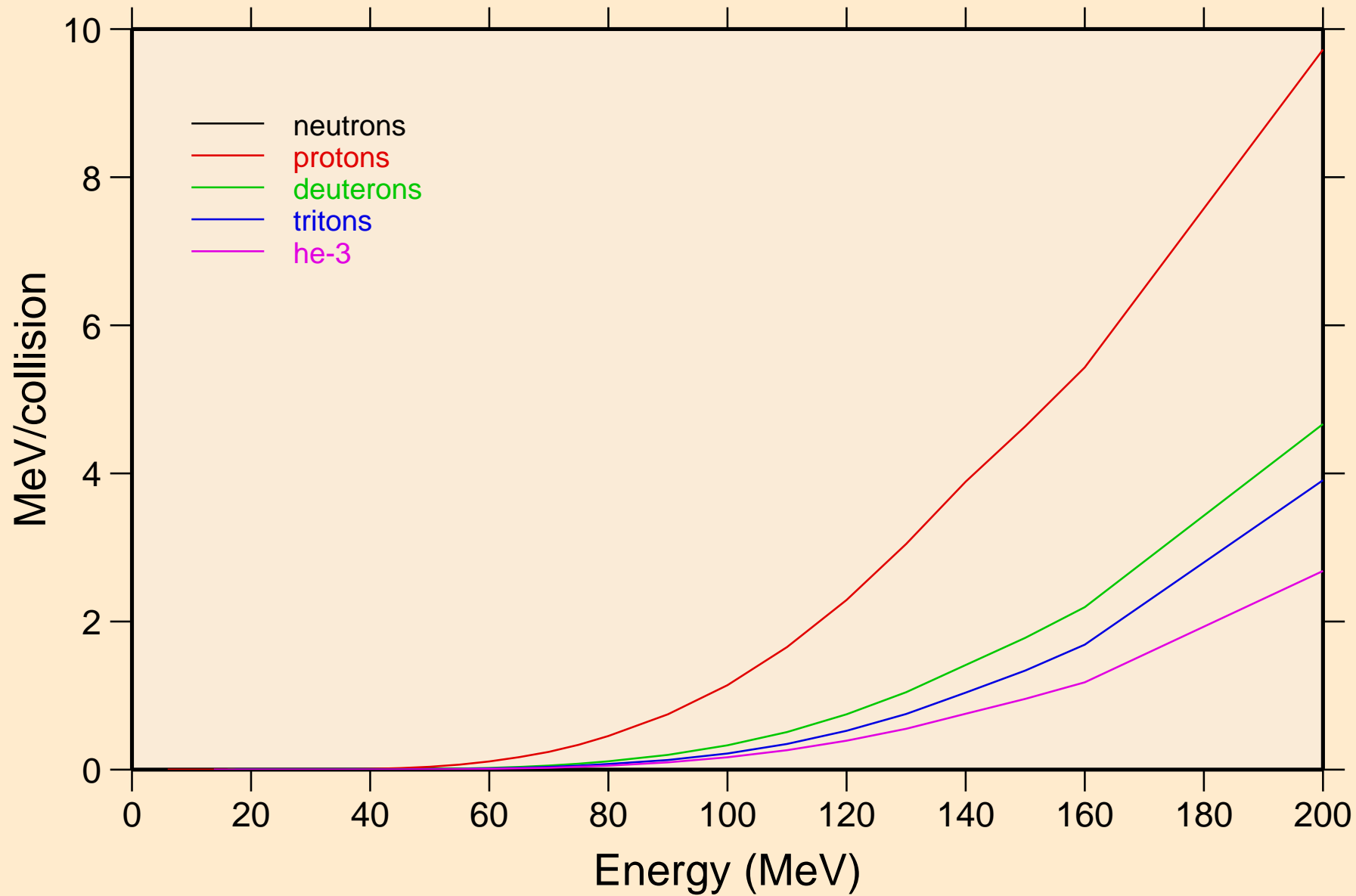

W176 ALPHA ACER TENDL-2024 LIBRARY; T=0.K
Recoil Heating

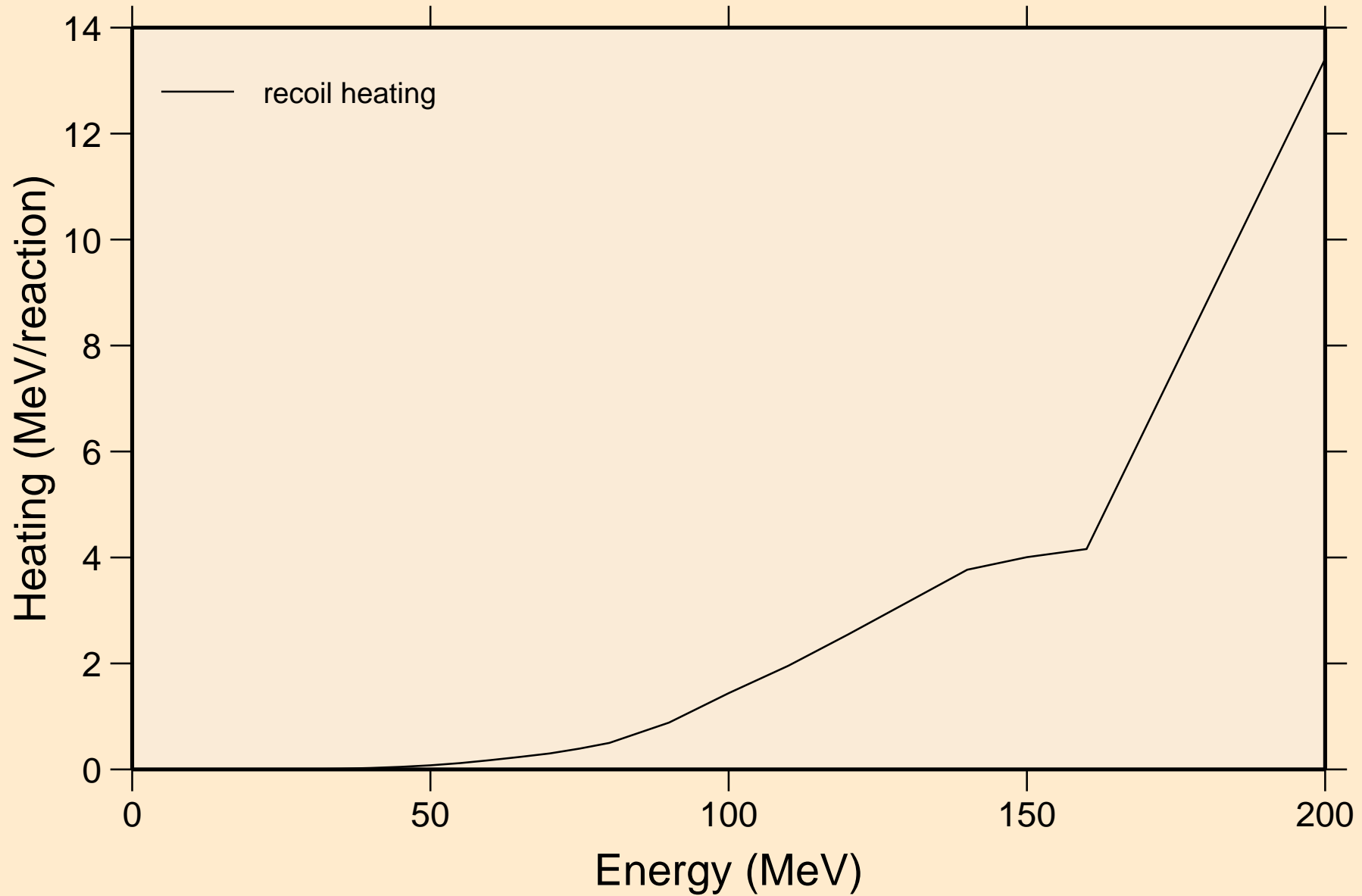

W176 ALPHA ACER TENDL-2024 LIBRARY; T=0.K

Particle production cross sections

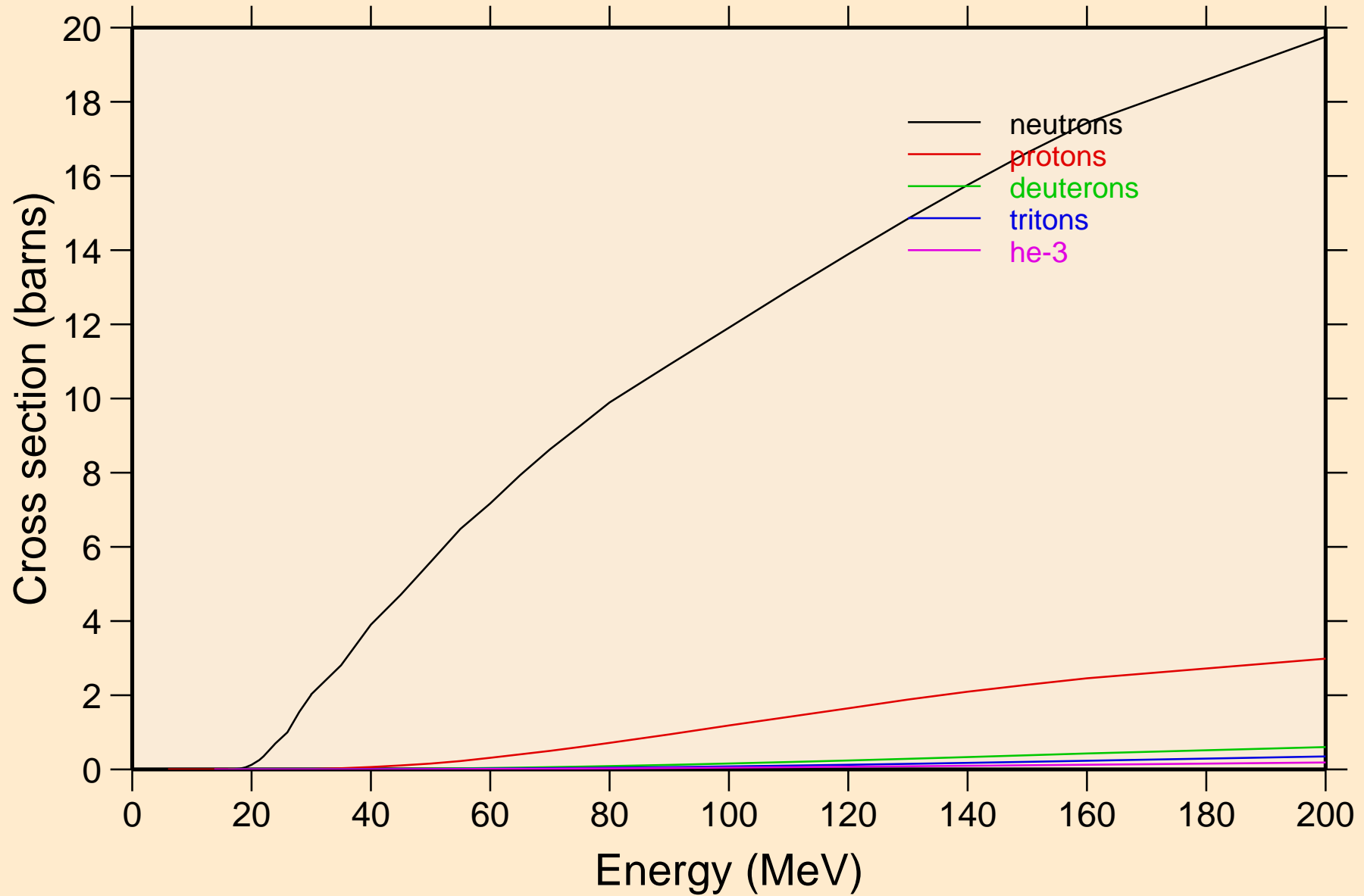

W176 ALPHA ACER TENDL-2024 LIBRARY; T=0.K
neutrons from (a,n)

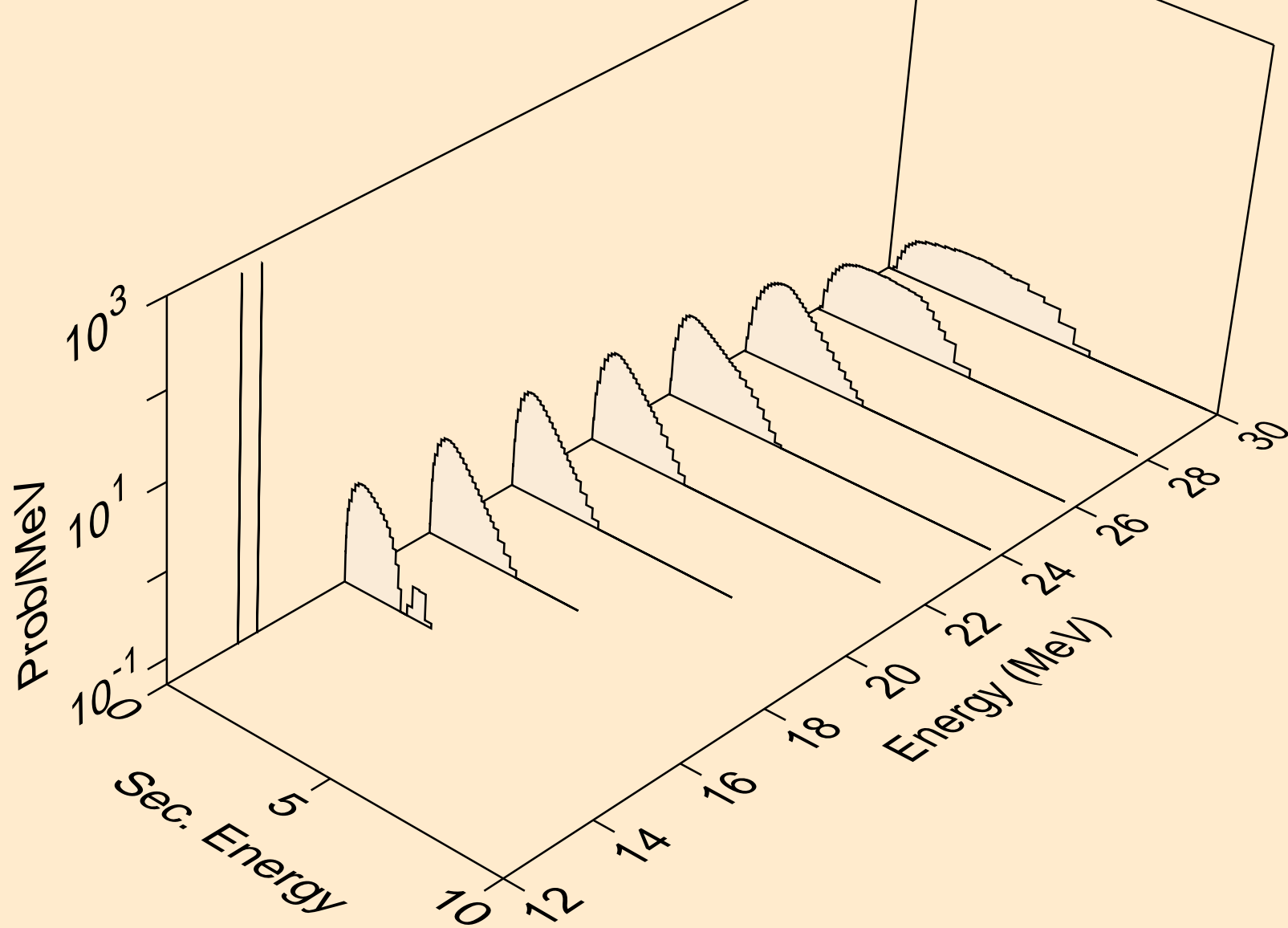

W176 ALPHA ACER TENDL-2024 LIBRARY; T=0.K
neutrons from (a,x)

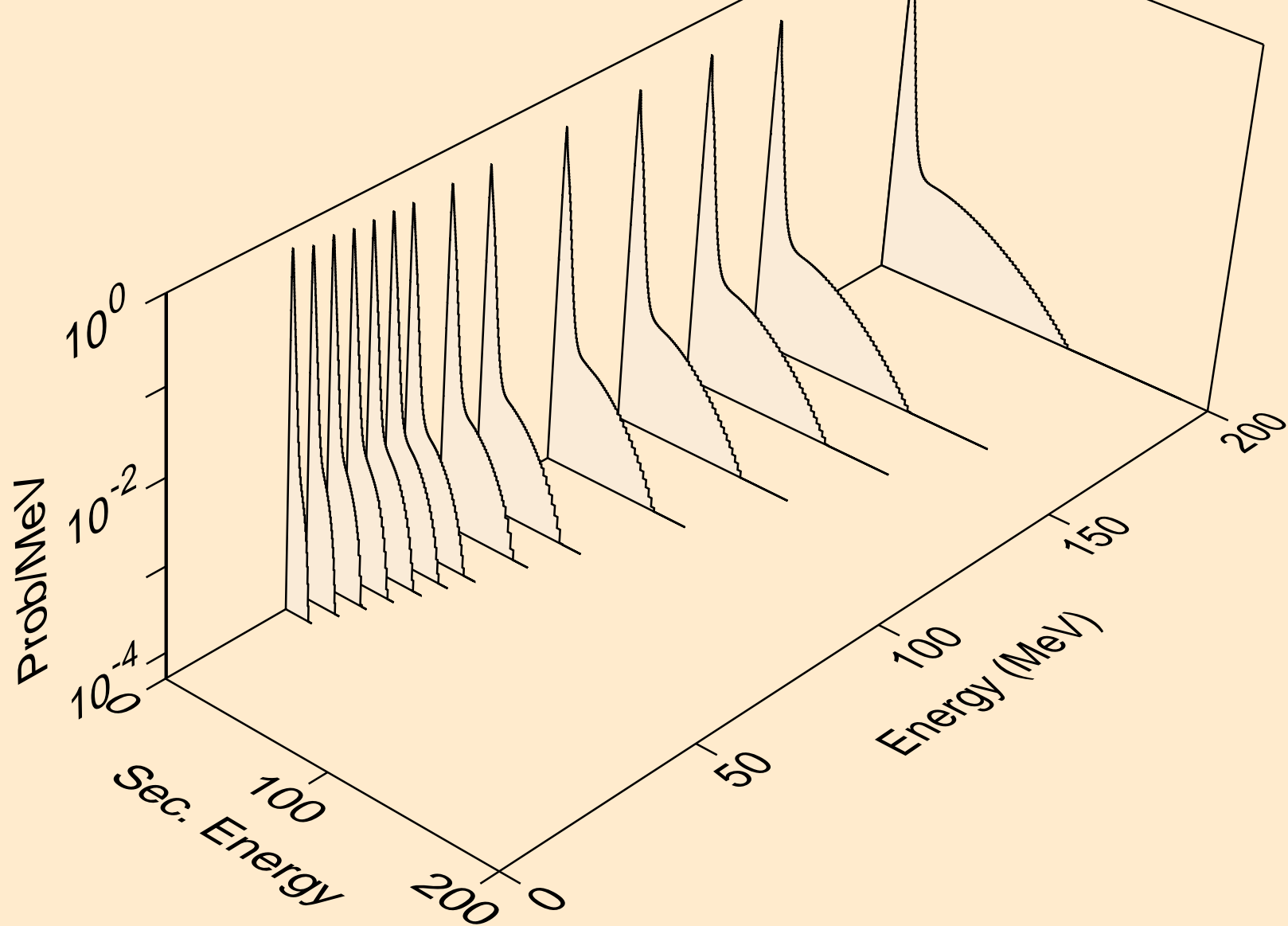

W176 ALPHA ACER TENDL-2024 LIBRARY; T=0.K
neutrons from (a,2n)

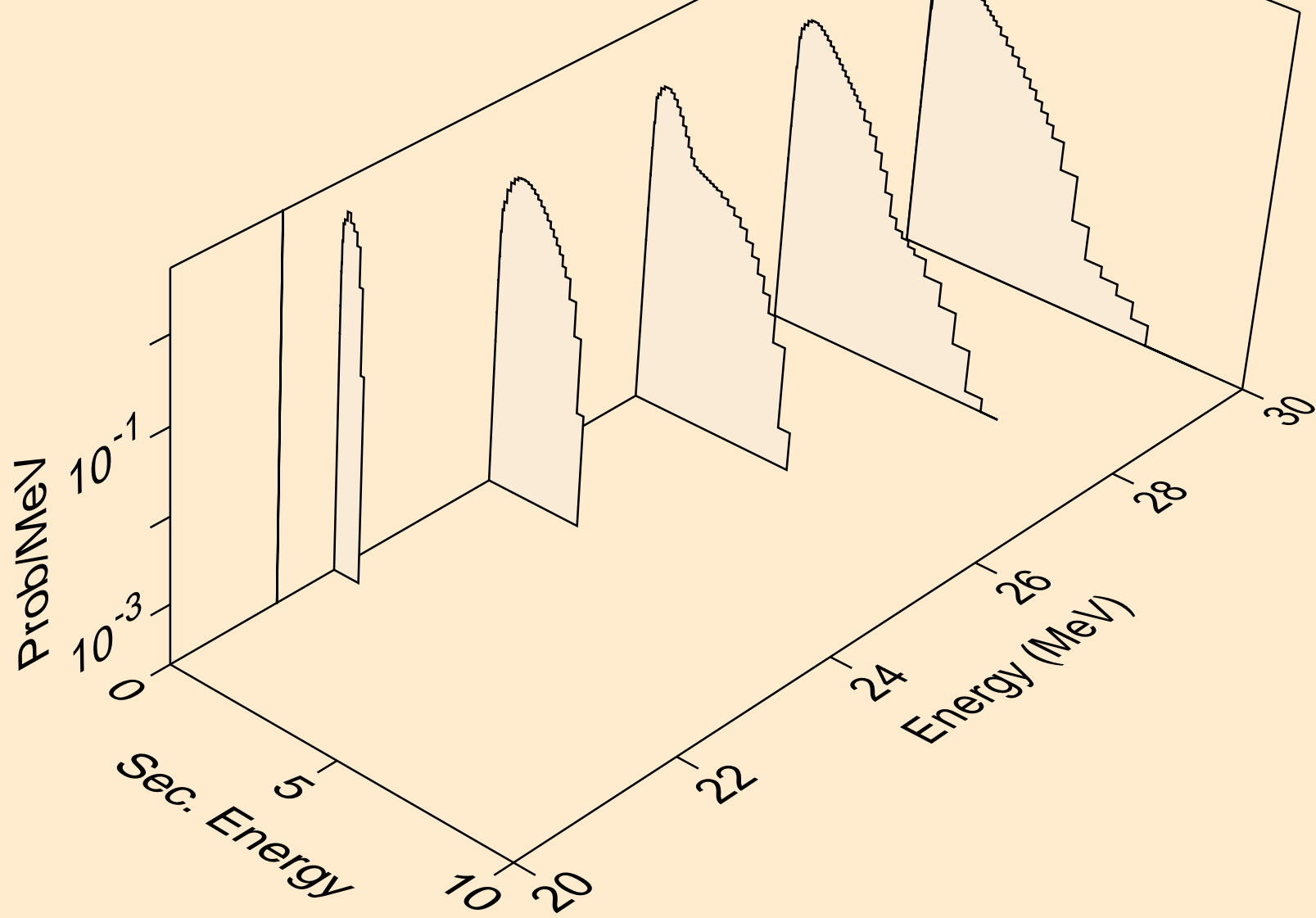

W176 ALPHA ACER TENDL-2024 LIBRARY; T=0.K
neutrons from (a,n*)a

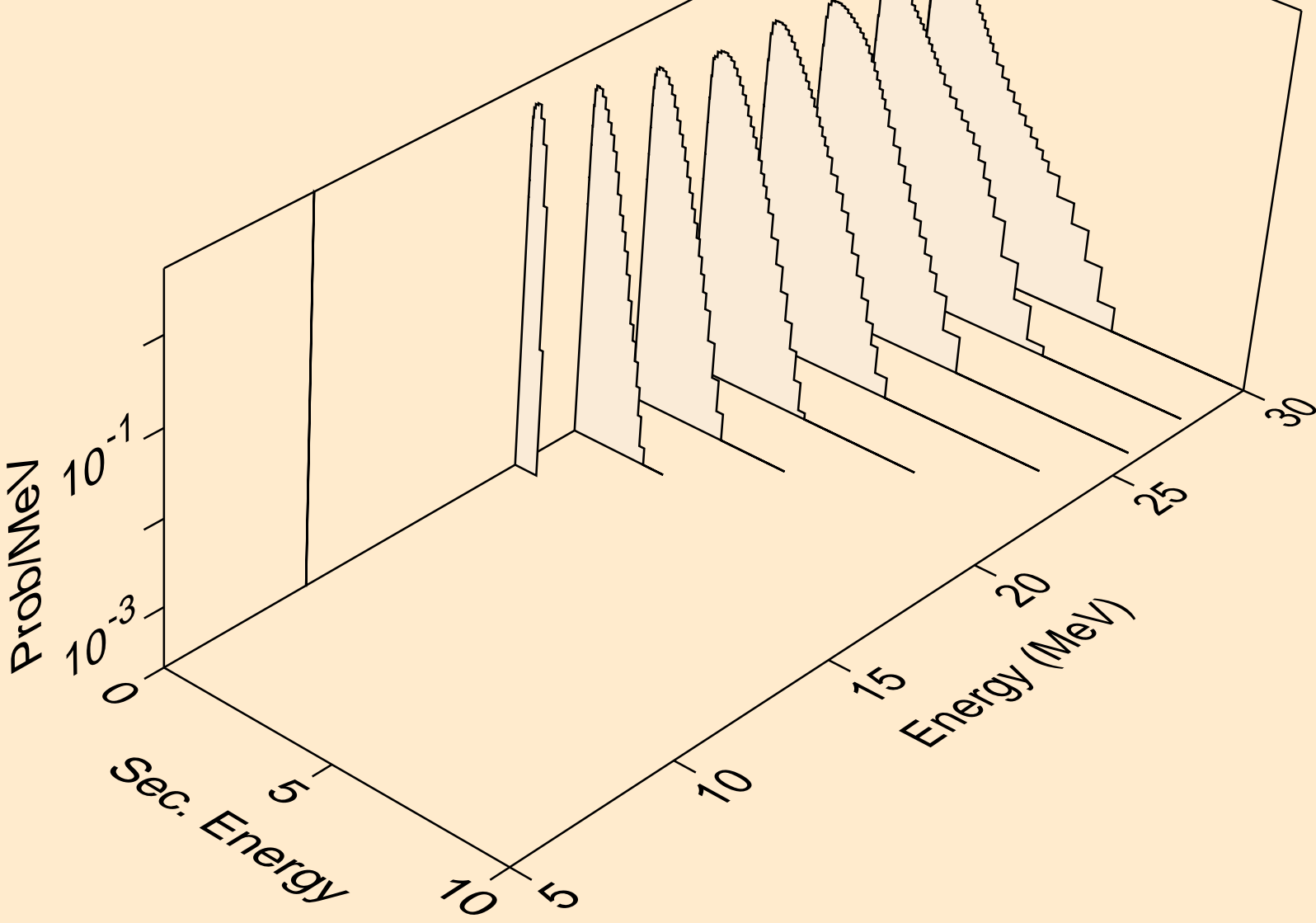

W176 ALPHA ACER TENDL-2024 LIBRARY; T=0.K
neutrons from (a,2n)a

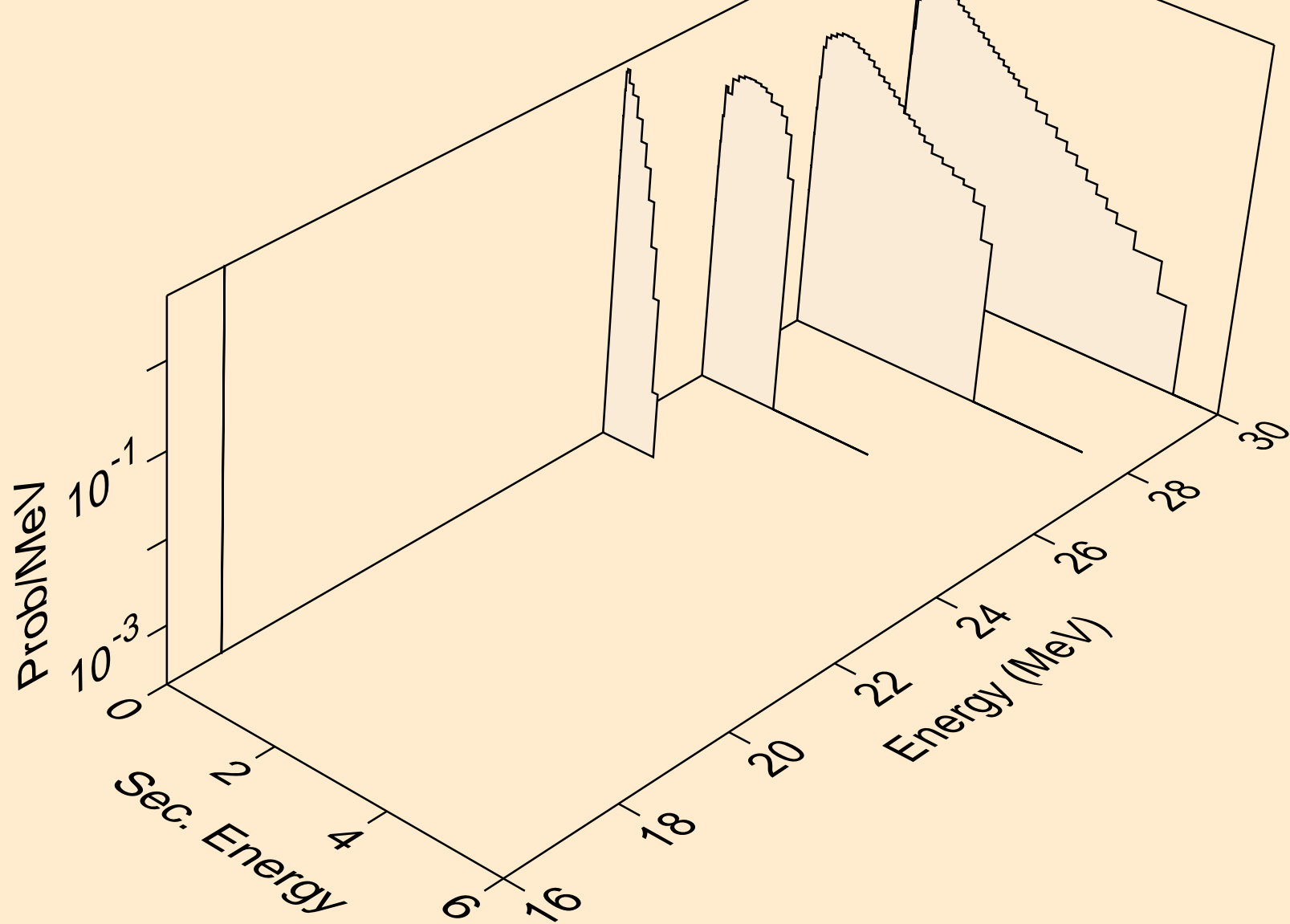

W176 ALPHA ACER TENDL-2024 LIBRARY; T=0.K
neutrons from (a,n*)p

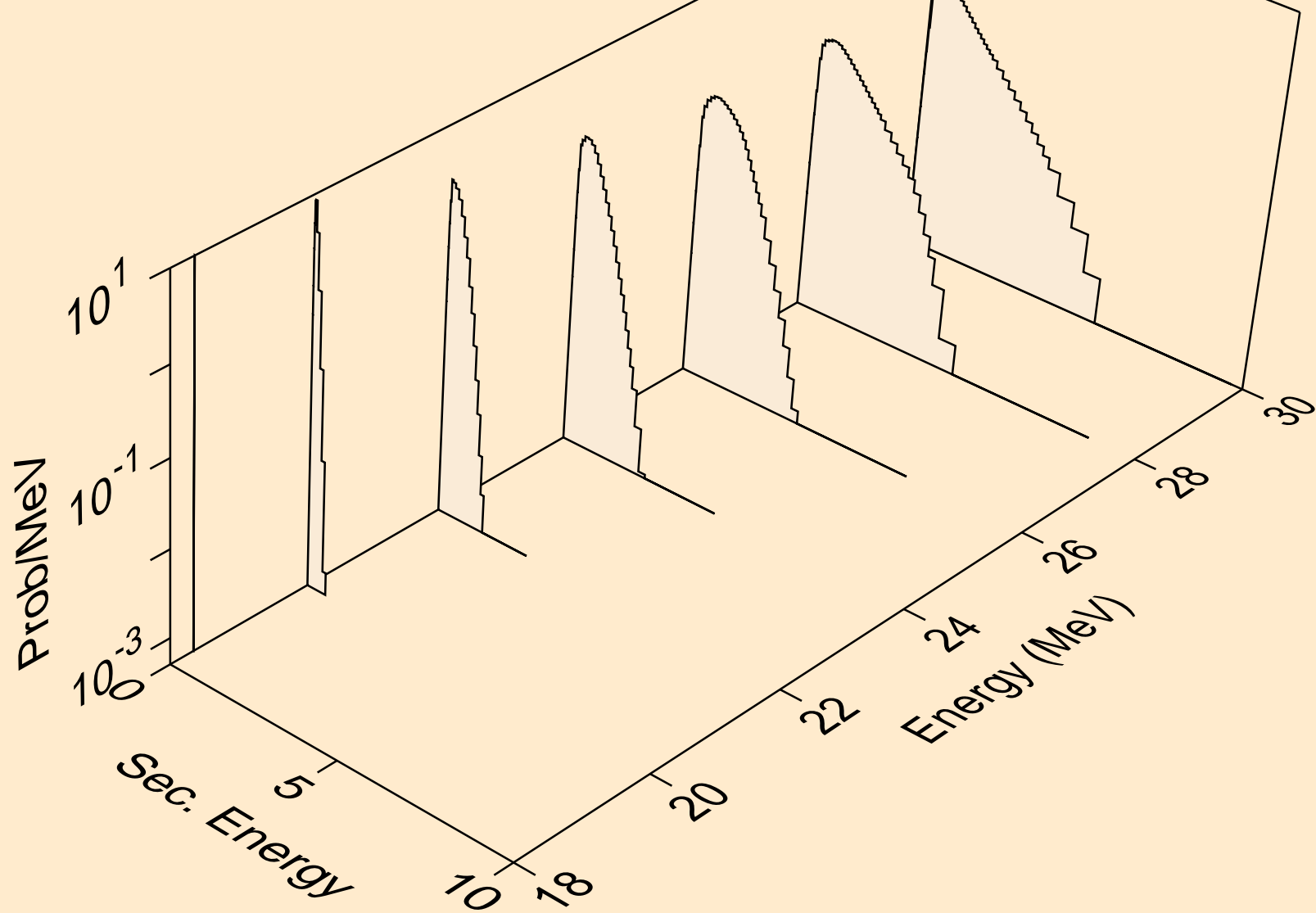

W176 ALPHA ACER TENDL-2024 LIBRARY; T=0.K
neutrons from (a,n*)d

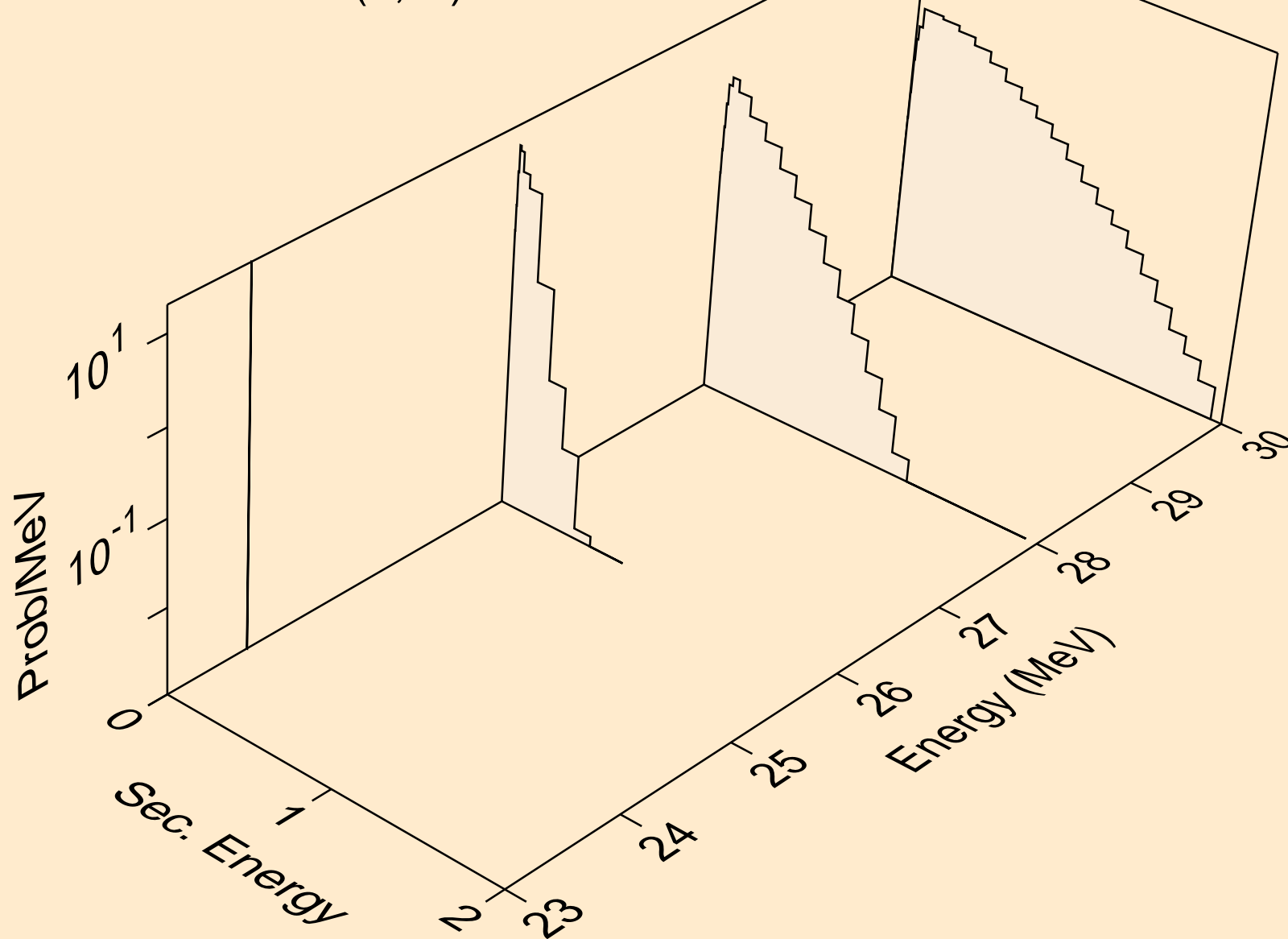

W176 ALPHA ACER TENDL-2024 LIBRARY; T=0.K
neutrons from (a,2np)

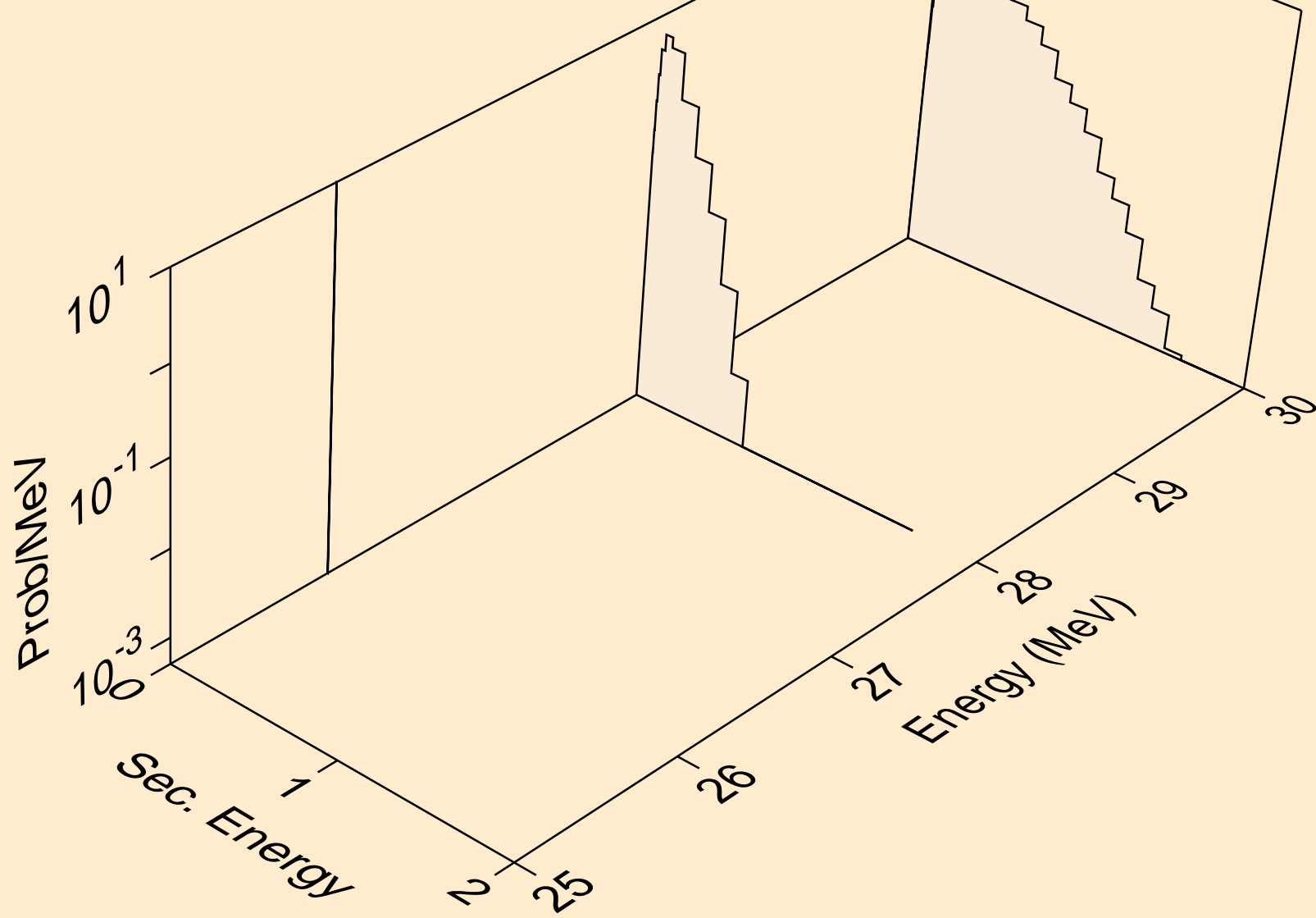

W176 ALPHA ACER TENDL-2024 LIBRARY; T=0.K
protons from (a,x)

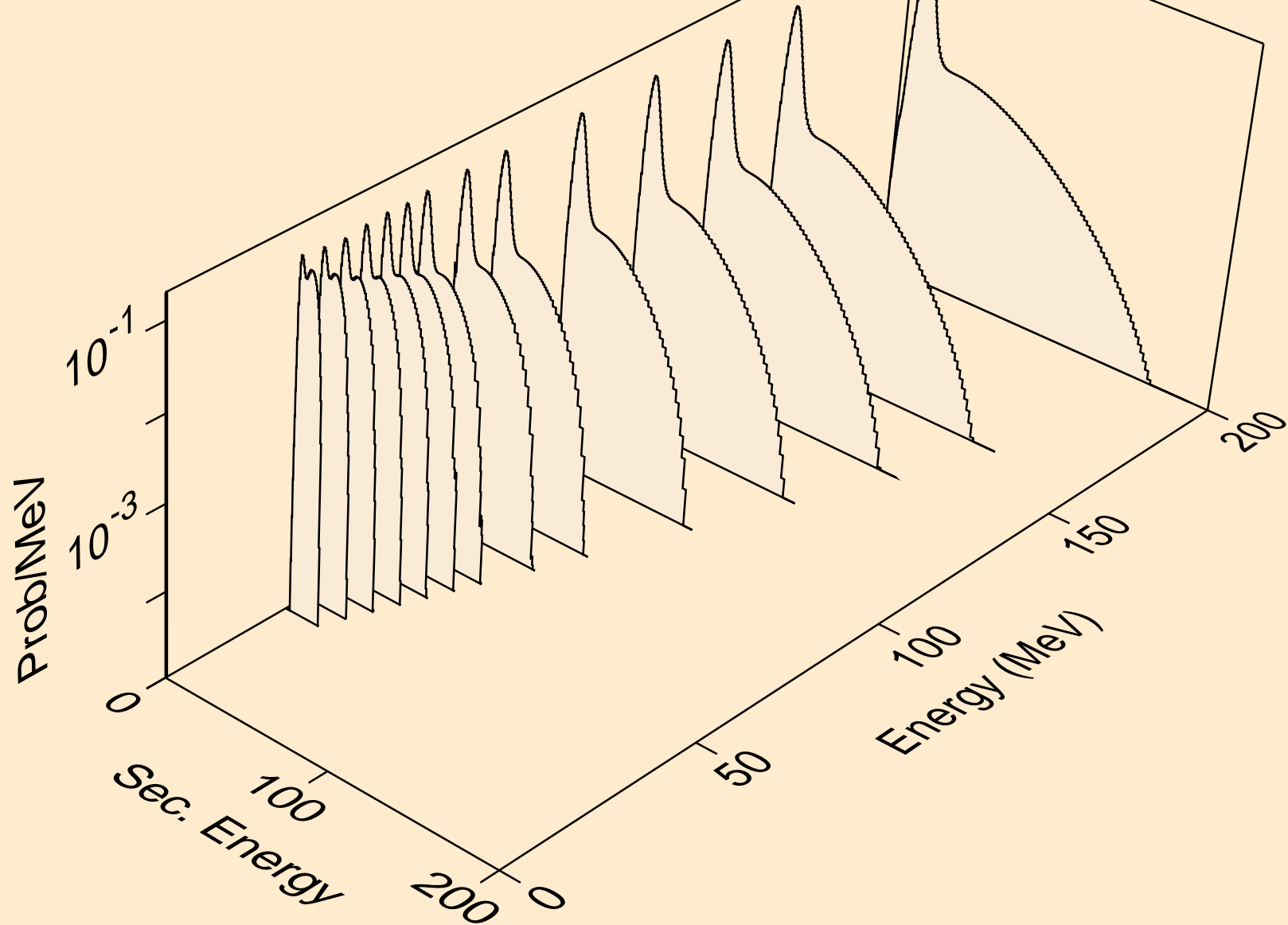

W176 ALPHA ACER TENDL-2024 LIBRARY; T=0.K
protons from (a,n*)p

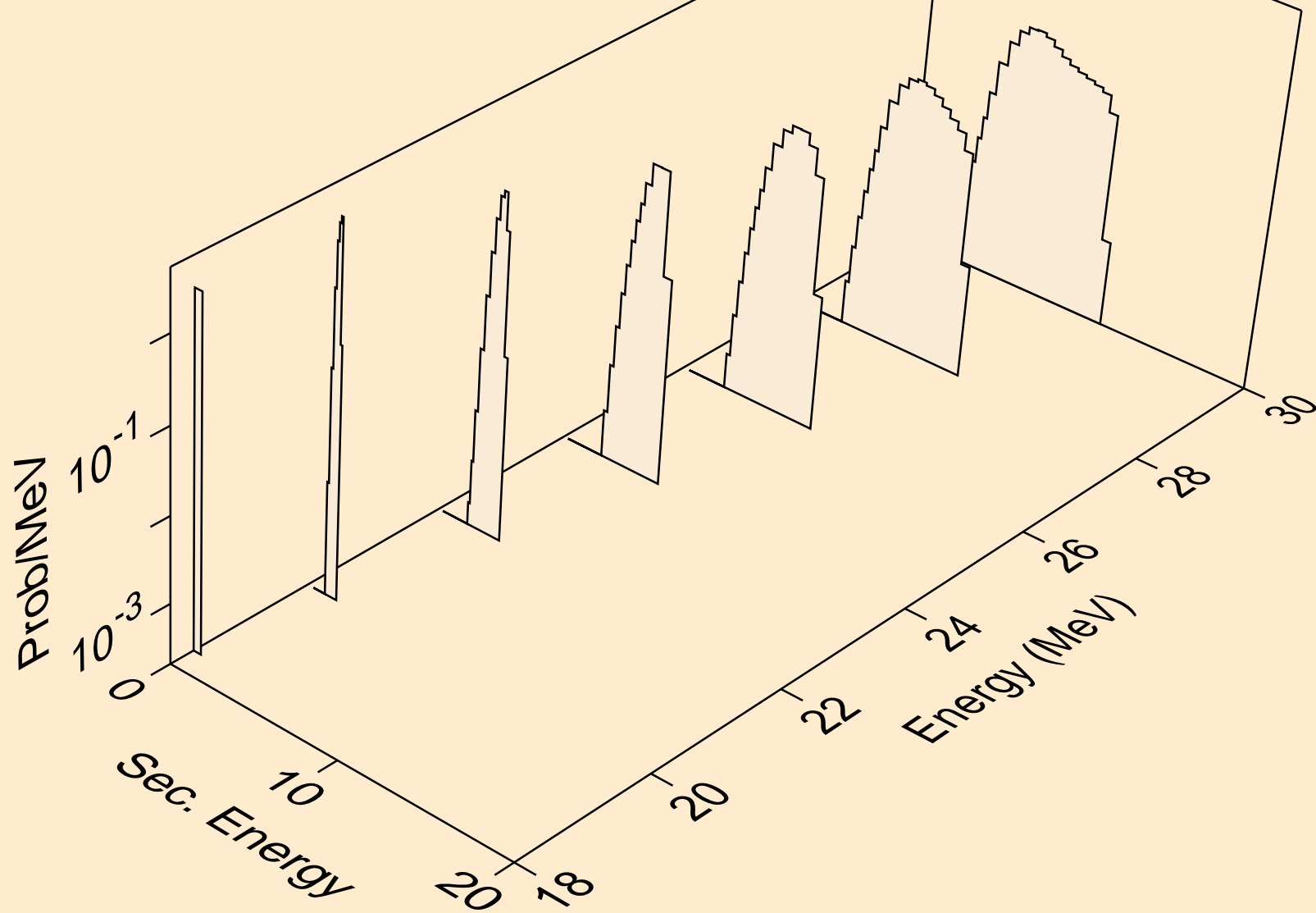

W176 ALPHA ACER TENDL-2024 LIBRARY; T=0.K
protons from (a,2np)

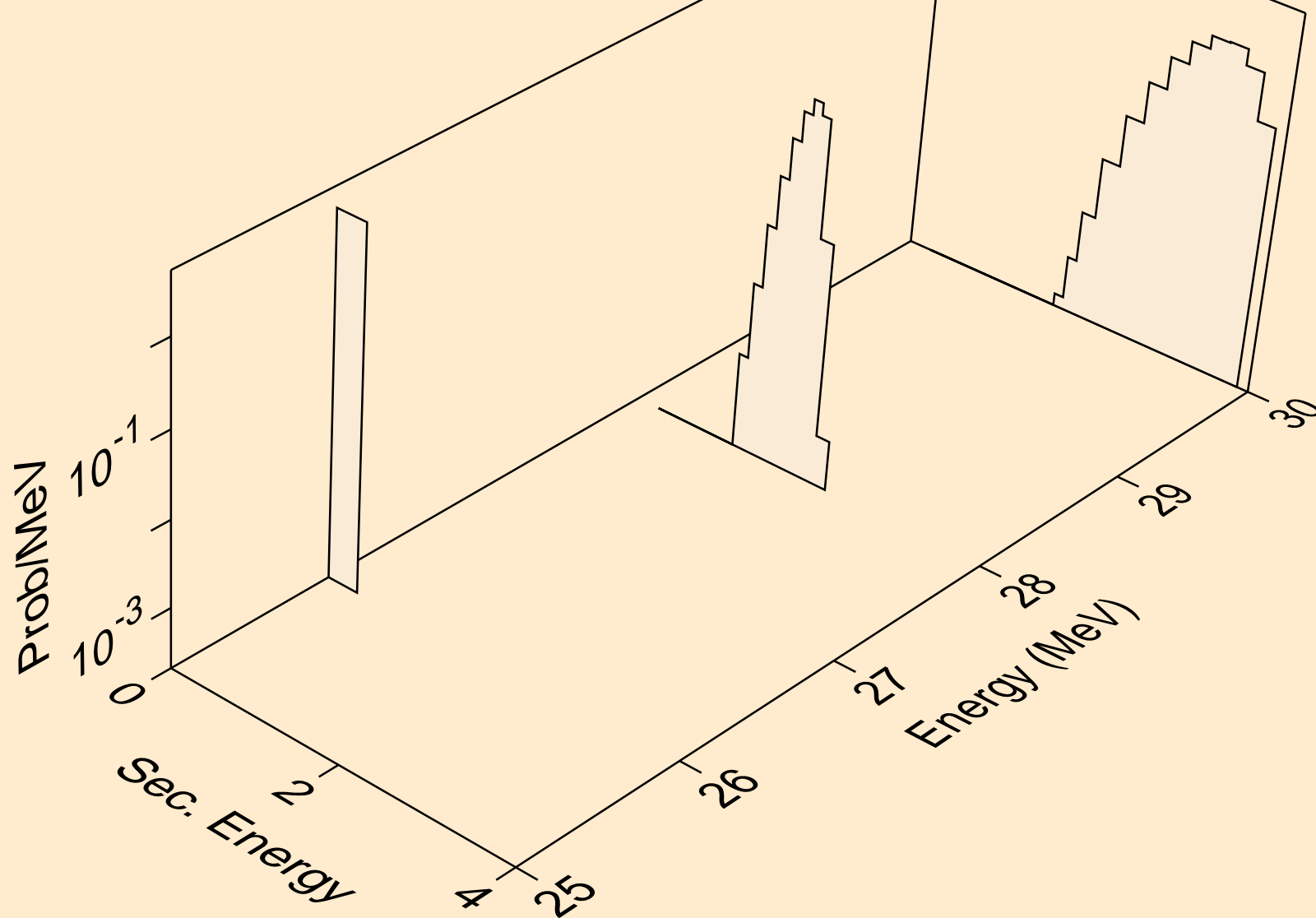

W176 ALPHA ACER TENDL-2024 LIBRARY; T=0.K
protons from (a,p)

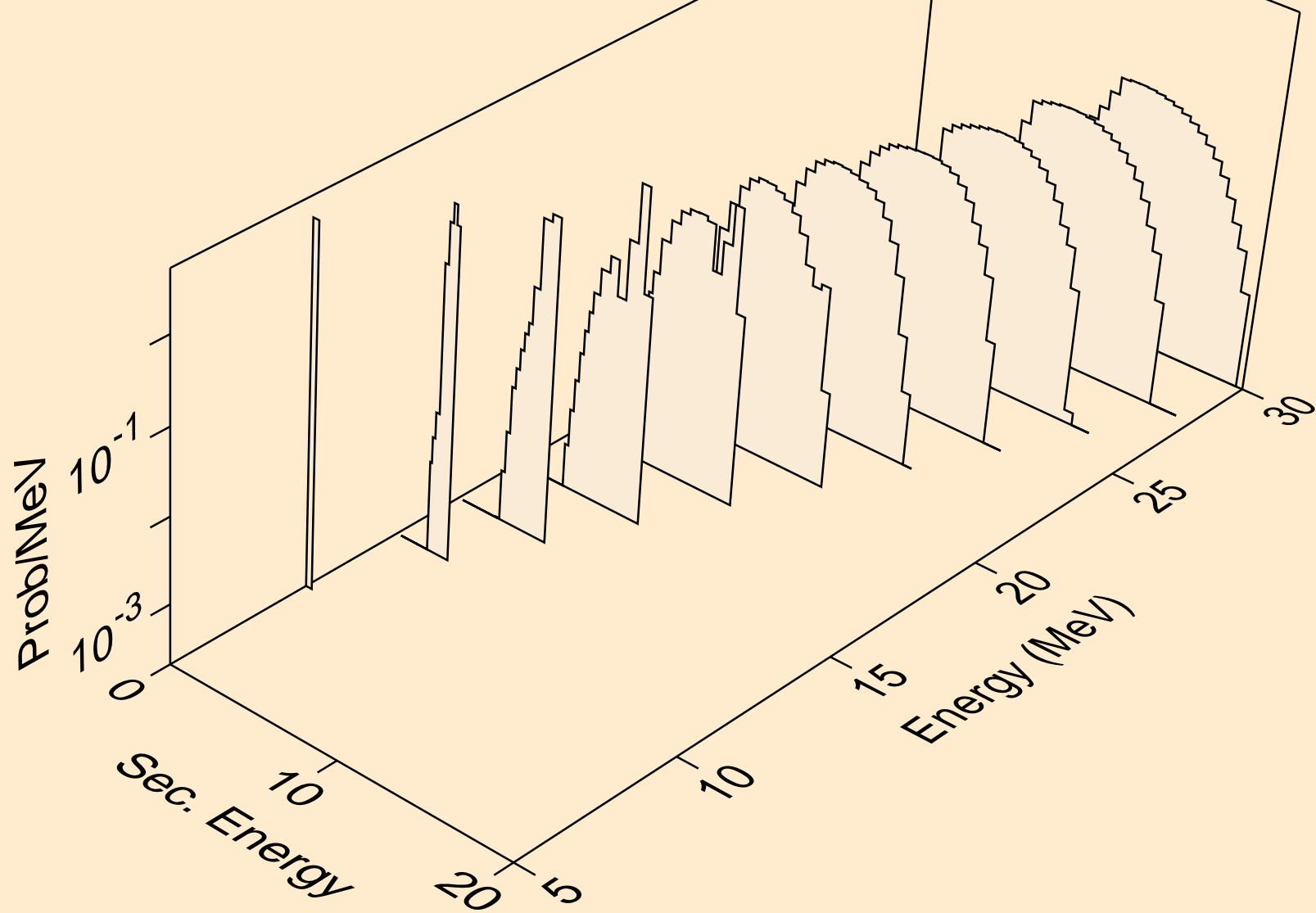

W176 ALPHA ACER TENDL-2024 LIBRARY; T=0.K
protons from (a,2p)

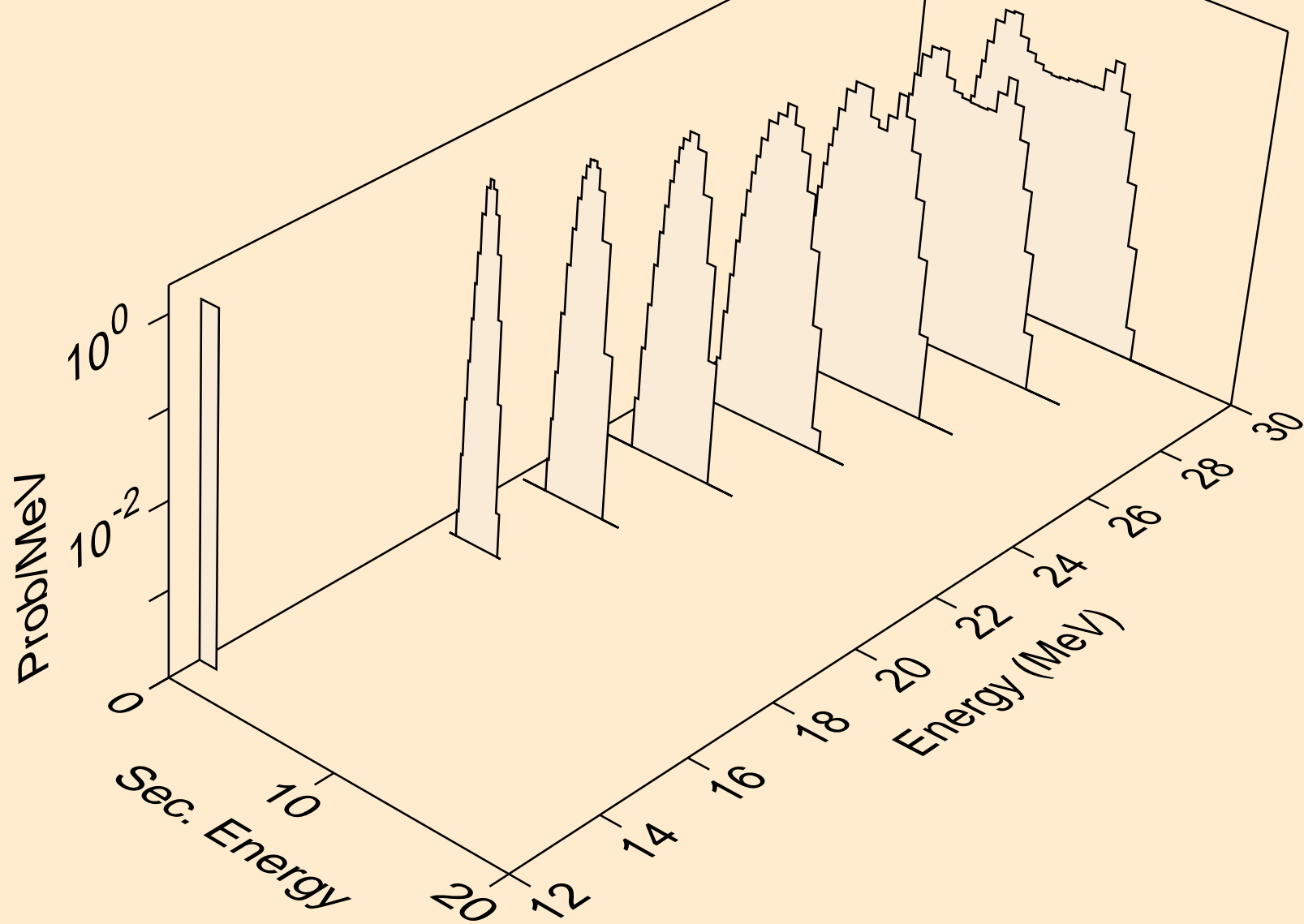

W176 ALPHA ACER TENDL-2024 LIBRARY; T=0.K
protons from (a,pa)

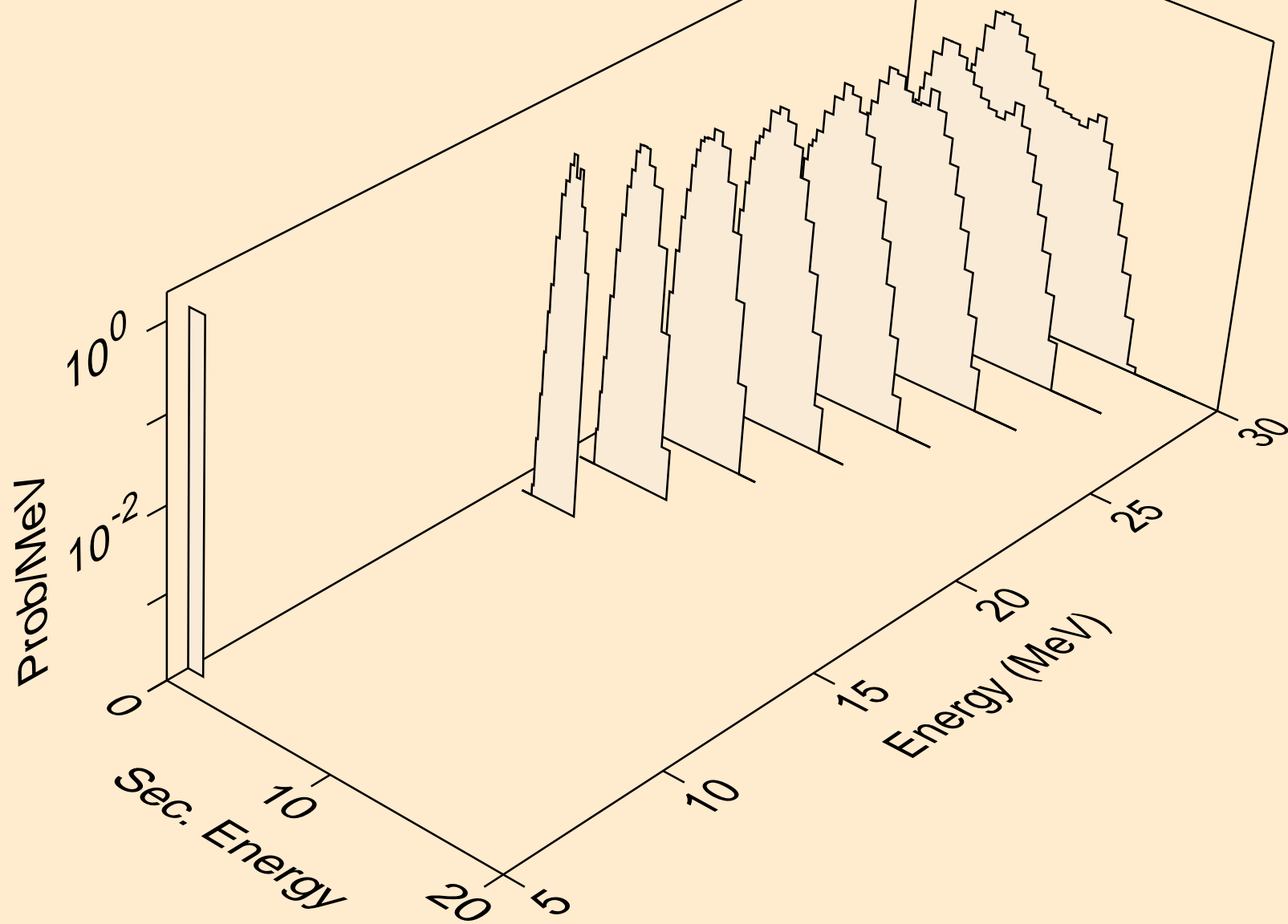

W176 ALPHA ACER TENDL-2024 LIBRARY; T=0.K
deuterons from (a,x)

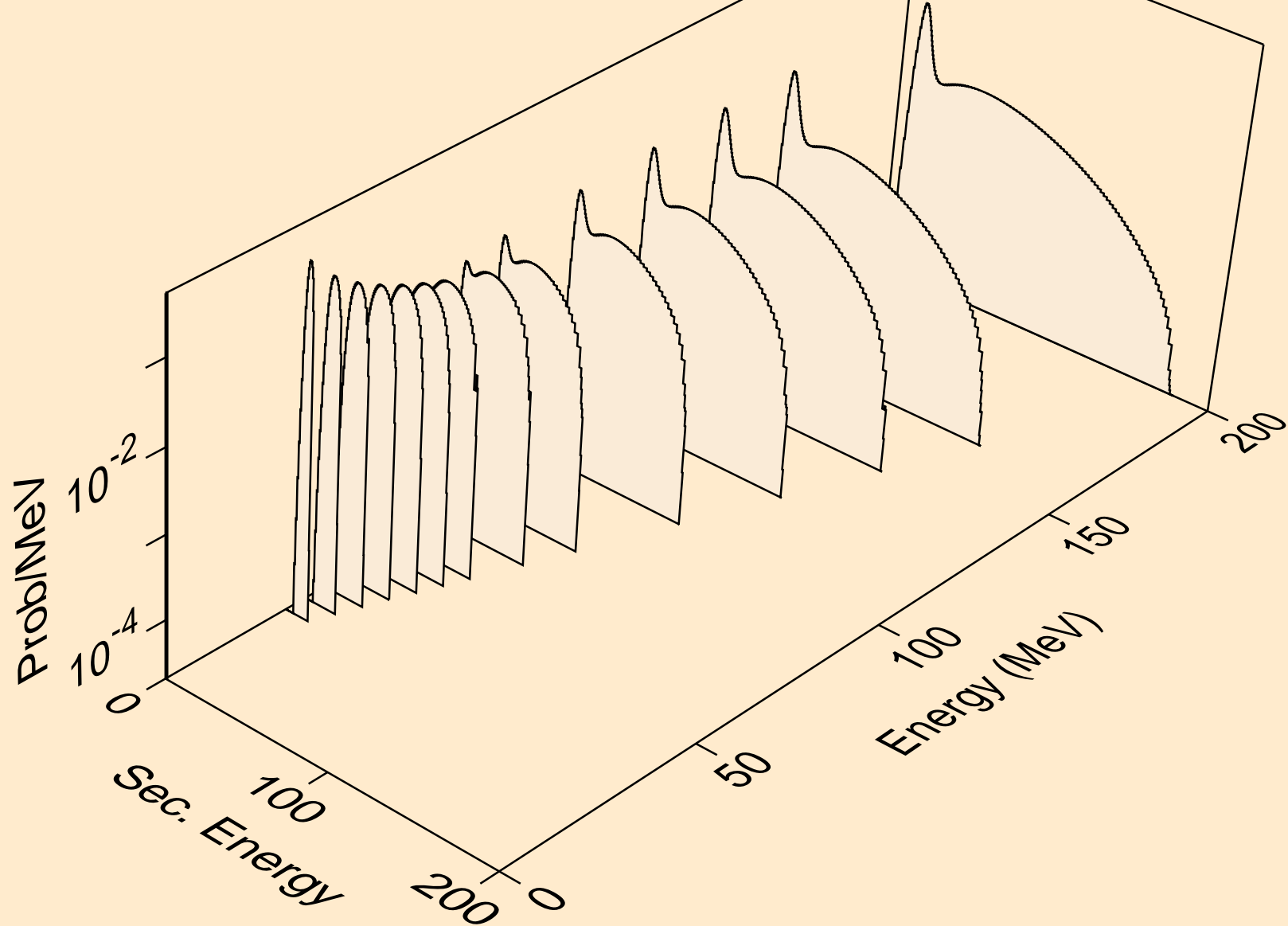

W176 ALPHA ACER TENDL-2024 LIBRARY; T=0.K
deuterons from (a,n*)d

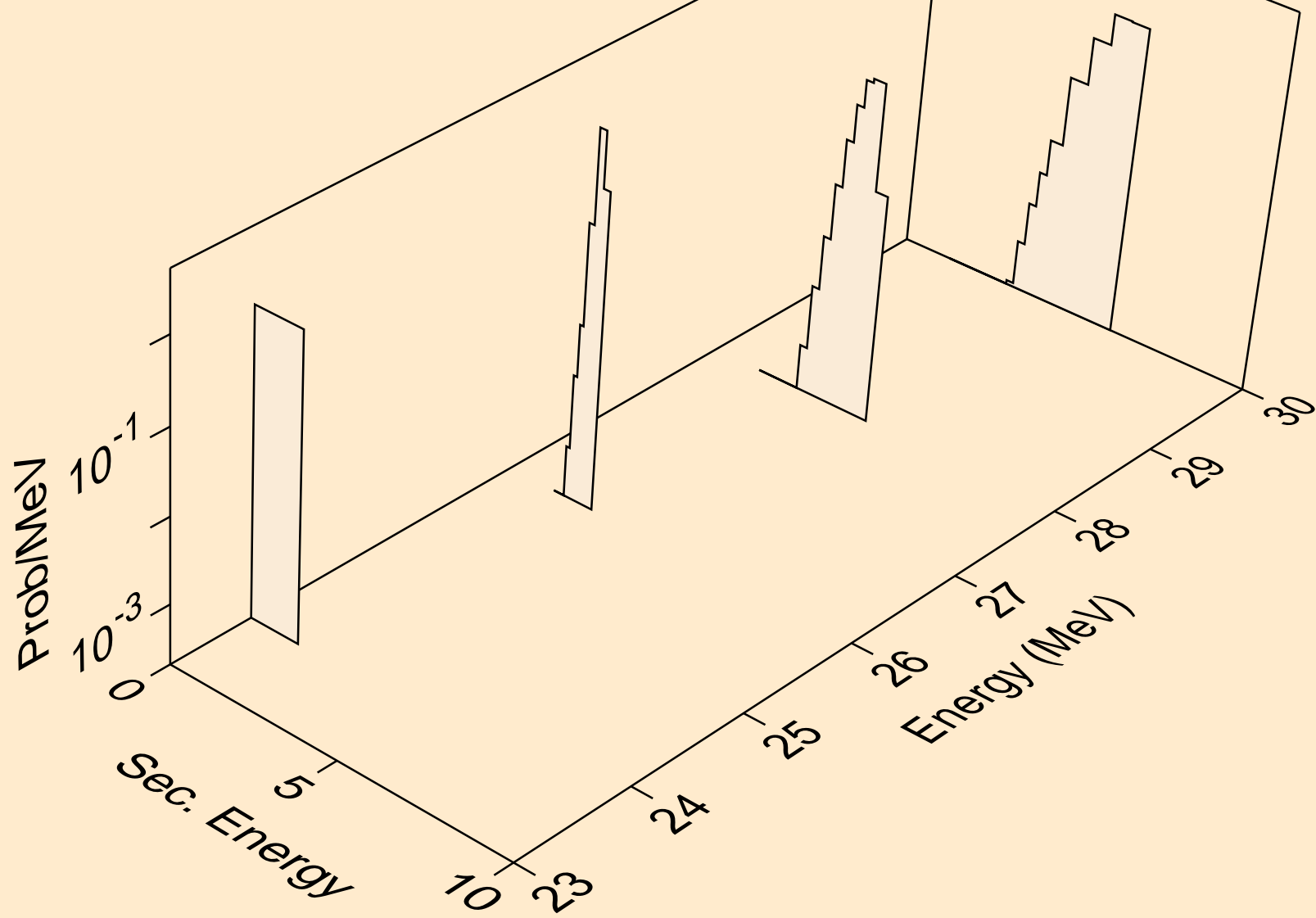

W176 ALPHA ACER TENDL-2024 LIBRARY; T=0.K
deuterons from (a,d)

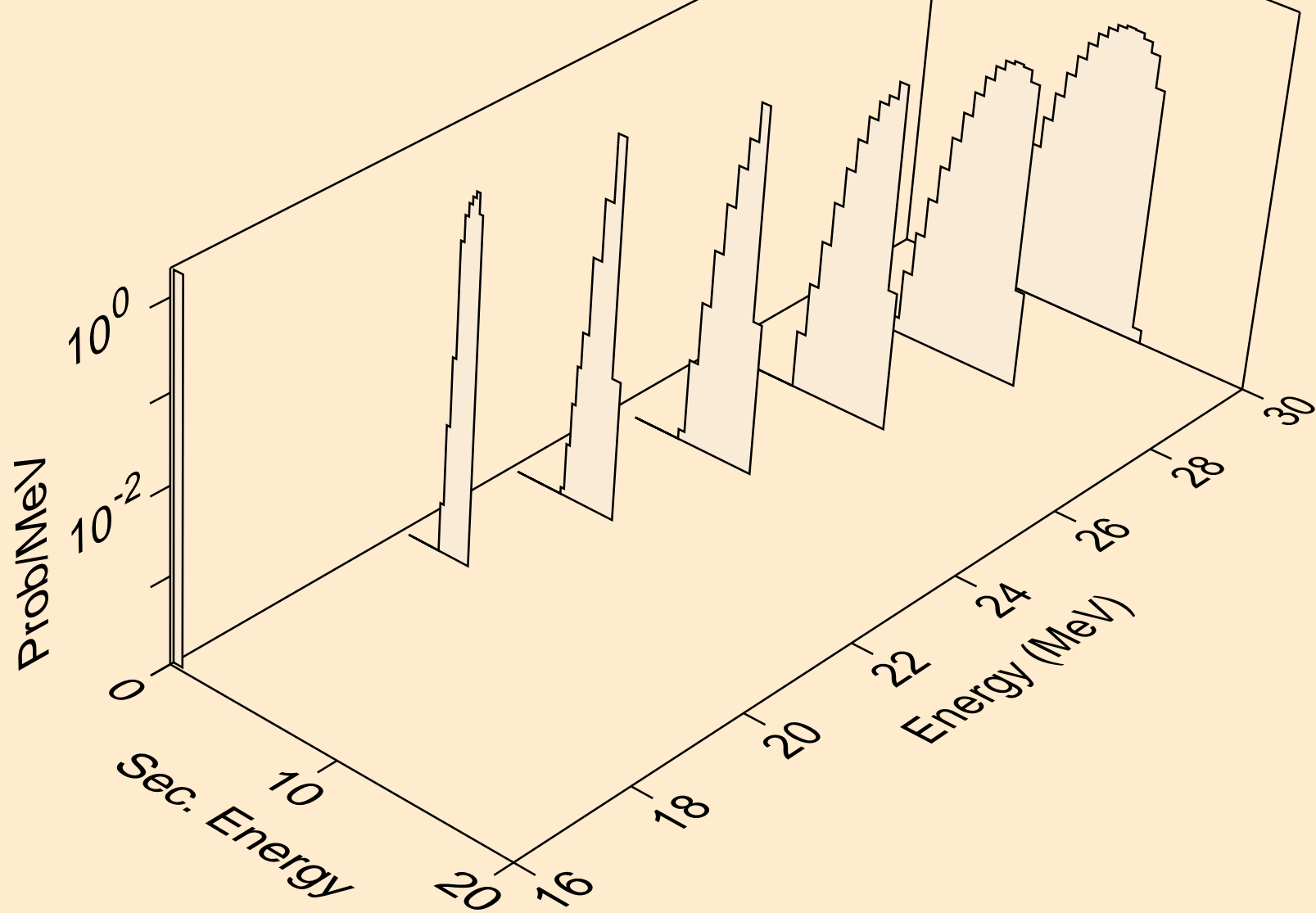

W176 ALPHA ACER TENDL-2024 LIBRARY; T=0.K
tritons from (a,x)

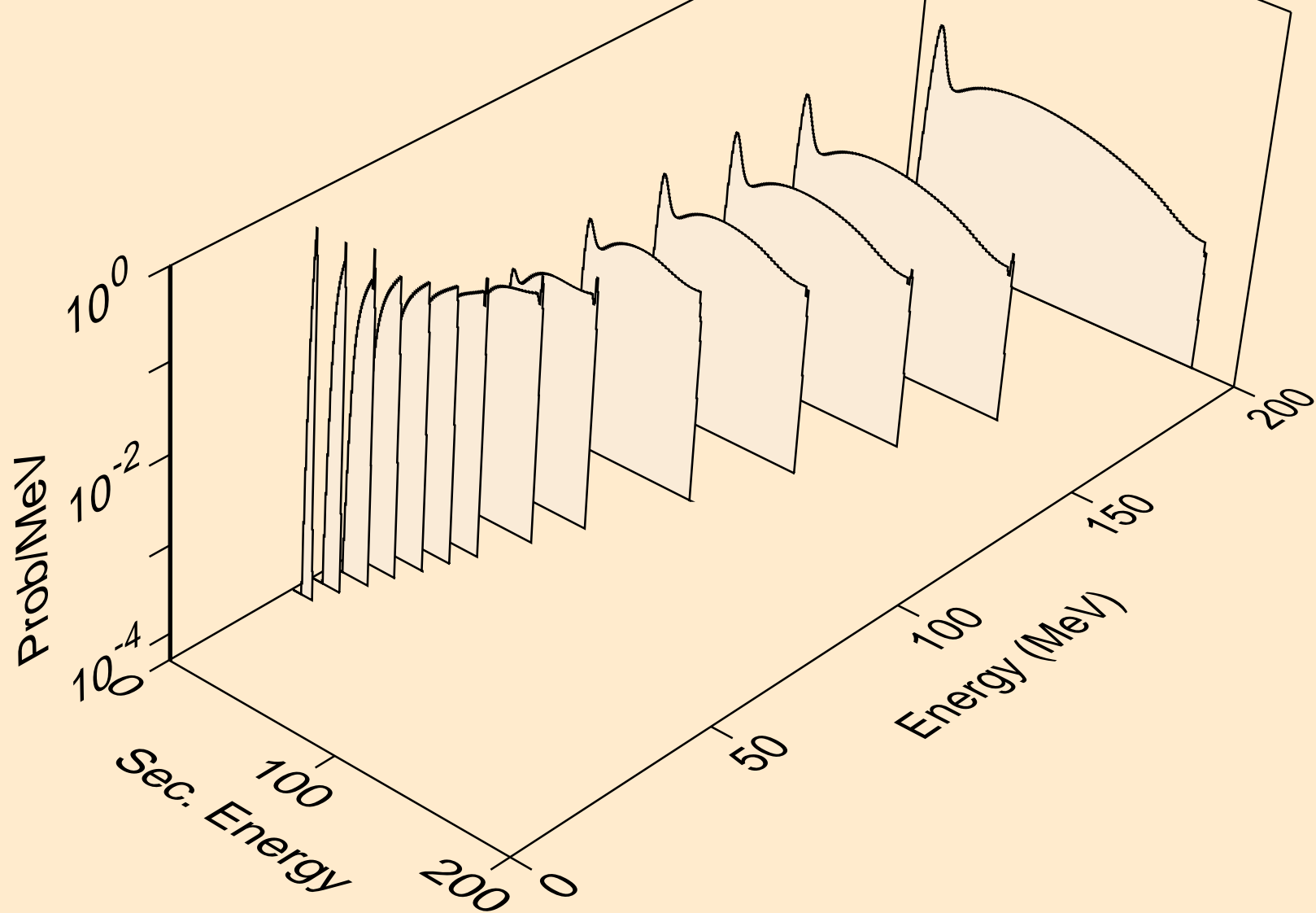

W176 ALPHA ACER TENDL-2024 LIBRARY; T=0.K
tritons from (a,t)

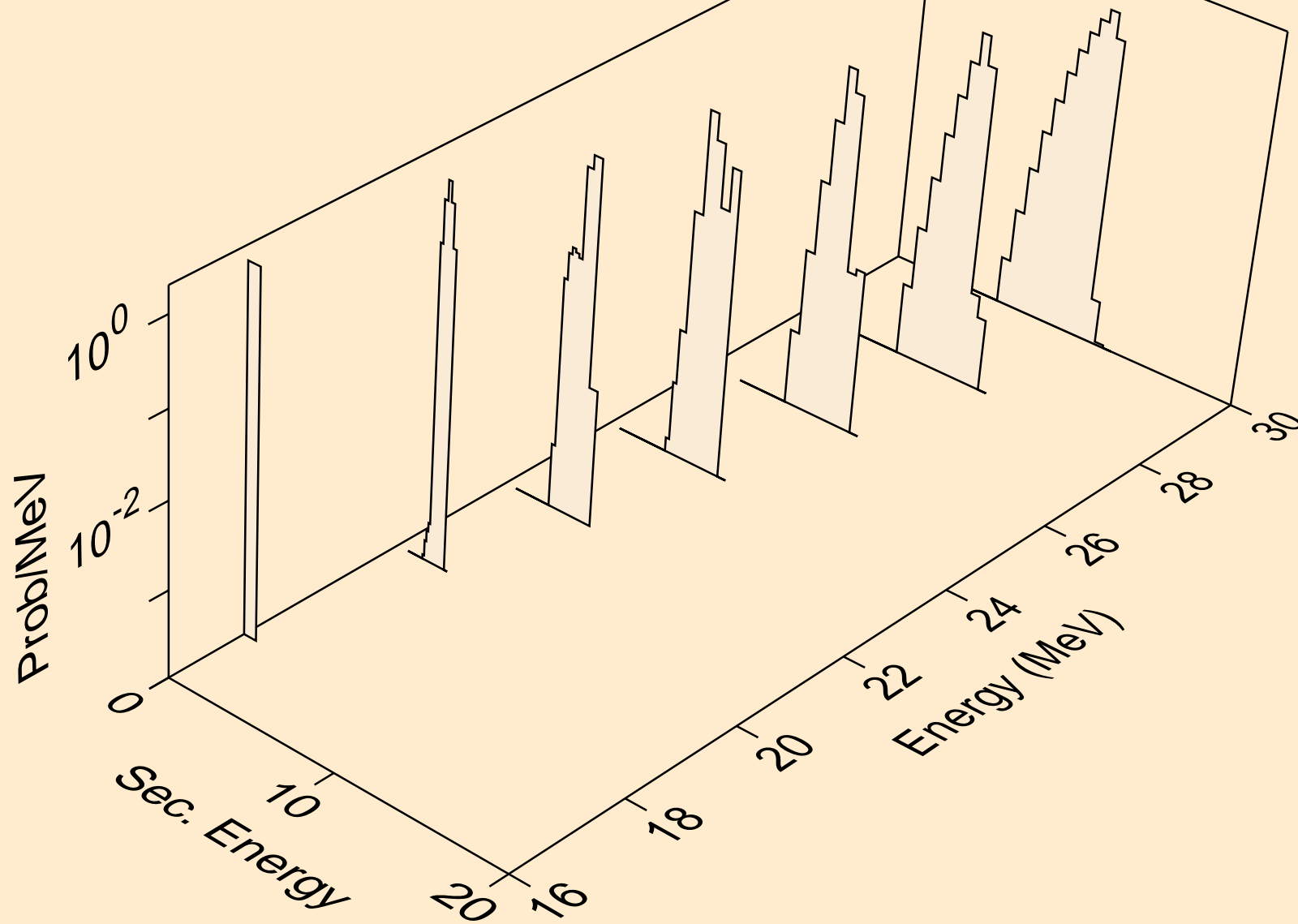

W176 ALPHA ACER TENDL-2024 LIBRARY; T=0.K
he3s from (a,x)

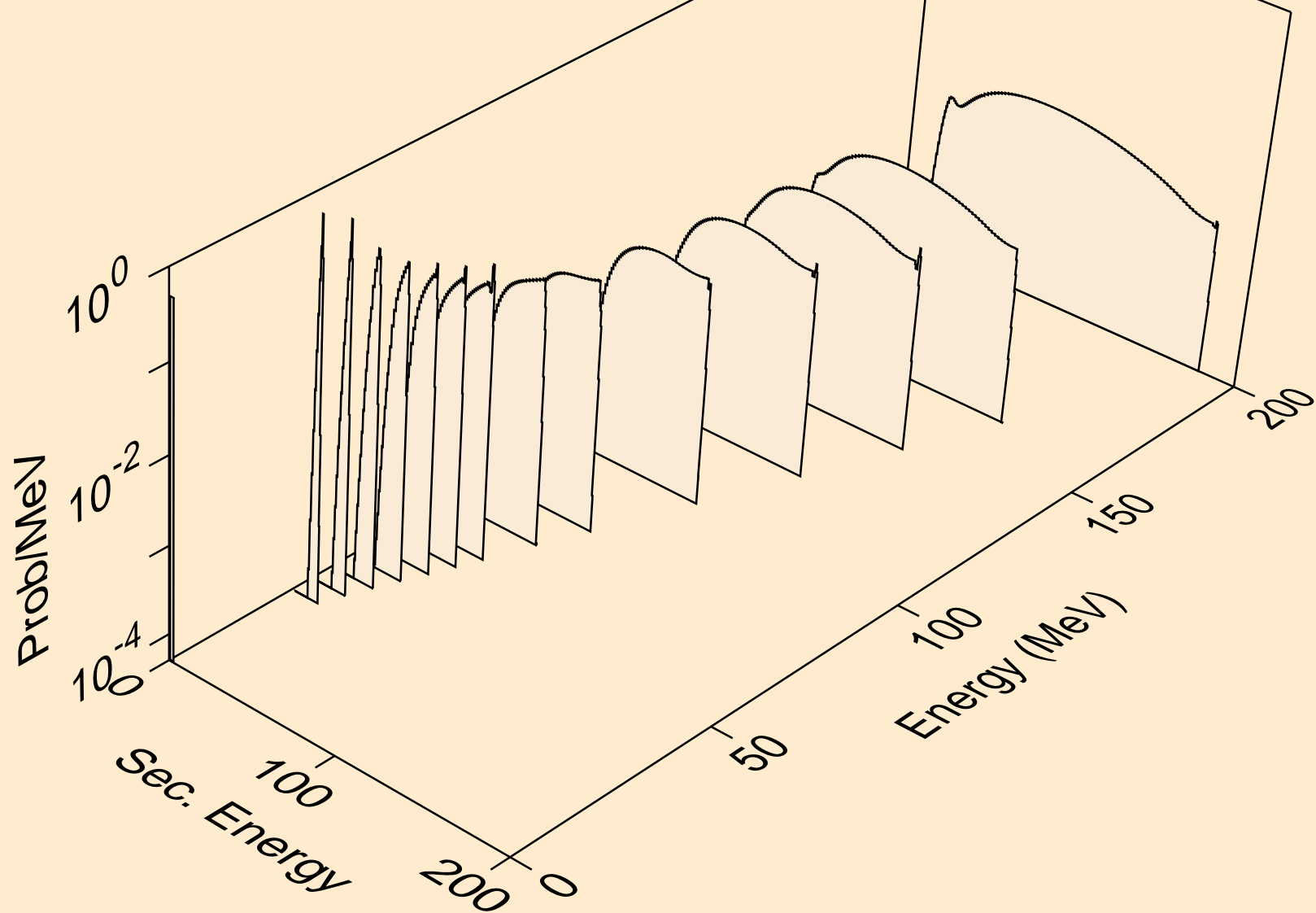

W176 ALPHA ACER TENDL-2024 LIBRARY; T=0.K
he3s from (a,he3)

