

# YB152 ALPHA ACER TENDL-2024 LIBRARY; T=0.K

## Principal cross sections

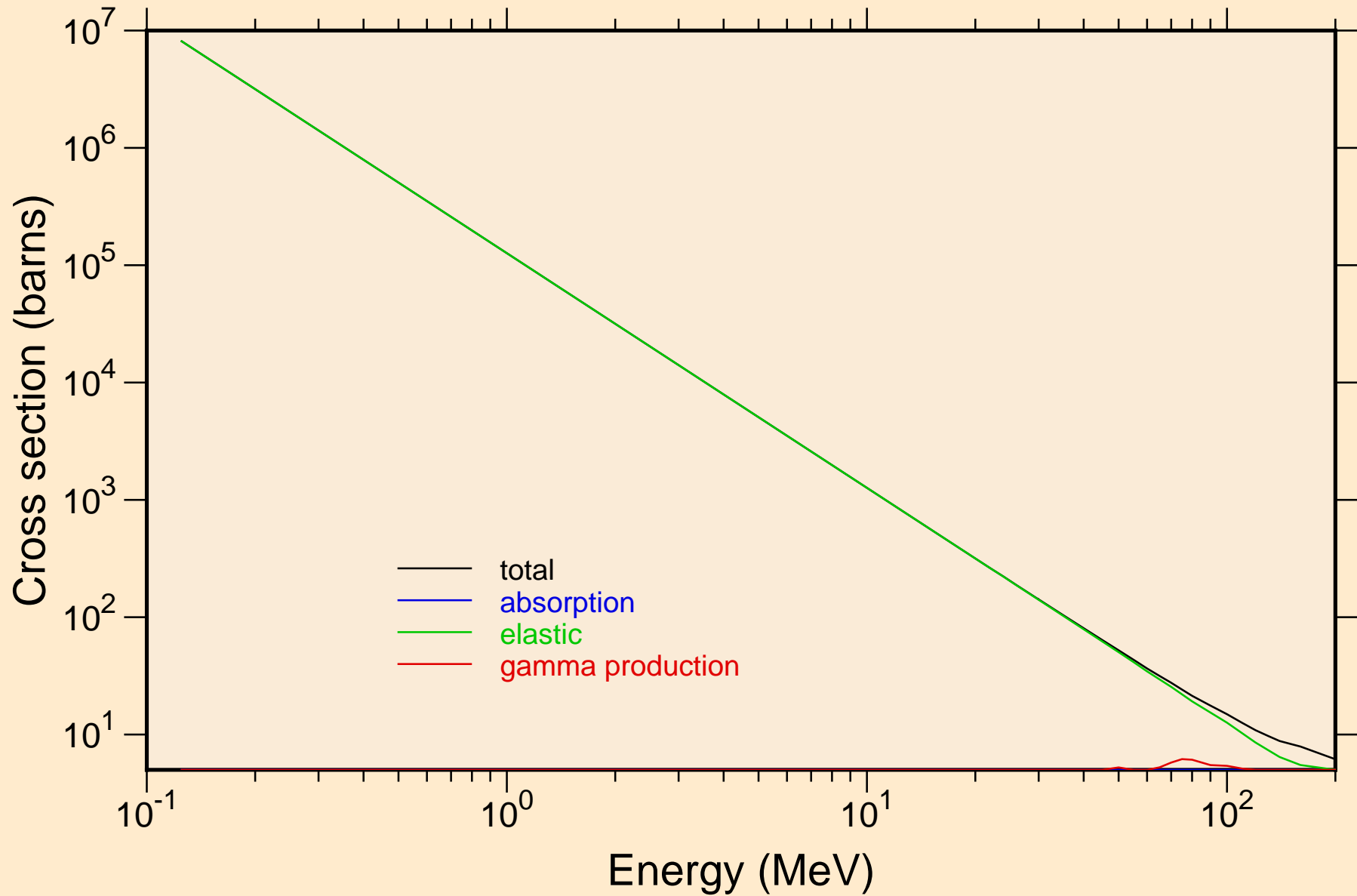

# YB152 ALPHA ACER TENDL-2024 LIBRARY; T=0.K

## Heating

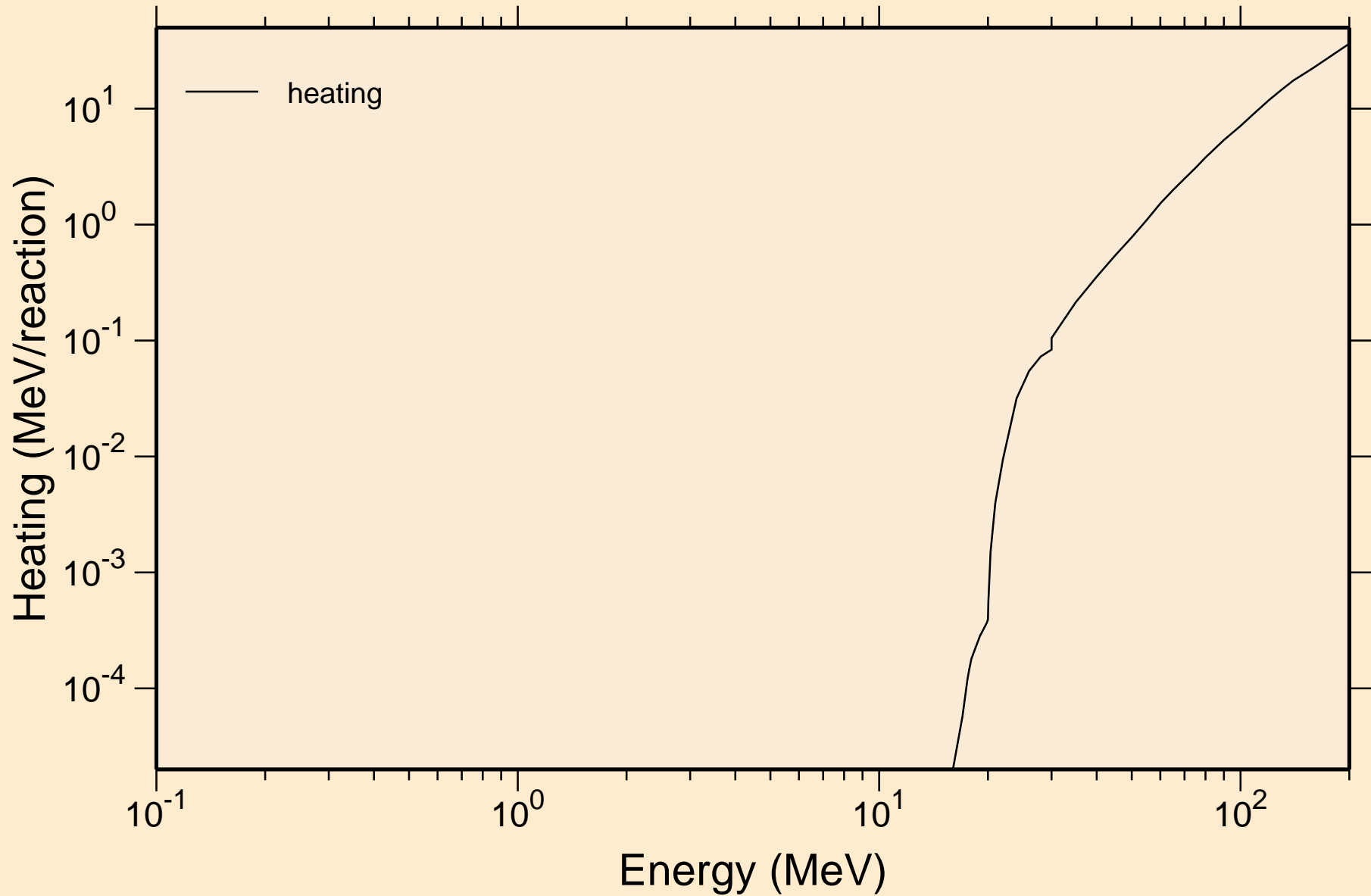

# YB152 ALPHA ACER TENDL-2024 LIBRARY; T=0.K

## Principal cross sections

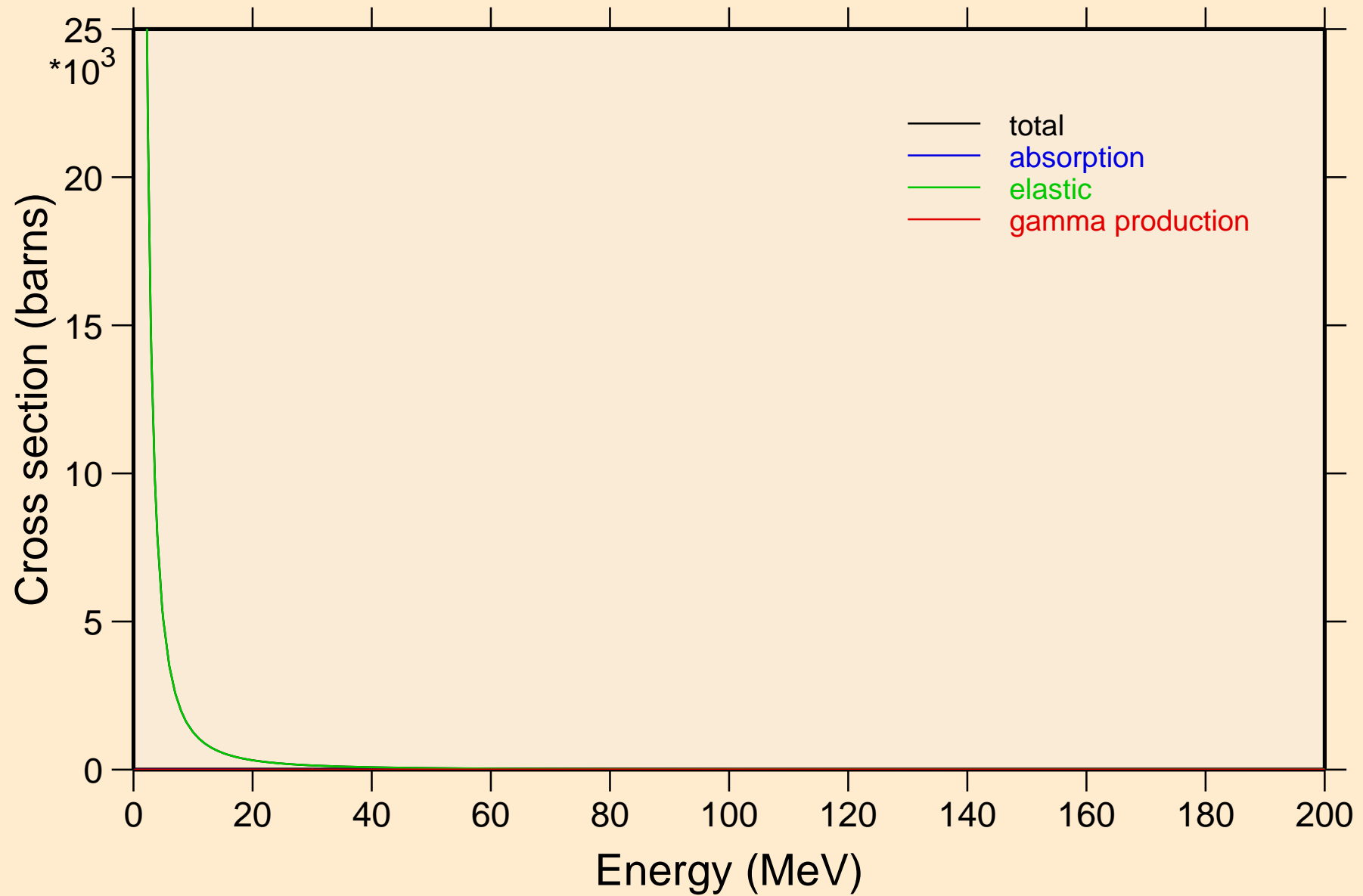

YB152 ALPHA ACER TENDL-2024 LIBRARY; T=0.K

Heating

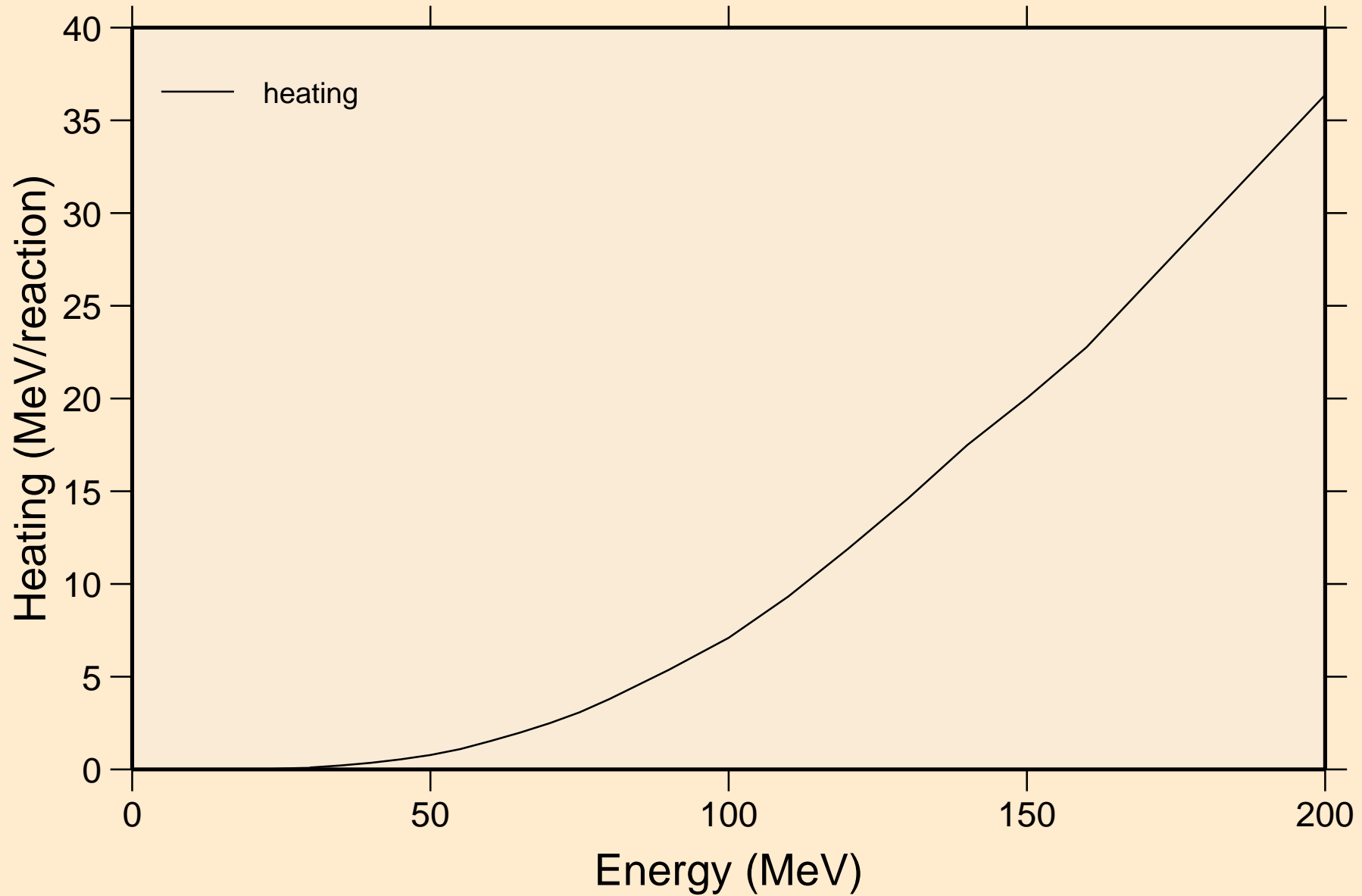

YB152 ALPHA ACER TENDL-2024 LIBRARY; T=0.K  
Threshold reactions

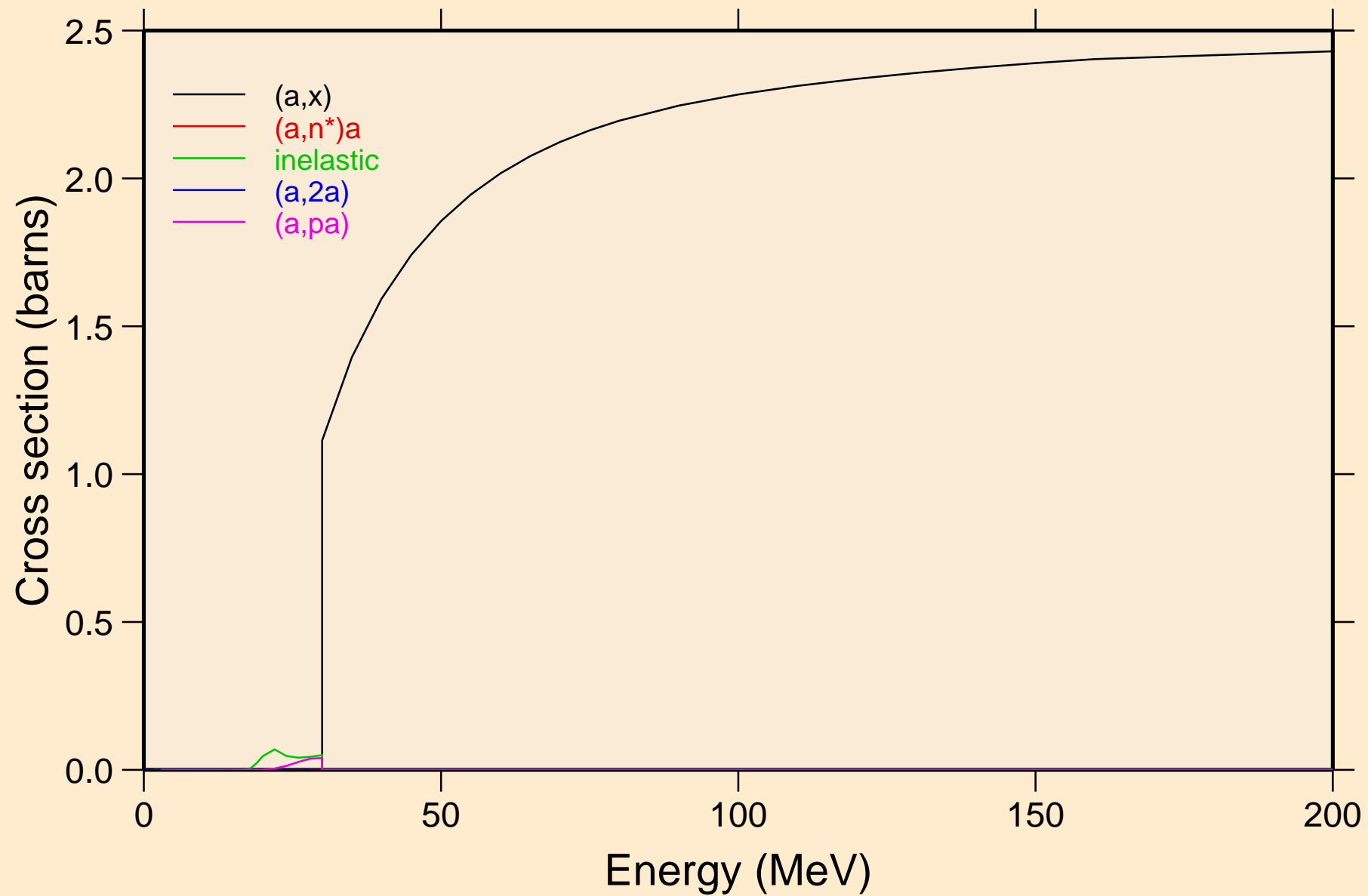

YB152 ALPHA ACER TENDL-2024 LIBRARY; T=0.K  
Threshold reactions

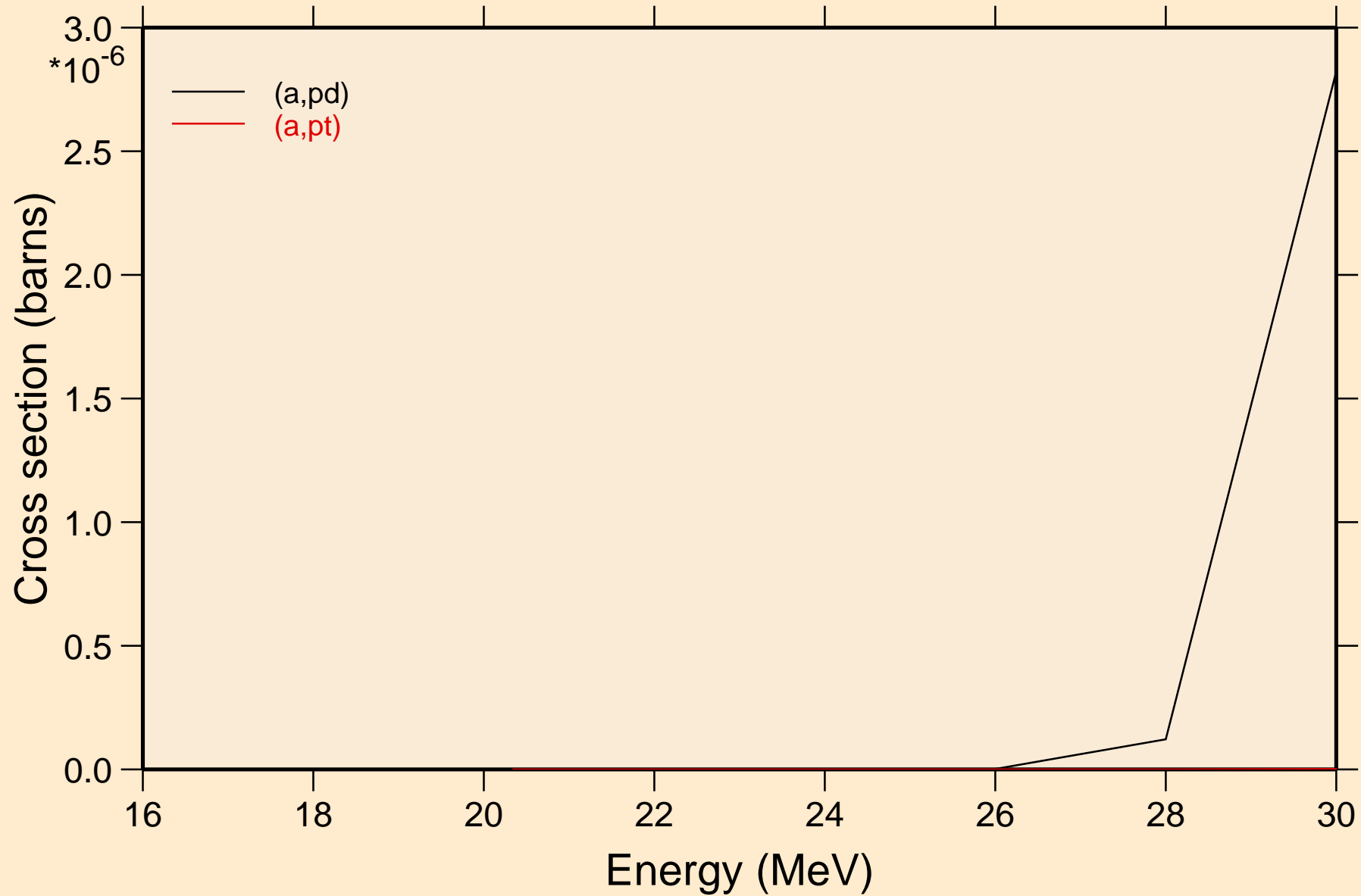

YB152 ALPHA ACER TENDL-2024 LIBRARY; T=0.K  
angular distribution for elastic

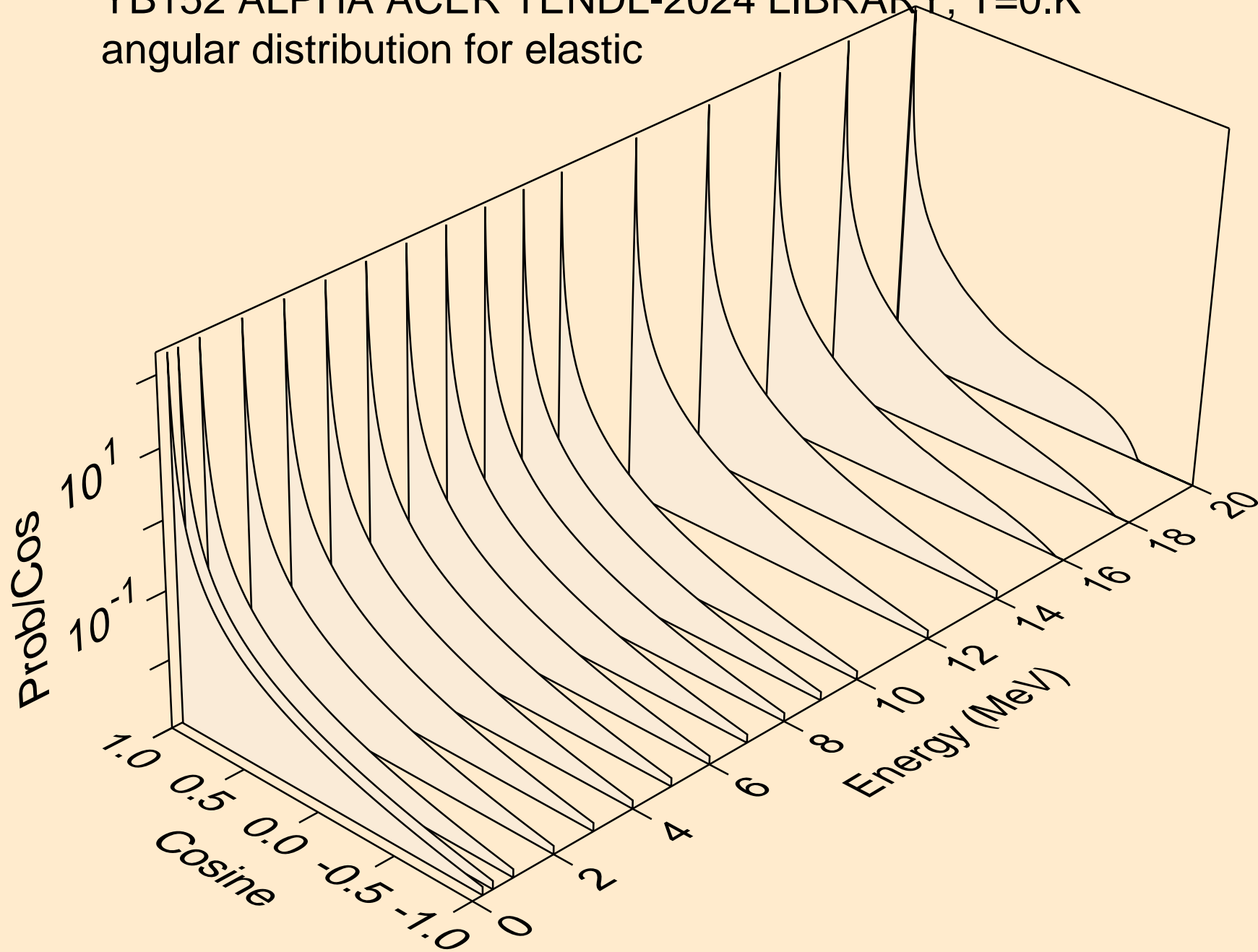

YB152 ALPHA ACER TENDL-2024 LIBRARY; T=0.K  
angular distribution for elastic

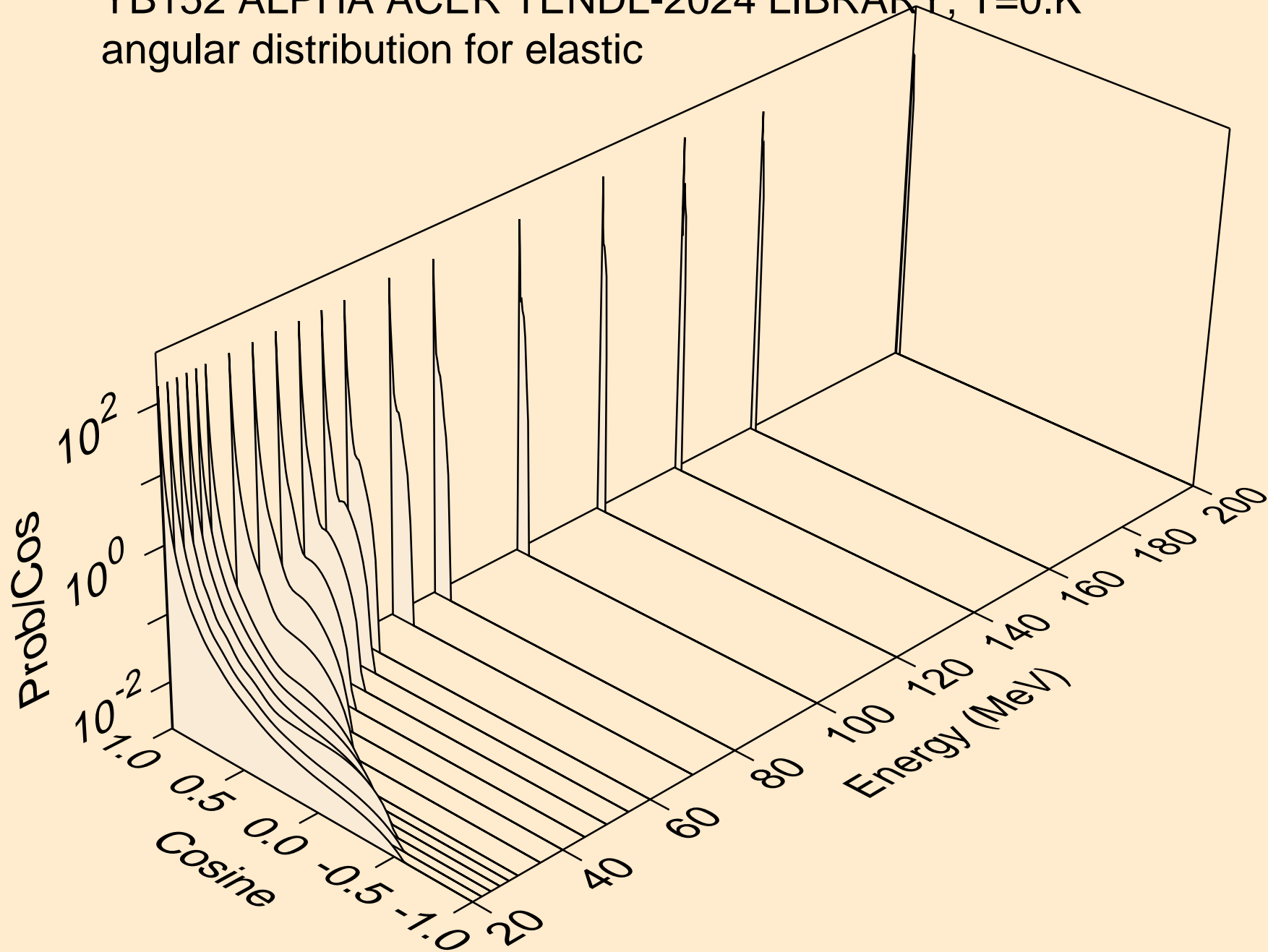

YB152 ALPHA ACER TENDL-2024 LIBRARY; T=0.K  
Alpha emission for (a,x)

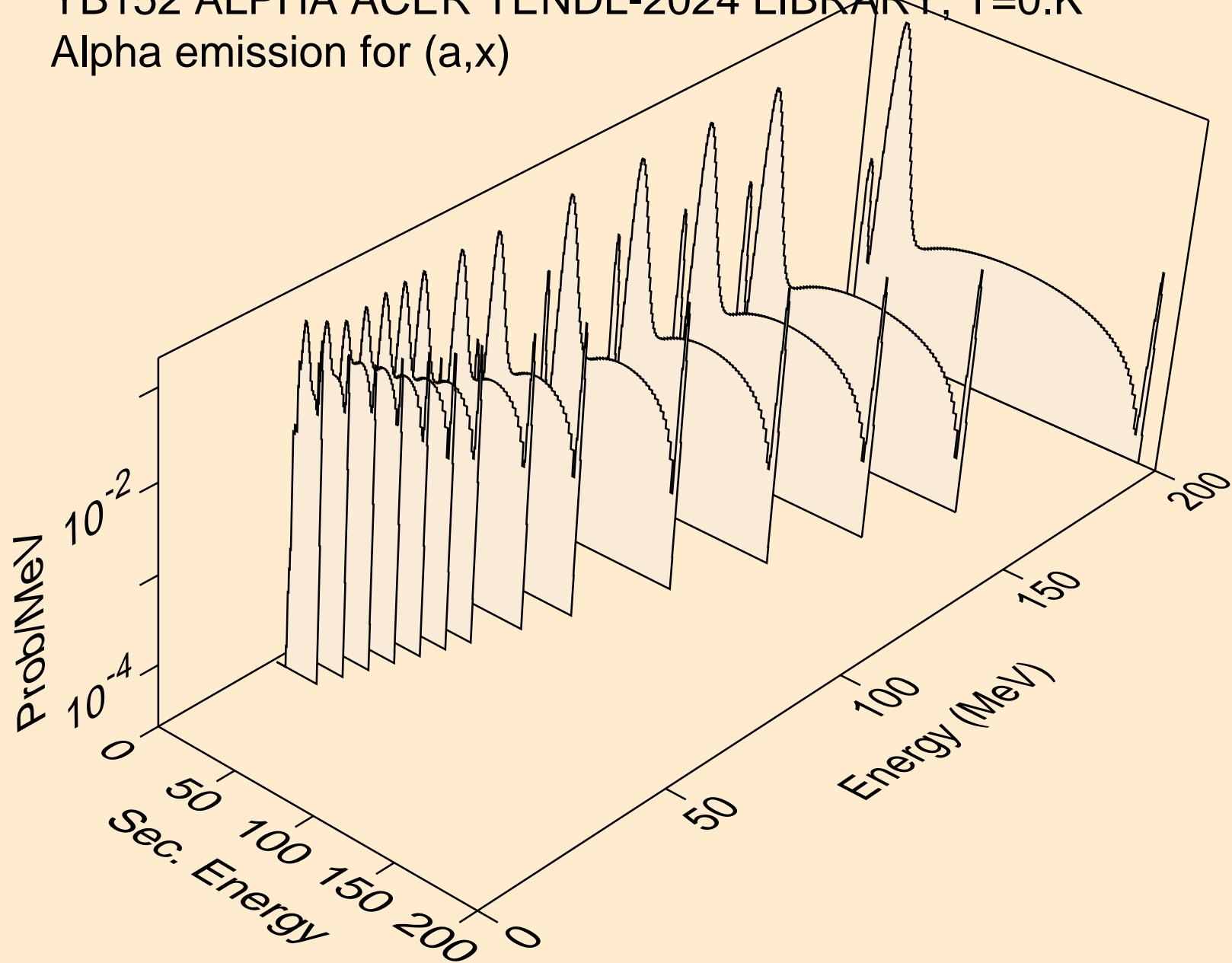

YB152 ALPHA ACER TENDL-2024 LIBRARY; T=0.K  
Alpha emission for (a,n\*)a

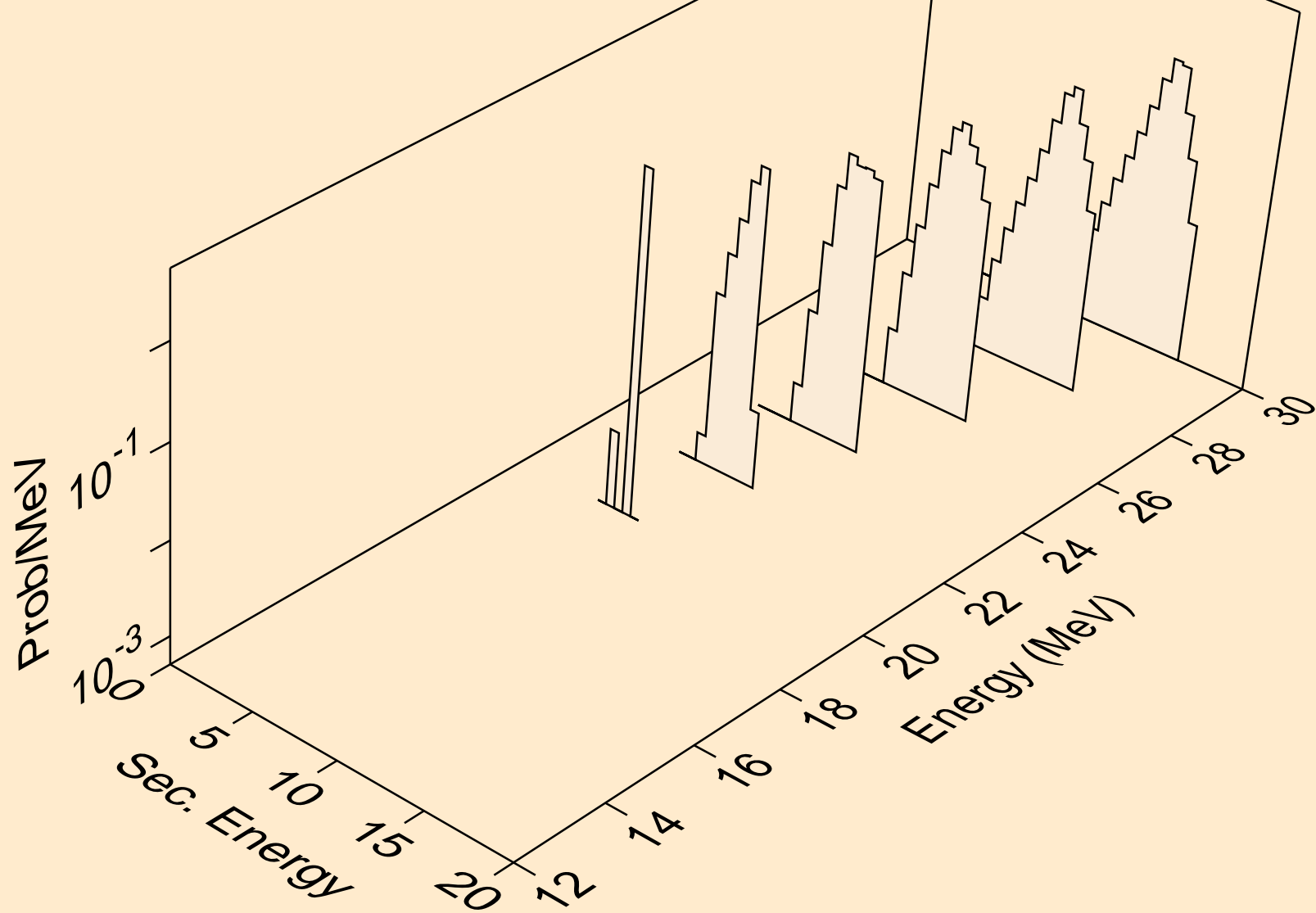

YB152 ALPHA ACER TENDL-2024 LIBRARY; T=0.K  
Alpha emission for inelastic

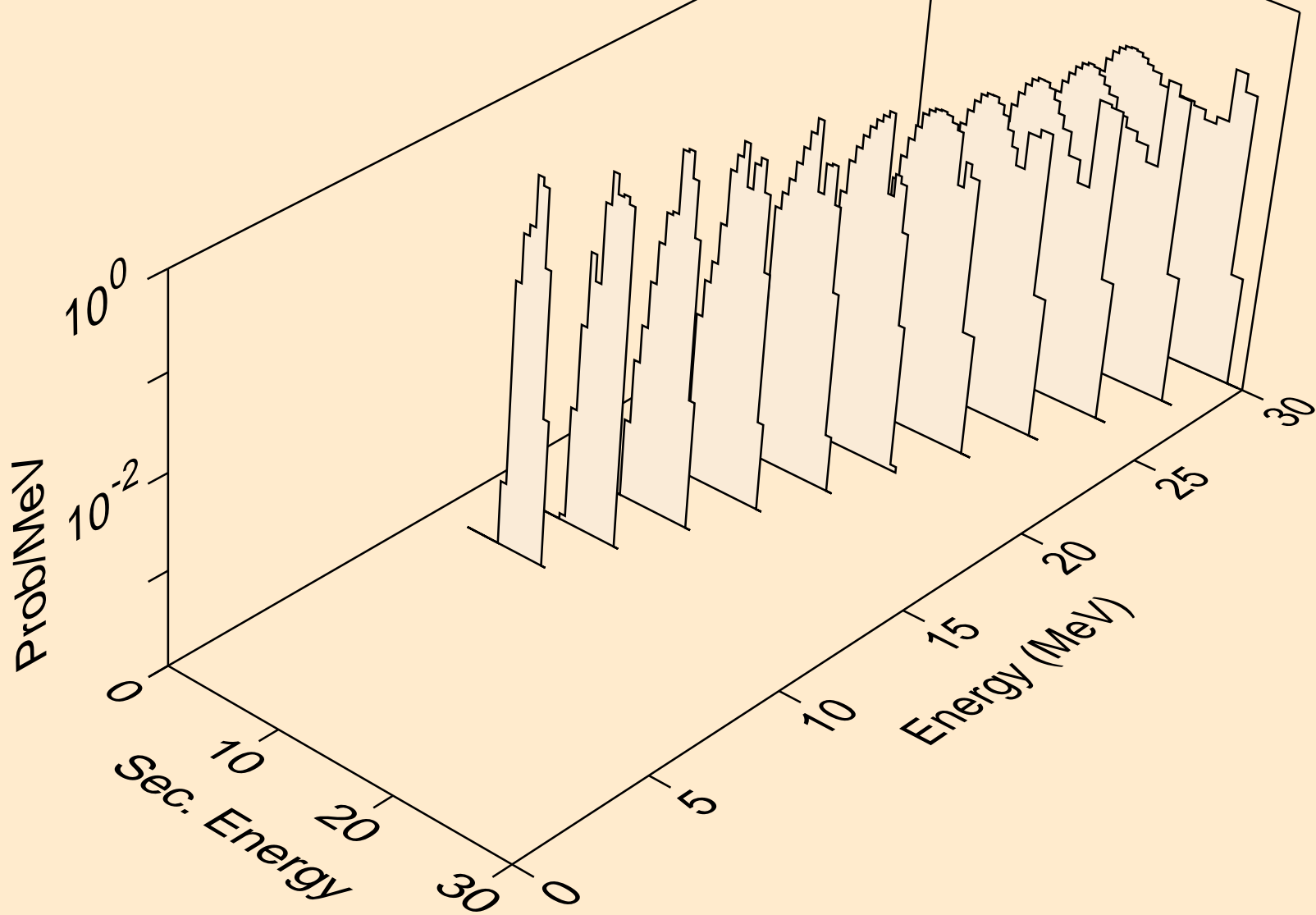

YB152 ALPHA ACER TENDL-2024 LIBRARY; T=0.K

Alpha emission for (a,2a)

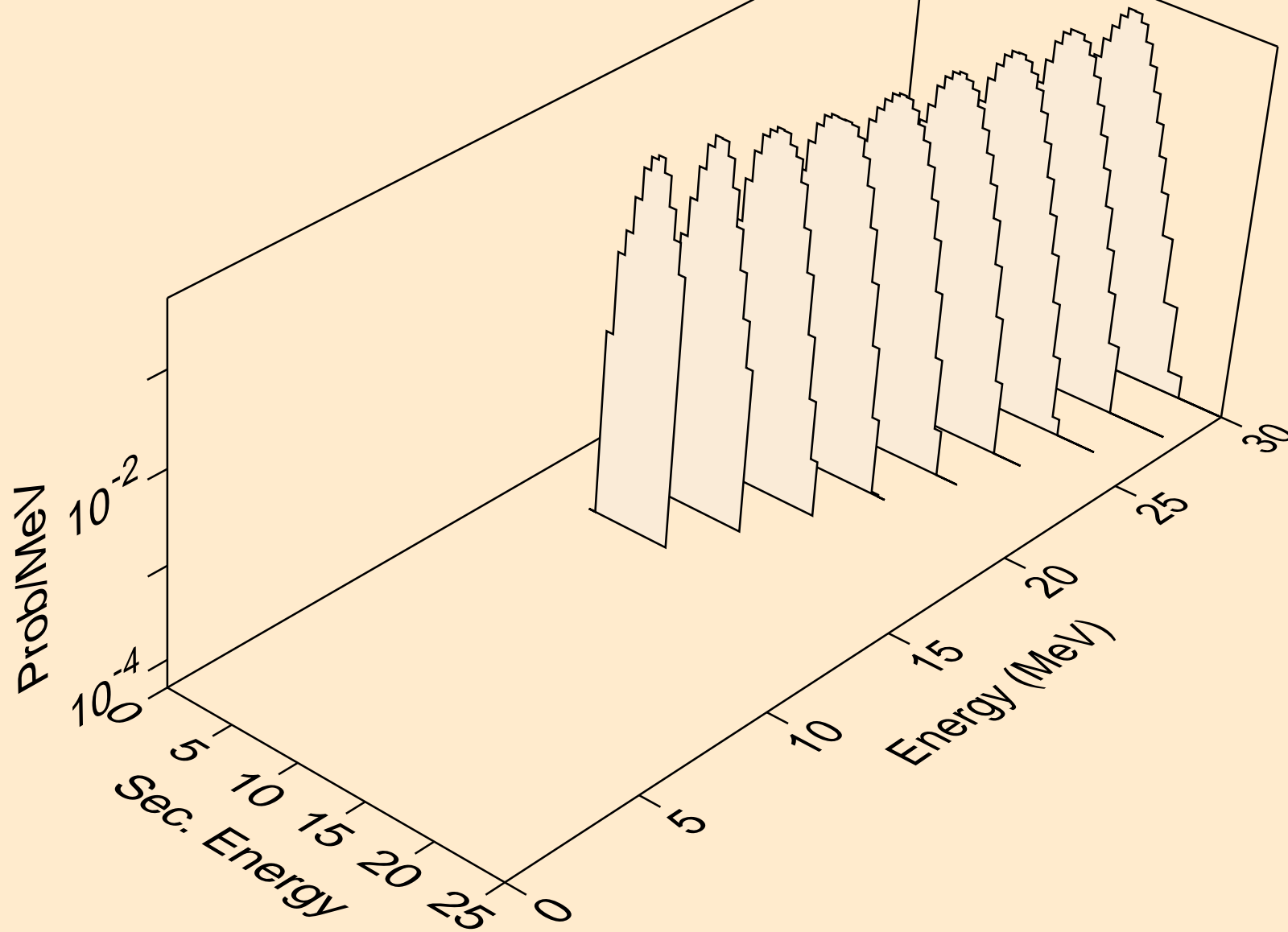

YB152 ALPHA ACER TENDL-2024 LIBRARY; T=0.K

Alpha emission for (a,pa)

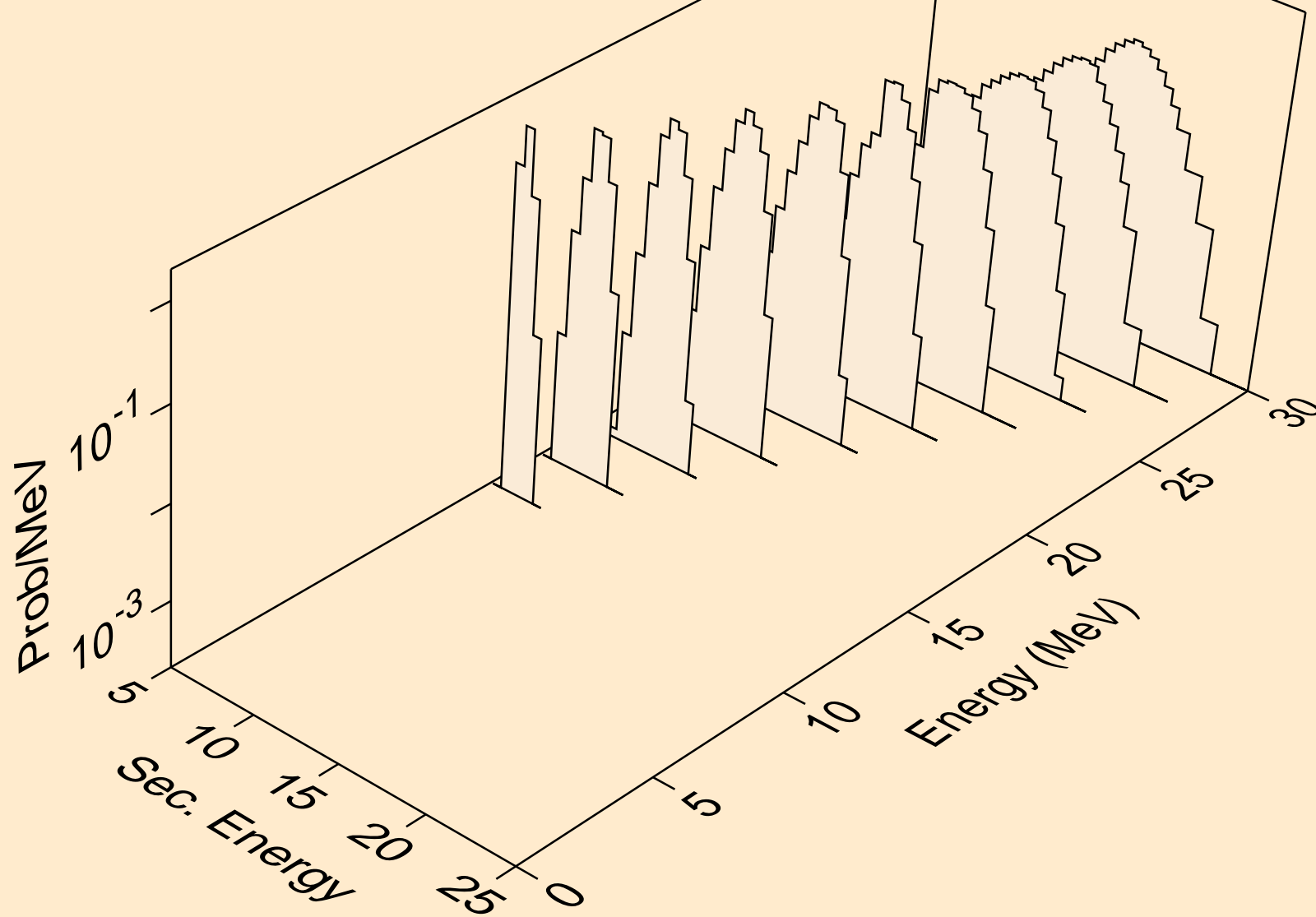

YB152 ALPHA ACER TENDL-2024 LIBRARY; T=0.K  
Photon emission for (z,n)

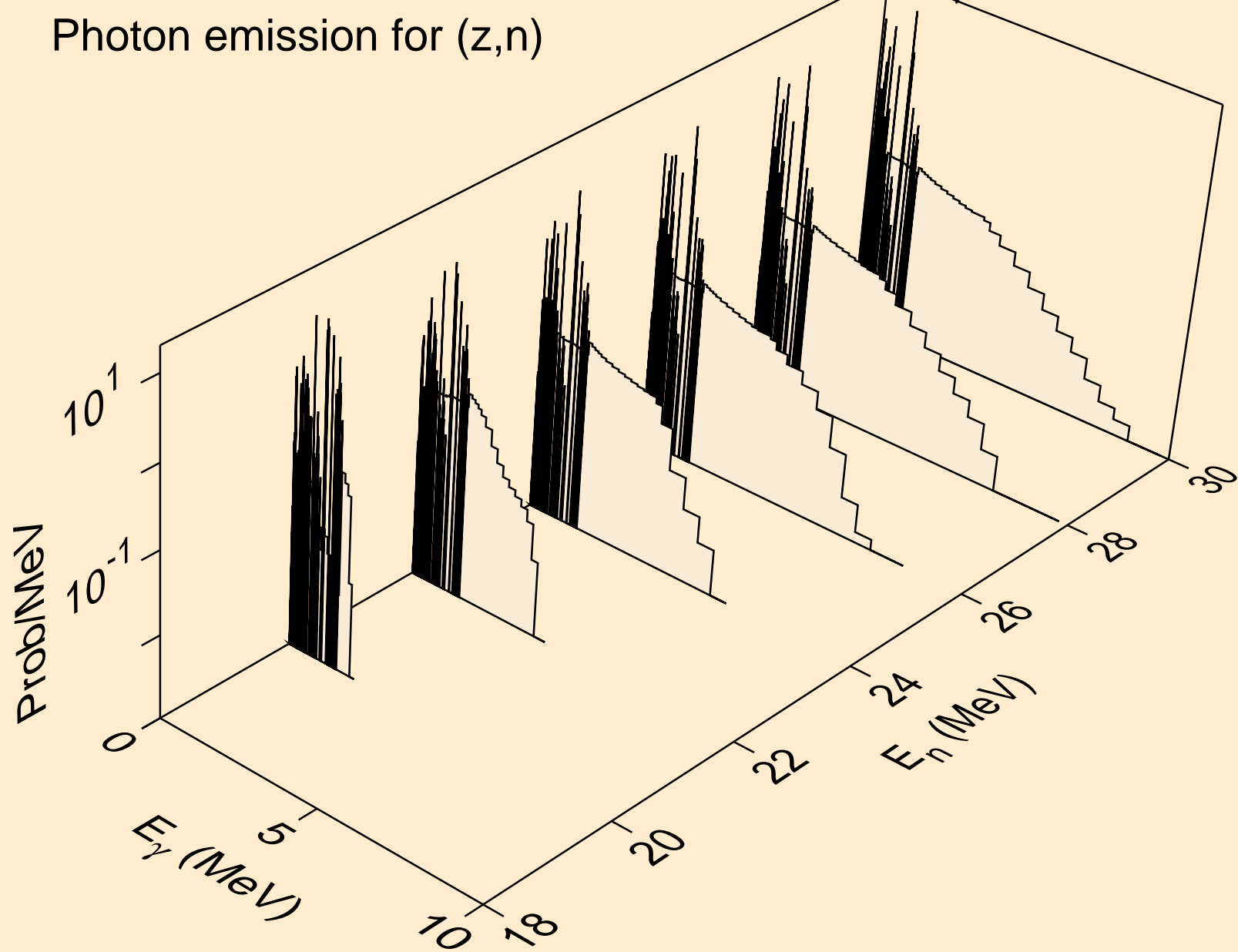

YB152 ALPHA ACER TENDL-2024 LIBRARY; T=0.K  
Photon emission for (z,x)

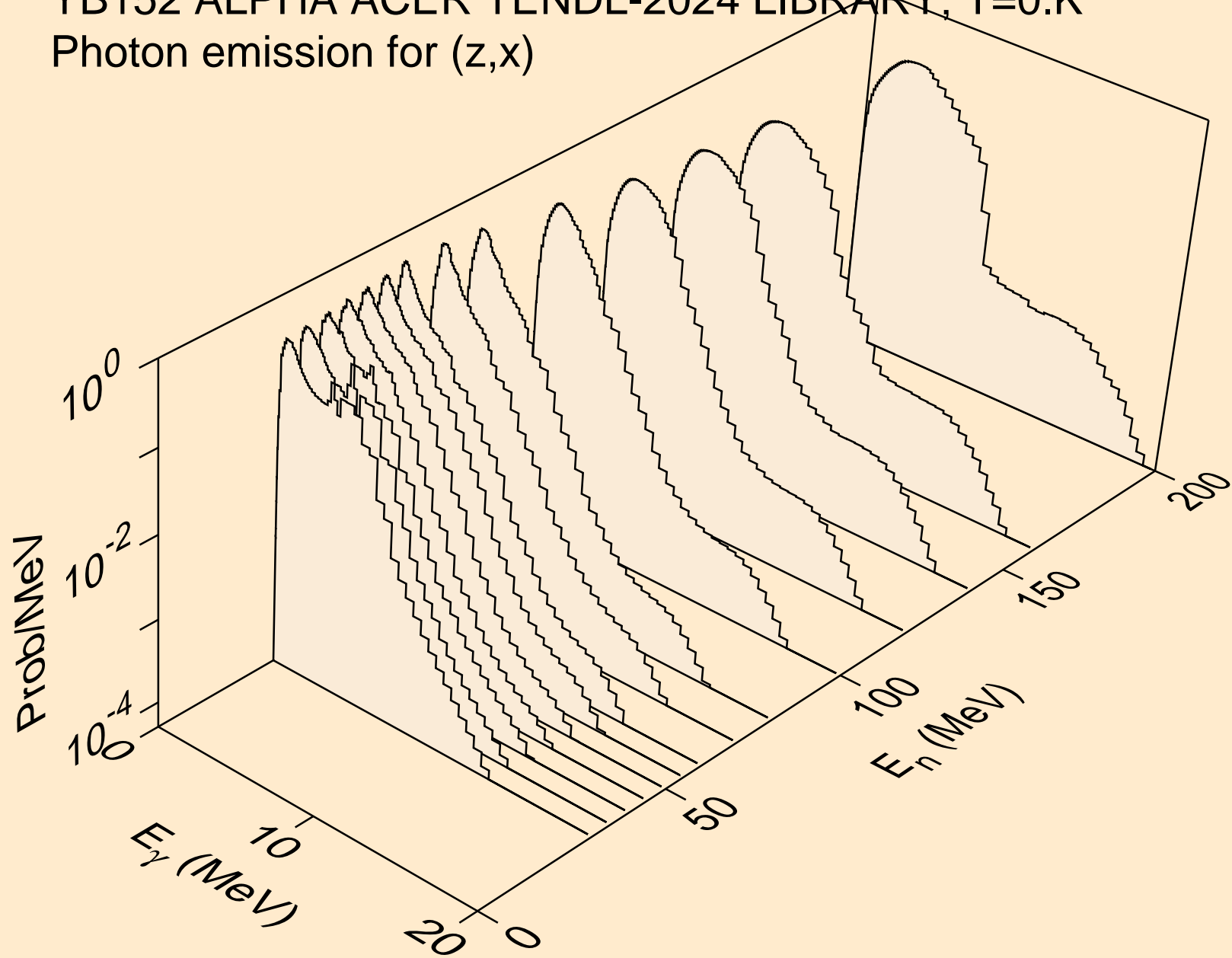

YB152 ALPHA ACER TENDL-2024 LIBRARY; T=0.K  
Photon emission for (n,2n)

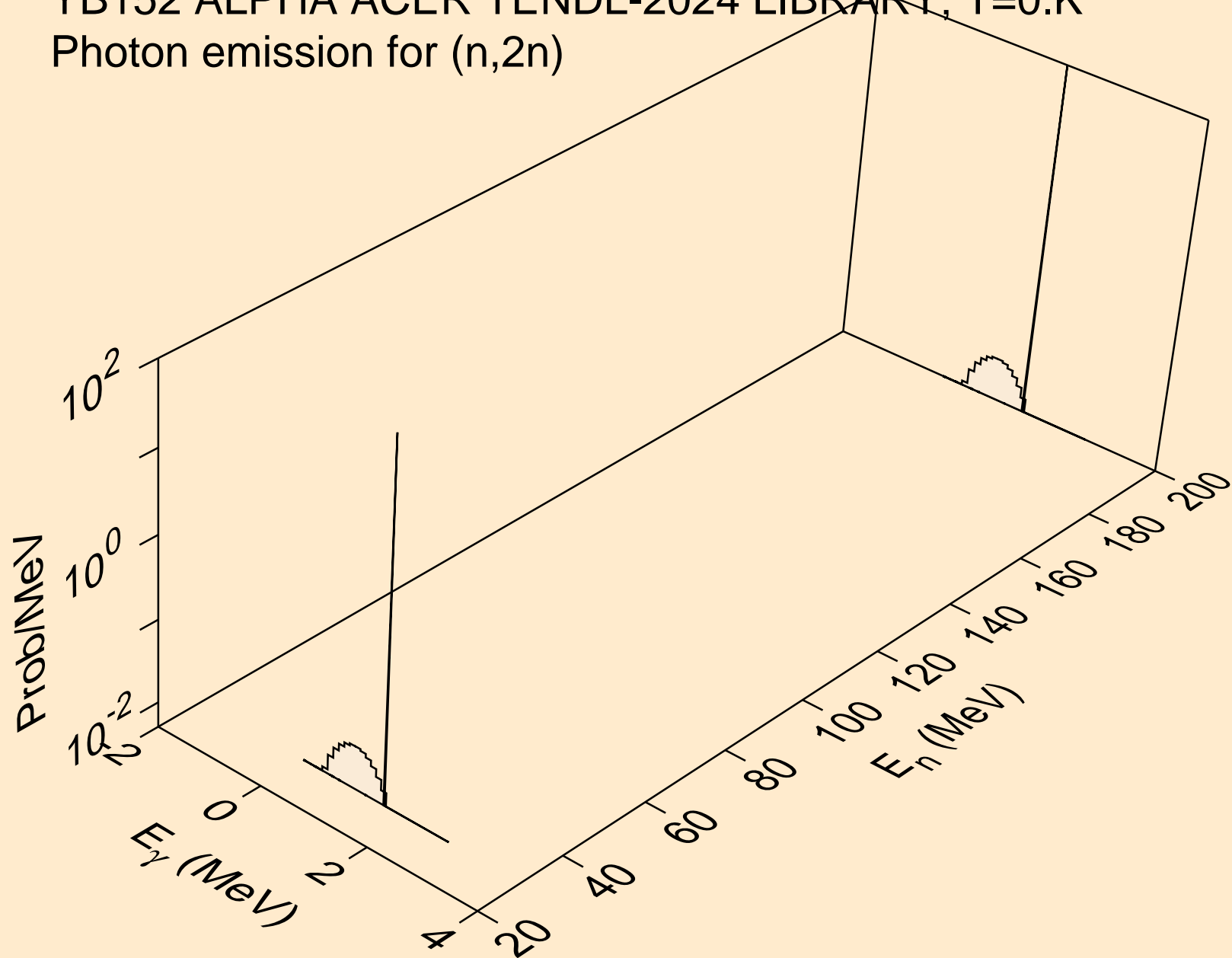

YB152 ALPHA ACER TENDL-2024 LIBRARY; T=0.K  
Photon emission for (n,n\*)a

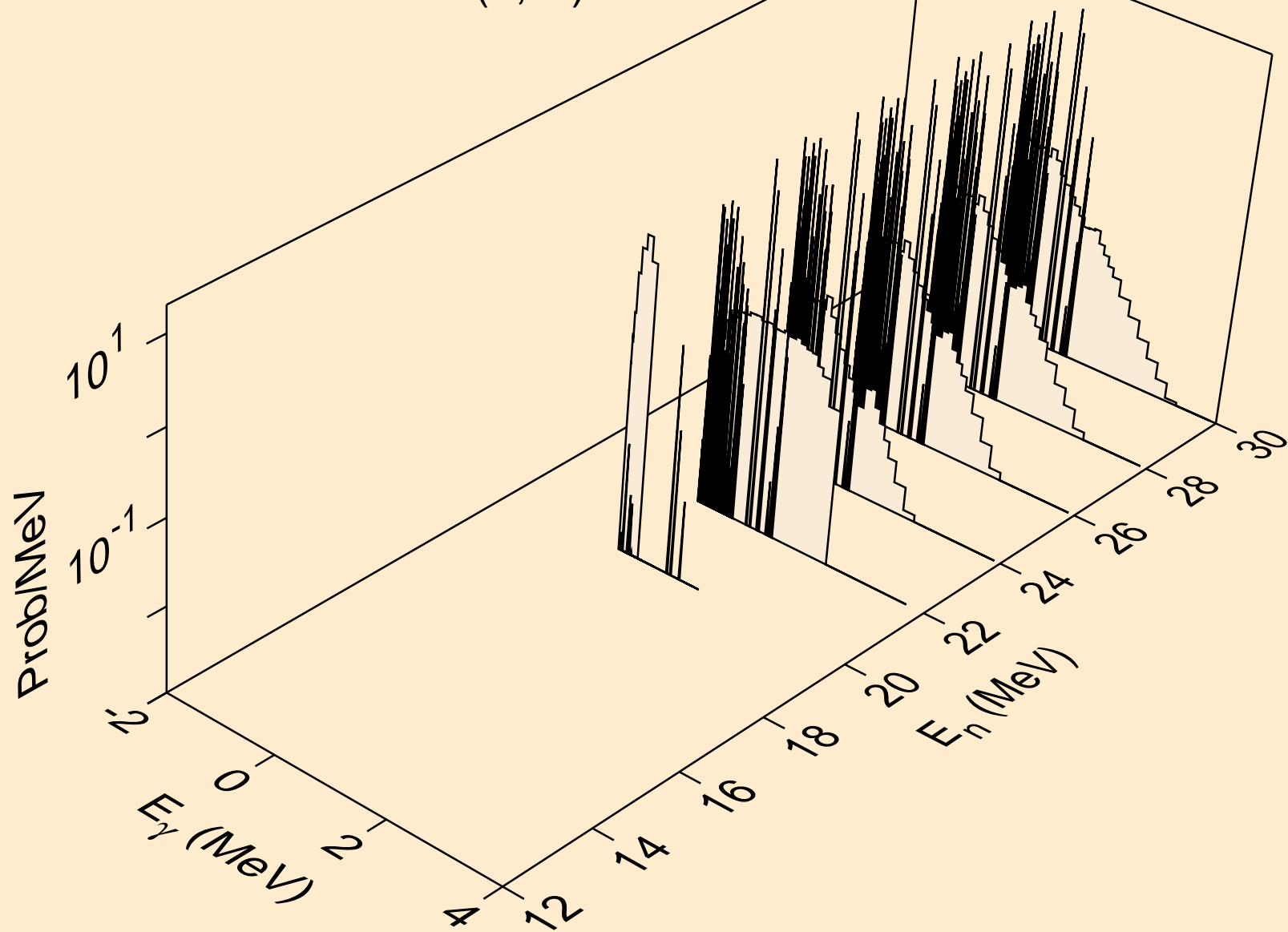

YB152 ALPHA ACER TENDL-2024 LIBRARY; T=0.K  
Photon emission for (n,n\*)p

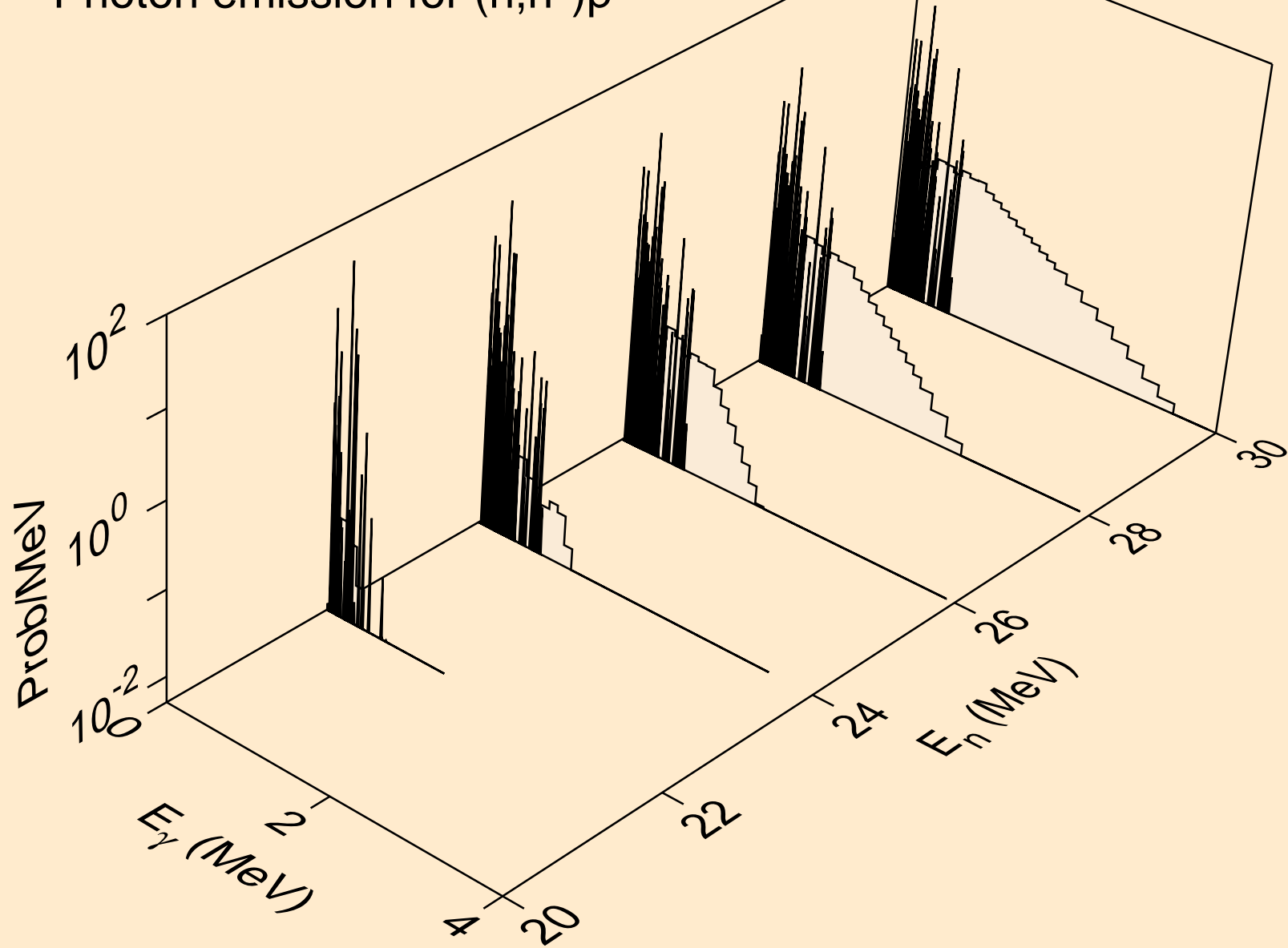

YB152 ALPHA ACER TENDL-2024 LIBRARY; T=0.K  
Photon emission for (n,n2p)

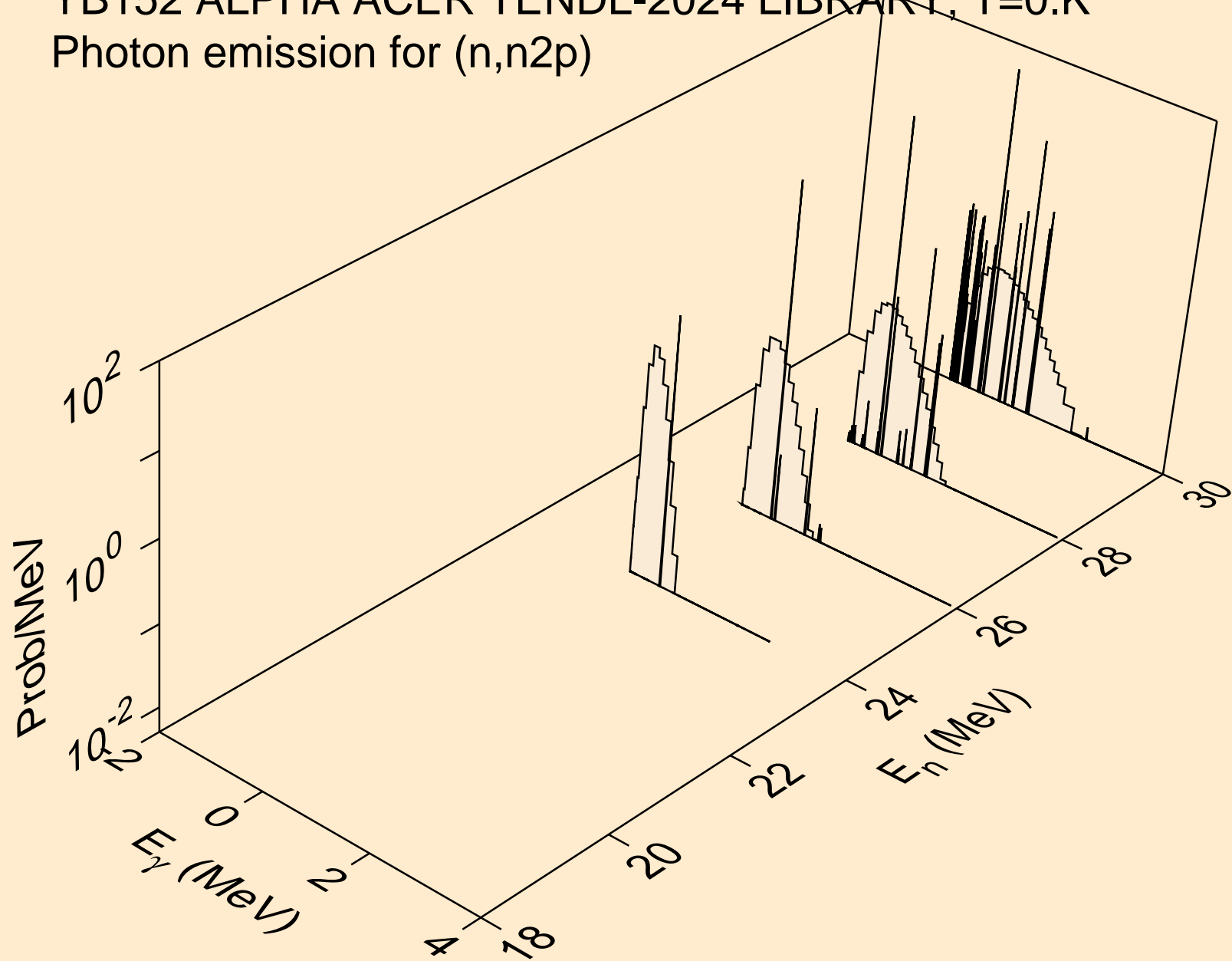

YB152 ALPHA ACER TENDL-2024 LIBRARY; T=0.K  
Photon emission for (n,npa)

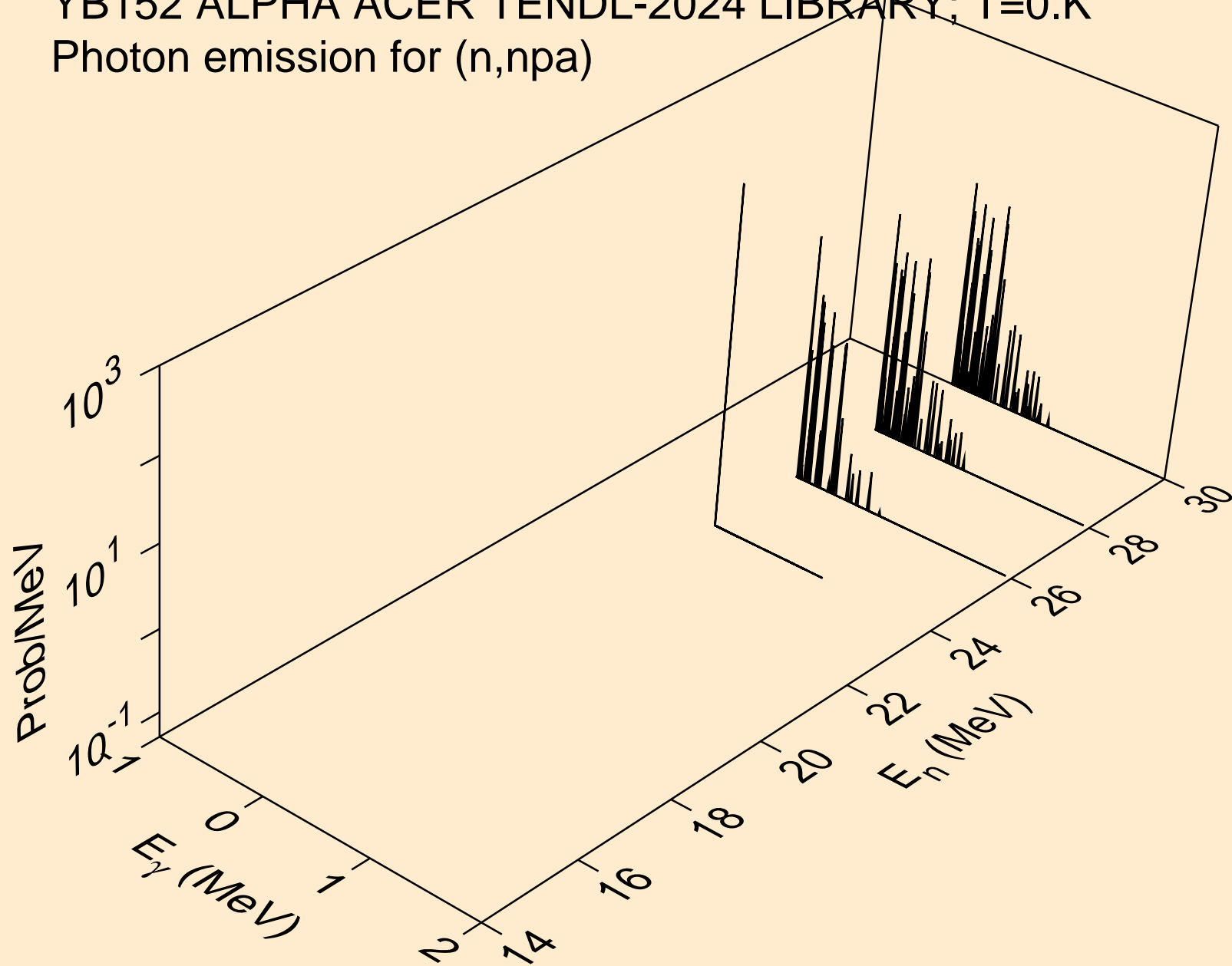

YB152 ALPHA ACER TENDL-2024 LIBRARY; T=0.K  
Photon emission for (n,gma)

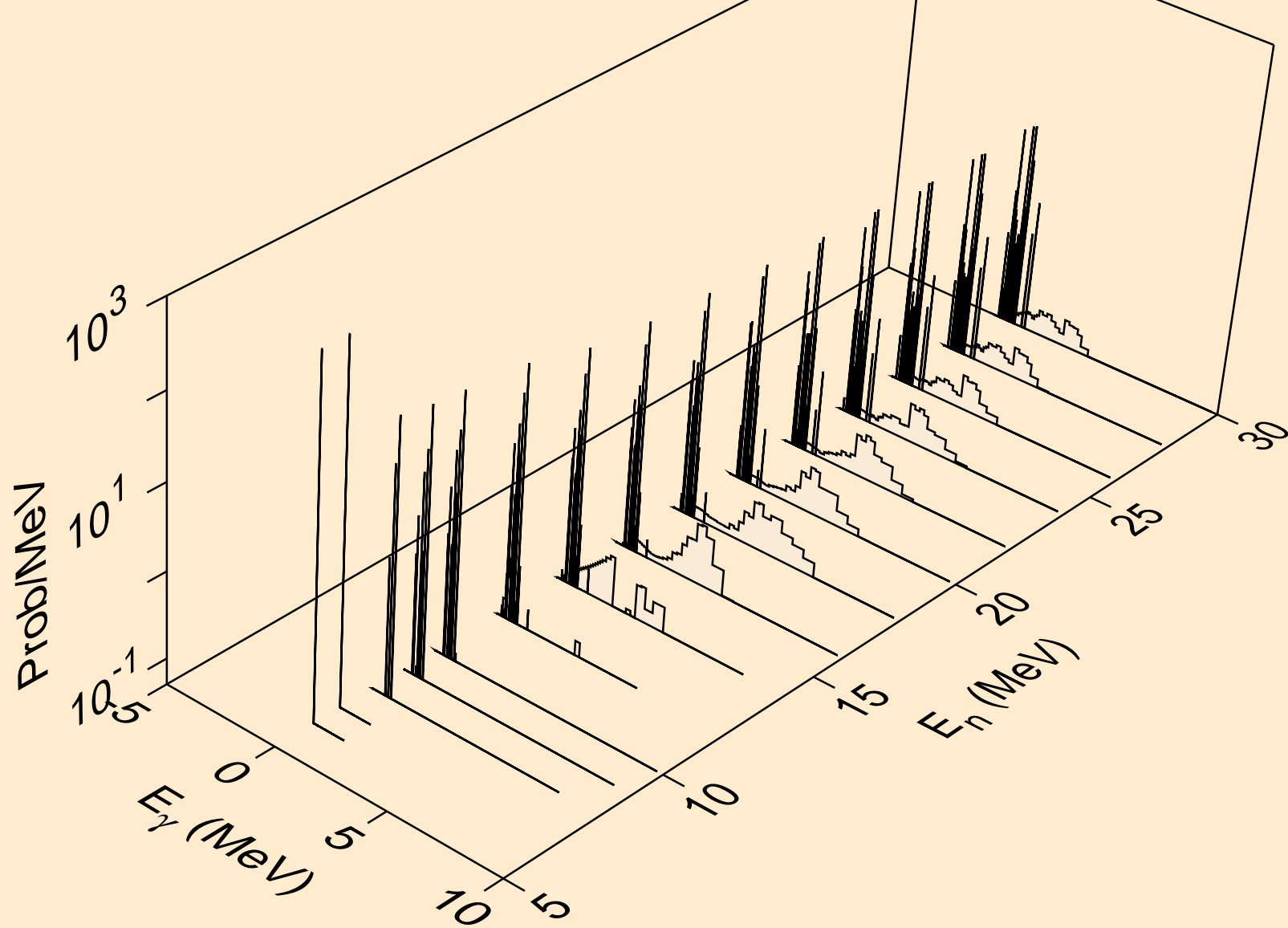

YB152 ALPHA ACER TENDL-2024 LIBRARY; T=0.K  
Photon emission for (n,p)

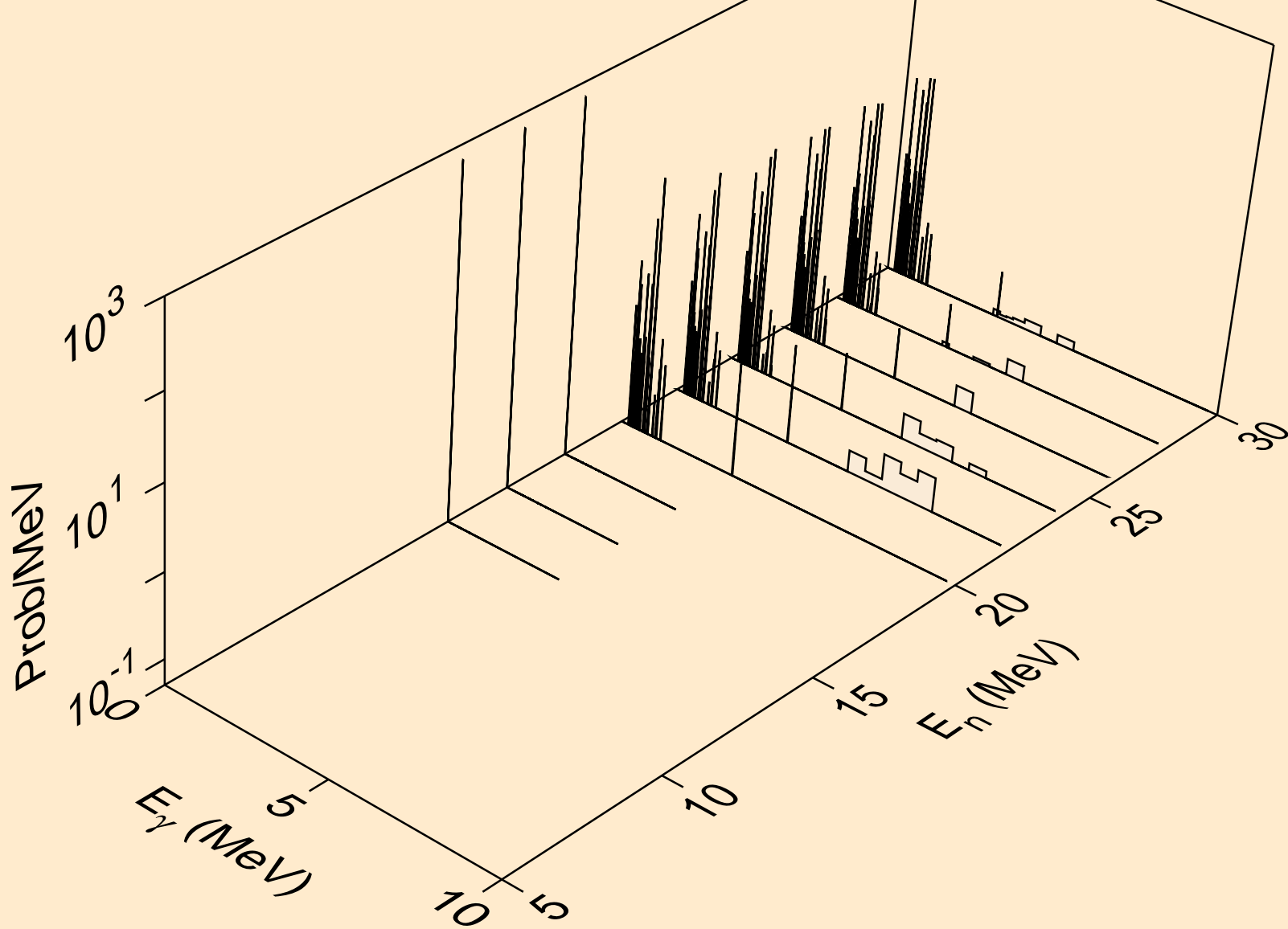

YB152 ALPHA ACER TENDL-2024 LIBRARY; T=0.K  
Photon emission for (n,d)

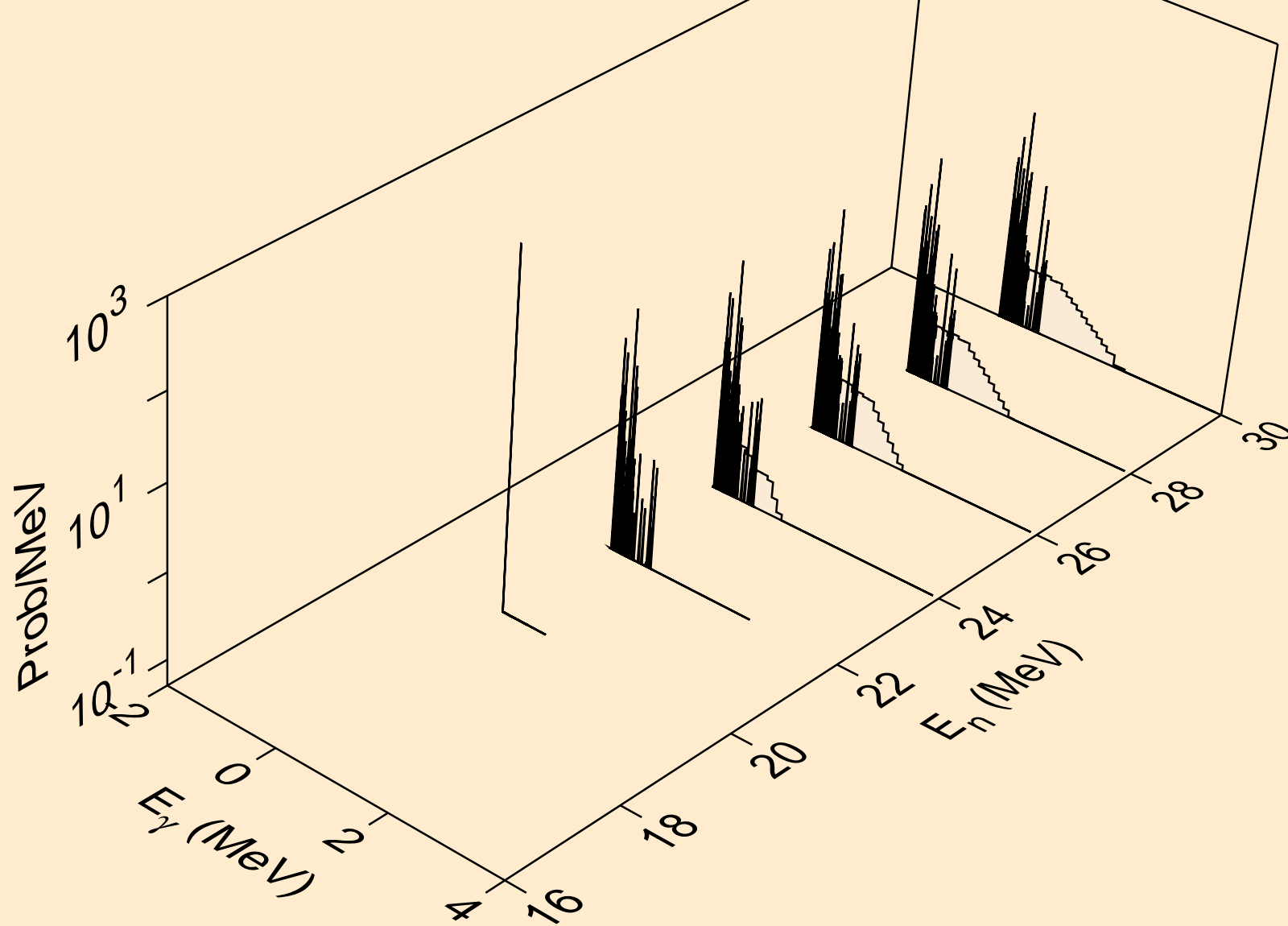

YB152 ALPHA ACER TENDL-2024 LIBRARY; T=0.K  
Photon emission for (n,t)

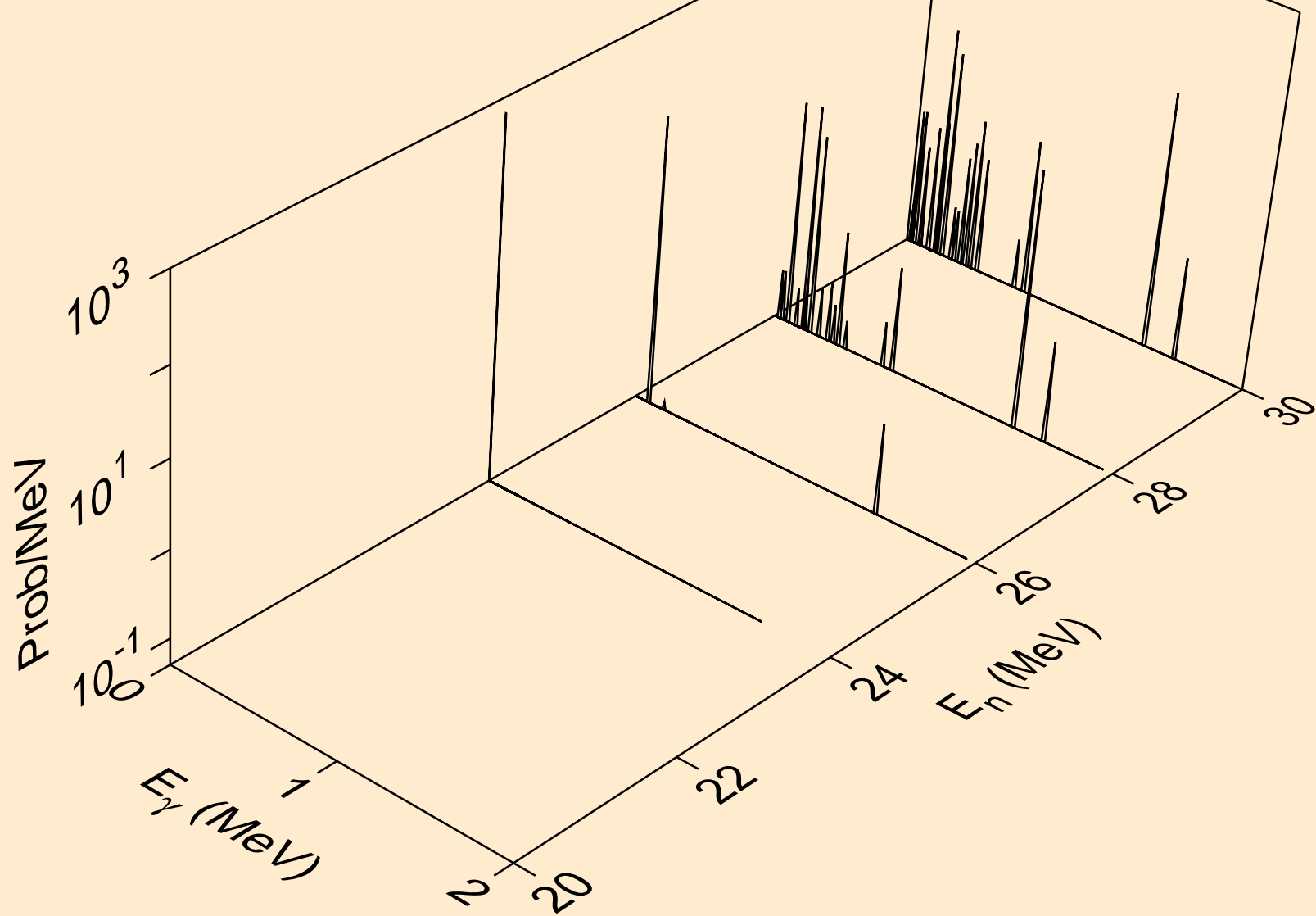

YB152 ALPHA ACER TENDL-2024 LIBRARY; T=0.K  
Photon emission for (n,he3)

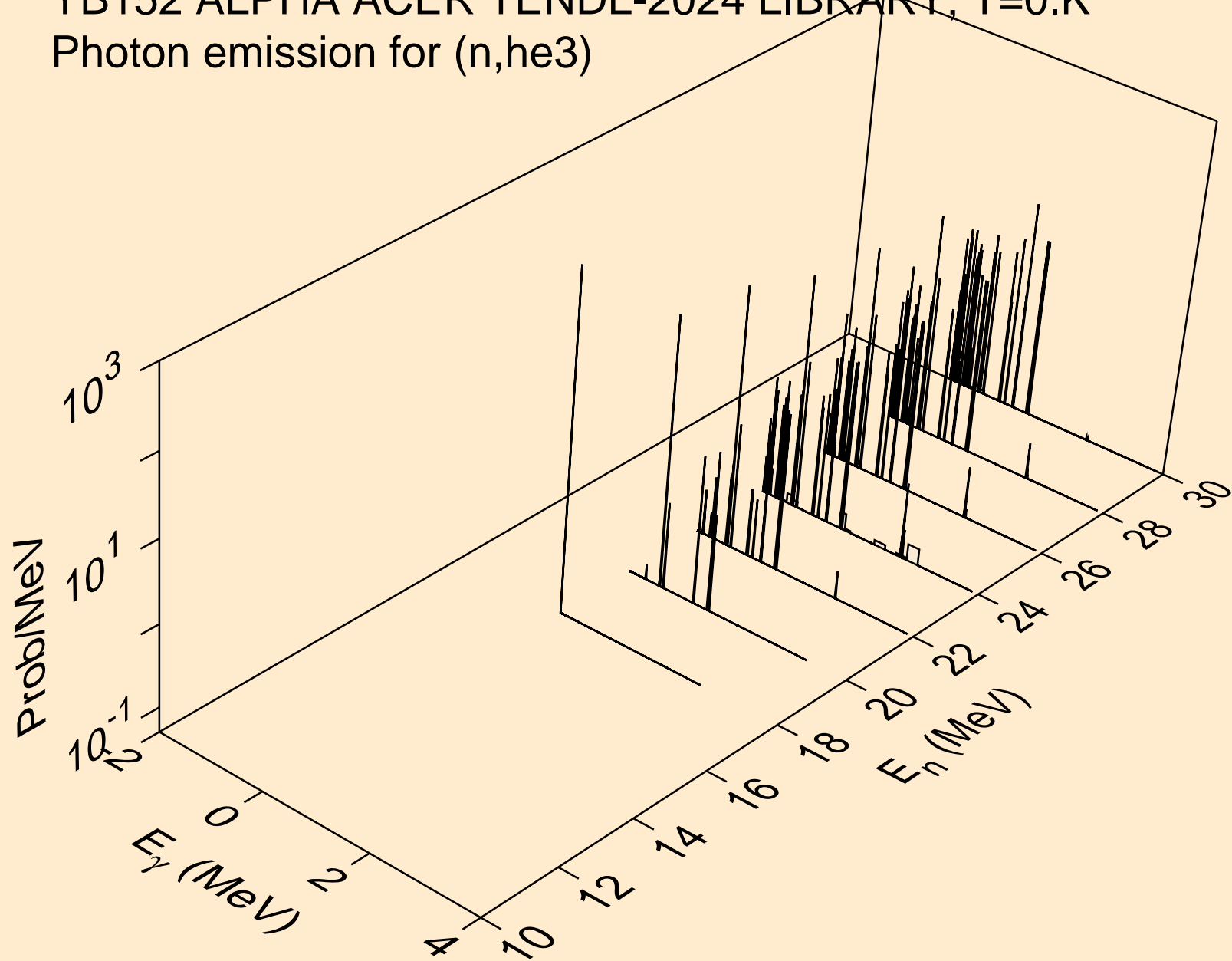

YB152 ALPHA ACER TENDL-2024 LIBRARY; T=0.K  
Photon emission for inelastic

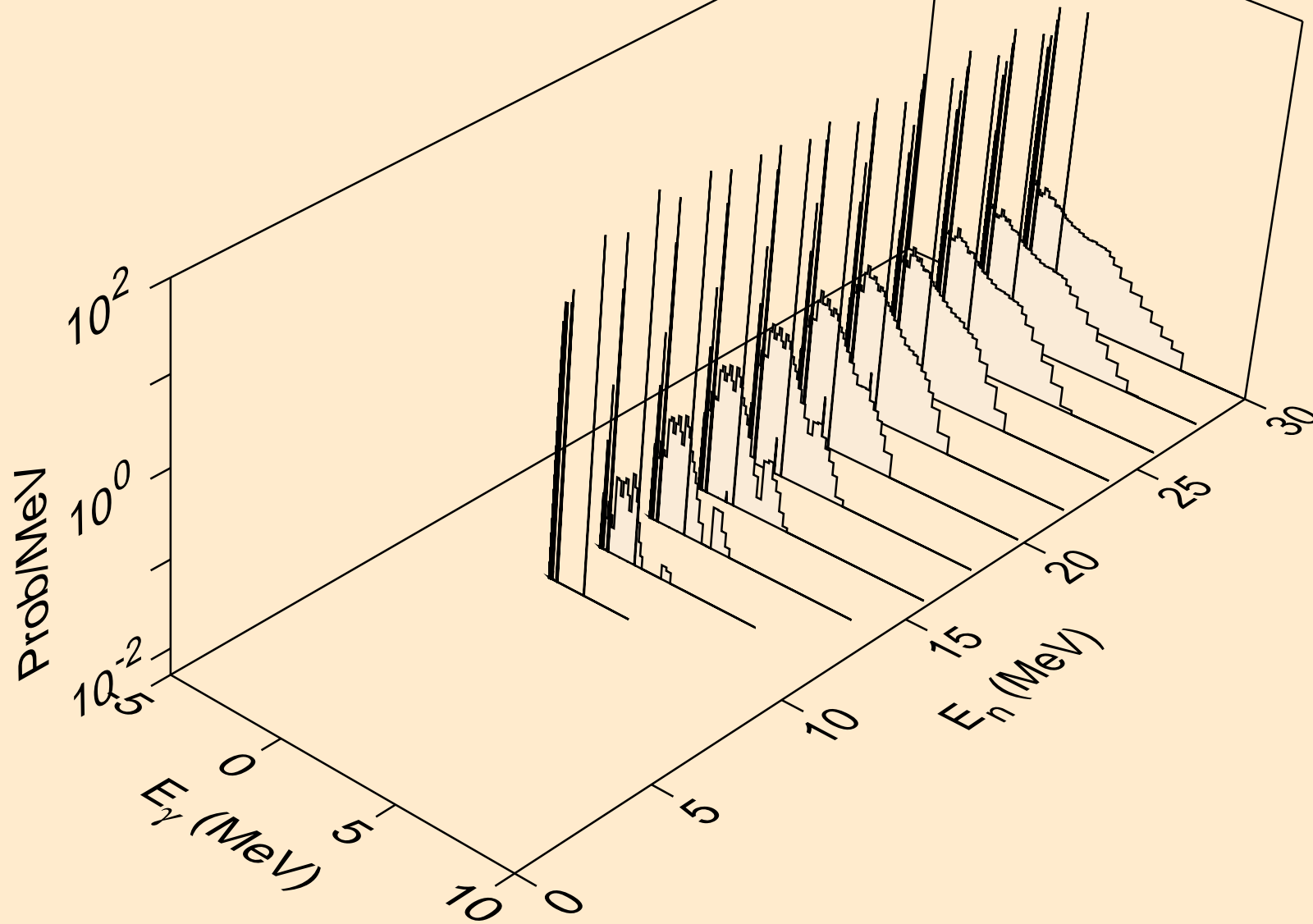

YB152 ALPHA ACER TENDL-2024 LIBRARY; T=0.K  
Photon emission for (n,2a)

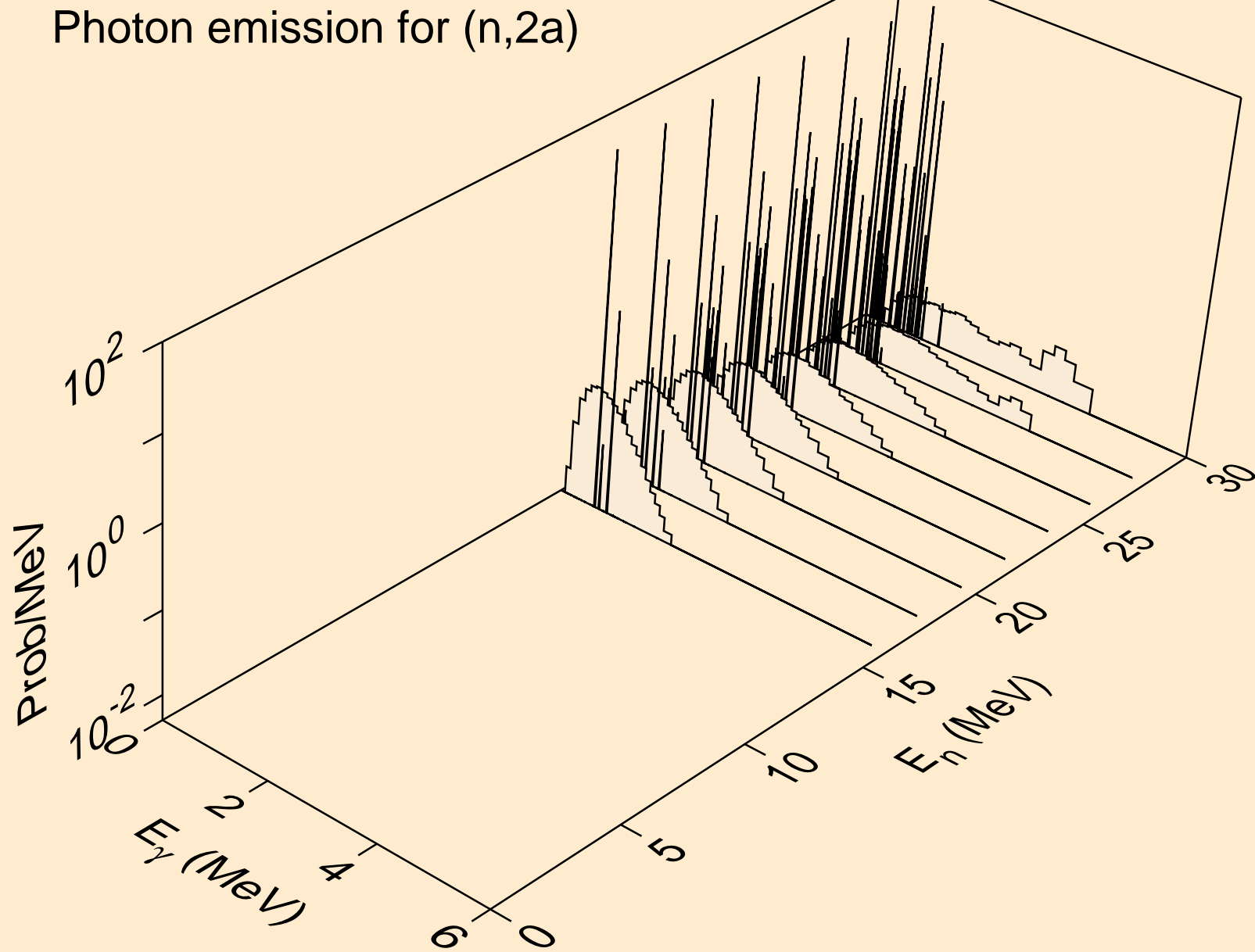

YB152 ALPHA ACER TENDL-2024 LIBRARY; T=0.K  
Photon emission for (n,2p)

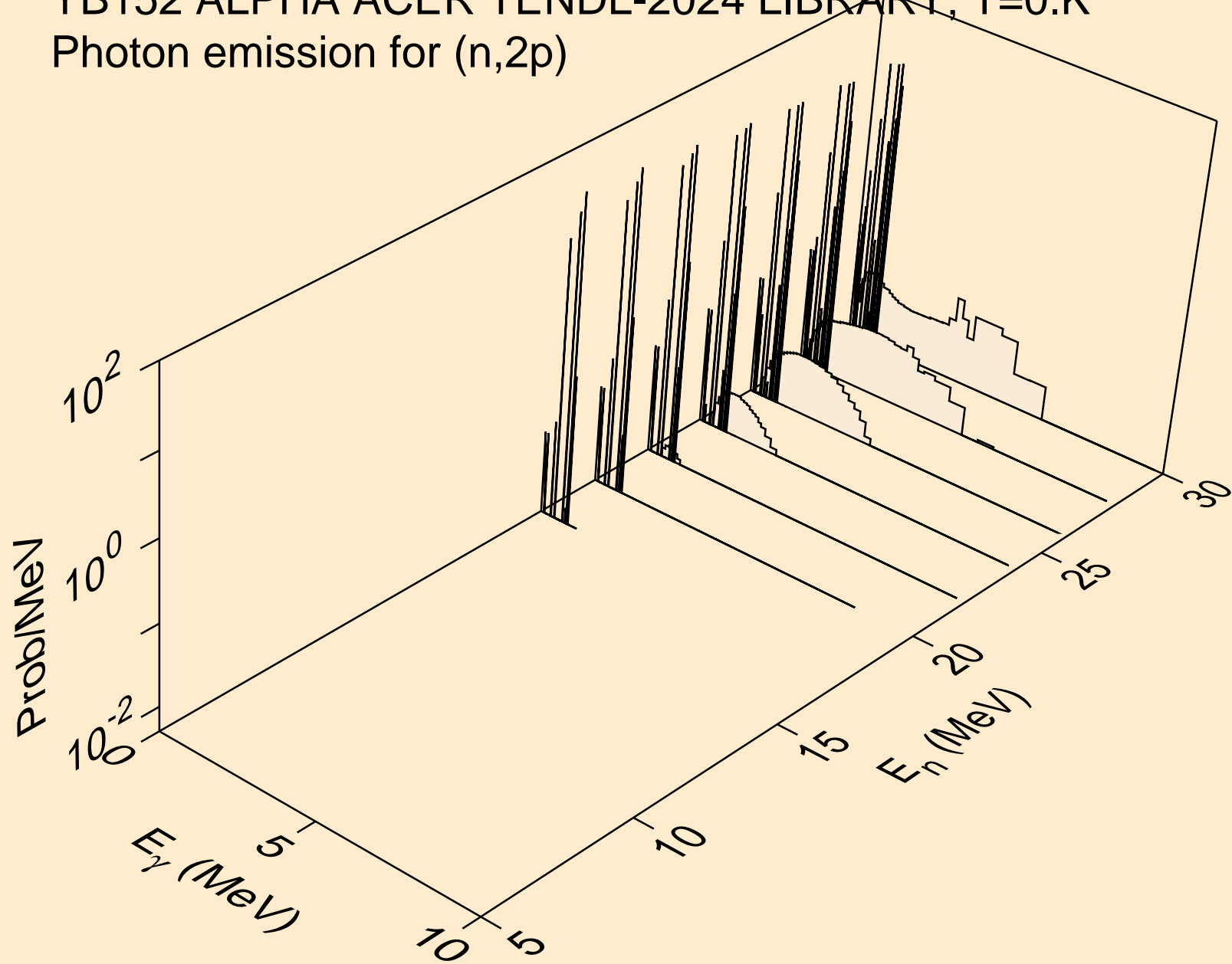

YB152 ALPHA ACER TENDL-2024 LIBRARY; T=0.K  
Photon emission for (n,pa)

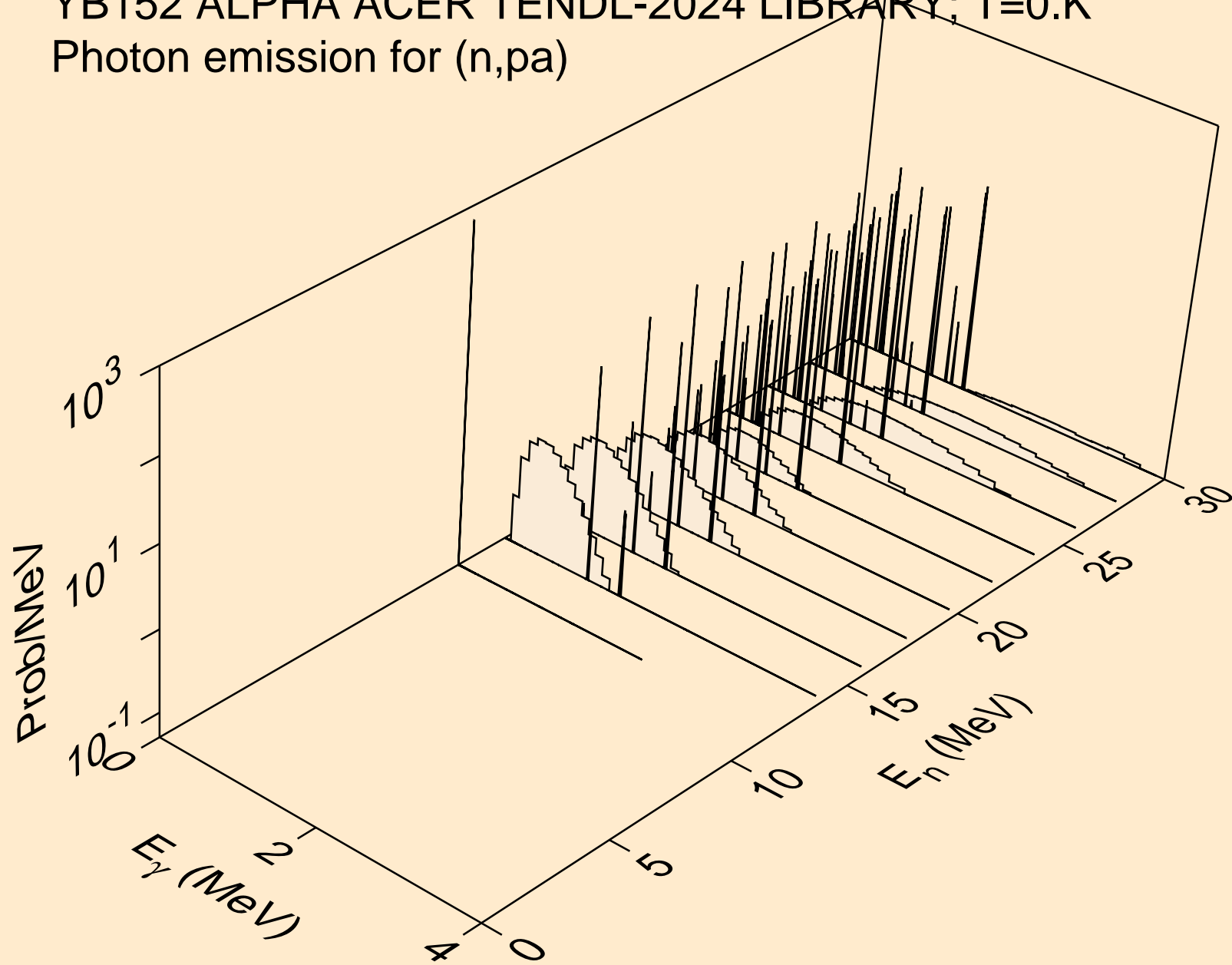

YB152 ALPHA ACER TENDL-2024 LIBRARY; T=0.K  
Photon emission for (n,pd)

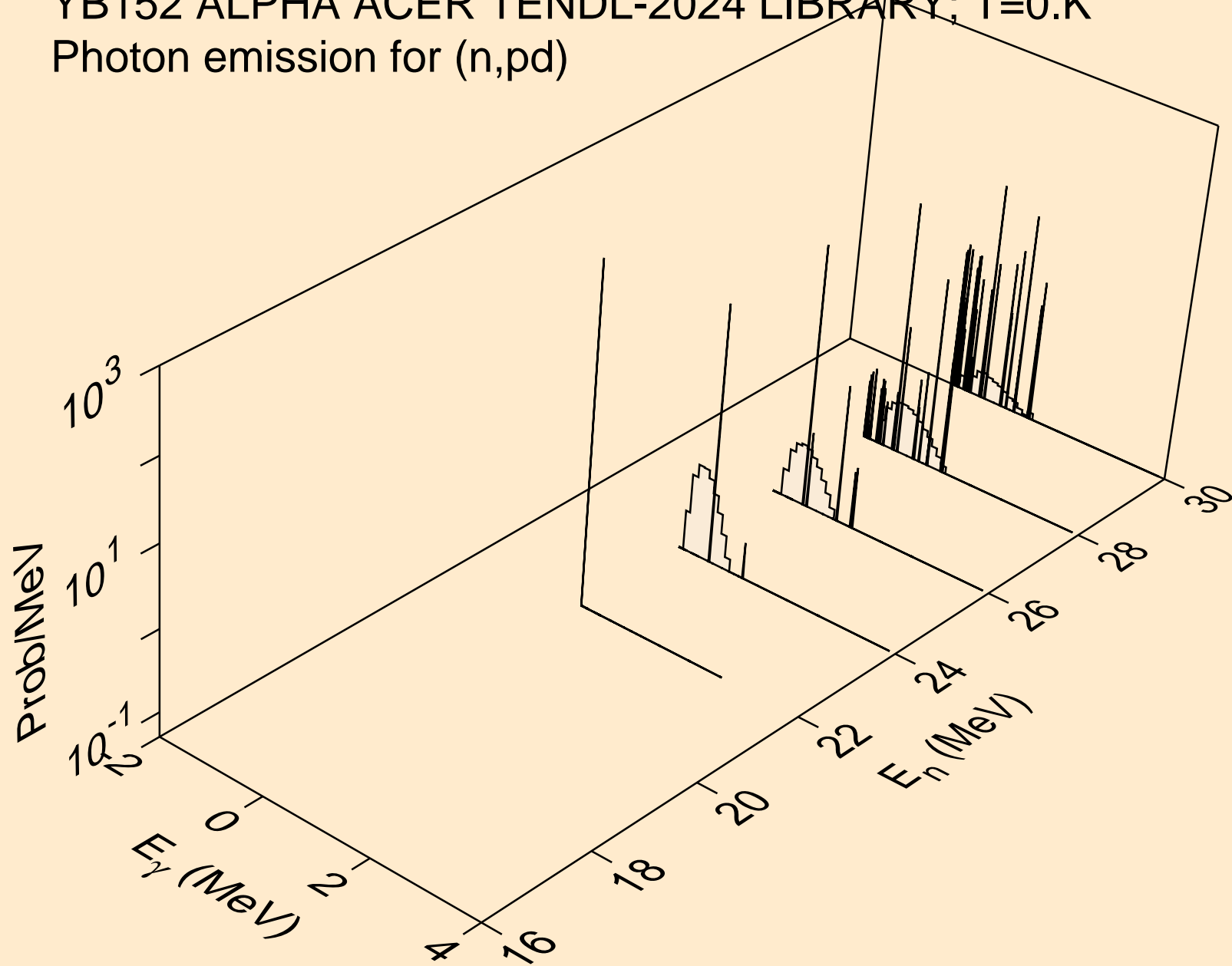

YB152 ALPHA ACER TENDL-2024 LIBRARY; T=0.K

Photon emission for (n,pt)

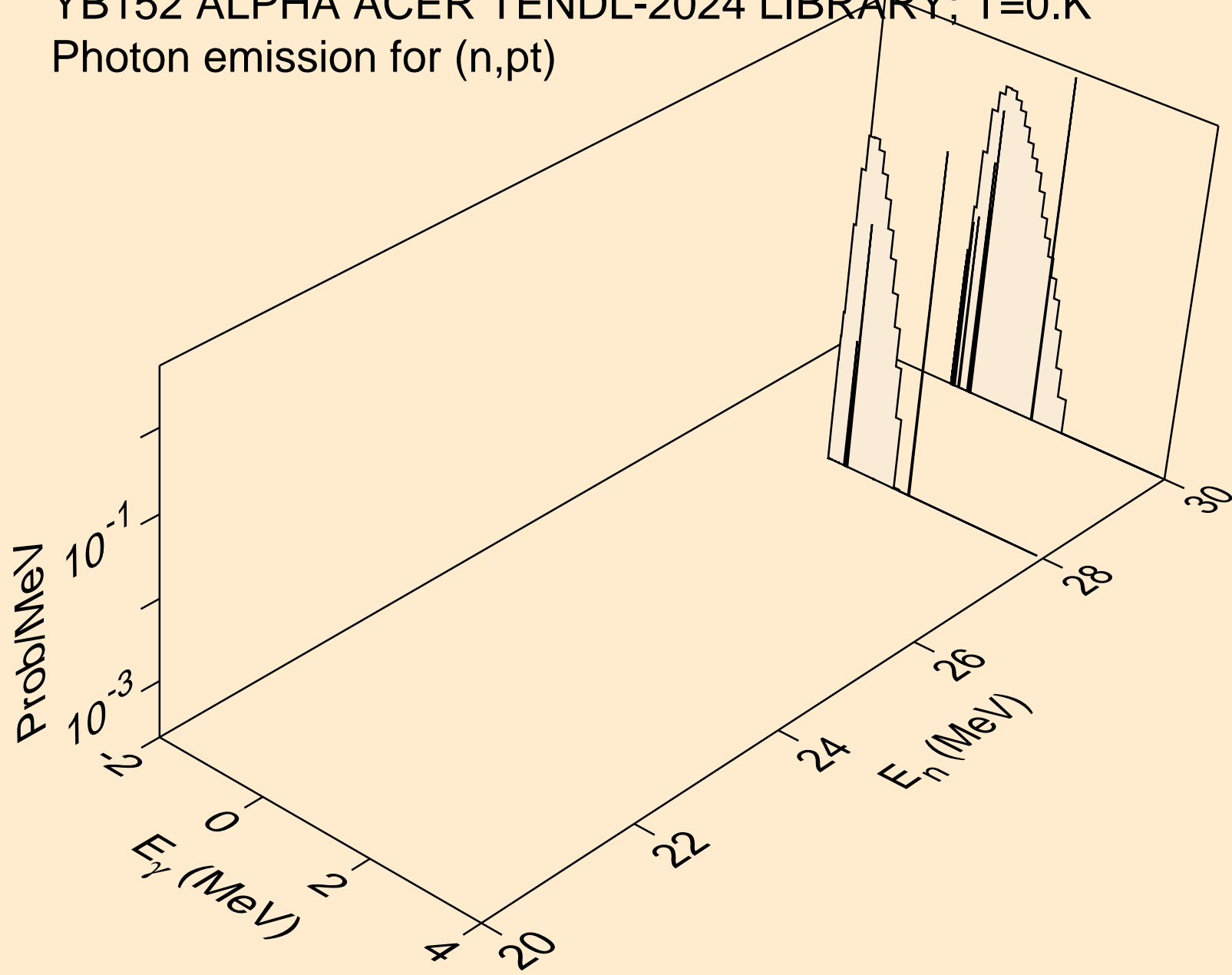

# YB152 ALPHA ACER TENDL-2024 LIBRARY; T=0.K

## Particle heating contributions

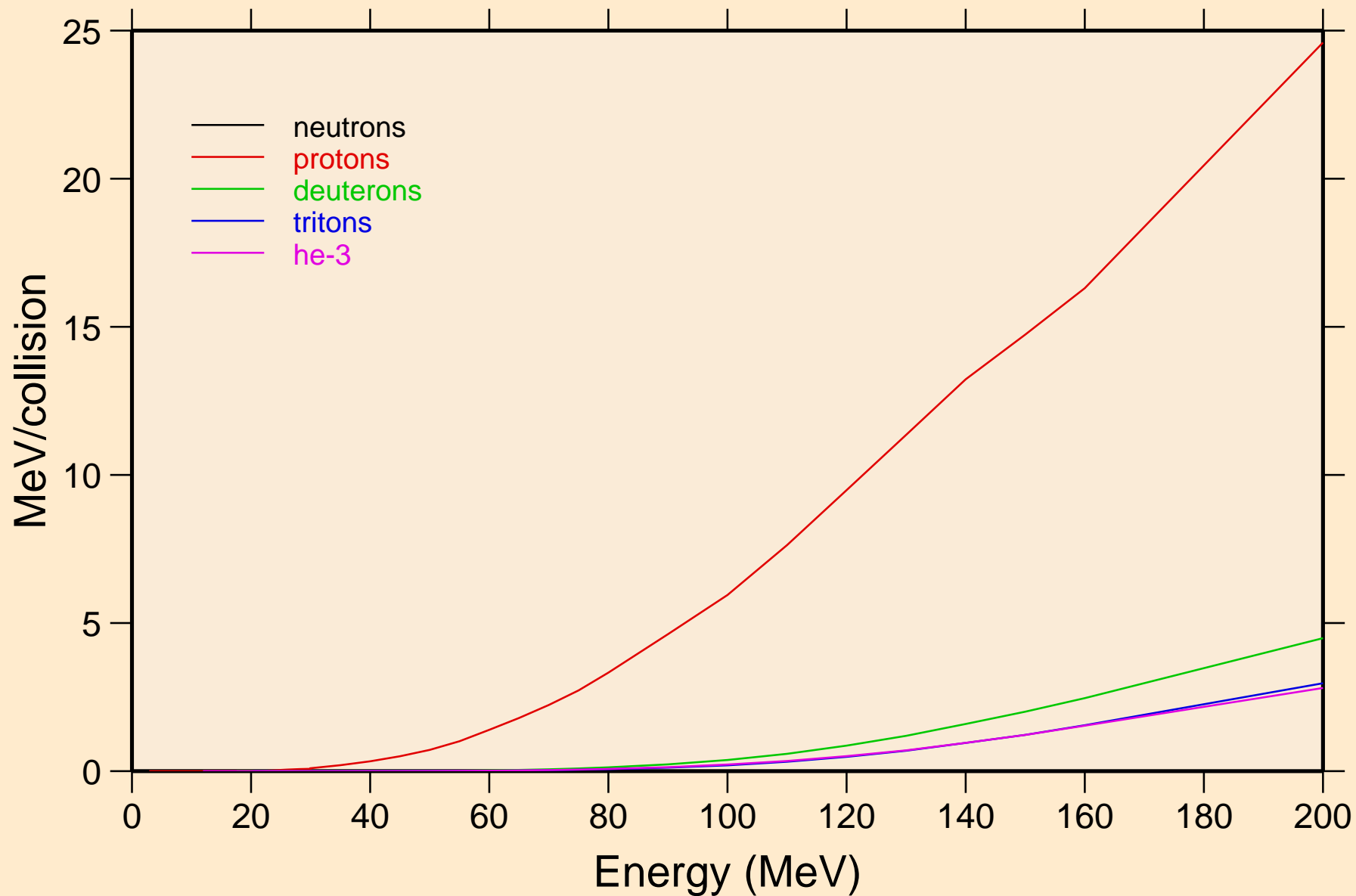

YB152 ALPHA ACER TENDL-2024 LIBRARY; T=0.K  
Recoil Heating

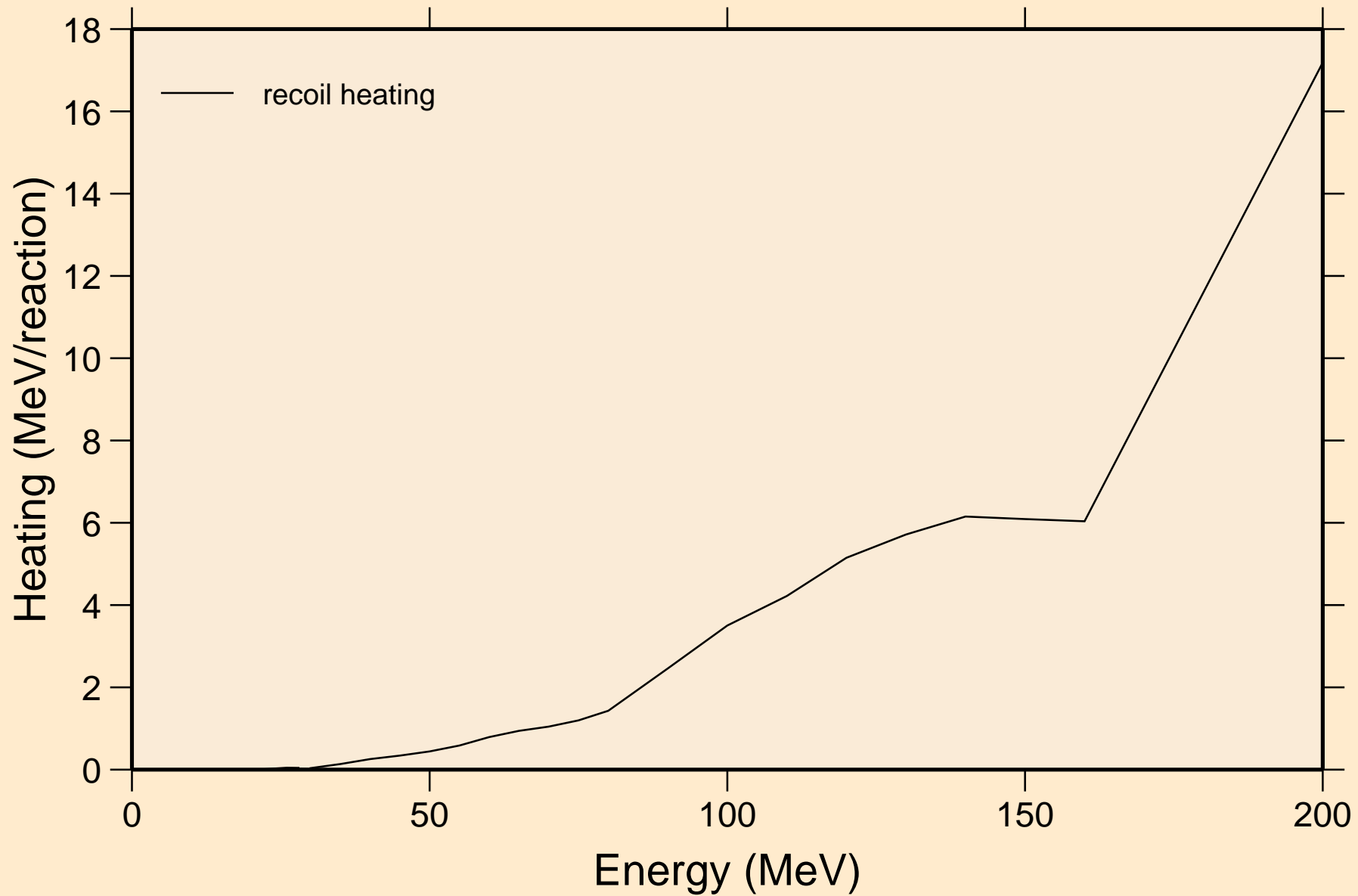

YB152 ALPHA ACER TENDL-2024 LIBRARY; T=0.K  
Particle production cross sections

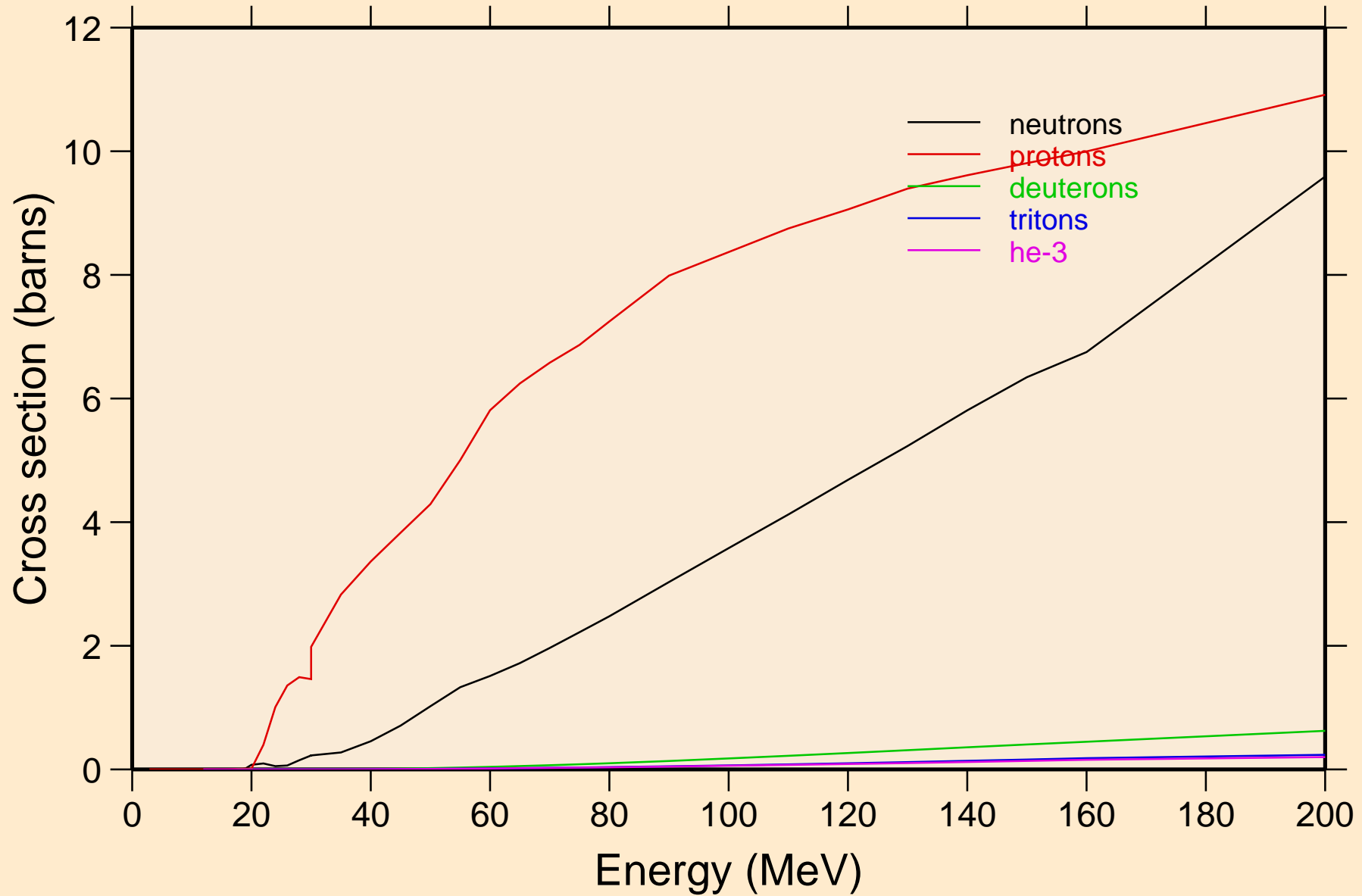

YB152 ALPHA ACER TENDL-2024 LIBRARY; T=0.K  
neutrons from (a,n)

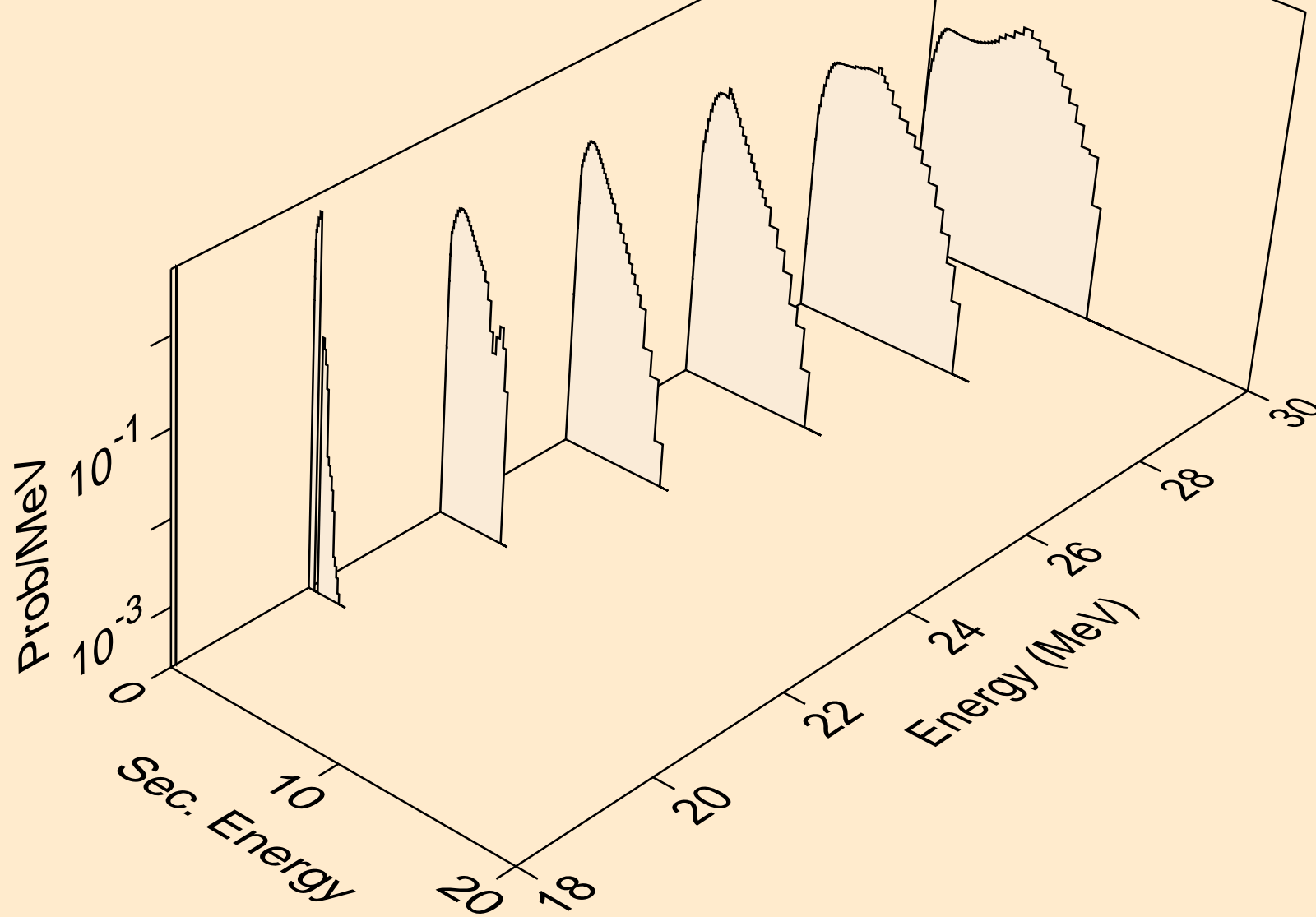

YB152 ALPHA ACER TENDL-2024 LIBRARY; T=0.K  
neutrons from (a,x)

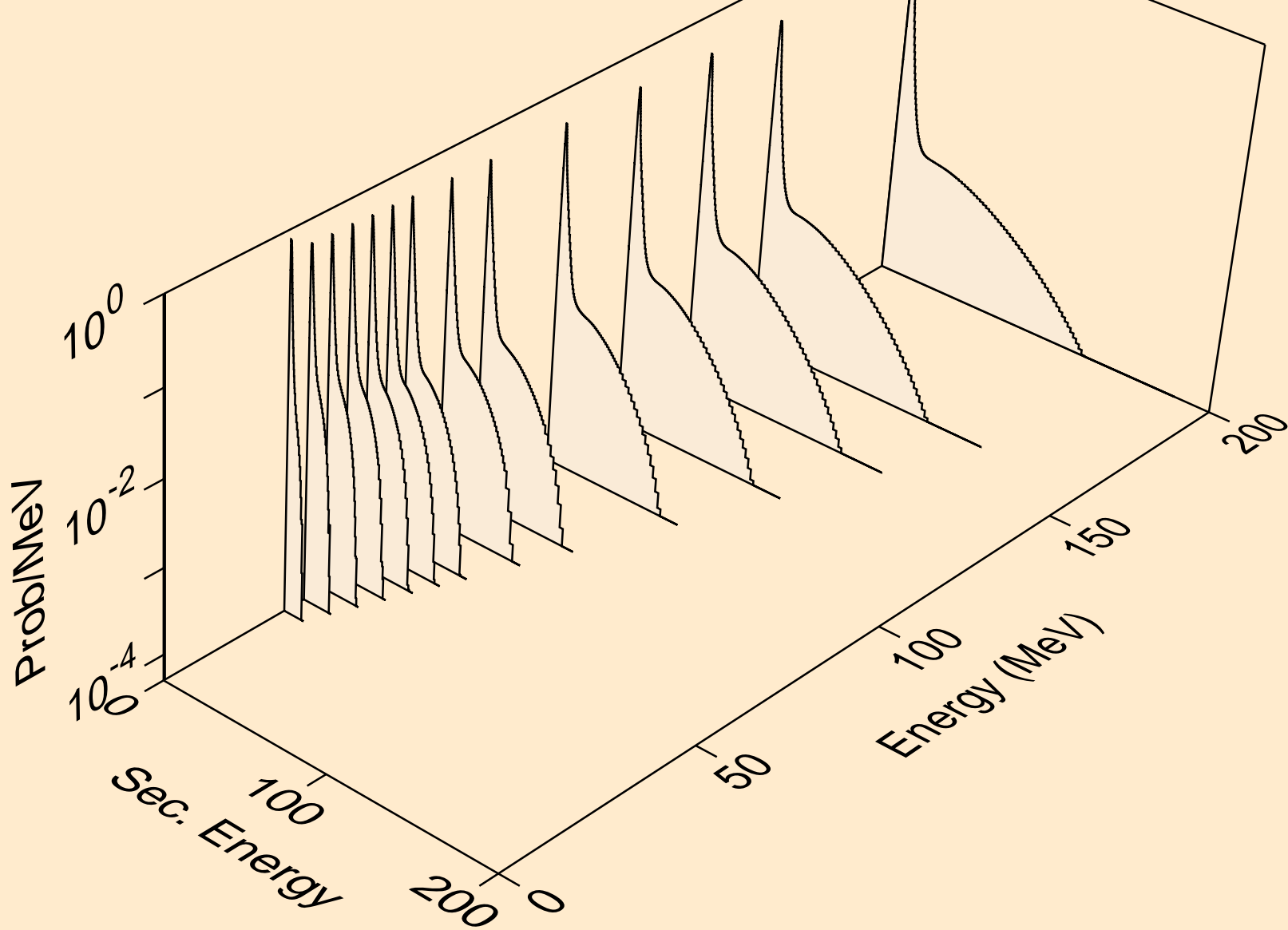

YB152 ALPHA ACER TENDL-2024 LIBRARY; T=0.K  
neutrons from (a,2n)

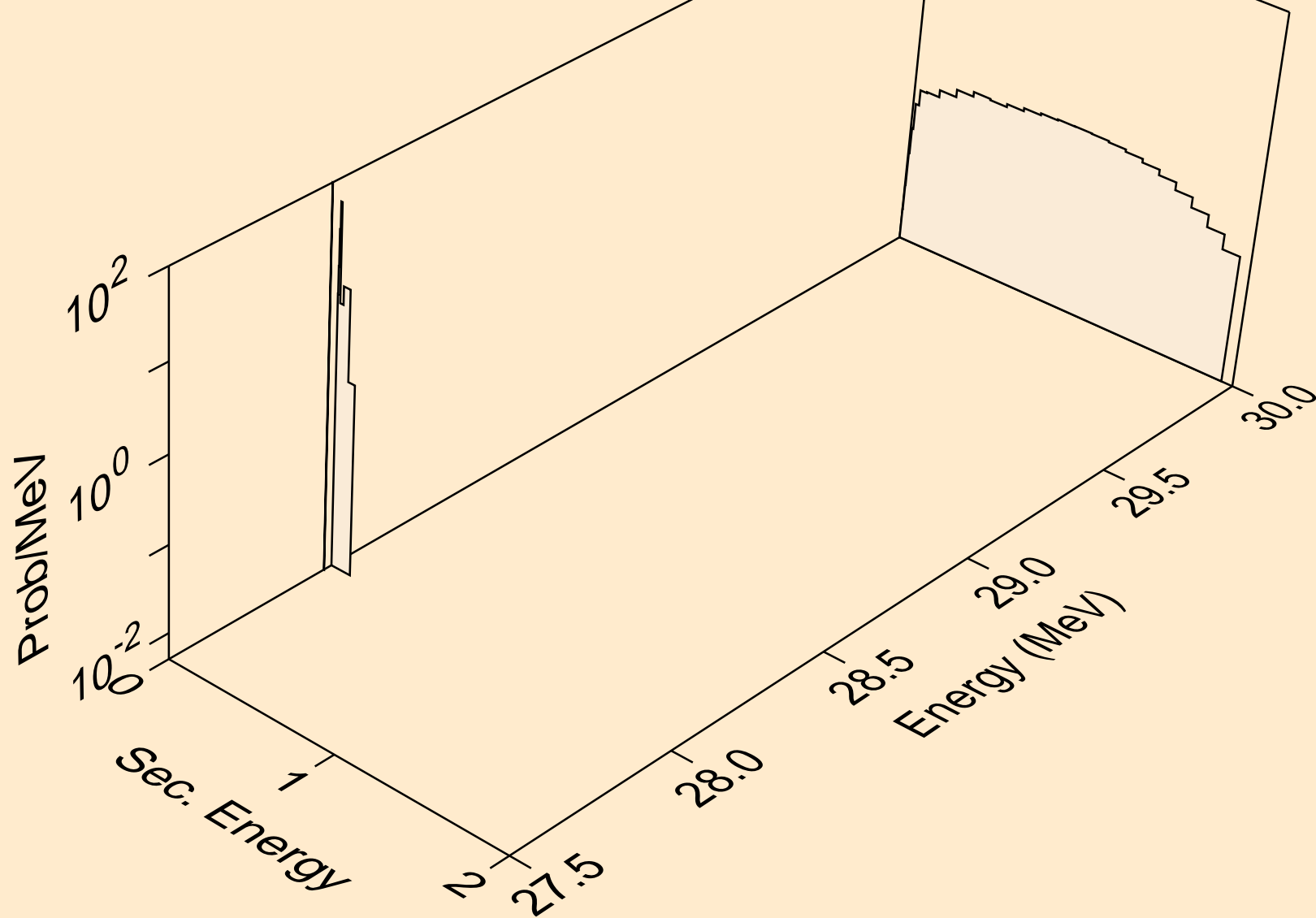

YB152 ALPHA ACER TENDL-2024 LIBRARY; T=0.K  
neutrons from (a,n\*)a

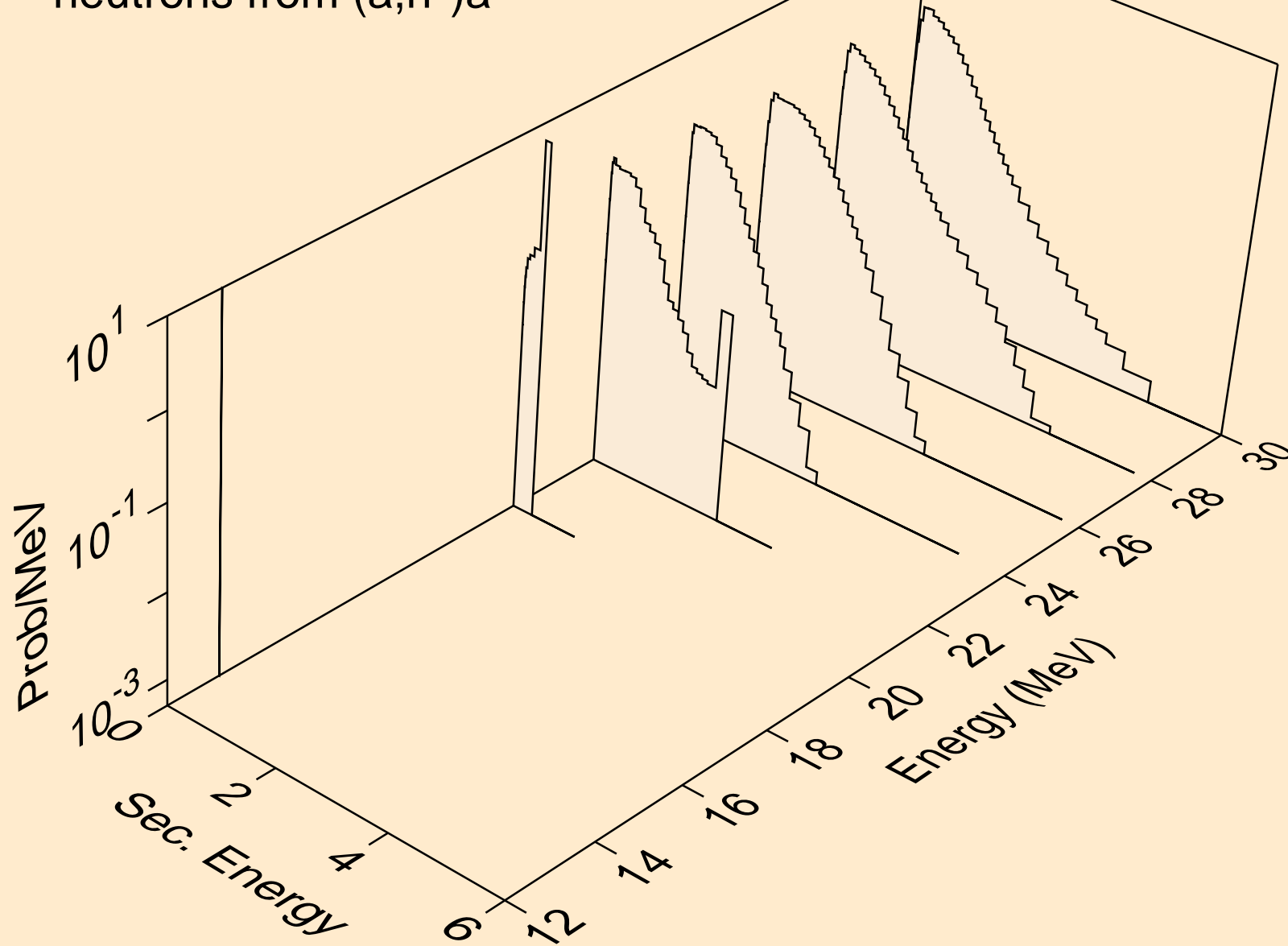

YB152 ALPHA ACER TENDL-2024 LIBRARY; T=0.K  
neutrons from (a,n\*)p

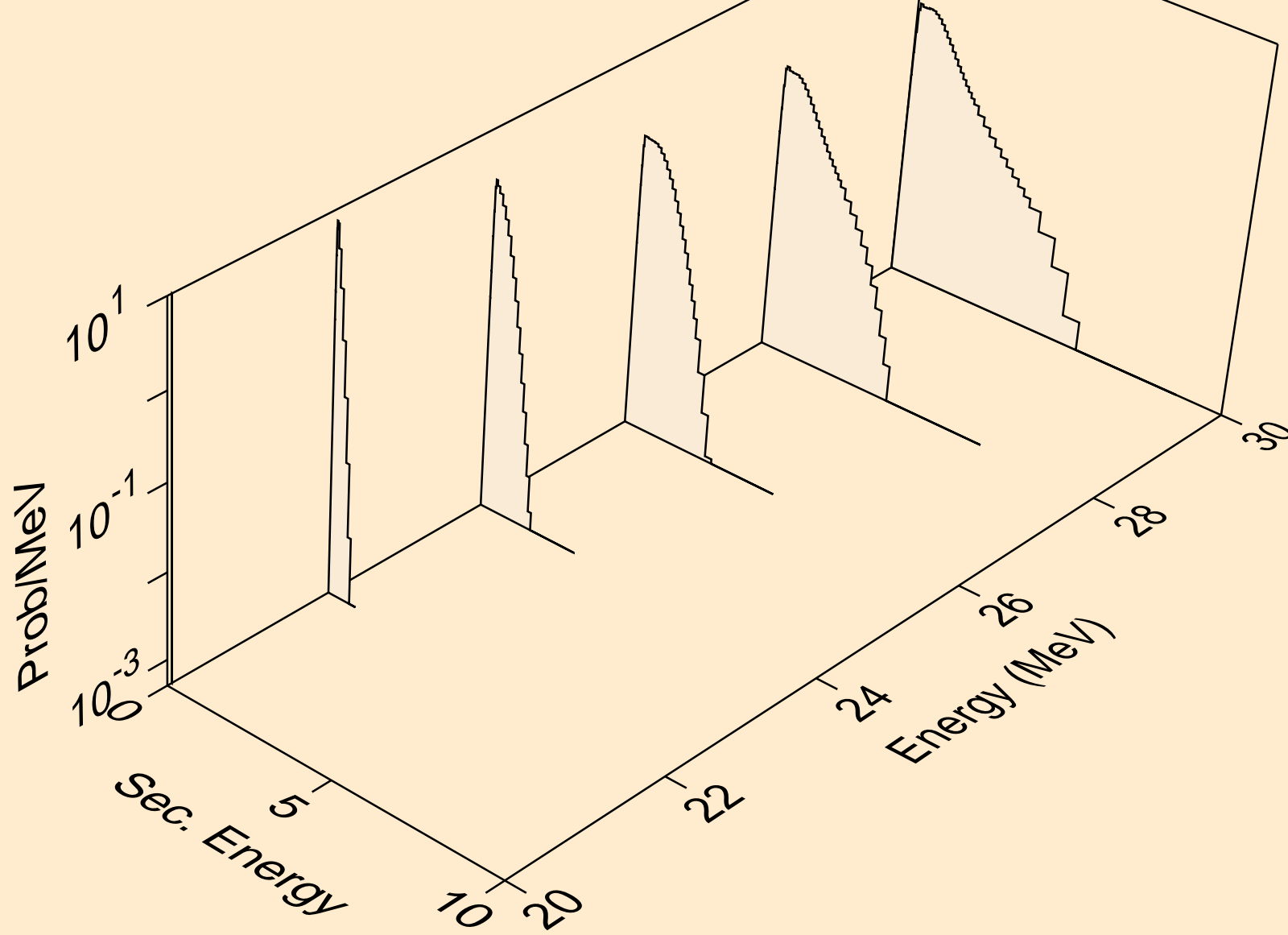

YB152 ALPHA ACER TENDL-2024 LIBRARY; T=0.K  
neutrons from (a,n2p)

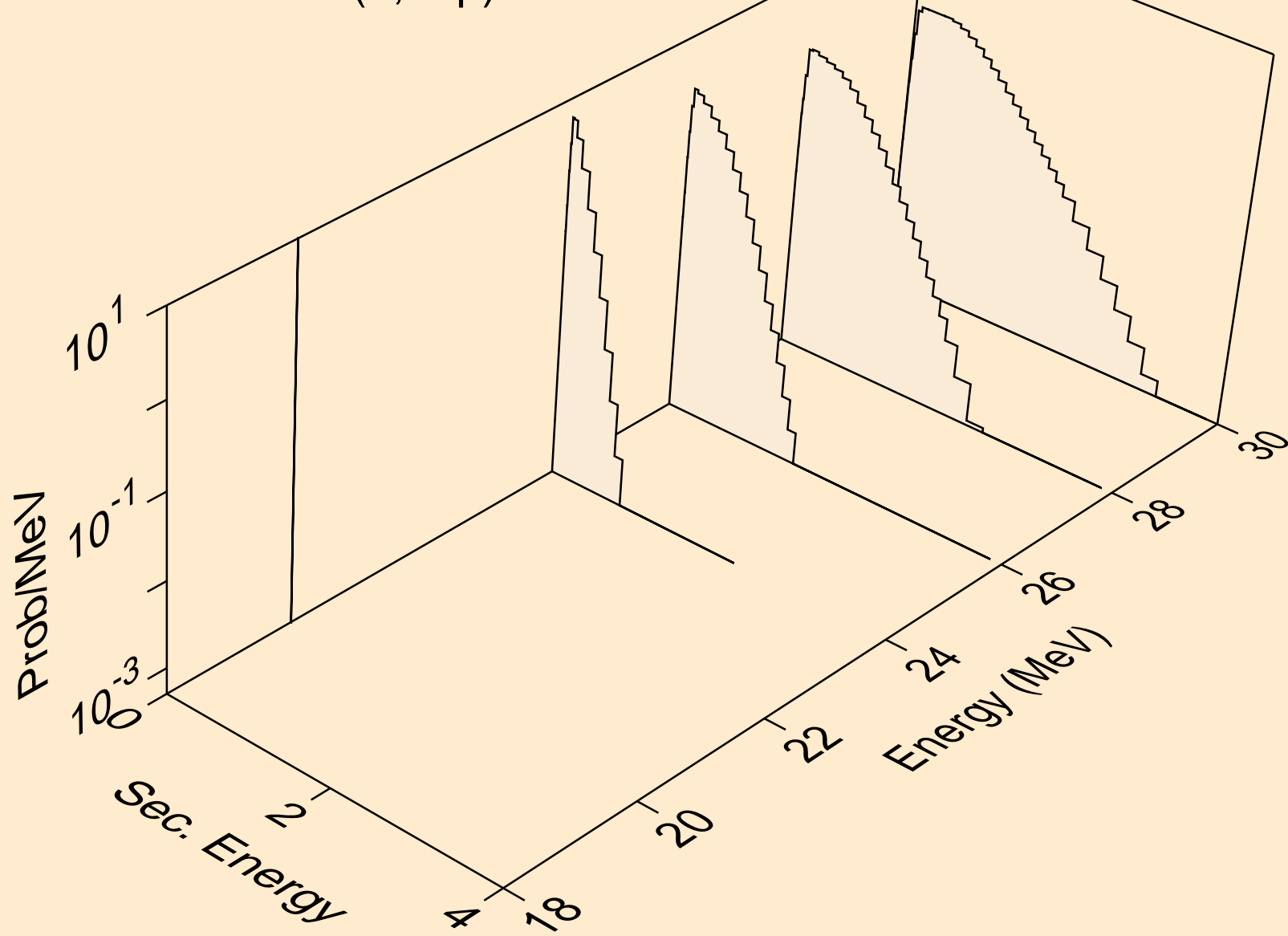

YB152 ALPHA ACER TENDL-2024 LIBRARY; T=0.K  
neutrons from (a,npa)

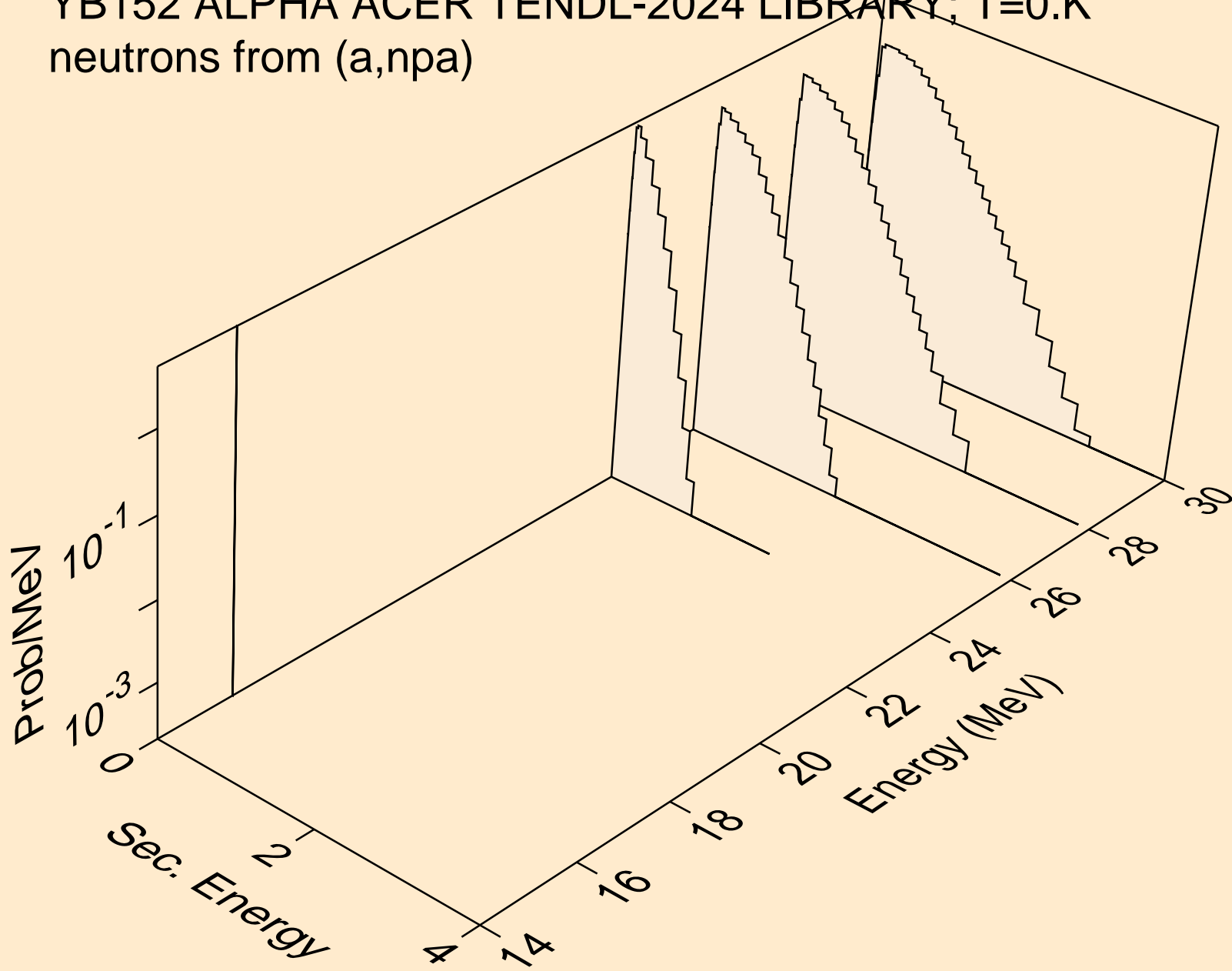

YB152 ALPHA ACER TENDL-2024 LIBRARY; T=0.K  
protons from (a,x)

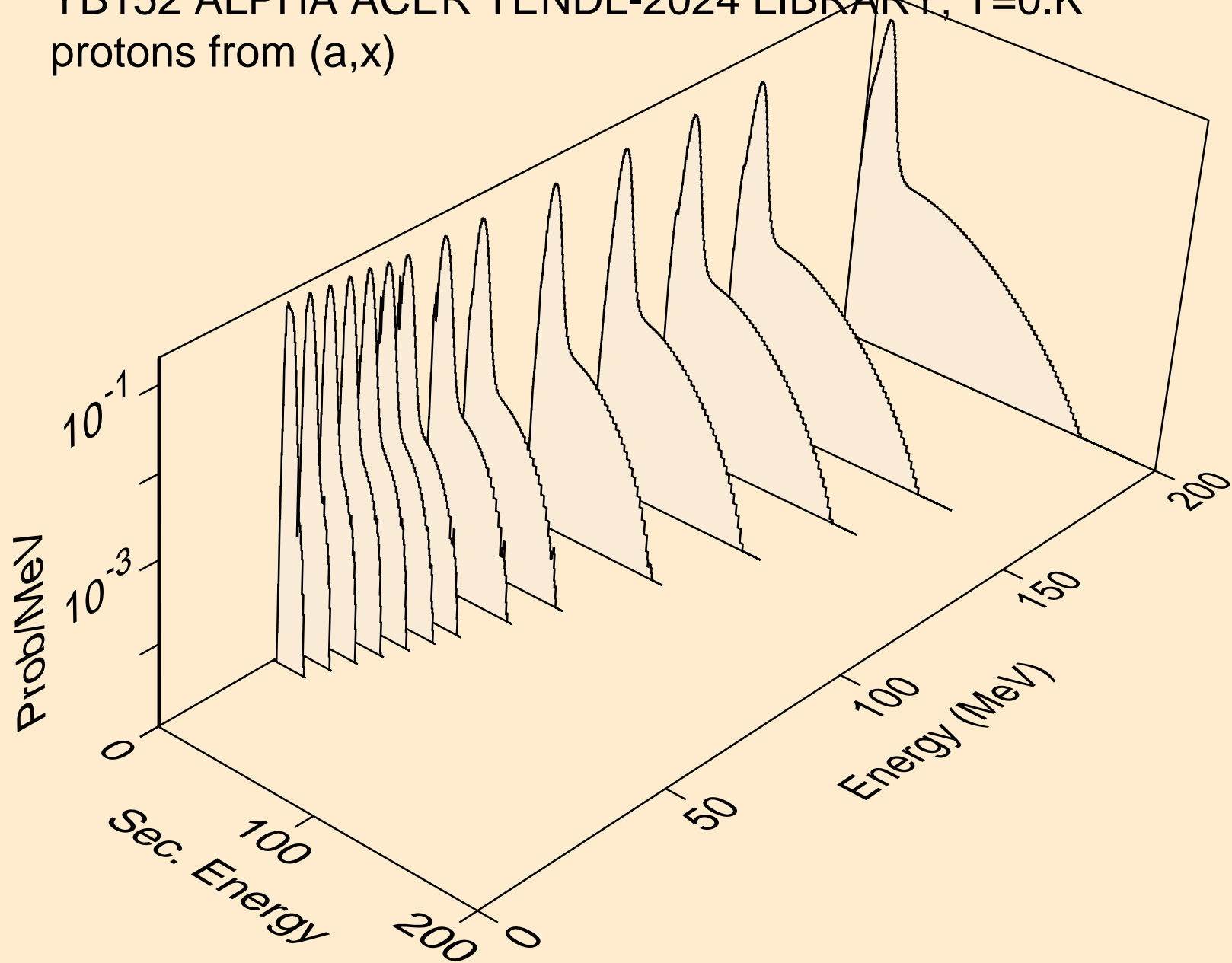

YB152 ALPHA ACER TENDL-2024 LIBRARY; T=0.K  
protons from (a,n\*)p

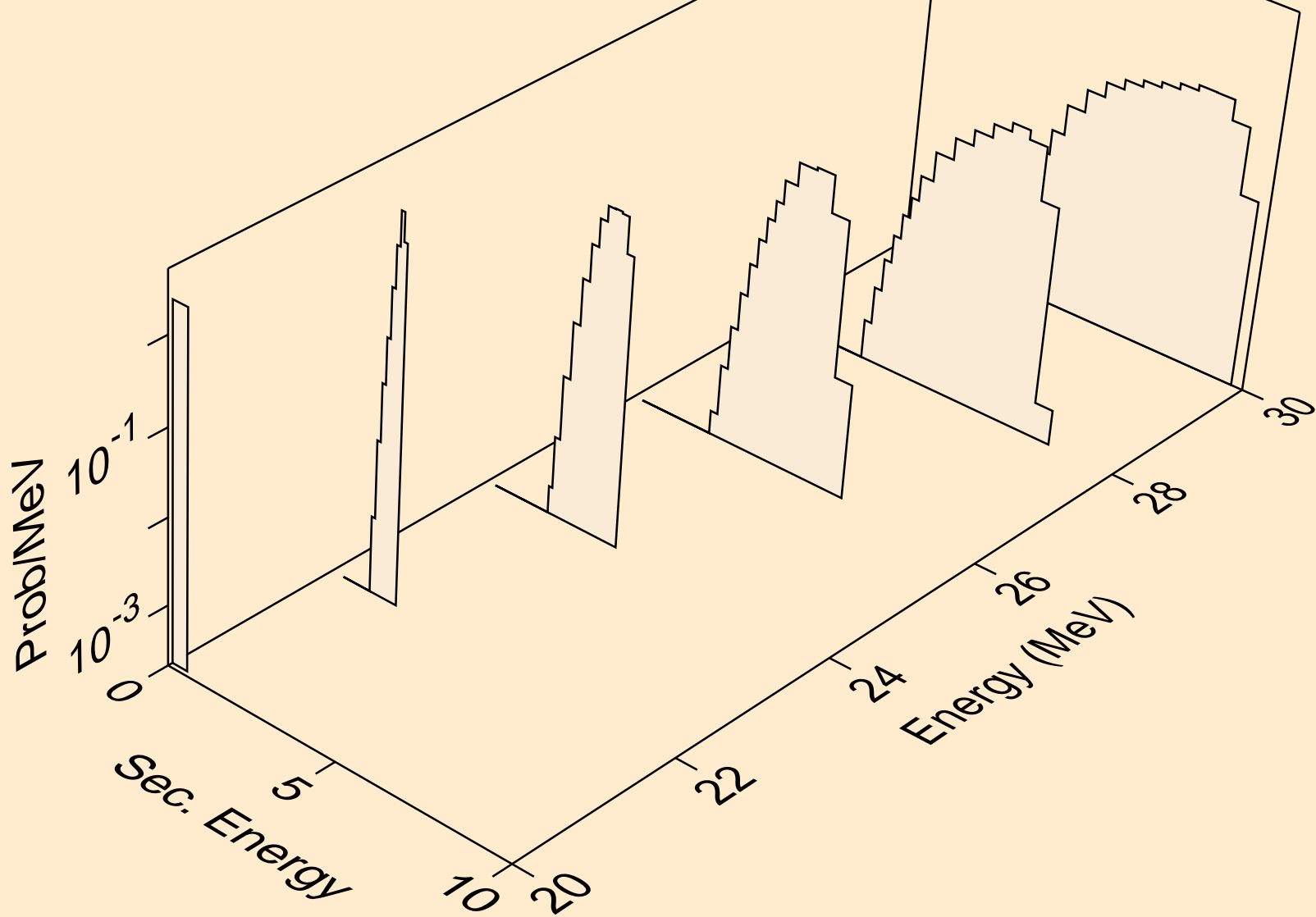

YB152 ALPHA ACER TENDL-2024 LIBRARY; T=0.K  
protons from (a,n2p)

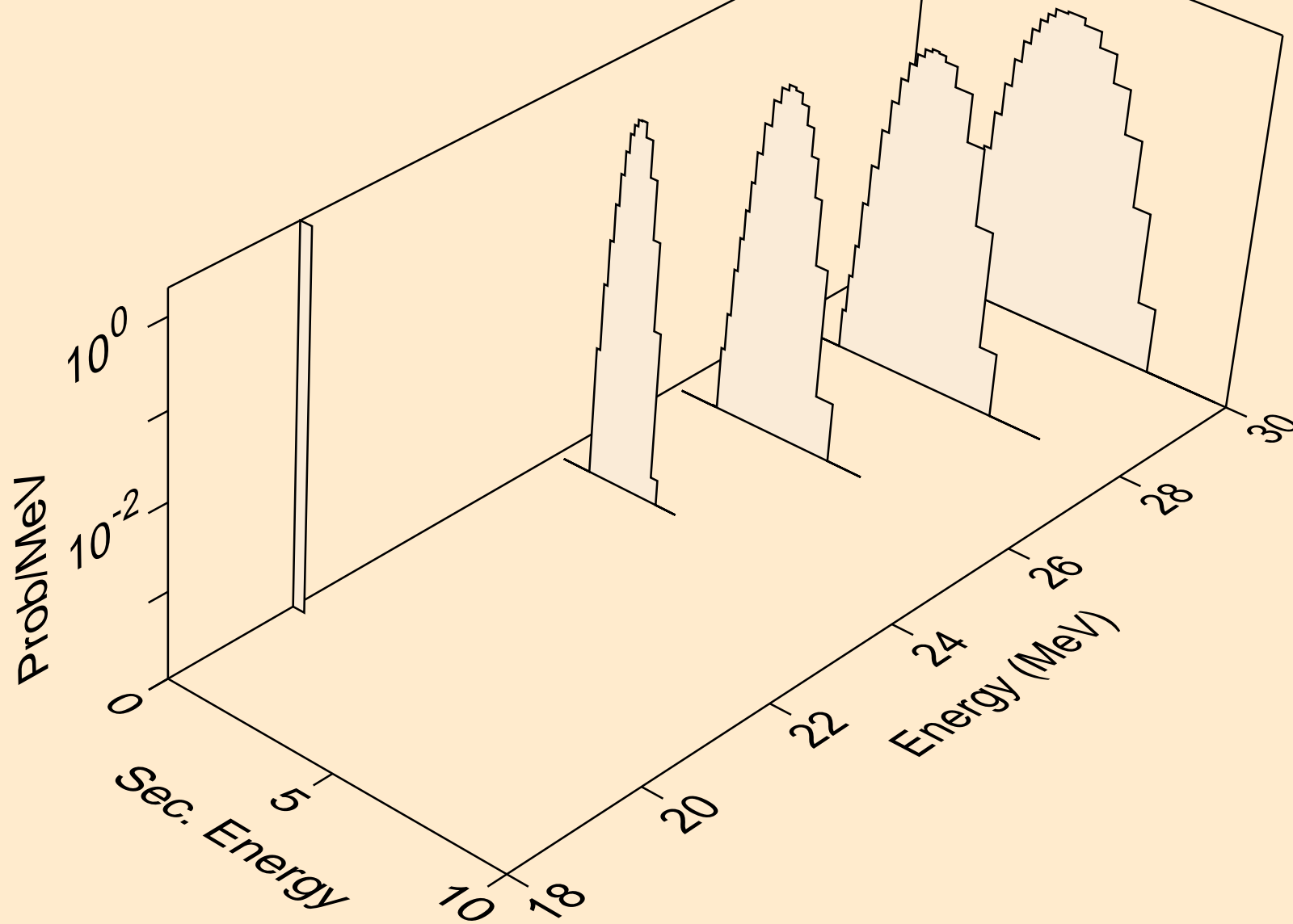

YB152 ALPHA ACER TENDL-2024 LIBRARY; T=0.K  
protons from (a,npa)

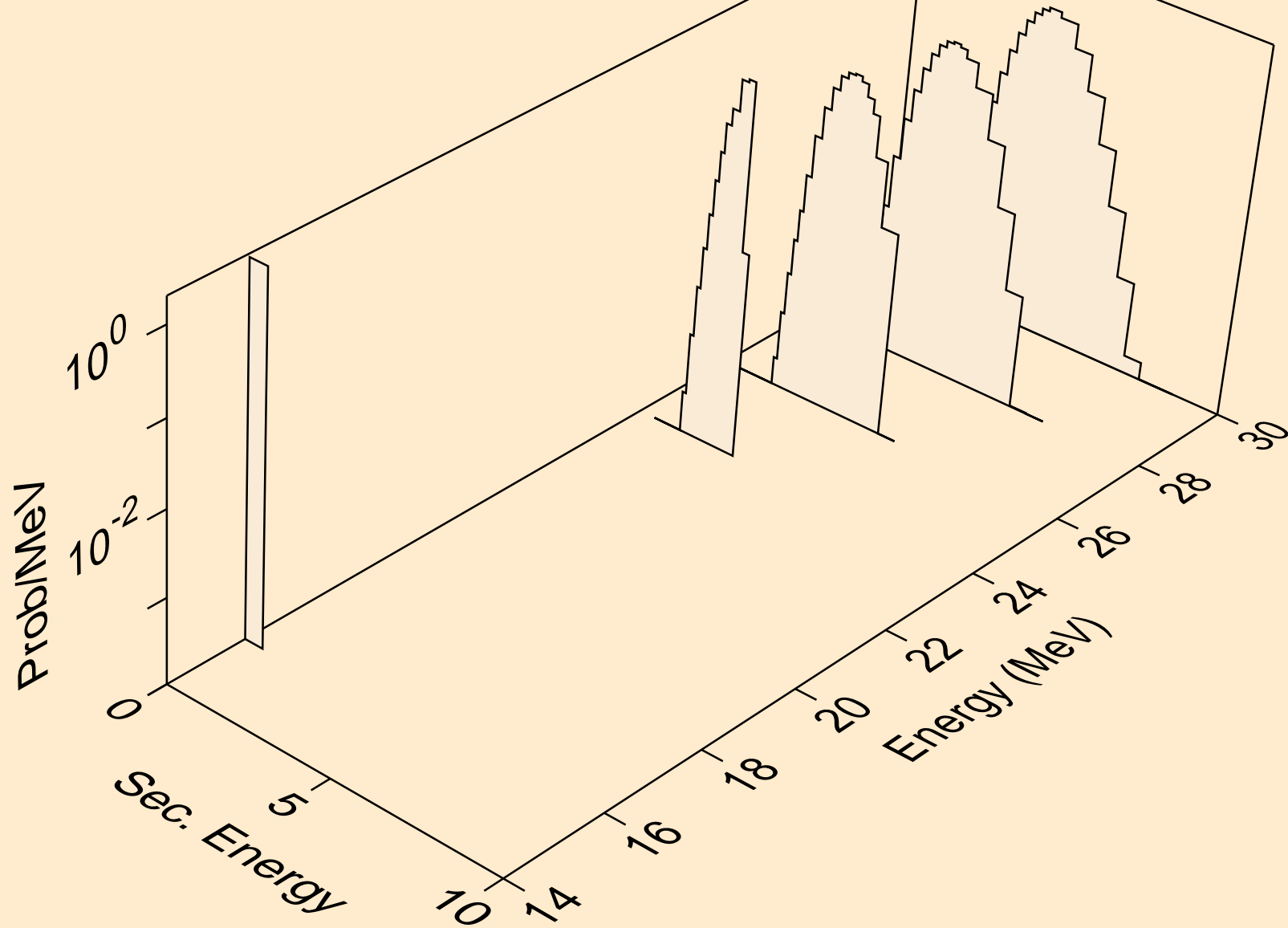

YB152 ALPHA ACER TENDL-2024 LIBRARY; T=0.K  
protons from (a,p)

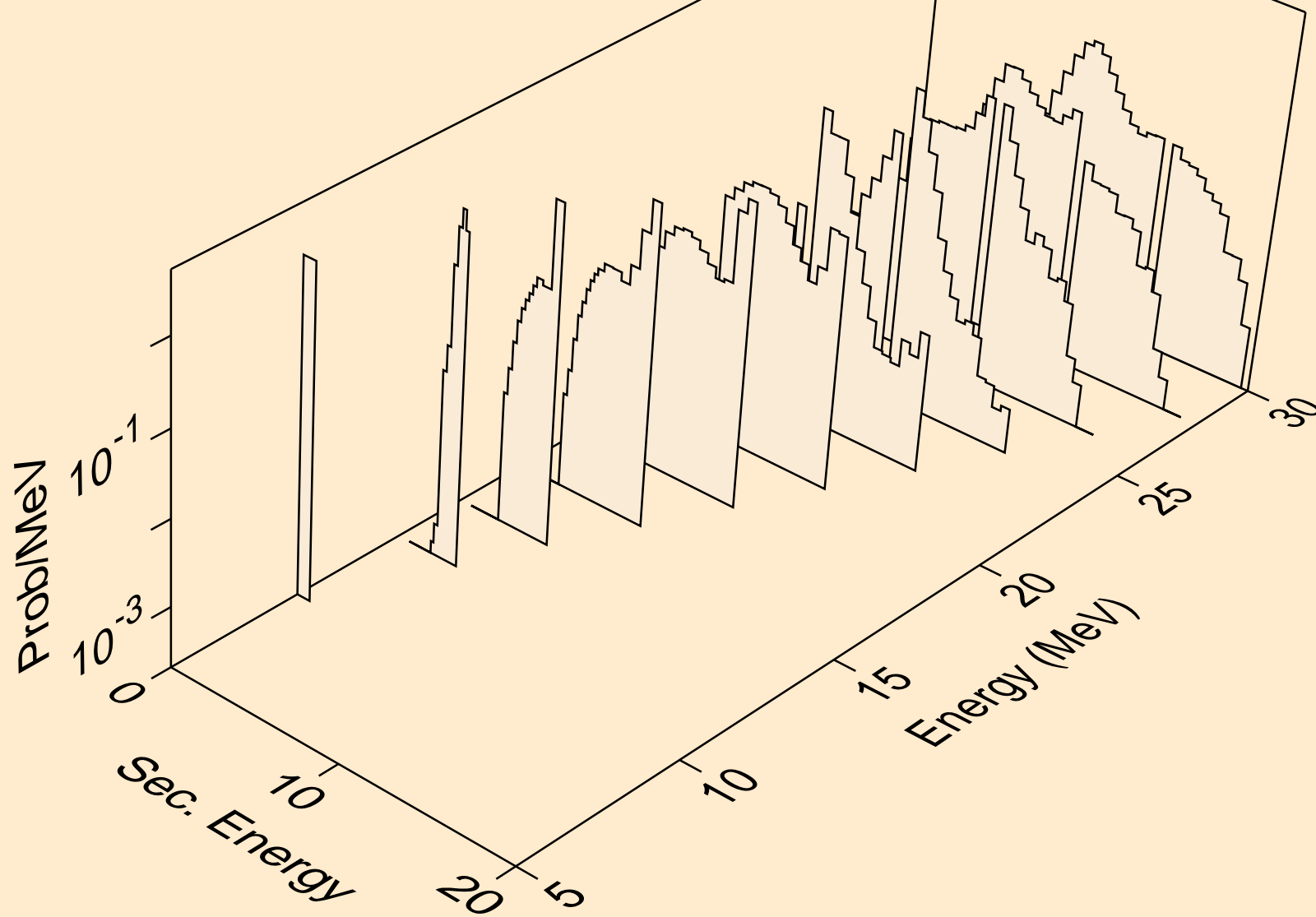

YB152 ALPHA ACER TENDL-2024 LIBRARY; T=0.K  
protons from (a,2p)

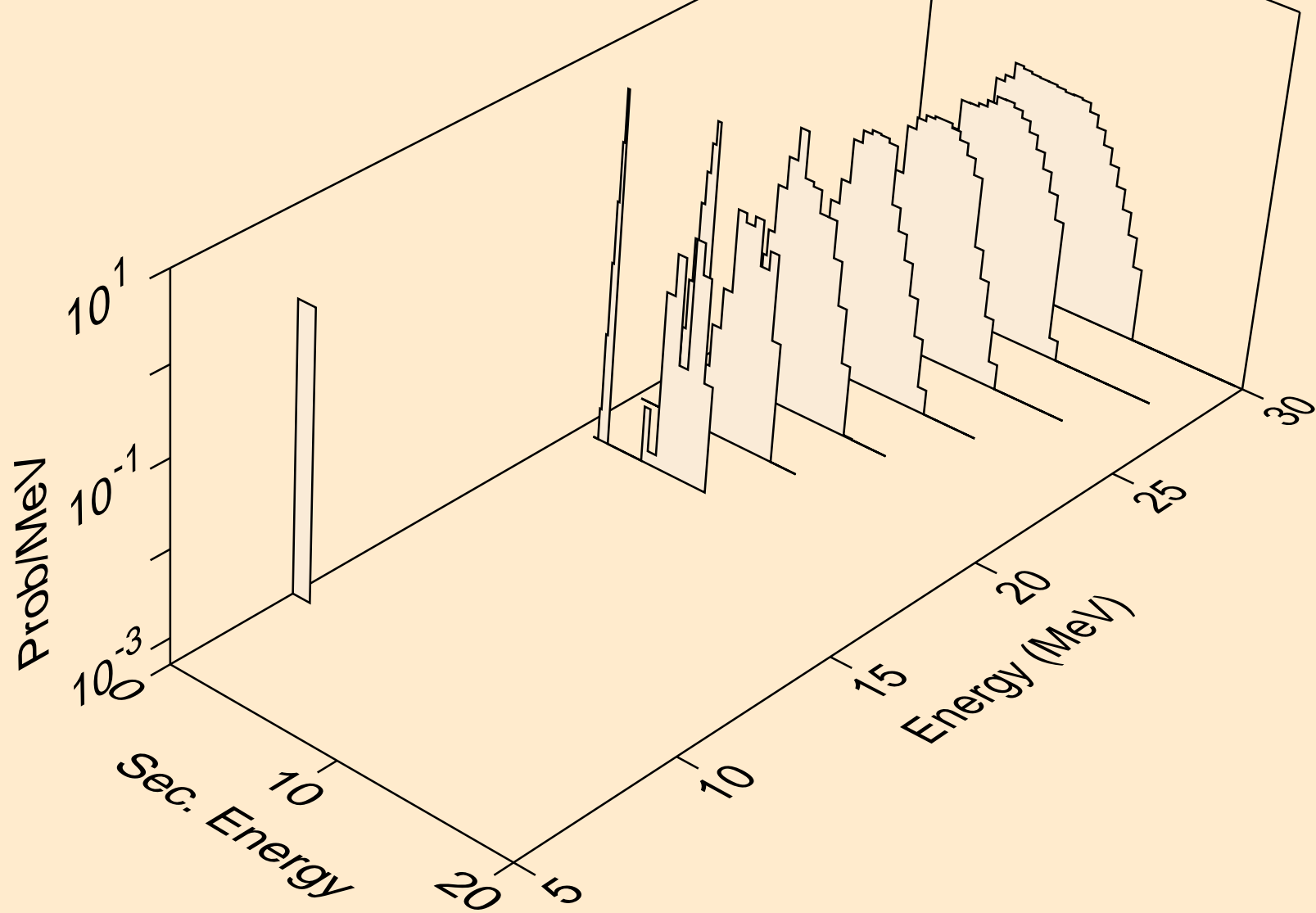

YB152 ALPHA ACER TENDL-2024 LIBRARY; T=0.K  
protons from (a,pa)

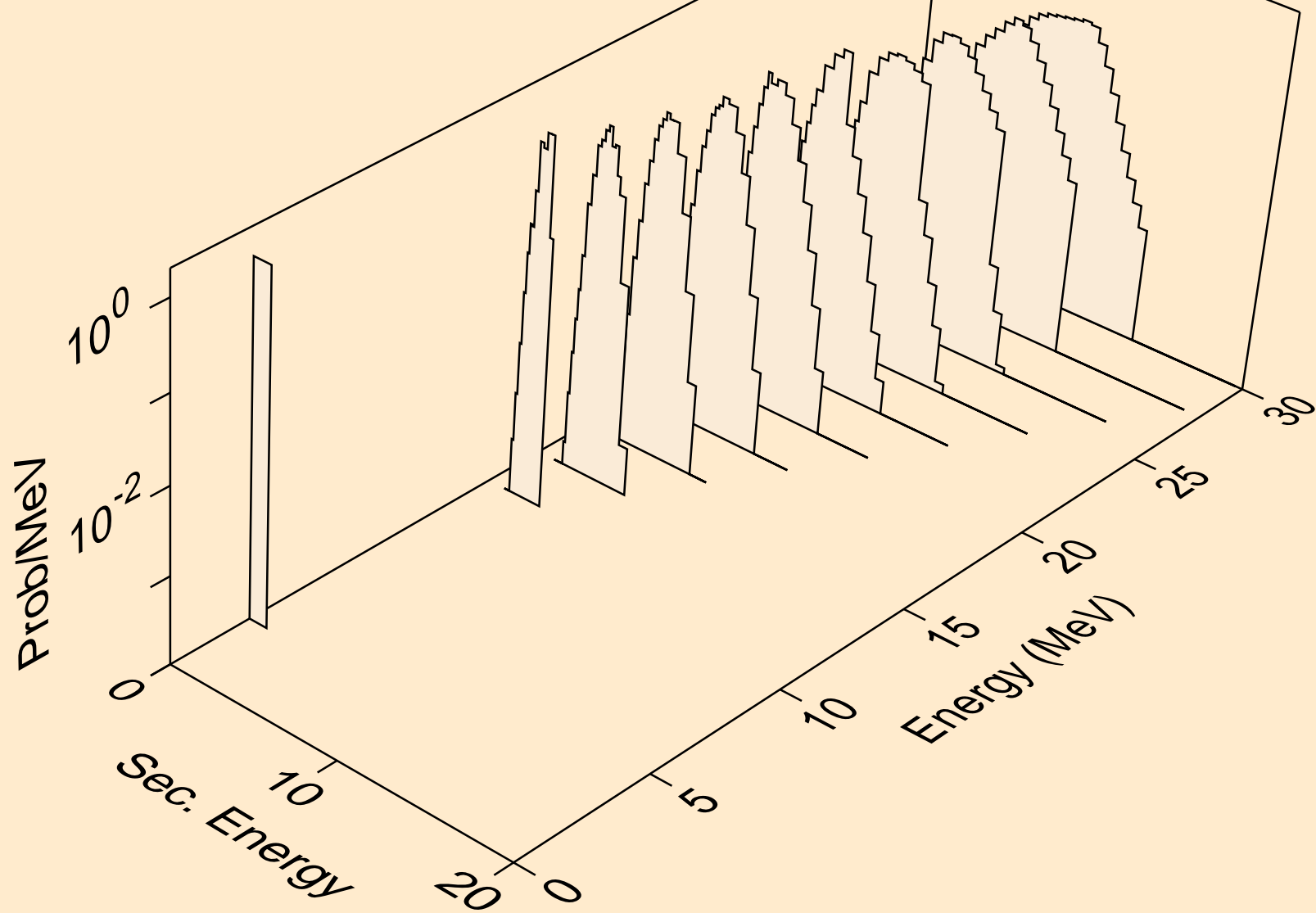

YB152 ALPHA ACER TENDL-2024 LIBRARY; T=0.K  
protons from (a,pd)

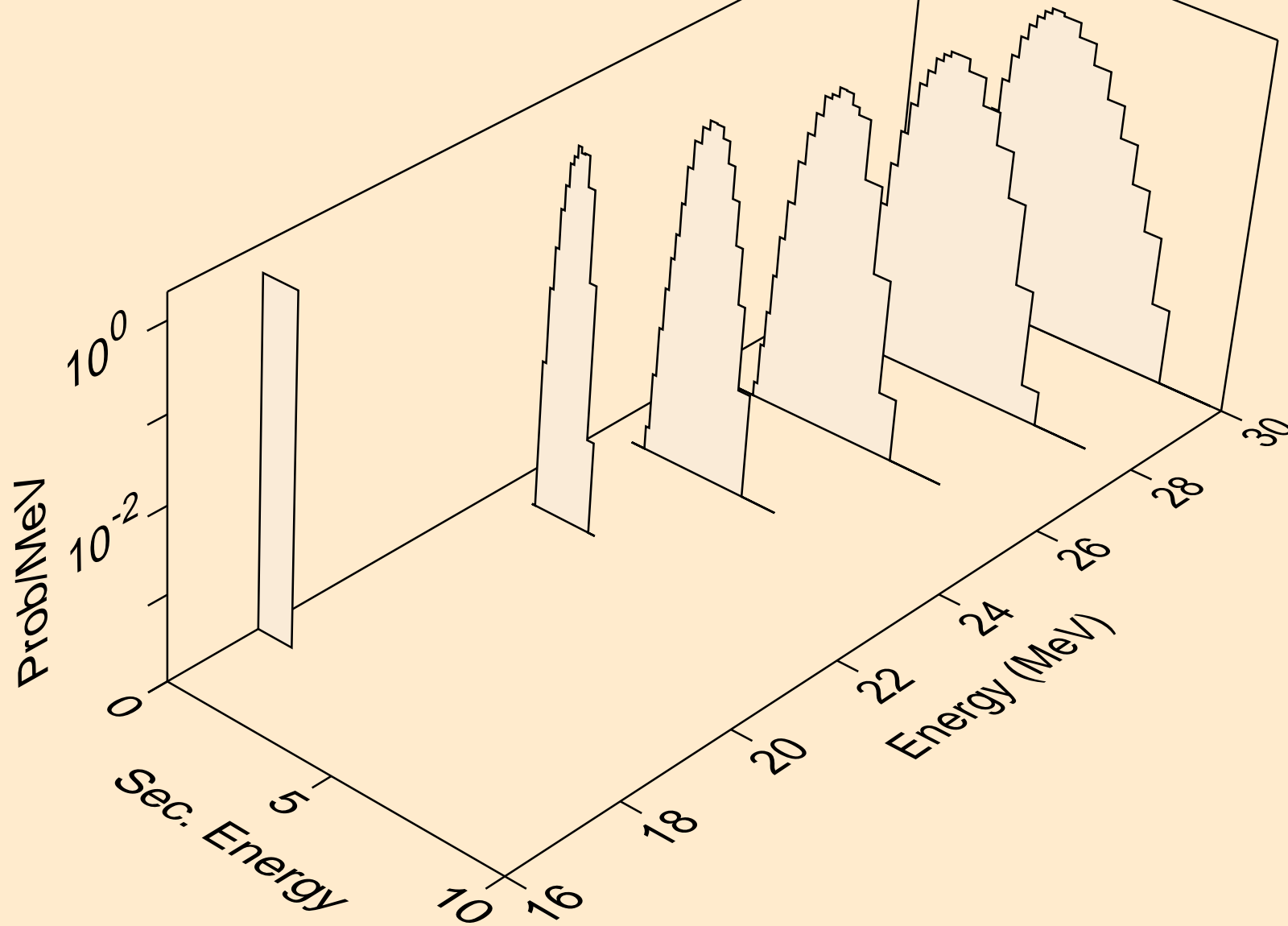

YB152 ALPHA ACER TENDL-2024 LIBRARY; T=0.K  
protons from (a,pt)

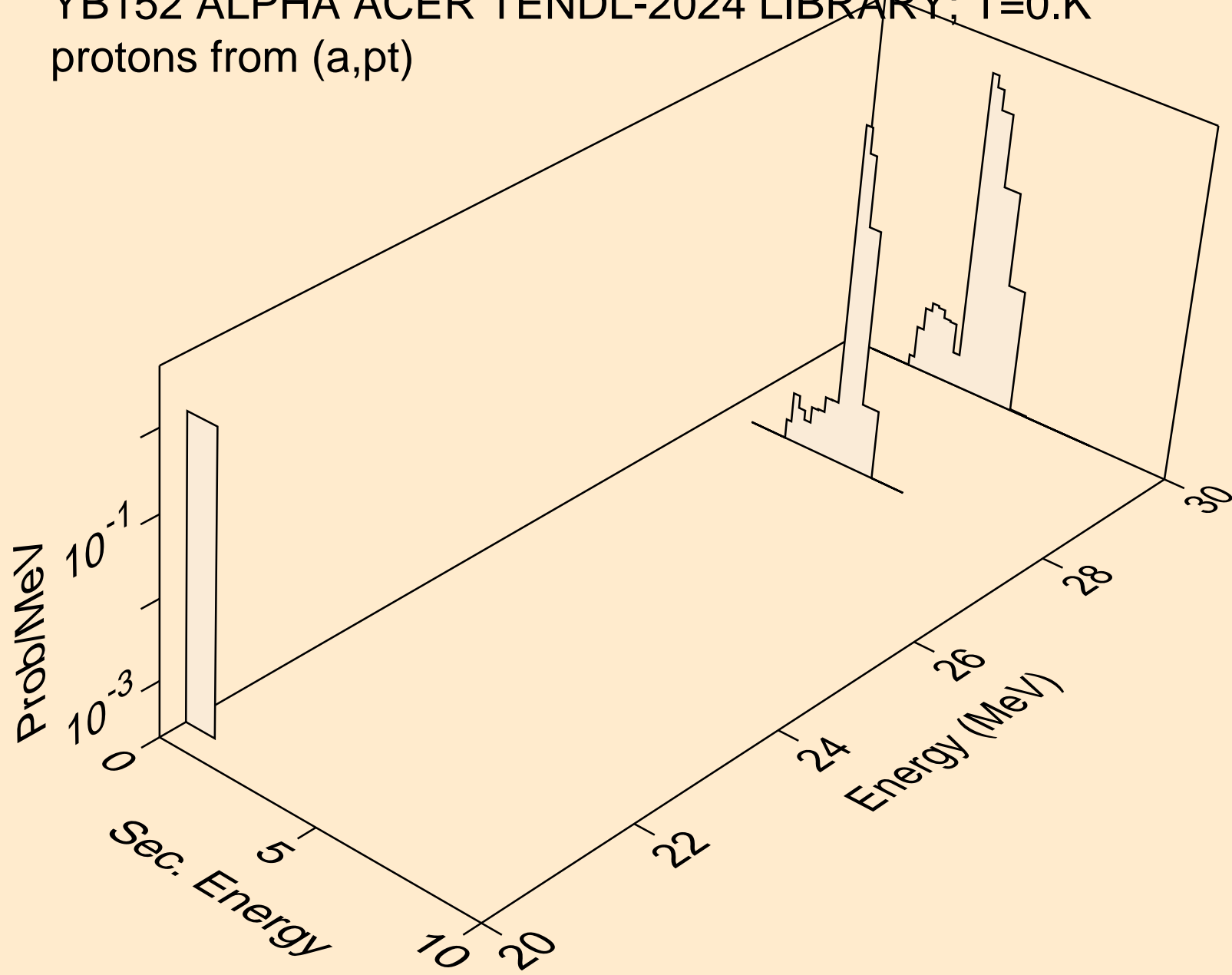

YB152 ALPHA ACER TENDL-2024 LIBRARY; T=0.K  
deuterons from (a,x)

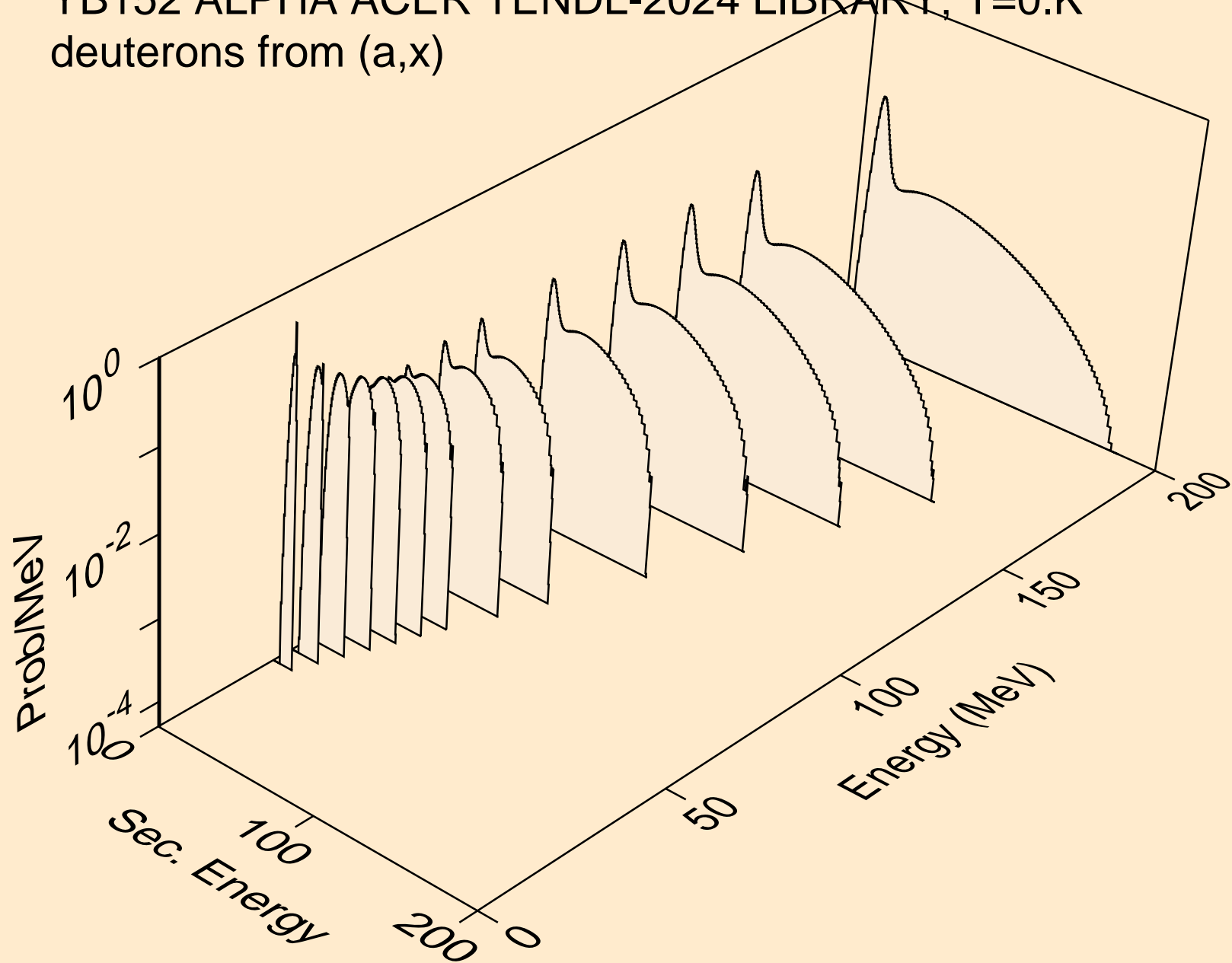

YB152 ALPHA ACER TENDL-2024 LIBRARY; T=0.K  
deuterons from (a,d)

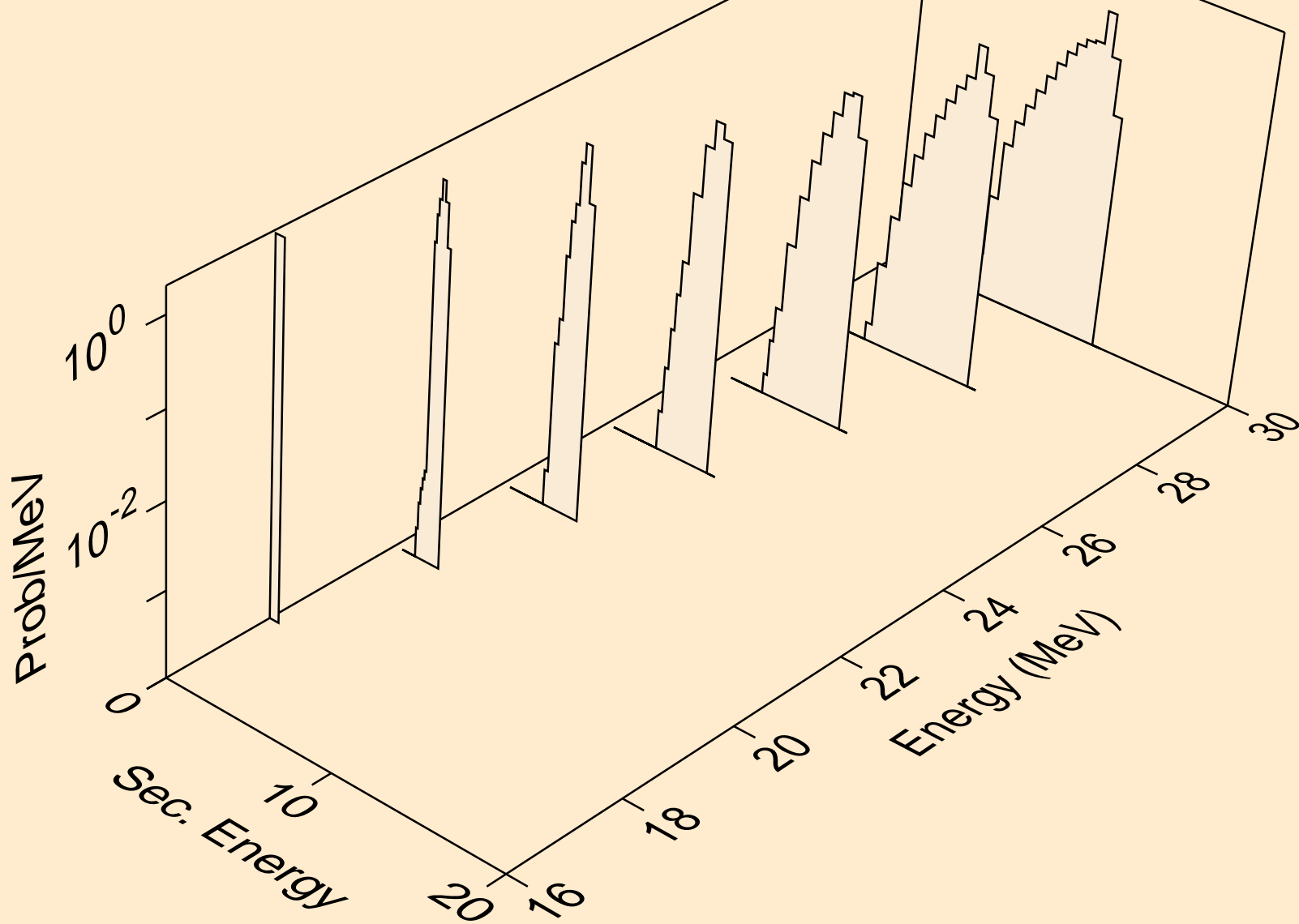

YB152 ALPHA ACER TENDL-2024 LIBRARY; T=0.K  
deuterons from (a,pd)

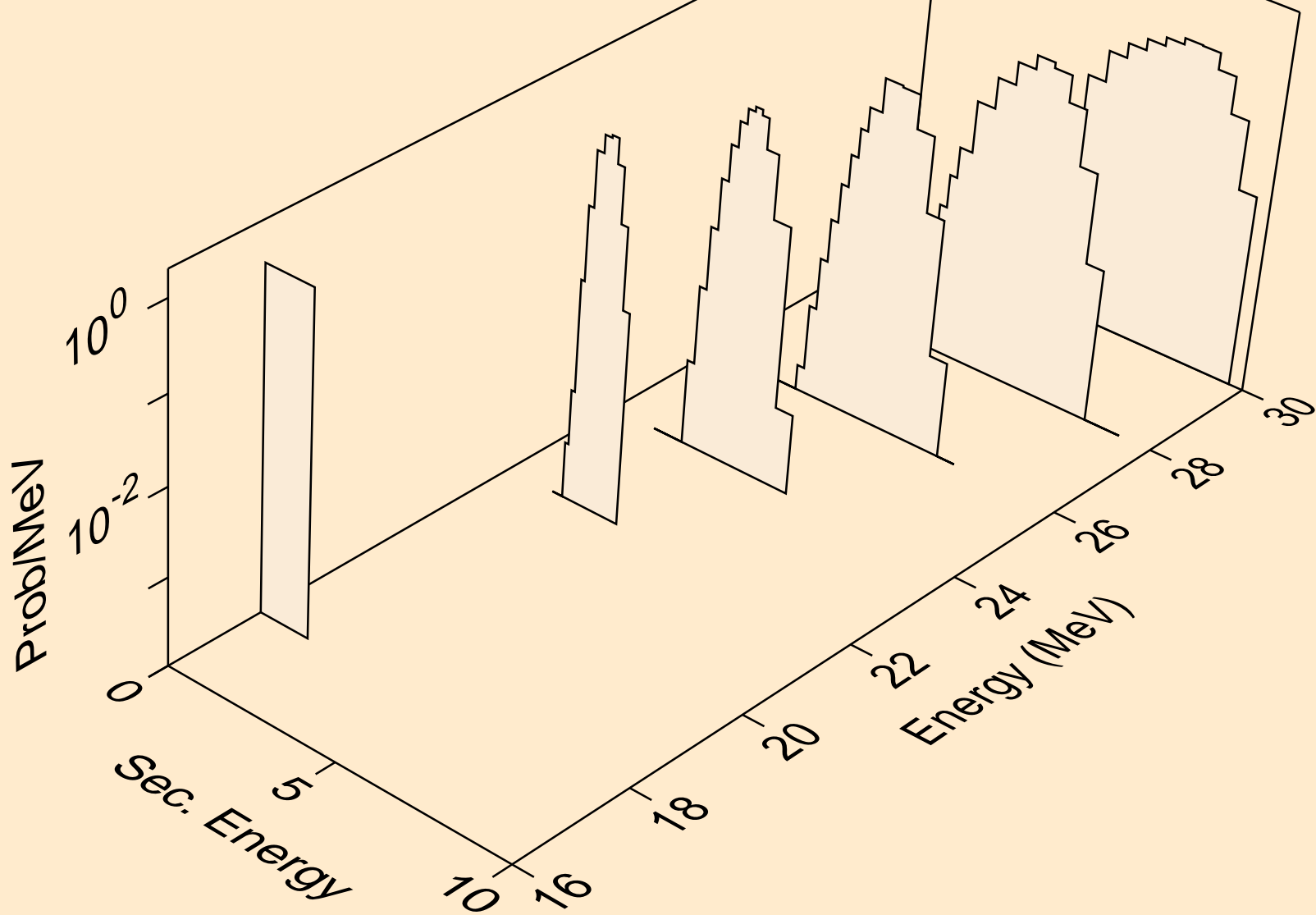

YB152 ALPHA ACER TENDL-2024 LIBRARY; T=0.K  
tritons from (a,x)

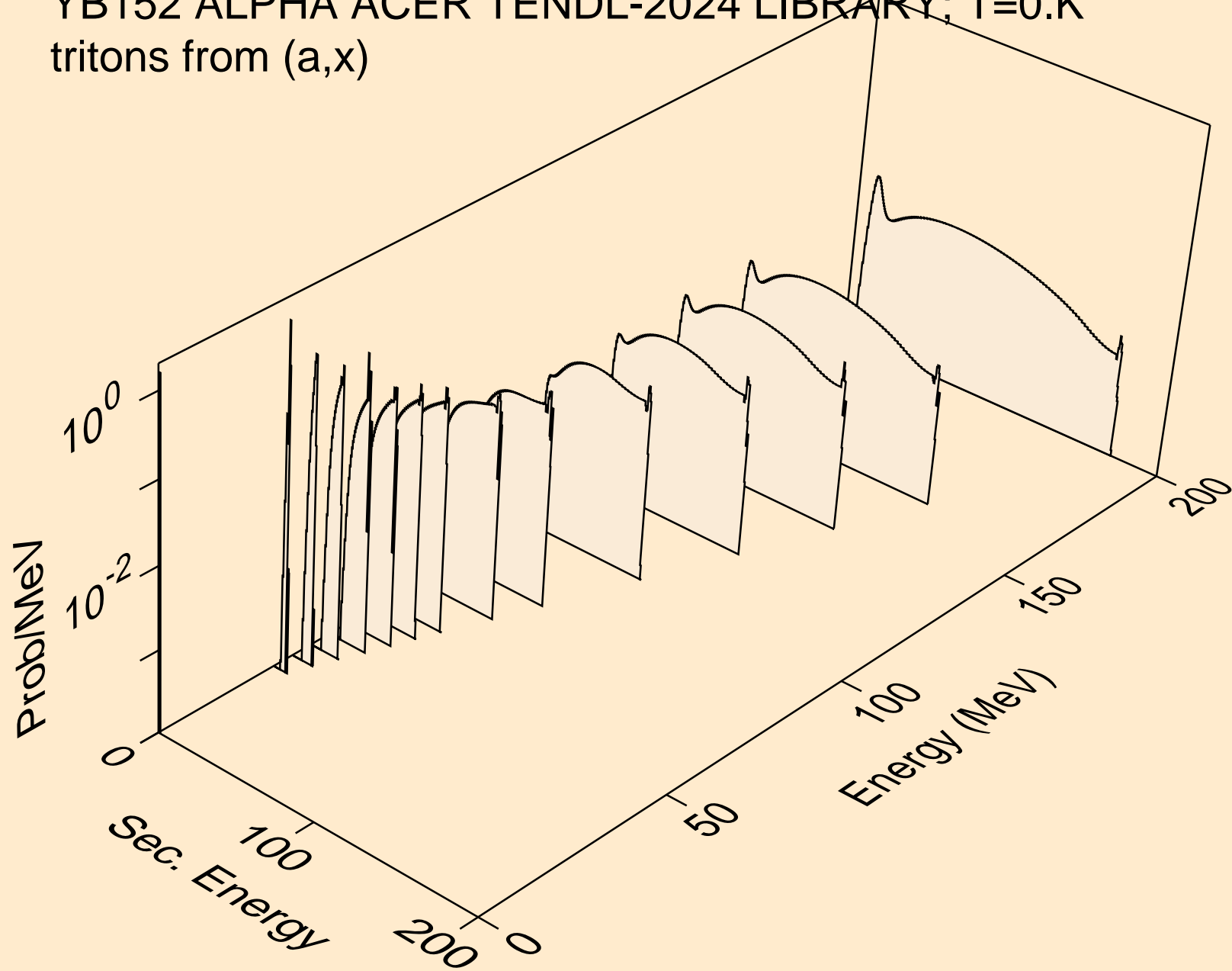

YB152 ALPHA ACER TENDL-2024 LIBRARY; T=0.K  
tritons from (a,t)

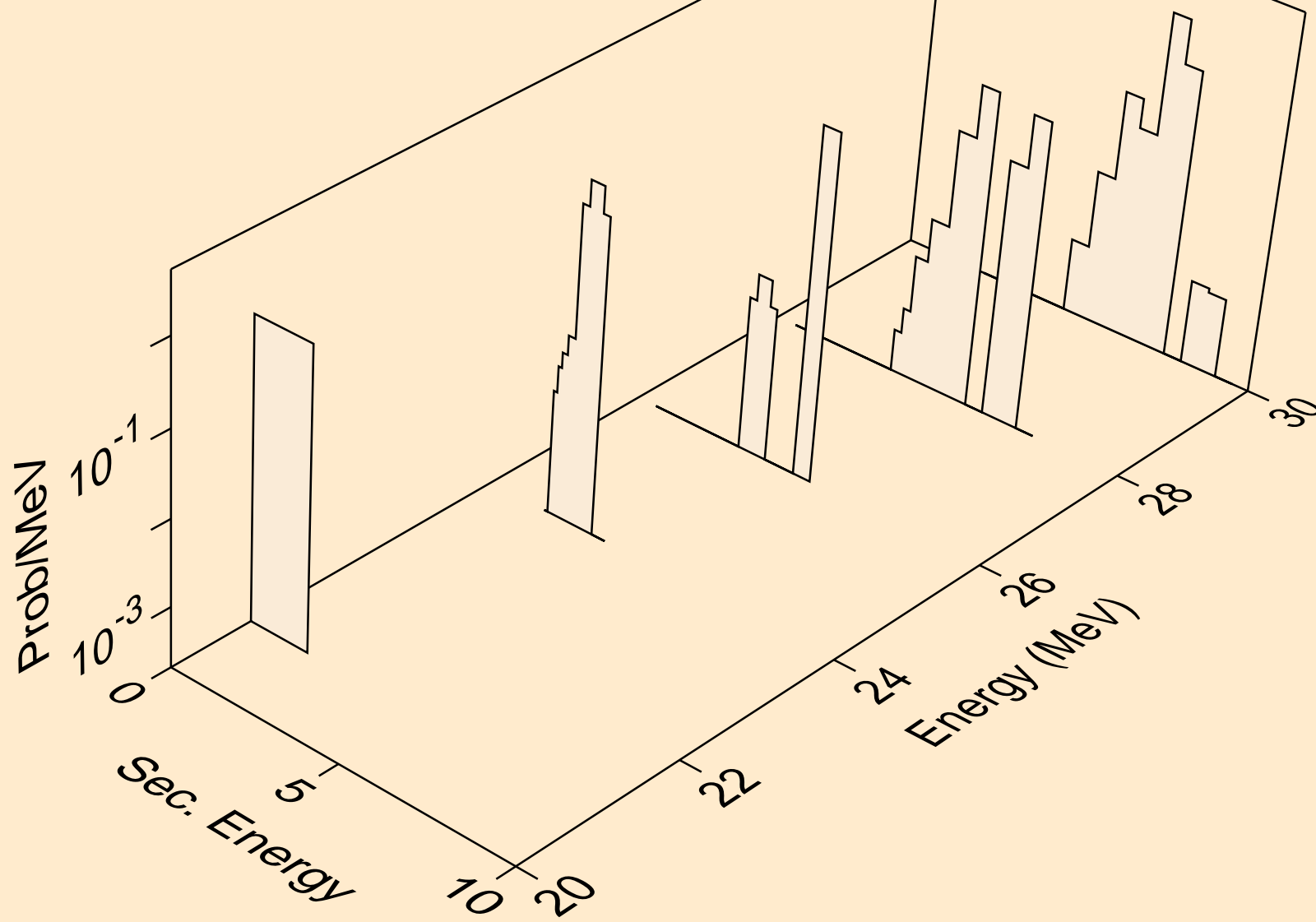

YB152 ALPHA ACER TENDL-2024 LIBRARY; T=0.K  
tritons from (a,pt)

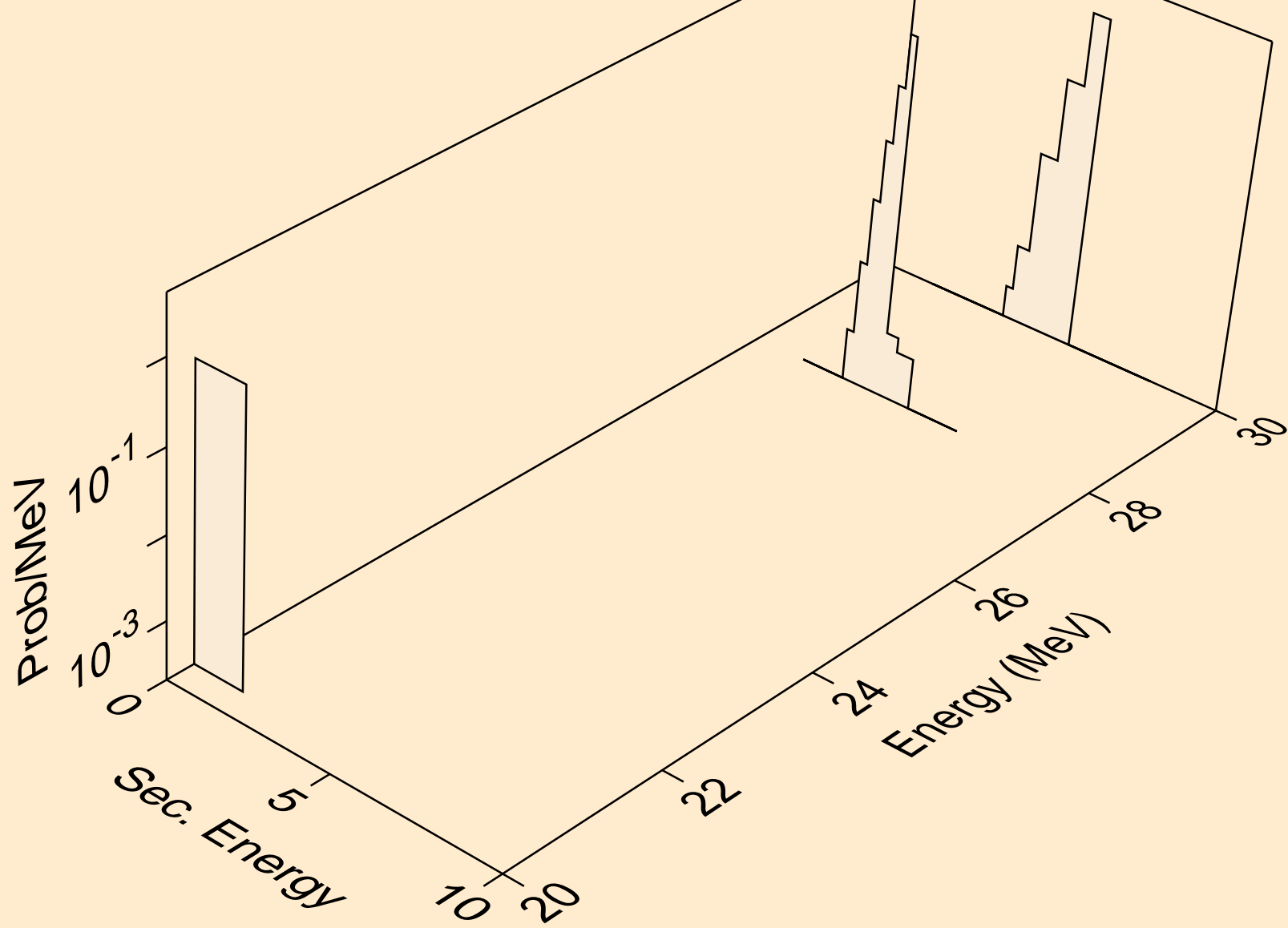

YB152 ALPHA ACER TENDL-2024 LIBRARY; T=0.K  
he3s from (a,x)

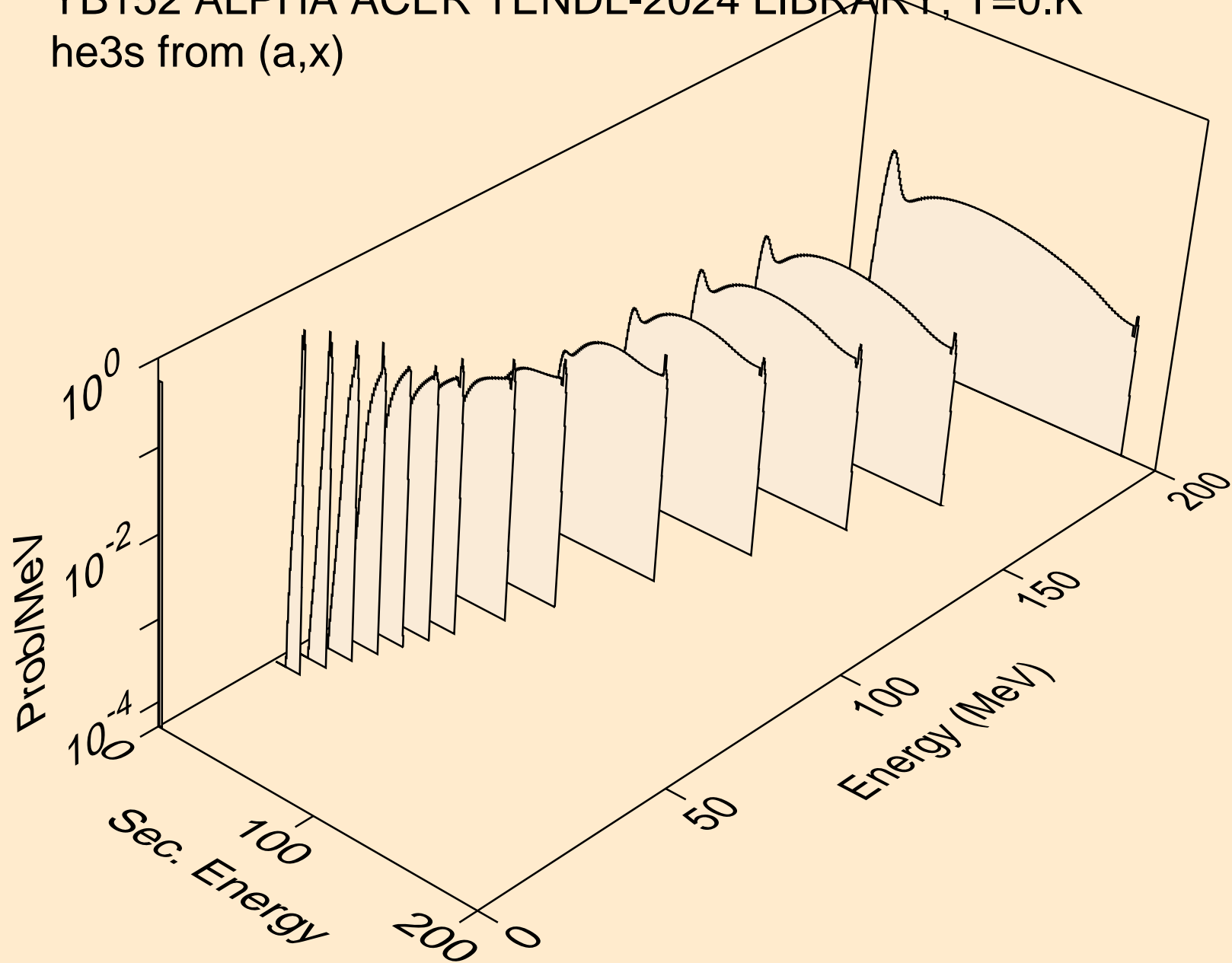

YB152 ALPHA ACER TENDL-2024 LIBRARY; T=0.K  
he3s from (a,he3)

