

# AM249 DEUTERON ACER TENDL-2024 LIBRARY; T=0.K

## Principal cross sections

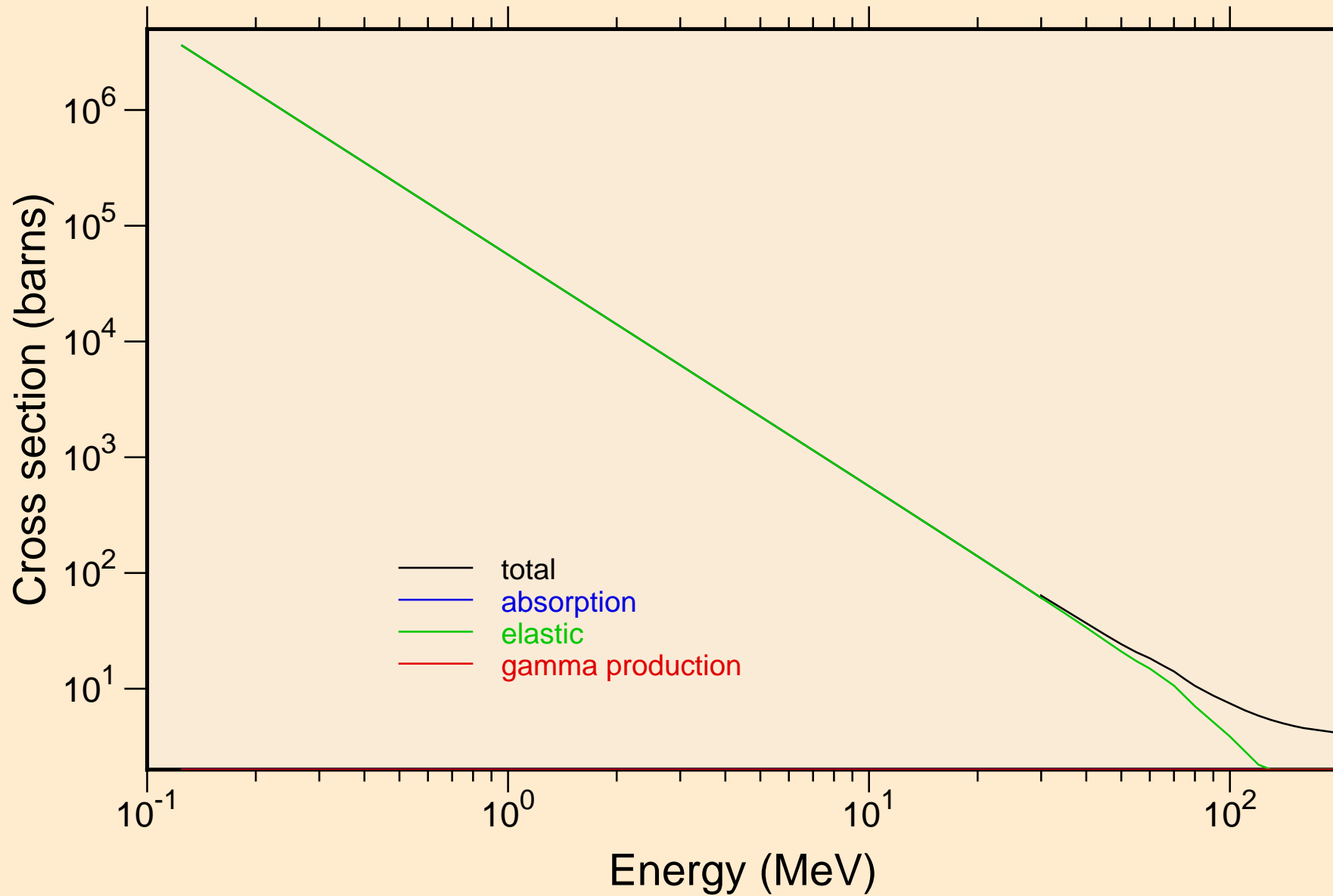

AM249 DEUTERON ACER TENDL-2024 LIBRARY; T=0.K  
Heating

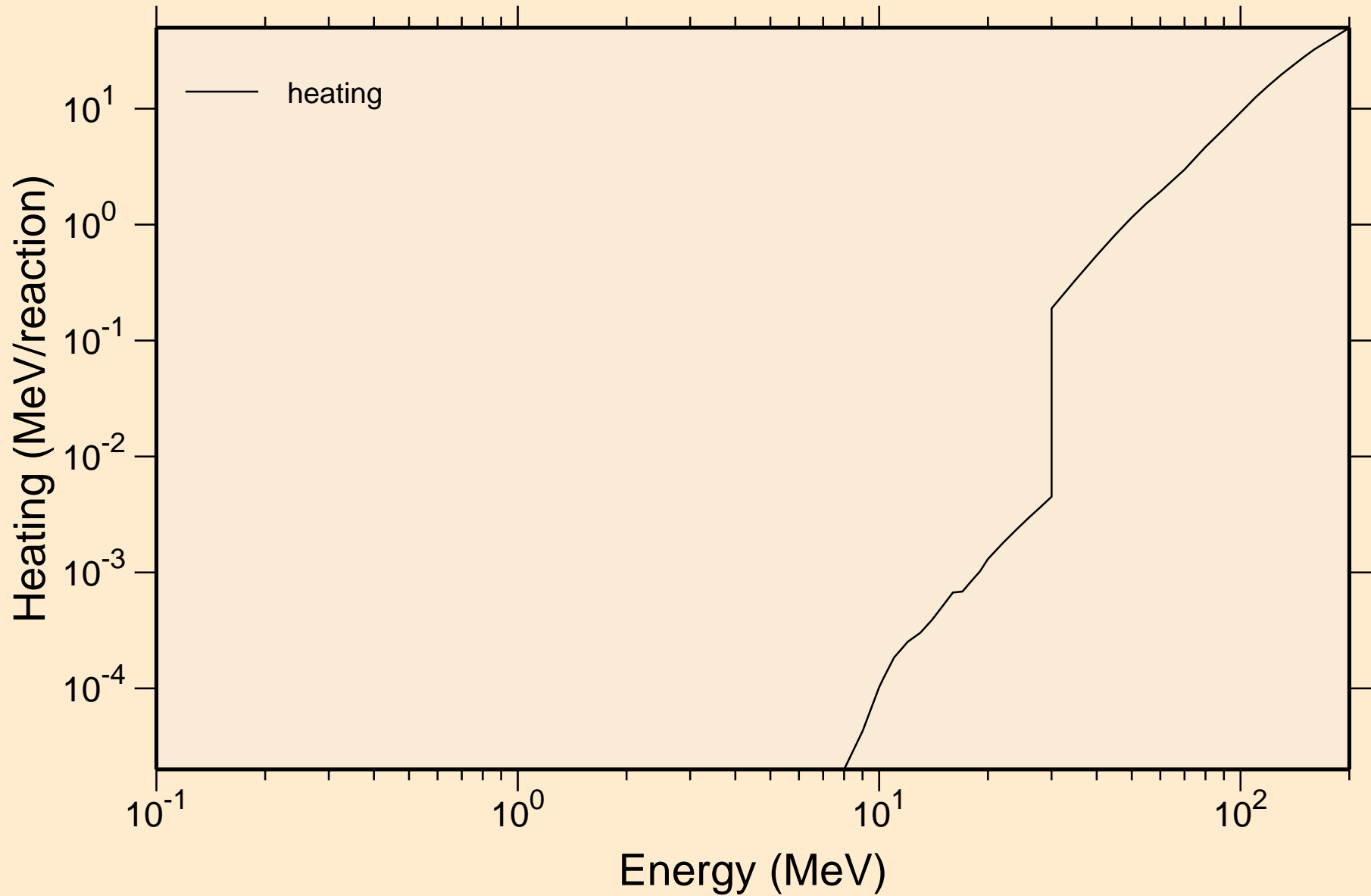

AM249 DEUTERON ACER TENDL-2024 LIBRARY; T=0.K  
Principal cross sections

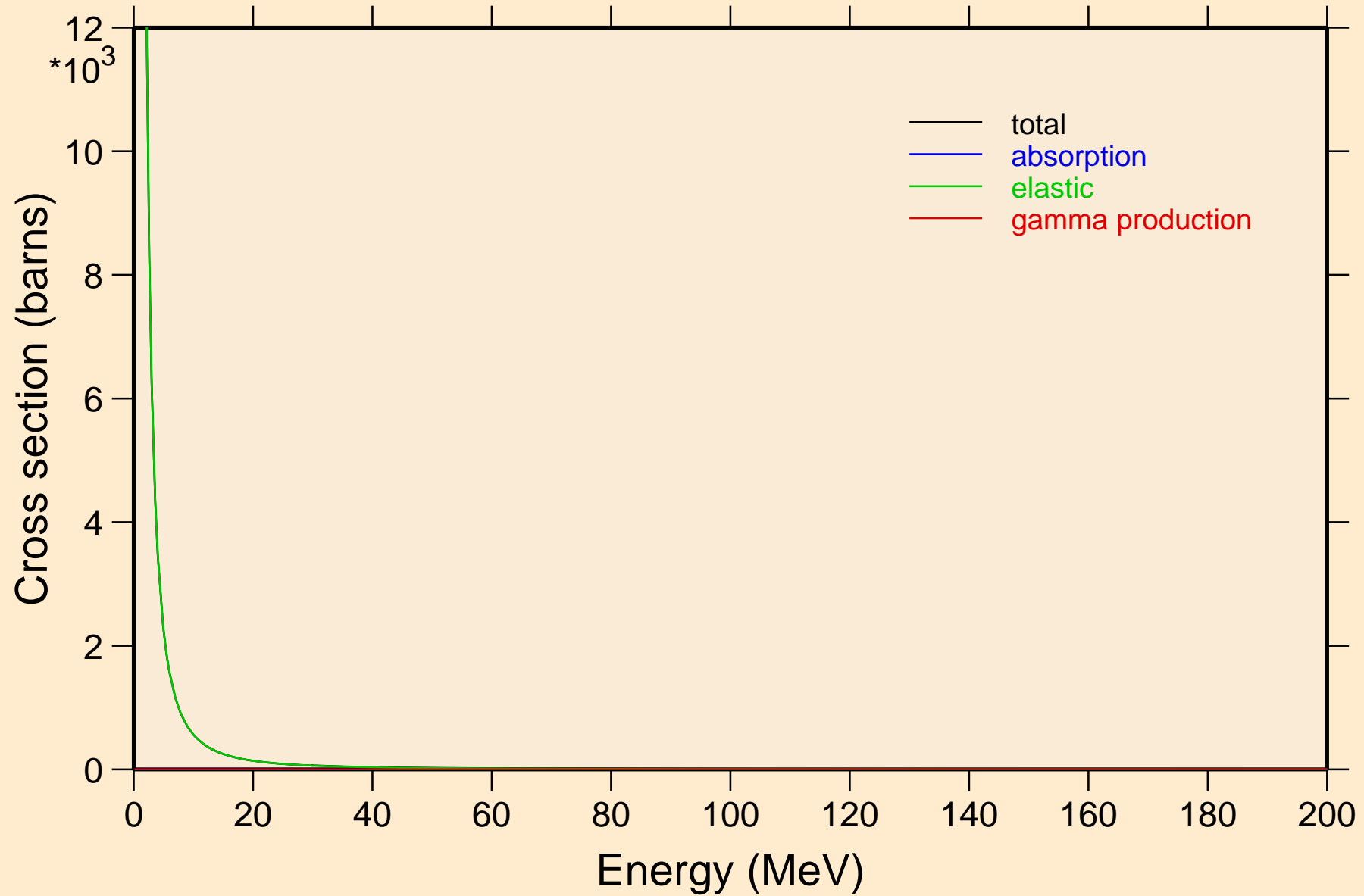

# AM249 DEUTERON ACER TENDL-2024 LIBRARY; T=0.K

## Heating

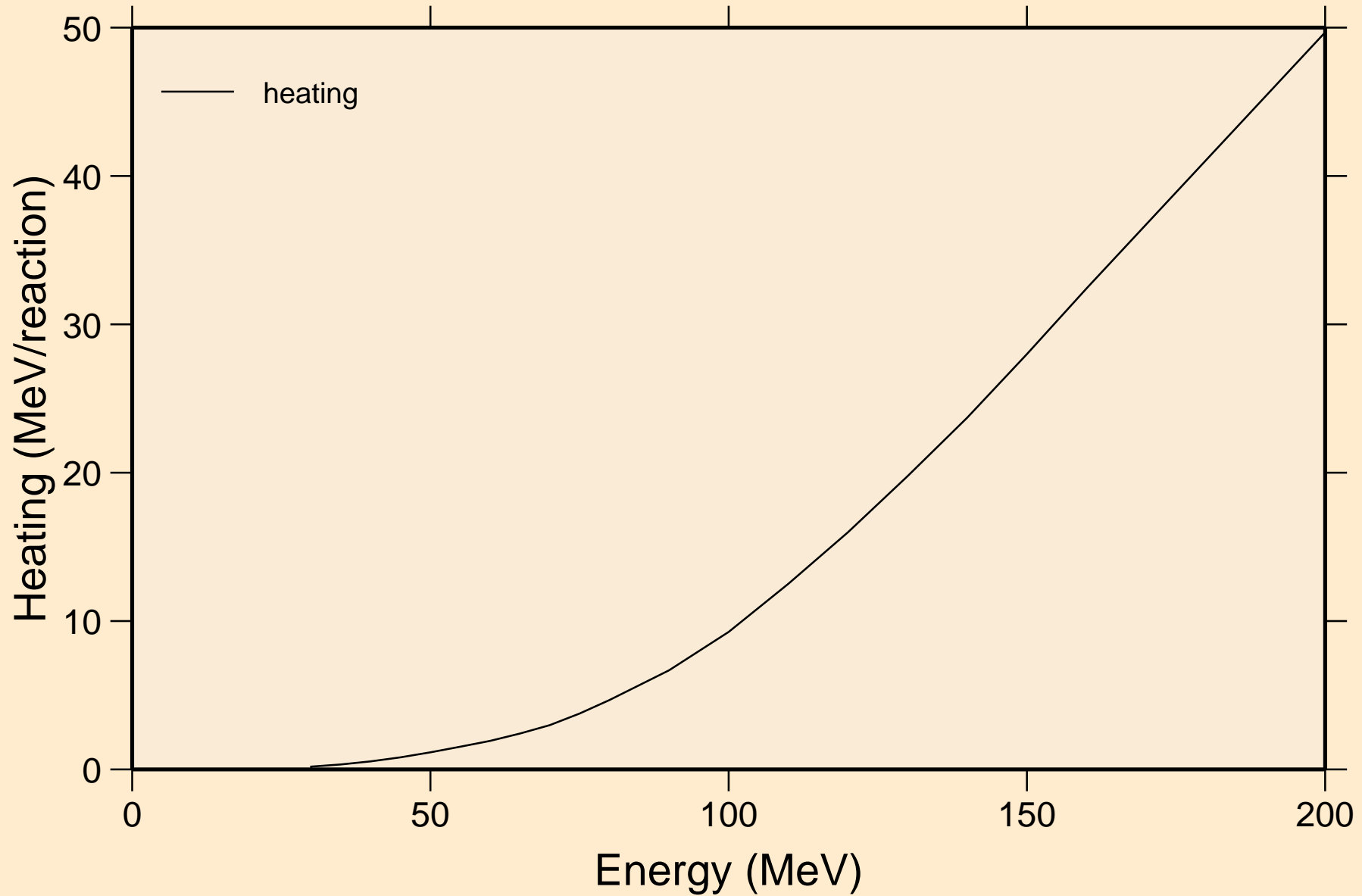

AM249 DEUTERON ACER TENDL-2024 LIBRARY; T=0.K  
Threshold reactions

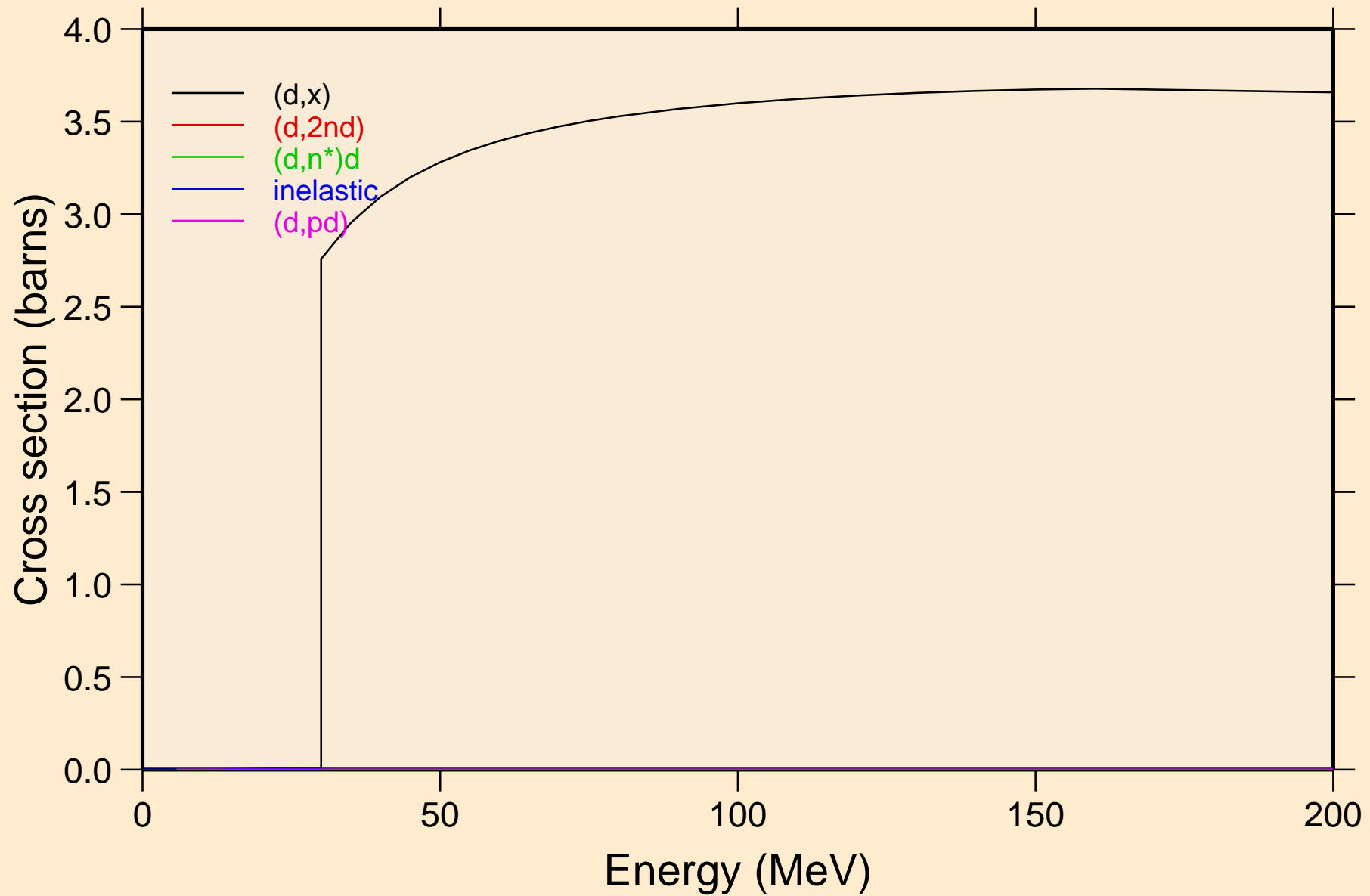

AM249 DEUTERON ACER TENDL-2024 LIBRARY; T=0.K  
angular distribution for elastic

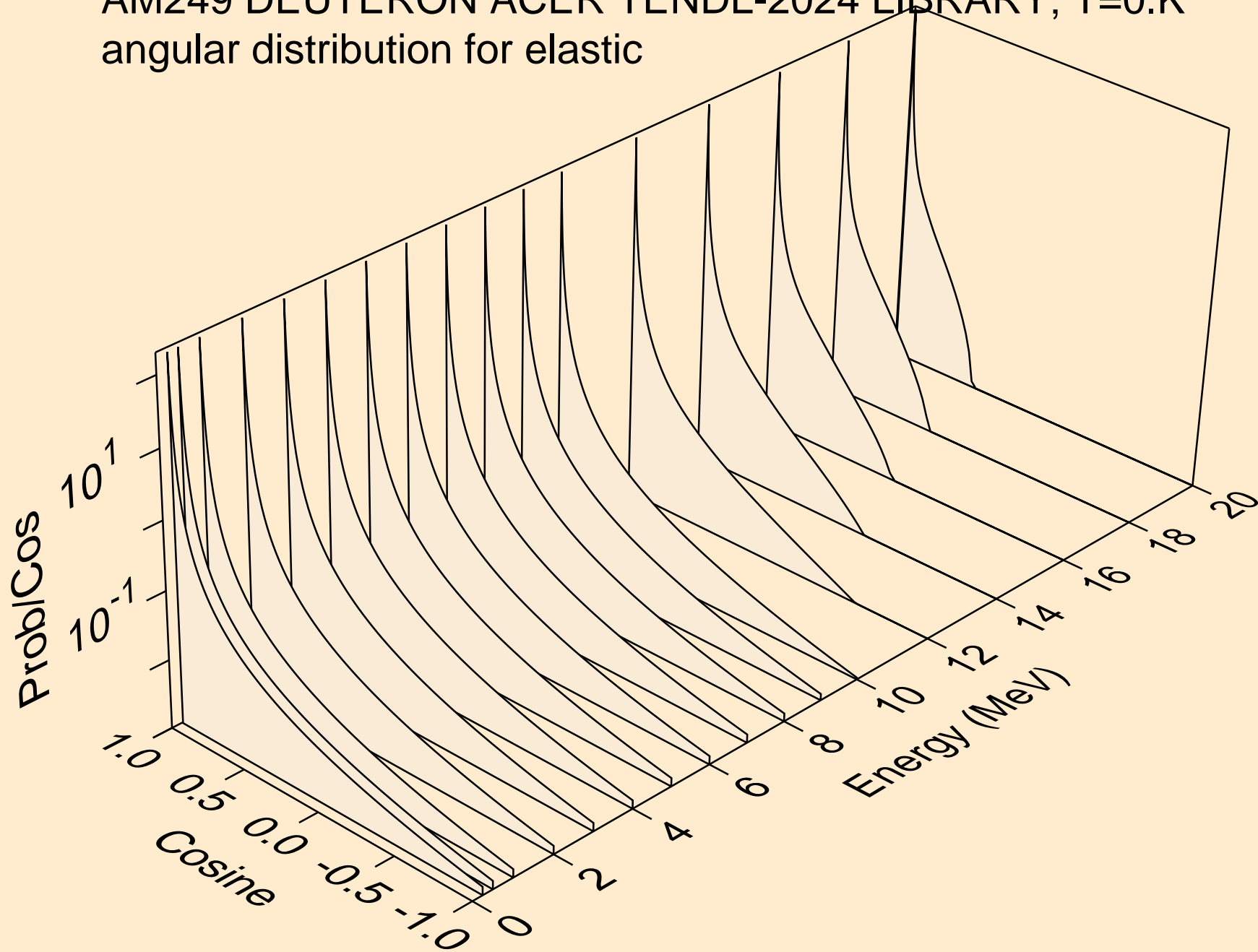

AM249 DEUTERON ACER TENDL-2024 LIBRARY; T=0.K  
angular distribution for elastic

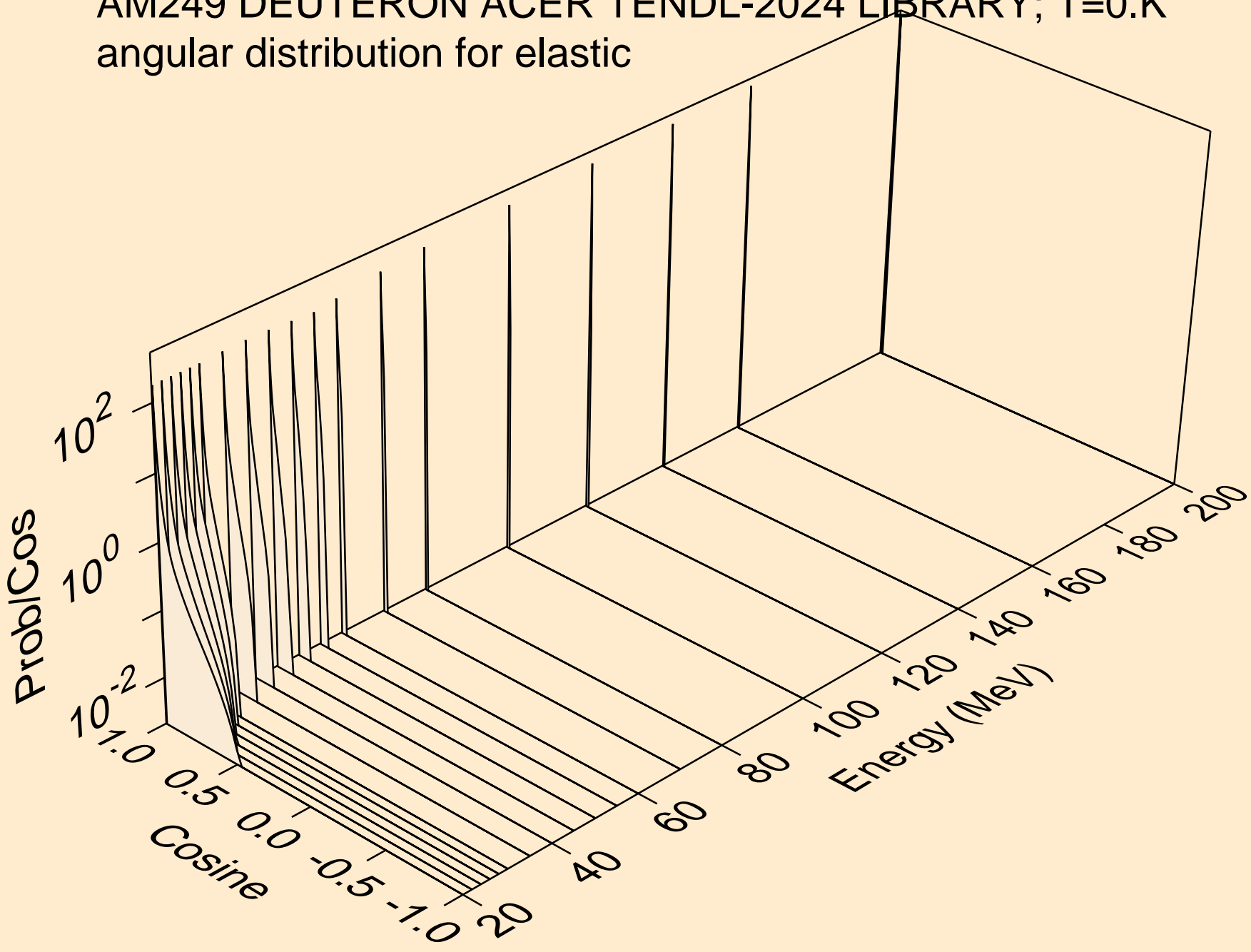

AM249 DEUTERON ACER TENDL-2024 LIBRARY; T=0.K  
Deuteron emission for (d,x)

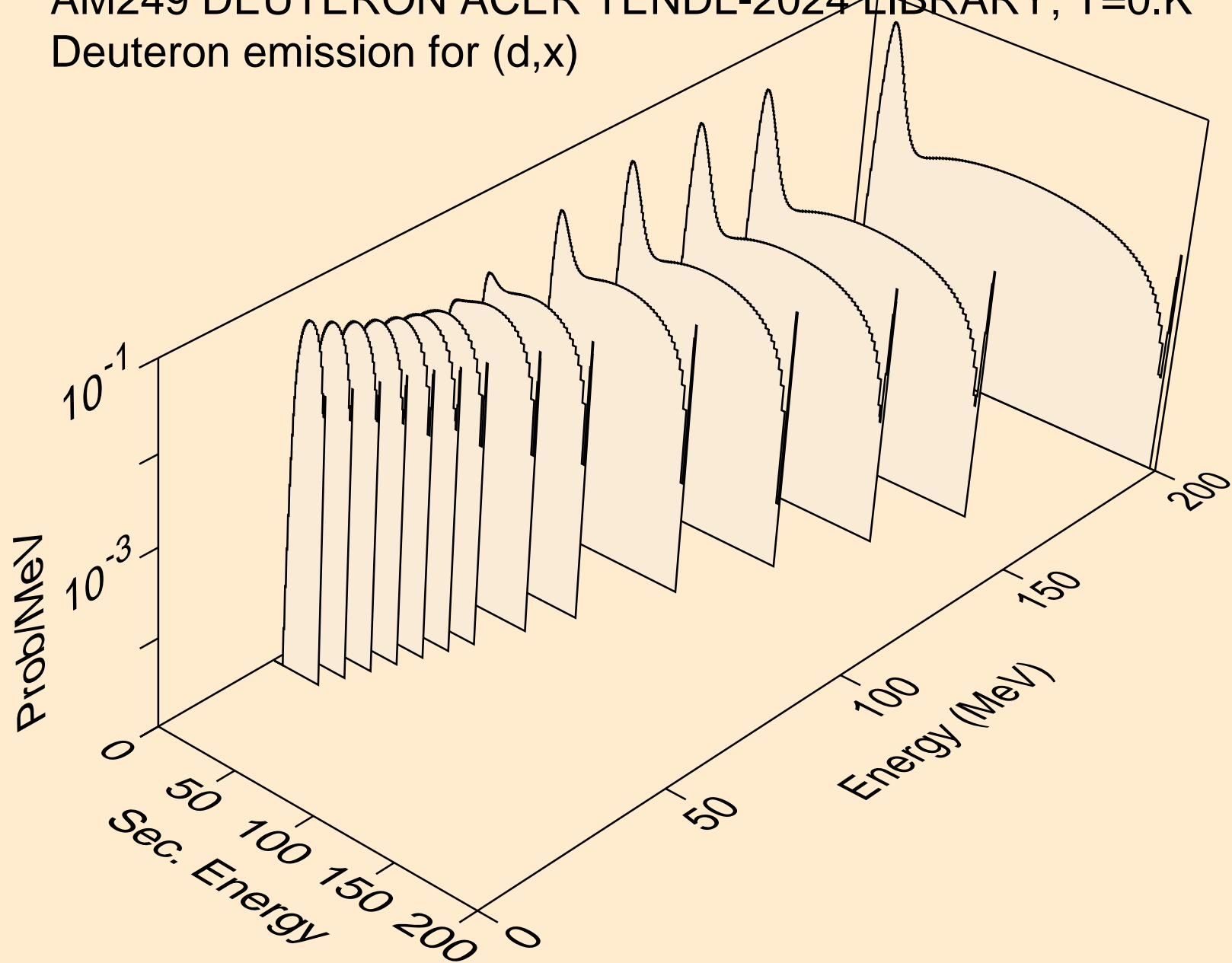

AM249 DEUTERON ACER TENDL-2024 LIBRARY; T=0.K  
Deuteron emission for (d,2nd)

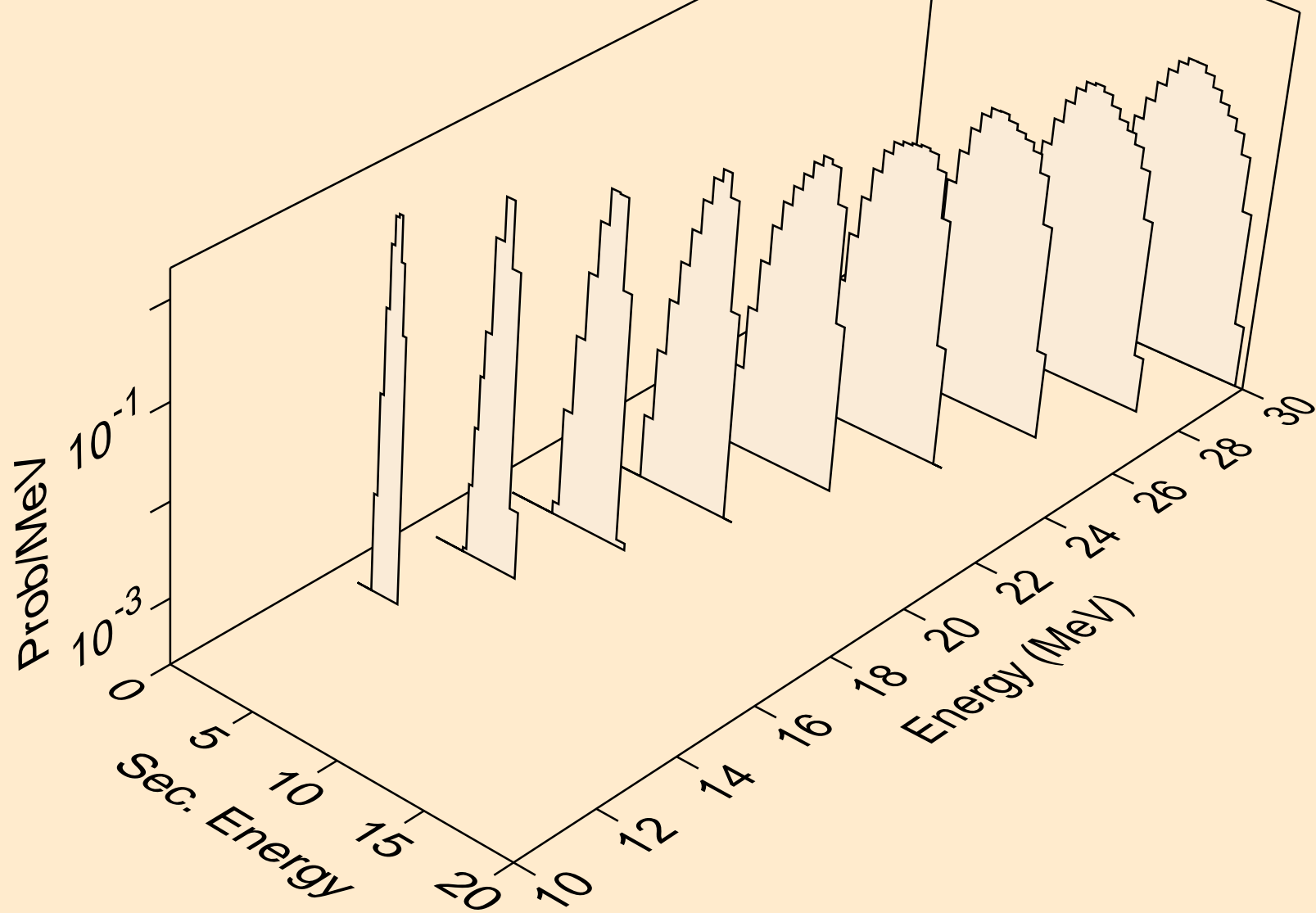

AM249 DEUTERON ACER TENDL-2024 LIBRARY; T=0.K  
Deuteron emission for (d,n\*)d

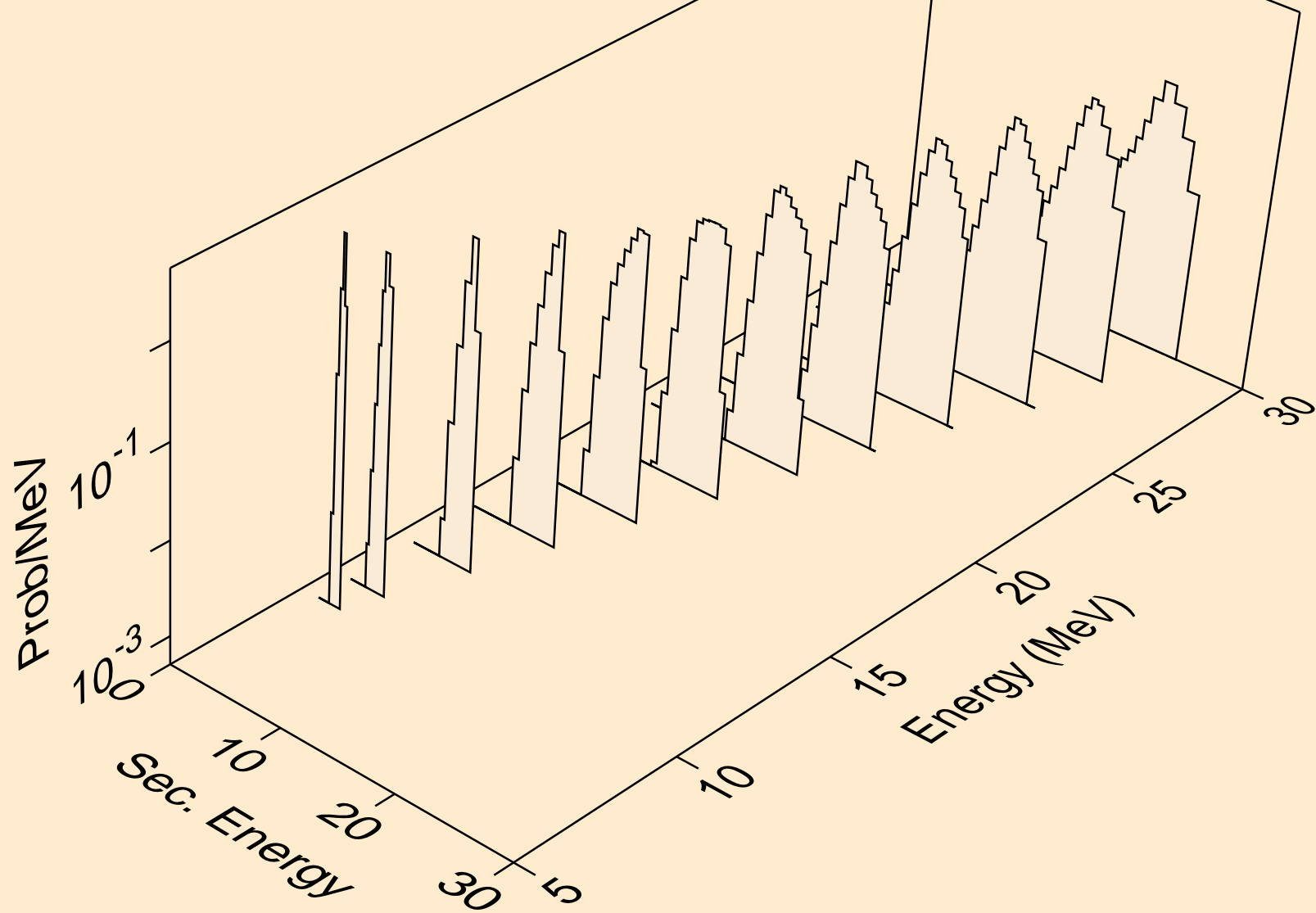

AM249 DEUTERON ACER TENDL-2024 LIBRARY; T=0.K  
Deuteron emission for inelastic

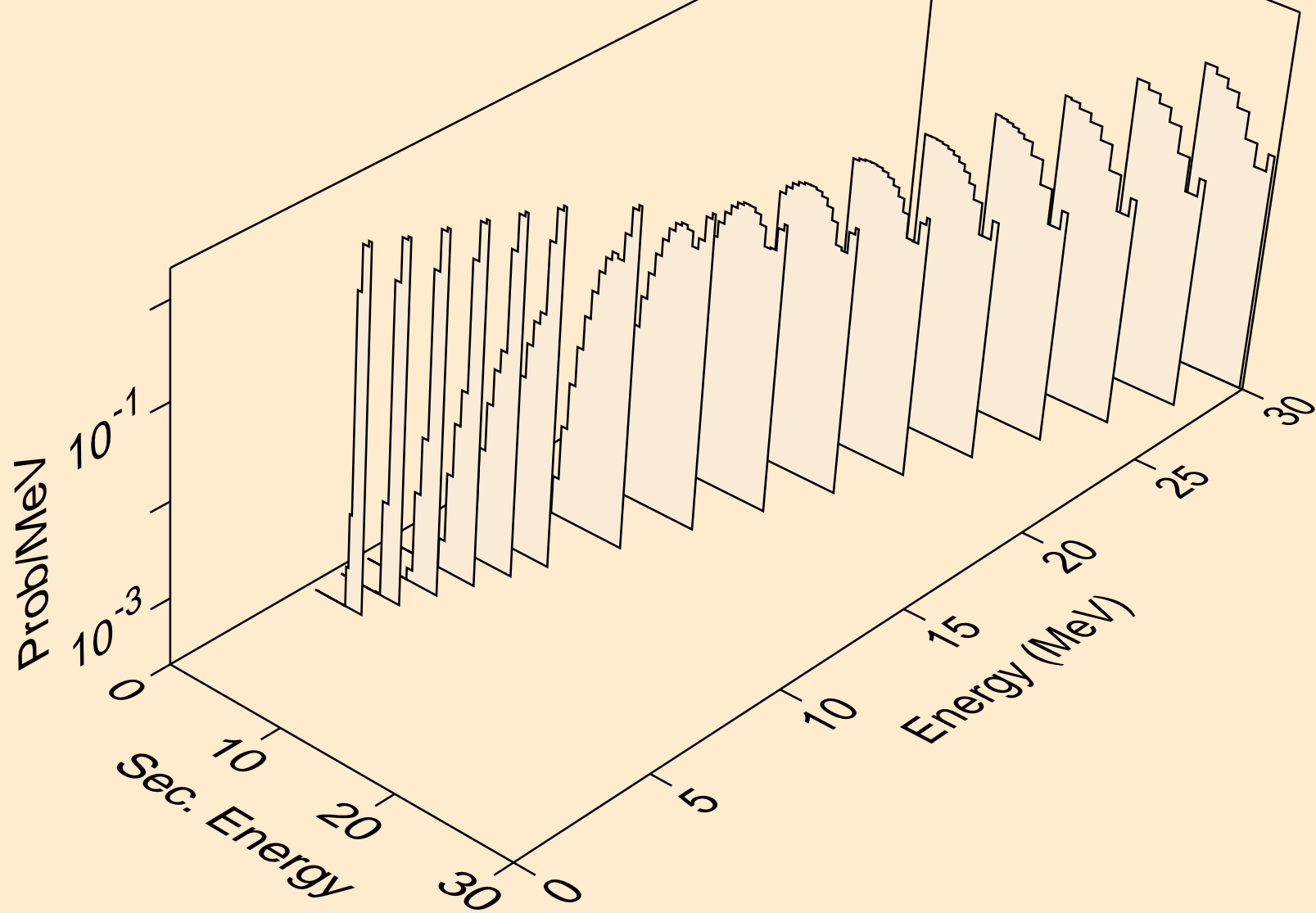

AM249 DEUTERON ACER TENDL-2024 LIBRARY; T=0.K  
Deuteron emission for (d,pd)

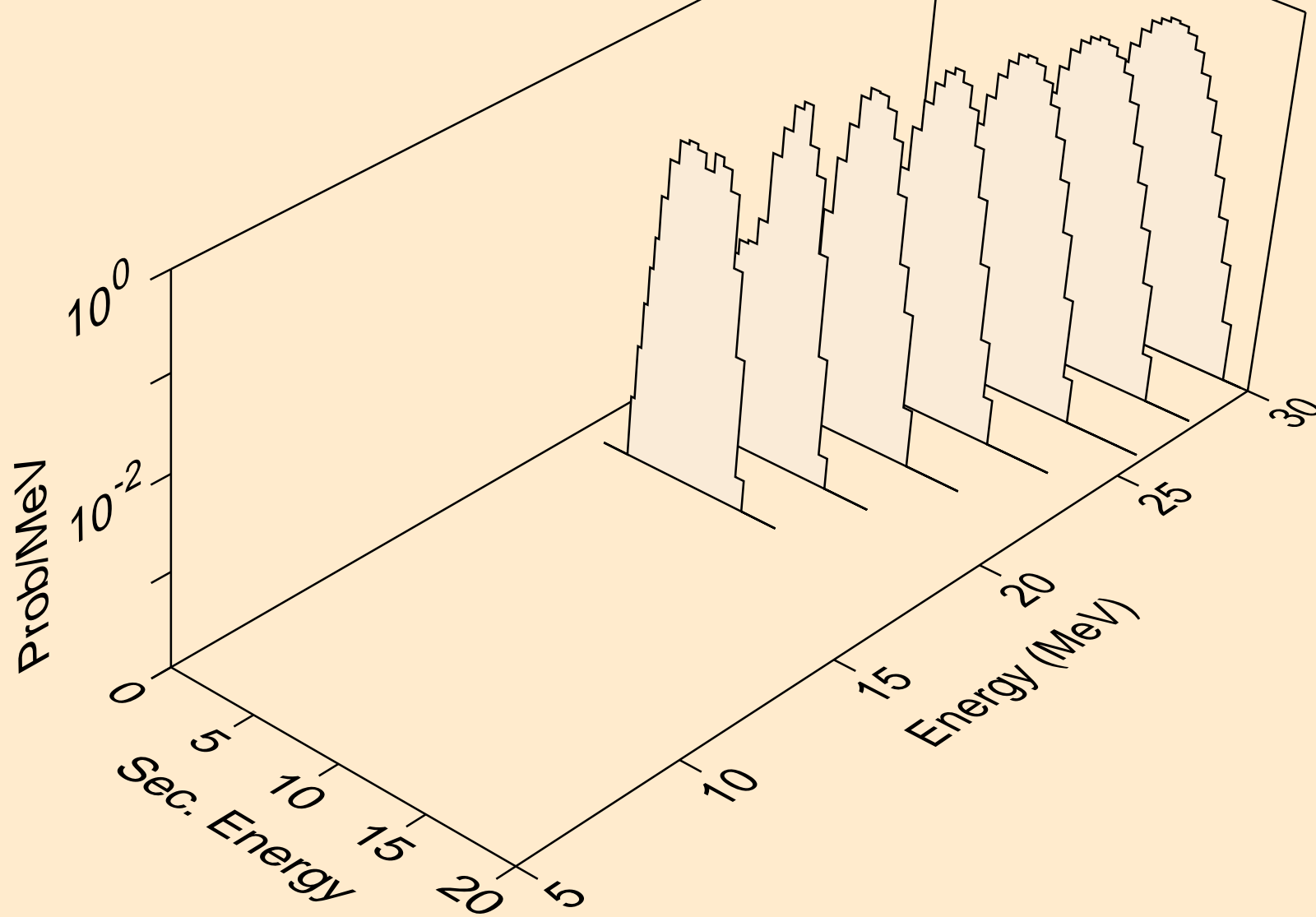

AM249 DEUTERON ACER TENDL-2024 LIBRARY; T=0.K  
Photon emission for (z,n)

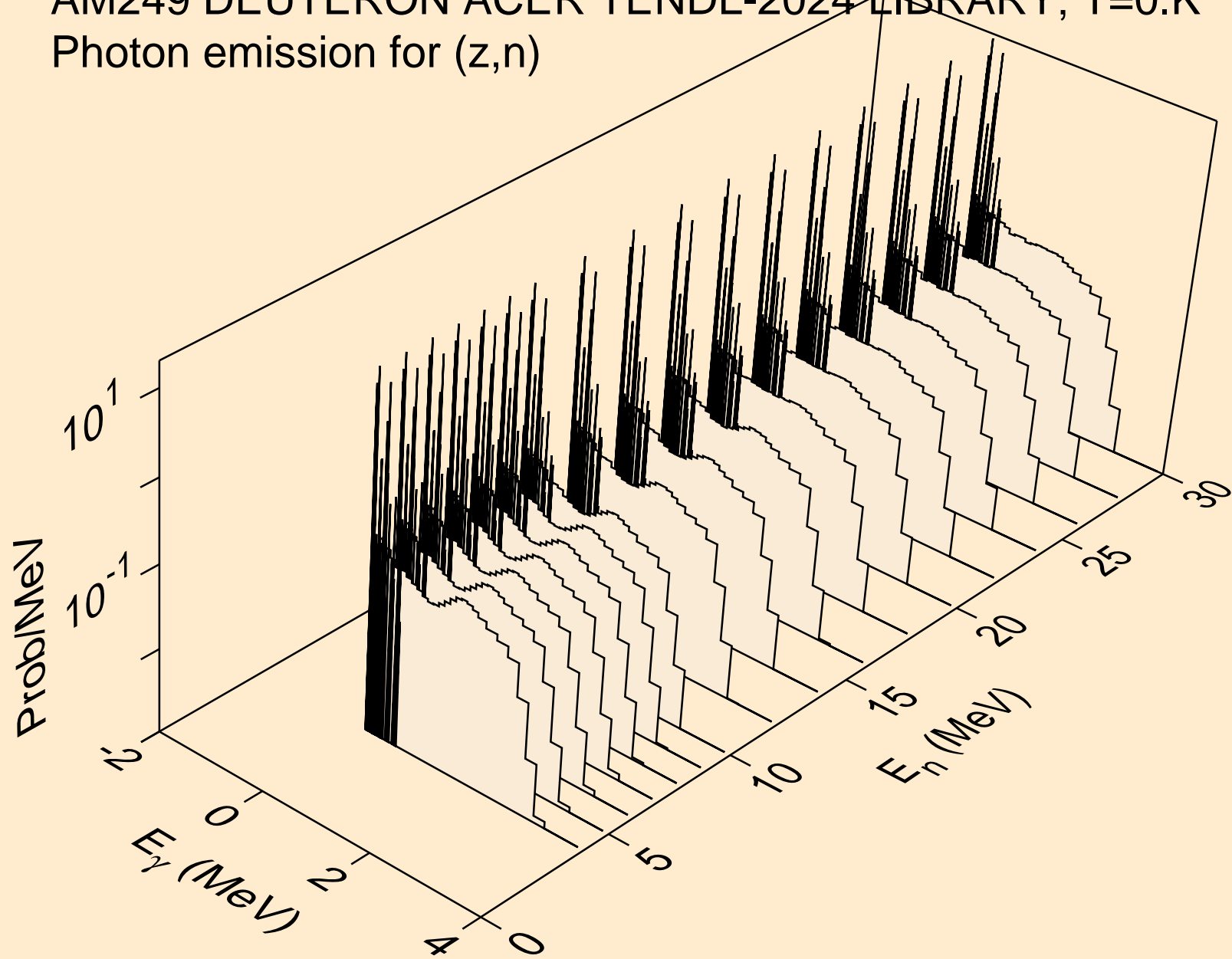

AM249 DEUTERON ACER TENDL-2024 LIBRARY; T=0.K  
Photon emission for (z,x)

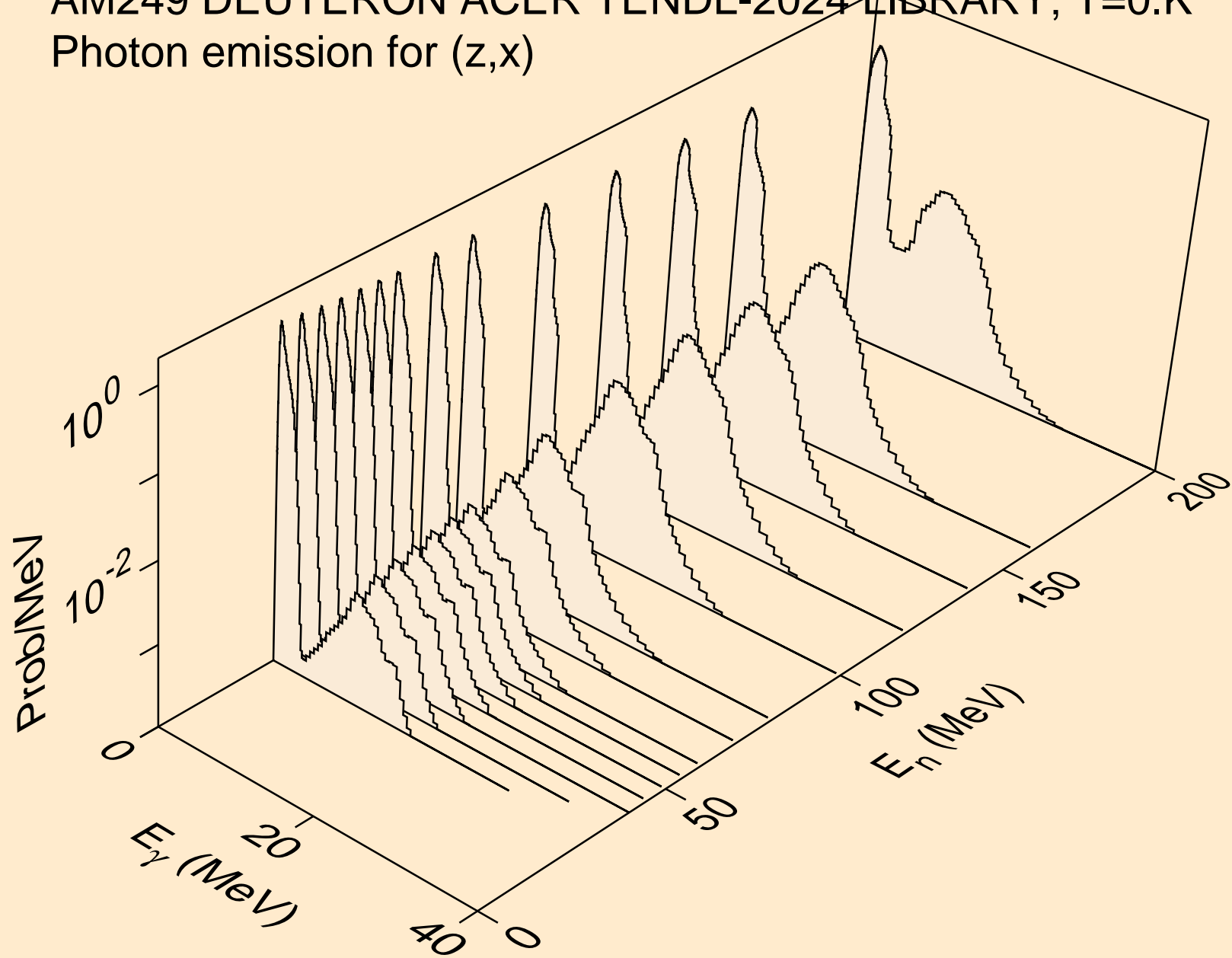

AM249 DEUTERON ACER TENDL-2024 LIBRARY; T=0.K  
Photon emission for (n,2nd)

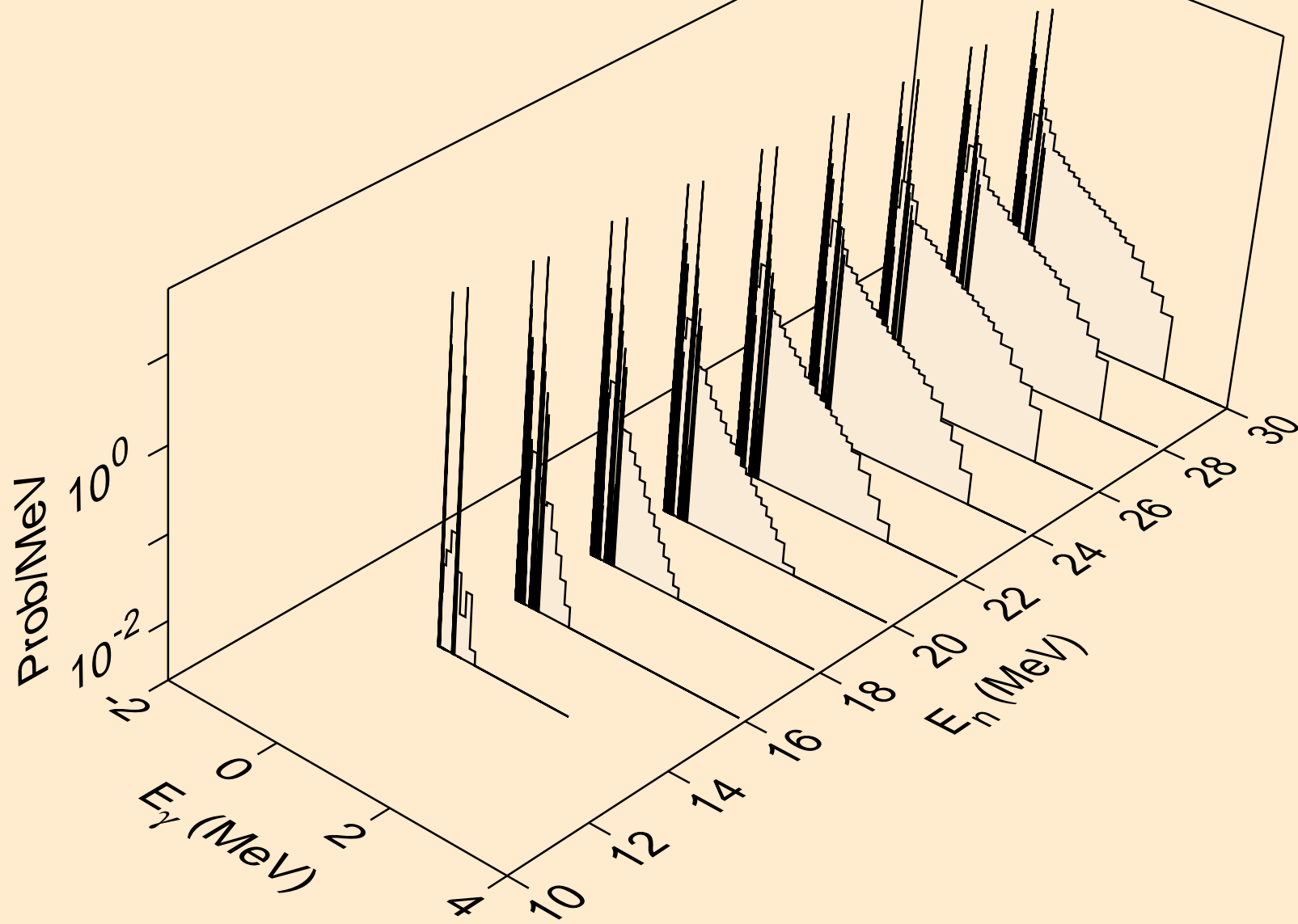

AM249 DEUTERON ACER TENDL-2024 LIBRARY; T=0.K  
Photon emission for (n,2n)

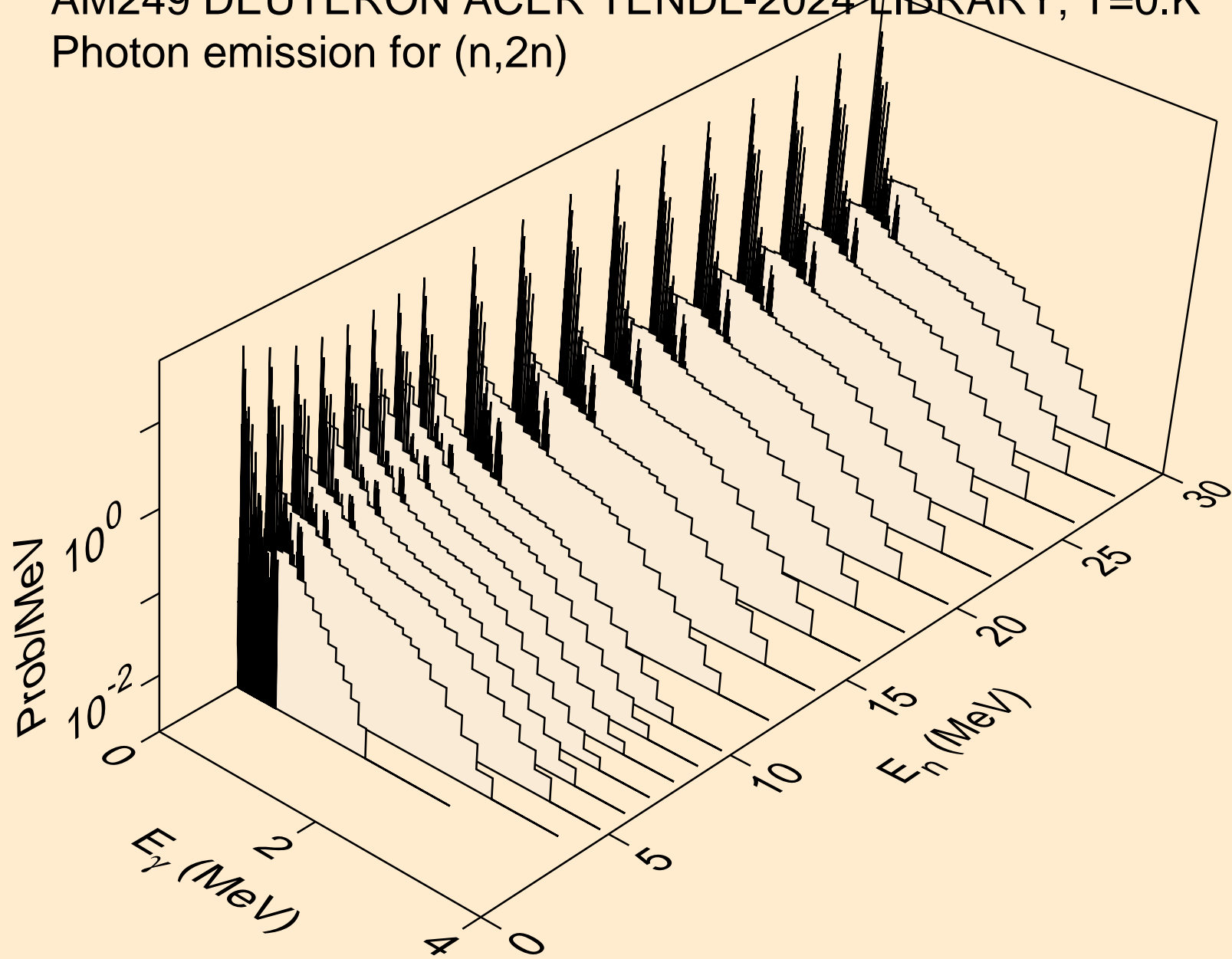

AM249 DEUTERON ACER TENDL-2024 LIBRARY; T=0.K  
Photon emission for (n,3n)

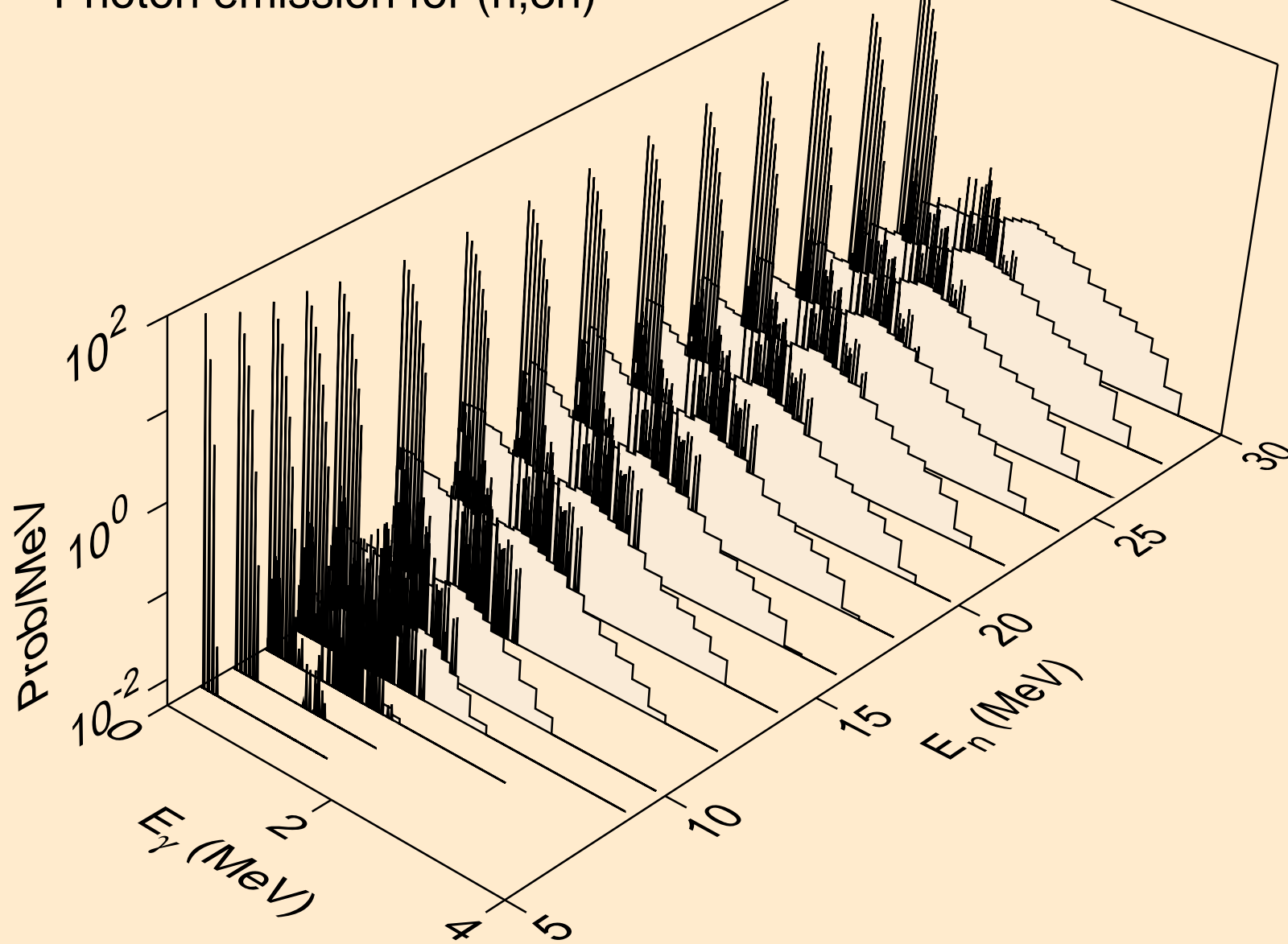

AM249 DEUTERON ACER TENDL-2024 LIBRARY; T=0.K  
Photon emission for (n,n\*)a

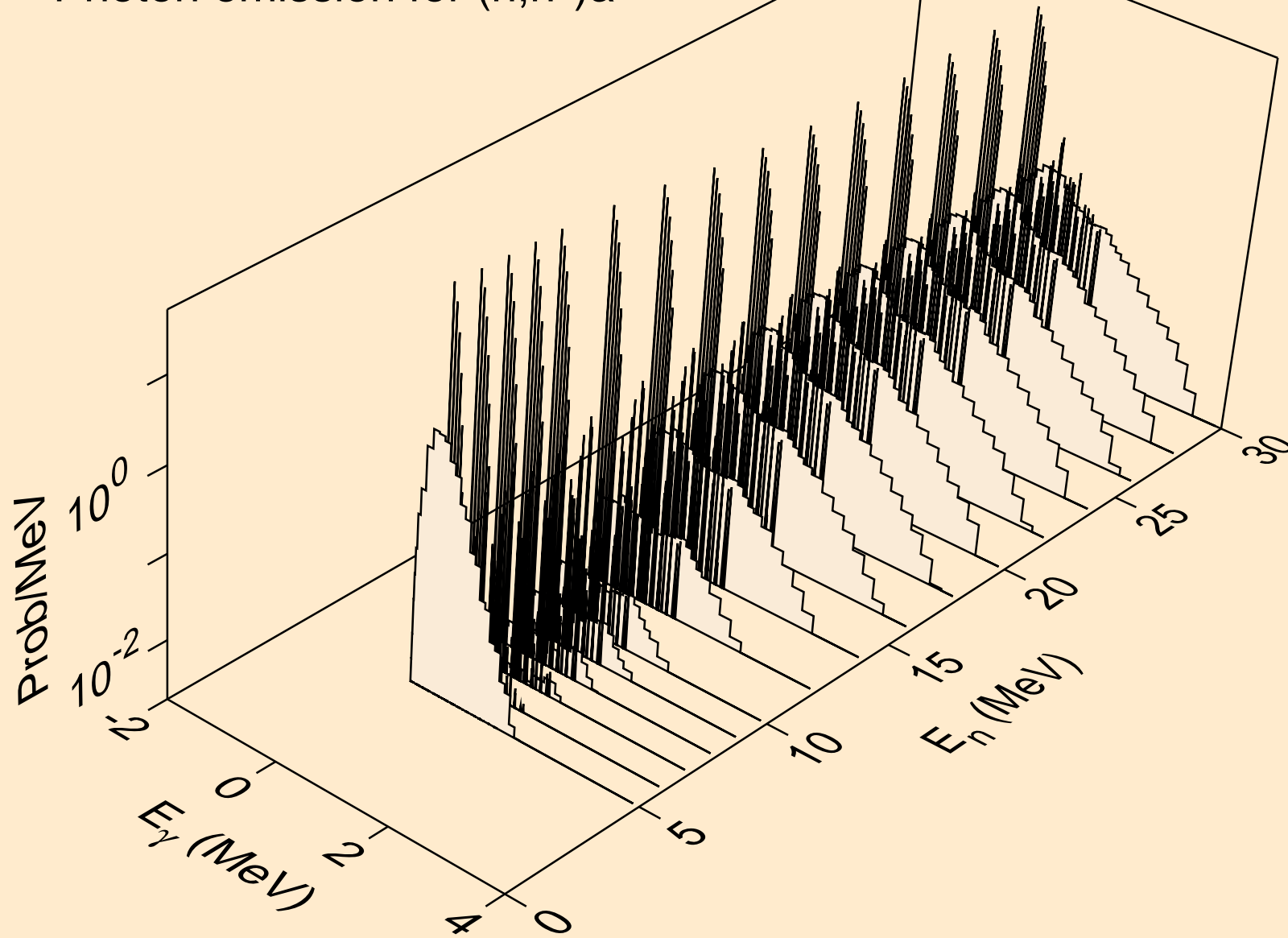

AM249 DEUTERON ACER TENDL-2024 LIBRARY; T=0.K  
Photon emission for (n,2n)a

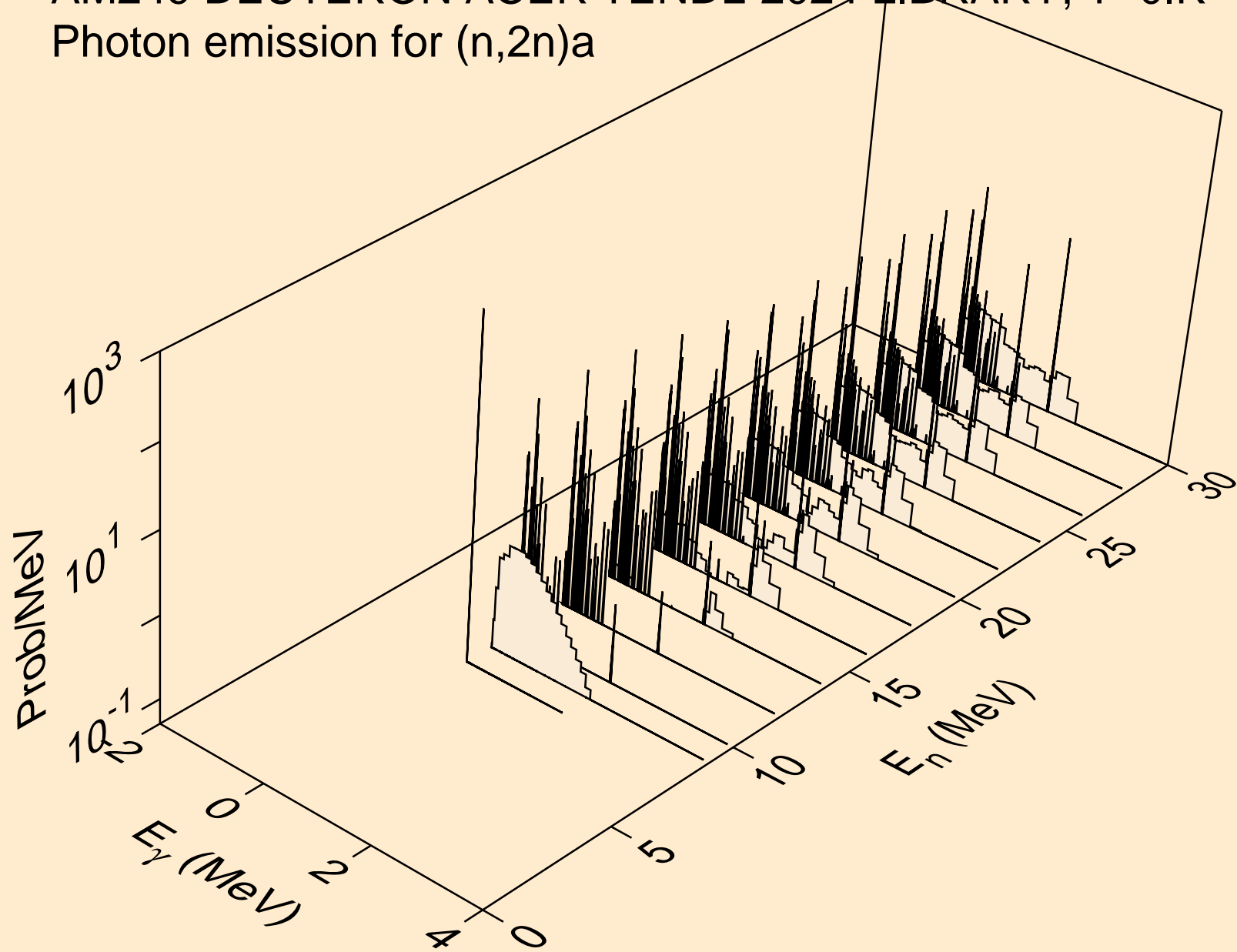

AM249 DEUTERON ACER TENDL-2024 LIBRARY; T=0.K  
Photon emission for (n,3n)a

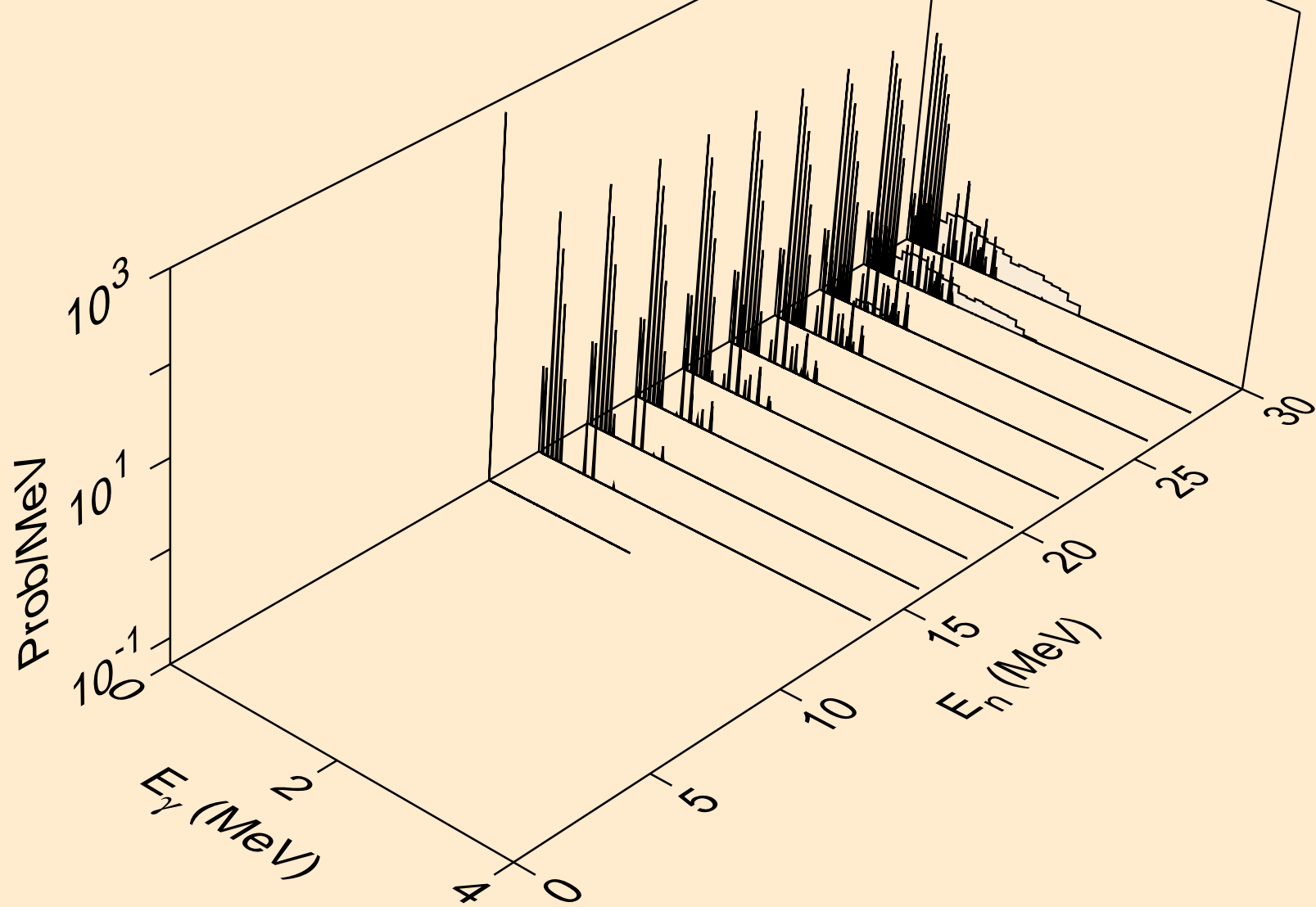

AM249 DEUTERON ACER TENDL-2024 LIBRARY; T=0.K  
Photon emission for (n,n\*)p

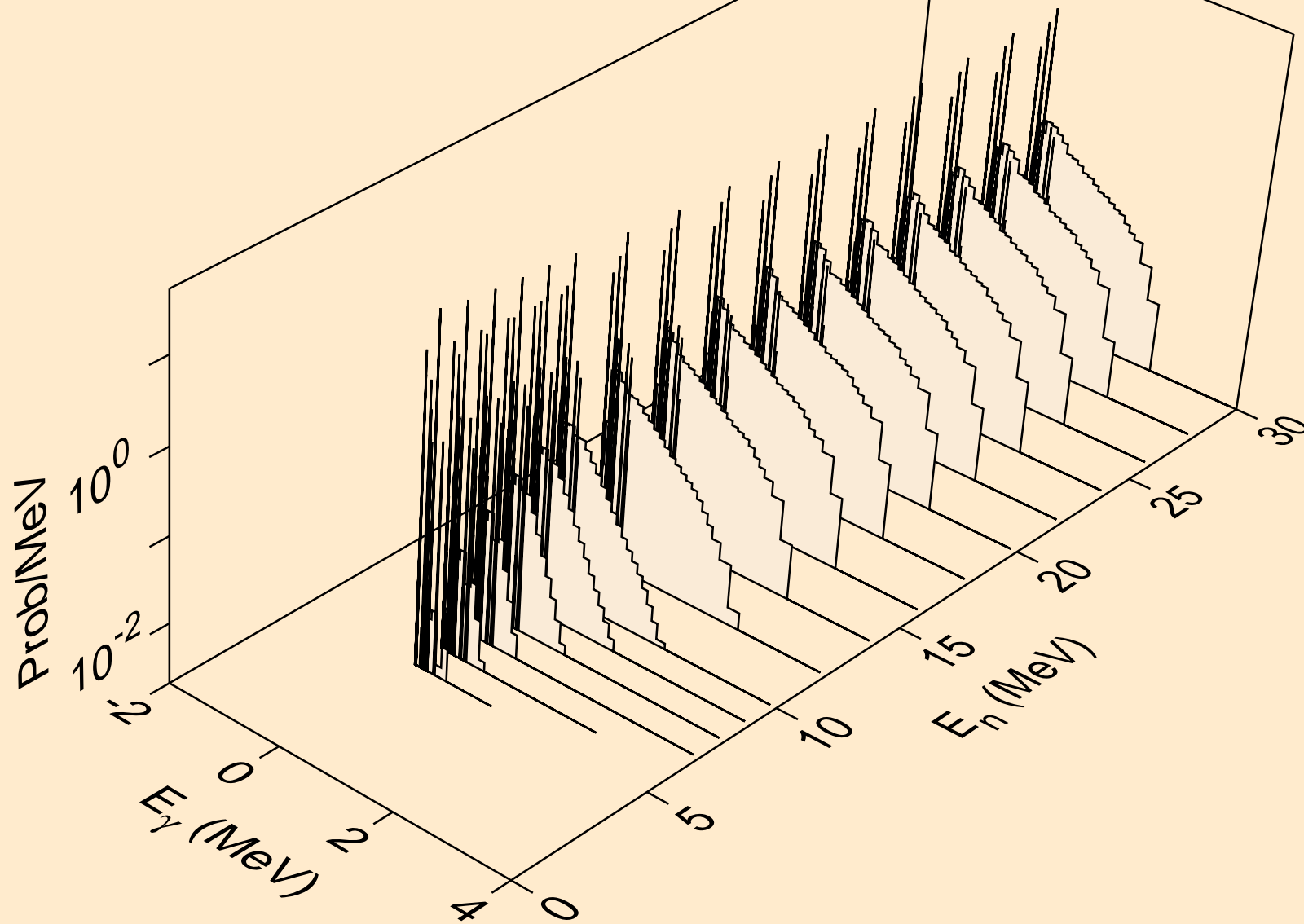

AM249 DEUTERON ACER TENDL-2024 LIBRARY; T=0.K  
Photon emission for (n,n\*)d

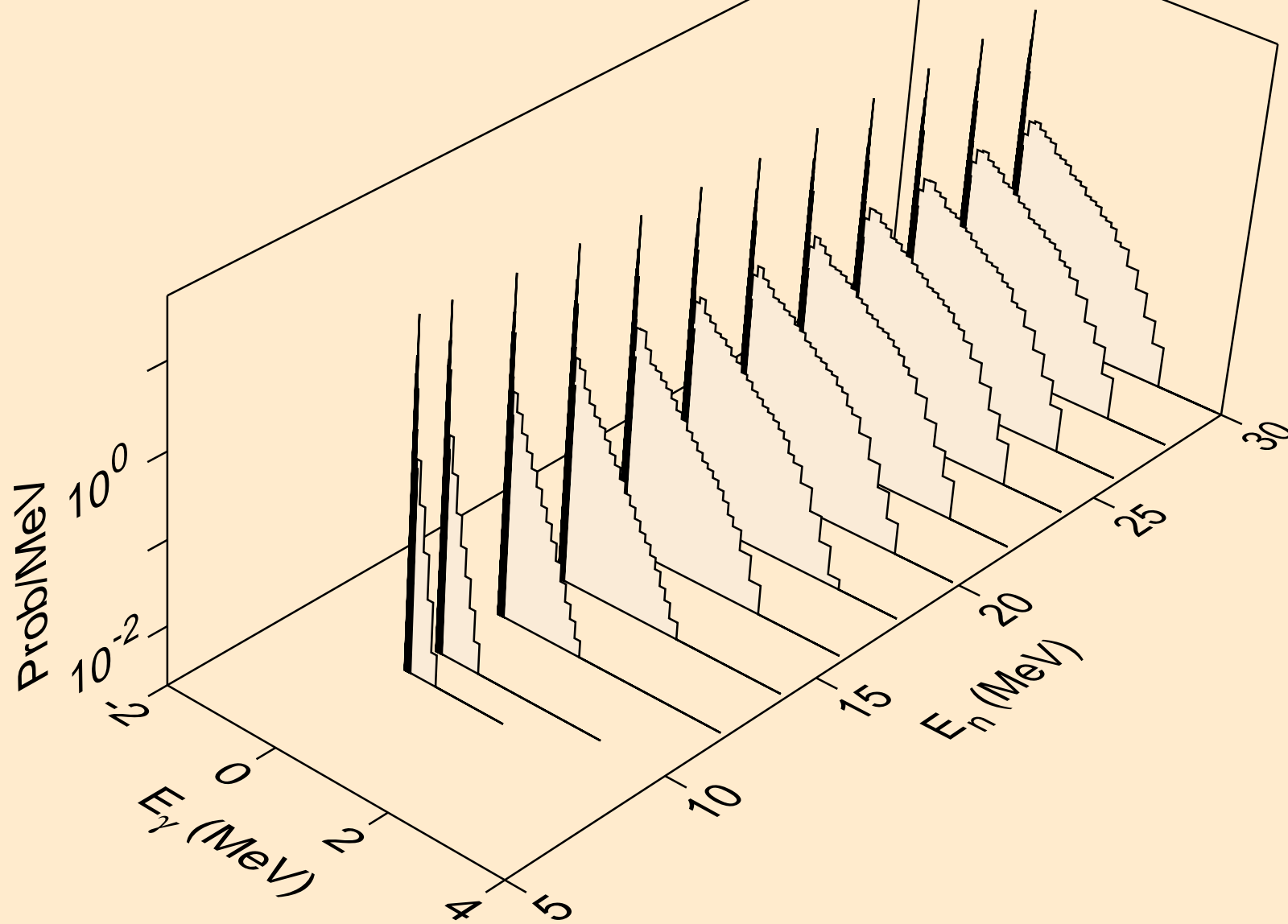

AM249 DEUTERON ACER TENDL-2024 LIBRARY; T=0.K  
Photon emission for (n,n\*)t

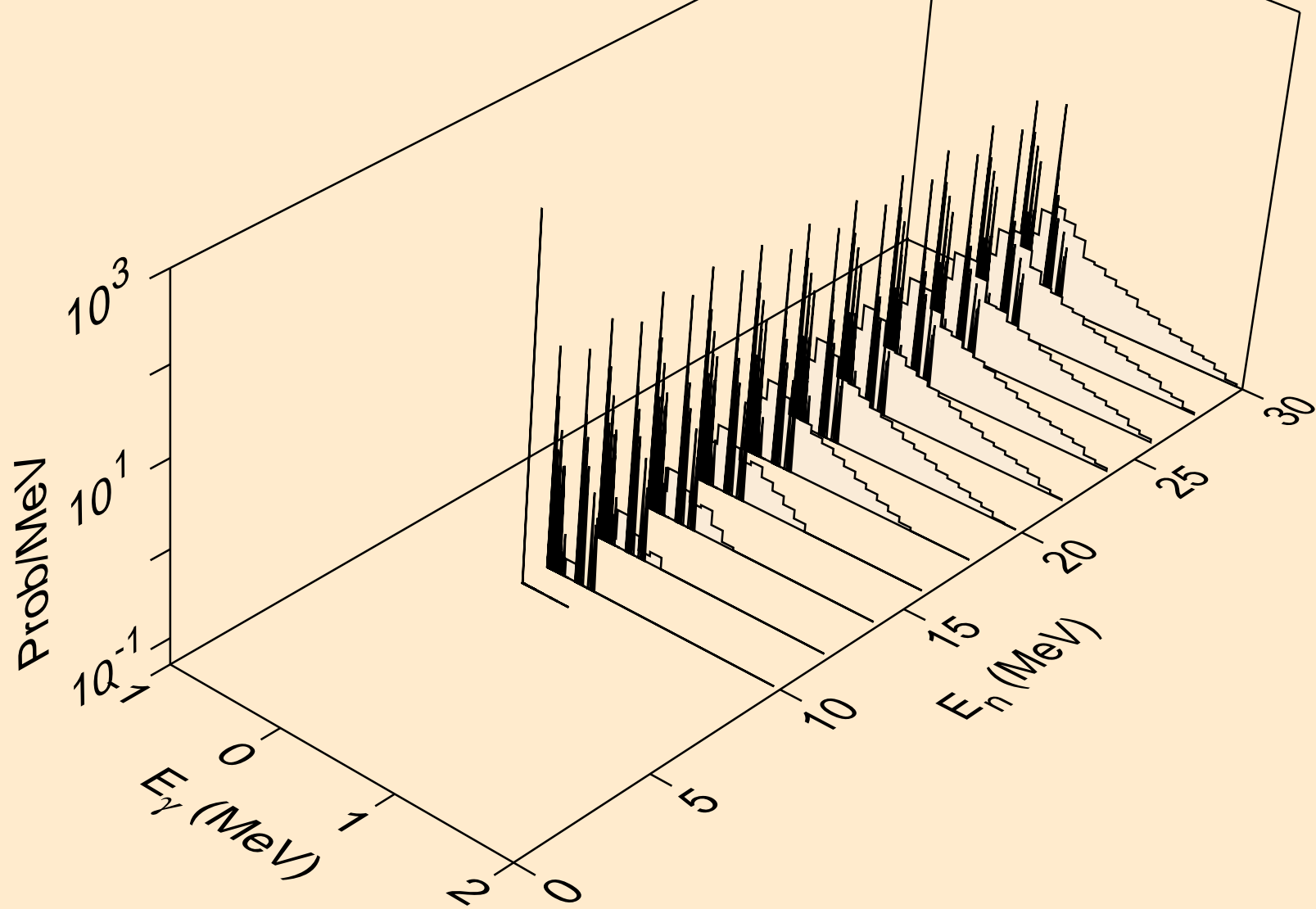

AM249 DEUTERON ACER TENDL-2024 LIBRARY; T=0.K  
Photon emission for (n,n\*)he3

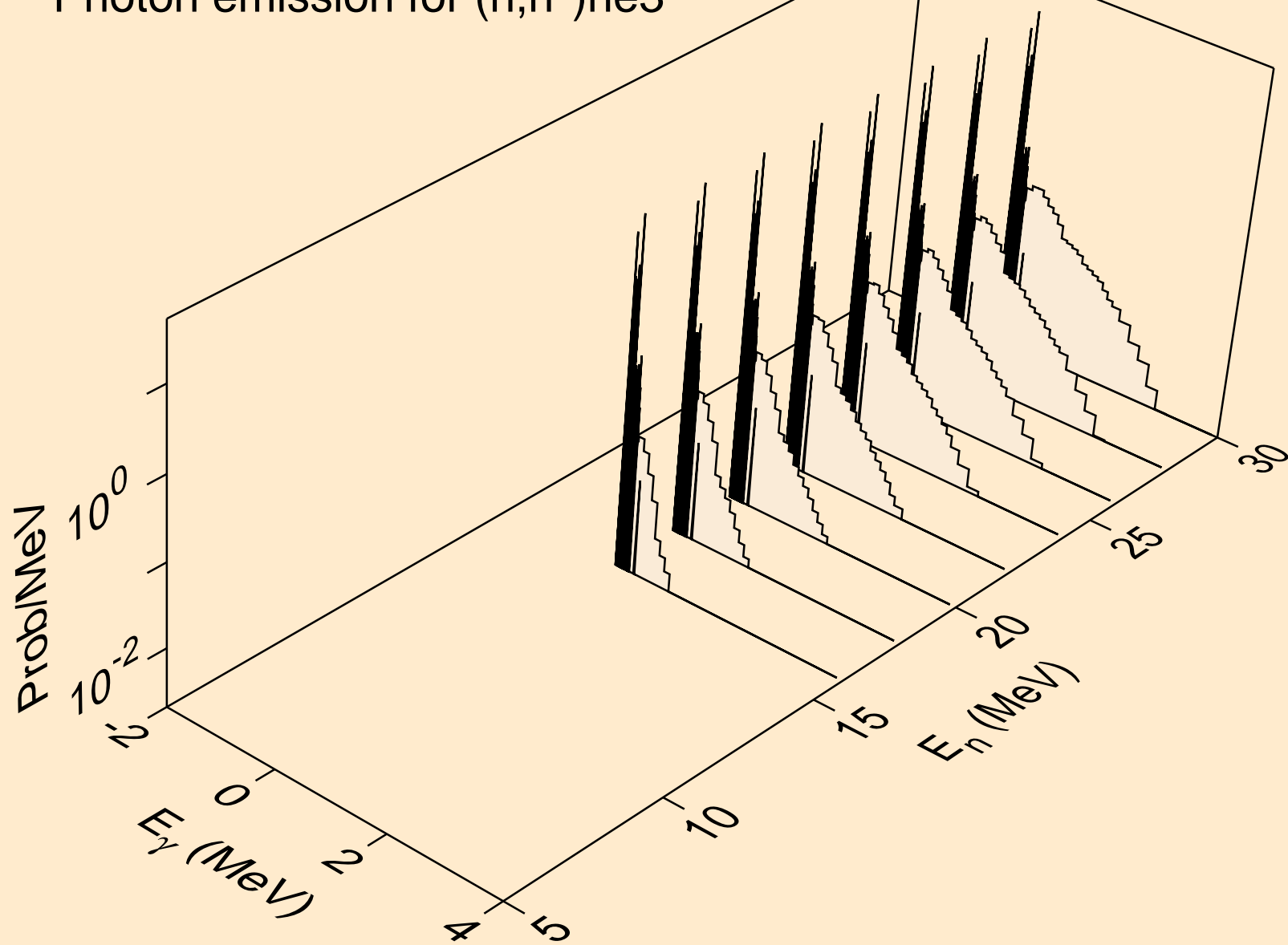

AM249 DEUTERON ACER TENDL-2024 LIBRARY; T=0.K  
Photon emission for (n,4n)

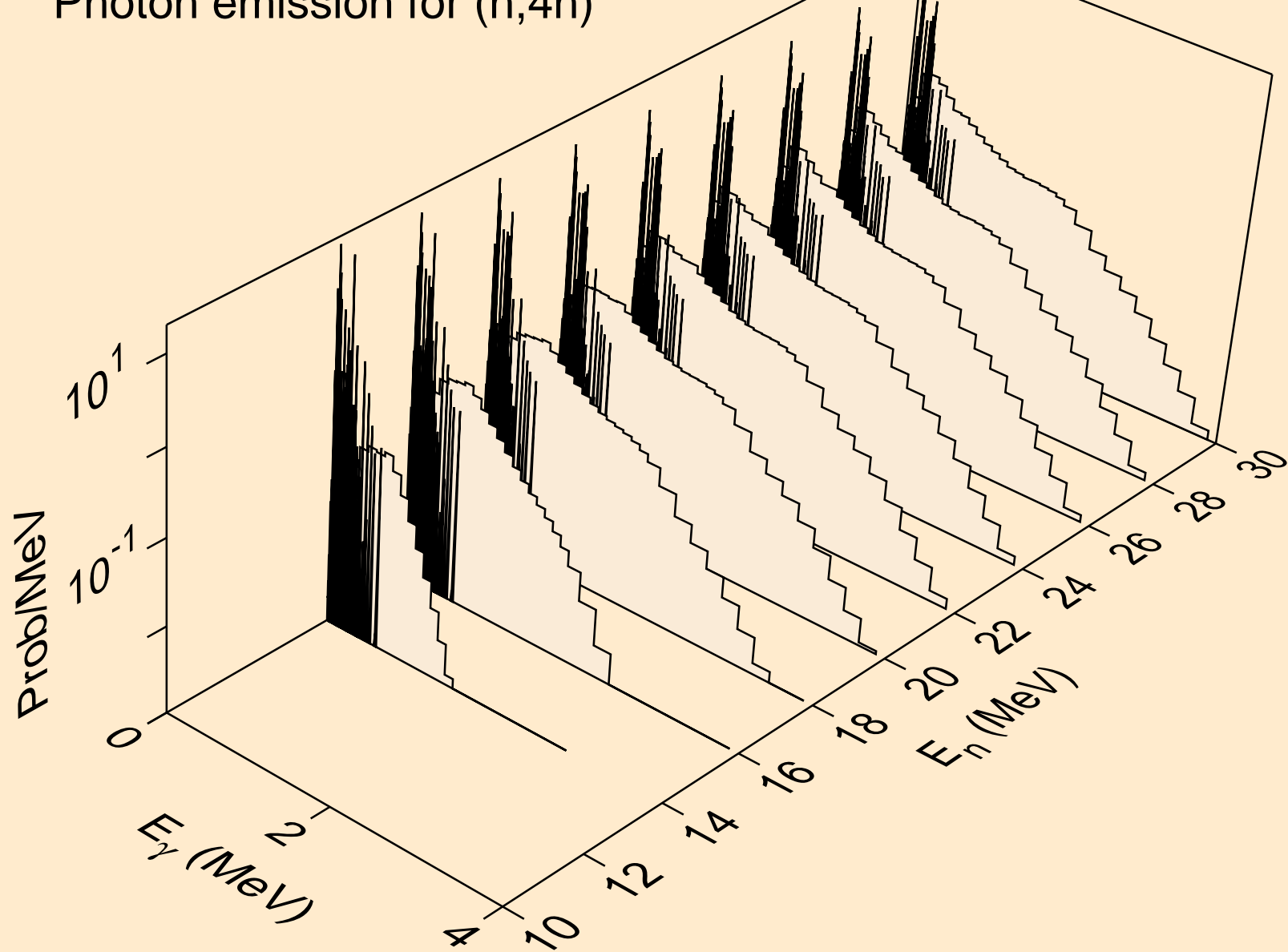

AM249 DEUTERON ACER TENDL-2024 LIBRARY; T=0.K  
Photon emission for (n,2np)

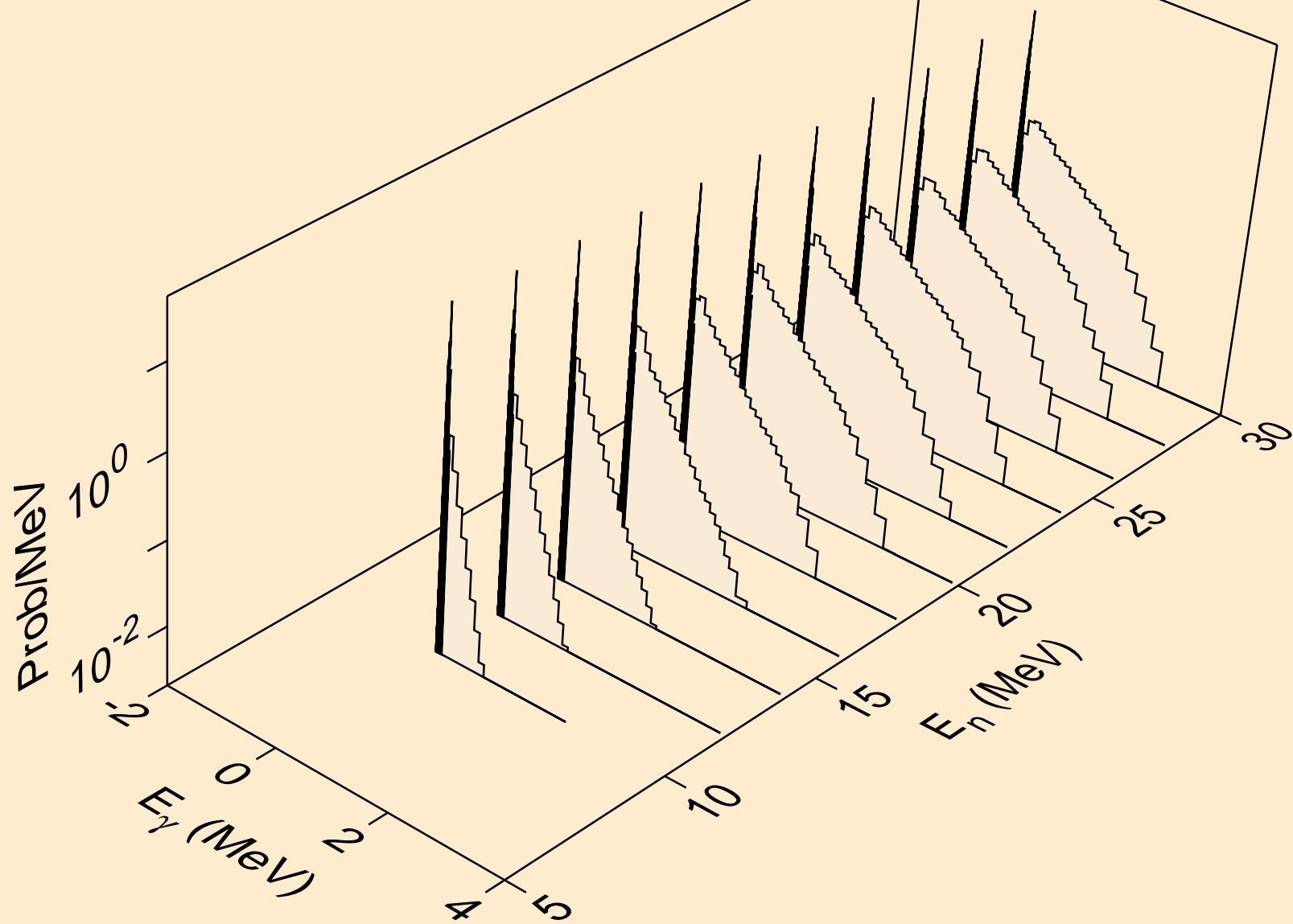

AM249 DEUTERON ACER TENDL-2024 LIBRARY; T=0.K  
Photon emission for (n,3np)

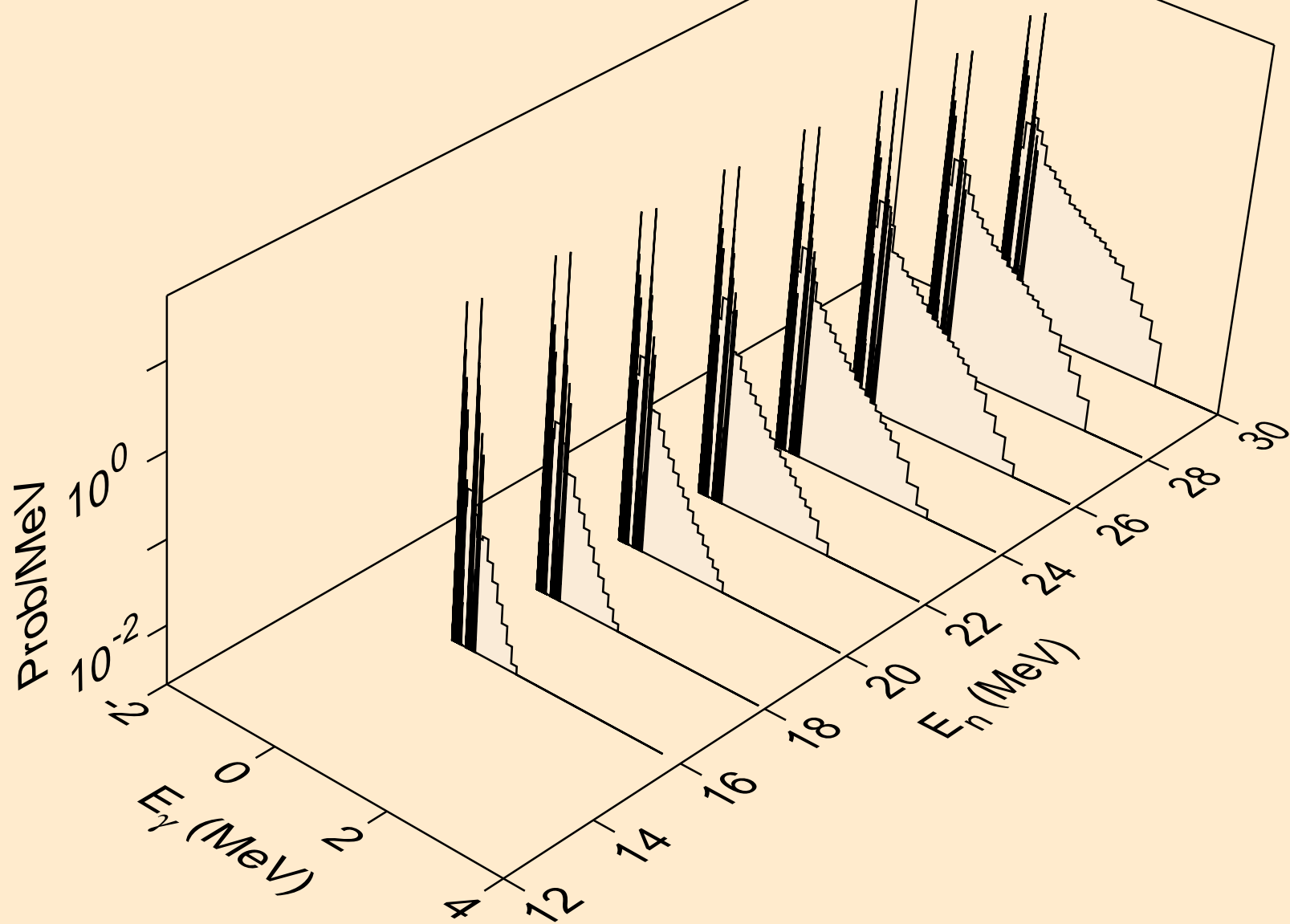

AM249 DEUTERON ACER TENDL-2024 LIBRARY; T=0.K  
Photon emission for (n,n2p)

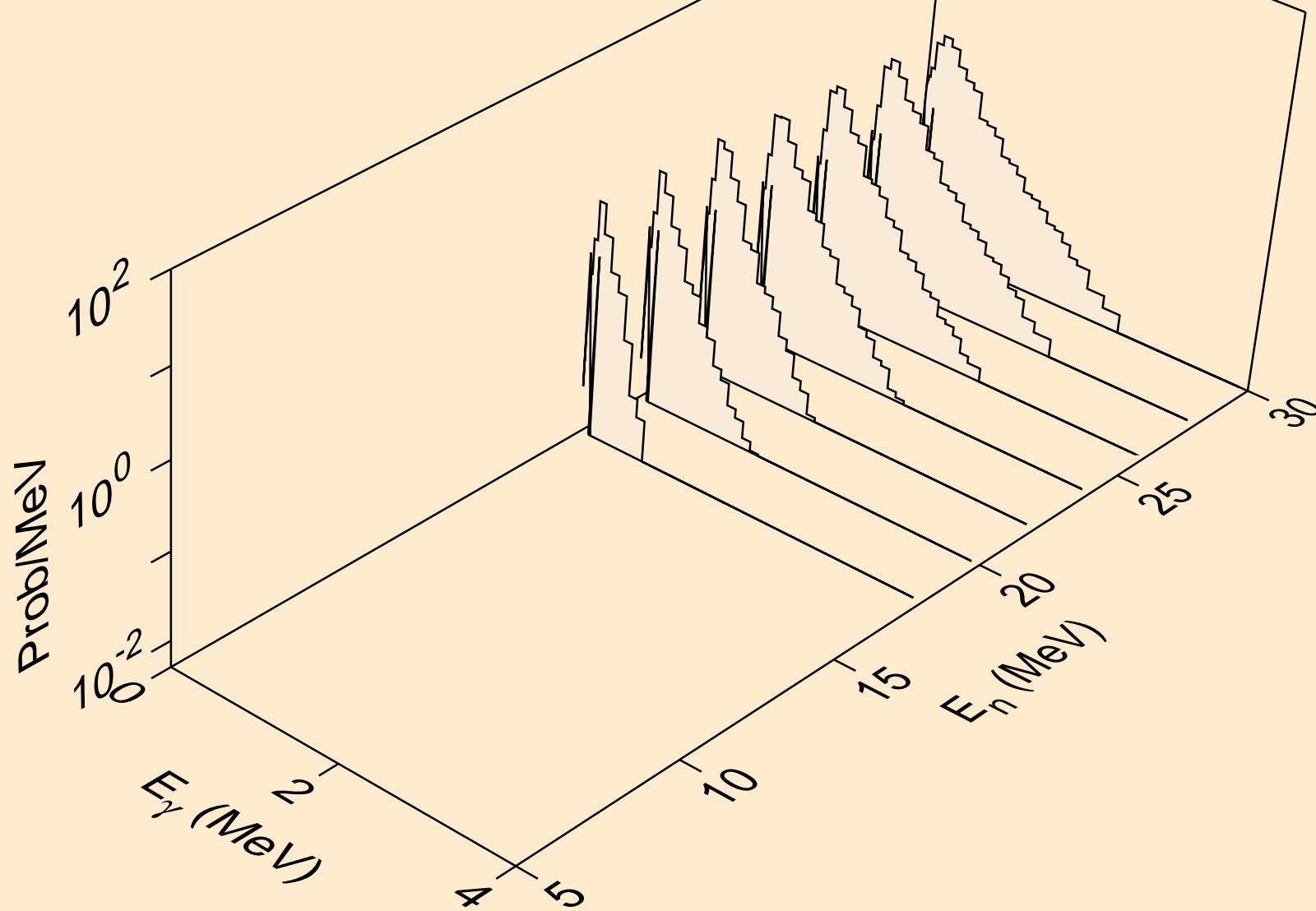

AM249 DEUTERON ACER TENDL-2024 LIBRARY; T=0.K  
Photon emission for (n,p)

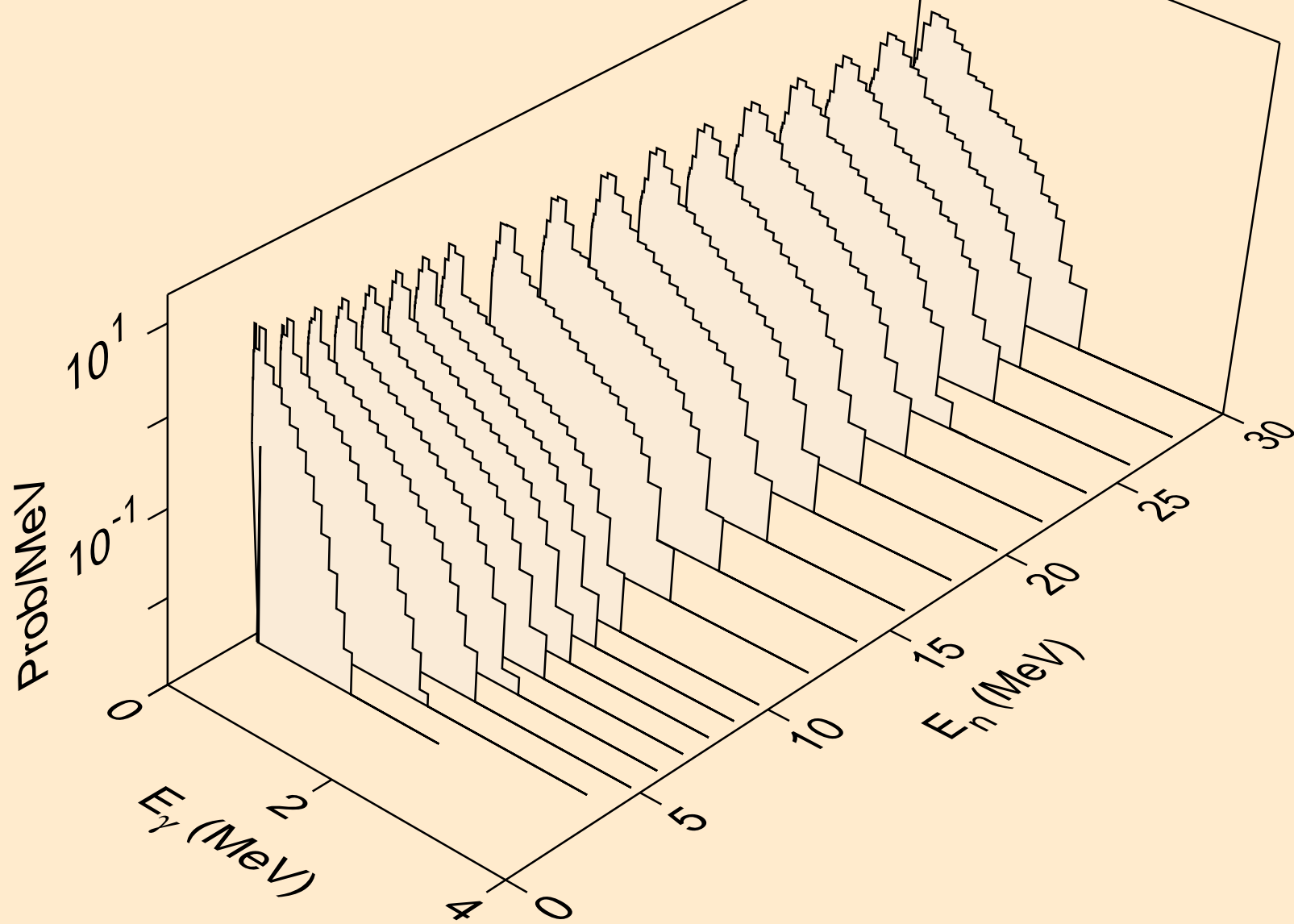

AM249 DEUTERON ACER TENDL-2024 LIBRARY; T=0.K  
Photon emission for inelastic

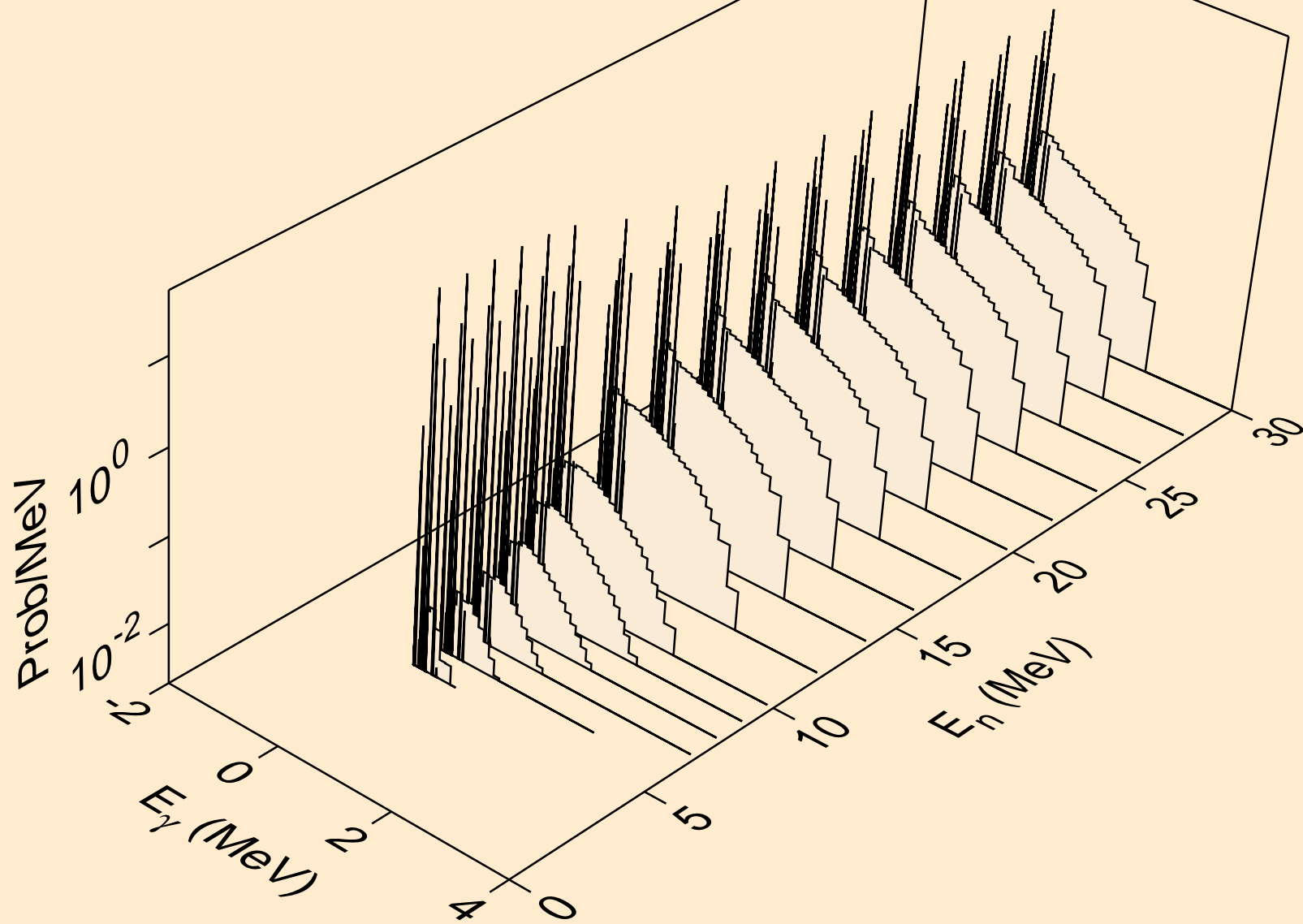

AM249 DEUTERON ACER TENDL-2024 LIBRARY; T=0.K  
Photon emission for (n,t)

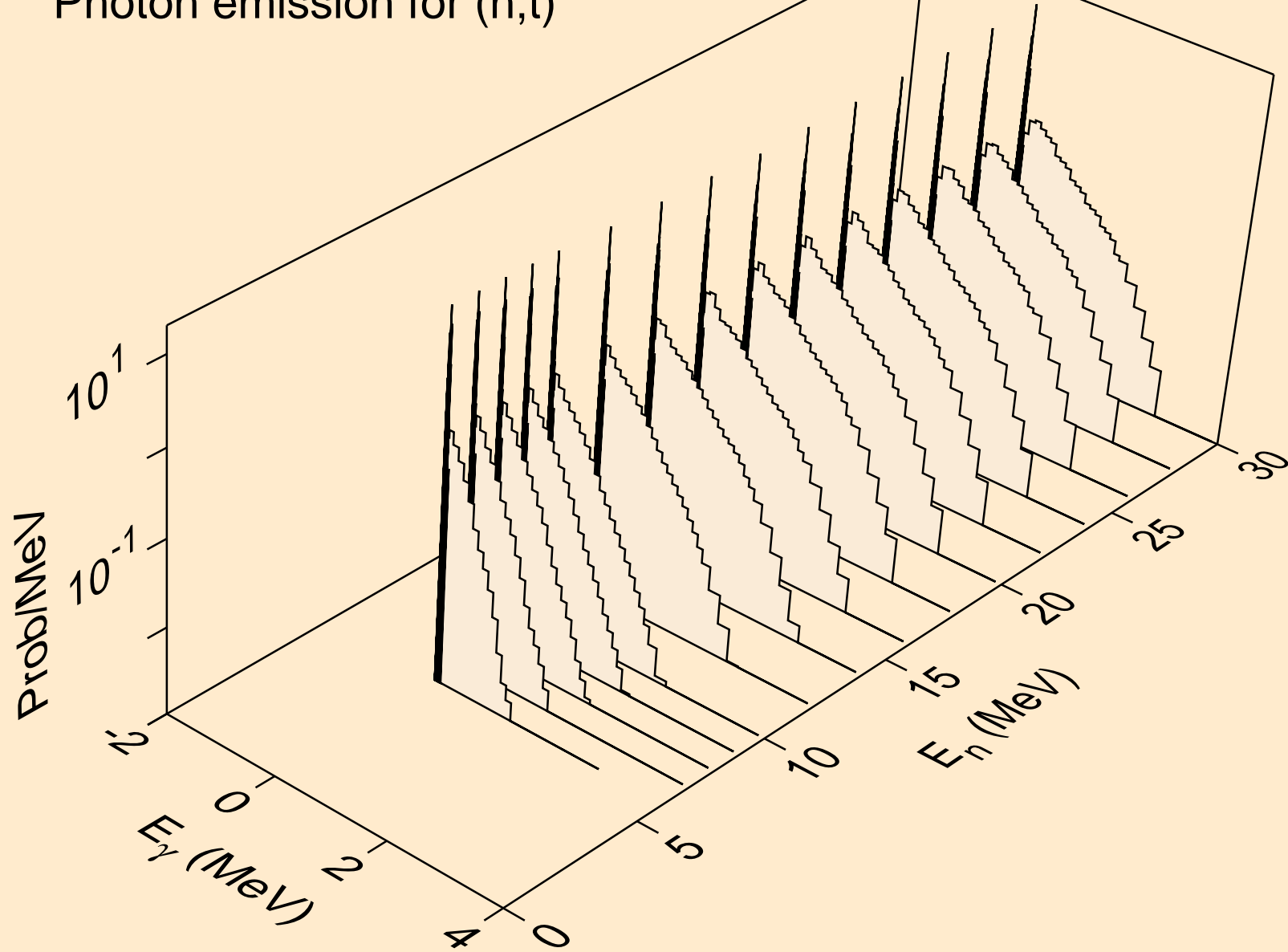

AM249 DEUTERON ACER TENDL-2024 LIBRARY; T=0.K  
Photon emission for (n,he3)

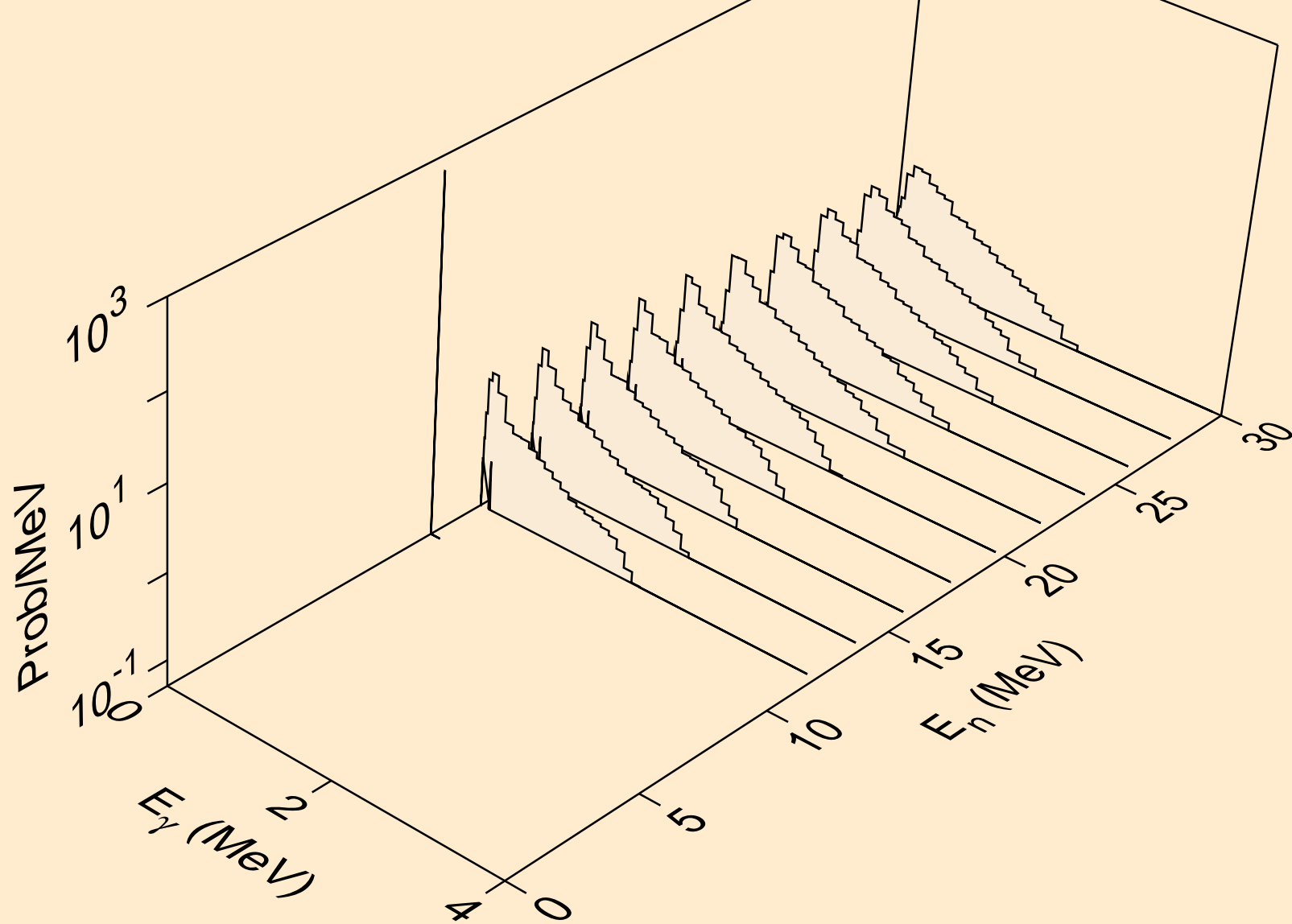

AM249 DEUTERON ACER TENDL-2024 LIBRARY; T=0.K  
Photon emission for (n,a)

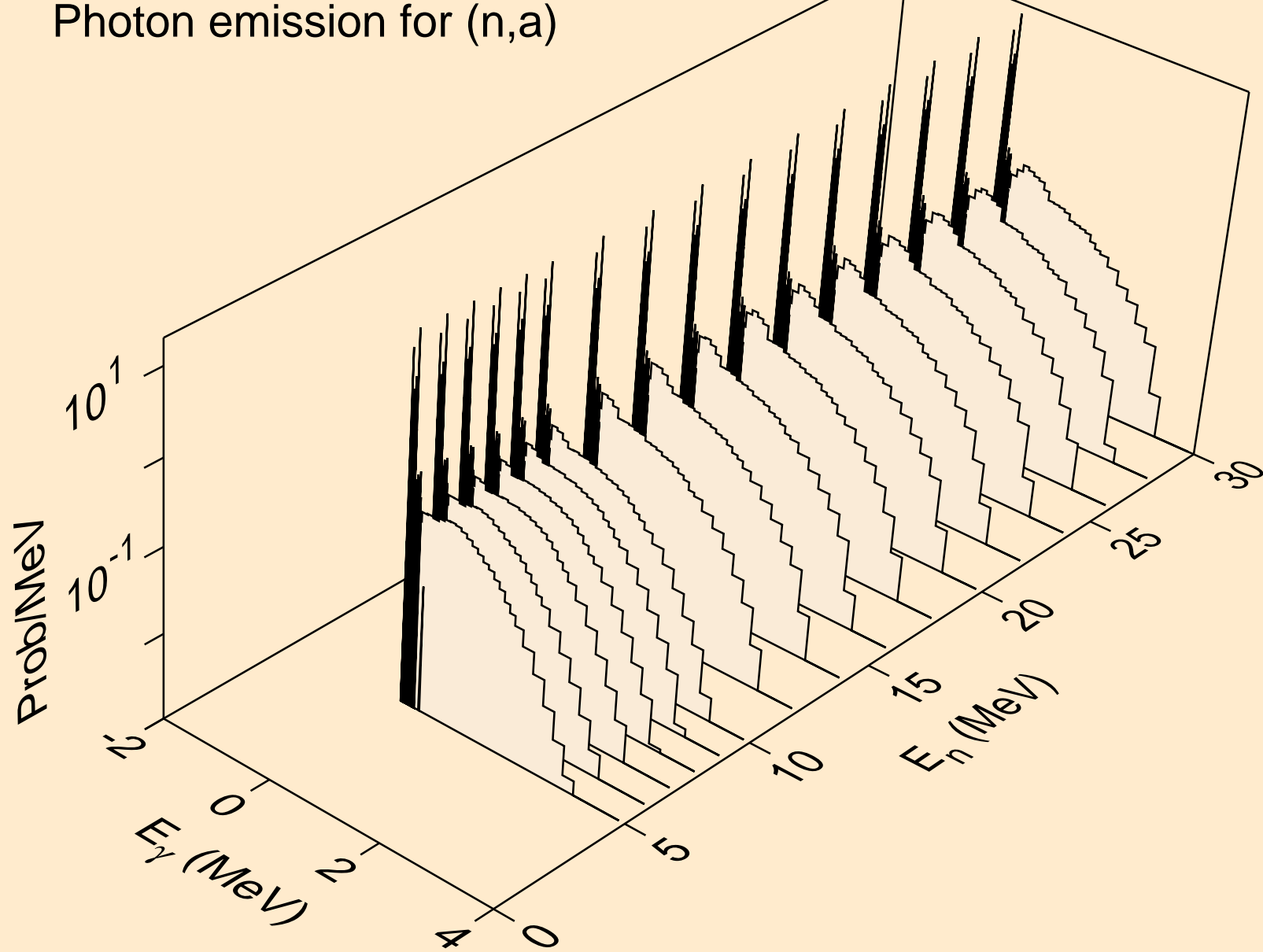

AM249 DEUTERON ACER TENDL-2024 LIBRARY; T=0.K  
Photon emission for (n,2p)

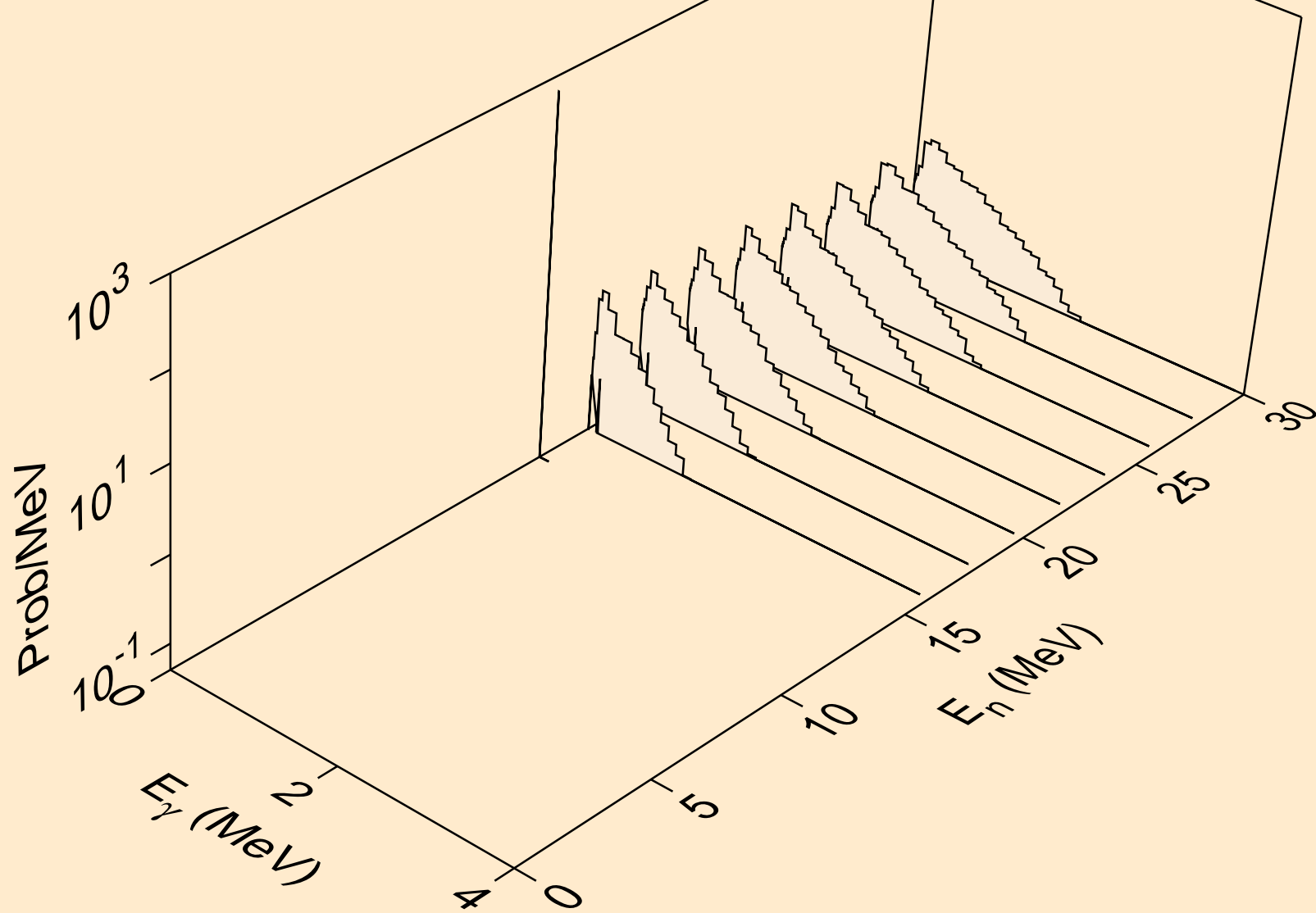

AM249 DEUTERON ACER TENDL-2024 LIBRARY; T=0.K  
Photon emission for (n,pd)

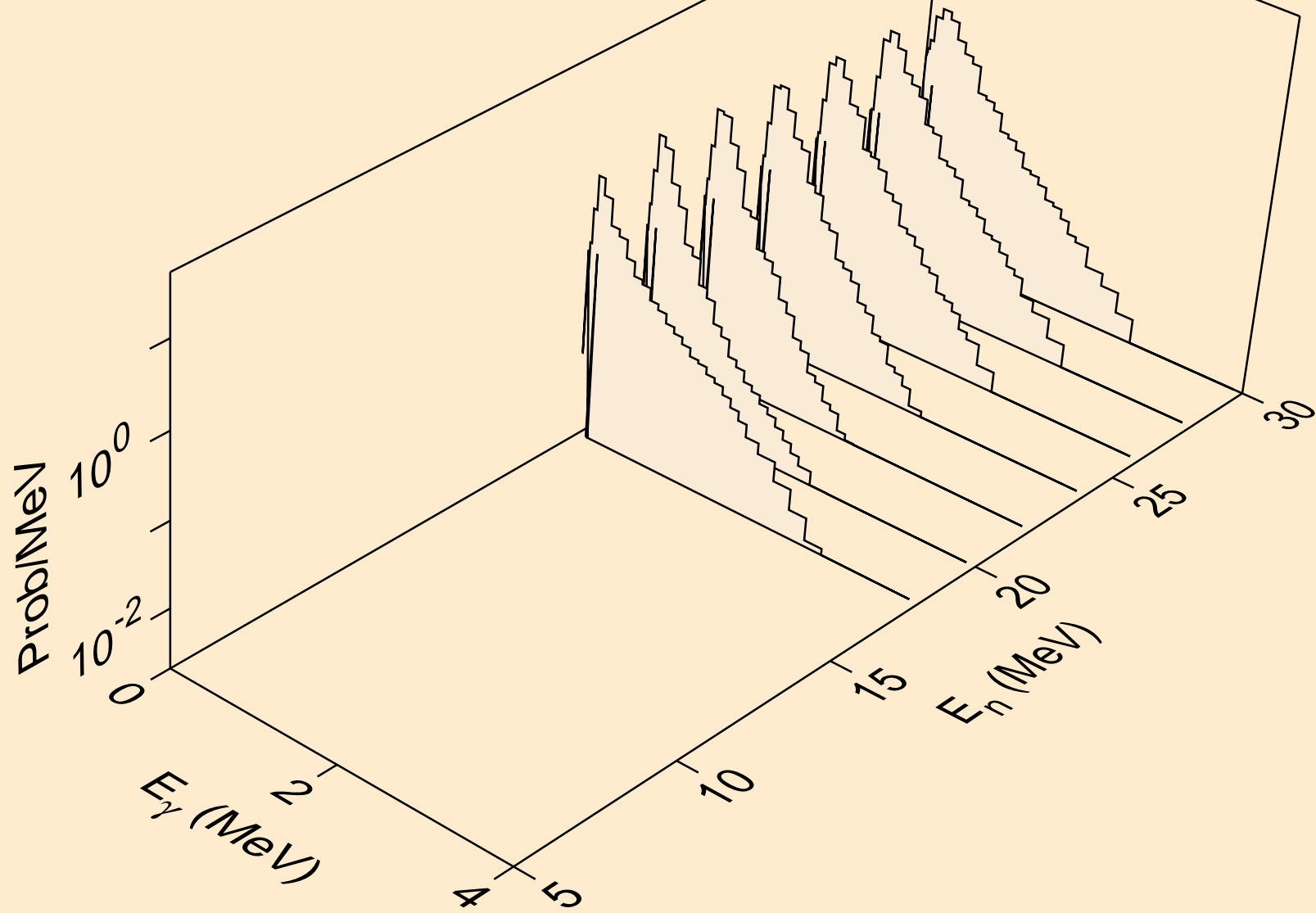

# AM249 DEUTERON ACER TENDL-2024 LIBRARY; T=0.K

## Particle heating contributions

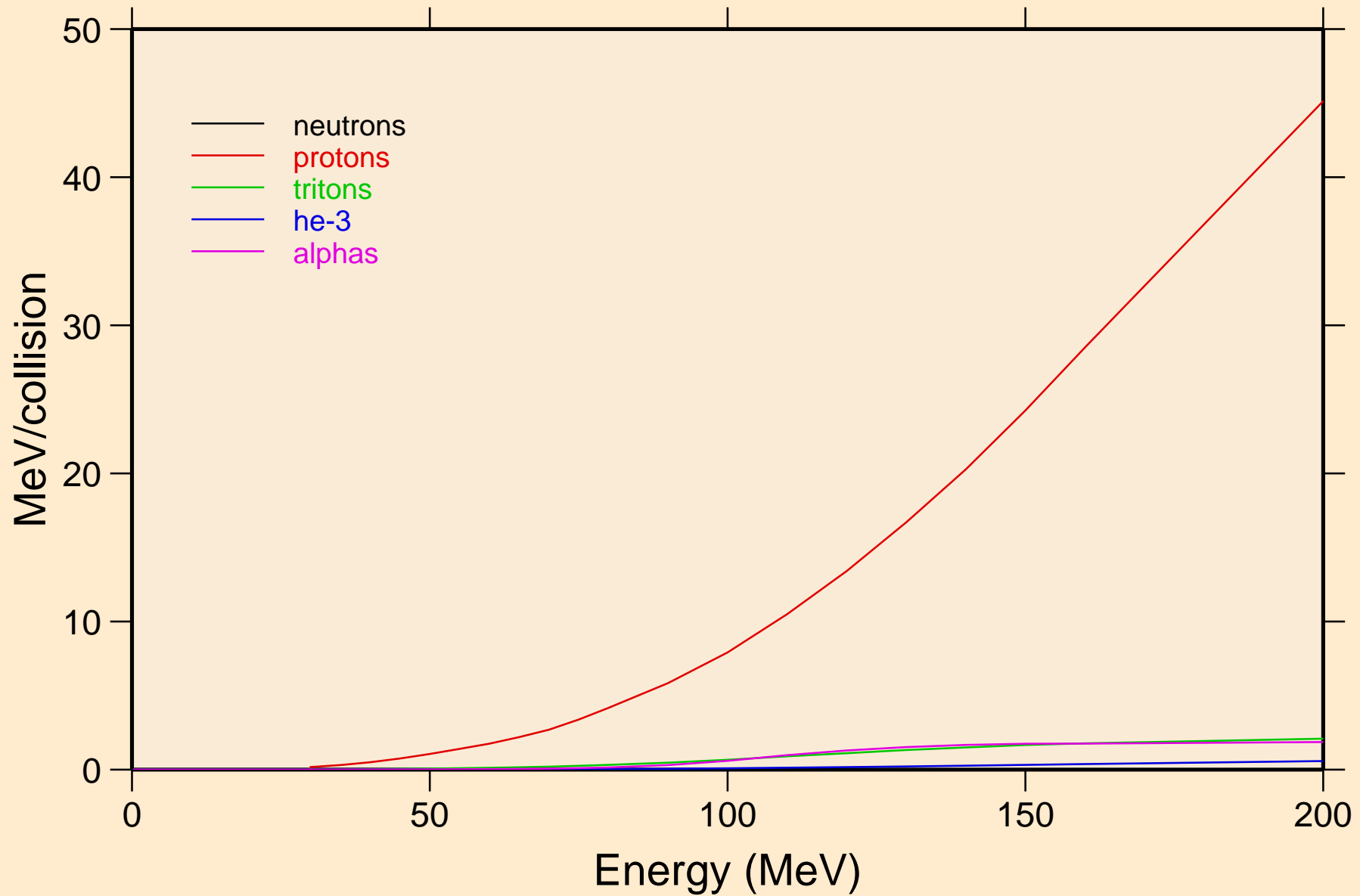

AM249 DEUTERON ACER TENDL-2024 LIBRARY; T=0.K  
Recoil Heating

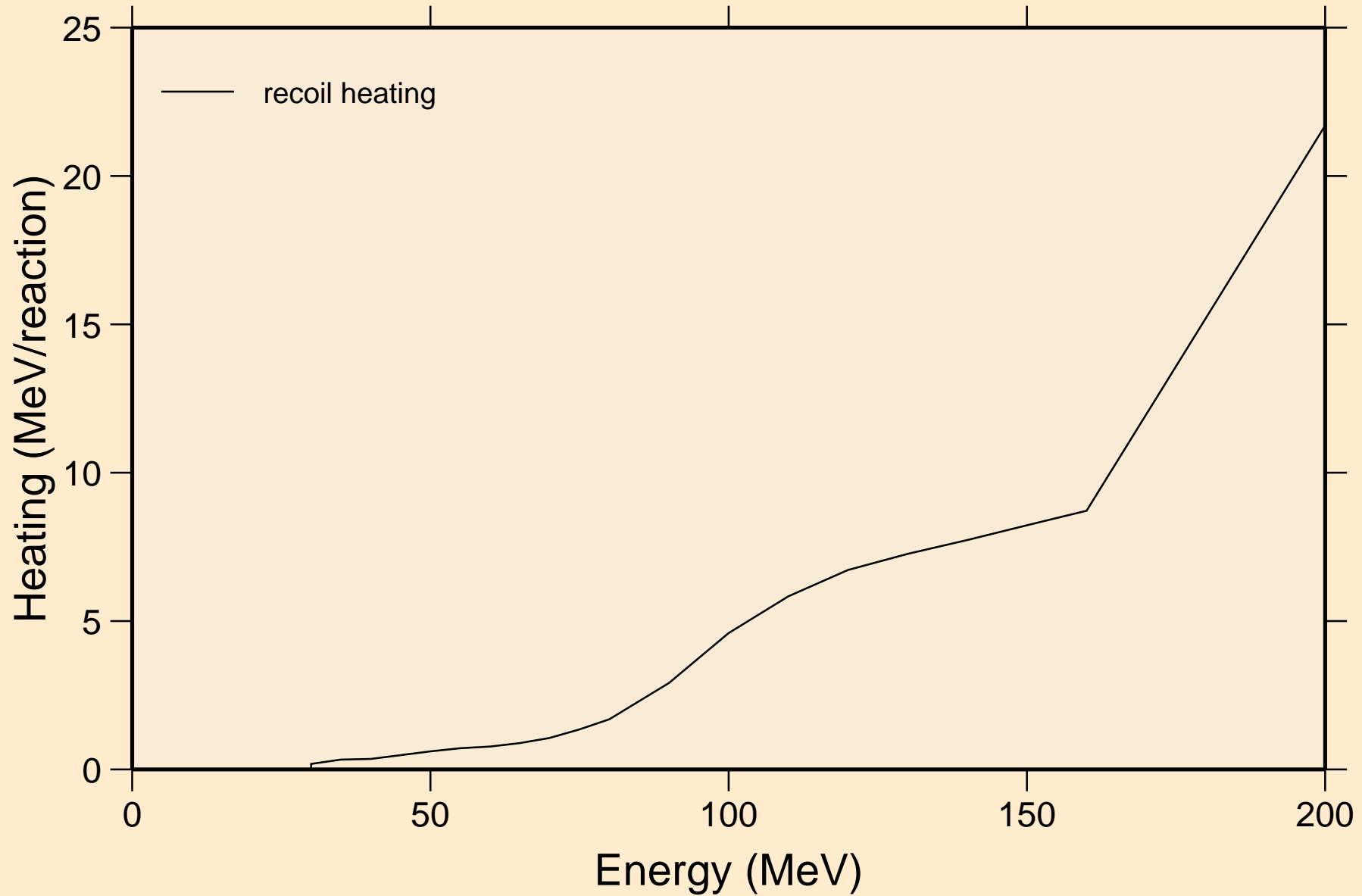

AM249 DEUTERON ACER TENDL-2024 LIBRARY; T=0.K  
Particle production cross sections

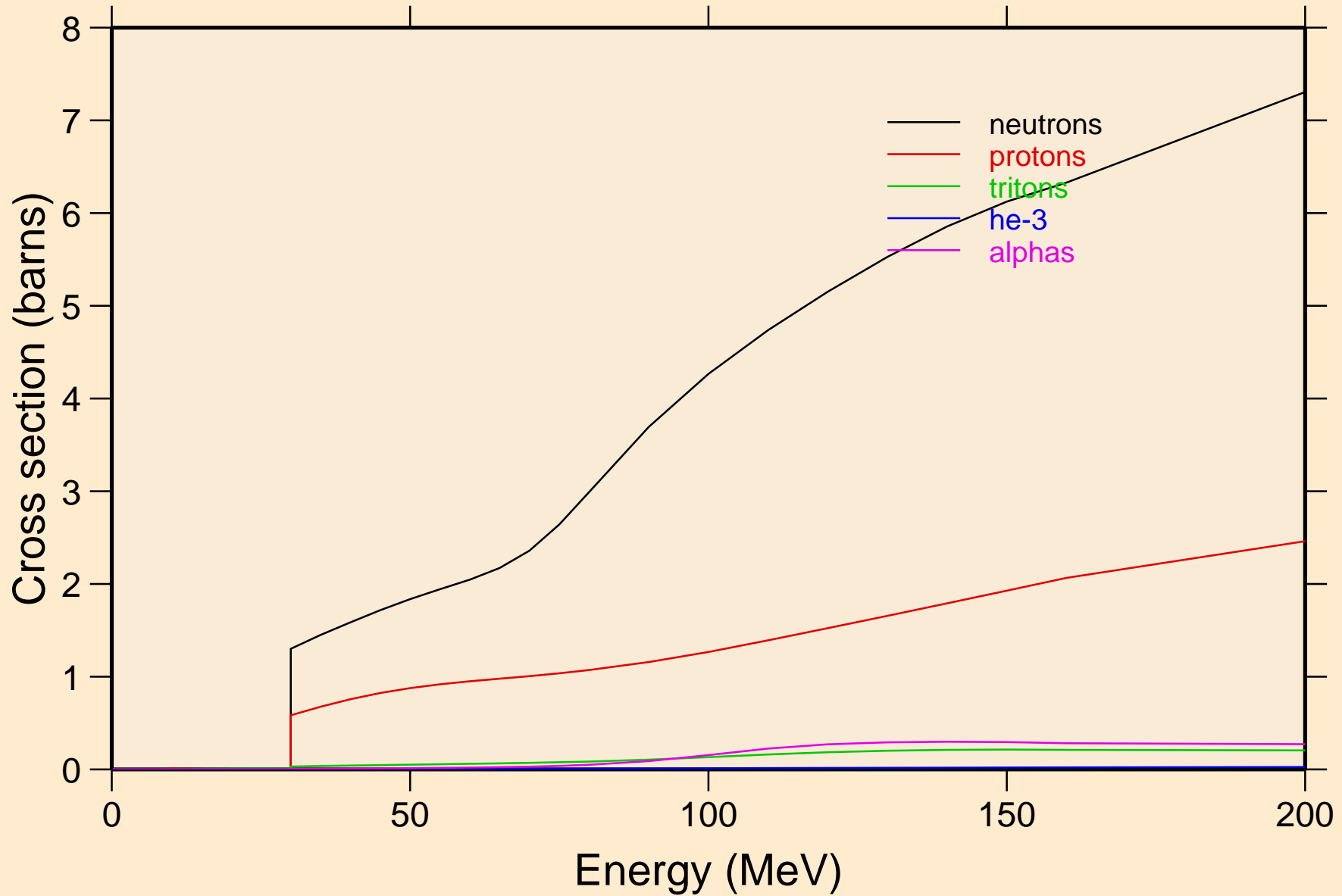

AM249 DEUTERON ACER TENDL-2024 LIBRARY; T=0.K  
neutrons from (d,n)

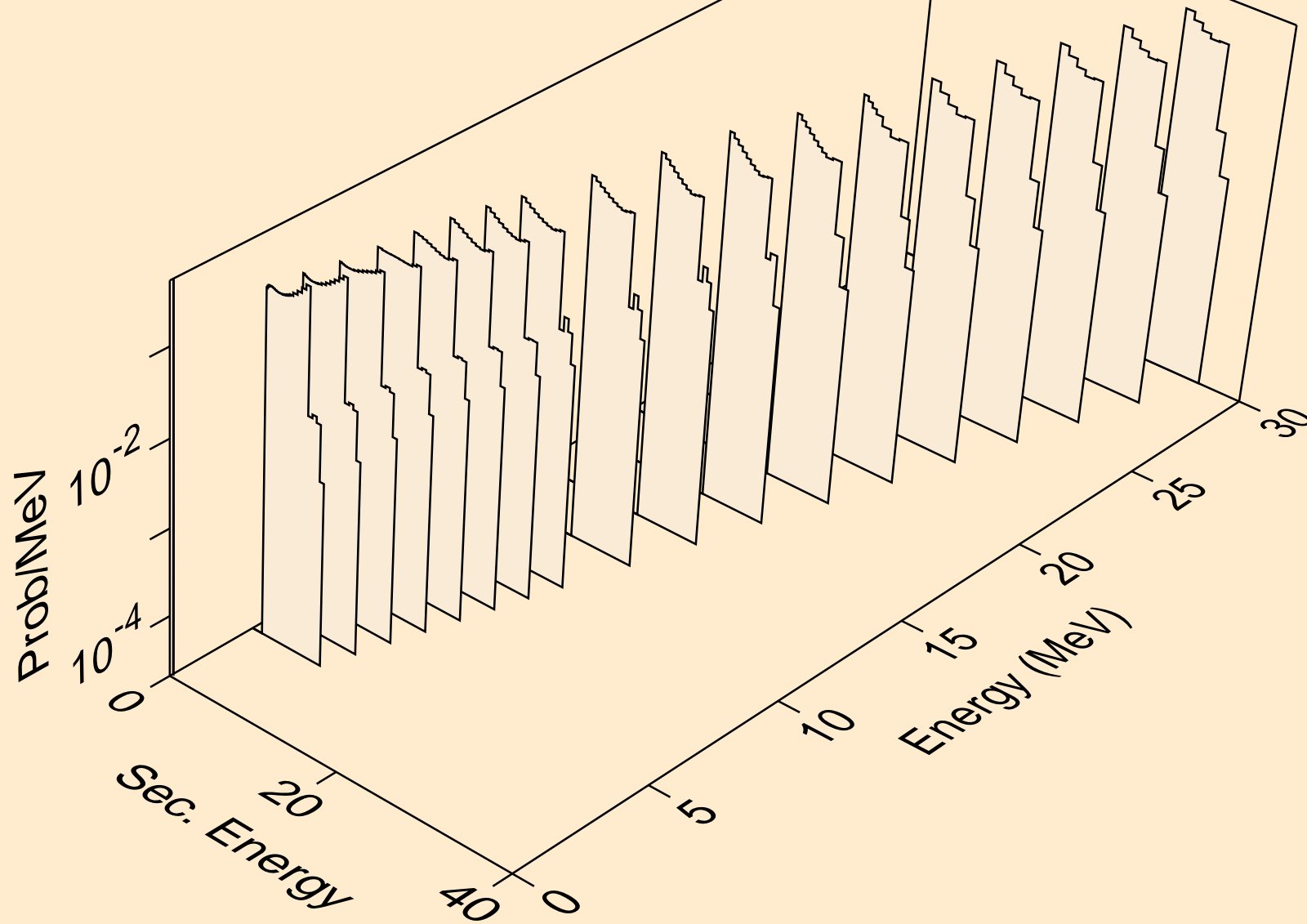

AM249 DEUTERON ACER TENDL-2024 LIBRARY; T=0.K  
neutrons from (d,x)

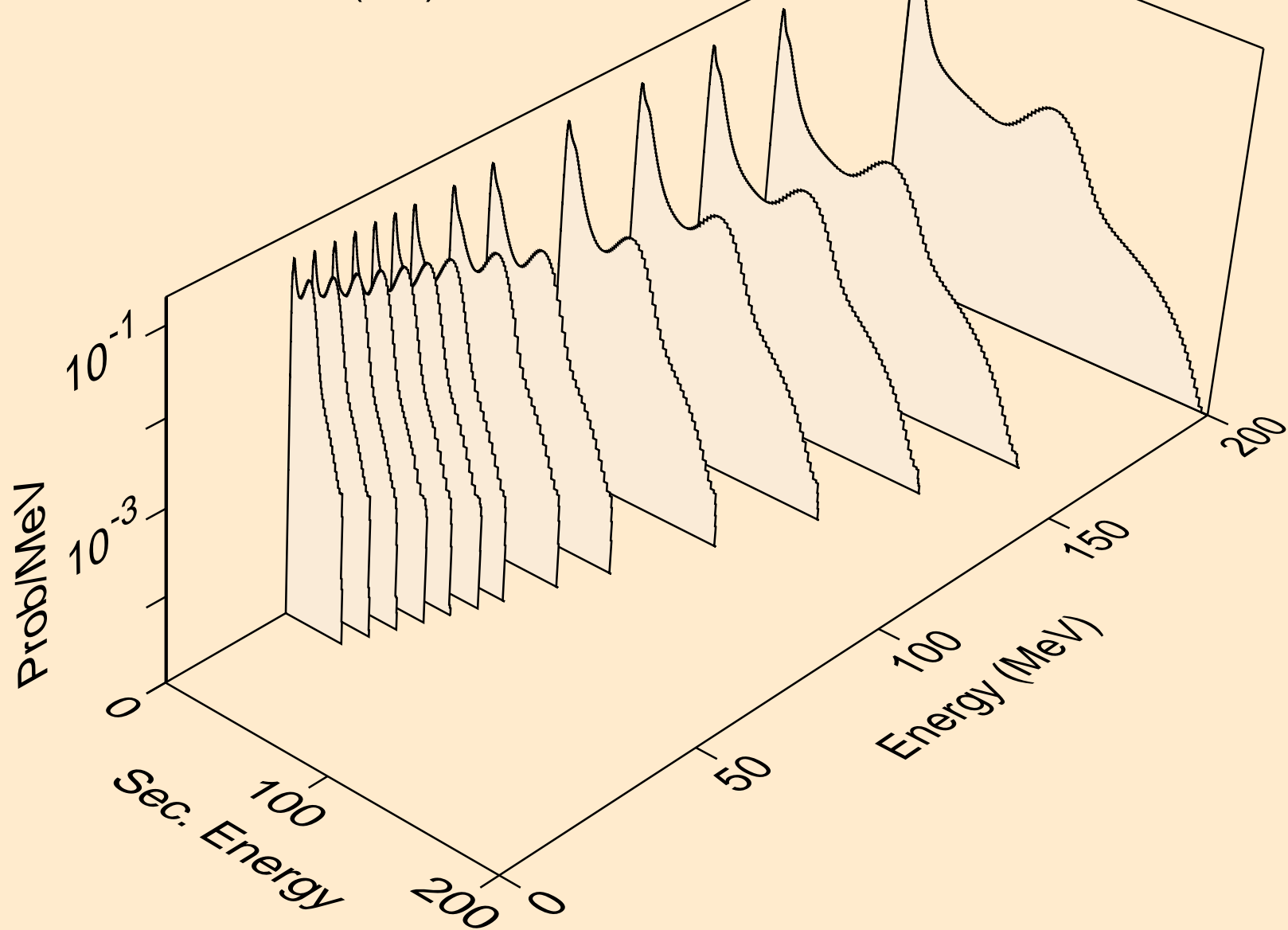

AM249 DEUTERON ACER TENDL-2024 LIBRARY; T=0.K  
neutrons from (d,2nd)

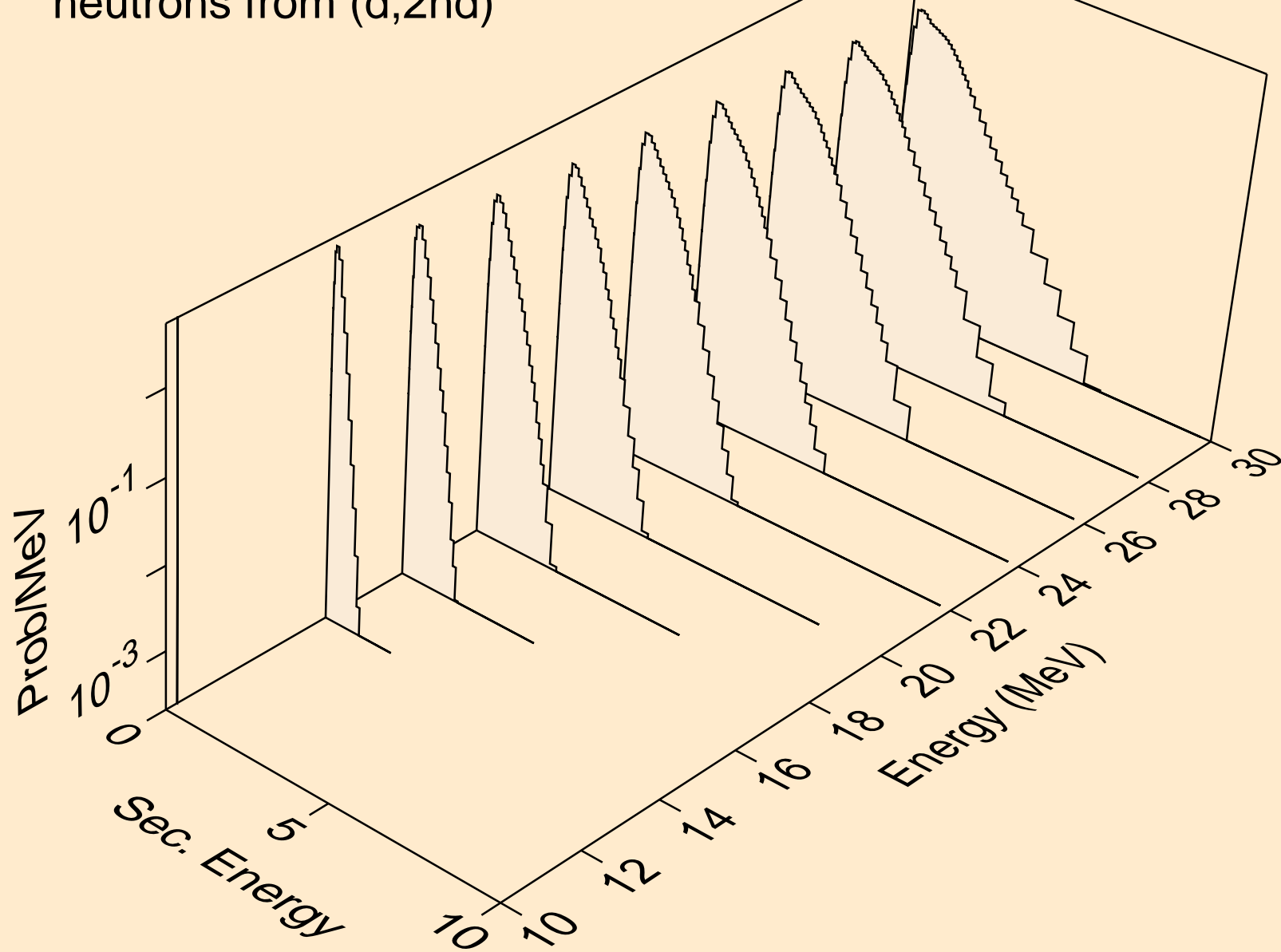

AM249 DEUTERON ACER TENDL-2024 LIBRARY; T=0.K  
neutrons from (d,2n)

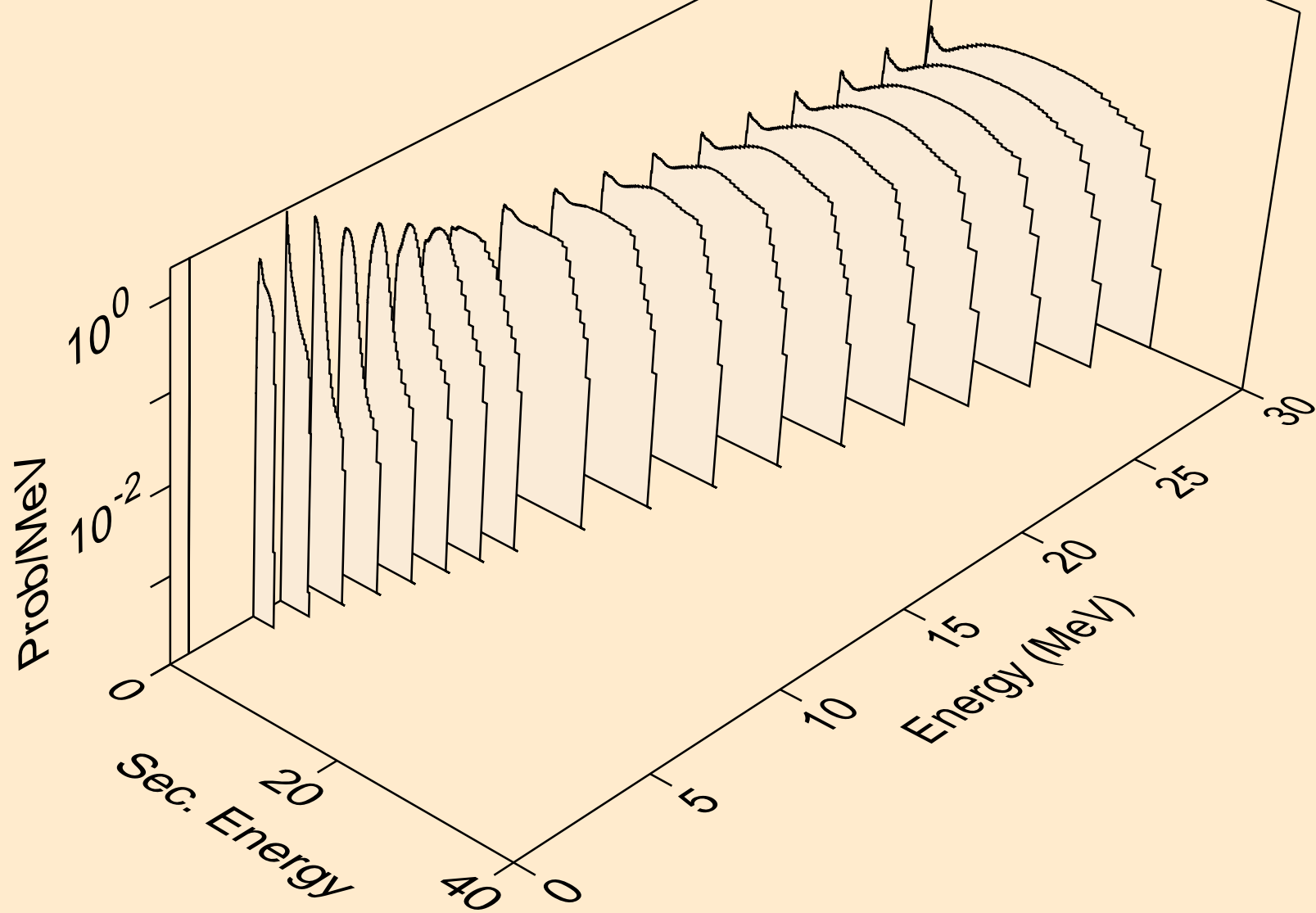

AM249 DEUTERON ACER TENDL-2024 LIBRARY; T=0.K  
neutrons from (d,3n)

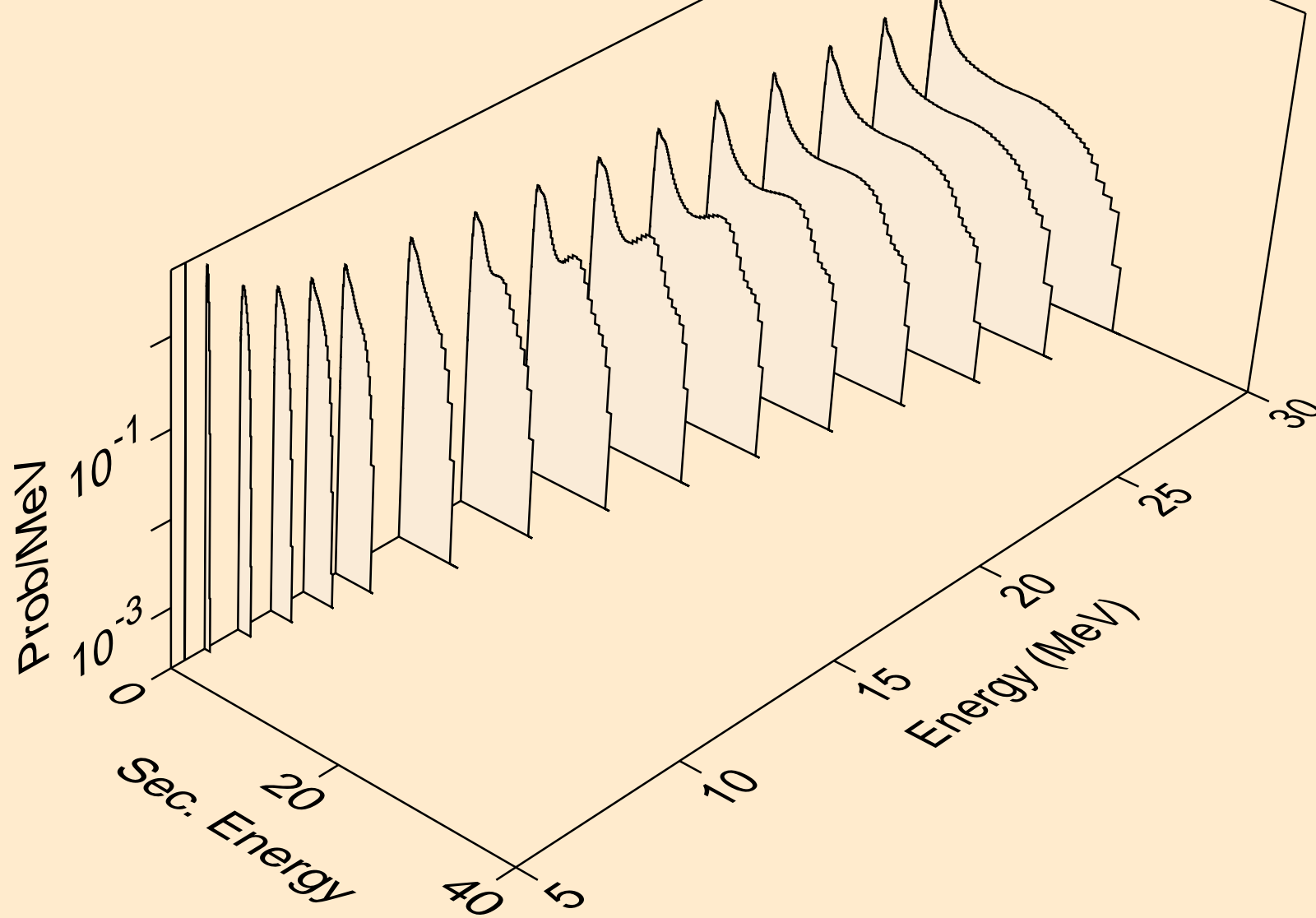

AM249 DEUTERON ACER TENDL-2024 LIBRARY; T=0.K  
neutrons from (d,n\*)a

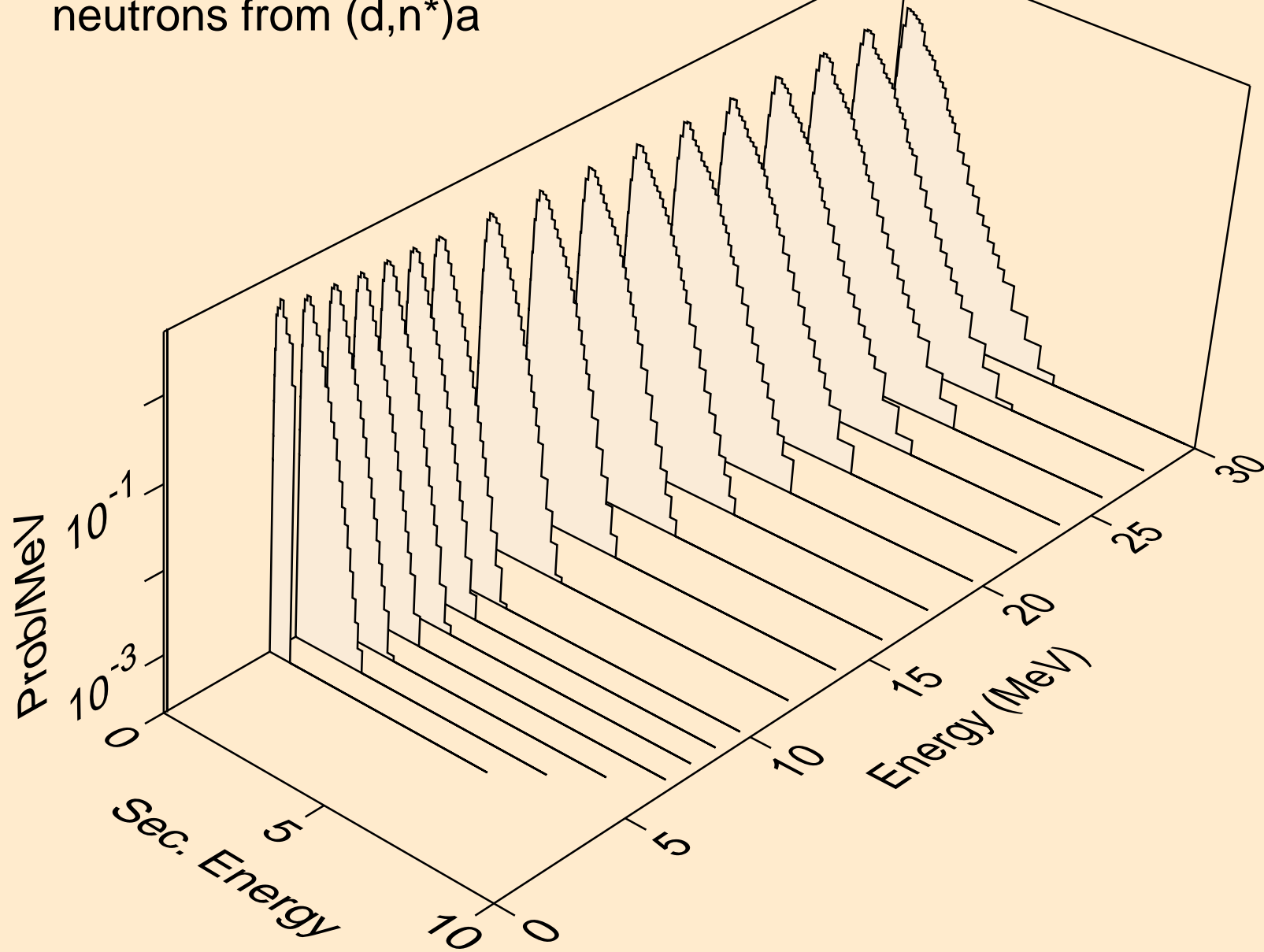

AM249 DEUTERON ACER TENDL-2024 LIBRARY; T=0.K  
neutrons from (d,2n)a

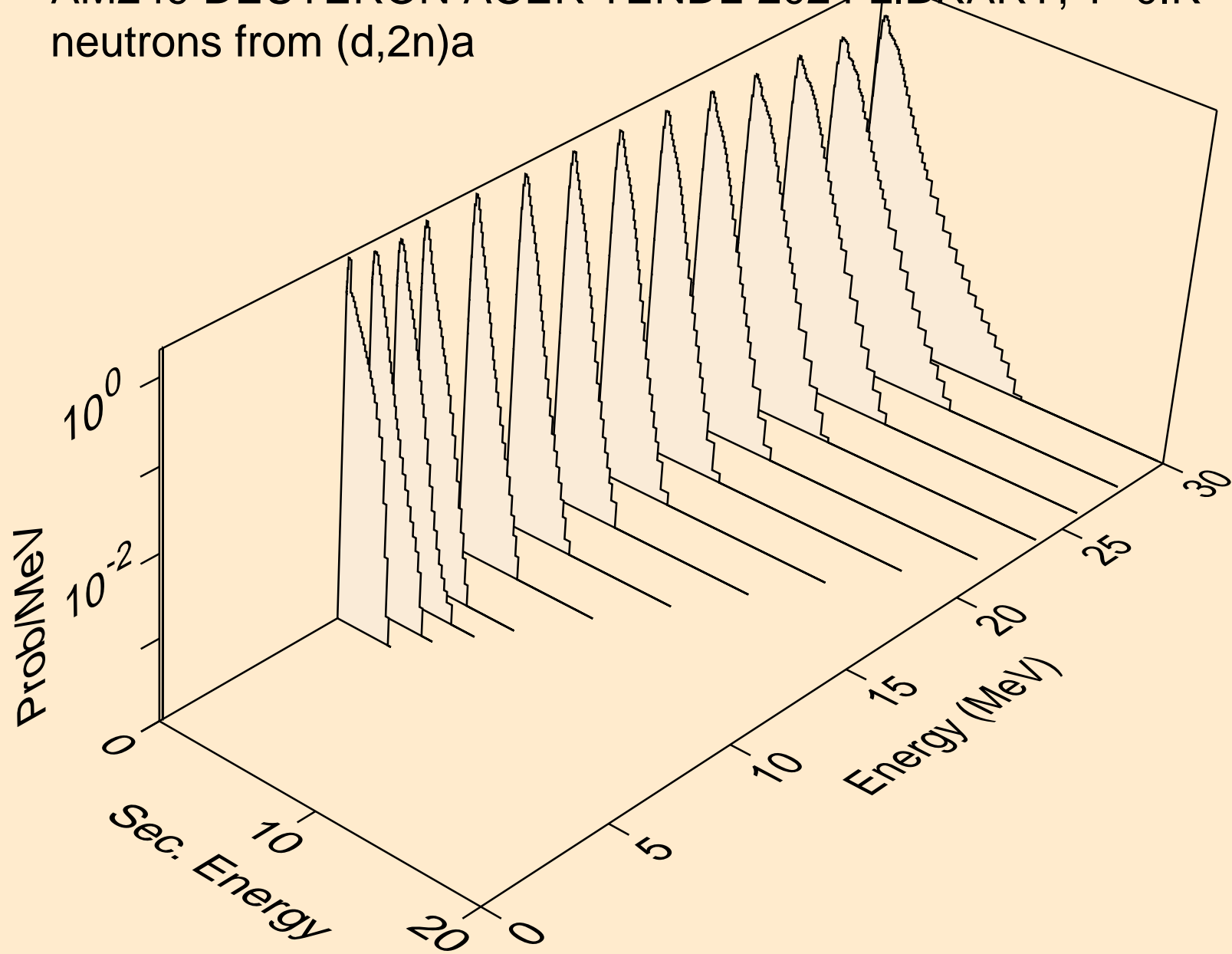

AM249 DEUTERON ACER TENDL-2024 LIBRARY; T=0.K  
neutrons from (d,3n)a

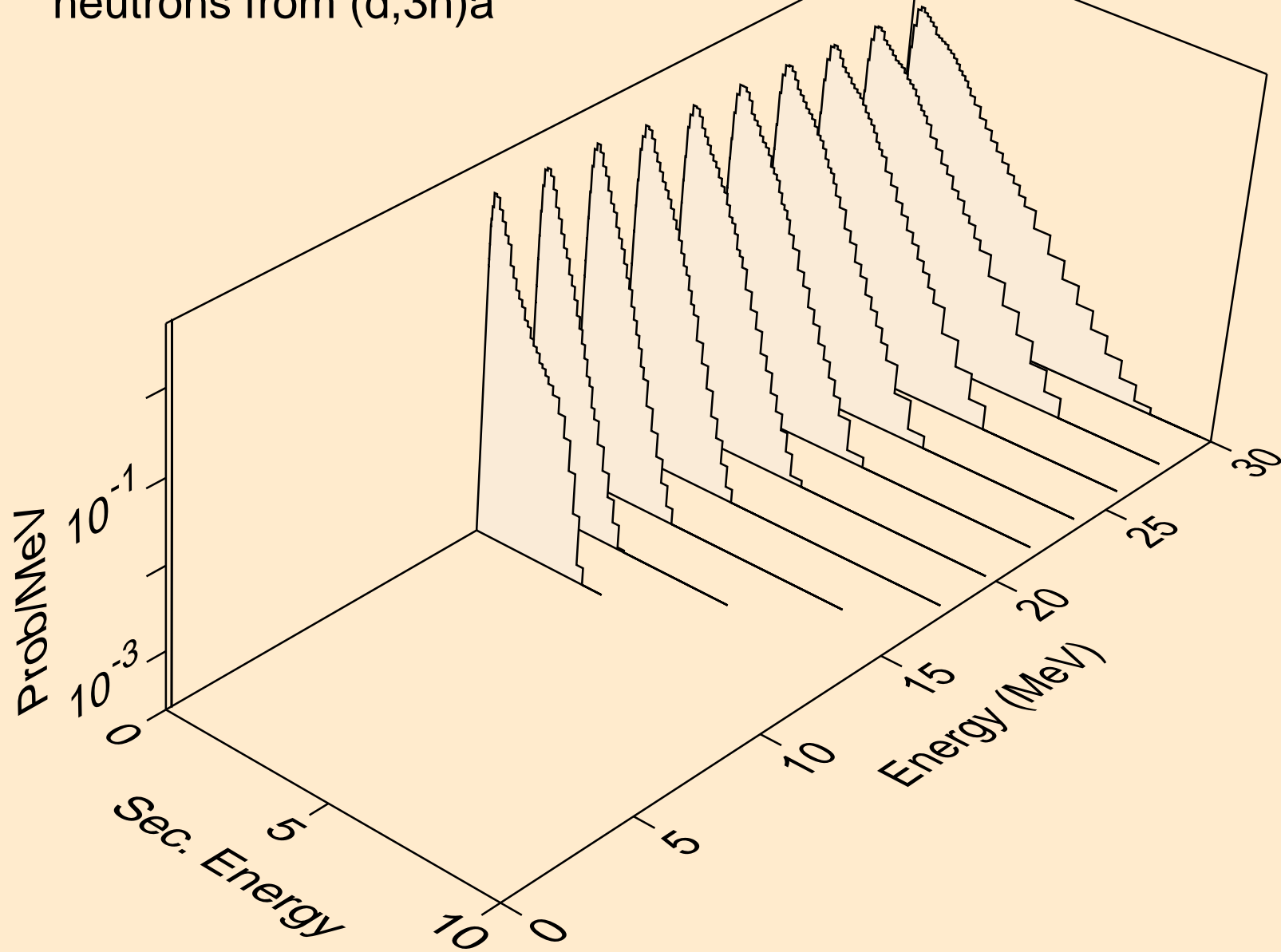

AM249 DEUTERON ACER TENDL-2024 LIBRARY; T=0.K  
neutrons from (d,n\*)p

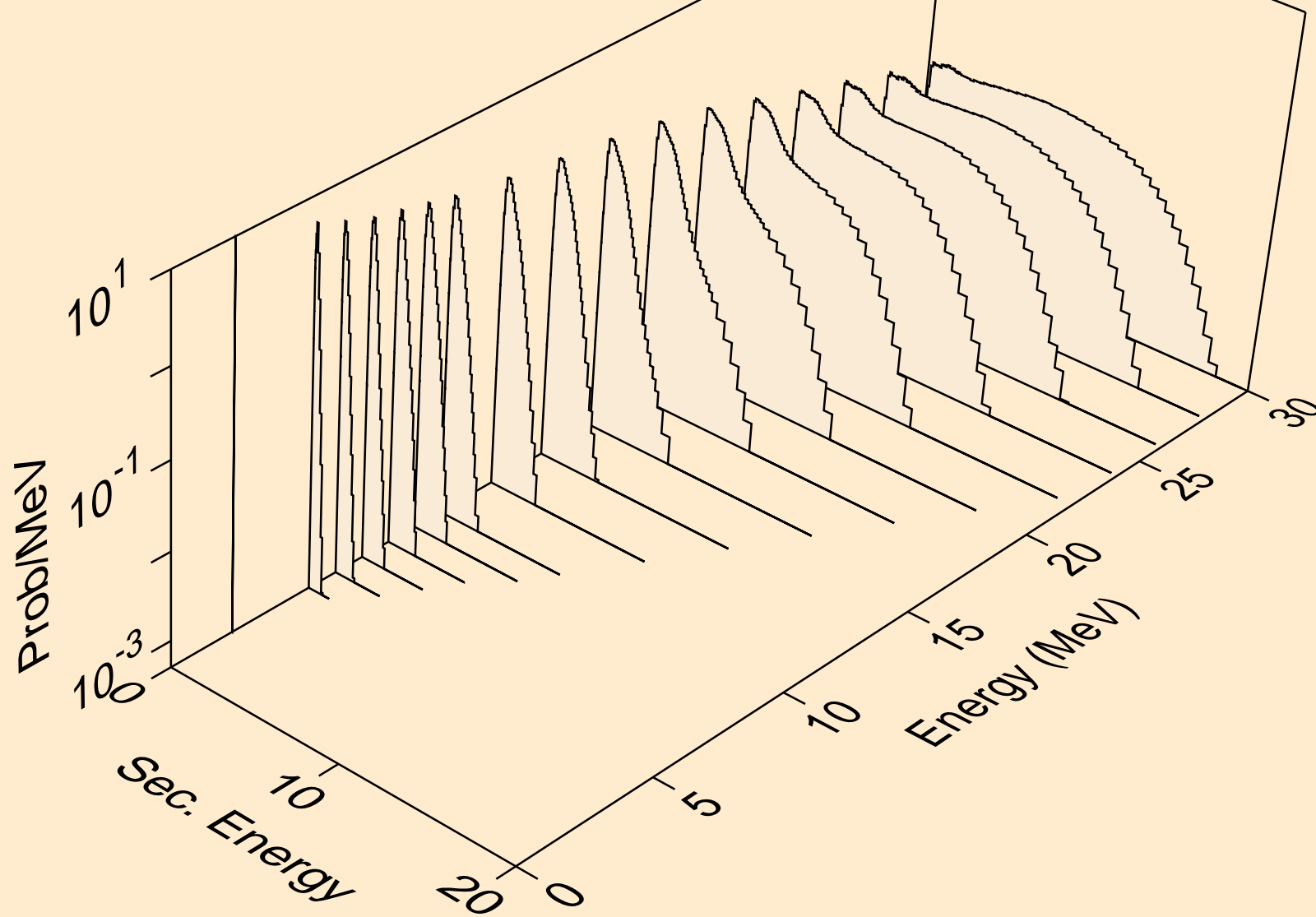

AM249 DEUTERON ACER TENDL-2024 LIBRARY; T=0.K  
neutrons from (d,n\*)d

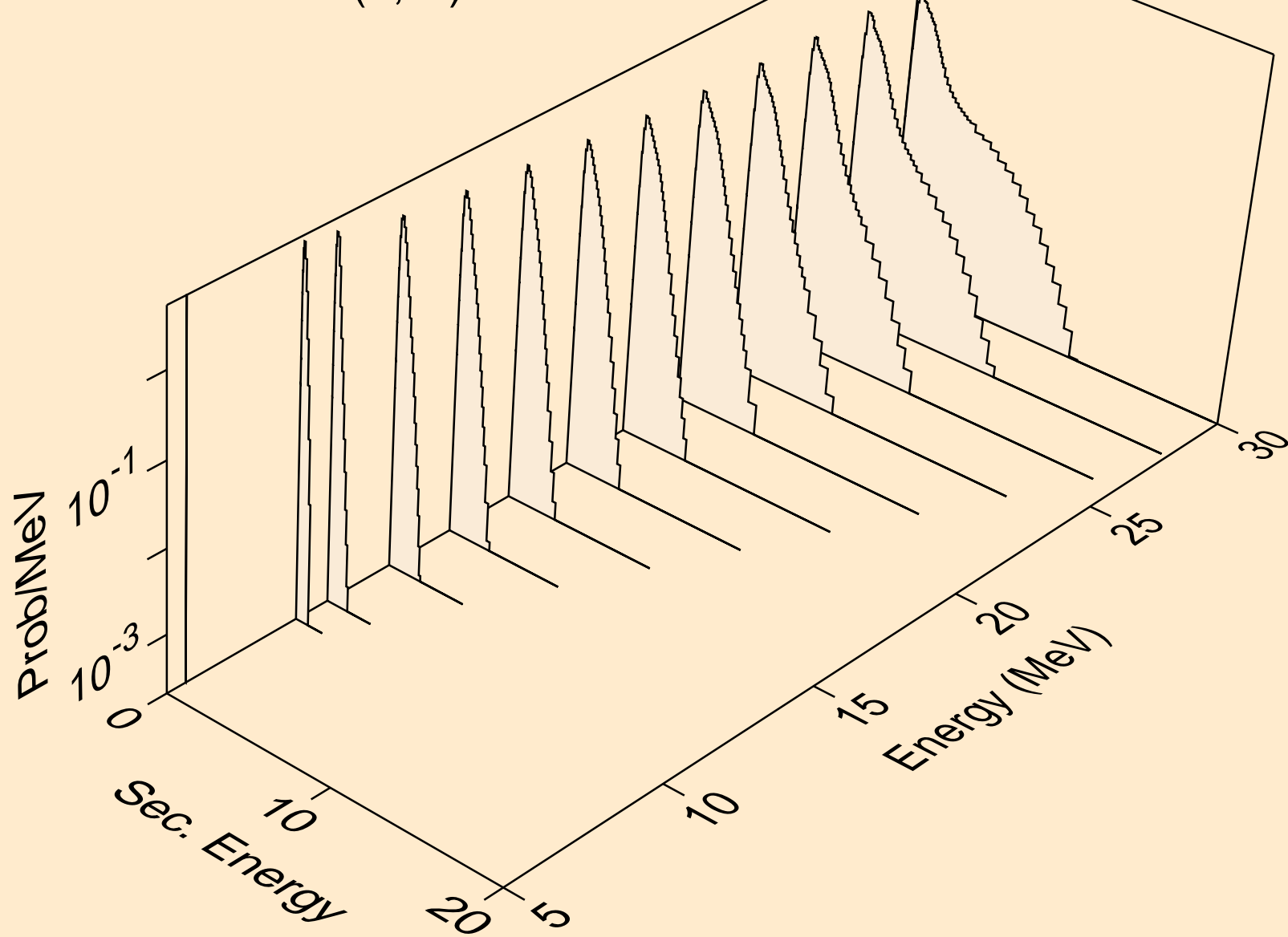

AM249 DEUTERON ACER TENDL-2024 LIBRARY; T=0.K  
neutrons from (d,n\*)t

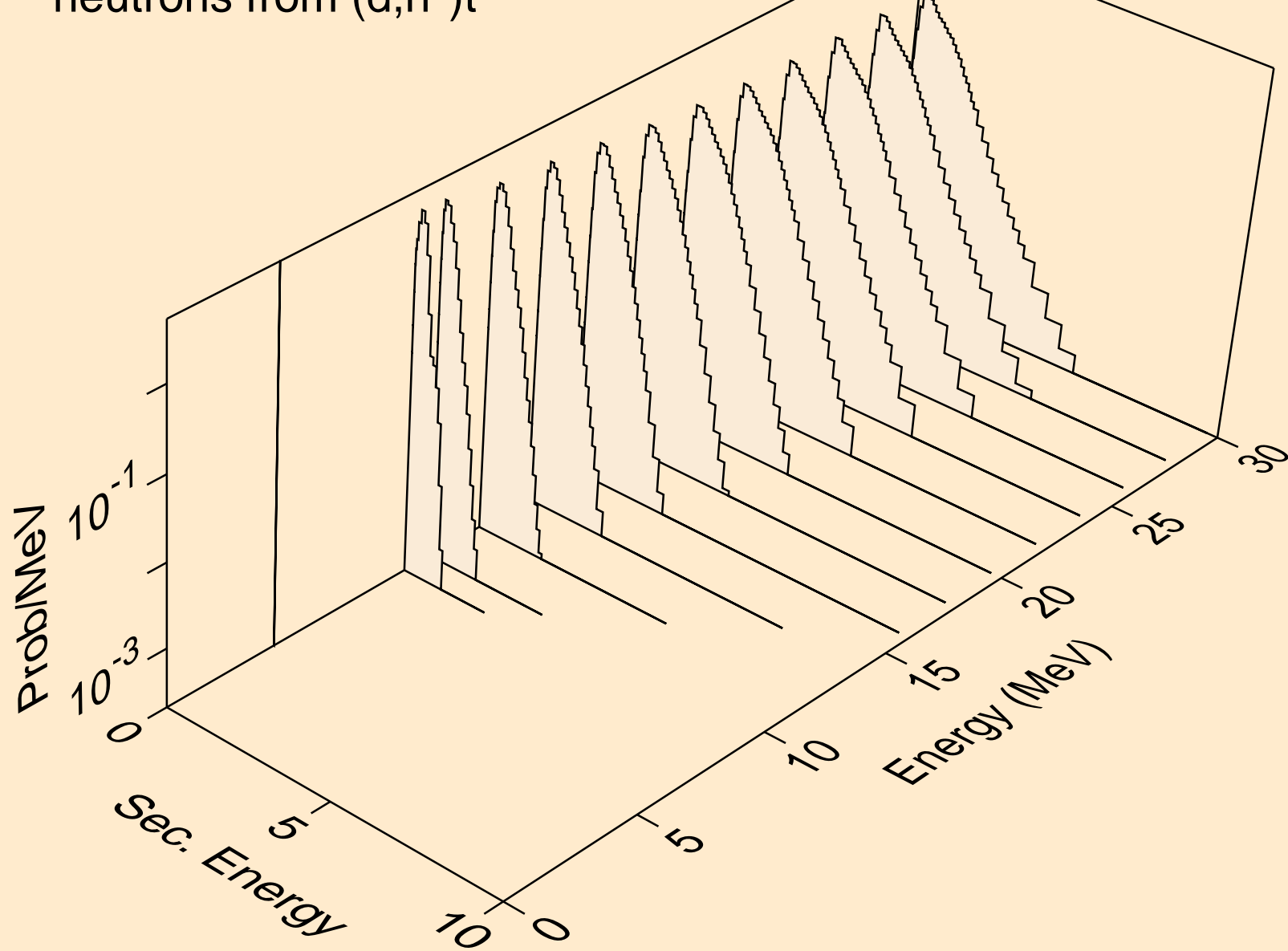

AM249 DEUTERON ACER TENDL-2024 LIBRARY; T=0.K  
neutrons from (d,n\*)he3

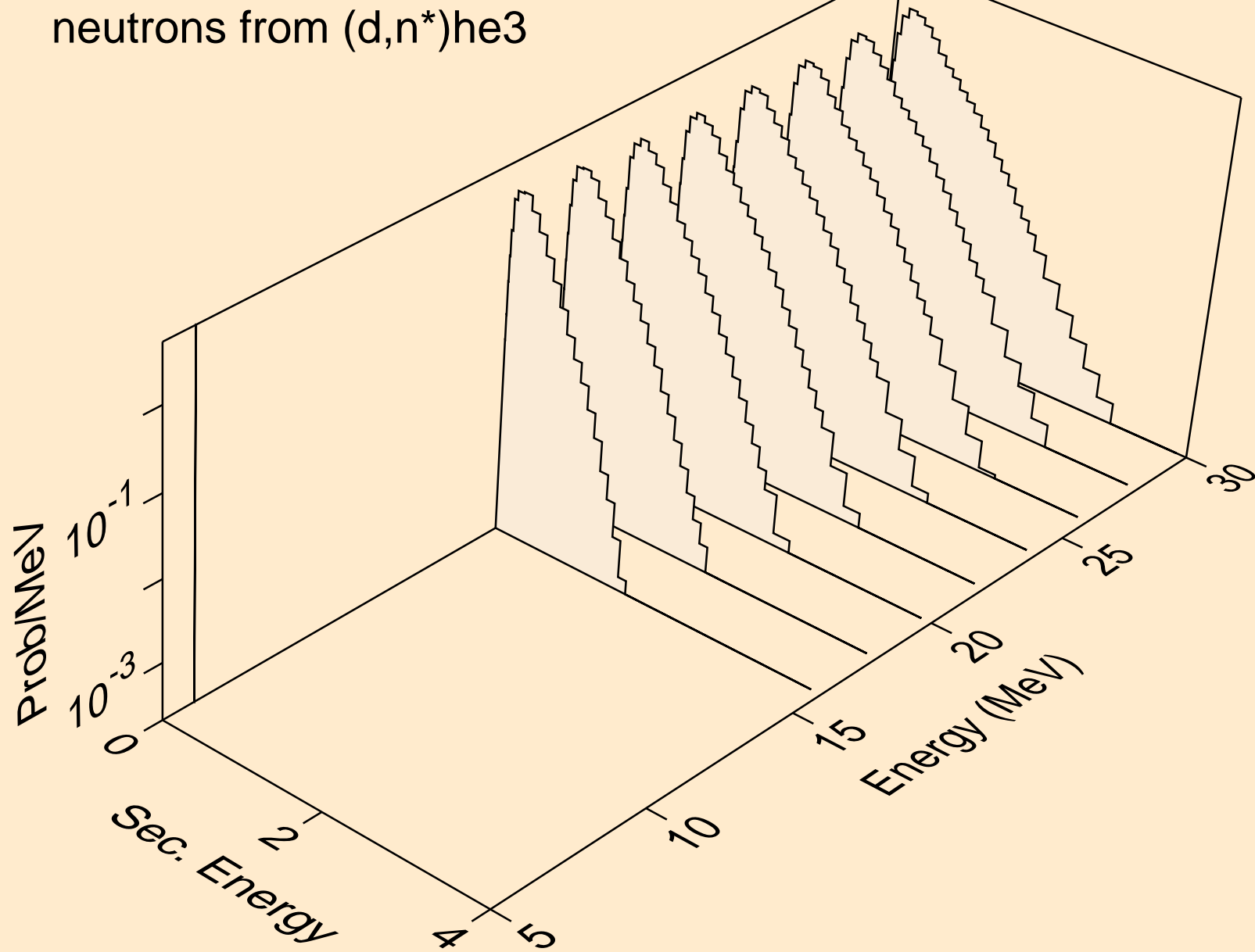

AM249 DEUTERON ACER TENDL-2024 LIBRARY; T=0.K  
neutrons from (d,4n)

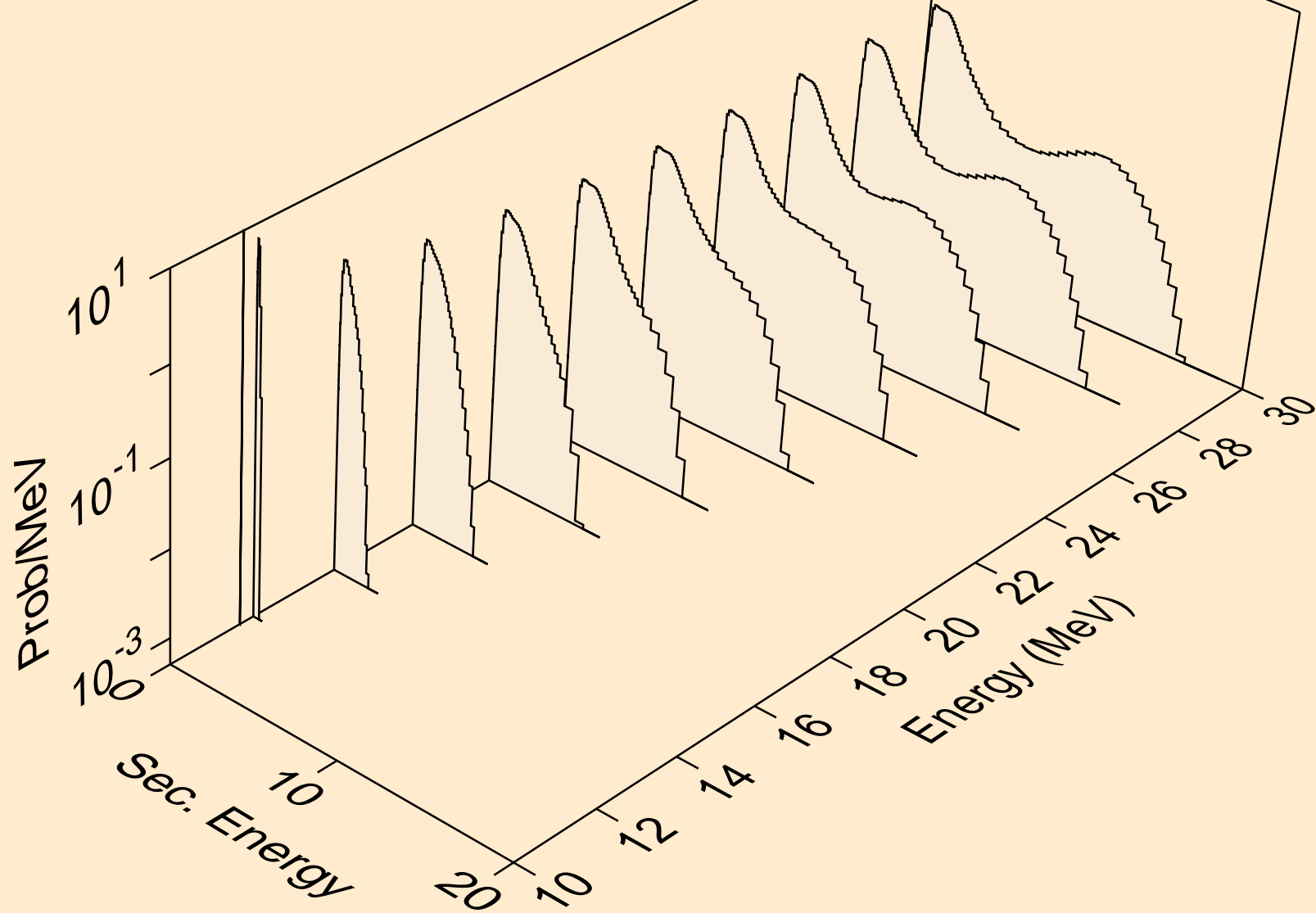

AM249 DEUTERON ACER TENDL-2024 LIBRARY; T=0.K  
neutrons from (d,2np)

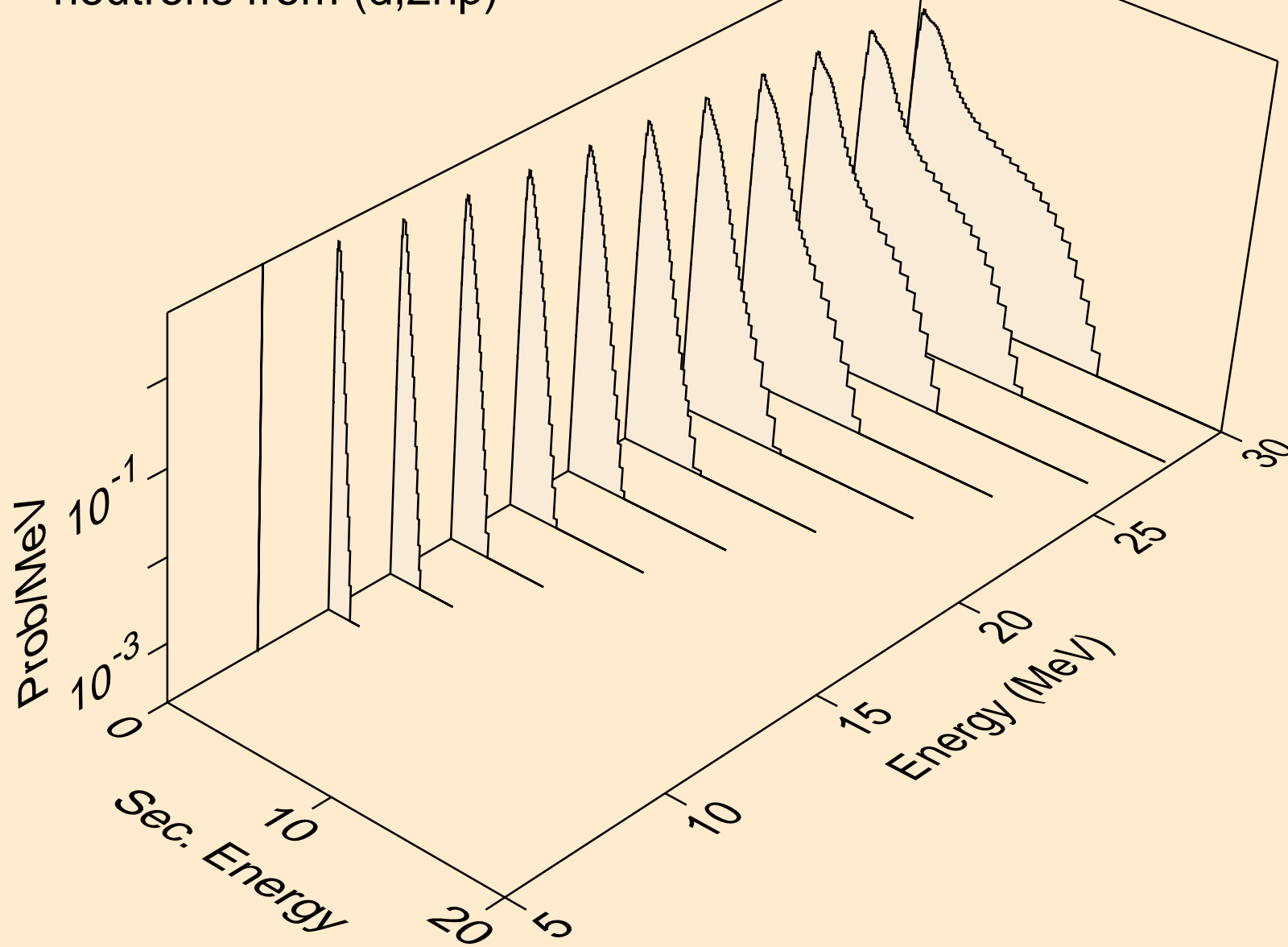

AM249 DEUTERON ACER TENDL-2024 LIBRARY; T=0.K  
neutrons from (d,3np)

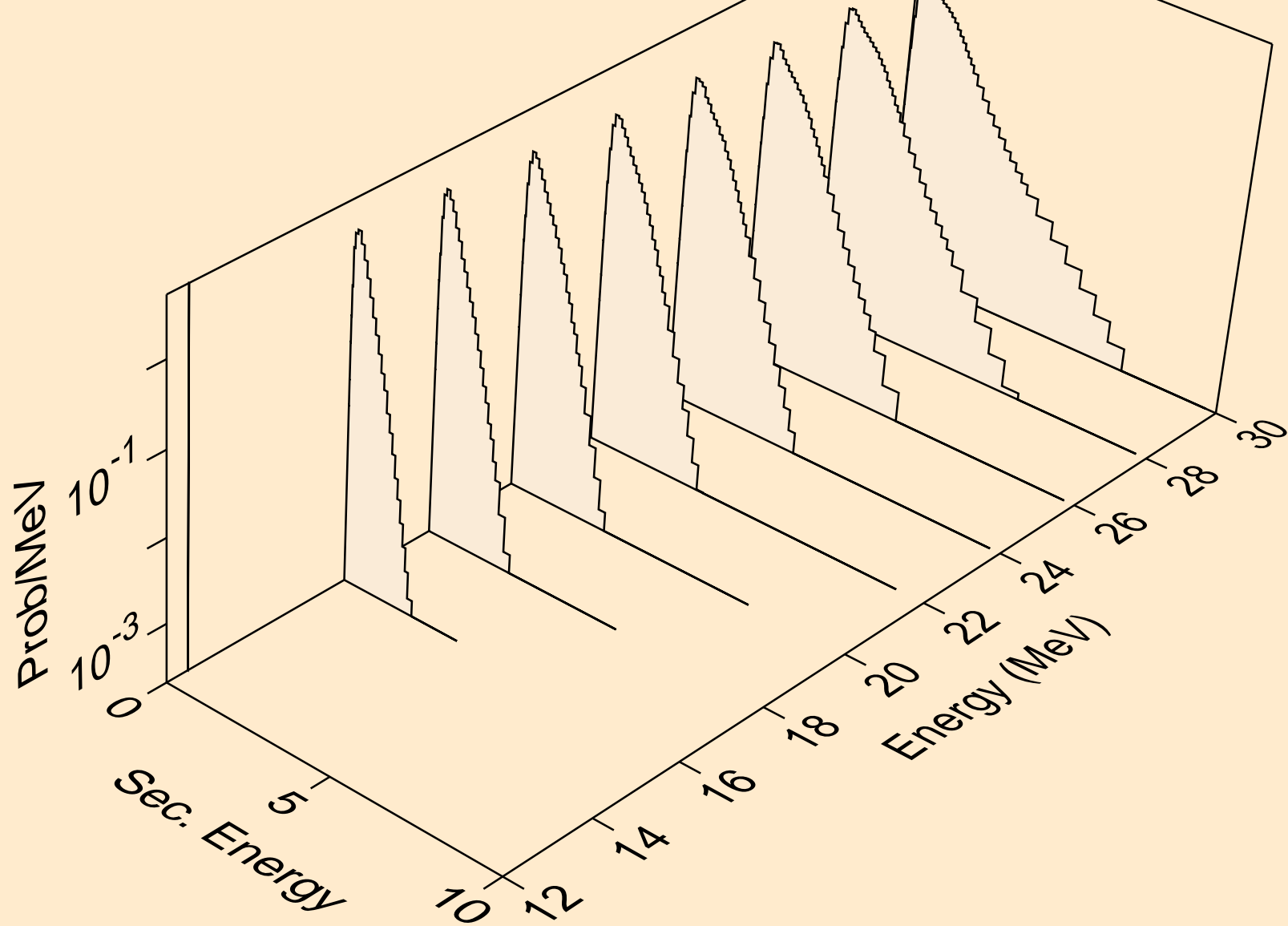

AM249 DEUTERON ACER TENDL-2024 LIBRARY; T=0.K  
neutrons from (d,n2p)

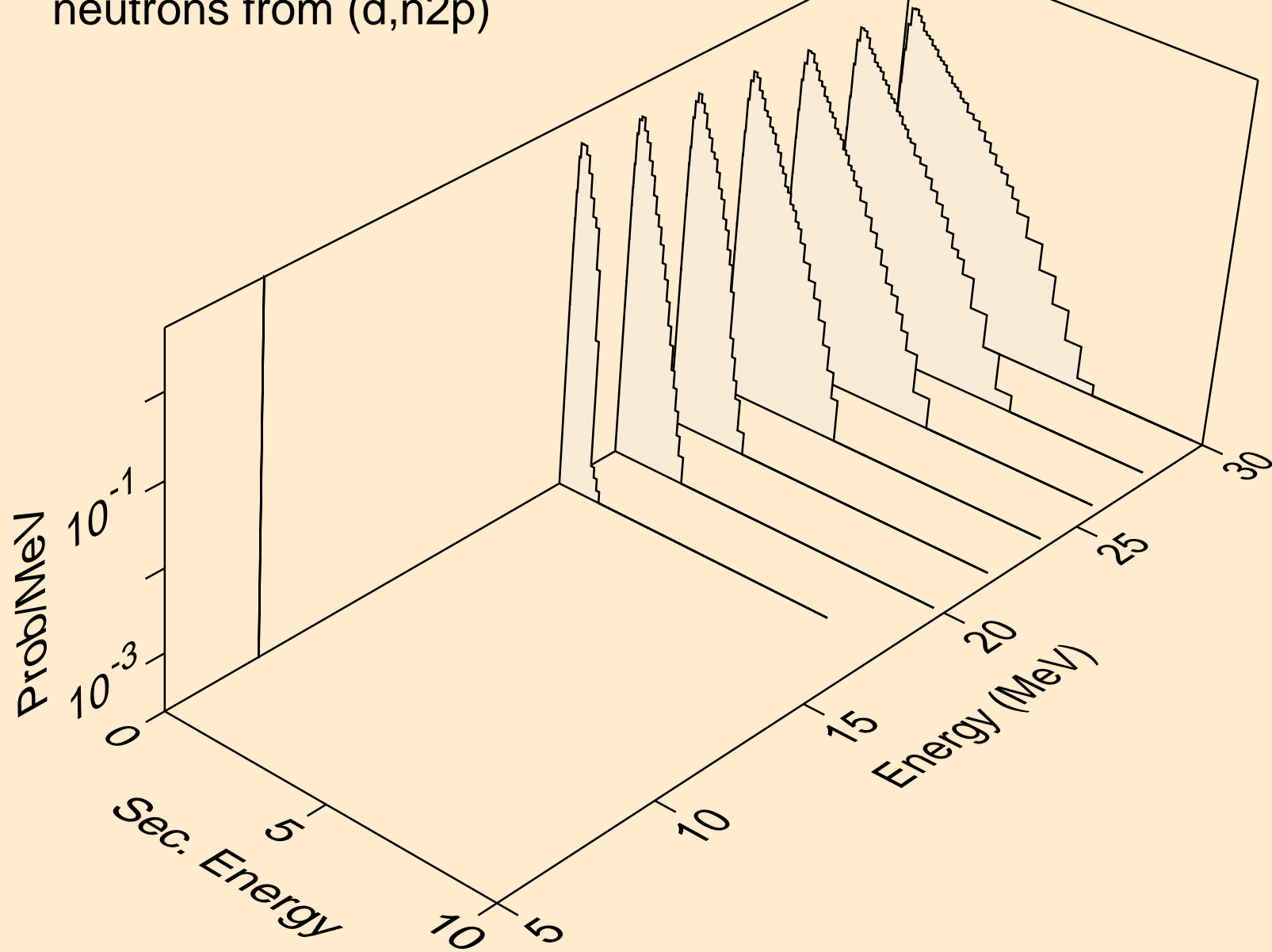

AM249 DEUTERON ACER TENDL-2024 LIBRARY; T=0.K  
protons from (d,x)

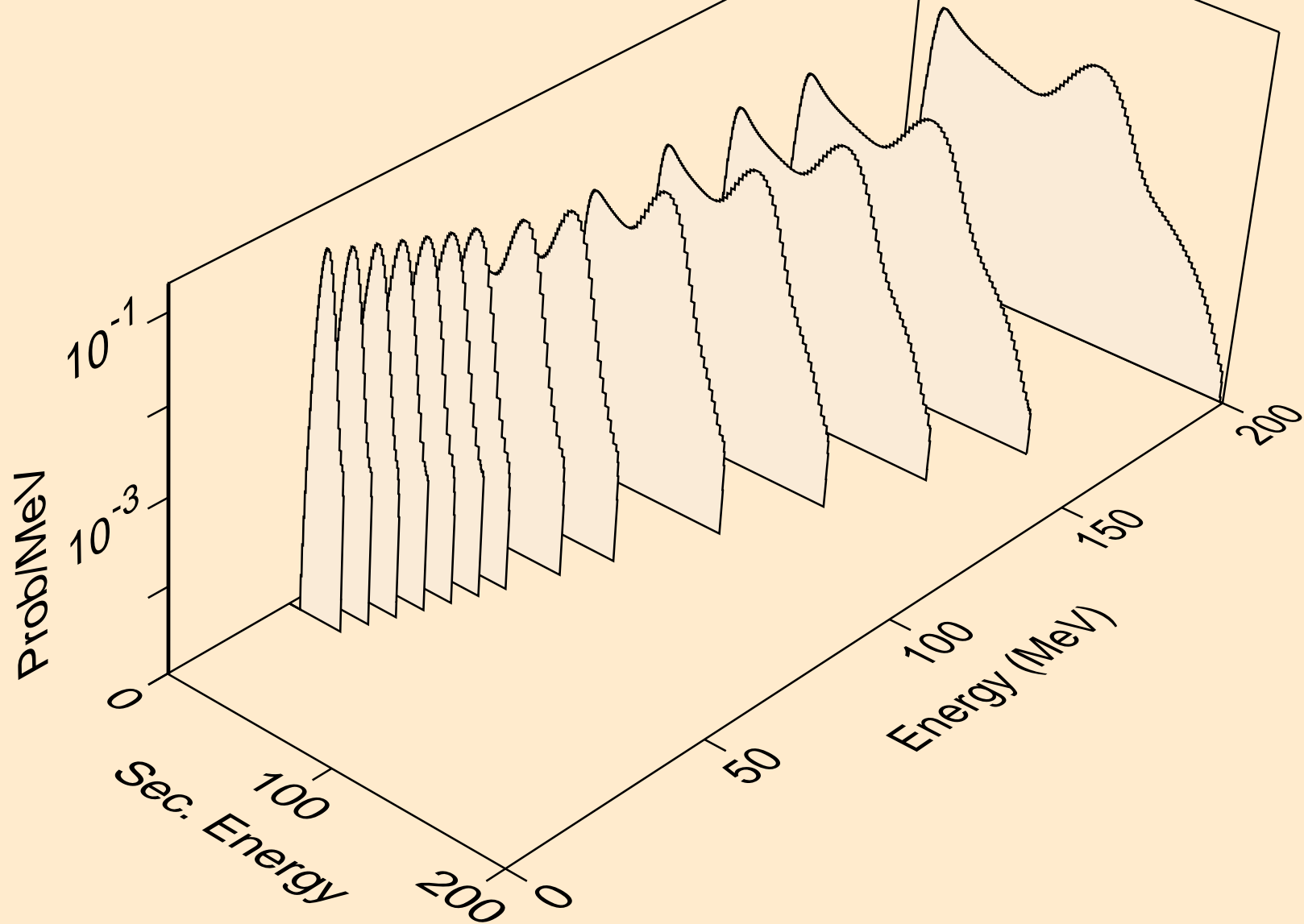

AM249 DEUTERON ACER TENDL-2024 LIBRARY; T=0.K  
protons from (d,n\*)p

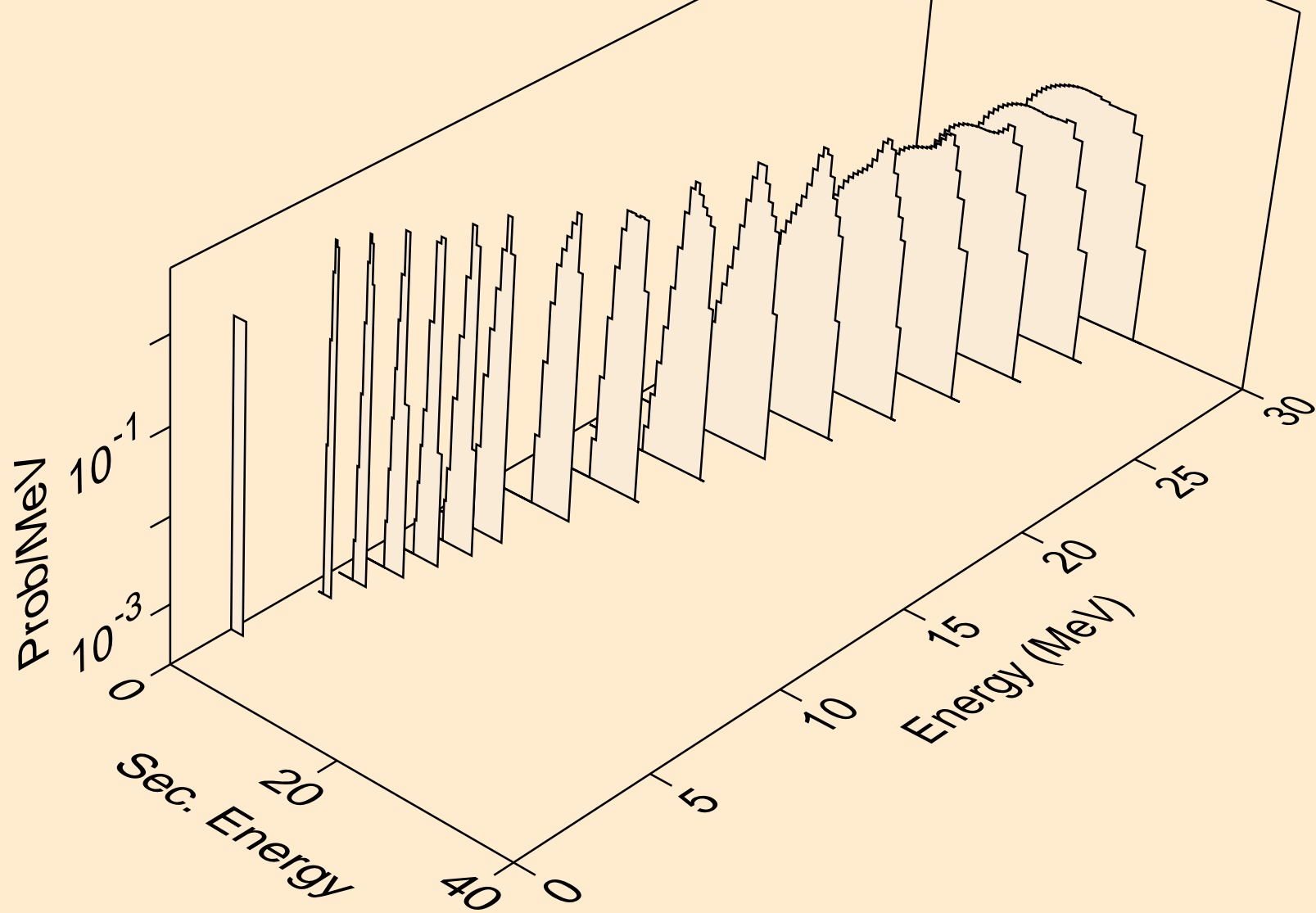

AM249 DEUTERON ACER TENDL-2024 LIBRARY; T=0.K  
protons from (d,2np)

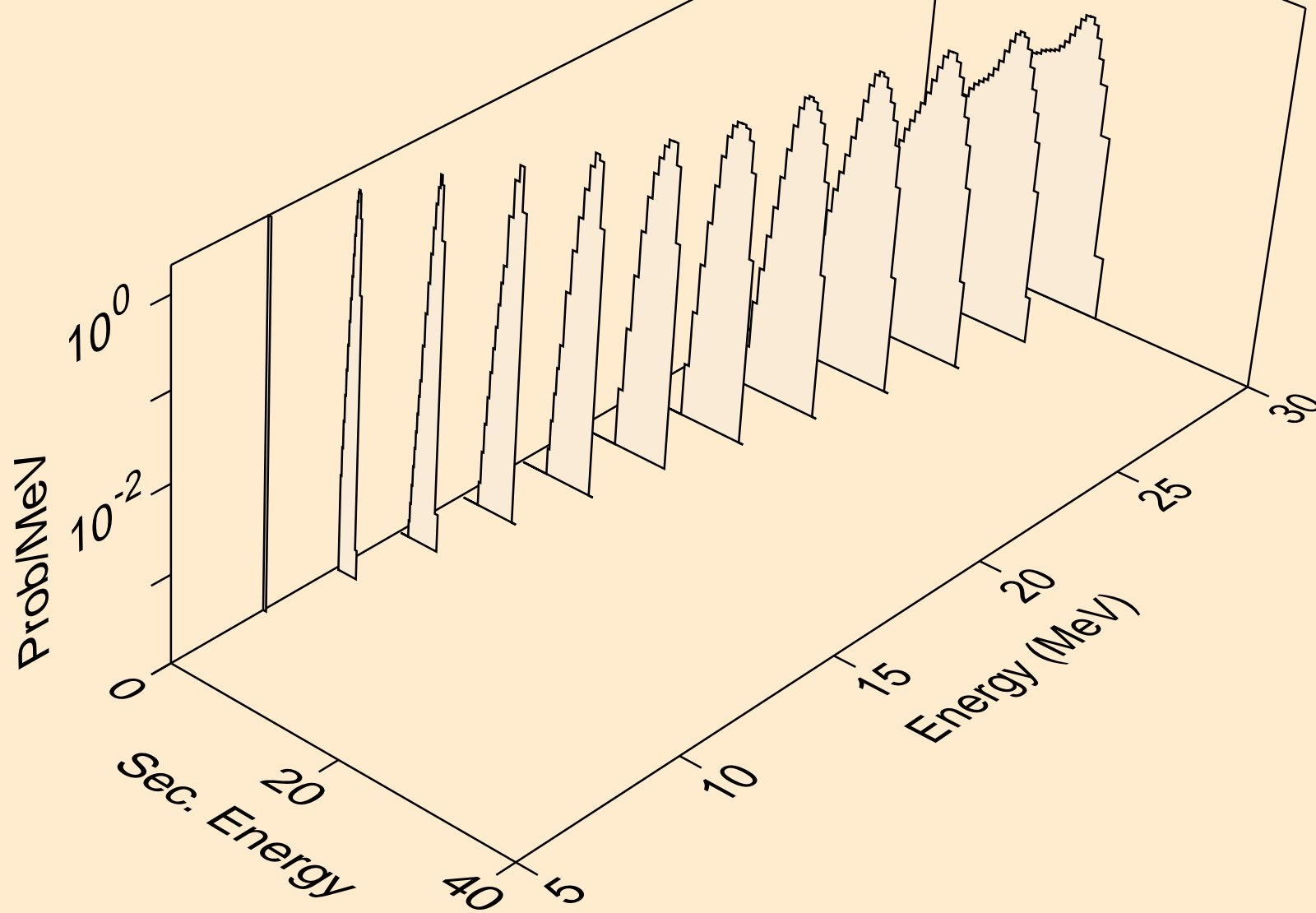

AM249 DEUTERON ACER TENDL-2024 LIBRARY; T=0.K  
protons from (d,3np)

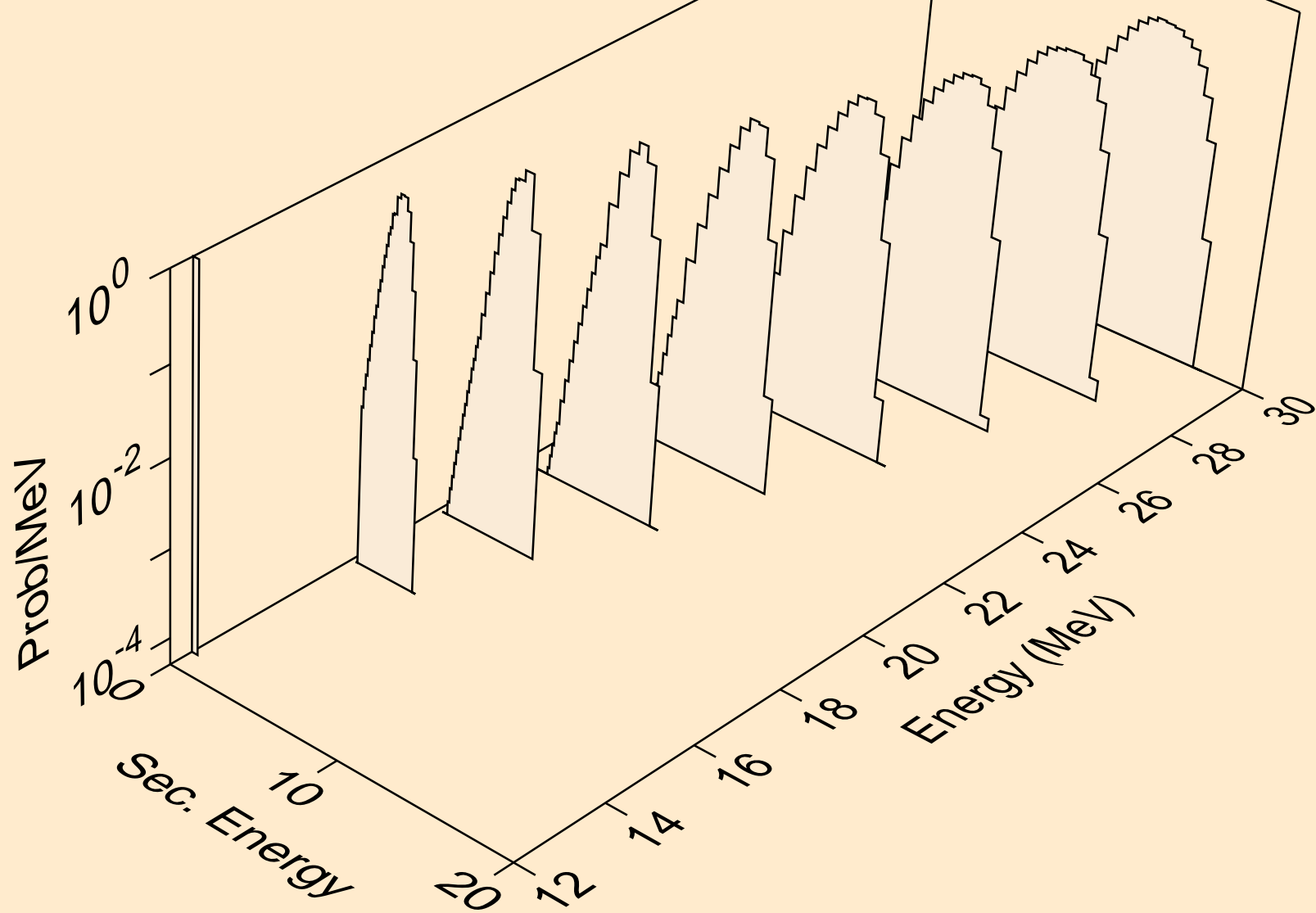

AM249 DEUTERON ACER TENDL-2024 LIBRARY; T=0.K  
protons from (d,n2p)

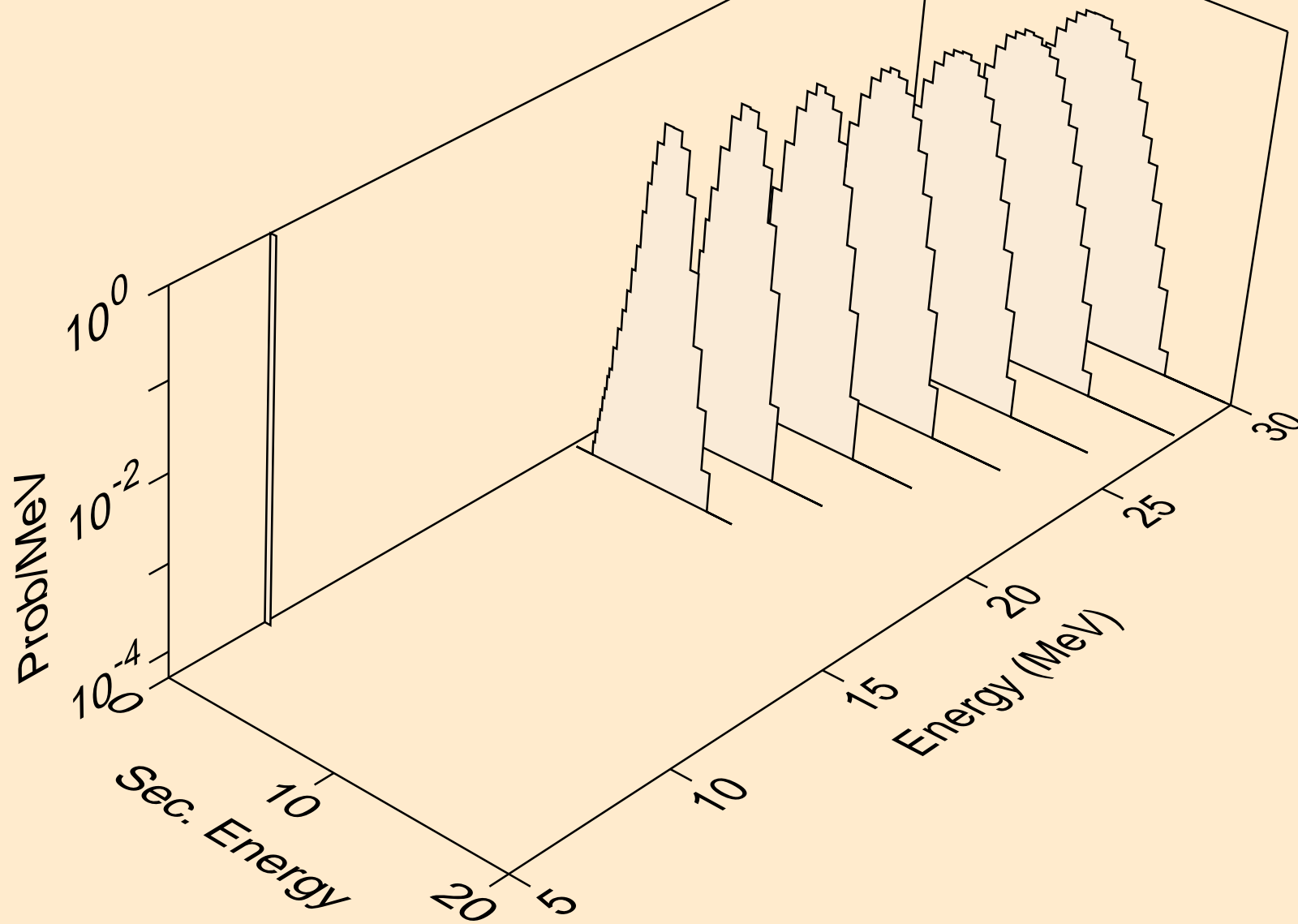

AM249 DEUTERON ACER TENDL-2024 LIBRARY; T=0.K  
protons from (d,p)

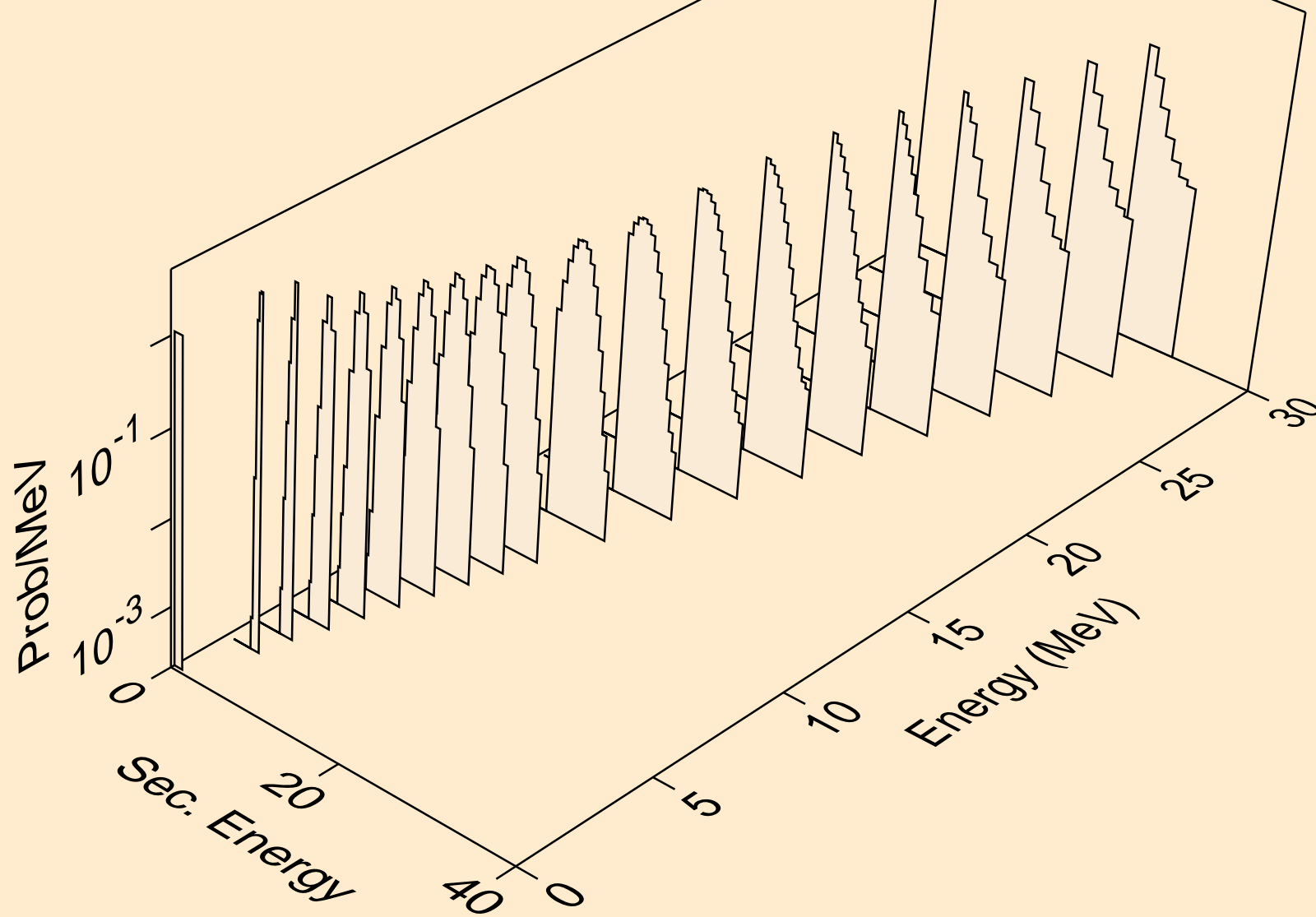

AM249 DEUTERON ACER TENDL-2024 LIBRARY; T=0.K  
protons from (d,2p)

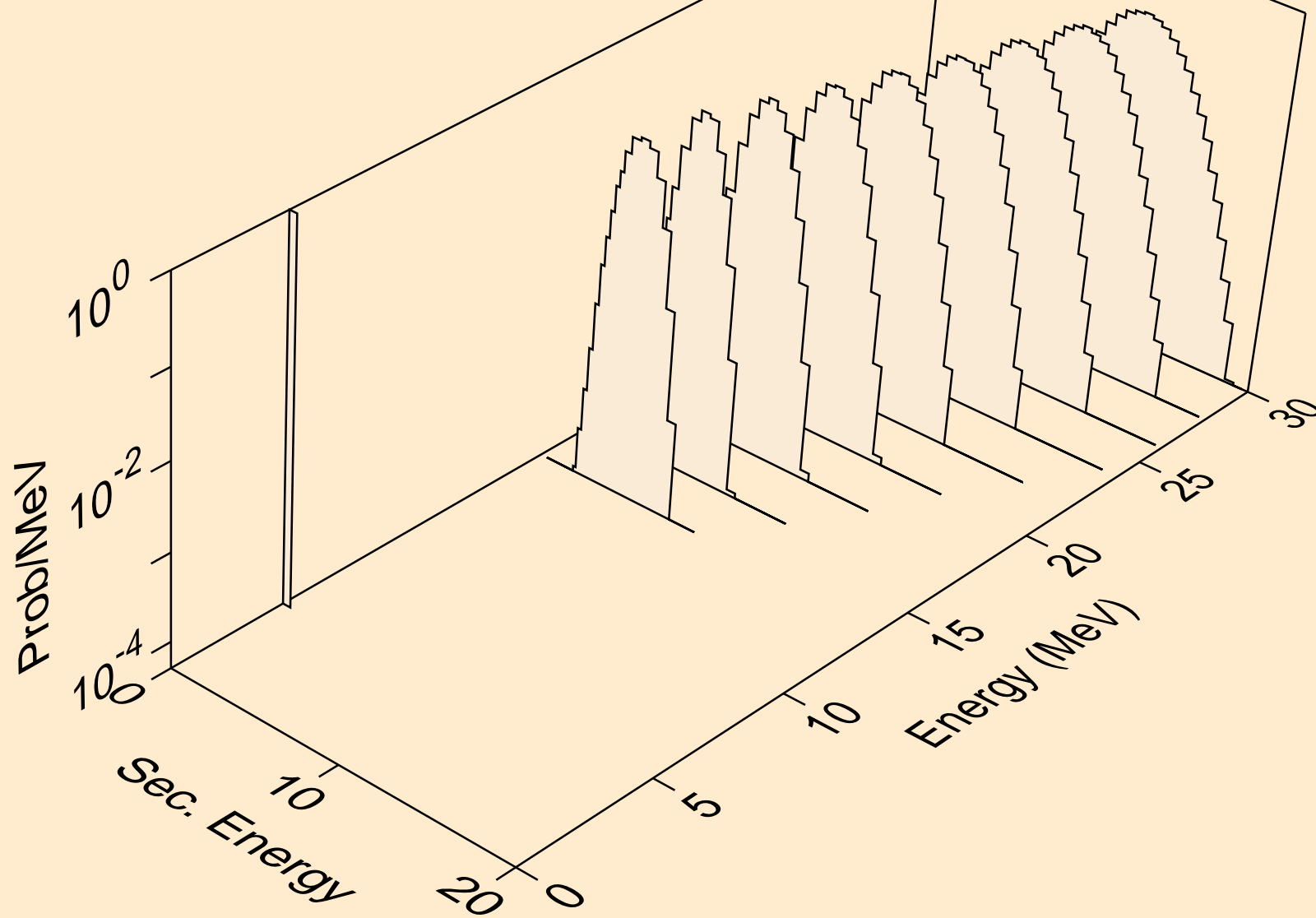

AM249 DEUTERON ACER TENDL-2024 LIBRARY; T=0.K  
protons from (d,pd)

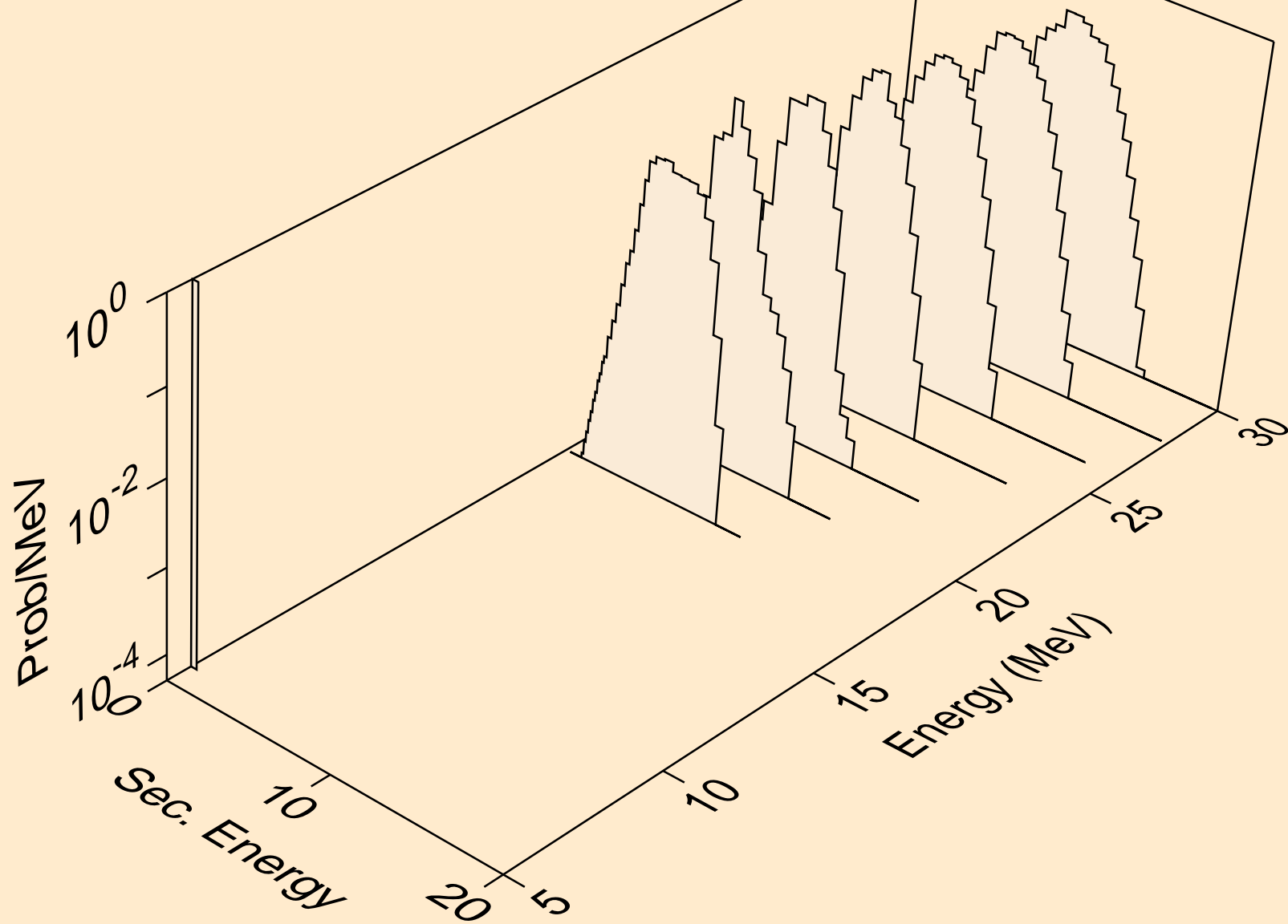

AM249 DEUTERON ACER TENDL-2024 LIBRARY; T=0.K  
tritons from (d,x)

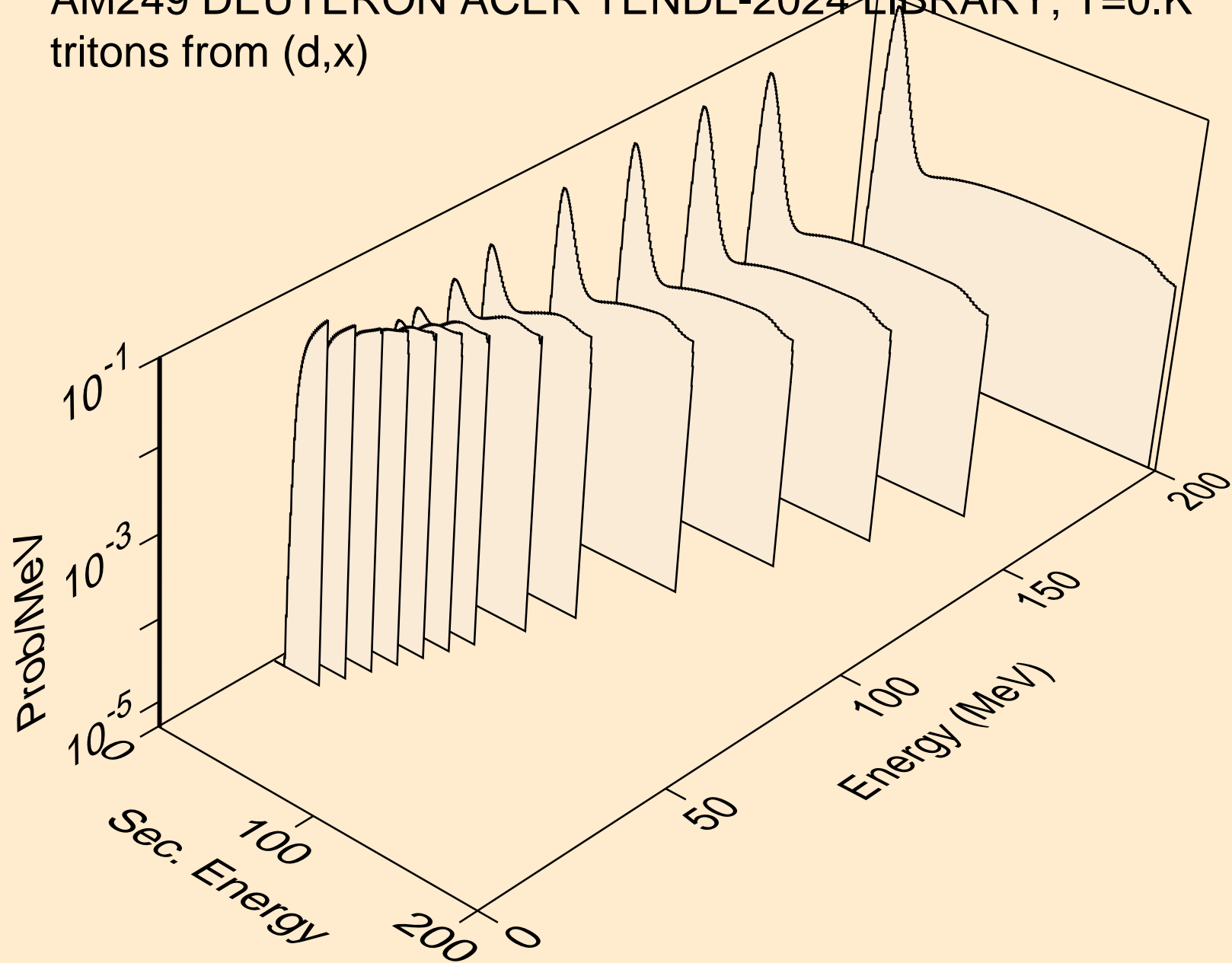

AM249 DEUTERON ACER TENDL-2024 LIBRARY; T=0.K  
tritons from (d,n\*)t

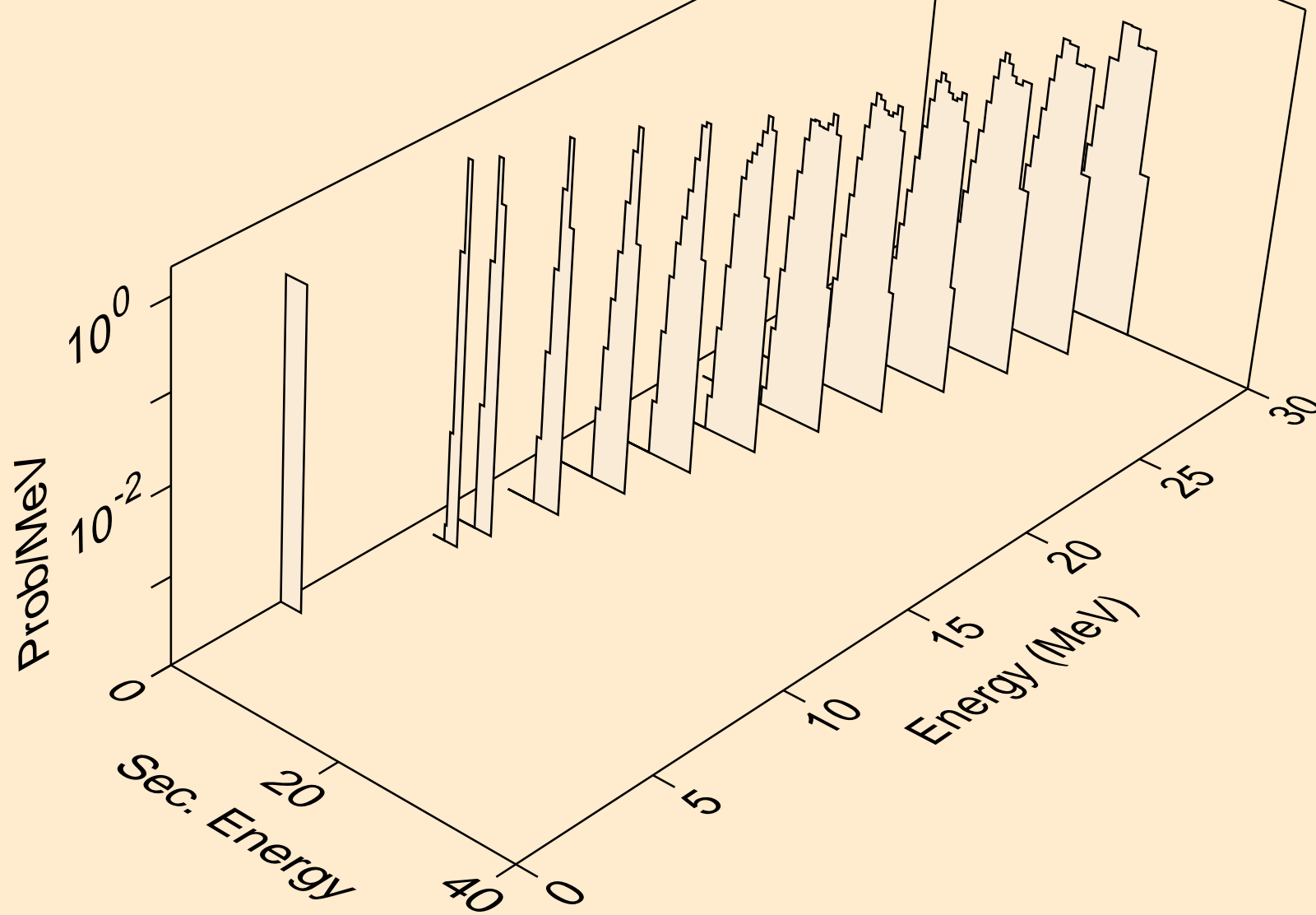

AM249 DEUTERON ACER TENDL-2024 LIBRARY; T=0.K  
tritons from (d,t)

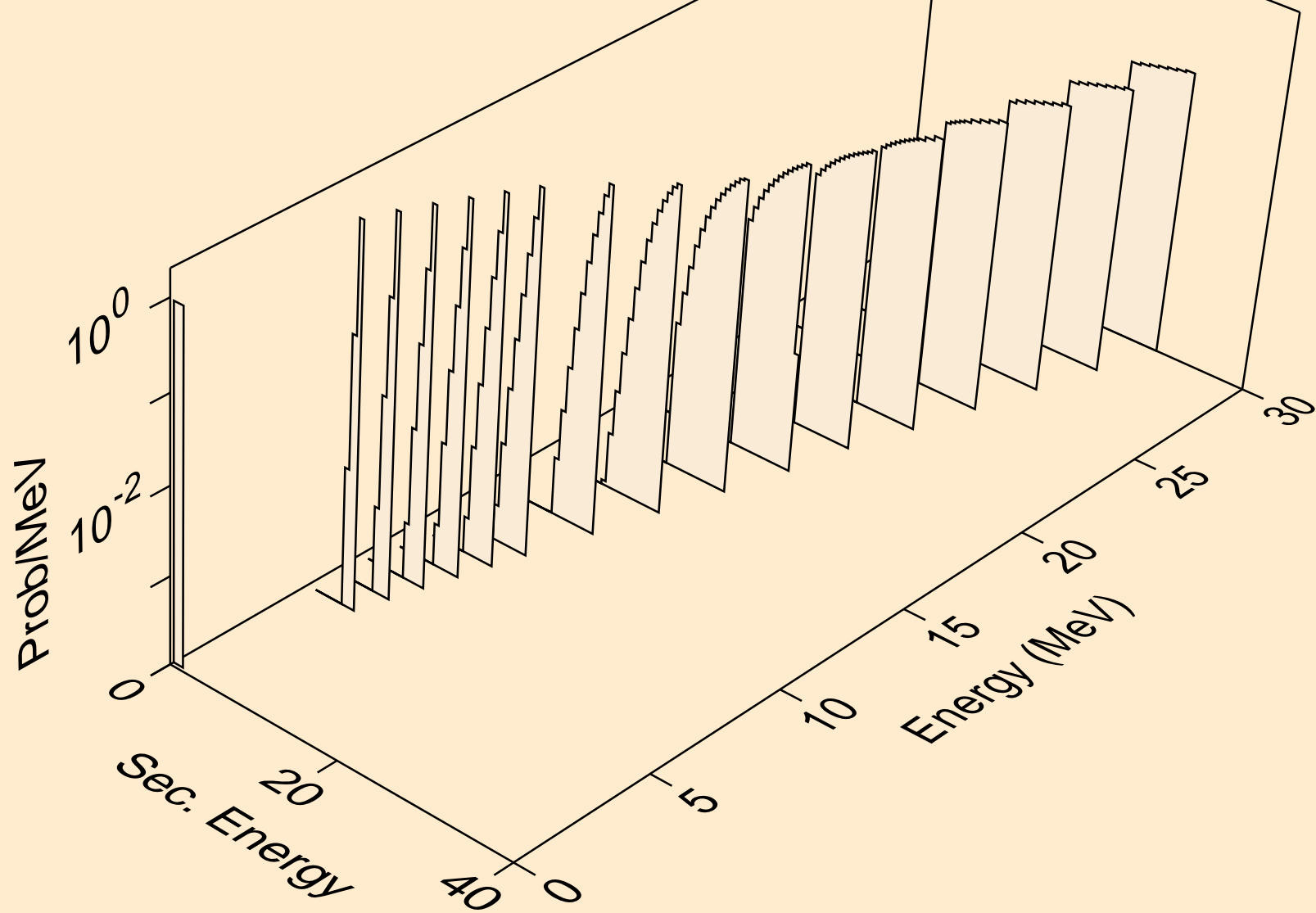

AM249 DEUTERON ACER TENDL-2024 LIBRARY; T=0.K  
he3s from (d,x)

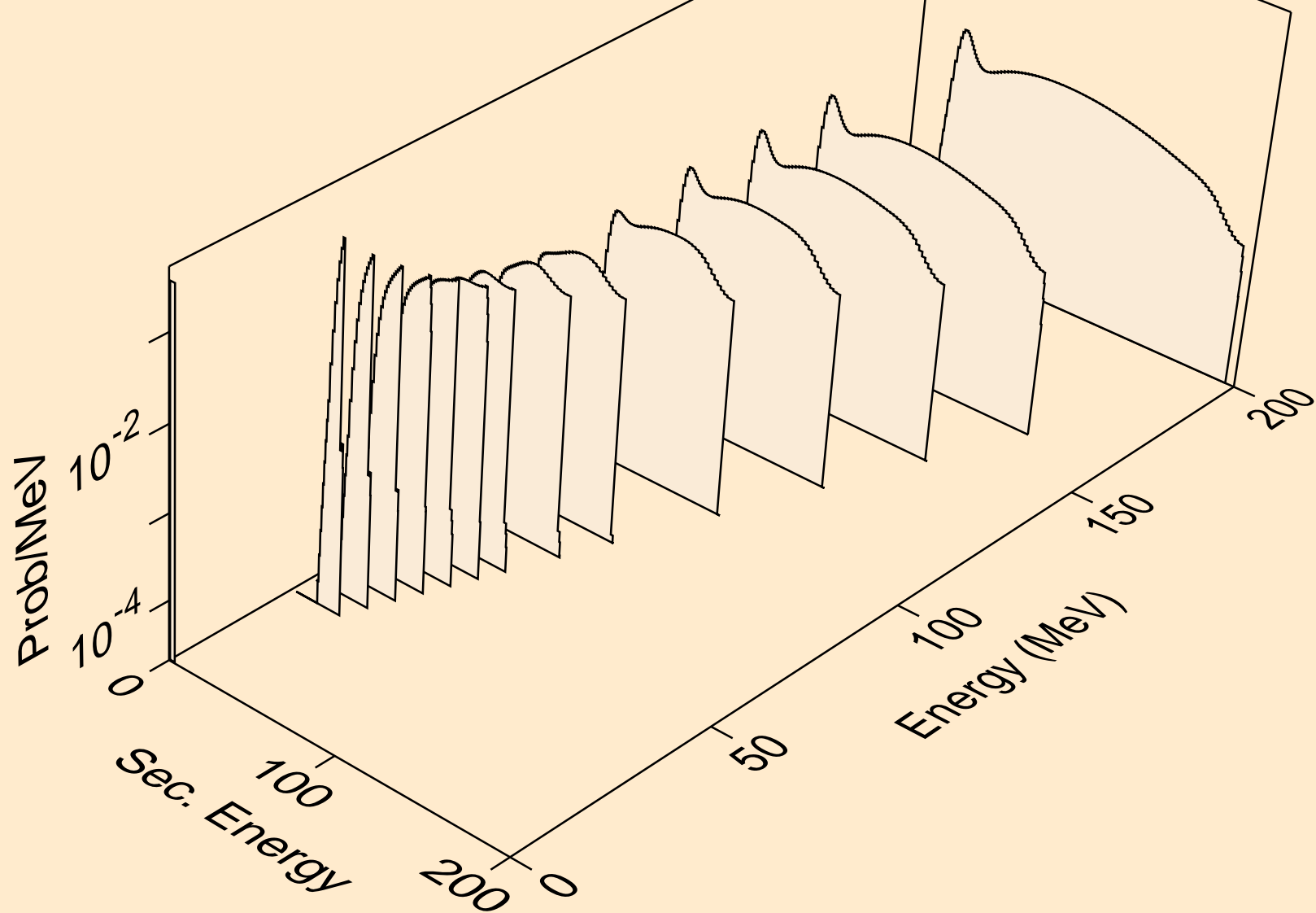

AM249 DEUTERON ACER TENDL-2024 LIBRARY; T=0.K  
he3s from (d,n\*)he3

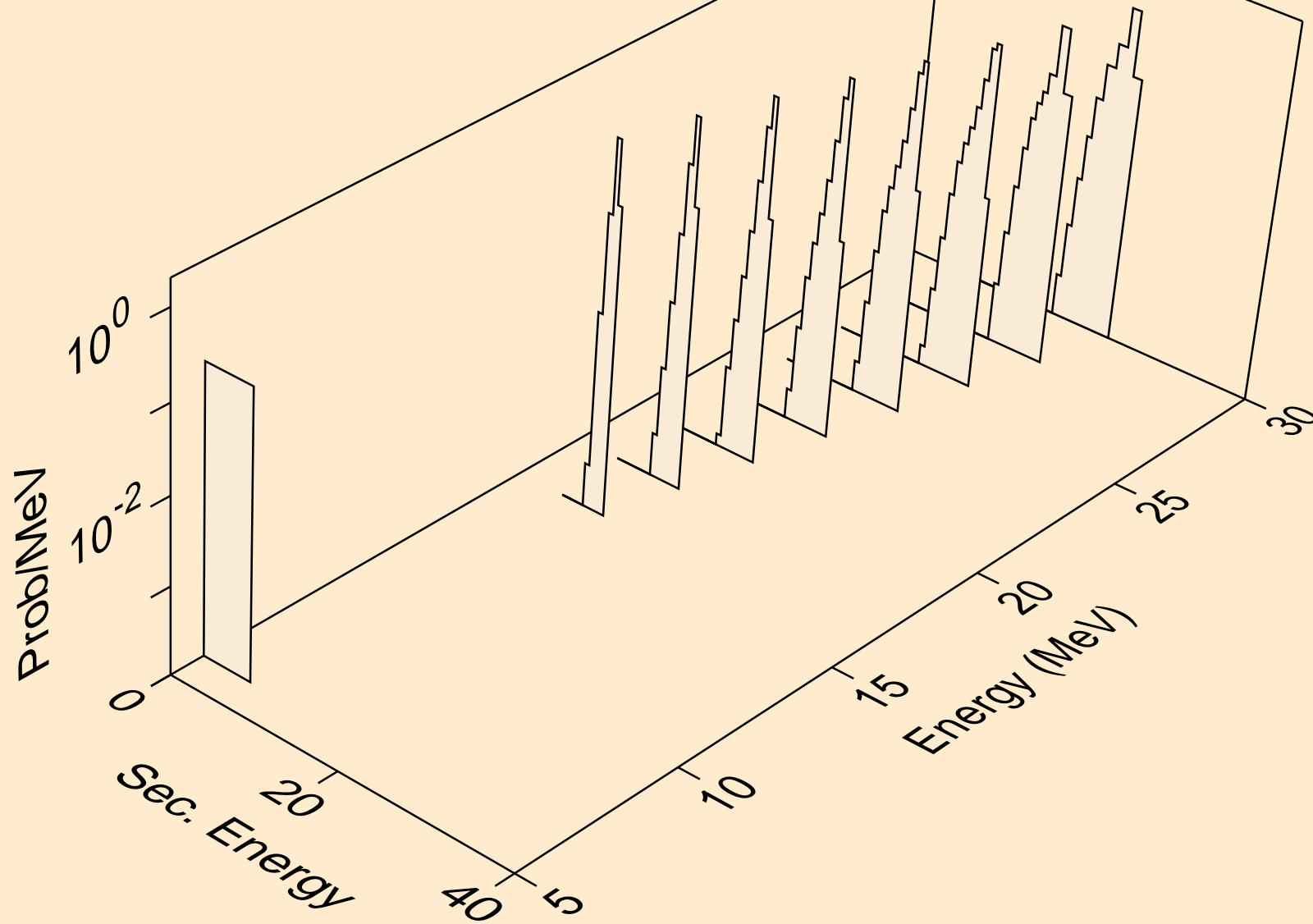

AM249 DEUTERON ACER TENDL-2024 LIBRARY; T=0.K  
he3s from (d,he3)

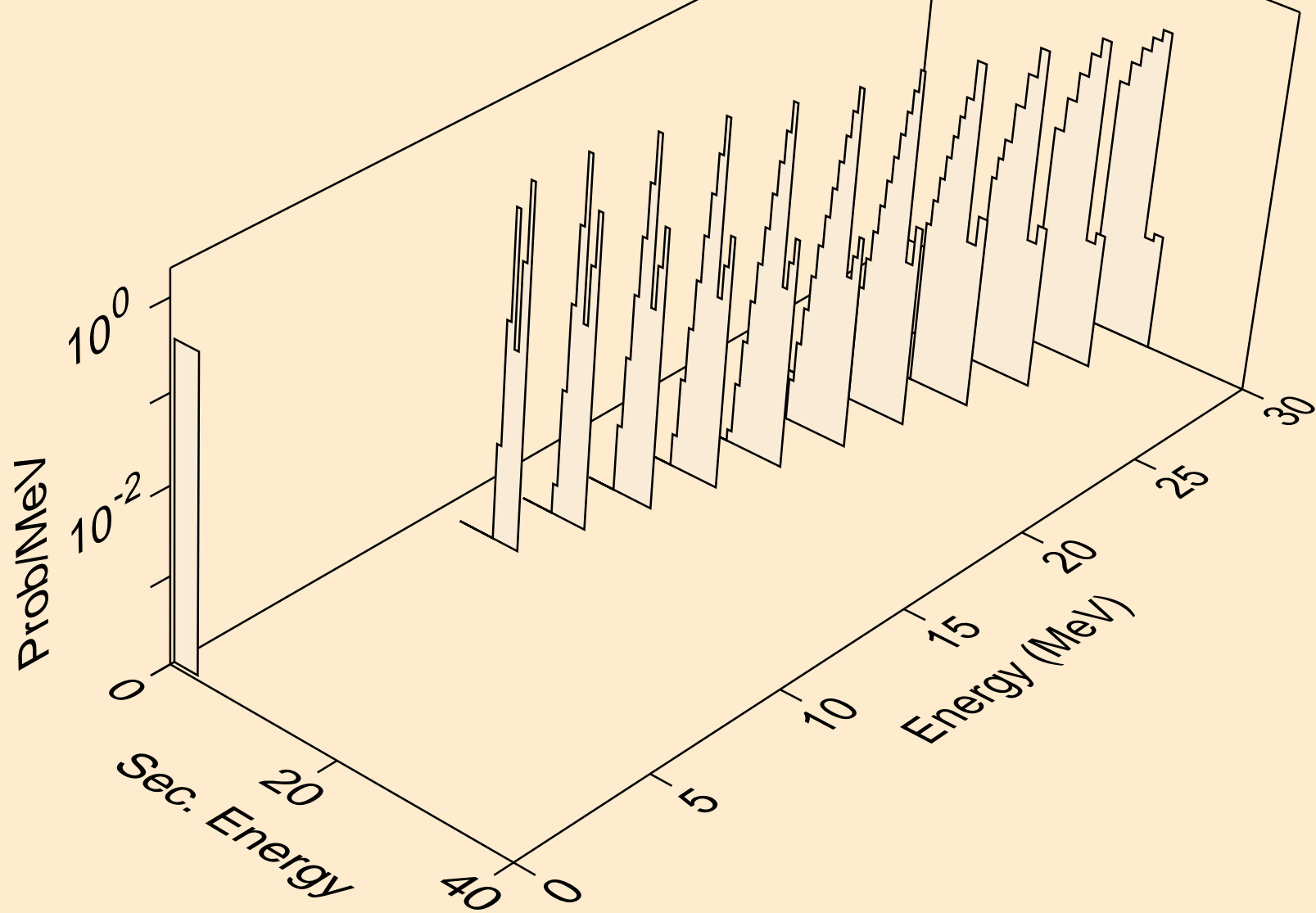

AM249 DEUTERON ACER TENDL-2024 LIBRARY; T=0.K  
alphas from (d,x)

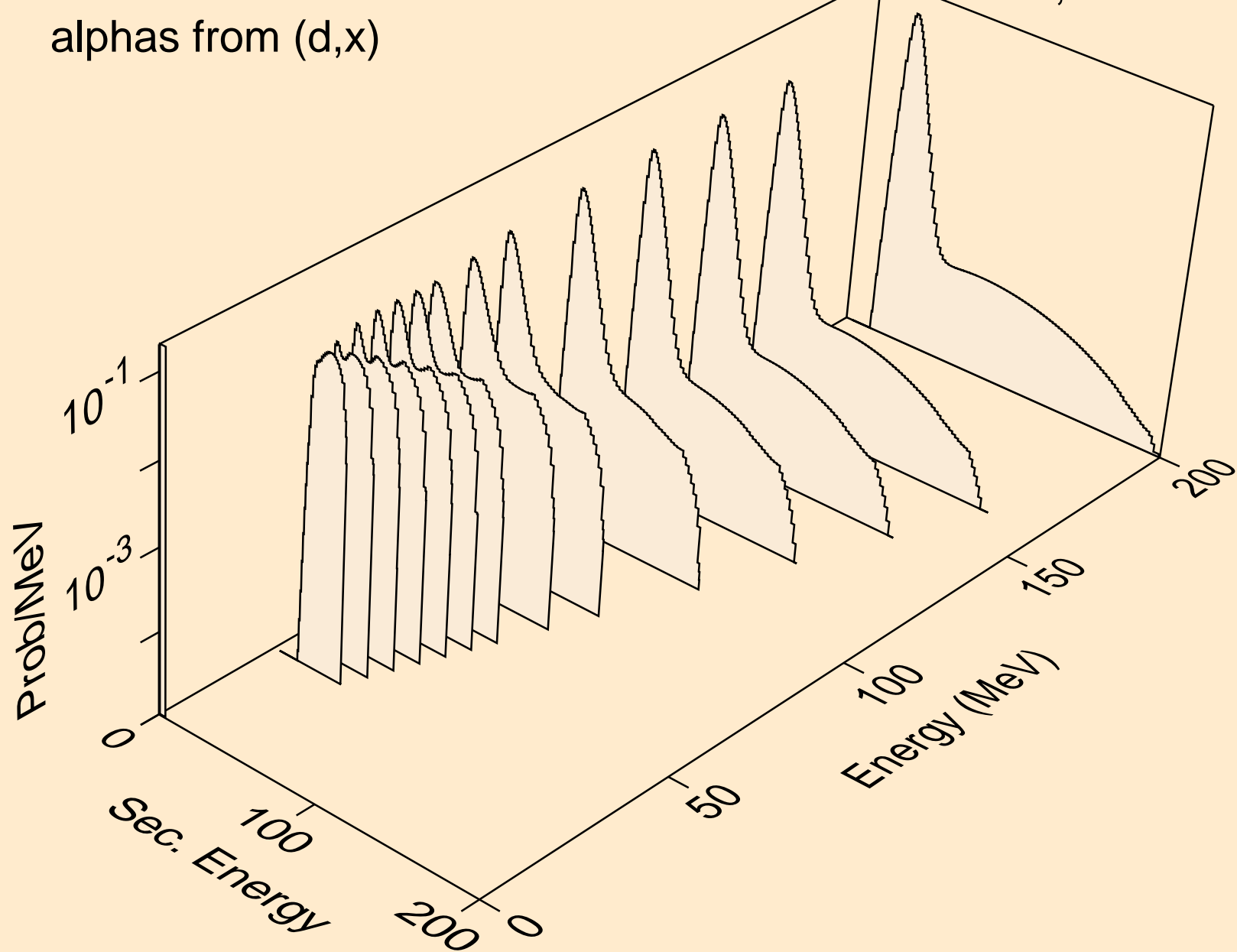

AM249 DEUTERON ACER TENDL-2024 LIBRARY; T=0.K  
alphas from (d,n\*)a

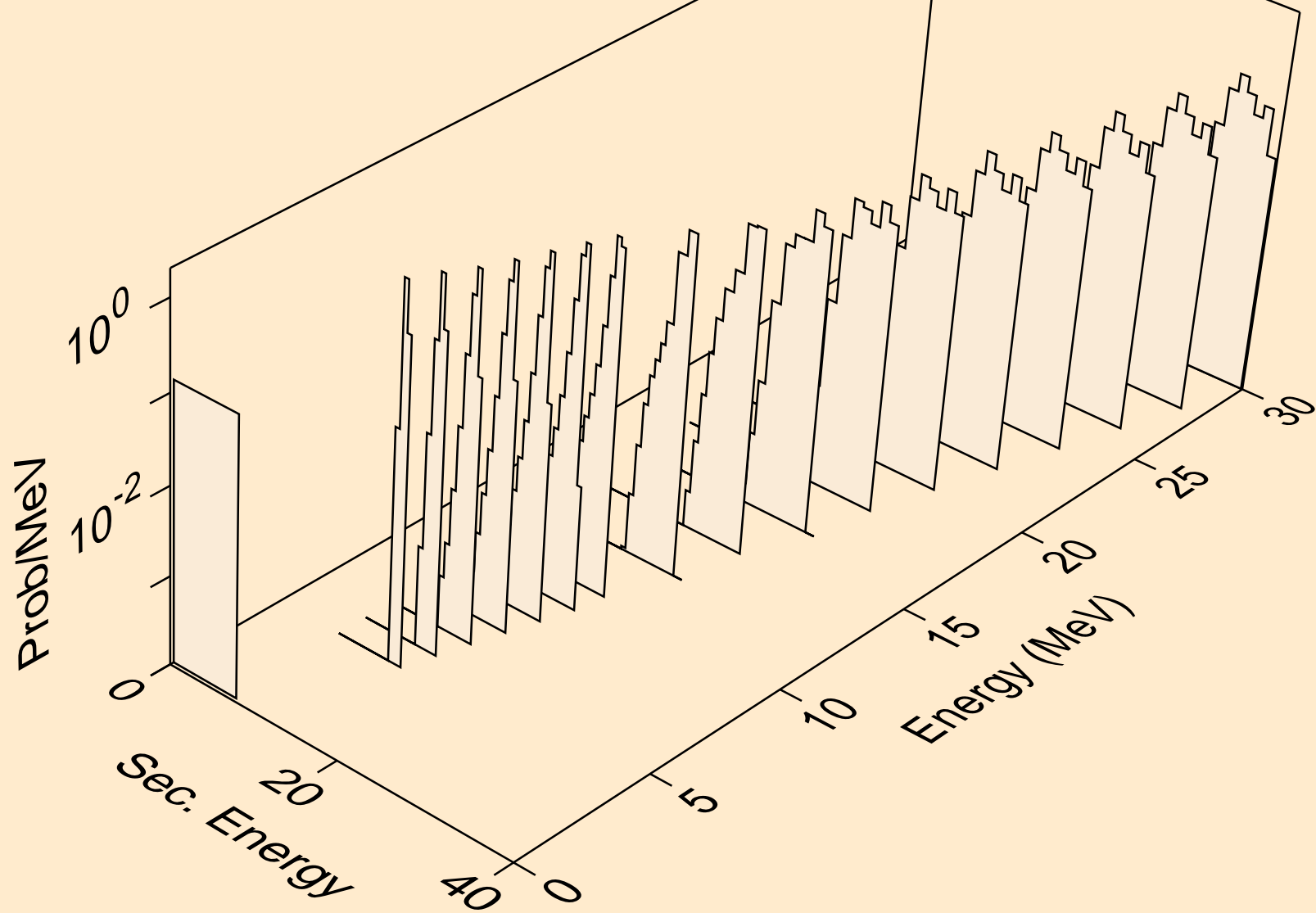

AM249 DEUTERON ACER TENDL-2024 LIBRARY; T=0.K  
alphas from (d,2n)a

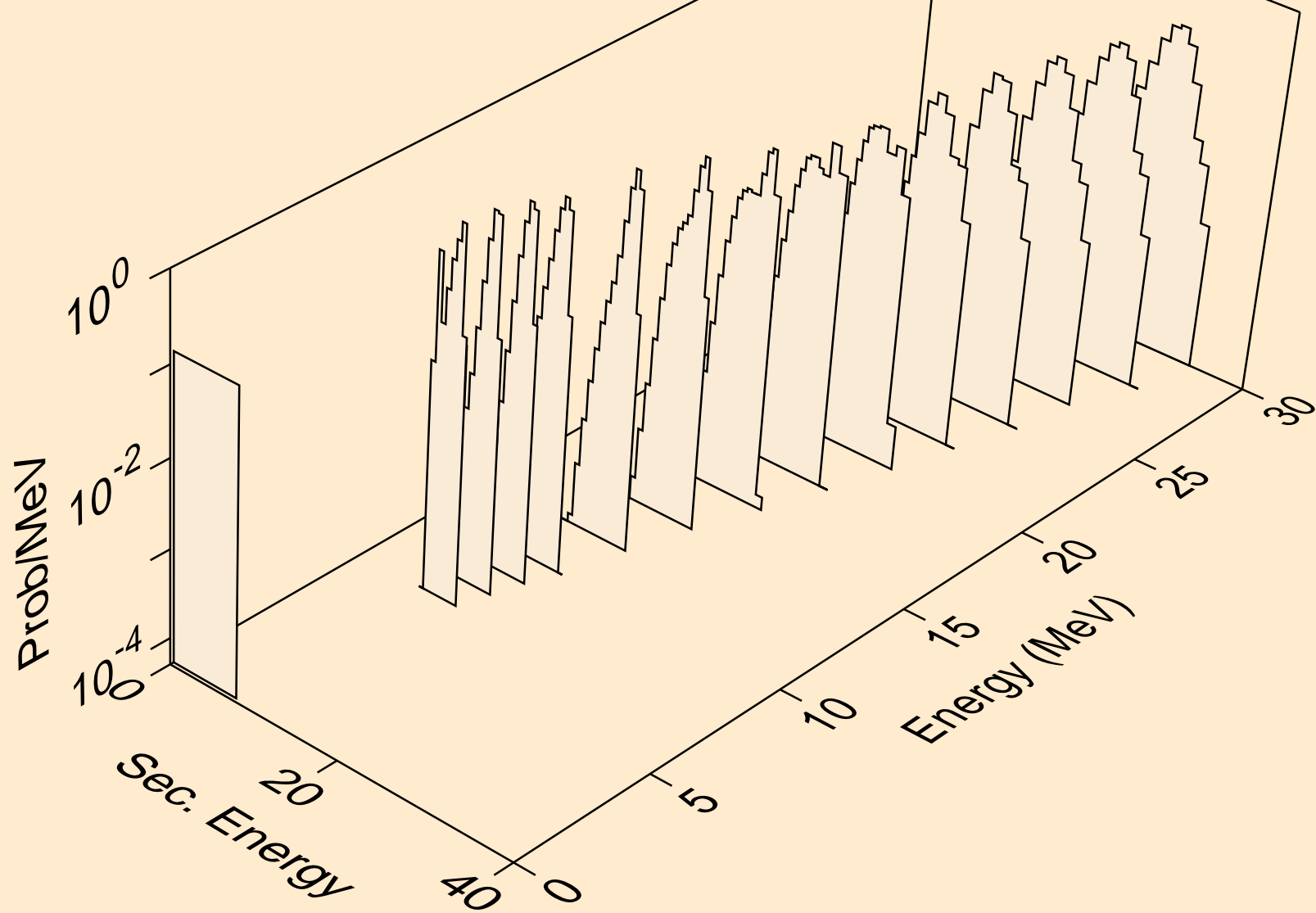

AM249 DEUTERON ACER TENDL-2024 LIBRARY; T=0.K  
alphas from (d,3n)a

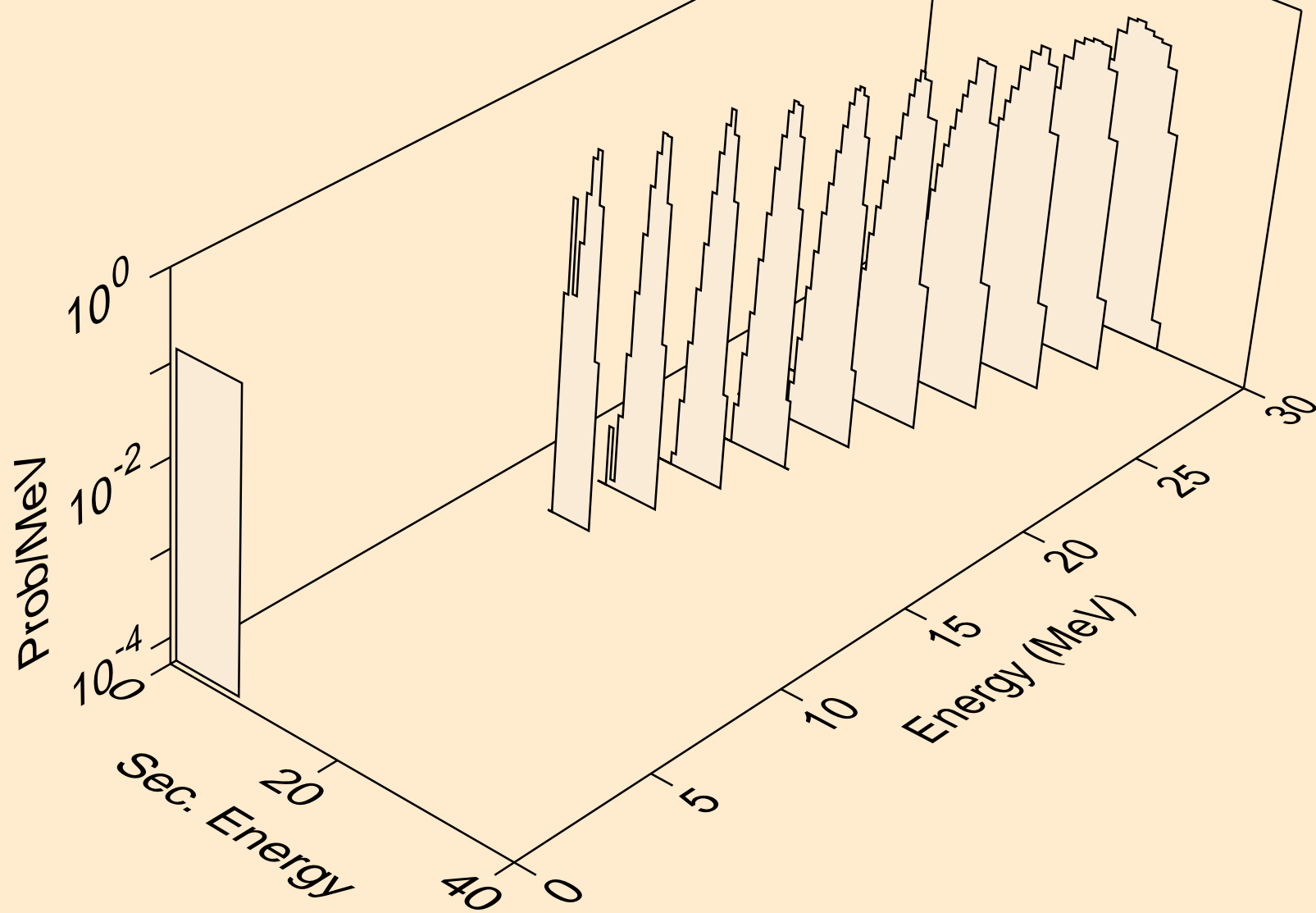

AM249 DEUTERON ACER TENDL-2024 LIBRARY; T=0.K  
alphas from (d,a)

