

BI223 DEUTERON ACER TENDL-2024 LIBRARY; T=0.K

Principal cross sections

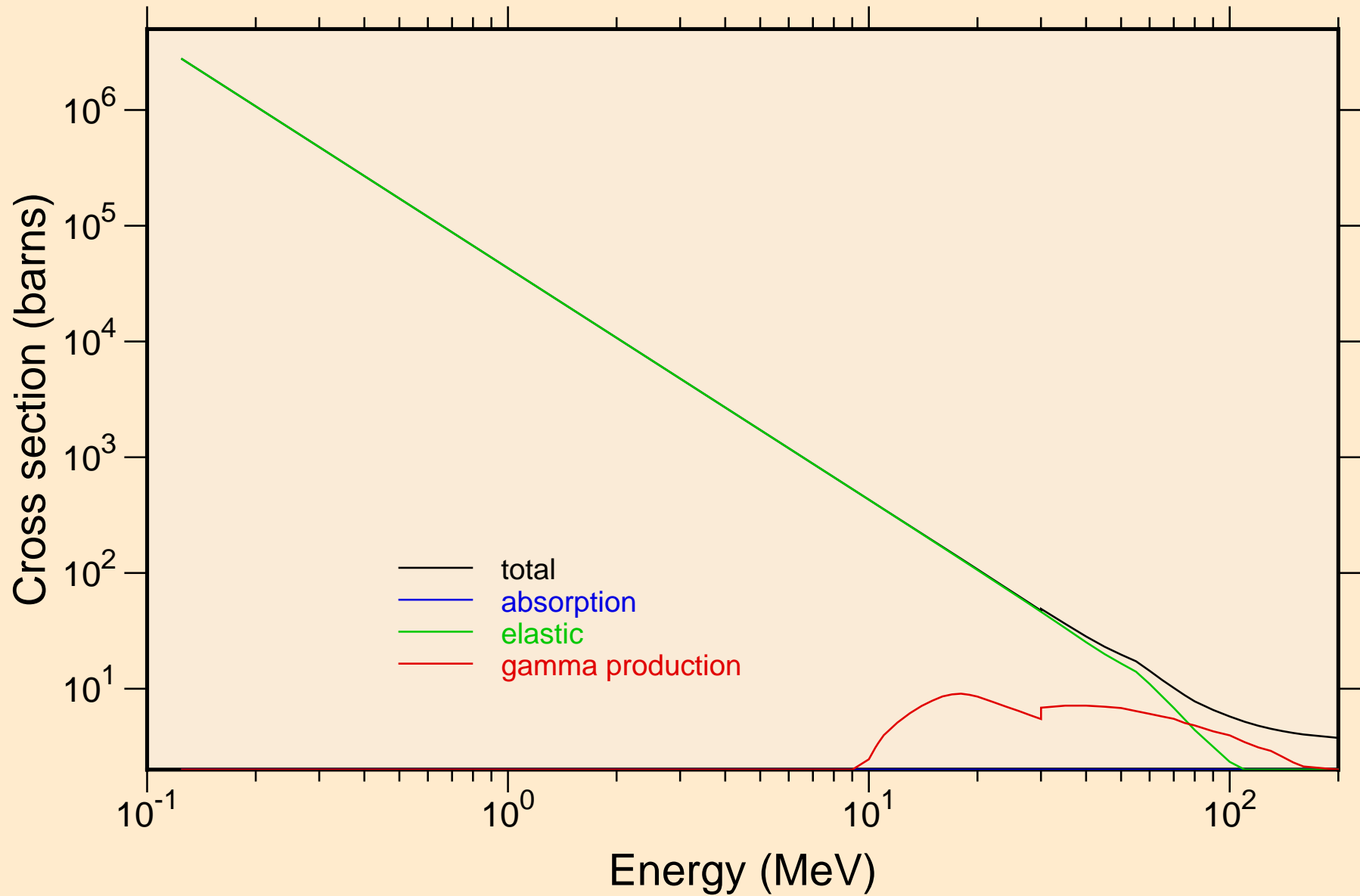

BI223 DEUTERON ACER TENDL-2024 LIBRARY; T=0.K

Heating

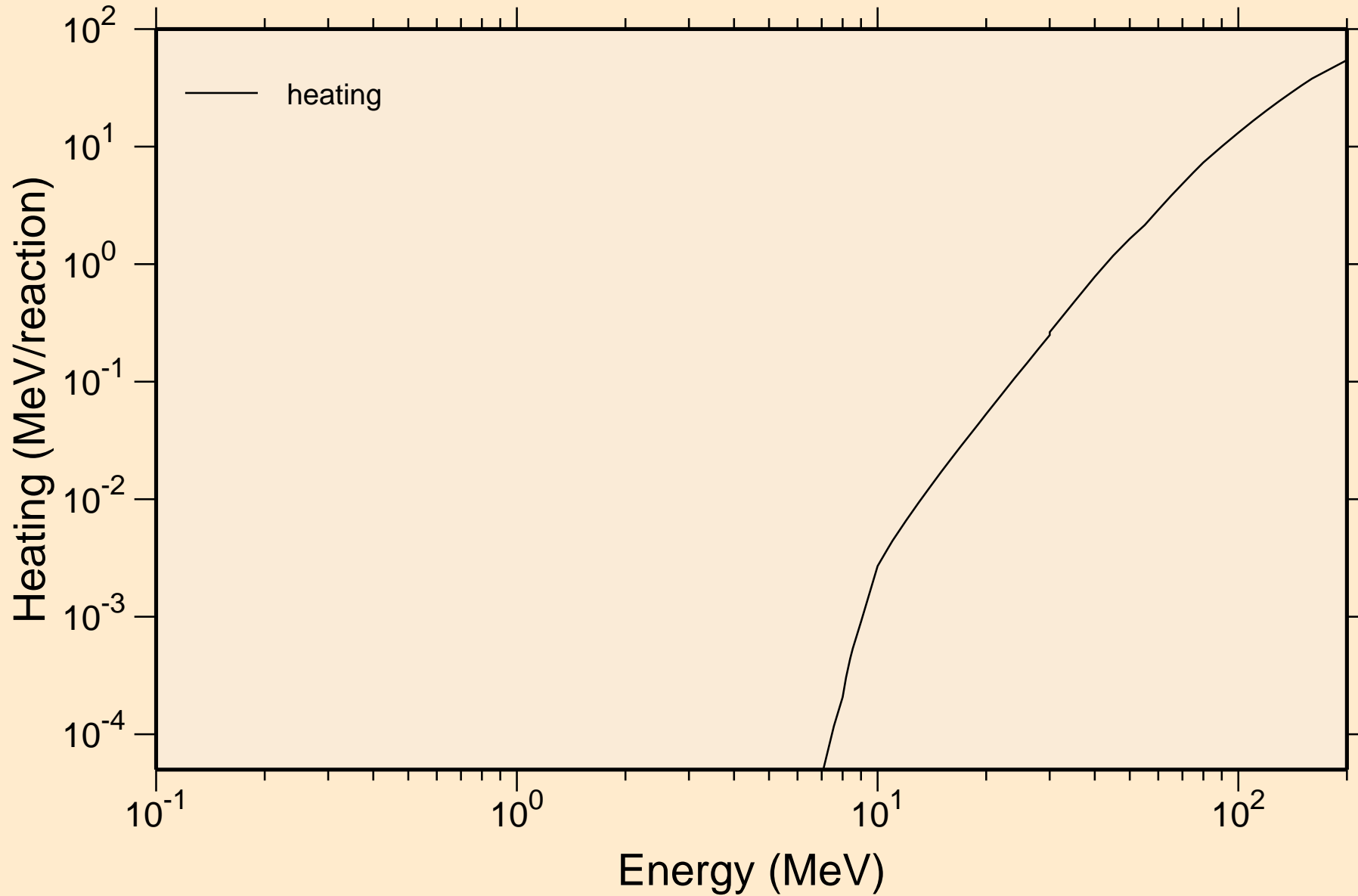

BI223 DEUTERON ACER TENDL-2024 LIBRARY; T=0.K
Principal cross sections

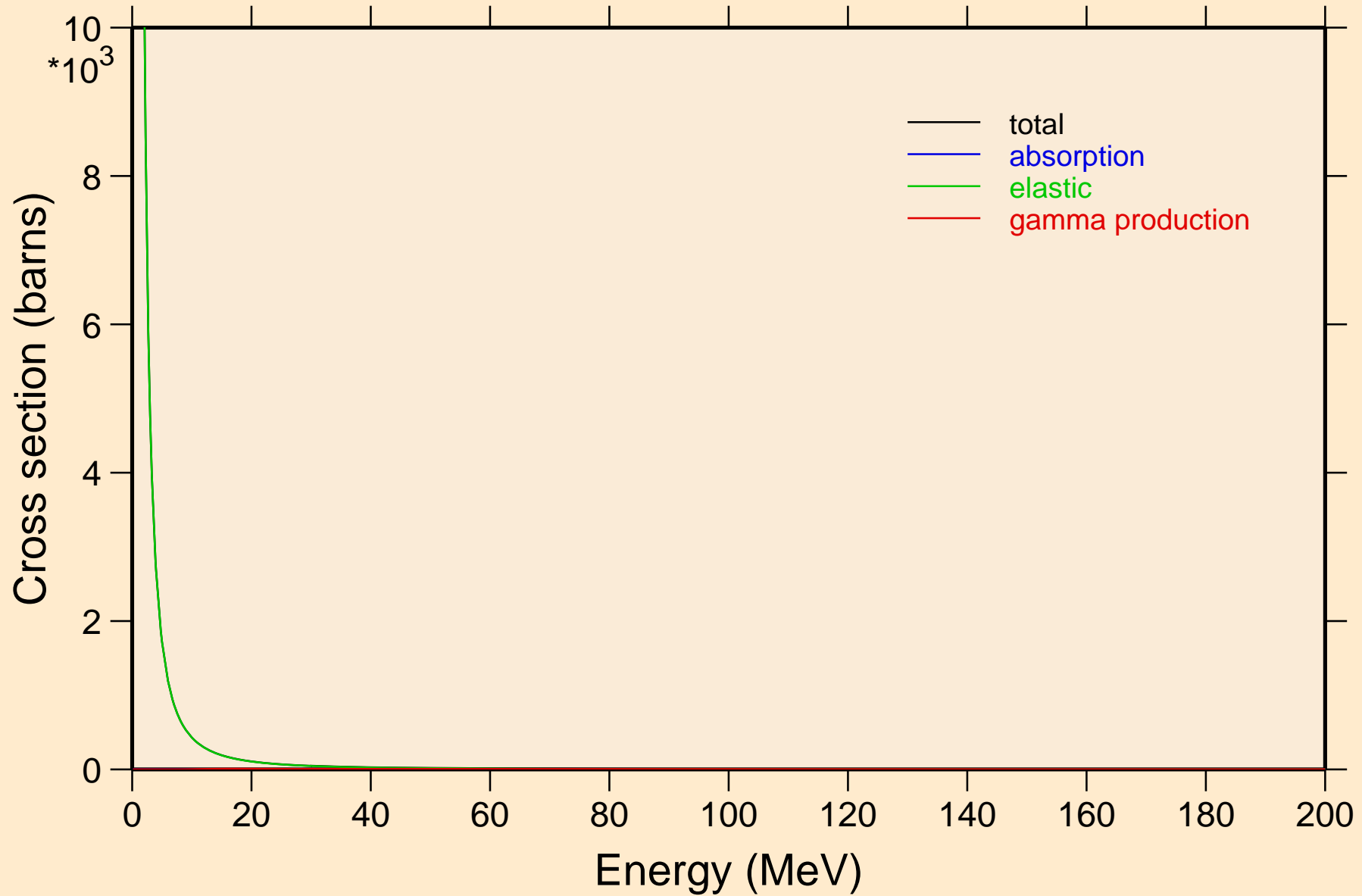

BI223 DEUTERON ACER TENDL-2024 LIBRARY; T=0.K

Heating

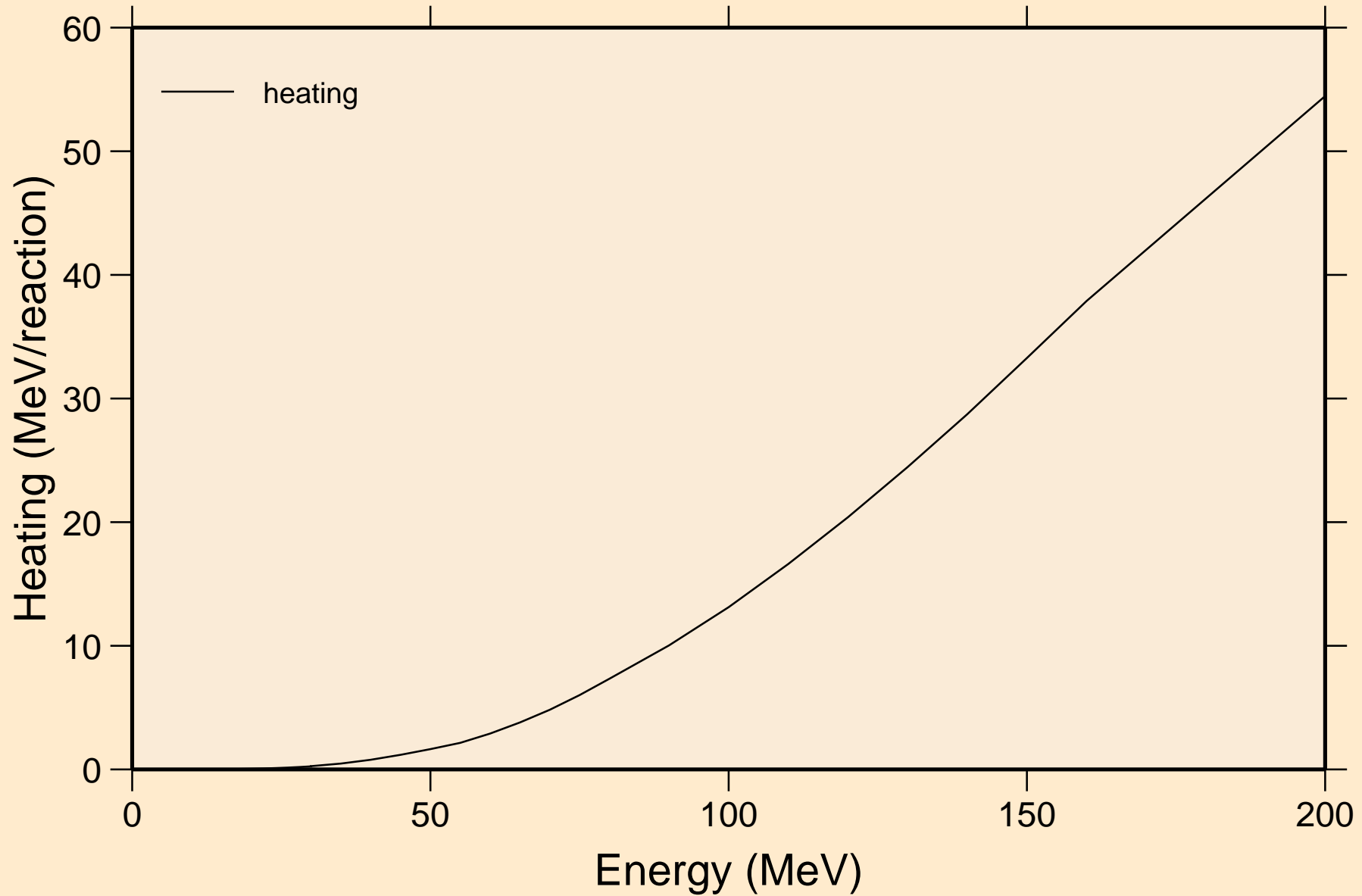

BI223 DEUTERON ACER TENDL-2024 LIBRARY; T=0.K

Threshold reactions

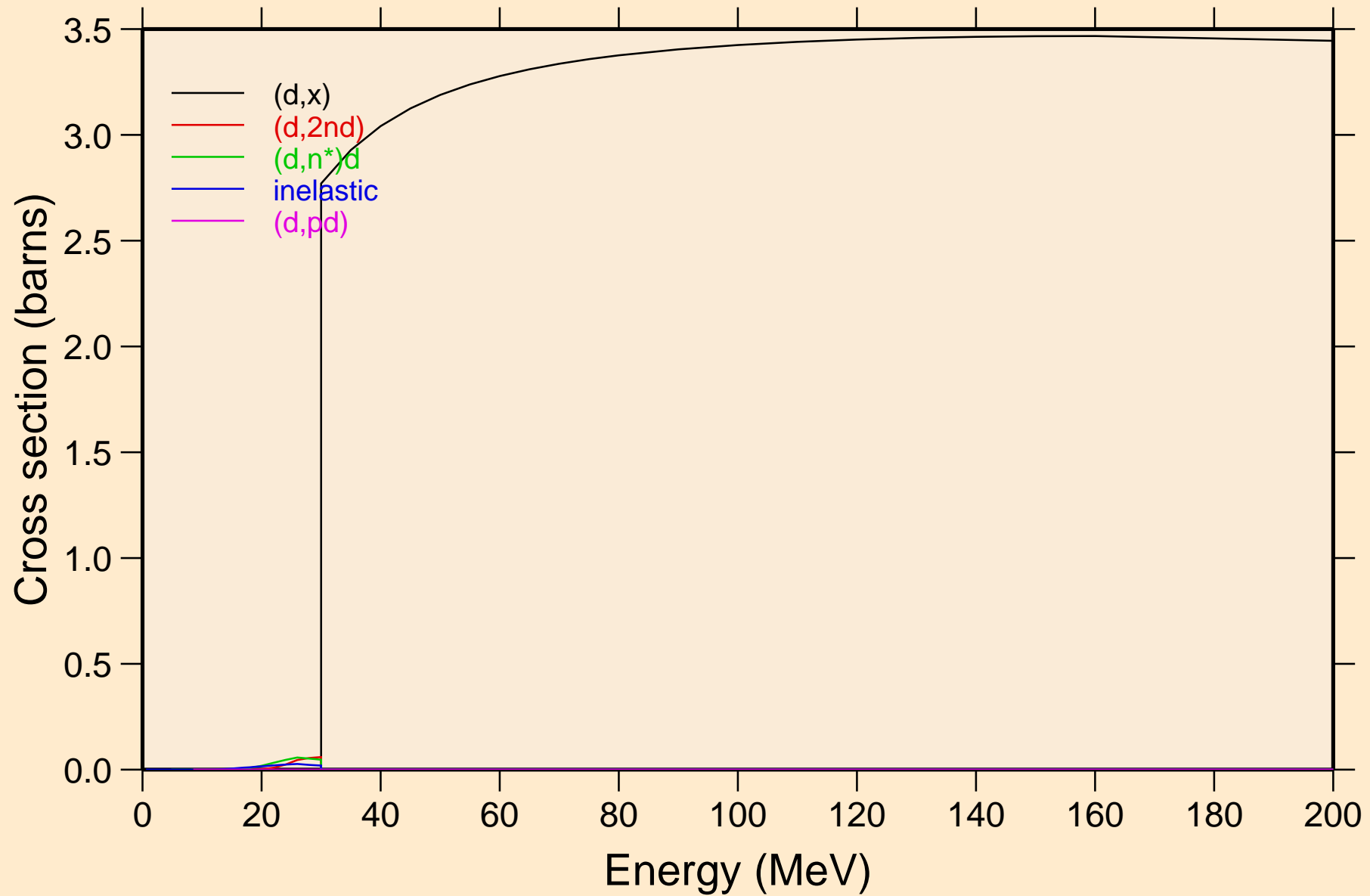

BI223 DEUTERON ACER TENDL-2024 LIBRARY; T=0.K
angular distribution for elastic

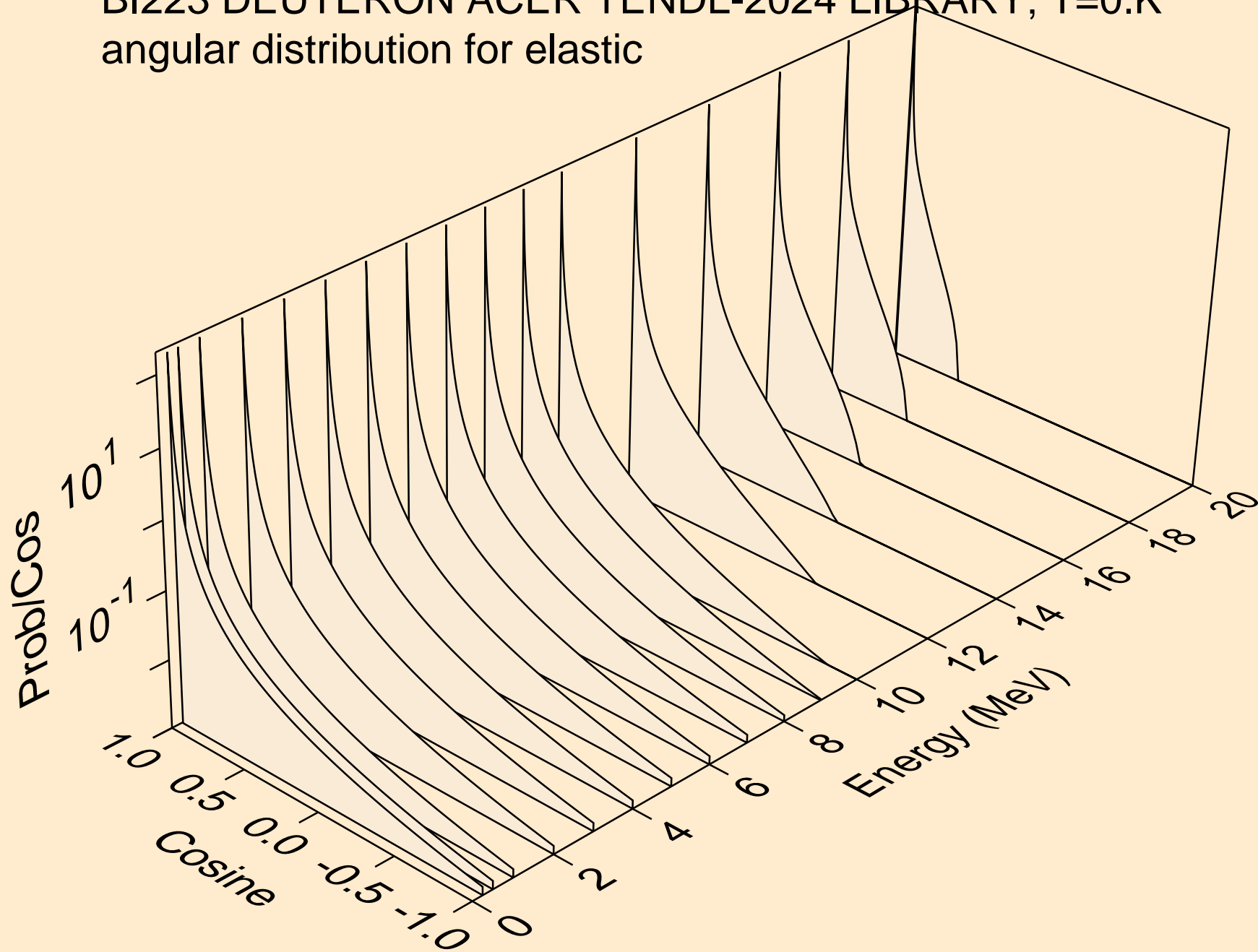

BI223 DEUTERON ACER TENDL-2024 LIBRARY; T=0.K
angular distribution for elastic

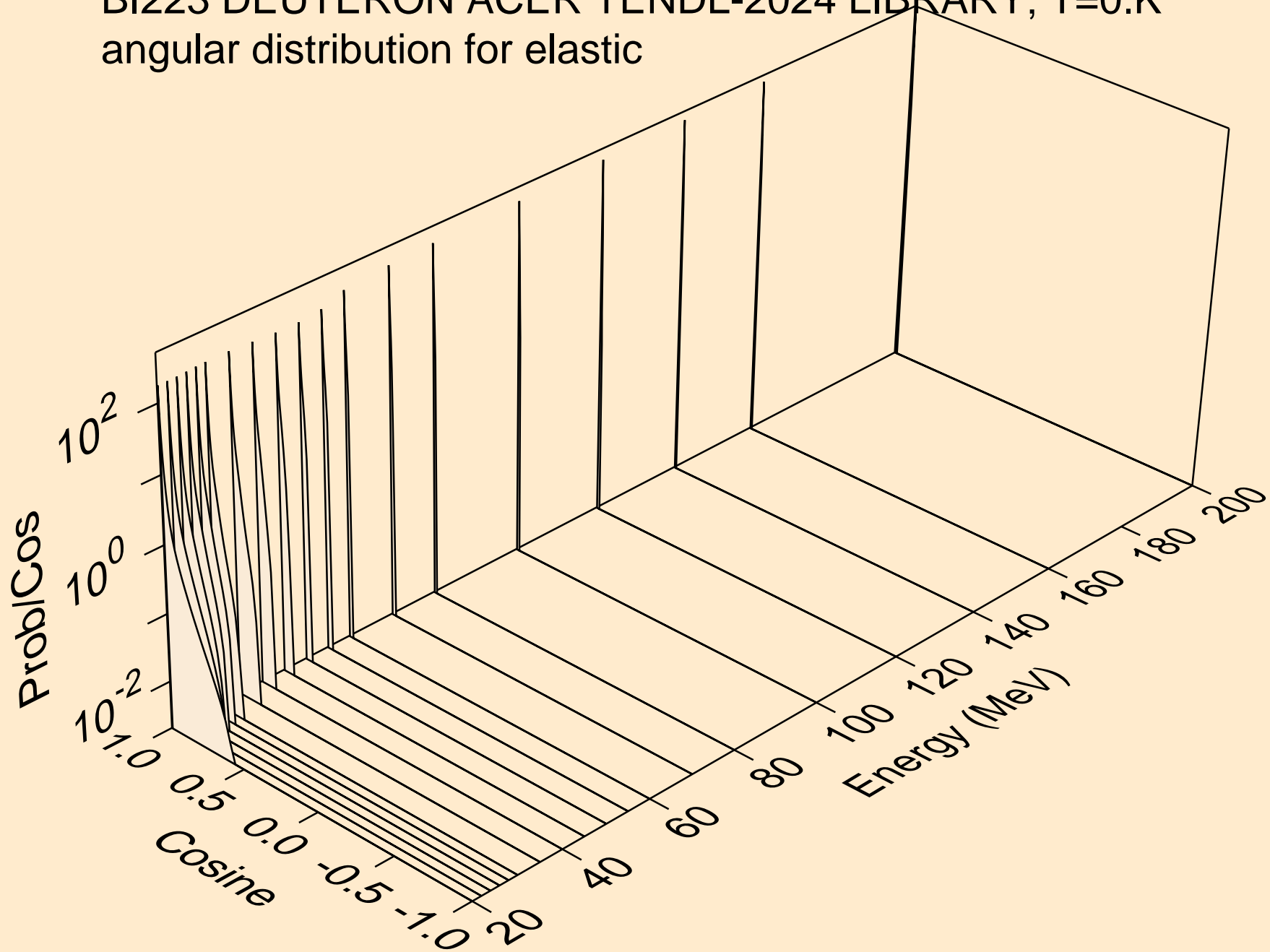

BI223 DEUTERON ACER TENDL-2024 LIBRARY; T=0.K
Deuteron emission for (d,x)

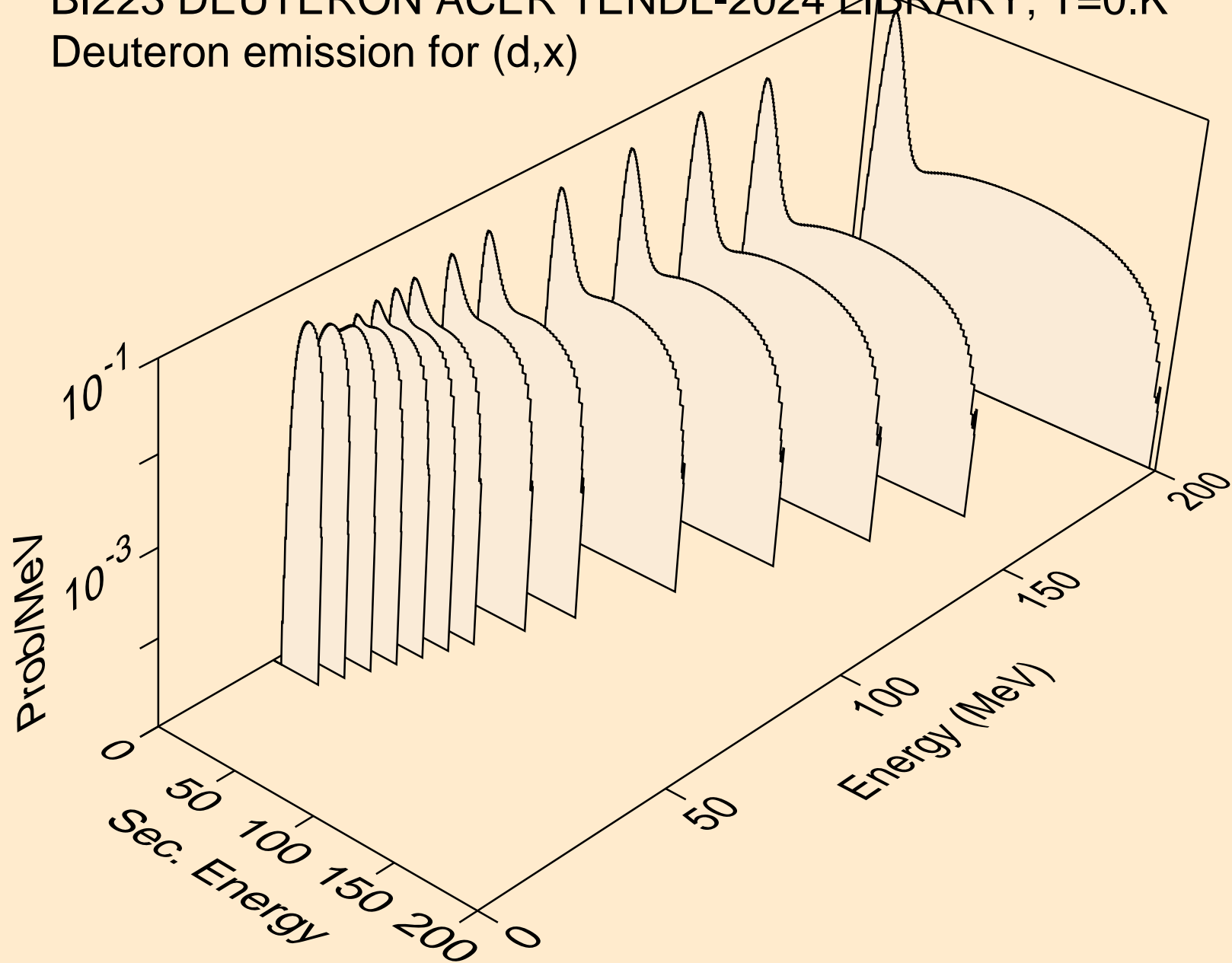

BI223 DEUTERON ACER TENDL-2024 LIBRARY; T=0.K
Deuteron emission for (d,2nd)

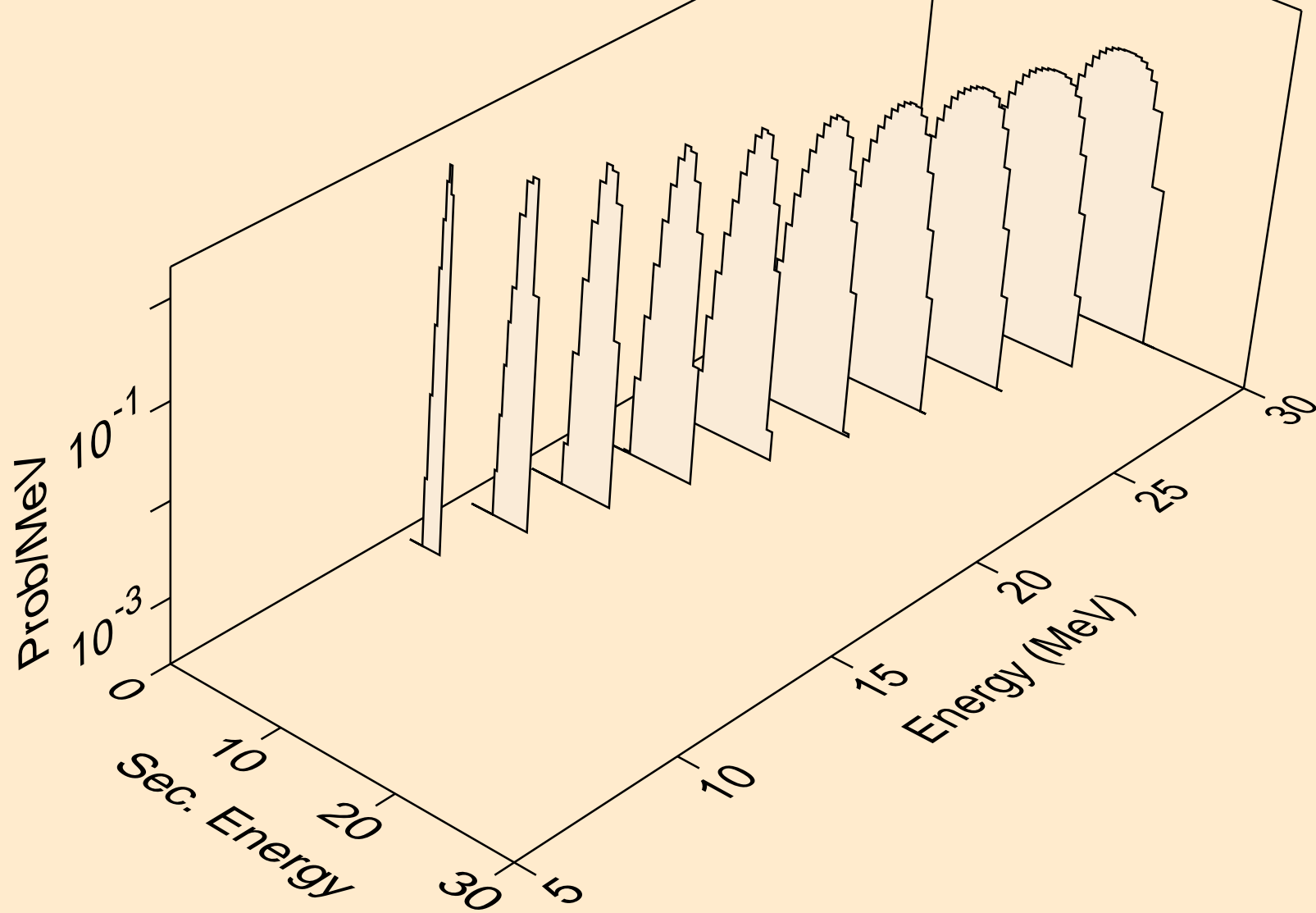

BI223 DEUTERON ACER TENDL-2024 LIBRARY; T=0.K
Deuteron emission for (d,n*)d

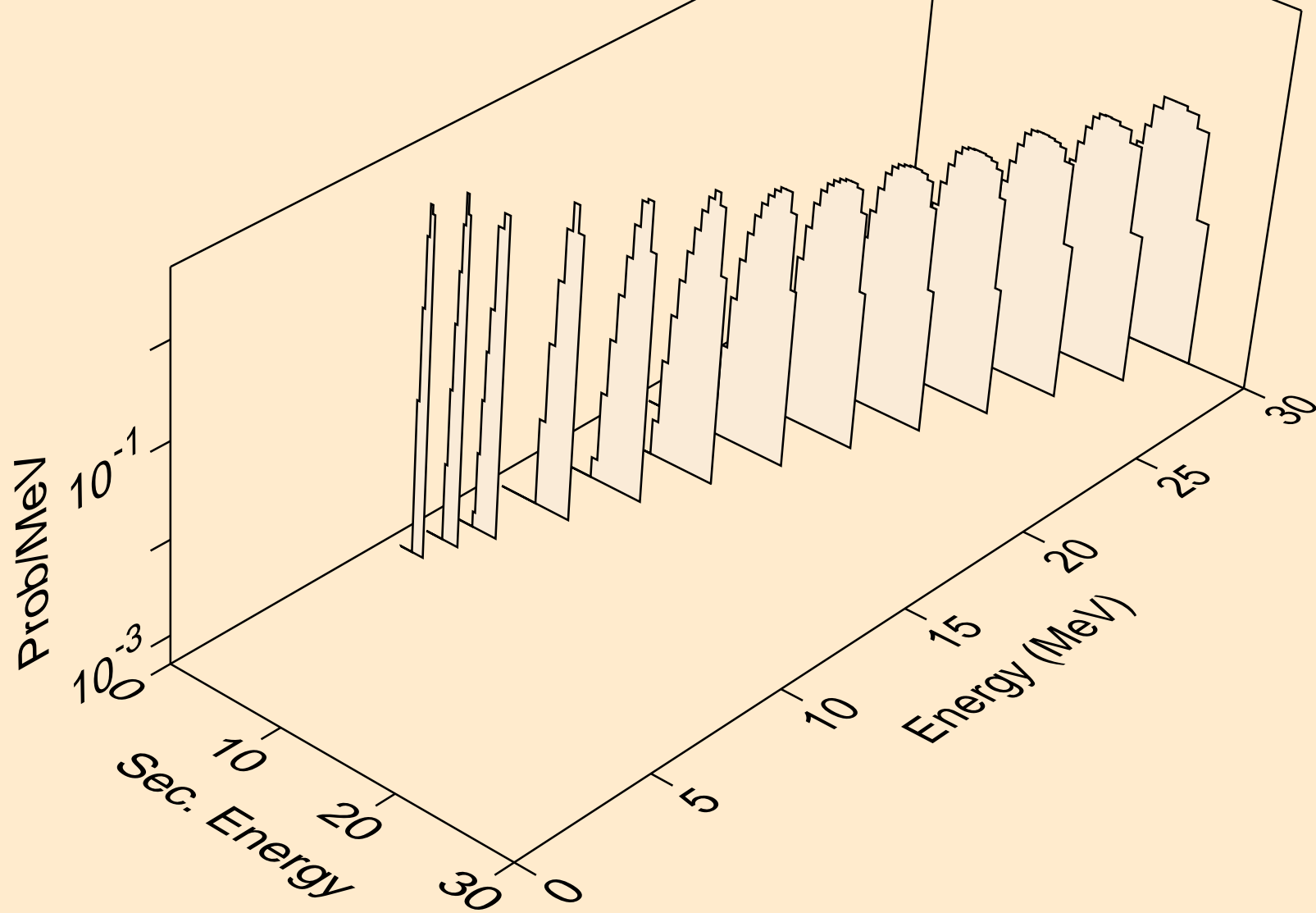

BI223 DEUTERON ACER TENDL-2024 LIBRARY; T=0.K
Deuteron emission for inelastic

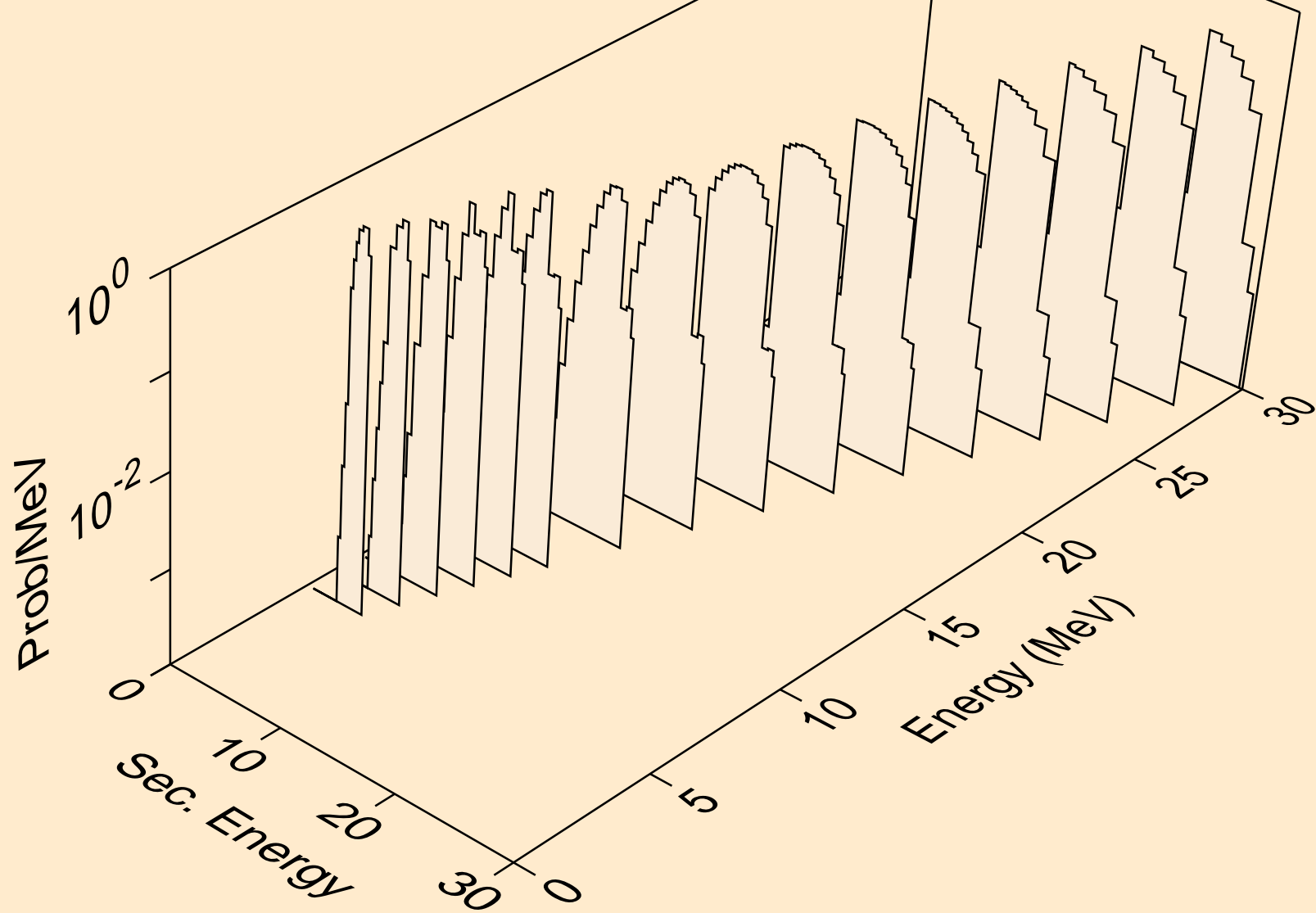

BI223 DEUTERON ACER TENDL-2024 LIBRARY; T=0.K
Deuteron emission for (d,pd)

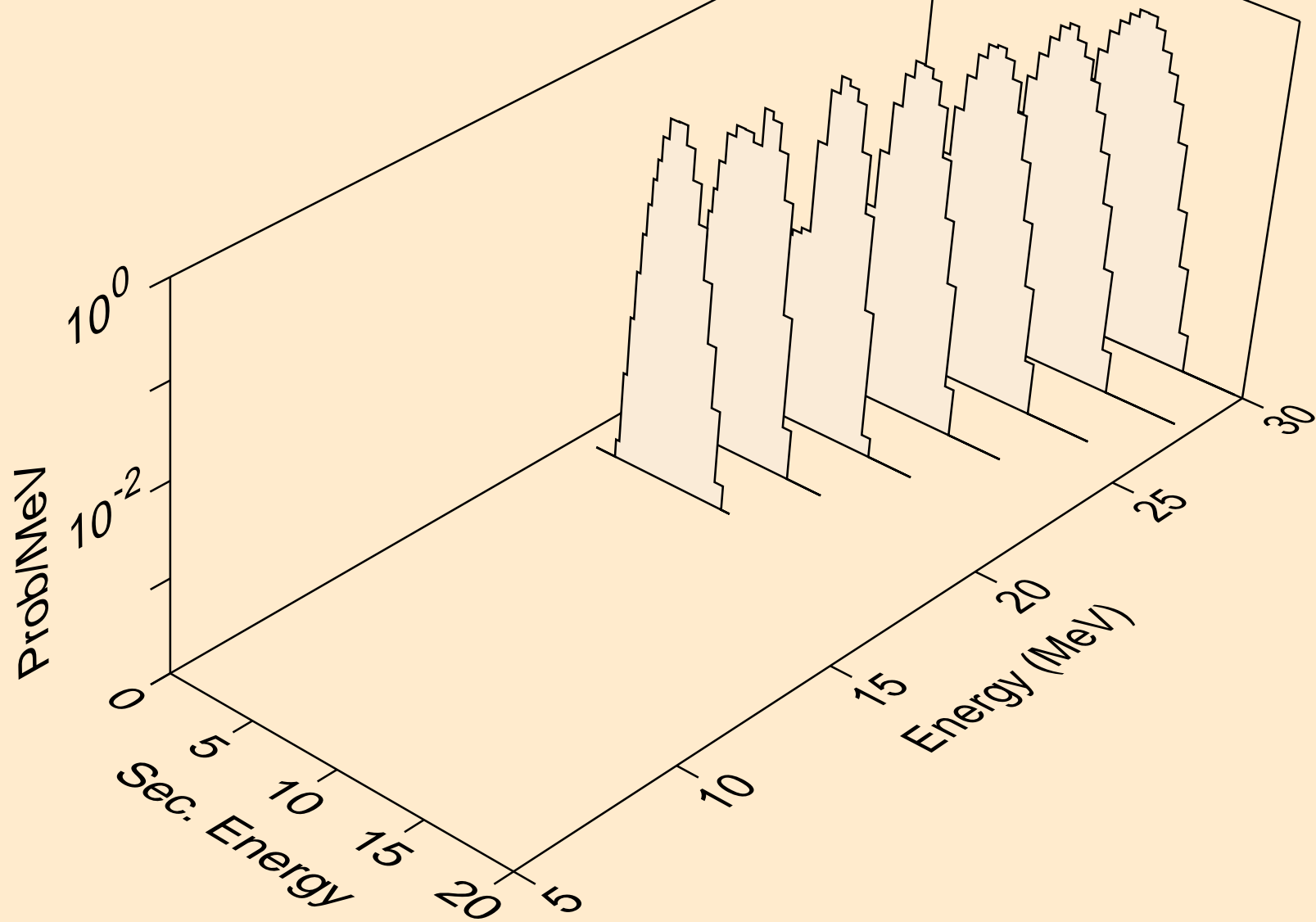

BI223 DEUTERON ACER TENDL-2024 LIBRARY; T=0.K
Photon emission for (z,n)

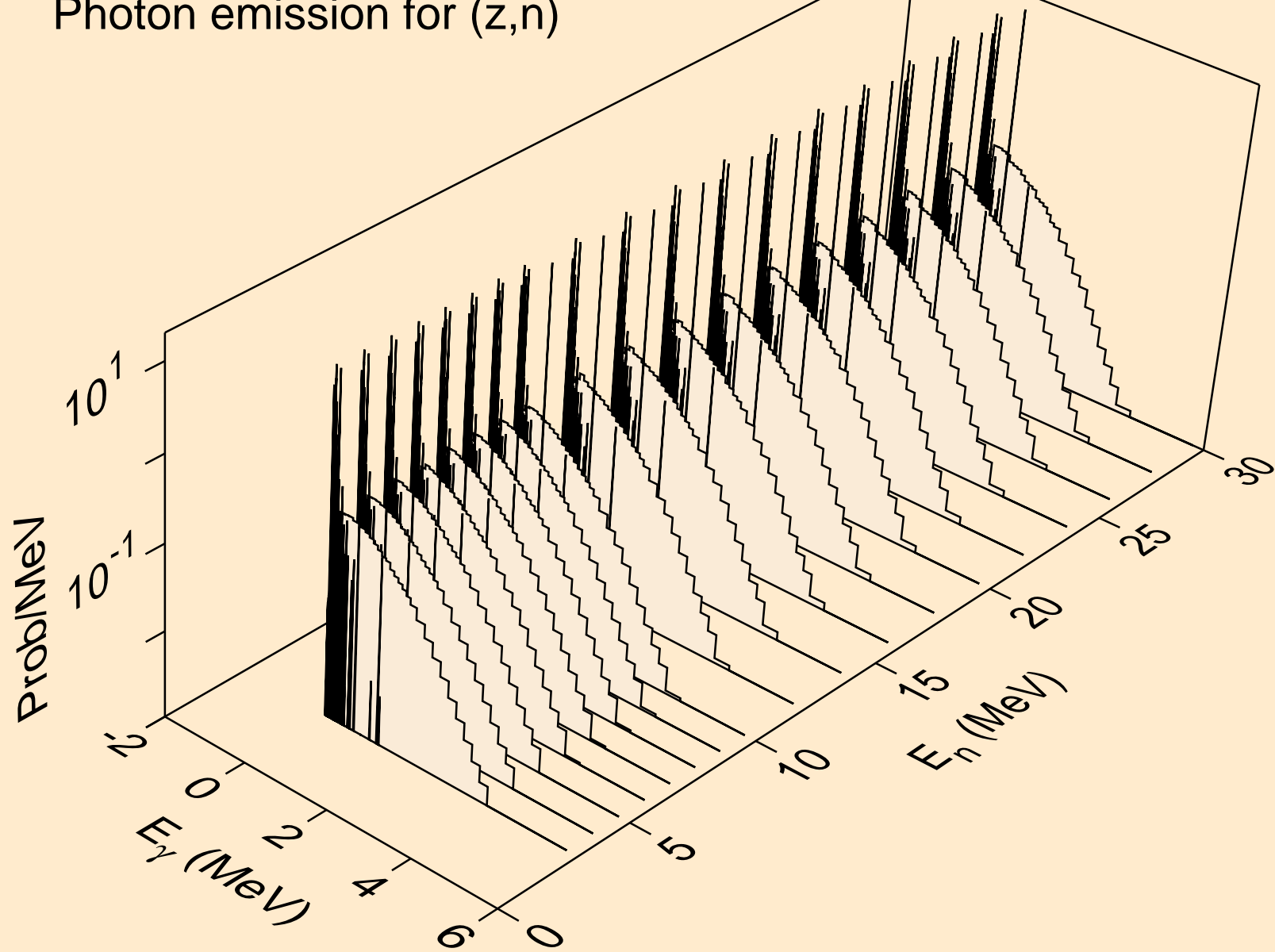

BI223 DEUTERON ACER TENDL-2024 LIBRARY; T=0.K
Photon emission for (z,x)

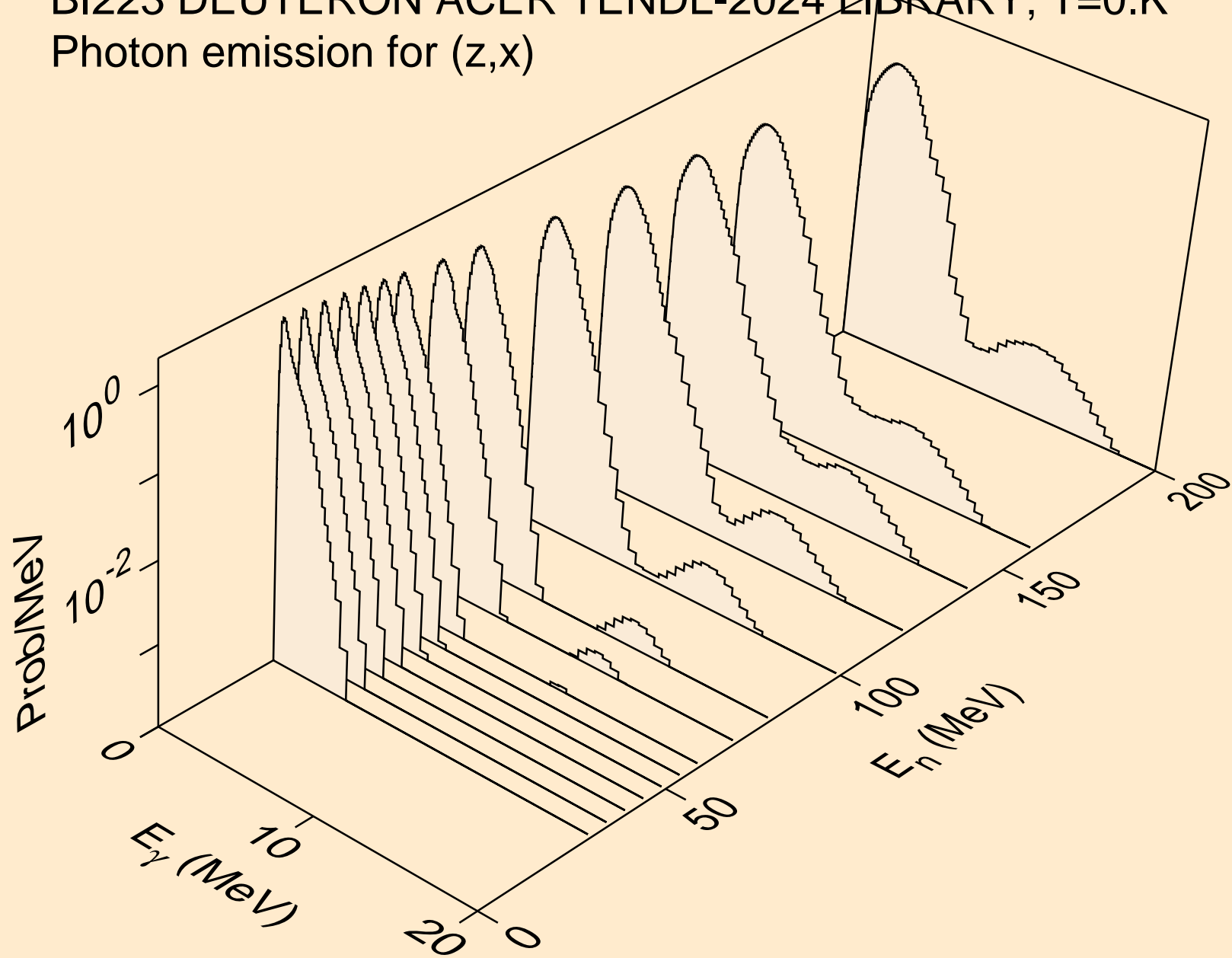

BI223 DEUTERON ACER TENDL-2024 LIBRARY; T=0.K
Photon emission for (n,2nd)

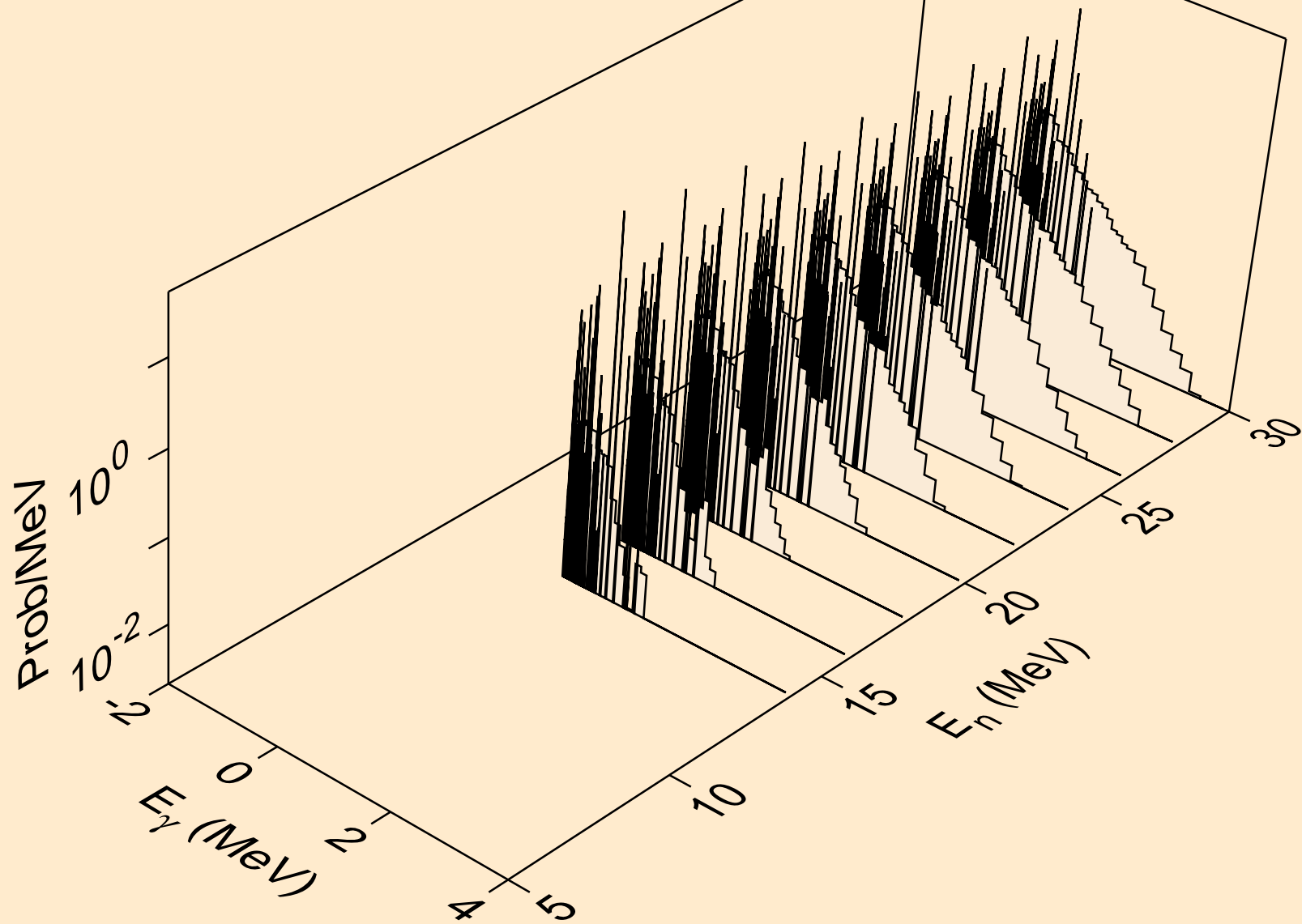

BI223 DEUTERON ACER TENDL-2024 LIBRARY; T=0.K
Photon emission for (n,2n)

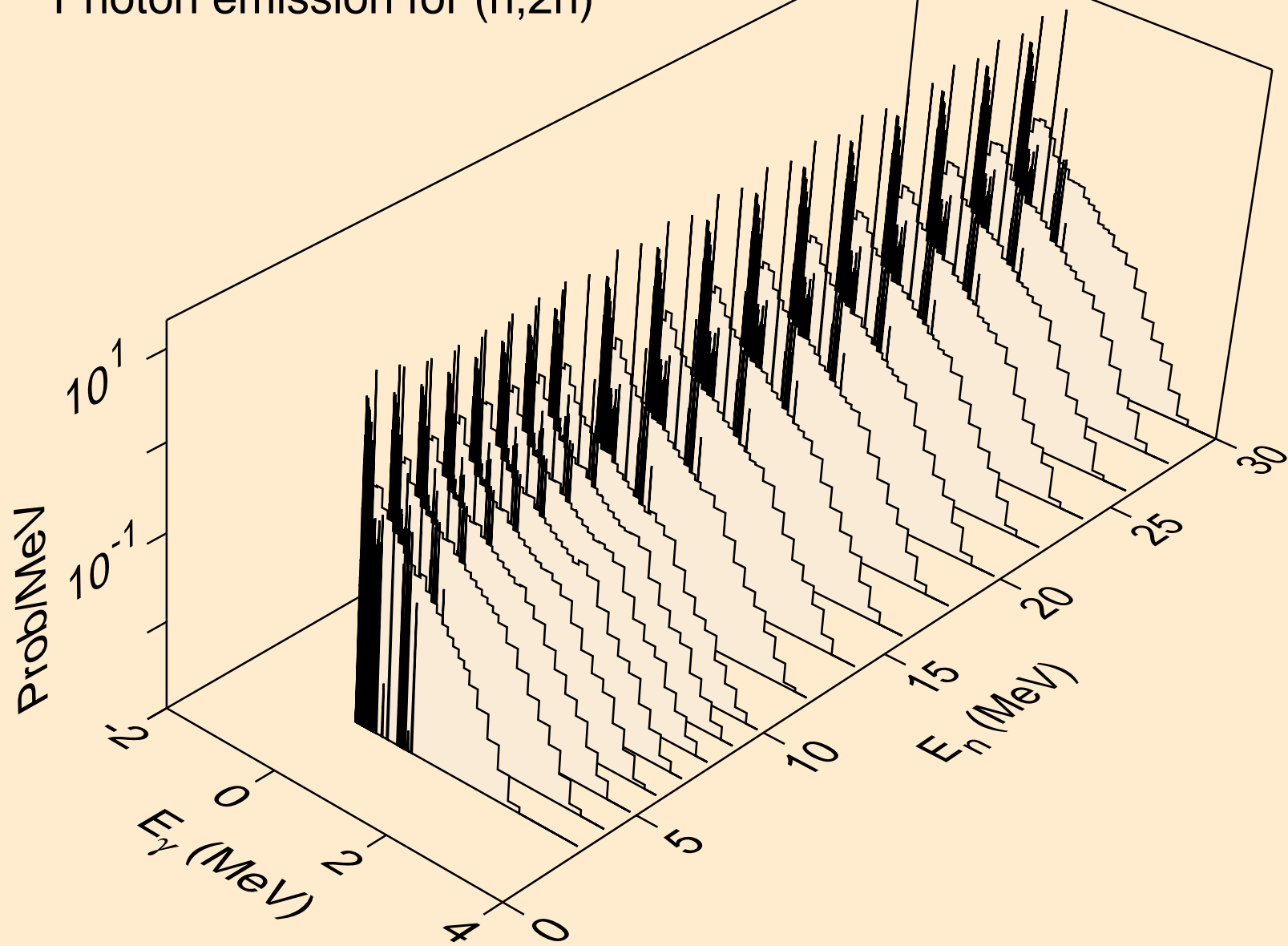

BI223 DEUTERON ACER TENDL-2024 LIBRARY; T=0.K
Photon emission for (n,3n)

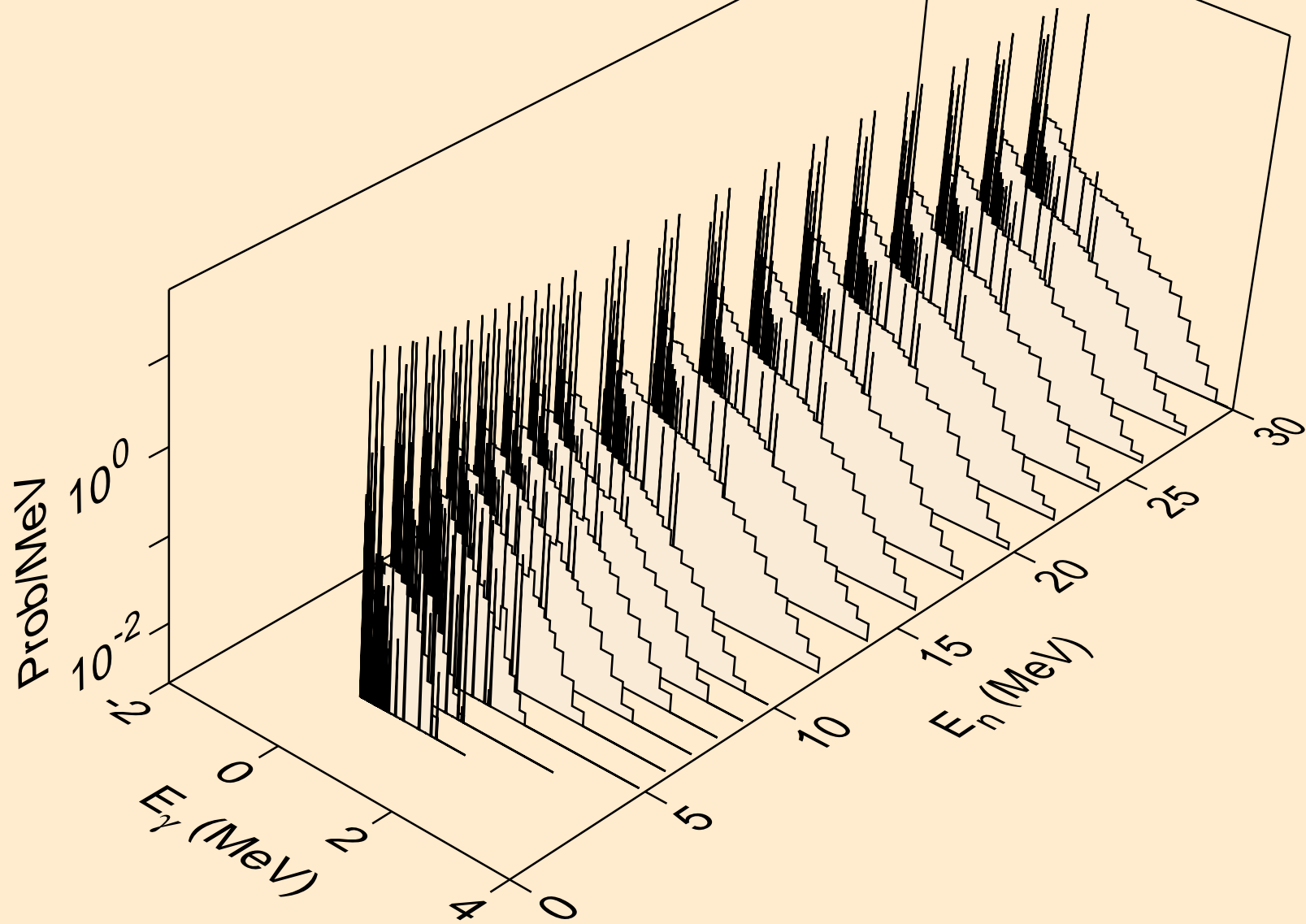

BI223 DEUTERON ACER TENDL-2024 LIBRARY; T=0.K
Photon emission for (n,n*)a

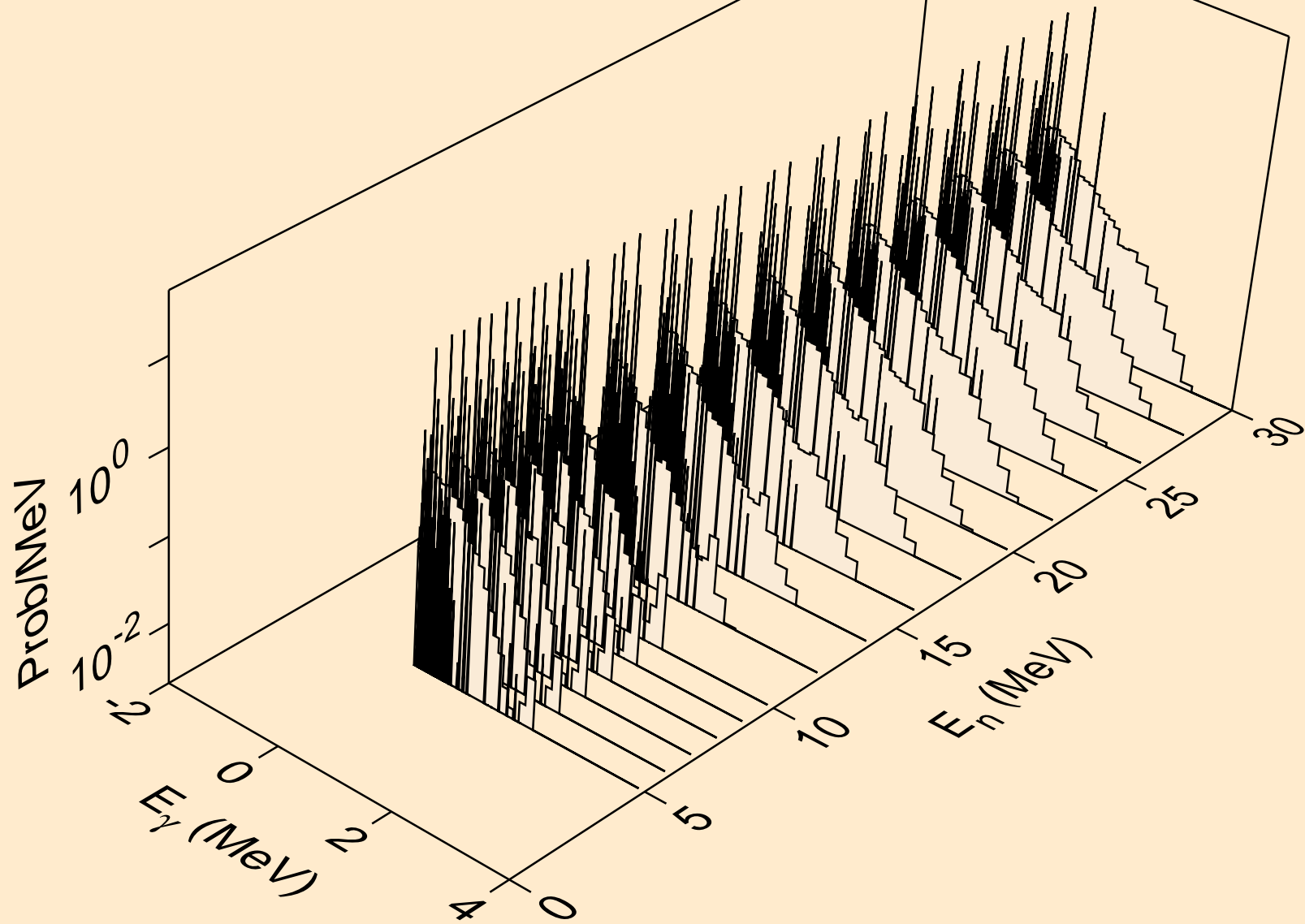

BI223 DEUTERON ACER TENDL-2024 LIBRARY; T=0.K
Photon emission for (n,2n)a

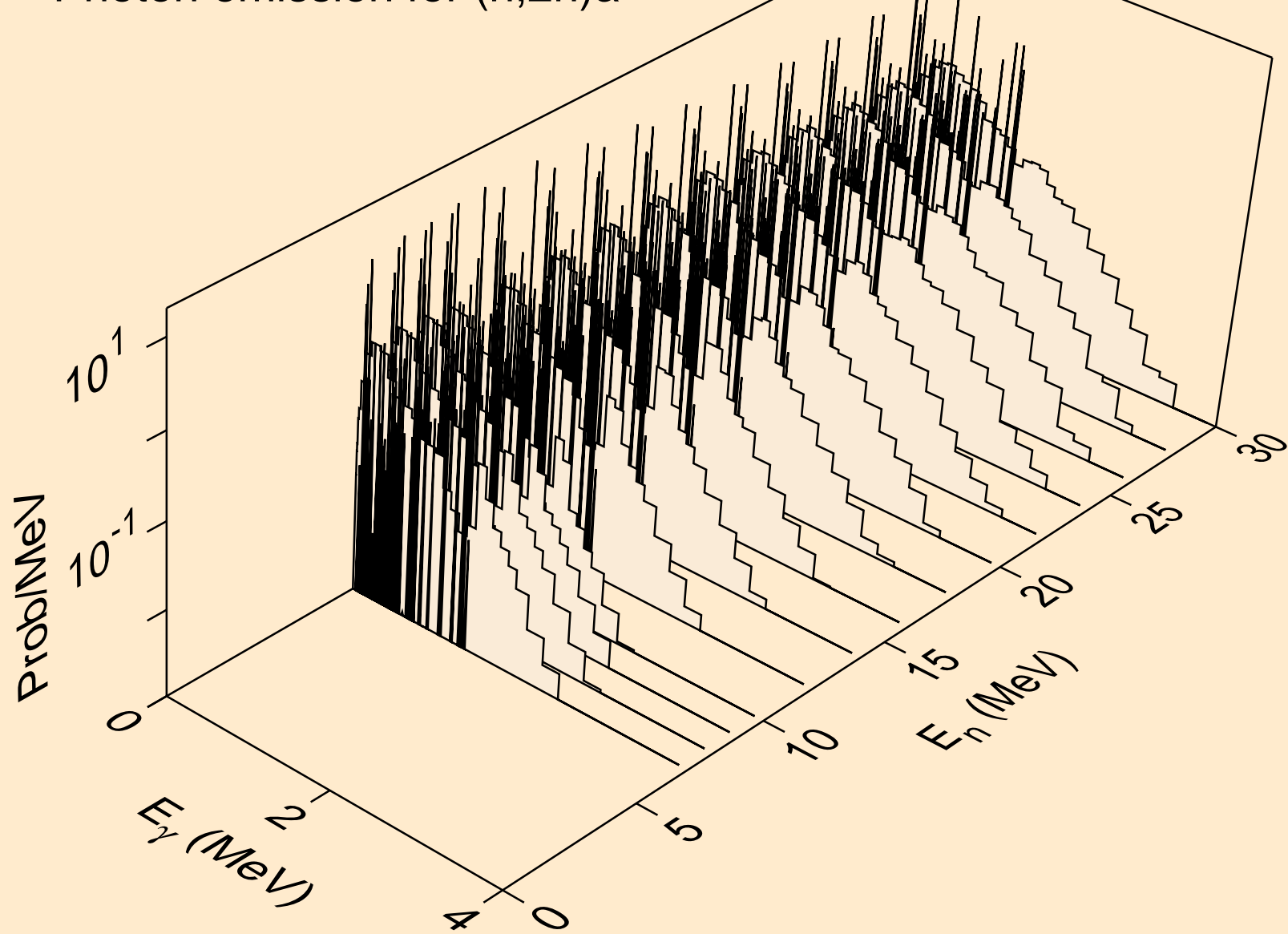

BI223 DEUTERON ACER TENDL-2024 LIBRARY; T=0.K
Photon emission for (n,3n)a

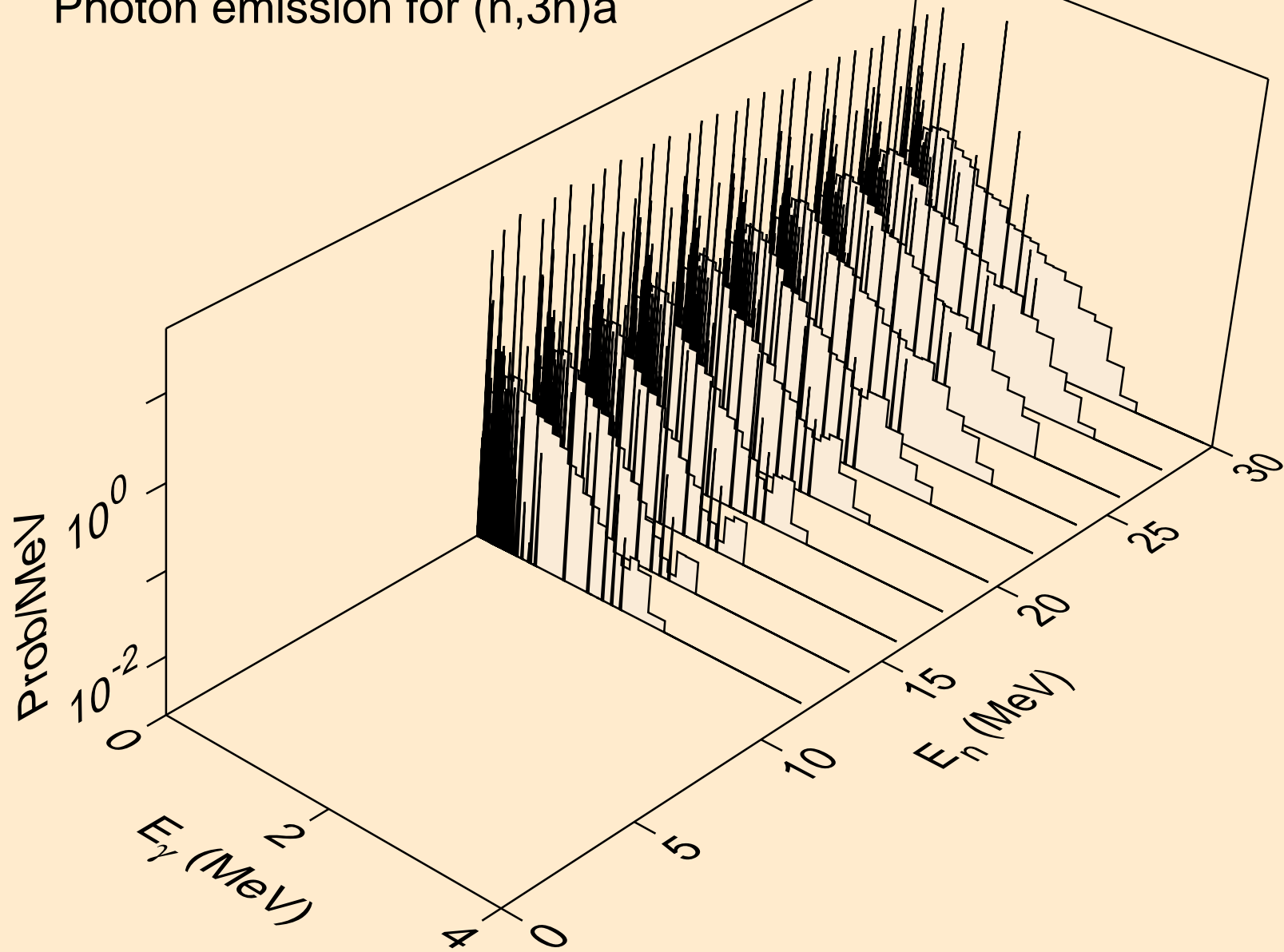

BI223 DEUTERON ACER TENDL-2024 LIBRARY; T=0.K
Photon emission for (n,n*)p

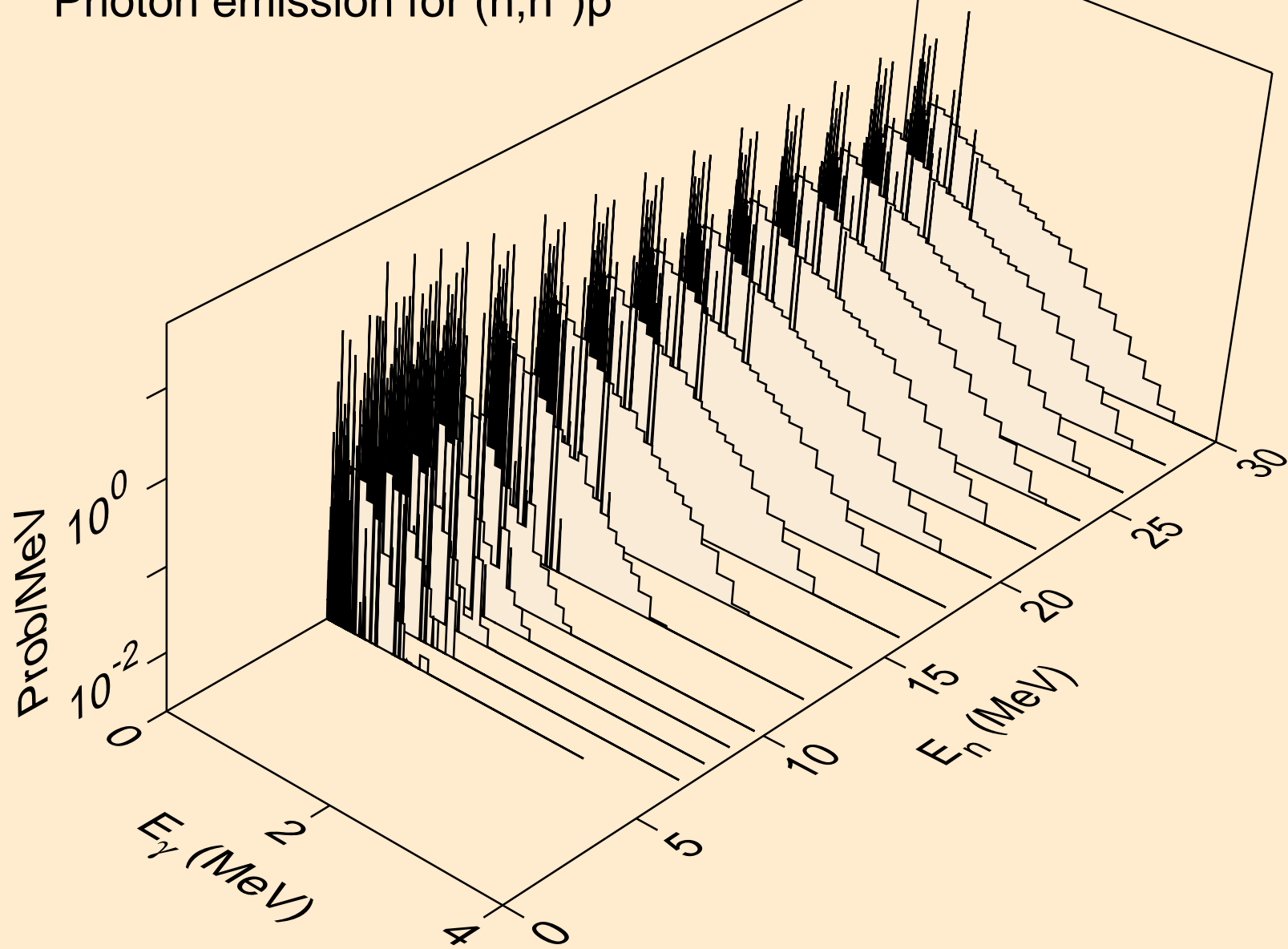

BI223 DEUTERON ACER TENDL-2024 LIBRARY; T=0.K
Photon emission for (n,n*)d

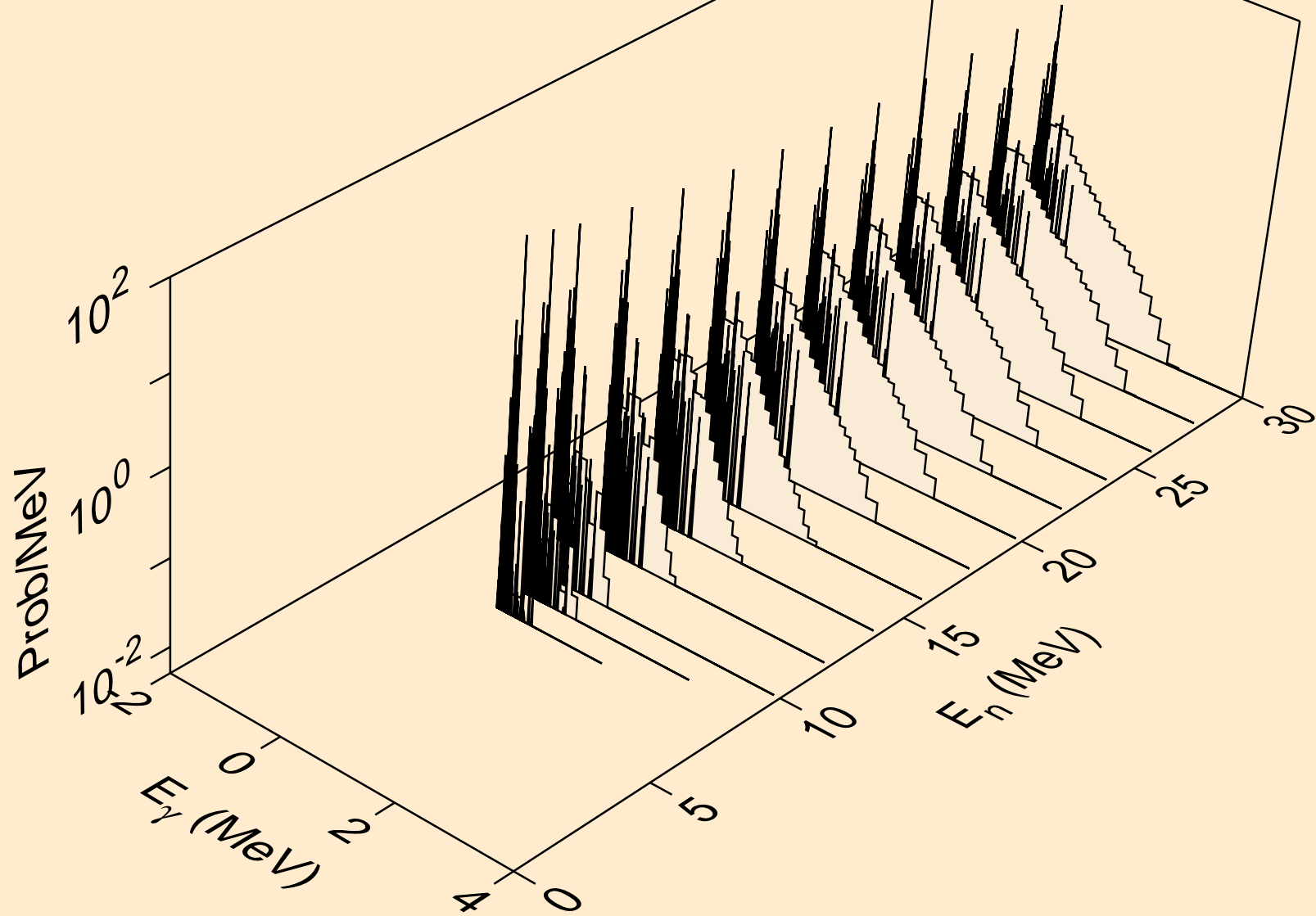

BI223 DEUTERON ACER TENDL-2024 LIBRARY; T=0.K
Photon emission for (n,n*)t

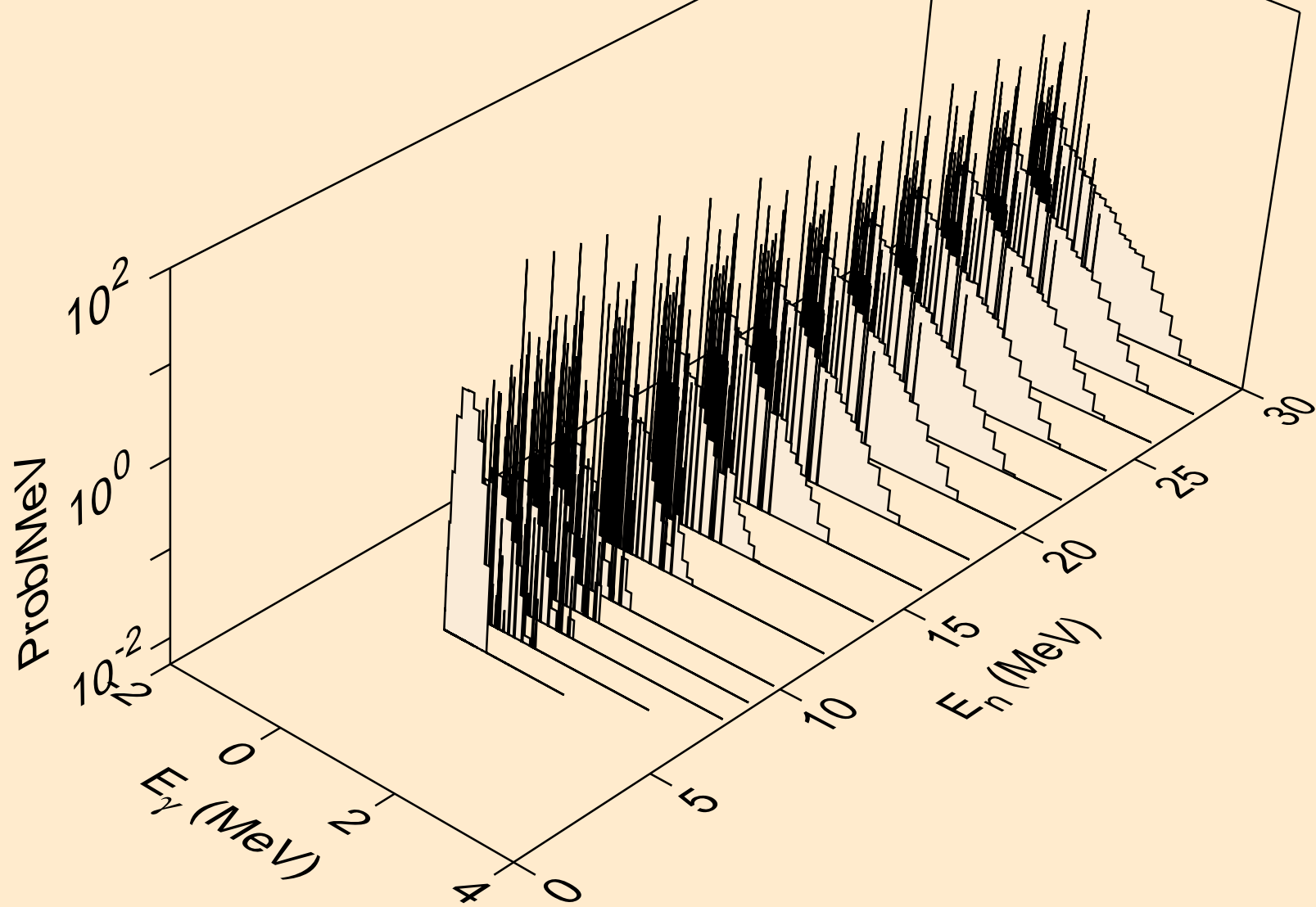

BI223 DEUTERON ACER TENDL-2024 LIBRARY; T=0.K
Photon emission for (n,n*)he3

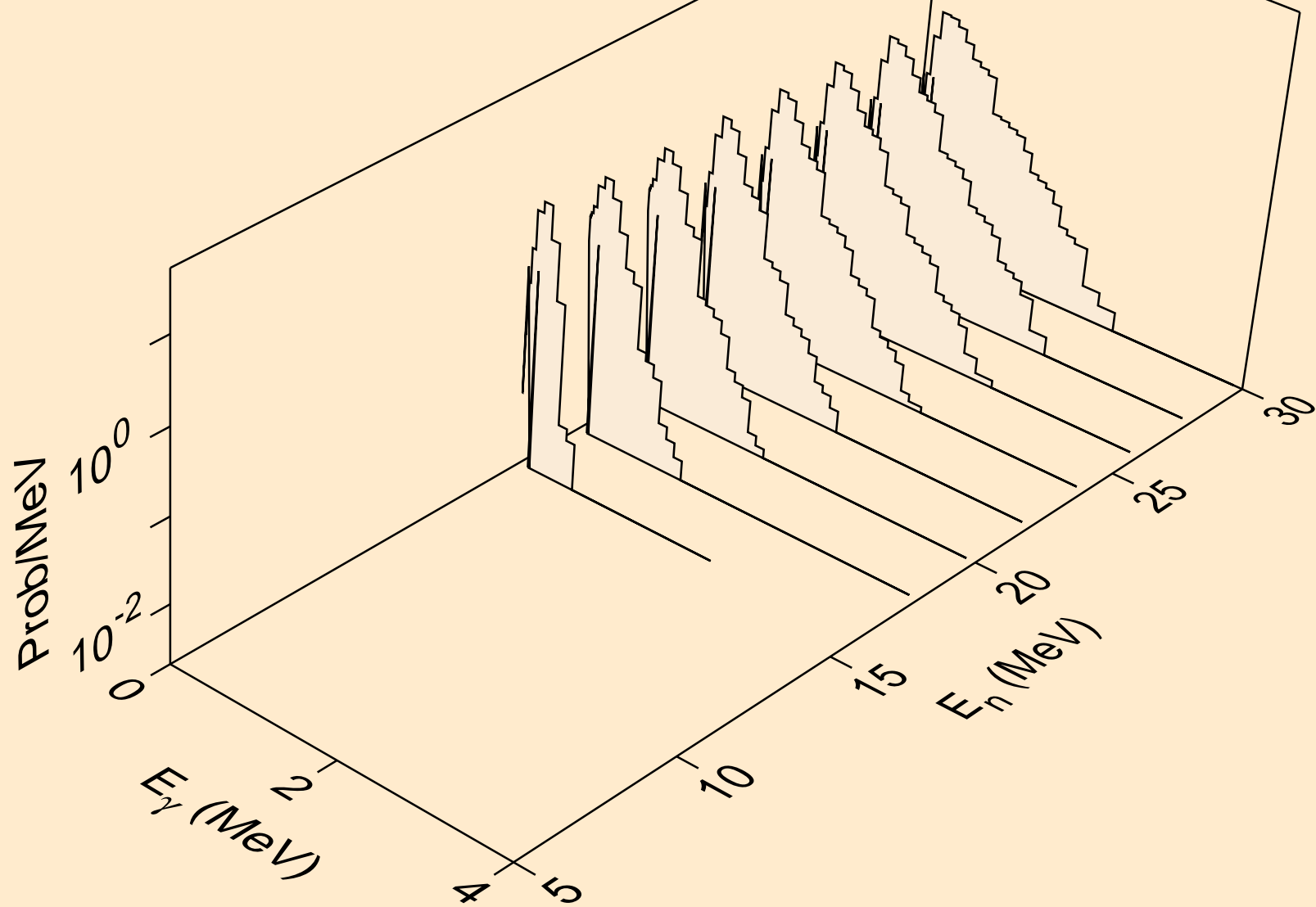

BI223 DEUTERON ACER TENDL-2024 LIBRARY; T=0.K
Photon emission for (n,4n)

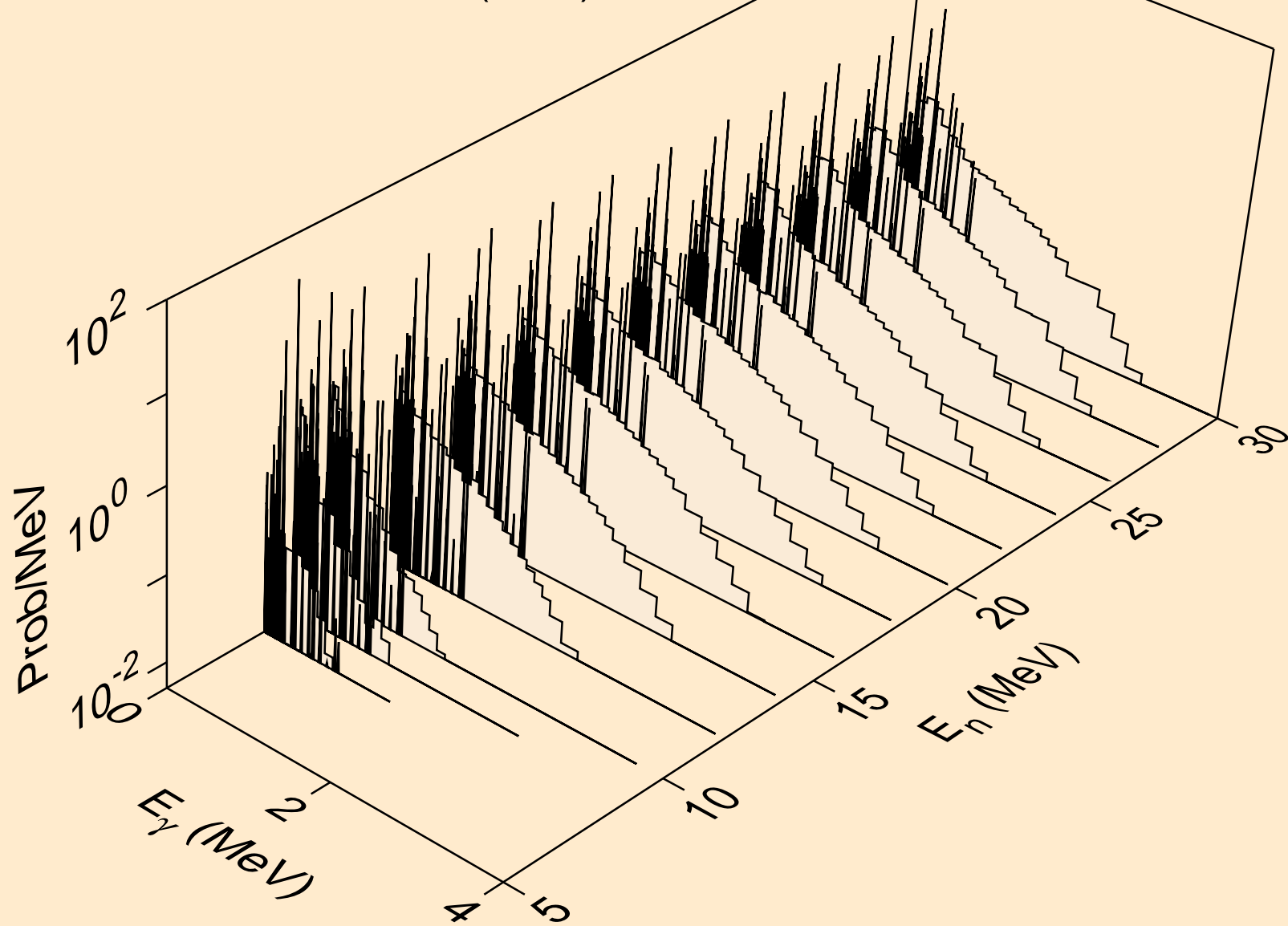

BI223 DEUTERON ACER TENDL-2024 LIBRARY; T=0.K
Photon emission for (n,2np)

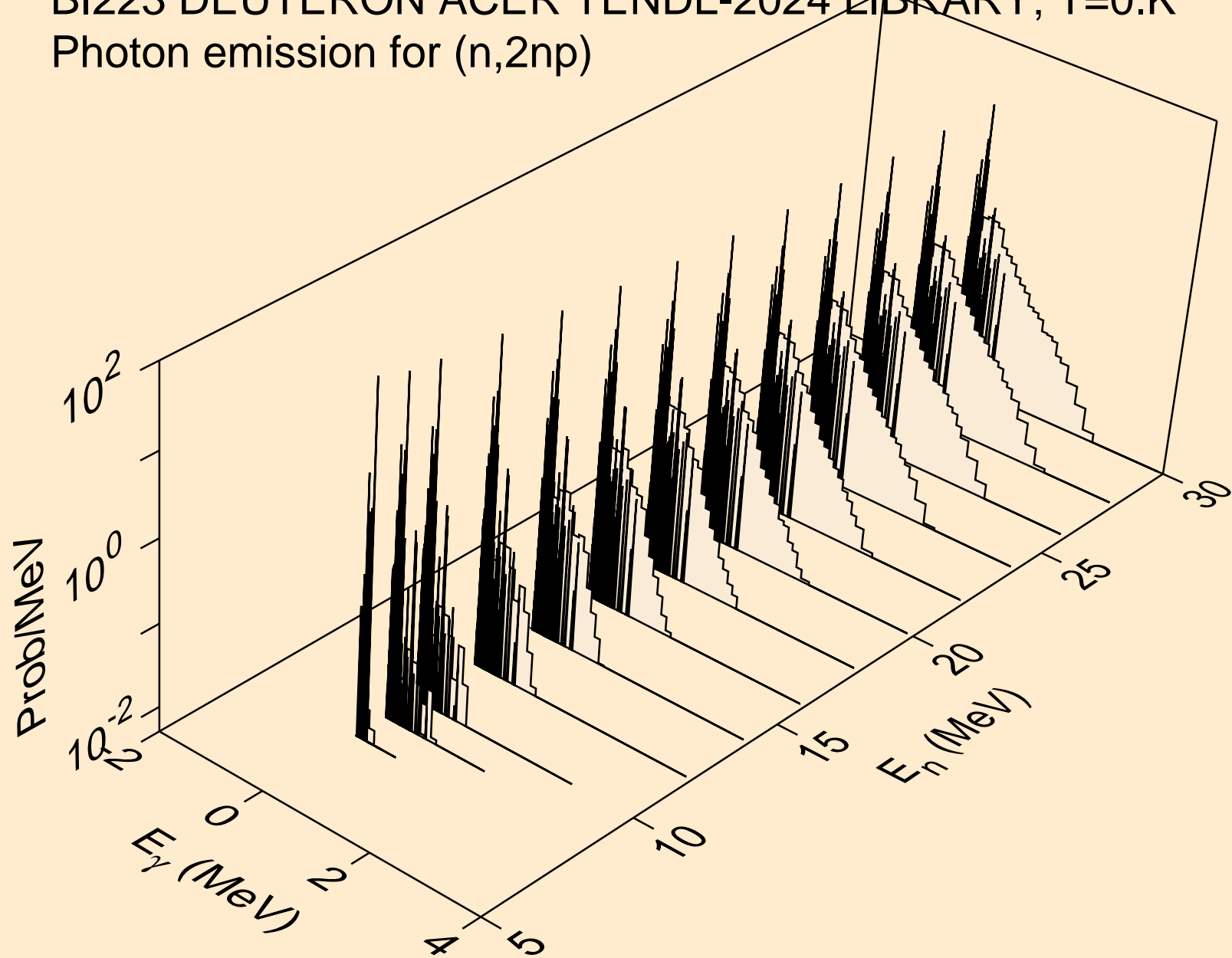

BI223 DEUTERON ACER TENDL-2024 LIBRARY; T=0.K
Photon emission for (n,3np)

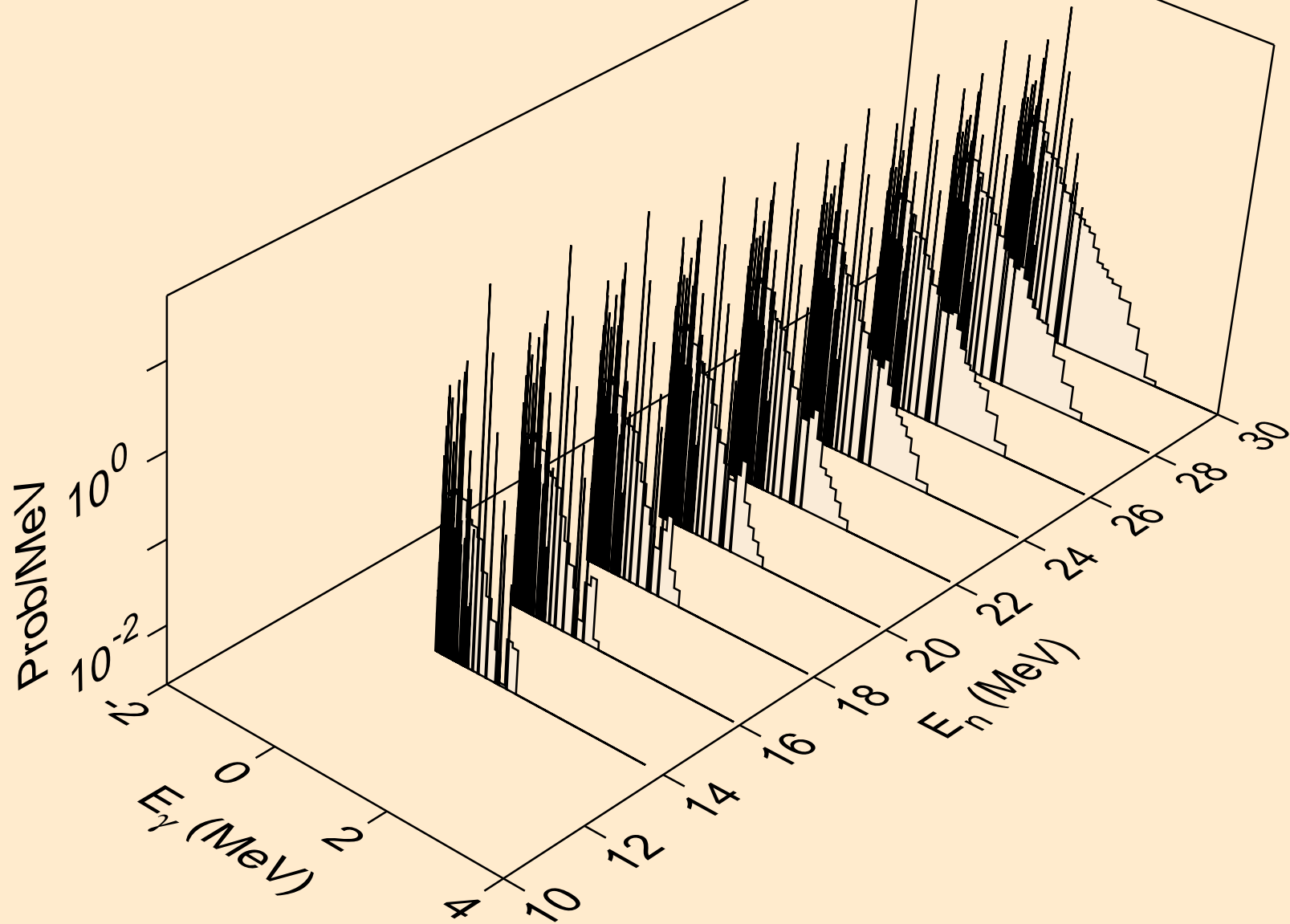

BI223 DEUTERON ACER TENDL-2024 LIBRARY; T=0.K
Photon emission for (n,n2p)

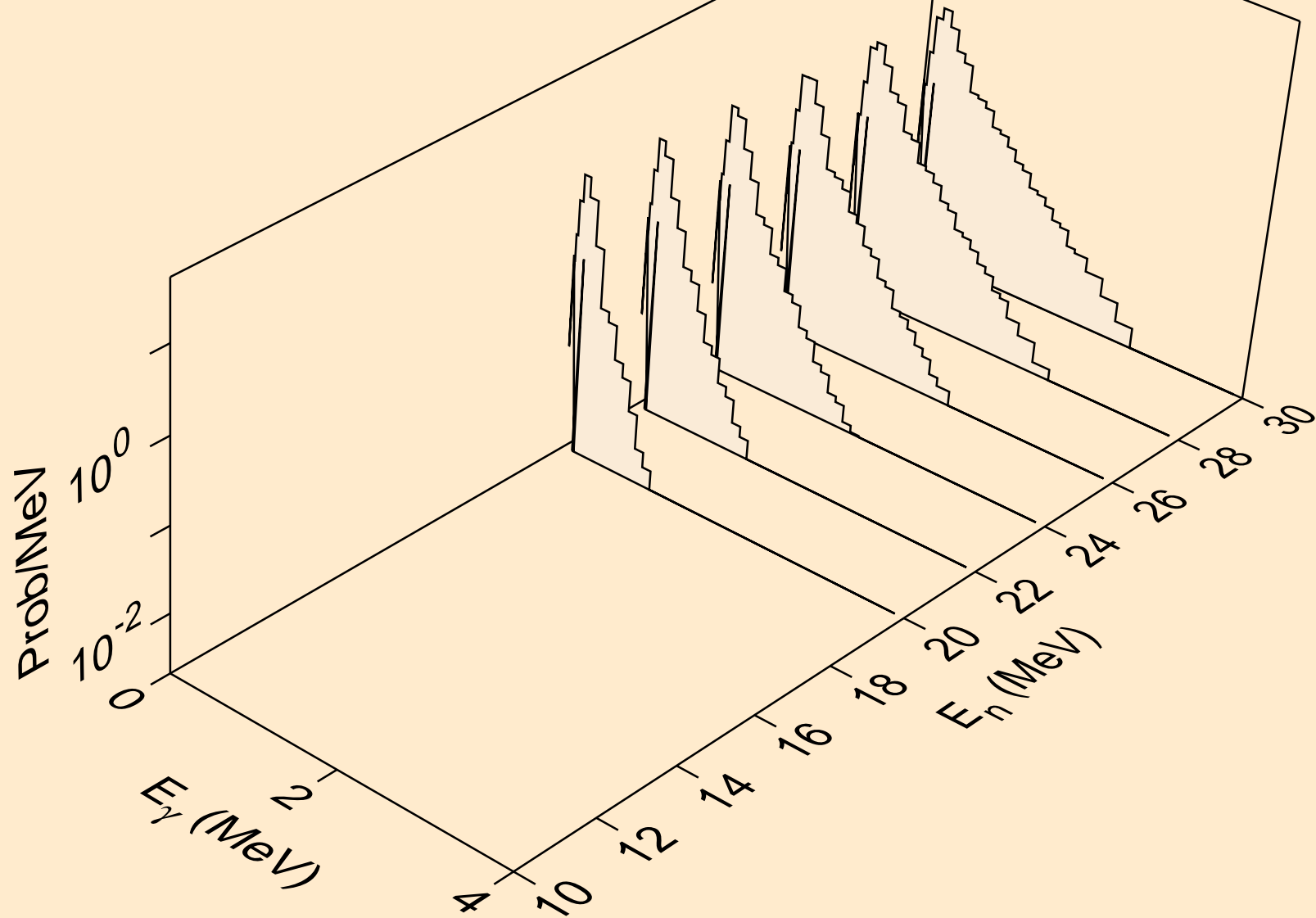

BI223 DEUTERON ACER TENDL-2024 LIBRARY; T=0.K
Photon emission for (n,gma)

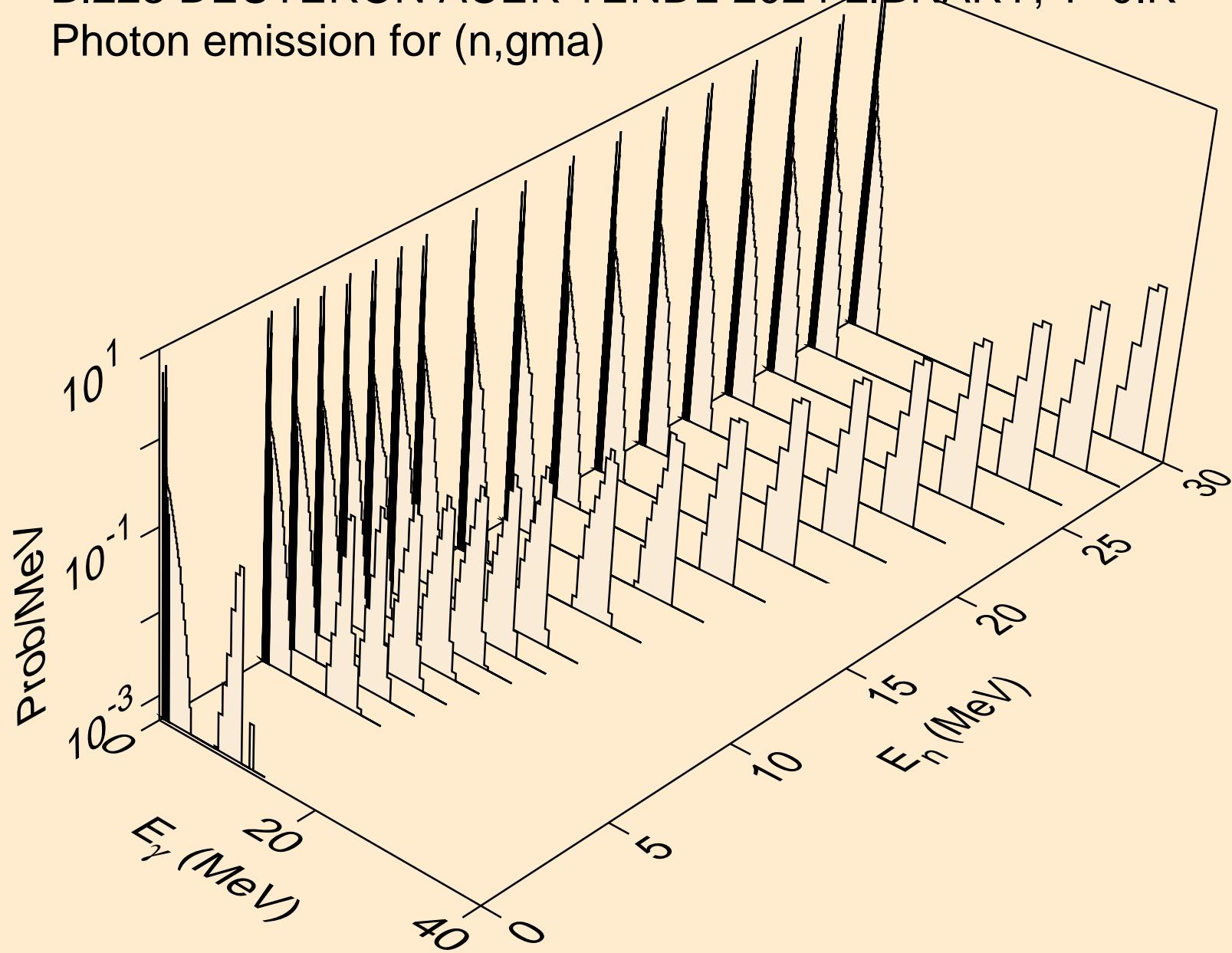

BI223 DEUTERON ACER TENDL-2024 LIBRARY; T=0.K
Photon emission for (n,p)

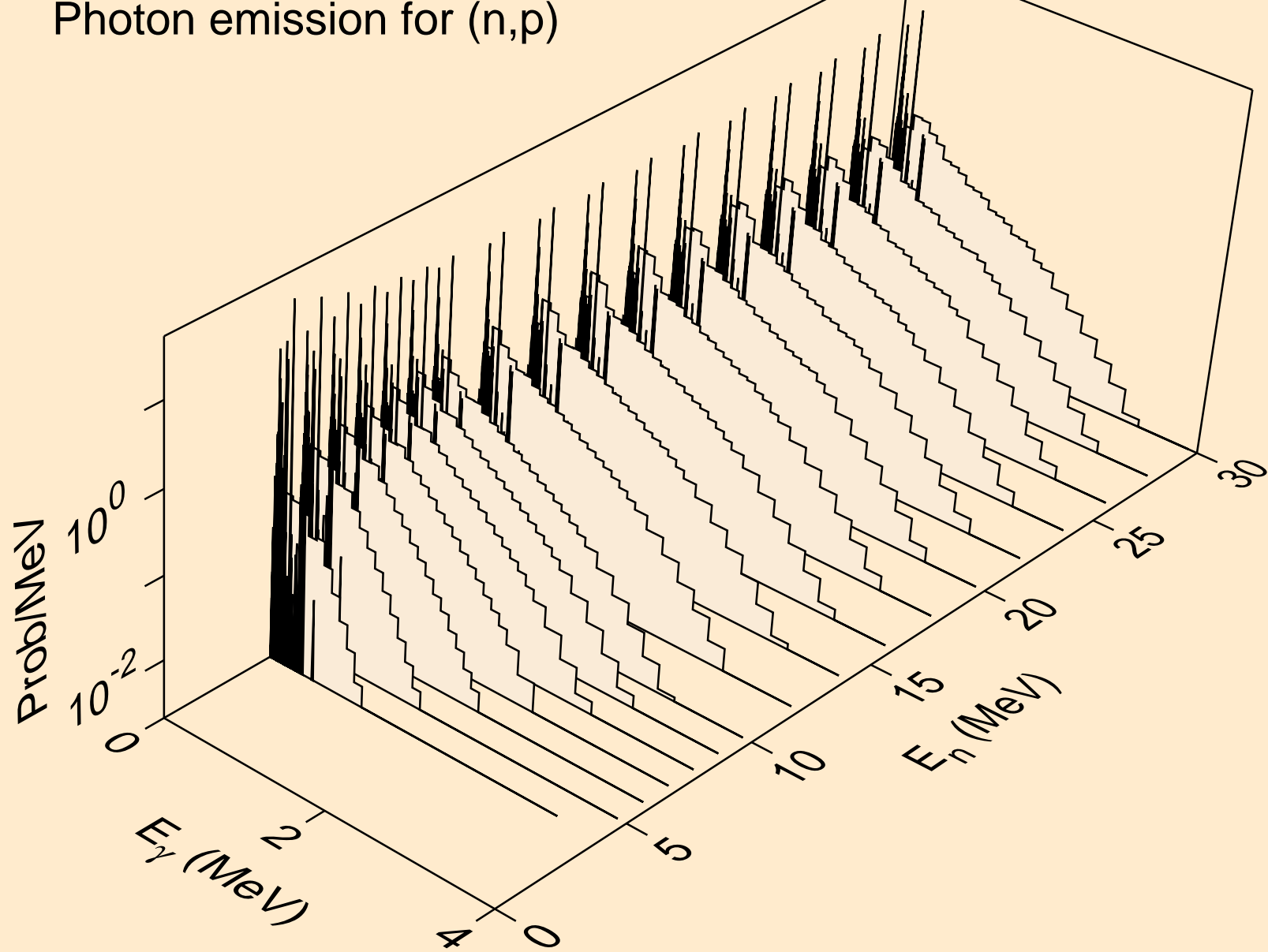

BI223 DEUTERON ACER TENDL-2024 LIBRARY; T=0.K
Photon emission for inelastic

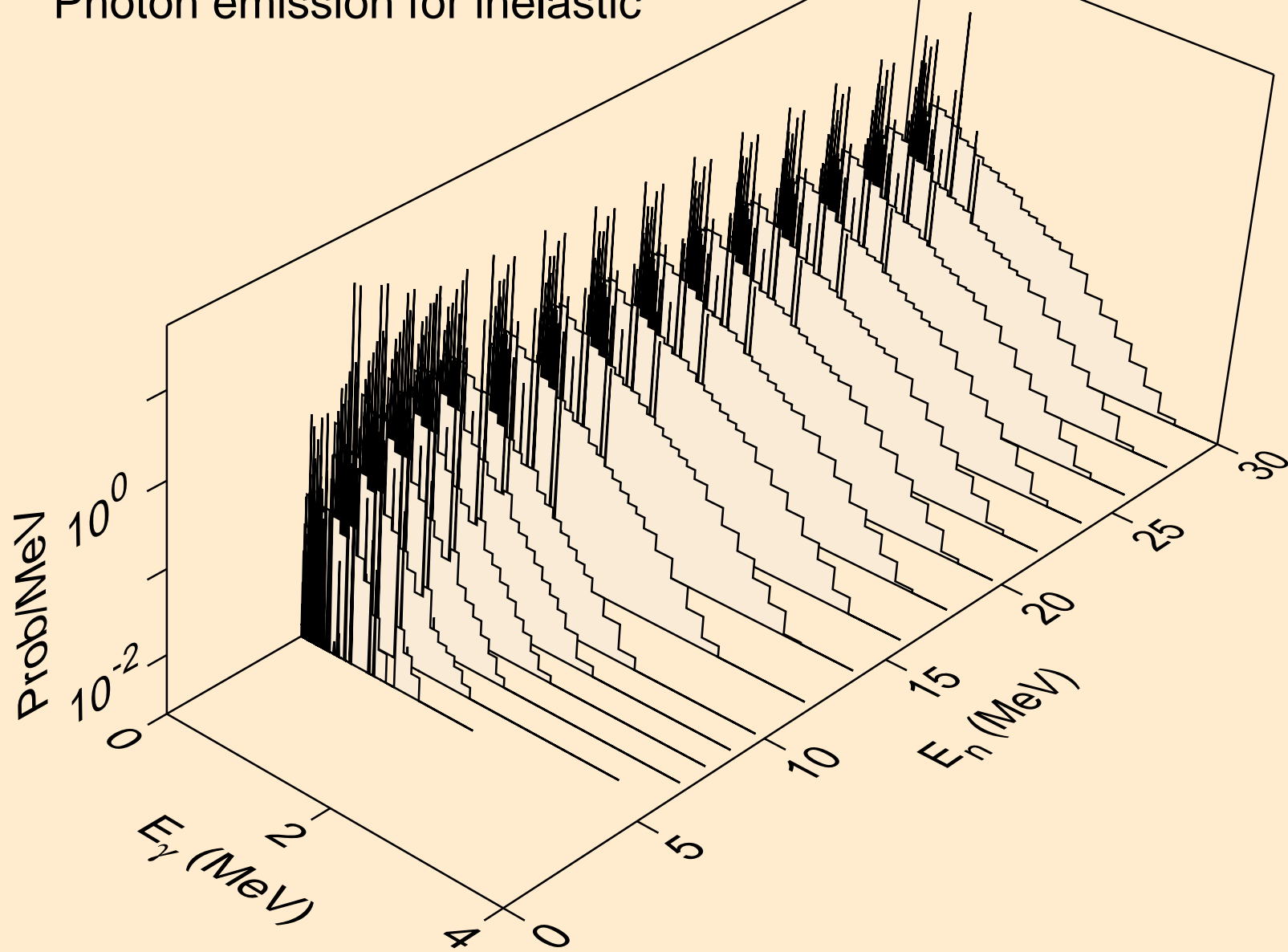

BI223 DEUTERON ACER TENDL-2024 LIBRARY; T=0.K
Photon emission for (n,t)

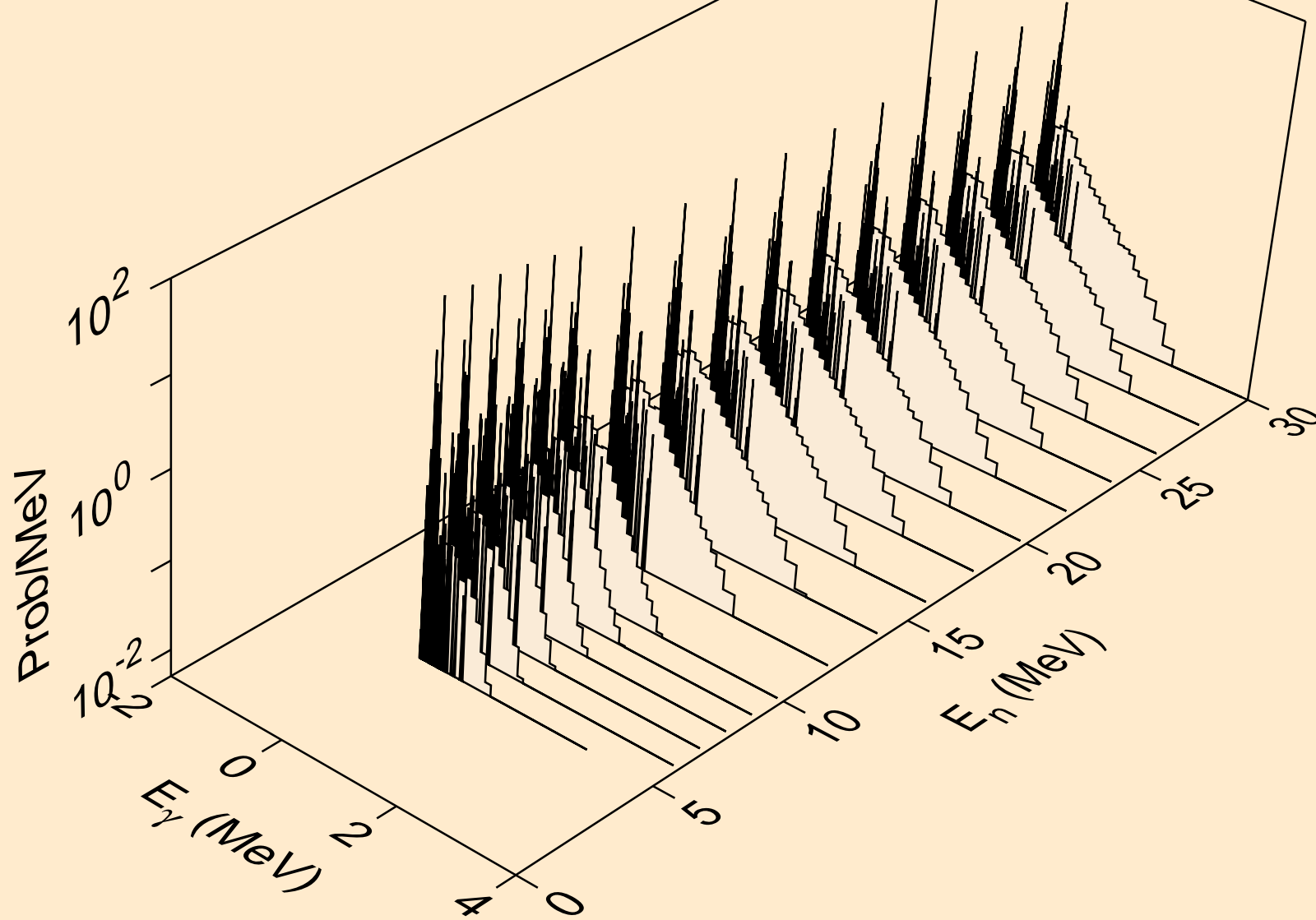

BI223 DEUTERON ACER TENDL-2024 LIBRARY; T=0.K
Photon emission for (n,he3)

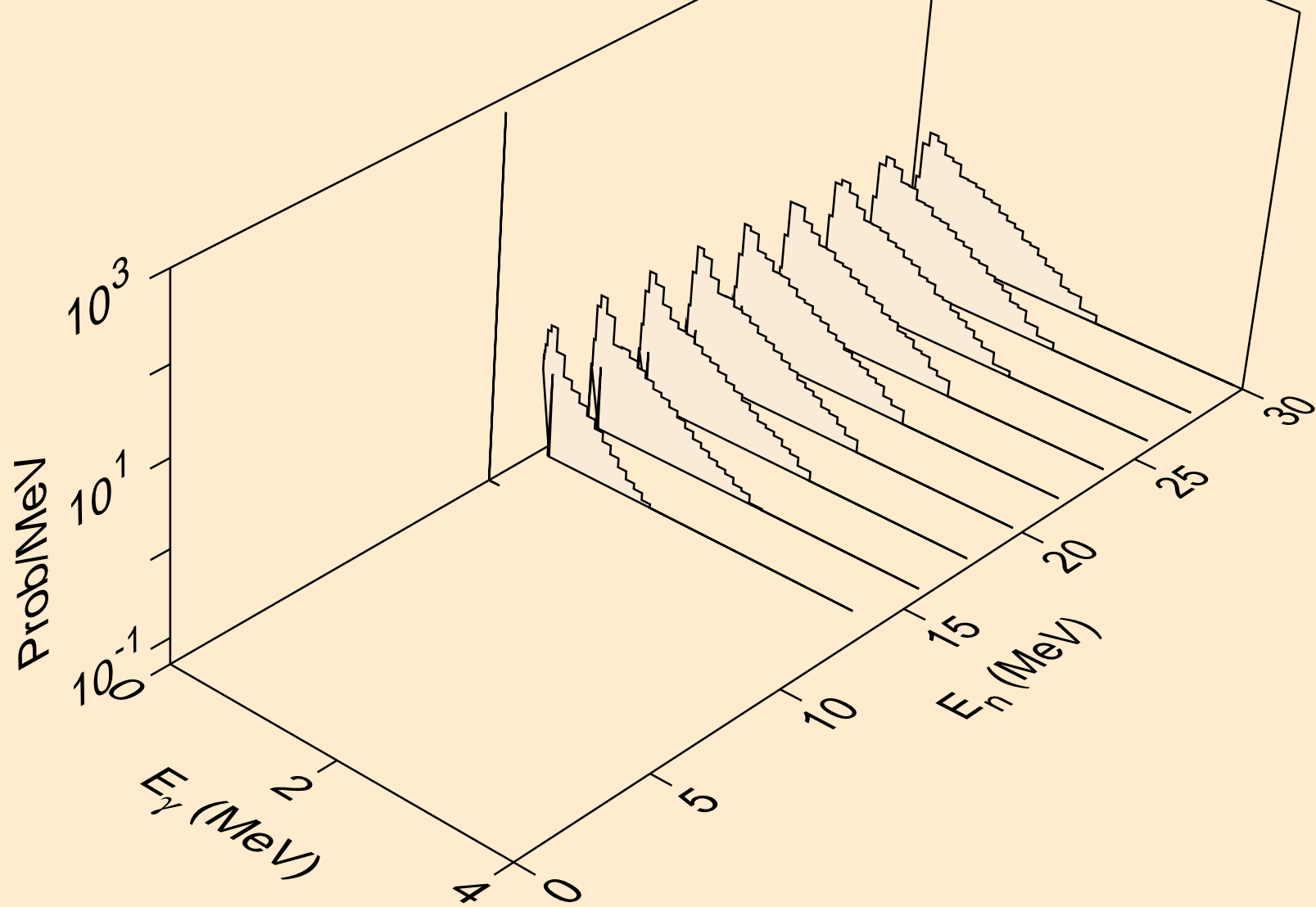

BI223 DEUTERON ACER TENDL-2024 LIBRARY; T=0.K
Photon emission for (n,a)

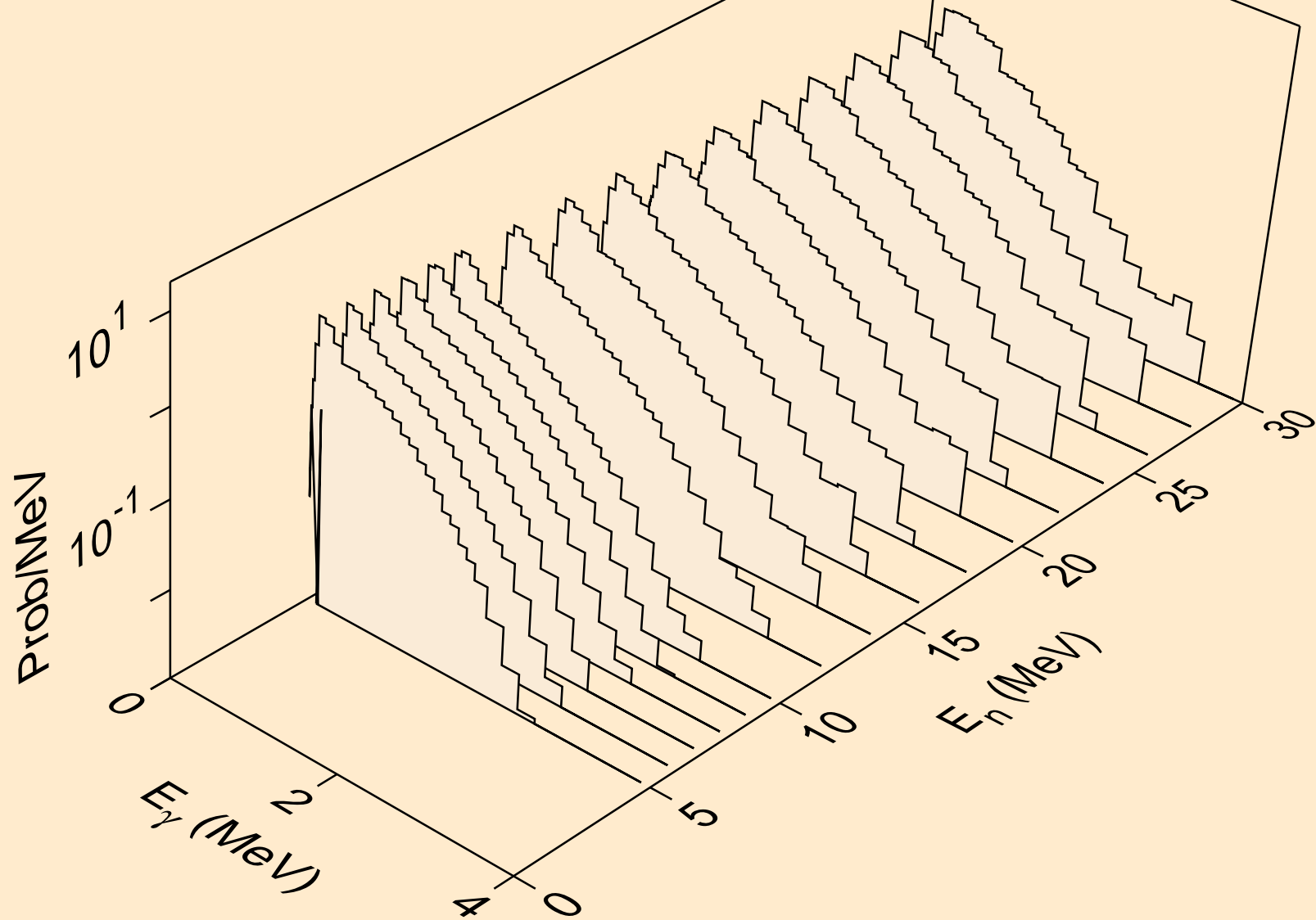

BI223 DEUTERON ACER TENDL-2024 LIBRARY; T=0.K
Photon emission for (n,2p)

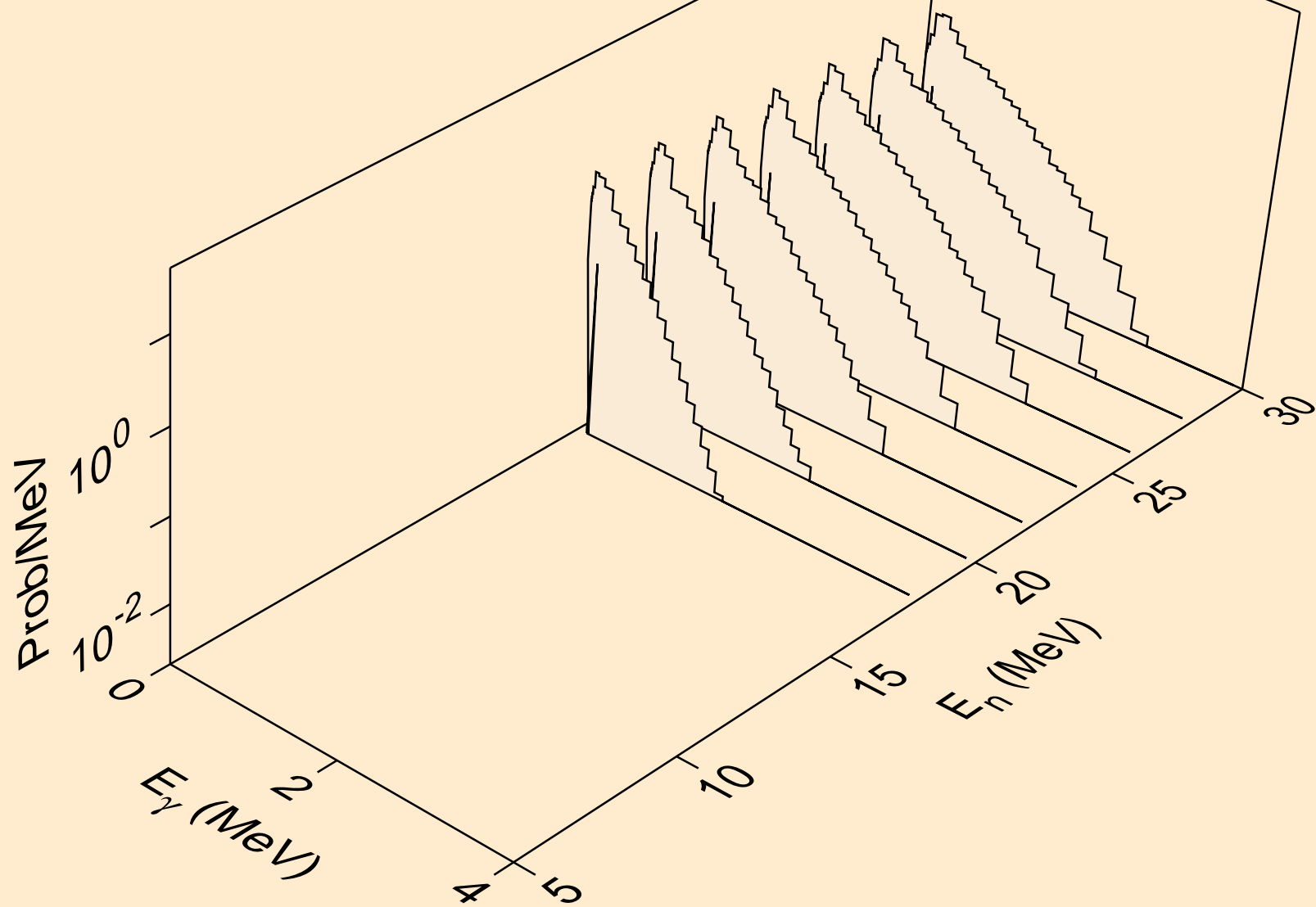

BI223 DEUTERON ACER TENDL-2024 LIBRARY; T=0.K
Photon emission for (n,pd)

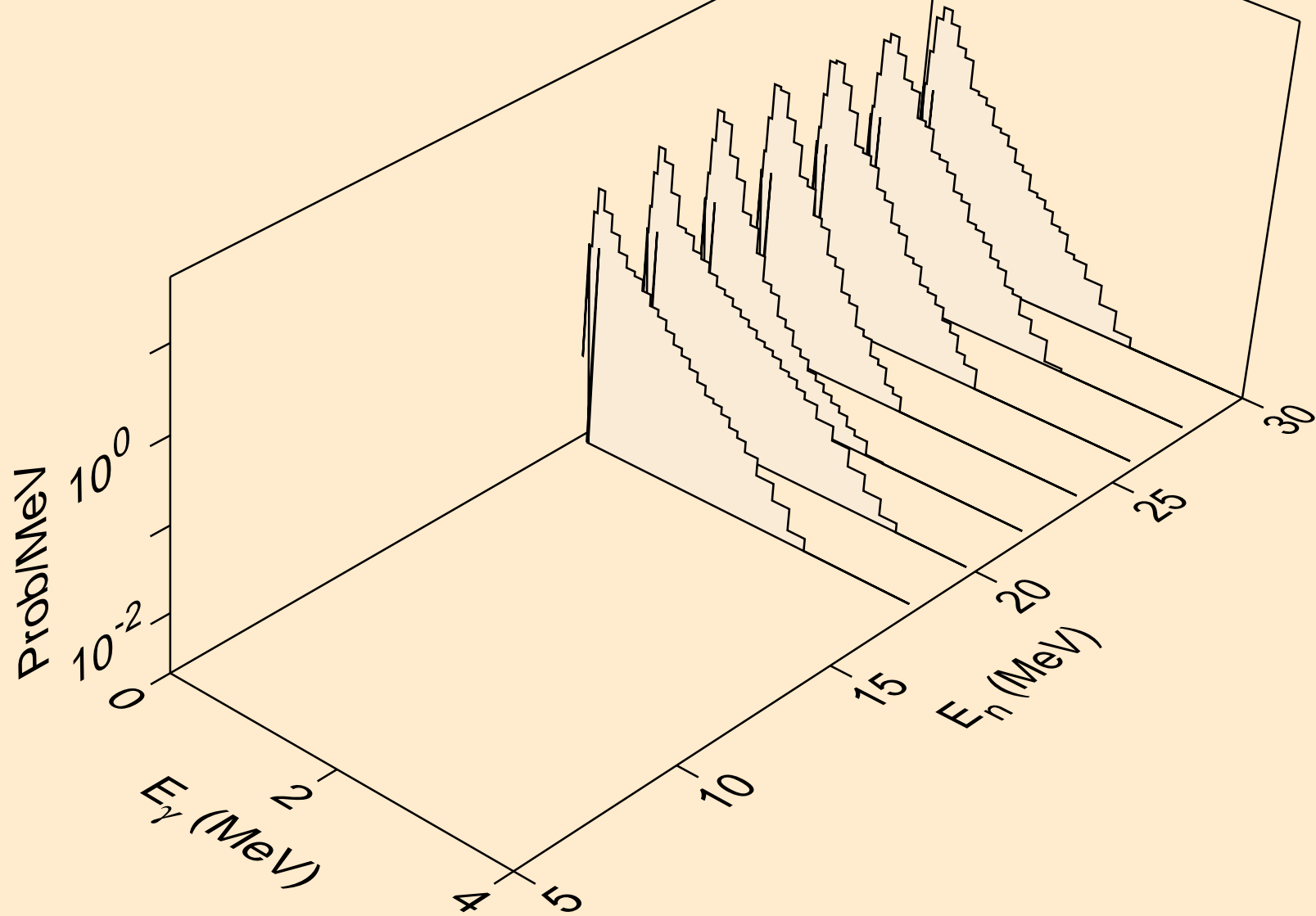

BI223 DEUTERON ACER TENDL-2024 LIBRARY; T=0.K

Particle heating contributions

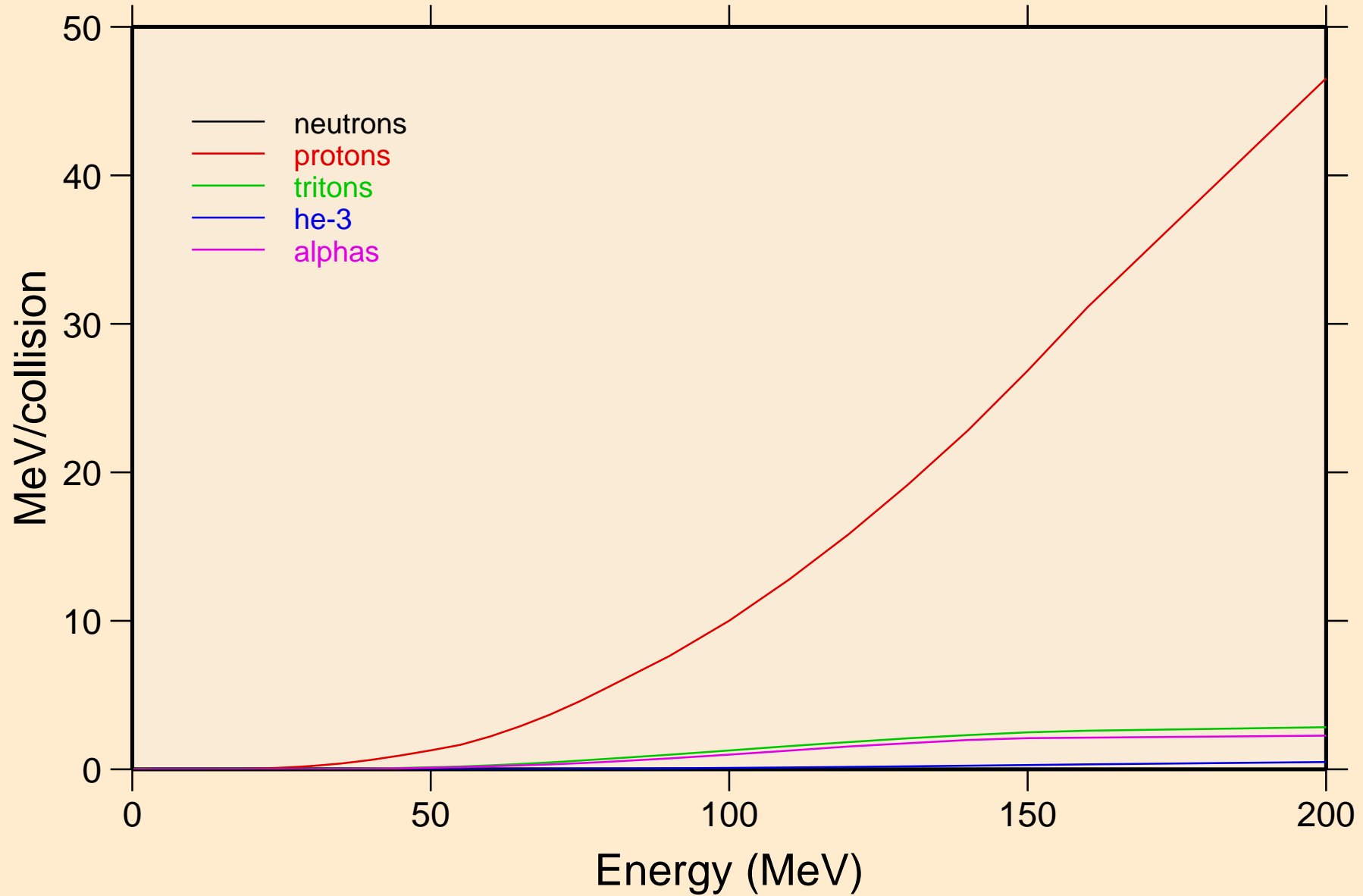

BI223 DEUTERON ACER TENDL-2024 LIBRARY; T=0.K
Recoil Heating

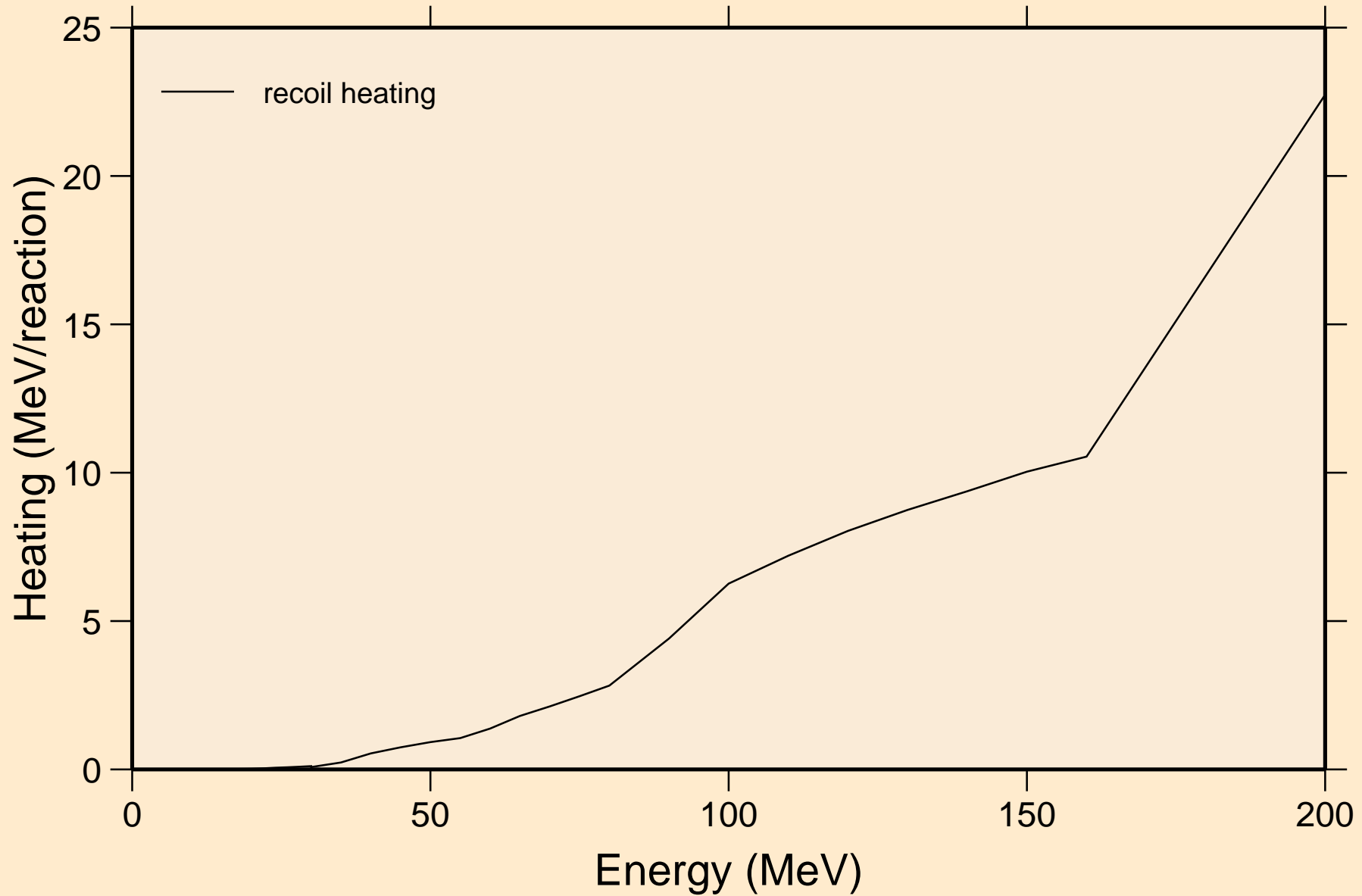

BI223 DEUTERON ACER TENDL-2024 LIBRARY; T=0.K

Particle production cross sections

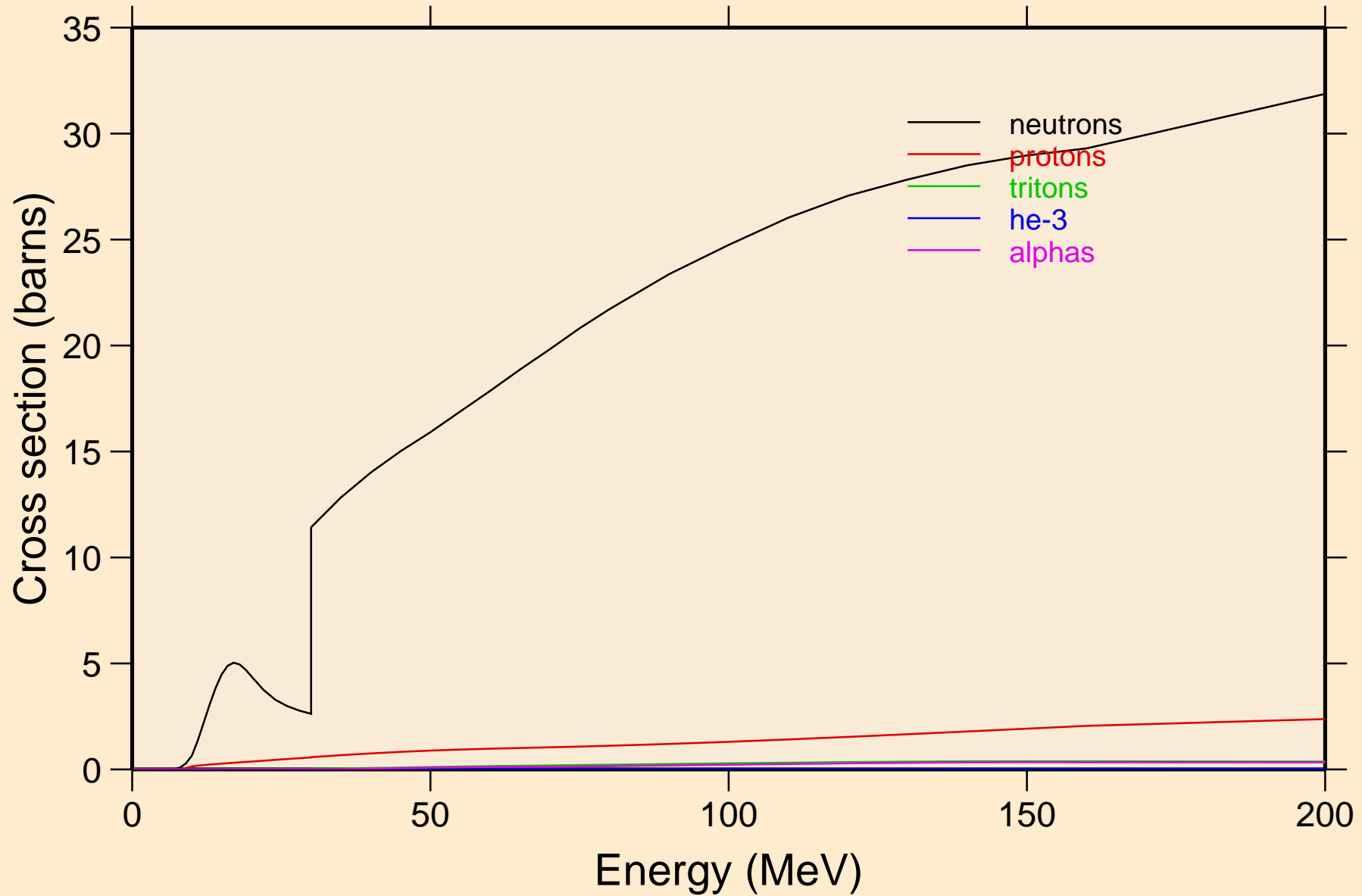

BI223 DEUTERON ACER TENDL-2024 LIBRARY; T=0.K
neutrons from (d,n)

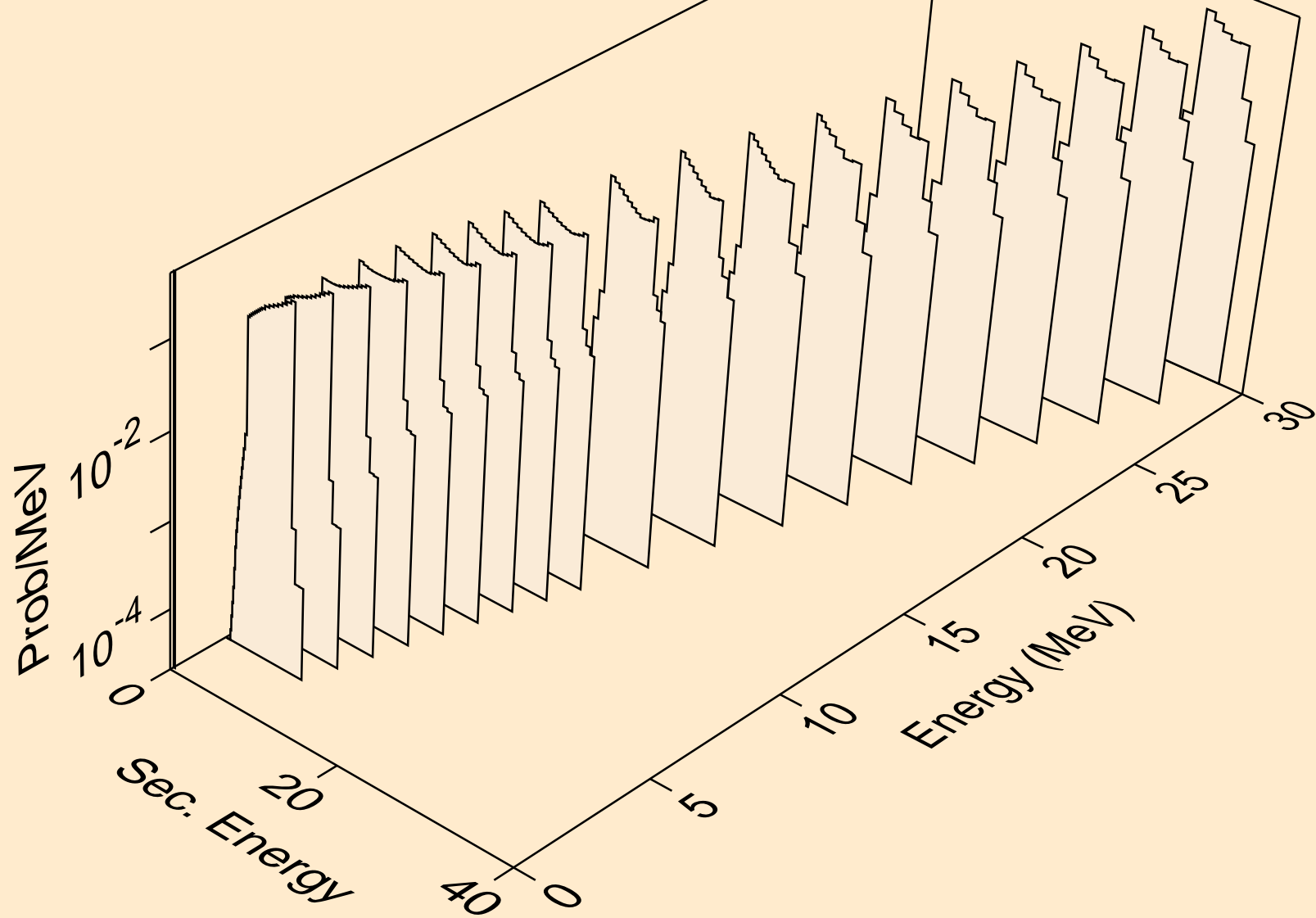

BI223 DEUTERON ACER TENDL-2024 LIBRARY; T=0.K
neutrons from (d,x)

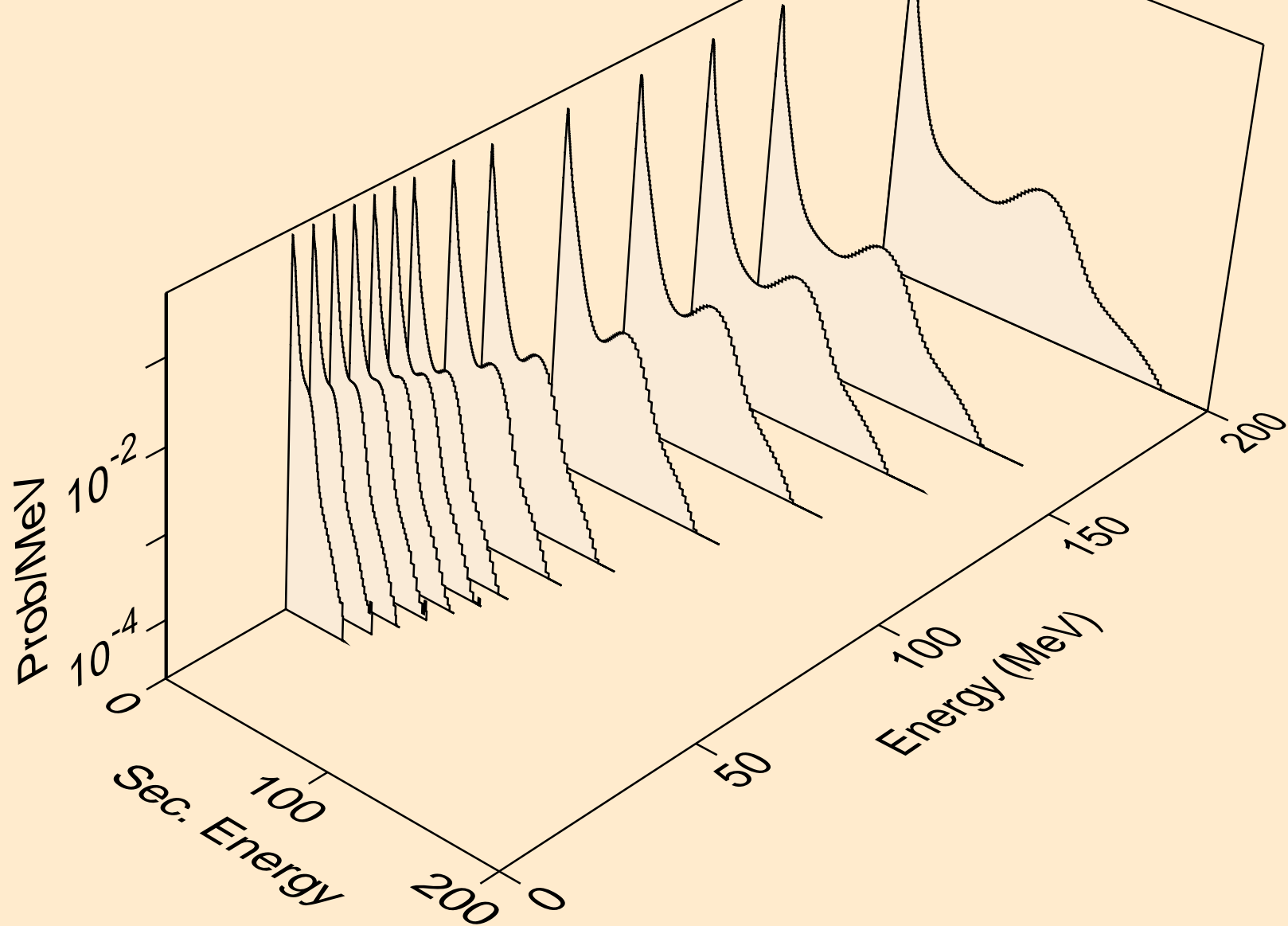

BI223 DEUTERON ACER TENDL-2024 LIBRARY; T=0.K
neutrons from (d,2nd)

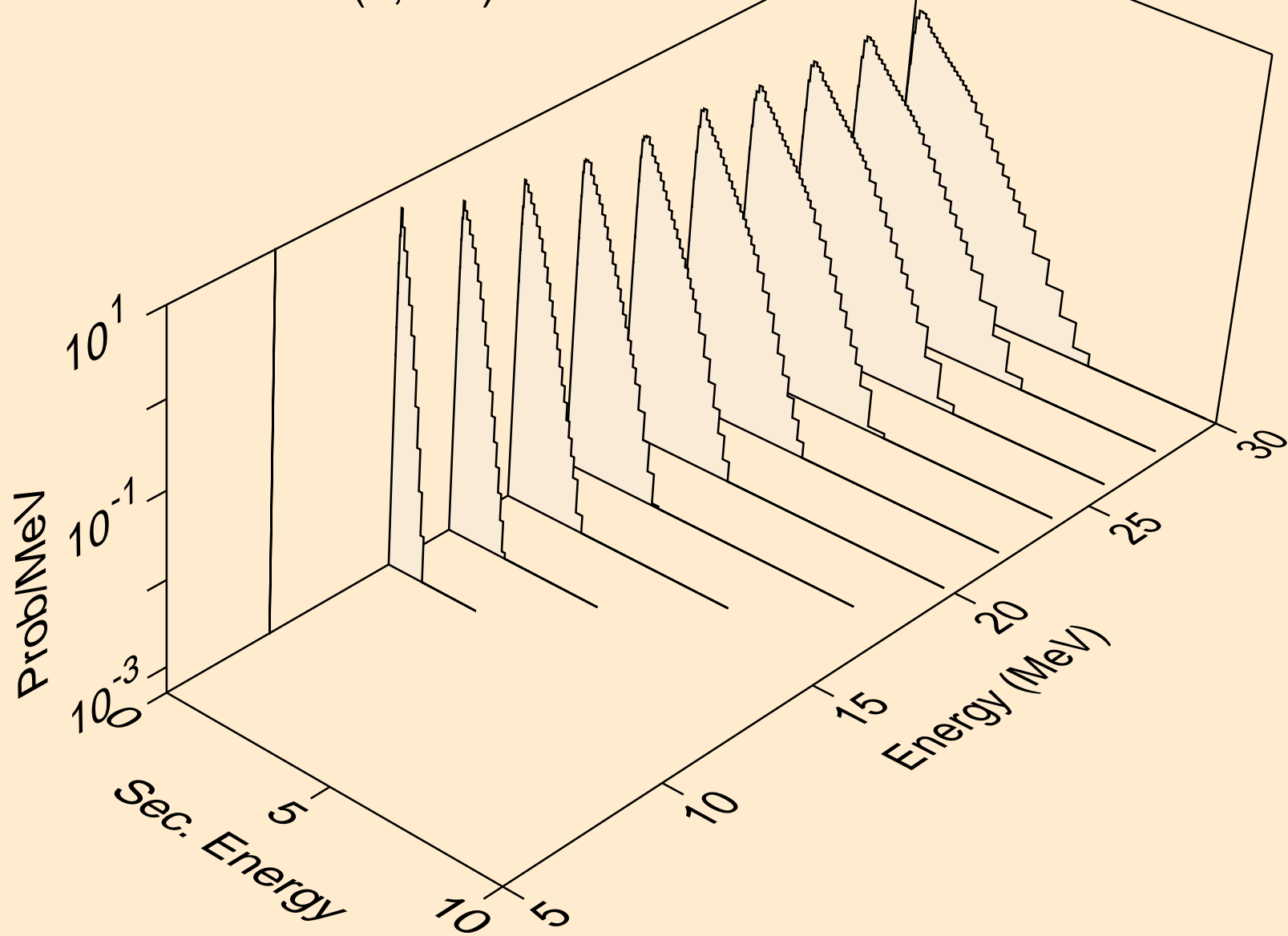

BI223 DEUTERON ACER TENDL-2024 LIBRARY; T=0.K
neutrons from (d,2n)

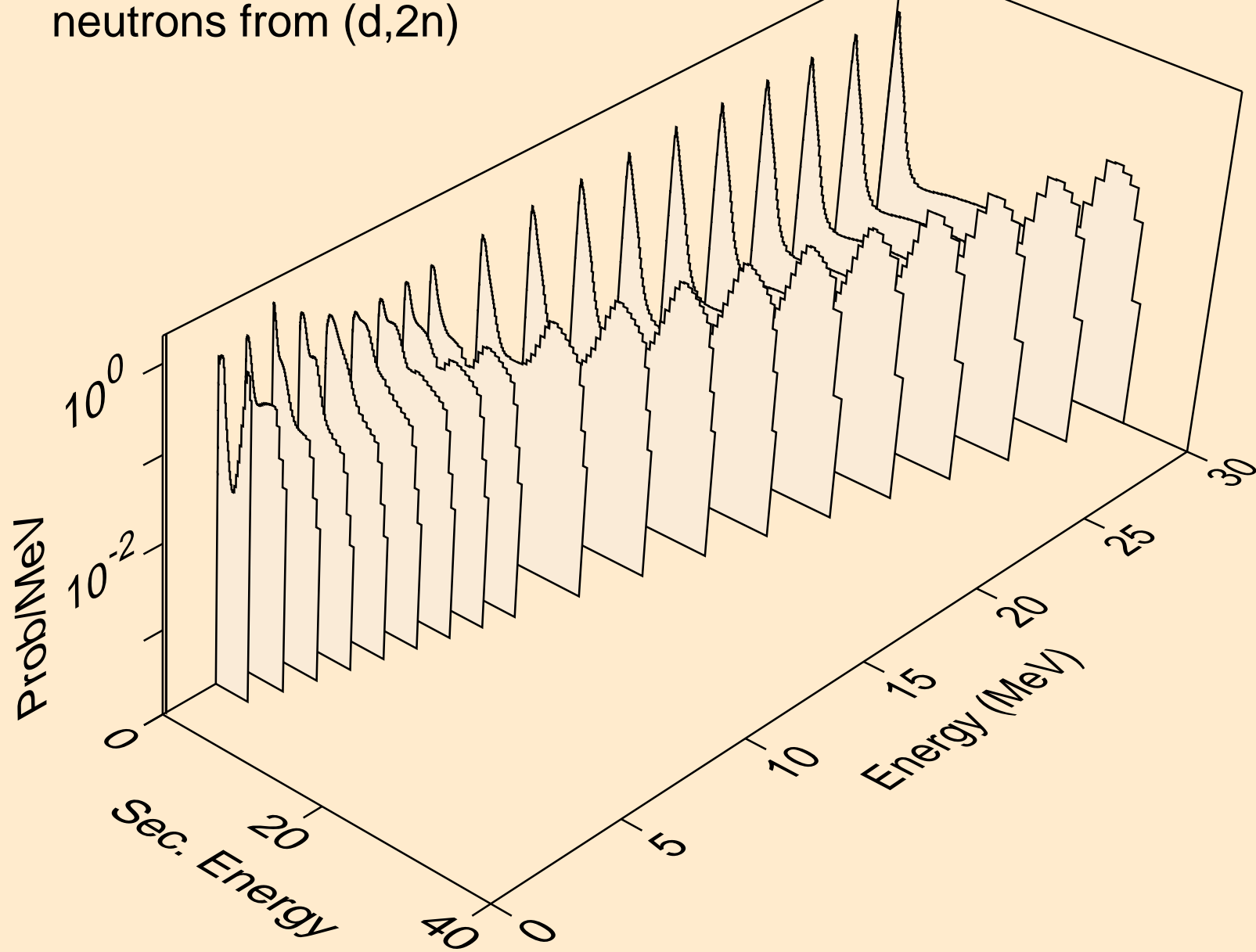

BI223 DEUTERON ACER TENDL-2024 LIBRARY; T=0.K
neutrons from (d,3n)

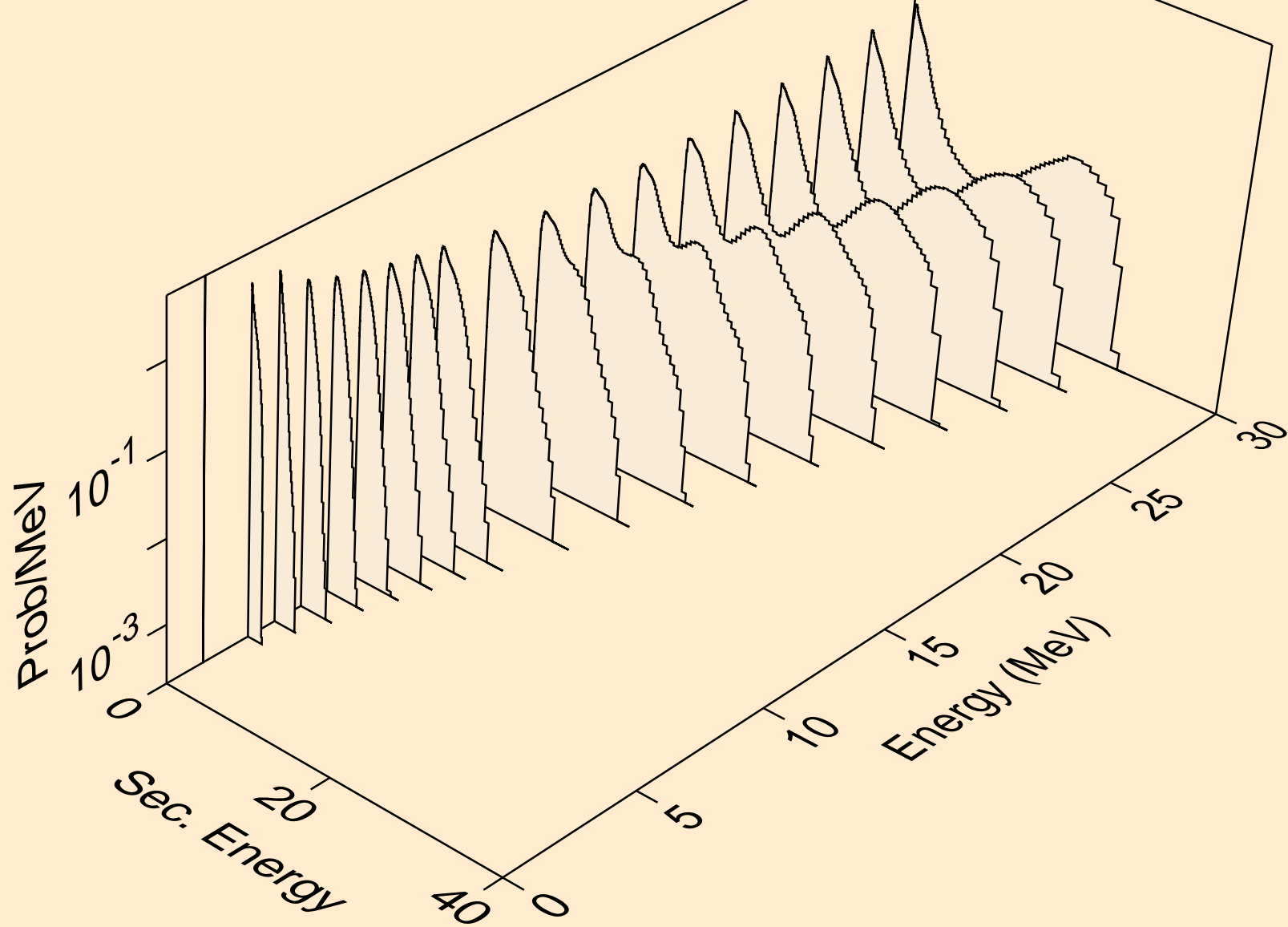

BI223 DEUTERON ACER TENDL-2024 LIBRARY; T=0.K
neutrons from (d,n*)a

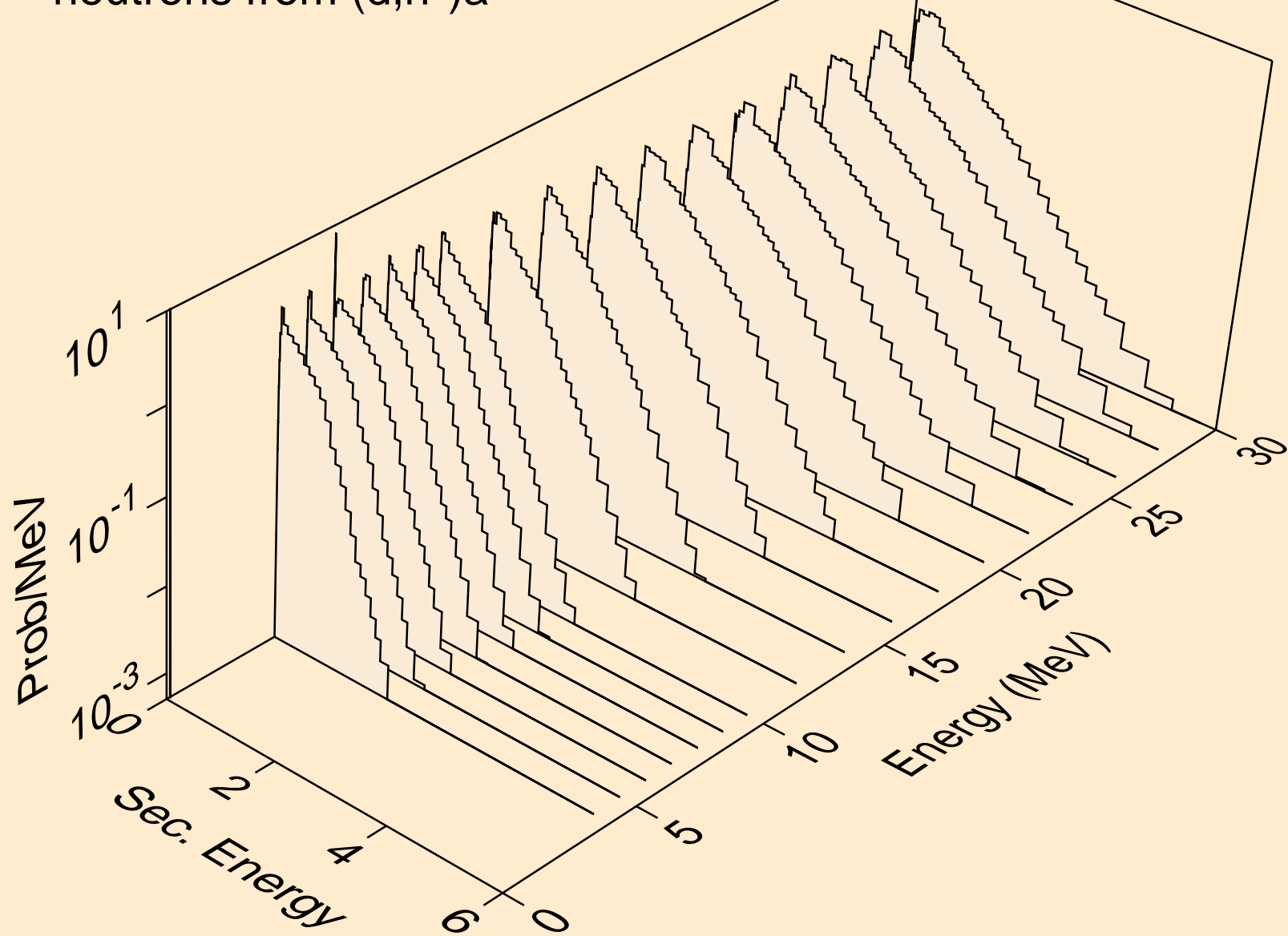

BI223 DEUTERON ACER TENDL-2024 LIBRARY; T=0.K
neutrons from (d,2n)a

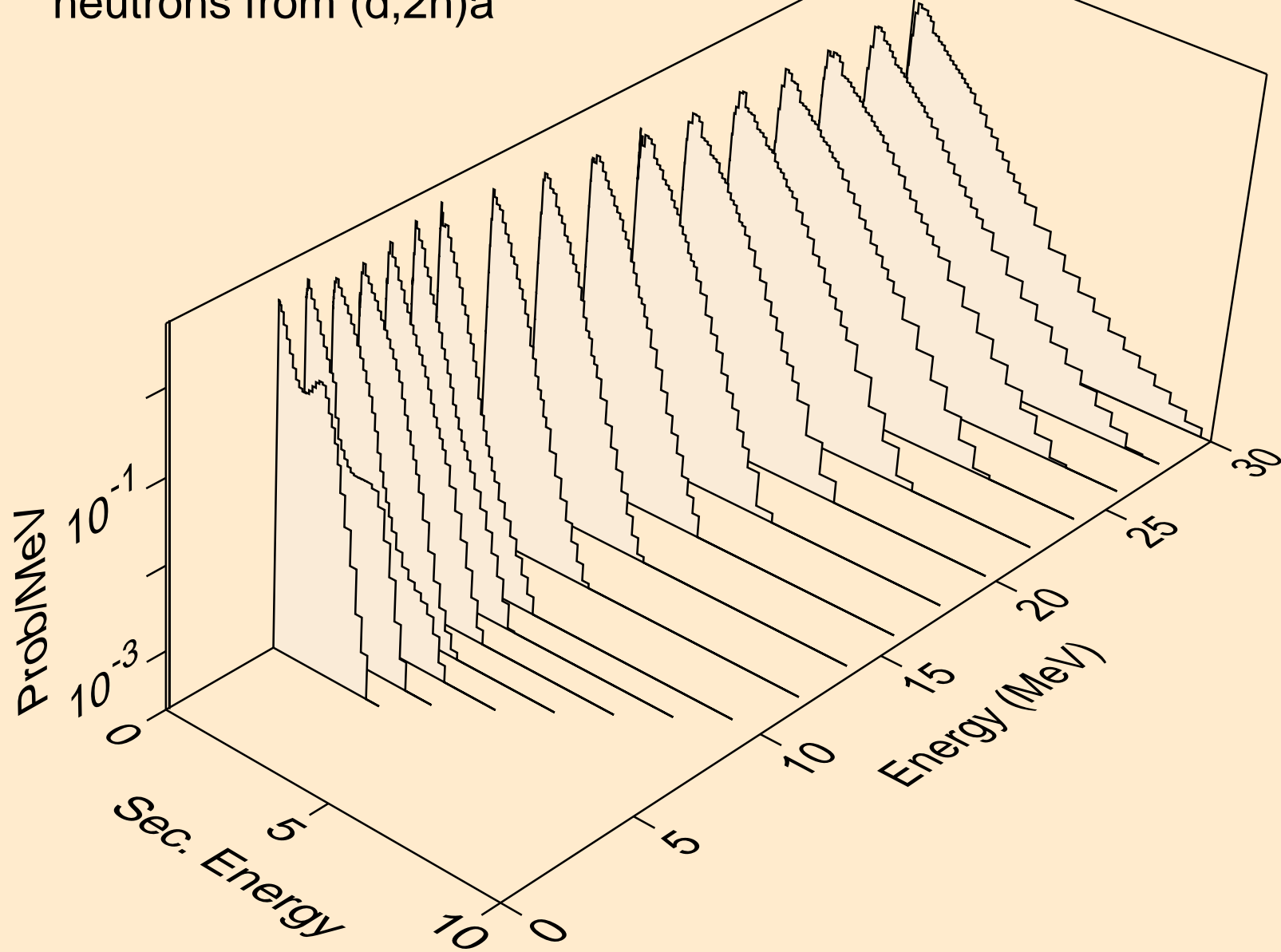

BI223 DEUTERON ACER TENDL-2024 LIBRARY; T=0.K
neutrons from (d,3n)a

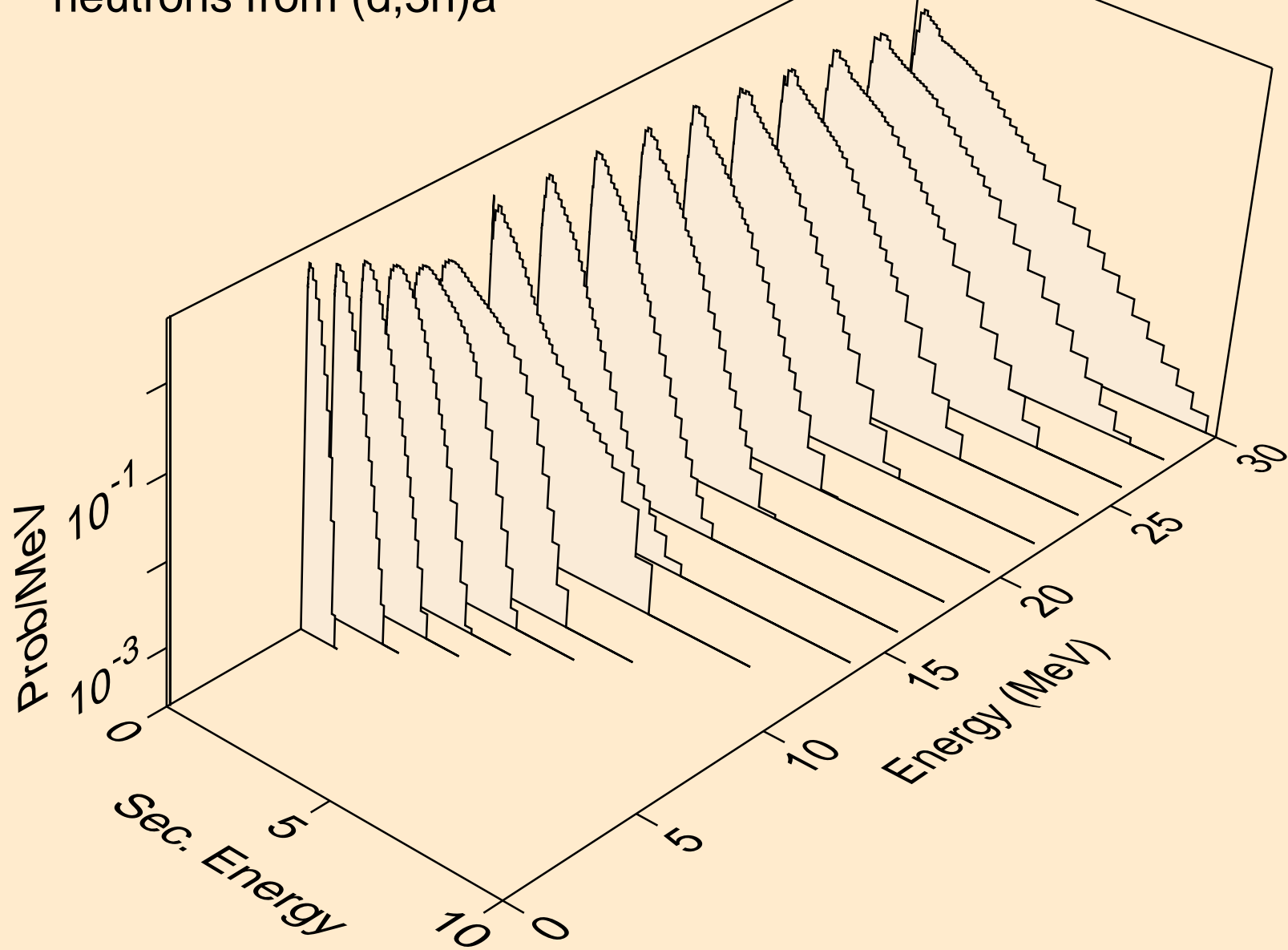

BI223 DEUTERON ACER TENDL-2024 LIBRARY; T=0.K
neutrons from (d,n*)p

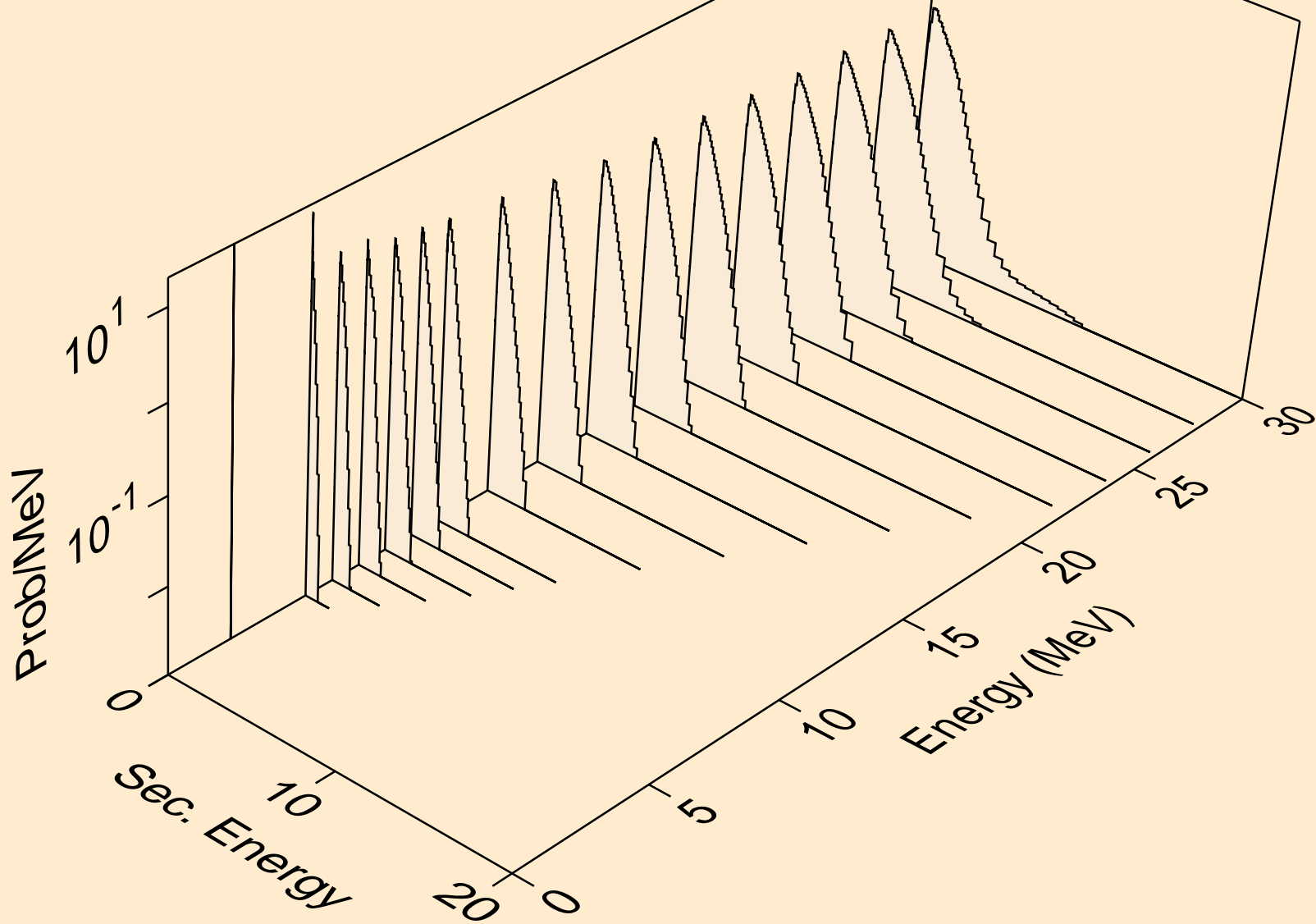

BI223 DEUTERON ACER TENDL-2024 LIBRARY; T=0.K
neutrons from (d,n*)d

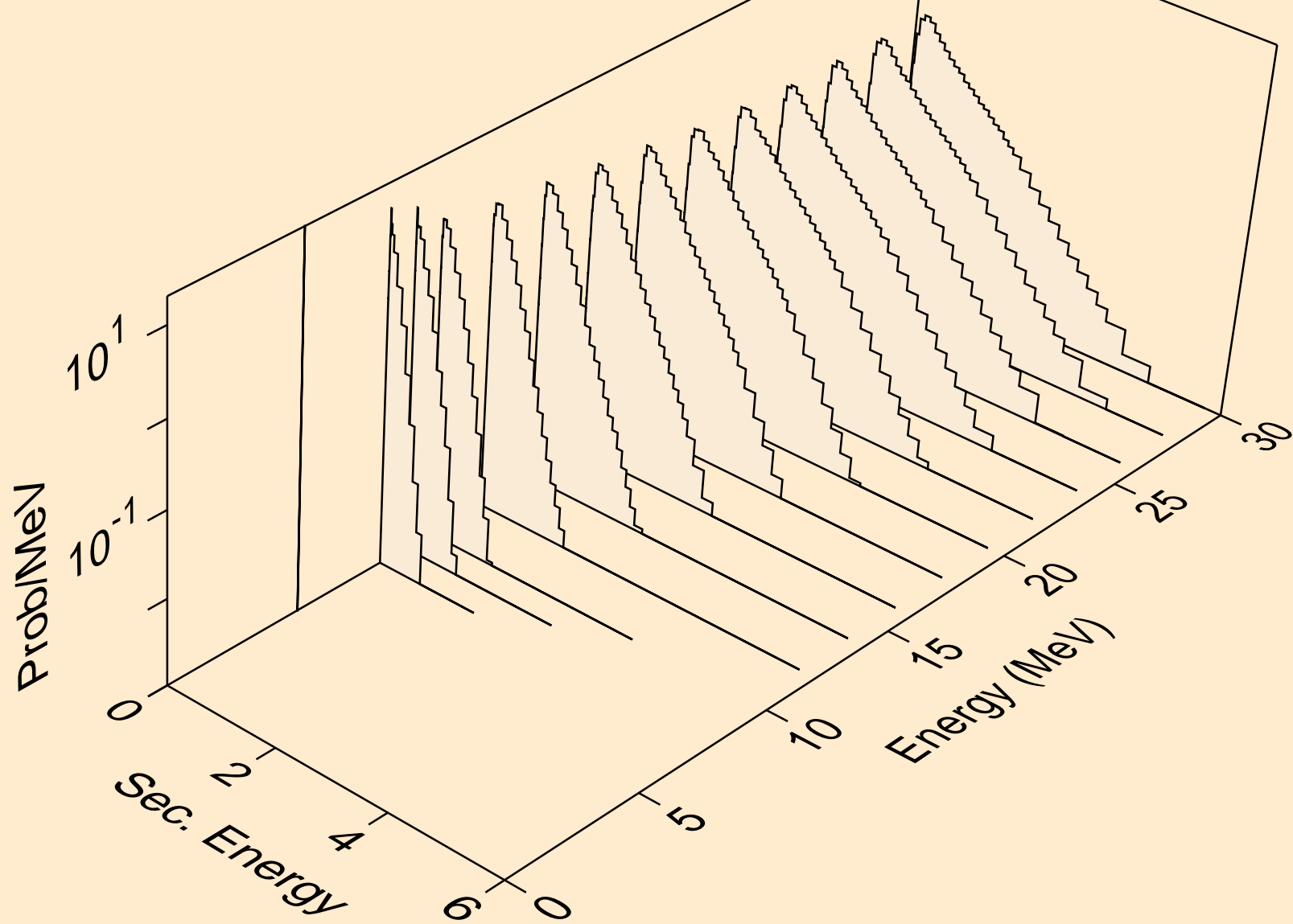

BI223 DEUTERON ACER TENDL-2024 LIBRARY; T=0.K
neutrons from (d,n*)t

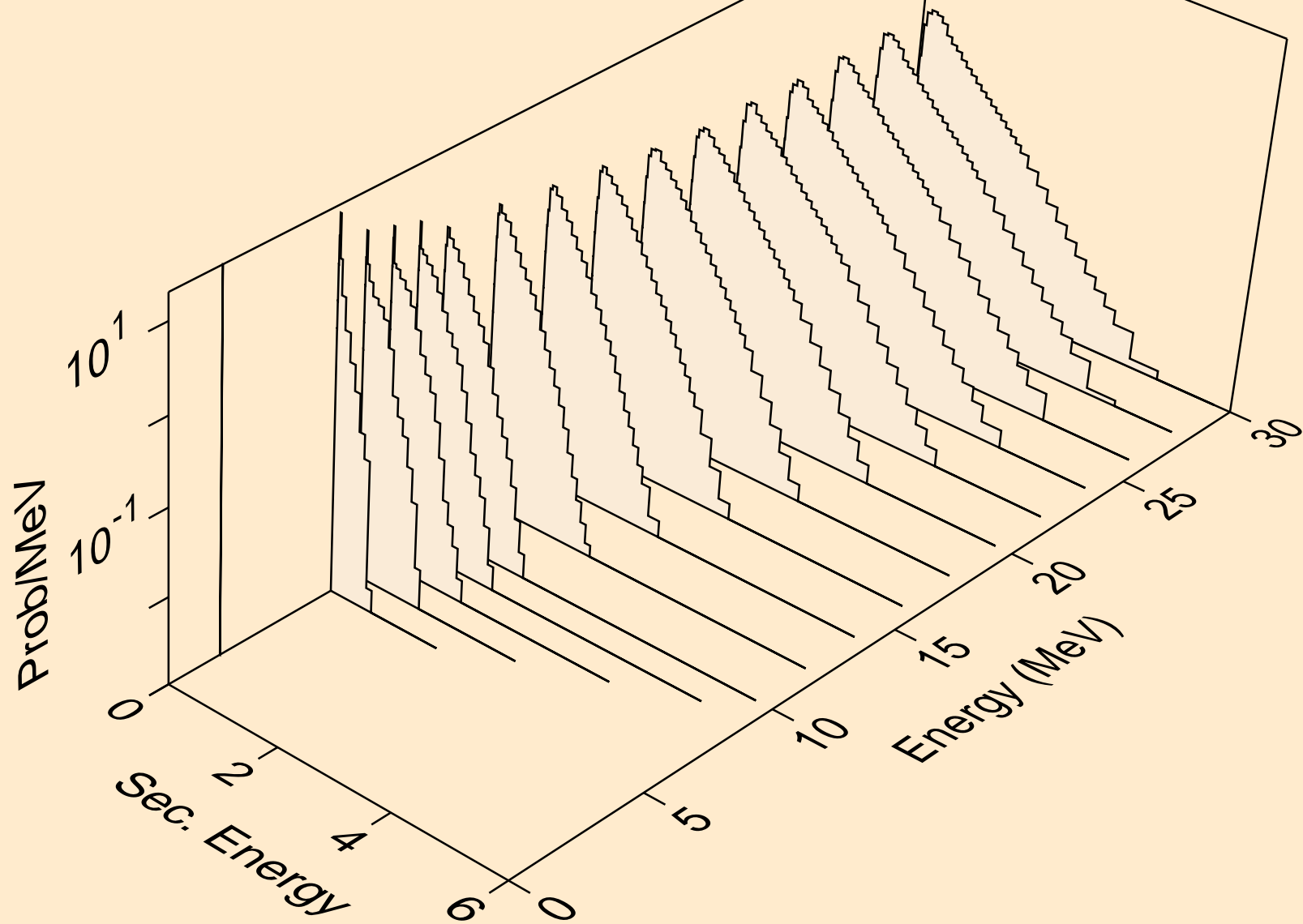

BI223 DEUTERON ACER TENDL-2024 LIBRARY; T=0.K
neutrons from (d,n*)he3

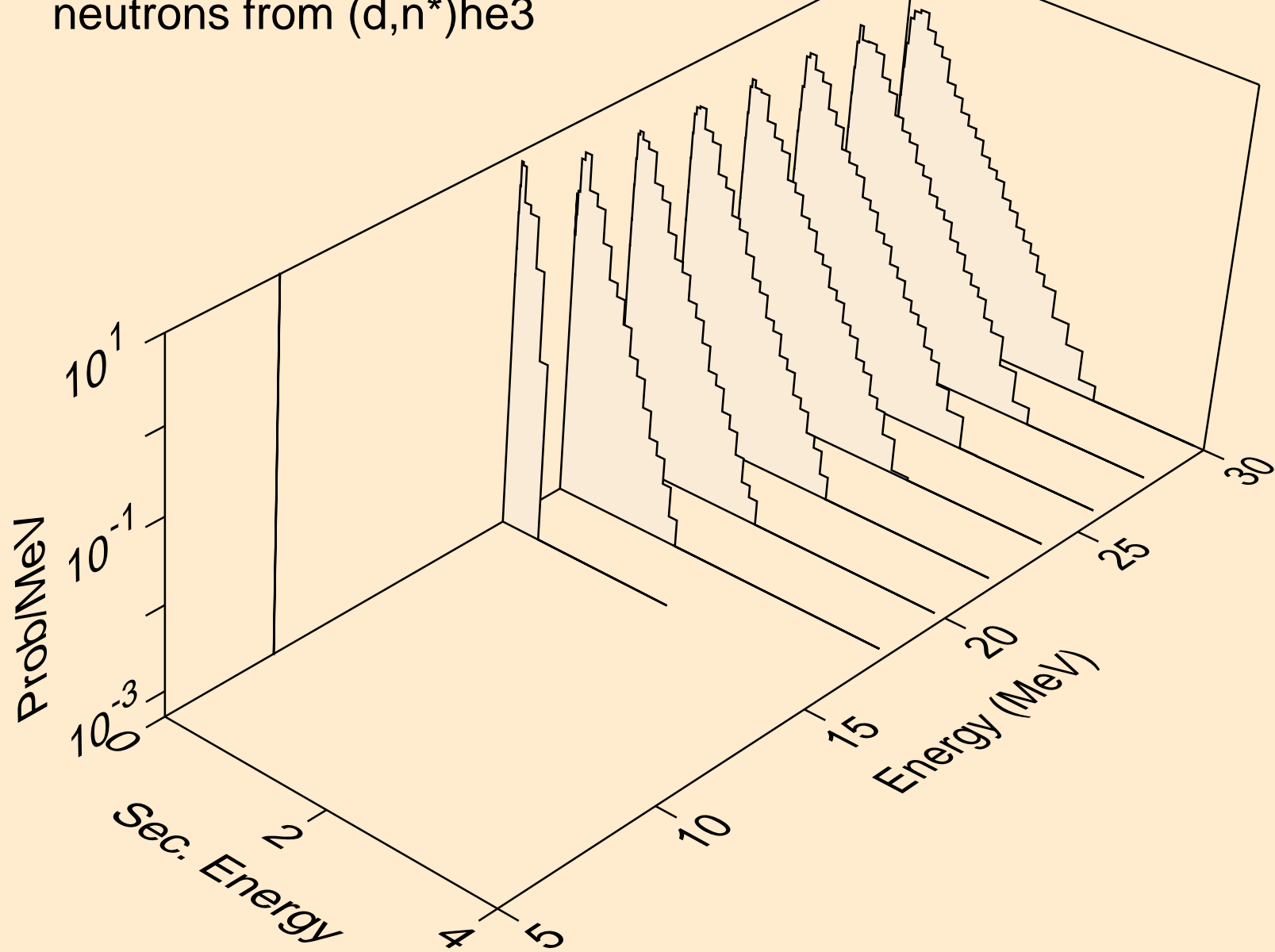

BI223 DEUTERON ACER TENDL-2024 LIBRARY; T=0.K
neutrons from (d,4n)

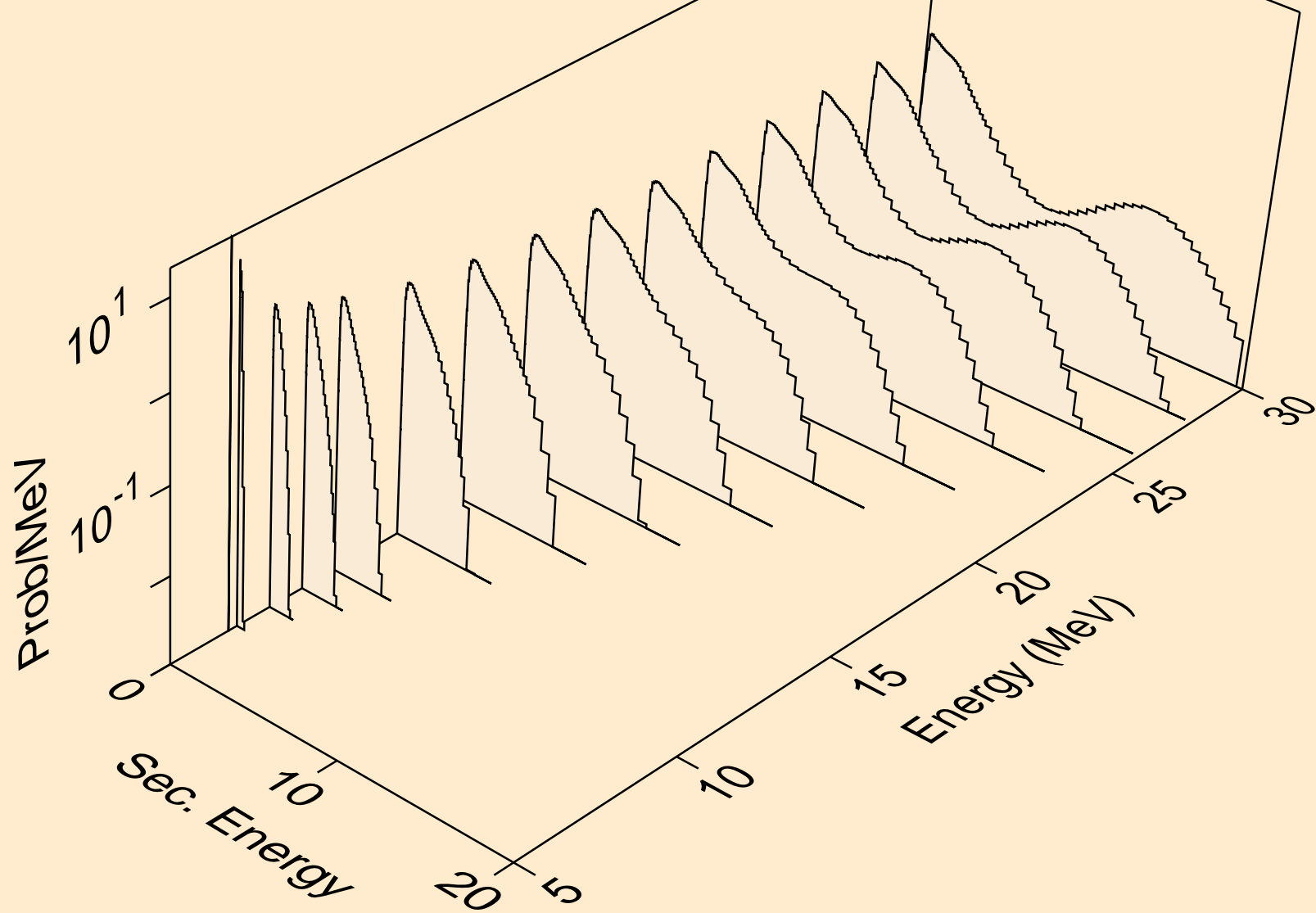

BI223 DEUTERON ACER TENDL-2024 LIBRARY; T=0.K
neutrons from (d,2np)

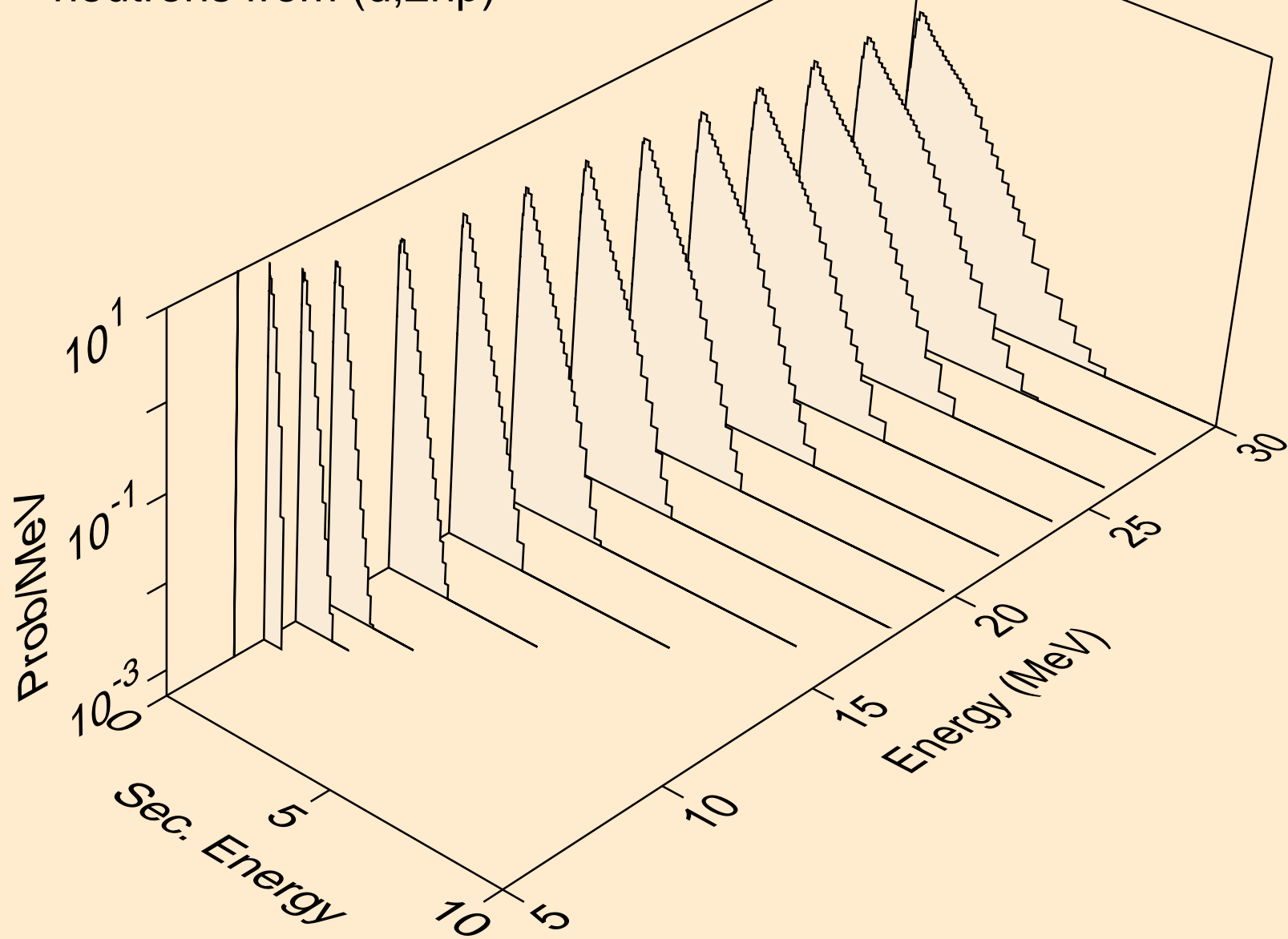

BI223 DEUTERON ACER TENDL-2024 LIBRARY; T=0.K
neutrons from (d,3np)

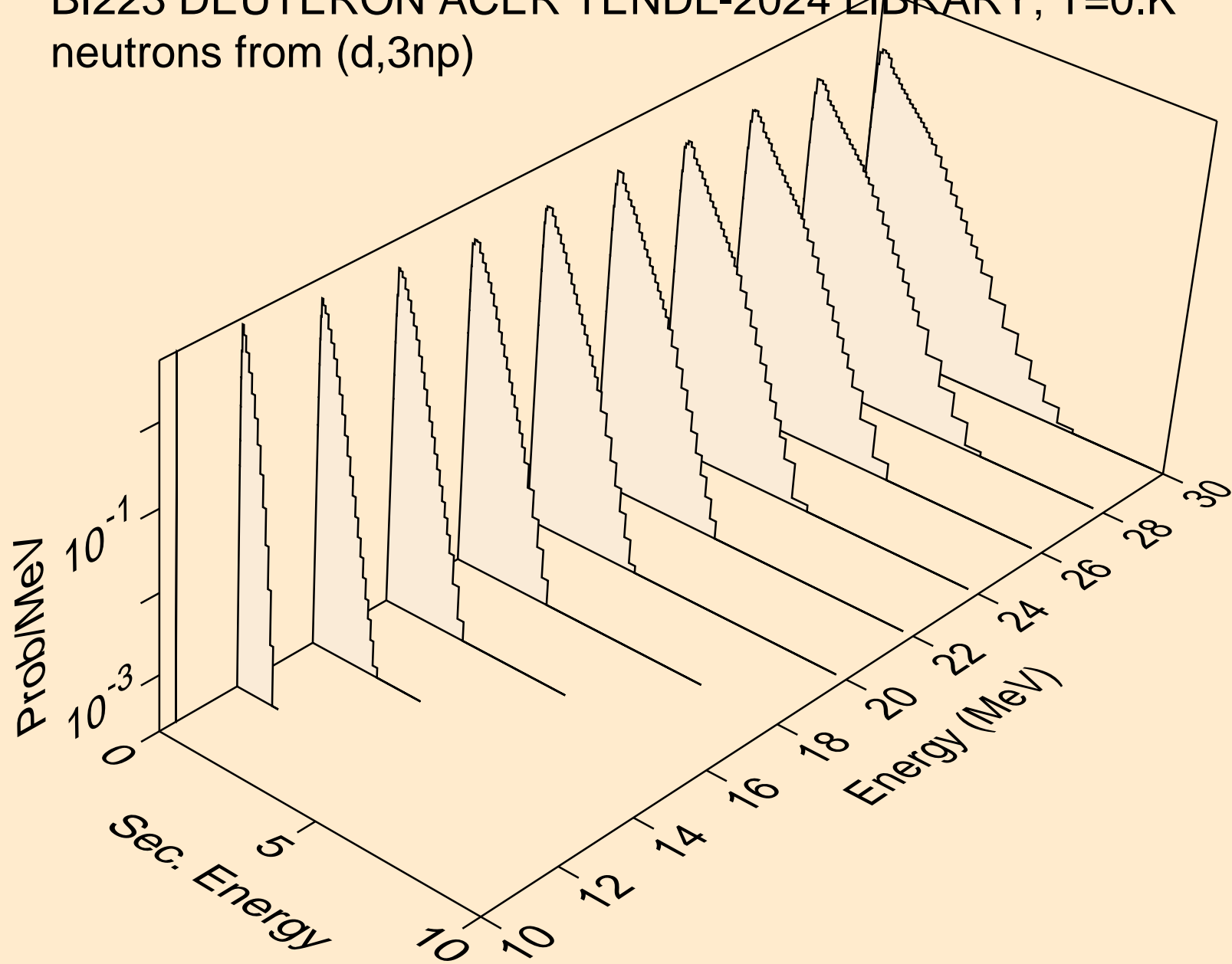

BI223 DEUTERON ACER TENDL-2024 LIBRARY; T=0.K
neutrons from (d,n2p)

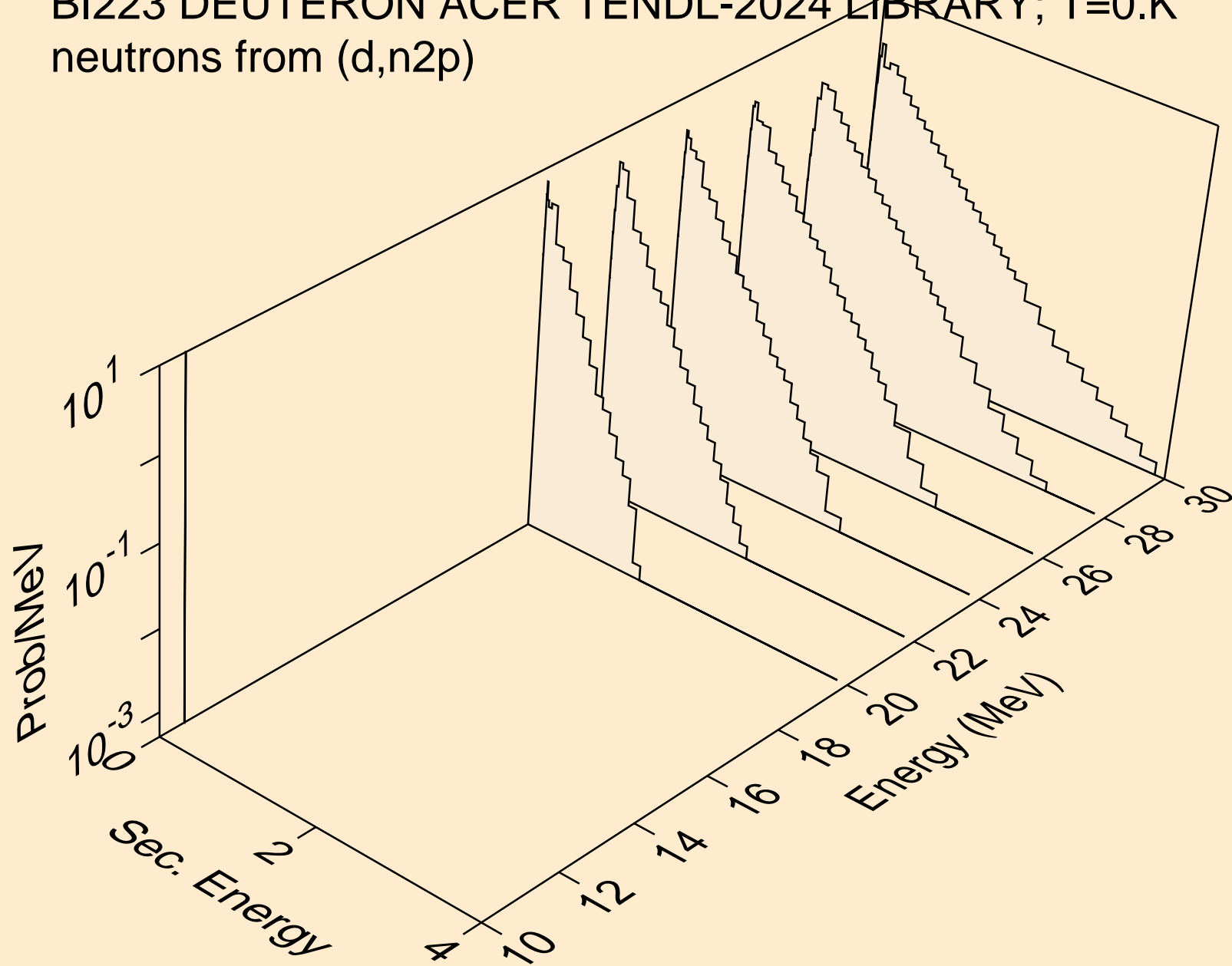

BI223 DEUTERON ACER TENDL-2024 LIBRARY; T=0.K
protons from (d,x)

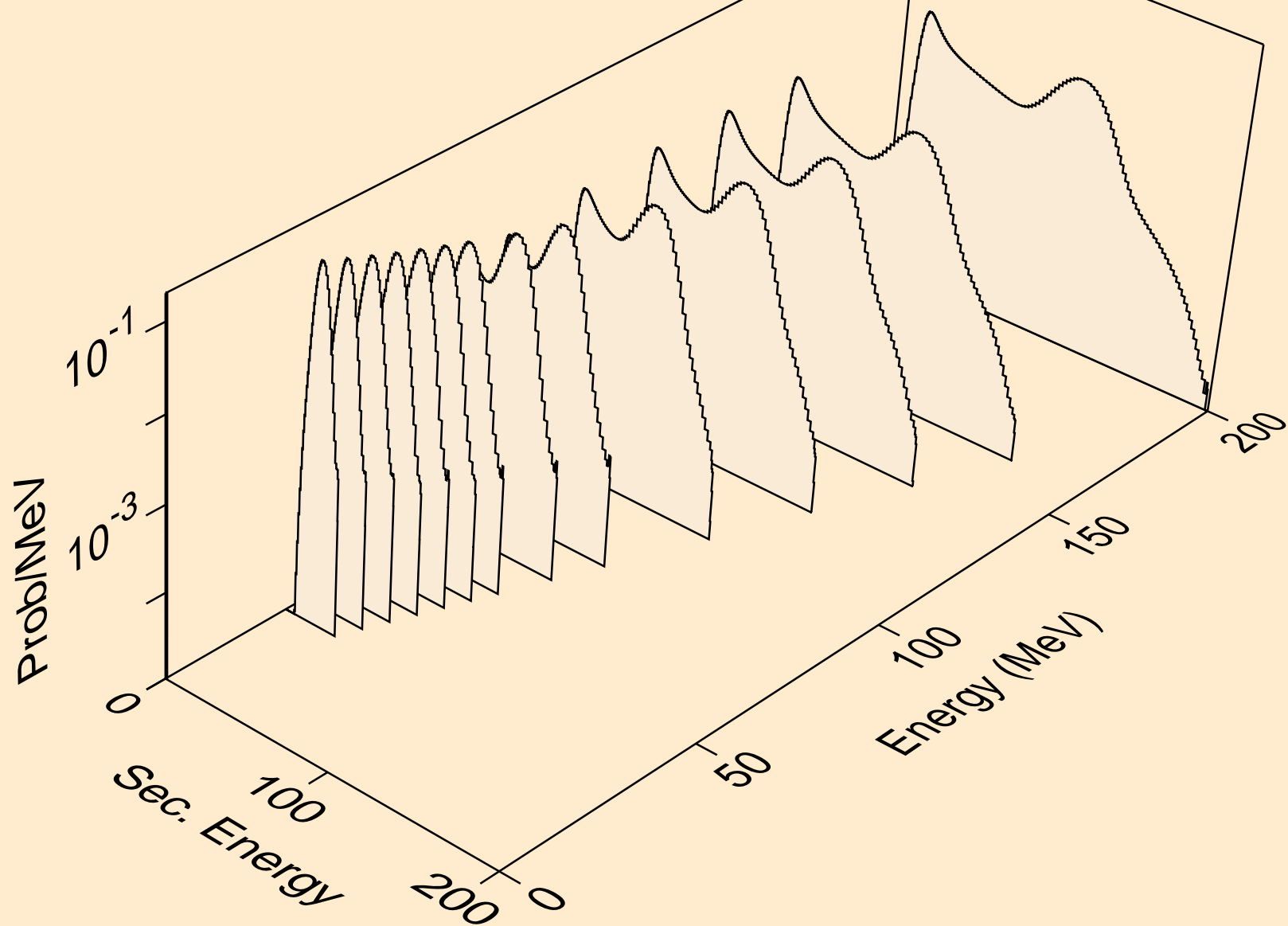

BI223 DEUTERON ACER TENDL-2024 LIBRARY; T=0.K
protons from (d,n*)p

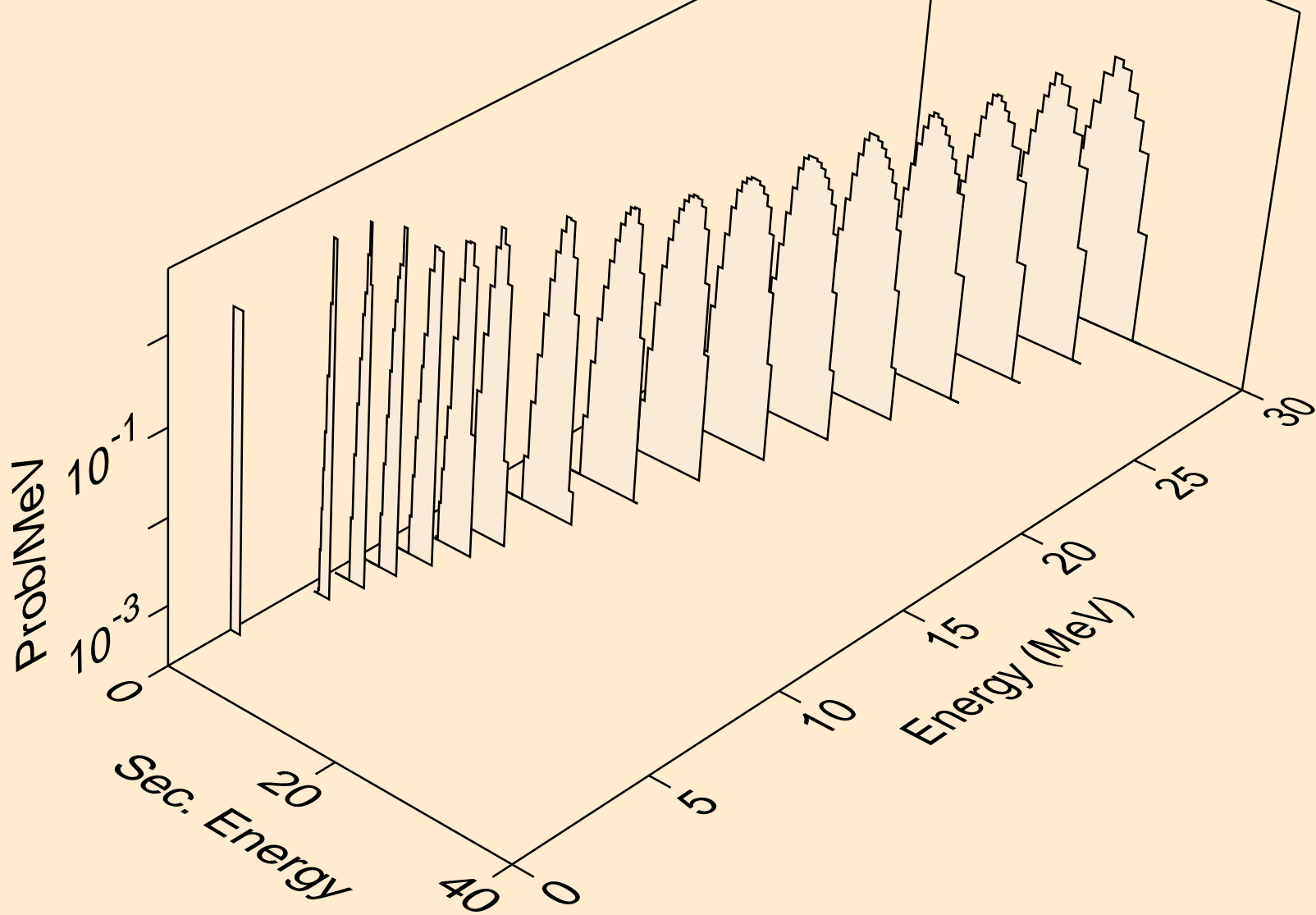

BI223 DEUTERON ACER TENDL-2024 LIBRARY; T=0.K
protons from (d,2np)

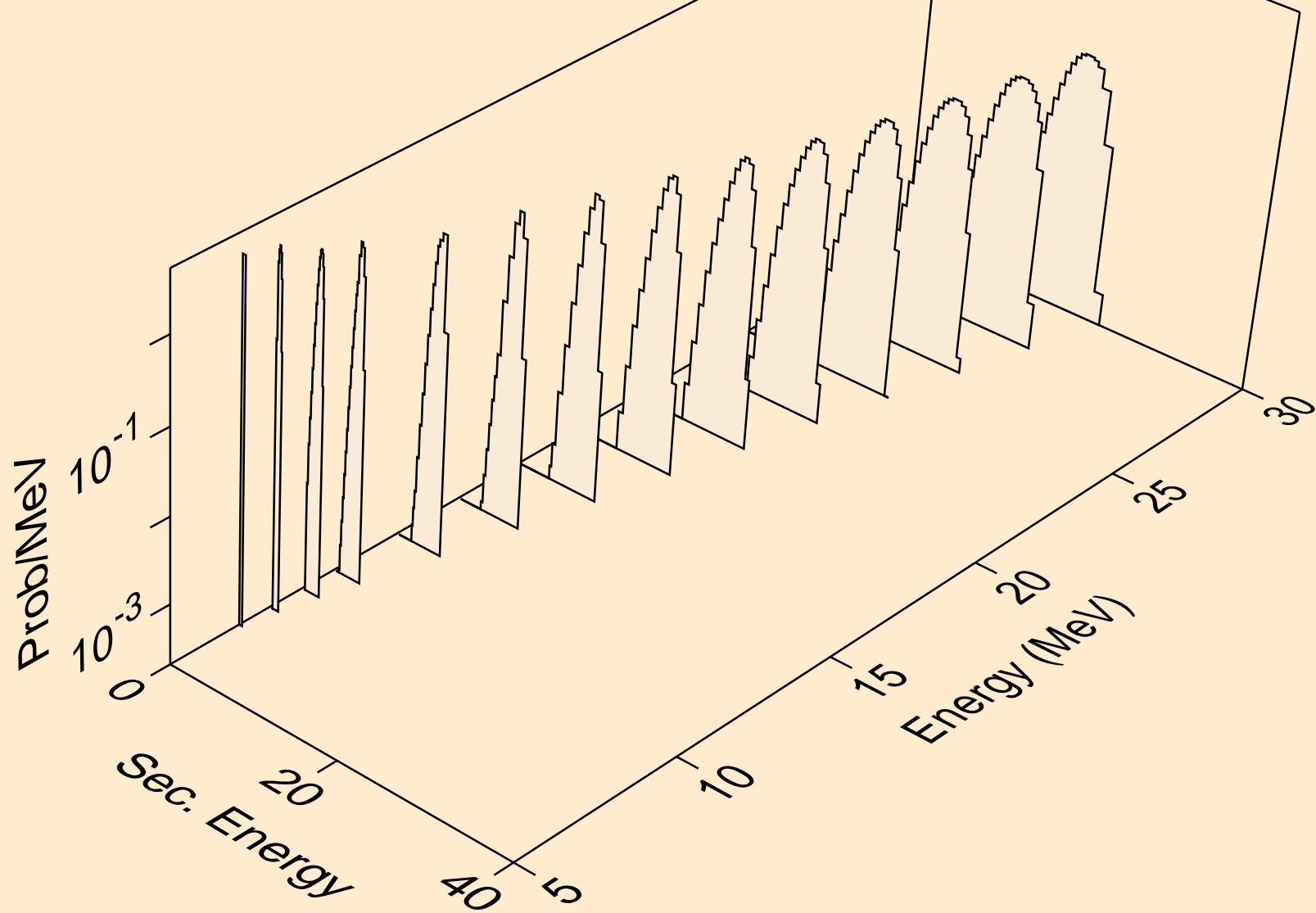

BI223 DEUTERON ACER TENDL-2024 LIBRARY; T=0.K
protons from (d,3np)

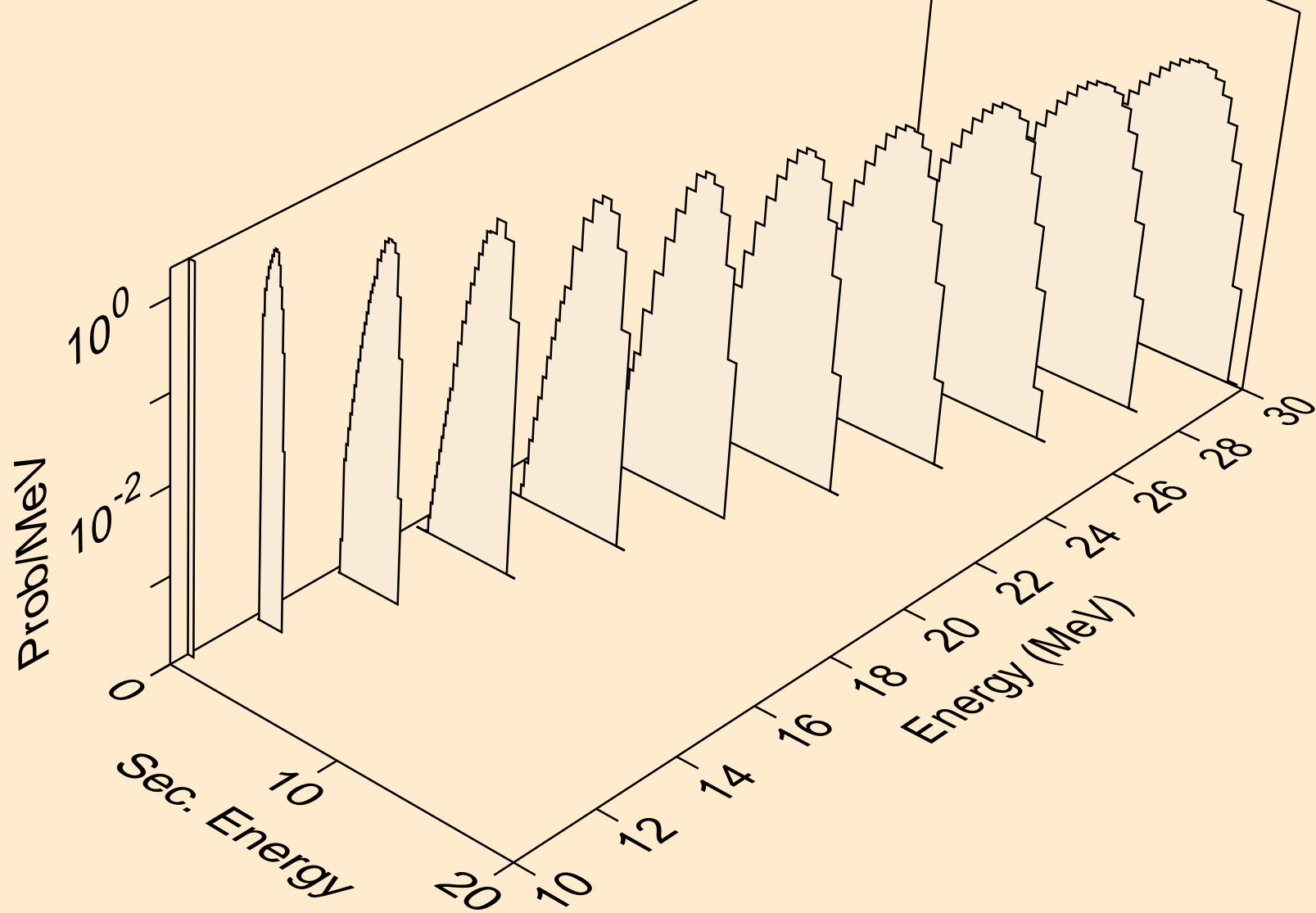

BI223 DEUTERON ACER TENDL-2024 LIBRARY; T=0.K
protons from (d,n2p)

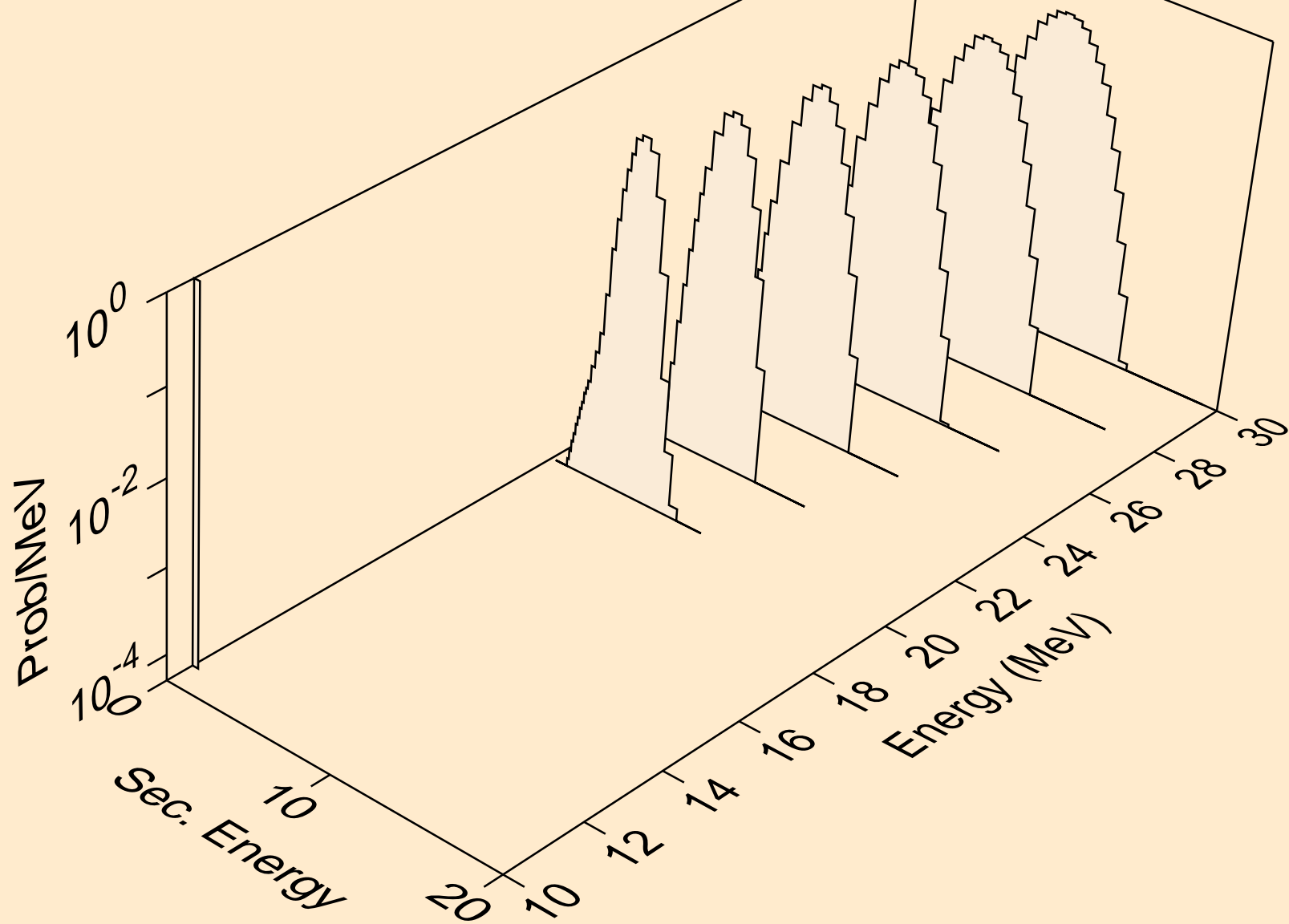

BI223 DEUTERON ACER TENDL-2024 LIBRARY; T=0.K
protons from (d,p)

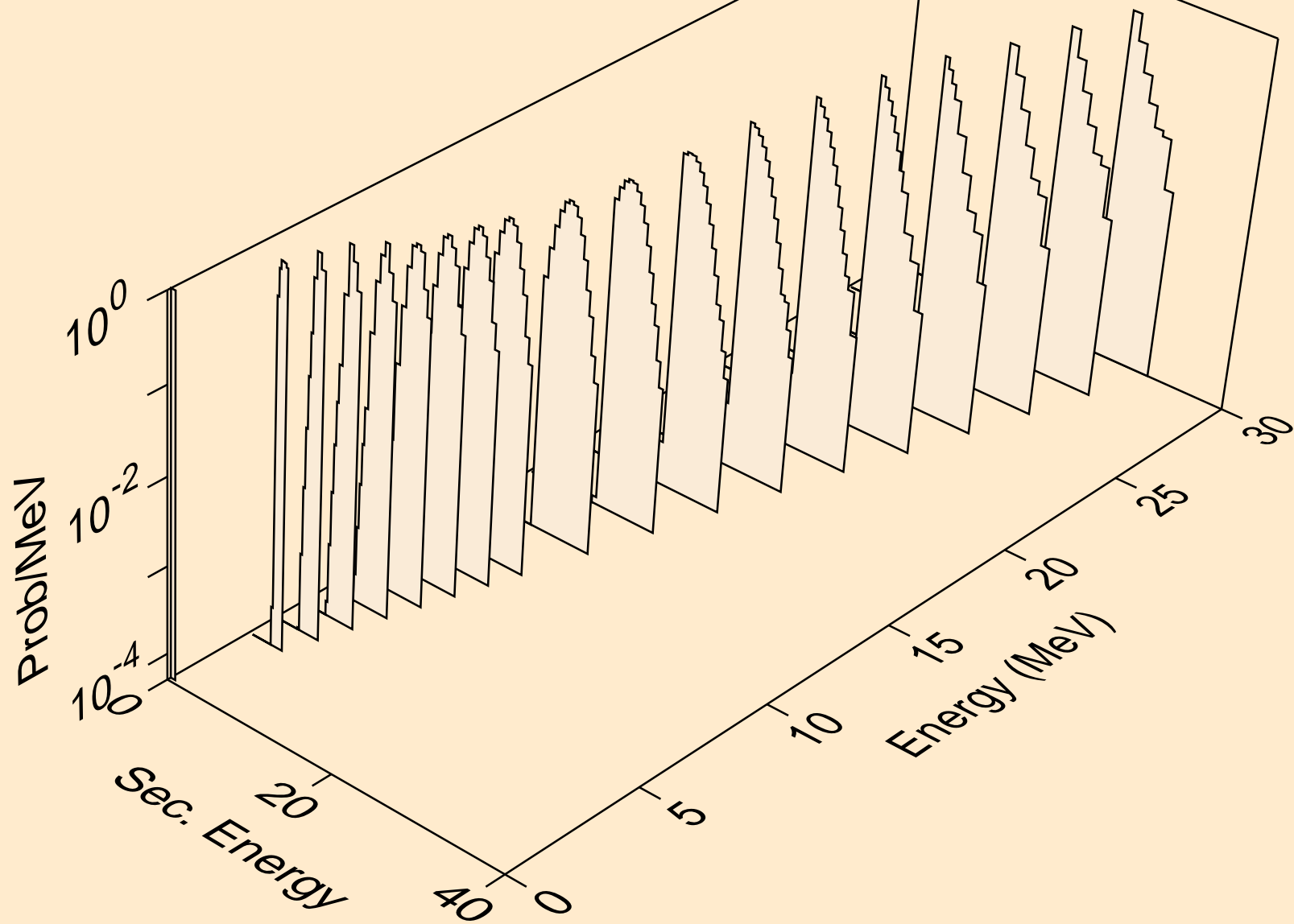

BI223 DEUTERON ACER TENDL-2024 LIBRARY; T=0.K
protons from (d,2p)

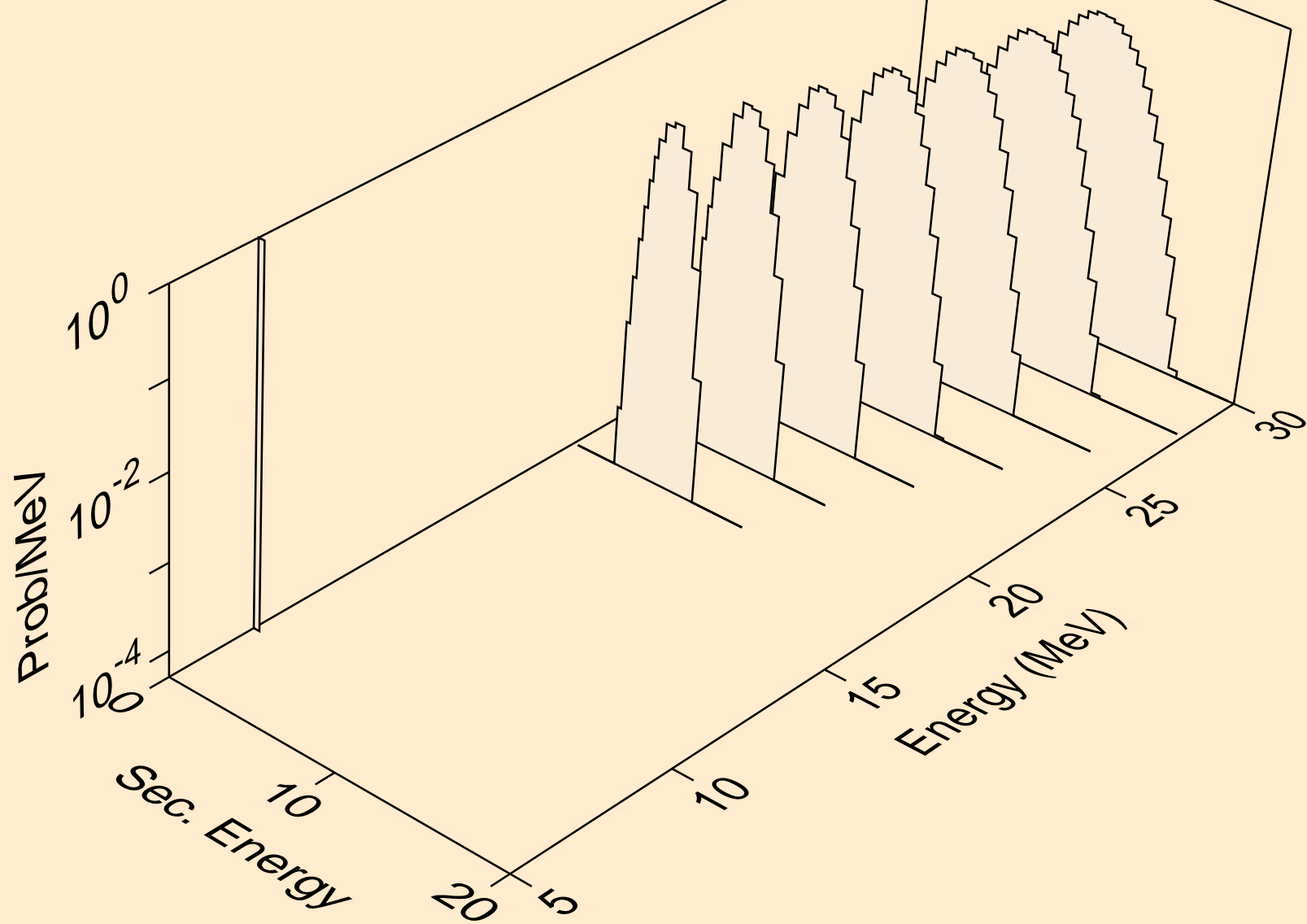

BI223 DEUTERON ACER TENDL-2024 LIBRARY; T=0.K
protons from (d,pd)

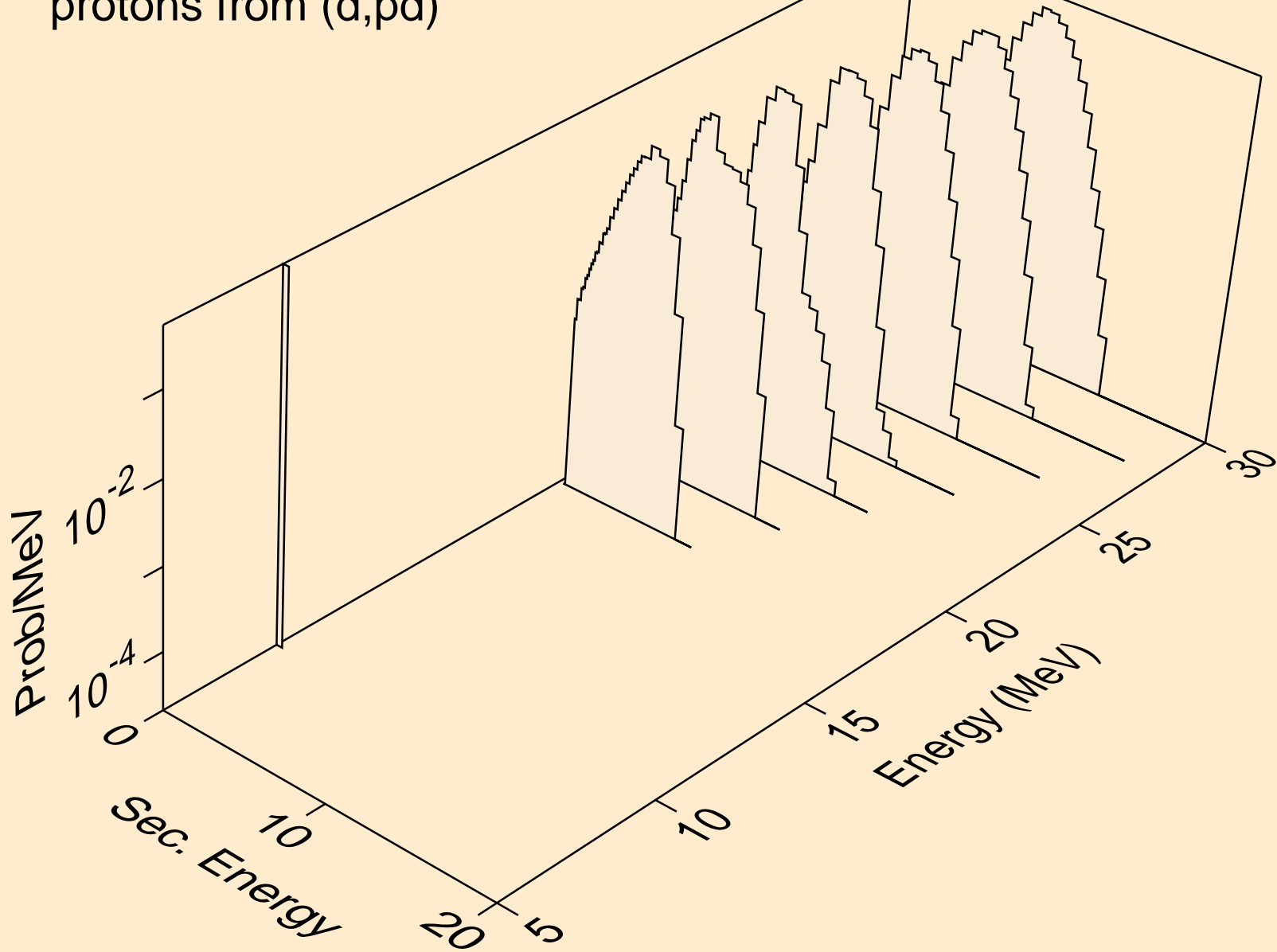

BI223 DEUTERON ACER TENDL-2024 LIBRARY; T=0.K
tritons from (d,x)

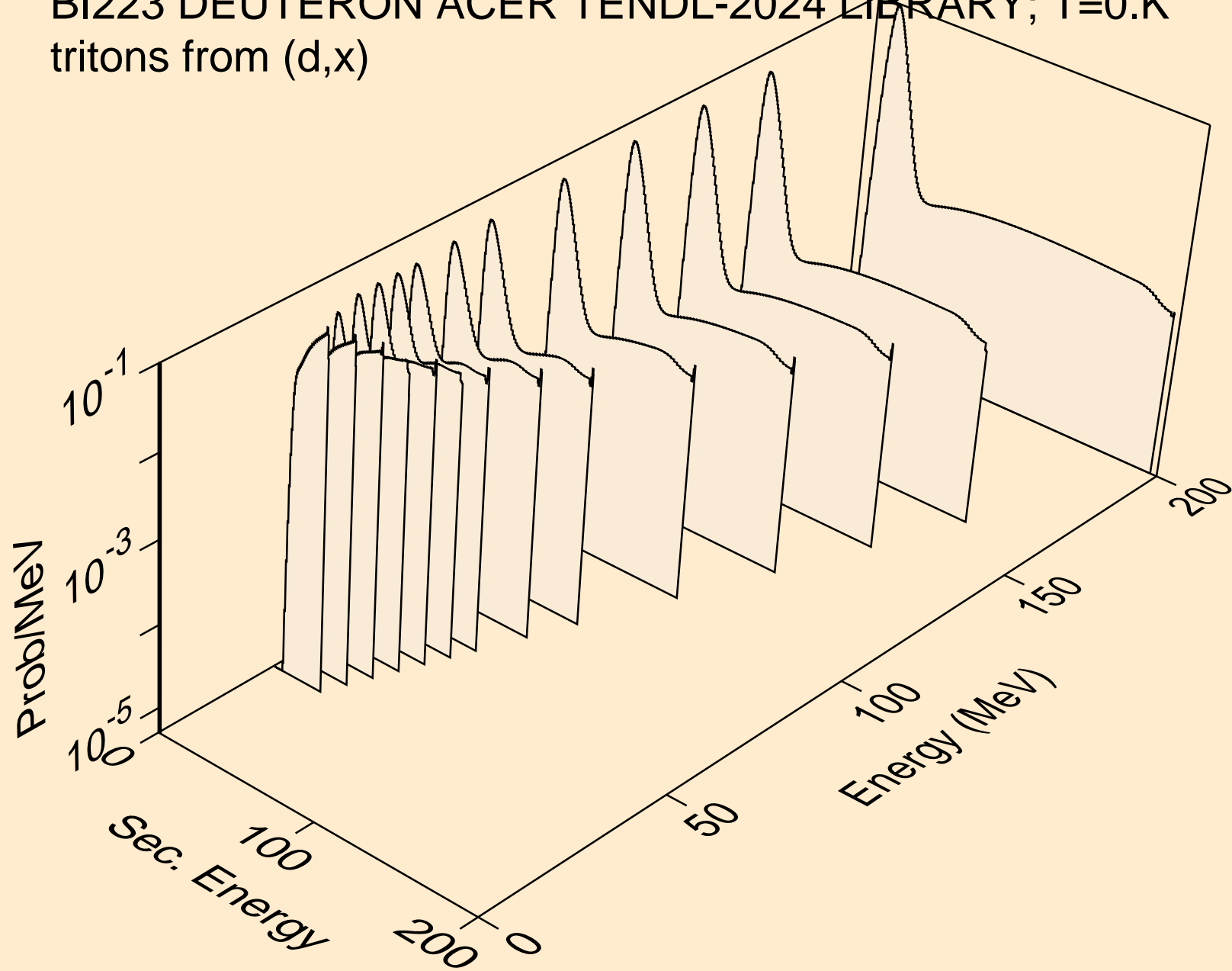

BI223 DEUTERON ACER TENDL-2024 LIBRARY; T=0.K
tritons from (d,n*)t

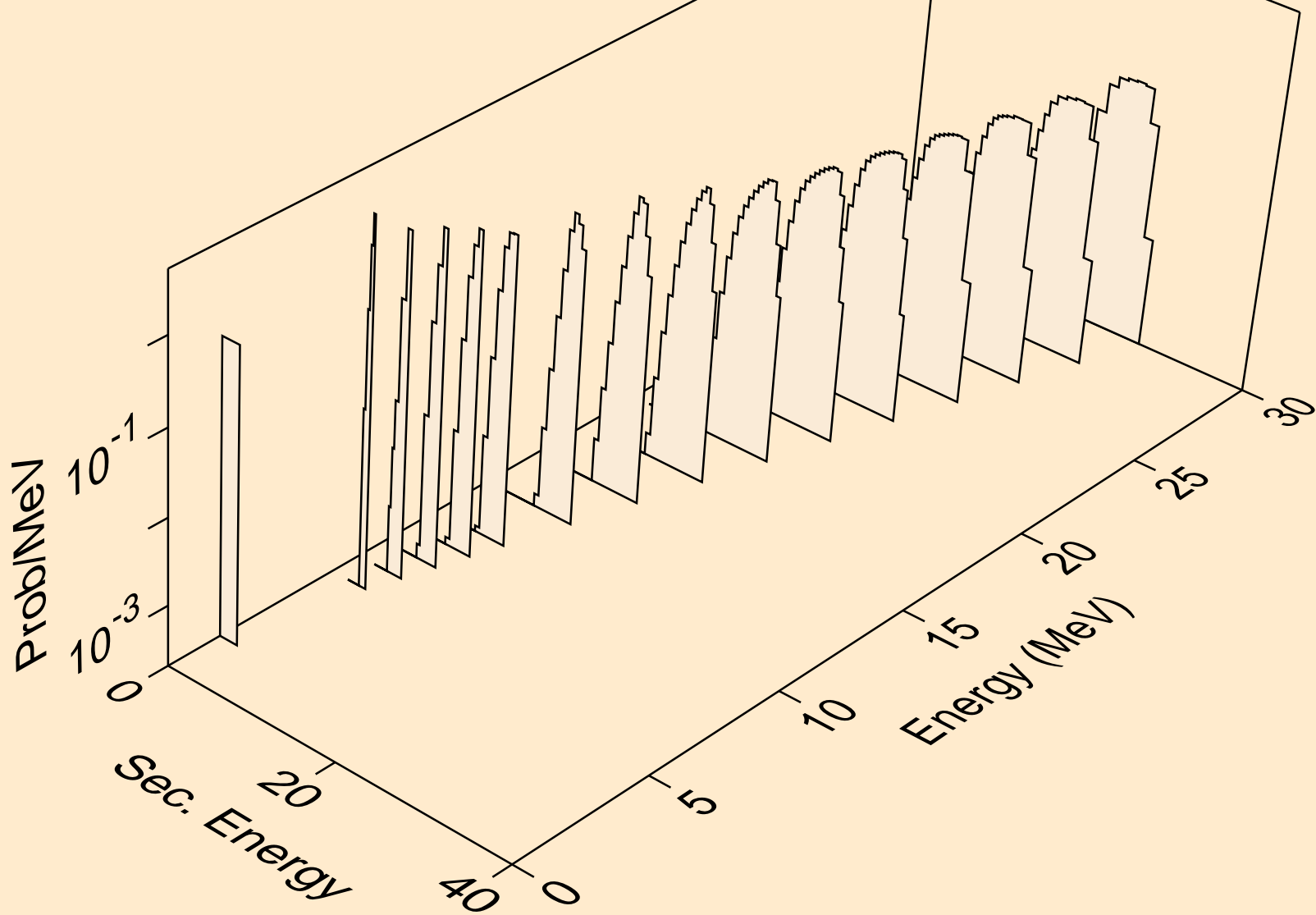

BI223 DEUTERON ACER TENDL-2024 LIBRARY; T=0.K
tritons from (d,t)

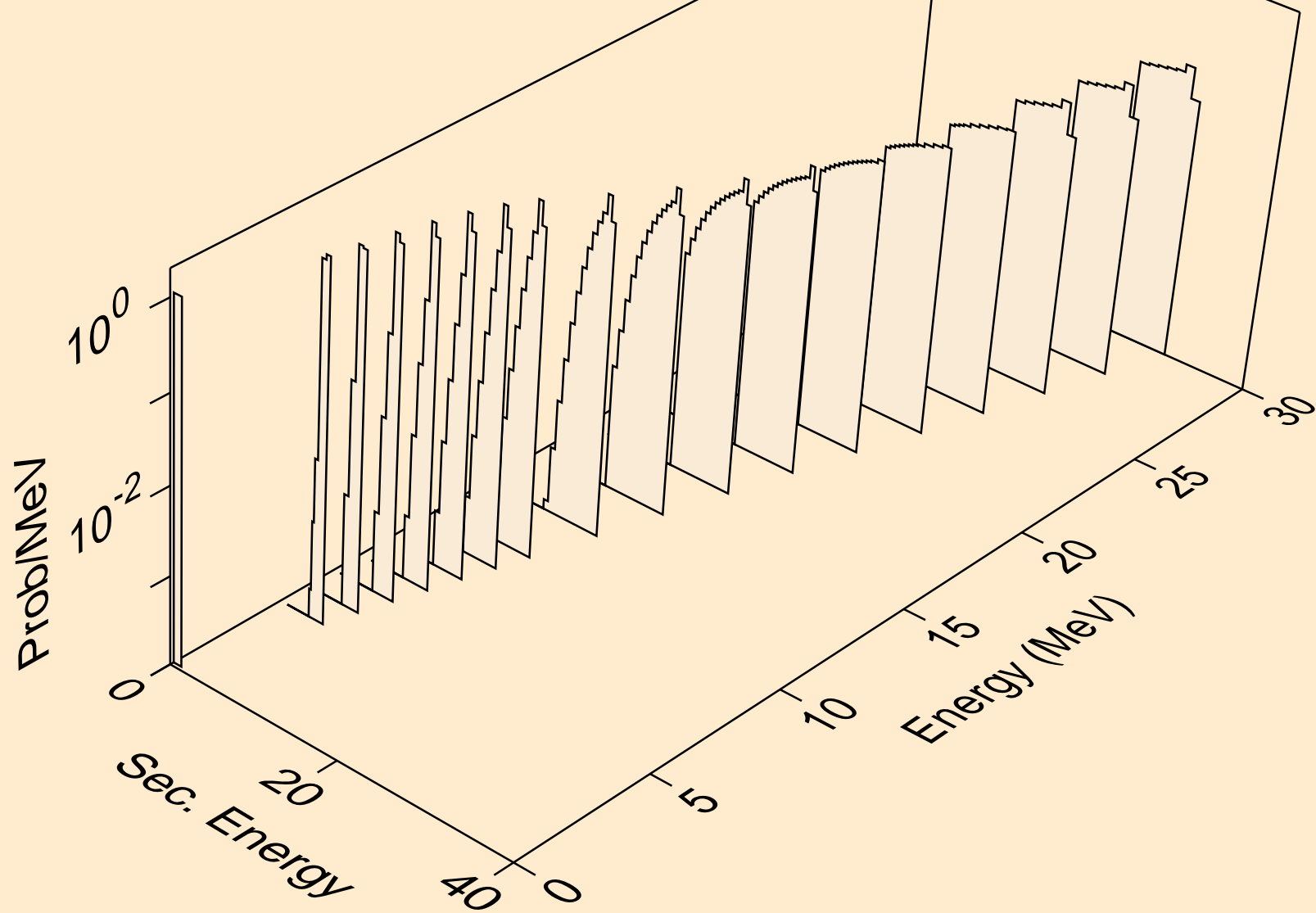

BI223 DEUTERON ACER TENDL-2024 LIBRARY; T=0.K
he3s from (d,x)

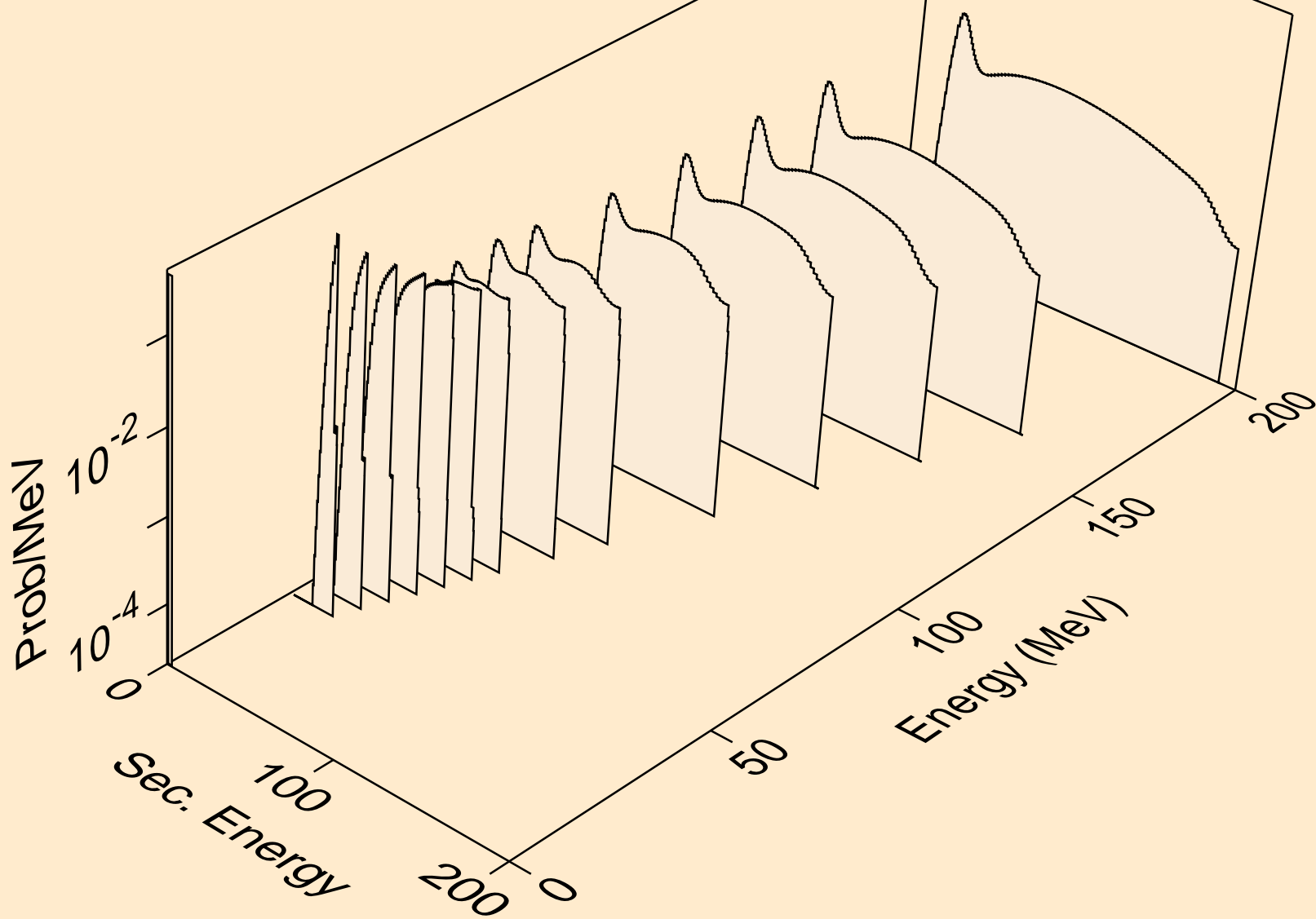

BI223 DEUTERON ACER TENDL-2024 LIBRARY; T=0.K
he3s from (d,n*)he3

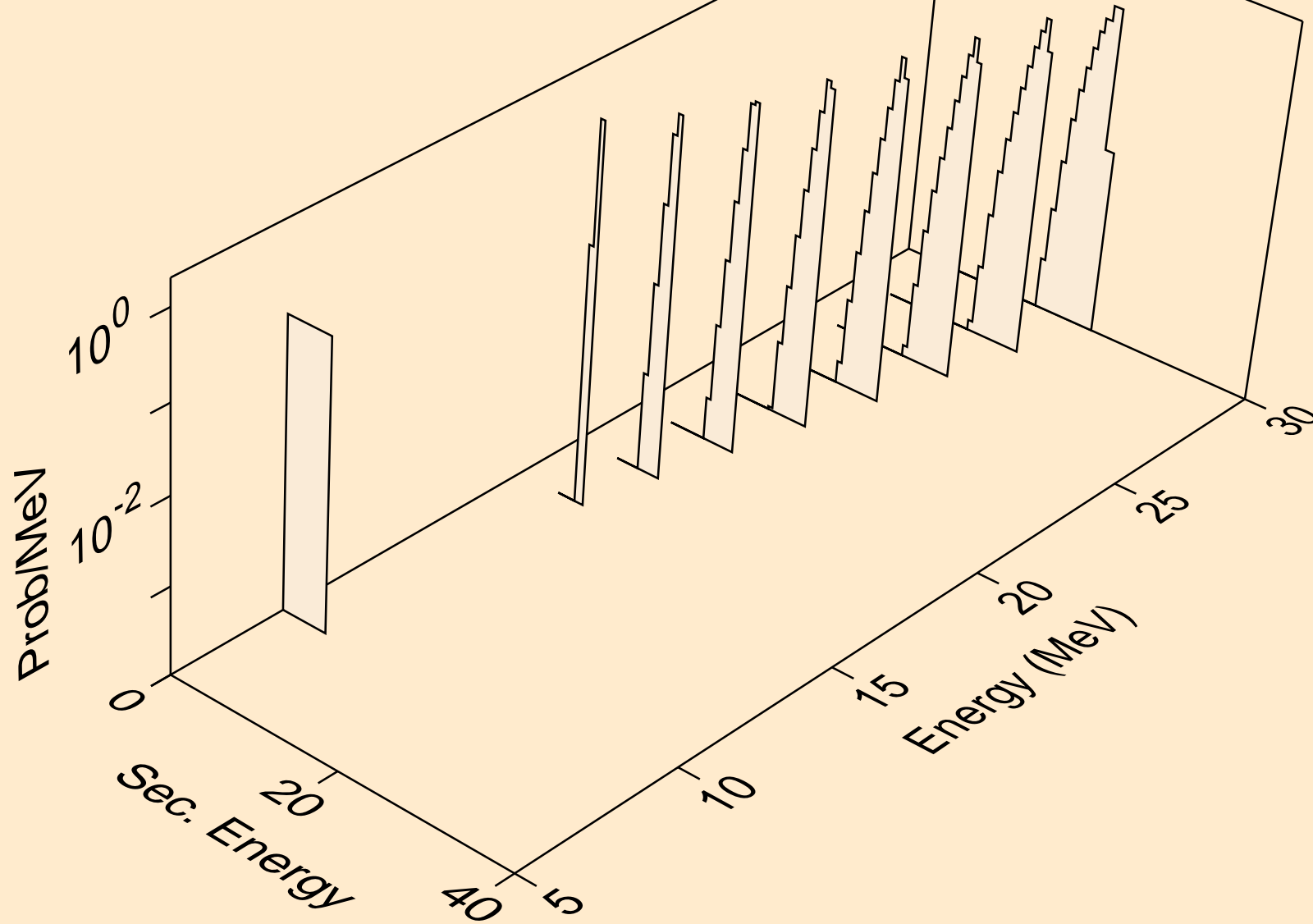

BI223 DEUTERON ACER TENDL-2024 LIBRARY; T=0.K
he3s from (d,he3)

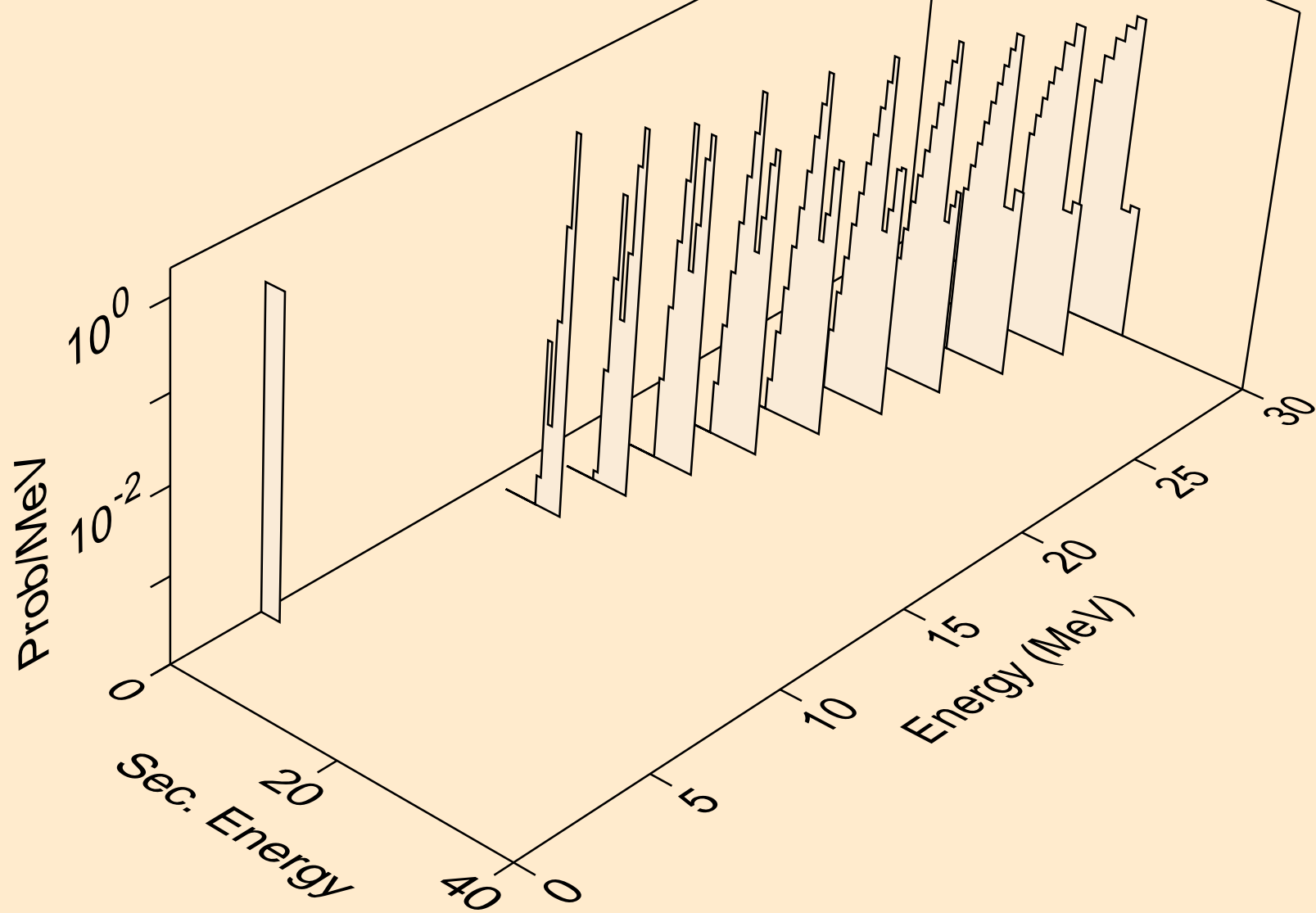

BI223 DEUTERON ACER TENDL-2024 LIBRARY; T=0.K
alphas from (d,x)

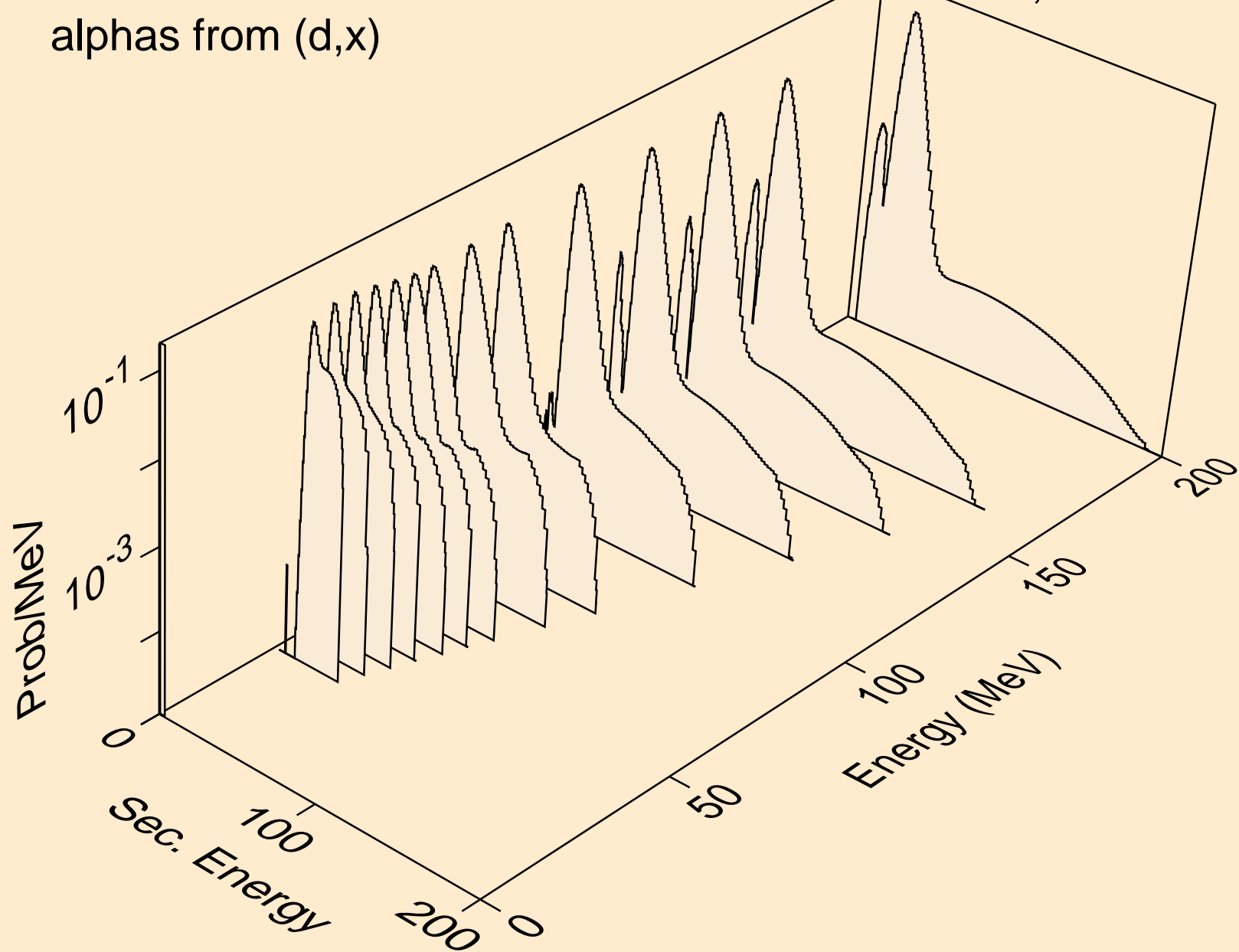

BI223 DEUTERON ACER TENDL-2024 LIBRARY; T=0.K
alphas from (d,n*)a

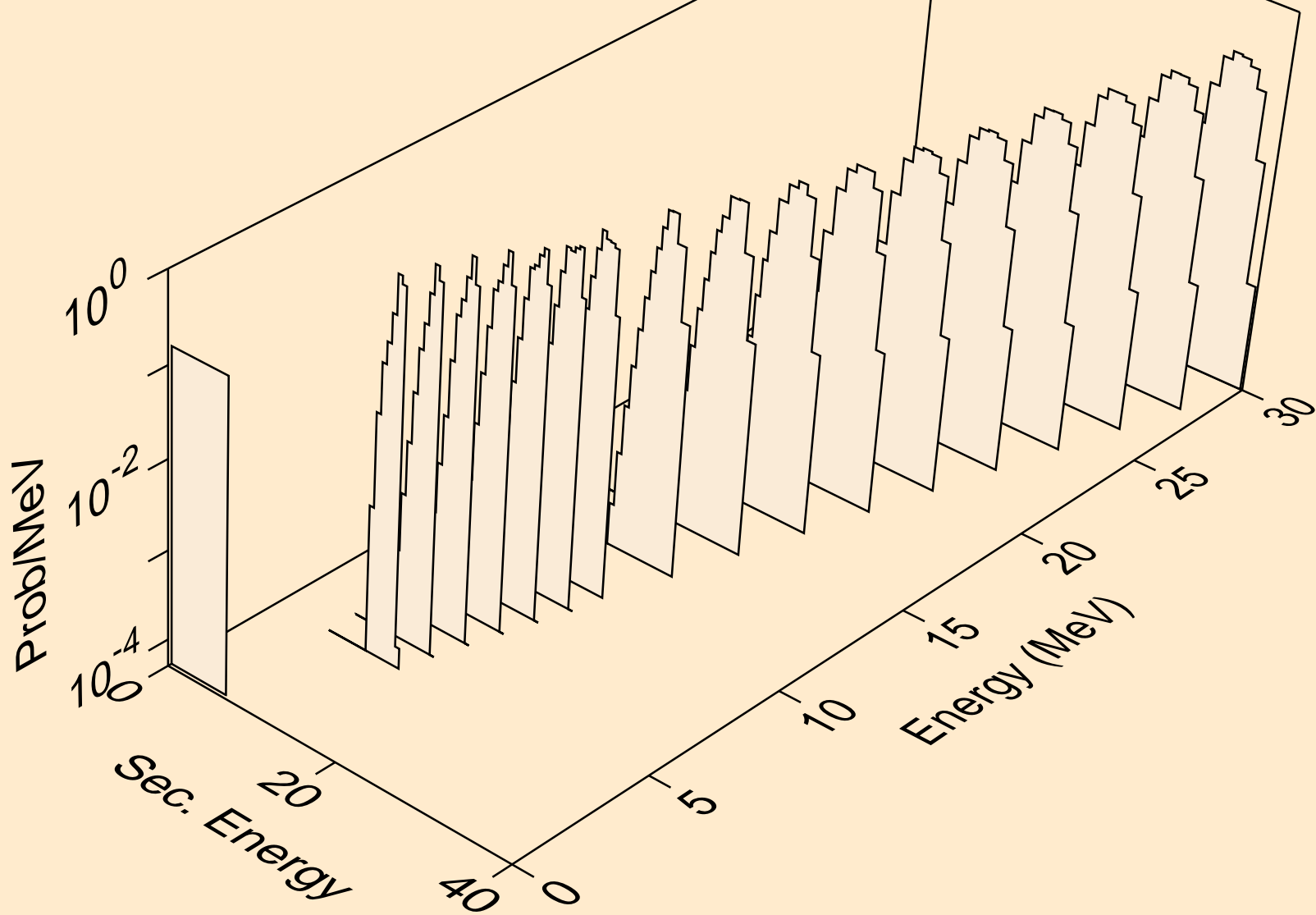

BI223 DEUTERON ACER TENDL-2024 LIBRARY; T=0.K
alphas from (d,2n)a

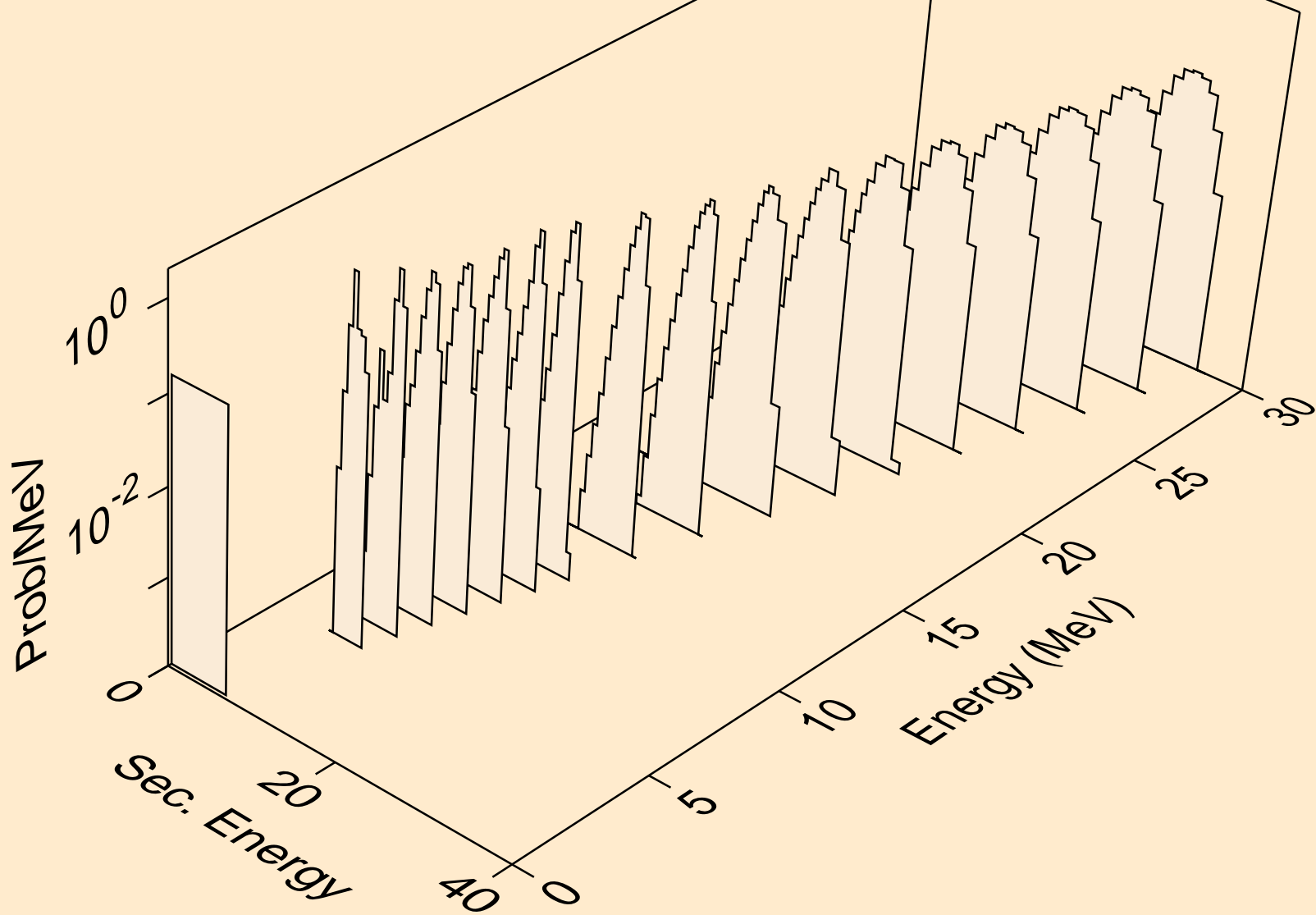

BI223 DEUTERON ACER TENDL-2024 LIBRARY; T=0.K
alphas from (d,3n)a

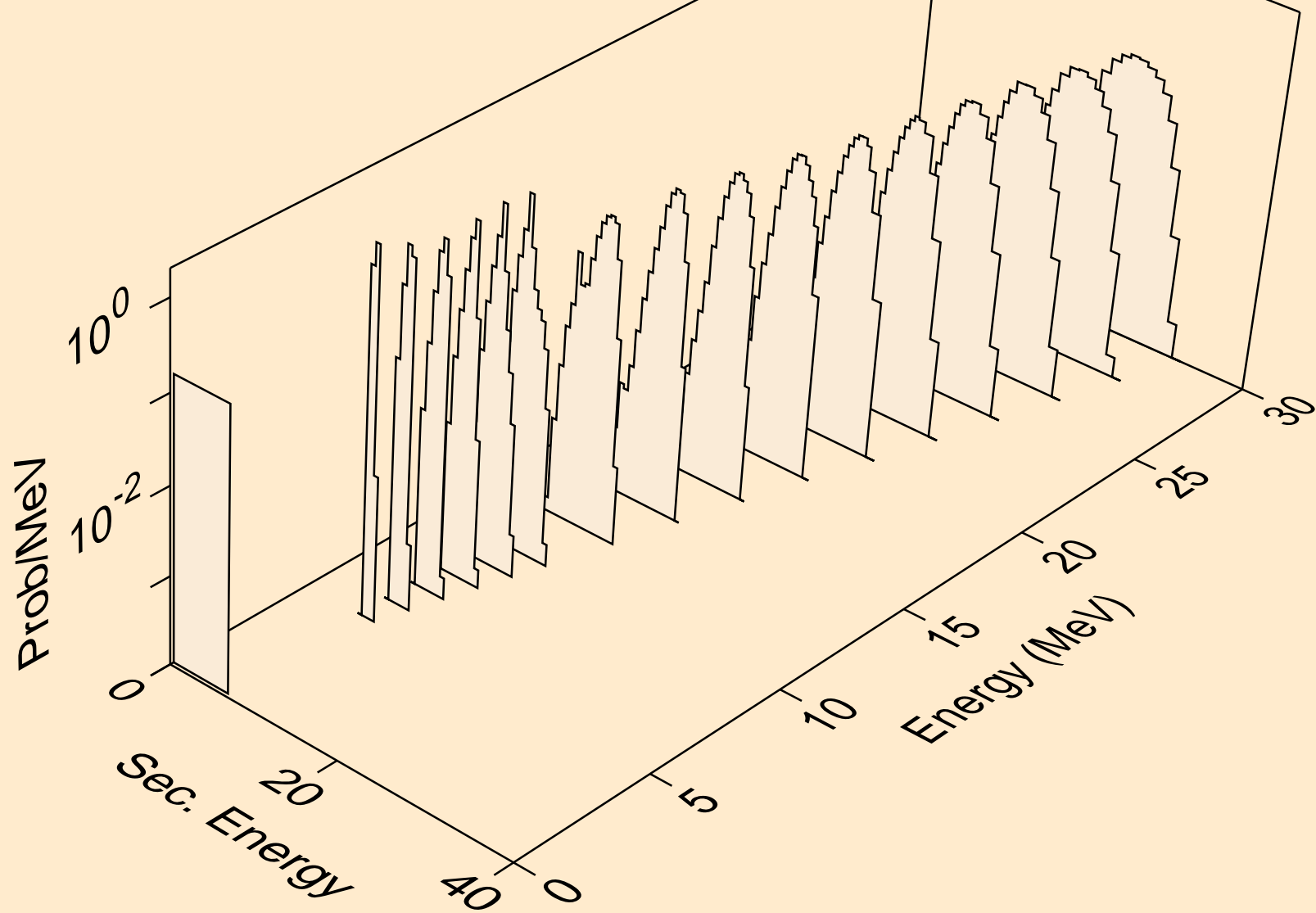

BI223 DEUTERON ACER TENDL-2024 LIBRARY; T=0.K
alphas from (d,a)

