

LU187 DEUTERON ACER TENDL-2024 LIBRARY; T=0.K

Principal cross sections

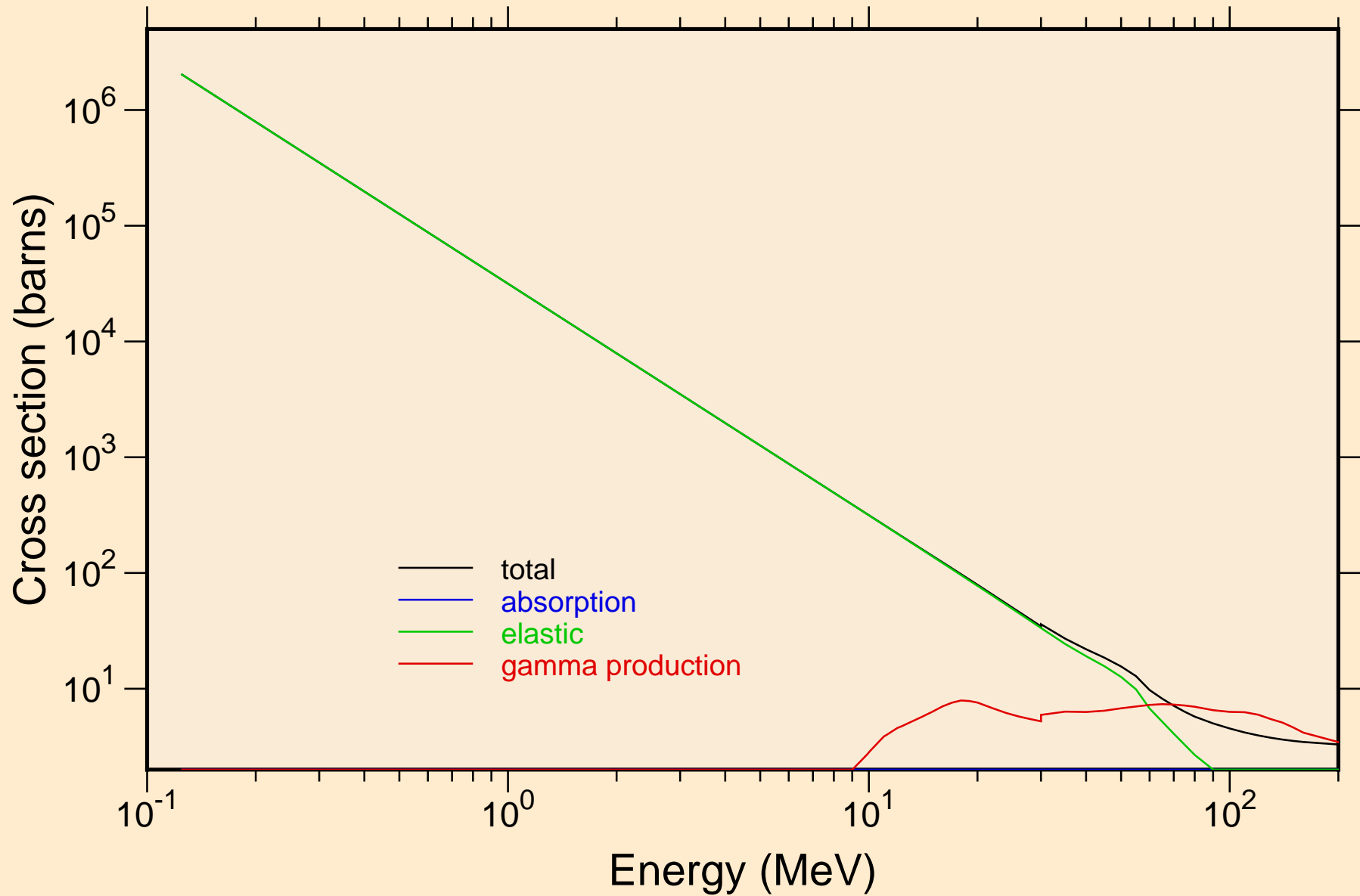

LU187 DEUTERON ACER TENDL-2024 LIBRARY; T=0.K
Heating

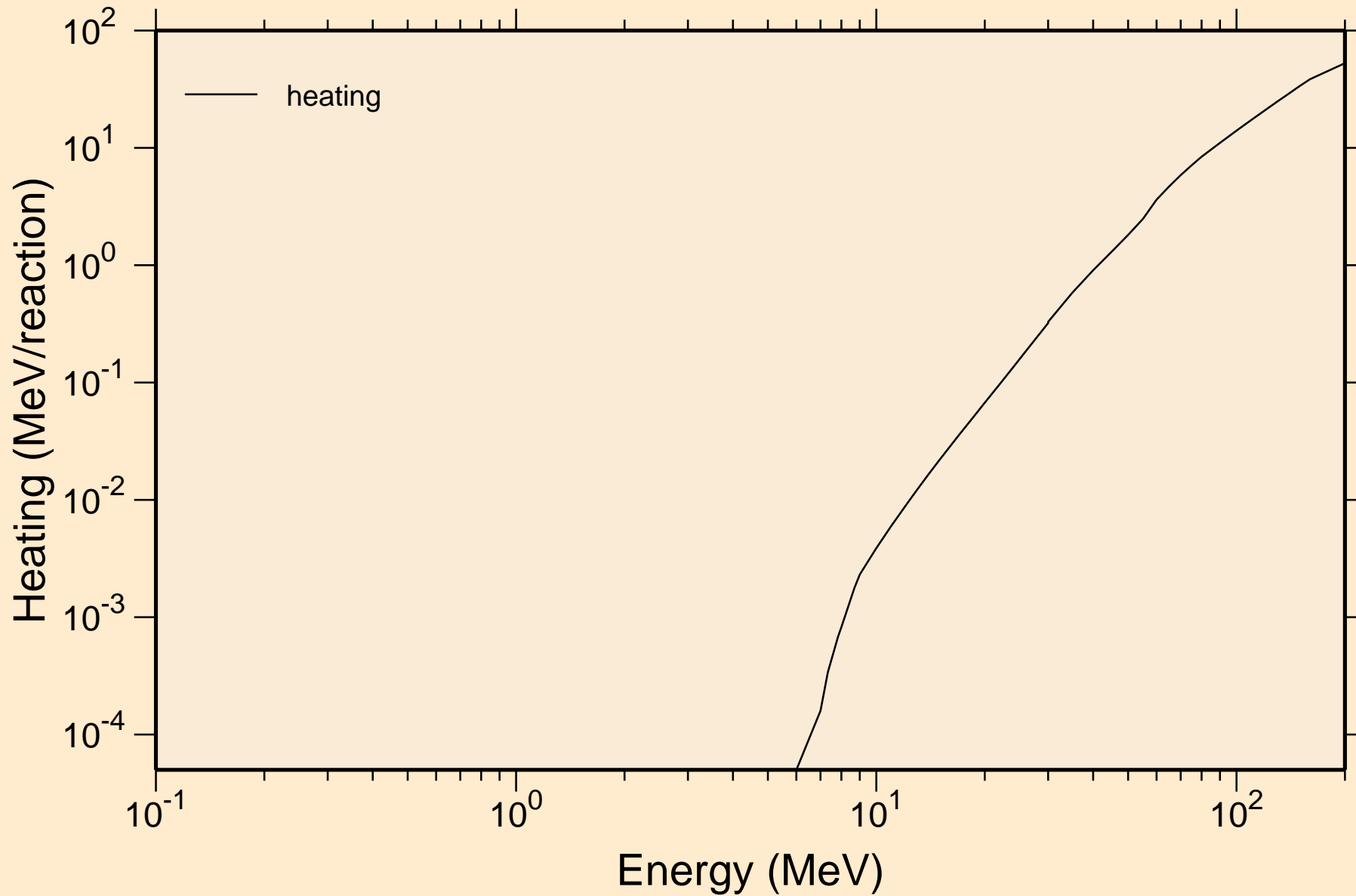

LU187 DEUTERON ACER TENDL-2024 LIBRARY; T=0.K
Principal cross sections

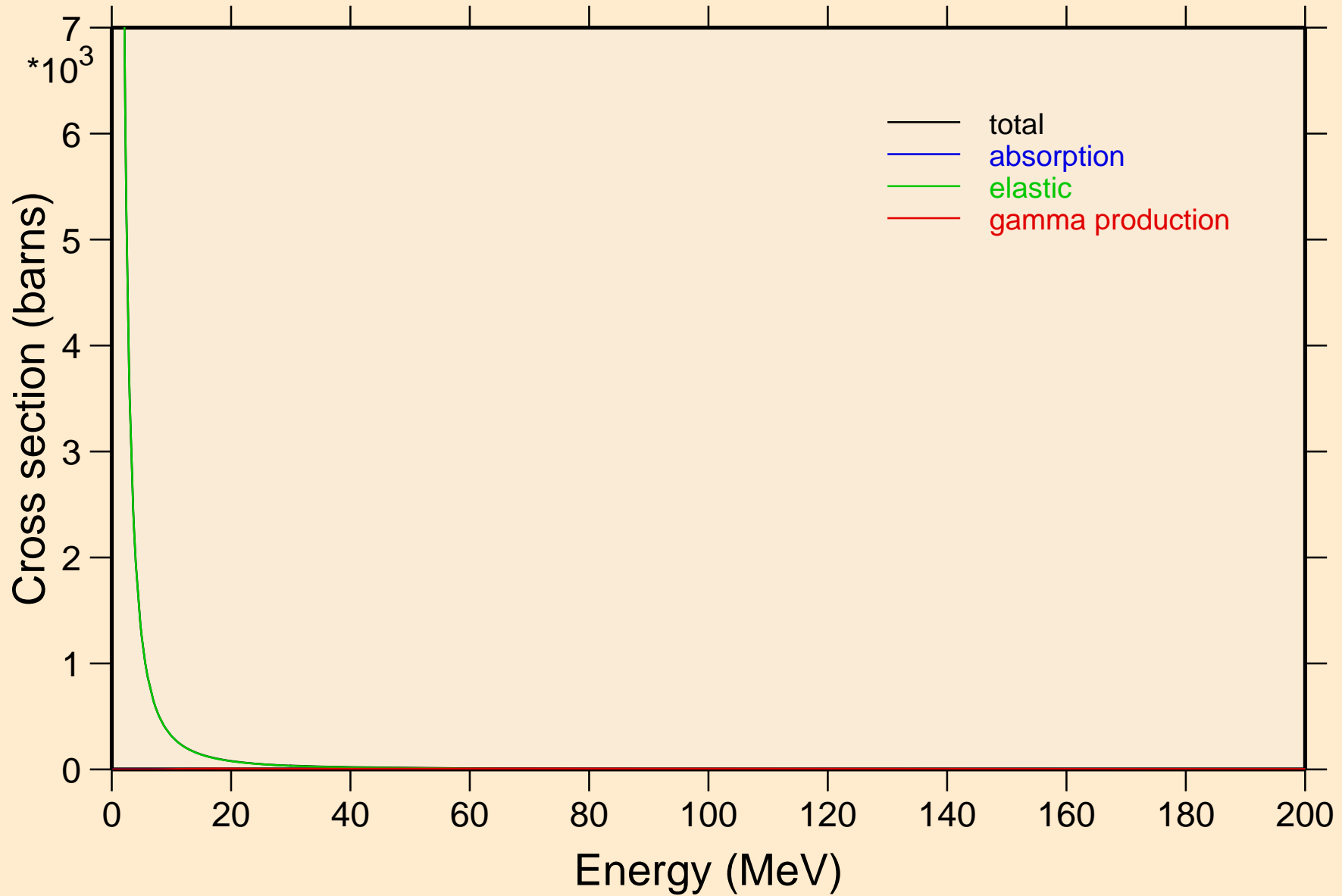

LU187 DEUTERON ACER TENDL-2024 LIBRARY; T=0.K
Heating

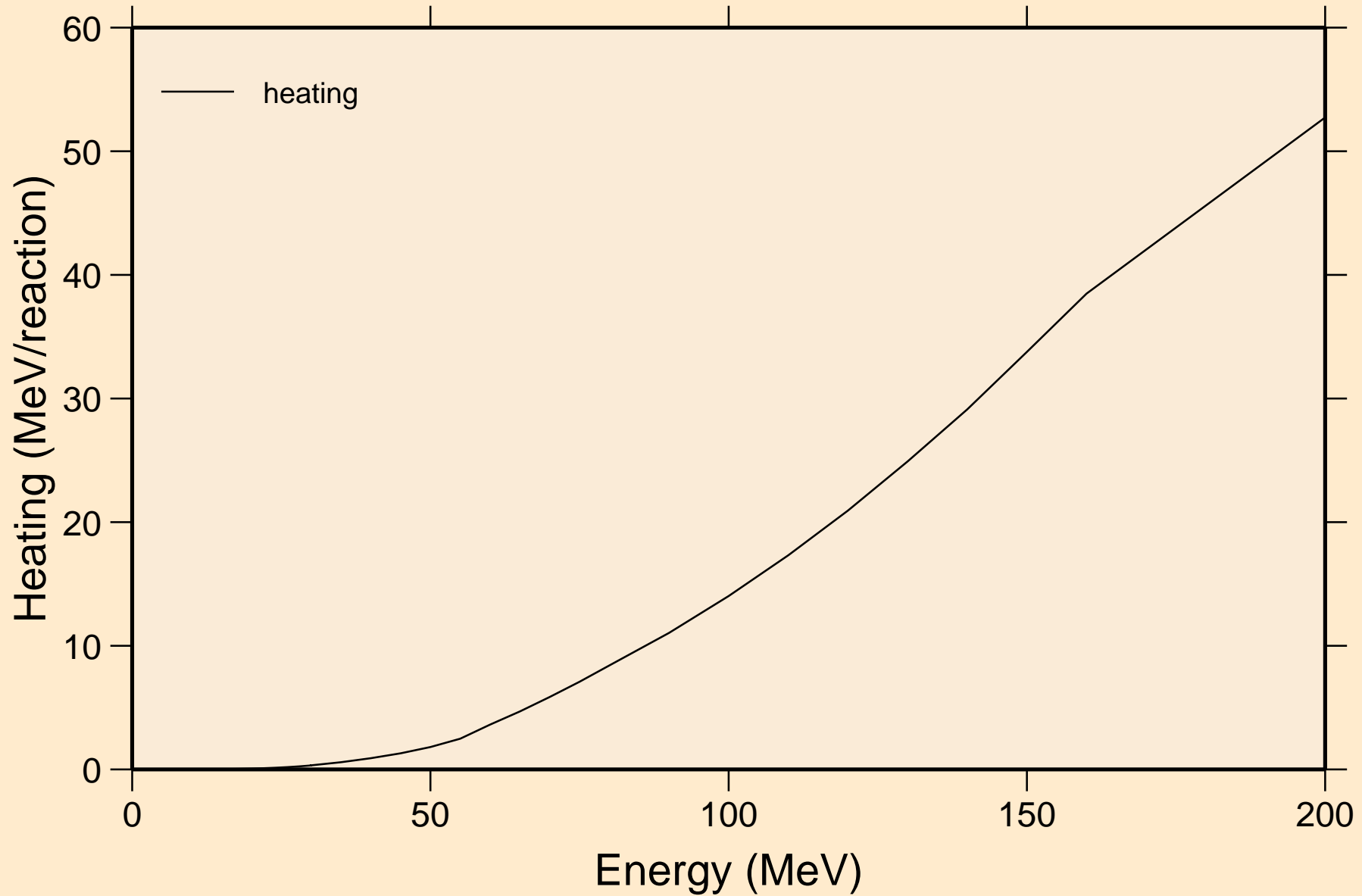

LU187 DEUTERON ACER TENDL-2024 LIBRARY; T=0.K

Threshold reactions

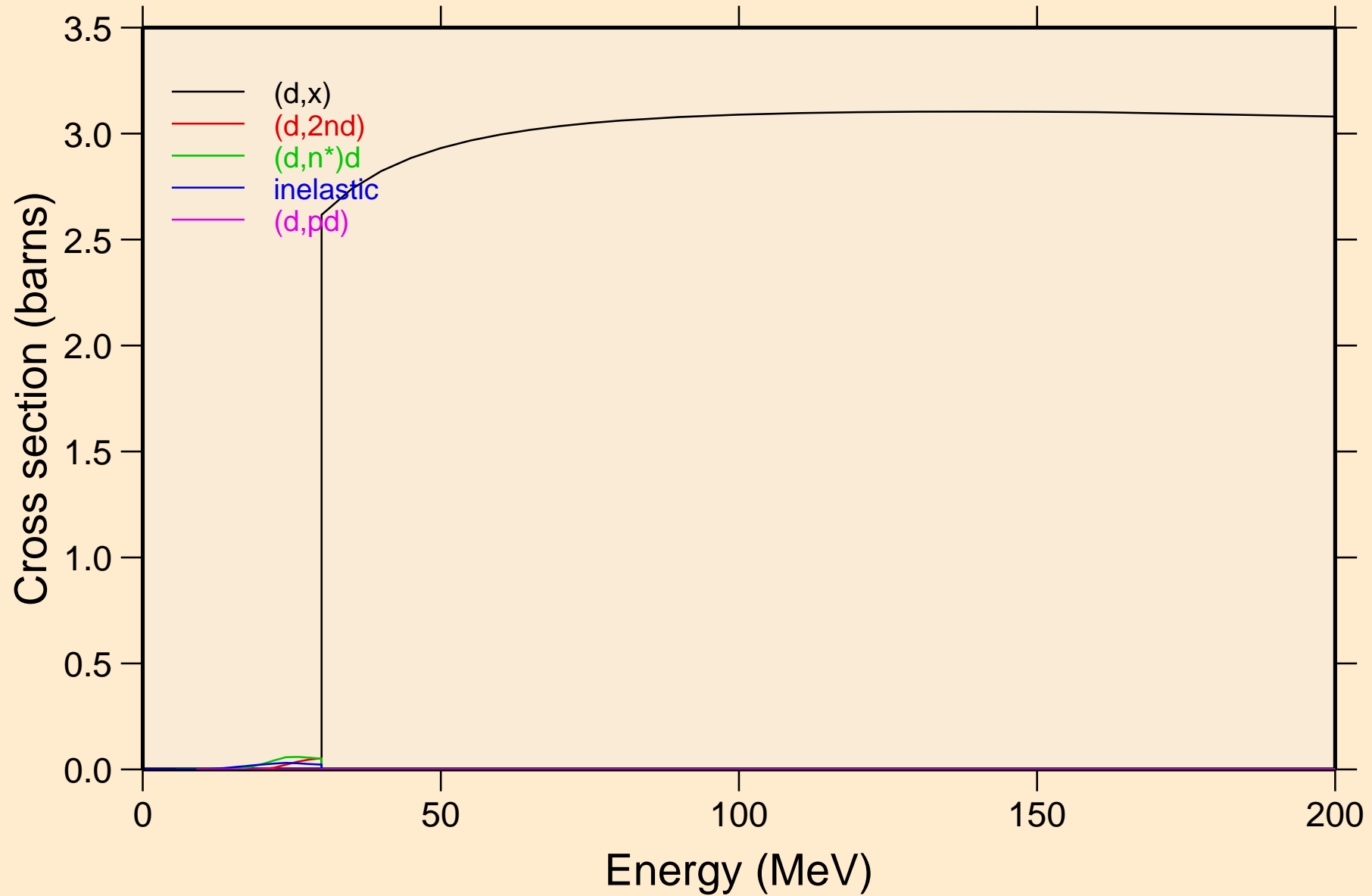

LU187 DEUTERON ACER TENDL-2024 LIBRARY; T=0.K
angular distribution for elastic

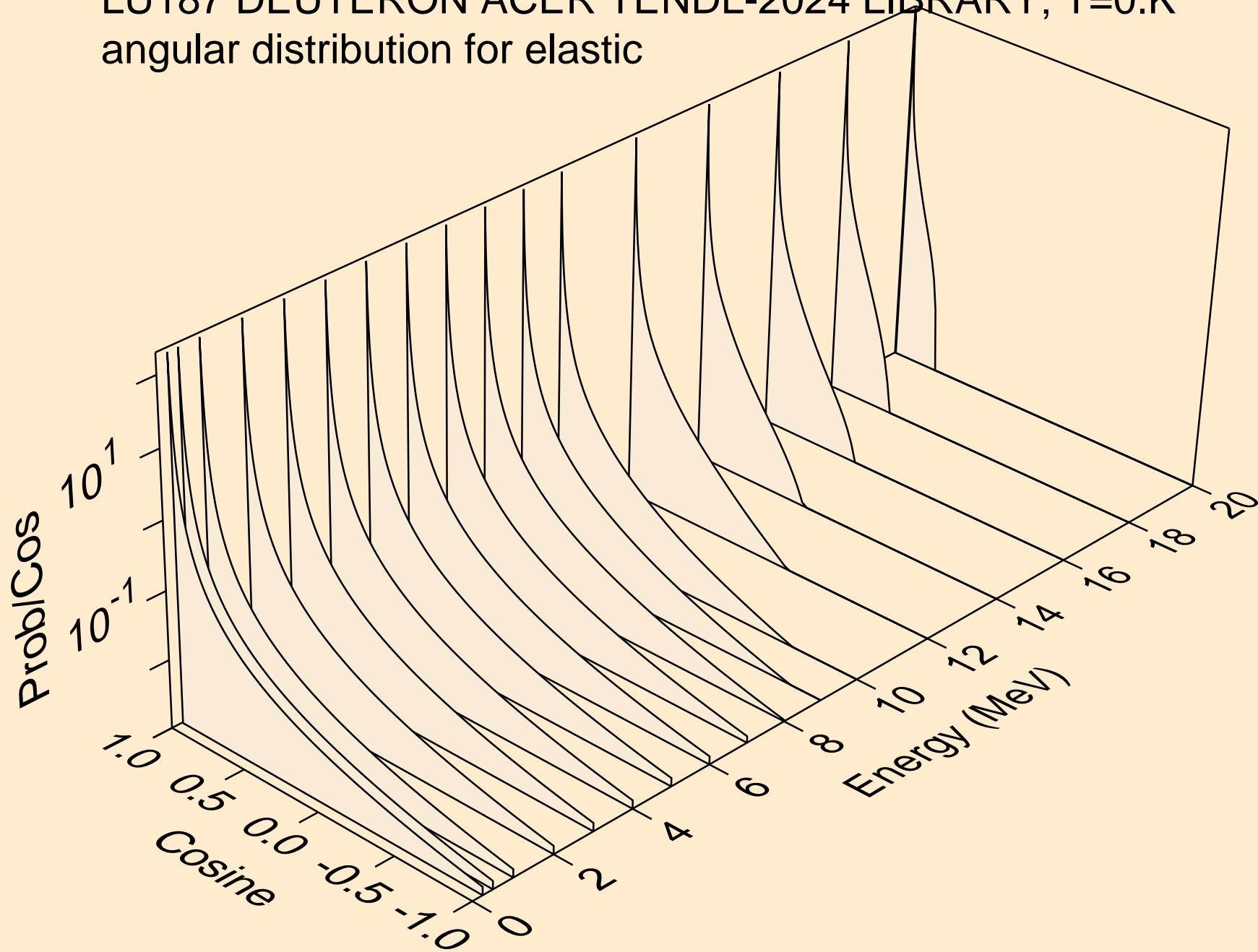

LU187 DEUTERON ACER TENDL-2024 LIBRARY; T=0.K
angular distribution for elastic

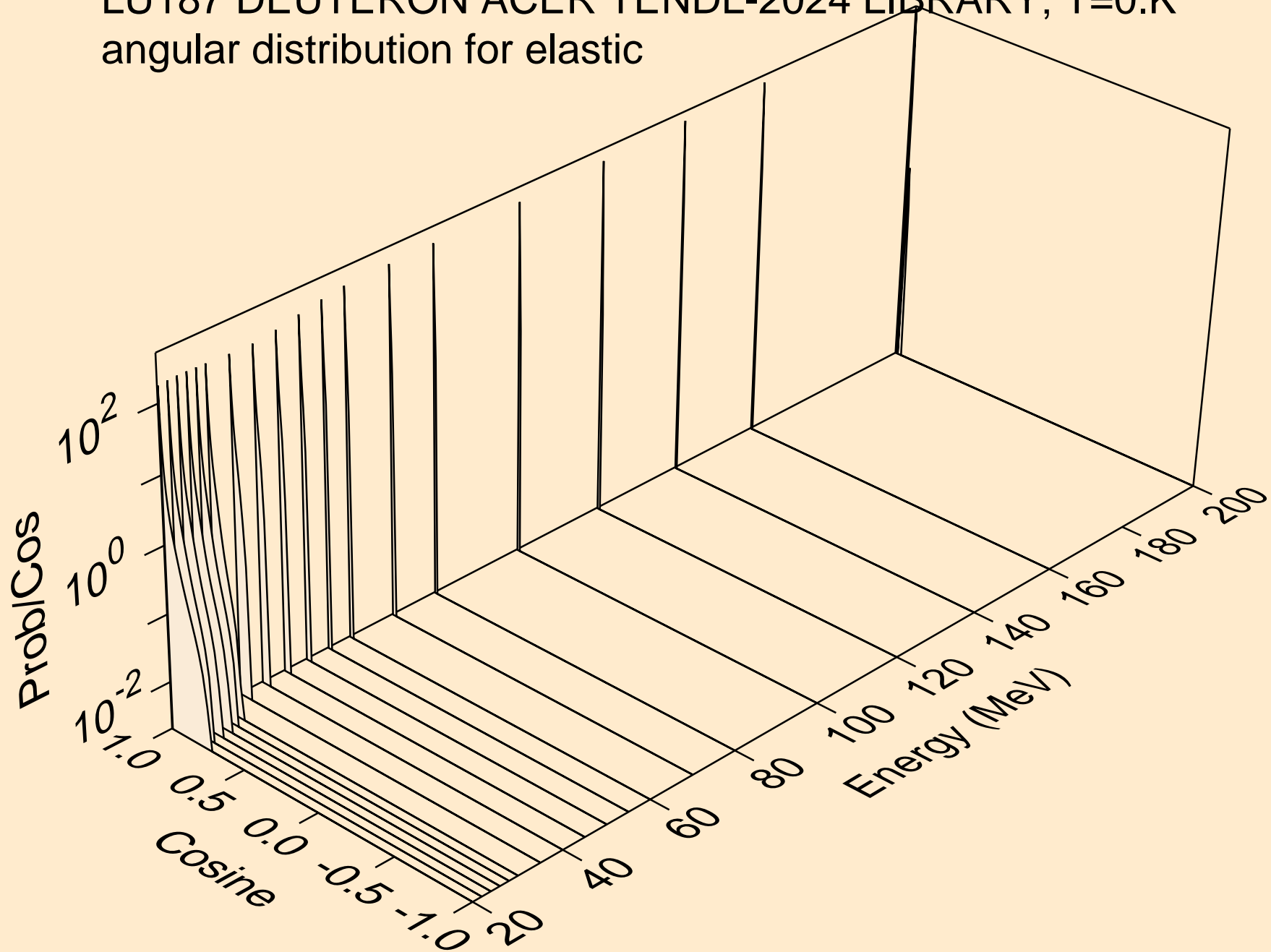

LU187 DEUTERON ACER TENDL-2024 LIBRARY; T=0.K
Deuteron emission for (d,x)

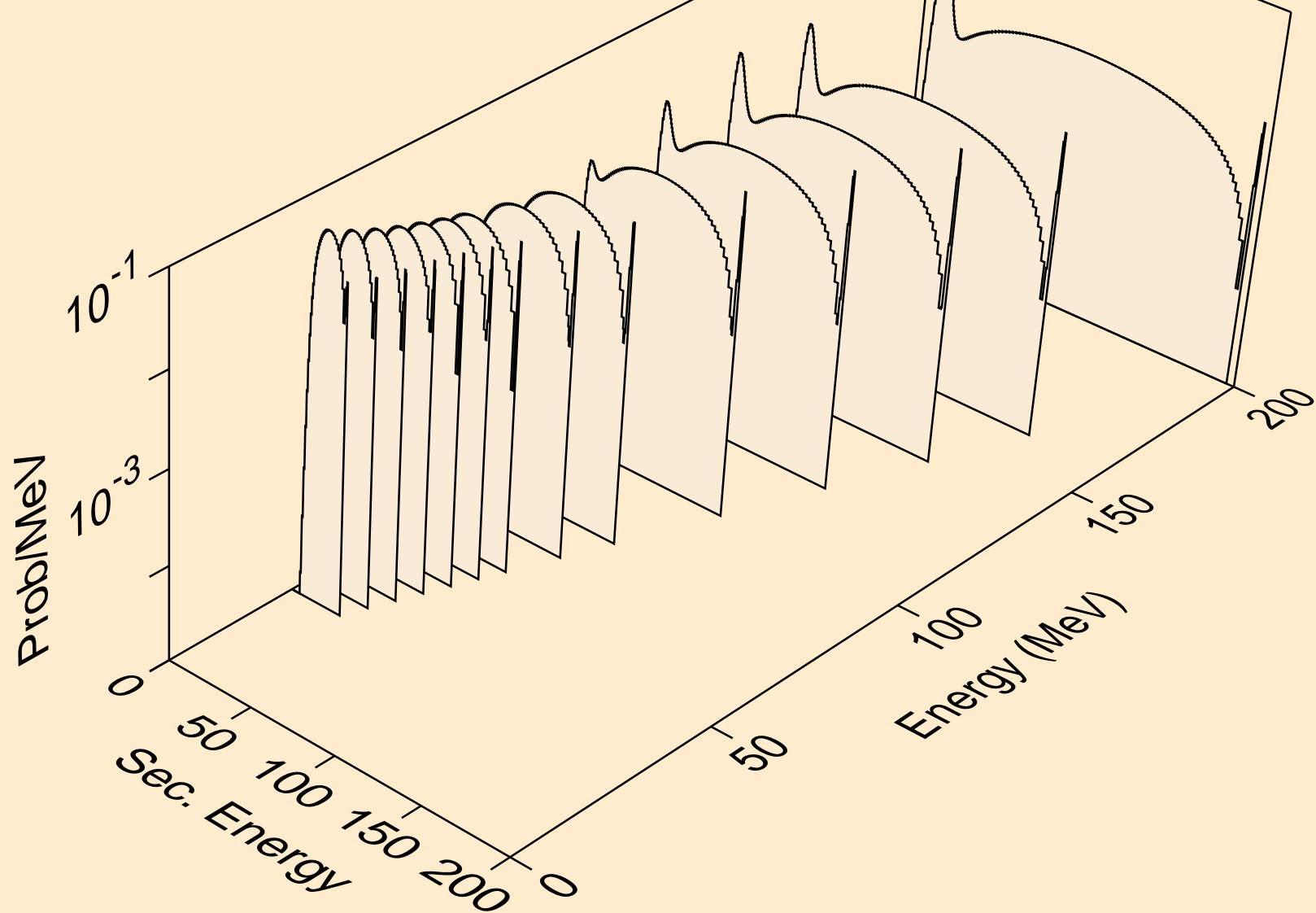

LU187 DEUTERON ACER TENDL-2024 LIBRARY; T=0.K
Deuteron emission for (d,2nd)

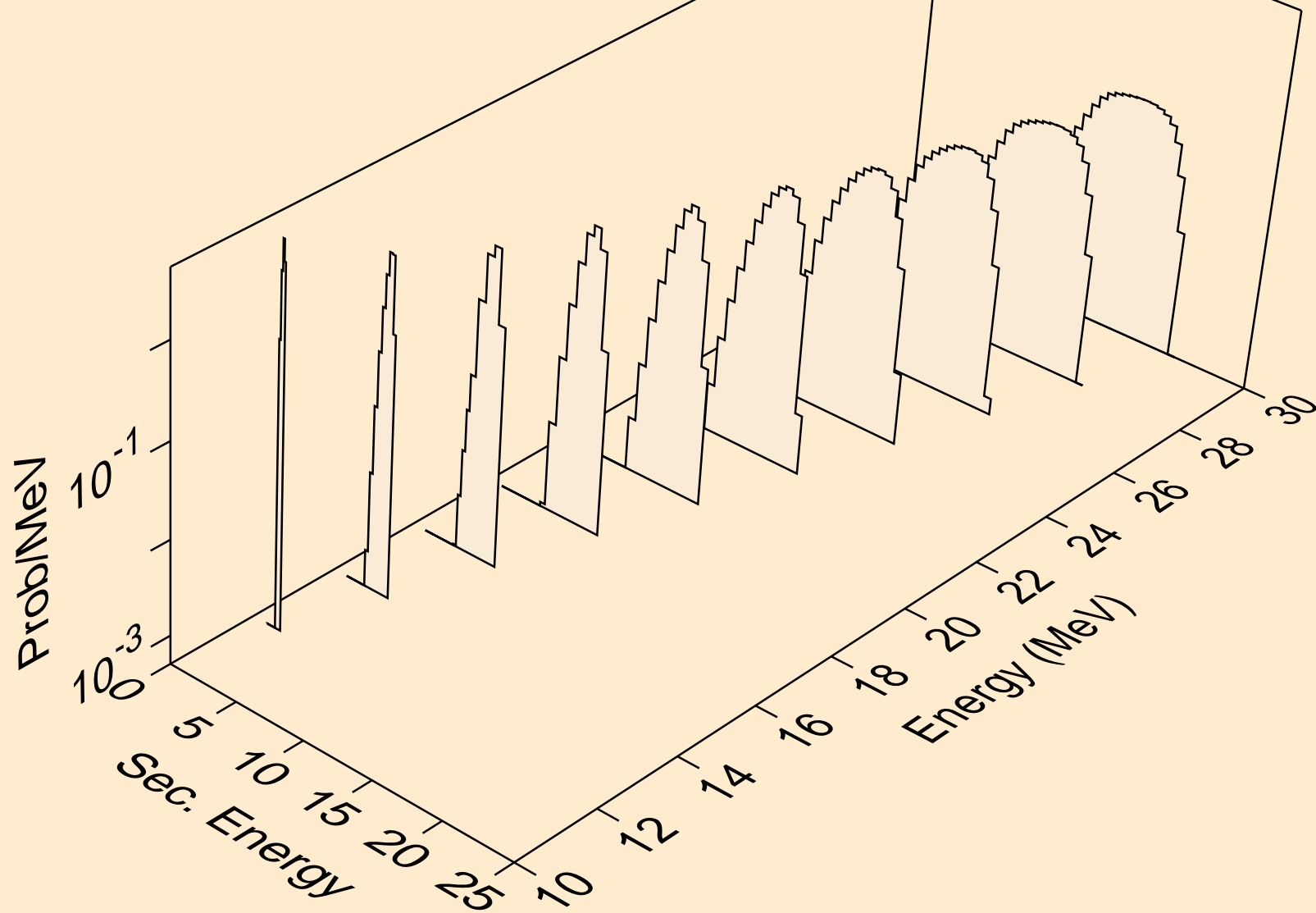

LU187 DEUTERON ACER TENDL-2024 LIBRARY; T=0.K
Deuteron emission for (d,n*)d

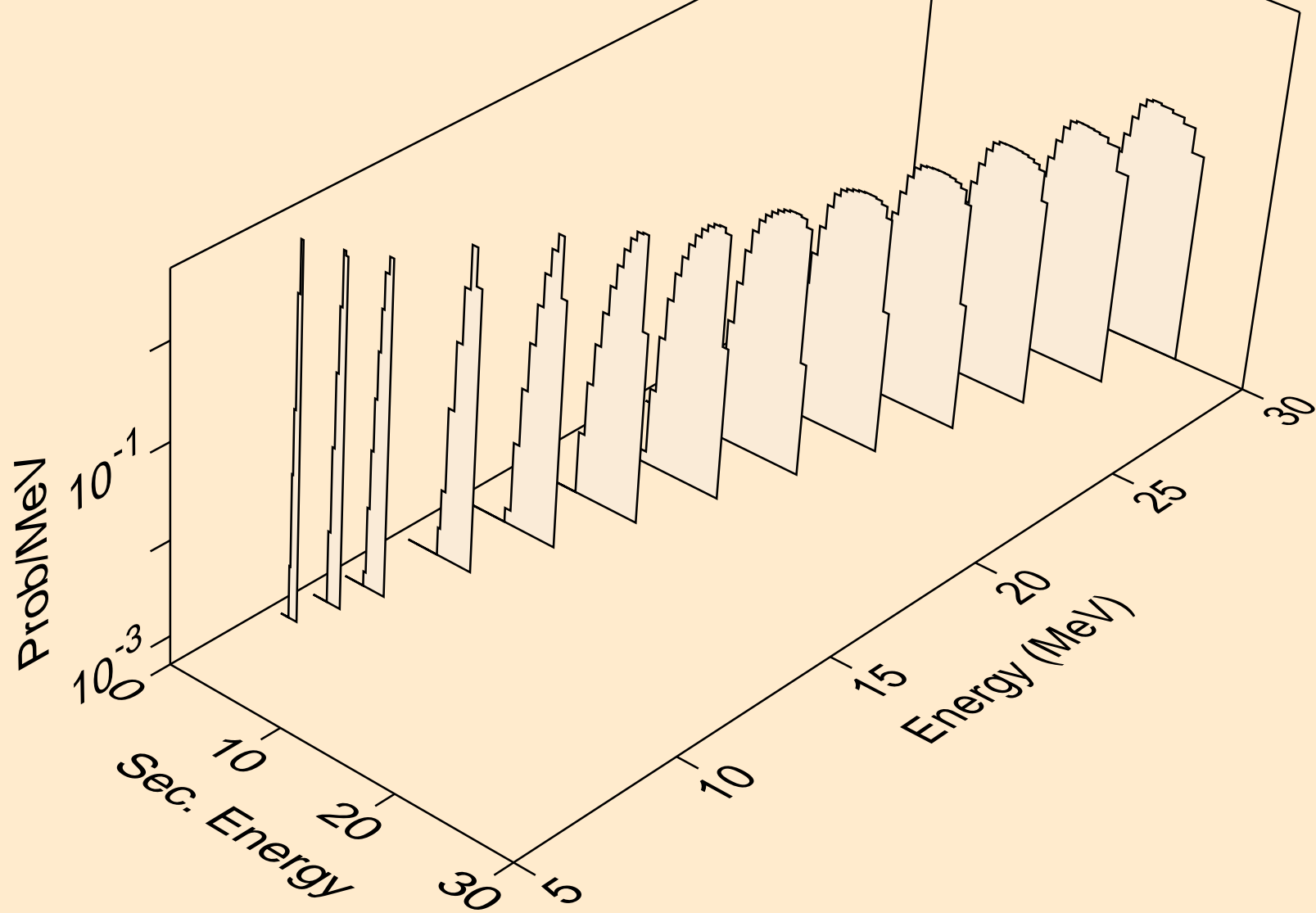

LU187 DEUTERON ACER TENDL-2024 LIBRARY; T=0.K
Deuteron emission for inelastic

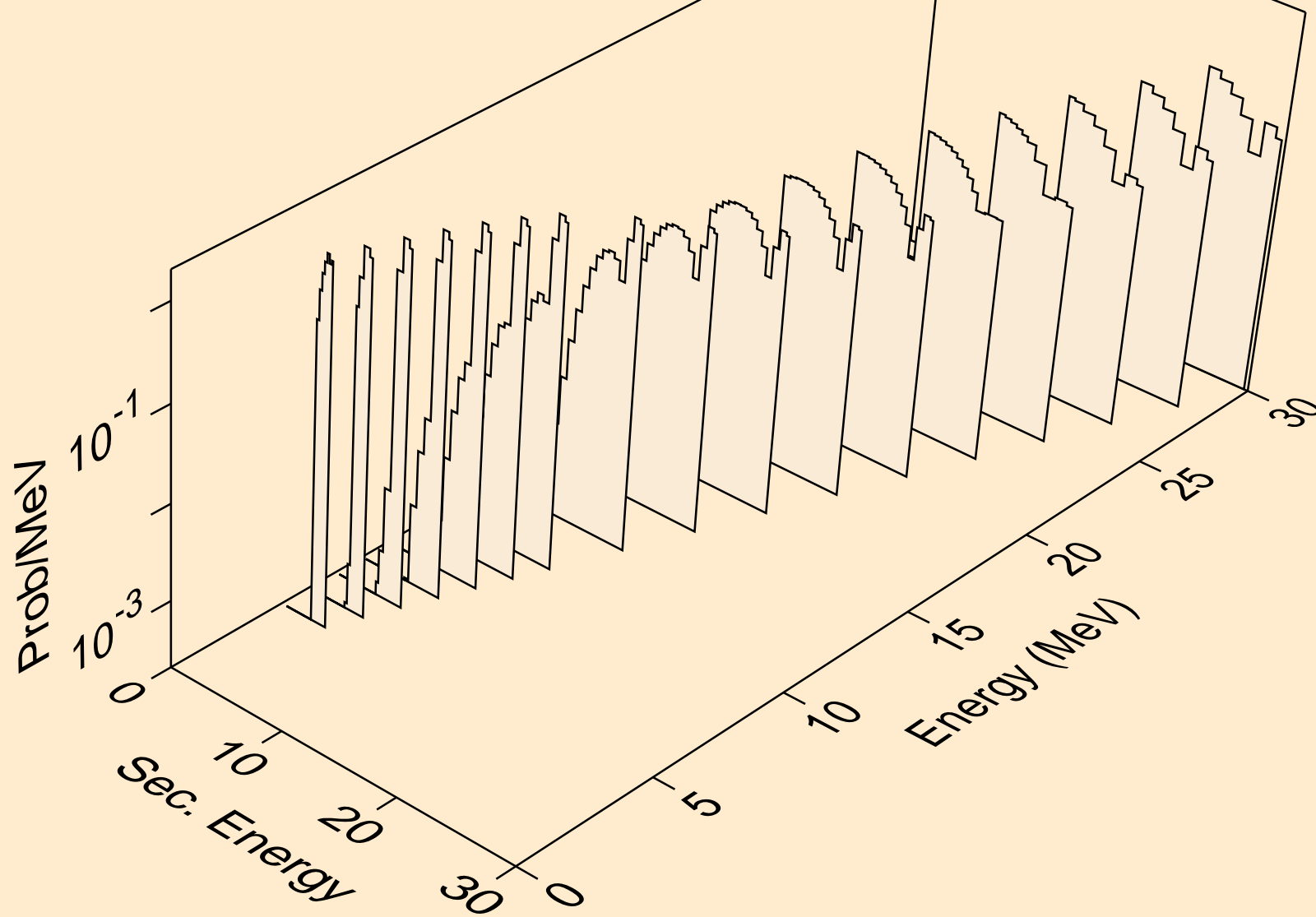

LU187 DEUTERON ACER TENDL-2024 LIBRARY; T=0.K
Deuteron emission for (d,pd)

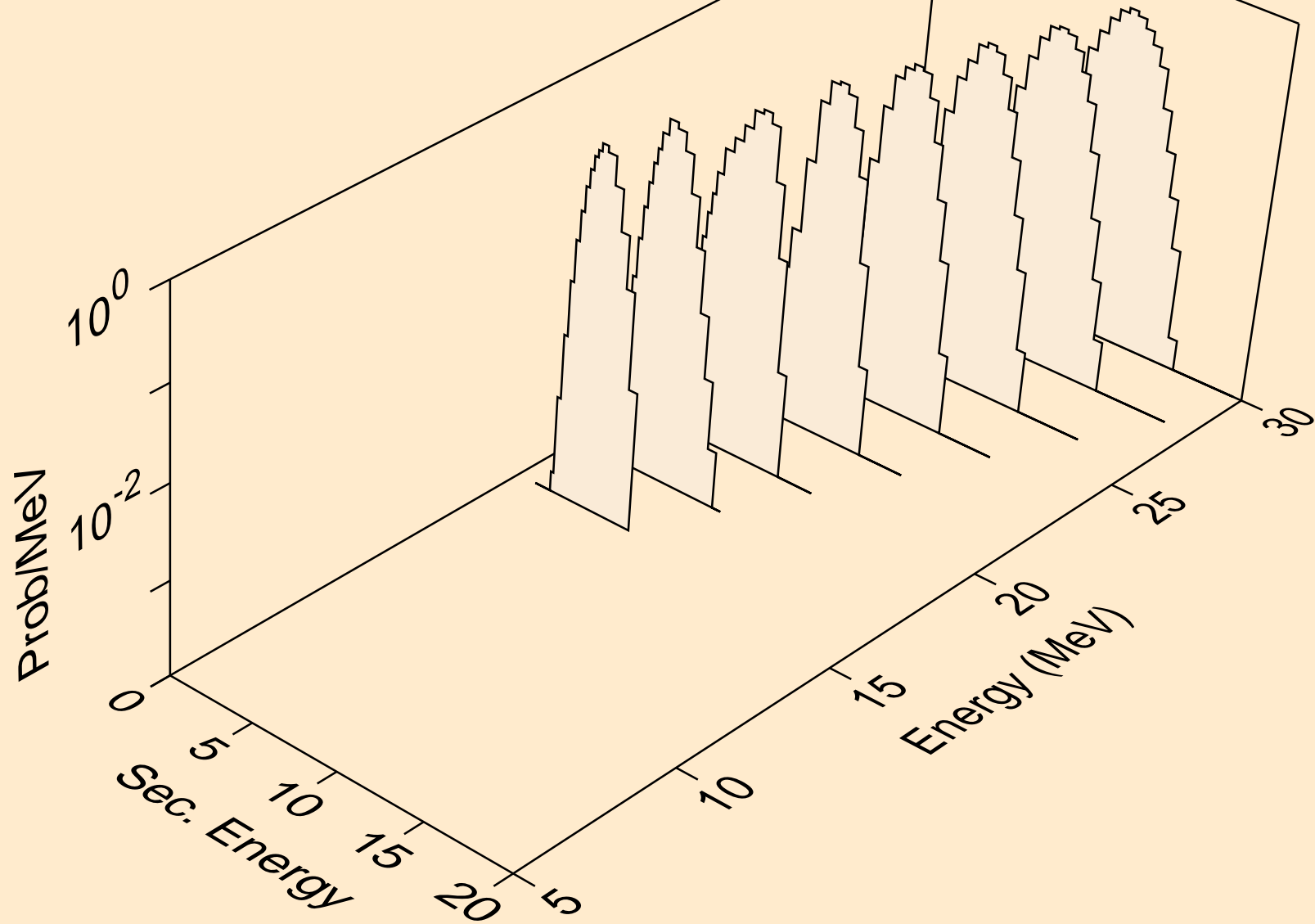

LU187 DEUTERON ACER TENDL-2024 LIBRARY; T=0.K
Photon emission for (z,n)

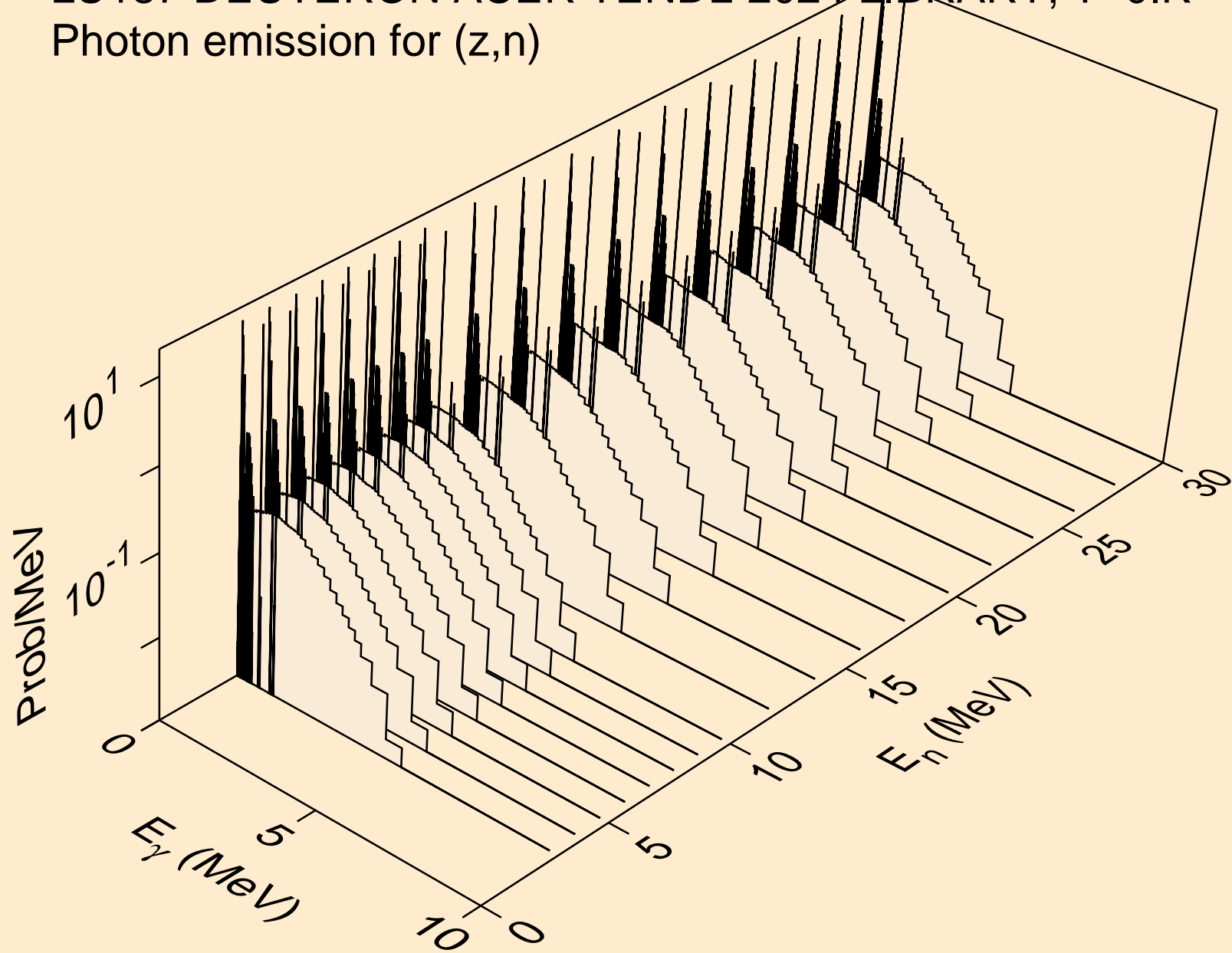

LU187 DEUTERON ACER TENDL-2024 LIBRARY; T=0.K
Photon emission for (z,x)

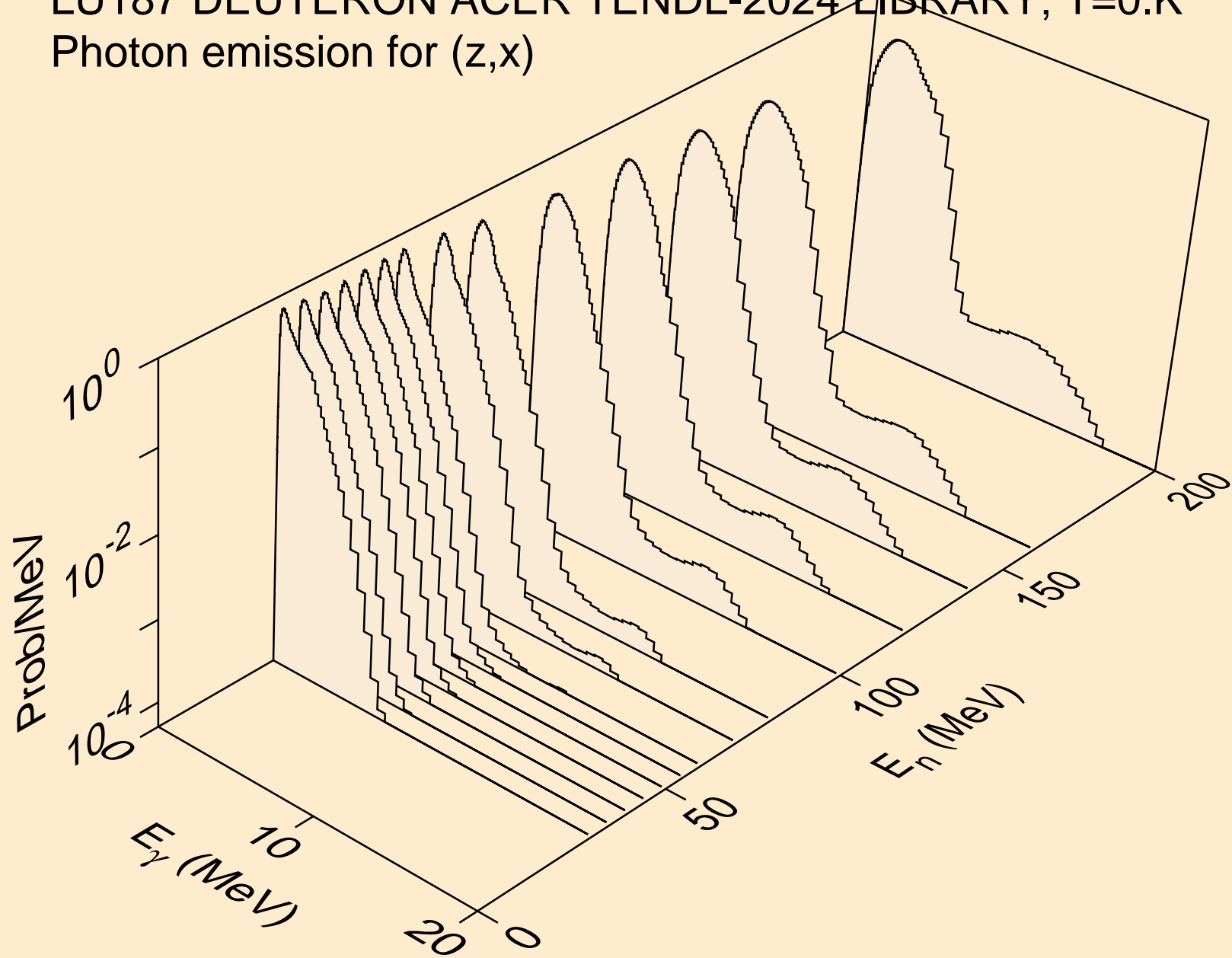

LU187 DEUTERON ACER TENDL-2024 LIBRARY; T=0.K
Photon emission for (n,2nd)

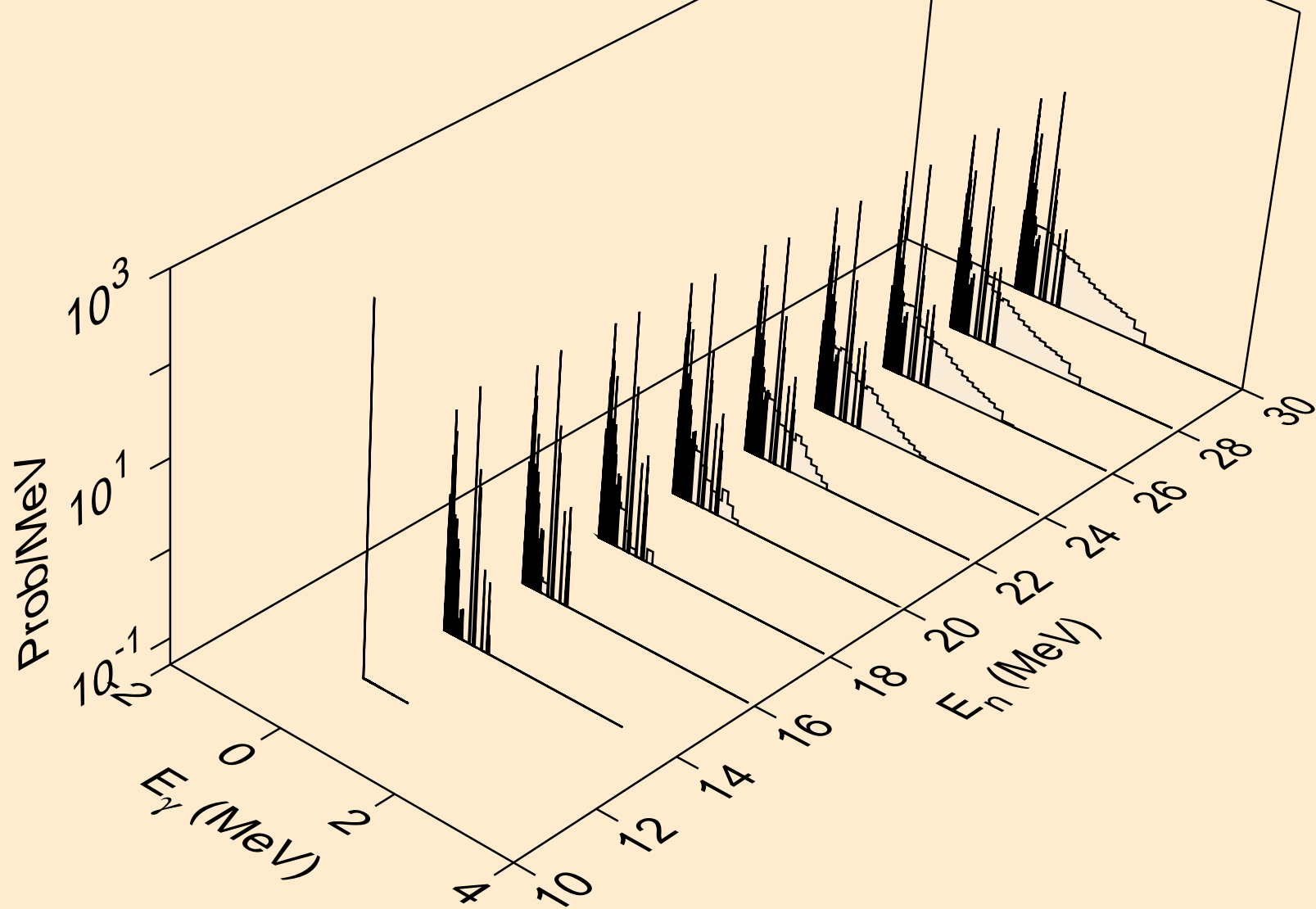

LU187 DEUTERON ACER TENDL-2024 LIBRARY; T=0.K
Photon emission for (n,2n)

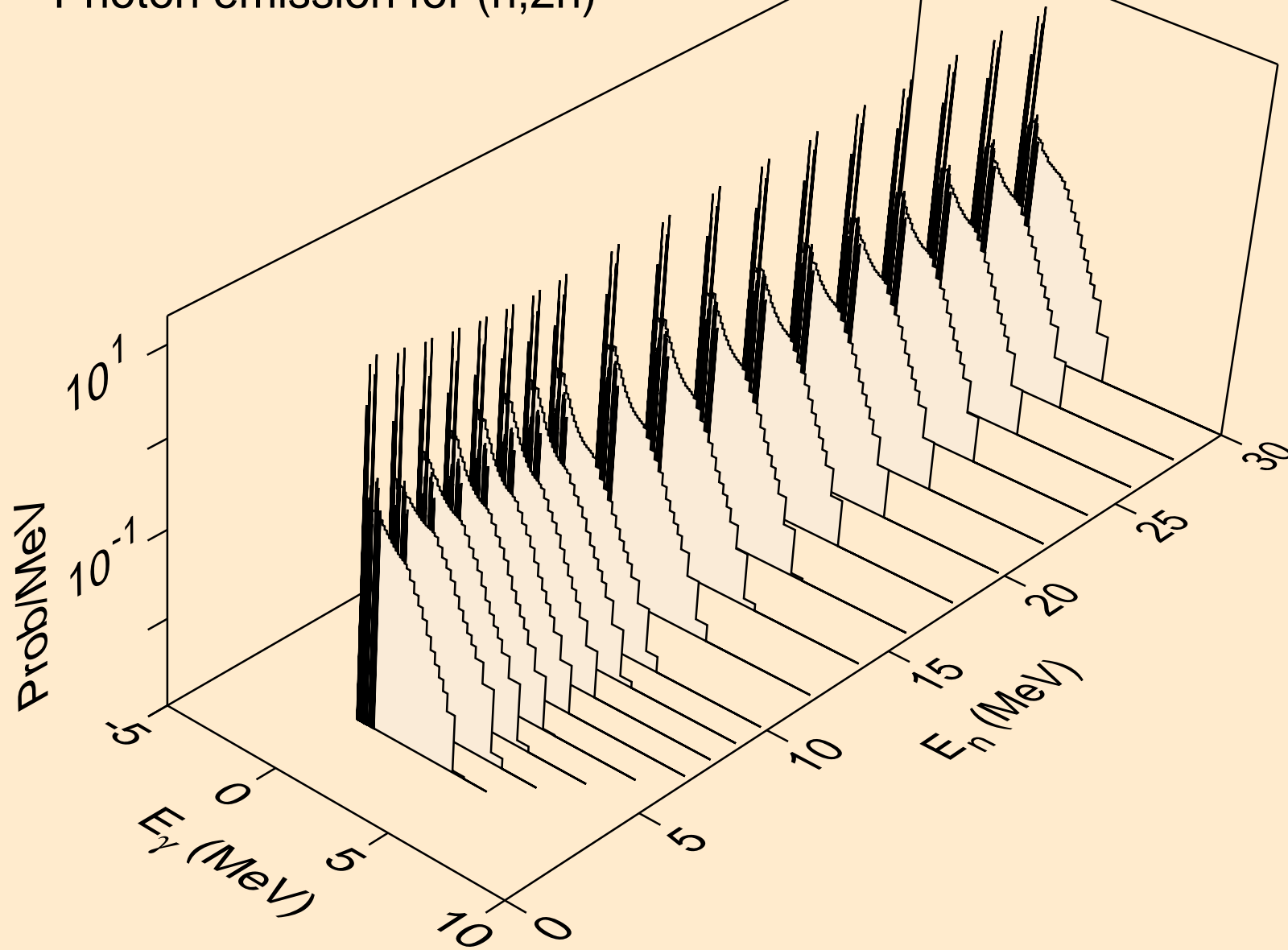

LU187 DEUTERON ACER TENDL-2024 LIBRARY; T=0.K
Photon emission for (n,3n)

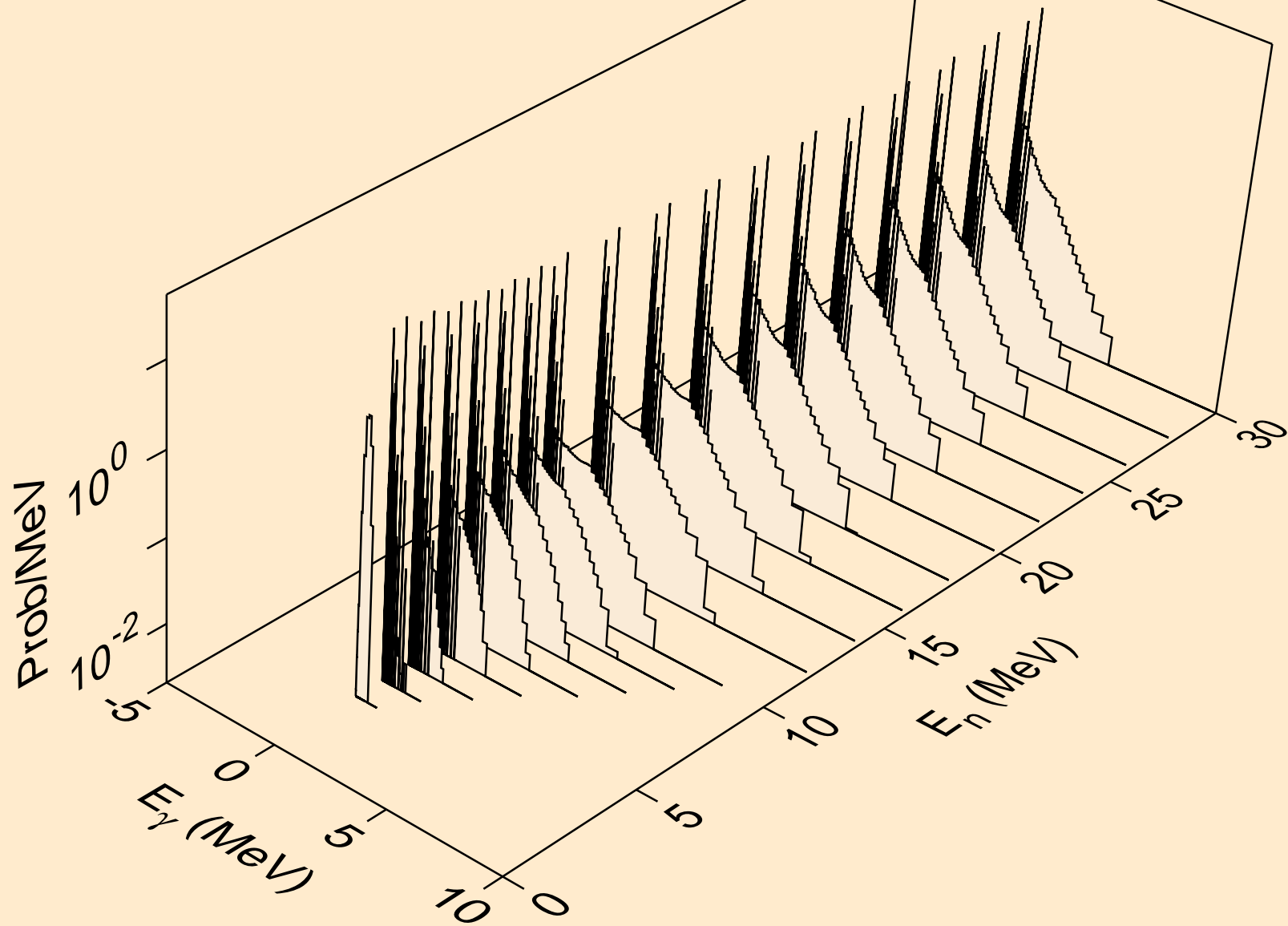

LU187 DEUTERON ACER TENDL-2024 LIBRARY; T=0.K
Photon emission for (n,n*)a

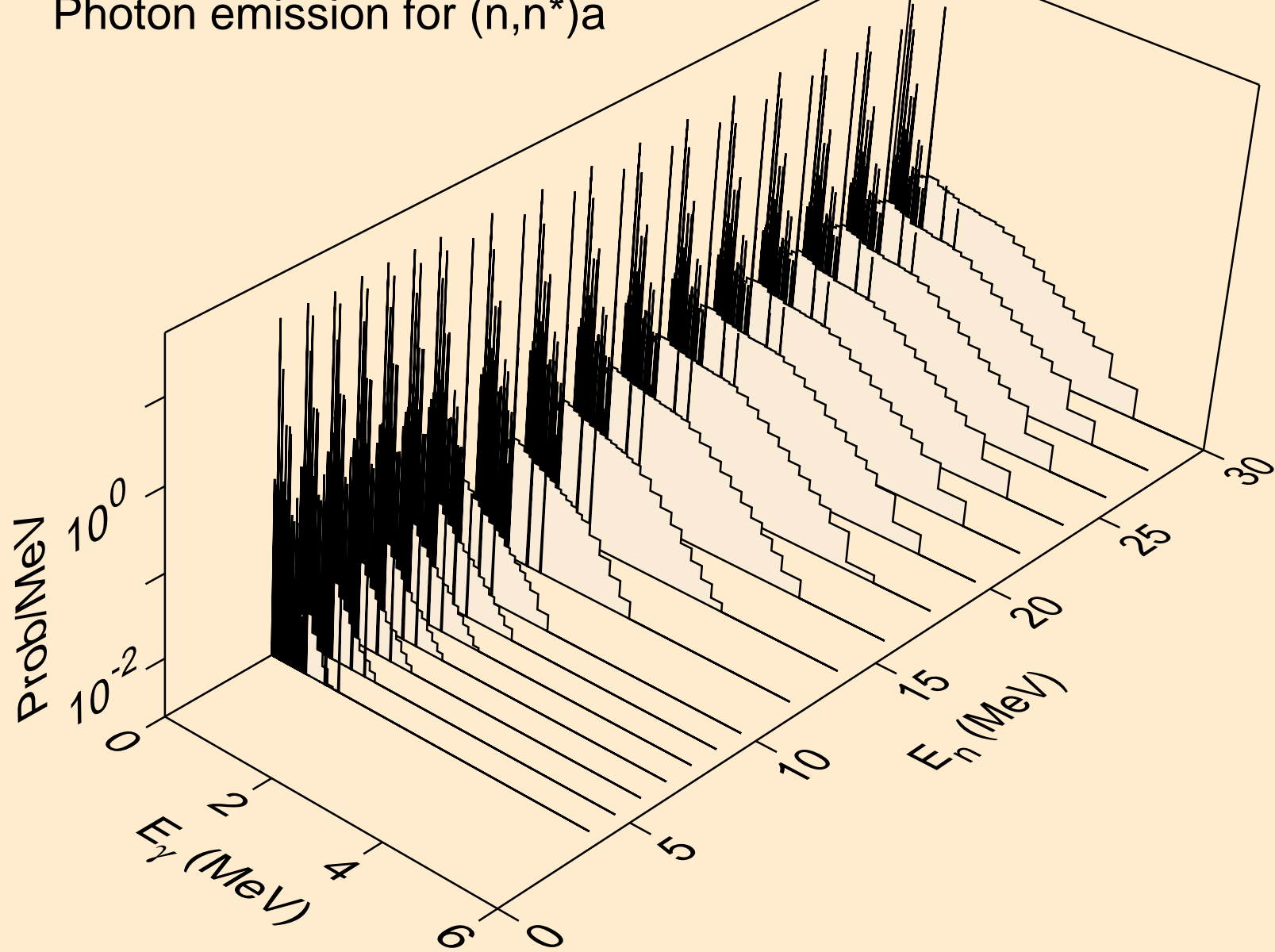

LU187 DEUTERON ACER TENDL-2024 LIBRARY; T=0.K
Photon emission for (n,2n)a

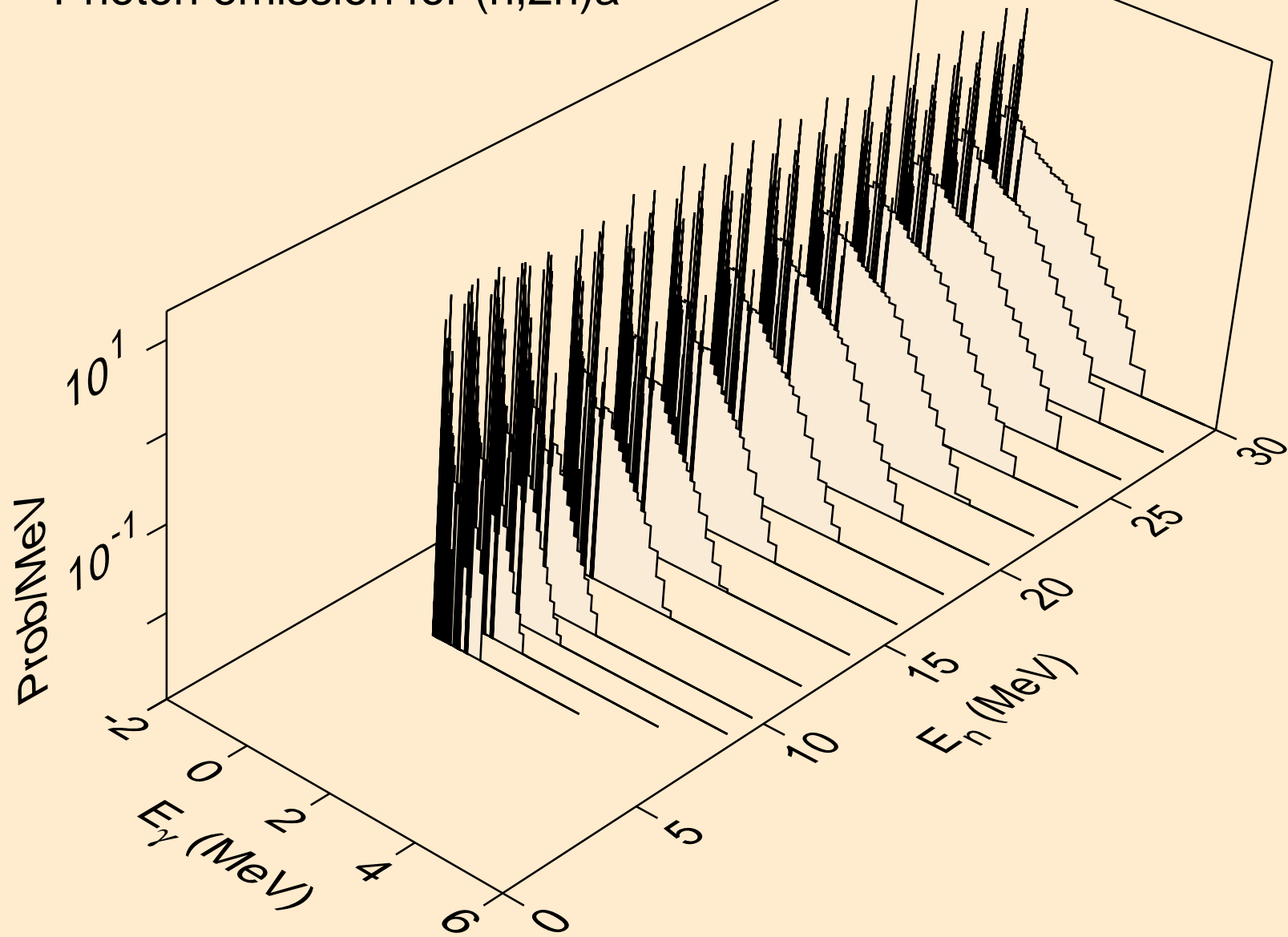

LU187 DEUTERON ACER TENDL-2024 LIBRARY; T=0.K
Photon emission for (n,3n)a

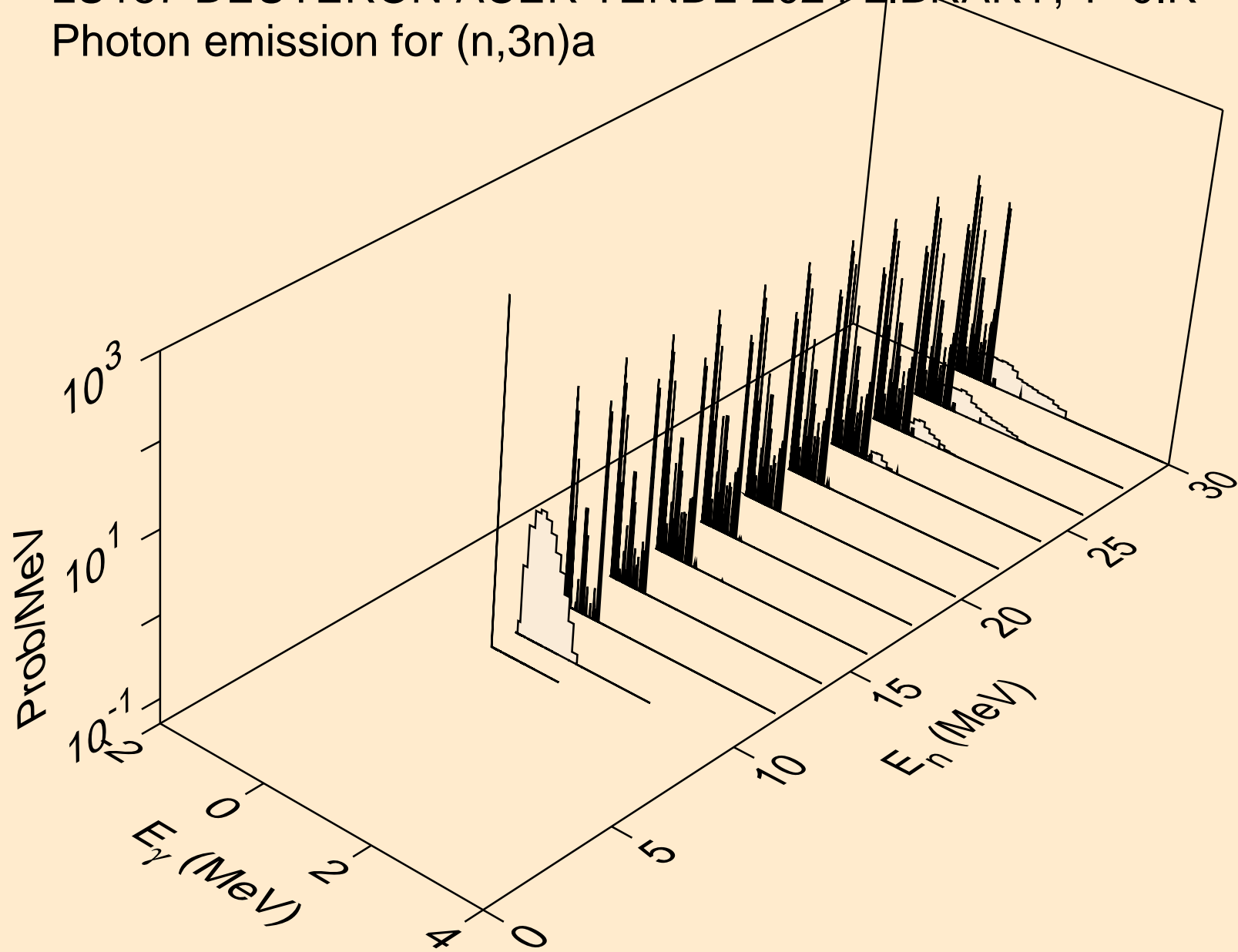

LU187 DEUTERON ACER TENDL-2024 LIBRARY; T=0.K
Photon emission for (n,n*)p

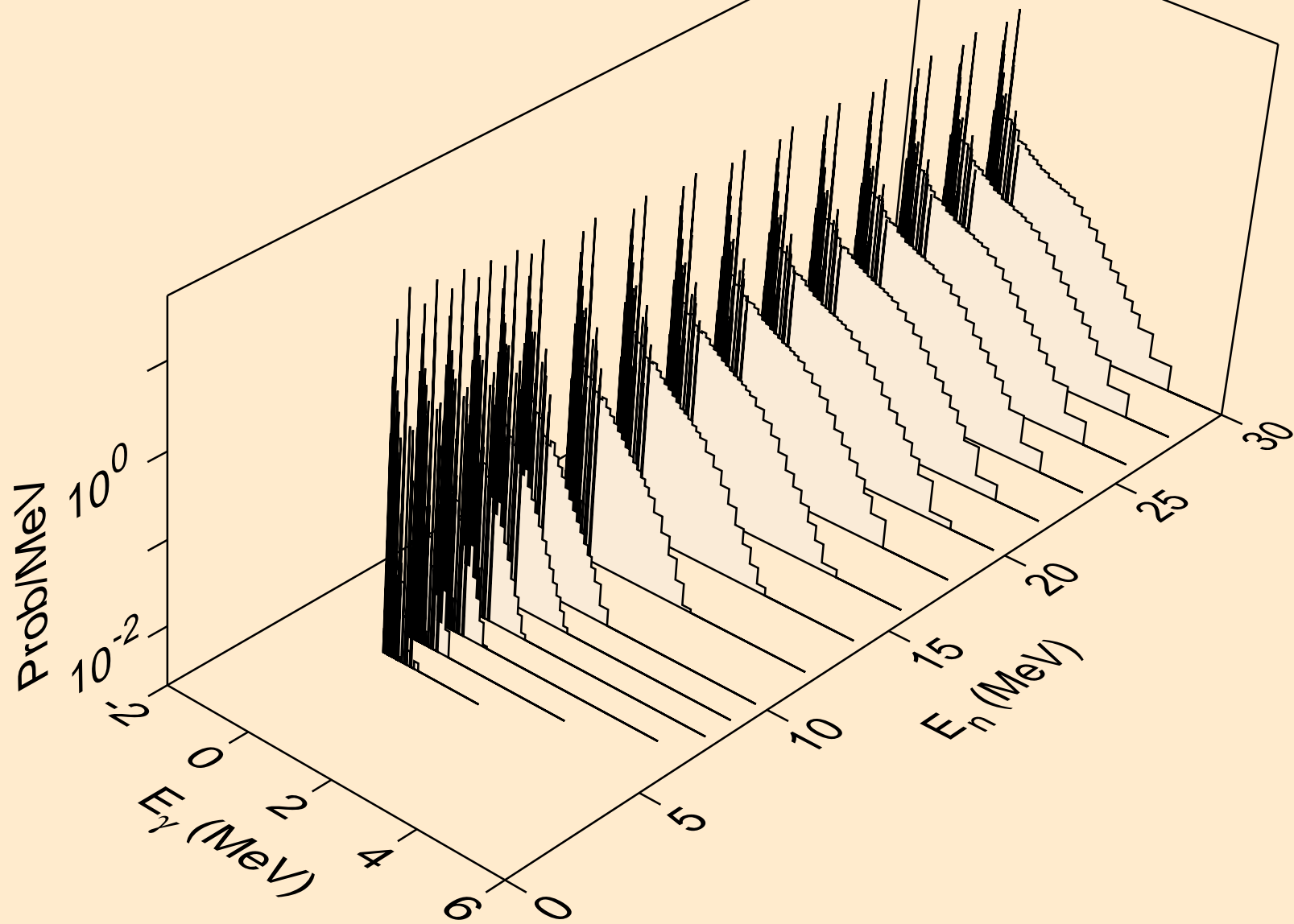

LU187 DEUTERON ACER TENDL-2024 LIBRARY; T=0.K
Photon emission for (n,n*)d

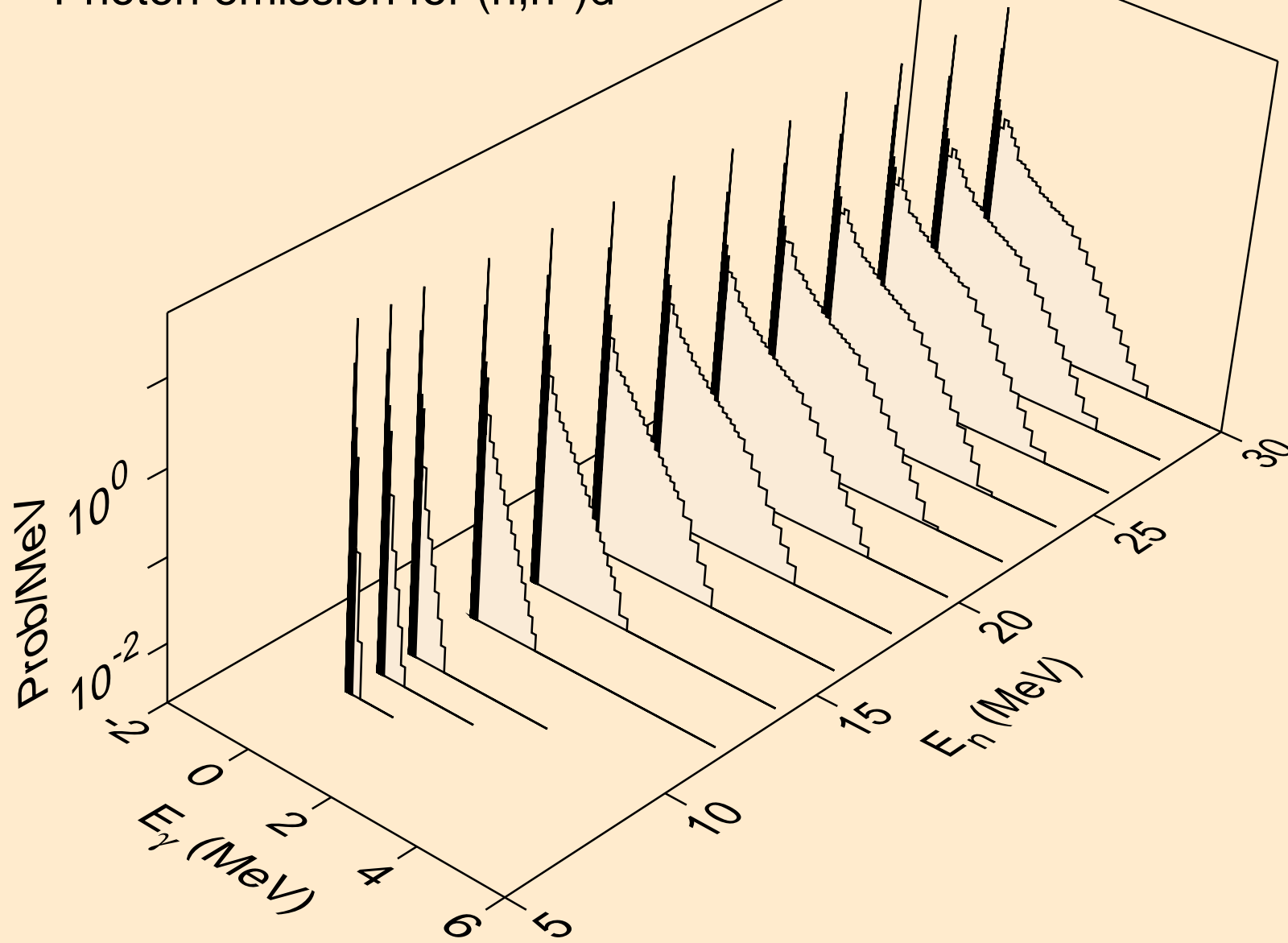

LU187 DEUTERON ACER TENDL-2024 LIBRARY; T=0.K
Photon emission for (n,n*)t

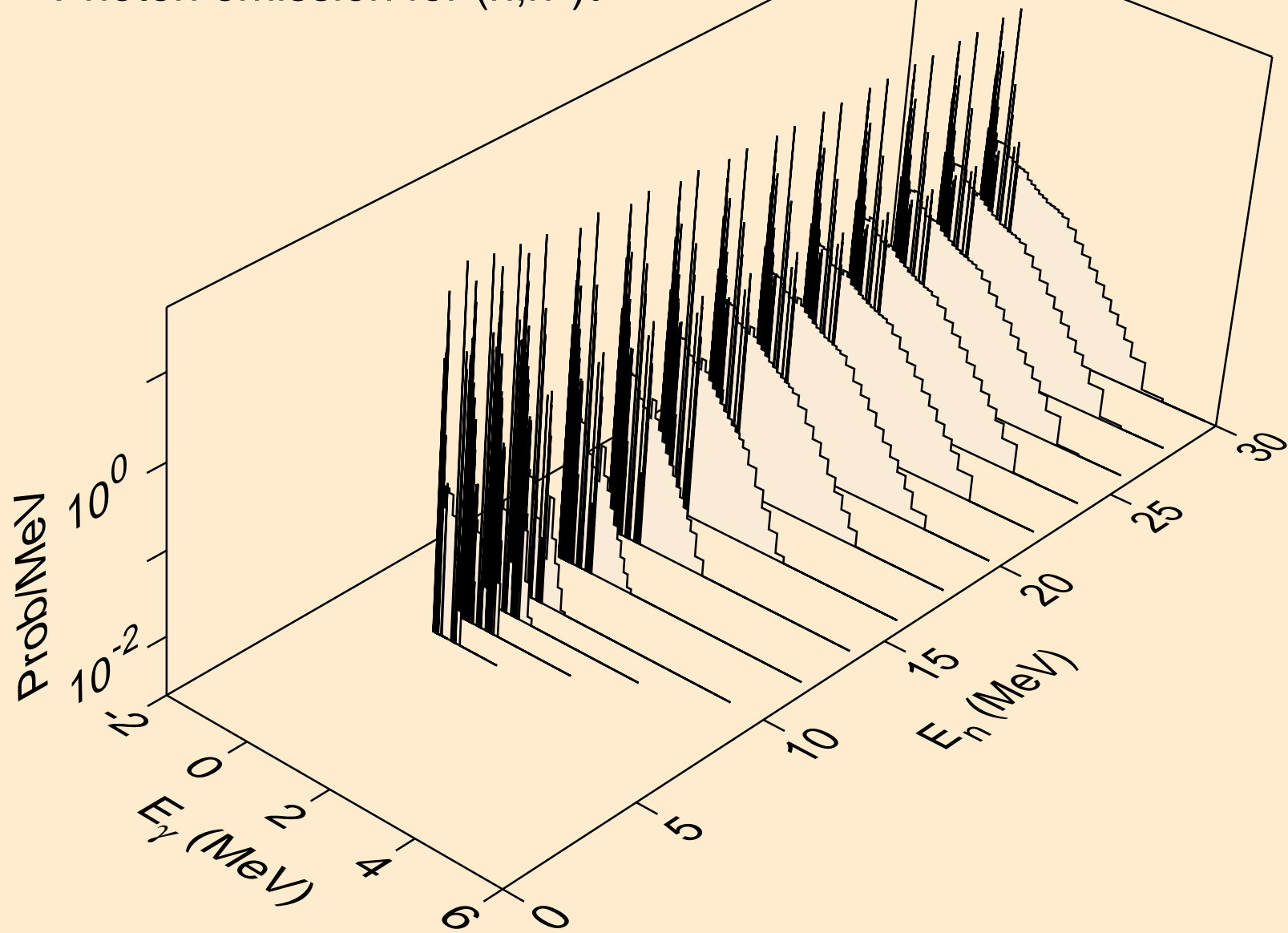

LU187 DEUTERON ACER TENDL-2024 LIBRARY; T=0.K
Photon emission for (n,n*)he3

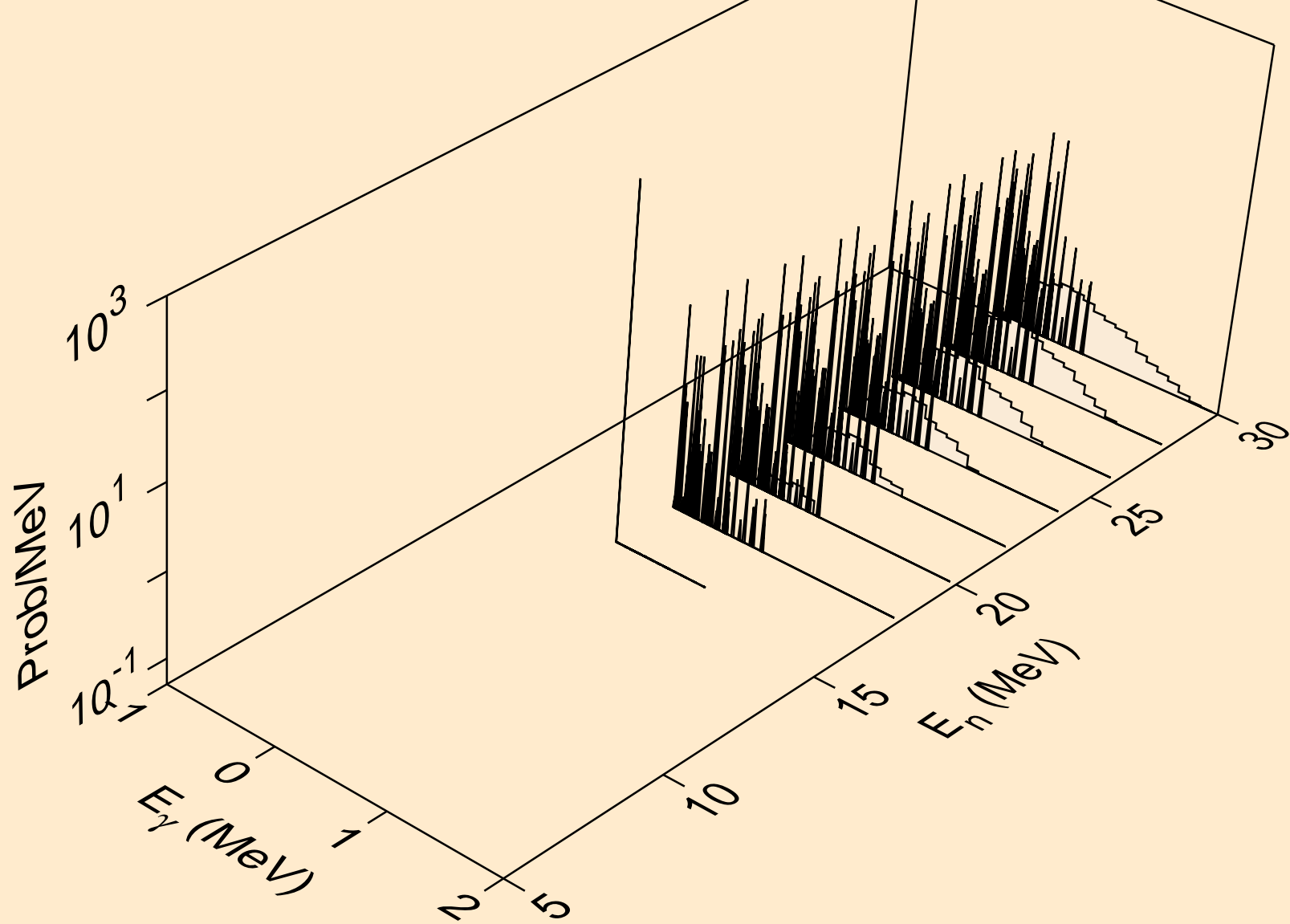

LU187 DEUTERON ACER TENDL-2024 LIBRARY; T=0.K
Photon emission for (n,4n)

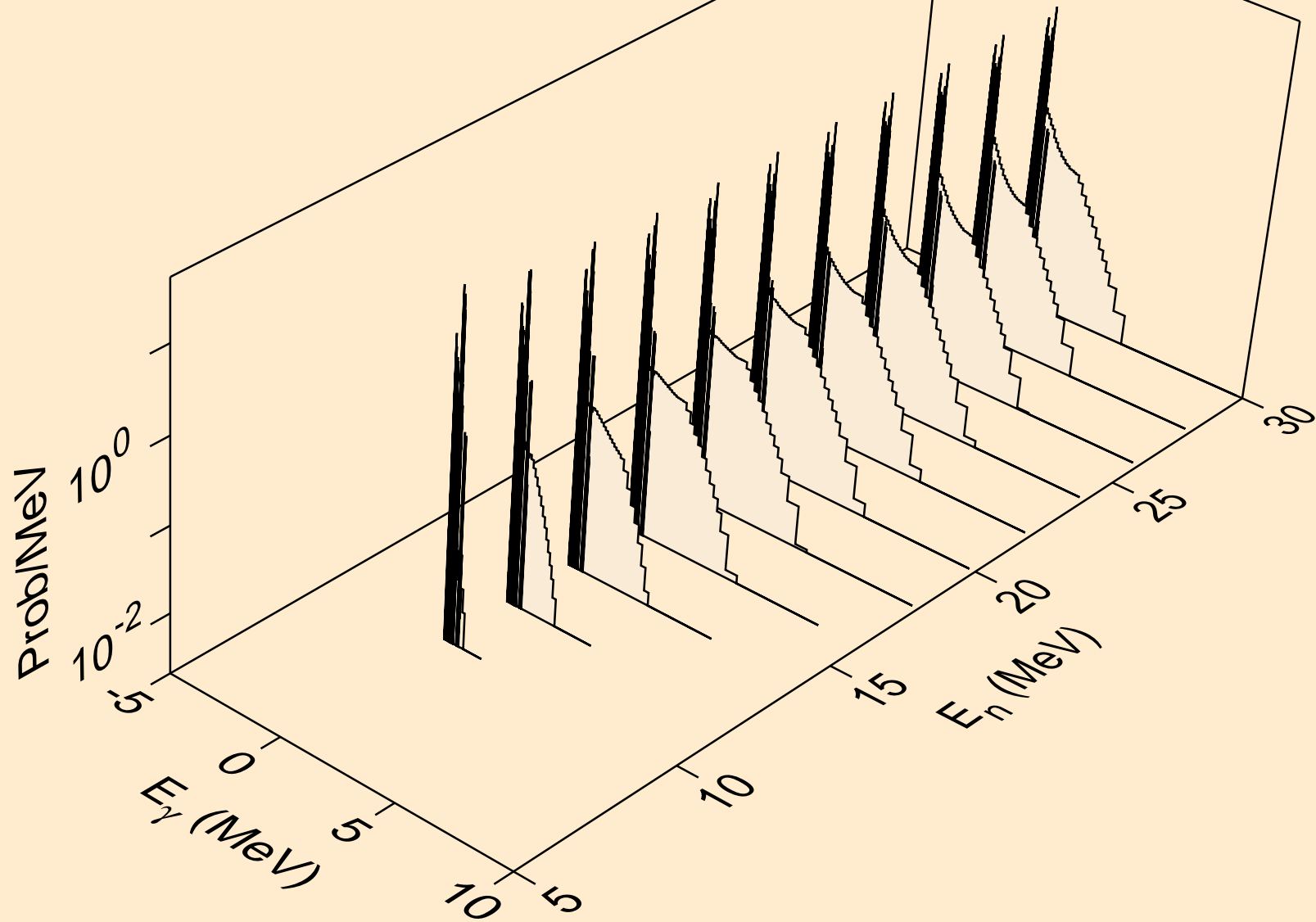

LU187 DEUTERON ACER TENDL-2024 LIBRARY; T=0.K
Photon emission for (n,2np)

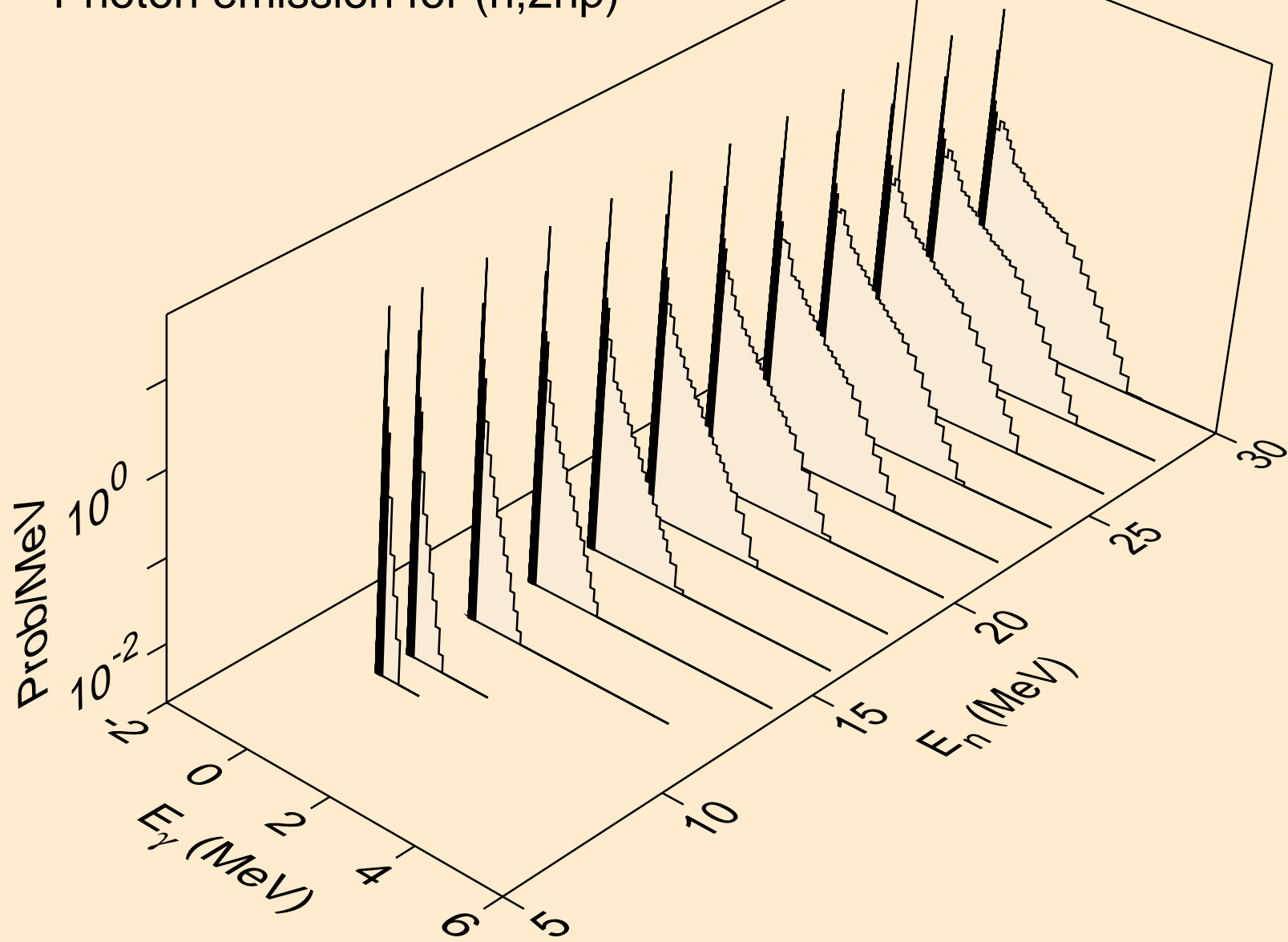

LU187 DEUTERON ACER TENDL-2024 LIBRARY; T=0.K
Photon emission for (n,3np)

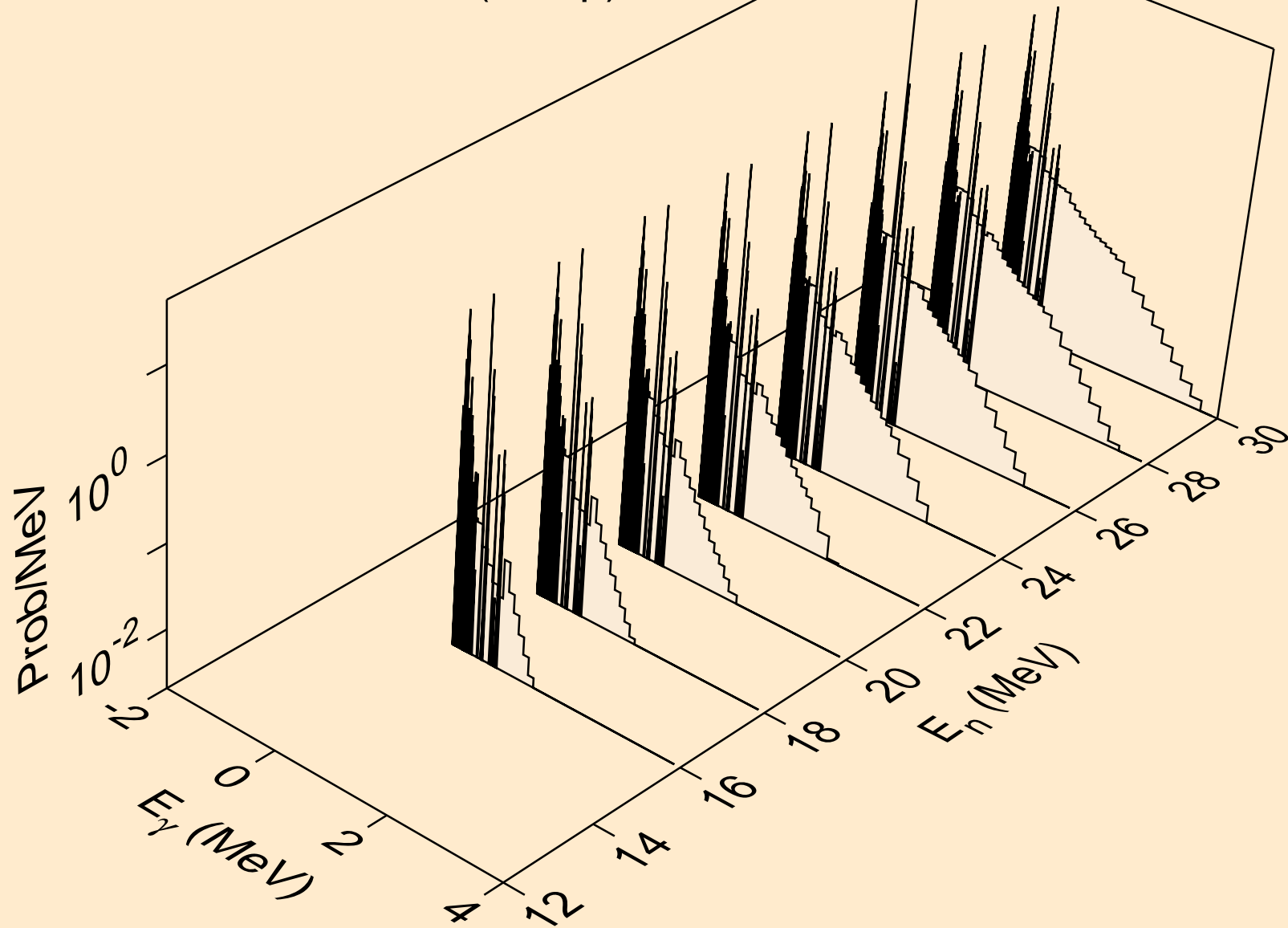

LU187 DEUTERON ACER TENDL-2024 LIBRARY; T=0.K
Photon emission for (n,n2p)

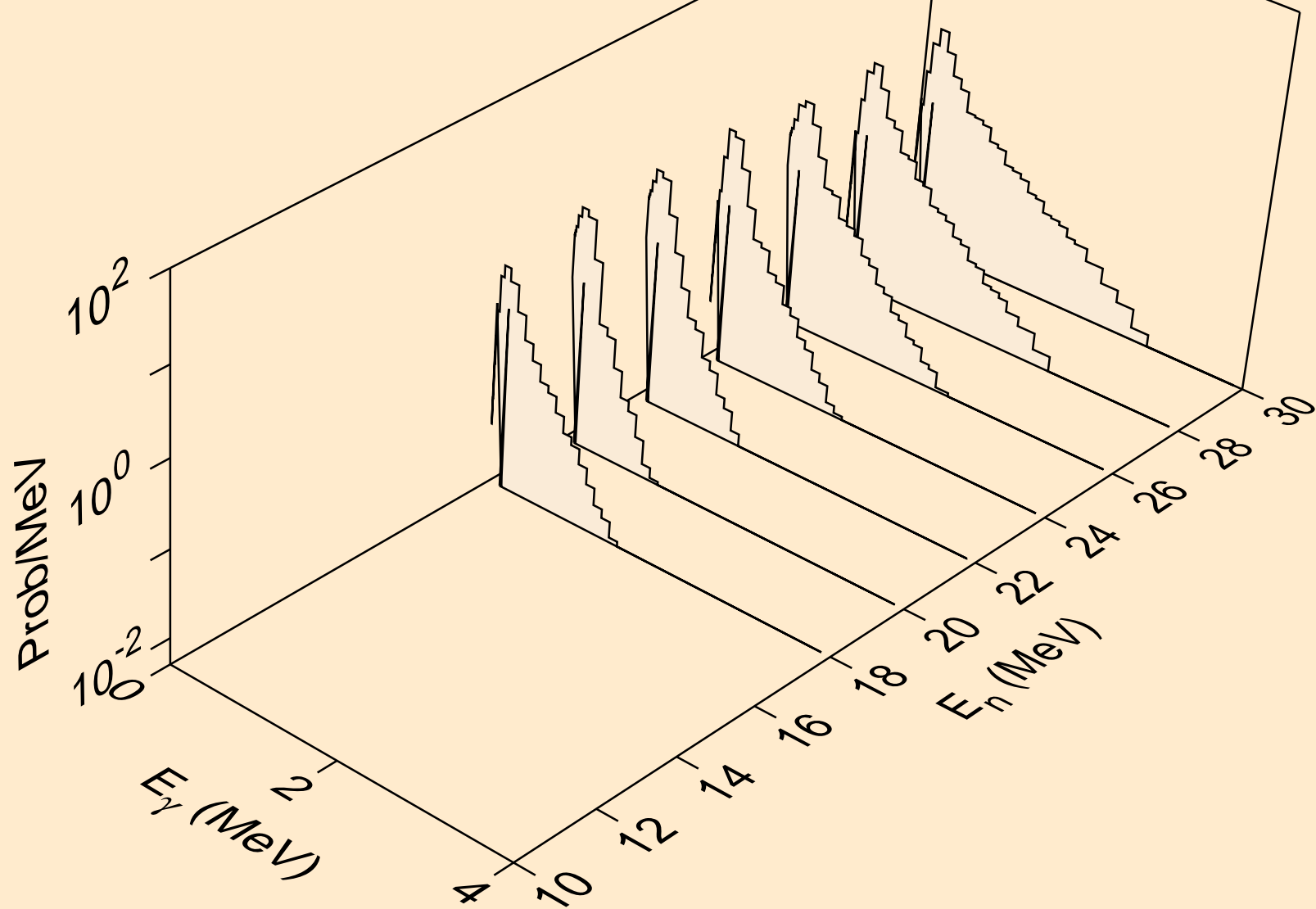

LU187 DEUTERON ACER TENDL-2024 LIBRARY; T=0.K
Photon emission for (n,gma)

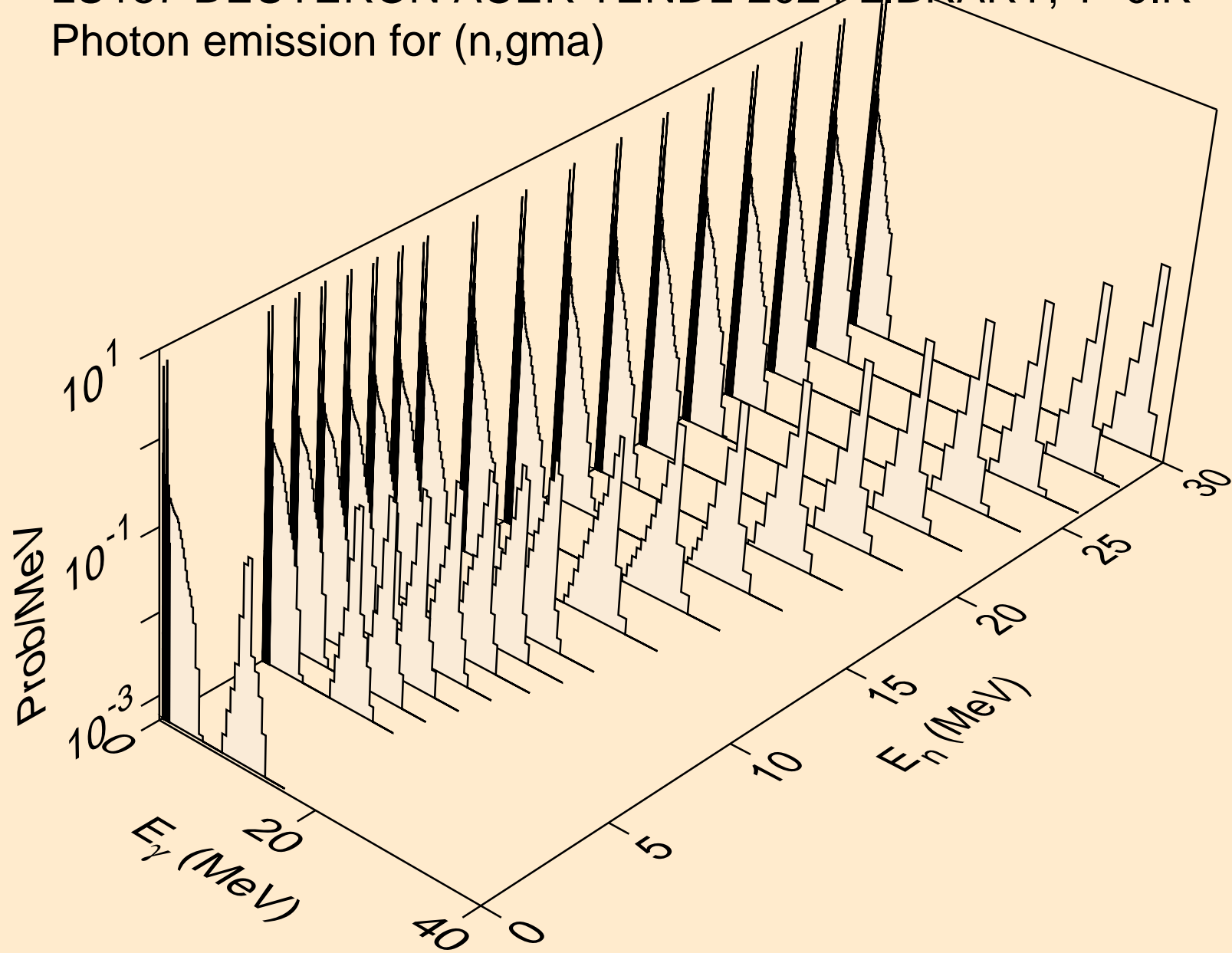

LU187 DEUTERON ACER TENDL-2024 LIBRARY; T=0.K
Photon emission for (n,p)

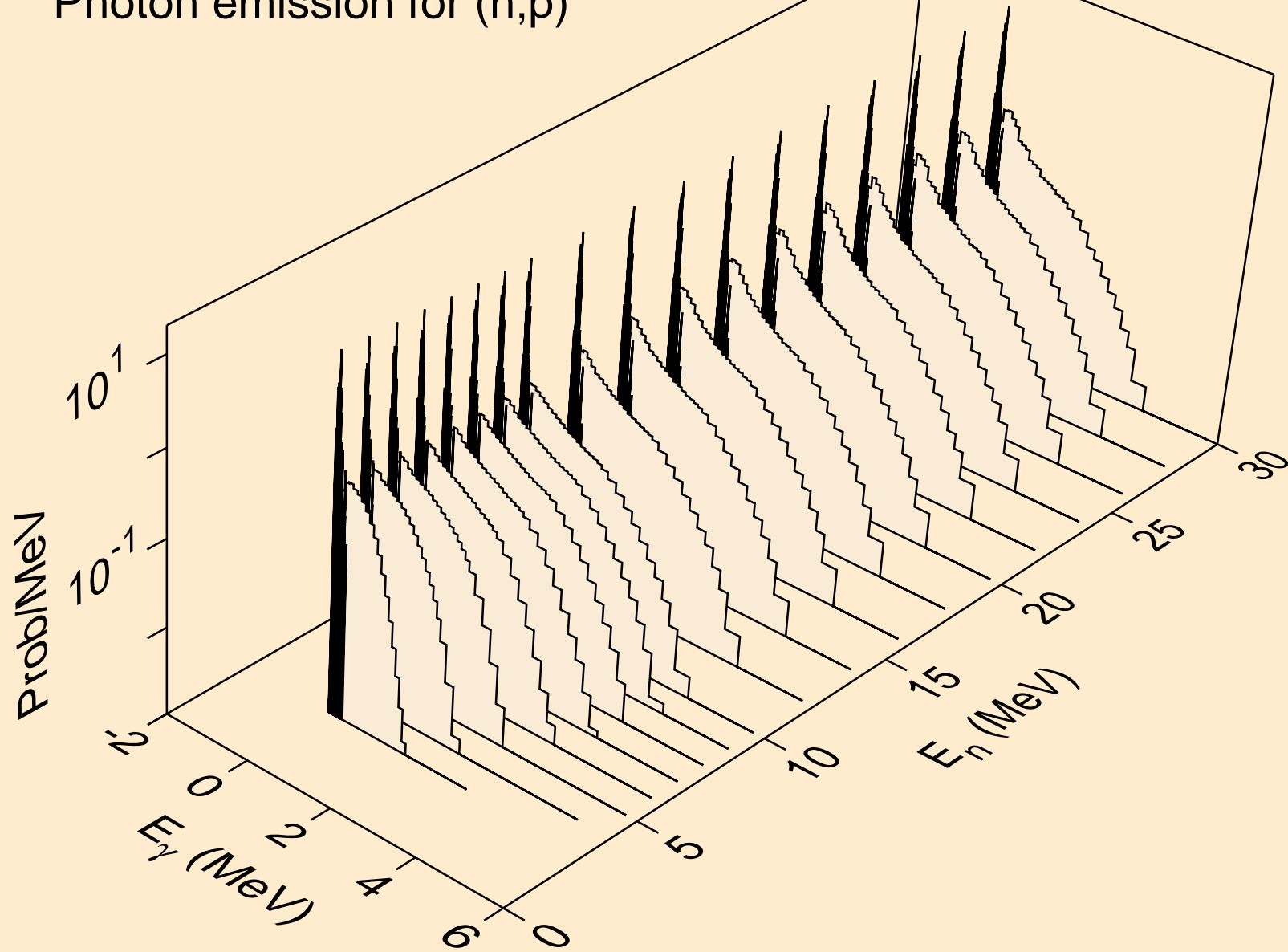

LU187 DEUTERON ACER TENDL-2024 LIBRARY; T=0.K
Photon emission for inelastic

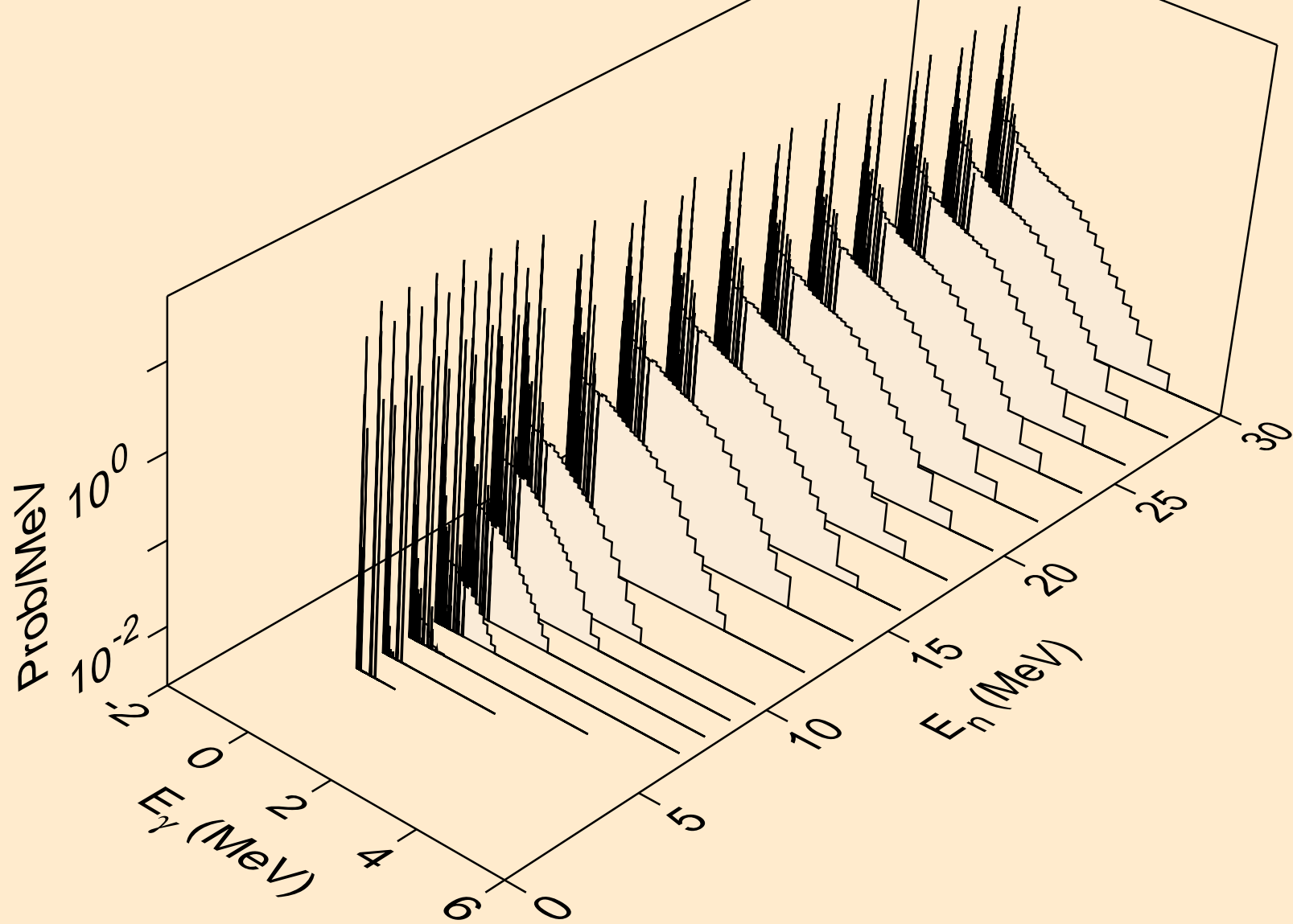

LU187 DEUTERON ACER TENDL-2024 LIBRARY; T=0.K
Photon emission for (n,t)

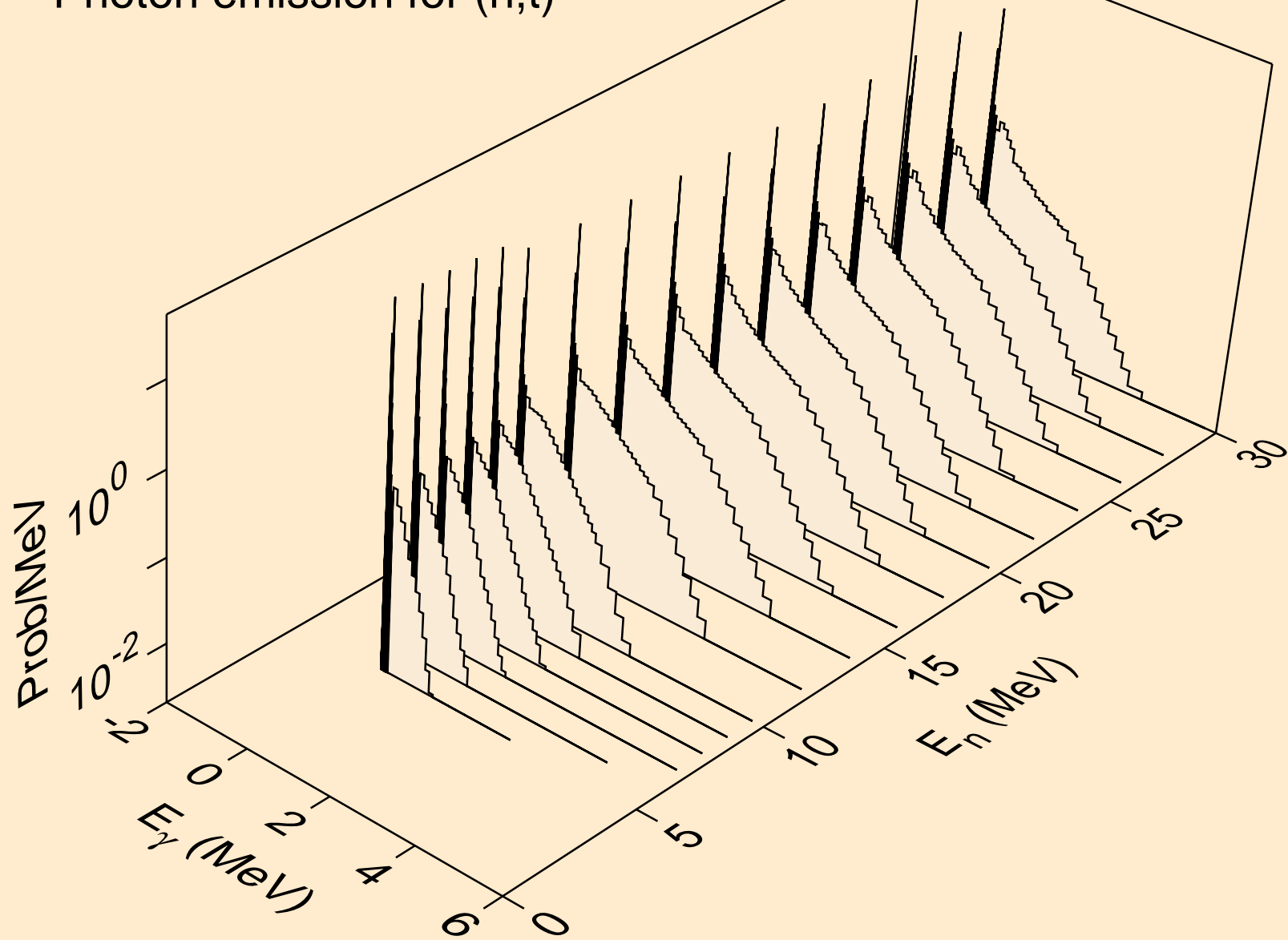

LU187 DEUTERON ACER TENDL-2024 LIBRARY; T=0.K
Photon emission for (n,he3)

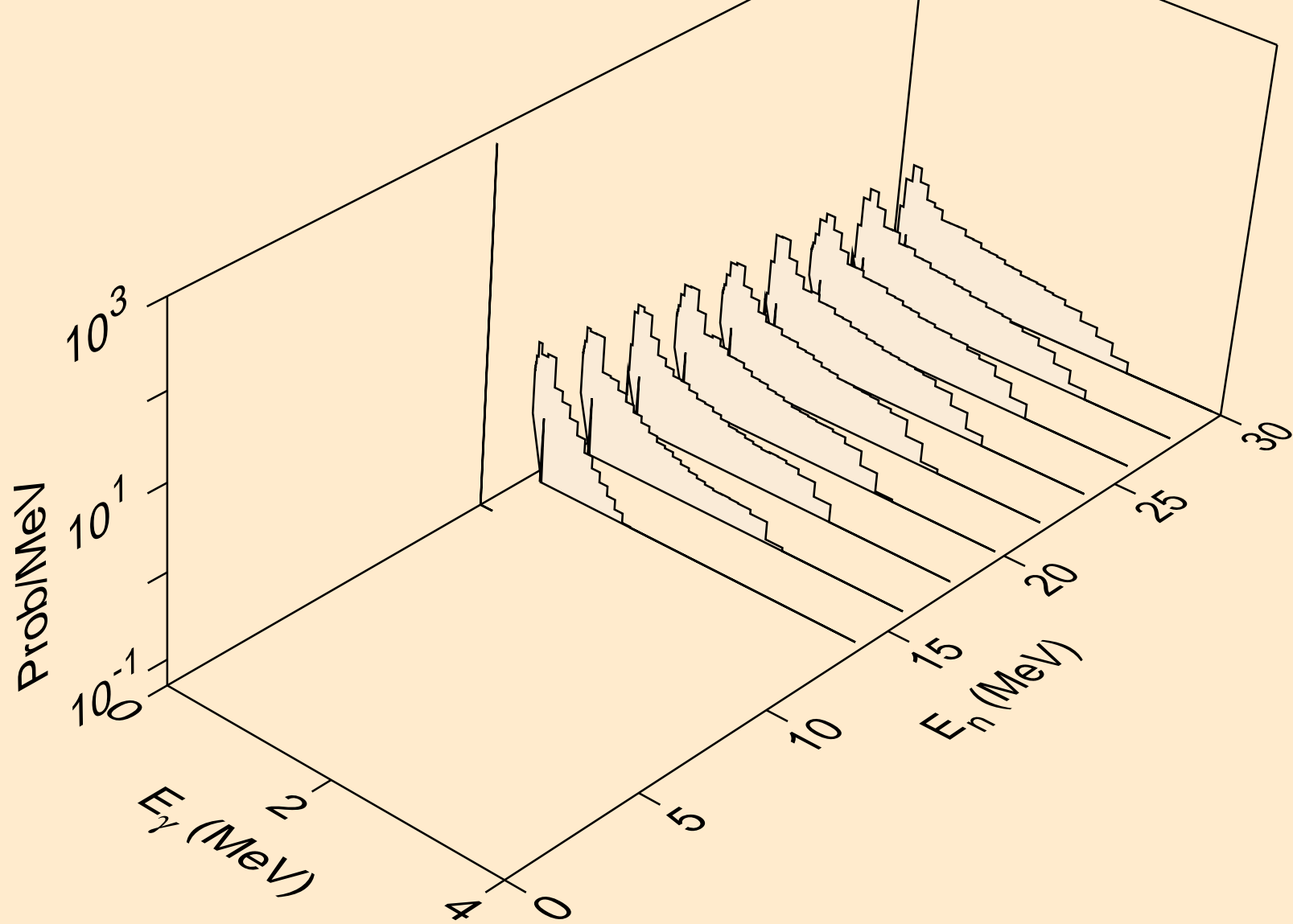

LU187 DEUTERON ACER TENDL-2024 LIBRARY; T=0.K
Photon emission for (n,a)

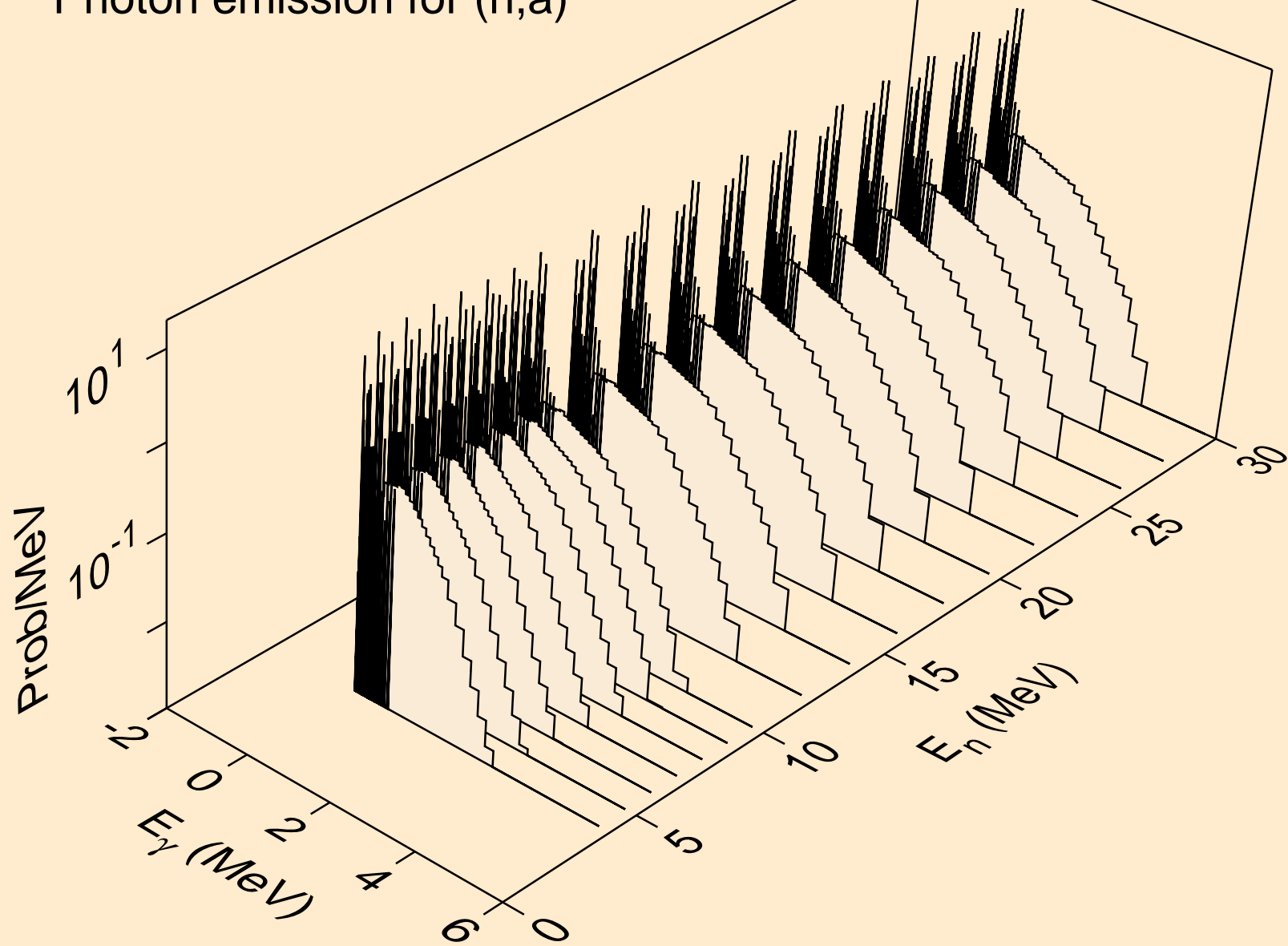

LU187 DEUTERON ACER TENDL-2024 LIBRARY; T=0.K
Photon emission for (n,2p)

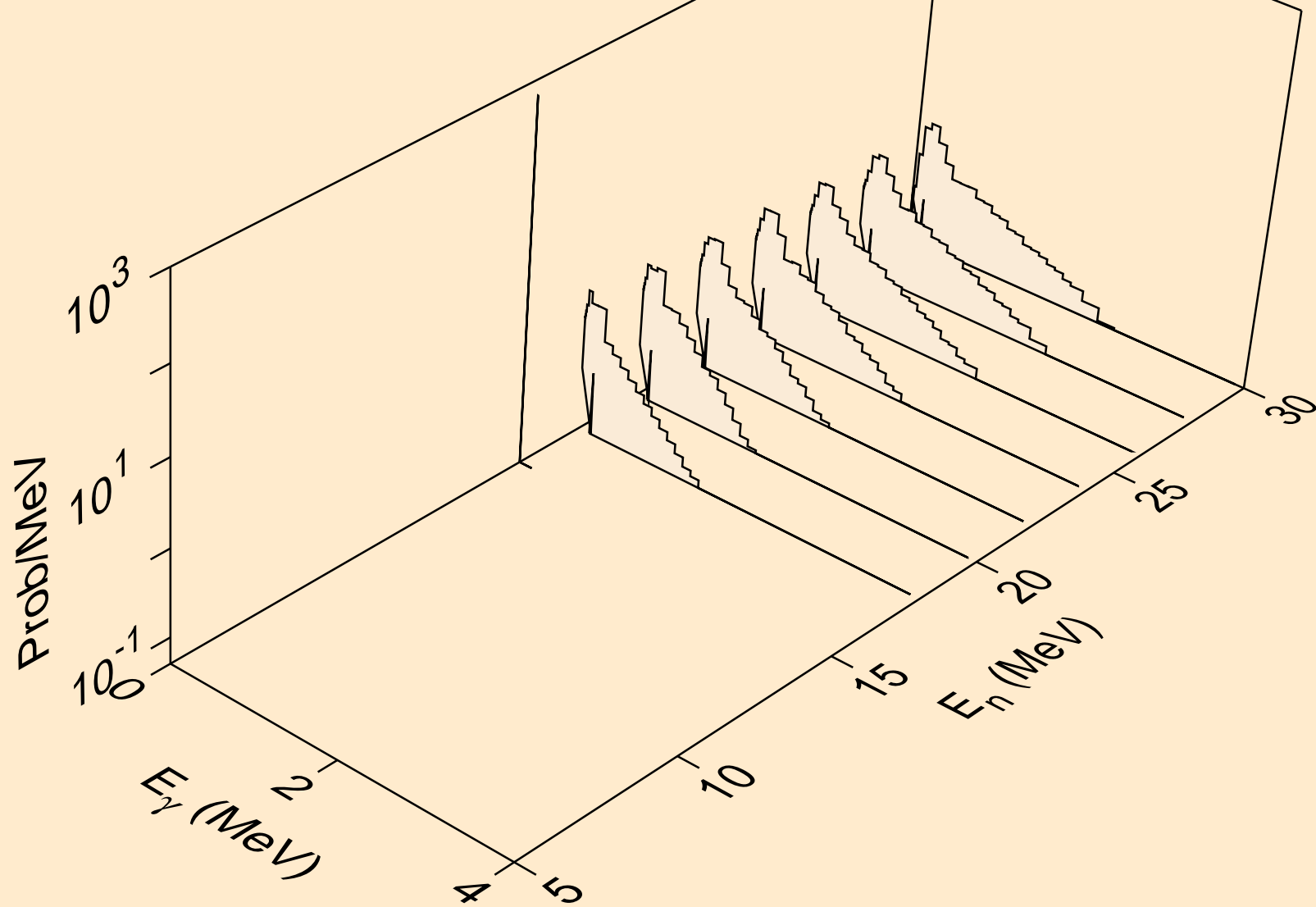

LU187 DEUTERON ACER TENDL-2024 LIBRARY; T=0.K
Photon emission for (n,pd)

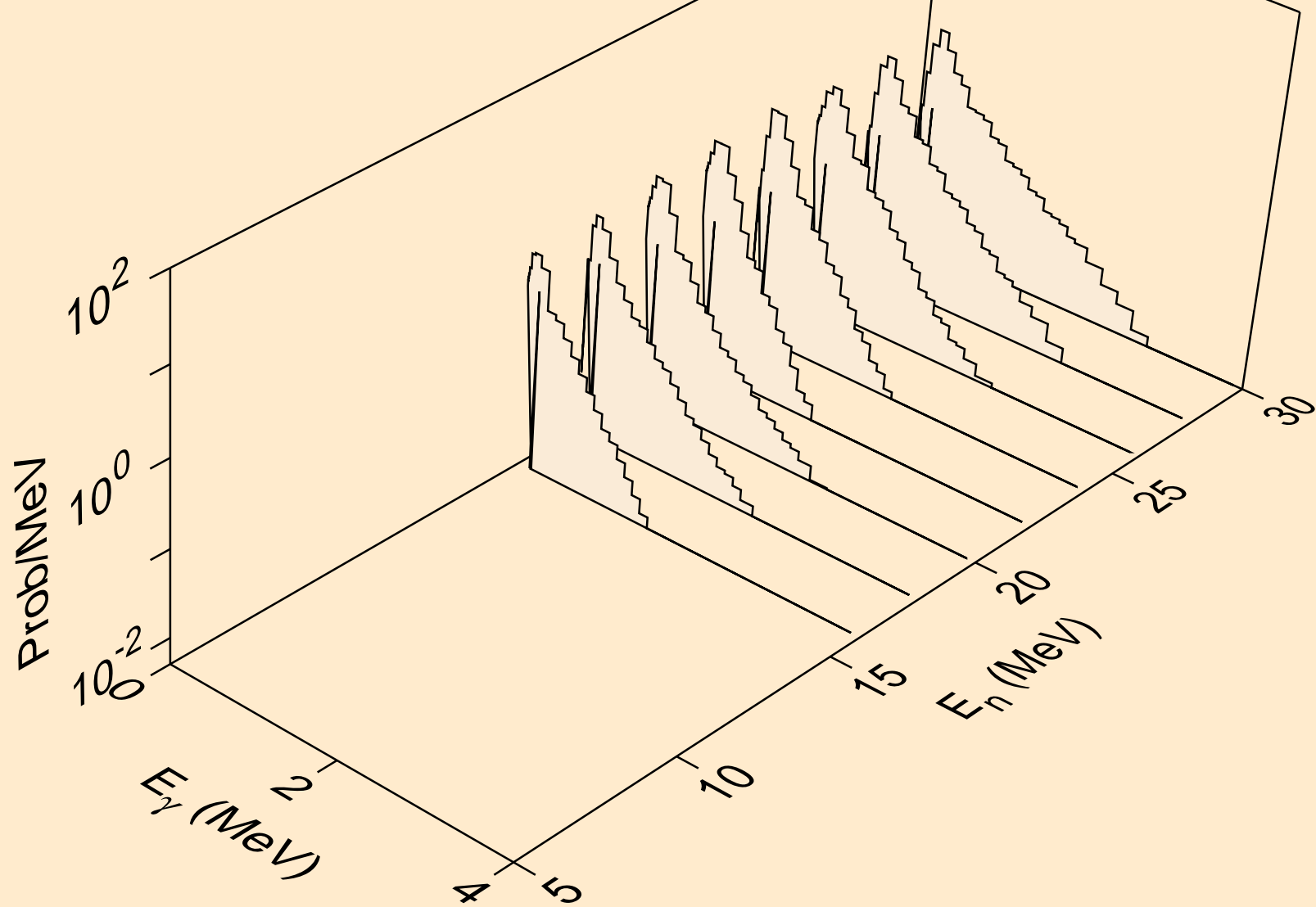

LU187 DEUTERON ACER TENDL-2024 LIBRARY; T=0.K
Particle heating contributions

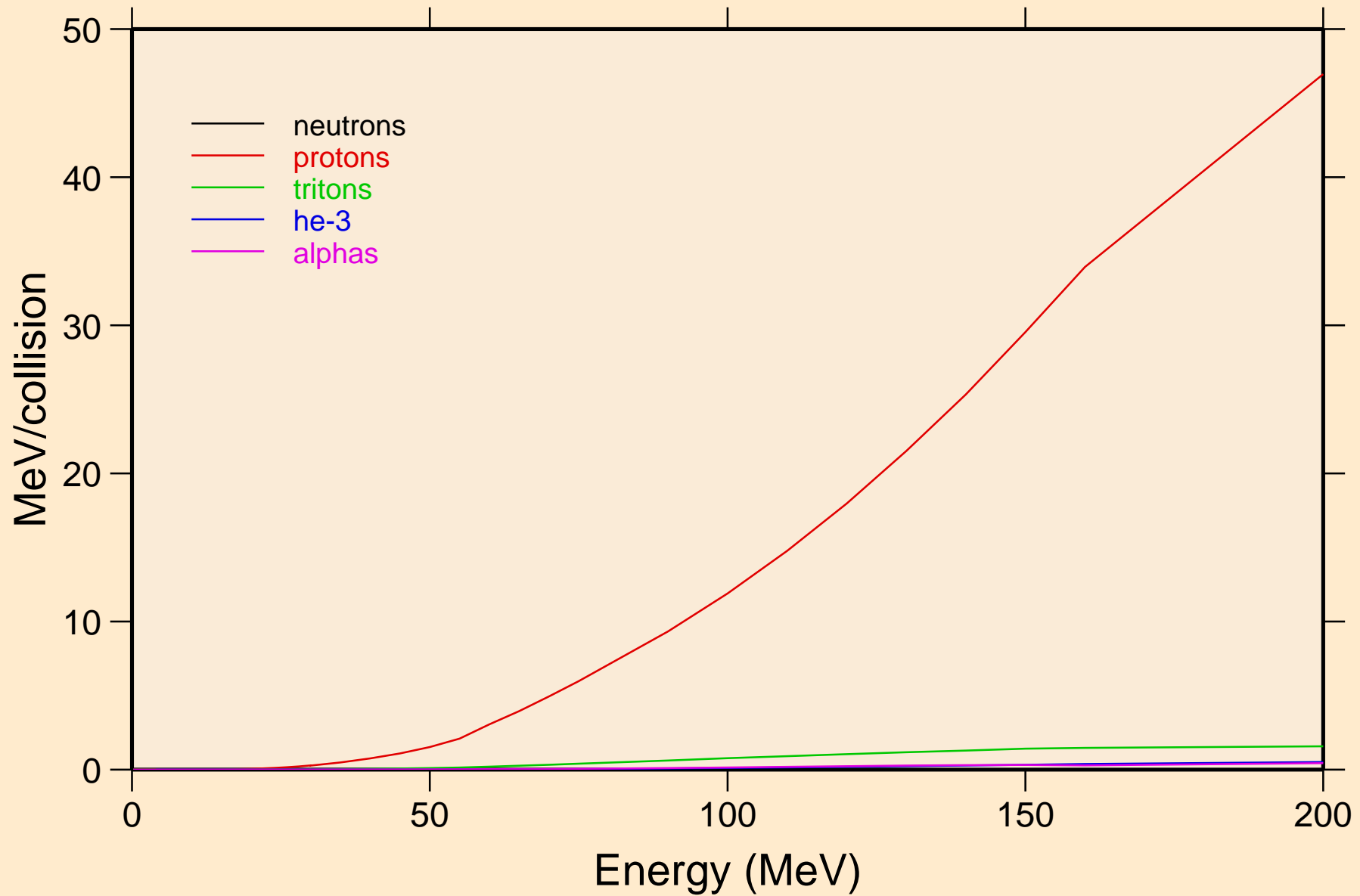

LU187 DEUTERON ACER TENDL-2024 LIBRARY; T=0.K
Recoil Heating

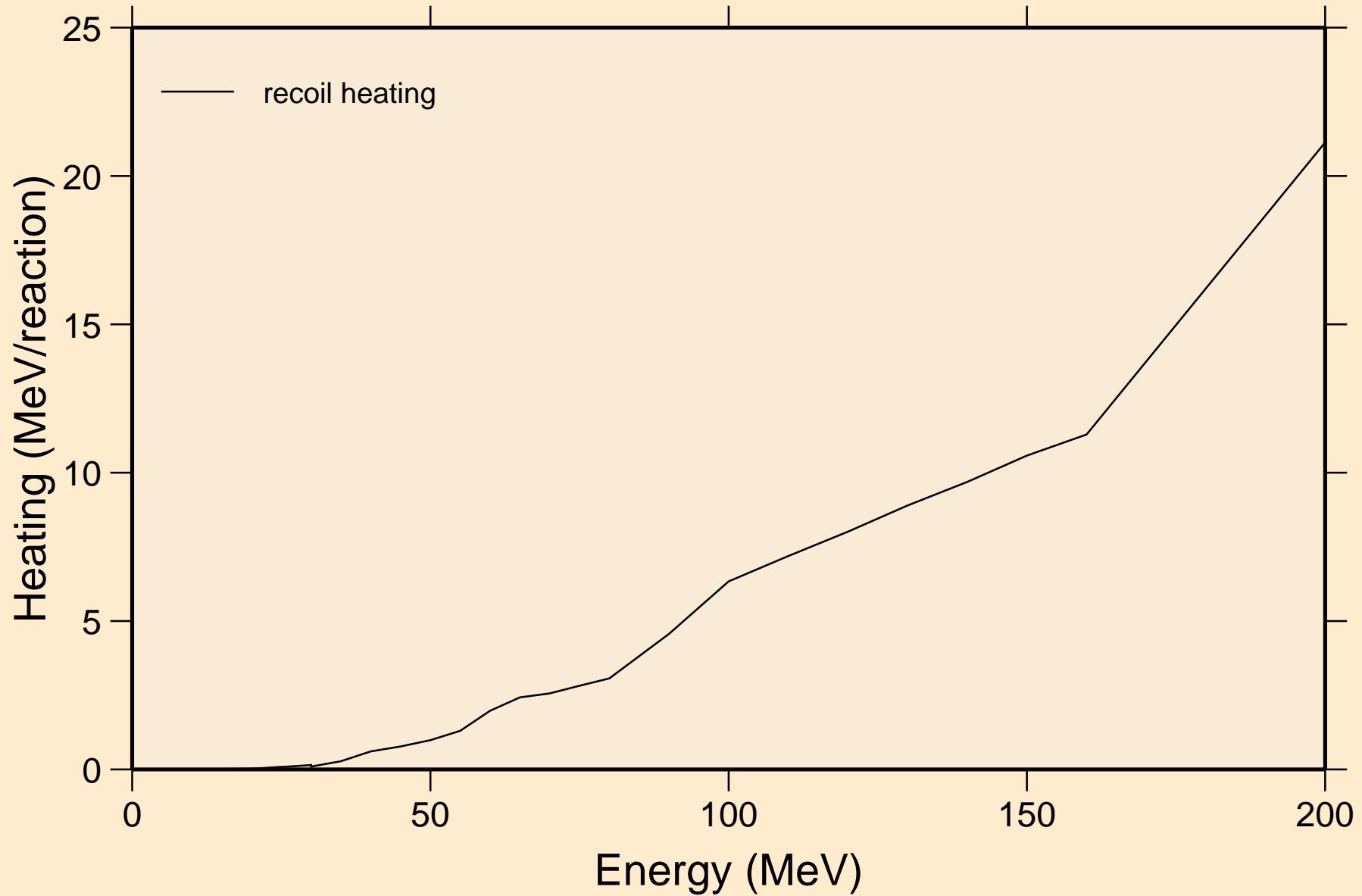

LU187 DEUTERON ACER TENDL-2024 LIBRARY; T=0.K

Particle production cross sections

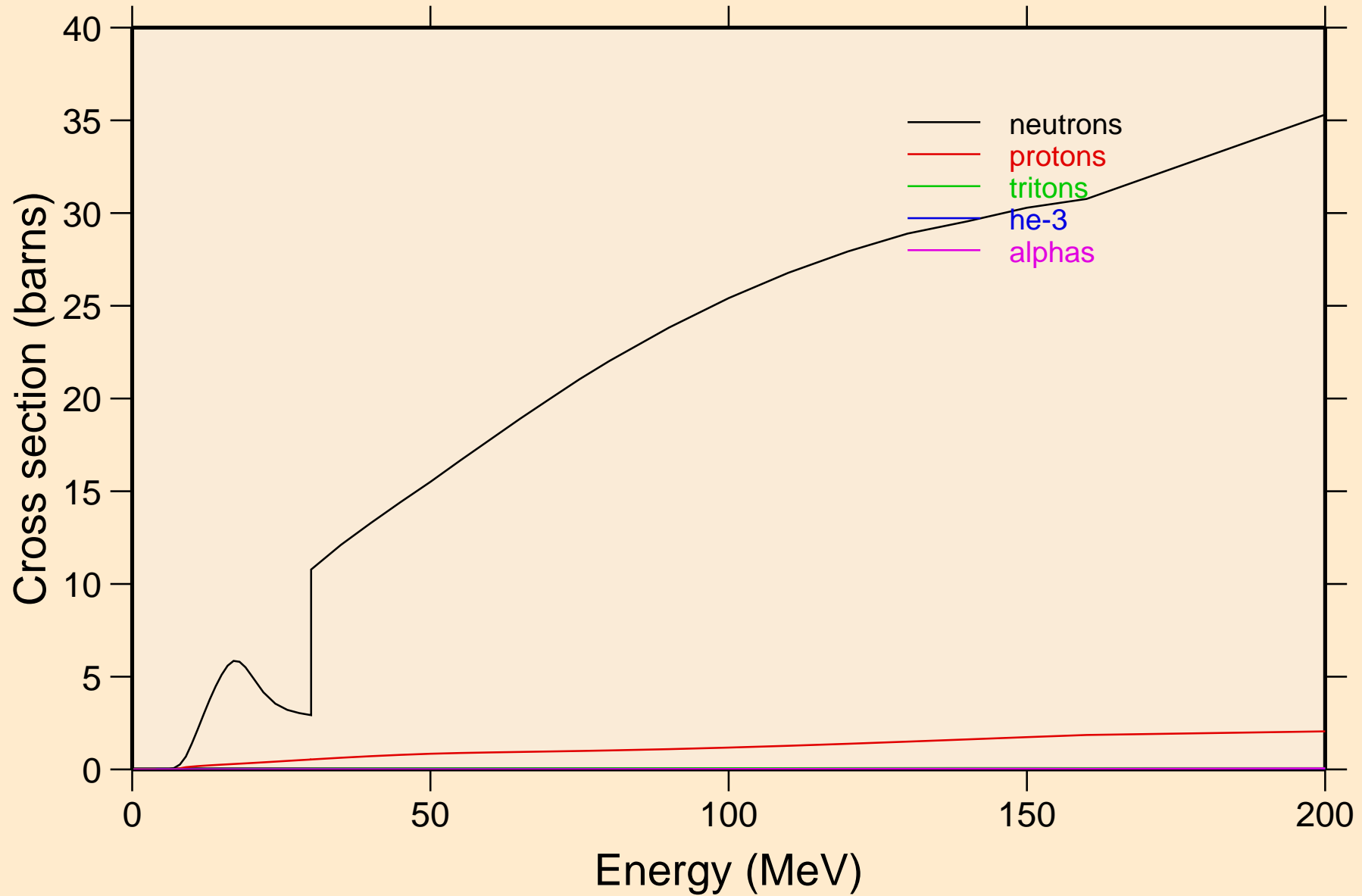

LU187 DEUTERON ACER TENDL-2024 LIBRARY; T=0.K
neutrons from (d,n)

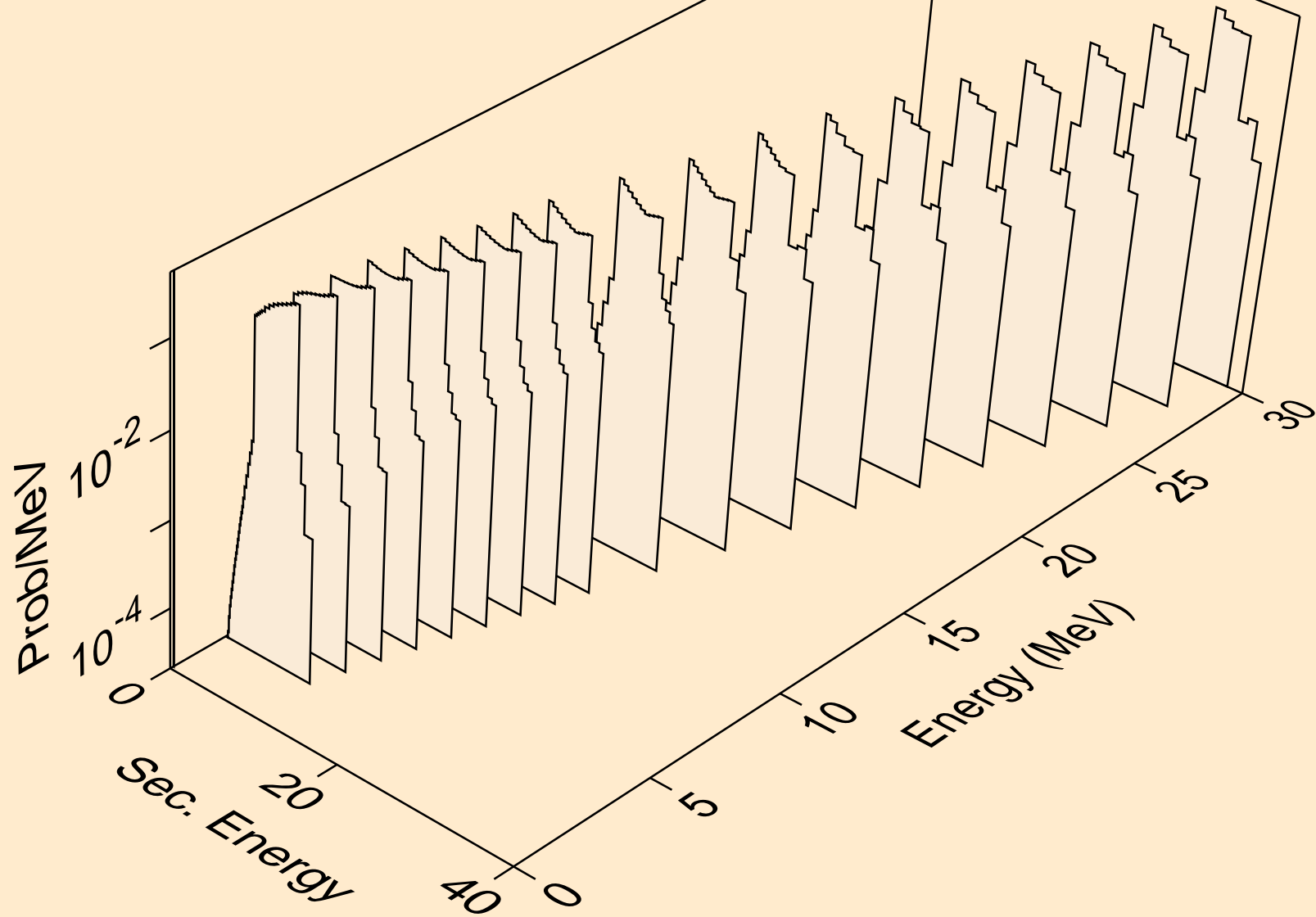

LU187 DEUTERON ACER TENDL-2024 LIBRARY; T=0.K
neutrons from (d,x)

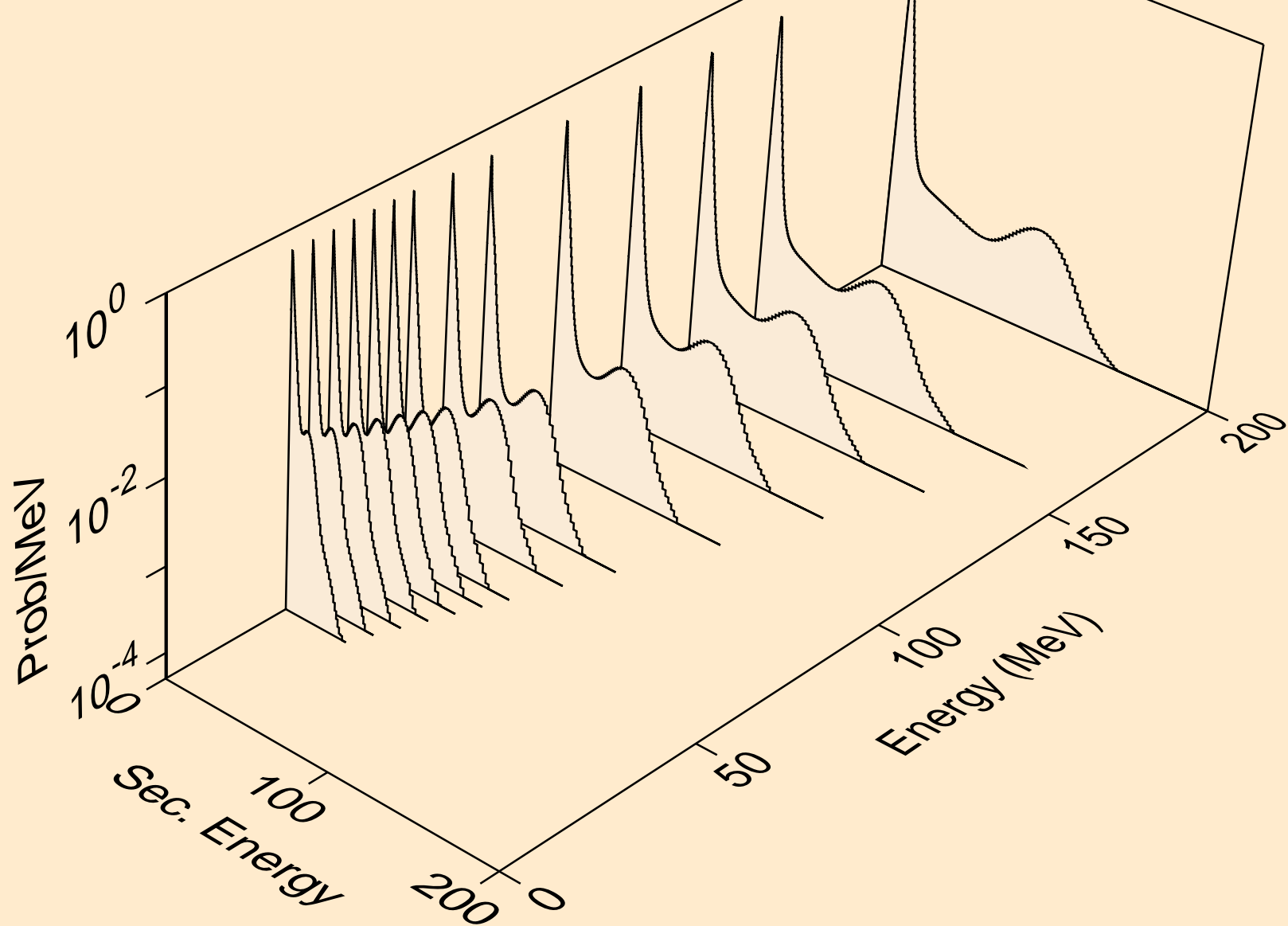

LU187 DEUTERON ACER TENDL-2024 LIBRARY; T=0.K
neutrons from (d,2nd)

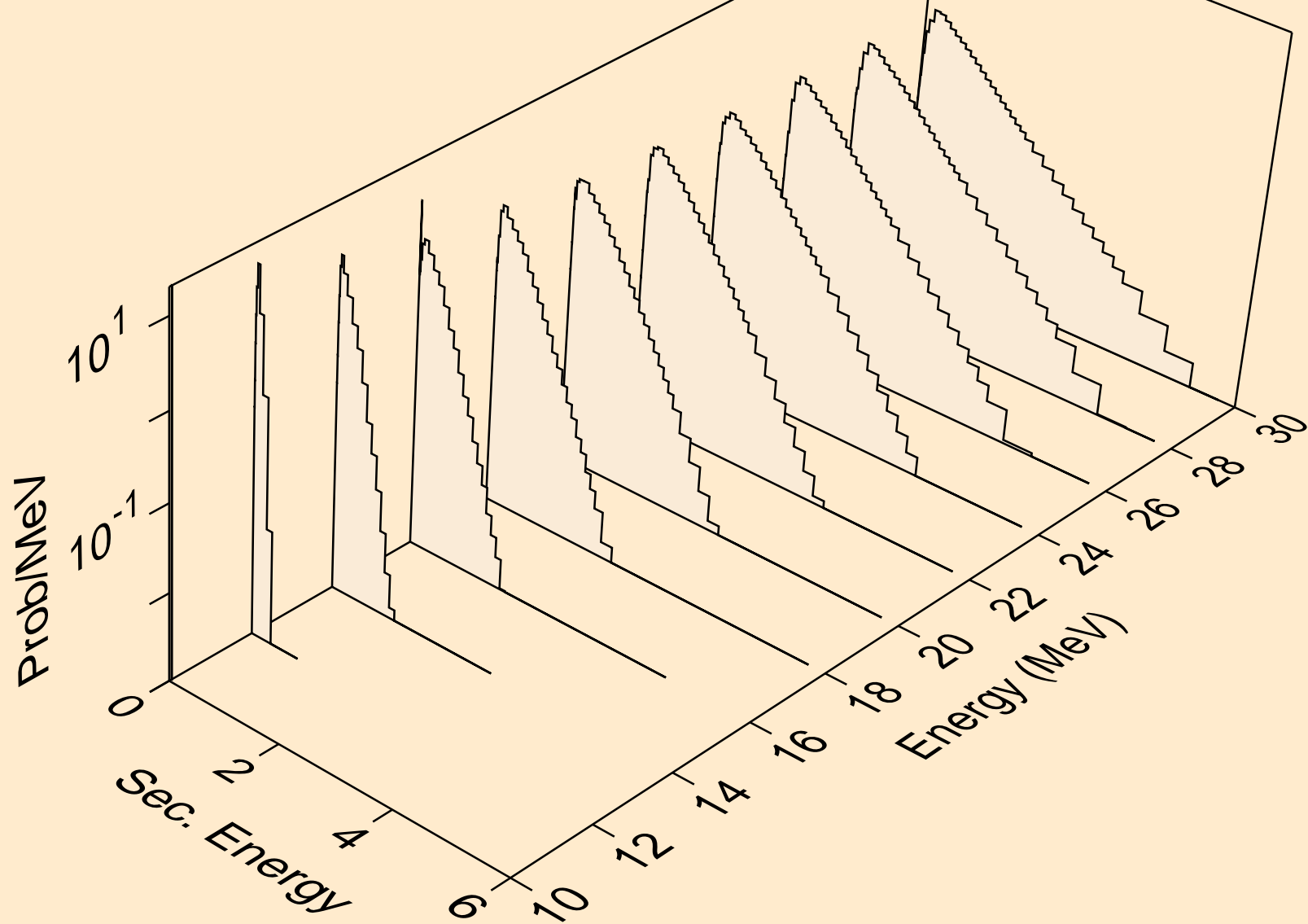

LU187 DEUTERON ACER TENDL-2024 LIBRARY; T=0.K
neutrons from (d,2n)

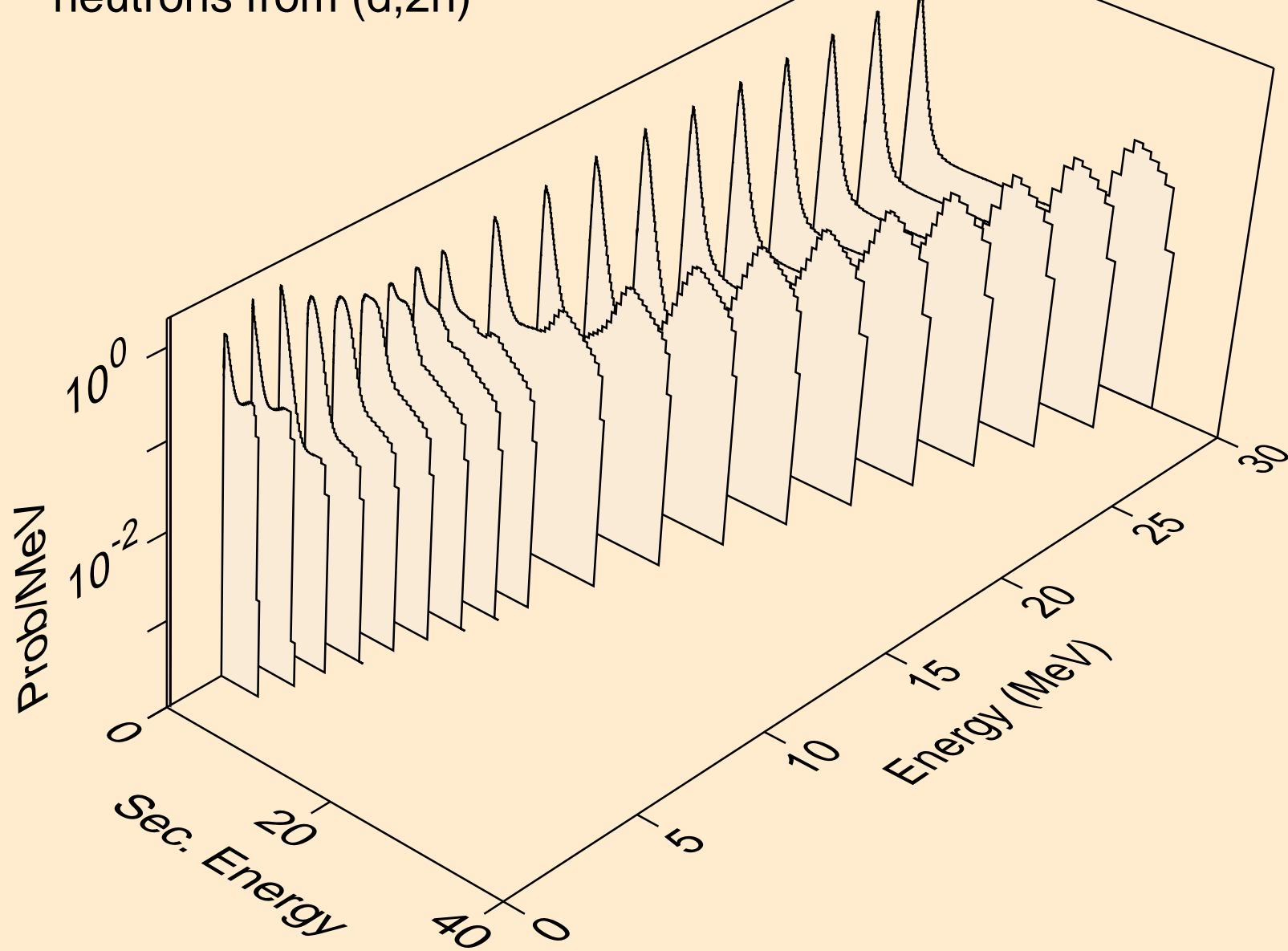

LU187 DEUTERON ACER TENDL-2024 LIBRARY; T=0.K
neutrons from (d,3n)

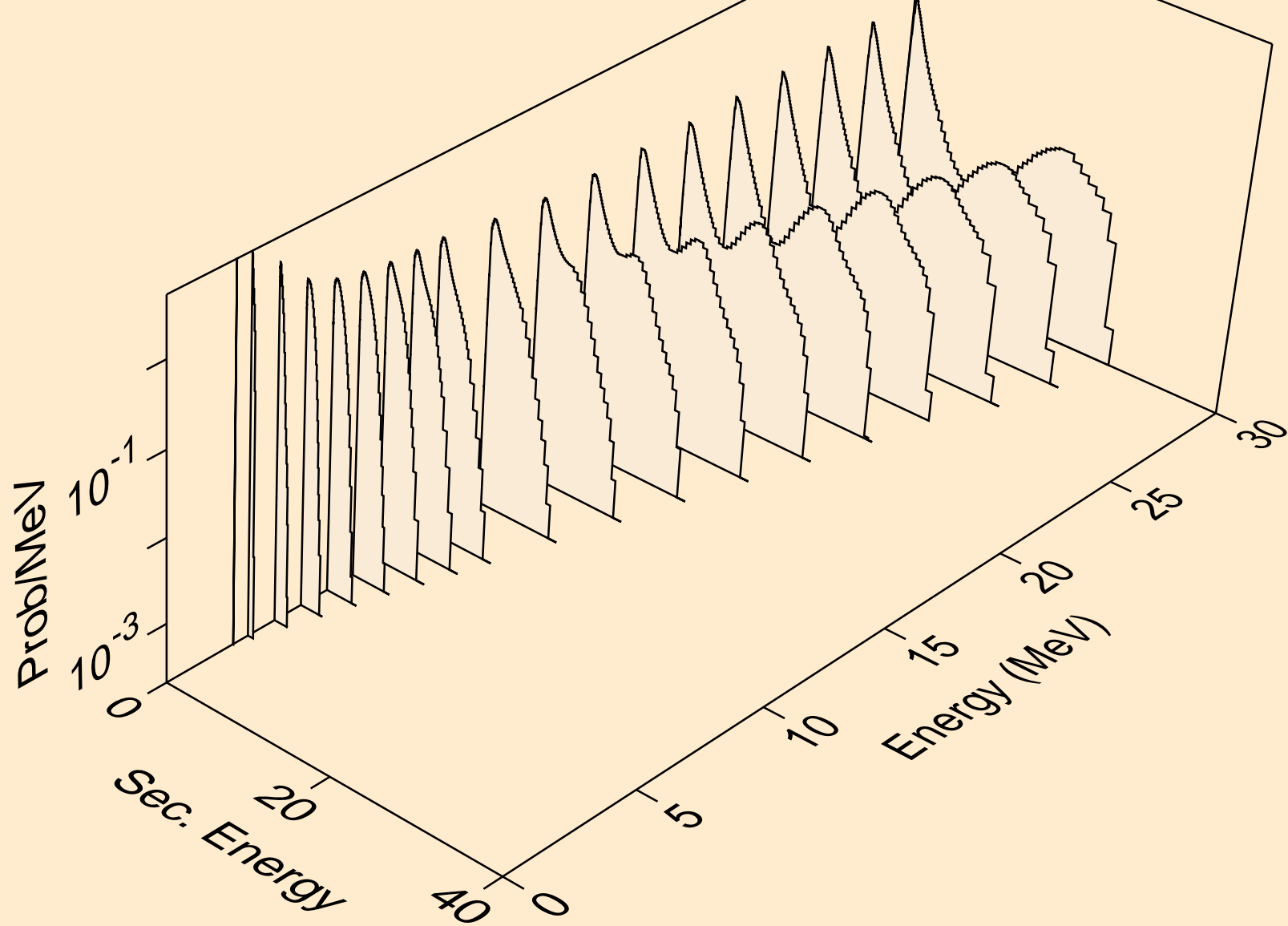

LU187 DEUTERON ACER TENDL-2024 LIBRARY; T=0.K
neutrons from (d,n*)a

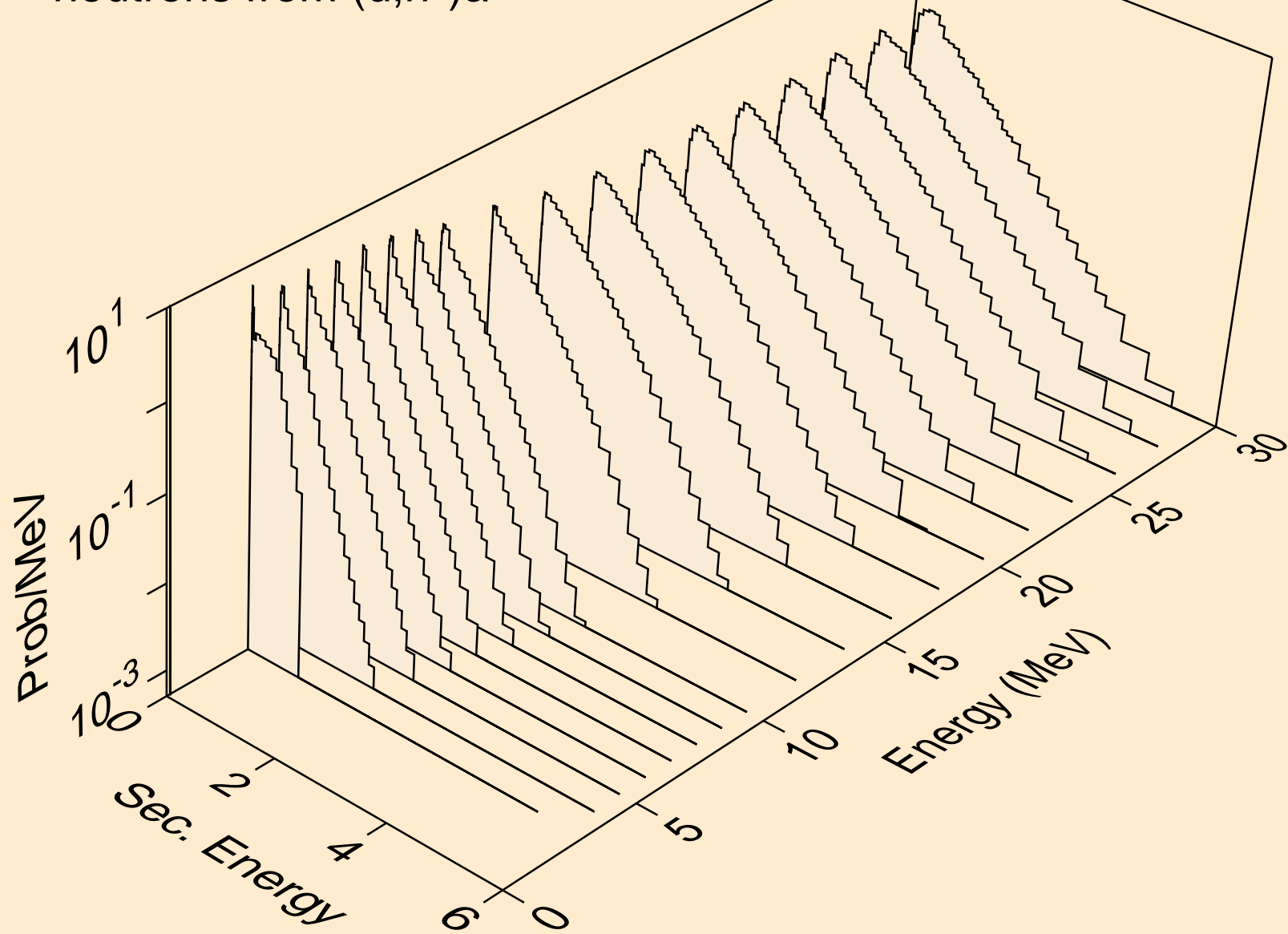

LU187 DEUTERON ACER TENDL-2024 LIBRARY; T=0.K
neutrons from (d,2n)a

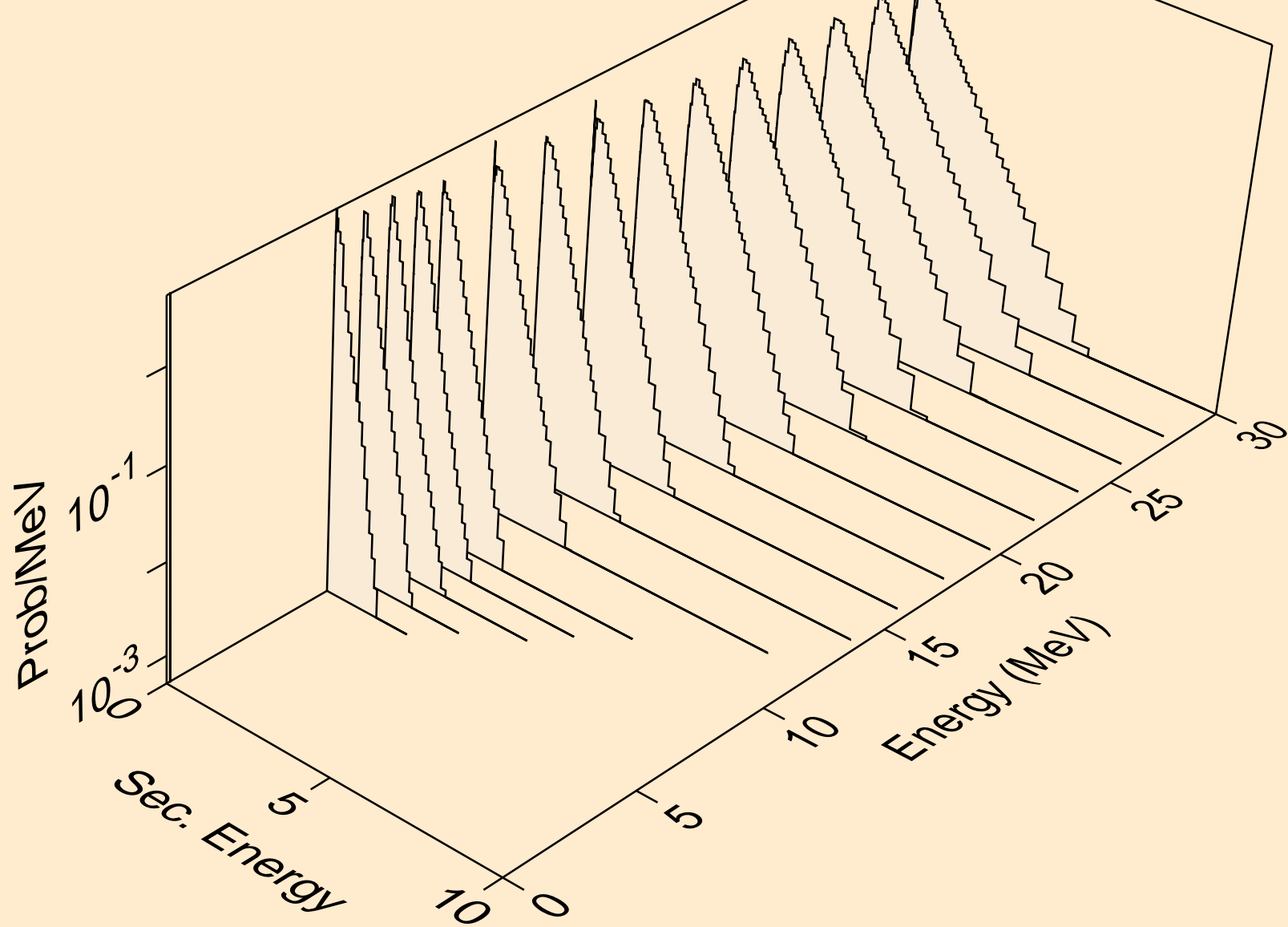

LU187 DEUTERON ACER TENDL-2024 LIBRARY; T=0.K
neutrons from (d,3n)a

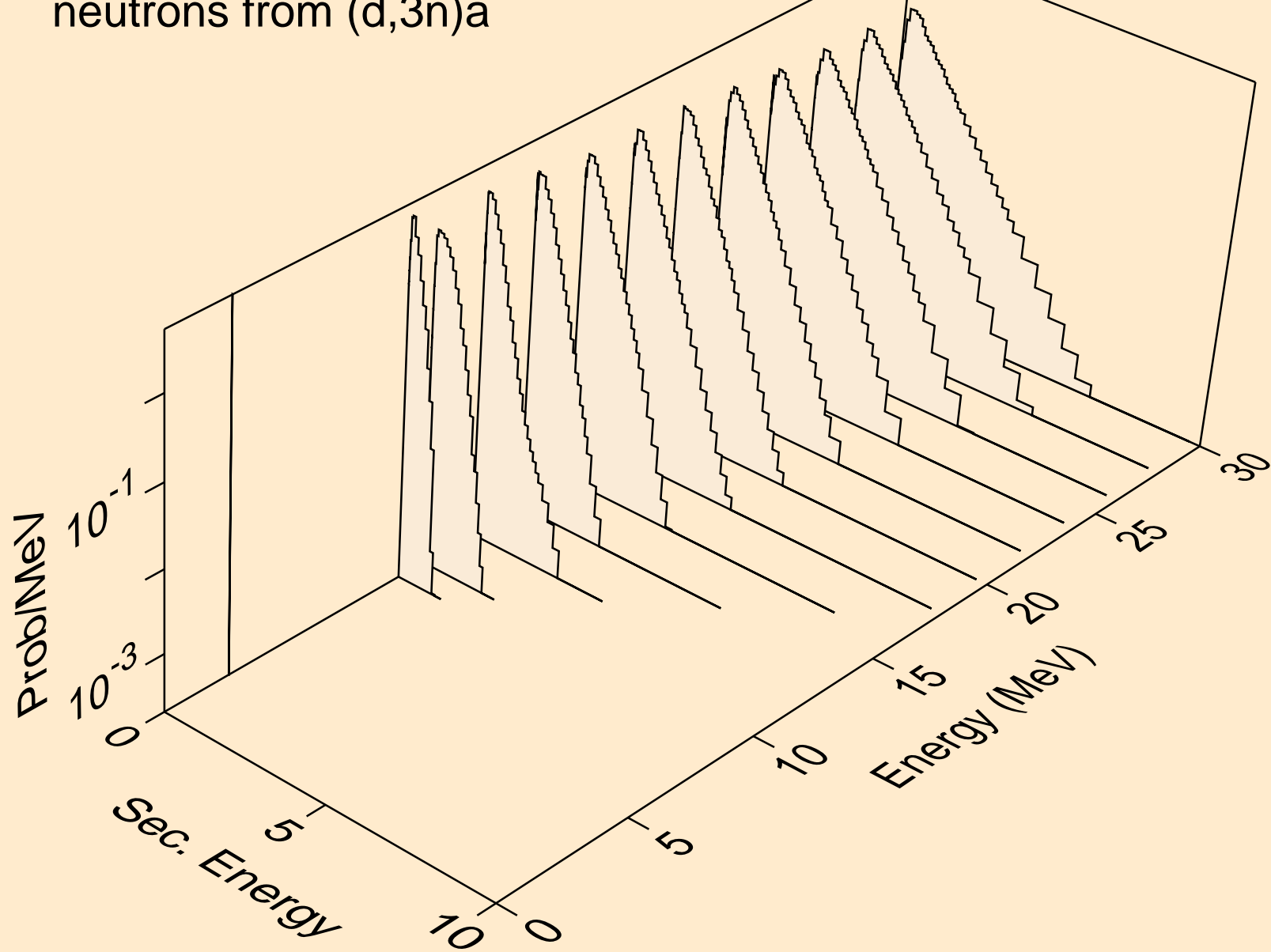

LU187 DEUTERON ACER TENDL-2024 LIBRARY; T=0.K
neutrons from (d,n*)p

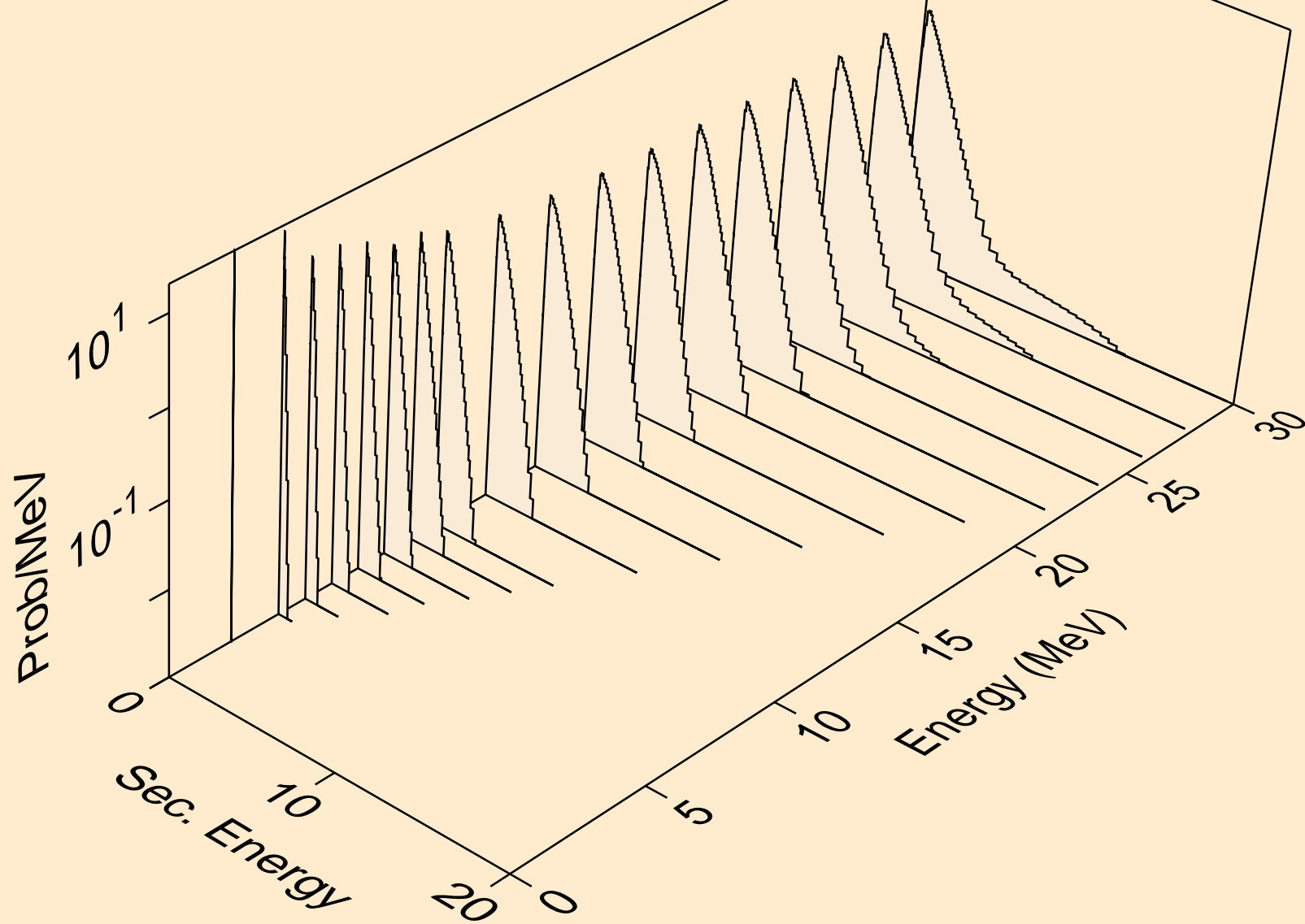

LU187 DEUTERON ACER TENDL-2024 LIBRARY; T=0.K
neutrons from (d,n*)d

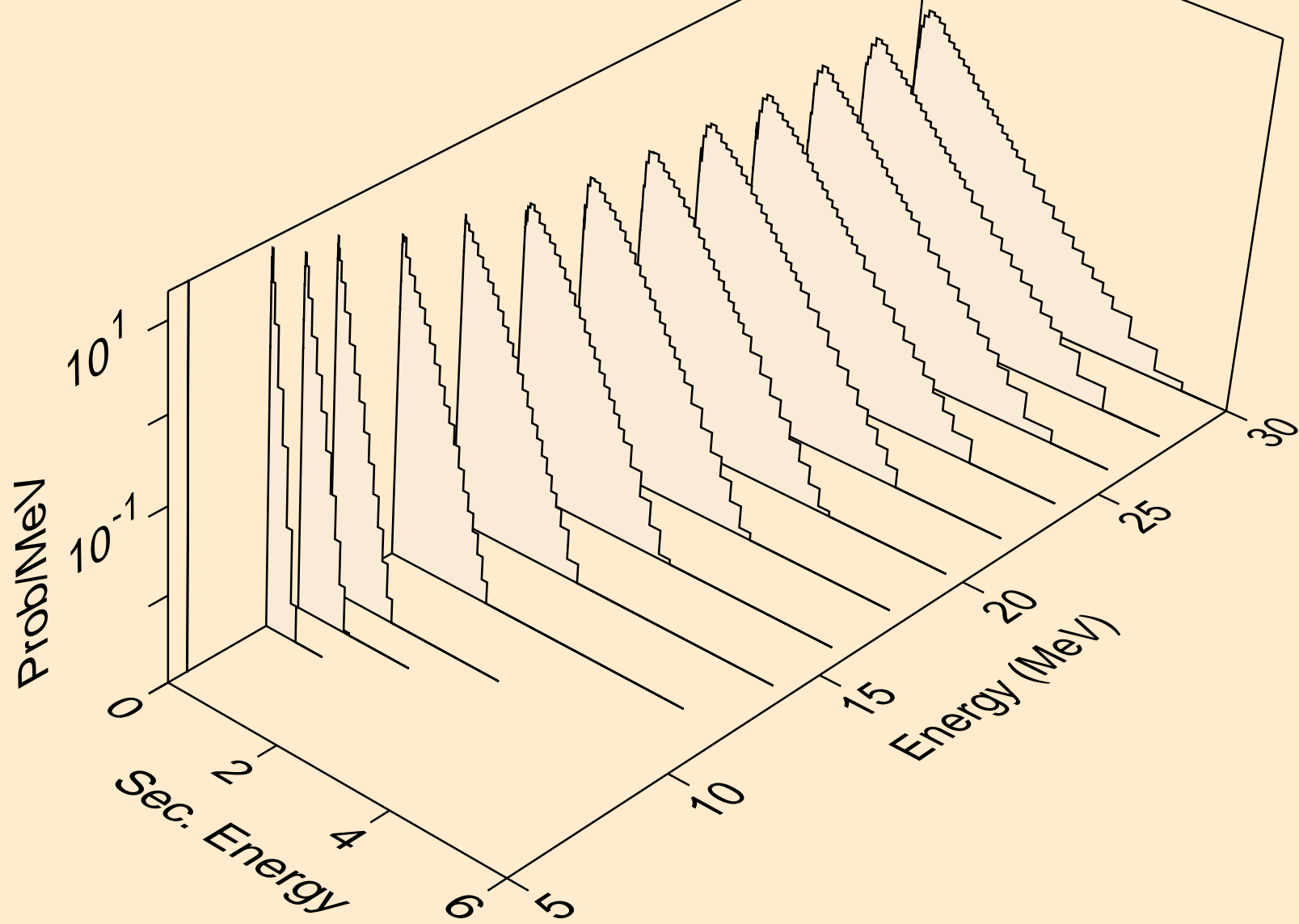

LU187 DEUTERON ACER TENDL-2024 LIBRARY; T=0.K
neutrons from (d,n*)t

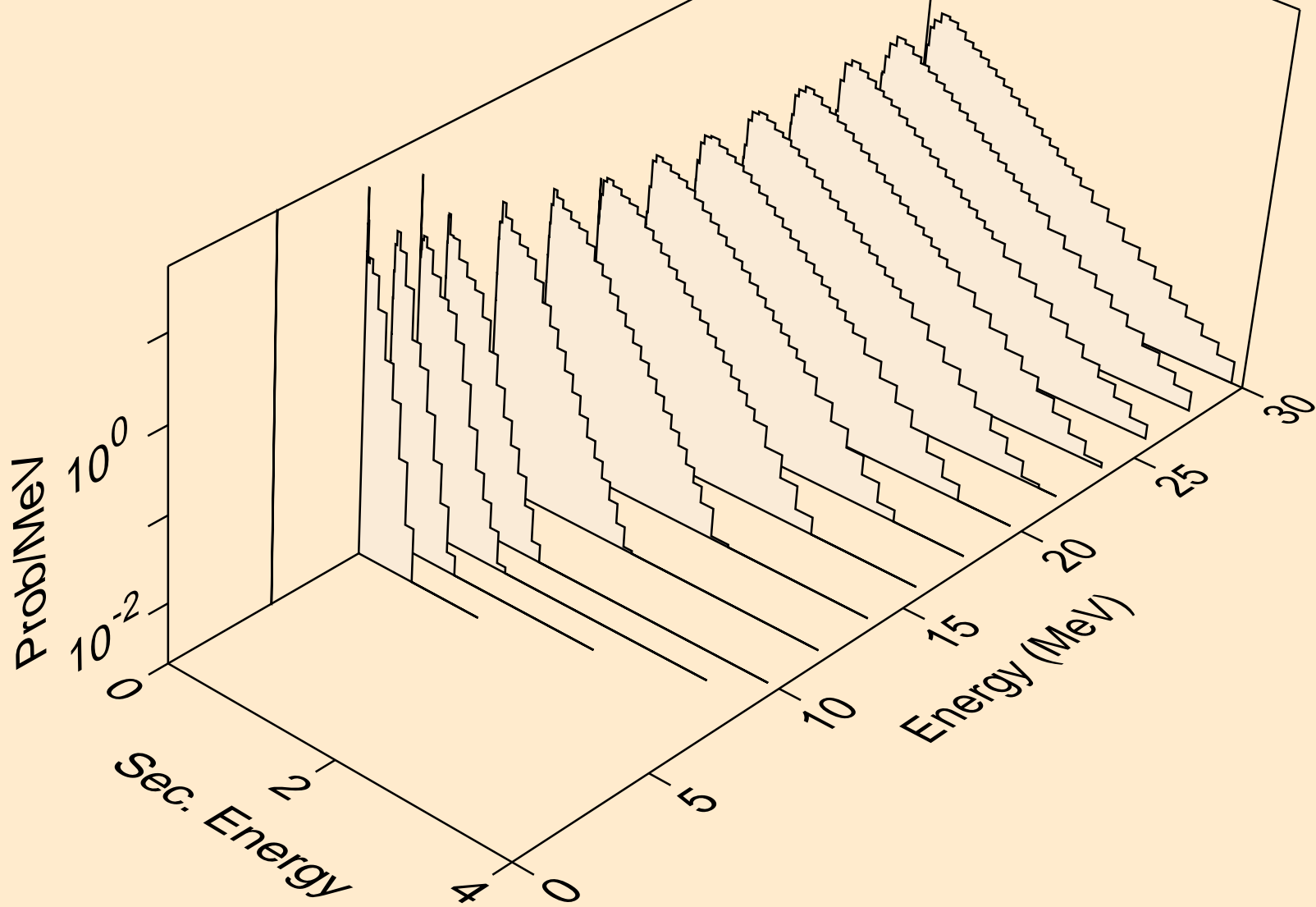

LU187 DEUTERON ACER TENDL-2024 LIBRARY; T=0.K
neutrons from (d,n*)he3

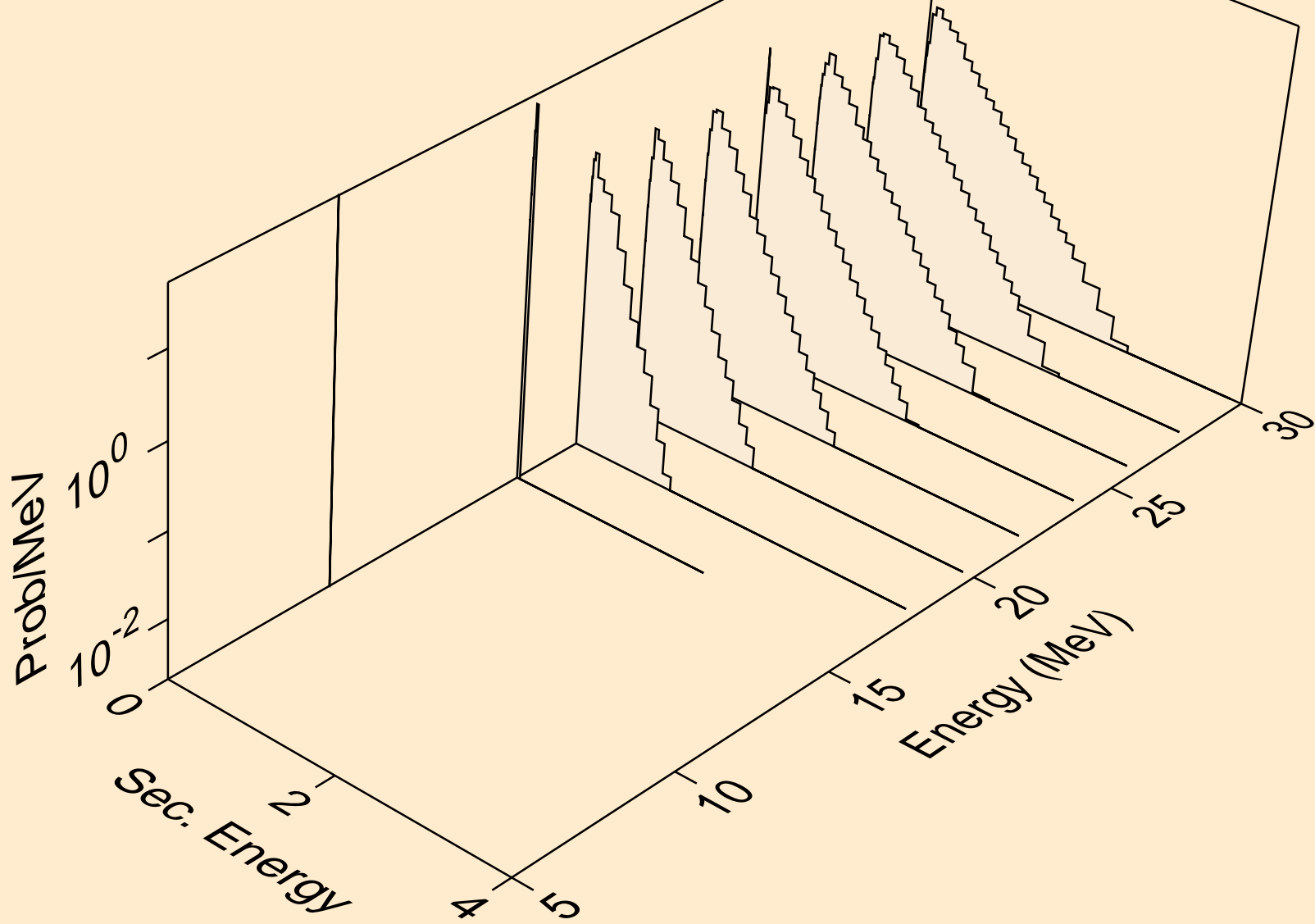

LU187 DEUTERON ACER TENDL-2024 LIBRARY; T=0.K
neutrons from (d,4n)

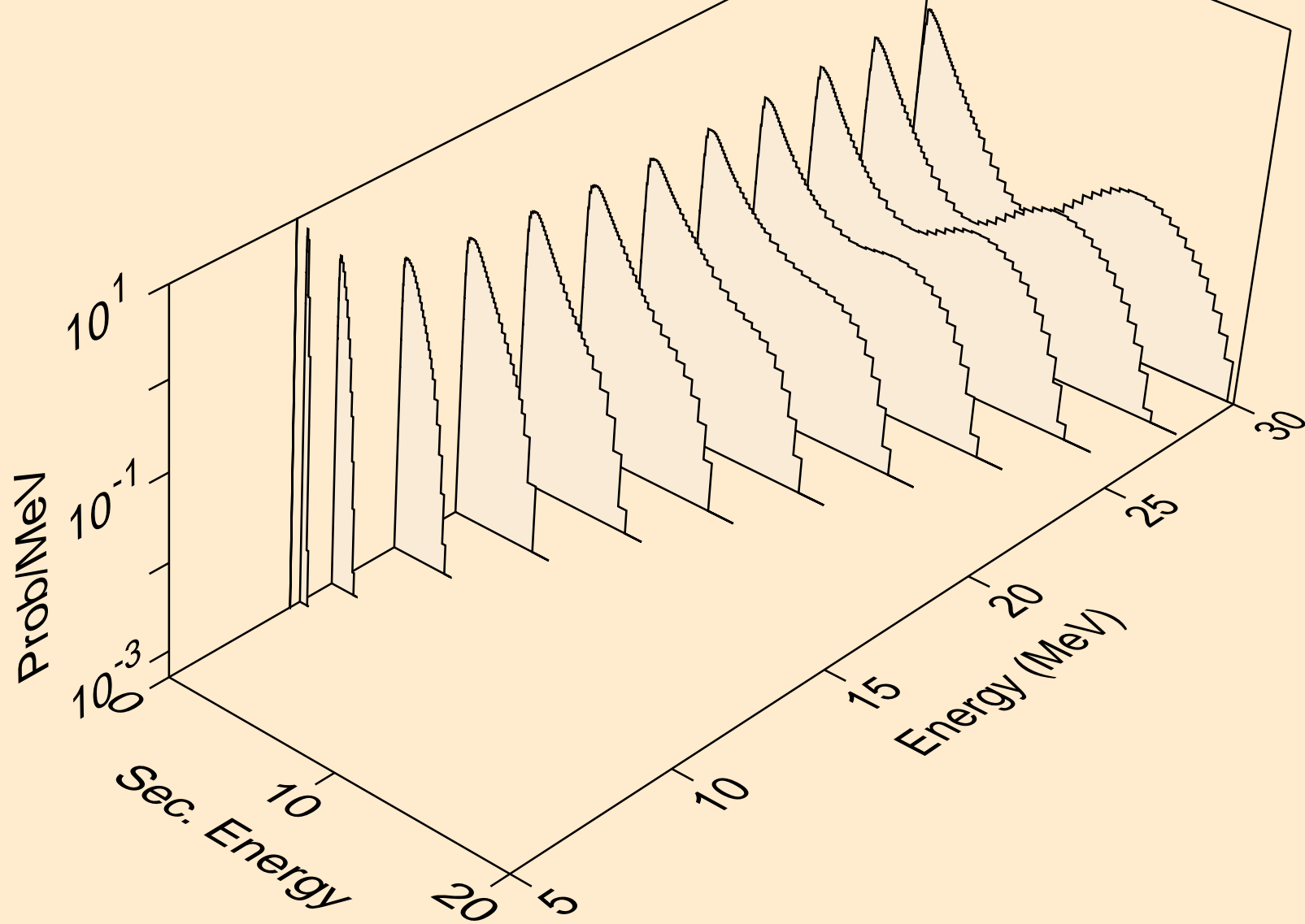

LU187 DEUTERON ACER TENDL-2024 LIBRARY; T=0.K
neutrons from (d,2np)

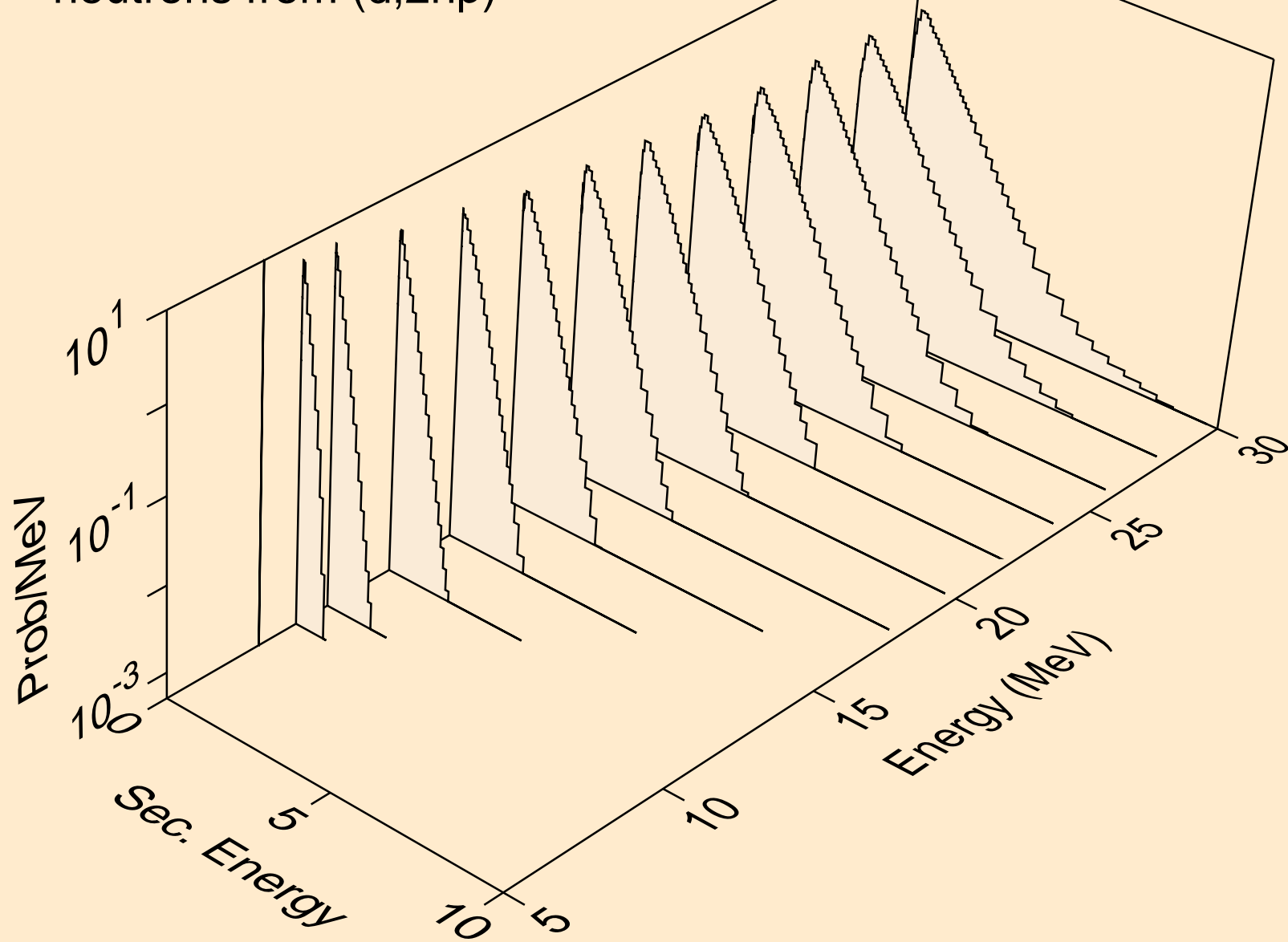

LU187 DEUTERON ACER TENDL-2024 LIBRARY; T=0.K
neutrons from (d,3np)

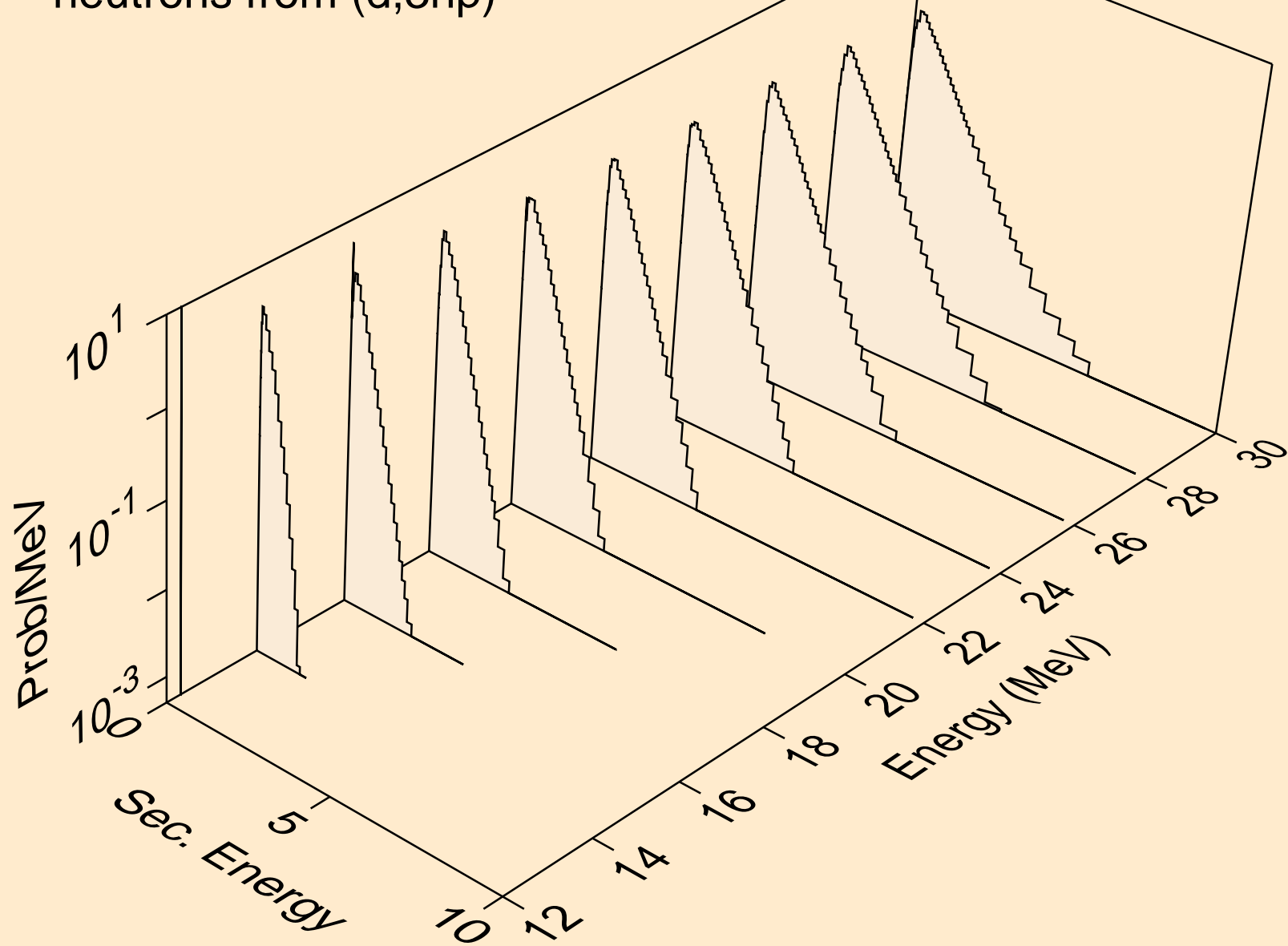

LU187 DEUTERON ACER TENDL-2024 LIBRARY; T=0.K
neutrons from (d,n2p)

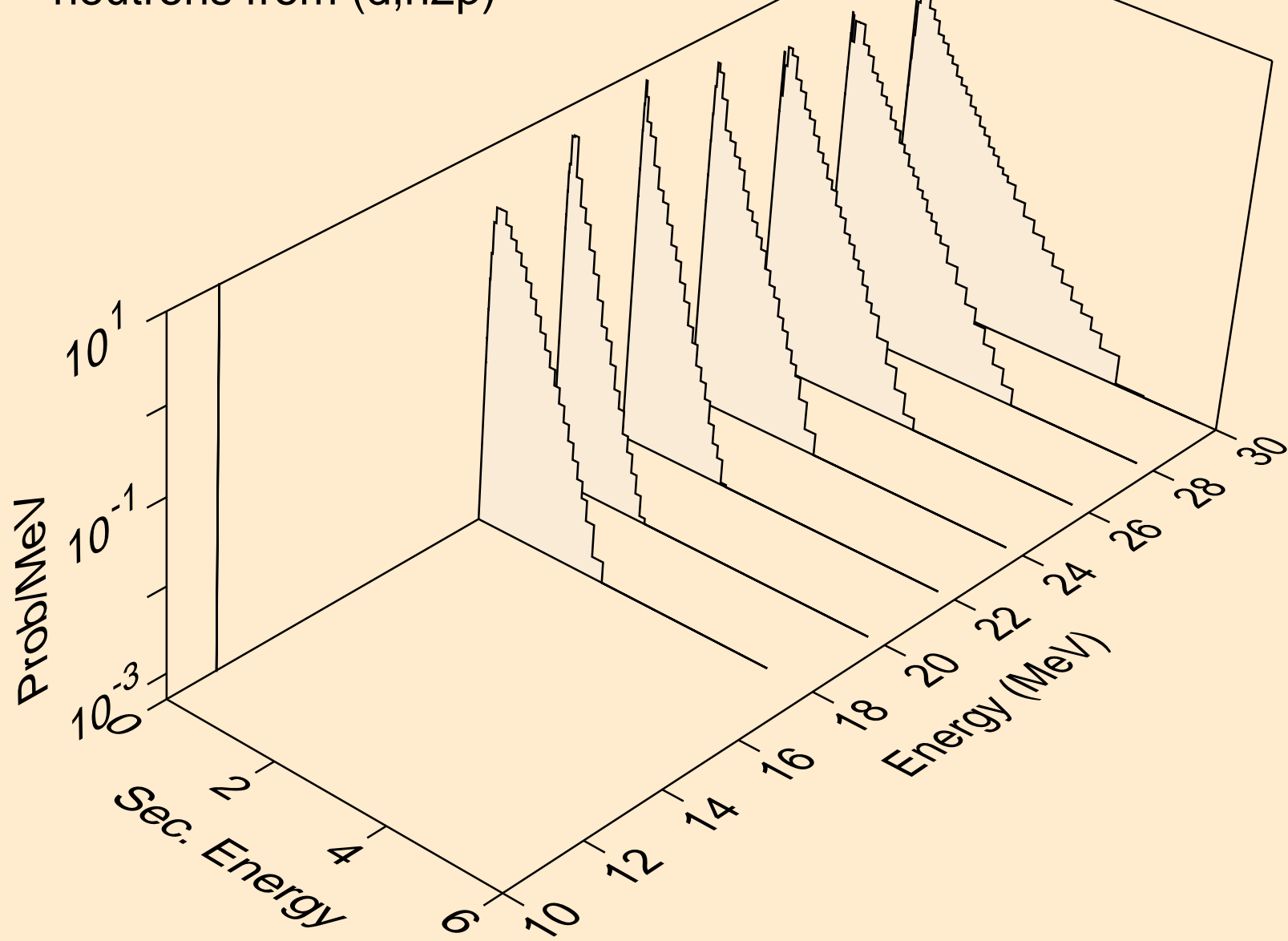

LU187 DEUTERON ACER TENDL-2024 LIBRARY; T=0.K
protons from (d,x)

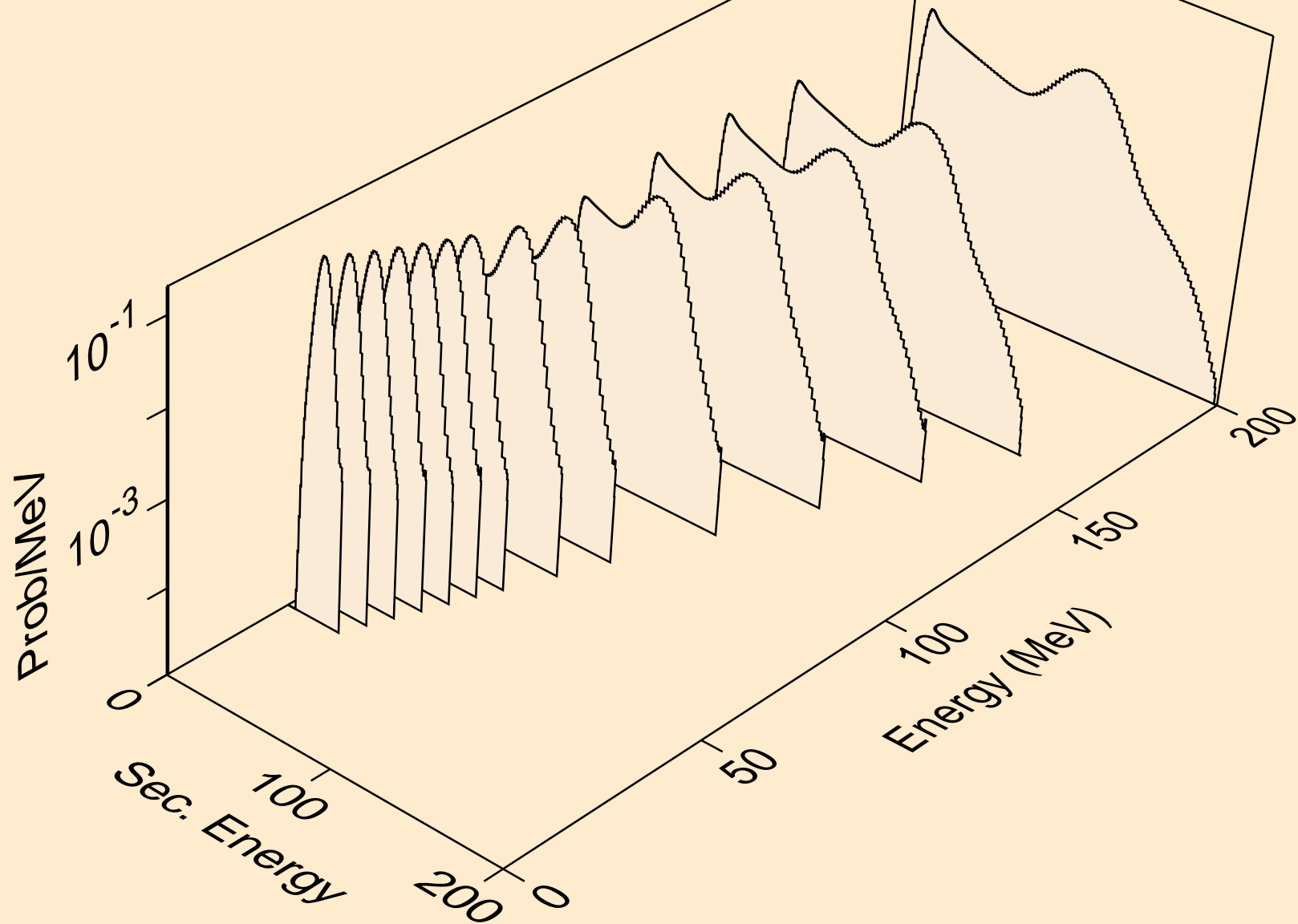

LU187 DEUTERON ACER TENDL-2024 LIBRARY; T=0.K
protons from (d,n*)p

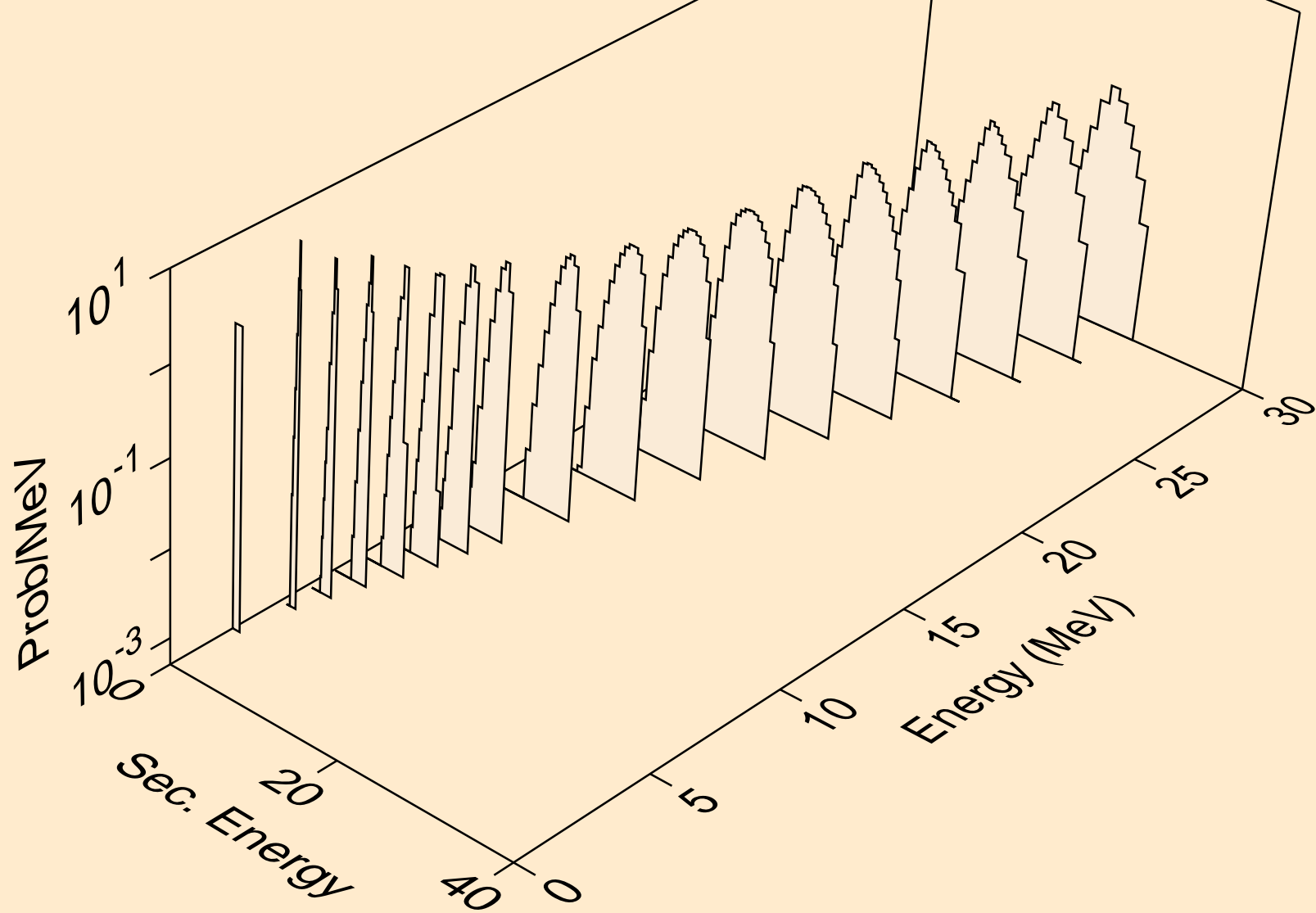

LU187 DEUTERON ACER TENDL-2024 LIBRARY; T=0.K
protons from (d,2np)

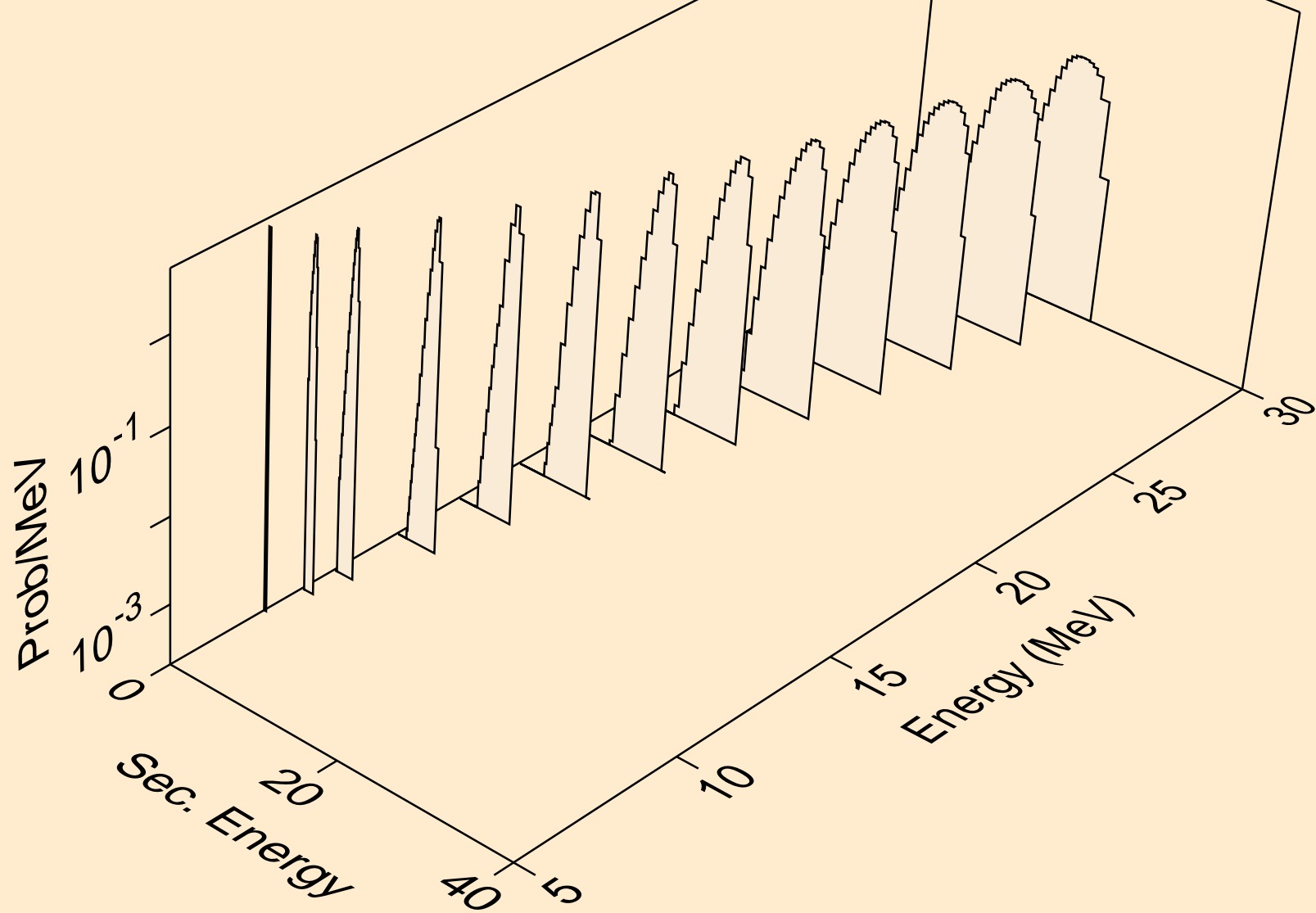

LU187 DEUTERON ACER TENDL-2024 LIBRARY; T=0.K
protons from (d,3np)

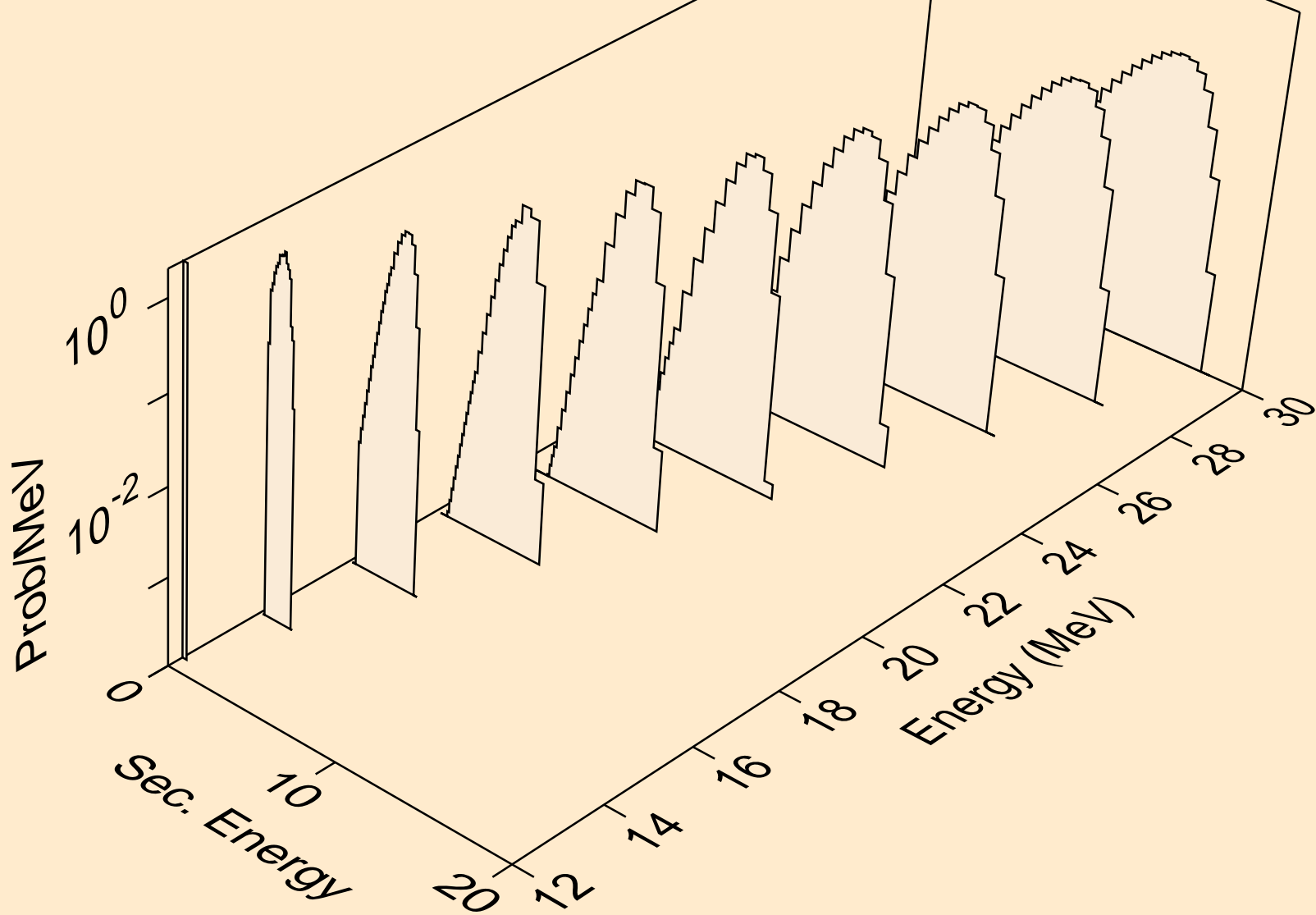

LU187 DEUTERON ACER TENDL-2024 LIBRARY; T=0.K
protons from (d,n2p)

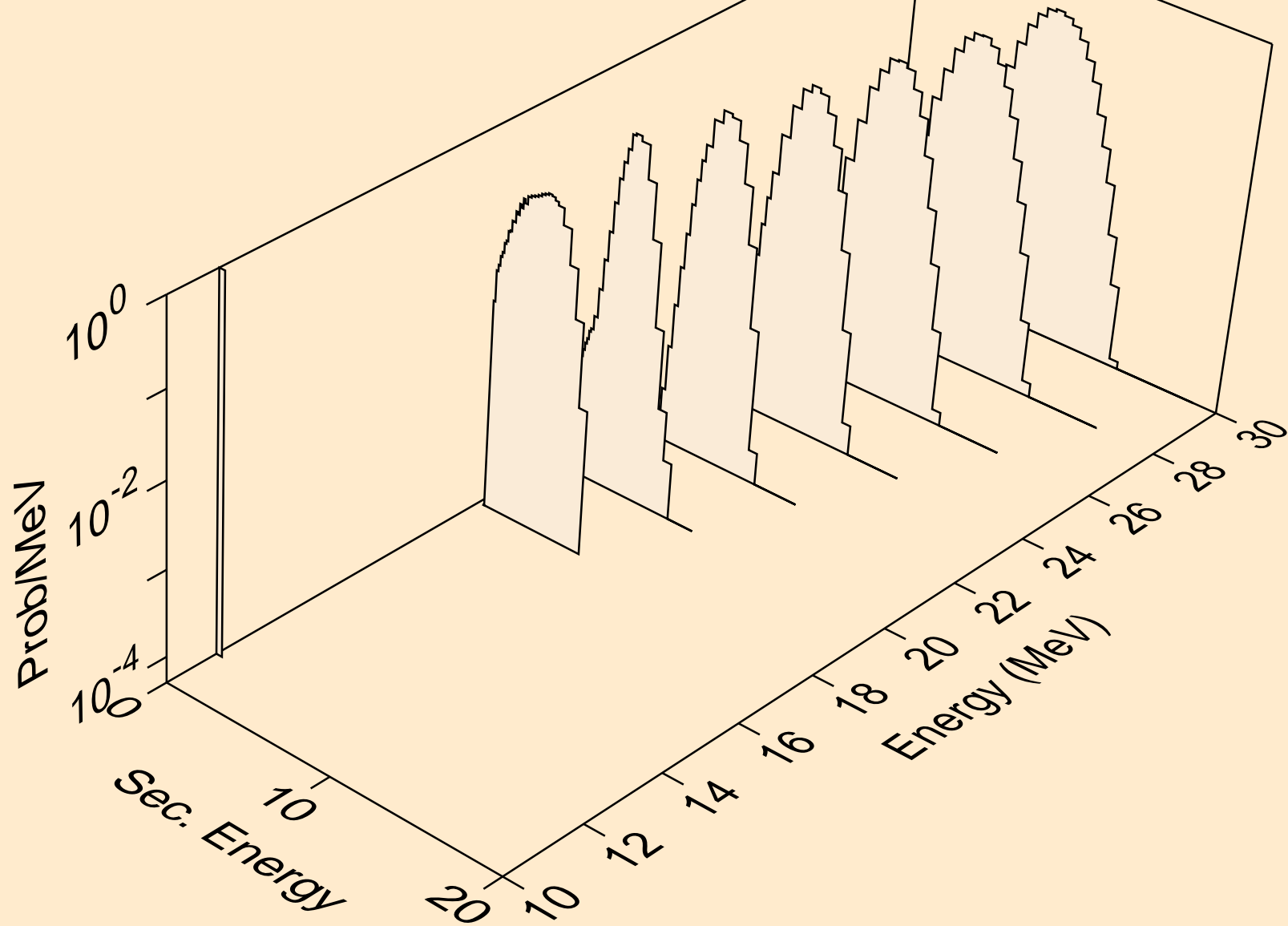

LU187 DEUTERON ACER TENDL-2024 LIBRARY; T=0.K
protons from (d,p)

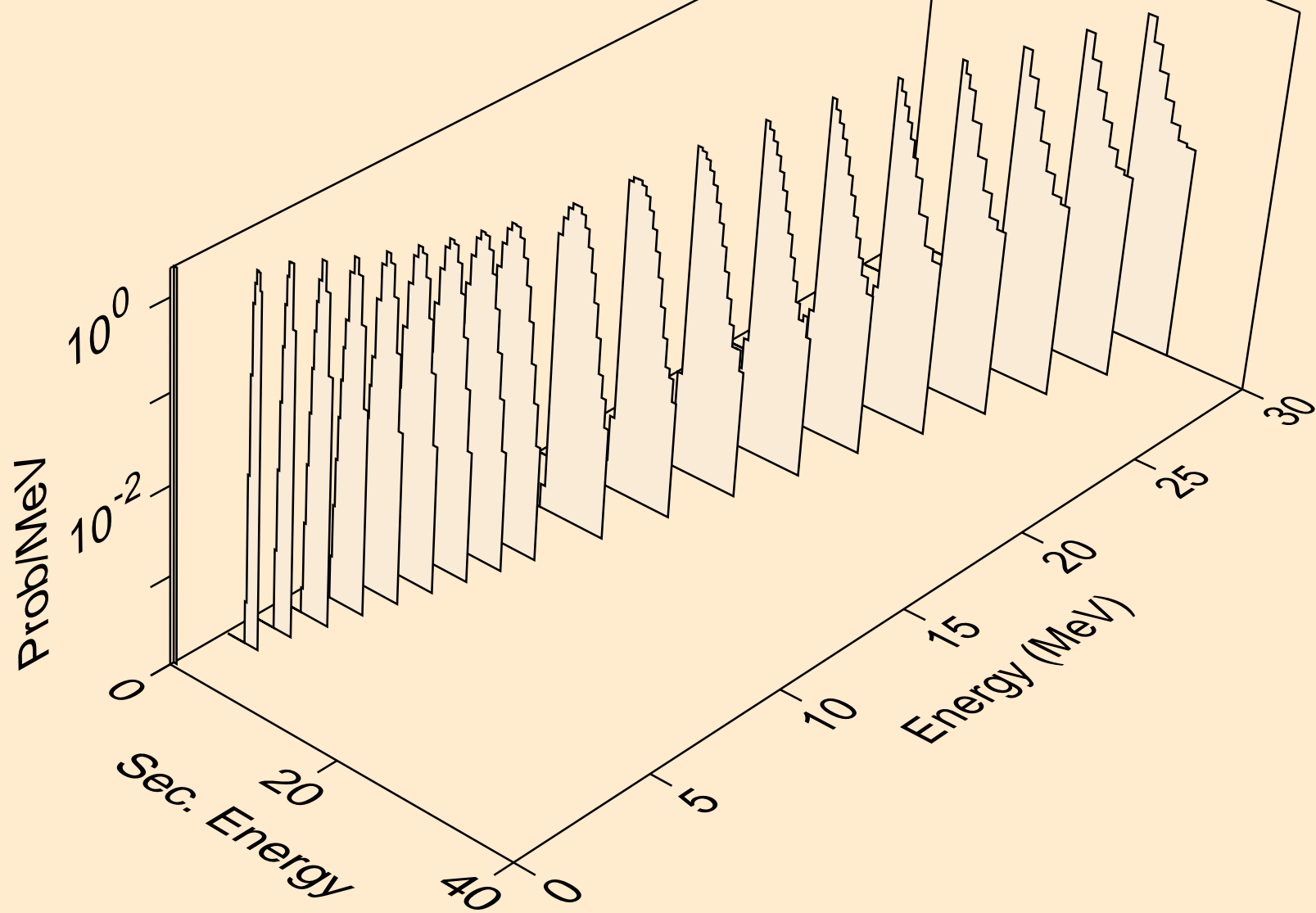

LU187 DEUTERON ACER TENDL-2024 LIBRARY; T=0.K
protons from (d,2p)

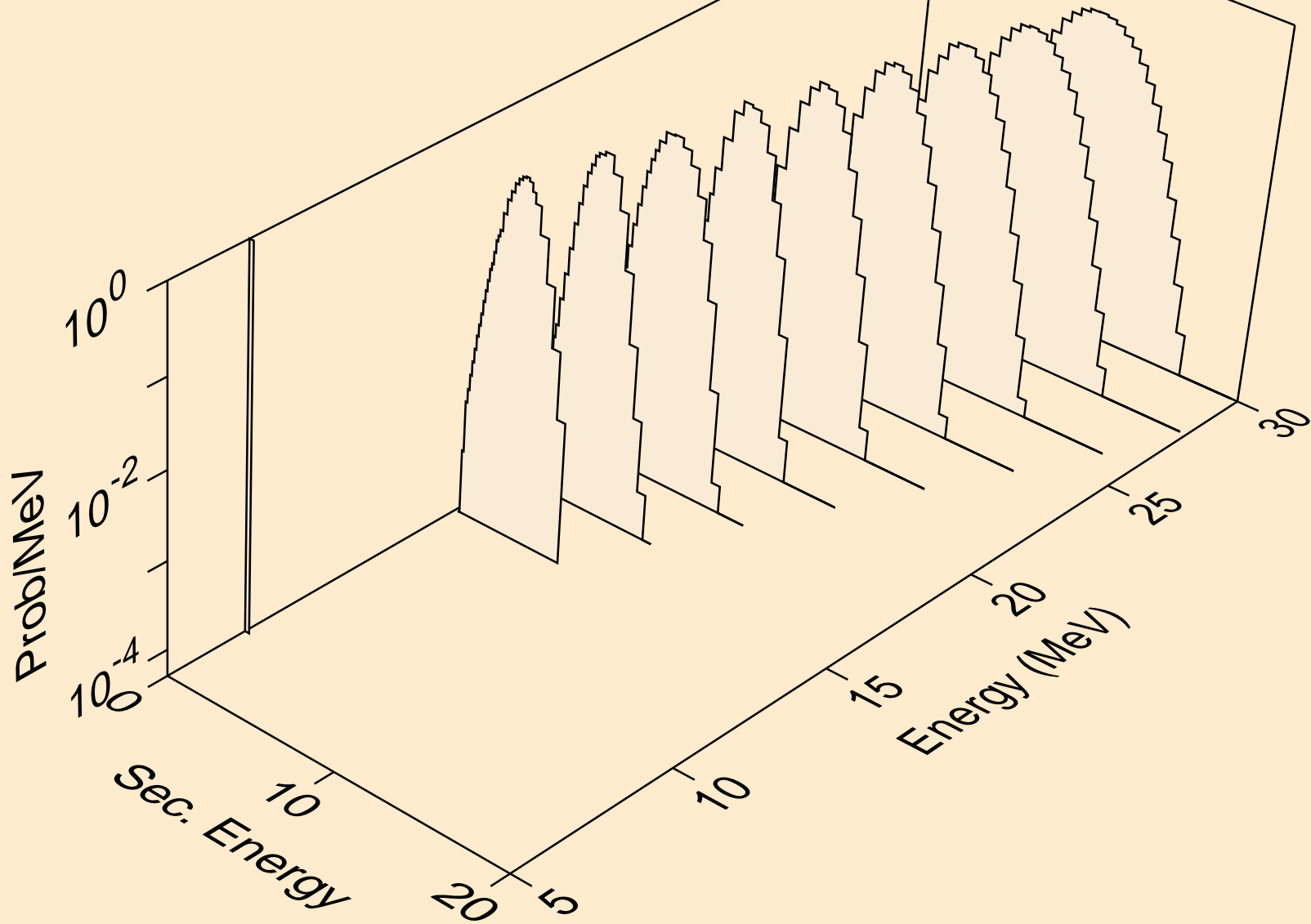

LU187 DEUTERON ACER TENDL-2024 LIBRARY; T=0.K
protons from (d,pd)

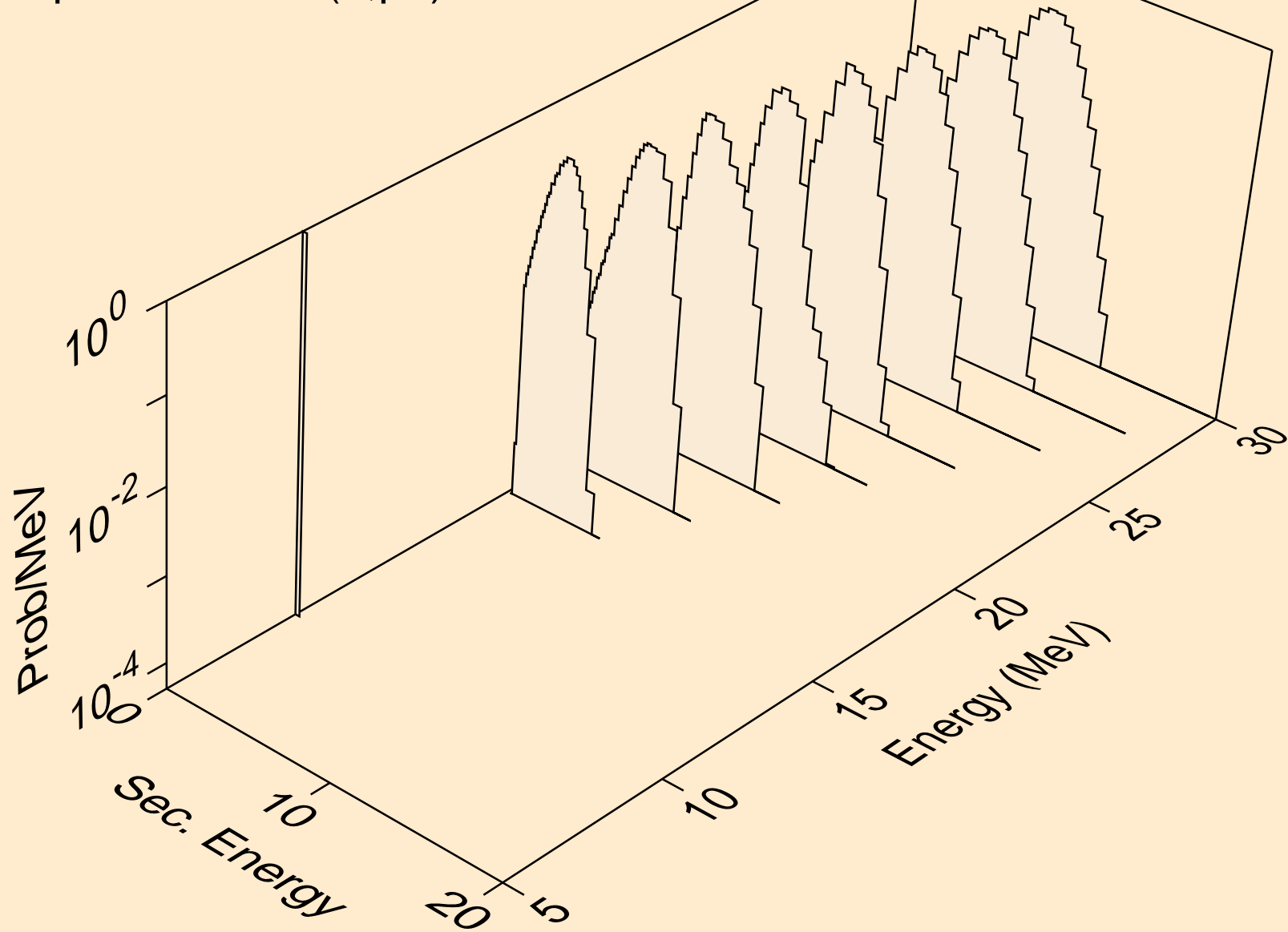

LU187 DEUTERON ACER TENDL-2024 LIBRARY; T=0.K
tritons from (d,x)

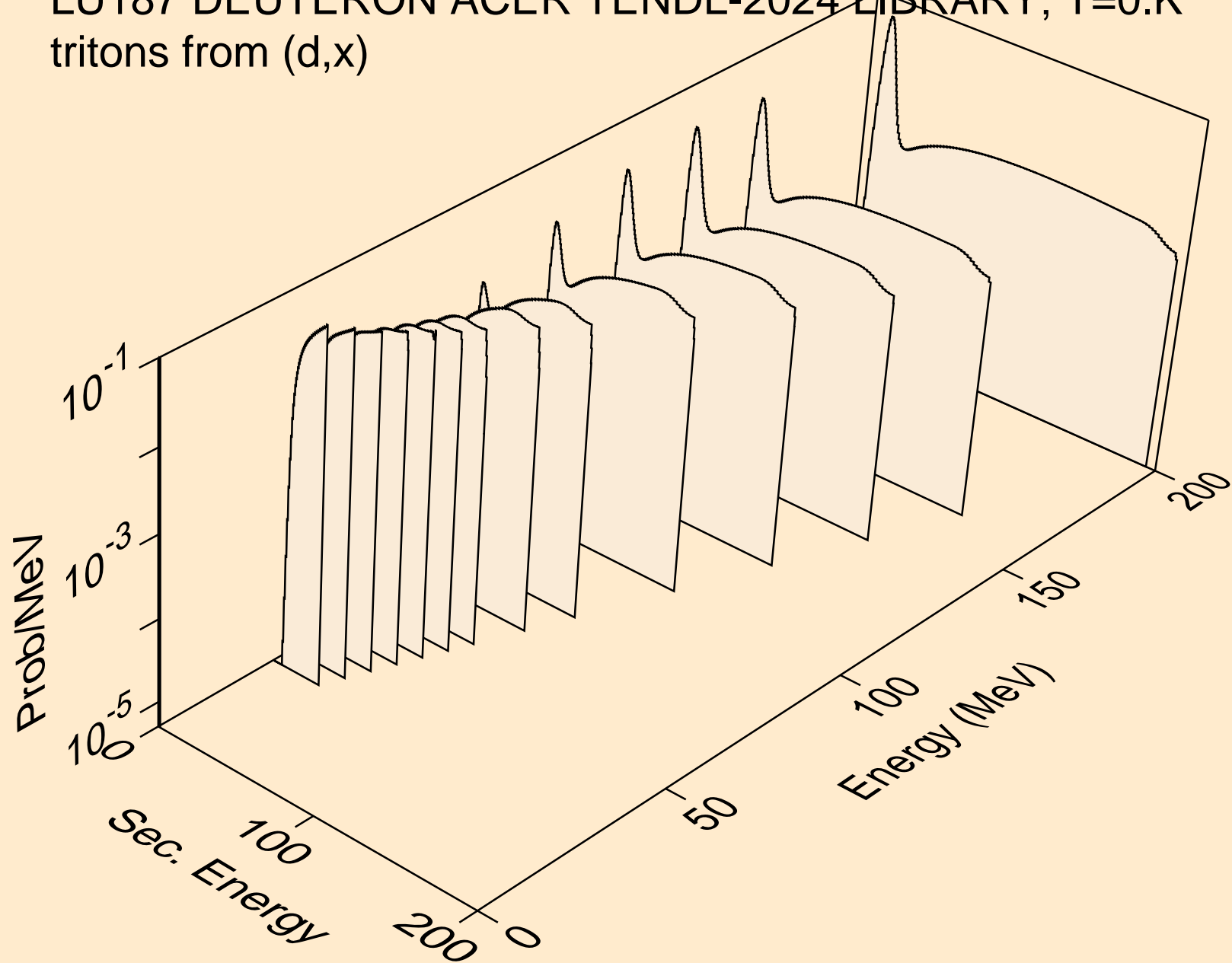

LU187 DEUTERON ACER TENDL-2024 LIBRARY; T=0.K
tritons from (d,n*)t

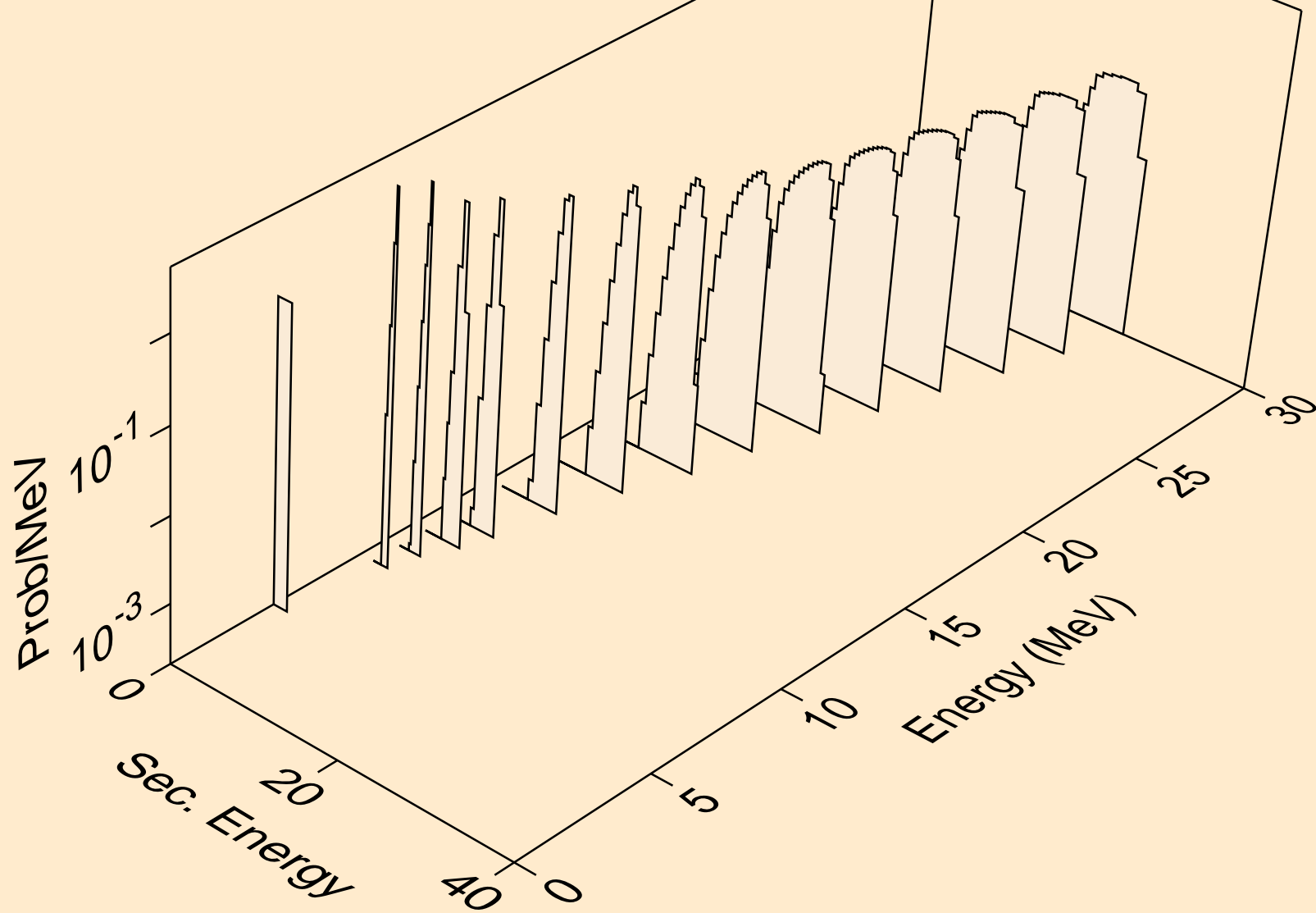

LU187 DEUTERON ACER TENDL-2024 LIBRARY; T=0.K
tritons from (d,t)

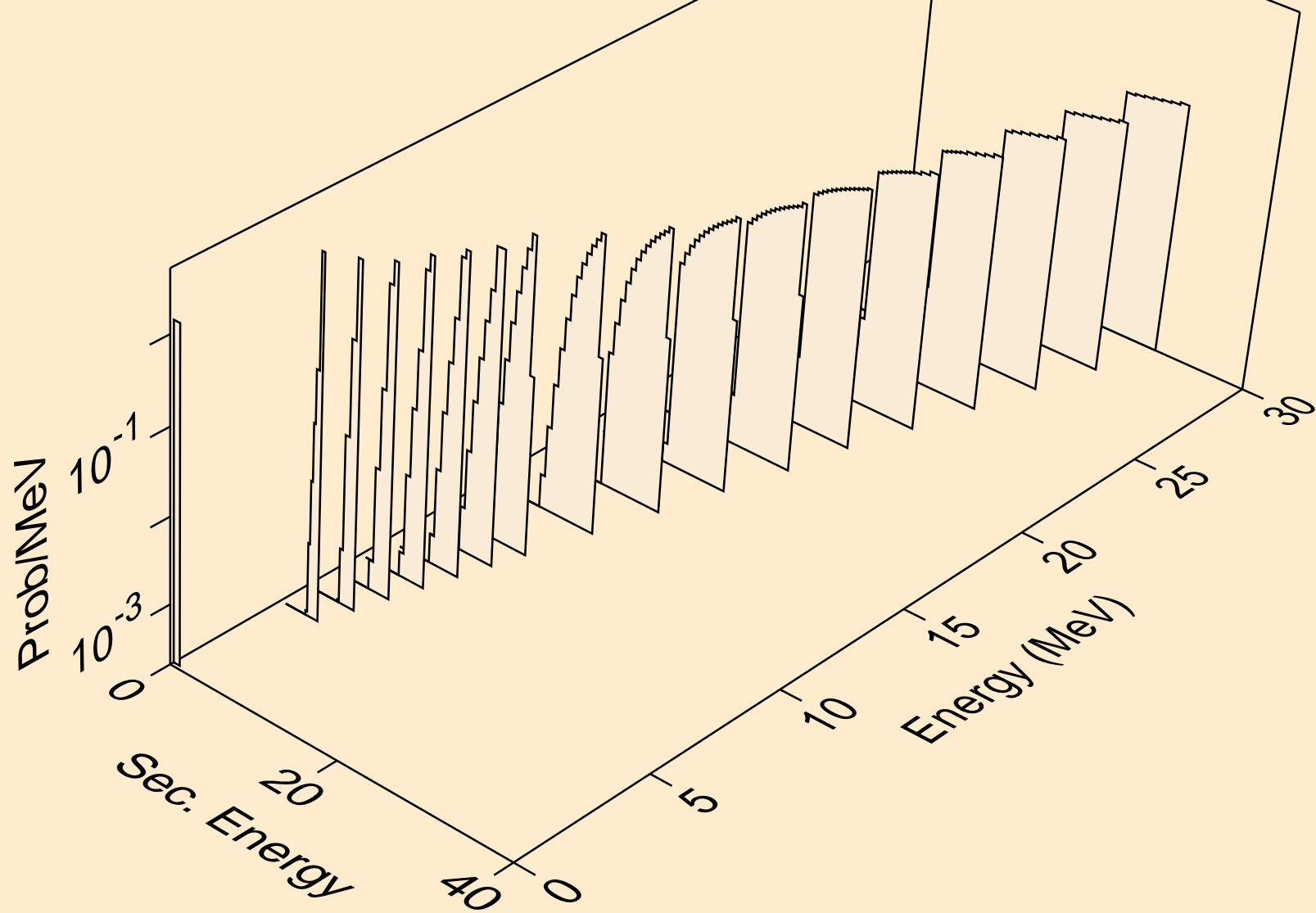

LU187 DEUTERON ACER TENDL-2024 LIBRARY; T=0.K
he3s from (d,x)

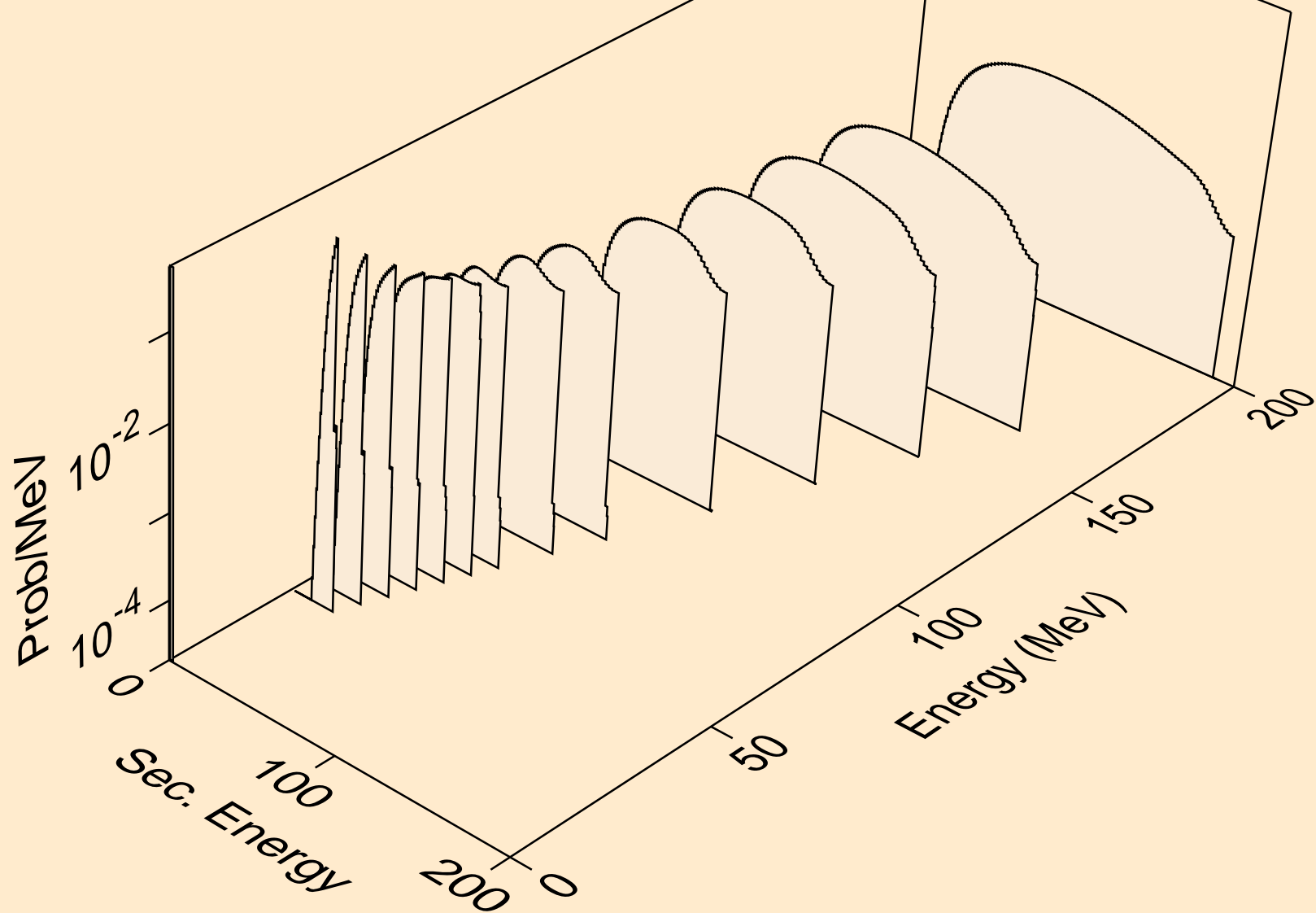

LU187 DEUTERON ACER TENDL-2024 LIBRARY; T=0.K
he3s from (d,n*)he3

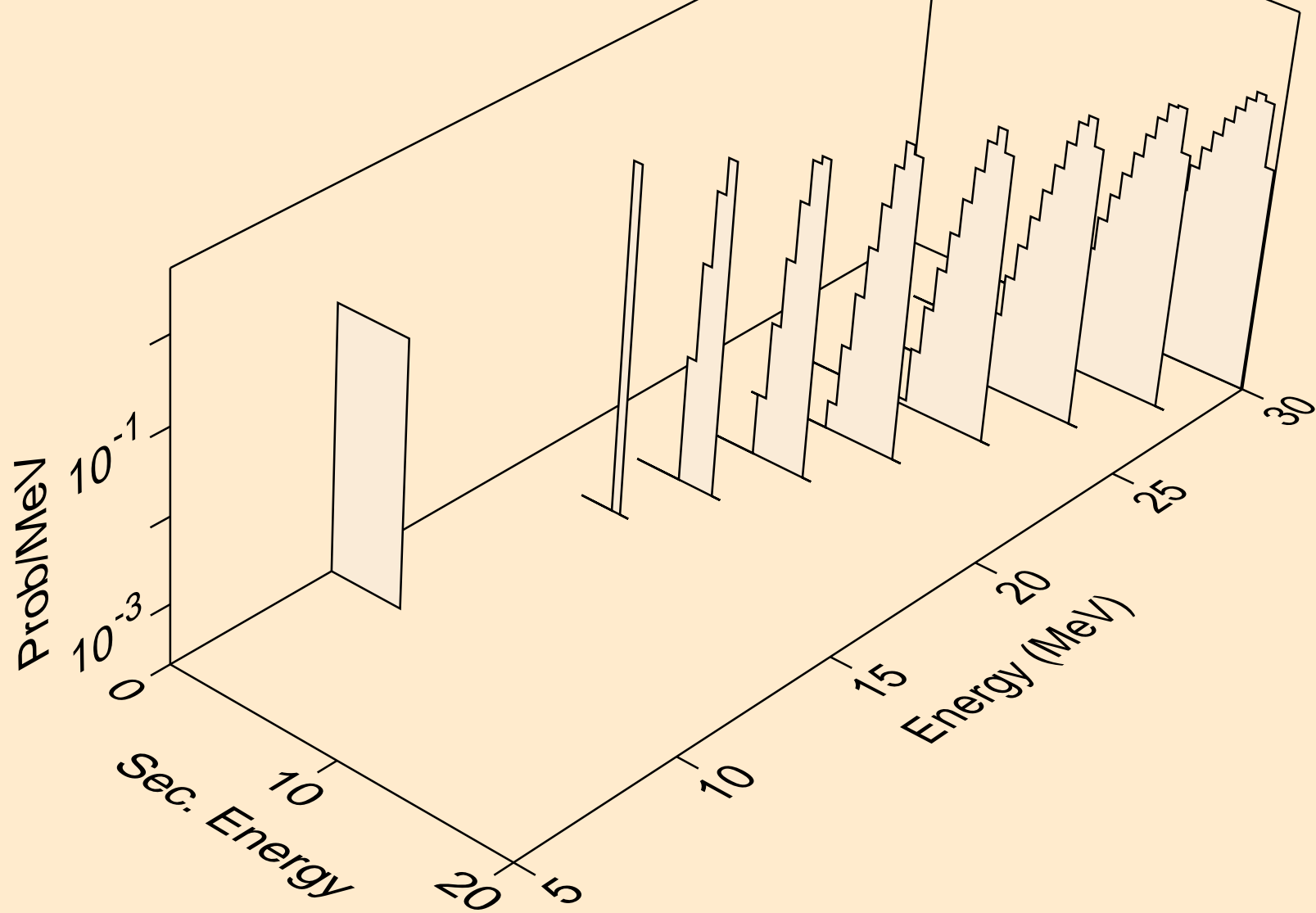

LU187 DEUTERON ACER TENDL-2024 LIBRARY; T=0.K
he3s from (d,he3)

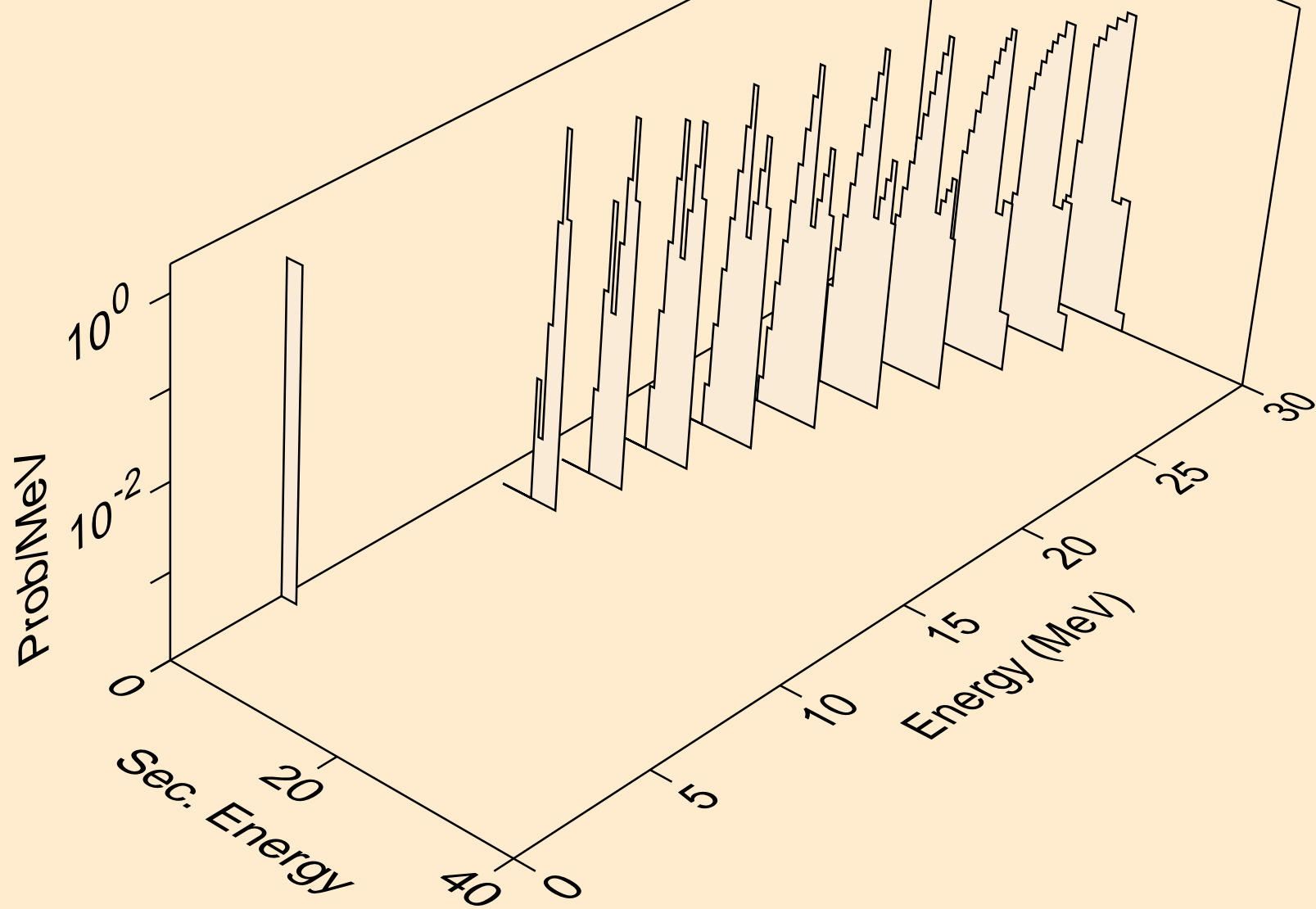

LU187 DEUTERON ACER TENDL-2024 LIBRARY; T=0.K
alphas from (d,x)

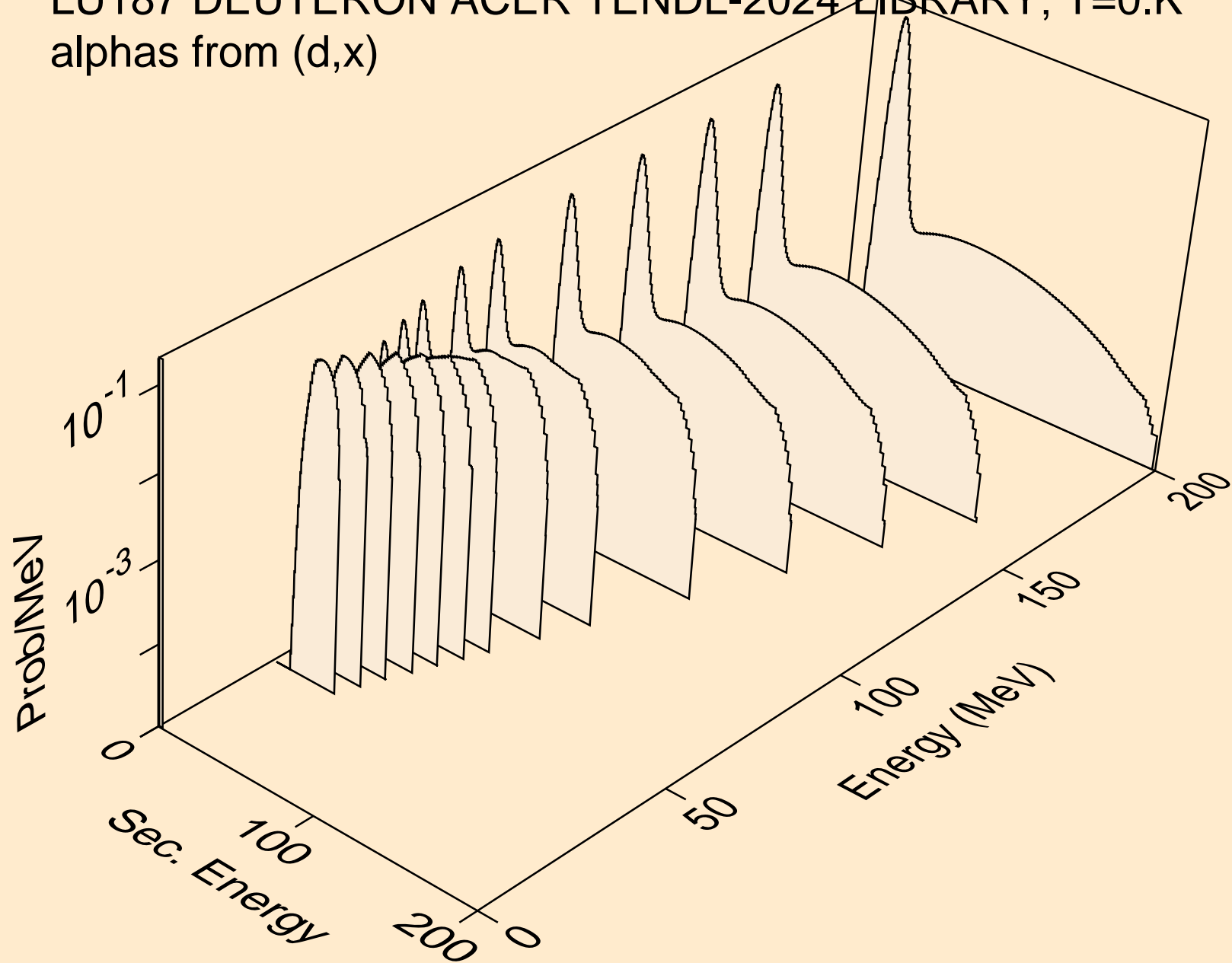

LU187 DEUTERON ACER TENDL-2024 LIBRARY; T=0.K
alphas from (d,n*)a

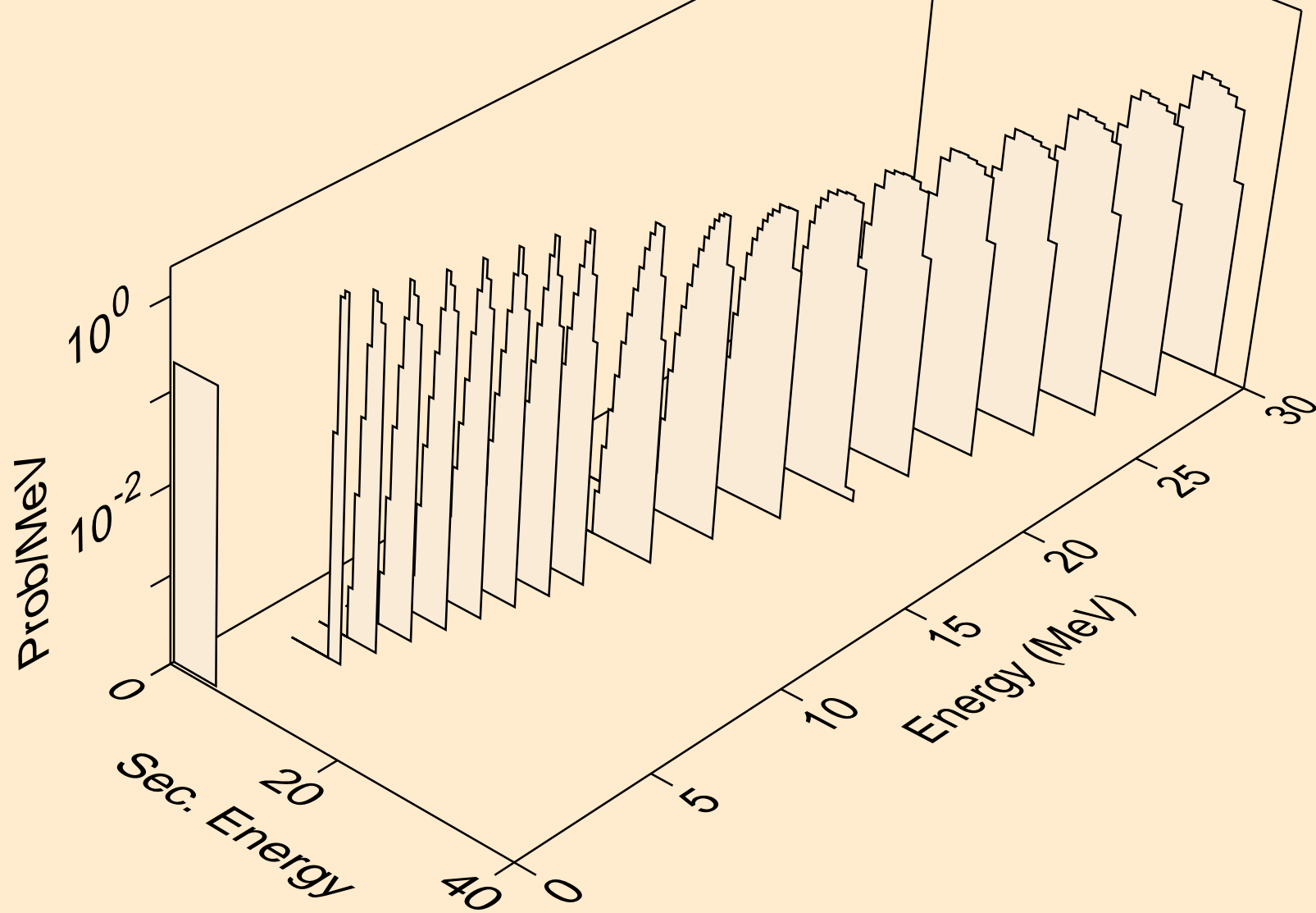

LU187 DEUTERON ACER TENDL-2024 LIBRARY; T=0.K
alphas from (d,2n)a

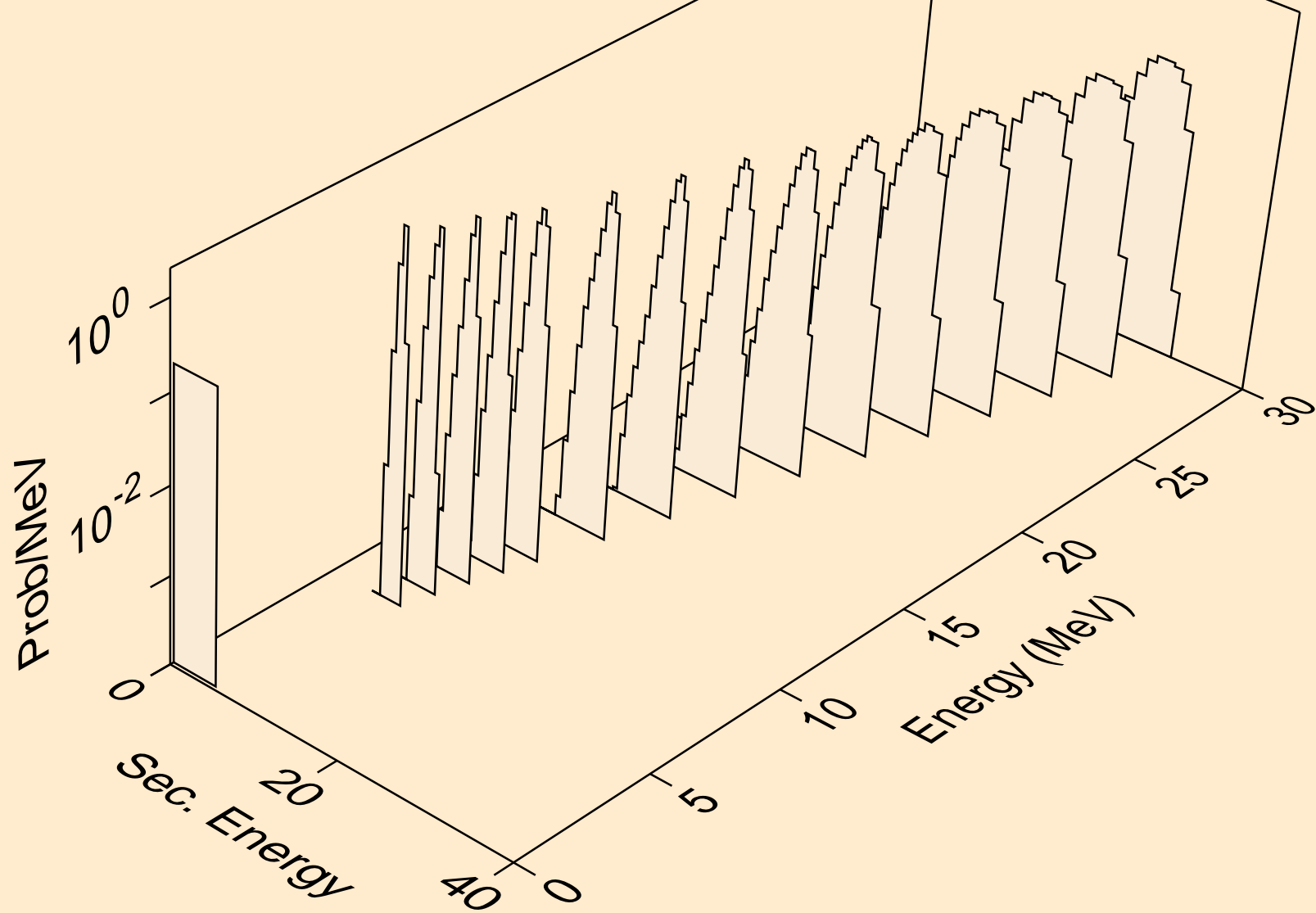

LU187 DEUTERON ACER TENDL-2024 LIBRARY; T=0.K
alphas from (d,3n)a

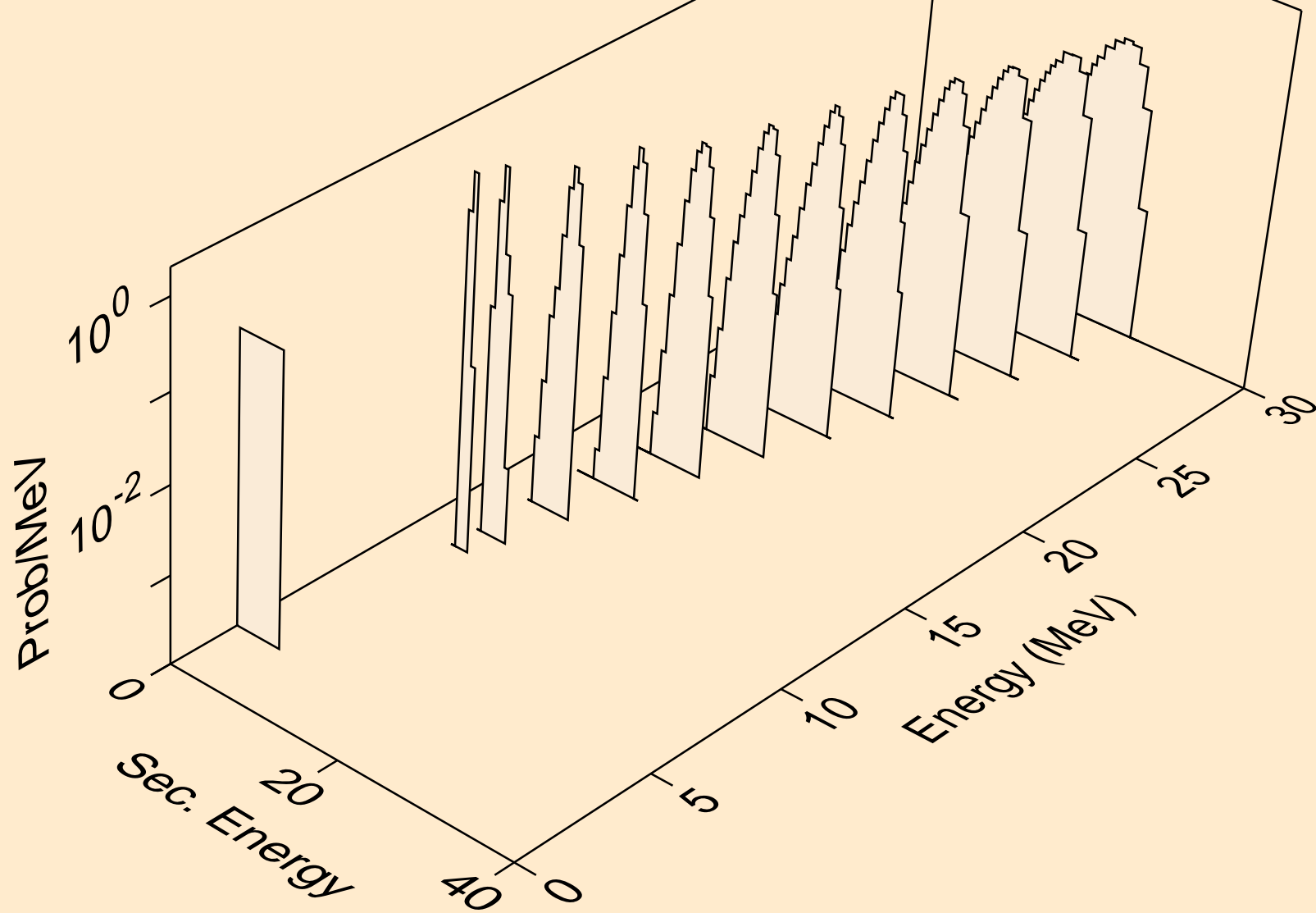

LU187 DEUTERON ACER TENDL-2024 LIBRARY; T=0.K
alphas from (d,a)

