

# OS170 DEUTERON ACER TENDL-2024 LIBRARY; T=0.K

## Principal cross sections

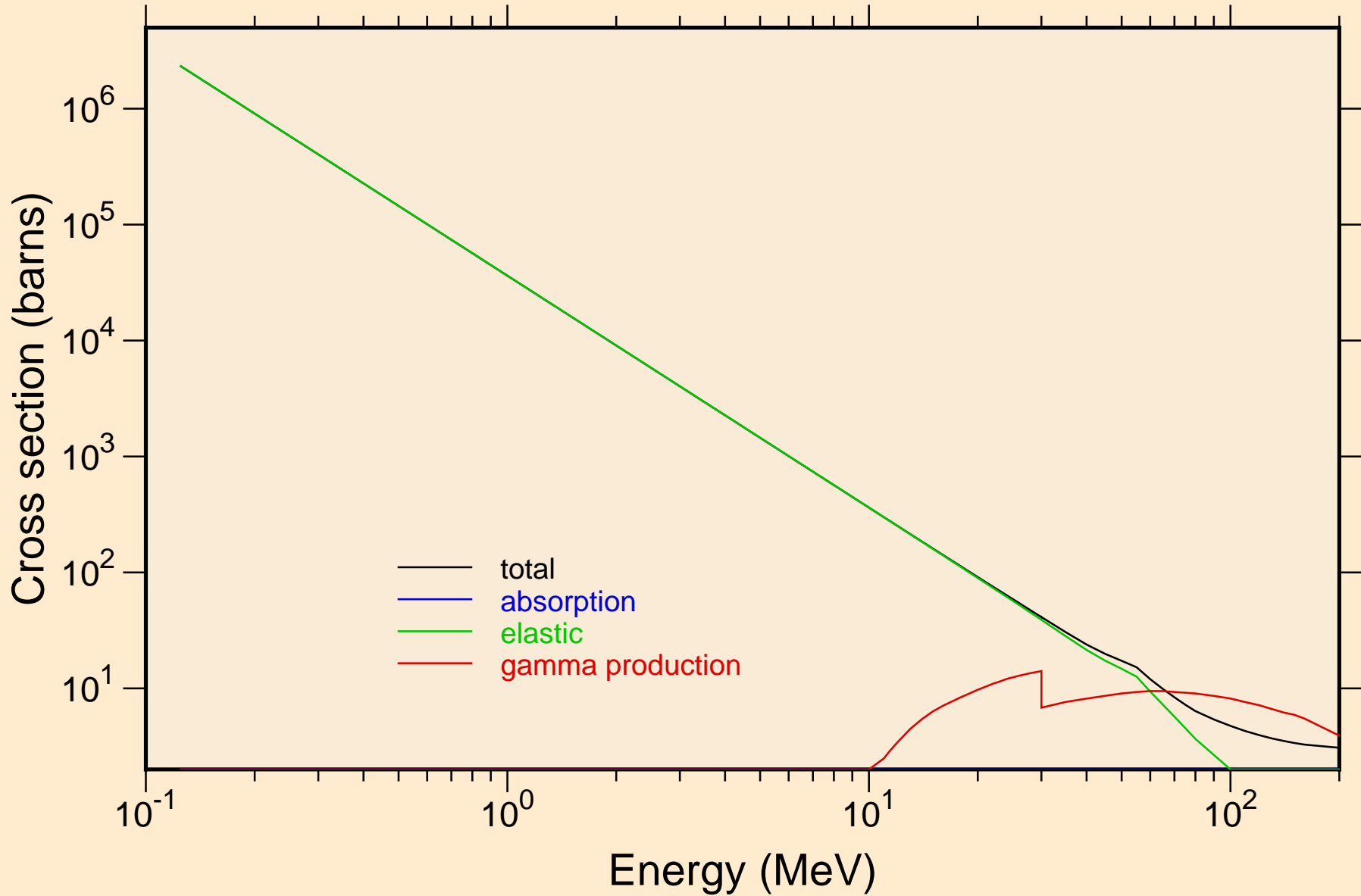

# OS170 DEUTERON ACER TENDL-2024 LIBRARY; T=0.K

## Heating

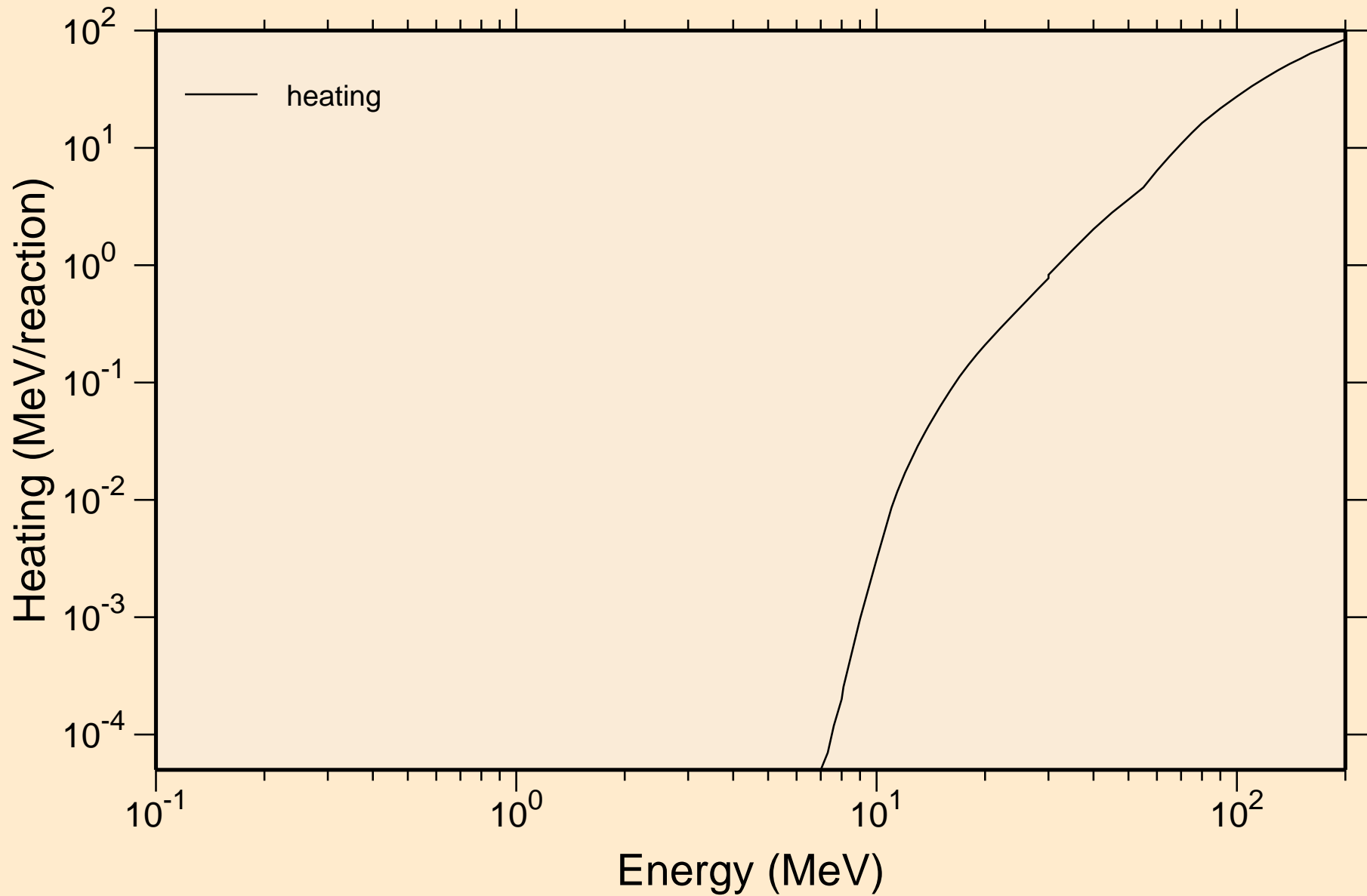

# OS170 DEUTERON ACER TENDL-2024 LIBRARY; T=0.K

## Principal cross sections

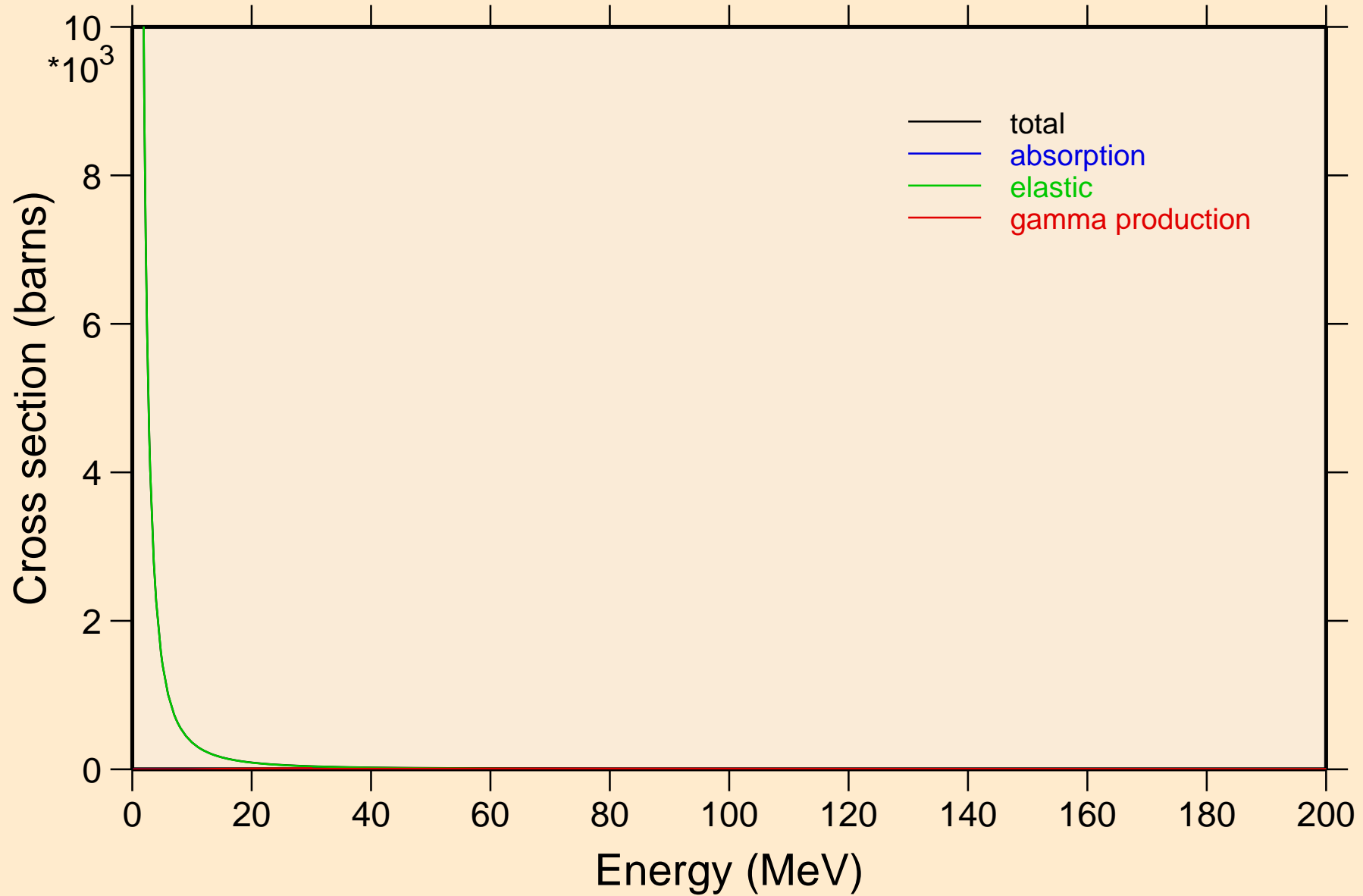

OS170 DEUTERON ACER TENDL-2024 LIBRARY; T=0.K  
Heating

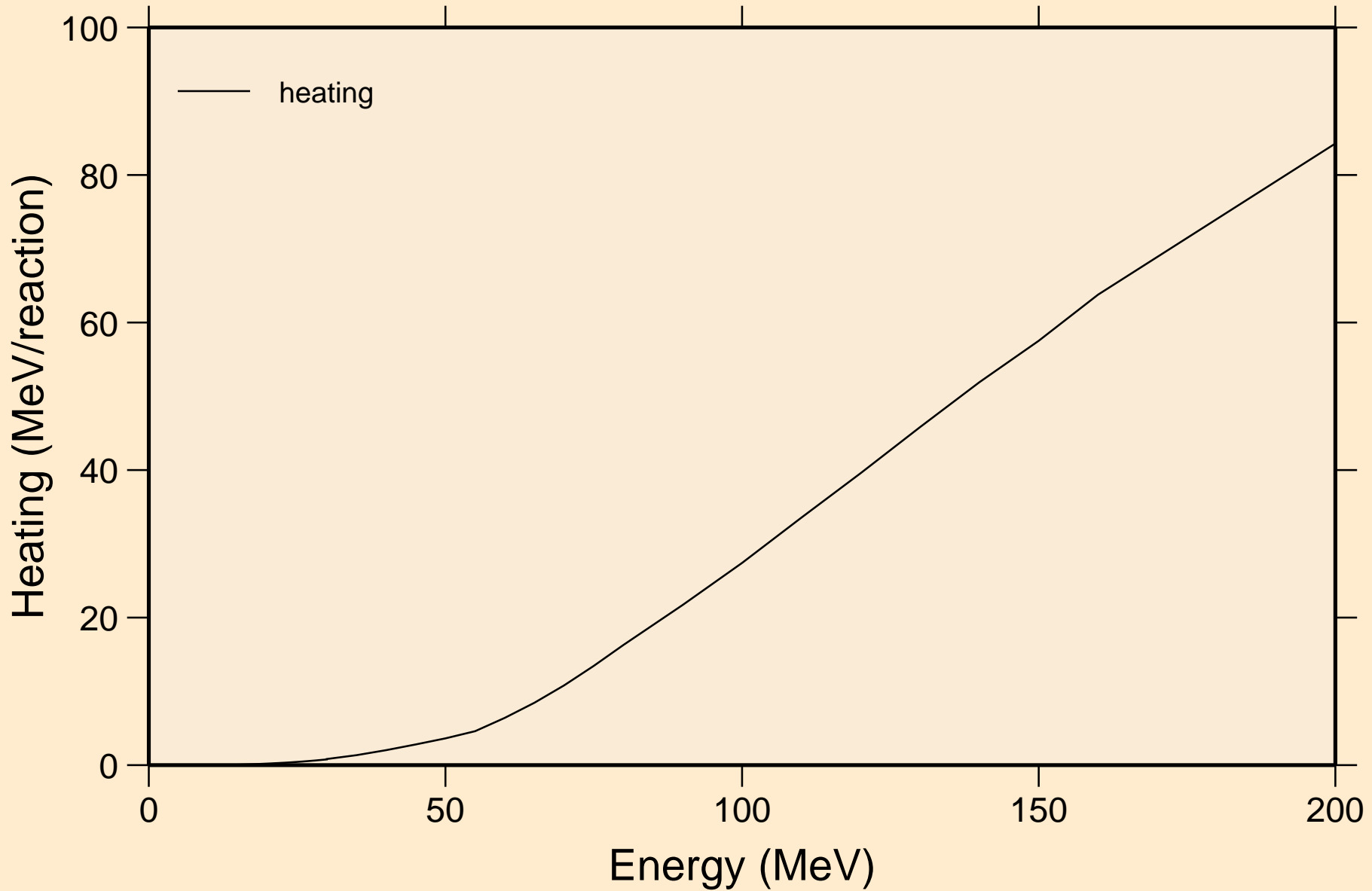

# OS170 DEUTERON ACER TENDL-2024 LIBRARY; T=0.K

## Threshold reactions

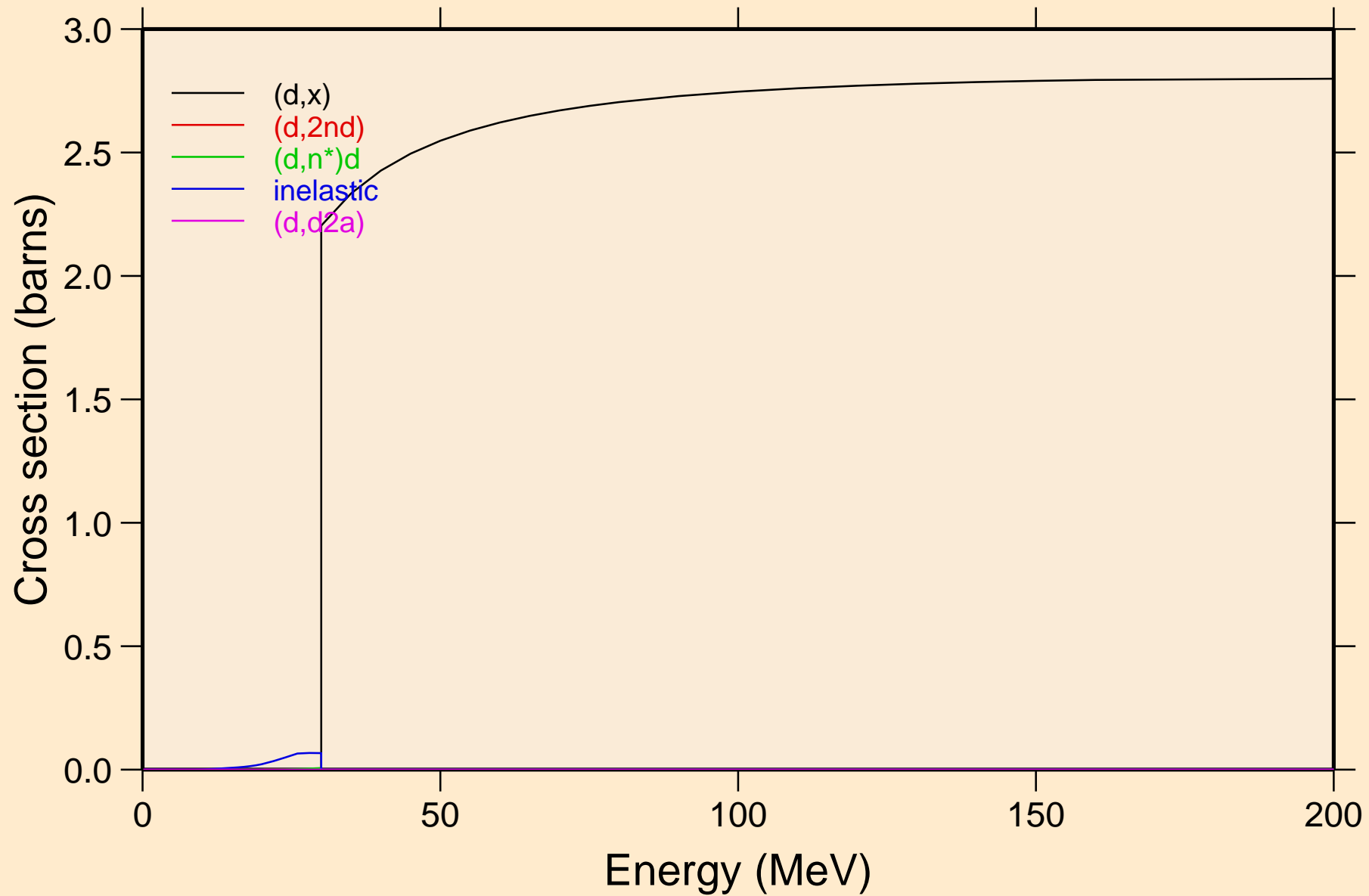

# OS170 DEUTERON ACER TENDL-2024 LIBRARY; T=0.K

## Threshold reactions

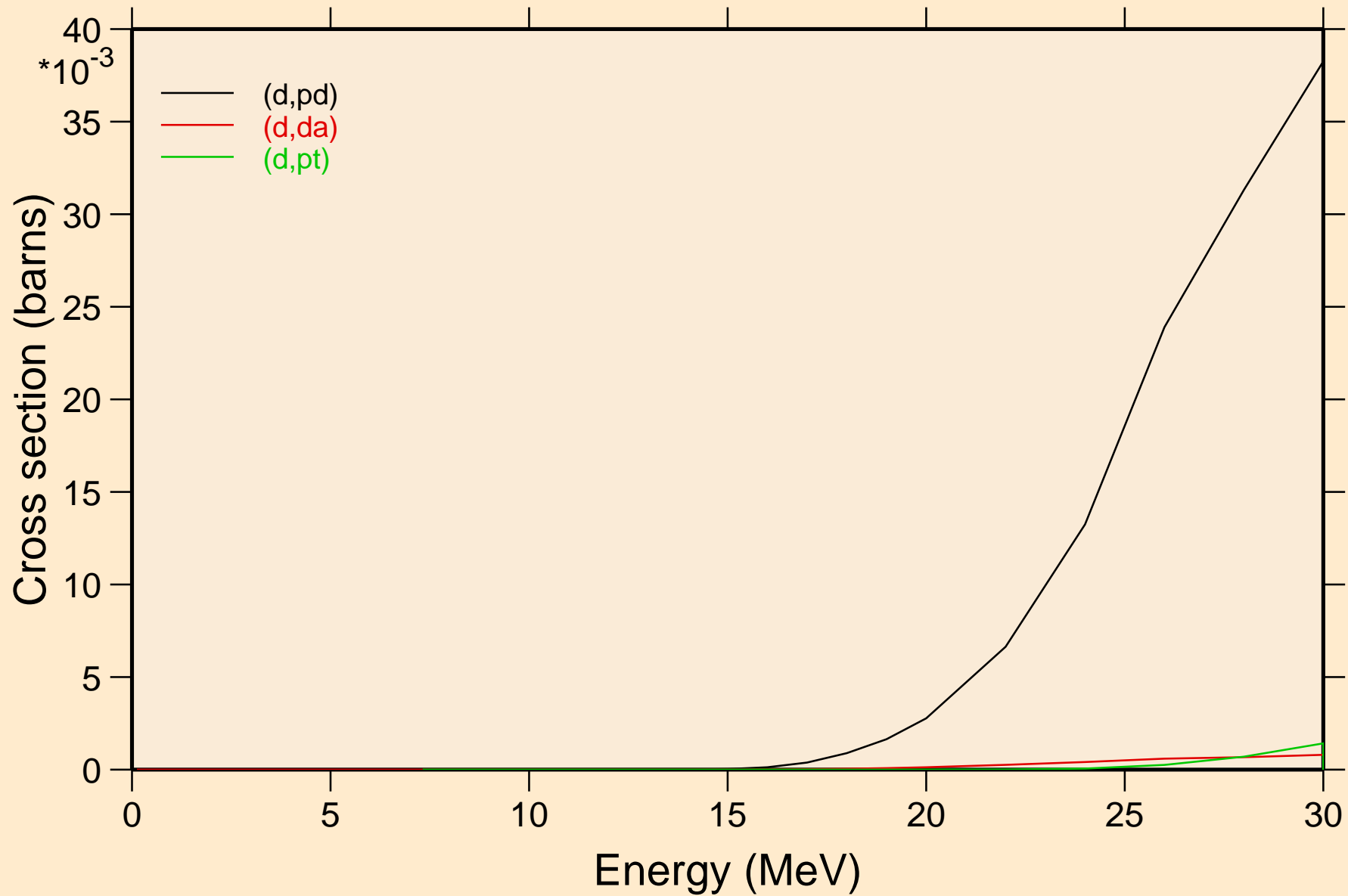

OS170 DEUTERON ACER TENDL-2024 LIBRARY; T=0.K  
Threshold reactions

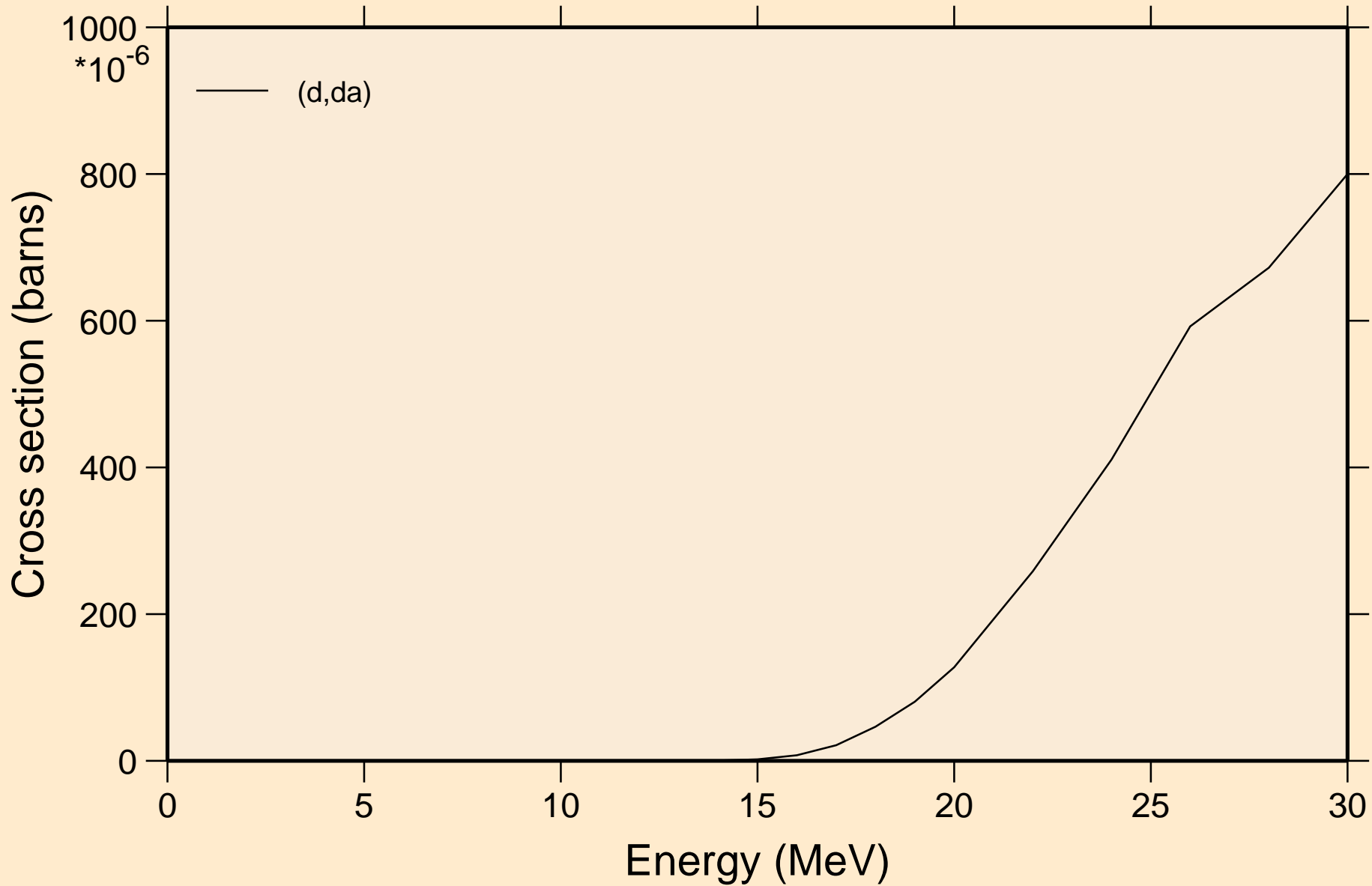

OS170 DEUTERON ACER TENDL-2024 LIBRARY; T=0.K  
angular distribution for elastic

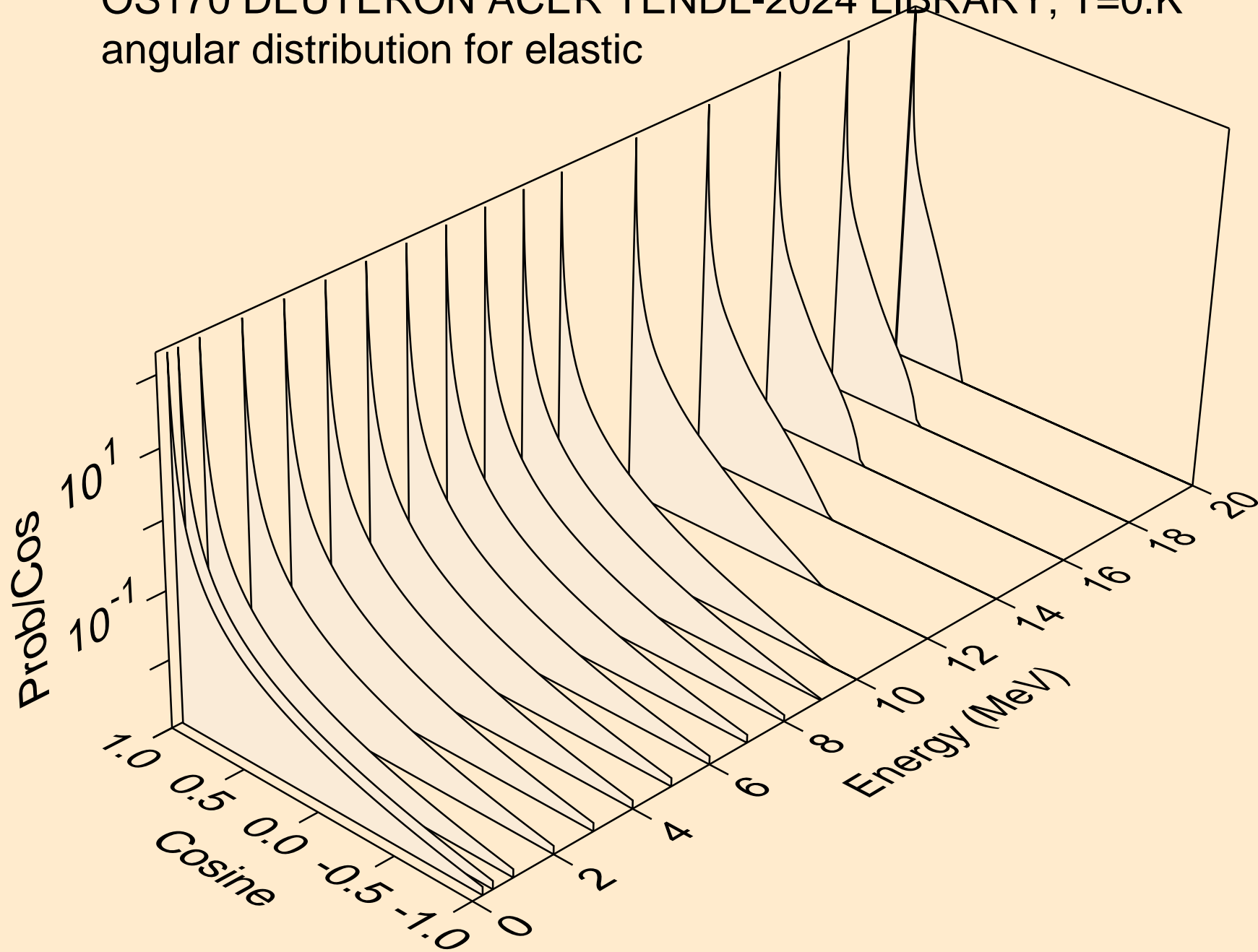

OS170 DEUTERON ACER TENDL-2024 LIBRARY; T=0.K  
angular distribution for elastic

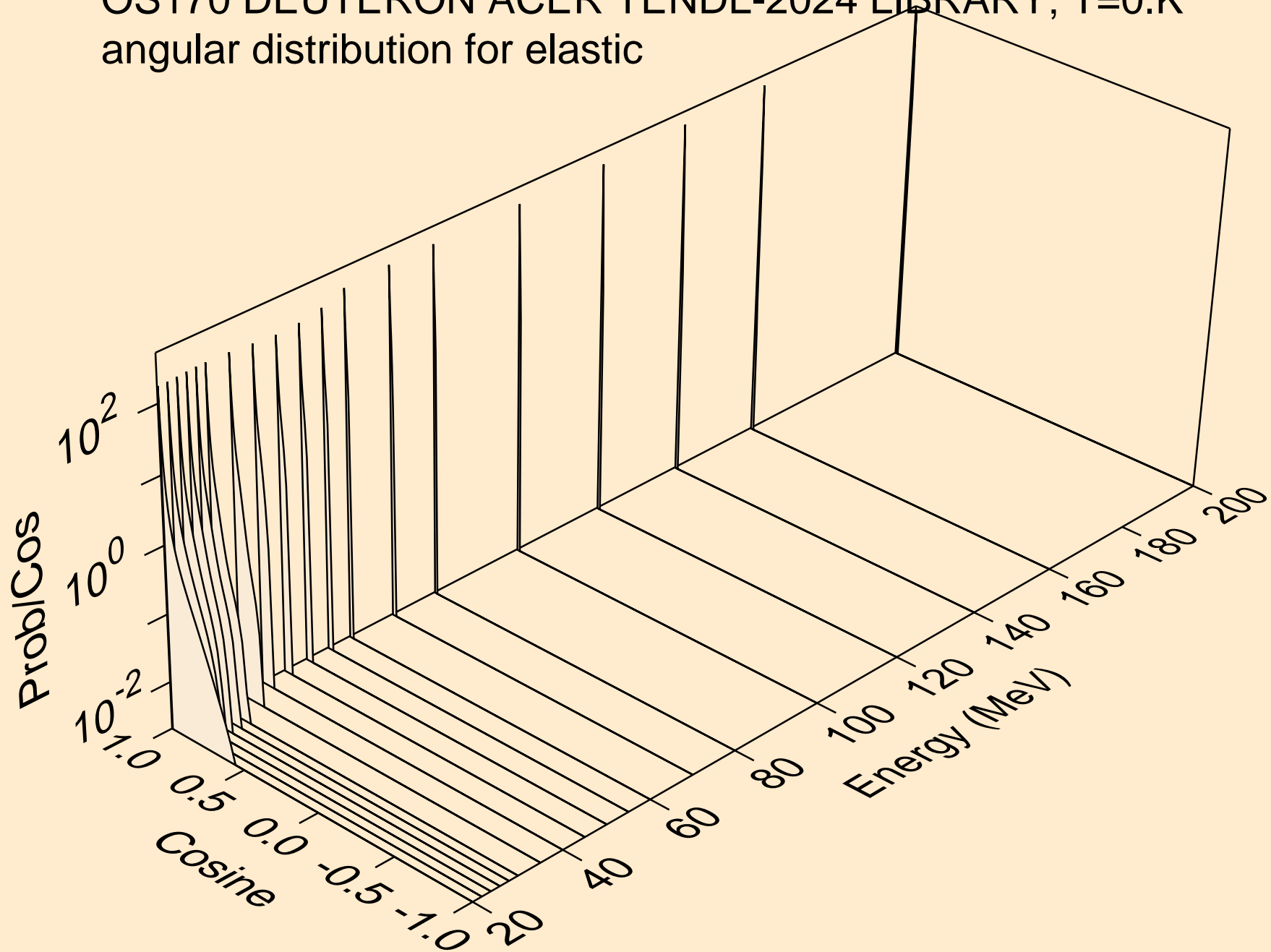

OS170 DEUTERON ACER TENDL-2024 LIBRARY; T=0.K  
Deuteron emission for (d,x)

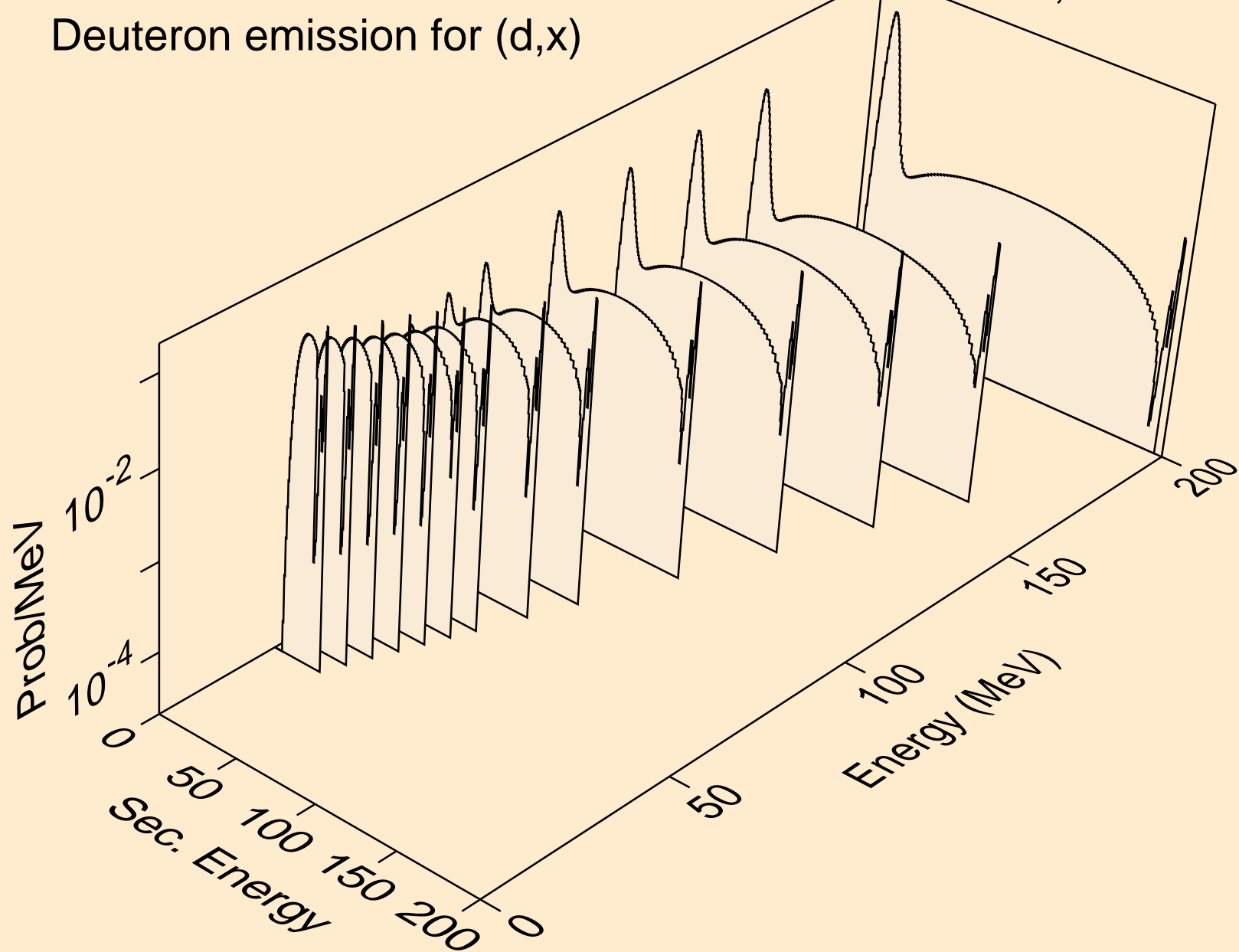

OS170 DEUTERON ACER TENDL-2024 LIBRARY; T=0.K  
Deuteron emission for (d,2nd)

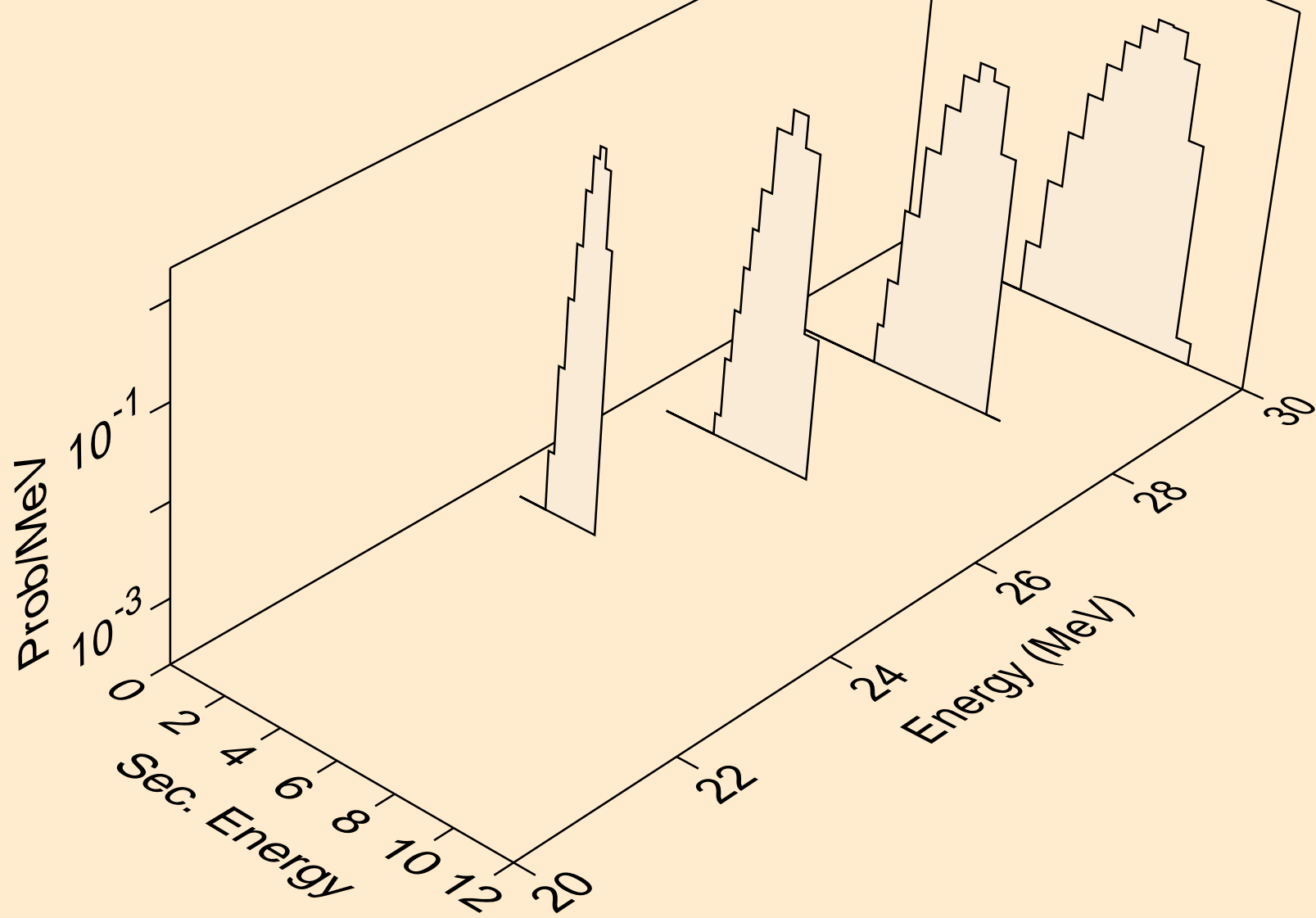

OS170 DEUTERON ACER TENDL-2024 LIBRARY; T=0.K  
Deuteron emission for (d,n\*)d

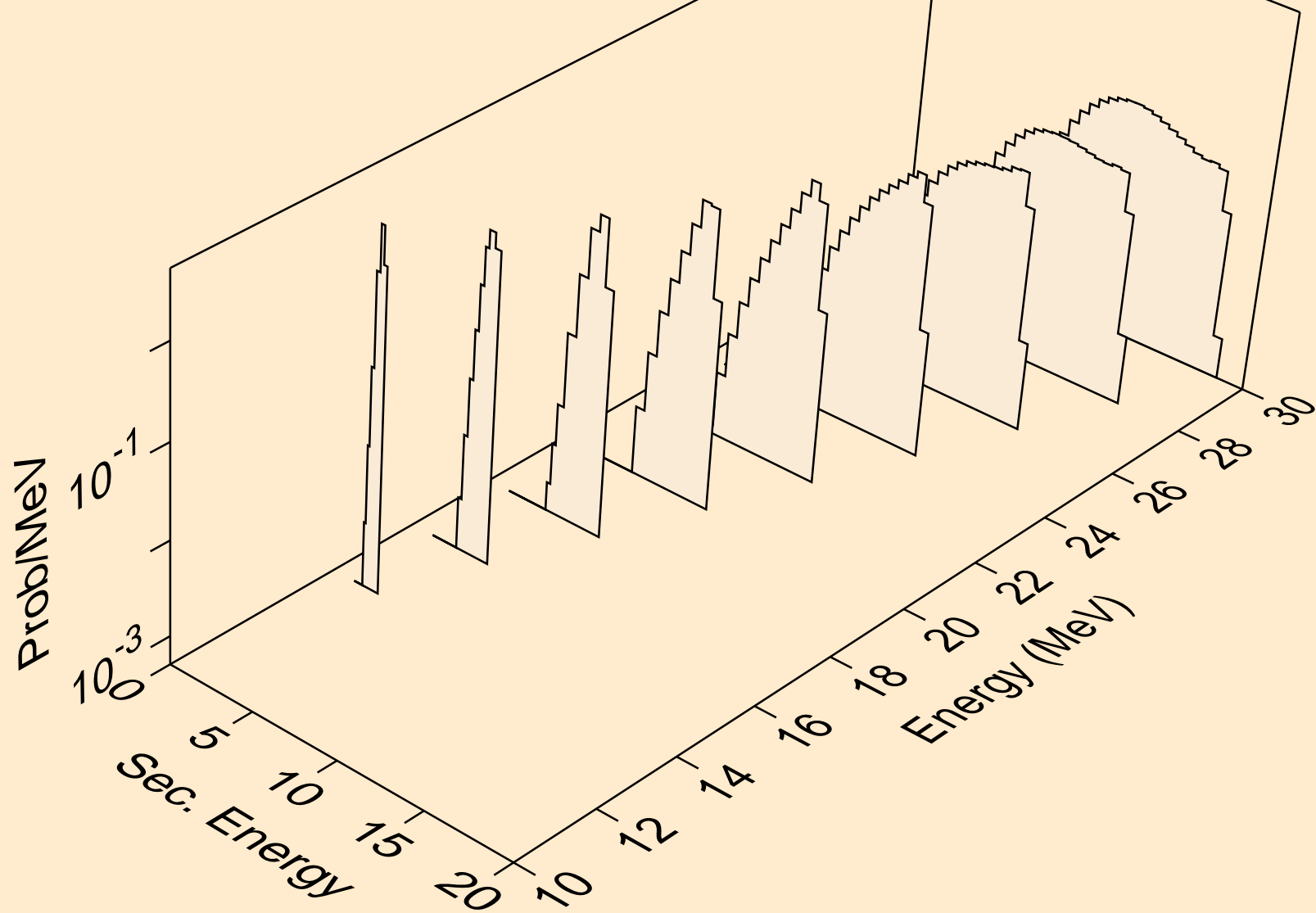

OS170 DEUTERON ACER TENDL-2024 LIBRARY; T=0.K  
Deuteron emission for inelastic

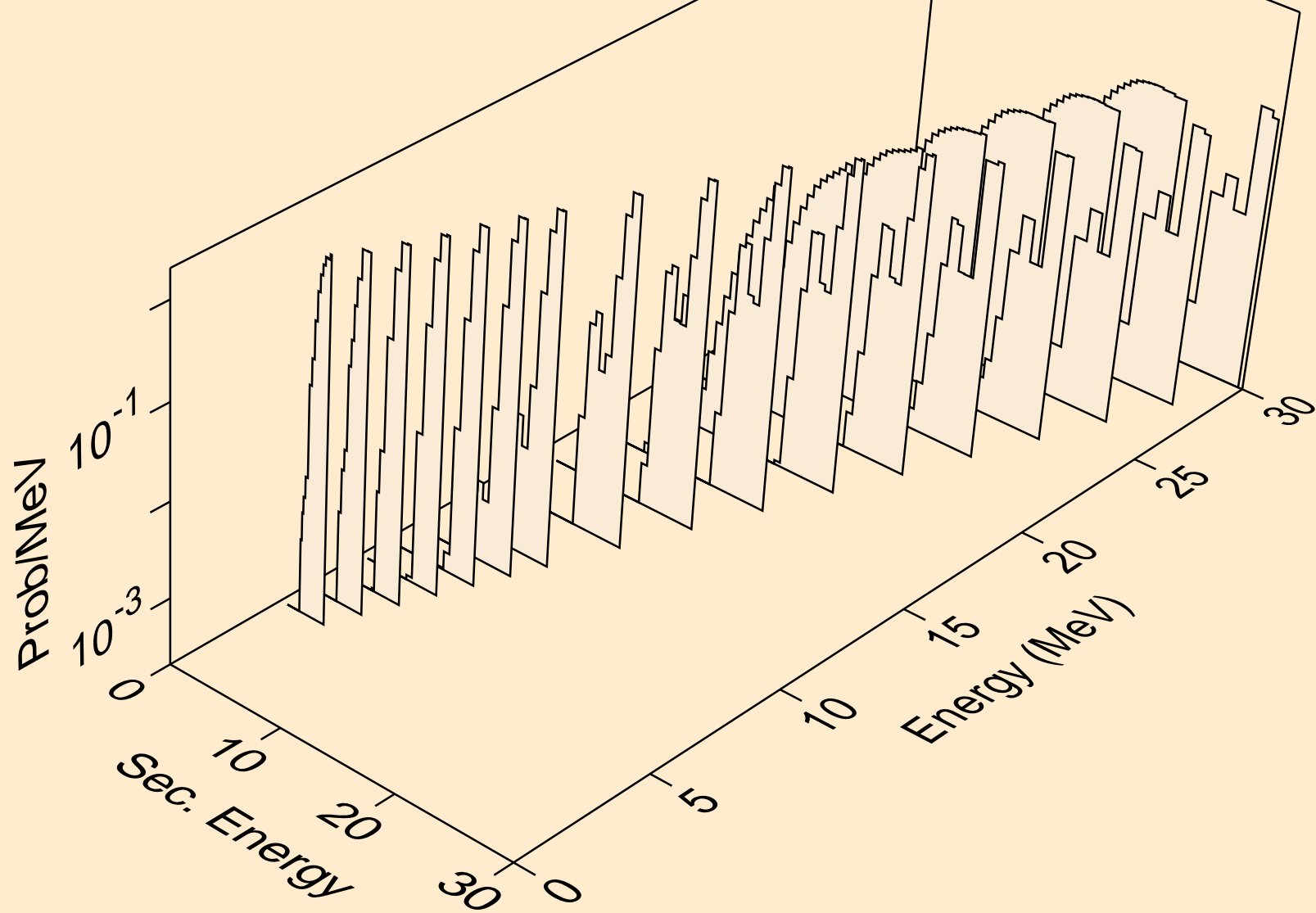

OS170 DEUTERON ACER TENDL-2024 LIBRARY; T=0.K  
Deuteron emission for (d,d2a)

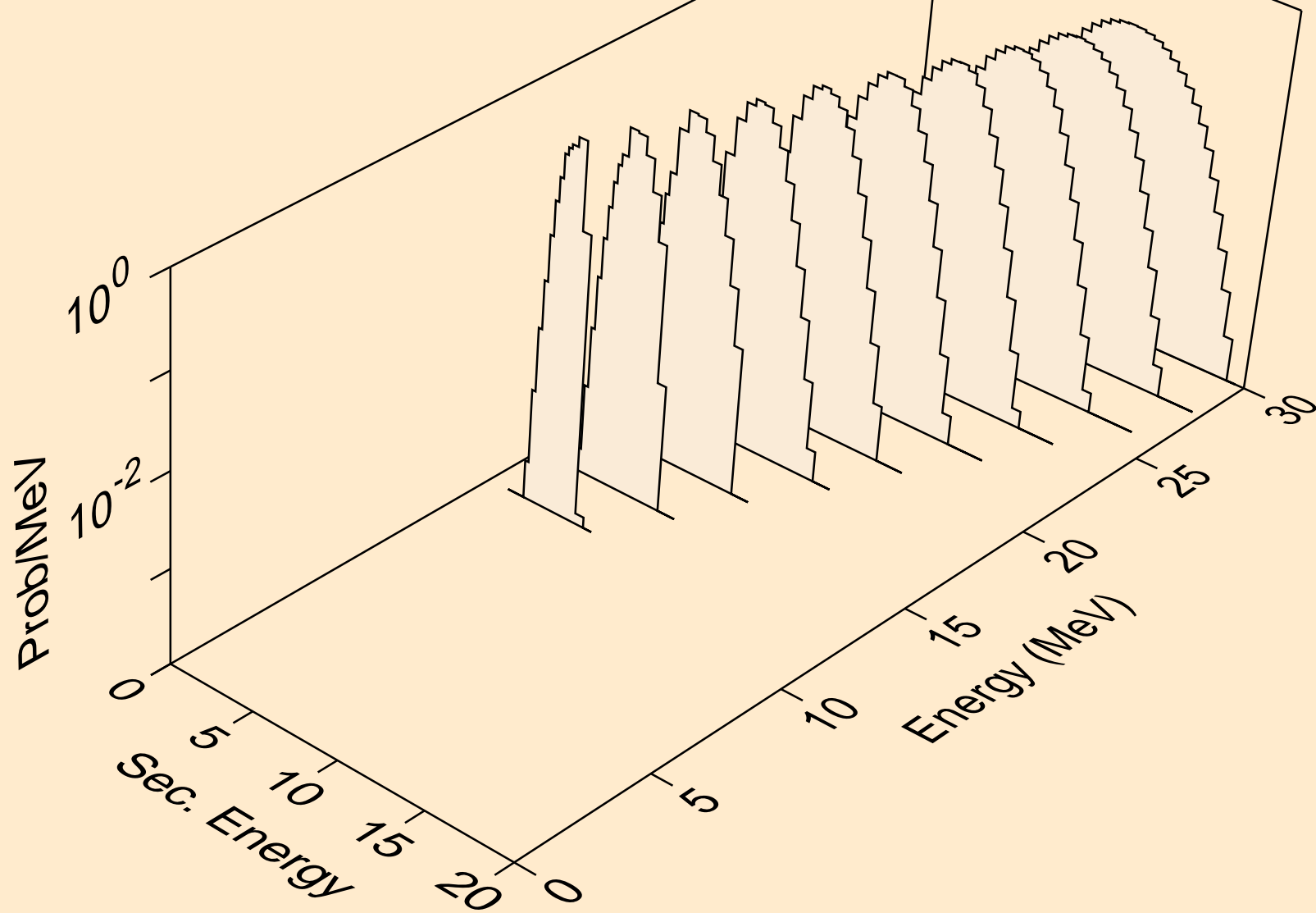

OS170 DEUTERON ACER TENDL-2024 LIBRARY; T=0.K  
Deuteron emission for (d,pd)

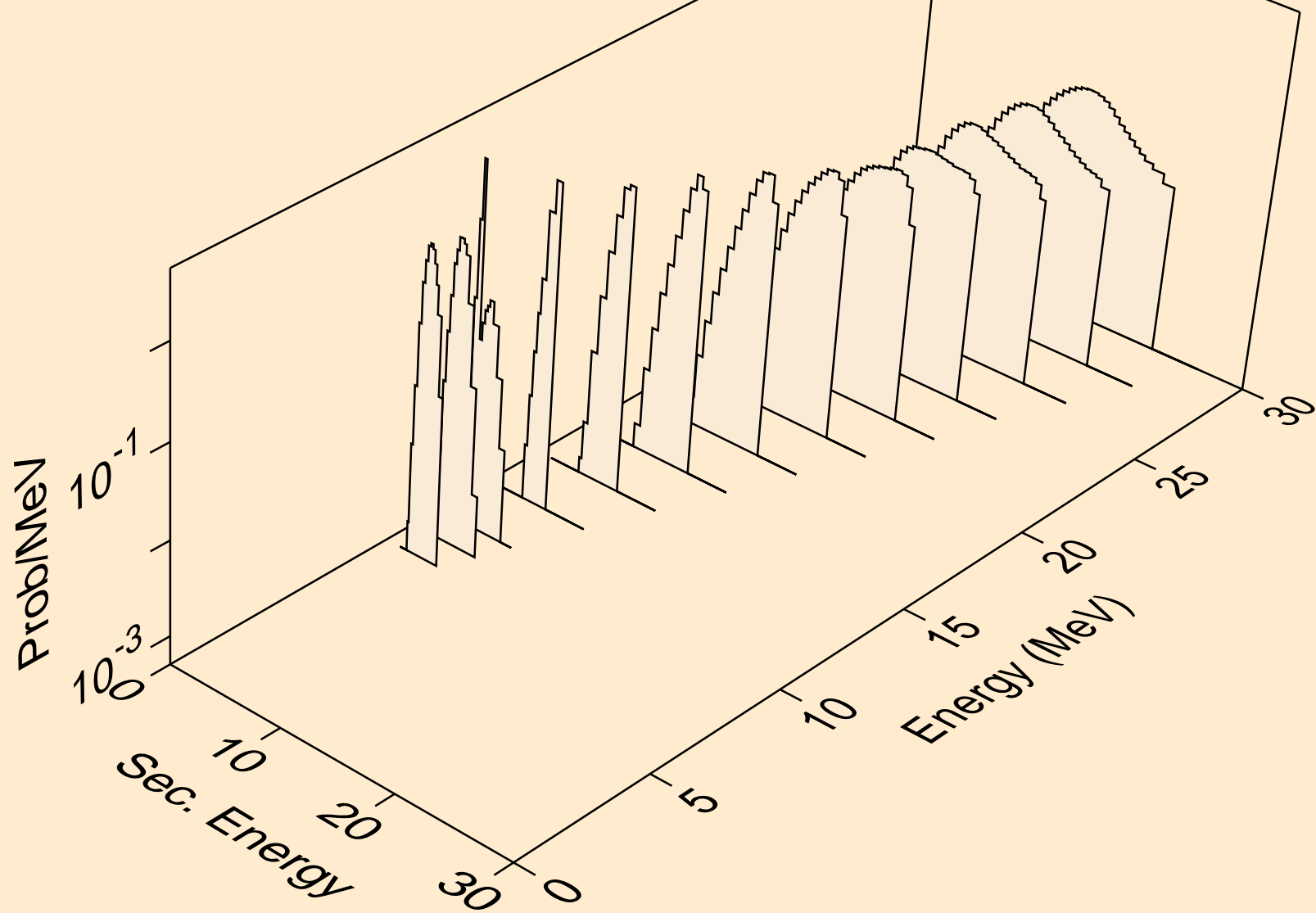

OS170 DEUTERON ACER TENDL-2024 LIBRARY; T=0.K  
Deuteron emission for (d,da)

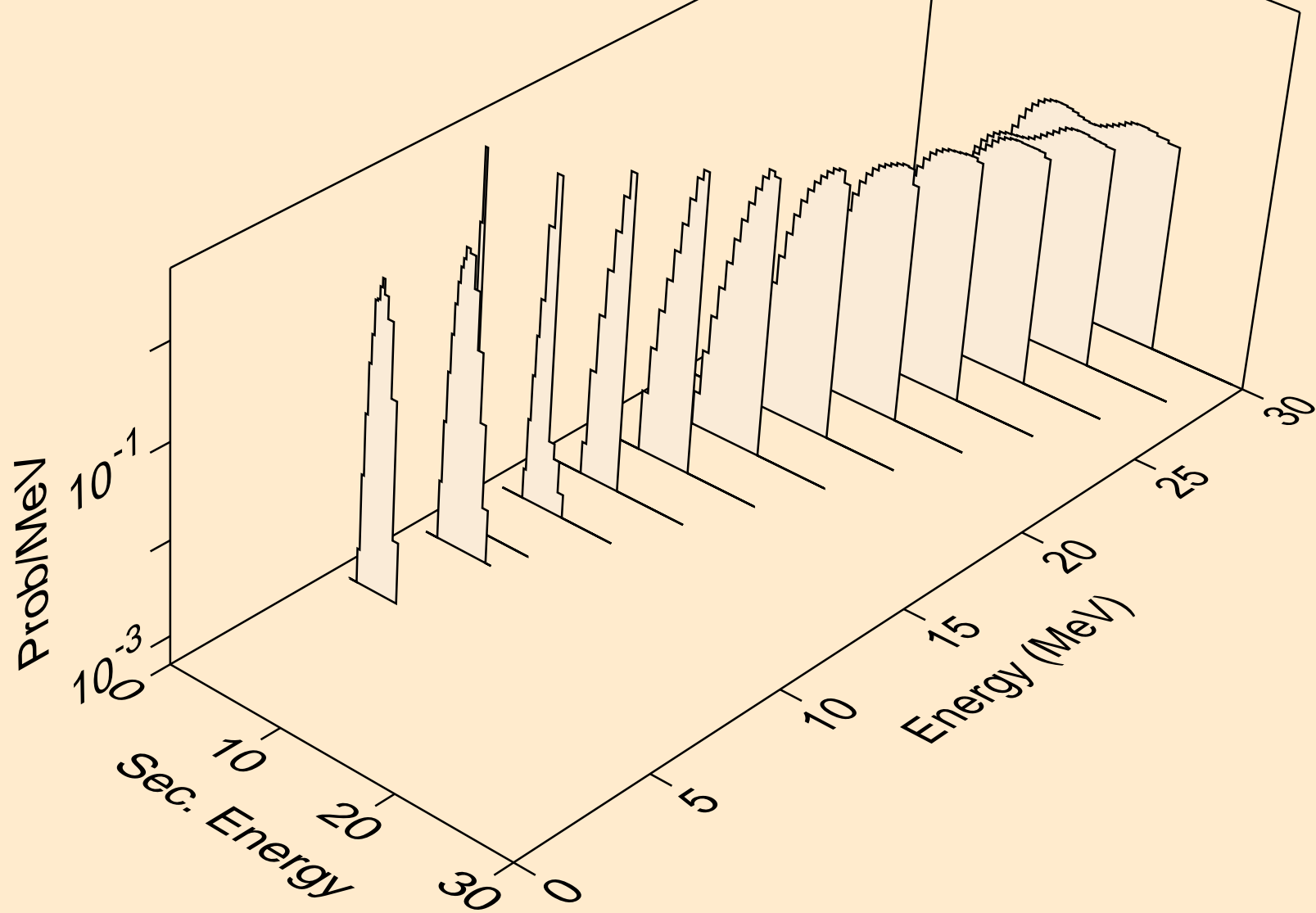

OS170 DEUTERON ACER TENDL-2024 LIBRARY; T=0.K  
Photon emission for (z,n)

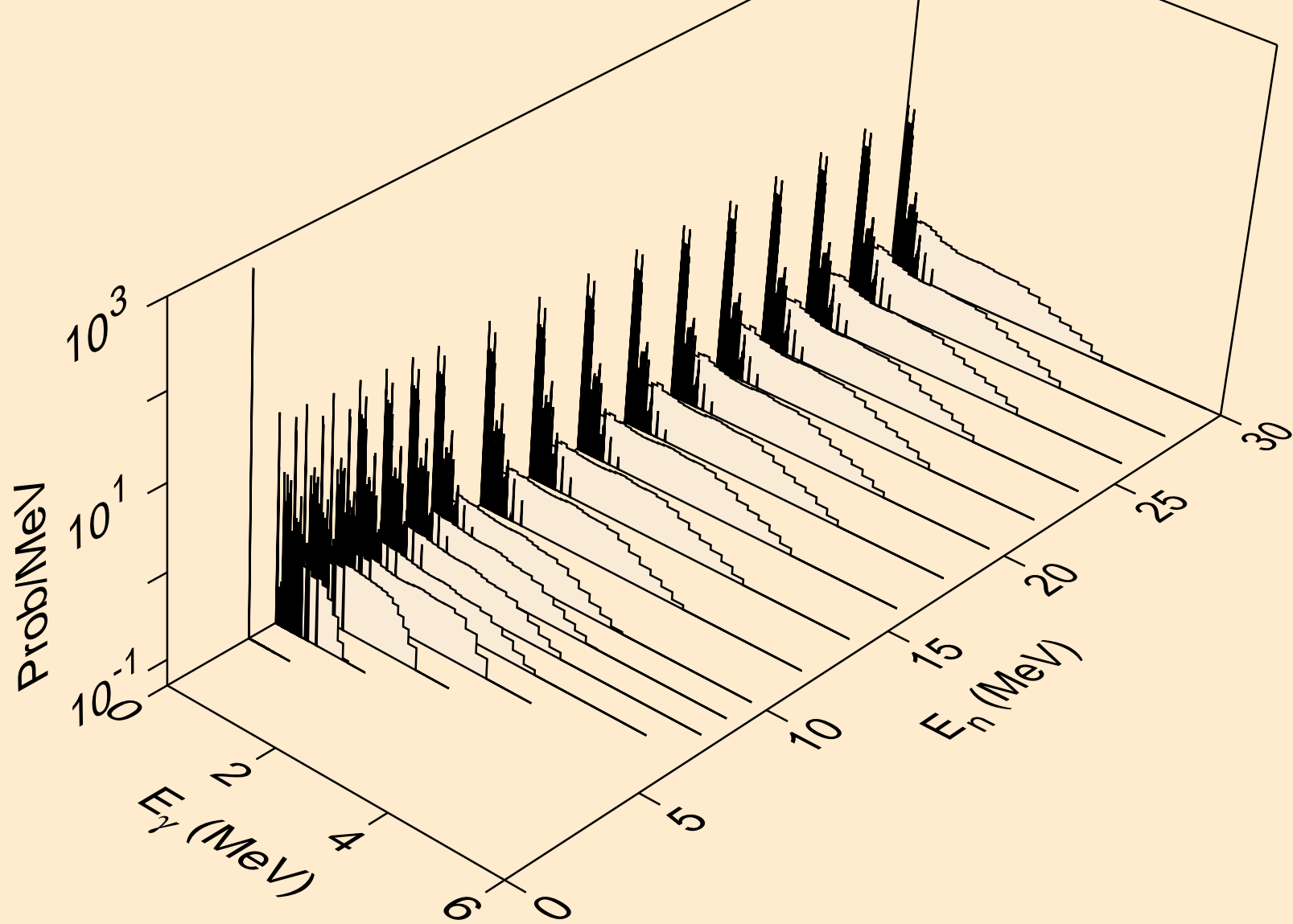

OS170 DEUTERON ACER TENDL-2024 LIBRARY; T=0.K  
Photon emission for (z,x)

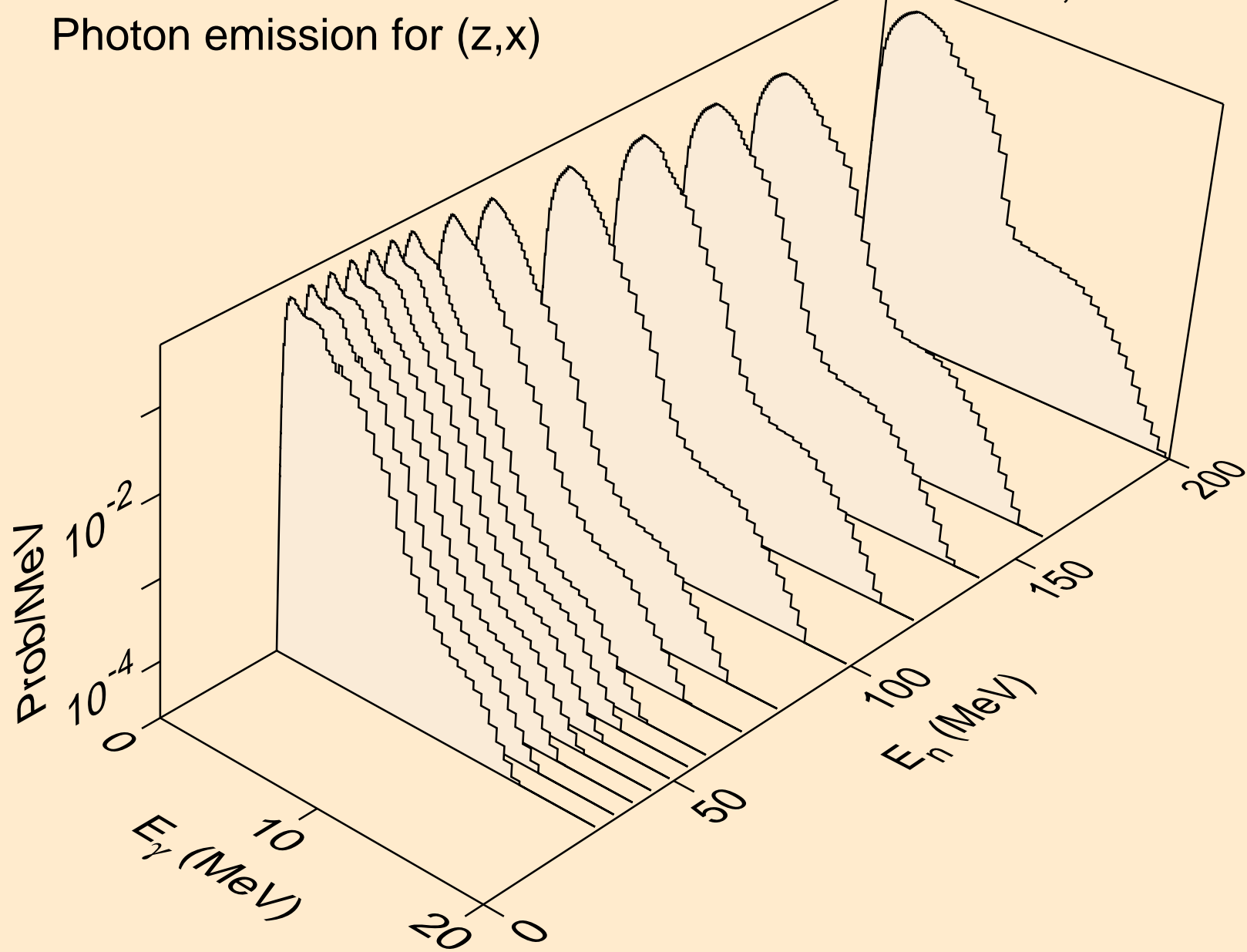

OS170 DEUTERON ACER TENDL-2024 LIBRARY; T=0.K  
Photon emission for (n,2nd)

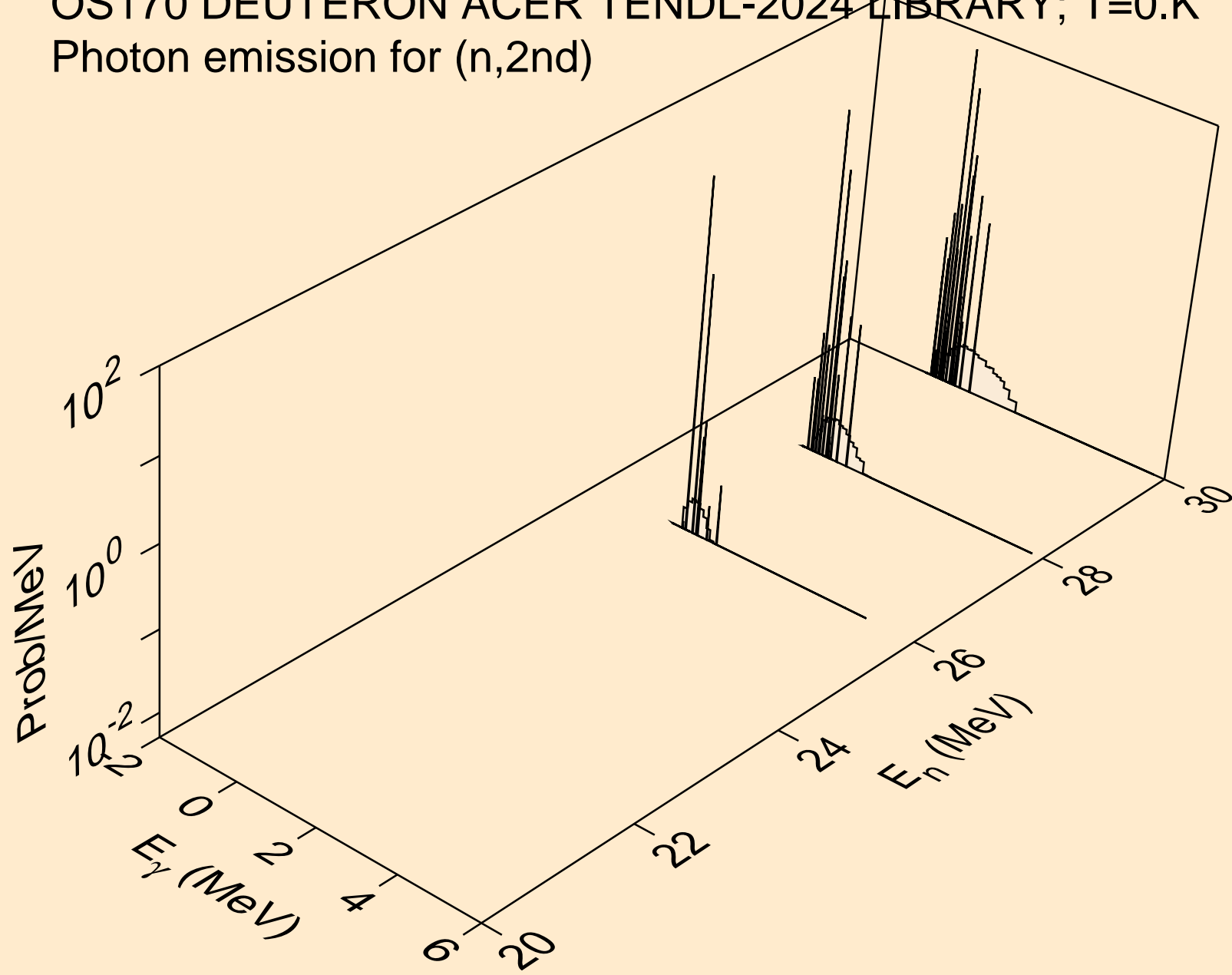

OS170 DEUTERON ACER TENDL-2024 LIBRARY; T=0.K  
Photon emission for (n,2n)

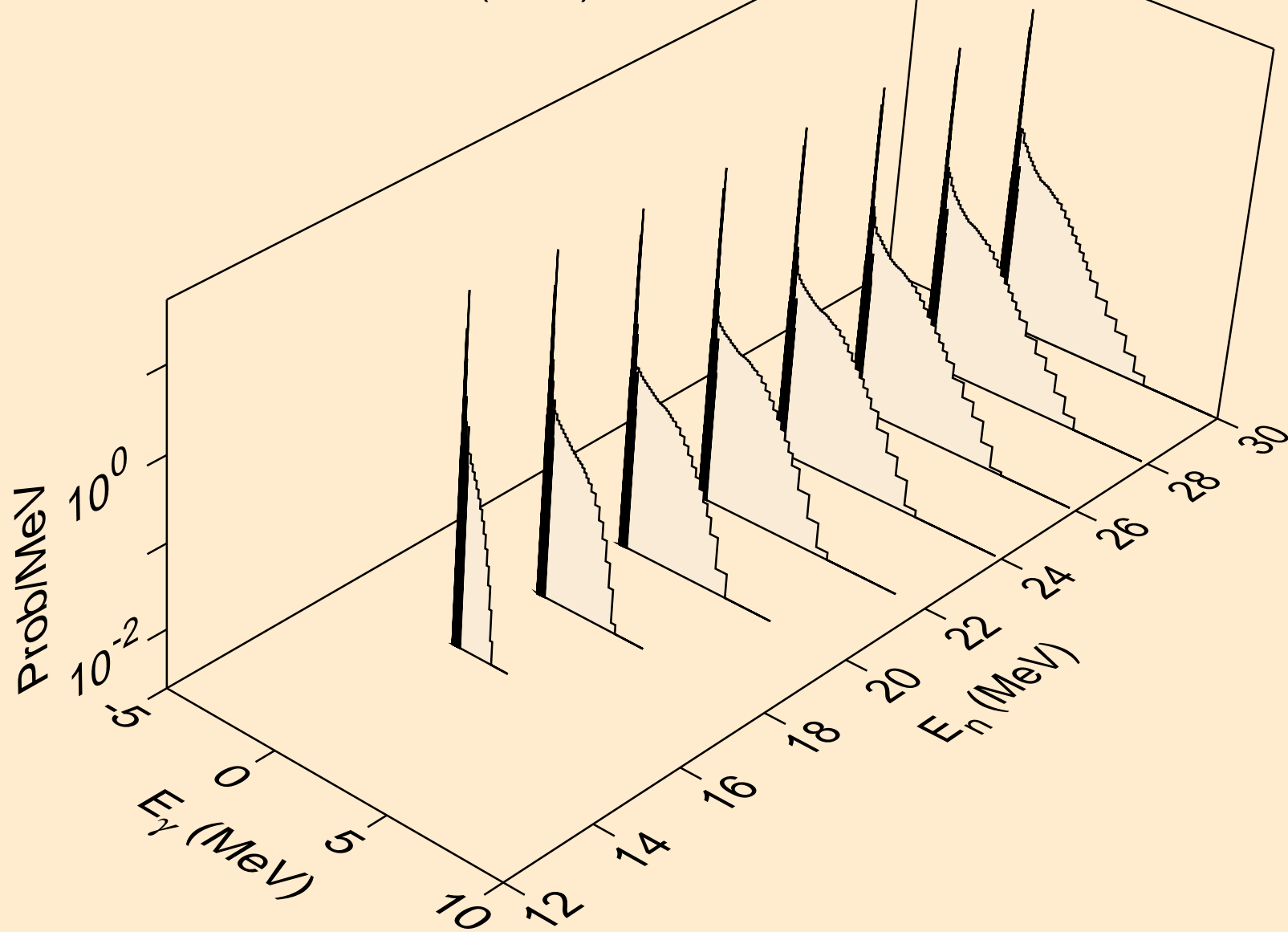

OS170 DEUTERON ACER TENDL-2024 LIBRARY; T=0.K  
Photon emission for (n,3n)

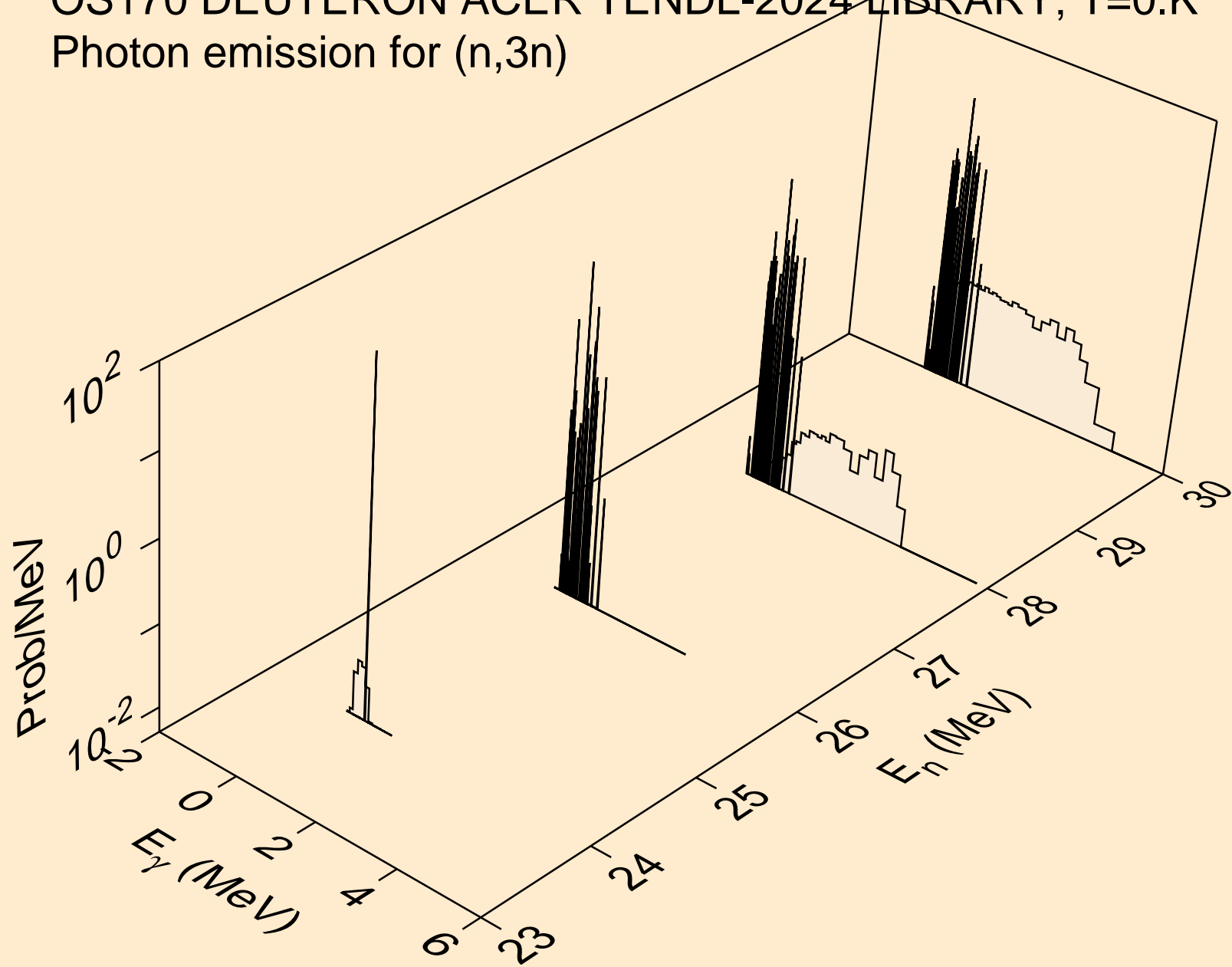

OS170 DEUTERON ACER TENDL-2024 LIBRARY; T=0.K  
Photon emission for (n,n\*)a

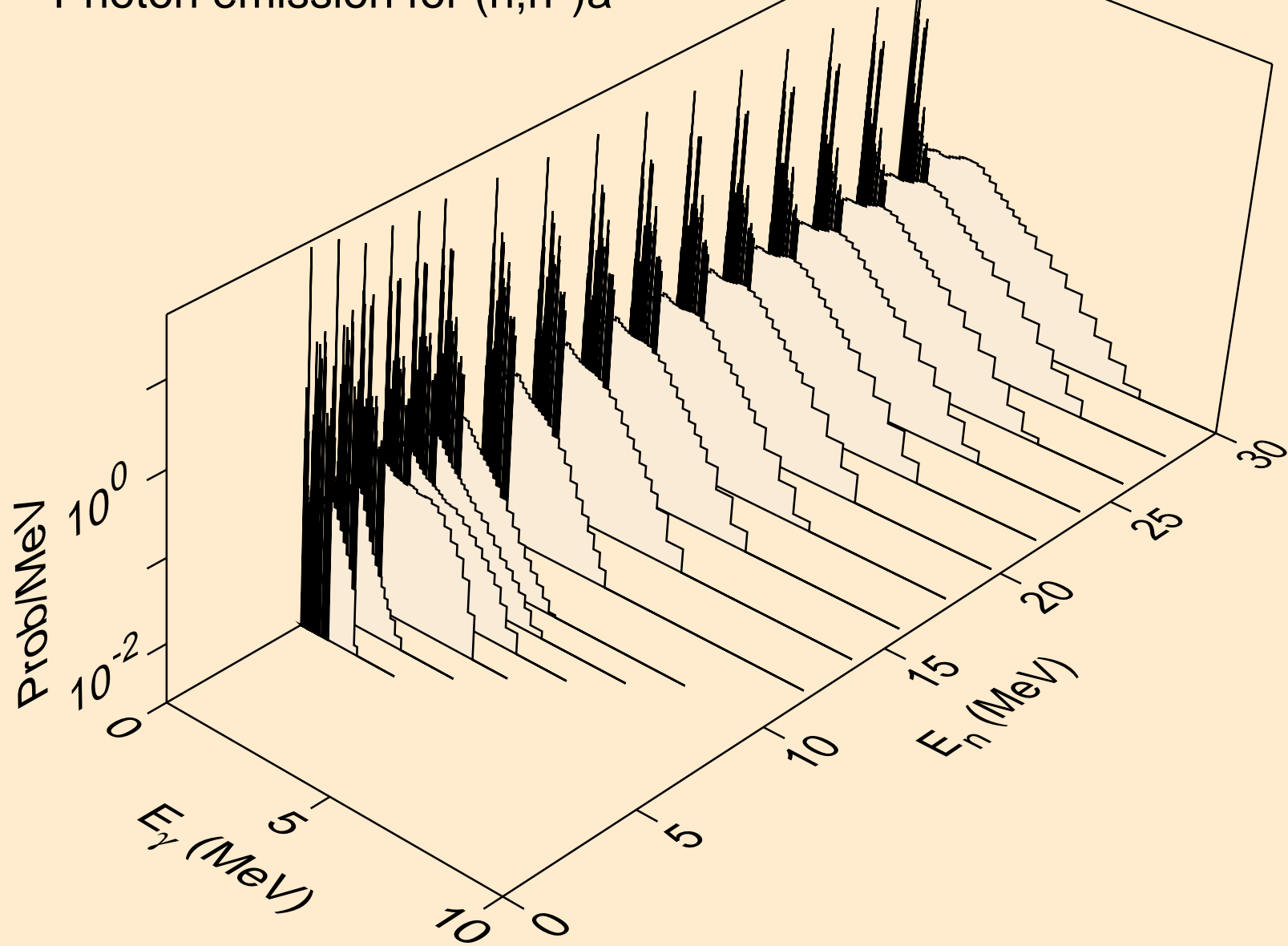

OS170 DEUTERON ACER TENDL-2024 LIBRARY; T=0.K  
Photon emission for (n,n\*)3a

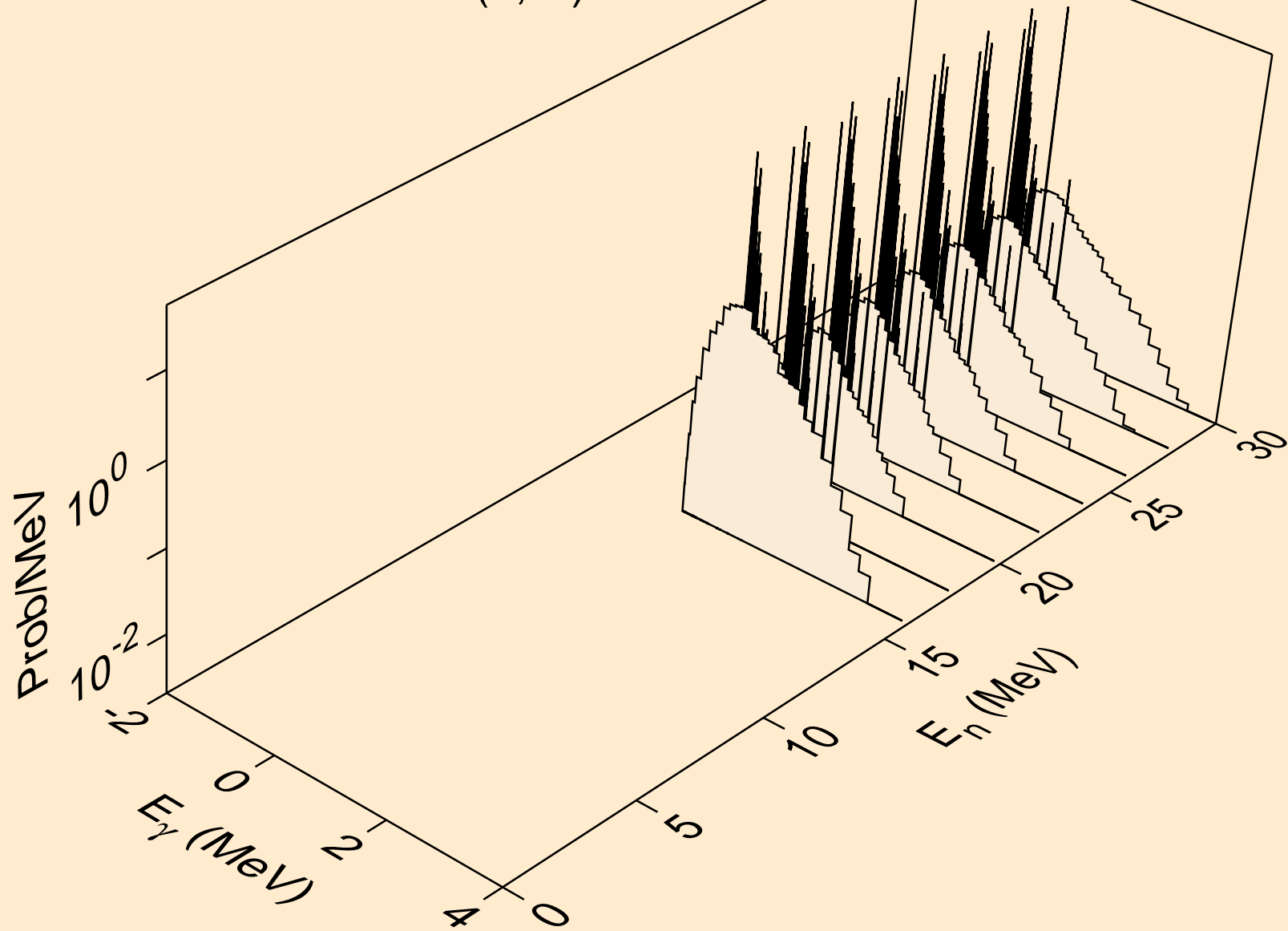

OS170 DEUTERON ACER TENDL-2024 LIBRARY; T=0.K  
Photon emission for (n,2n)a

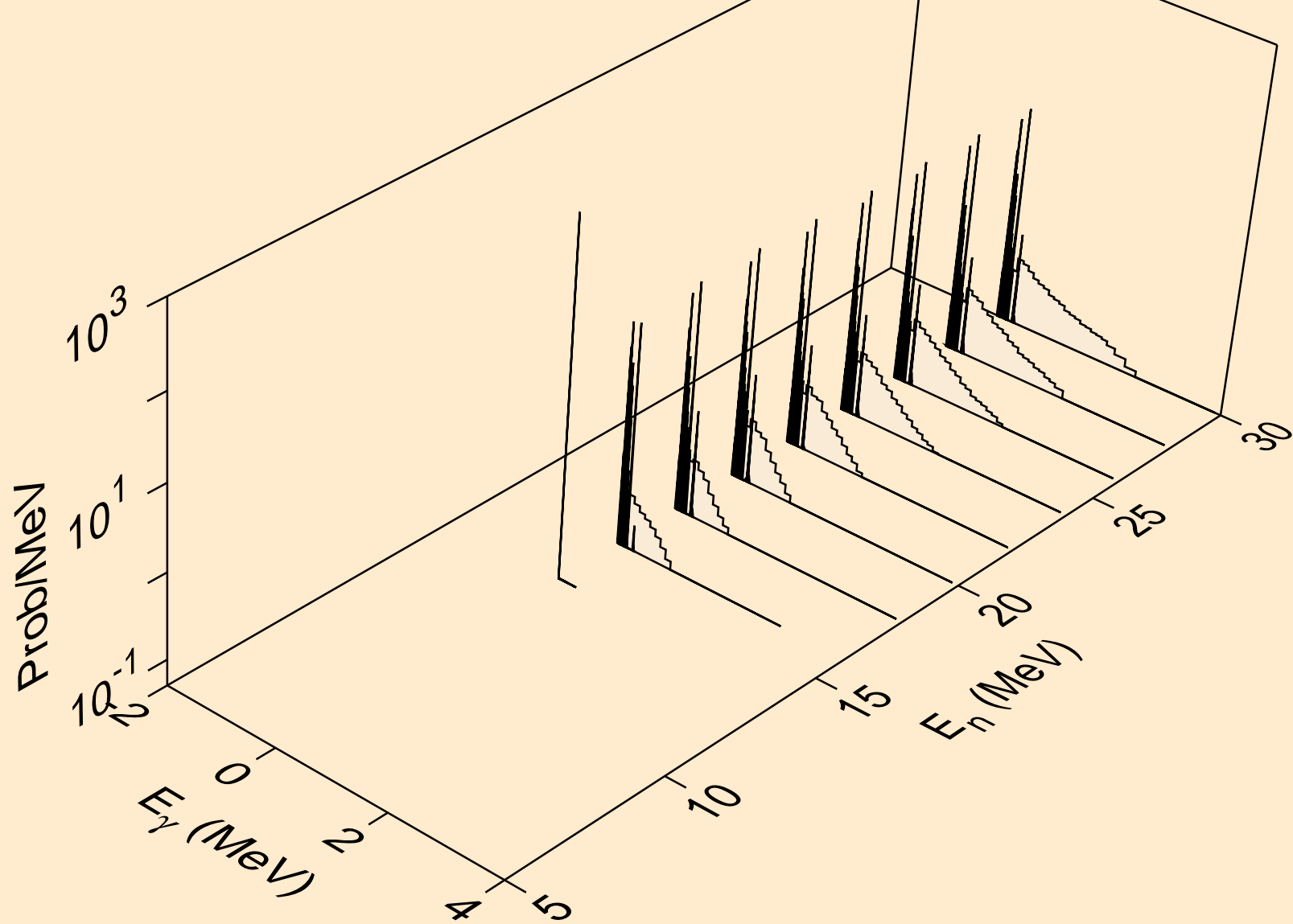

OS170 DEUTERON ACER TENDL-2024 LIBRARY; T=0.K  
Photon emission for (n,3n)a

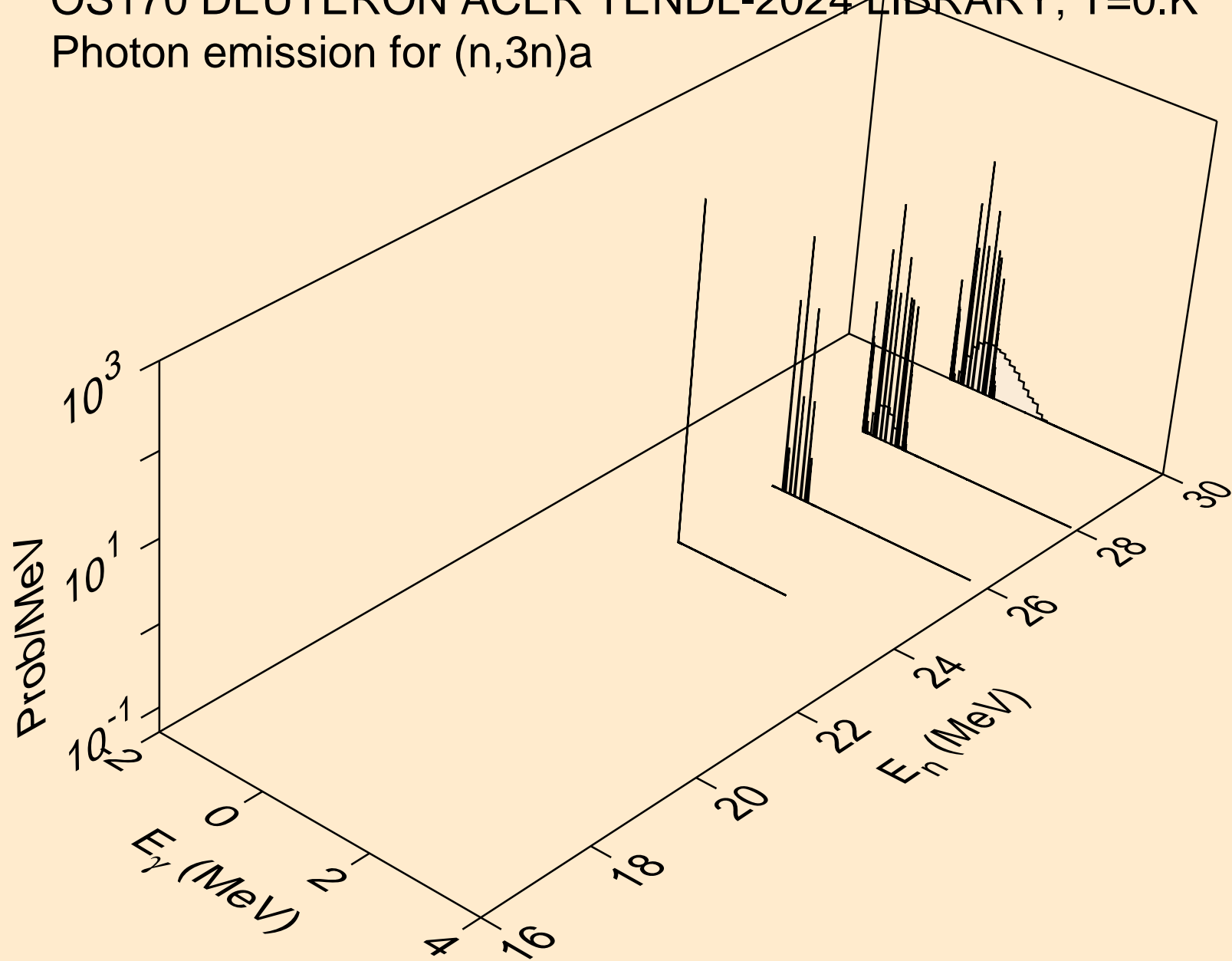

OS170 DEUTERON ACER TENDL-2024 LIBRARY; T=0.K  
Photon emission for (n,n\*)p

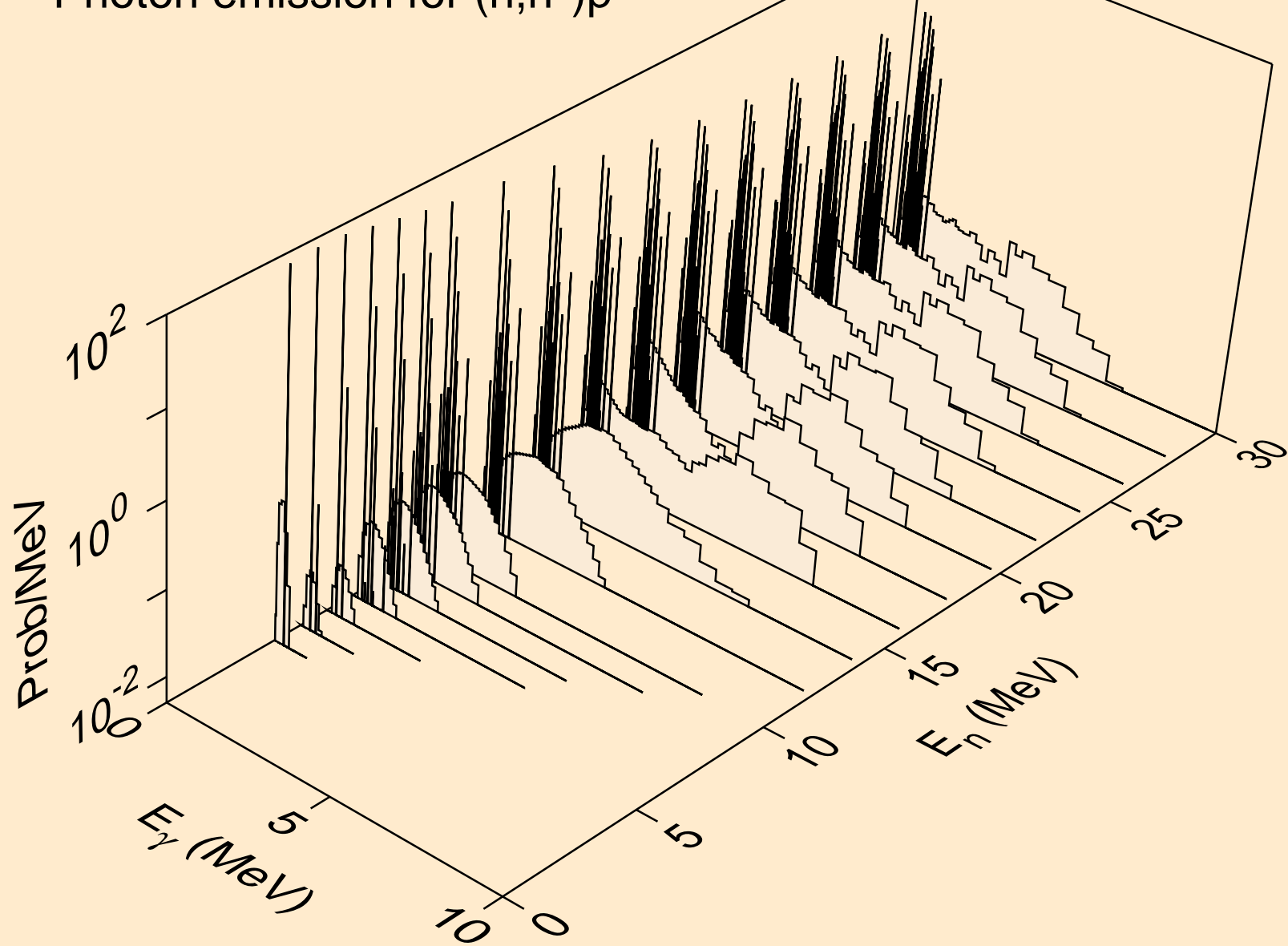

OS170 DEUTERON ACER TENDL-2024 LIBRARY; T=0.K  
Photon emission for (n,n\*)2a

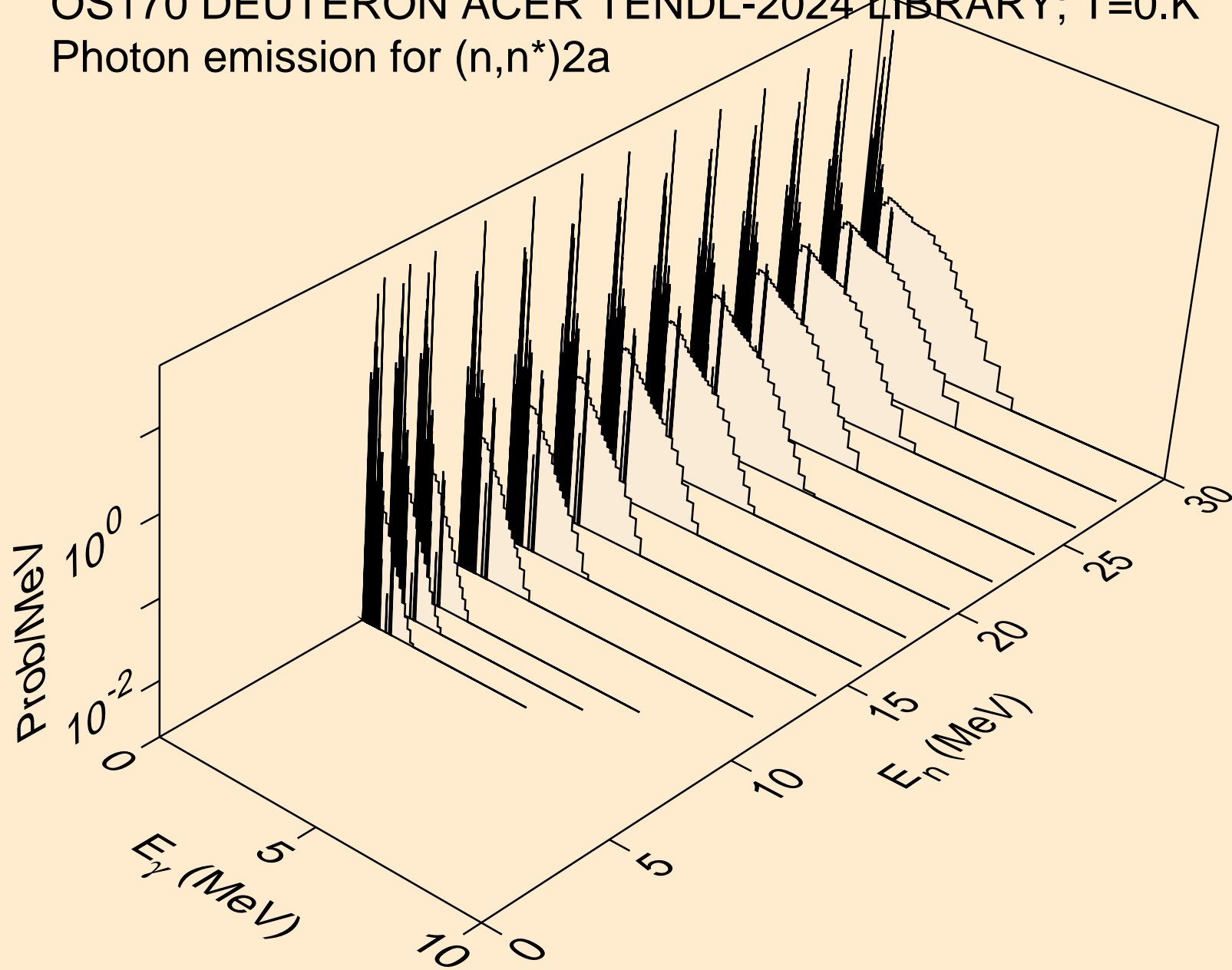

OS170 DEUTERON ACER TENDL-2024 LIBRARY; T=0.K  
Photon emission for (n,2n)2a

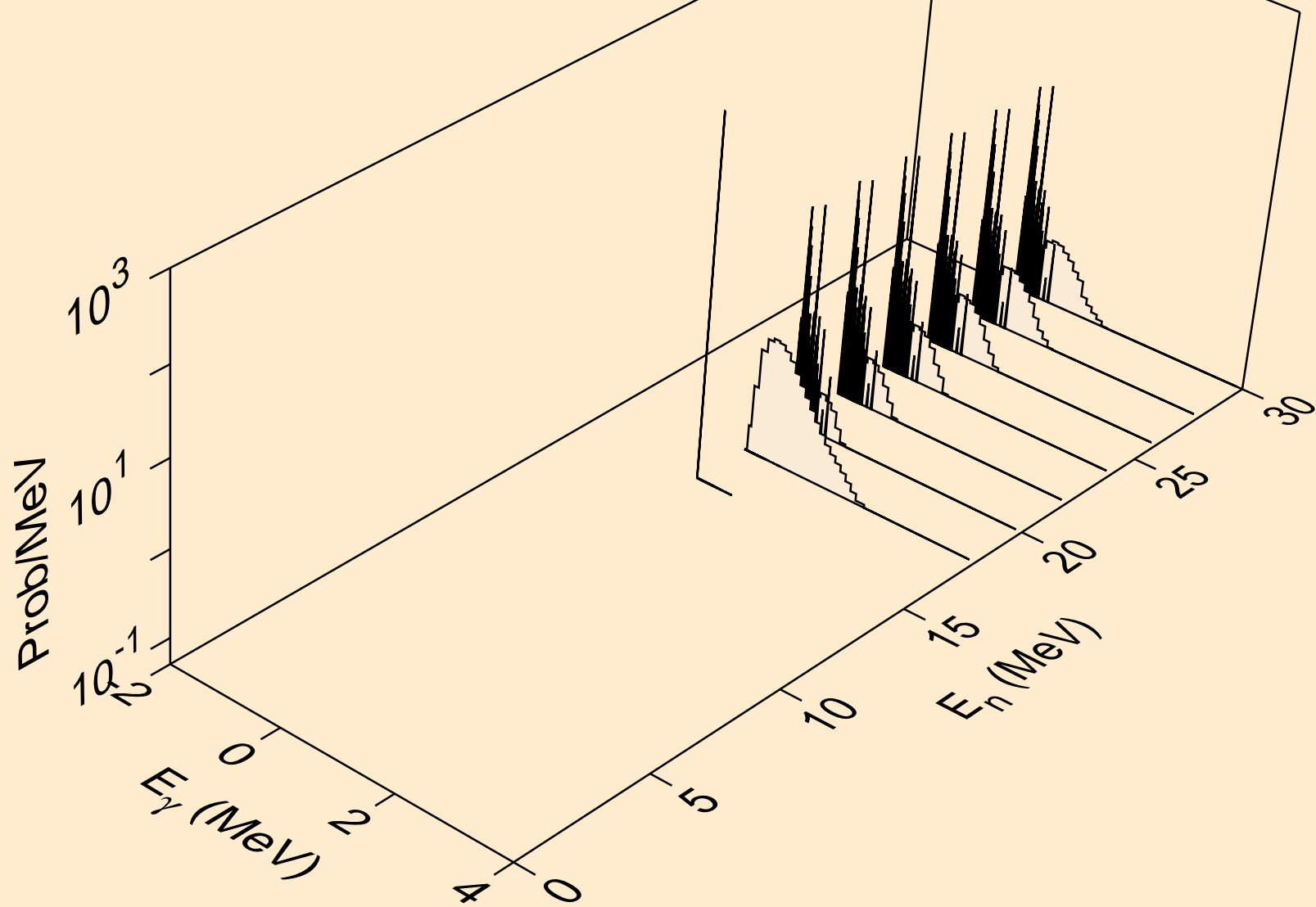

OS170 DEUTERON ACER TENDL-2024 LIBRARY; T=0.K  
Photon emission for (n,n\*)d

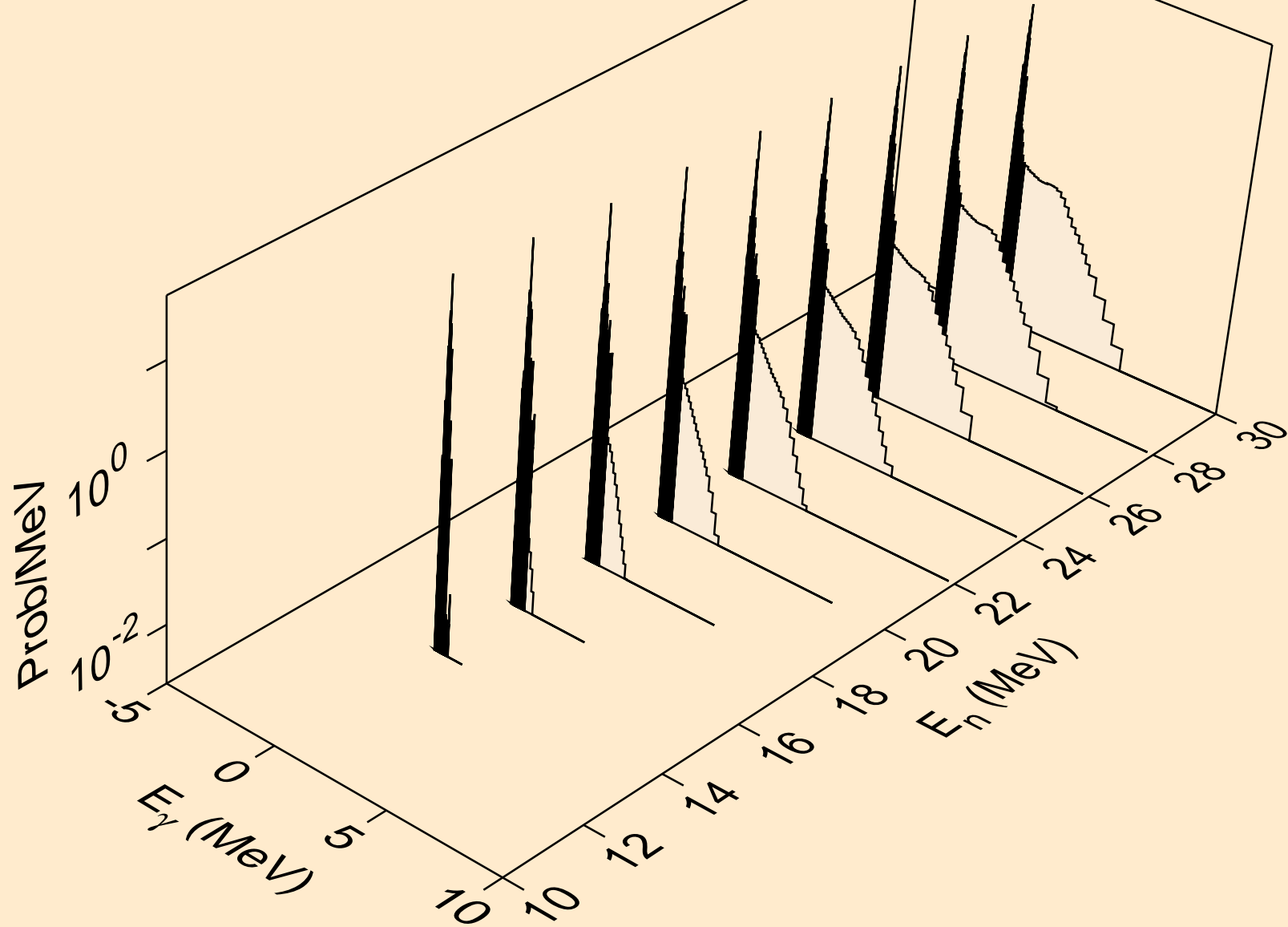

OS170 DEUTERON ACER TENDL-2024 LIBRARY; T=0.K  
Photon emission for (n,n\*)t

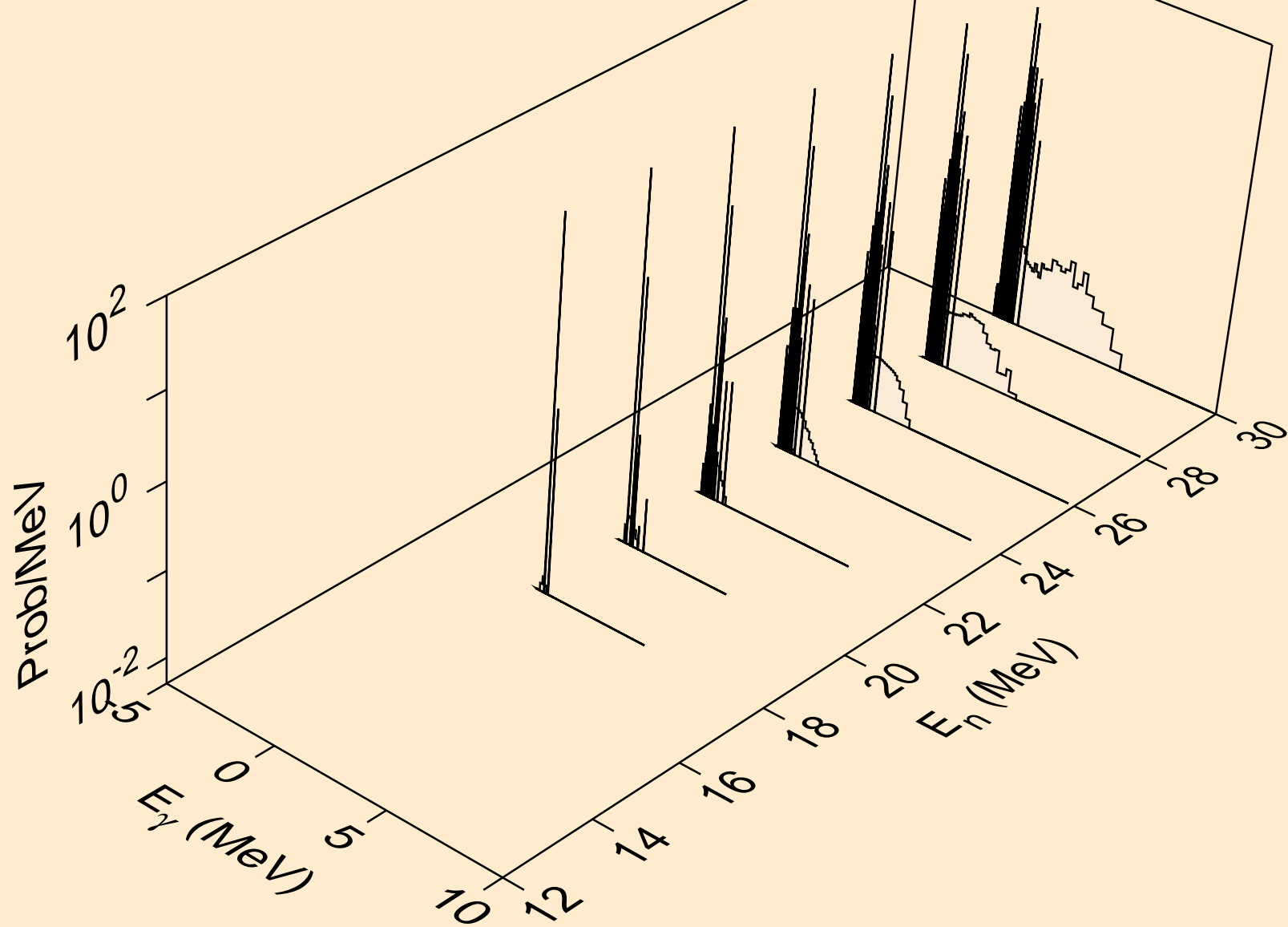

OS170 DEUTERON ACER TENDL-2024 LIBRARY; T=0.K  
Photon emission for (n,n\*)he3

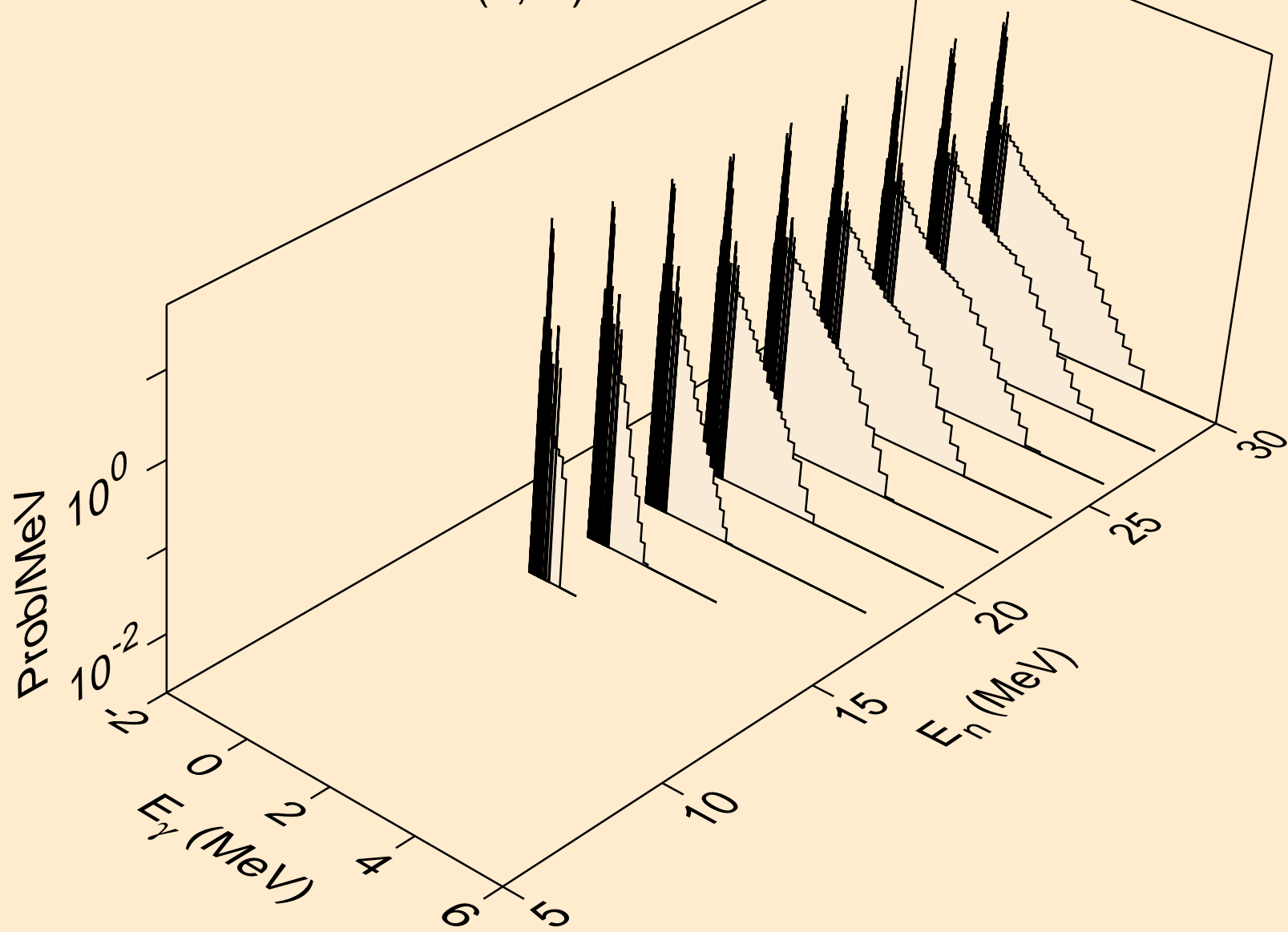

OS170 DEUTERON ACER TENDL-2024 LIBRARY; T=0.K  
Photon emission for (n,2np)

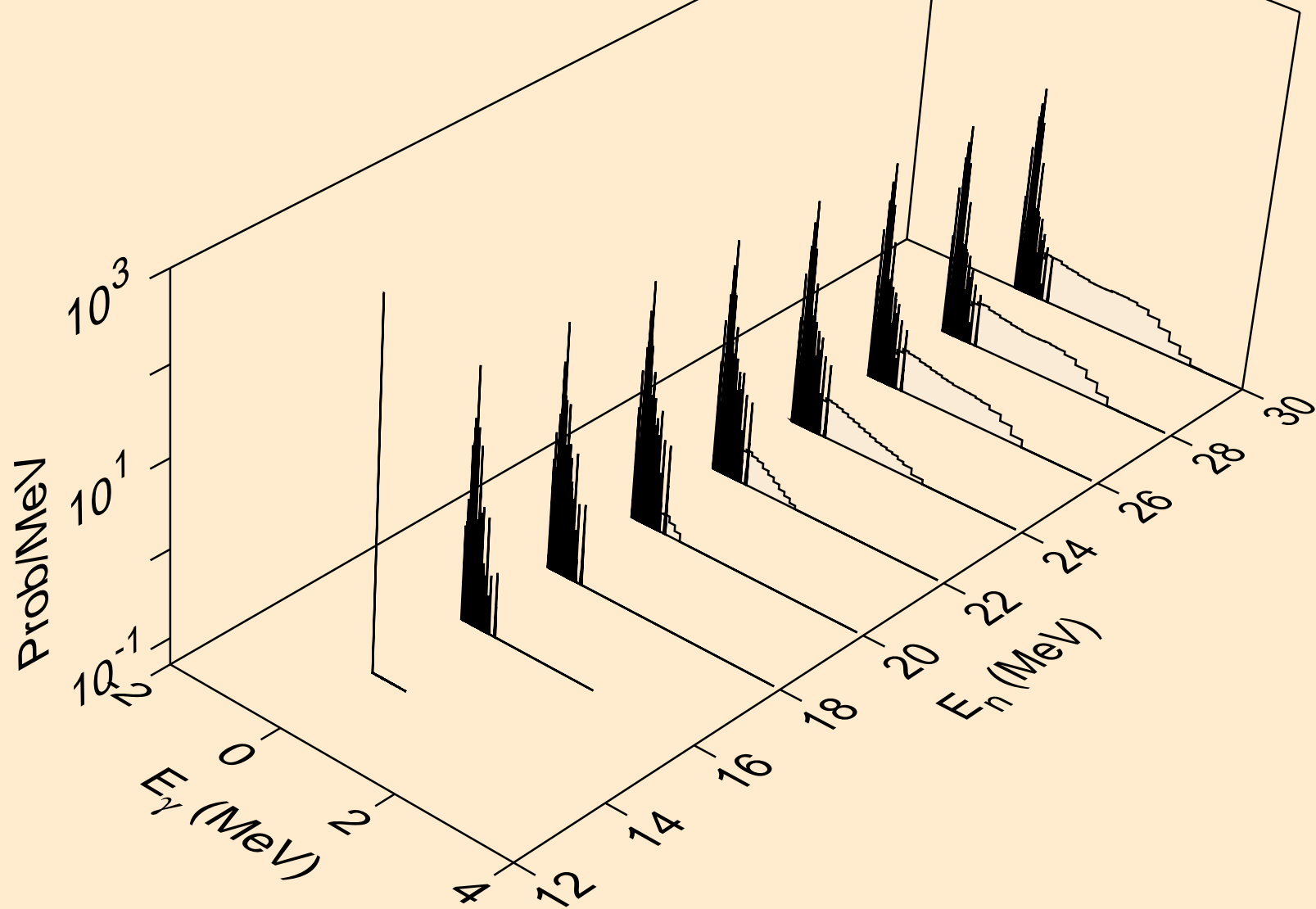

OS170 DEUTERON ACER TENDL-2024 LIBRARY; T=0.K  
Photon emission for (n,3np)

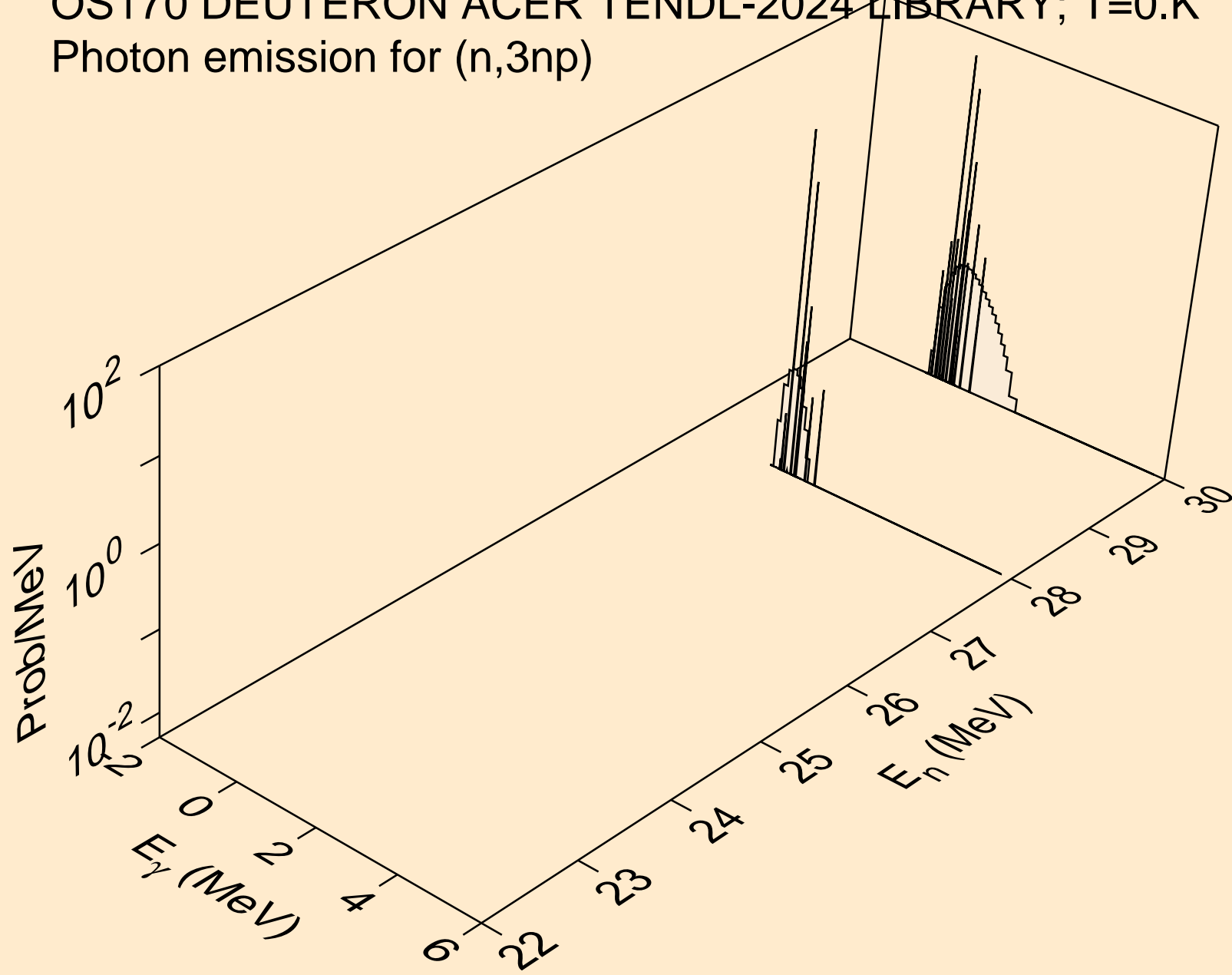

OS170 DEUTERON ACER TENDL-2024 LIBRARY; T=0.K  
Photon emission for (n,n2p)

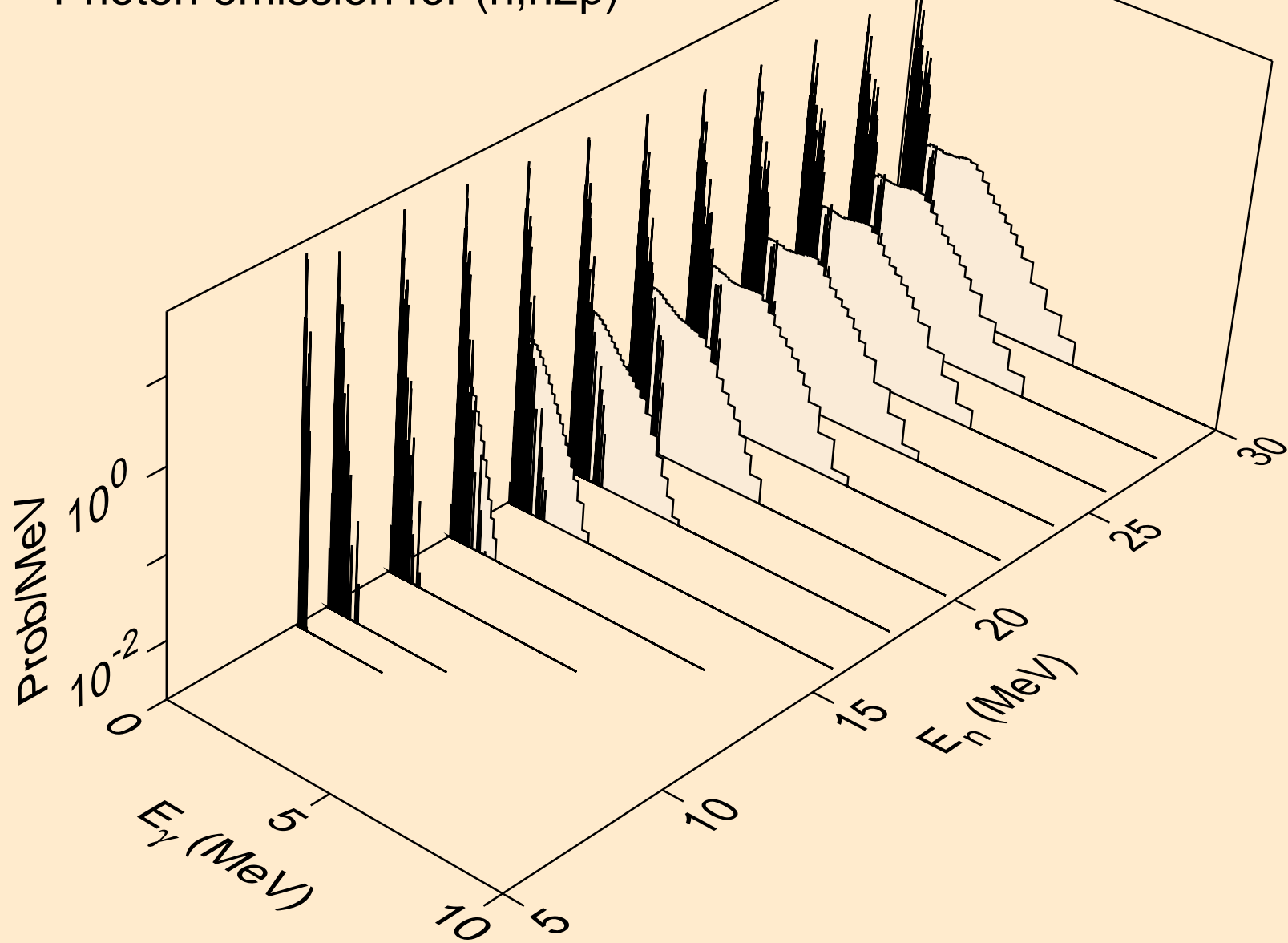

OS170 DEUTERON ACER TENDL-2024 LIBRARY; T=0.K  
Photon emission for (n,npa)

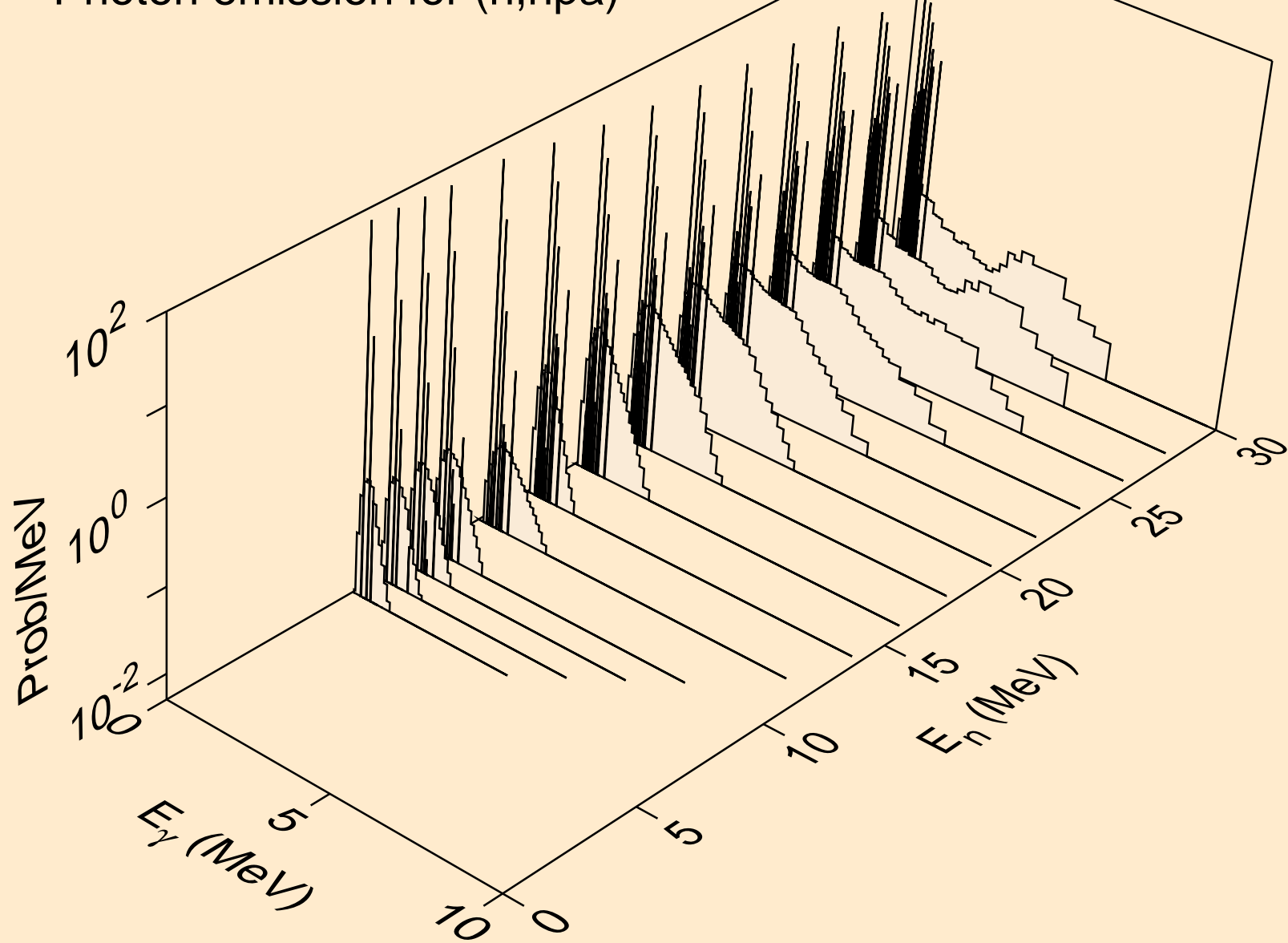

OS170 DEUTERON ACER TENDL-2024 LIBRARY; T=0.K  
Photon emission for (n,gma)

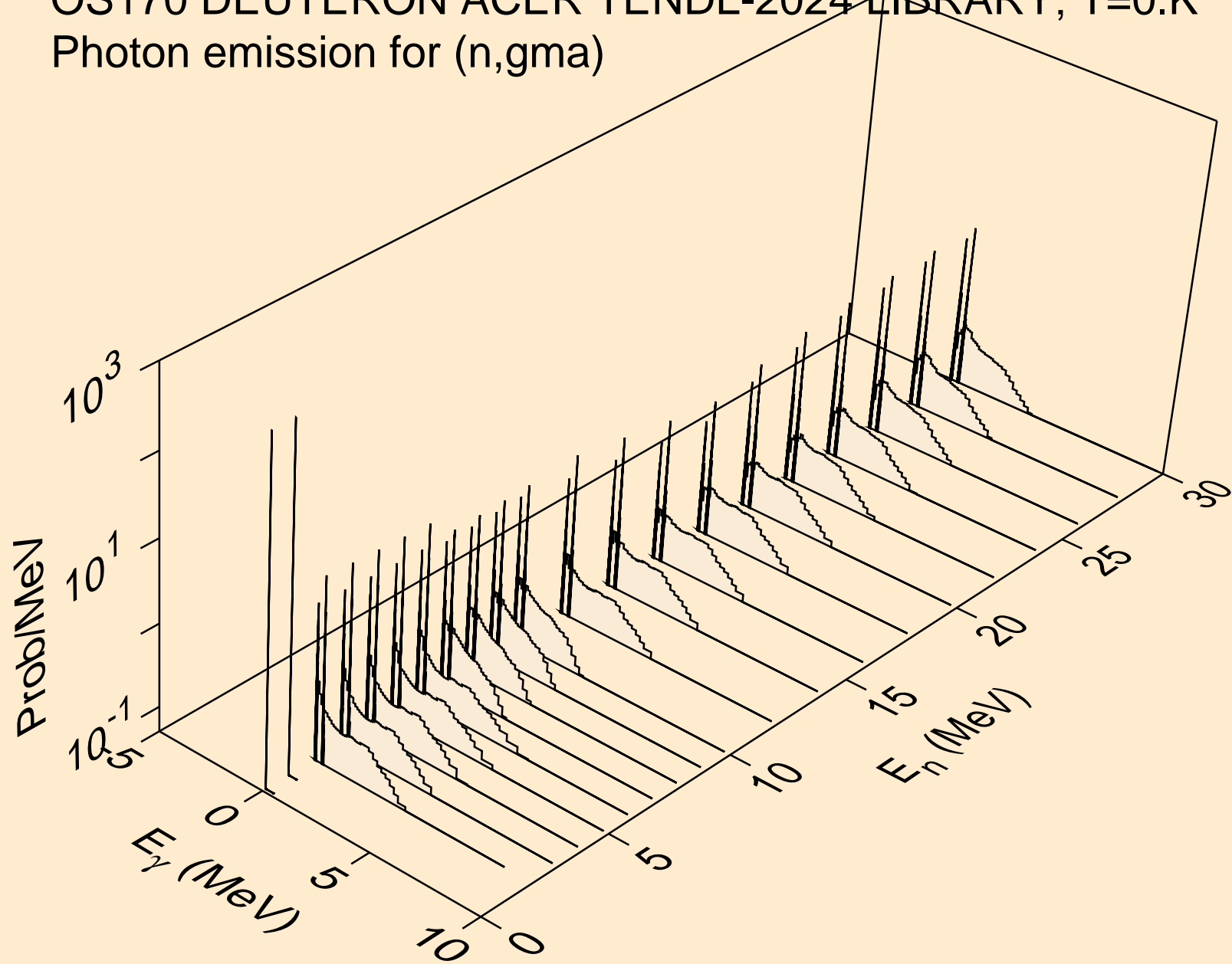

OS170 DEUTERON ACER TENDL-2024 LIBRARY; T=0.K  
Photon emission for (n,p)

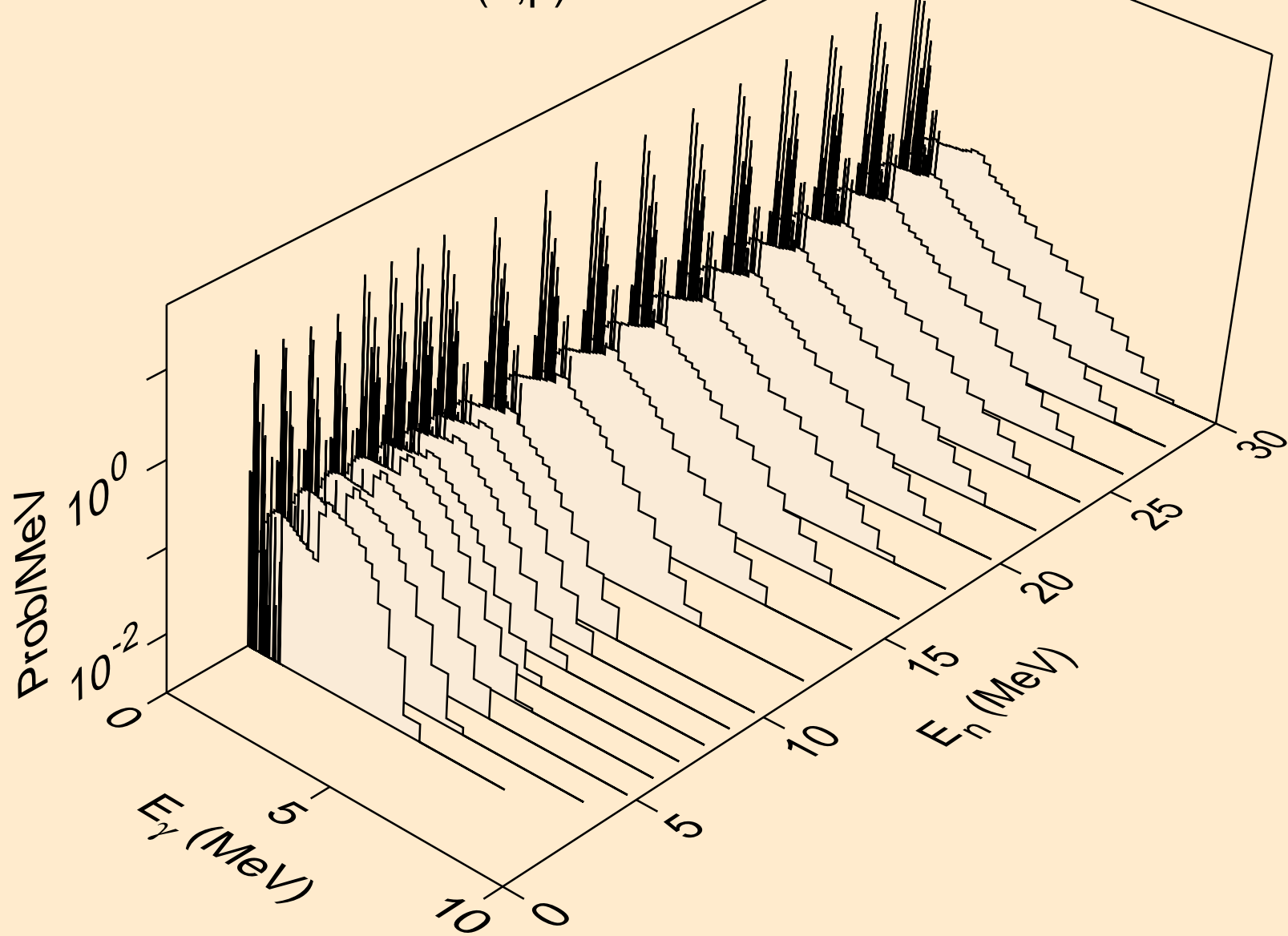

OS170 DEUTERON ACER TENDL-2024 LIBRARY; T=0.K  
Photon emission for inelastic

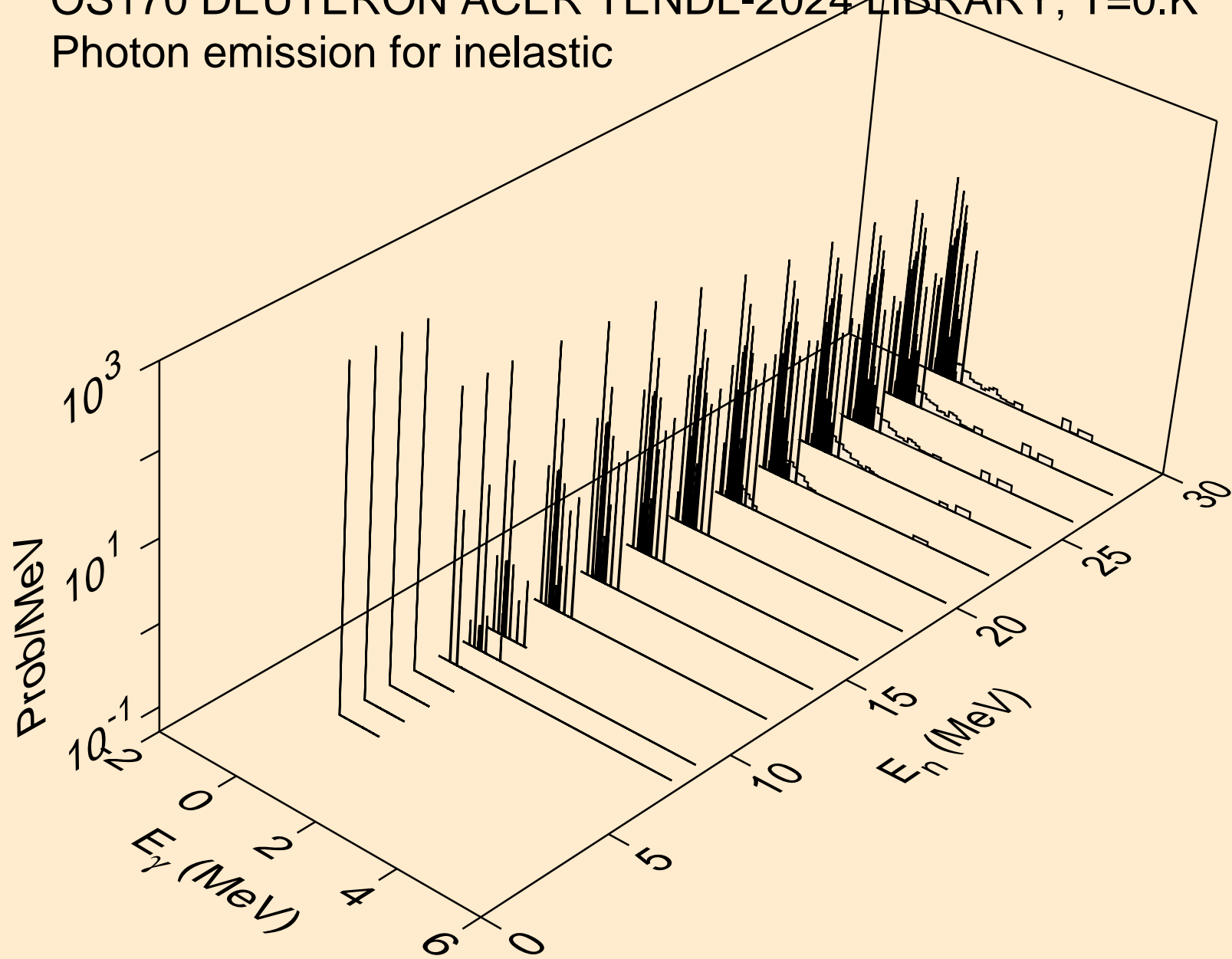

OS170 DEUTERON ACER TENDL-2024 LIBRARY; T=0.K  
Photon emission for (n,t)

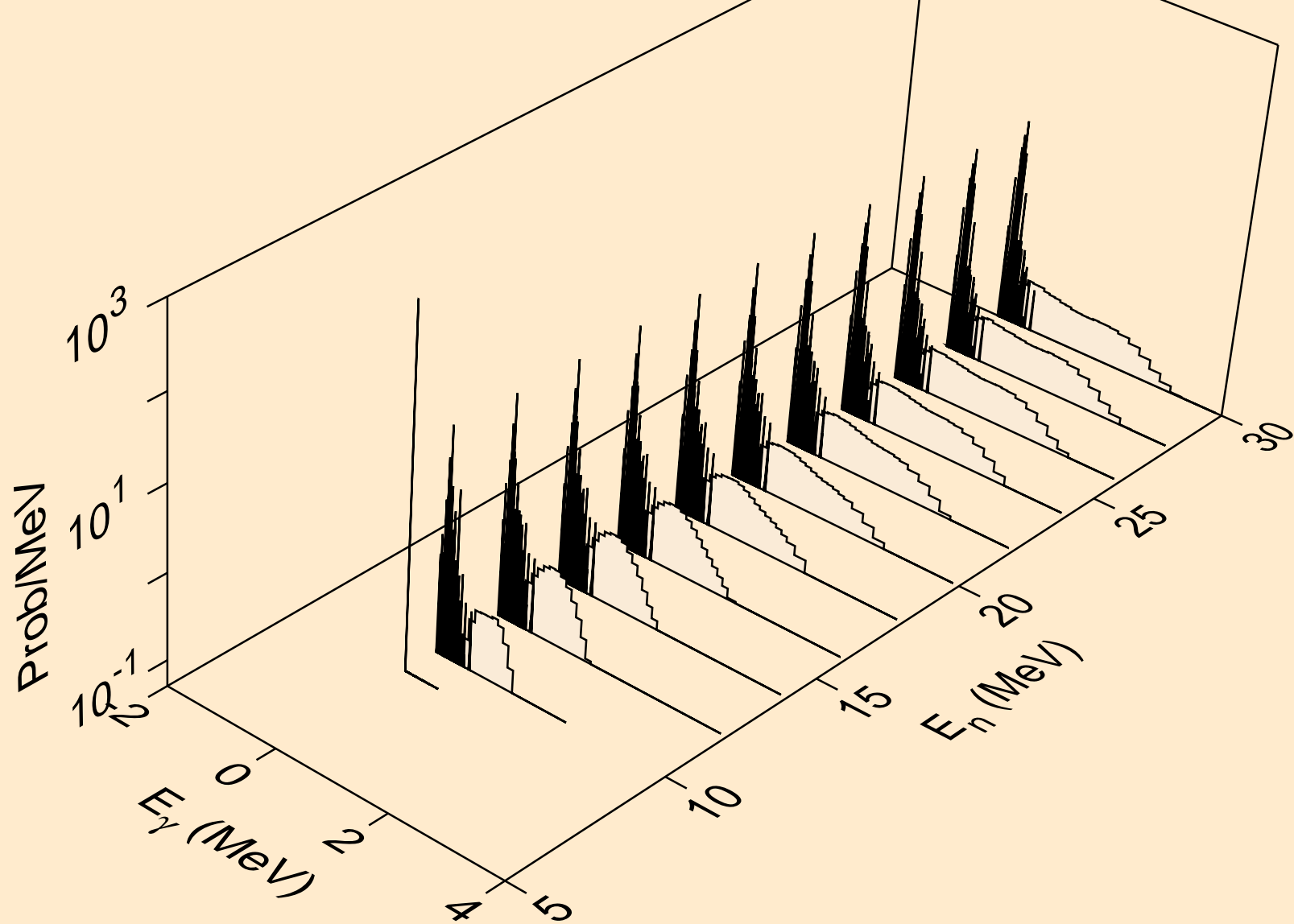

OS170 DEUTERON ACER TENDL-2024 LIBRARY; T=0.K  
Photon emission for (n,he3)

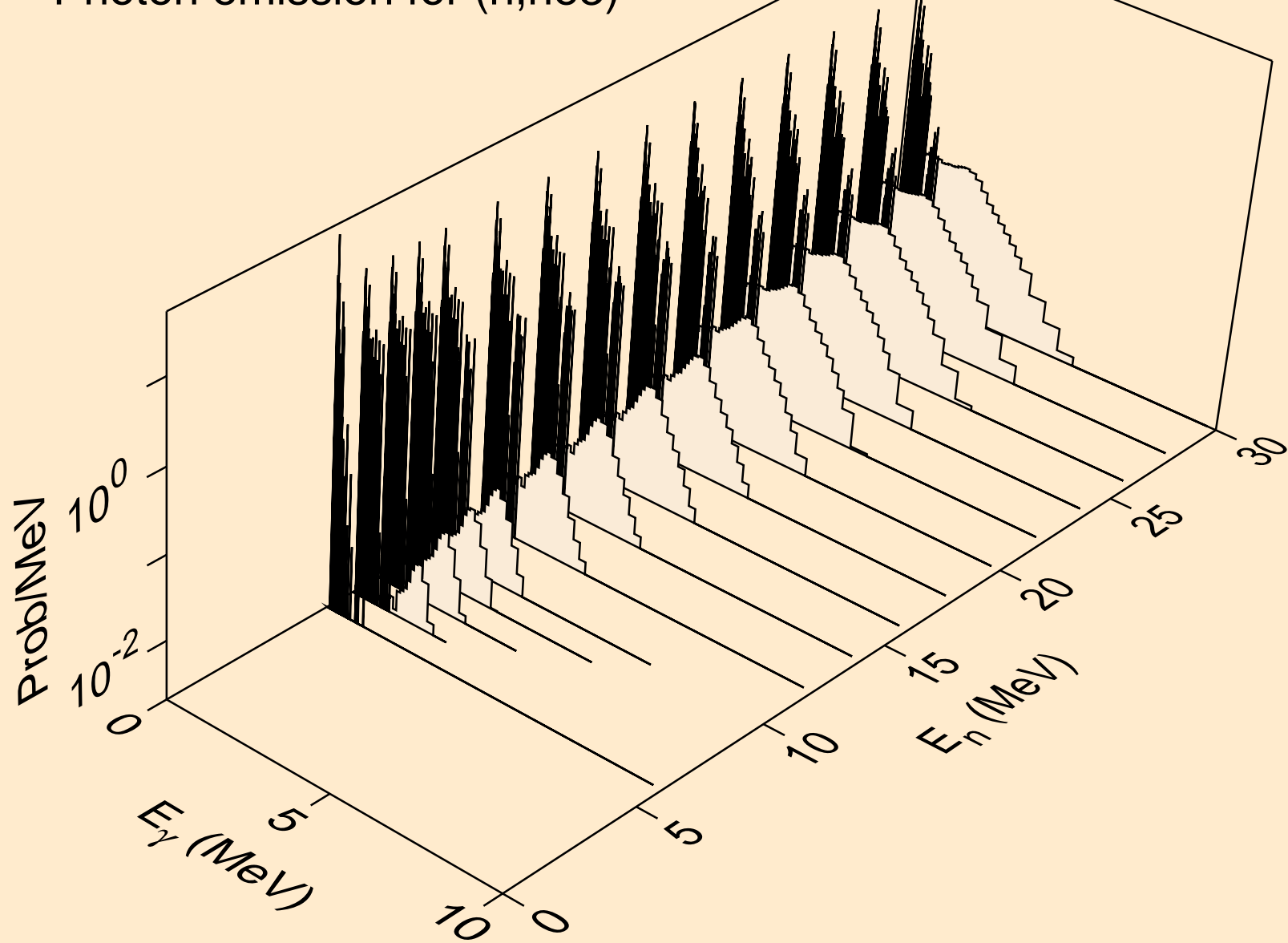

OS170 DEUTERON ACER TENDL-2024 LIBRARY; T=0.K  
Photon emission for (n,a)

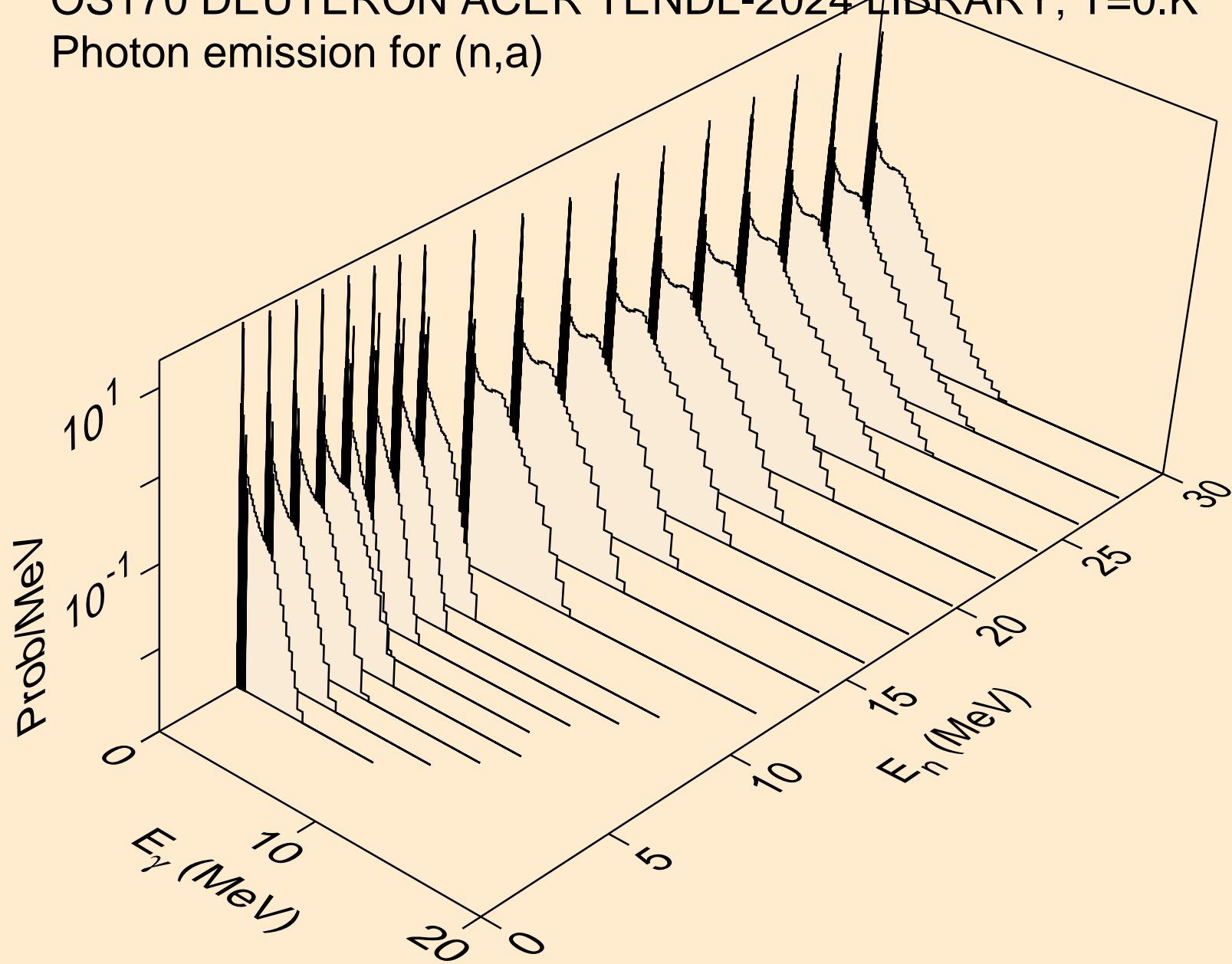

OS170 DEUTERON ACER TENDL-2024 LIBRARY; T=0.K  
Photon emission for (n,2a)

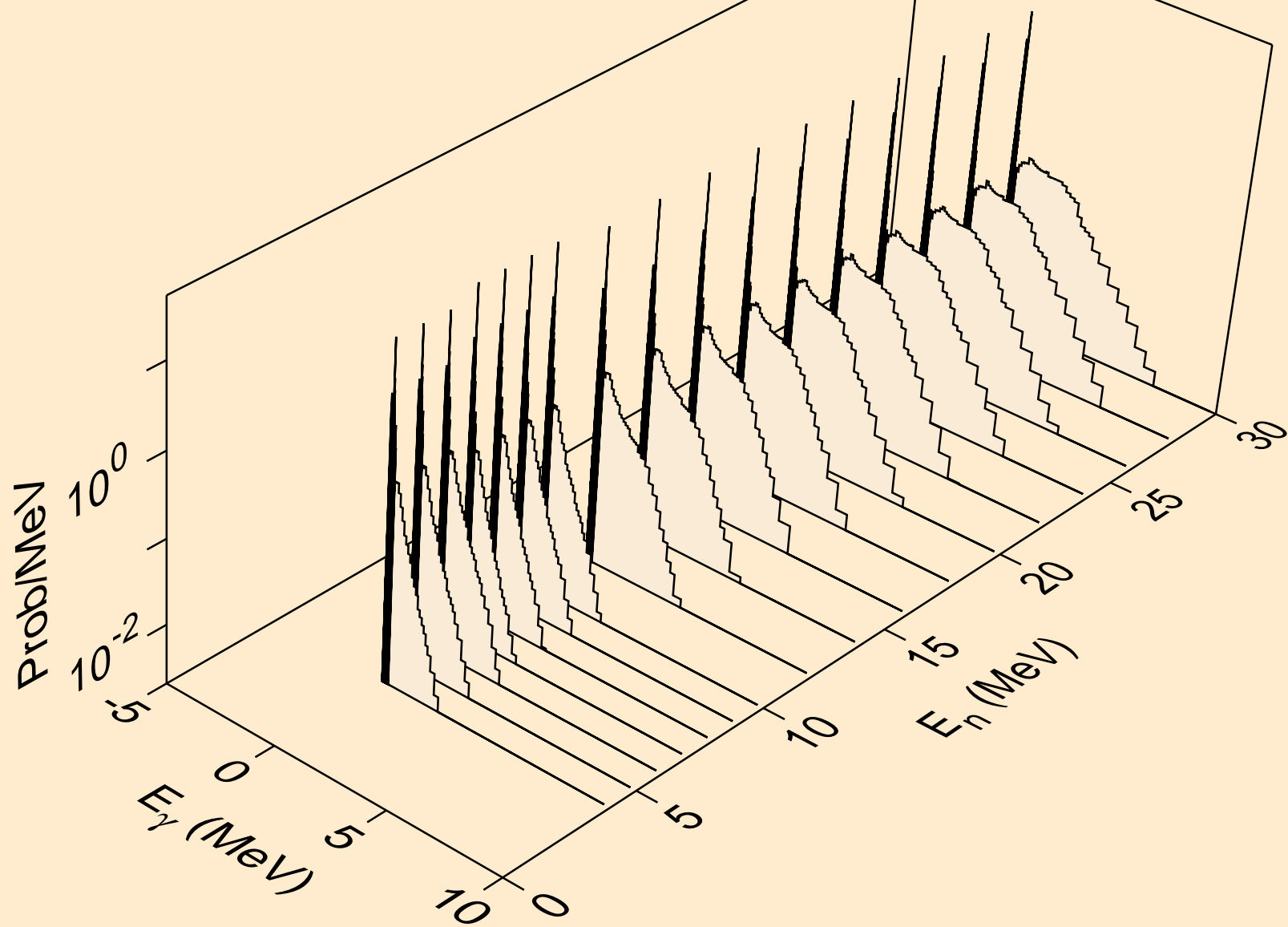

OS170 DEUTERON ACER TENDL-2024 LIBRARY; T=0.K  
Photon emission for (n,3a)

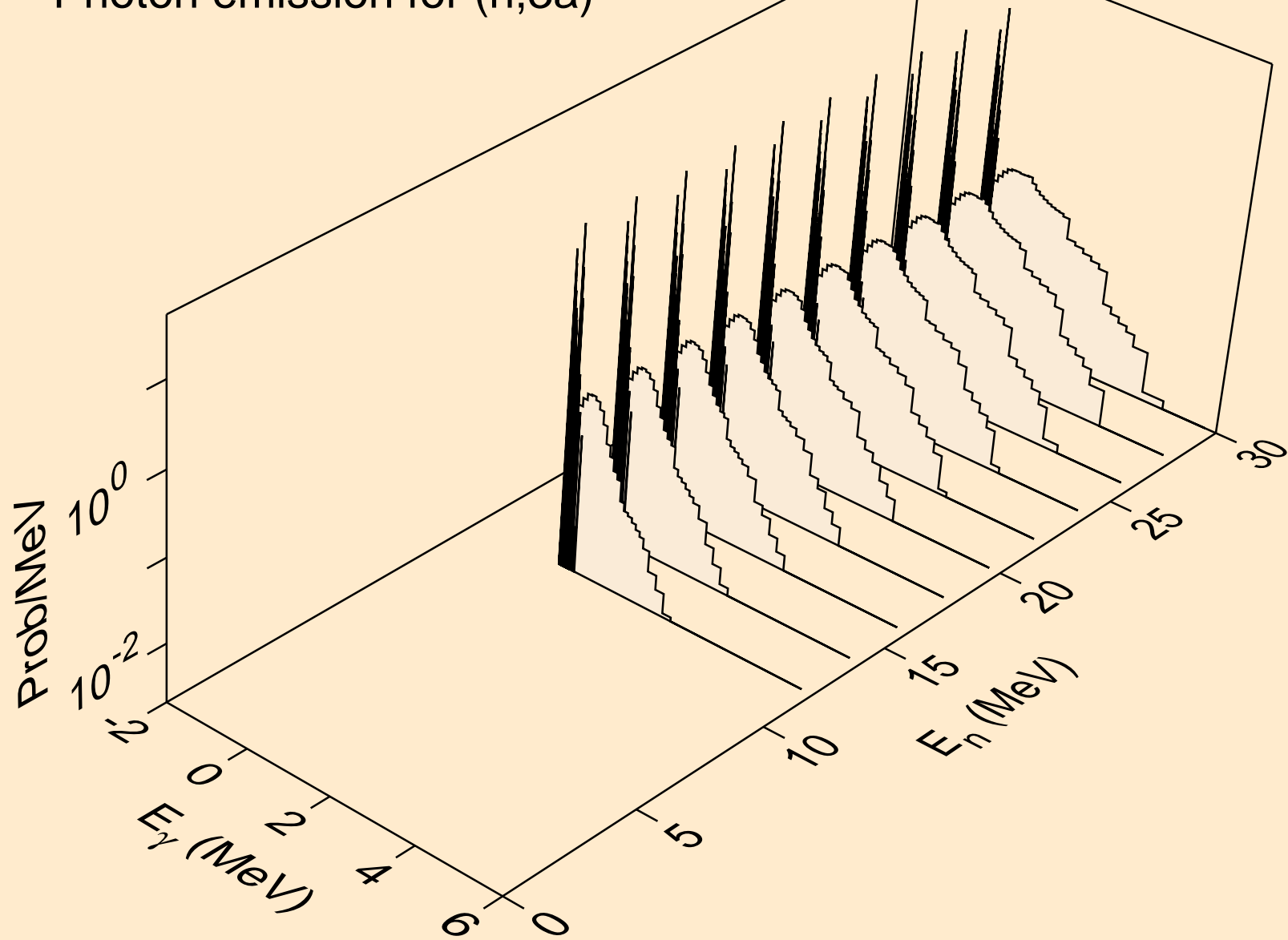

OS170 DEUTERON ACER TENDL-2024 LIBRARY; T=0.K  
Photon emission for (n,2p)

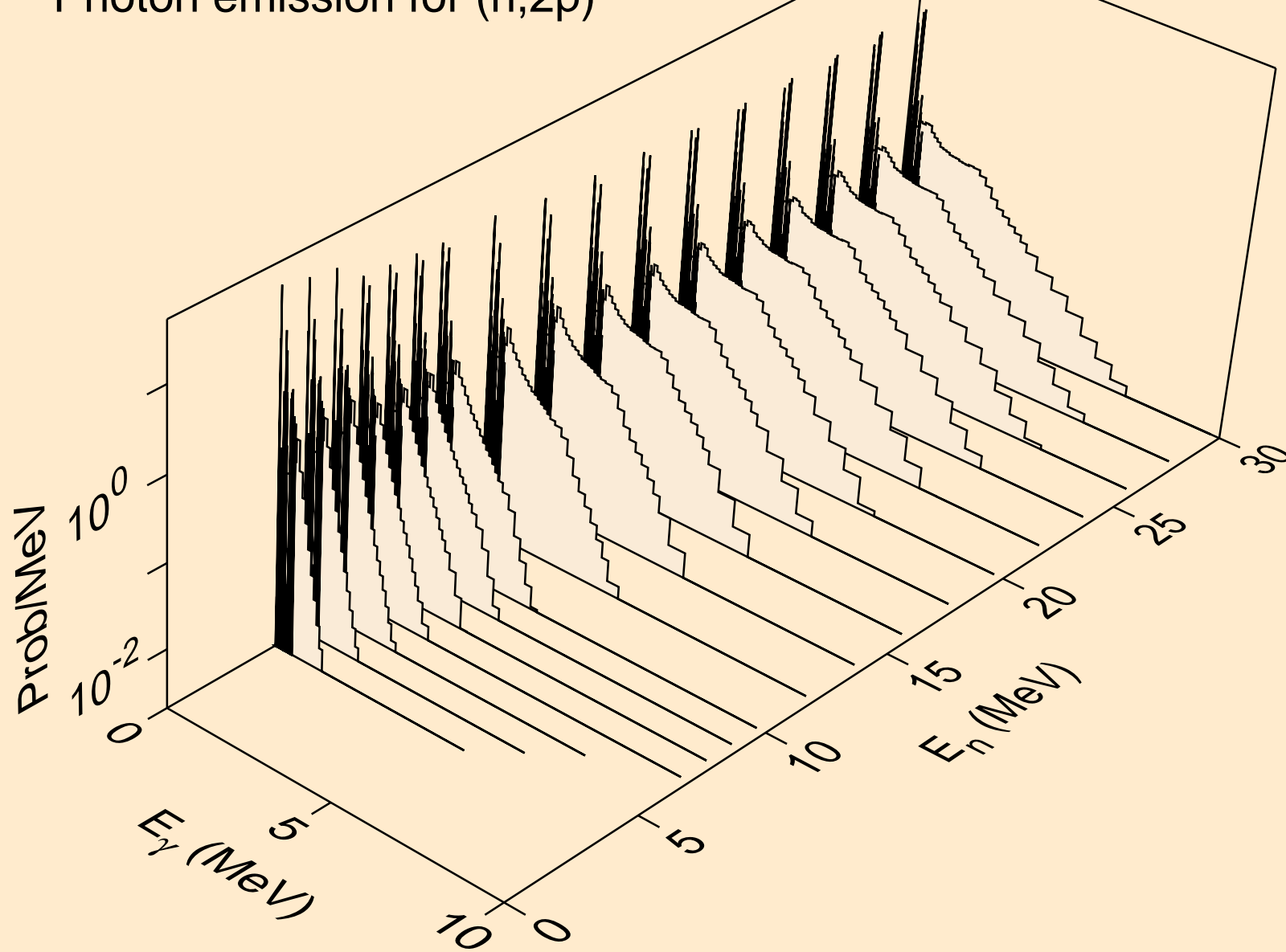

OS170 DEUTERON ACER TENDL-2024 LIBRARY; T=0.K  
Photon emission for (n,p)

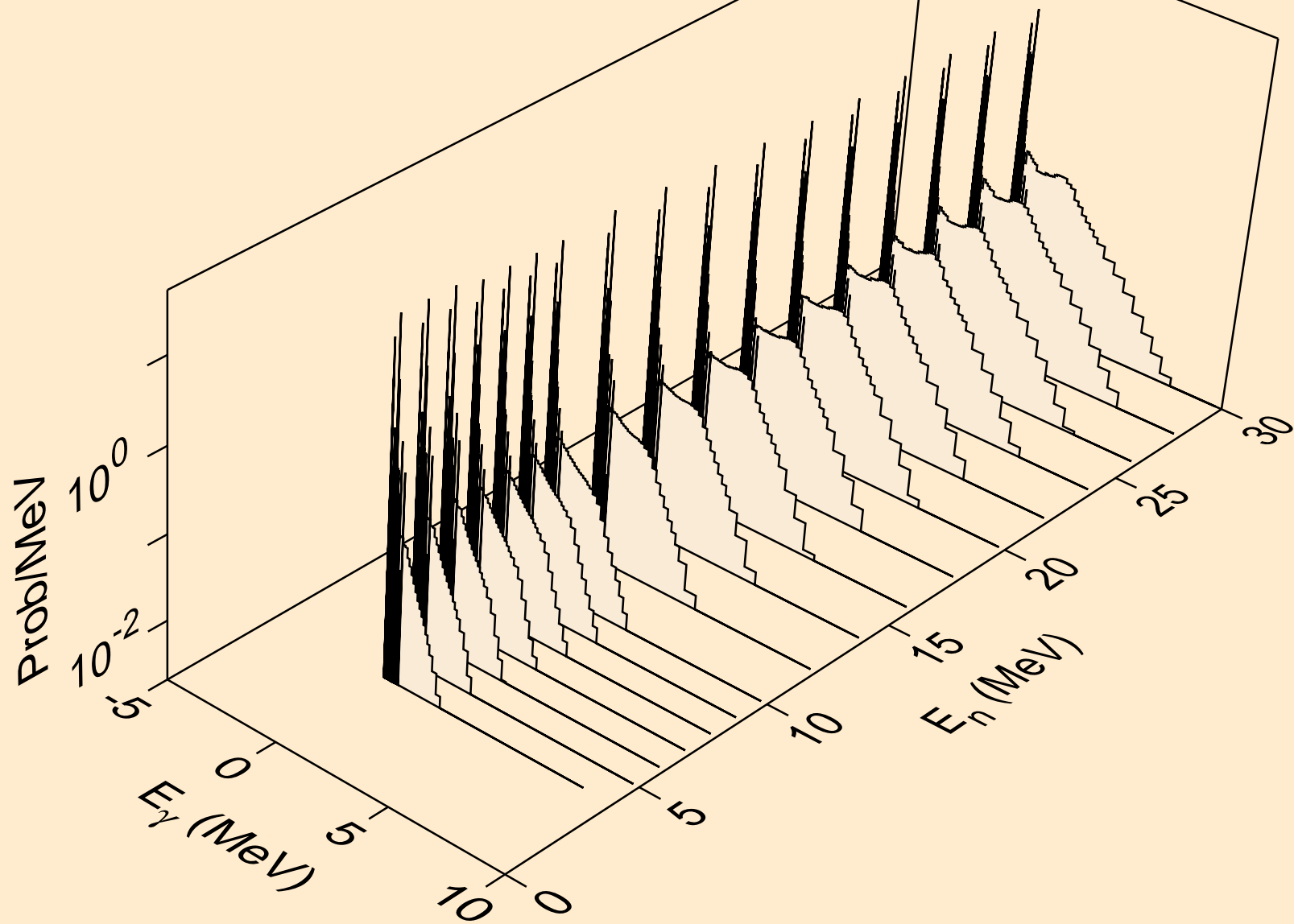

OS170 DEUTERON ACER TENDL-2024 LIBRARY; T=0.K  
Photon emission for (n,d2a)

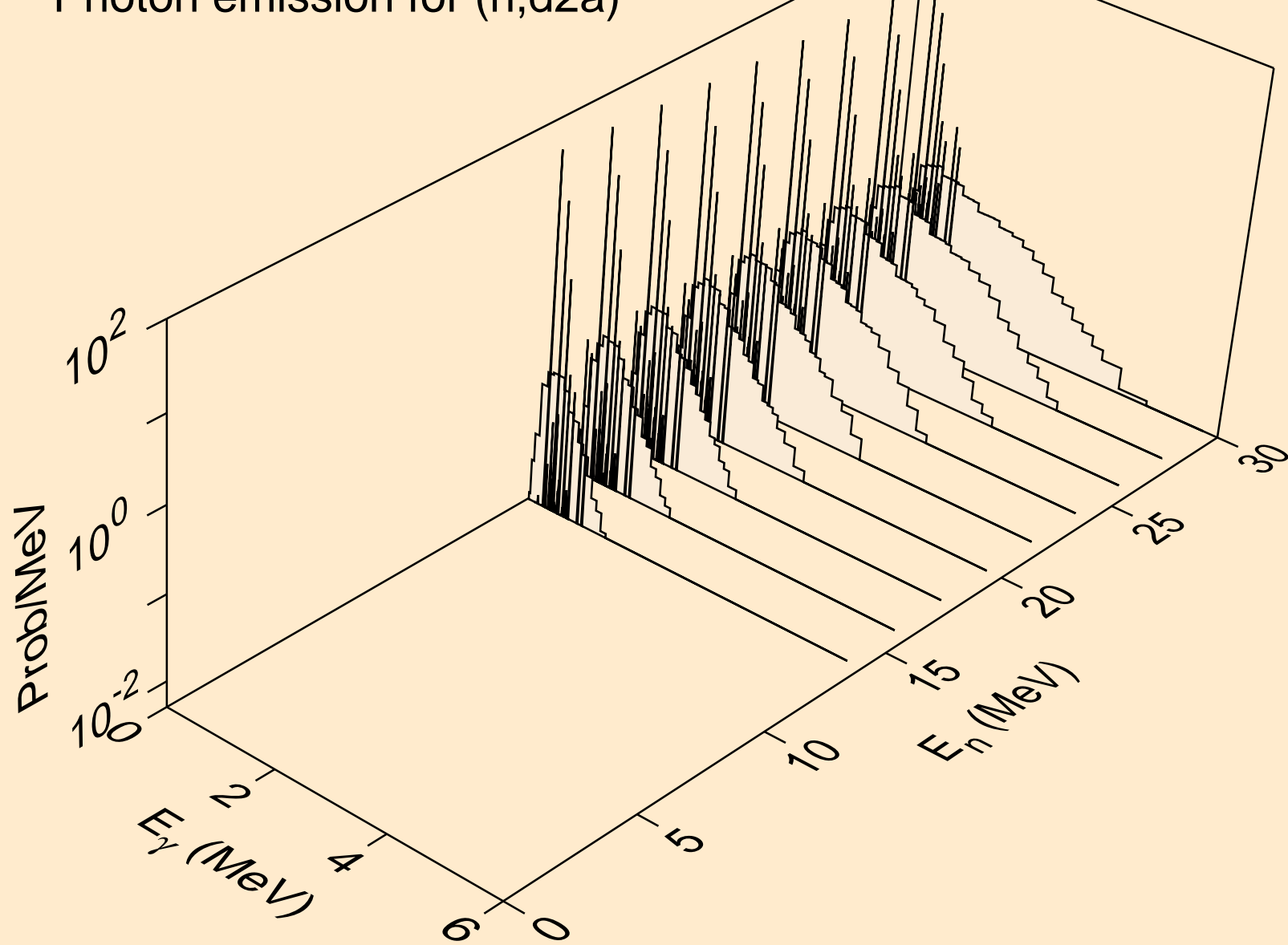

OS170 DEUTERON ACER TENDL-2024 LIBRARY; T=0.K  
Photon emission for (n,pd)

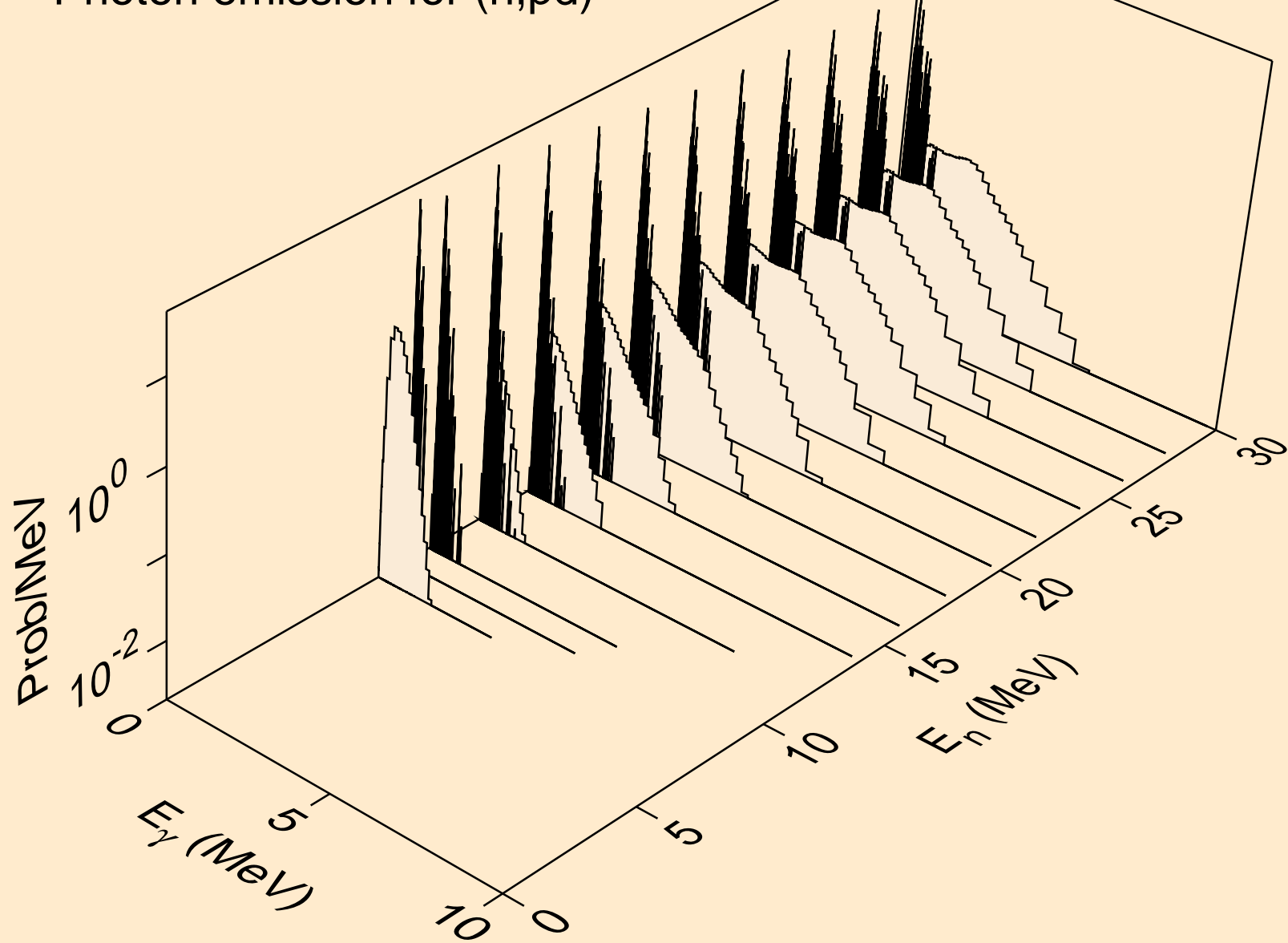

OS170 DEUTERON ACER TENDL-2024 LIBRARY; T=0.K  
Photon emission for (n,pt)

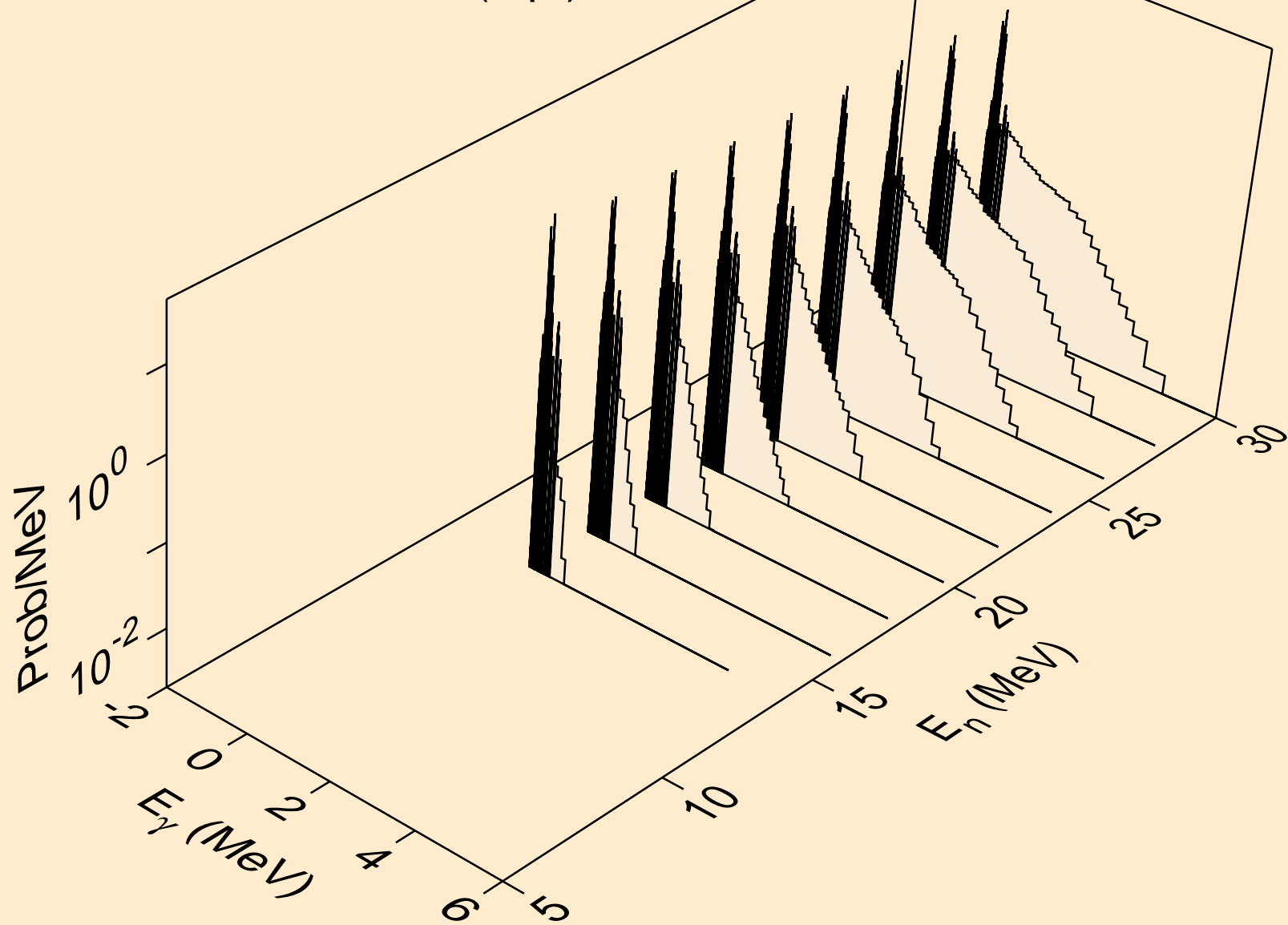

OS170 DEUTERON ACER TENDL-2024 LIBRARY; T=0.K  
Photon emission for (n,da)

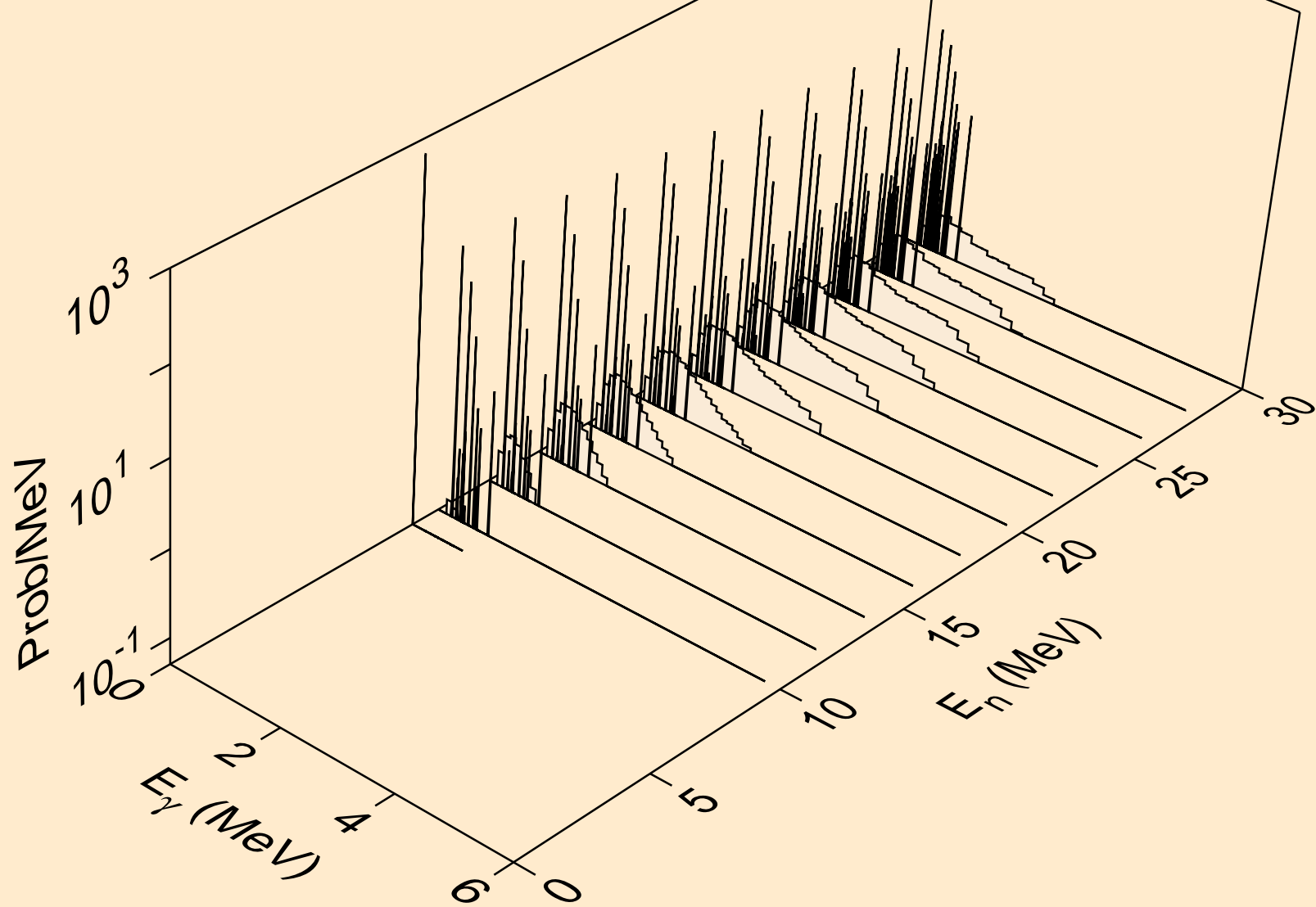

# OS170 DEUTERON ACER TENDL-2024 LIBRARY; T=0.K

## Particle heating contributions

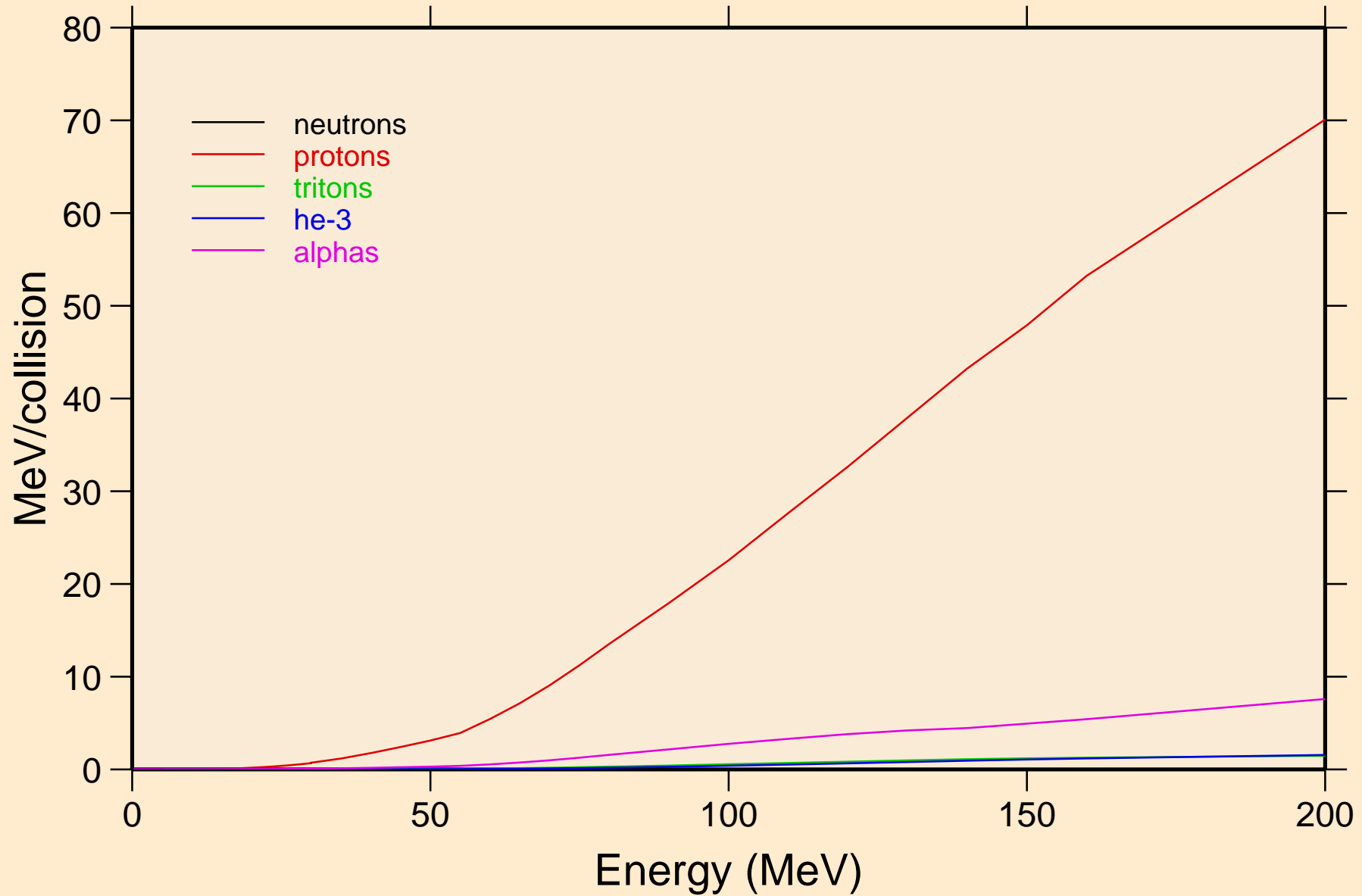

OS170 DEUTERON ACER TENDL-2024 LIBRARY; T=0.K  
Recoil Heating

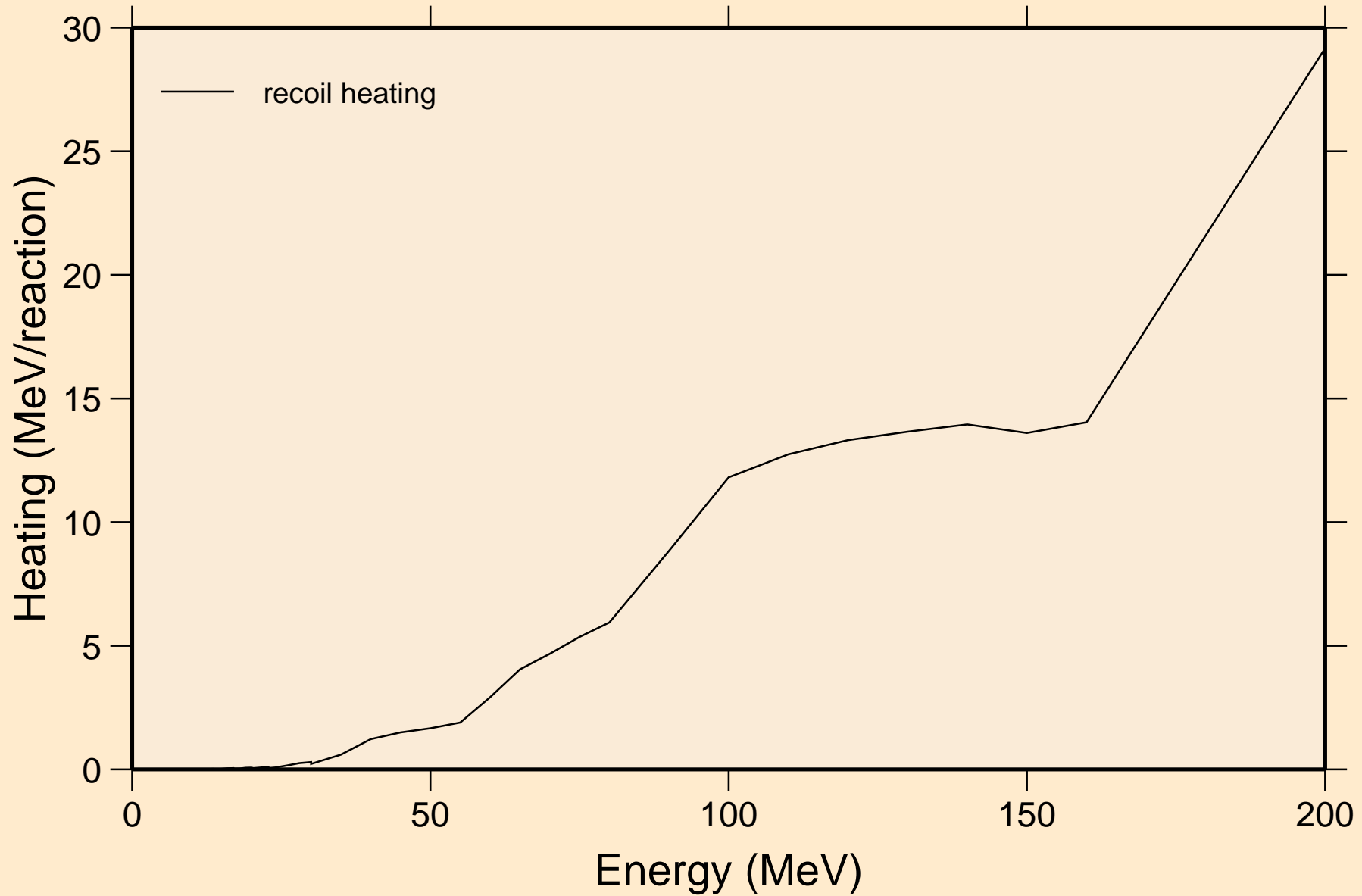

# OS170 DEUTERON ACER TENDL-2024 LIBRARY; T=0.K

## Particle production cross sections

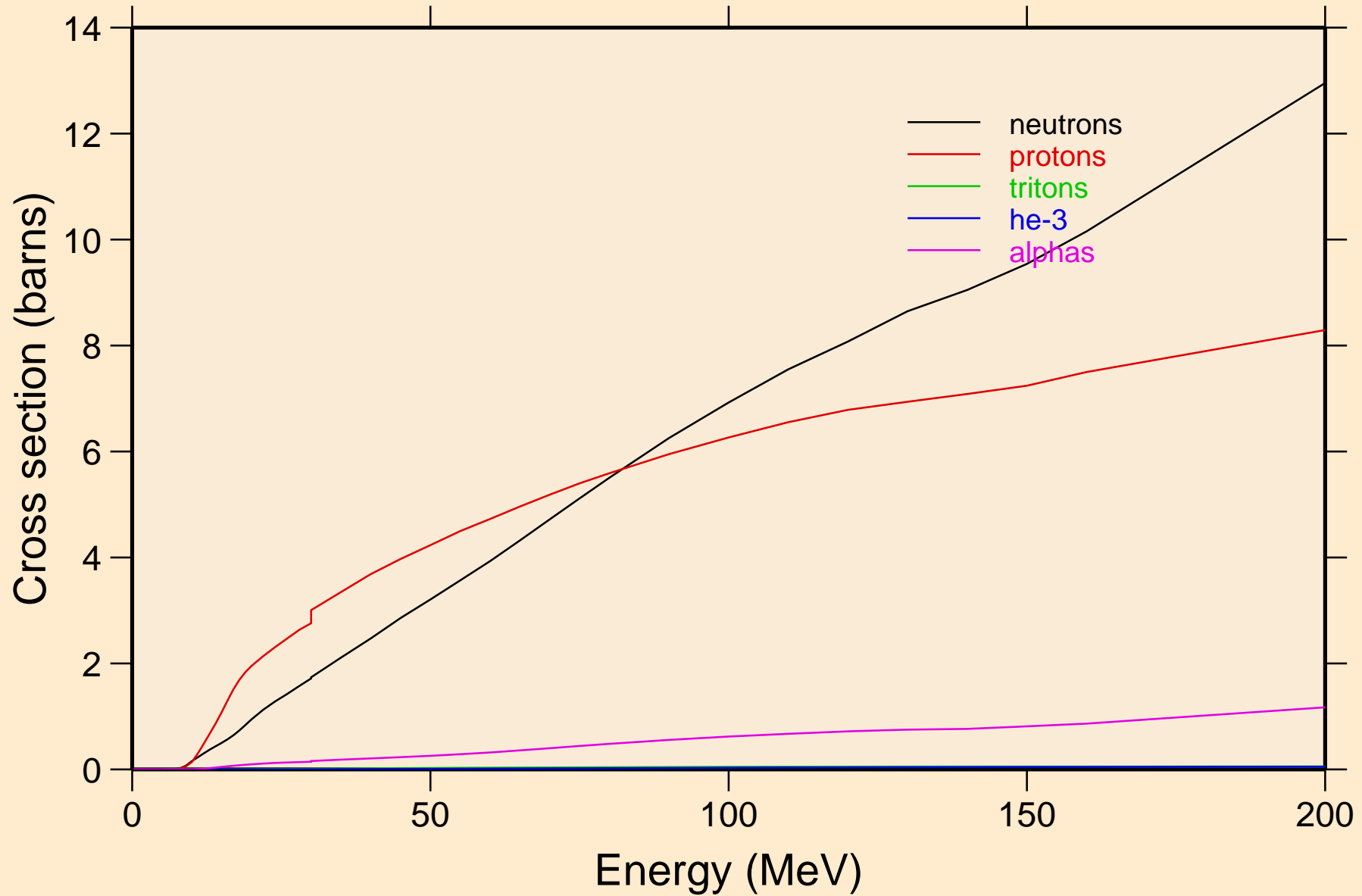

OS170 DEUTERON ACER TENDL-2024 LIBRARY; T=0.K  
neutrons from (d,n)

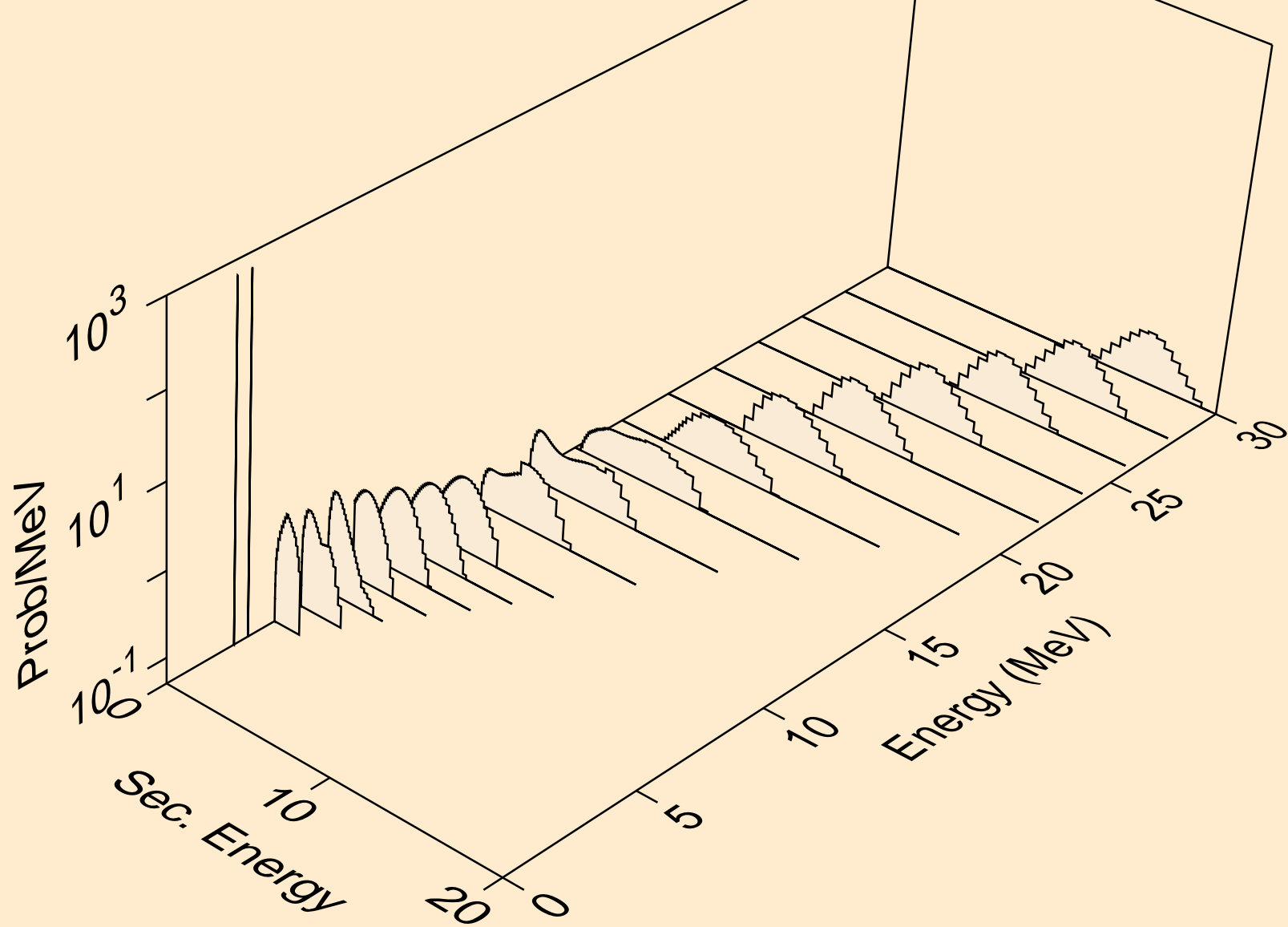

OS170 DEUTERON ACER TENDL-2024 LIBRARY; T=0.K  
neutrons from (d,x)

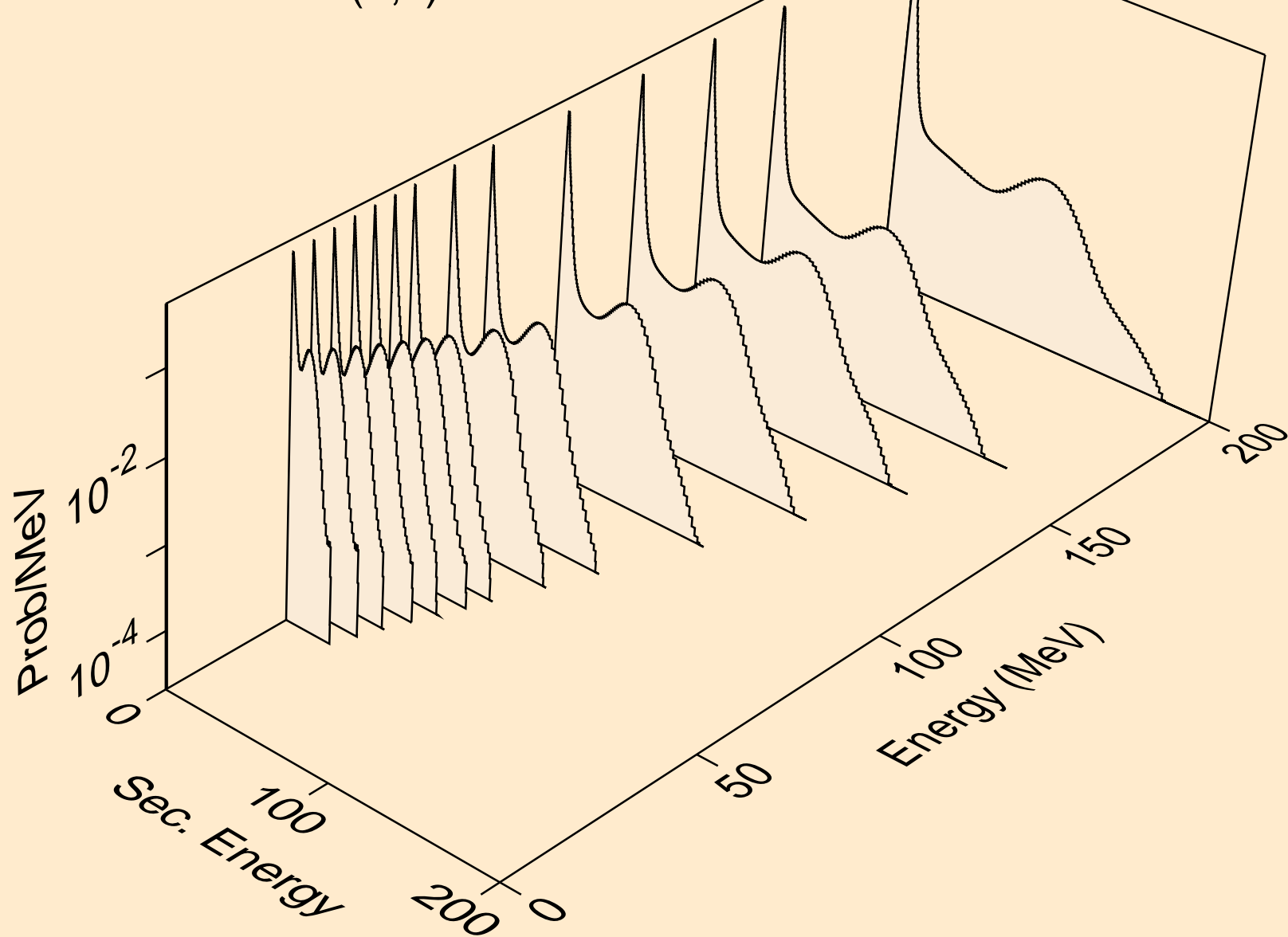

OS170 DEUTERON ACER TENDL-2024 LIBRARY; T=0.K  
neutrons from (d,2nd)

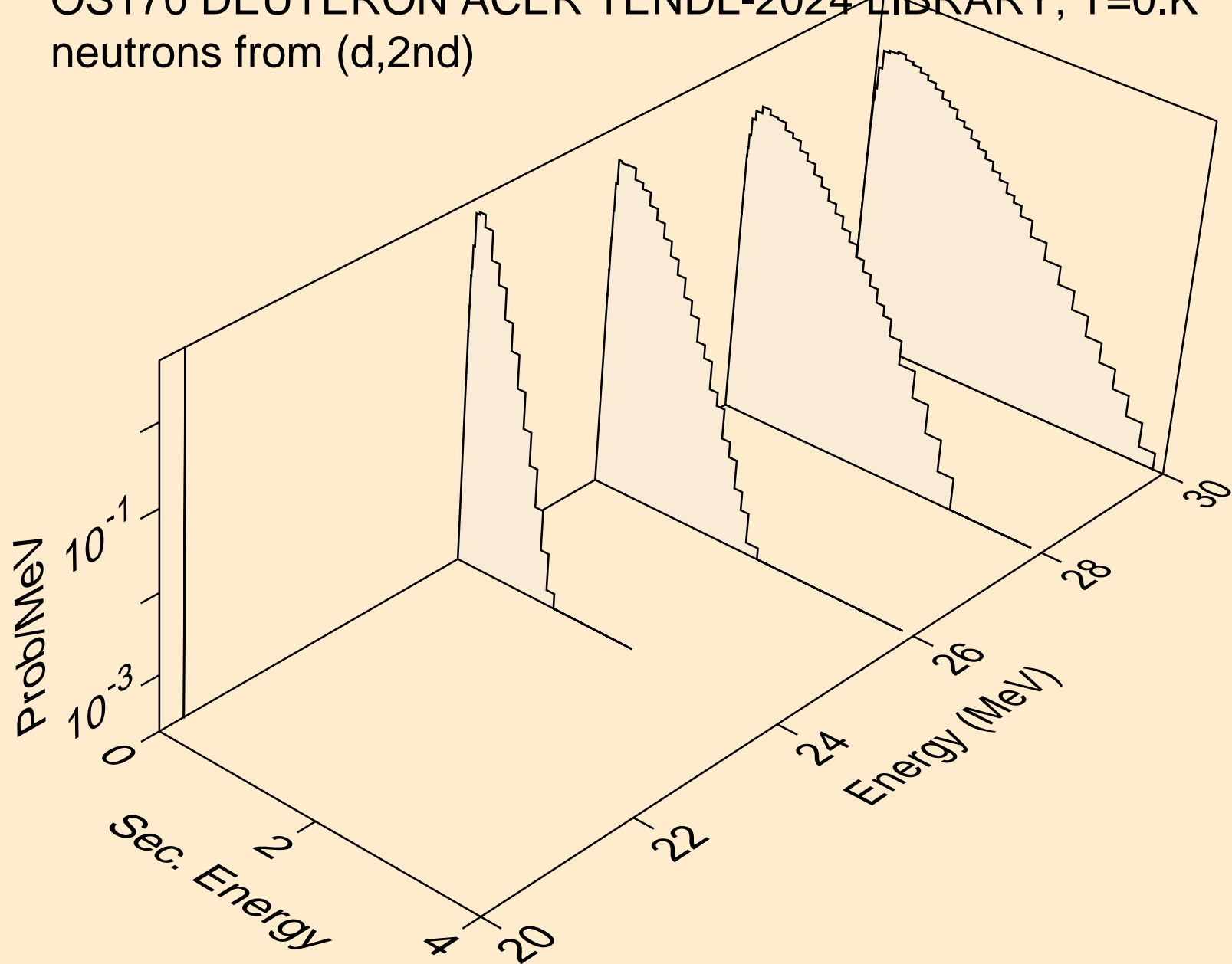

OS170 DEUTERON ACER TENDL-2024 LIBRARY; T=0.K  
neutrons from (d,2n)

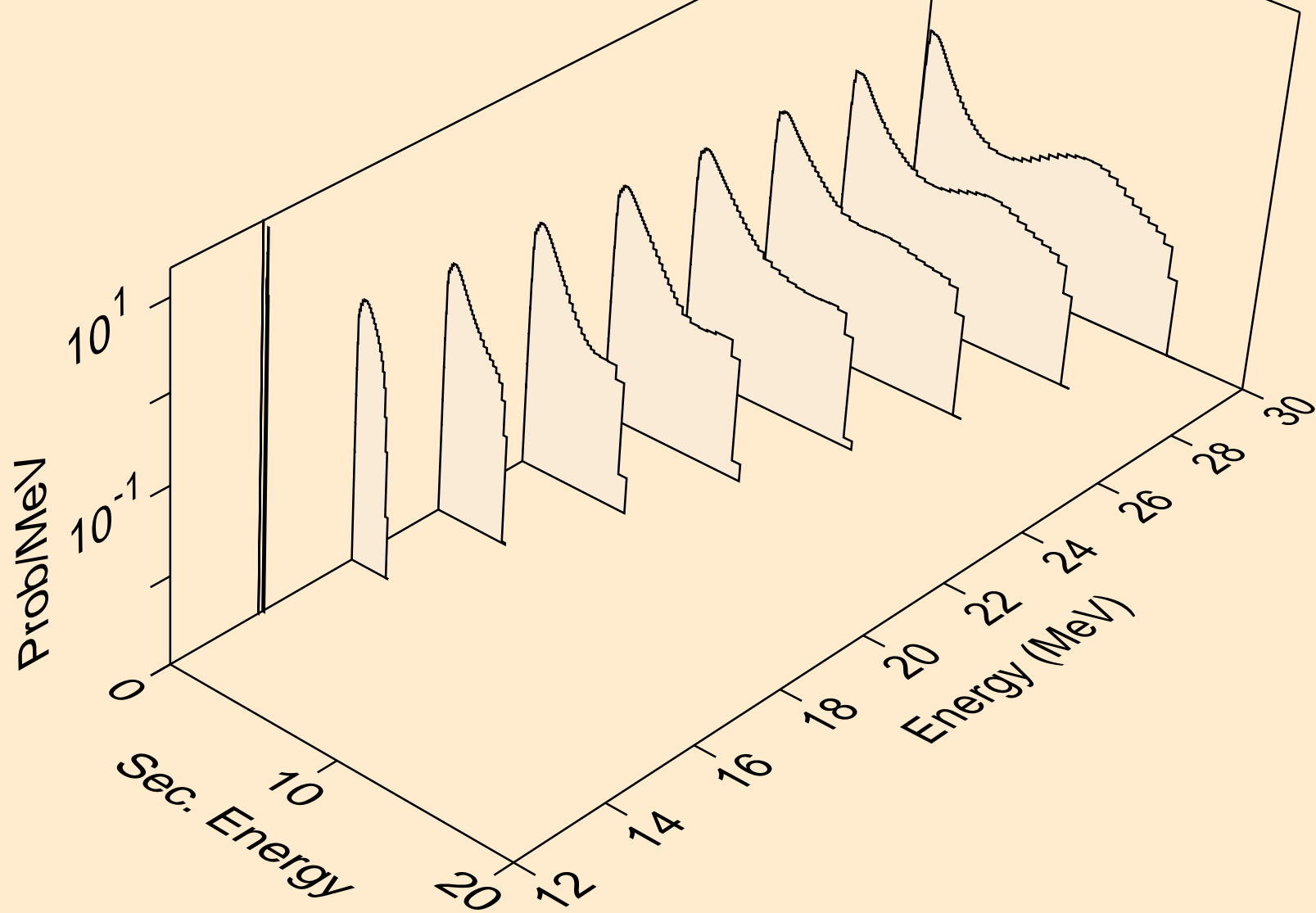

OS170 DEUTERON ACER TENDL-2024 LIBRARY; T=0.K  
neutrons from (d,3n)

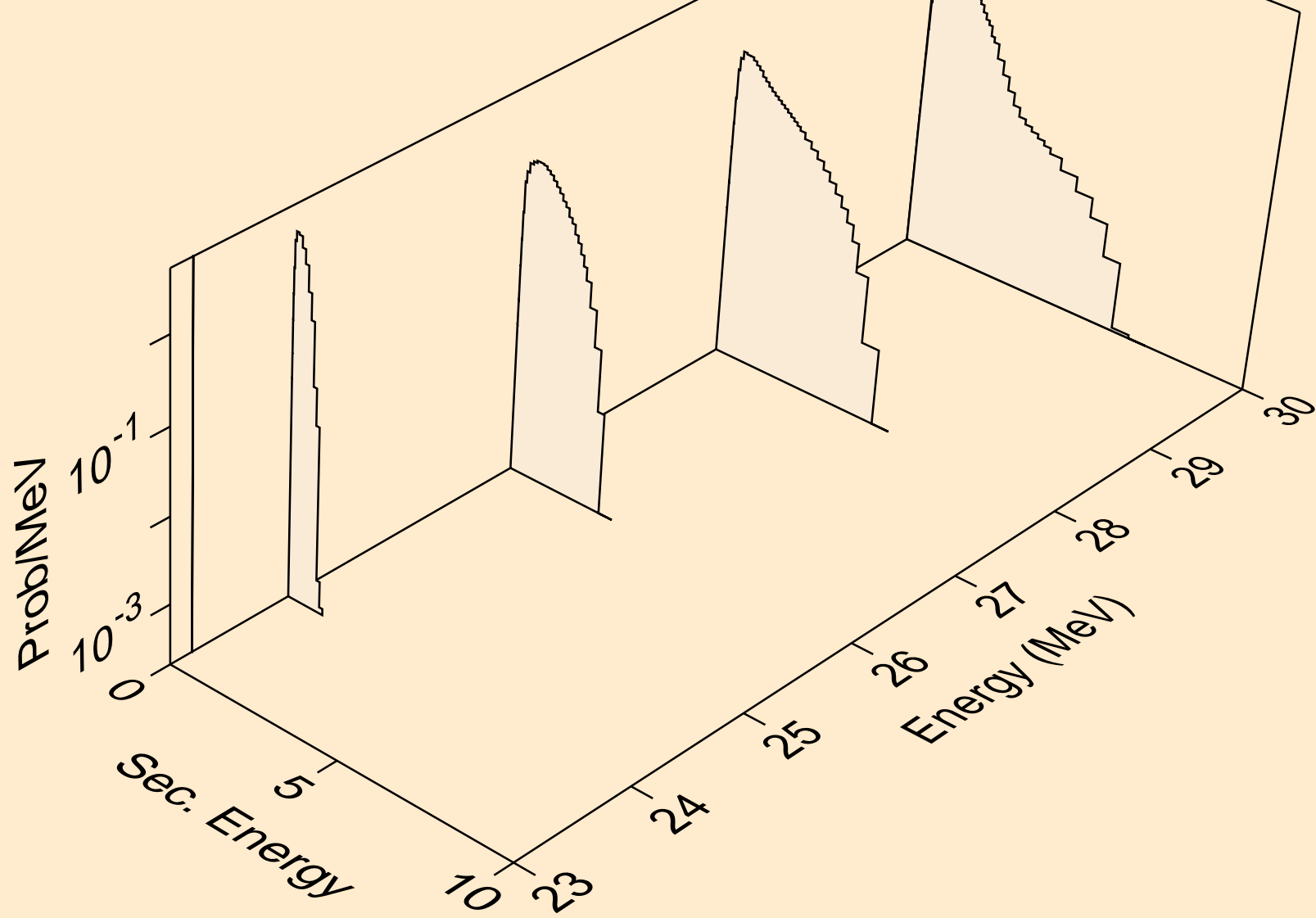

OS170 DEUTERON ACER TENDL-2024 LIBRARY; T=0.K  
neutrons from (d,n\*)a

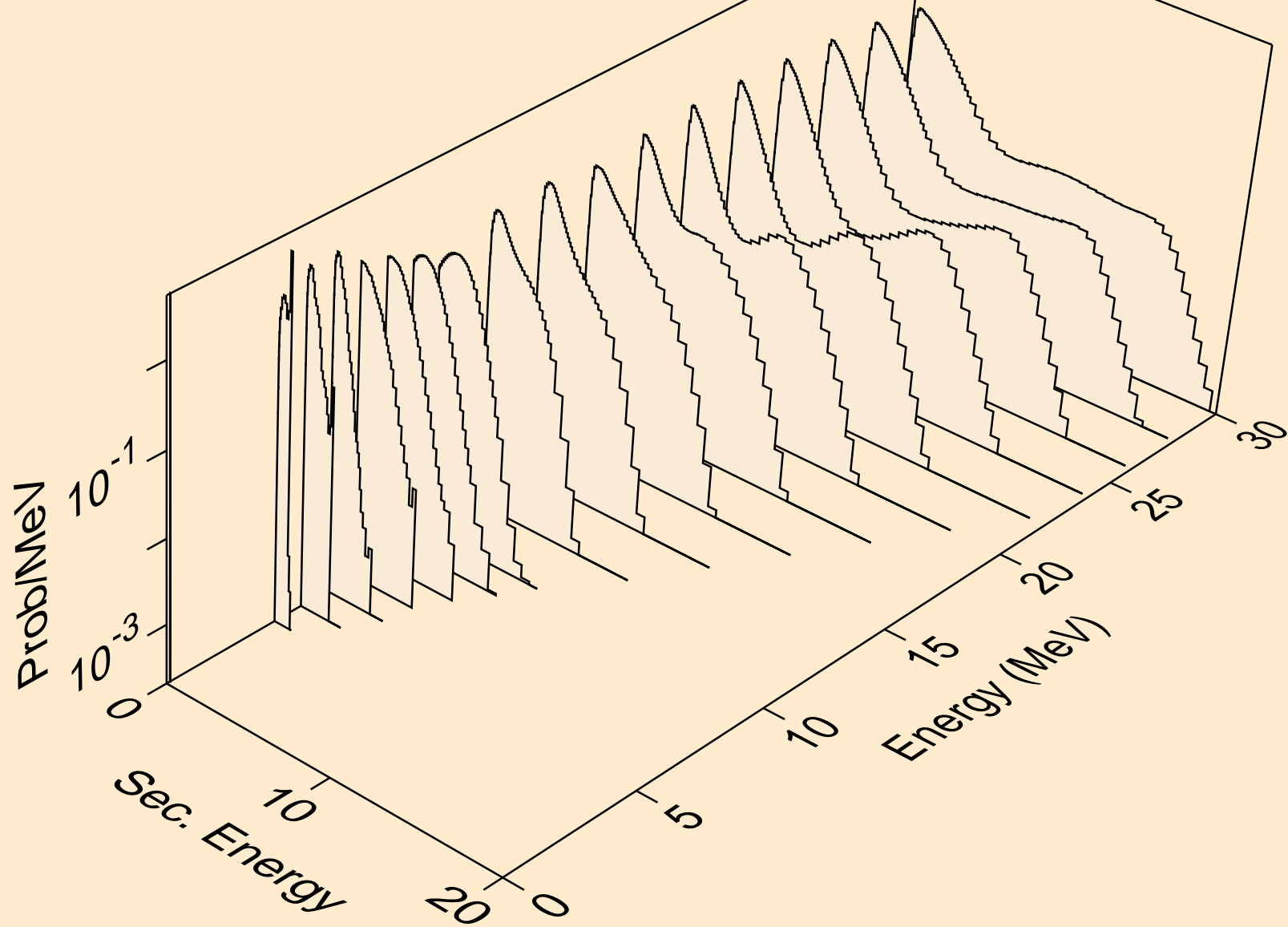

OS170 DEUTERON ACER TENDL-2024 LIBRARY; T=0.K  
neutrons from (d,n\*)3a

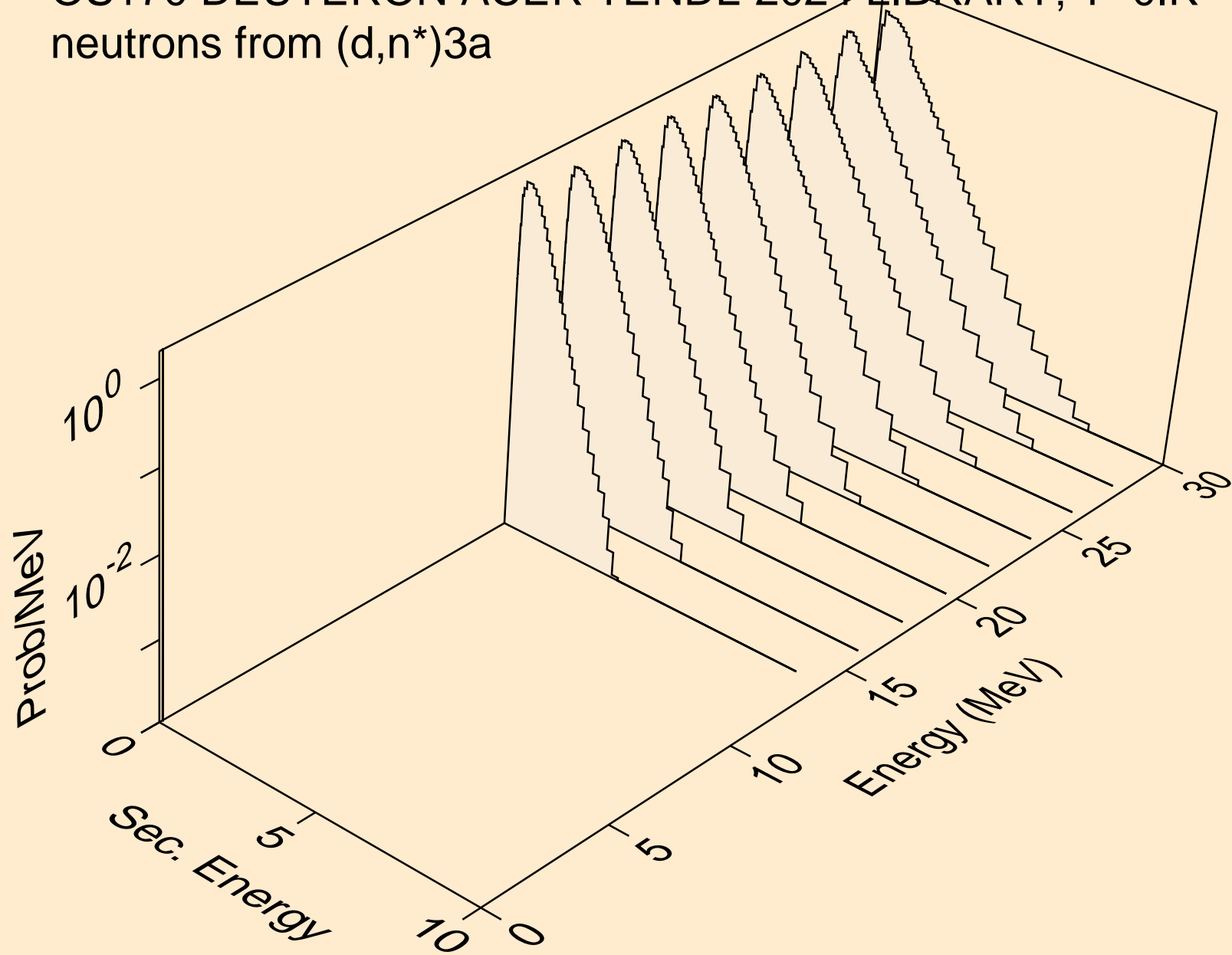

OS170 DEUTERON ACER TENDL-2024 LIBRARY; T=0.K  
neutrons from (d,2n)a

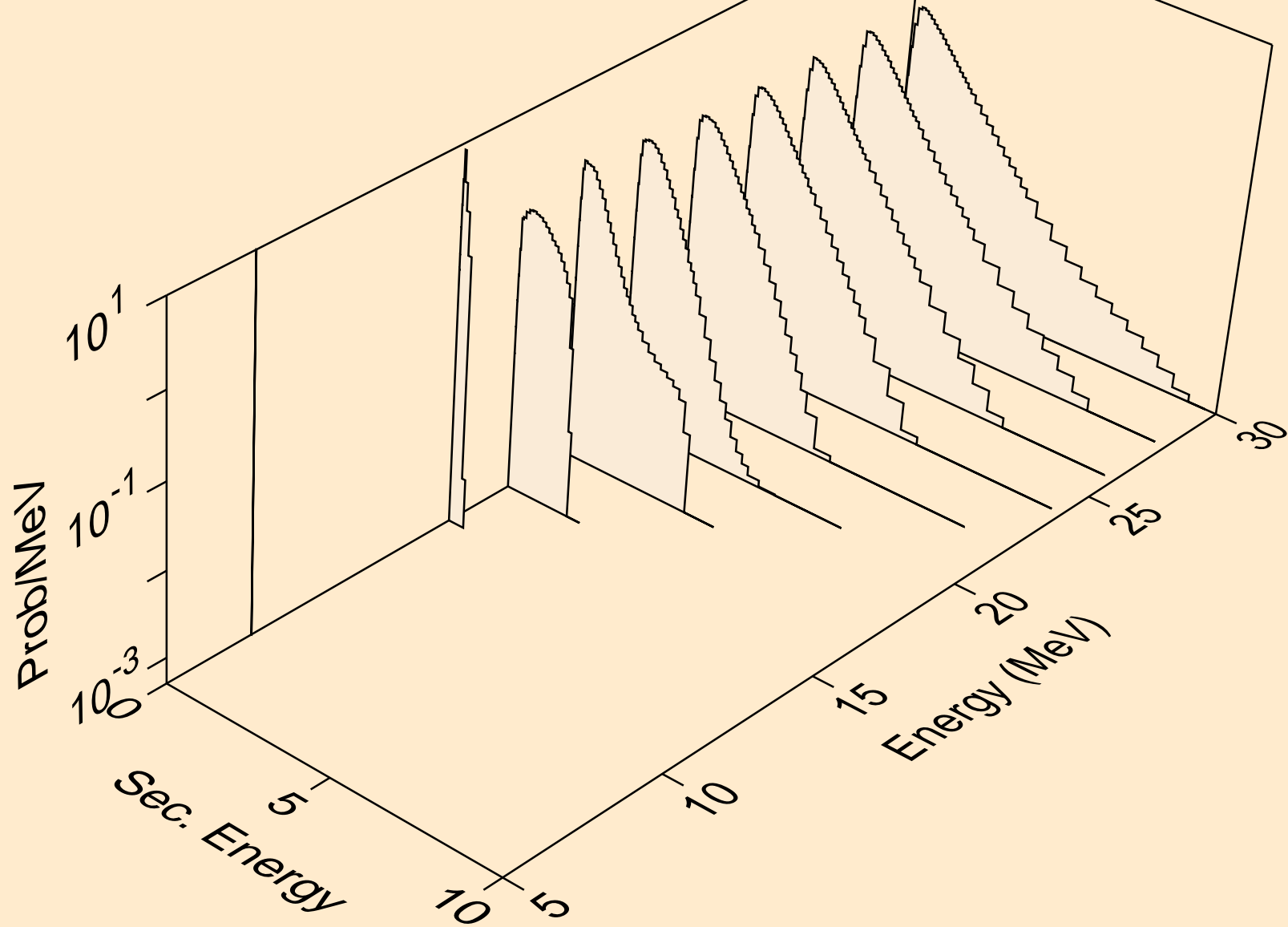

OS170 DEUTERON ACER TENDL-2024 LIBRARY; T=0.K  
neutrons from (d,3n)a

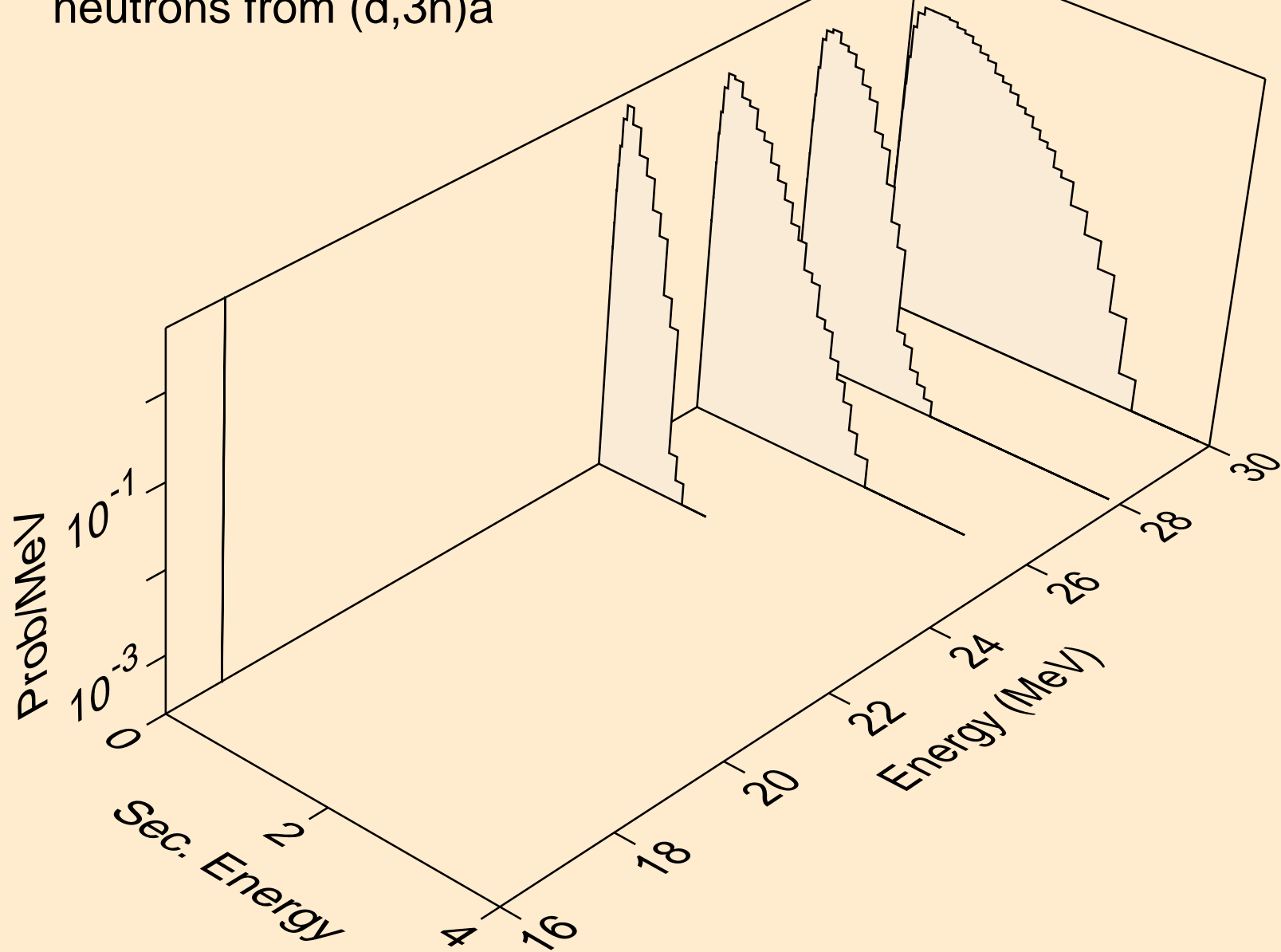

OS170 DEUTERON ACER TENDL-2024 LIBRARY; T=0.K  
neutrons from (d,n\*)p

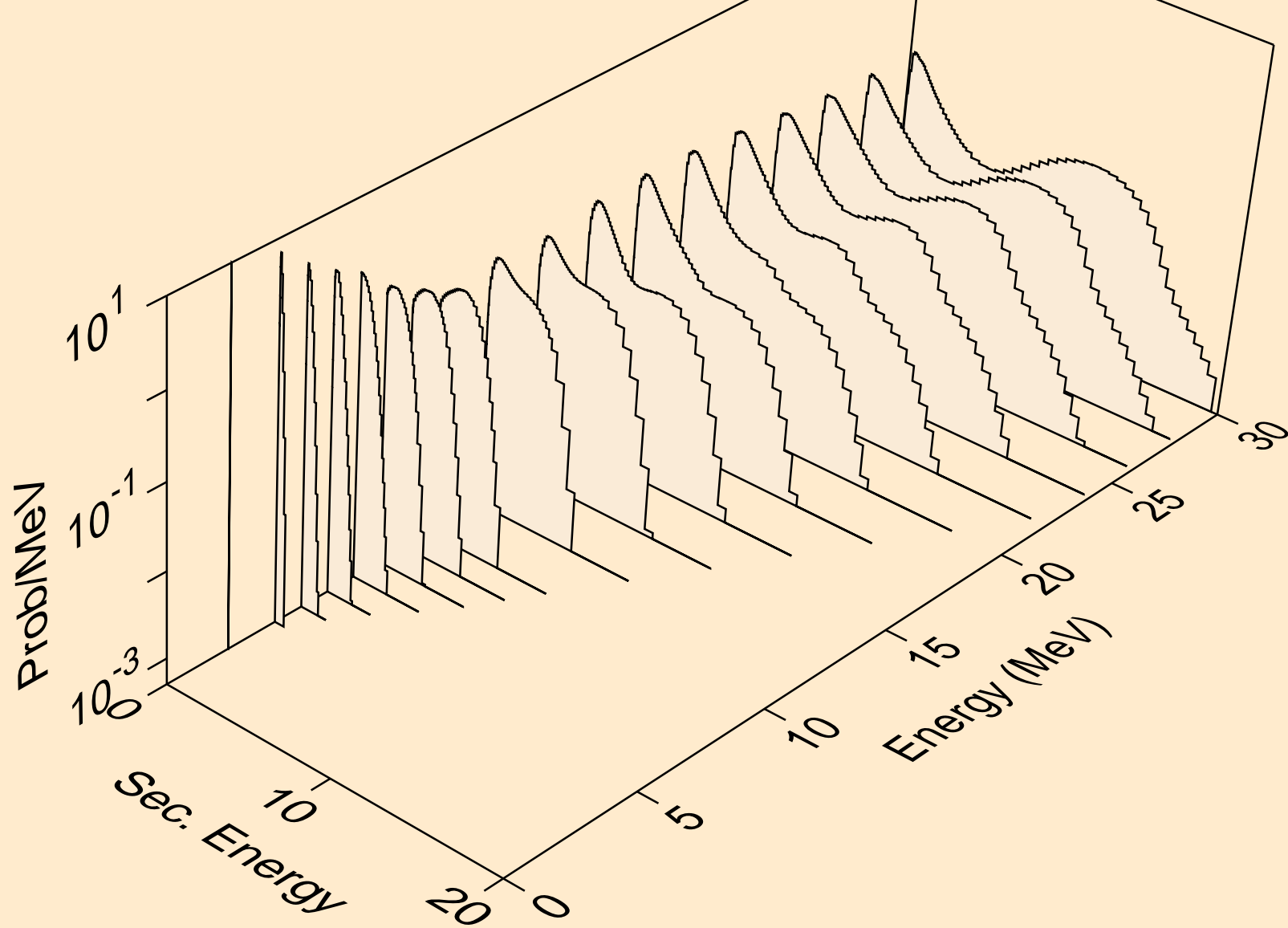

OS170 DEUTERON ACER TENDL-2024 LIBRARY; T=0.K  
neutrons from (d,n\*)2a

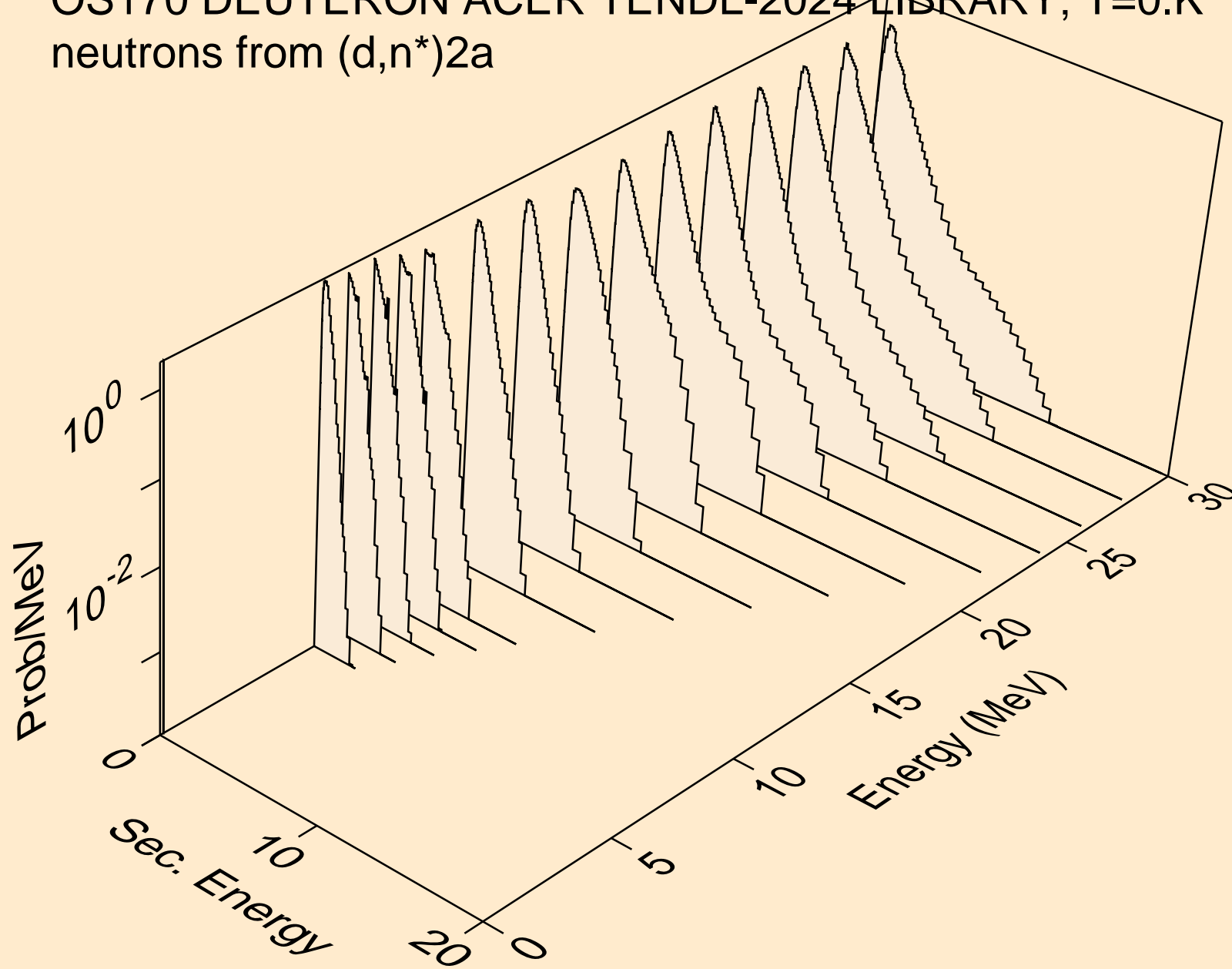

OS170 DEUTERON ACER TENDL-2024 LIBRARY; T=0.K  
neutrons from (d,2n)2a

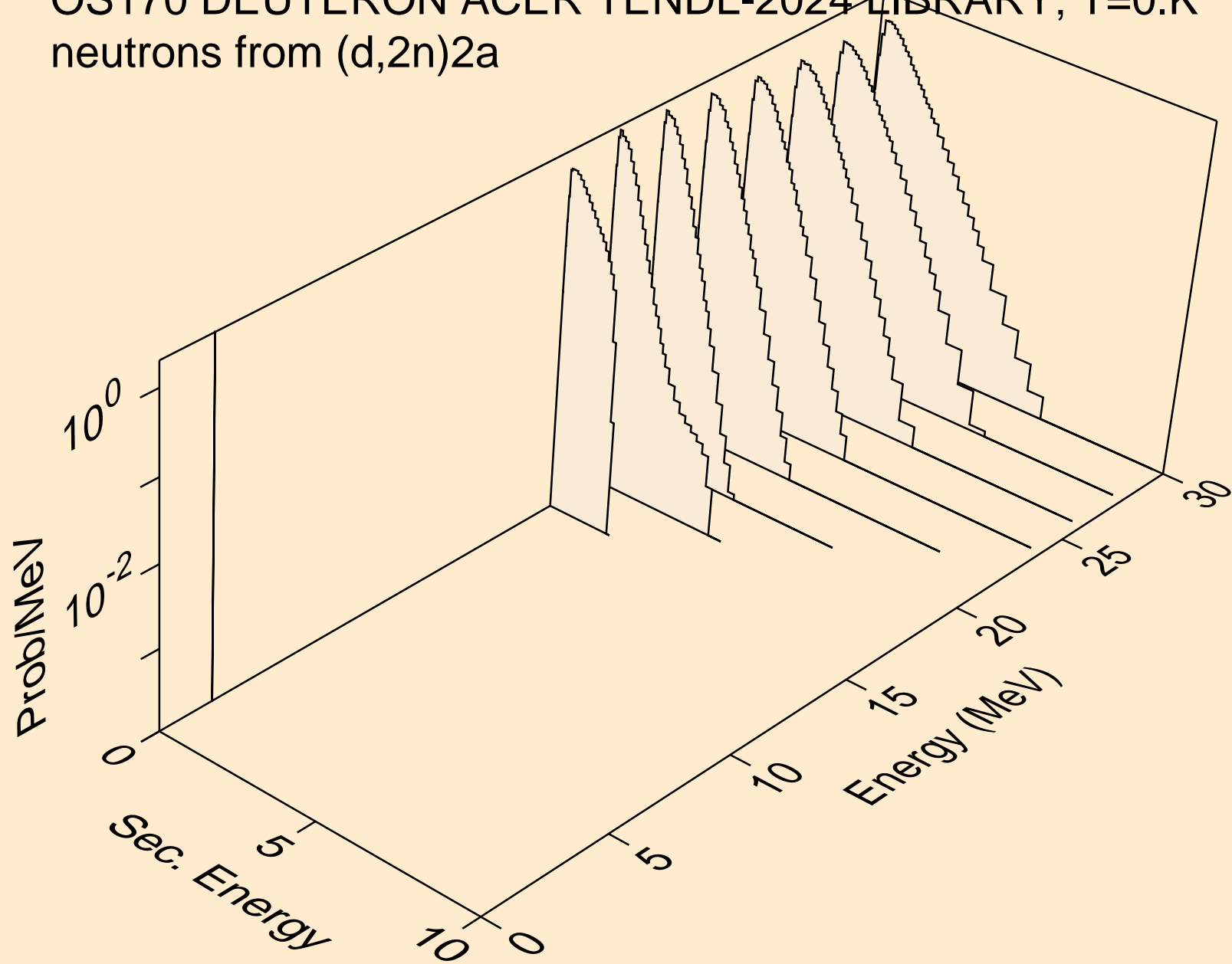

OS170 DEUTERON ACER TENDL-2024 LIBRARY; T=0.K  
neutrons from (d,n\*)d

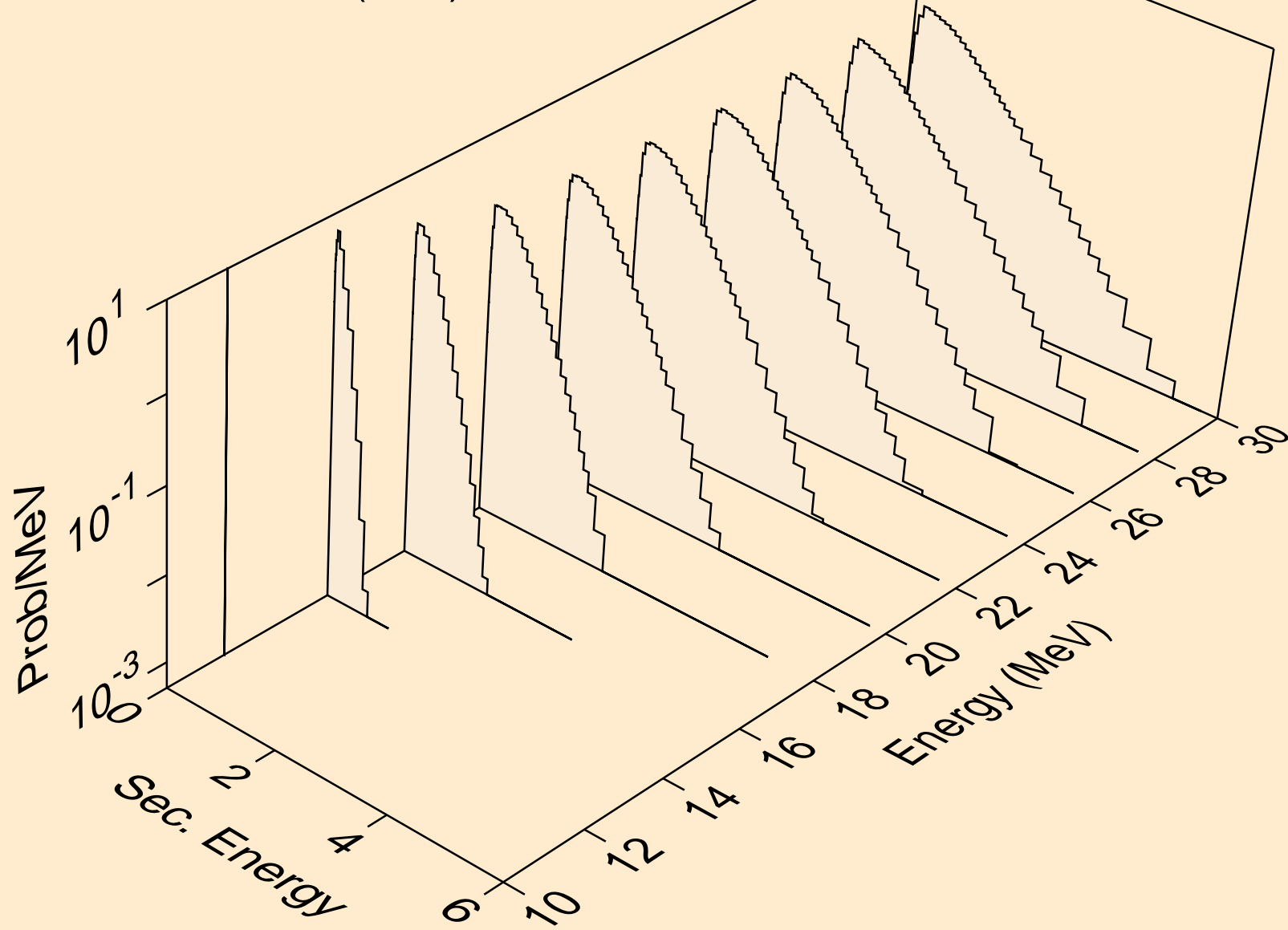

OS170 DEUTERON ACER TENDL-2024 LIBRARY; T=0.K  
neutrons from (d,n\*)t

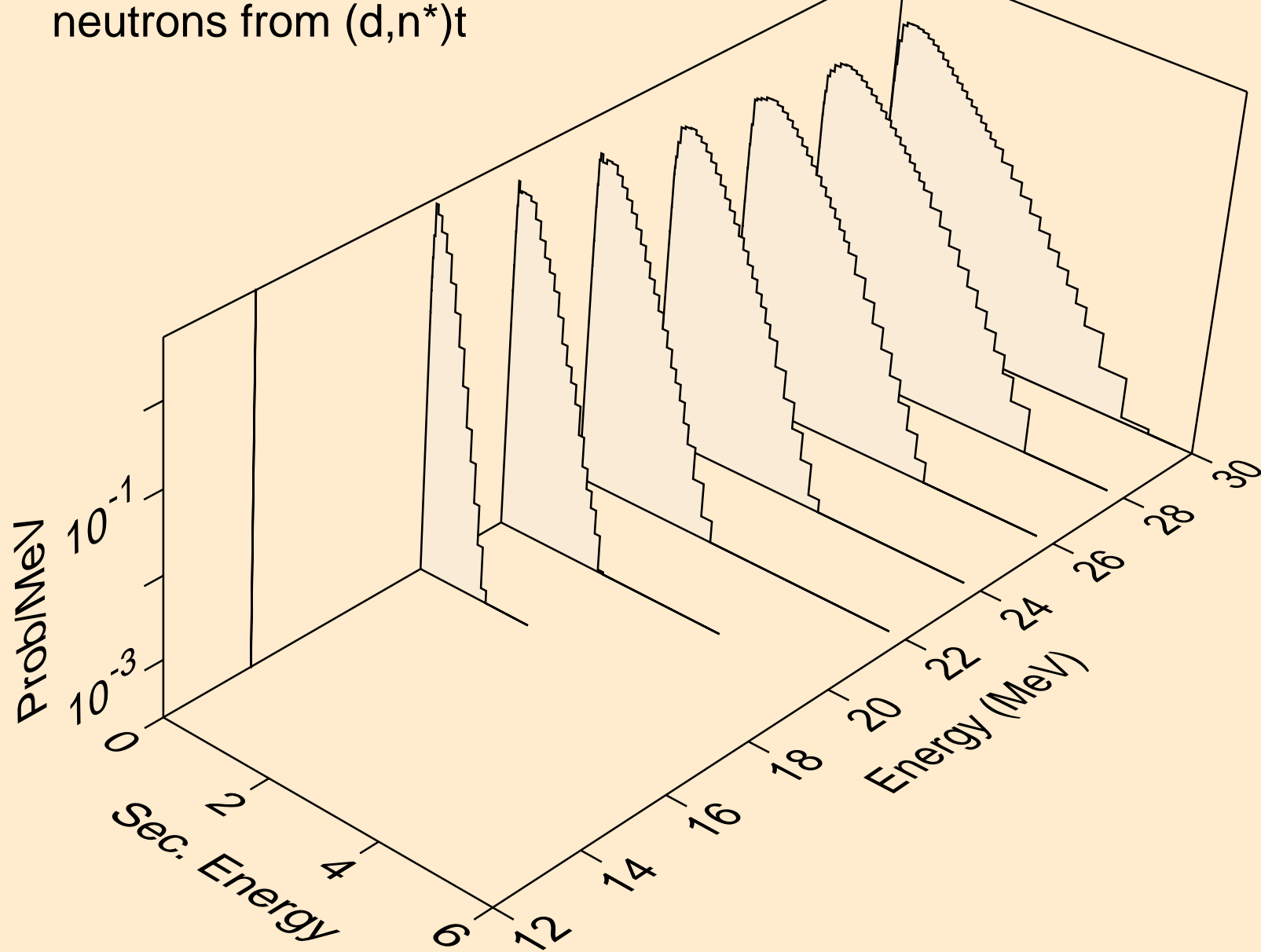

OS170 DEUTERON ACER TENDL-2024 LIBRARY; T=0.K  
neutrons from (d,n\*)he3

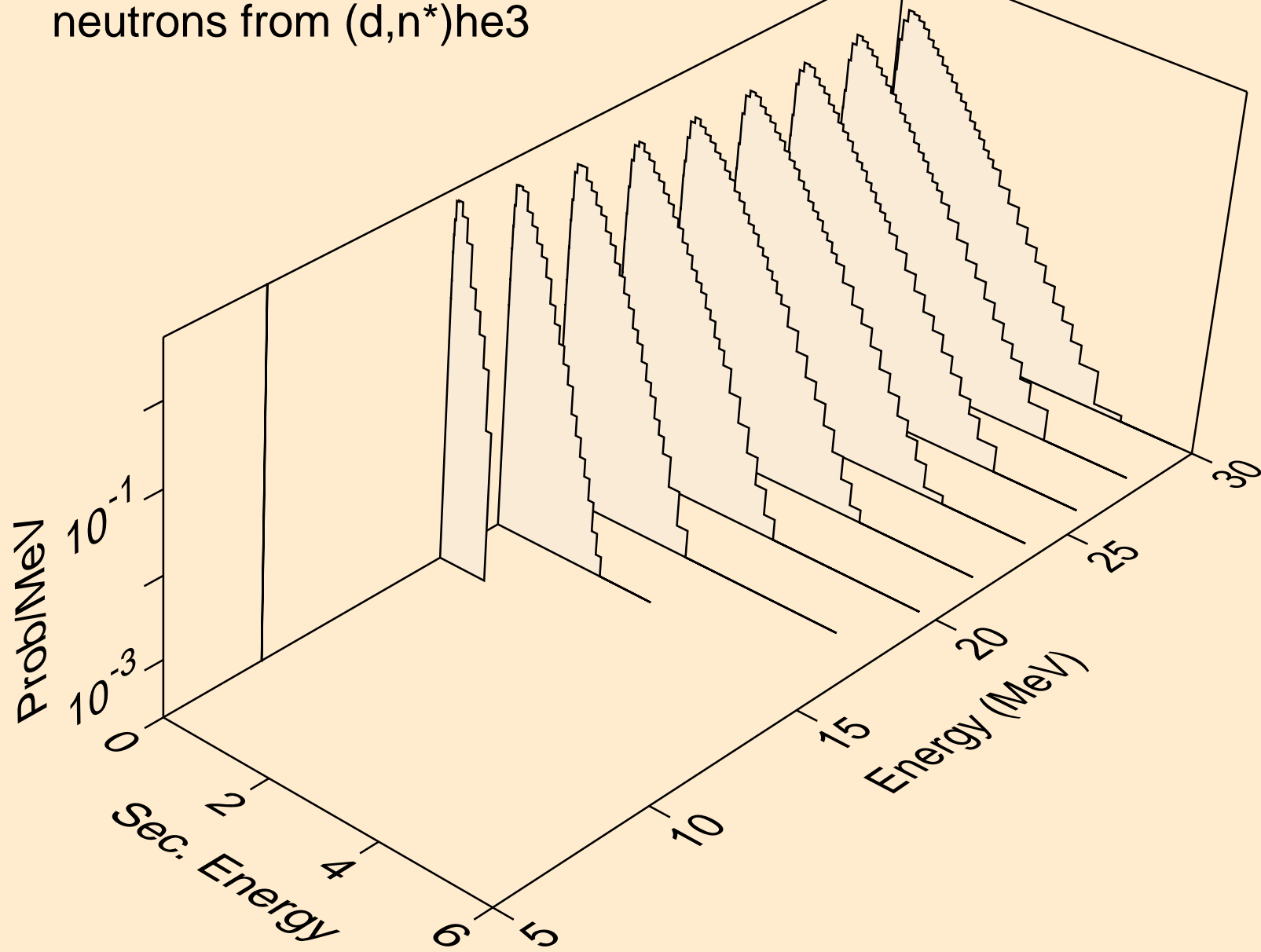

OS170 DEUTERON ACER TENDL-2024 LIBRARY; T=0.K  
neutrons from (d,2np)

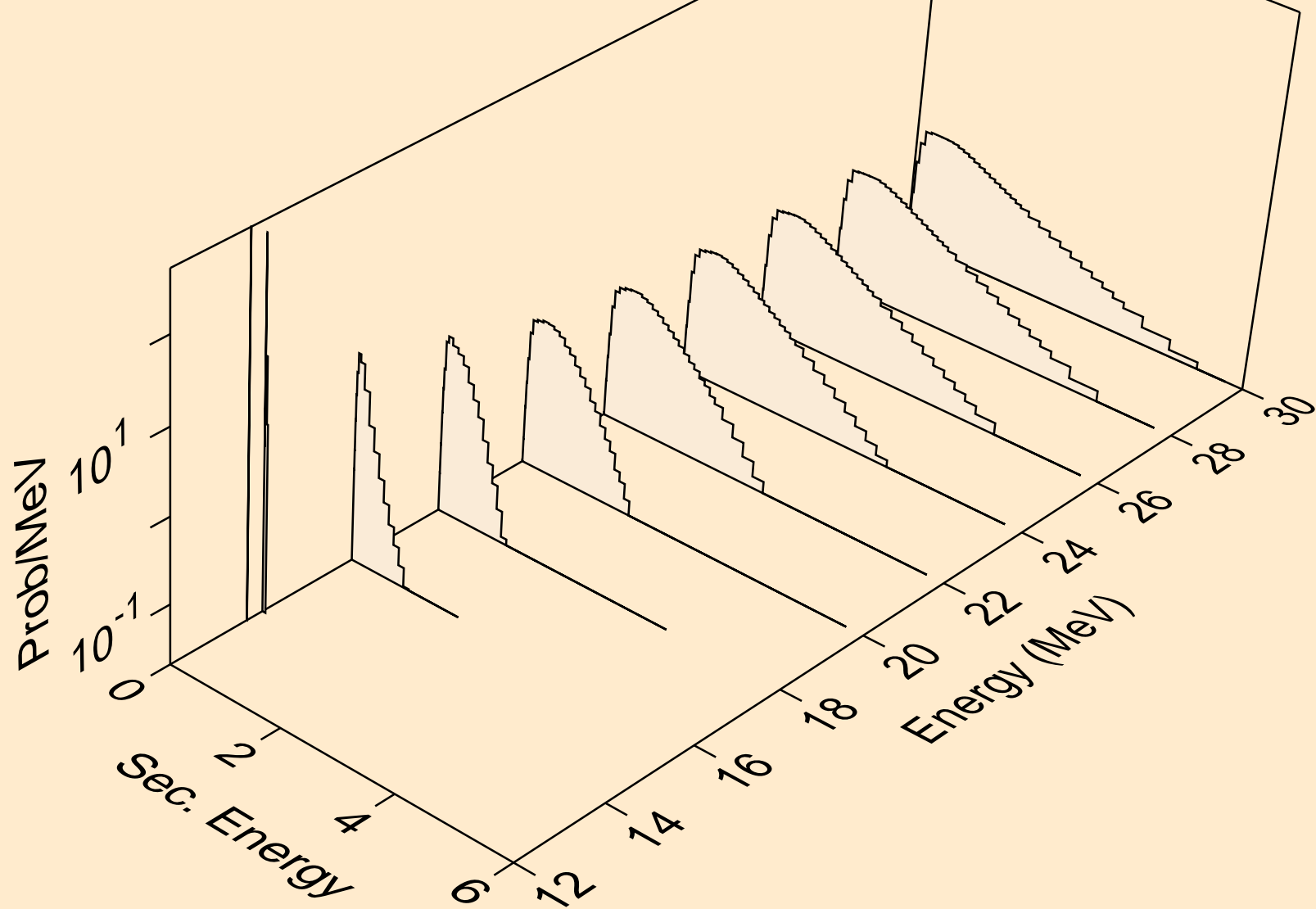

OS170 DEUTERON ACER TENDL-2024 LIBRARY; T=0.K  
neutrons from (d,3np)

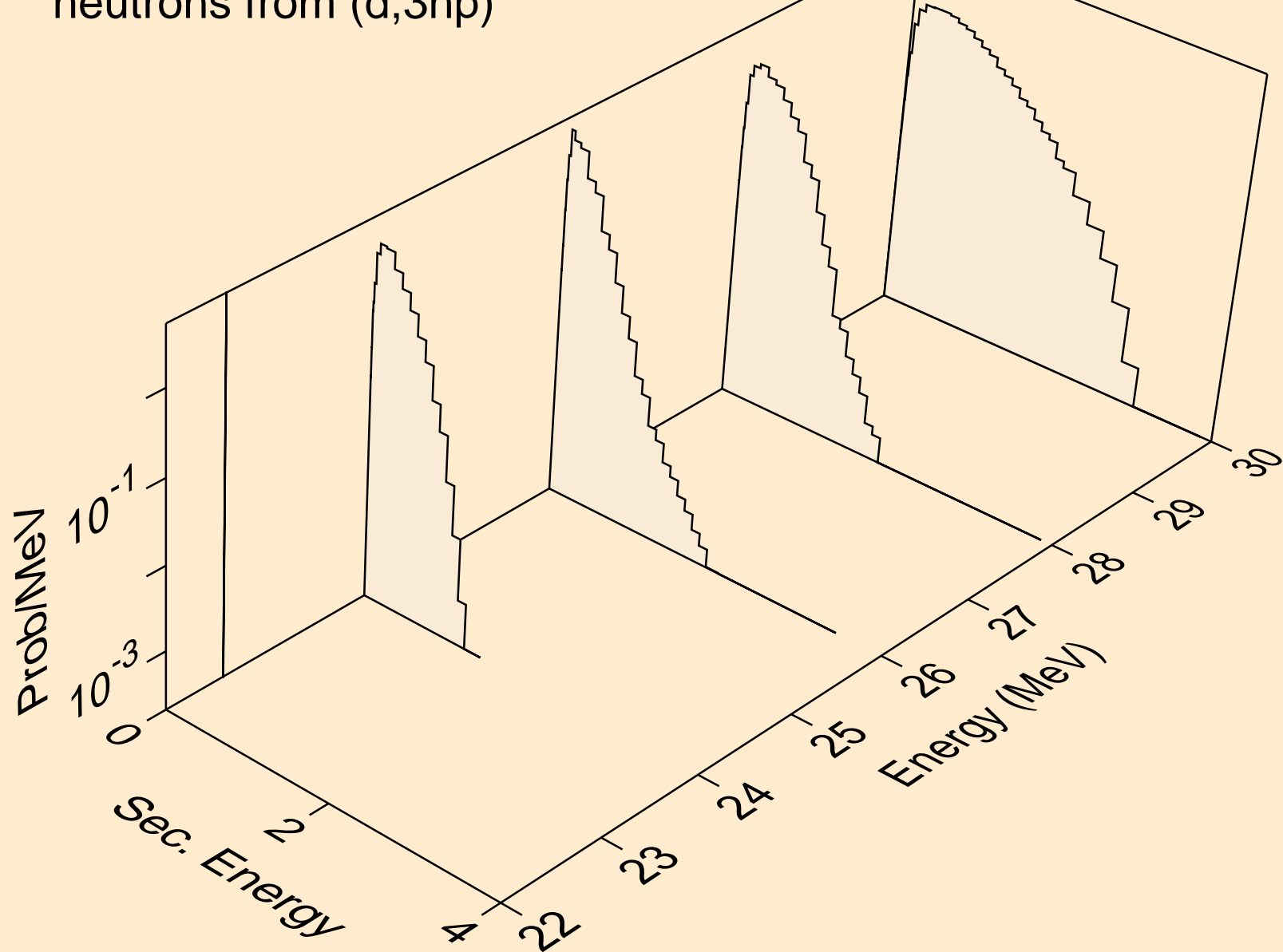

OS170 DEUTERON ACER TENDL-2024 LIBRARY; T=0.K  
neutrons from (d,n2p)

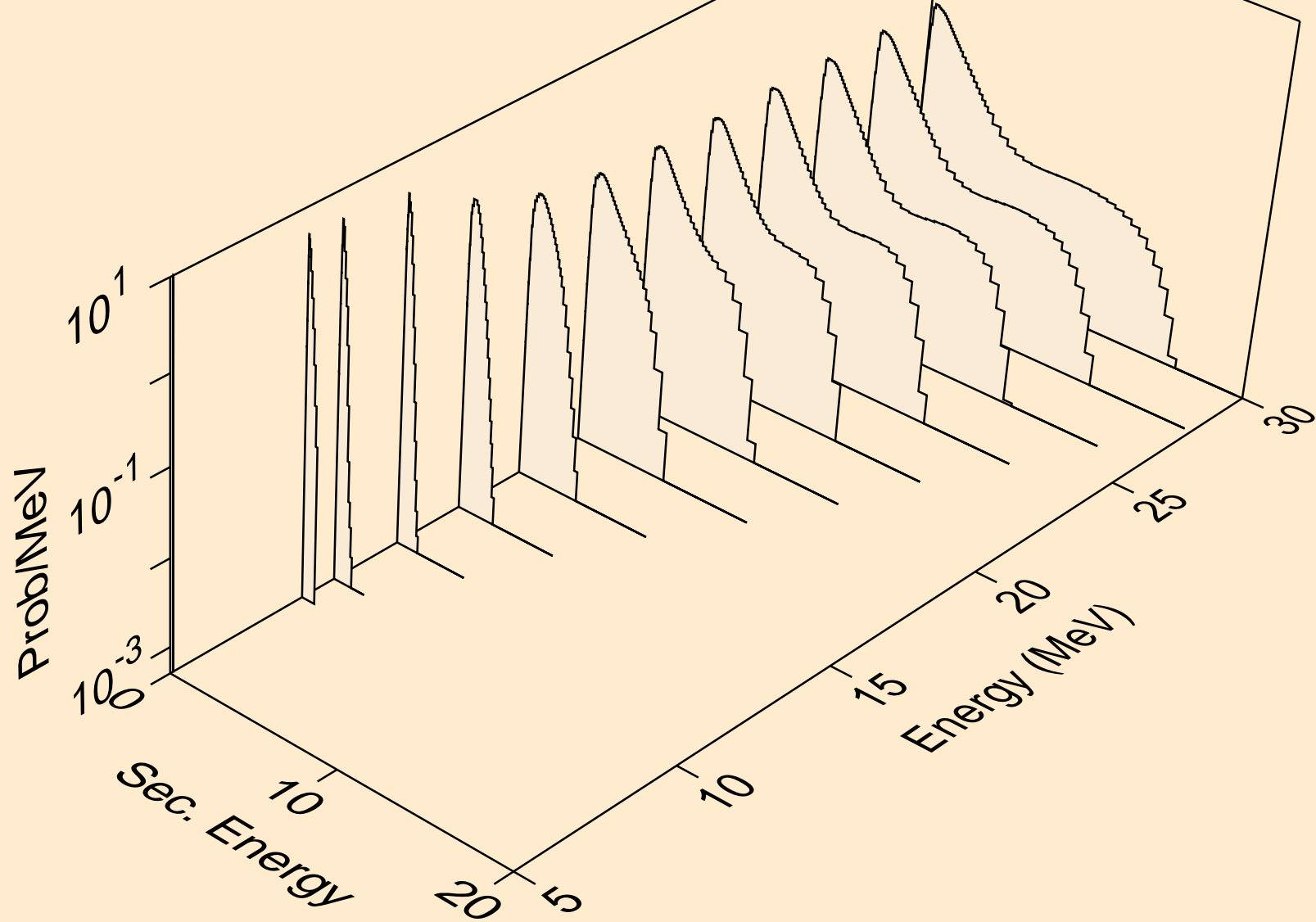

OS170 DEUTERON ACER TENDL-2024 LIBRARY; T=0.K  
neutrons from (d,npa)

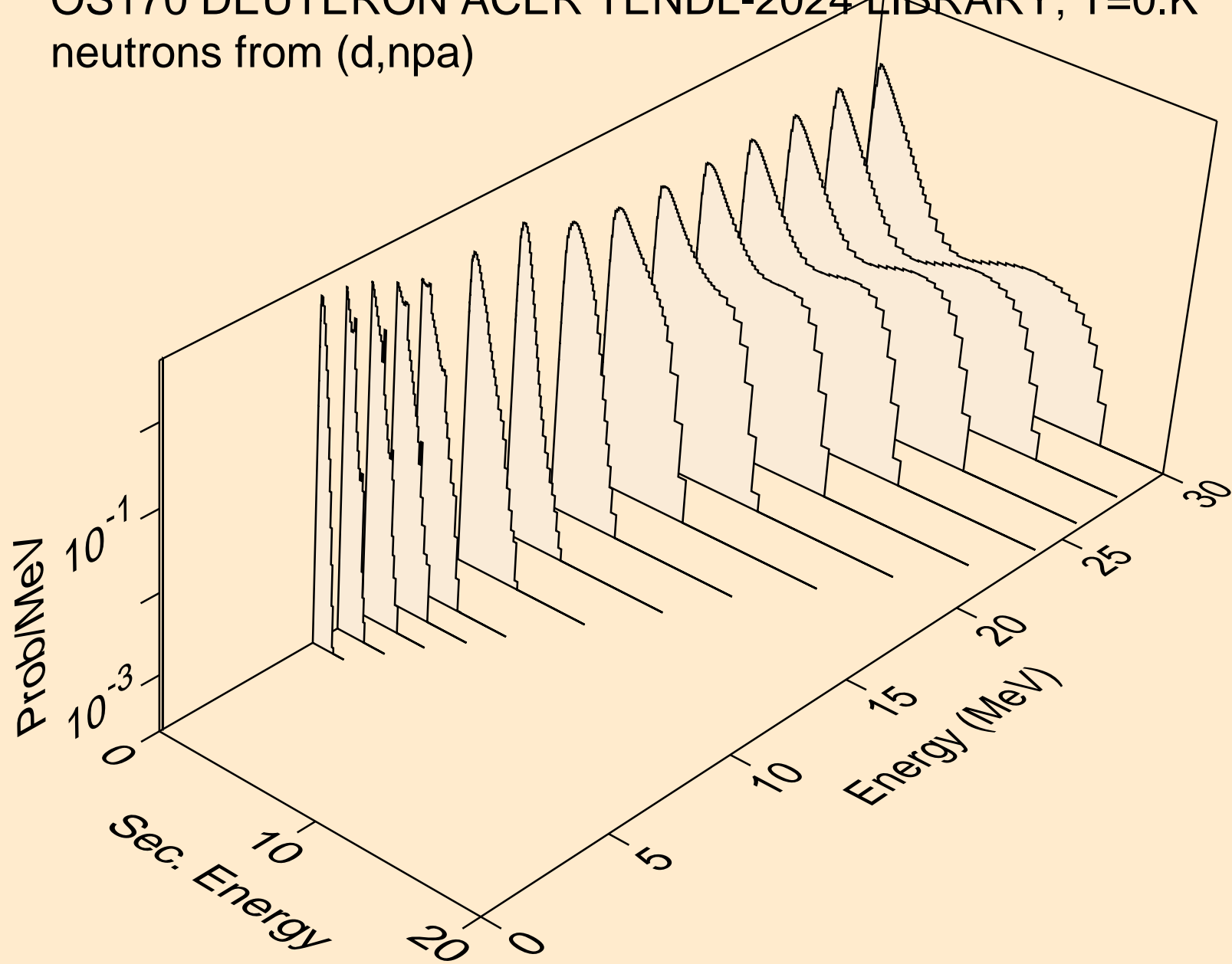

OS170 DEUTERON ACER TENDL-2024 LIBRARY; T=0.K  
protons from (d,x)

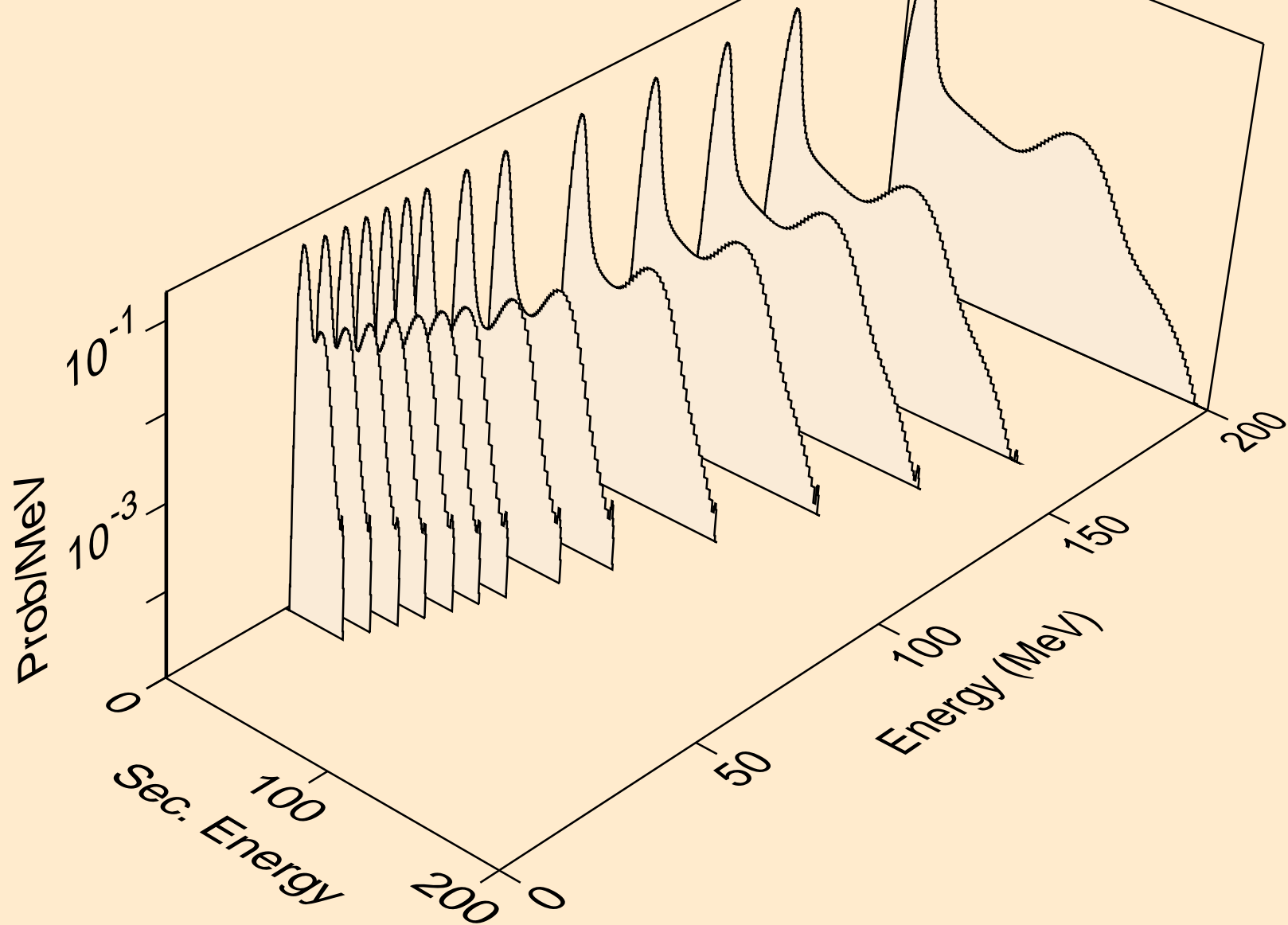

OS170 DEUTERON ACER TENDL-2024 LIBRARY; T=0.K  
protons from (d,n\*)p

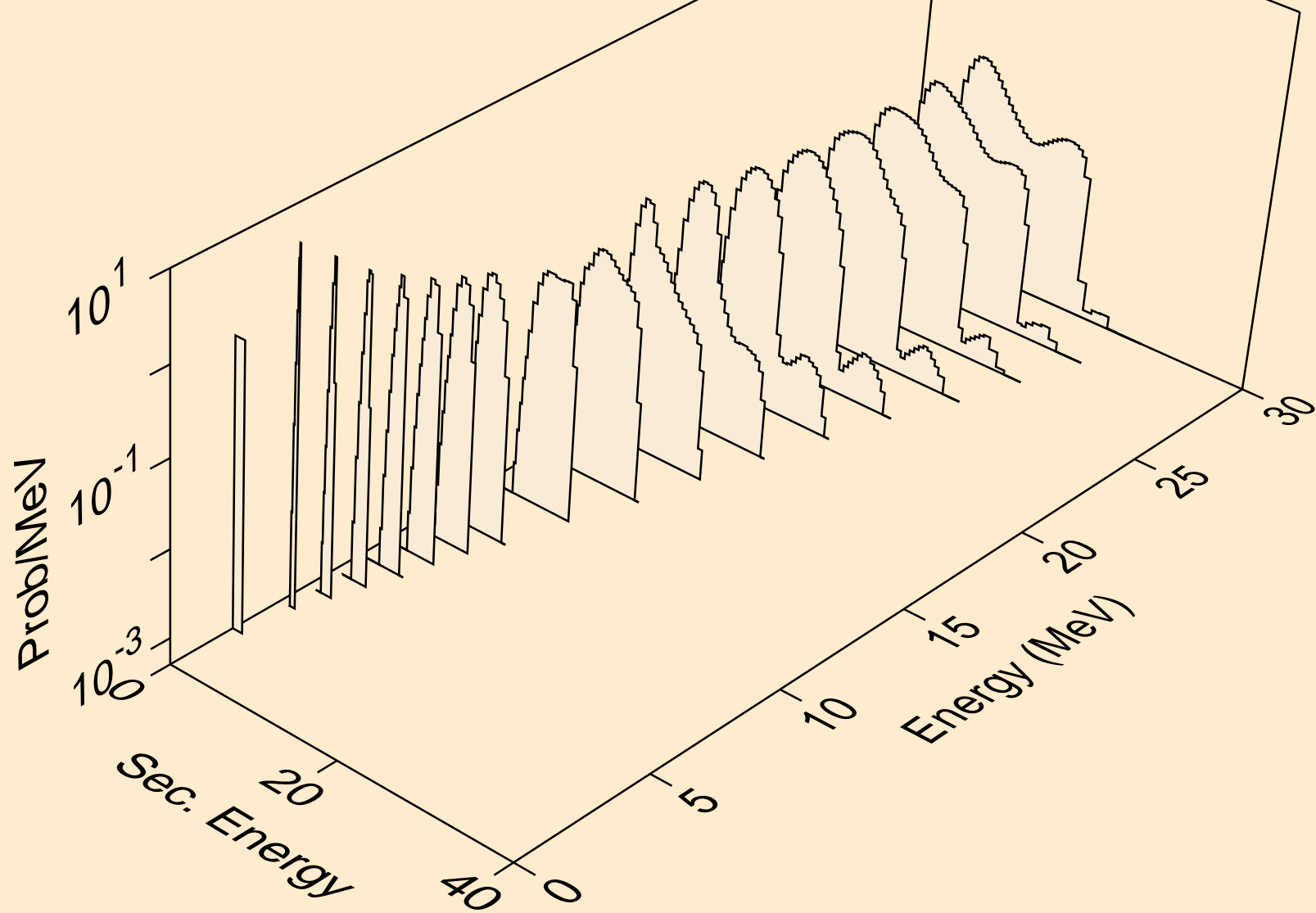

OS170 DEUTERON ACER TENDL-2024 LIBRARY; T=0.K  
protons from (d,2np)

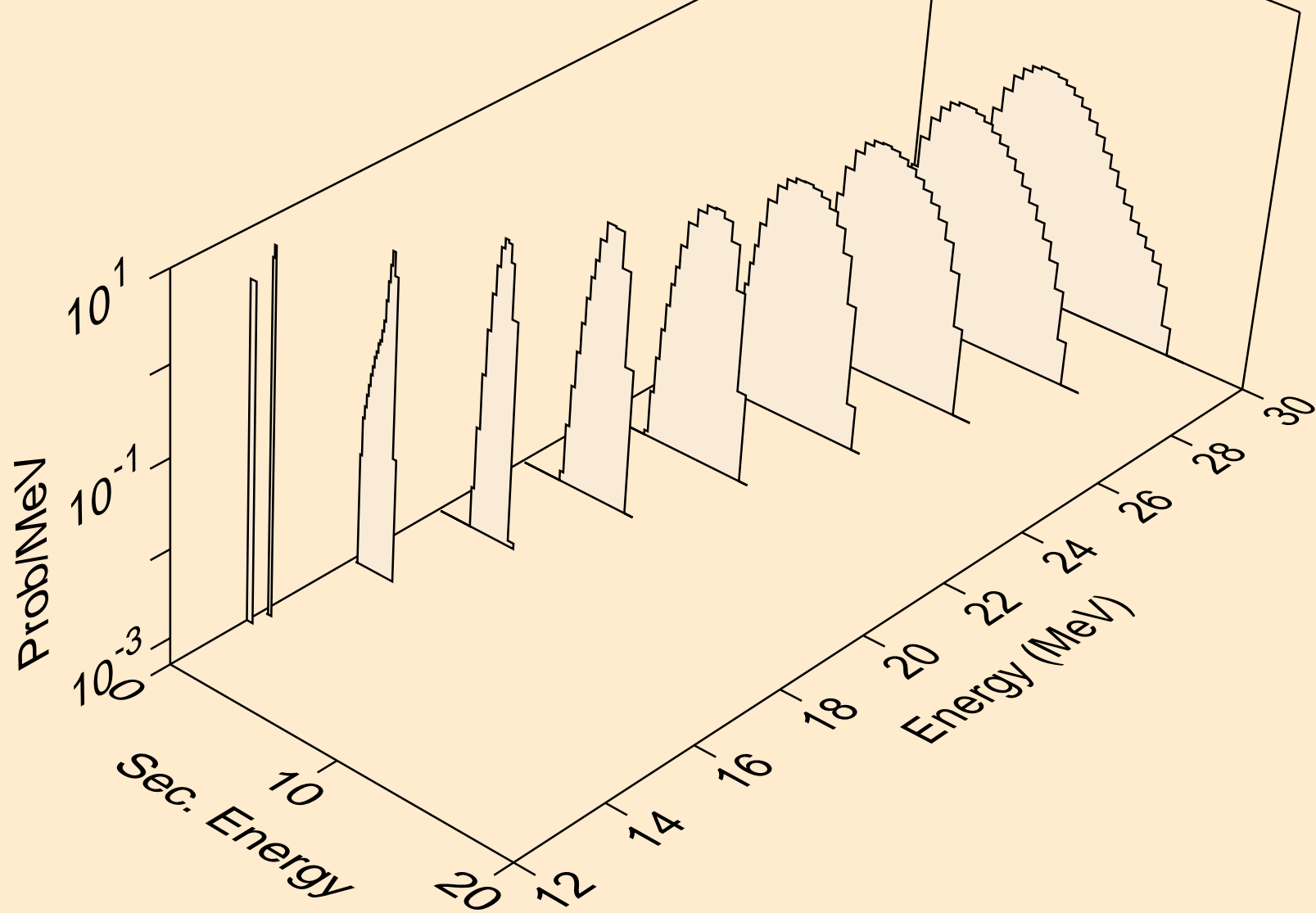

OS170 DEUTERON ACER TENDL-2024 LIBRARY; T=0.K  
protons from (d,3np)

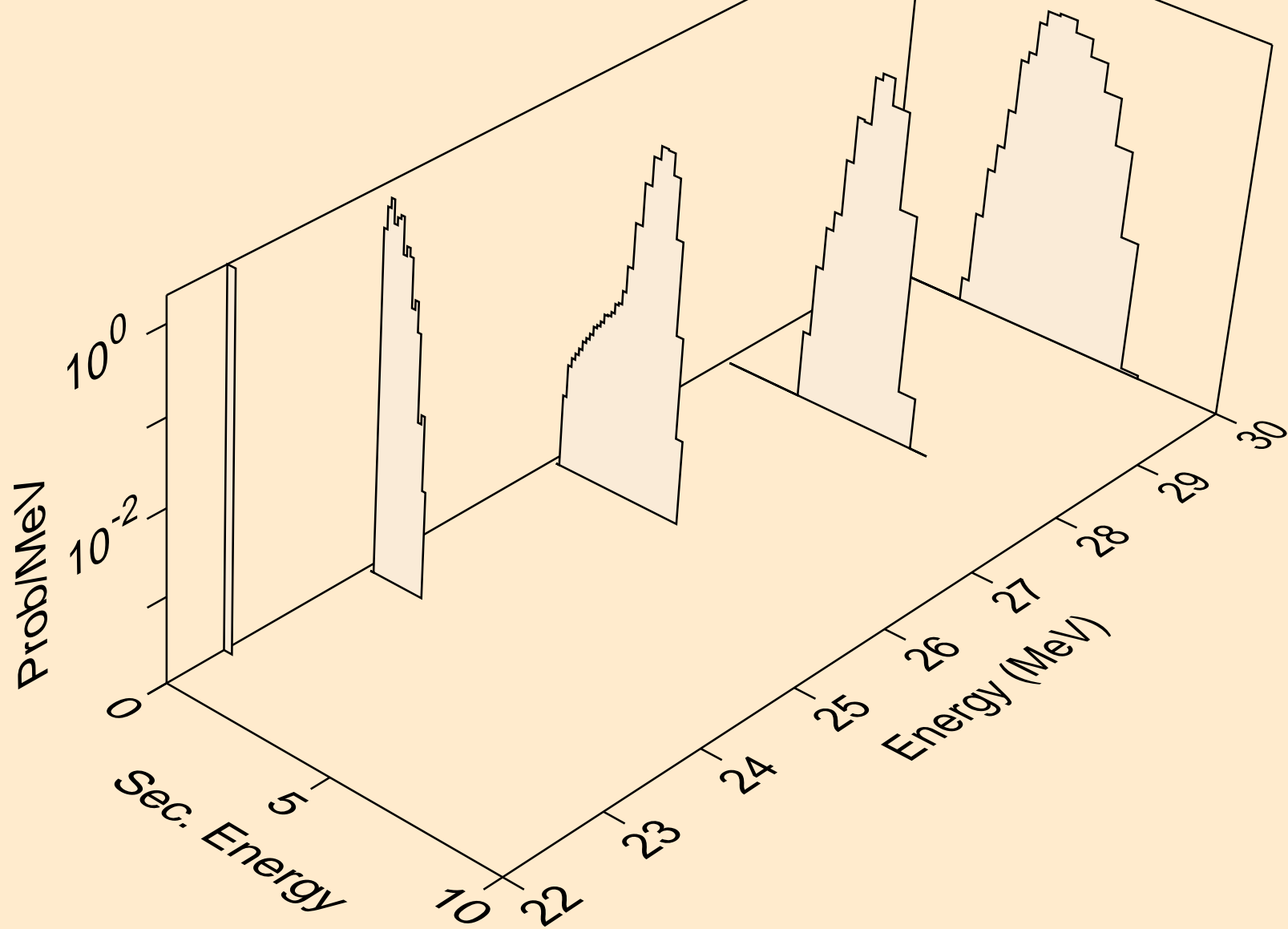

OS170 DEUTERON ACER TENDL-2024 LIBRARY; T=0.K  
protons from (d,n2p)

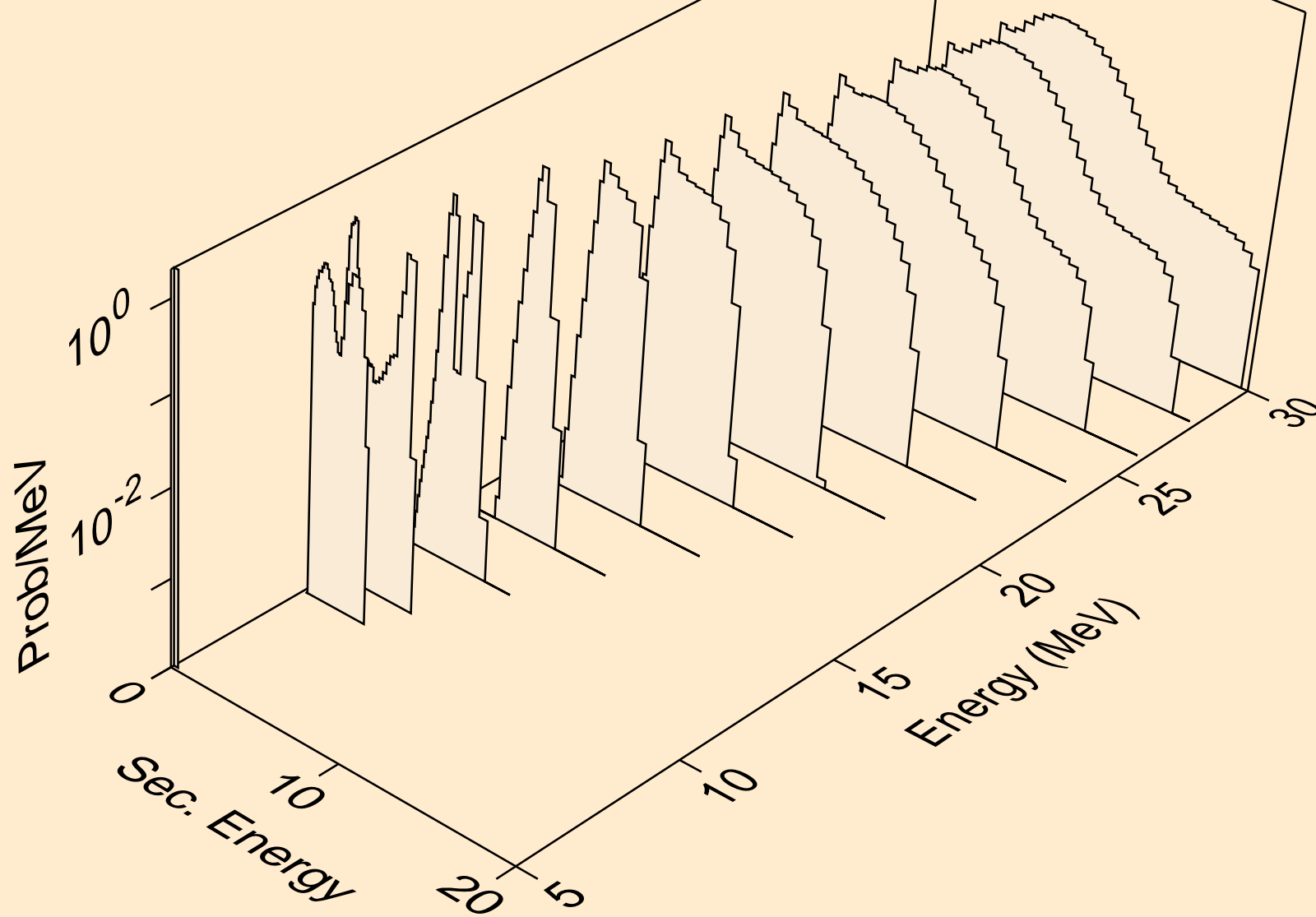

OS170 DEUTERON ACER TENDL-2024 LIBRARY; T=0.K  
protons from (d,npa)

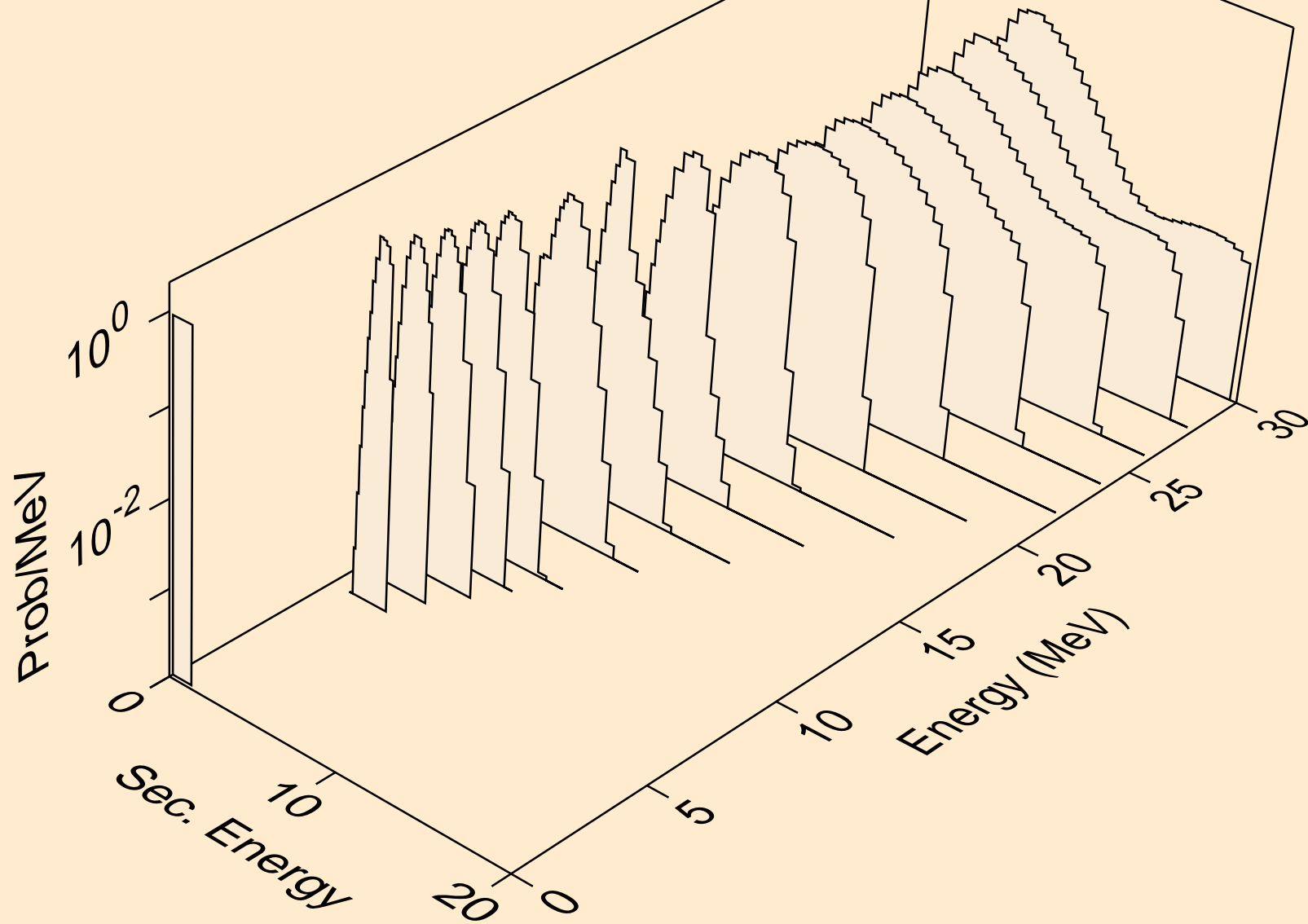

OS170 DEUTERON ACER TENDL-2024 LIBRARY; T=0.K  
protons from (d,p)

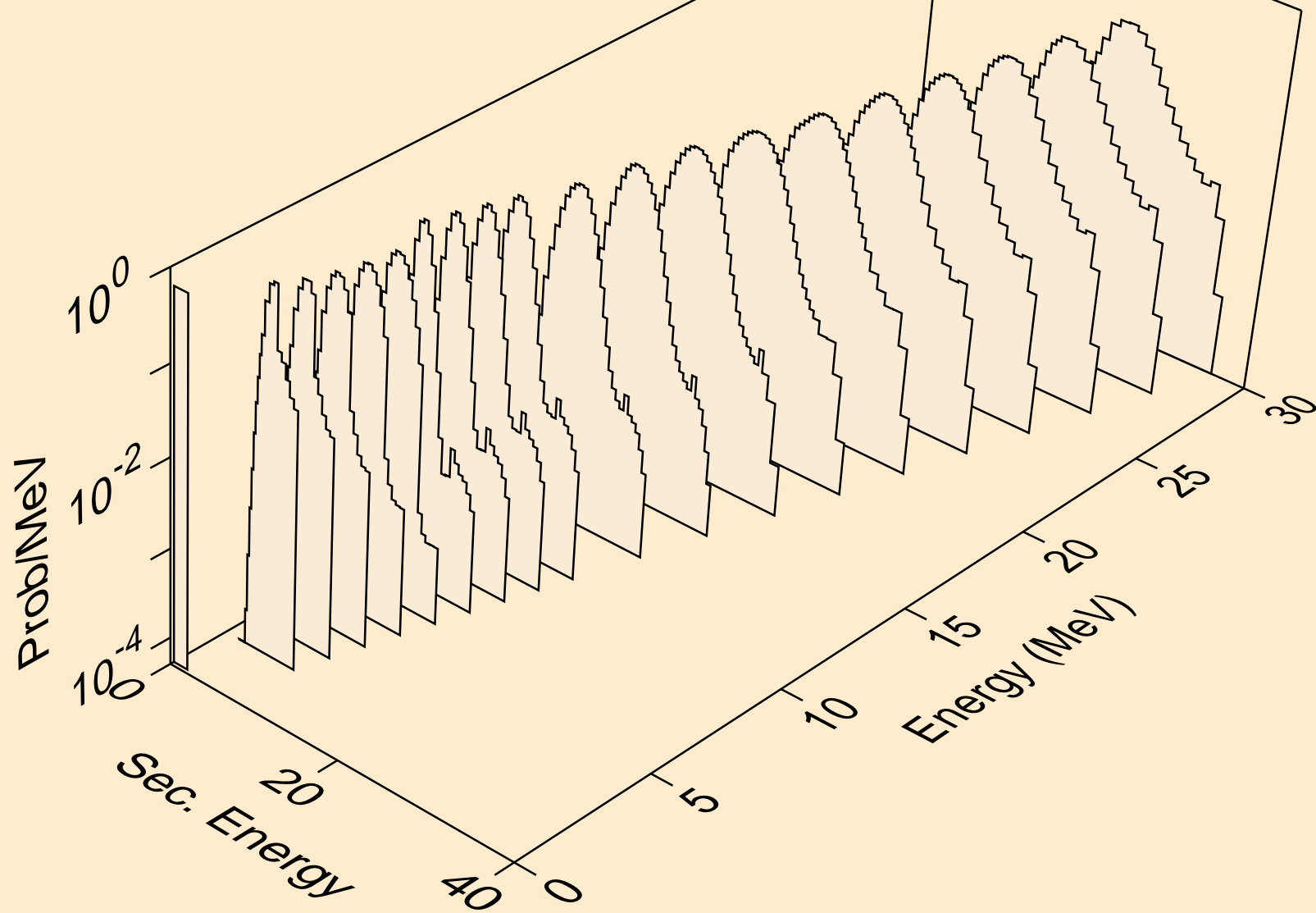

OS170 DEUTERON ACER TENDL-2024 LIBRARY; T=0.K  
protons from (d,2p)

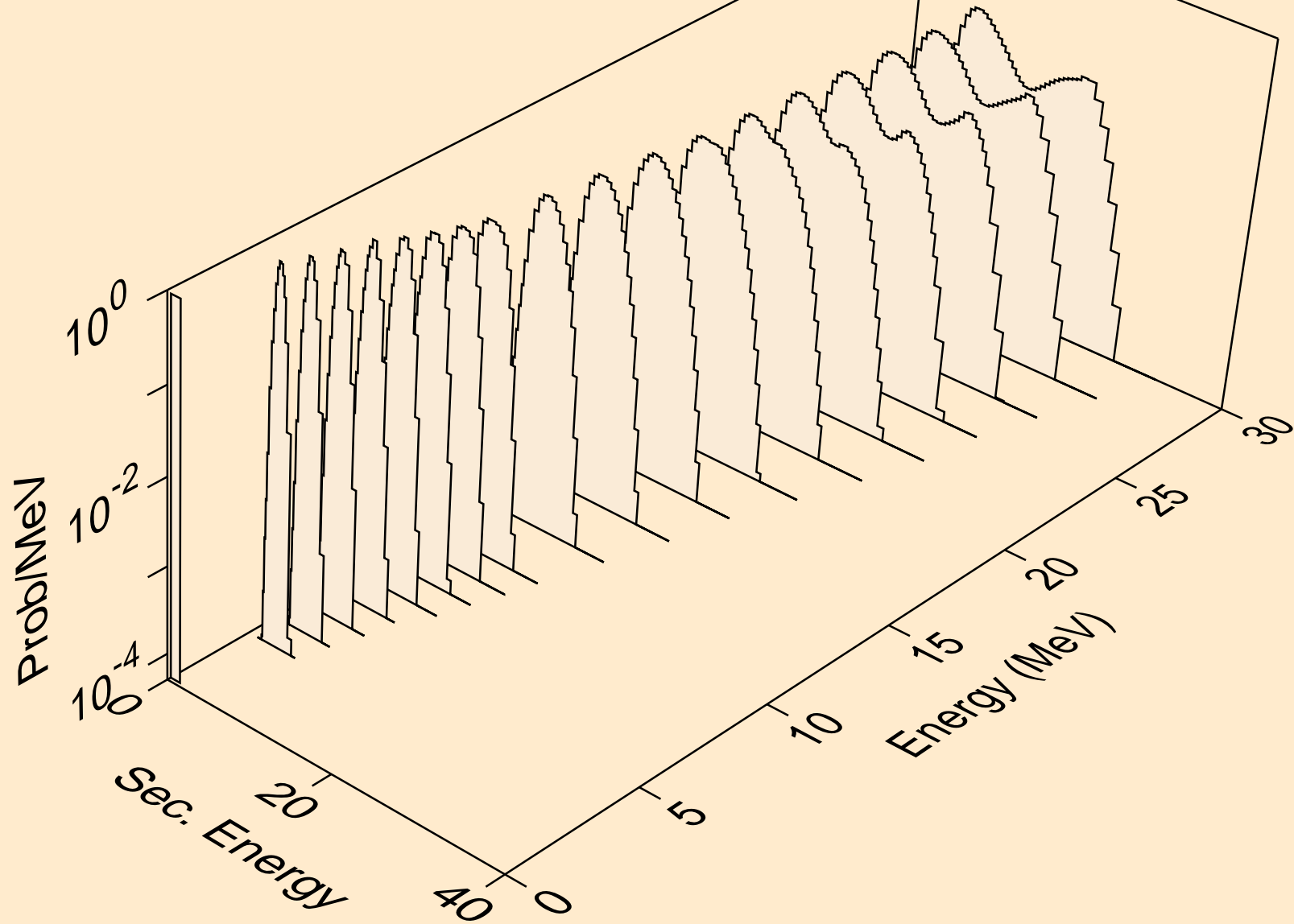

OS170 DEUTERON ACER TENDL-2024 LIBRARY; T=0.K  
protons from (d,pa)

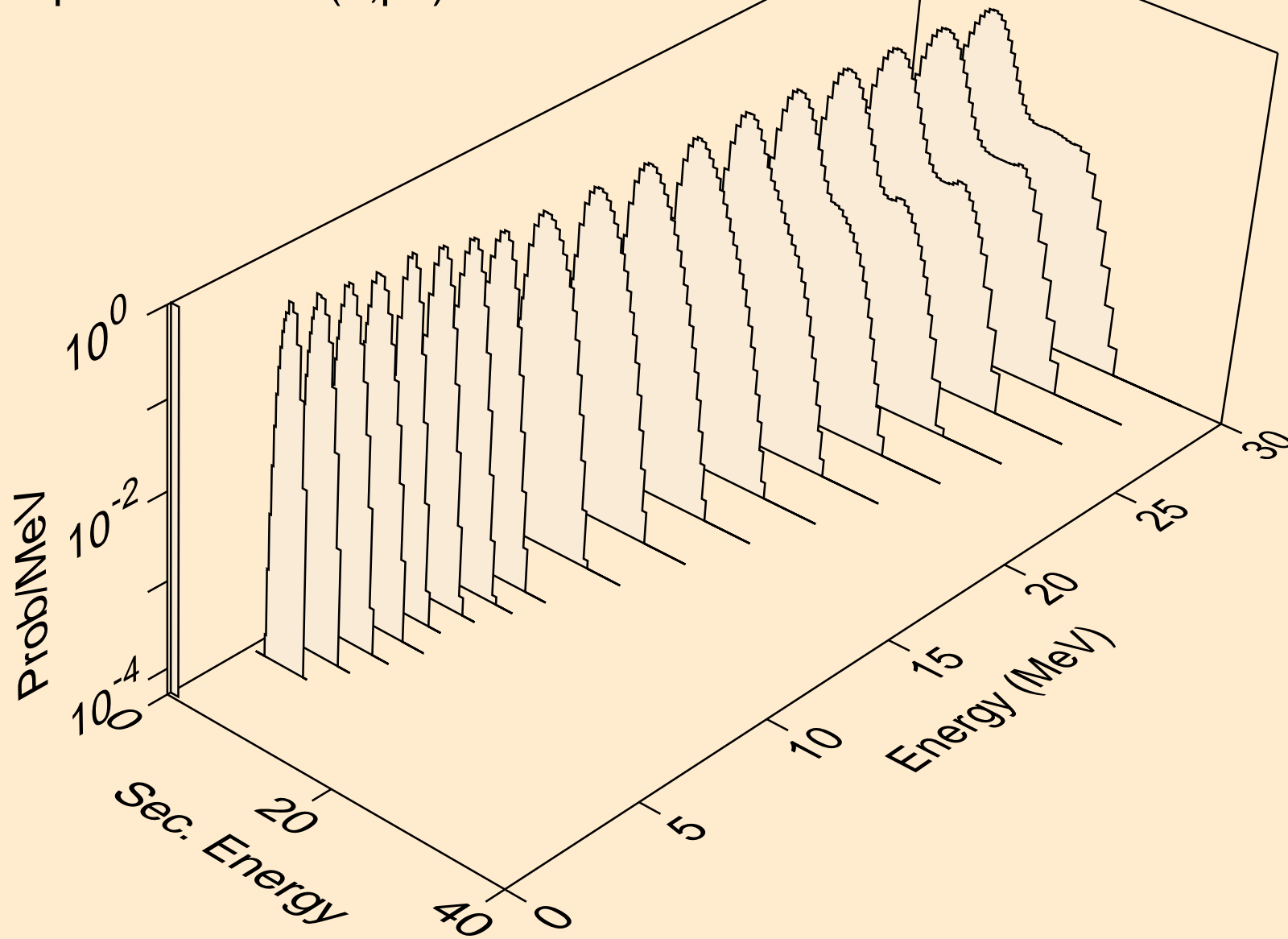

OS170 DEUTERON ACER TENDL-2024 LIBRARY; T=0.K  
protons from (d,pd)

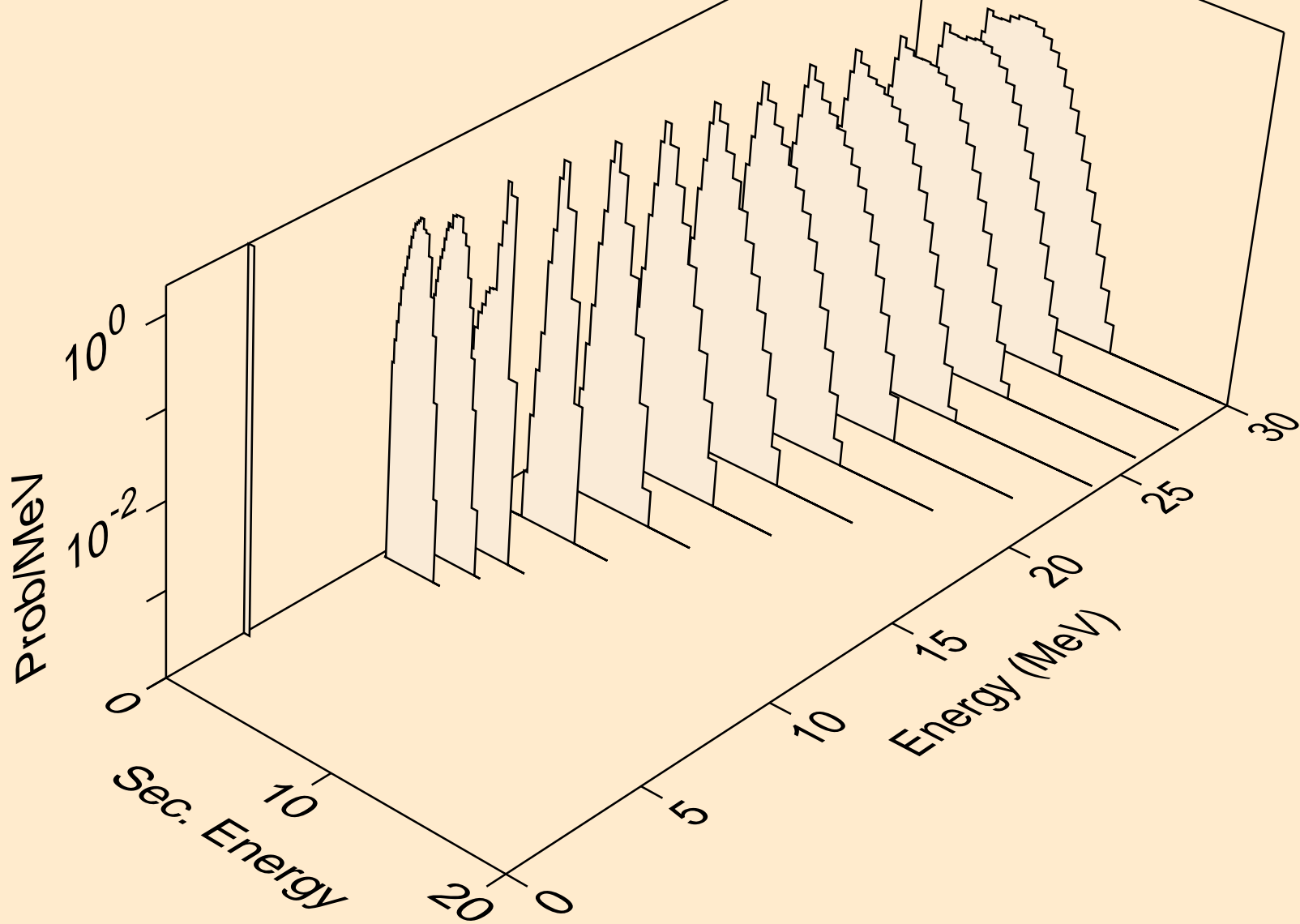

OS170 DEUTERON ACER TENDL-2024 LIBRARY; T=0.K  
protons from (d,pt)

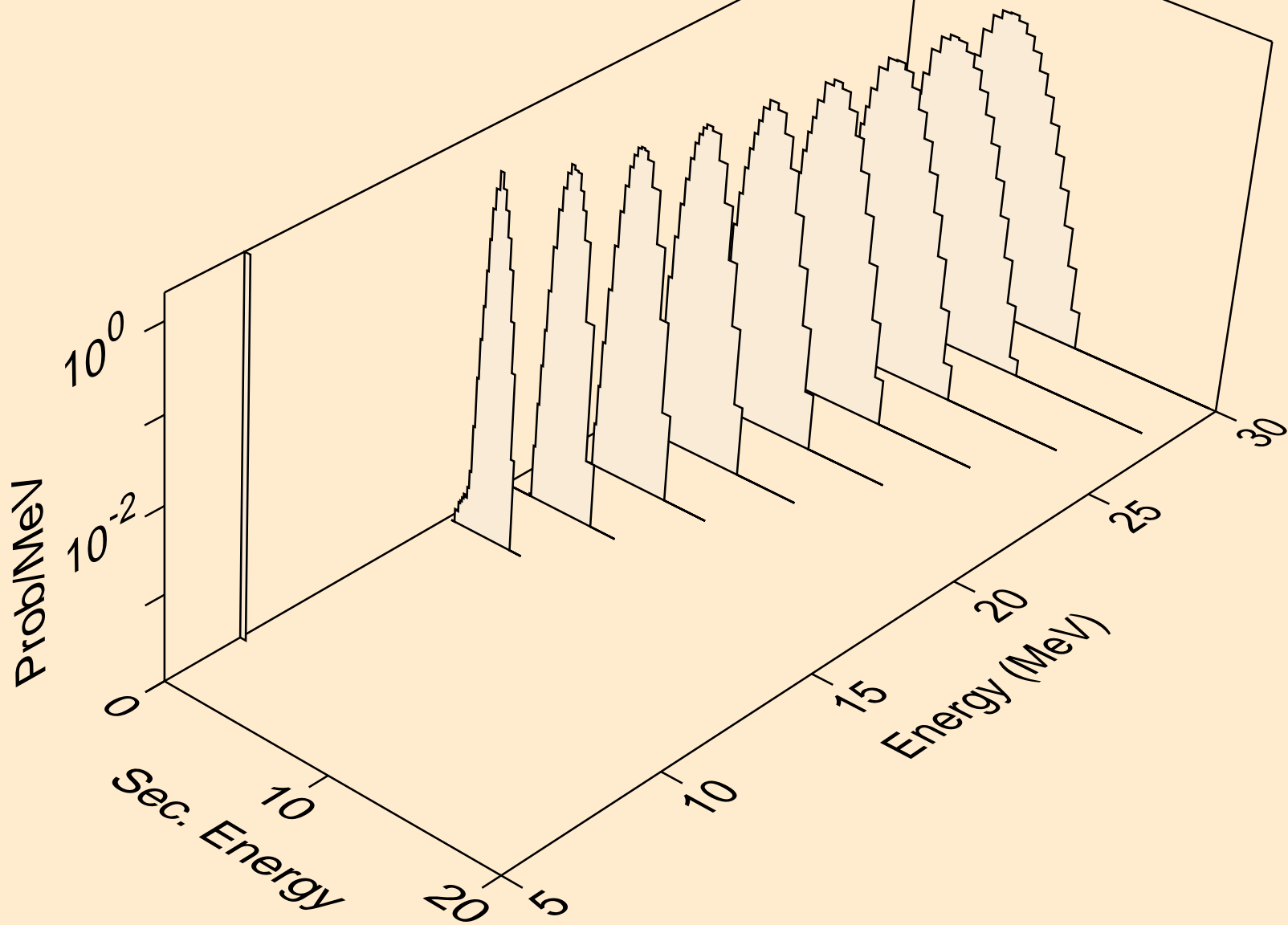

OS170 DEUTERON ACER TENDL-2024 LIBRARY; T=0.K  
tritons from (d,x)

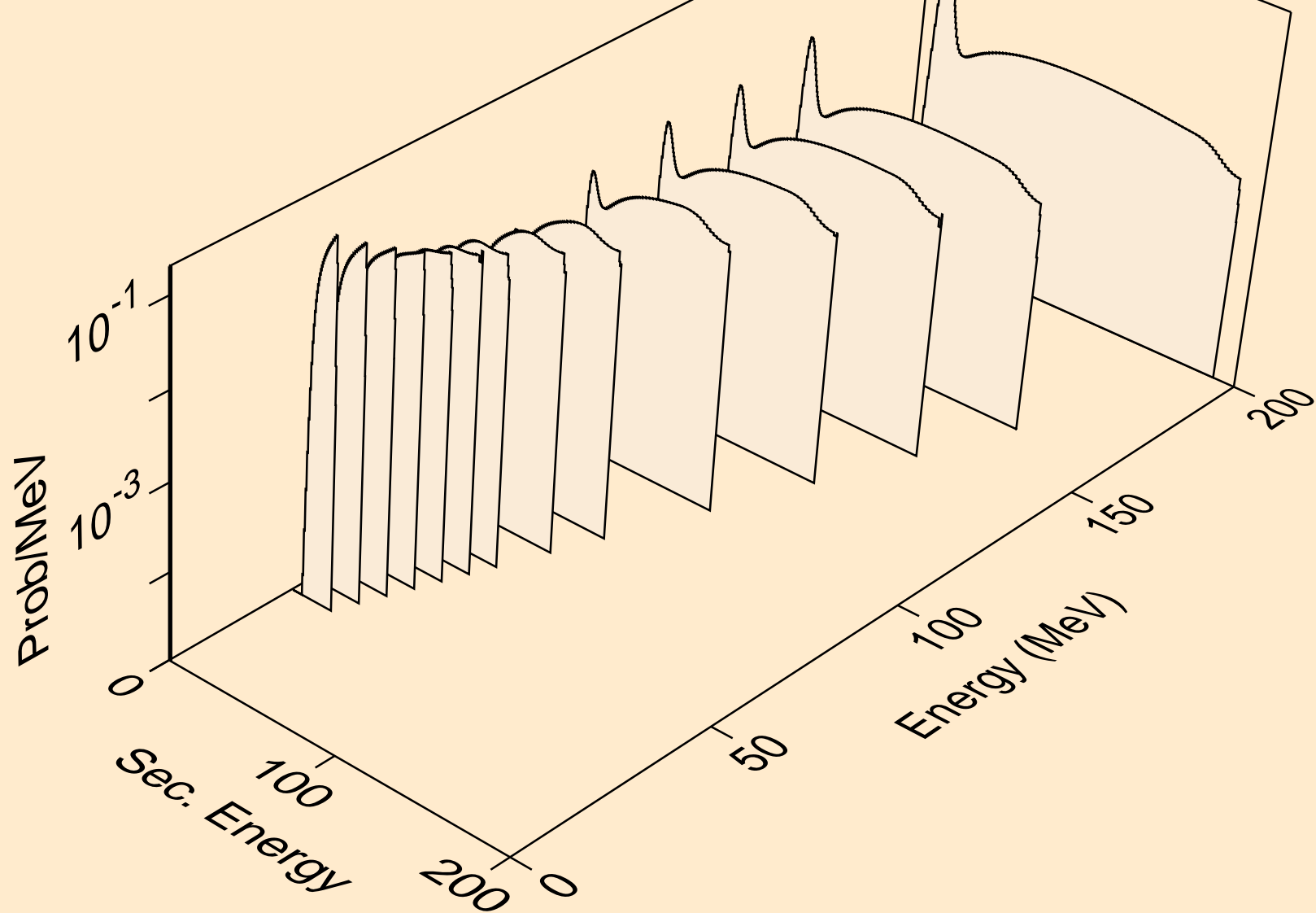

OS170 DEUTERON ACER TENDL-2024 LIBRARY; T=0.K  
tritons from (d,n\*)t

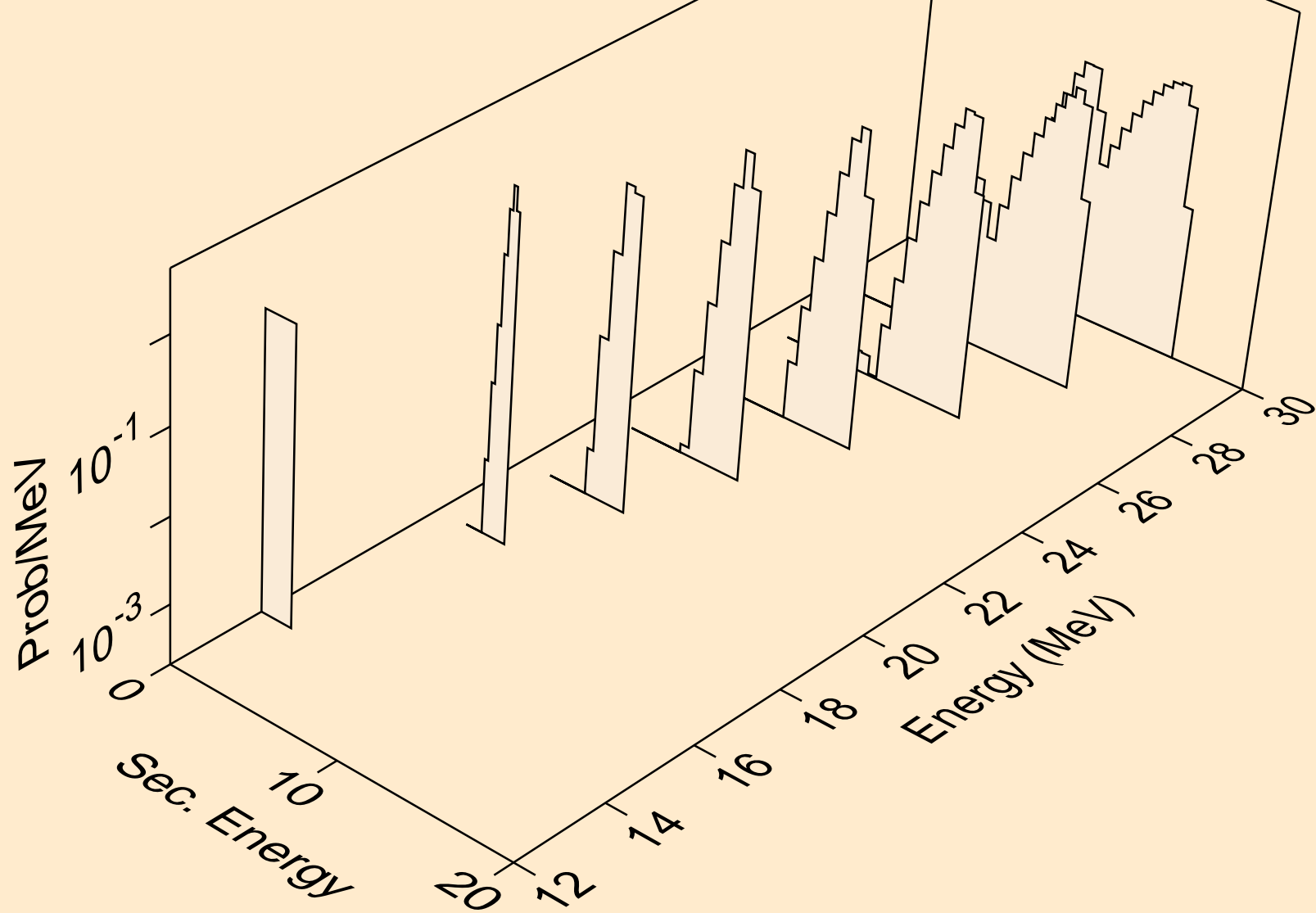

OS170 DEUTERON ACER TENDL-2024 LIBRARY; T=0.K  
tritons from (d,t)

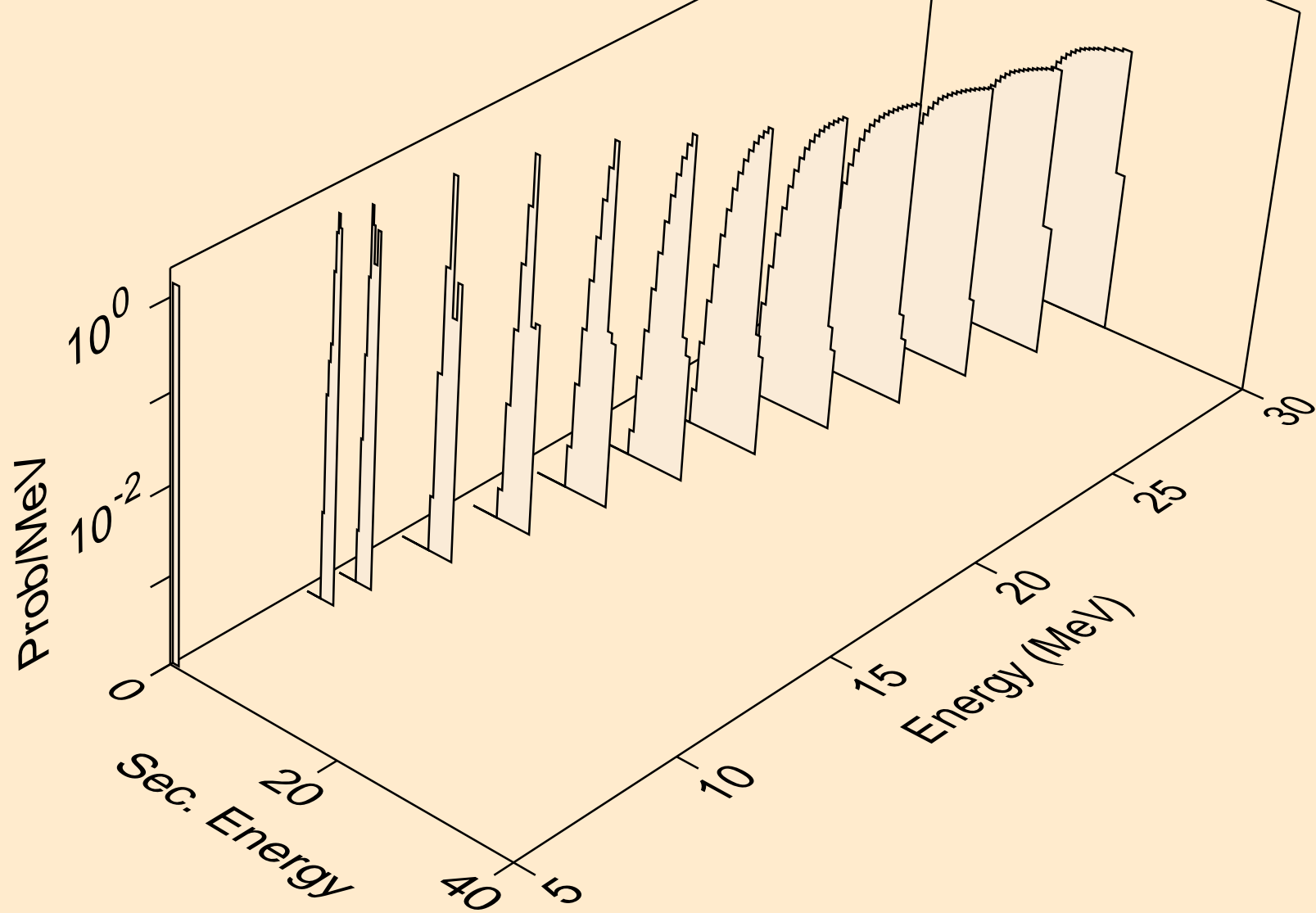

OS170 DEUTERON ACER TENDL-2024 LIBRARY; T=0.K  
tritons from (d,pt)

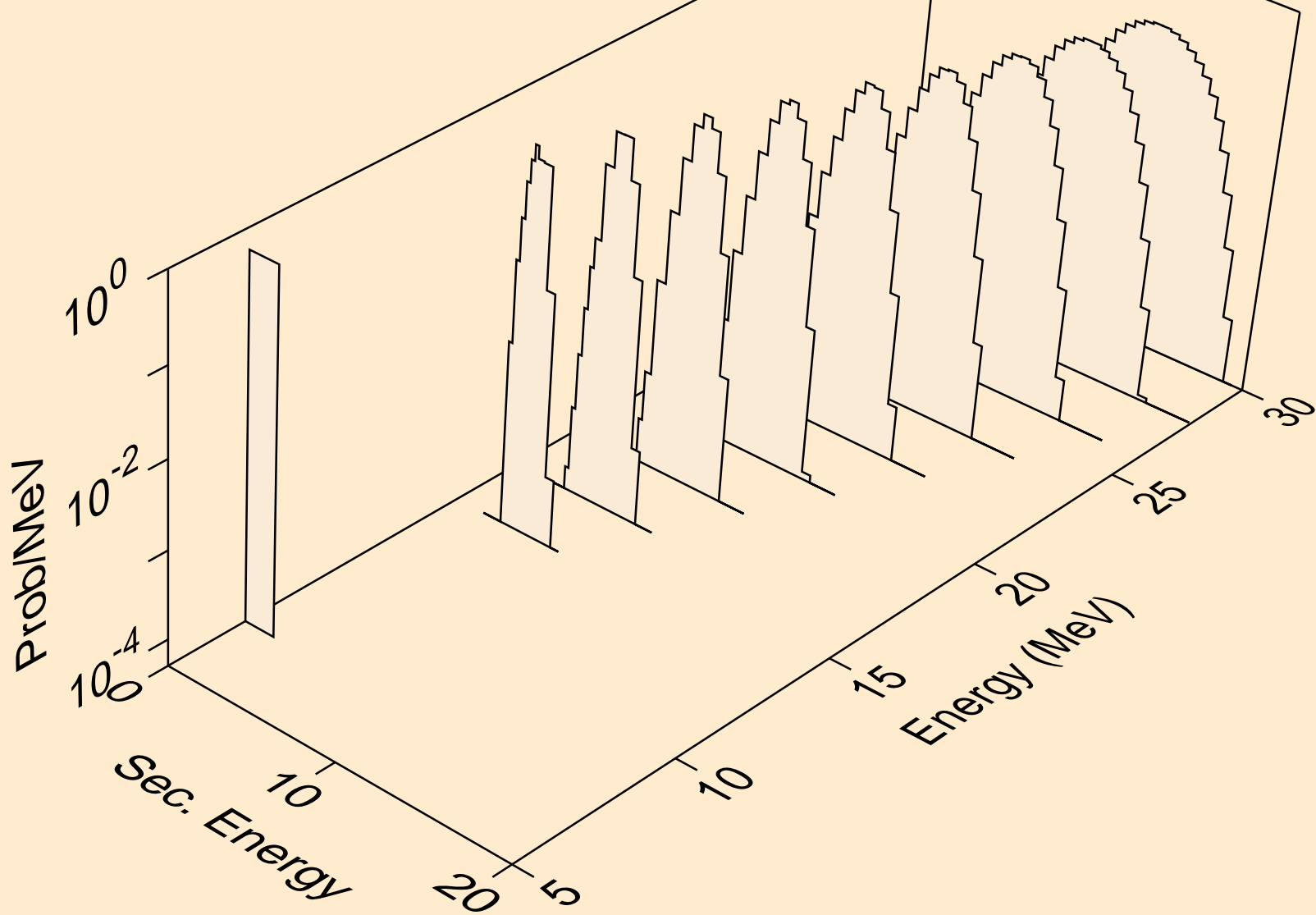

OS170 DEUTERON ACER TENDL-2024 LIBRARY; T=0.K  
he3s from (d,x)

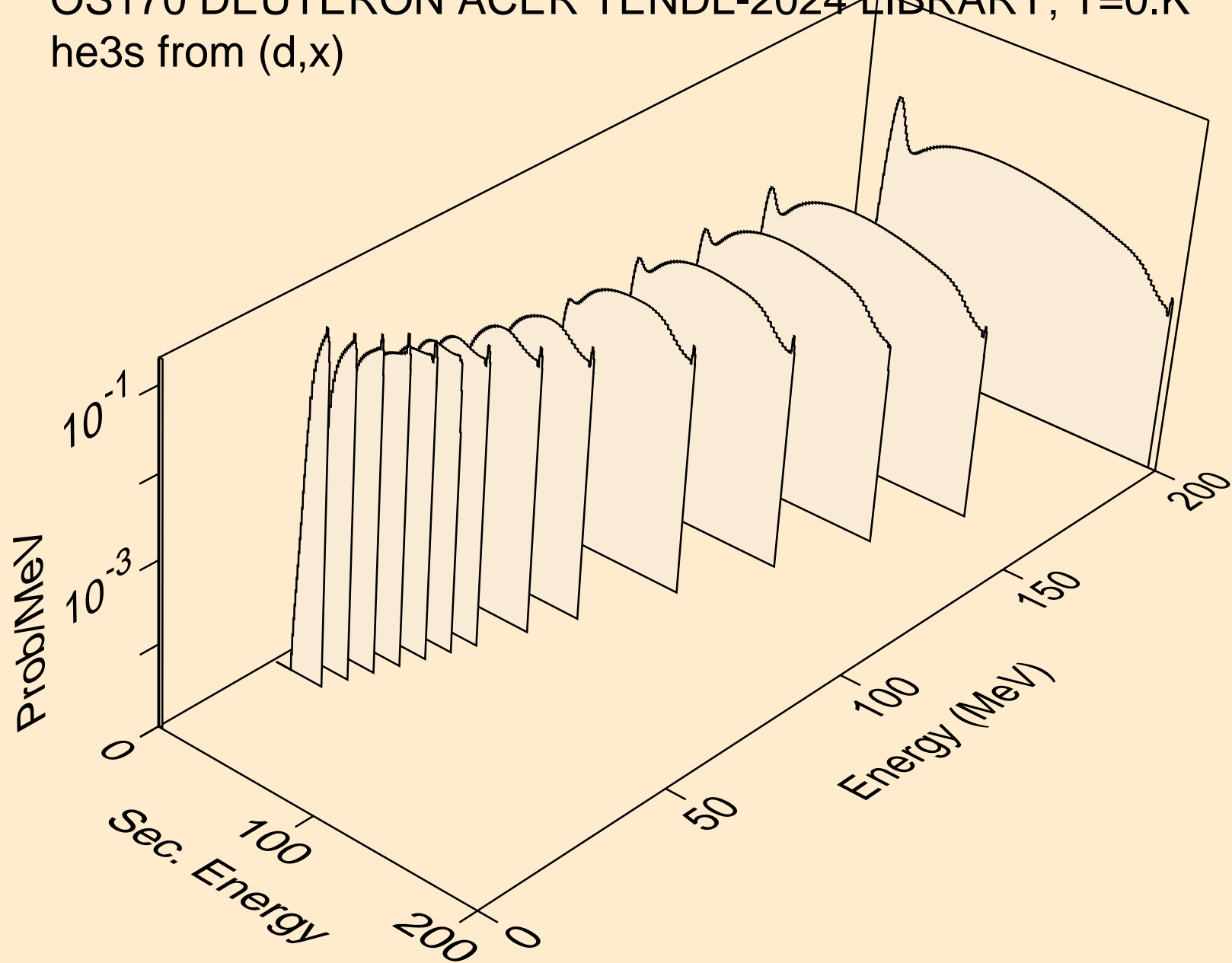

OS170 DEUTERON ACER TENDL-2024 LIBRARY; T=0.K  
he3s from (d,n\*)he3

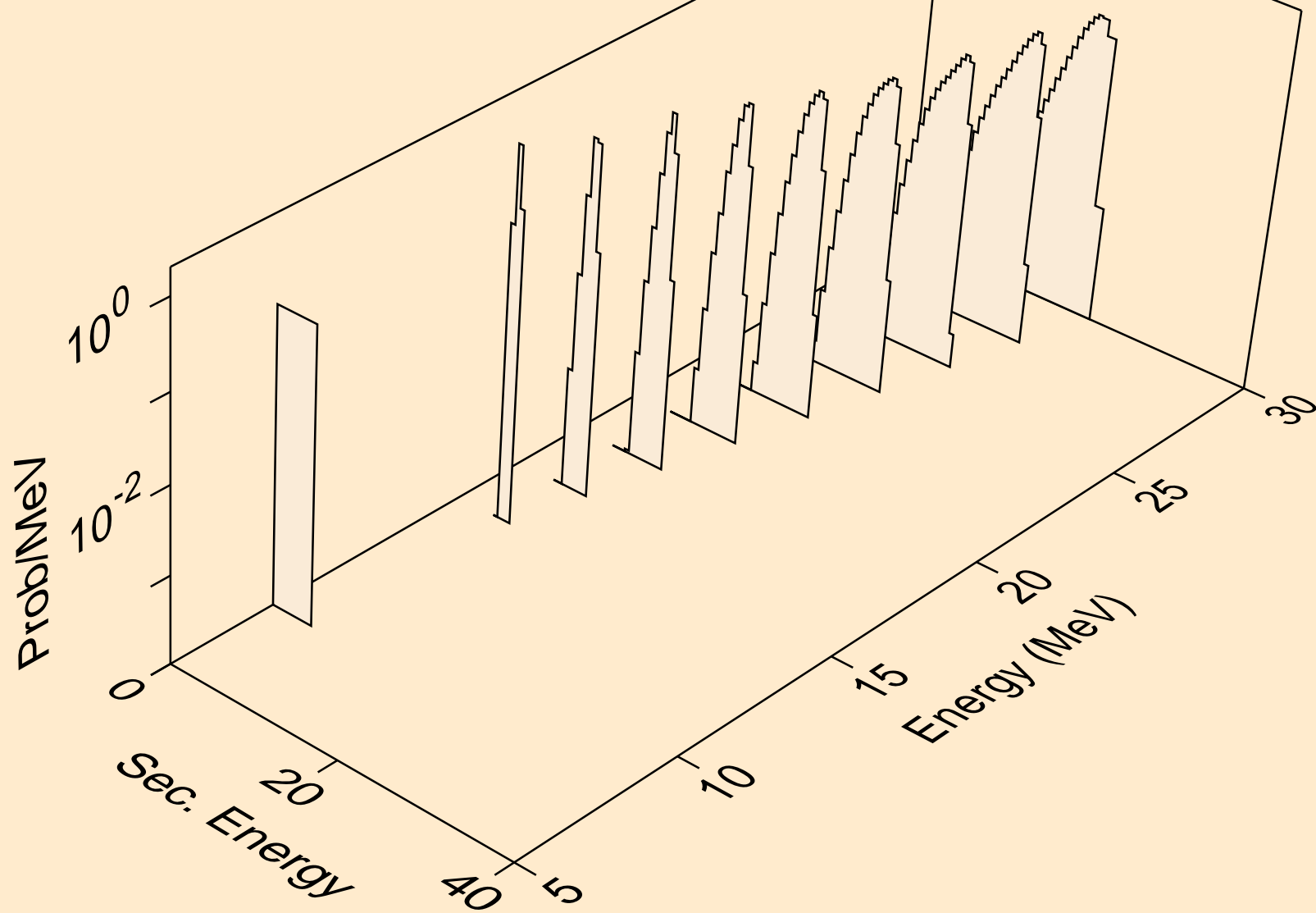

OS170 DEUTERON ACER TENDL-2024 LIBRARY; T=0.K  
he3s from (d,he3)

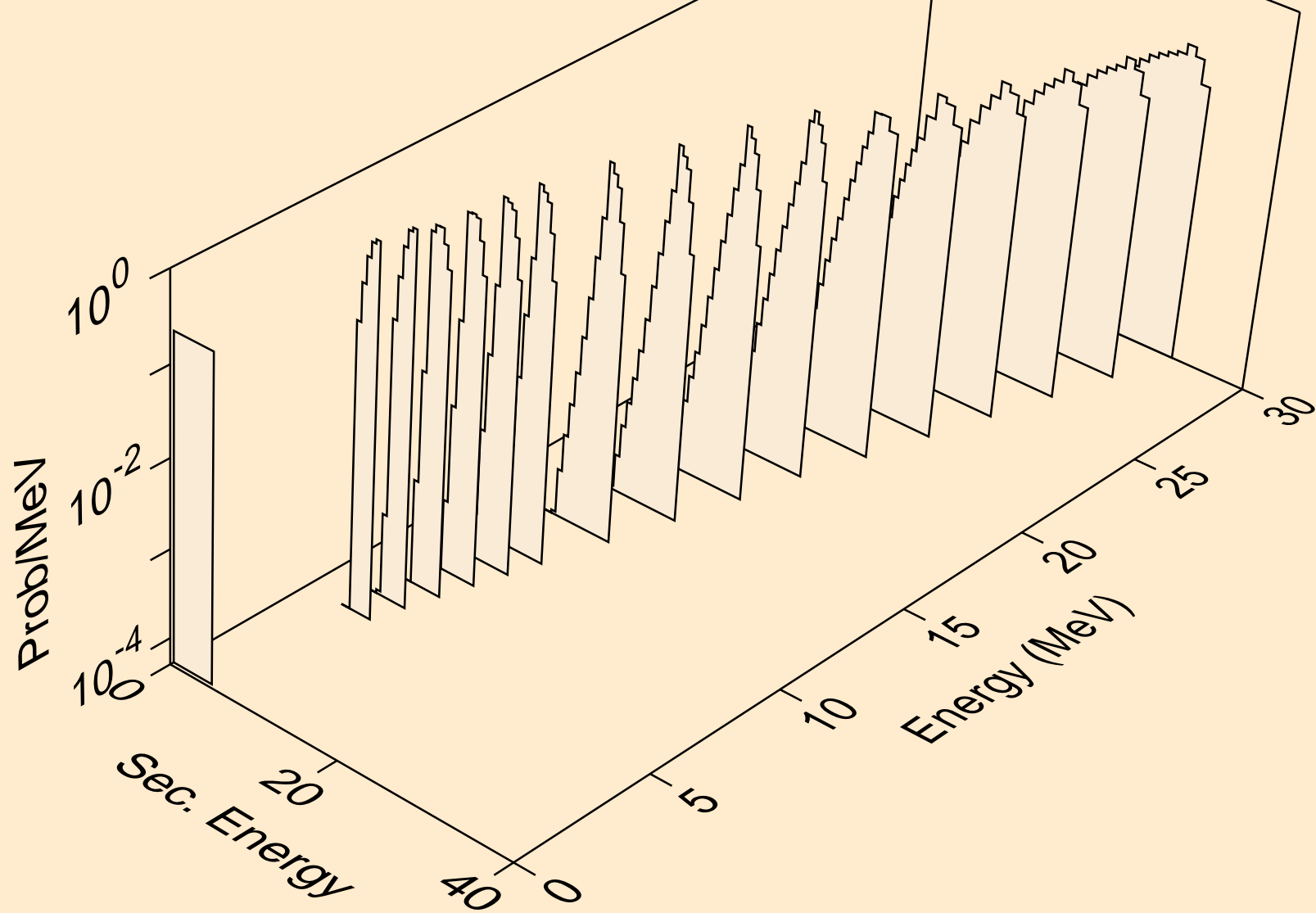

OS170 DEUTERON ACER TENDL-2024 LIBRARY; T=0.K  
alphas from (d,x)

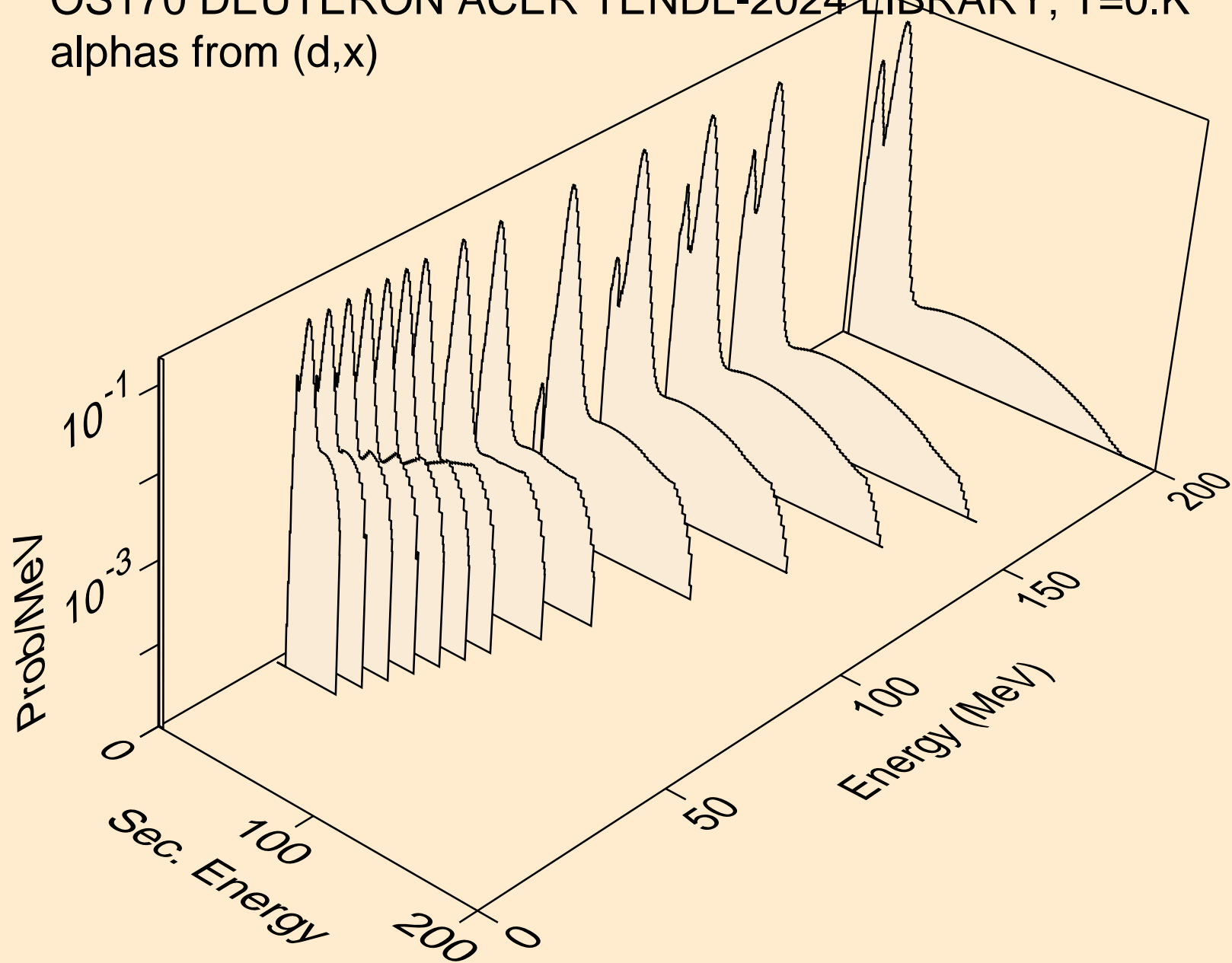

OS170 DEUTERON ACER TENDL-2024 LIBRARY; T=0.K  
alphas from (d,n\*)a

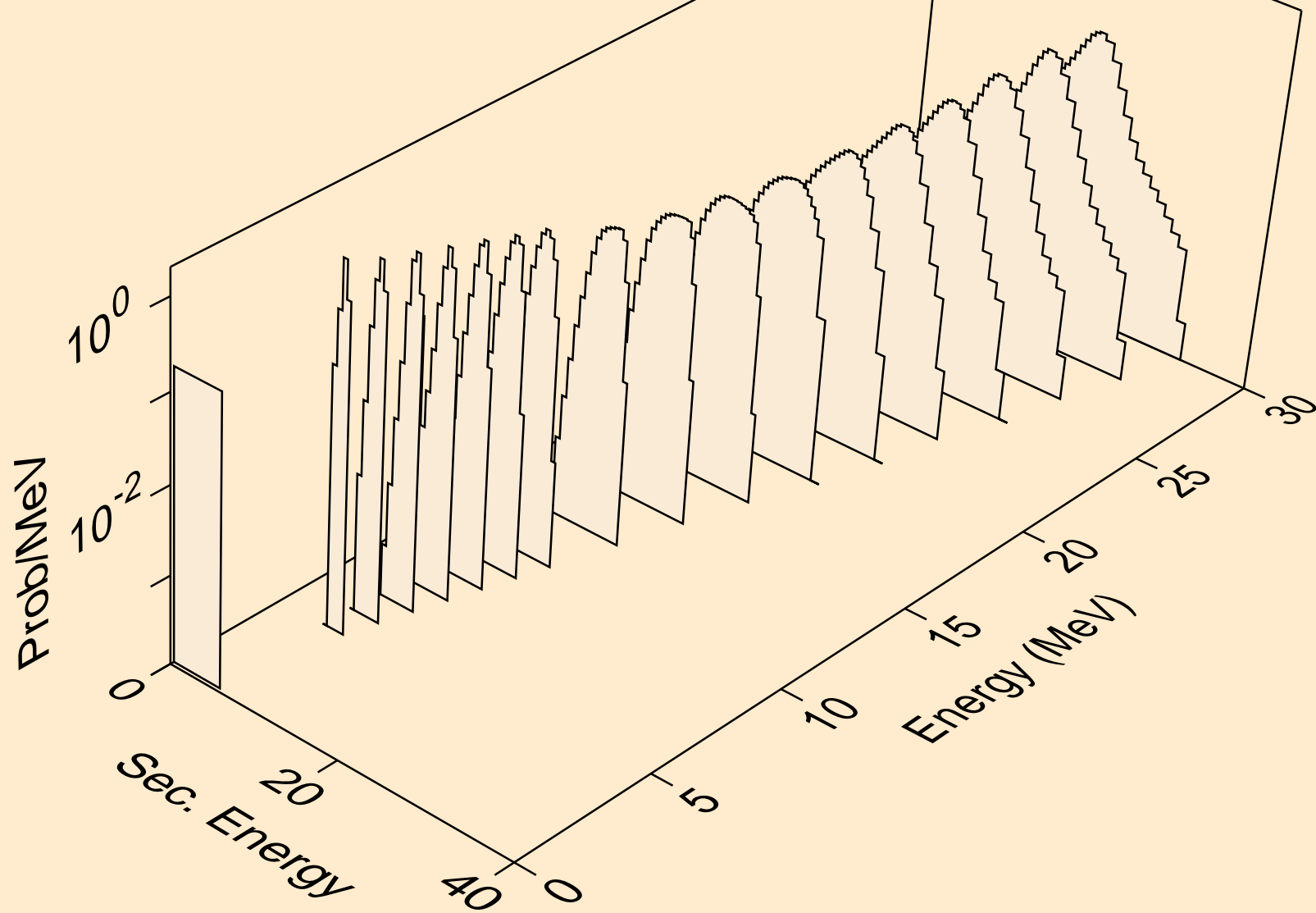

OS170 DEUTERON ACER TENDL-2024 LIBRARY; T=0.K  
alphas from (d,n\*)3a

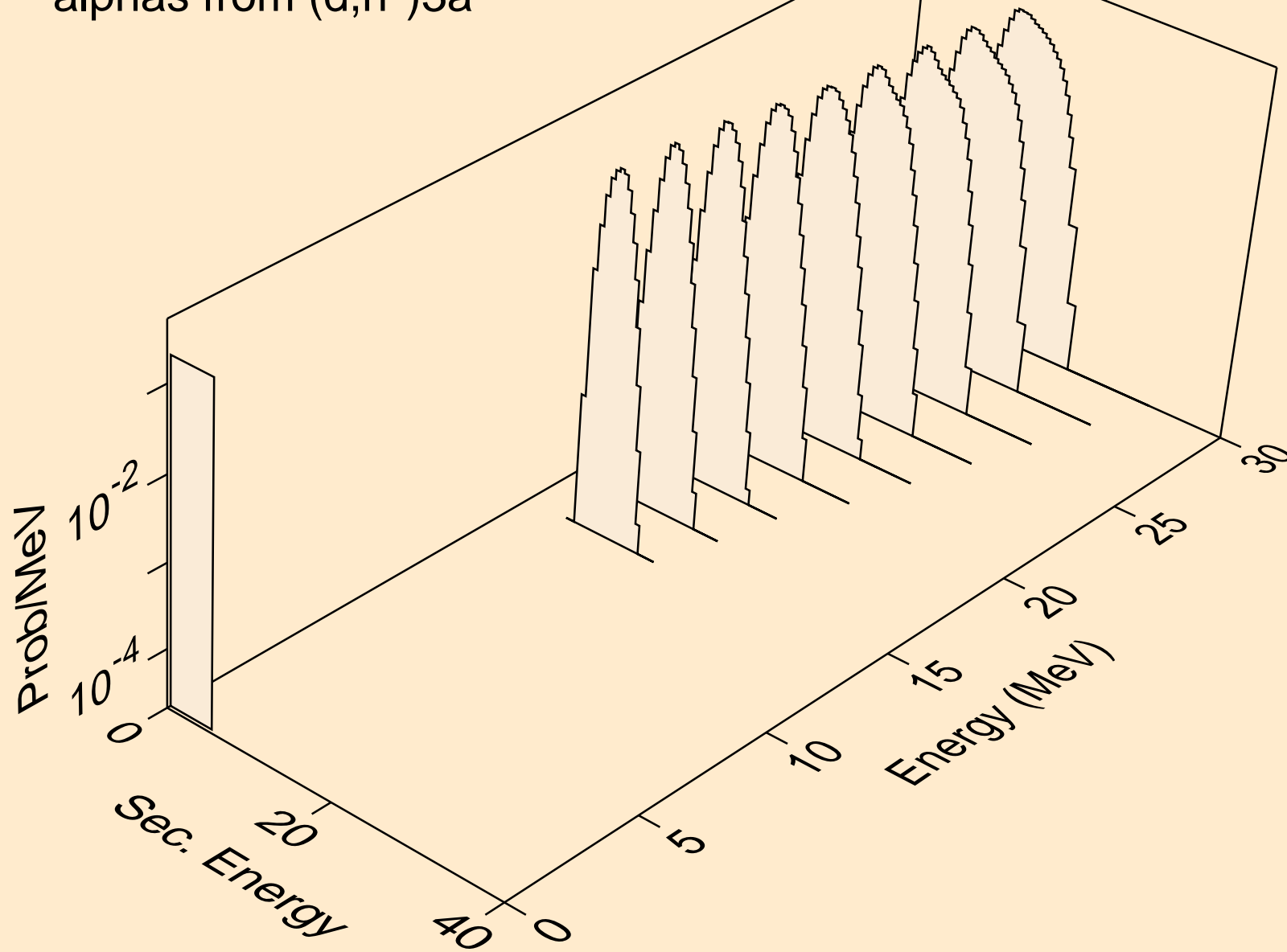

OS170 DEUTERON ACER TENDL-2024 LIBRARY; T=0.K  
alphas from (d,2n)a

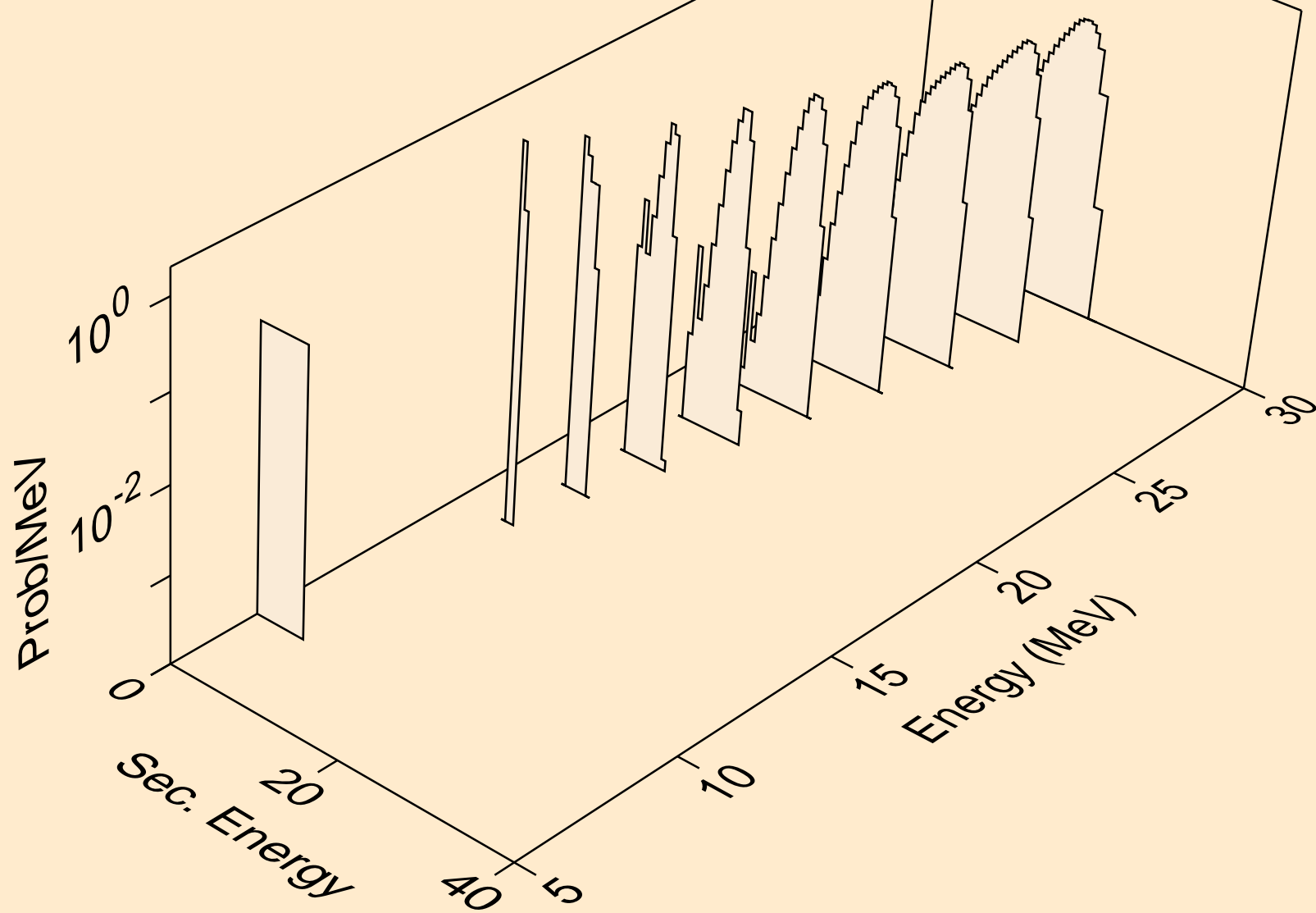

OS170 DEUTERON ACER TENDL-2024 LIBRARY; T=0.K  
alphas from (d,3n)a

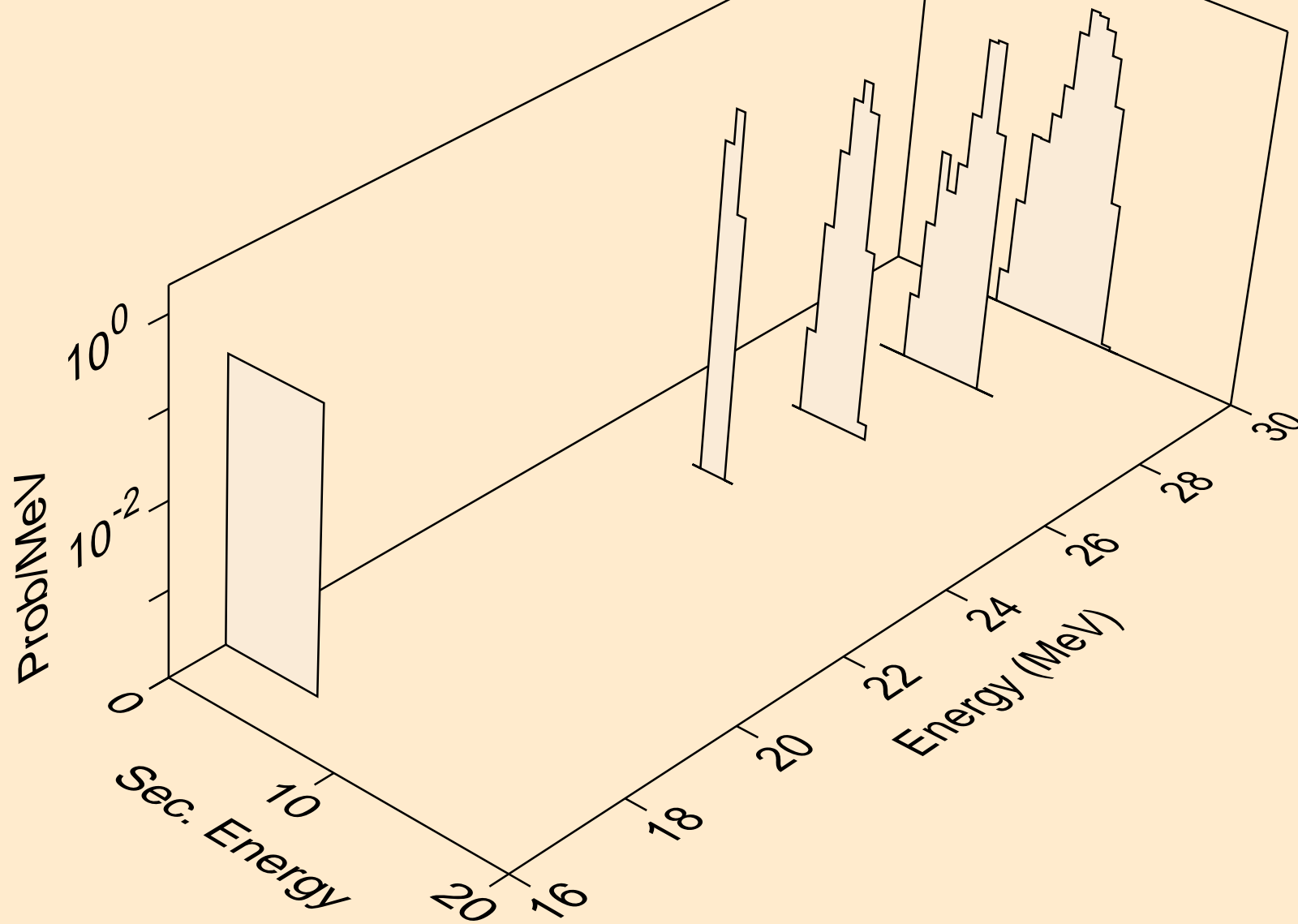

OS170 DEUTERON ACER TENDL-2024 LIBRARY; T=0.K  
alphas from (d,n\*)2a

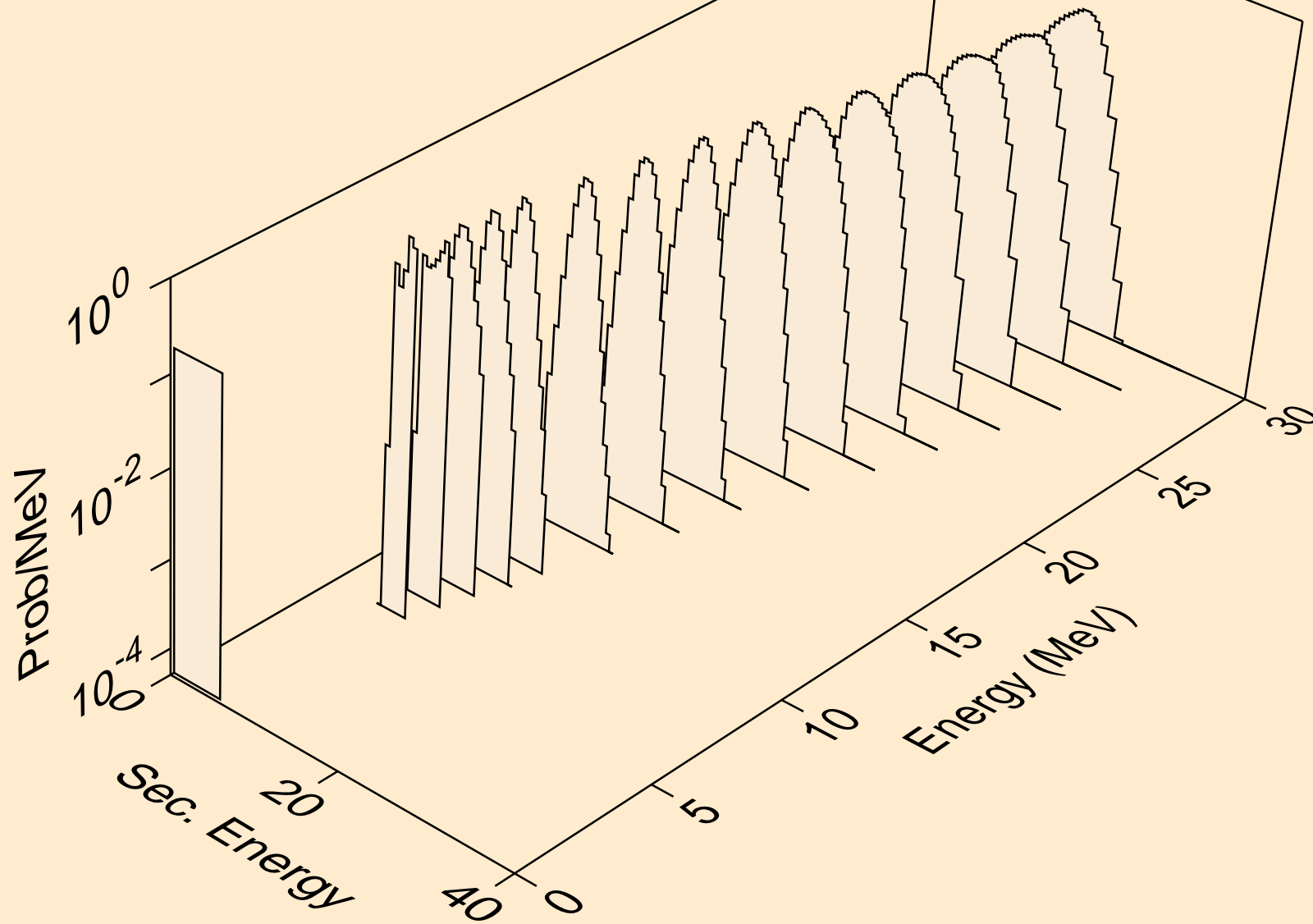

OS170 DEUTERON ACER TENDL-2024 LIBRARY; T=0.K  
alphas from (d,2n)2a

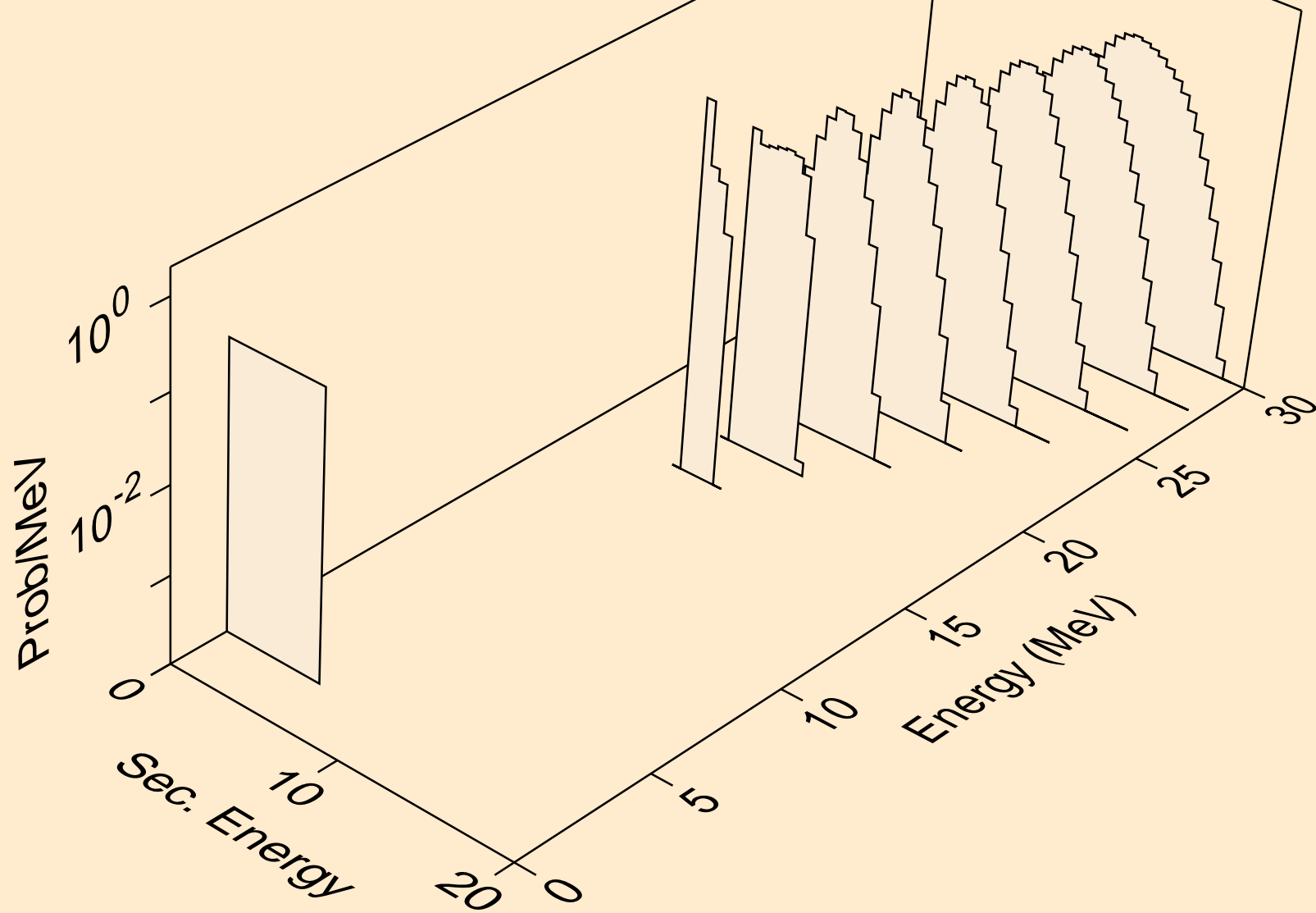

OS170 DEUTERON ACER TENDL-2024 LIBRARY; T=0.K  
alphas from (d,npa)

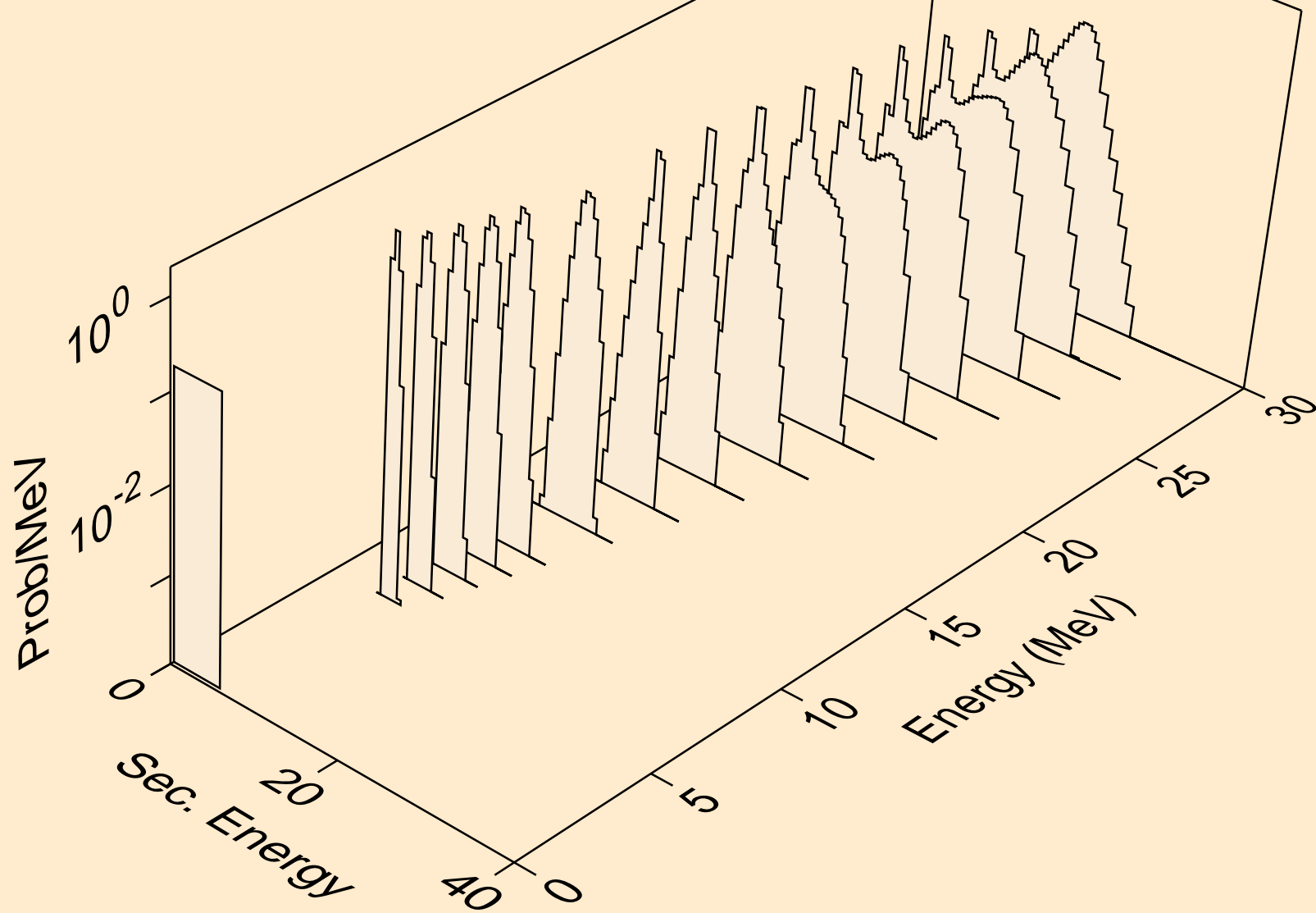

OS170 DEUTERON ACER TENDL-2024 LIBRARY; T=0.K  
alphas from (d,a)

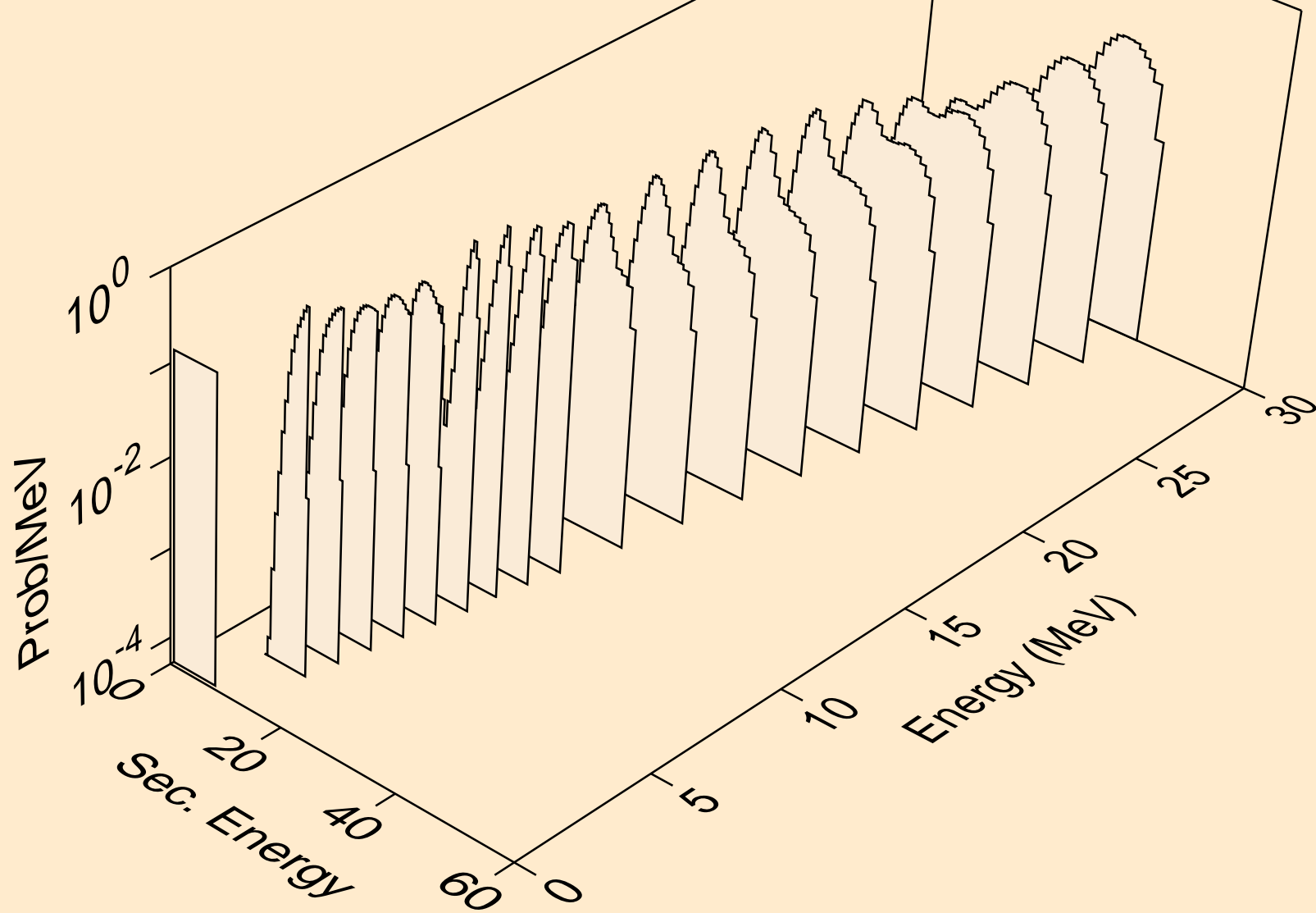

OS170 DEUTERON ACER TENDL-2024 LIBRARY; T=0.K  
alphas from (d,2a)

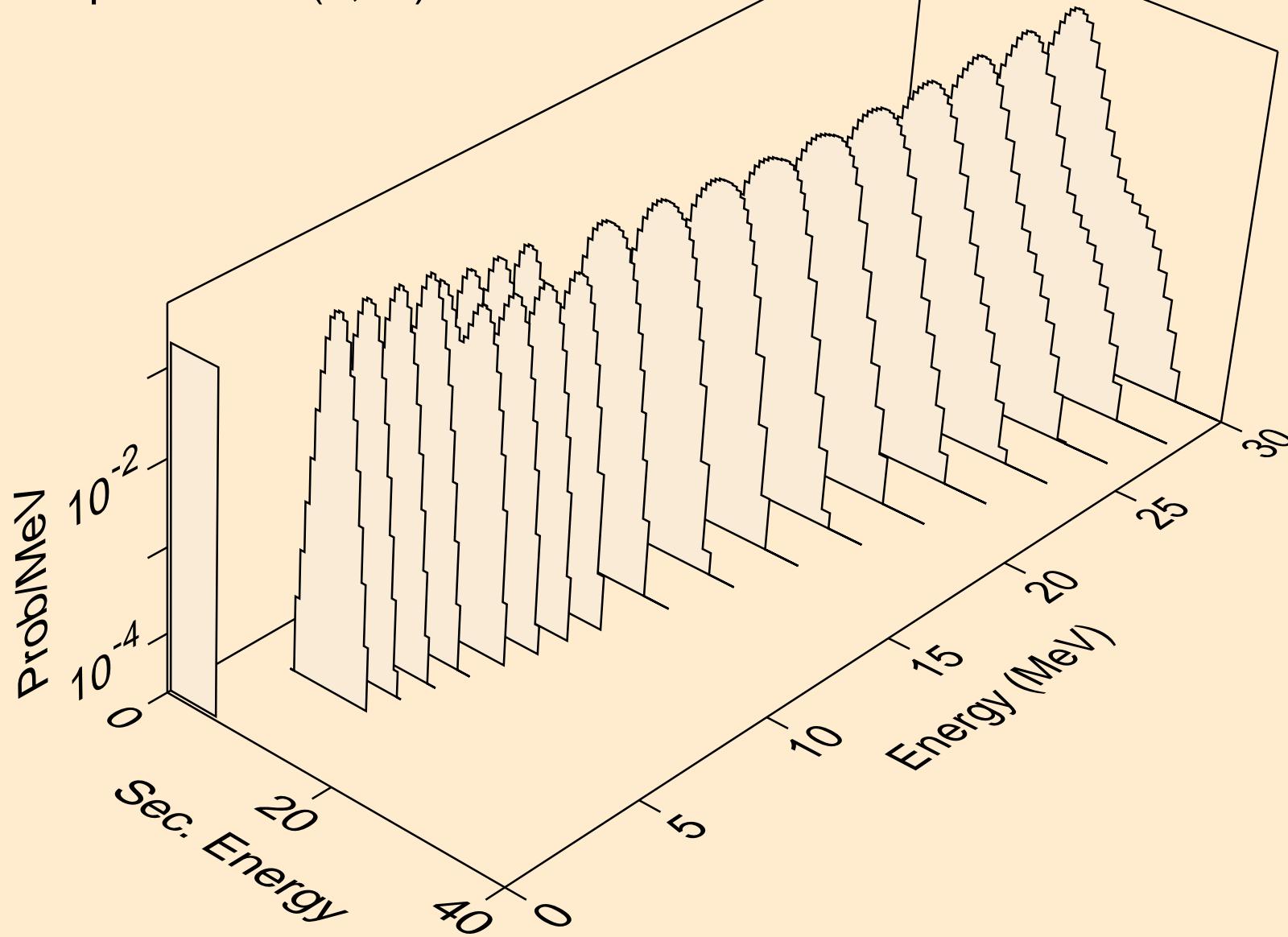

OS170 DEUTERON ACER TENDL-2024 LIBRARY; T=0.K  
alphas from (d,3a)

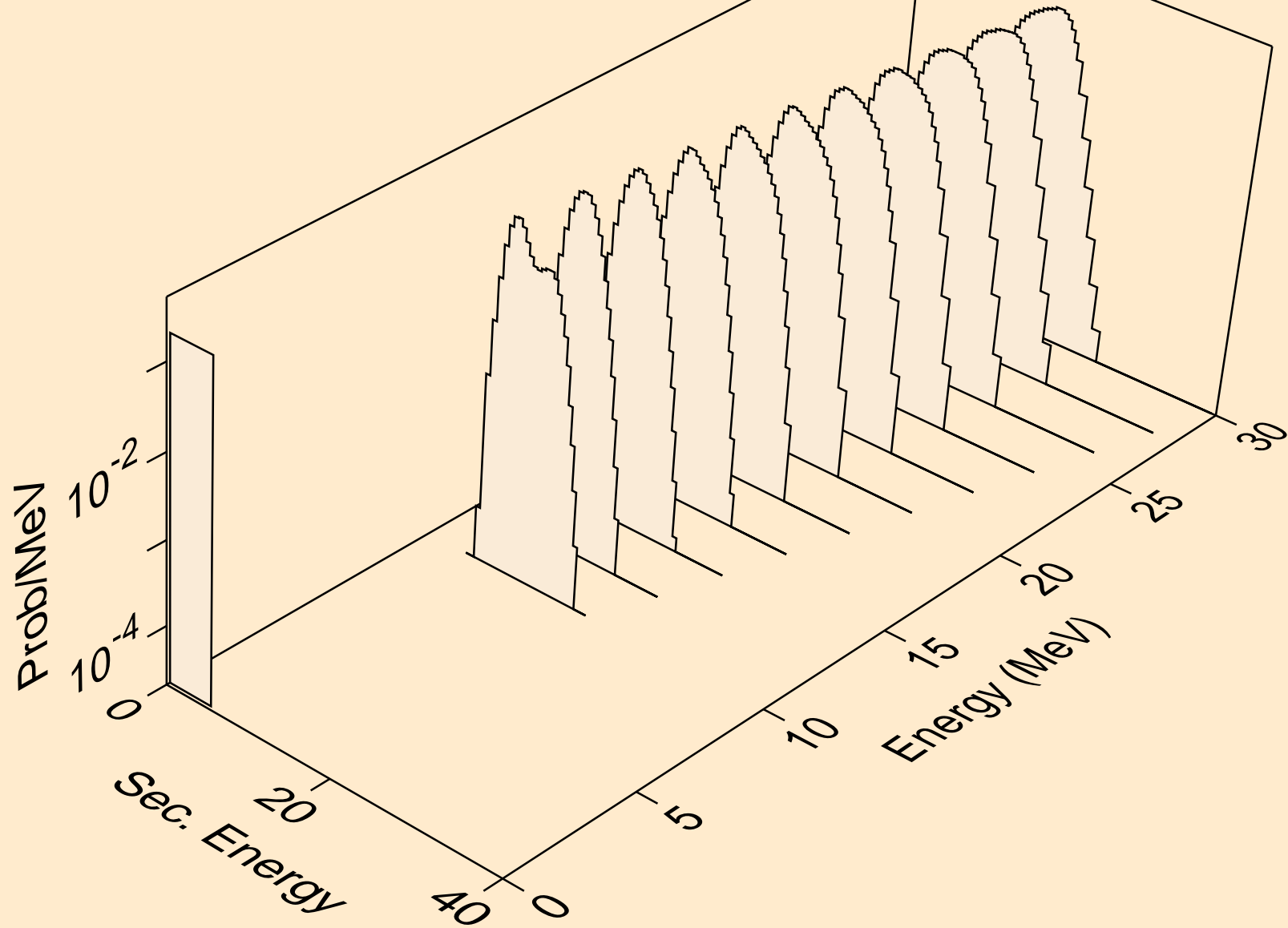

OS170 DEUTERON ACER TENDL-2024 LIBRARY; T=0.K  
alphas from (d,pa)

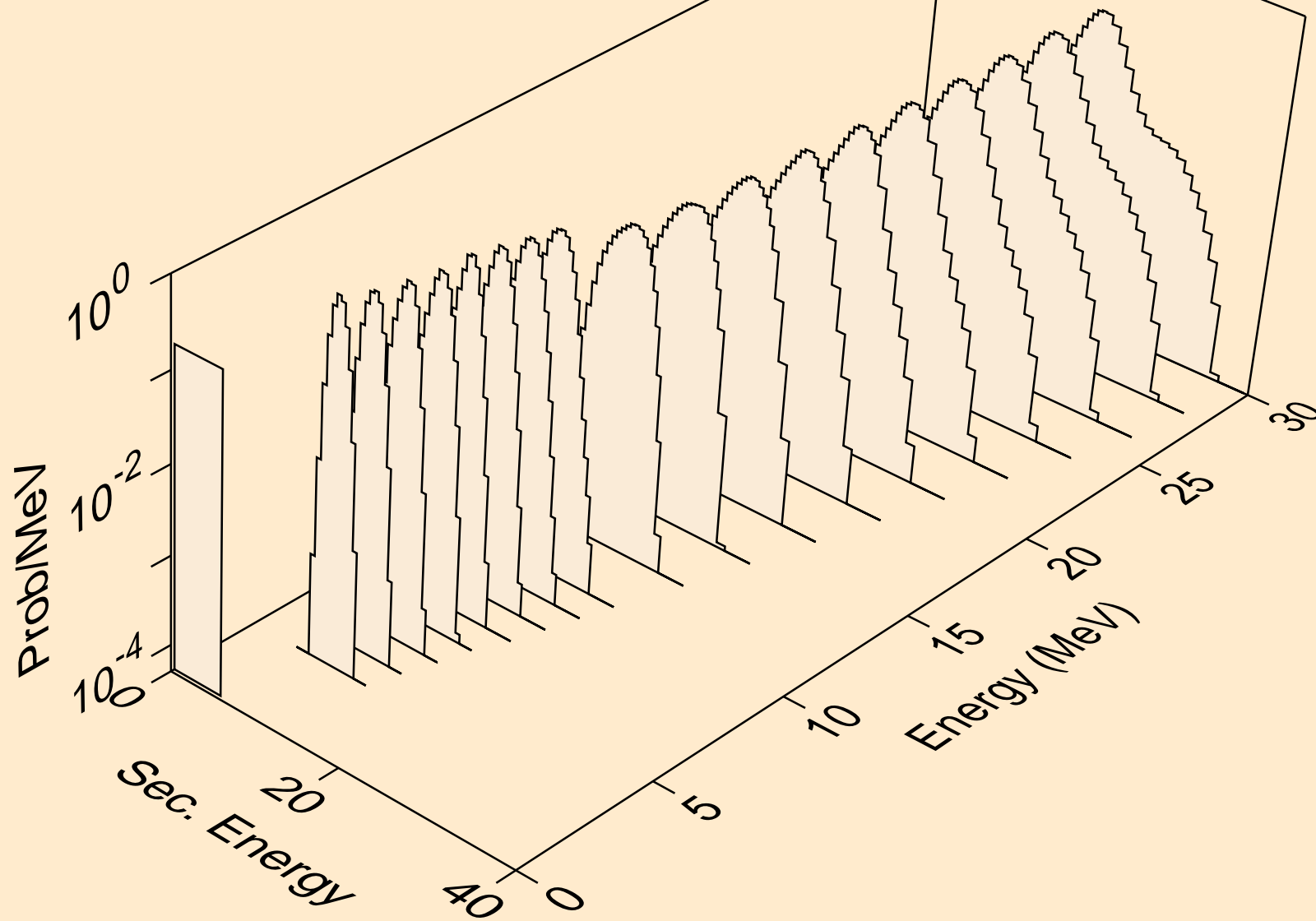

OS170 DEUTERON ACER TENDL-2024 LIBRARY; T=0.K  
alphas from (d,d2a)

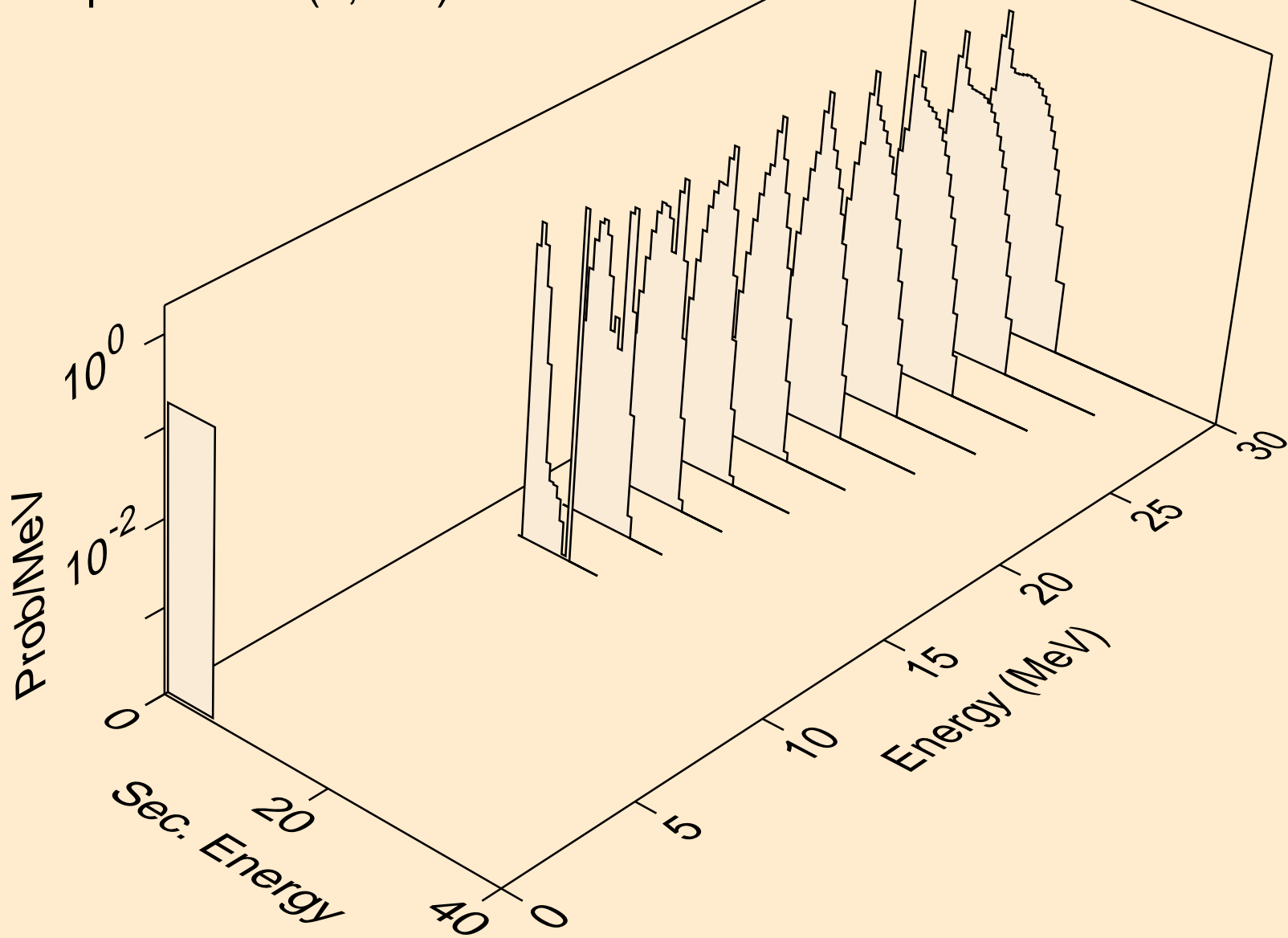

OS170 DEUTERON ACER TENDL-2024 LIBRARY; T=0.K  
alphas from (d,da)

