

PU247 DEUTERON ACER TENDL-2024 LIBRARY; T=0.K  
Principal cross sections

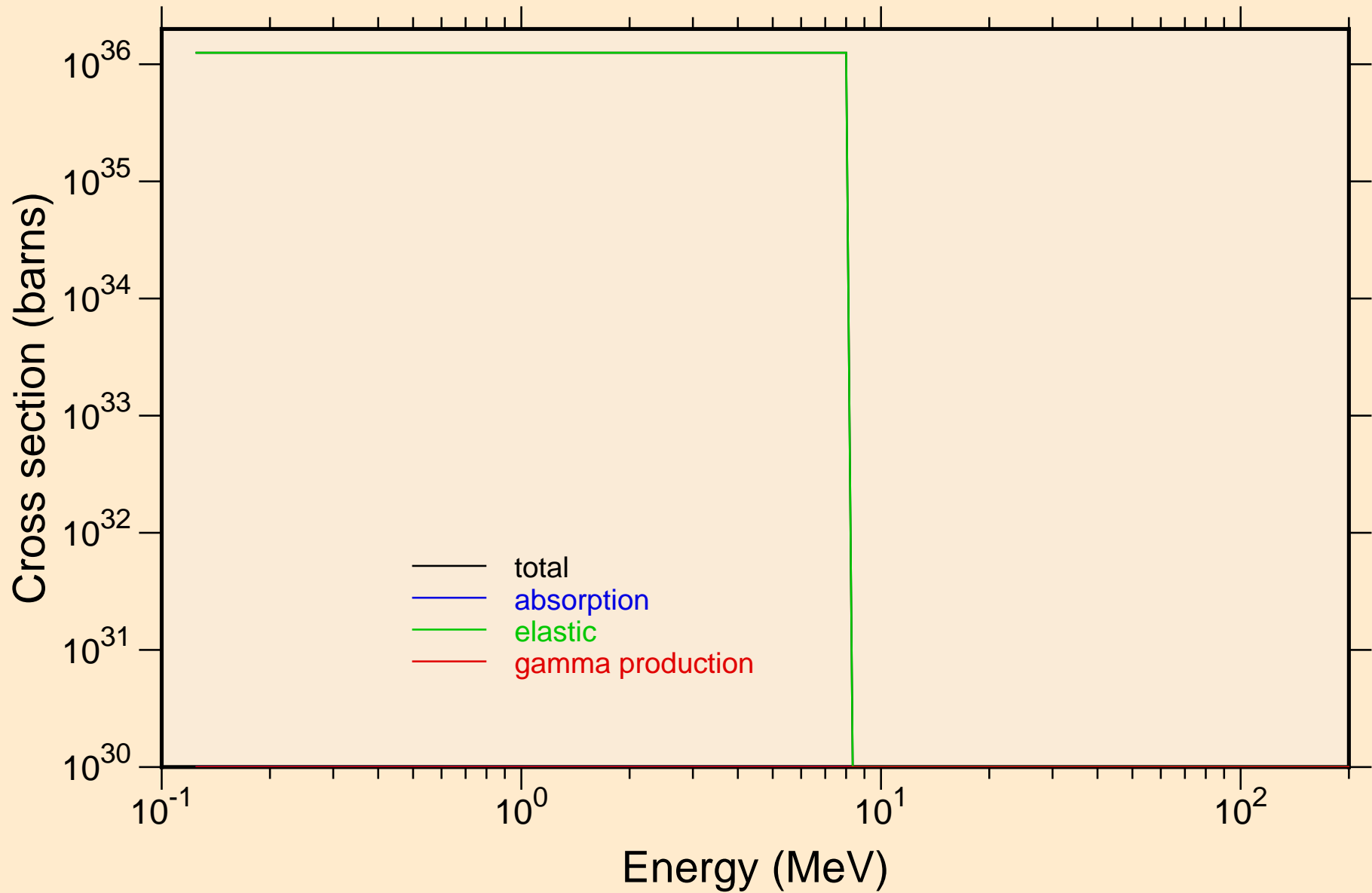

PU247 DEUTERON ACER TENDL-2024 LIBRARY; T=0.K  
Heating

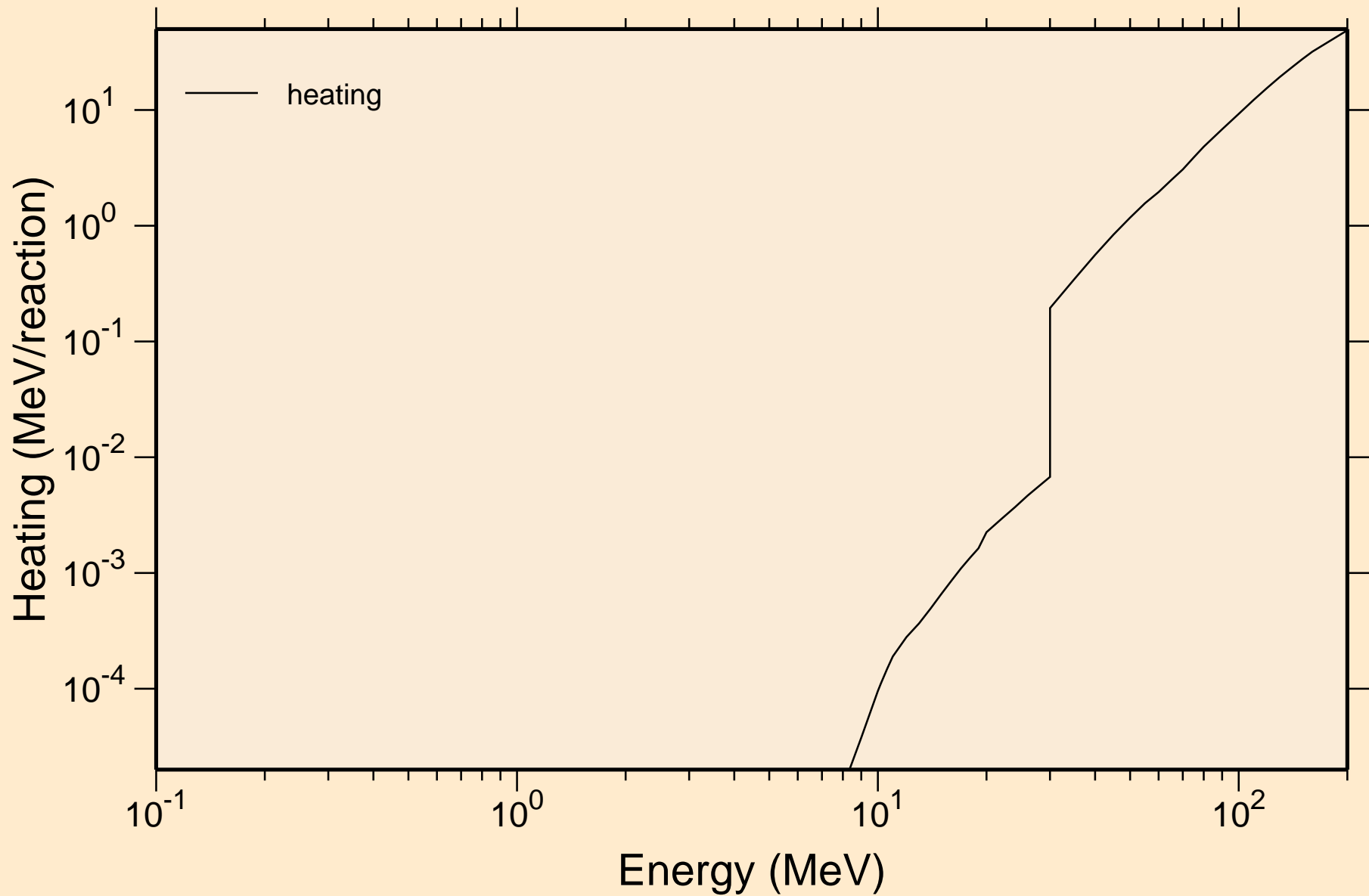

PU247 DEUTERON ACER TENDL-2024 LIBRARY; T=0.K  
Principal cross sections

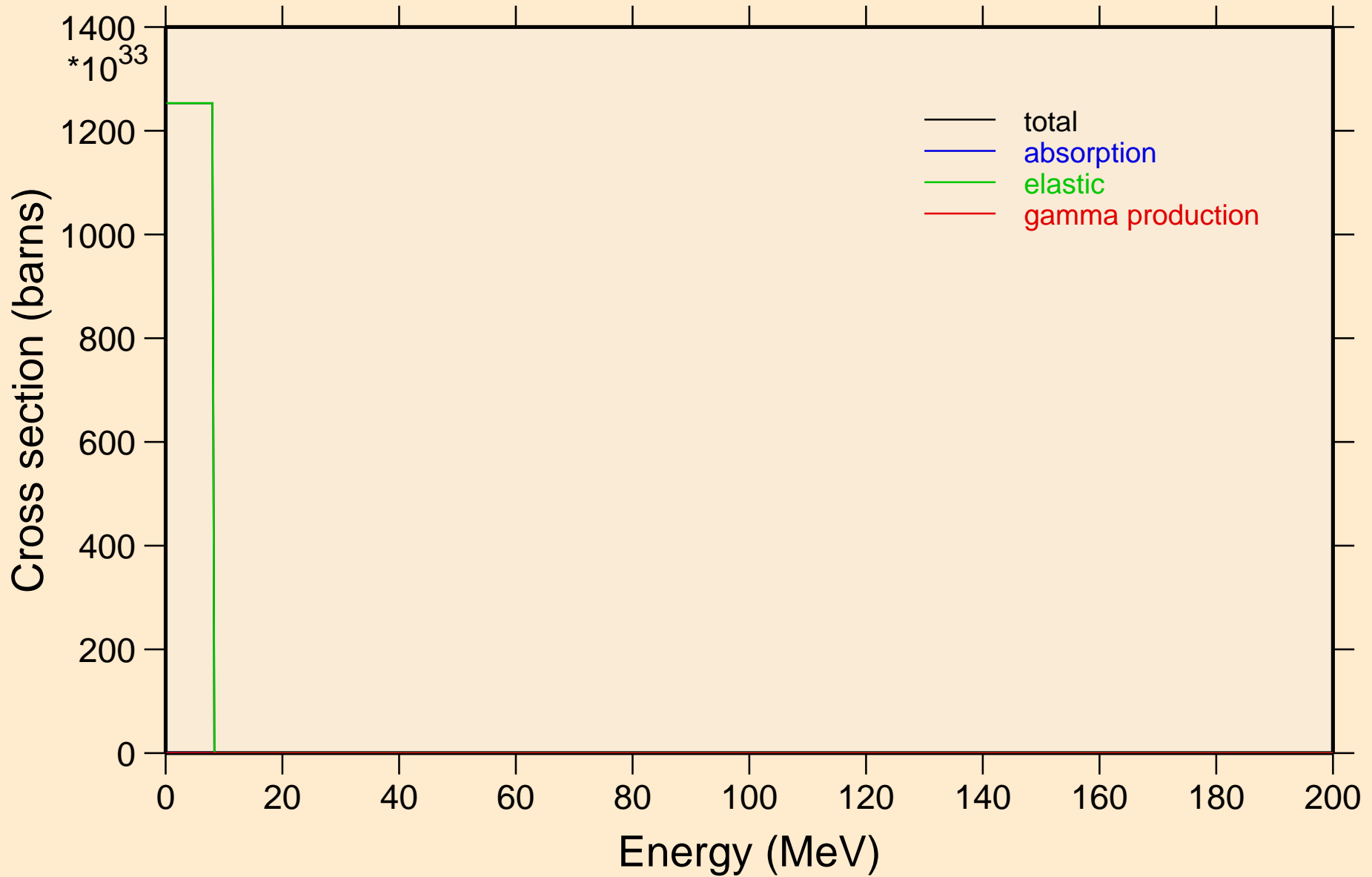

PU247 DEUTERON ACER TENDL-2024 LIBRARY; T=0.K

Heating

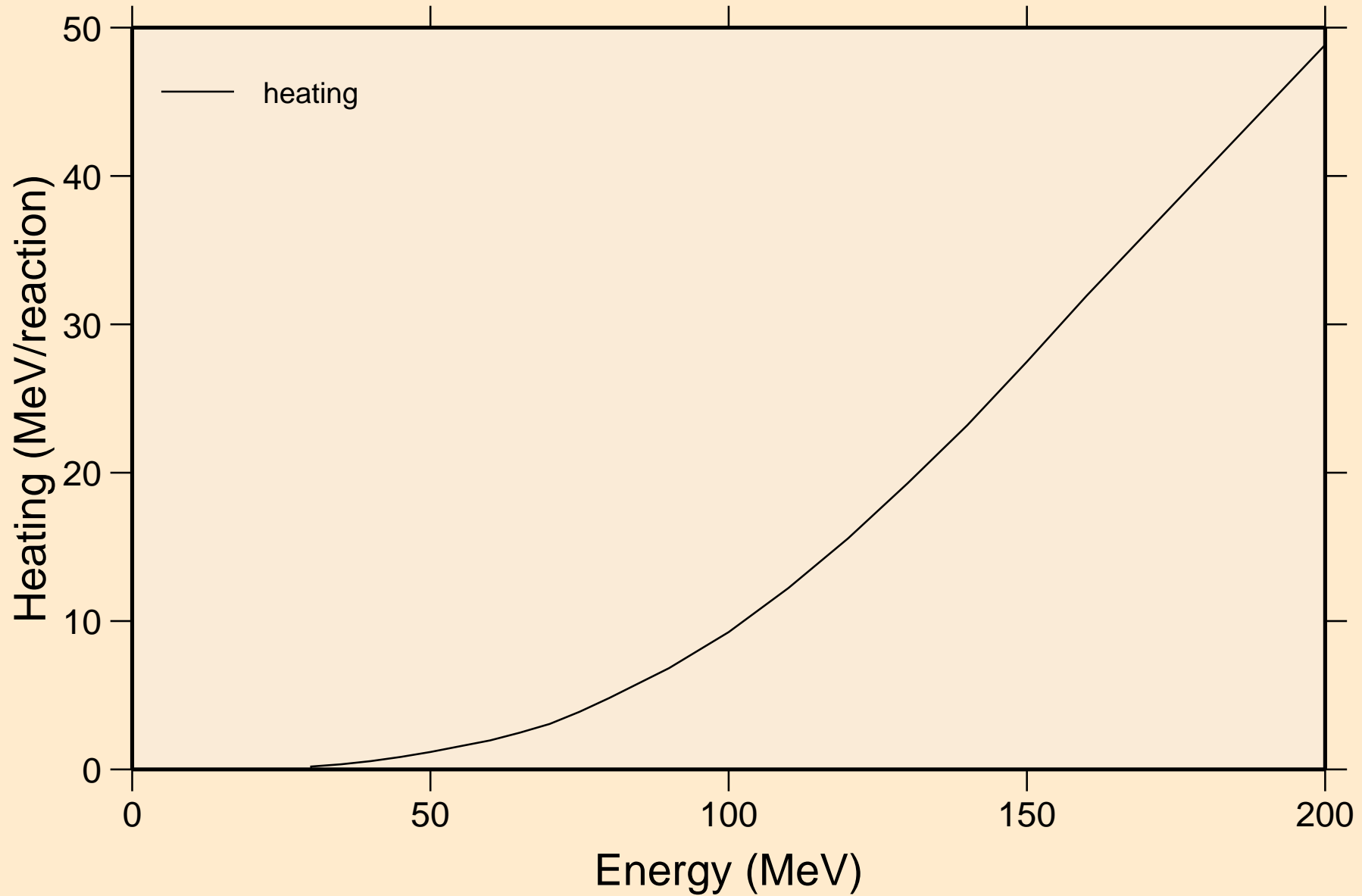

PU247 DEUTERON ACER TENDL-2024 LIBRARY; T=0.K  
Threshold reactions

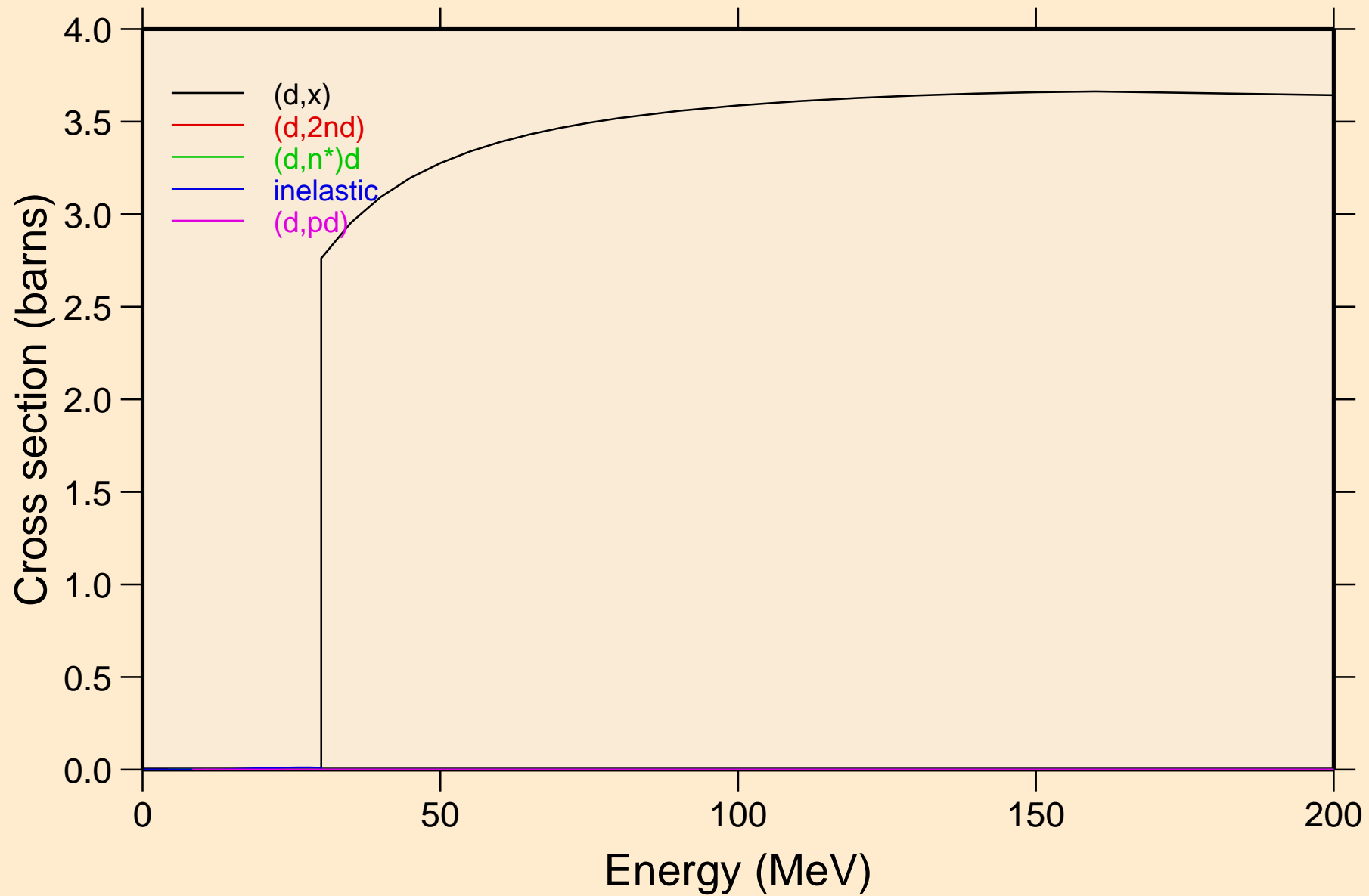

PU247 DEUTERON ACER TENDL-2024 LIBRARY; T=0.K  
angular distribution for elastic

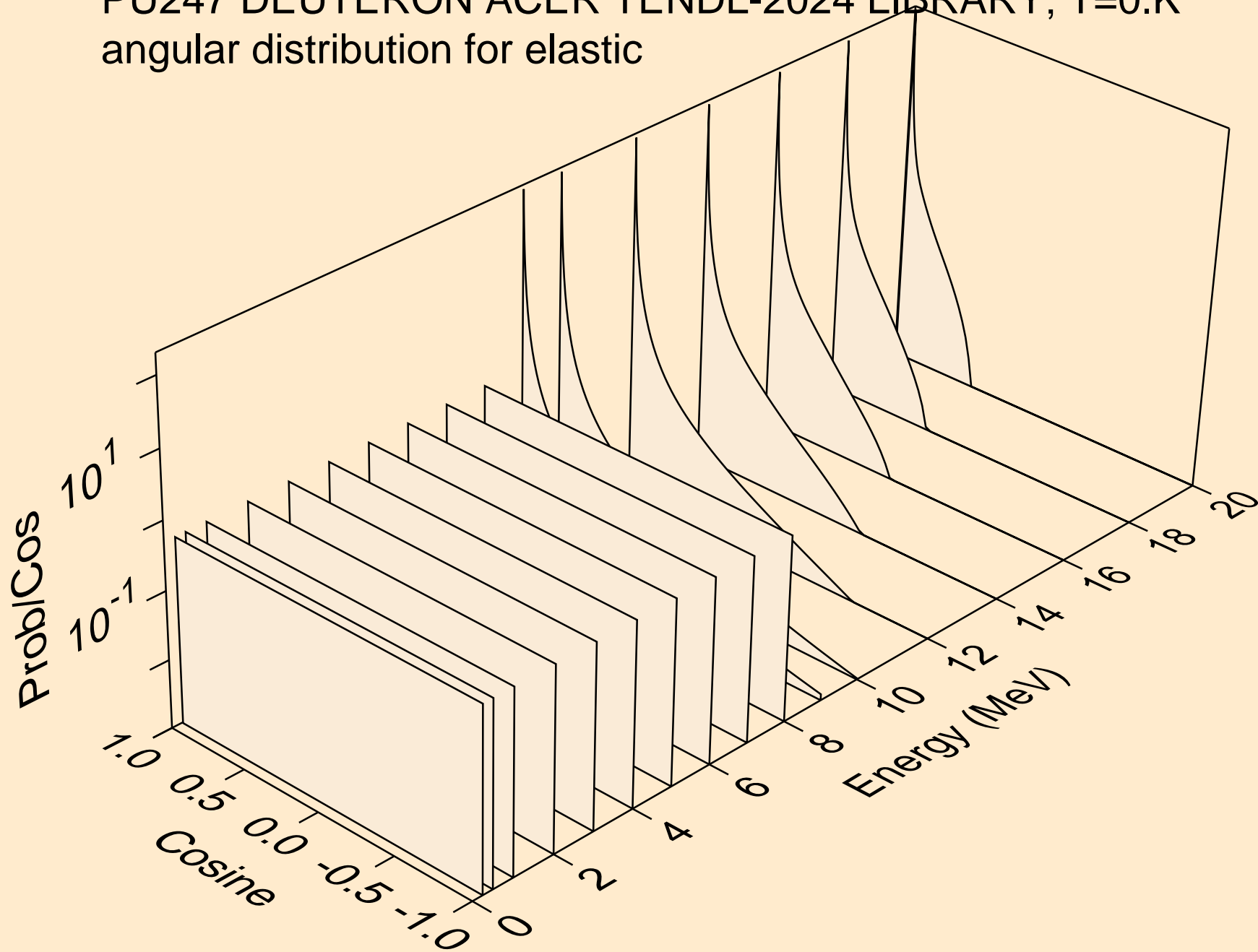

PU247 DEUTERON ACER TENDL-2024 LIBRARY; T=0.K  
angular distribution for elastic

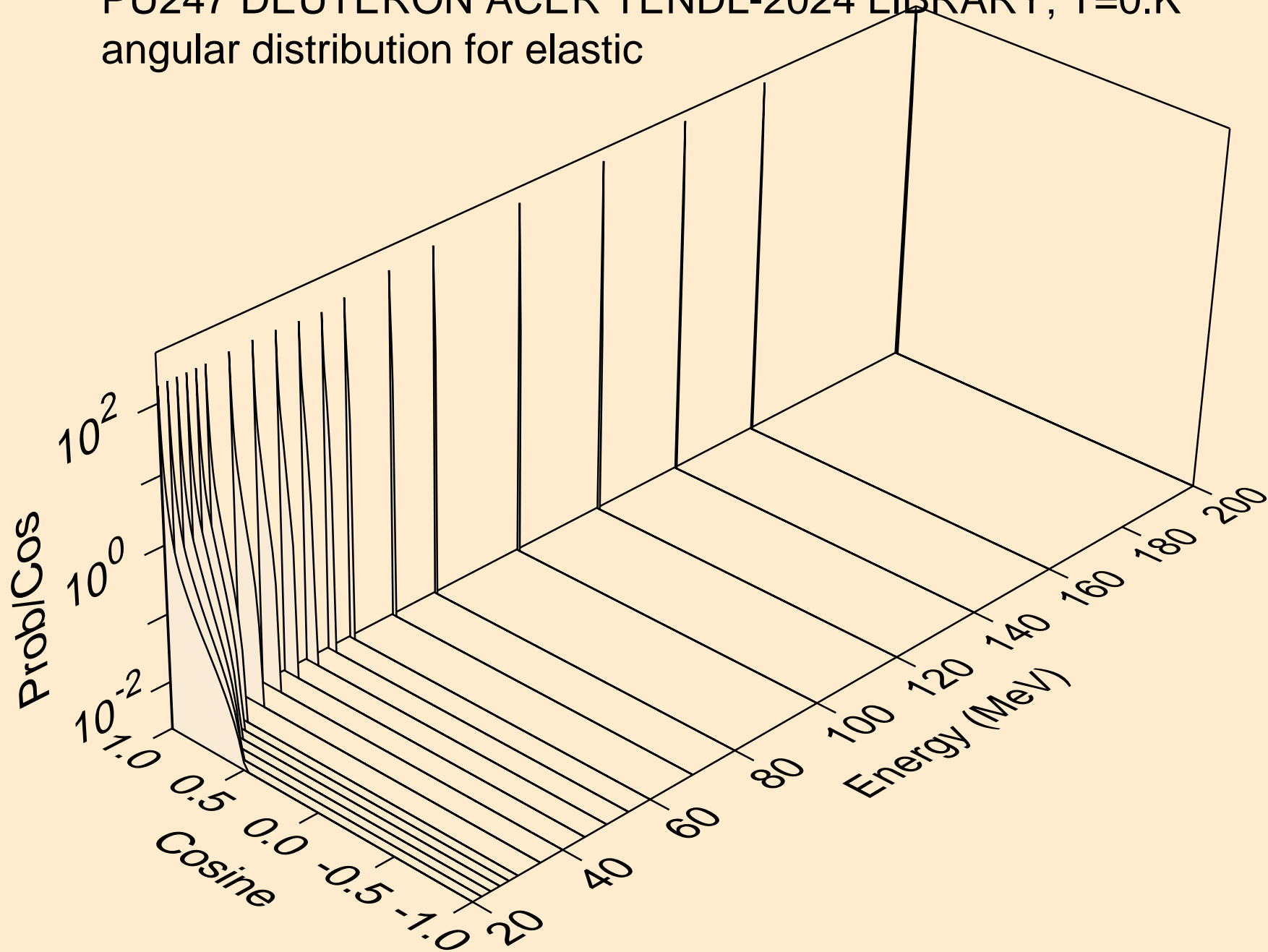

PU247 DEUTERON ACER TENDL-2024 LIBRARY; T=0.K  
Deuteron emission for (d,x)

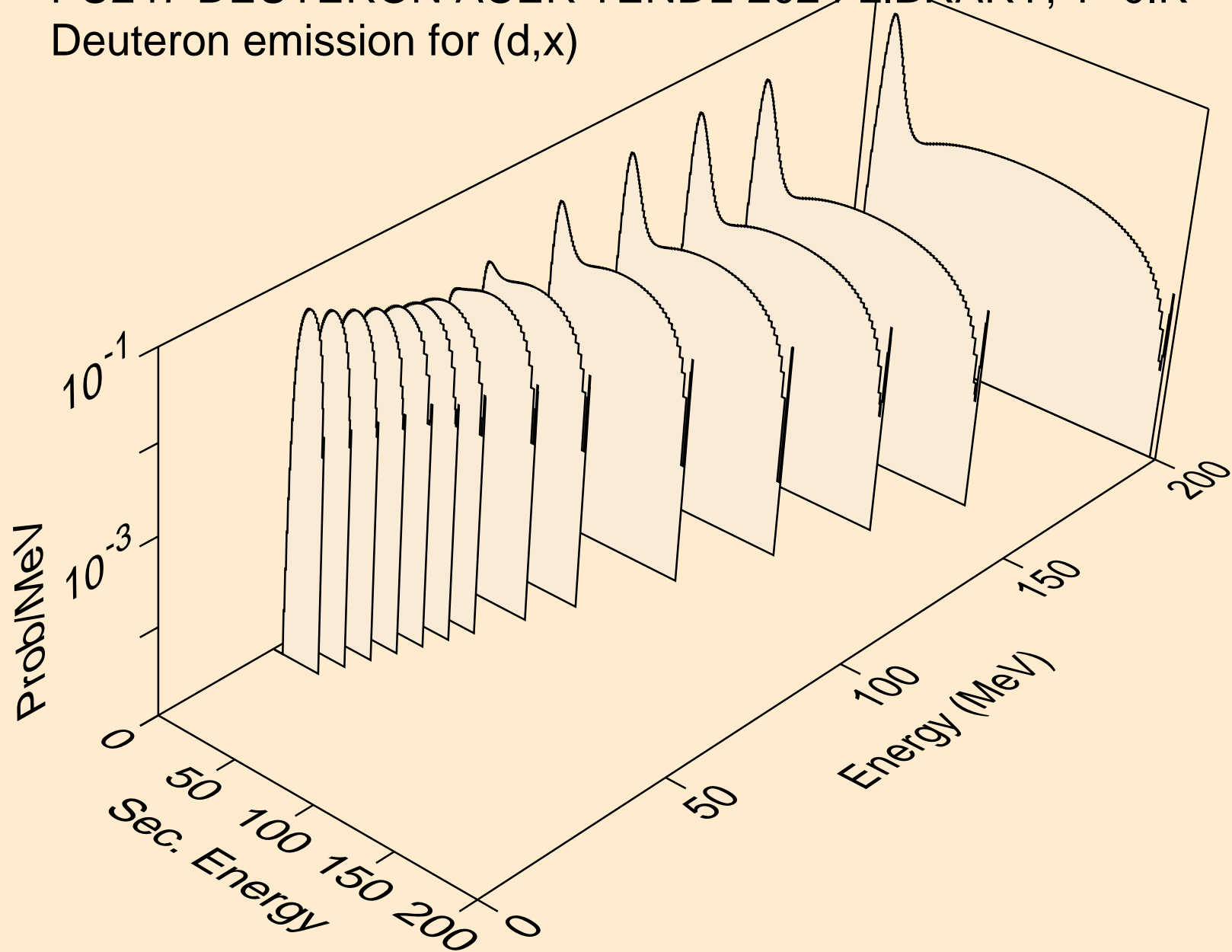

PU247 DEUTERON ACER TENDL-2024 LIBRARY; T=0.K  
Deuteron emission for (d,2nd)

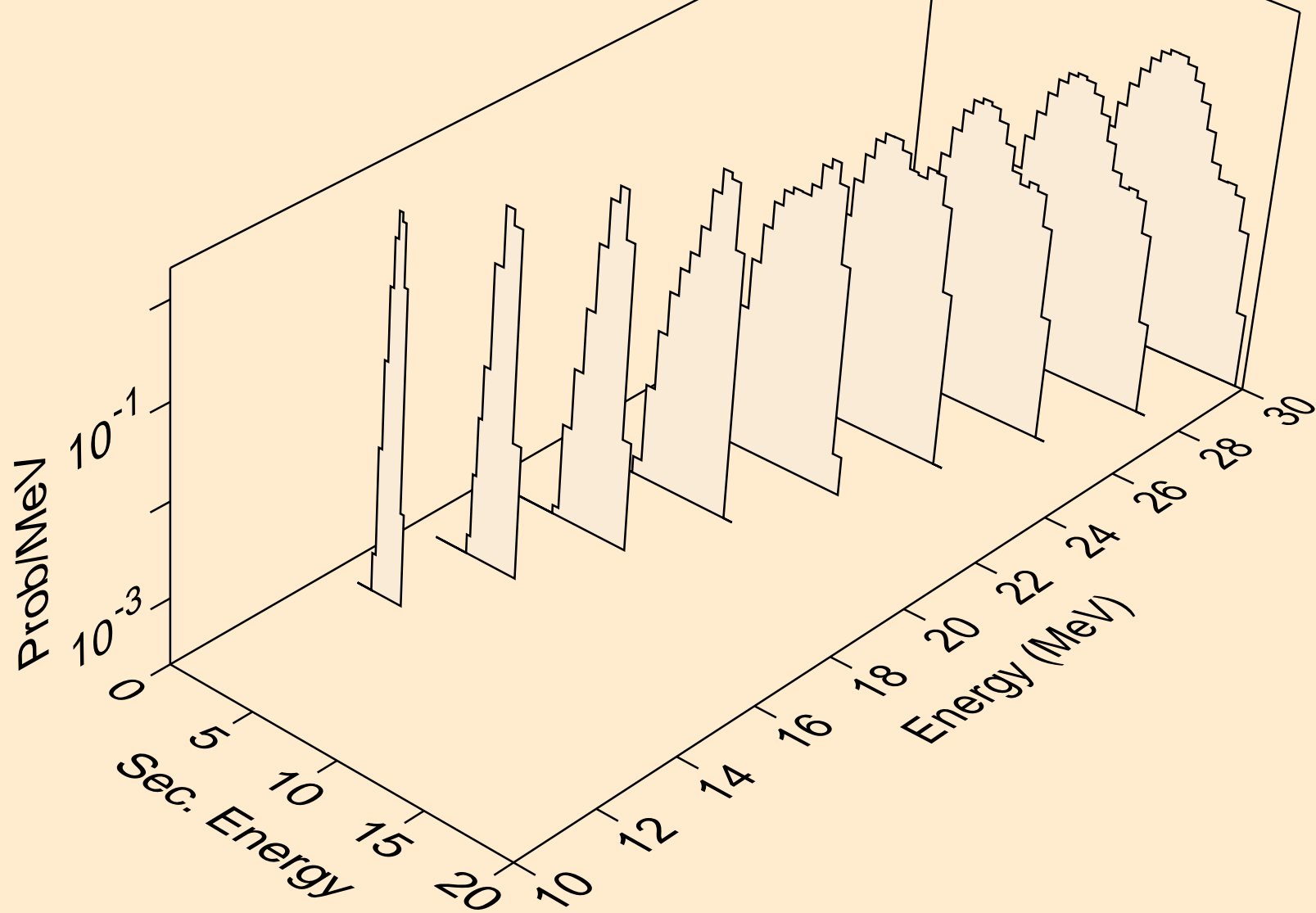

PU247 DEUTERON ACER TENDL-2024 LIBRARY; T=0.K  
Deuteron emission for (d,n\*)d

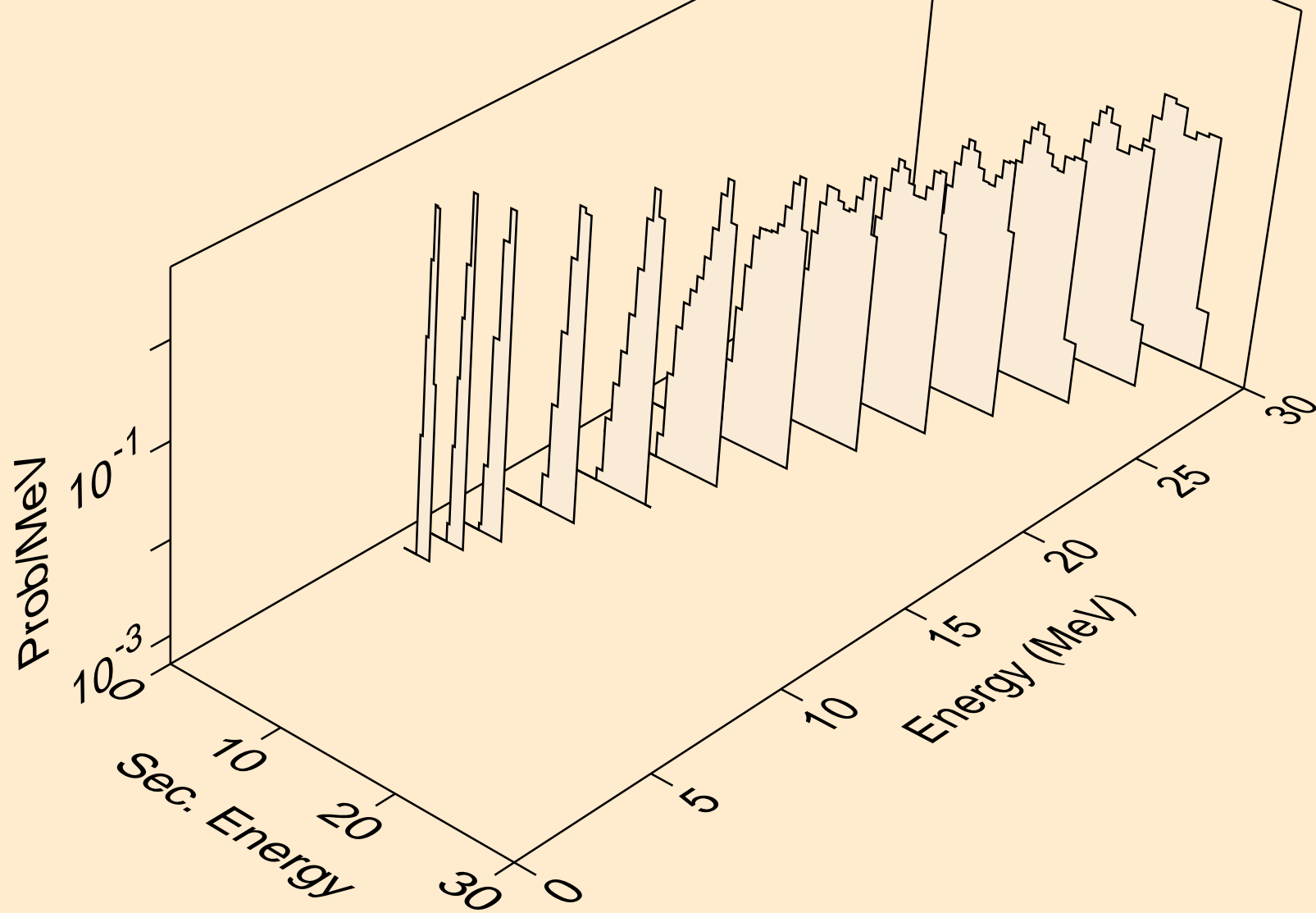

PU247 DEUTERON ACER TENDL-2024 LIBRARY; T=0.K  
Deuteron emission for inelastic

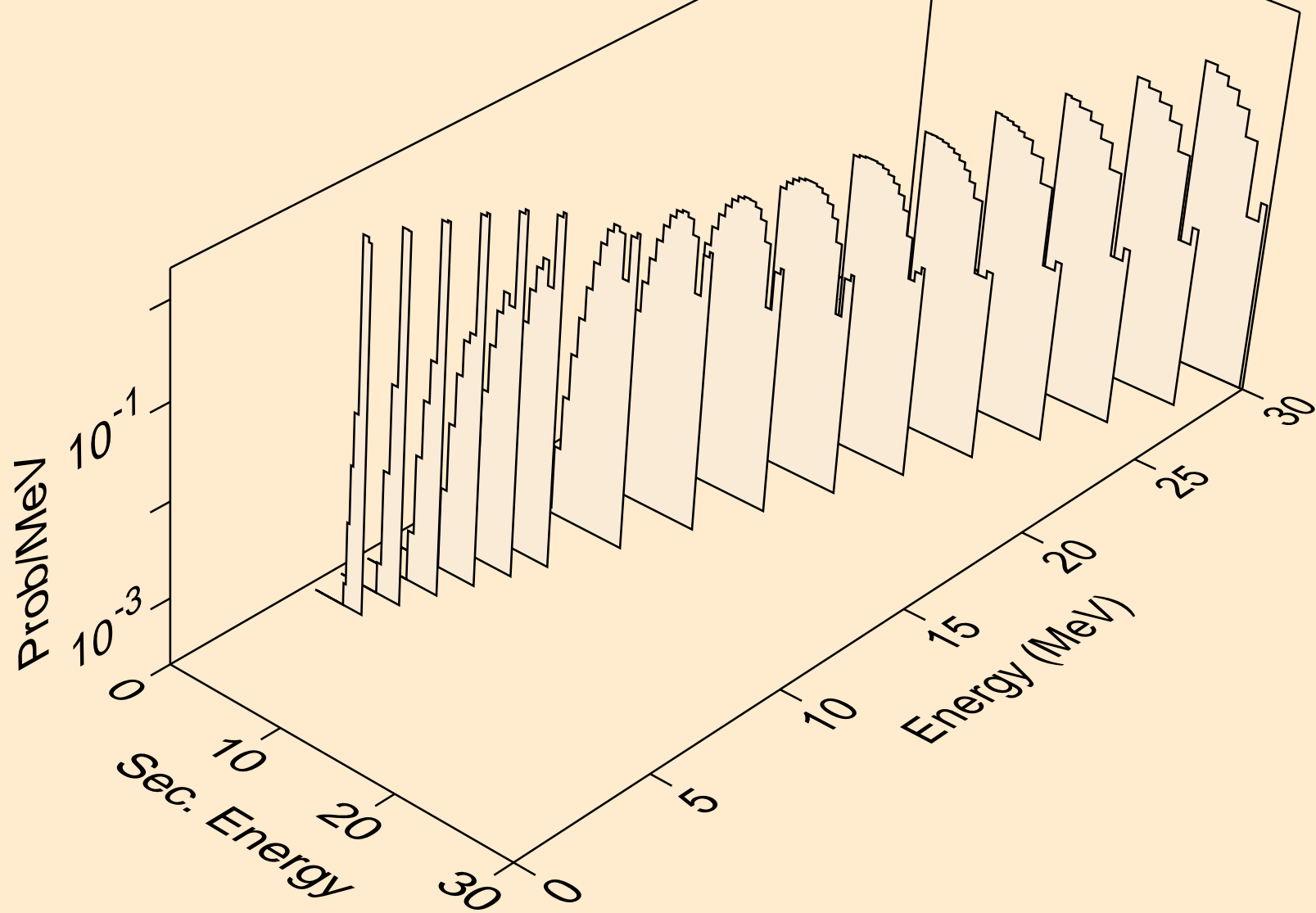

PU247 DEUTERON ACER TENDL-2024 LIBRARY; T=0.K  
Deuteron emission for (d,pd)

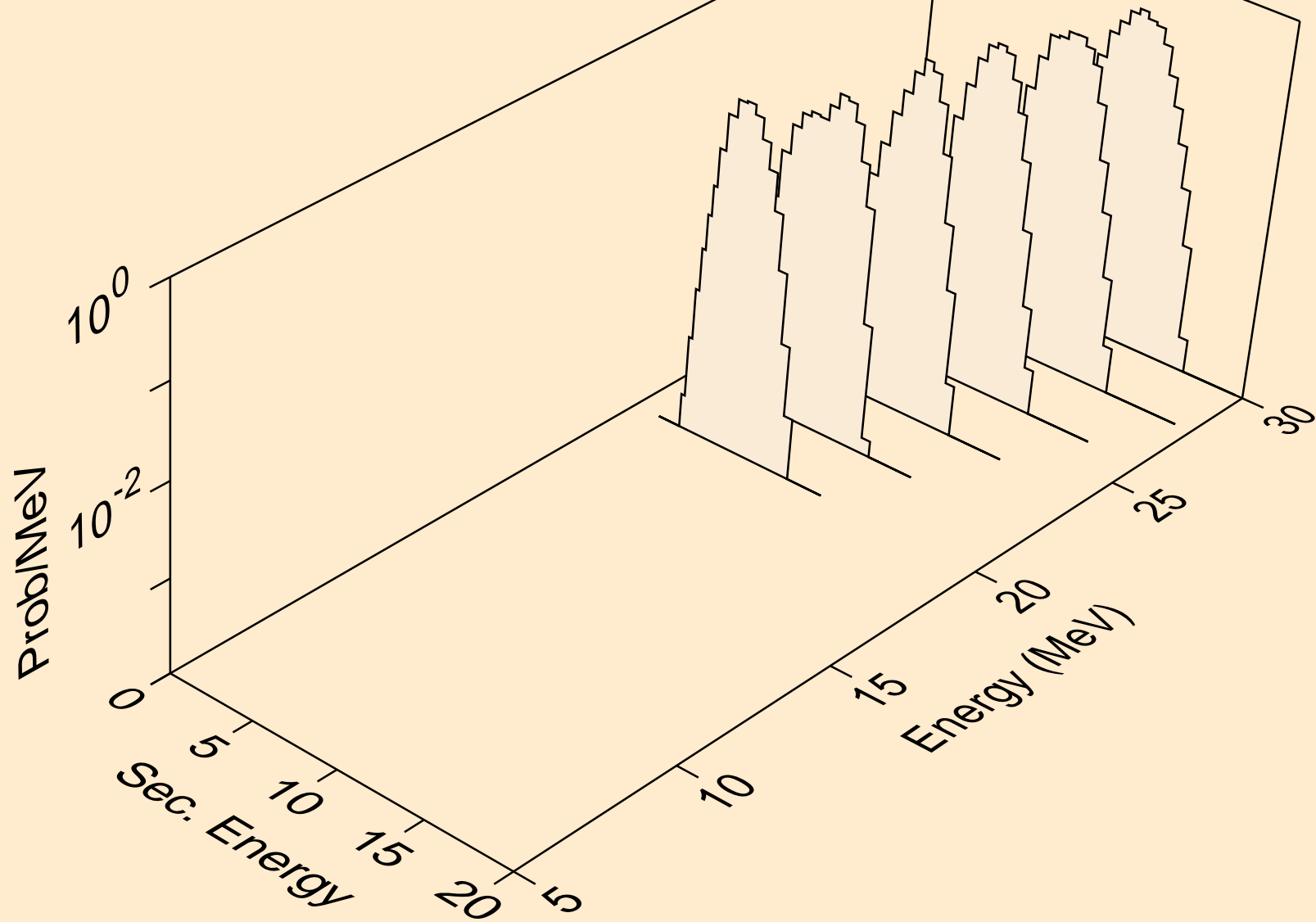

PU247 DEUTERON ACER TENDL-2024 LIBRARY; T=0.K  
Photon emission for (z,n)

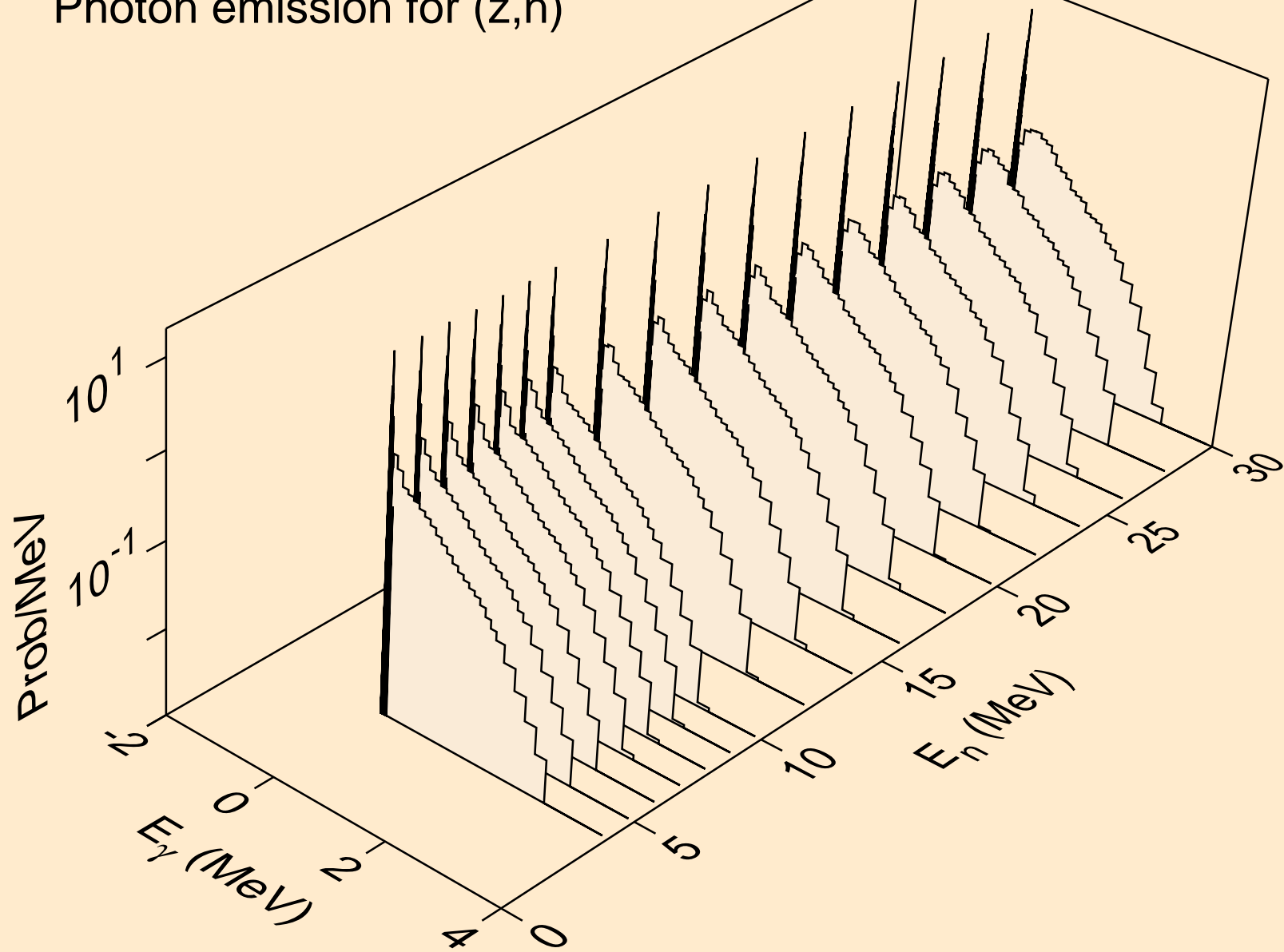

PU247 DEUTERON ACER TENDL-2024 LIBRARY; T=0.K  
Photon emission for (z,x)

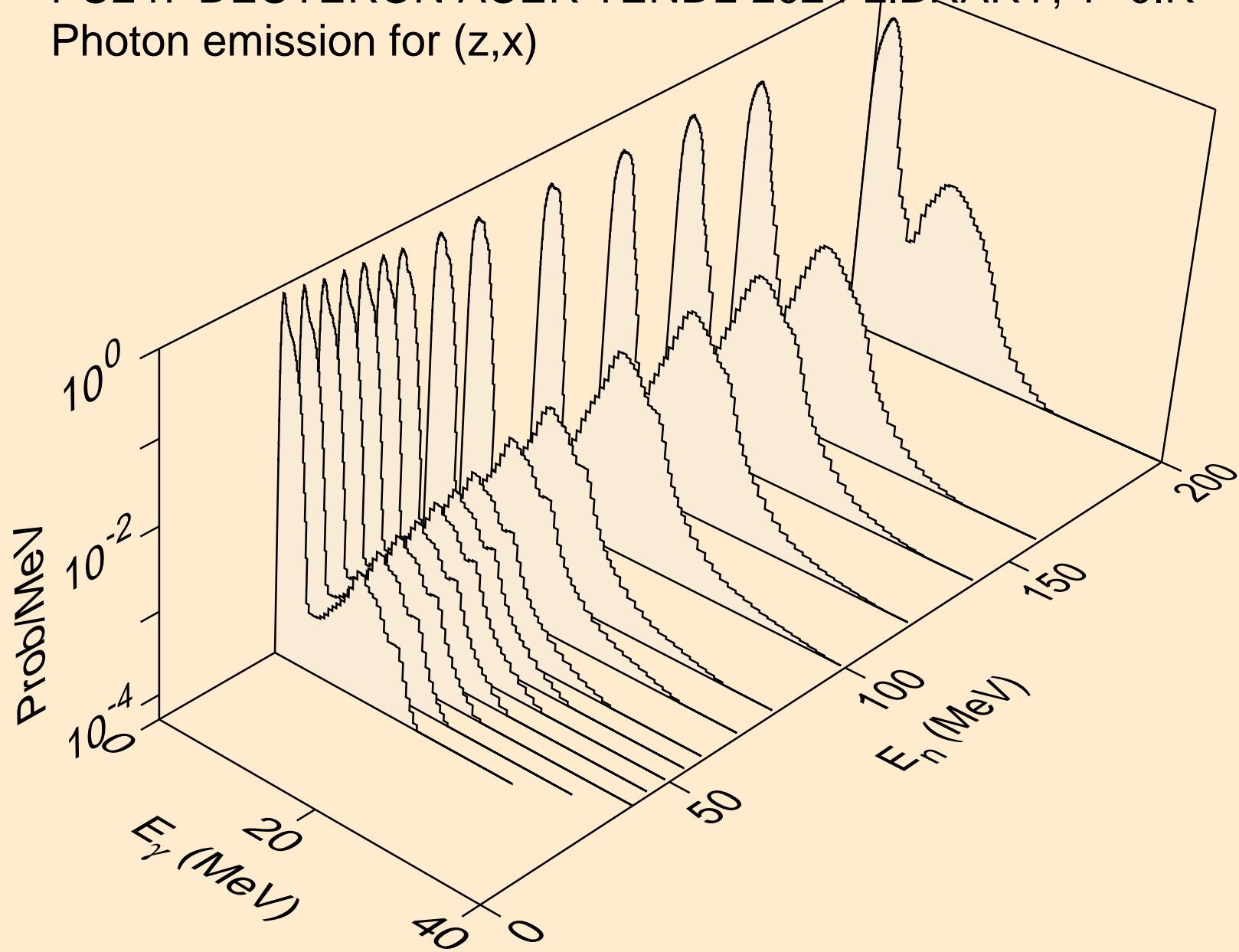

PU247 DEUTERON ACER TENDL-2024 LIBRARY; T=0.K  
Photon emission for (n,2nd)

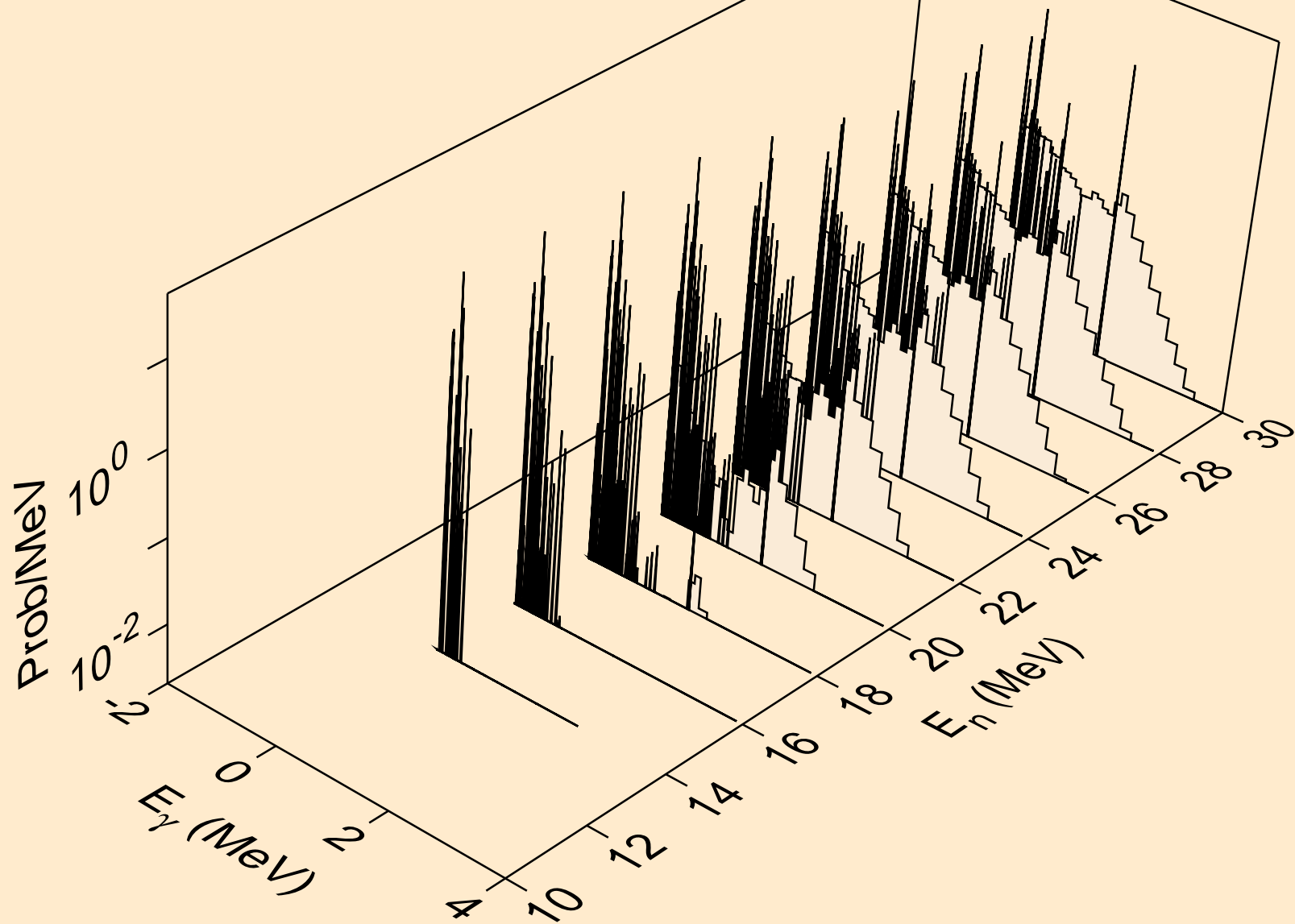

PU247 DEUTERON ACER TENDL-2024 LIBRARY; T=0.K  
Photon emission for (n,2n)

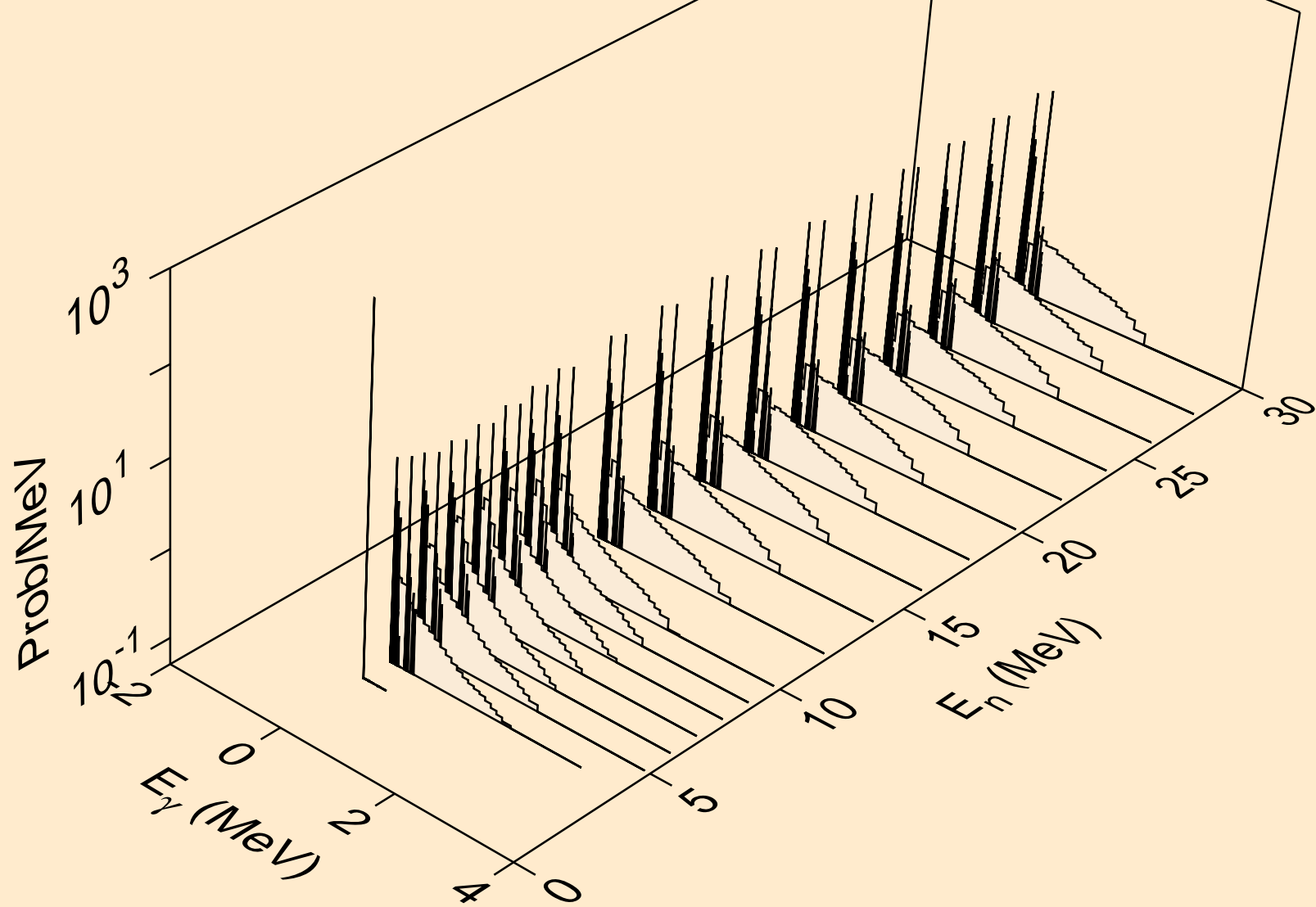

PU247 DEUTERON ACER TENDL-2024 LIBRARY; T=0.K  
Photon emission for (n,3n)

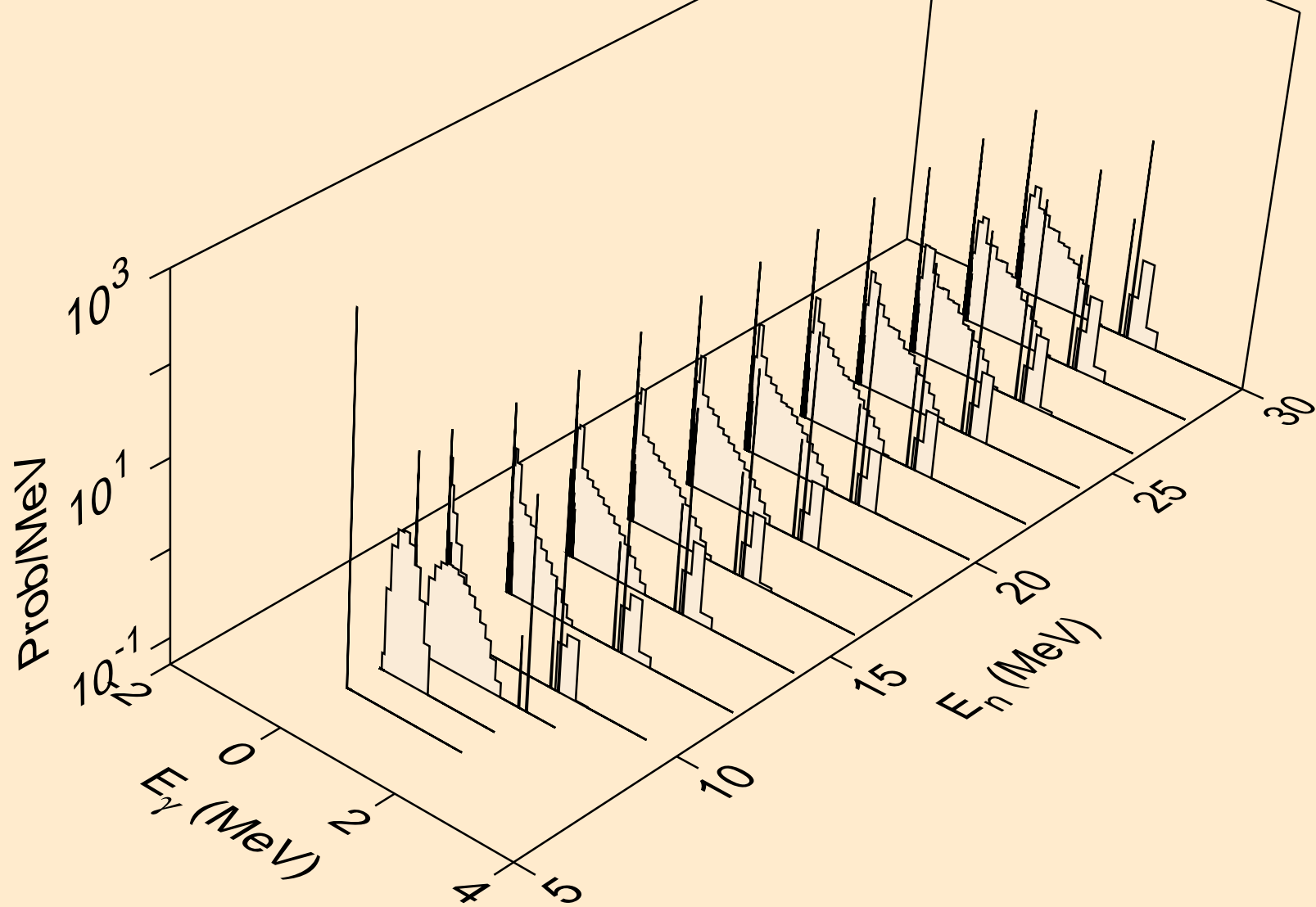

PU247 DEUTERON ACER TENDL-2024 LIBRARY; T=0.K  
Photon emission for (n,n\*)a

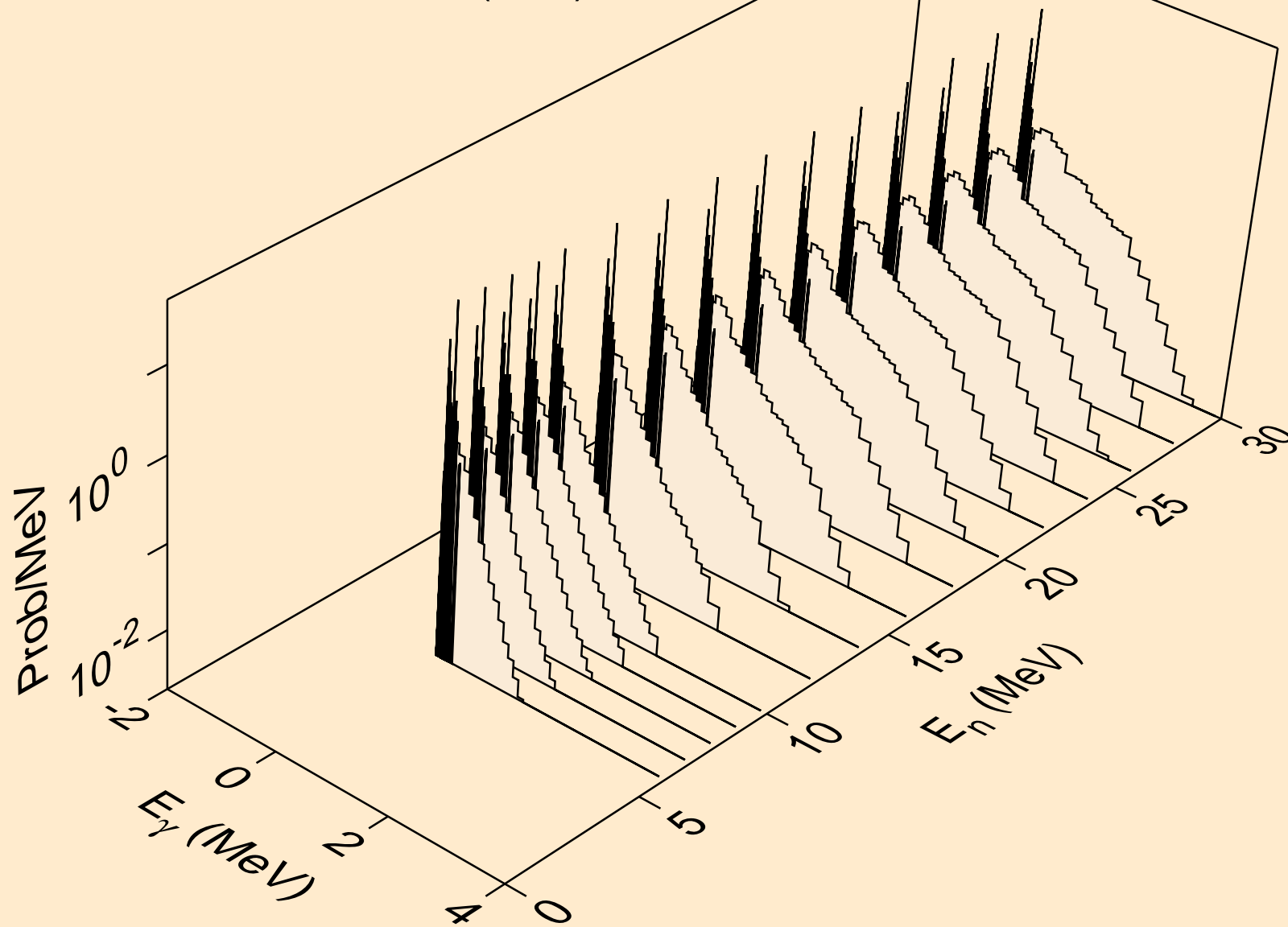

PU247 DEUTERON ACER TENDL-2024 LIBRARY; T=0.K  
Photon emission for (n,2n)a

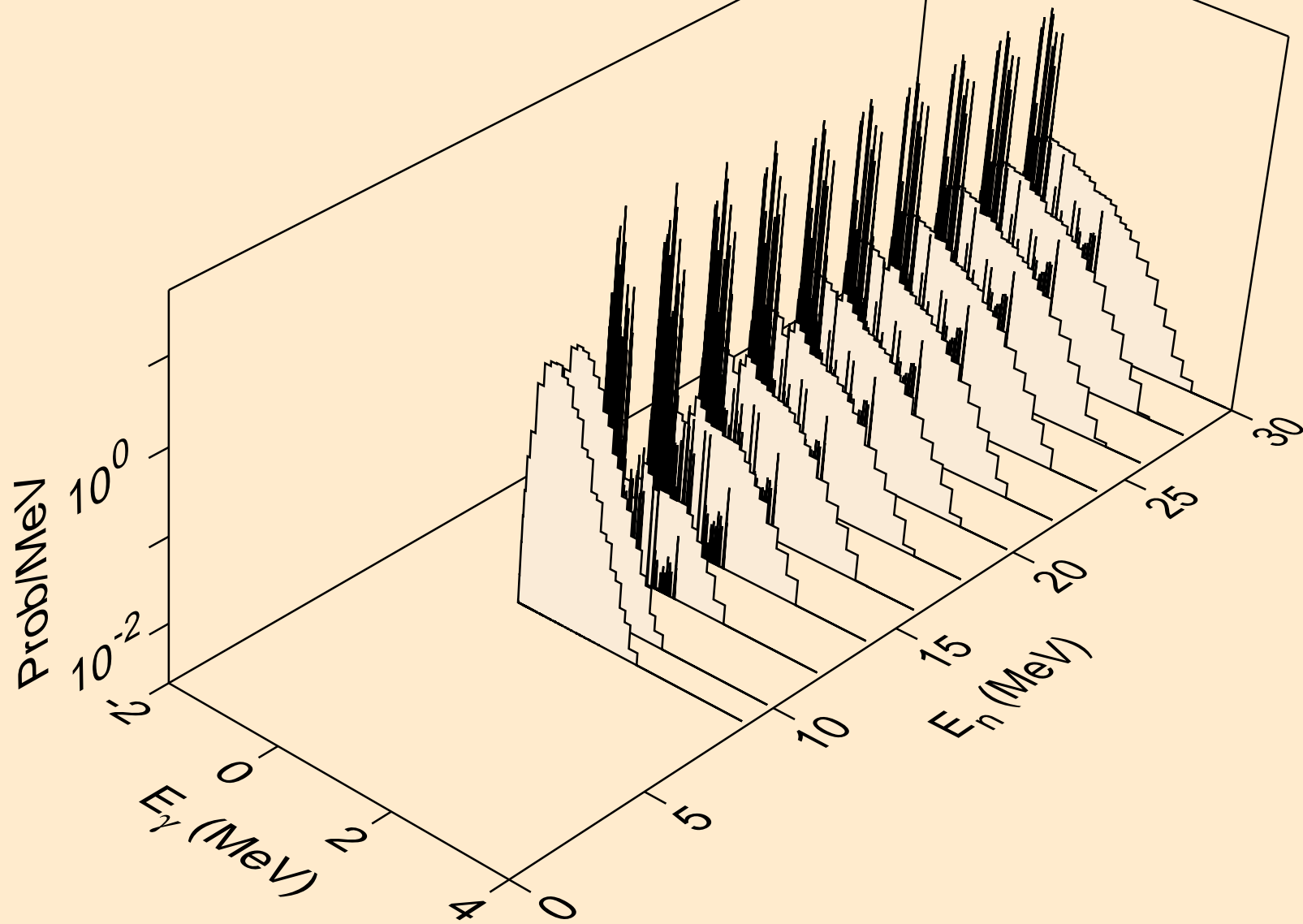

PU247 DEUTERON ACER TENDL-2024 LIBRARY; T=0.K  
Photon emission for (n,3n)a

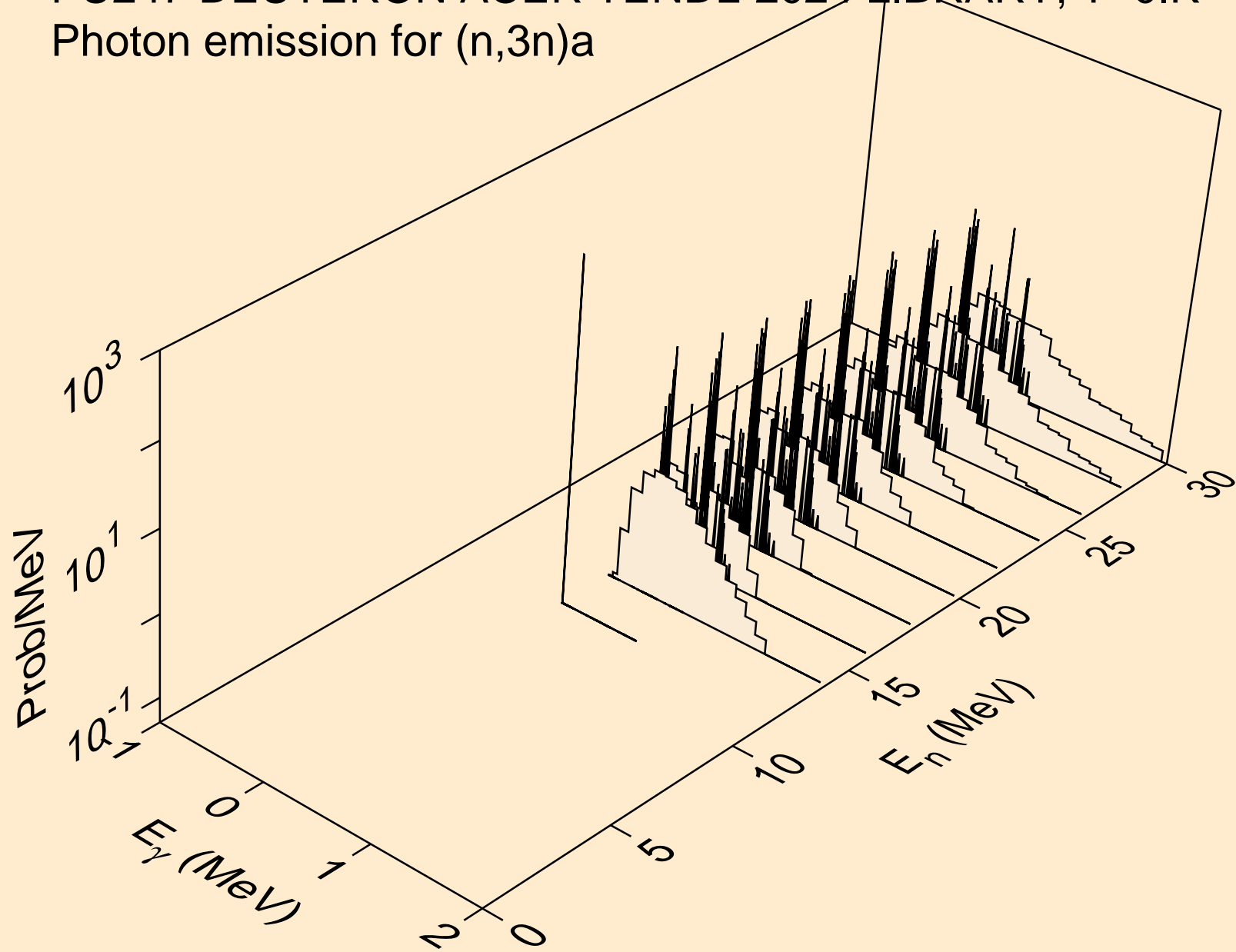

PU247 DEUTERON ACER TENDL-2024 LIBRARY; T=0.K  
Photon emission for (n,n\*)p

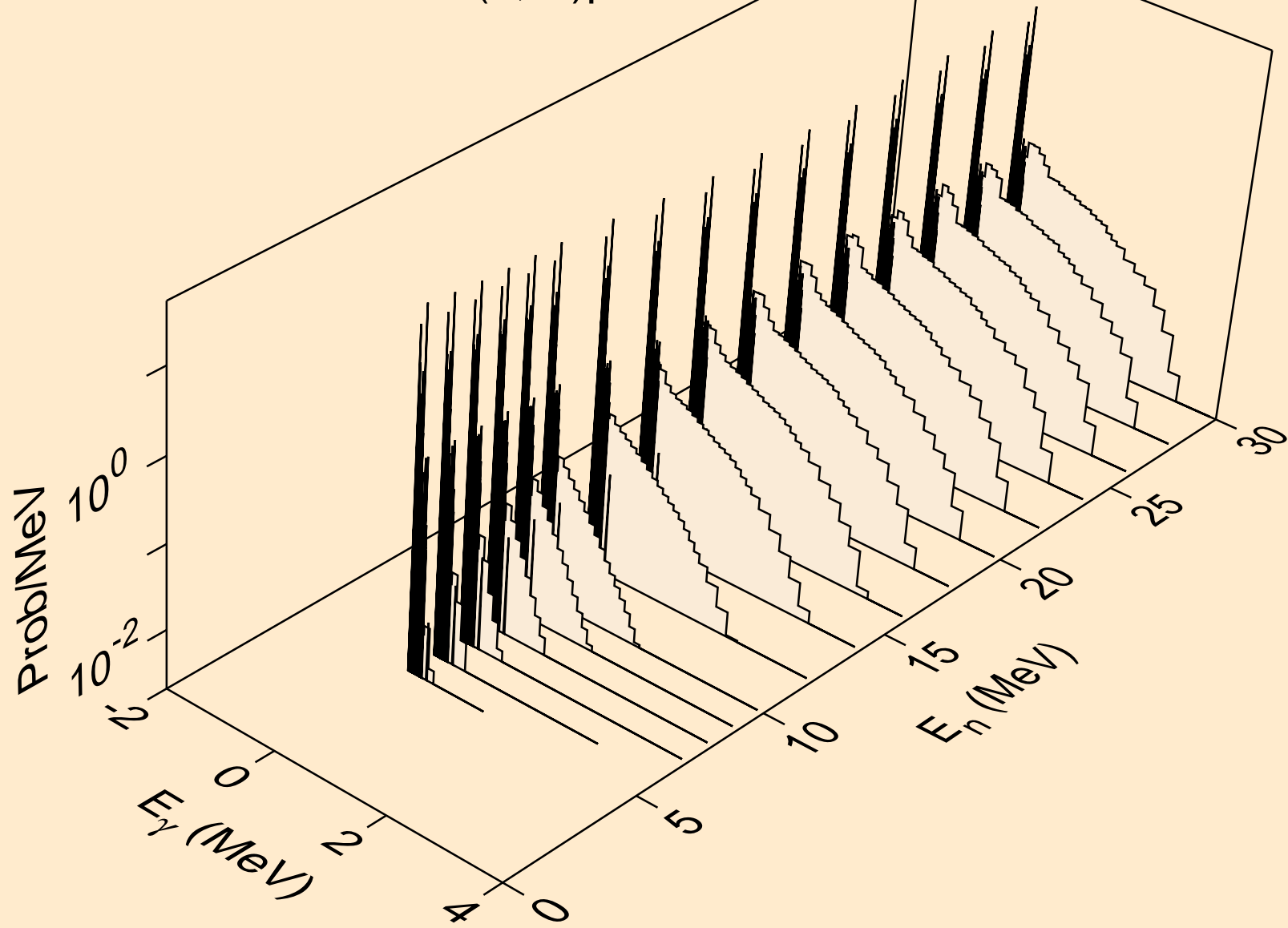

PU247 DEUTERON ACER TENDL-2024 LIBRARY; T=0.K  
Photon emission for (n,n\*)d

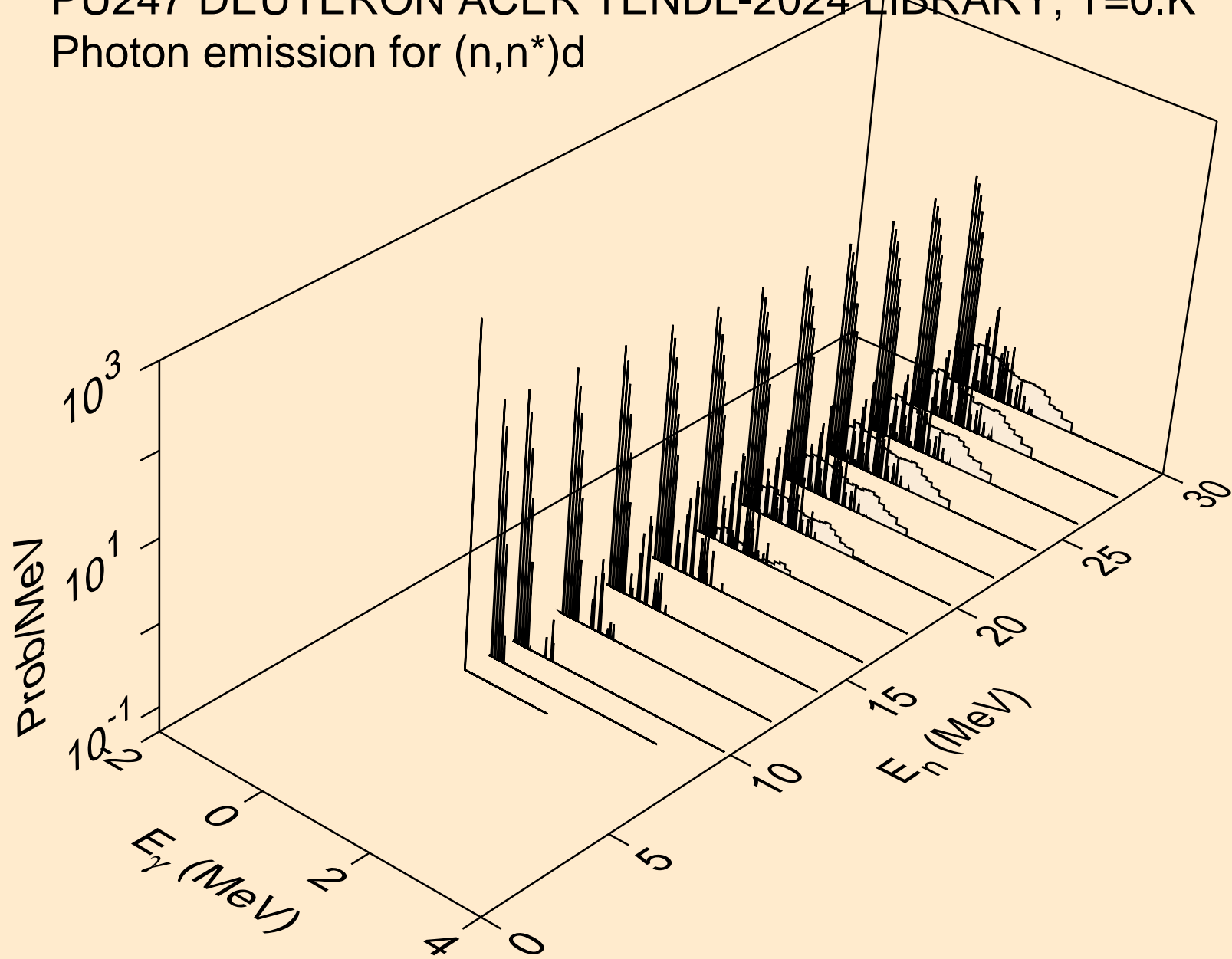

PU247 DEUTERON ACER TENDL-2024 LIBRARY; T=0.K  
Photon emission for (n,n\*)t

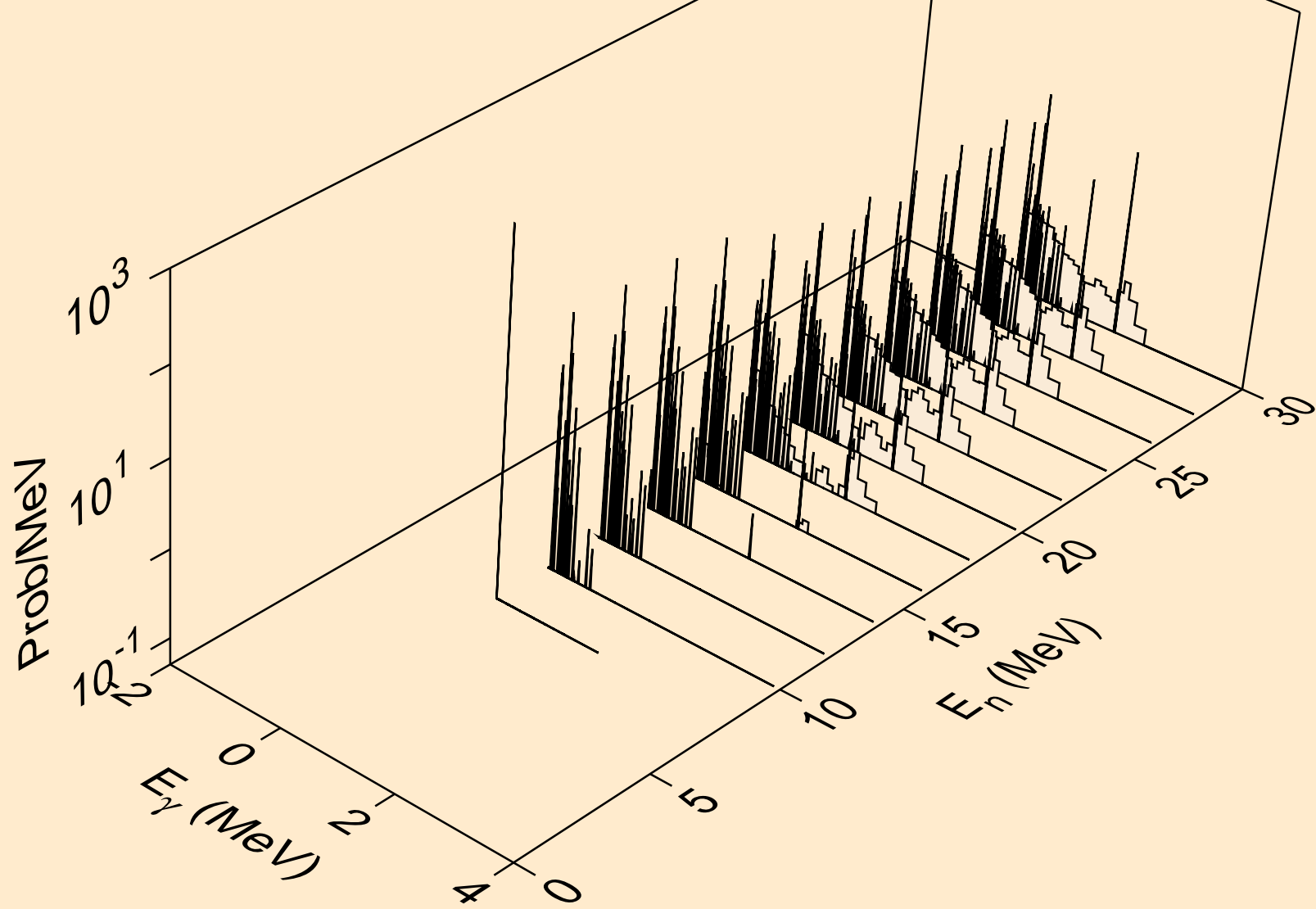

PU247 DEUTERON ACER TENDL-2024 LIBRARY; T=0.K  
Photon emission for (n,n\*)he3

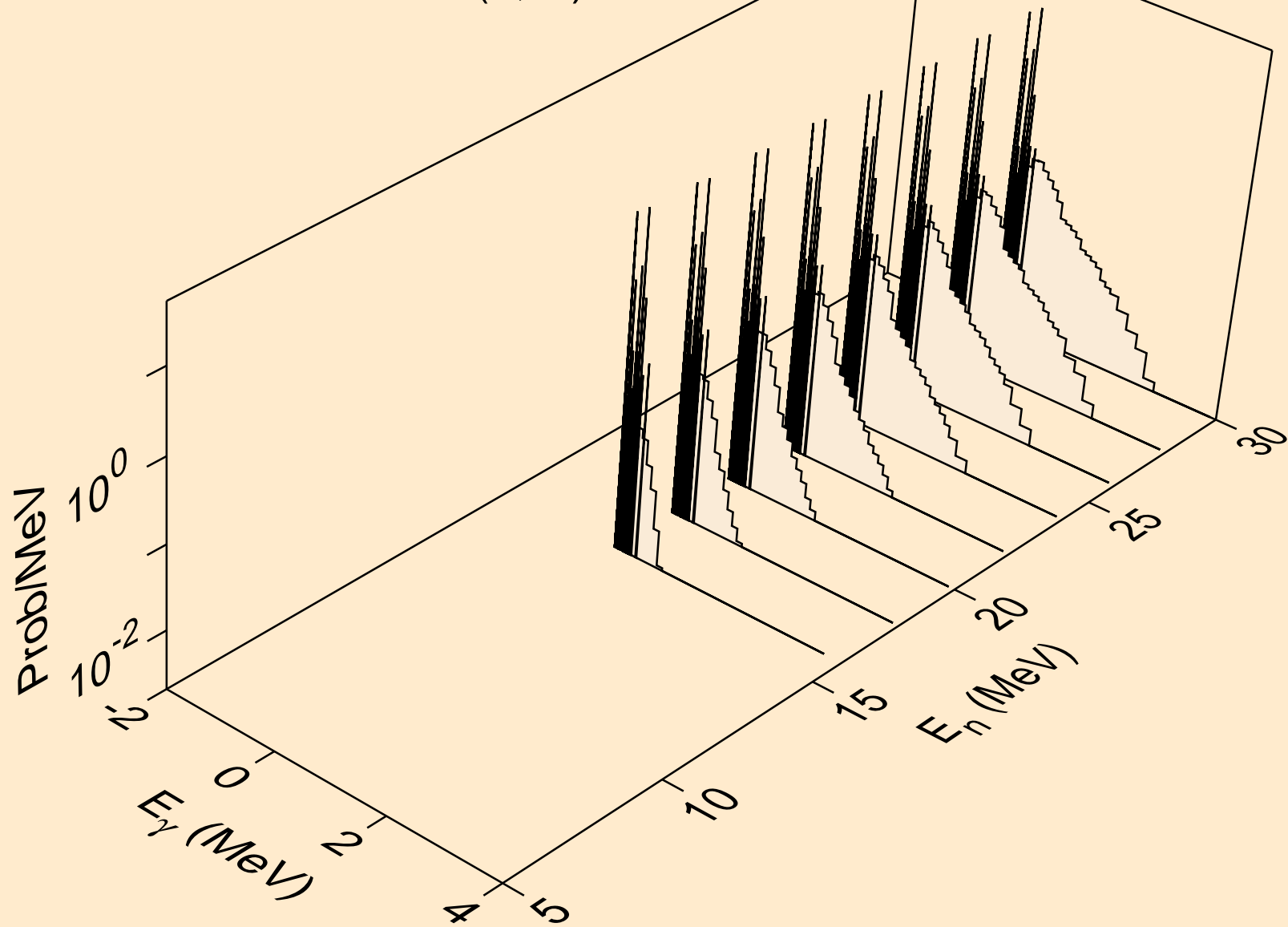

PU247 DEUTERON ACER TENDL-2024 LIBRARY; T=0.K  
Photon emission for (n,4n)

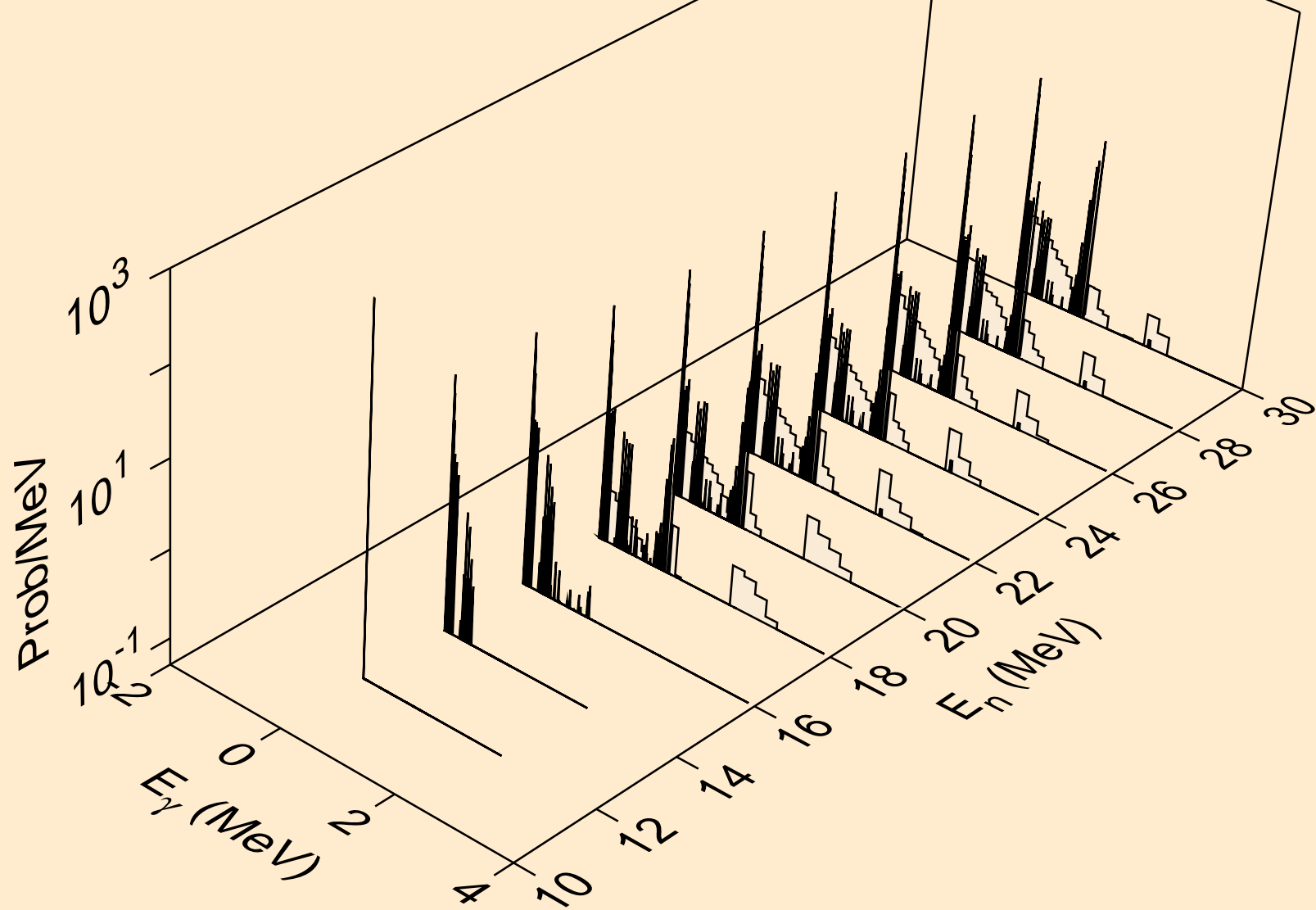

PU247 DEUTERON ACER TENDL-2024 LIBRARY; T=0.K  
Photon emission for (n,2np)

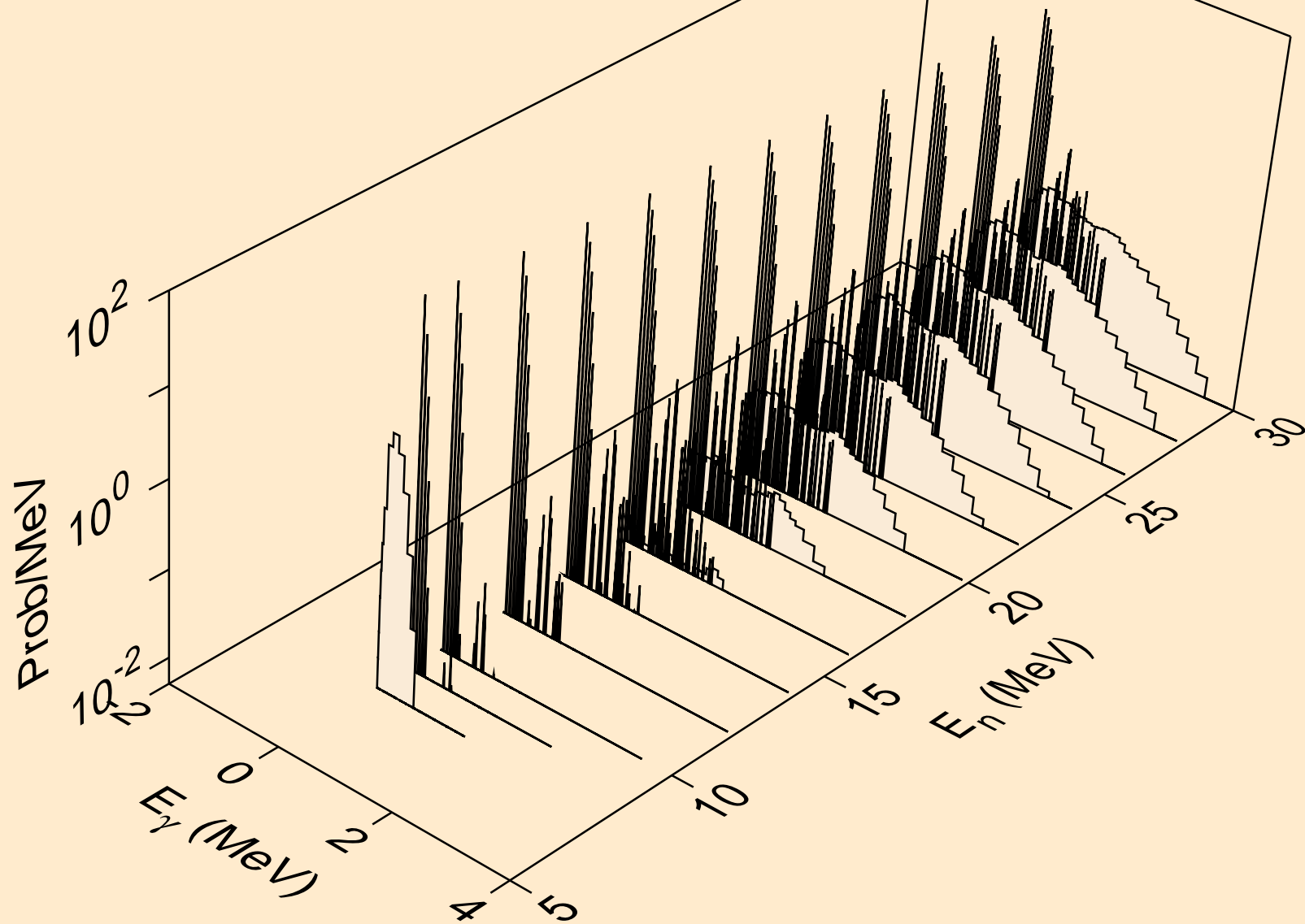

PU247 DEUTERON ACER TENDL-2024 LIBRARY; T=0.K  
Photon emission for (n,3np)

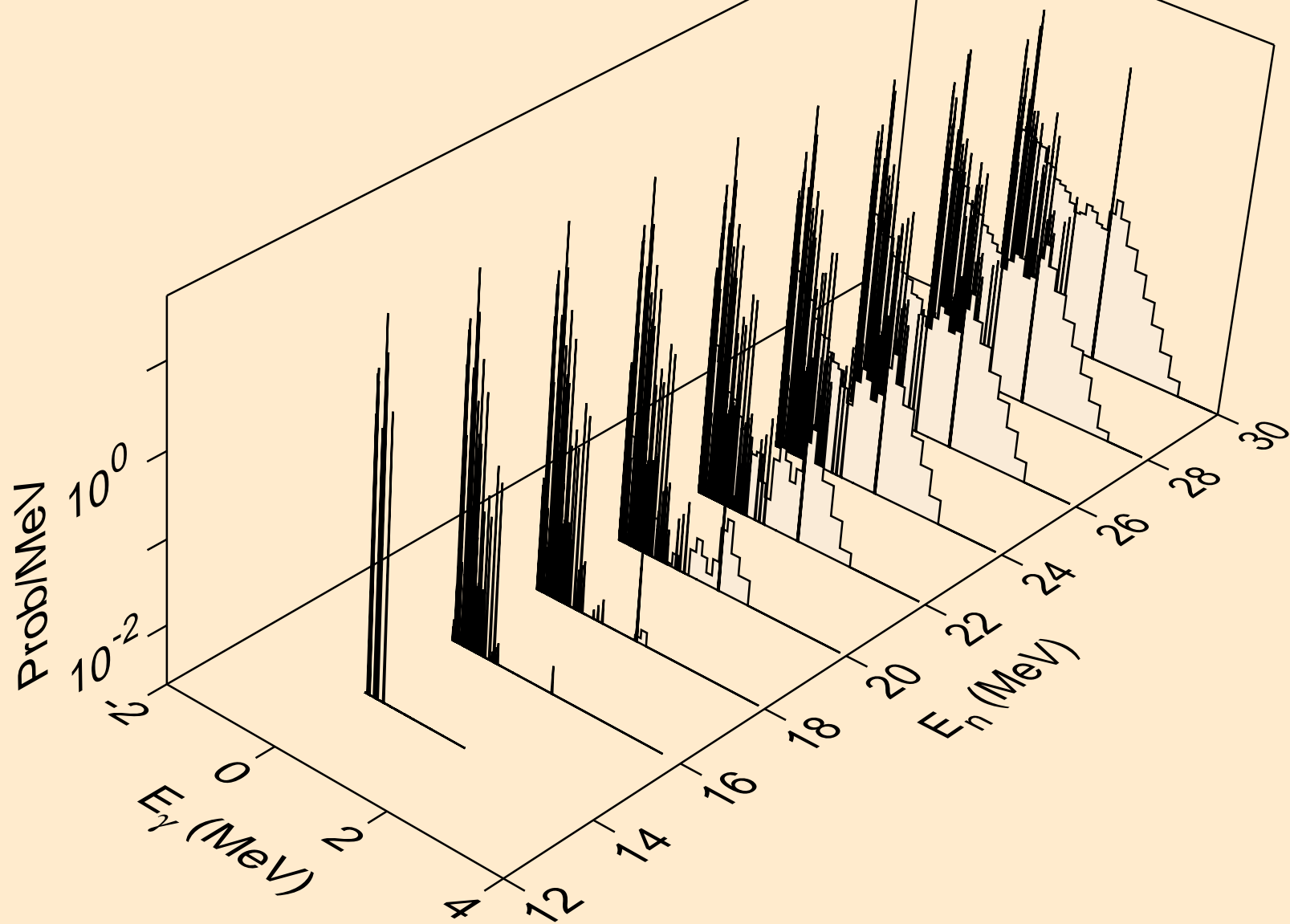

PU247 DEUTERON ACER TENDL-2024 LIBRARY; T=0.K  
Photon emission for (n,n2p)

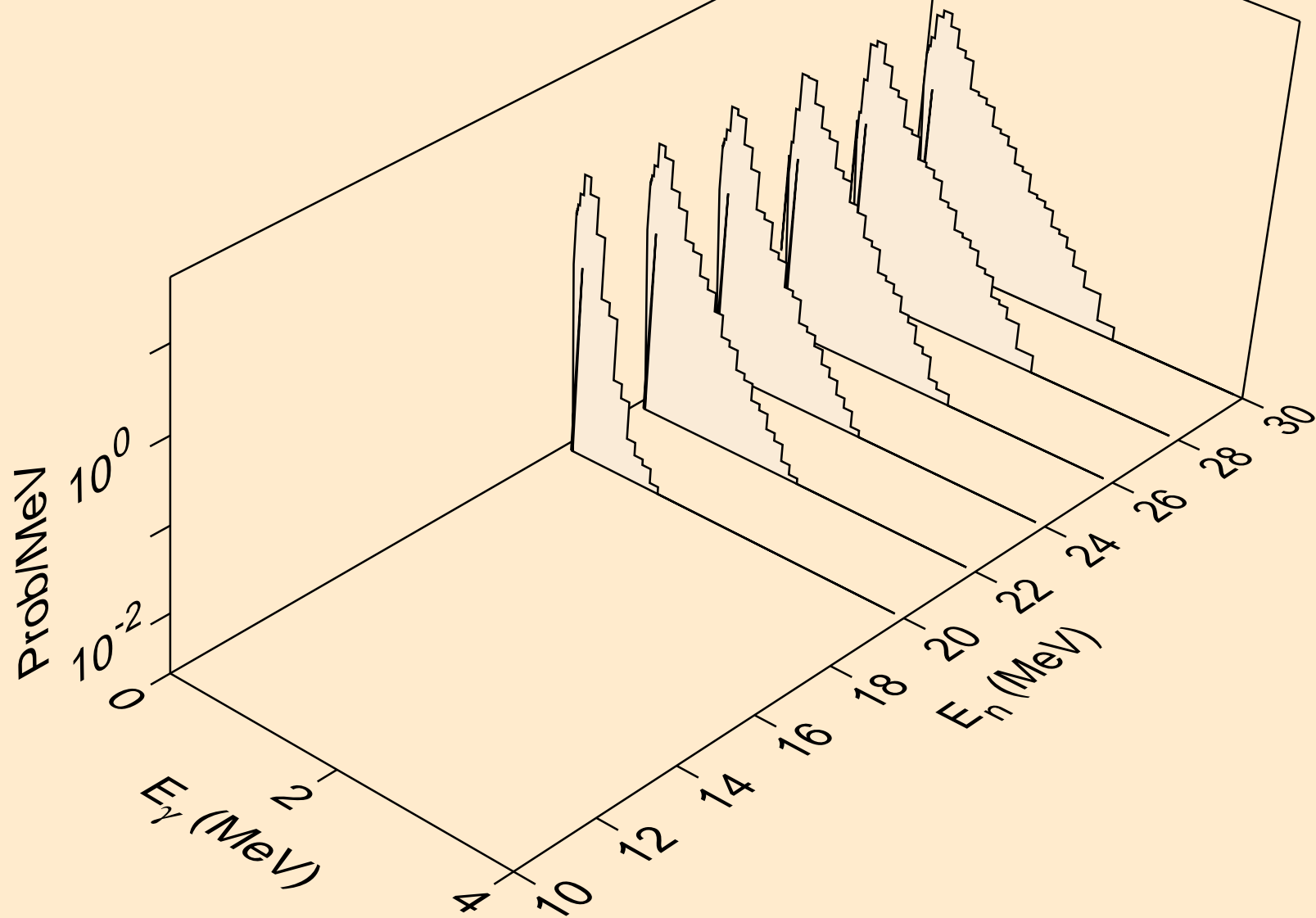

PU247 DEUTERON ACER TENDL-2024 LIBRARY; T=0.K  
Photon emission for (n,p)

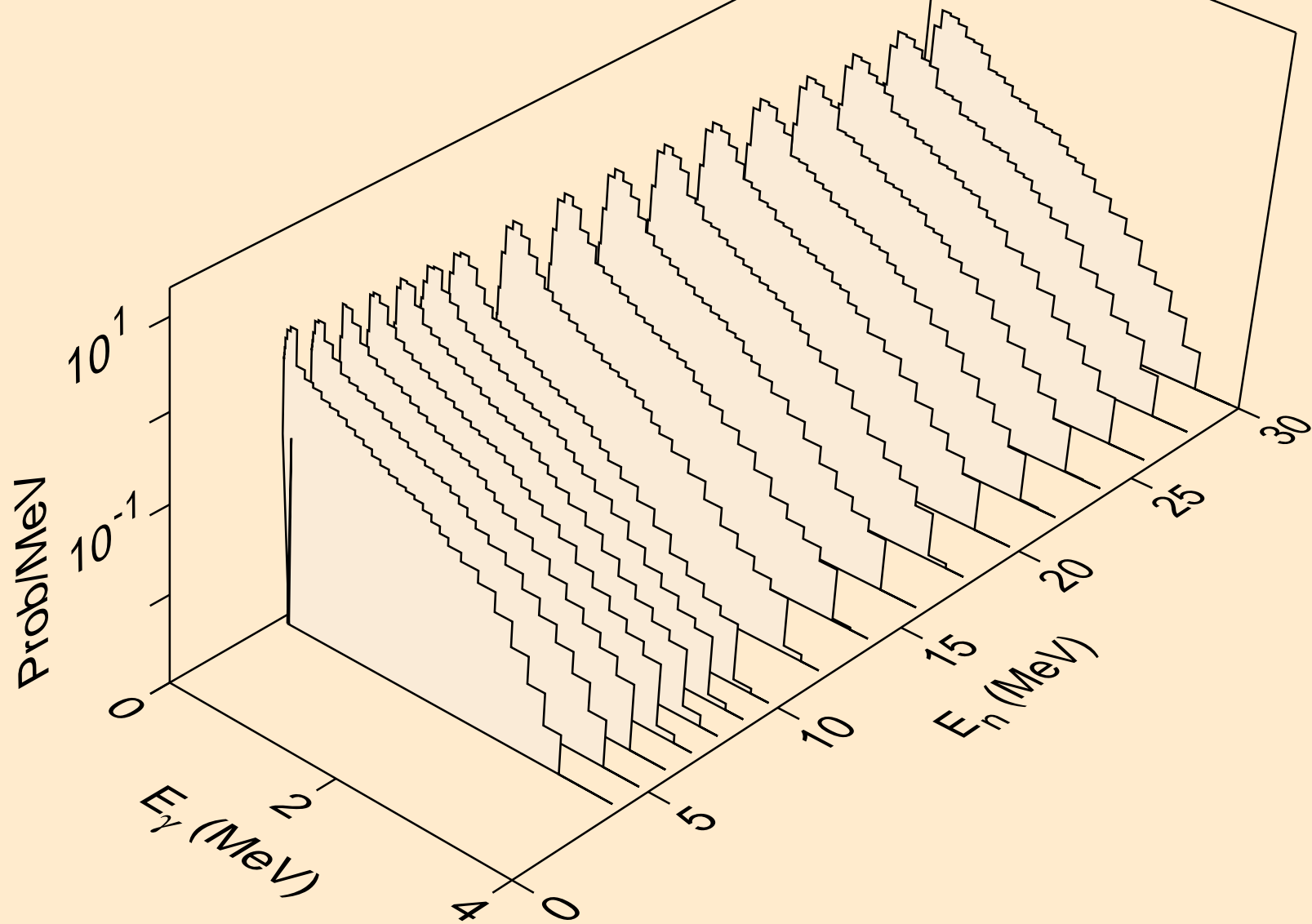

PU247 DEUTERON ACER TENDL-2024 LIBRARY; T=0.K  
Photon emission for inelastic

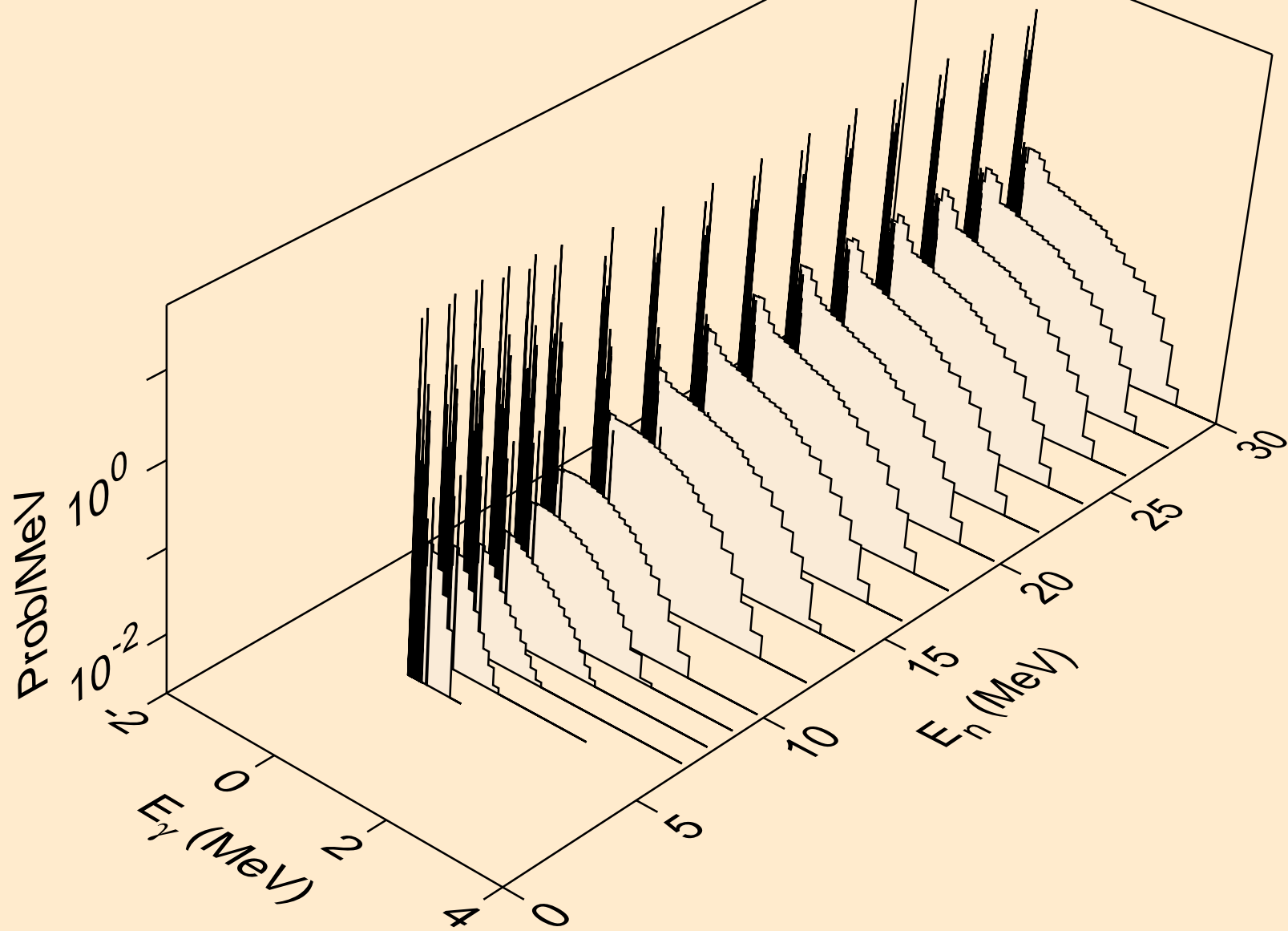

PU247 DEUTERON ACER TENDL-2024 LIBRARY; T=0.K  
Photon emission for (n,t)

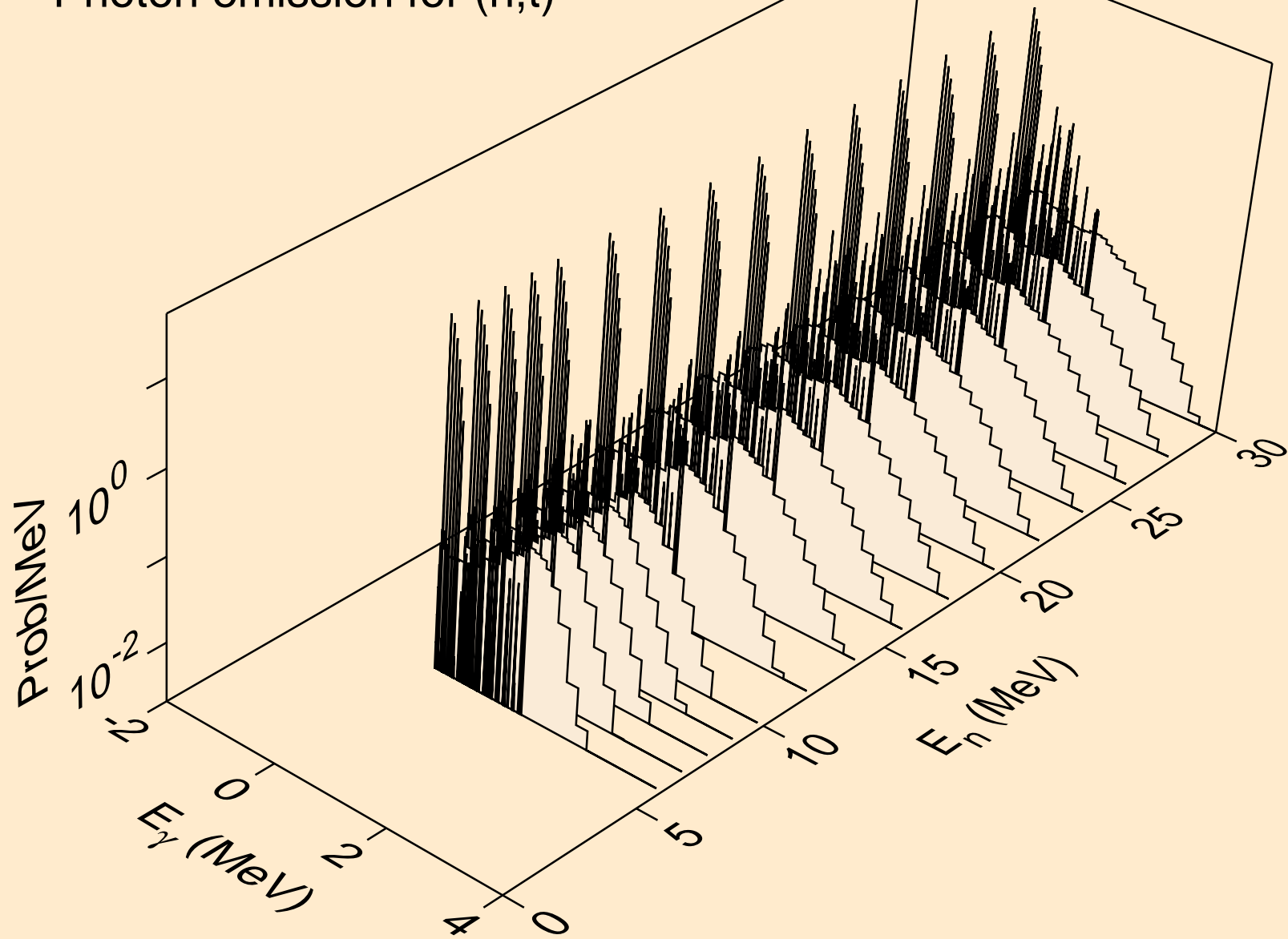

PU247 DEUTERON ACER TENDL-2024 LIBRARY; T=0.K  
Photon emission for (n,he3)

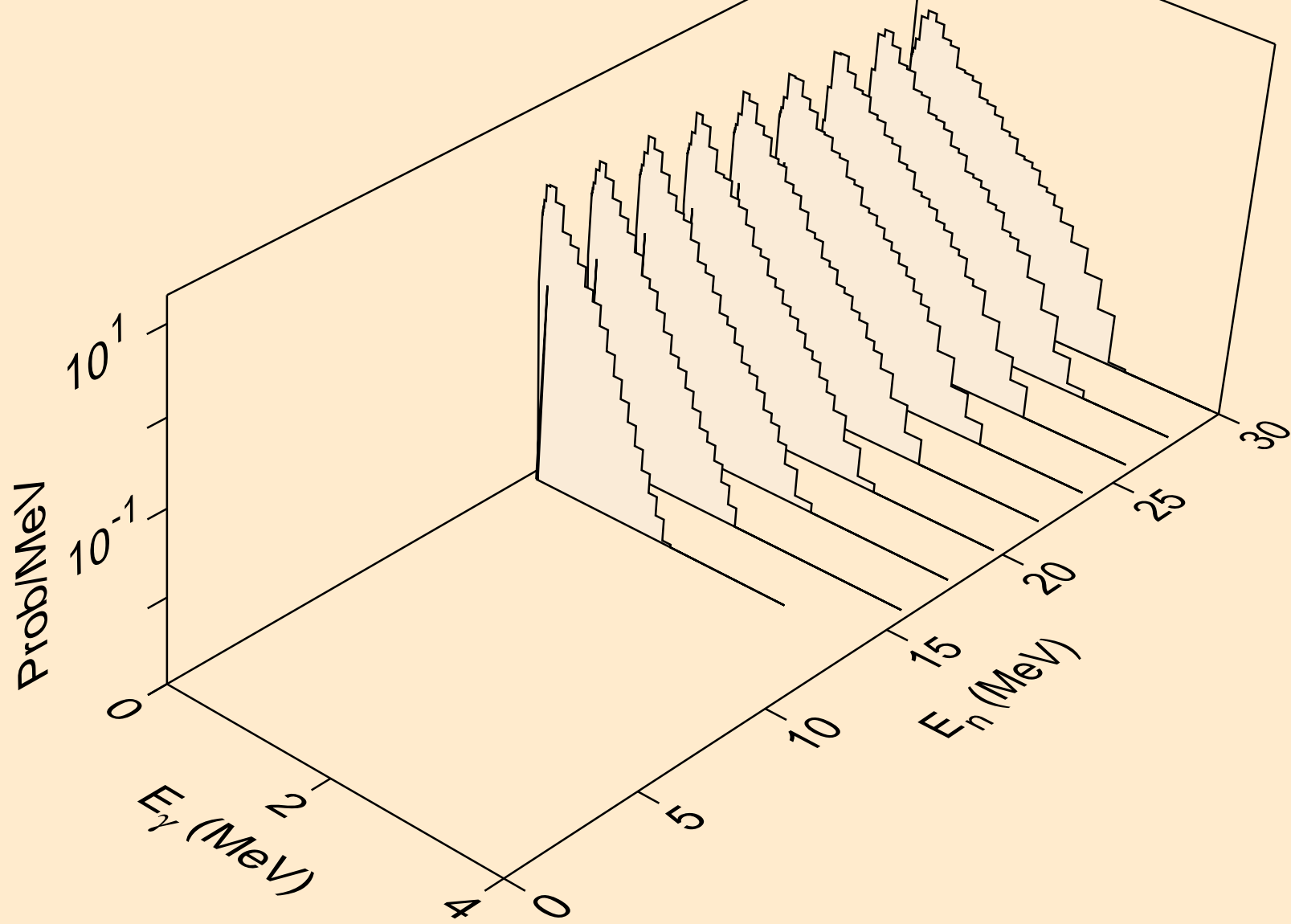

PU247 DEUTERON ACER TENDL-2024 LIBRARY; T=0.K  
Photon emission for (n,a)

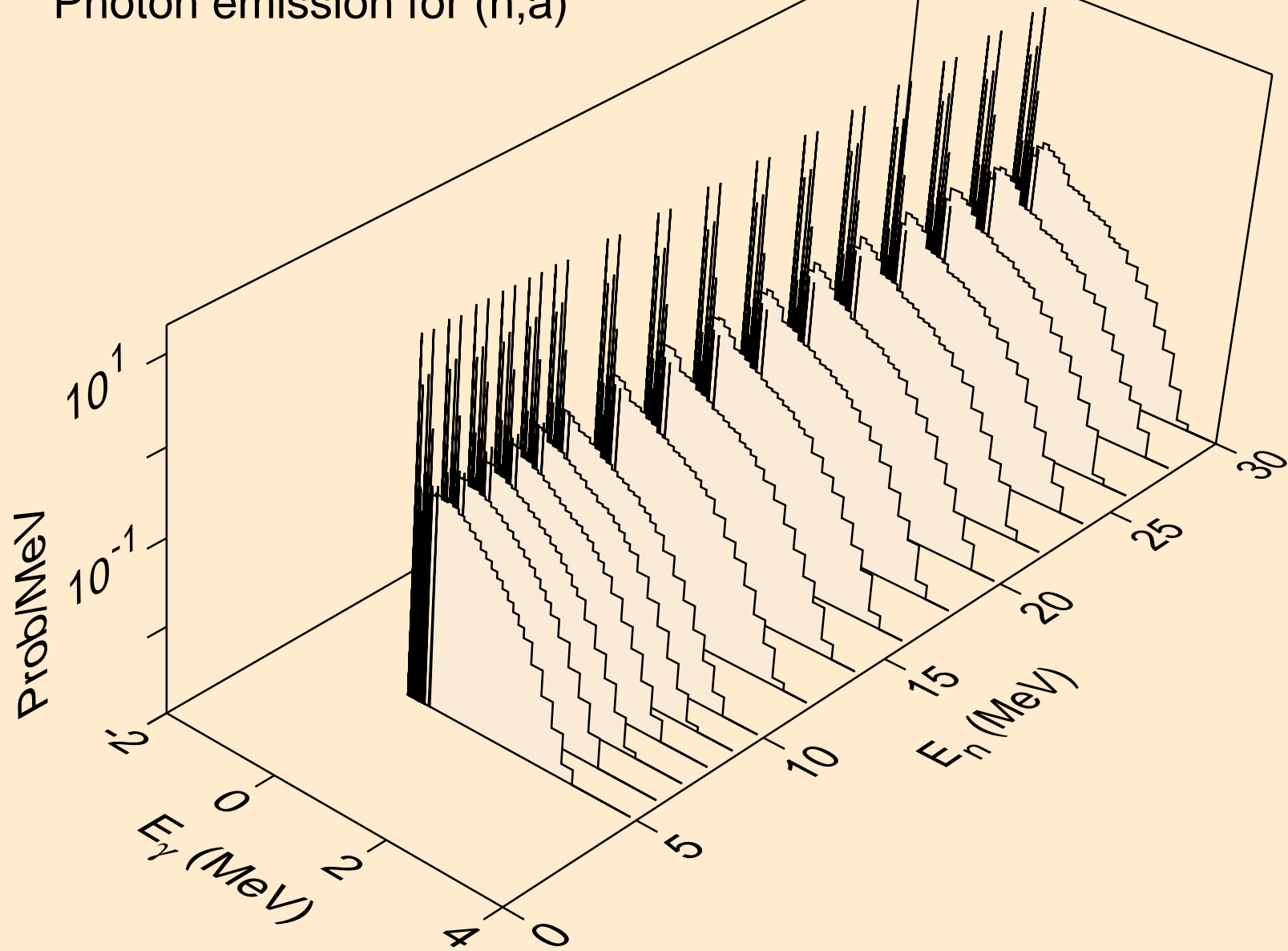

PU247 DEUTERON ACER TENDL-2024 LIBRARY; T=0.K  
Photon emission for (n,2p)

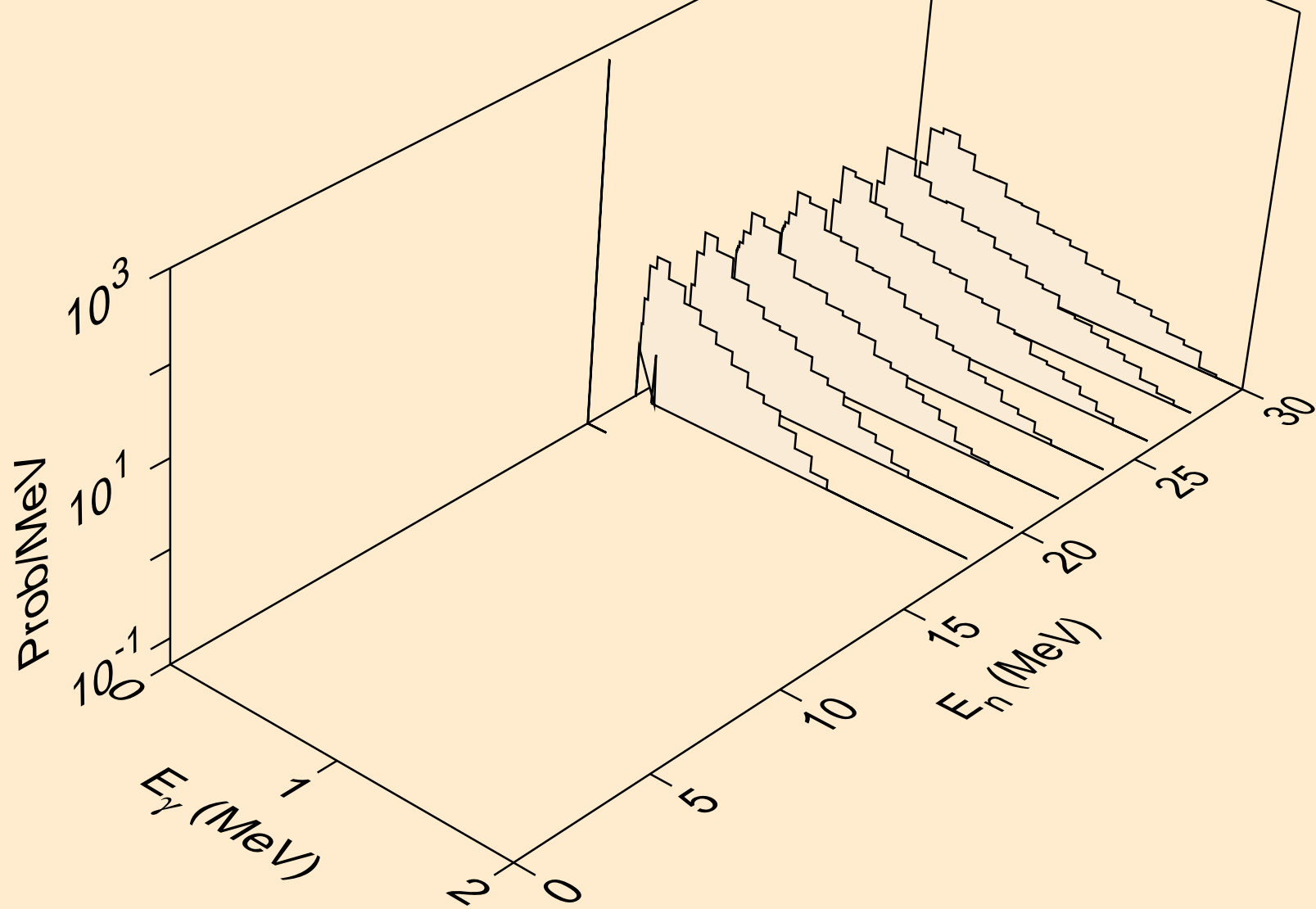

PU247 DEUTERON ACER TENDL-2024 LIBRARY; T=0.K  
Photon emission for (n,pd)

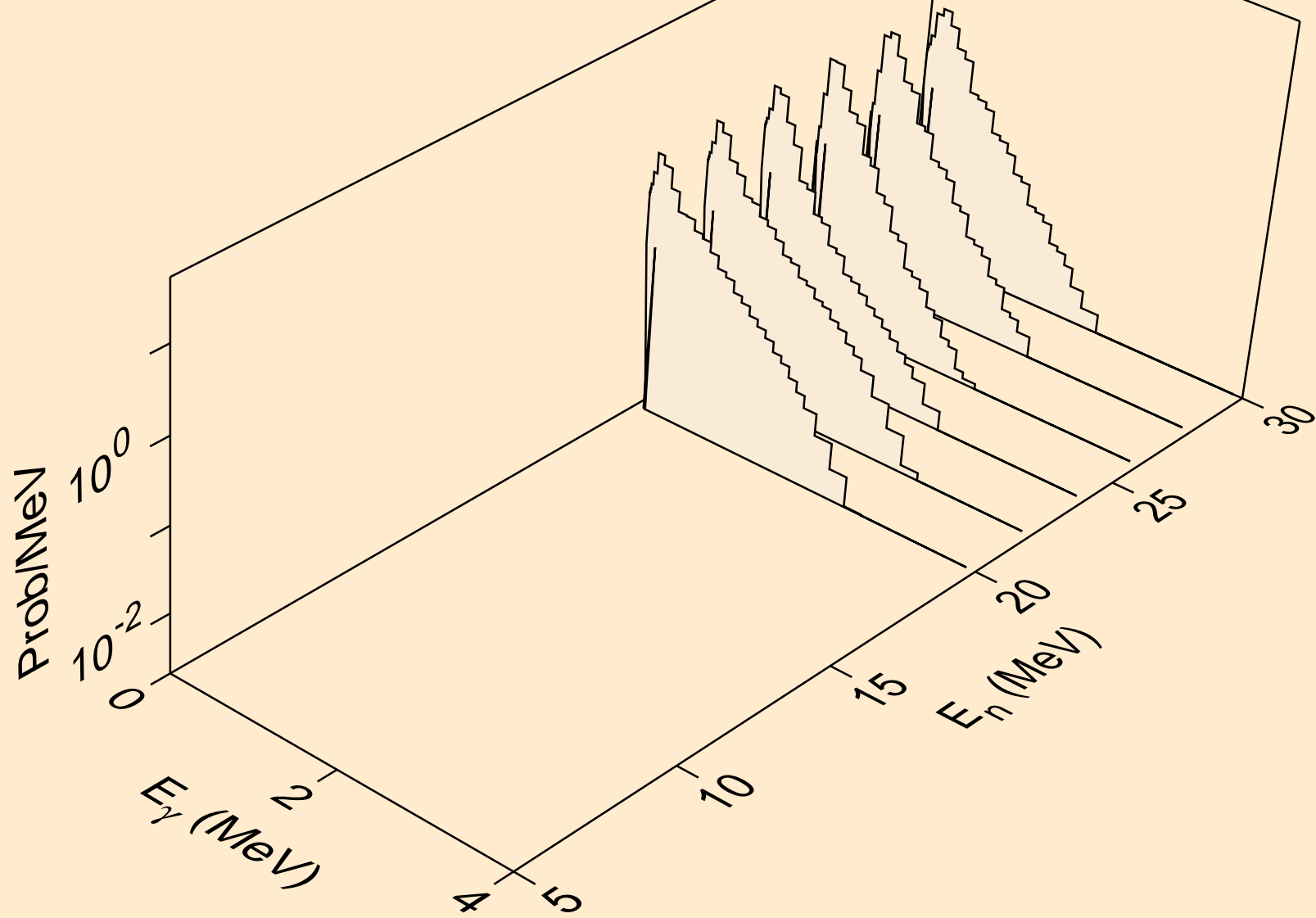

PU247 DEUTERON ACER TENDL-2024 LIBRARY; T=0.K  
Particle heating contributions

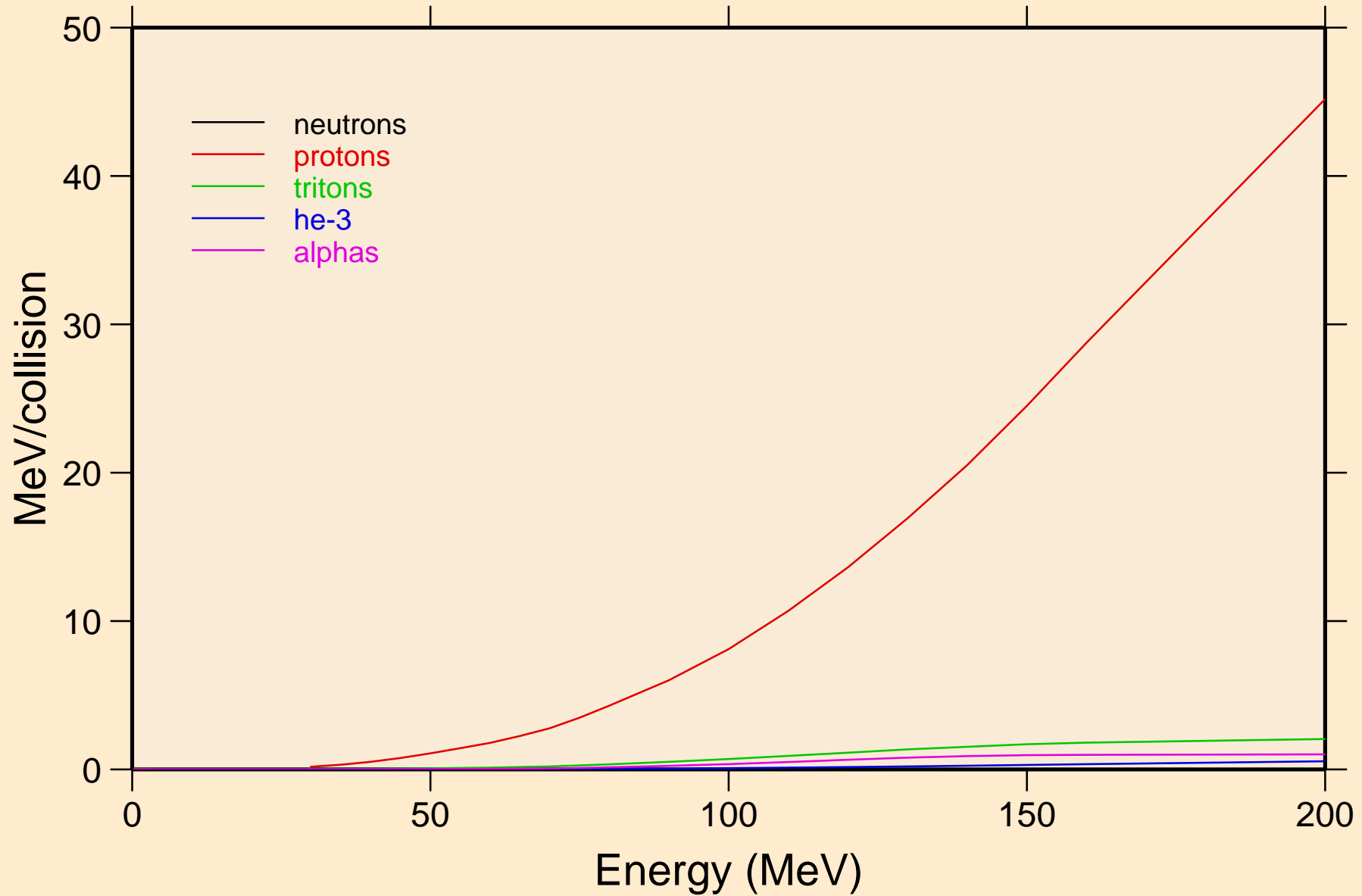

PU247 DEUTERON ACER TENDL-2024 LIBRARY; T=0.K  
Recoil Heating

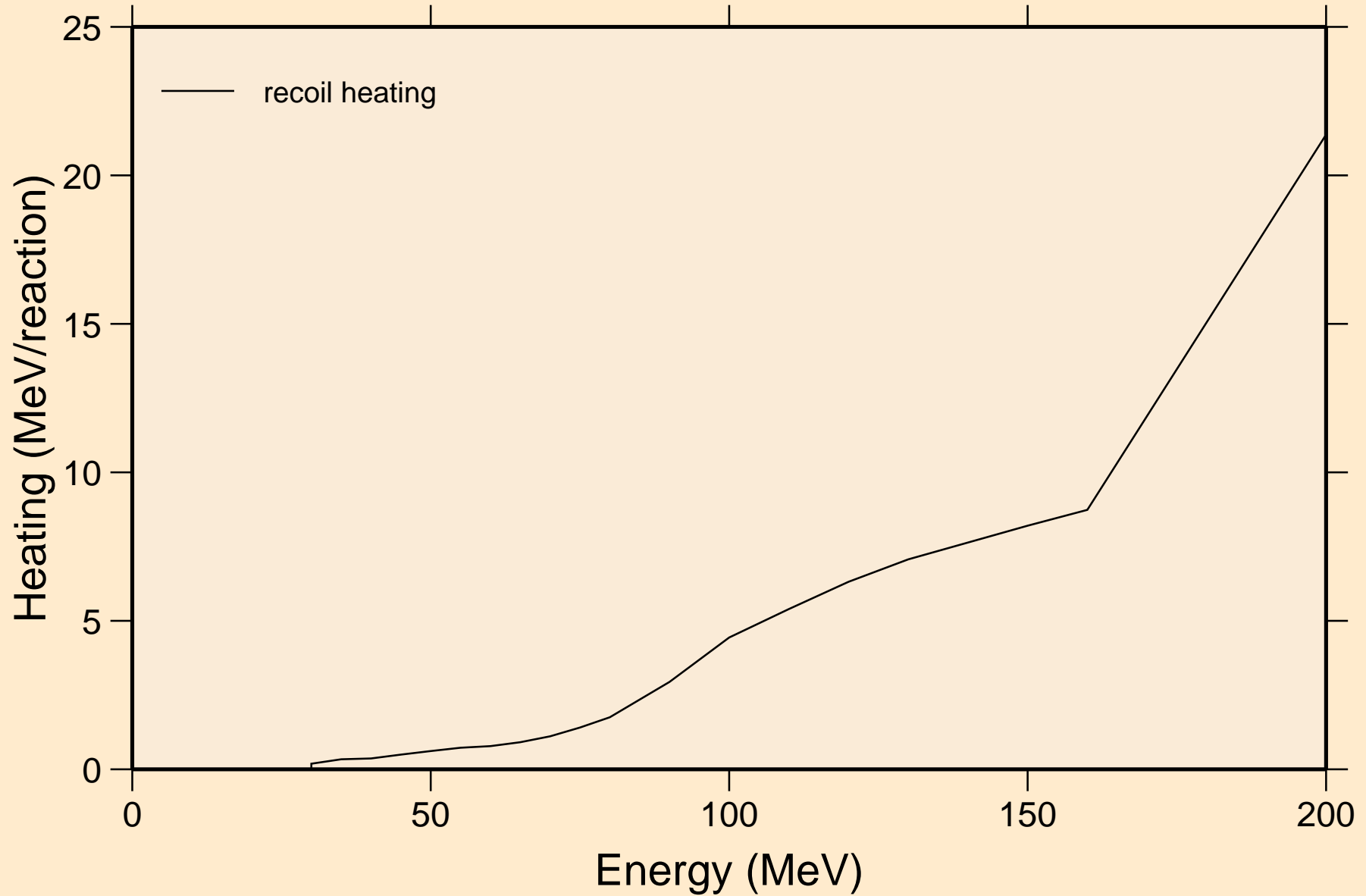

PU247 DEUTERON ACER TENDL-2024 LIBRARY; T=0.K  
Particle production cross sections

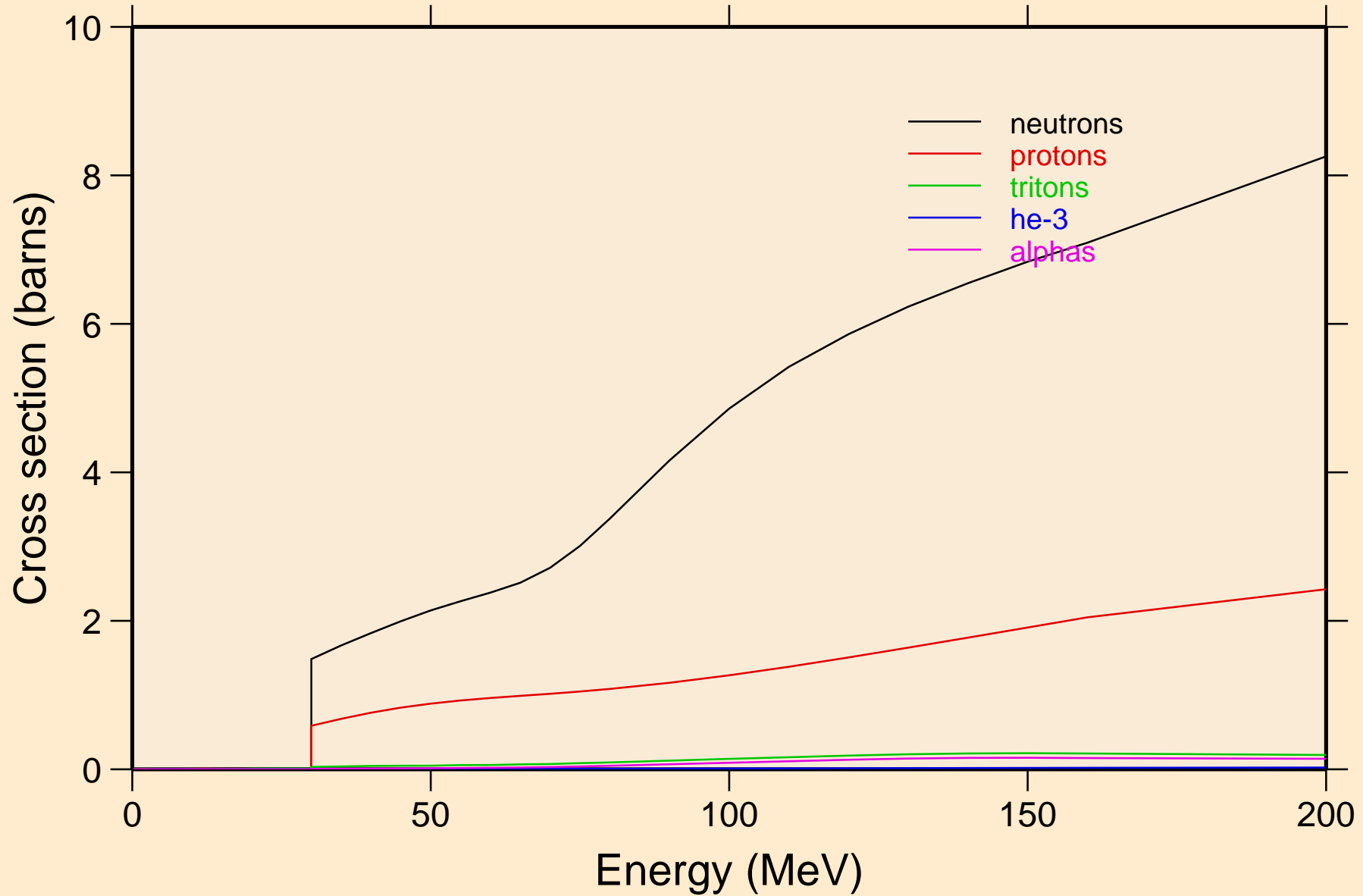

PU247 DEUTERON ACER TENDL-2024 LIBRARY; T=0.K  
neutrons from (d,n)

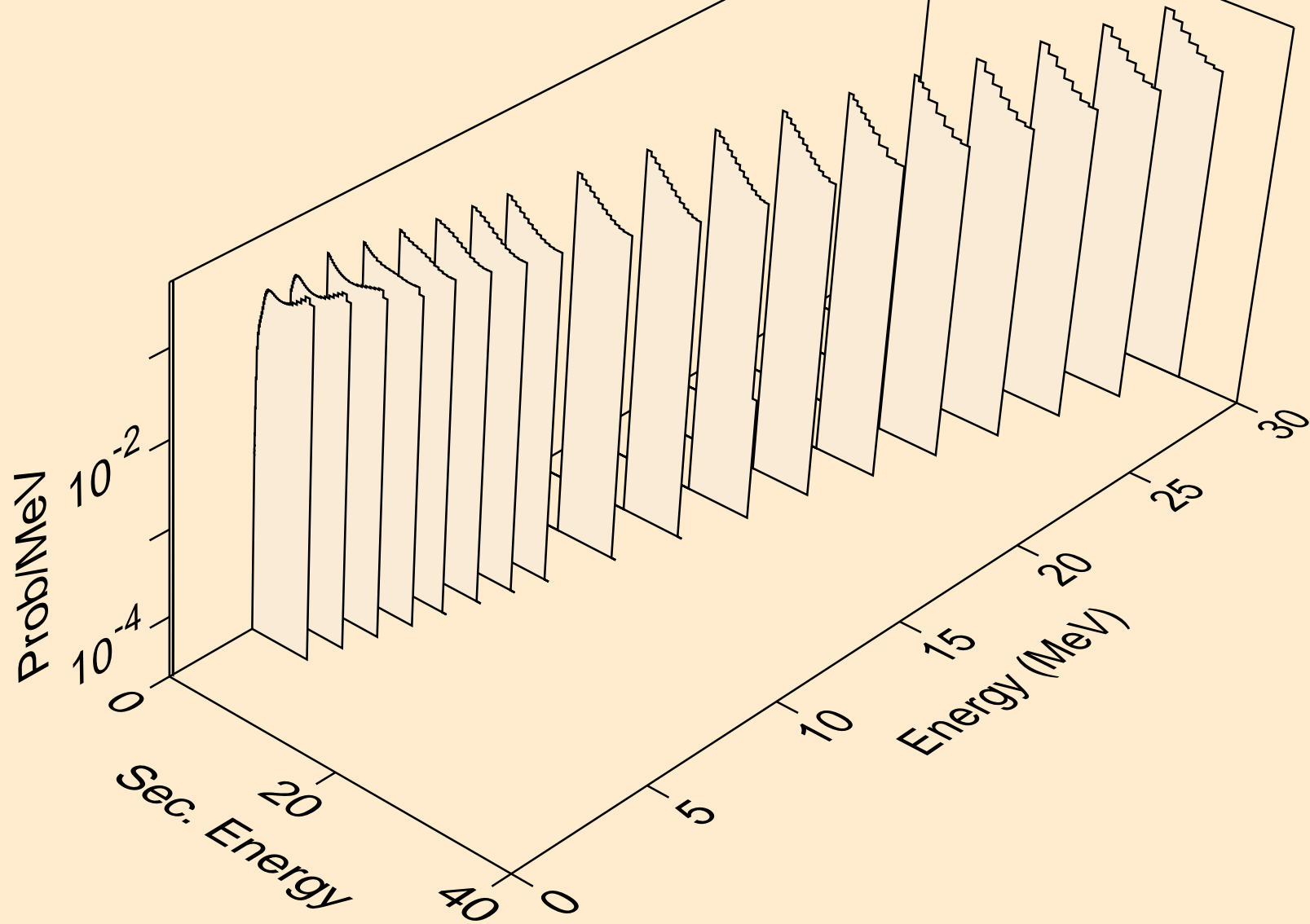

PU247 DEUTERON ACER TENDL-2024 LIBRARY; T=0.K  
neutrons from (d,x)

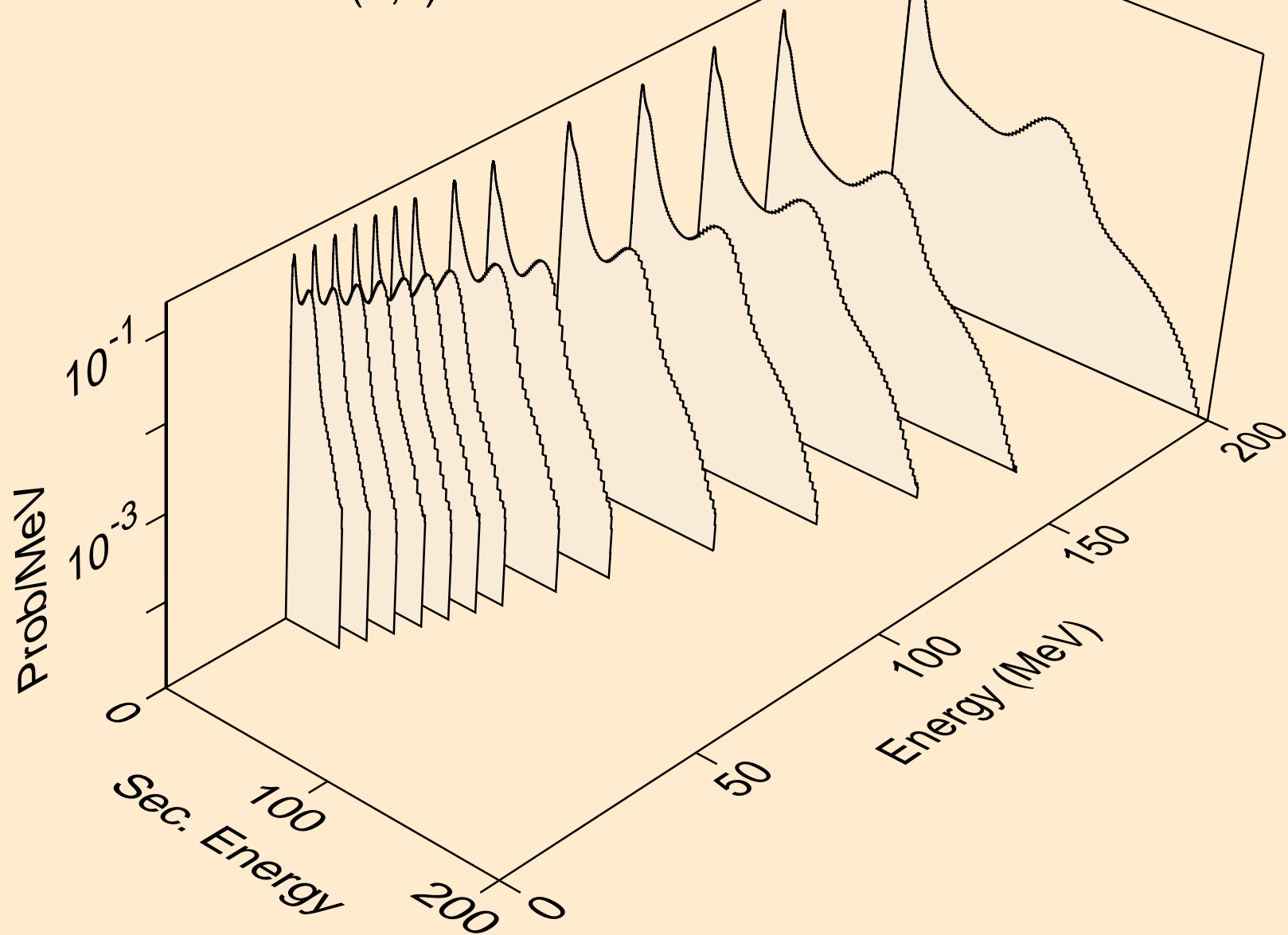

PU247 DEUTERON ACER TENDL-2024 LIBRARY; T=0.K  
neutrons from (d,2nd)

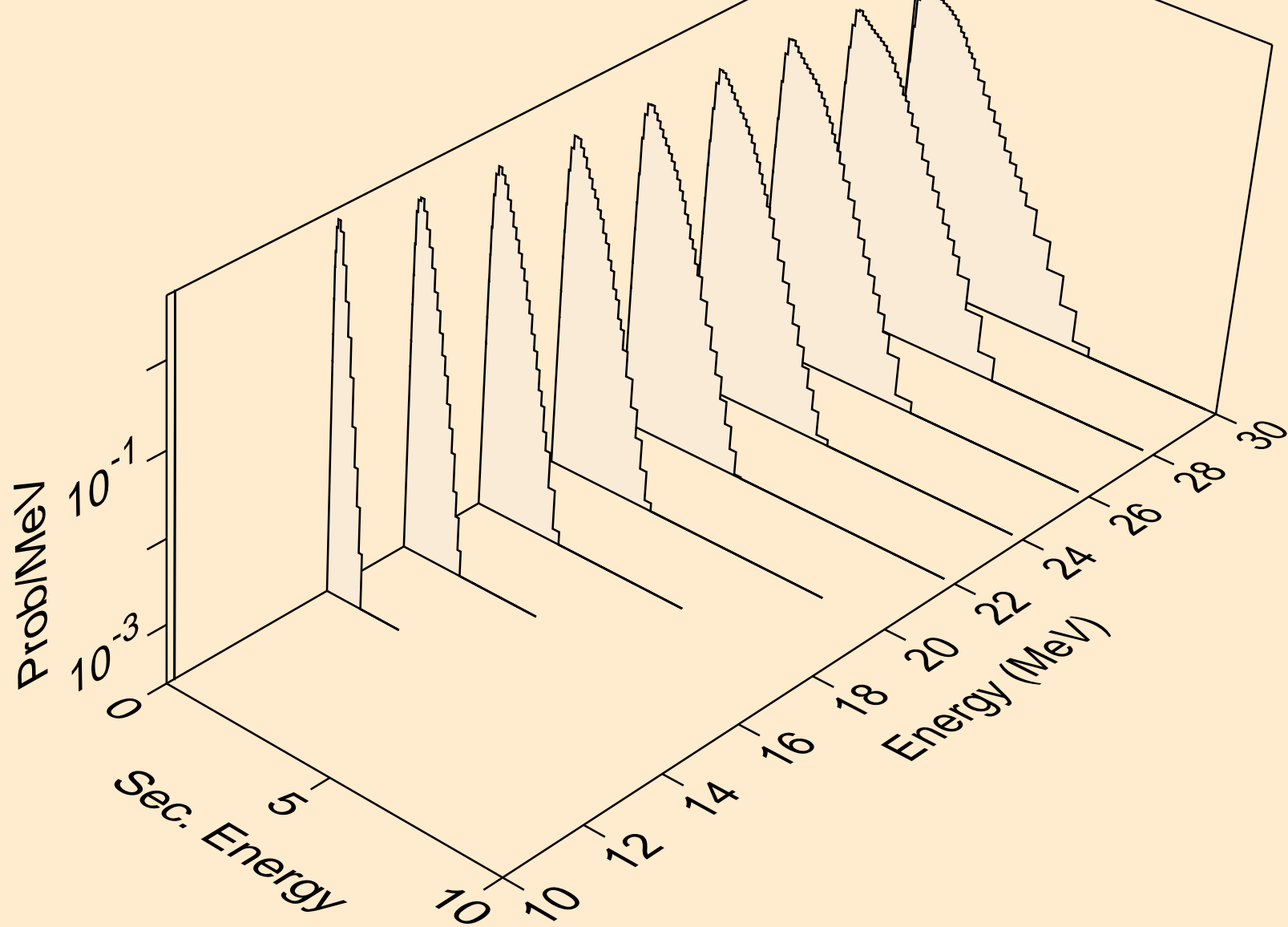

PU247 DEUTERON ACER TENDL-2024 LIBRARY; T=0.K  
neutrons from (d,2n)

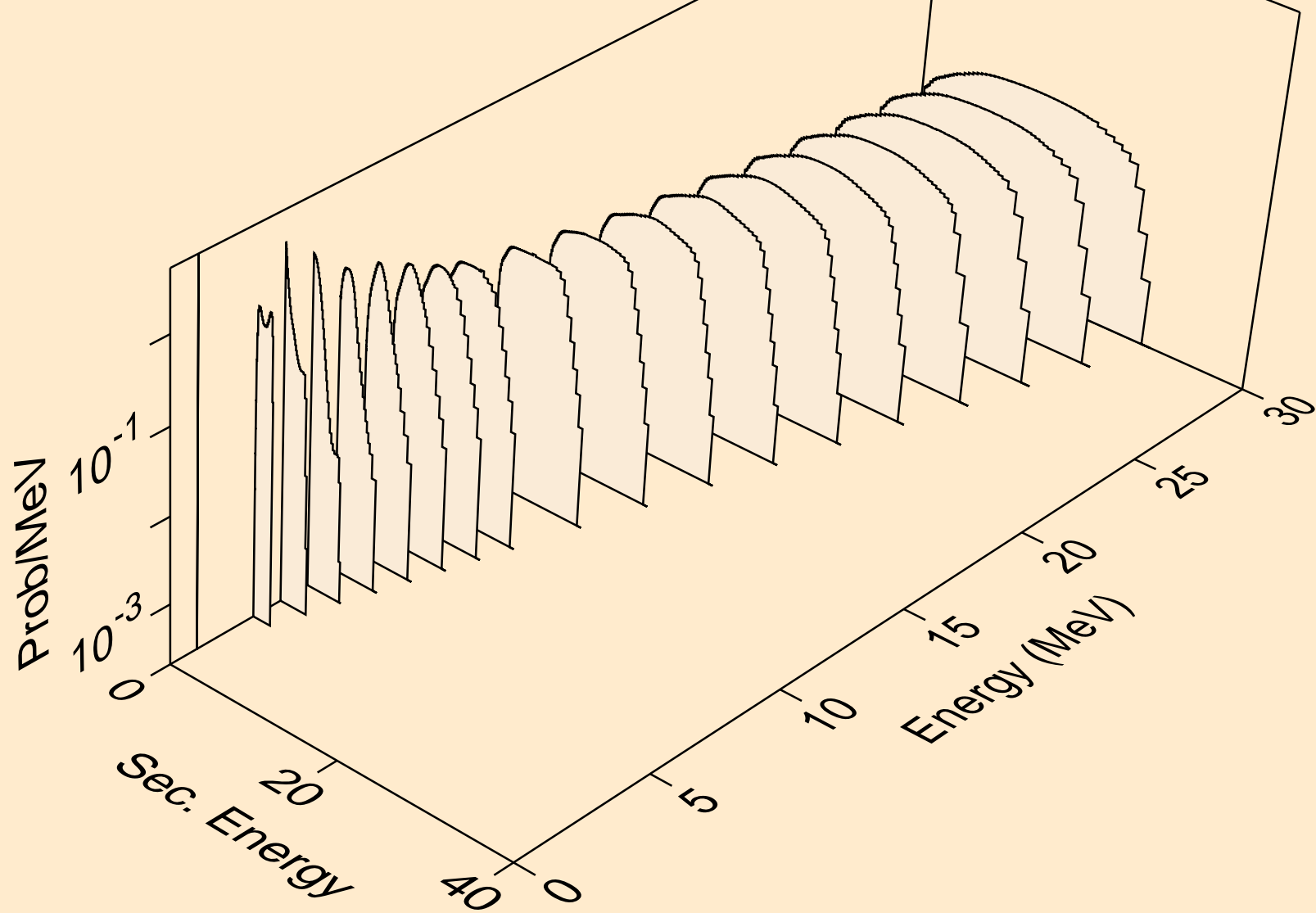

PU247 DEUTERON ACER TENDL-2024 LIBRARY; T=0.K  
neutrons from (d,3n)

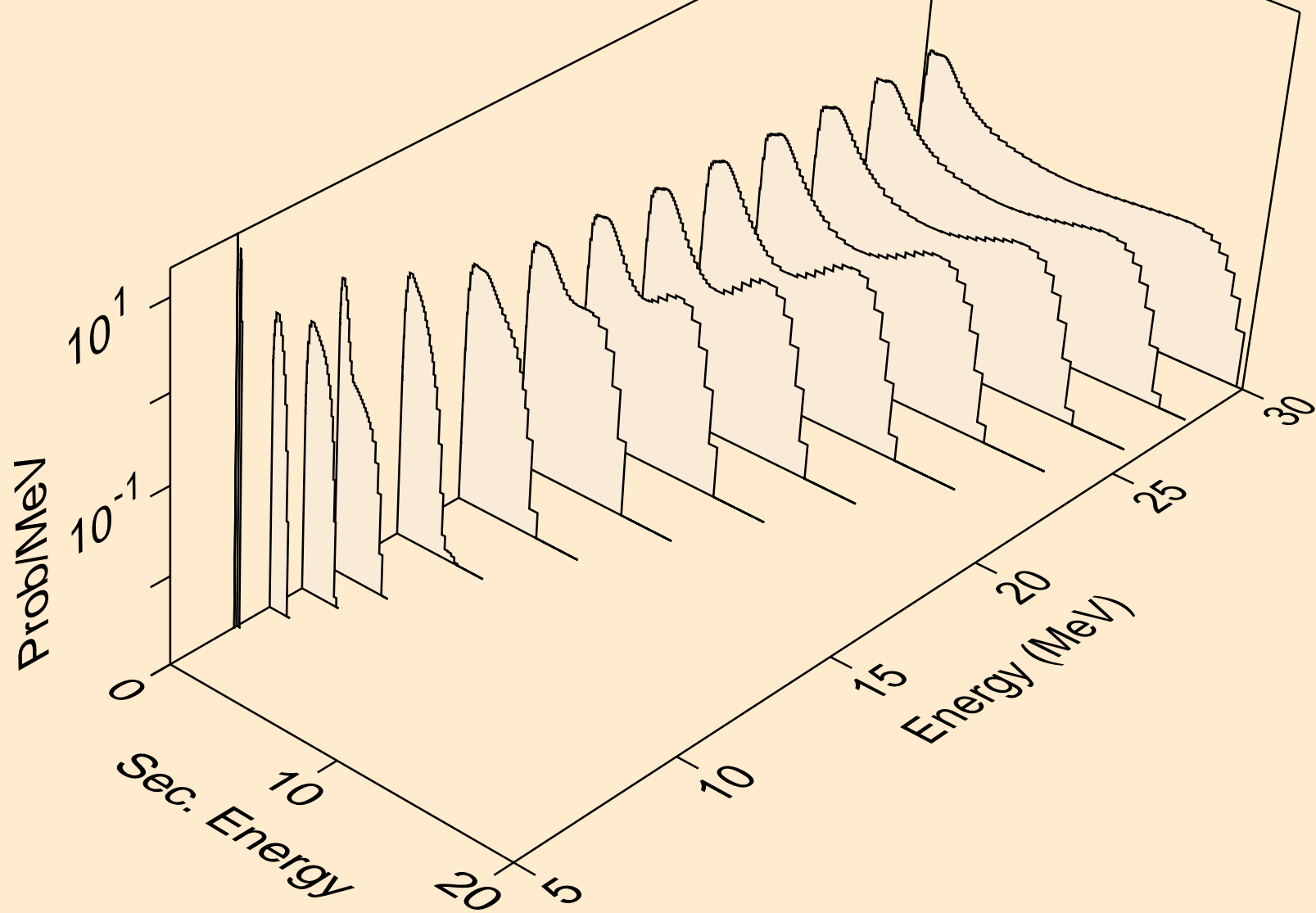

PU247 DEUTERON ACER TENDL-2024 LIBRARY; T=0.K  
neutrons from (d,n\*)a

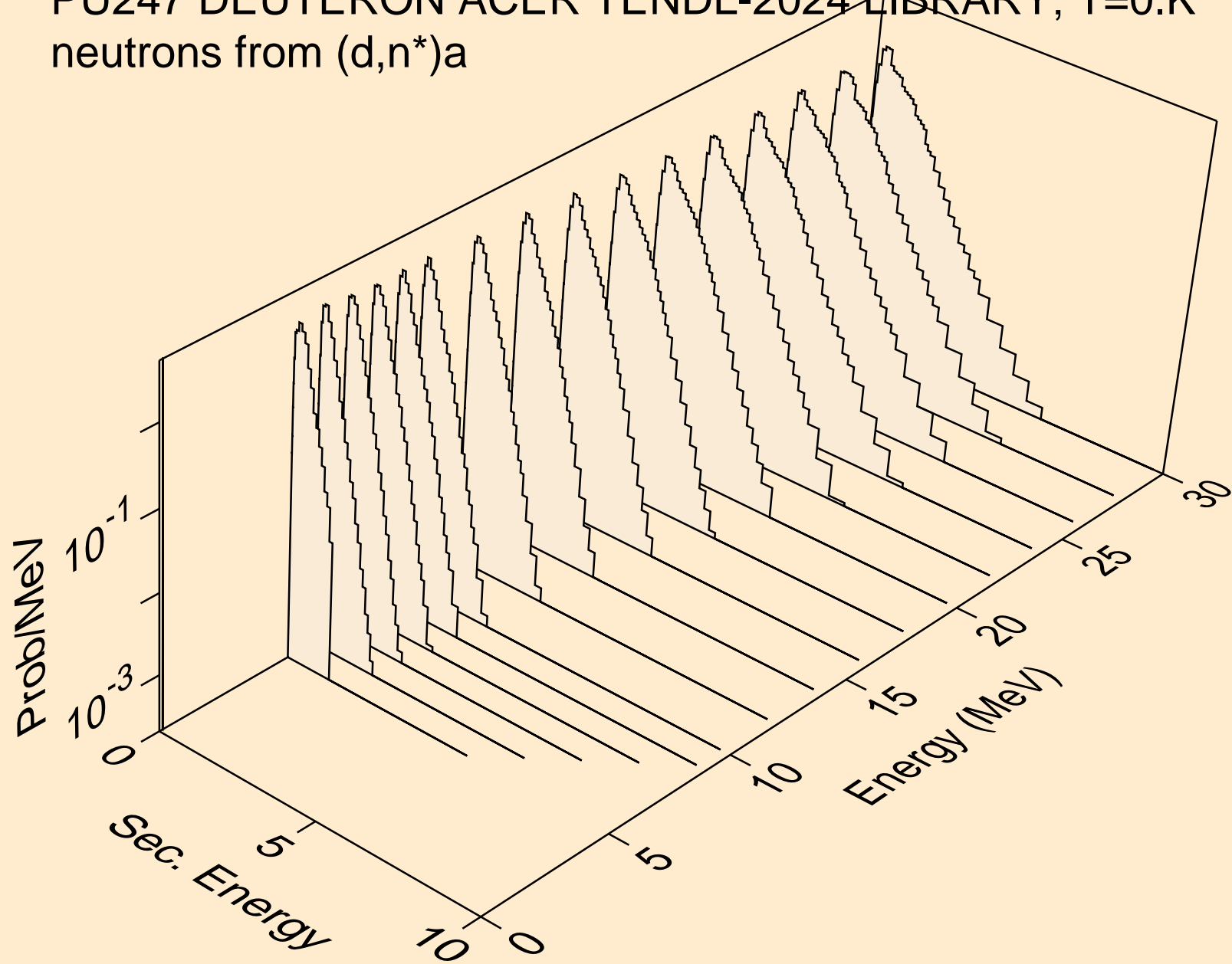

PU247 DEUTERON ACER TENDL-2024 LIBRARY; T=0.K  
neutrons from (d,2n)a

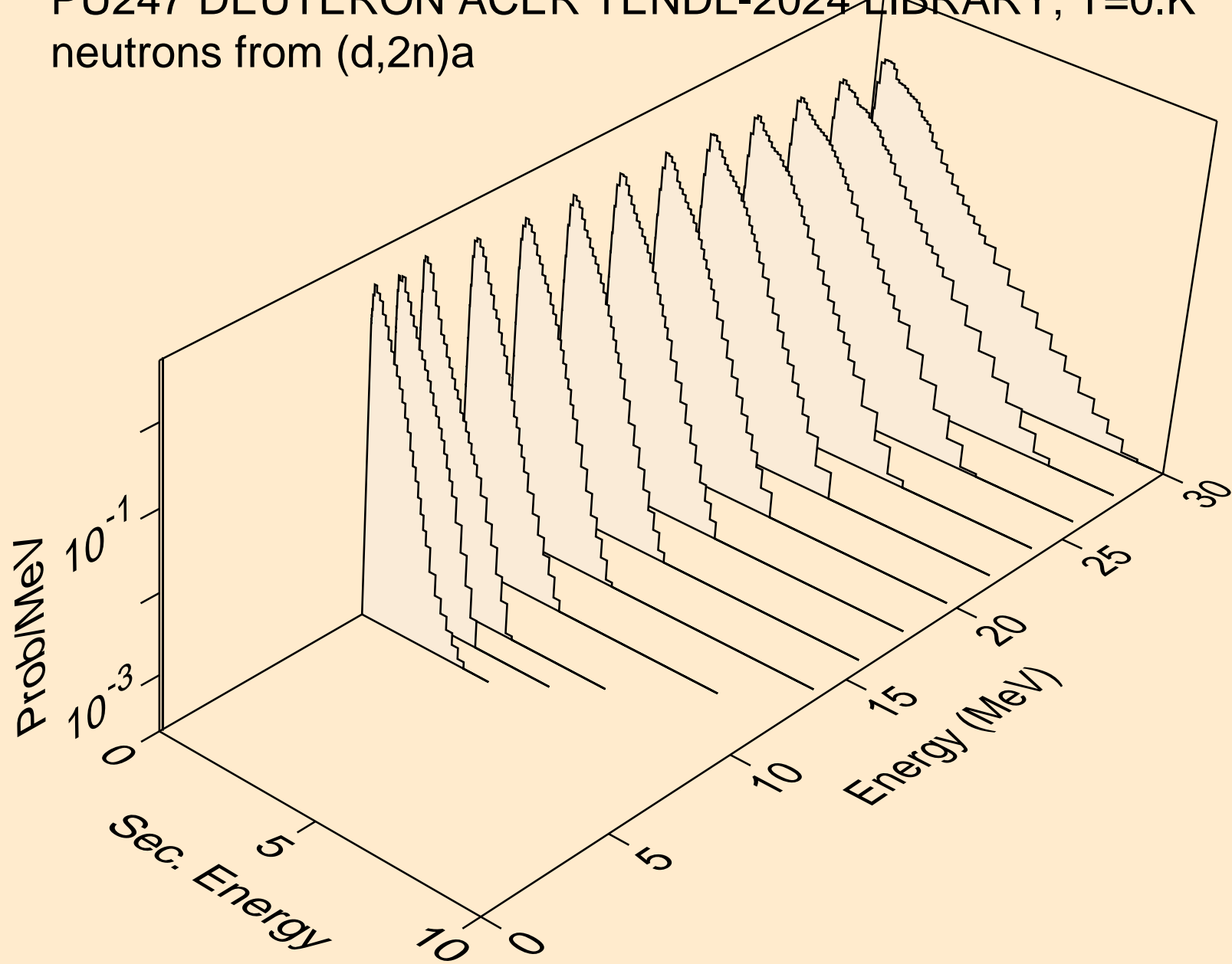

PU247 DEUTERON ACER TENDL-2024 LIBRARY; T=0.K  
neutrons from (d,3n)a

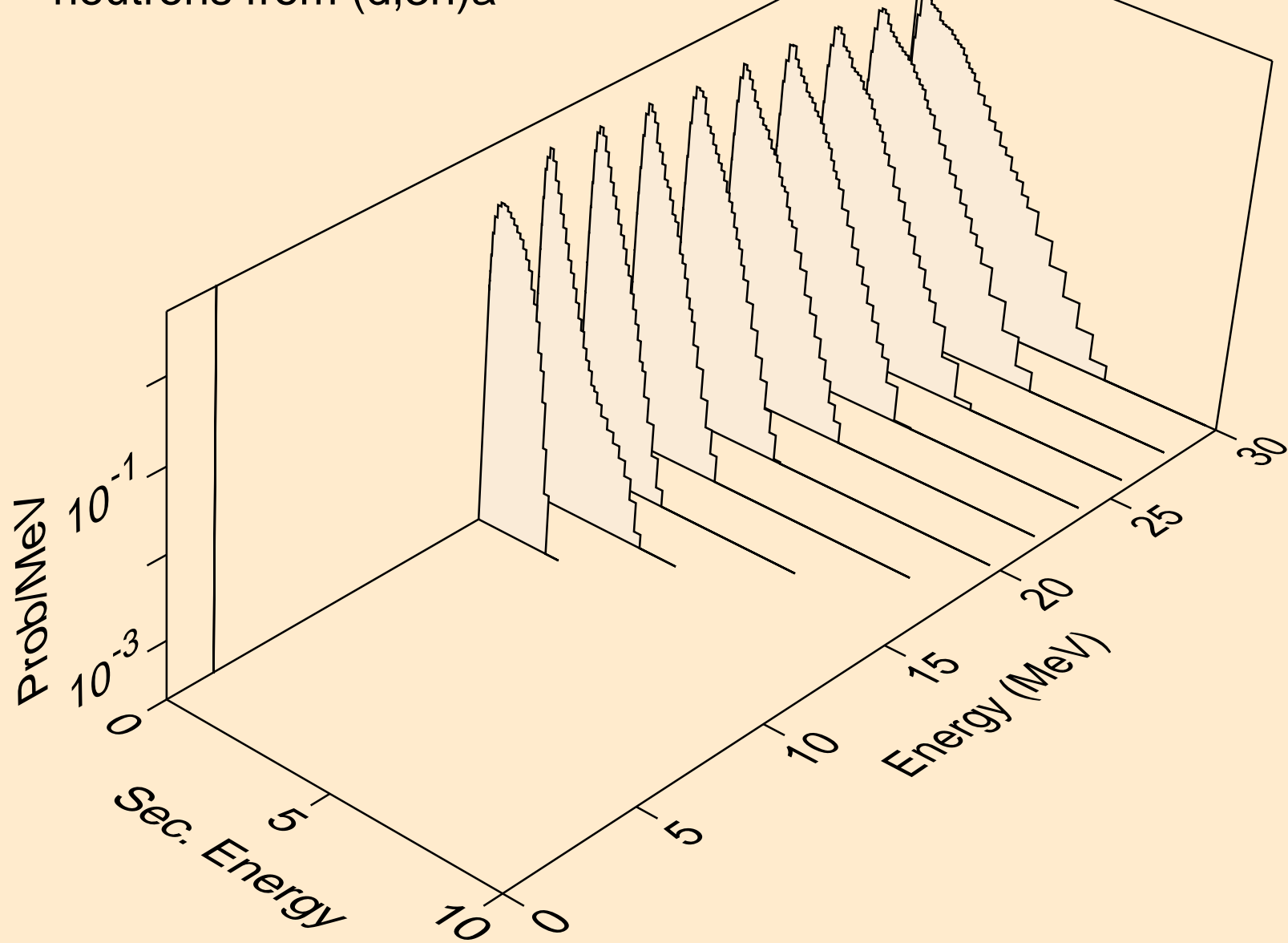

PU247 DEUTERON ACER TENDL-2024 LIBRARY; T=0.K  
neutrons from (d,n\*)p

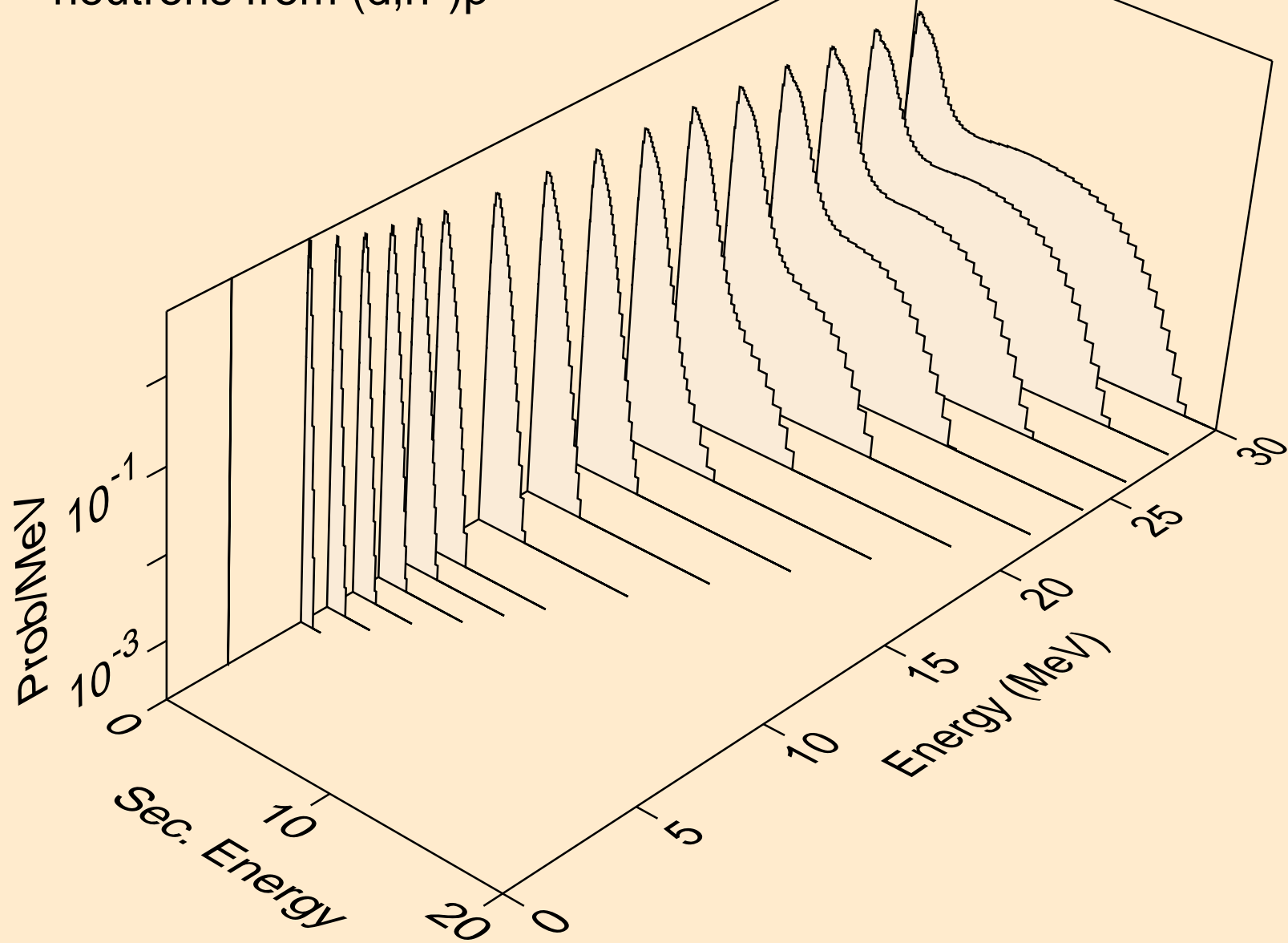

PU247 DEUTERON ACER TENDL-2024 LIBRARY; T=0.K  
neutrons from (d,n\*)d

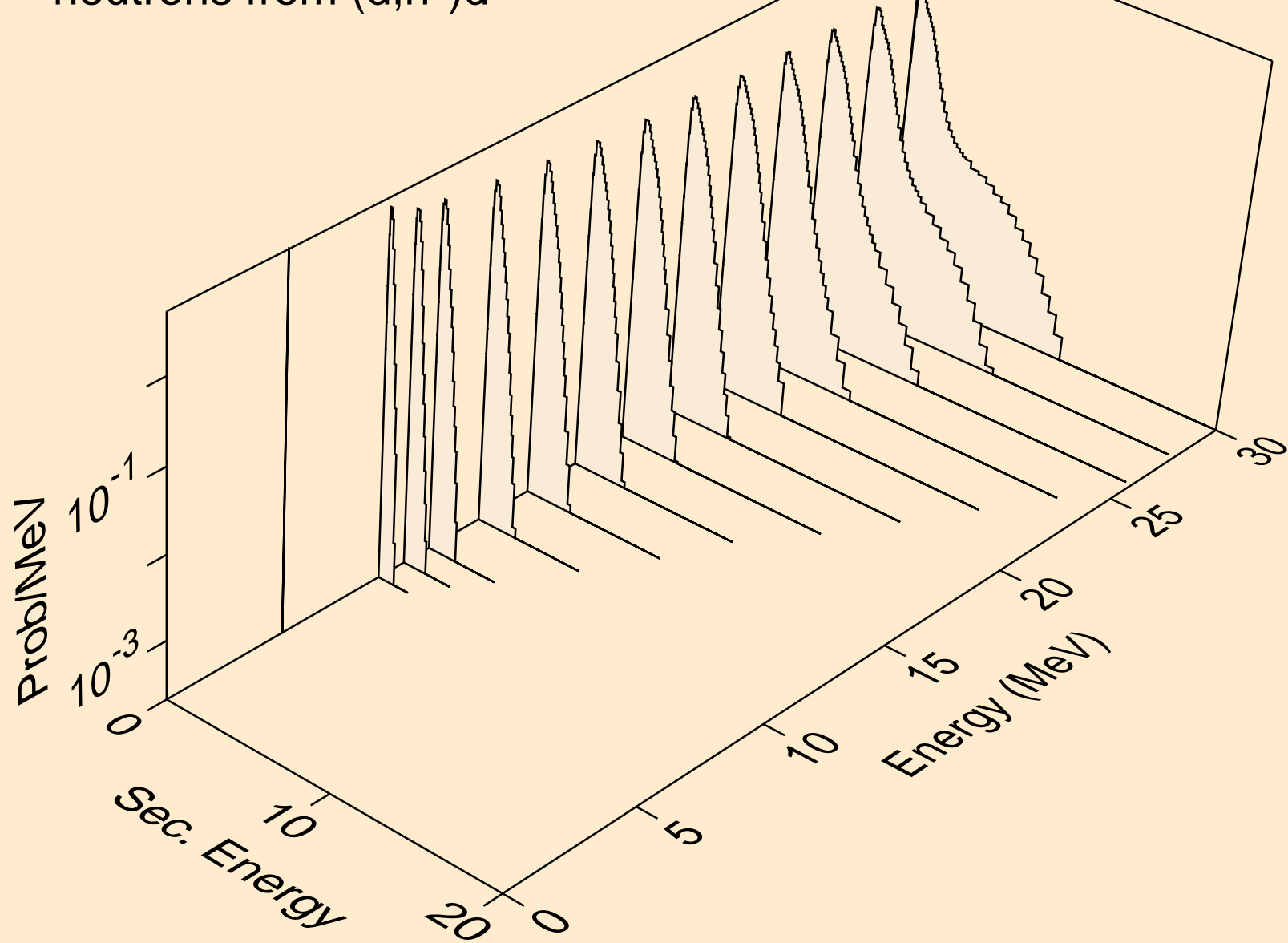

PU247 DEUTERON ACER TENDL-2024 LIBRARY; T=0.K  
neutrons from (d,n\*)t

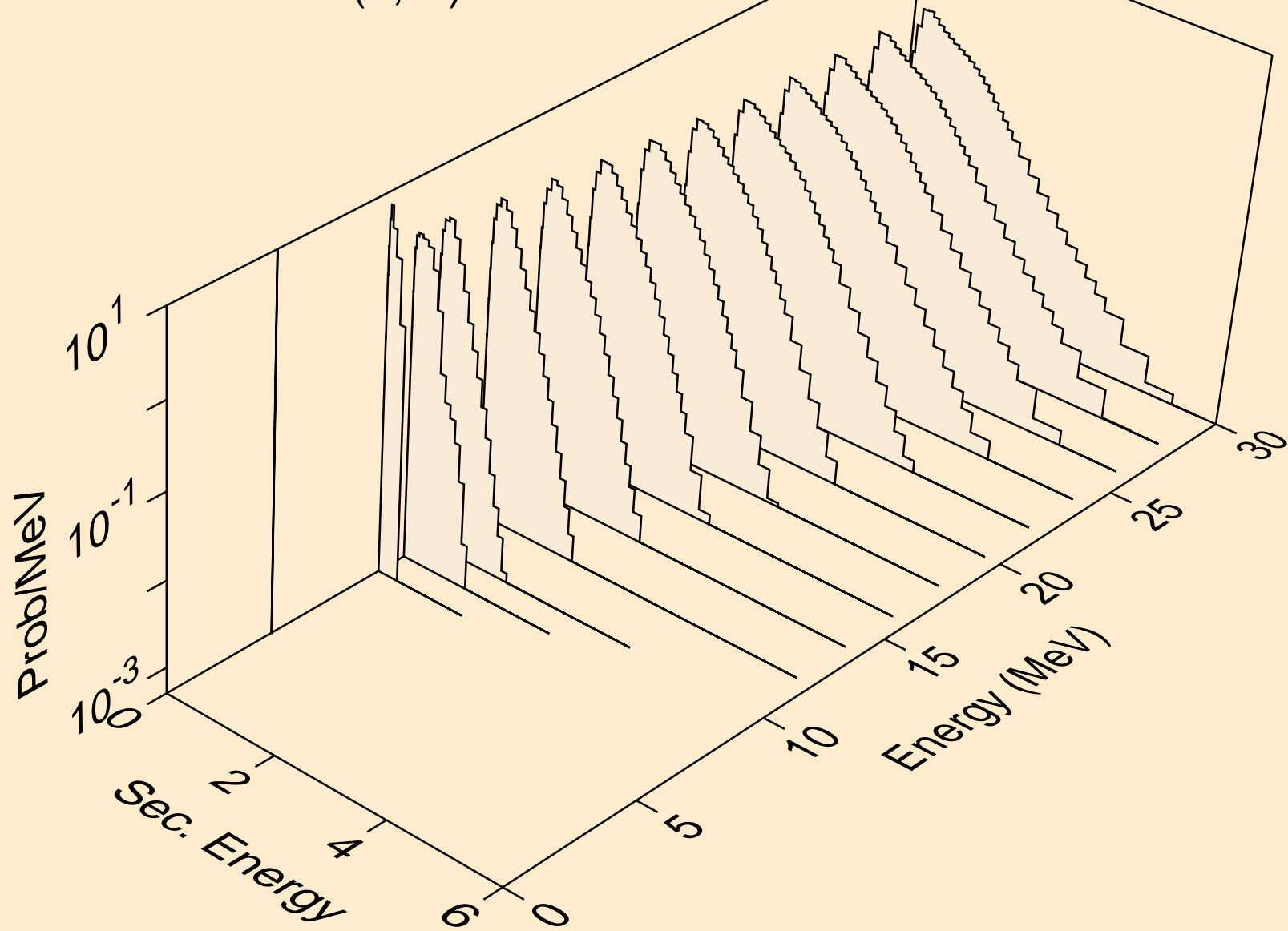

PU247 DEUTERON ACER TENDL-2024 LIBRARY; T=0.K  
neutrons from (d,n\*)he3

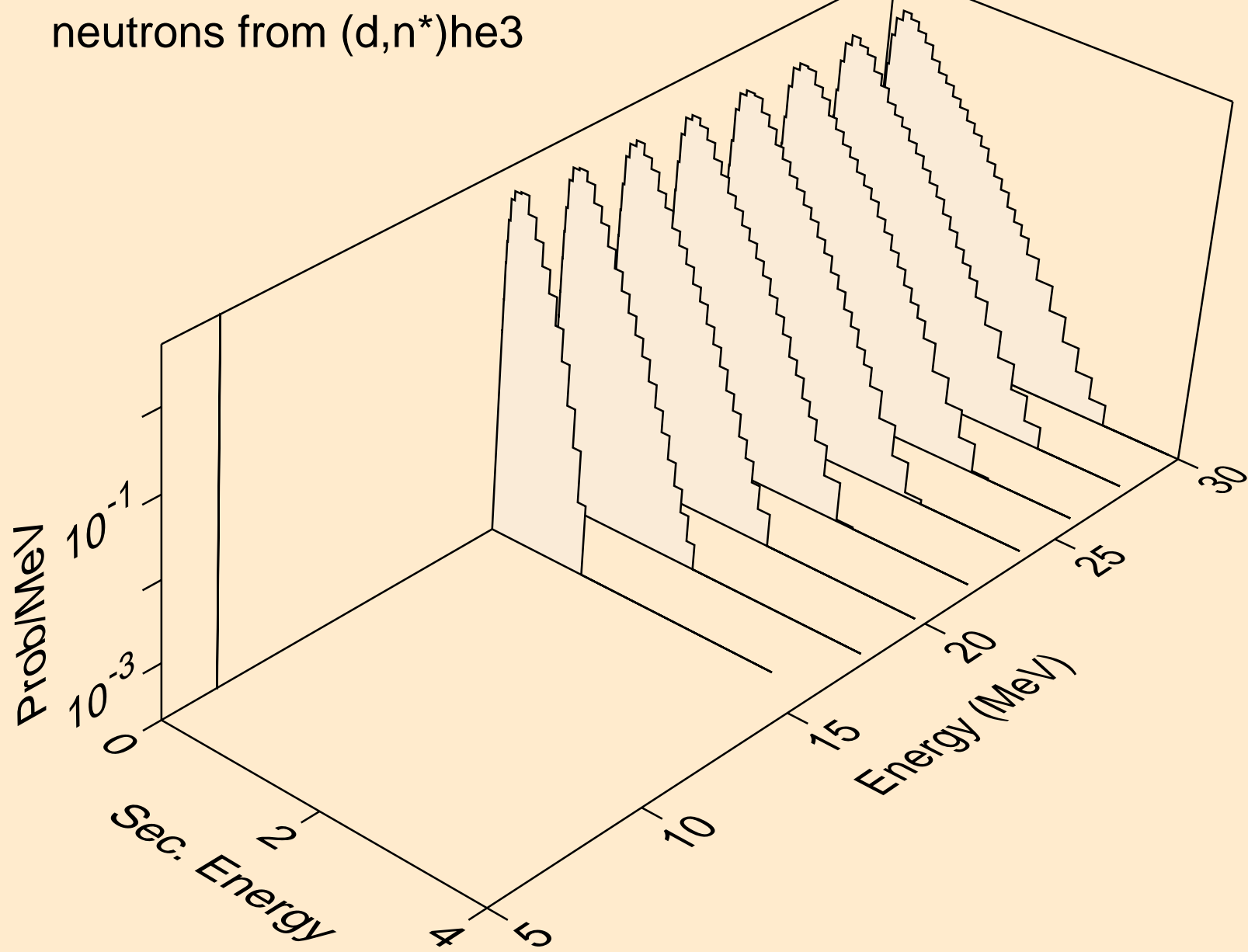

PU247 DEUTERON ACER TENDL-2024 LIBRARY; T=0.K  
neutrons from (d,4n)

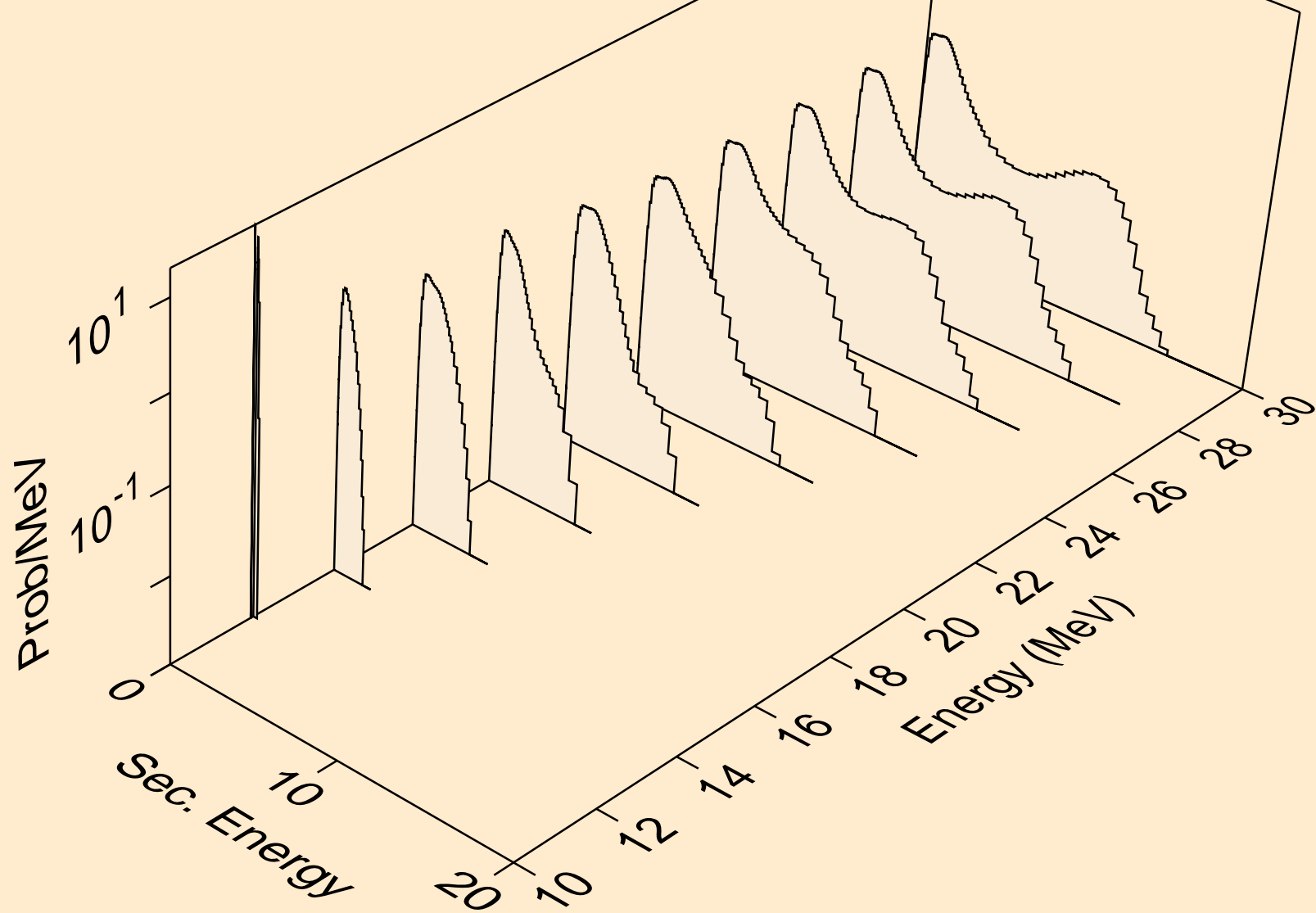

PU247 DEUTERON ACER TENDL-2024 LIBRARY; T=0.K  
neutrons from (d,2np)

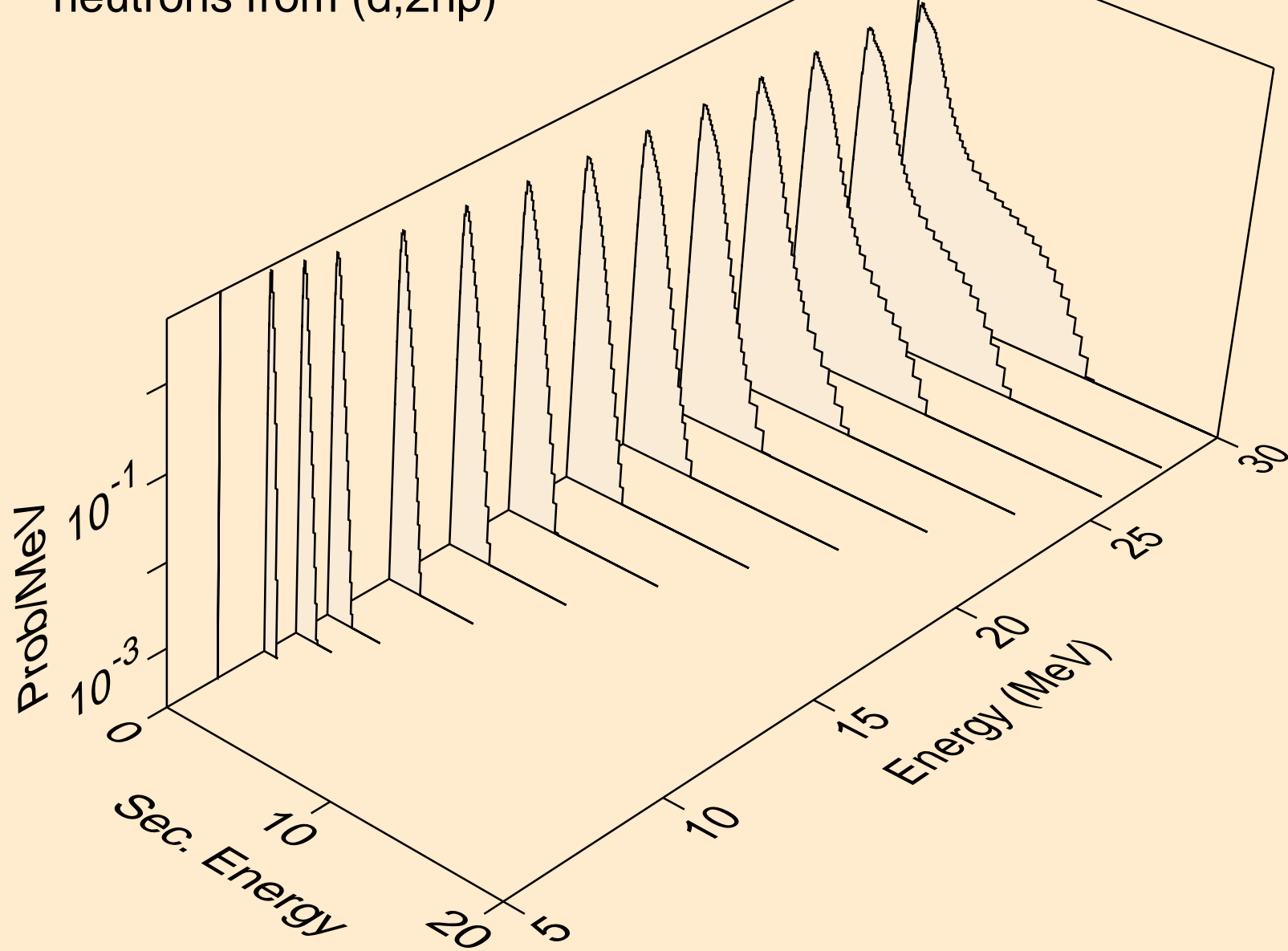

PU247 DEUTERON ACER TENDL-2024 LIBRARY; T=0.K  
neutrons from (d,3np)

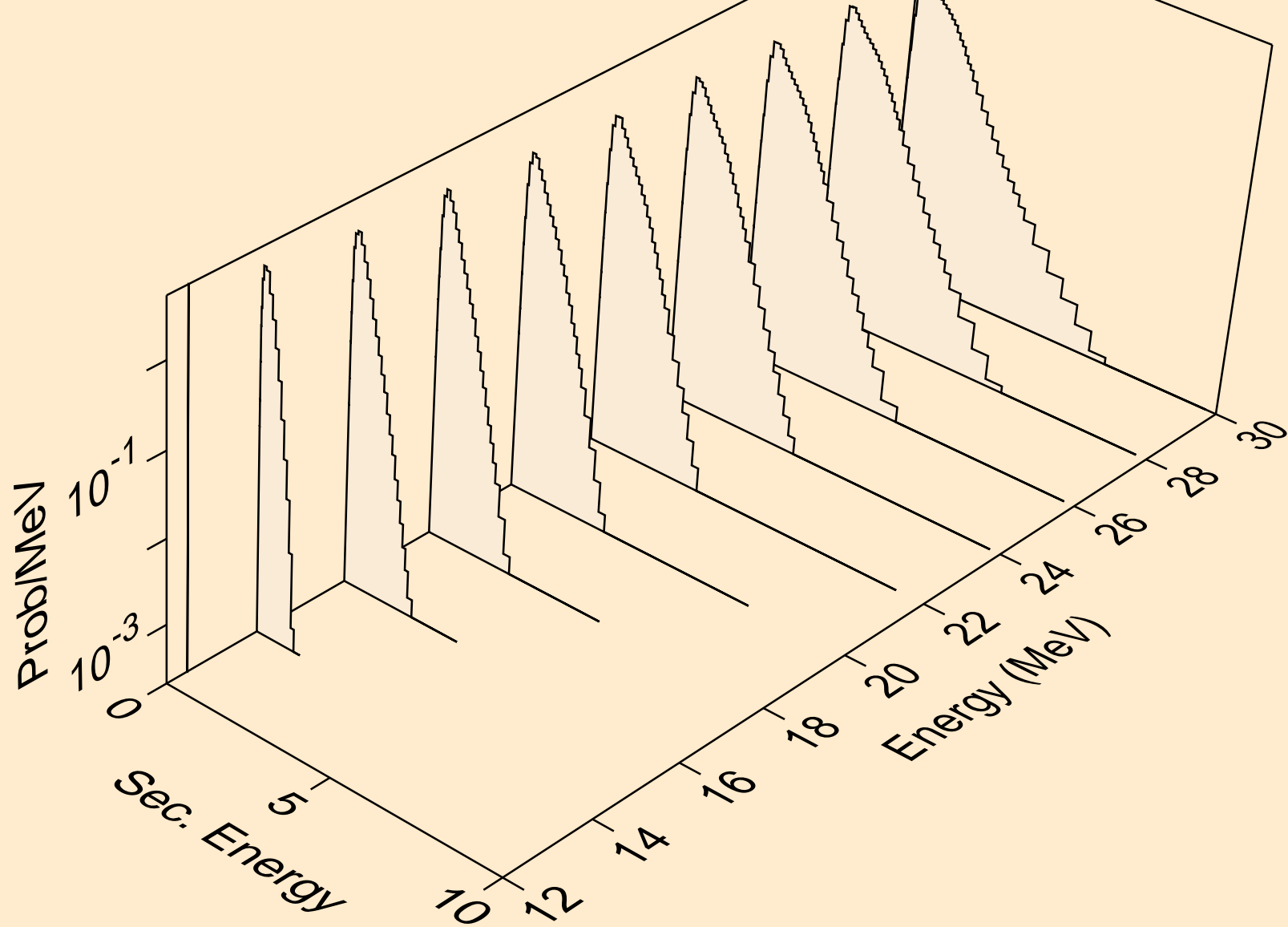

PU247 DEUTERON ACER TENDL-2024 LIBRARY; T=0.K  
neutrons from (d,n2p)

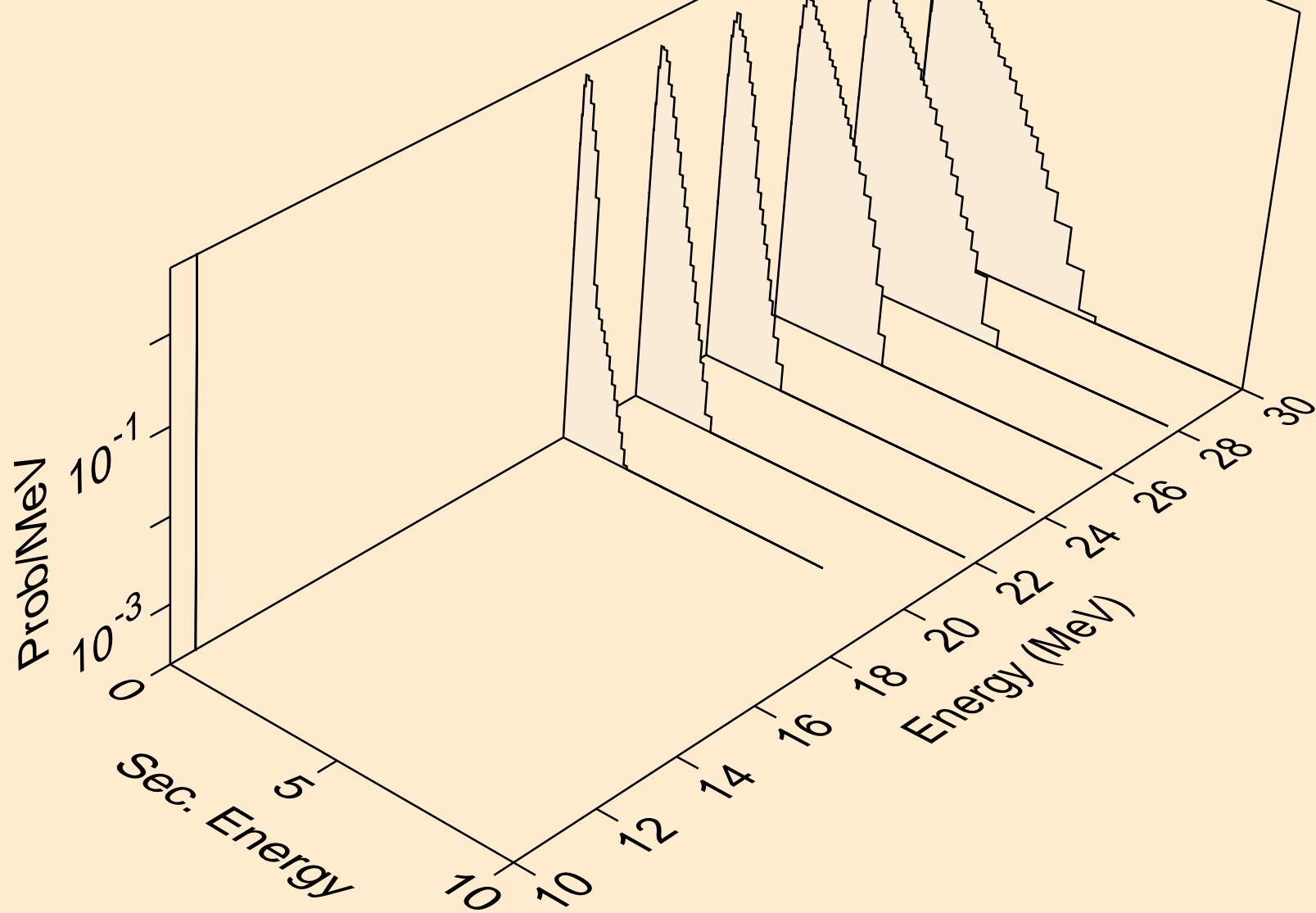

PU247 DEUTERON ACER TENDL-2024 LIBRARY; T=0.K  
protons from (d,x)

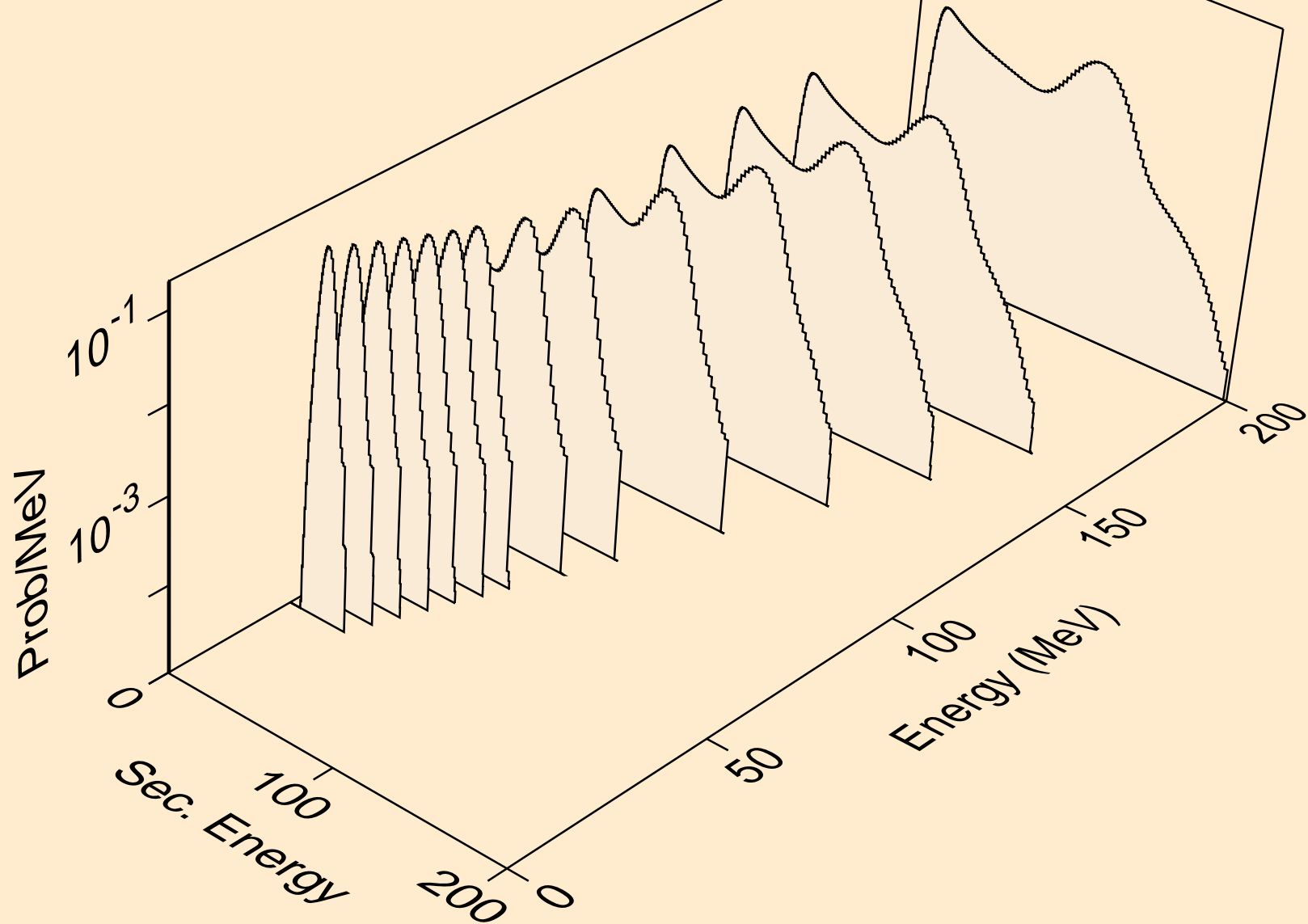

PU247 DEUTERON ACER TENDL-2024 LIBRARY; T=0.K  
protons from (d,n\*)p

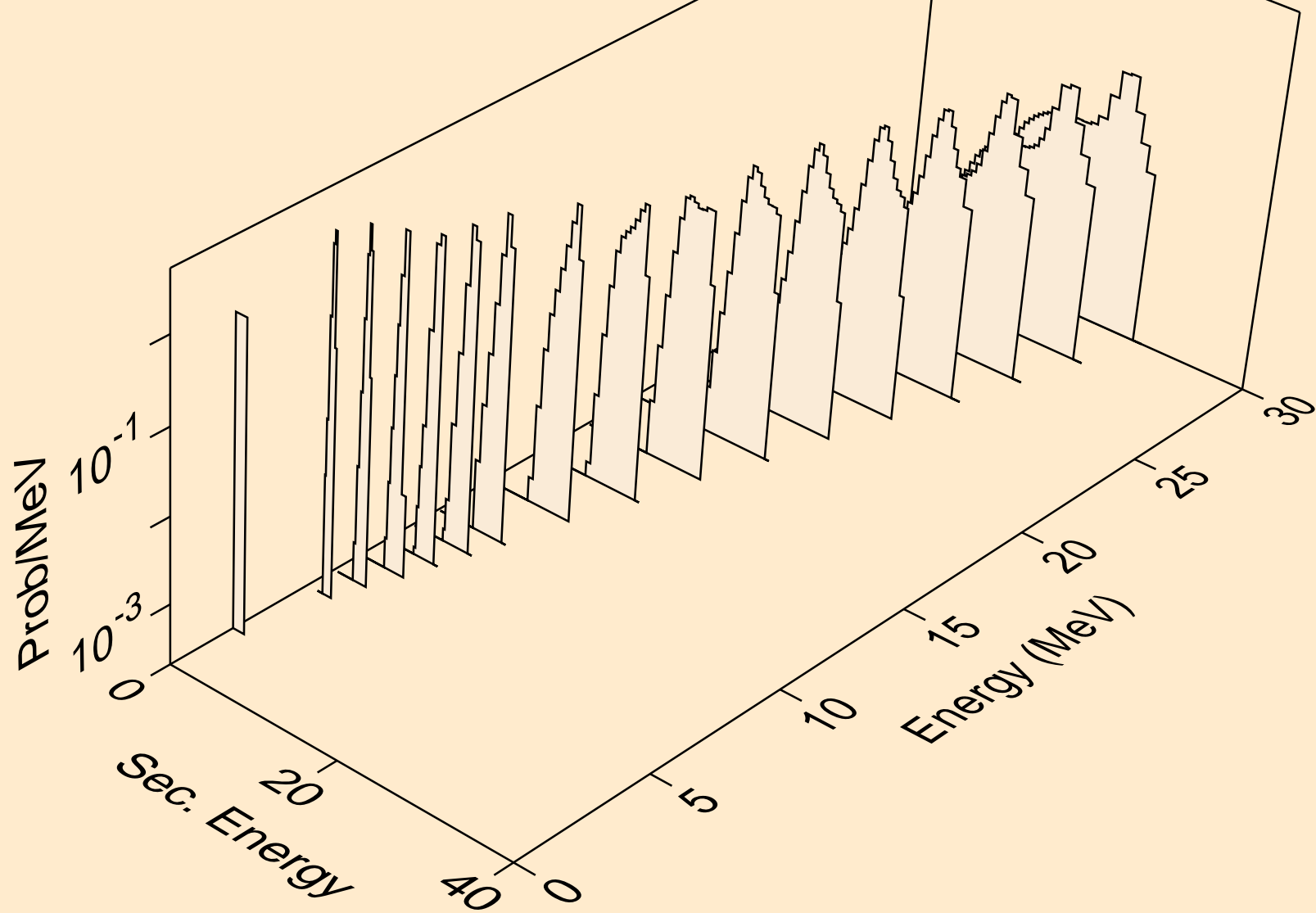

PU247 DEUTERON ACER TENDL-2024 LIBRARY; T=0.K  
protons from (d,2np)

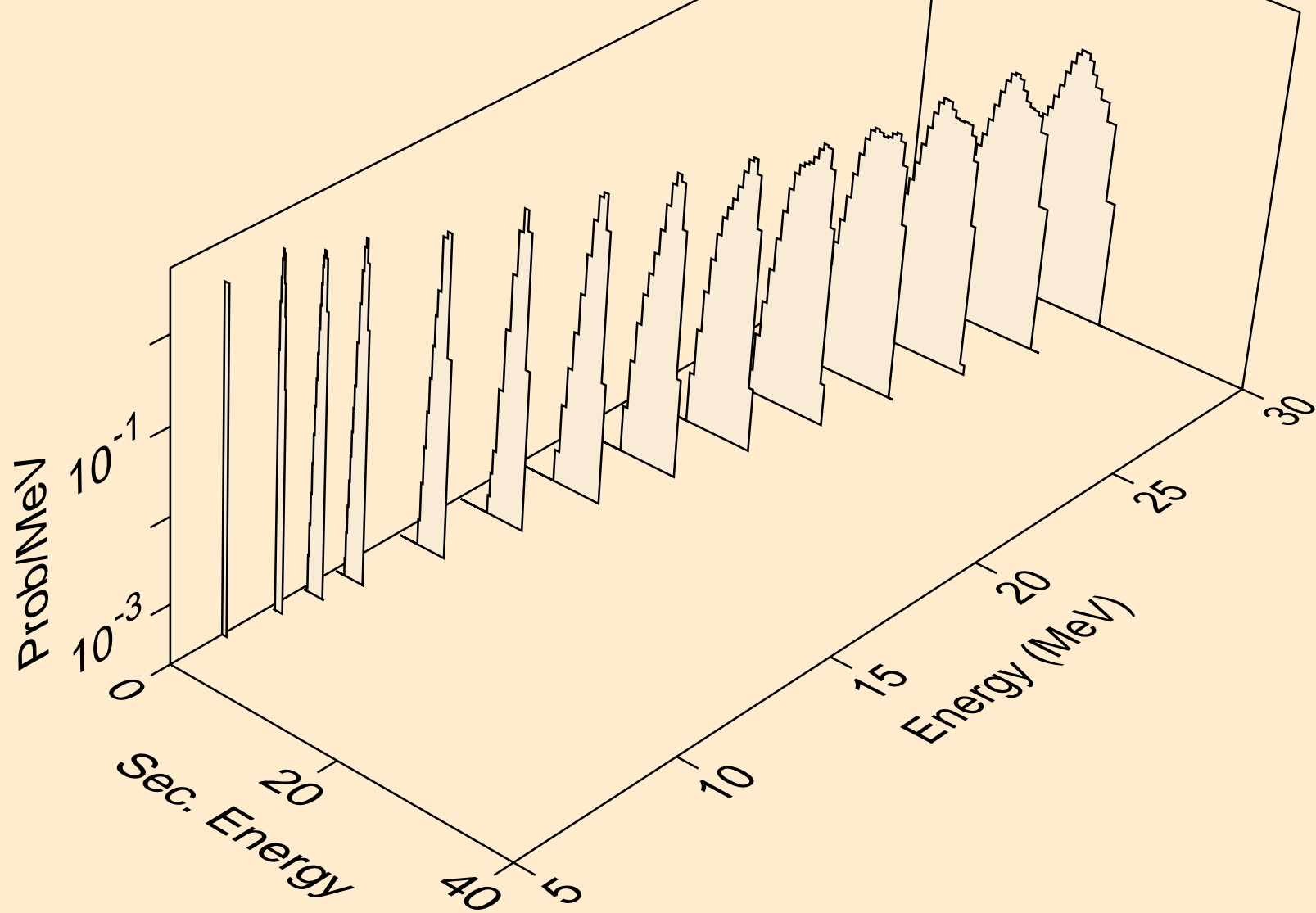

PU247 DEUTERON ACER TENDL-2024 LIBRARY; T=0.K  
protons from (d,3np)

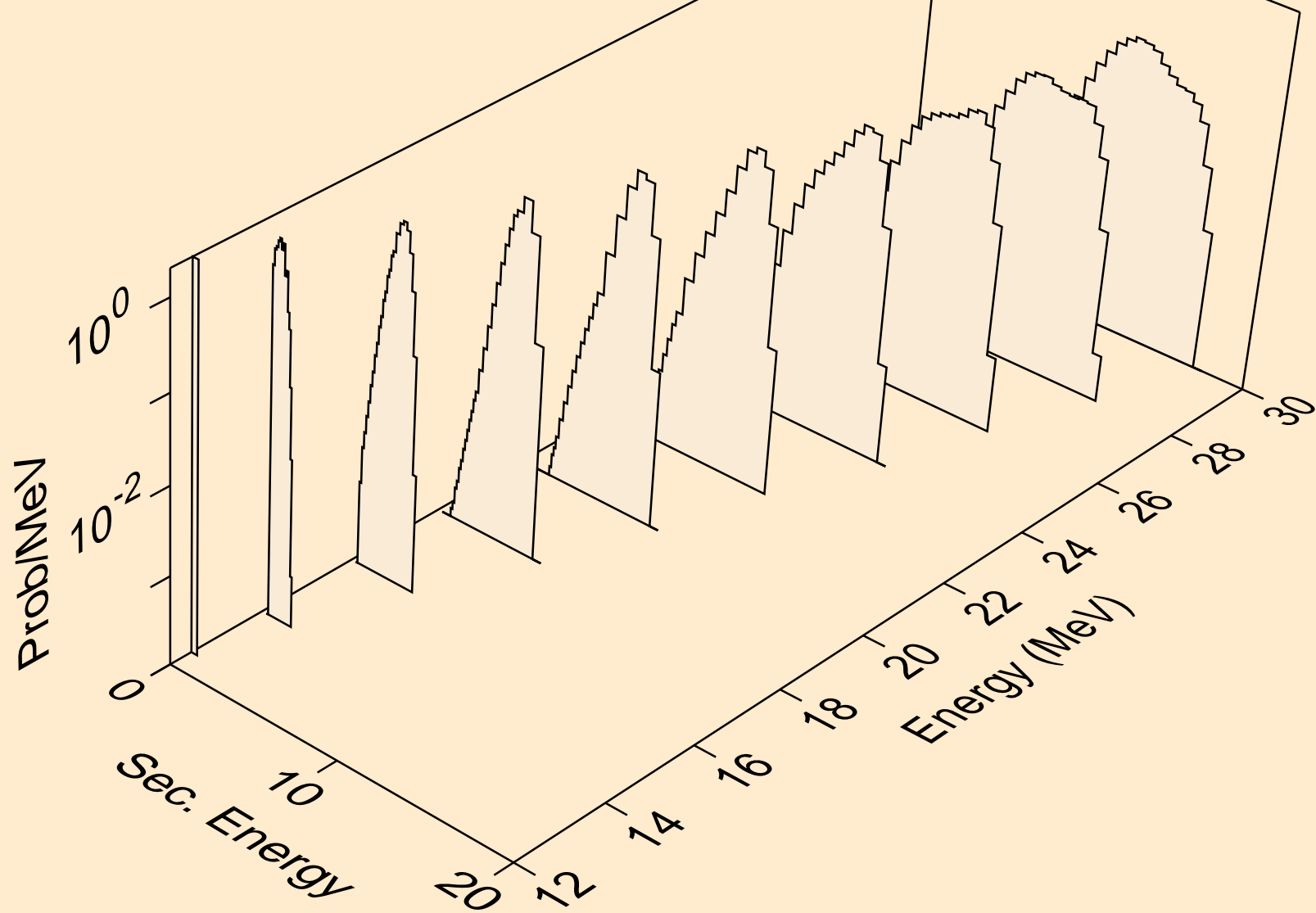

PU247 DEUTERON ACER TENDL-2024 LIBRARY; T=0.K  
protons from (d,n2p)

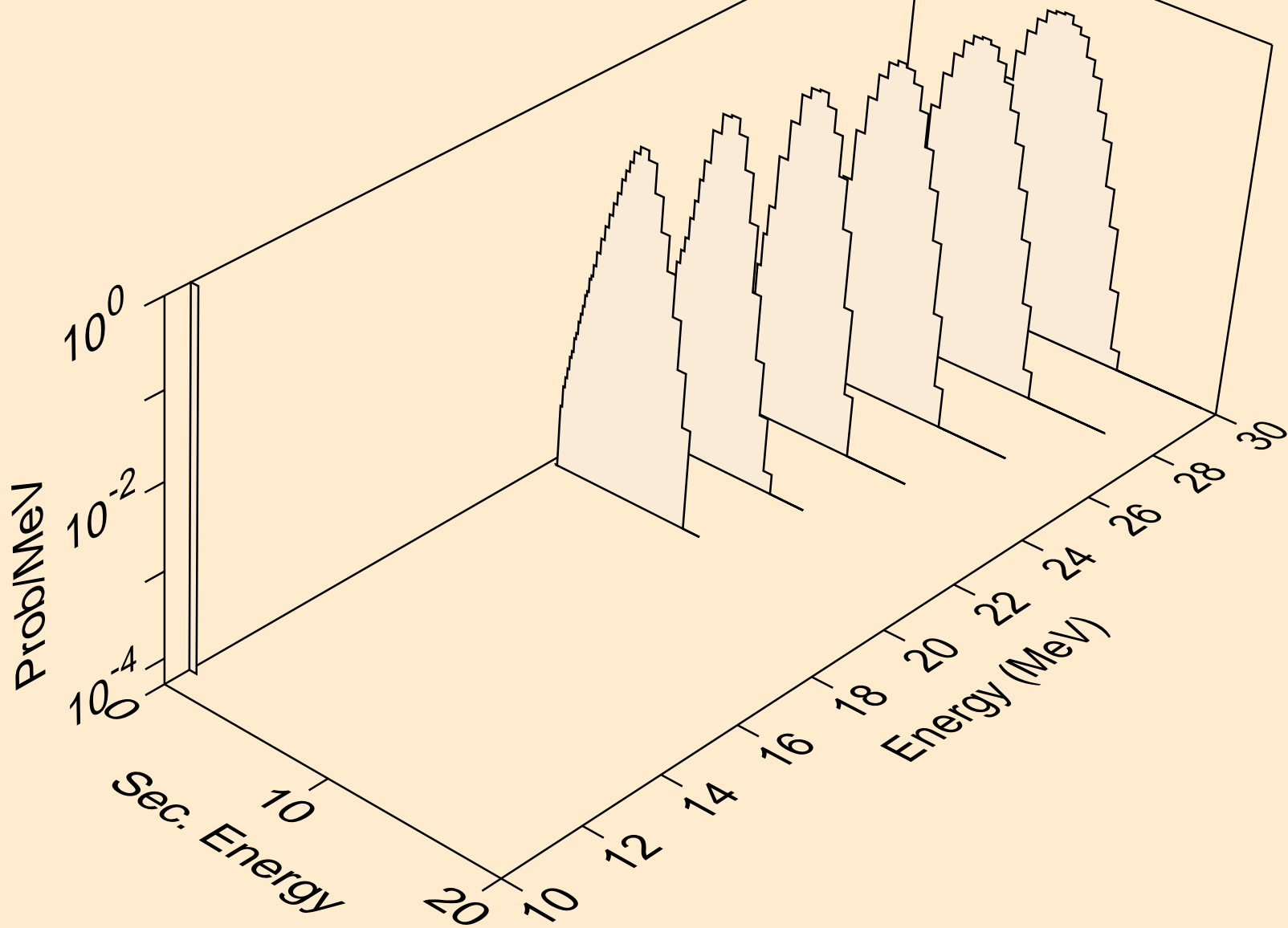

PU247 DEUTERON ACER TENDL-2024 LIBRARY; T=0.K  
protons from (d,p)

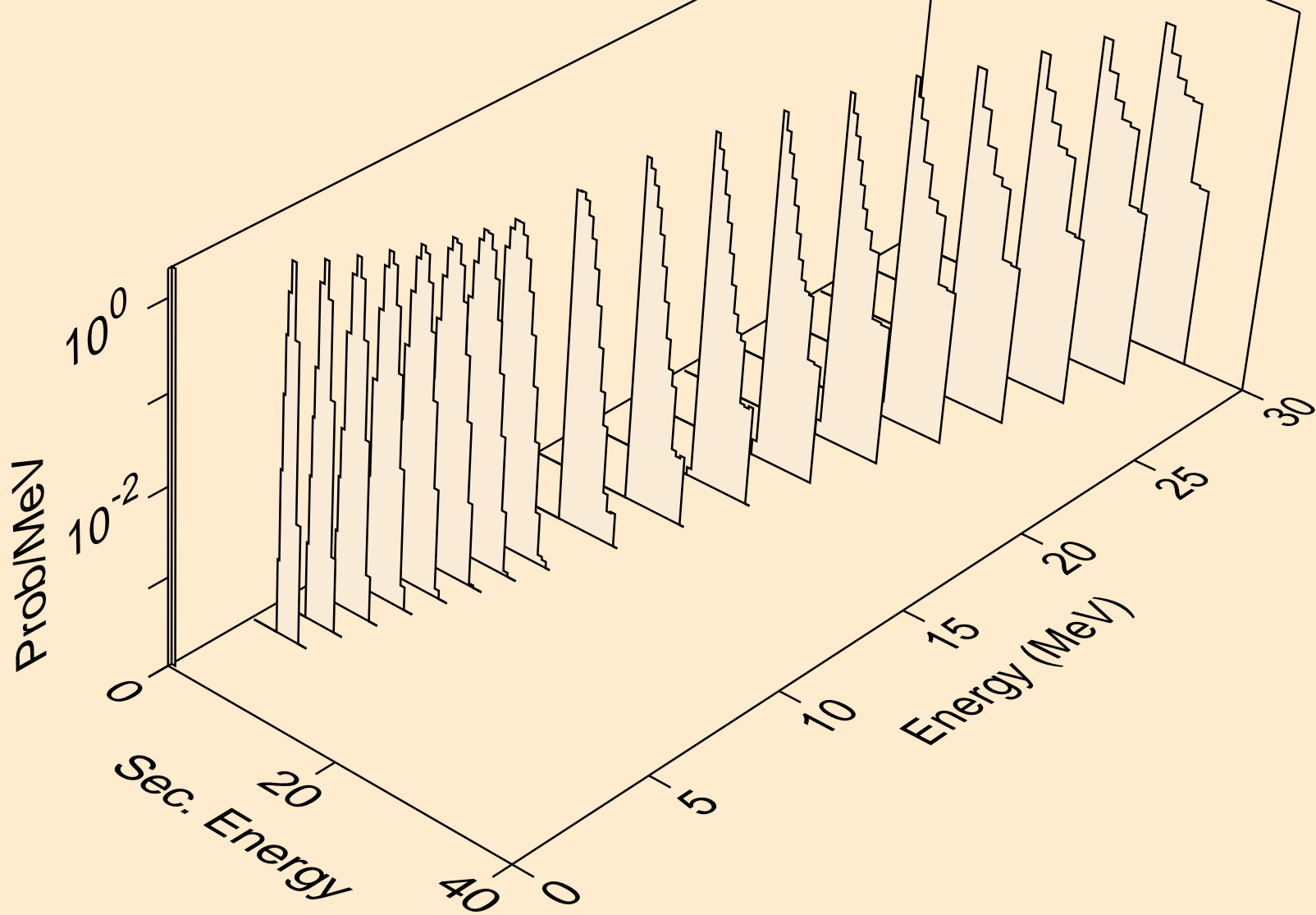

PU247 DEUTERON ACER TENDL-2024 LIBRARY; T=0.K  
protons from (d,2p)

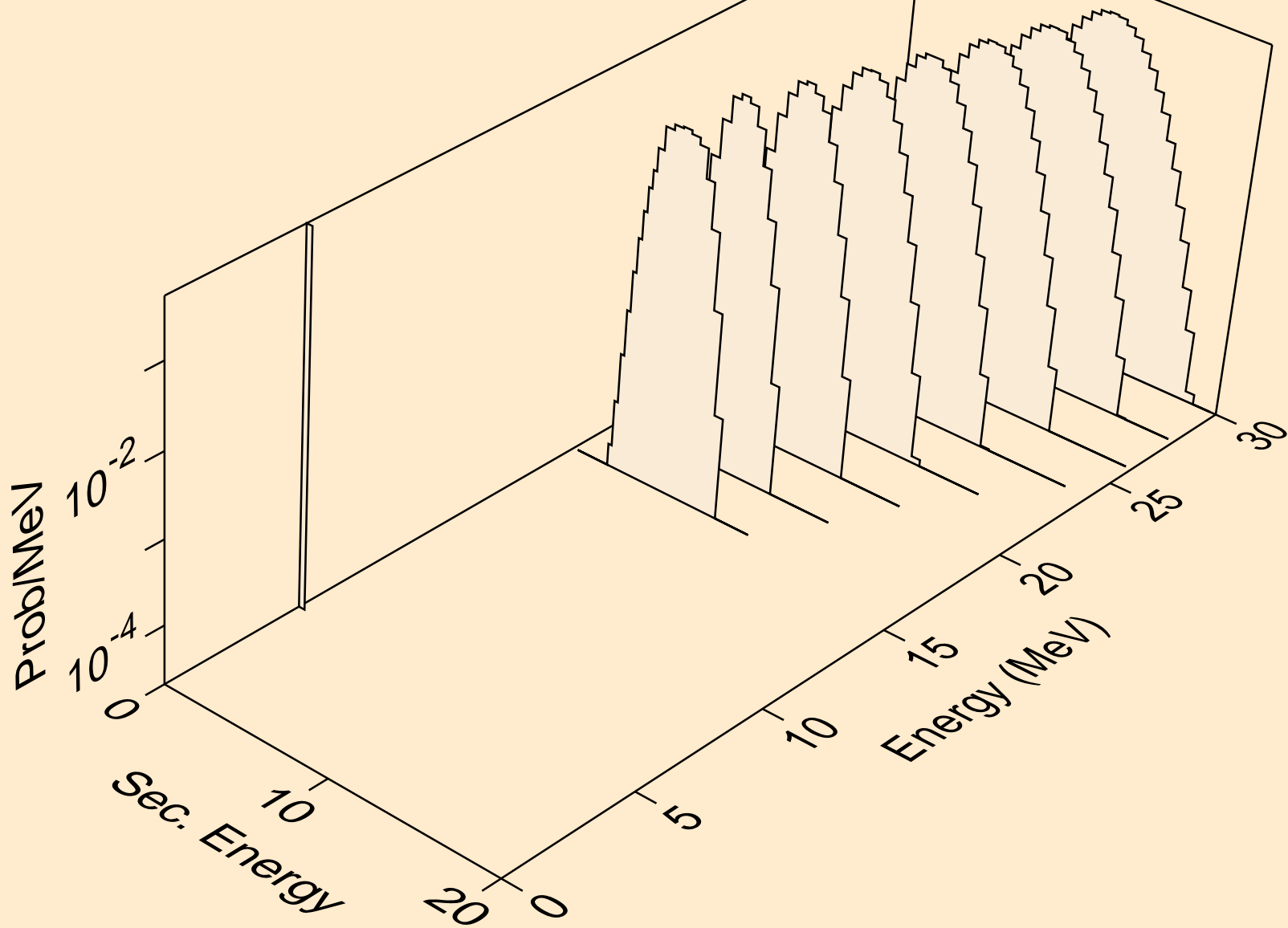

PU247 DEUTERON ACER TENDL-2024 LIBRARY; T=0.K  
protons from (d,pd)

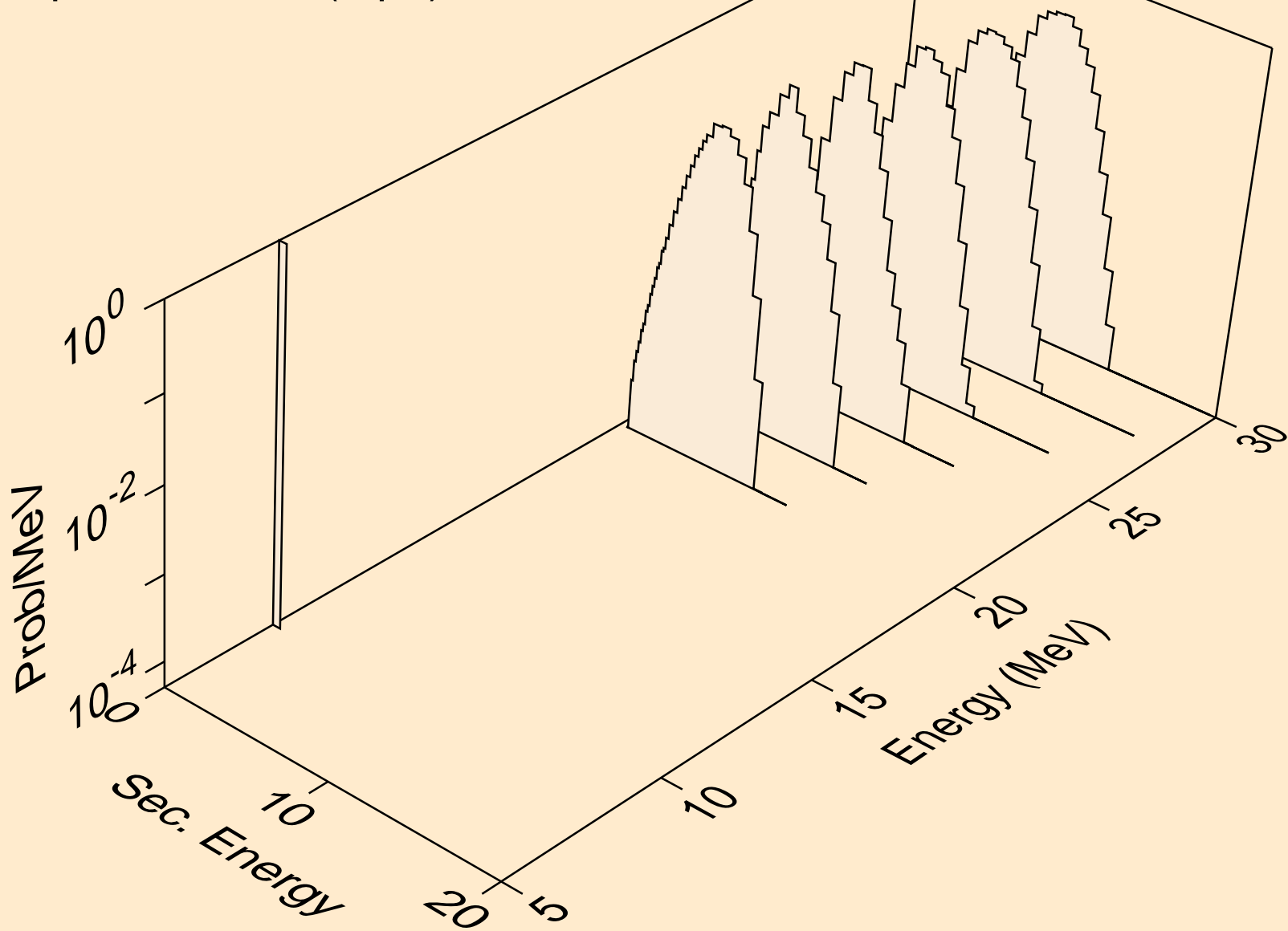

PU247 DEUTERON ACER TENDL-2024 LIBRARY; T=0.K  
tritons from (d,x)

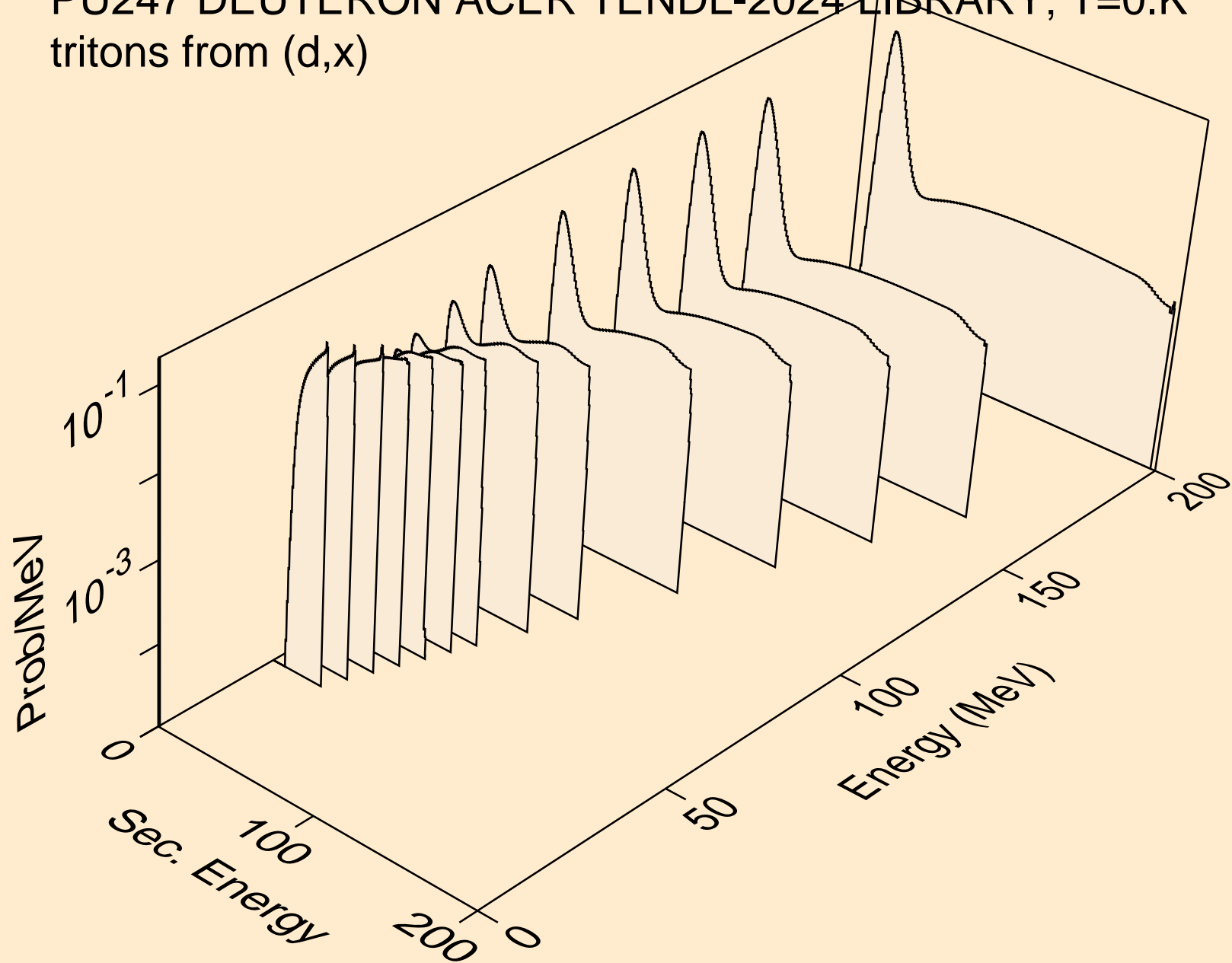

PU247 DEUTERON ACER TENDL-2024 LIBRARY; T=0.K  
tritons from (d,n\*)t

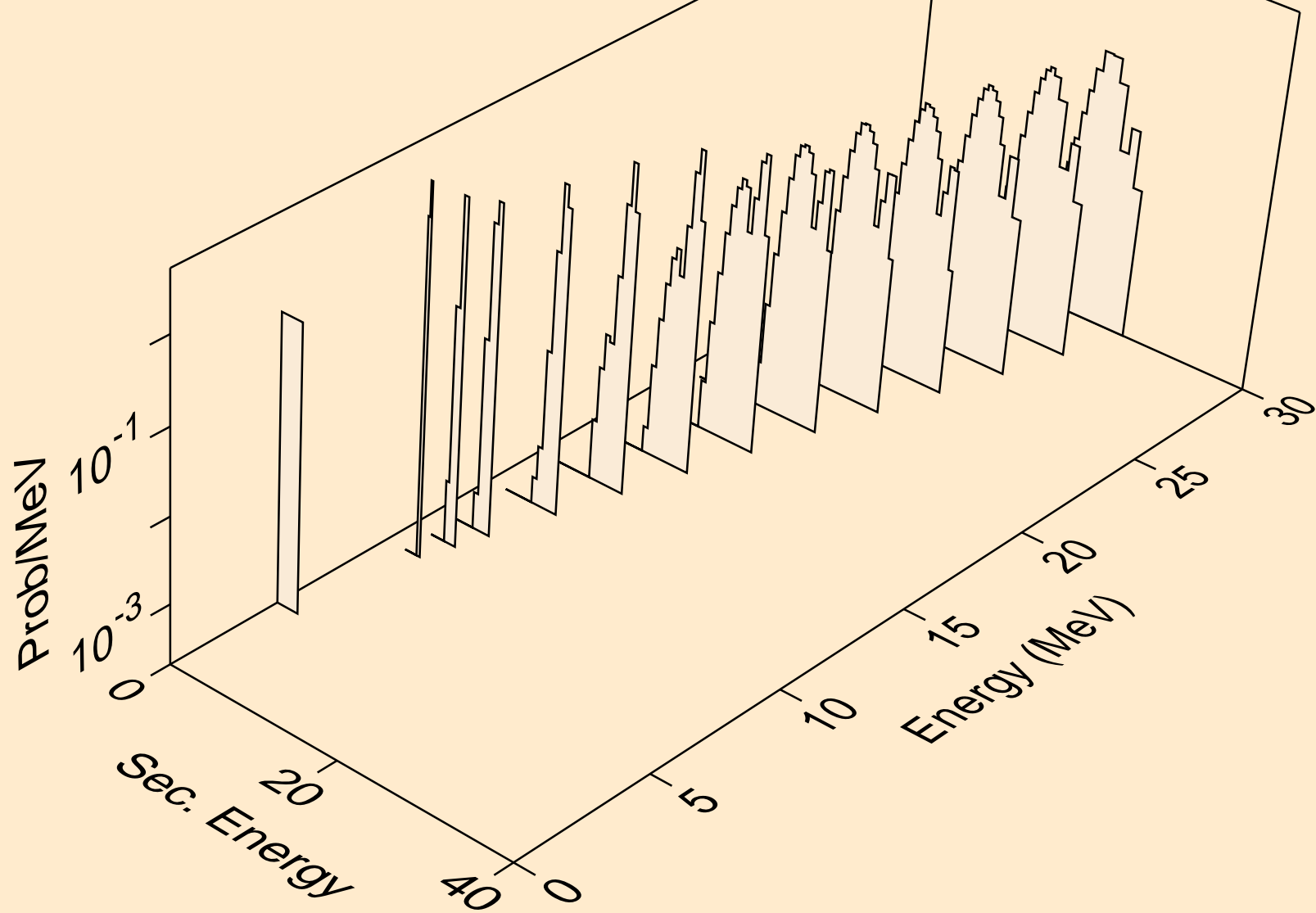

PU247 DEUTERON ACER TENDL-2024 LIBRARY; T=0.K  
tritons from (d,t)

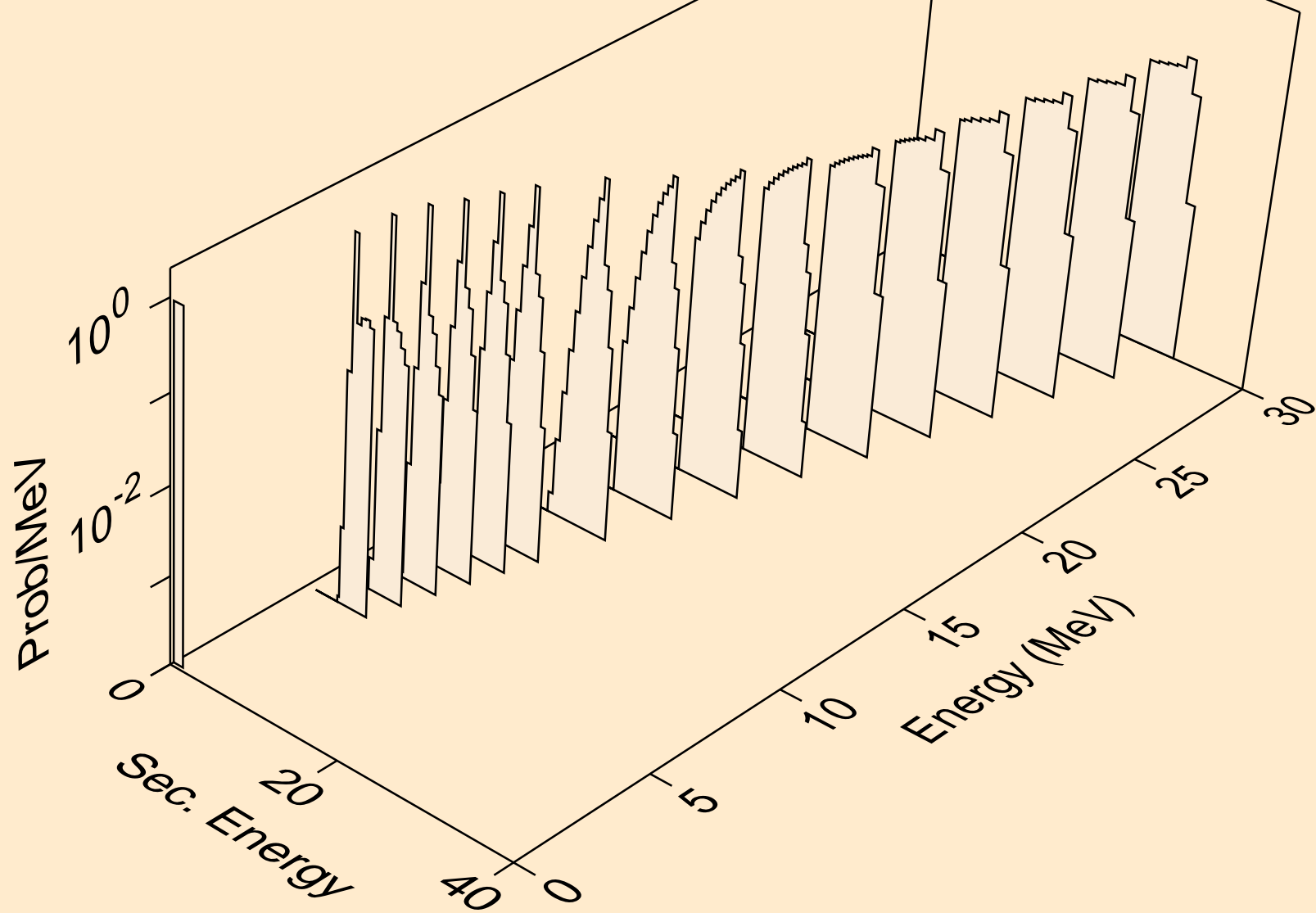

PU247 DEUTERON ACER TENDL-2024 LIBRARY; T=0.K  
he3s from (d,x)

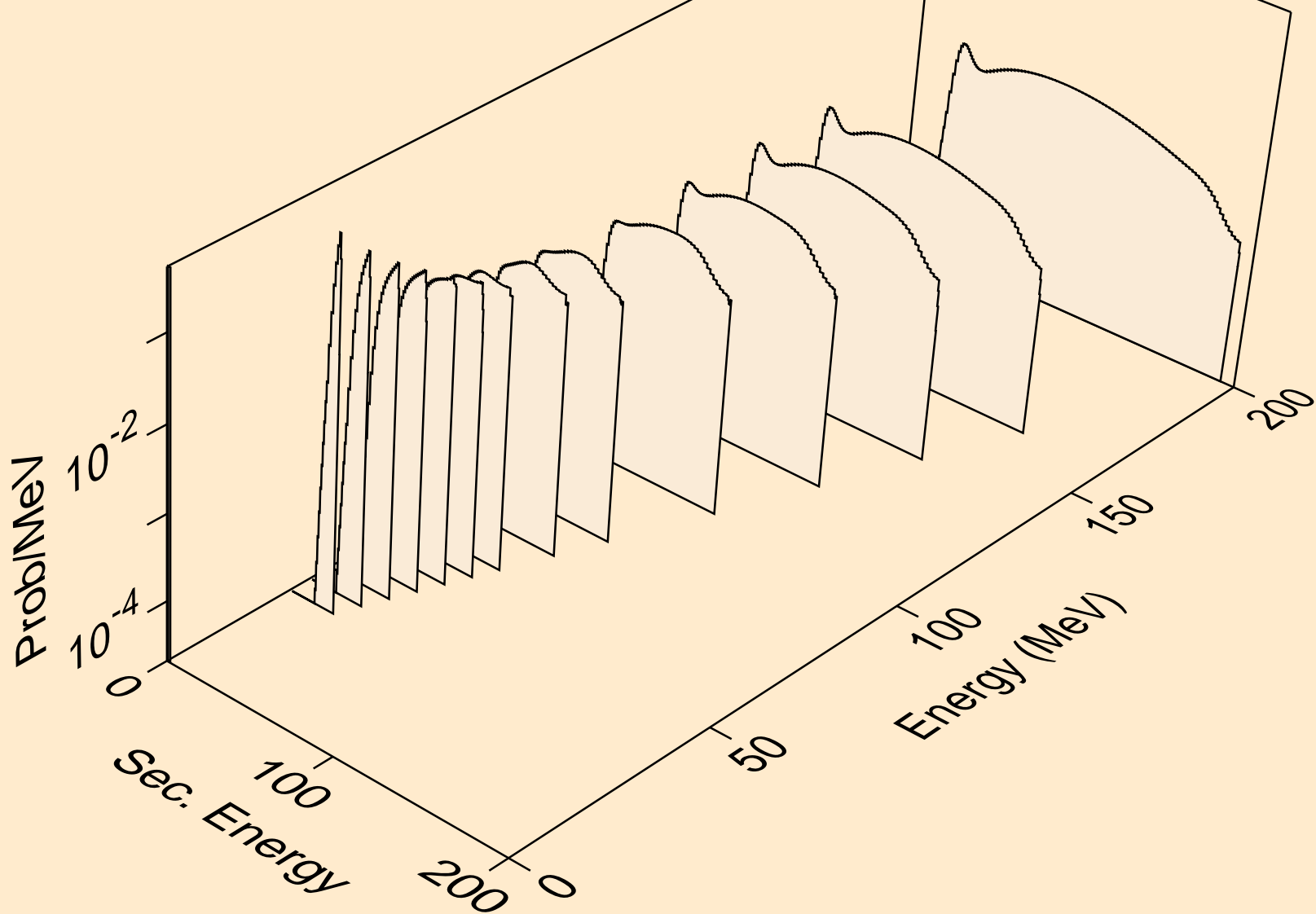

PU247 DEUTERON ACER TENDL-2024 LIBRARY; T=0.K  
he3s from (d,n\*)he3

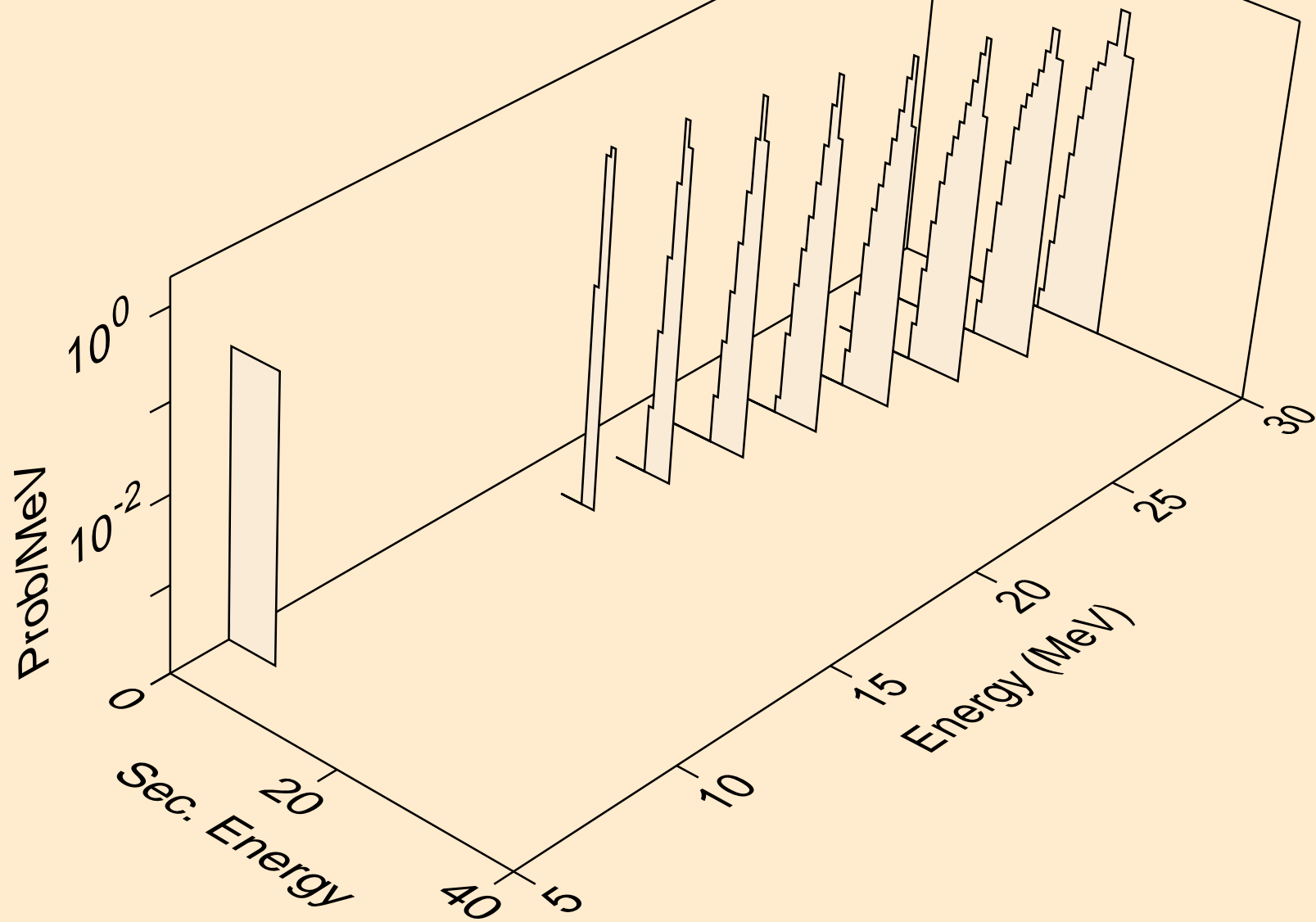

PU247 DEUTERON ACER TENDL-2024 LIBRARY; T=0.K  
he3s from (d,he3)

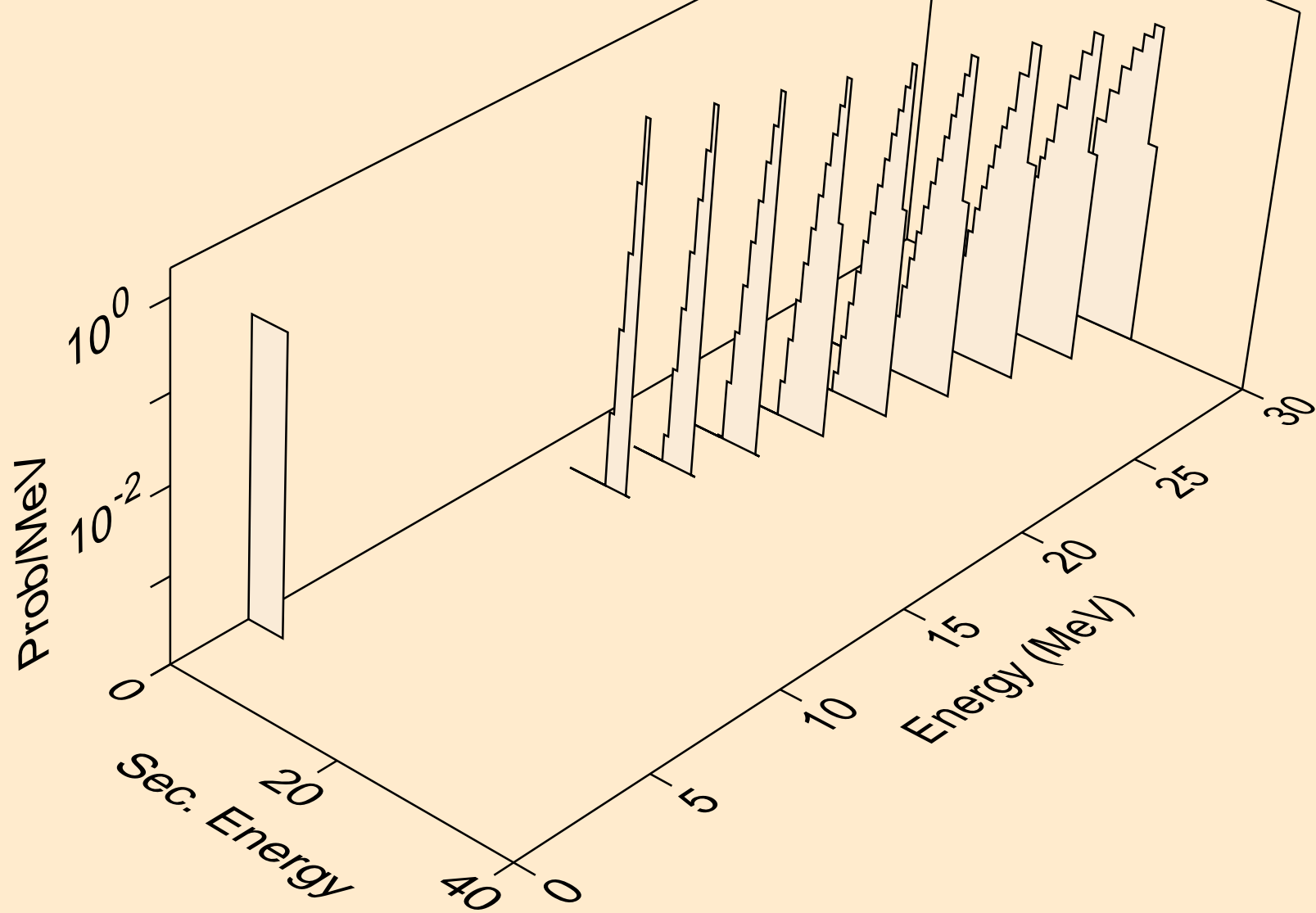

PU247 DEUTERON ACER TENDL-2024 LIBRARY; T=0.K  
alphas from (d,x)

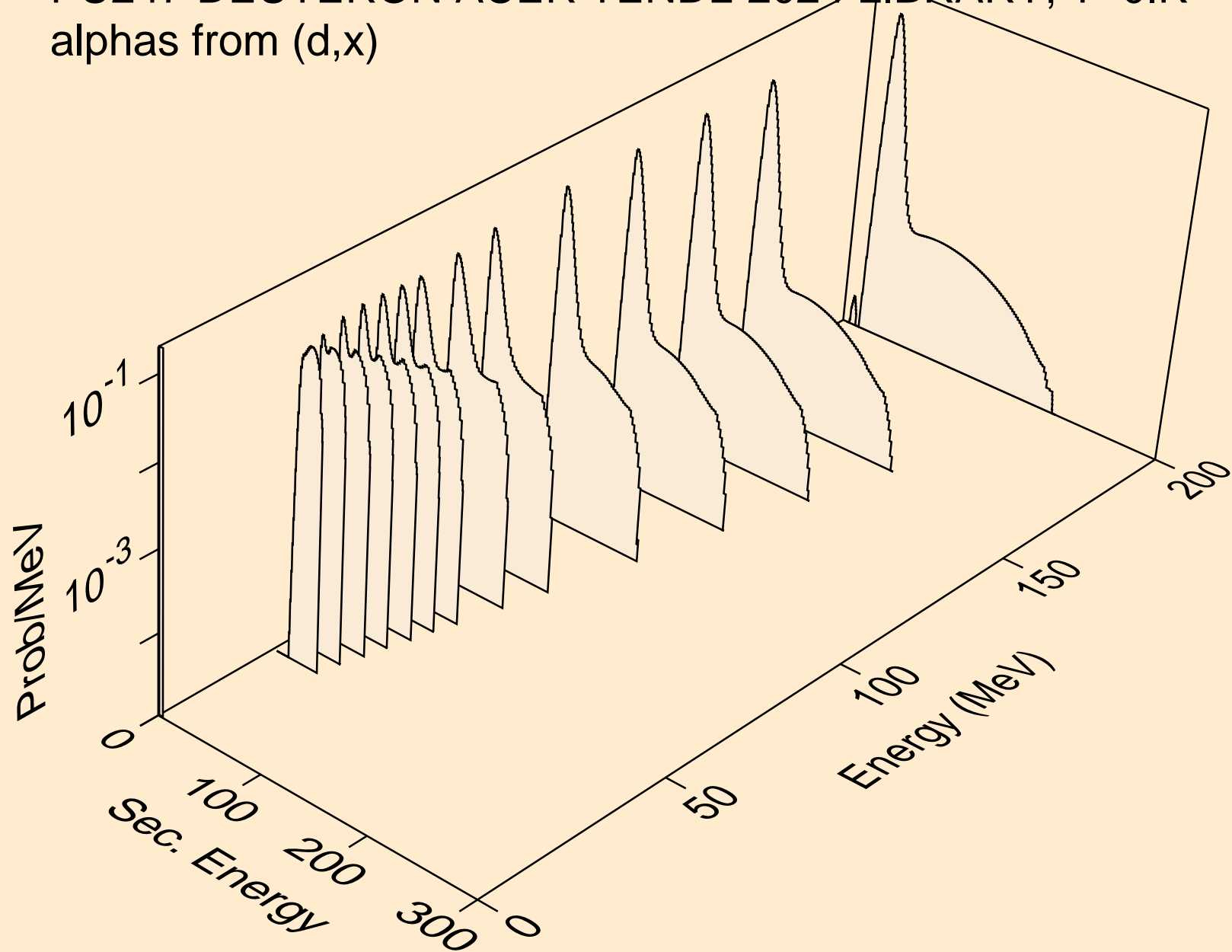

PU247 DEUTERON ACER TENDL-2024 LIBRARY; T=0.K  
alphas from (d,n\*)a

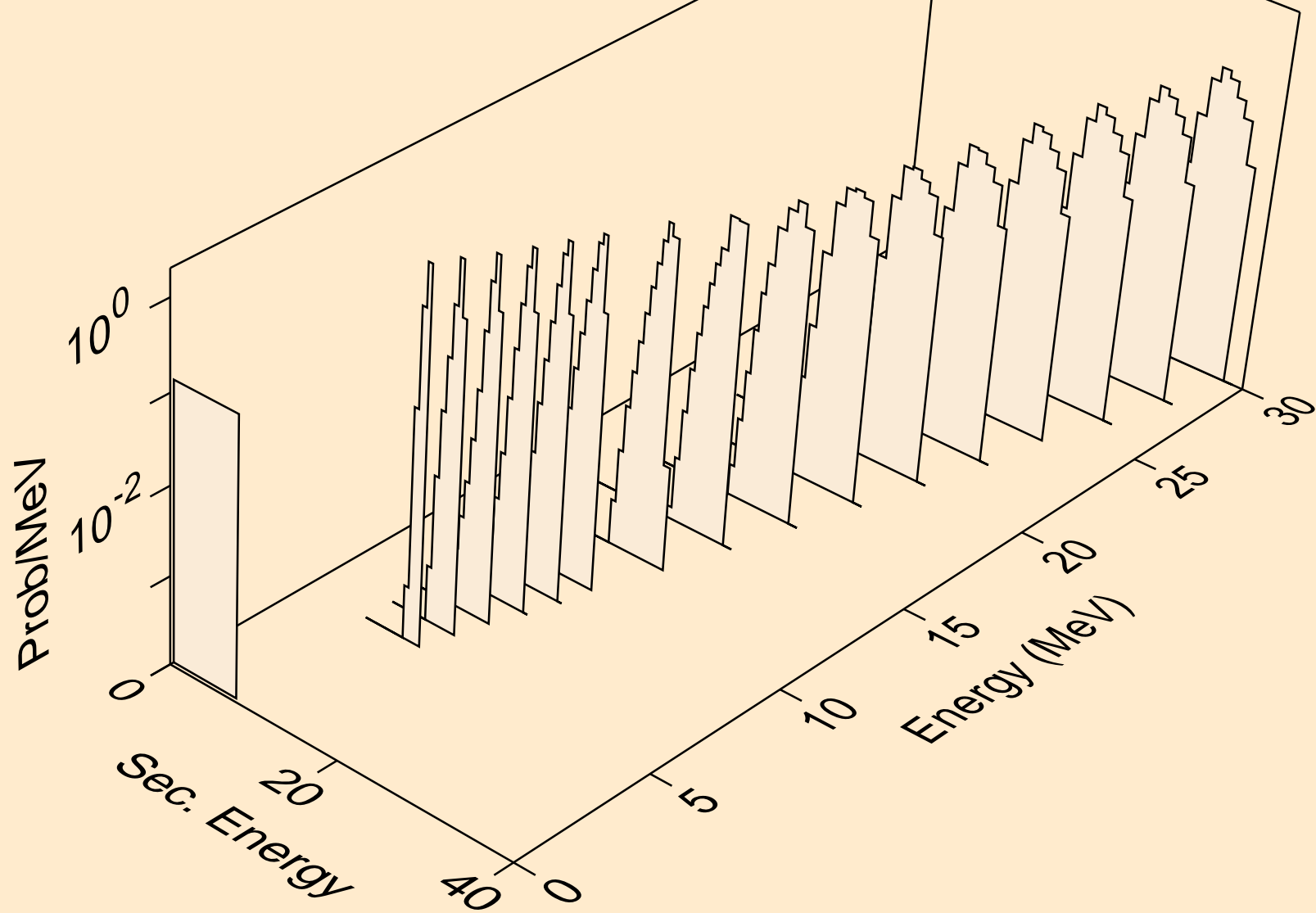

PU247 DEUTERON ACER TENDL-2024 LIBRARY; T=0.K  
alphas from (d,2n)a

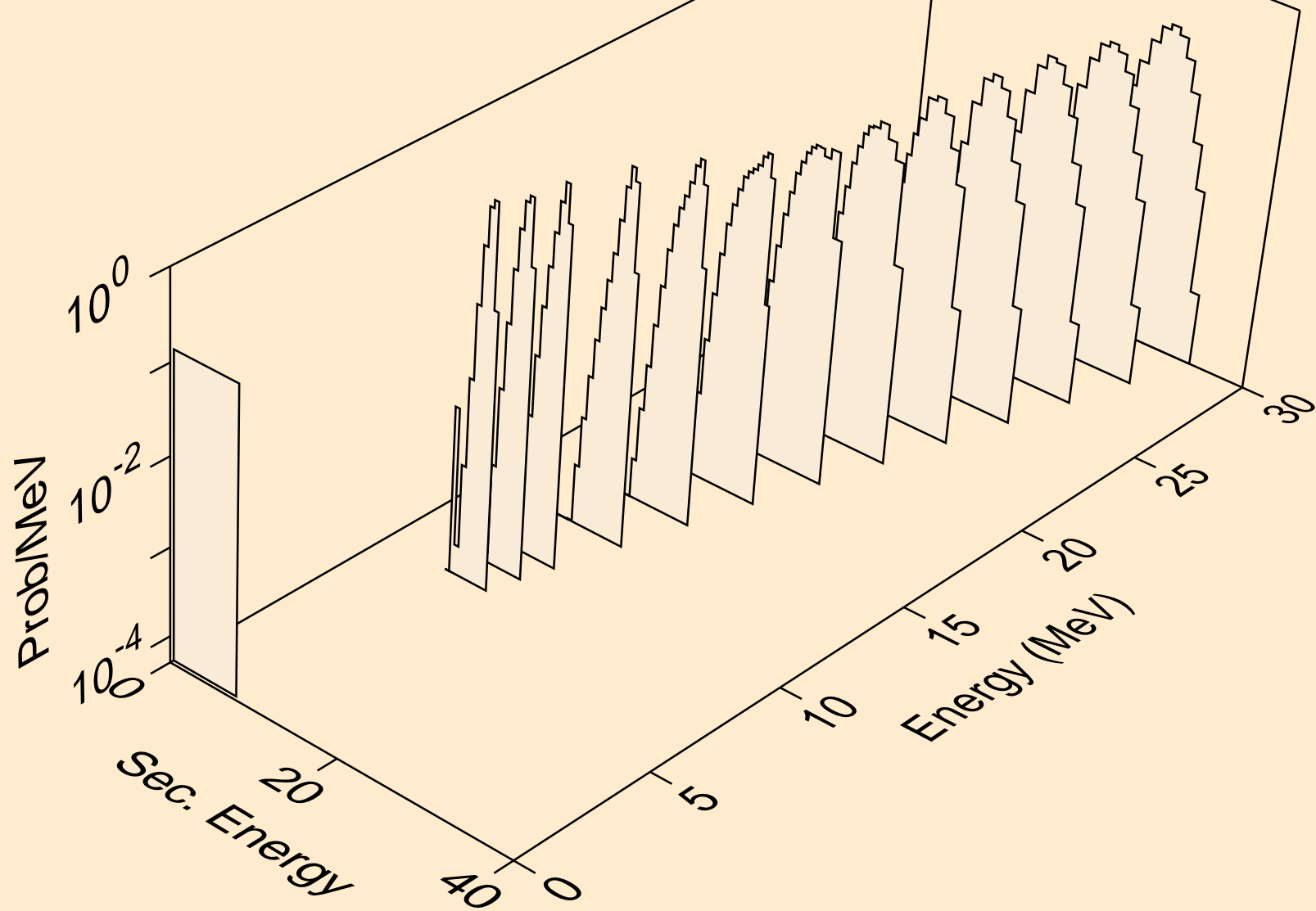

PU247 DEUTERON ACER TENDL-2024 LIBRARY; T=0.K  
alphas from (d,3n)a

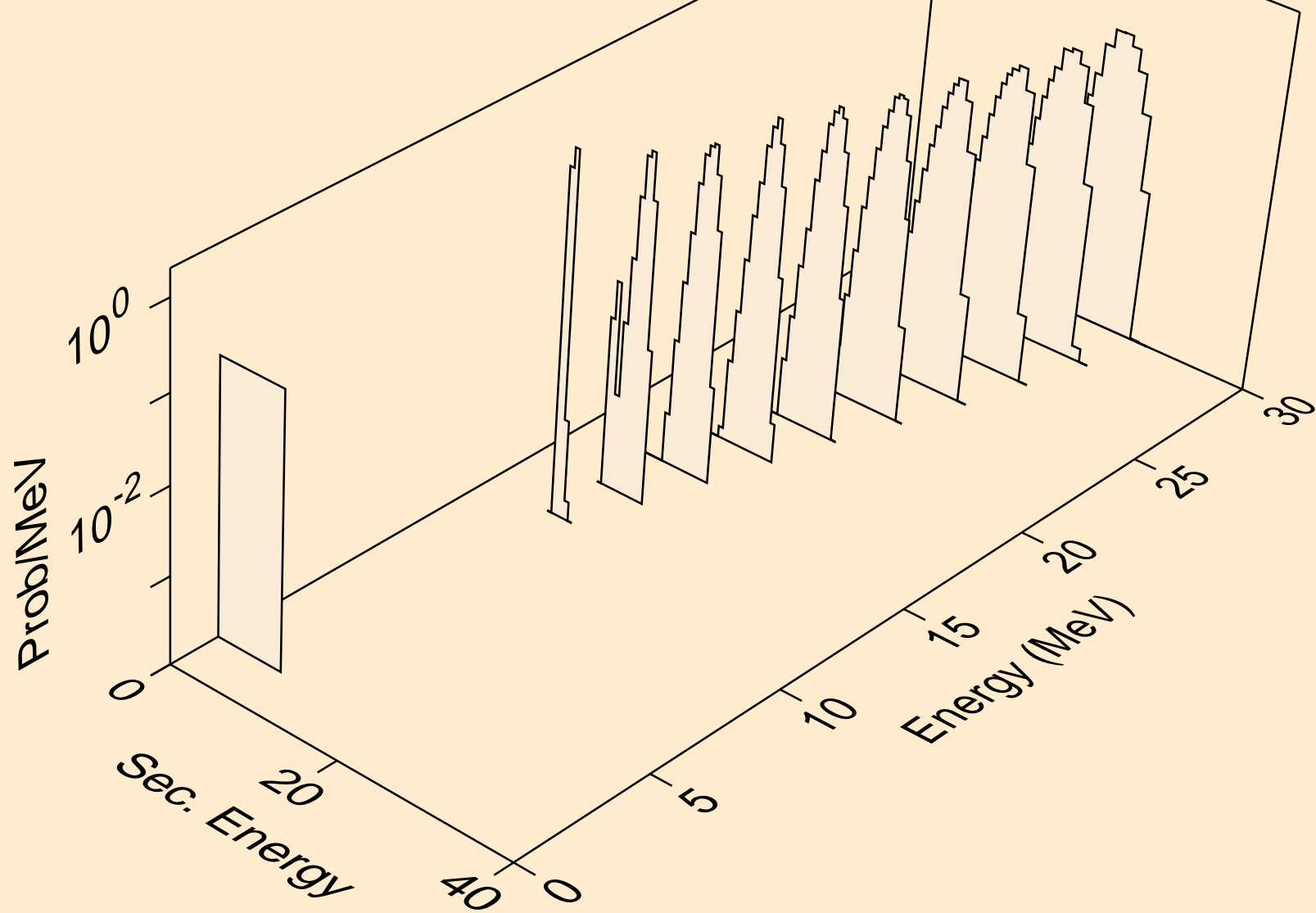

PU247 DEUTERON ACER TENDL-2024 LIBRARY; T=0.K  
alphas from (d,a)

