

# RE198 DEUTERON ACER TENDL-2024 LIBRARY; T=0.K

## Principal cross sections

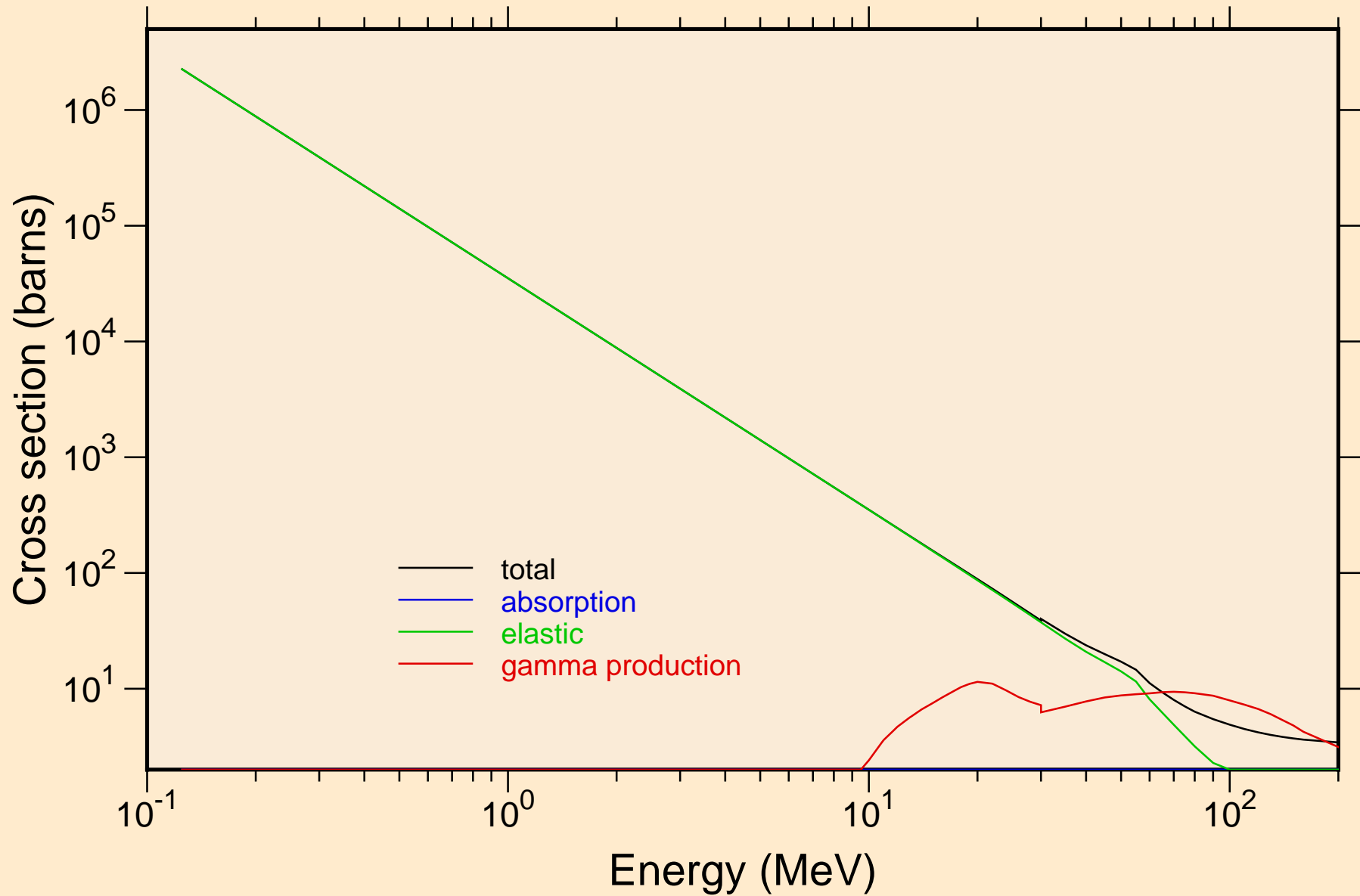

RE198 DEUTERON ACER TENDL-2024 LIBRARY; T=0.K  
Heating

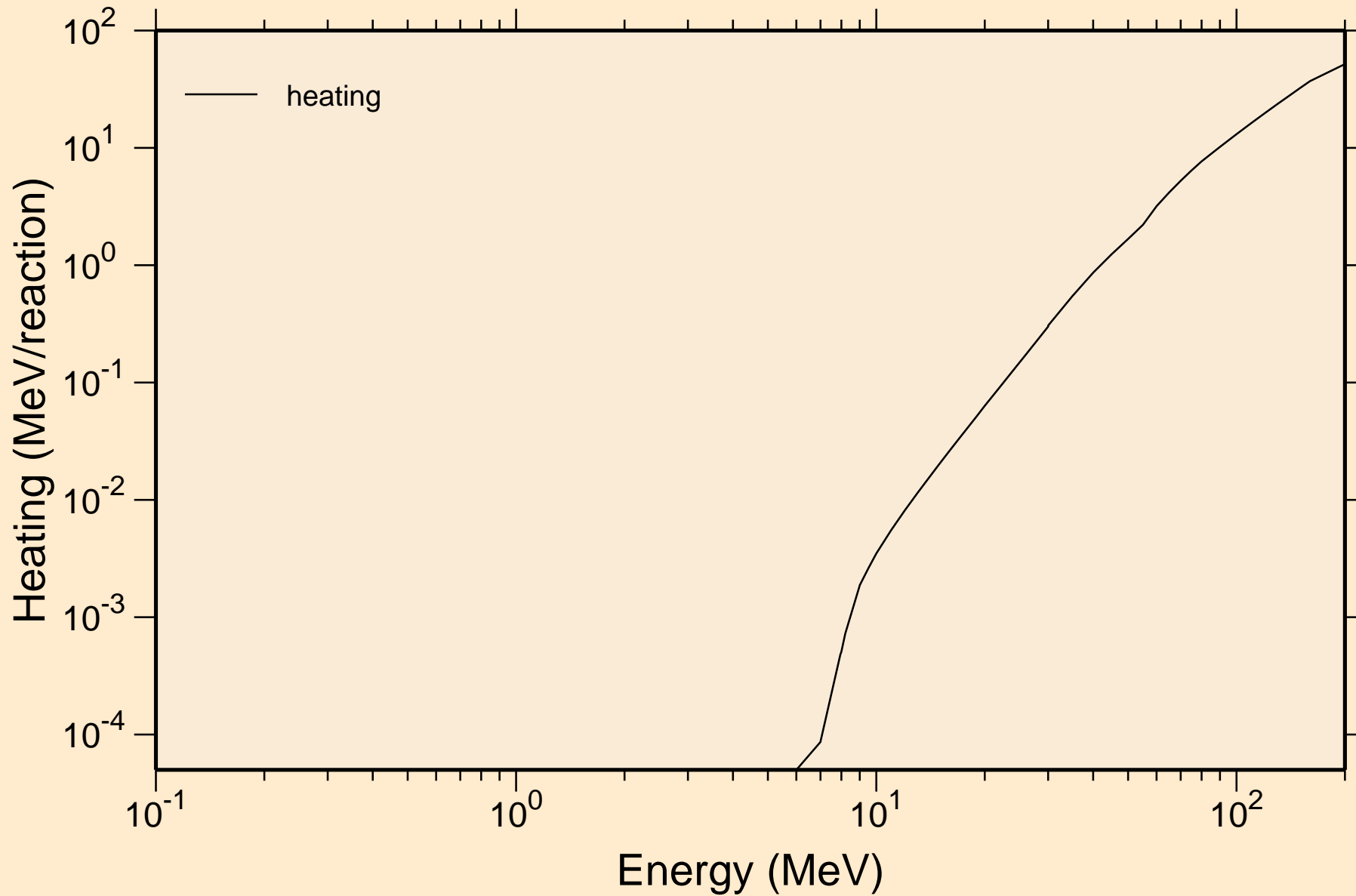

RE198 DEUTERON ACER TENDL-2024 LIBRARY; T=0.K  
Principal cross sections

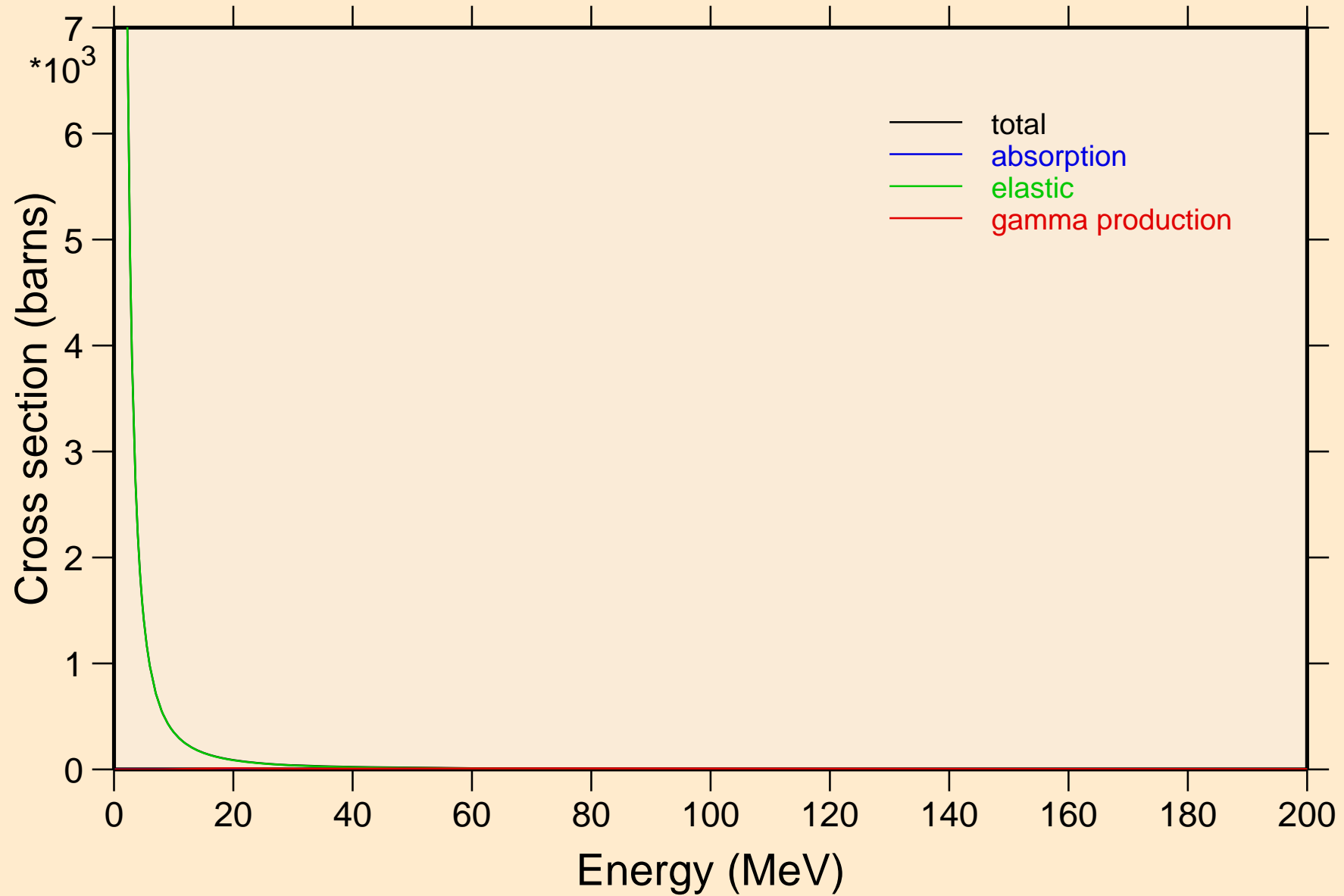

# RE198 DEUTERON ACER TENDL-2024 LIBRARY; T=0.K

## Heating

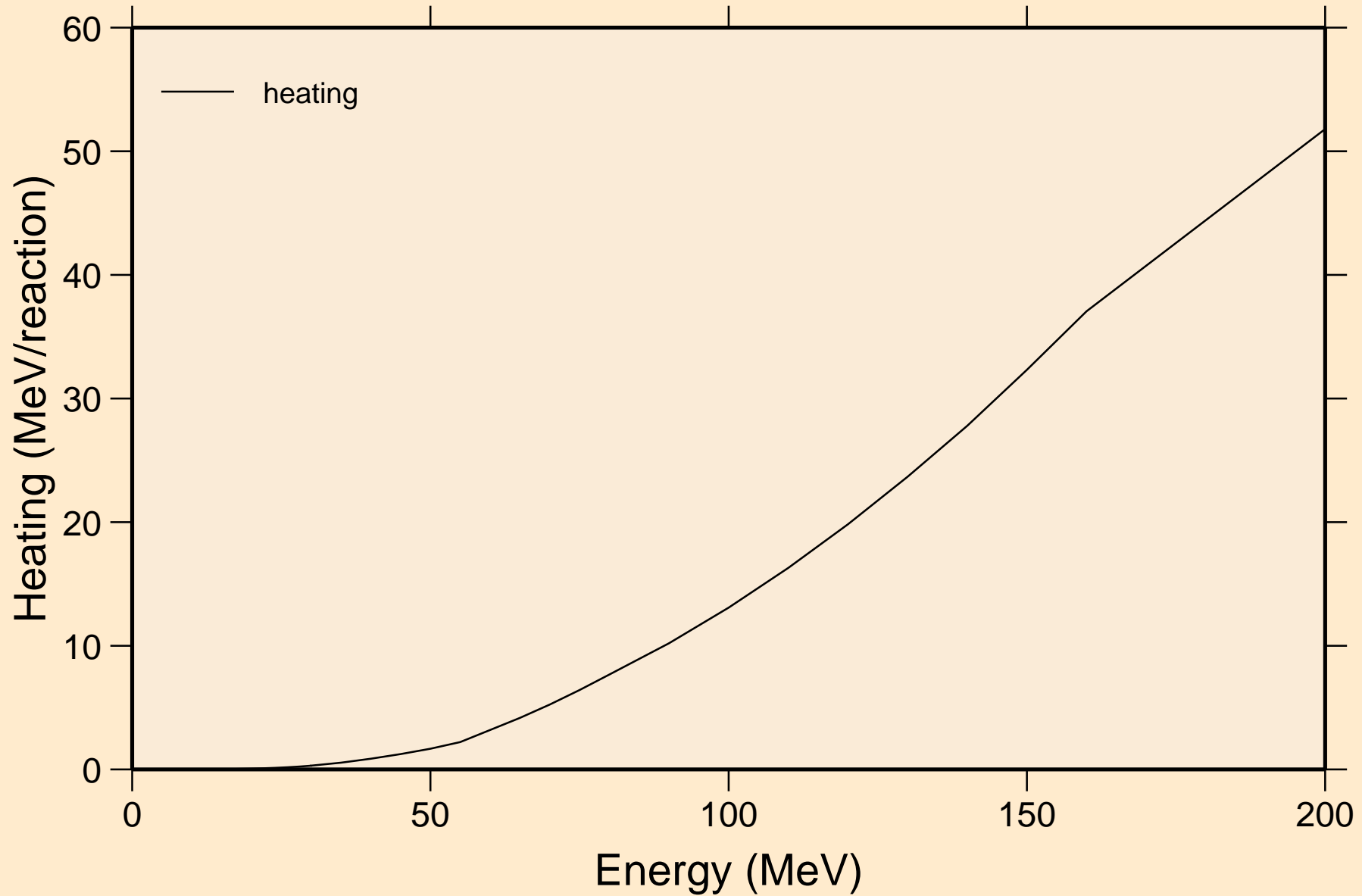

RE198 DEUTERON ACER TENDL-2024 LIBRARY; T=0.K  
Threshold reactions

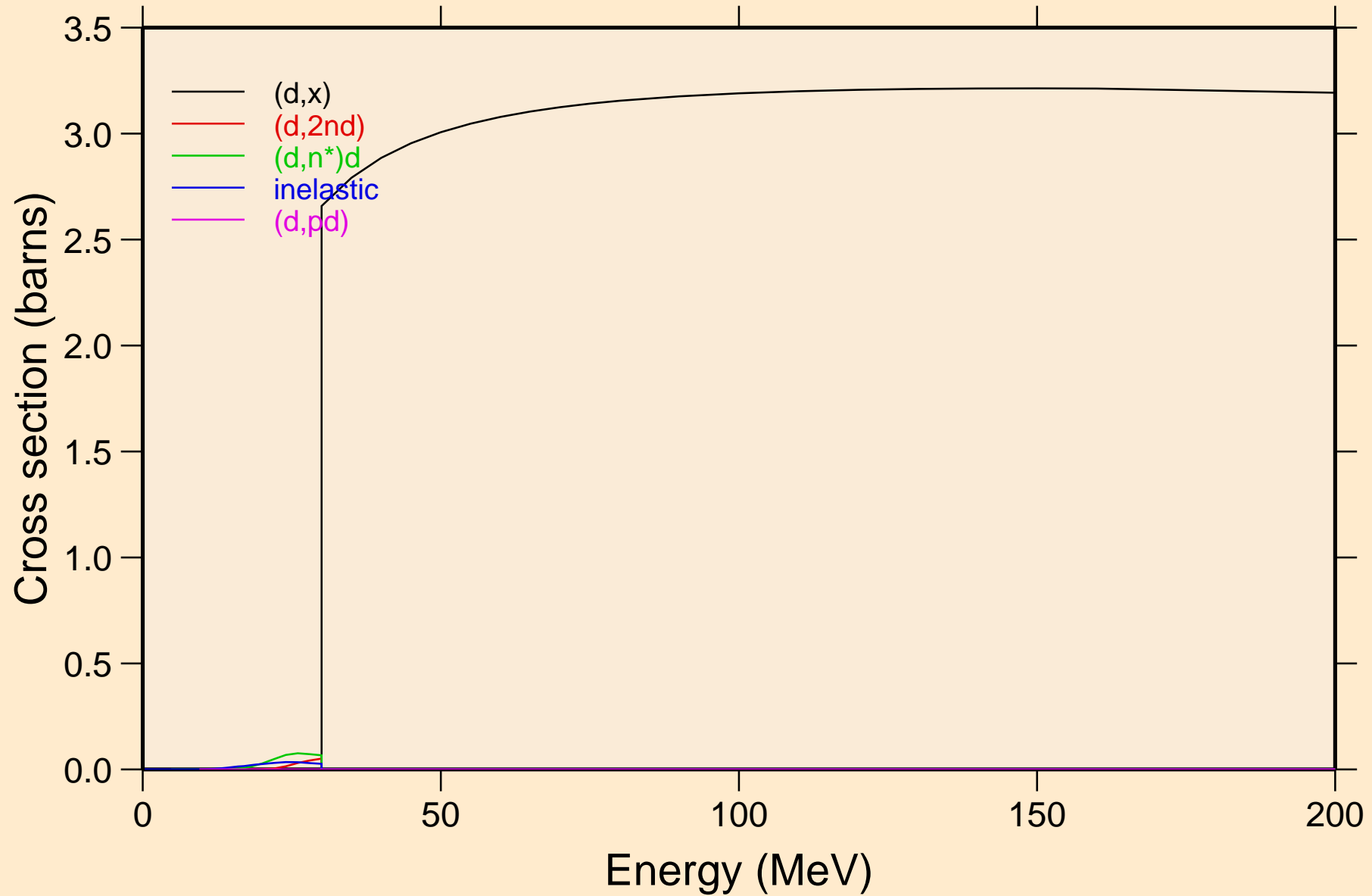

RE198 DEUTERON ACER TENDL-2024 LIBRARY; T=0.K  
angular distribution for elastic

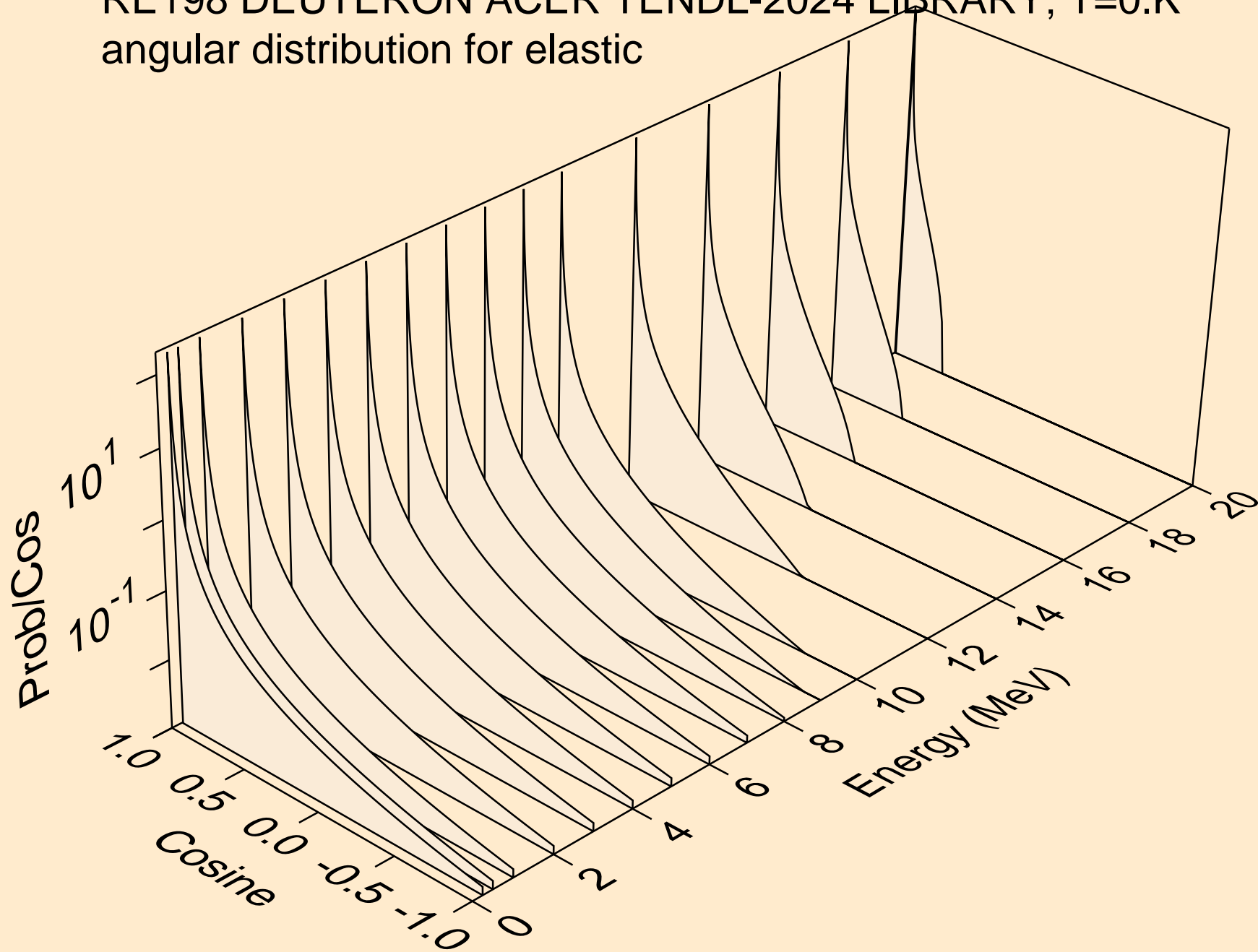

RE198 DEUTERON ACER TENDL-2024 LIBRARY; T=0.K  
angular distribution for elastic

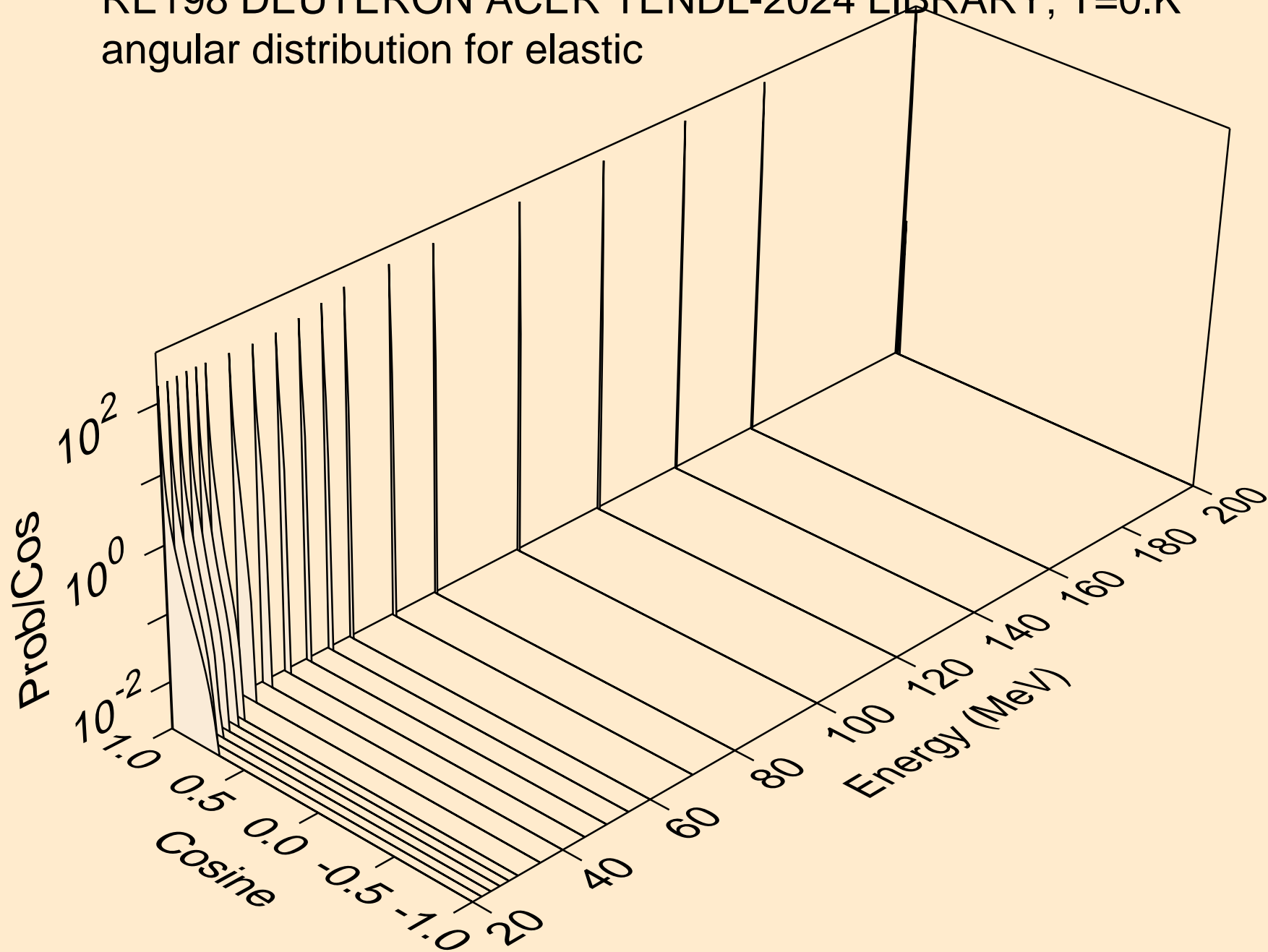

RE198 DEUTERON ACER TENDL-2024 LIBRARY; T=0.K  
Deuteron emission for (d,x)

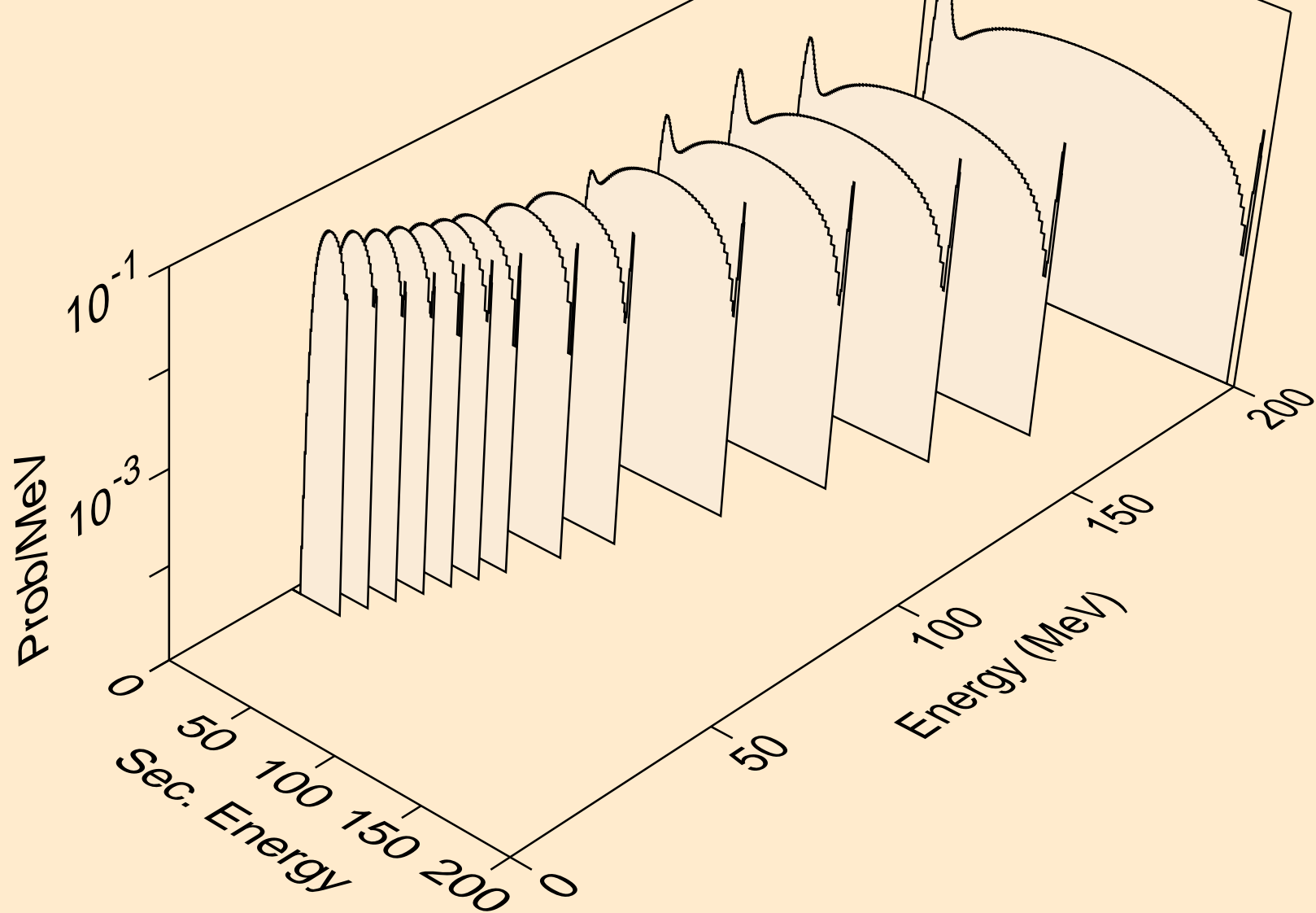

RE198 DEUTERON ACER TENDL-2024 LIBRARY; T=0.K  
Deuteron emission for (d,2nd)

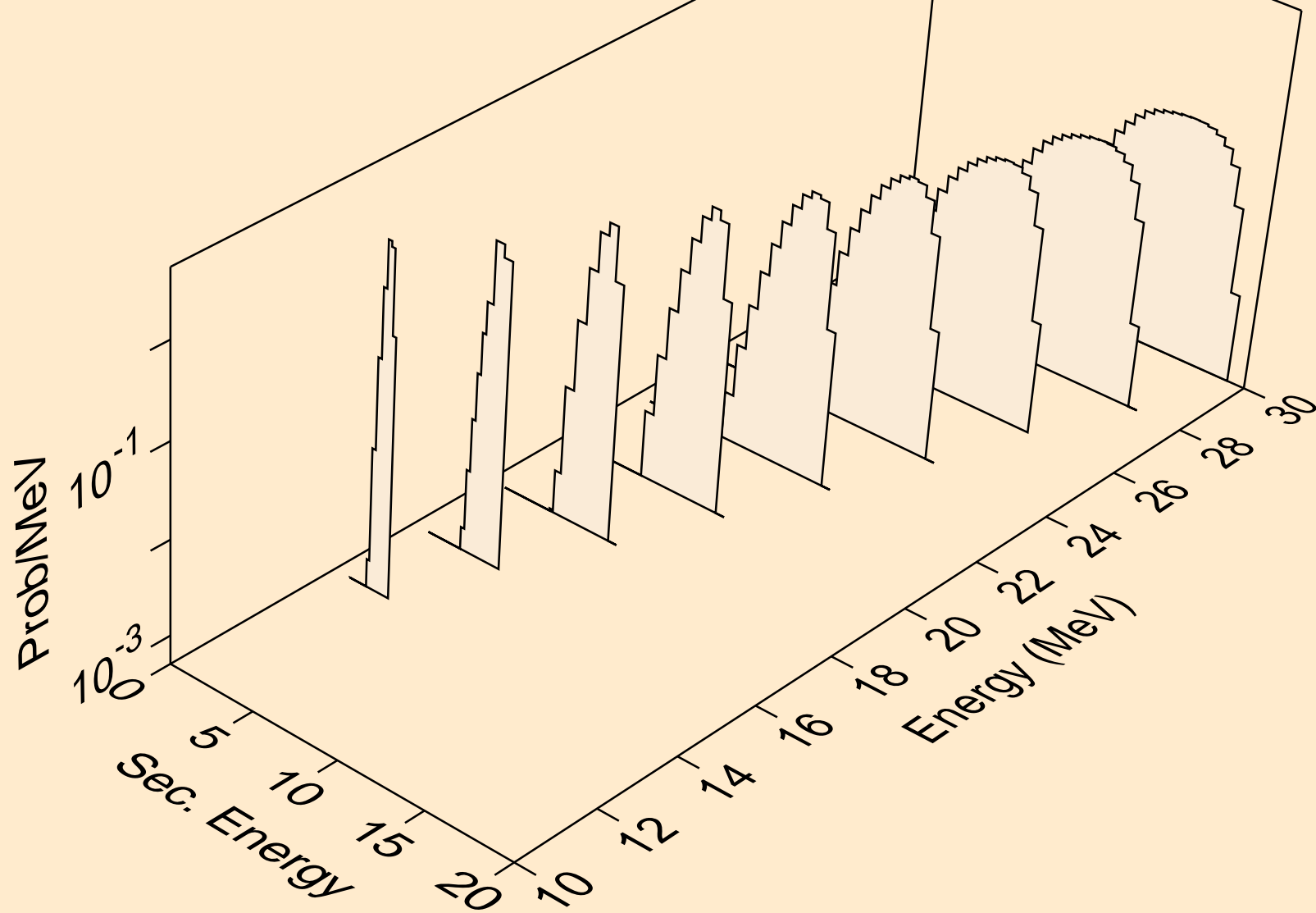

RE198 DEUTERON ACER TENDL-2024 LIBRARY; T=0.K  
Deuteron emission for (d,n\*)d

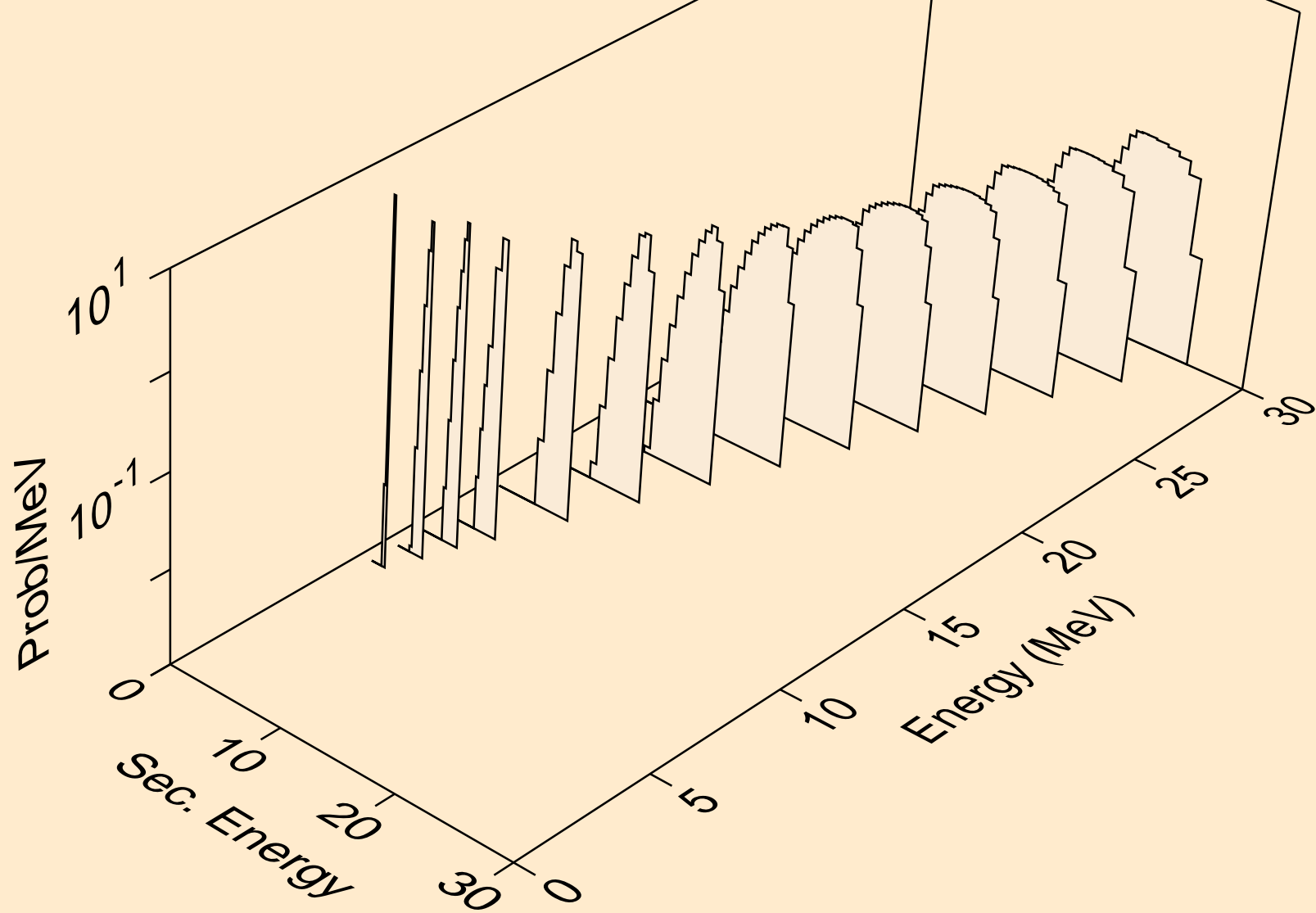

RE198 DEUTERON ACER TENDL-2024 LIBRARY; T=0.K  
Deuteron emission for inelastic

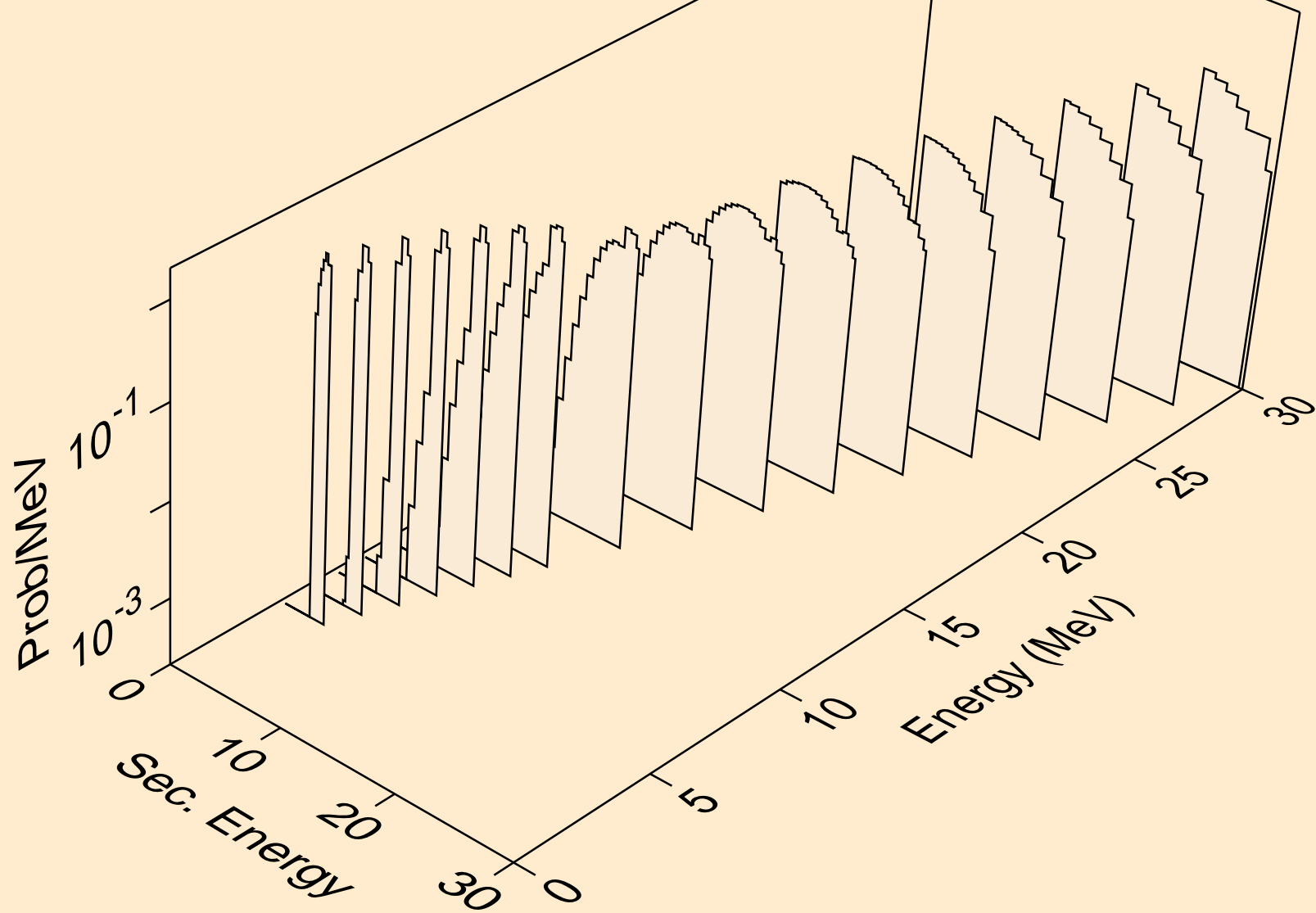

RE198 DEUTERON ACER TENDL-2024 LIBRARY; T=0.K  
Deuteron emission for (d,pd)

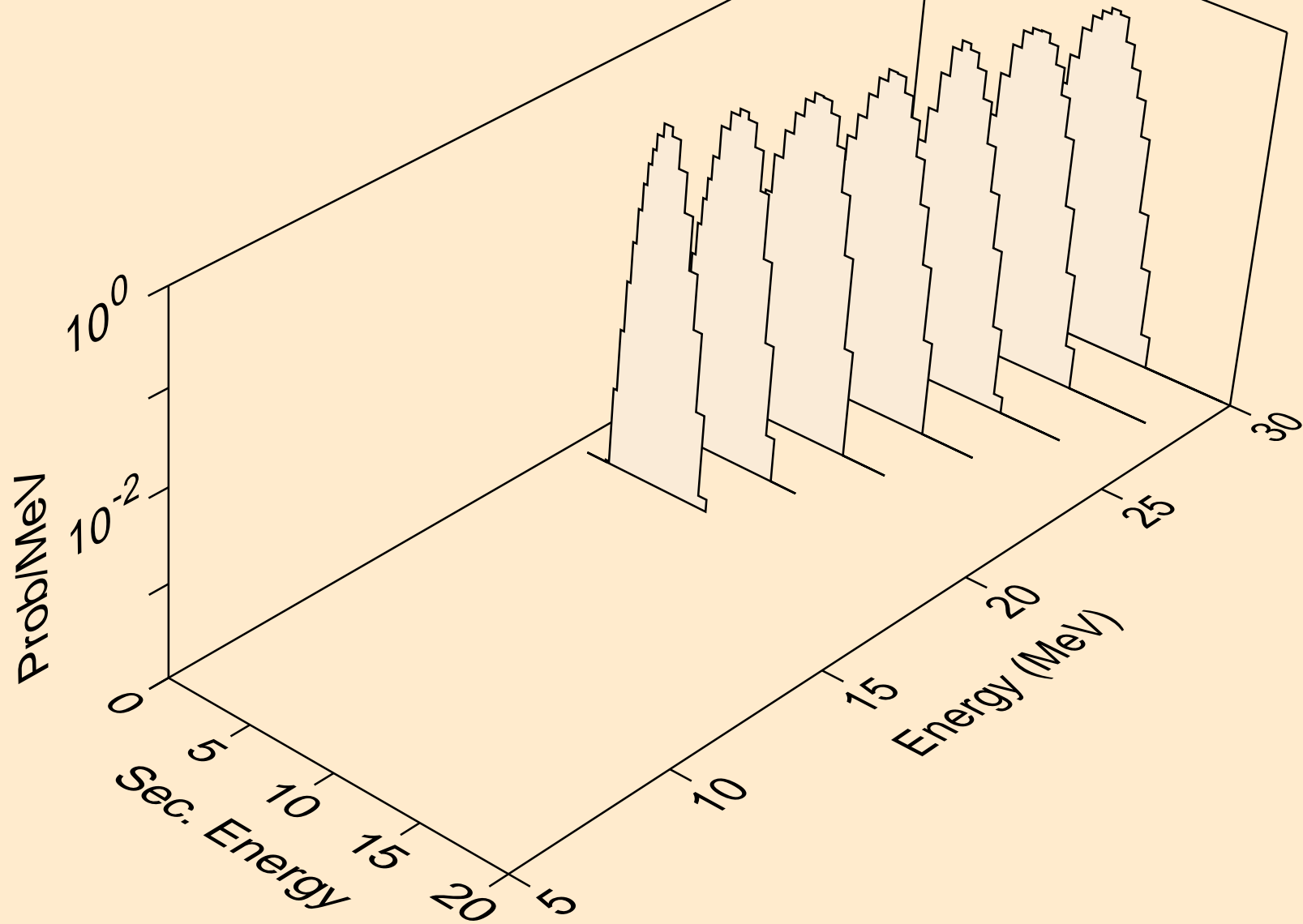

RE198 DEUTERON ACER TENDL-2024 LIBRARY; T=0.K  
Photon emission for (z,n)

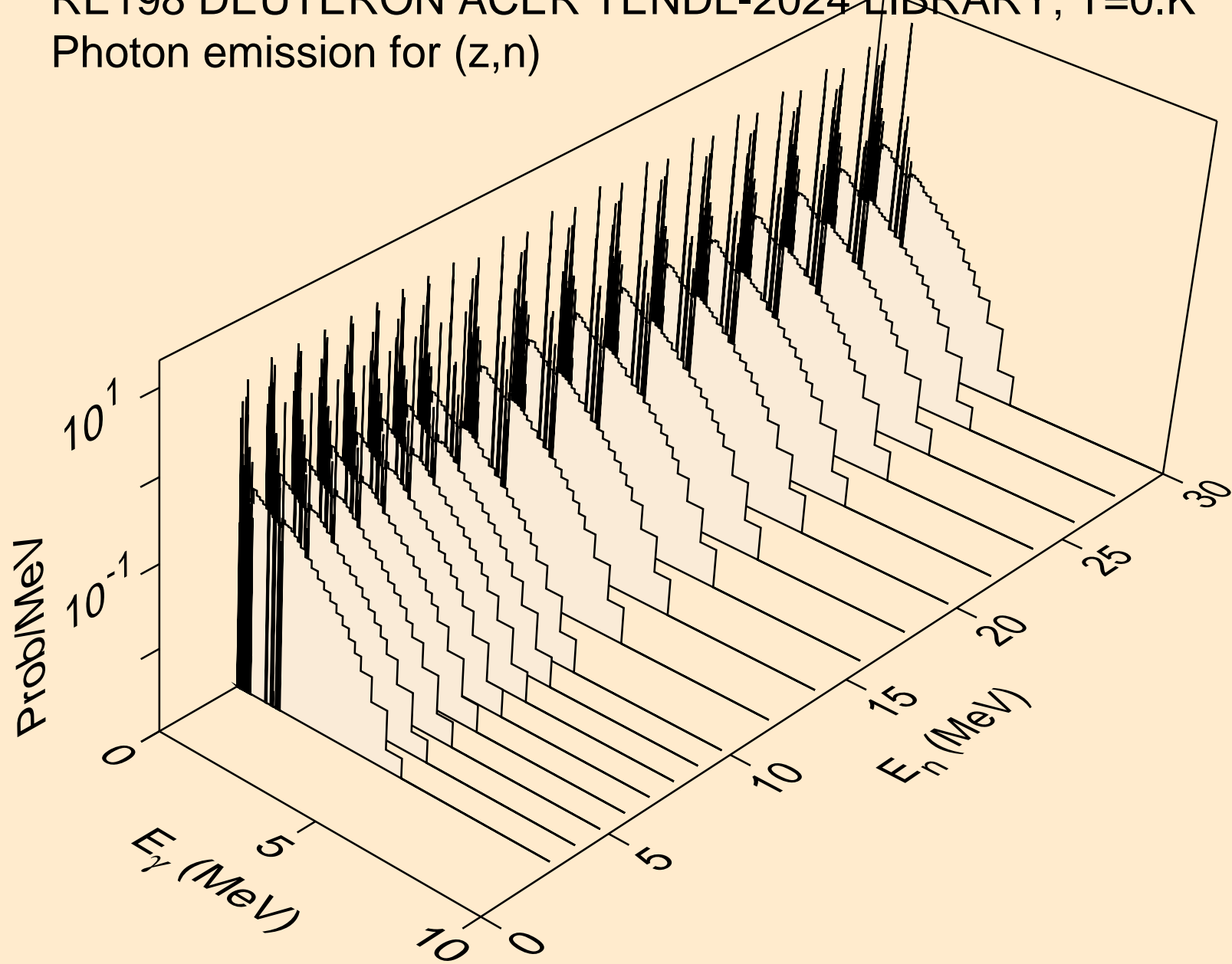

RE198 DEUTERON ACER TENDL-2024 LIBRARY; T=0.K  
Photon emission for (z,x)

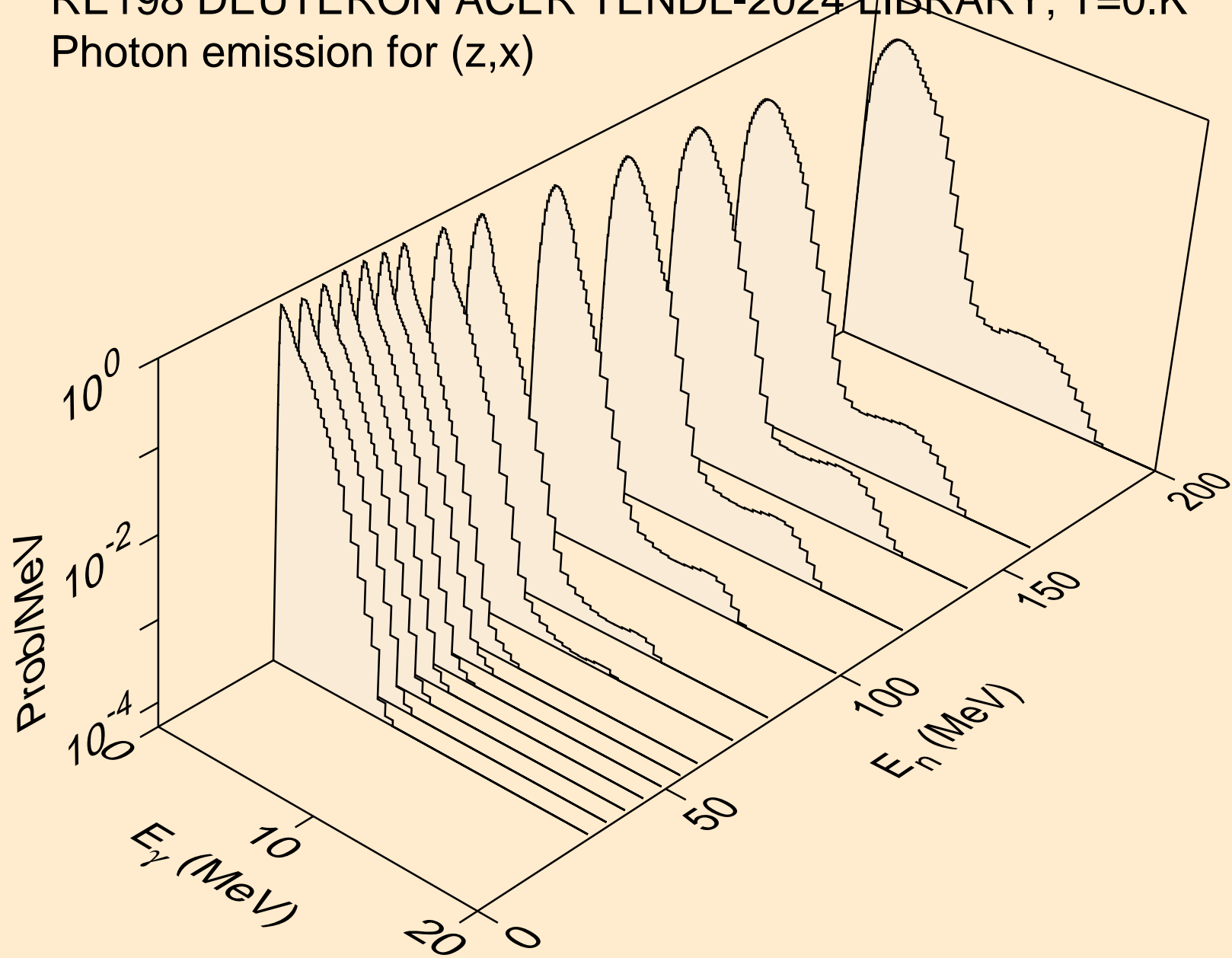

RE198 DEUTERON ACER TENDL-2024 LIBRARY; T=0.K  
Photon emission for (n,2nd)

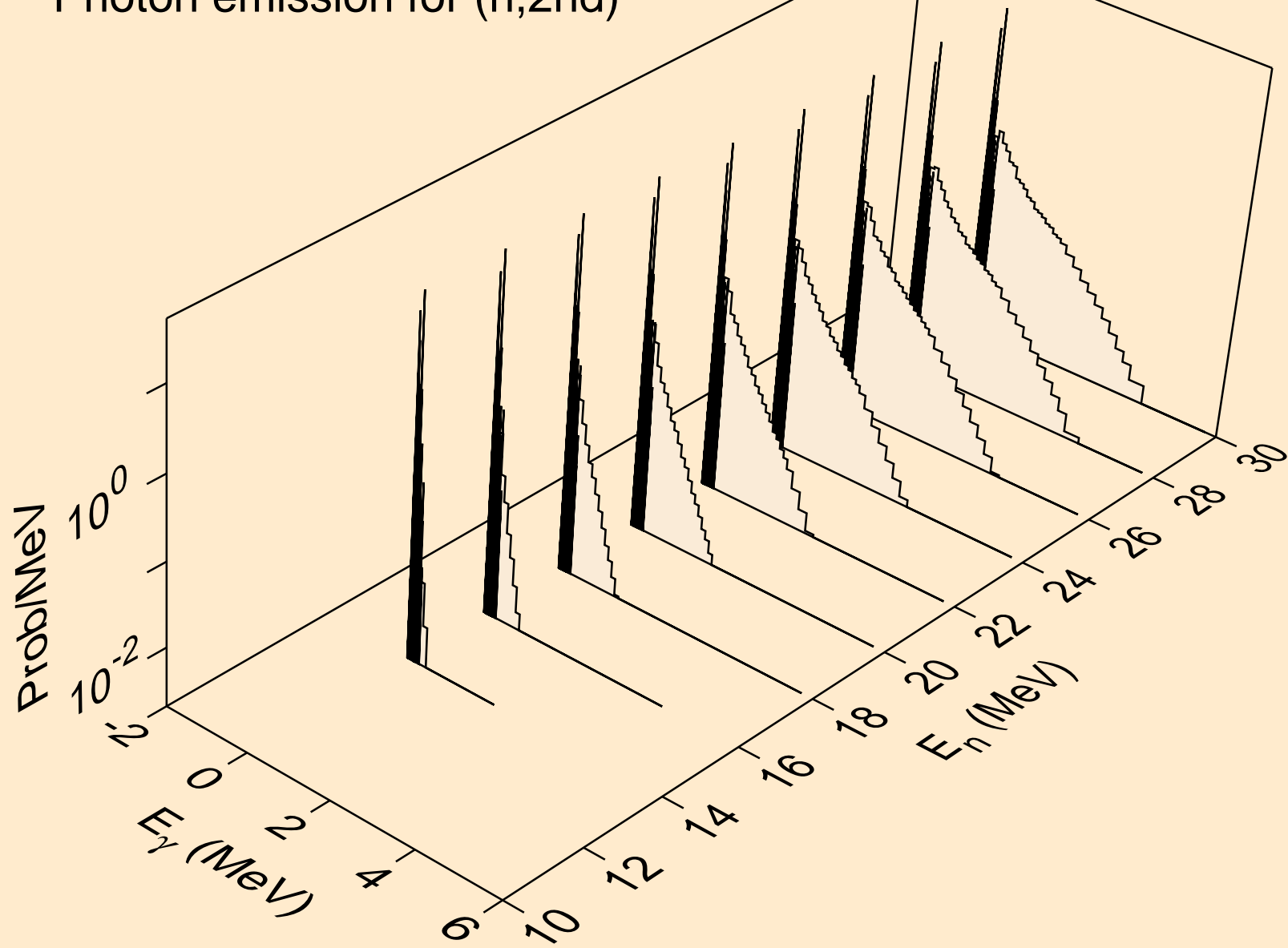

RE198 DEUTERON ACER TENDL-2024 LIBRARY; T=0.K  
Photon emission for (n,2n)

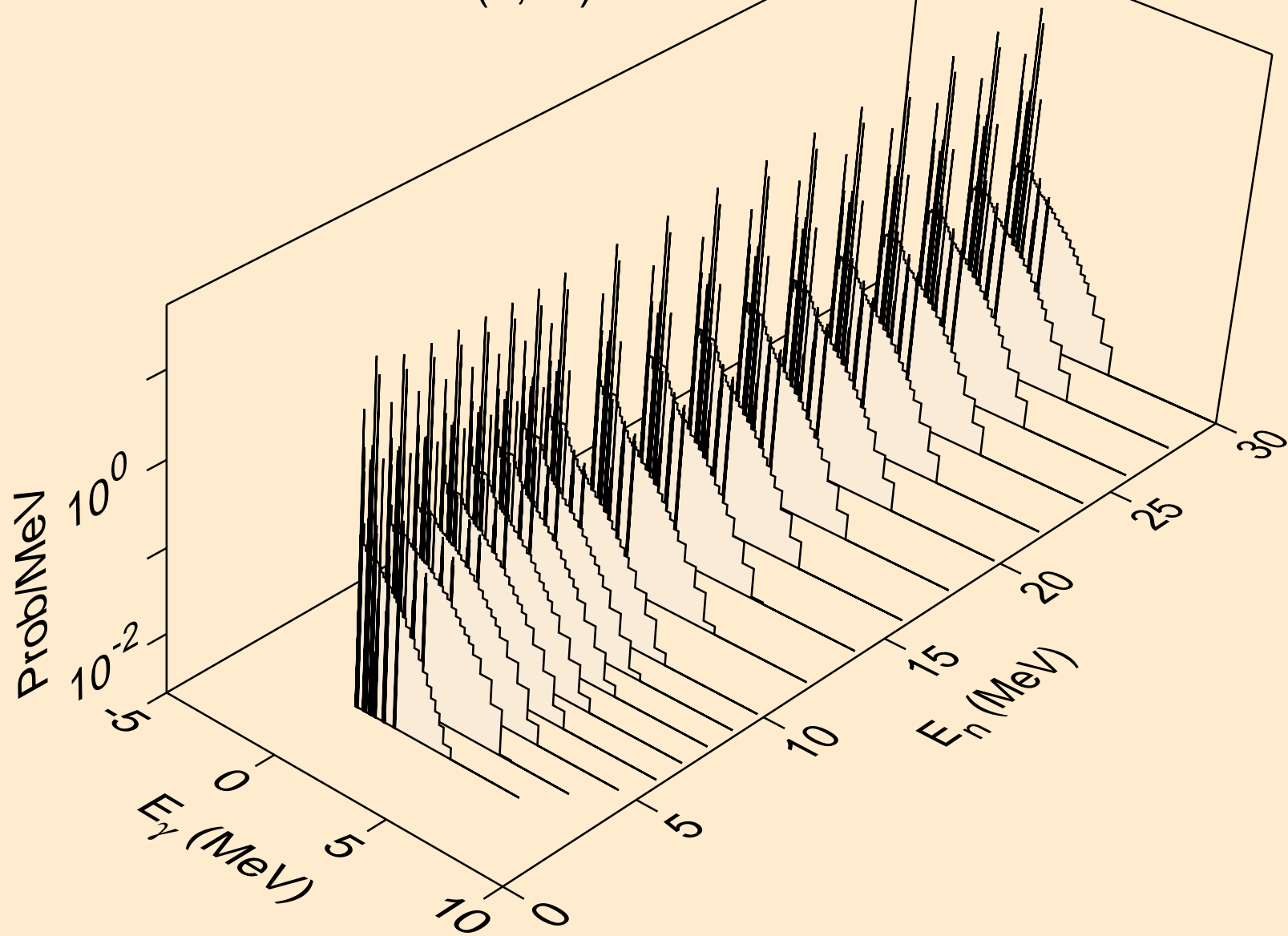

RE198 DEUTERON ACER TENDL-2024 LIBRARY; T=0.K  
Photon emission for (n,3n)

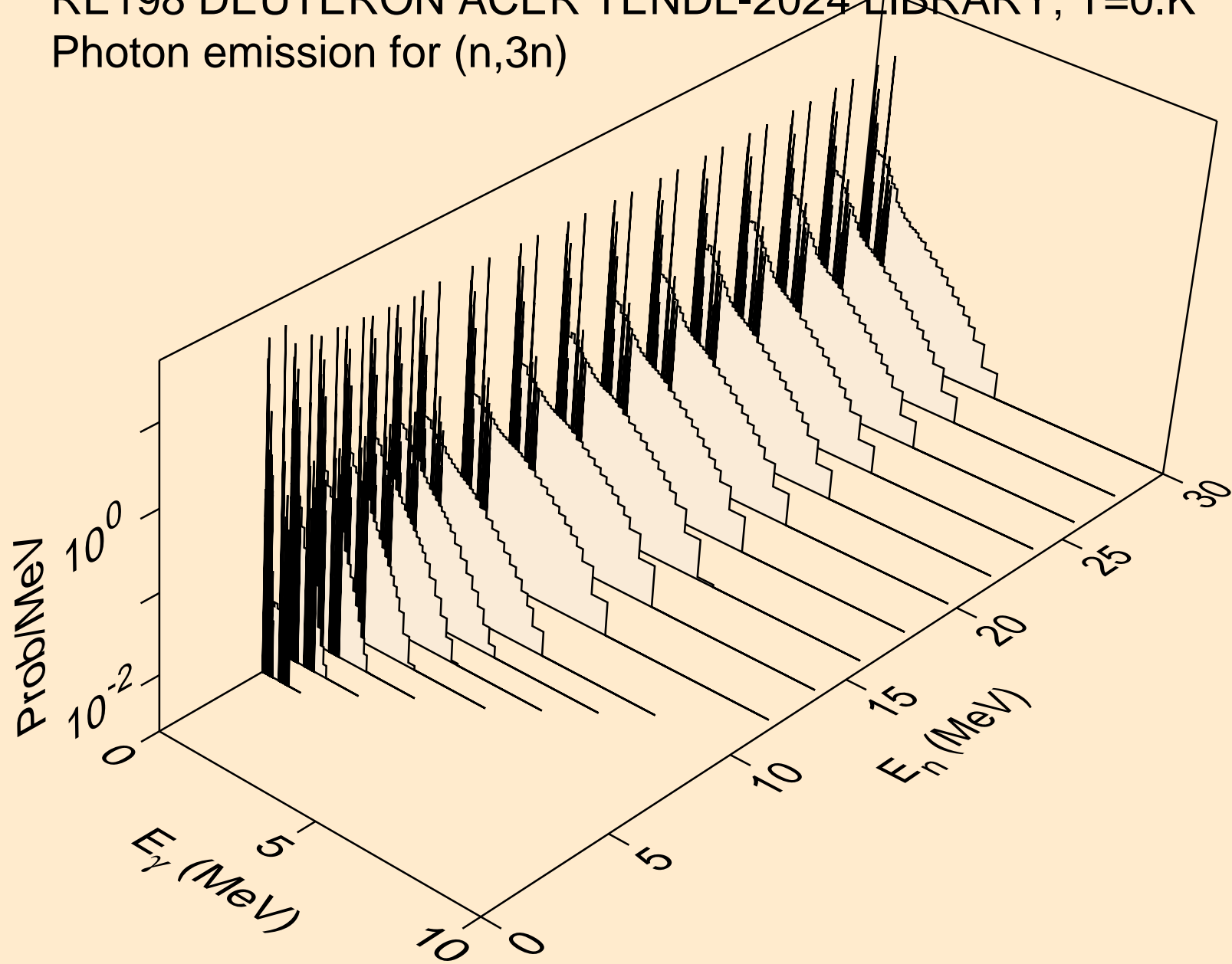

RE198 DEUTERON ACER TENDL-2024 LIBRARY; T=0.K  
Photon emission for (n,n\*)a

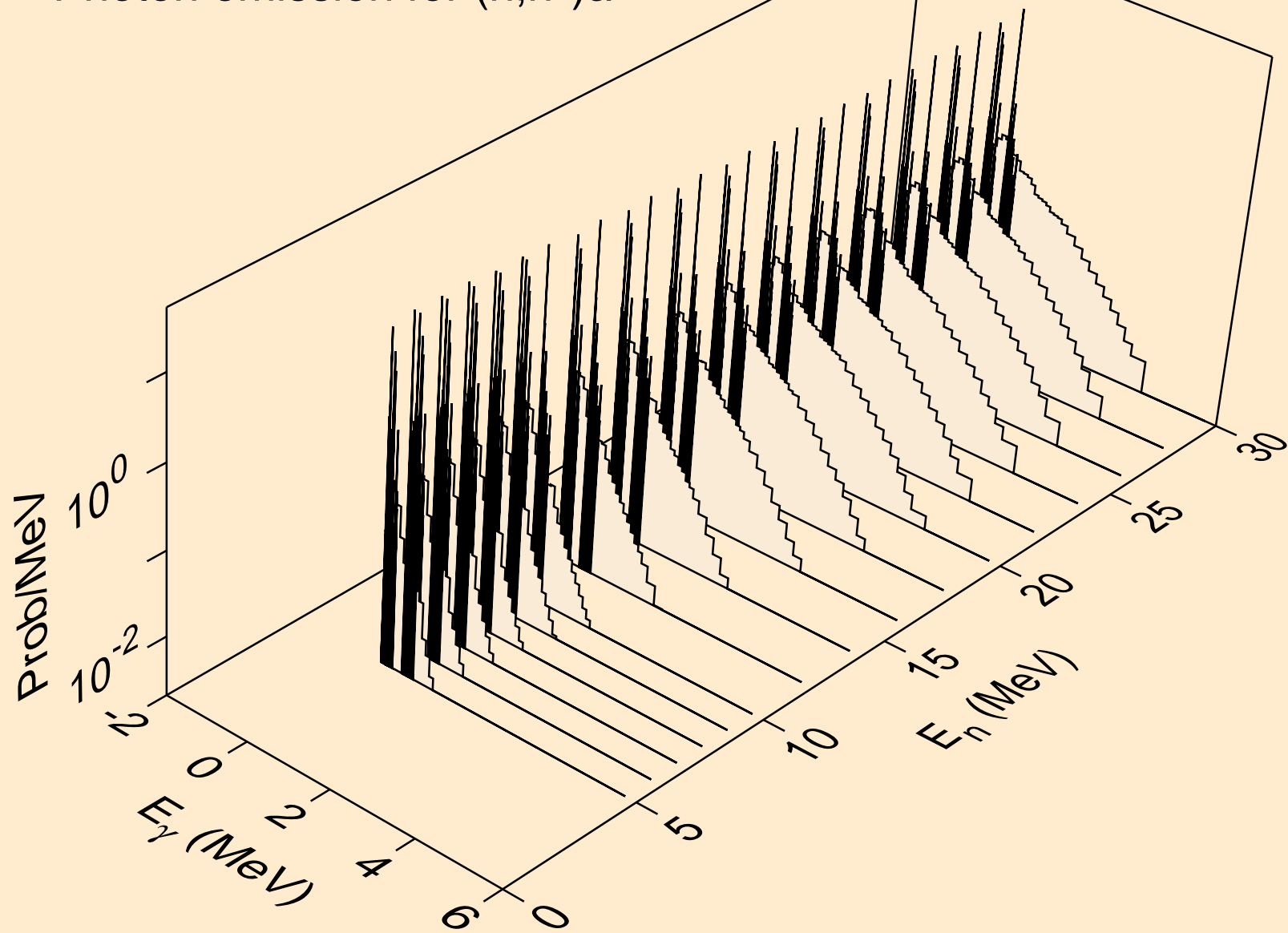

RE198 DEUTERON ACER TENDL-2024 LIBRARY; T=0.K  
Photon emission for (n,2n)a

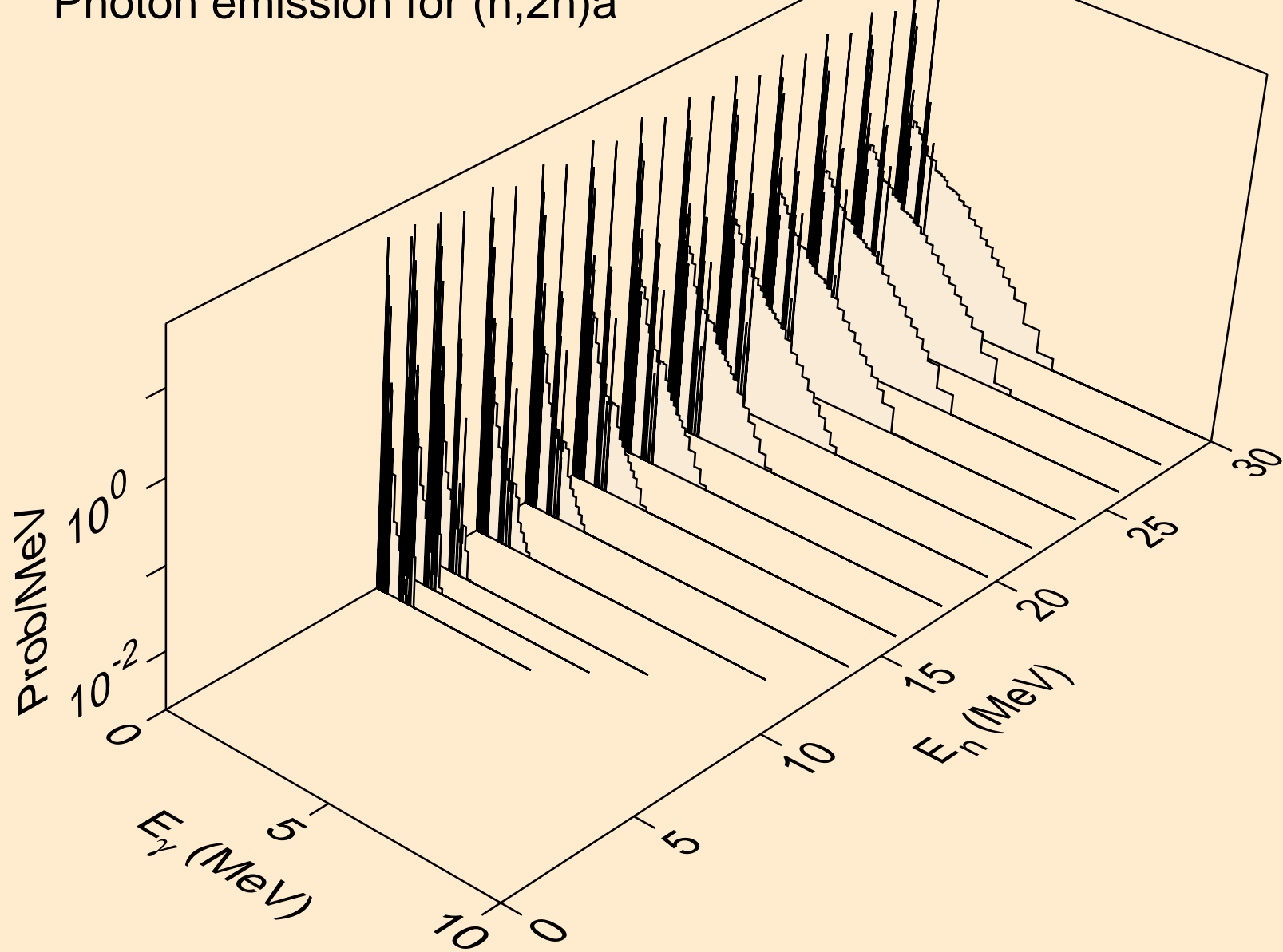

RE198 DEUTERON ACER TENDL-2024 LIBRARY; T=0.K  
Photon emission for (n,3n)a

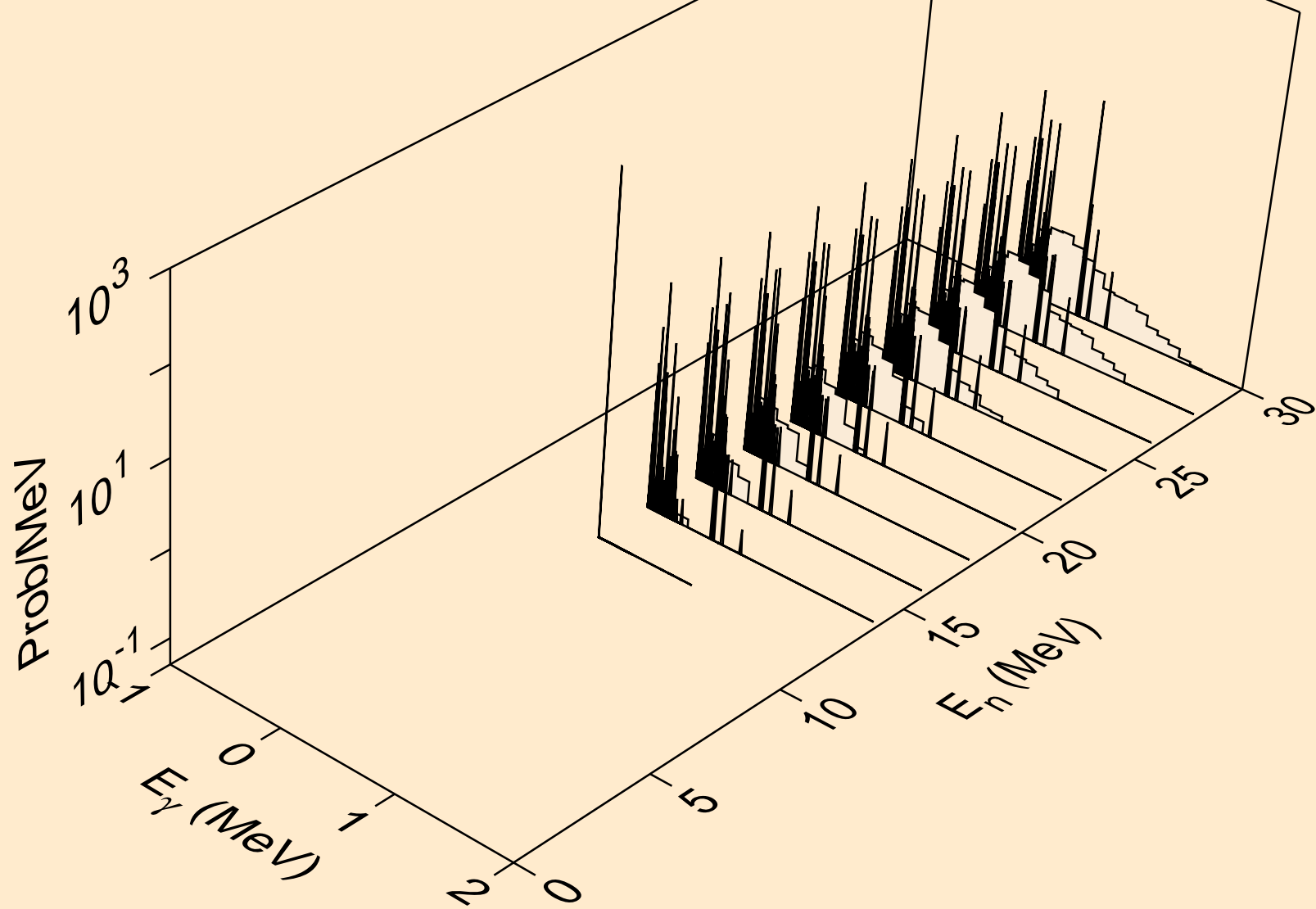

RE198 DEUTERON ACER TENDL-2024 LIBRARY; T=0.K  
Photon emission for (n,n\*)p

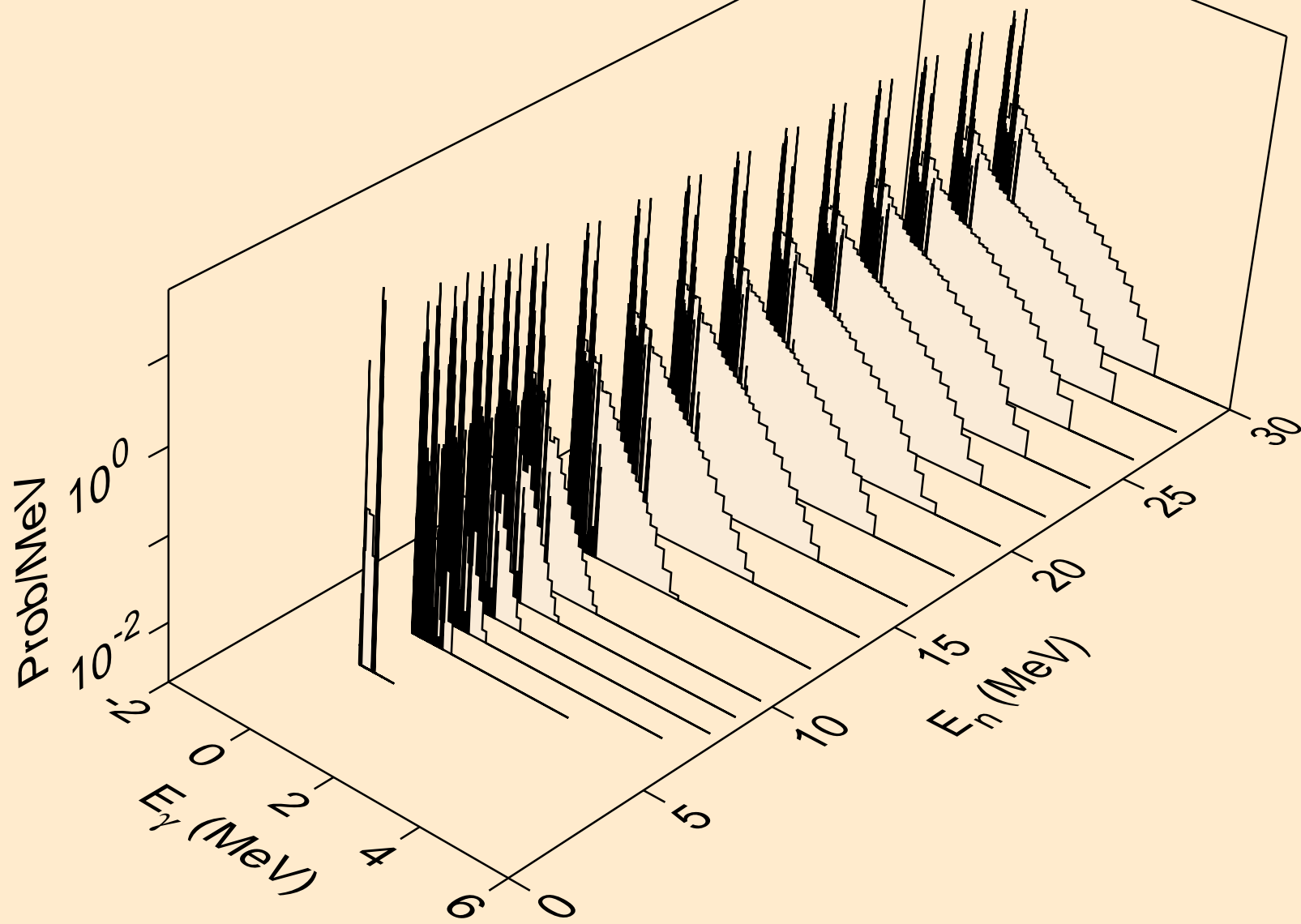

RE198 DEUTERON ACER TENDL-2024 LIBRARY; T=0.K  
Photon emission for (n,n\*)d

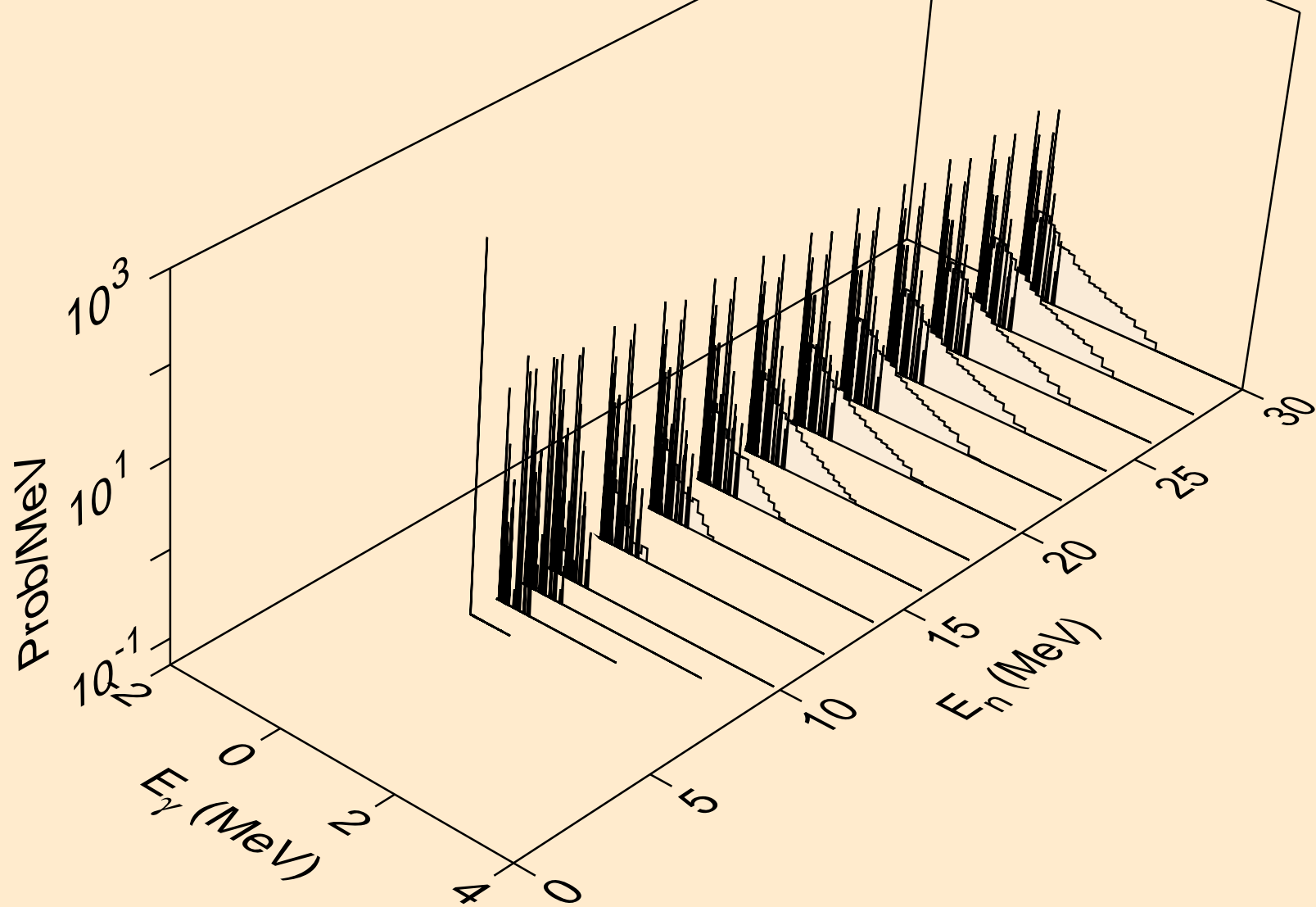

RE198 DEUTERON ACER TENDL-2024 LIBRARY; T=0.K  
Photon emission for (n,n\*)t

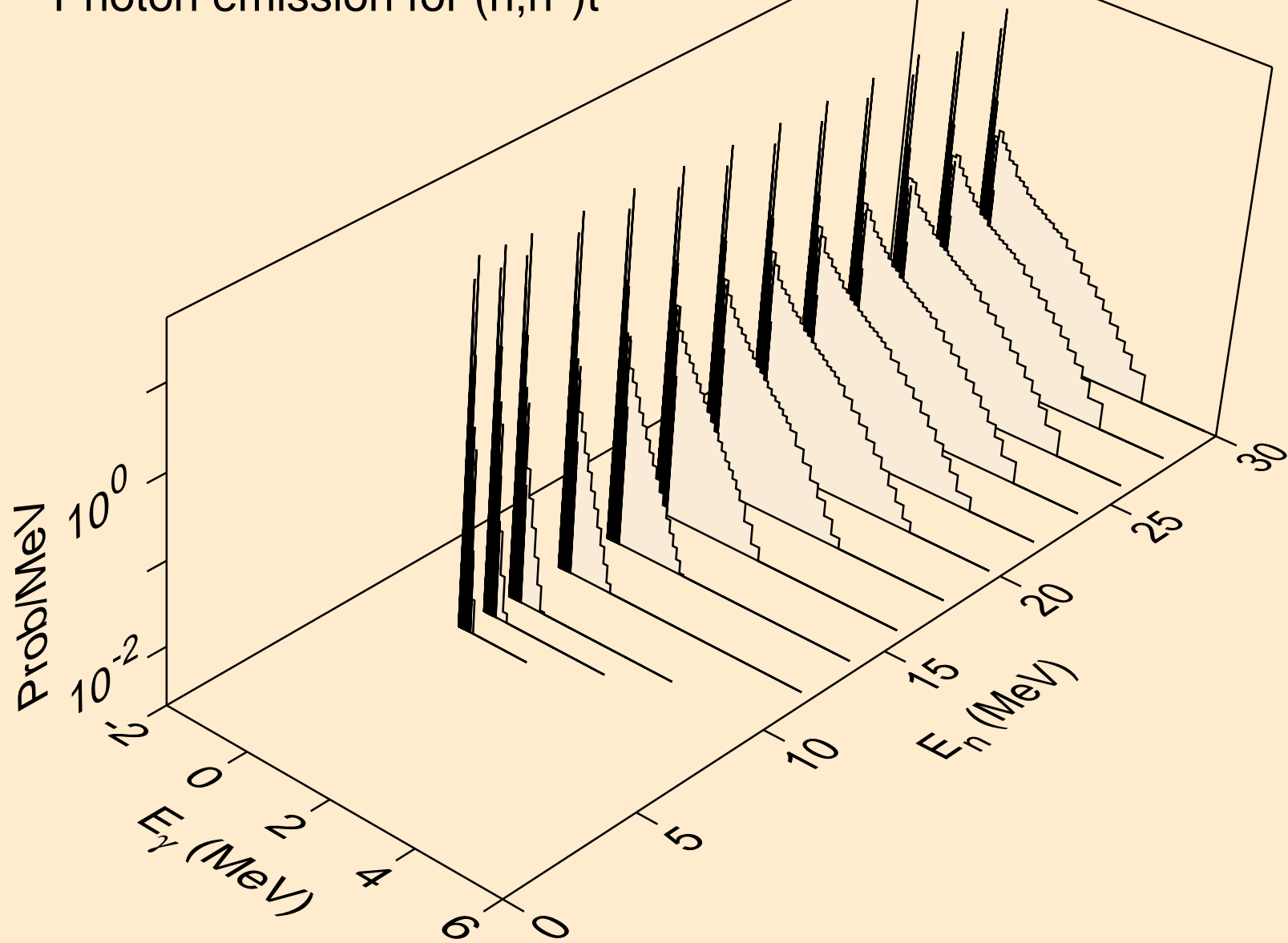

RE198 DEUTERON ACER TENDL-2024 LIBRARY; T=0.K  
Photon emission for (n,n\*)he3

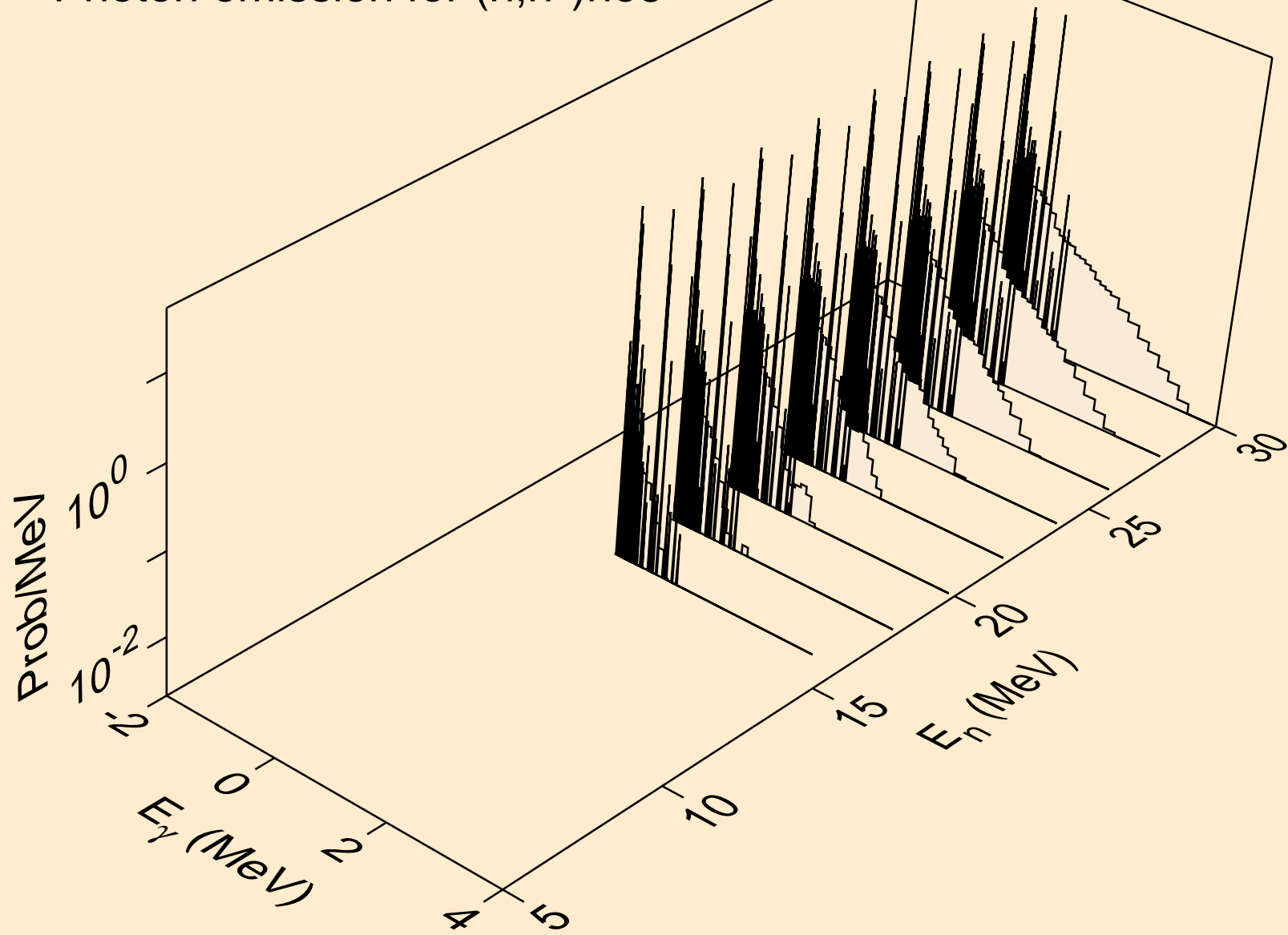

RE198 DEUTERON ACER TENDL-2024 LIBRARY; T=0.K  
Photon emission for (n,4n)

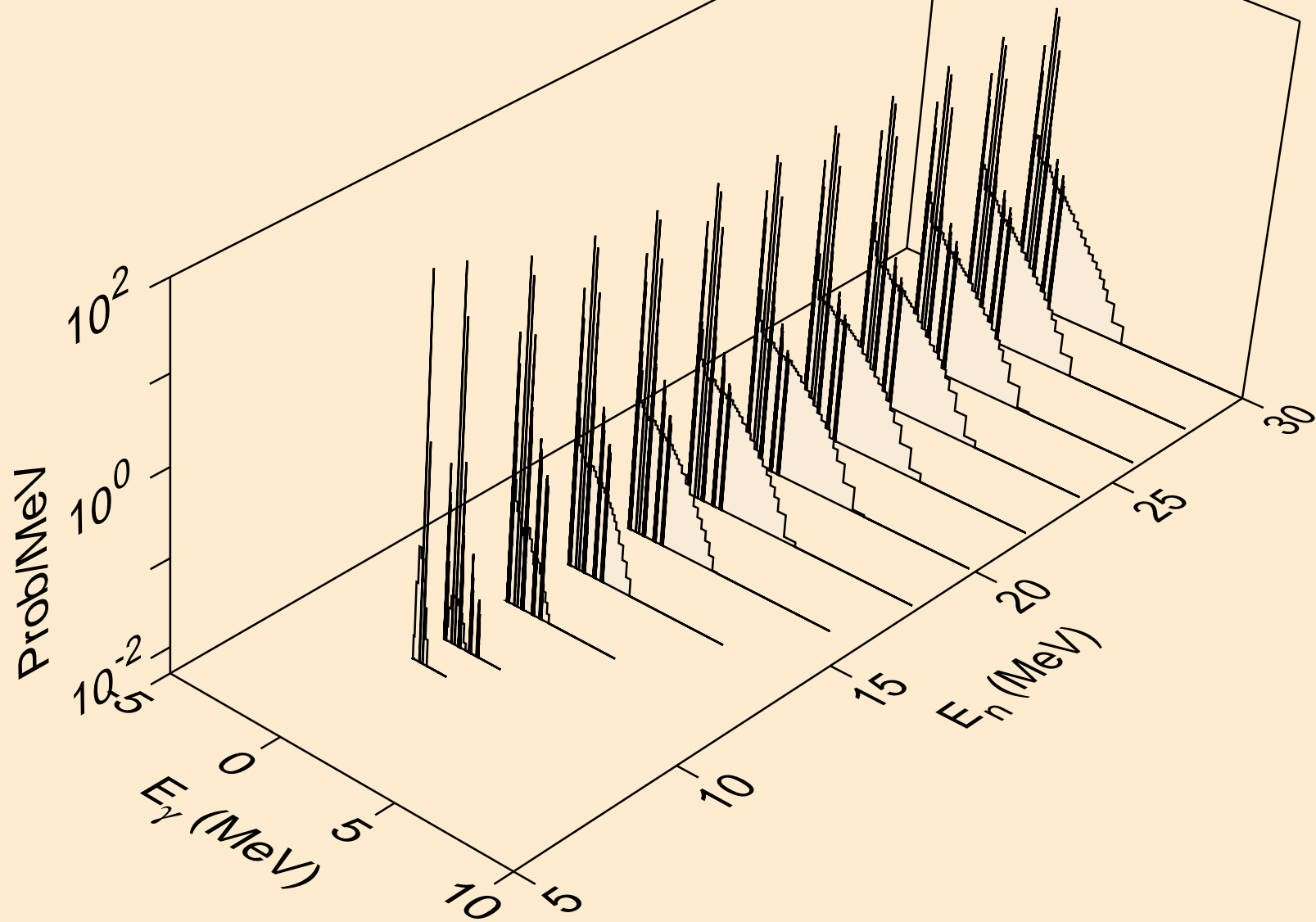

RE198 DEUTERON ACER TENDL-2024 LIBRARY; T=0.K  
Photon emission for (n,2np)

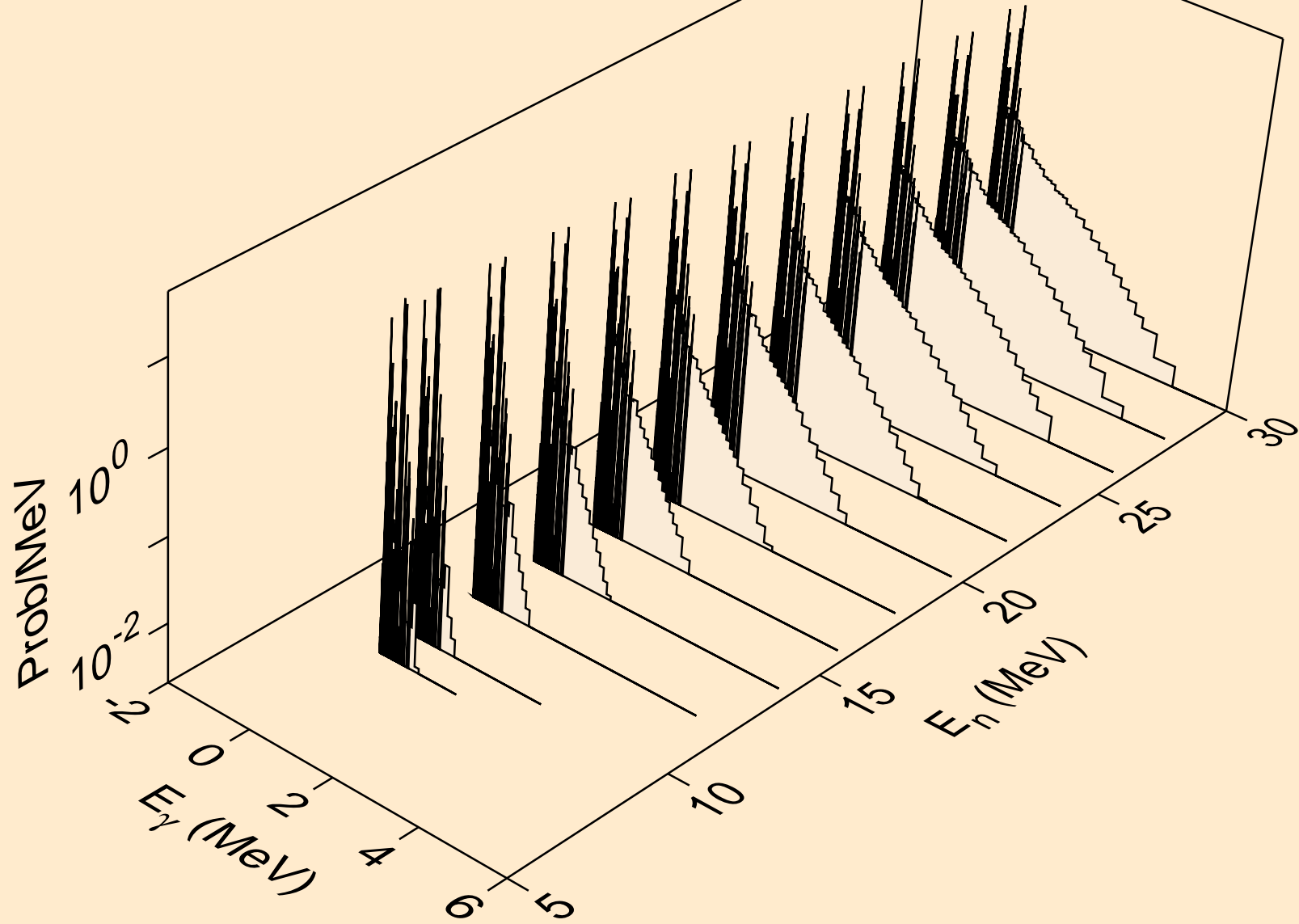

RE198 DEUTERON ACER TENDL-2024 LIBRARY; T=0.K  
Photon emission for (n,3np)

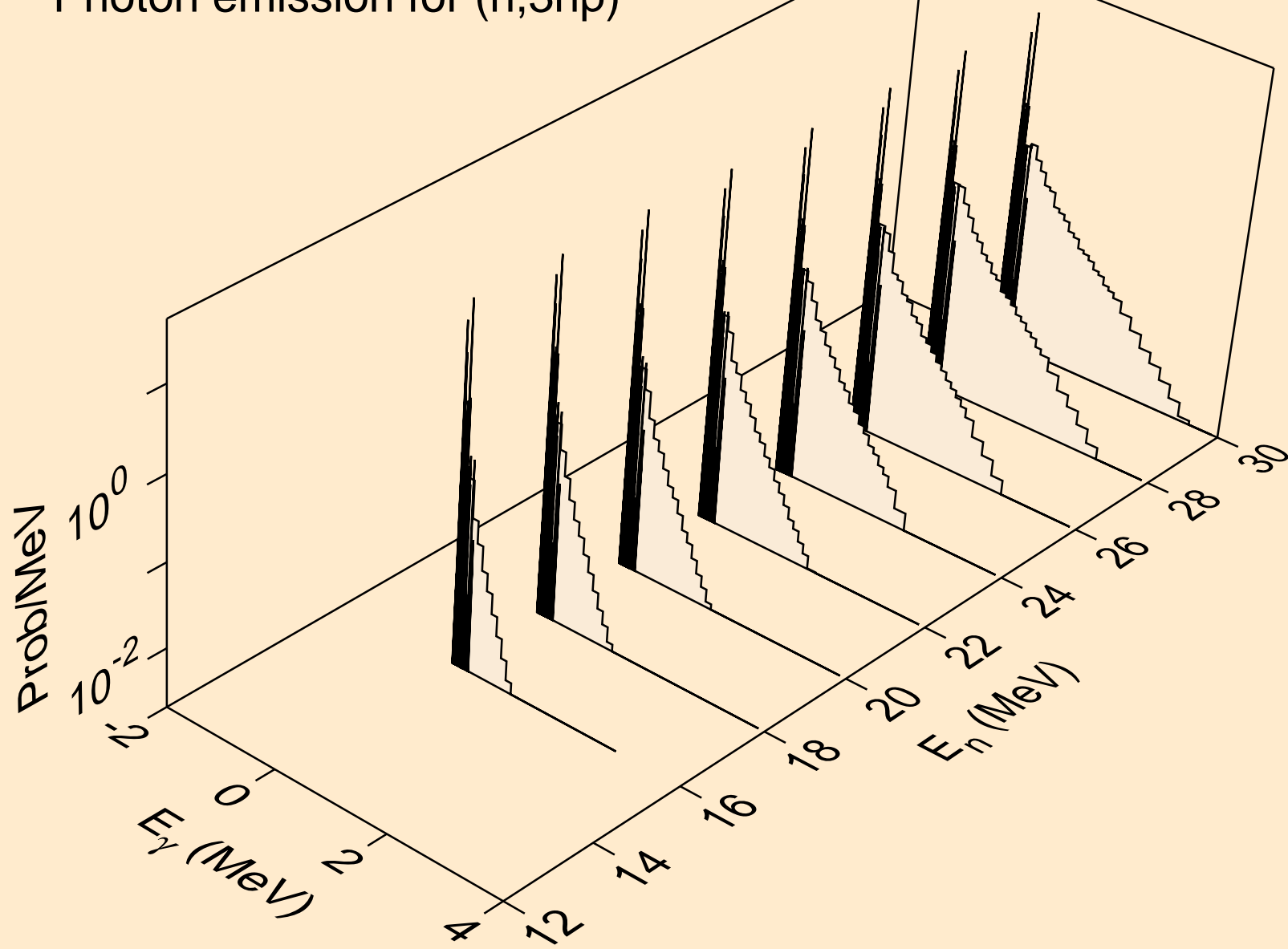

RE198 DEUTERON ACER TENDL-2024 LIBRARY; T=0.K  
Photon emission for (n,n2p)

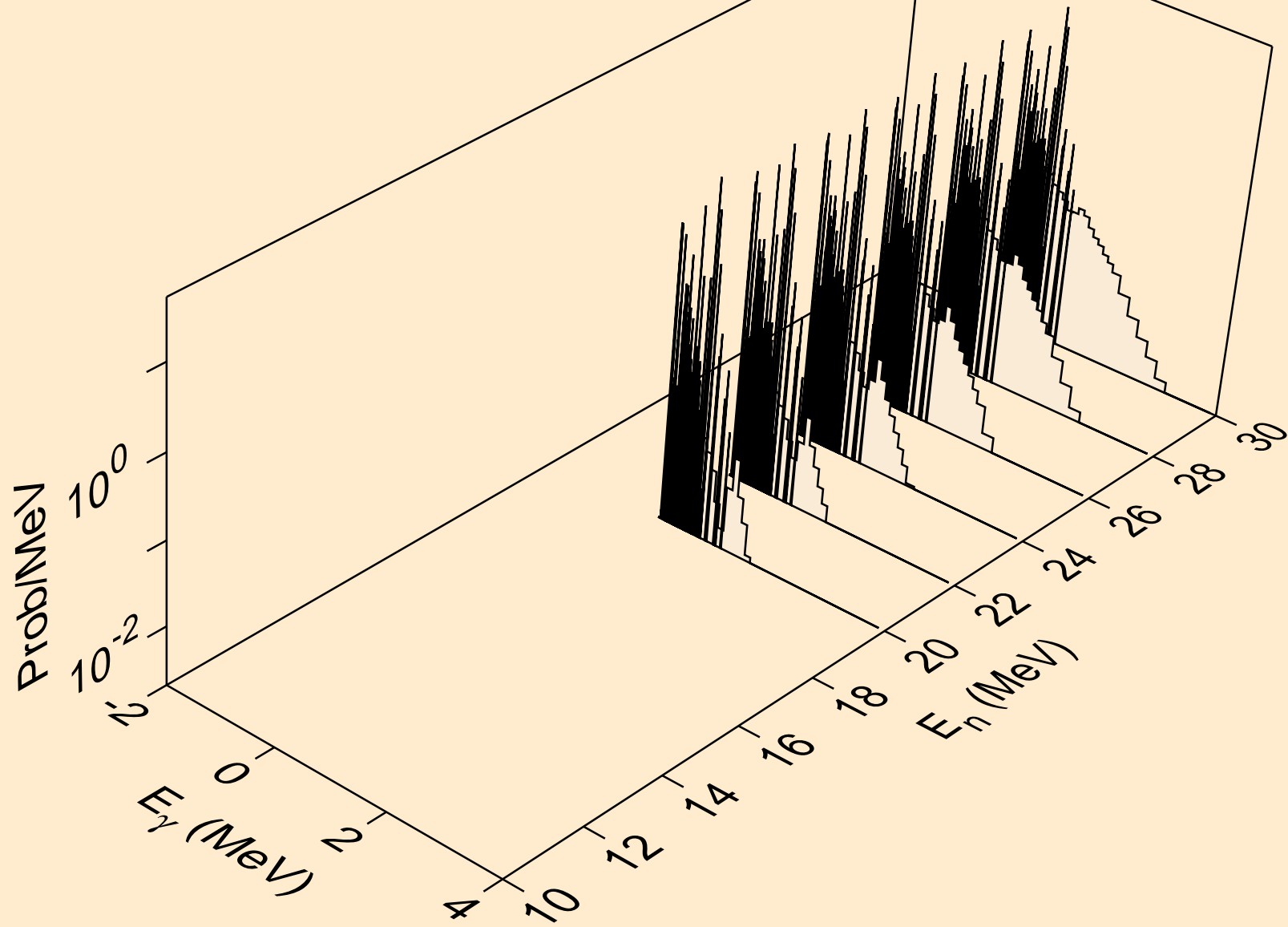

RE198 DEUTERON ACER TENDL-2024 LIBRARY; T=0.K  
Photon emission for (n,gma)

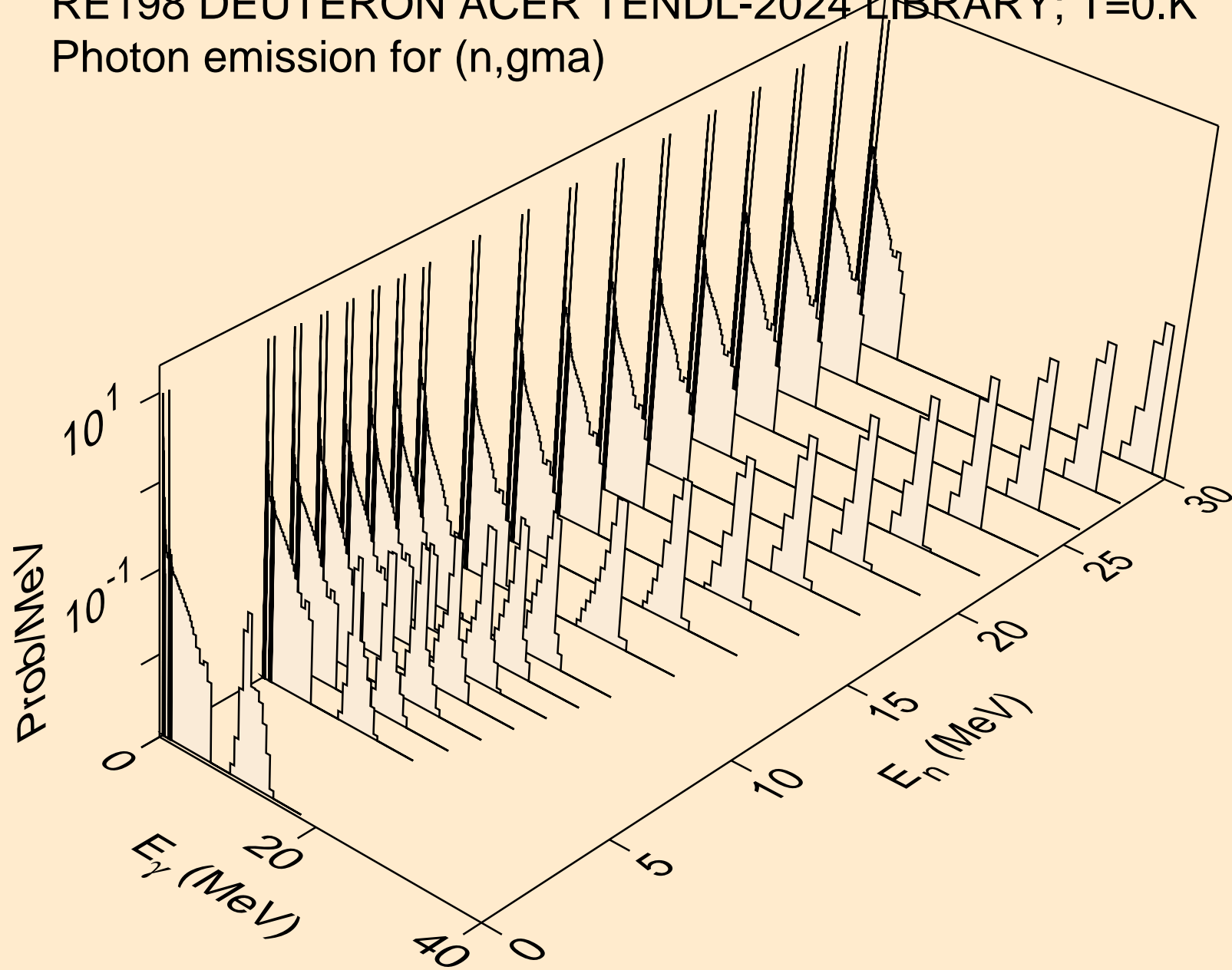

RE198 DEUTERON ACER TENDL-2024 LIBRARY; T=0.K  
Photon emission for (n,p)

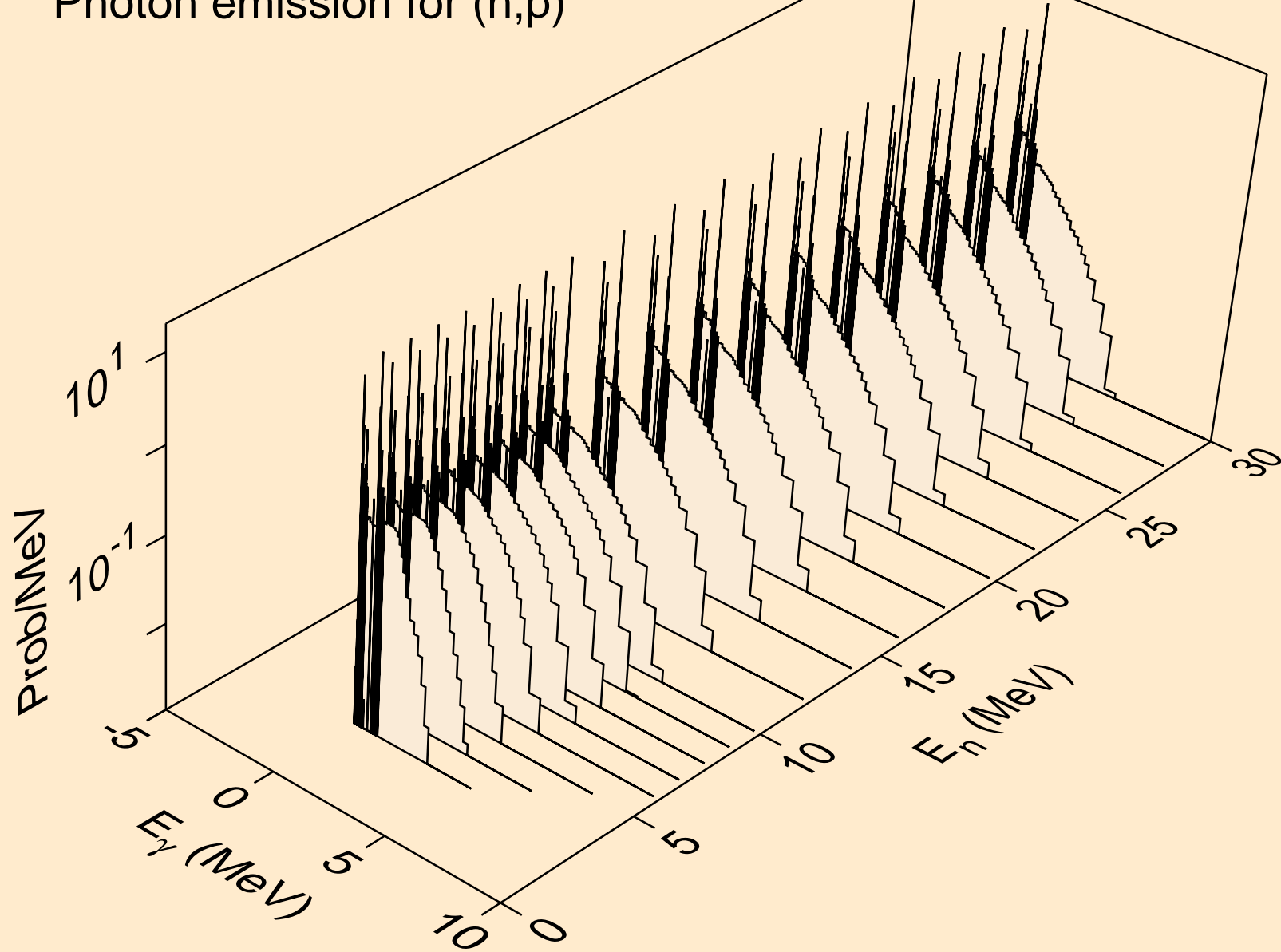

RE198 DEUTERON ACER TENDL-2024 LIBRARY; T=0.K  
Photon emission for inelastic

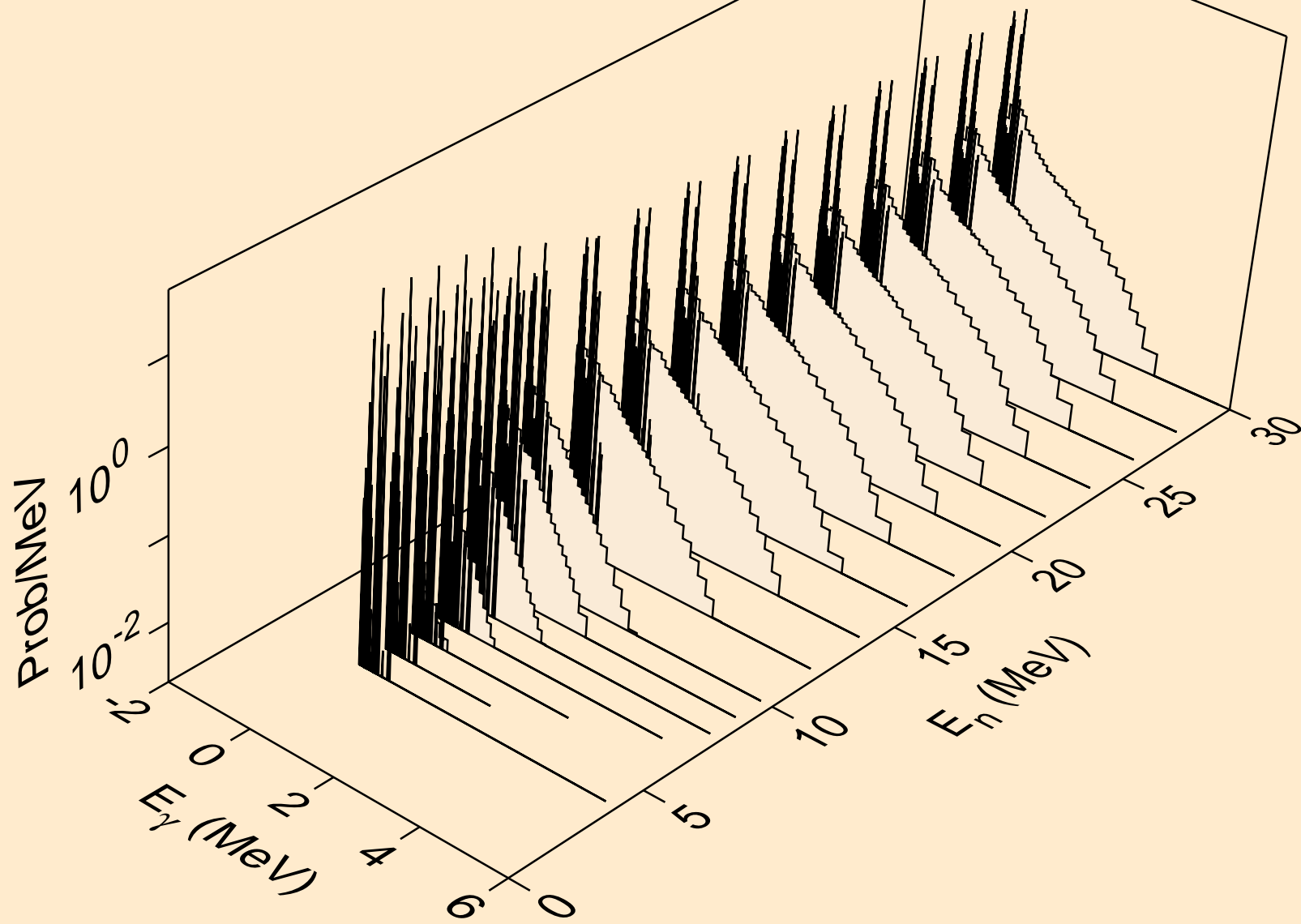

RE198 DEUTERON ACER TENDL-2024 LIBRARY; T=0.K  
Photon emission for (n,t)

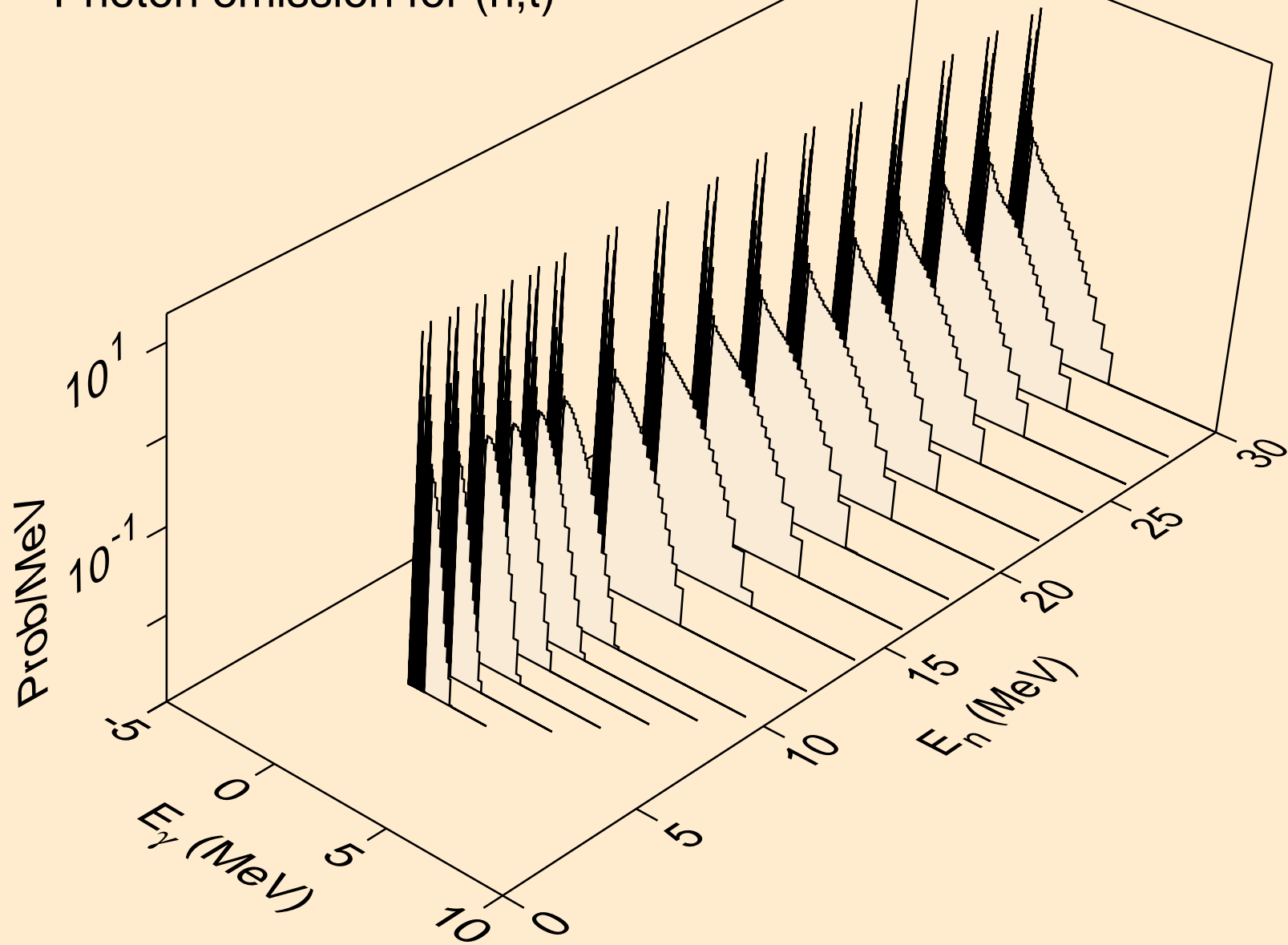

RE198 DEUTERON ACER TENDL-2024 LIBRARY; T=0.K  
Photon emission for (n,he3)

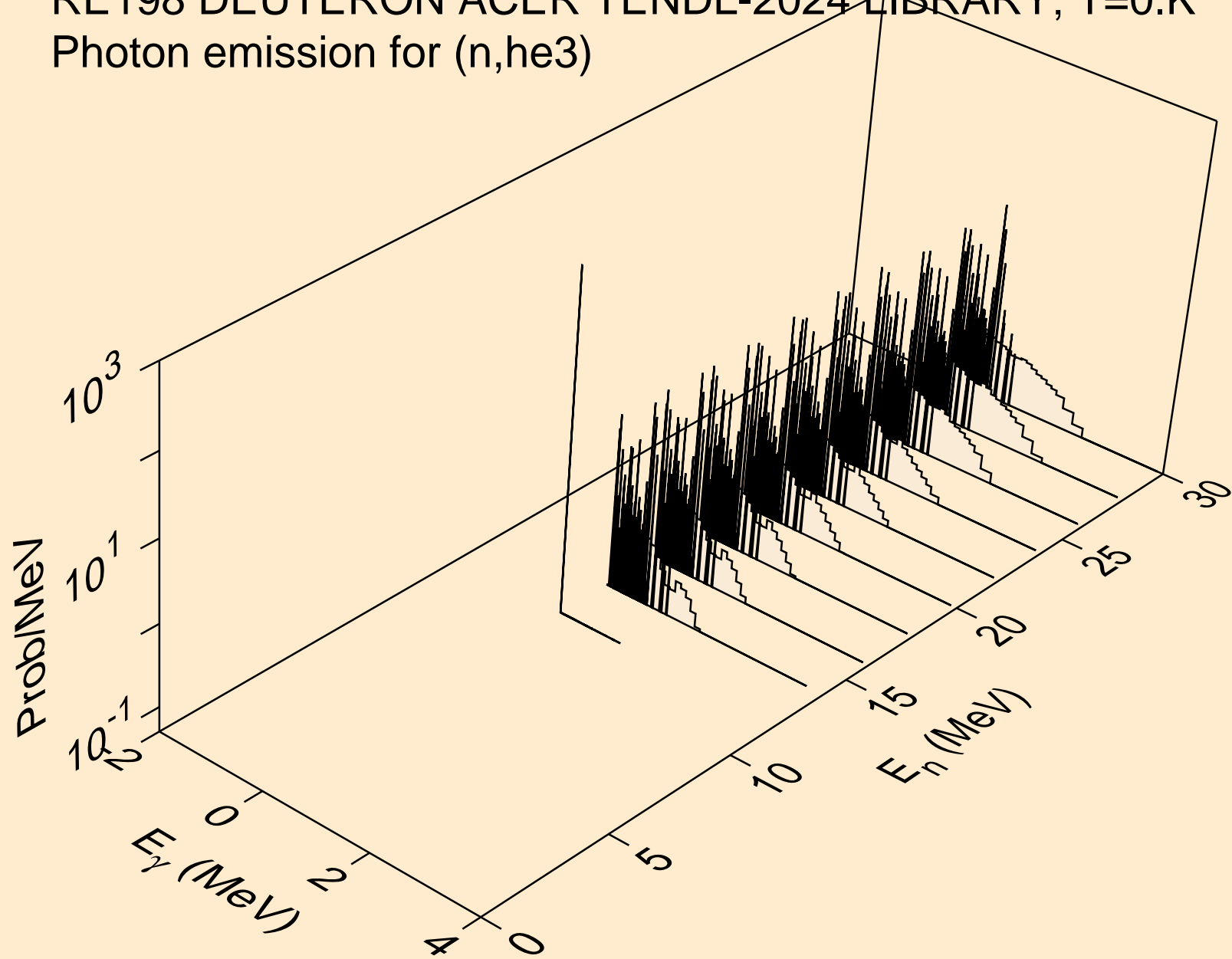

RE198 DEUTERON ACER TENDL-2024 LIBRARY; T=0.K  
Photon emission for (n,a)

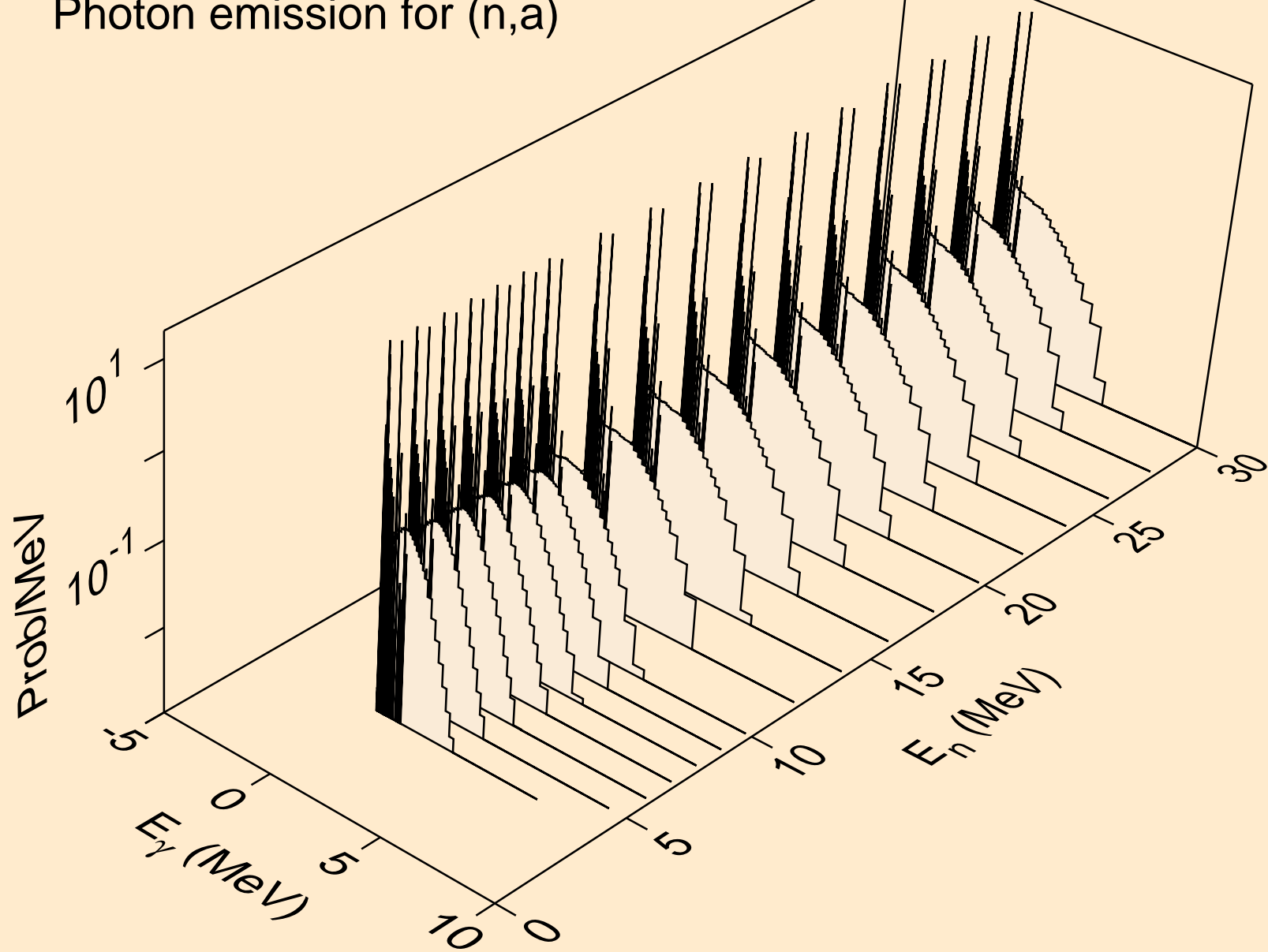

RE198 DEUTERON ACER TENDL-2024 LIBRARY; T=0.K  
Photon emission for (n,2p)

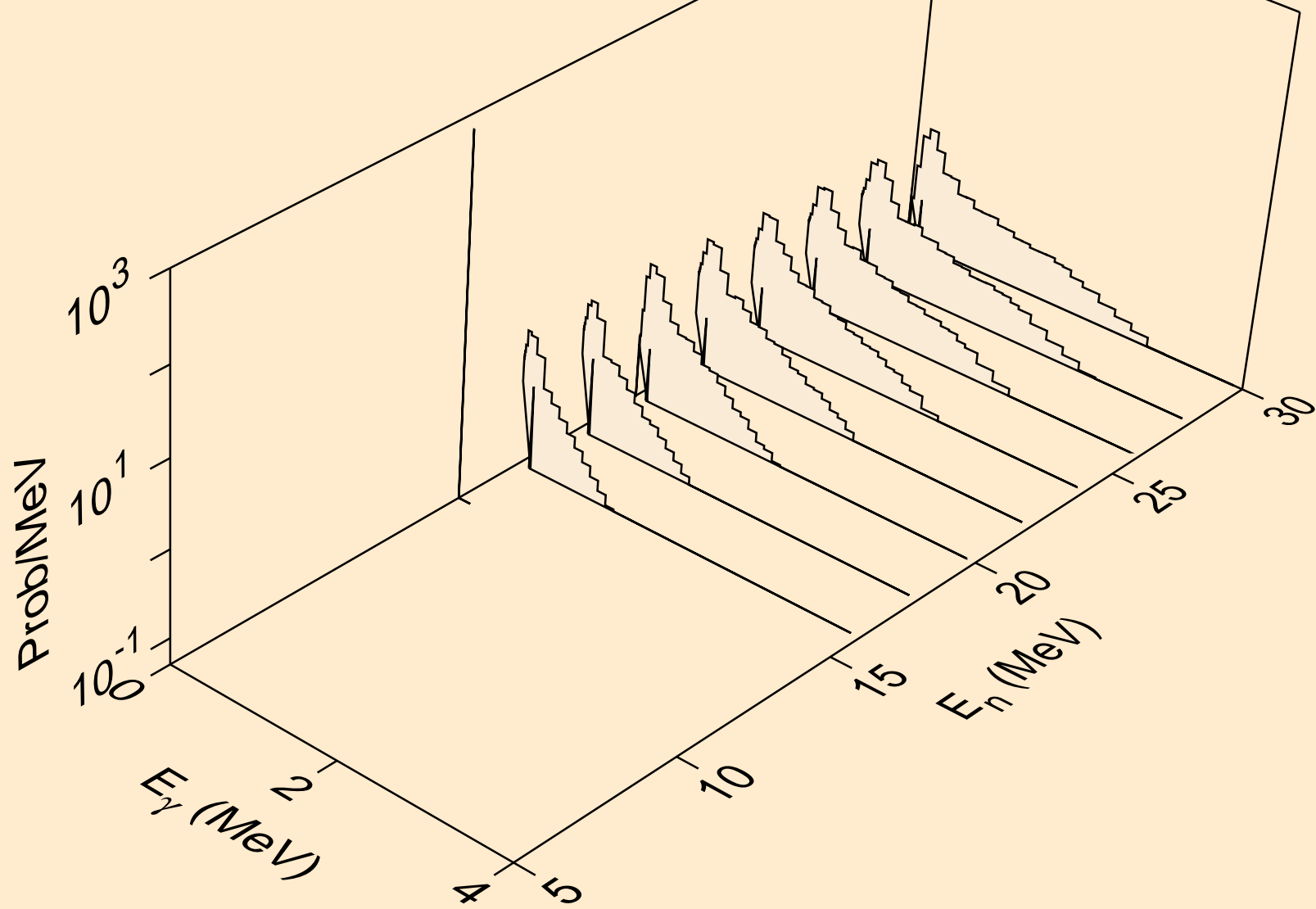

RE198 DEUTERON ACER TENDL-2024 LIBRARY; T=0.K  
Photon emission for (n,pd)

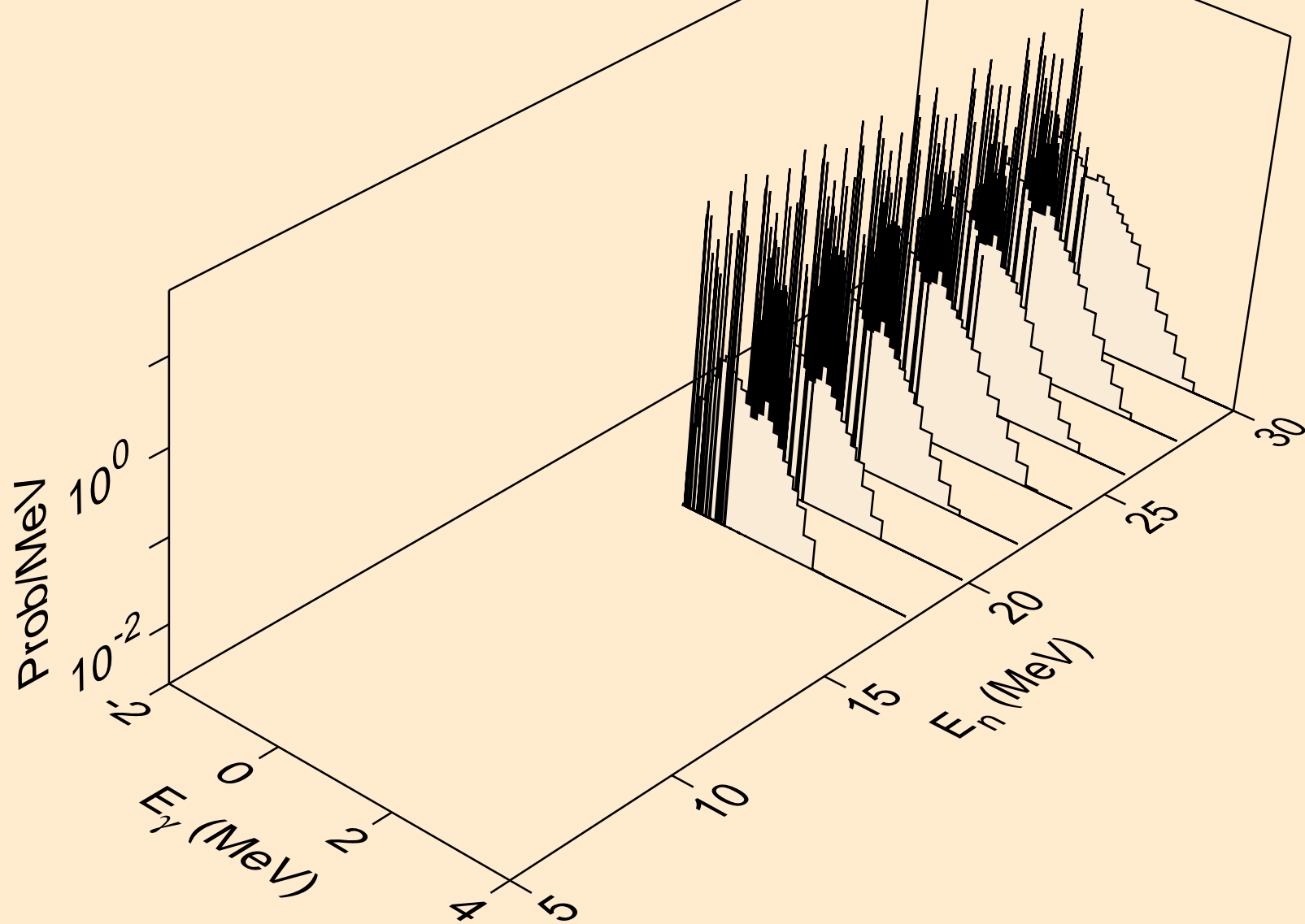

# RE198 DEUTERON ACER TENDL-2024 LIBRARY; T=0.K

## Particle heating contributions

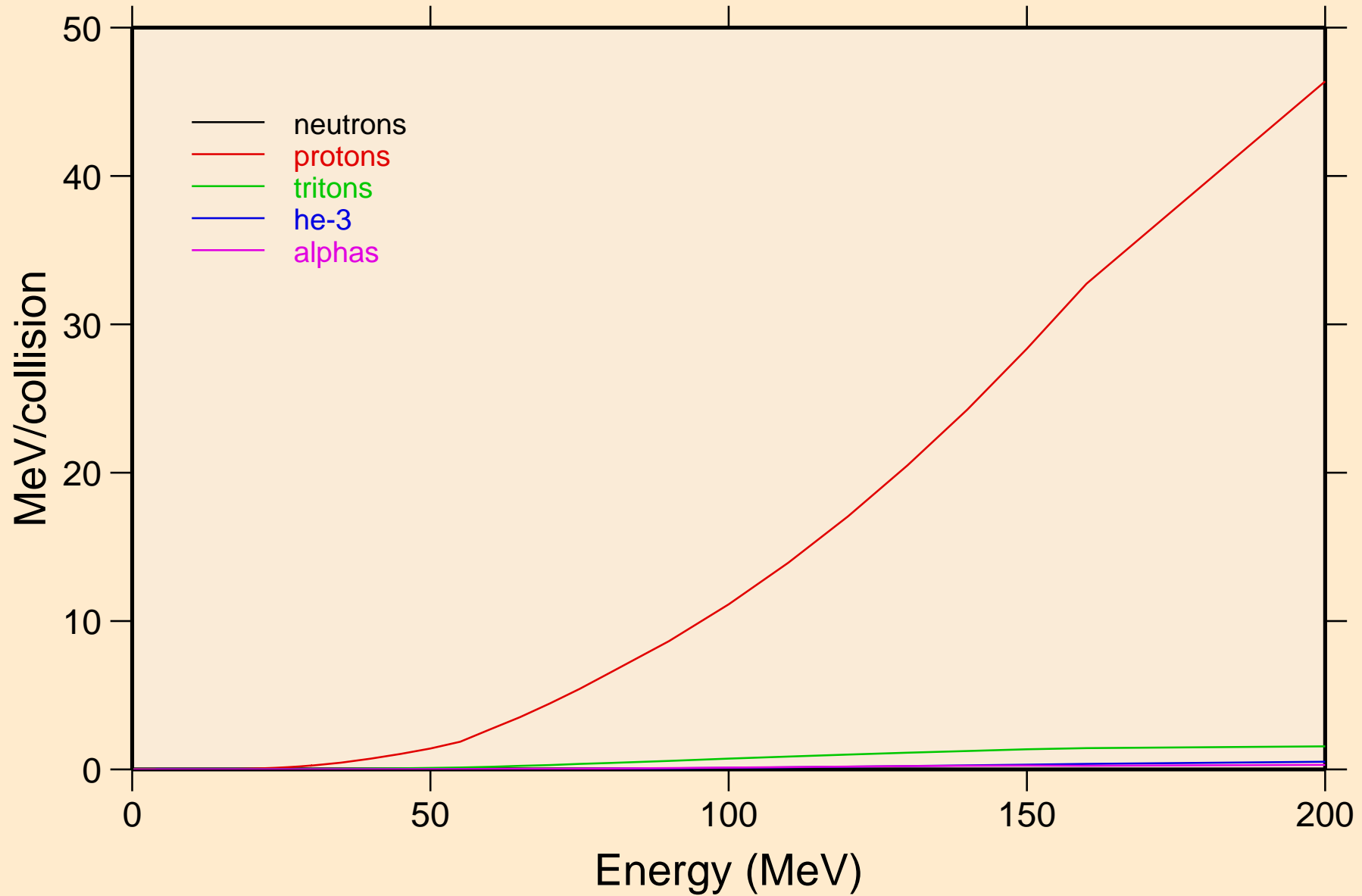

RE198 DEUTERON ACER TENDL-2024 LIBRARY; T=0.K  
Recoil Heating

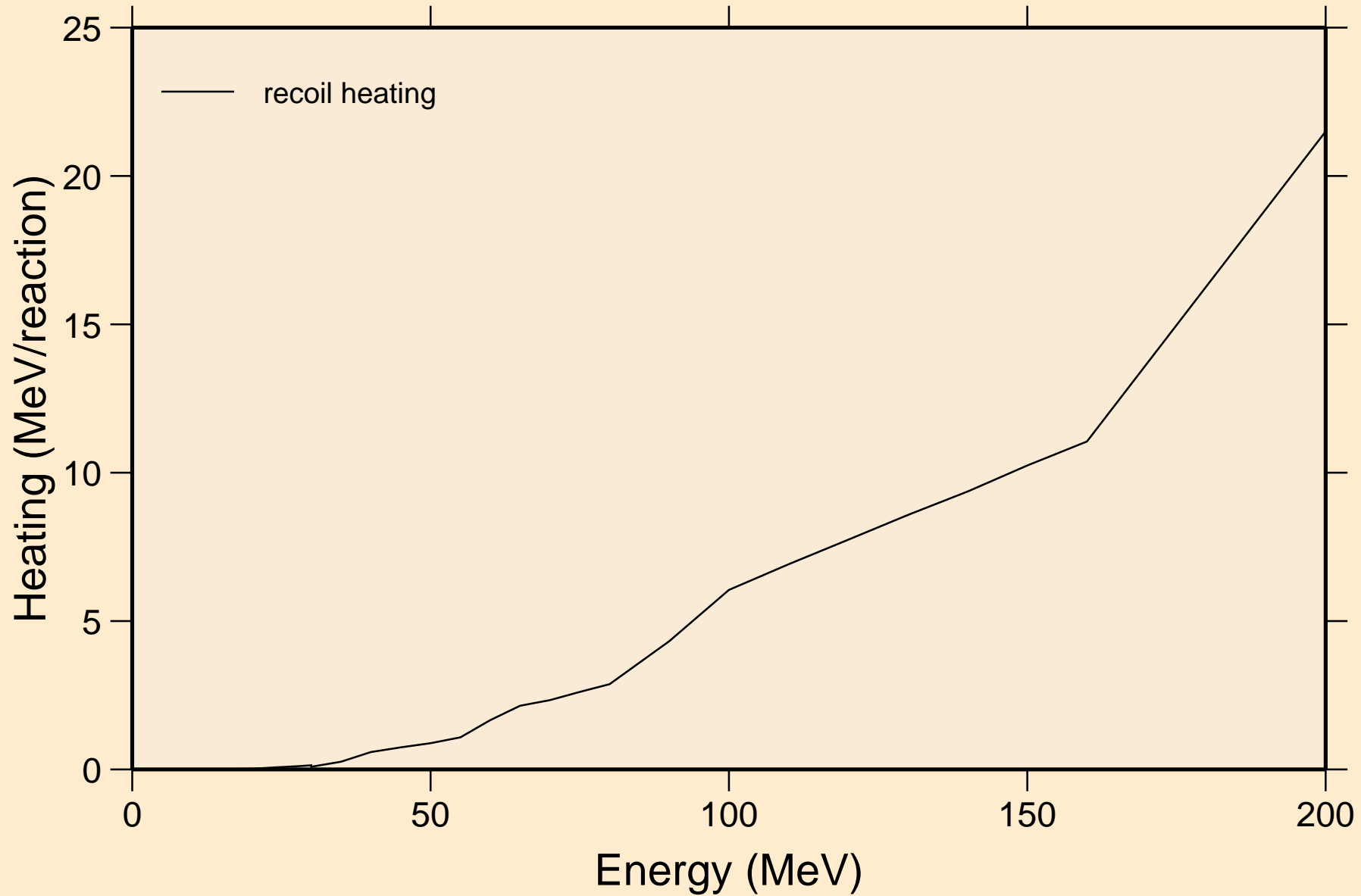

RE198 DEUTERON ACER TENDL-2024 LIBRARY; T=0.K  
Particle production cross sections

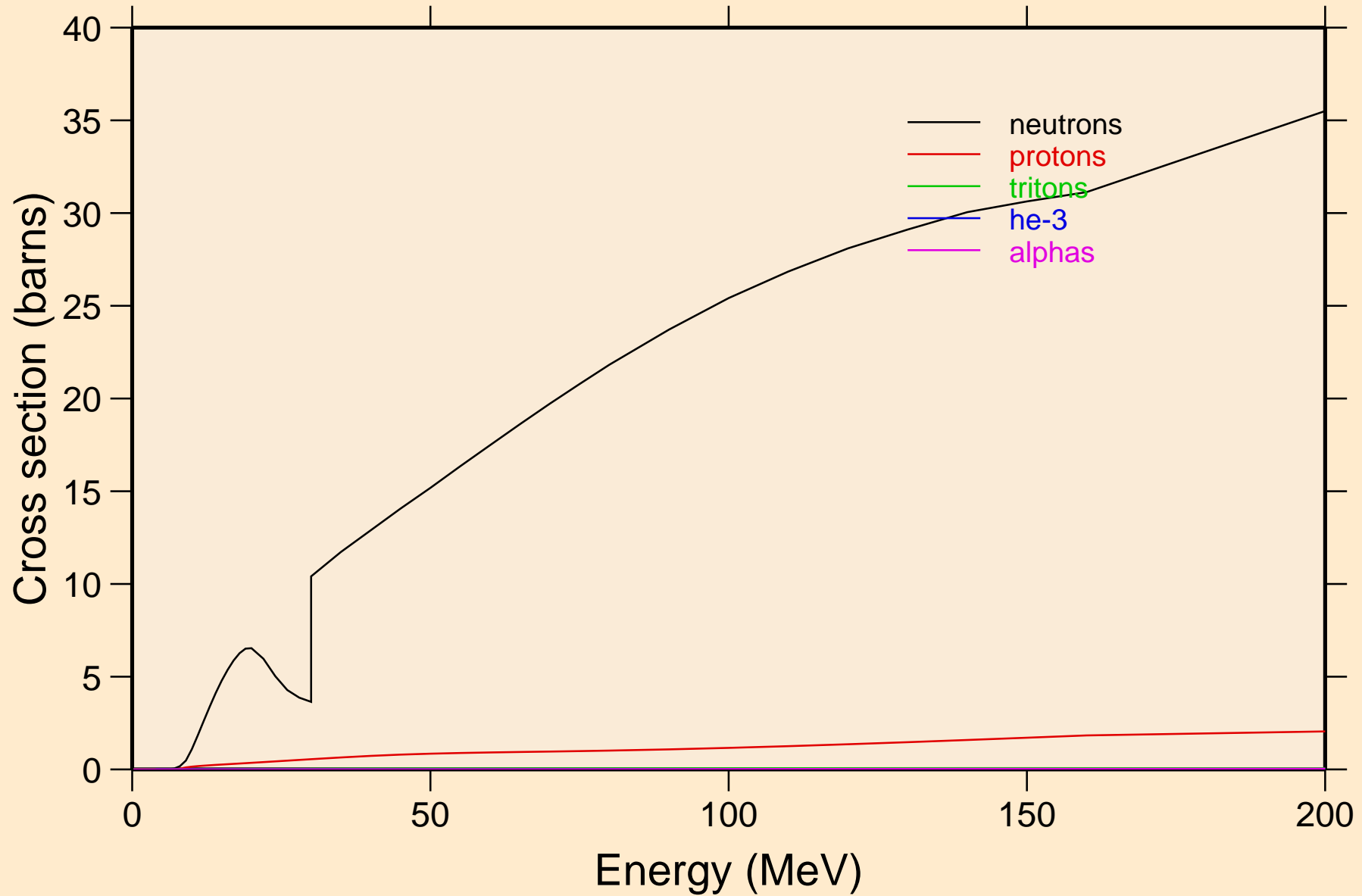

RE198 DEUTERON ACER TENDL-2024 LIBRARY; T=0.K  
neutrons from (d,n)

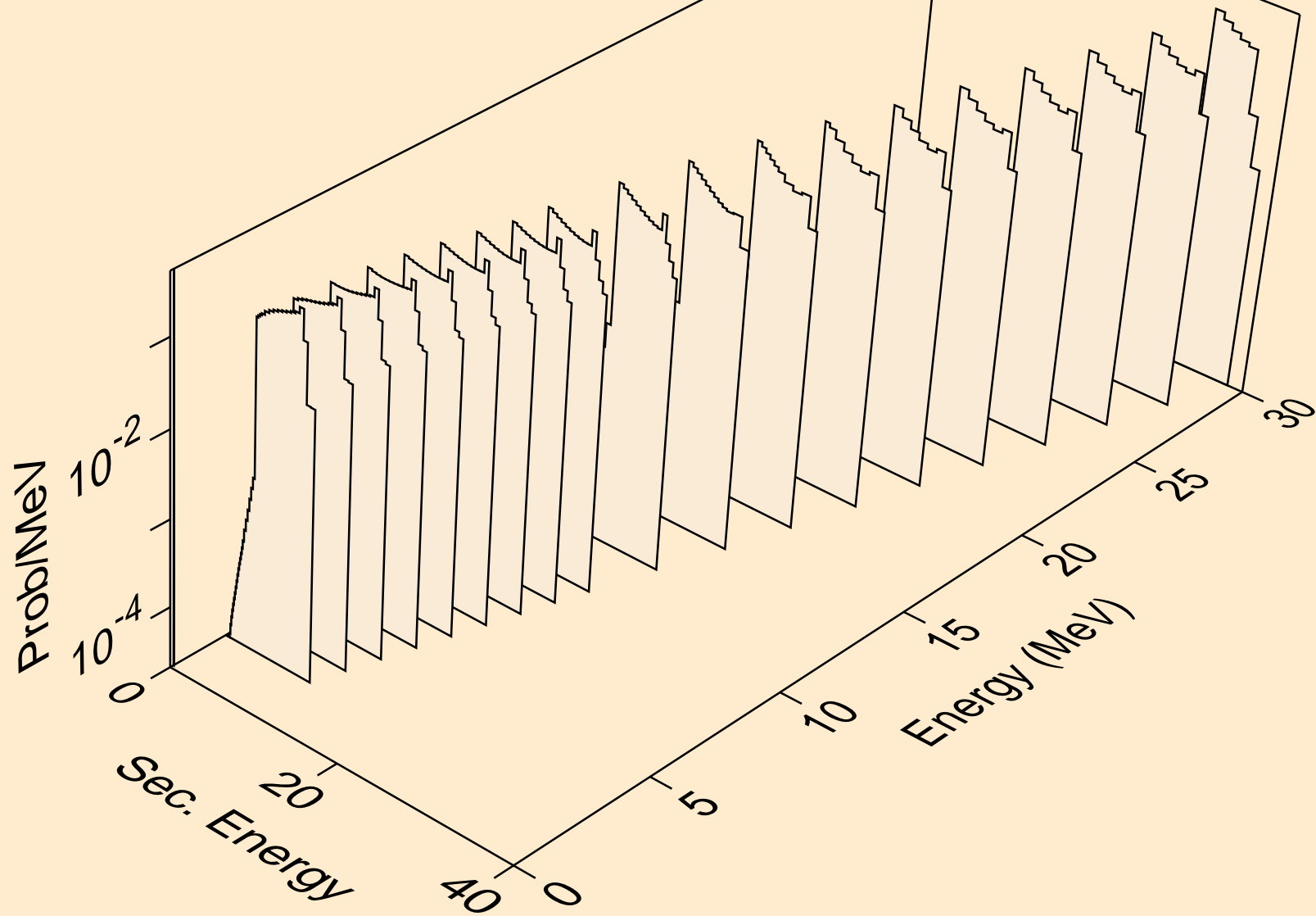

RE198 DEUTERON ACER TENDL-2024 LIBRARY; T=0.K  
neutrons from (d,x)

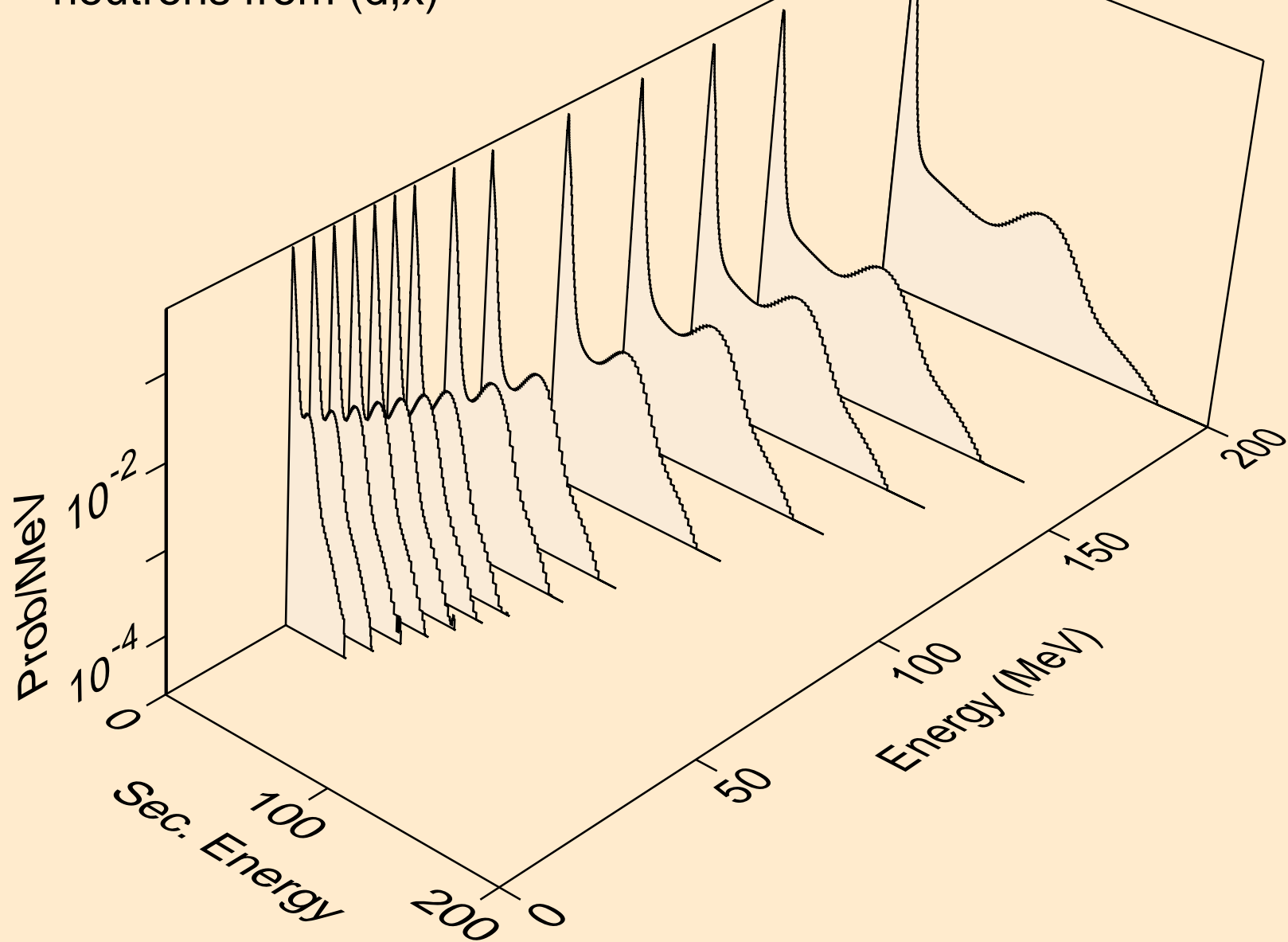

RE198 DEUTERON ACER TENDL-2024 LIBRARY; T=0.K  
neutrons from (d,2nd)

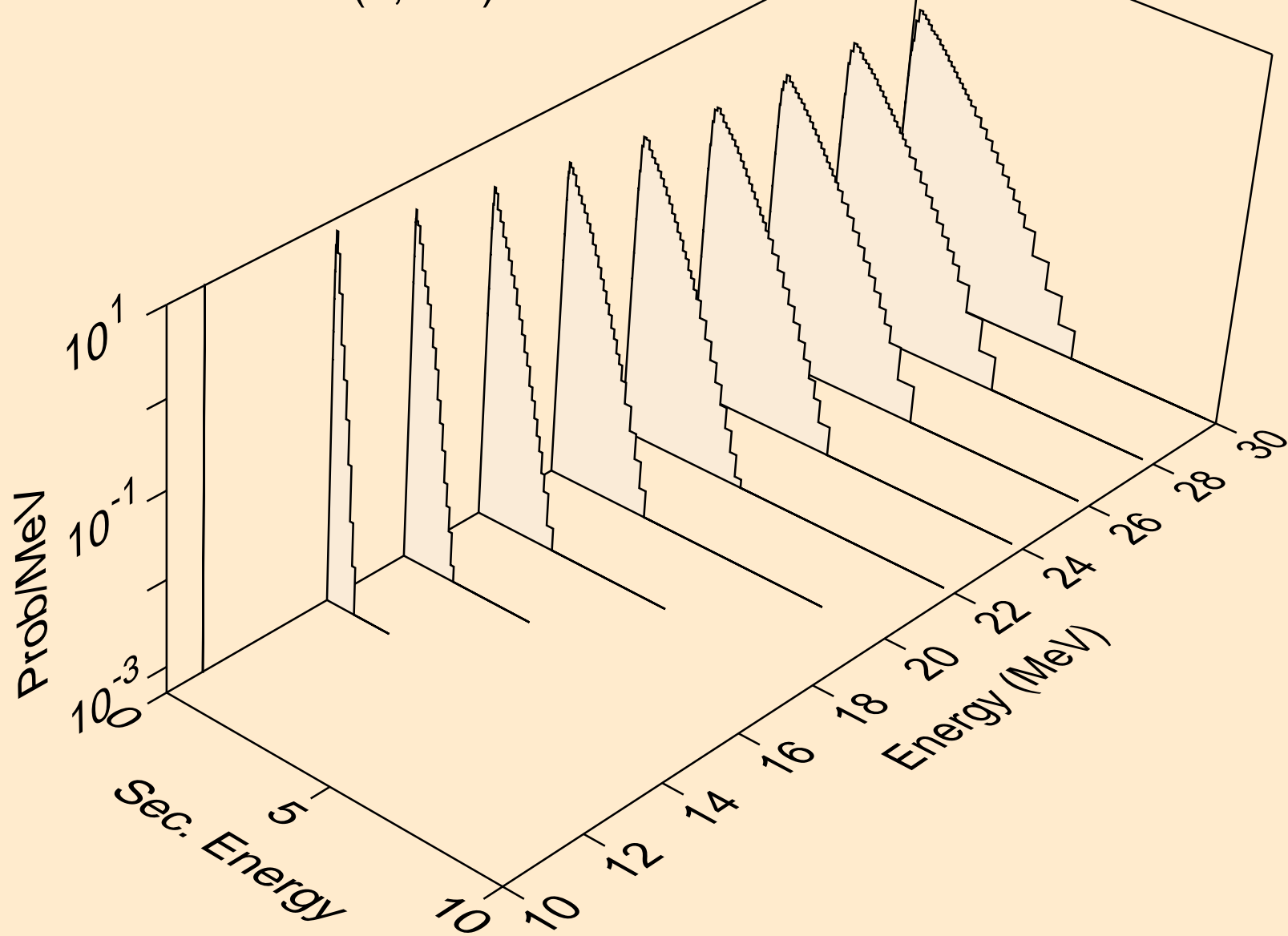

RE198 DEUTERON ACER TENDL-2024 LIBRARY; T=0.K  
neutrons from (d,2n)

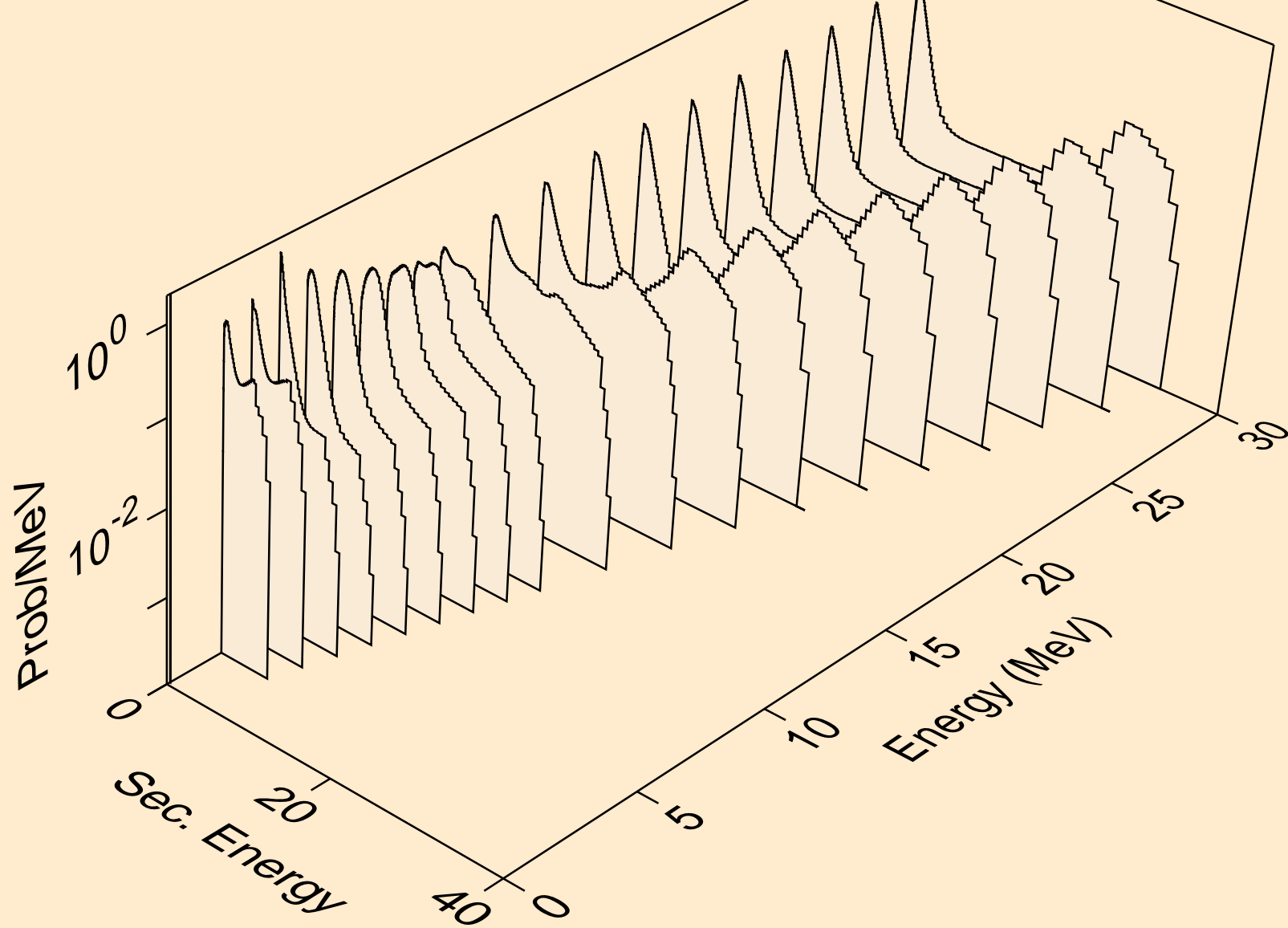

RE198 DEUTERON ACER TENDL-2024 LIBRARY; T=0.K  
neutrons from (d,3n)

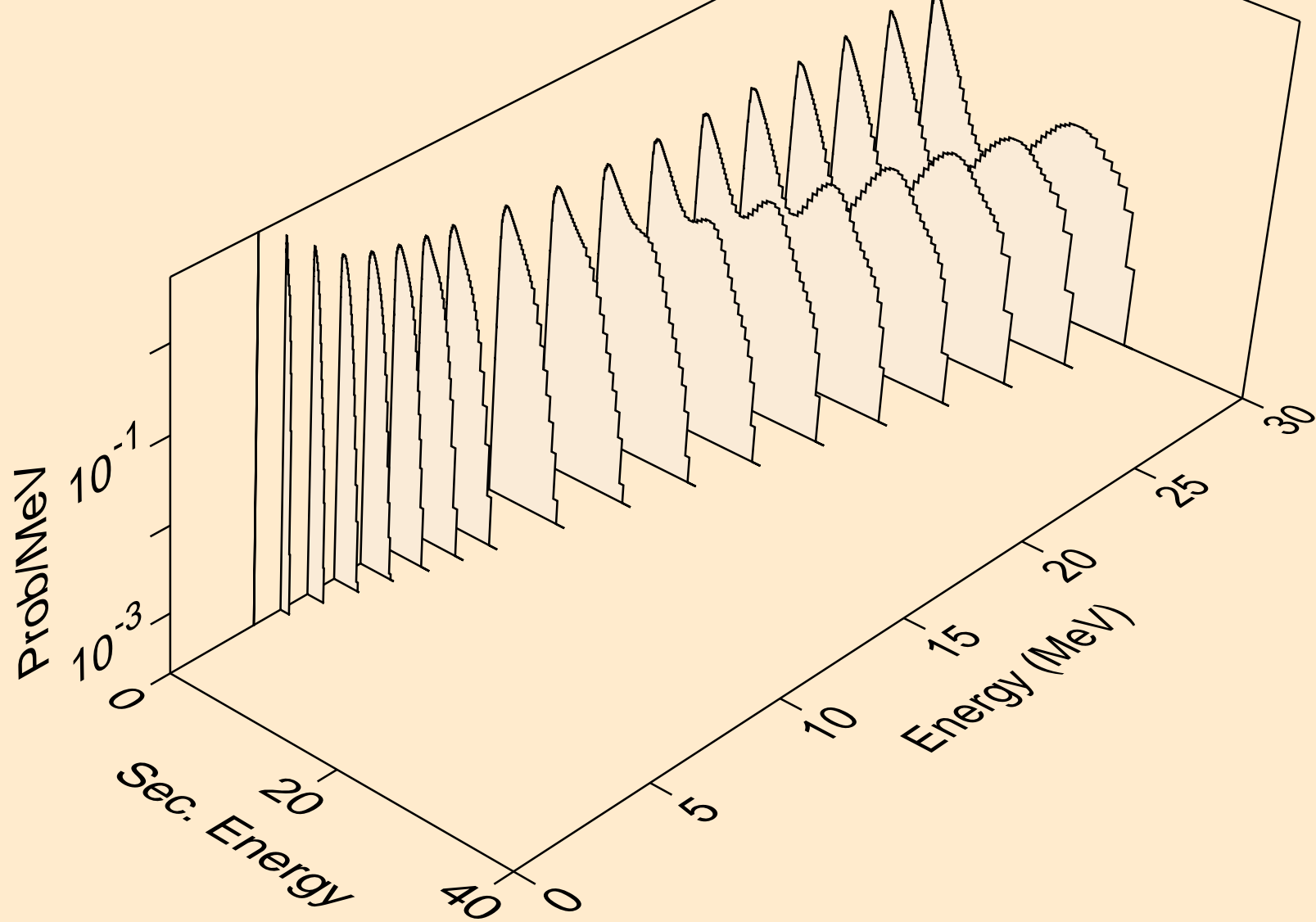

RE198 DEUTERON ACER TENDL-2024 LIBRARY; T=0.K  
neutrons from (d,n\*)a

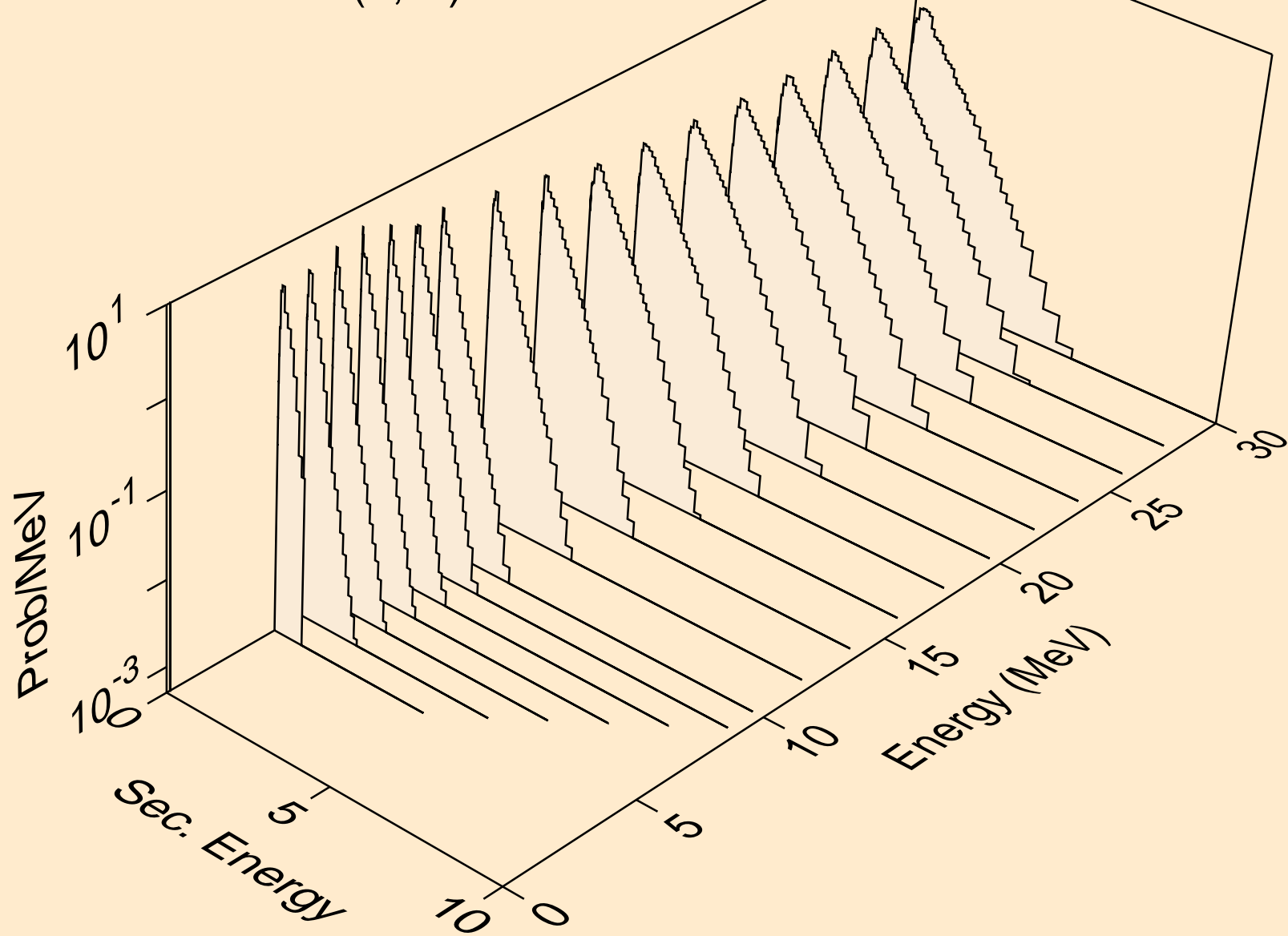

RE198 DEUTERON ACER TENDL-2024 LIBRARY; T=0.K  
neutrons from (d,2n)a

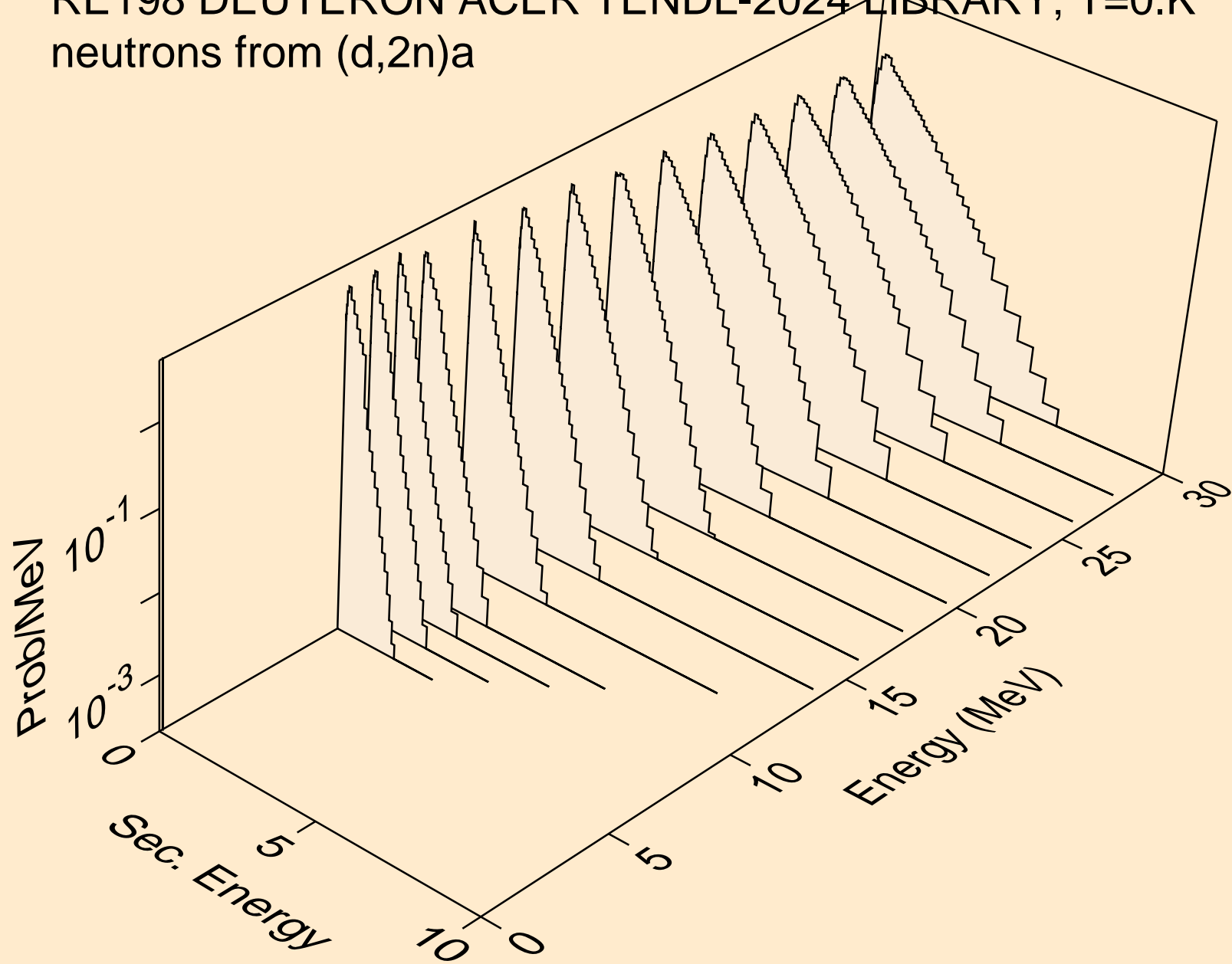

RE198 DEUTERON ACER TENDL-2024 LIBRARY; T=0.K  
neutrons from (d,3n)a

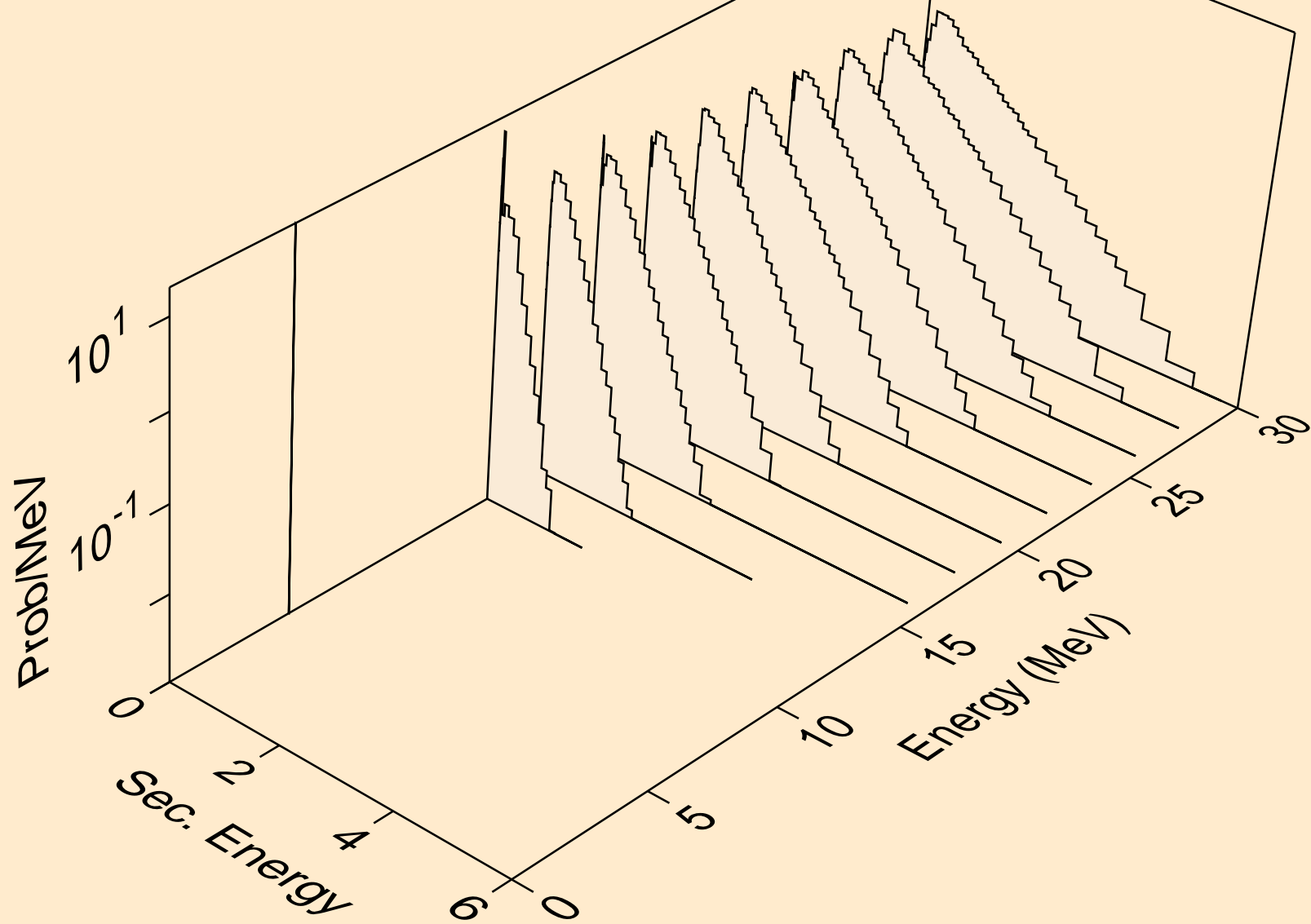

RE198 DEUTERON ACER TENDL-2024 LIBRARY; T=0.K  
neutrons from (d,n\*)p

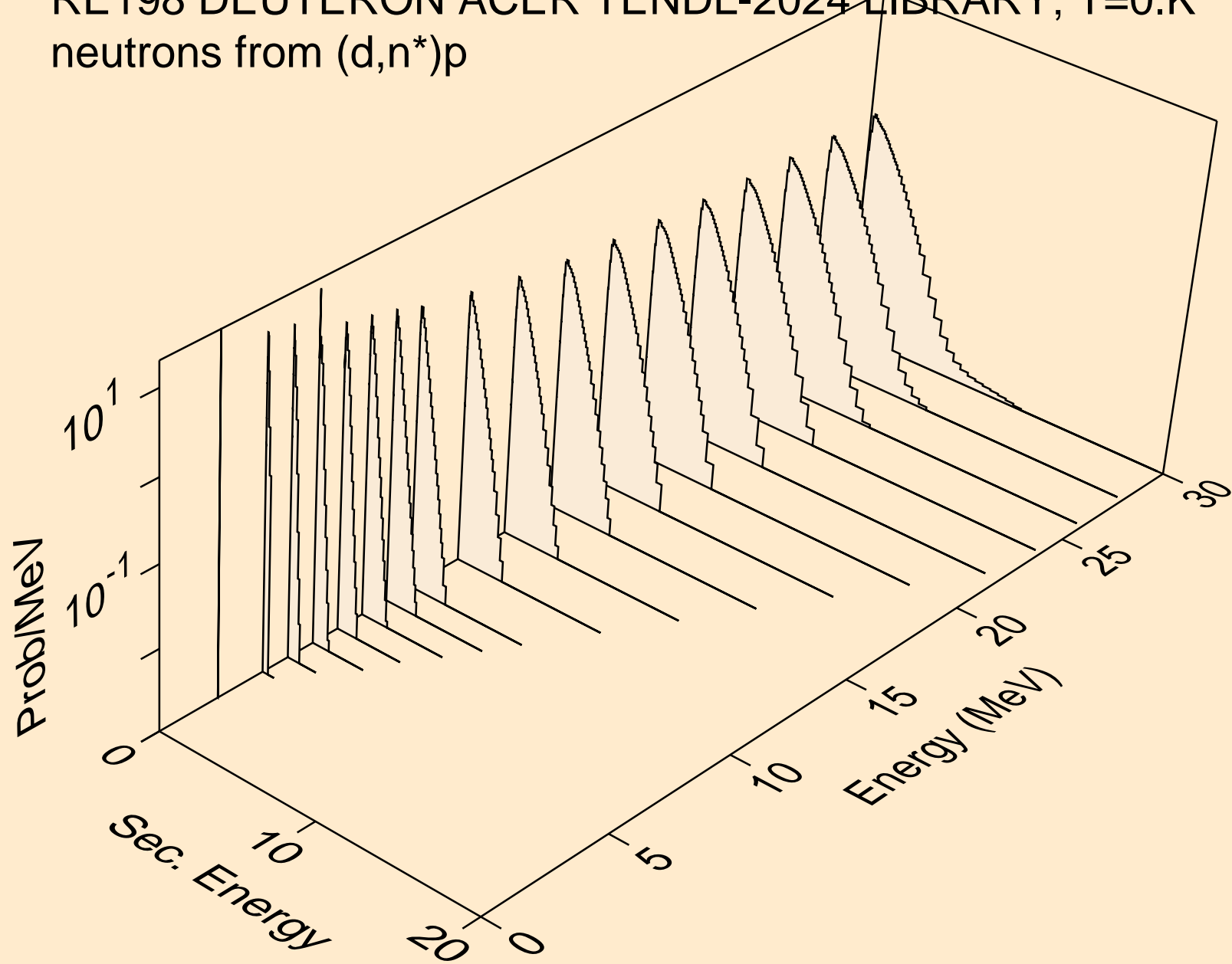

RE198 DEUTERON ACER TENDL-2024 LIBRARY; T=0.K  
neutrons from (d,n\*)d

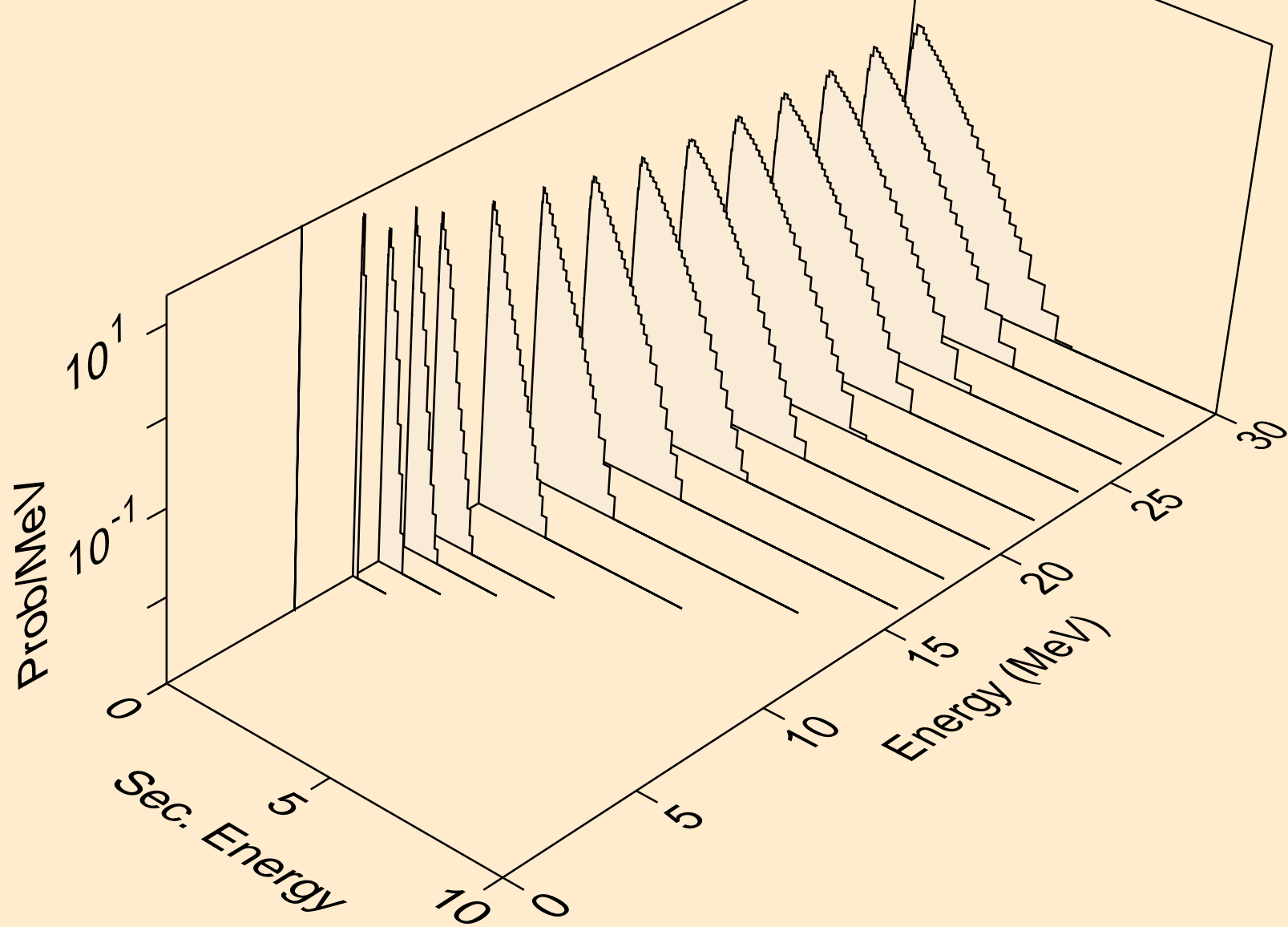

RE198 DEUTERON ACER TENDL-2024 LIBRARY; T=0.K  
neutrons from (d,n\*)t

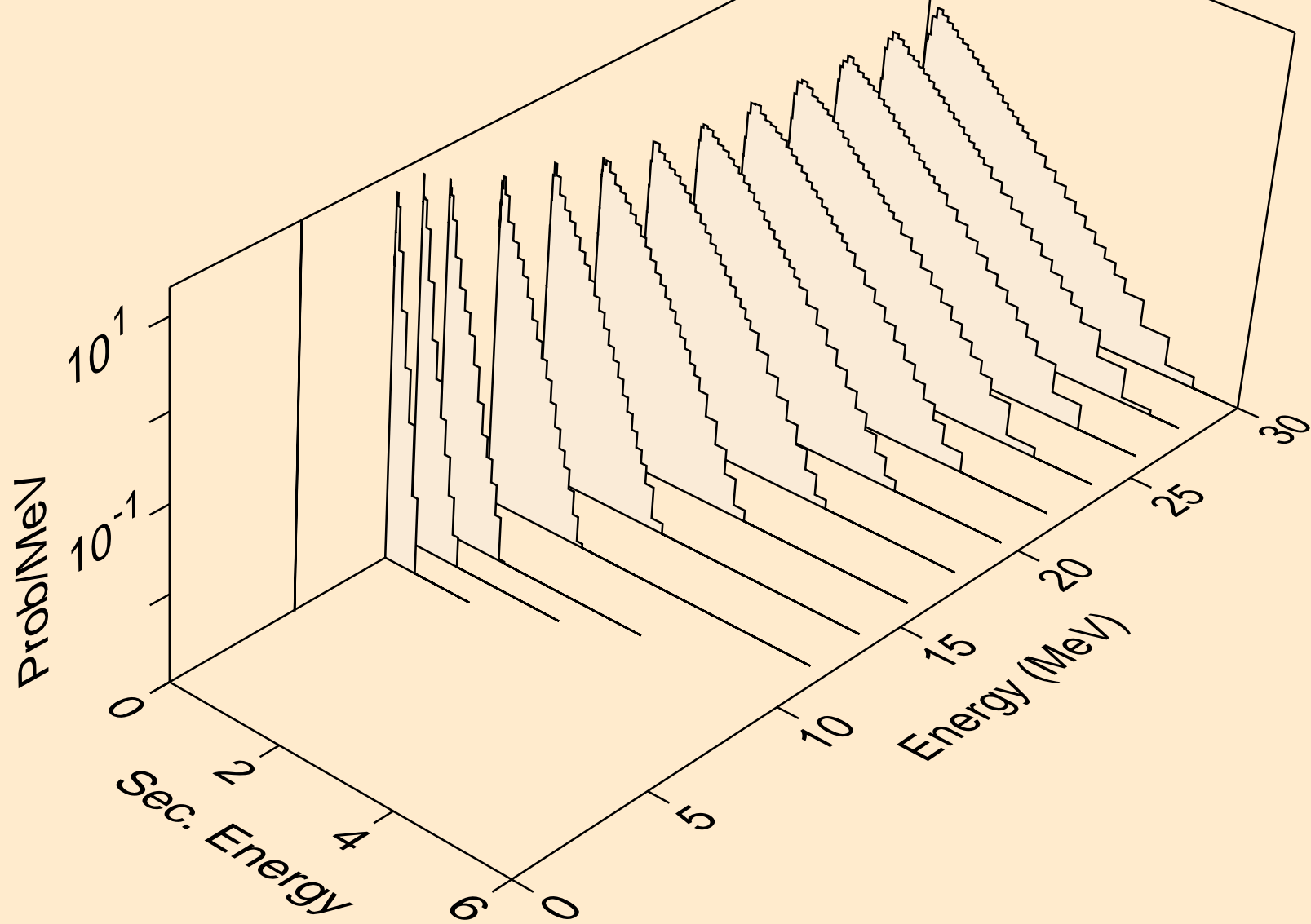

RE198 DEUTERON ACER TENDL-2024 LIBRARY; T=0.K  
neutrons from (d,n\*)he3

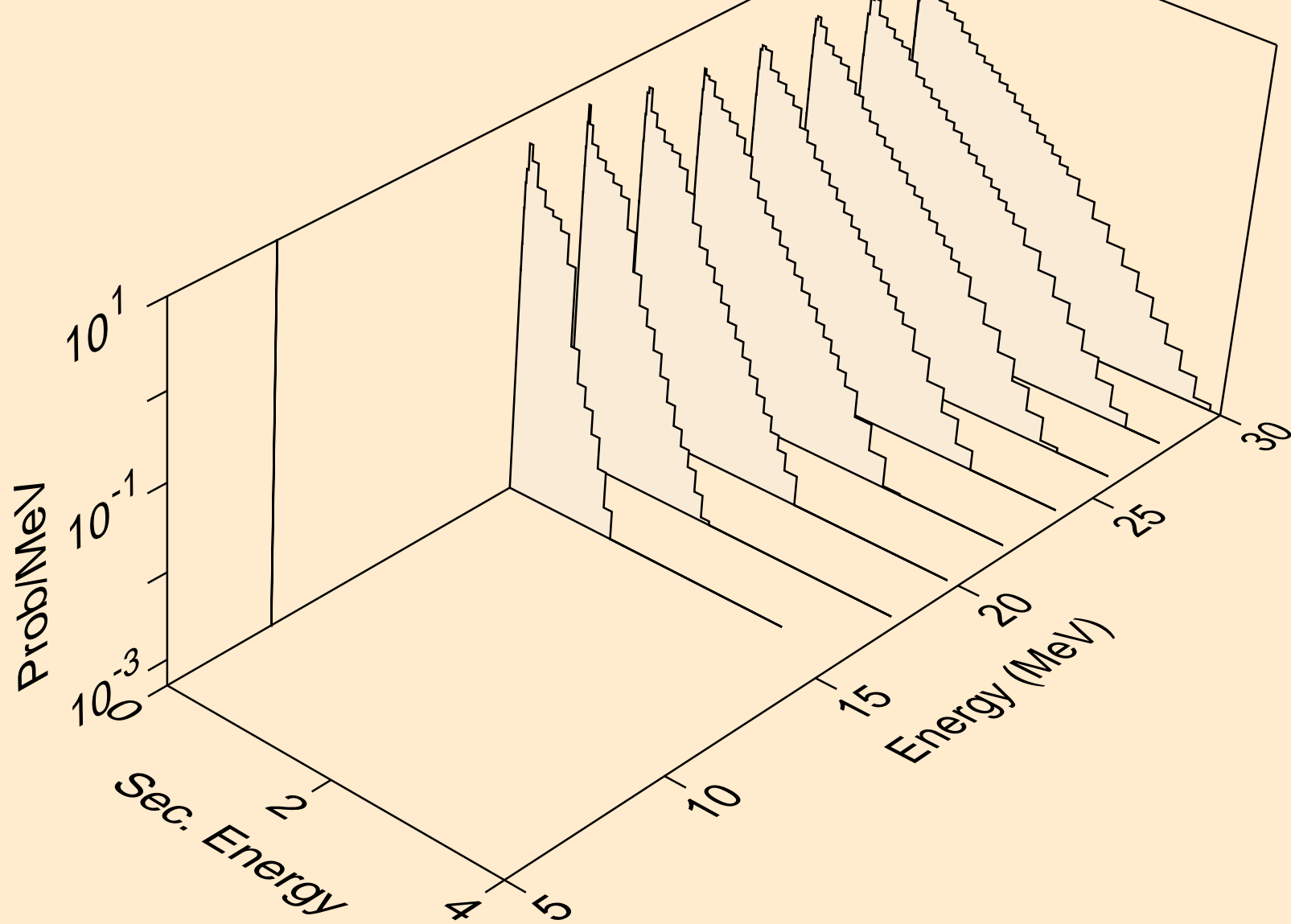

RE198 DEUTERON ACER TENDL-2024 LIBRARY; T=0.K  
neutrons from (d,4n)

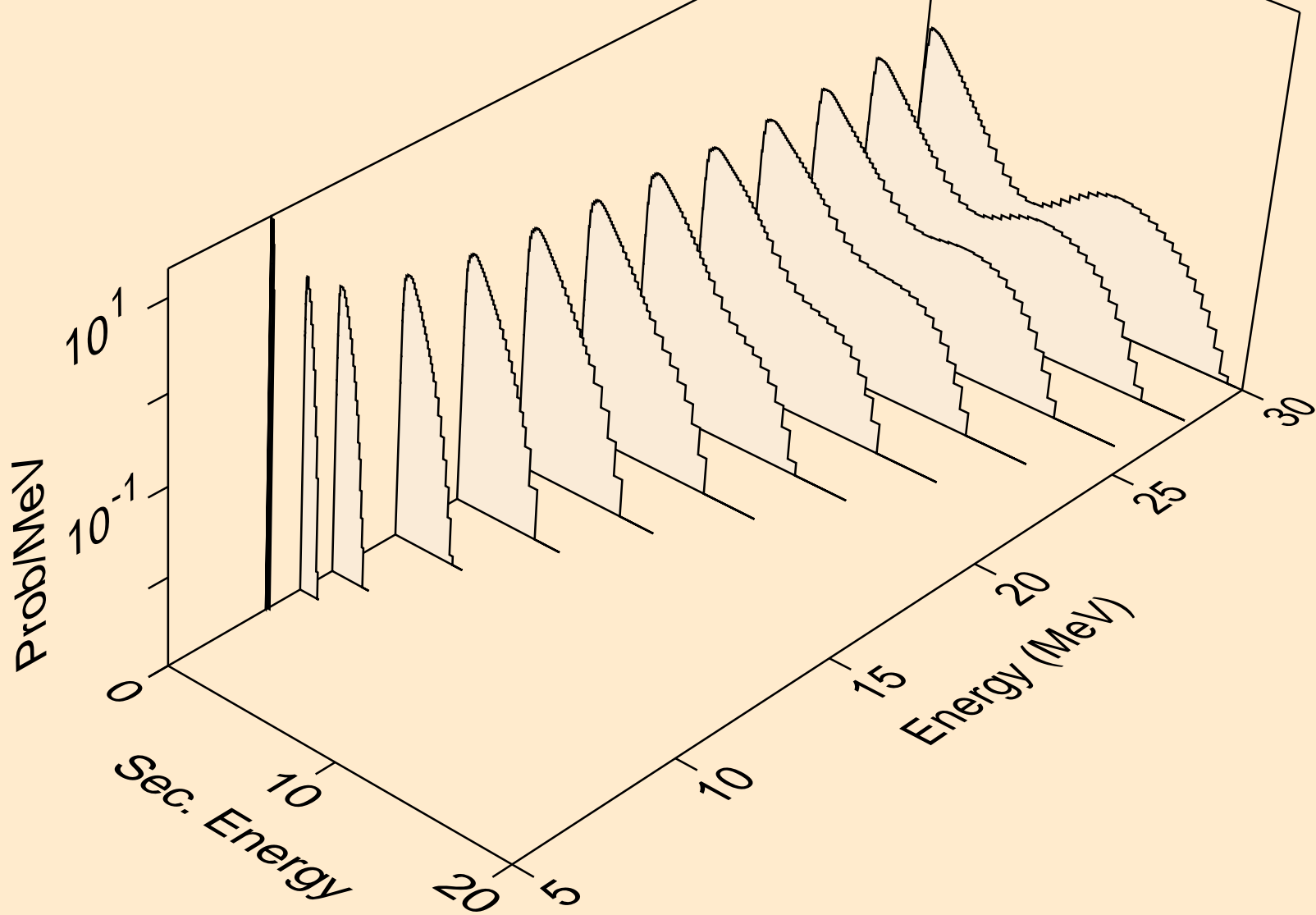

RE198 DEUTERON ACER TENDL-2024 LIBRARY; T=0.K  
neutrons from (d,2np)

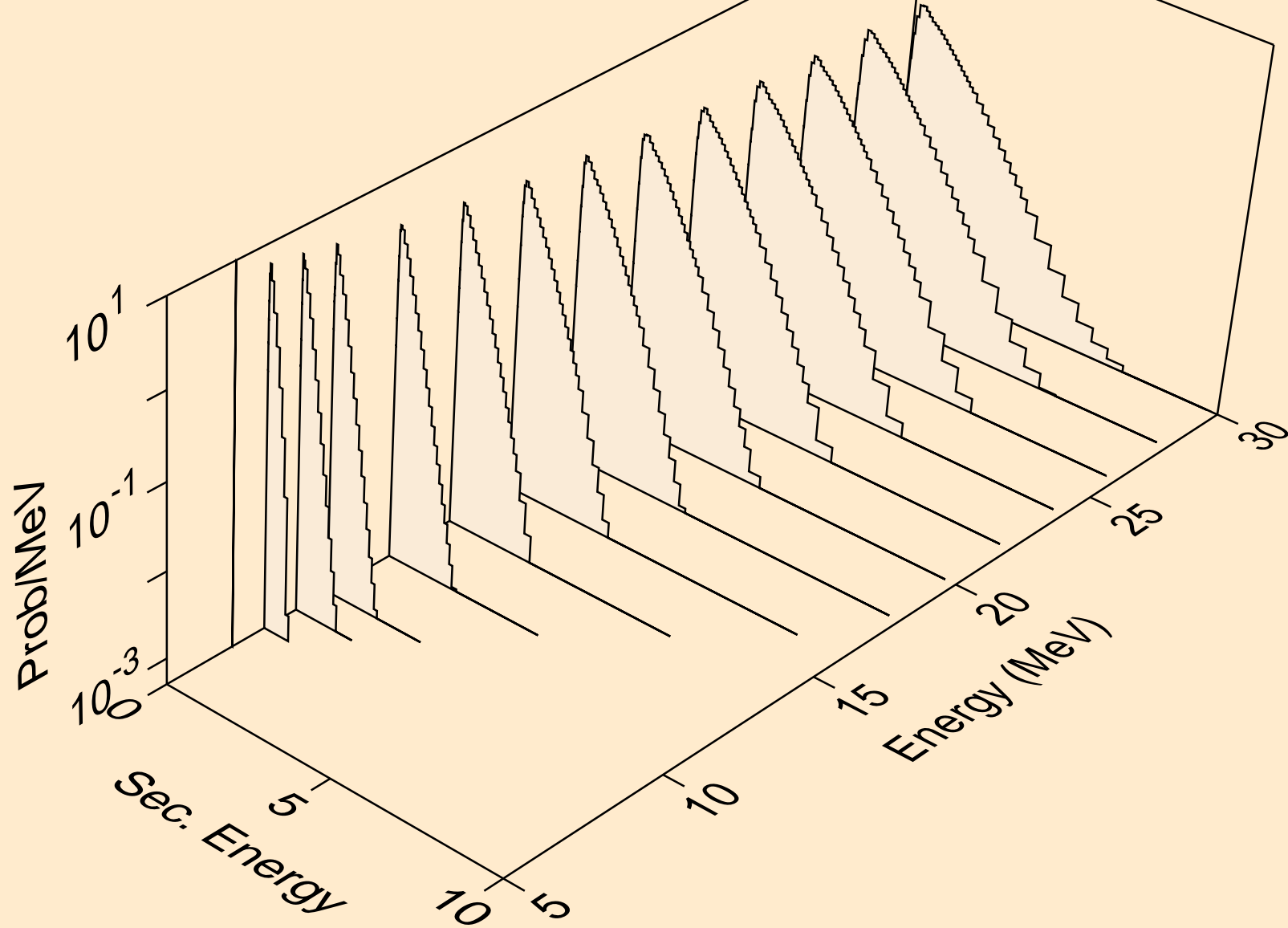

RE198 DEUTERON ACER TENDL-2024 LIBRARY; T=0.K  
neutrons from (d,3np)

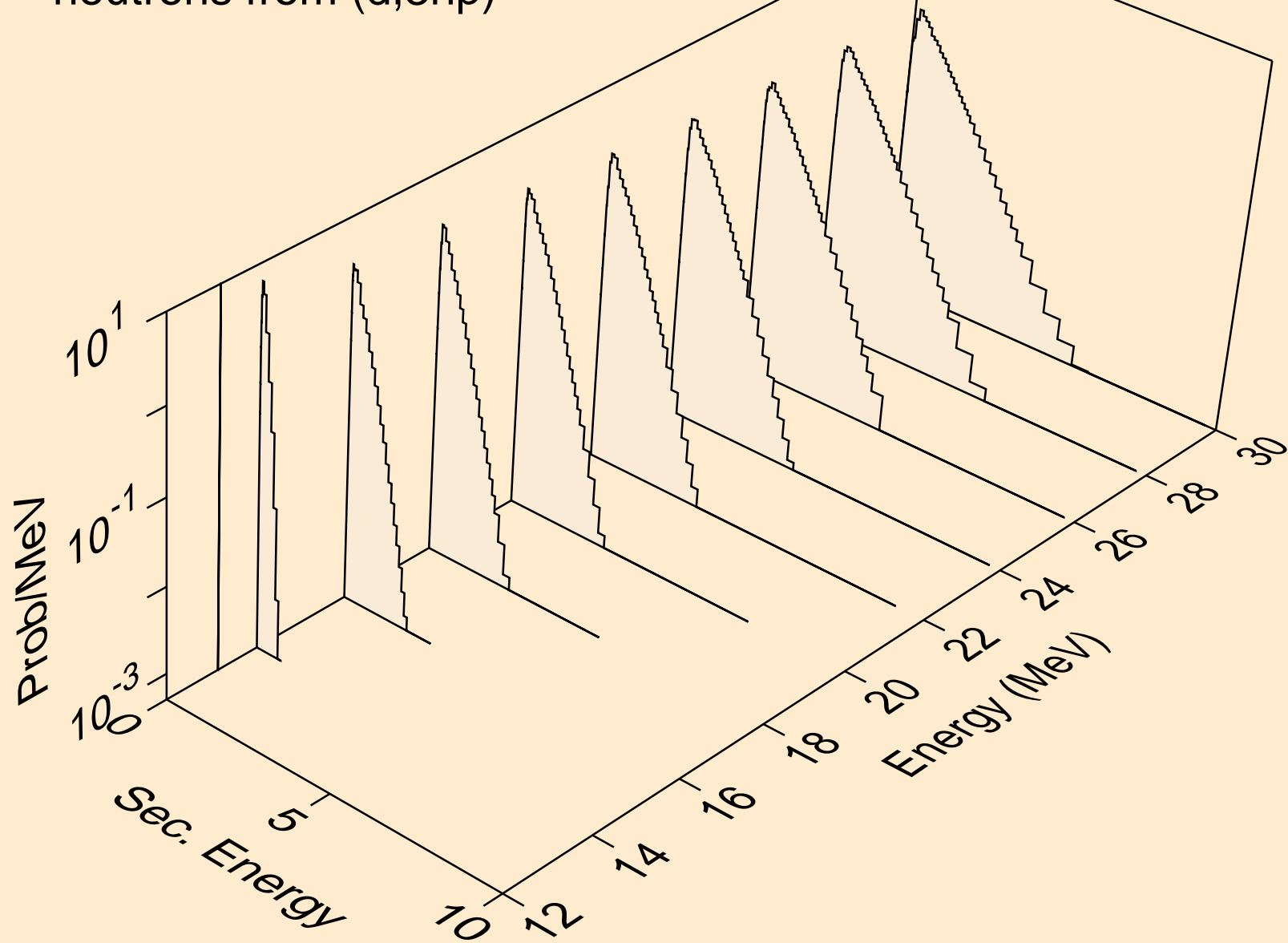

RE198 DEUTERON ACER TENDL-2024 LIBRARY; T=0.K  
neutrons from (d,n2p)

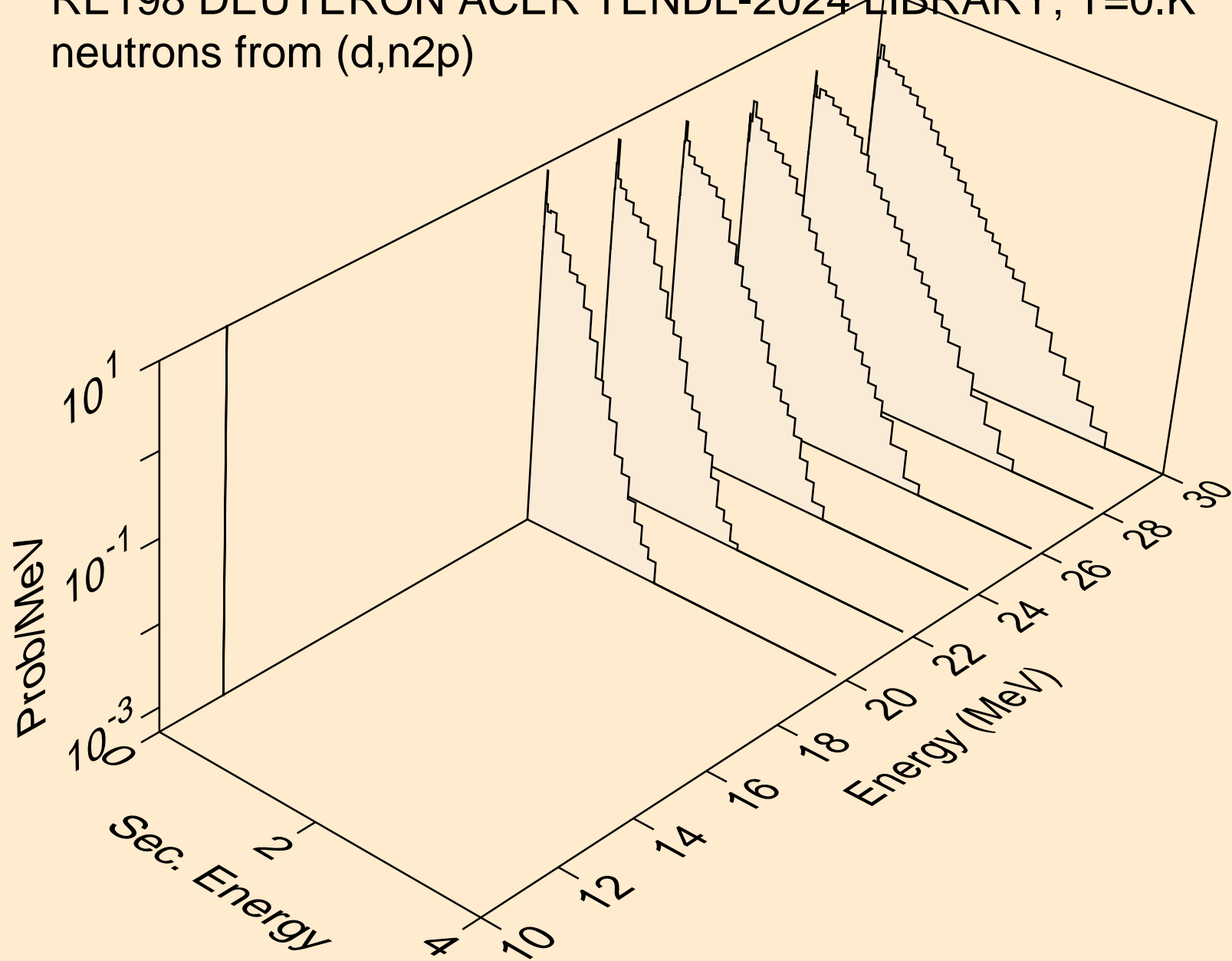

RE198 DEUTERON ACER TENDL-2024 LIBRARY; T=0.K  
protons from (d,x)

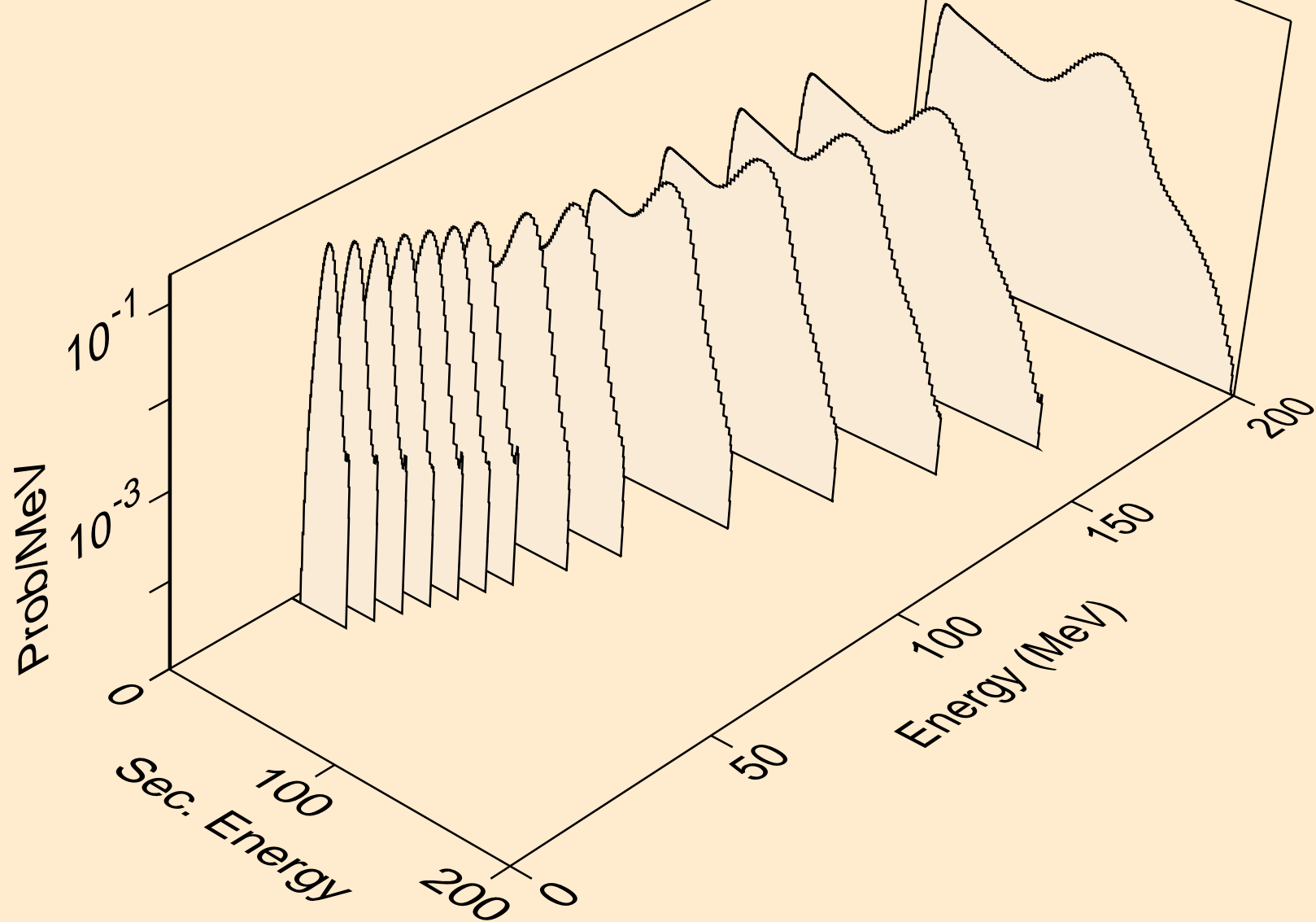

RE198 DEUTERON ACER TENDL-2024 LIBRARY; T=0.K  
protons from (d,n\*)p

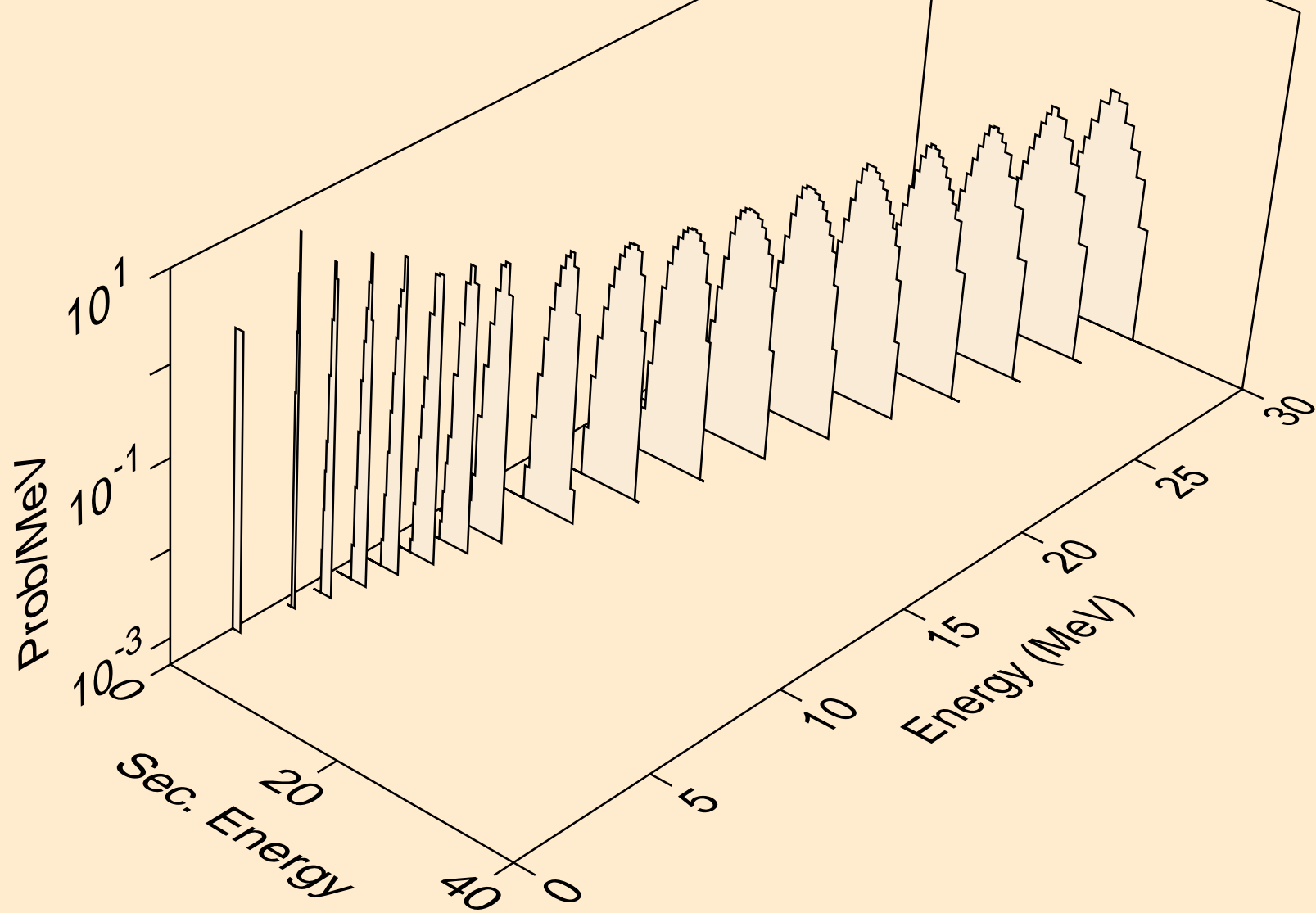

RE198 DEUTERON ACER TENDL-2024 LIBRARY; T=0.K  
protons from (d,2np)

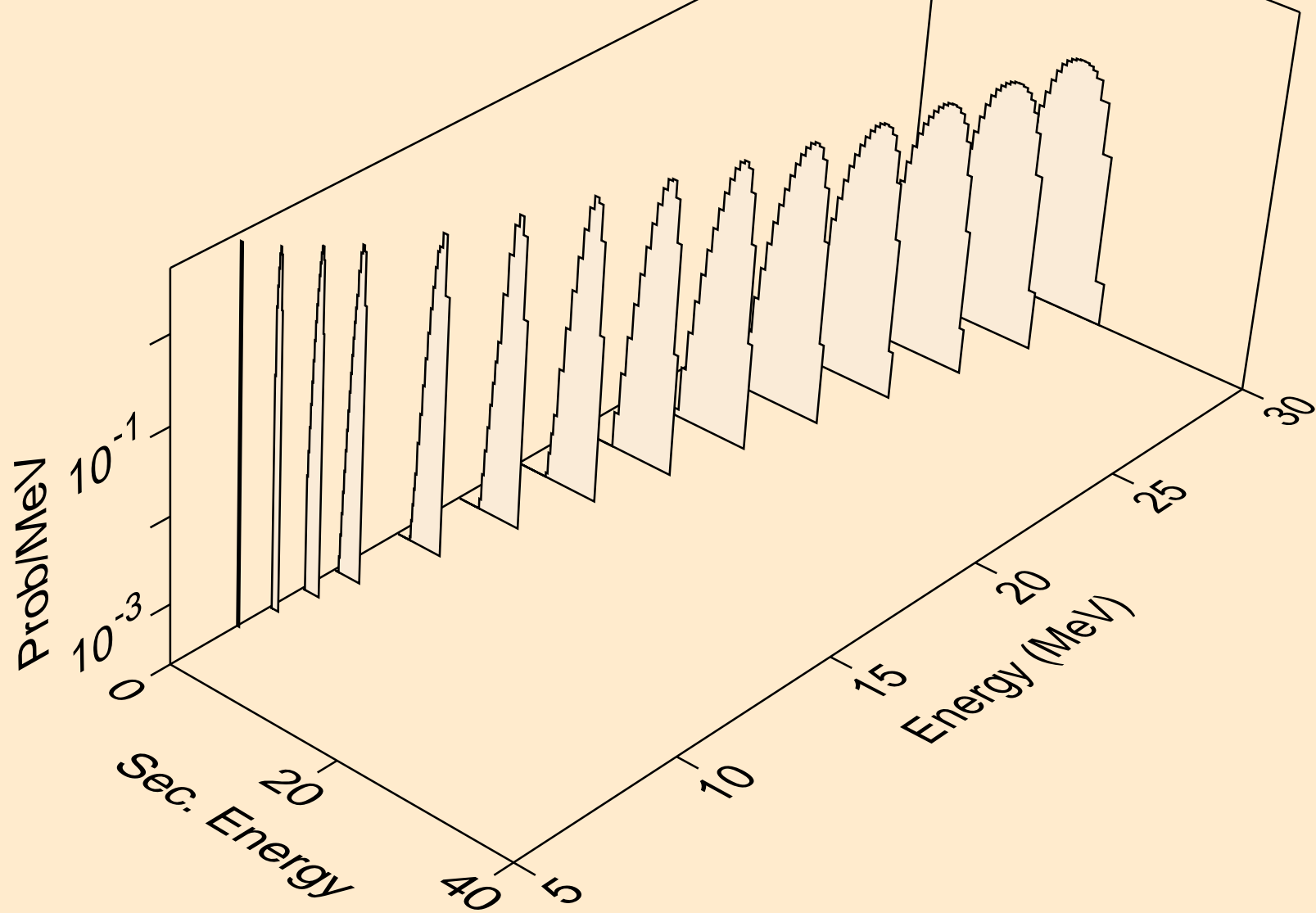

RE198 DEUTERON ACER TENDL-2024 LIBRARY; T=0.K  
protons from (d,3np)

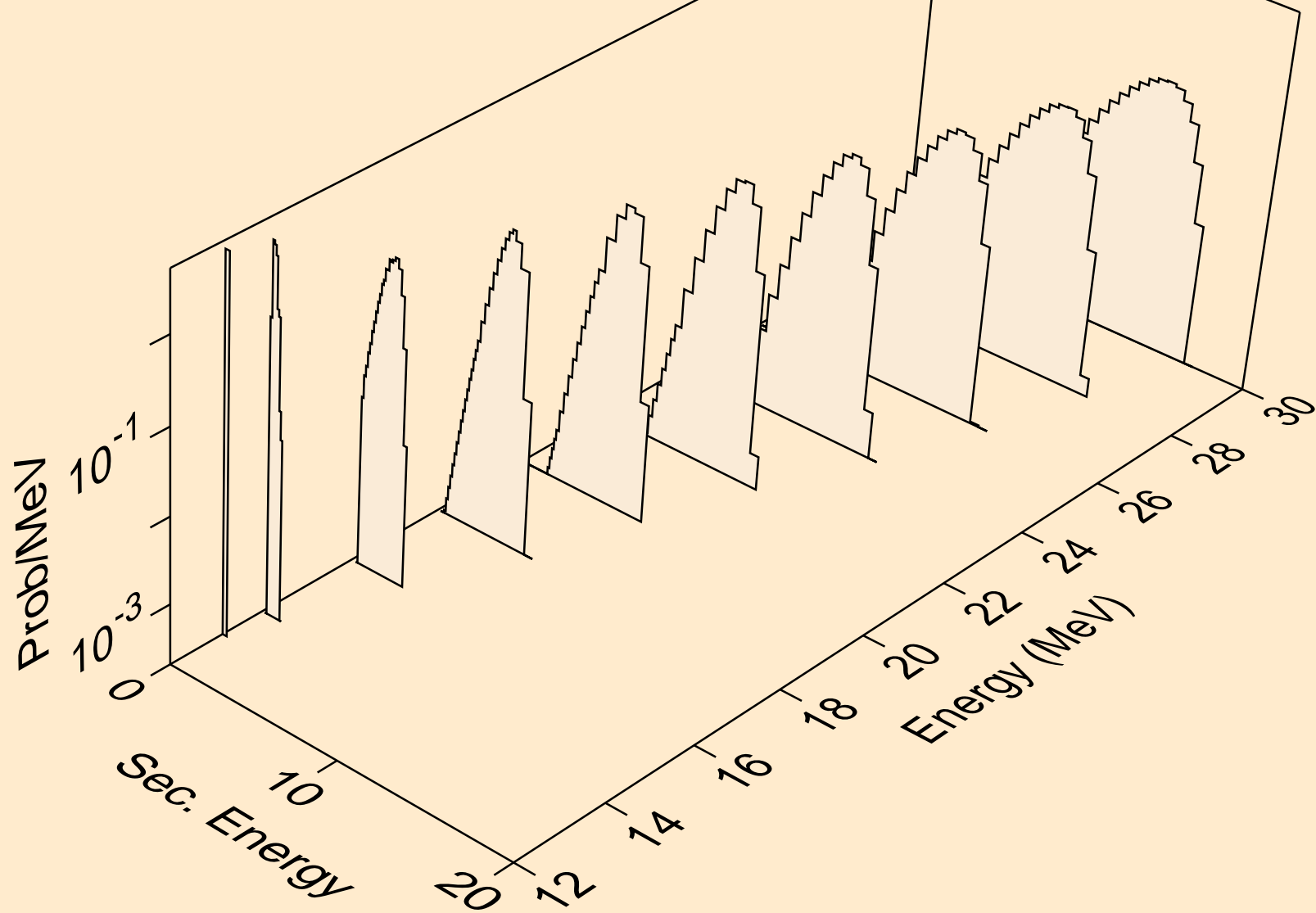

RE198 DEUTERON ACER TENDL-2024 LIBRARY; T=0.K  
protons from (d,n2p)

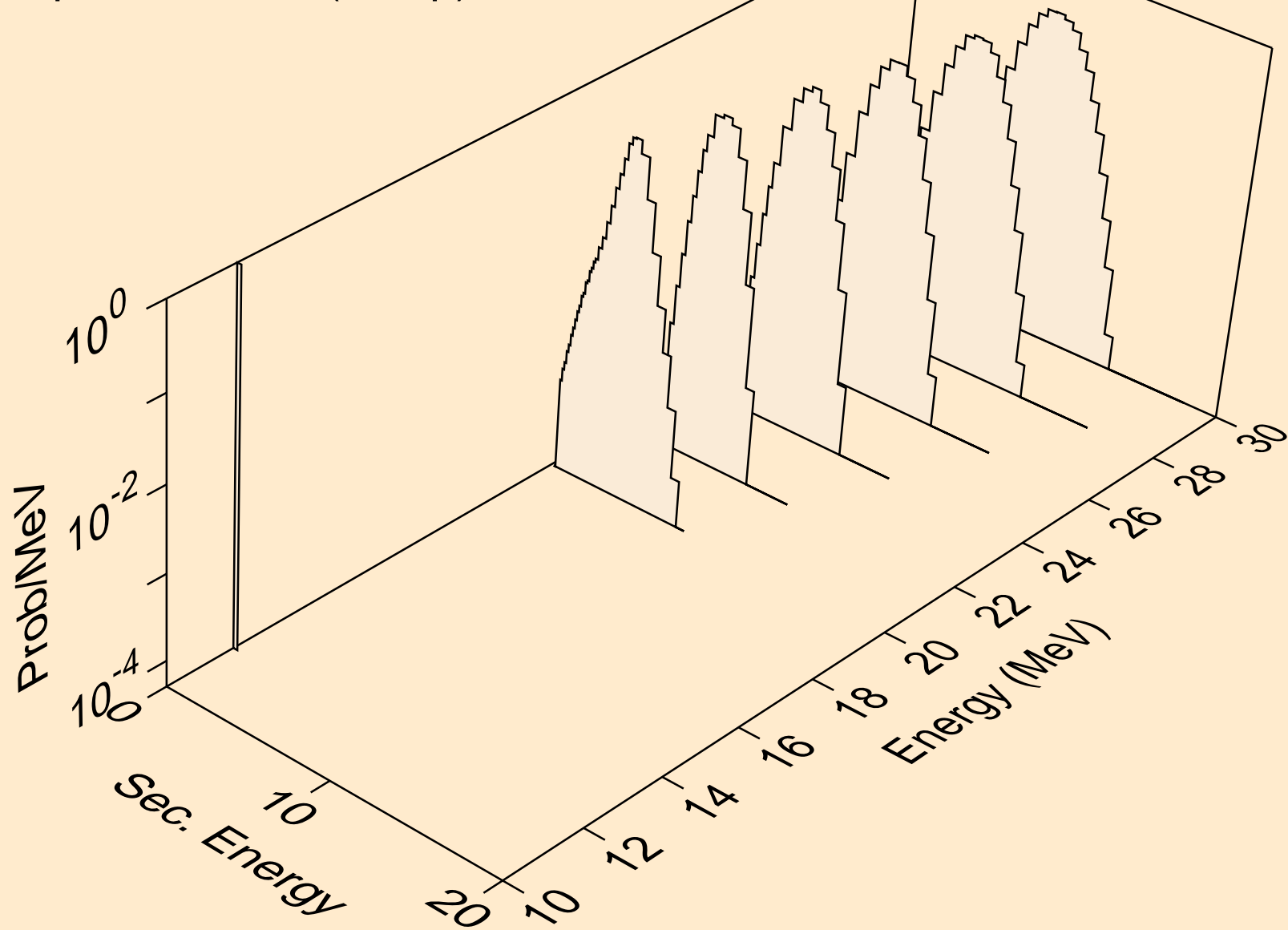

RE198 DEUTERON ACER TENDL-2024 LIBRARY; T=0.K  
protons from (d,p)

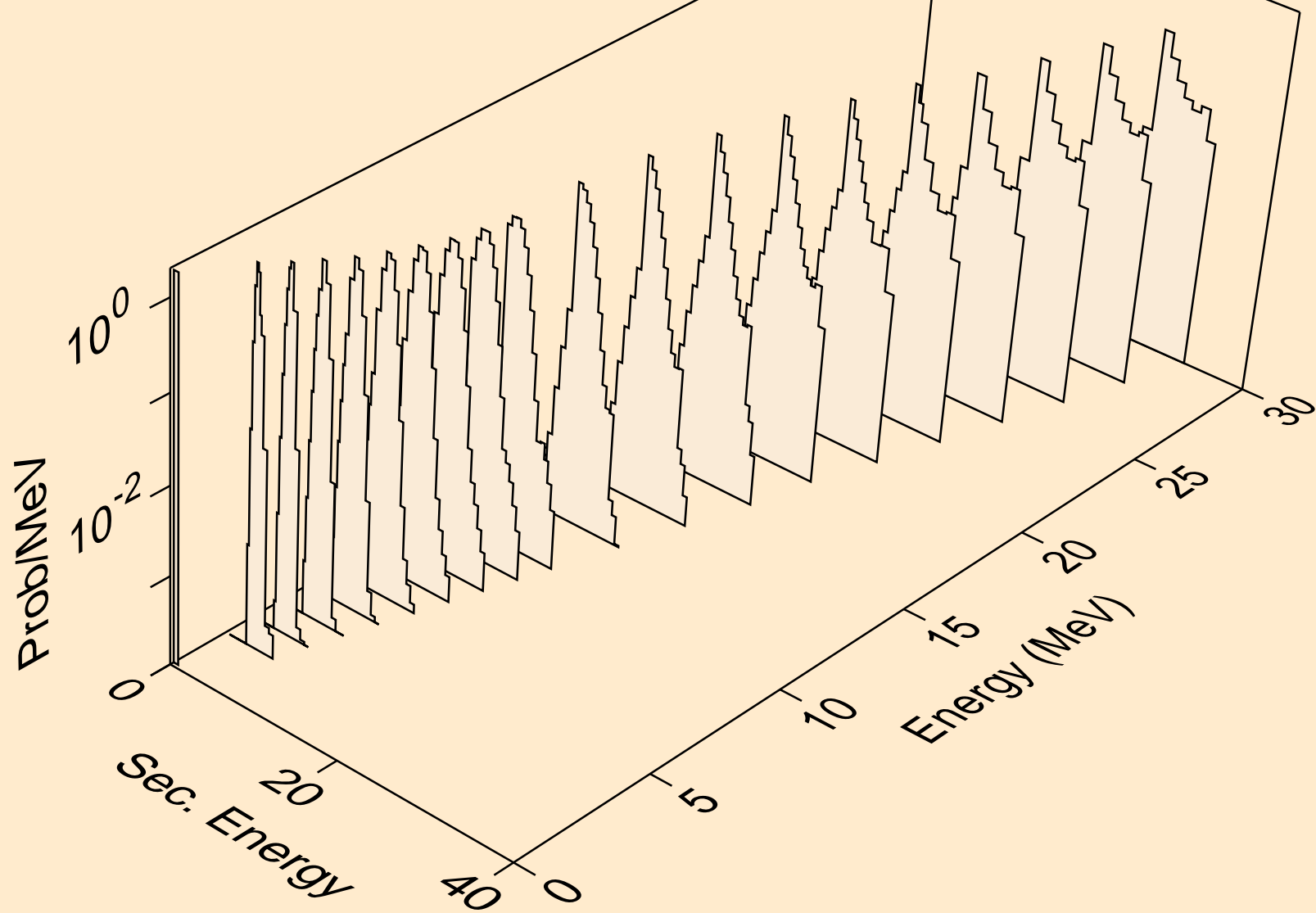

RE198 DEUTERON ACER TENDL-2024 LIBRARY; T=0.K  
protons from (d,2p)

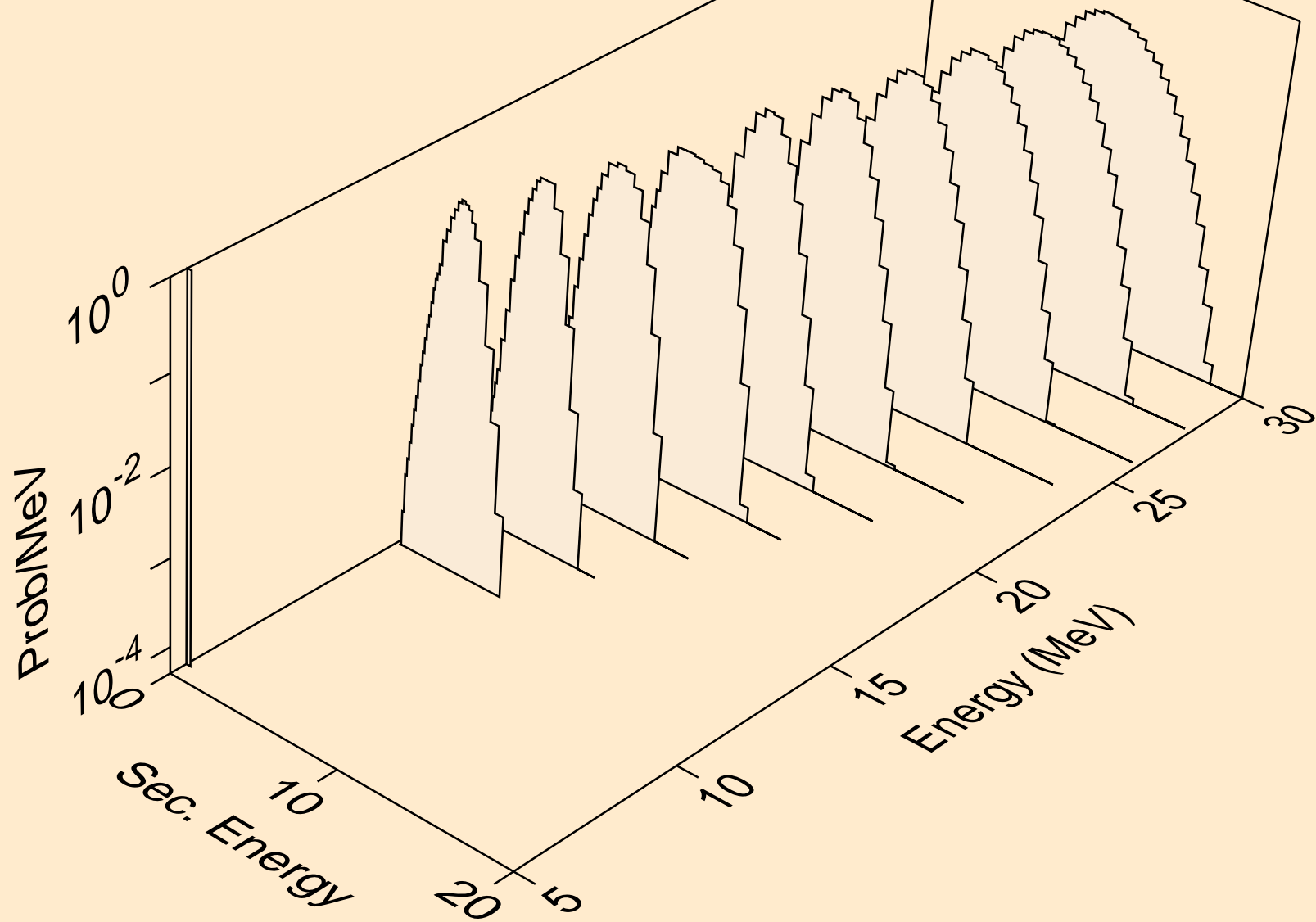

RE198 DEUTERON ACER TENDL-2024 LIBRARY; T=0.K  
protons from (d,pd)

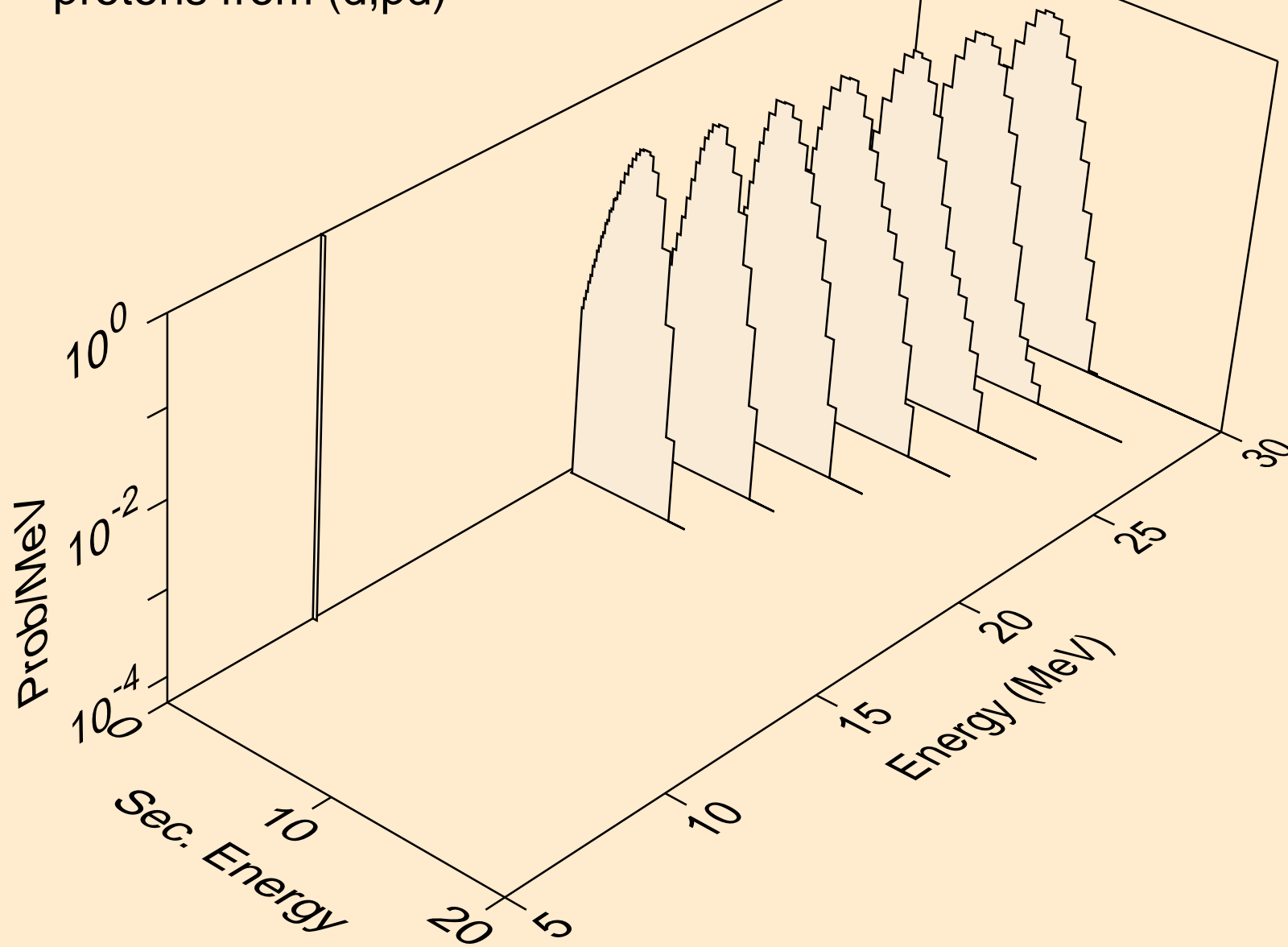

RE198 DEUTERON ACER TENDL-2024 LIBRARY; T=0.K  
tritons from (d,x)

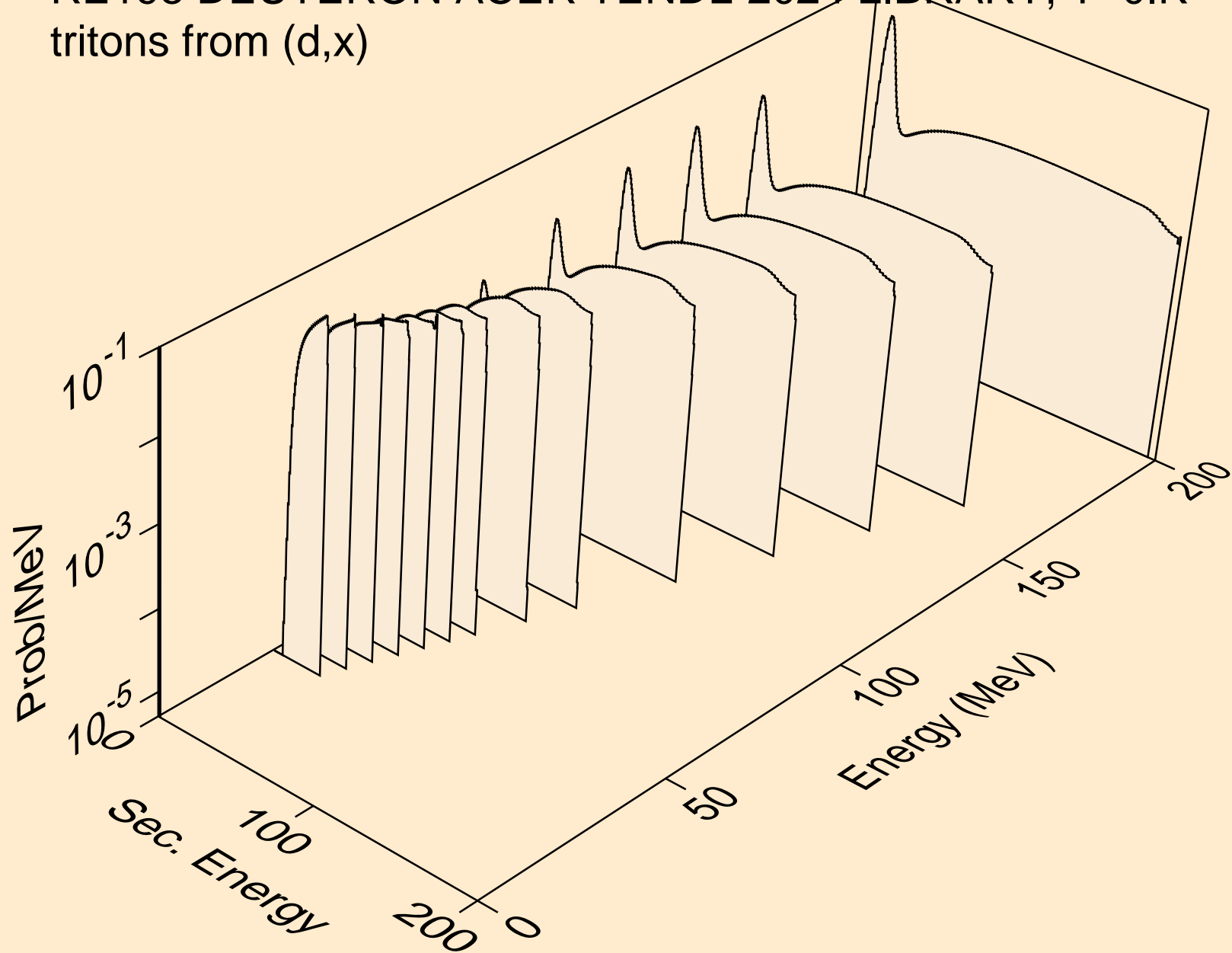

RE198 DEUTERON ACER TENDL-2024 LIBRARY; T=0.K  
tritons from (d,n\*)t

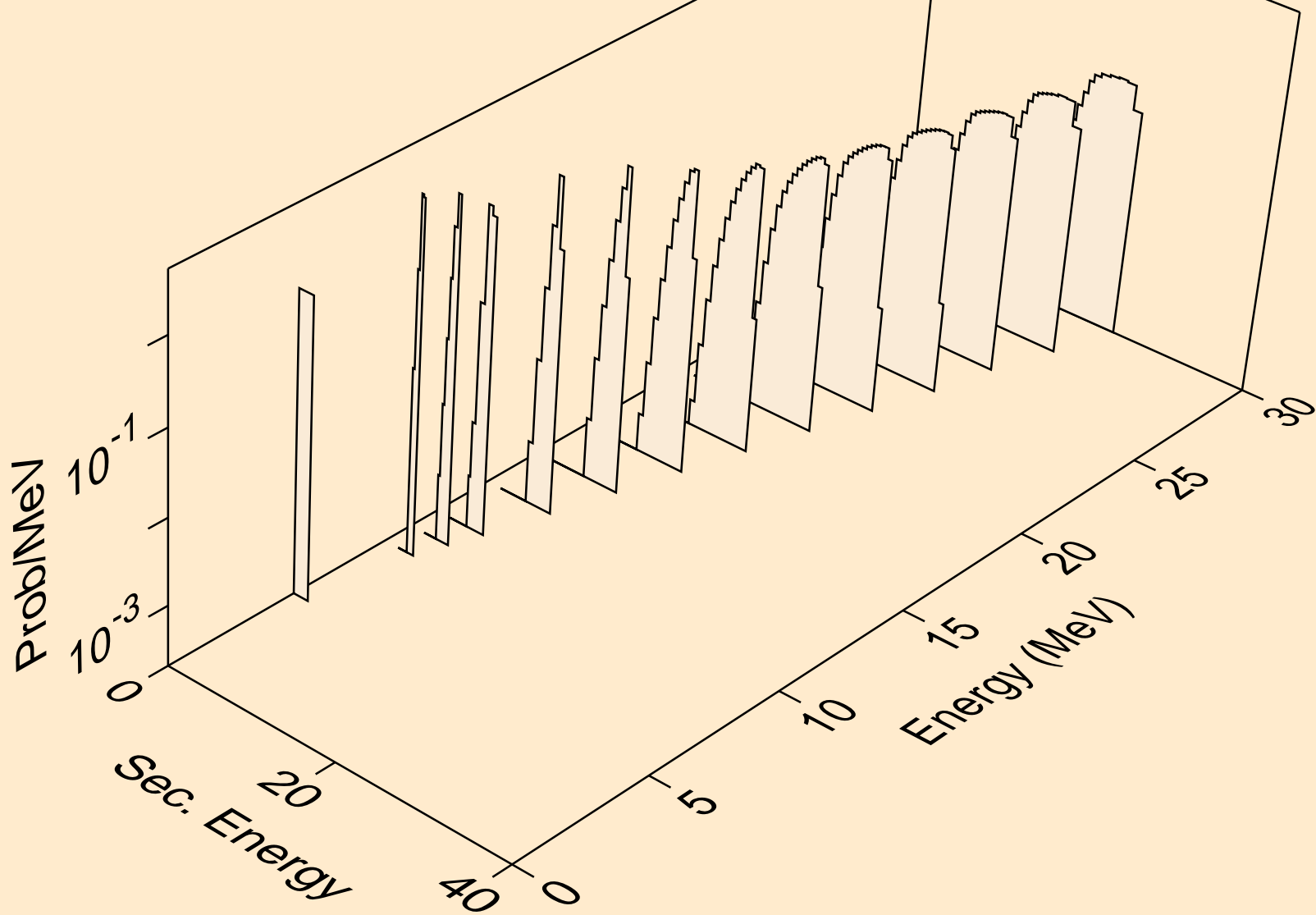

RE198 DEUTERON ACER TENDL-2024 LIBRARY; T=0.K  
tritons from (d,t)

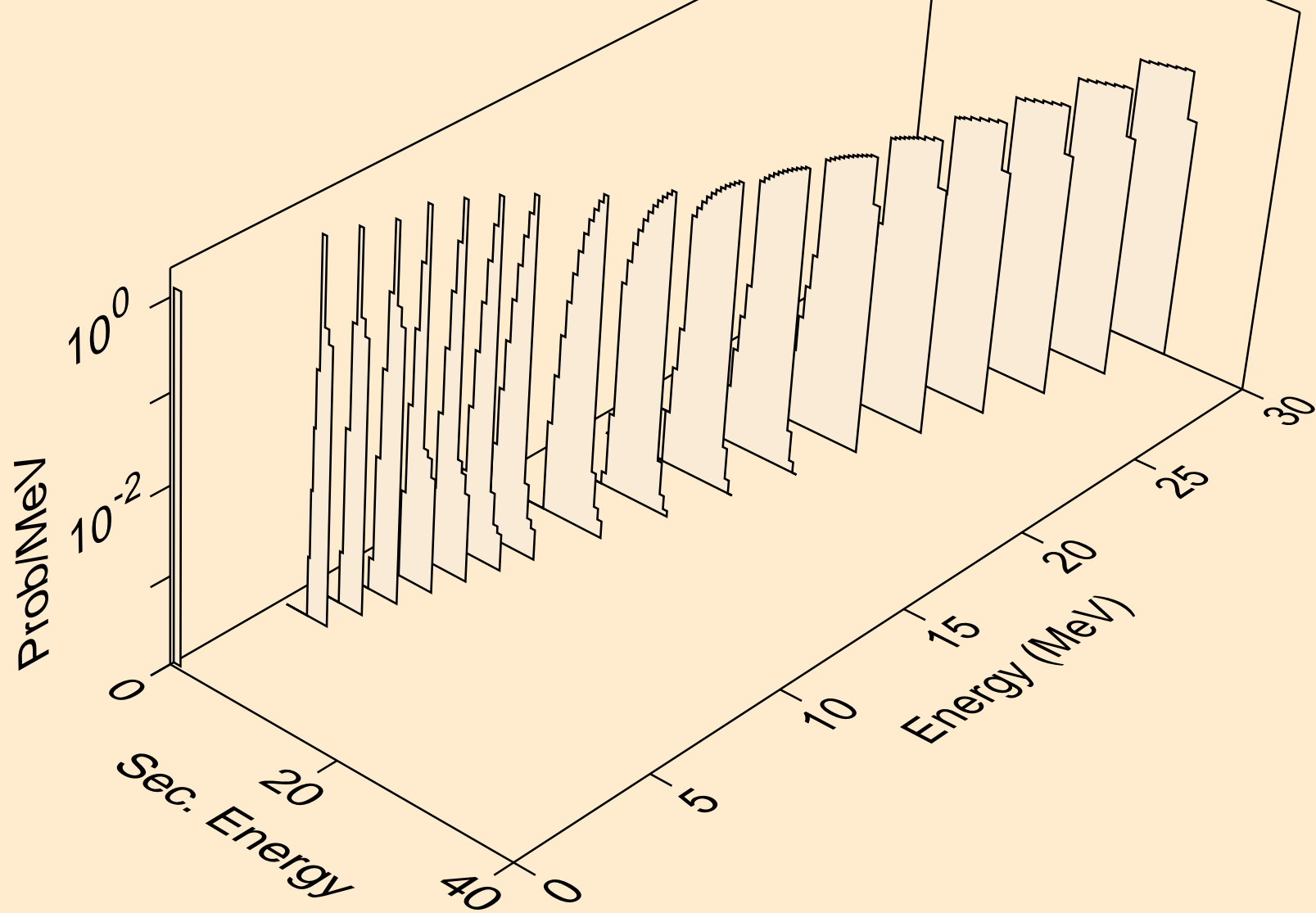

RE198 DEUTERON ACER TENDL-2024 LIBRARY; T=0.K  
he3s from (d,x)

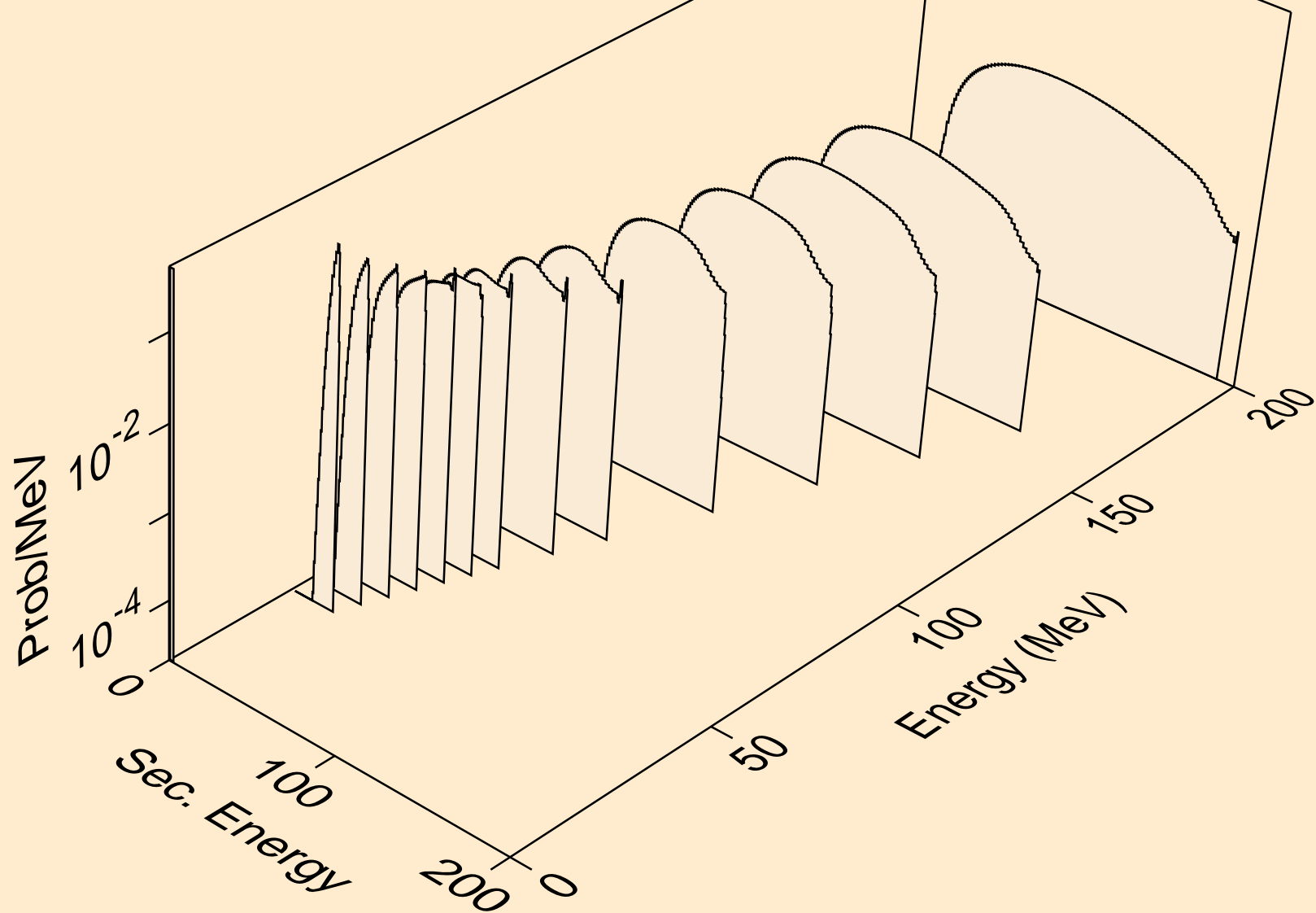

RE198 DEUTERON ACER TENDL-2024 LIBRARY; T=0.K  
he3s from (d,n\*)he3

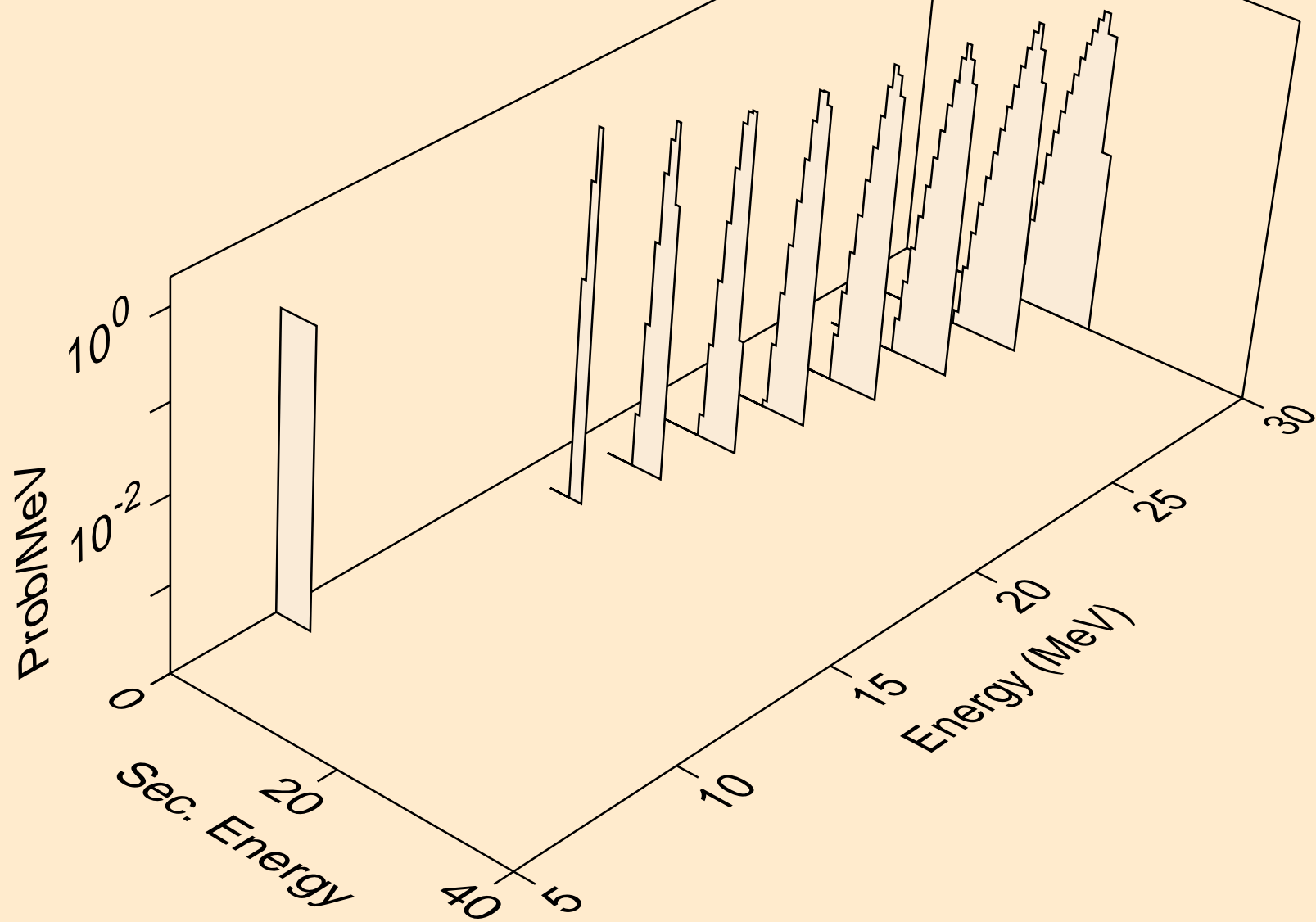

RE198 DEUTERON ACER TENDL-2024 LIBRARY; T=0.K  
he3s from (d,he3)

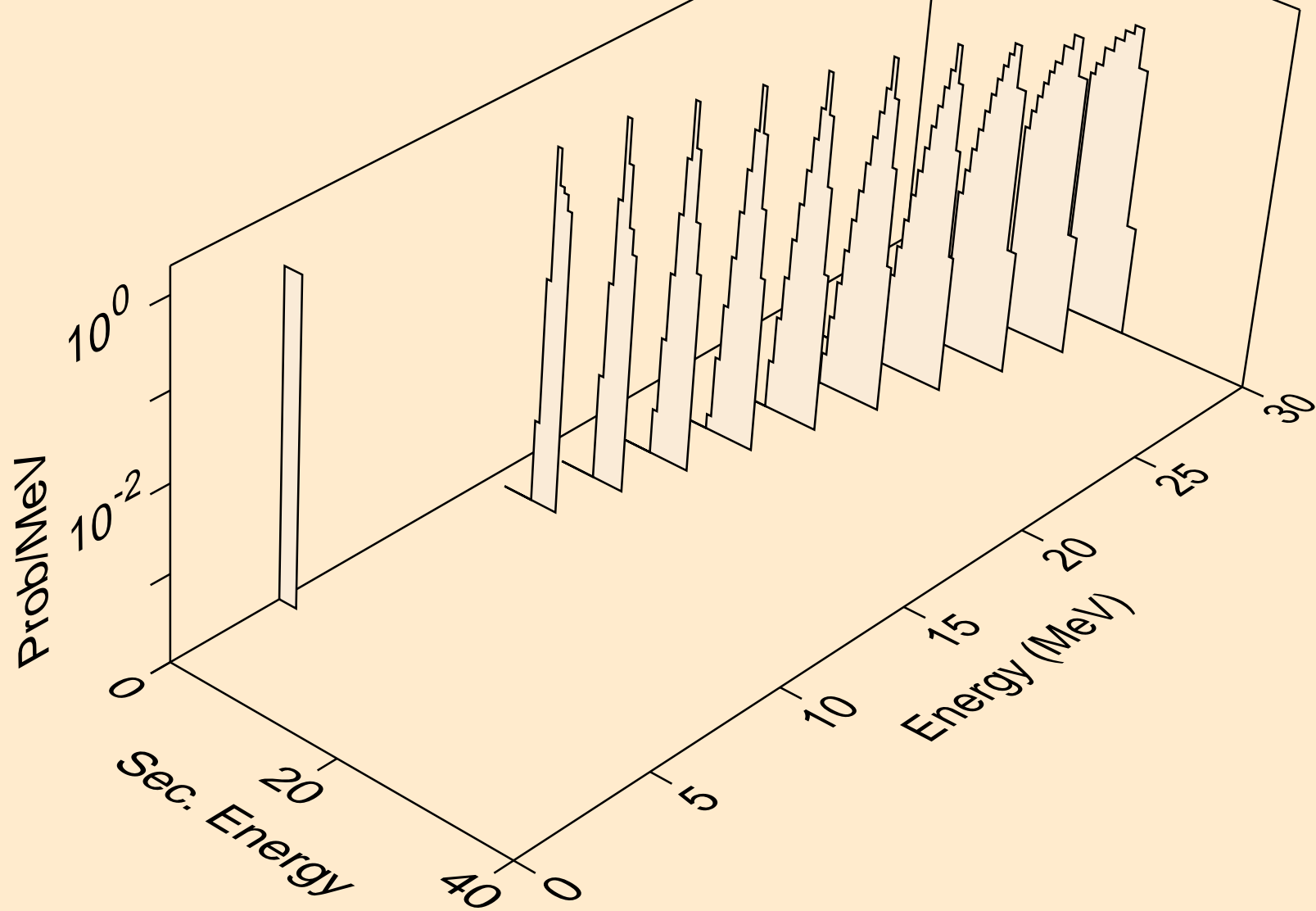

RE198 DEUTERON ACER TENDL-2024 LIBRARY; T=0.K  
alphas from (d,x)

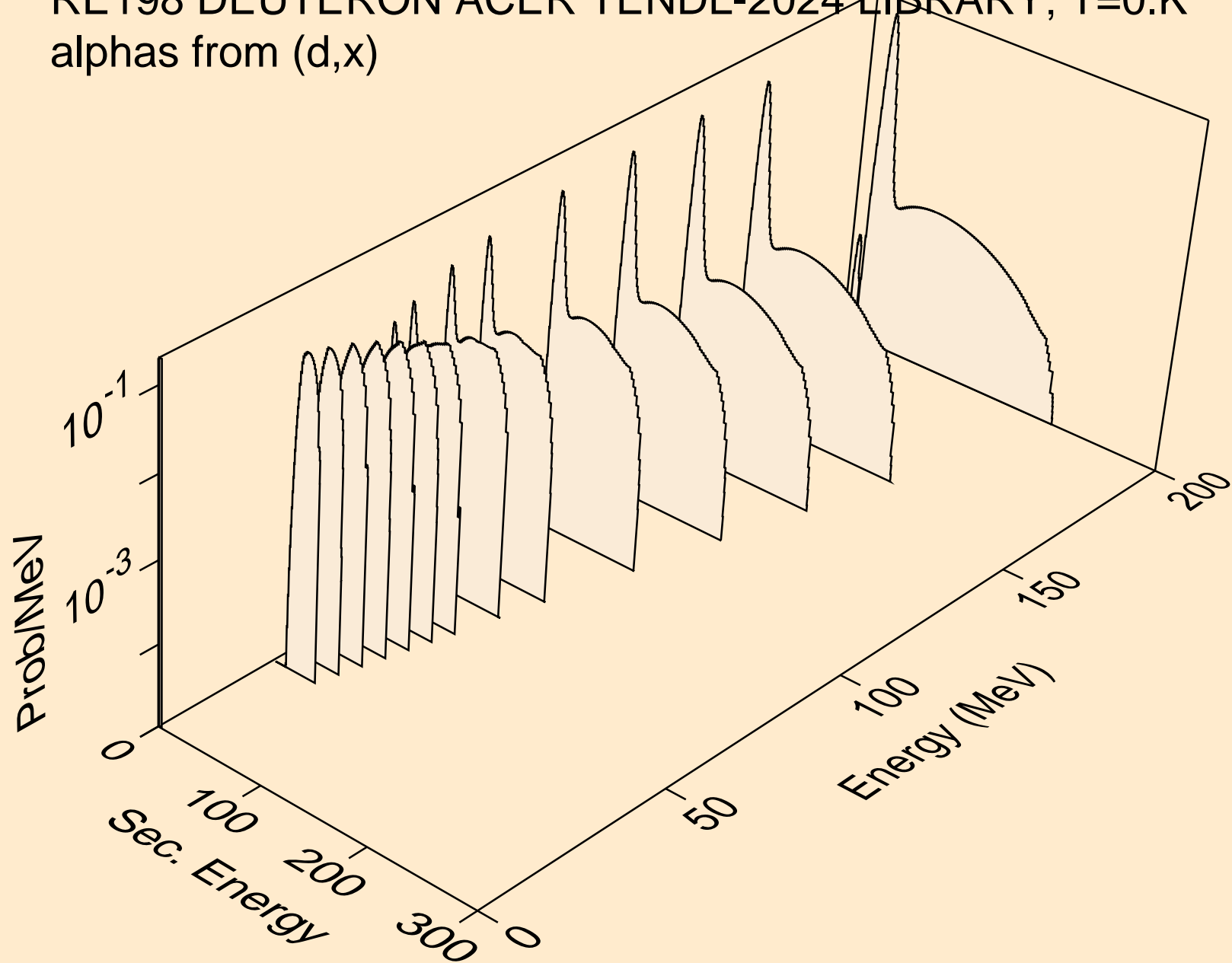

RE198 DEUTERON ACER TENDL-2024 LIBRARY; T=0.K  
alphas from (d,n\*)a

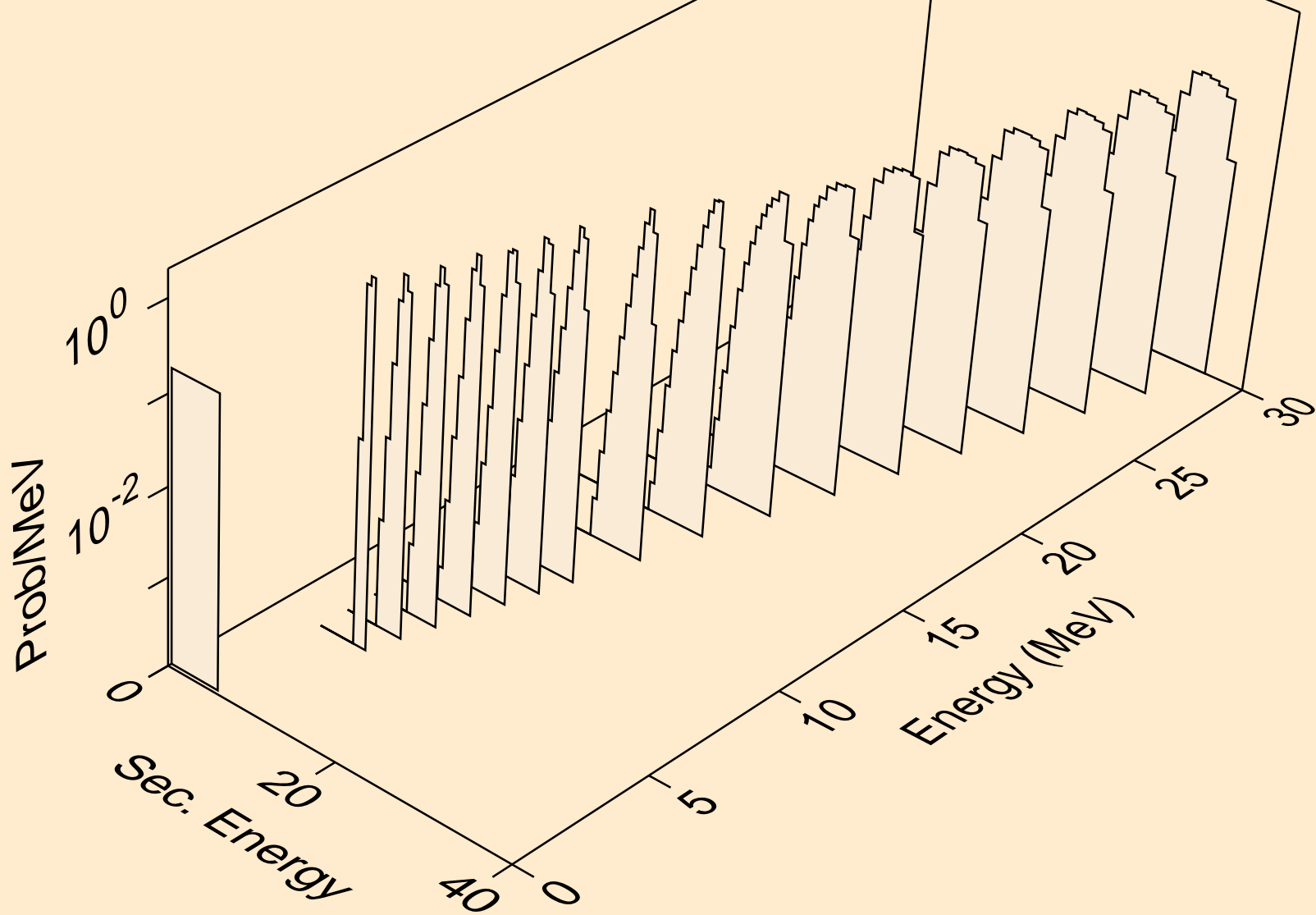

RE198 DEUTERON ACER TENDL-2024 LIBRARY; T=0.K  
alphas from (d,2n)a

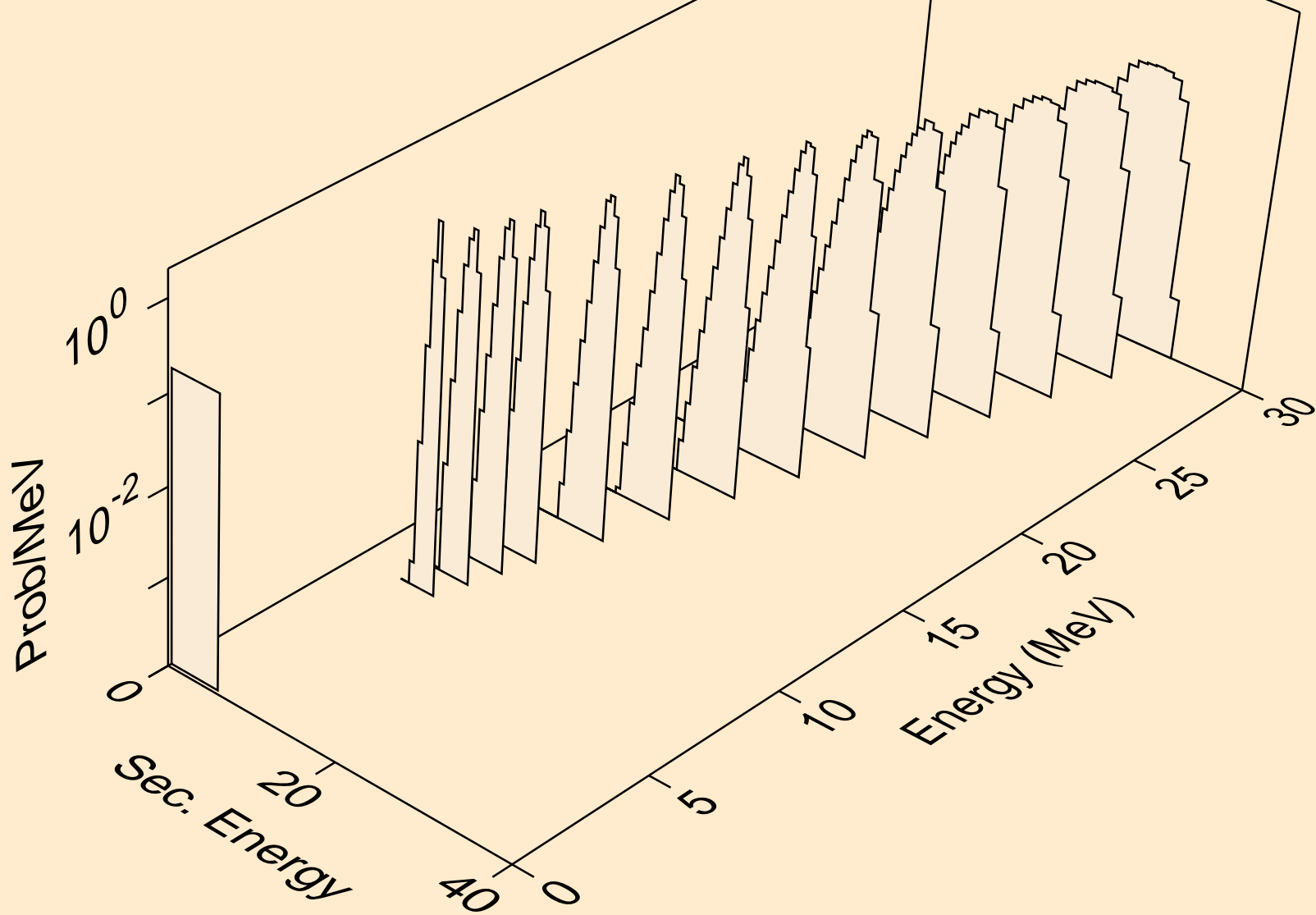

RE198 DEUTERON ACER TENDL-2024 LIBRARY; T=0.K  
alphas from (d,3n)a

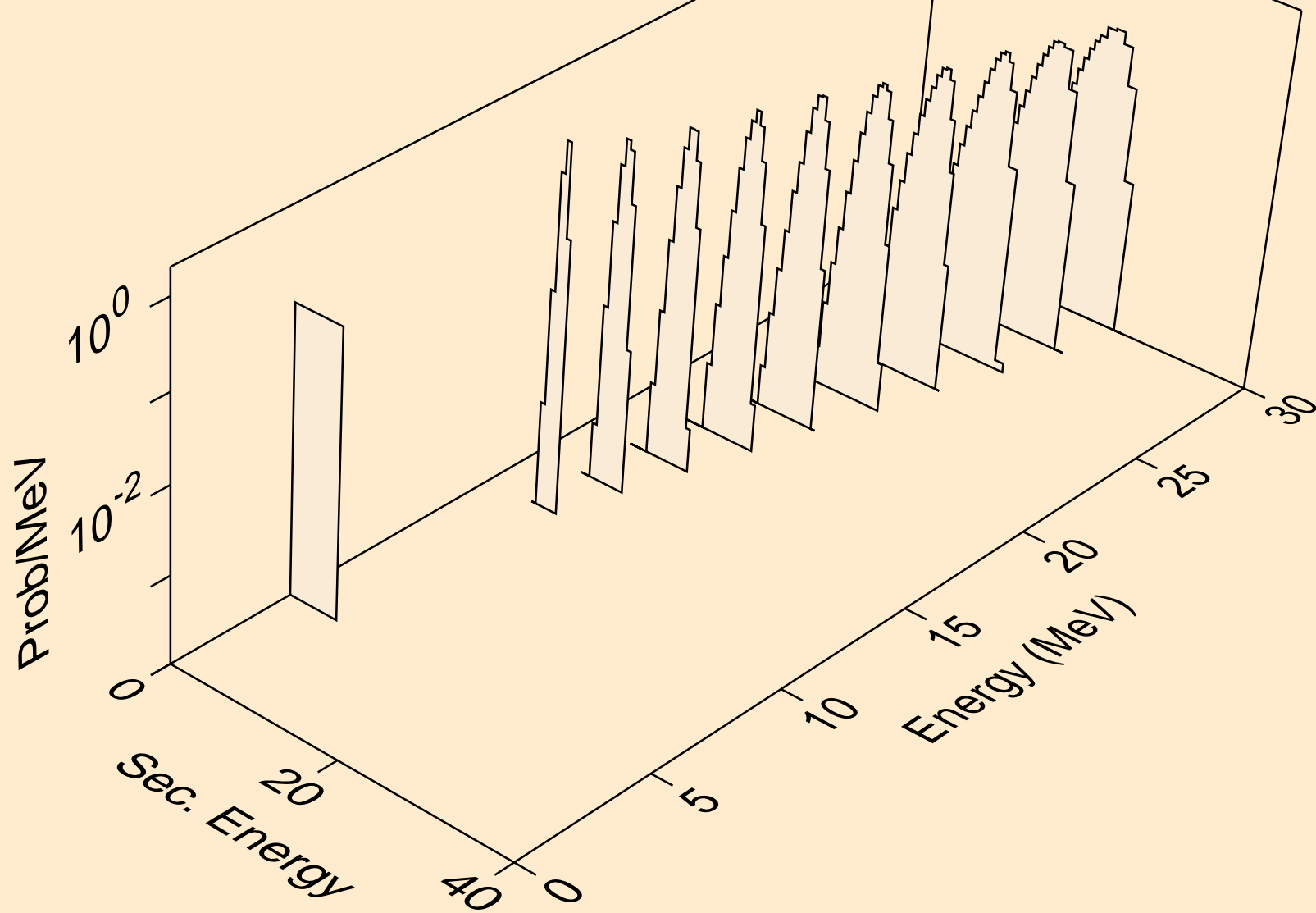

RE198 DEUTERON ACER TENDL-2024 LIBRARY; T=0.K  
alphas from (d,a)

