

TA192 DEUTERON ACER TENDL-2024 LIBRARY; T=0.K  
Principal cross sections

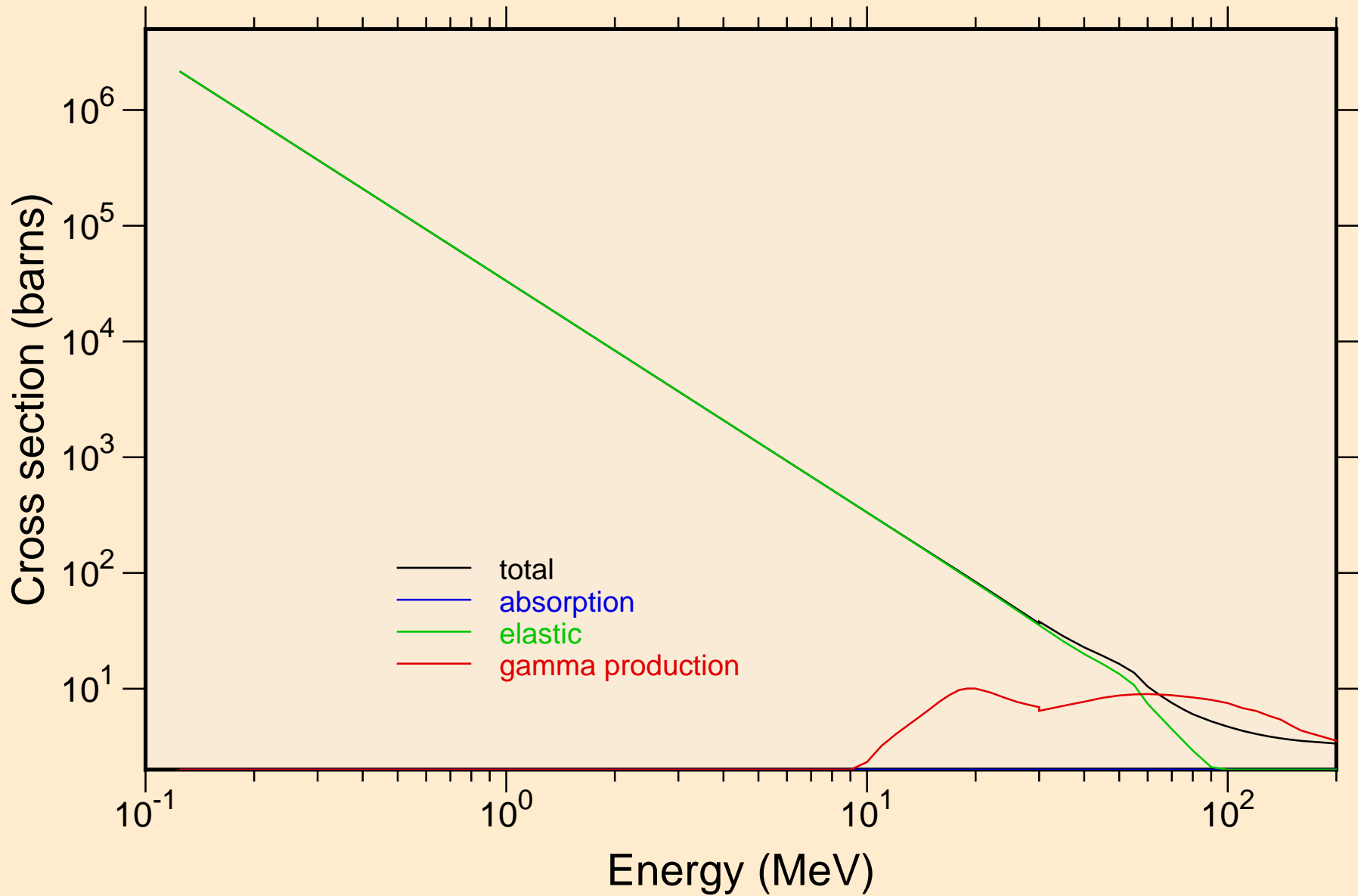

TA192 DEUTERON ACER TENDL-2024 LIBRARY; T=0.K  
Heating

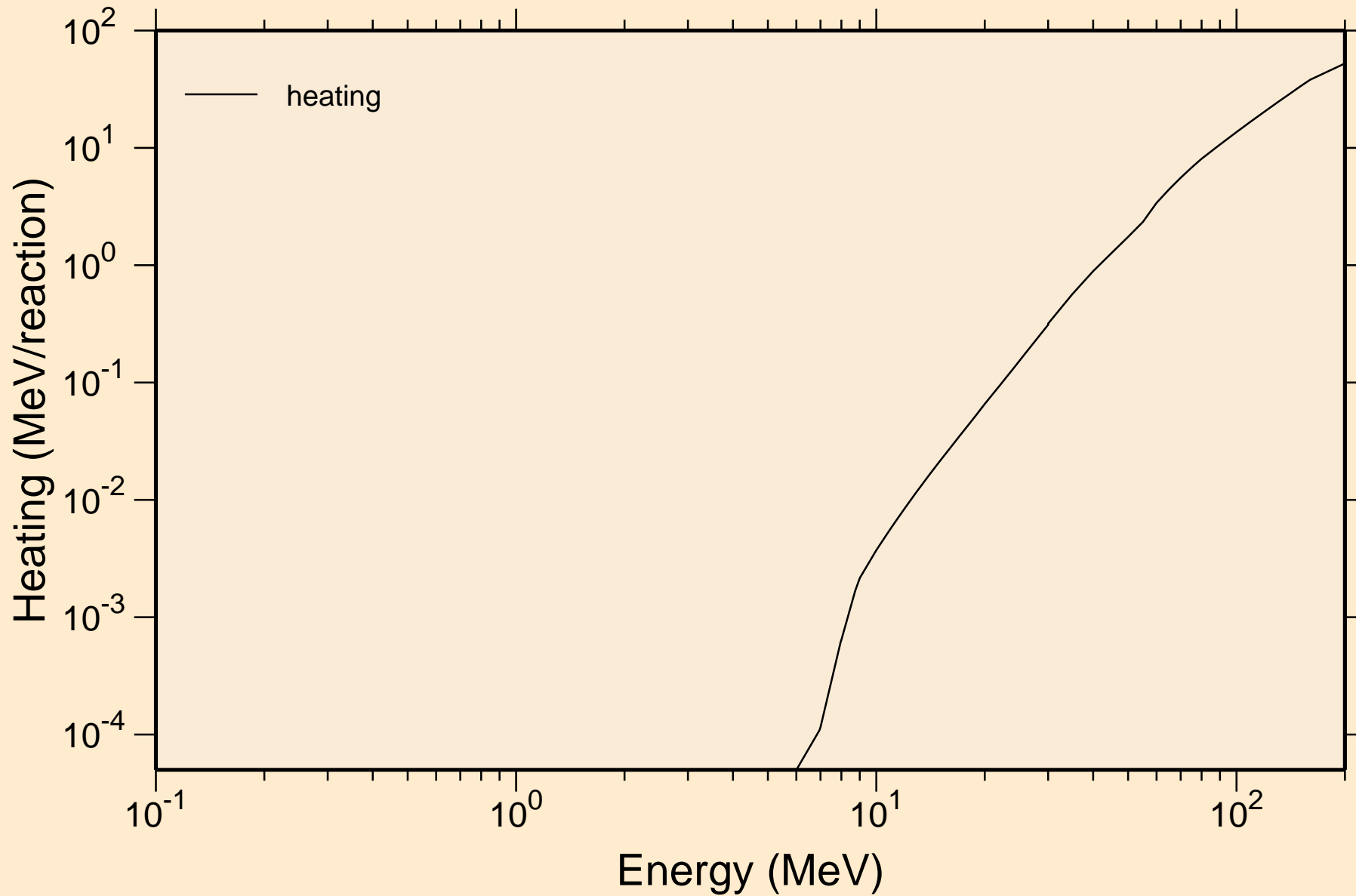

TA192 DEUTERON ACER TENDL-2024 LIBRARY; T=0.K  
Principal cross sections

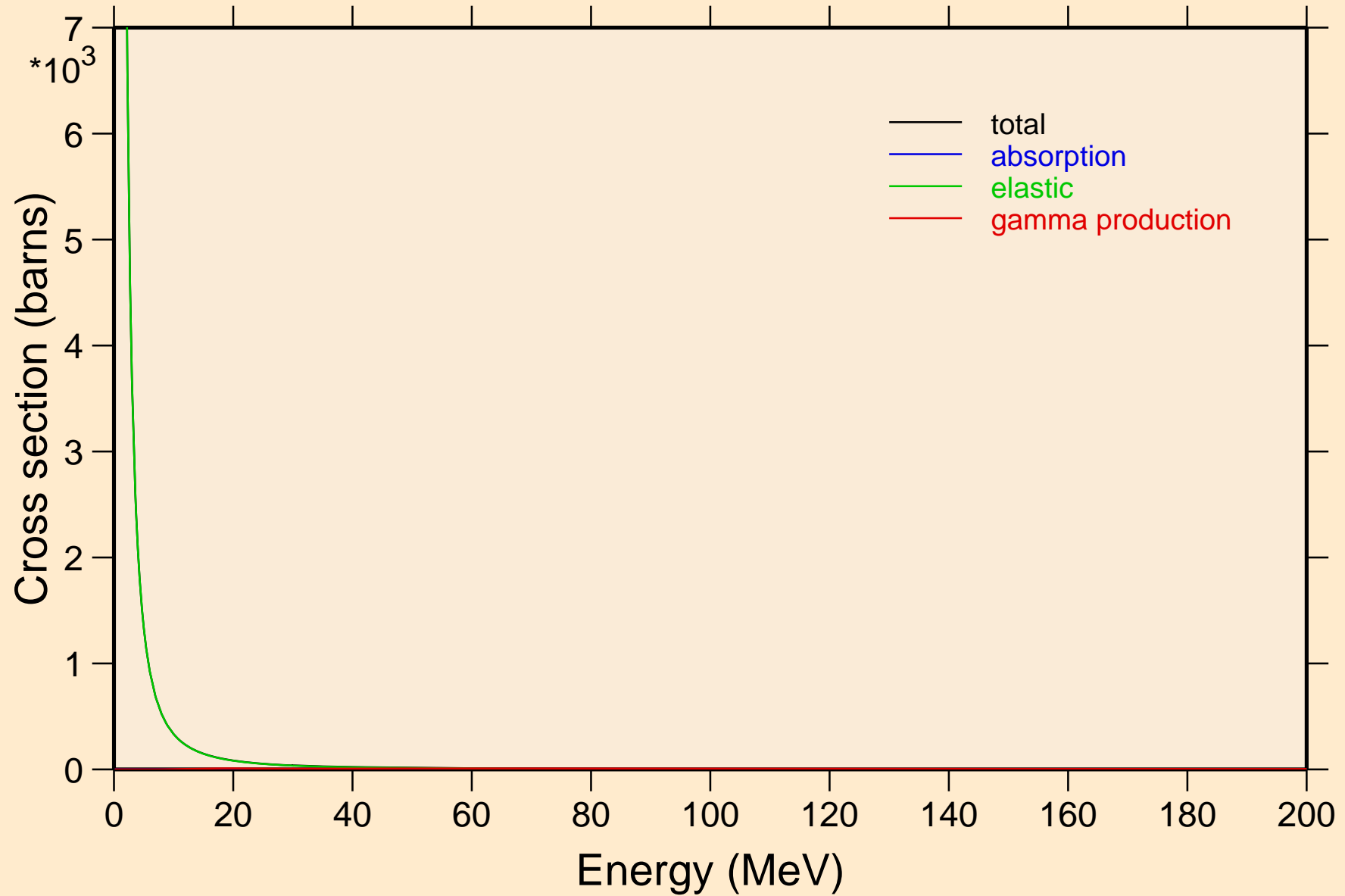

TA192 DEUTERON ACER TENDL-2024 LIBRARY; T=0.K  
Heating

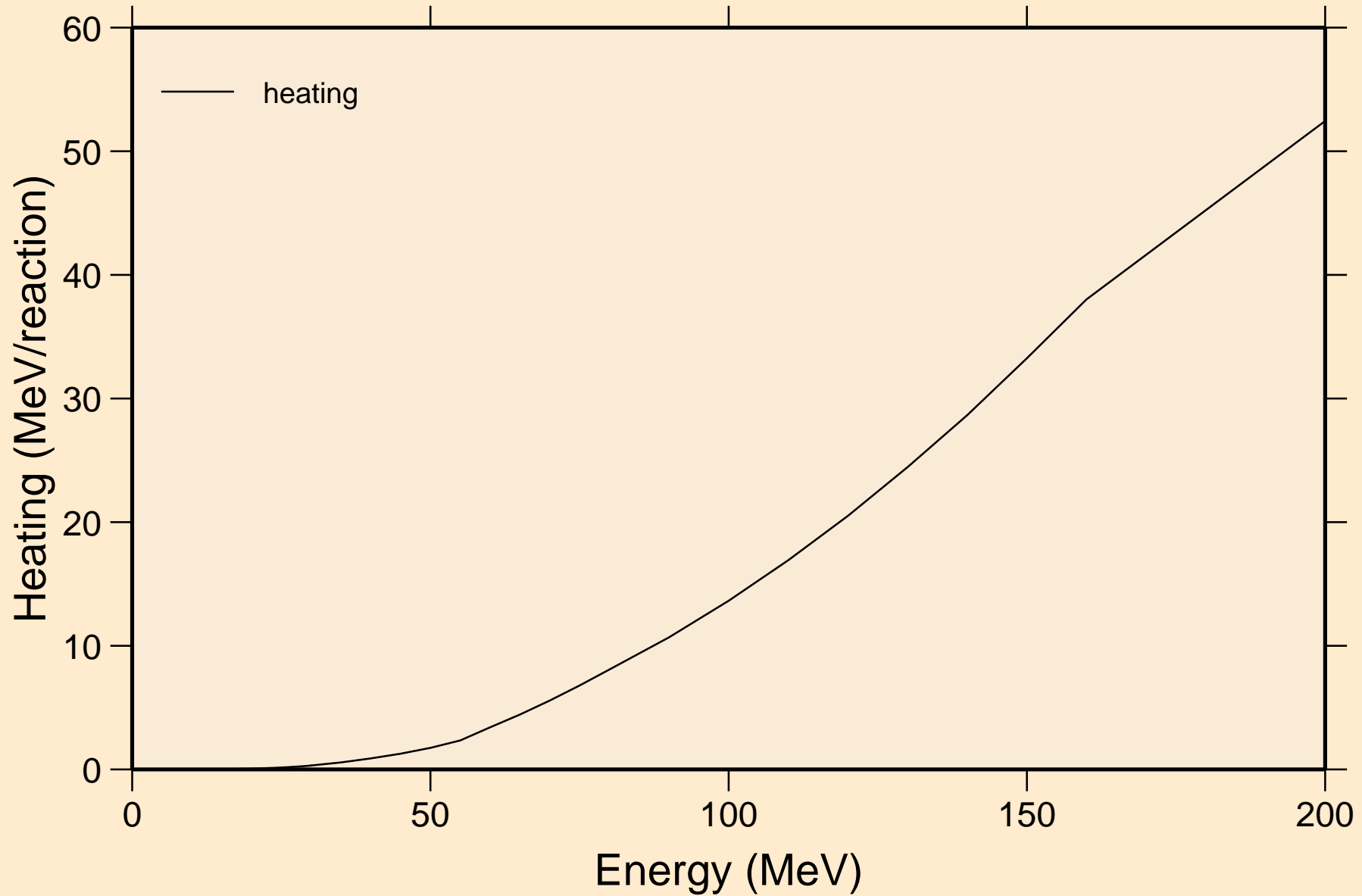

TA192 DEUTERON ACER TENDL-2024 LIBRARY; T=0.K  
Threshold reactions

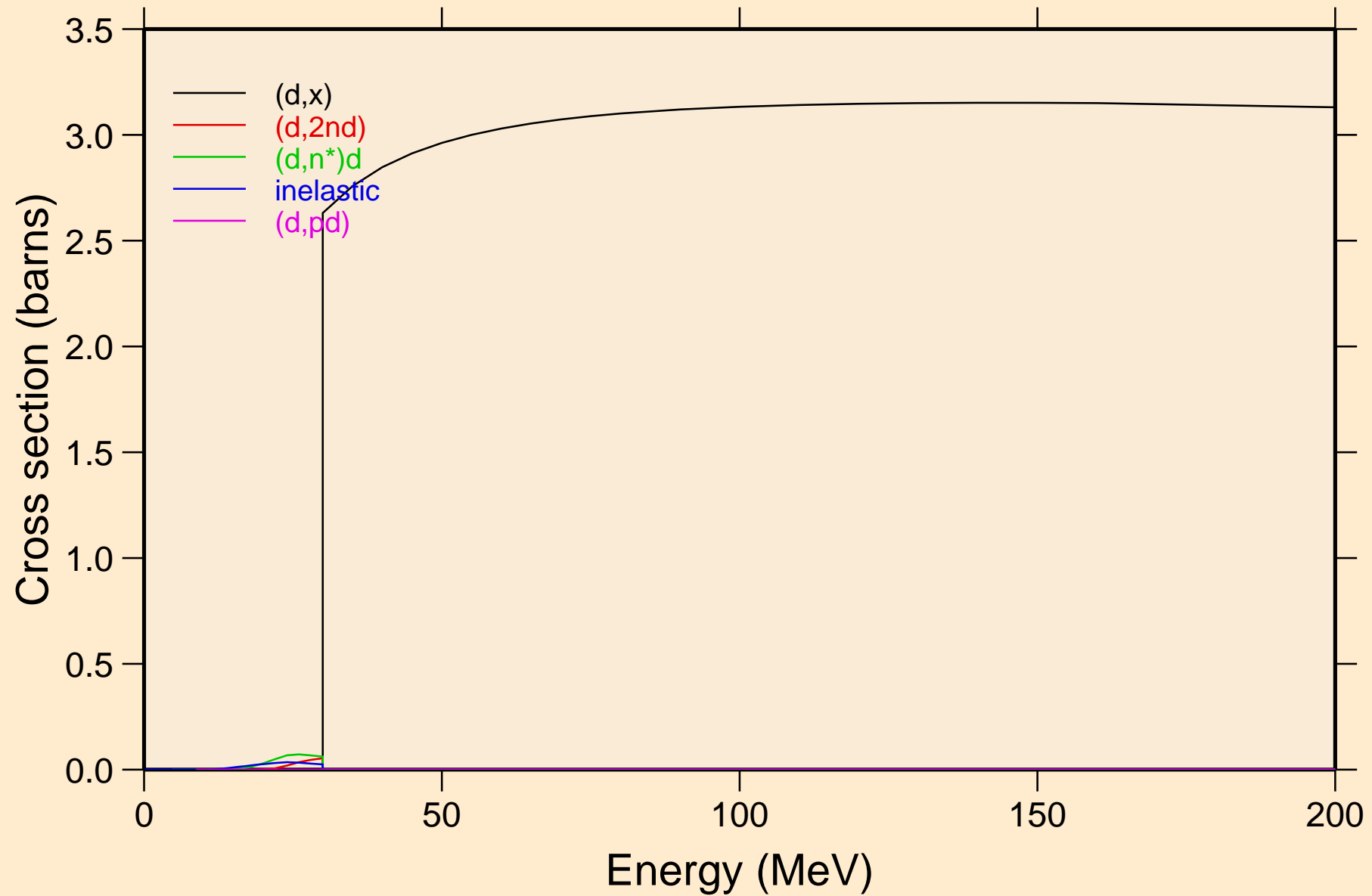

TA192 DEUTERON ACER TENDL-2024 LIBRARY; T=0.K  
angular distribution for elastic

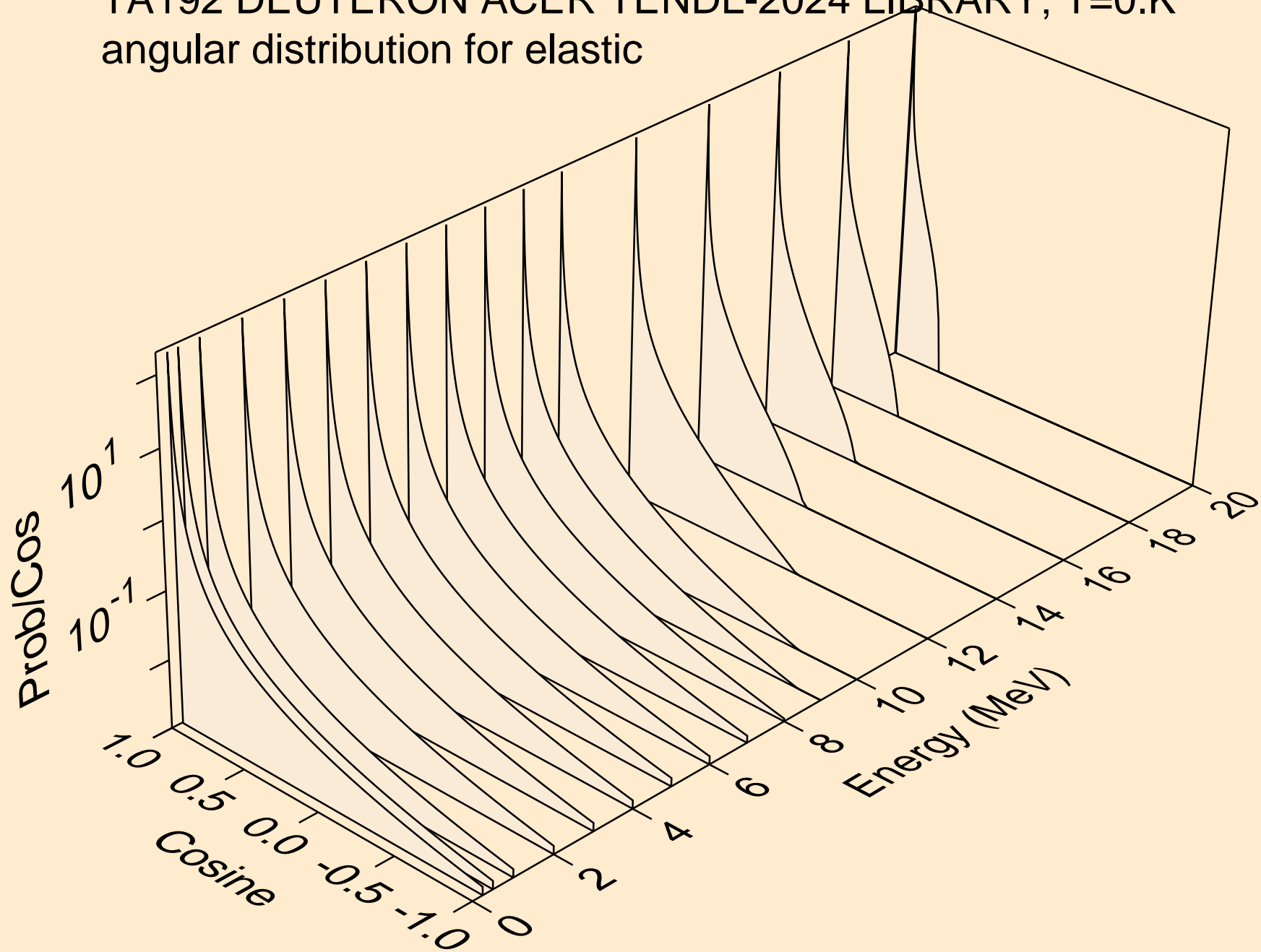

TA192 DEUTERON ACER TENDL-2024 LIBRARY; T=0.K  
angular distribution for elastic

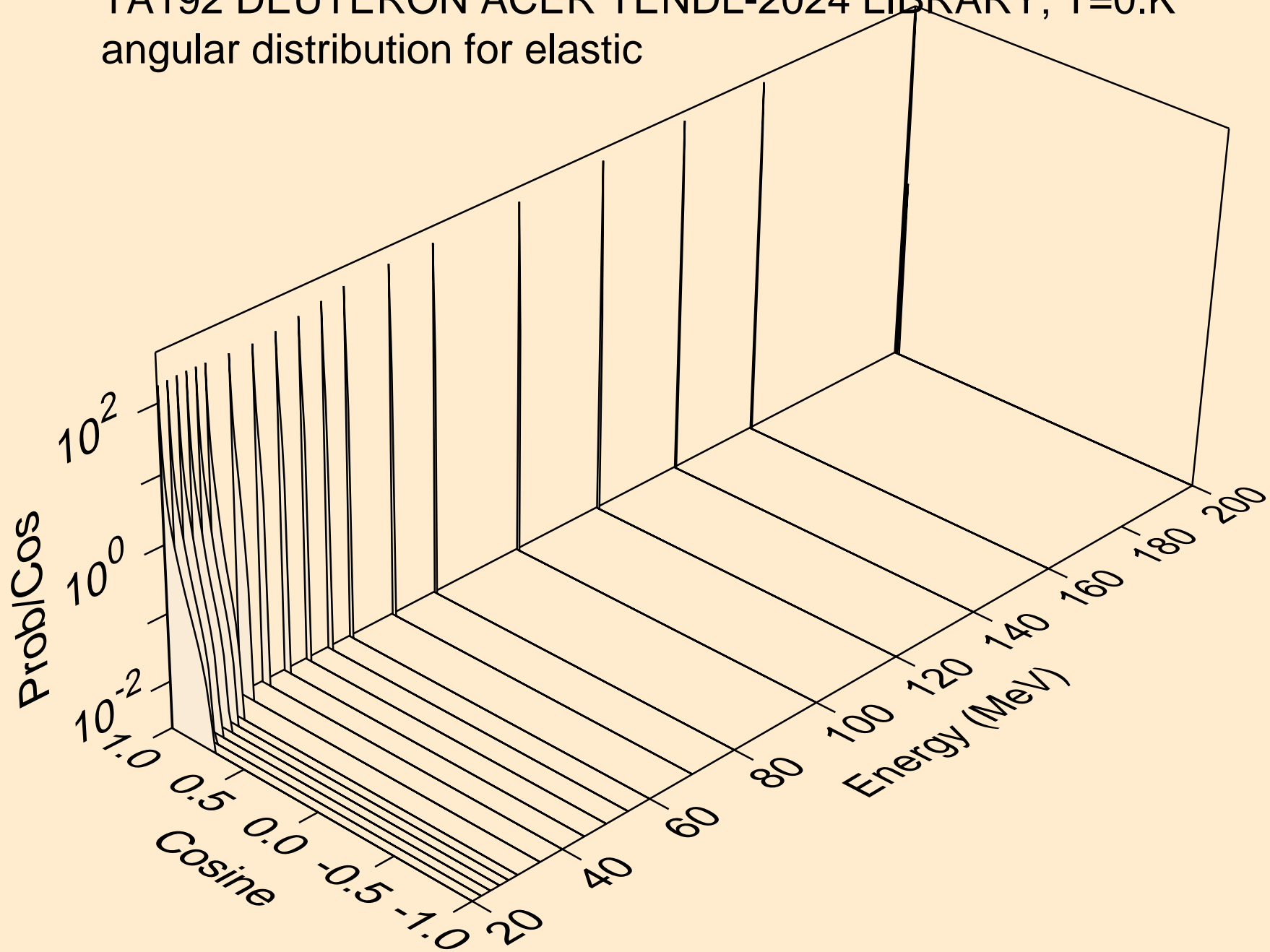

TA192 DEUTERON ACER TENDL-2024 LIBRARY; T=0.K  
Deuteron emission for (d,x)

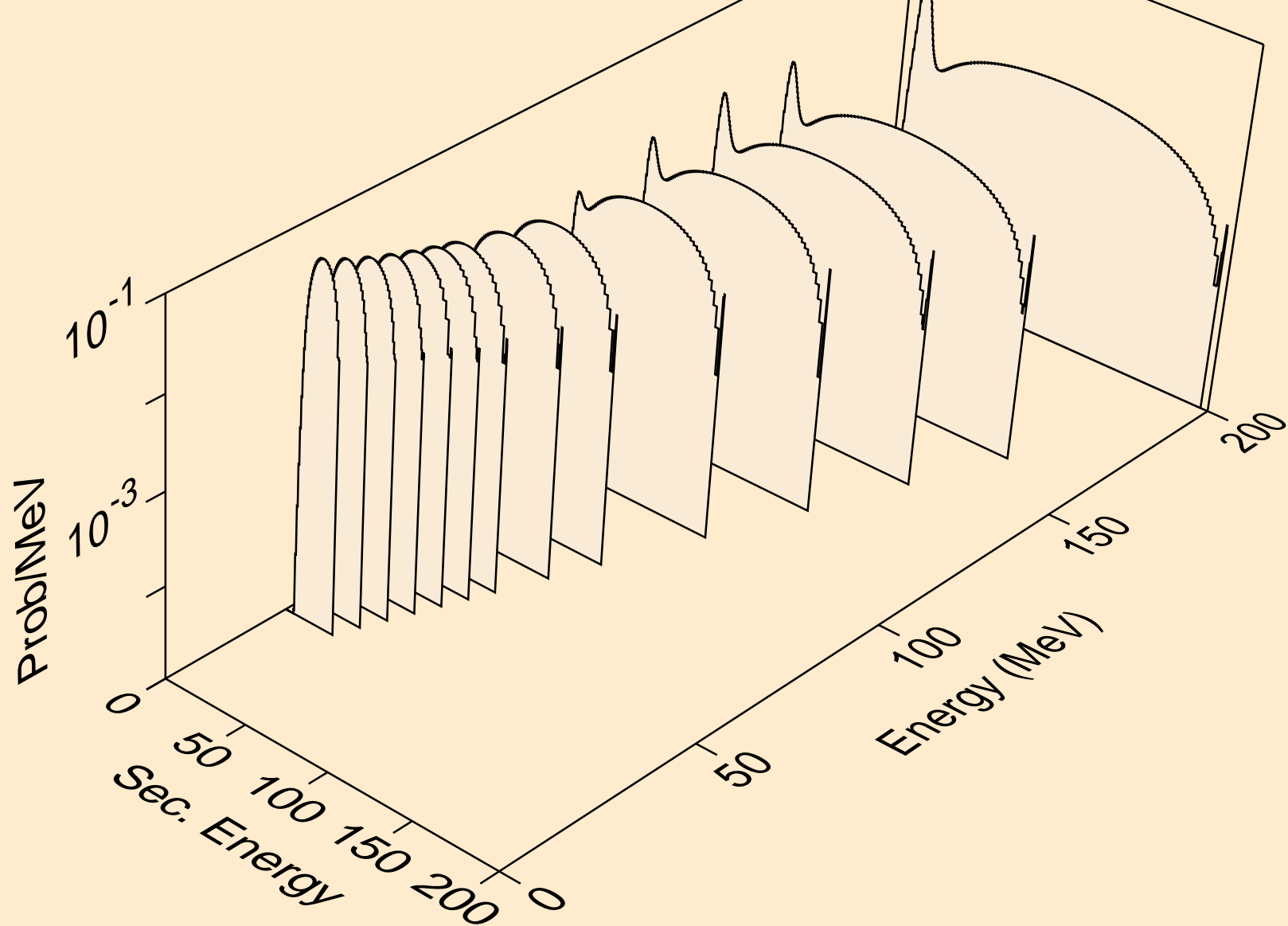

TA192 DEUTERON ACER TENDL-2024 LIBRARY; T=0.K  
Deuteron emission for (d,2nd)

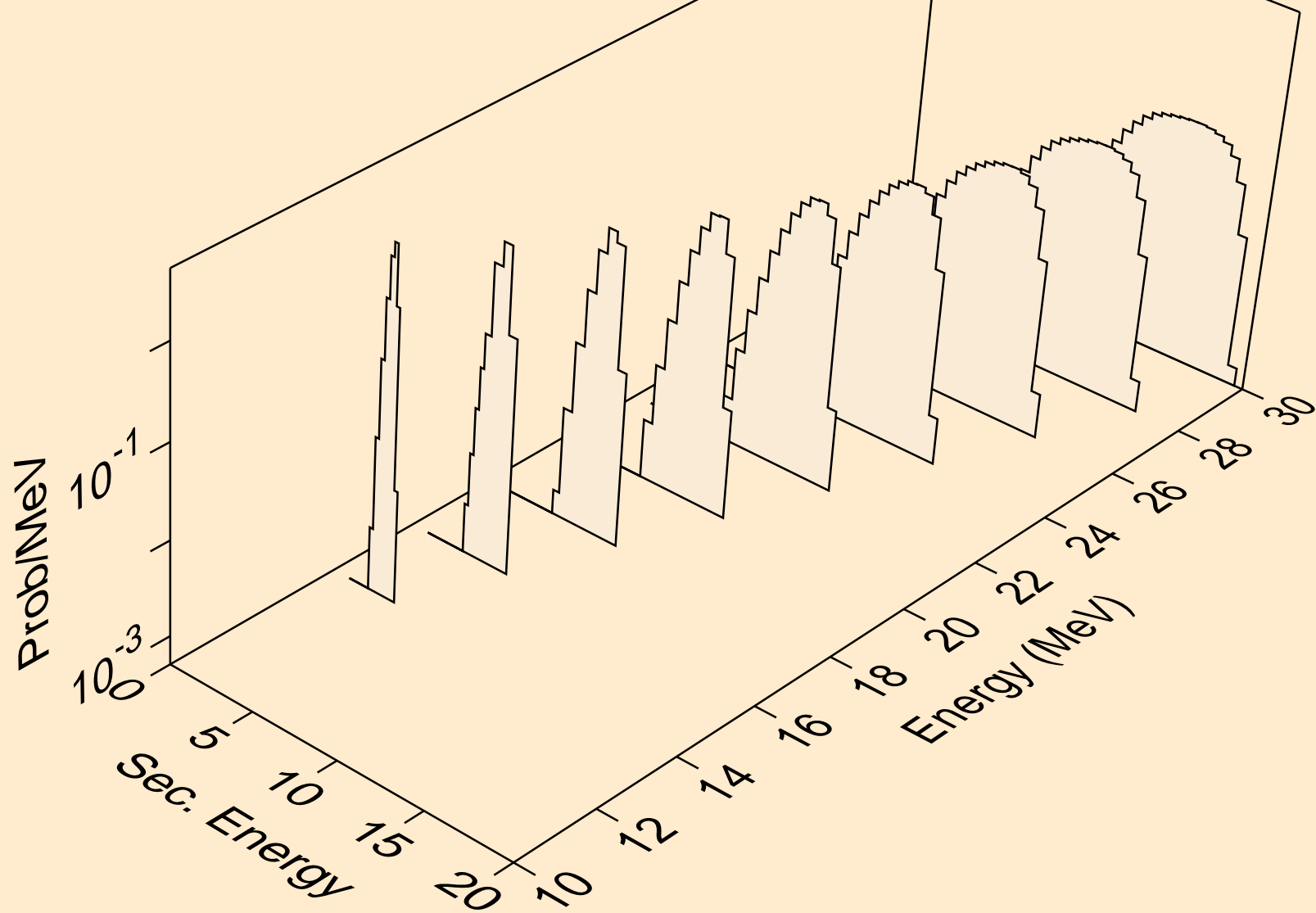

TA192 DEUTERON ACER TENDL-2024 LIBRARY; T=0.K  
Deuteron emission for (d,n\*)d

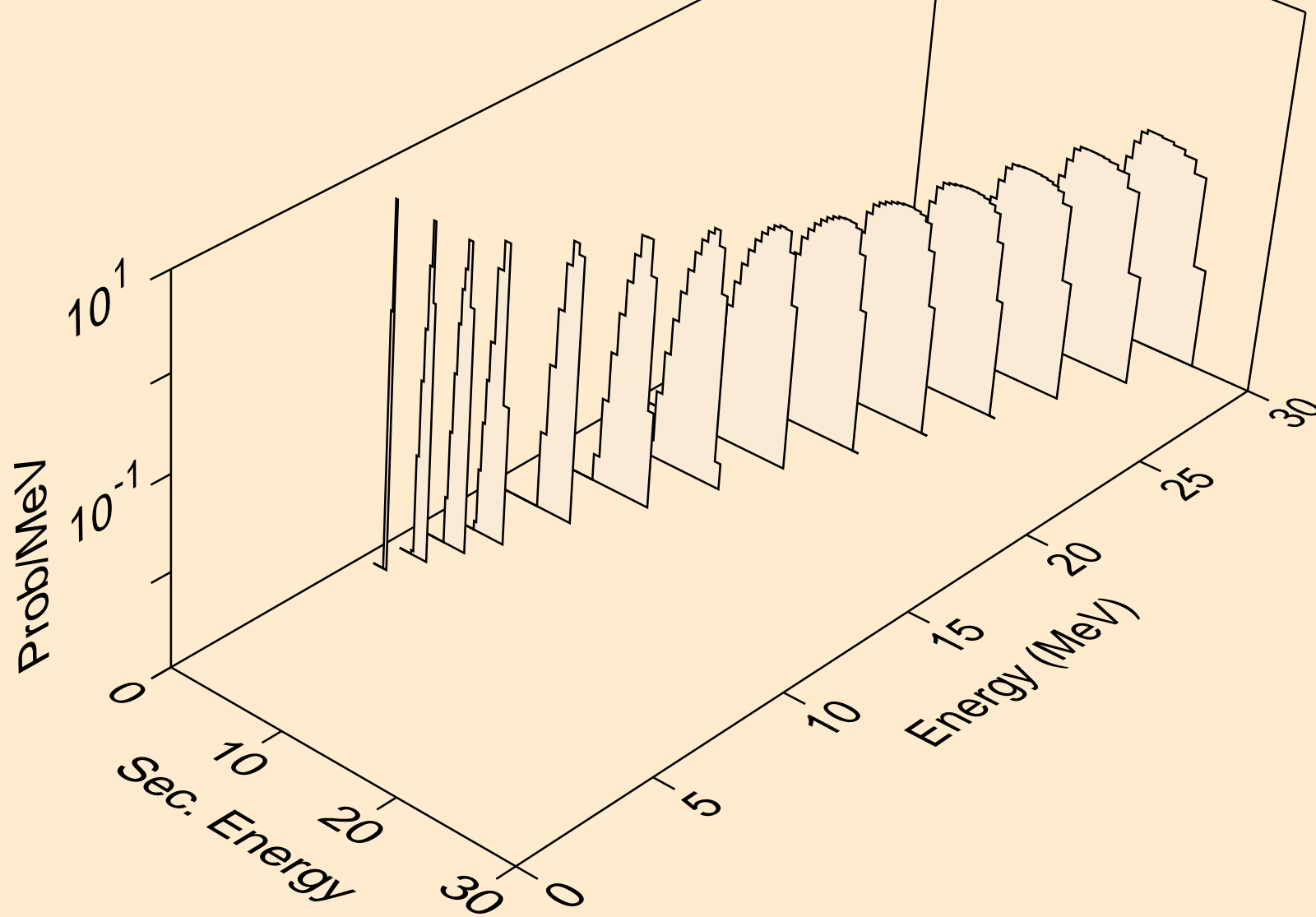

TA192 DEUTERON ACER TENDL-2024 LIBRARY; T=0.K  
Deuteron emission for inelastic

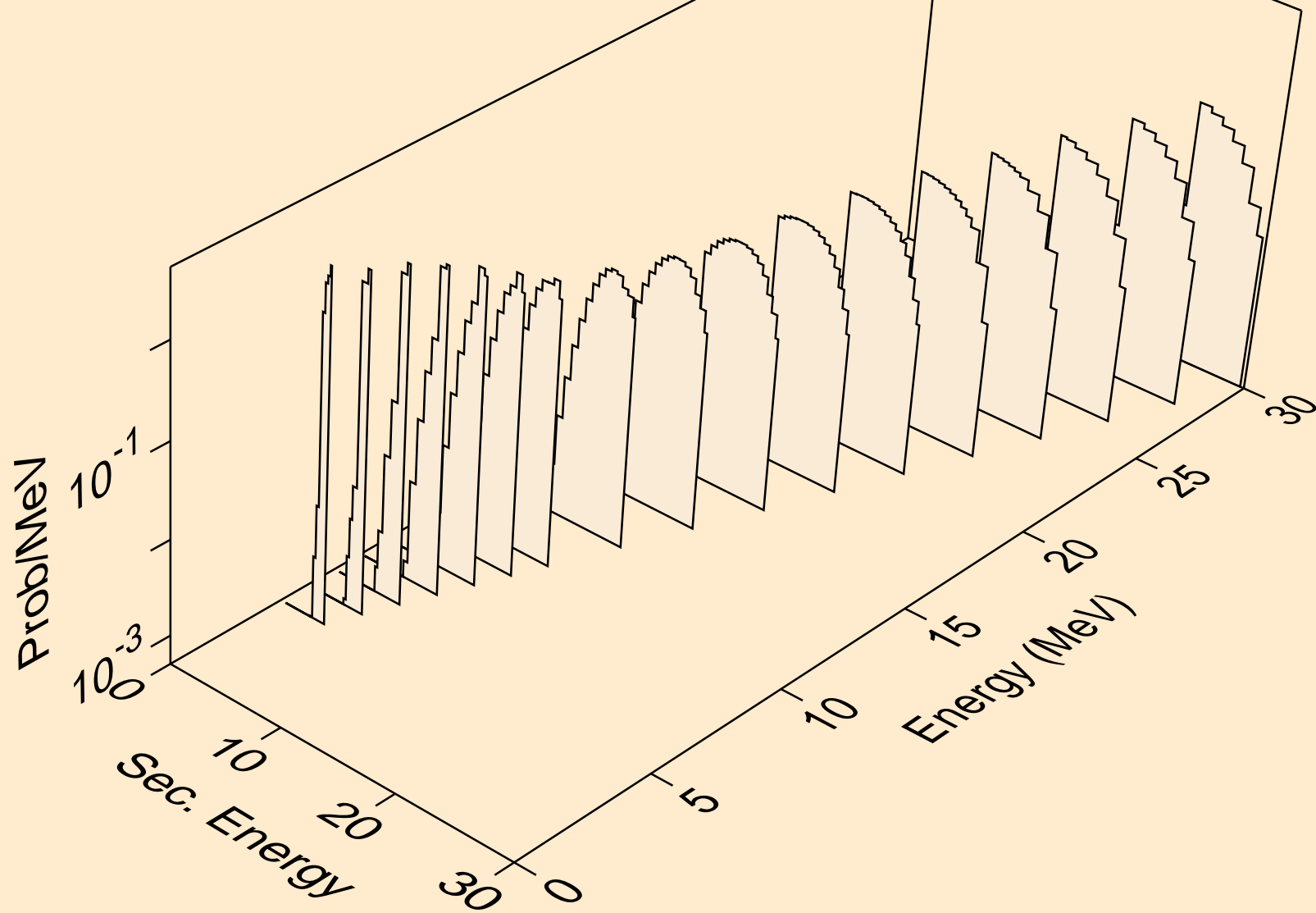

TA192 DEUTERON ACER TENDL-2024 LIBRARY; T=0.K  
Deuteron emission for (d,pd)

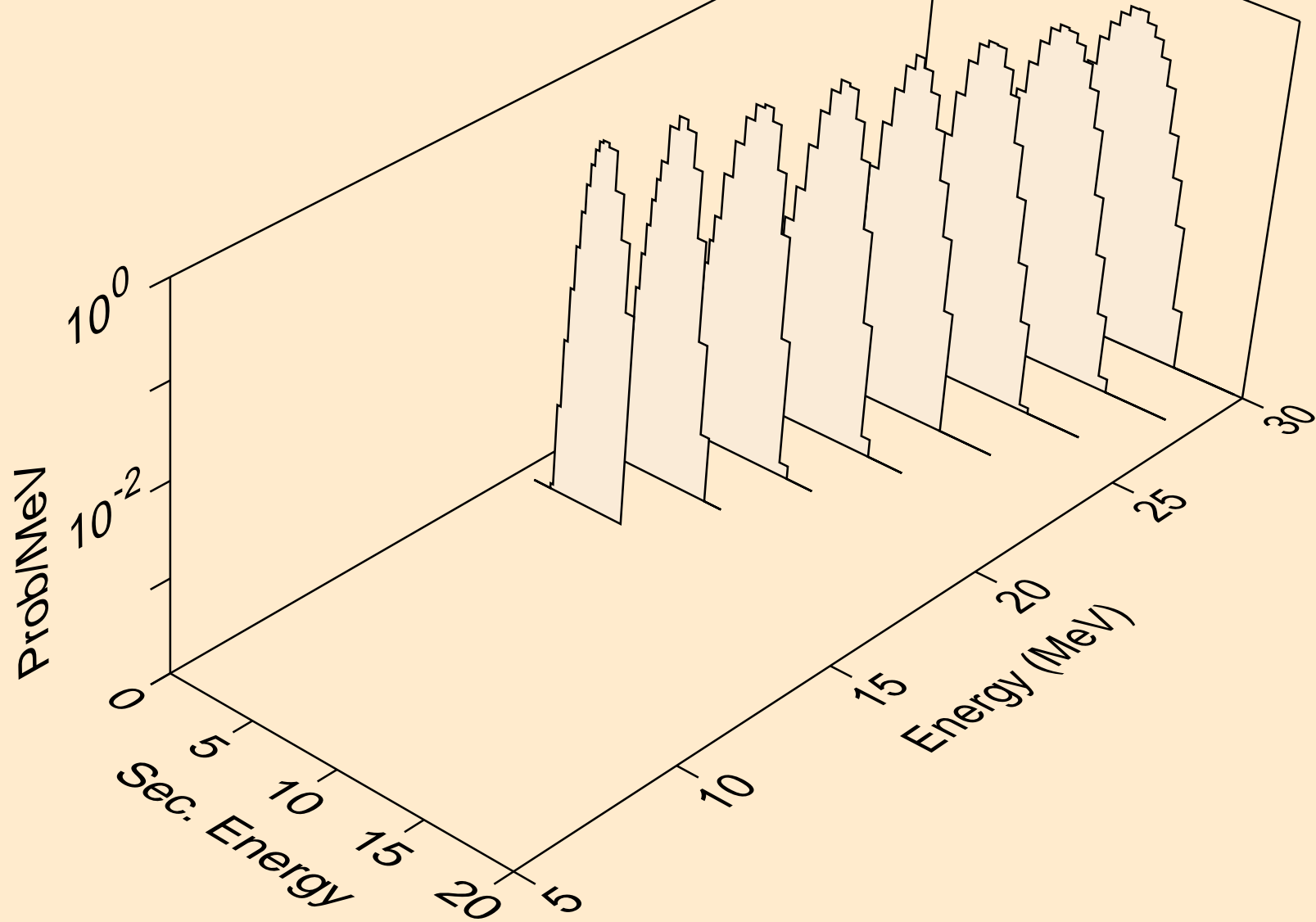

TA192 DEUTERON ACER TENDL-2024 LIBRARY; T=0.K  
Photon emission for (z,n)

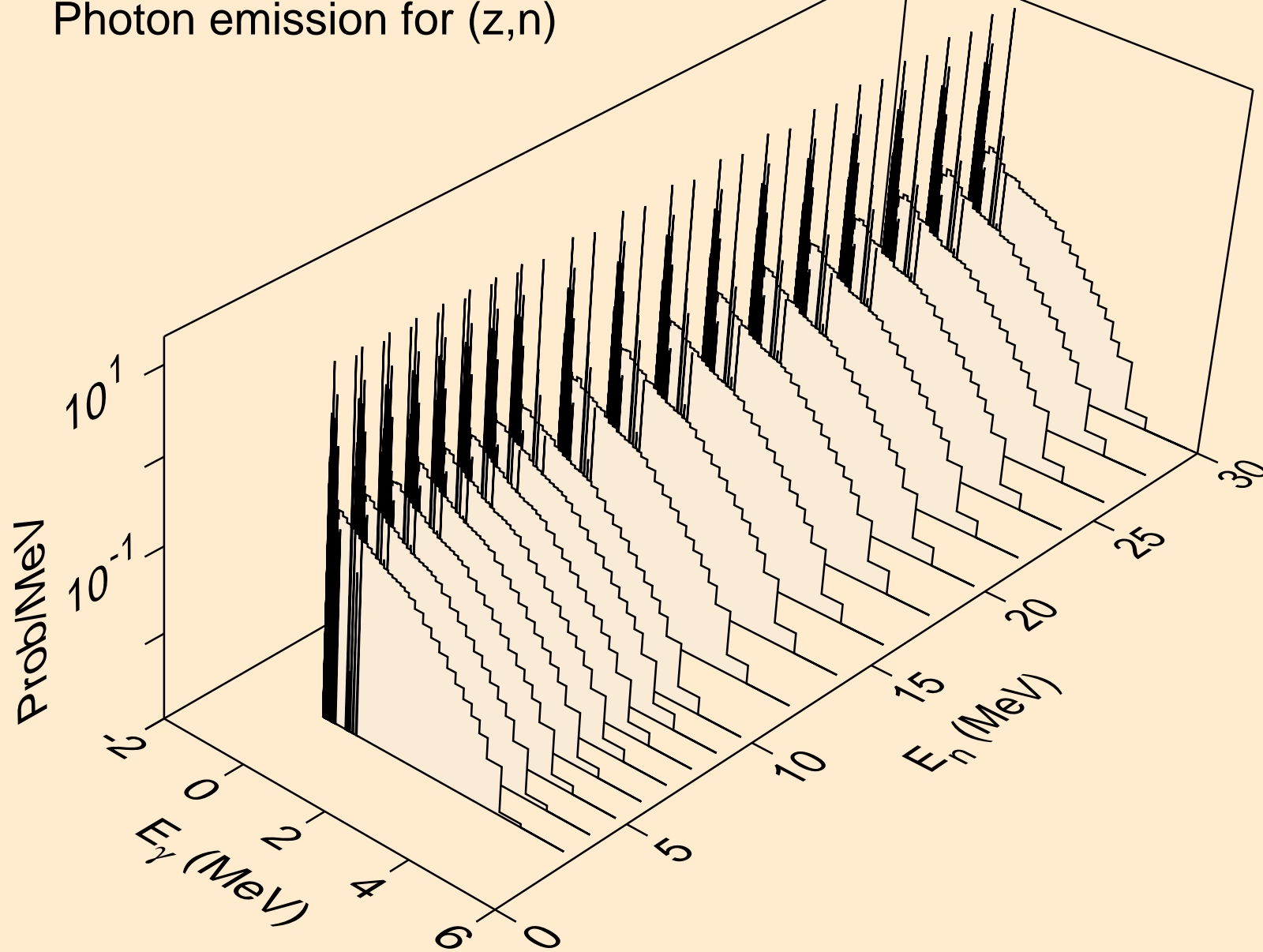

TA192 DEUTERON ACER TENDL-2024 LIBRARY; T=0.K  
Photon emission for (z,x)

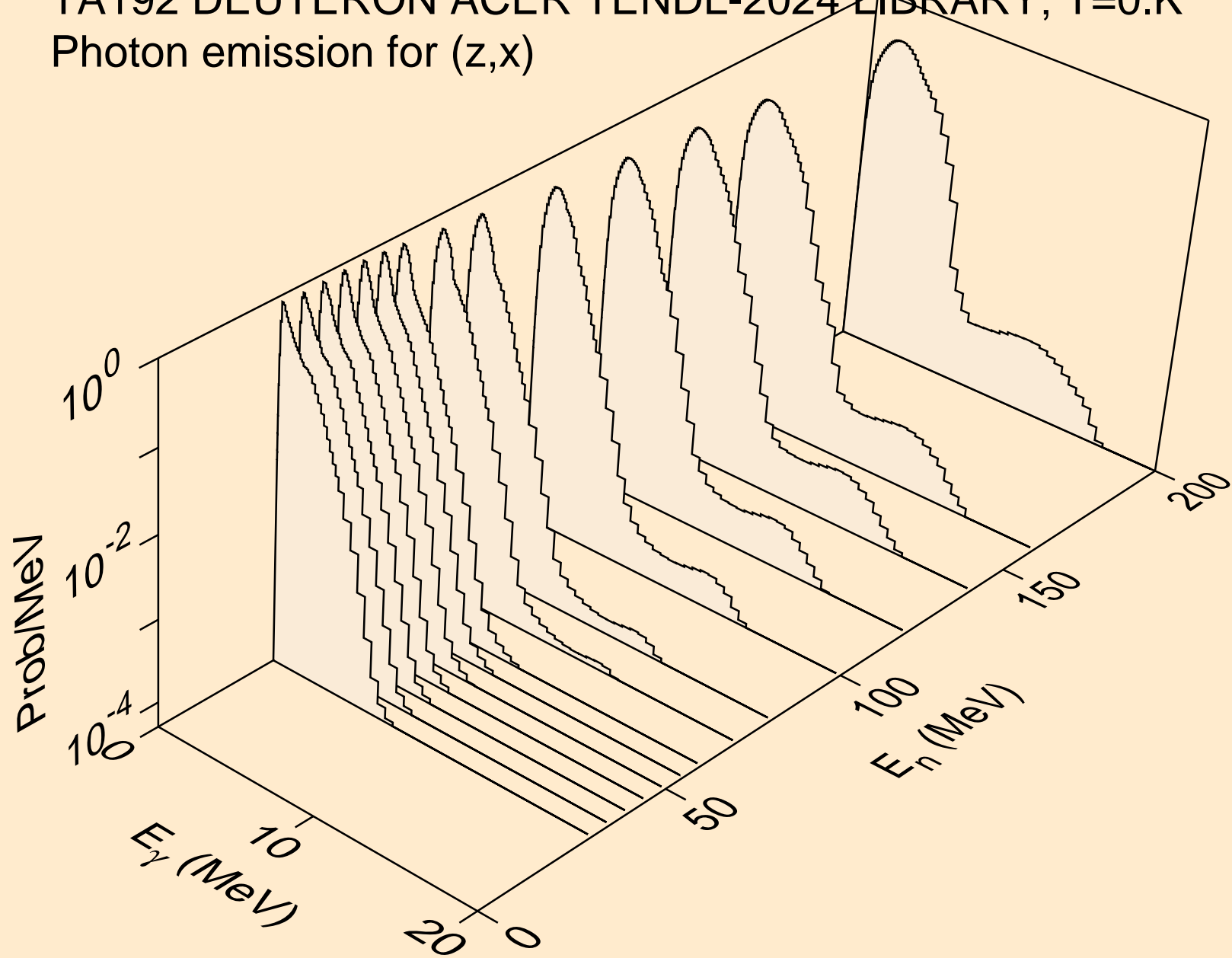

TA192 DEUTERON ACER TENDL-2024 LIBRARY; T=0.K  
Photon emission for (n,2nd)

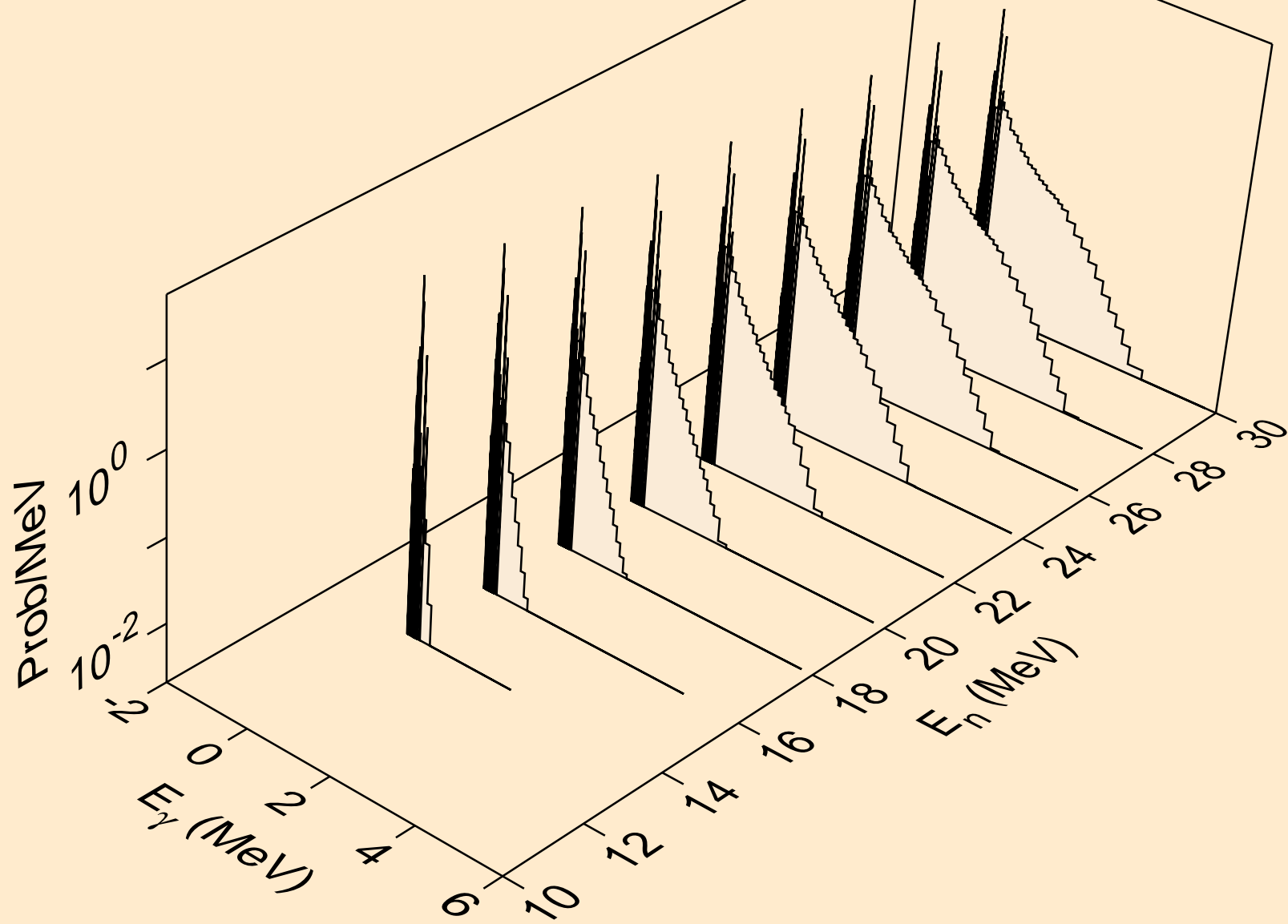

TA192 DEUTERON ACER TENDL-2024 LIBRARY; T=0.K  
Photon emission for (n,2n)

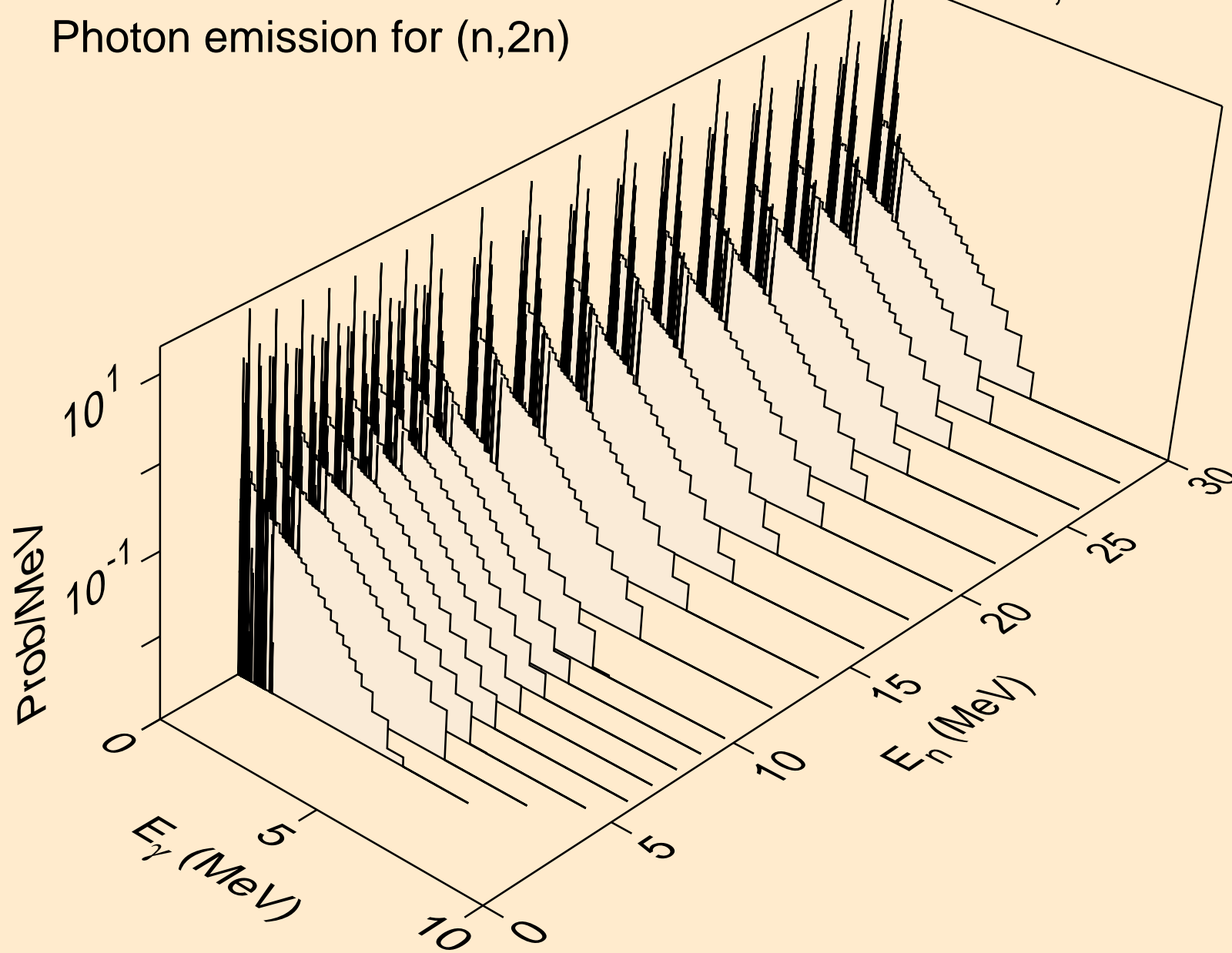

TA192 DEUTERON ACER TENDL-2024 LIBRARY; T=0.K  
Photon emission for (n,3n)

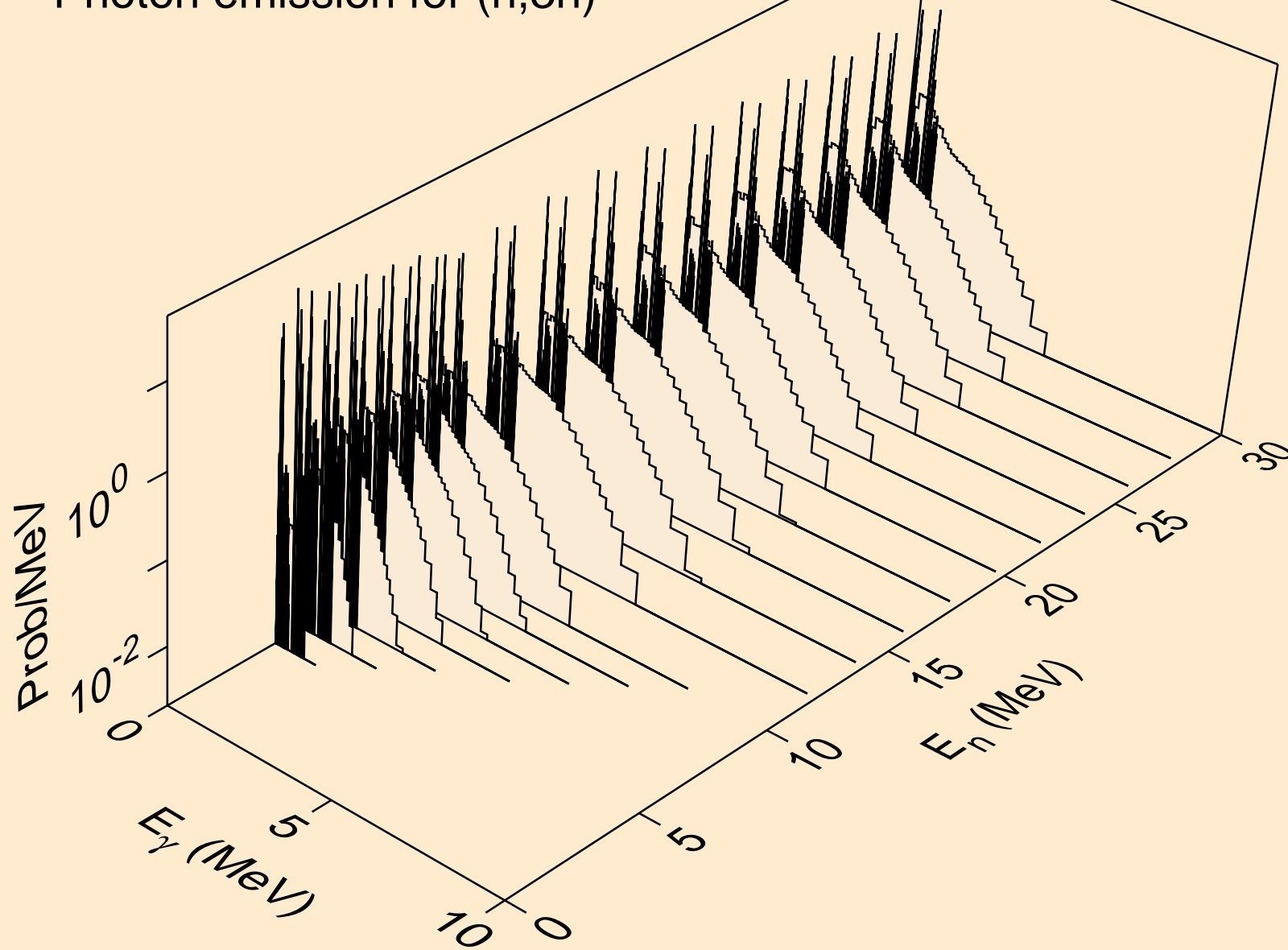

TA192 DEUTERON ACER TENDL-2024 LIBRARY; T=0.K  
Photon emission for (n,n\*)a

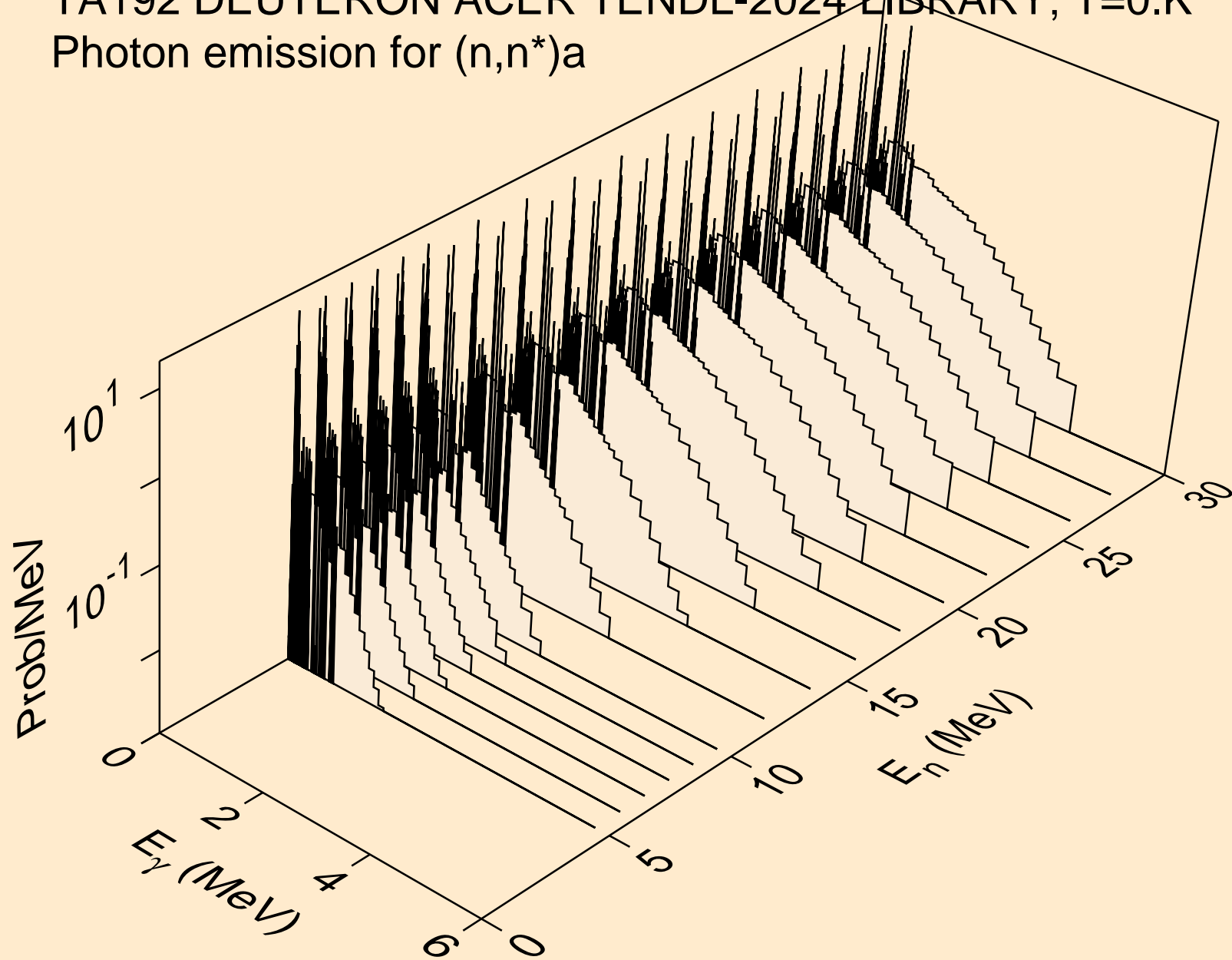

TA192 DEUTERON ACER TENDL-2024 LIBRARY; T=0.K  
Photon emission for (n,2n)a

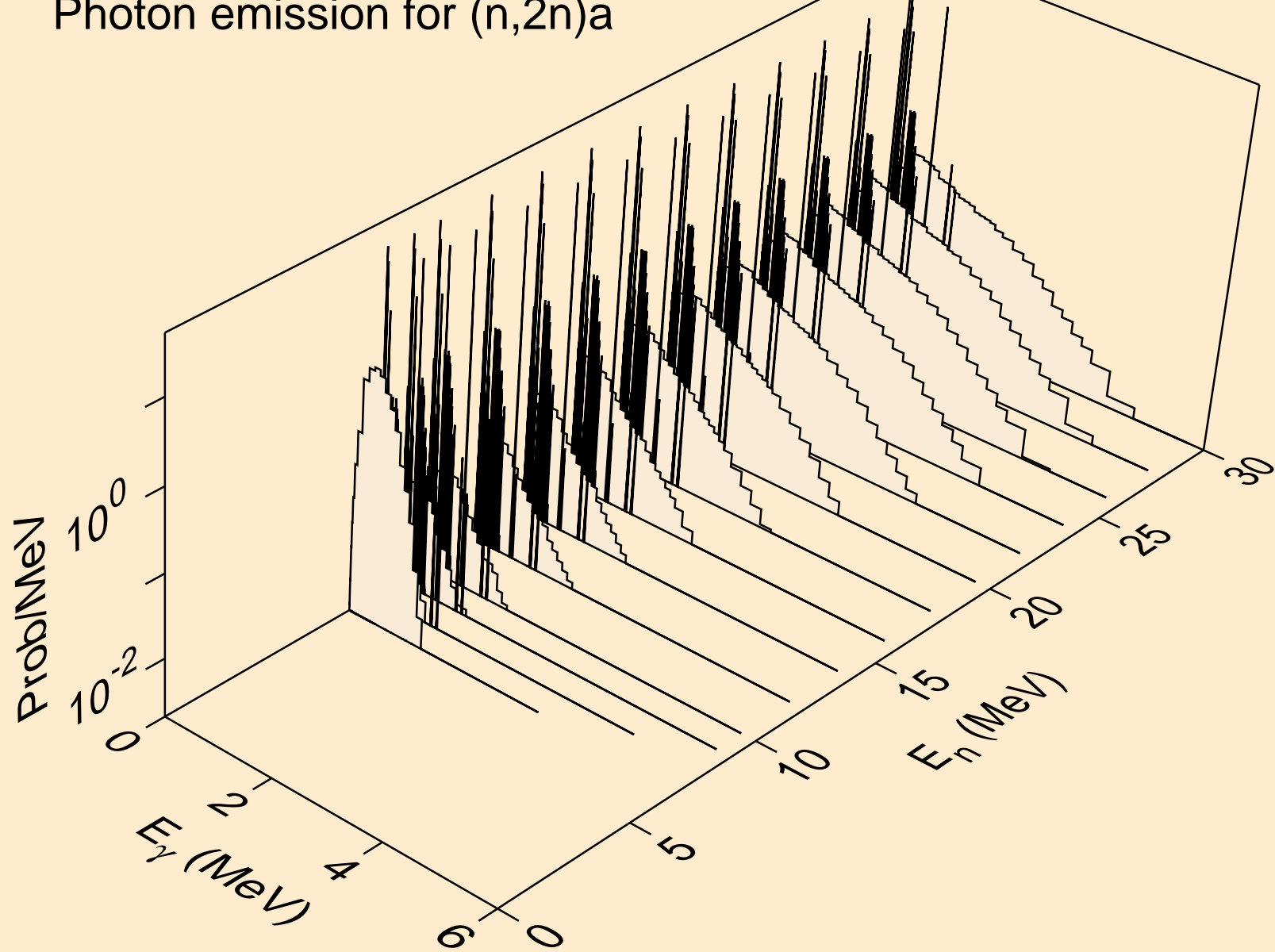

TA192 DEUTERON ACER TENDL-2024 LIBRARY; T=0.K  
Photon emission for (n,3n)a

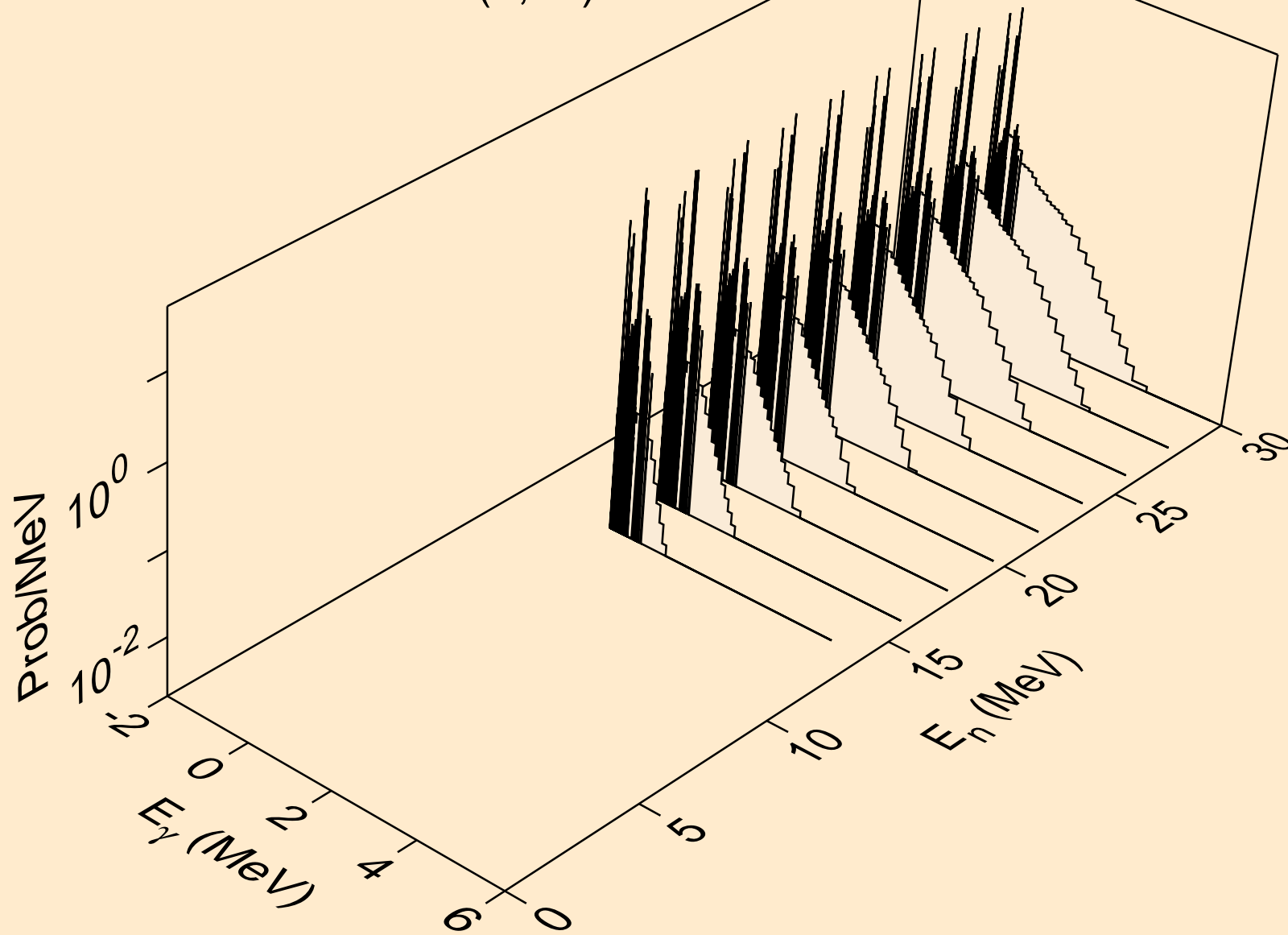

TA192 DEUTERON ACER TENDL-2024 LIBRARY; T=0.K  
Photon emission for (n,n\*)p

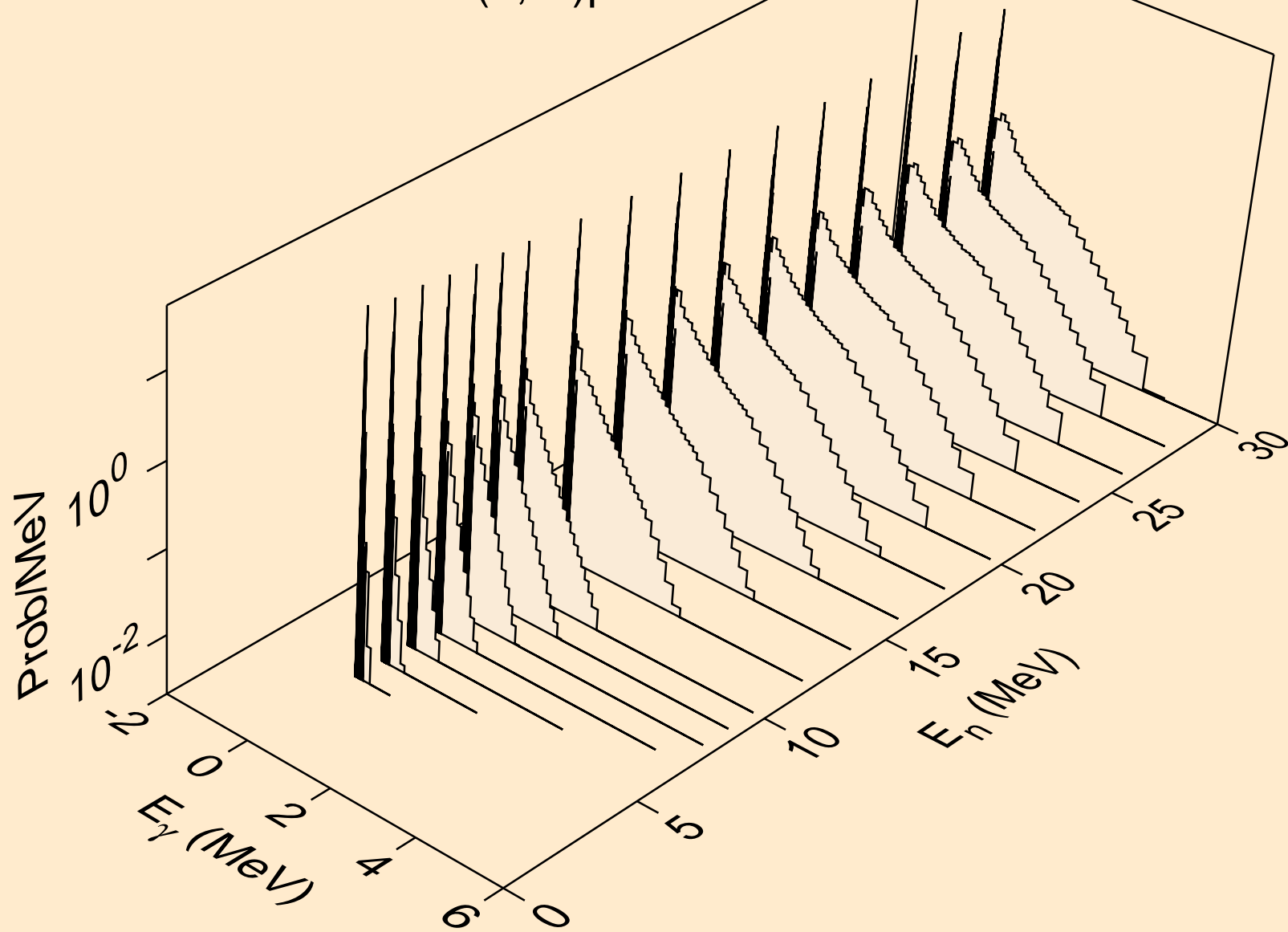

TA192 DEUTERON ACER TENDL-2024 LIBRARY; T=0.K  
Photon emission for (n,n\*)d

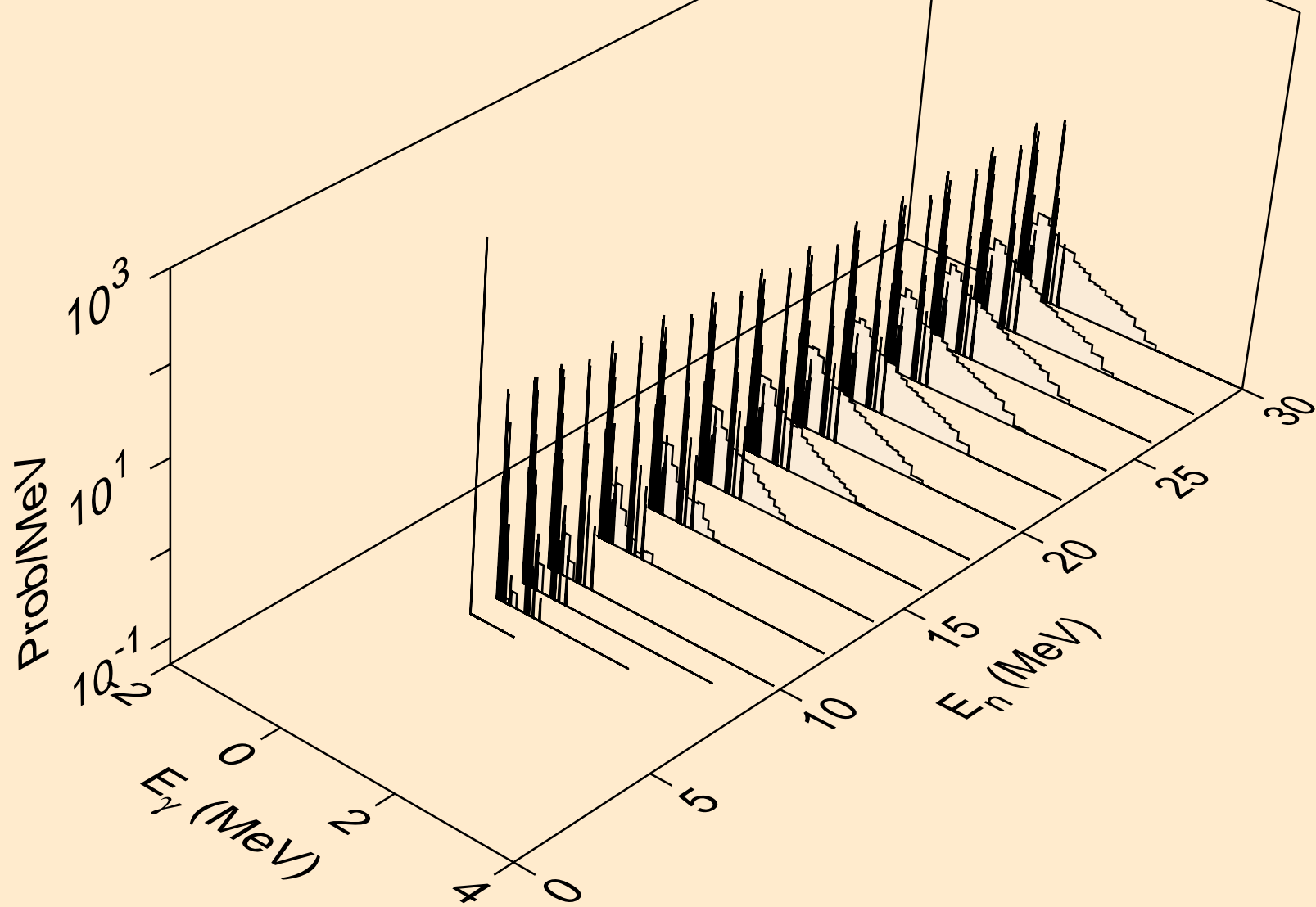

TA192 DEUTERON ACER TENDL-2024 LIBRARY; T=0.K  
Photon emission for (n,n\*)t

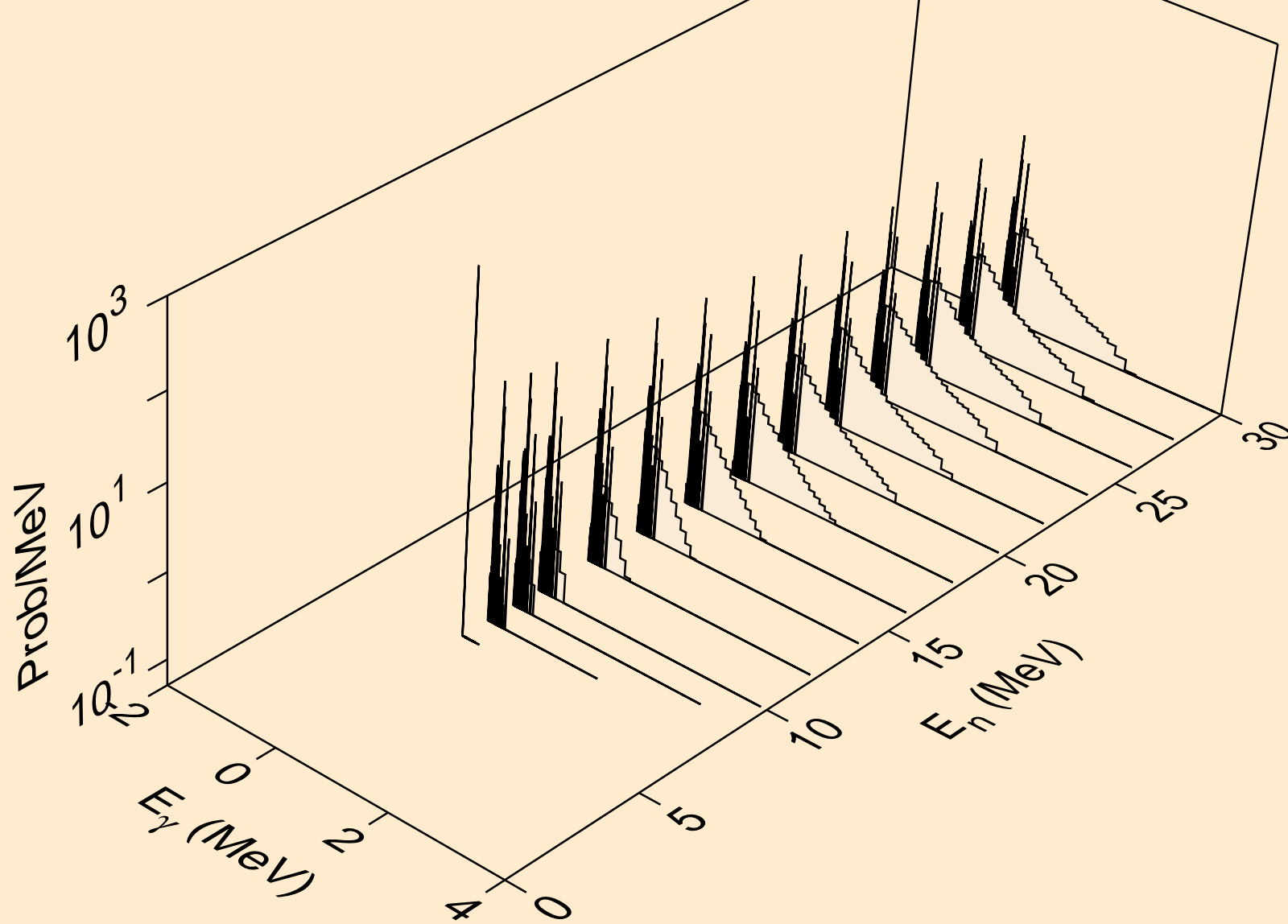

TA192 DEUTERON ACER TENDL-2024 LIBRARY; T=0.K  
Photon emission for (n,n\*)he3

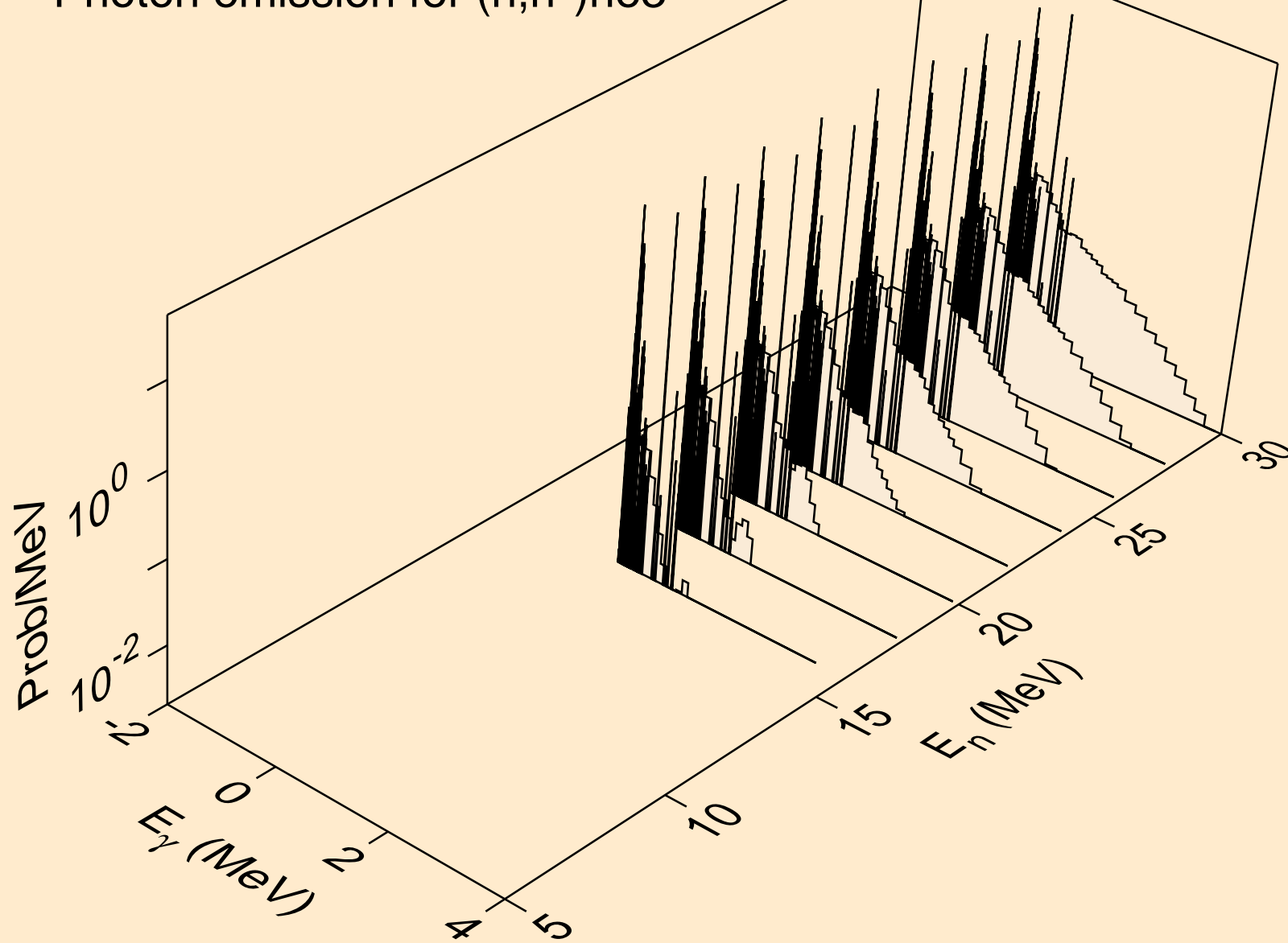

TA192 DEUTERON ACER TENDL-2024 LIBRARY; T=0.K  
Photon emission for (n,4n)

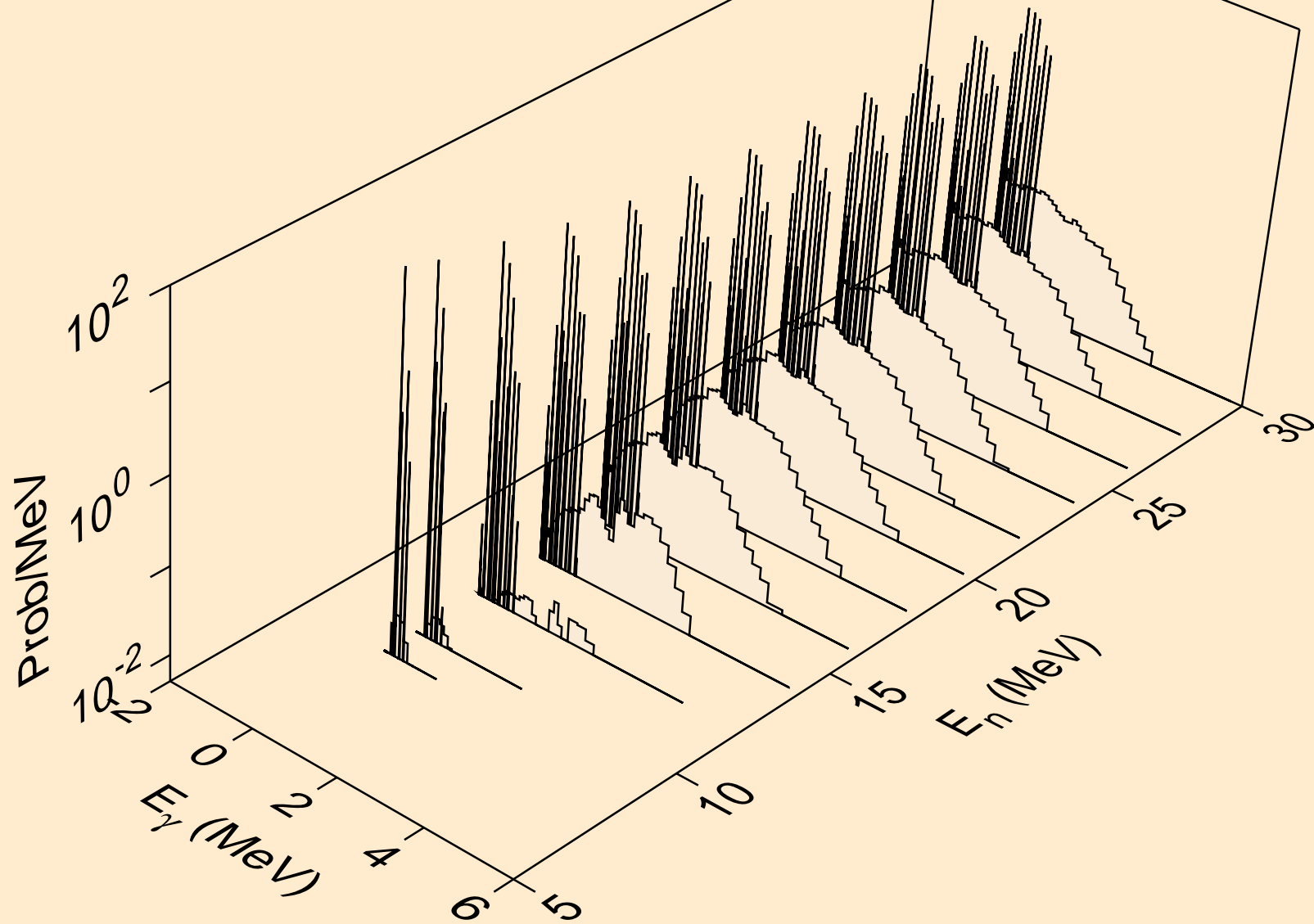

TA192 DEUTERON ACER TENDL-2024 LIBRARY; T=0.K  
Photon emission for (n,2np)

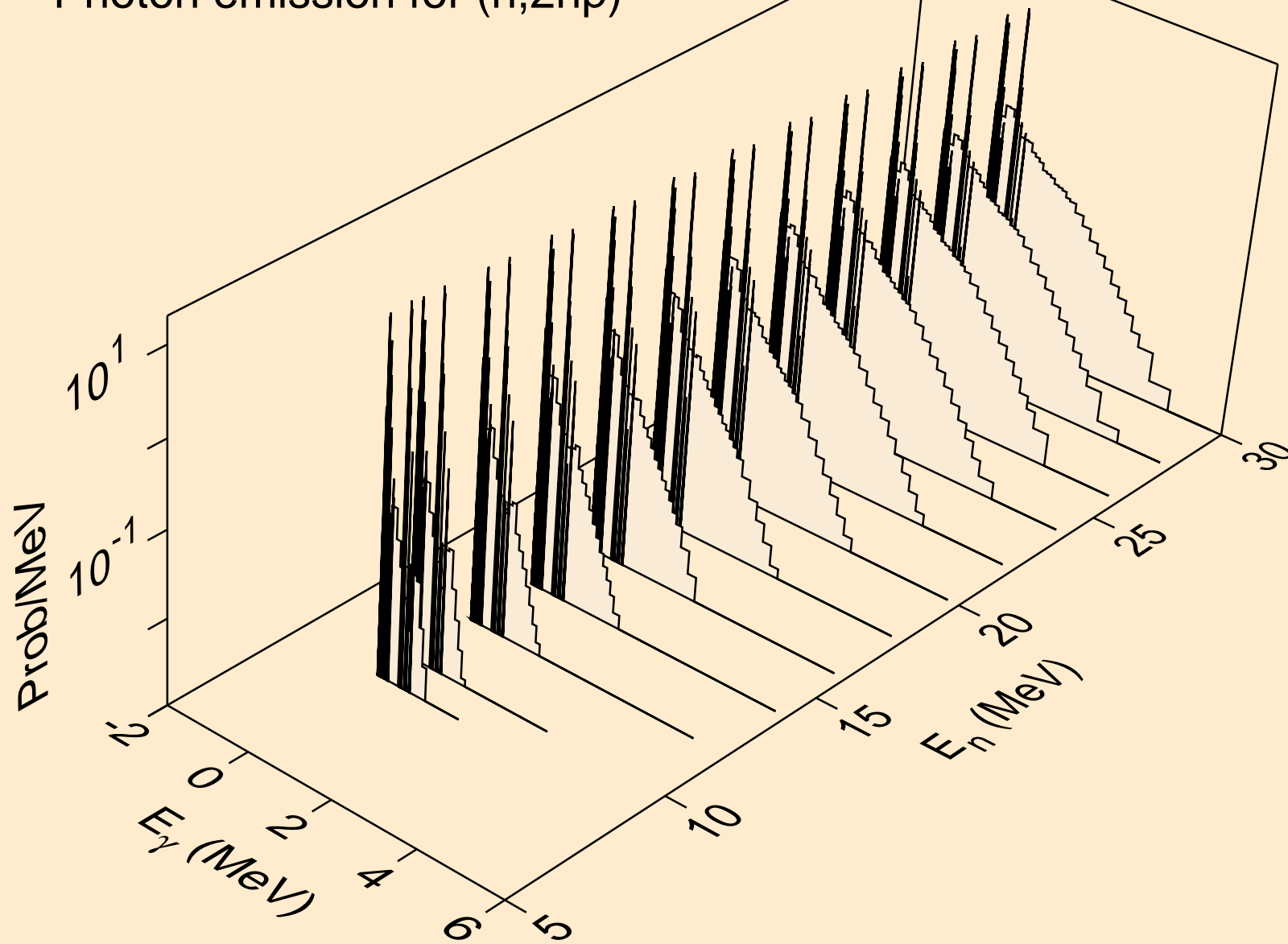

TA192 DEUTERON ACER TENDL-2024 LIBRARY; T=0.K  
Photon emission for (n,3np)

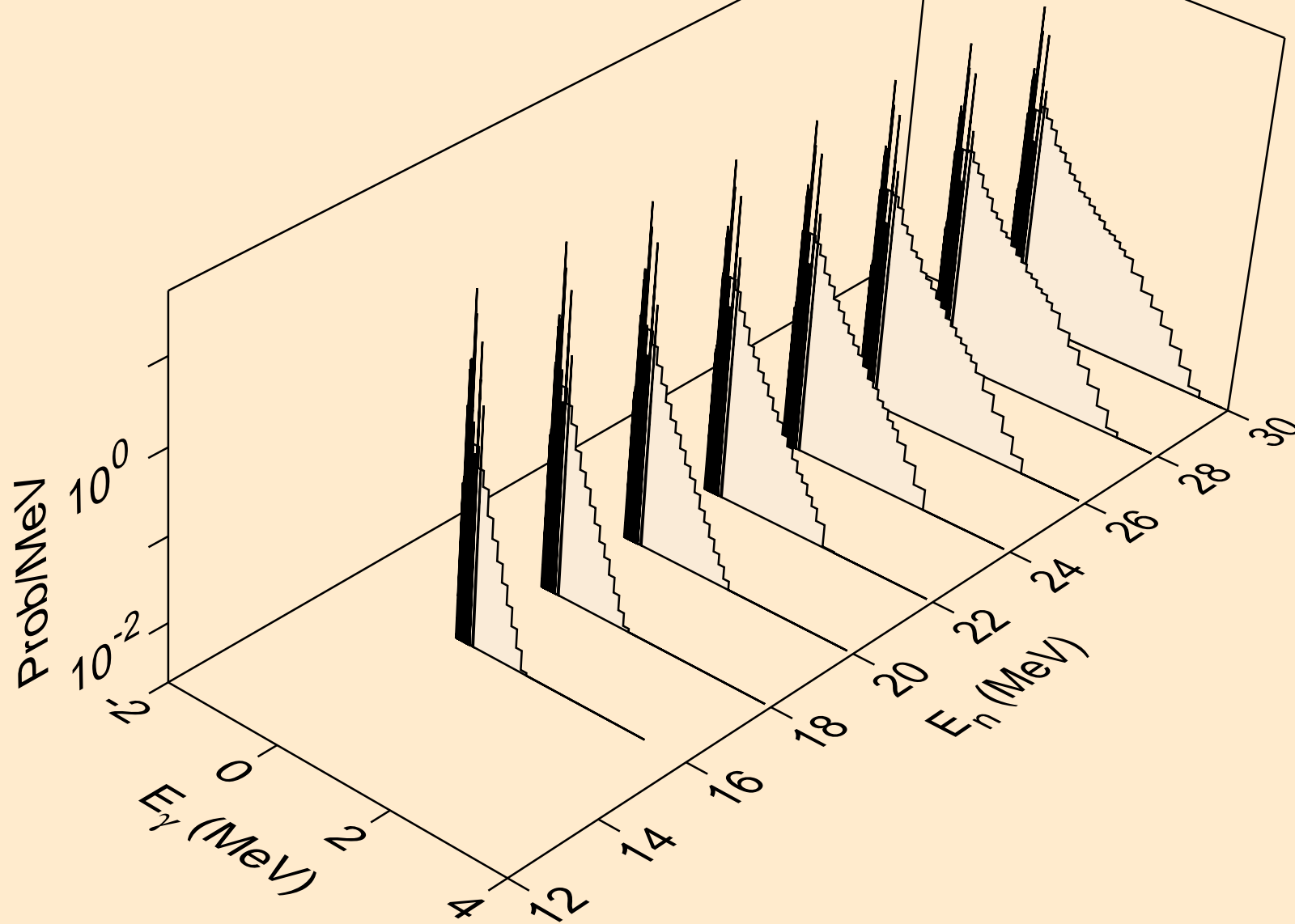

TA192 DEUTERON ACER TENDL-2024 LIBRARY; T=0.K  
Photon emission for (n,n2p)

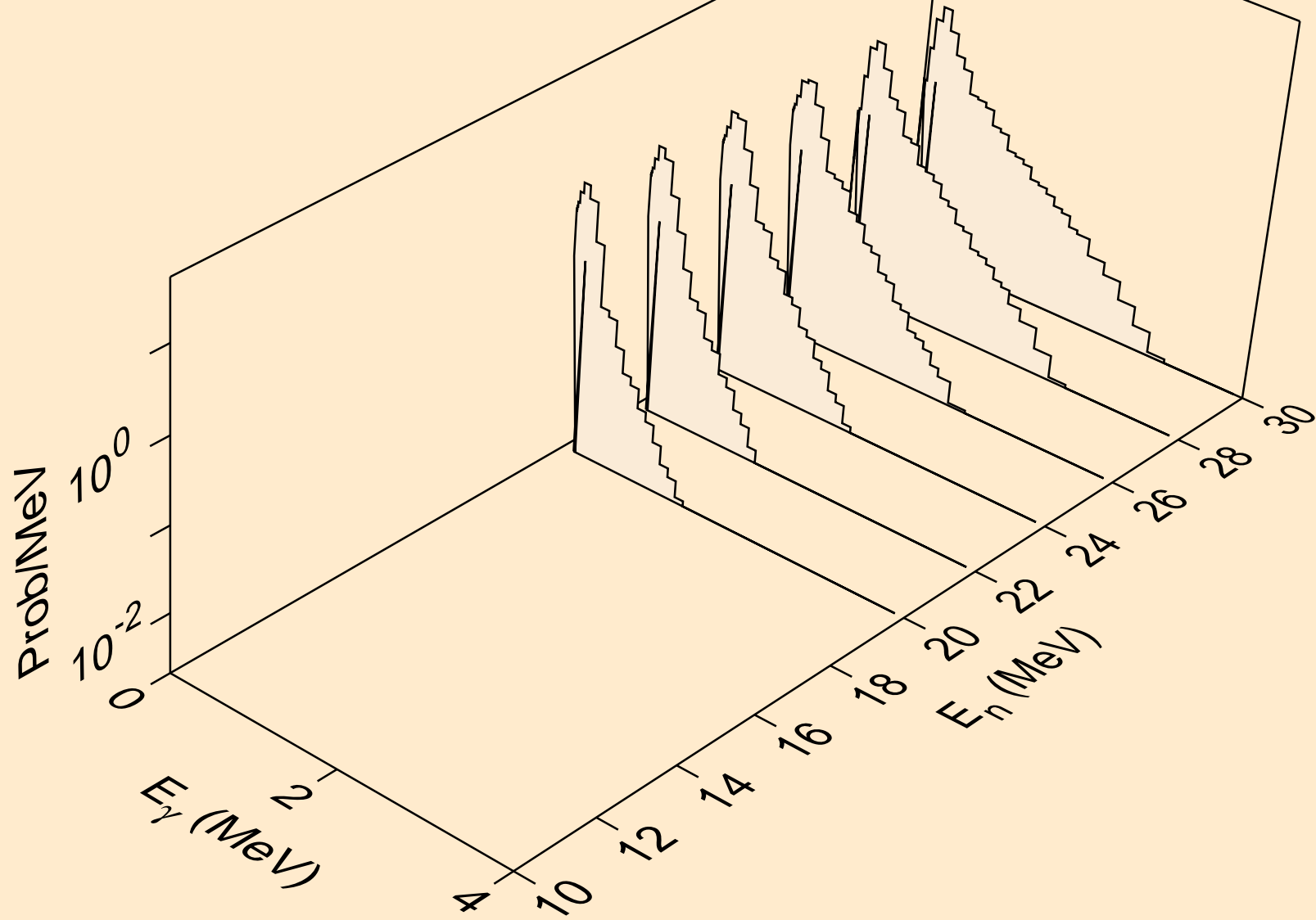

TA192 DEUTERON ACER TENDL-2024 LIBRARY; T=0.K  
Photon emission for (n,gma)

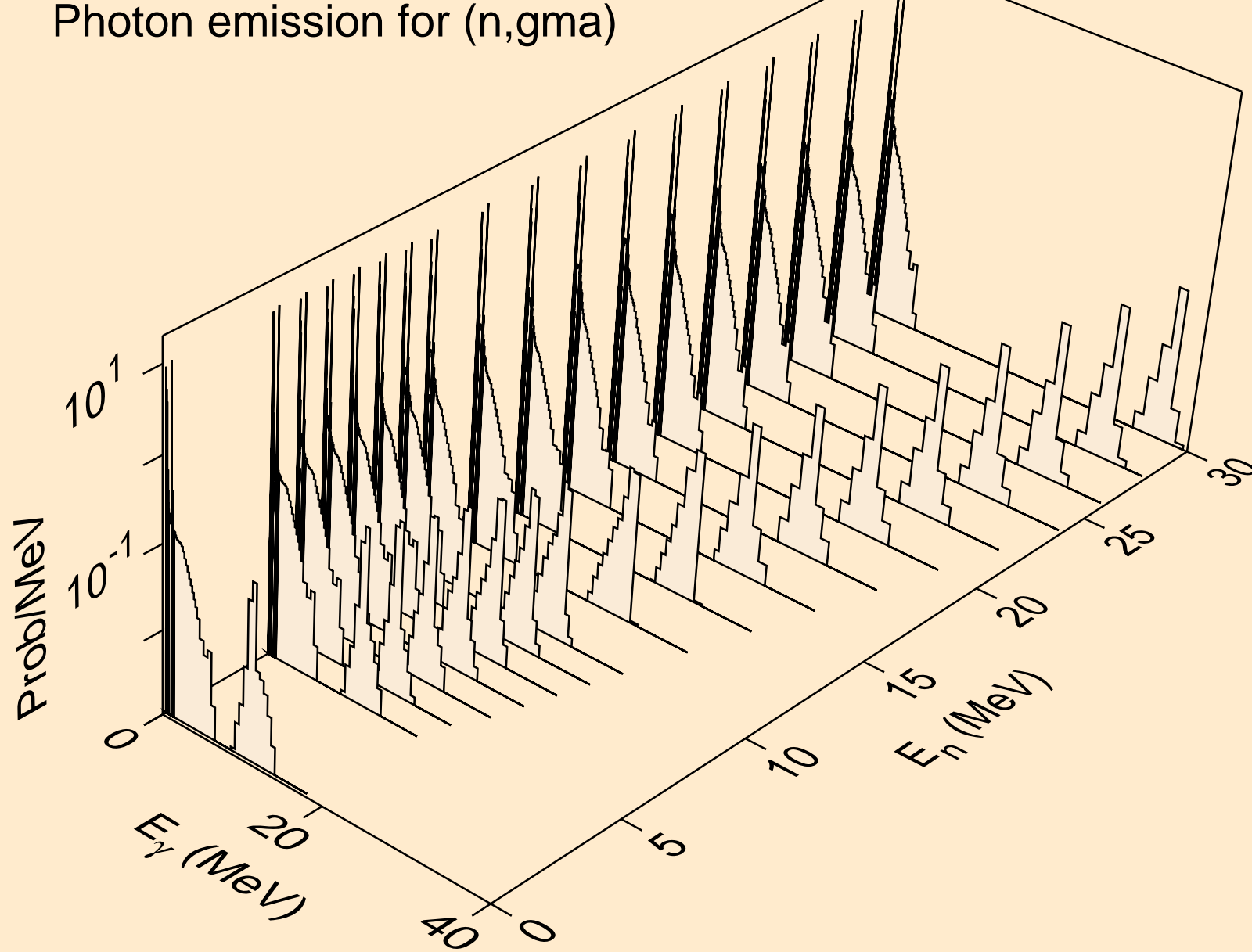

TA192 DEUTERON ACER TENDL-2024 LIBRARY; T=0.K  
Photon emission for (n,p)

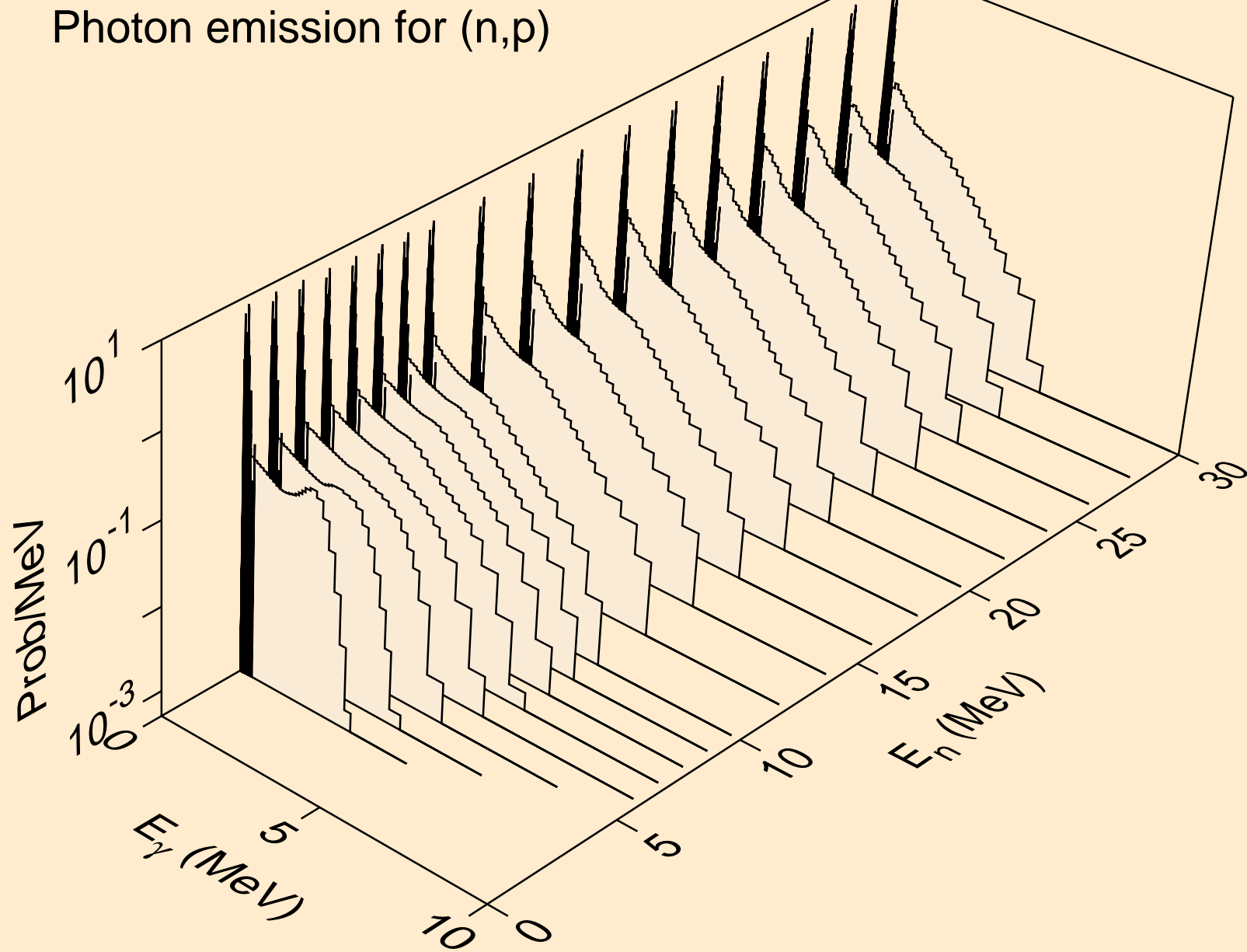

TA192 DEUTERON ACER TENDL-2024 LIBRARY; T=0.K  
Photon emission for inelastic

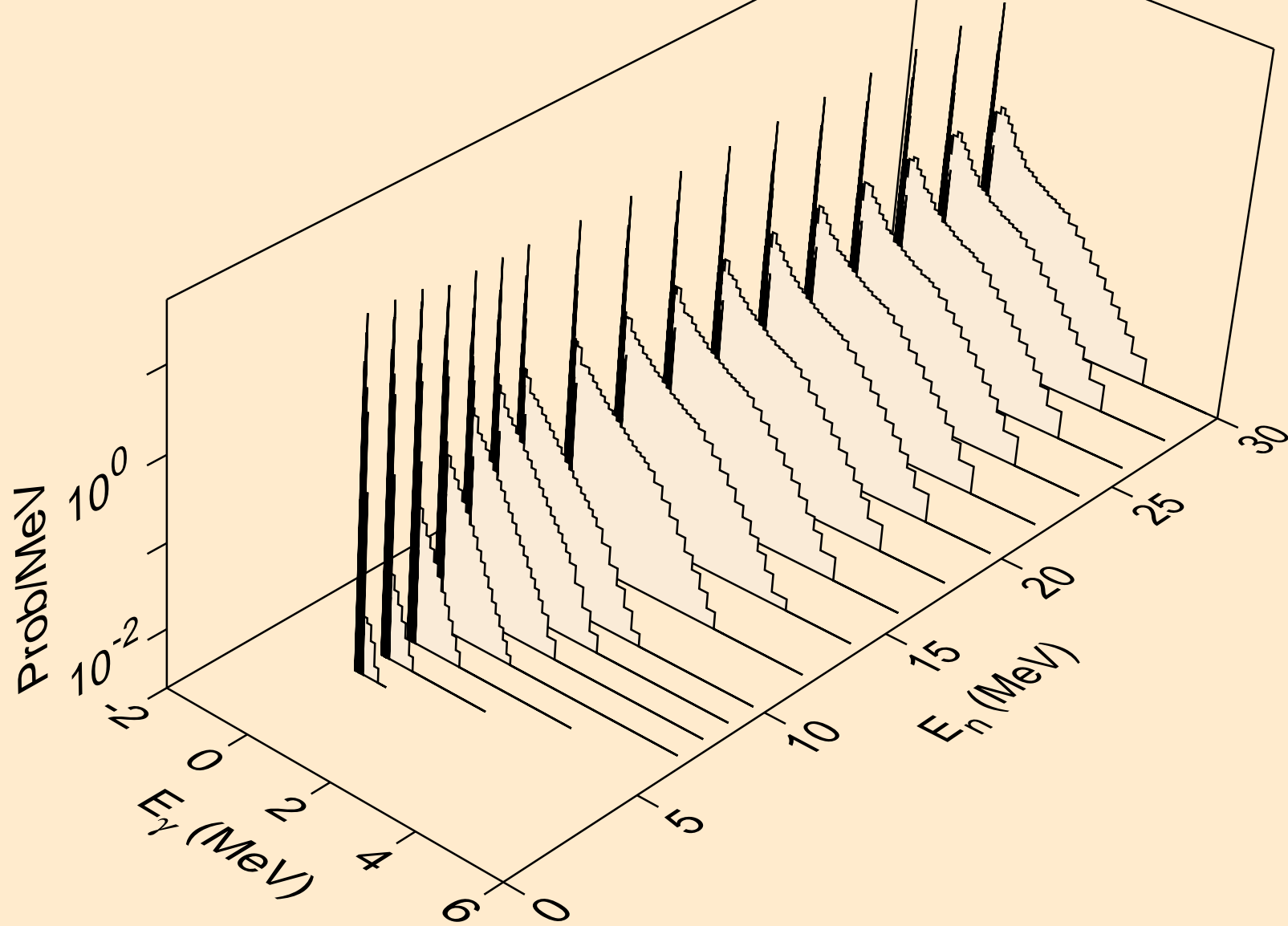

TA192 DEUTERON ACER TENDL-2024 LIBRARY; T=0.K  
Photon emission for (n,t)

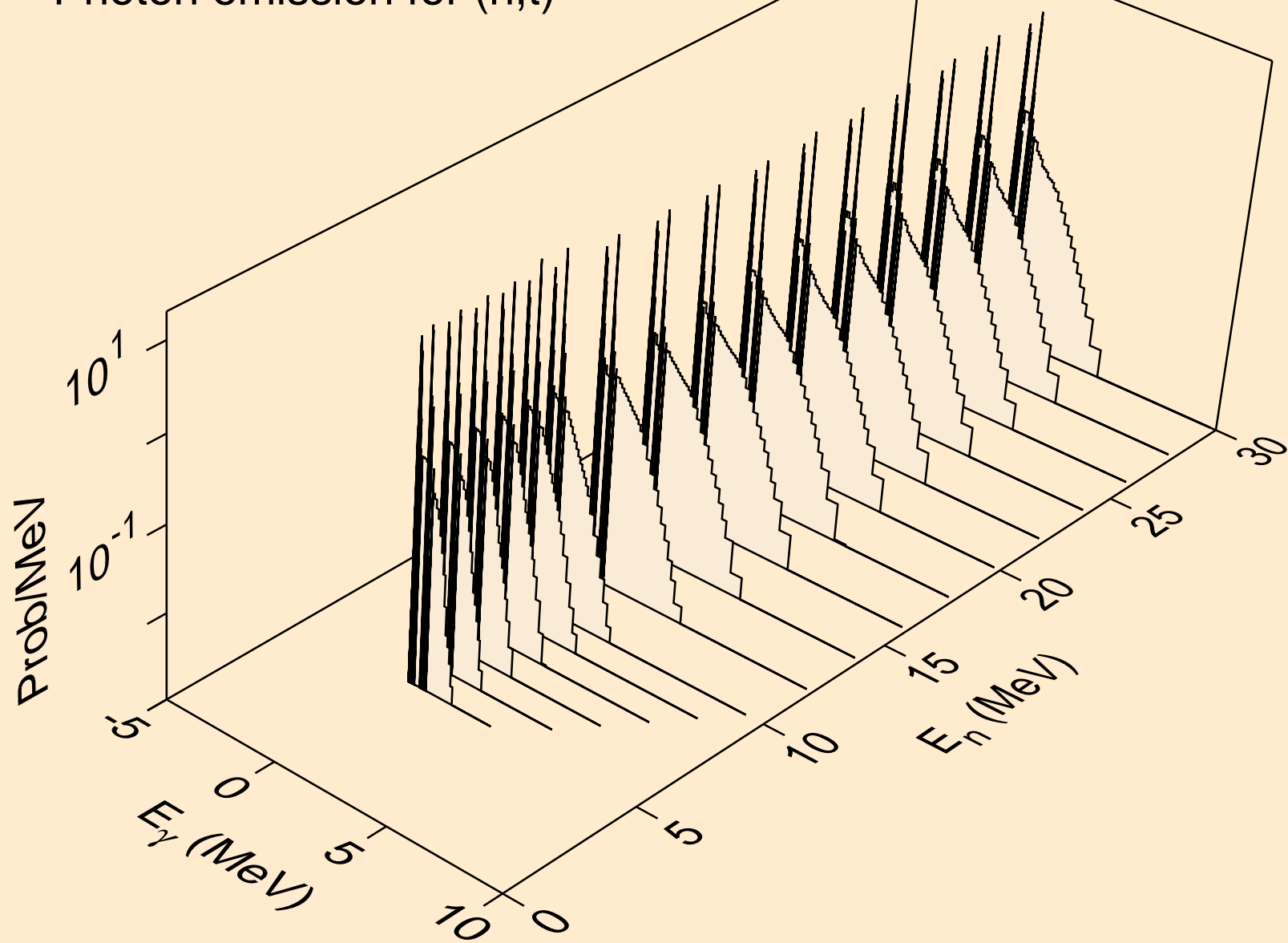

TA192 DEUTERON ACER TENDL-2024 LIBRARY; T=0.K  
Photon emission for (n,he3)

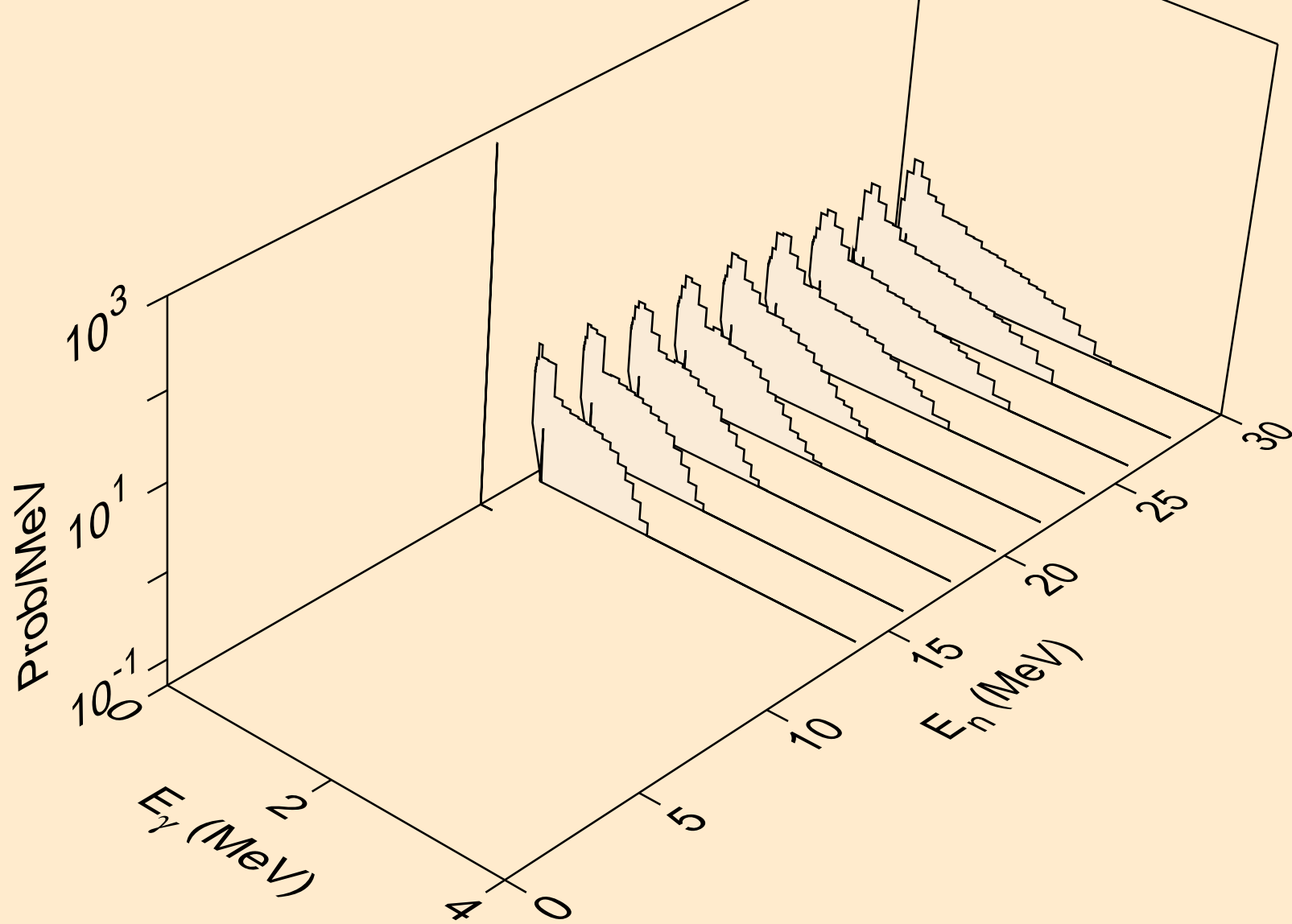

TA192 DEUTERON ACER TENDL-2024 LIBRARY; T=0.K  
Photon emission for (n,a)

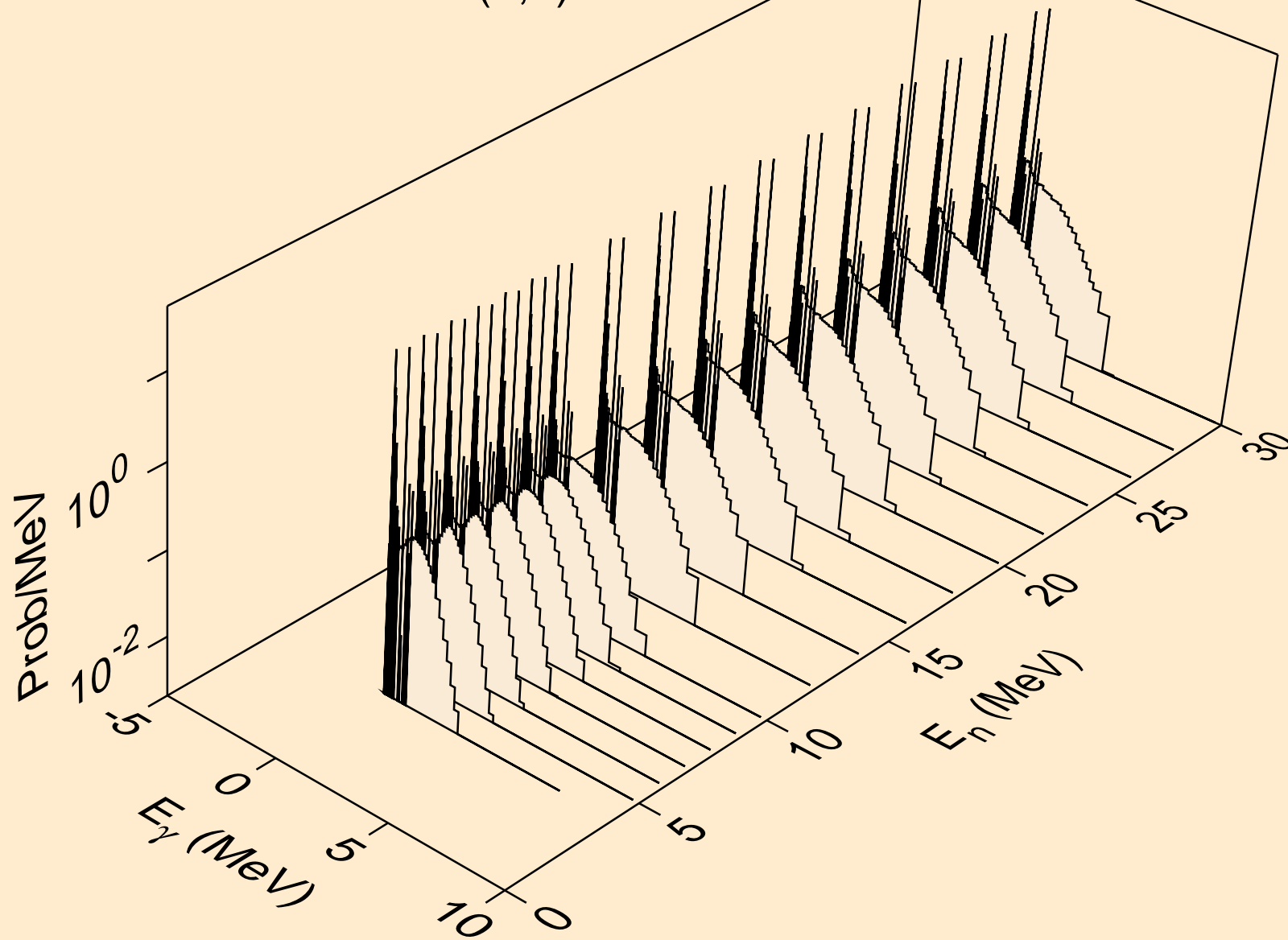

TA192 DEUTERON ACER TENDL-2024 LIBRARY; T=0.K  
Photon emission for (n,2p)

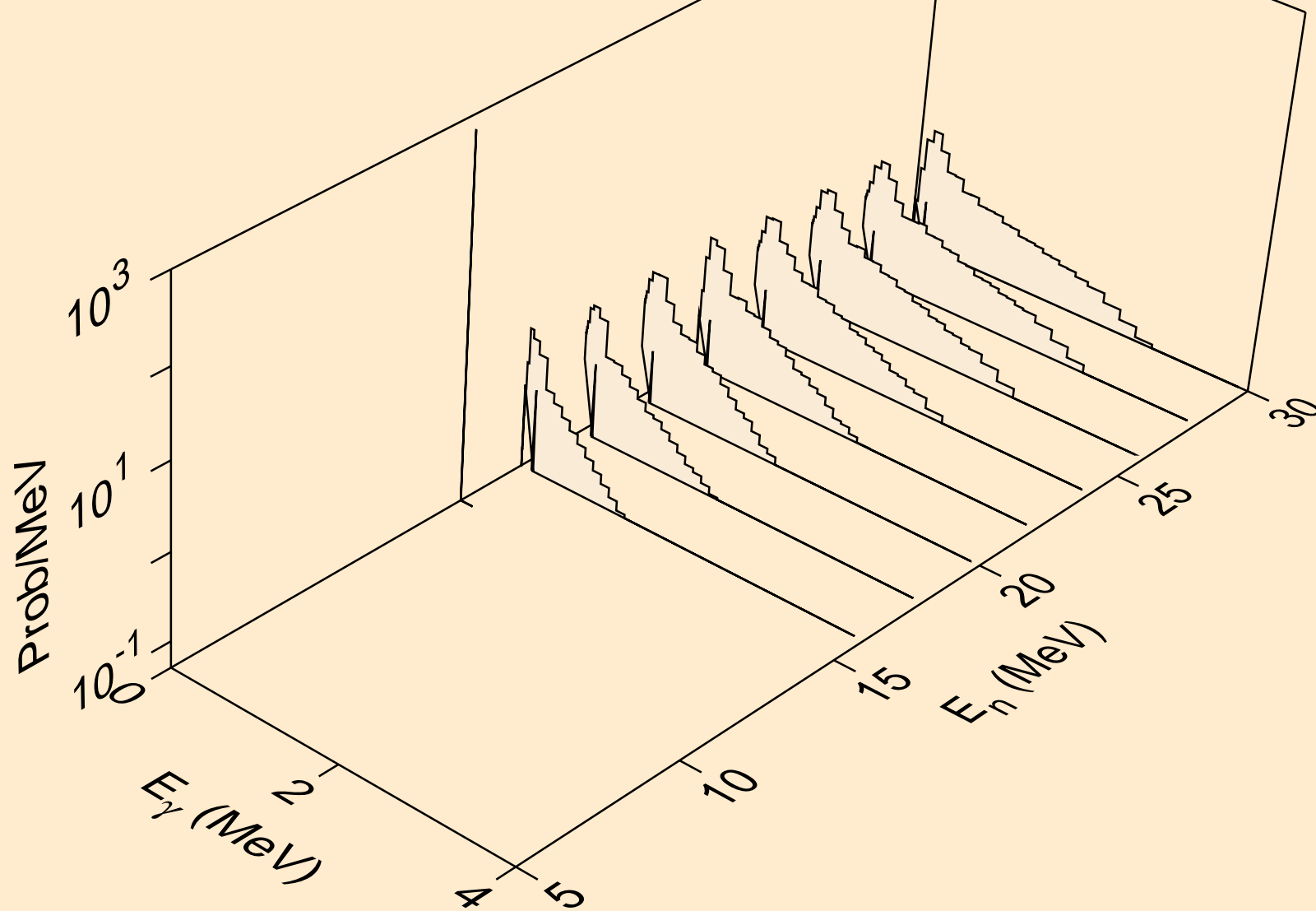

TA192 DEUTERON ACER TENDL-2024 LIBRARY; T=0.K  
Photon emission for (n,pd)

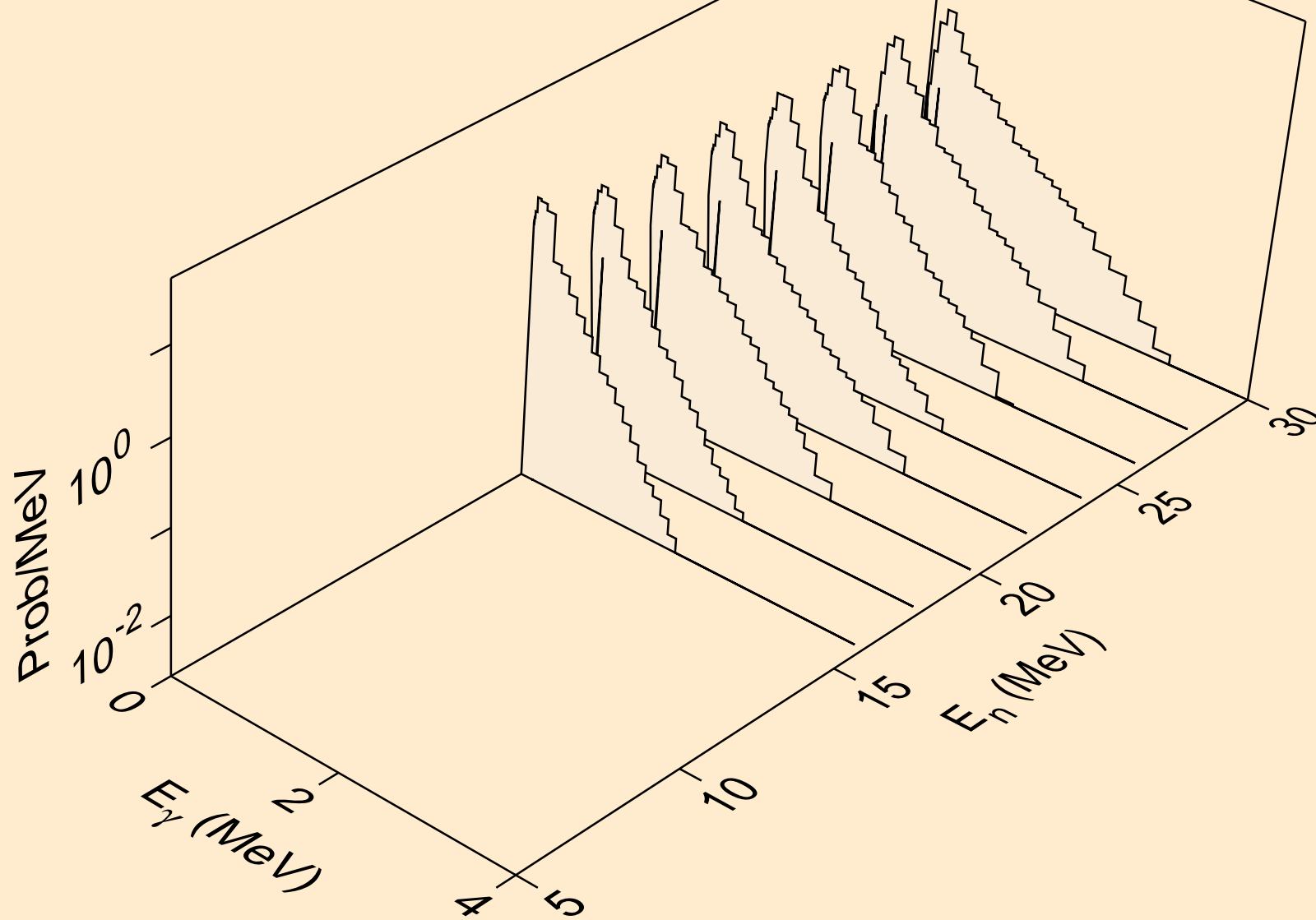

# TA192 DEUTERON ACER TENDL-2024 LIBRARY; T=0.K

## Particle heating contributions

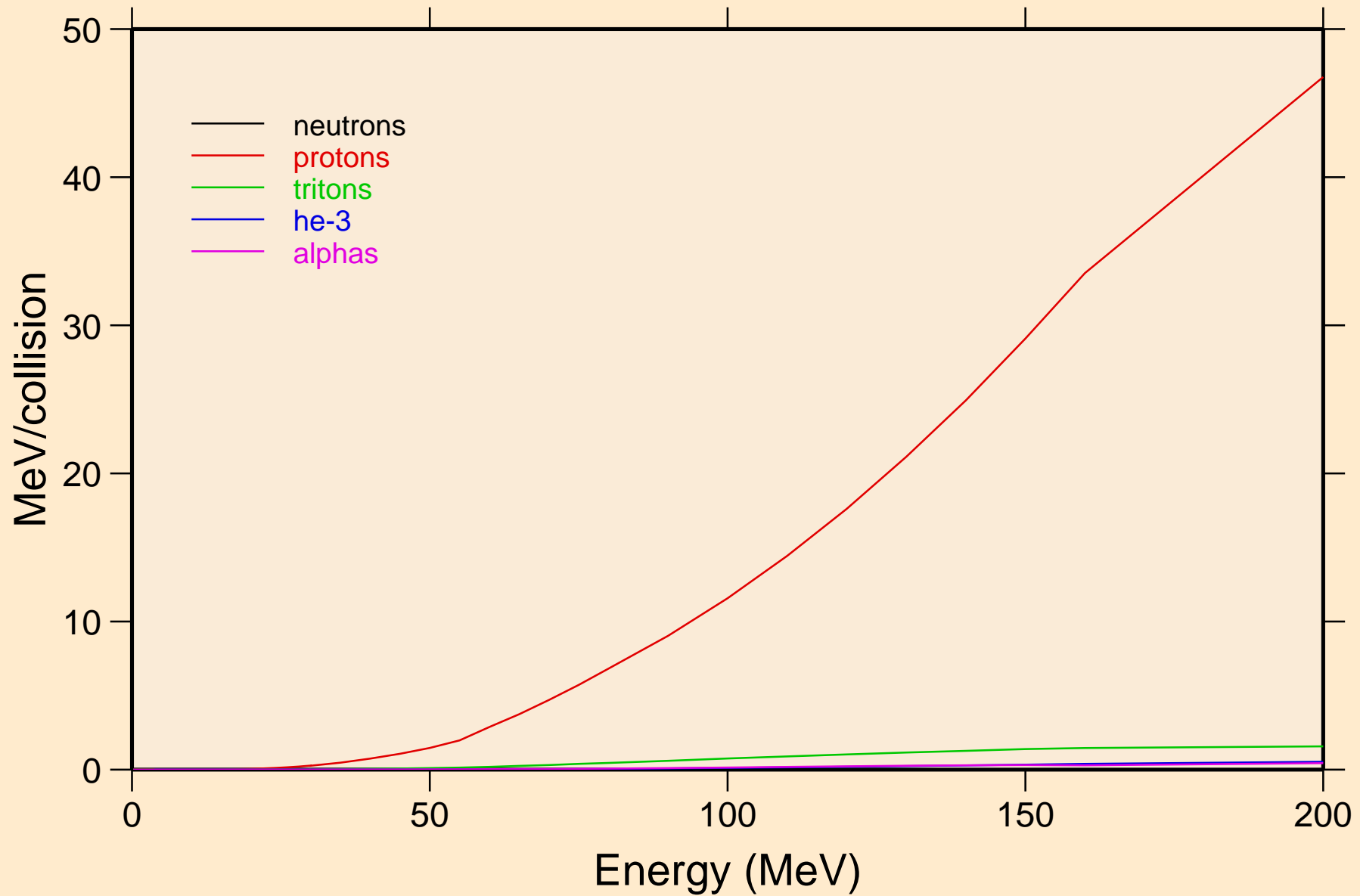

TA192 DEUTERON ACER TENDL-2024 LIBRARY; T=0.K  
Recoil Heating

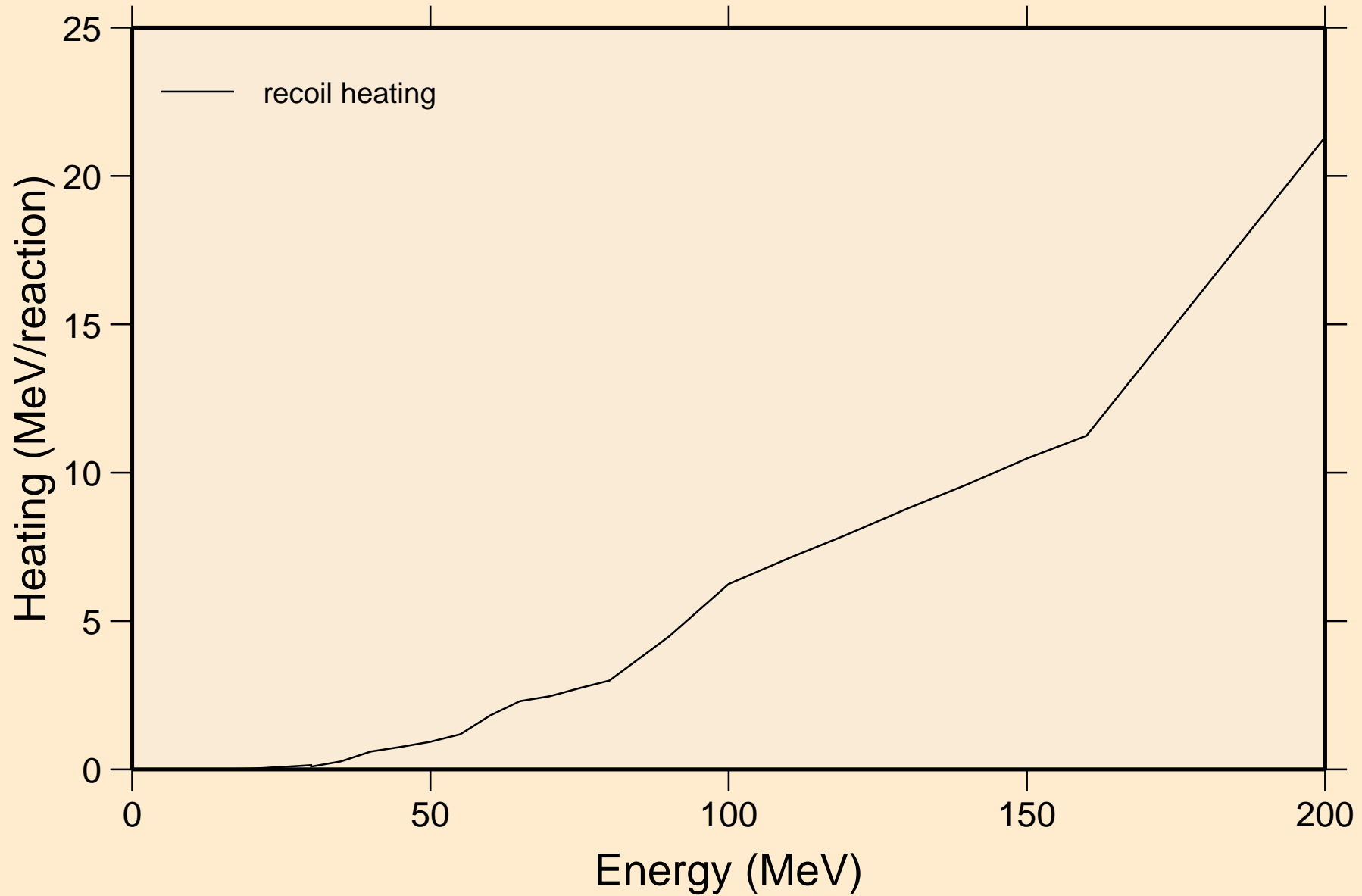

TA192 DEUTERON ACER TENDL-2024 LIBRARY; T=0.K  
Particle production cross sections

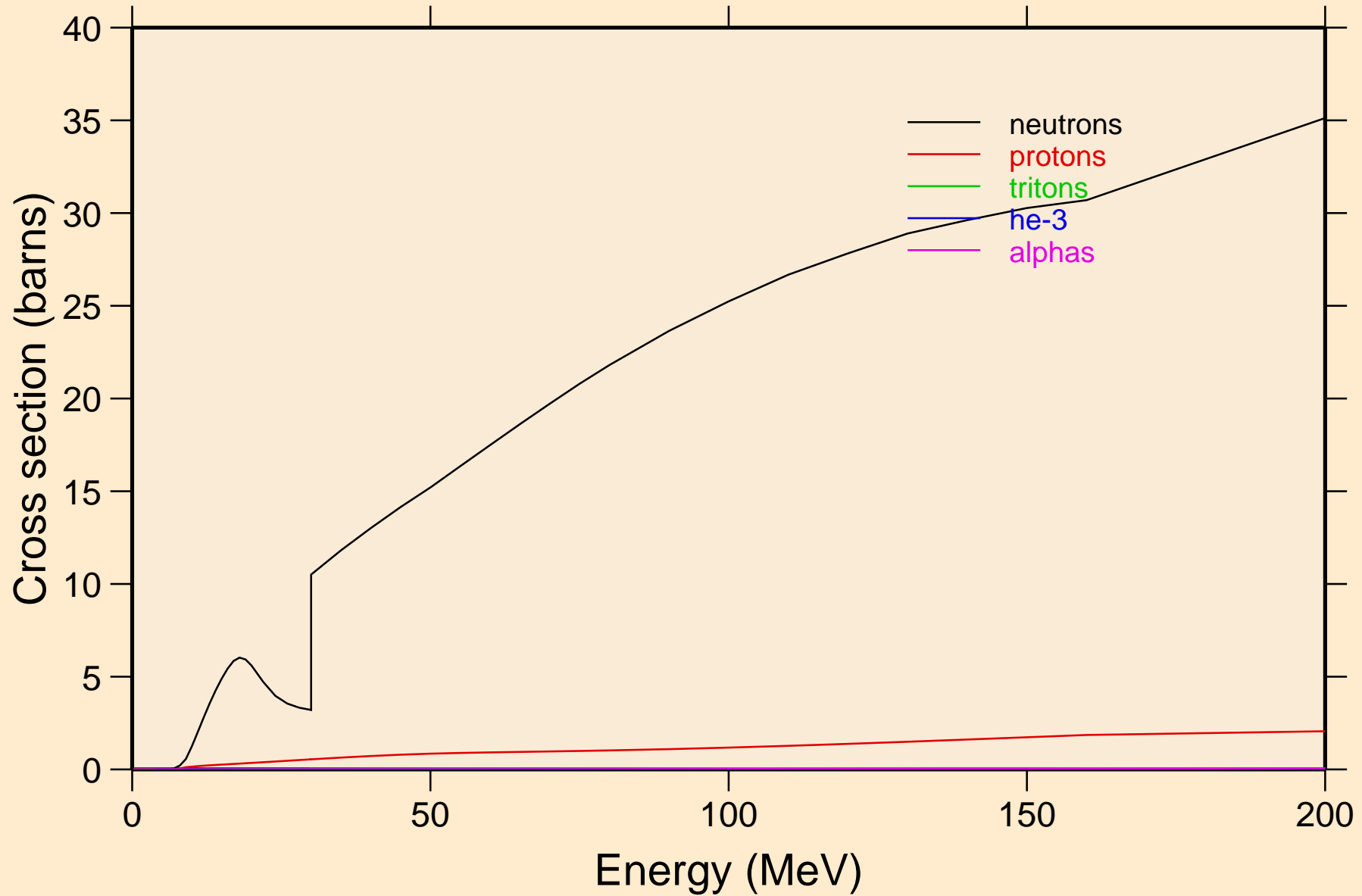

TA192 DEUTERON ACER TENDL-2024 LIBRARY; T=0.K  
neutrons from (d,n)

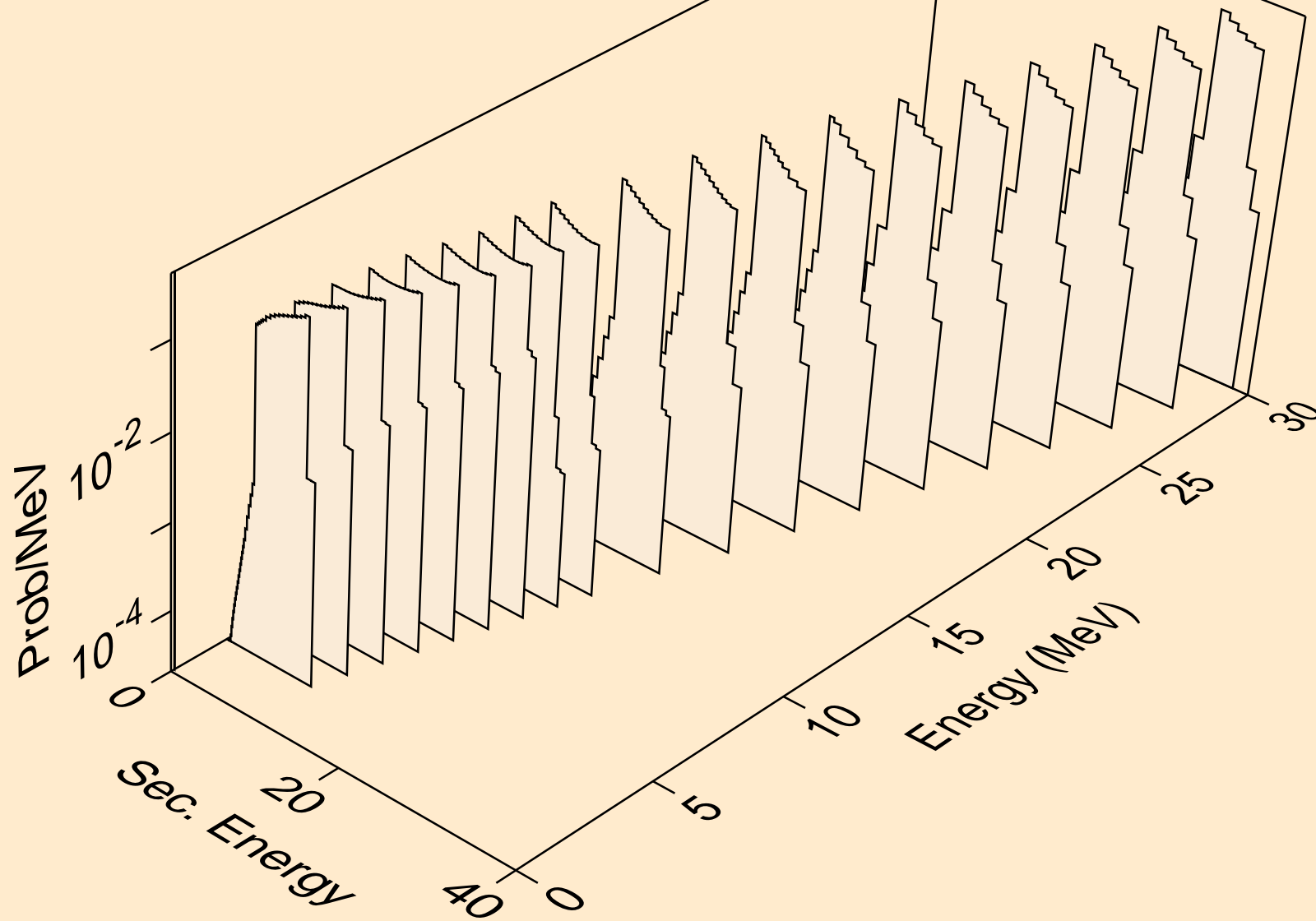

TA192 DEUTERON ACER TENDL-2024 LIBRARY; T=0.K  
neutrons from (d,x)

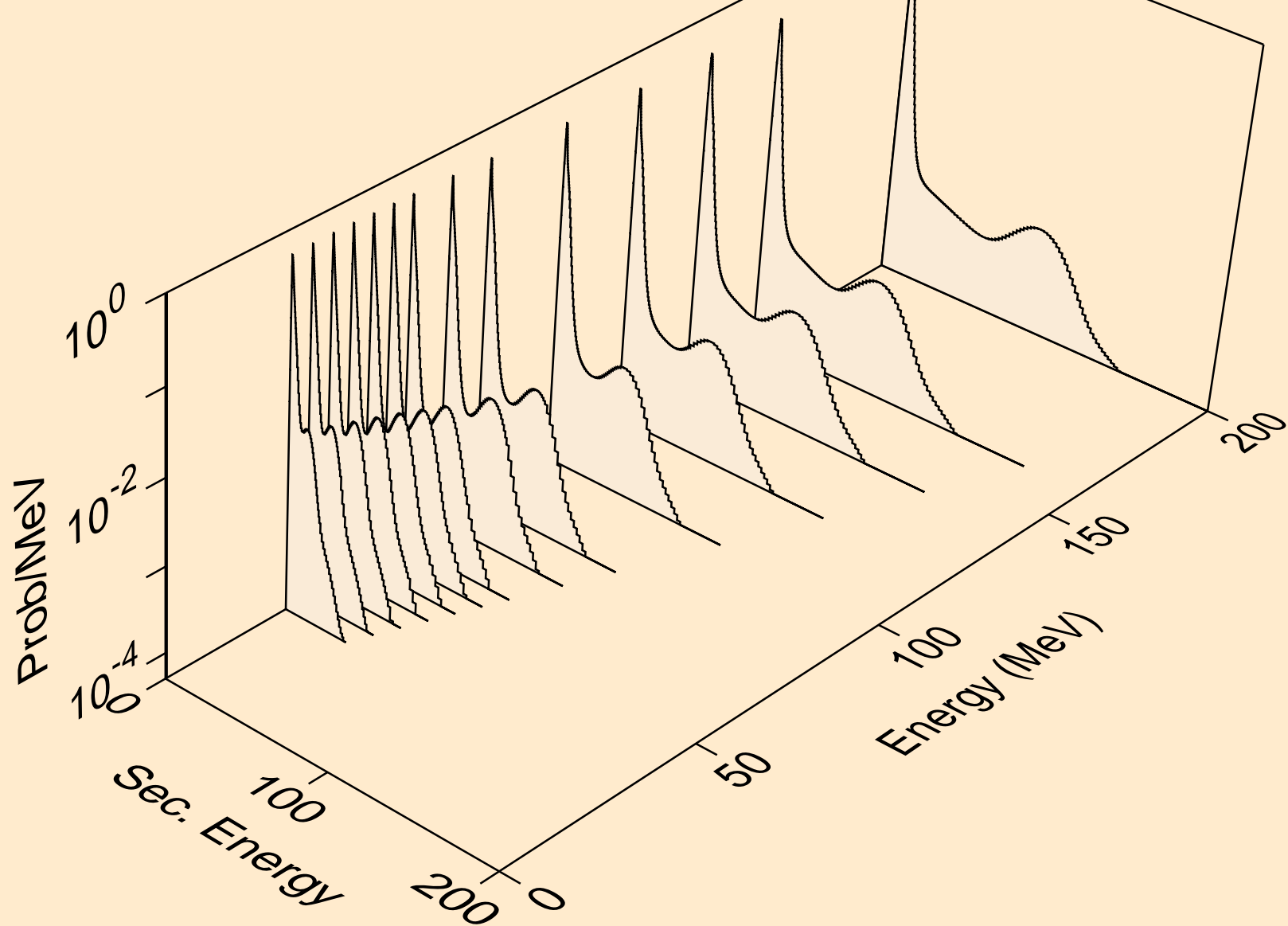

TA192 DEUTERON ACER TENDL-2024 LIBRARY; T=0.K  
neutrons from (d,2nd)

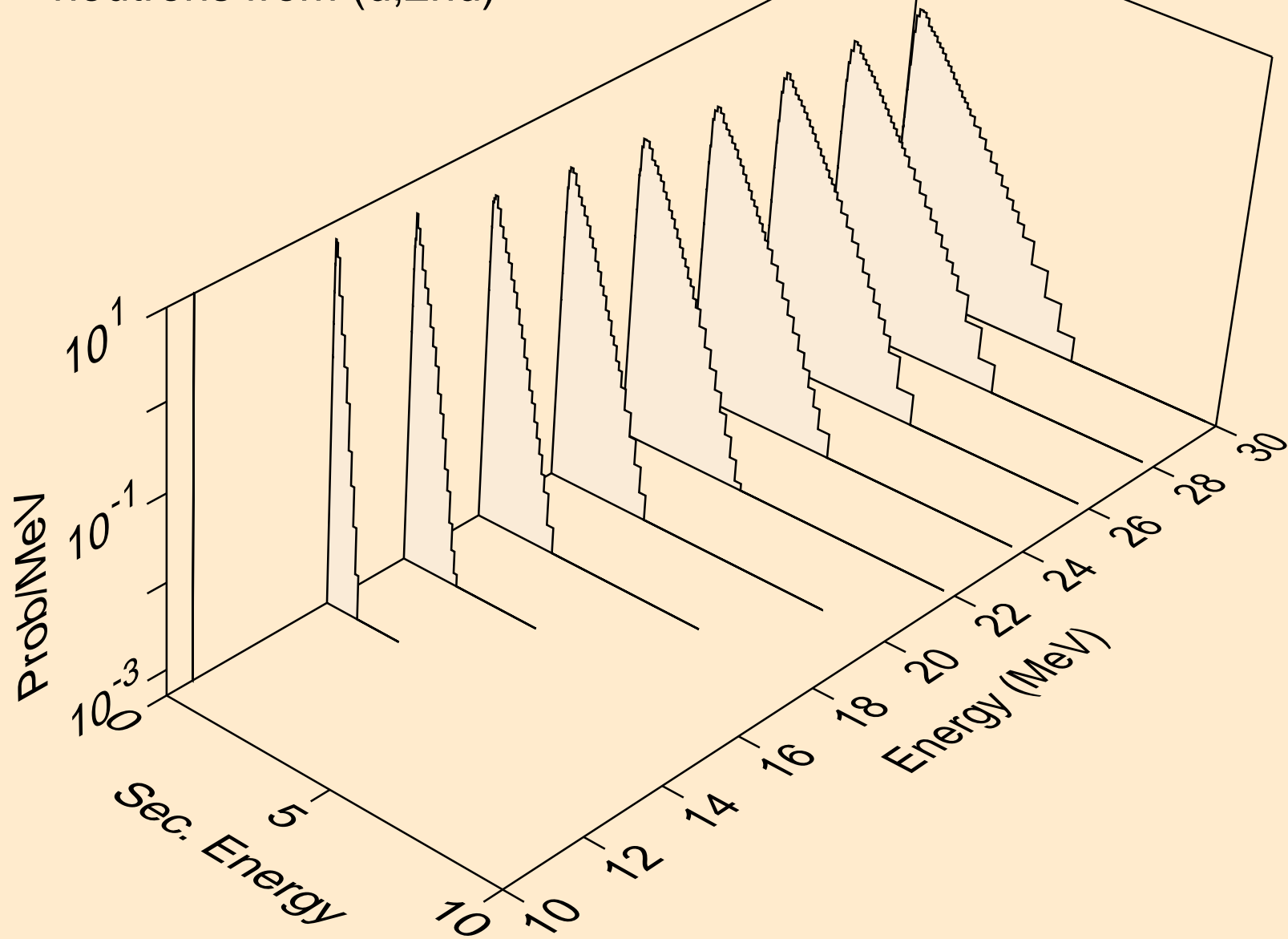

TA192 DEUTERON ACER TENDL-2024 LIBRARY; T=0.K  
neutrons from (d,2n)

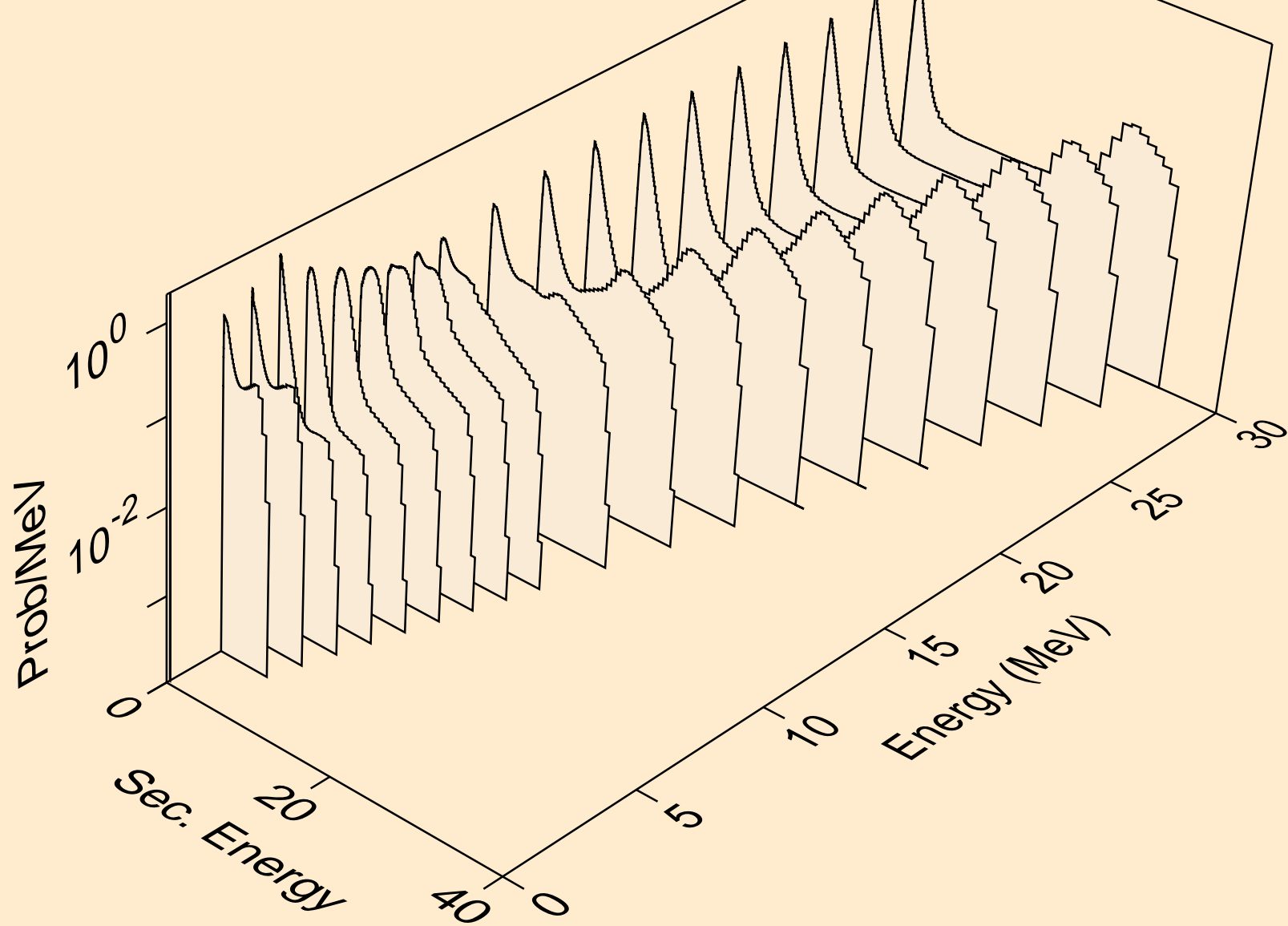

TA192 DEUTERON ACER TENDL-2024 LIBRARY; T=0.K  
neutrons from (d,3n)

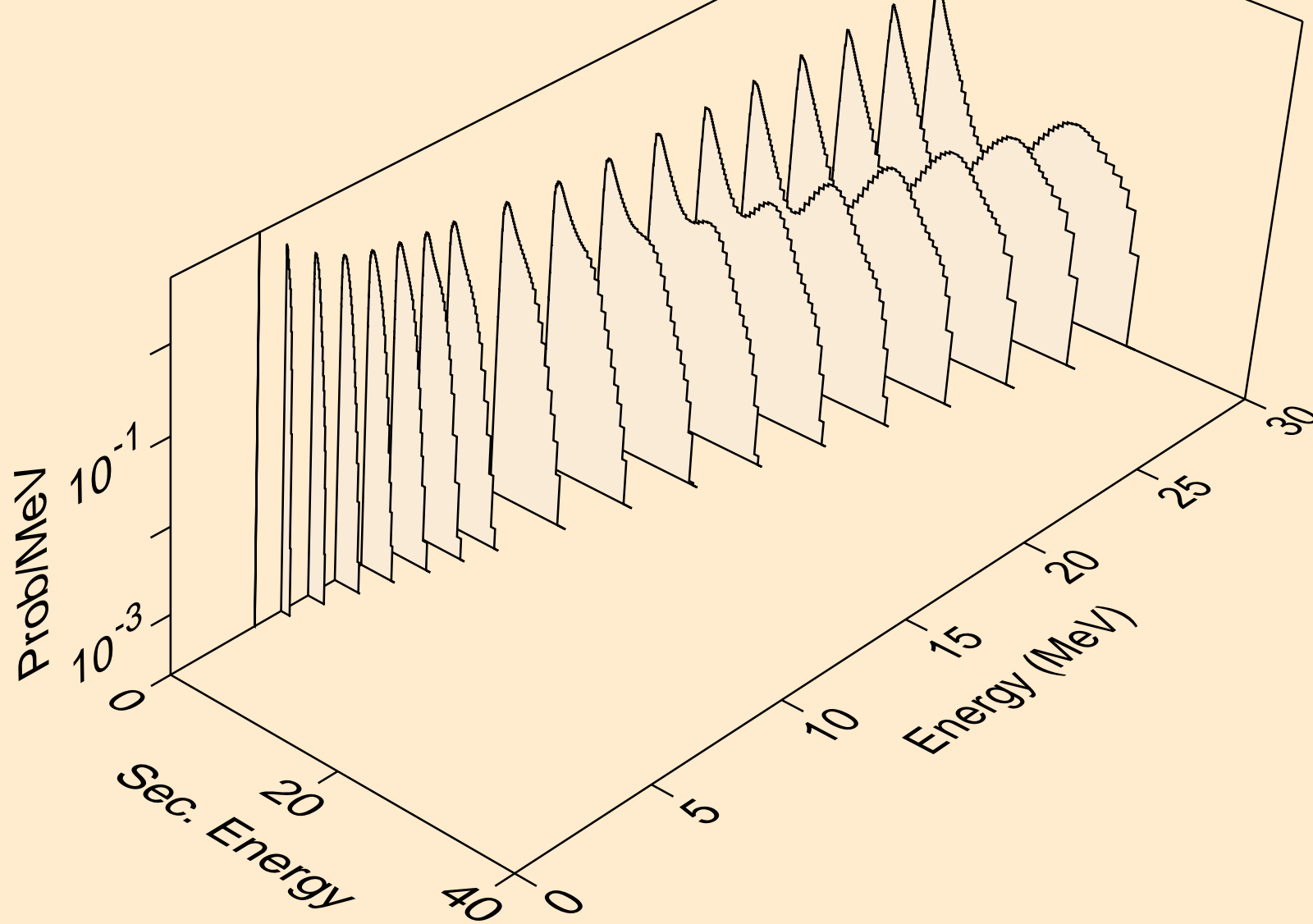

TA192 DEUTERON ACER TENDL-2024 LIBRARY; T=0.K  
neutrons from (d,n\*)a

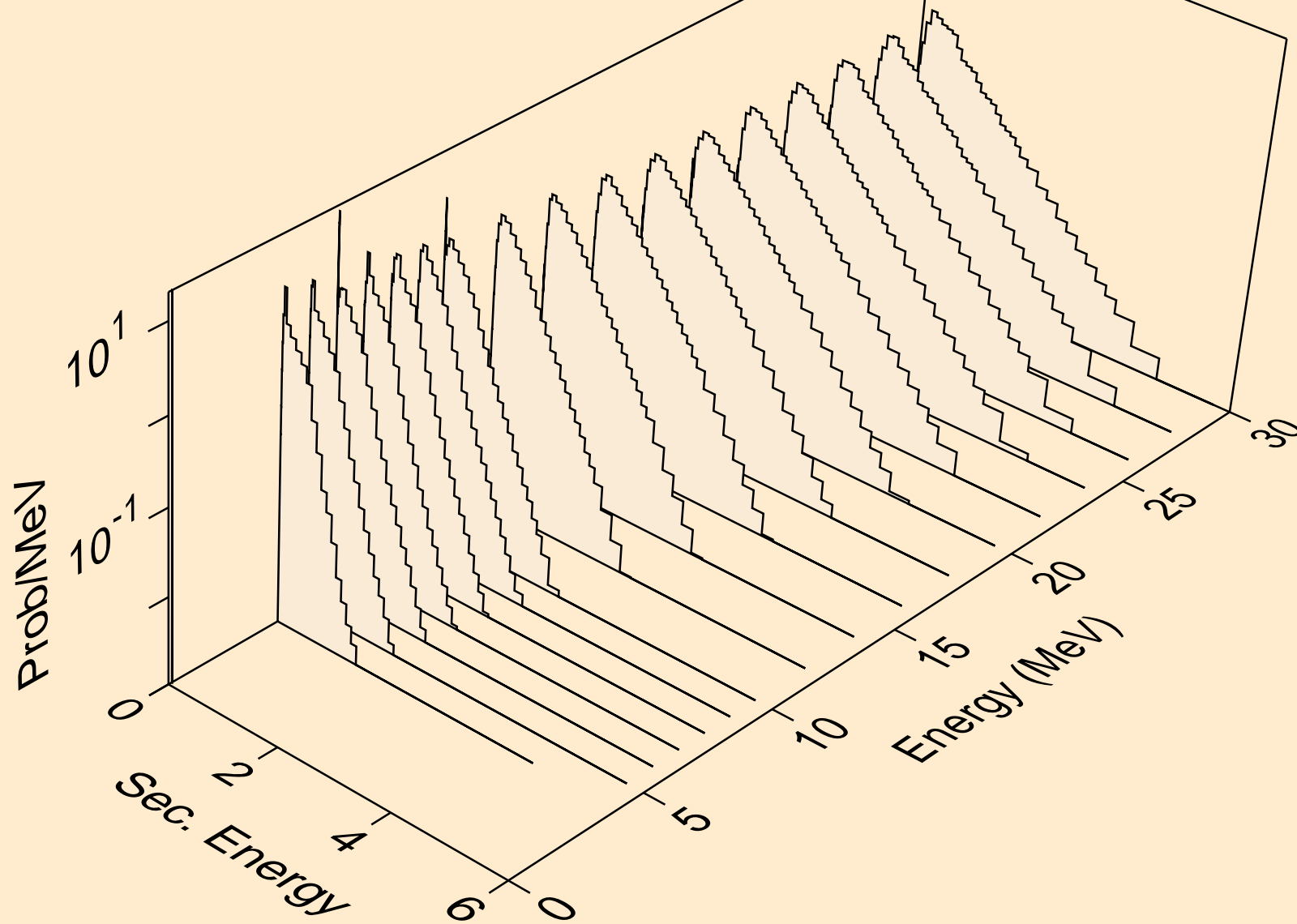

TA192 DEUTERON ACER TENDL-2024 LIBRARY; T=0.K  
neutrons from (d,2n)a

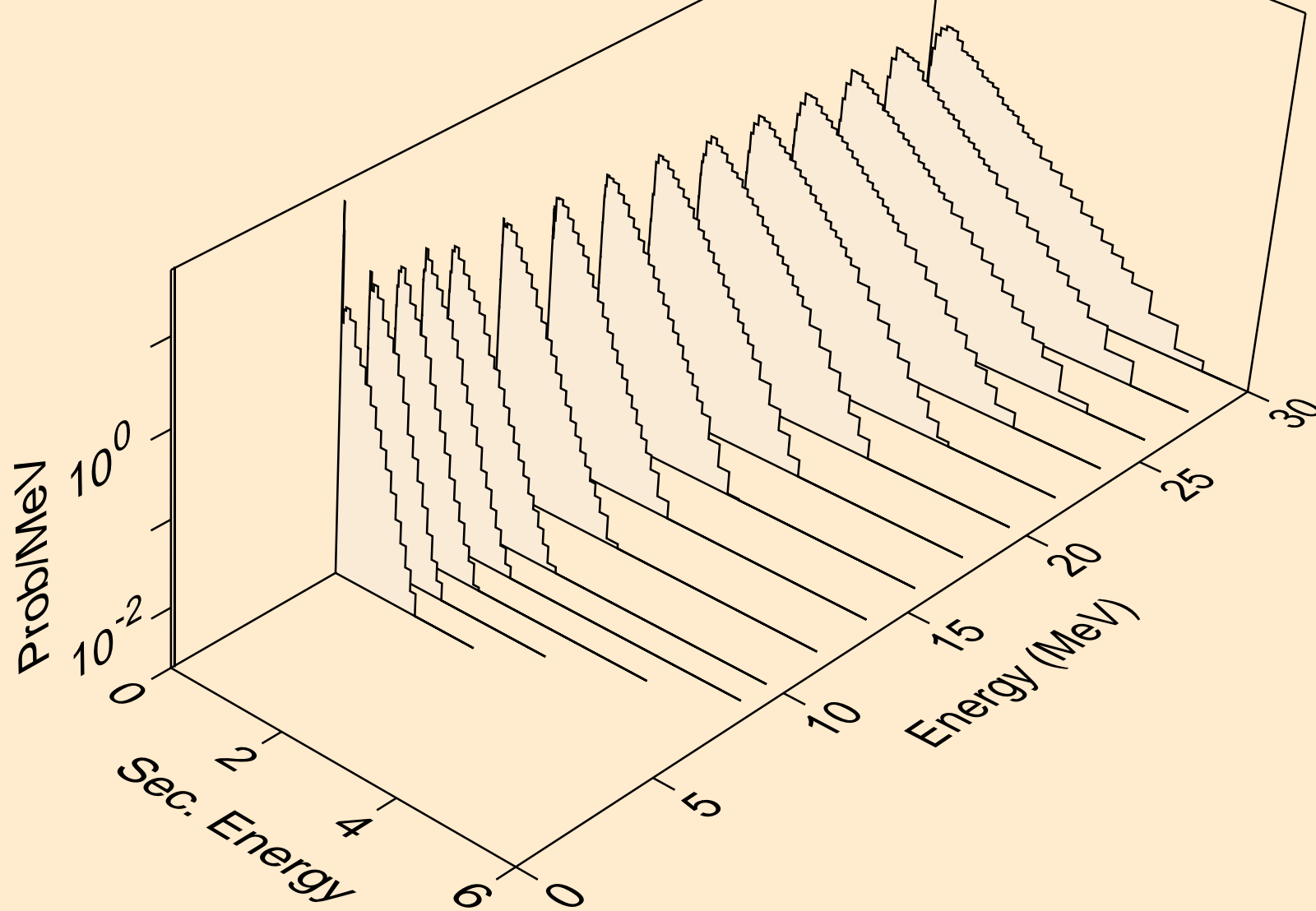

TA192 DEUTERON ACER TENDL-2024 LIBRARY; T=0.K  
neutrons from (d,3n)a

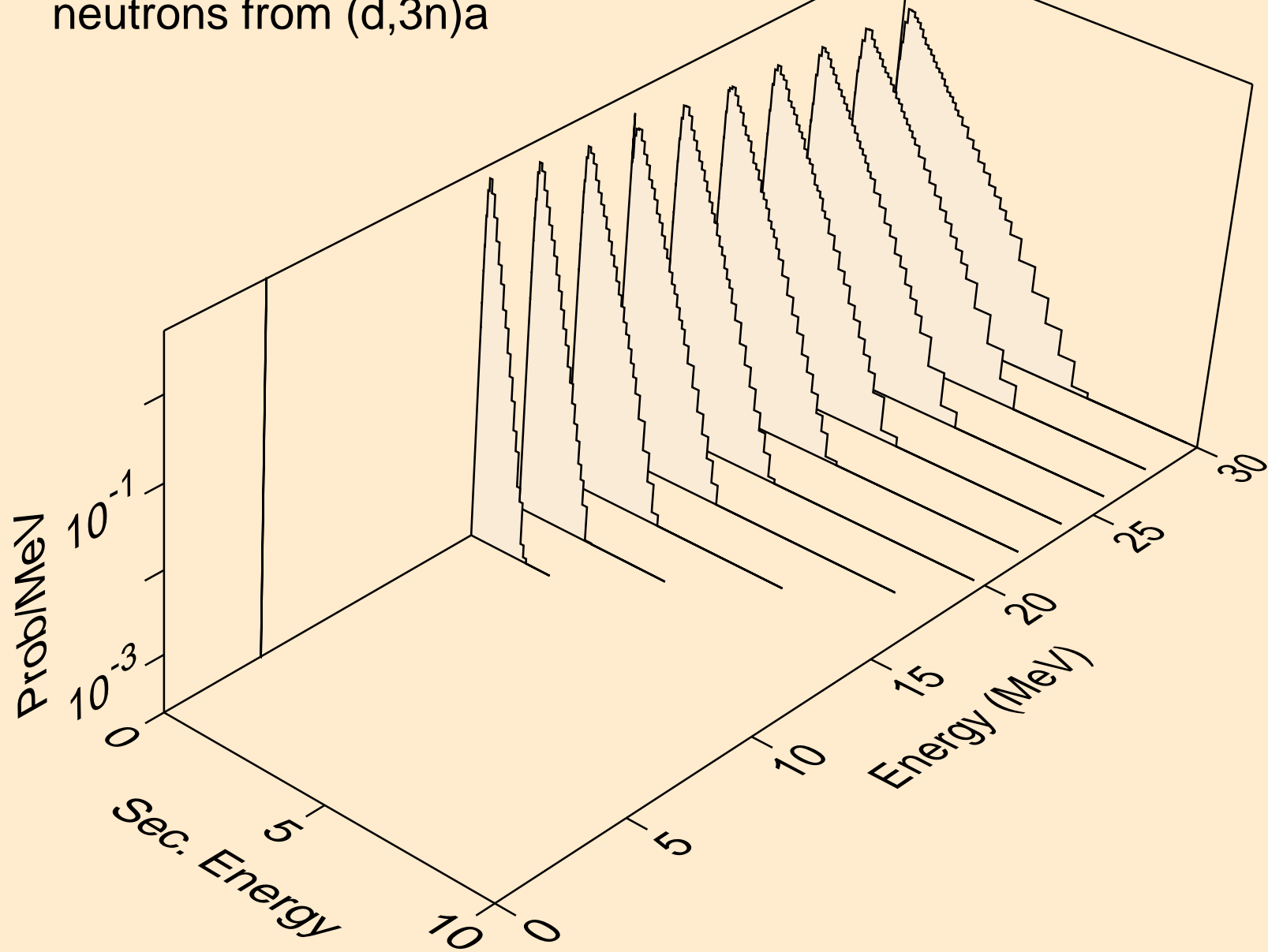

TA192 DEUTERON ACER TENDL-2024 LIBRARY; T=0.K  
neutrons from (d,n\*)p

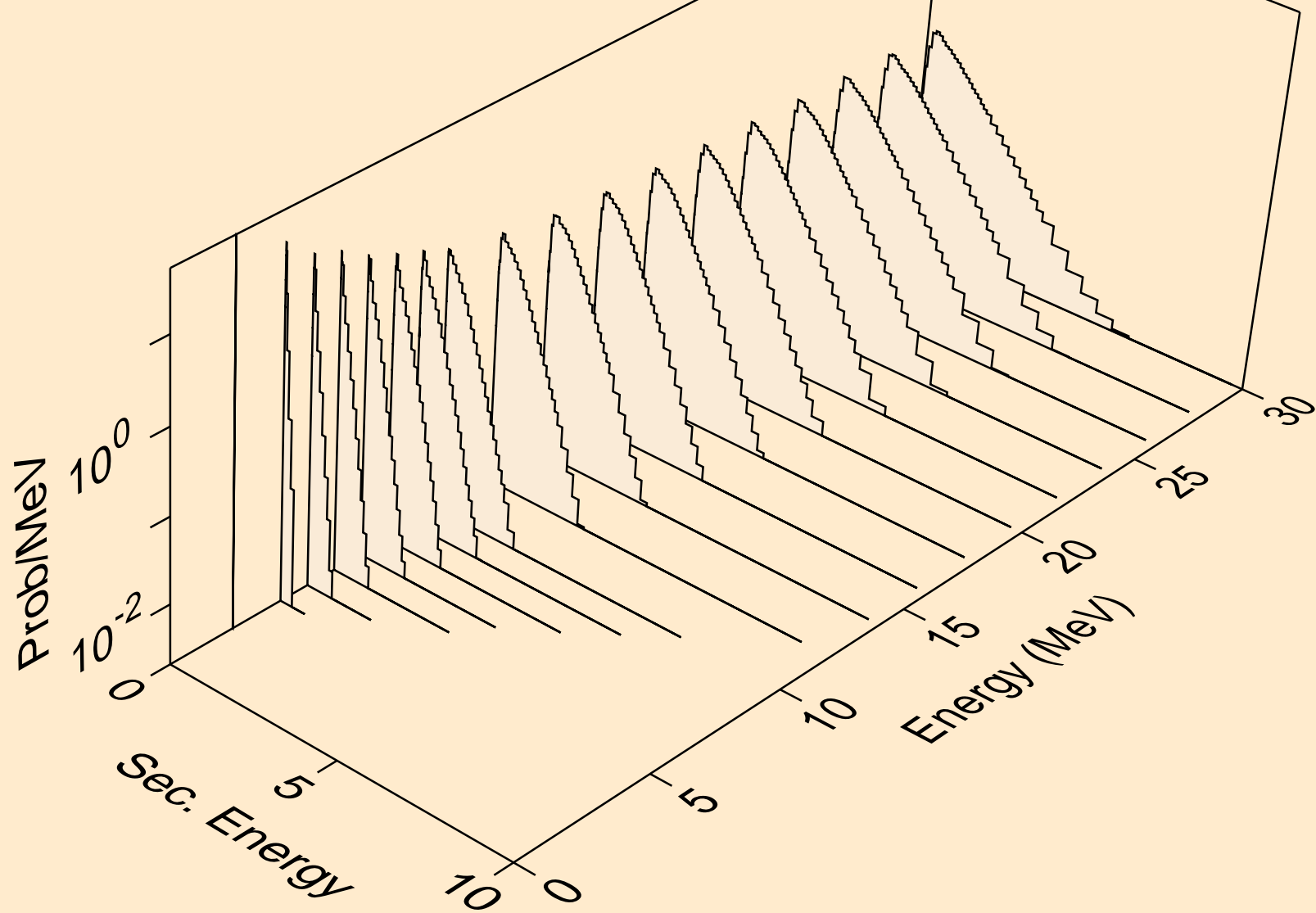

TA192 DEUTERON ACER TENDL-2024 LIBRARY; T=0.K  
neutrons from (d,n\*)d

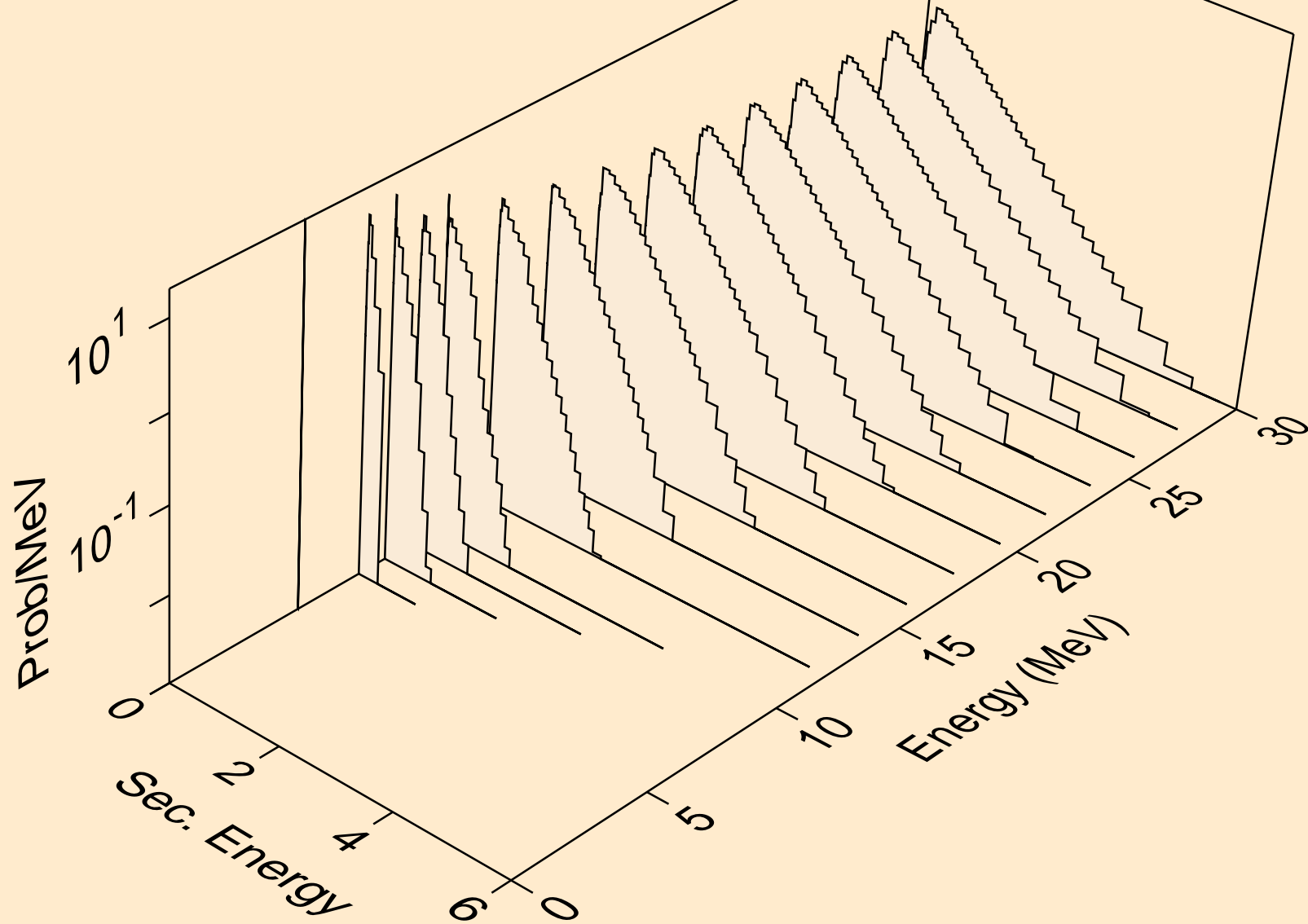

TA192 DEUTERON ACER TENDL-2024 LIBRARY; T=0.K  
neutrons from (d,n\*)t

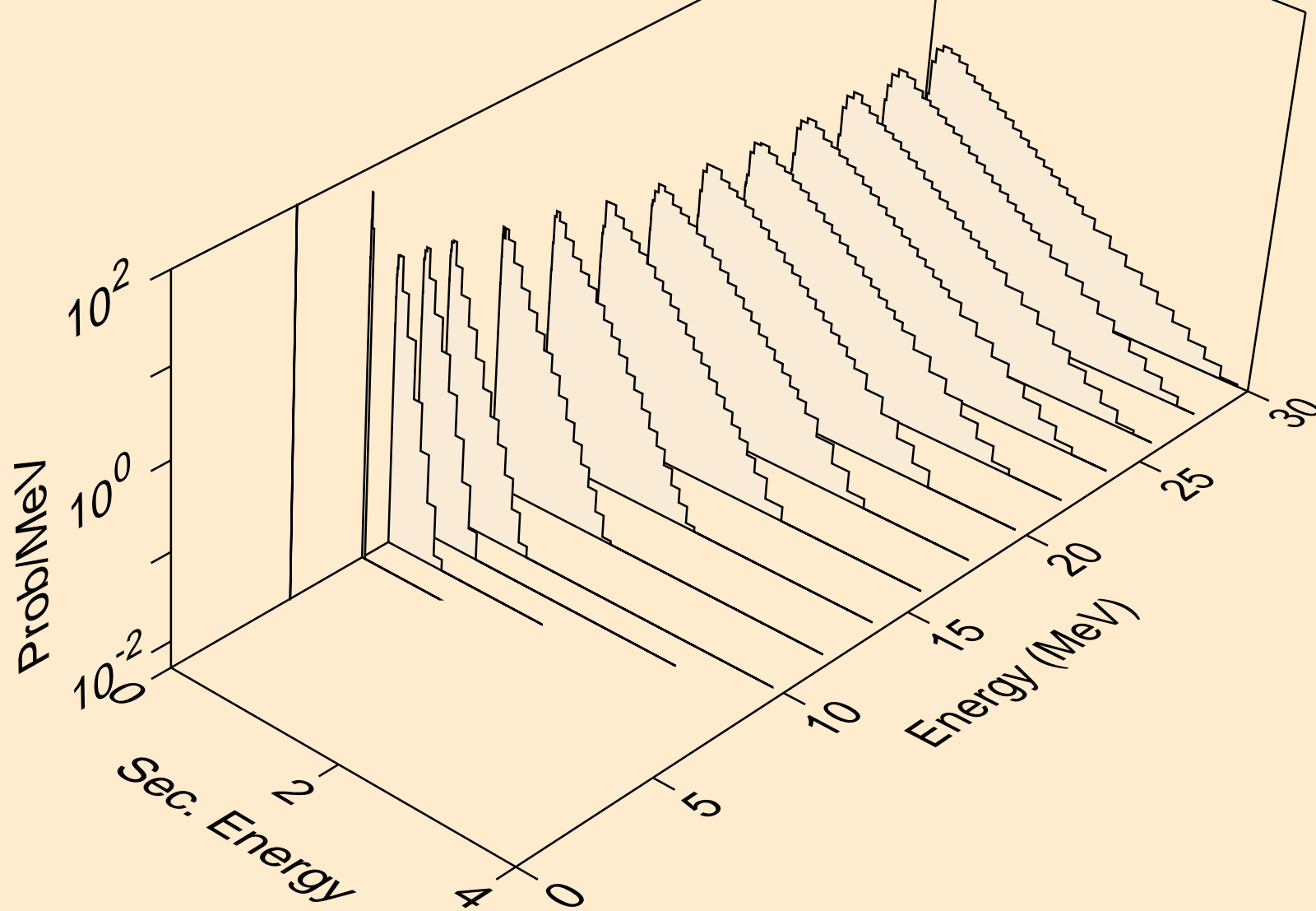

TA192 DEUTERON ACER TENDL-2024 LIBRARY; T=0.K  
neutrons from (d,n\*)he3

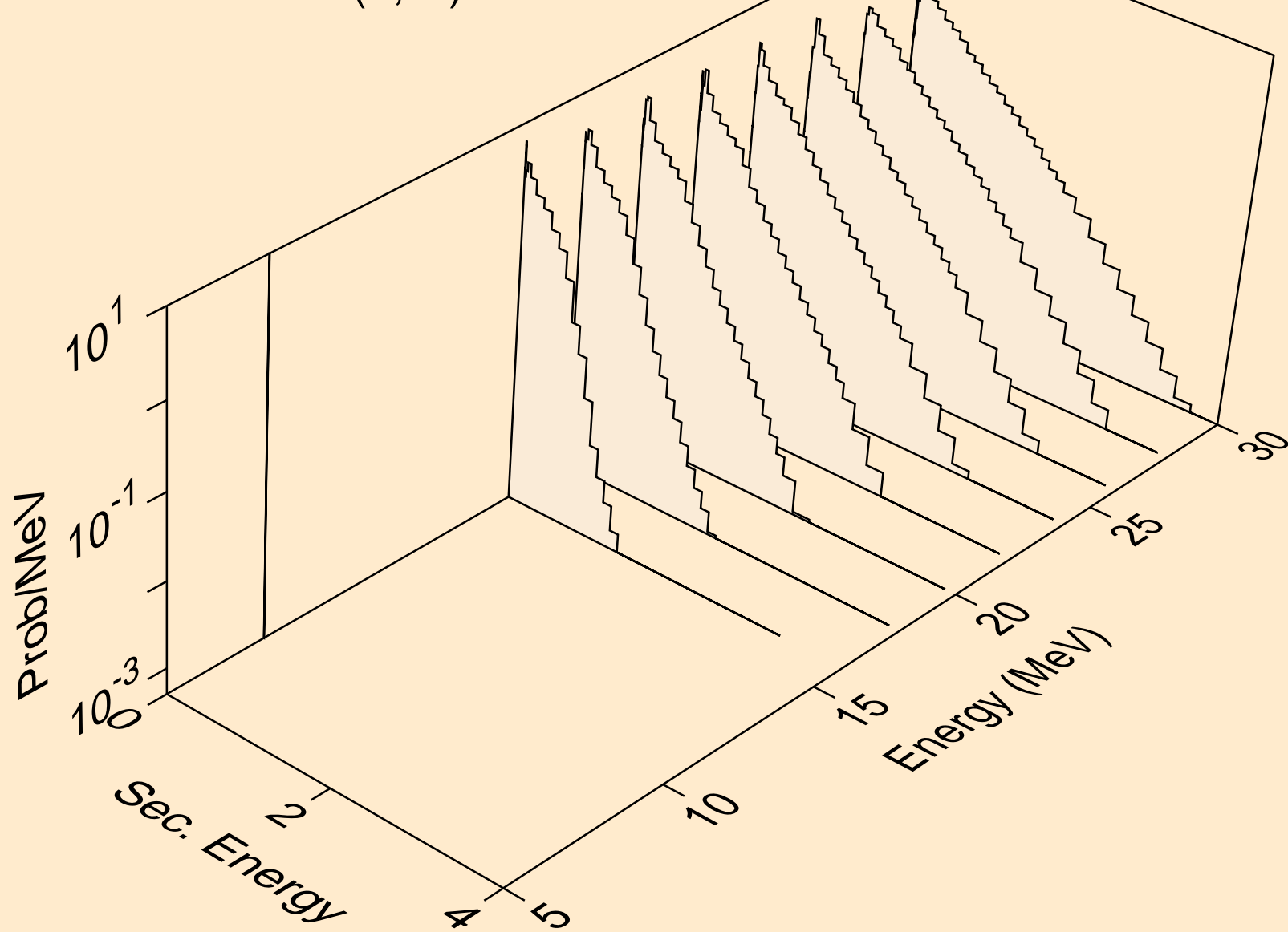

TA192 DEUTERON ACER TENDL-2024 LIBRARY; T=0.K  
neutrons from (d,4n)

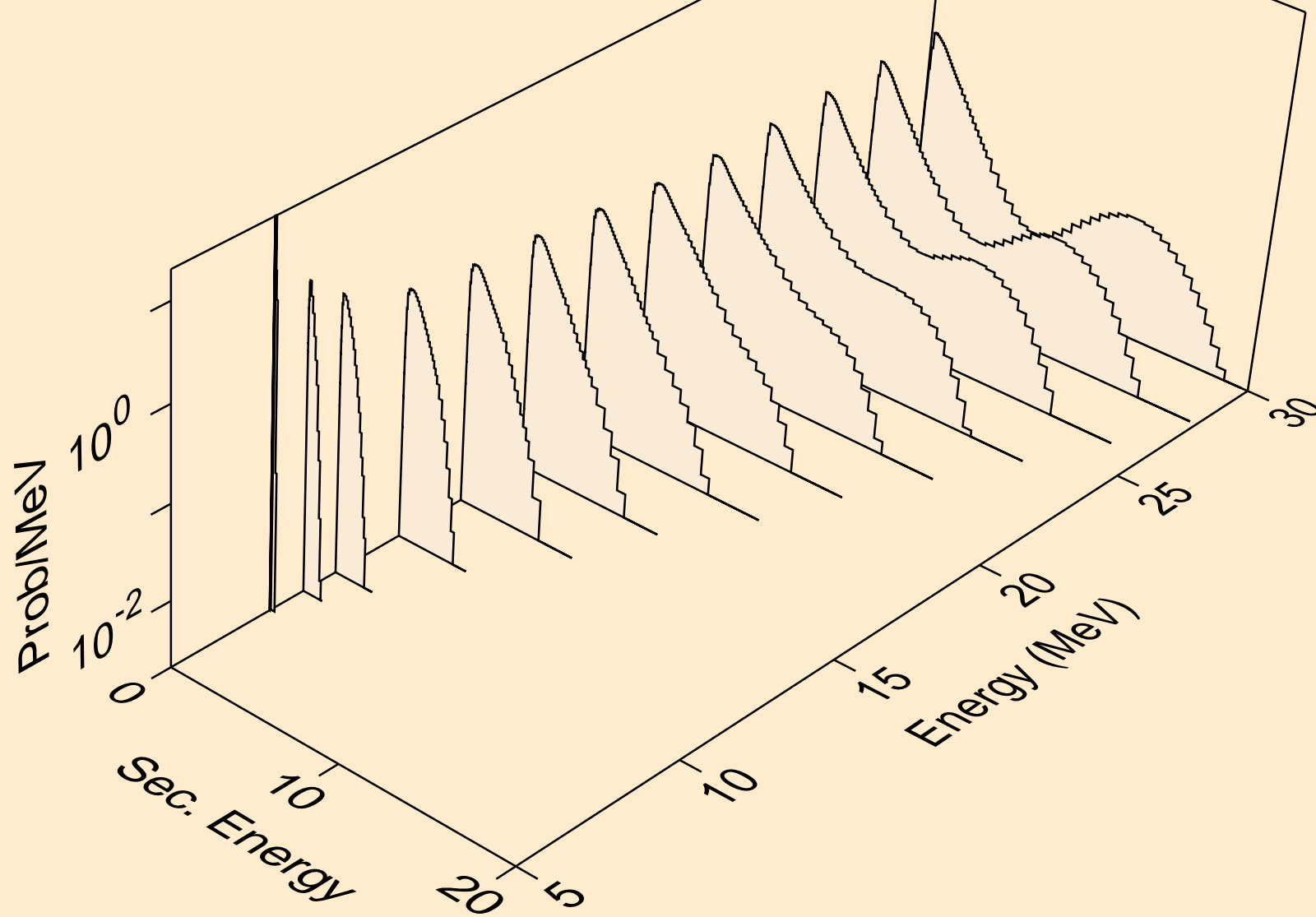

TA192 DEUTERON ACER TENDL-2024 LIBRARY; T=0.K  
neutrons from (d,2np)

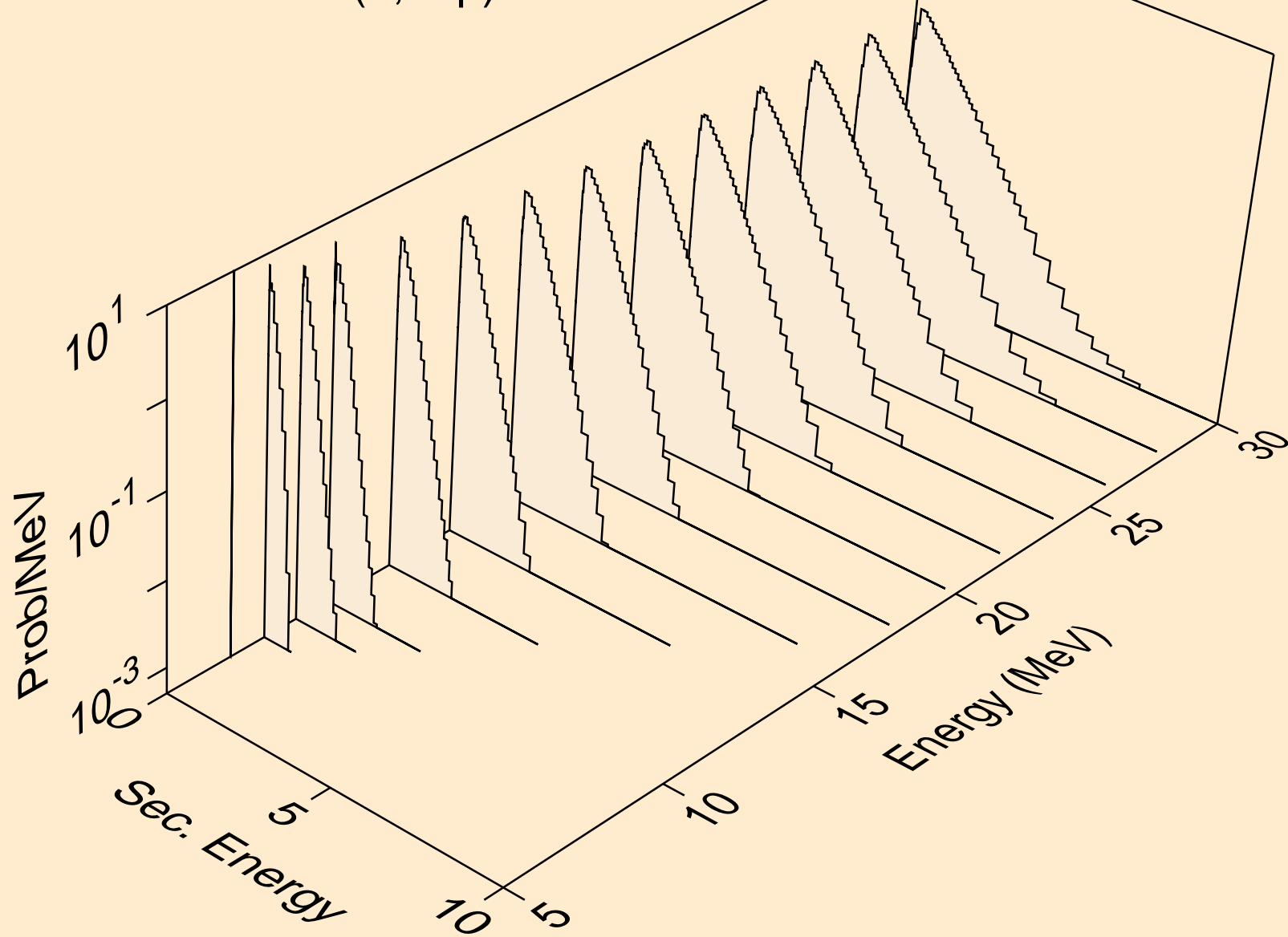

TA192 DEUTERON ACER TENDL-2024 LIBRARY; T=0.K  
neutrons from (d,3np)

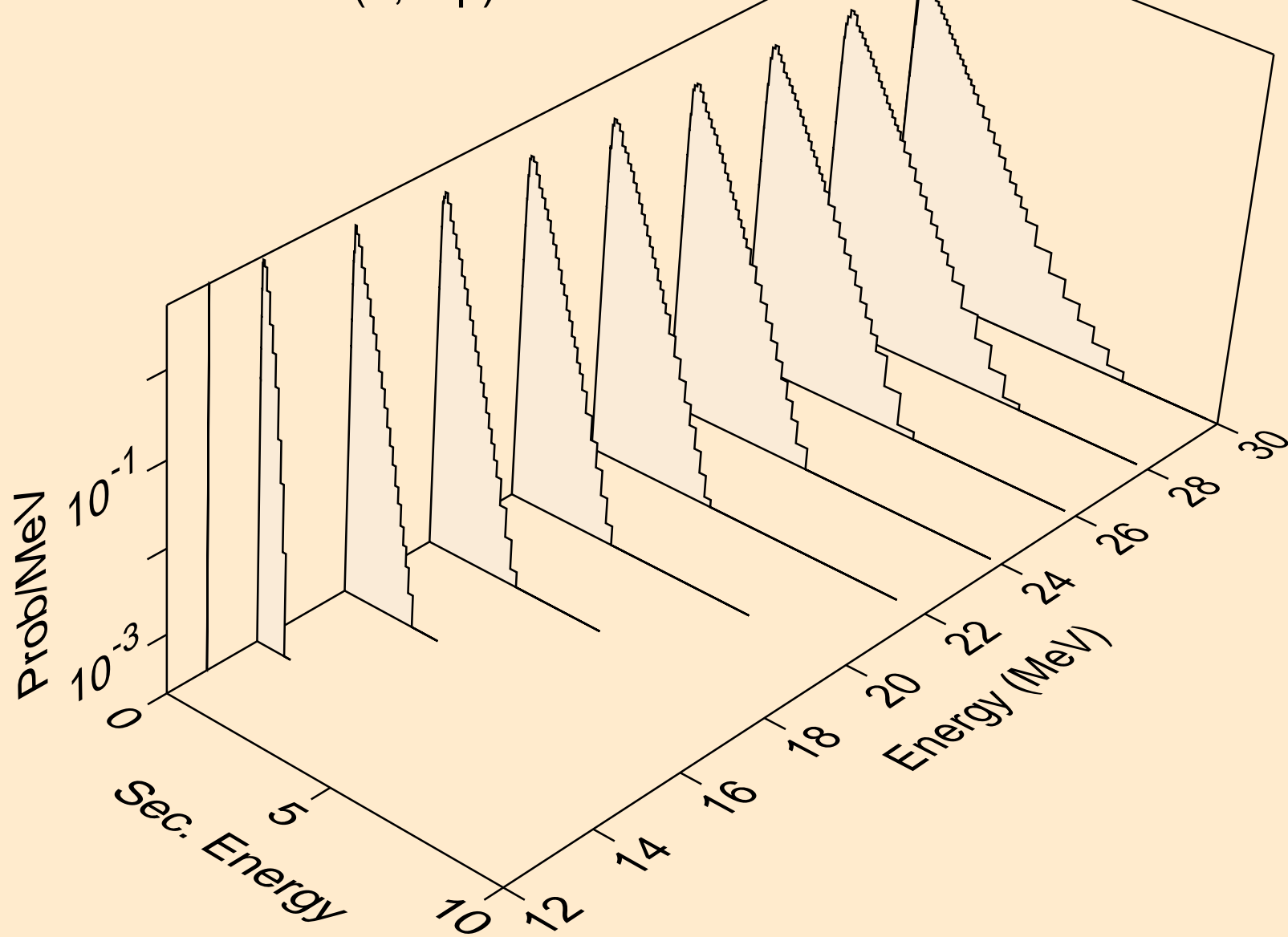

TA192 DEUTERON ACER TENDL-2024 LIBRARY; T=0.K  
neutrons from (d,n2p)

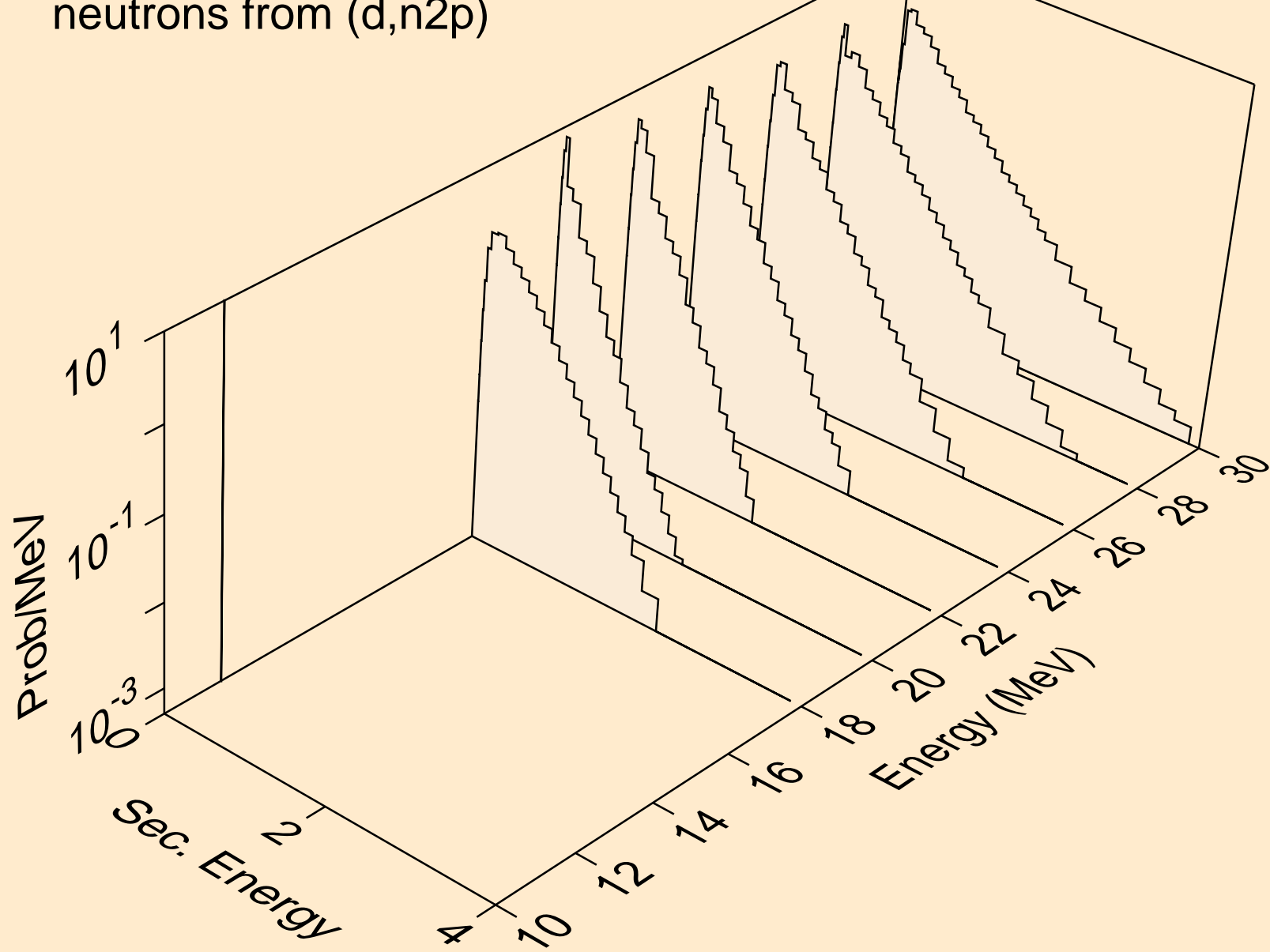

TA192 DEUTERON ACER TENDL-2024 LIBRARY; T=0.K  
protons from (d,x)

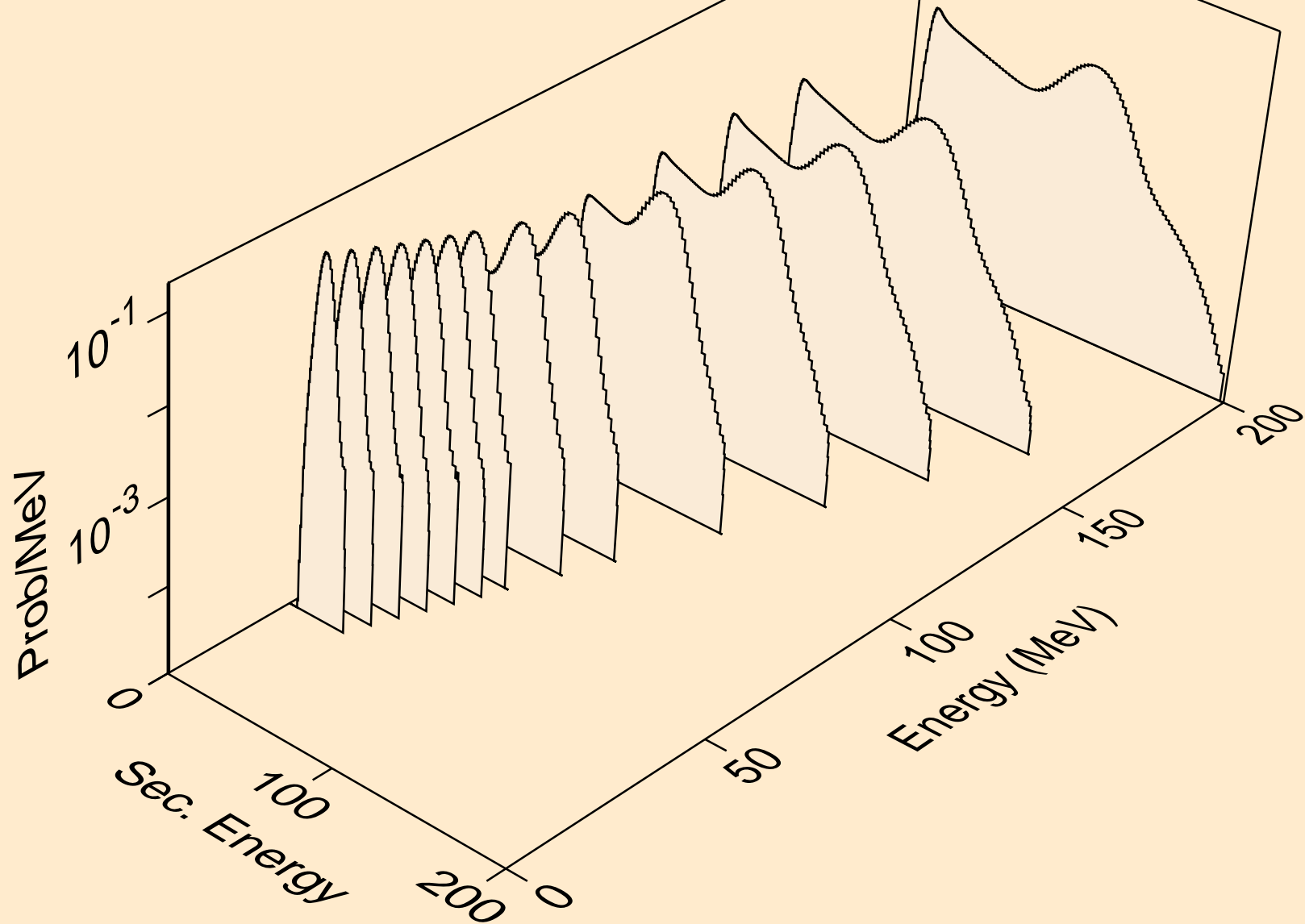

TA192 DEUTERON ACER TENDL-2024 LIBRARY; T=0.K  
protons from (d,n\*)p

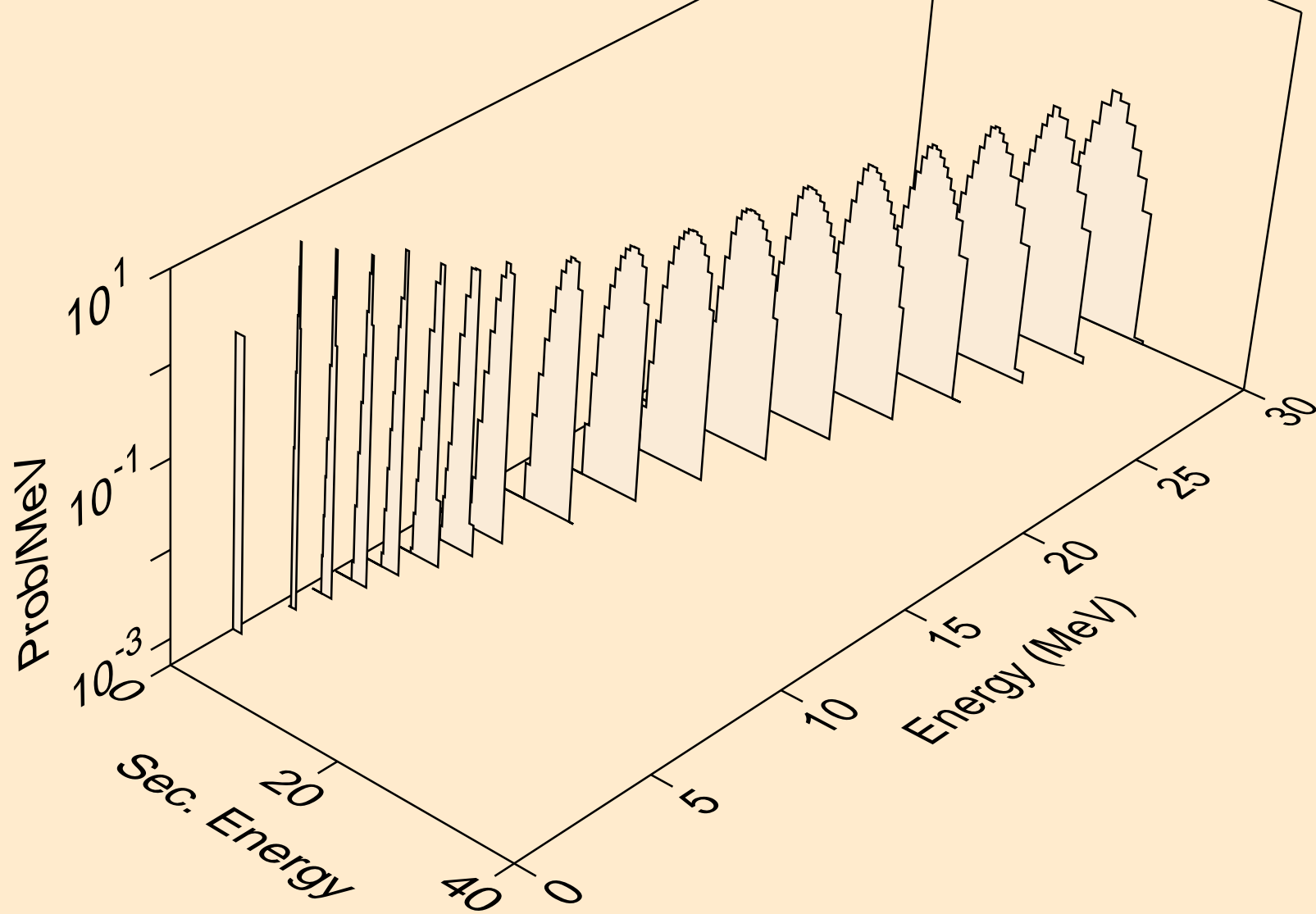

TA192 DEUTERON ACER TENDL-2024 LIBRARY; T=0.K  
protons from (d,2np)

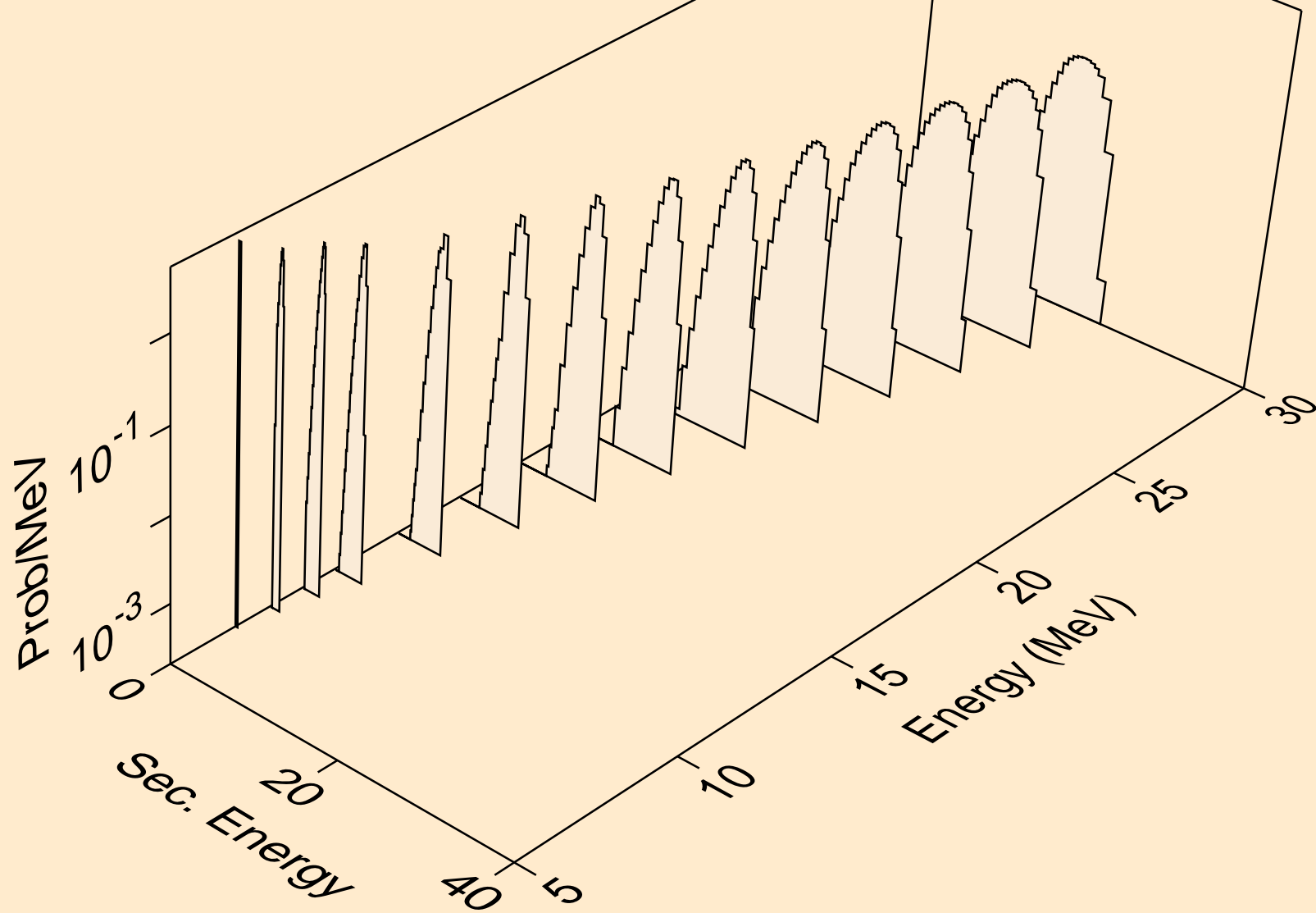

TA192 DEUTERON ACER TENDL-2024 LIBRARY; T=0.K  
protons from (d,3np)

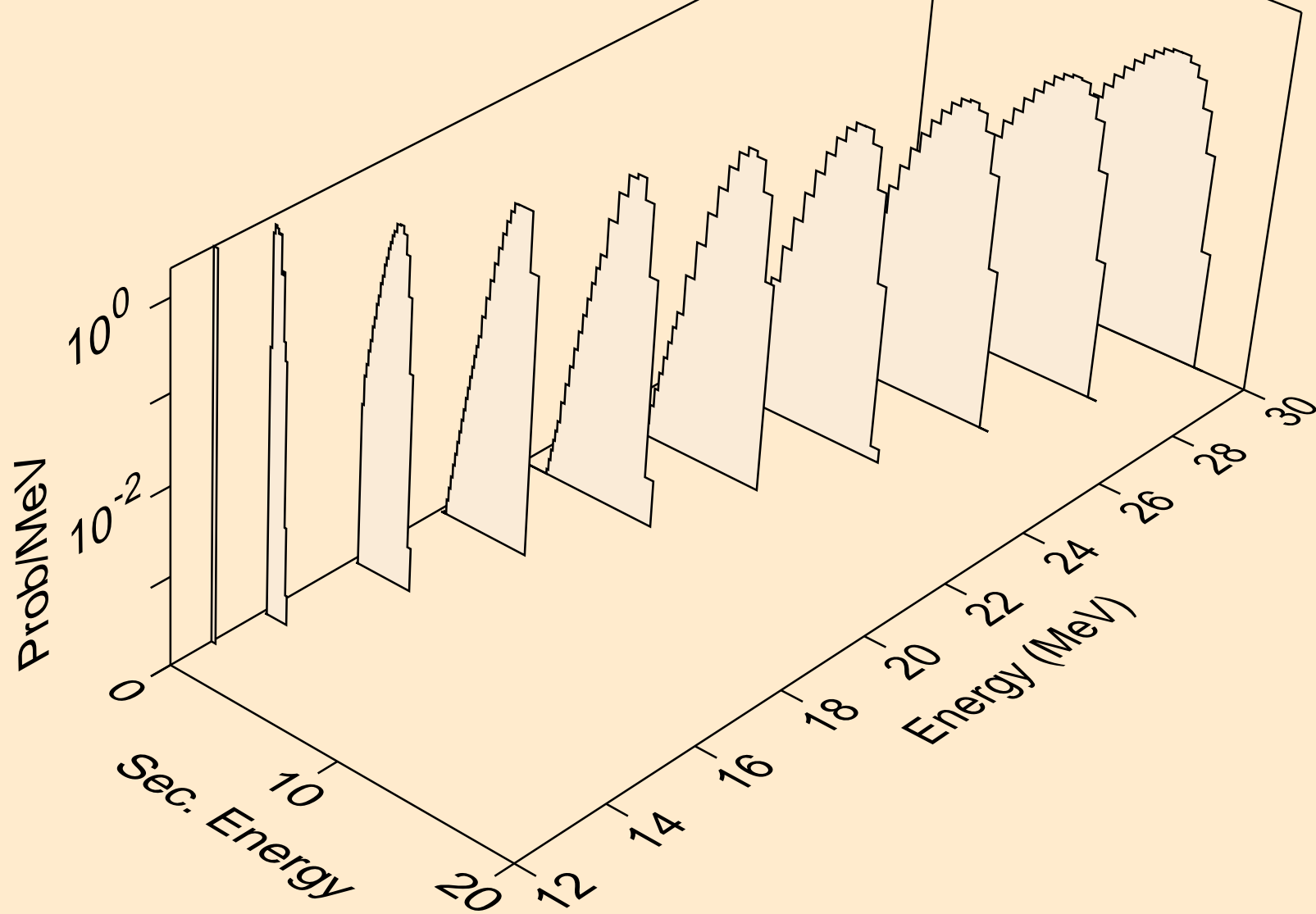

TA192 DEUTERON ACER TENDL-2024 LIBRARY; T=0.K  
protons from (d,n2p)

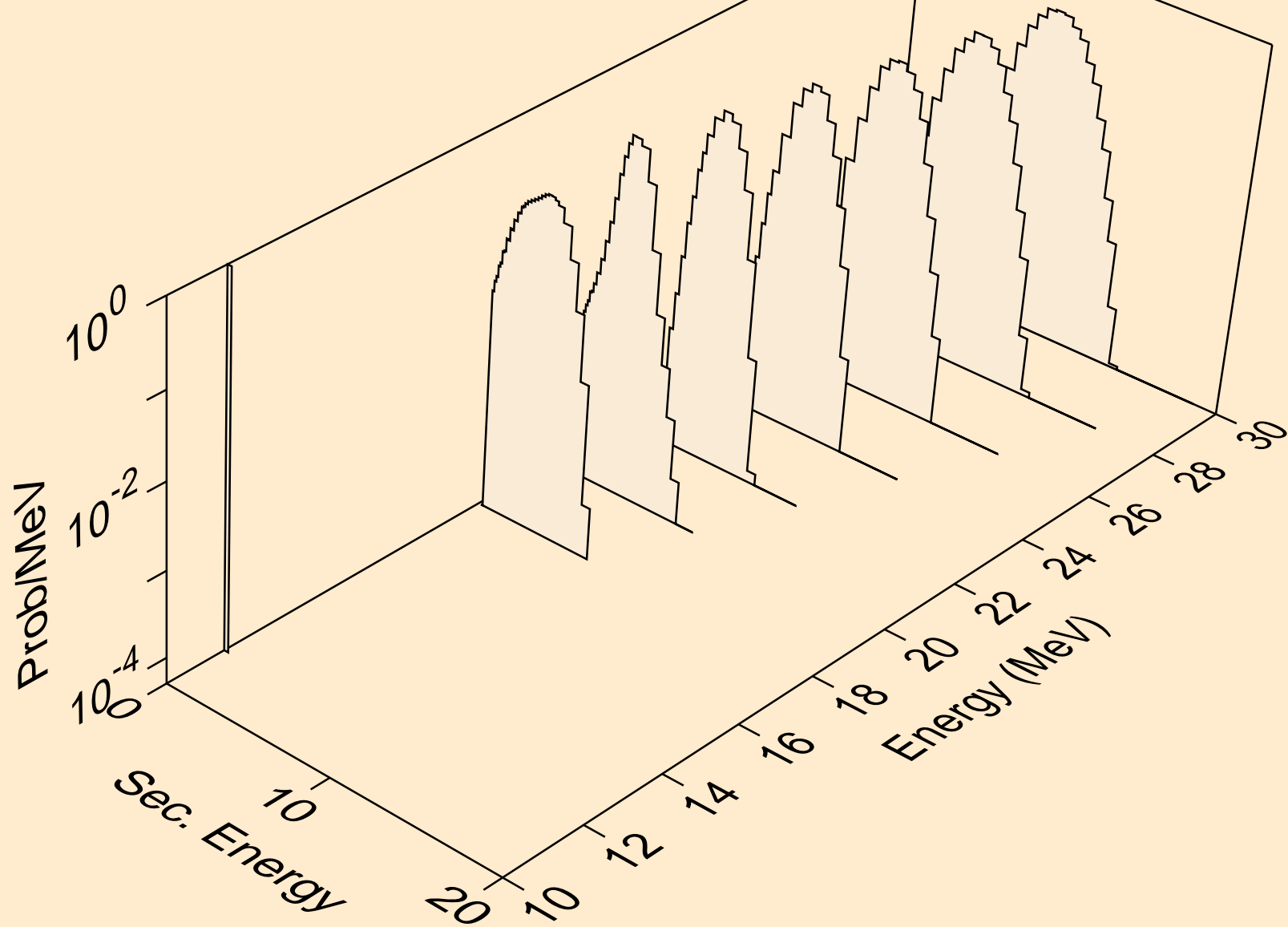

TA192 DEUTERON ACER TENDL-2024 LIBRARY; T=0.K  
protons from (d,p)

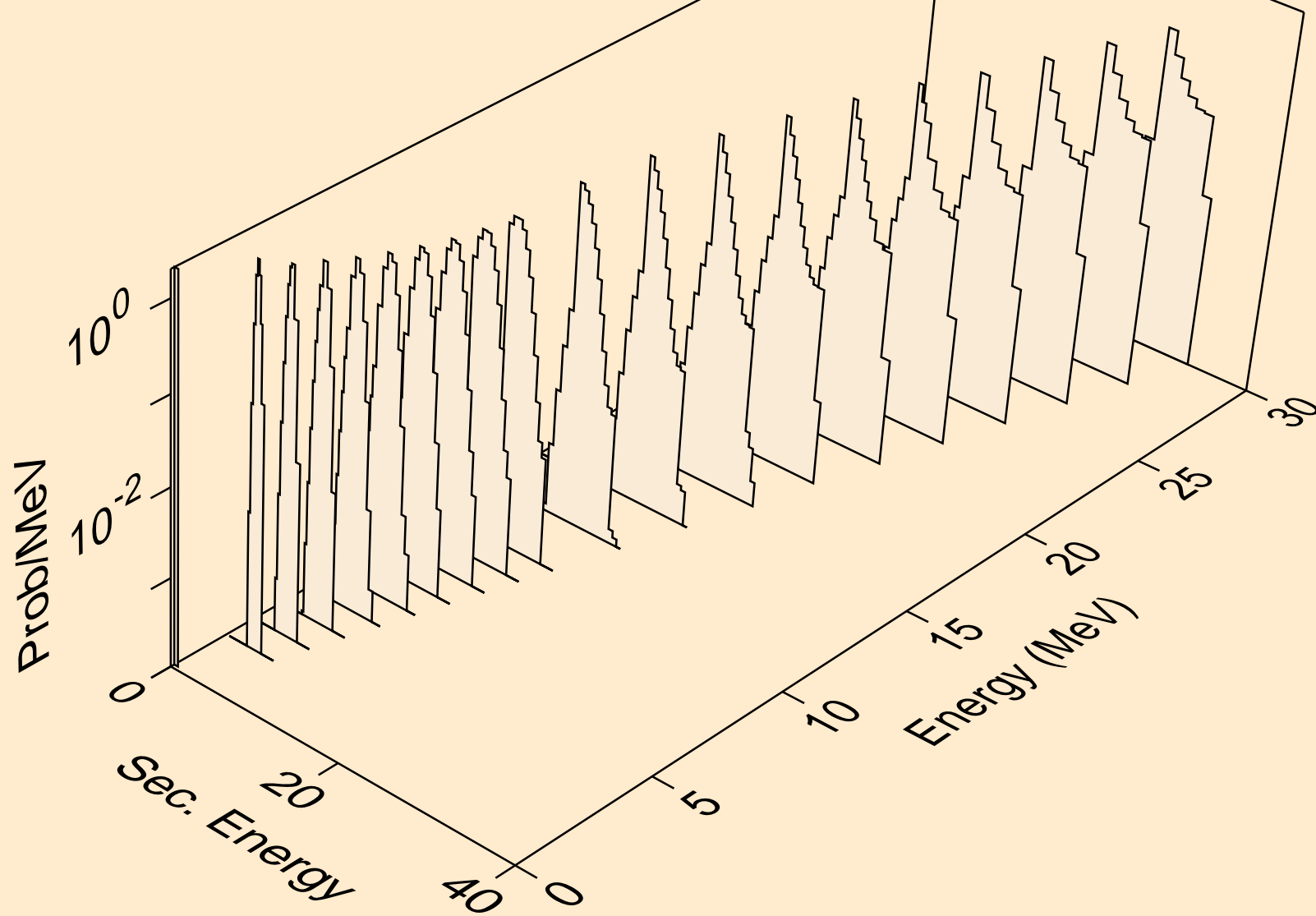

TA192 DEUTERON ACER TENDL-2024 LIBRARY; T=0.K  
protons from (d,2p)

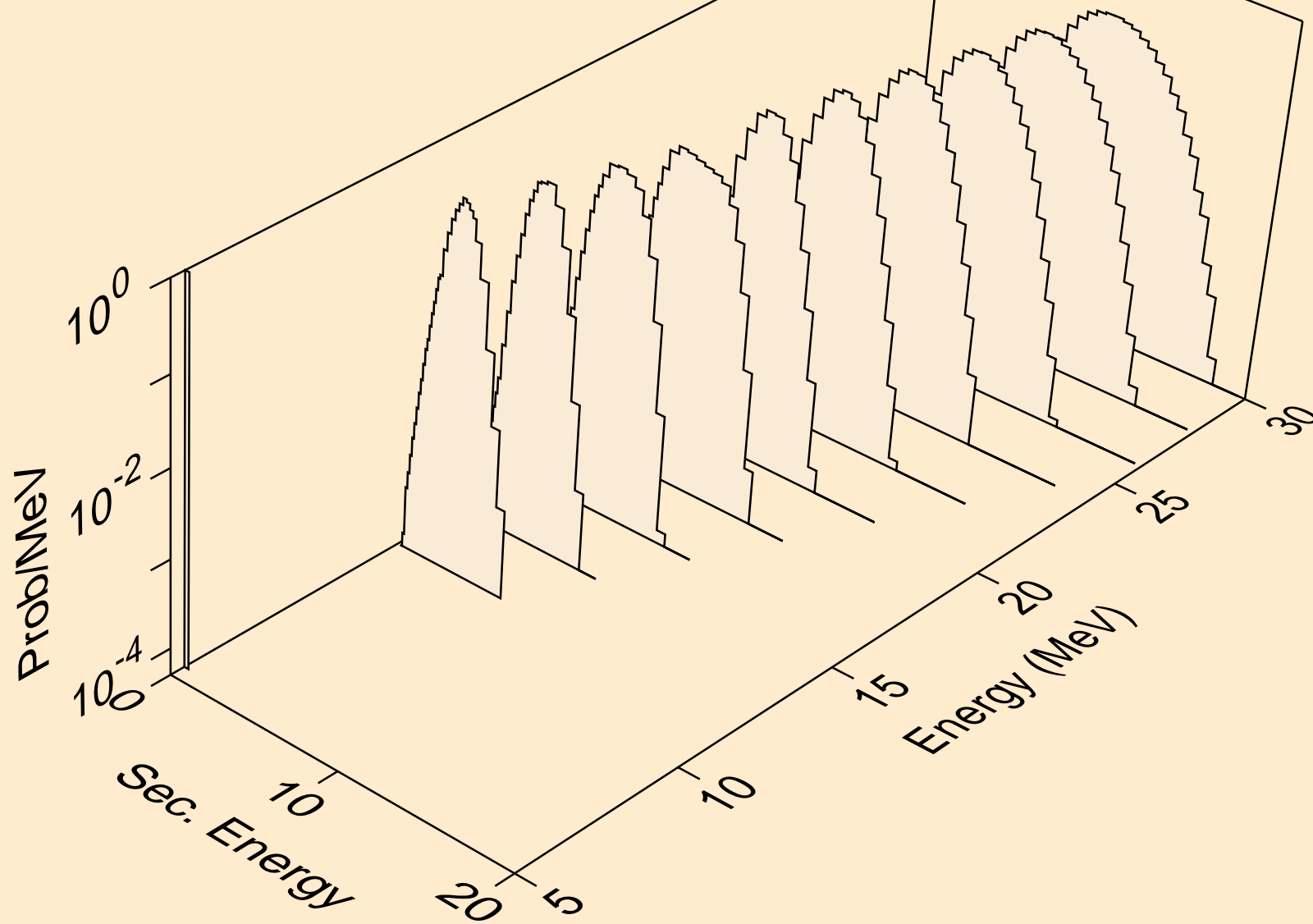

TA192 DEUTERON ACER TENDL-2024 LIBRARY; T=0.K  
protons from (d,pd)

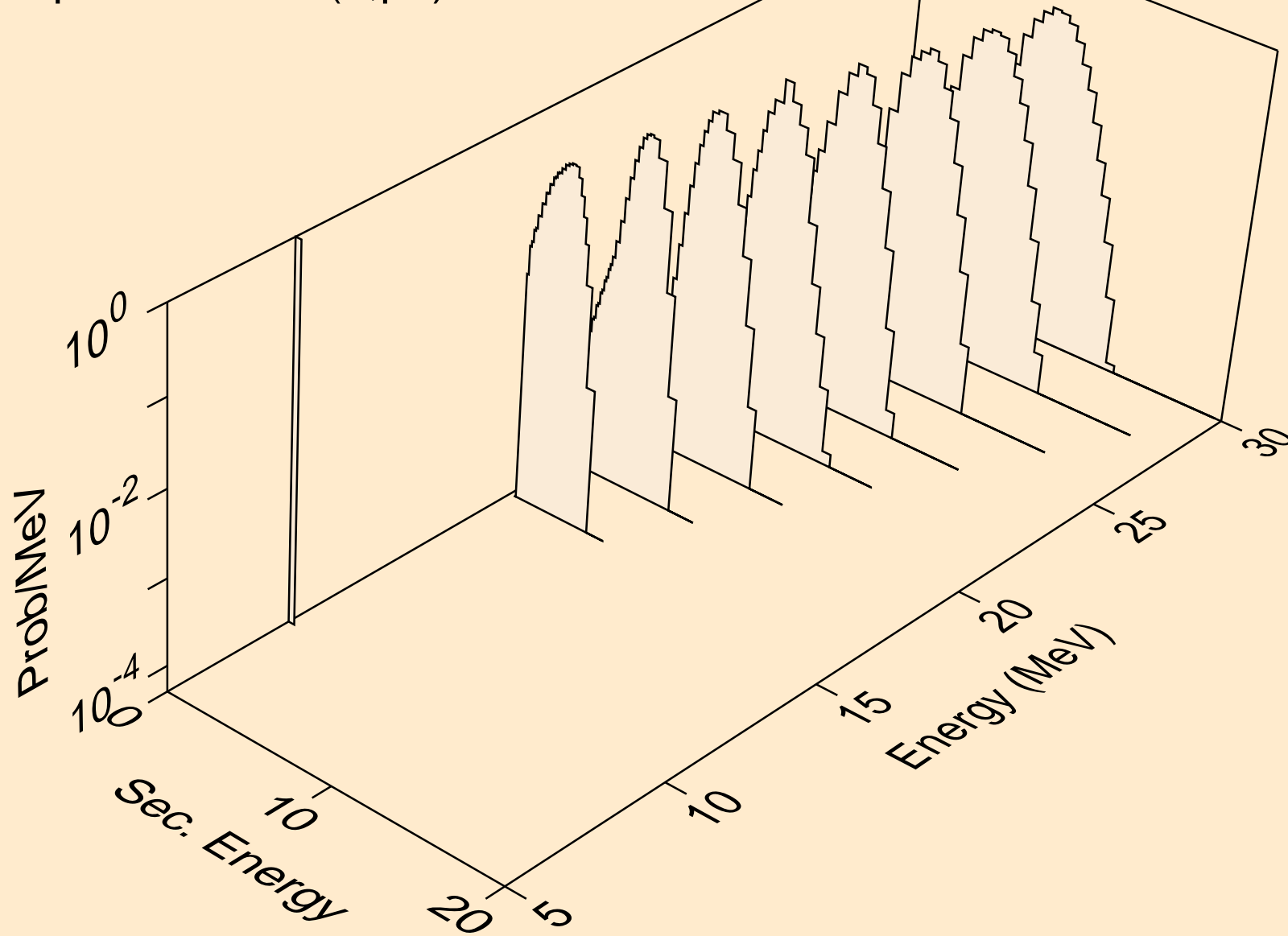

TA192 DEUTERON ACER TENDL-2024 LIBRARY; T=0.K  
tritons from (d,x)

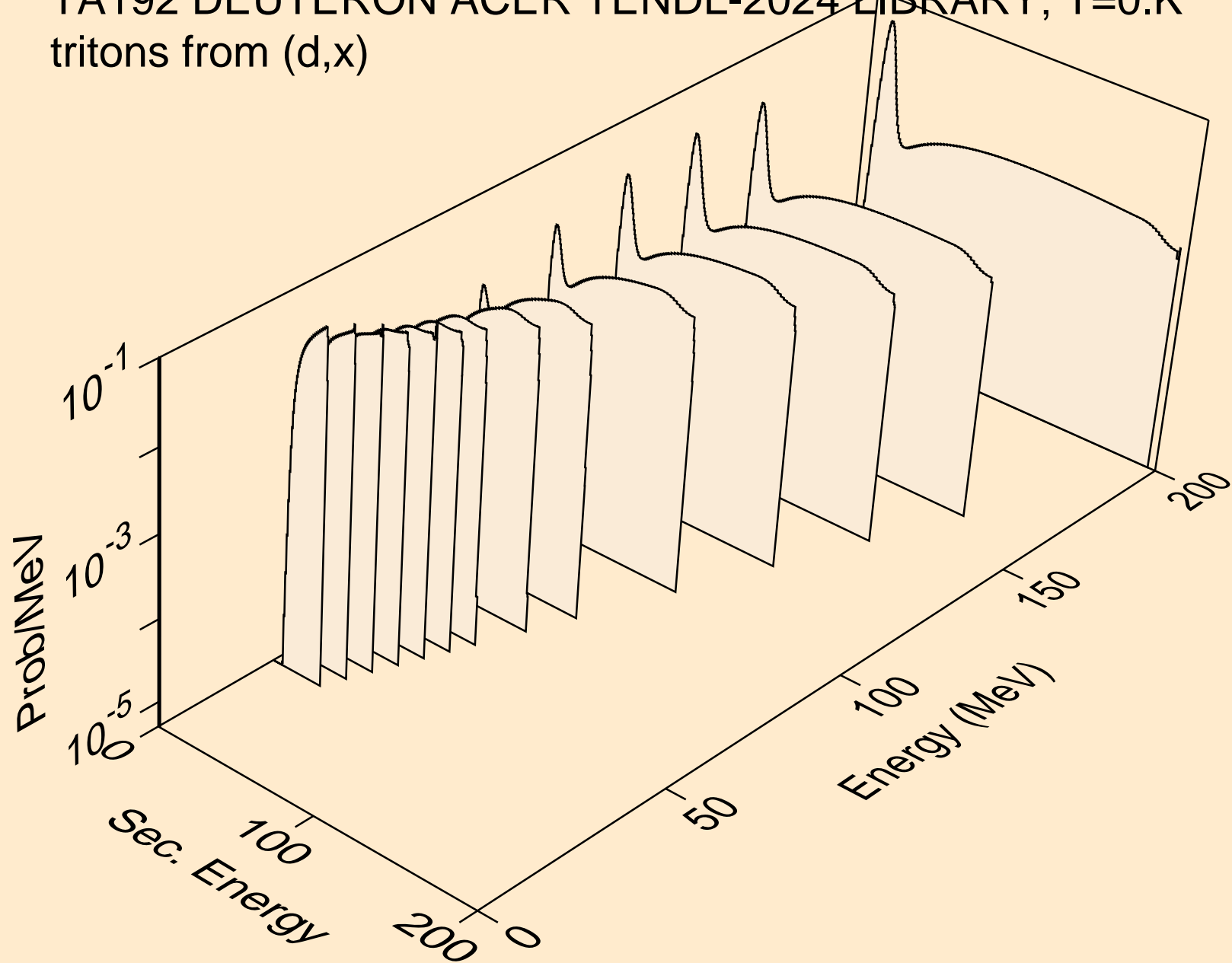

TA192 DEUTERON ACER TENDL-2024 LIBRARY; T=0.K  
tritons from (d,n\*)t

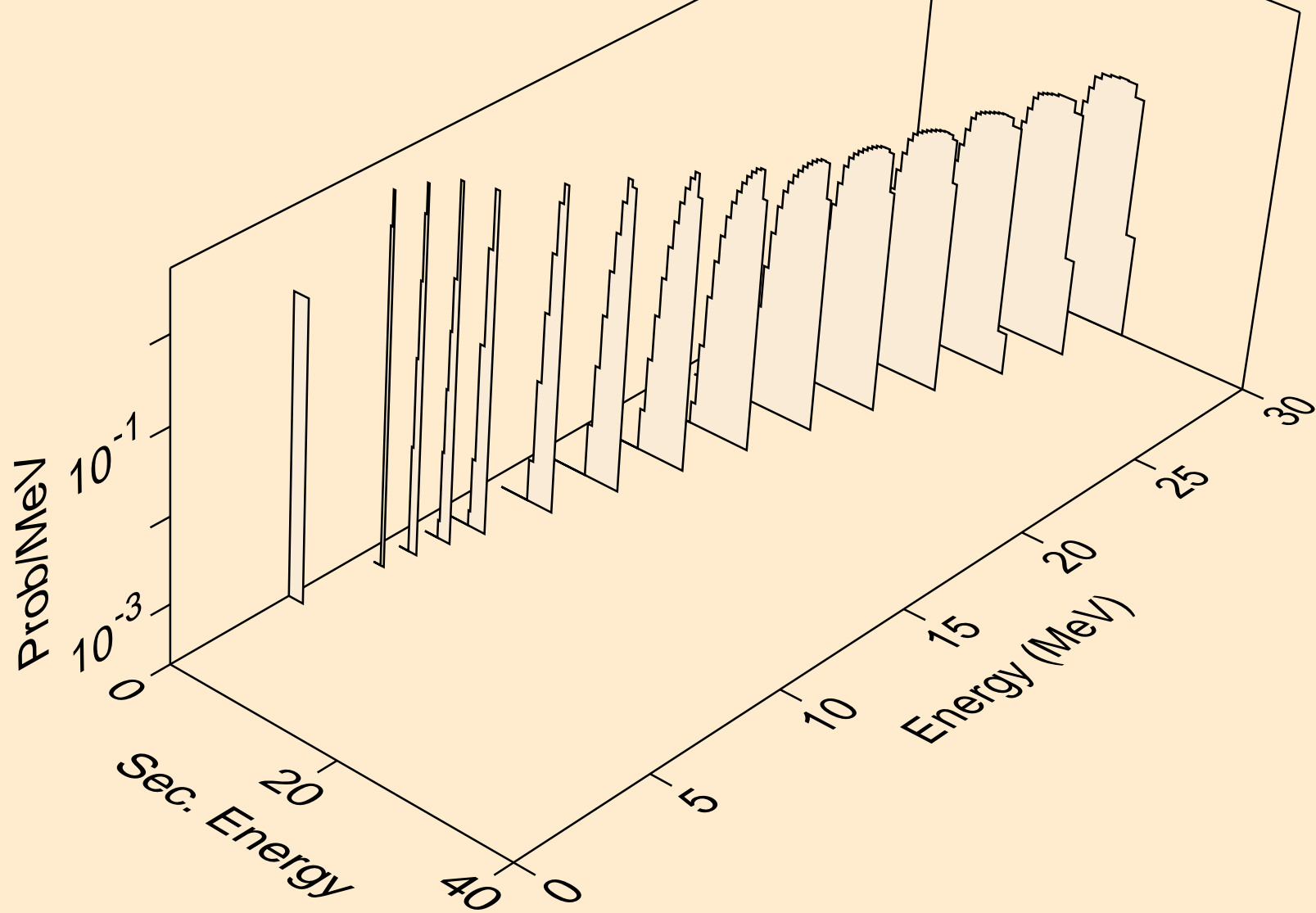

TA192 DEUTERON ACER TENDL-2024 LIBRARY; T=0.K  
tritons from (d,t)

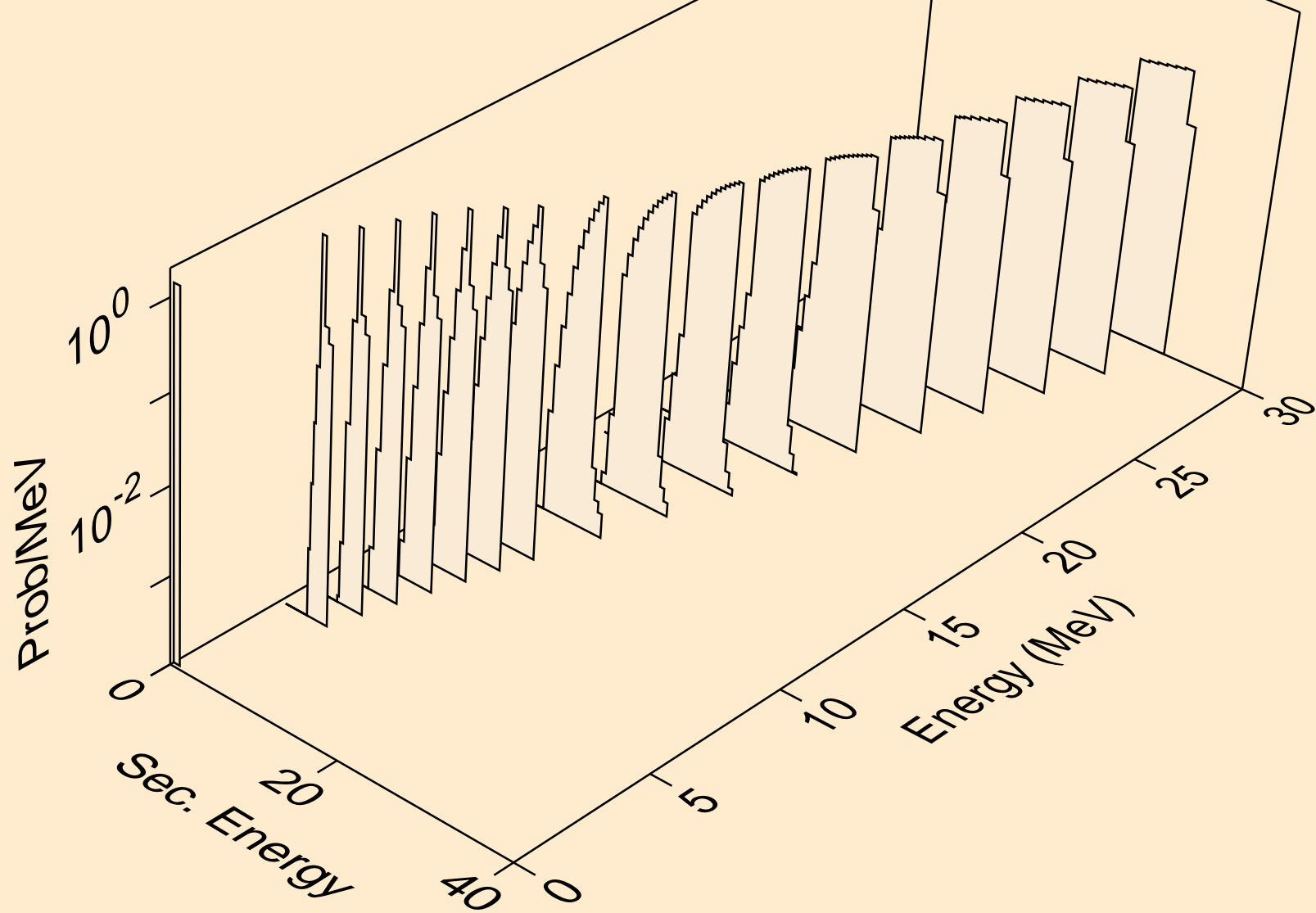

TA192 DEUTERON ACER TENDL-2024 LIBRARY; T=0.K  
he3s from (d,x)

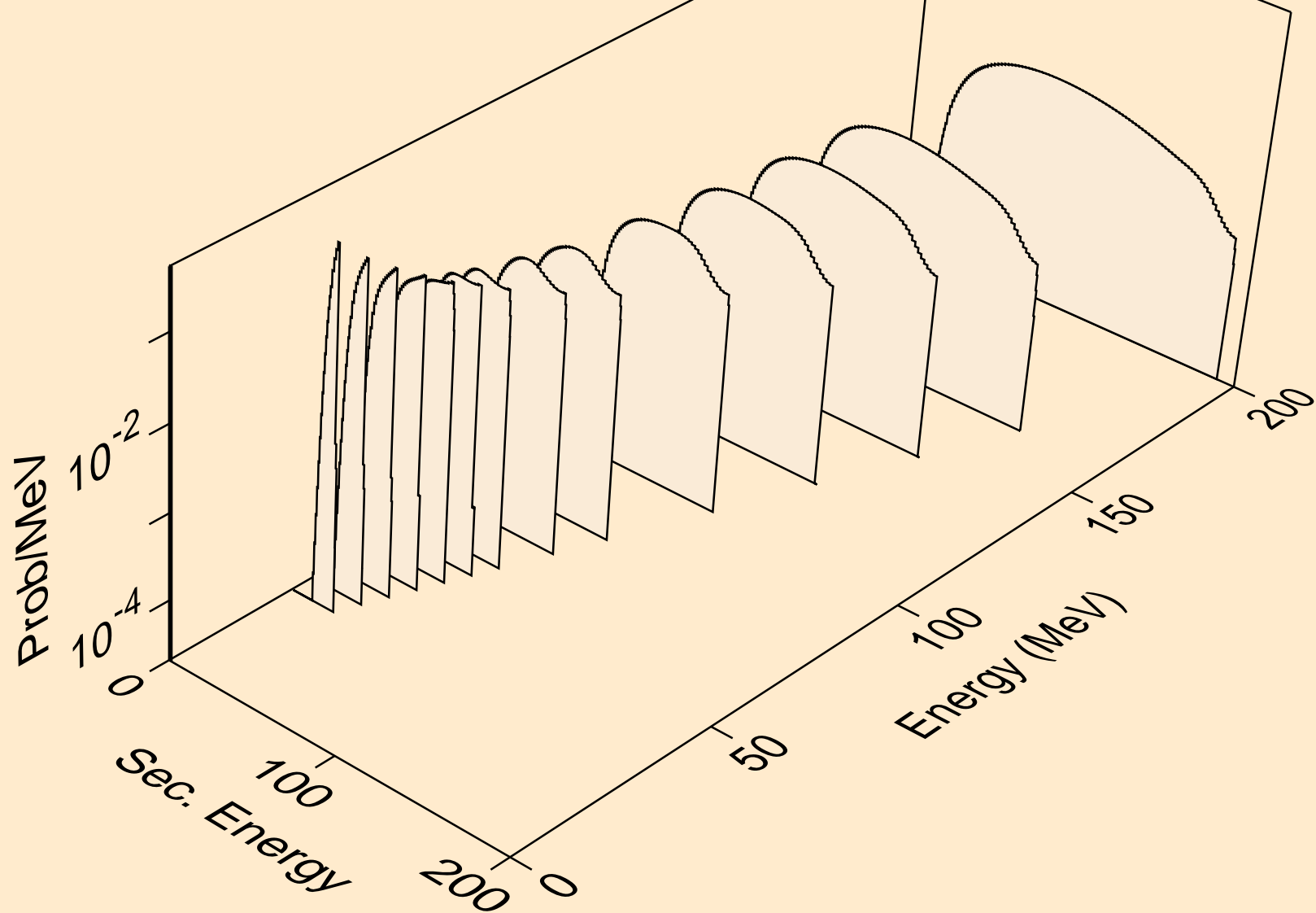

TA192 DEUTERON ACER TENDL-2024 LIBRARY; T=0.K  
he3s from (d,n\*)he3

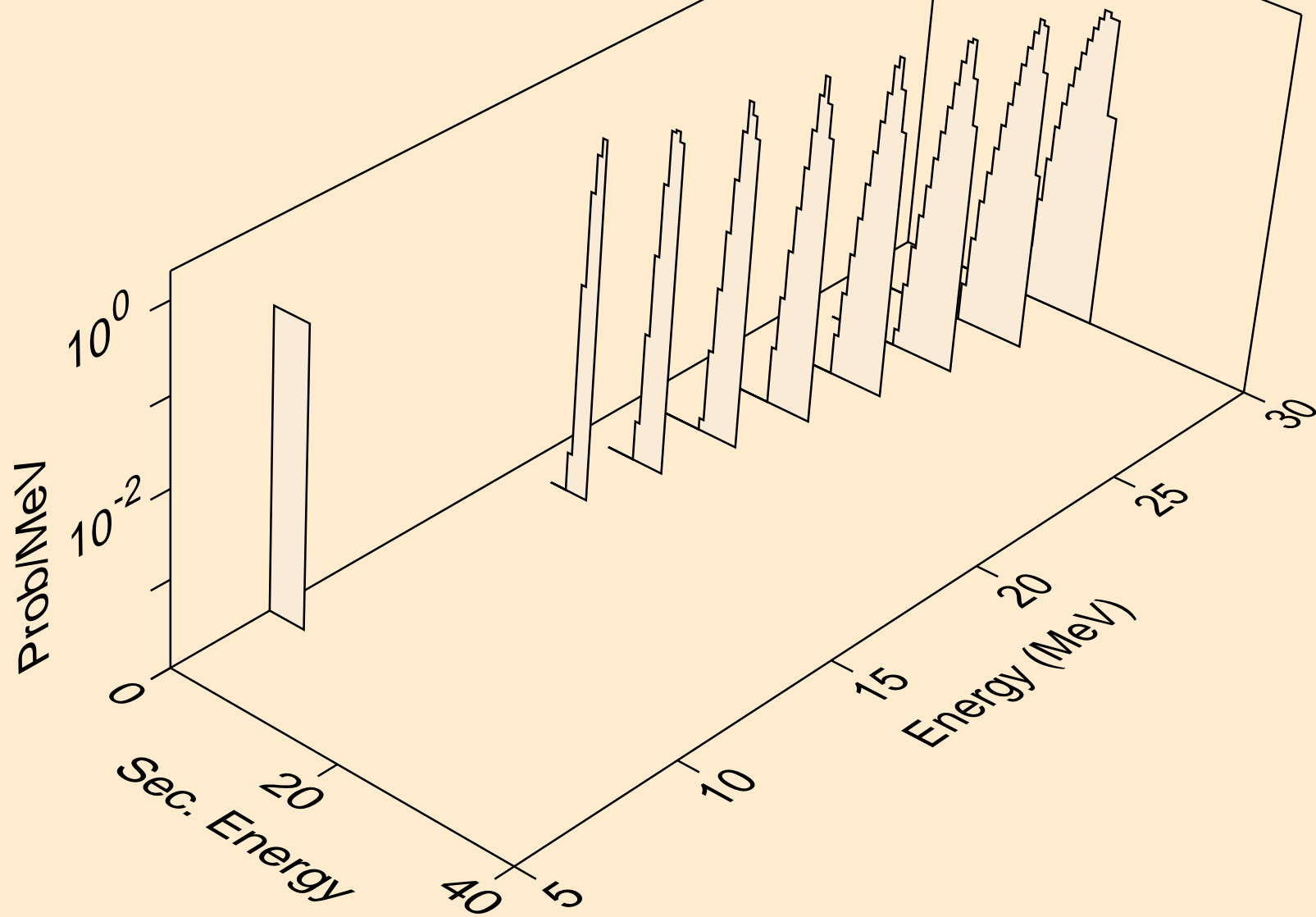

TA192 DEUTERON ACER TENDL-2024 LIBRARY; T=0.K  
he3s from (d,he3)

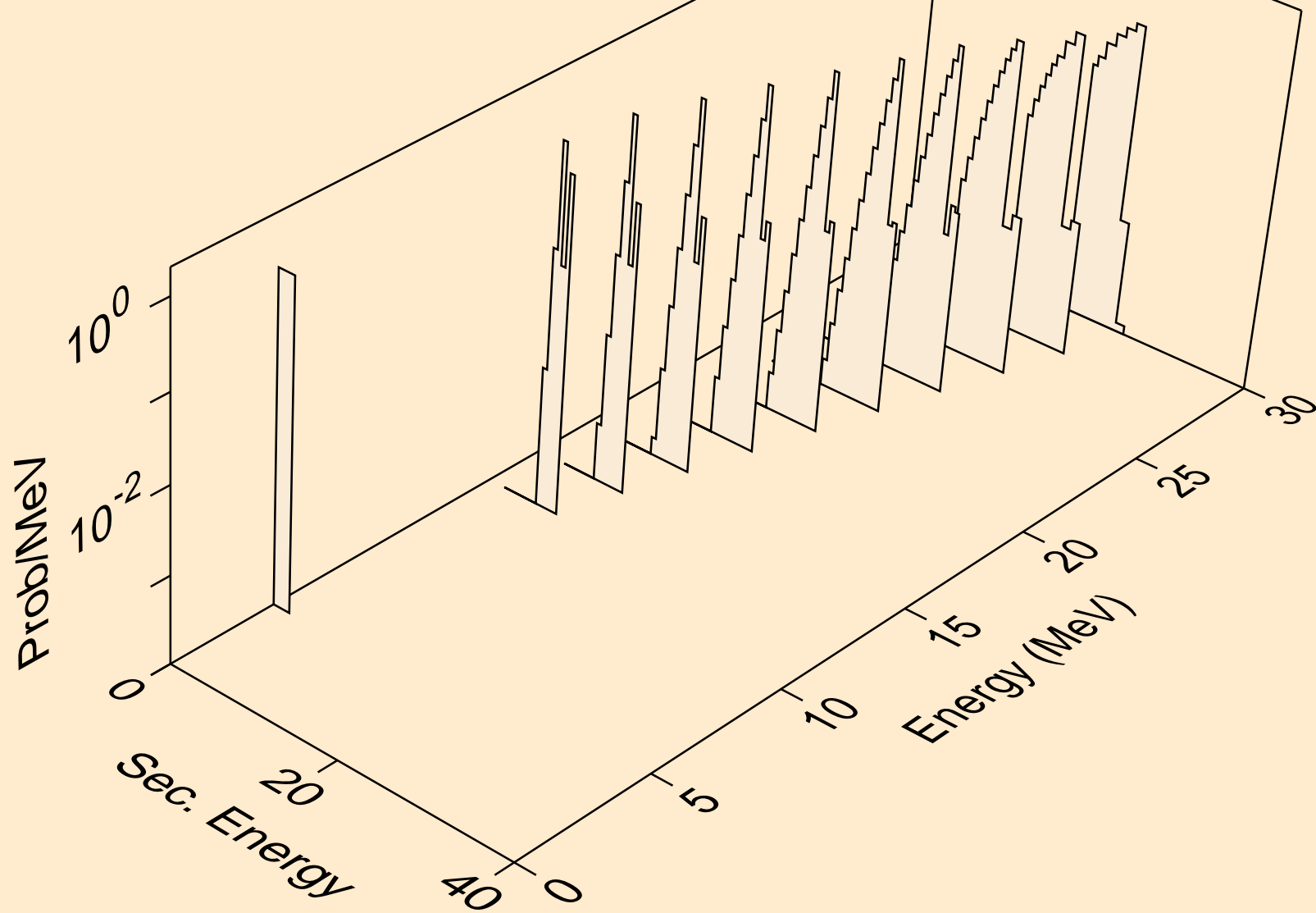

TA192 DEUTERON ACER TENDL-2024 LIBRARY; T=0.K  
alphas from (d,x)

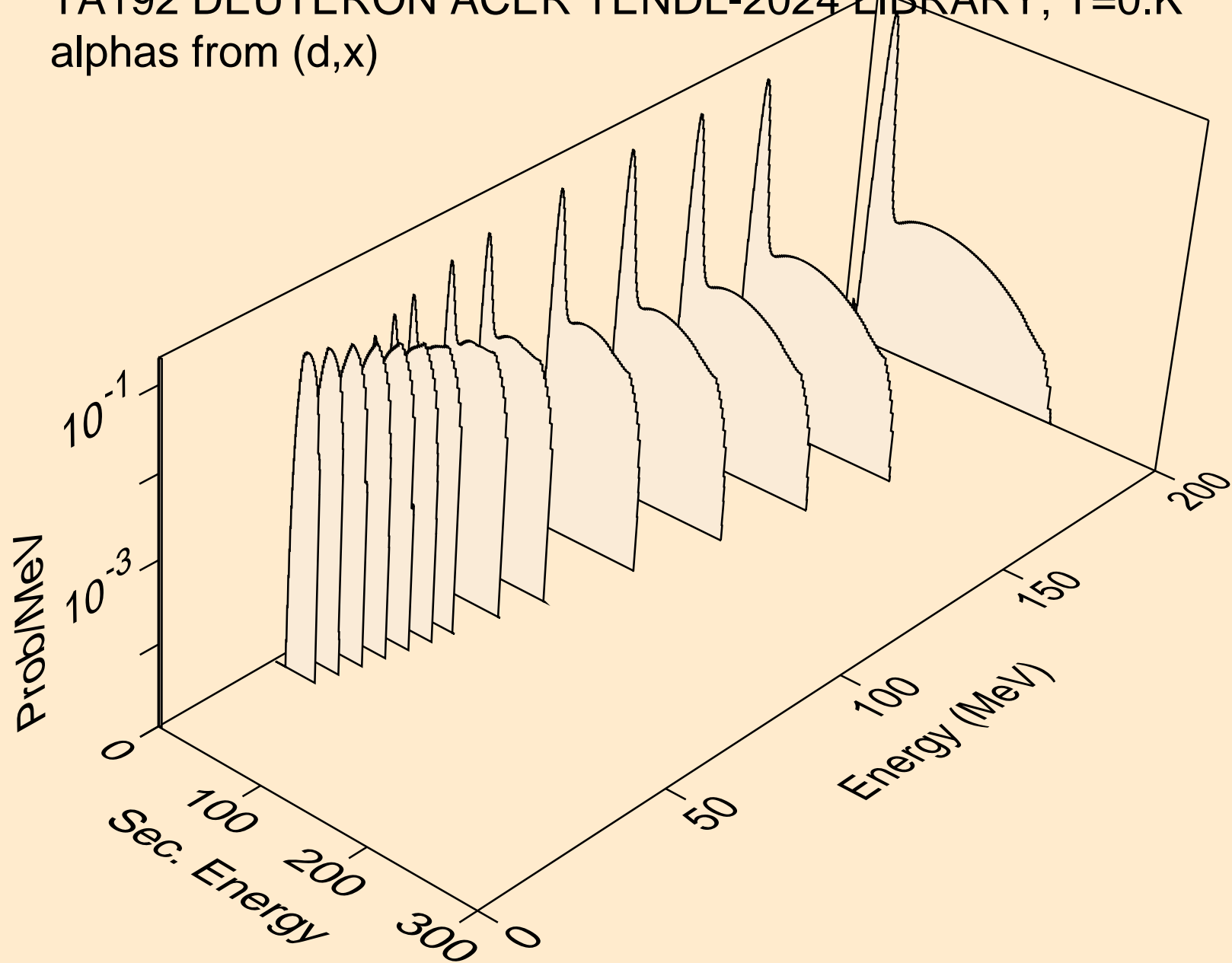

TA192 DEUTERON ACER TENDL-2024 LIBRARY; T=0.K  
alphas from (d,n\*)a

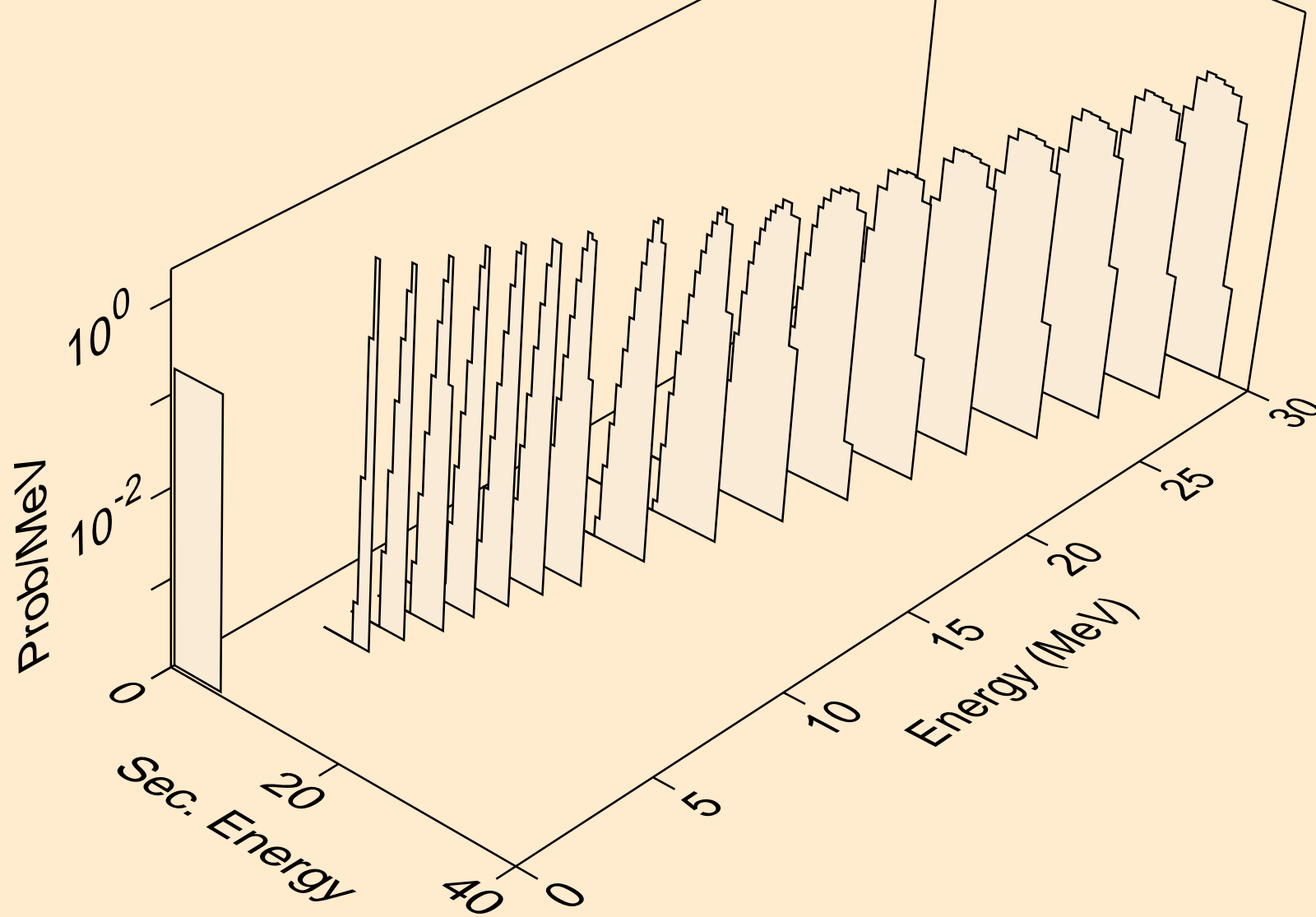

TA192 DEUTERON ACER TENDL-2024 LIBRARY; T=0.K  
alphas from (d,2n)a

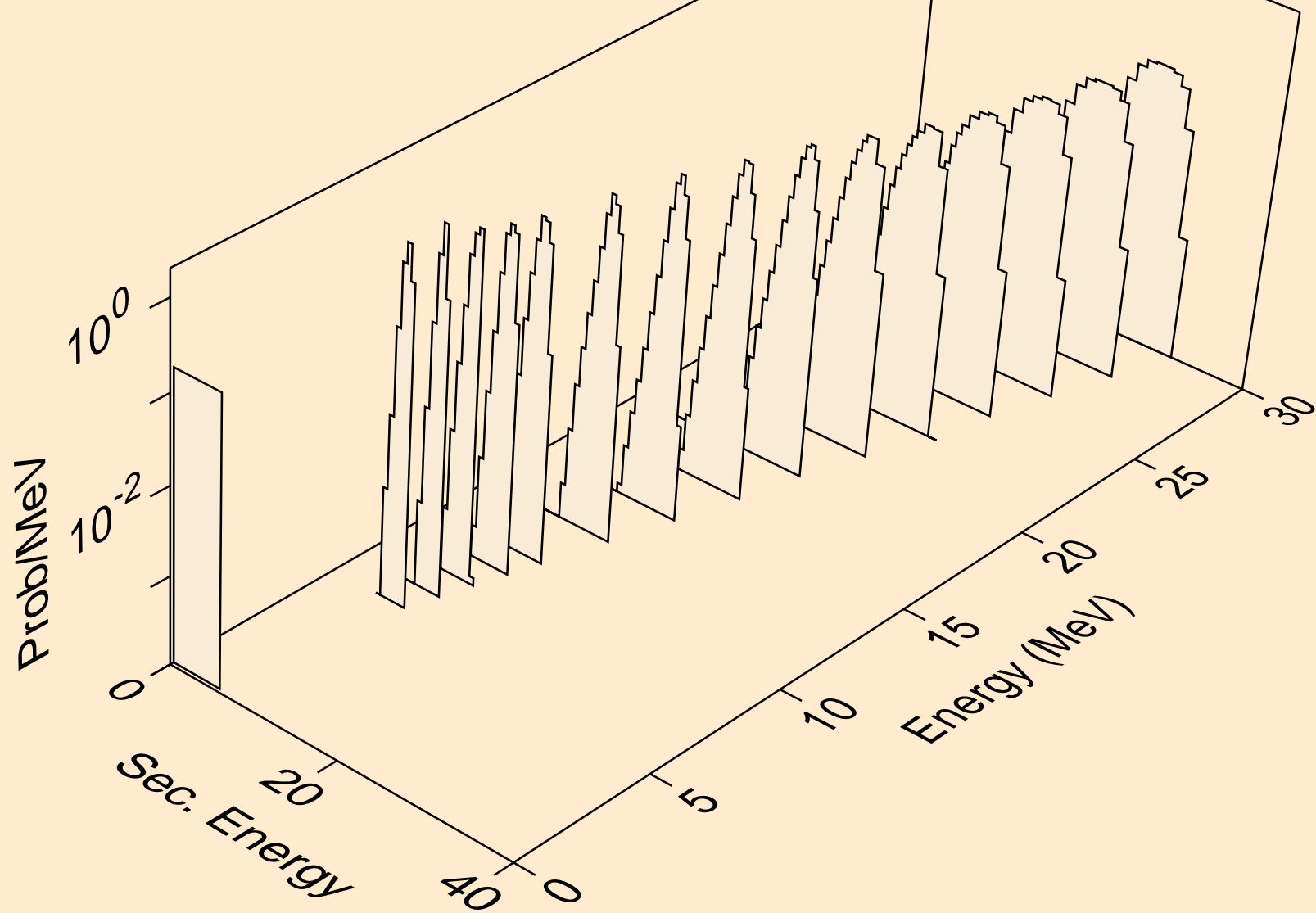

TA192 DEUTERON ACER TENDL-2024 LIBRARY; T=0.K  
alphas from (d,3n)a

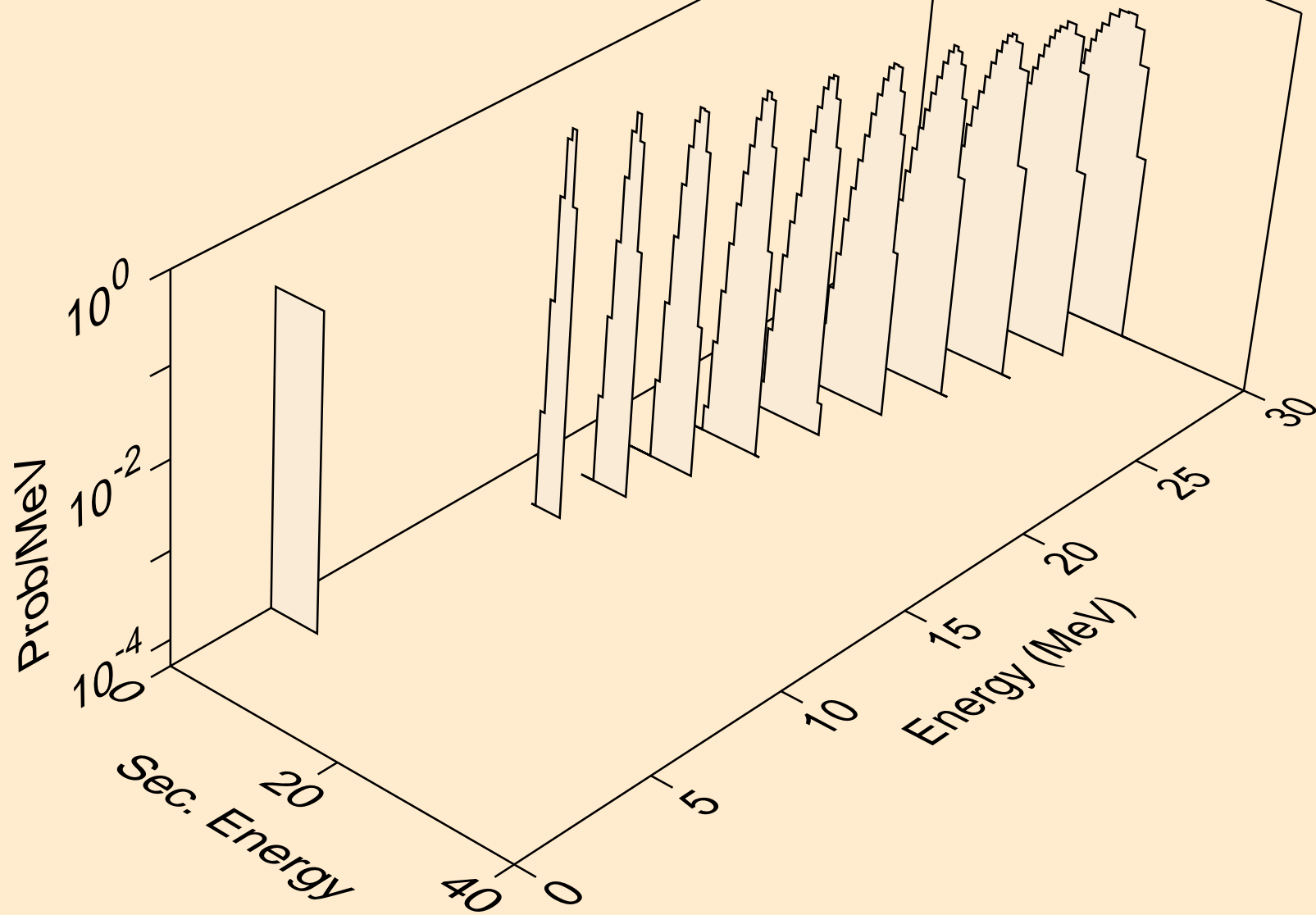

TA192 DEUTERON ACER TENDL-2024 LIBRARY; T=0.K  
alphas from (d,a)

