

U227 DEUTERON ACER TENDL-2024 LIBRARY; T=0.K  
Principal cross sections

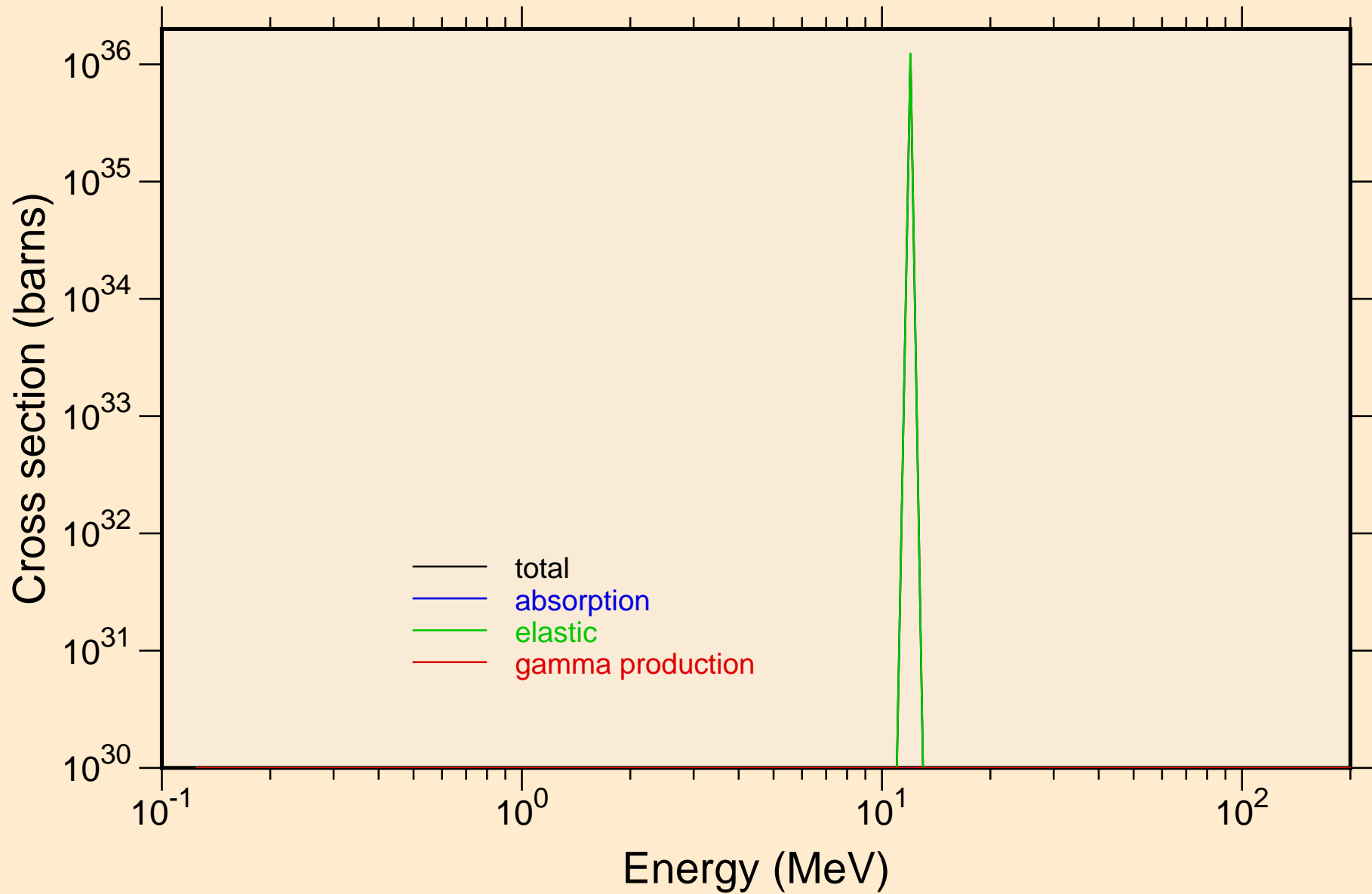

# U227 DEUTERON ACER TENDL-2024 LIBRARY; T=0.K

## Heating

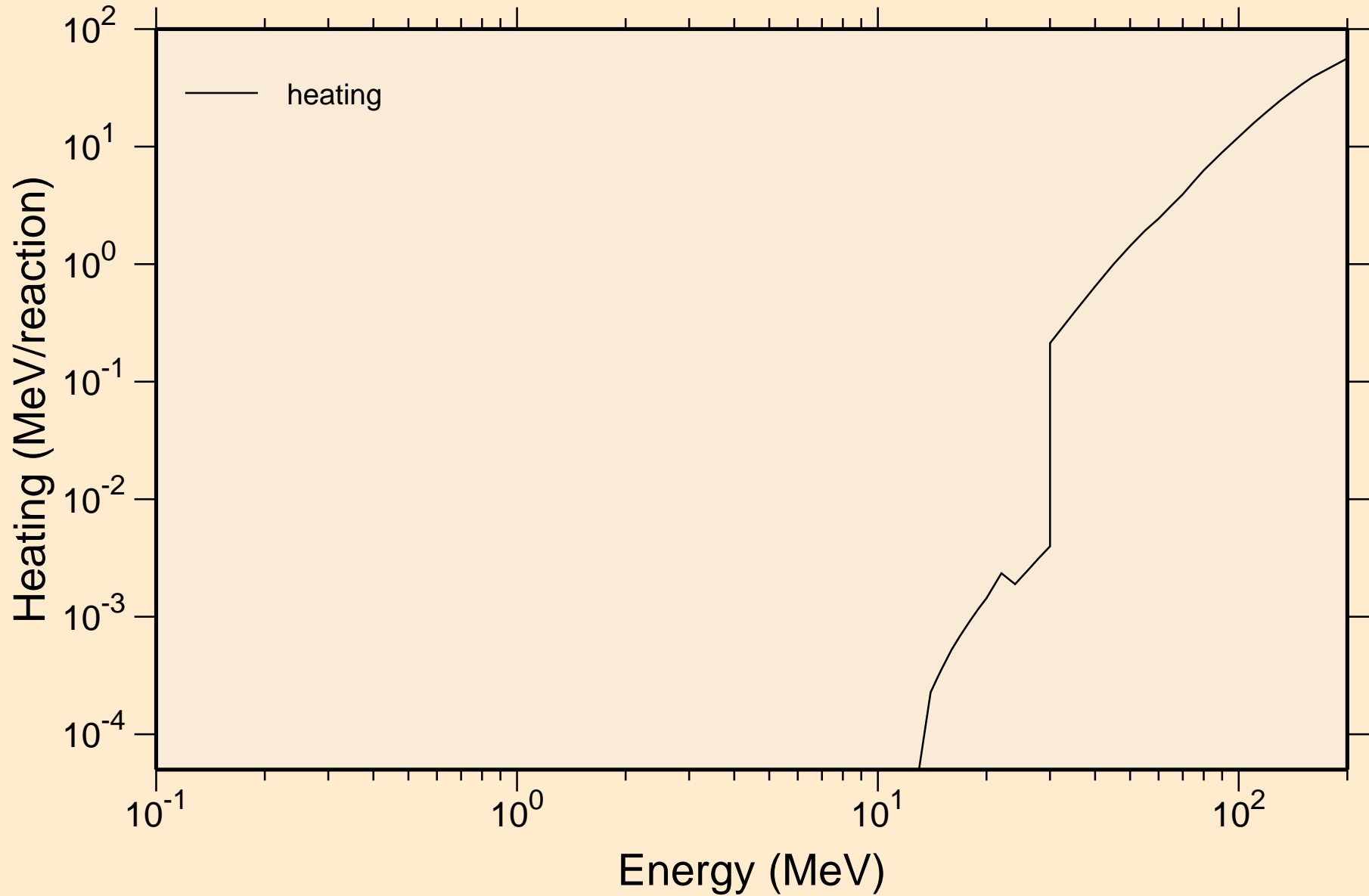

# U227 DEUTERON ACER TENDL-2024 LIBRARY; T=0.K

## Principal cross sections

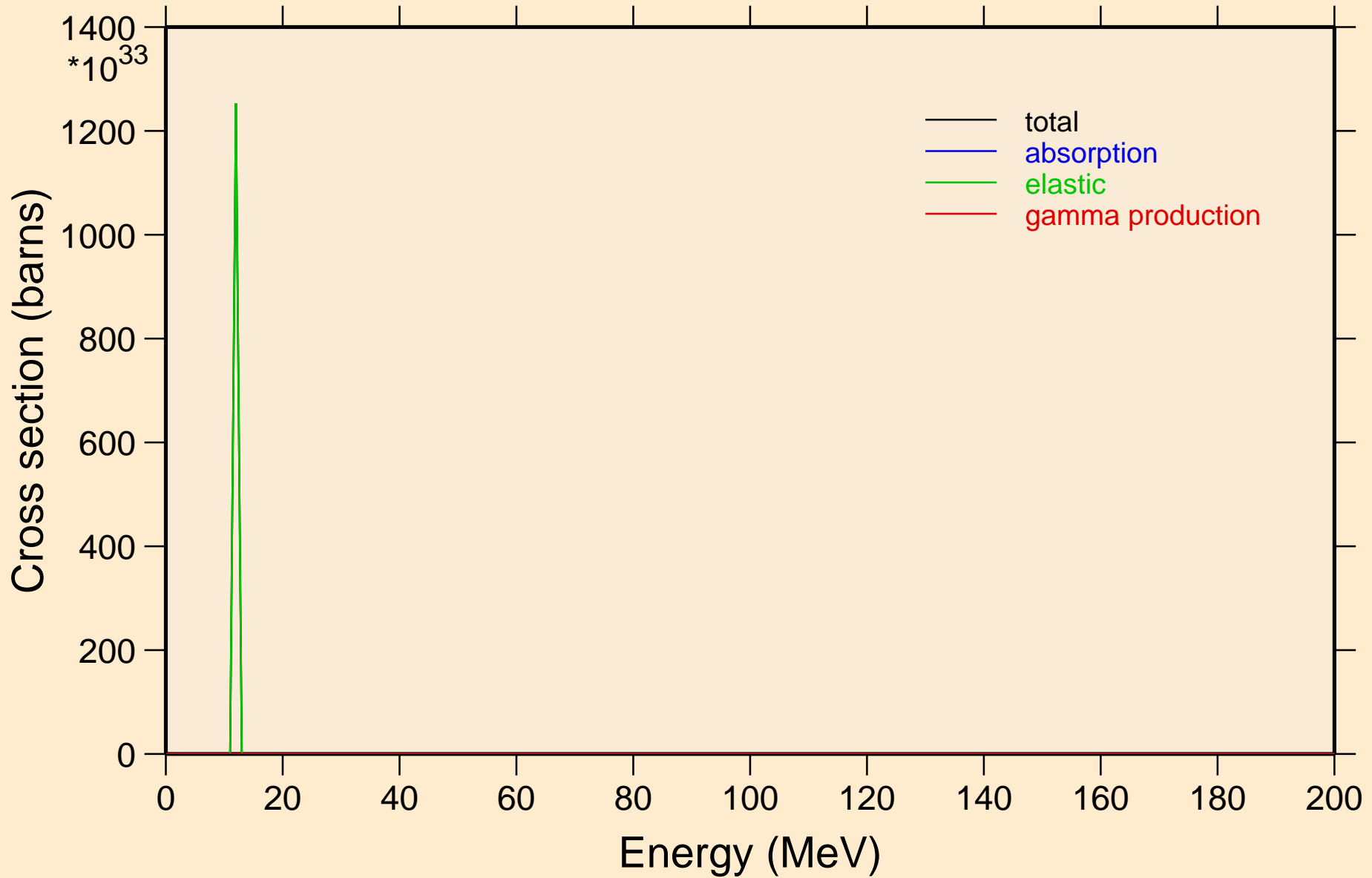

# U227 DEUTERON ACER TENDL-2024 LIBRARY; T=0.K

## Heating

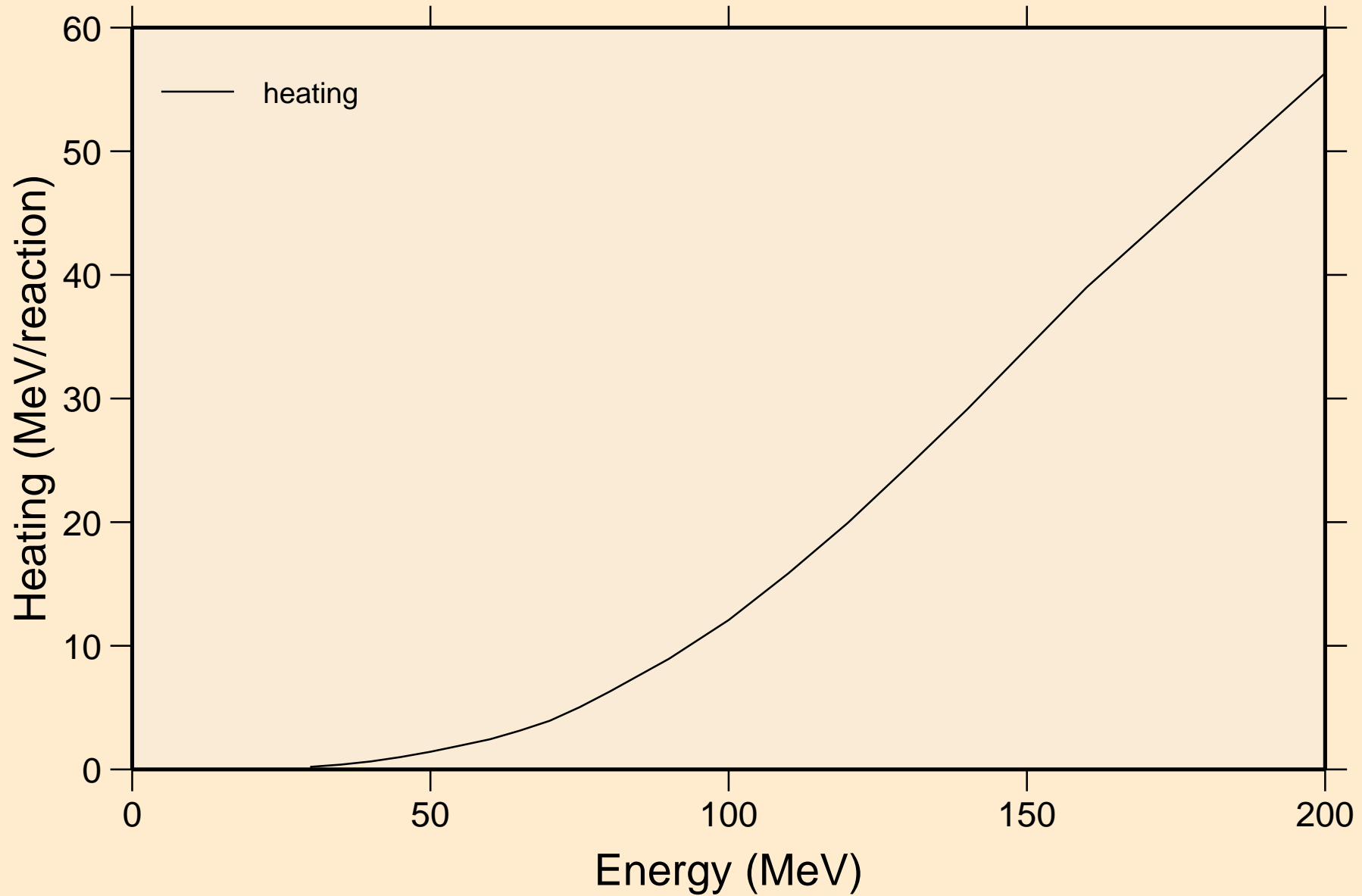

# U227 DEUTERON ACER TENDL-2024 LIBRARY; T=0.K

## Threshold reactions

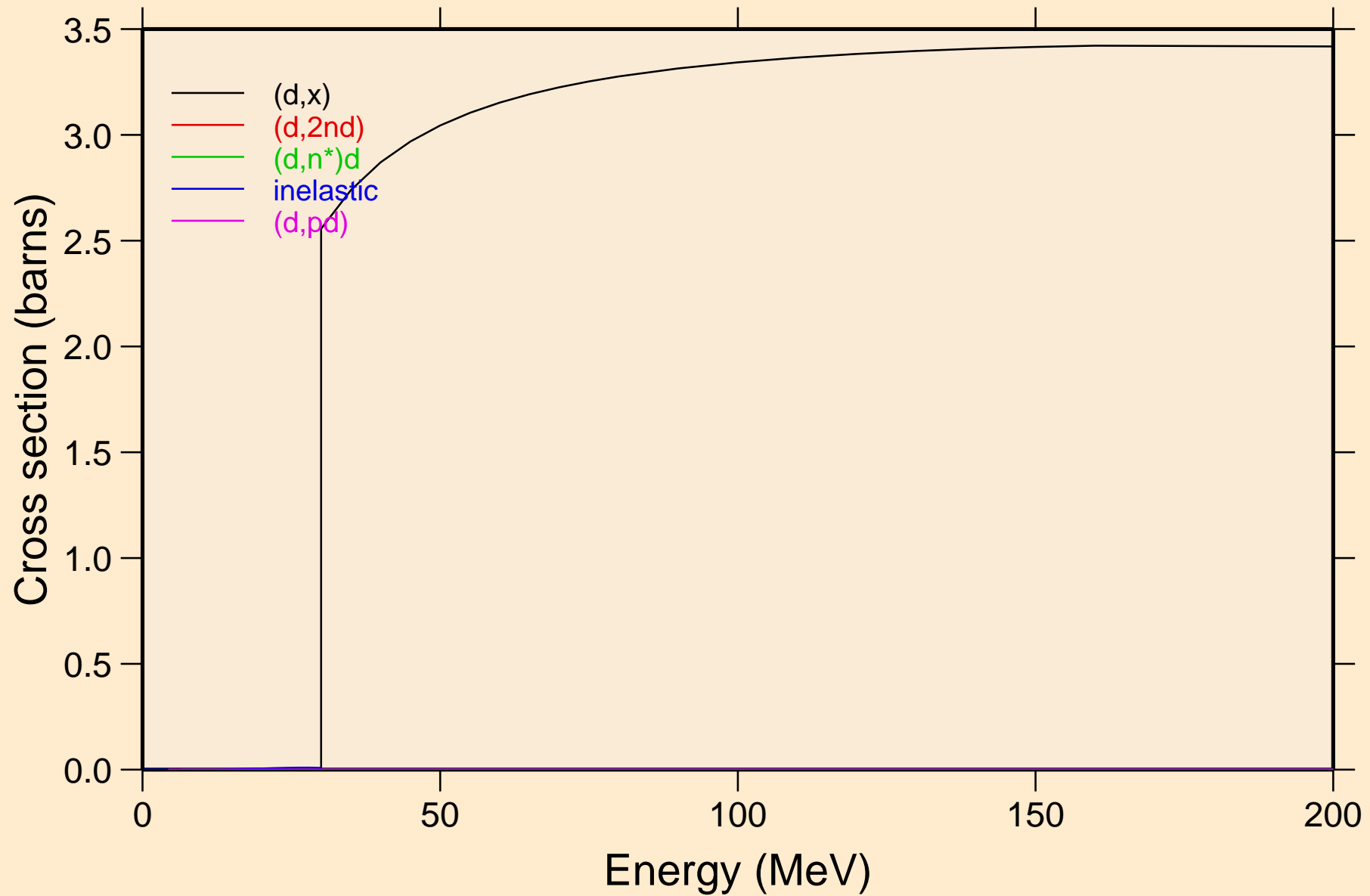

U227 DEUTERON ACER TENDL-2024 LIBRARY; T=0.K  
Threshold reactions

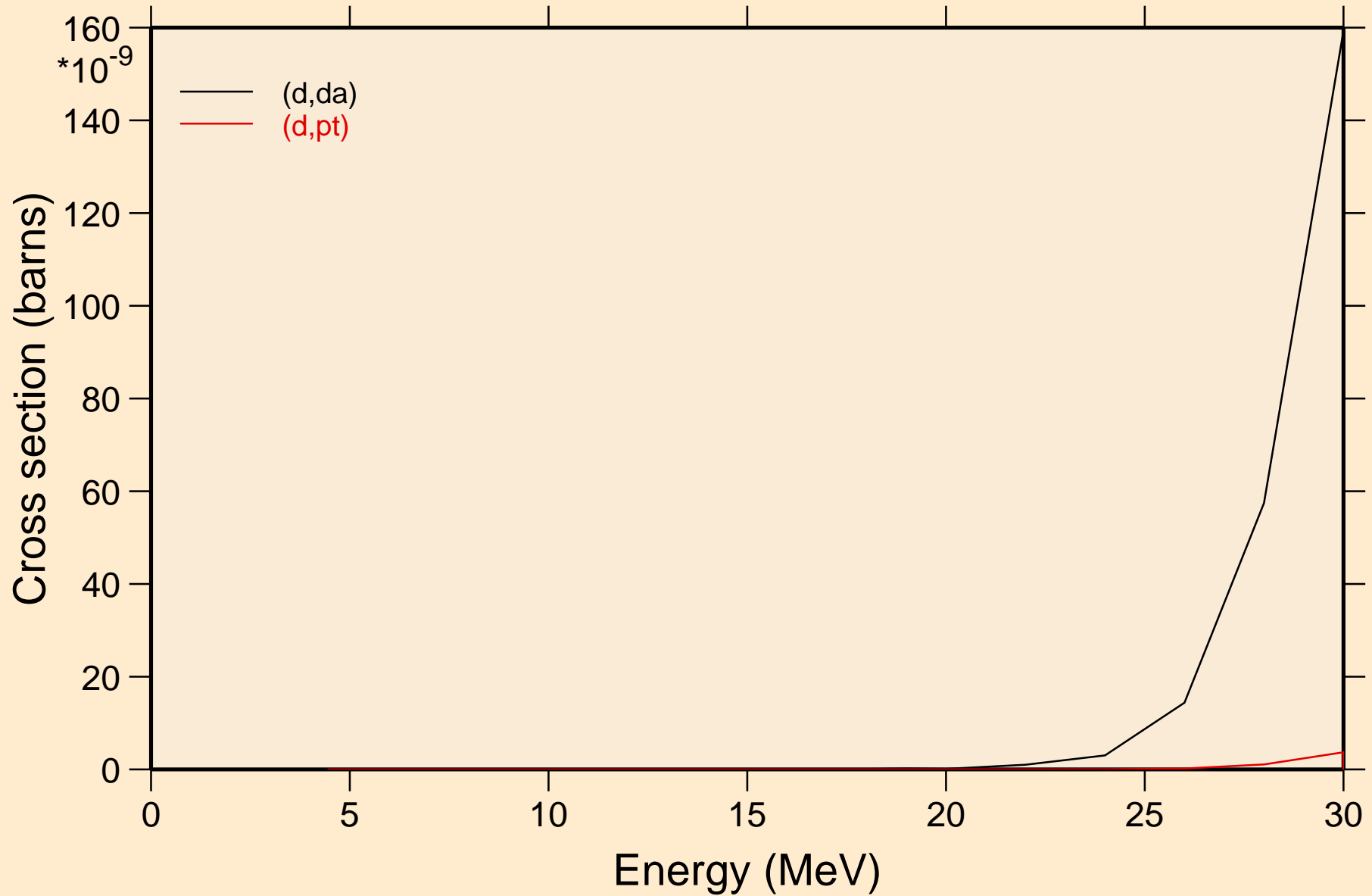

U227 DEUTERON ACER TENDL-2024 LIBRARY; T=0.K  
Threshold reactions

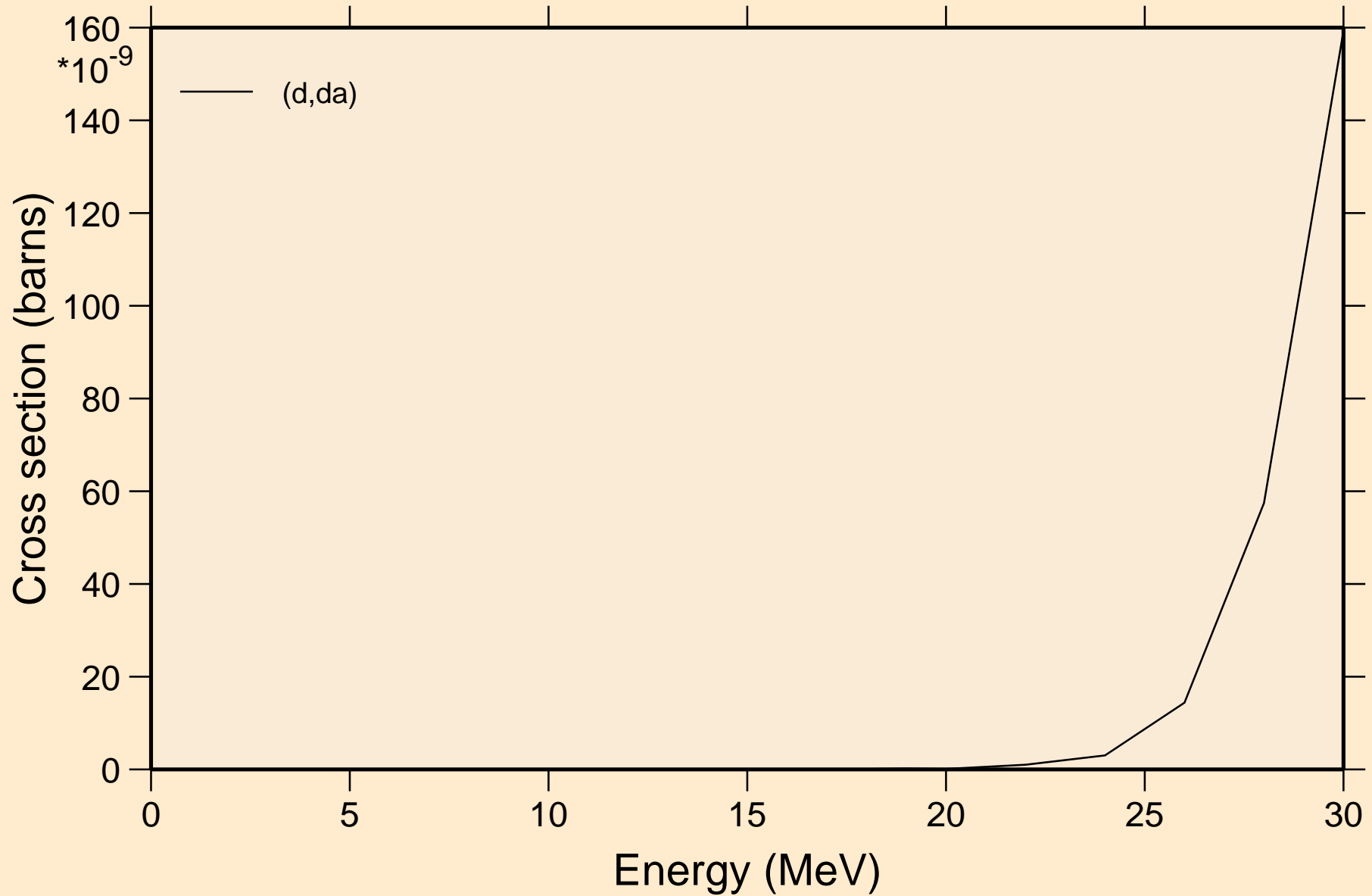

U227 DEUTERON ACER TENDL-2024 LIBRARY; T=0.K  
angular distribution for elastic

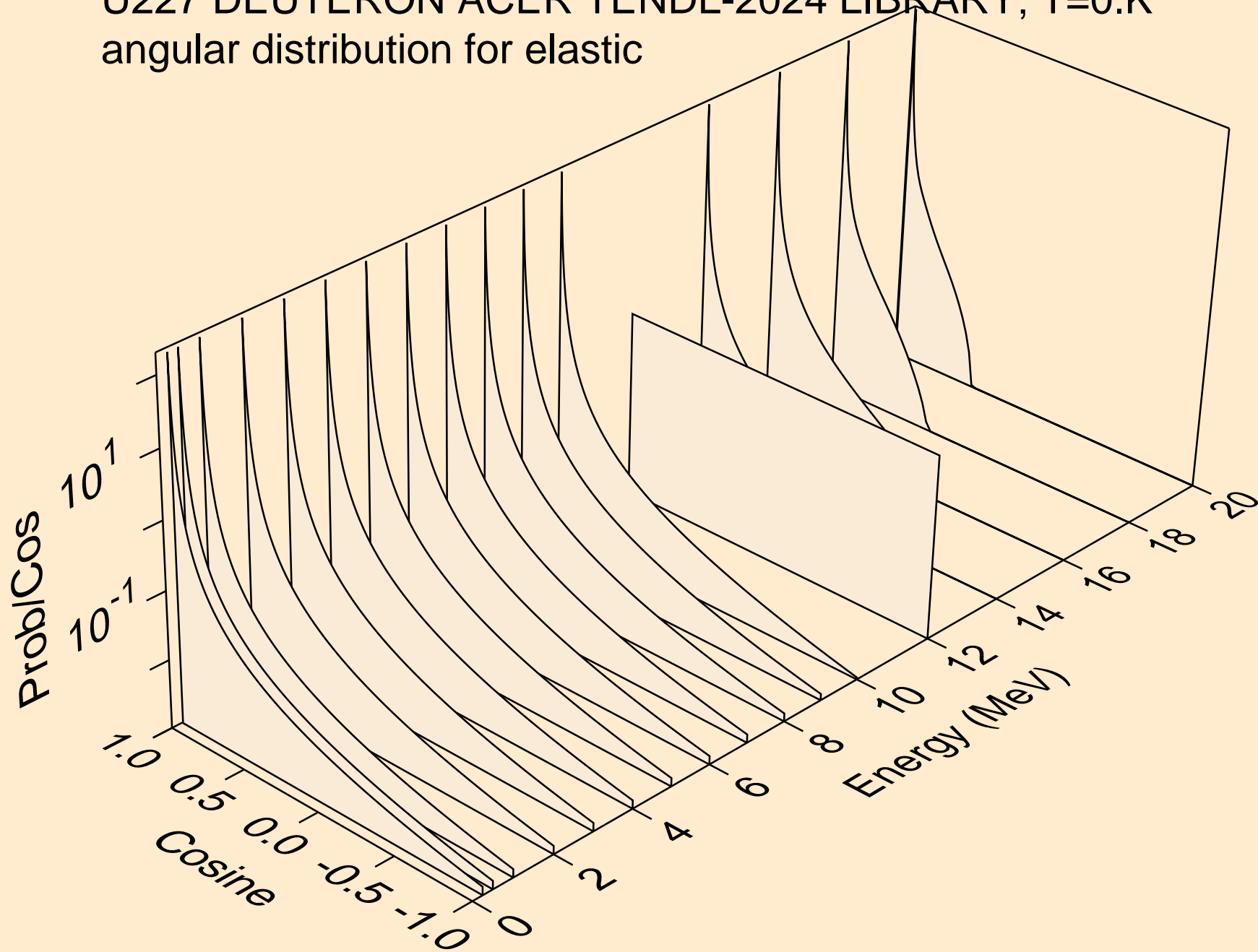

U227 DEUTERON ACER TENDL-2024 LIBRARY; T=0.K  
angular distribution for elastic

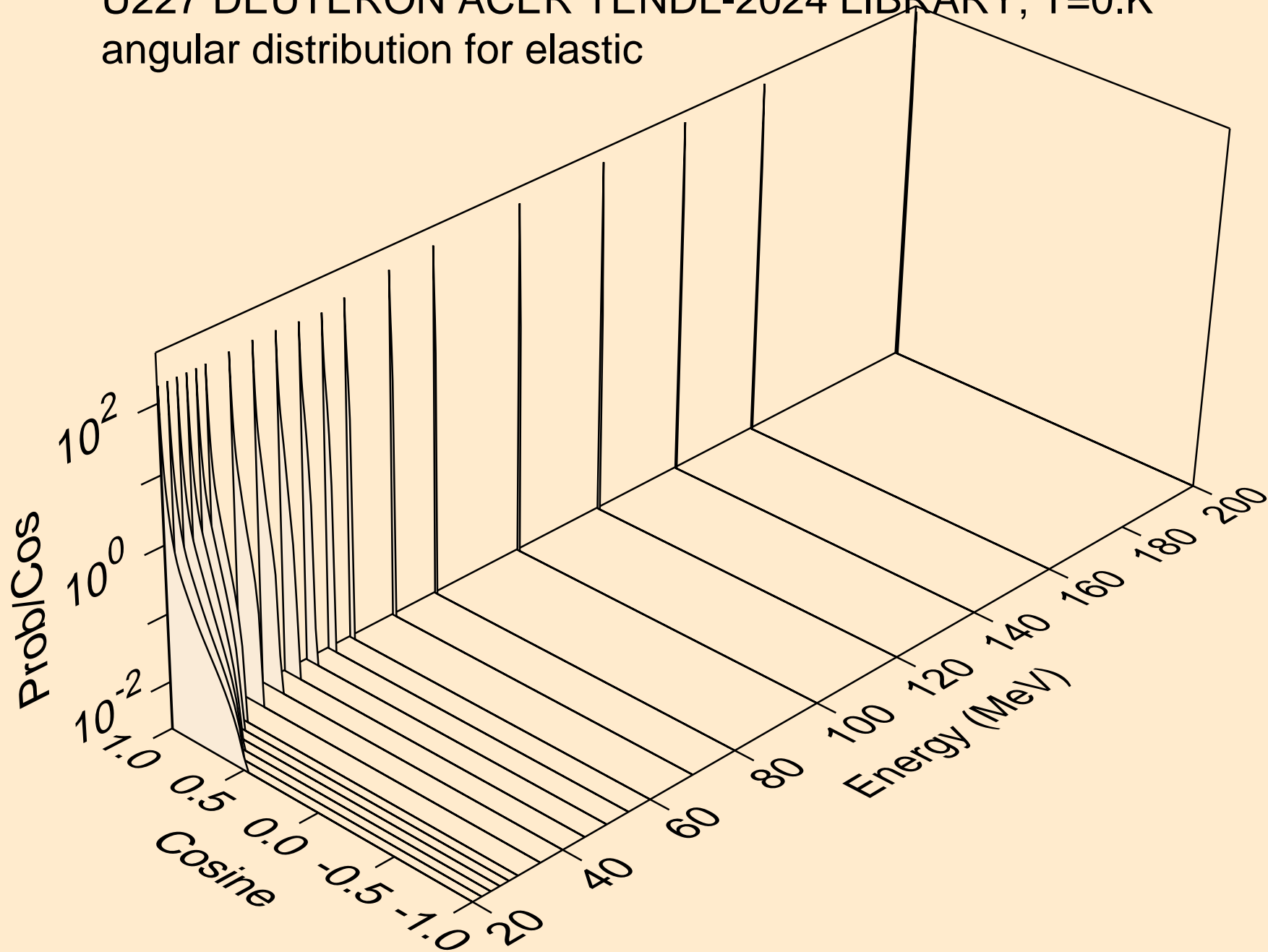

U227 DEUTERON ACER TENDL-2024 LIBRARY; T=0.K  
Deuteron emission for (d,x)

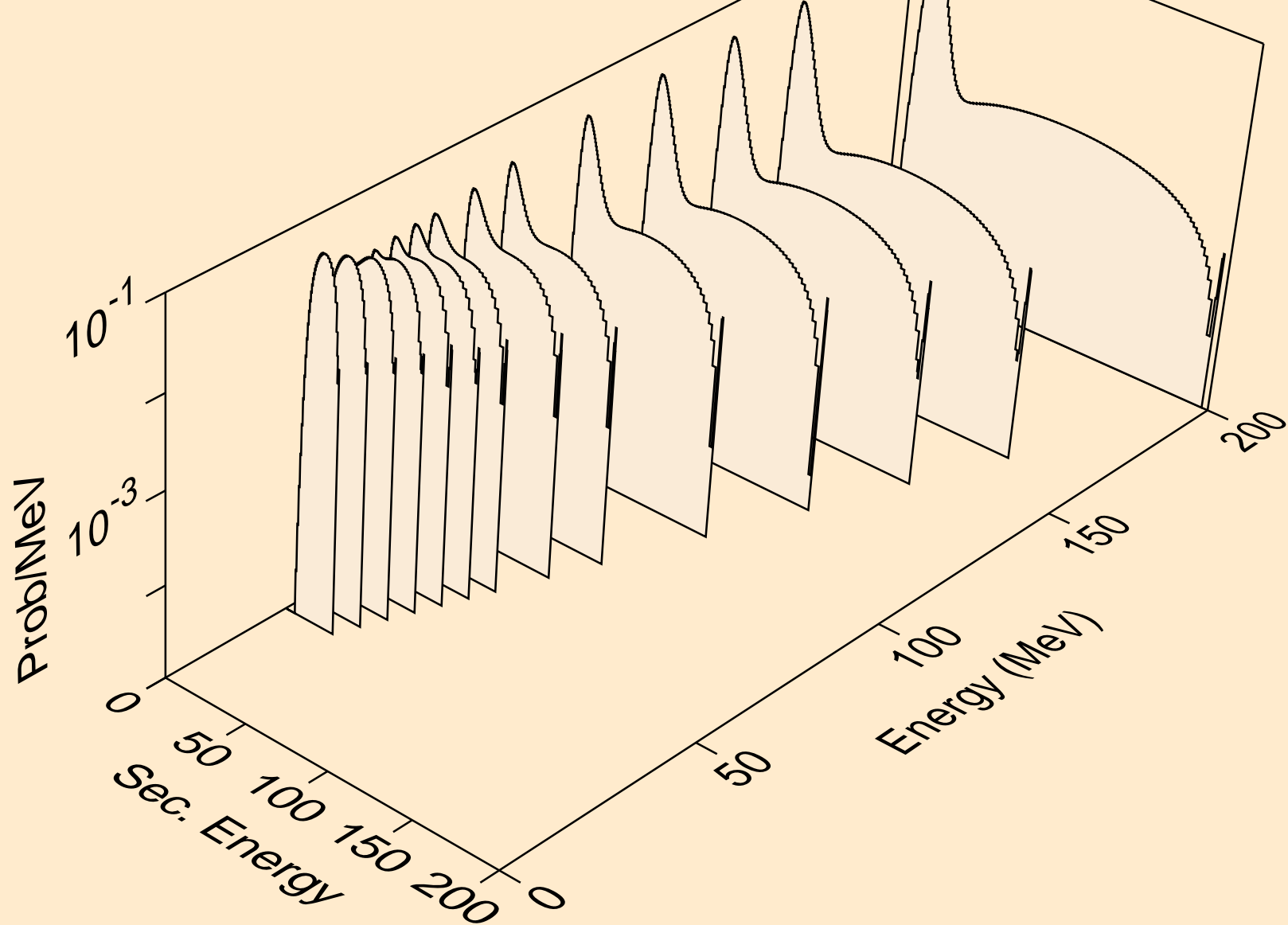

U227 DEUTERON ACER TENDL-2024 LIBRARY; T=0.K  
Deuteron emission for (d,2nd)

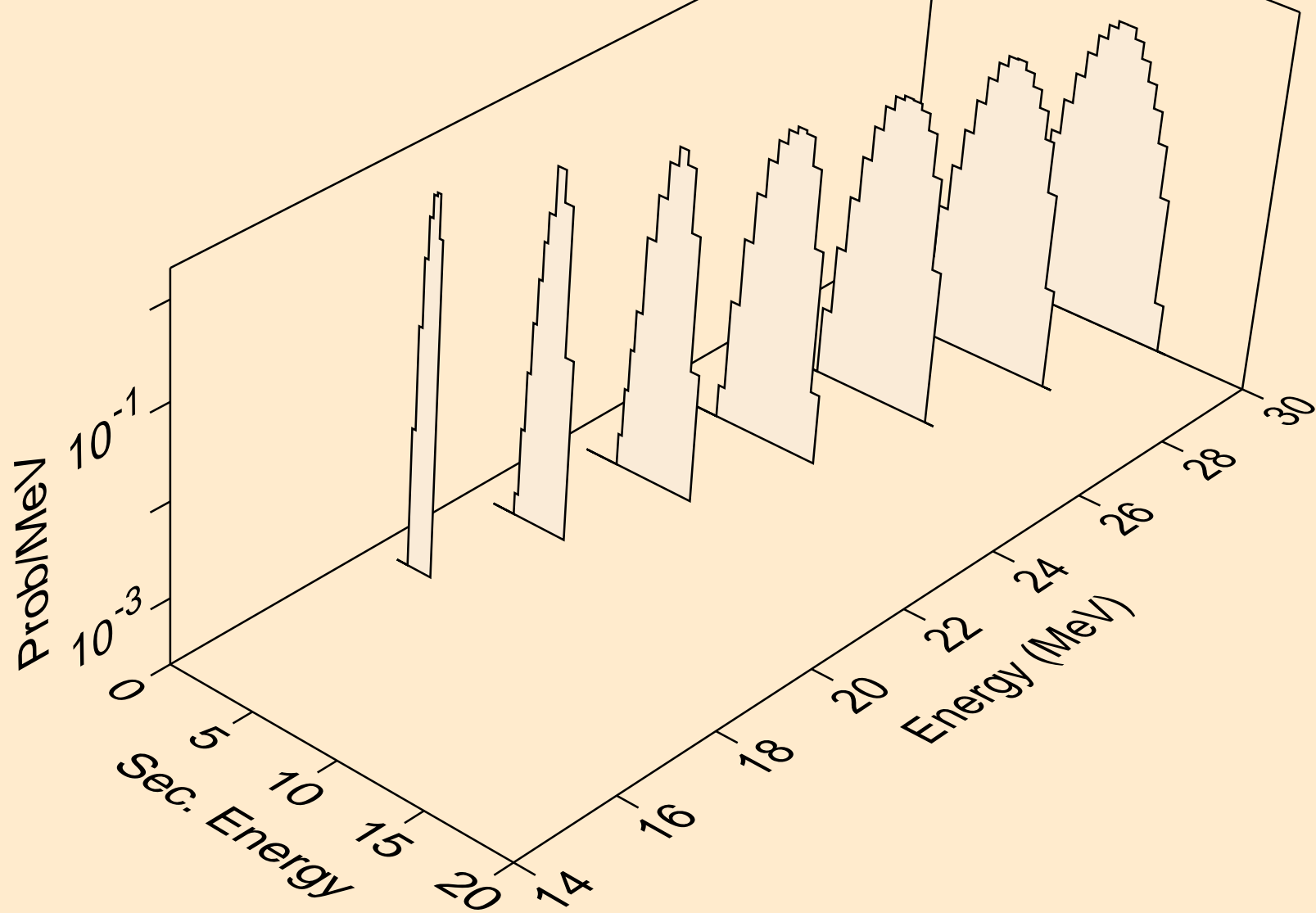

U227 DEUTERON ACER TENDL-2024 LIBRARY; T=0.K  
Deuteron emission for (d,n\*)d

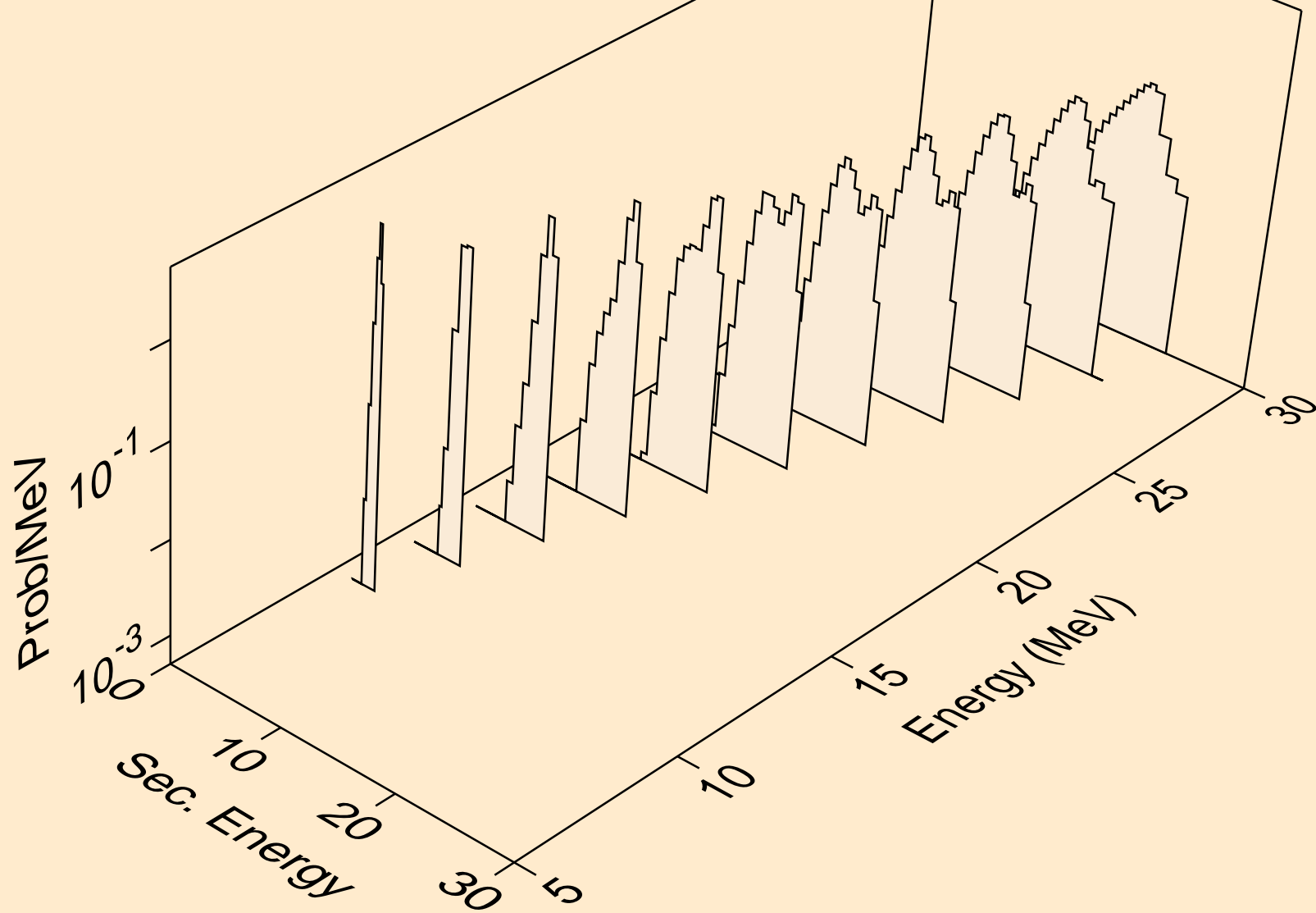

U227 DEUTERON ACER TENDL-2024 LIBRARY; T=0.K  
Deuteron emission for inelastic

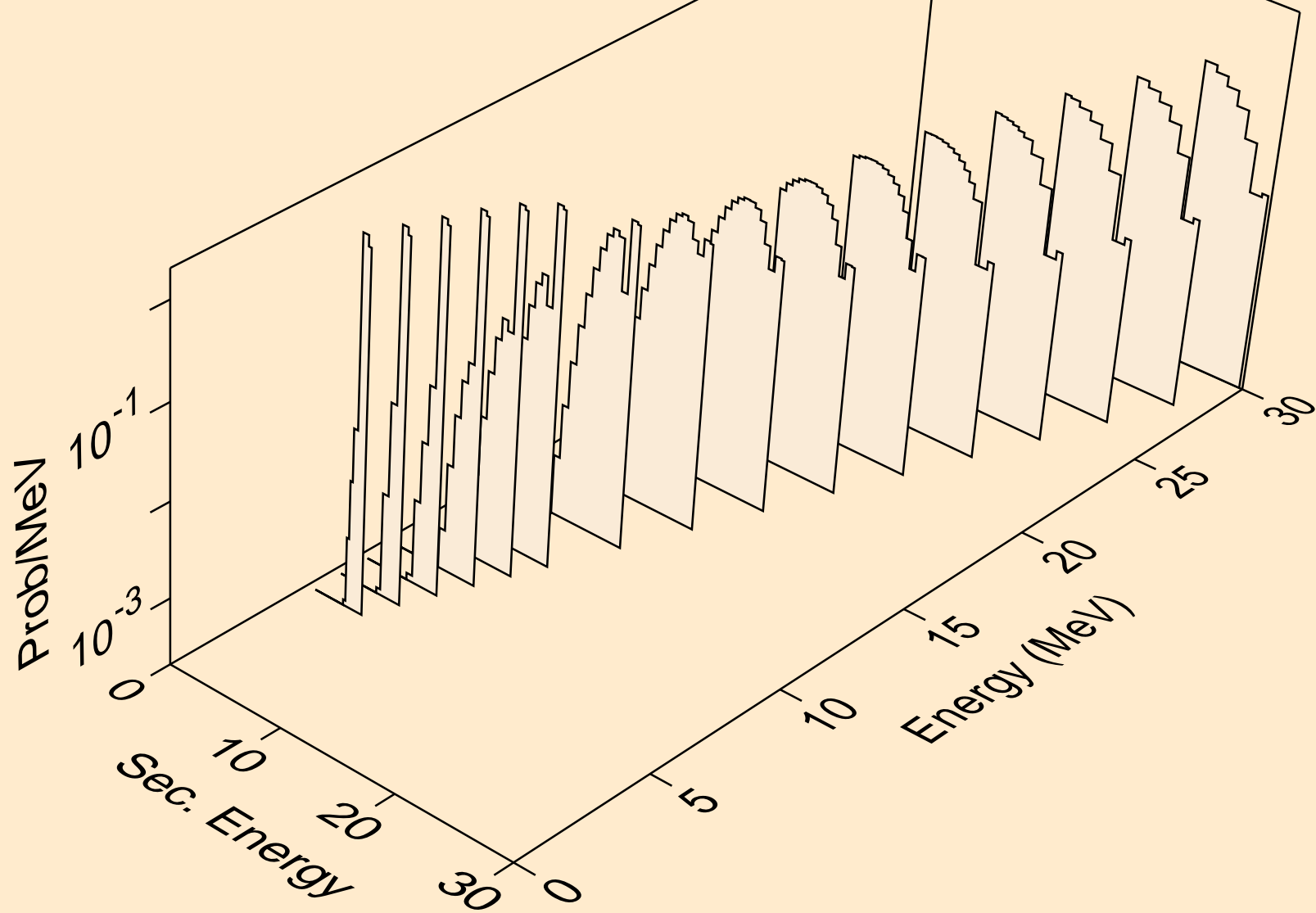

U227 DEUTERON ACER TENDL-2024 LIBRARY; T=0.K  
Deuteron emission for (d,pd)

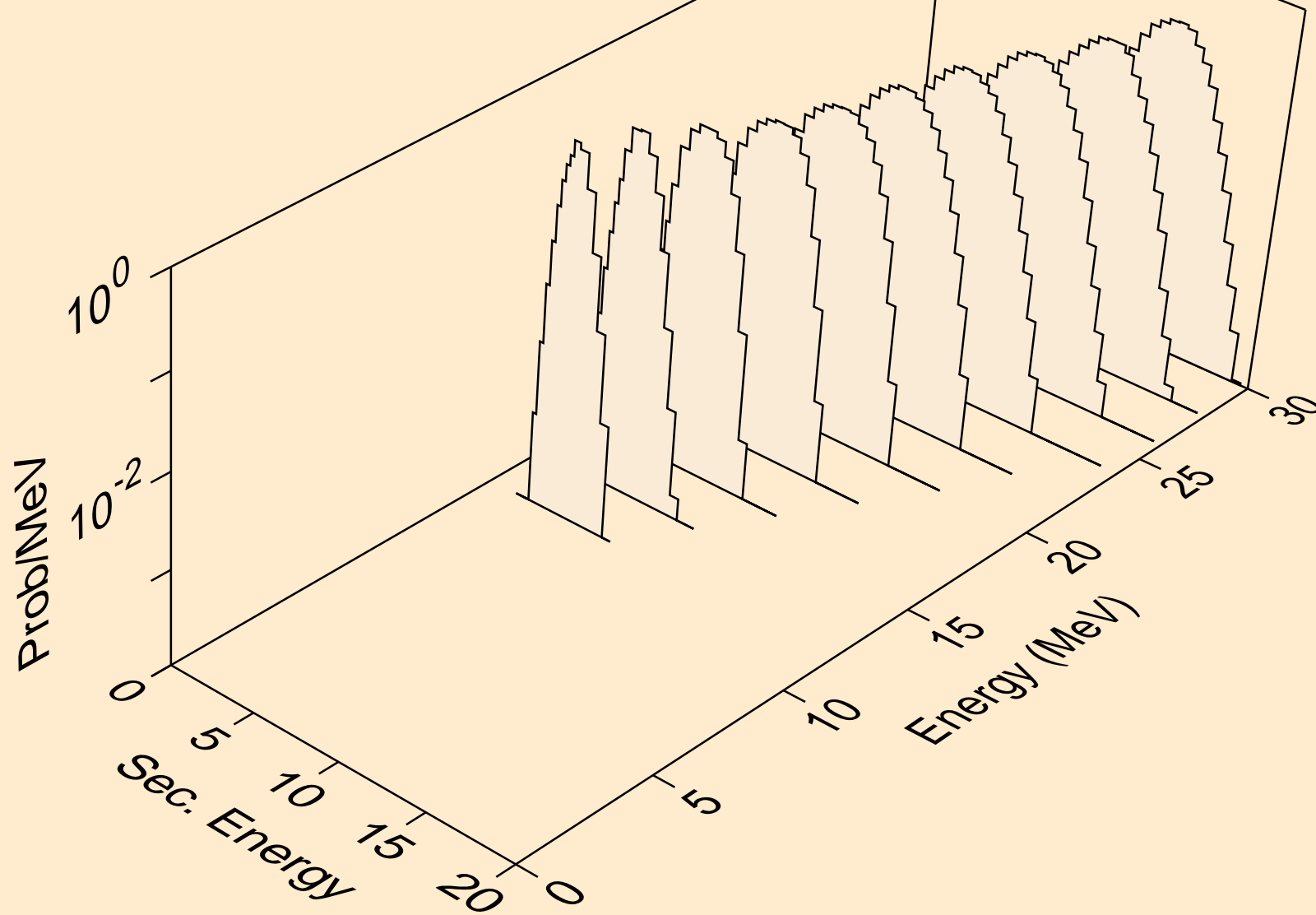

U227 DEUTERON ACER TENDL-2024 LIBRARY; T=0.K  
Deuteron emission for (d,da)

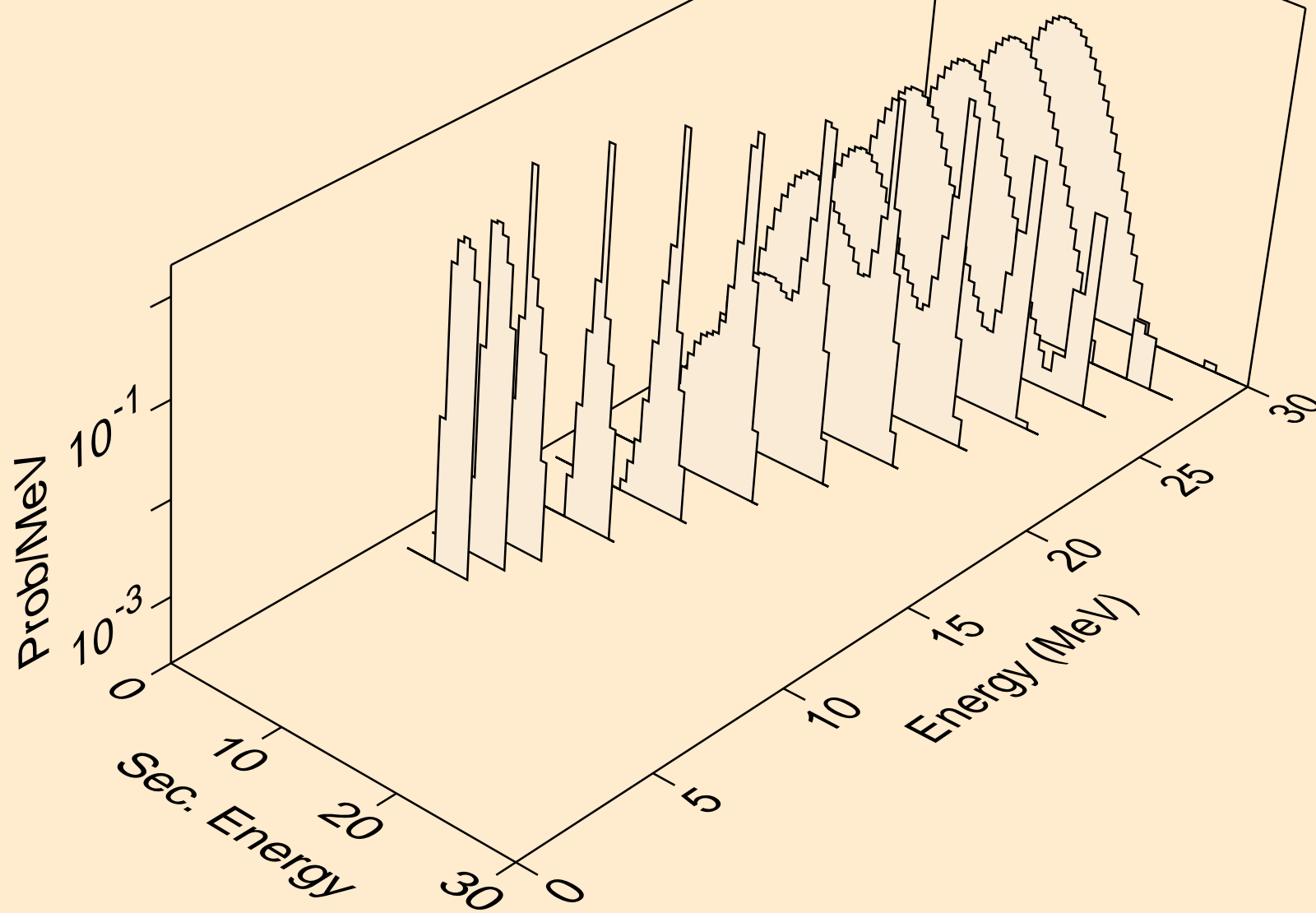

U227 DEUTERON ACER TENDL-2024 LIBRARY; T=0.K  
Photon emission for (z,n)

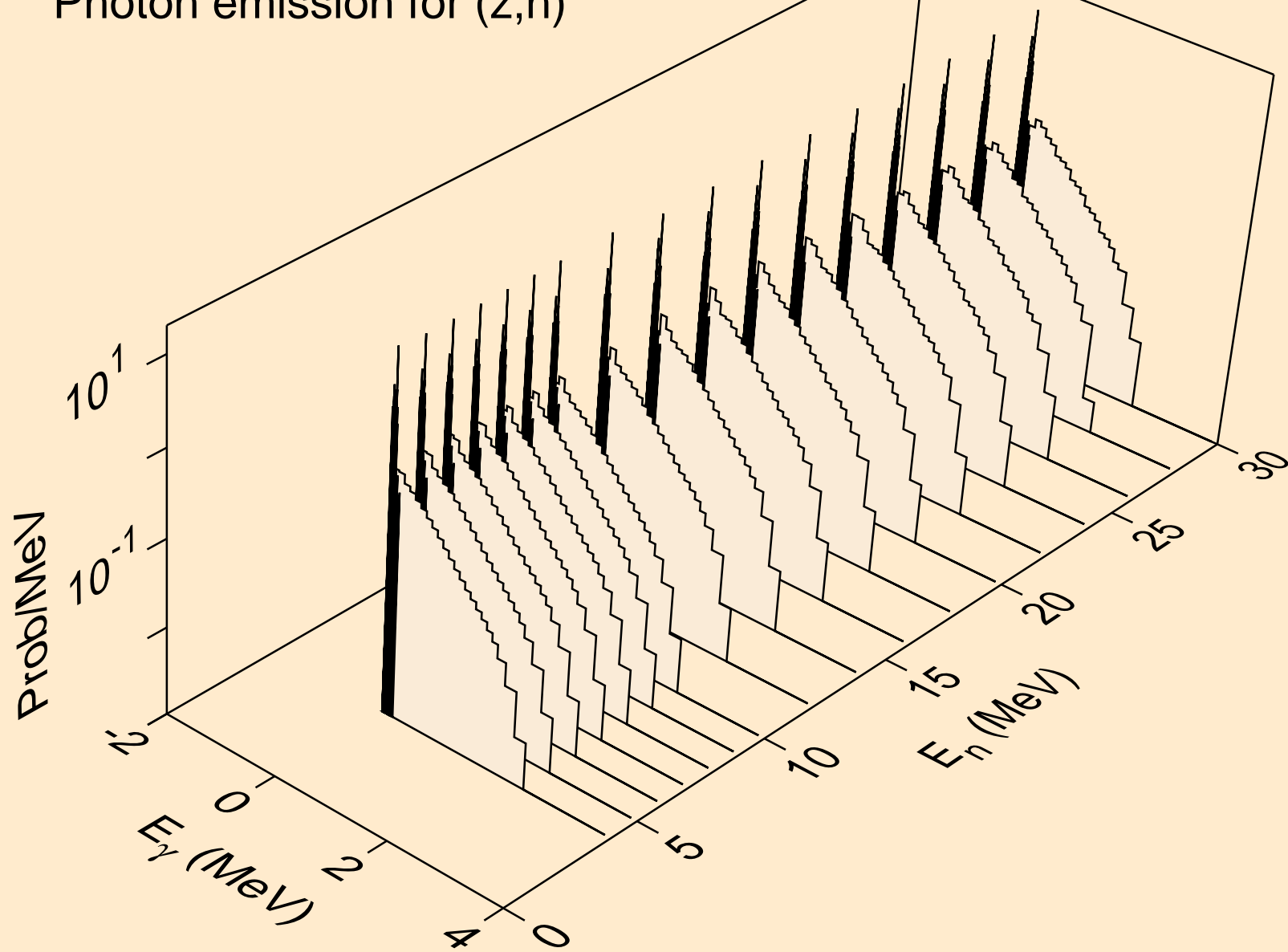

U227 DEUTERON ACER TENDL-2024 LIBRARY; T=0.K  
Photon emission for (z,x)

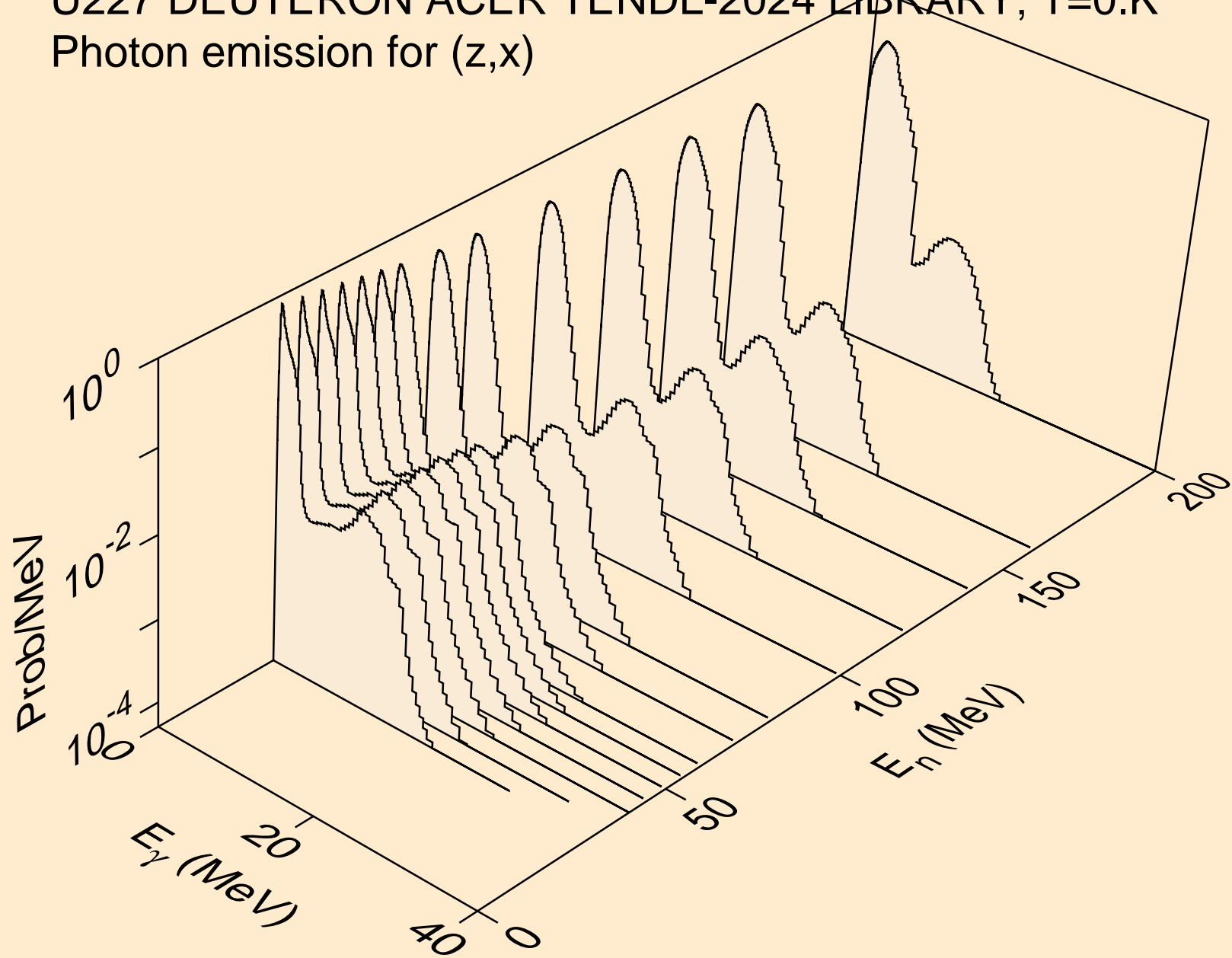

U227 DEUTERON ACER TENDL-2024 LIBRARY; T=0.K  
Photon emission for (n,2nd)

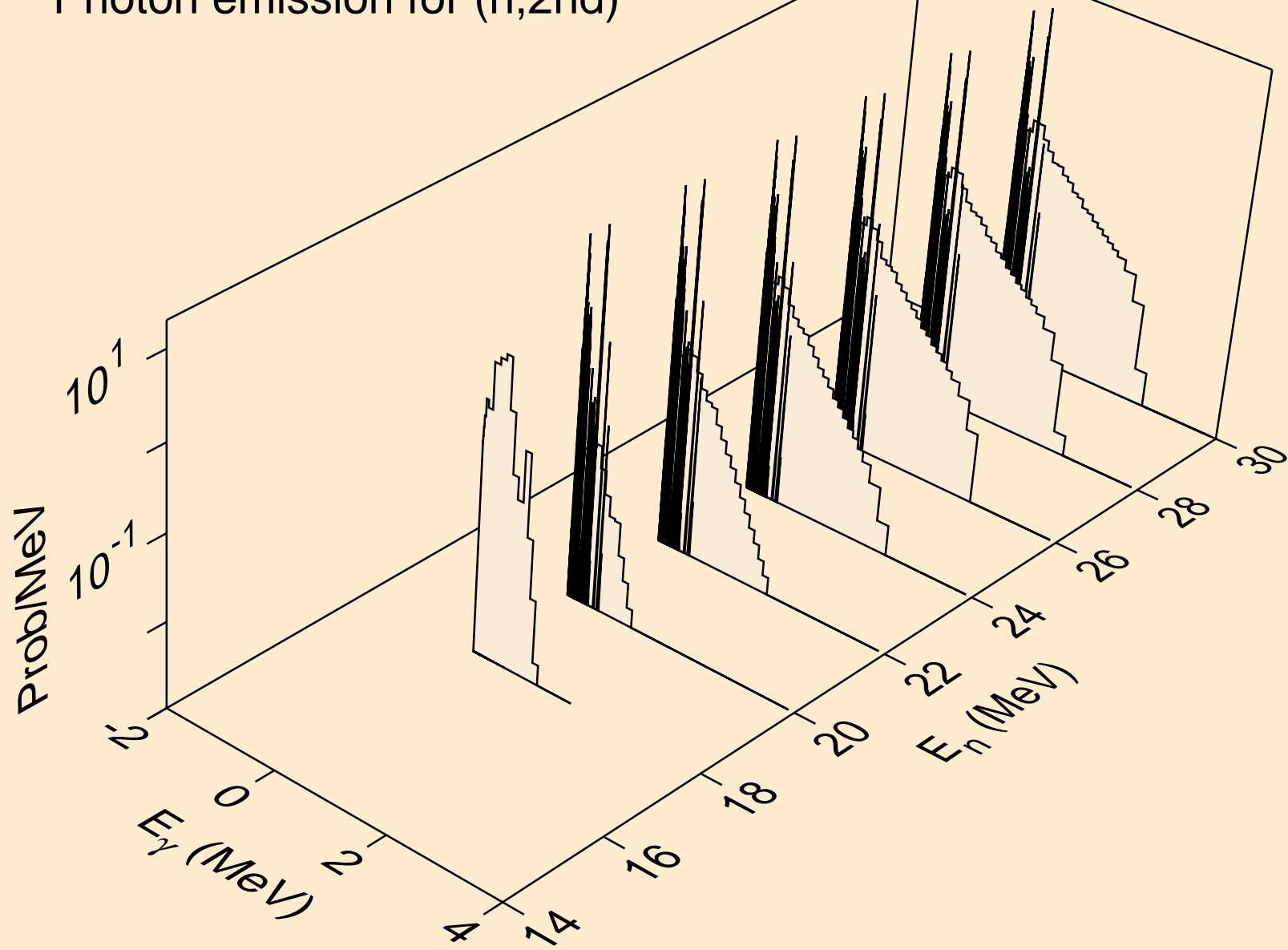

U227 DEUTERON ACER TENDL-2024 LIBRARY; T=0.K  
Photon emission for (n,2n)

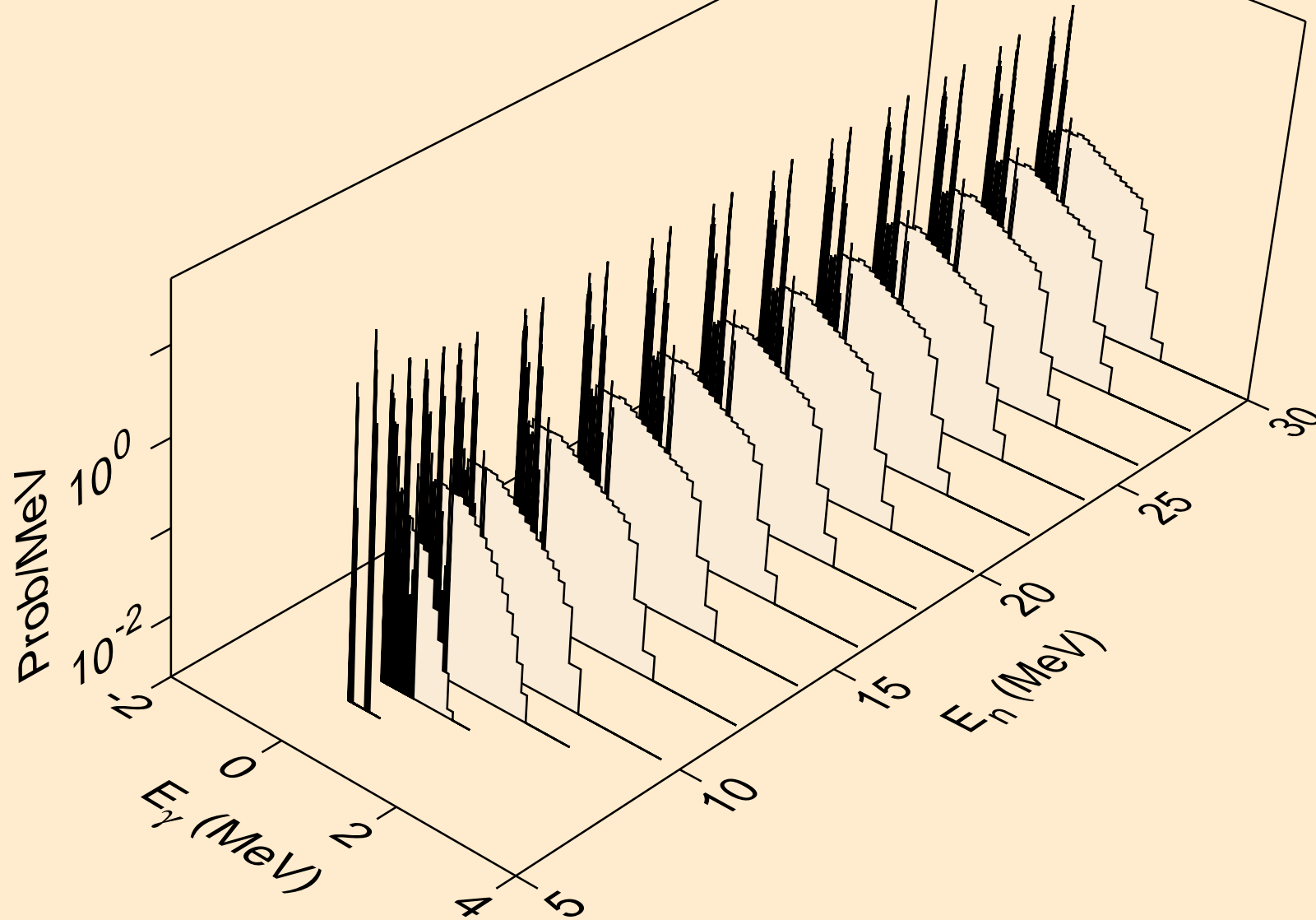

U227 DEUTERON ACER TENDL-2024 LIBRARY; T=0.K  
Photon emission for (n,3n)

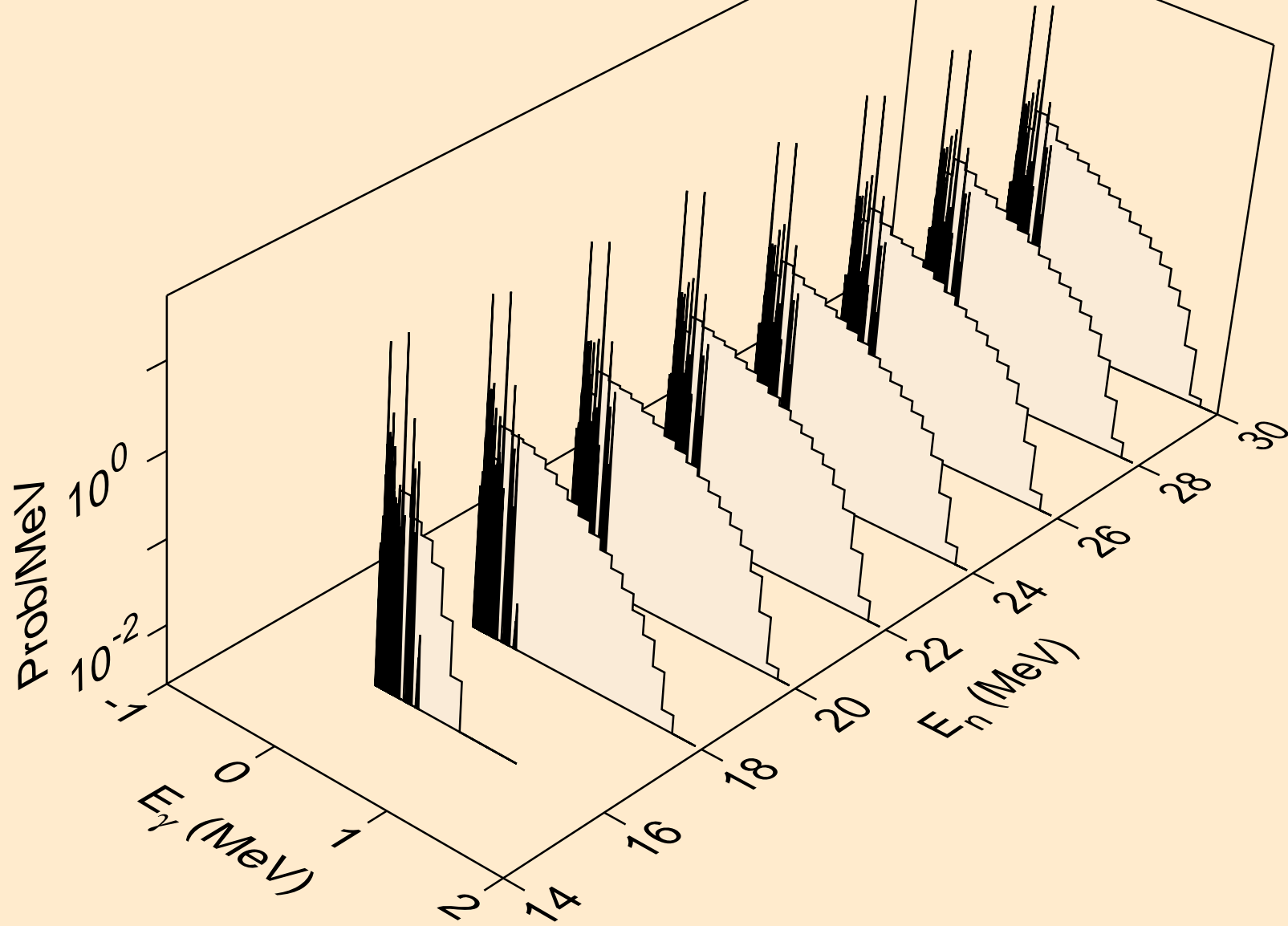

U227 DEUTERON ACER TENDL-2024 LIBRARY; T=0.K  
Photon emission for (n,n\*)a

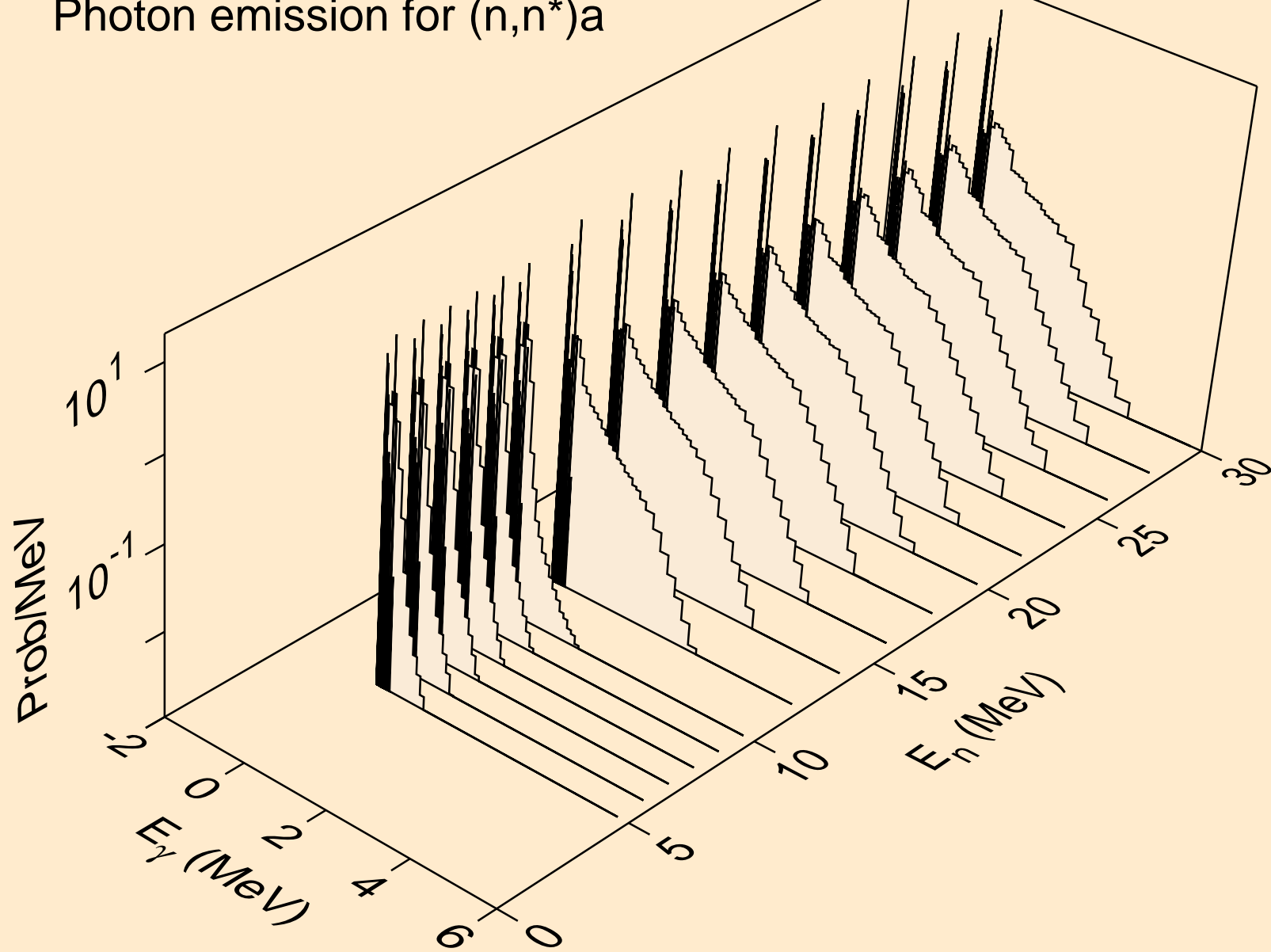

U227 DEUTERON ACER TENDL-2024 LIBRARY; T=0.K  
Photon emission for (n,2n)a

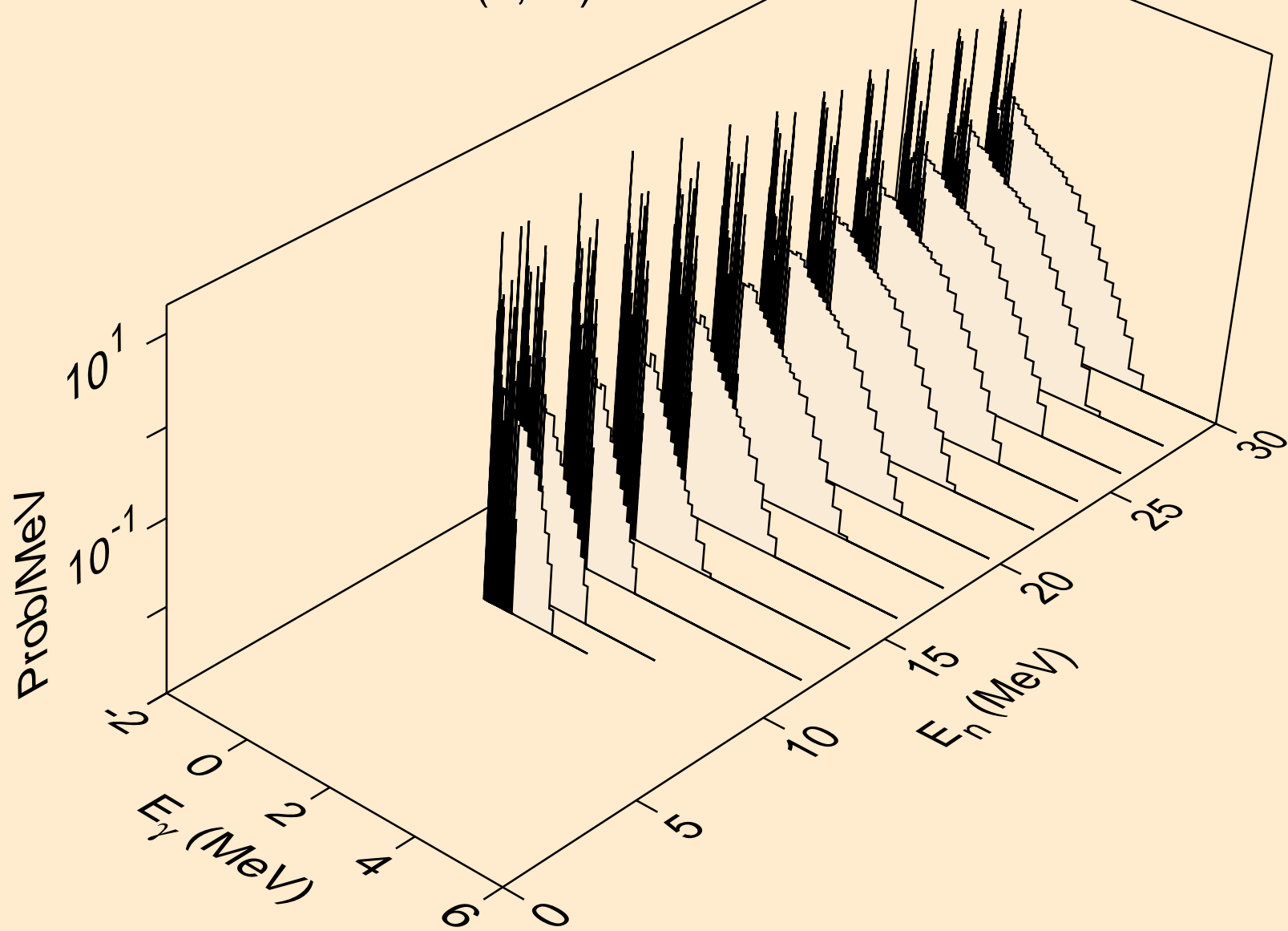

U227 DEUTERON ACER TENDL-2024 LIBRARY; T=0.K  
Photon emission for (n,3n)a

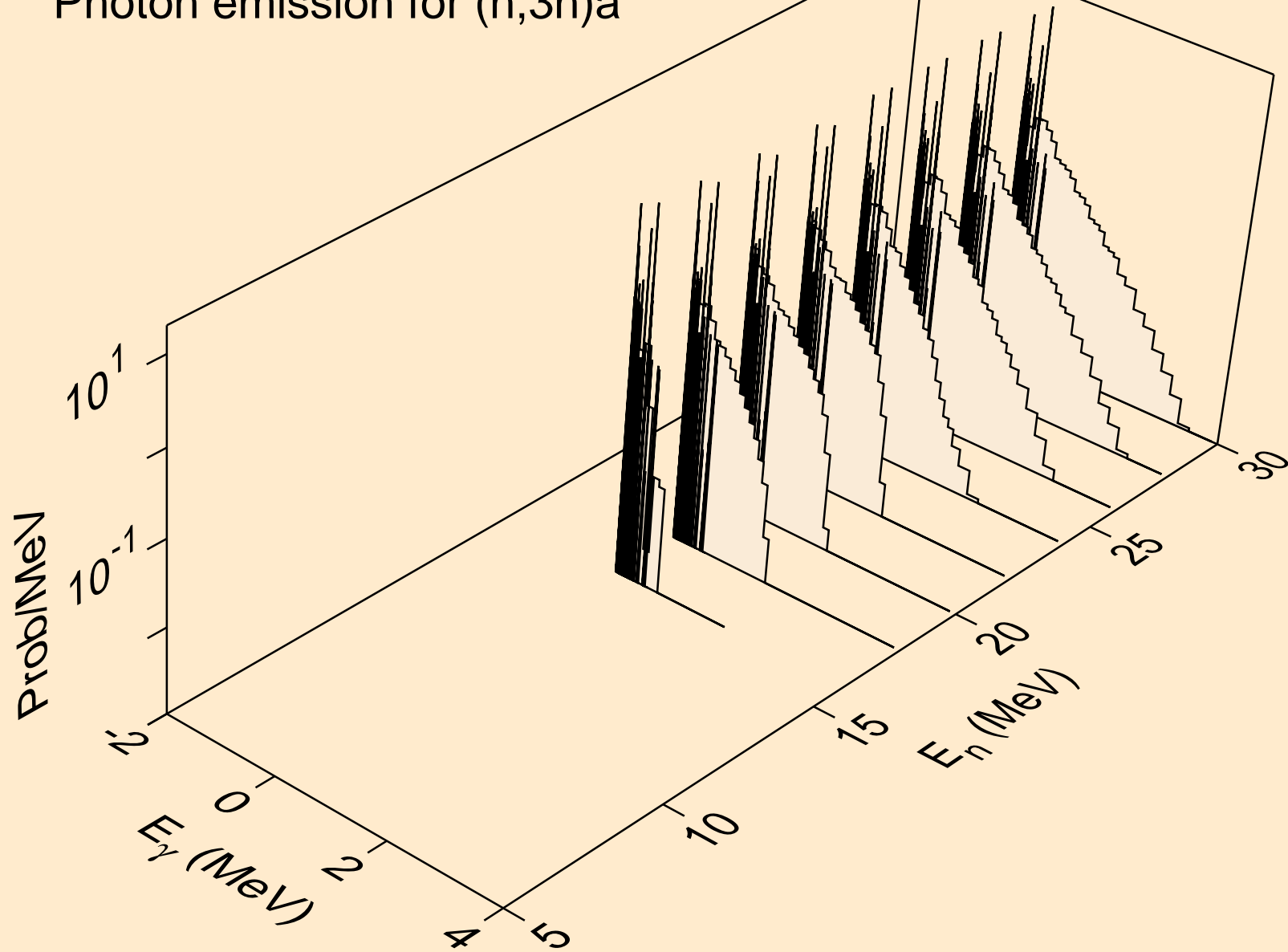

U227 DEUTERON ACER TENDL-2024 LIBRARY; T=0.K  
Photon emission for (n,n\*)p

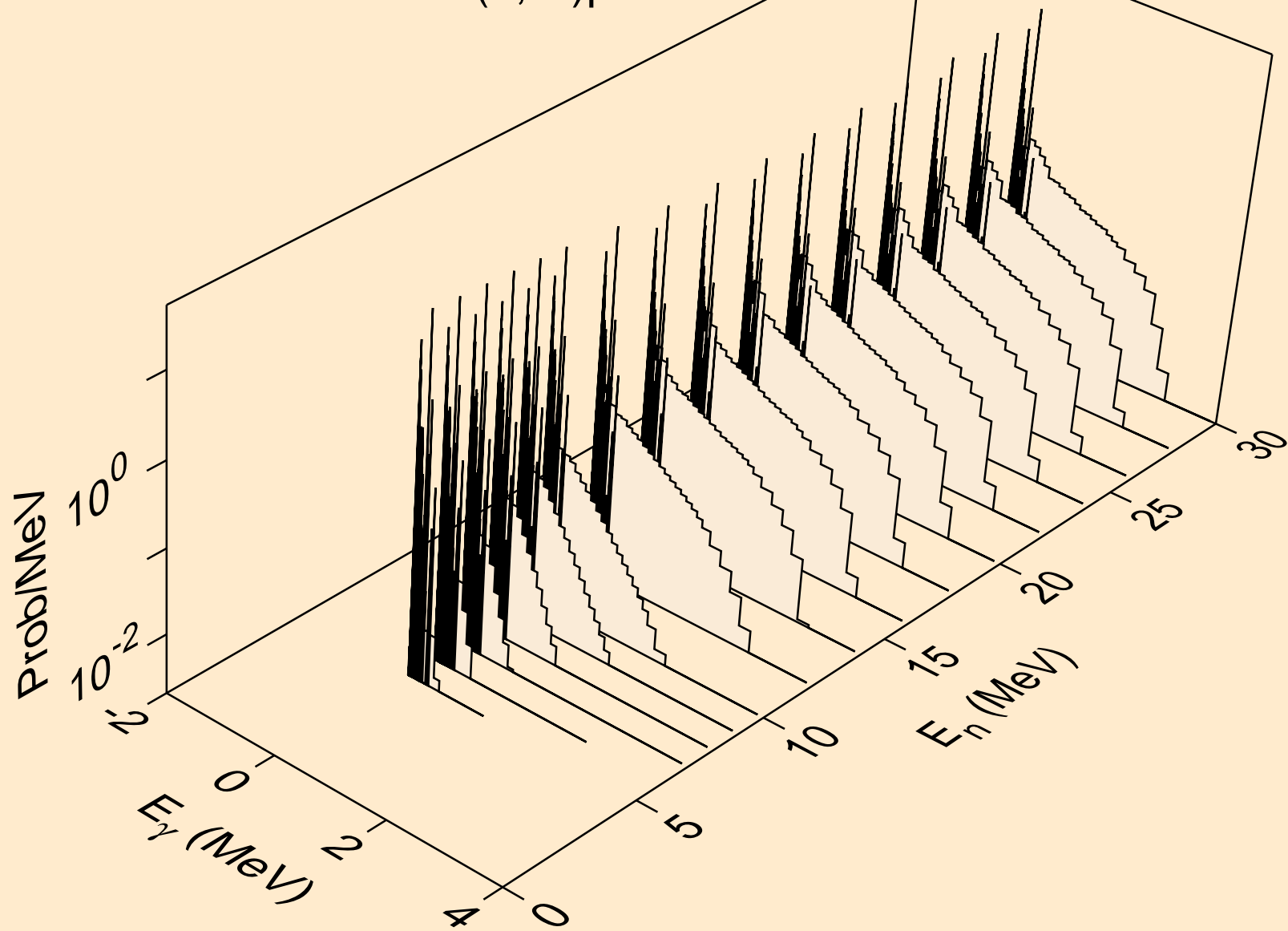

U227 DEUTERON ACER TENDL-2024 LIBRARY; T=0.K  
Photon emission for (n,n\*)2a

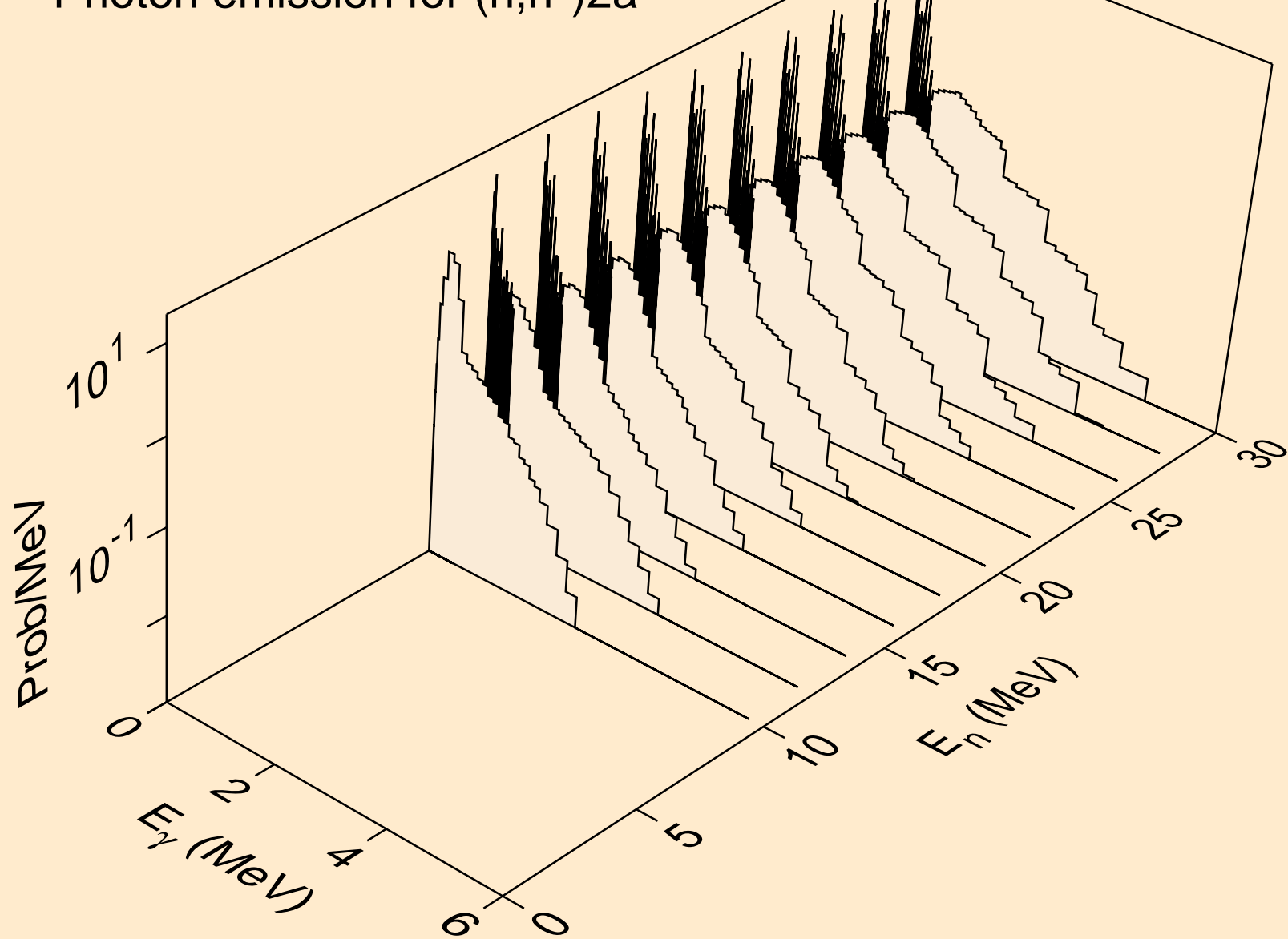

U227 DEUTERON ACER TENDL-2024 LIBRARY; T=0.K  
Photon emission for (n,2n)2a

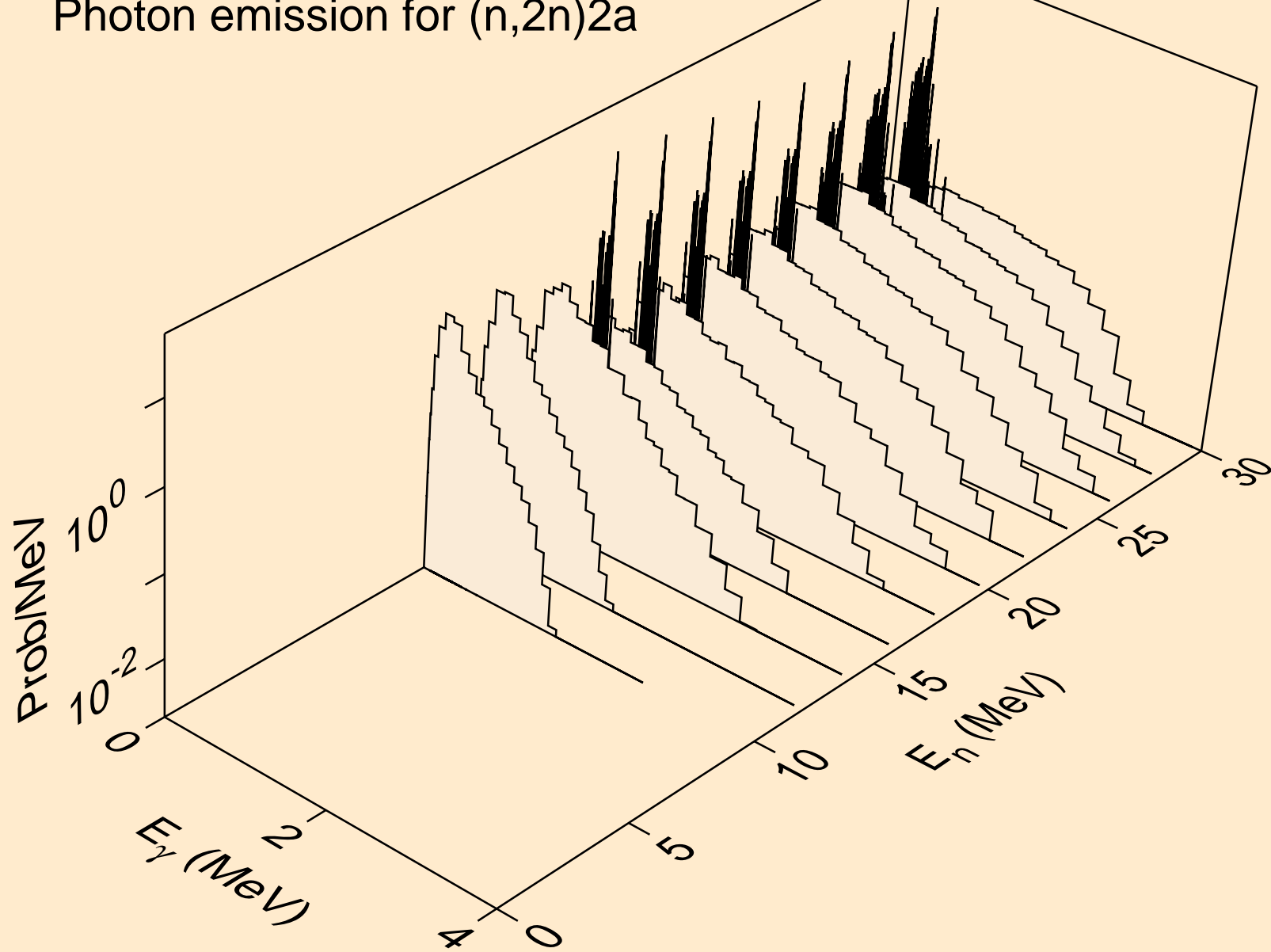

U227 DEUTERON ACER TENDL-2024 LIBRARY; T=0.K  
Photon emission for (n,n\*)d

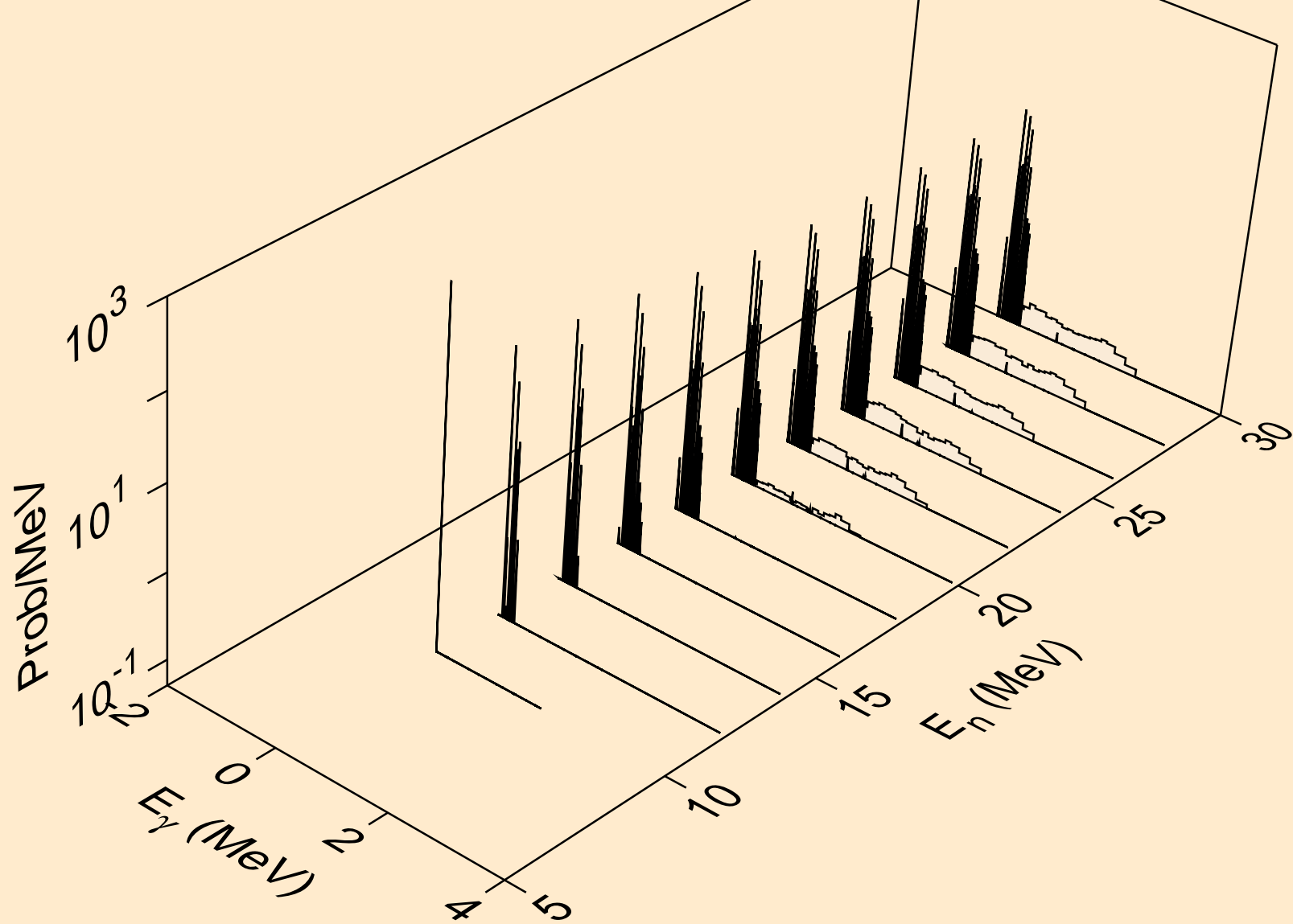

U227 DEUTERON ACER TENDL-2024 LIBRARY; T=0.K  
Photon emission for (n,n\*)t

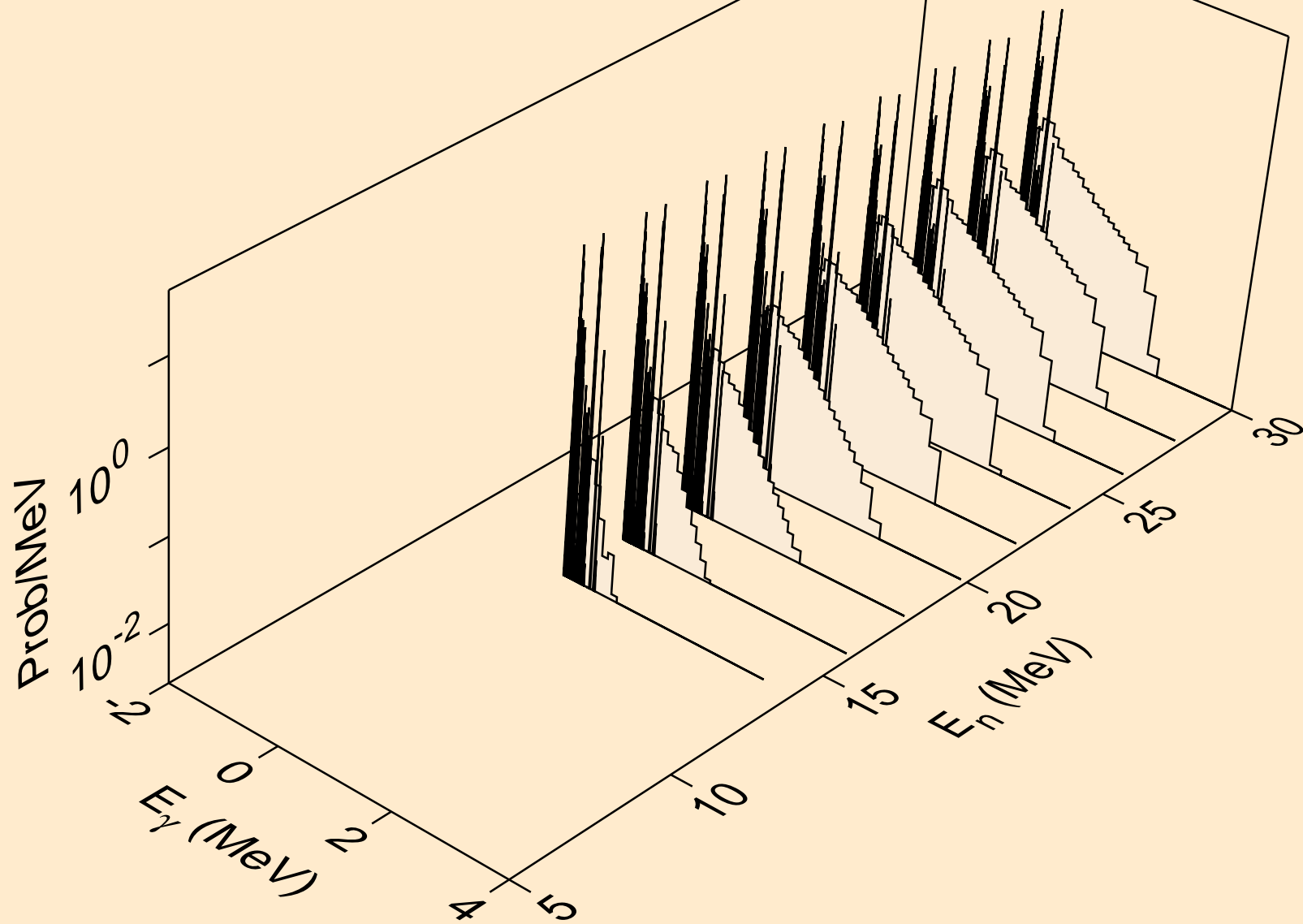

U227 DEUTERON ACER TENDL-2024 LIBRARY; T=0.K  
Photon emission for (n,n\*)he3

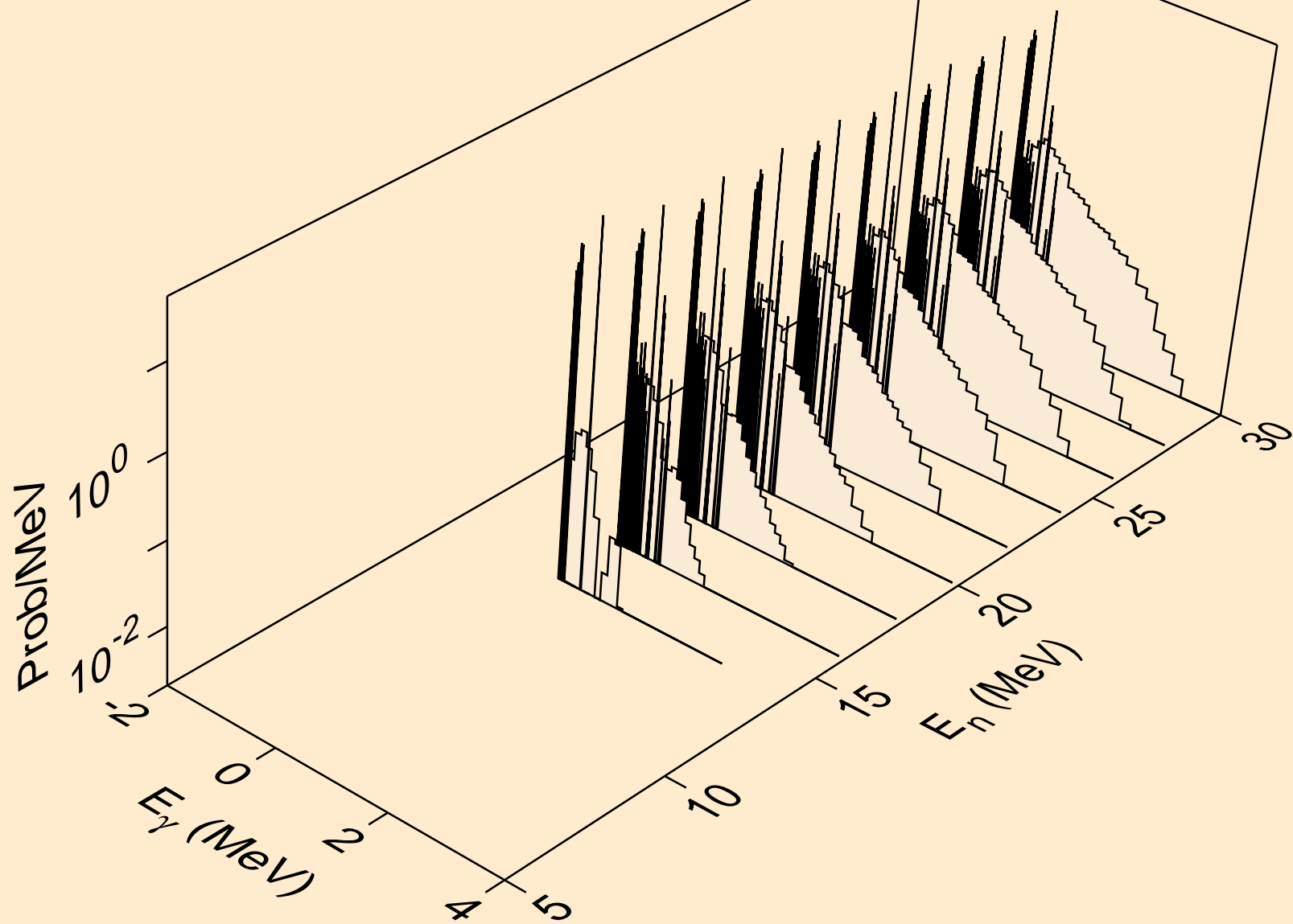

U227 DEUTERON ACER TENDL-2024 LIBRARY; T=0.K  
Photon emission for (n,4n)

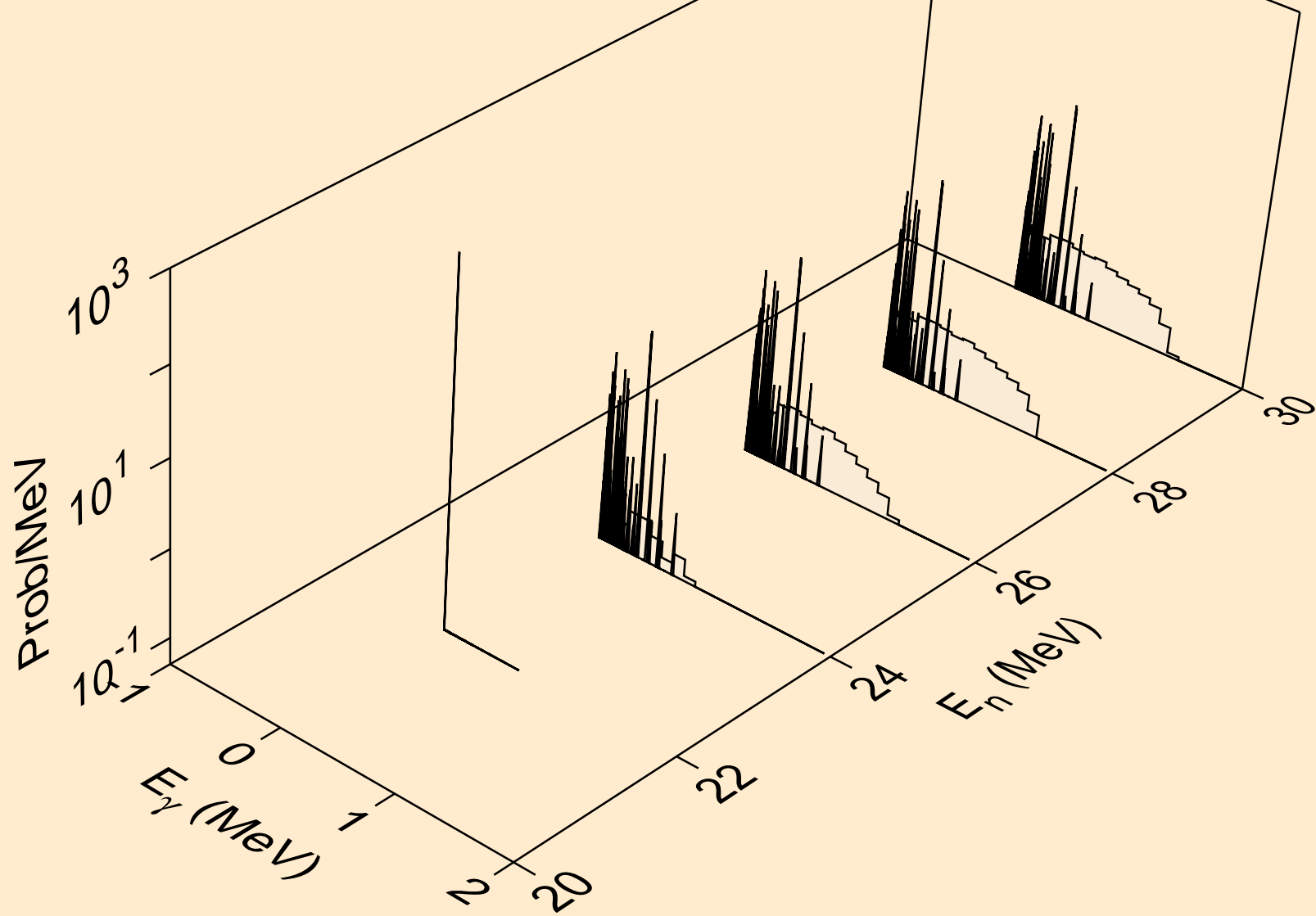

U227 DEUTERON ACER TENDL-2024 LIBRARY; T=0.K  
Photon emission for (n,2np)

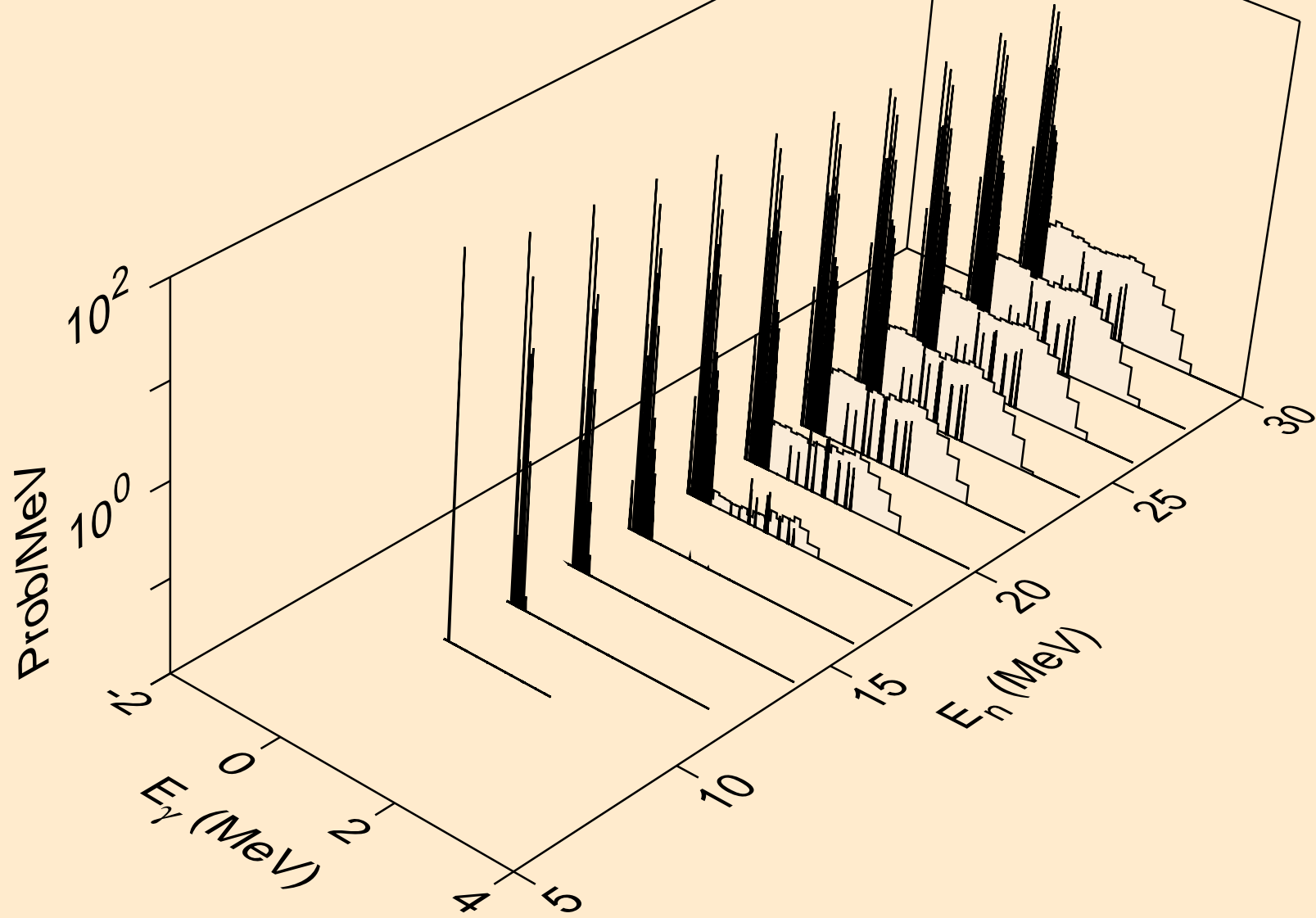

U227 DEUTERON ACER TENDL-2024 LIBRARY; T=0.K  
Photon emission for (n,3np)

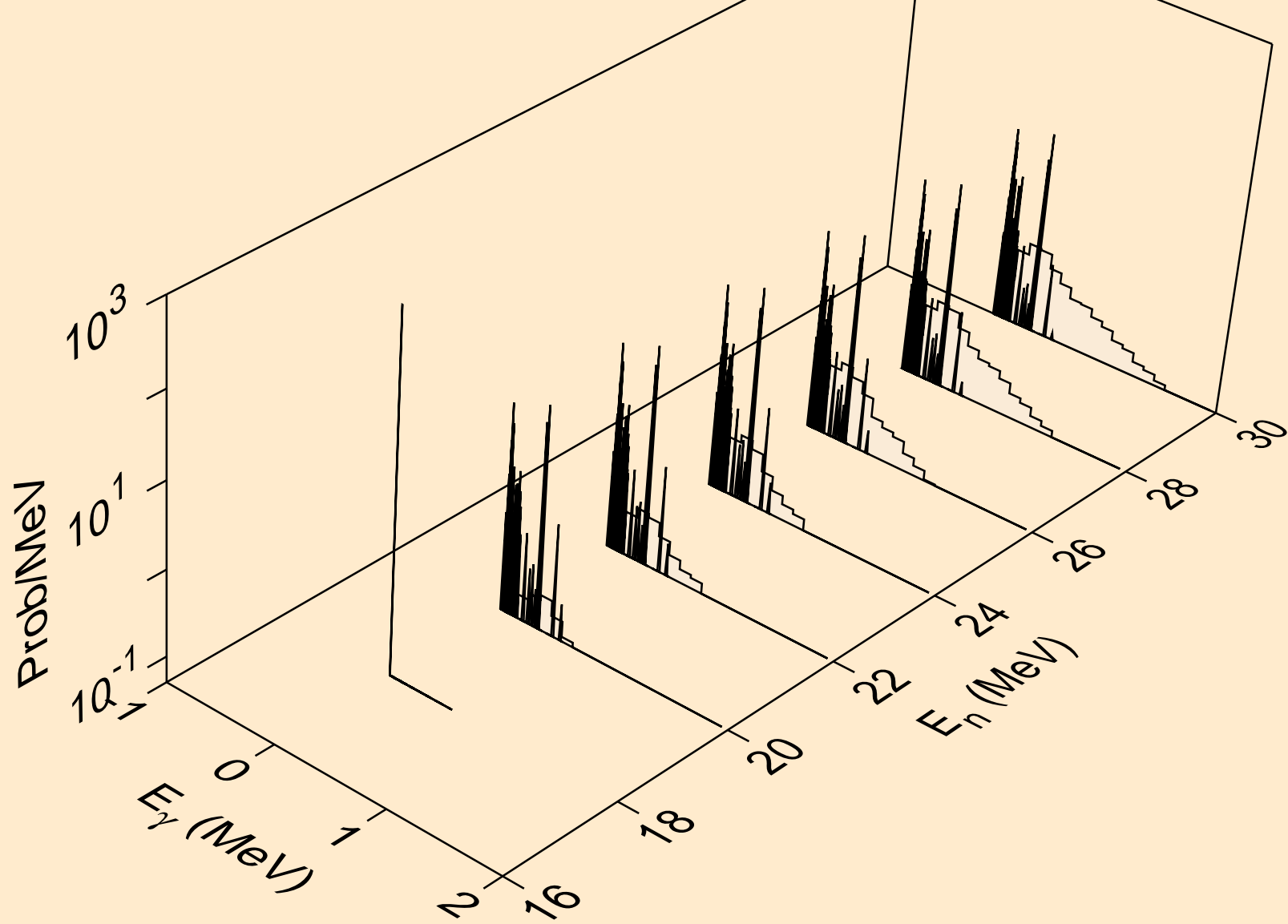

U227 DEUTERON ACER TENDL-2024 LIBRARY; T=0.K  
Photon emission for (n,n2p)

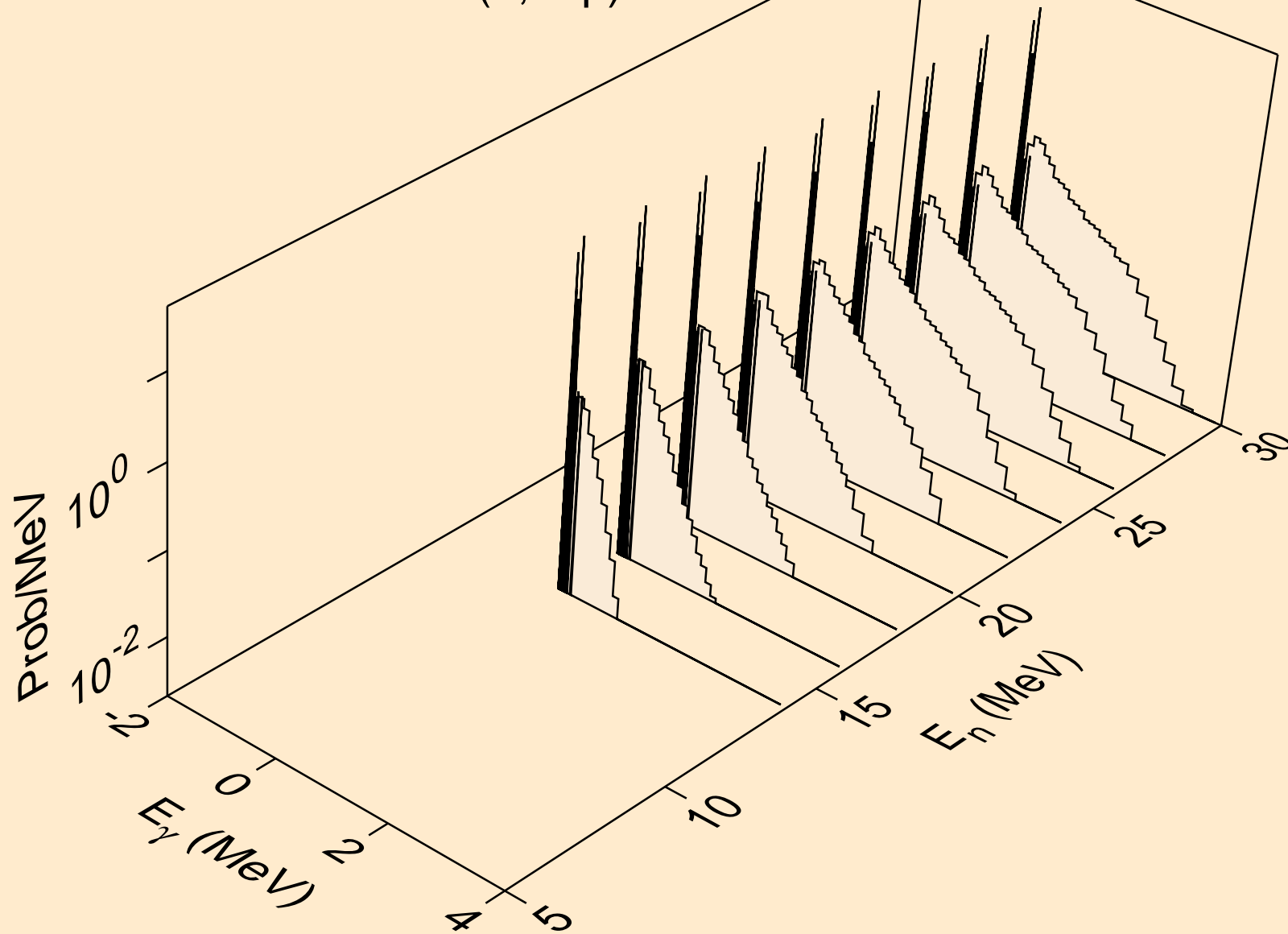

U227 DEUTERON ACER TENDL-2024 LIBRARY; T=0.K  
Photon emission for (n,npa)

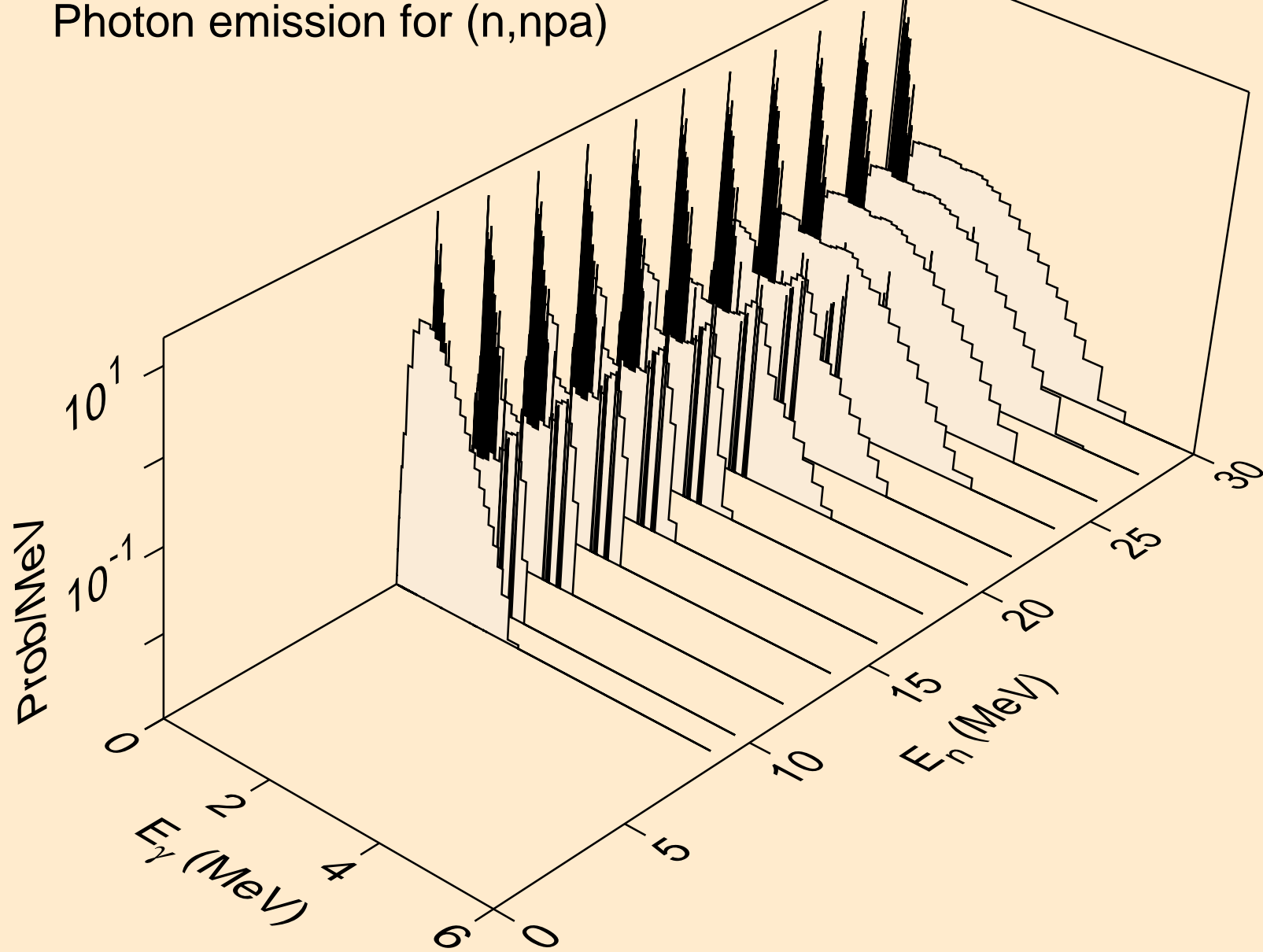

U227 DEUTERON ACER TENDL-2024 LIBRARY; T=0.K  
Photon emission for (n,gma)

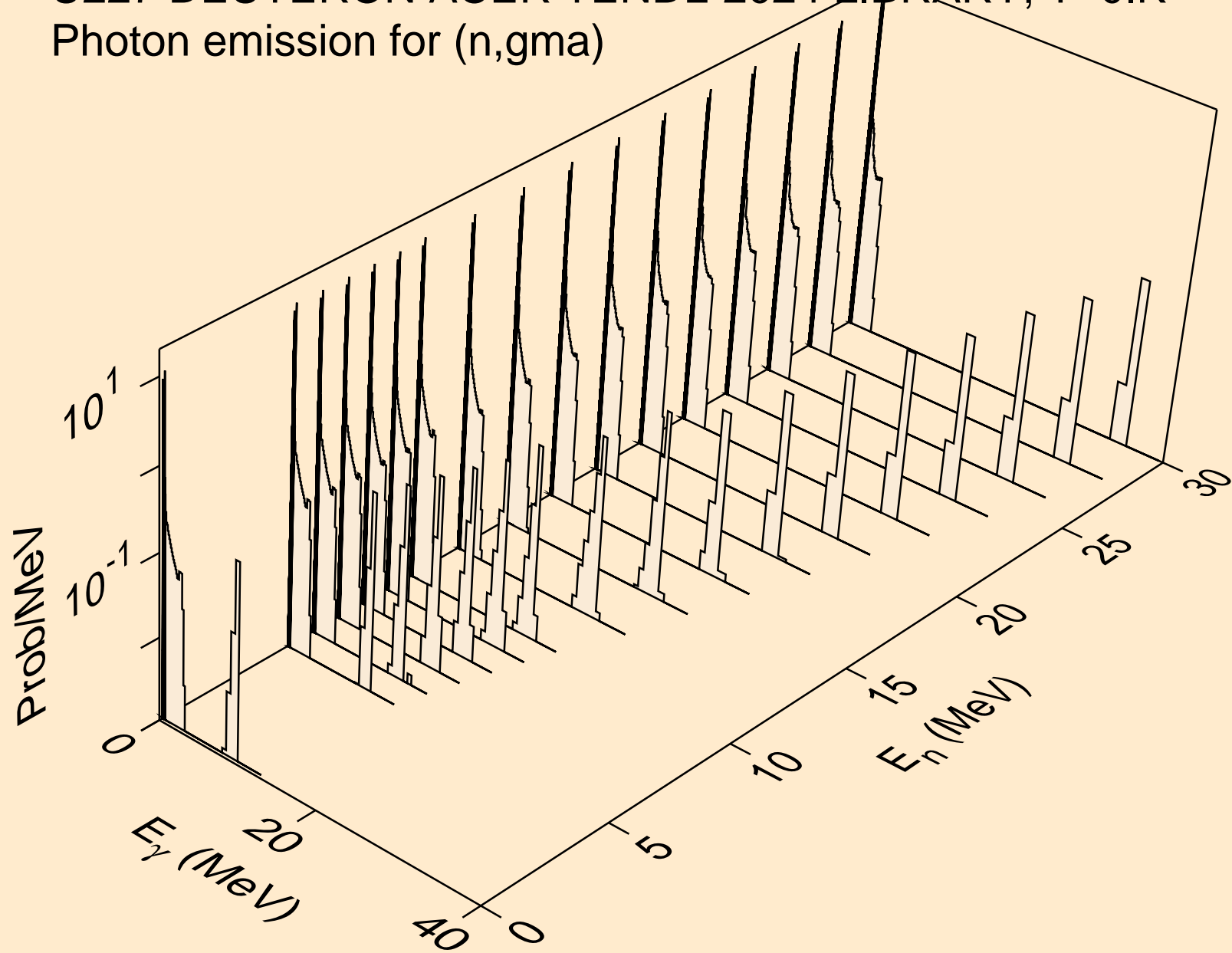

U227 DEUTERON ACER TENDL-2024 LIBRARY; T=0.K  
Photon emission for (n,p)

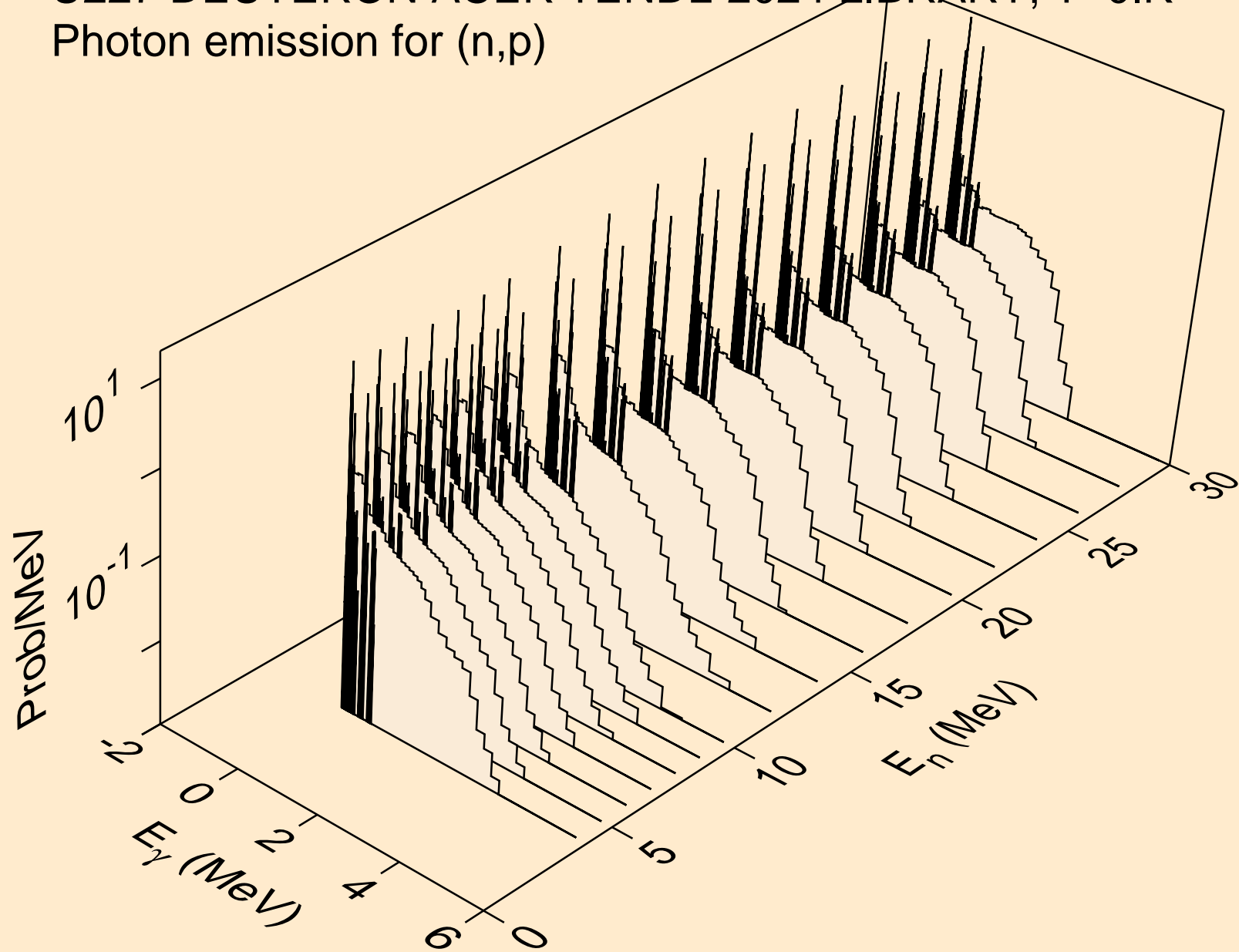

U227 DEUTERON ACER TENDL-2024 LIBRARY; T=0.K  
Photon emission for inelastic

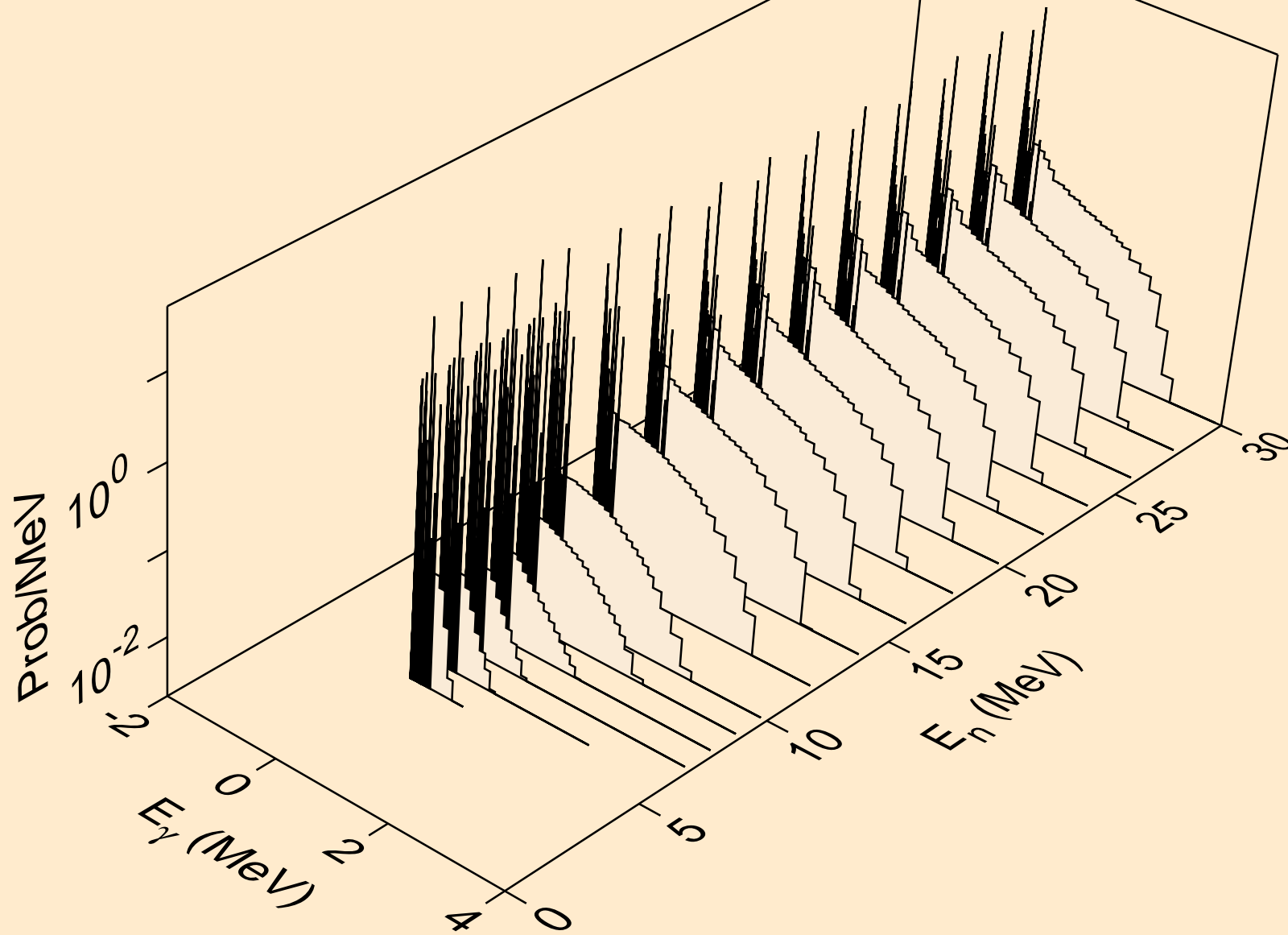

U227 DEUTERON ACER TENDL-2024 LIBRARY; T=0.K  
Photon emission for (n,t)

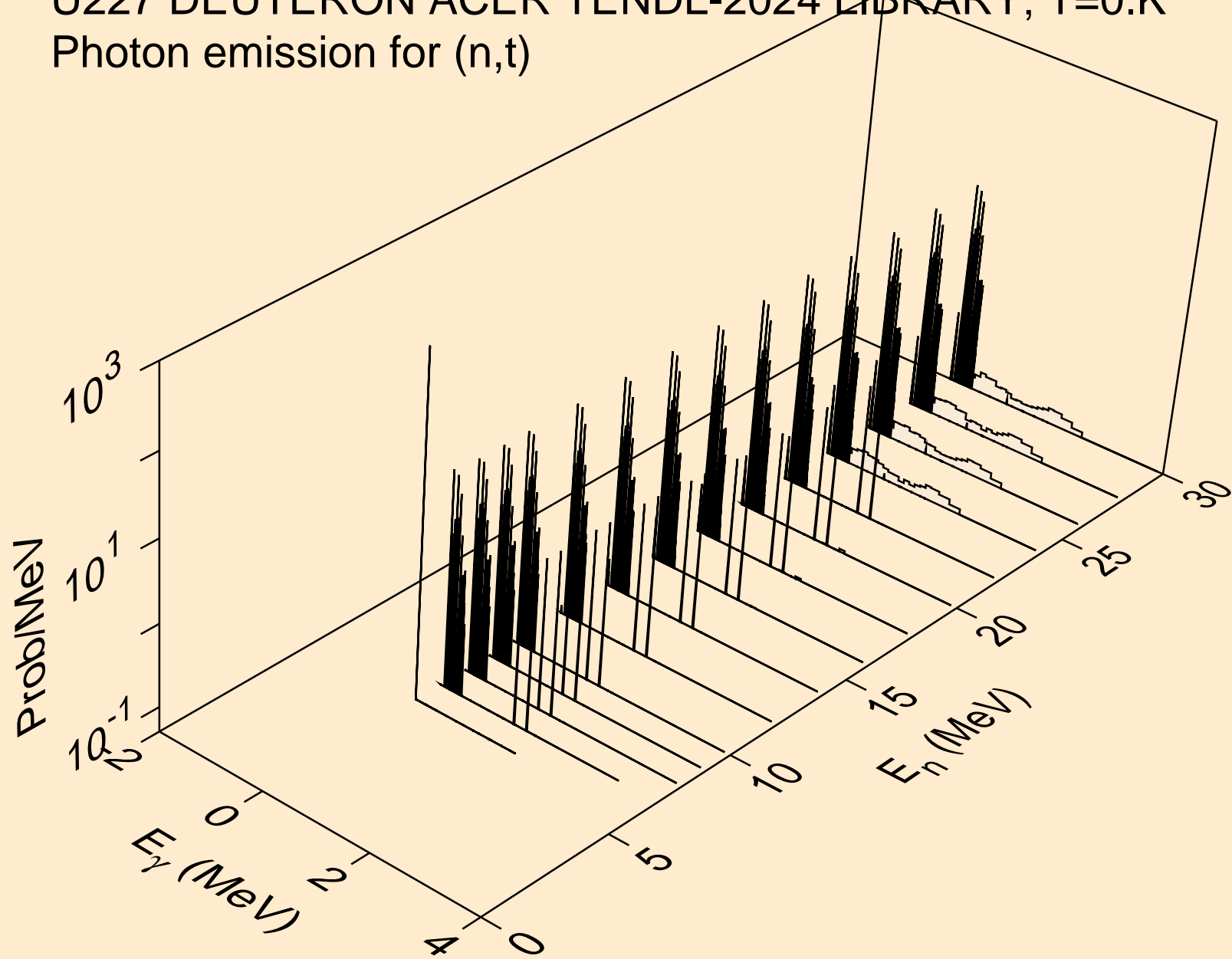

U227 DEUTERON ACER TENDL-2024 LIBRARY; T=0.K  
Photon emission for (n,he3)

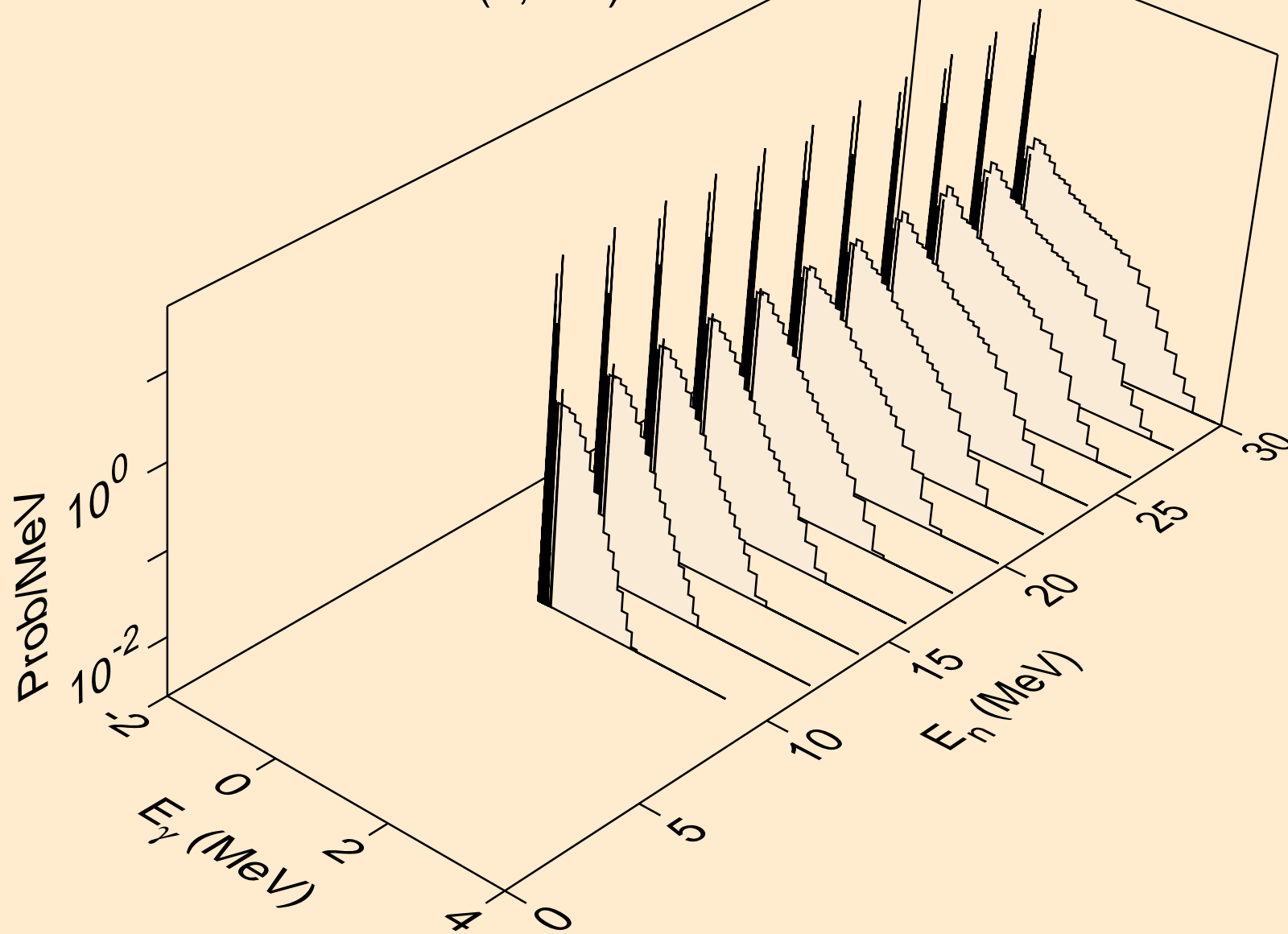

U227 DEUTERON ACER TENDL-2024 LIBRARY; T=0.K  
Photon emission for (n,a)

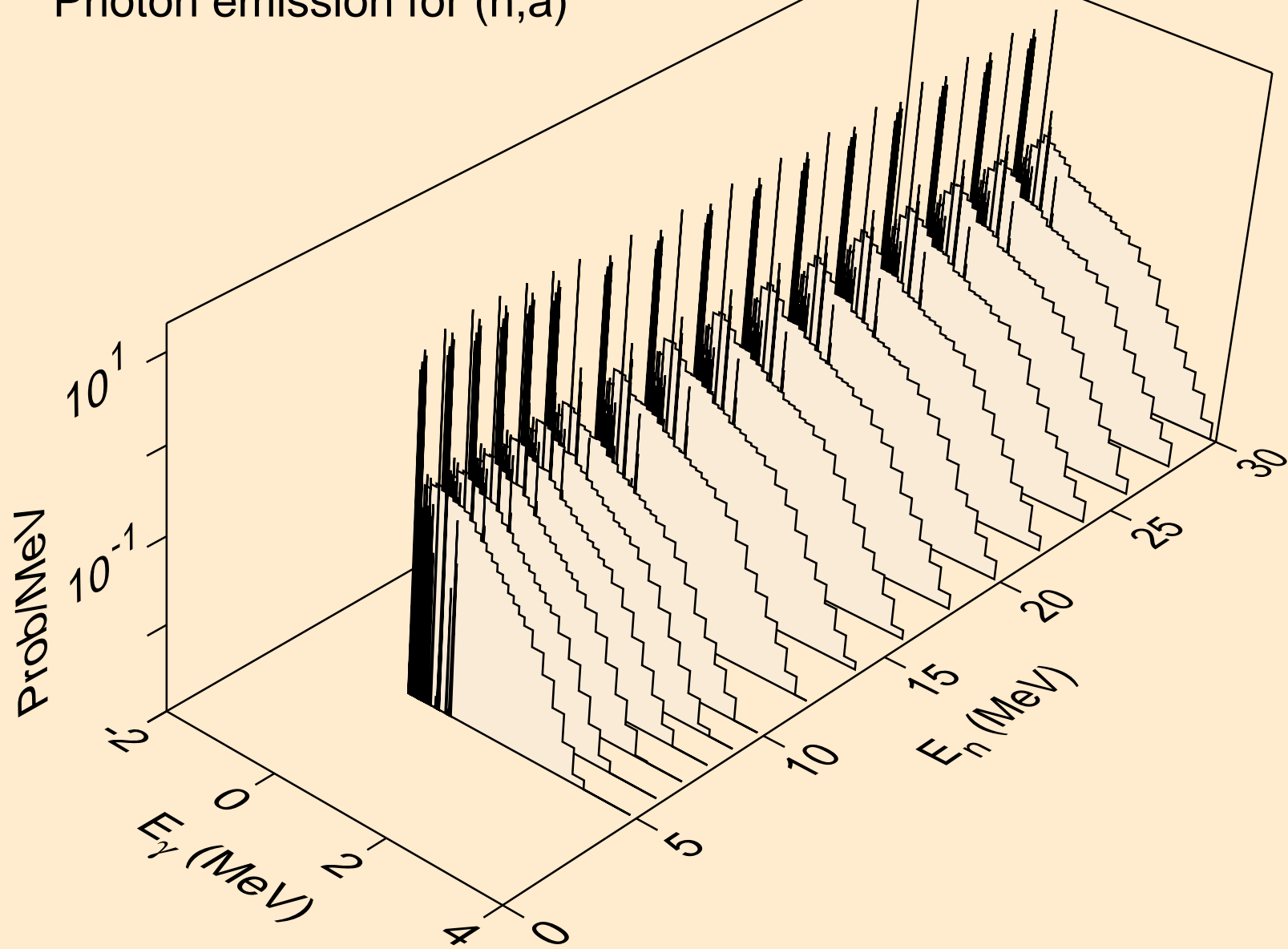

U227 DEUTERON ACER TENDL-2024 LIBRARY; T=0.K  
Photon emission for (n,2a)

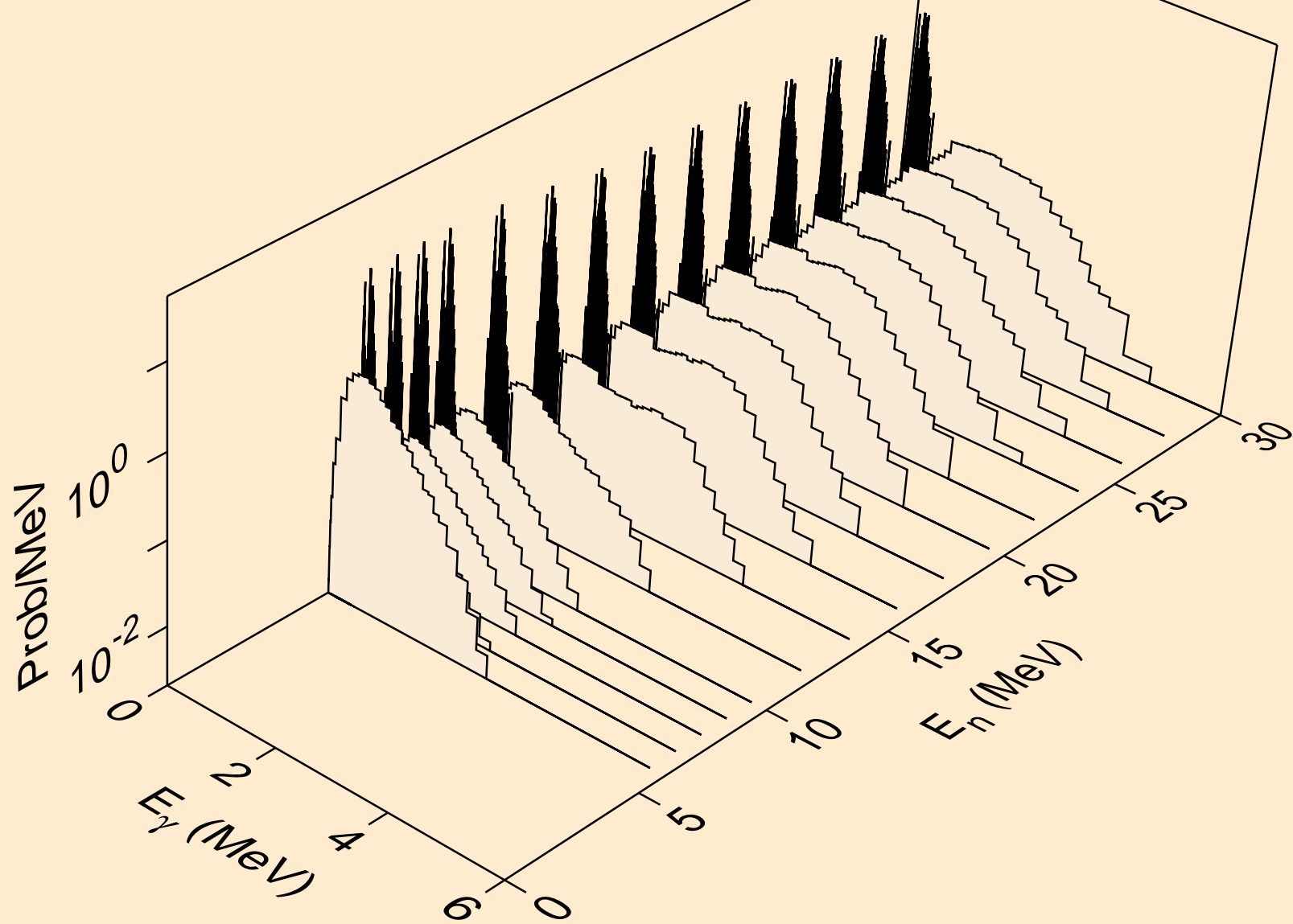

U227 DEUTERON ACER TENDL-2024 LIBRARY; T=0.K  
Photon emission for (n,2p)

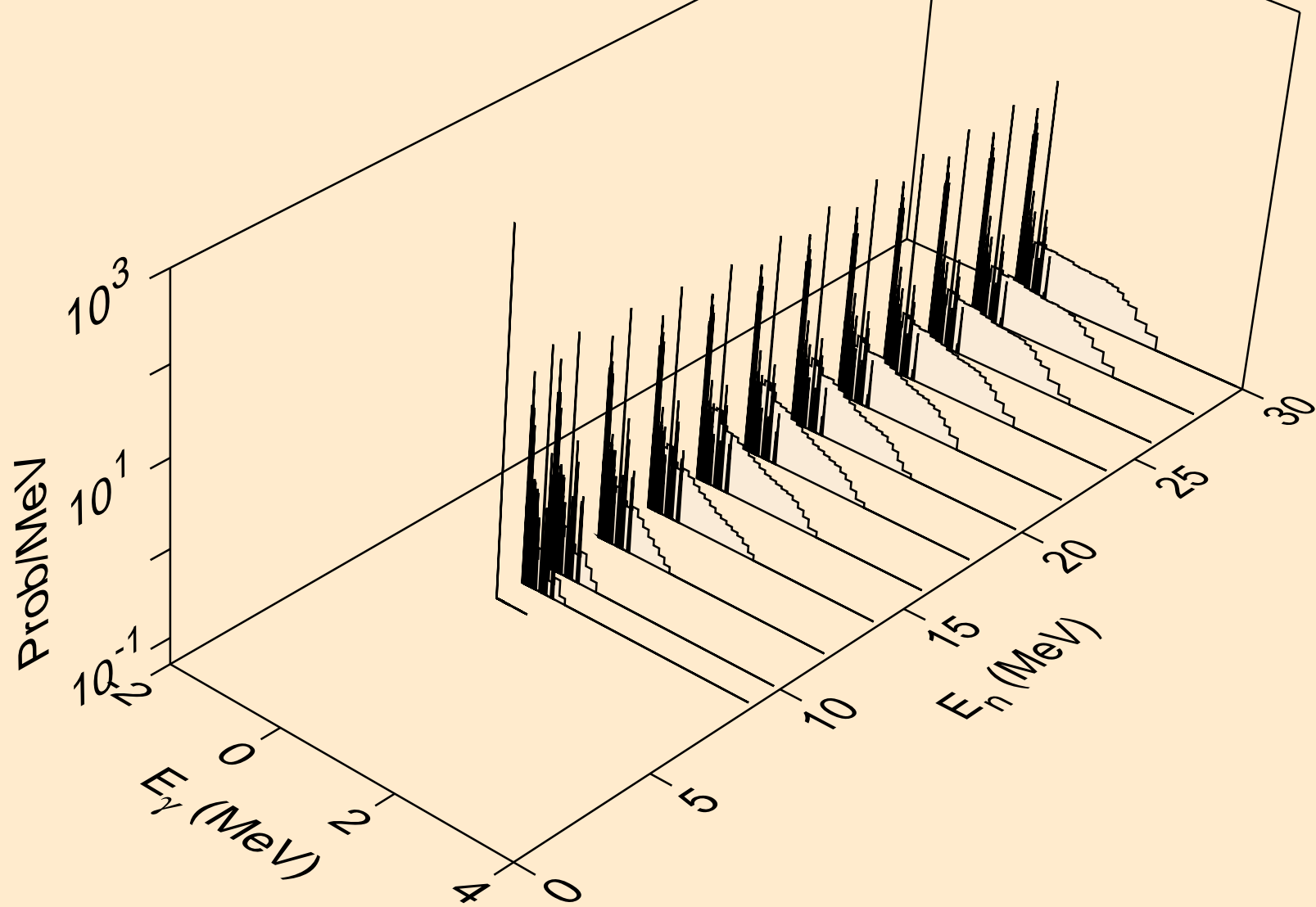

U227 DEUTERON ACER TENDL-2024 LIBRARY; T=0.K  
Photon emission for (n,pa)

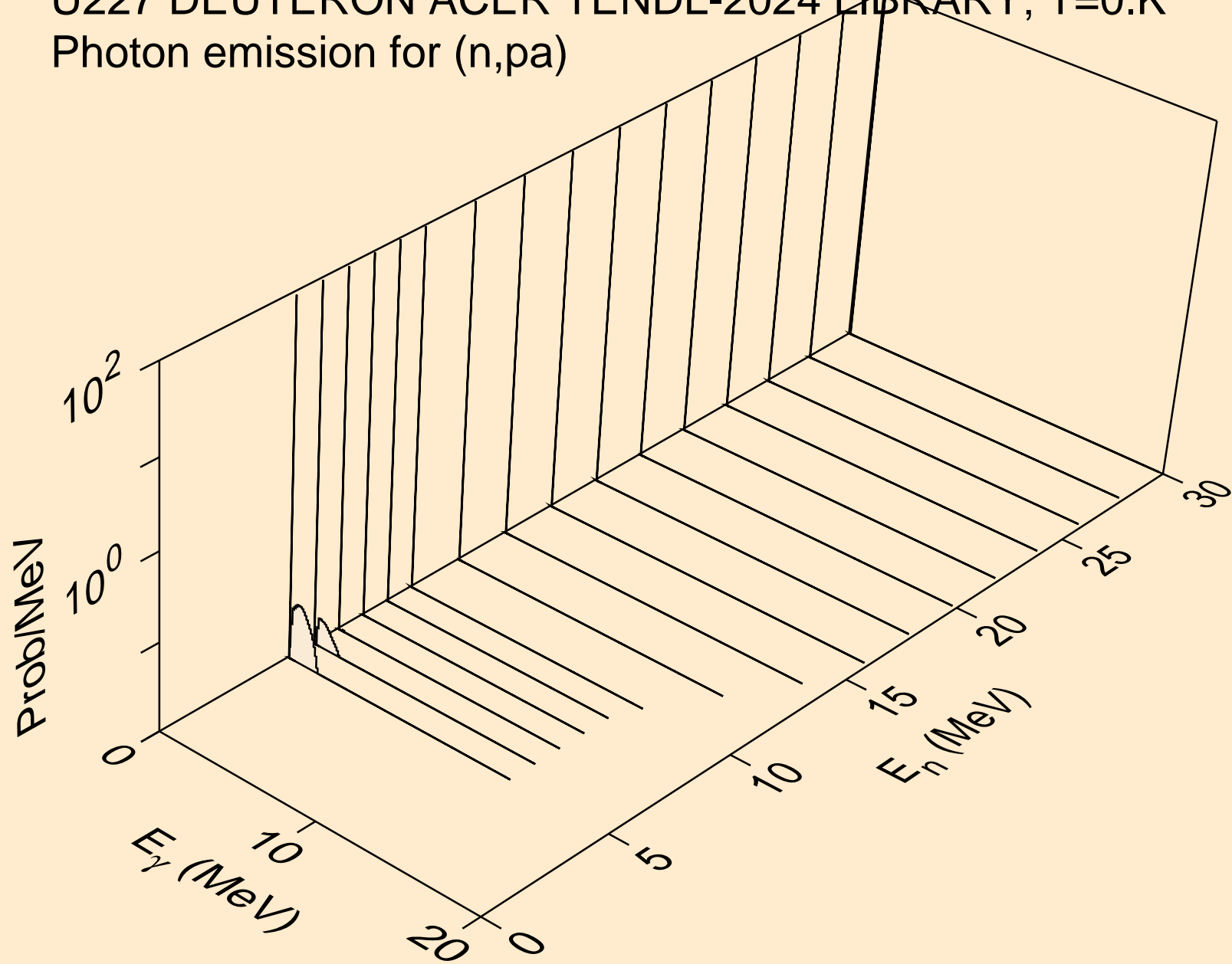

U227 DEUTERON ACER TENDL-2024 LIBRARY; T=0.K  
Photon emission for (n,pd)

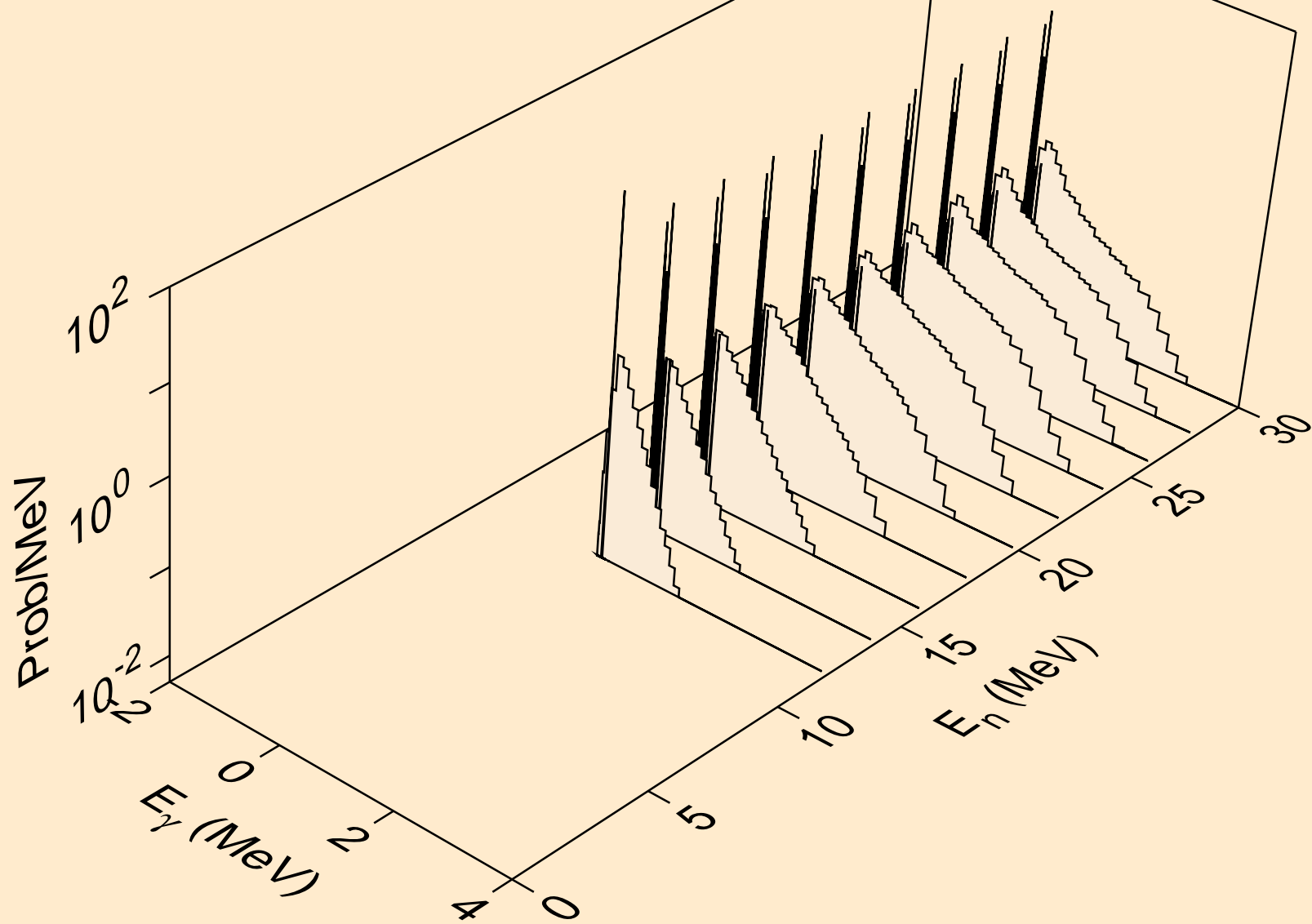

U227 DEUTERON ACER TENDL-2024 LIBRARY; T=0.K  
Photon emission for (n,pt)

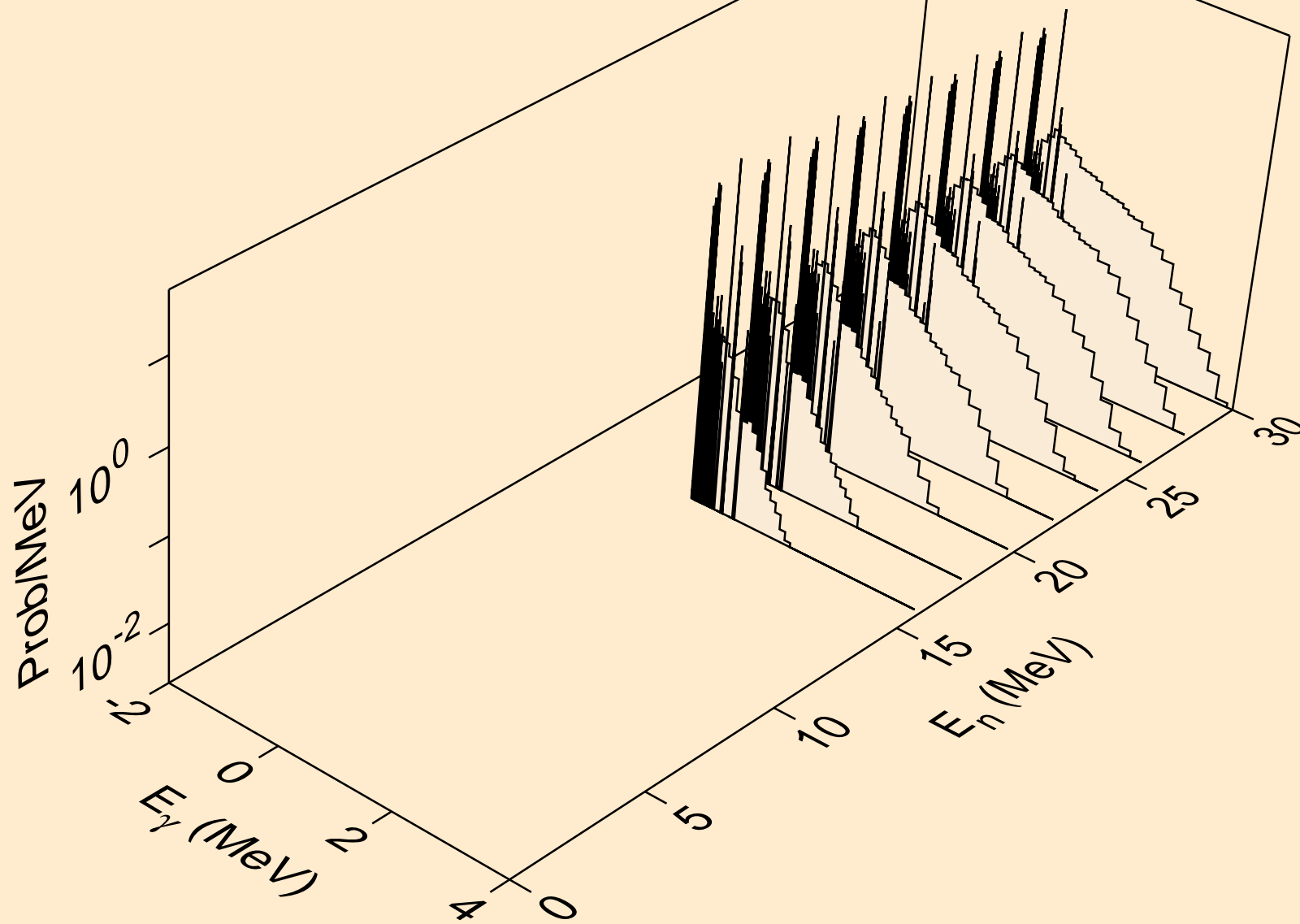

U227 DEUTERON ACER TENDL-2024 LIBRARY; T=0.K  
Photon emission for (n,da)

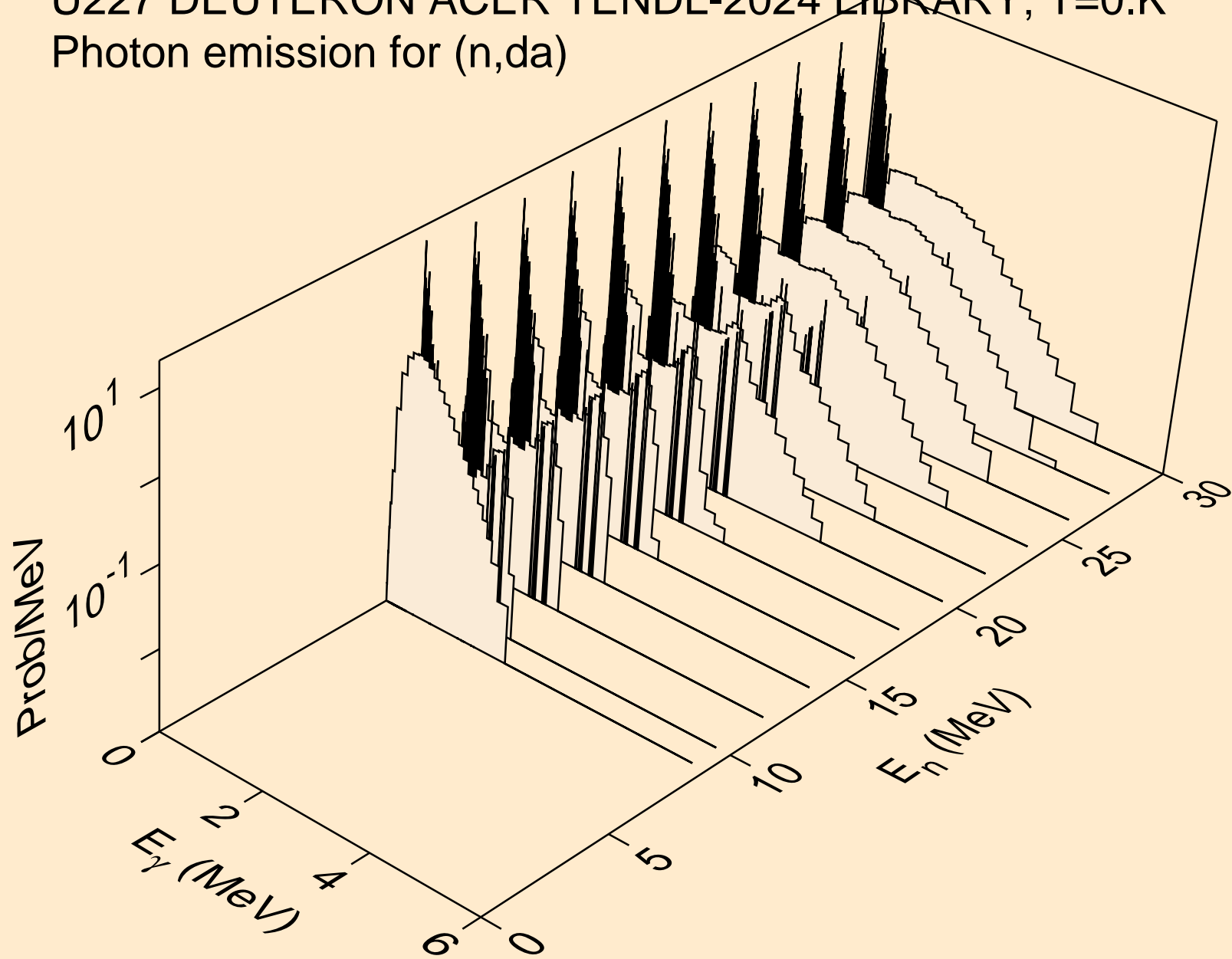

# U227 DEUTERON ACER TENDL-2024 LIBRARY; T=0.K

## Particle heating contributions

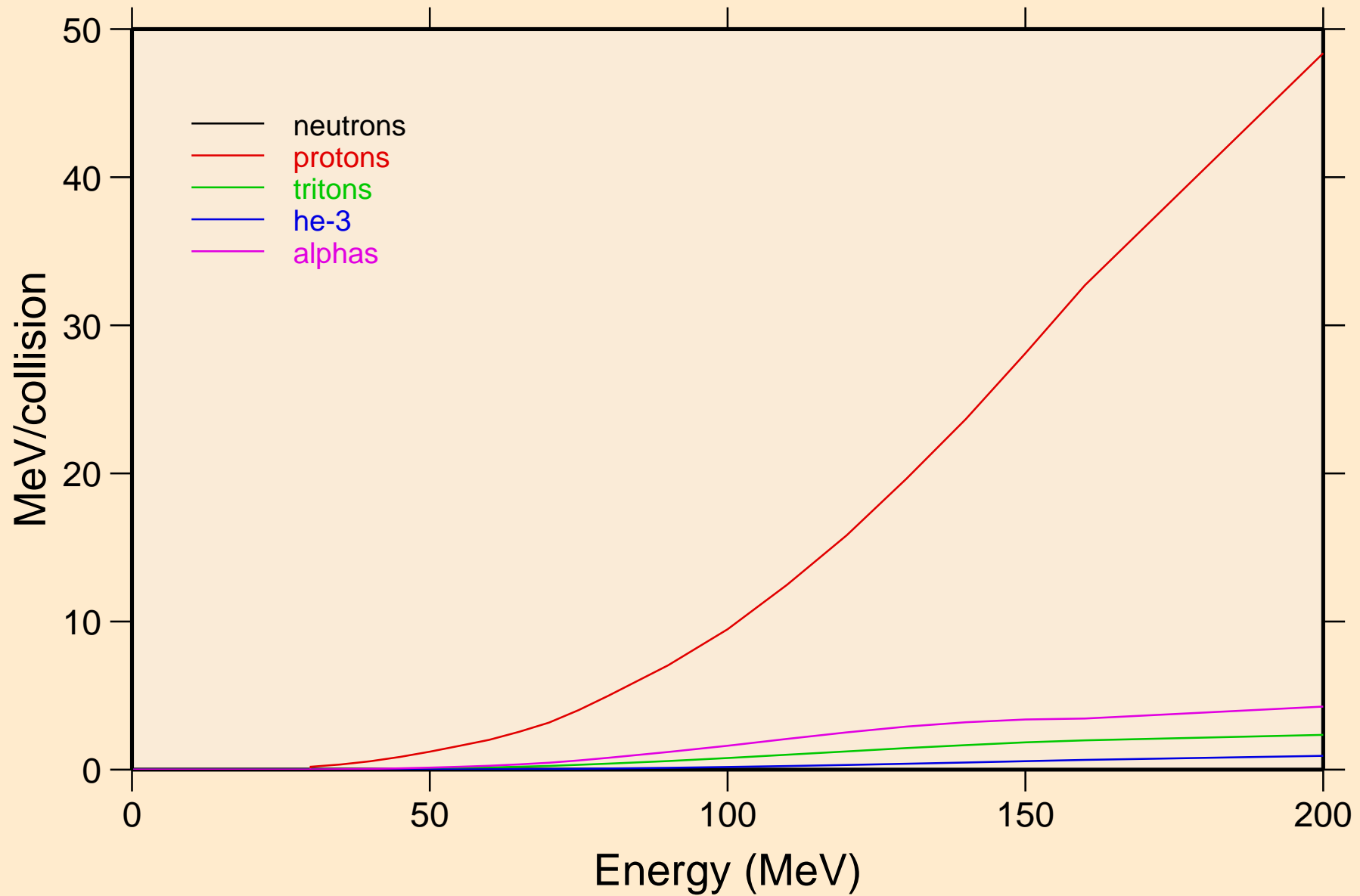

U227 DEUTERON ACER TENDL-2024 LIBRARY; T=0.K  
Recoil Heating

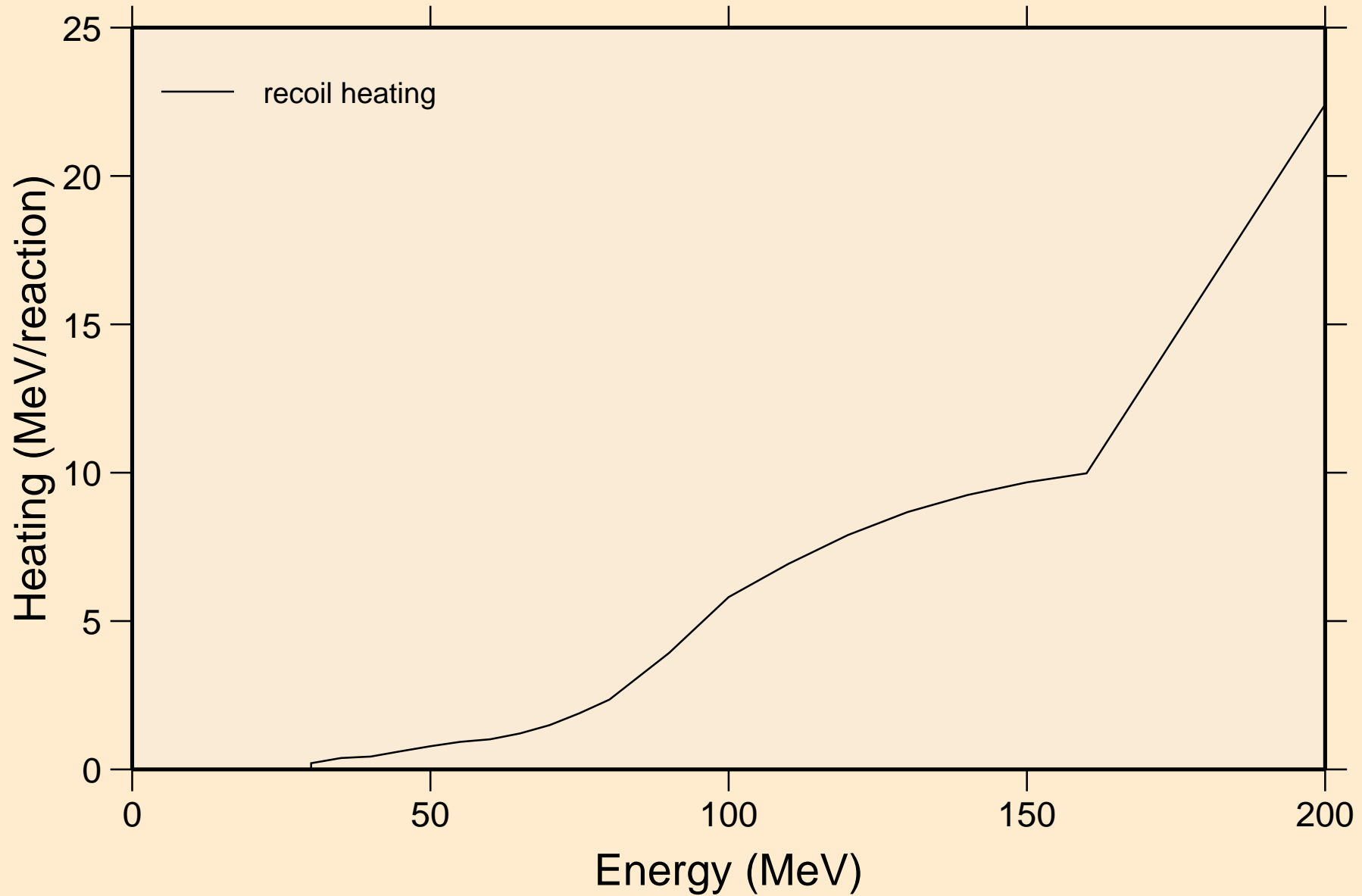

U227 DEUTERON ACER TENDL-2024 LIBRARY; T=0.K  
Particle production cross sections

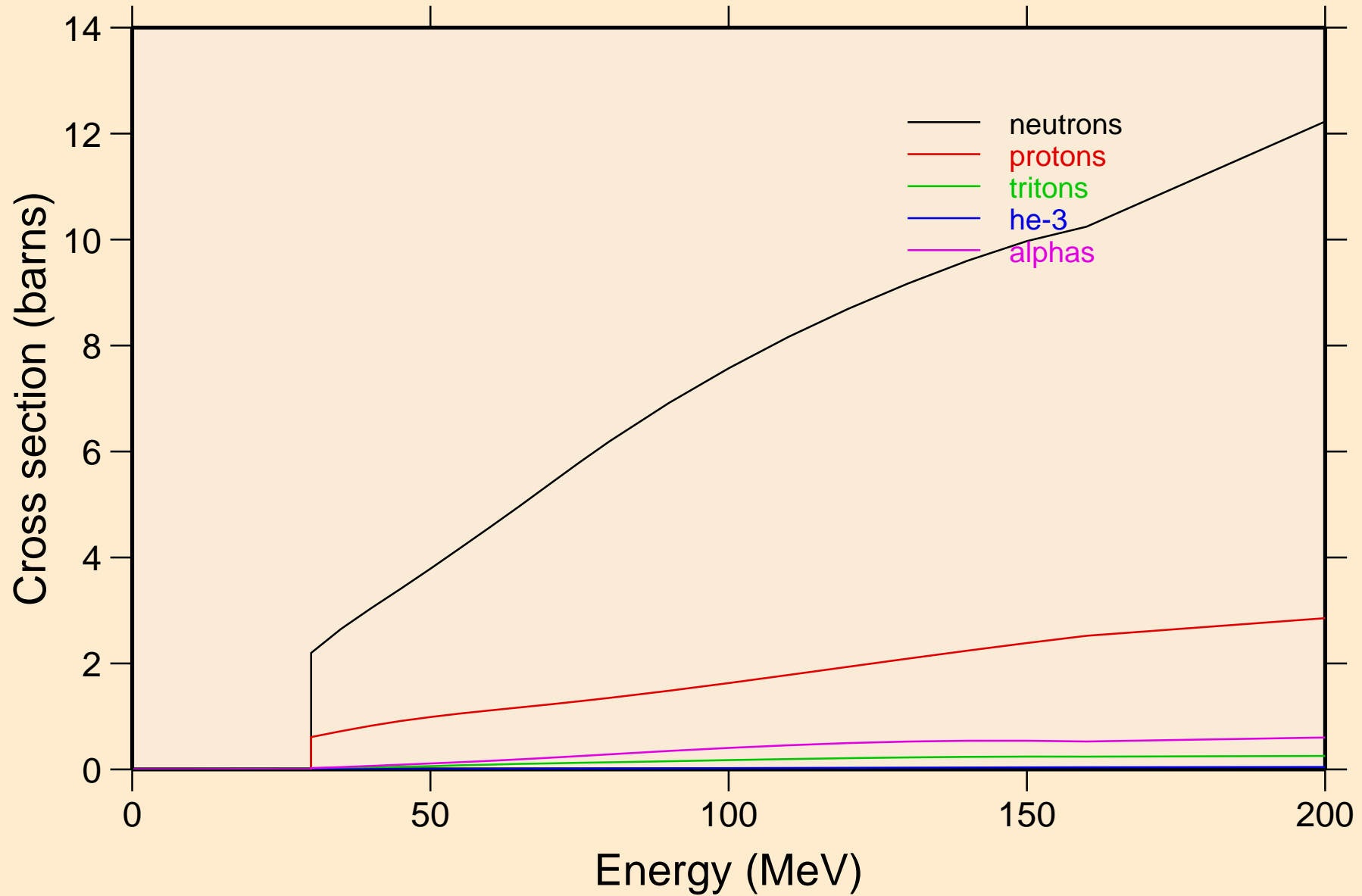

U227 DEUTERON ACER TENDL-2024 LIBRARY; T=0.K  
neutrons from (d,n)

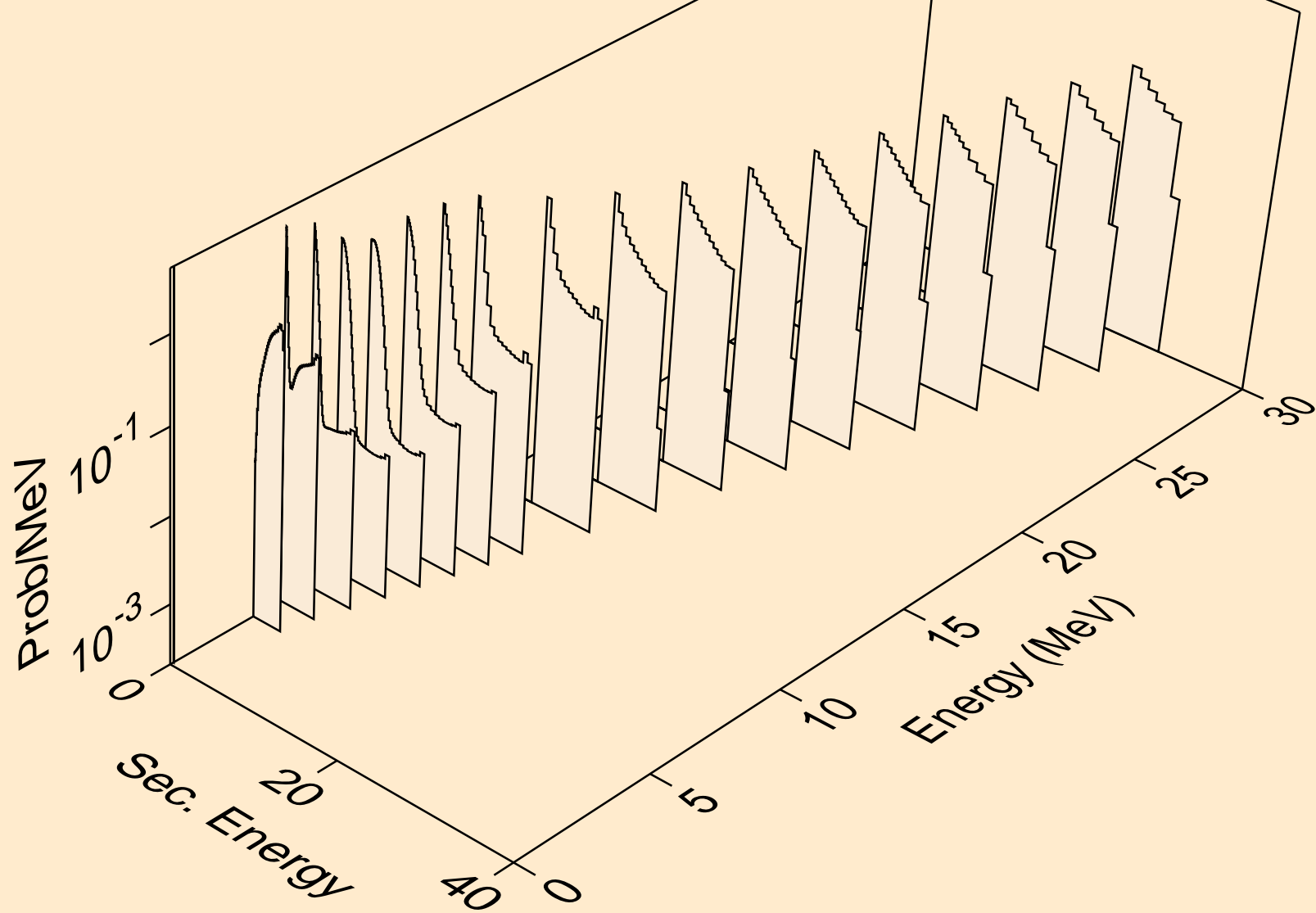

U227 DEUTERON ACER TENDL-2024 LIBRARY; T=0.K  
neutrons from (d,x)

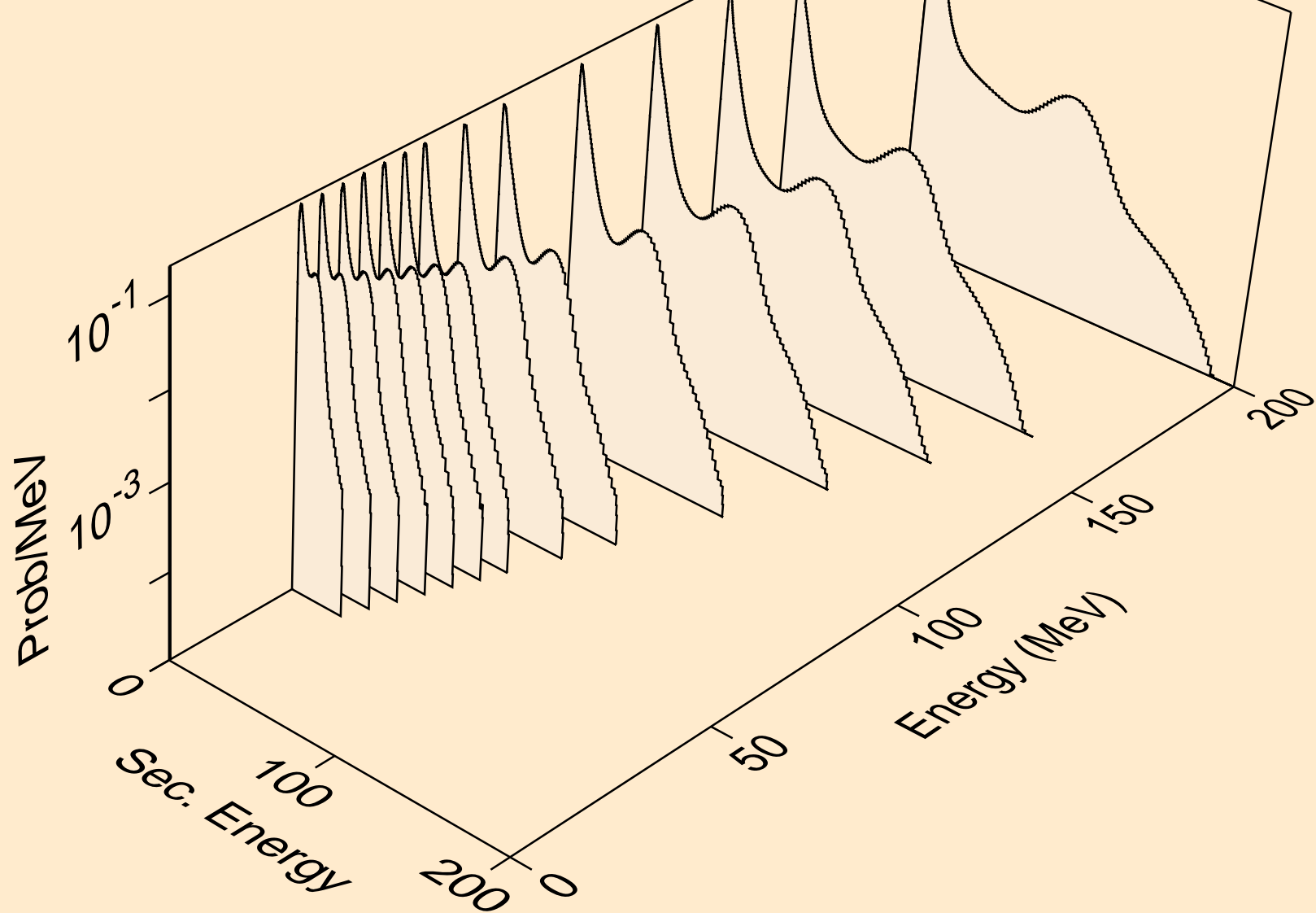

U227 DEUTERON ACER TENDL-2024 LIBRARY; T=0.K  
neutrons from (d,2nd)

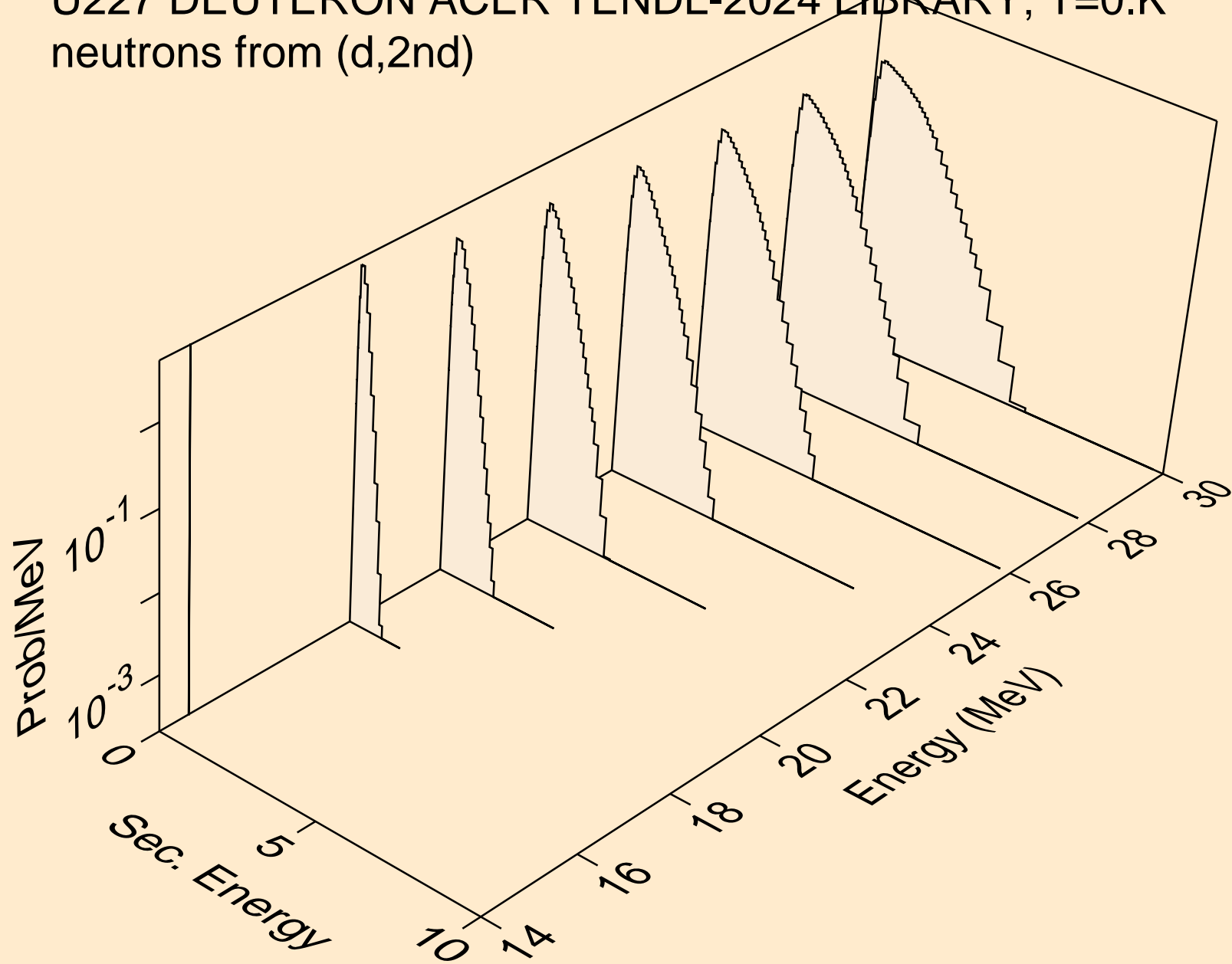

U227 DEUTERON ACER TENDL-2024 LIBRARY; T=0.K  
neutrons from (d,2n)

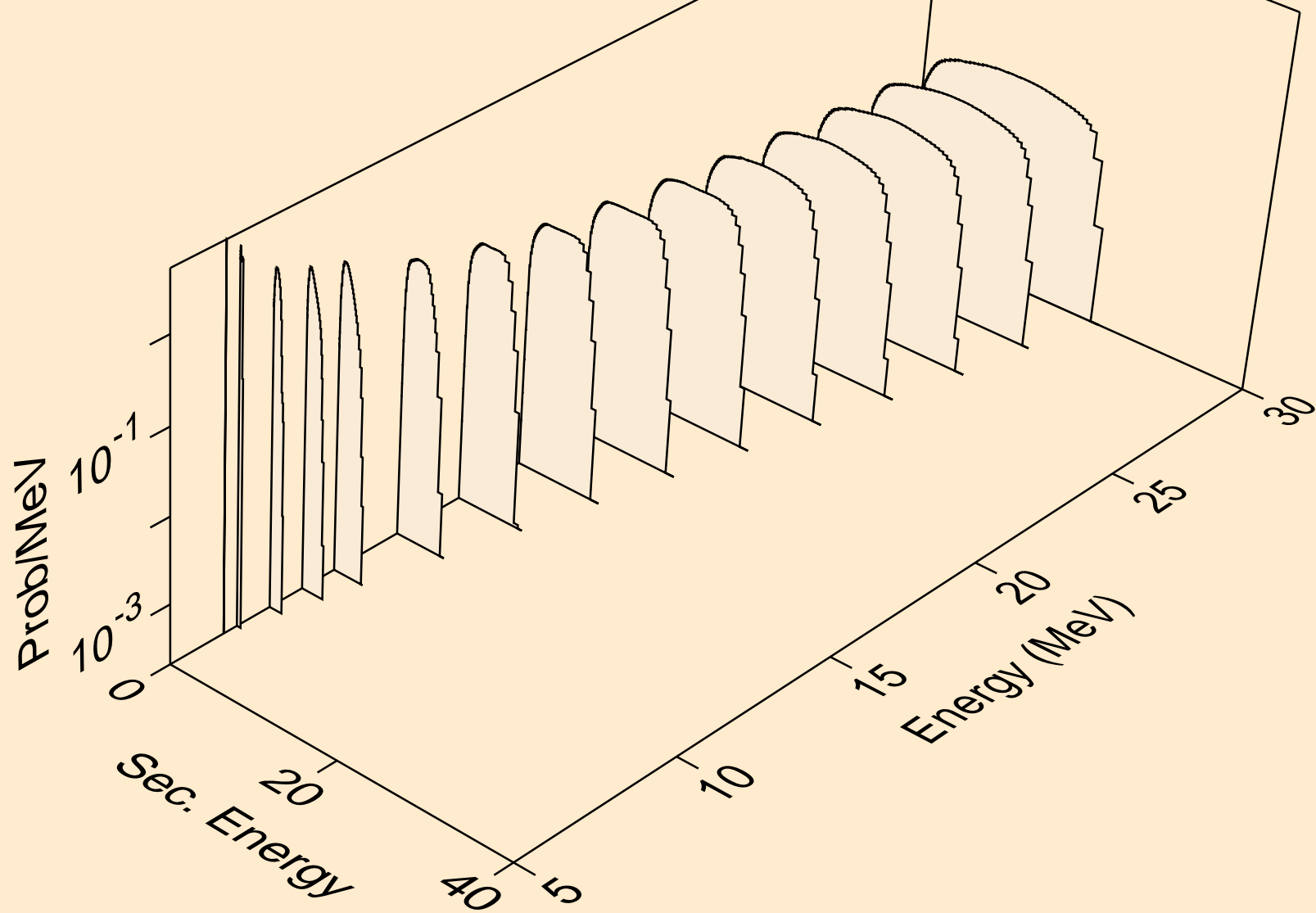

U227 DEUTERON ACER TENDL-2024 LIBRARY; T=0.K  
neutrons from (d,3n)

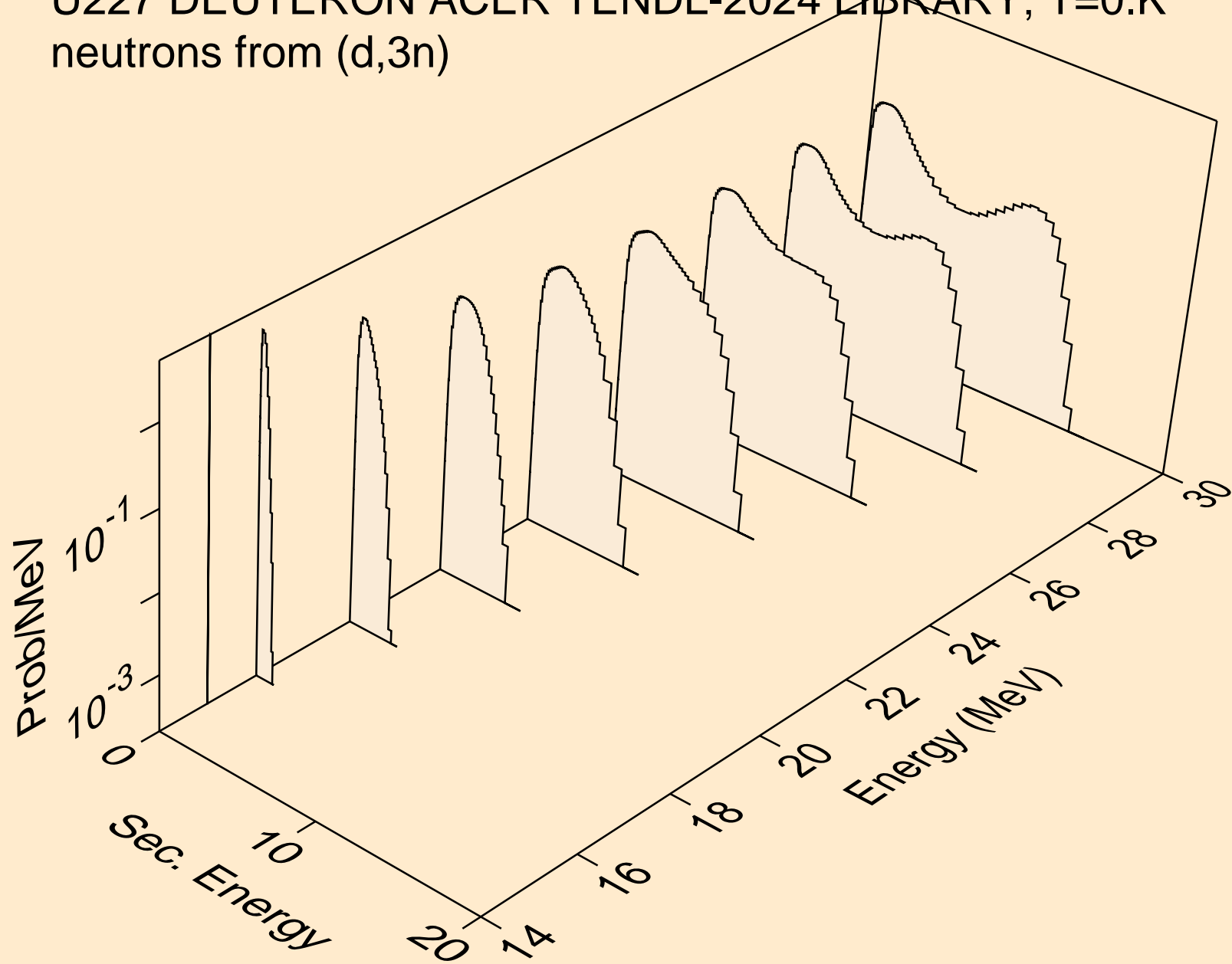

U227 DEUTERON ACER TENDL-2024 LIBRARY; T=0.K  
neutrons from (d,n\*)a

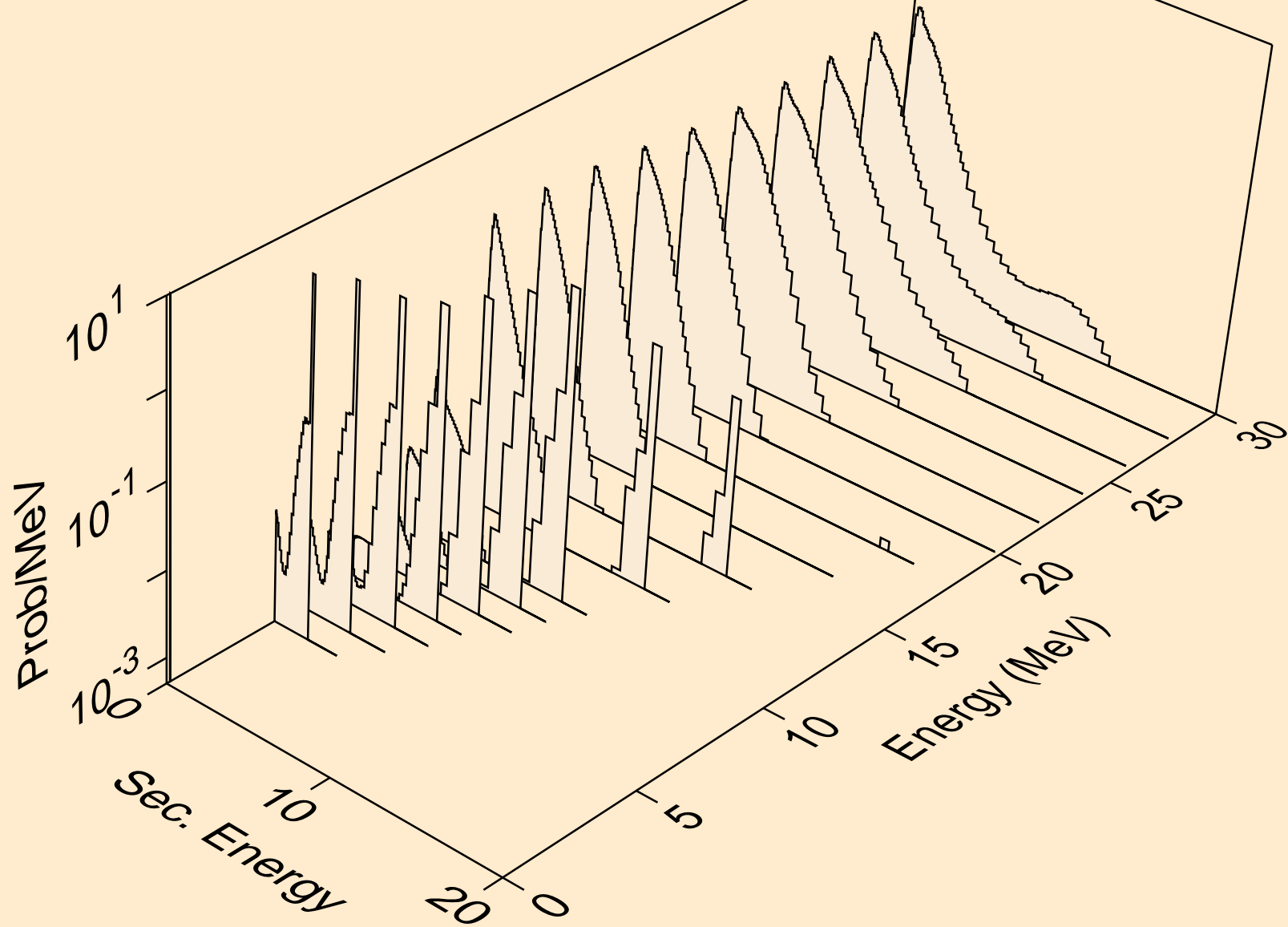

U227 DEUTERON ACER TENDL-2024 LIBRARY; T=0.K  
neutrons from (d,2n)a

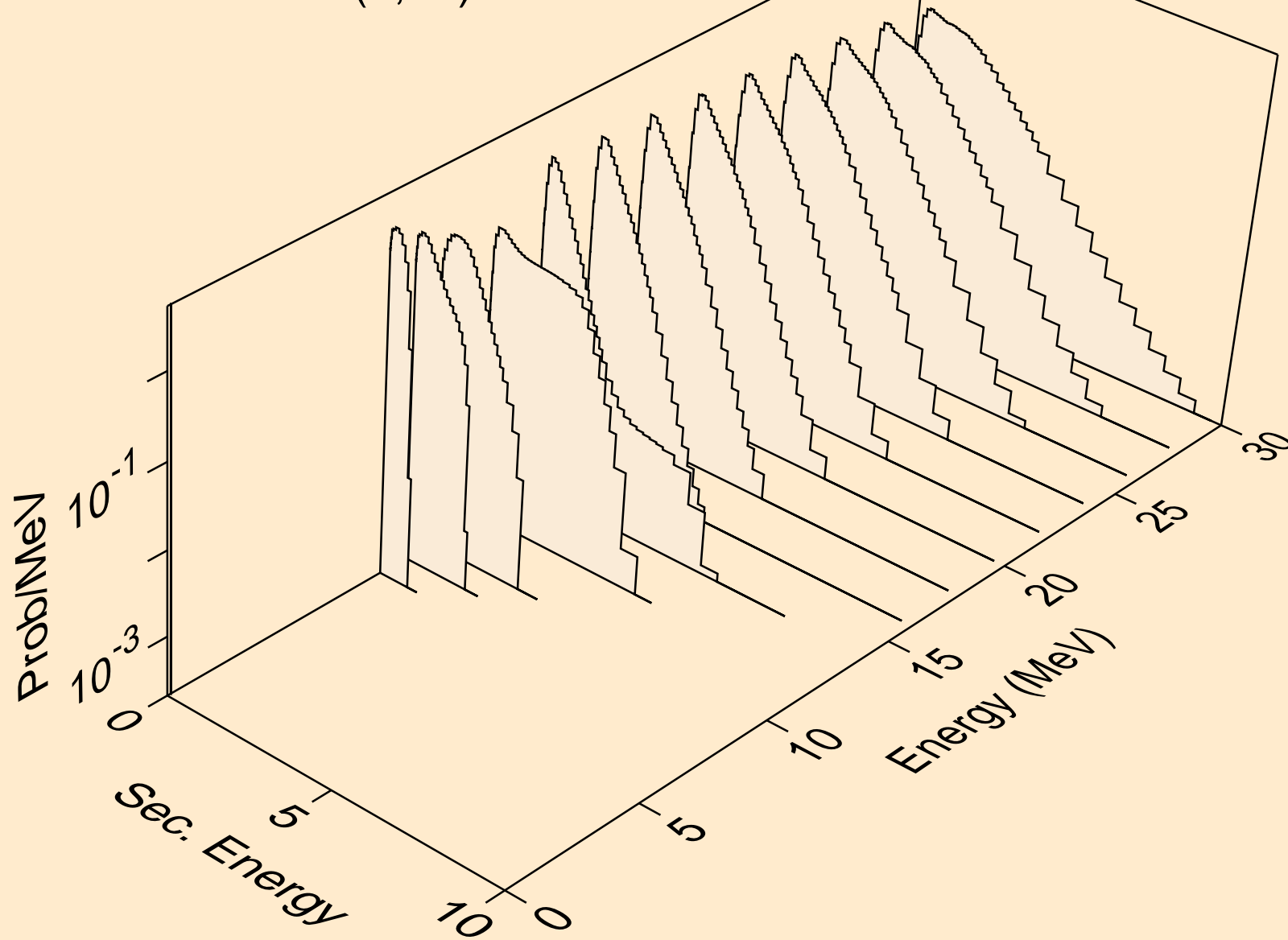

U227 DEUTERON ACER TENDL-2024 LIBRARY; T=0.K  
neutrons from (d,3n)a

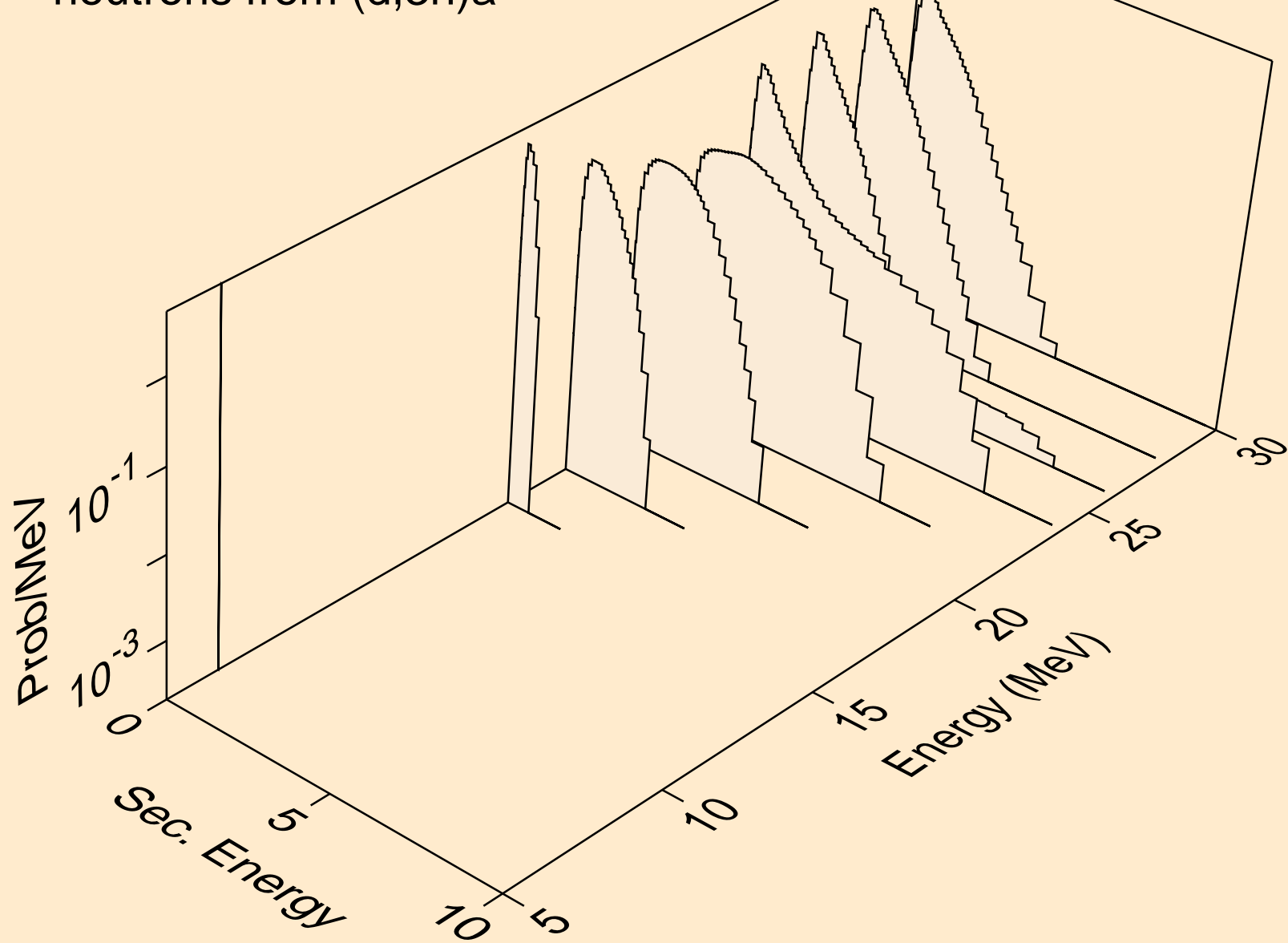

U227 DEUTERON ACER TENDL-2024 LIBRARY; T=0.K  
neutrons from (d,n\*)p

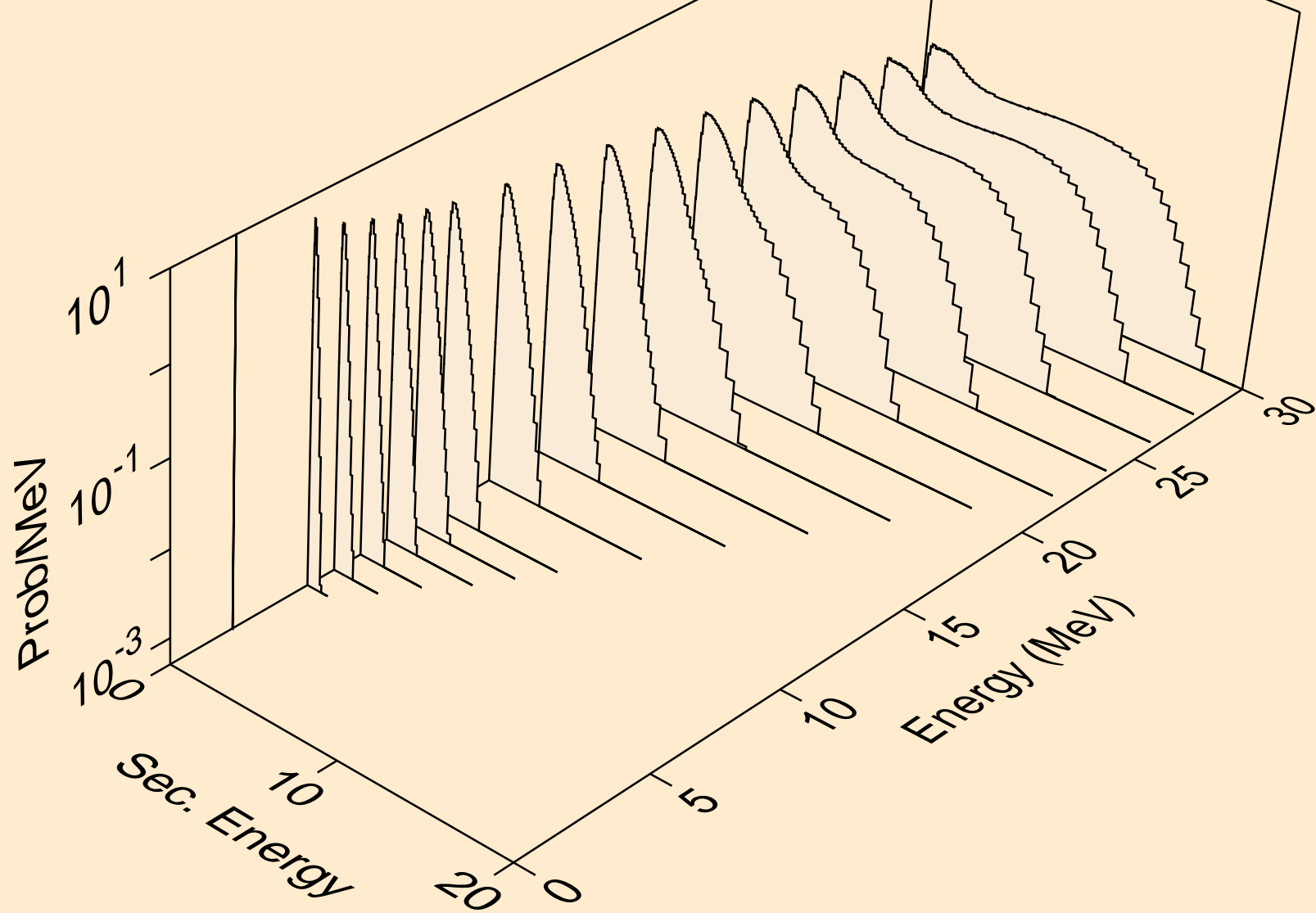

U227 DEUTERON ACER TENDL-2024 LIBRARY; T=0.K  
neutrons from (d,n\*)2a

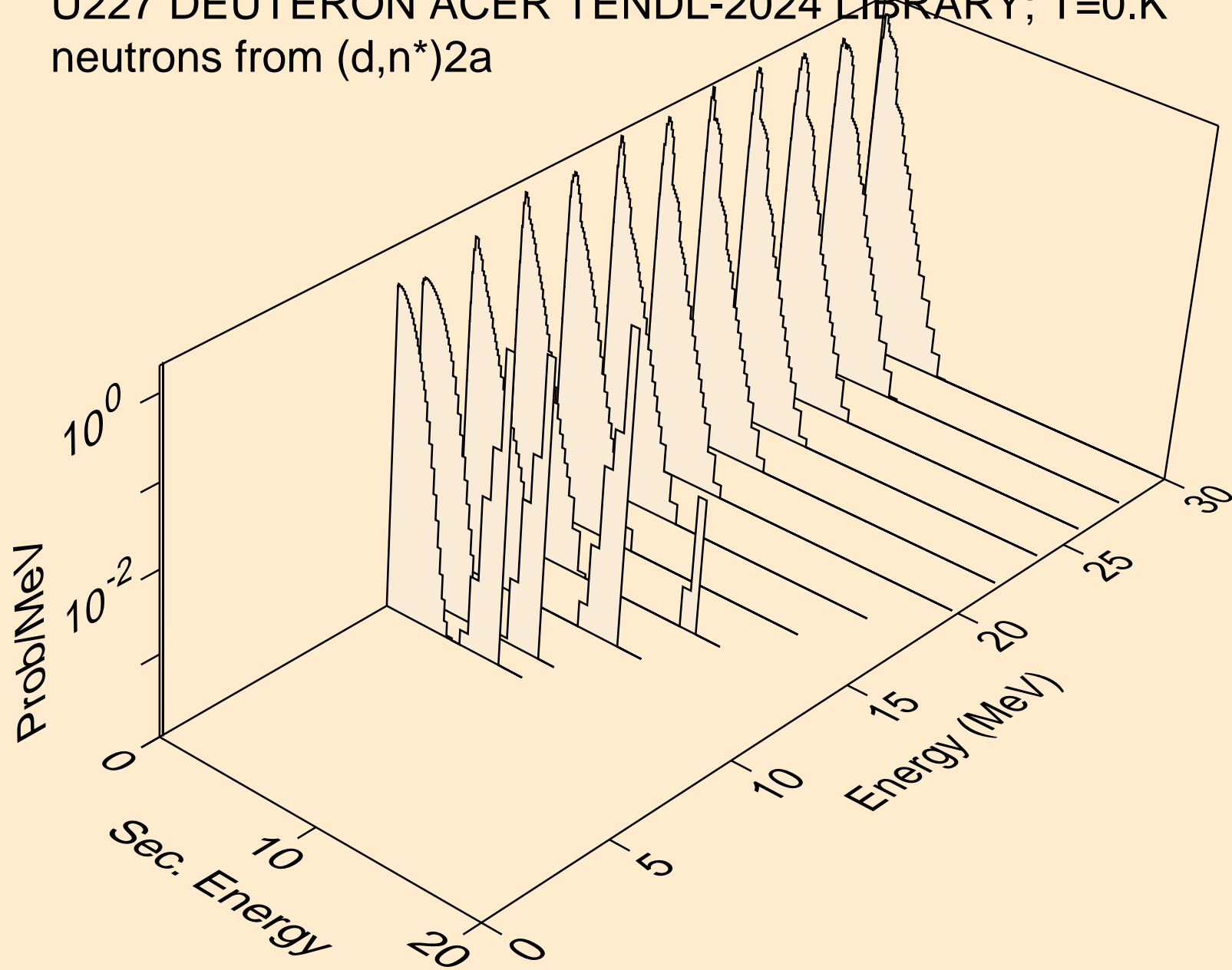

U227 DEUTERON ACER TENDL-2024 LIBRARY; T=0.K  
neutrons from (d,2n)2a

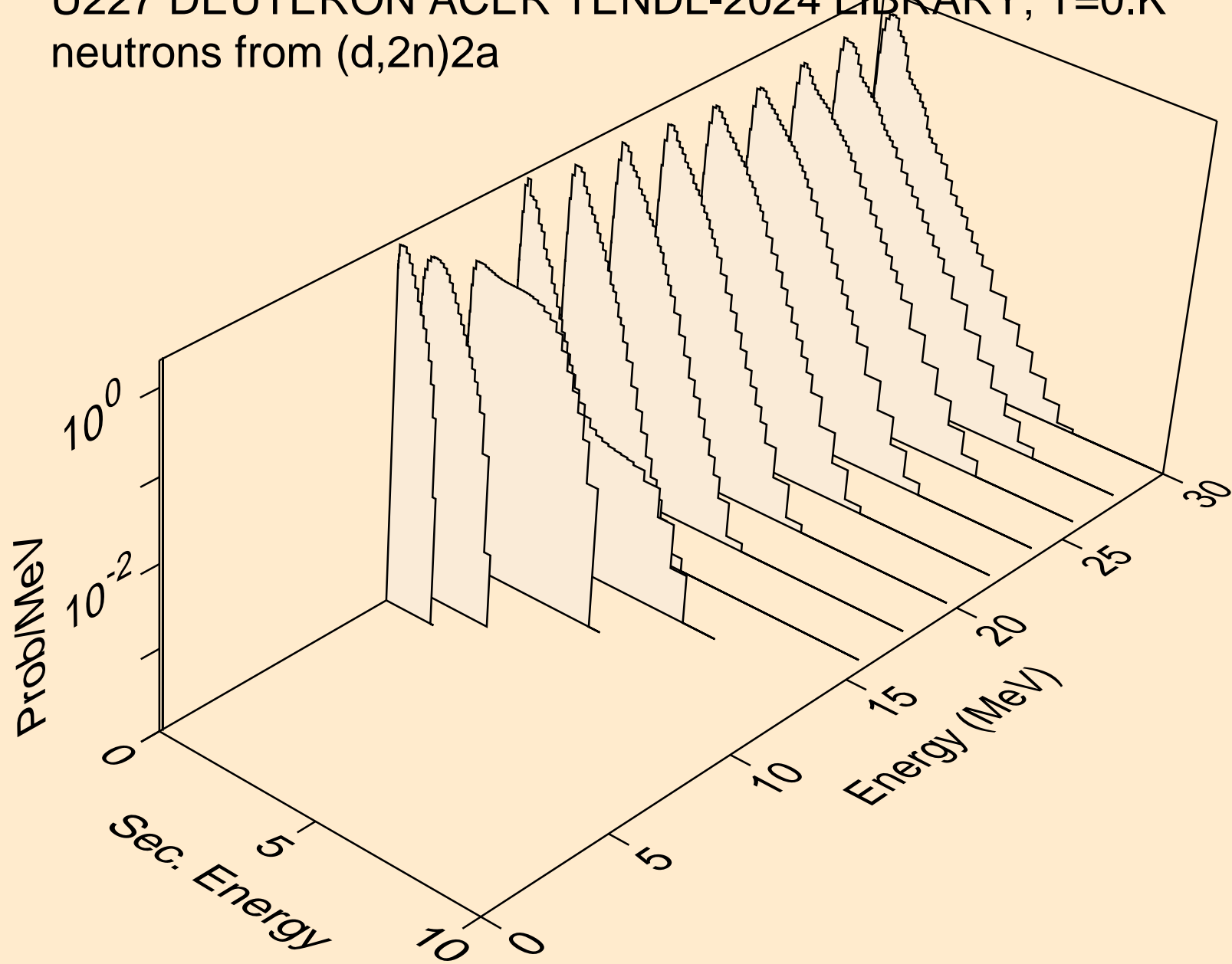

U227 DEUTERON ACER TENDL-2024 LIBRARY; T=0.K  
neutrons from (d,n\*)d

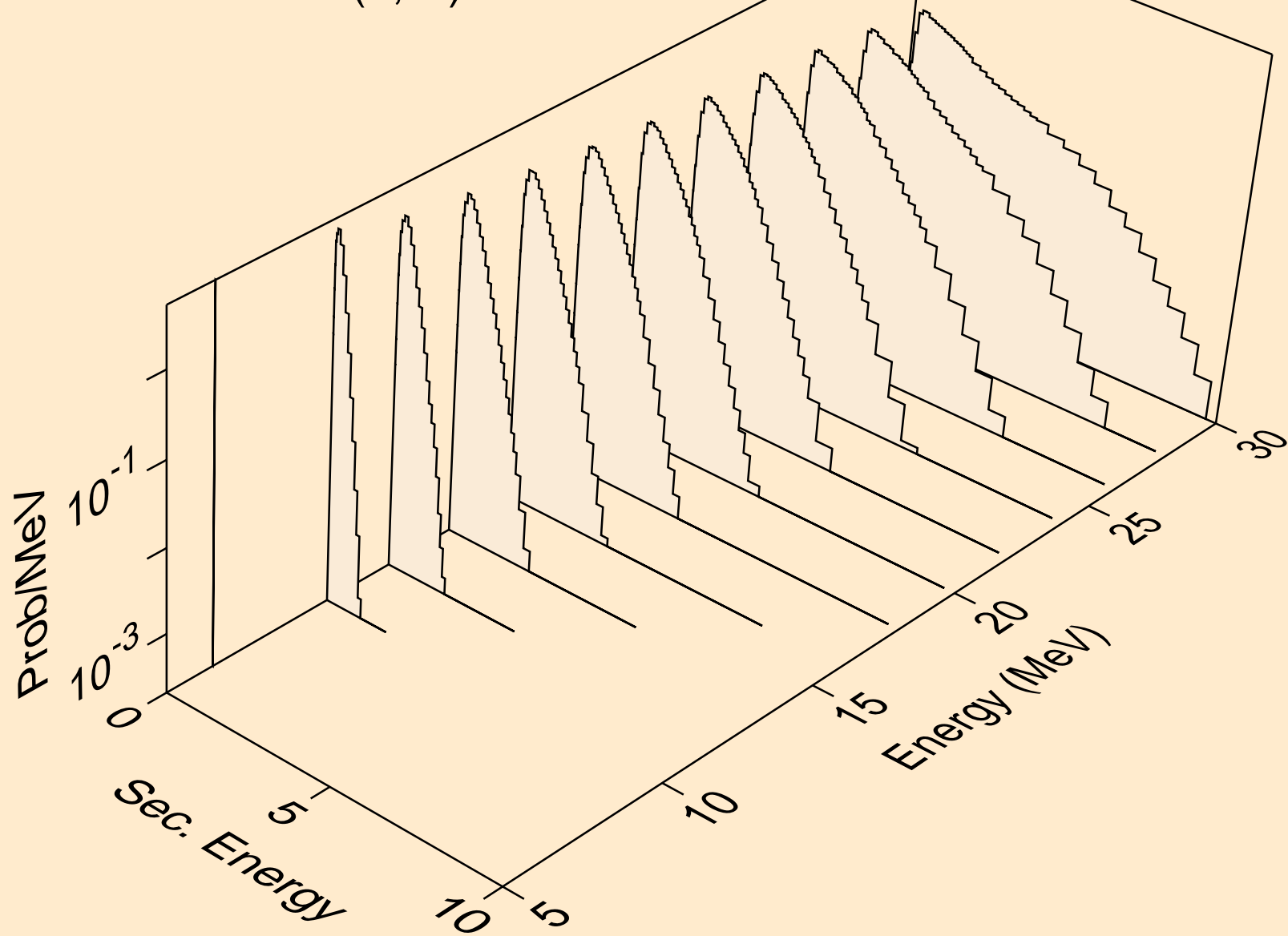

U227 DEUTERON ACER TENDL-2024 LIBRARY; T=0.K  
neutrons from (d,n\*)t

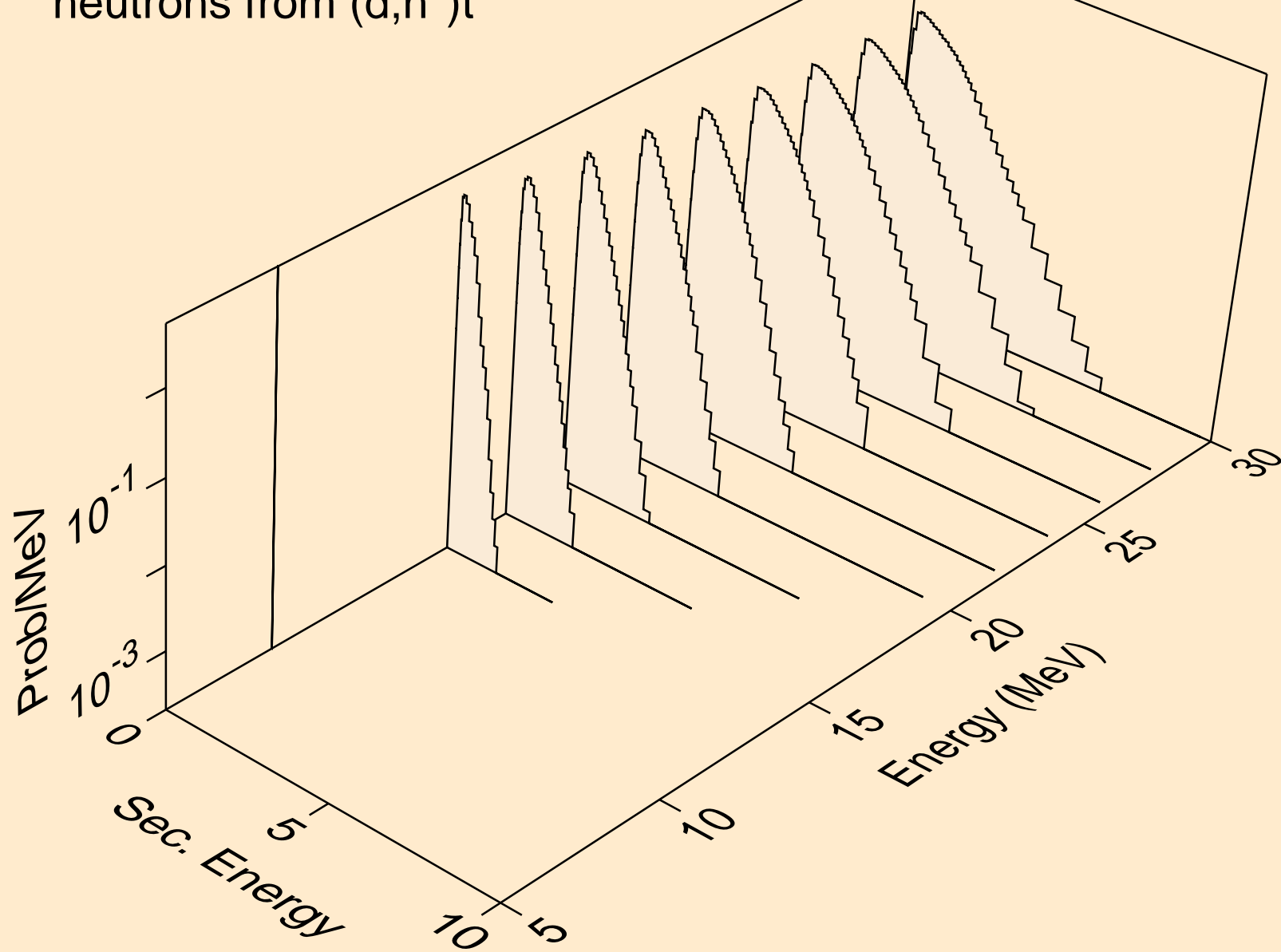

U227 DEUTERON ACER TENDL-2024 LIBRARY; T=0.K  
neutrons from (d,n\*)he3

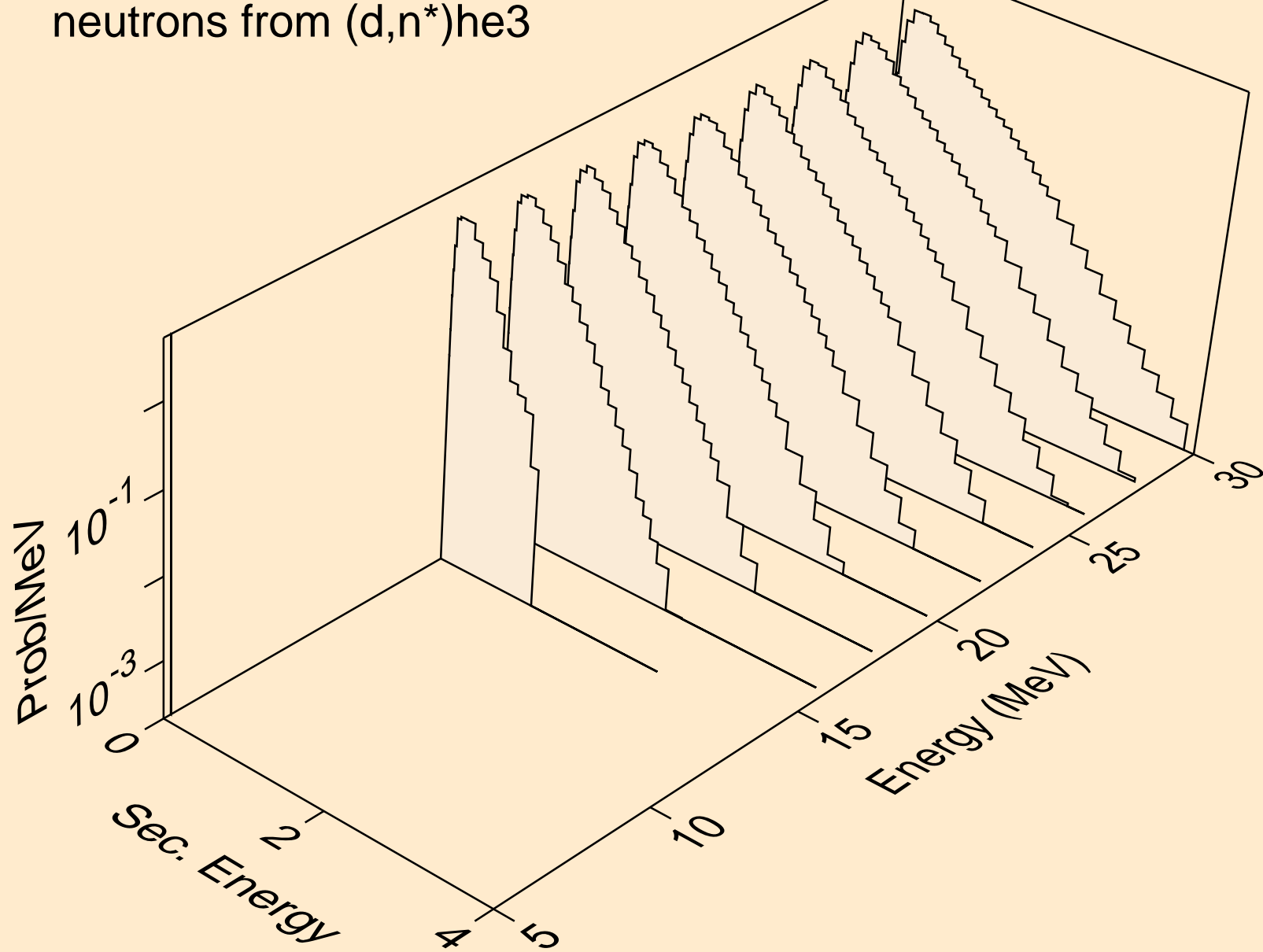

U227 DEUTERON ACER TENDL-2024 LIBRARY; T=0.K  
neutrons from (d,4n)

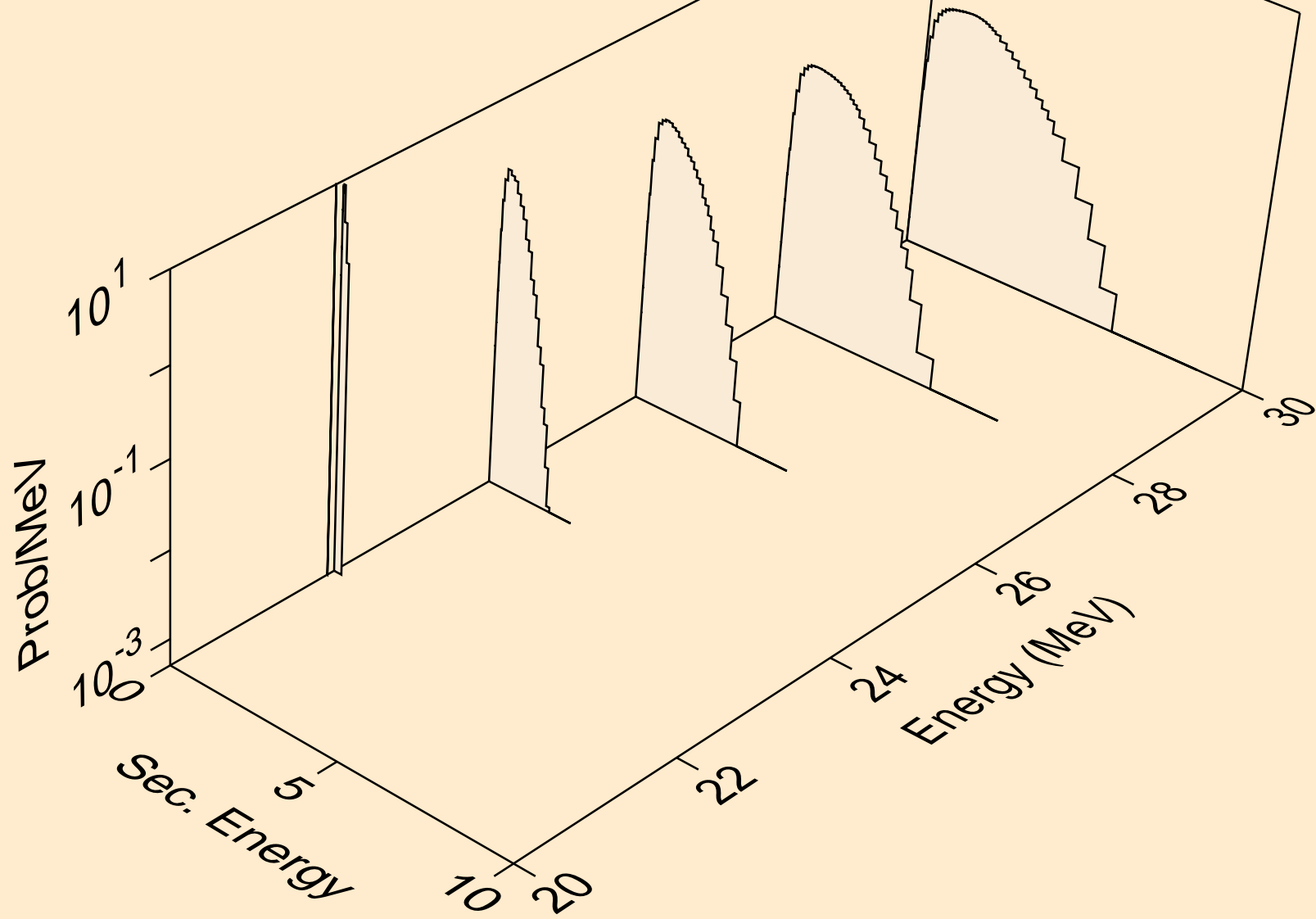

U227 DEUTERON ACER TENDL-2024 LIBRARY; T=0.K  
neutrons from (d,2np)

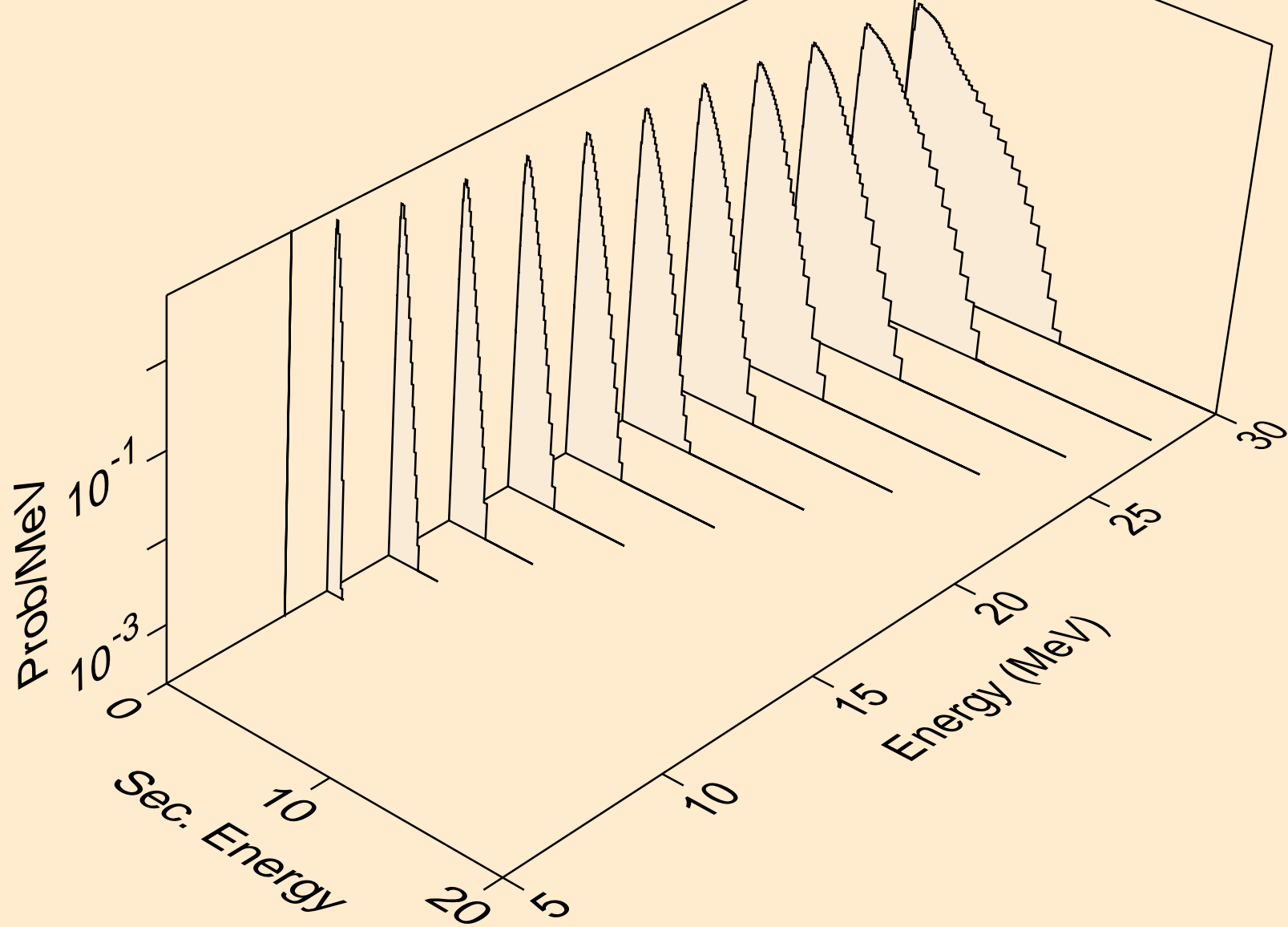

U227 DEUTERON ACER TENDL-2024 LIBRARY; T=0.K  
neutrons from (d,3np)

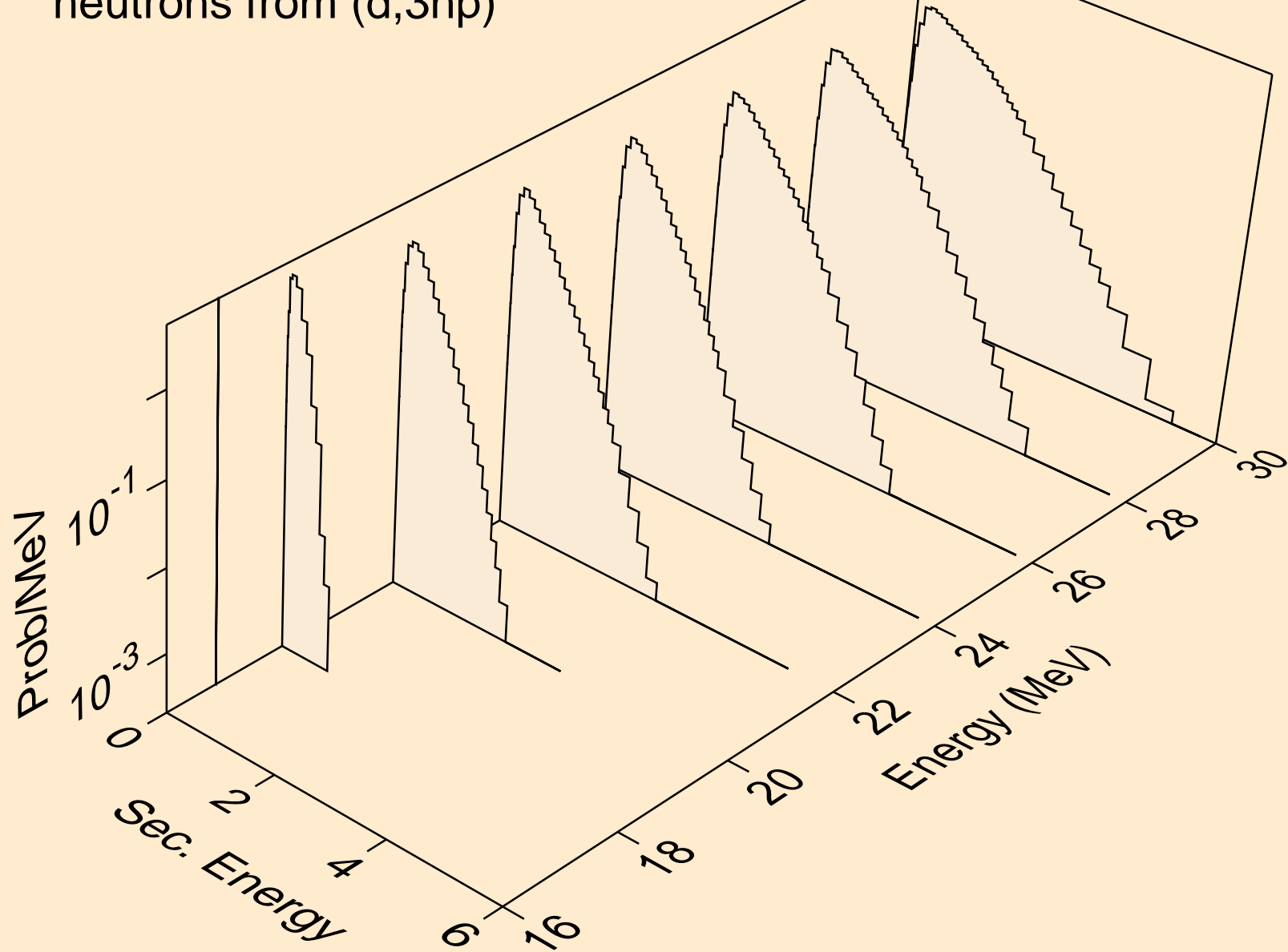

U227 DEUTERON ACER TENDL-2024 LIBRARY; T=0.K  
neutrons from (d,n2p)

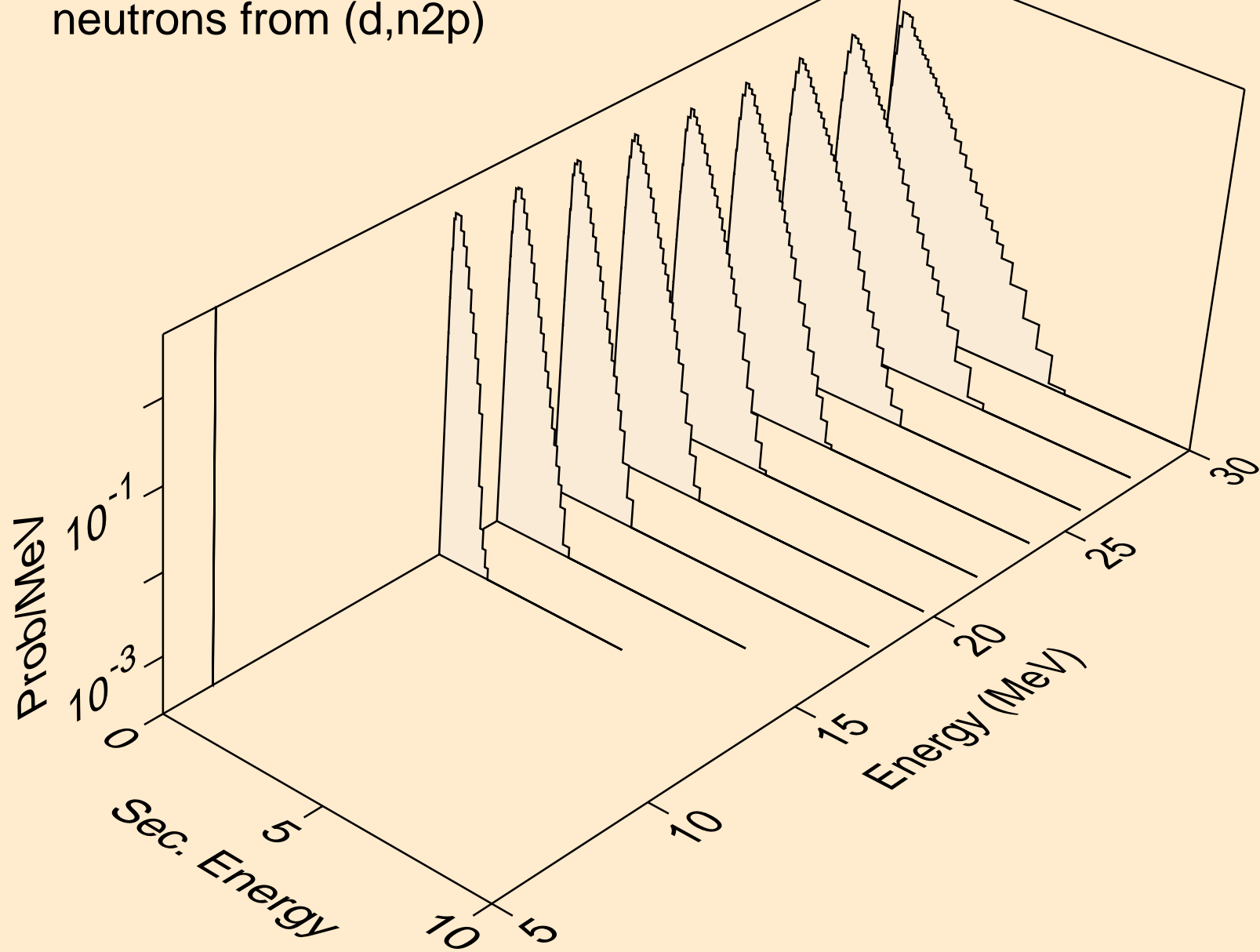

U227 DEUTERON ACER TENDL-2024 LIBRARY; T=0.K  
neutrons from (d,npa)

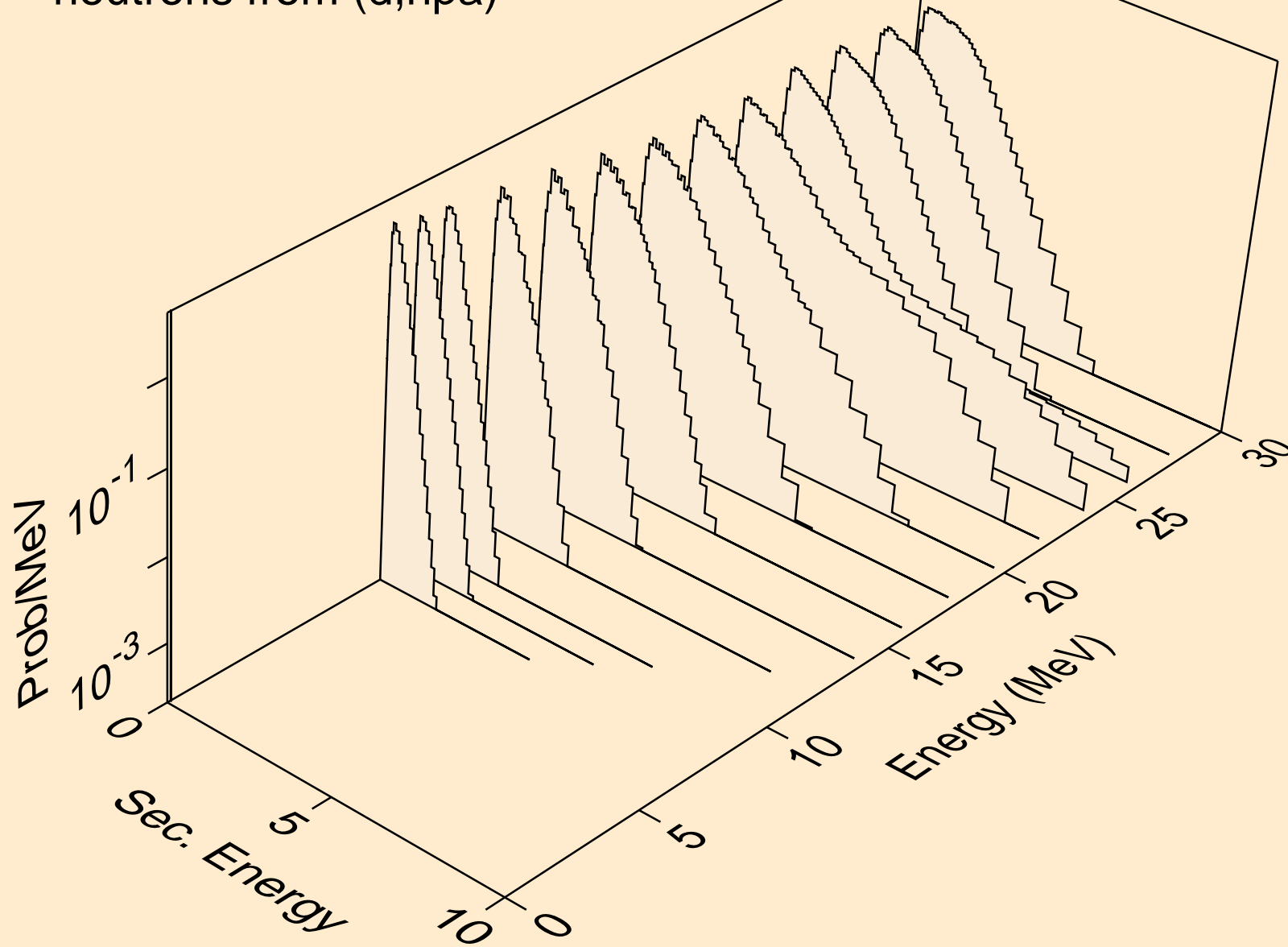

U227 DEUTERON ACER TENDL-2024 LIBRARY; T=0.K  
protons from (d,x)

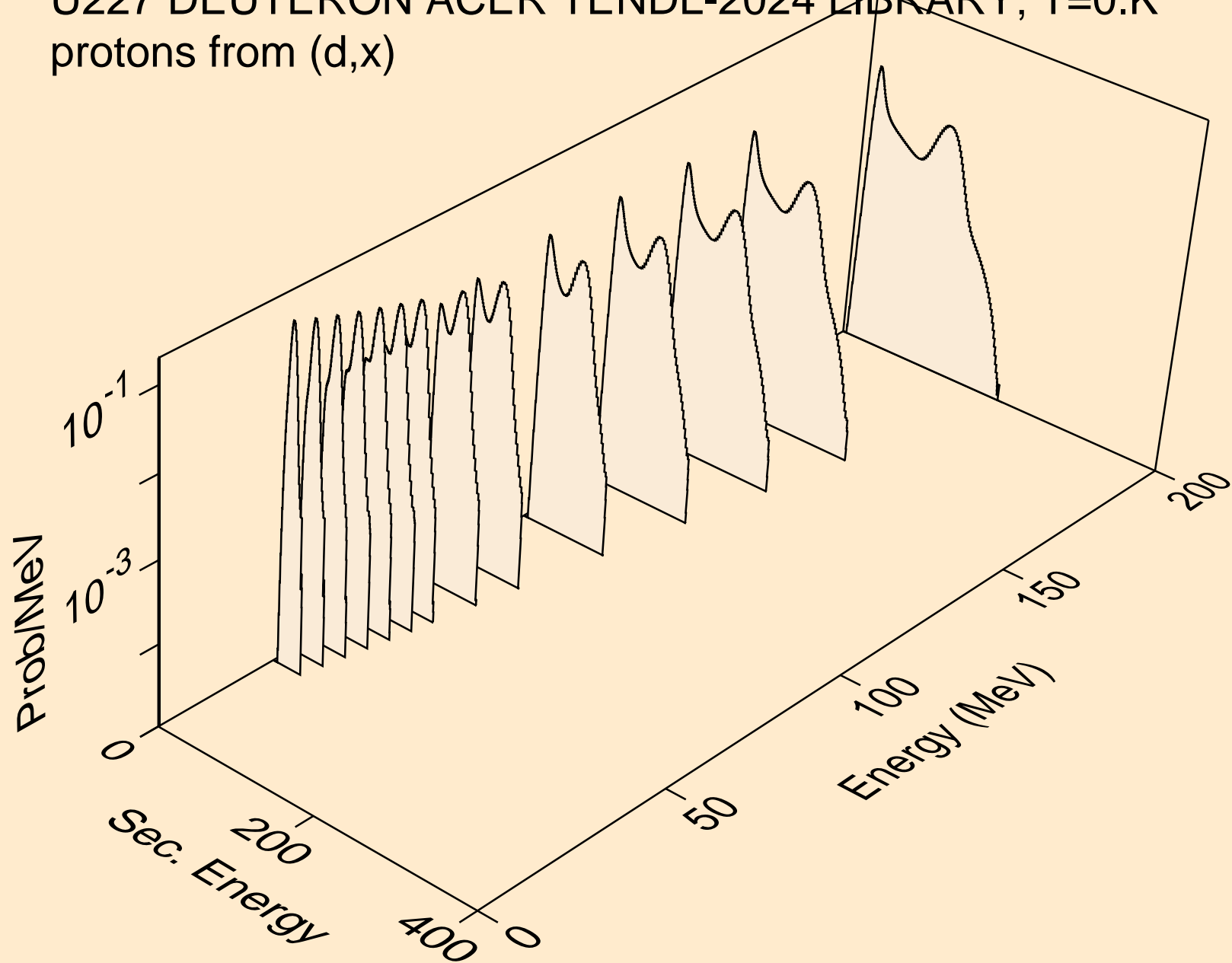

U227 DEUTERON ACER TENDL-2024 LIBRARY; T=0.K  
protons from (d,n\*)p

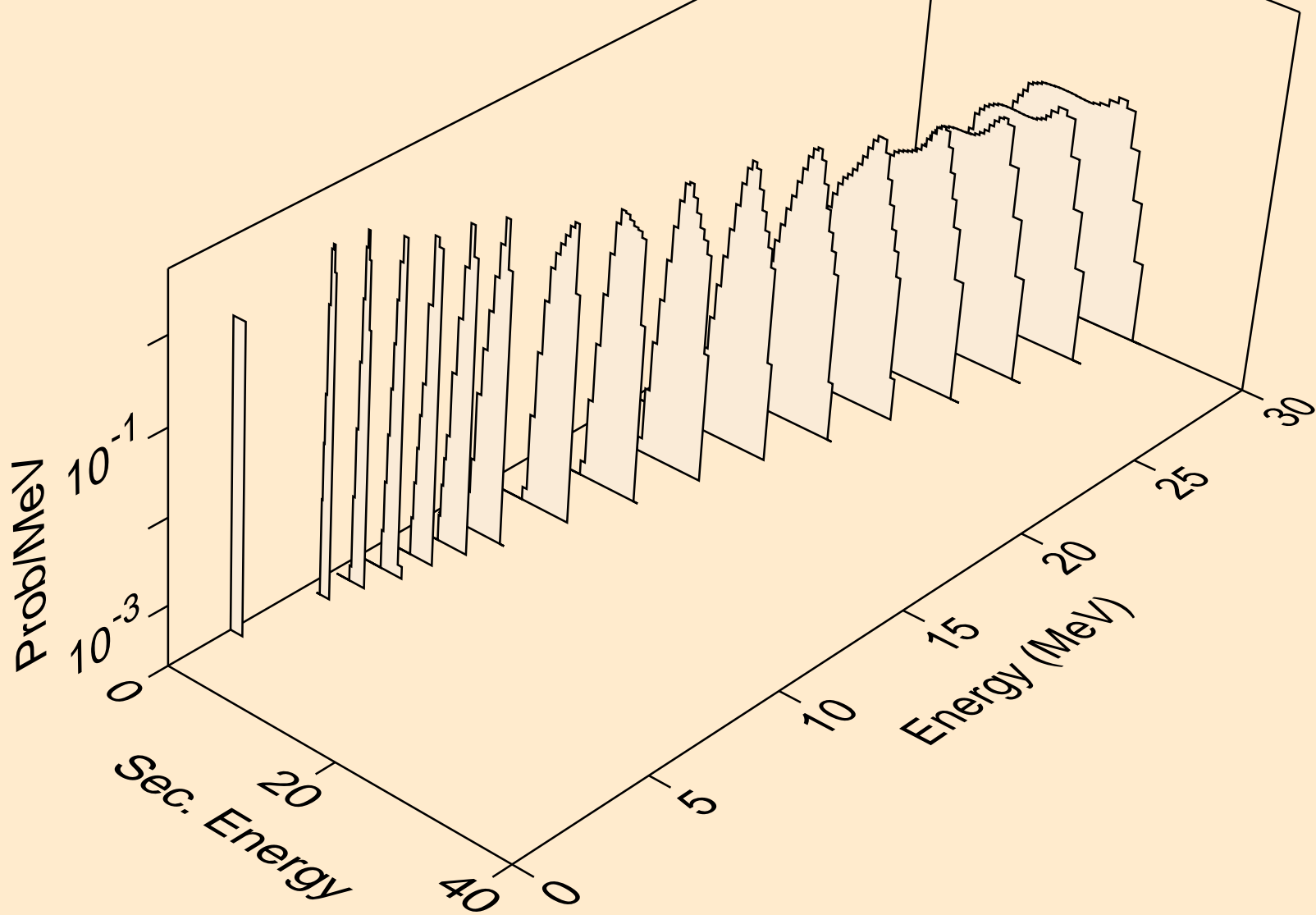

U227 DEUTERON ACER TENDL-2024 LIBRARY; T=0.K  
protons from (d,2np)

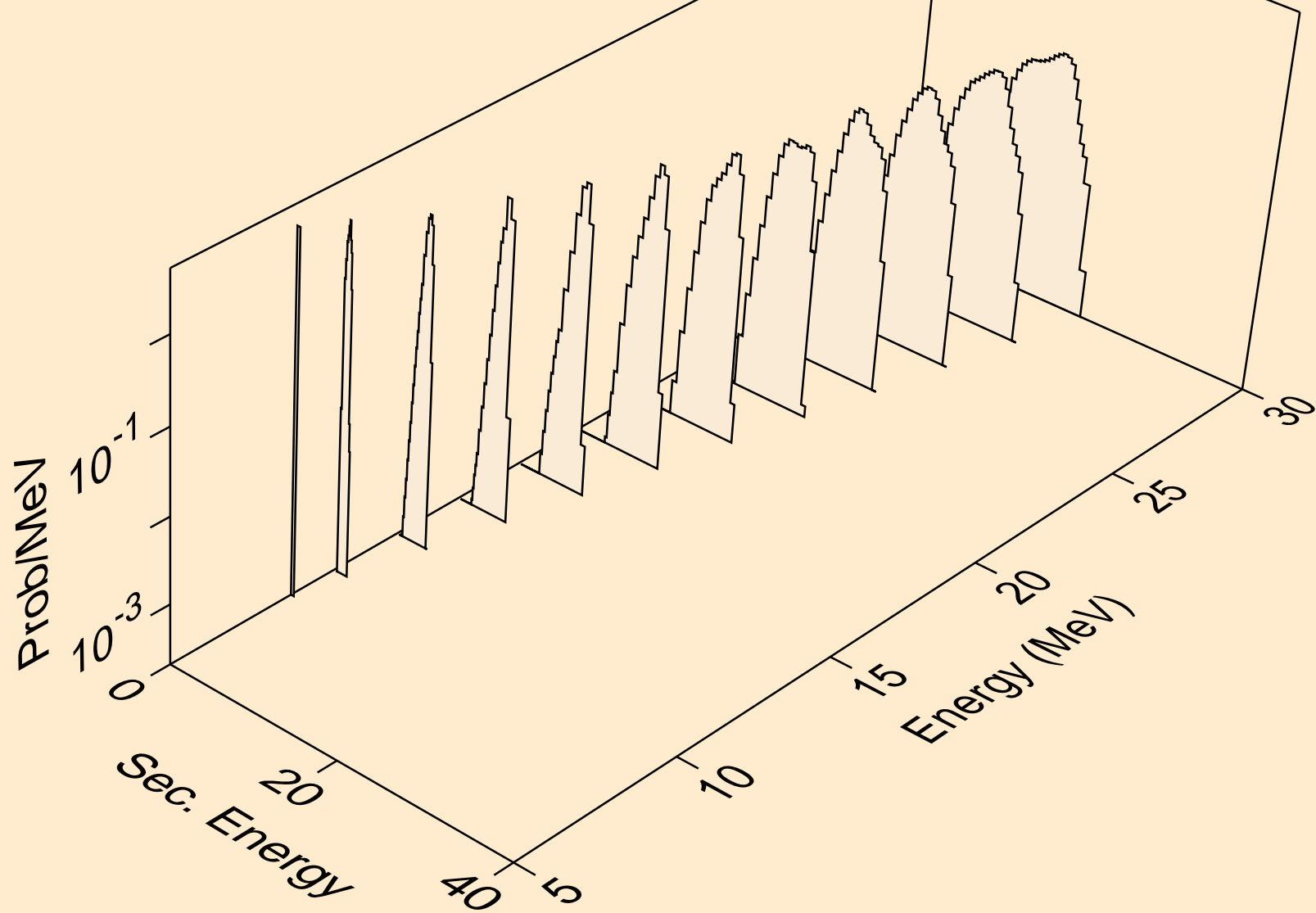

U227 DEUTERON ACER TENDL-2024 LIBRARY; T=0.K  
protons from (d,3np)

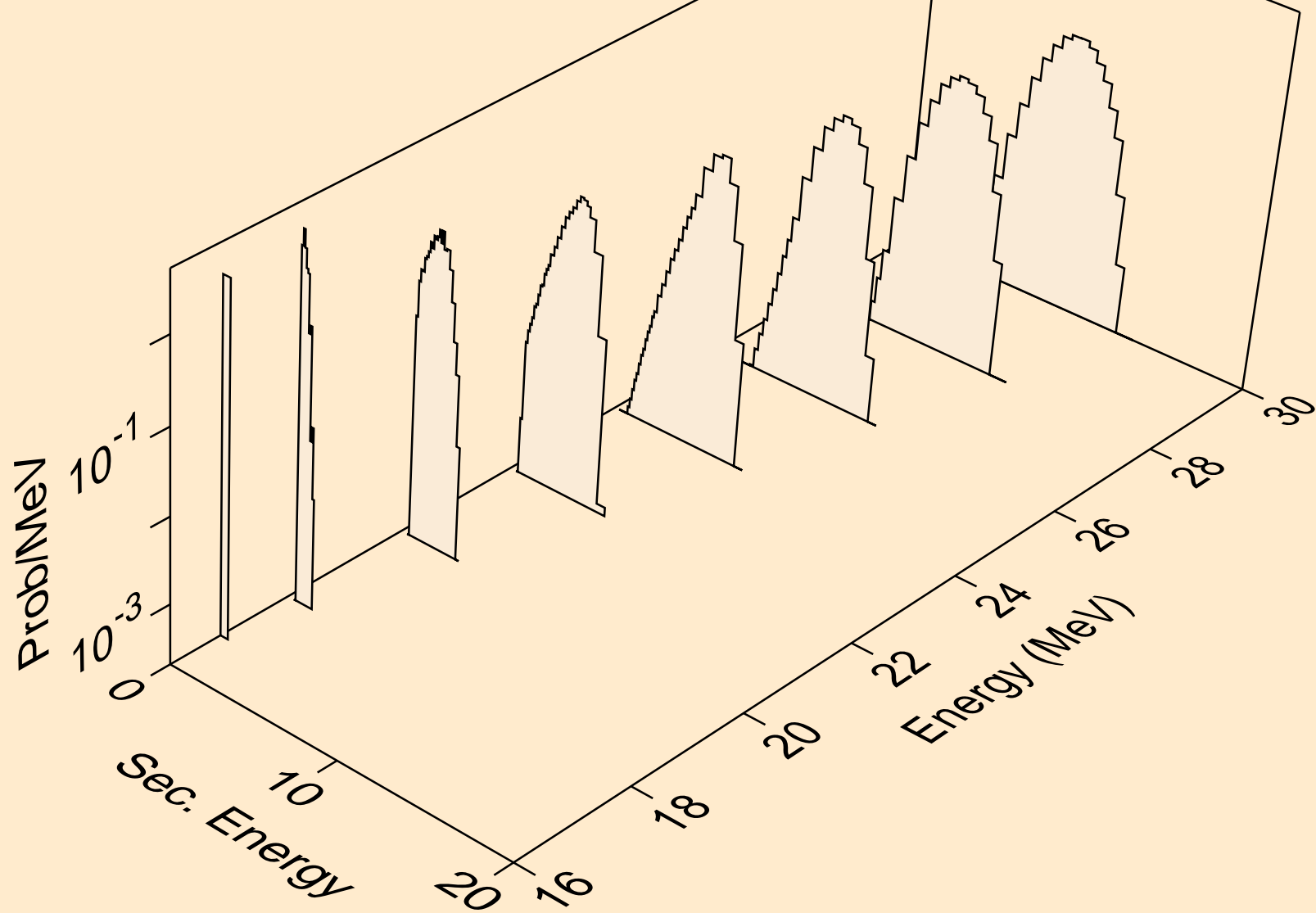

U227 DEUTERON ACER TENDL-2024 LIBRARY; T=0.K  
protons from (d,n2p)

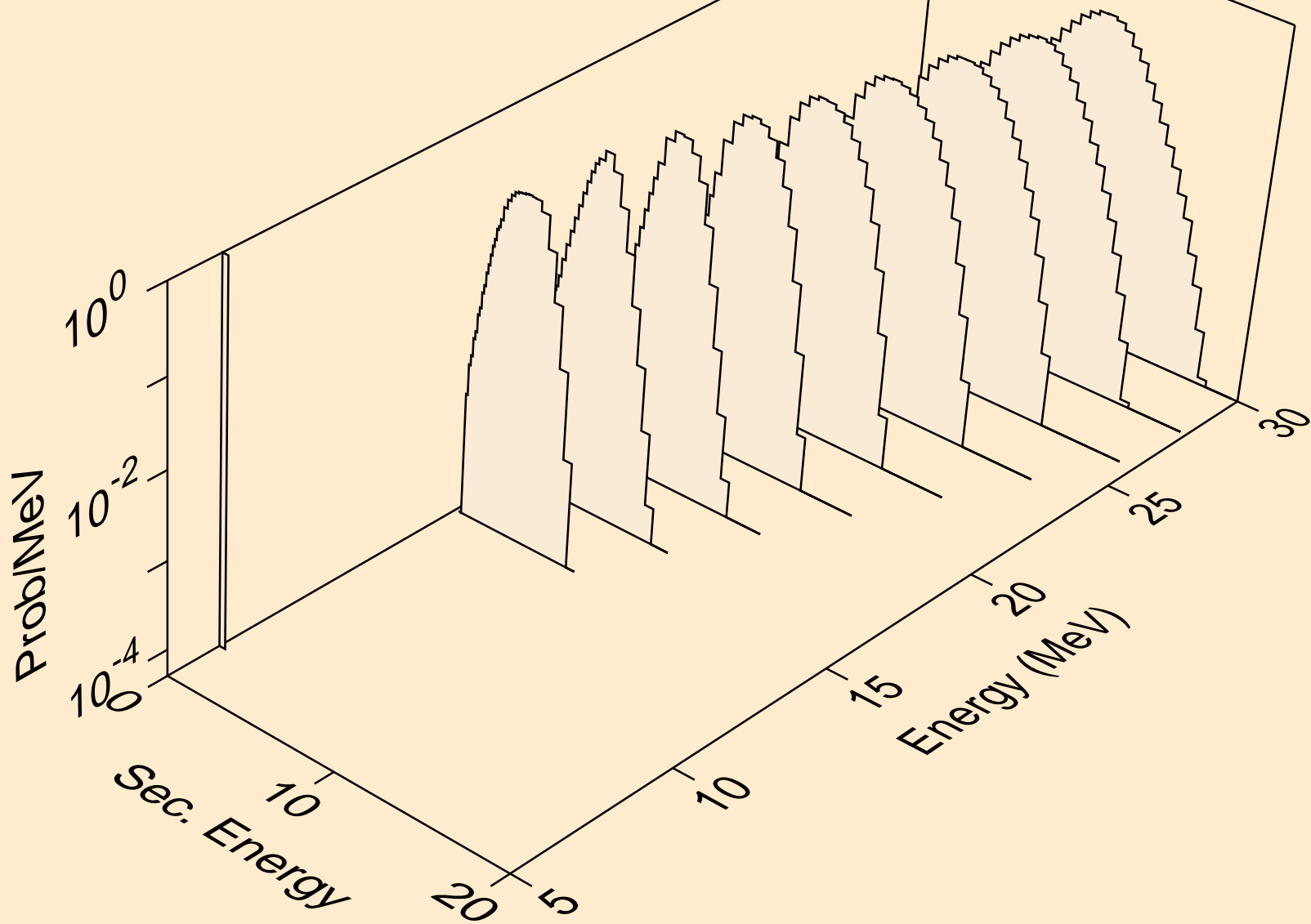

U227 DEUTERON ACER TENDL-2024 LIBRARY; T=0.K  
protons from (d,npa)

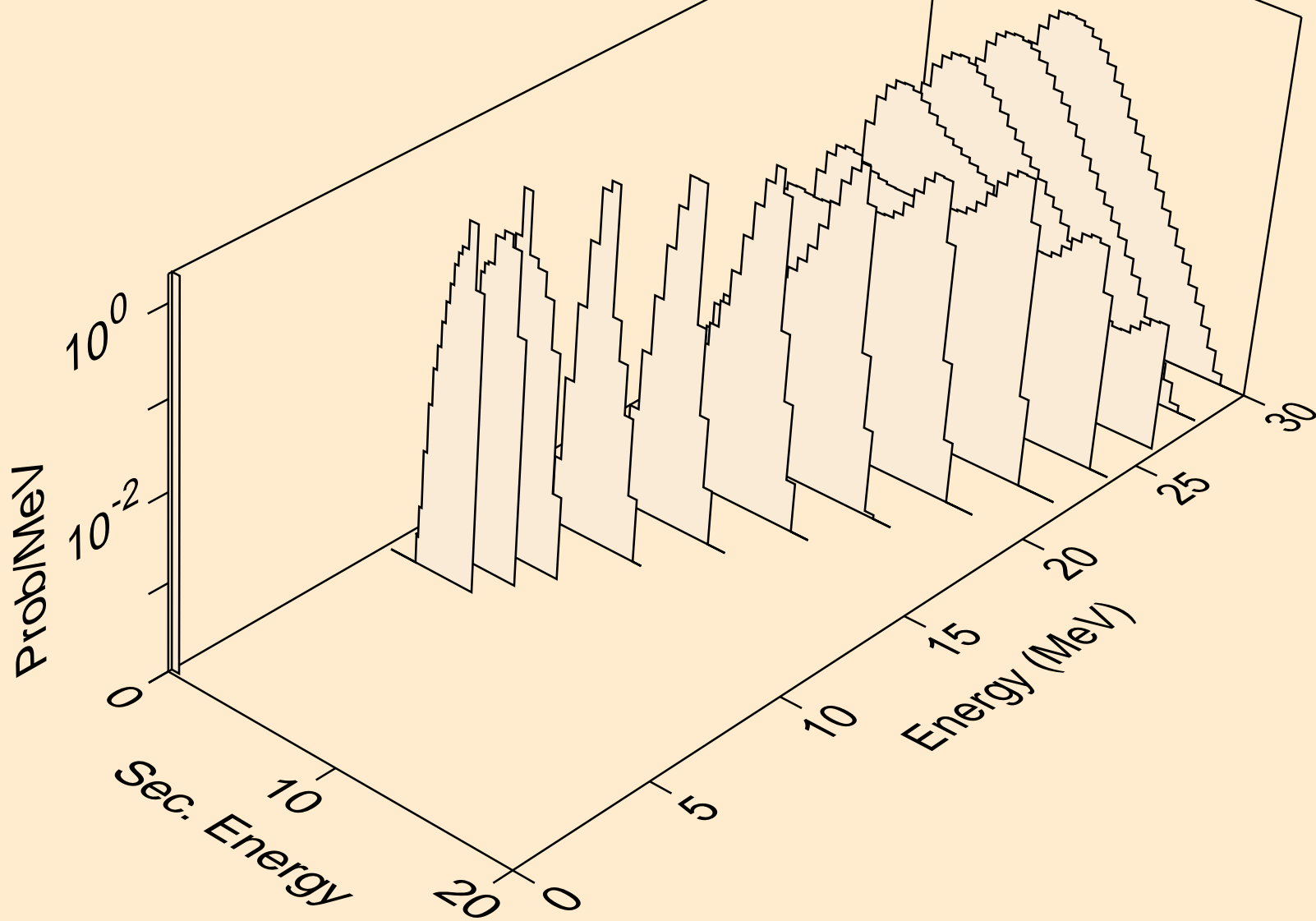

U227 DEUTERON ACER TENDL-2024 LIBRARY; T=0.K  
protons from (d,p)

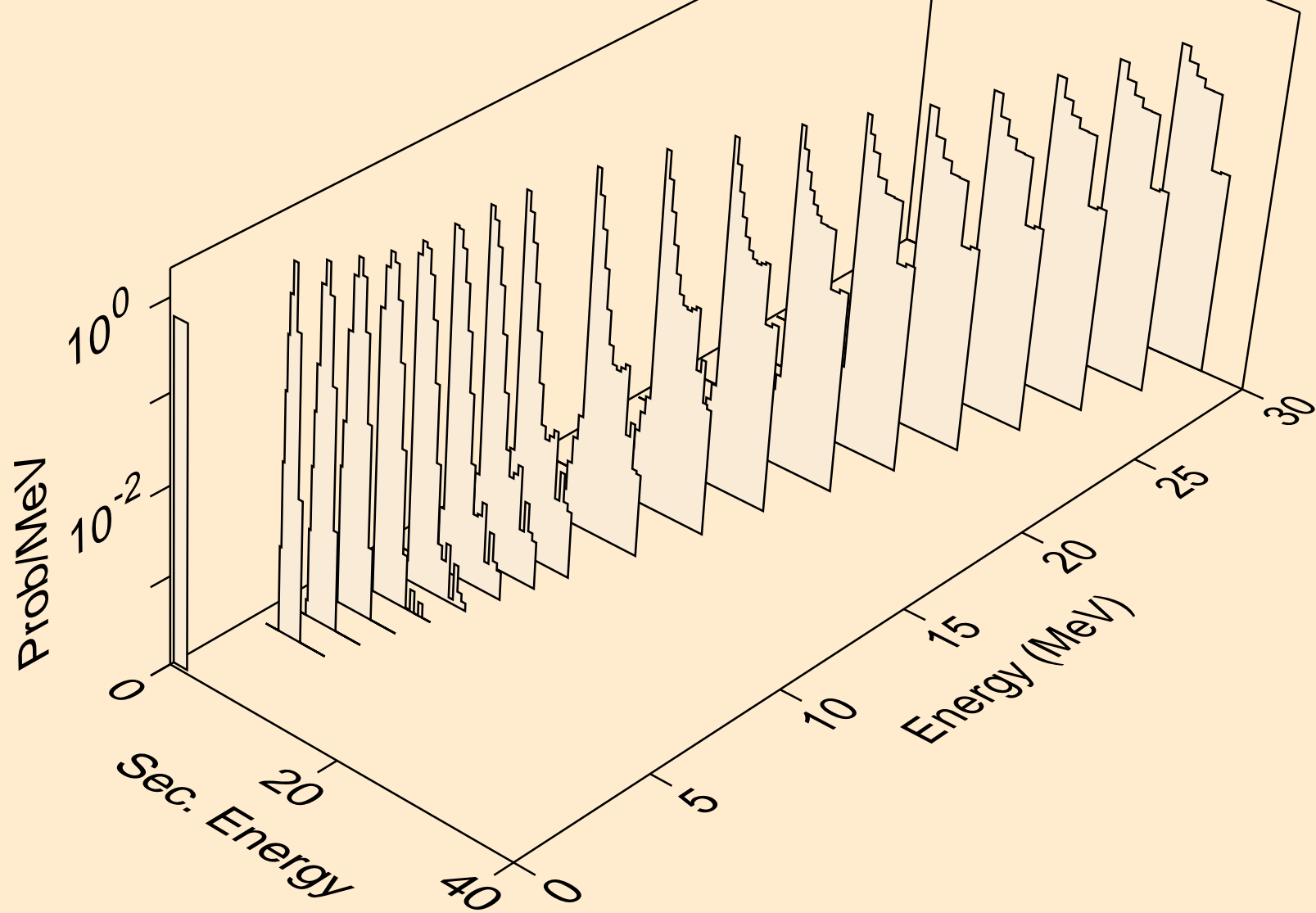

U227 DEUTERON ACER TENDL-2024 LIBRARY; T=0.K  
protons from (d,2p)

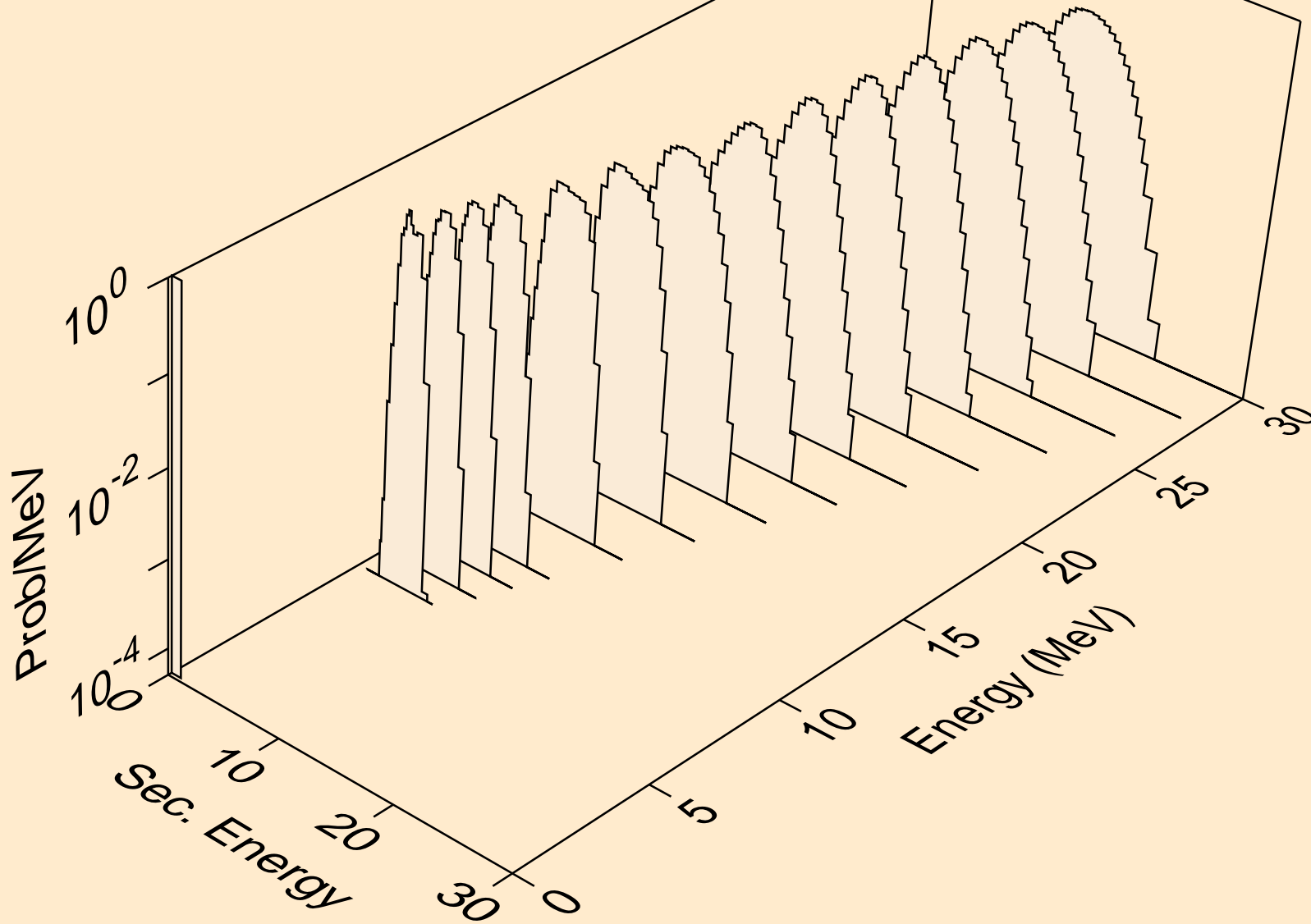

U227 DEUTERON ACER TENDL-2024 LIBRARY; T=0.K  
protons from (d,pa)

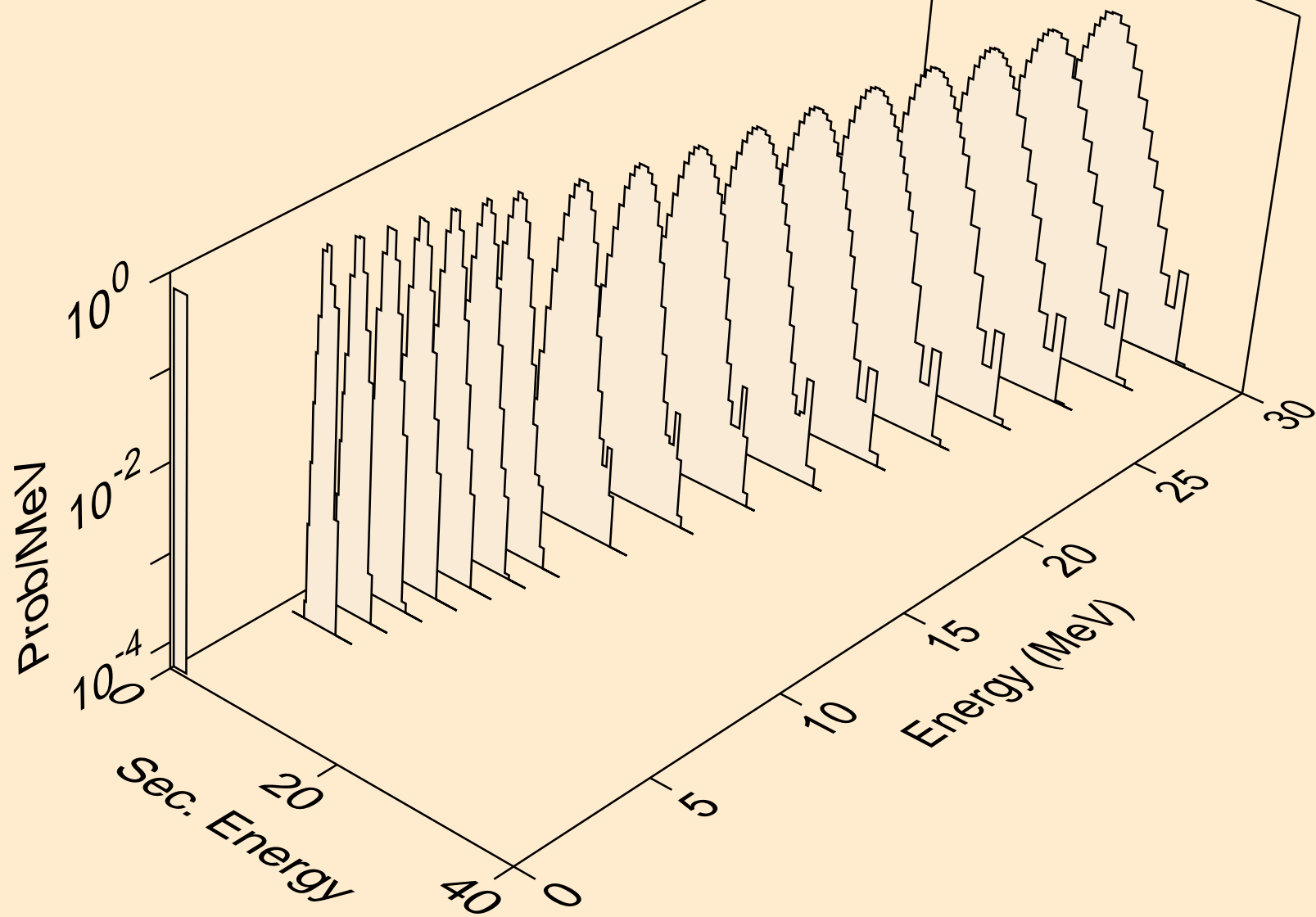

U227 DEUTERON ACER TENDL-2024 LIBRARY; T=0.K  
protons from (d,pd)

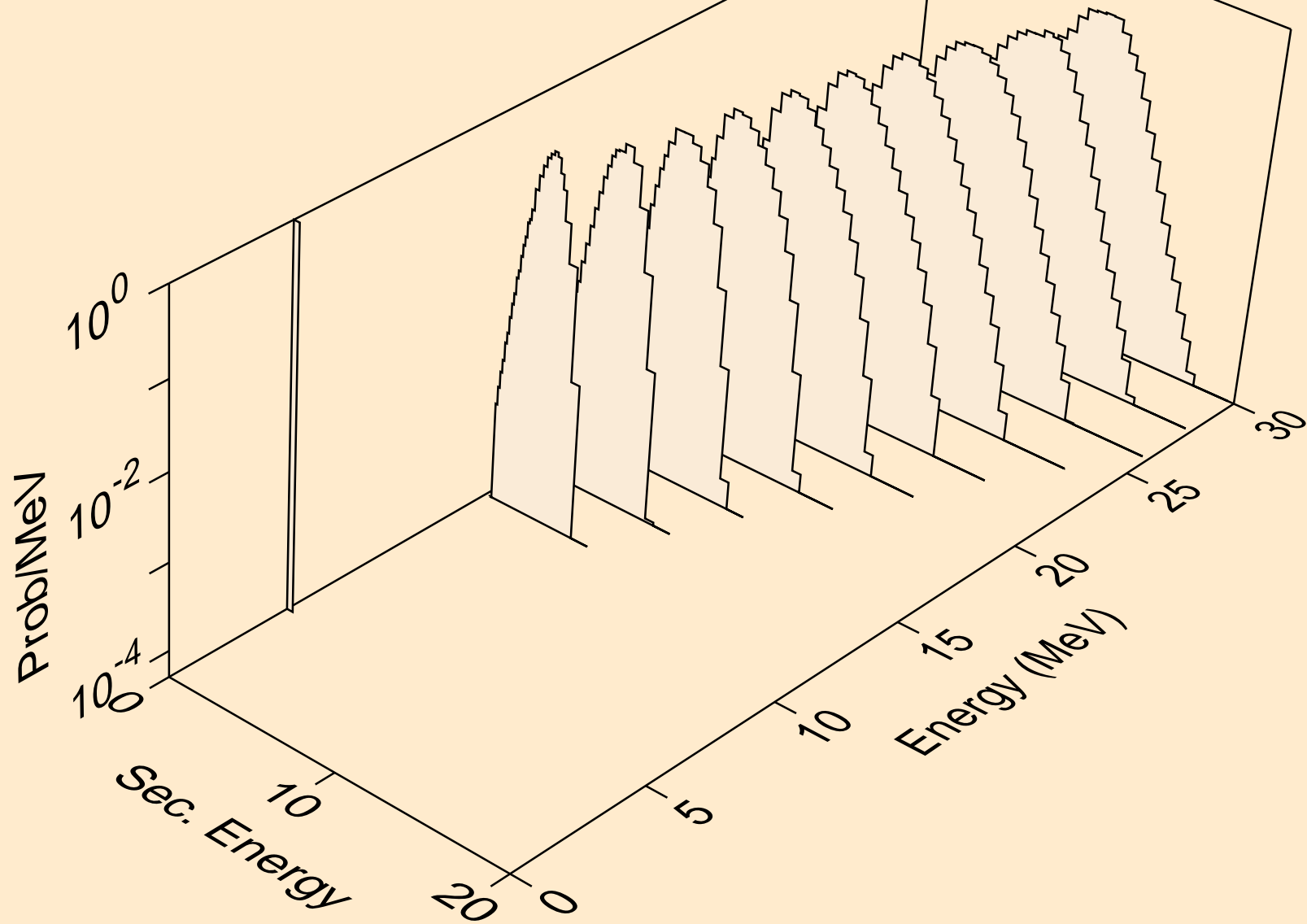

U227 DEUTERON ACER TENDL-2024 LIBRARY; T=0.K  
protons from (d,pt)

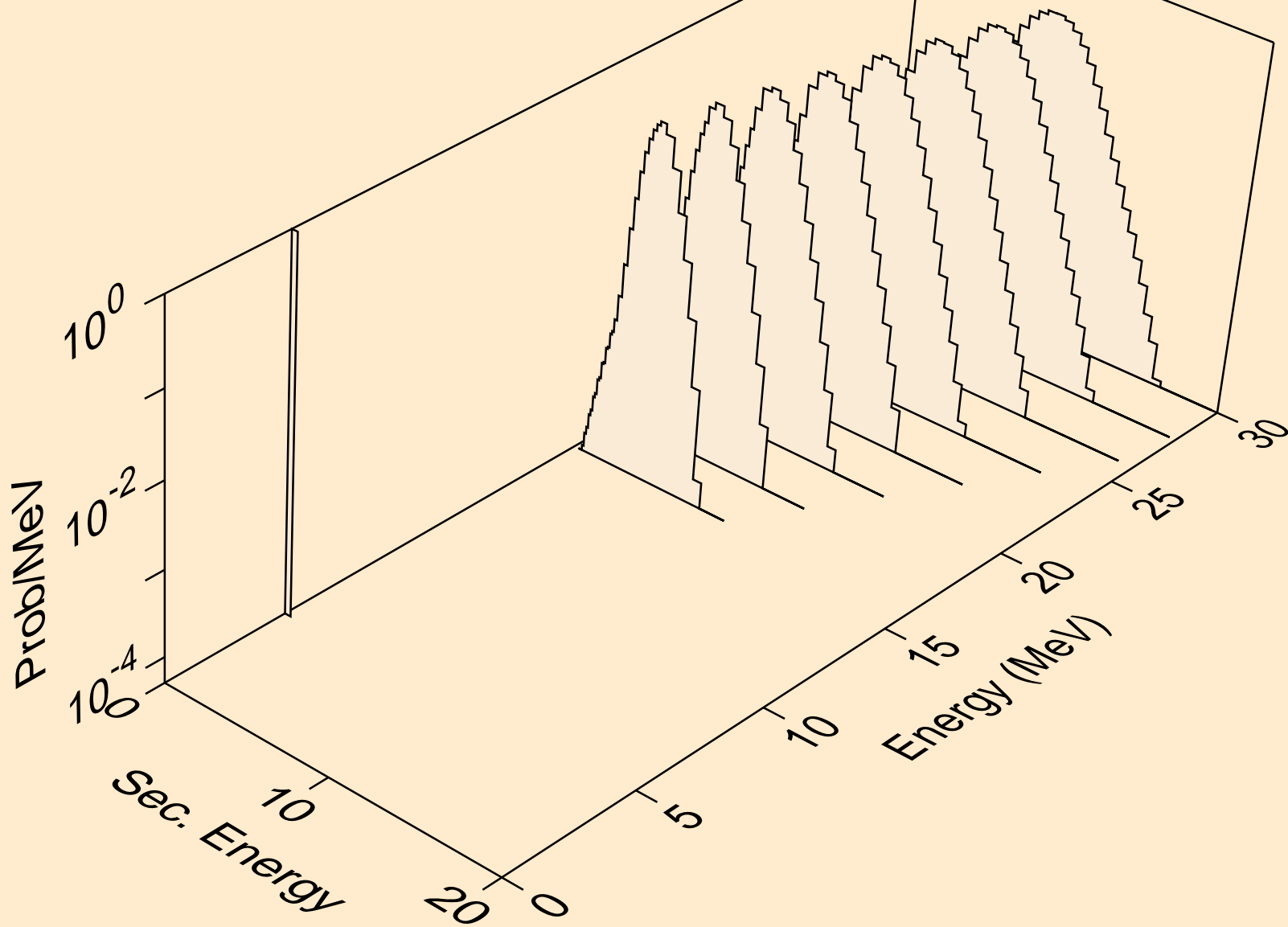

U227 DEUTERON ACER TENDL-2024 LIBRARY; T=0.K  
tritons from (d,x)

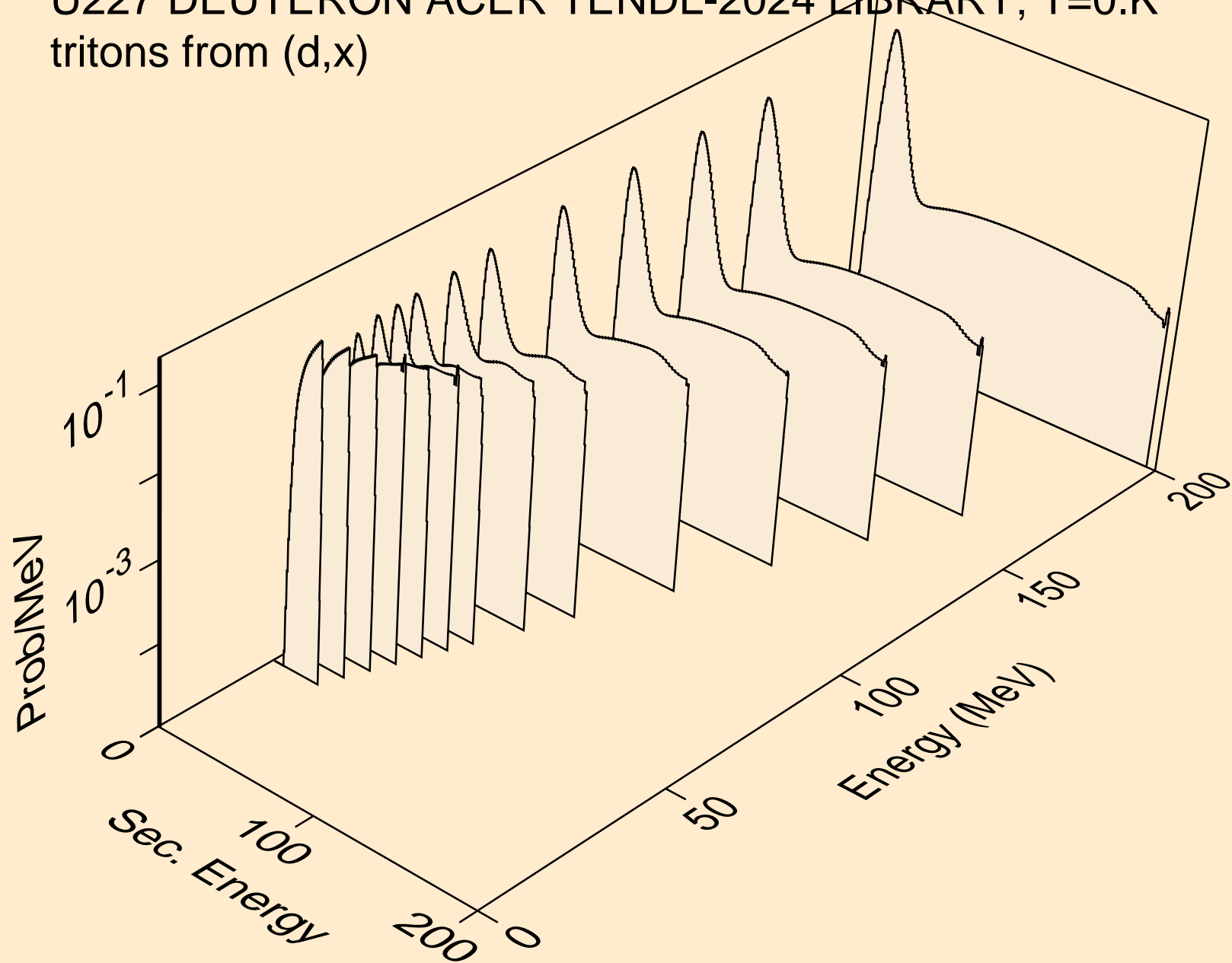

U227 DEUTERON ACER TENDL-2024 LIBRARY; T=0.K  
tritons from (d,n\*)t

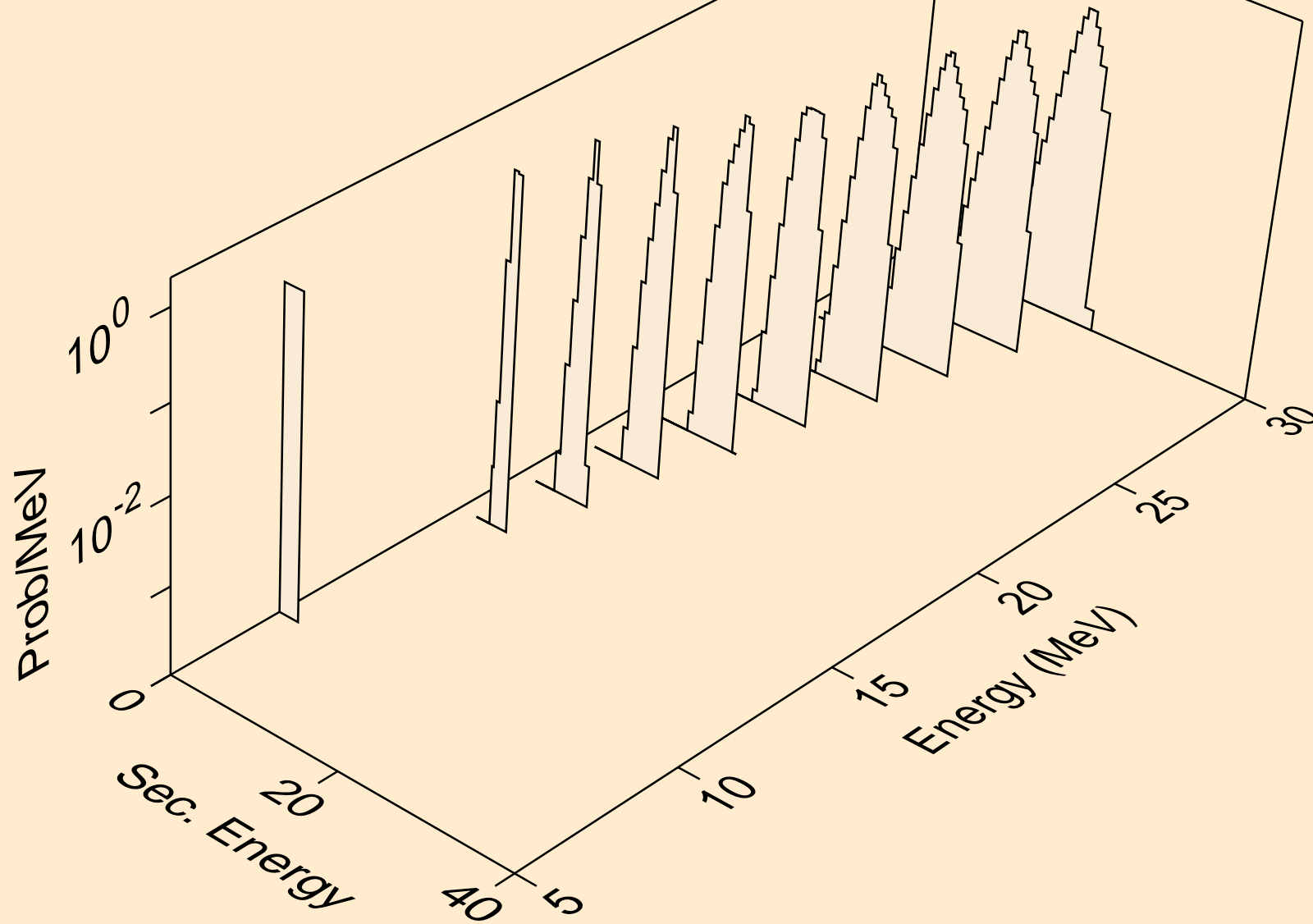

U227 DEUTERON ACER TENDL-2024 LIBRARY; T=0.K  
tritons from (d,t)

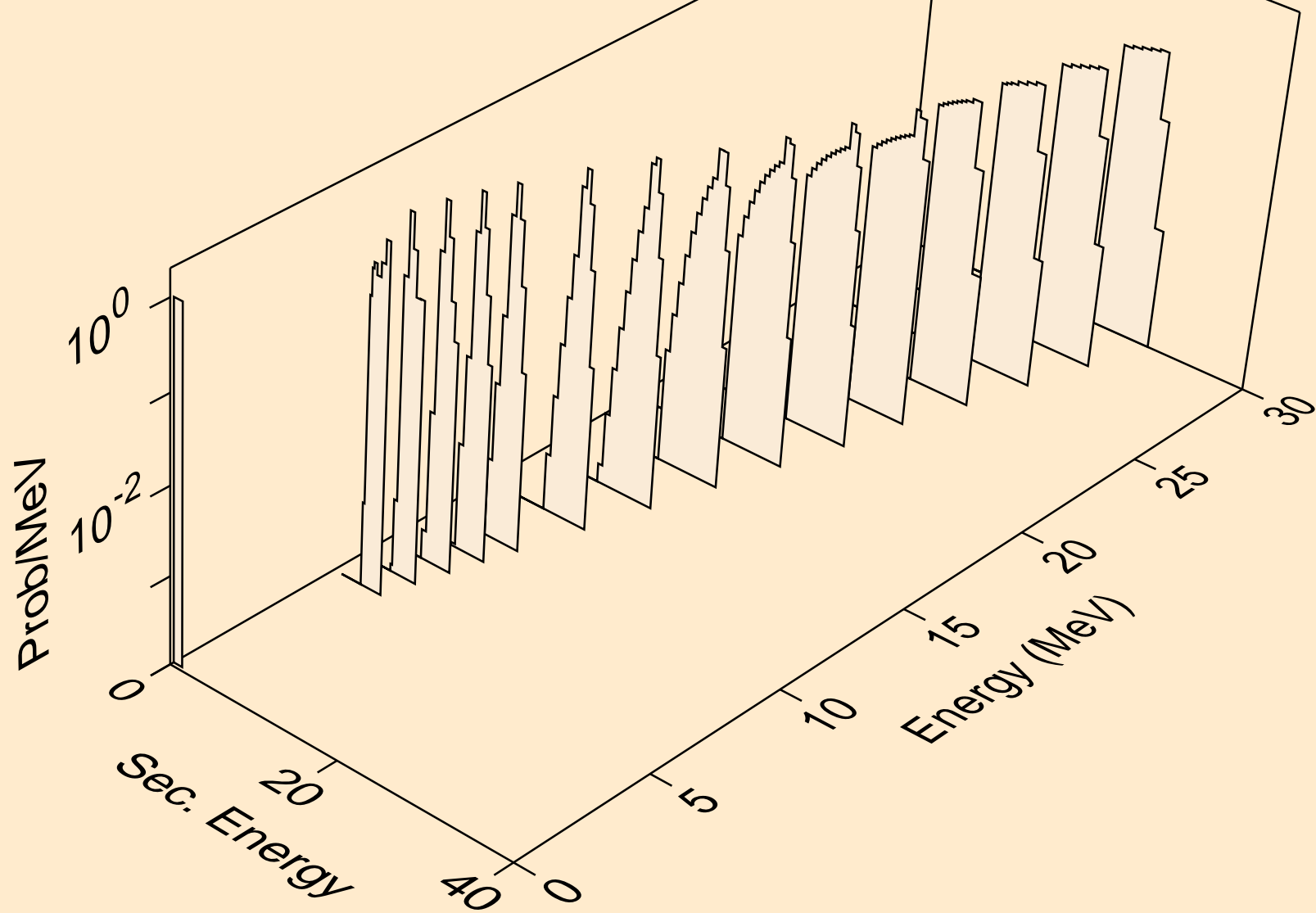

U227 DEUTERON ACER TENDL-2024 LIBRARY; T=0.K  
tritons from (d,pt)

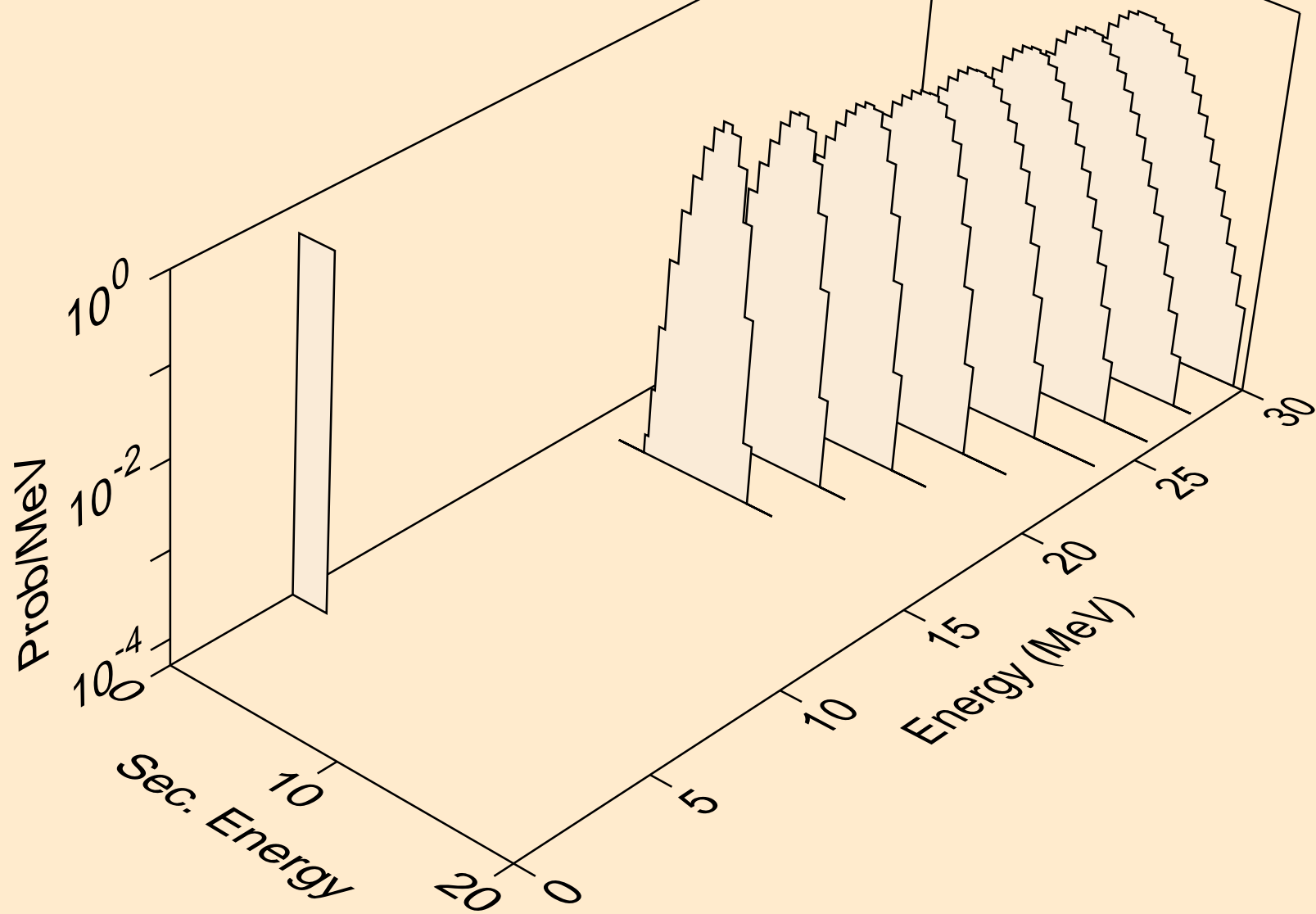

U227 DEUTERON ACER TENDL-2024 LIBRARY; T=0.K  
he3s from (d,x)

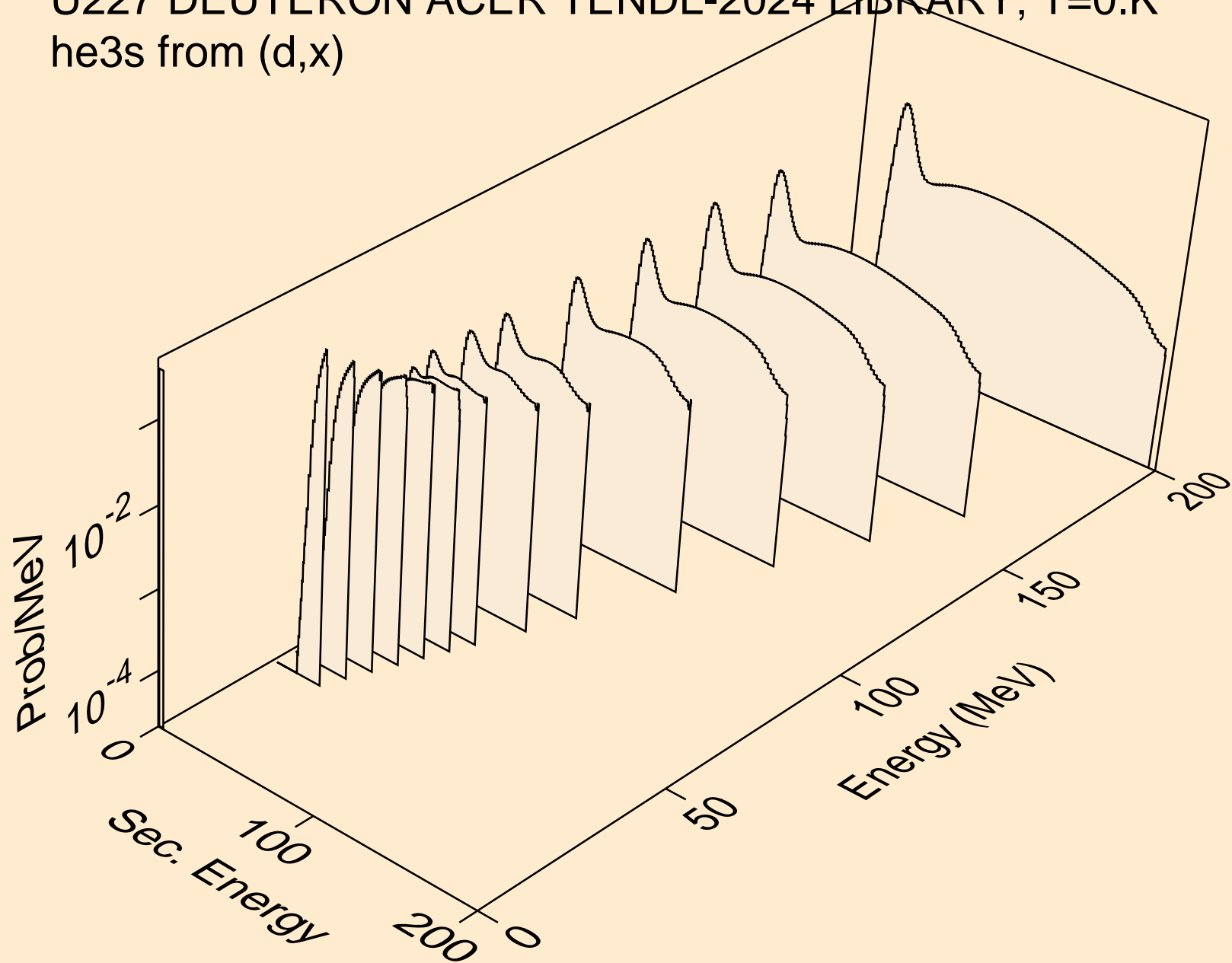

U227 DEUTERON ACER TENDL-2024 LIBRARY; T=0.K  
he3s from (d,n\*)he3

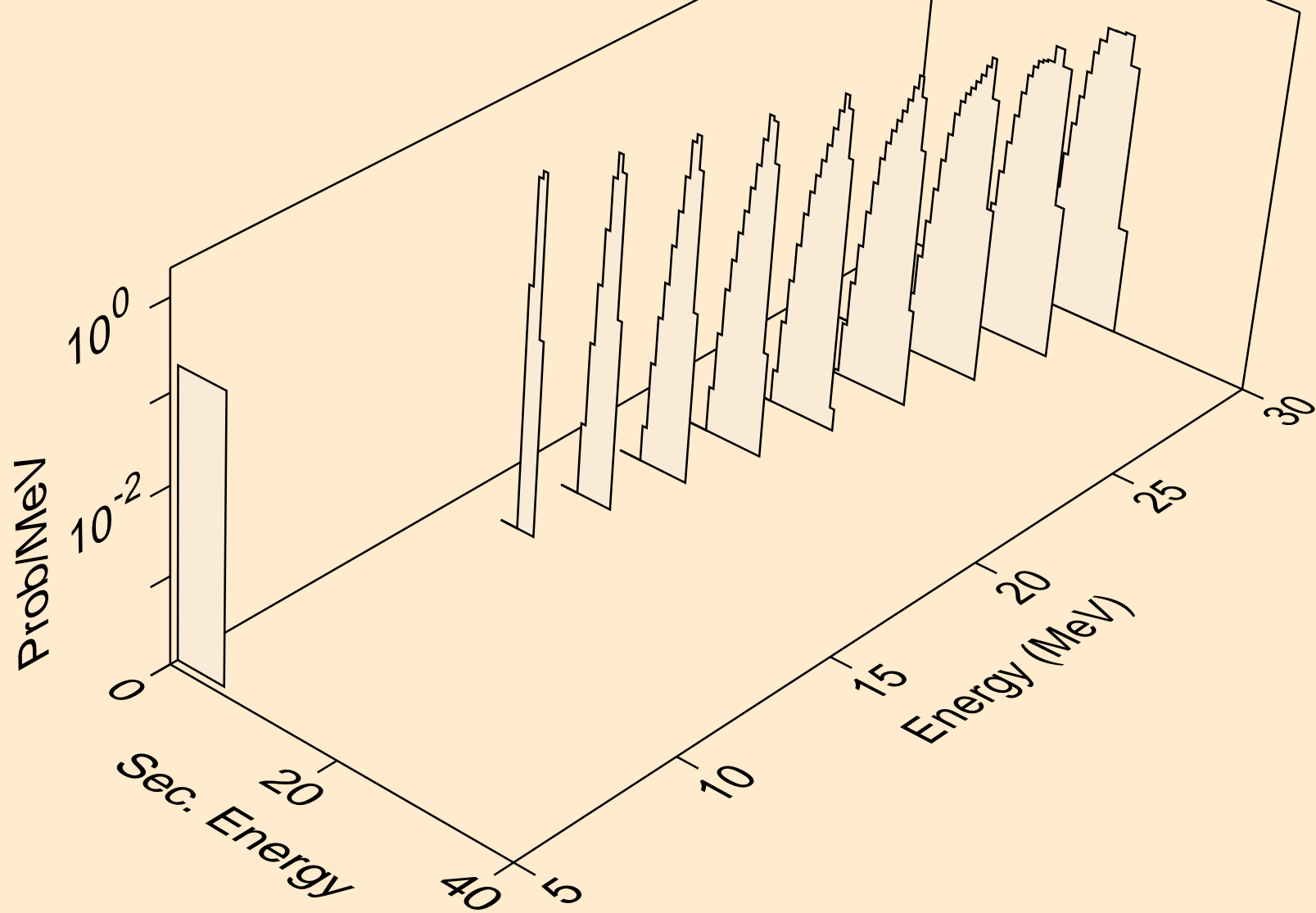

U227 DEUTERON ACER TENDL-2024 LIBRARY; T=0.K  
he3s from (d,he3)

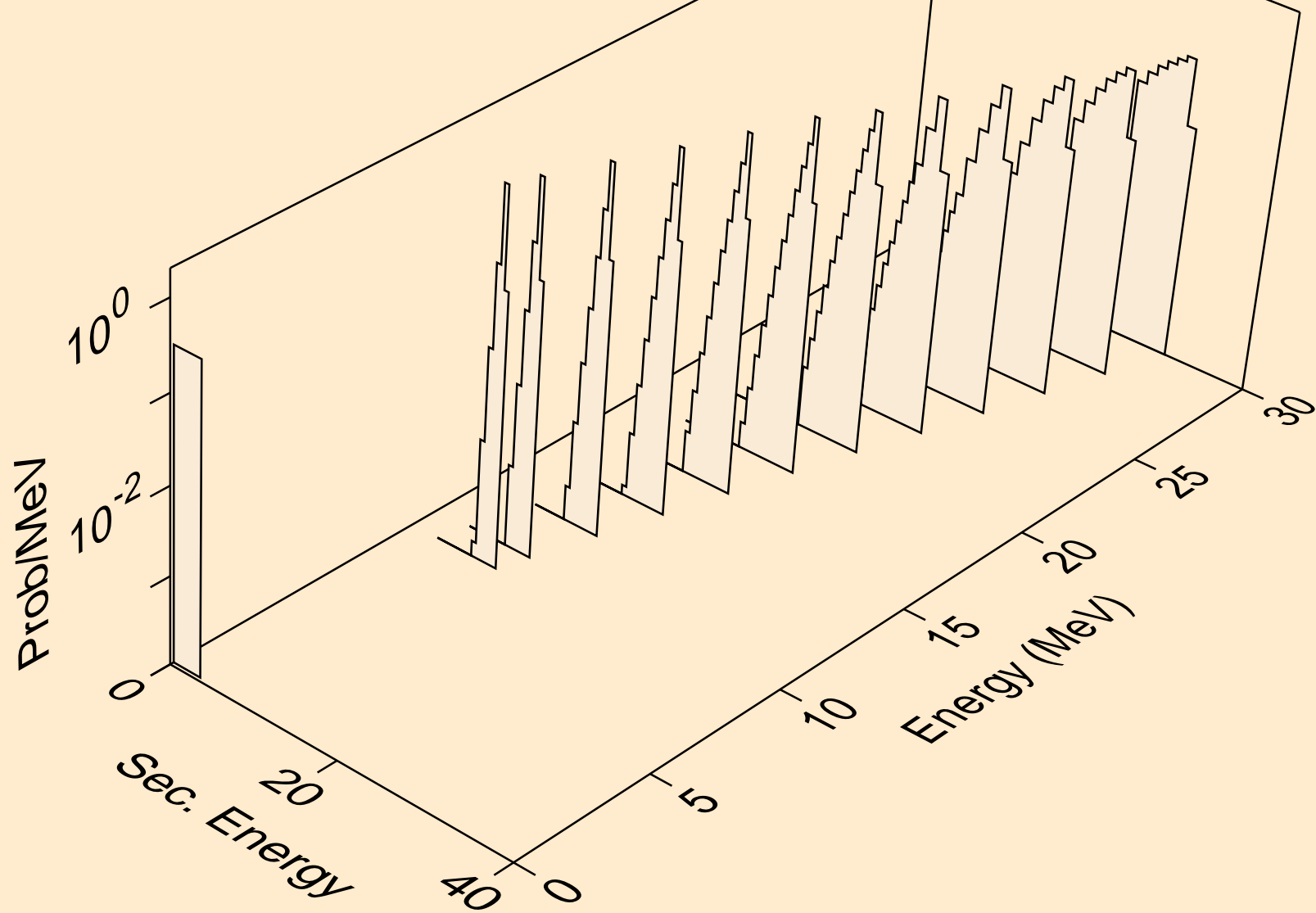

U227 DEUTERON ACER TENDL-2024 LIBRARY; T=0.K  
alphas from (d,x)

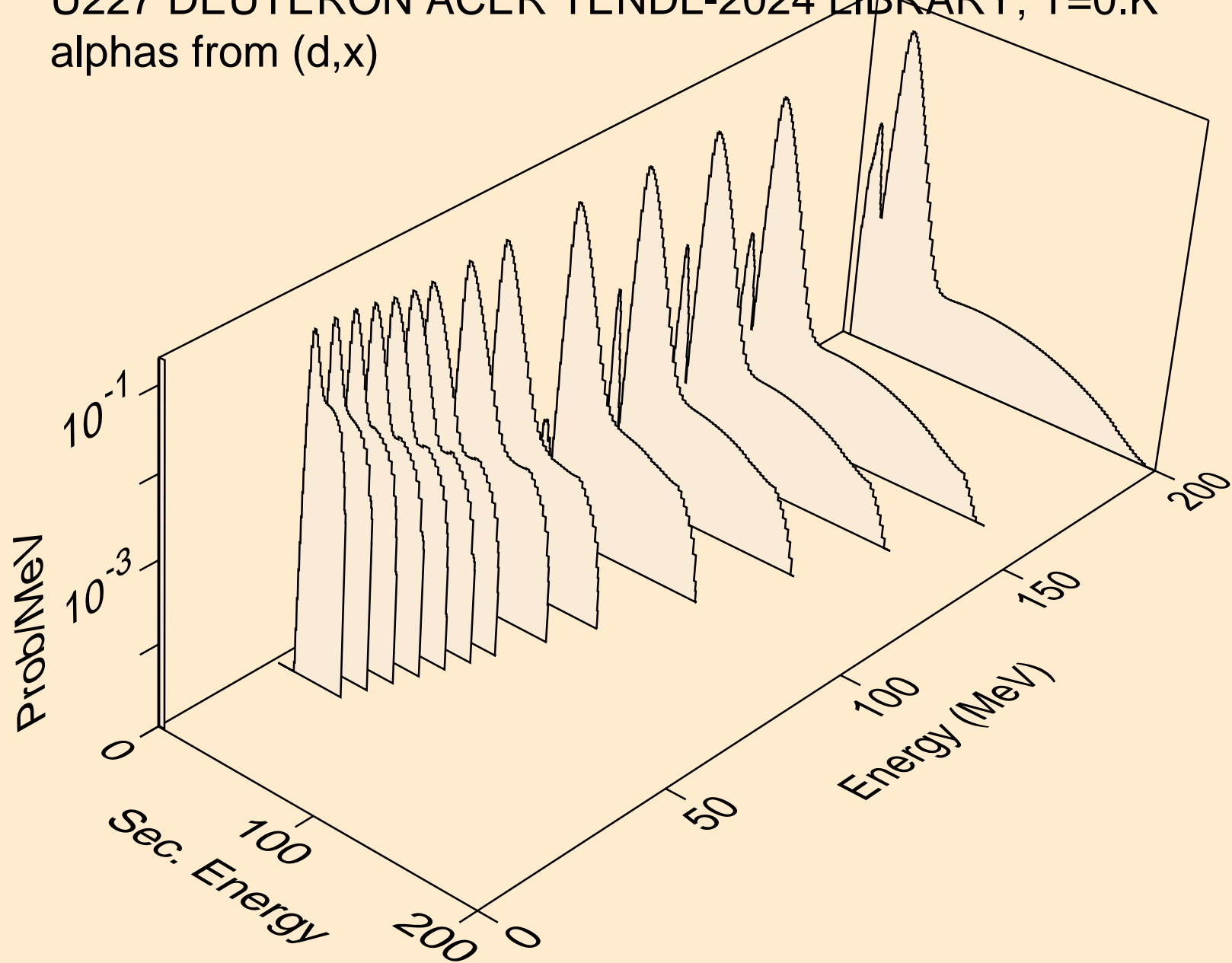

U227 DEUTERON ACER TENDL-2024 LIBRARY; T=0.K  
alphas from (d,n\*)a

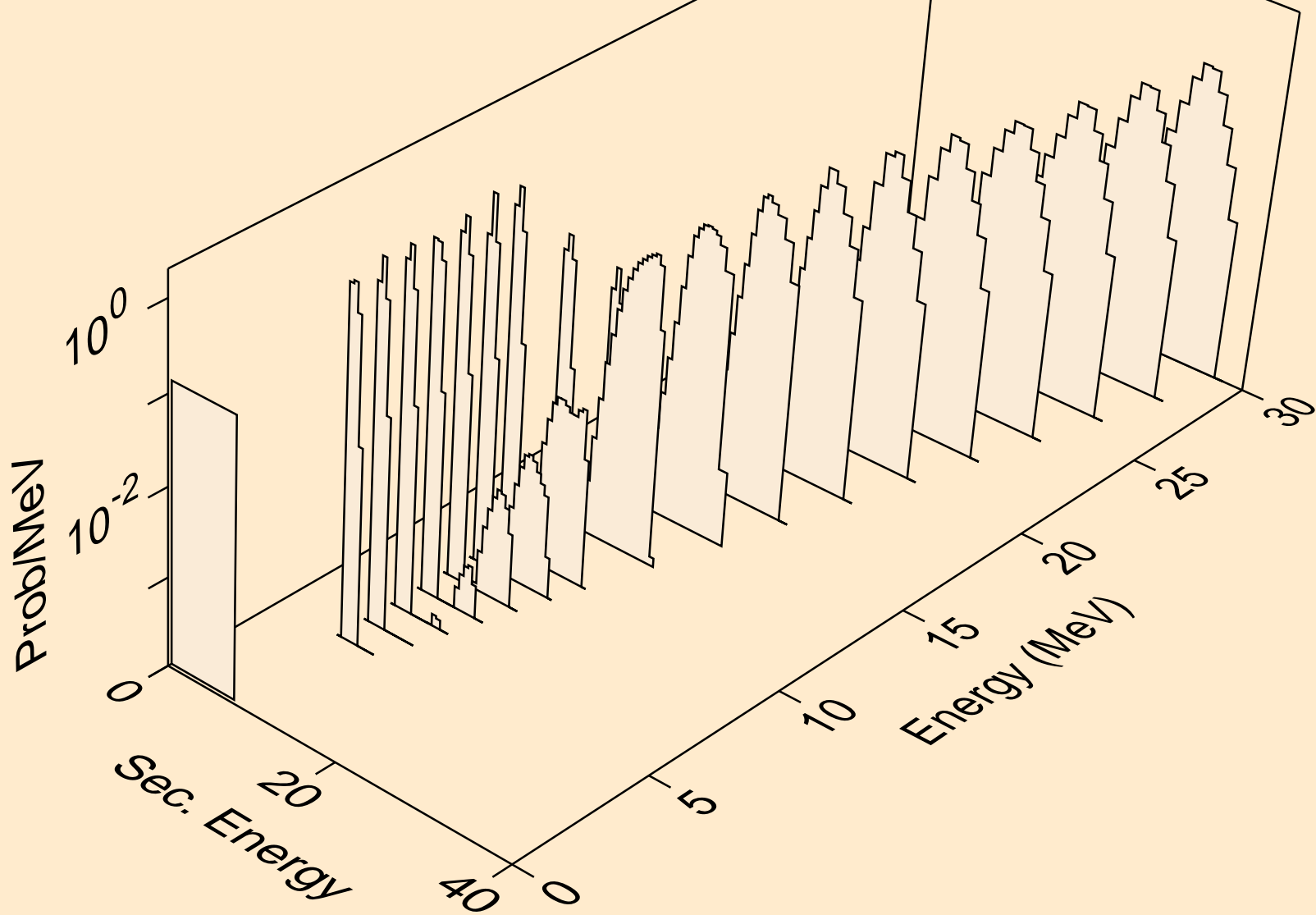

U227 DEUTERON ACER TENDL-2024 LIBRARY; T=0.K  
alphas from (d,2n)a

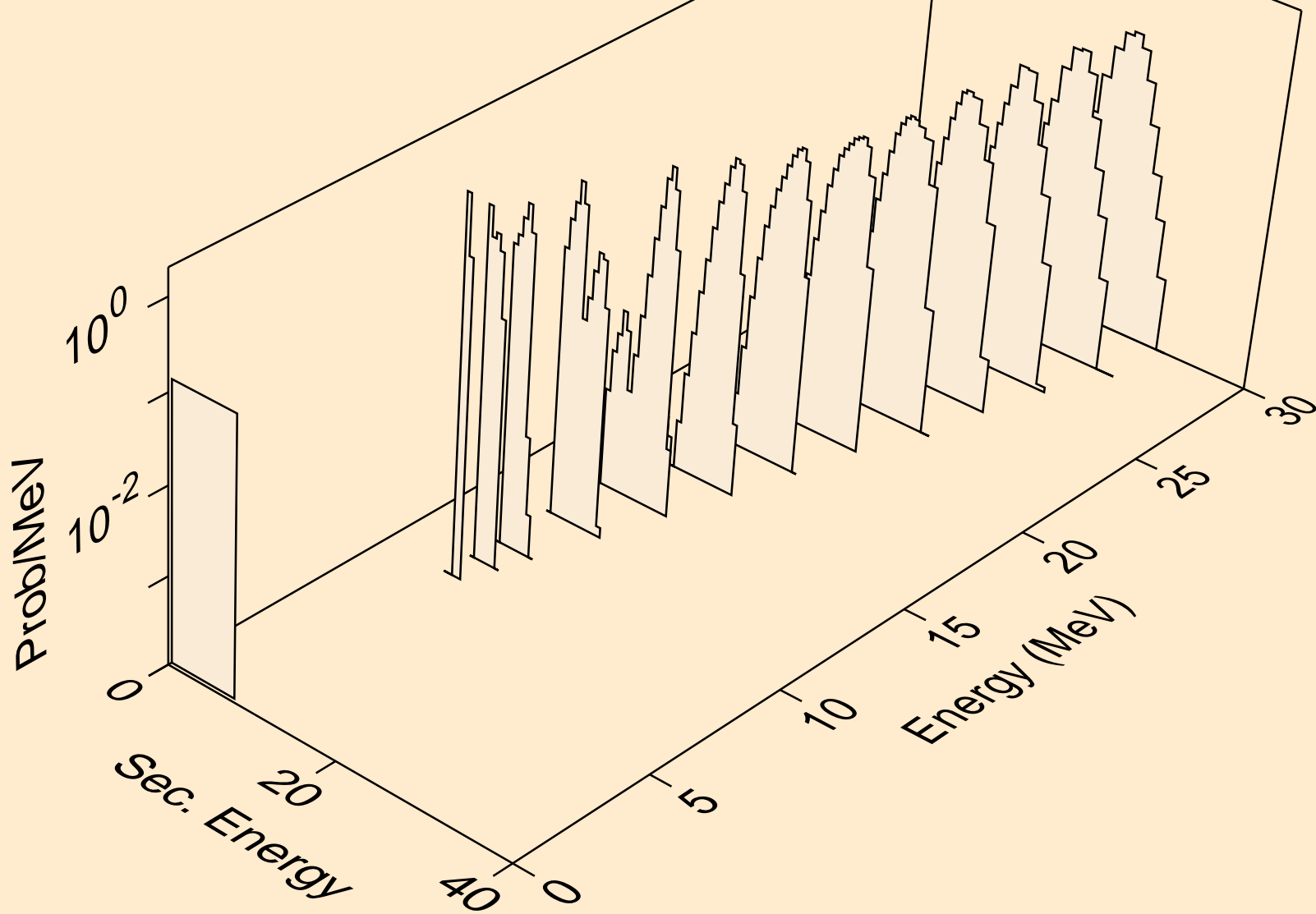

U227 DEUTERON ACER TENDL-2024 LIBRARY; T=0.K  
alphas from (d,3n)a

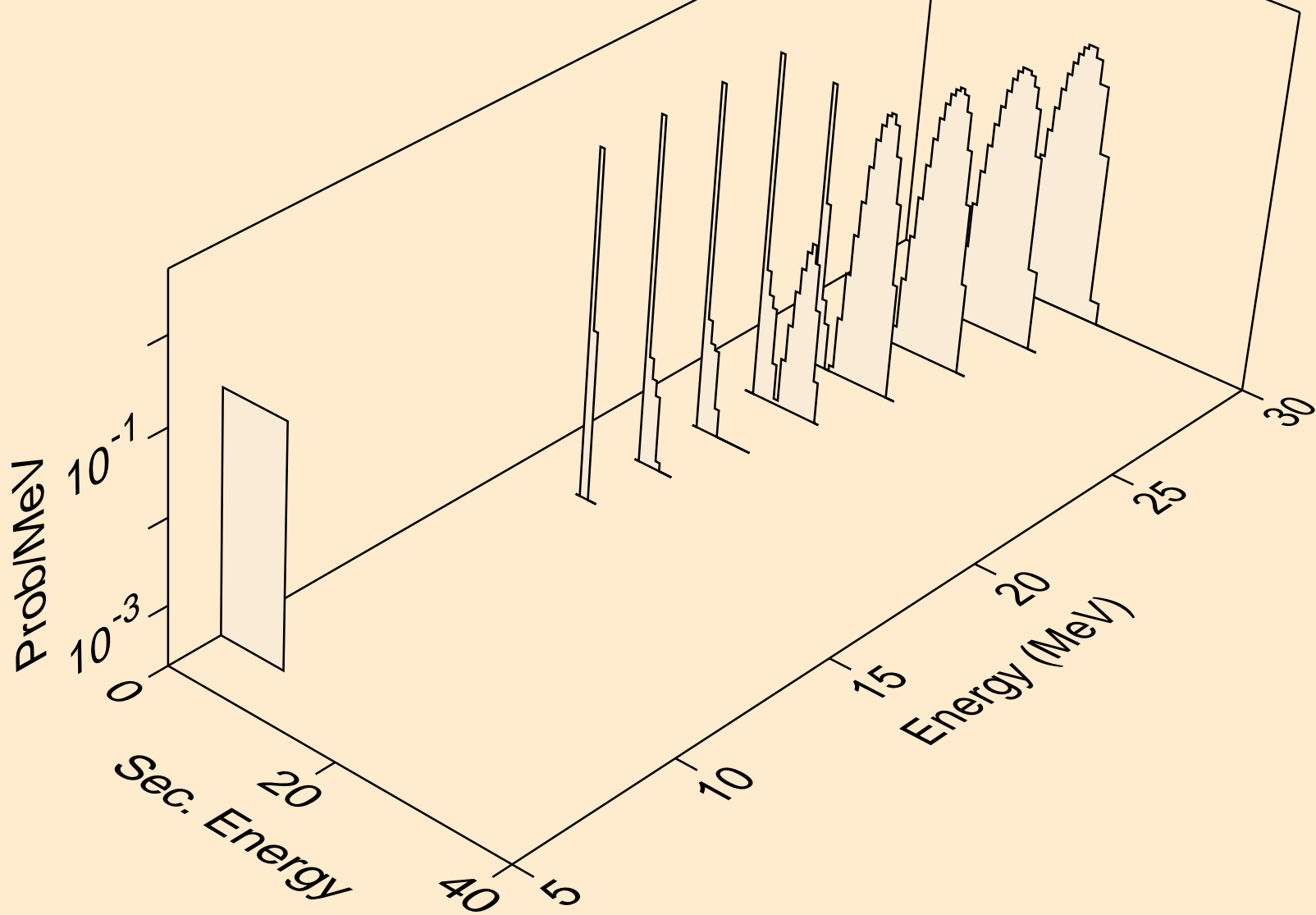

U227 DEUTERON ACER TENDL-2024 LIBRARY; T=0.K  
alphas from (d,n\*)2a

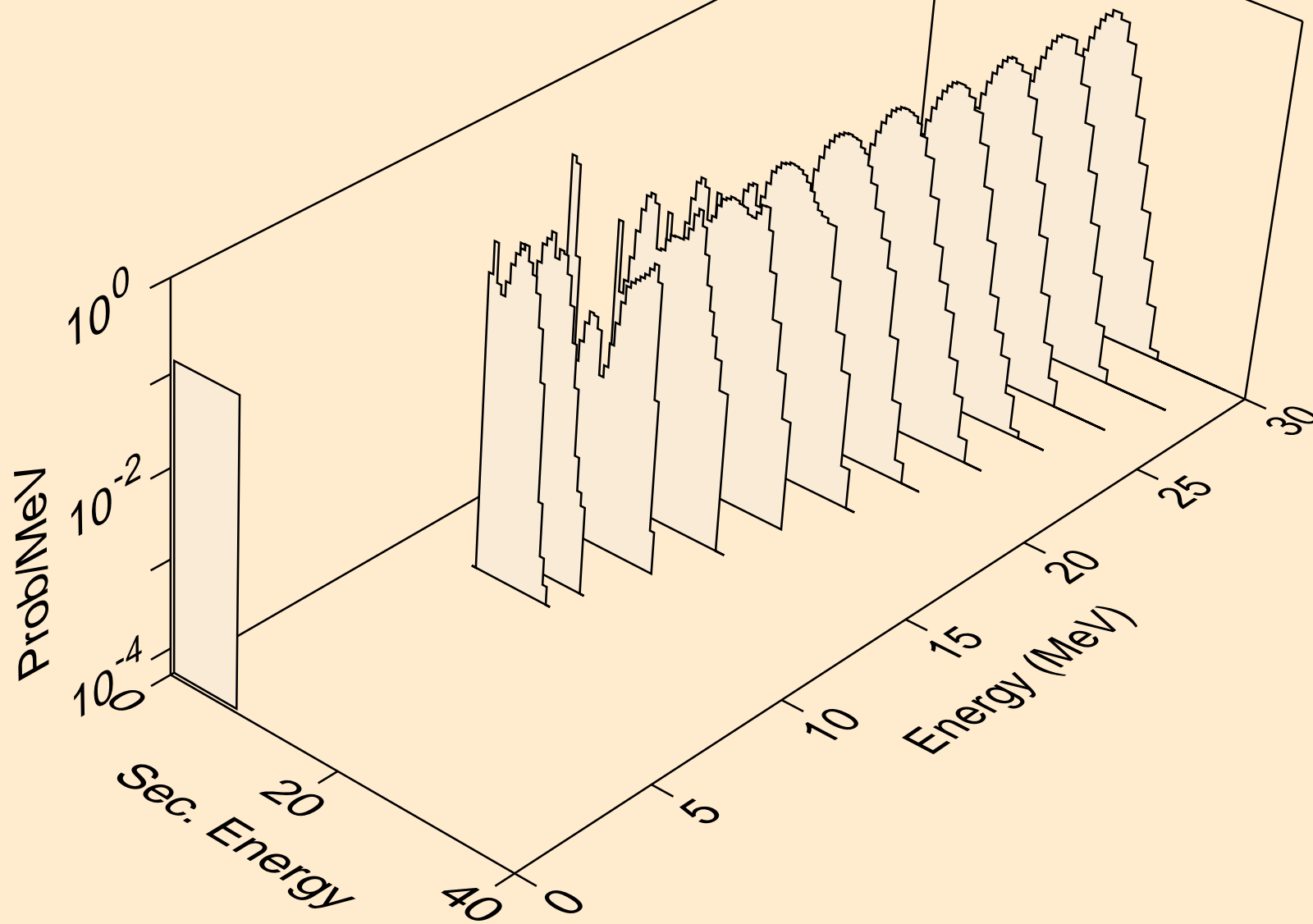

U227 DEUTERON ACER TENDL-2024 LIBRARY; T=0.K  
alphas from (d,2n)2a

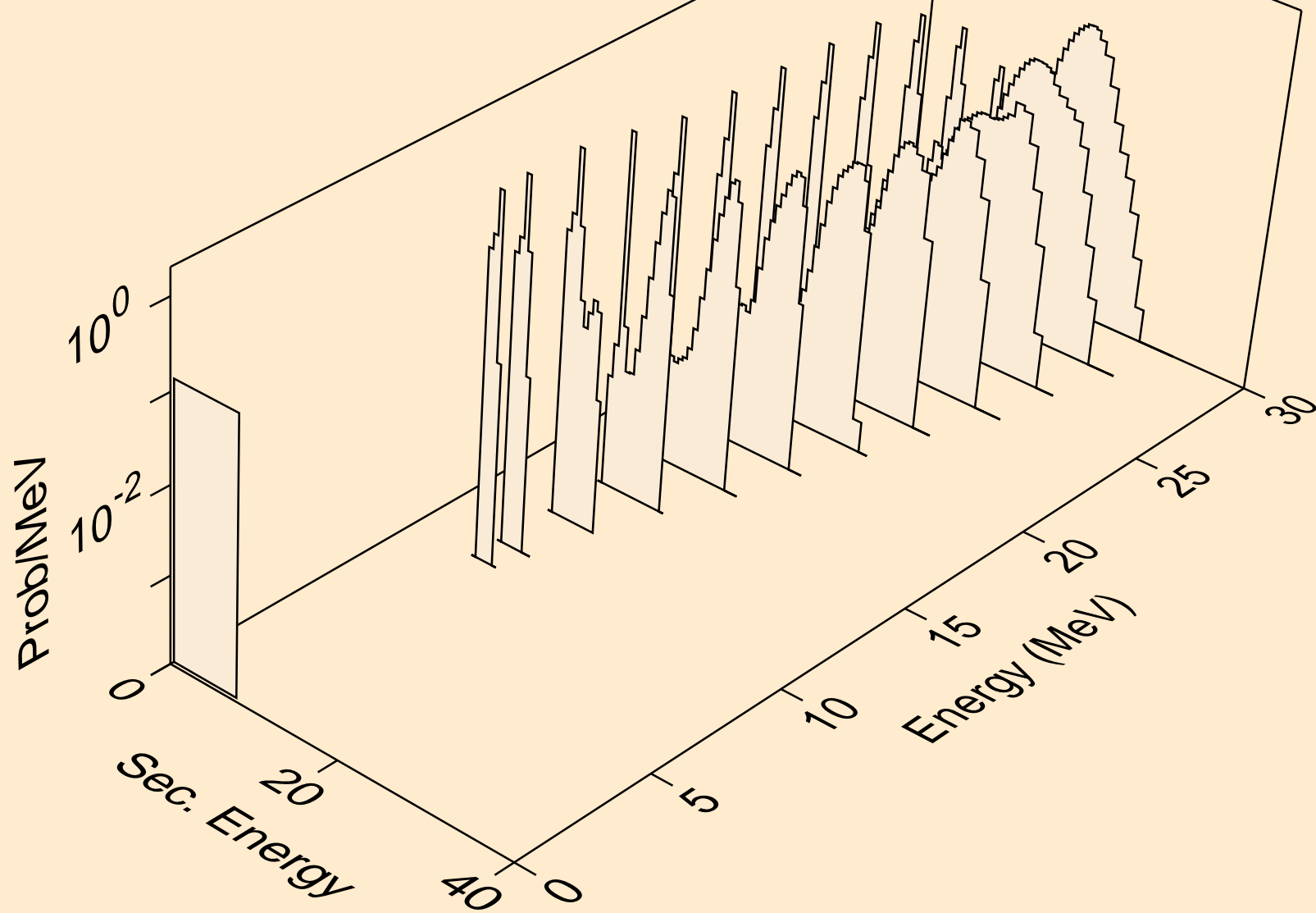

U227 DEUTERON ACER TENDL-2024 LIBRARY; T=0.K  
alphas from (d,npa)

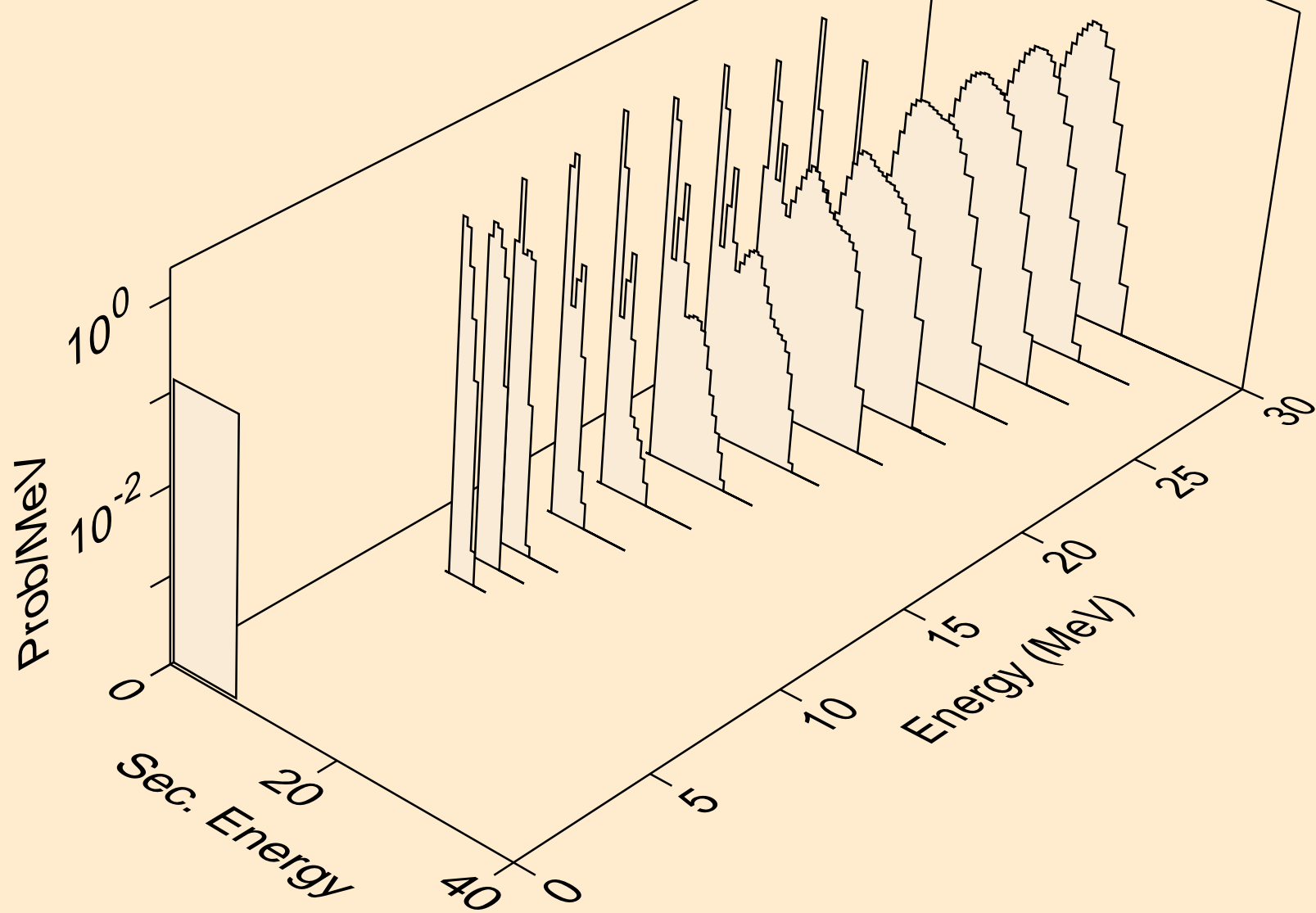

U227 DEUTERON ACER TENDL-2024 LIBRARY; T=0.K  
alphas from (d,a)

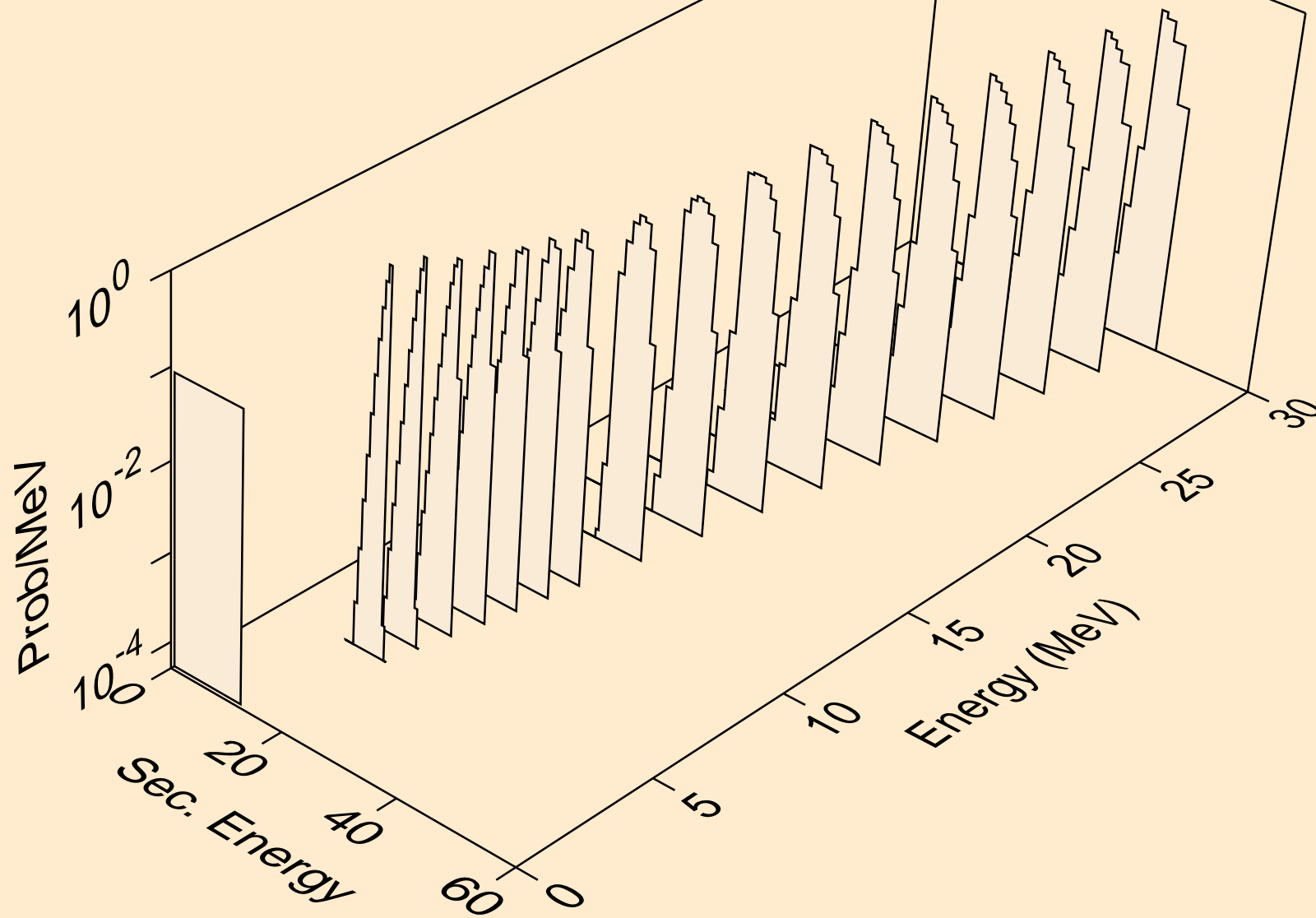

U227 DEUTERON ACER TENDL-2024 LIBRARY; T=0.K  
alphas from (d,2a)

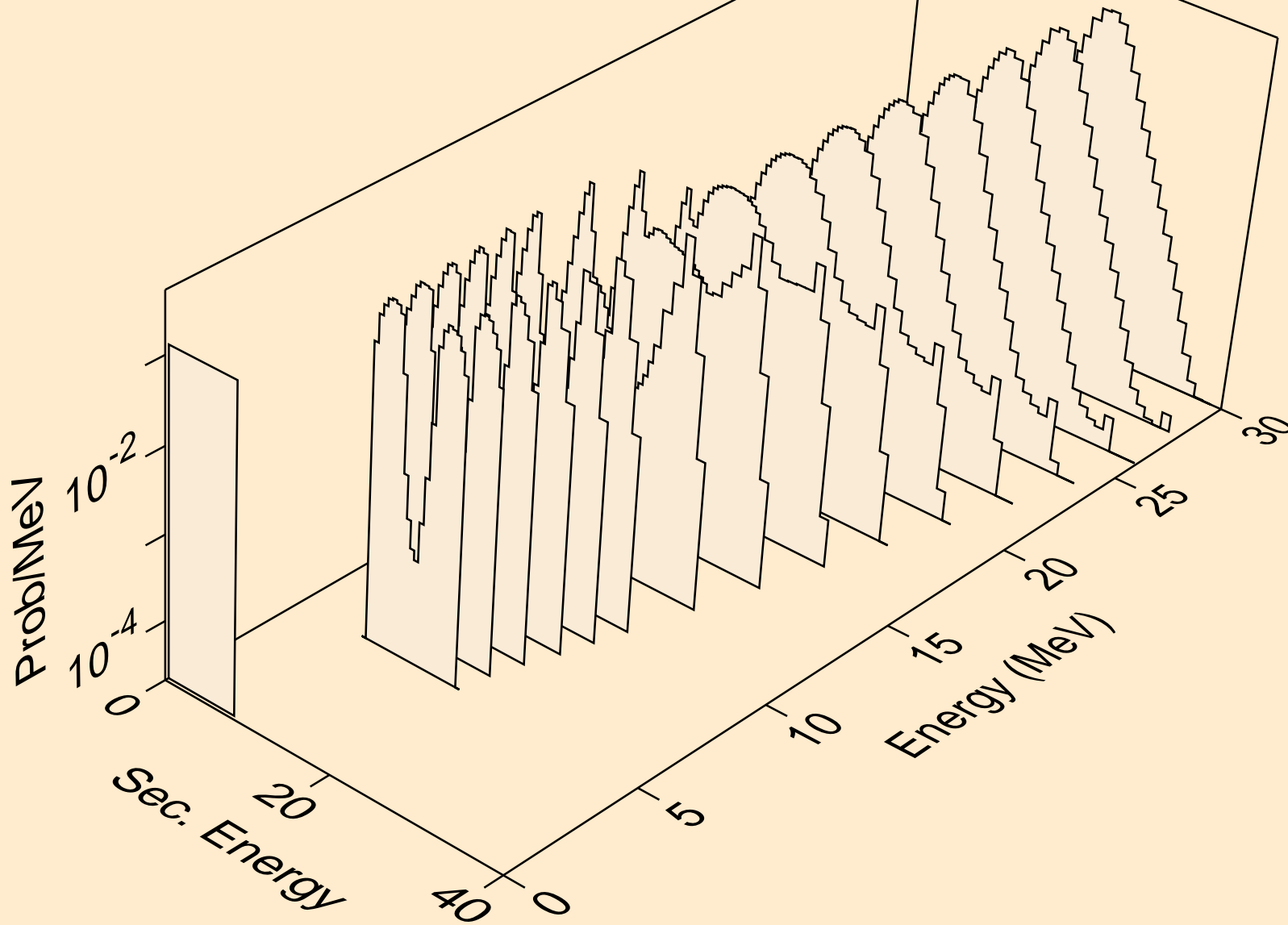

U227 DEUTERON ACER TENDL-2024 LIBRARY; T=0.K  
alphas from (d,pa)

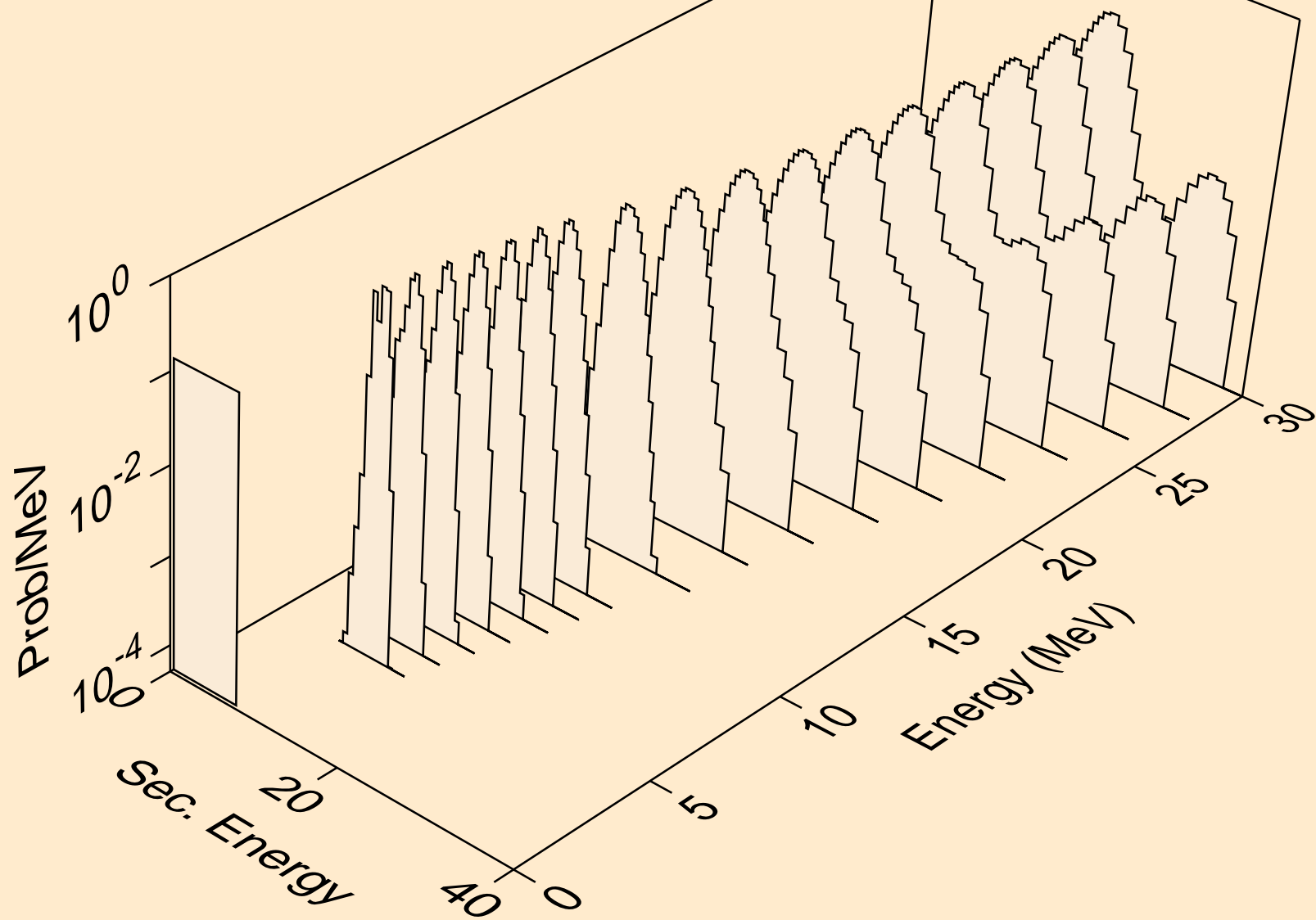

U227 DEUTERON ACER TENDL-2024 LIBRARY; T=0.K  
alphas from (d,da)

