

# W196 DEUTERON ACER TENDL-2024 LIBRARY; T=0.K

## Principal cross sections

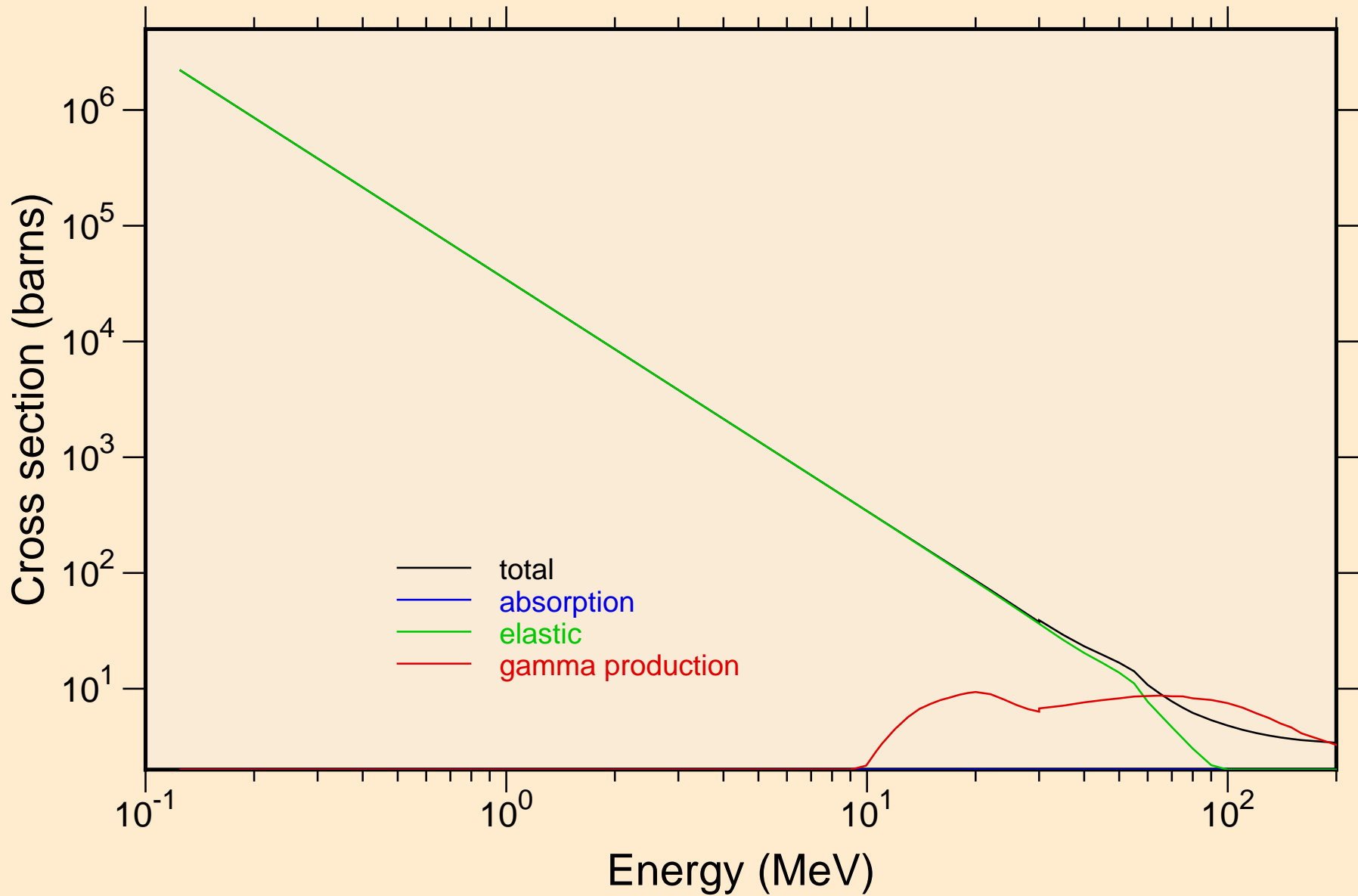

# W196 DEUTERON ACER TENDL-2024 LIBRARY; T=0.K

## Heating

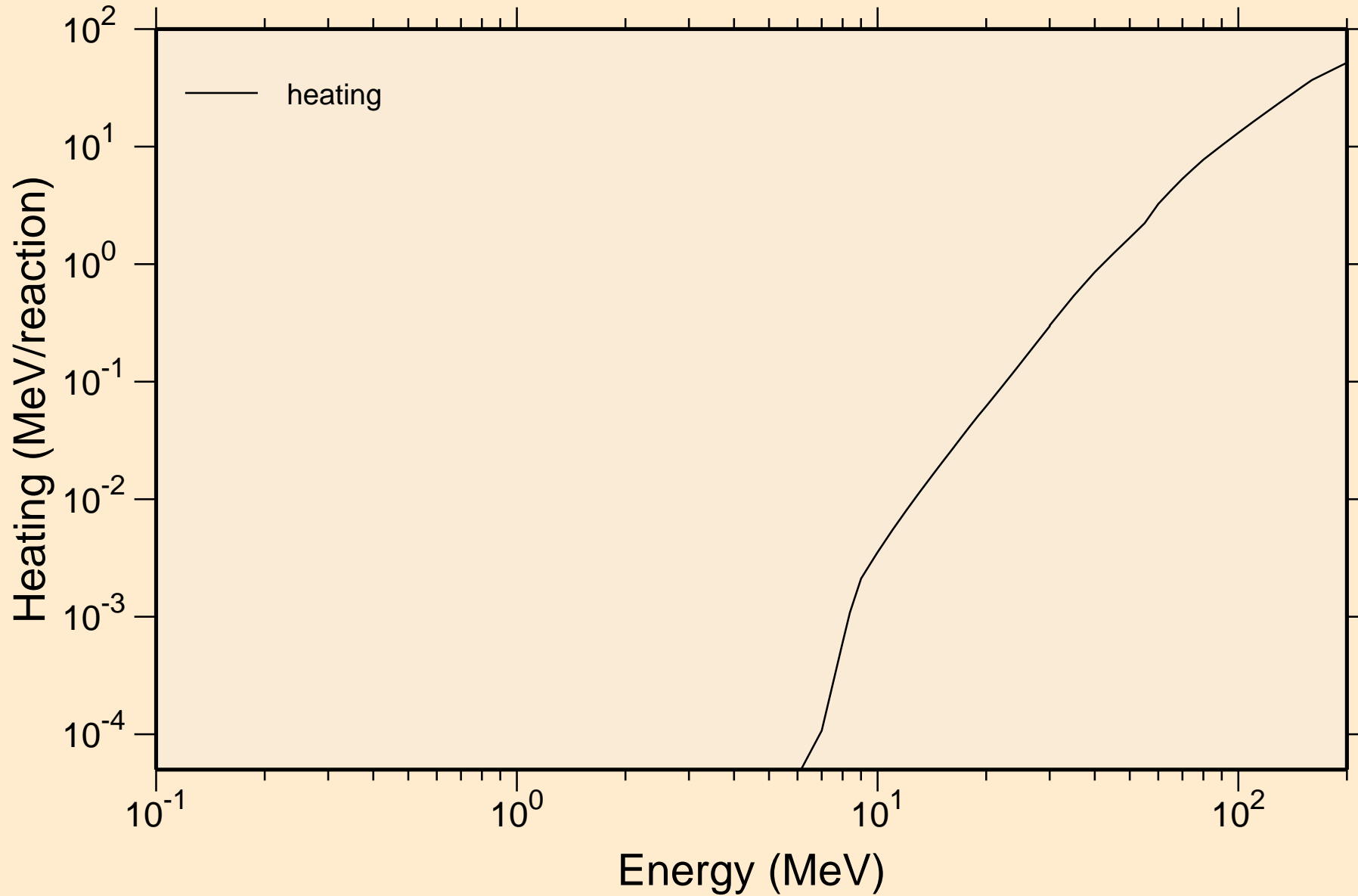

# W196 DEUTERON ACER TENDL-2024 LIBRARY; T=0.K

## Principal cross sections

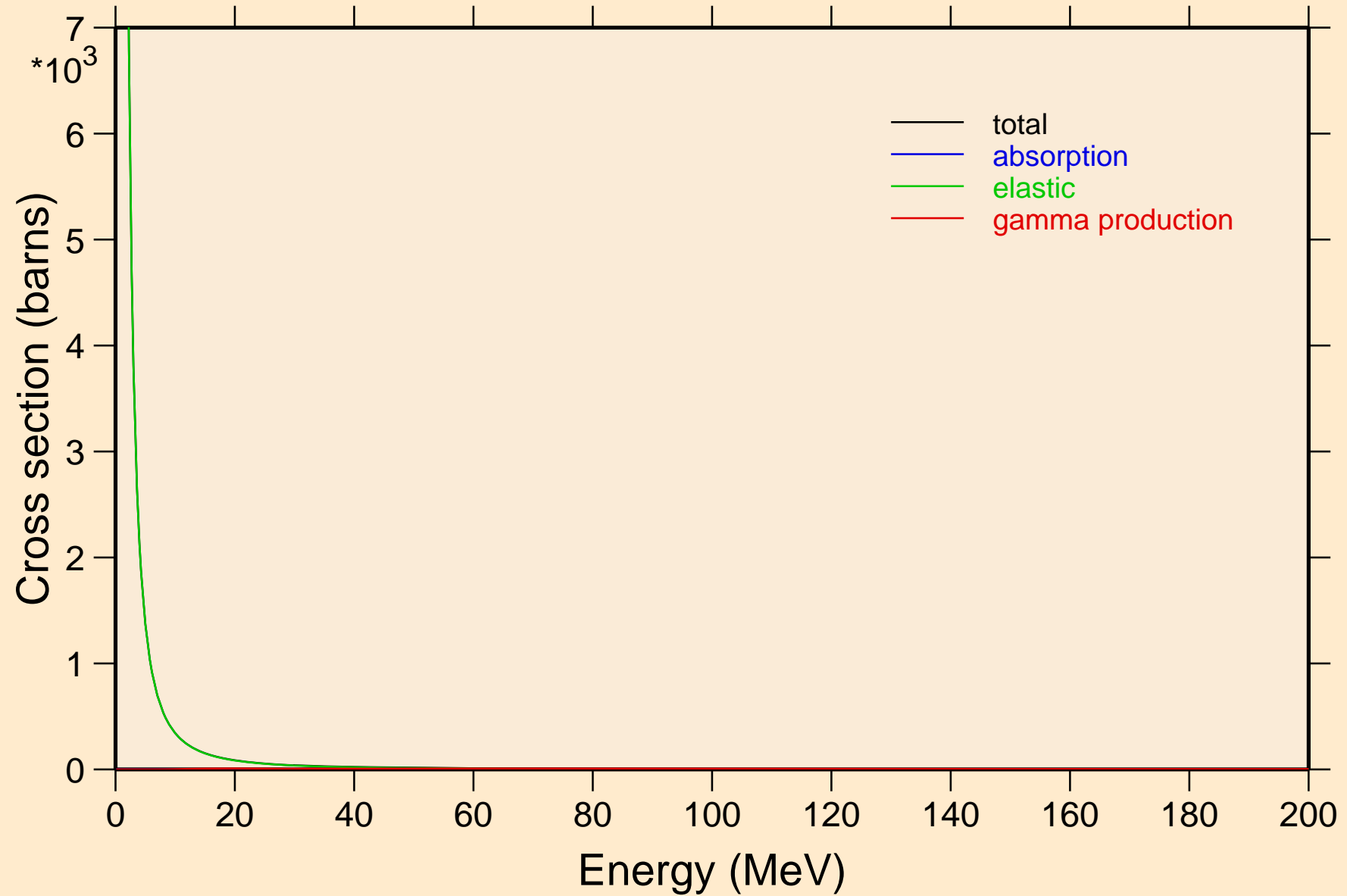

# W196 DEUTERON ACER TENDL-2024 LIBRARY; T=0.K

## Heating

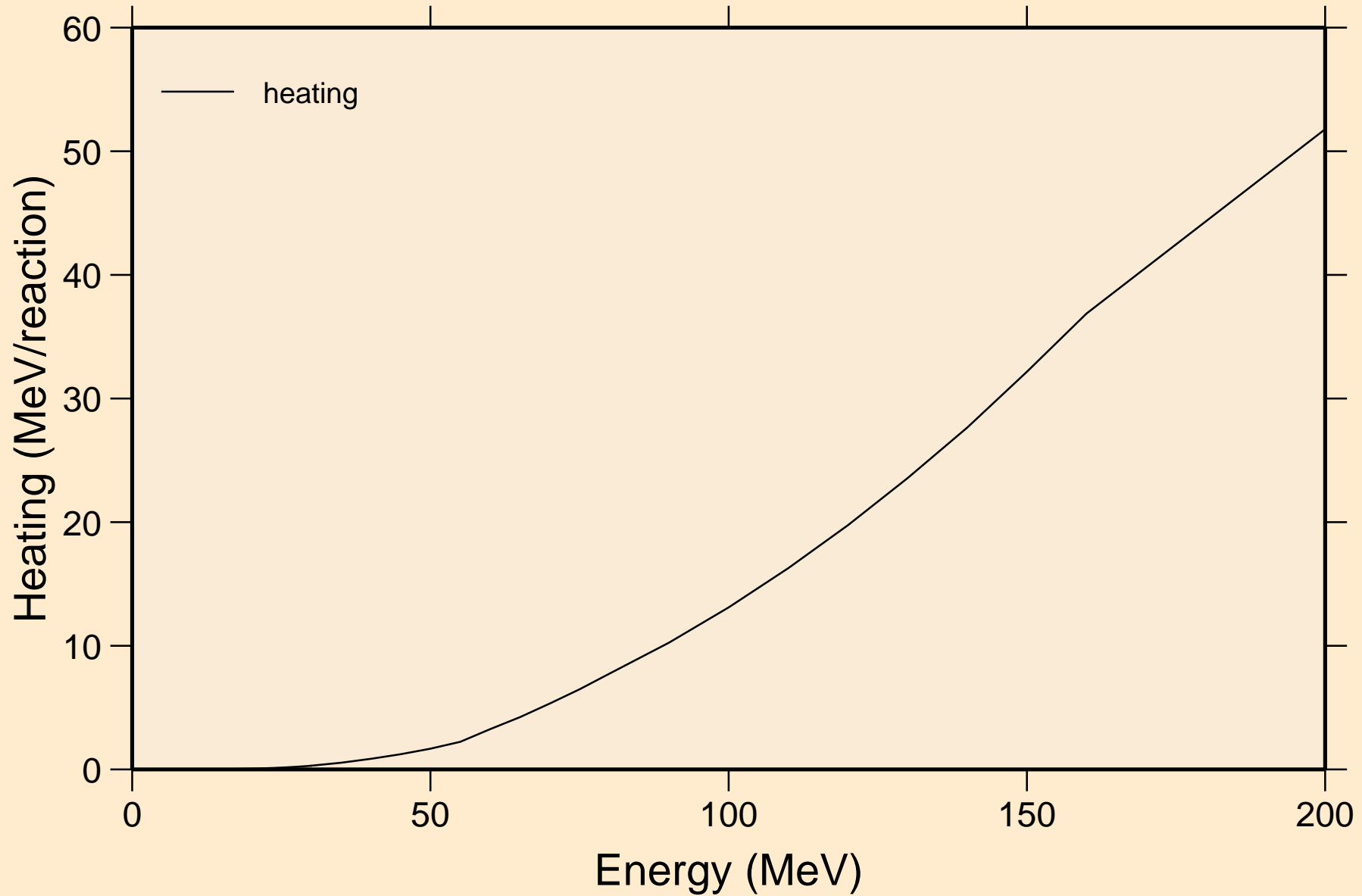

# W196 DEUTERON ACER TENDL-2024 LIBRARY; T=0.K

## Threshold reactions

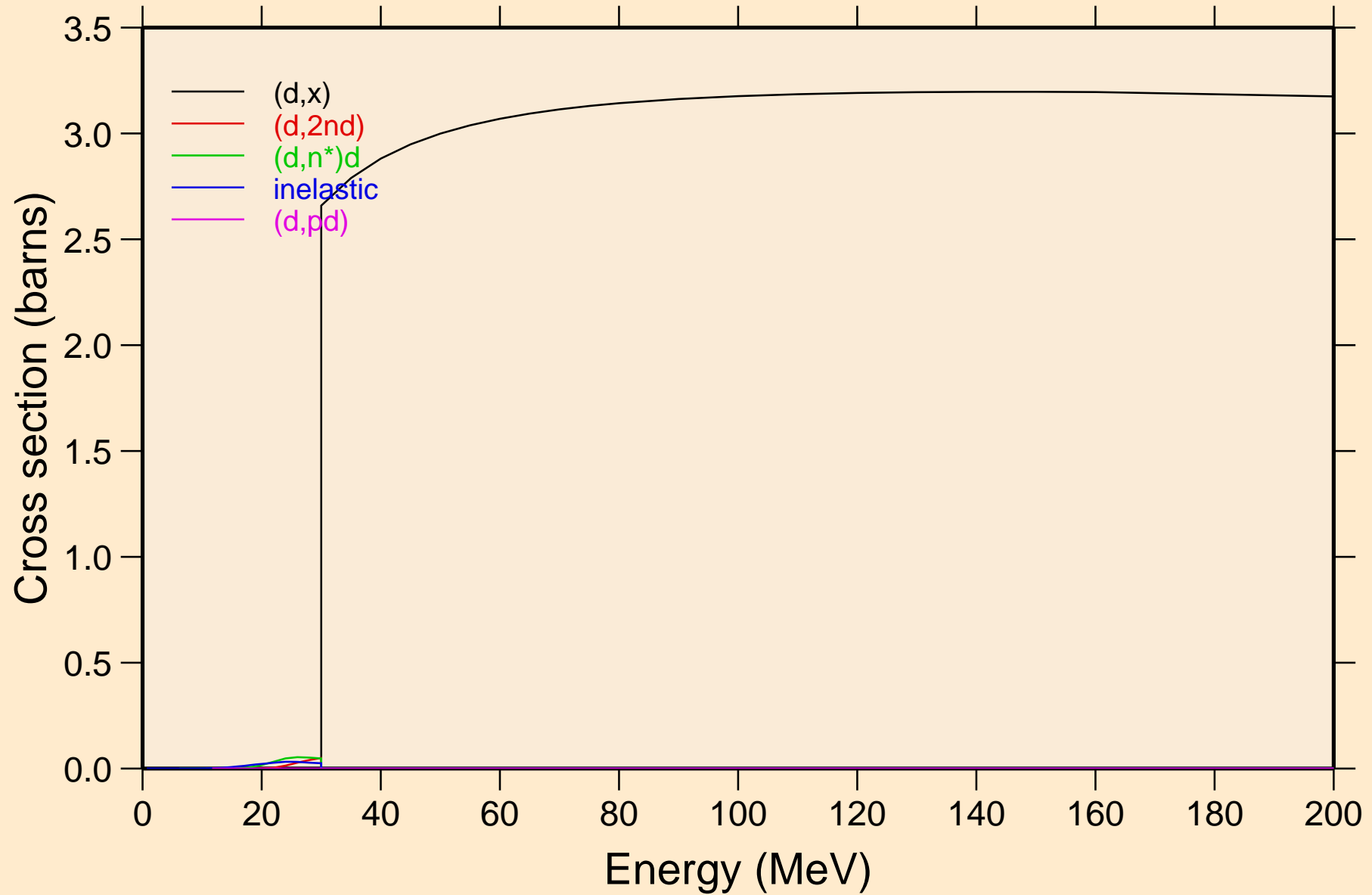

W196 DEUTERON ACER TENDL-2024 LIBRARY; T=0.K  
angular distribution for elastic

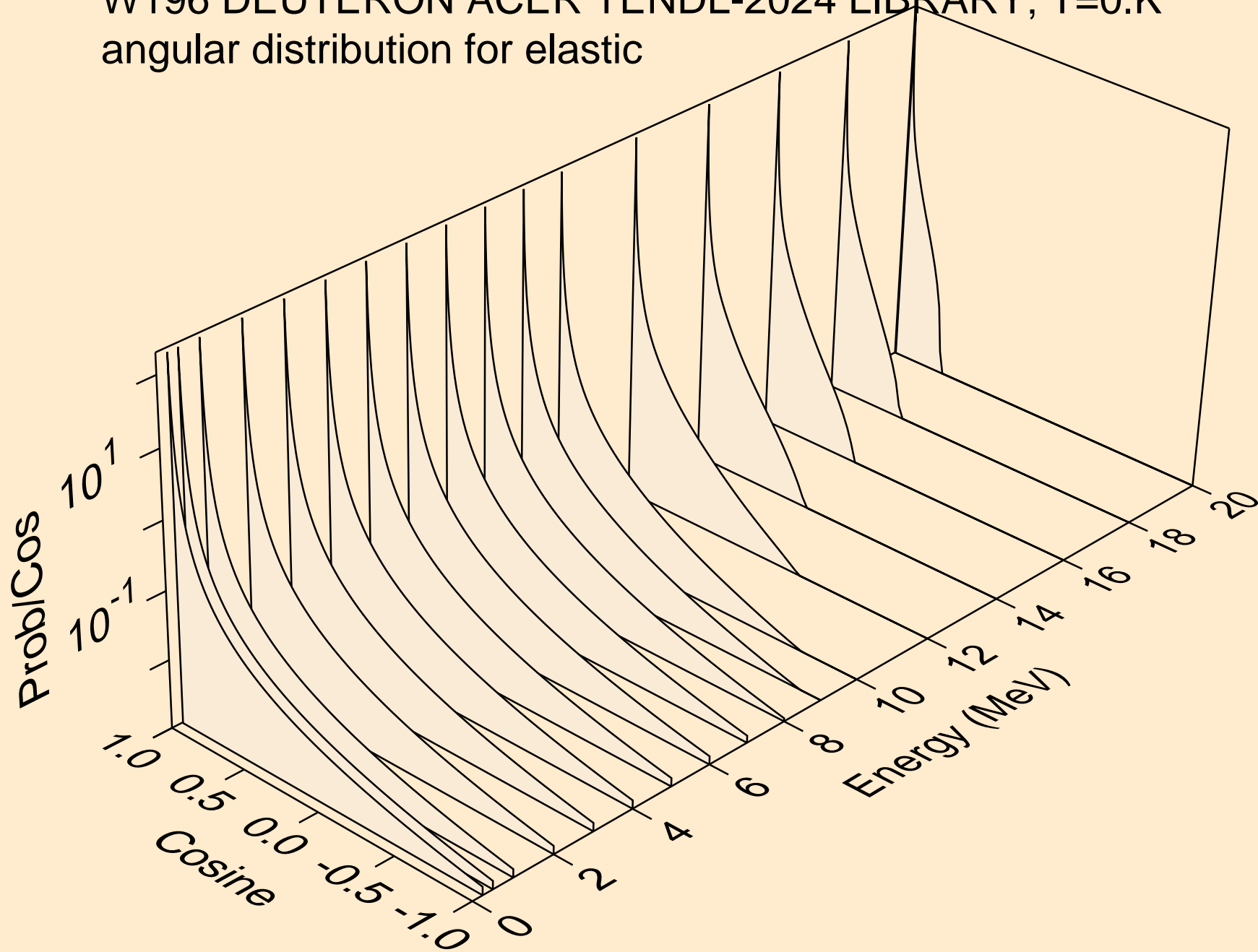

W196 DEUTERON ACER TENDL-2024 LIBRARY; T=0.K  
angular distribution for elastic

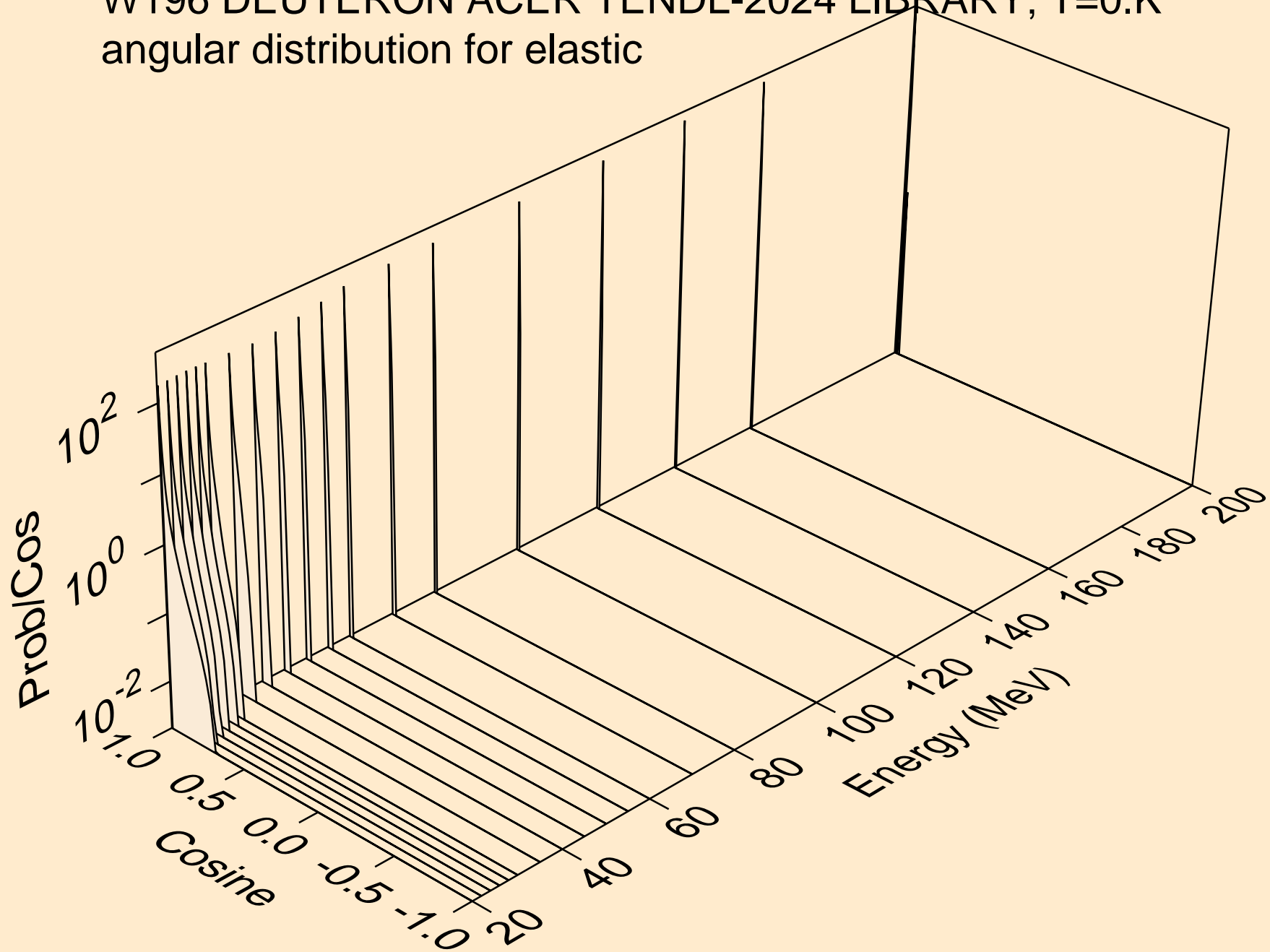

W196 DEUTERON ACER TENDL-2024 LIBRARY; T=0.K  
Deuteron emission for (d,x)

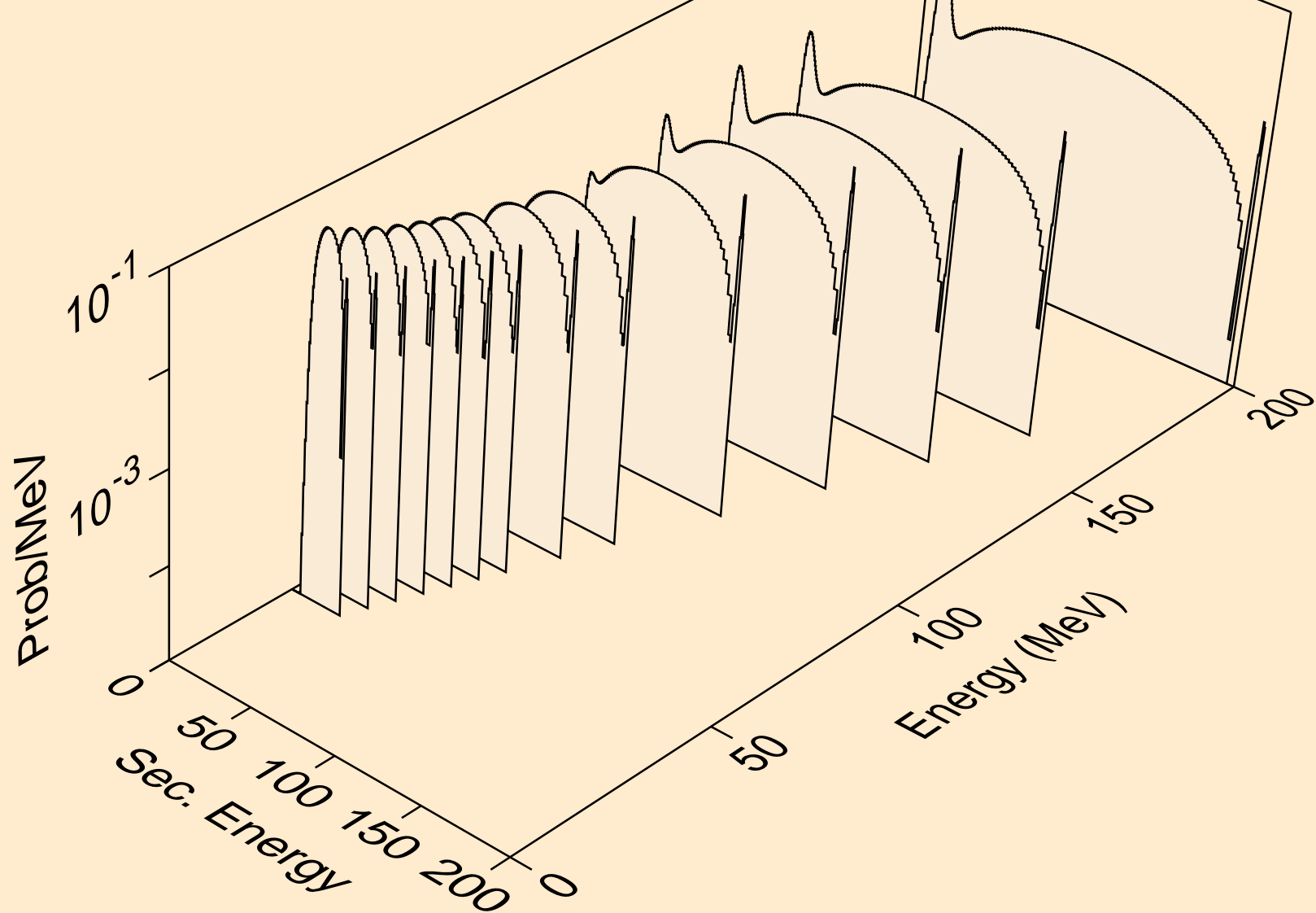

W196 DEUTERON ACER TENDL-2024 LIBRARY; T=0.K  
Deuteron emission for (d,2nd)

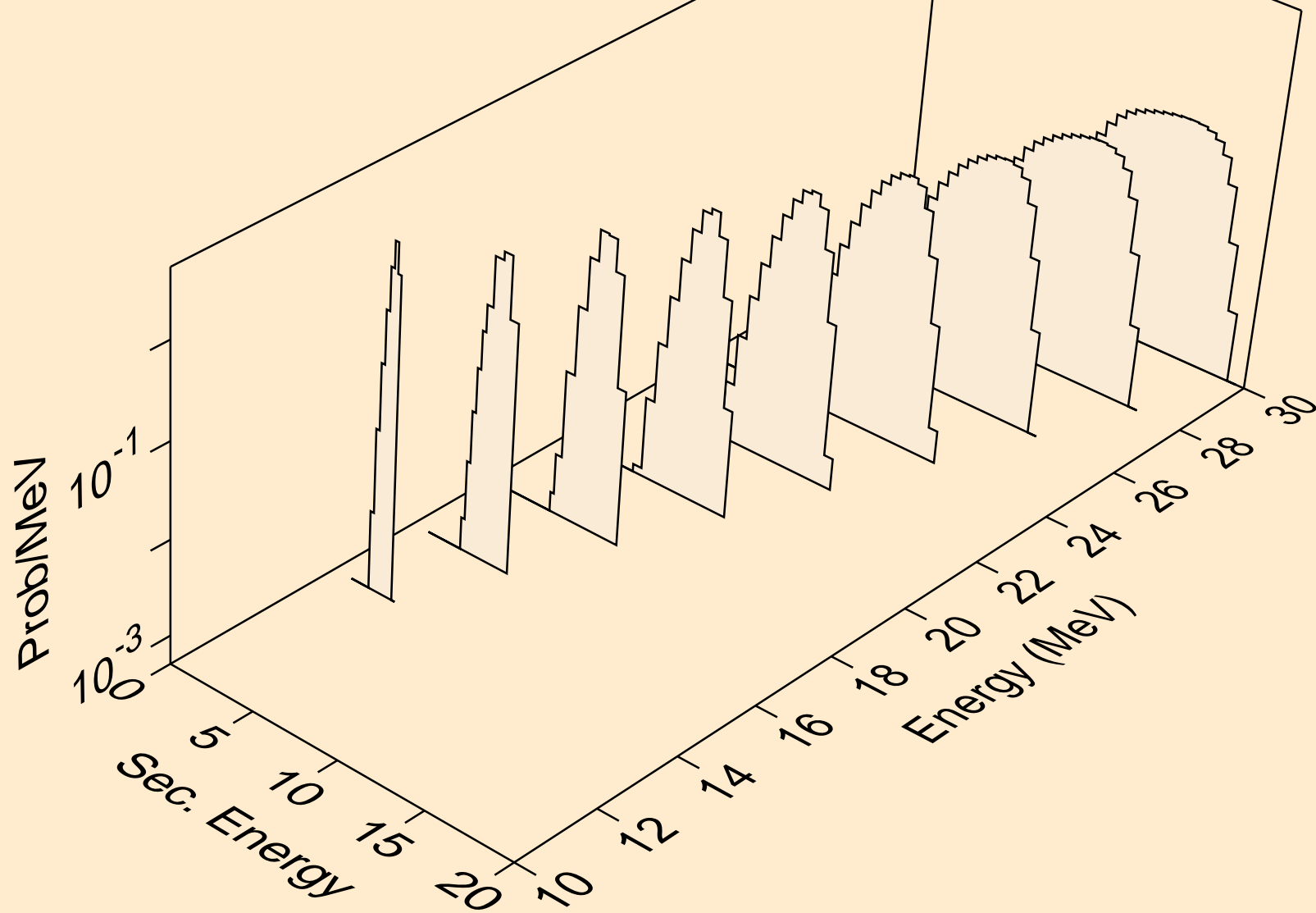

W196 DEUTERON ACER TENDL-2024 LIBRARY; T=0.K  
Deuteron emission for (d,n\*)d

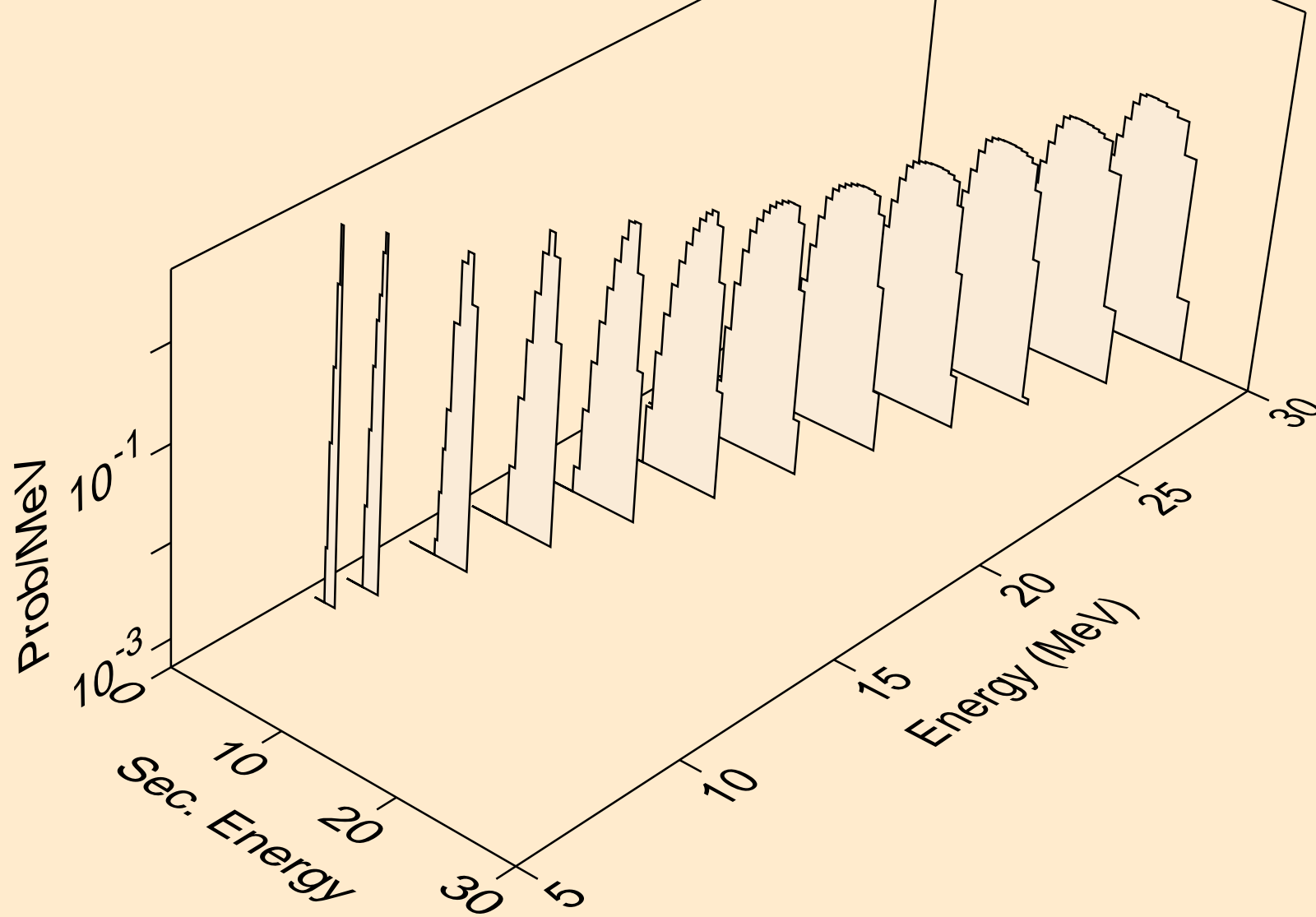

W196 DEUTERON ACER TENDL-2024 LIBRARY; T=0.K  
Deuteron emission for inelastic

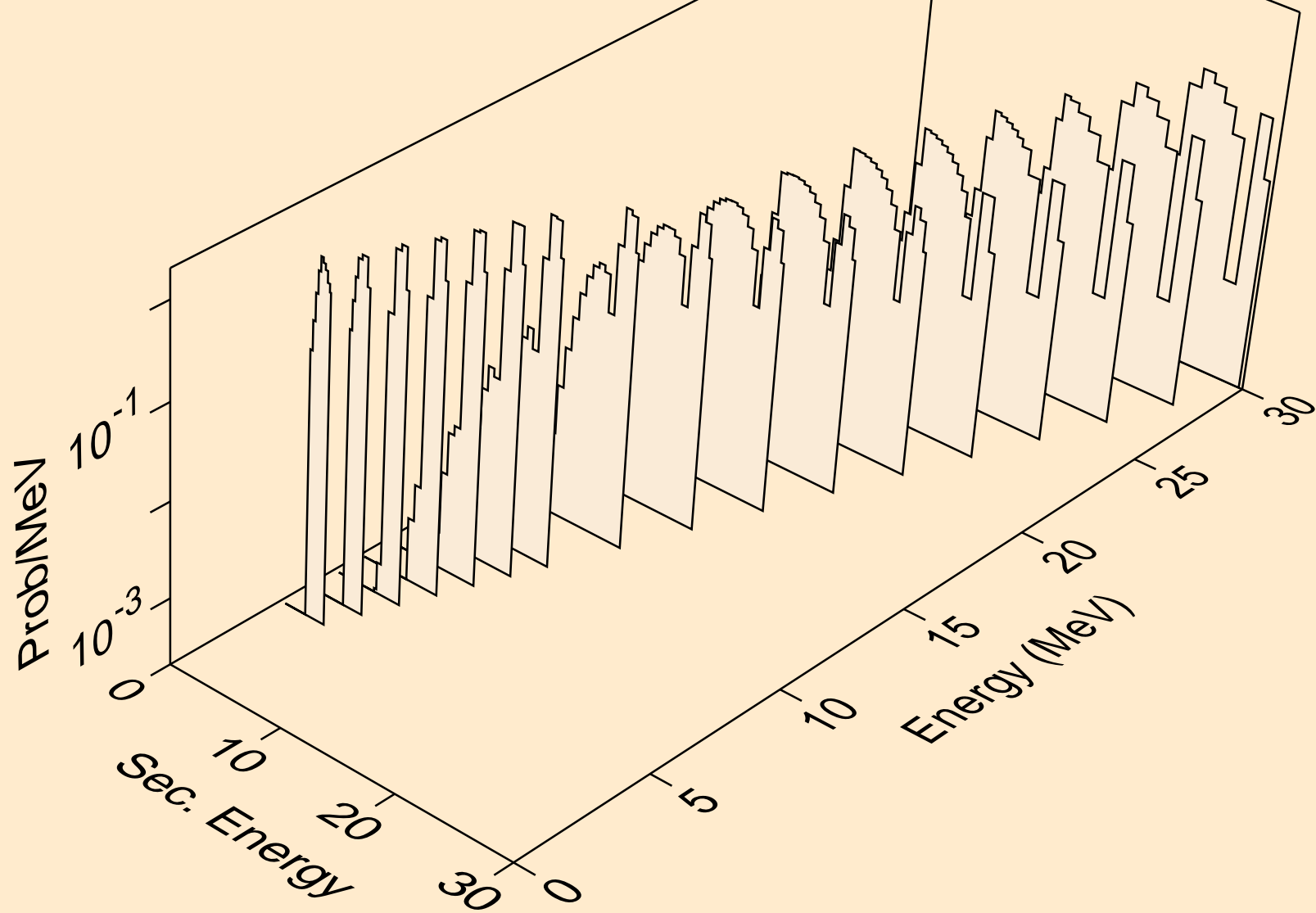

W196 DEUTERON ACER TENDL-2024 LIBRARY; T=0.K  
Deuteron emission for (d,pd)

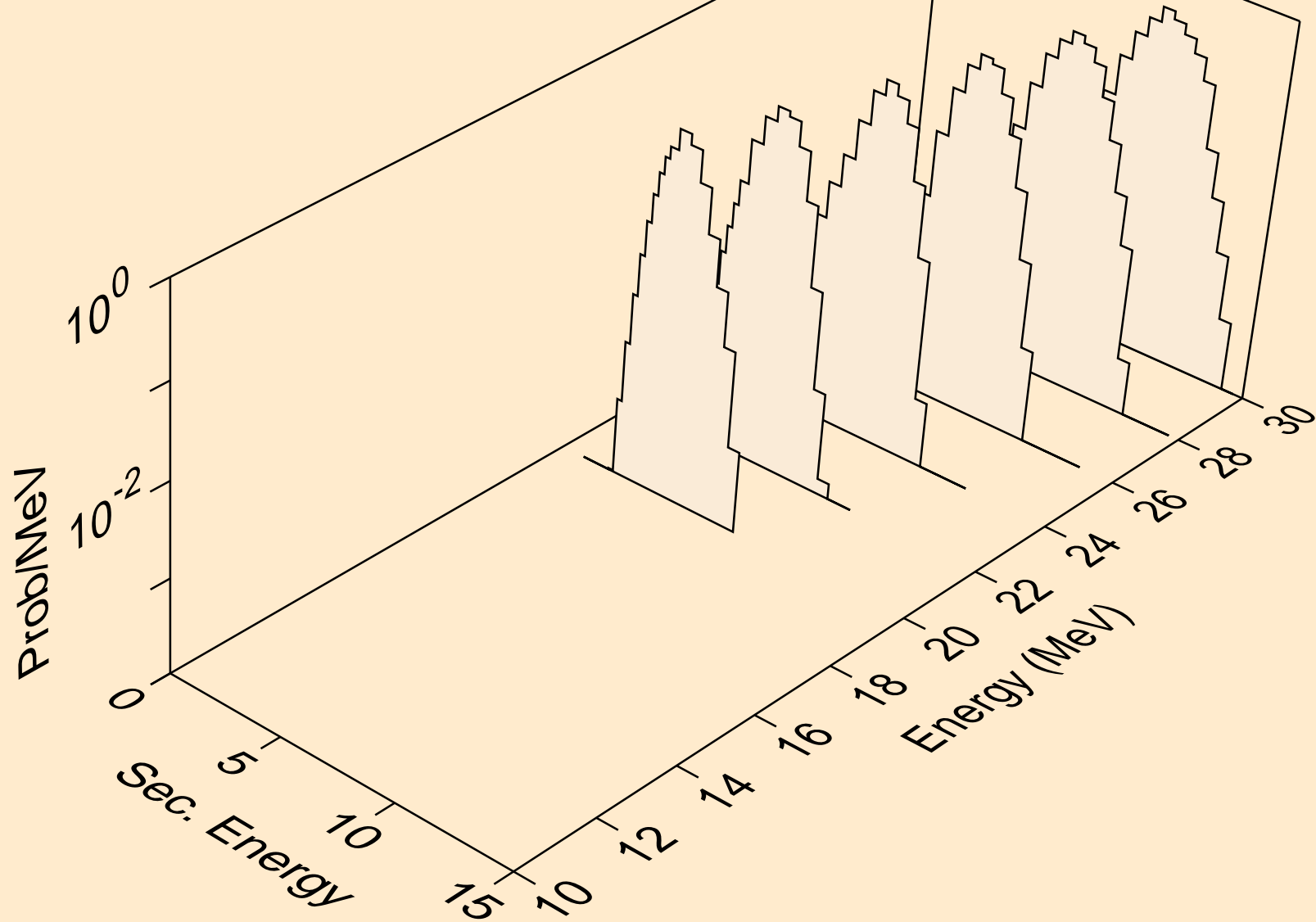

W196 DEUTERON ACER TENDL-2024 LIBRARY; T=0.K  
Photon emission for (z,n)

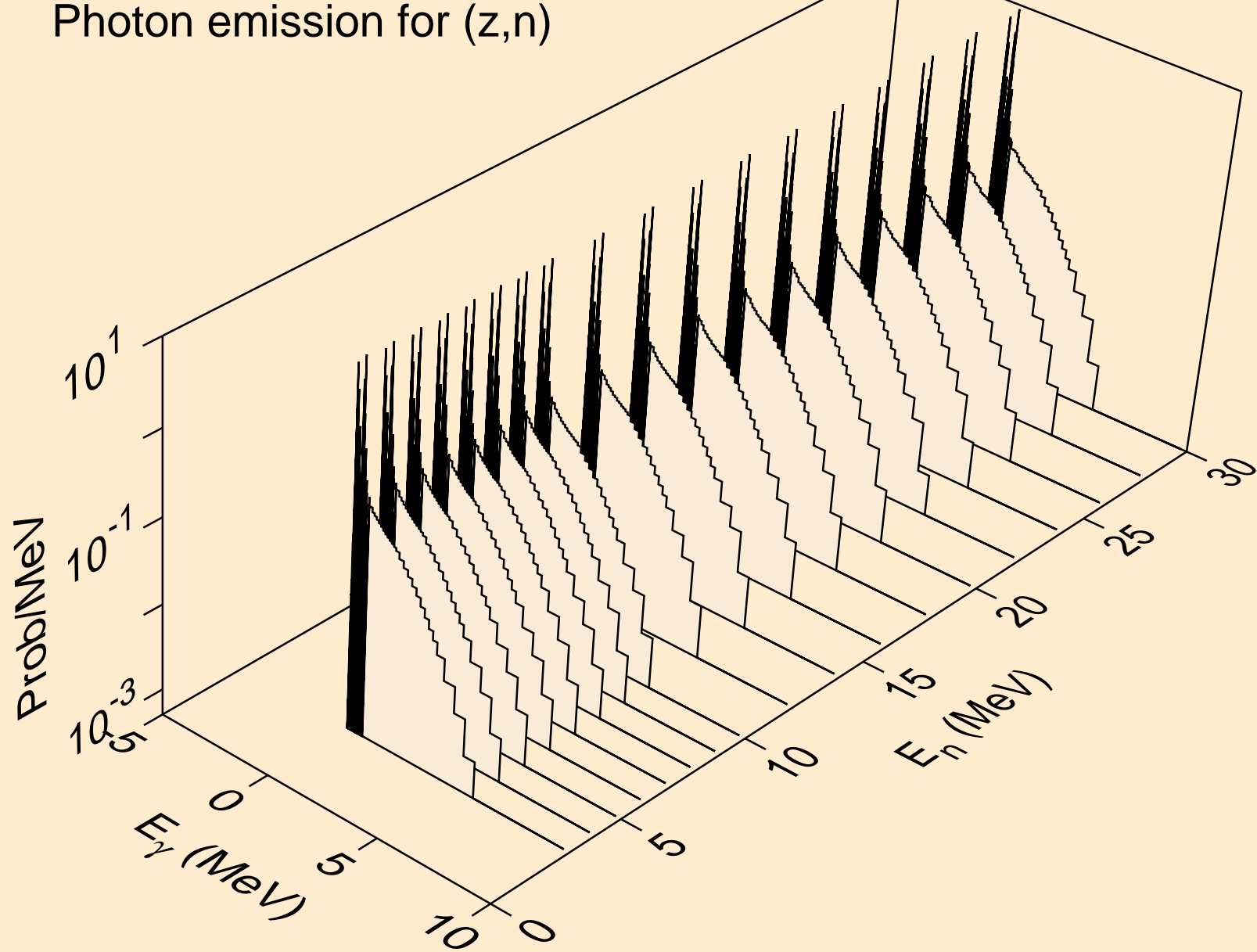

W196 DEUTERON ACER TENDL-2024 LIBRARY; T=0.K  
Photon emission for (z,x)

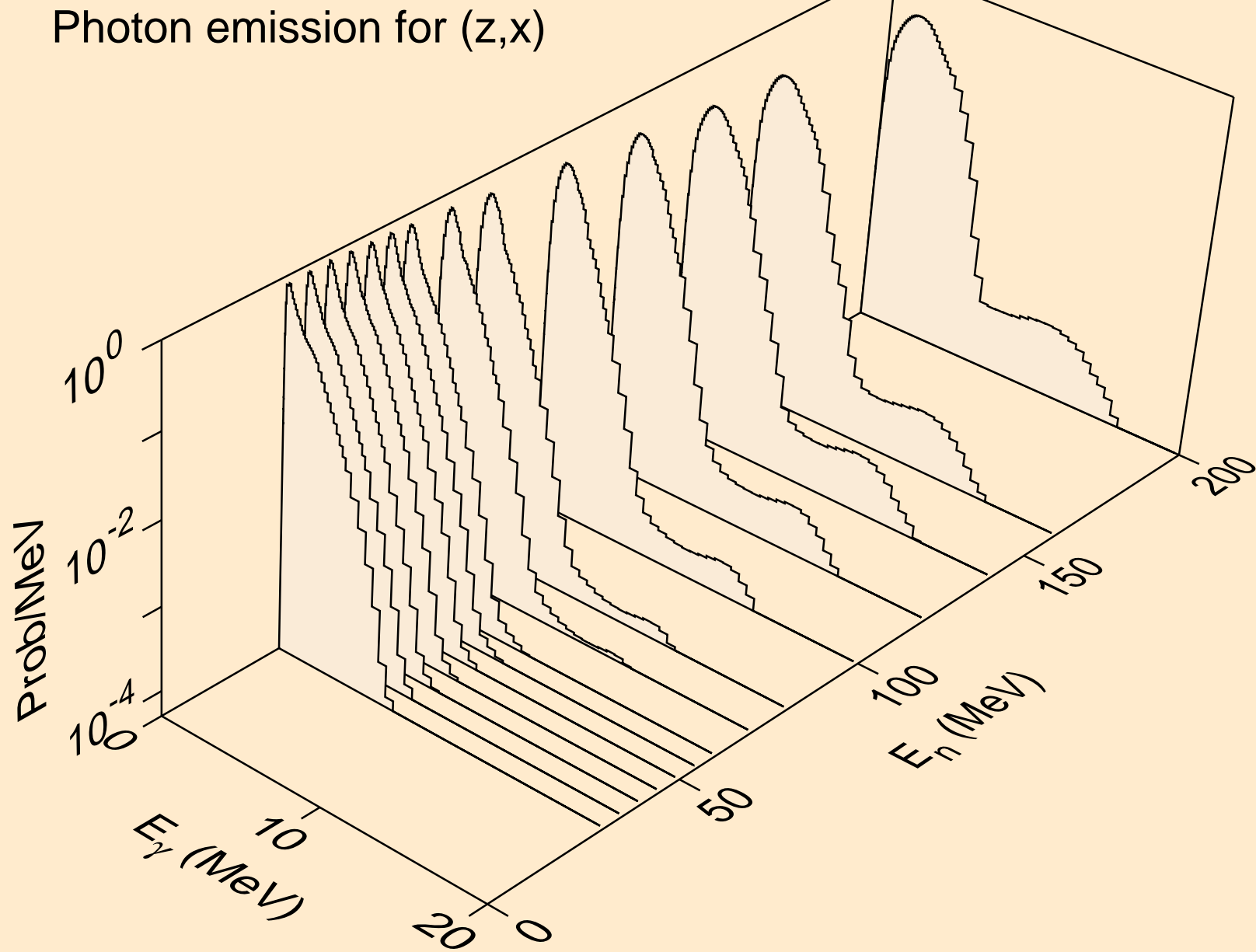

W196 DEUTERON ACER TENDL-2024 LIBRARY; T=0.K  
Photon emission for (n,2nd)

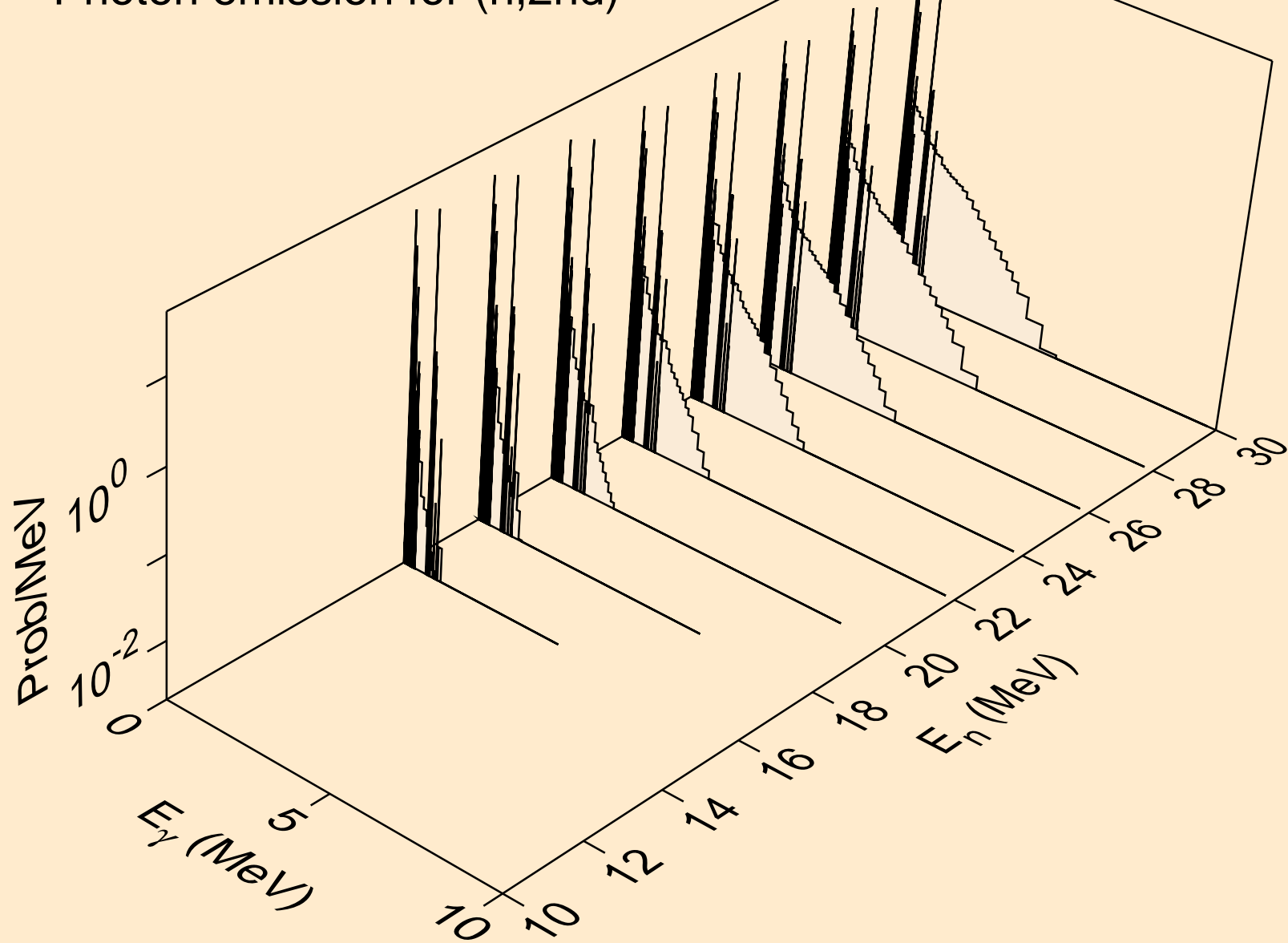

W196 DEUTERON ACER TENDL-2024 LIBRARY; T=0.K  
Photon emission for (n,2n)

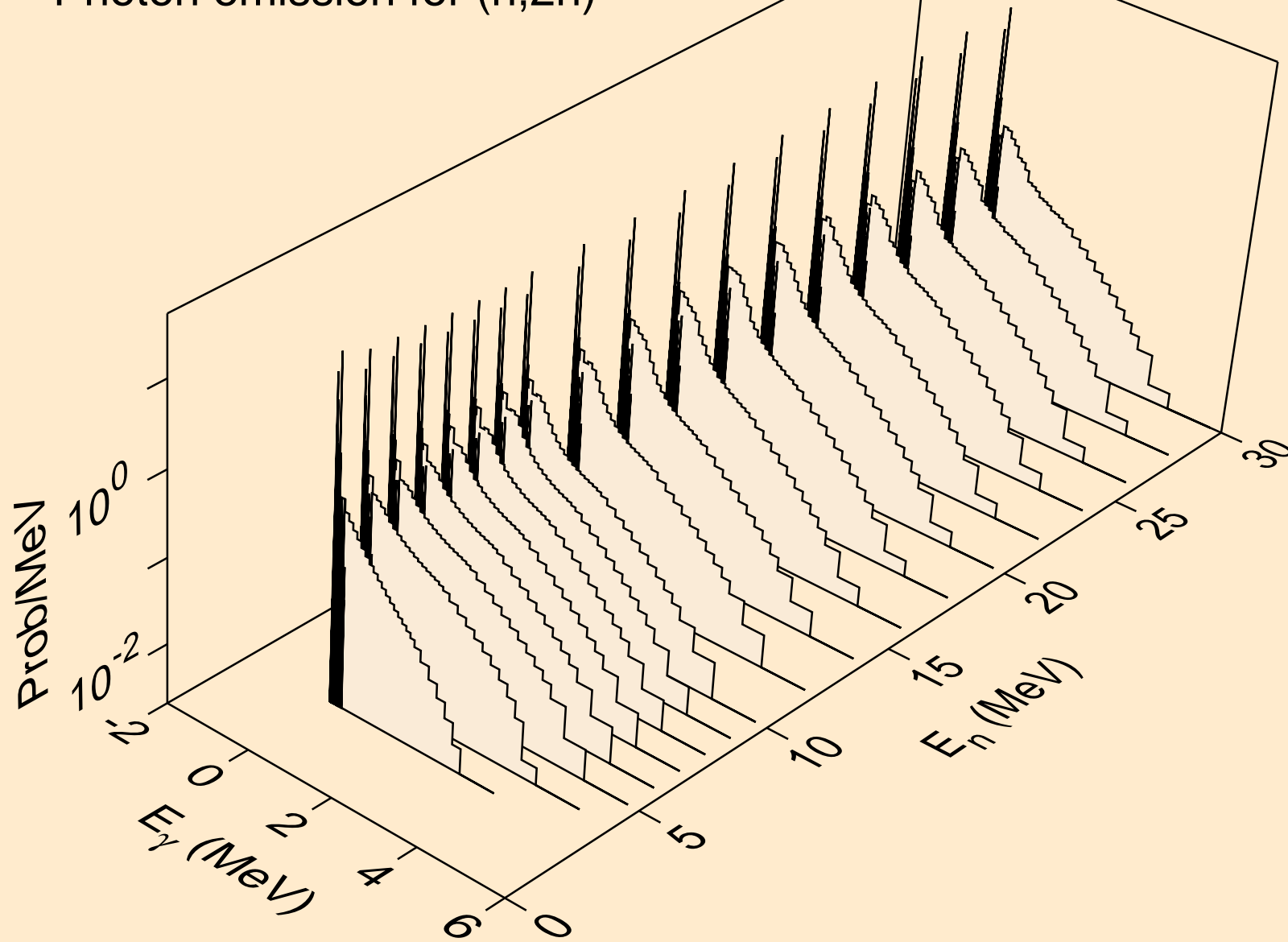

W196 DEUTERON ACER TENDL-2024 LIBRARY; T=0.K  
Photon emission for (n,3n)

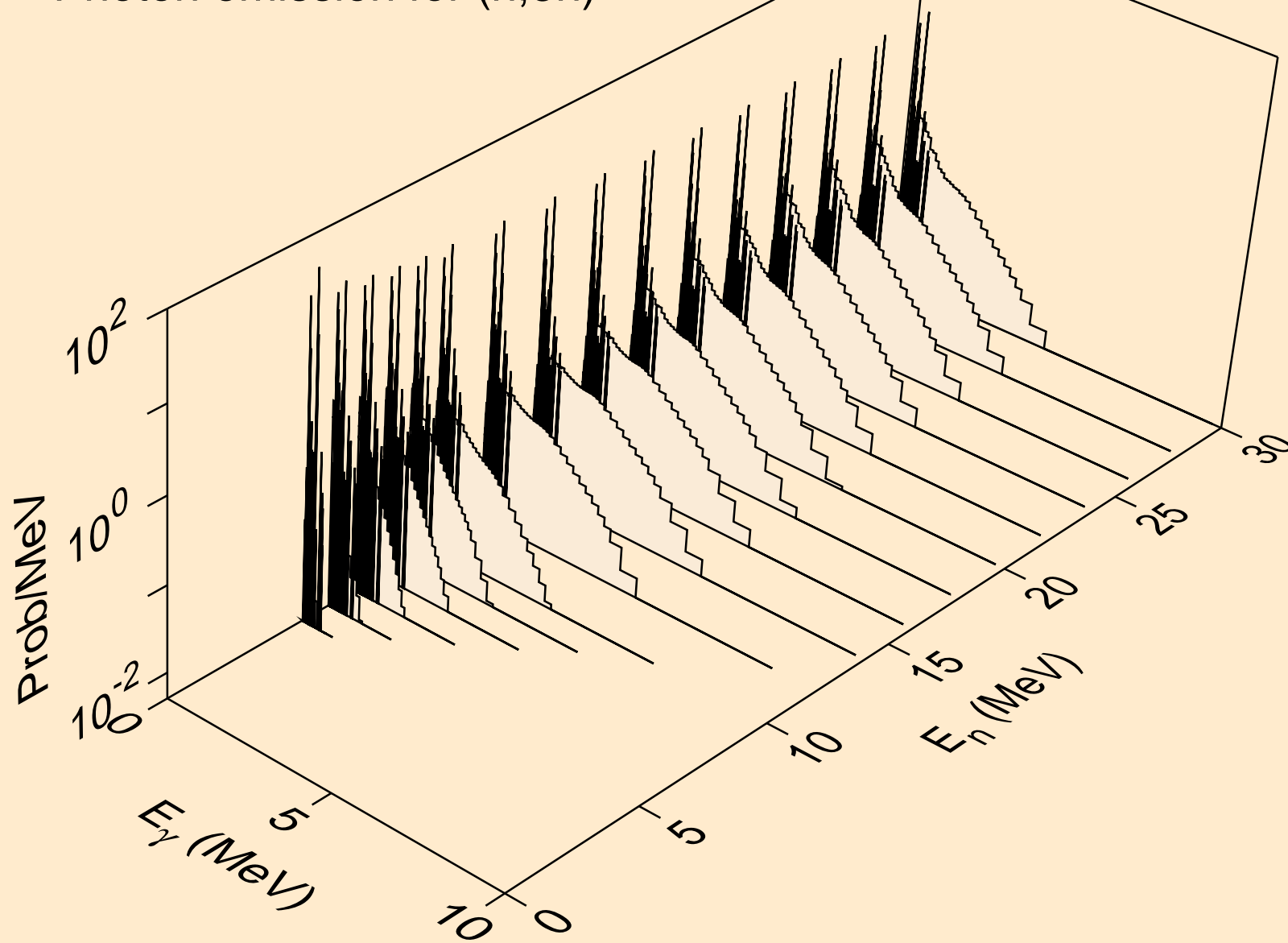

W196 DEUTERON ACER TENDL-2024 LIBRARY; T=0.K  
Photon emission for (n,n\*)a

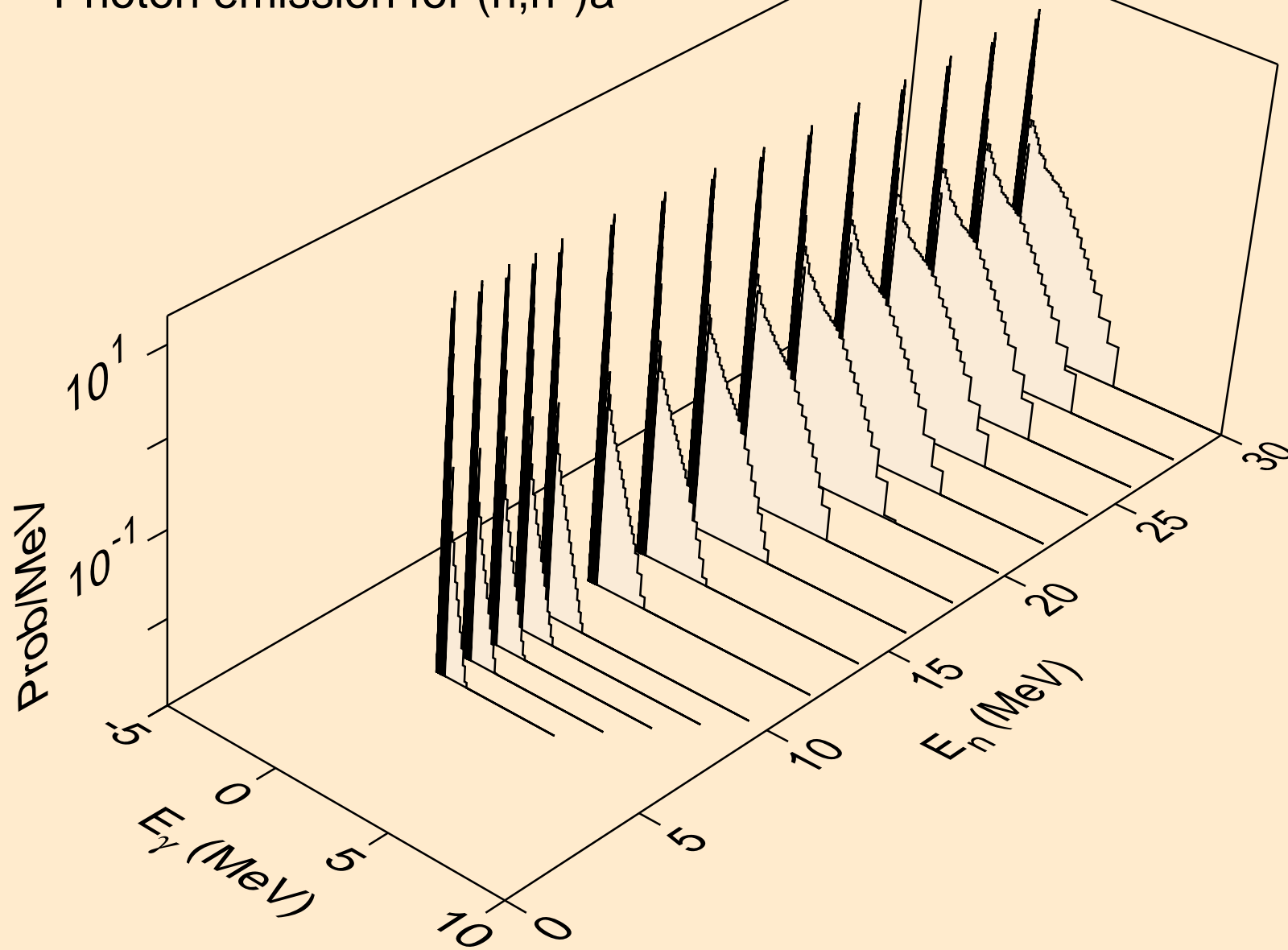

W196 DEUTERON ACER TENDL-2024 LIBRARY; T=0.K  
Photon emission for (n,2n)a

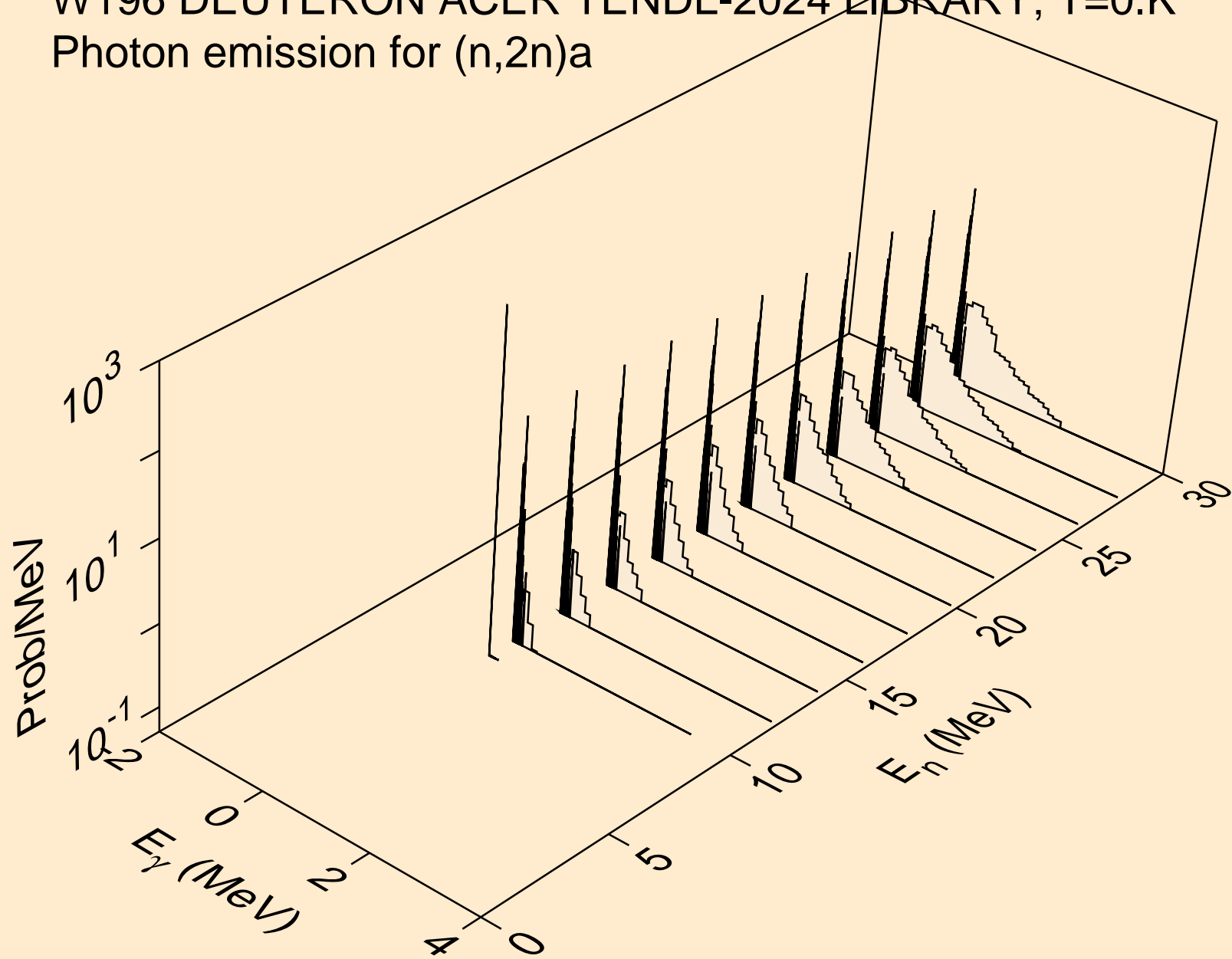

W196 DEUTERON ACER TENDL-2024 LIBRARY; T=0.K  
Photon emission for (n,3n)a

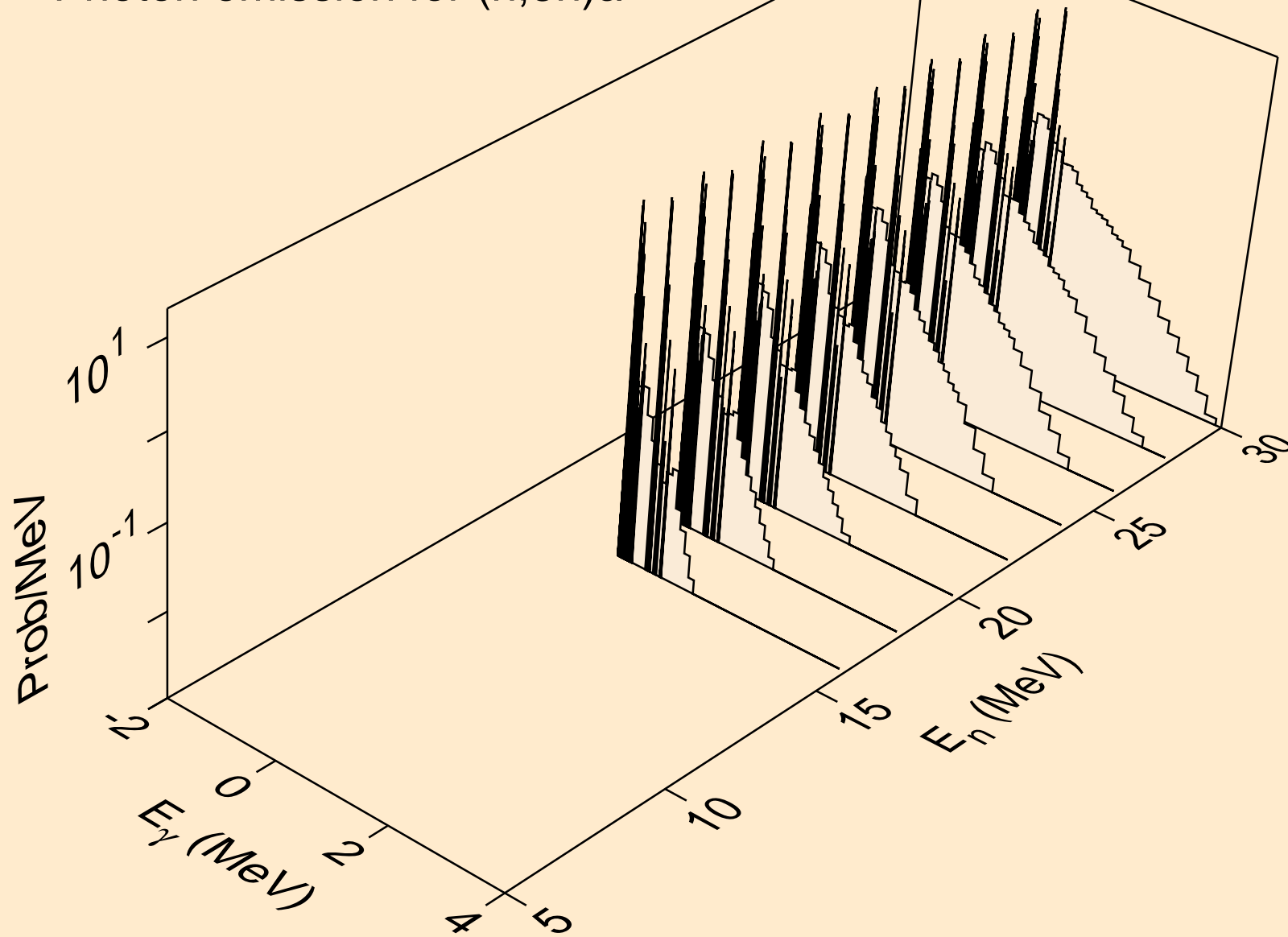

W196 DEUTERON ACER TENDL-2024 LIBRARY; T=0.K  
Photon emission for (n,n\*)p

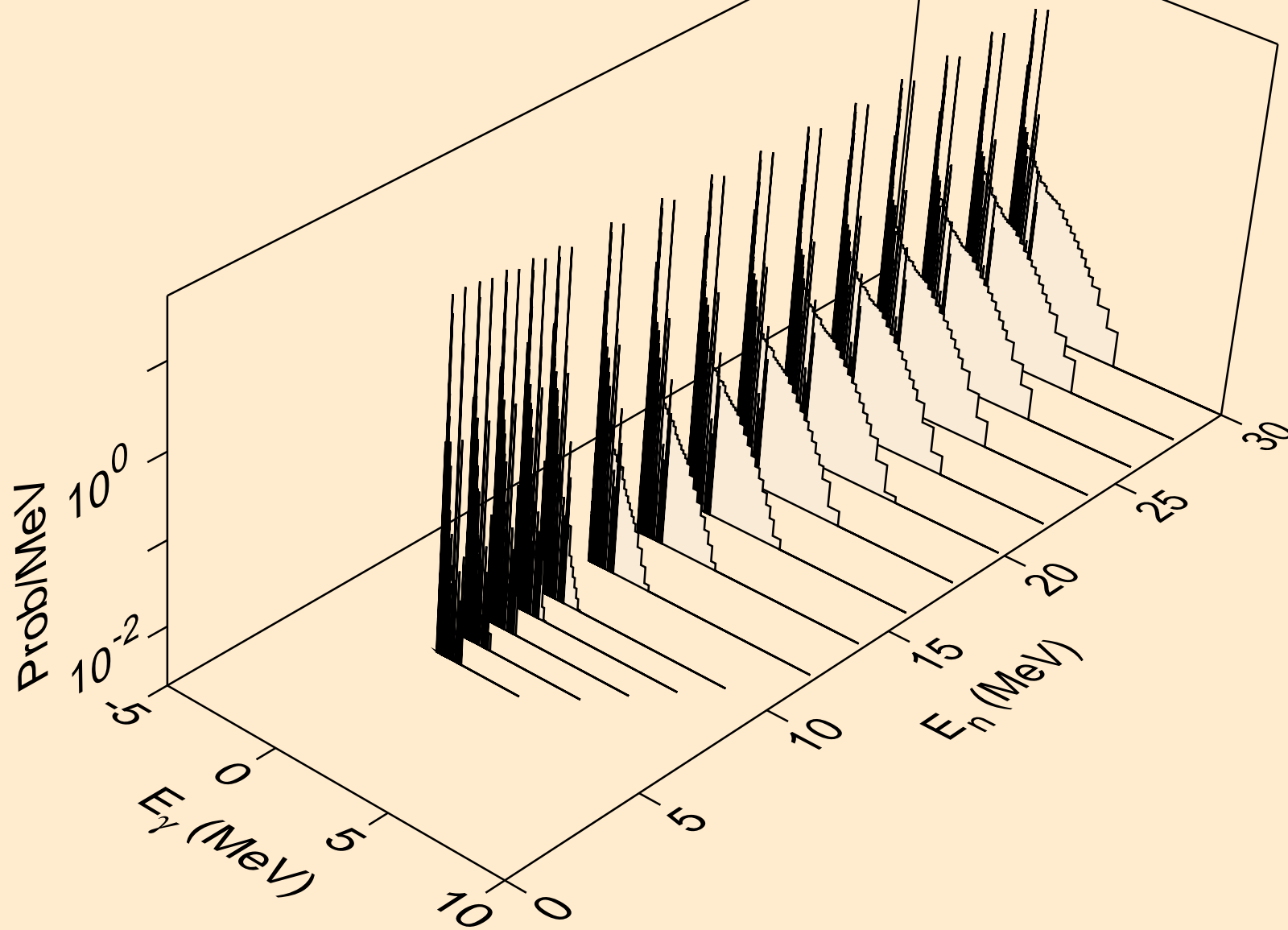

W196 DEUTERON ACER TENDL-2024 LIBRARY; T=0.K  
Photon emission for (n,n\*)d

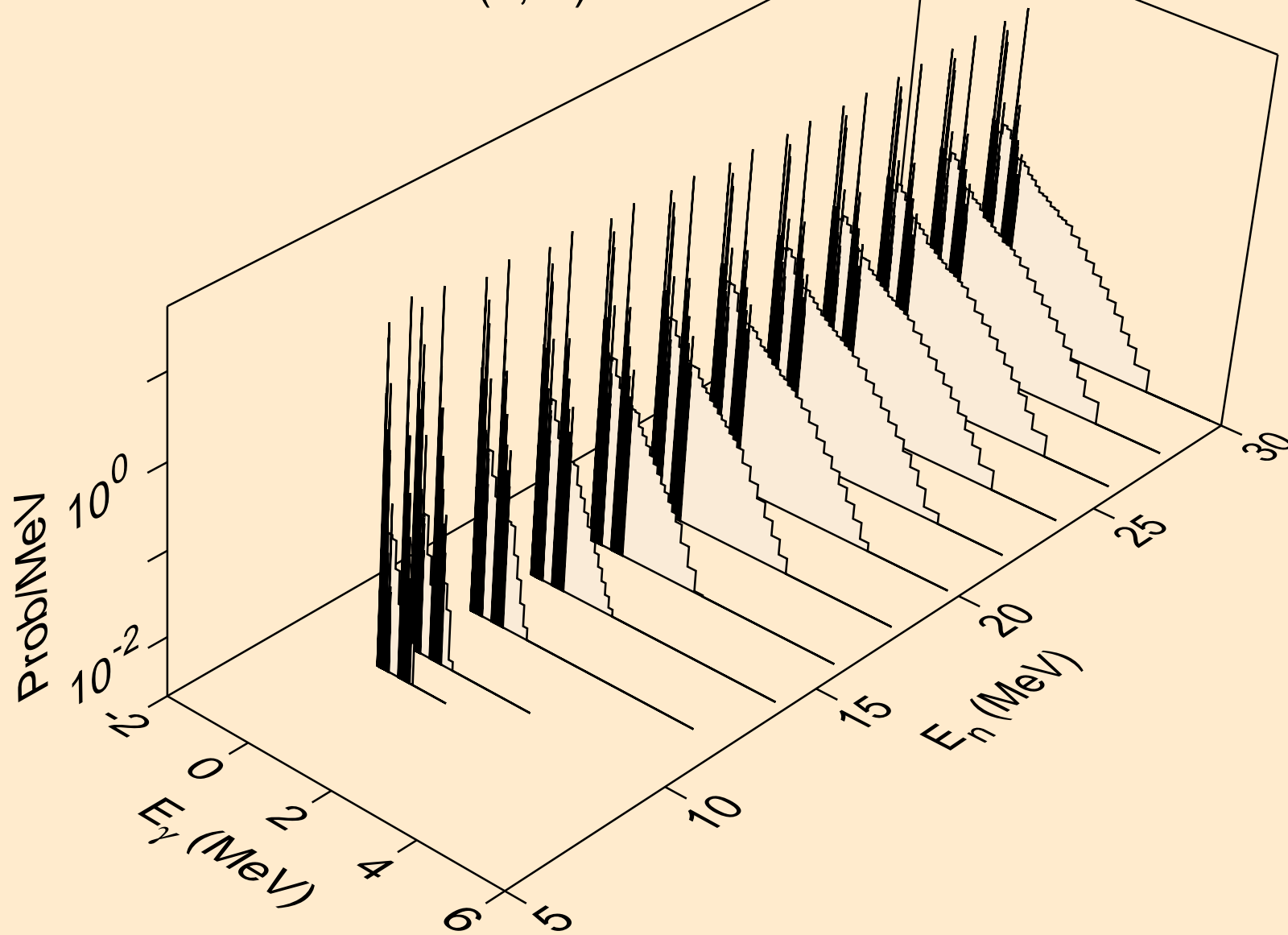

W196 DEUTERON ACER TENDL-2024 LIBRARY; T=0.K  
Photon emission for (n,n\*)t

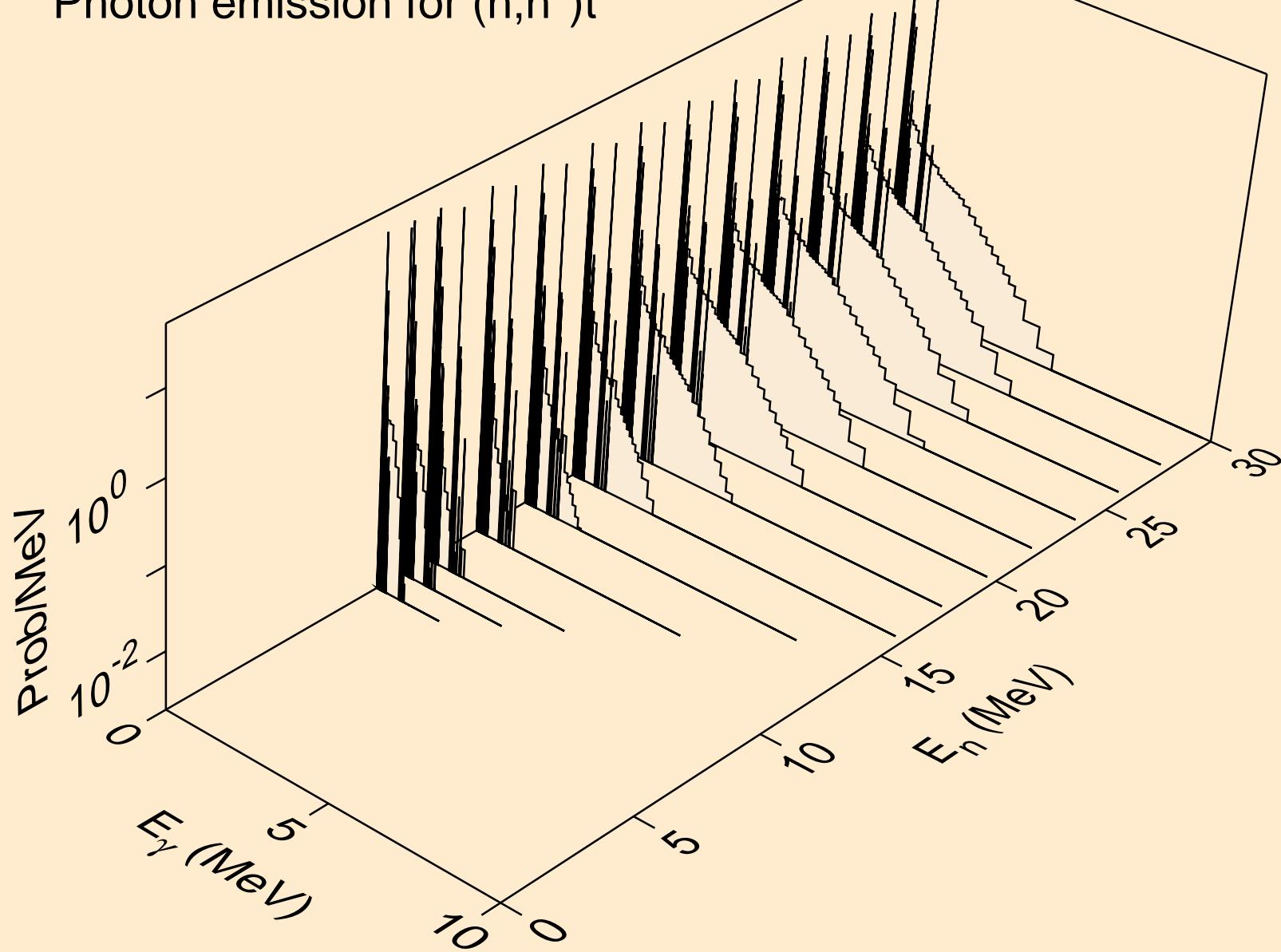

W196 DEUTERON ACER TENDL-2024 LIBRARY; T=0.K  
Photon emission for (n,n\*)he3

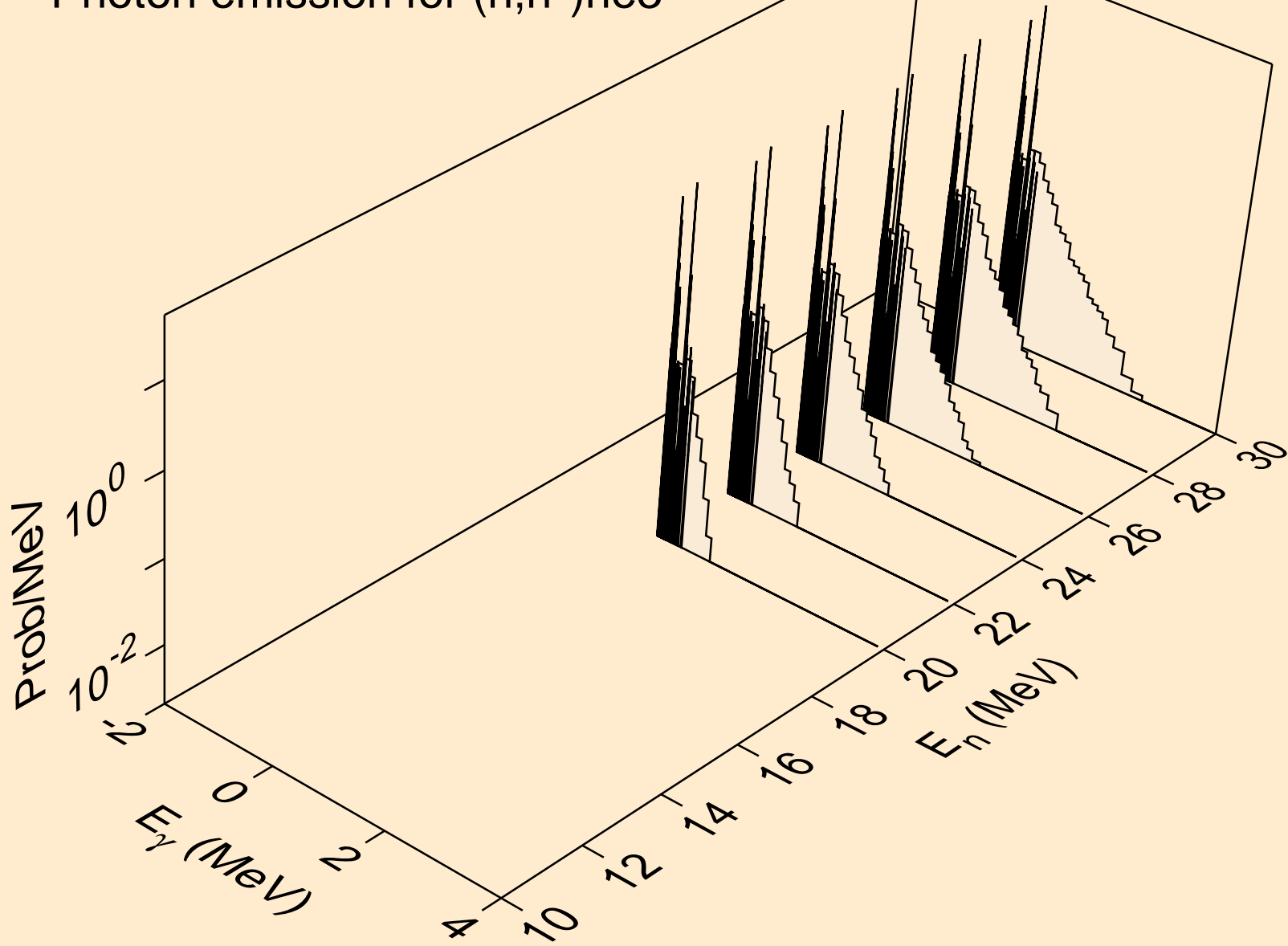

W196 DEUTERON ACER TENDL-2024 LIBRARY; T=0.K  
Photon emission for (n,4n)

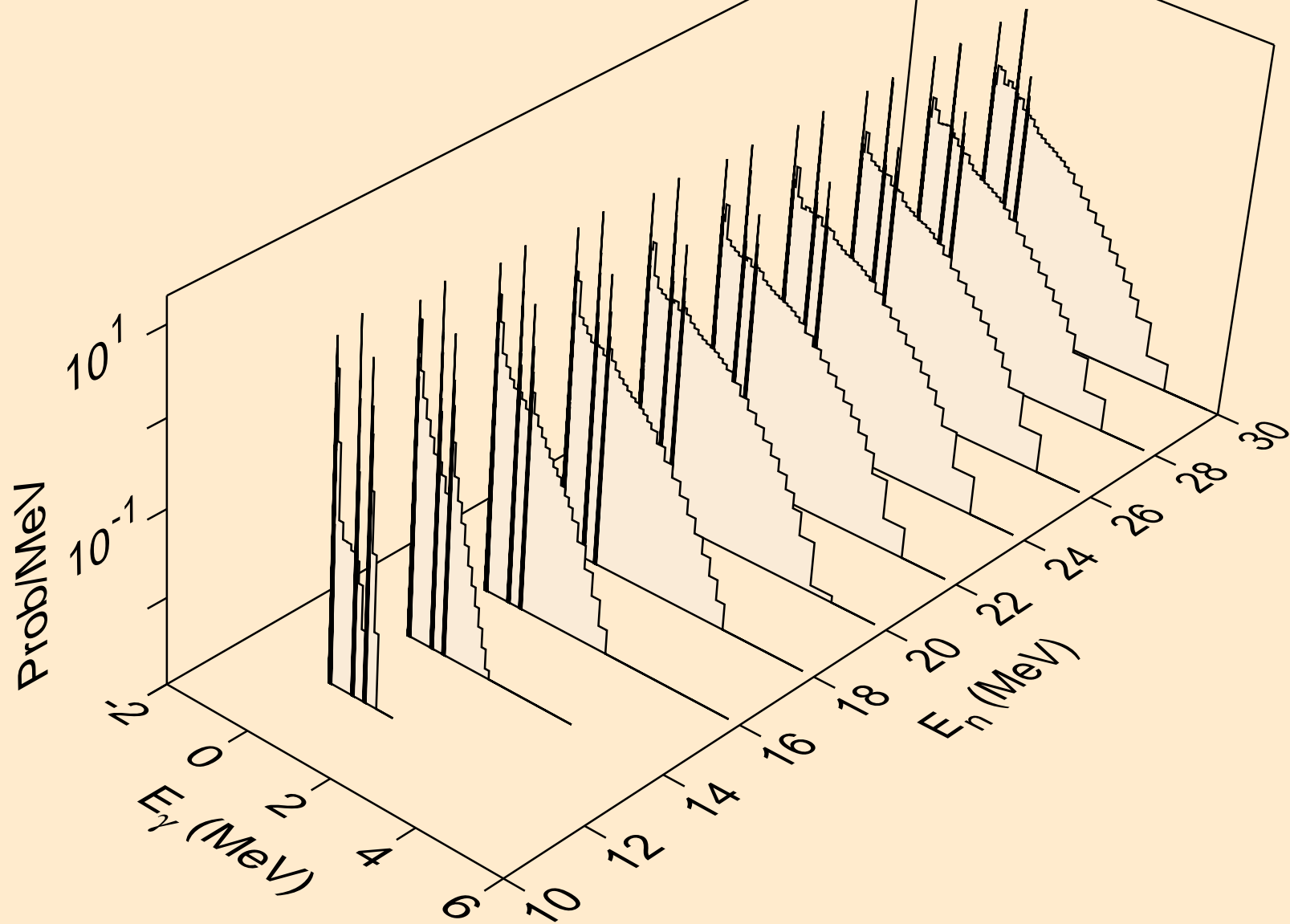

W196 DEUTERON ACER TENDL-2024 LIBRARY; T=0.K  
Photon emission for (n,2np)

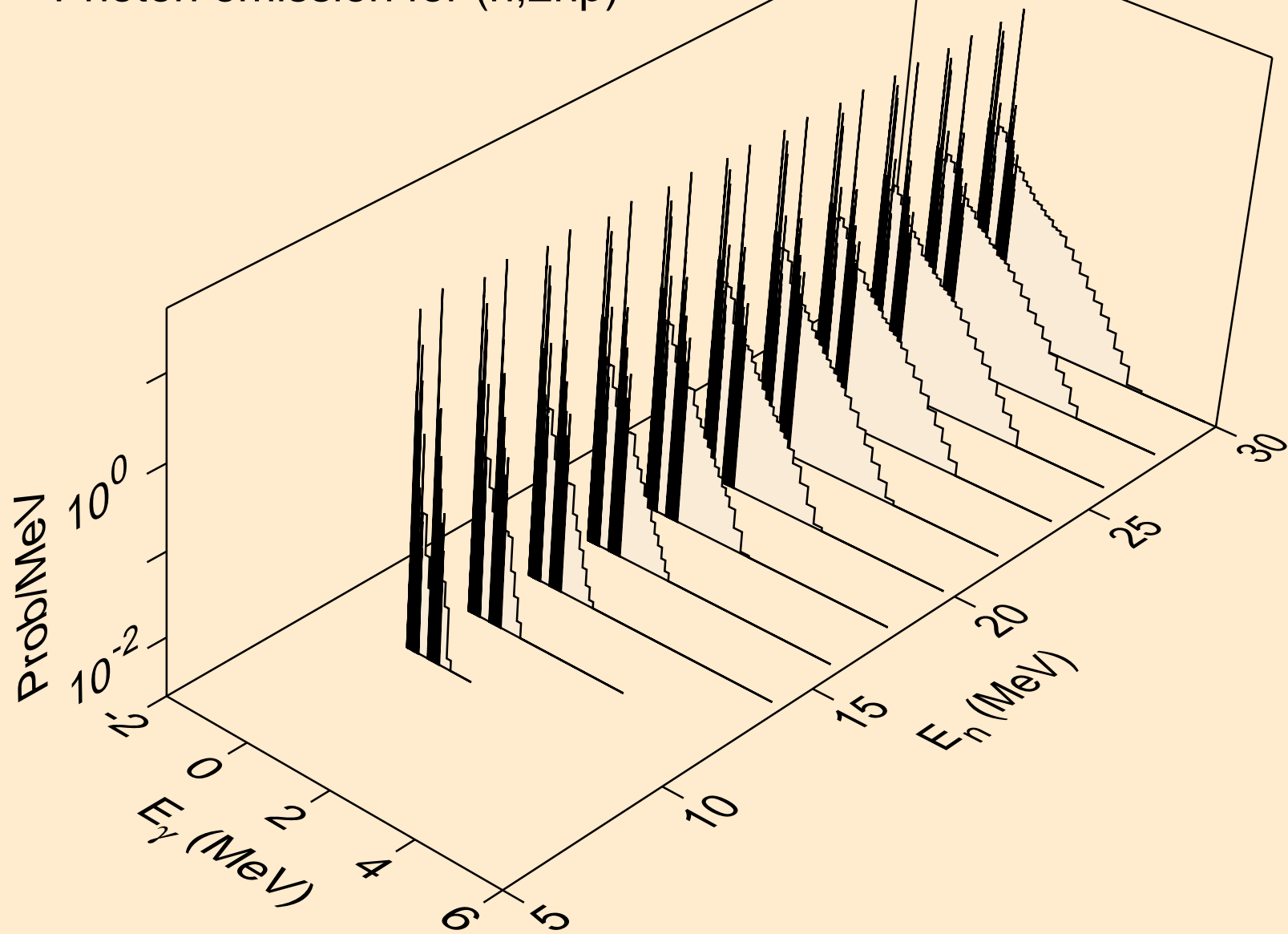

W196 DEUTERON ACER TENDL-2024 LIBRARY; T=0.K  
Photon emission for (n,3np)

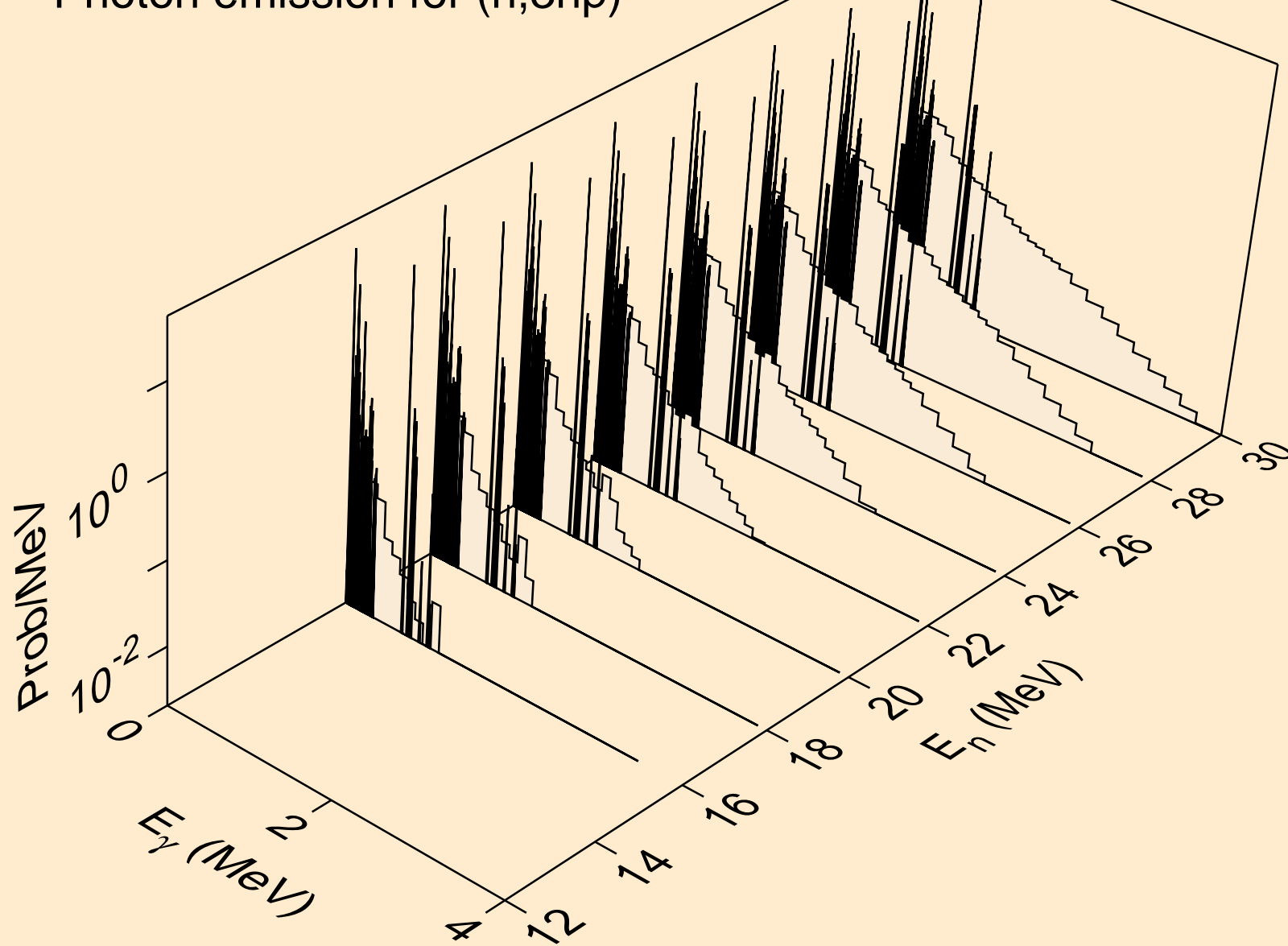

W196 DEUTERON ACER TENDL-2024 LIBRARY; T=0.K  
Photon emission for (n,n2p)

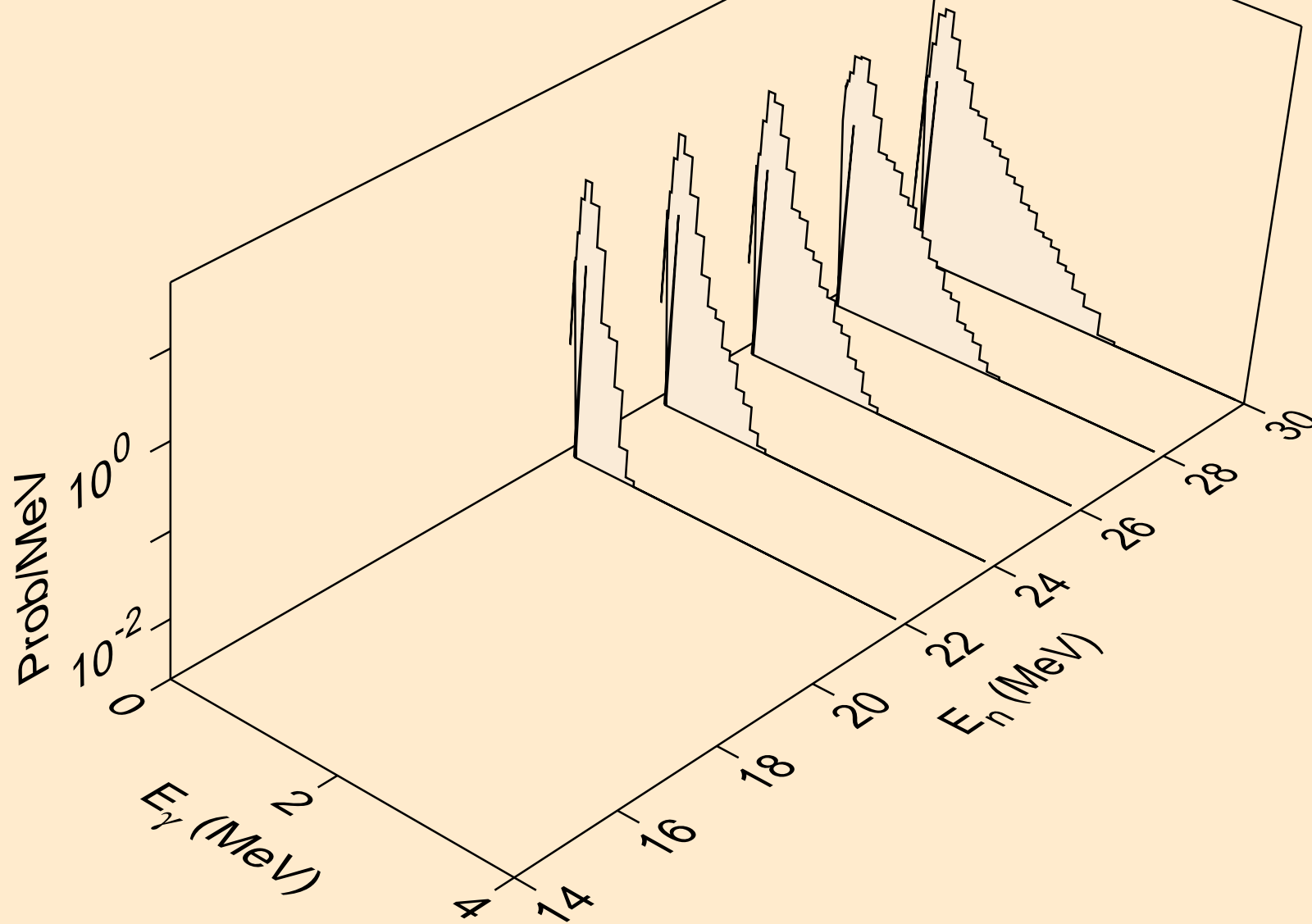

W196 DEUTERON ACER TENDL-2024 LIBRARY; T=0.K  
Photon emission for (n,gma)

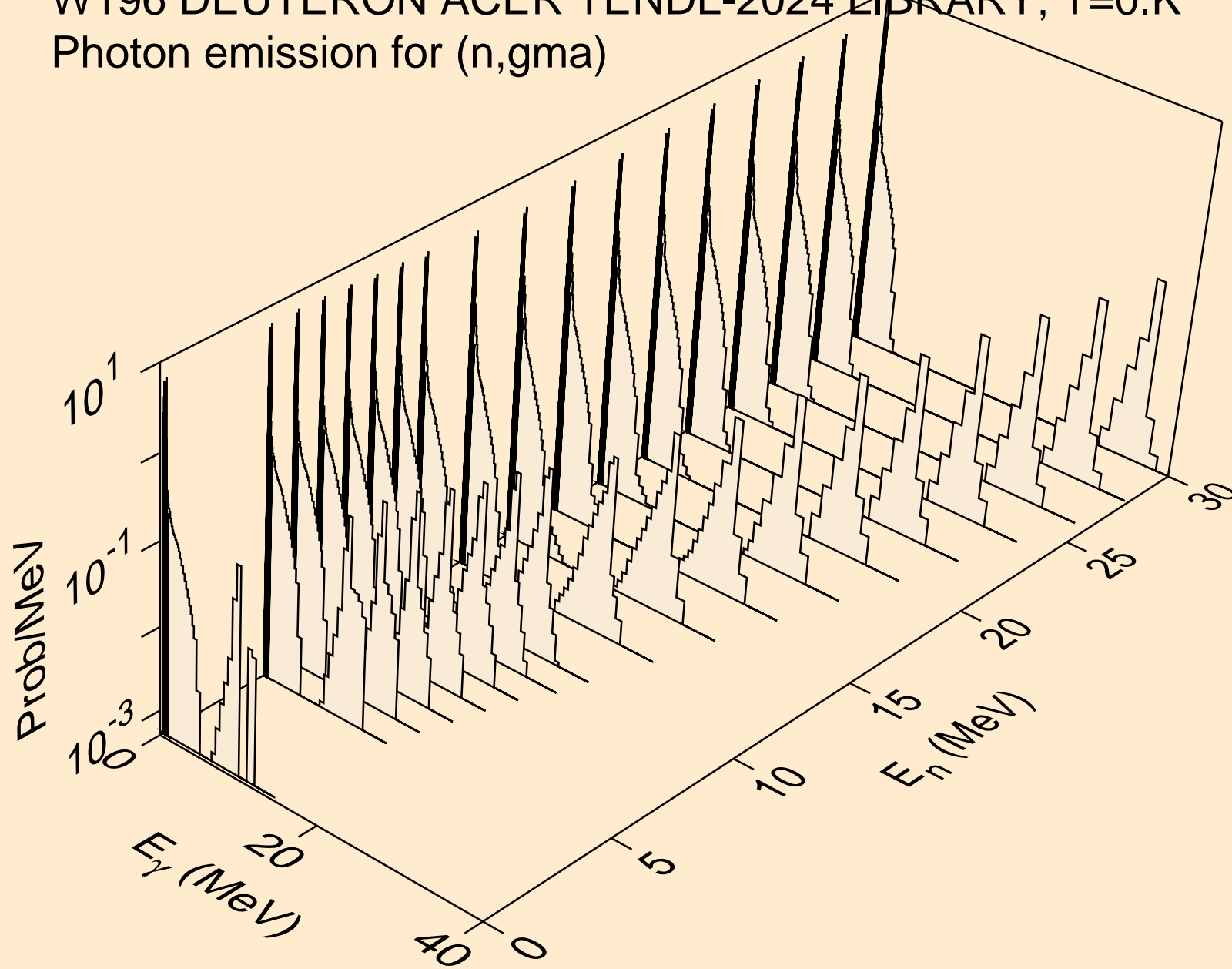

W196 DEUTERON ACER TENDL-2024 LIBRARY; T=0.K  
Photon emission for (n,p)

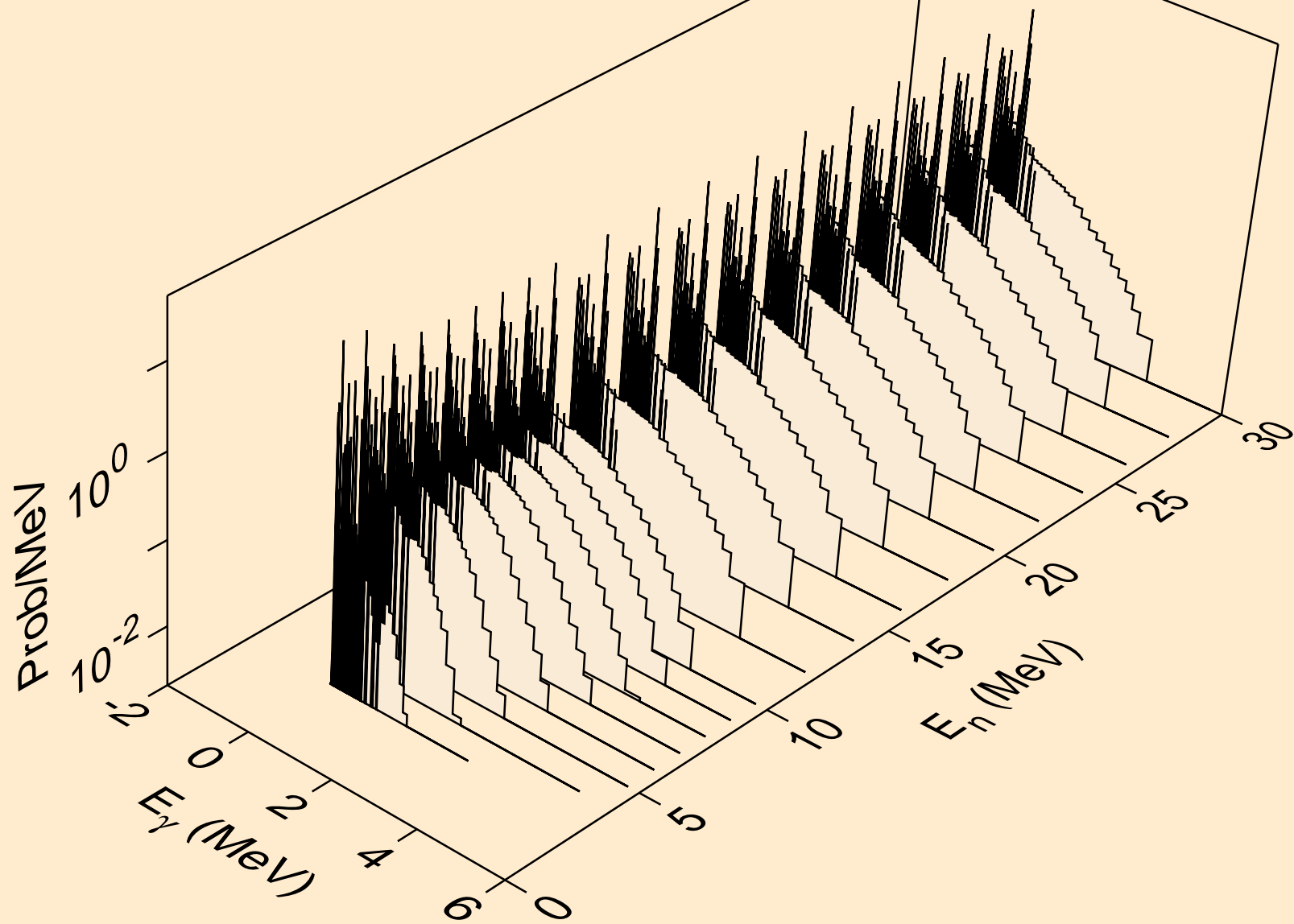

W196 DEUTERON ACER TENDL-2024 LIBRARY; T=0.K  
Photon emission for inelastic

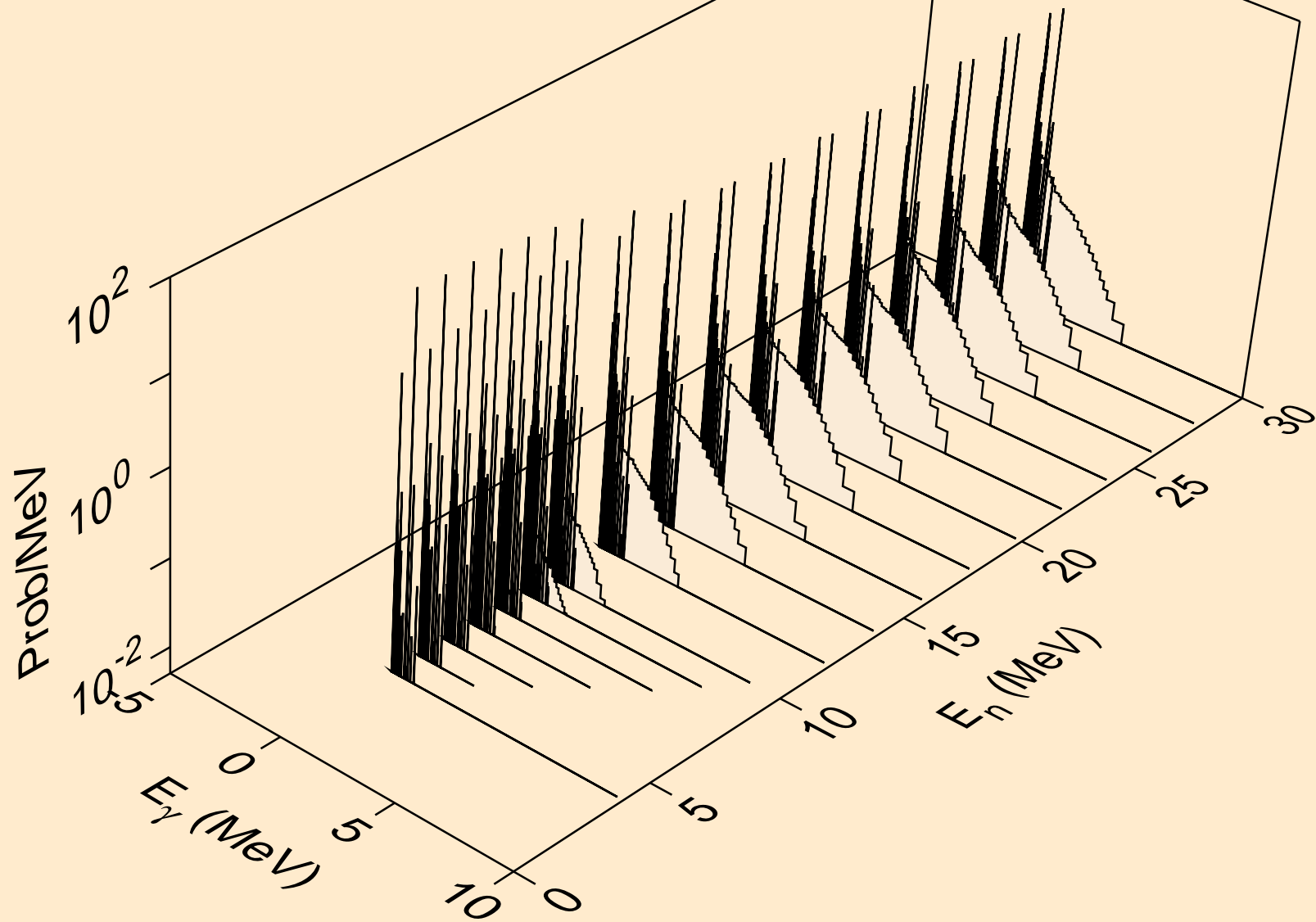

W196 DEUTERON ACER TENDL-2024 LIBRARY; T=0.K  
Photon emission for (n,t)

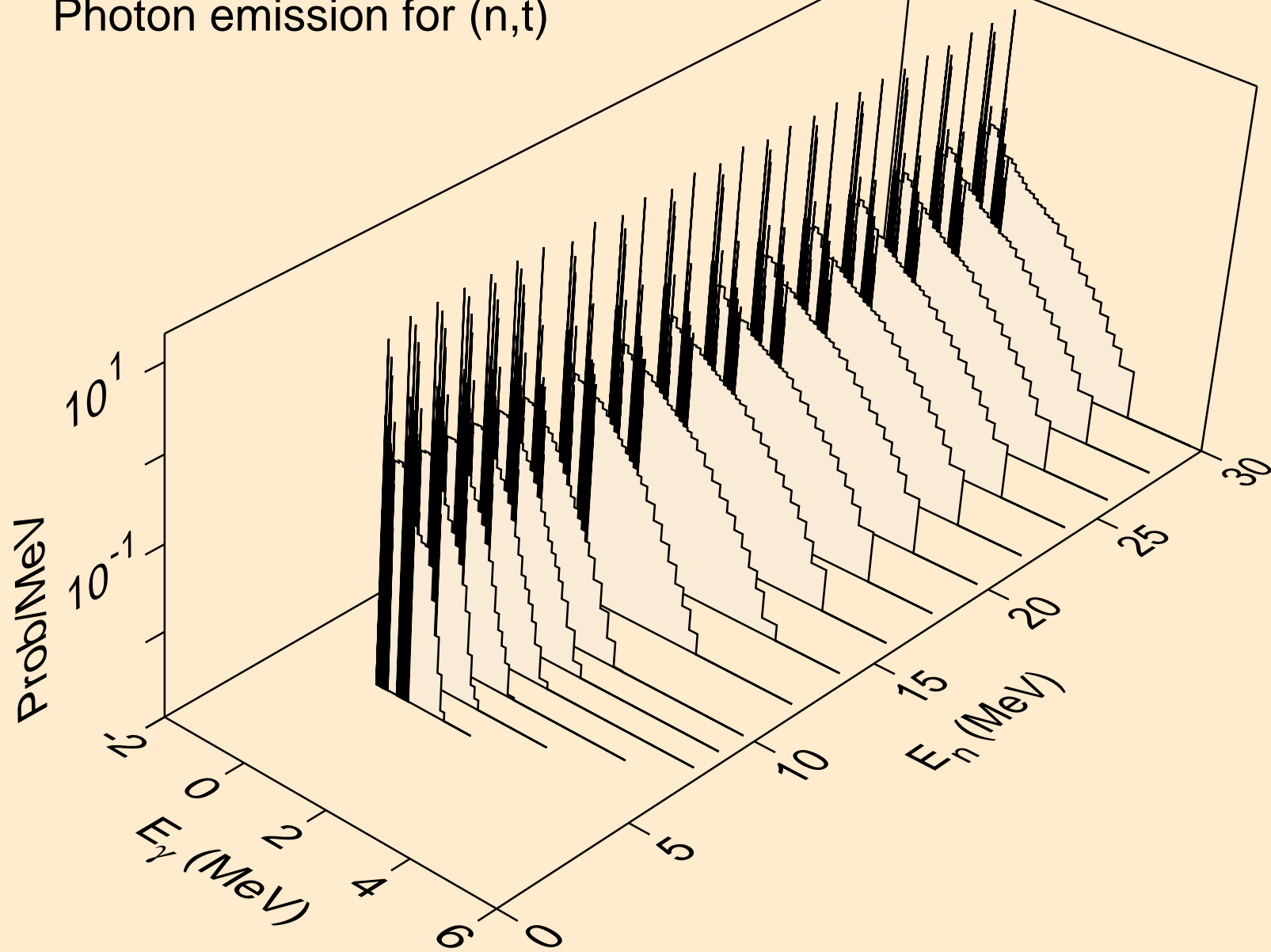

W196 DEUTERON ACER TENDL-2024 LIBRARY; T=0.K  
Photon emission for (n,he3)

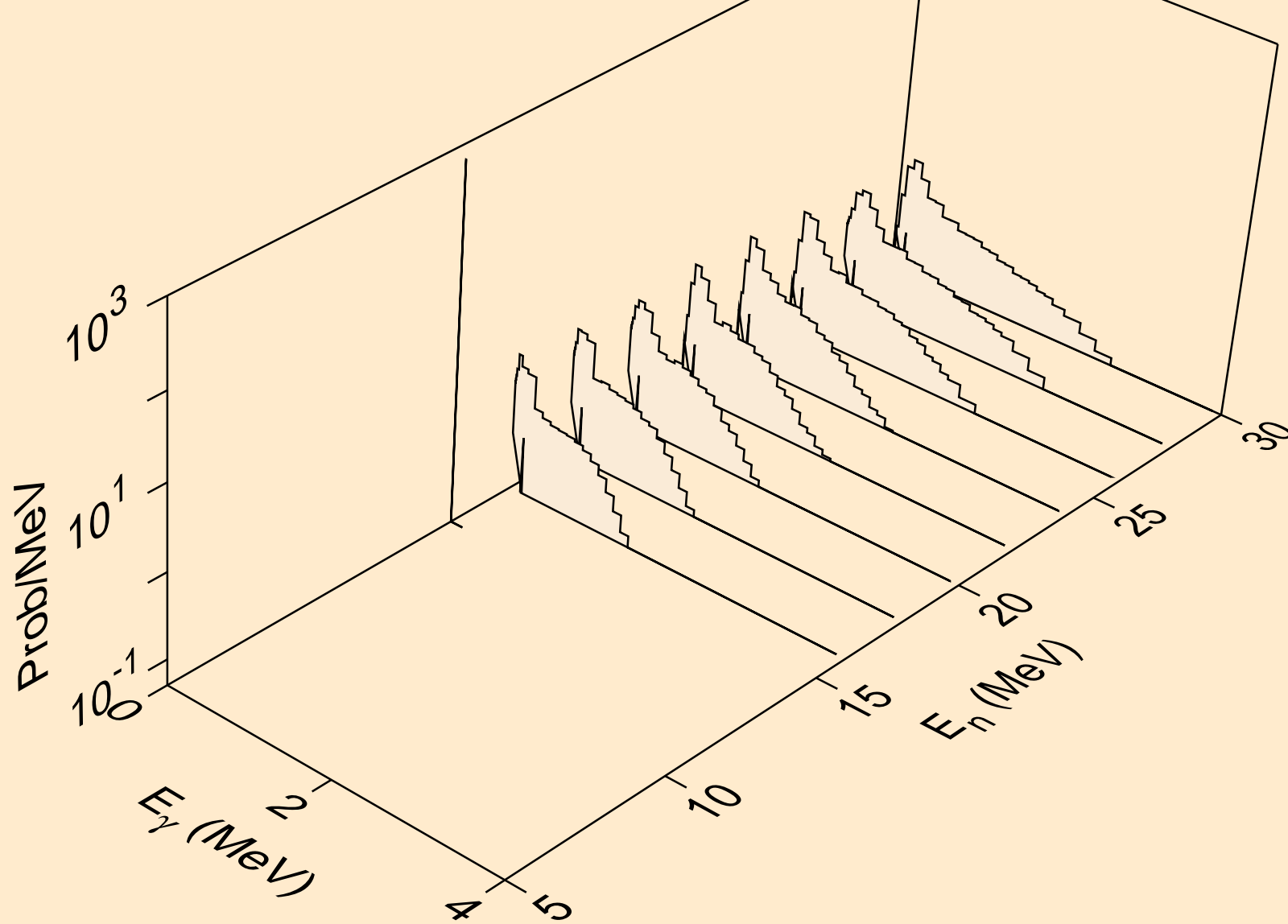

W196 DEUTERON ACER TENDL-2024 LIBRARY; T=0.K  
Photon emission for (n,a)

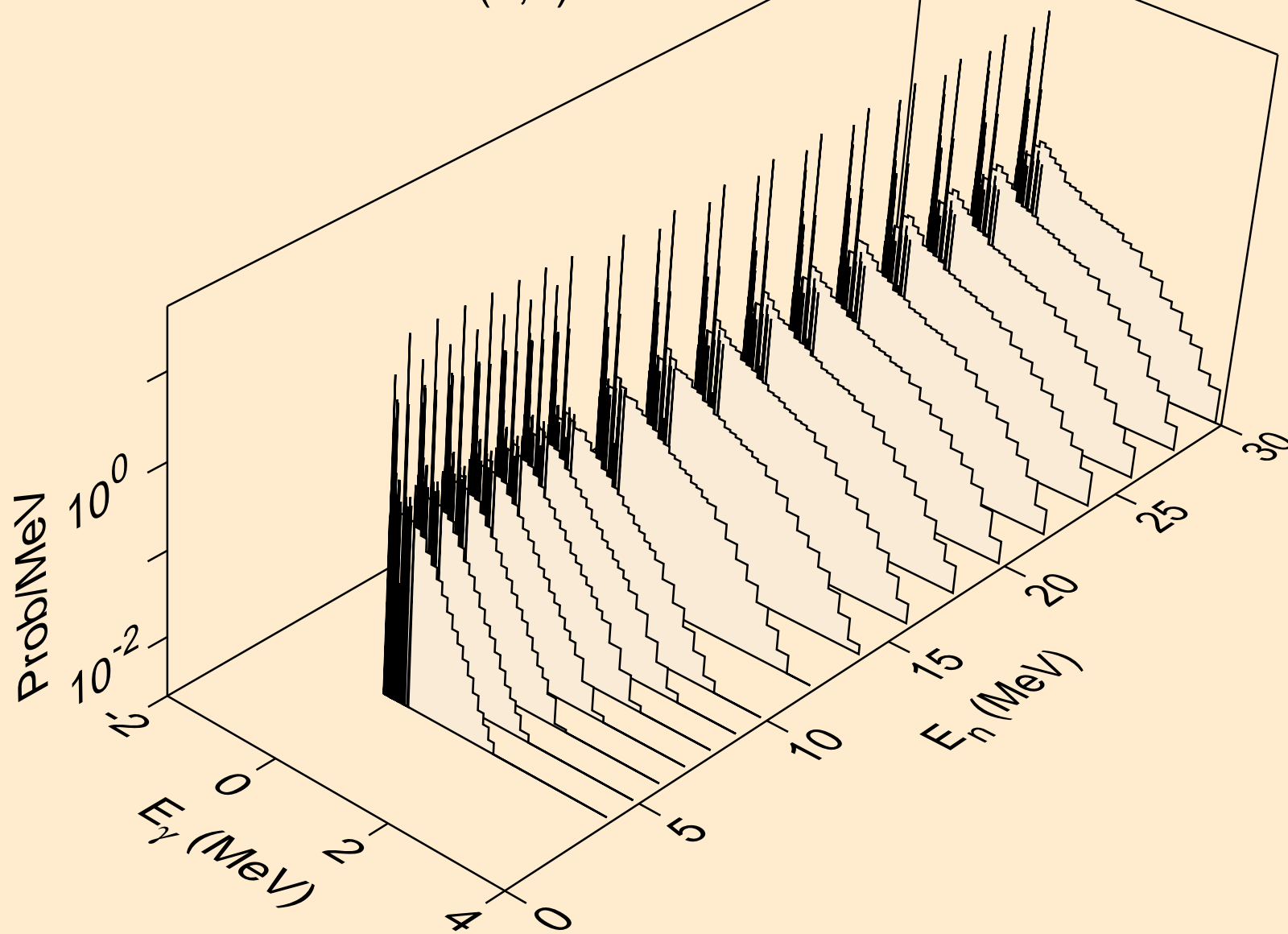

W196 DEUTERON ACER TENDL-2024 LIBRARY; T=0.K  
Photon emission for (n,2p)

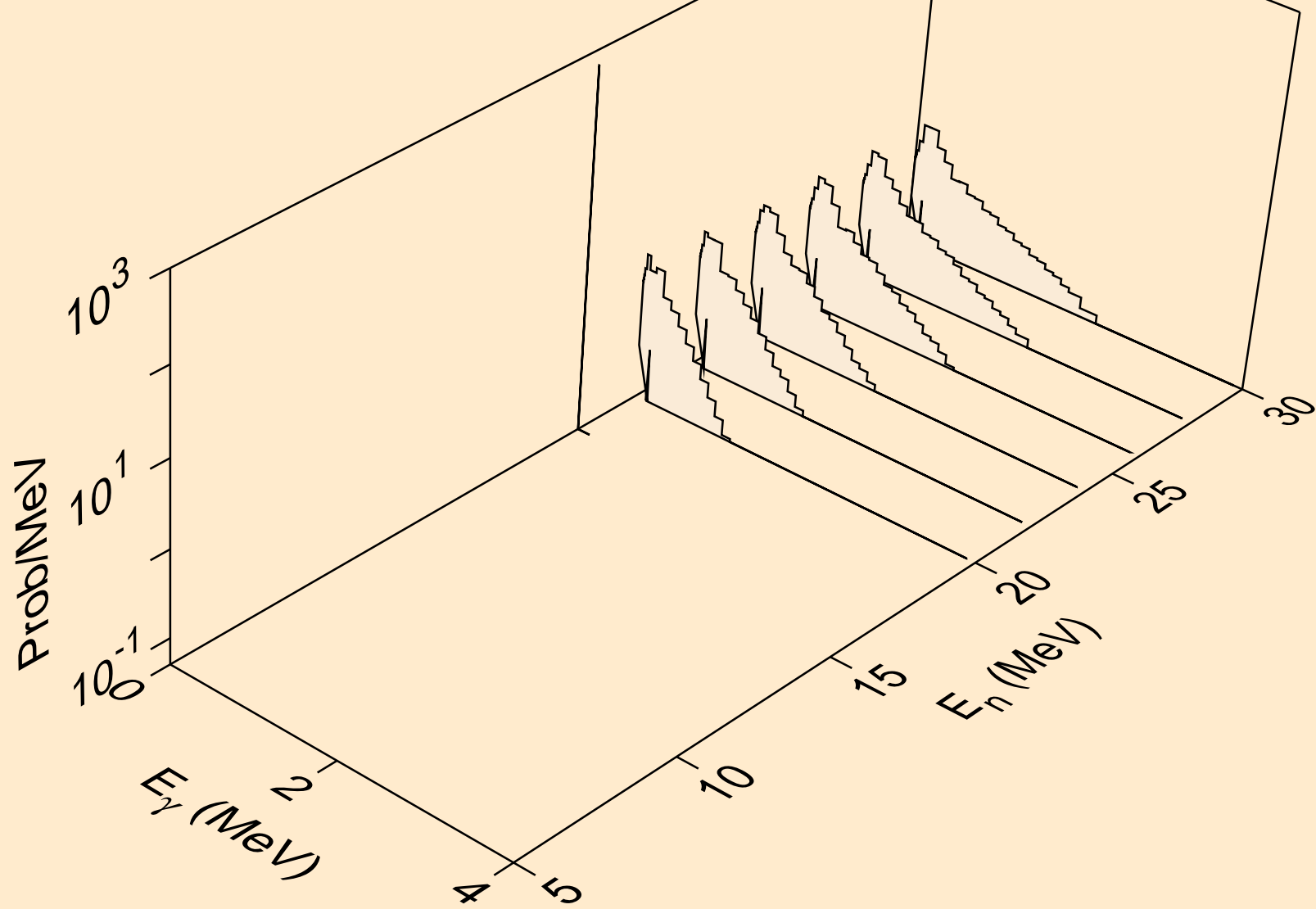

W196 DEUTERON ACER TENDL-2024 LIBRARY; T=0.K  
Photon emission for (n,pd)

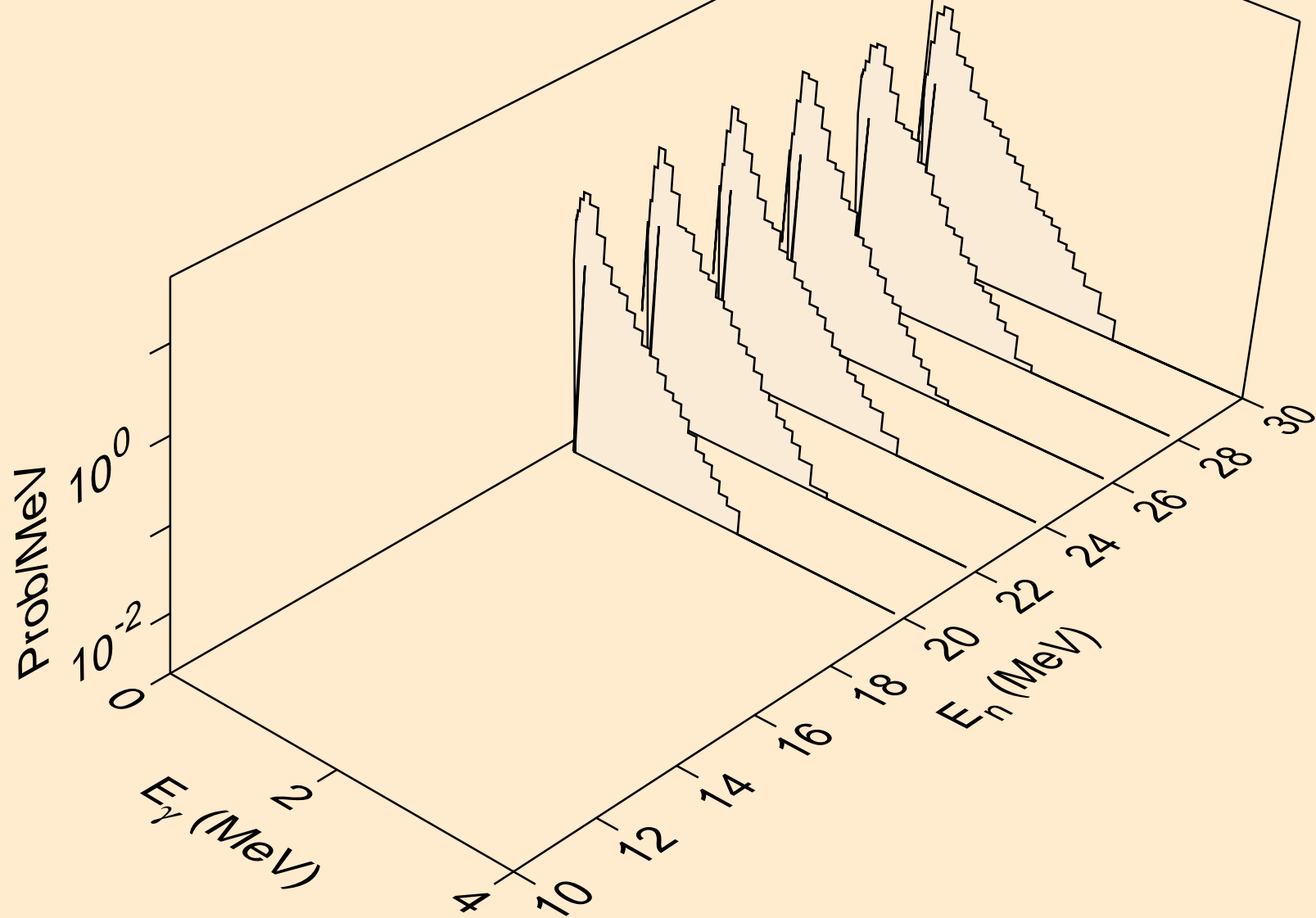

# W196 DEUTERON ACER TENDL-2024 LIBRARY; T=0.K

## Particle heating contributions

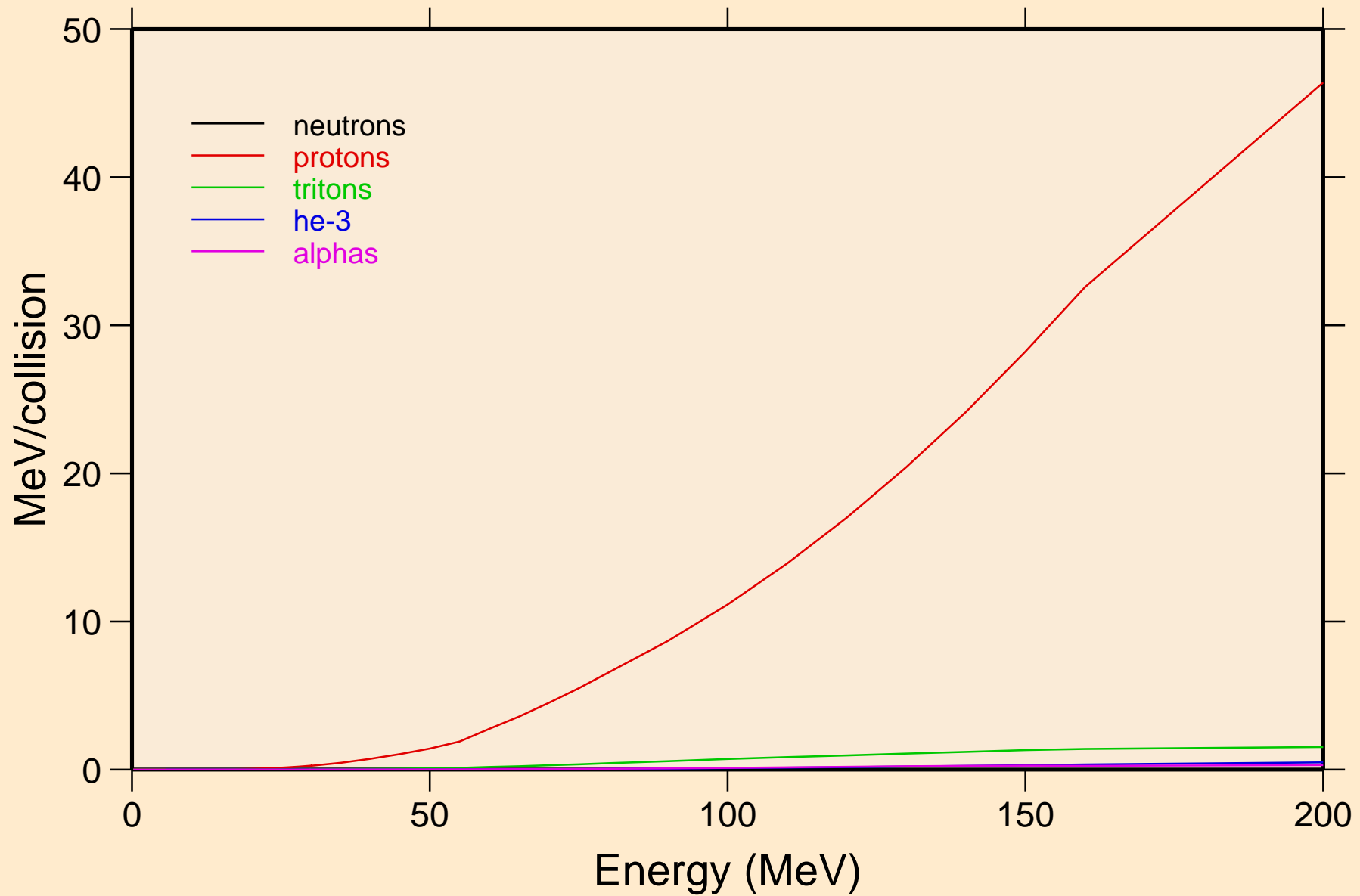

W196 DEUTERON ACER TENDL-2024 LIBRARY; T=0.K  
Recoil Heating

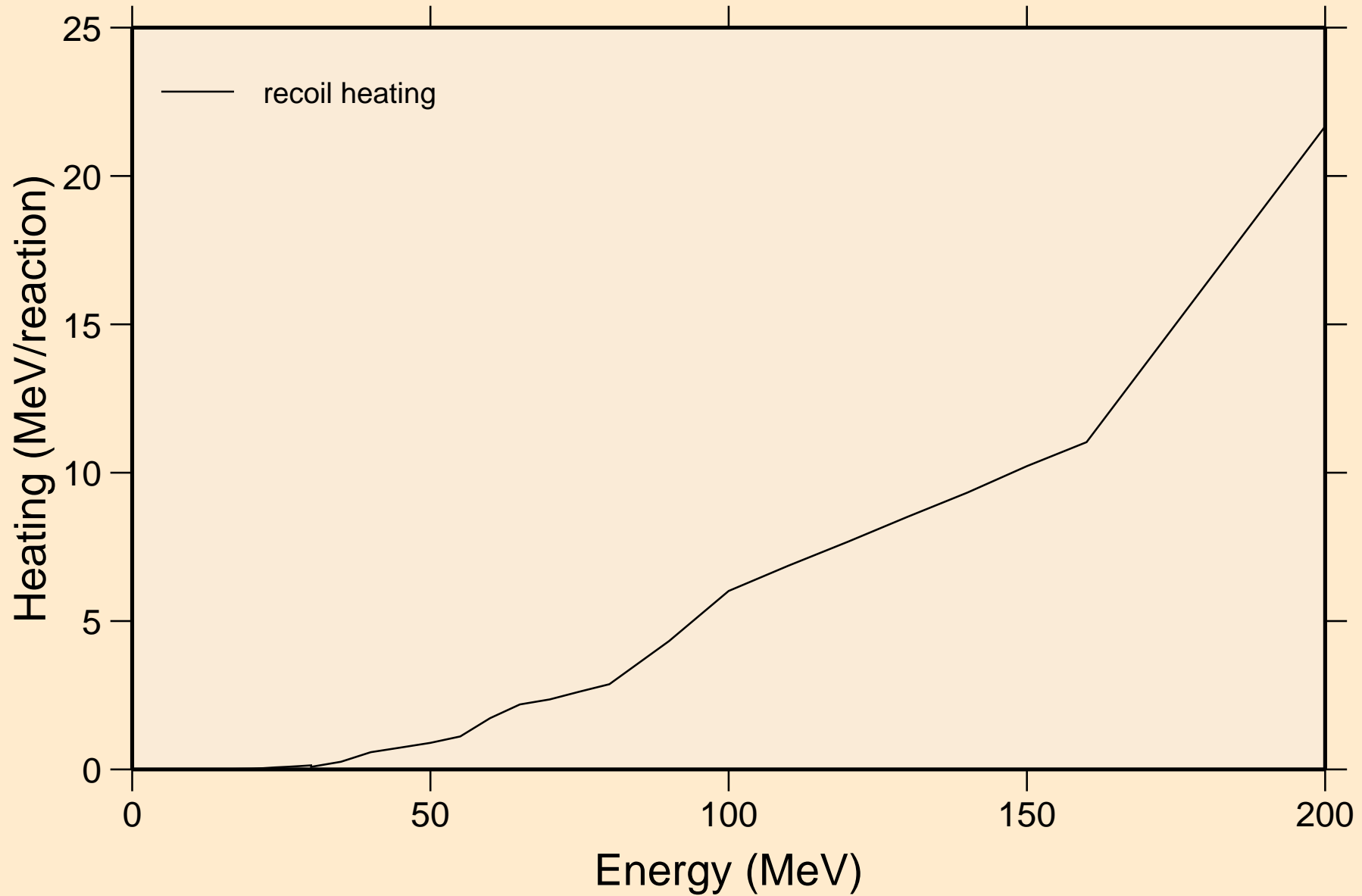

# W196 DEUTERON ACER TENDL-2024 LIBRARY; T=0.K

## Particle production cross sections

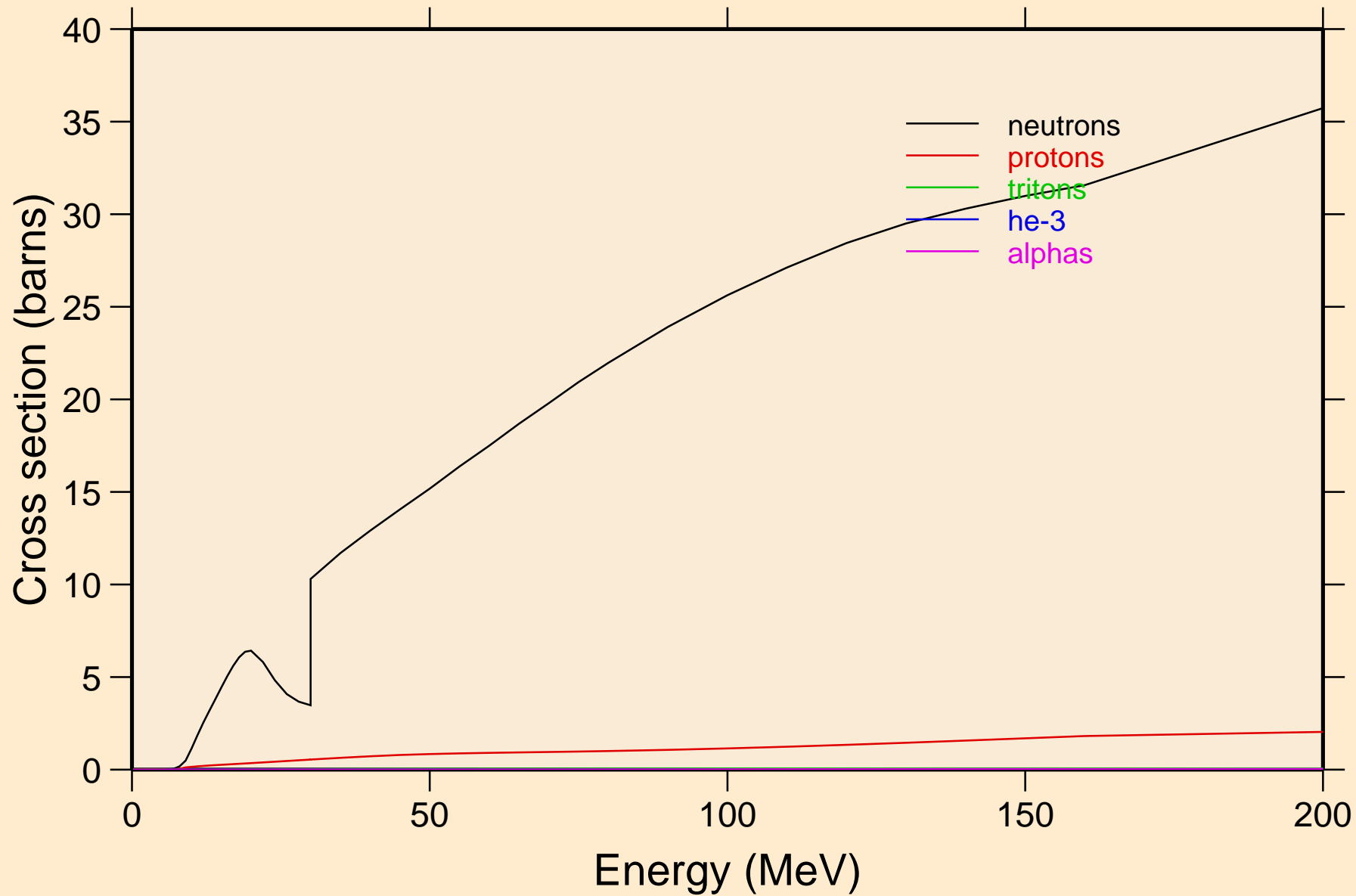

W196 DEUTERON ACER TENDL-2024 LIBRARY; T=0.K  
neutrons from (d,n)

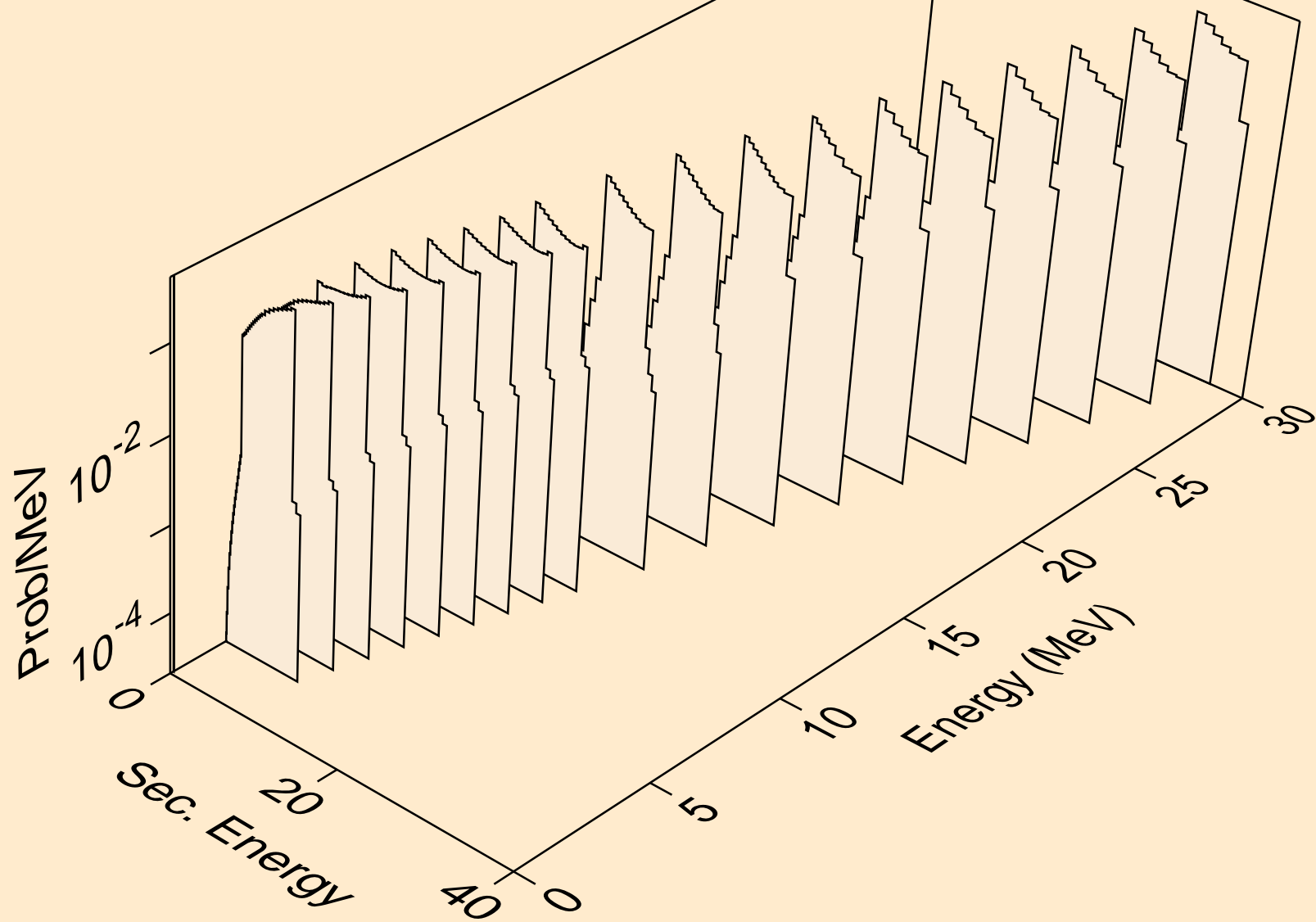

W196 DEUTERON ACER TENDL-2024 LIBRARY; T=0.K  
neutrons from (d,x)

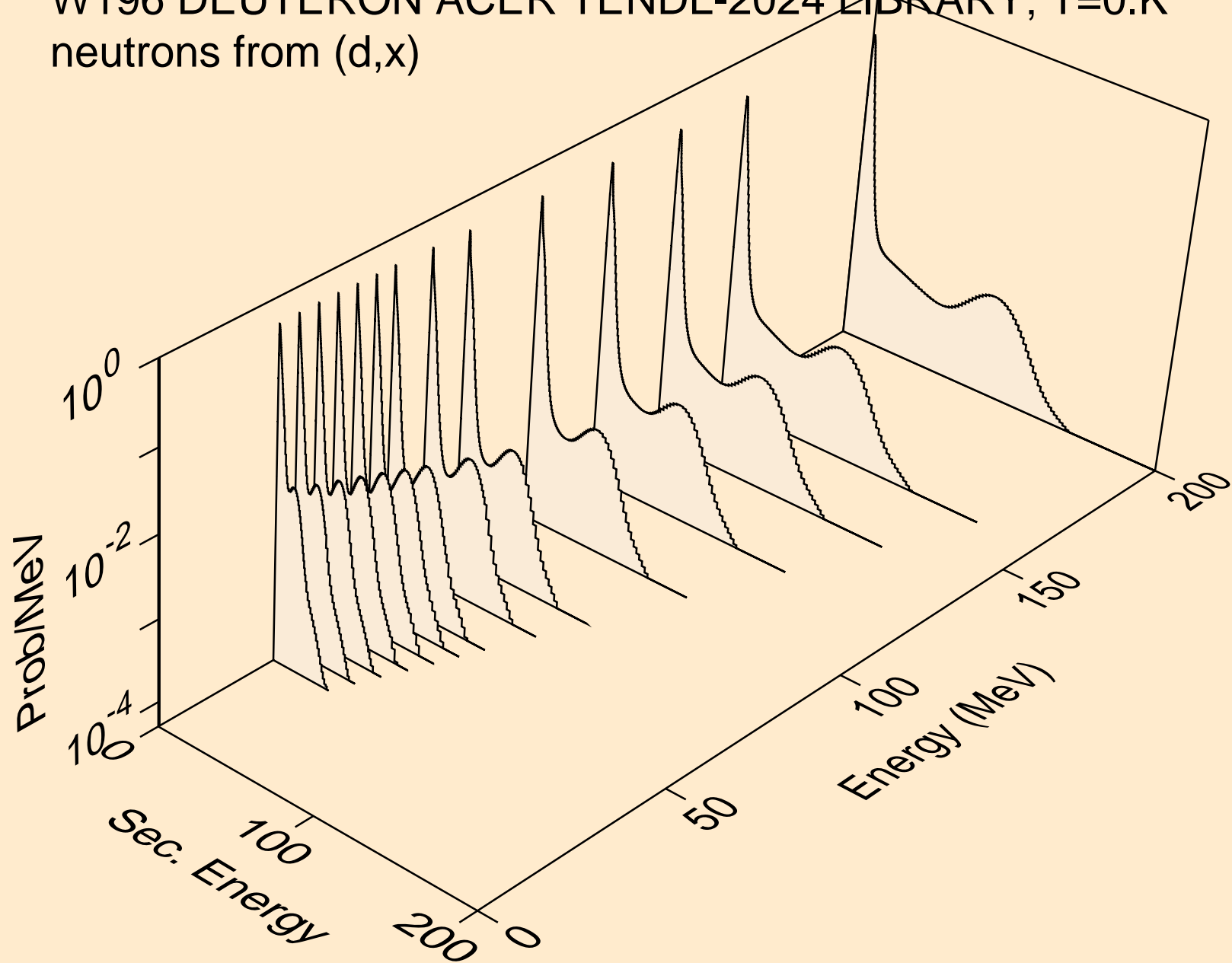

W196 DEUTERON ACER TENDL-2024 LIBRARY; T=0.K  
neutrons from (d,2nd)

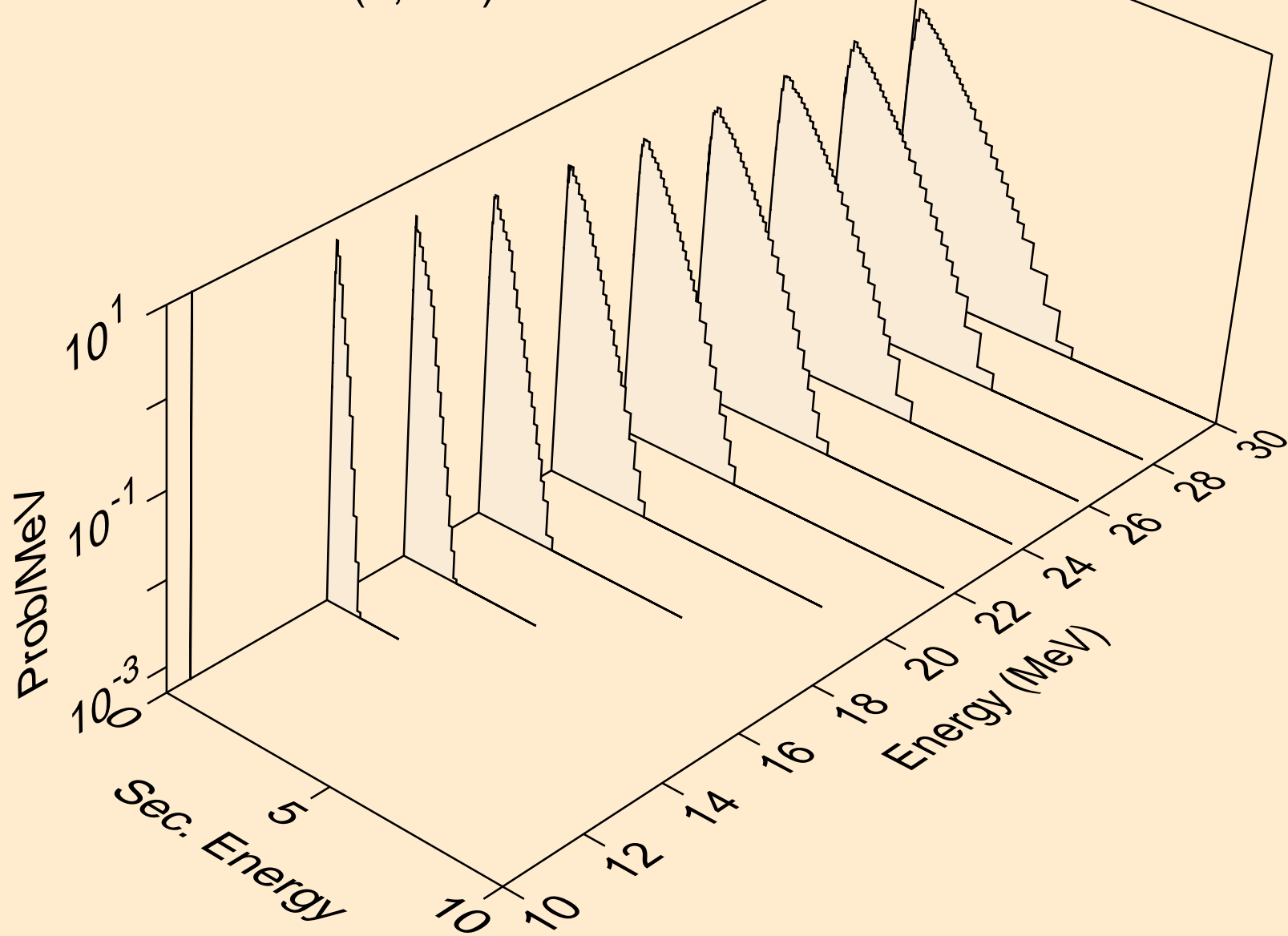

W196 DEUTERON ACER TENDL-2024 LIBRARY; T=0.K  
neutrons from (d,2n)

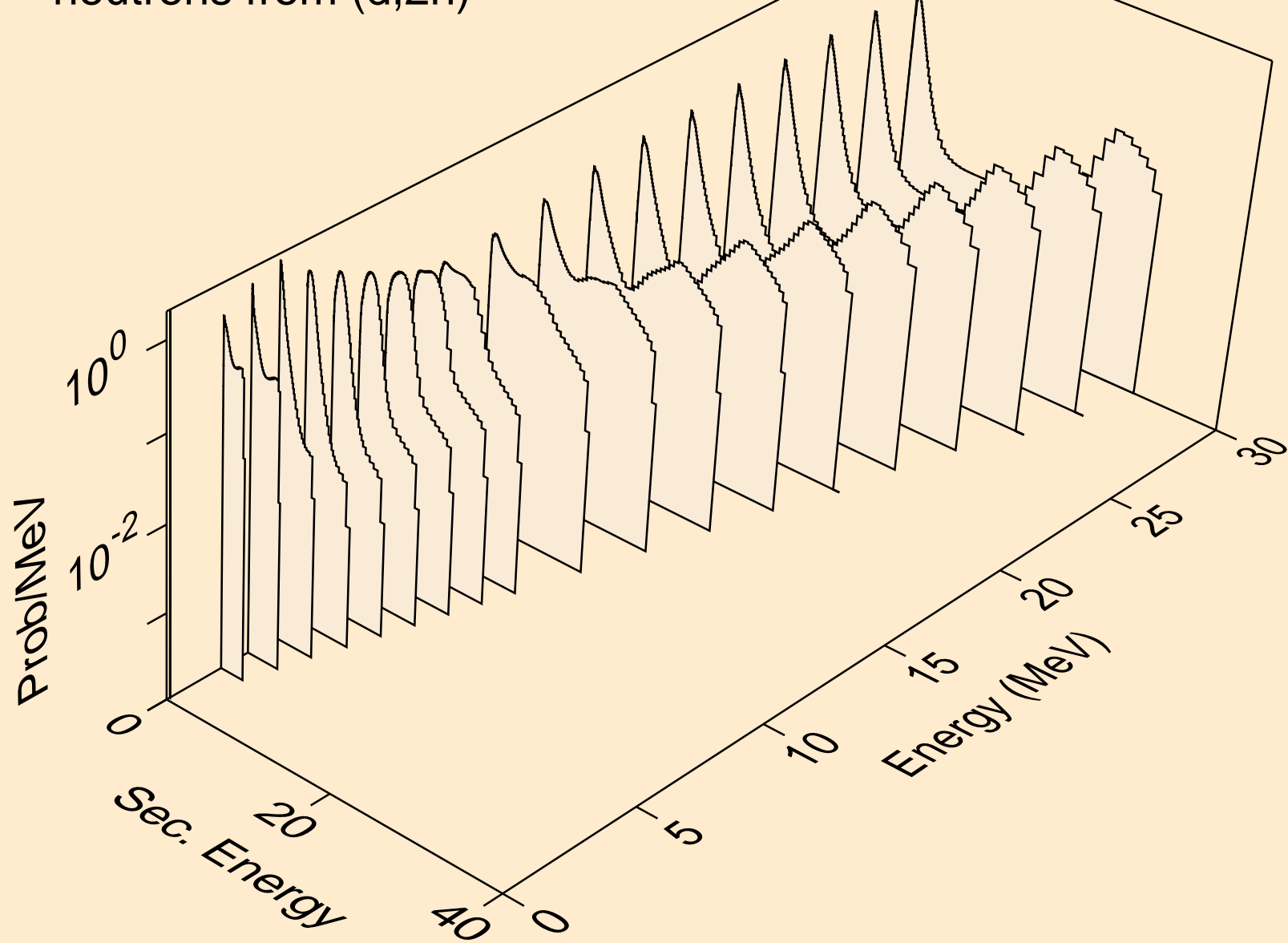

W196 DEUTERON ACER TENDL-2024 LIBRARY; T=0.K  
neutrons from (d,3n)

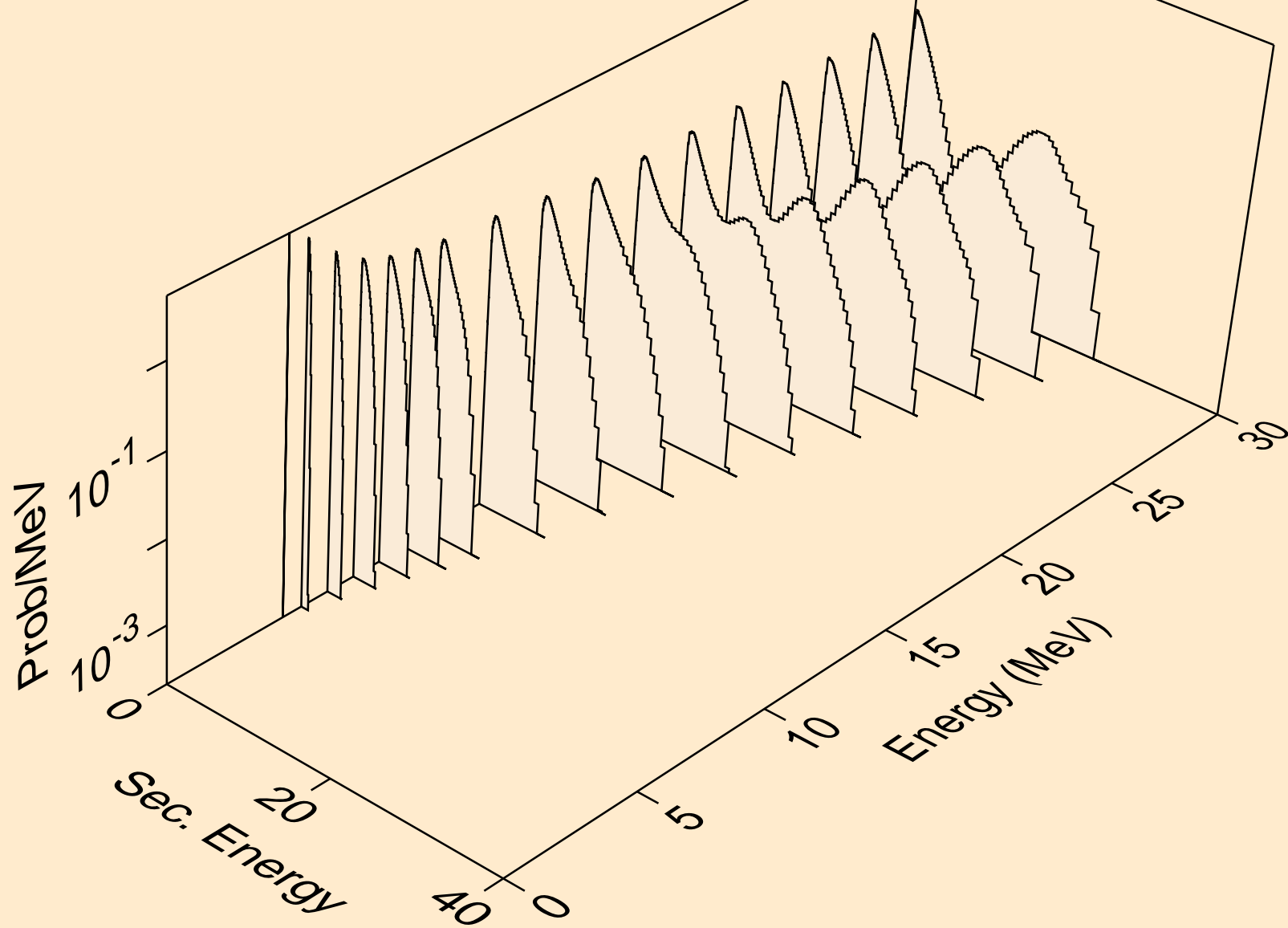

W196 DEUTERON ACER TENDL-2024 LIBRARY; T=0.K  
neutrons from (d,n\*)a

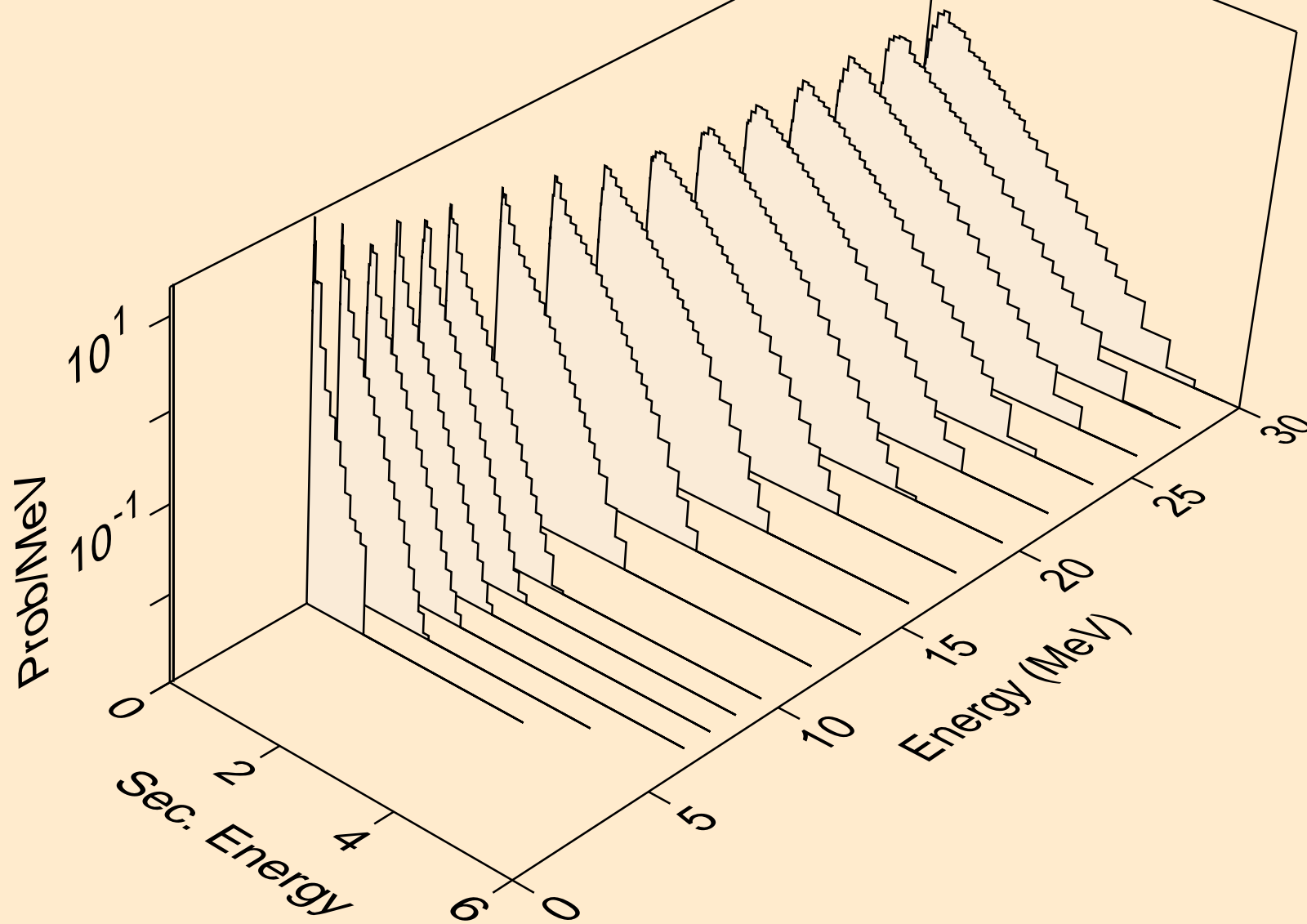

W196 DEUTERON ACER TENDL-2024 LIBRARY; T=0.K  
neutrons from (d,2n)a

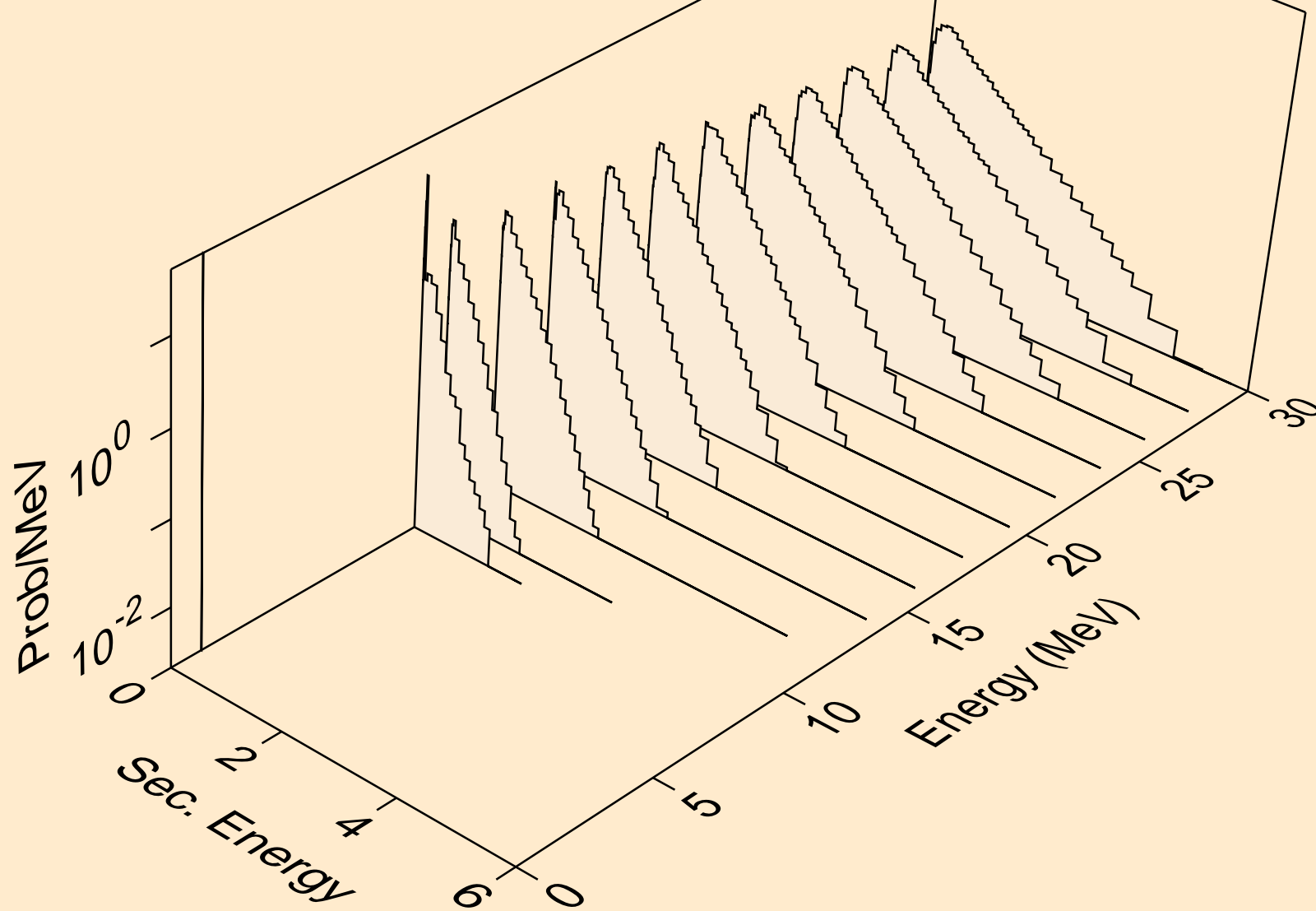

W196 DEUTERON ACER TENDL-2024 LIBRARY; T=0.K  
neutrons from (d,3n)a

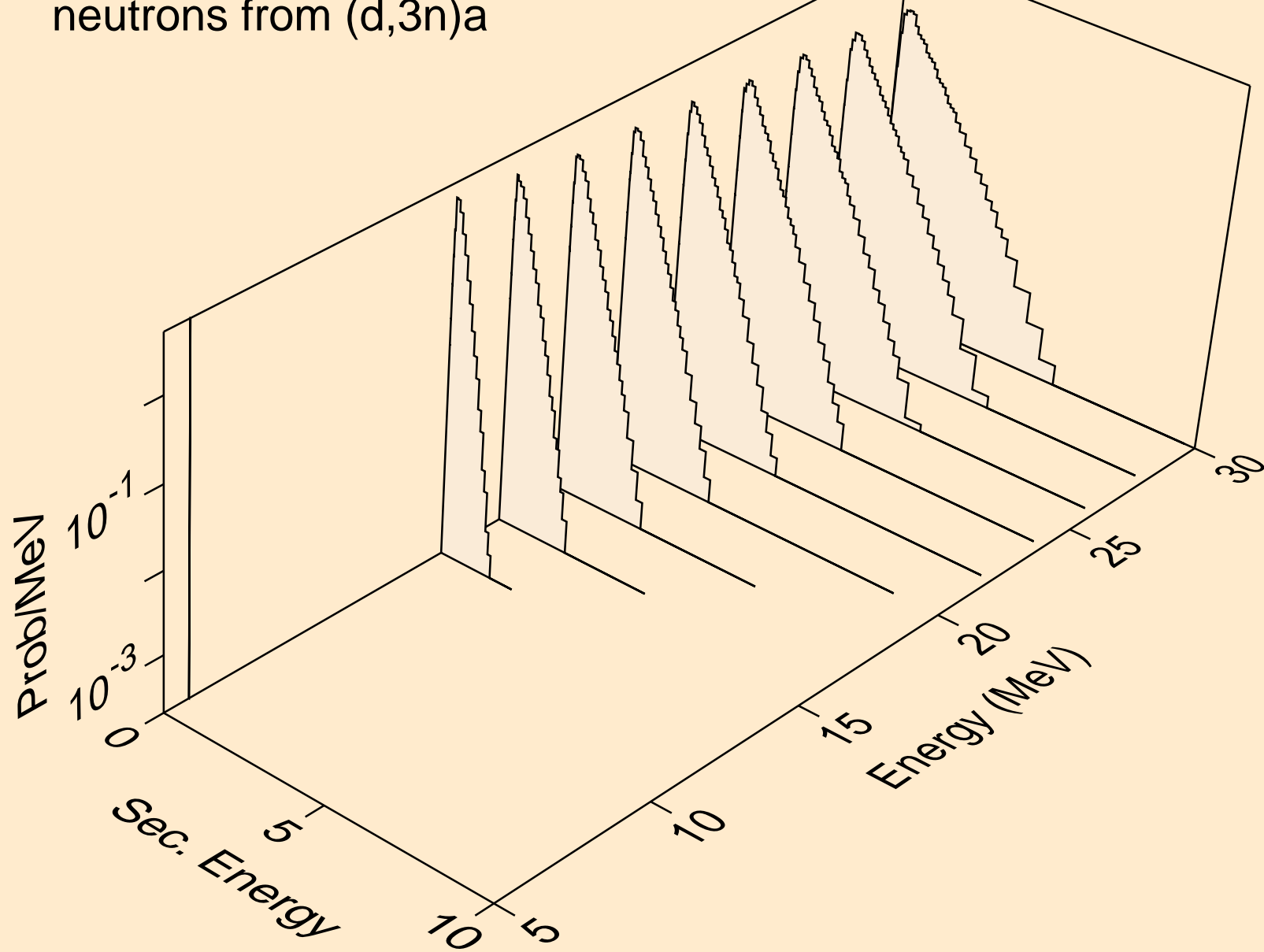

W196 DEUTERON ACER TENDL-2024 LIBRARY; T=0.K  
neutrons from (d,n\*)p

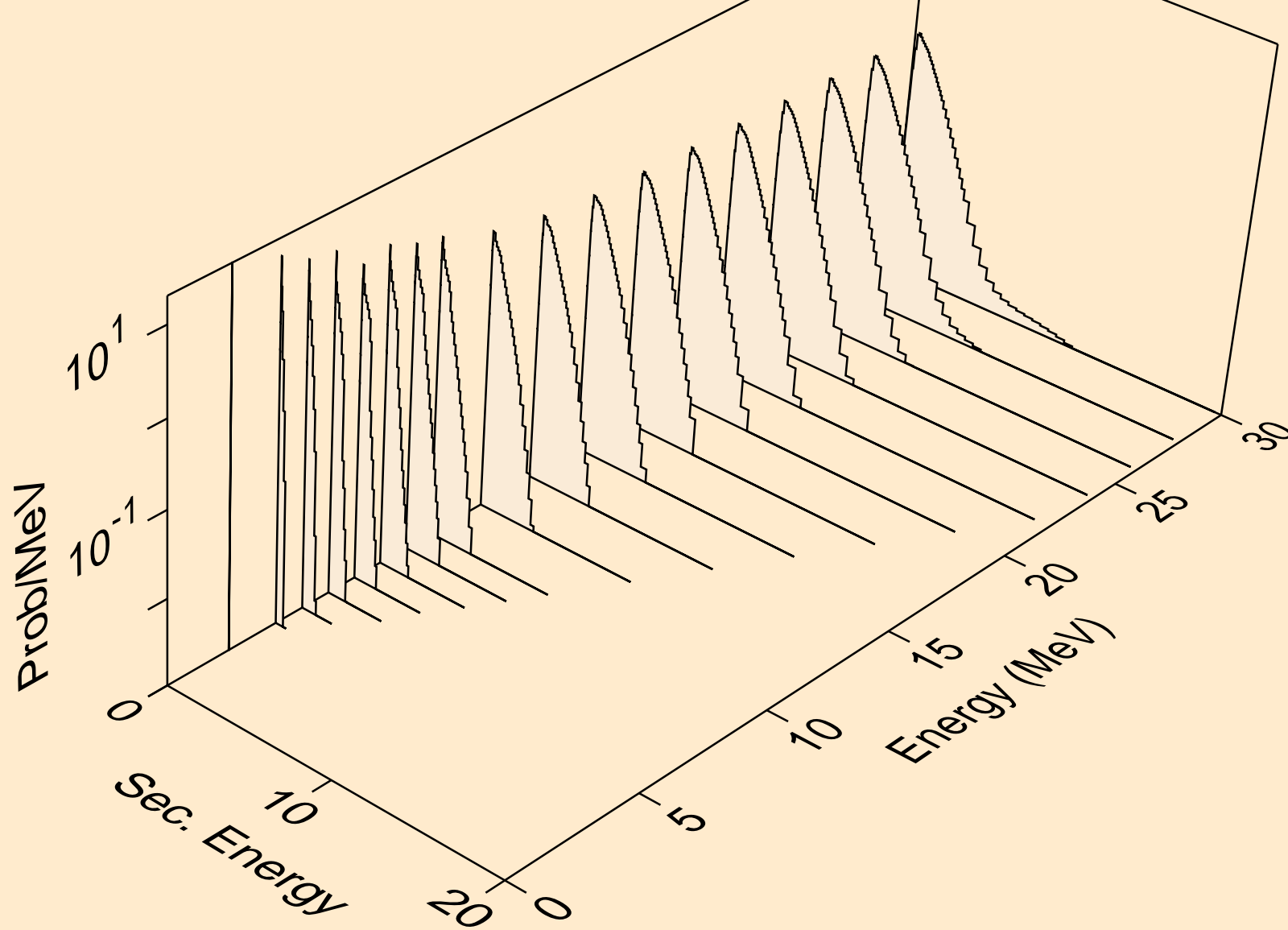

W196 DEUTERON ACER TENDL-2024 LIBRARY; T=0.K  
neutrons from (d,n\*)d

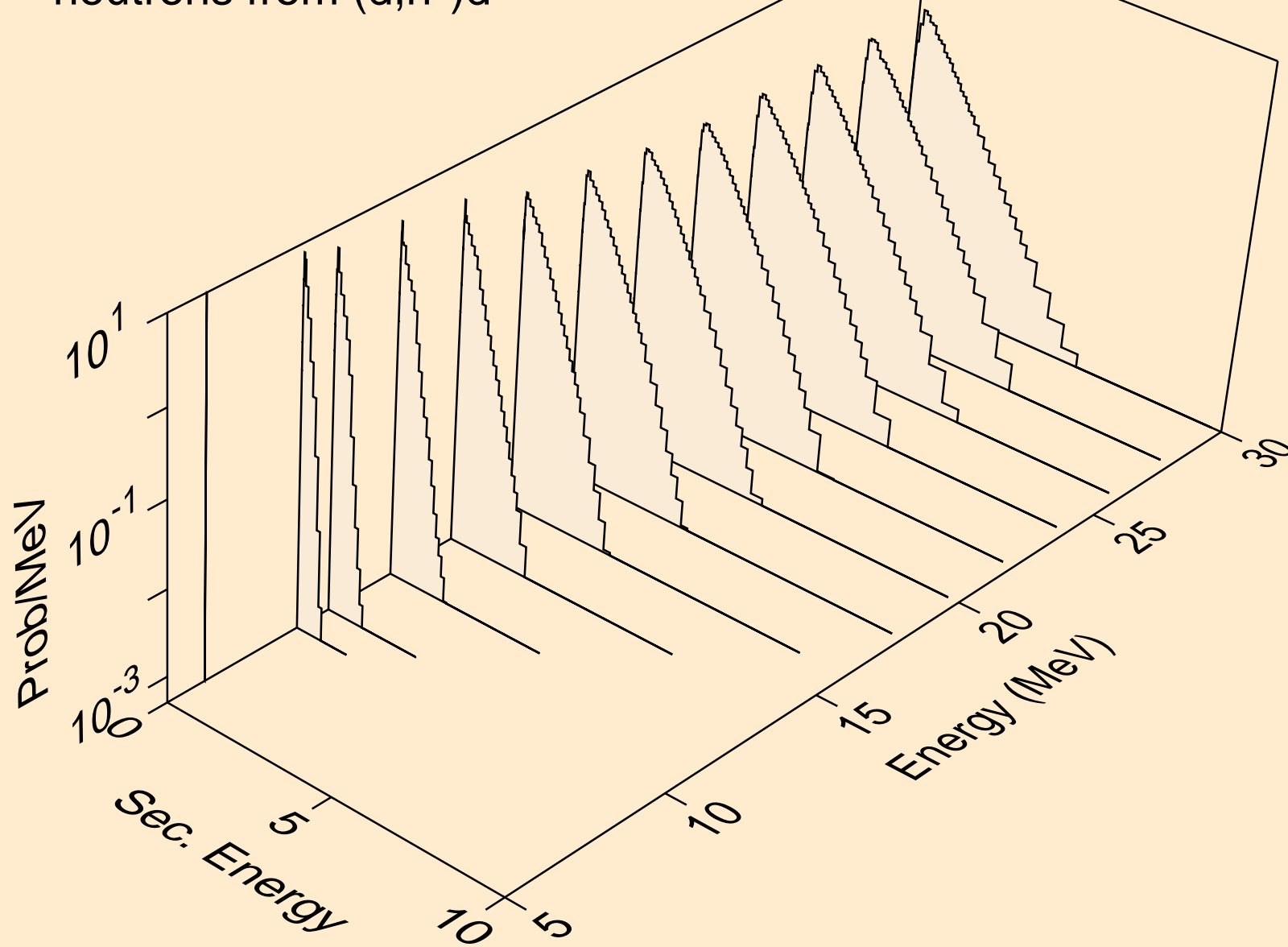

W196 DEUTERON ACER TENDL-2024 LIBRARY; T=0.K  
neutrons from (d,n\*)t

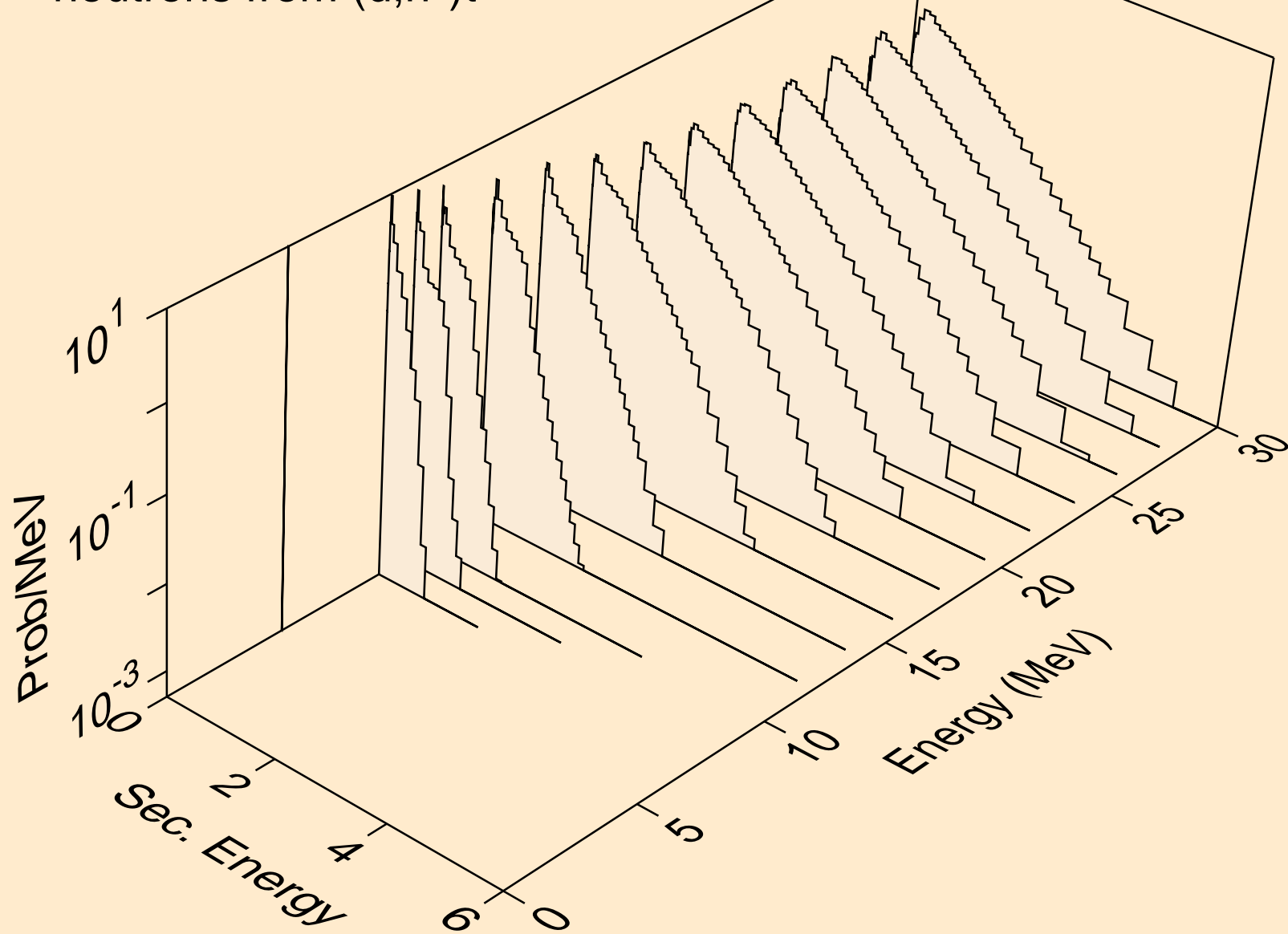

W196 DEUTERON ACER TENDL-2024 LIBRARY; T=0.K  
neutrons from (d,n\*)he3

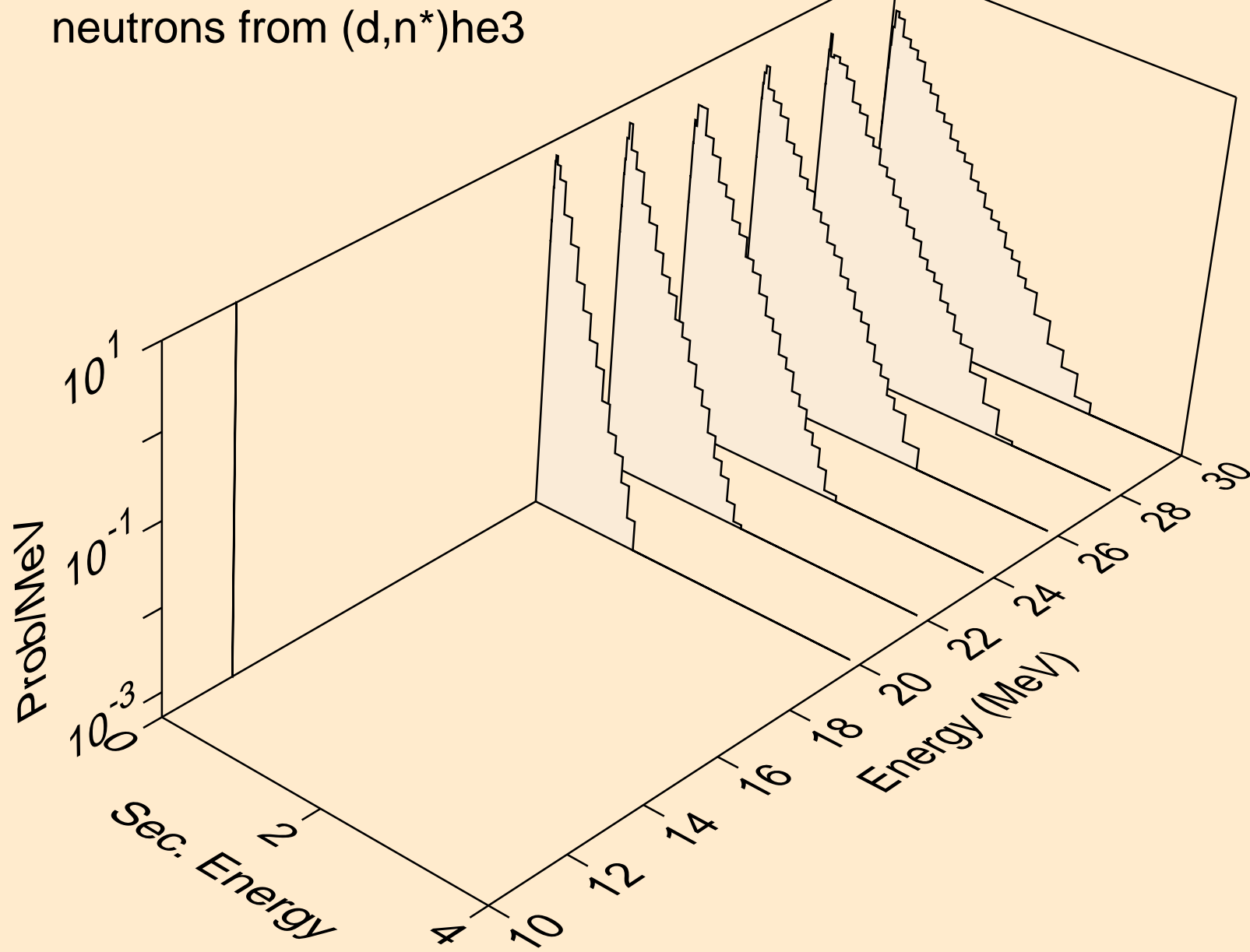

W196 DEUTERON ACER TENDL-2024 LIBRARY; T=0.K  
neutrons from (d,4n)

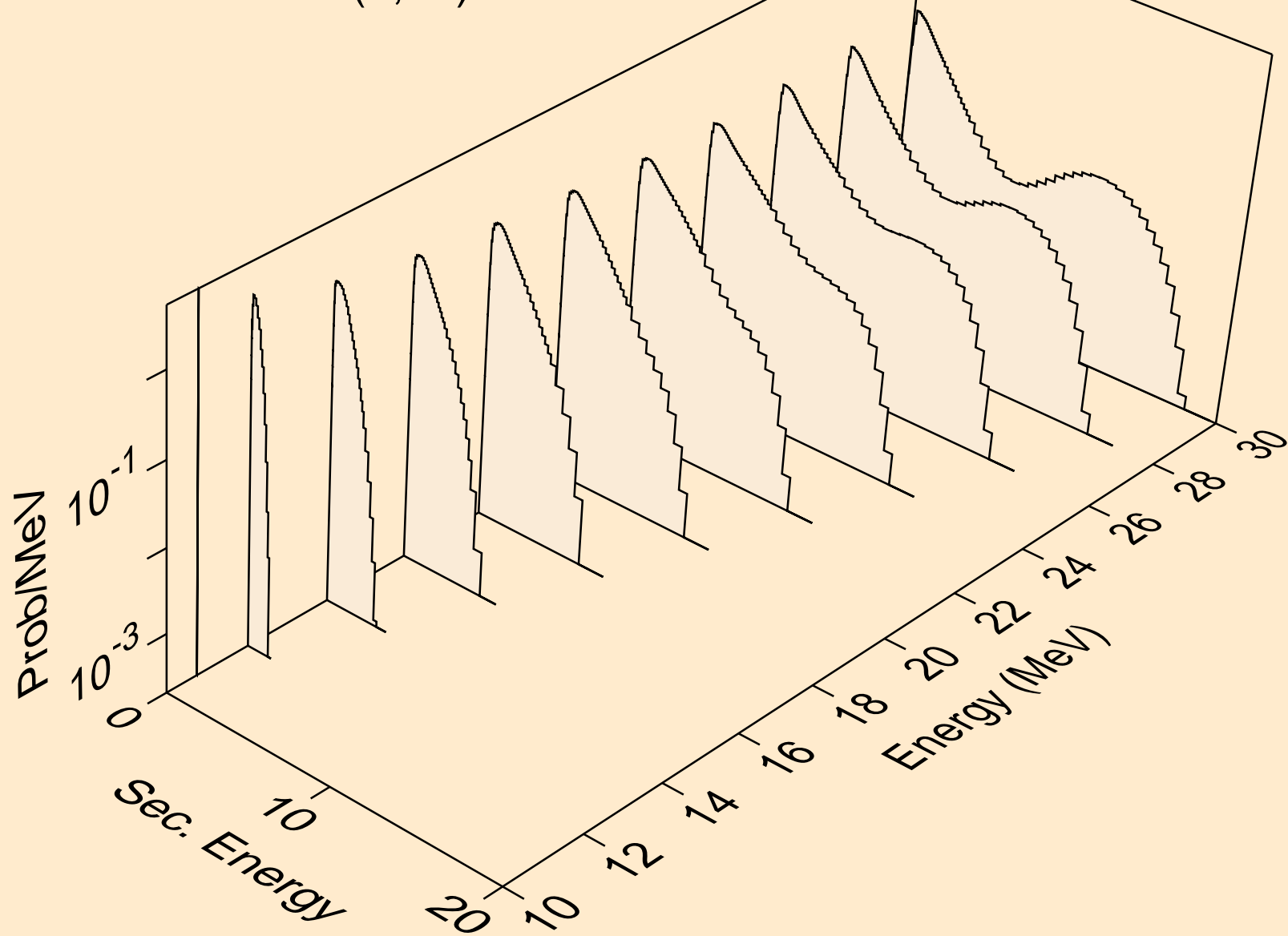

W196 DEUTERON ACER TENDL-2024 LIBRARY; T=0.K  
neutrons from (d,2np)

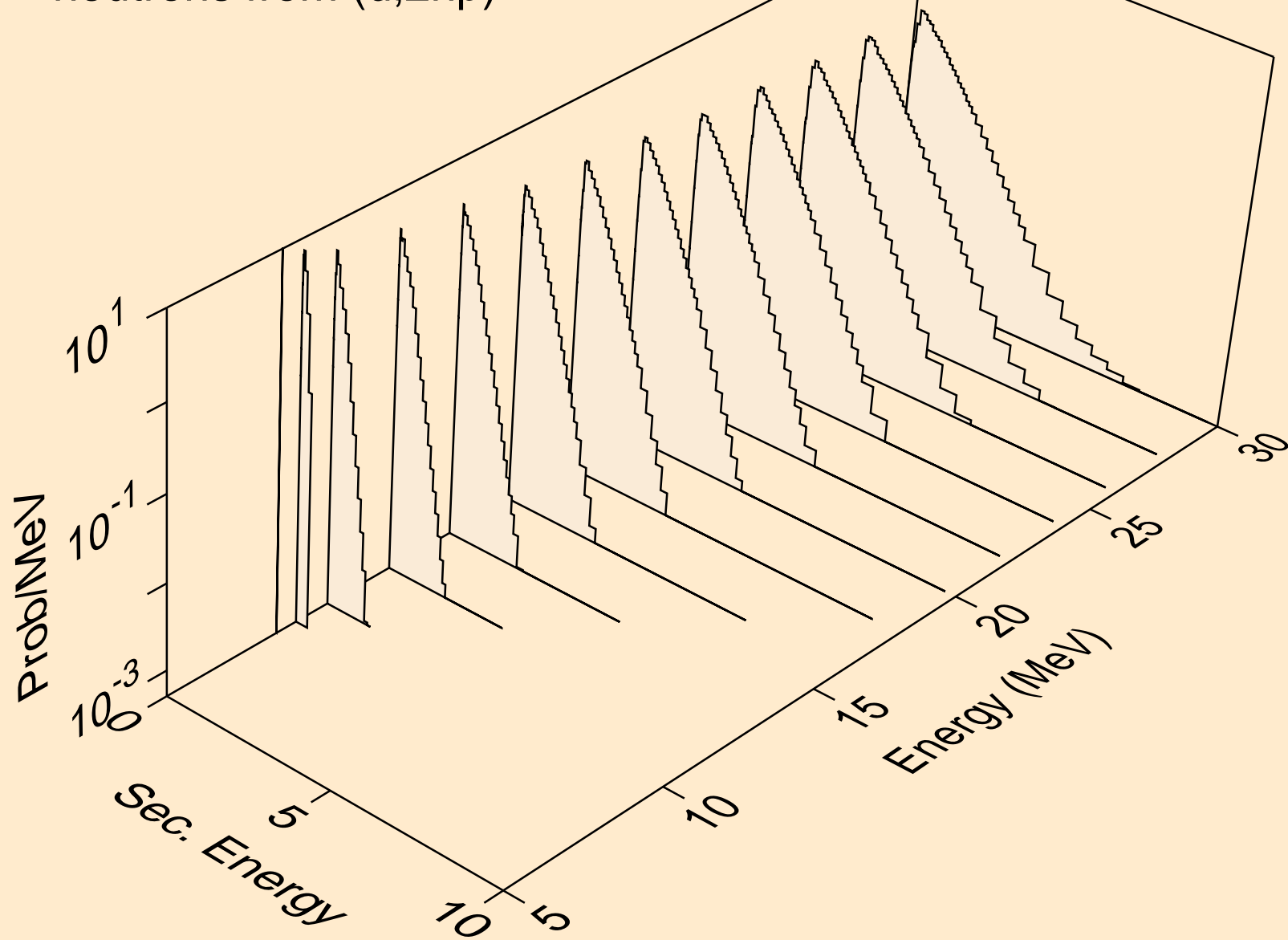

W196 DEUTERON ACER TENDL-2024 LIBRARY; T=0.K  
neutrons from (d,3np)

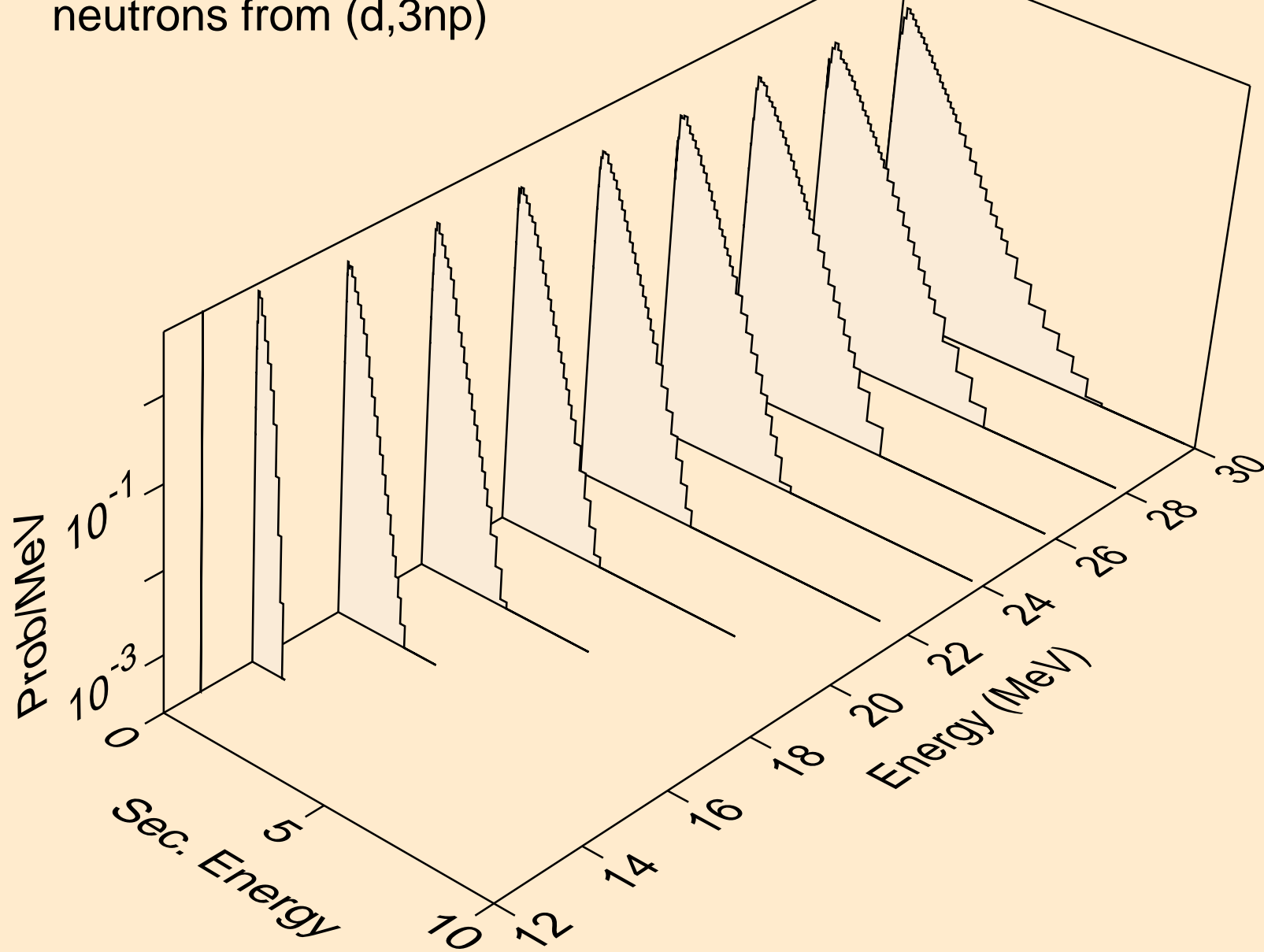

W196 DEUTERON ACER TENDL-2024 LIBRARY; T=0.K  
neutrons from (d,n2p)

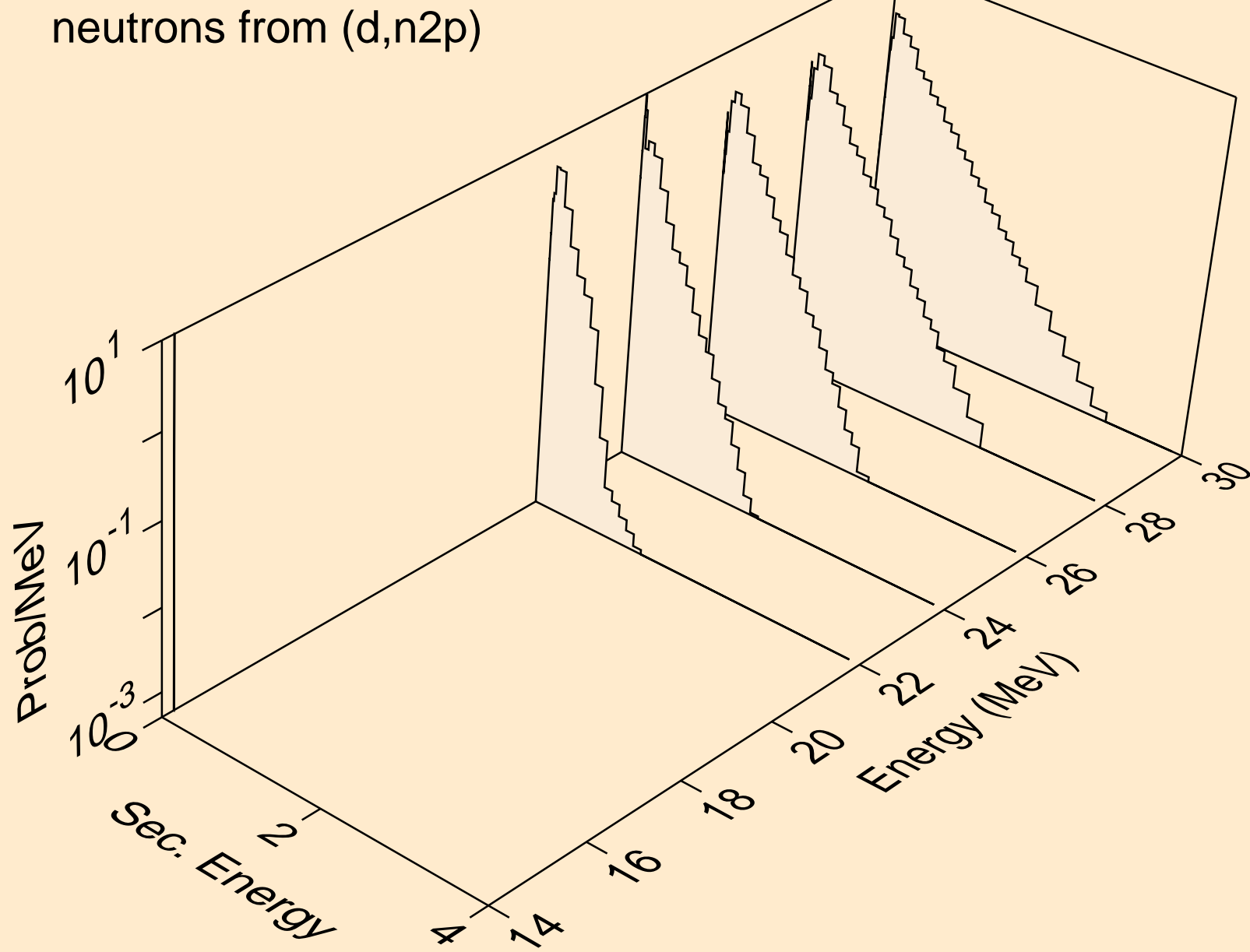

W196 DEUTERON ACER TENDL-2024 LIBRARY; T=0.K  
protons from (d,x)

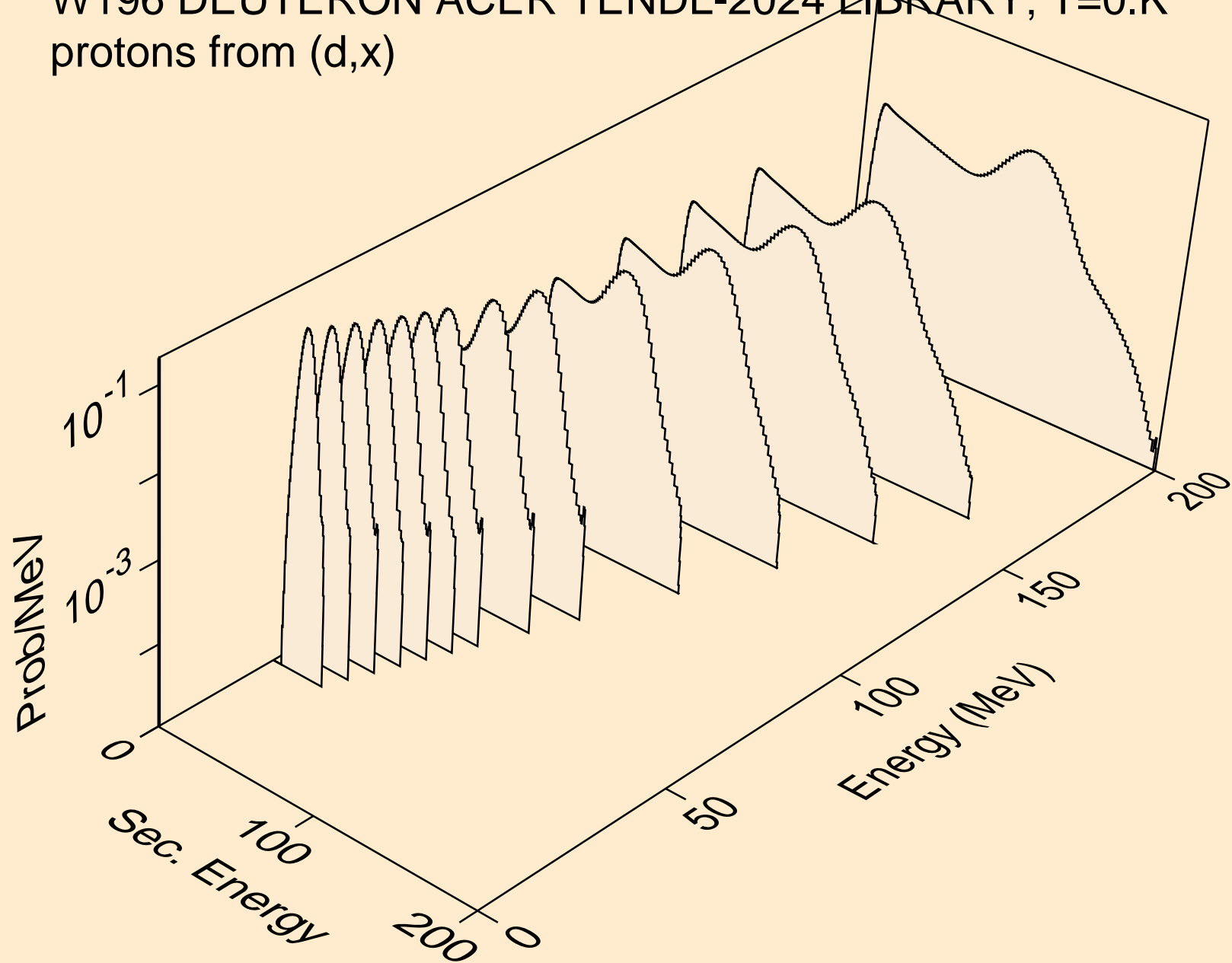

W196 DEUTERON ACER TENDL-2024 LIBRARY; T=0.K  
protons from (d,n\*)p

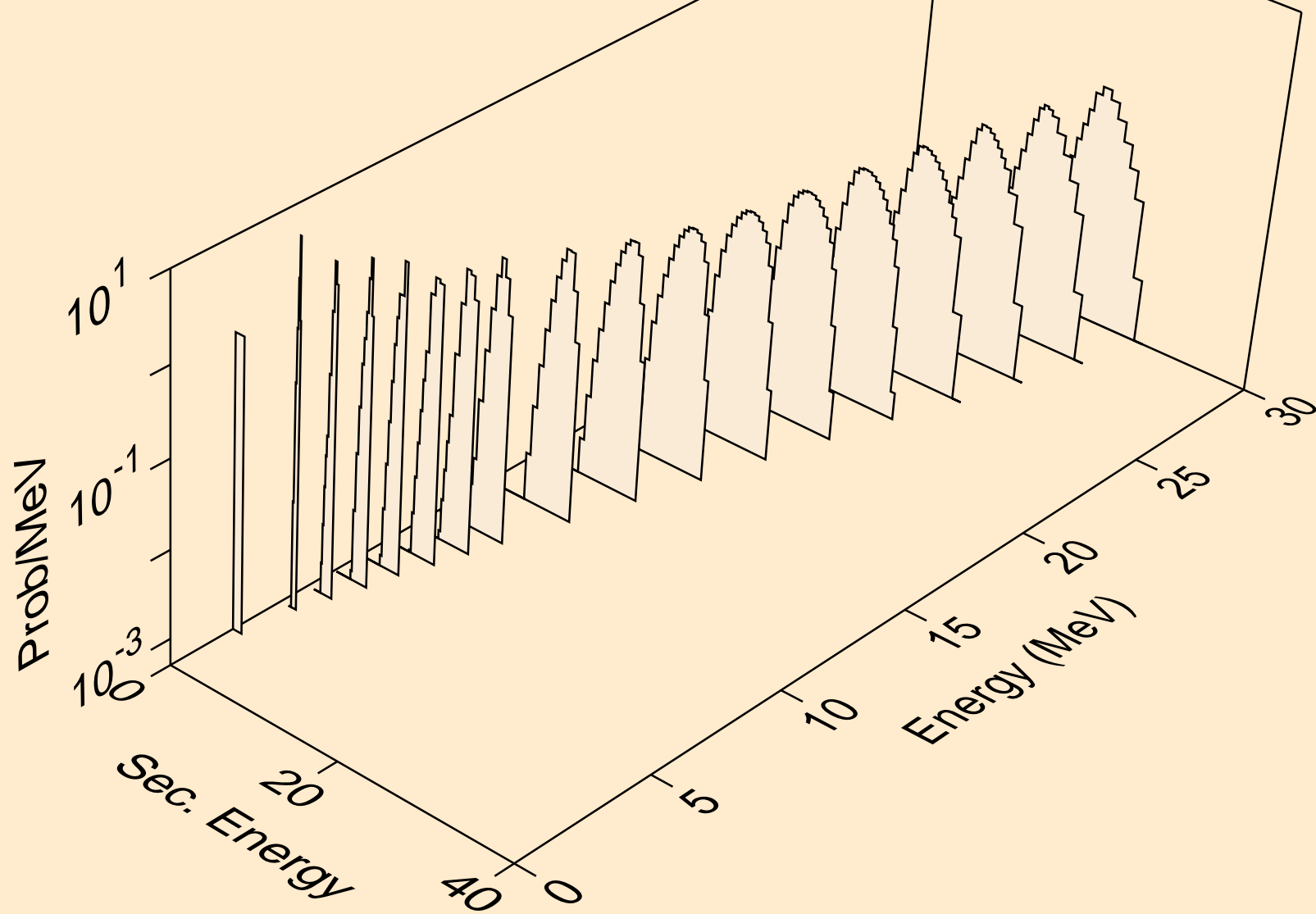

W196 DEUTERON ACER TENDL-2024 LIBRARY; T=0.K  
protons from (d,2np)

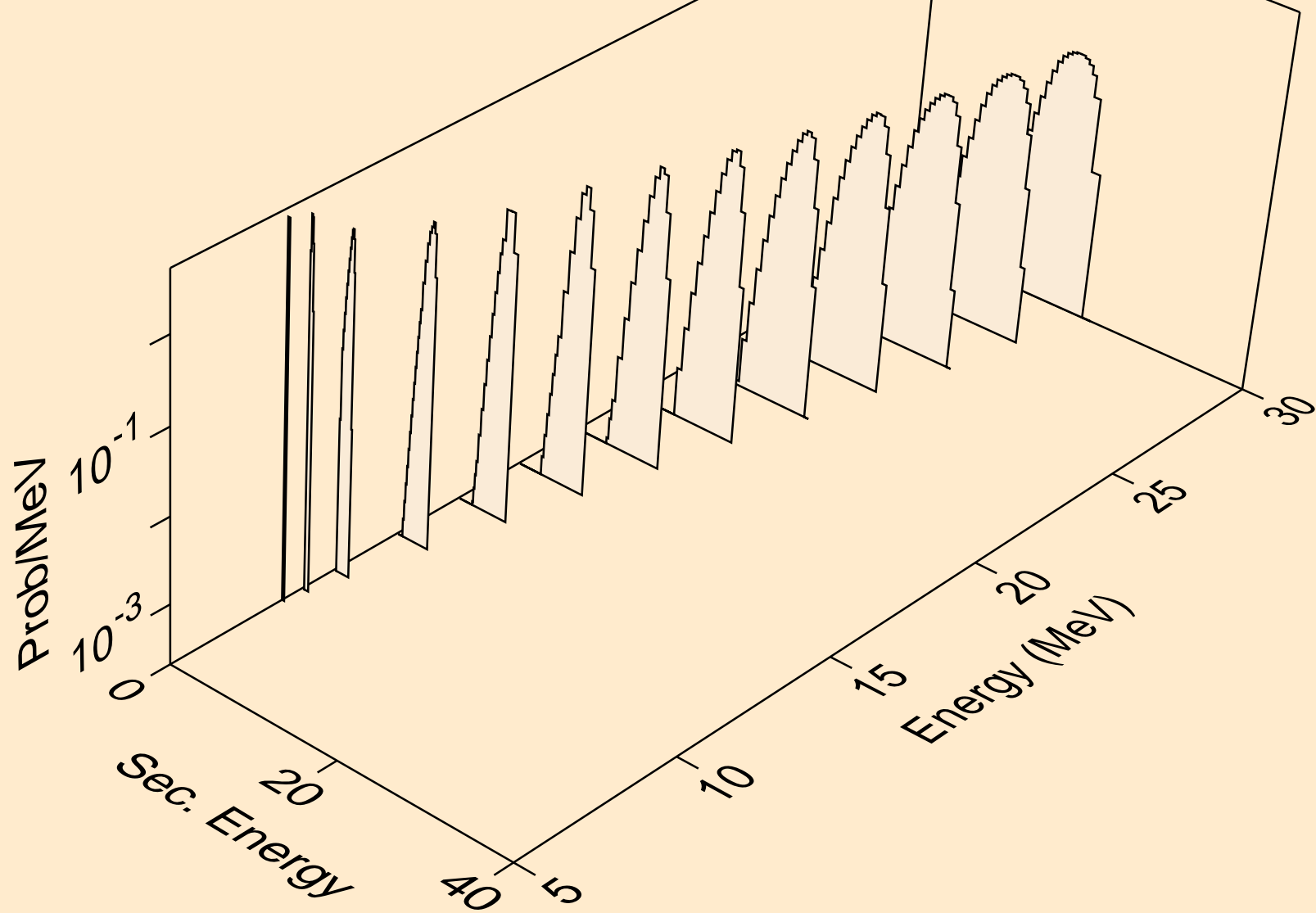

W196 DEUTERON ACER TENDL-2024 LIBRARY; T=0.K  
protons from (d,3np)

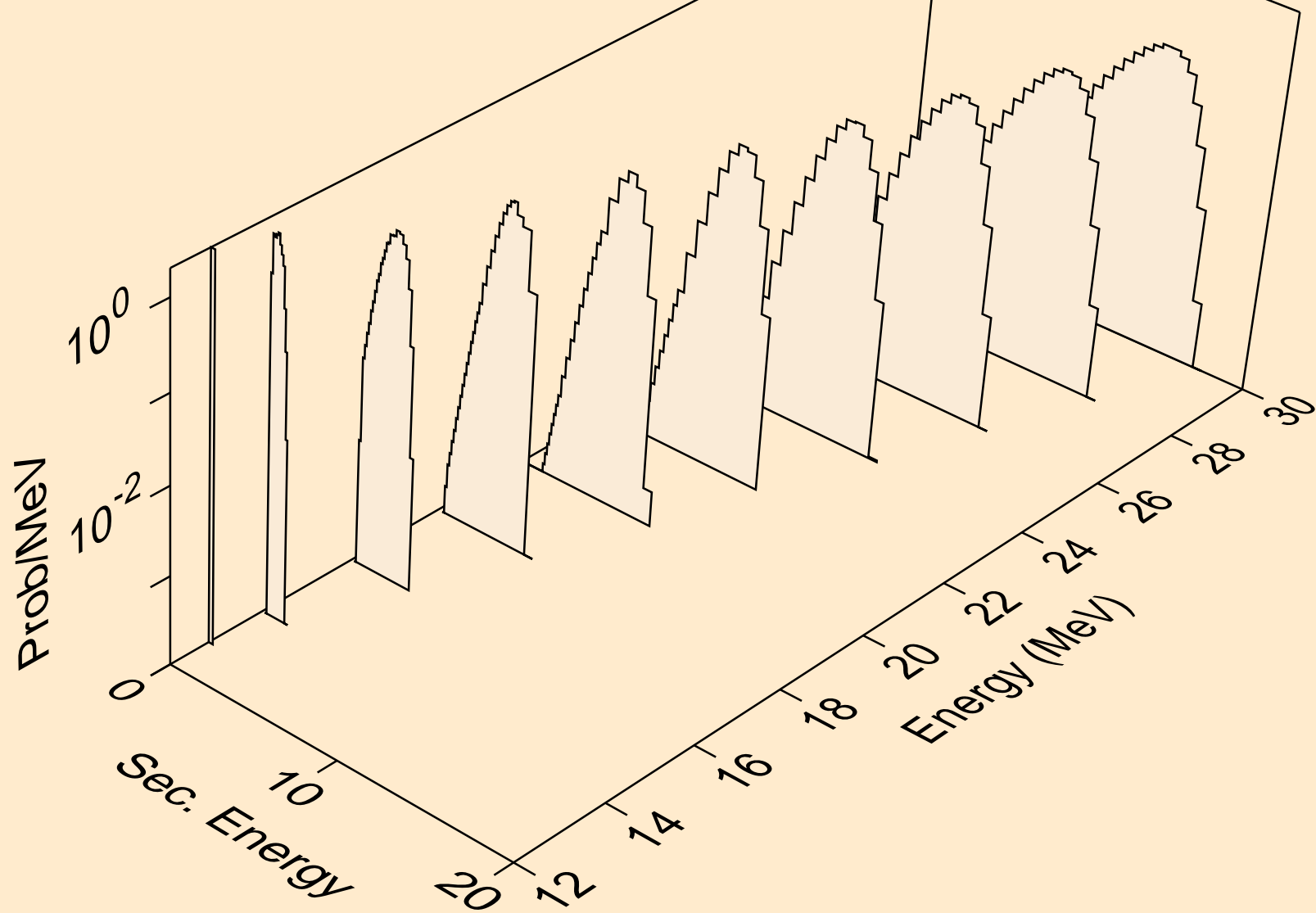

W196 DEUTERON ACER TENDL-2024 LIBRARY; T=0.K  
protons from (d,n2p)

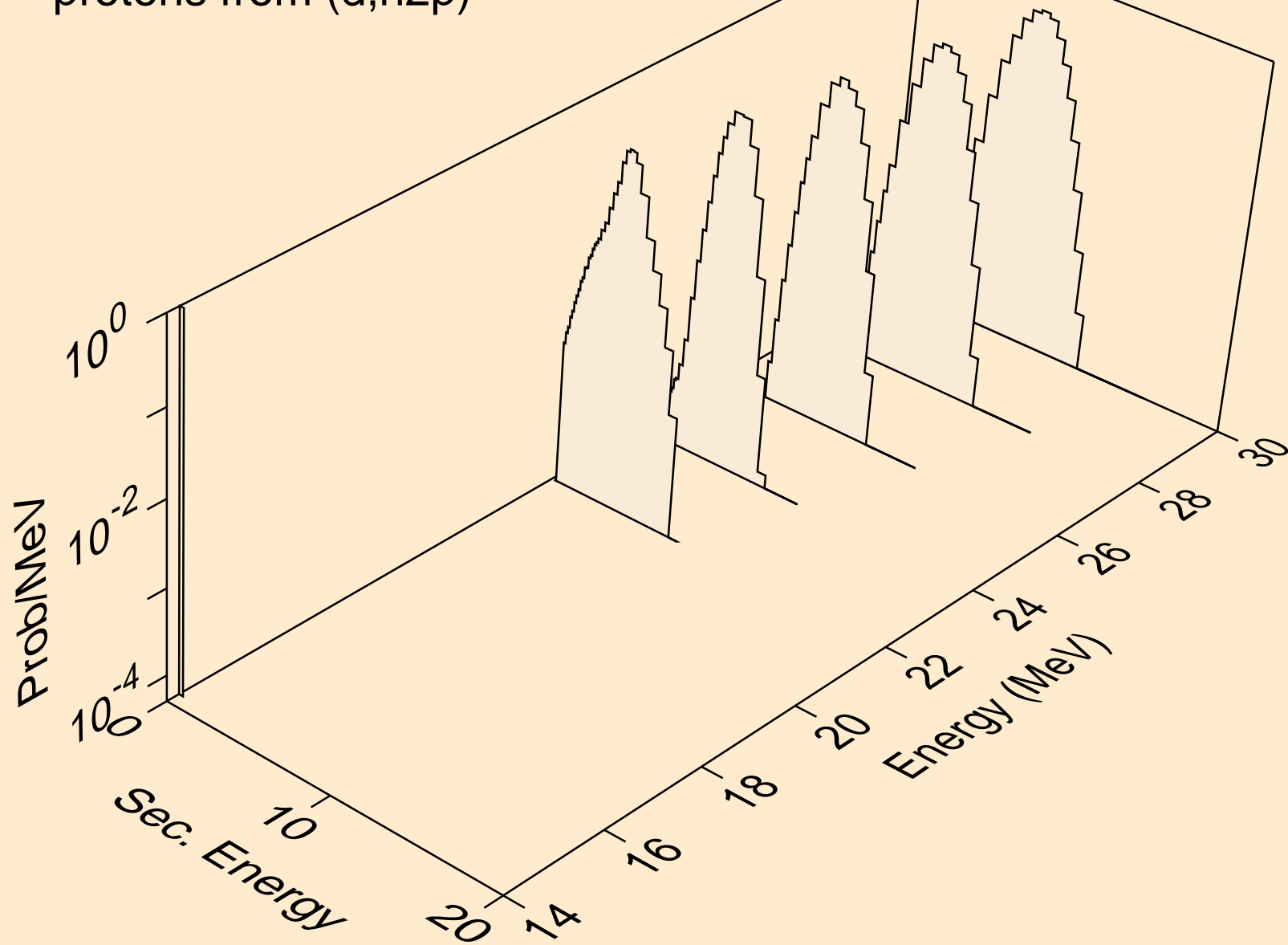

W196 DEUTERON ACER TENDL-2024 LIBRARY; T=0.K  
protons from (d,p)

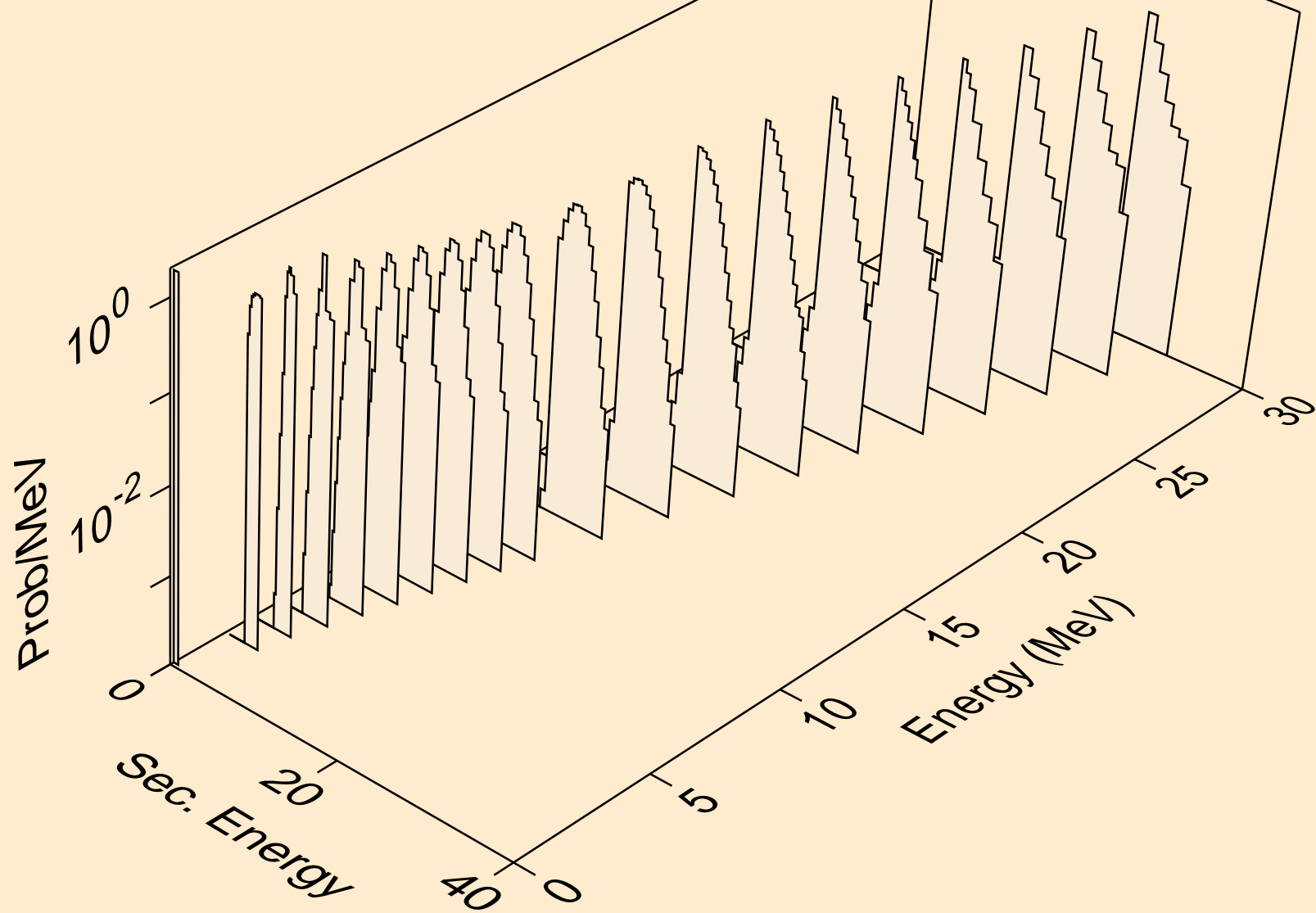

W196 DEUTERON ACER TENDL-2024 LIBRARY; T=0.K  
protons from (d,2p)

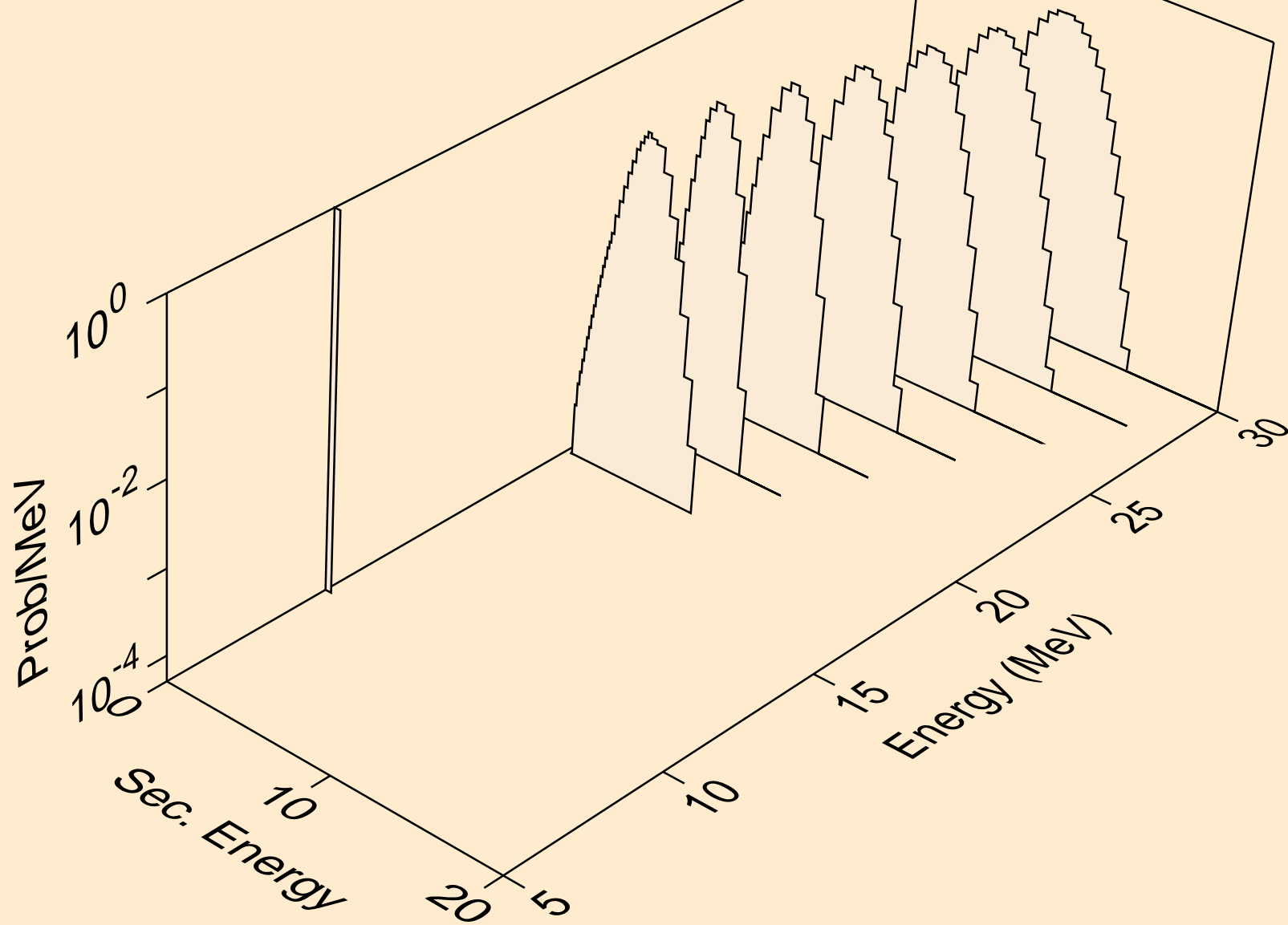

W196 DEUTERON ACER TENDL-2024 LIBRARY; T=0.K  
protons from (d,pd)

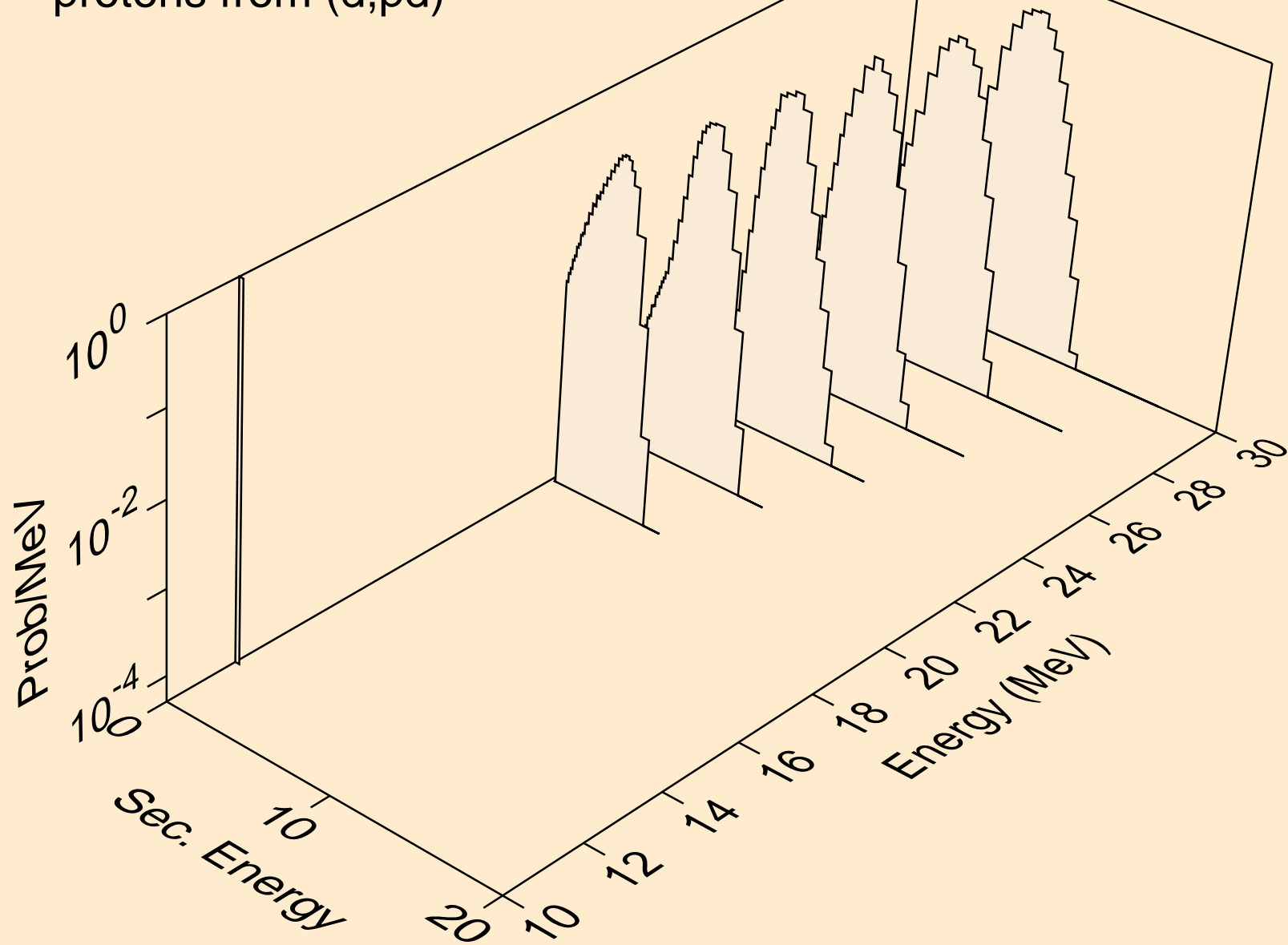

W196 DEUTERON ACER TENDL-2024 LIBRARY; T=0.K  
tritons from (d,x)

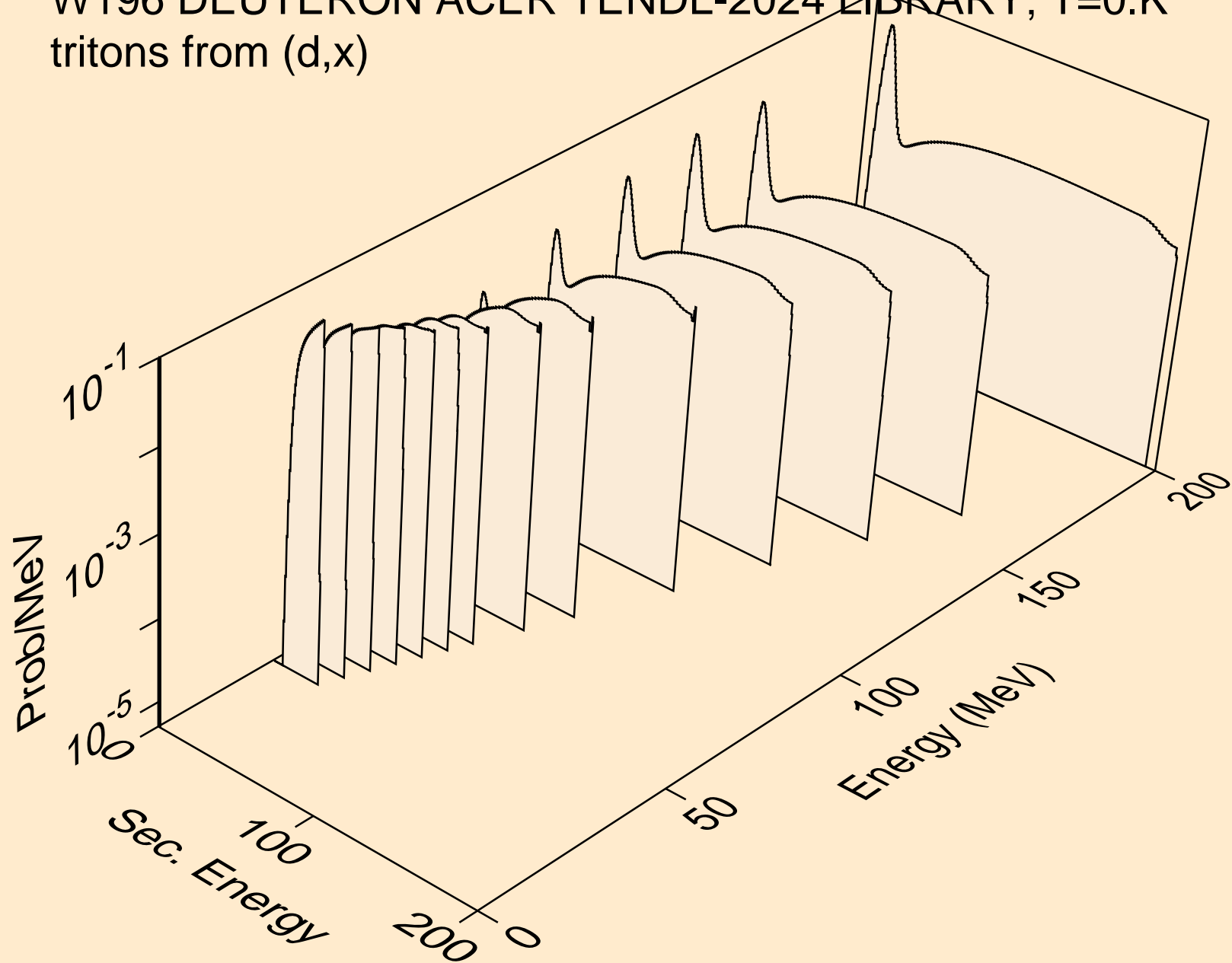

W196 DEUTERON ACER TENDL-2024 LIBRARY; T=0.K  
tritons from (d,n\*)t

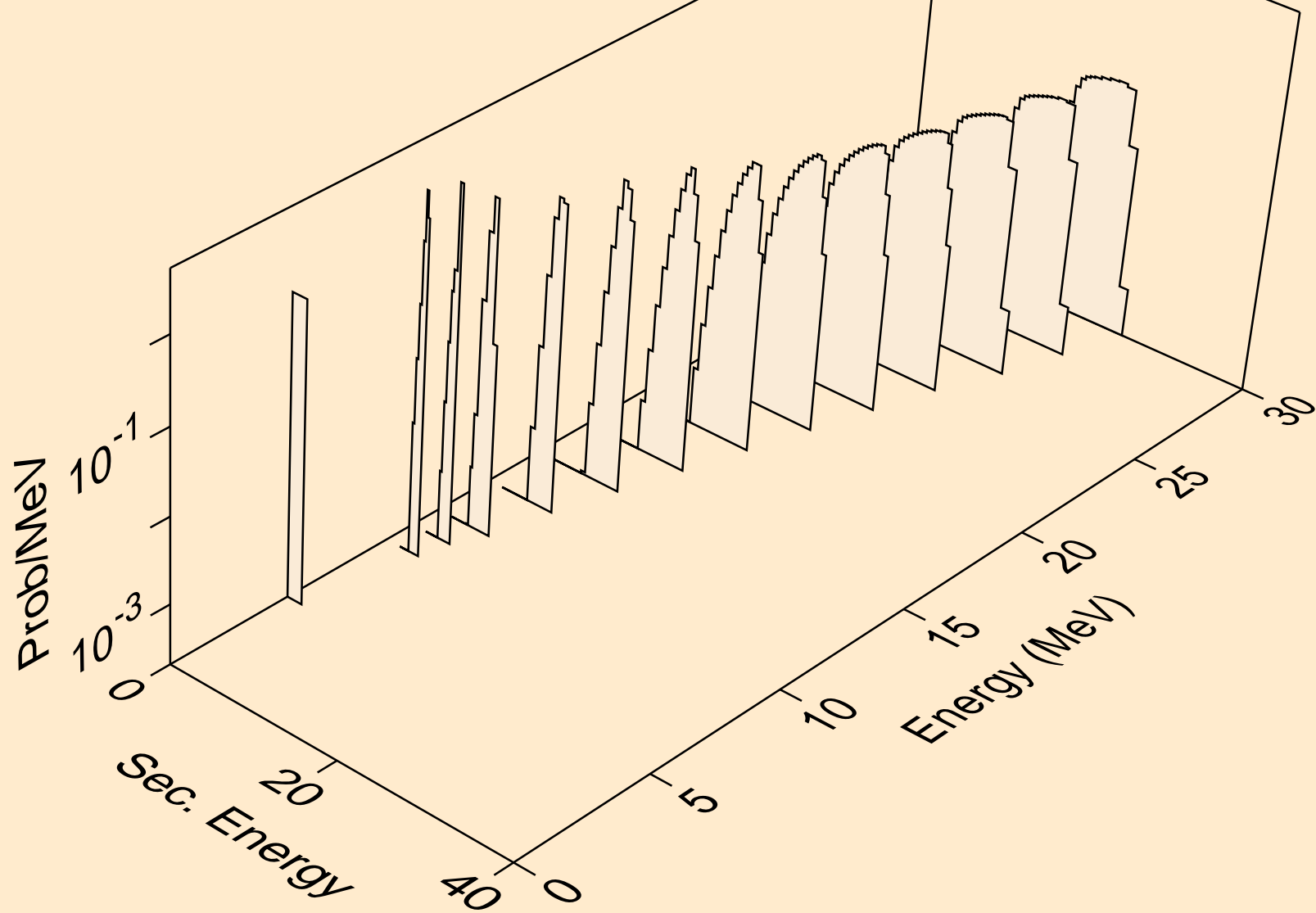

W196 DEUTERON ACER TENDL-2024 LIBRARY; T=0.K  
tritons from (d,t)

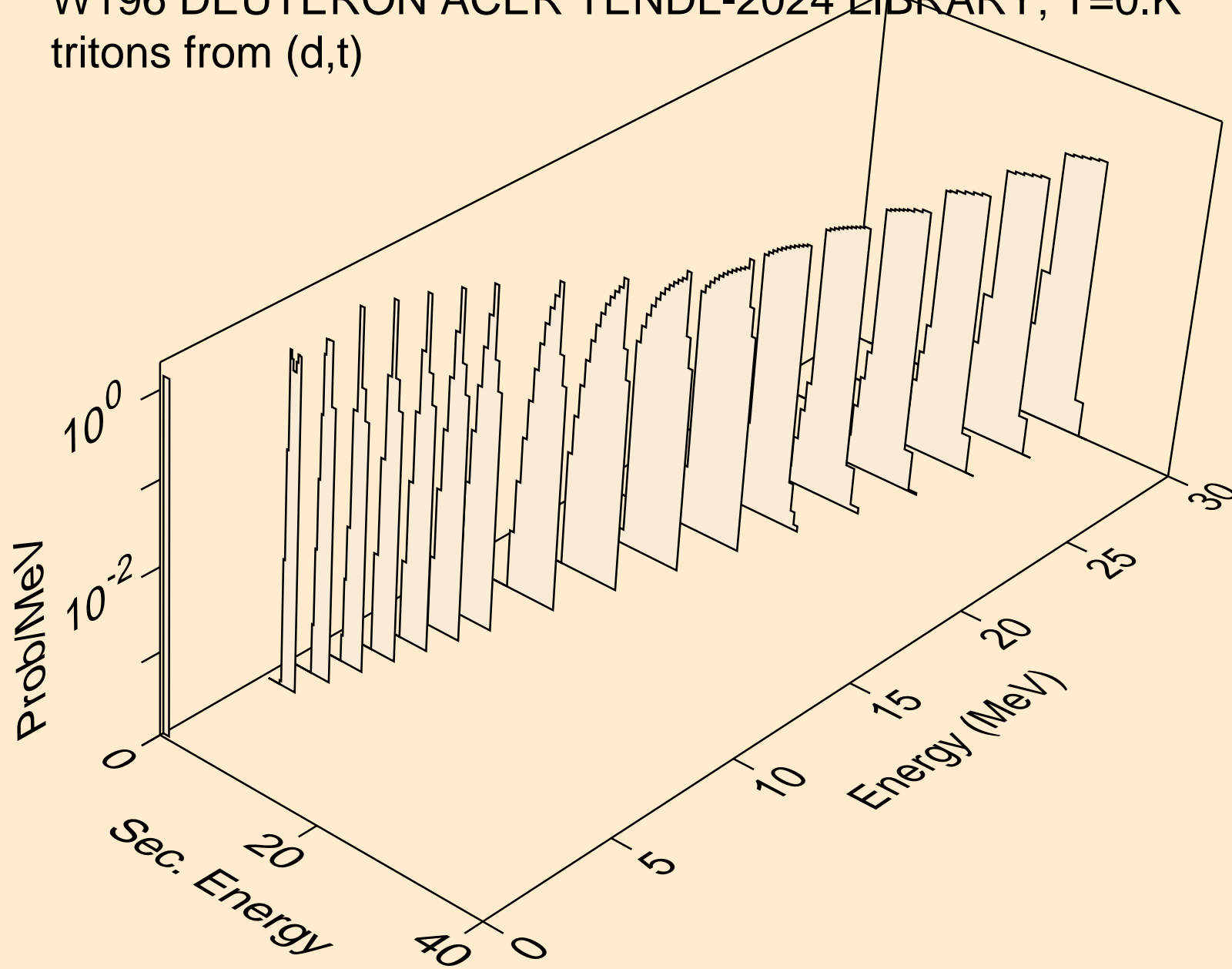

W196 DEUTERON ACER TENDL-2024 LIBRARY; T=0.K  
he3s from (d,x)

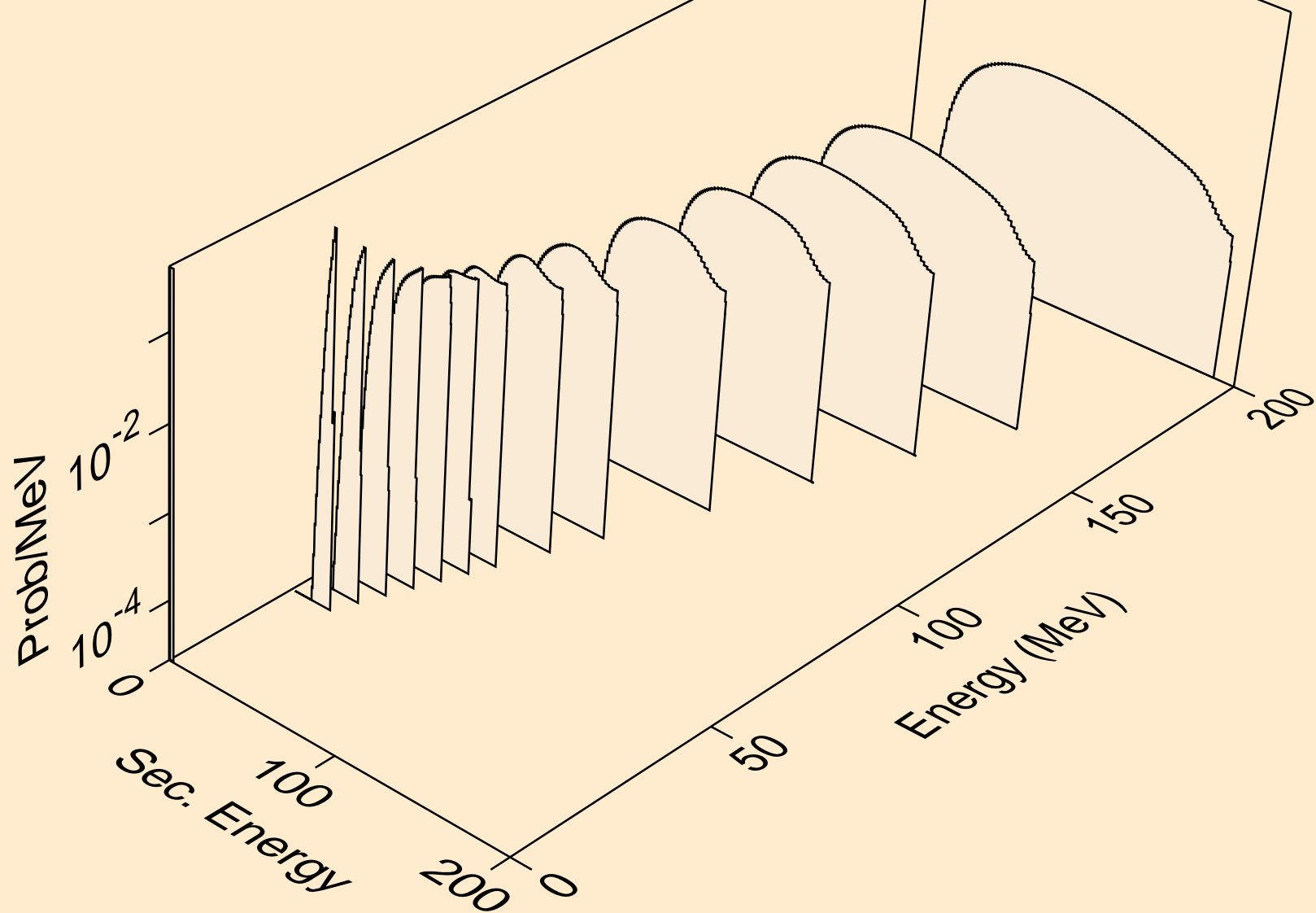

W196 DEUTERON ACER TENDL-2024 LIBRARY; T=0.K  
he3s from (d,n\*)he3

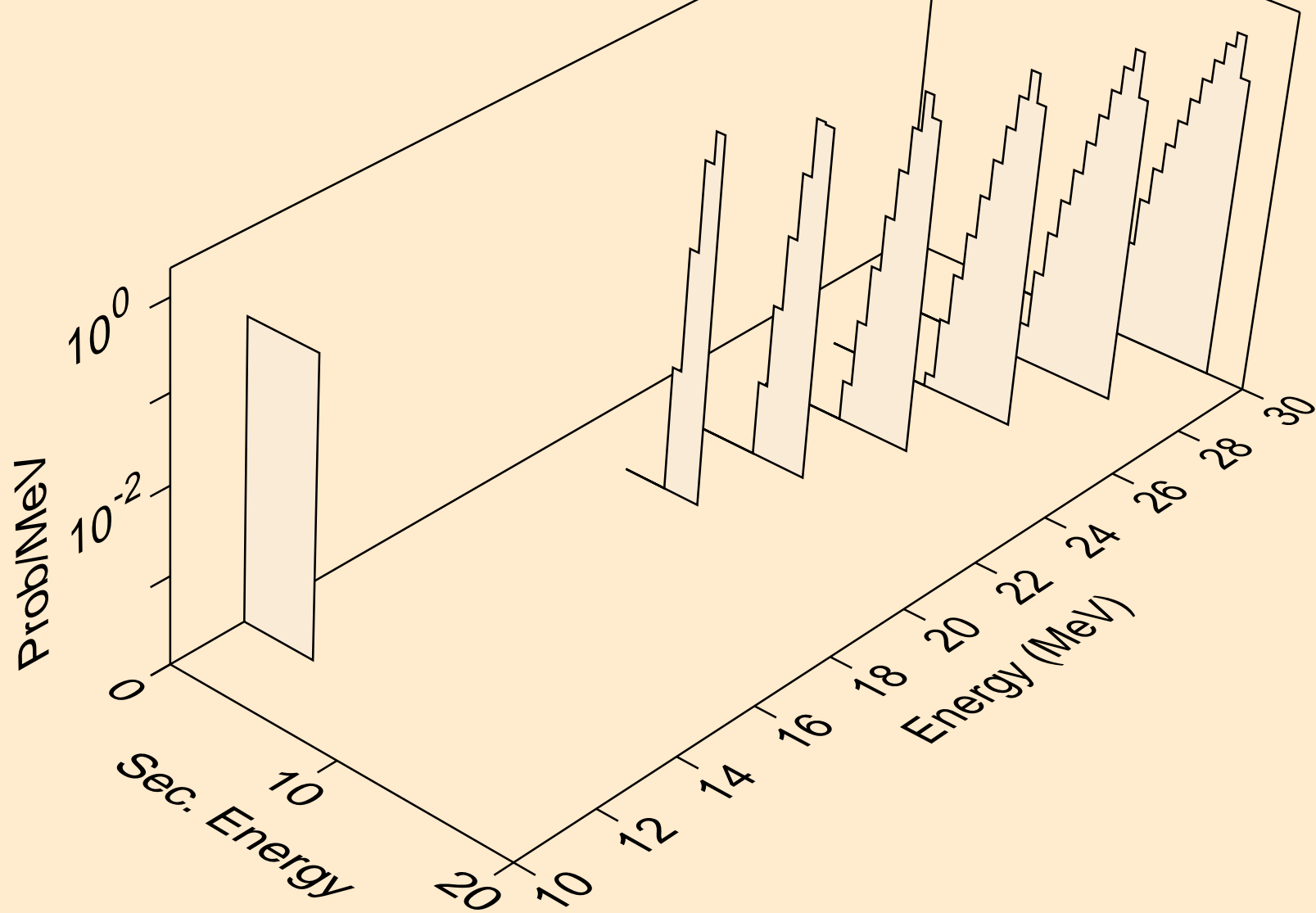

W196 DEUTERON ACER TENDL-2024 LIBRARY; T=0.K  
he3s from (d,he3)

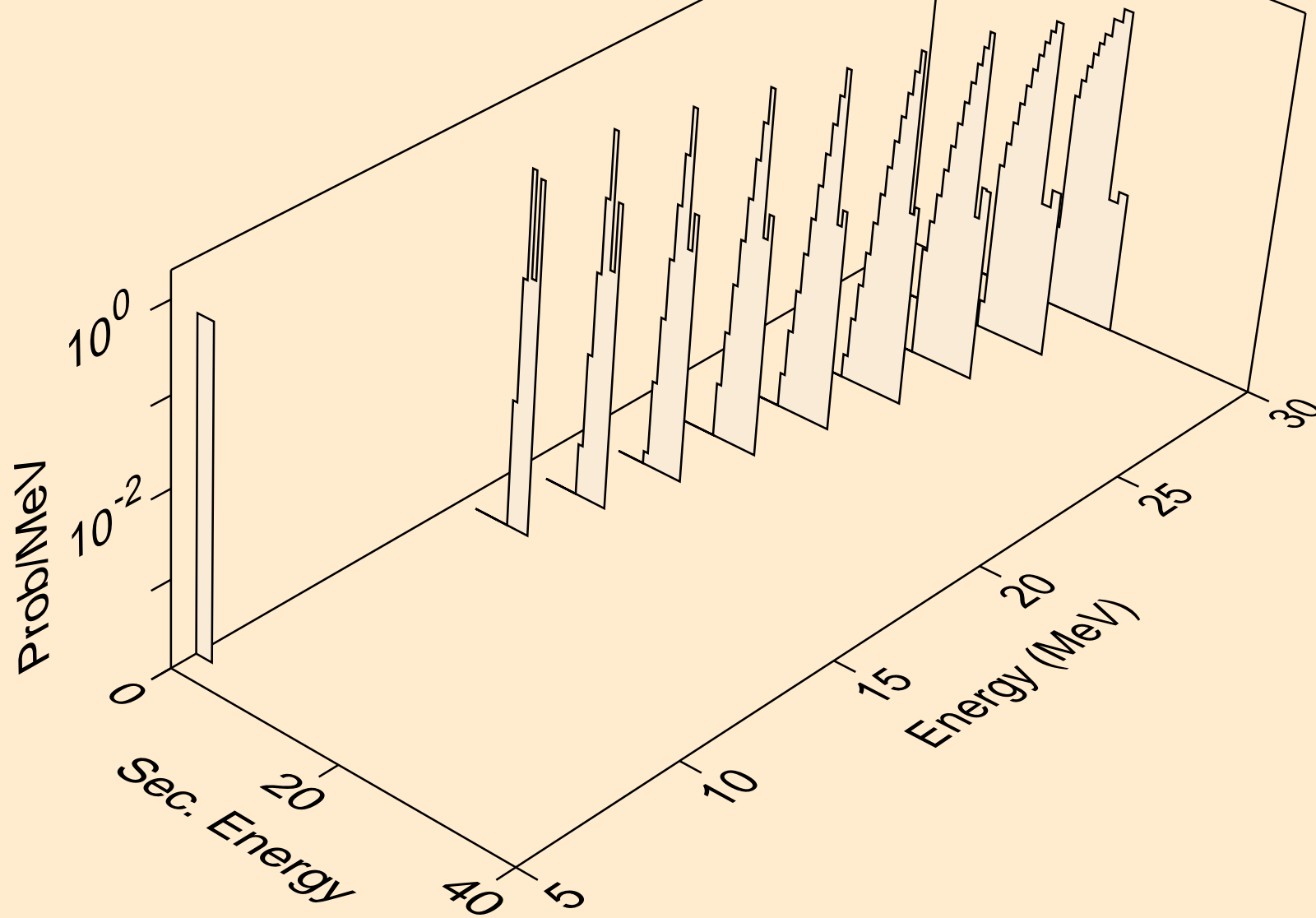

W196 DEUTERON ACER TENDL-2024 LIBRARY; T=0.K  
alphas from (d,x)

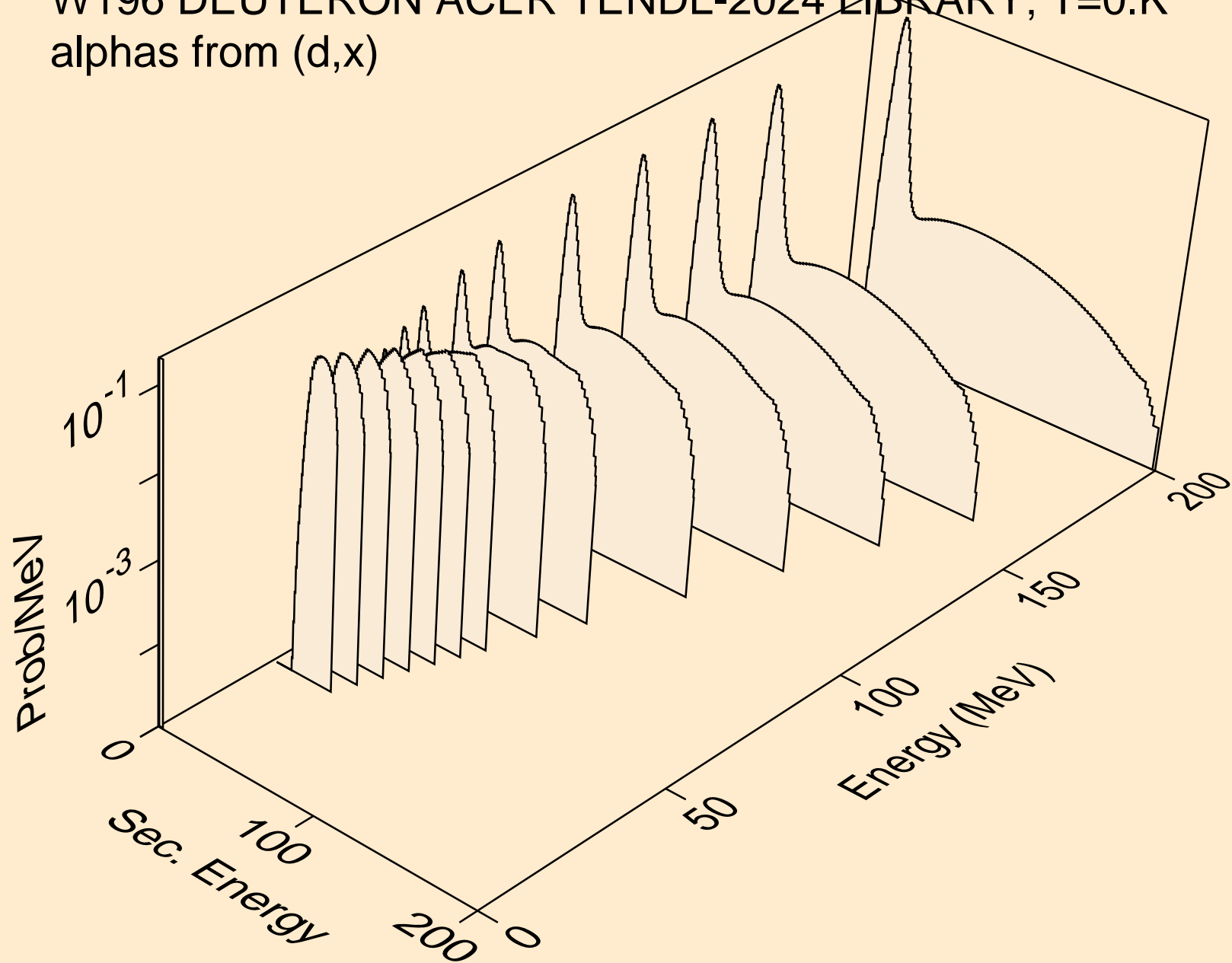

W196 DEUTERON ACER TENDL-2024 LIBRARY; T=0.K  
alphas from (d,n\*)a

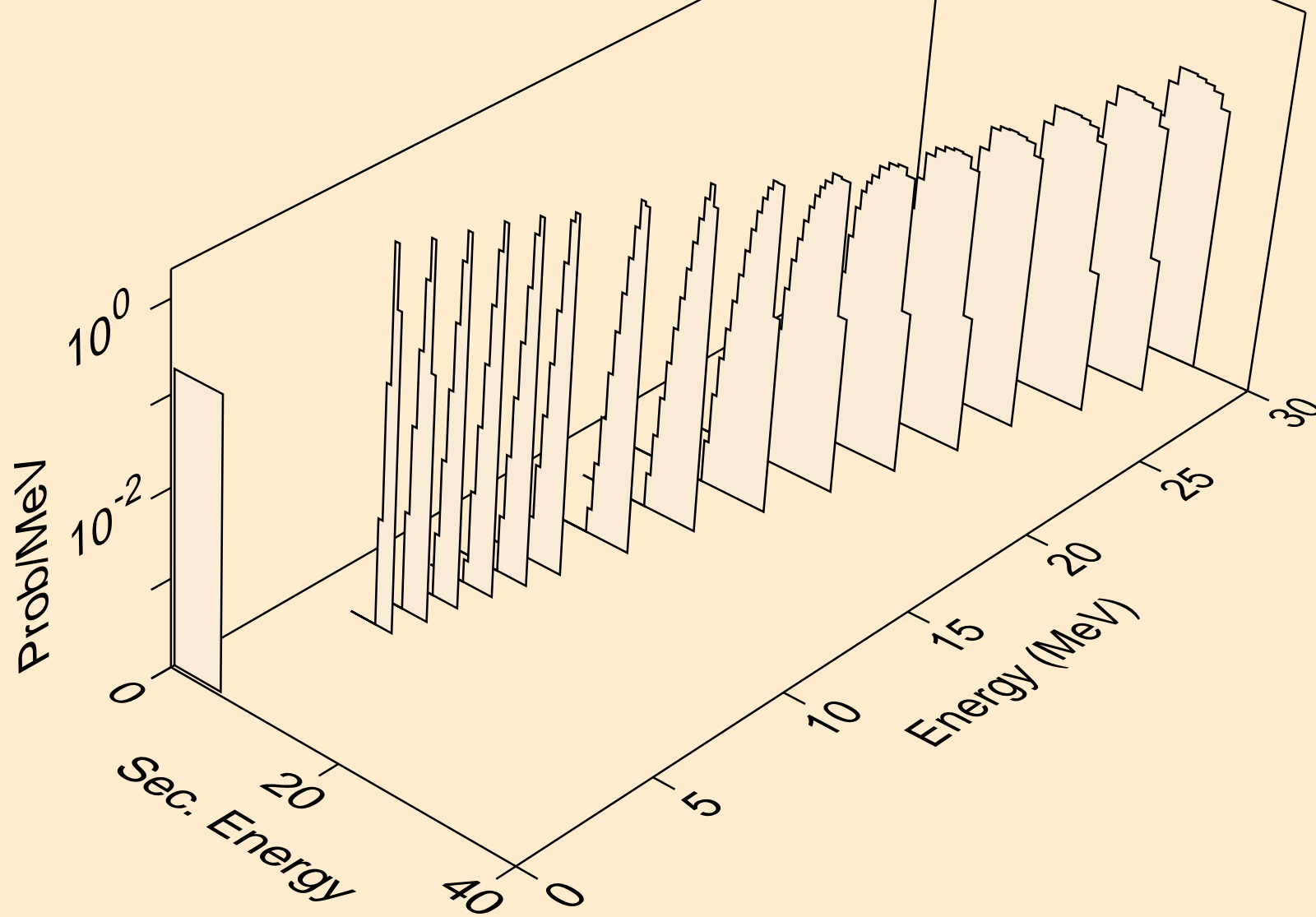

W196 DEUTERON ACER TENDL-2024 LIBRARY; T=0.K  
alphas from (d,2n)a

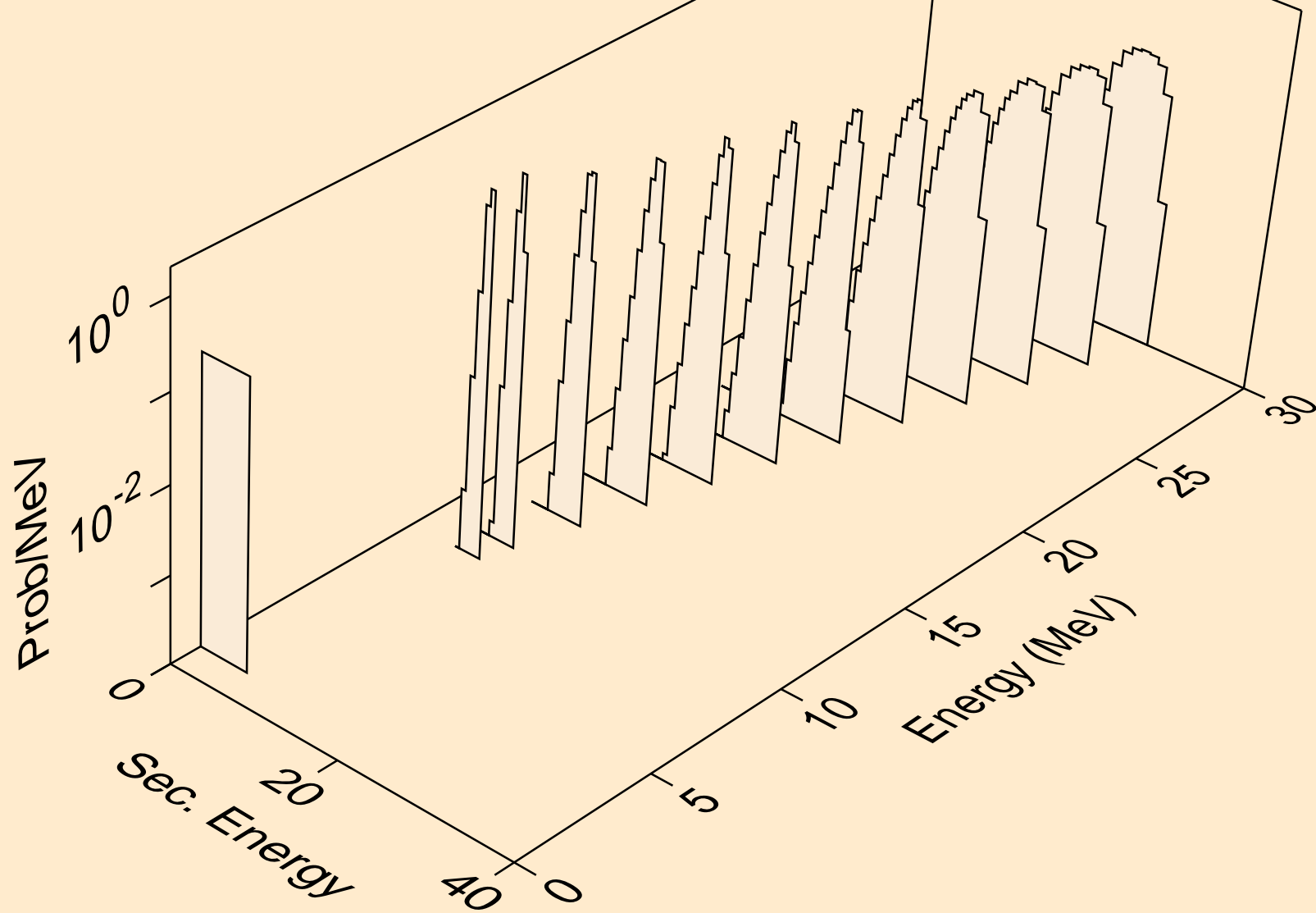

W196 DEUTERON ACER TENDL-2024 LIBRARY; T=0.K  
alphas from (d,3n)a

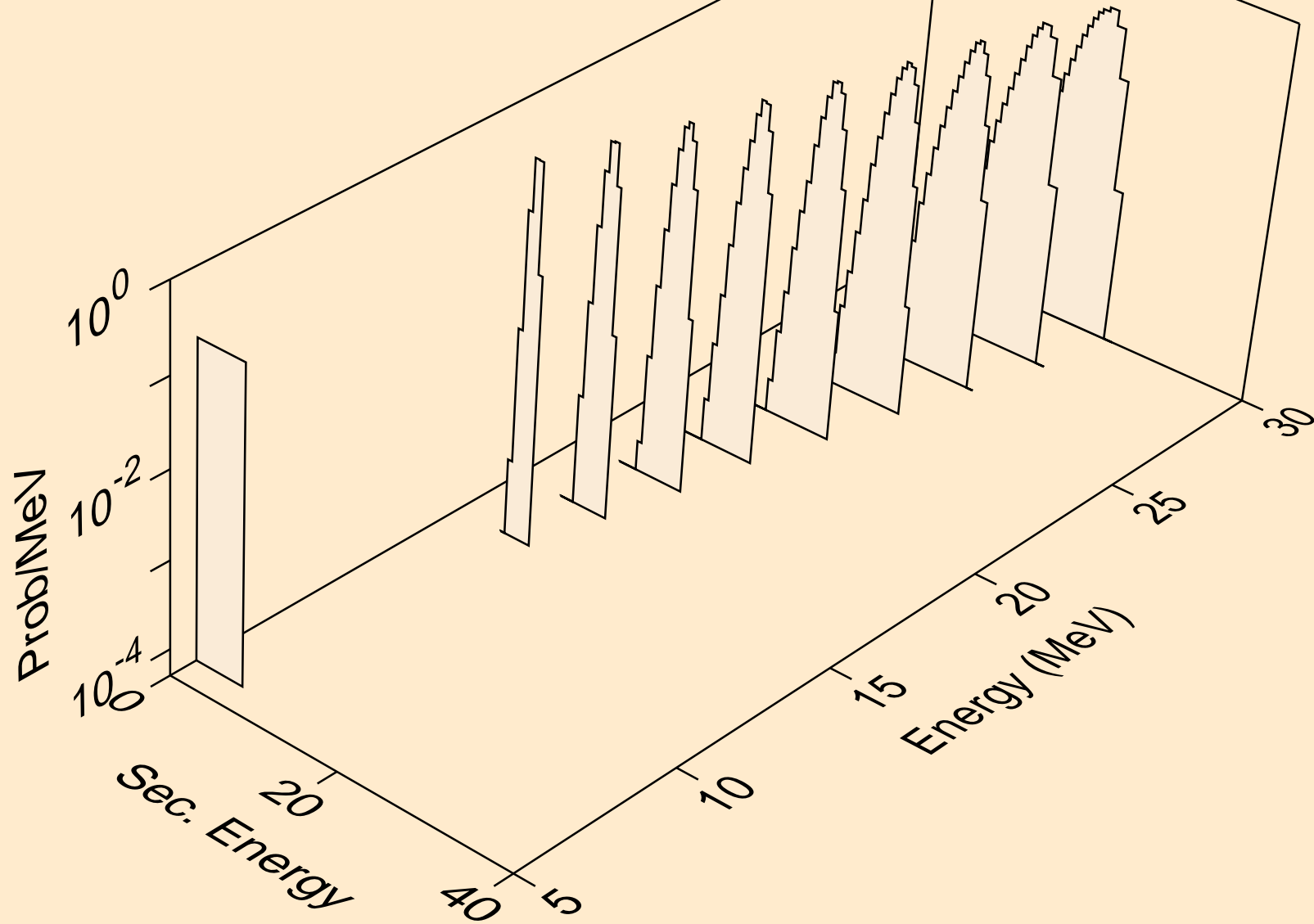

W196 DEUTERON ACER TENDL-2024 LIBRARY; T=0.K  
alphas from (d,a)

