

Y081 DEUTERON ACER TENDL-2024 LIBRARY; T=0.K
Principal cross sections

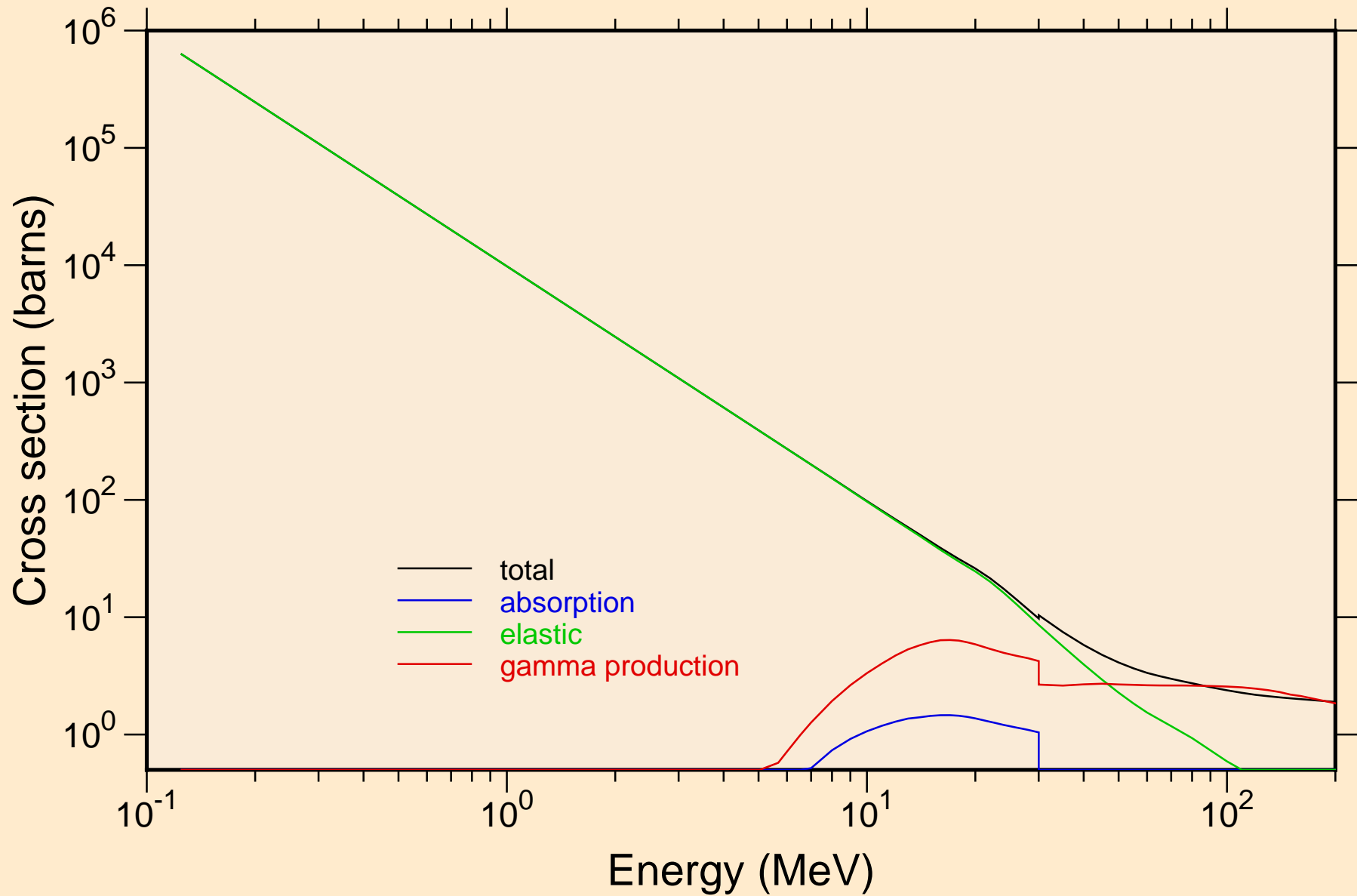

Y081 DEUTERON ACER TENDL-2024 LIBRARY; T=0.K

Heating

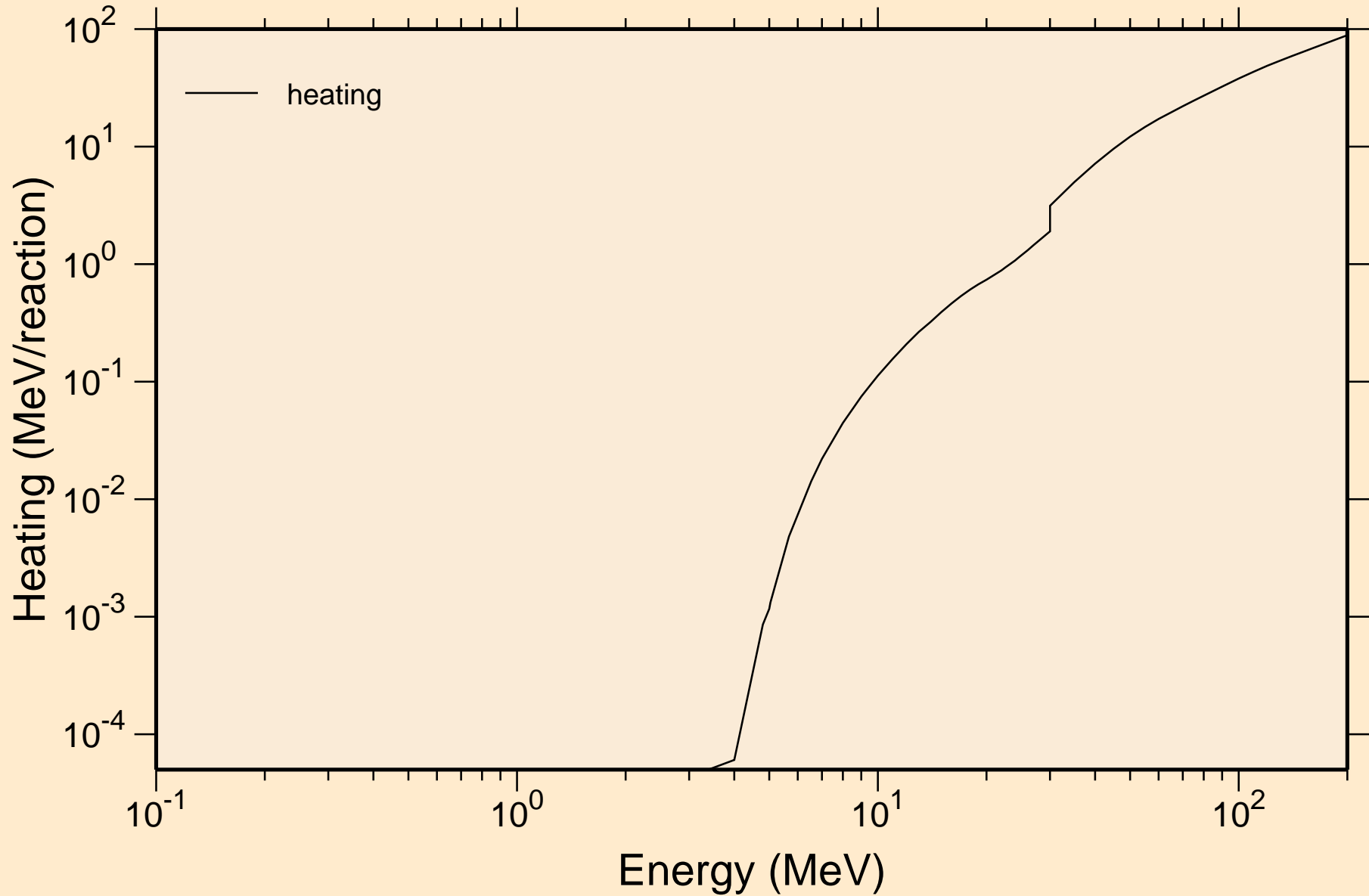

Y081 DEUTERON ACER TENDL-2024 LIBRARY; T=0.K
Principal cross sections

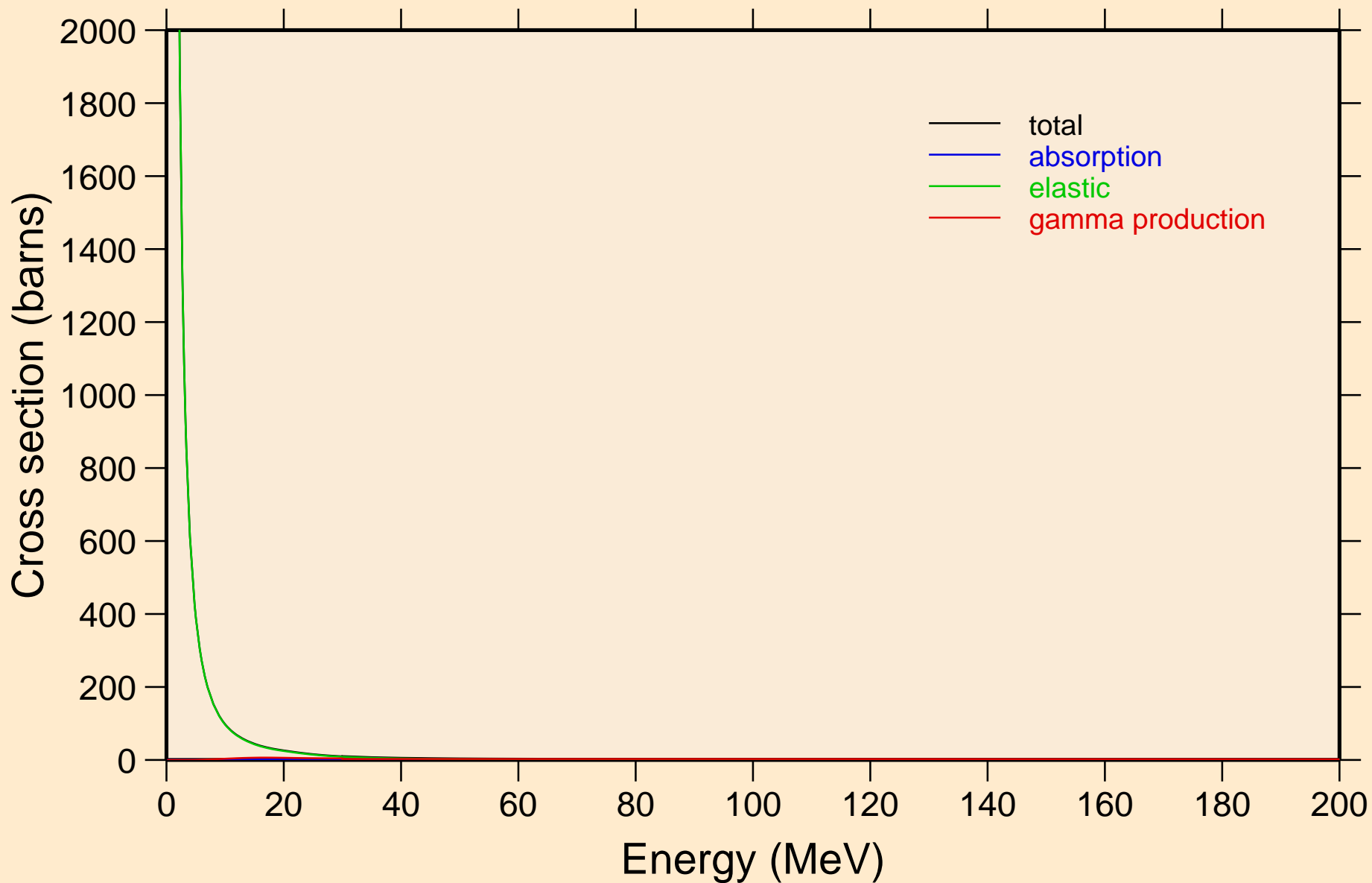

Y081 DEUTERON ACER TENDL-2024 LIBRARY; T=0.K

Heating

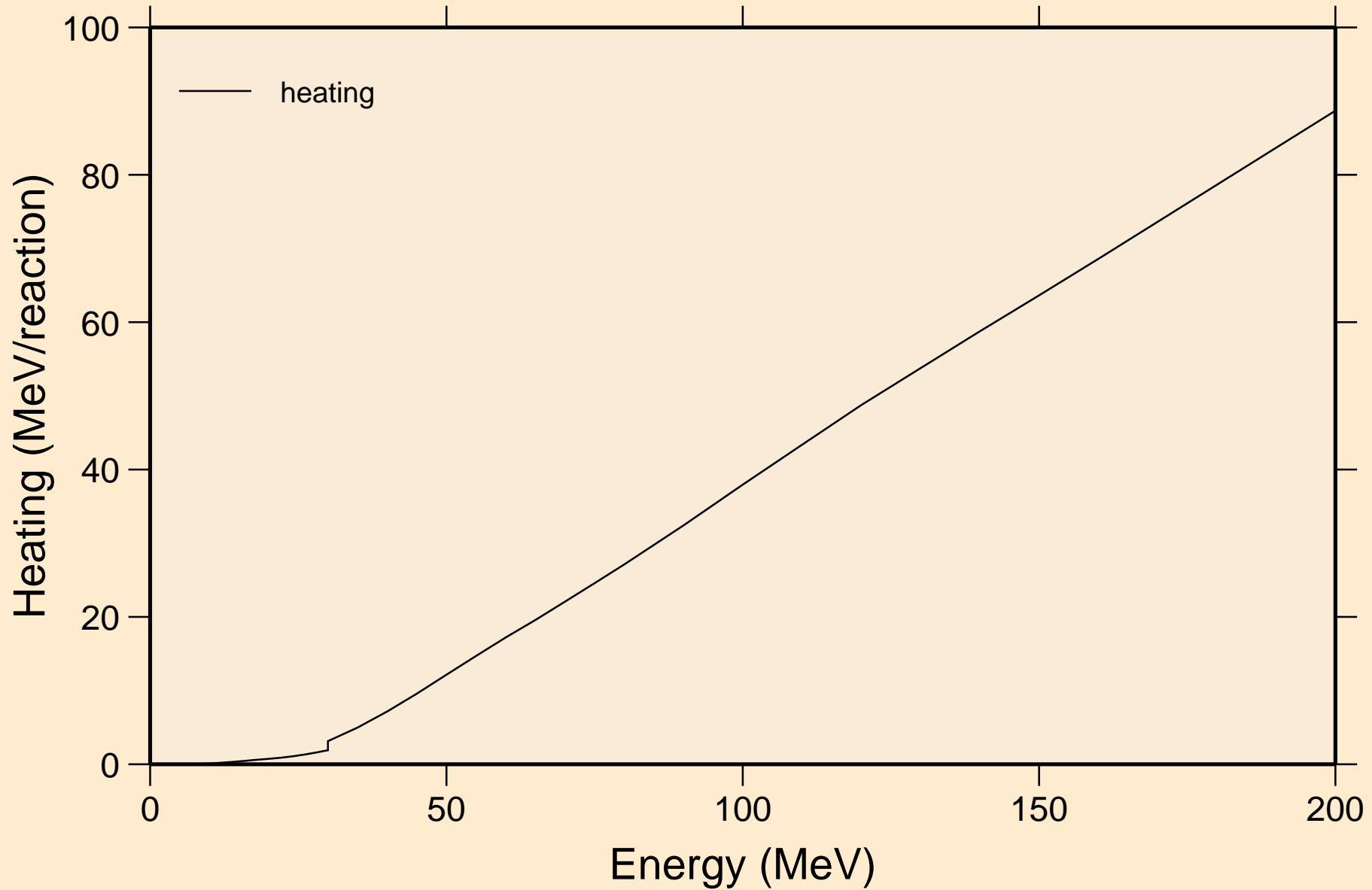

Y081 DEUTERON ACER TENDL-2024 LIBRARY; T=0.K
Threshold reactions

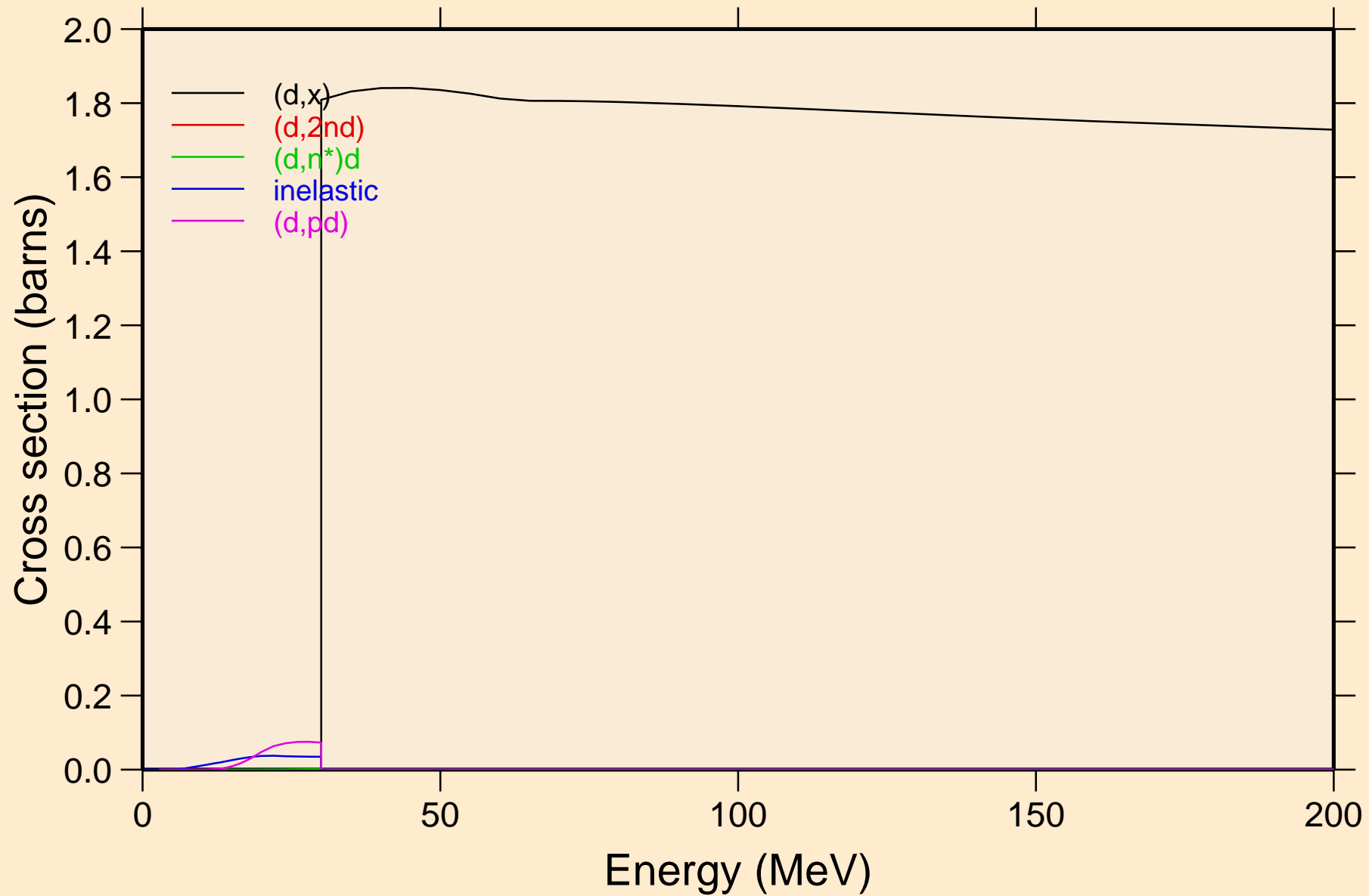

Y081 DEUTERON ACER TENDL-2024 LIBRARY; T=0.K
Threshold reactions

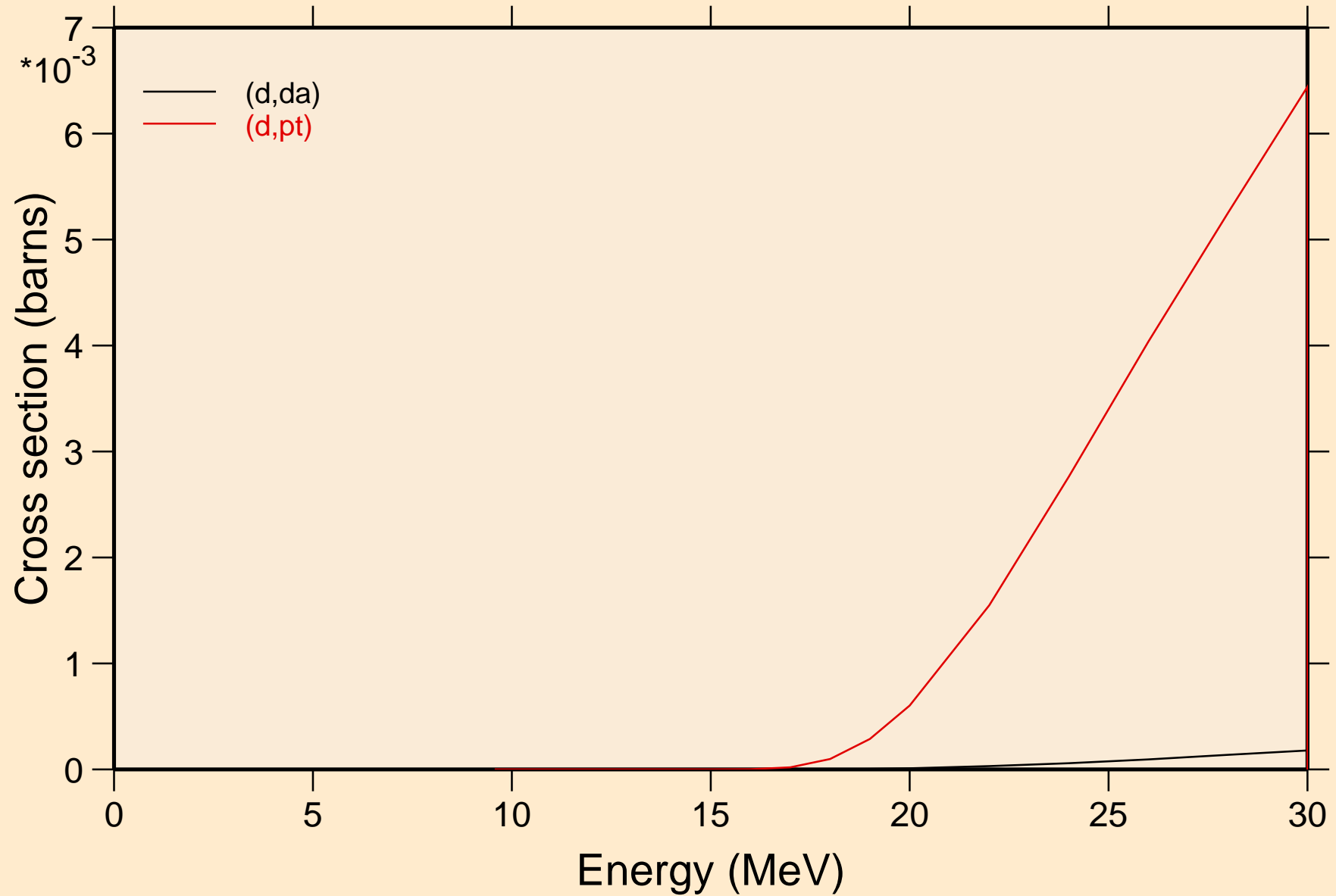

Y081 DEUTERON ACER TENDL-2024 LIBRARY; T=0.K
Threshold reactions

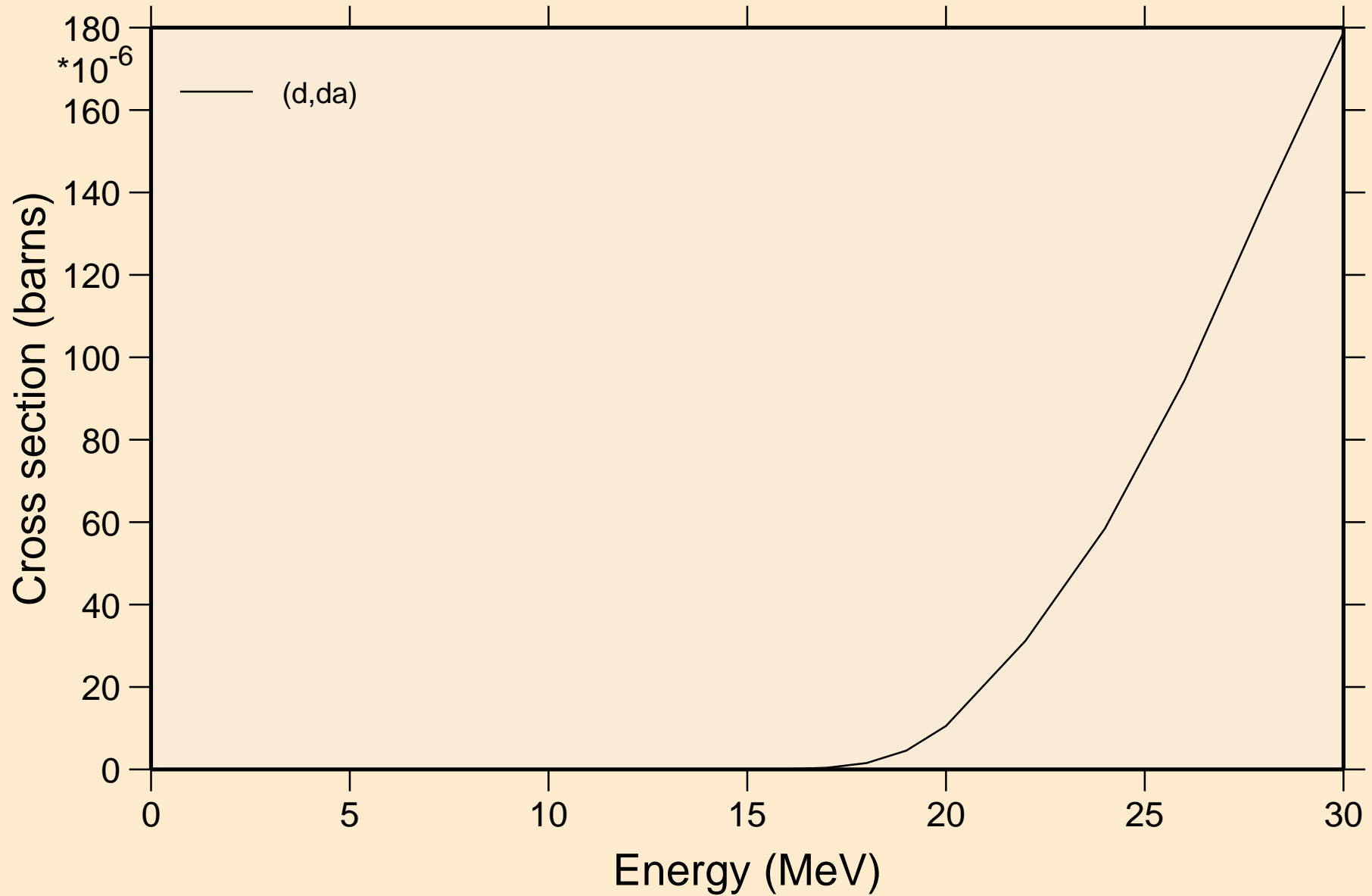

Y081 DEUTERON ACER TENDL-2024 LIBRARY; T=0.K
angular distribution for elastic

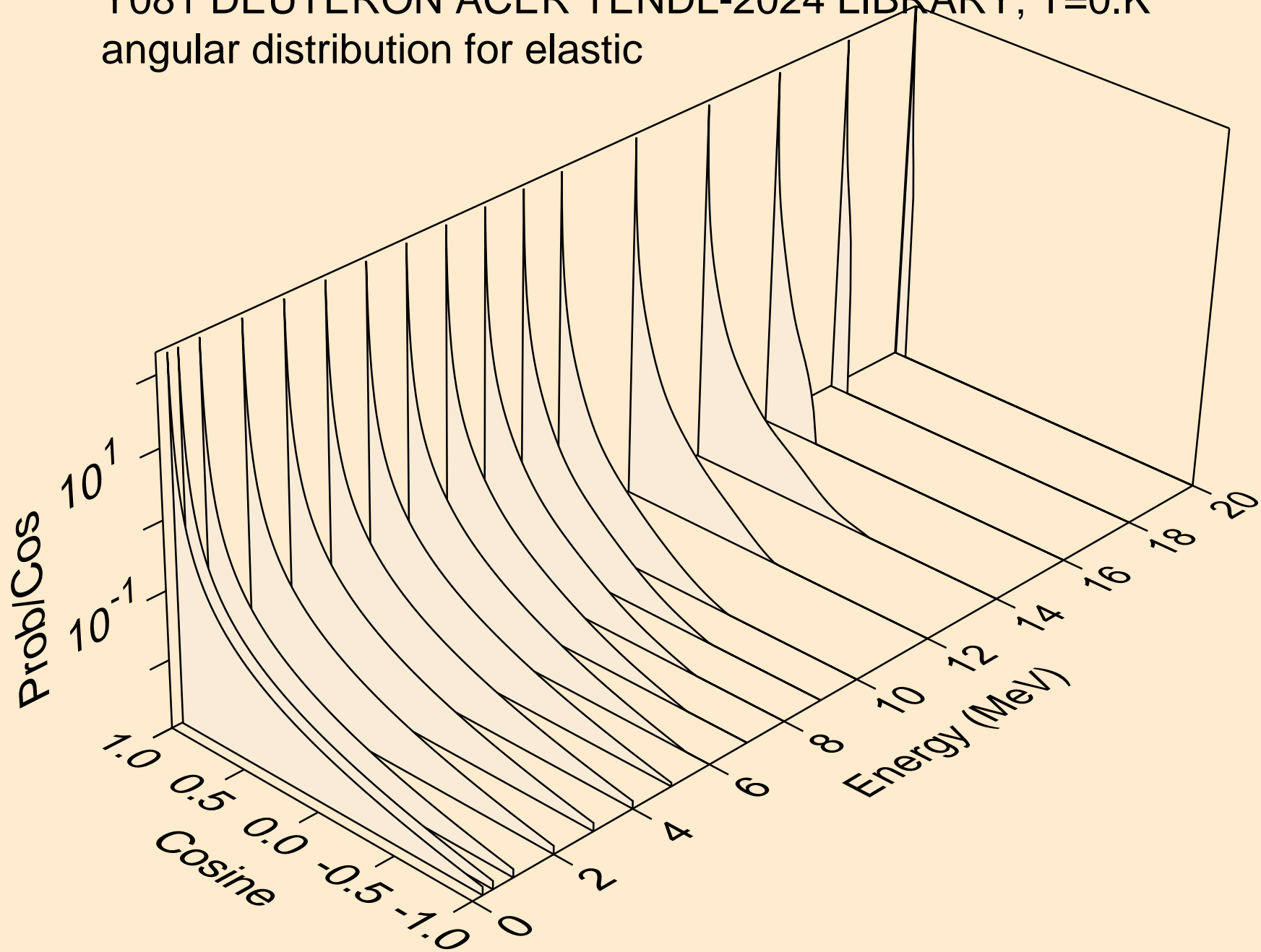

Y081 DEUTERON ACER TENDL-2024 LIBRARY; T=0.K
angular distribution for elastic

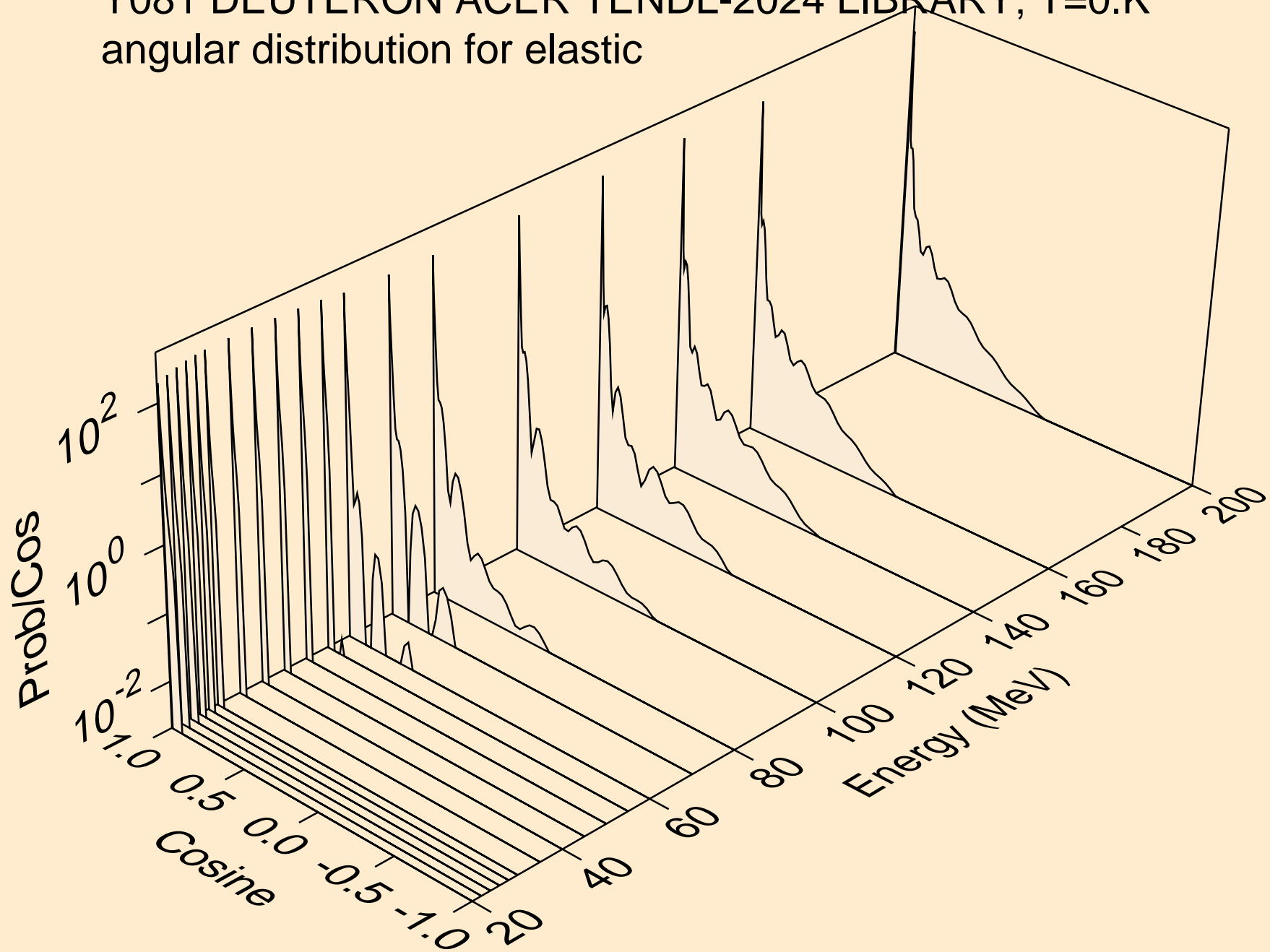

Y081 DEUTERON ACER TENDL-2024 LIBRARY; T=0.K
Deuteron emission for (d,x)

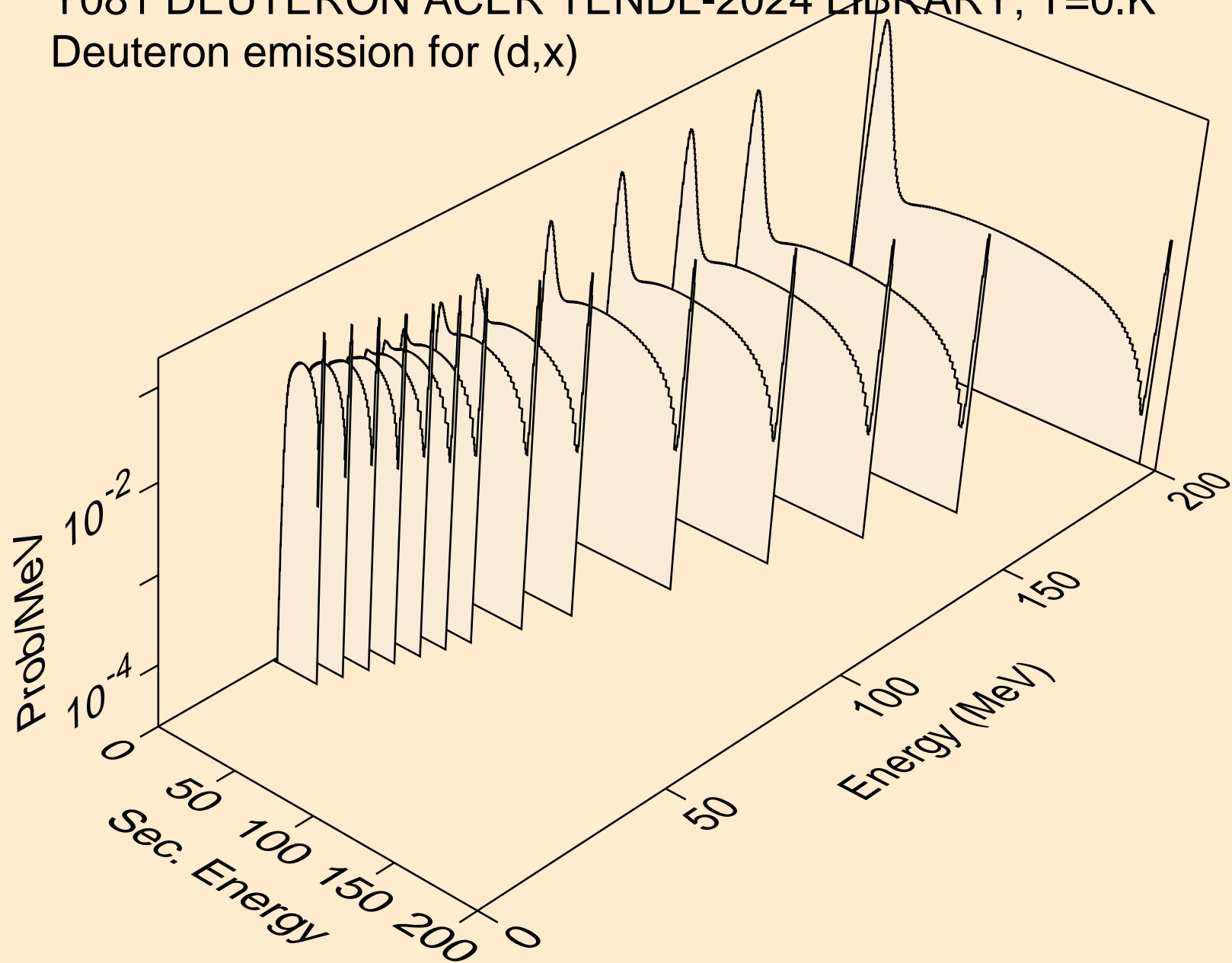

Y081 DEUTERON ACER TENDL-2024 LIBRARY; T=0.K
Deuteron emission for (d,2nd)

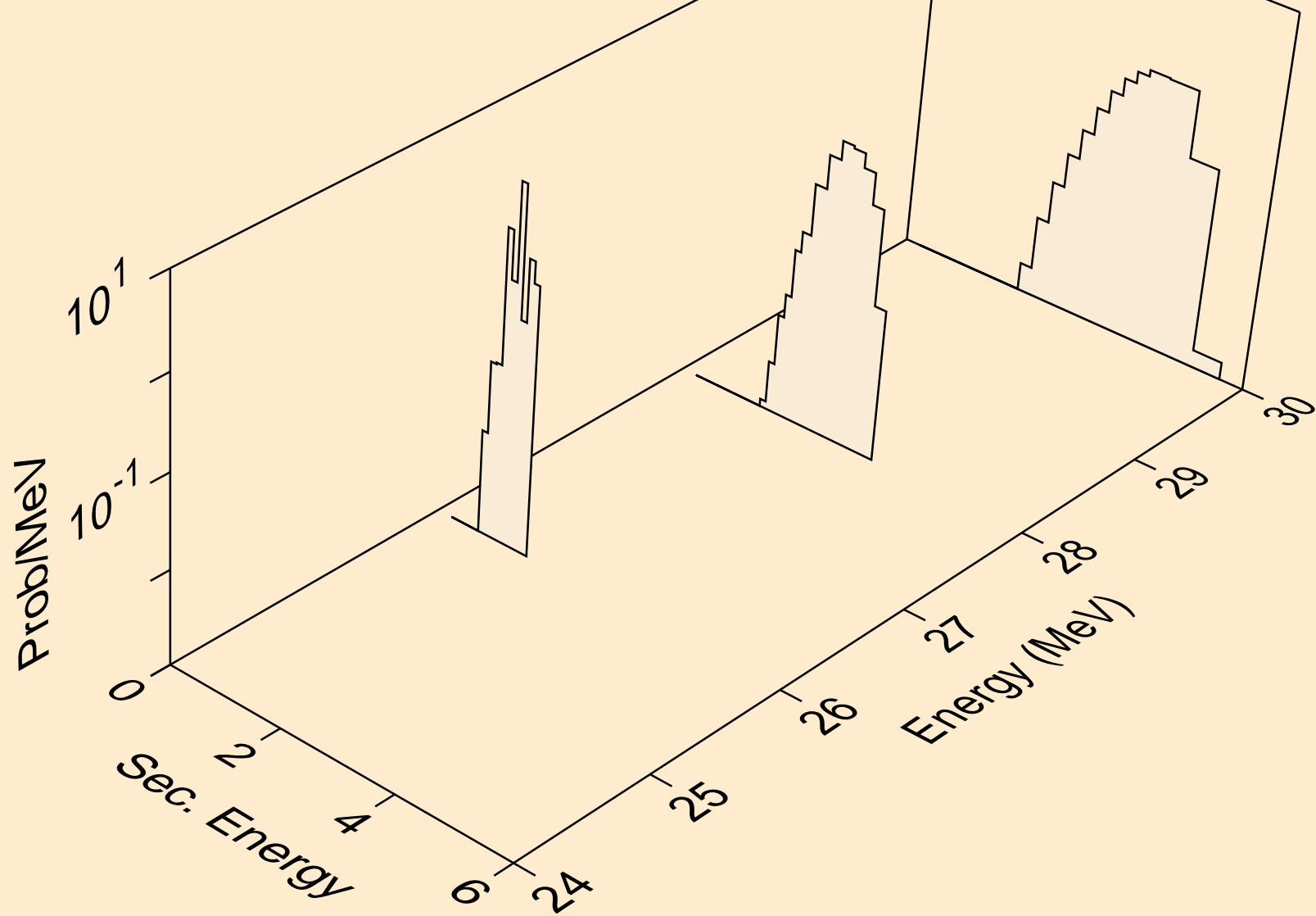

Y081 DEUTERON ACER TENDL-2024 LIBRARY; T=0.K
Deuteron emission for (d,n*)d

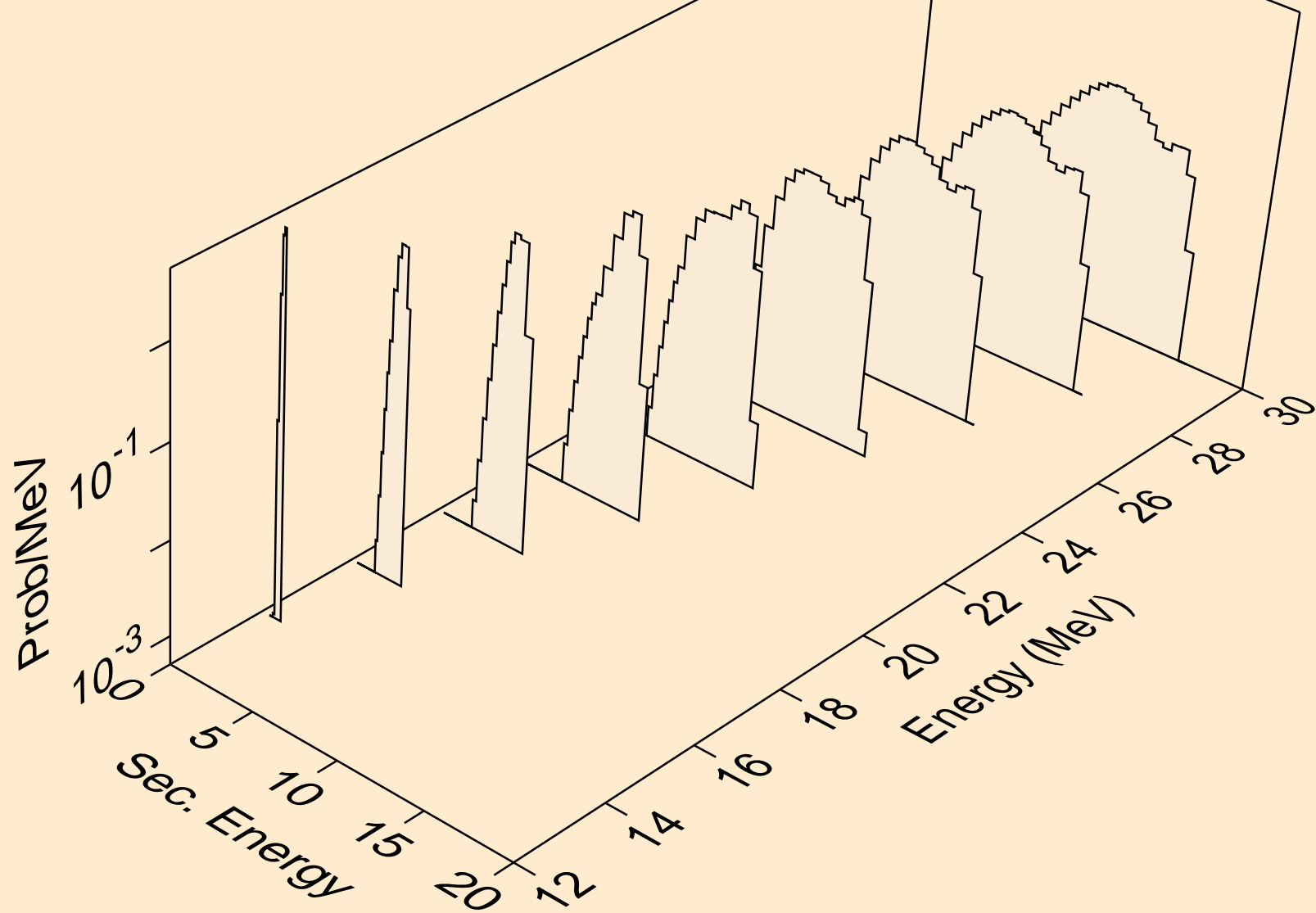

Y081 DEUTERON ACER TENDL-2024 LIBRARY; T=0.K
Deuteron emission for inelastic

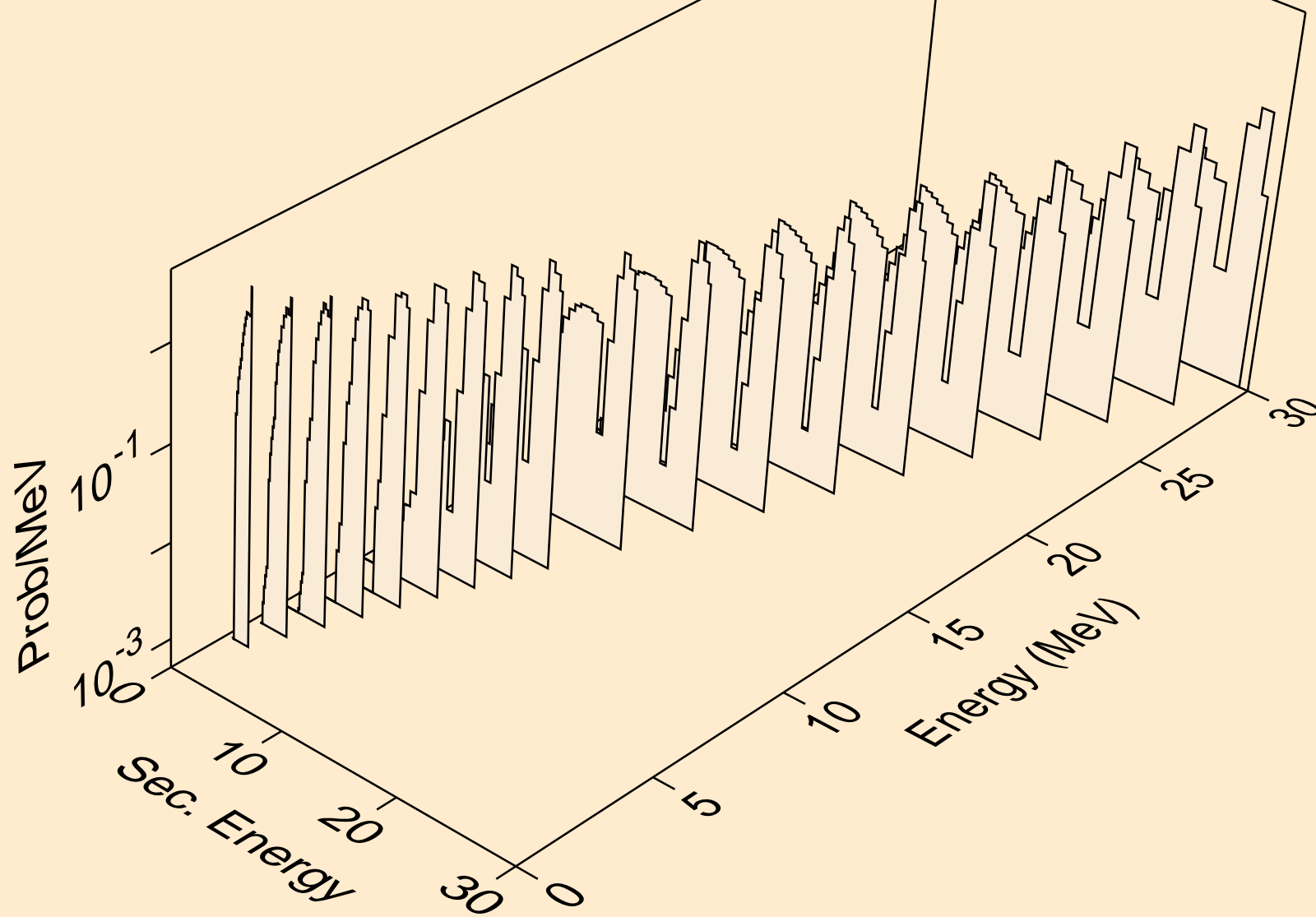

Y081 DEUTERON ACER TENDL-2024 LIBRARY; T=0.K
Deuteron emission for (d,pd)

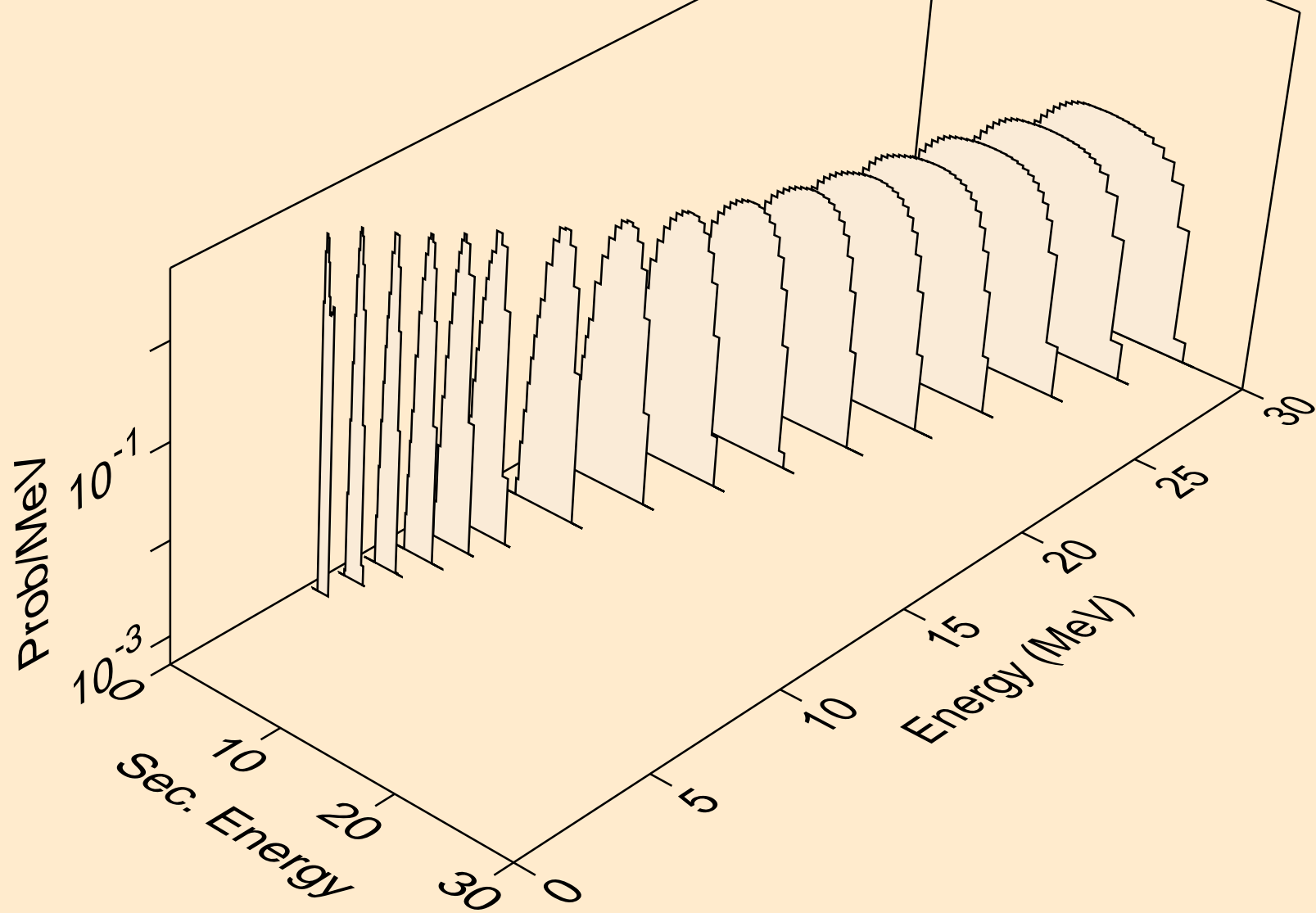

Y081 DEUTERON ACER TENDL-2024 LIBRARY; T=0.K
Deuteron emission for (d,da)

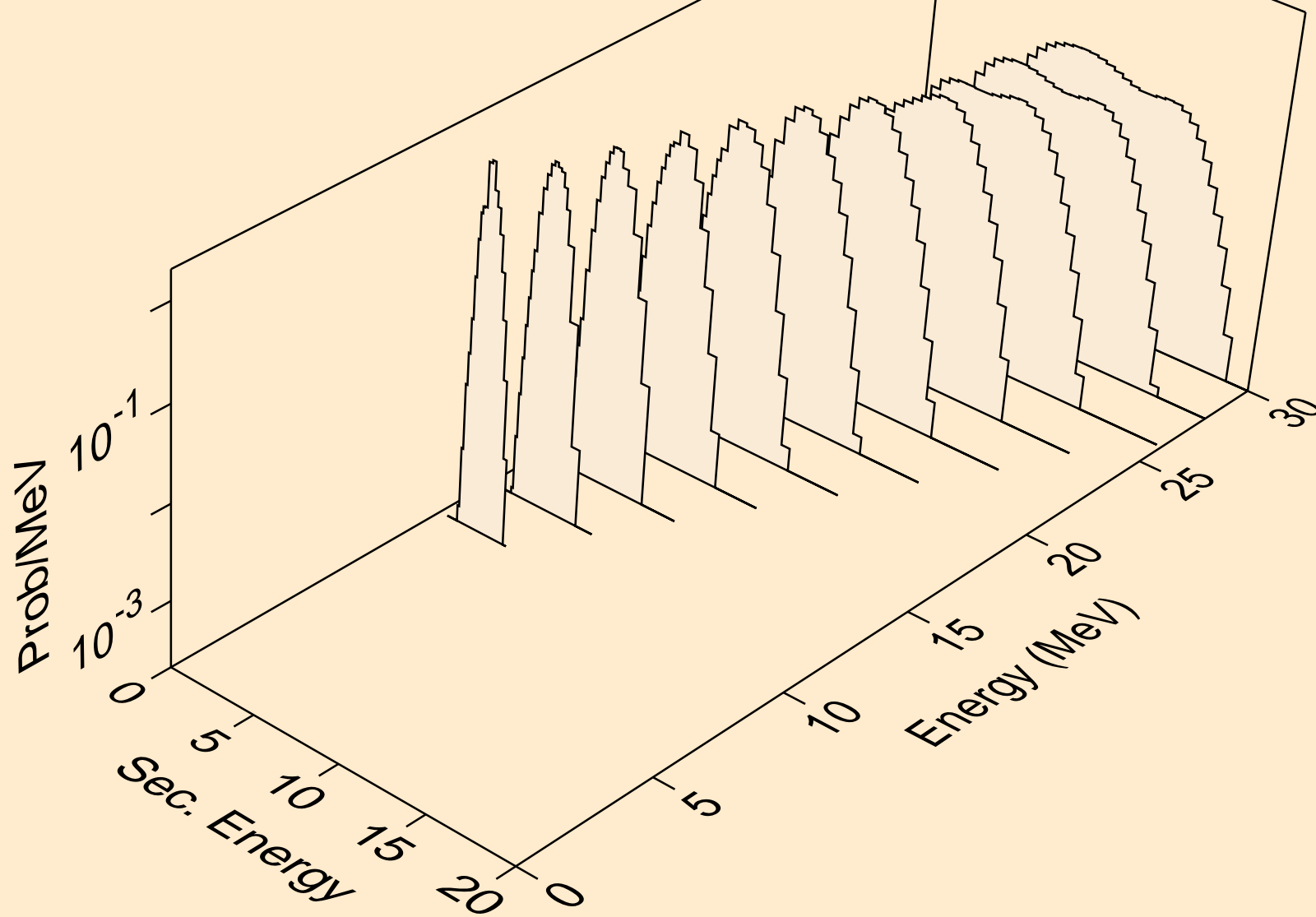

Y081 DEUTERON ACER TENDL-2024 LIBRARY; T=0.K
Photon emission for (z,n)

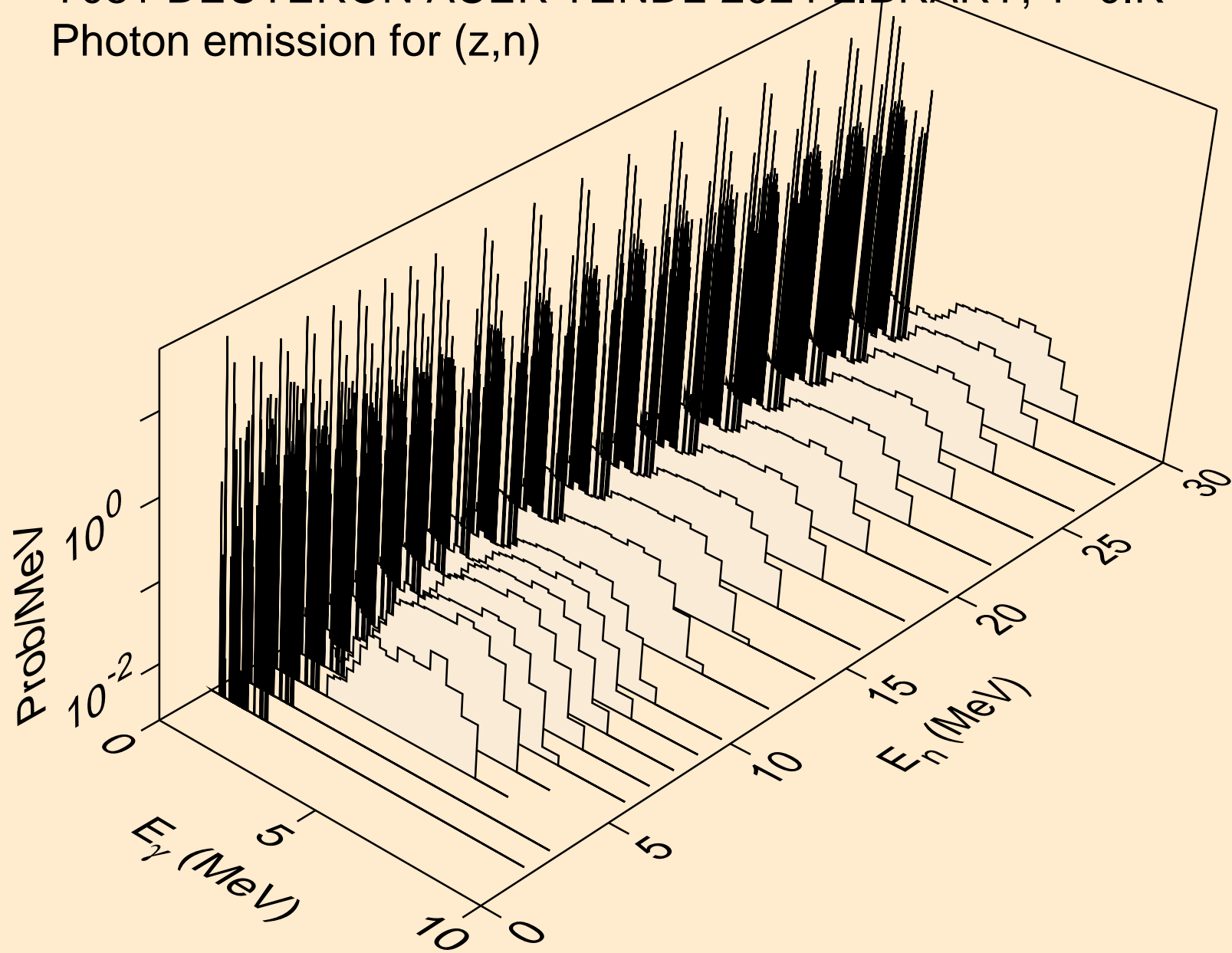

Y081 DEUTERON ACER TENDL-2024 LIBRARY; T=0.K
Photon emission for (z,x)

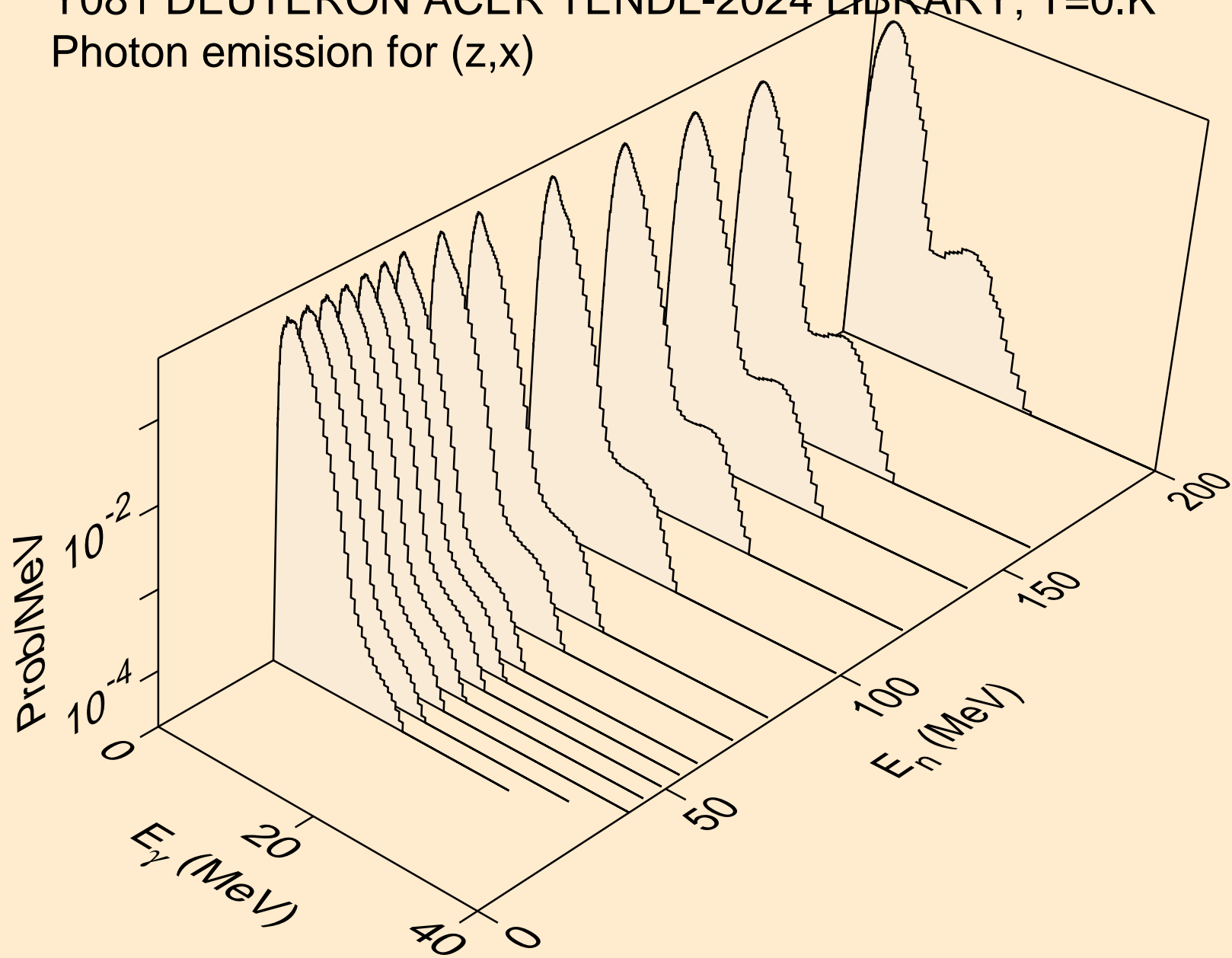

Y081 DEUTERON ACER TENDL-2024 LIBRARY; T=0.K
Photon emission for (n,2nd)

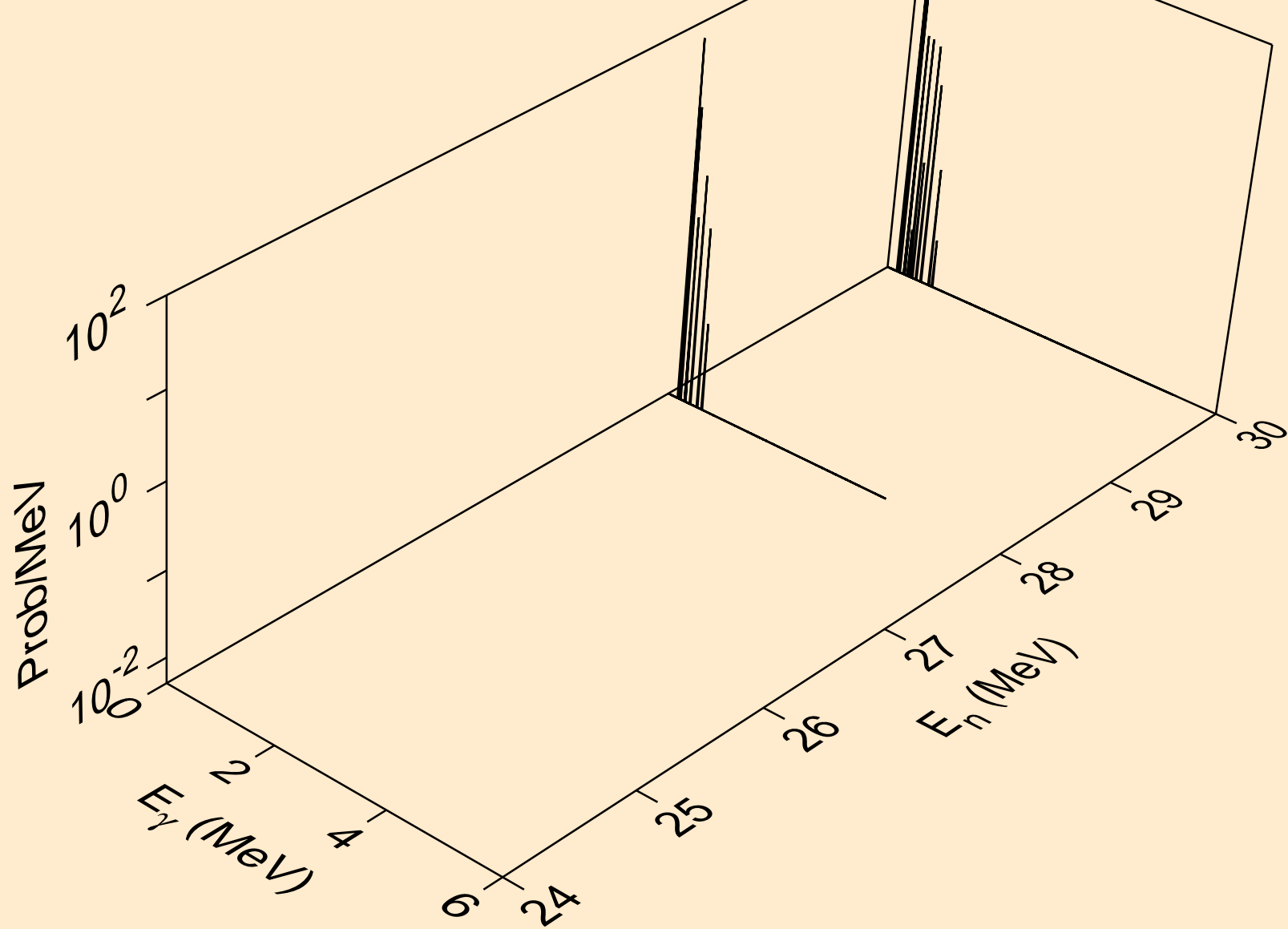

Y081 DEUTERON ACER TENDL-2024 LIBRARY; T=0.K
Photon emission for (n,2n)

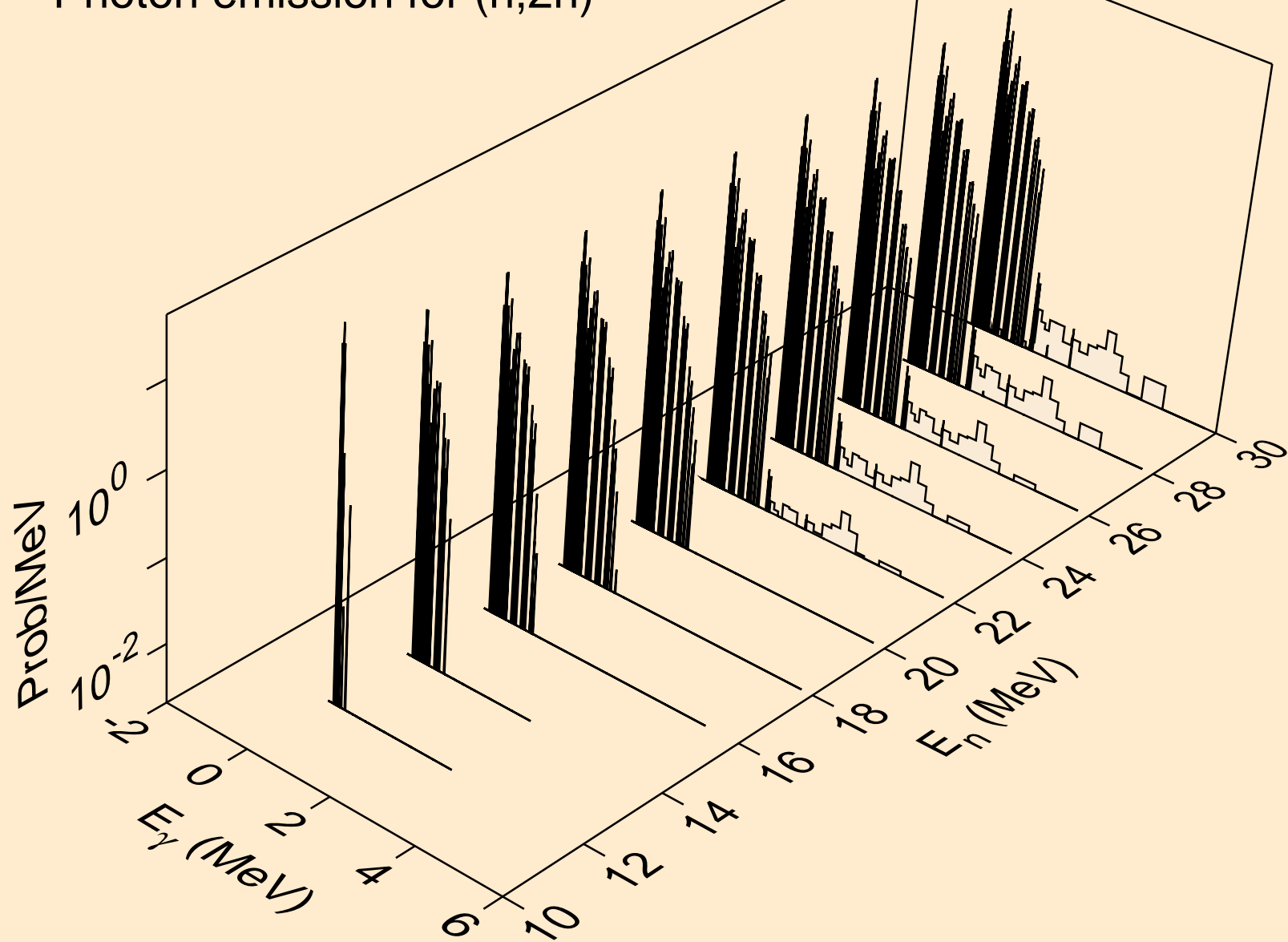

Y081 DEUTERON ACER TENDL-2024 LIBRARY; T=0.K
Photon emission for (n,3n)

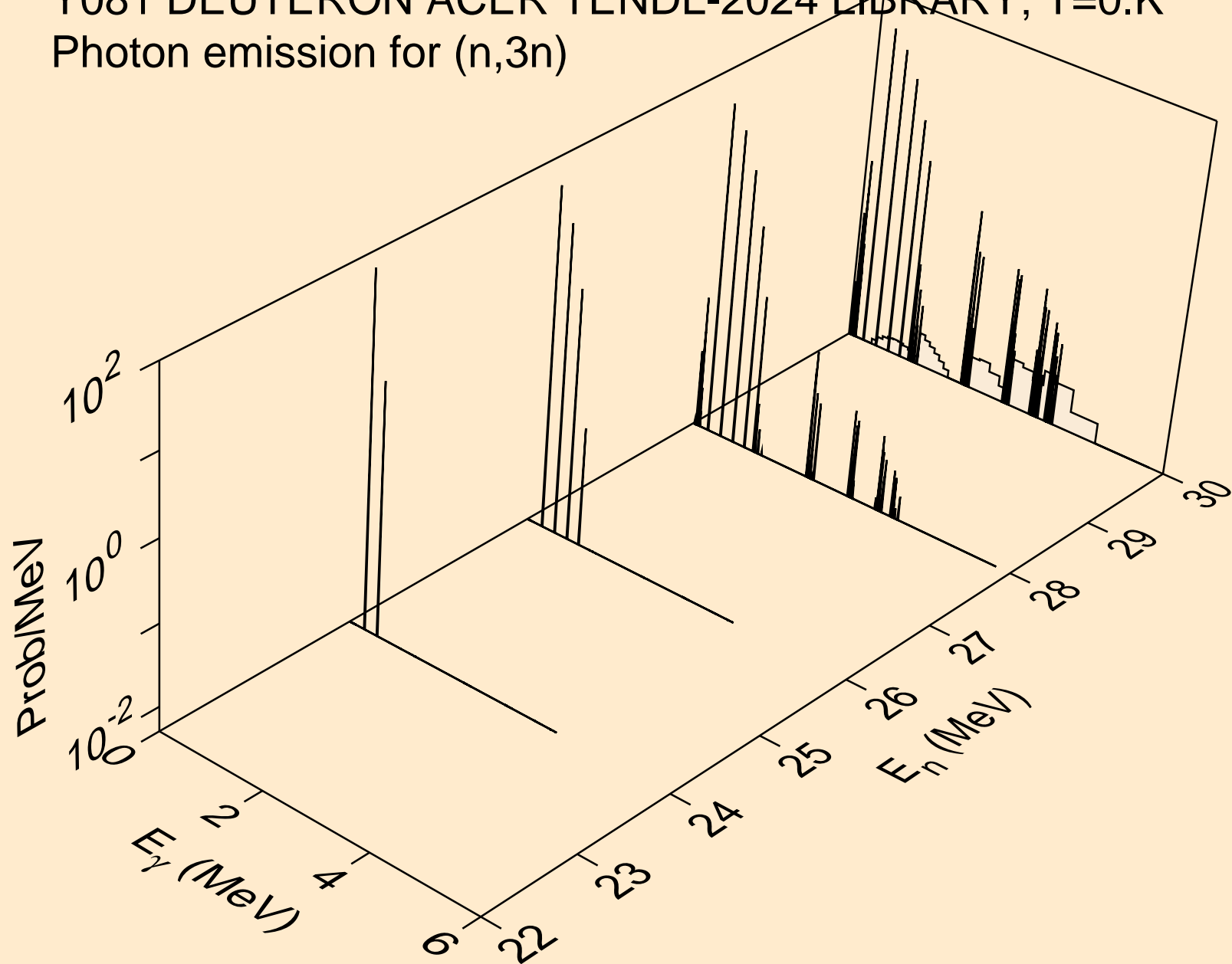

Y081 DEUTERON ACER TENDL-2024 LIBRARY; T=0.K
Photon emission for (n,n*)a

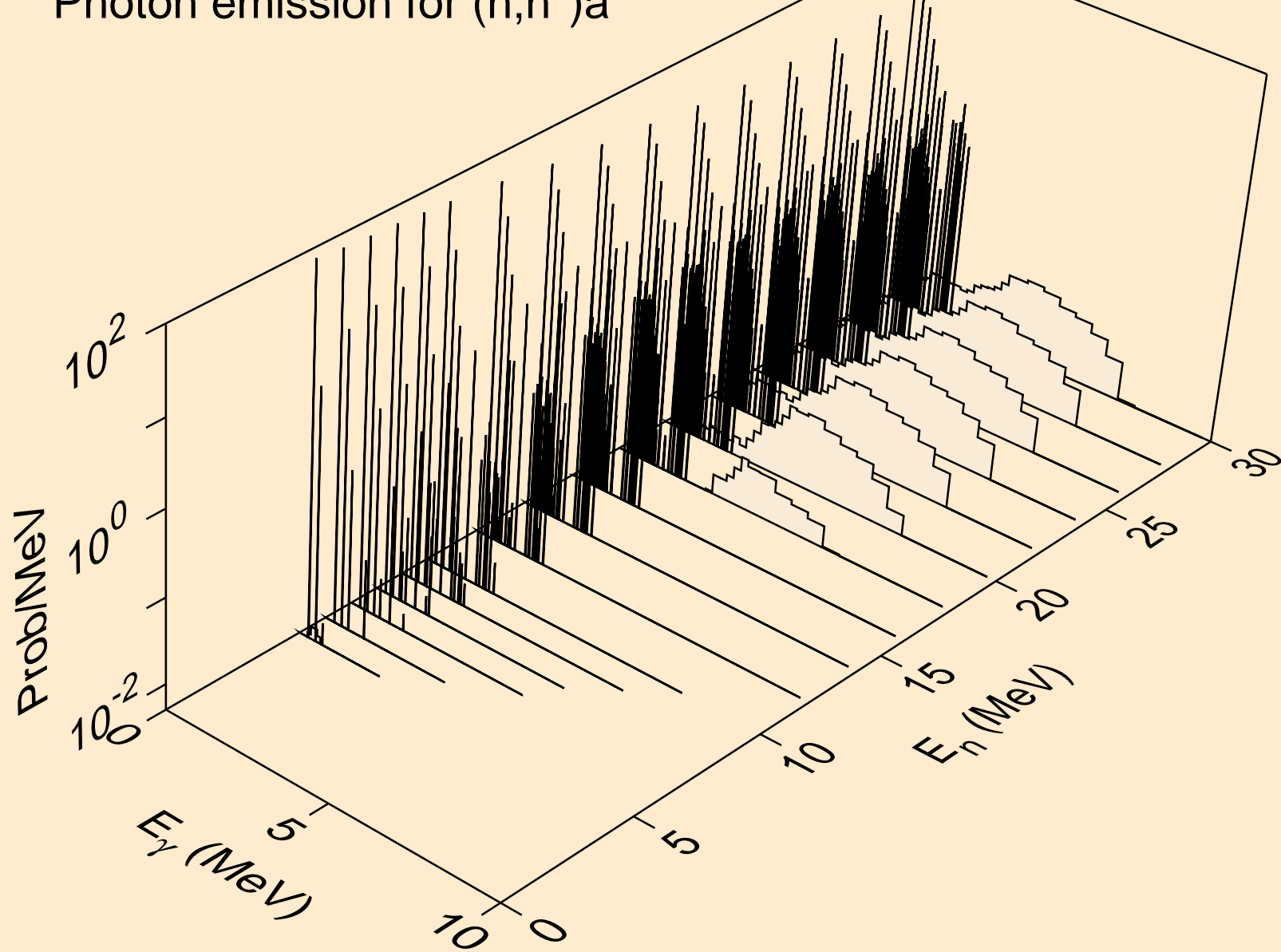

Y081 DEUTERON ACER TENDL-2024 LIBRARY; T=0.K
Photon emission for (n,2n)a

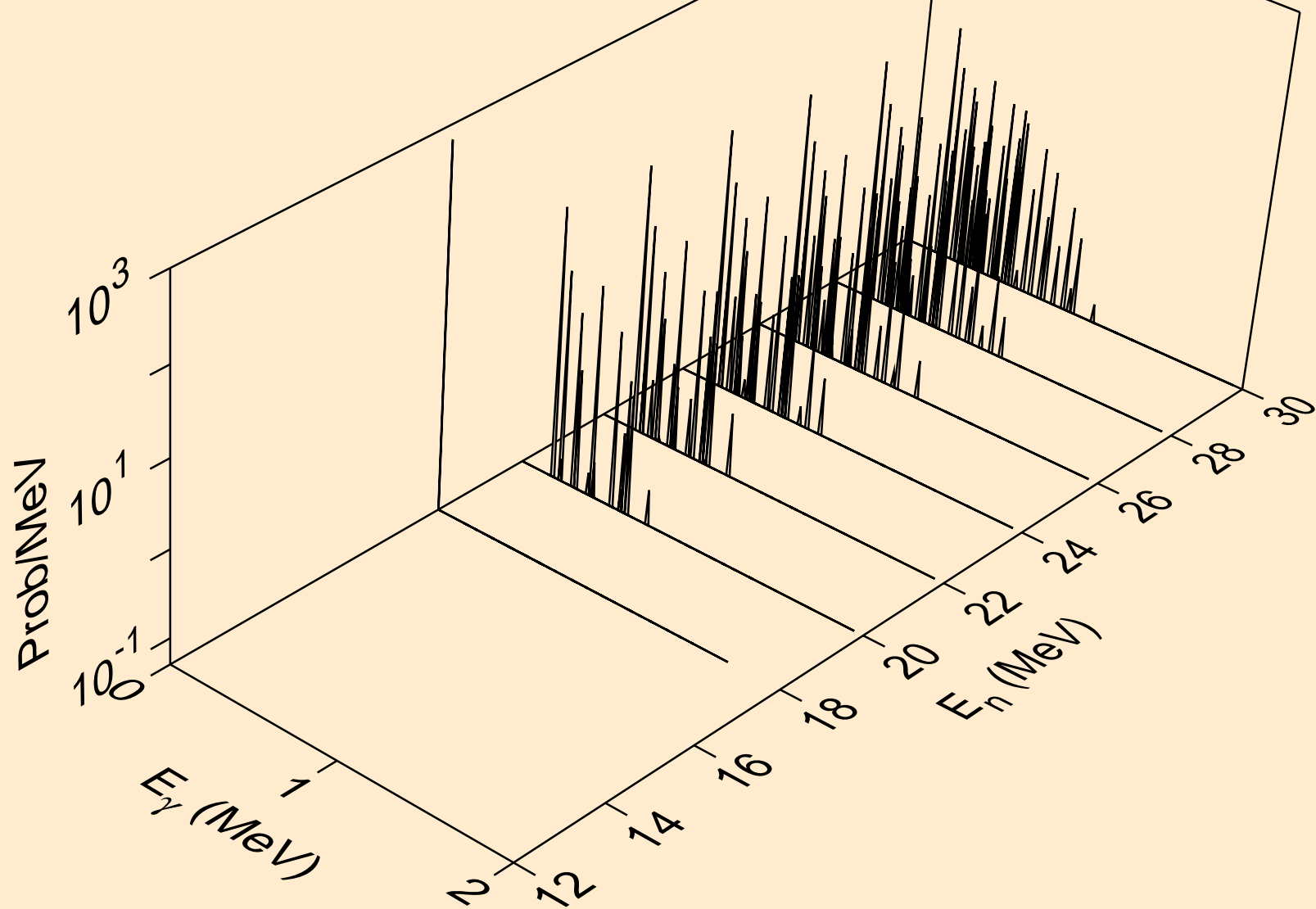

Y081 DEUTERON ACER TENDL-2024 LIBRARY; T=0.K
Photon emission for (n,n*)p

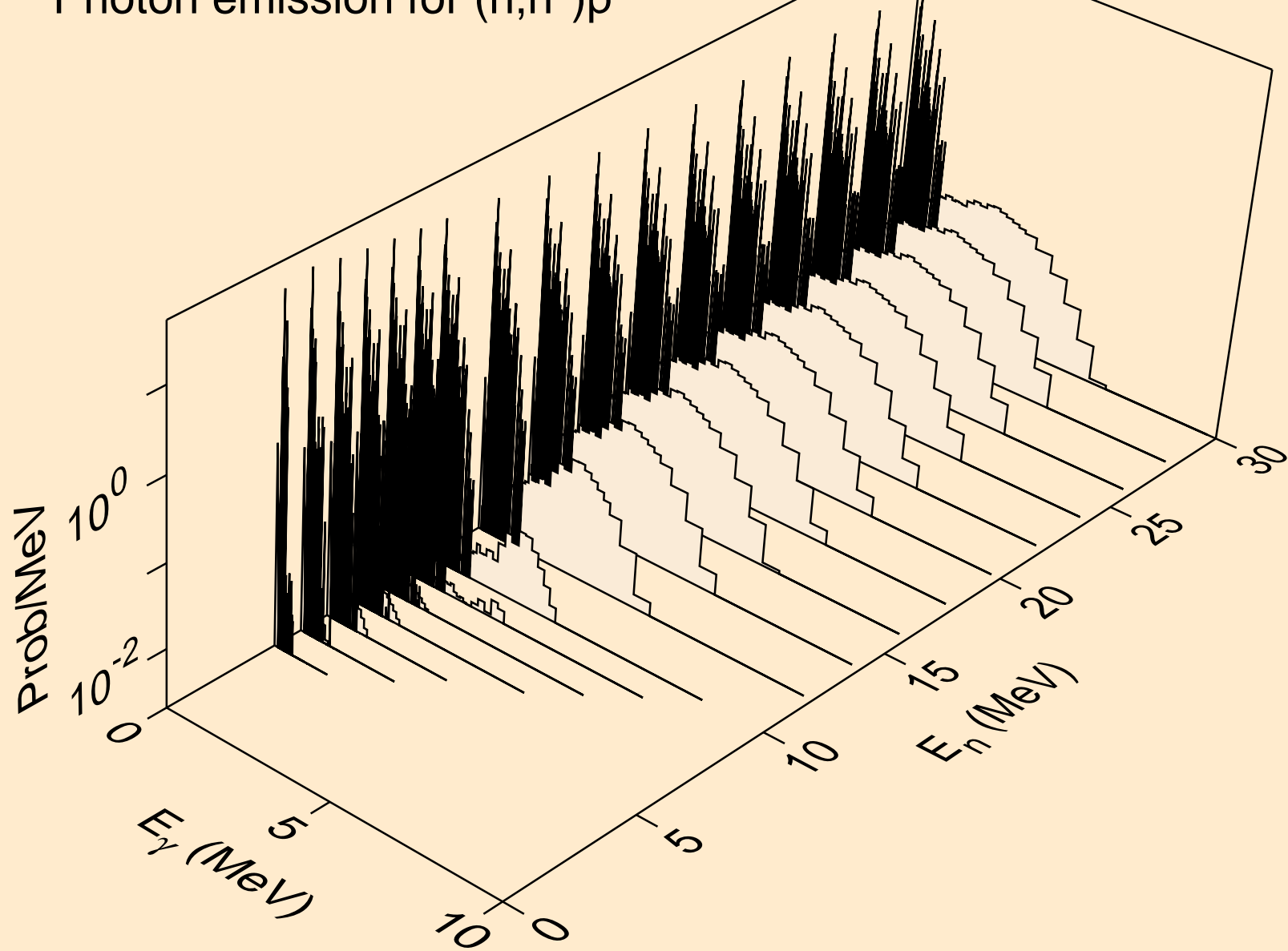

Y081 DEUTERON ACER TENDL-2024 LIBRARY; T=0.K
Photon emission for (n,n*)2a

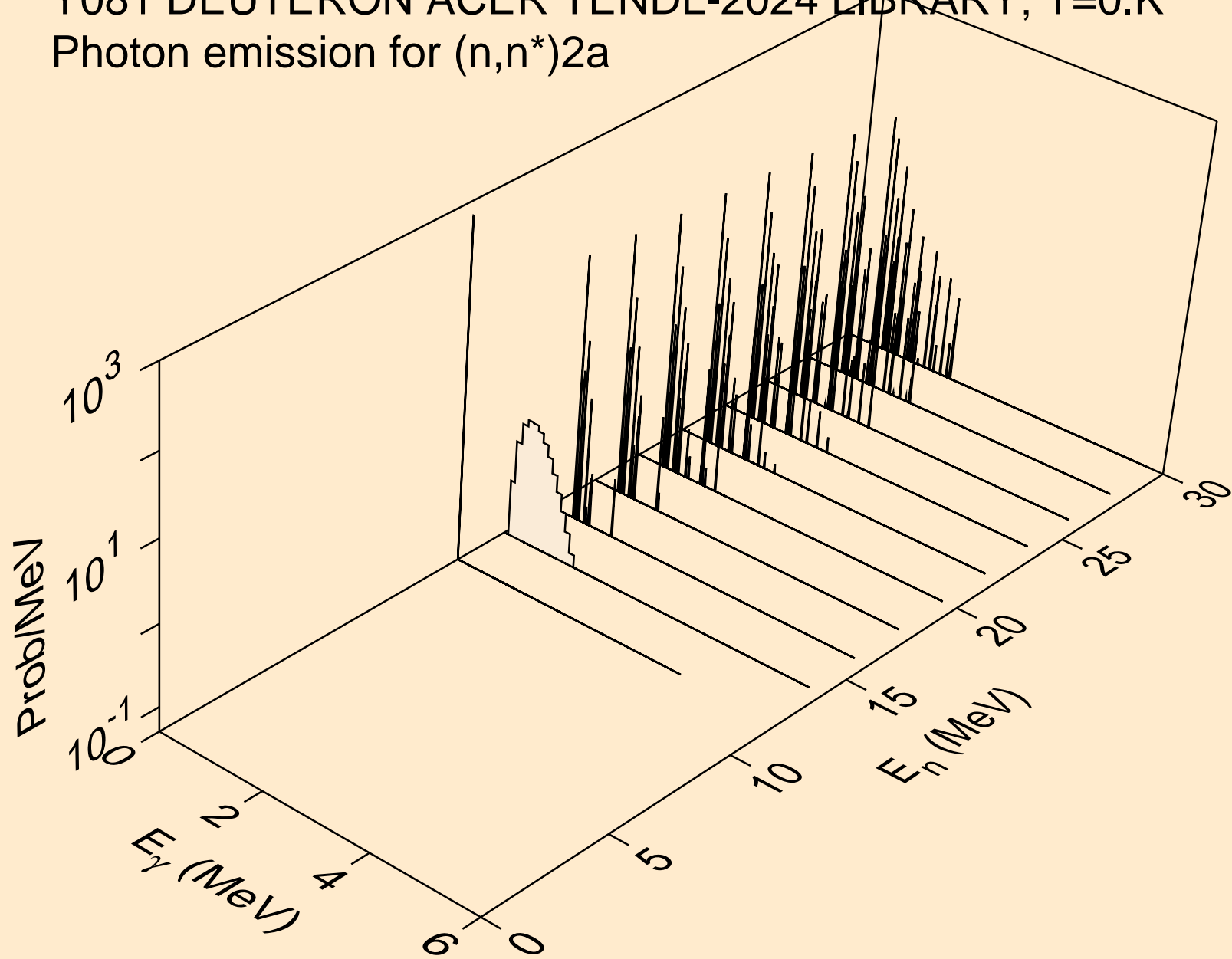

Y081 DEUTERON ACER TENDL-2024 LIBRARY; T=0.K
Photon emission for (n,n*)d

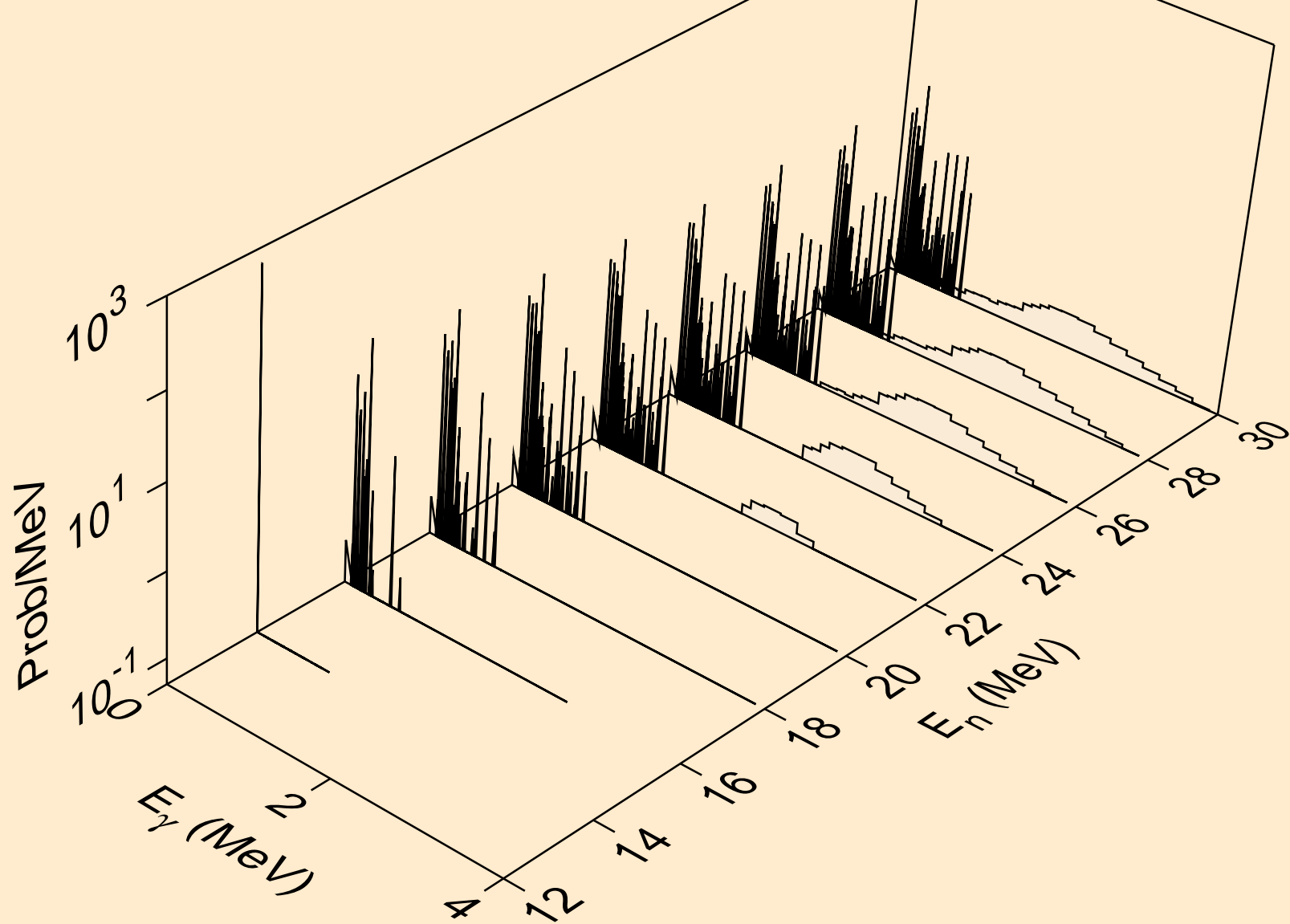

Y081 DEUTERON ACER TENDL-2024 LIBRARY; T=0.K
Photon emission for (n,n*)t

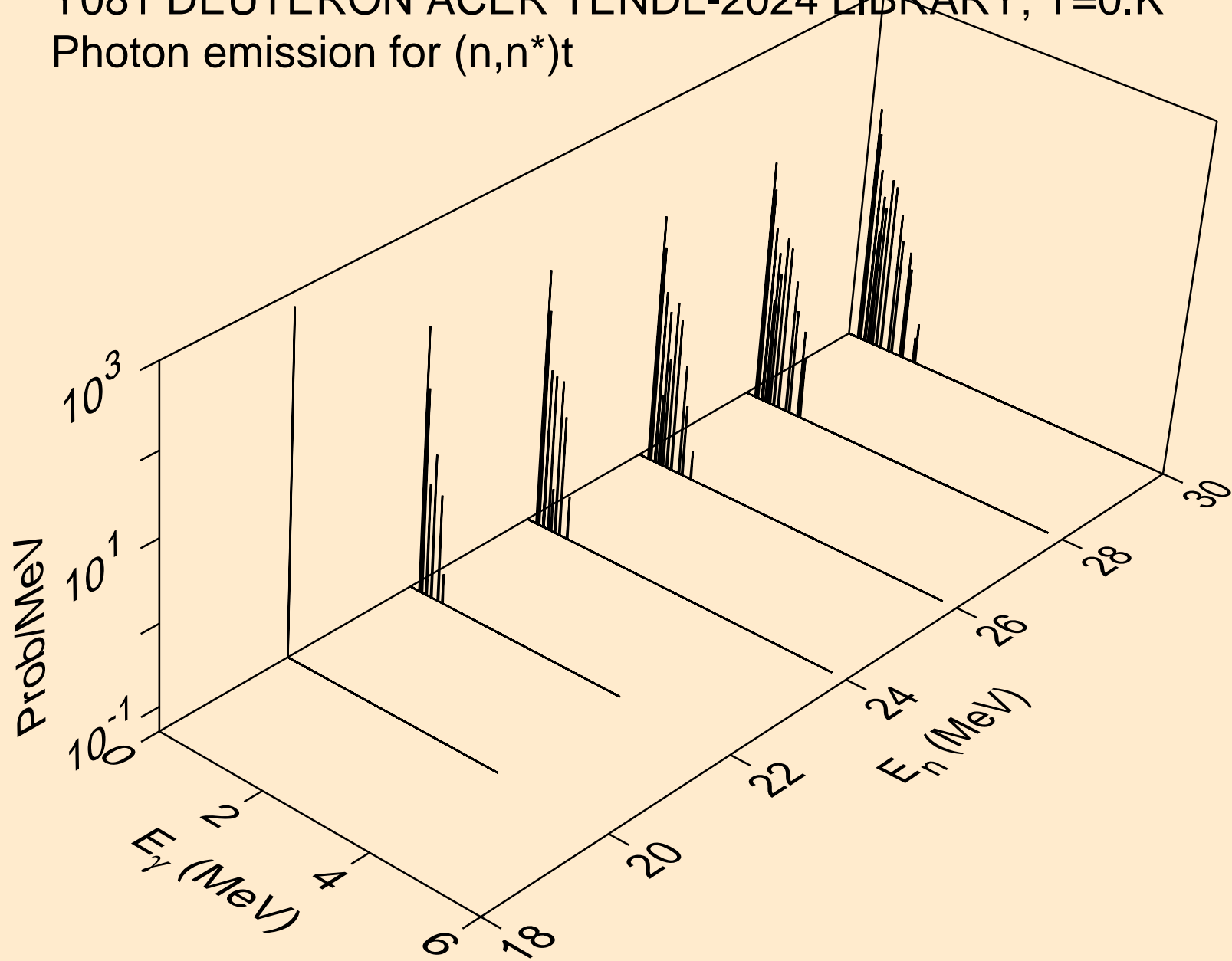

Y081 DEUTERON ACER TENDL-2024 LIBRARY; T=0.K
Photon emission for (n,n*)he3

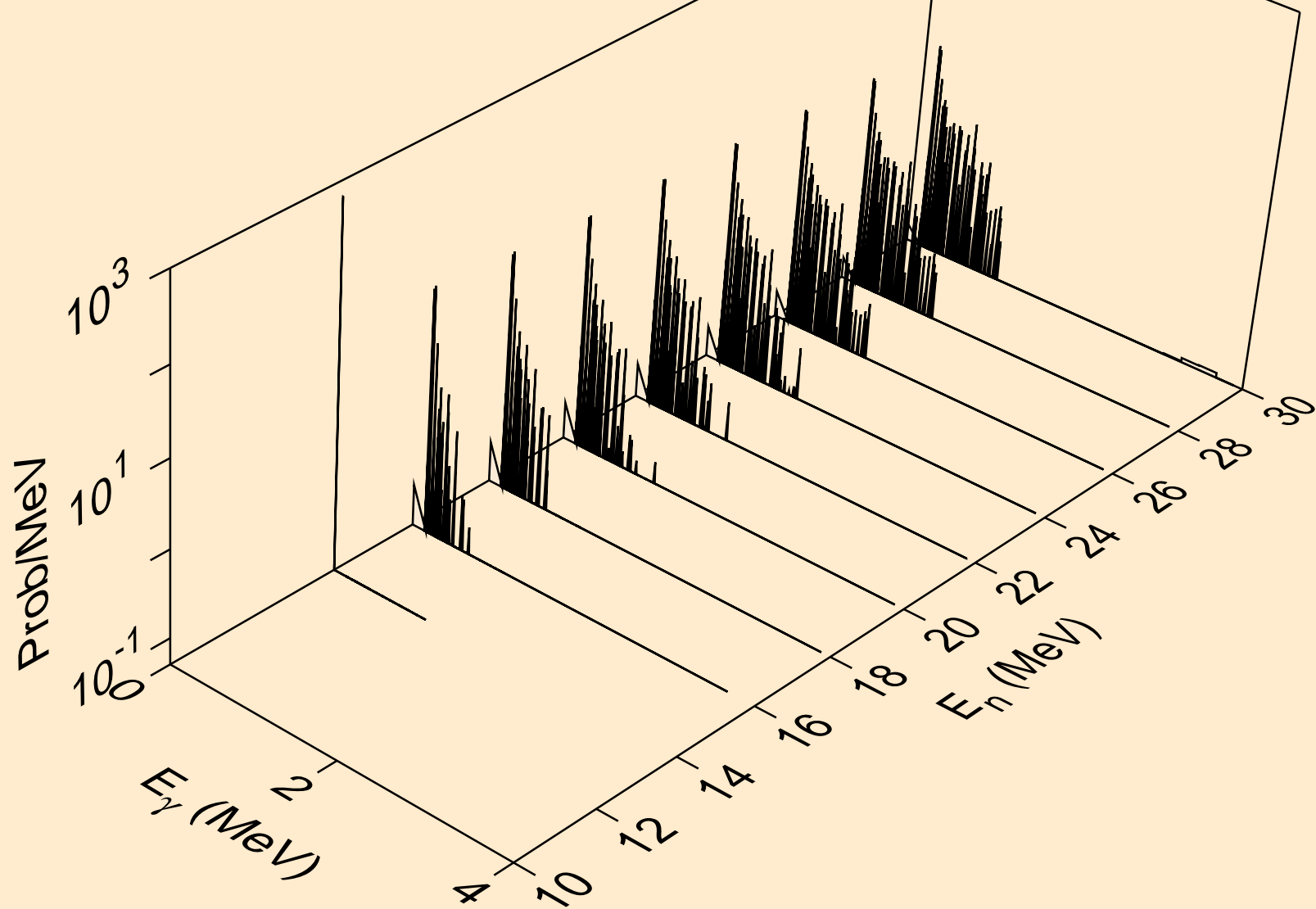

Y081 DEUTERON ACER TENDL-2024 LIBRARY; T=0.K
Photon emission for (n,2np)

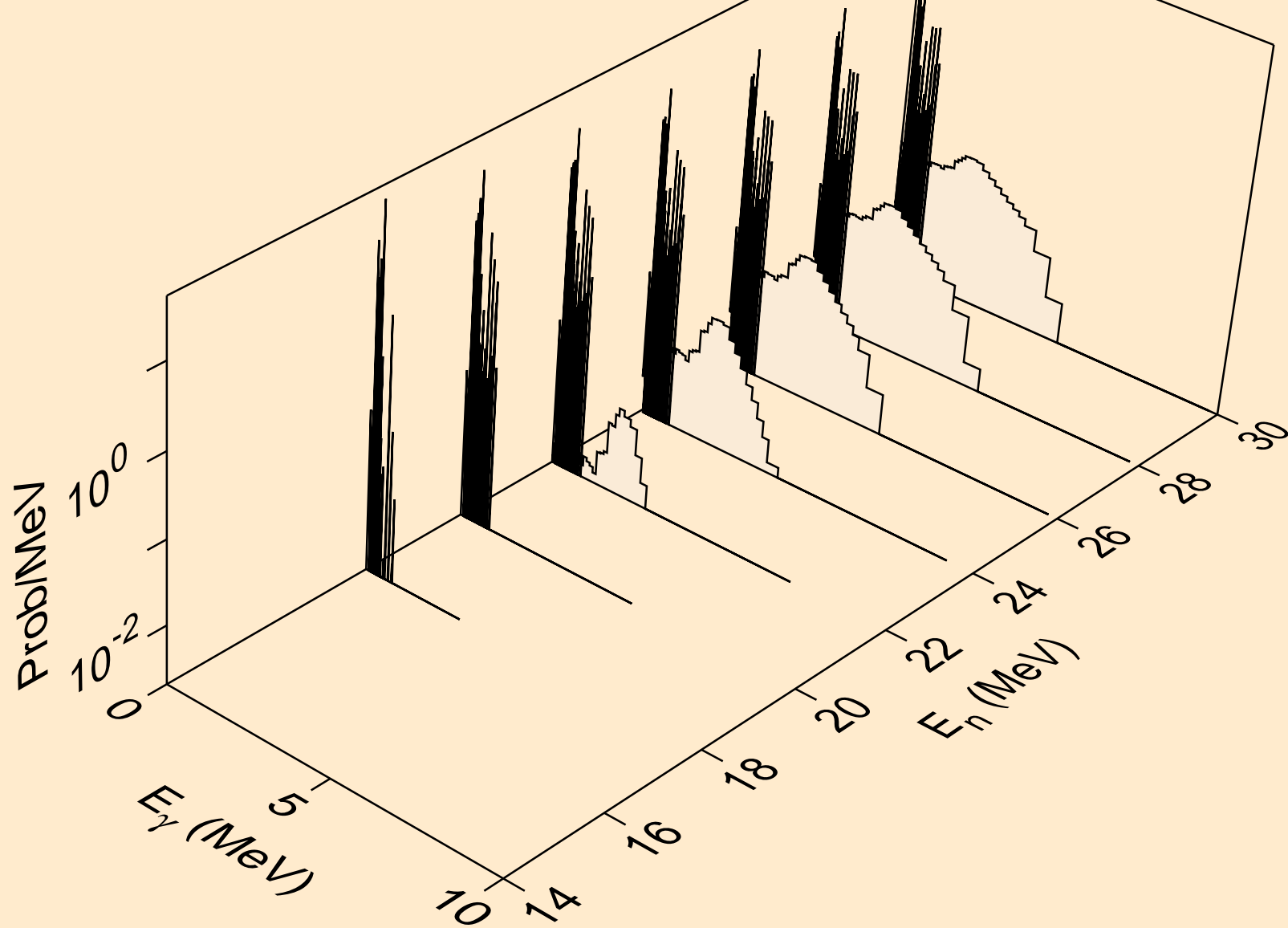

Y081 DEUTERON ACER TENDL-2024 LIBRARY; T=0.K
Photon emission for (n,3np)

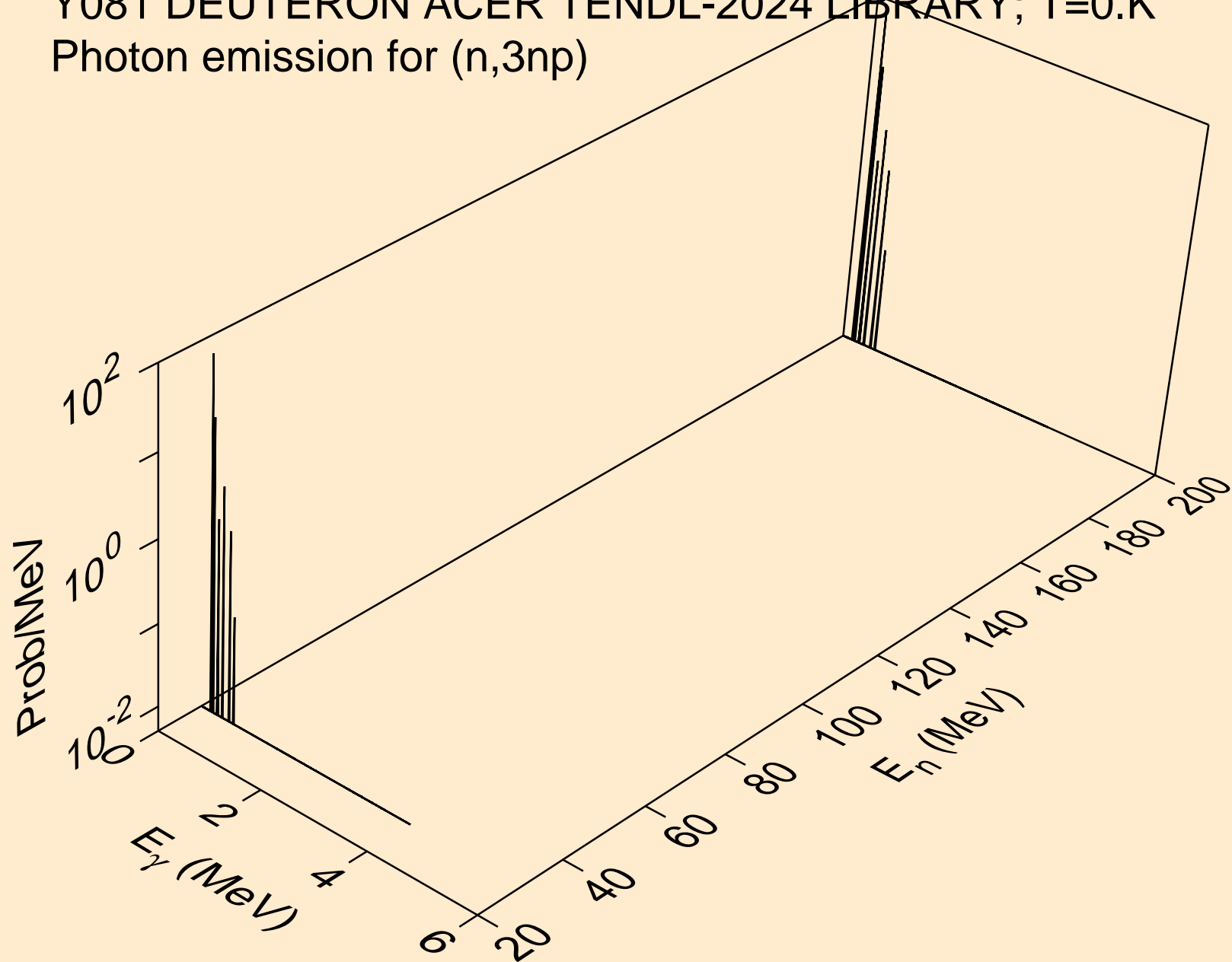

Y081 DEUTERON ACER TENDL-2024 LIBRARY; T=0.K
Photon emission for (n,n2p)

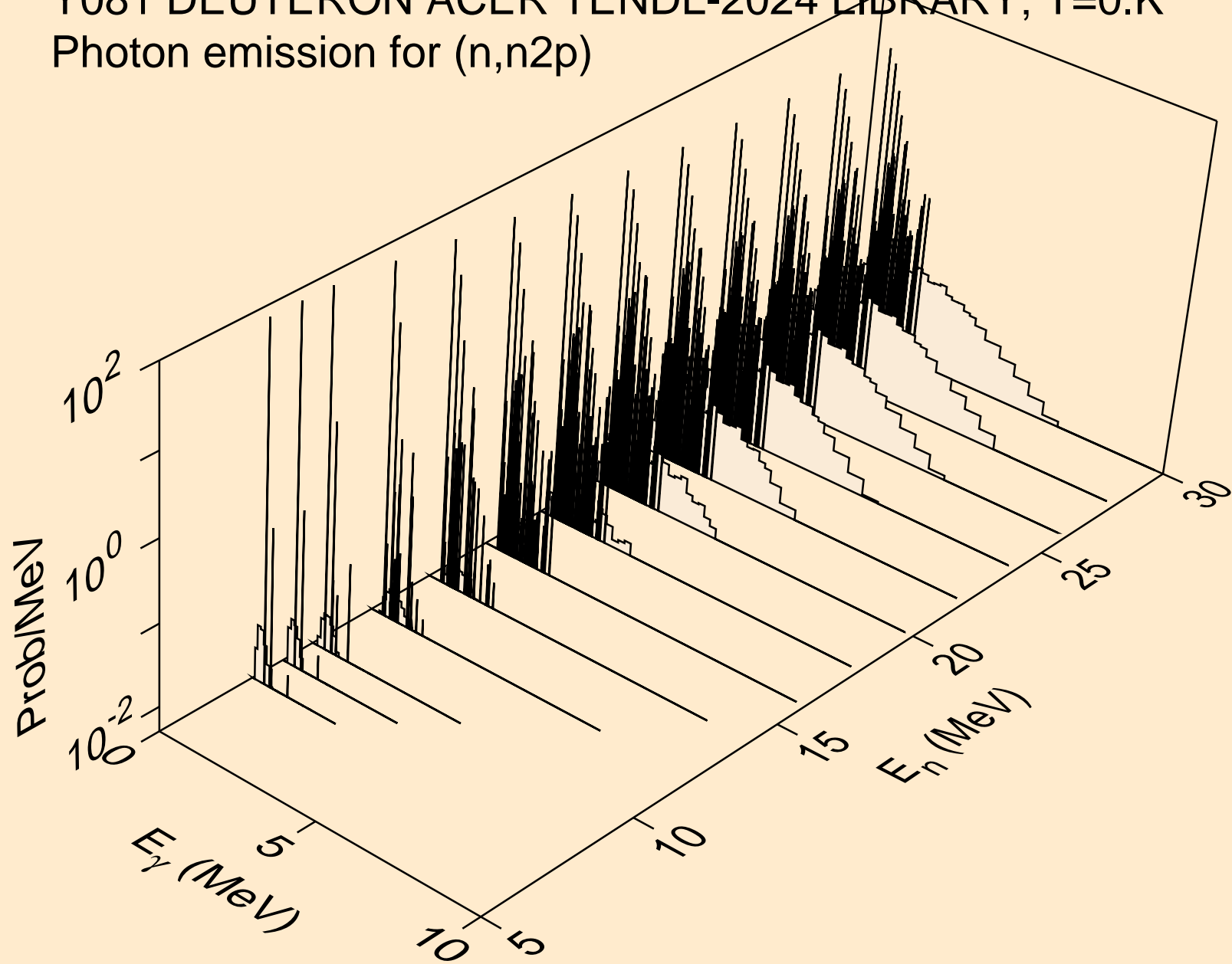

Y081 DEUTERON ACER TENDL-2024 LIBRARY; T=0.K
Photon emission for (n,npa)

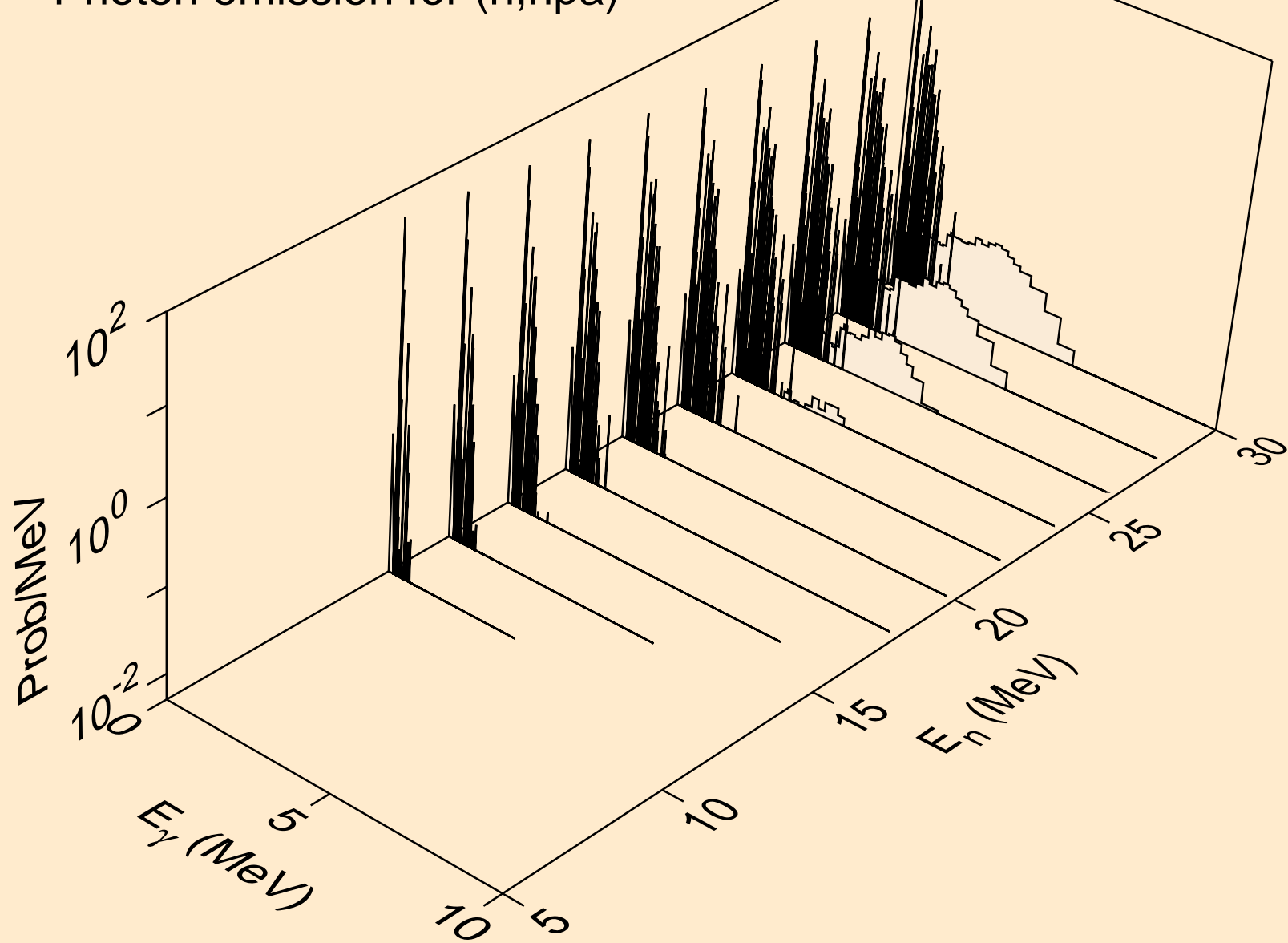

Y081 DEUTERON ACER TENDL-2024 LIBRARY; T=0.K
Photon emission for (n,gma)

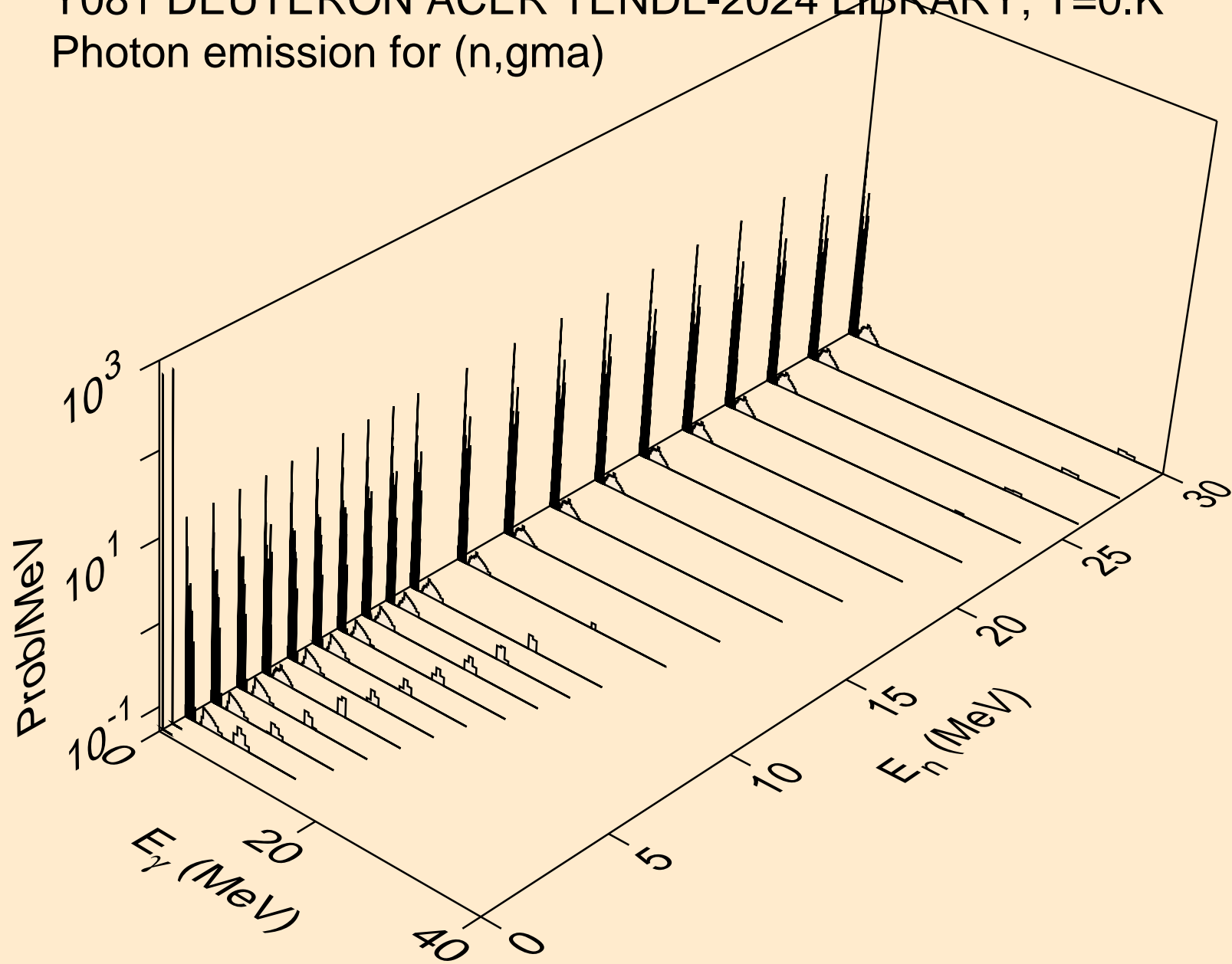

Y081 DEUTERON ACER TENDL-2024 LIBRARY; T=0.K
Photon emission for (n,p)

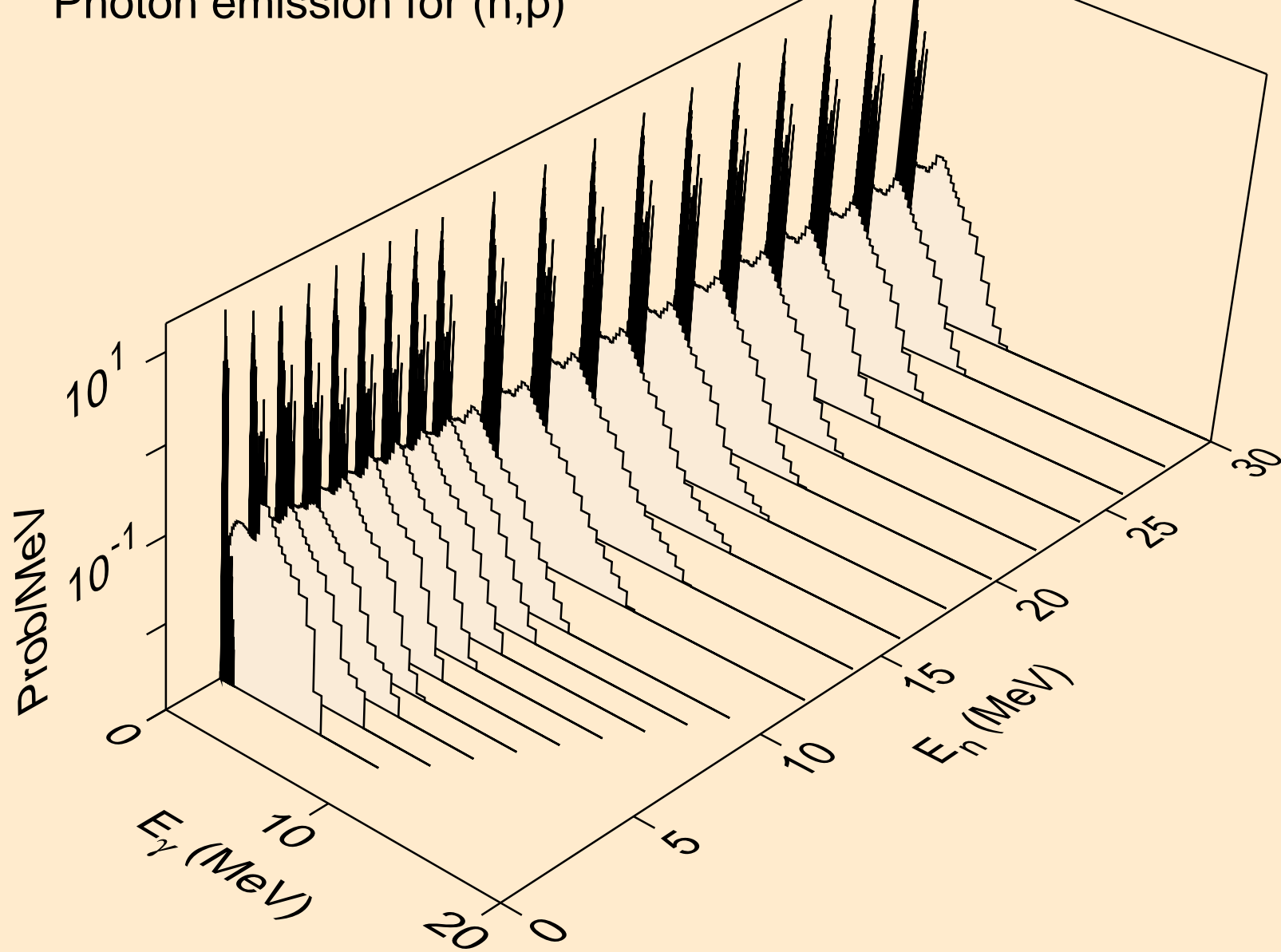

Y081 DEUTERON ACER TENDL-2024 LIBRARY; T=0.K
Photon emission for inelastic

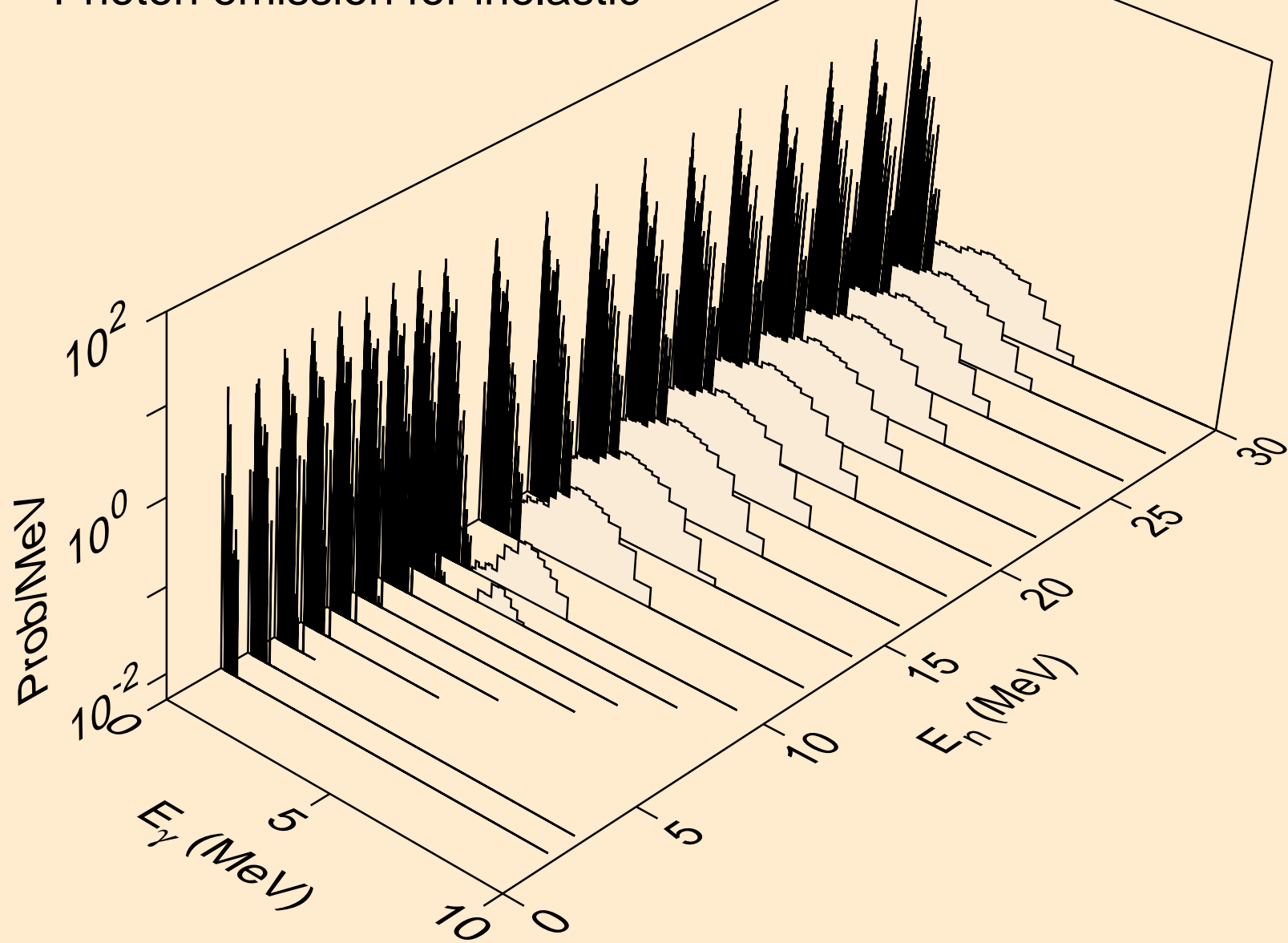

Y081 DEUTERON ACER TENDL-2024 LIBRARY; T=0.K
Photon emission for (n,t)

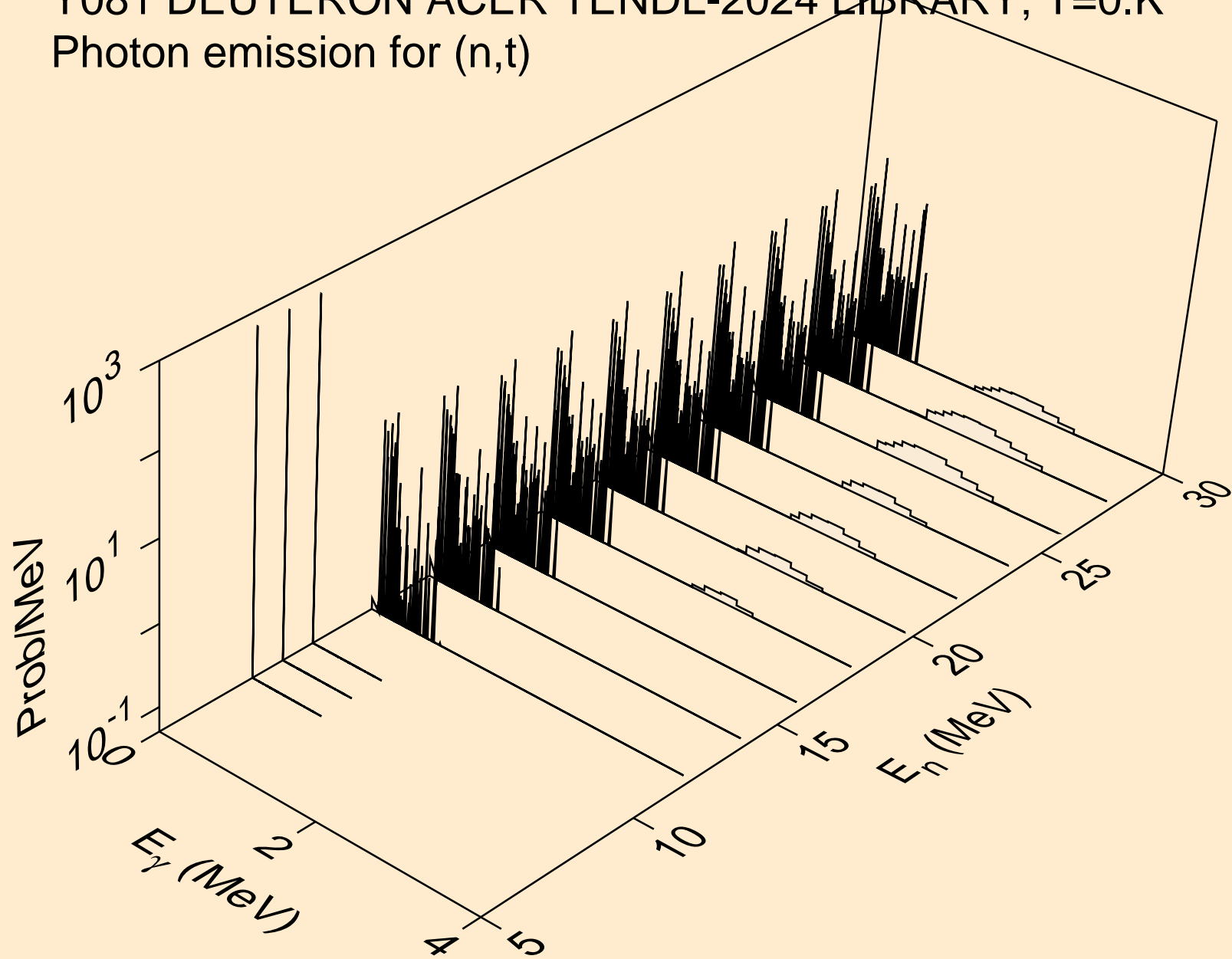

Y081 DEUTERON ACER TENDL-2024 LIBRARY; T=0.K
Photon emission for (n,he3)

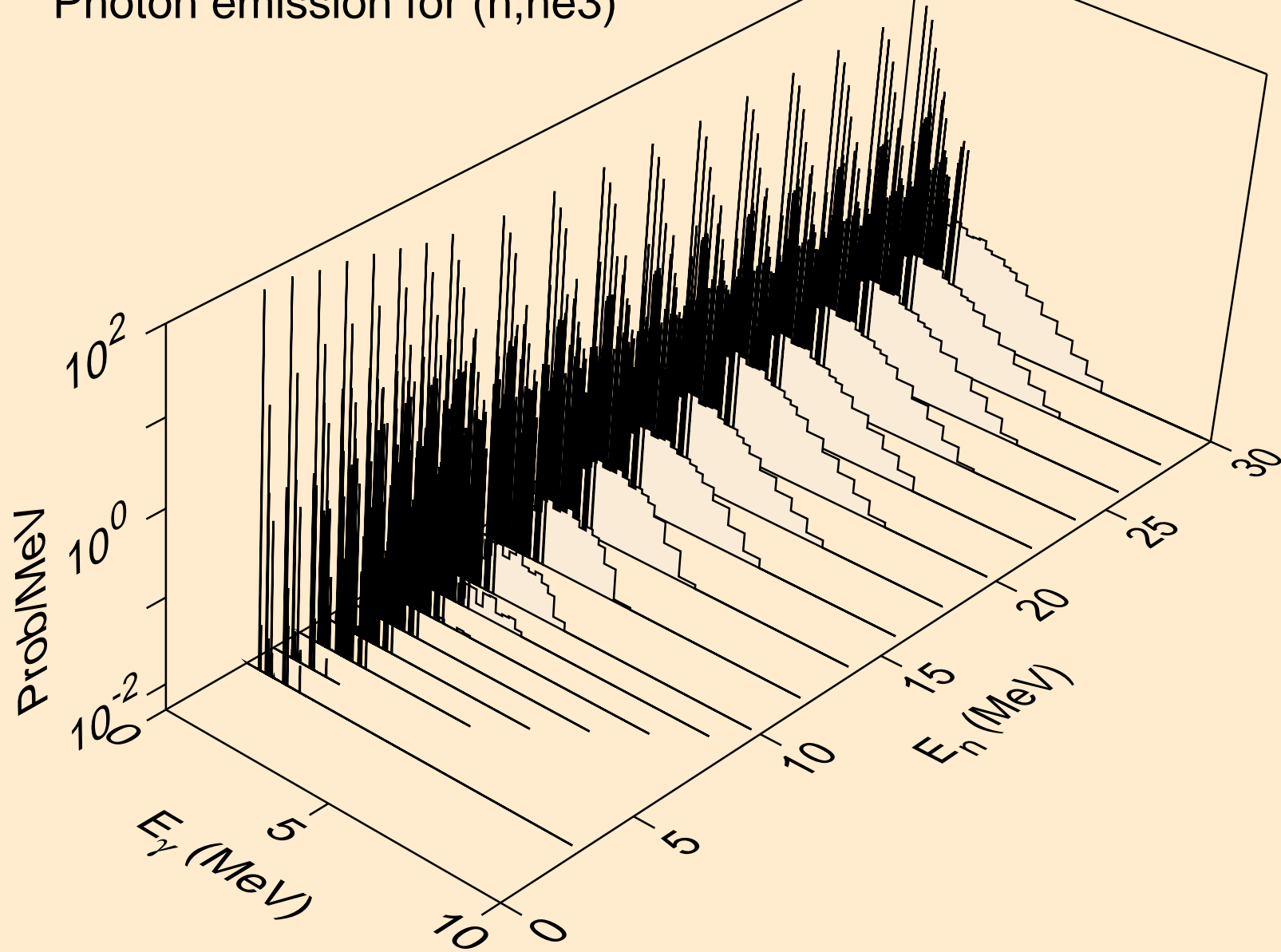

Y081 DEUTERON ACER TENDL-2024 LIBRARY; T=0.K
Photon emission for (n,a)

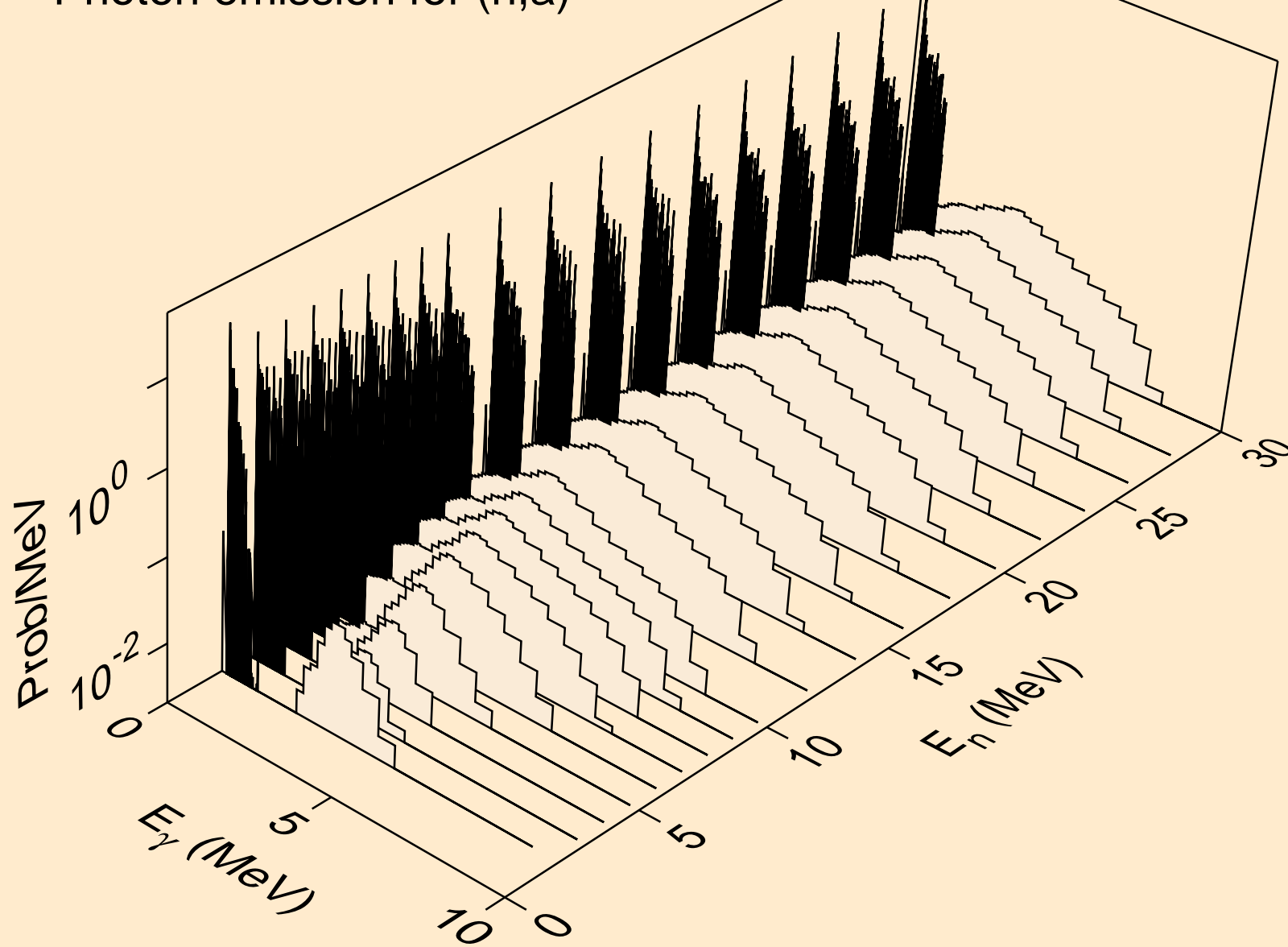

Y081 DEUTERON ACER TENDL-2024 LIBRARY; T=0.K
Photon emission for (n,2a)

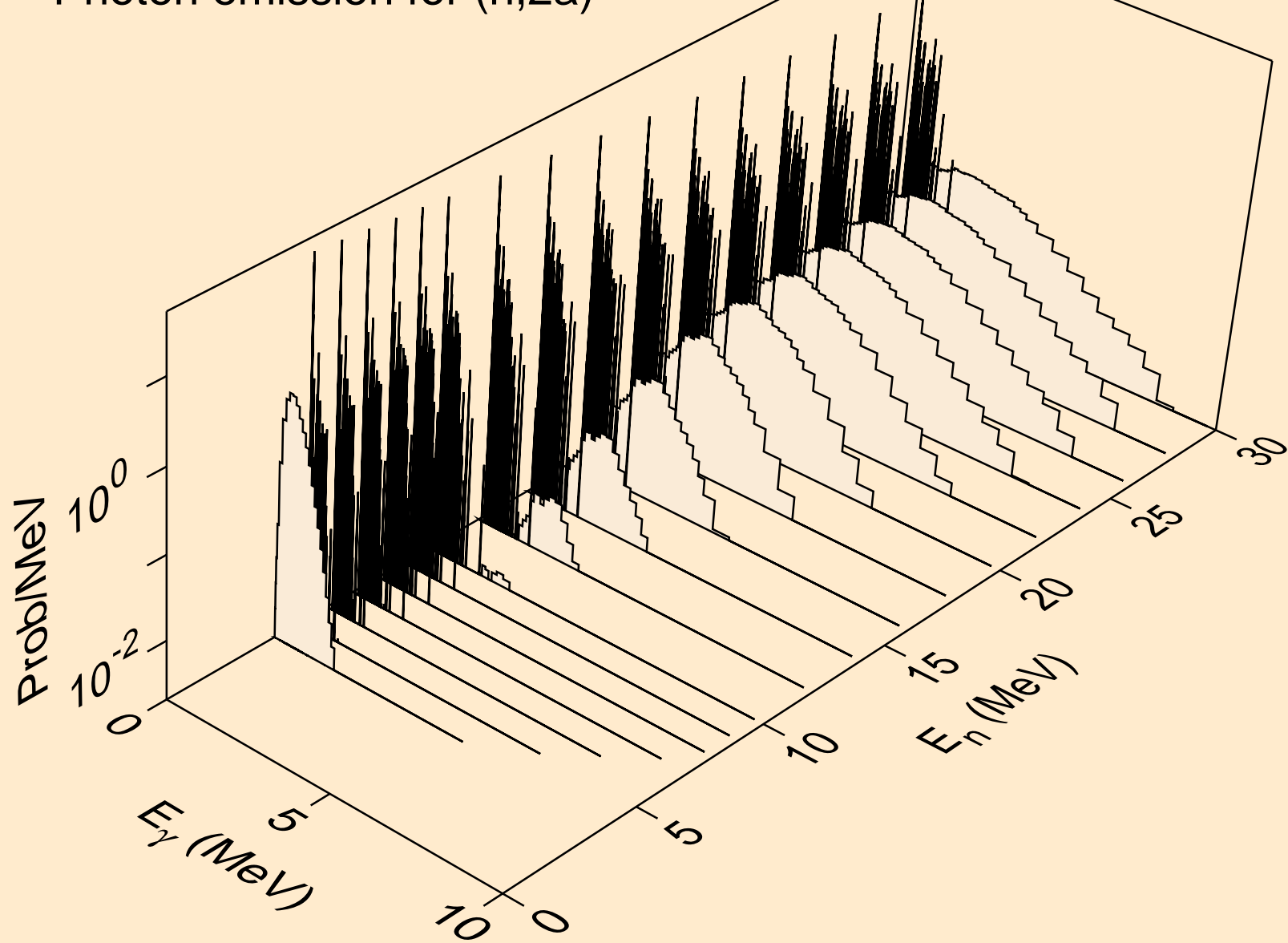

Y081 DEUTERON ACER TENDL-2024 LIBRARY; T=0.K
Photon emission for (n,3a)

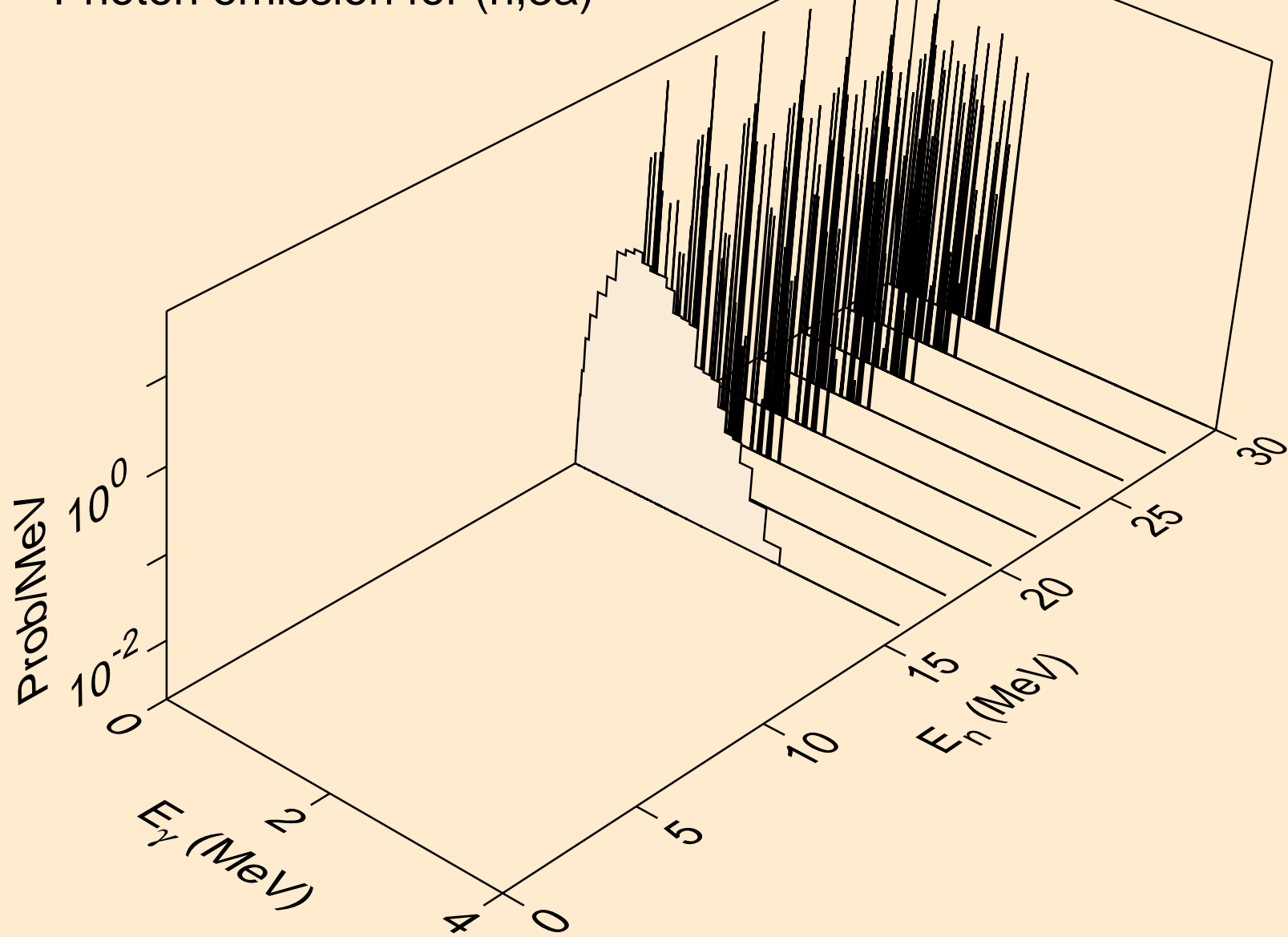

Y081 DEUTERON ACER TENDL-2024 LIBRARY; T=0.K
Photon emission for (n,2p)

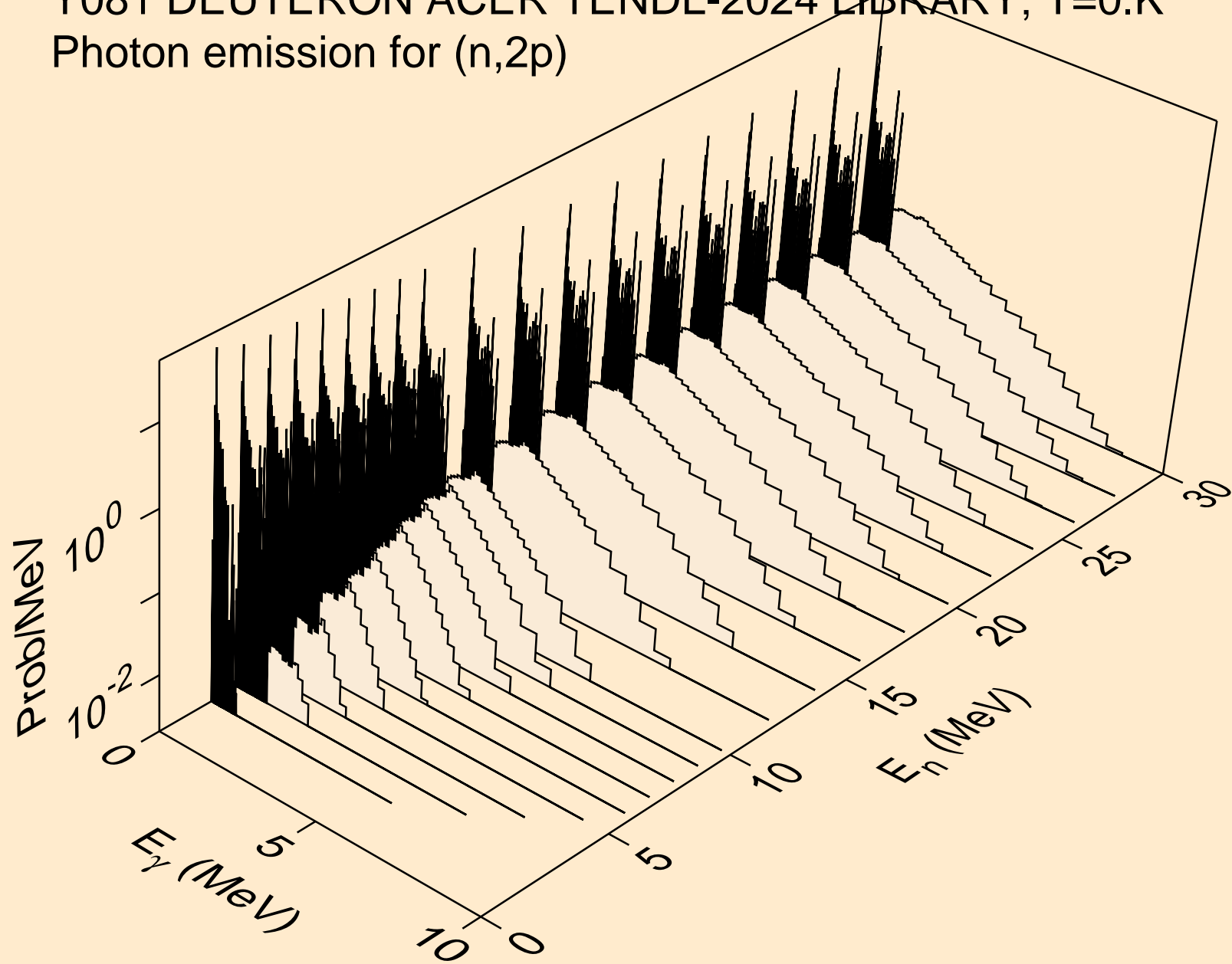

Y081 DEUTERON ACER TENDL-2024 LIBRARY; T=0.K
Photon emission for (n,p)

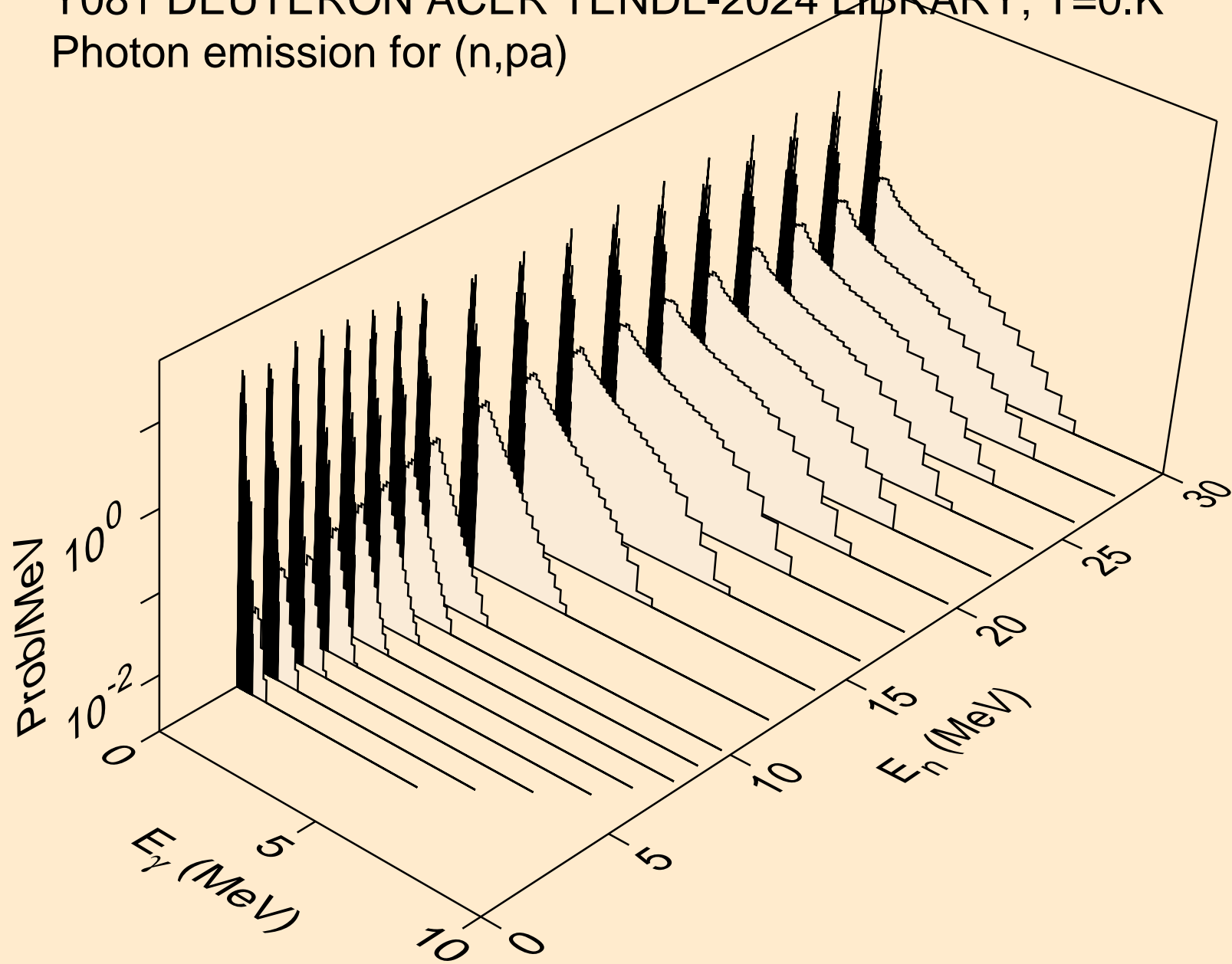

Y081 DEUTERON ACER TENDL-2024 LIBRARY; T=0.K
Photon emission for (n,pd)

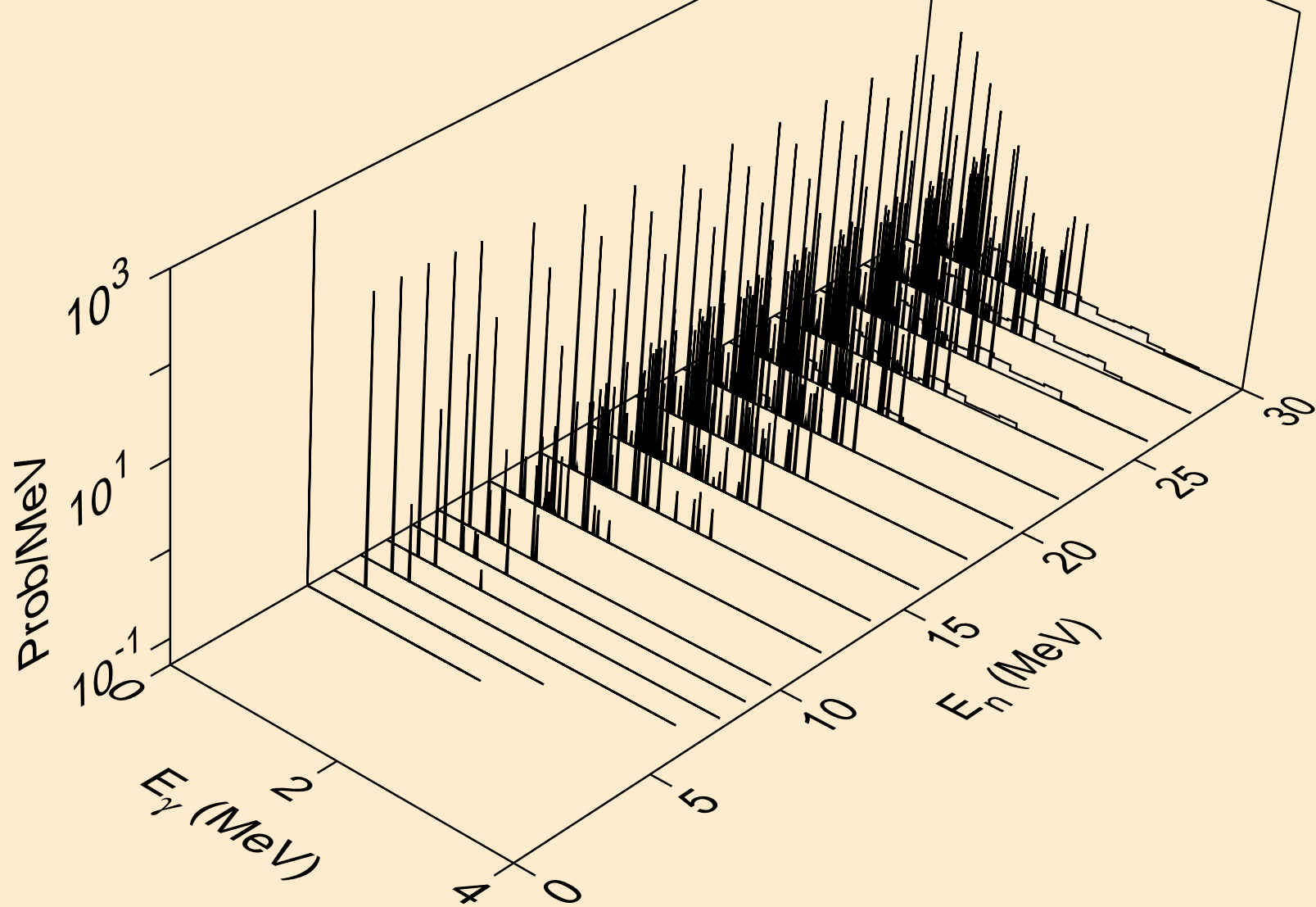

Y081 DEUTERON ACER TENDL-2024 LIBRARY; T=0.K
Photon emission for (n,pt)

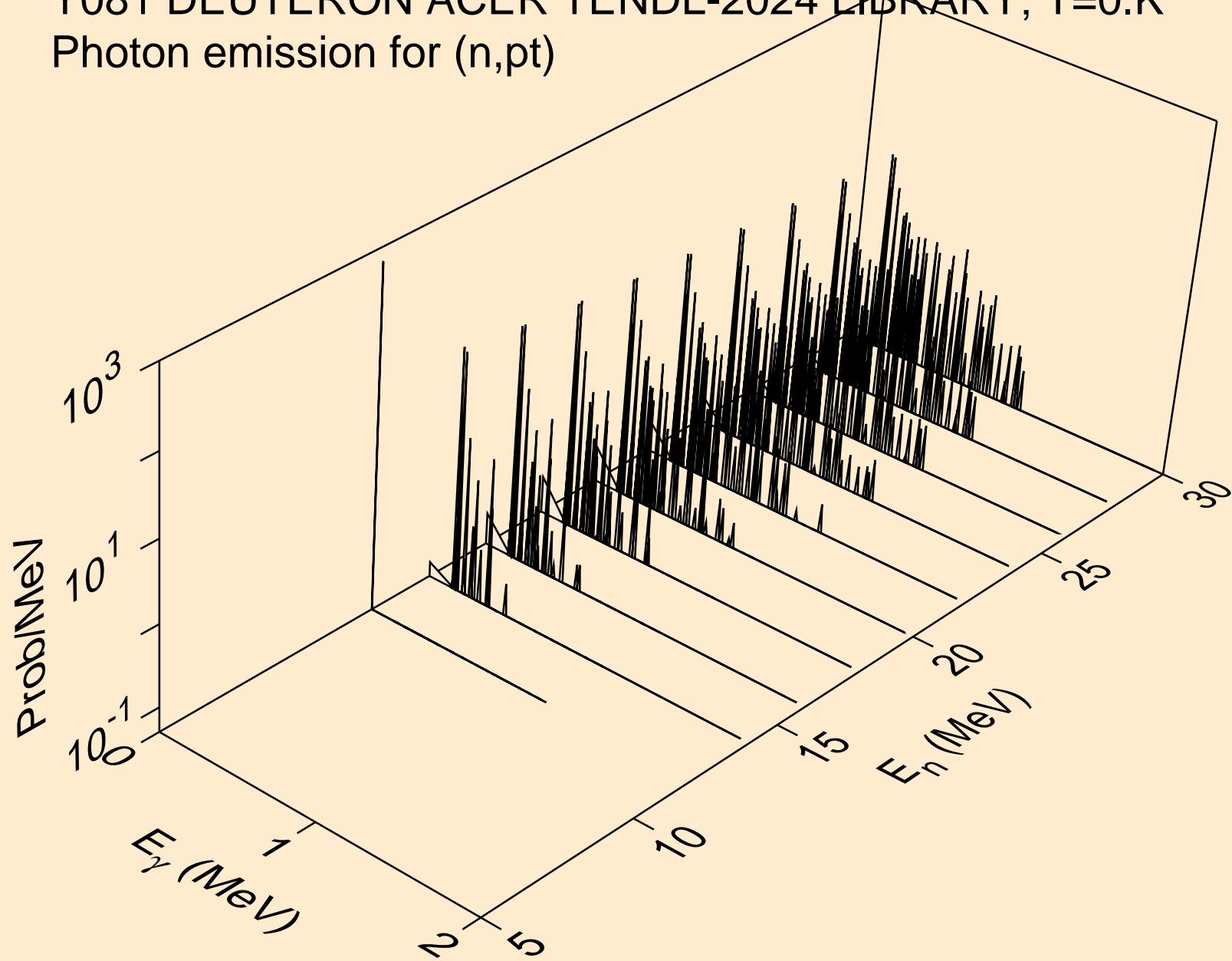

Y081 DEUTERON ACER TENDL-2024 LIBRARY; T=0.K
Photon emission for (n,da)

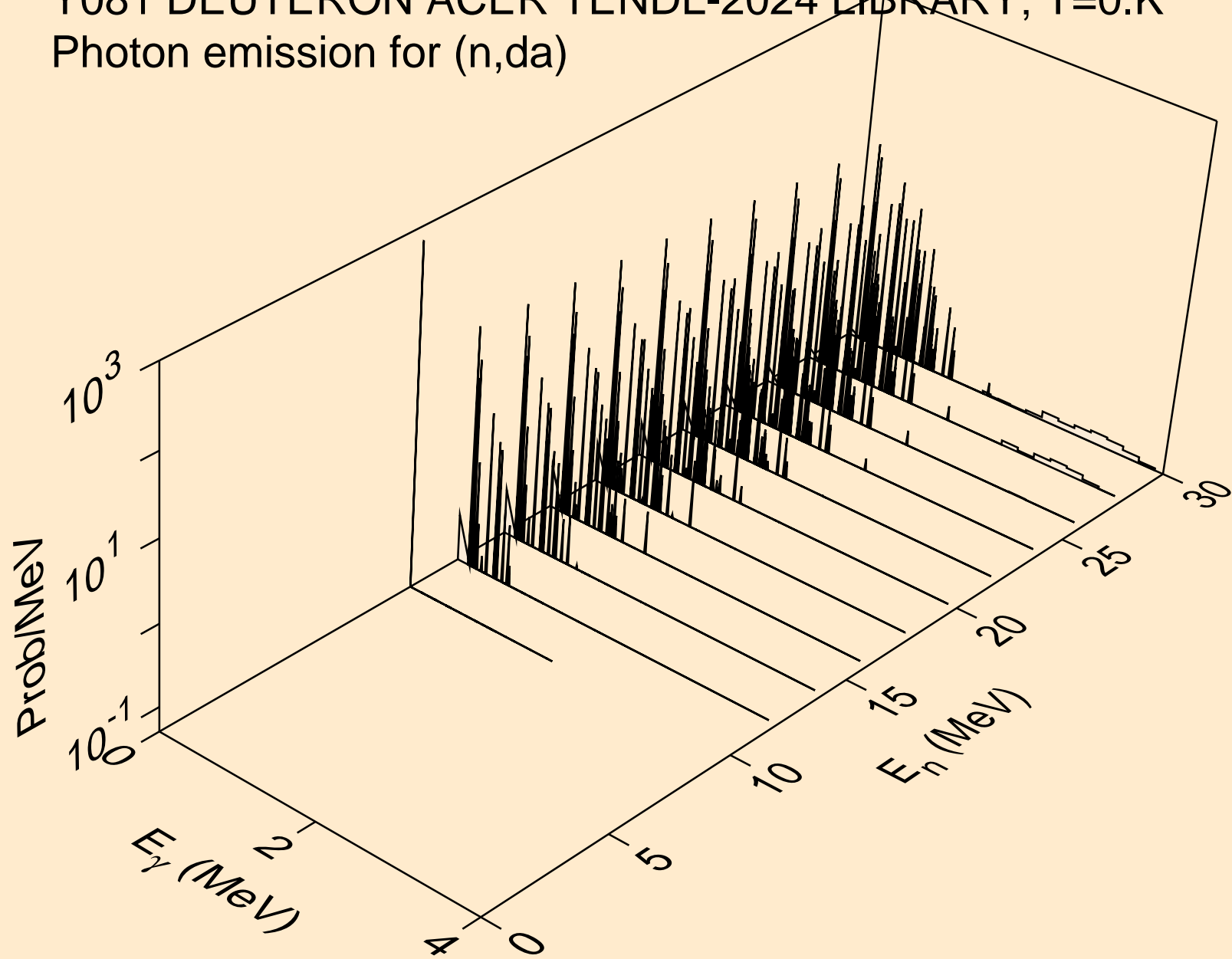

Y081 DEUTERON ACER TENDL-2024 LIBRARY; T=0.K

Particle heating contributions

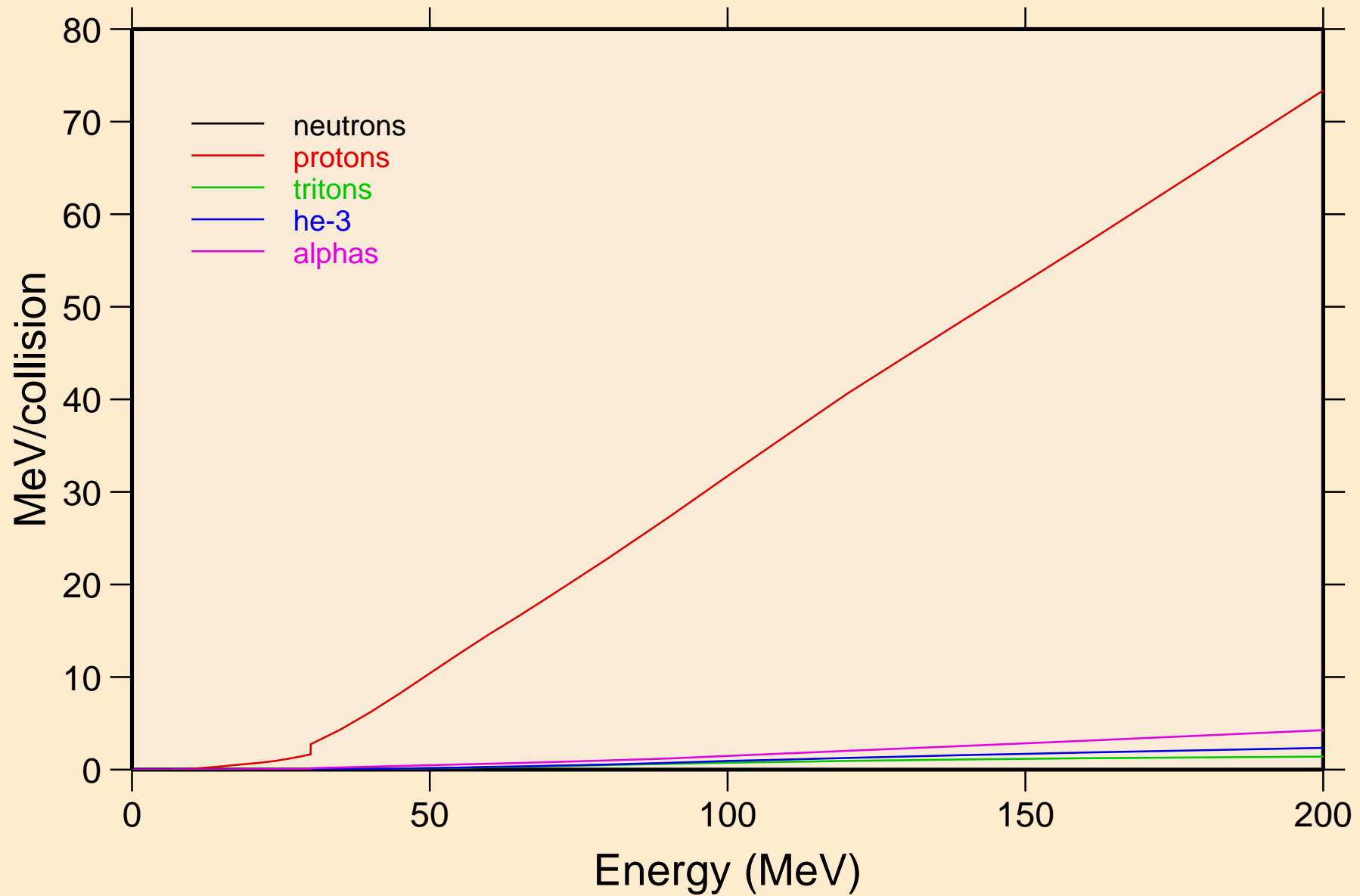

Y081 DEUTERON ACER TENDL-2024 LIBRARY; T=0.K
Recoil Heating

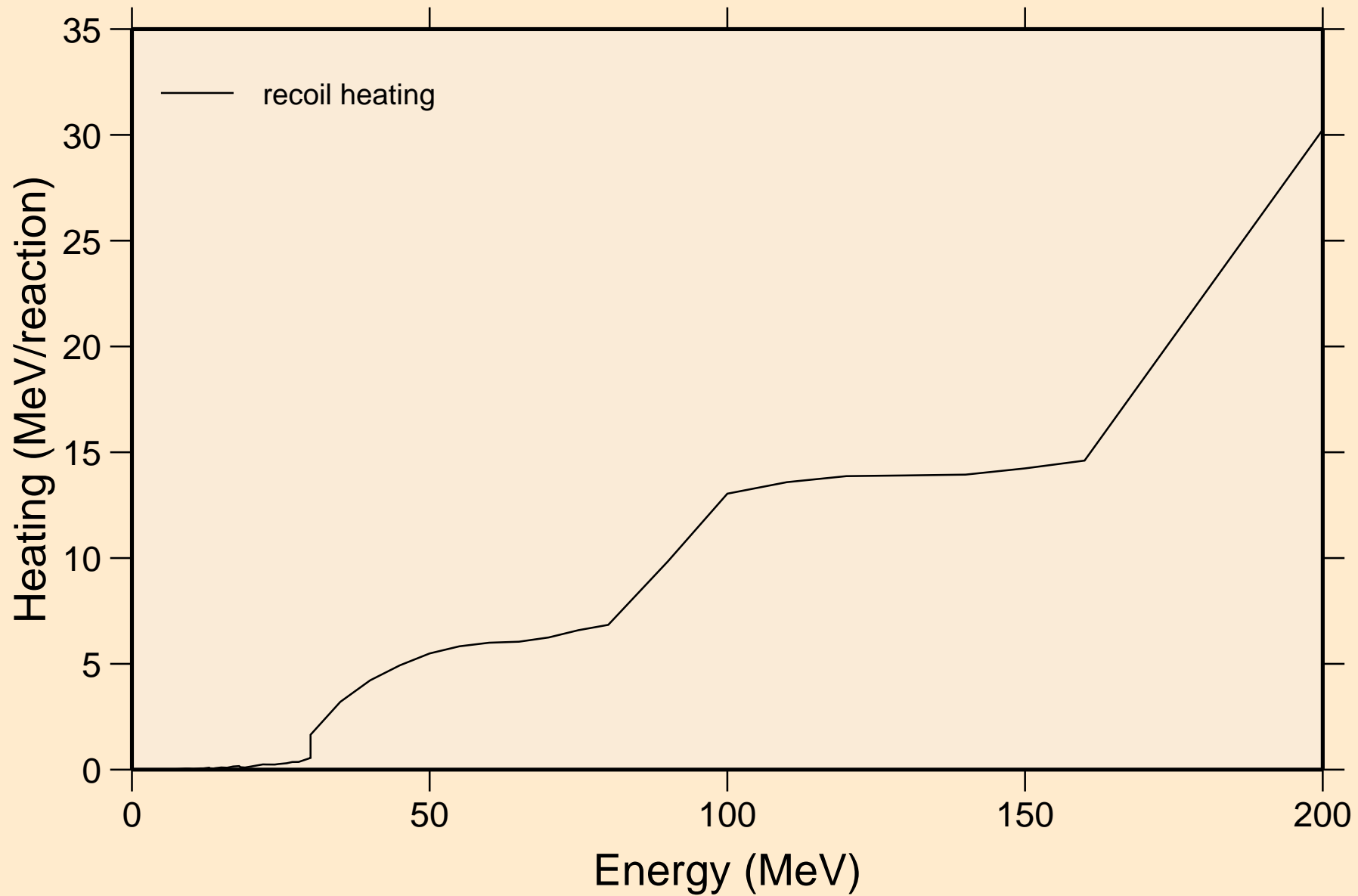

Y081 DEUTERON ACER TENDL-2024 LIBRARY; T=0.K

Particle production cross sections

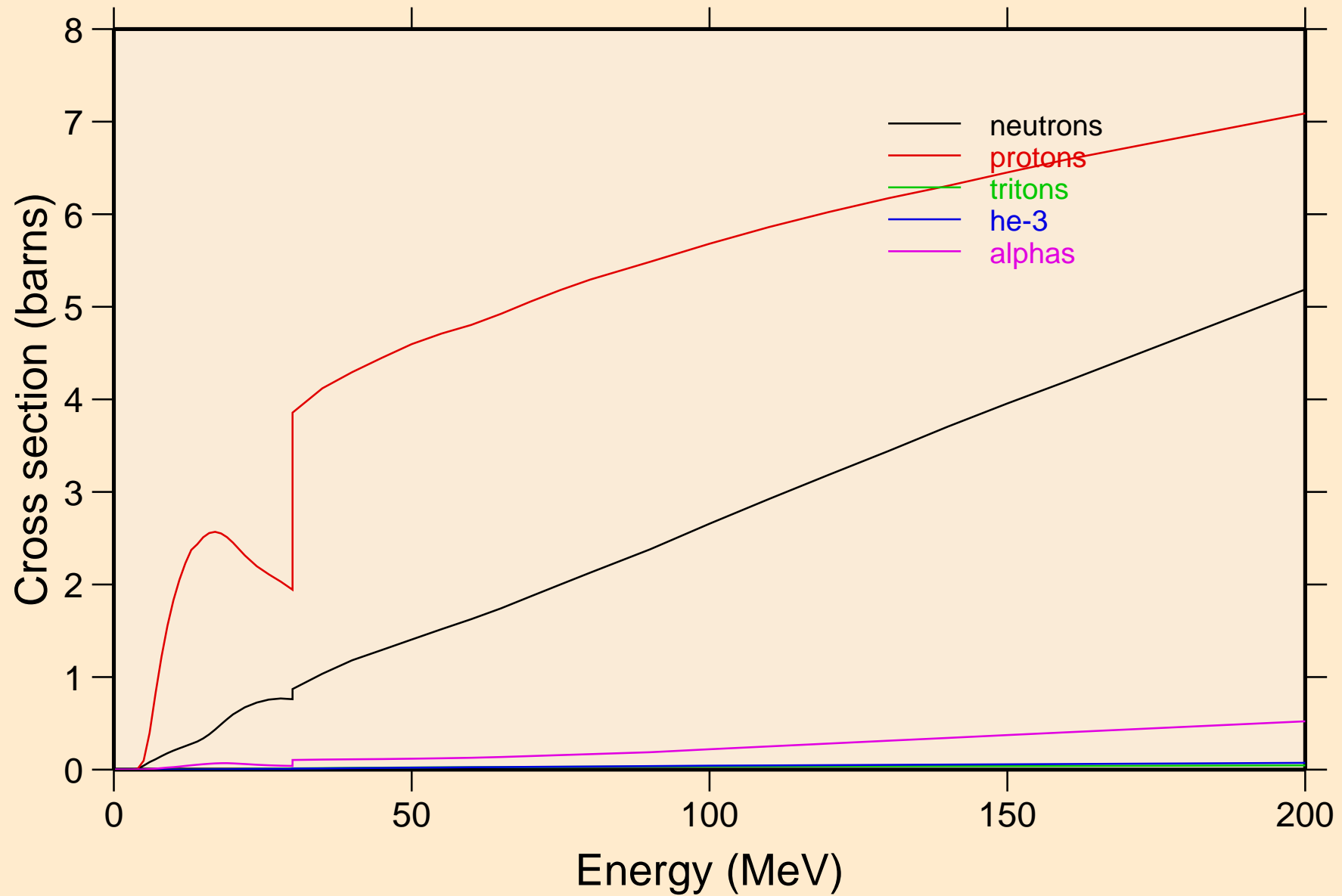

Y081 DEUTERON ACER TENDL-2024 LIBRARY; T=0.K
neutrons from (d,n)

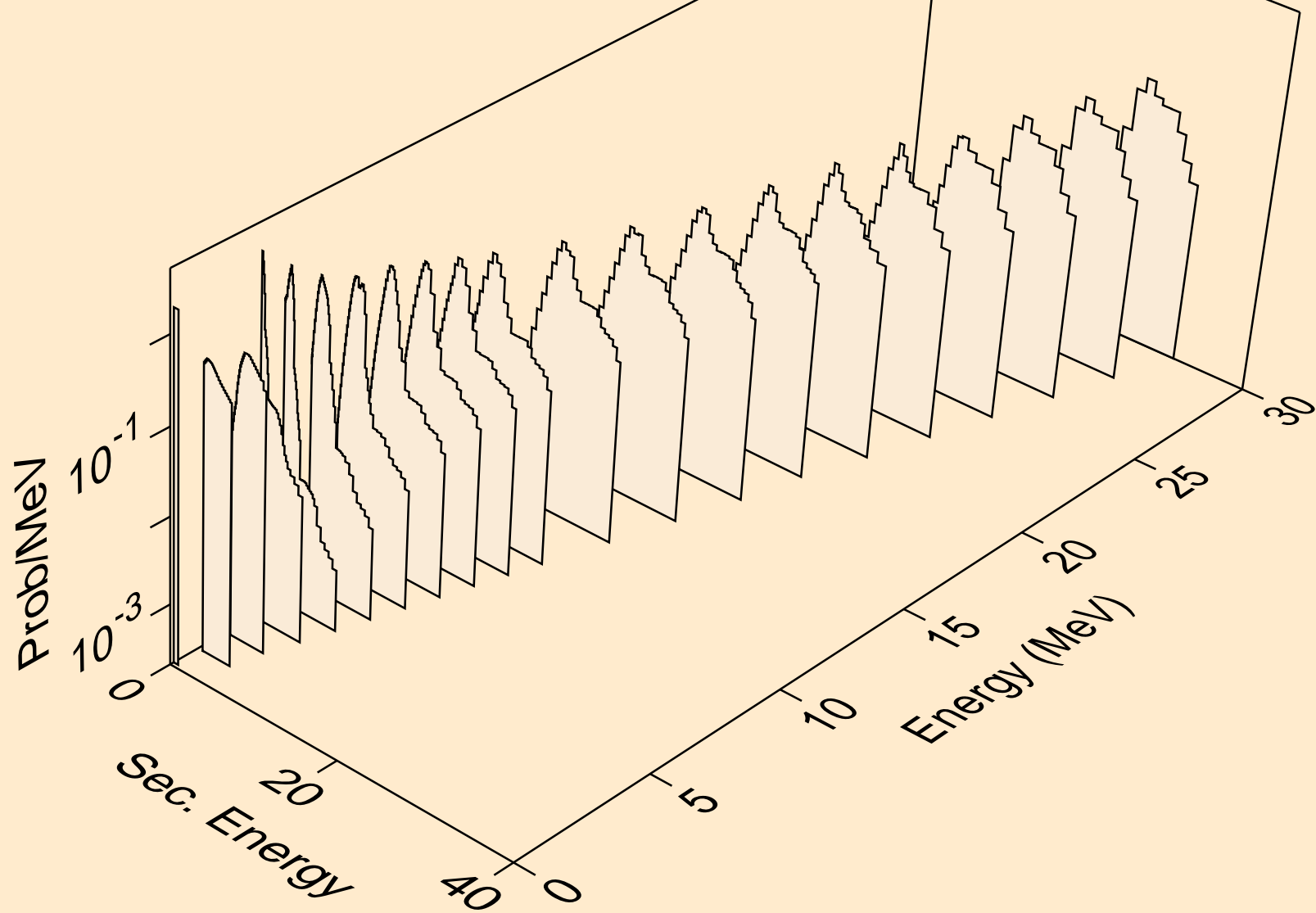

Y081 DEUTERON ACER TENDL-2024 LIBRARY; T=0.K
neutrons from (d,x)

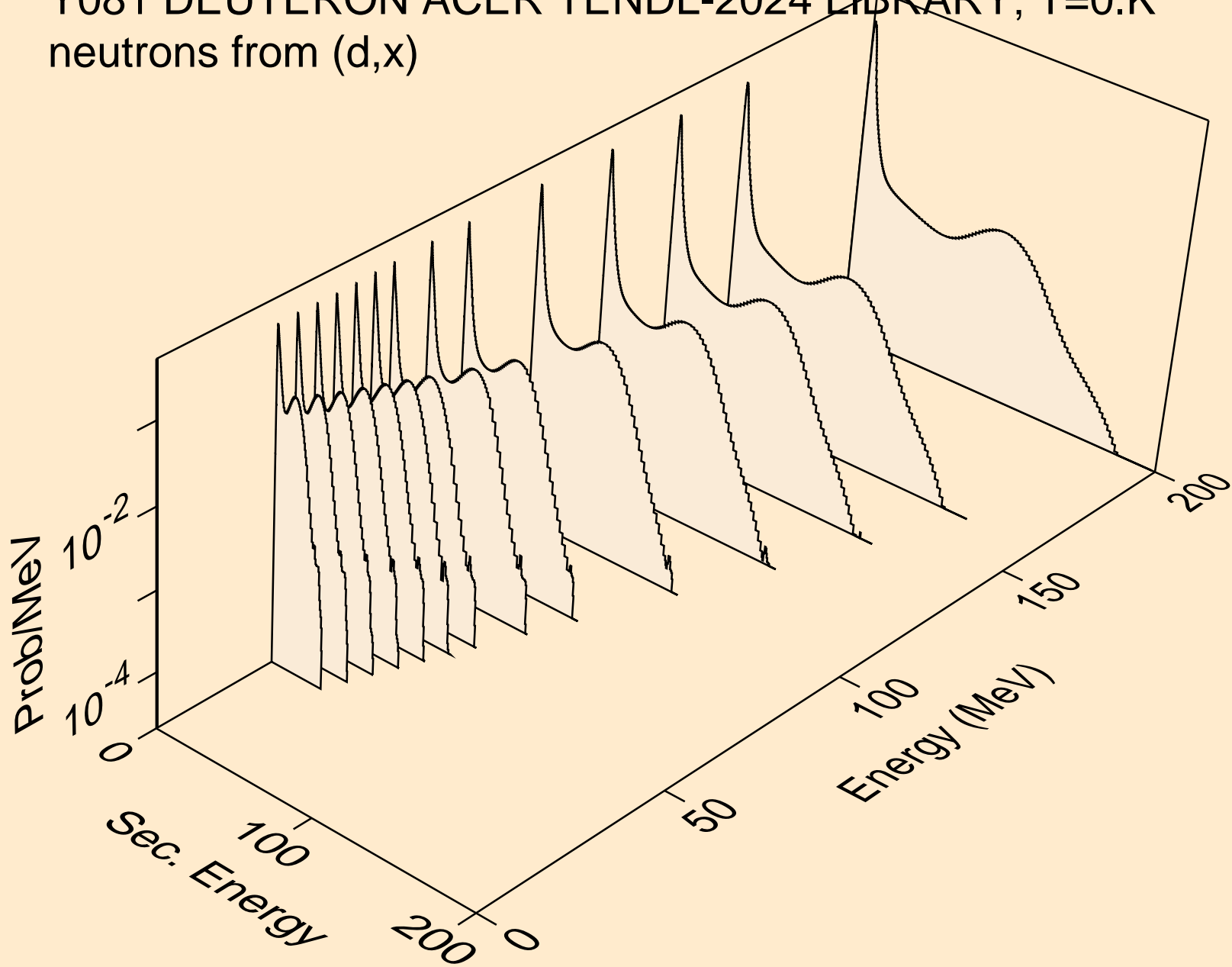

Y081 DEUTERON ACER TENDL-2024 LIBRARY; T=0.K
neutrons from (d,2nd)

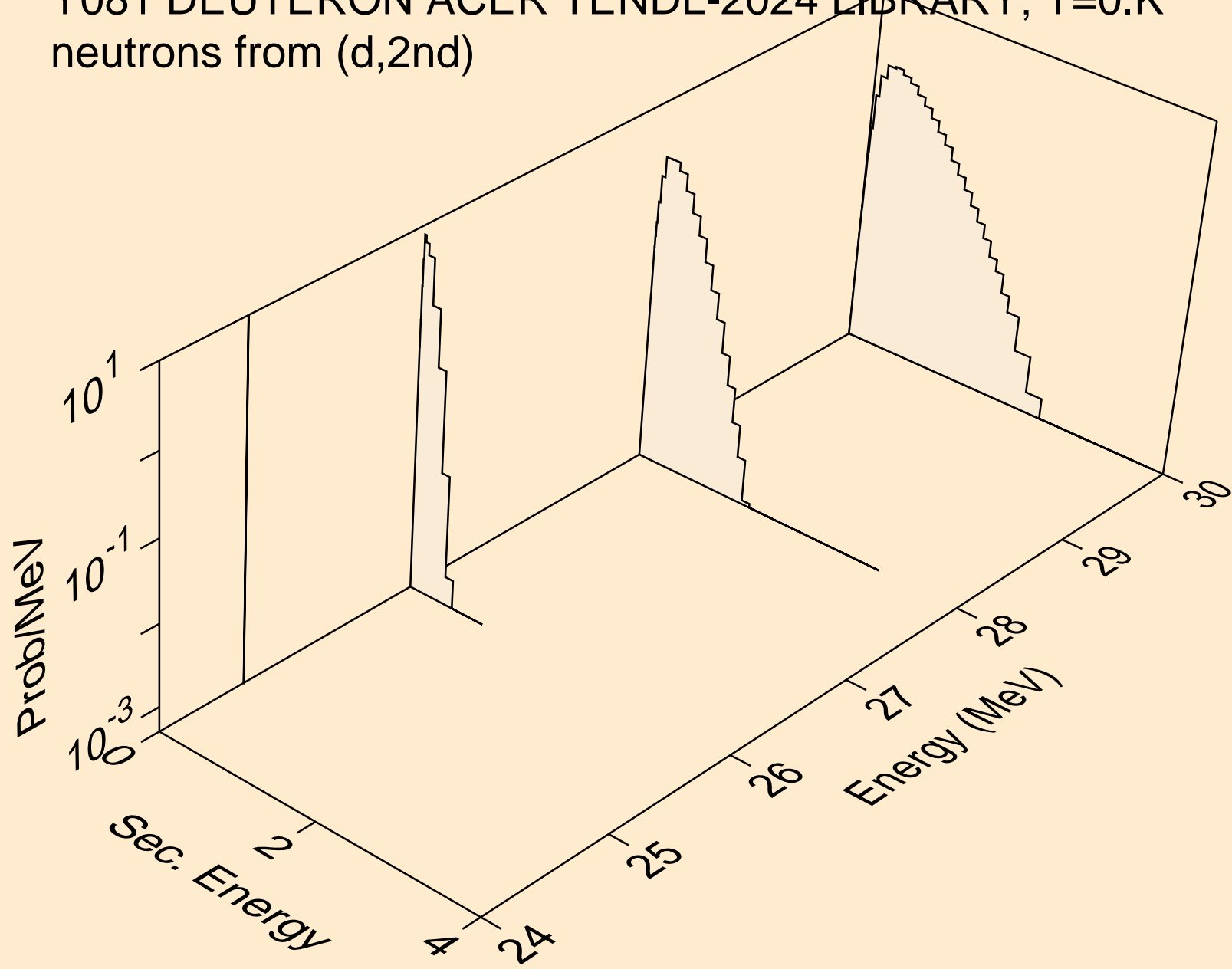

Y081 DEUTERON ACER TENDL-2024 LIBRARY; T=0.K
neutrons from (d,2n)

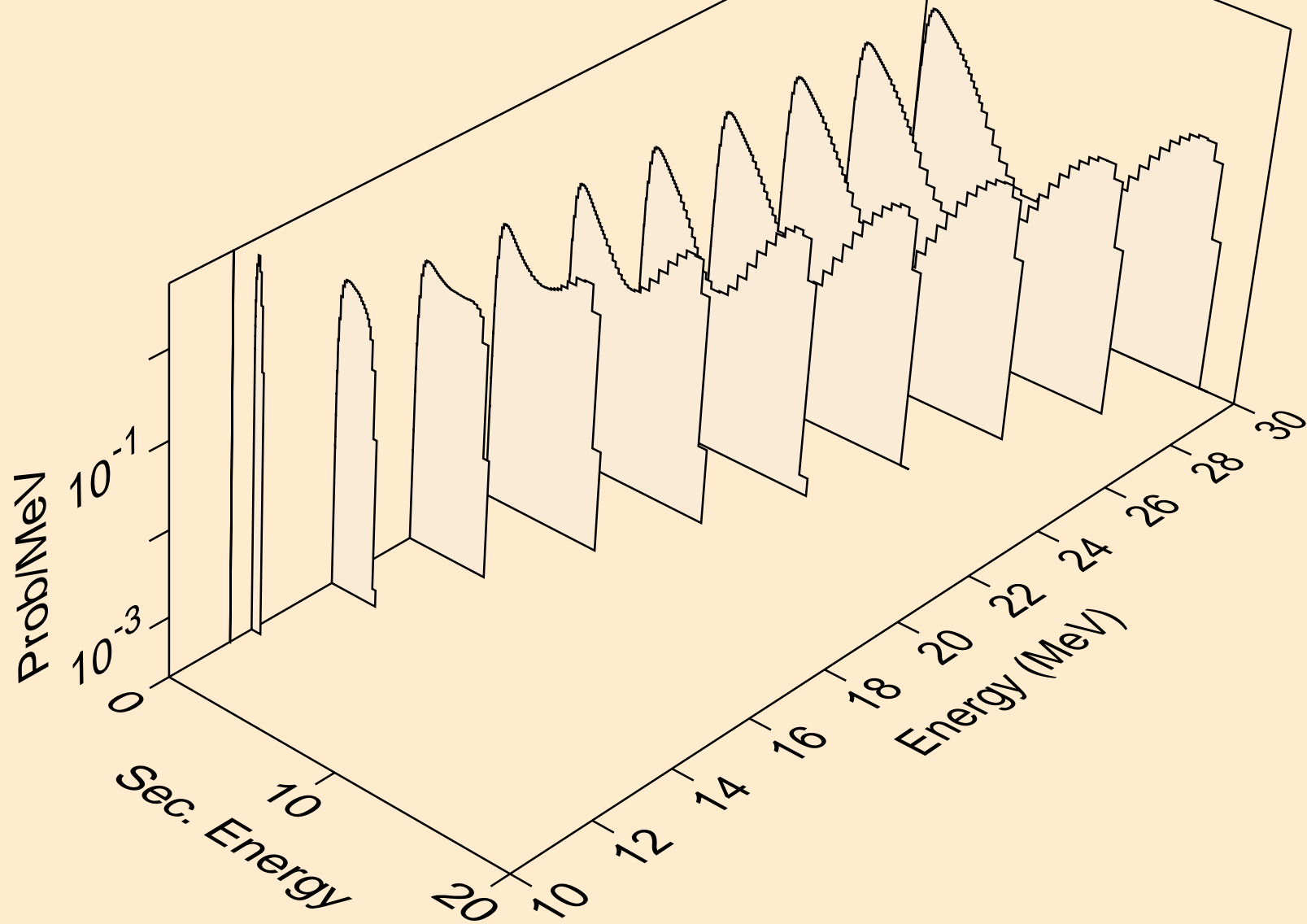

Y081 DEUTERON ACER TENDL-2024 LIBRARY; T=0.K
neutrons from (d,3n)

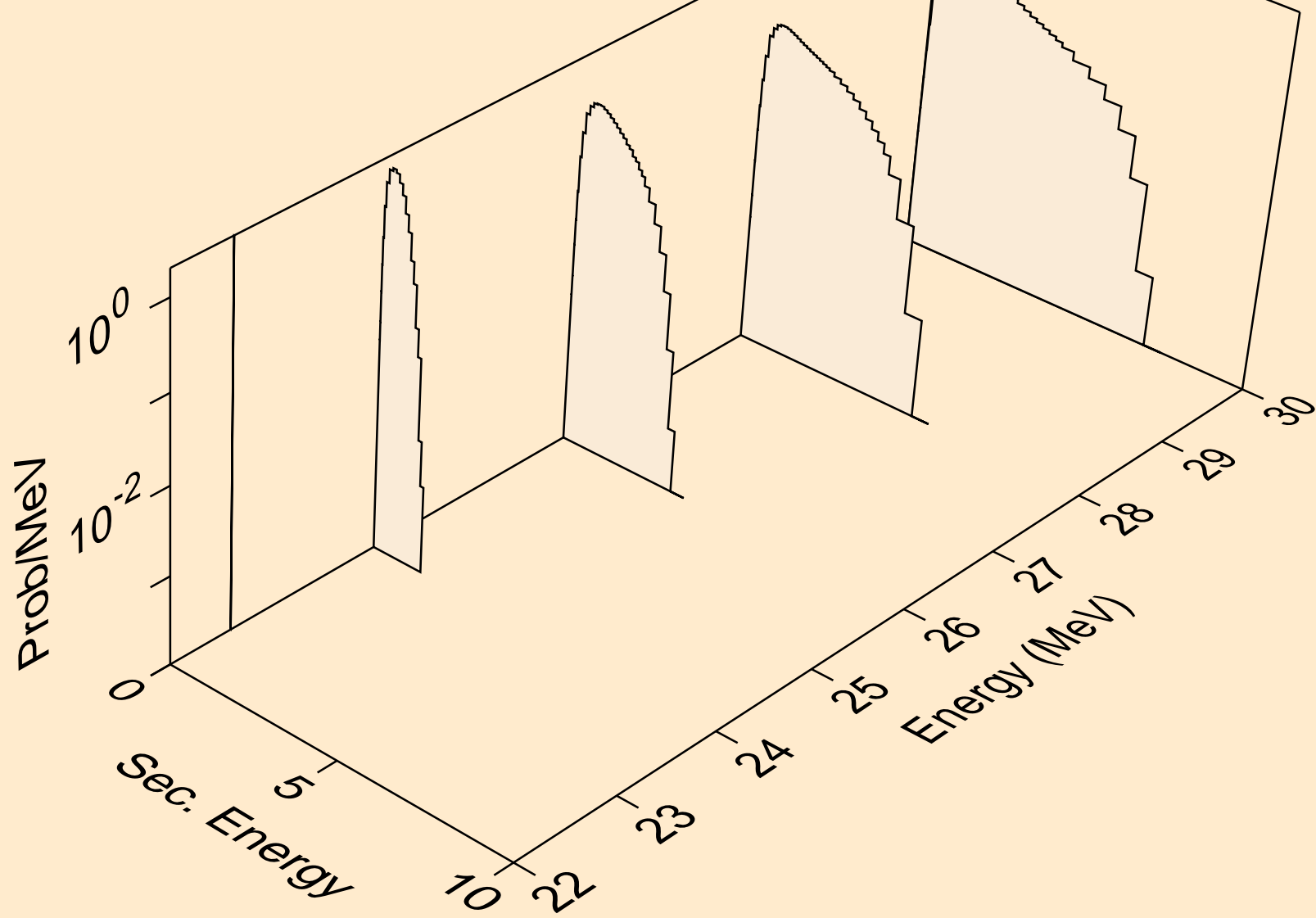

Y081 DEUTERON ACER TENDL-2024 LIBRARY; T=0.K
neutrons from (d,n*)a

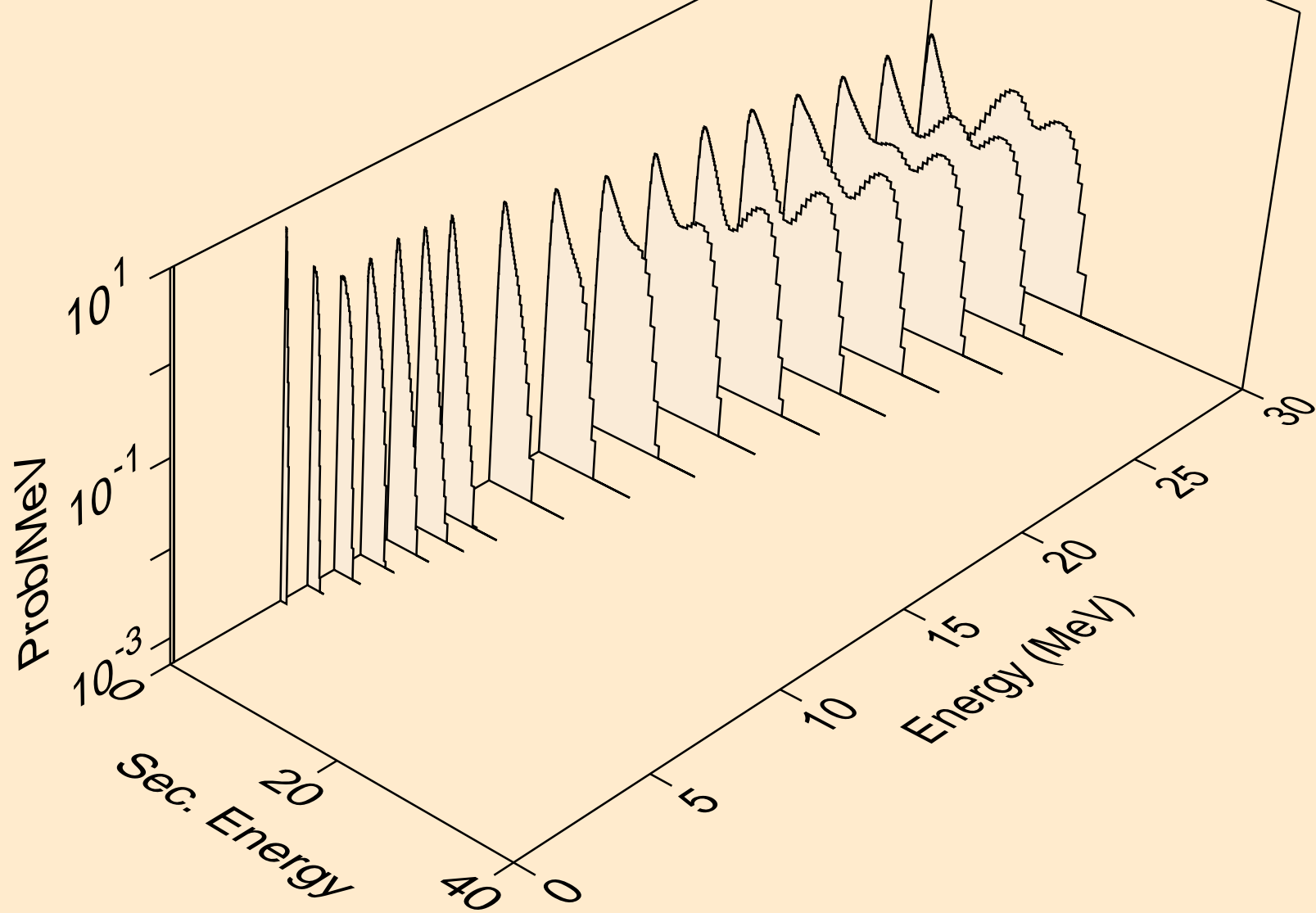

Y081 DEUTERON ACER TENDL-2024 LIBRARY; T=0.K
neutrons from (d,2n)a

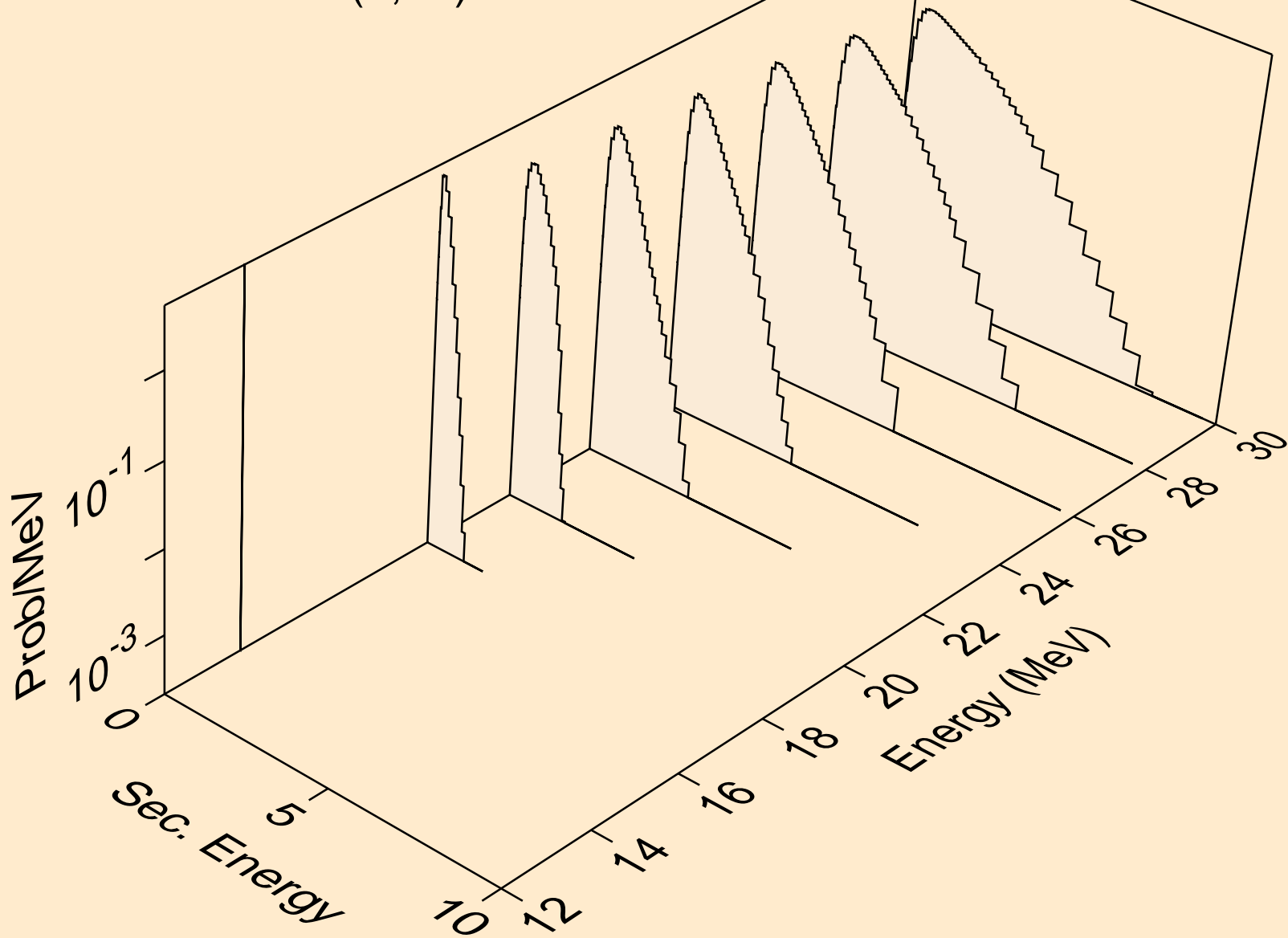

Y081 DEUTERON ACER TENDL-2024 LIBRARY; T=0.K
neutrons from (d,n*)p

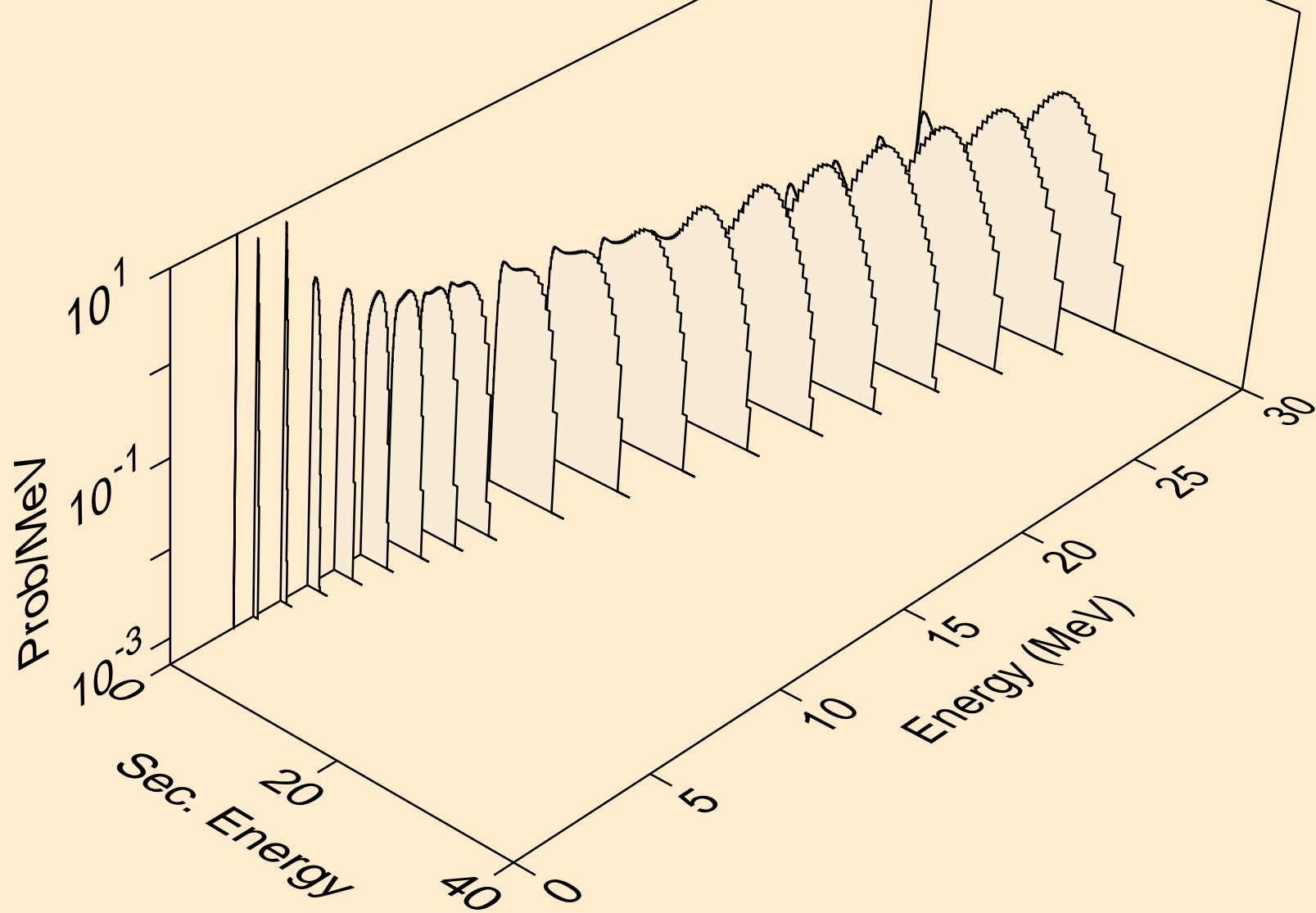

Y081 DEUTERON ACER TENDL-2024 LIBRARY; T=0.K
neutrons from (d,n*)2a

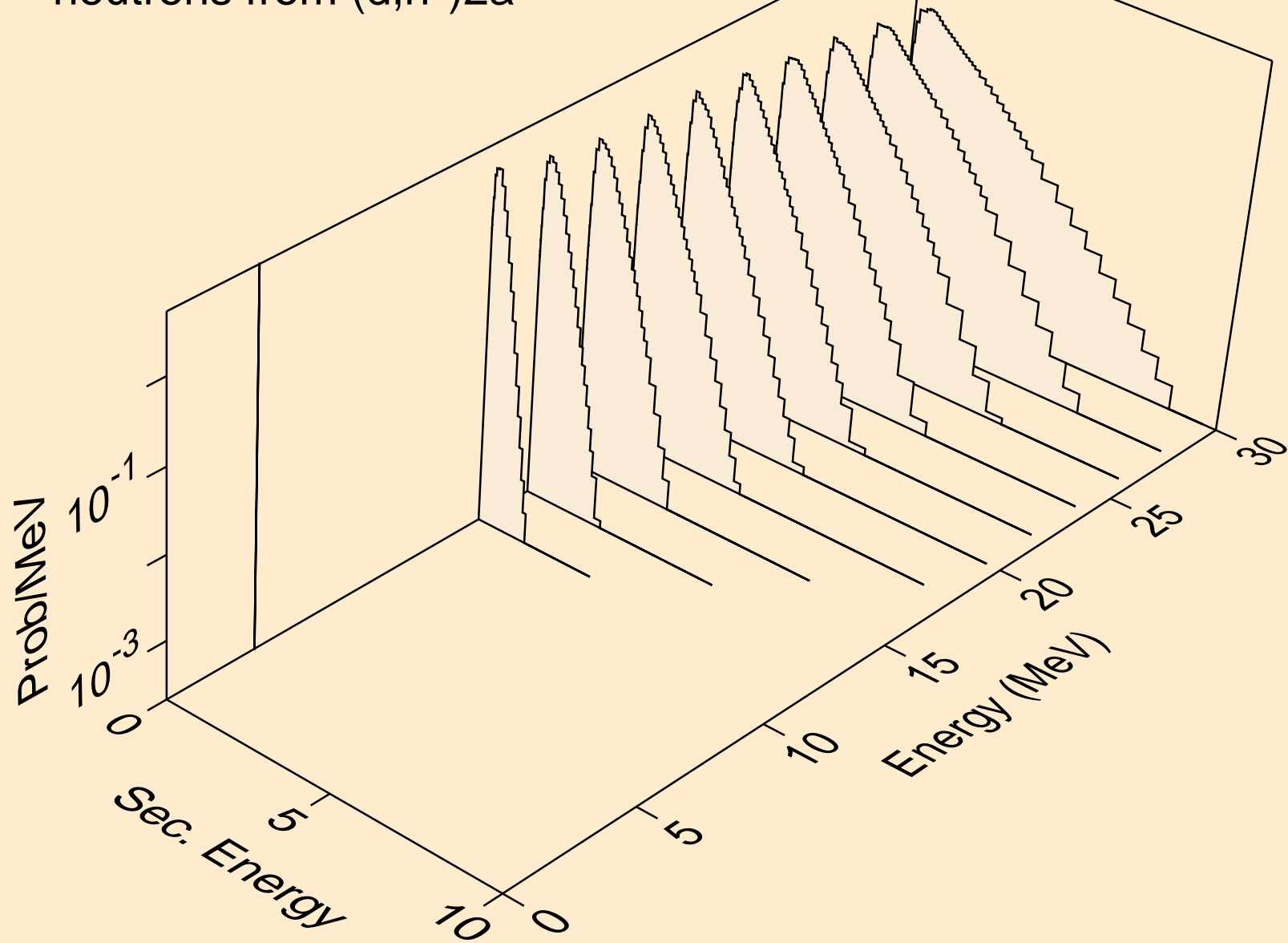

Y081 DEUTERON ACER TENDL-2024 LIBRARY; T=0.K
neutrons from (d,n*)d

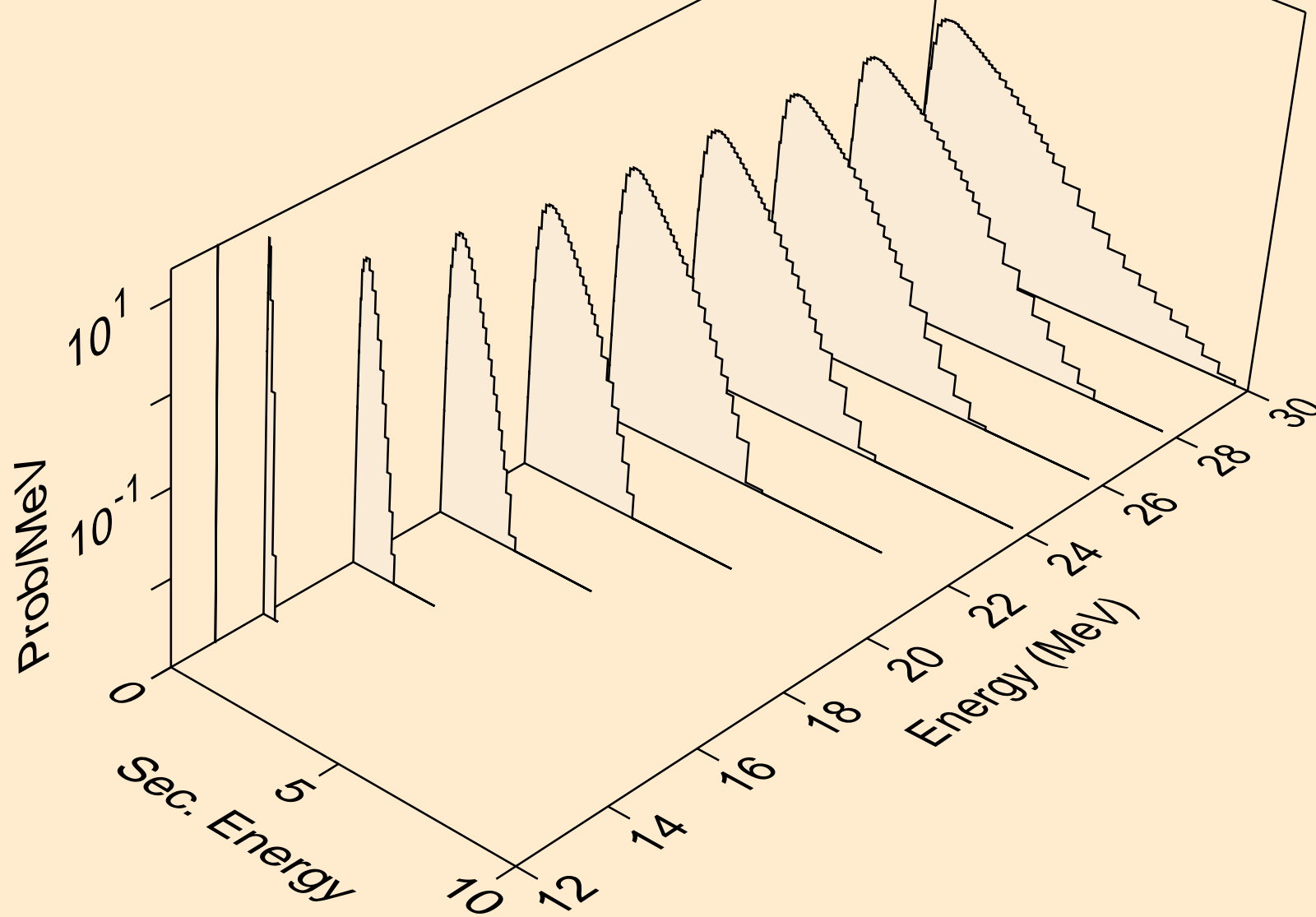

Y081 DEUTERON ACER TENDL-2024 LIBRARY; T=0.K
neutrons from (d,n*)t

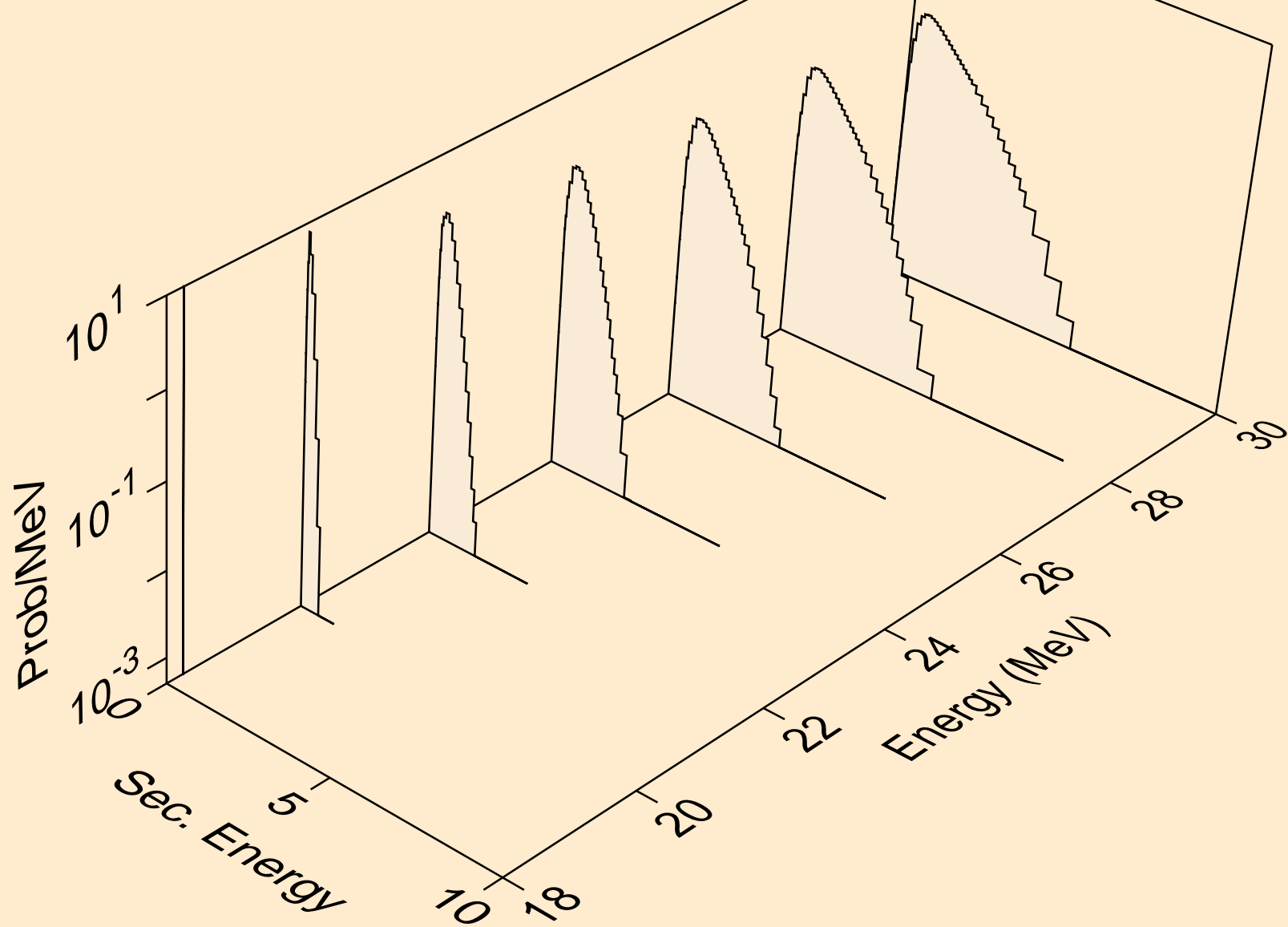

Y081 DEUTERON ACER TENDL-2024 LIBRARY; T=0.K
neutrons from (d,n*)he3

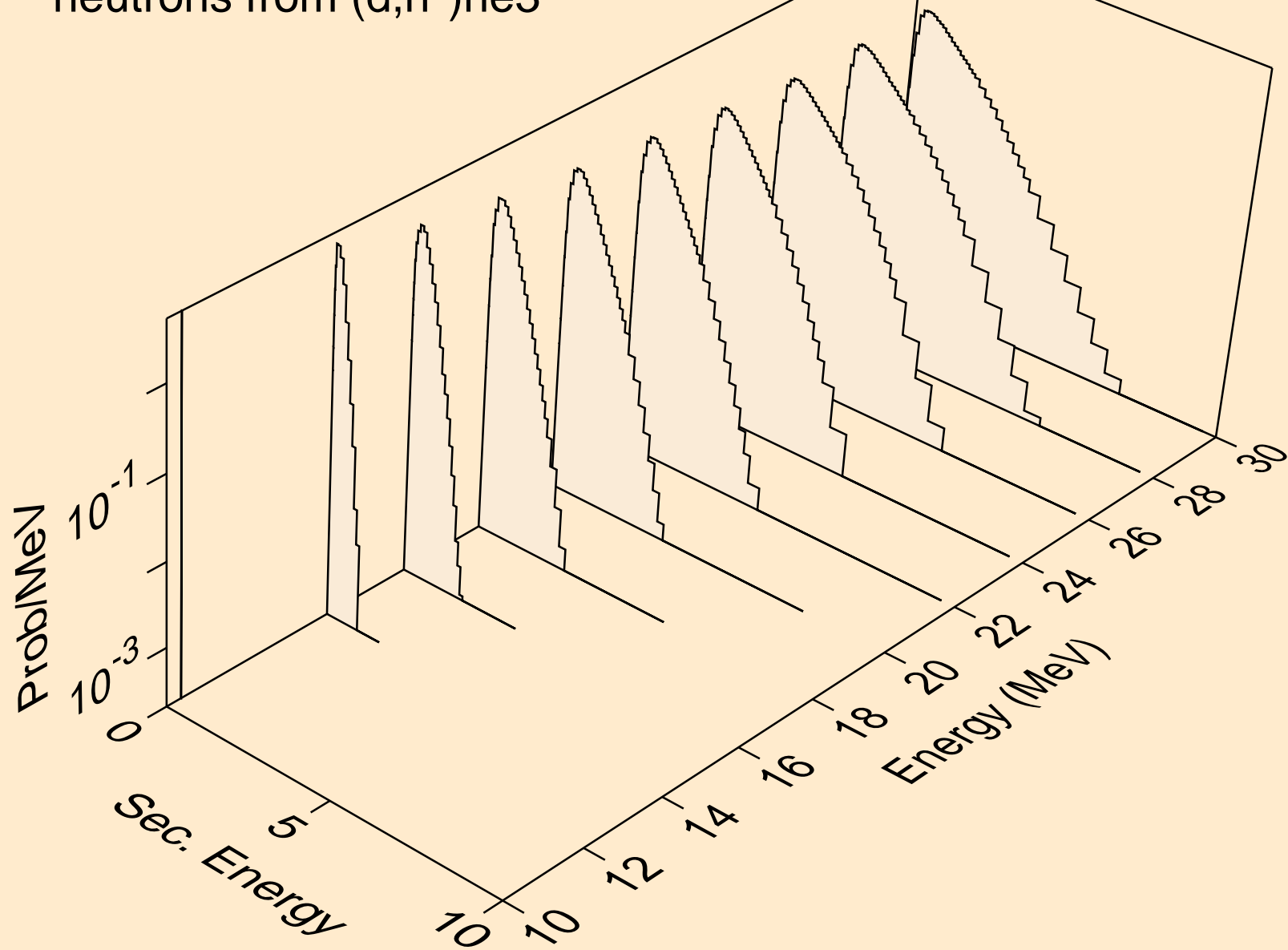

Y081 DEUTERON ACER TENDL-2024 LIBRARY; T=0.K
neutrons from (d,2np)

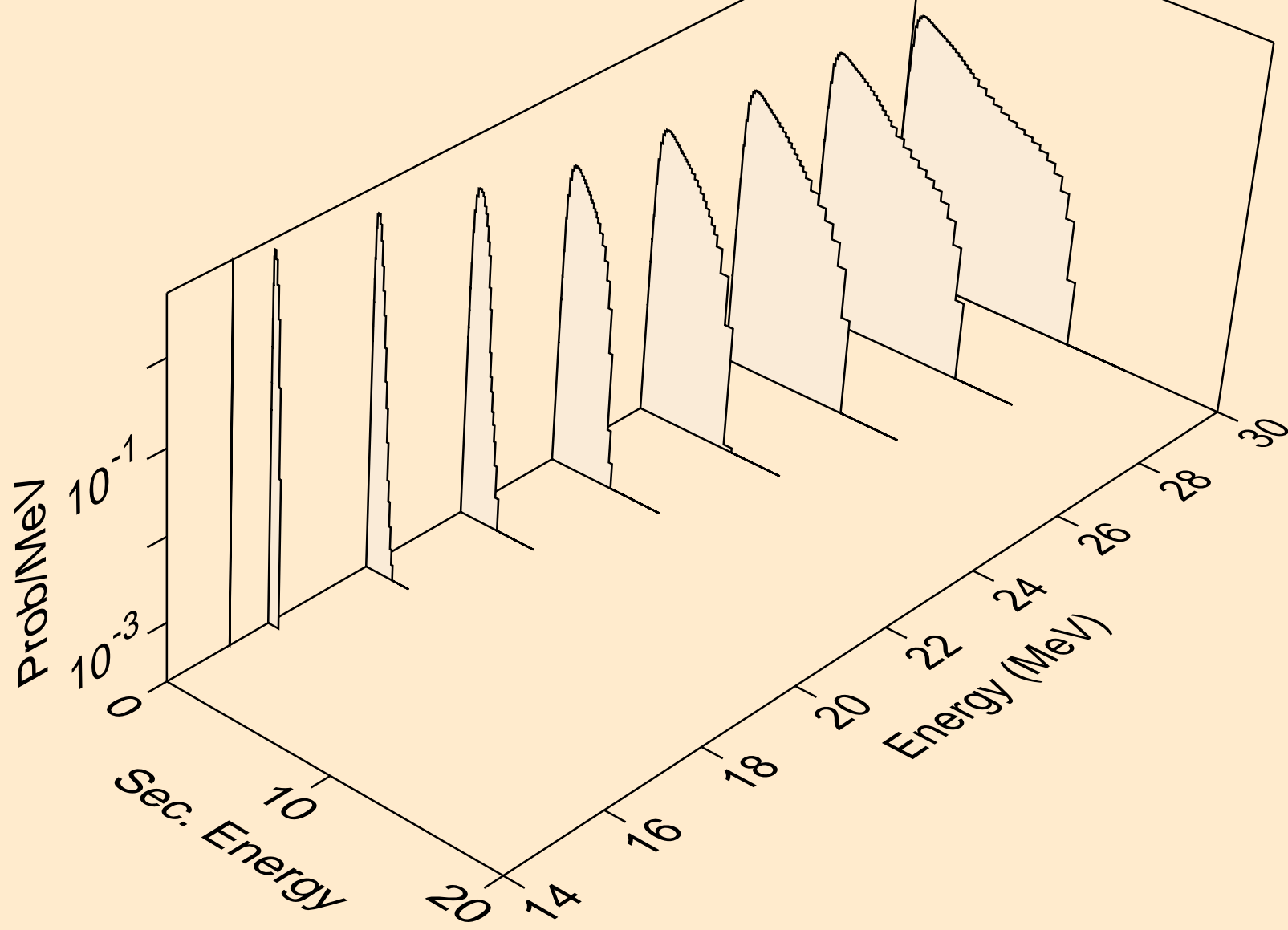

Y081 DEUTERON ACER TENDL-2024 LIBRARY; T=0.K
neutrons from (d,3np)

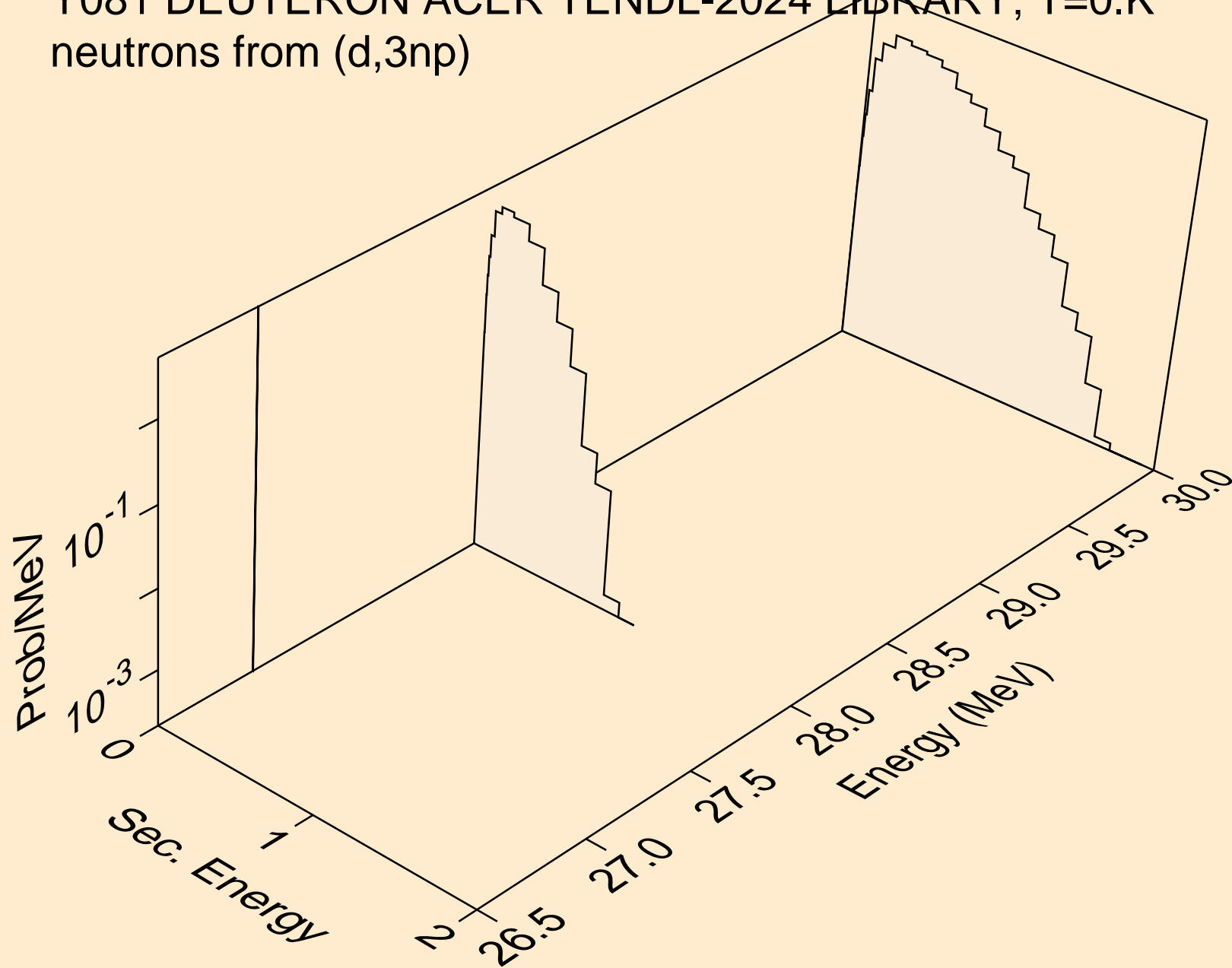

Y081 DEUTERON ACER TENDL-2024 LIBRARY; T=0.K
neutrons from (d,n2p)

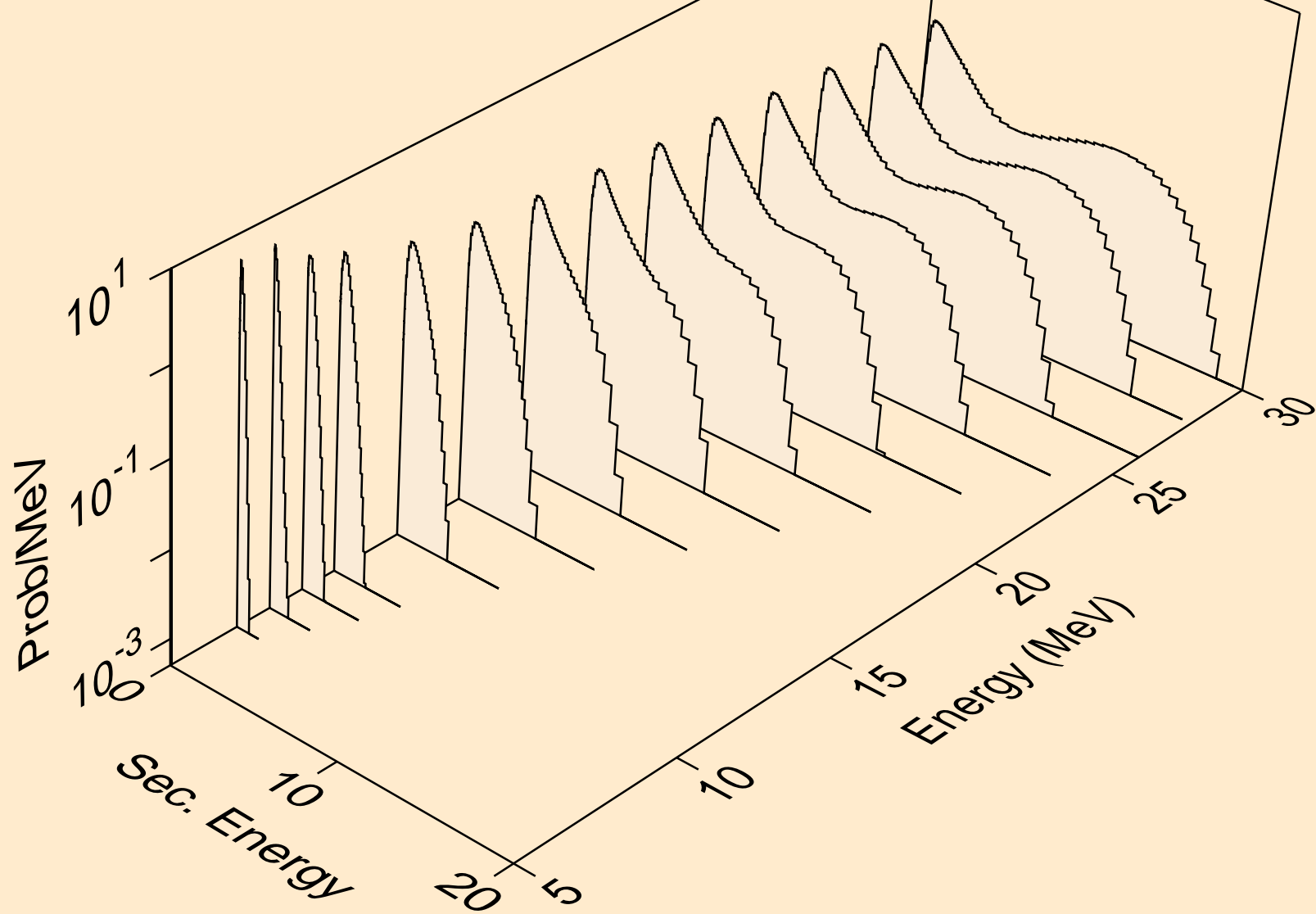

Y081 DEUTERON ACER TENDL-2024 LIBRARY; T=0.K
neutrons from (d,npa)

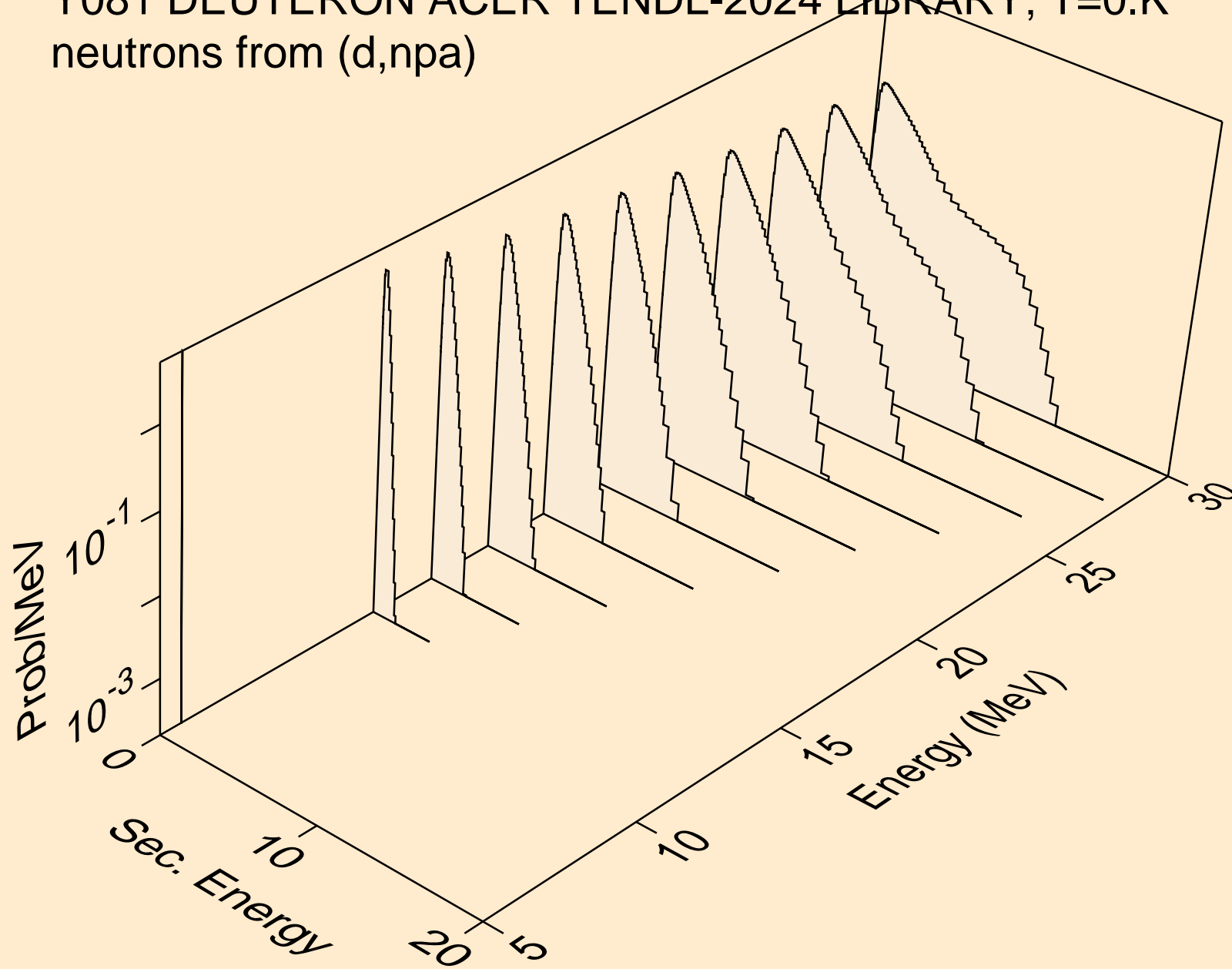

Y081 DEUTERON ACER TENDL-2024 LIBRARY; T=0.K
protons from (d,x)

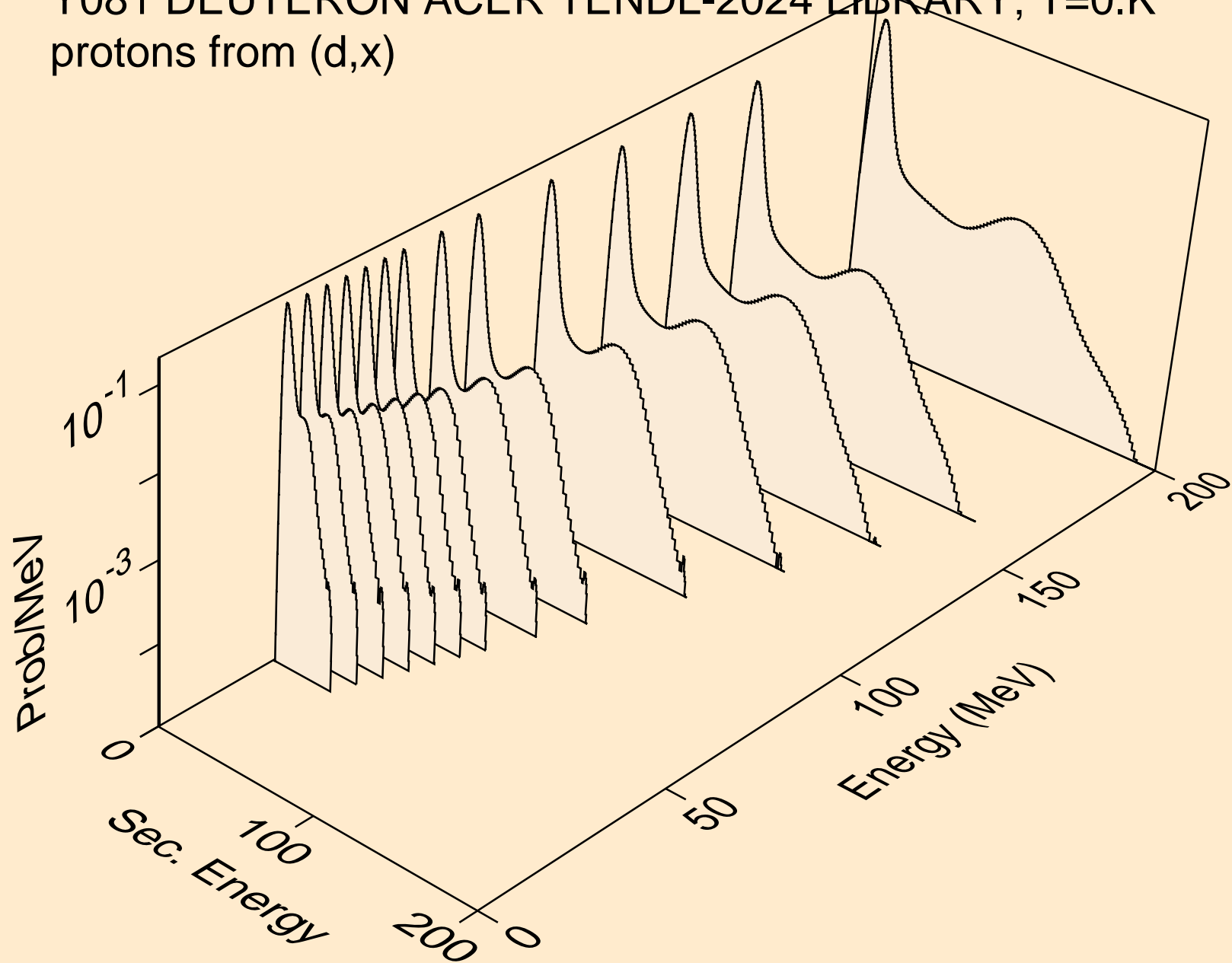

Y081 DEUTERON ACER TENDL-2024 LIBRARY; T=0.K
protons from (d,n*)p

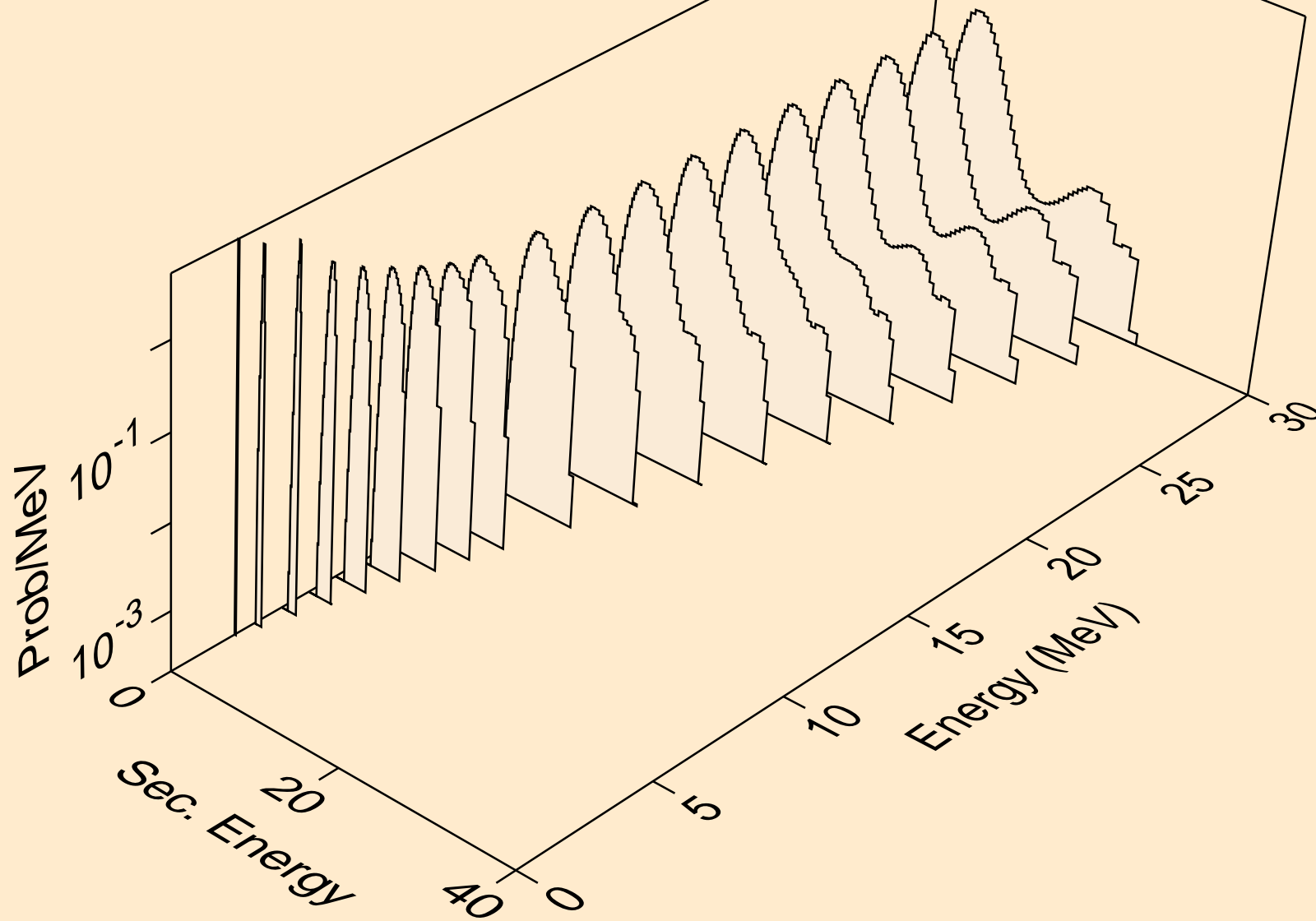

Y081 DEUTERON ACER TENDL-2024 LIBRARY; T=0.K
protons from (d,2np)

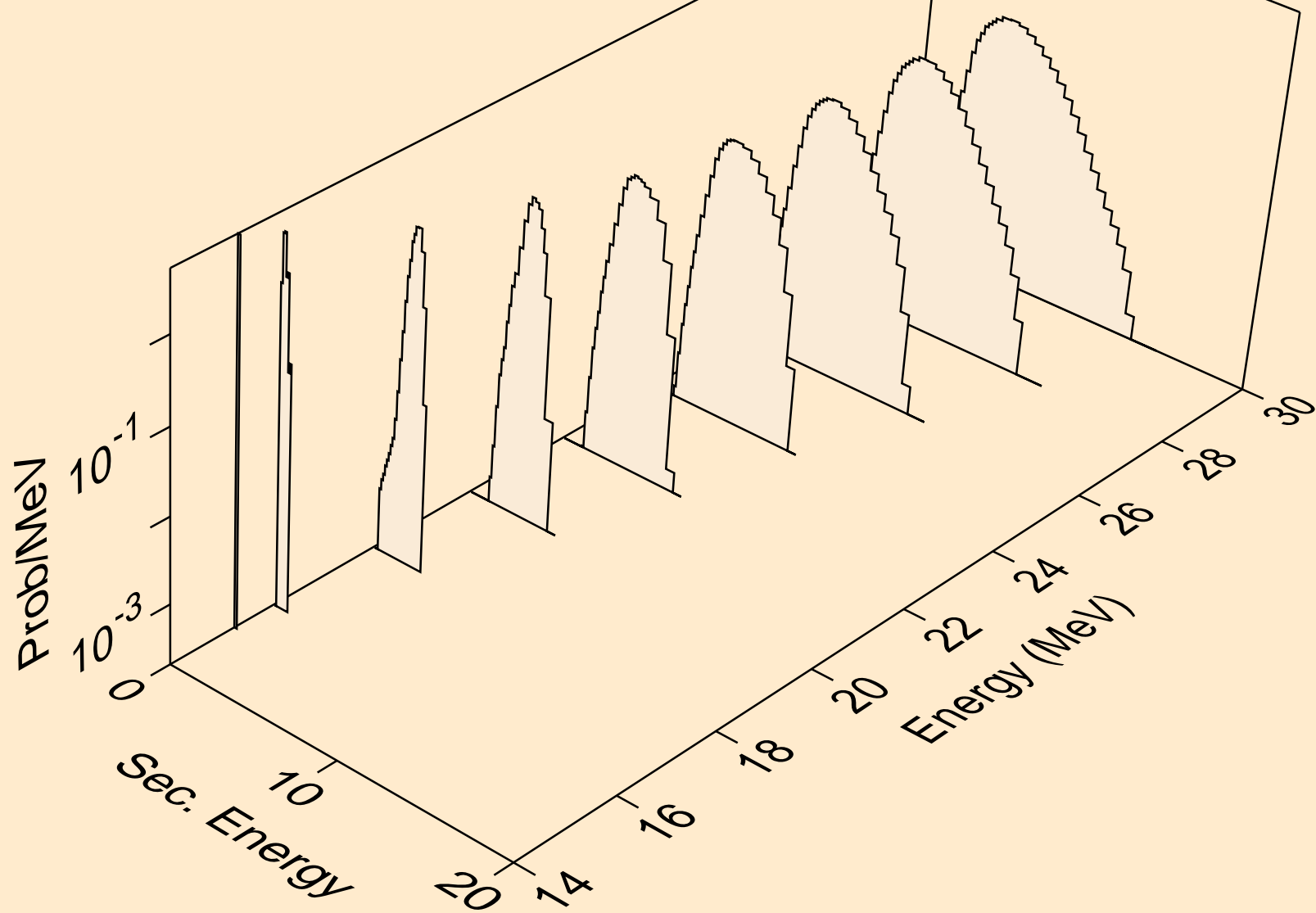

Y081 DEUTERON ACER TENDL-2024 LIBRARY; T=0.K
protons from (d,3np)

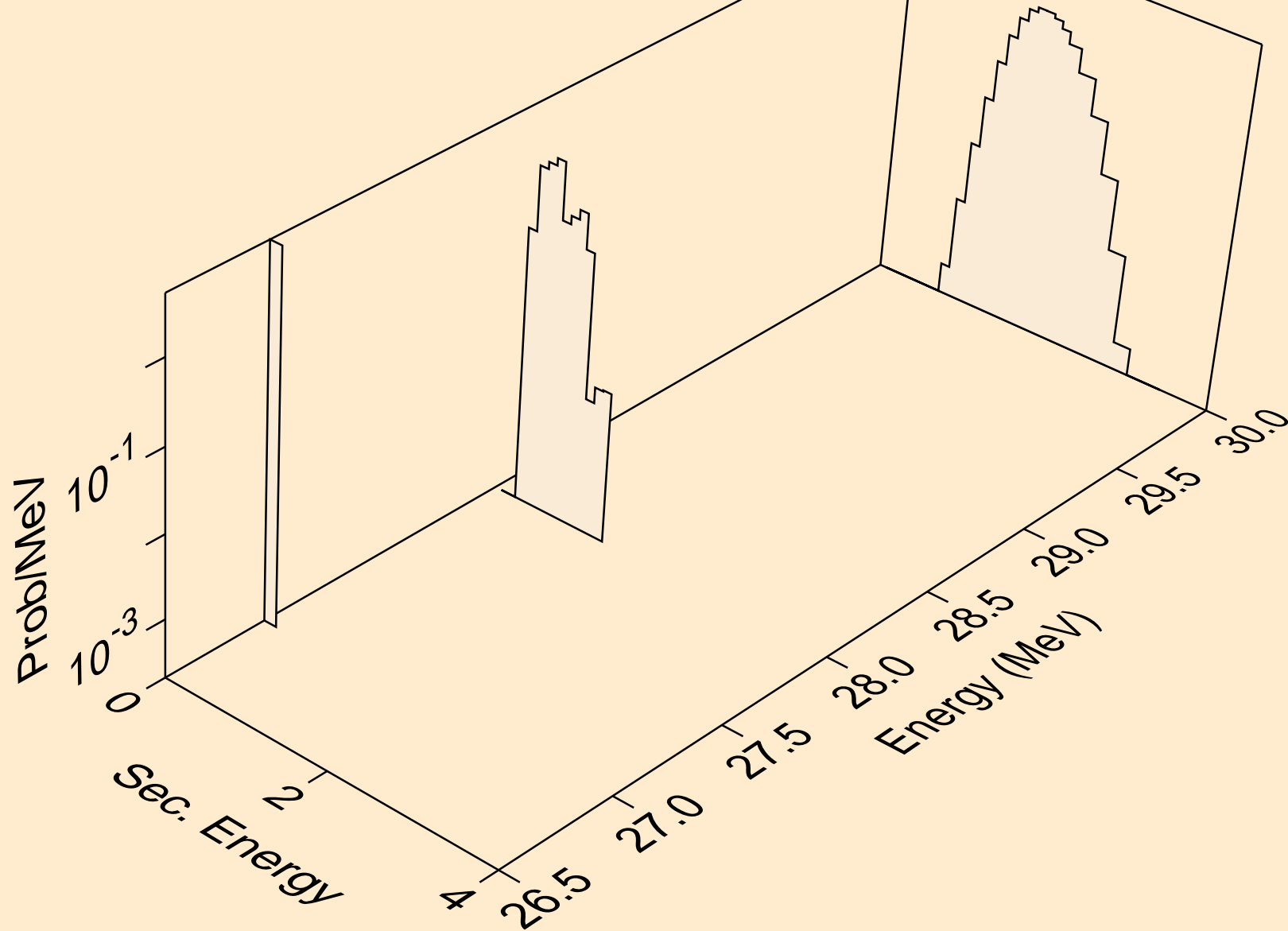

Y081 DEUTERON ACER TENDL-2024 LIBRARY; T=0.K
protons from (d,n2p)

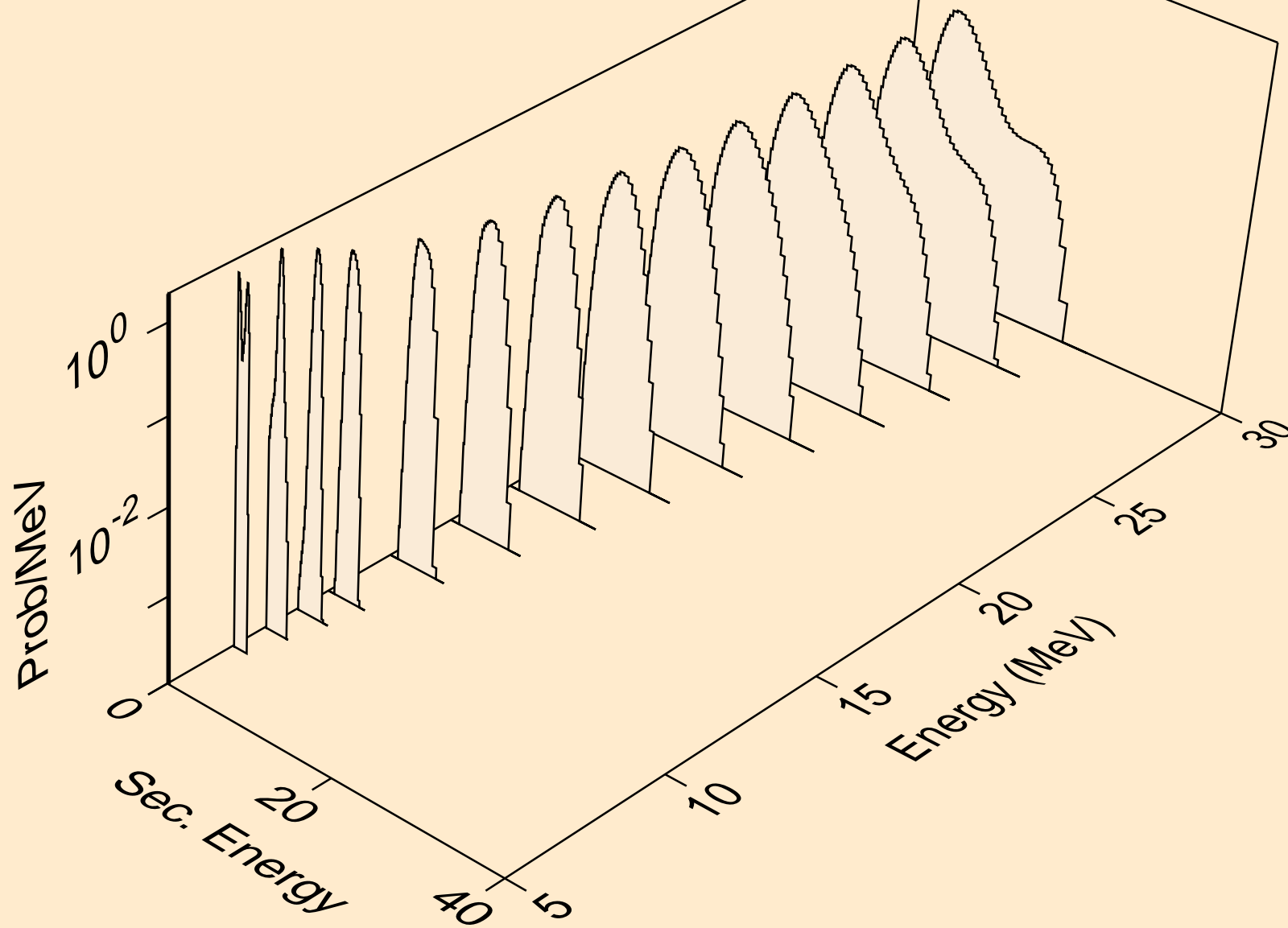

Y081 DEUTERON ACER TENDL-2024 LIBRARY; T=0.K
protons from (d,npa)

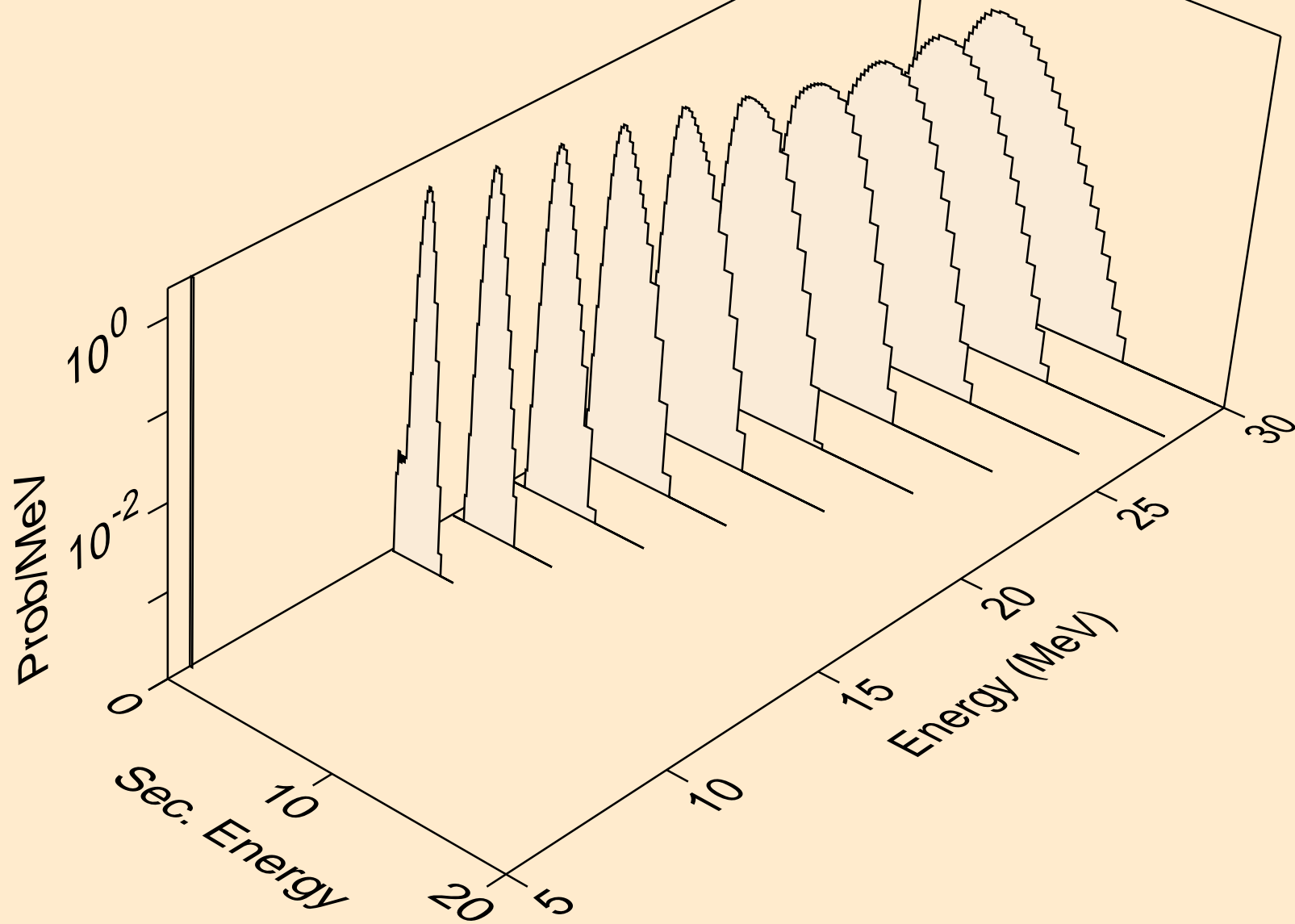

Y081 DEUTERON ACER TENDL-2024 LIBRARY; T=0.K
protons from (d,p)

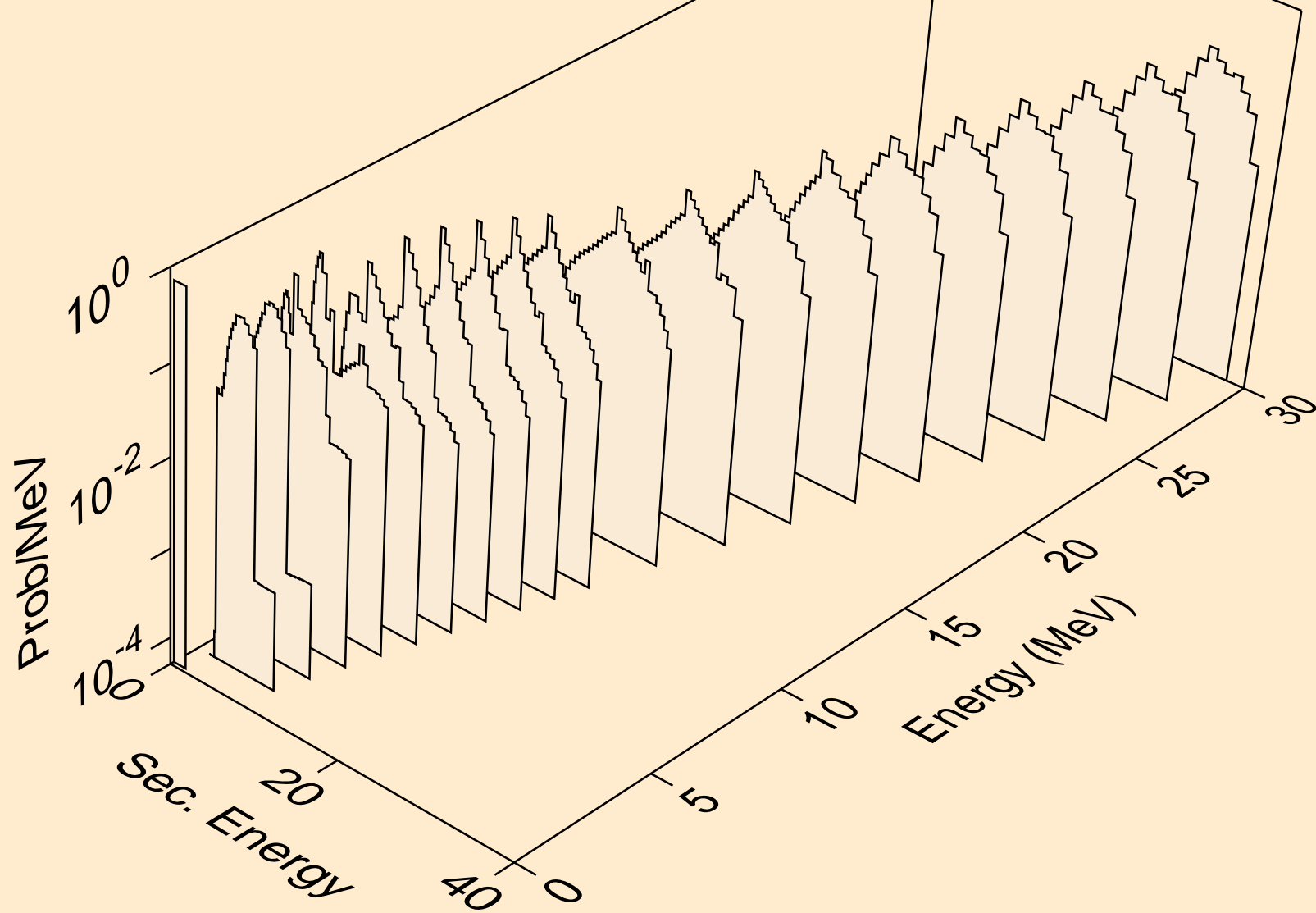

Y081 DEUTERON ACER TENDL-2024 LIBRARY; T=0.K
protons from (d,2p)

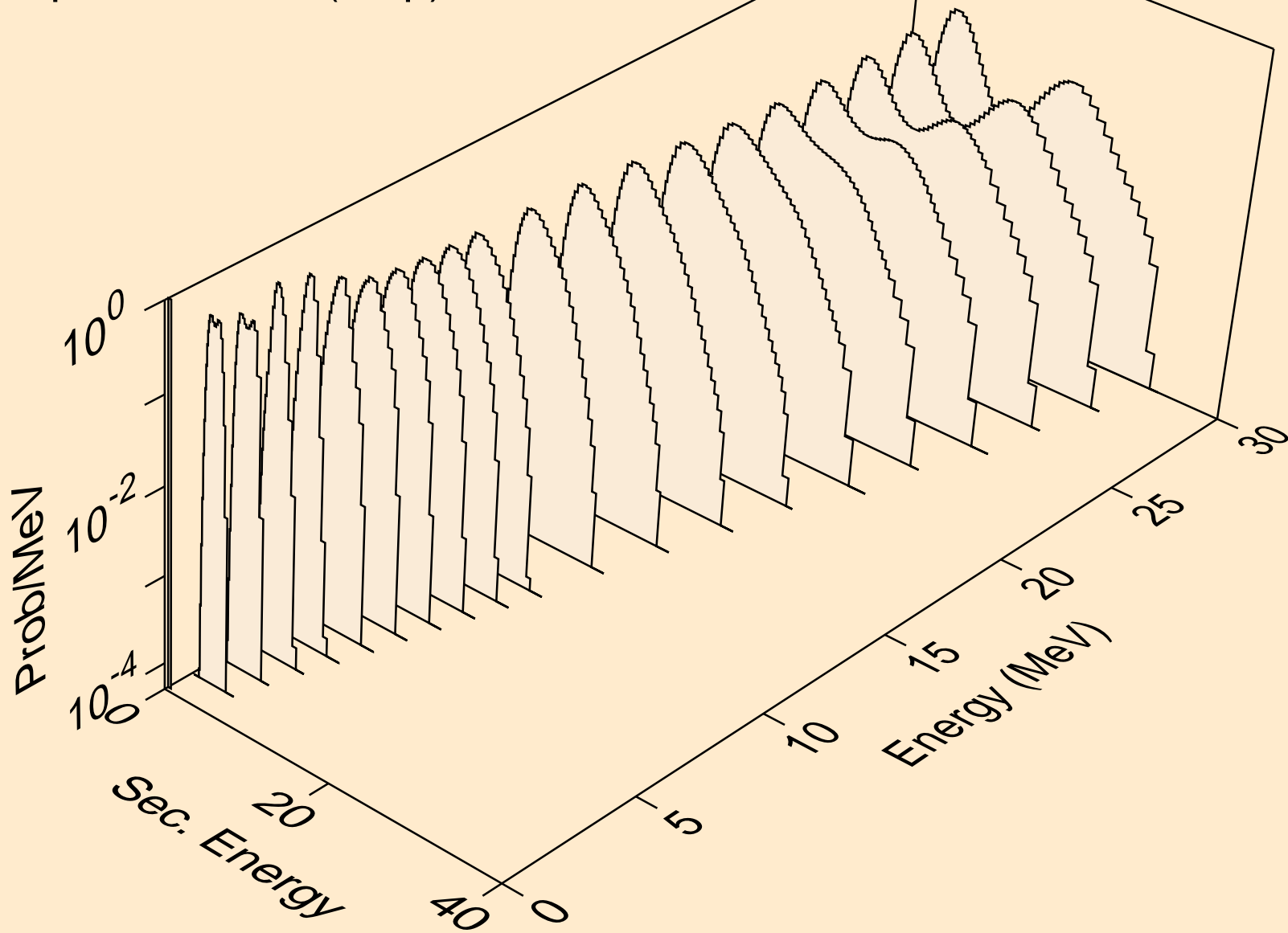

Y081 DEUTERON ACER TENDL-2024 LIBRARY; T=0.K
protons from (d,pa)

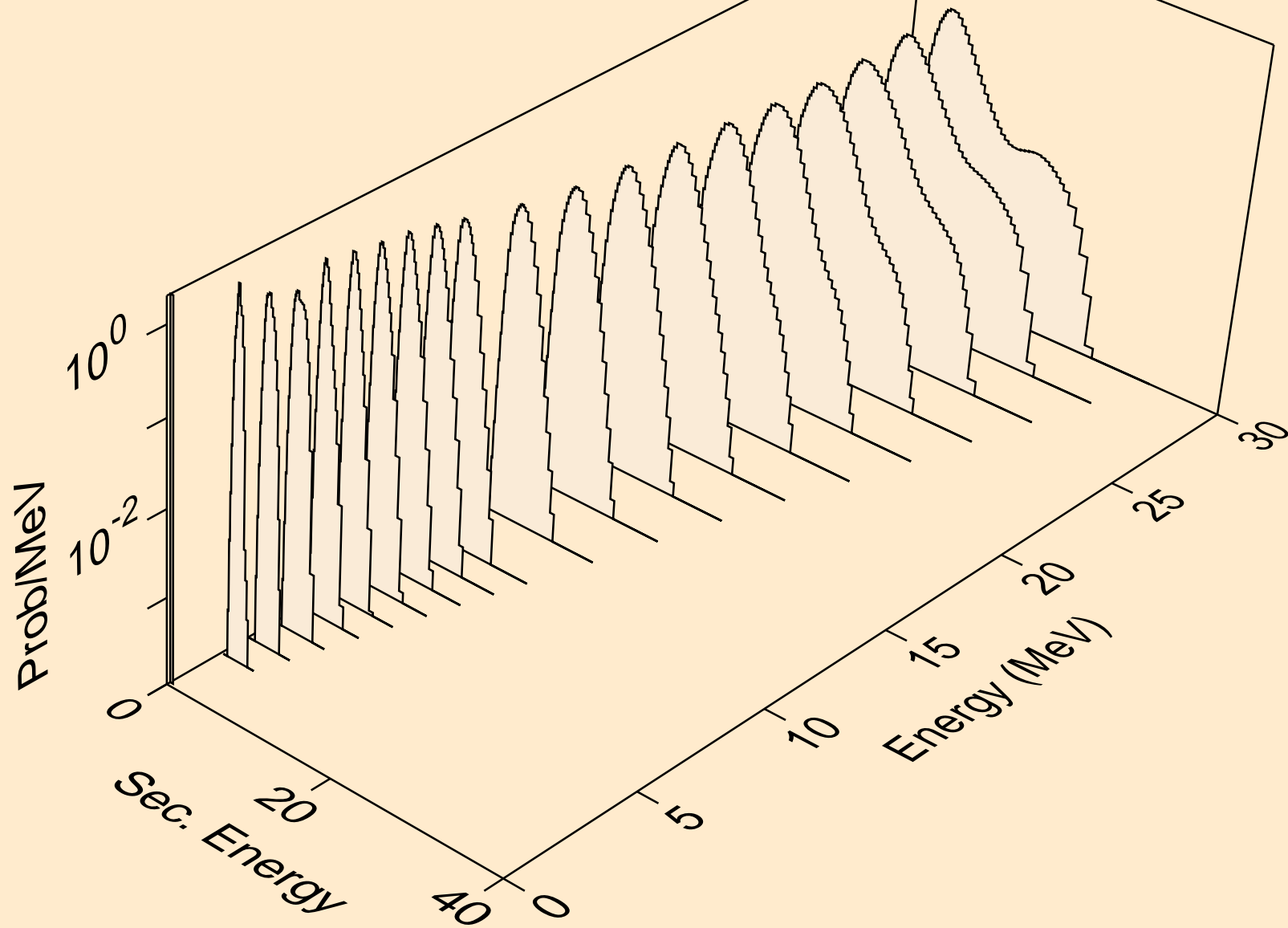

Y081 DEUTERON ACER TENDL-2024 LIBRARY; T=0.K
protons from (d,pd)

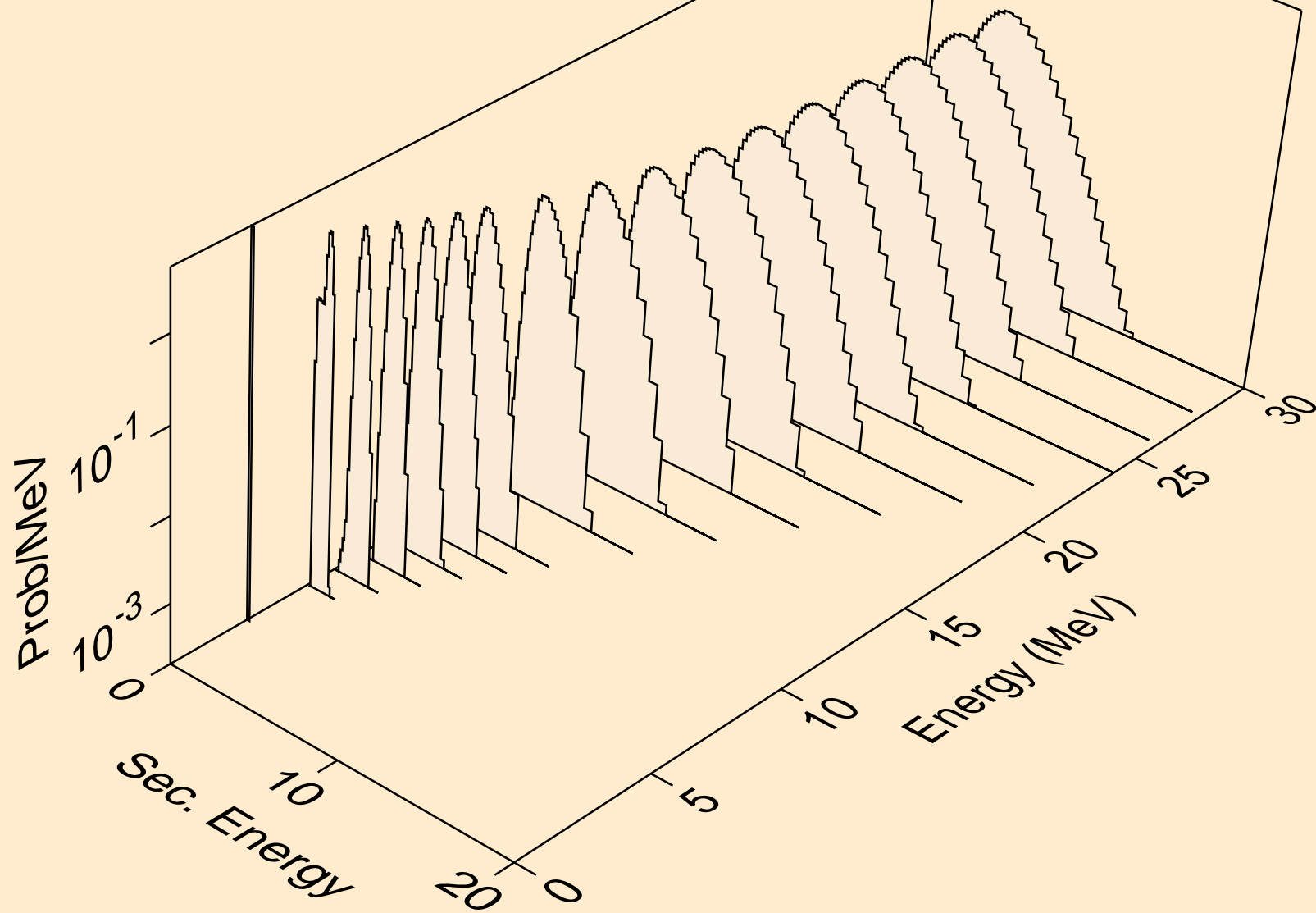

Y081 DEUTERON ACER TENDL-2024 LIBRARY; T=0.K
protons from (d,pt)

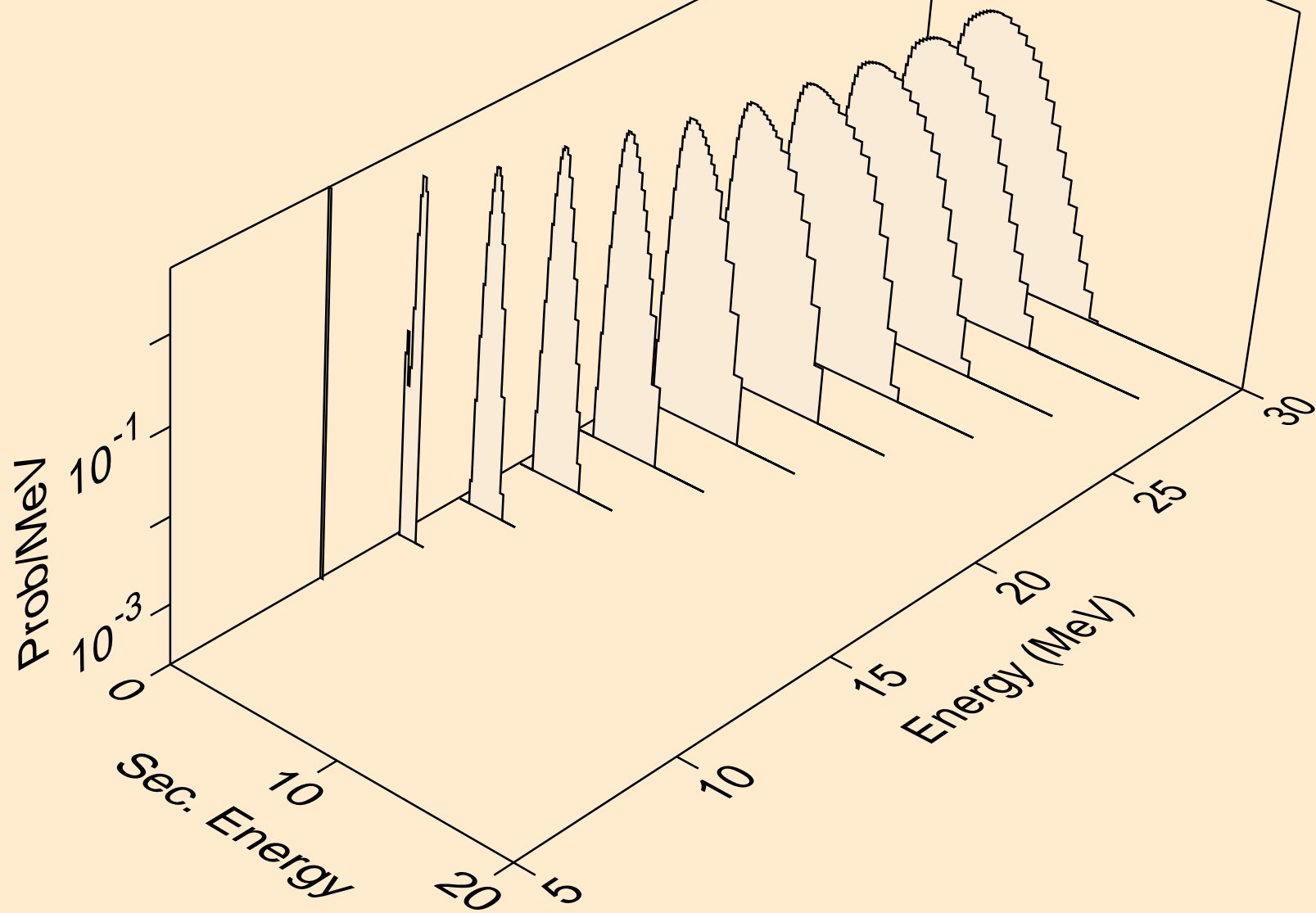

Y081 DEUTERON ACER TENDL-2024 LIBRARY; T=0.K
tritons from (d,x)

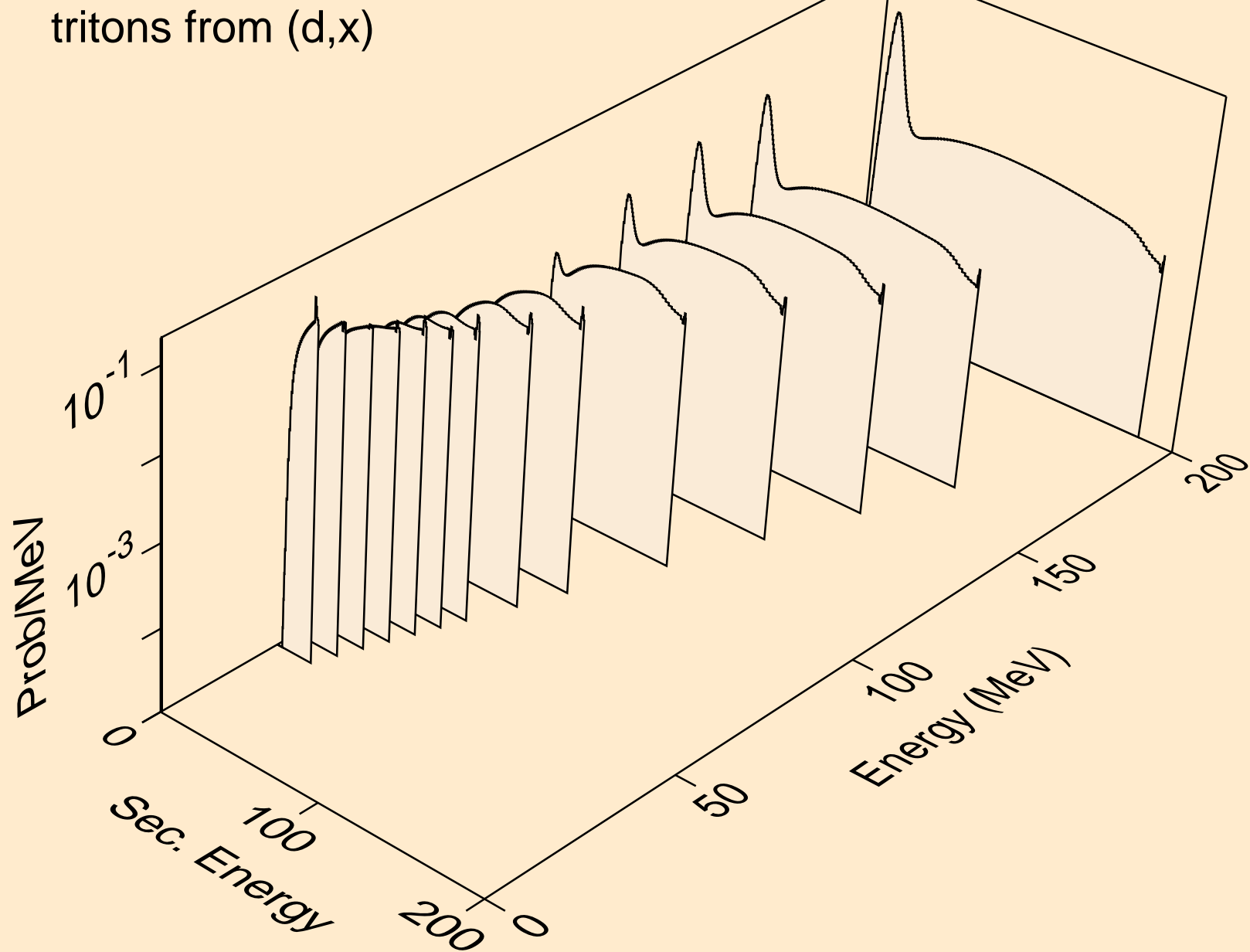

Y081 DEUTERON ACER TENDL-2024 LIBRARY; T=0.K
tritons from (d,n*)t

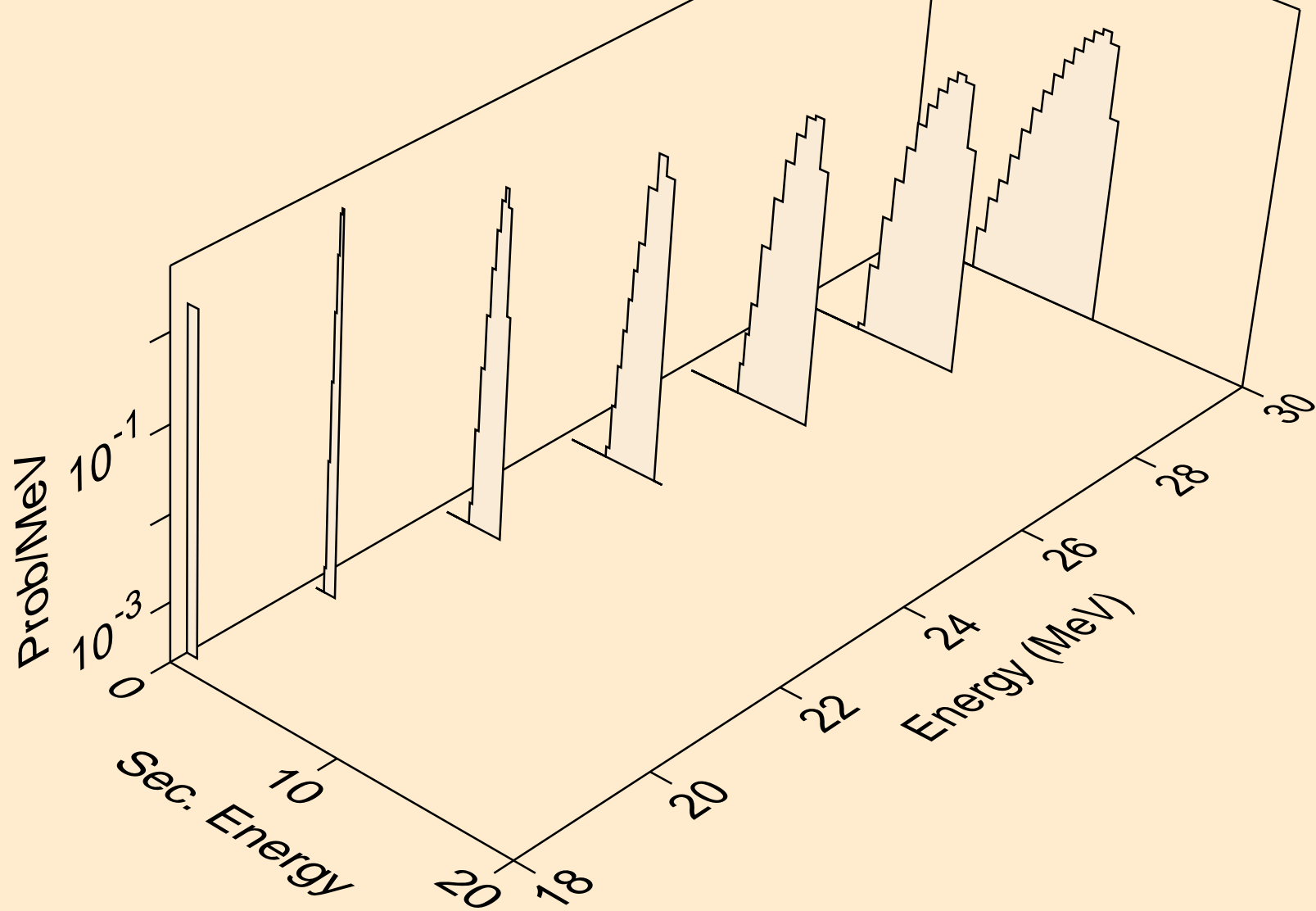

Y081 DEUTERON ACER TENDL-2024 LIBRARY; T=0.K
tritons from (d,t)

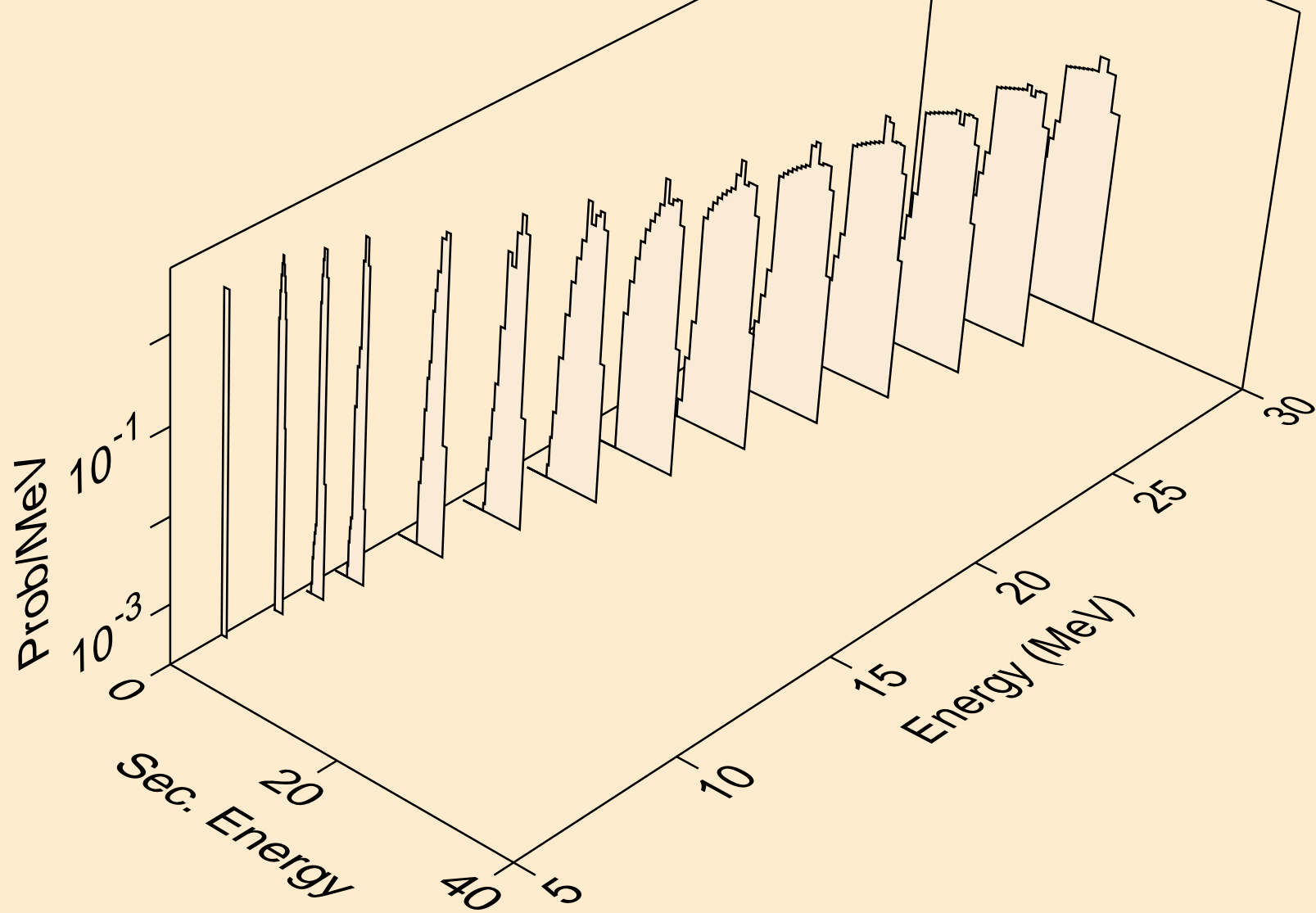

Y081 DEUTERON ACER TENDL-2024 LIBRARY; T=0.K
tritons from (d,pt)

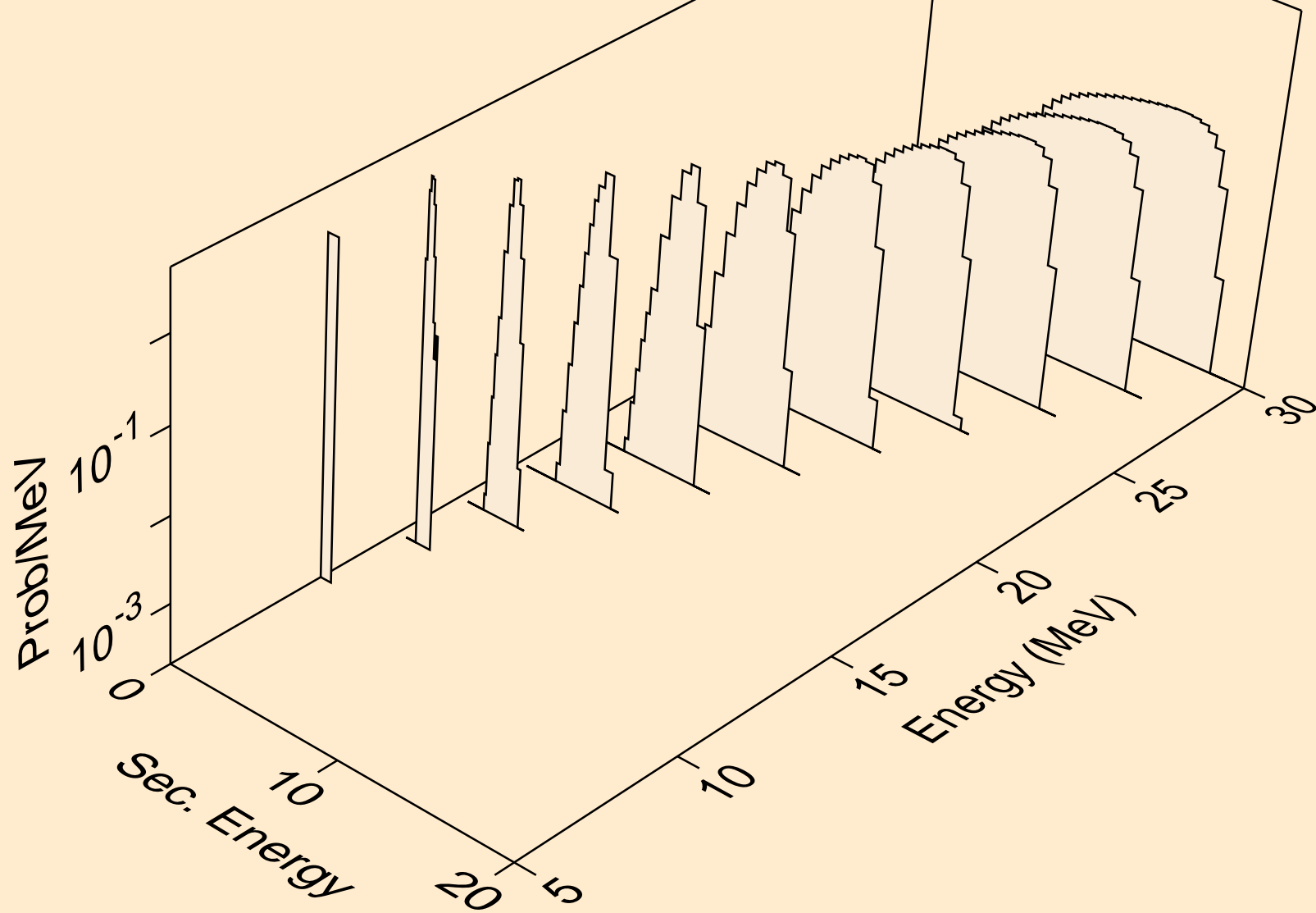

Y081 DEUTERON ACER TENDL-2024 LIBRARY; T=0.K
he3s from (d,x)

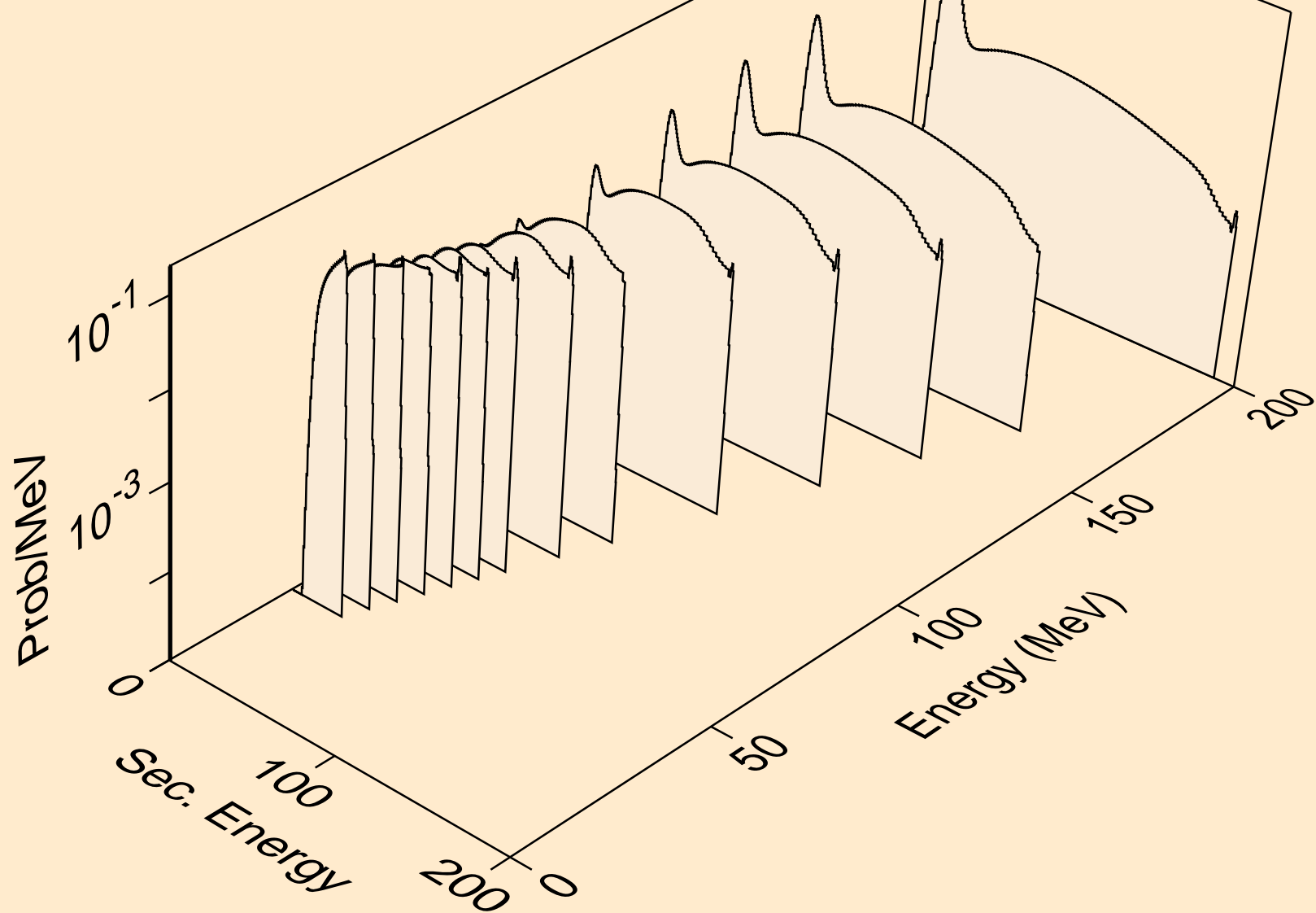

Y081 DEUTERON ACER TENDL-2024 LIBRARY; T=0.K
he3s from (d,n*)he3

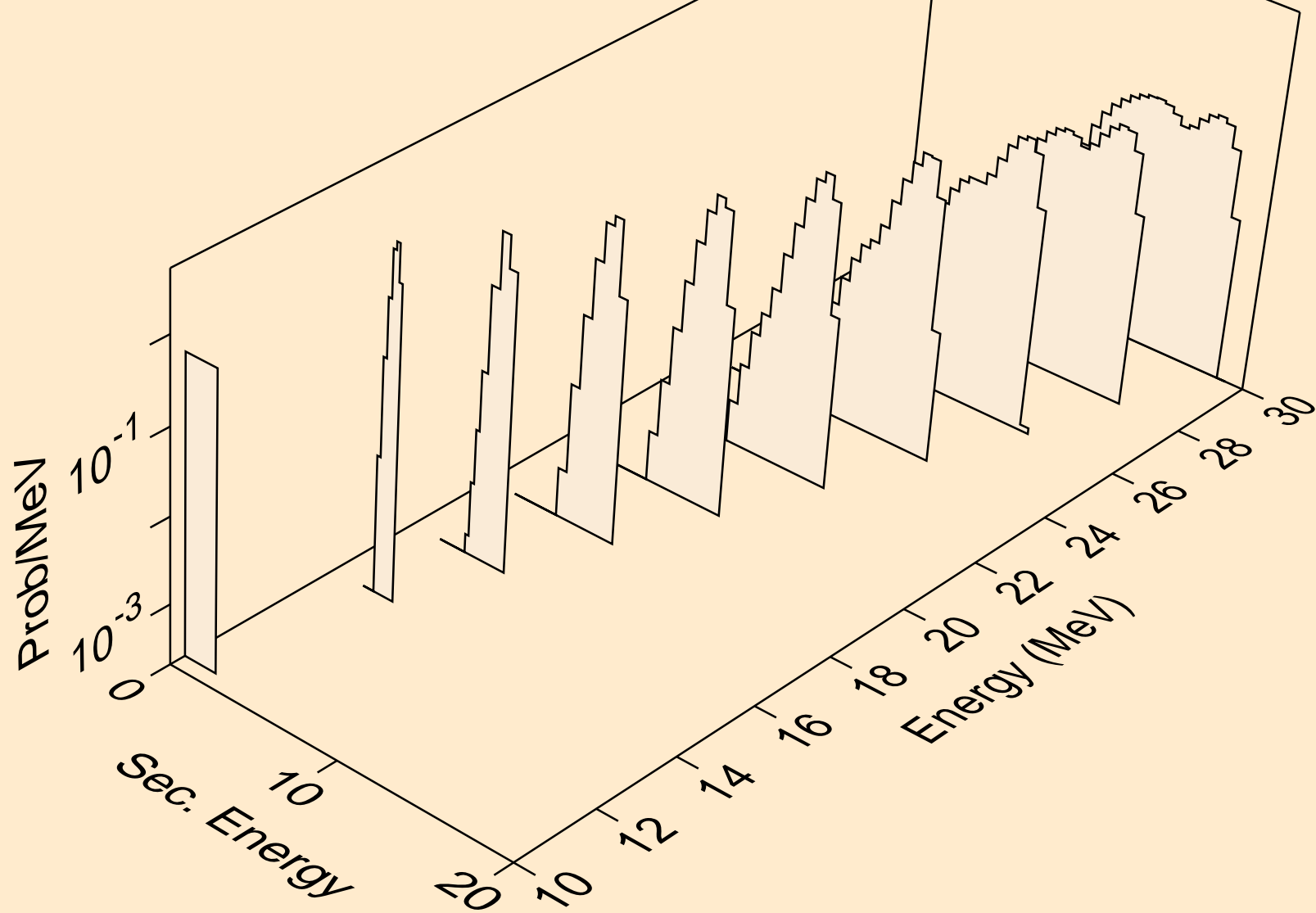

Y081 DEUTERON ACER TENDL-2024 LIBRARY; T=0.K
he3s from (d,he3)

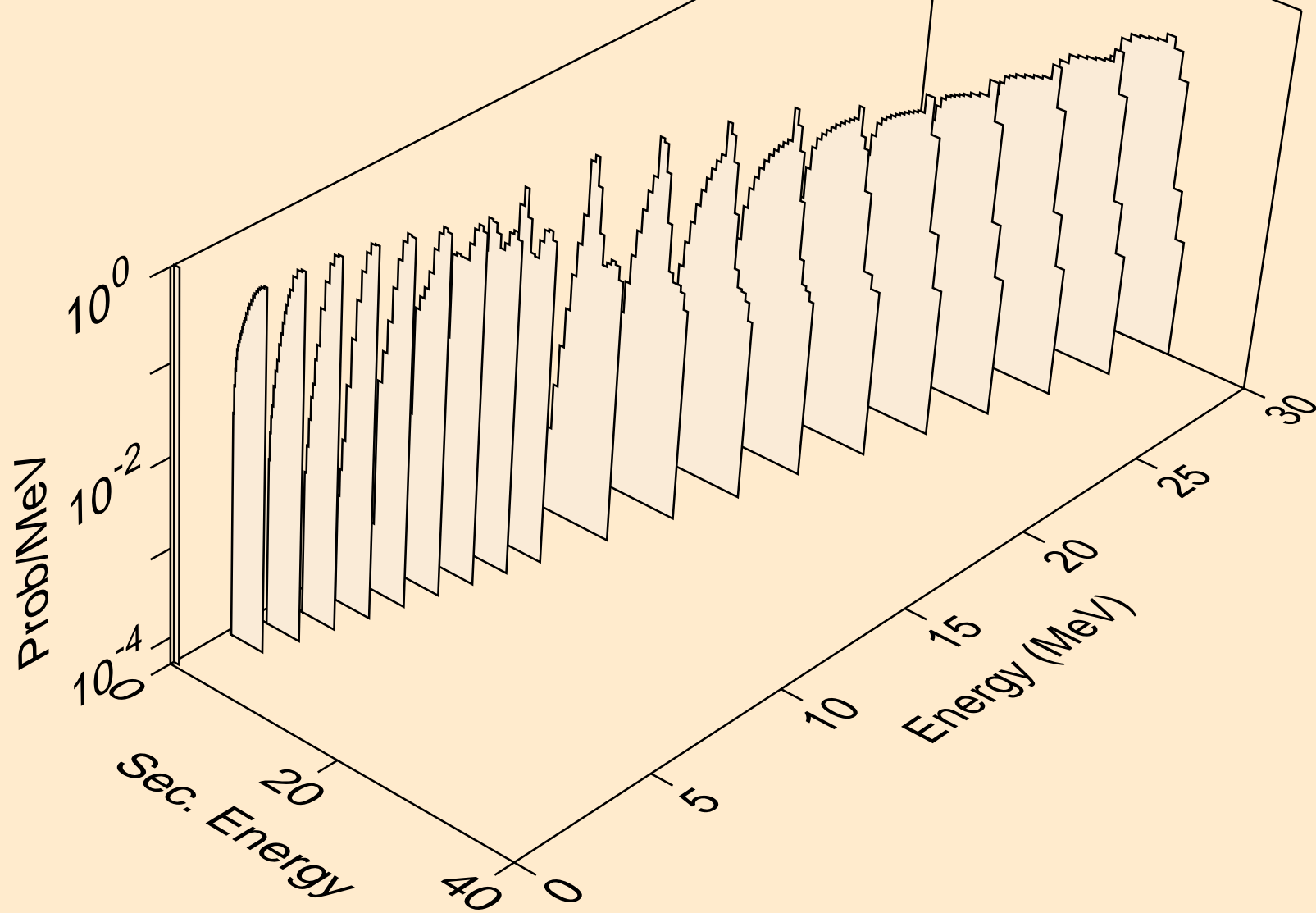

Y081 DEUTERON ACER TENDL-2024 LIBRARY; T=0.K
alphas from (d,x)

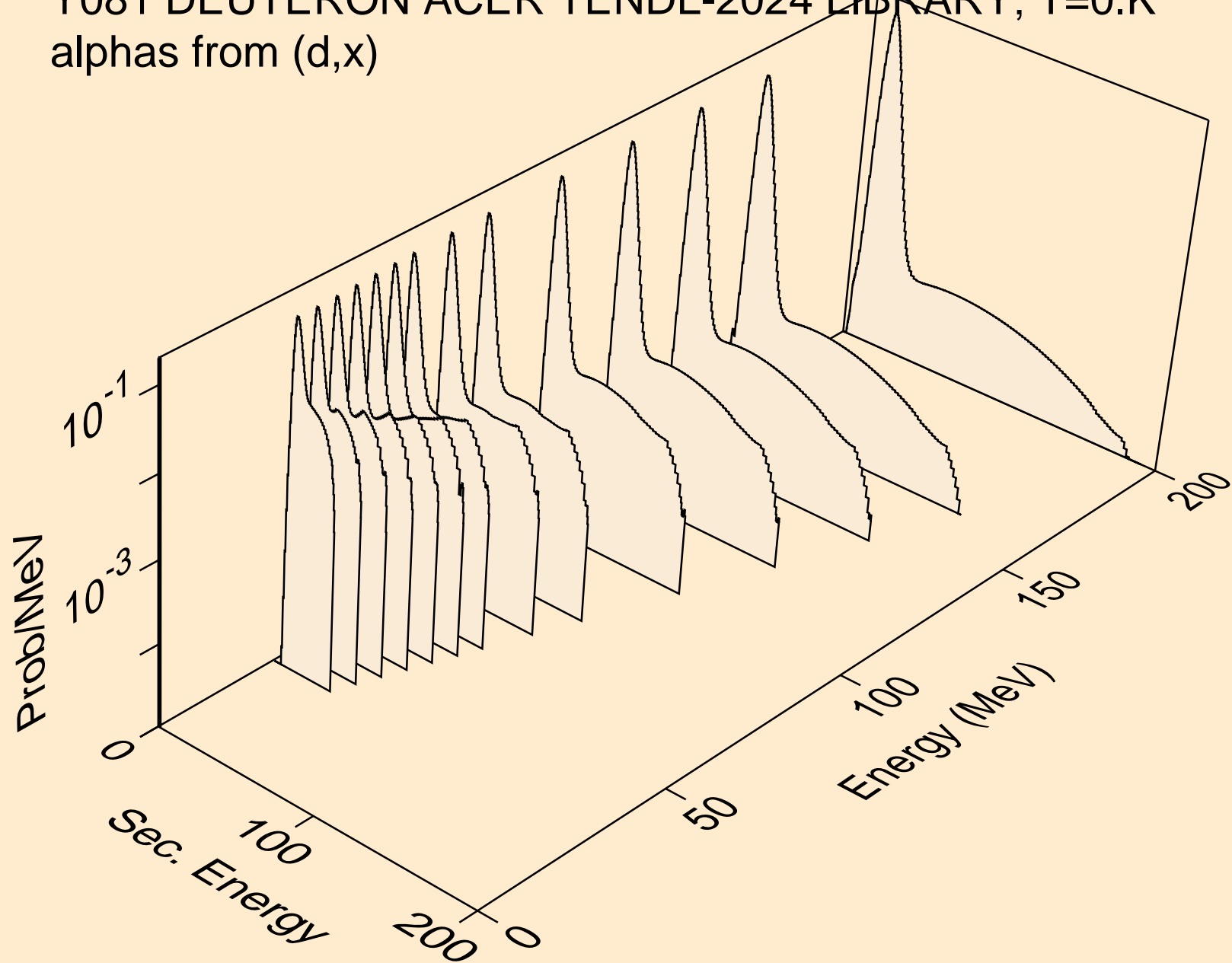

Y081 DEUTERON ACER TENDL-2024 LIBRARY; T=0.K
alphas from (d,n*)a

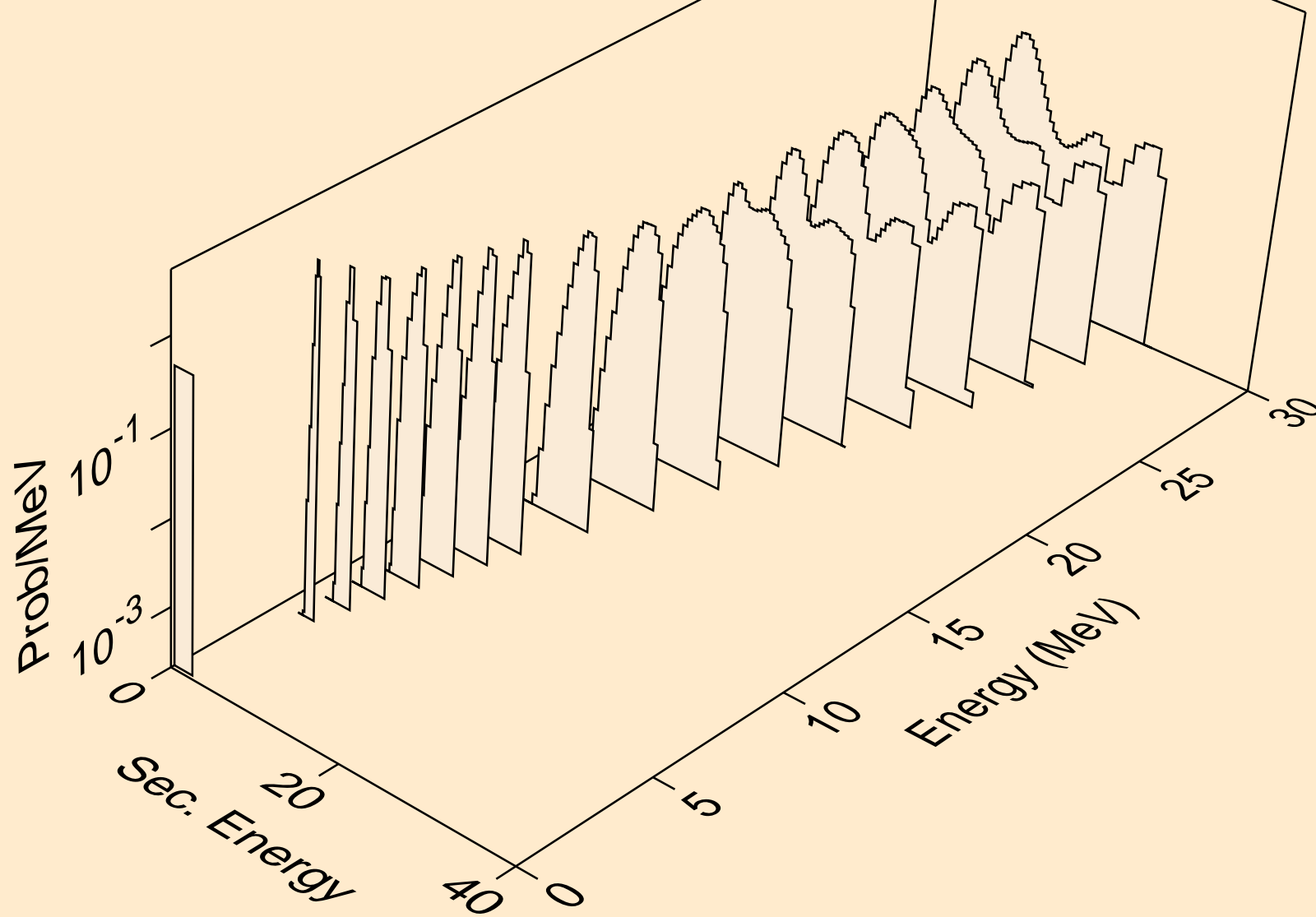

Y081 DEUTERON ACER TENDL-2024 LIBRARY; T=0.K
alphas from (d,2n)a

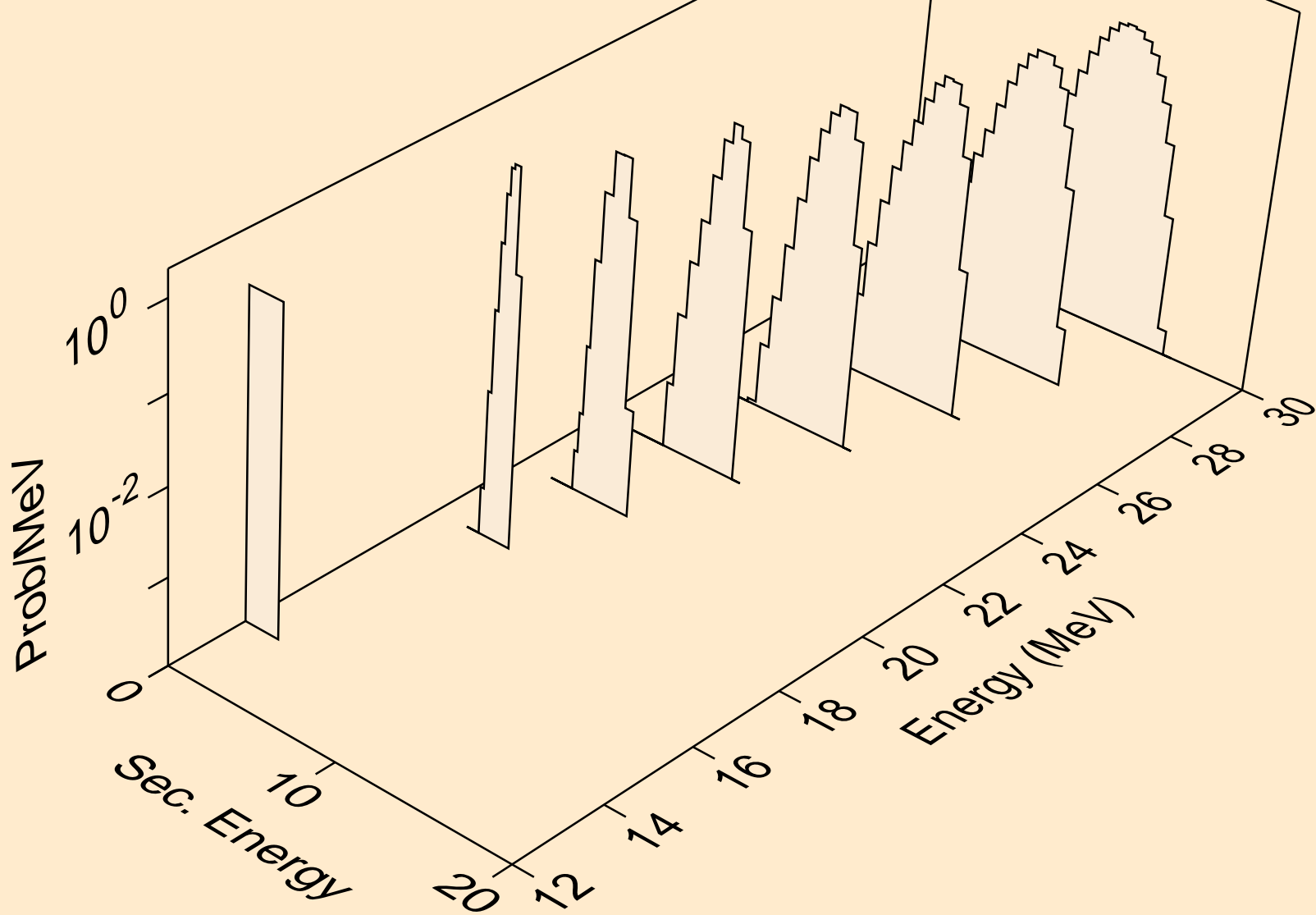

Y081 DEUTERON ACER TENDL-2024 LIBRARY; T=0.K
alphas from (d,n*)2a

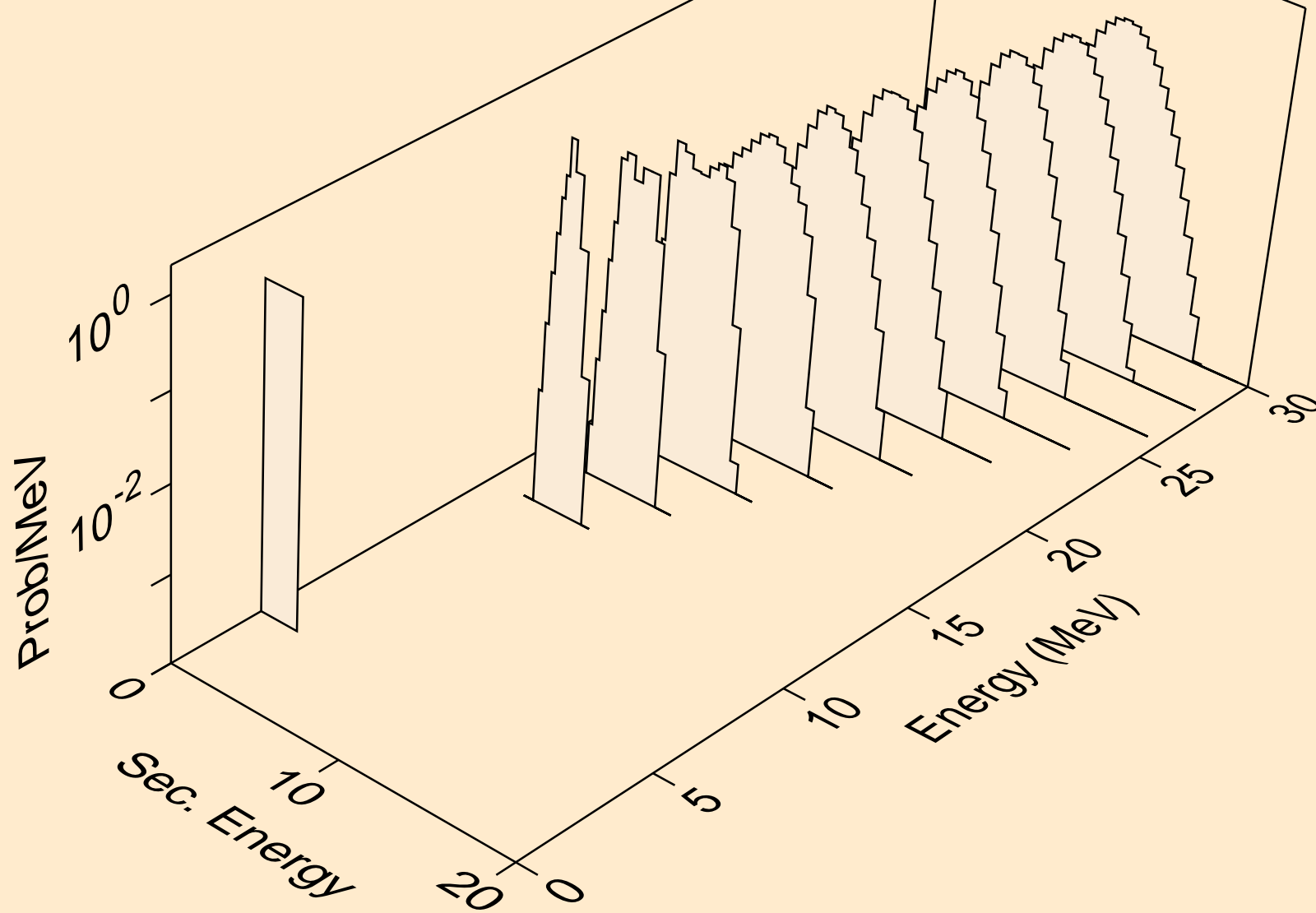

Y081 DEUTERON ACER TENDL-2024 LIBRARY; T=0.K
alphas from (d,npa)

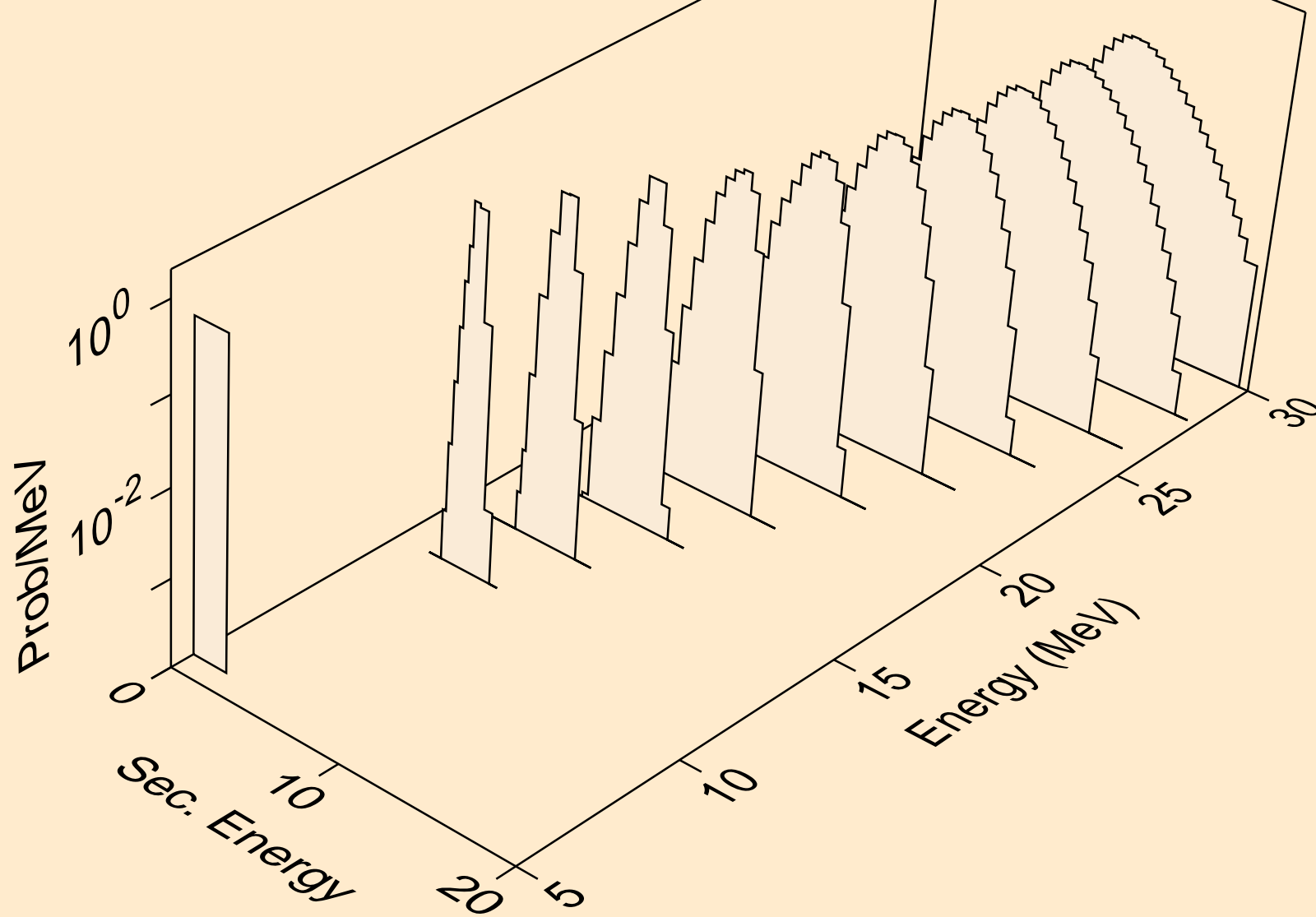

Y081 DEUTERON ACER TENDL-2024 LIBRARY; T=0.K
alphas from (d,a)

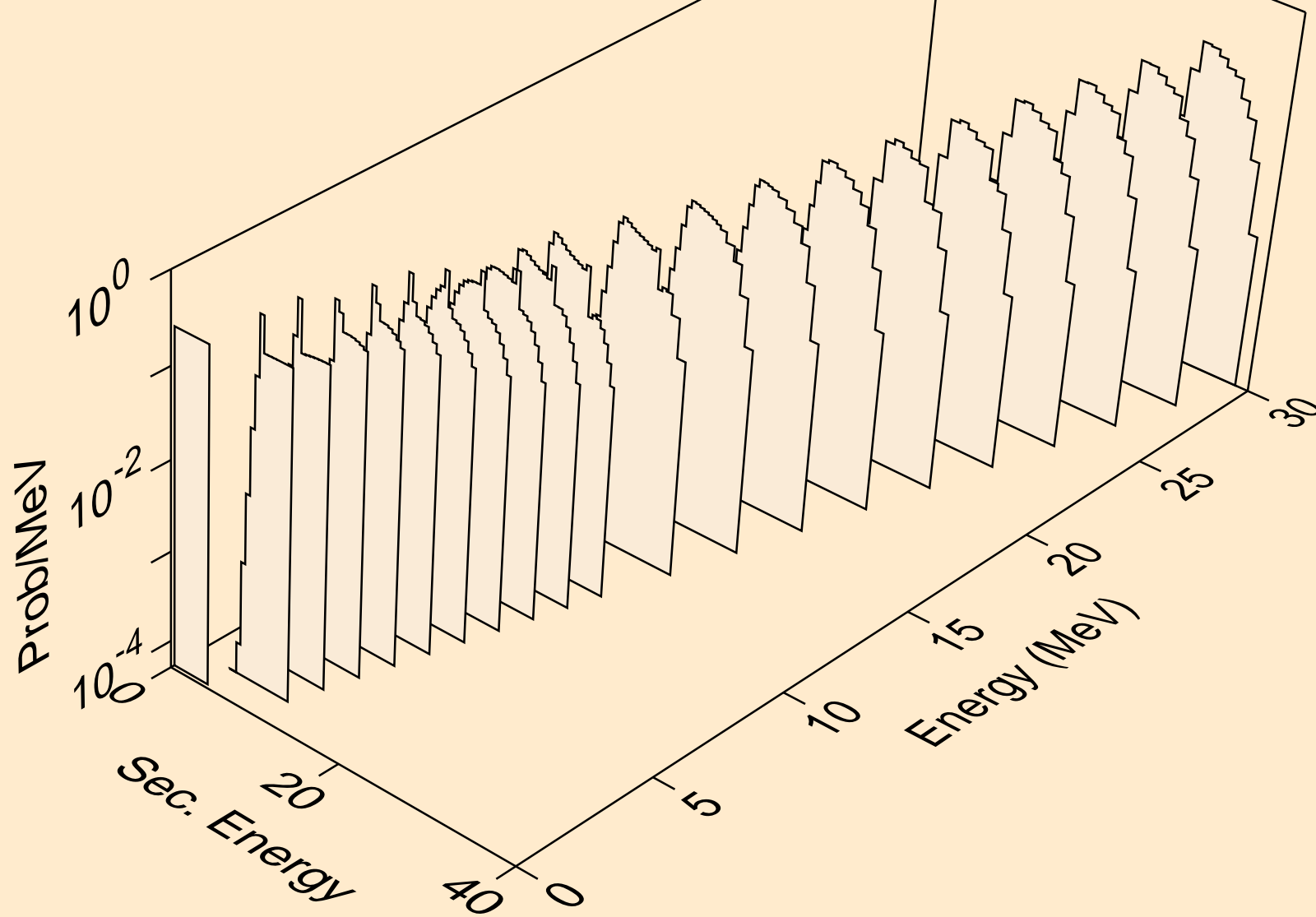

Y081 DEUTERON ACER TENDL-2024 LIBRARY; T=0.K
alphas from (d,2a)

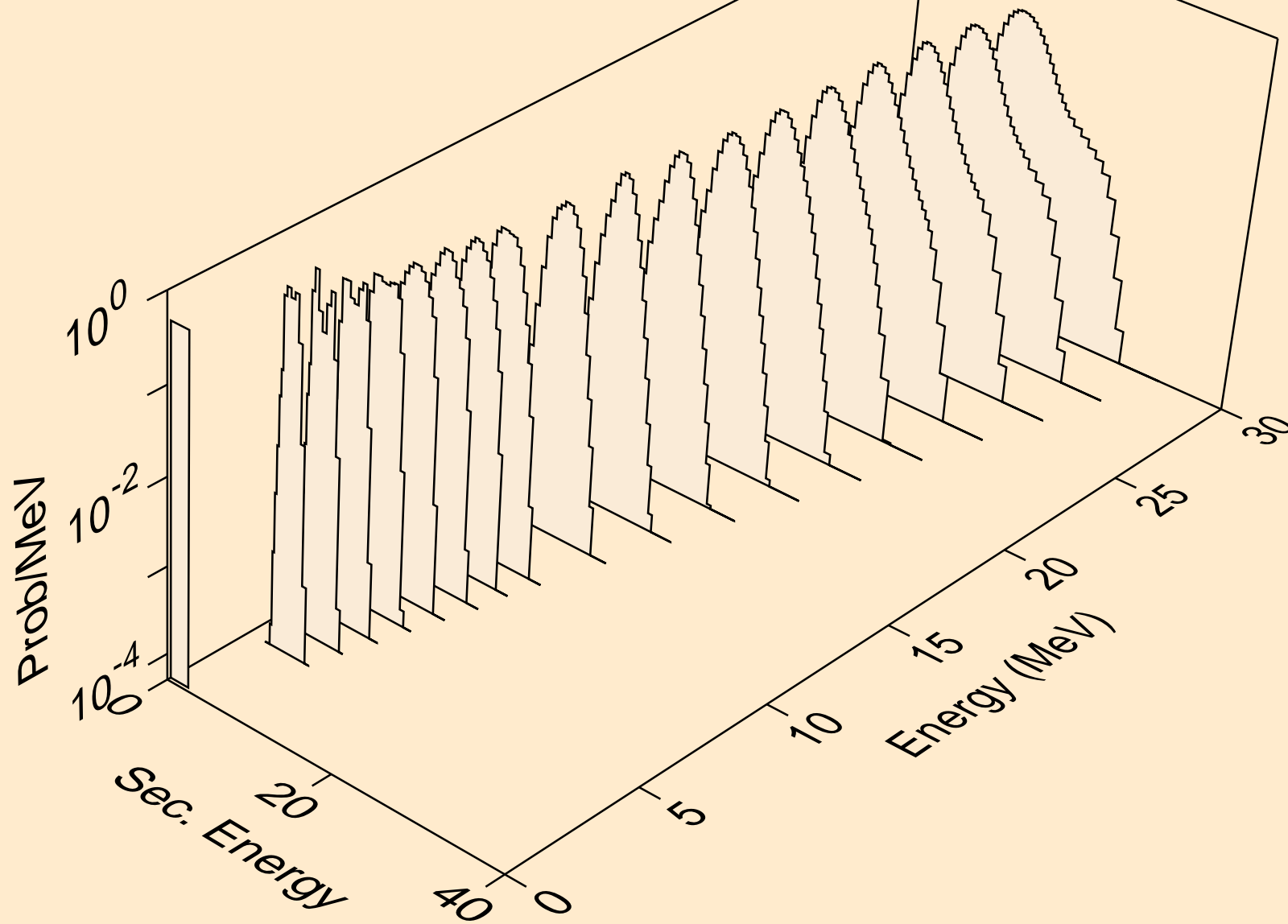

Y081 DEUTERON ACER TENDL-2024 LIBRARY; T=0.K
alphas from (d,3a)

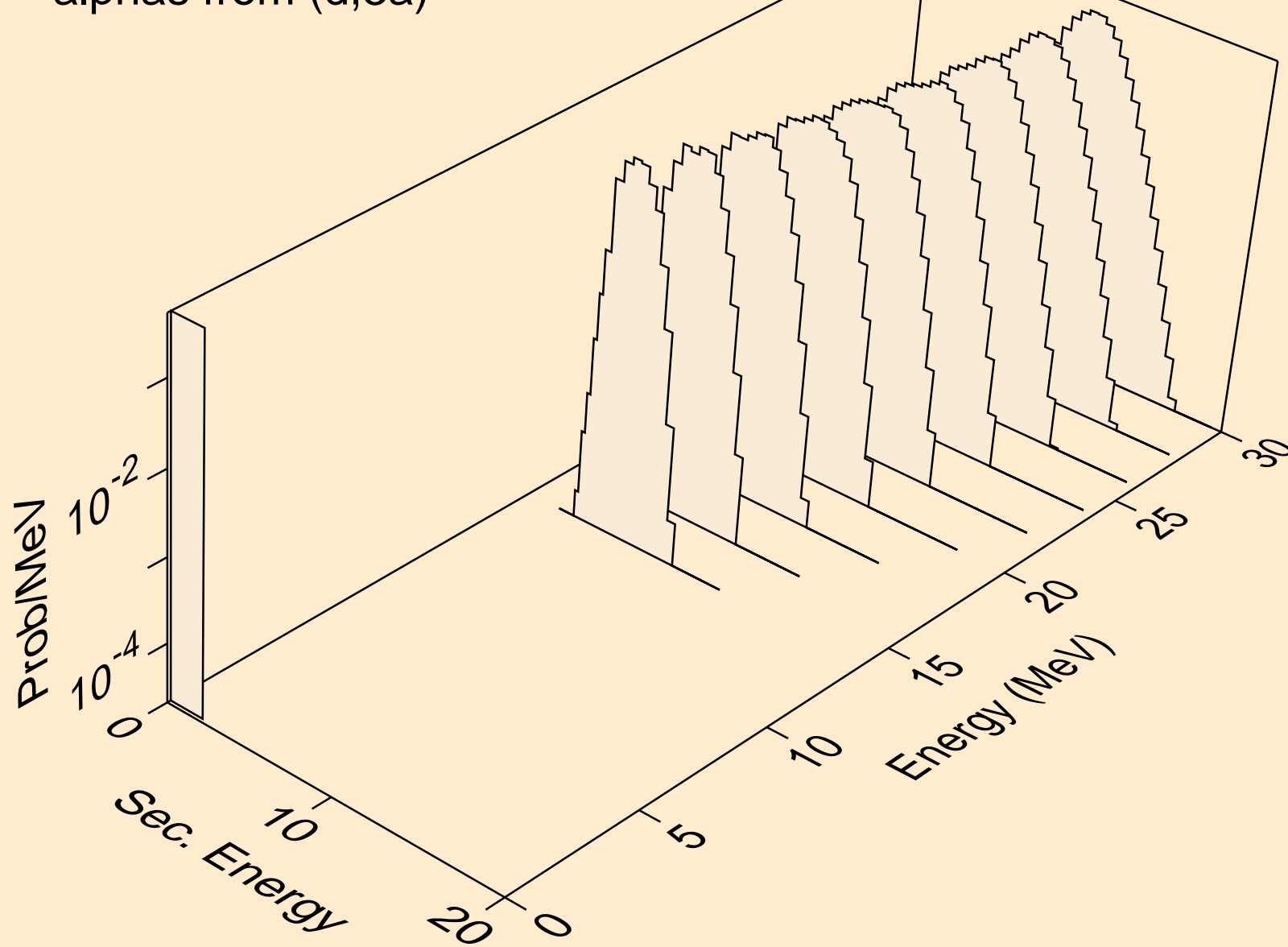

Y081 DEUTERON ACER TENDL-2024 LIBRARY; T=0.K
alphas from (d,pa)

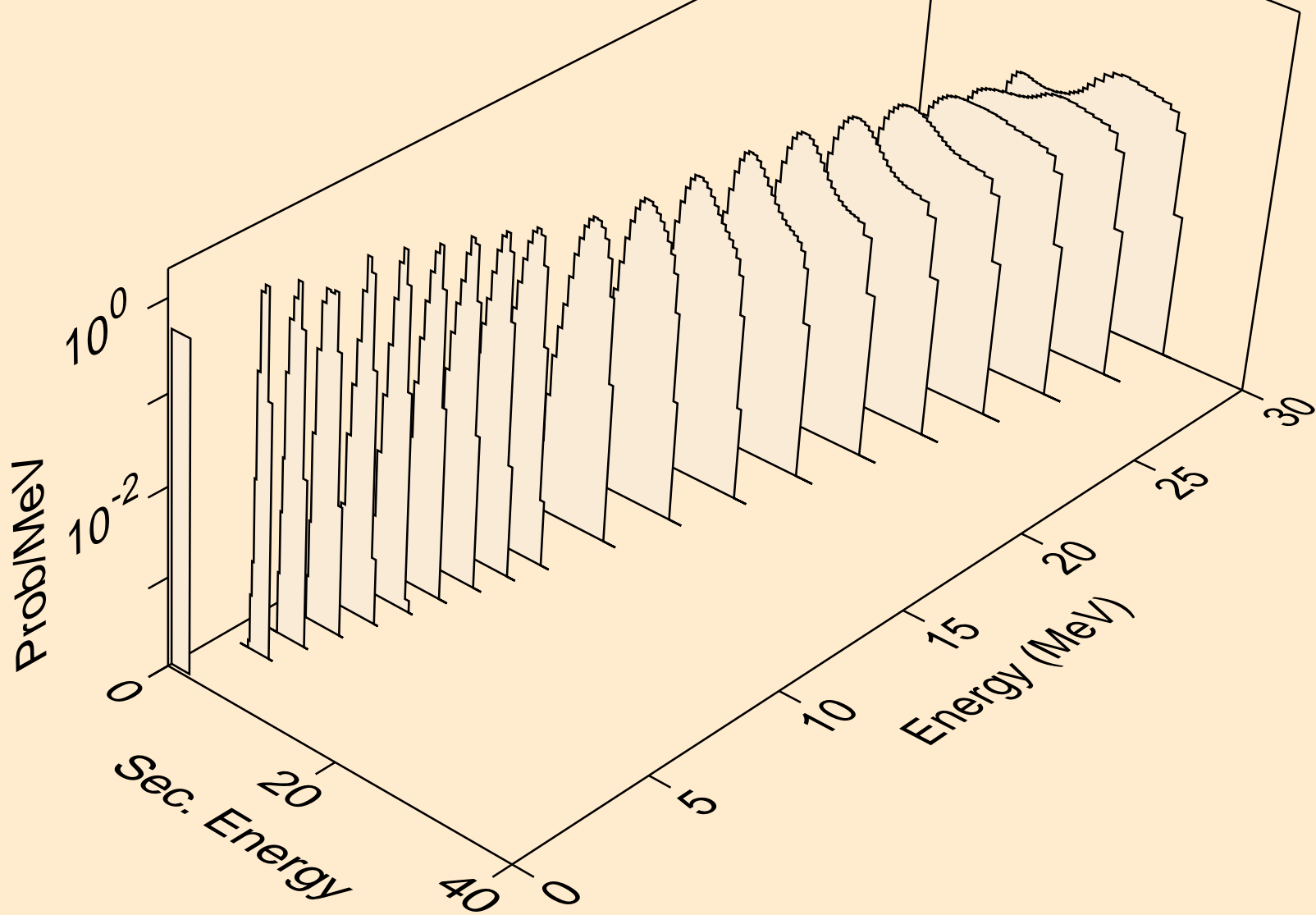

Y081 DEUTERON ACER TENDL-2024 LIBRARY; T=0.K
alphas from (d,da)

