

AR038 PHOTON ACER TENDL-2024 LIBRARY; T=0.K

Principal cross sections

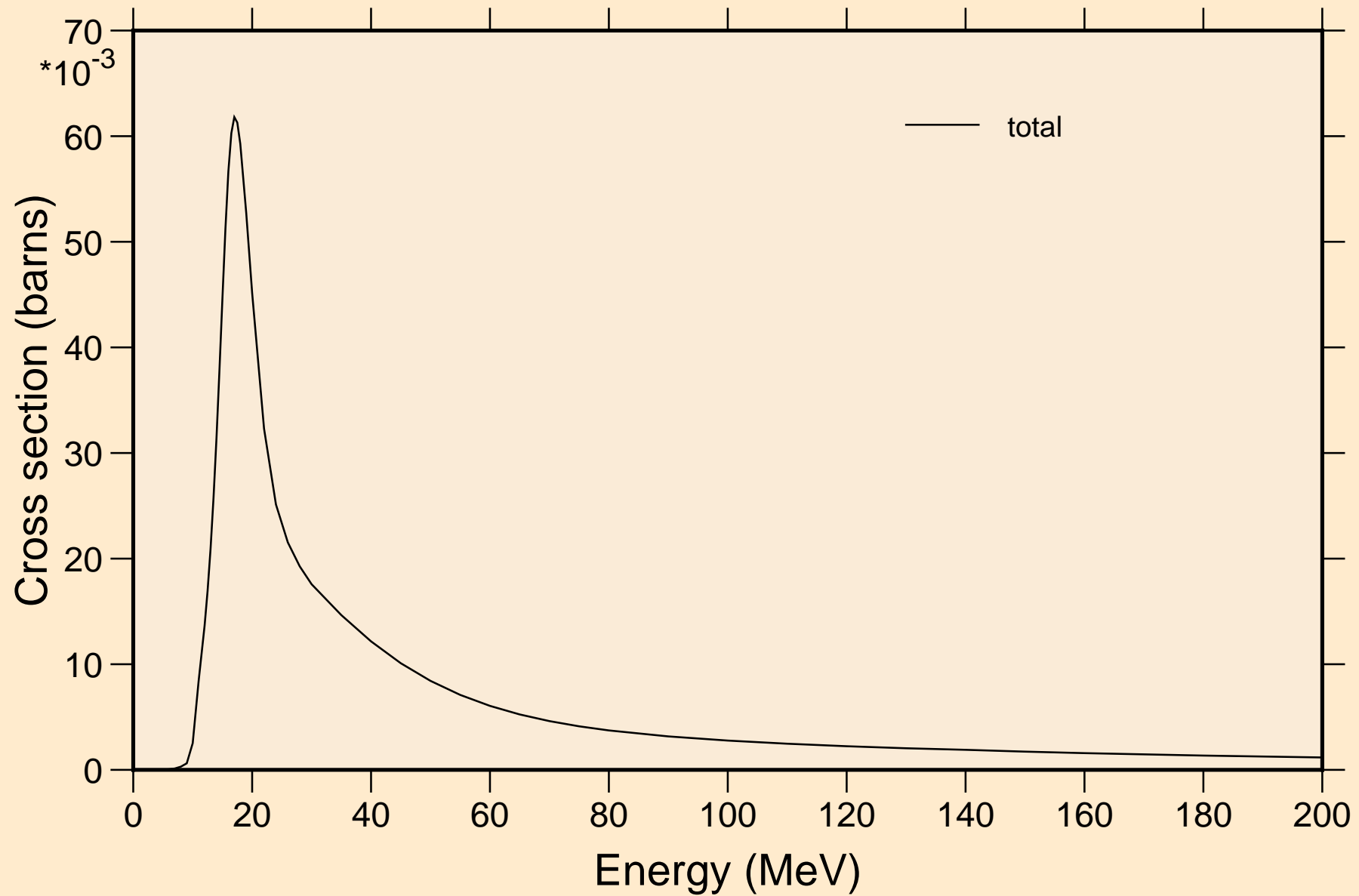

AR038 PHOTON ACER TENDL-2024 LIBRARY; T=0.K

Partial cross sections

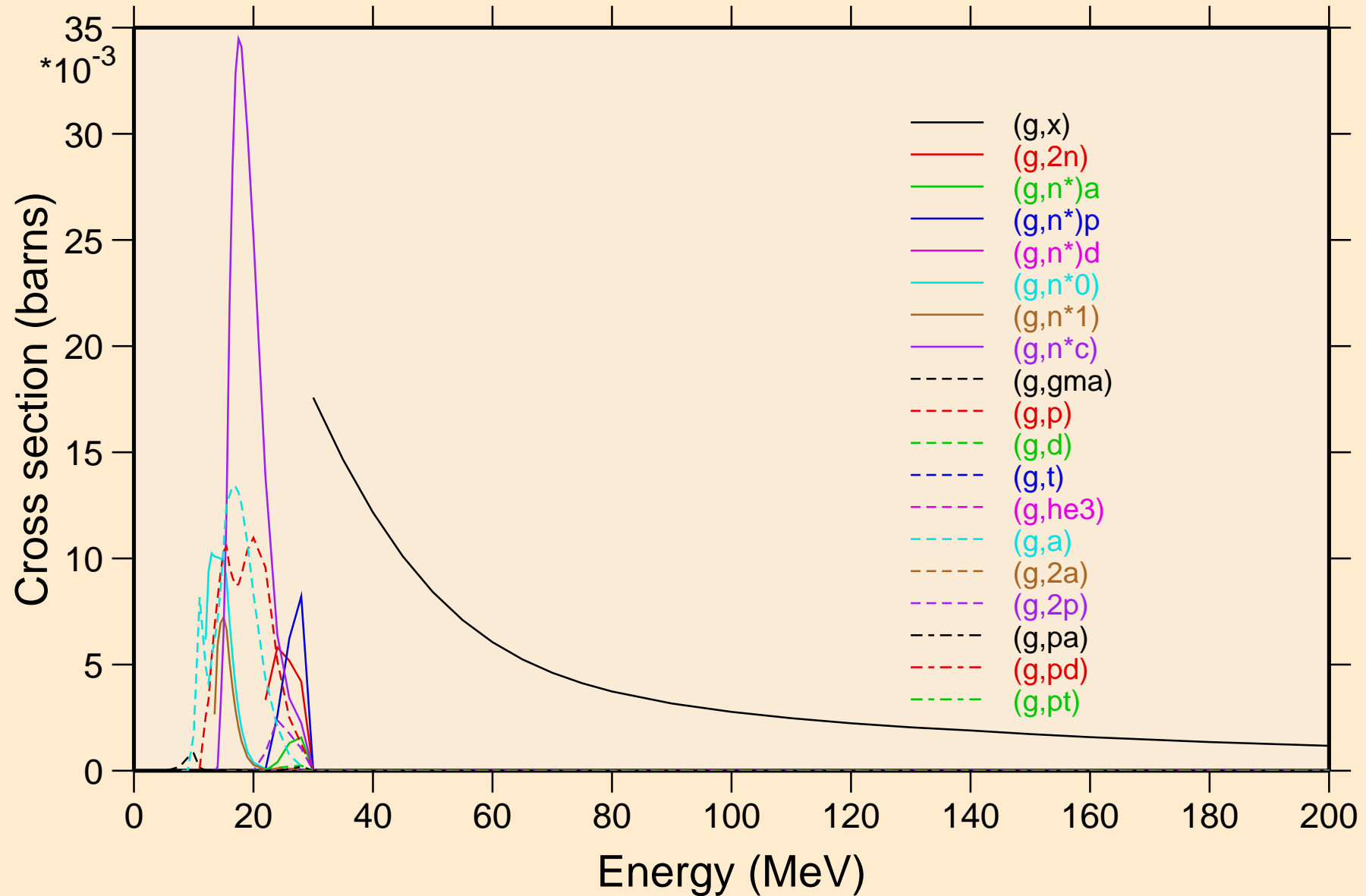

AR038 PHOTON ACER TENDL-2024 LIBRARY; T=0.K

Heating

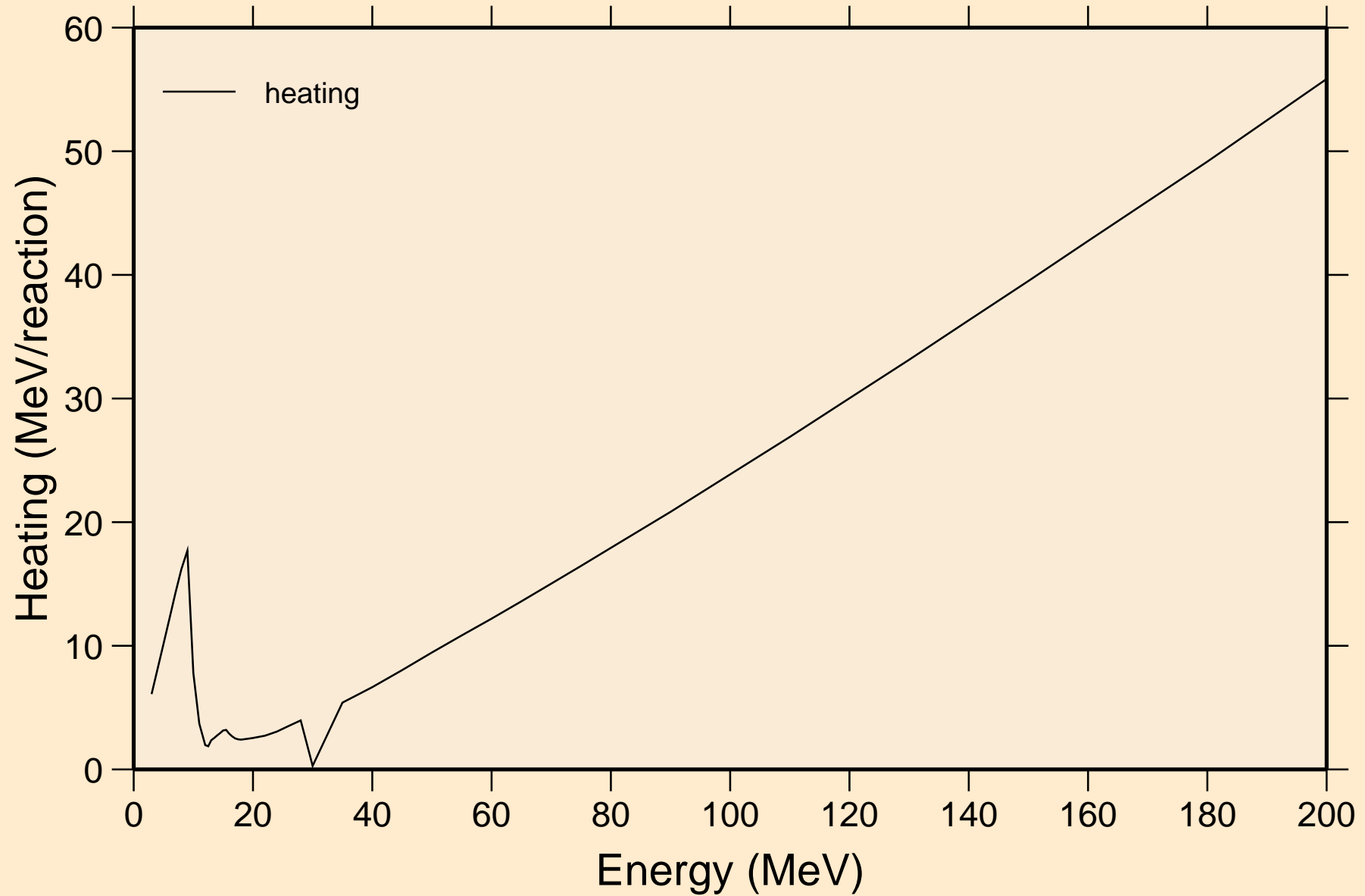

AR038 PHOTON ACER TENDL-2024 LIBRARY; T=0.K

Particle heating contributions

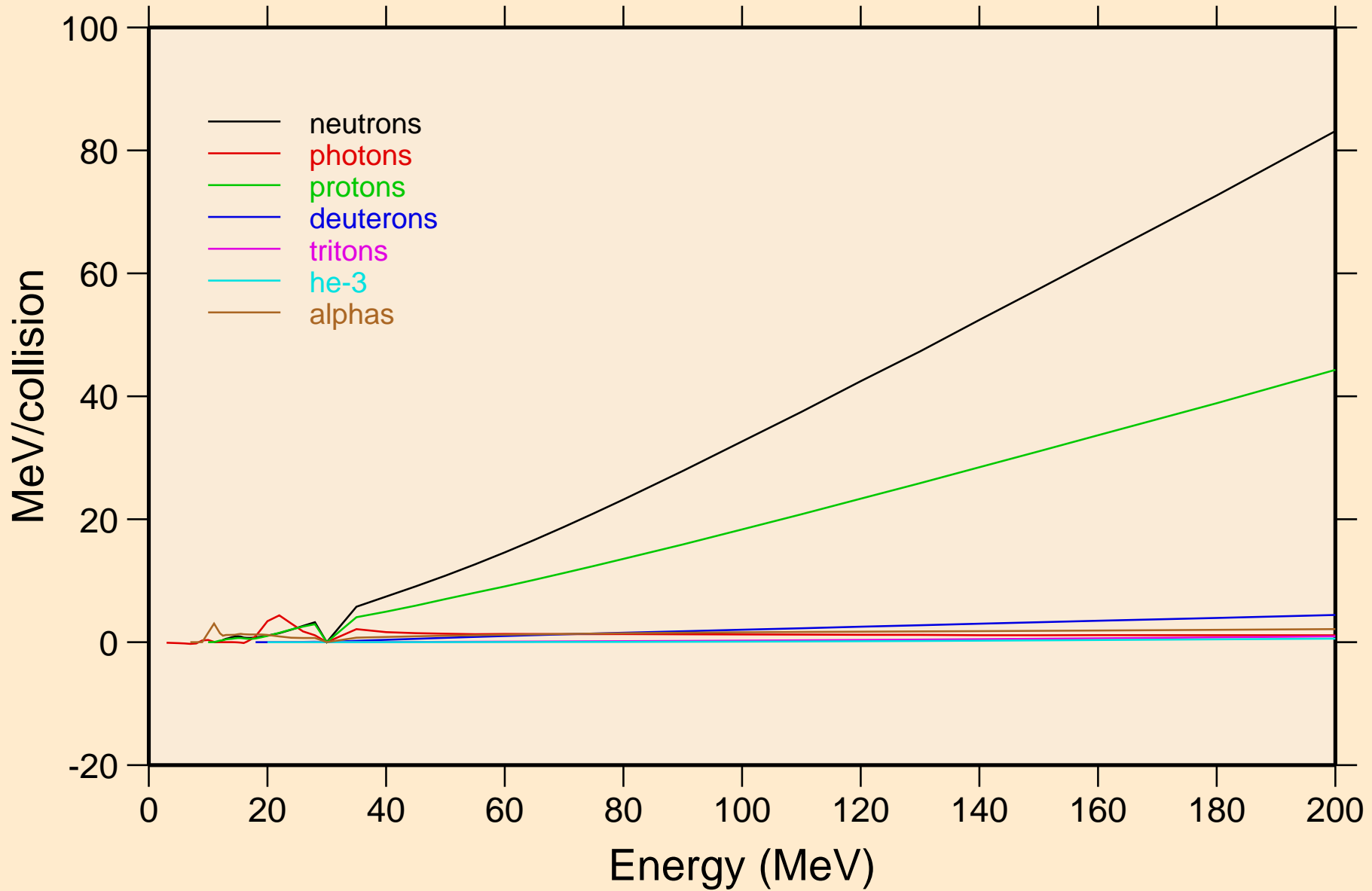

AR038 PHOTON ACER TENDL-2024 LIBRARY; T=0.K
Particle production cross sections

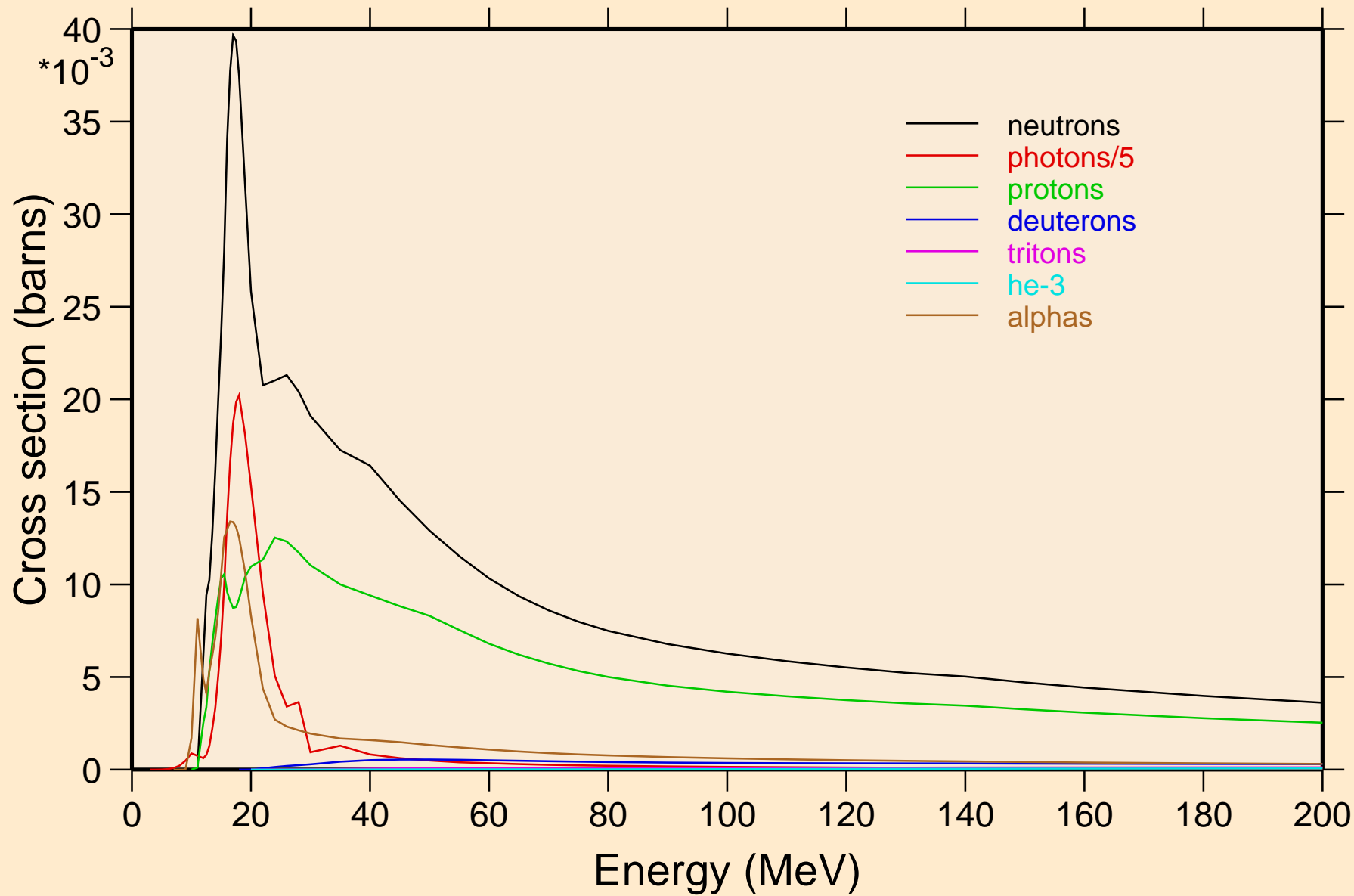

AR038 PHOTON ACER TENDL-2024 LIBRARY; T=0.K
neutrons from (g,x)

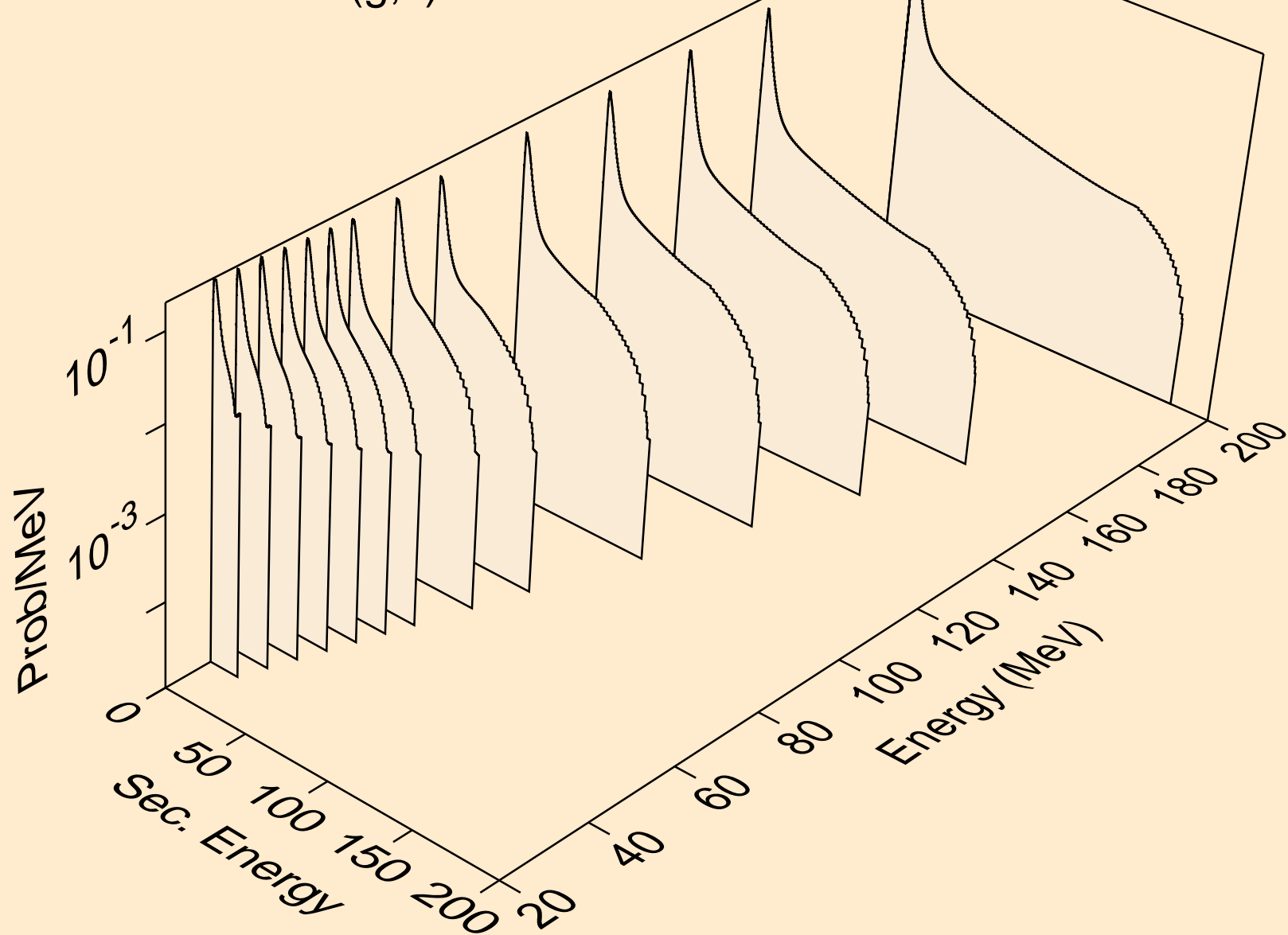

AR038 PHOTON ACER TENDL-2024 LIBRARY; T=0.K
neutrons from (g,2n)

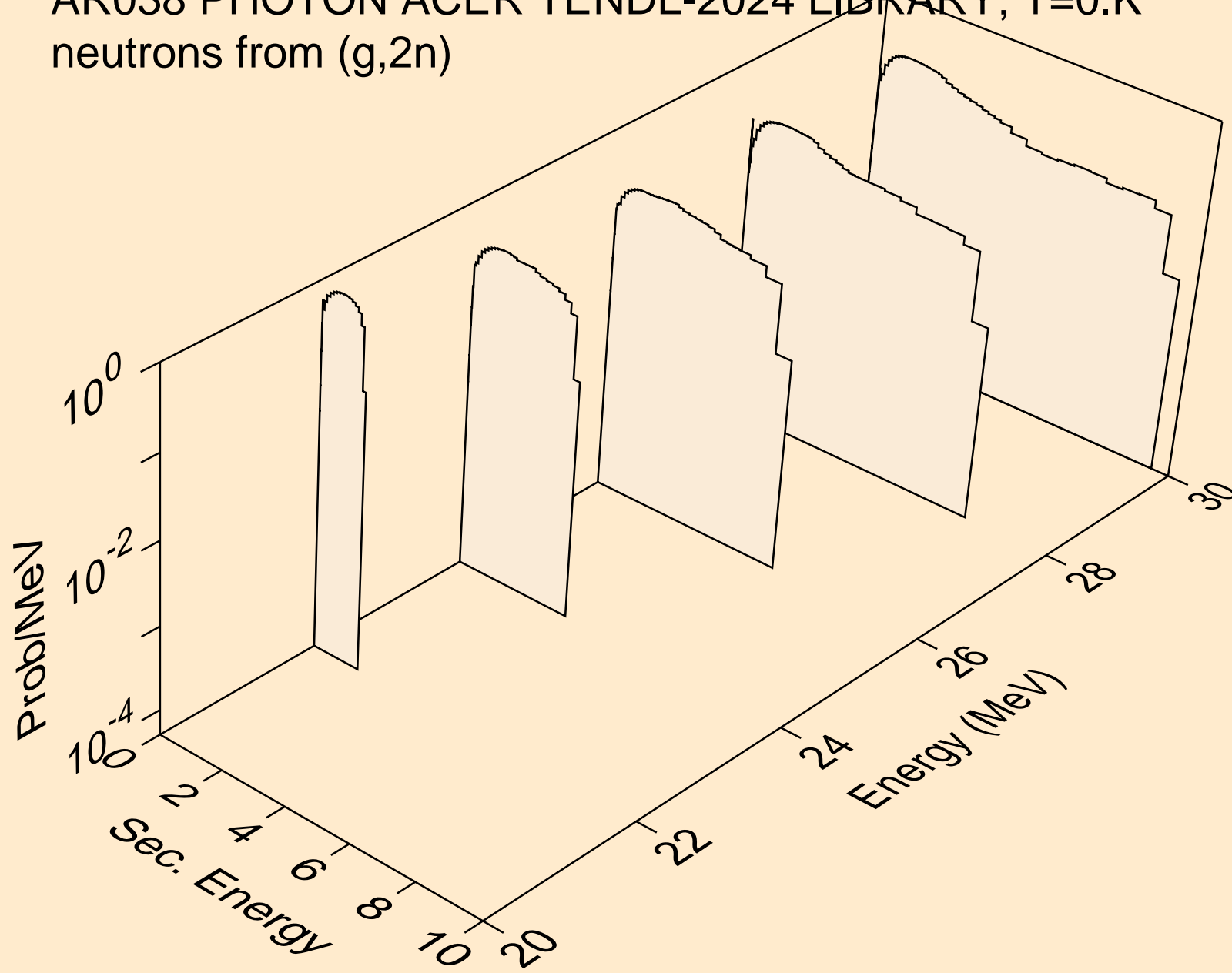

AR038 PHOTON ACER TENDL-2024 LIBRARY; T=0.K
neutrons from (g,n*)a

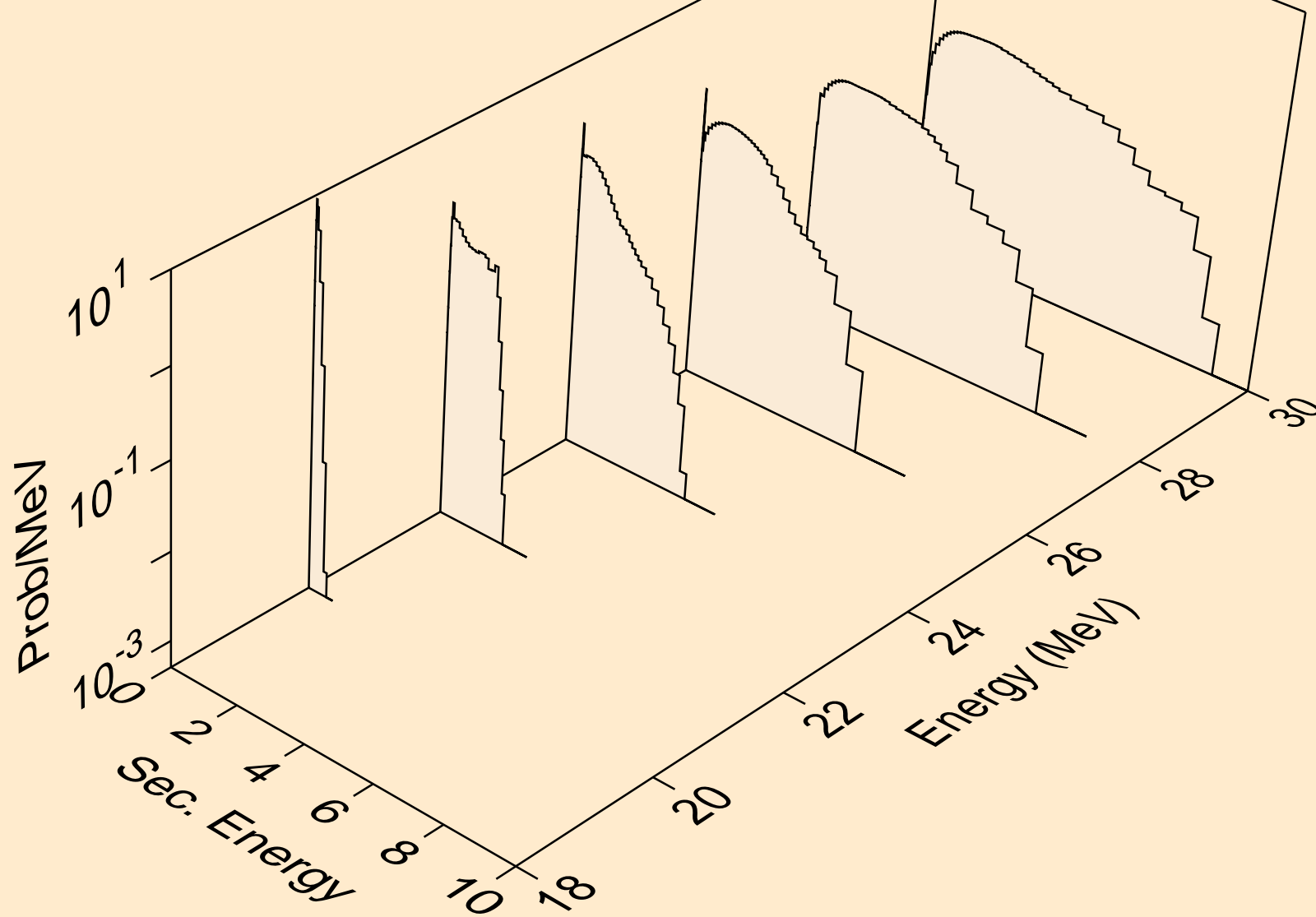

AR038 PHOTON ACER TENDL-2024 LIBRARY; T=0.K
neutrons from (g,n*)p

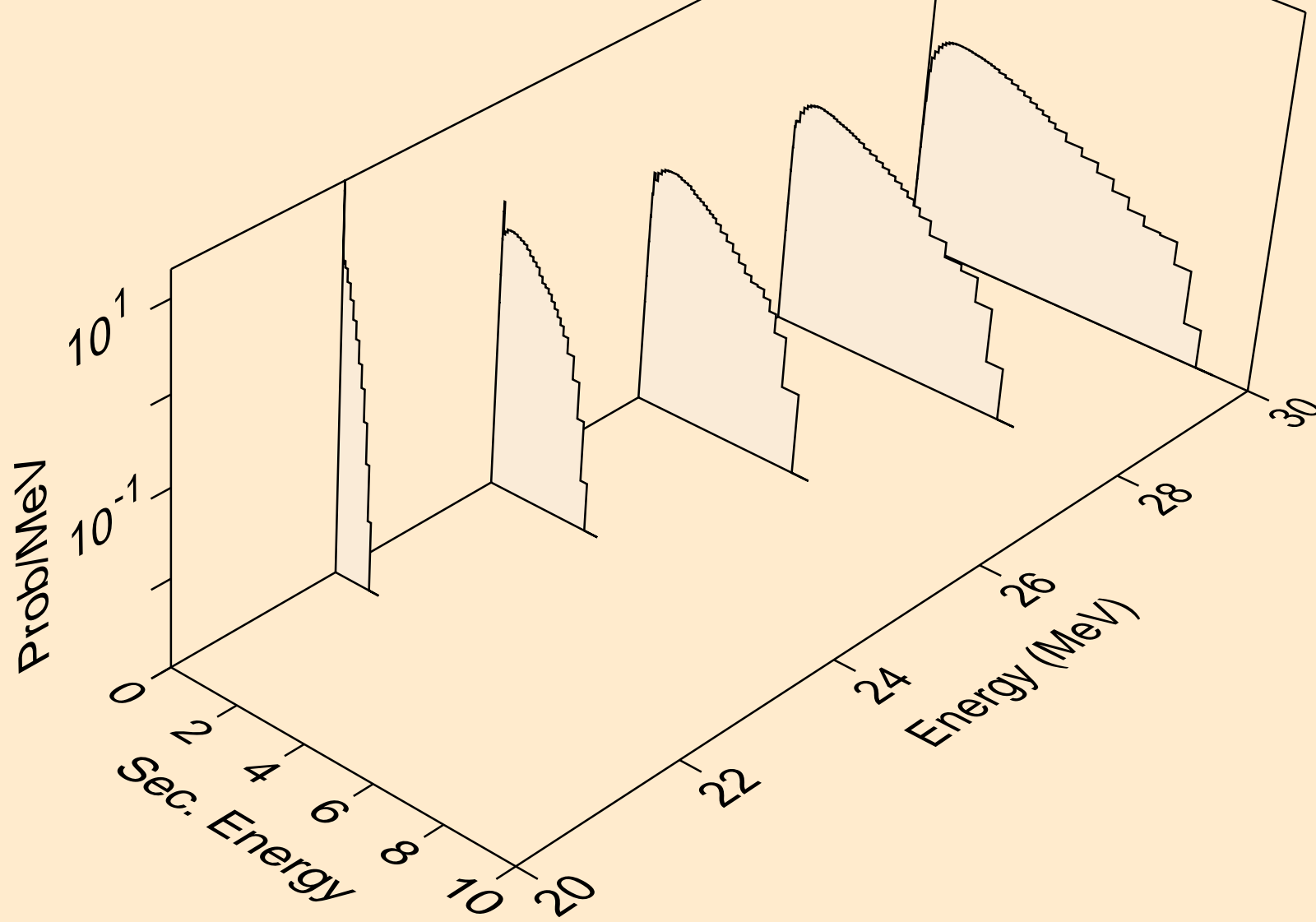

AR038 PHOTON ACER TENDL-2024 LIBRARY; T=0.K
neutrons from (g,n*)d

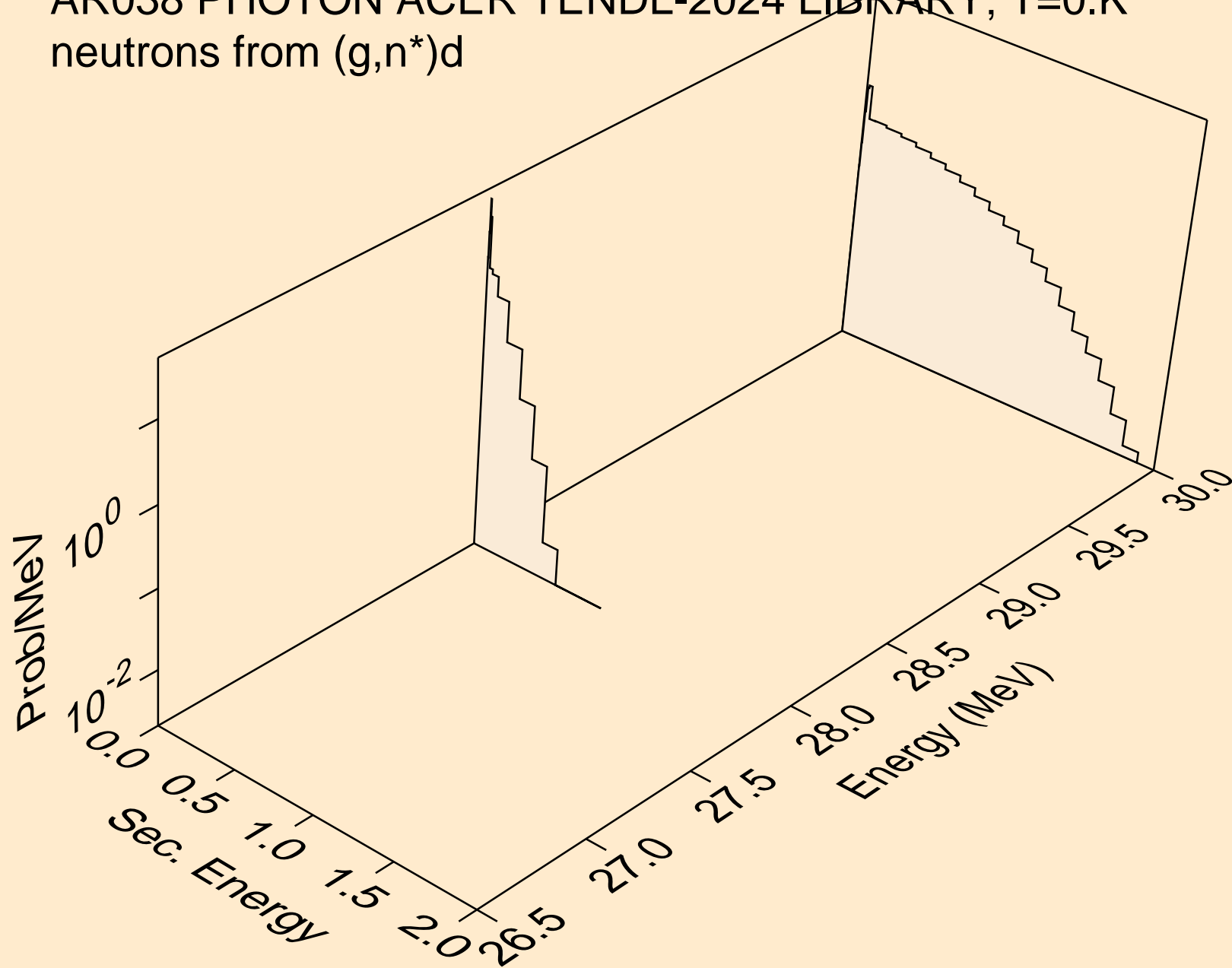

AR038 PHOTON ACER TENDL-2024 LIBRARY; T=0.K
angular distribution for (g,n*0) neutron

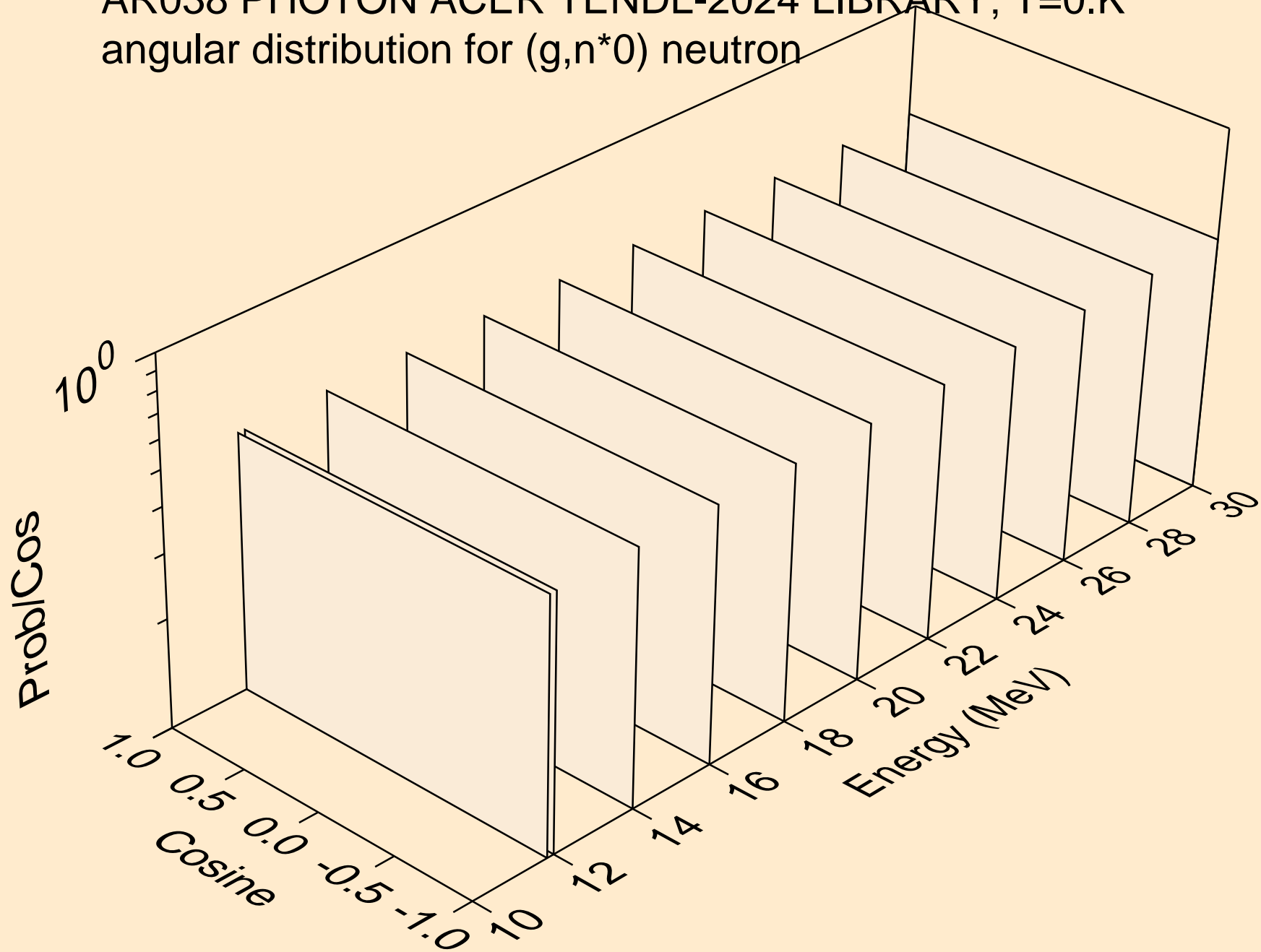

AR038 PHOTON ACER TENDL-2024 LIBRARY; T=0.K
angular distribution for (g,n*1) neutron

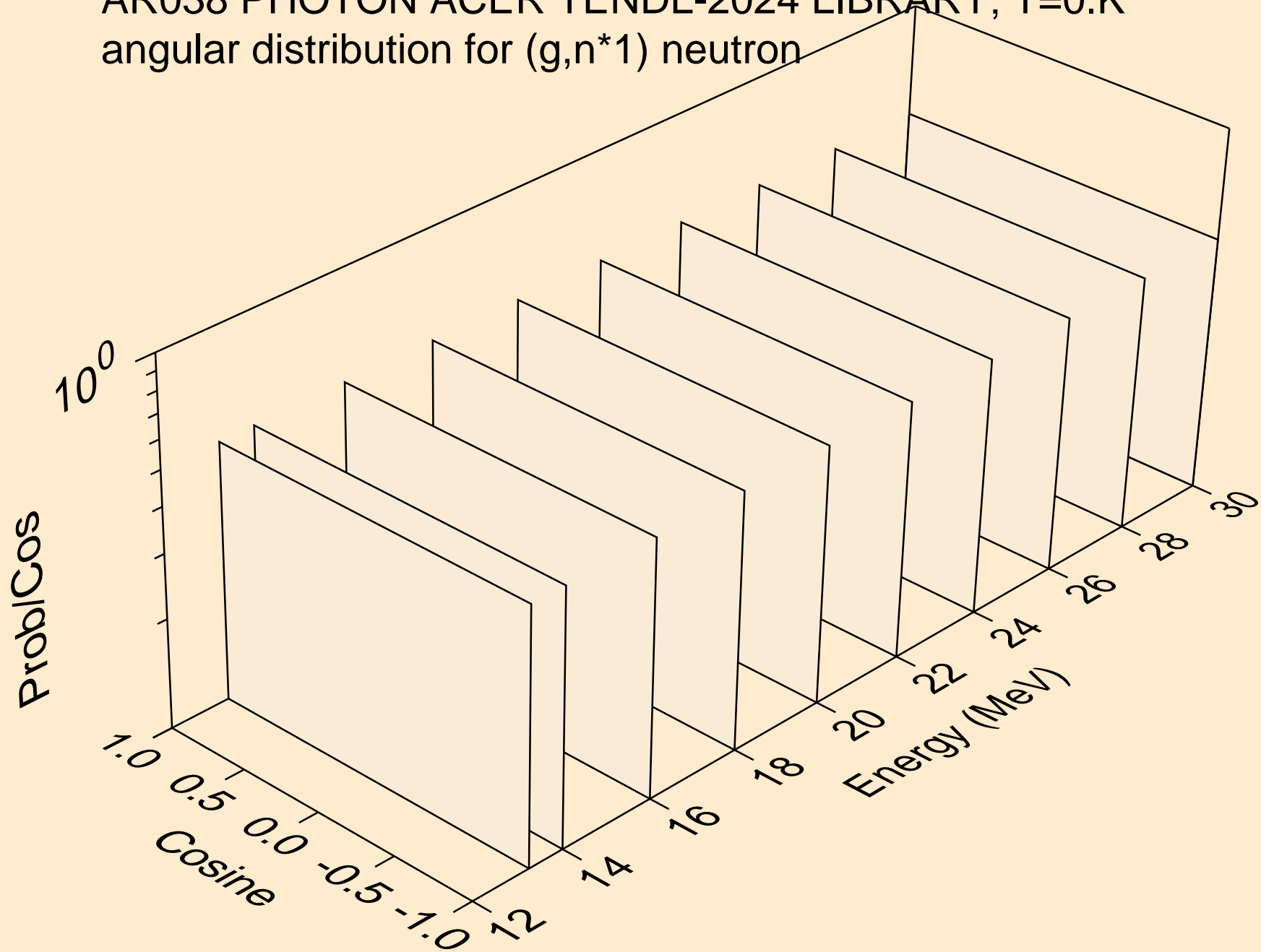

AR038 PHOTON ACER TENDL-2024 LIBRARY; T=0.K
neutrons from (g,n*c)

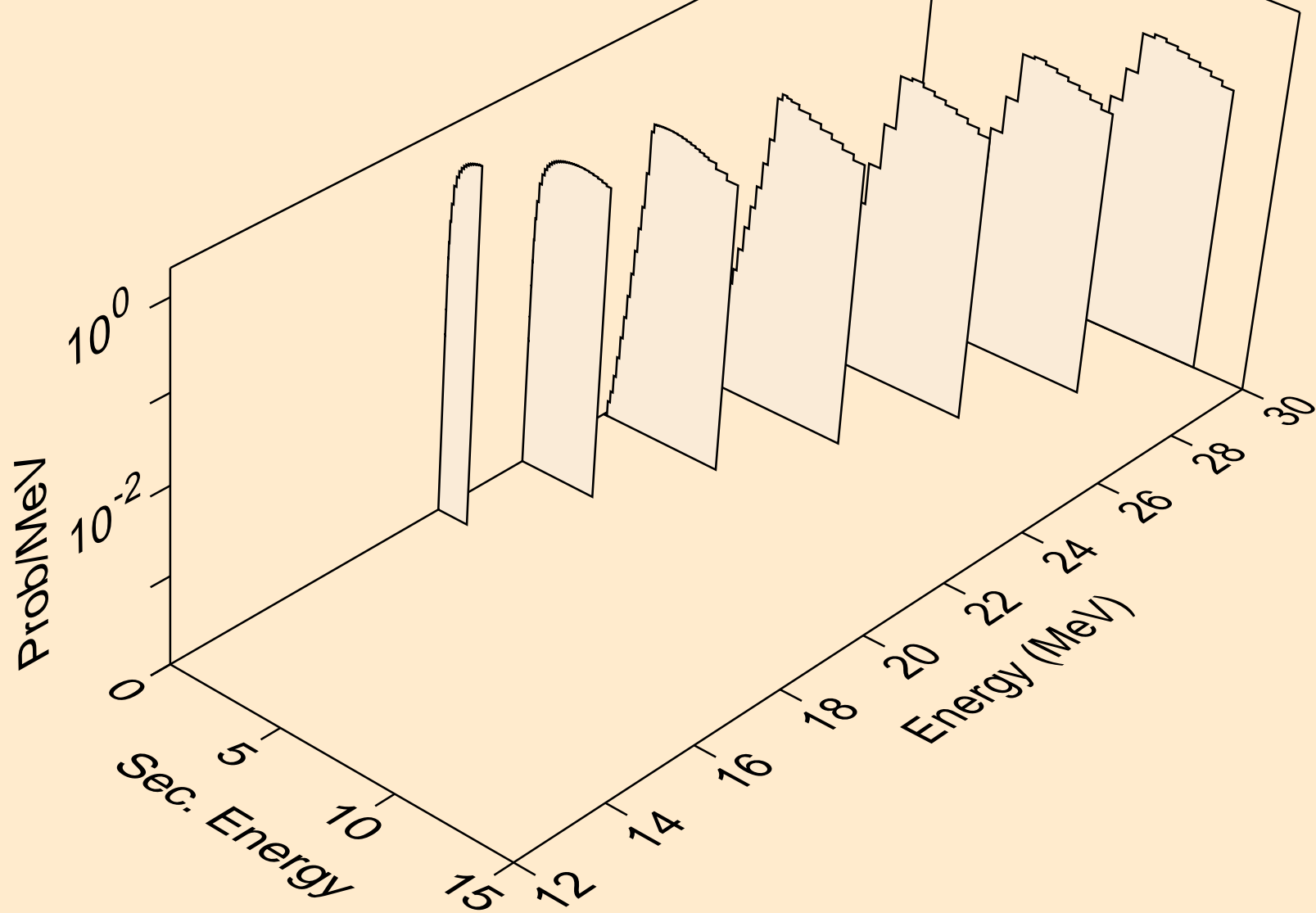

AR038 PHOTON ACER TENDL-2024 LIBRARY; T=0.K
photons from (g,x)

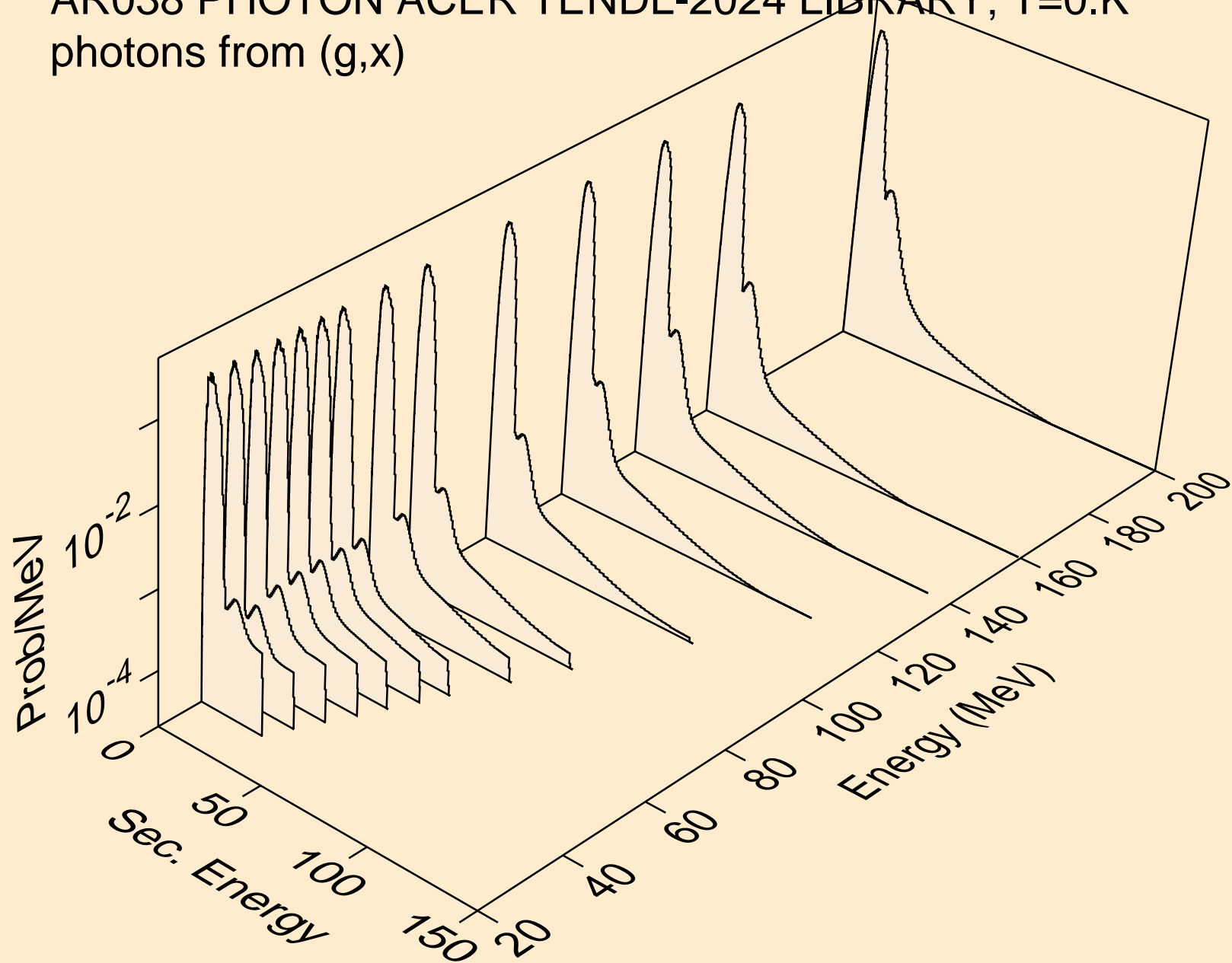

AR038 PHOTON ACER TENDL-2024 LIBRARY; T=0.K
photons from (g,2n)

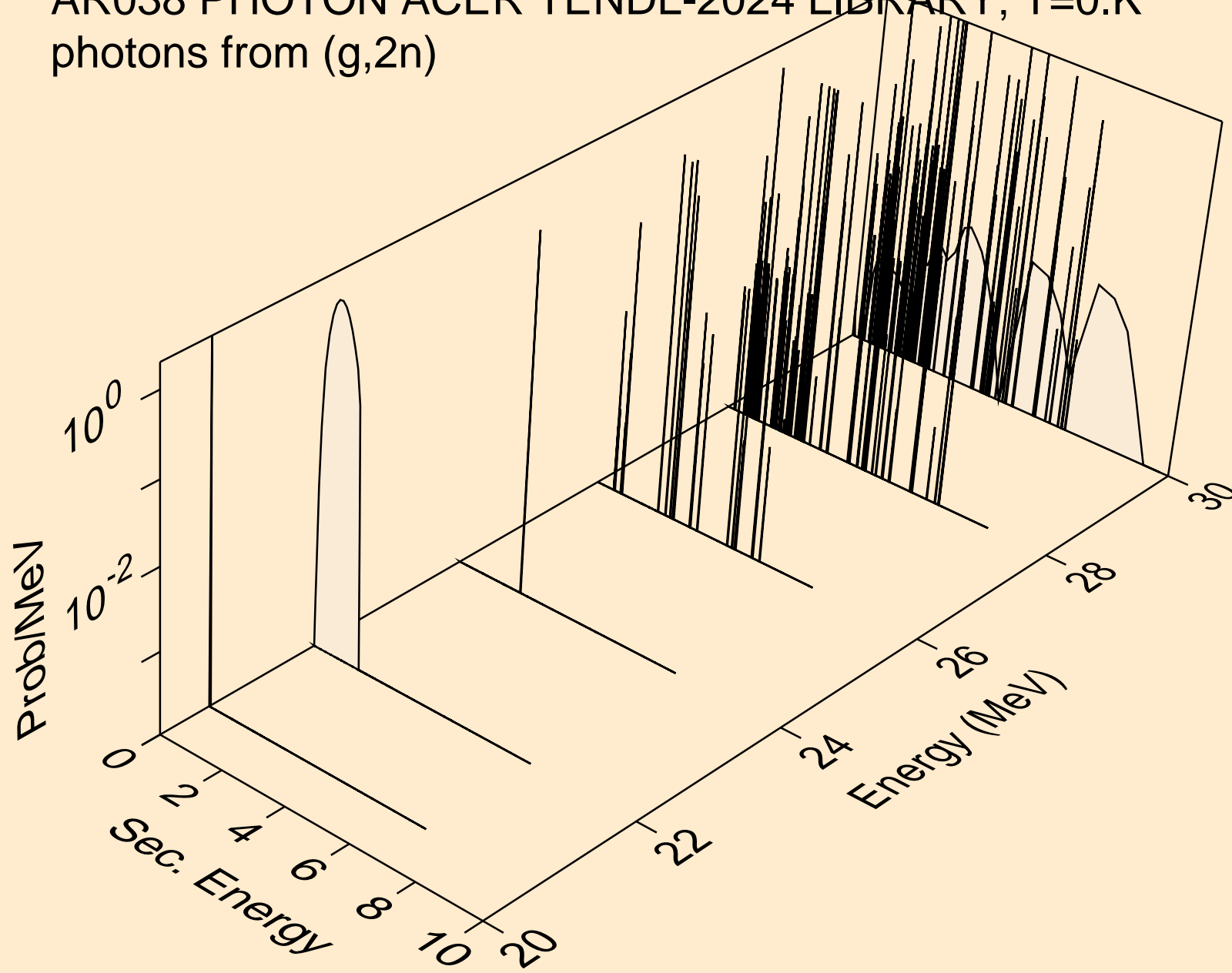

AR038 PHOTON ACER TENDL-2024 LIBRARY; T=0.K
photons from (g,n*)a

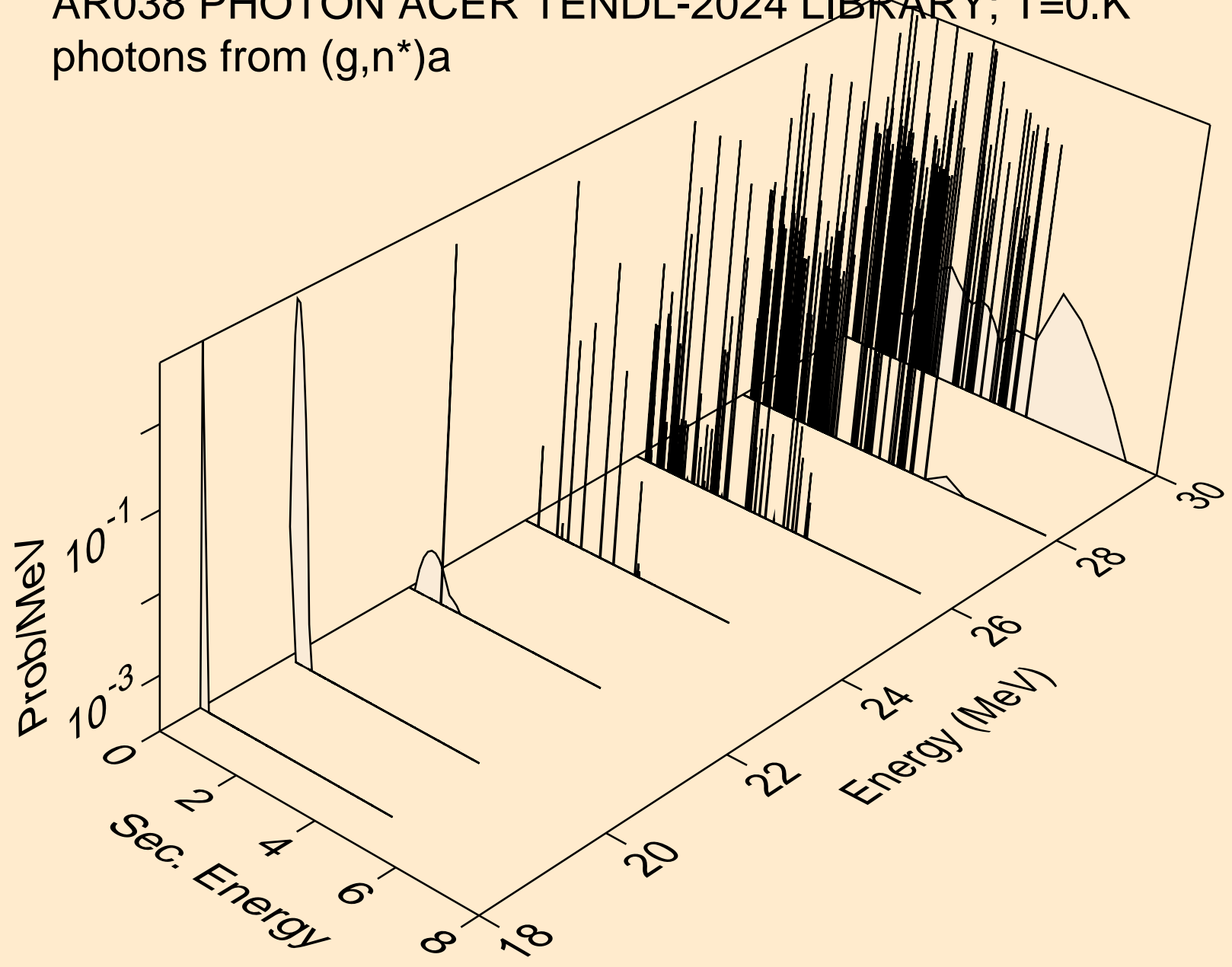

AR038 PHOTON ACER TENDL-2024 LIBRARY; T=0.K
photons from (g,n*)p

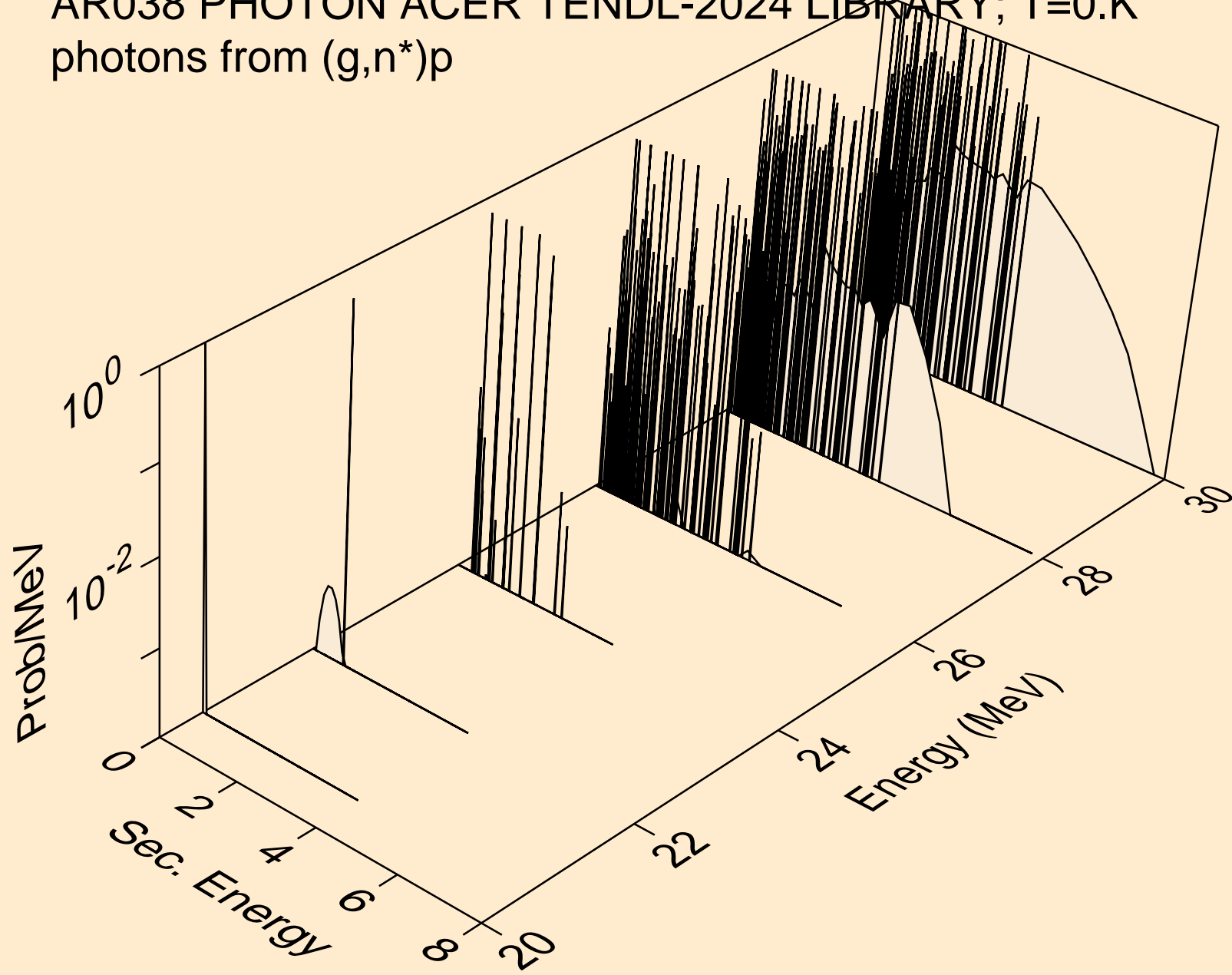

AR038 PHOTON ACER TENDL-2024 LIBRARY; T=0.K
photons from (g,n*)d

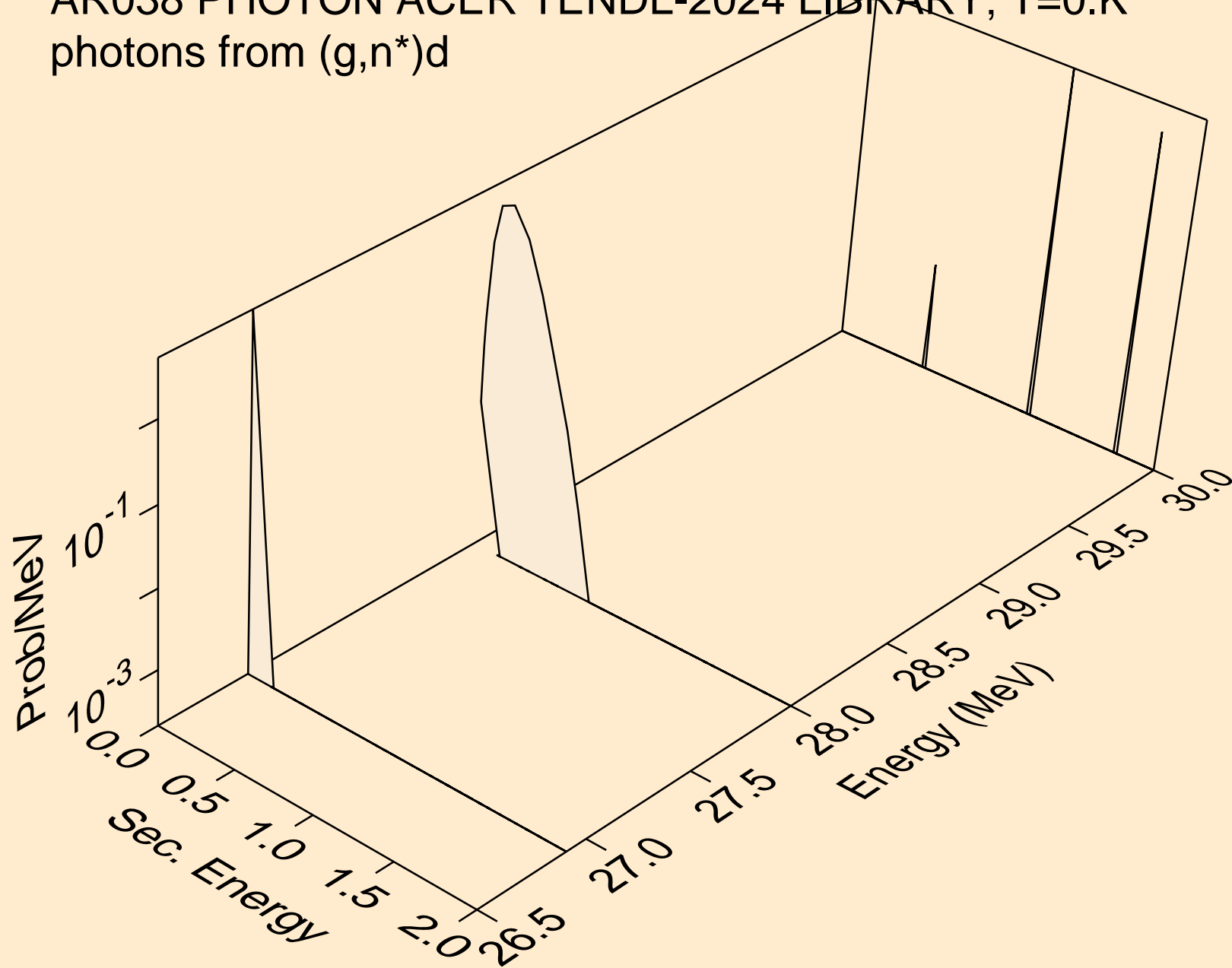

AR038 PHOTON ACER TENDL-2024 LIBRARY; T=0.K
photons from (g,n*c)

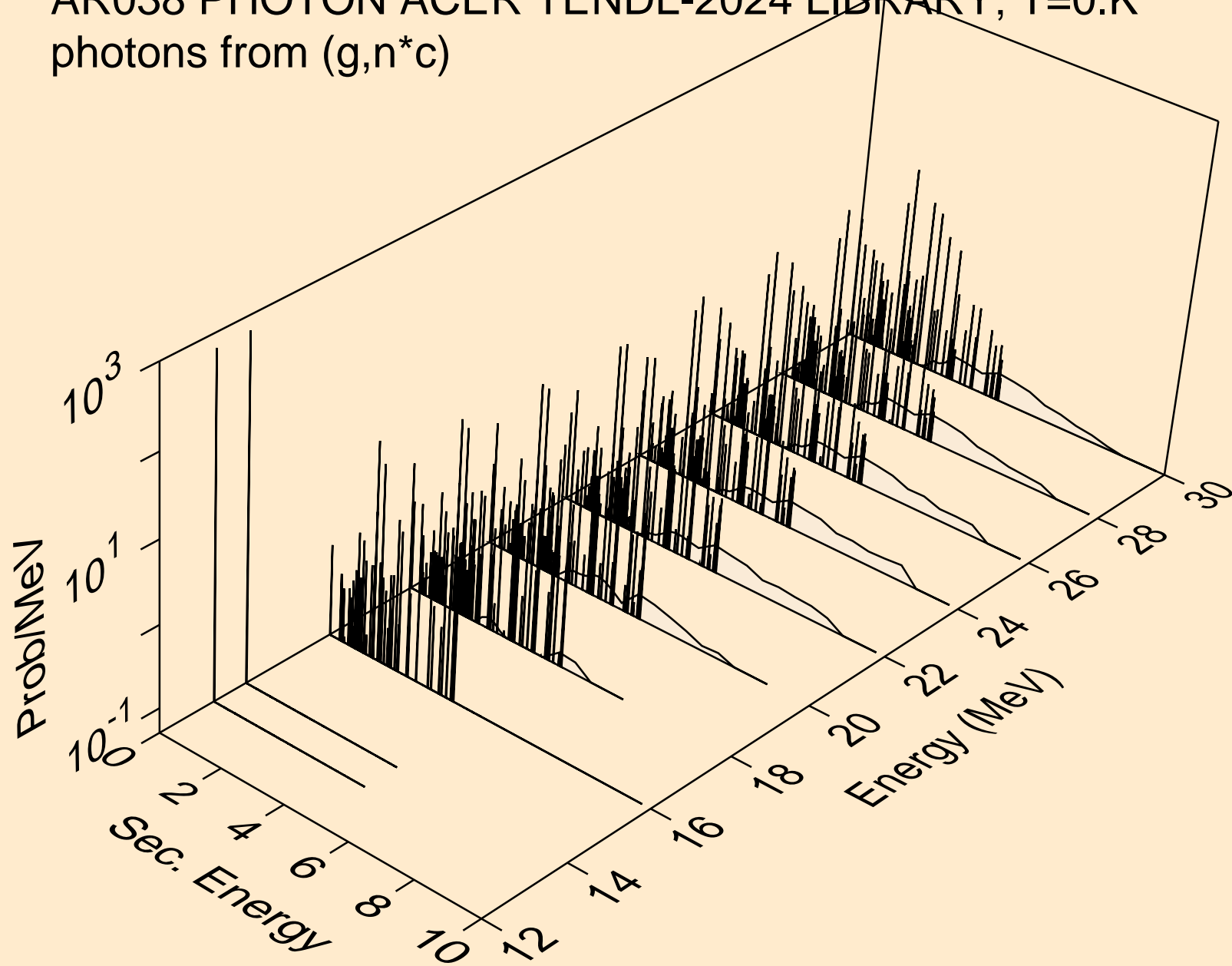

AR038 PHOTON ACER TENDL-2024 LIBRARY; T=0.K
photons from (g,gma)

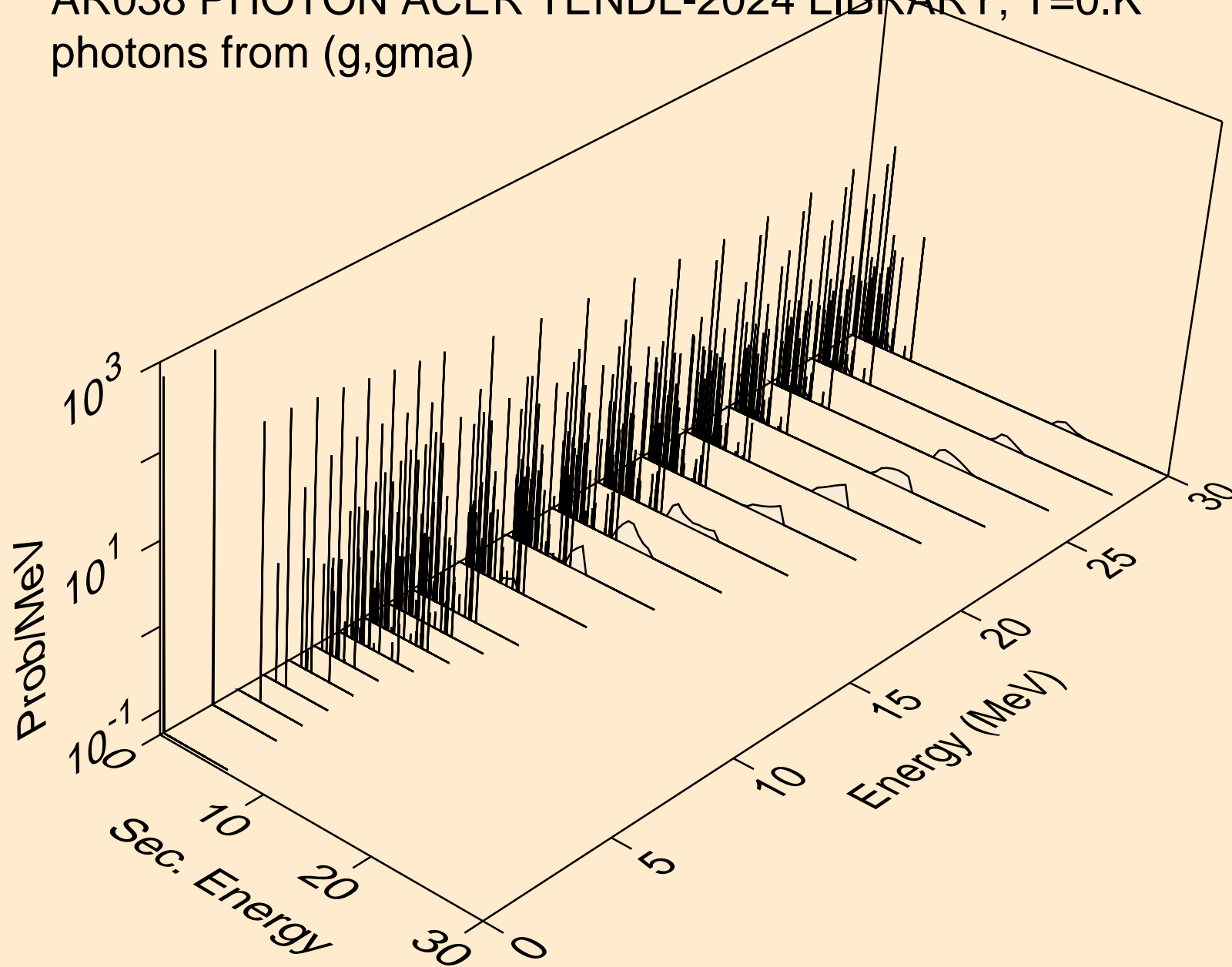

AR038 PHOTON ACER TENDL-2024 LIBRARY; T=0.K
photons from (g,p)

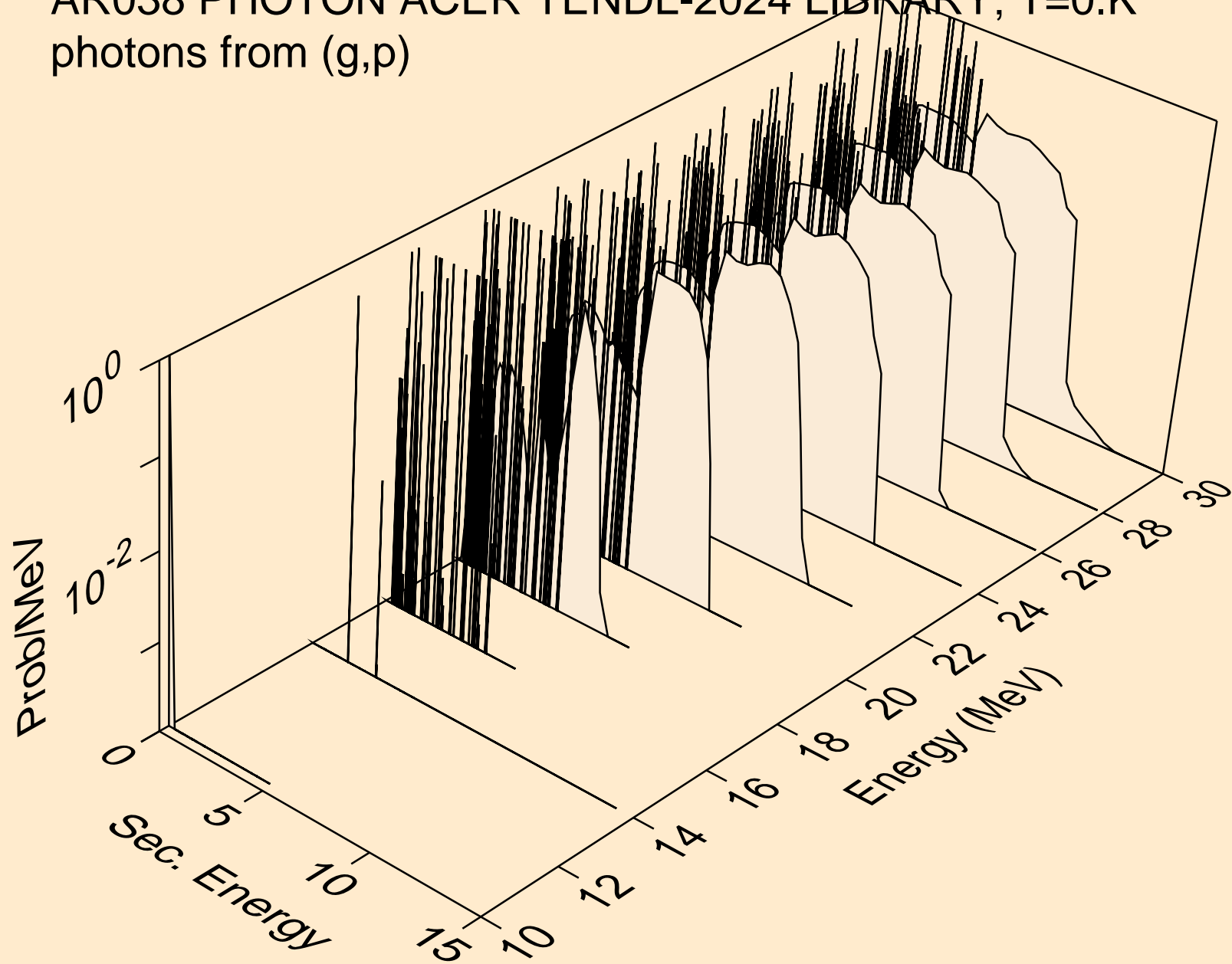

AR038 PHOTON ACER TENDL-2024 LIBRARY; T=0.K
photons from (g,d)

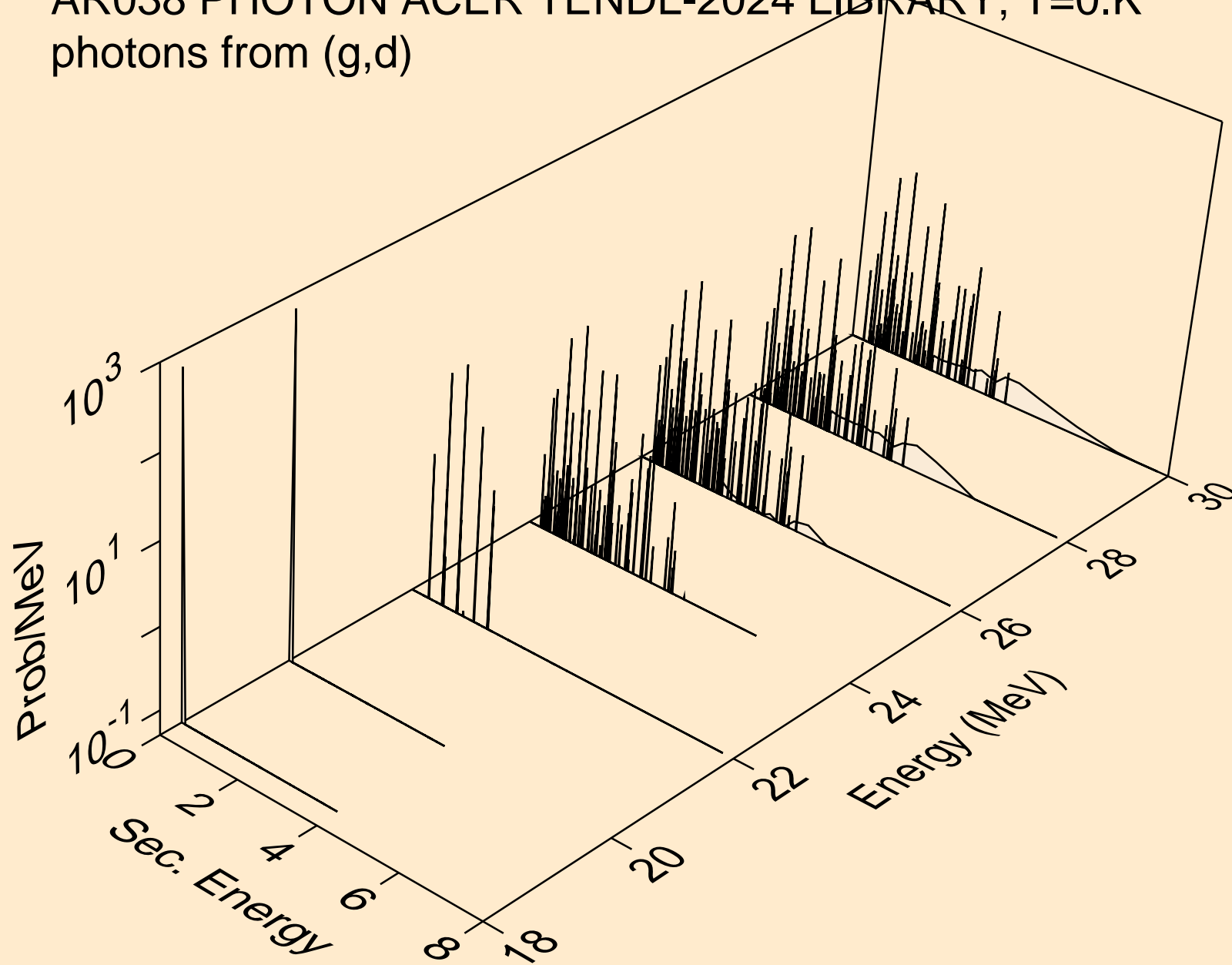

AR038 PHOTON ACER TENDL-2024 LIBRARY; T=0.K
photons from (g,t)

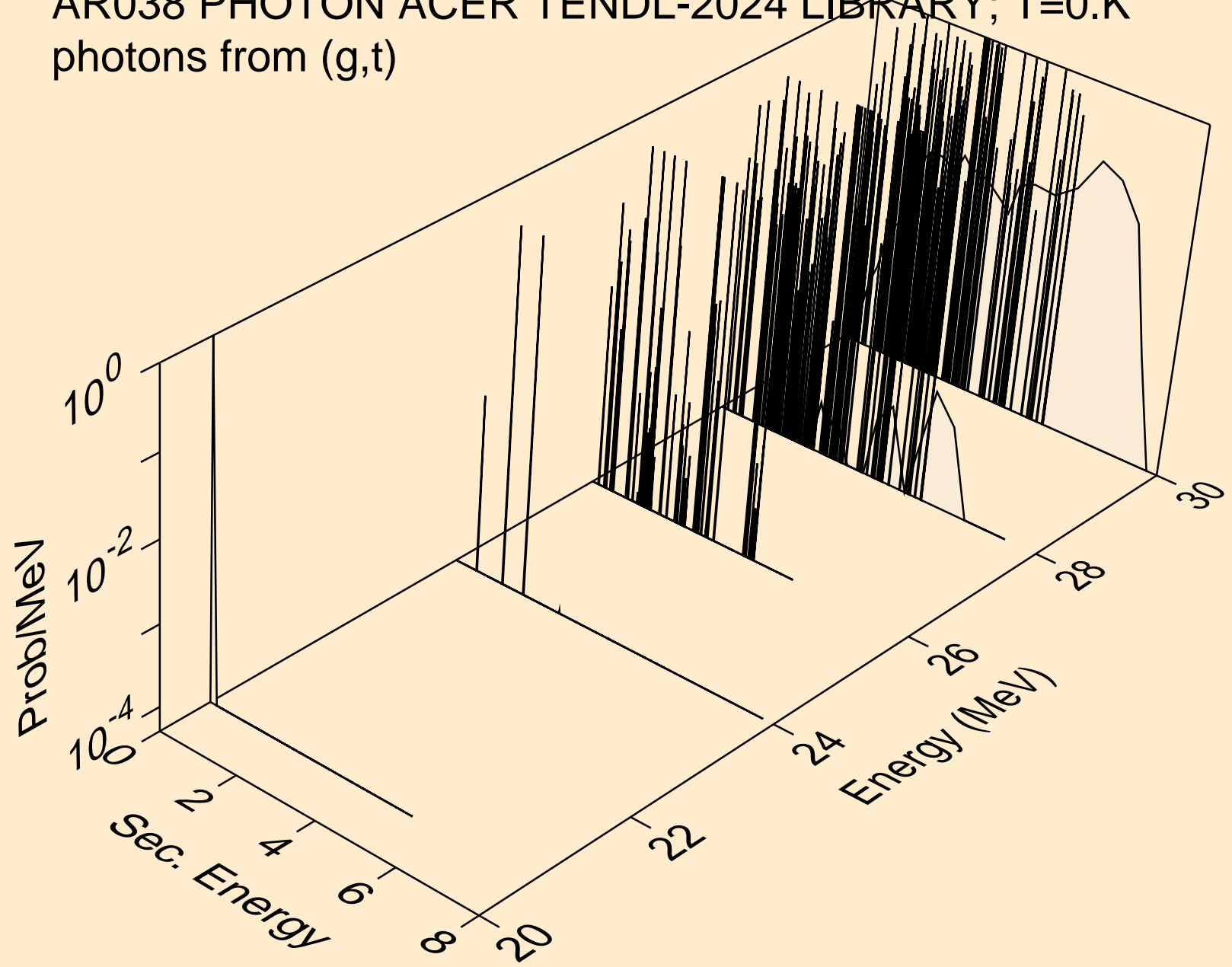

AR038 PHOTON ACER TENDL-2024 LIBRARY; T=0.K
photons from (g,he3)

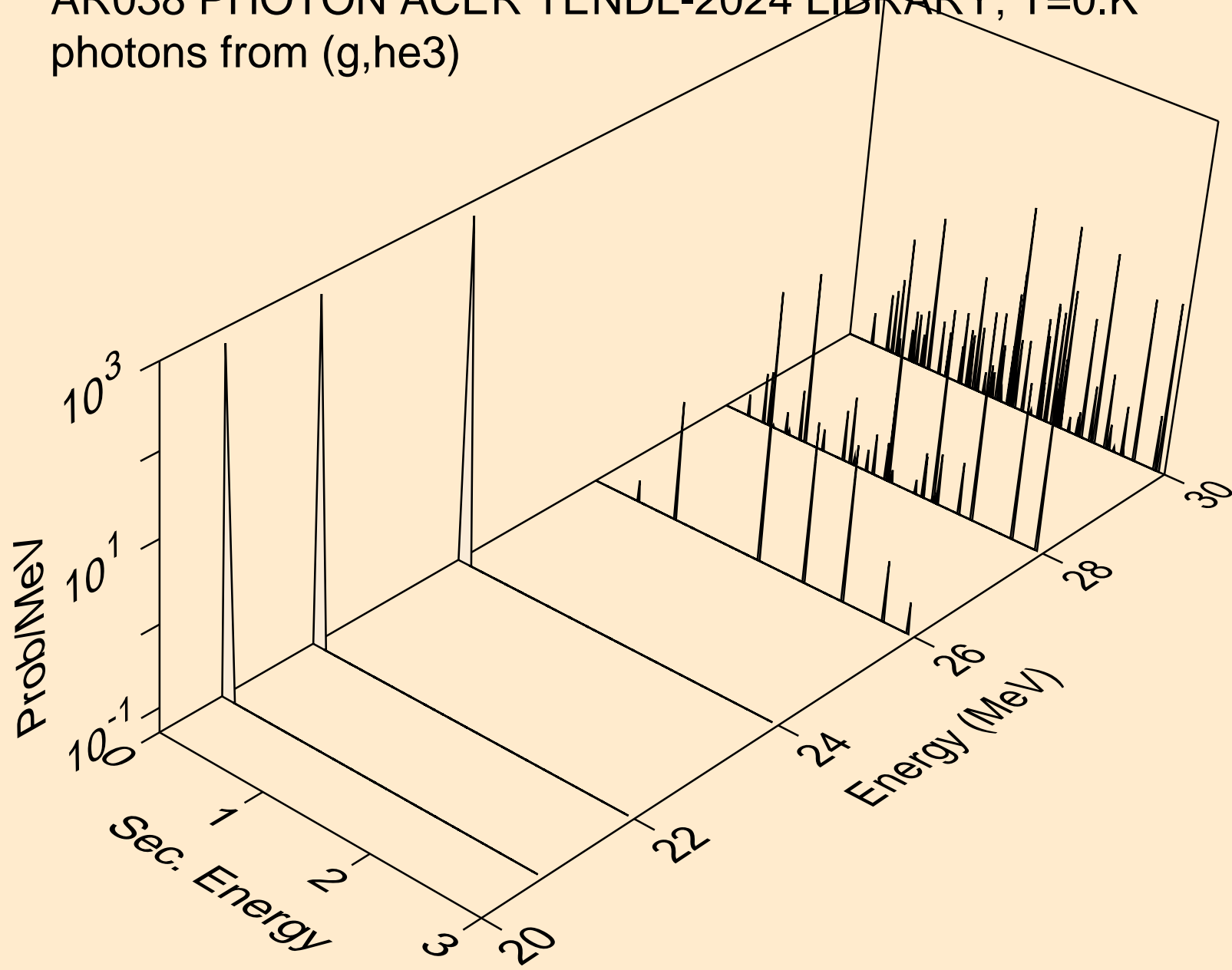

AR038 PHOTON ACER TENDL-2024 LIBRARY; T=0.K
photons from (g,a)

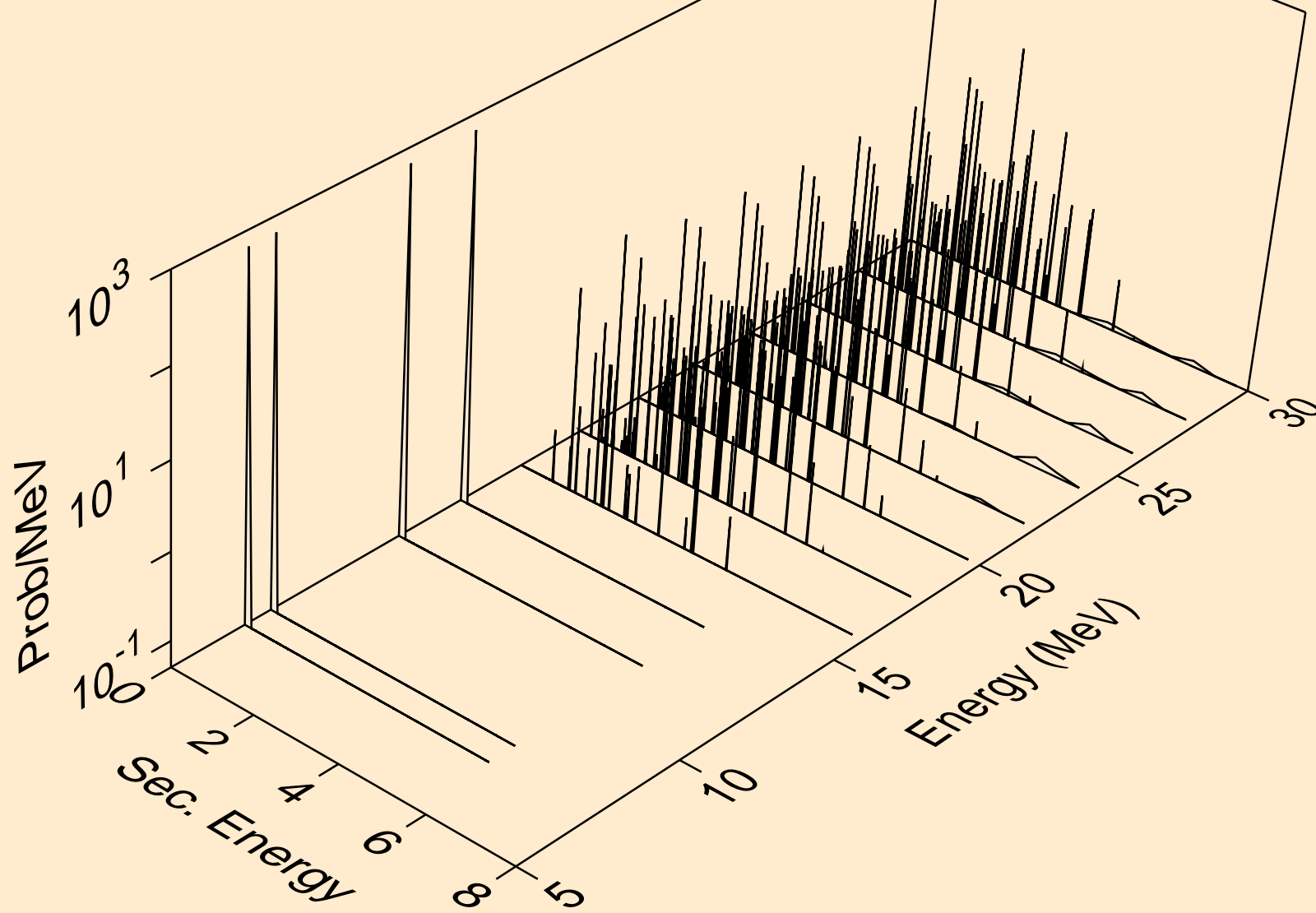

AR038 PHOTON ACER TENDL-2024 LIBRARY; T=0.K
photons from (g,2a)

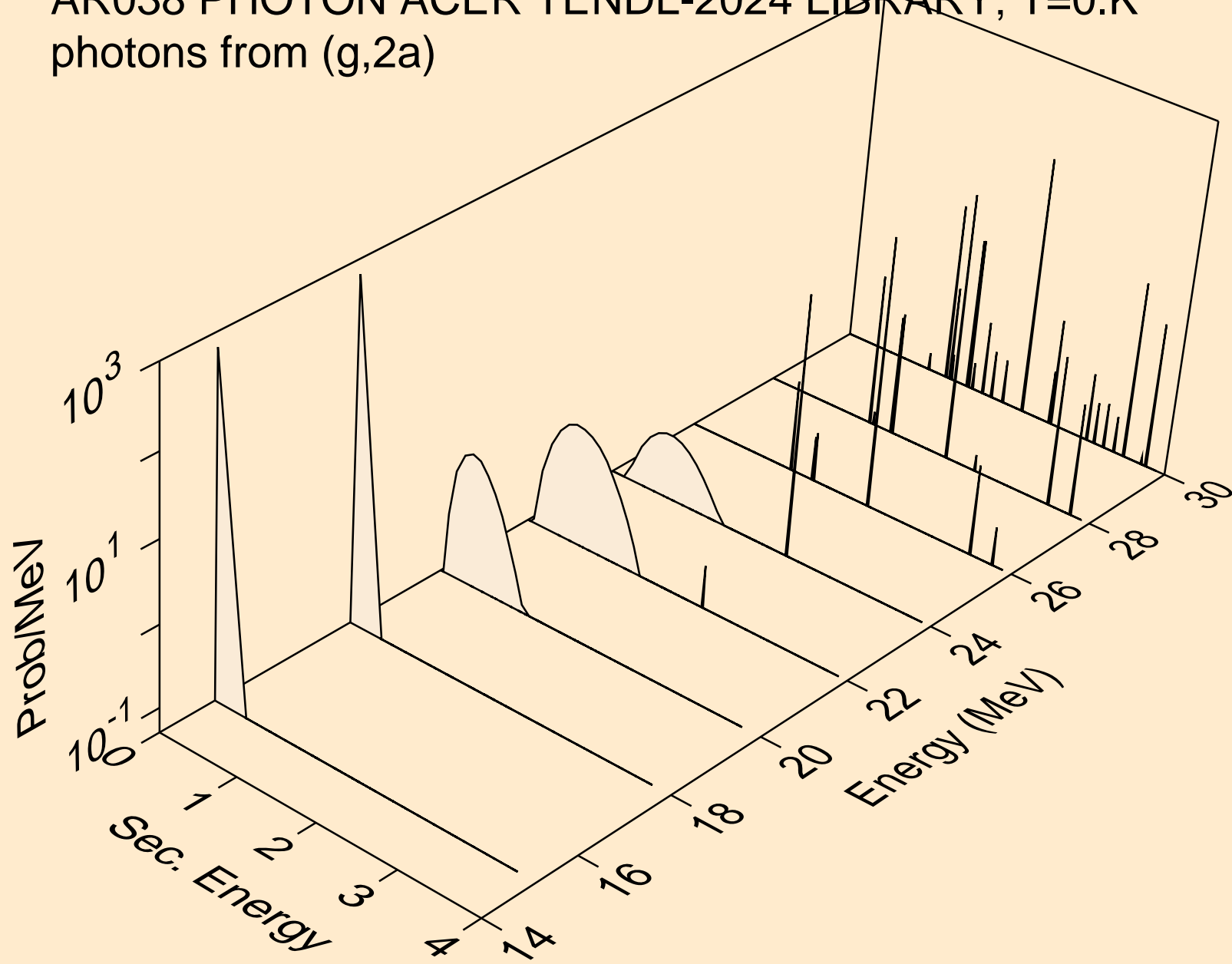

AR038 PHOTON ACER TENDL-2024 LIBRARY; T=0.K
photons from (g,2p)

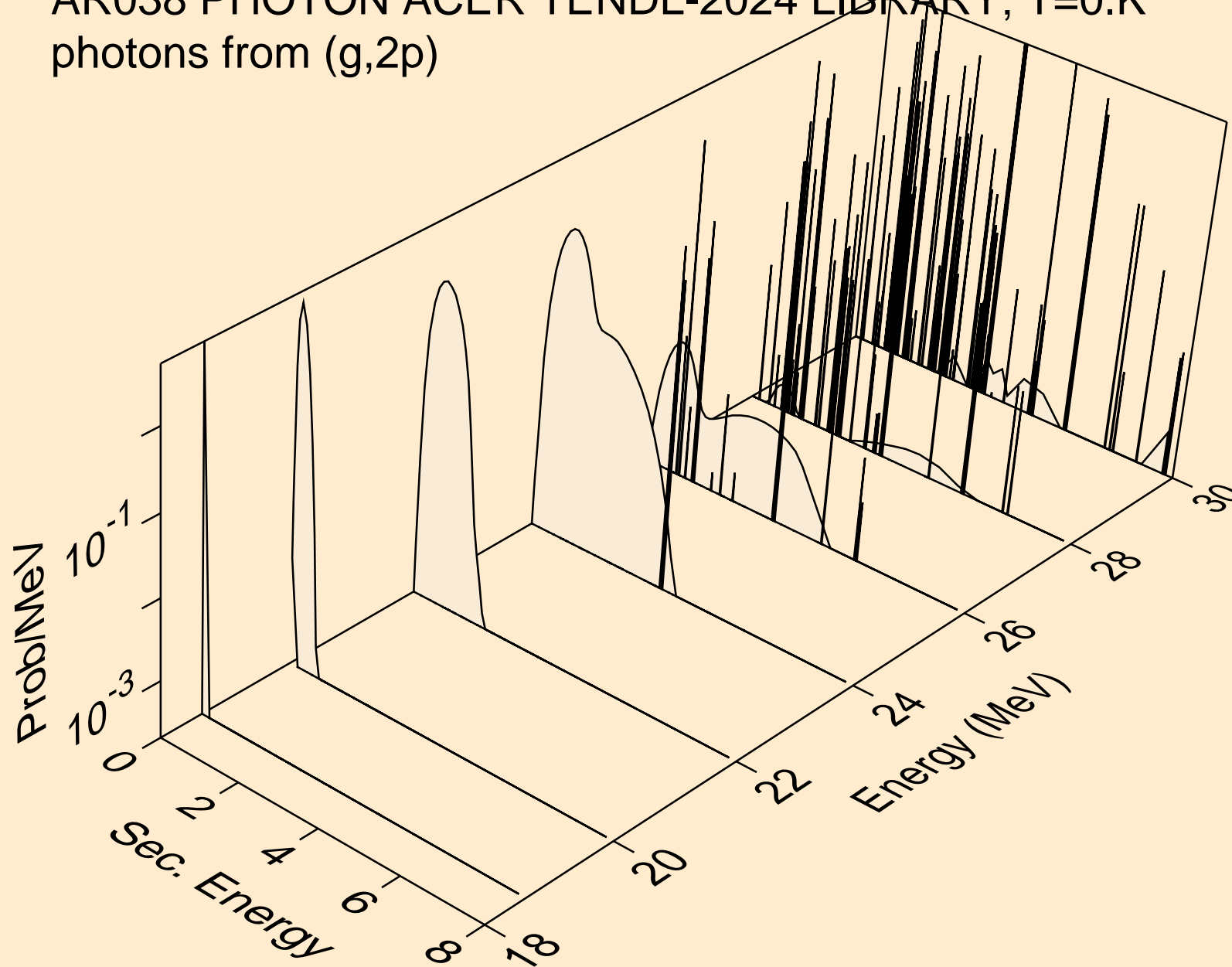

AR038 PHOTON ACER TENDL-2024 LIBRARY; T=0.K
photons from (g,pa)

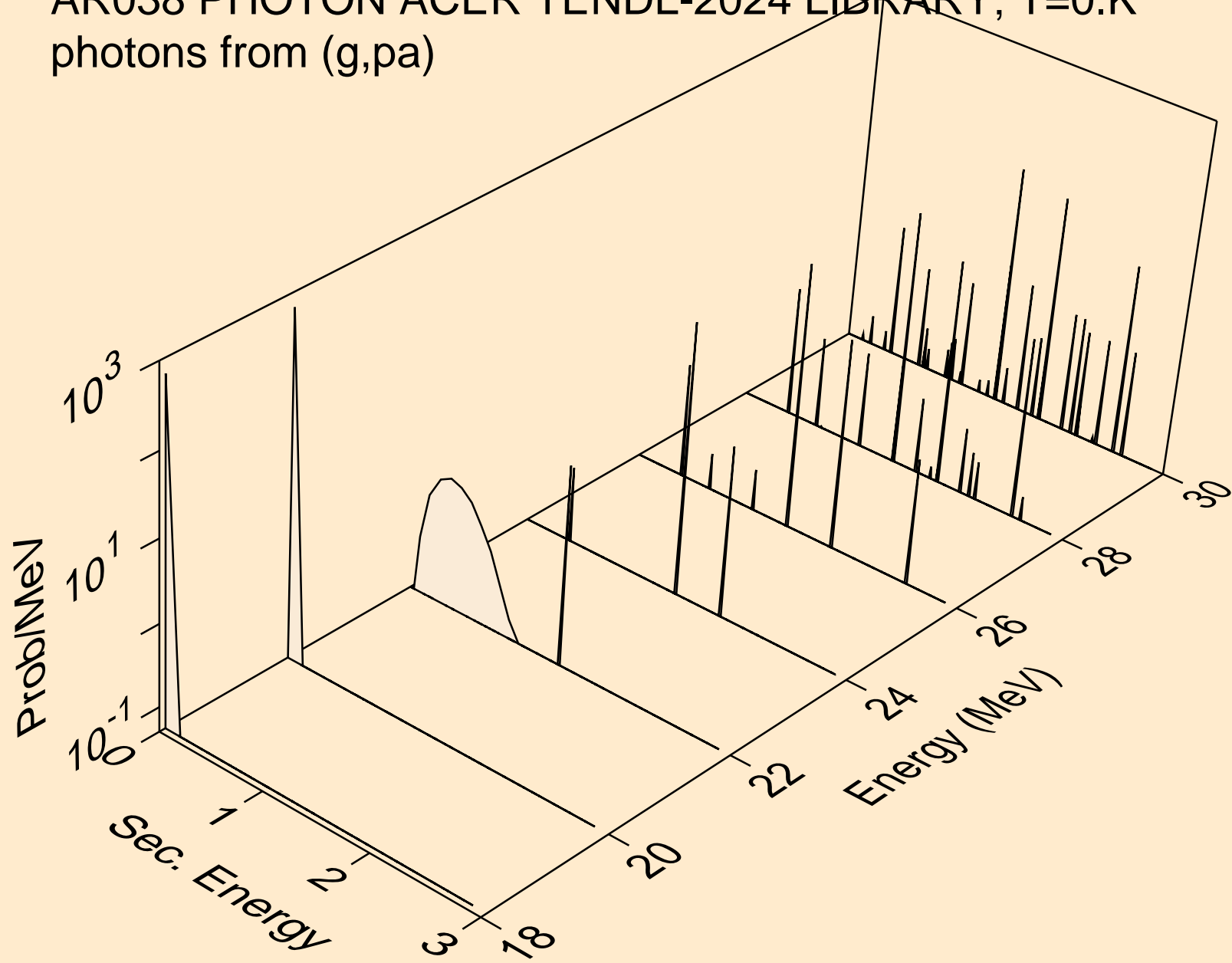

AR038 PHOTON ACER TENDL-2024 LIBRARY; T=0.K
photons from (g,pd)

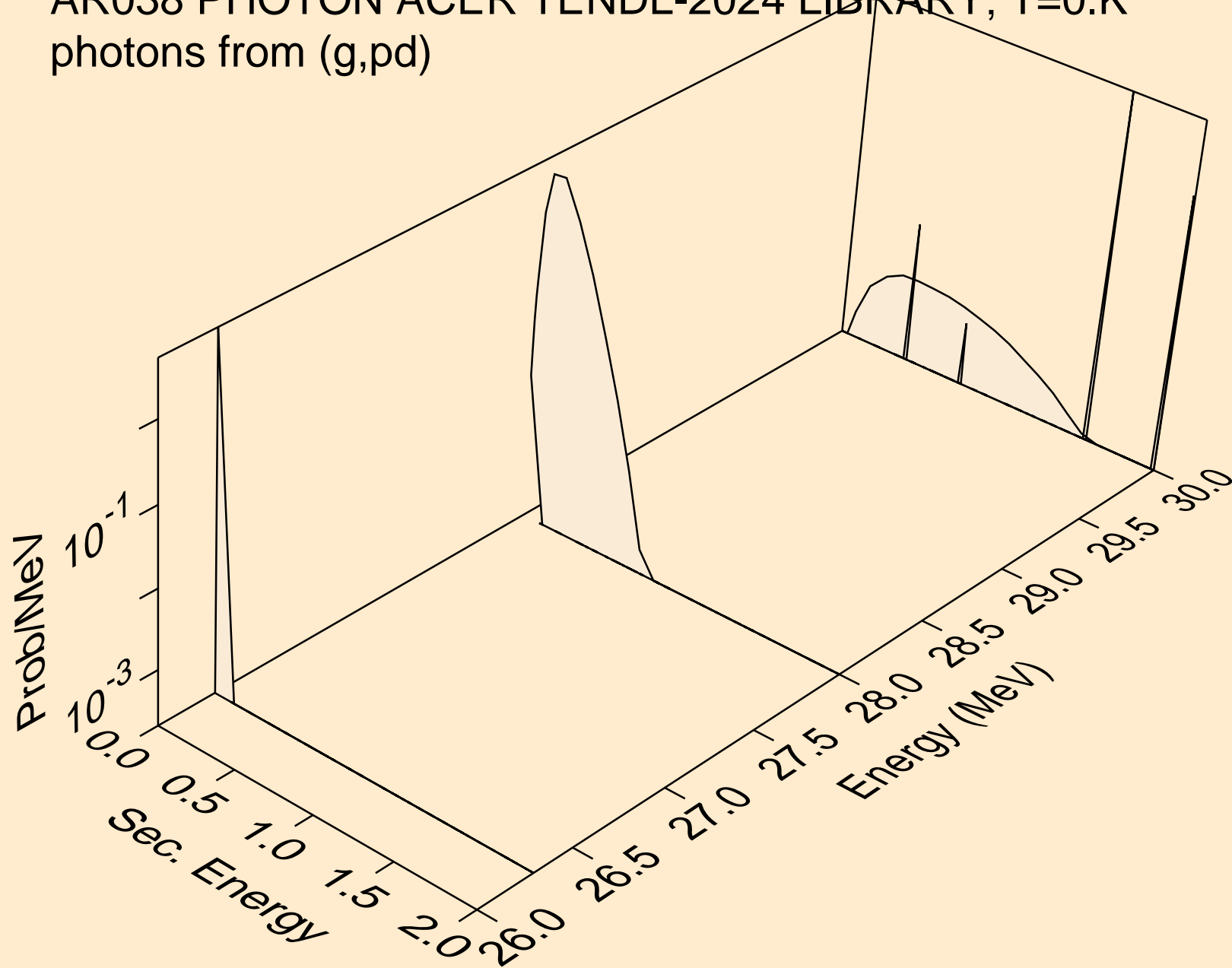

AR038 PHOTON ACER TENDL-2024 LIBRARY; T=0.K
photons from (g,pt)

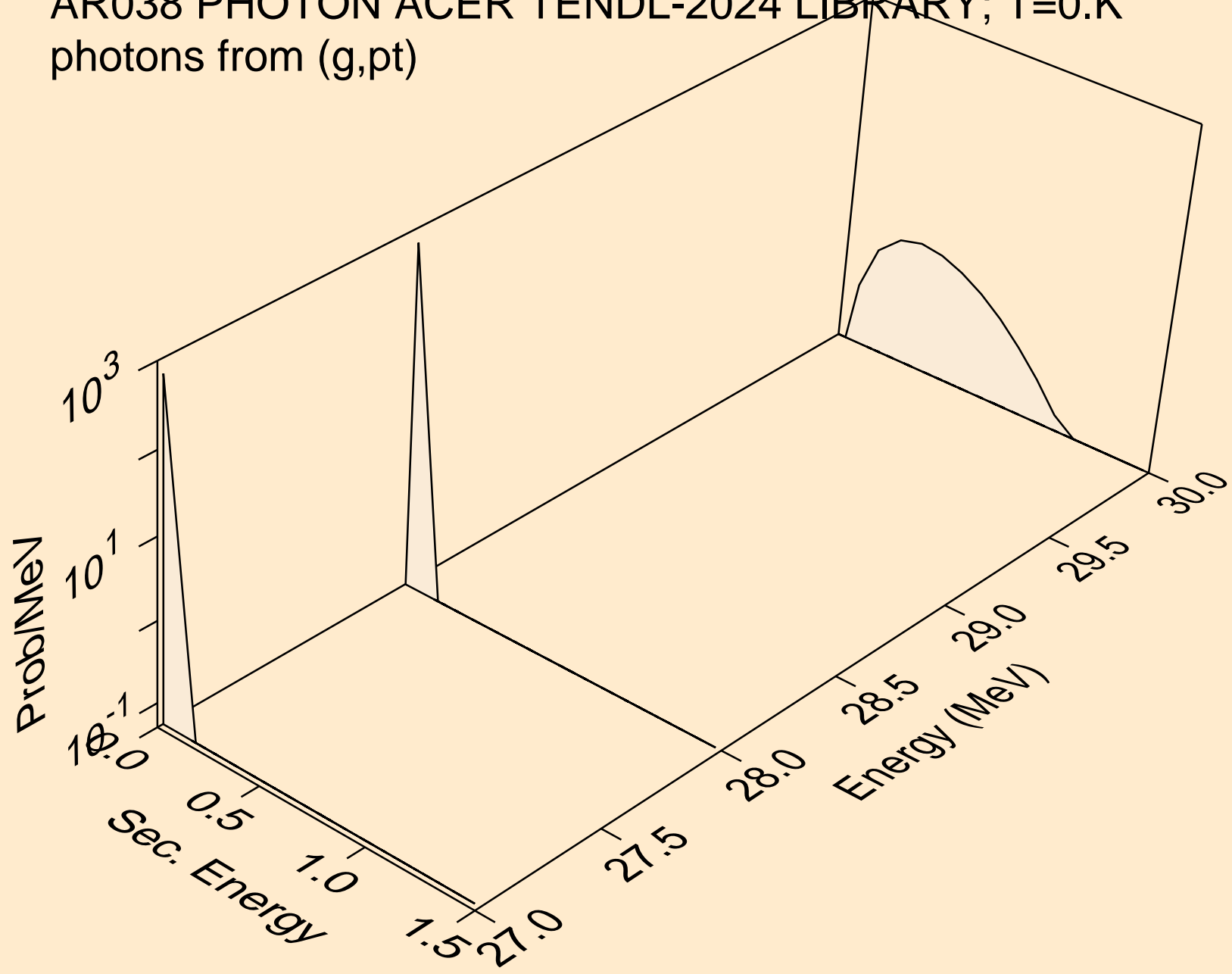

AR038 PHOTON ACER TENDL-2024 LIBRARY; T=0.K
protons from (g,x)

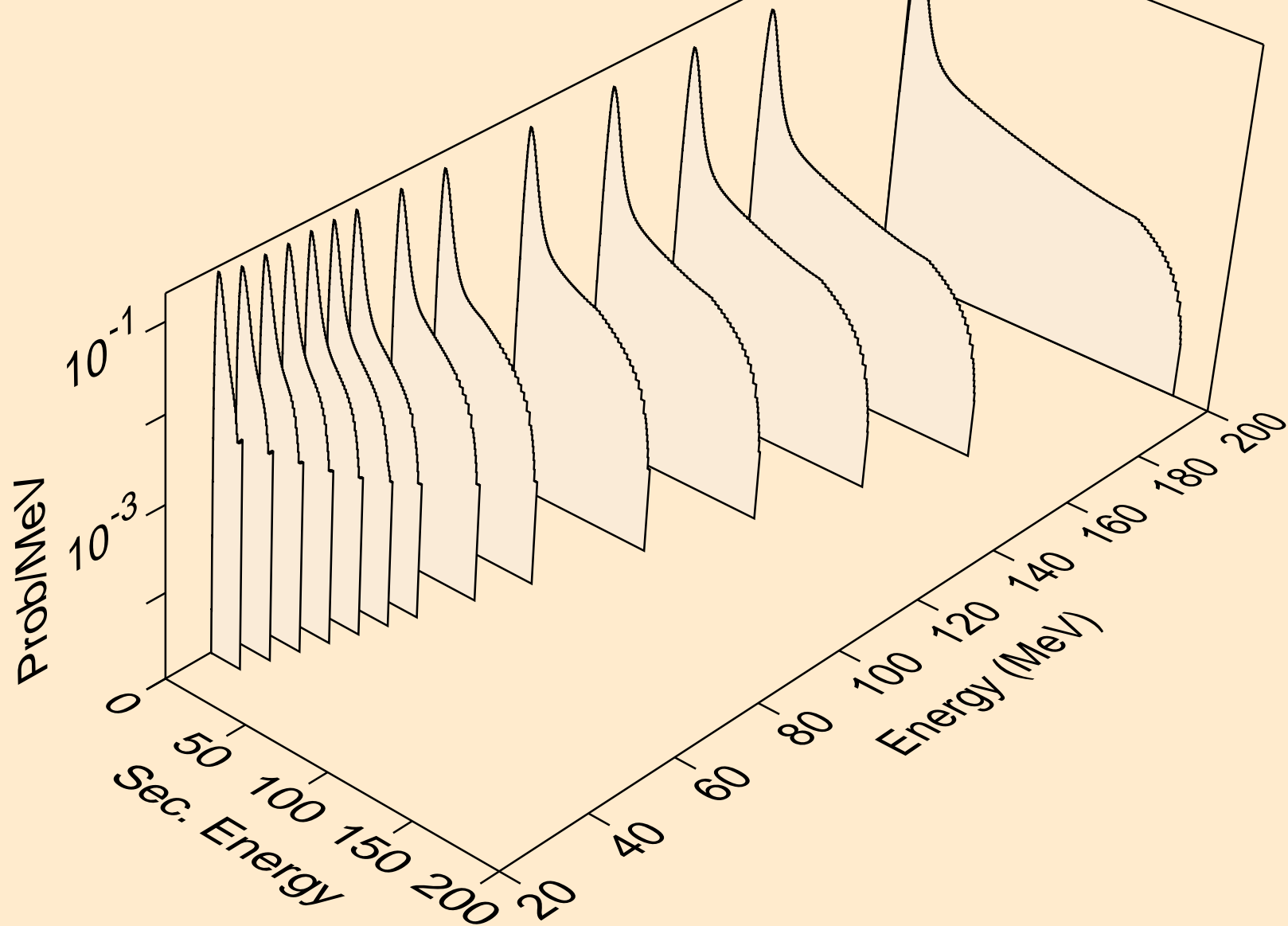

AR038 PHOTON ACER TENDL-2024 LIBRARY; T=0.K
protons from (g,n*)p

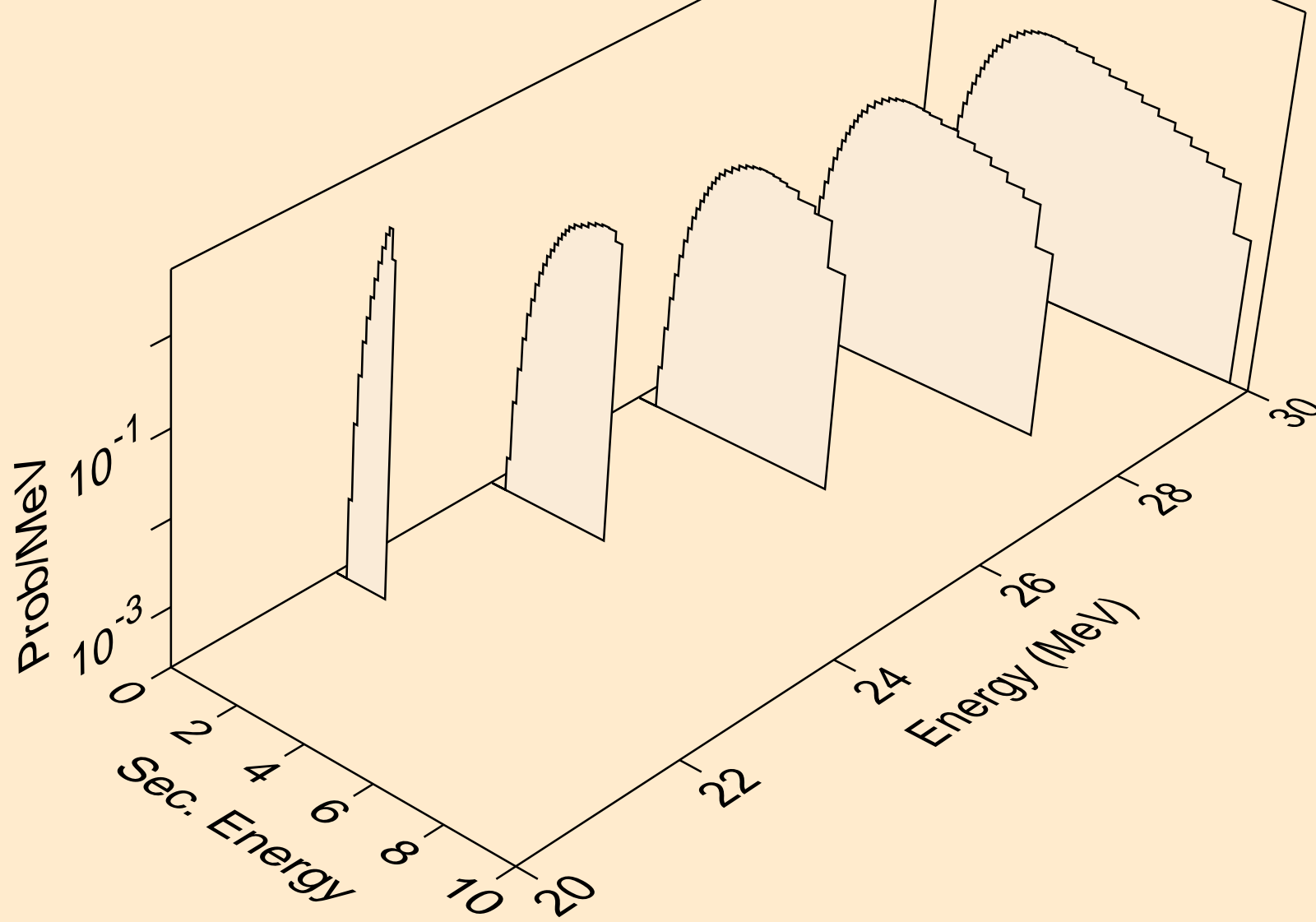

AR038 PHOTON ACER TENDL-2024 LIBRARY; T=0.K
protons from (g,p)

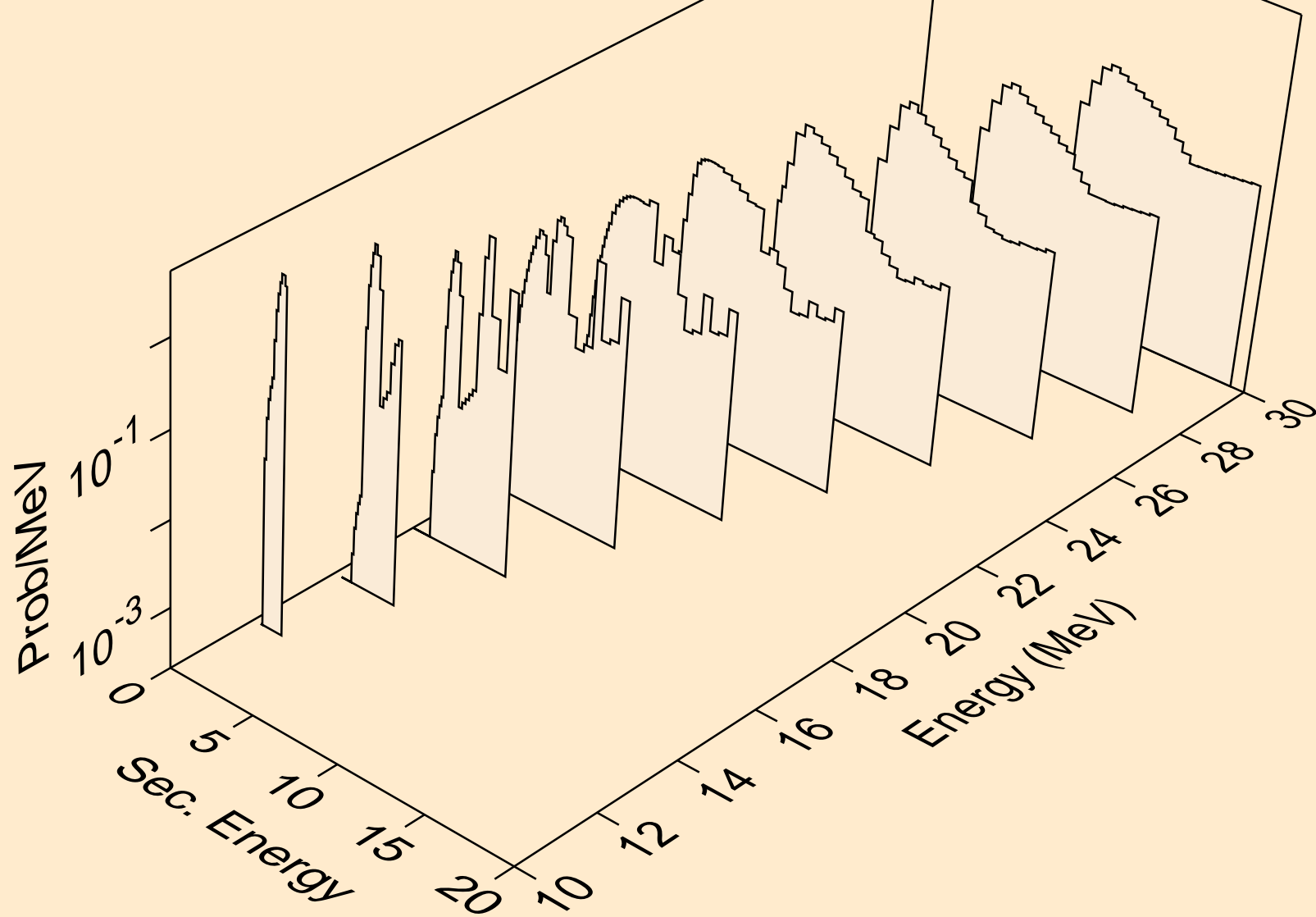

AR038 PHOTON ACER TENDL-2024 LIBRARY; T=0.K
protons from (g,2p)

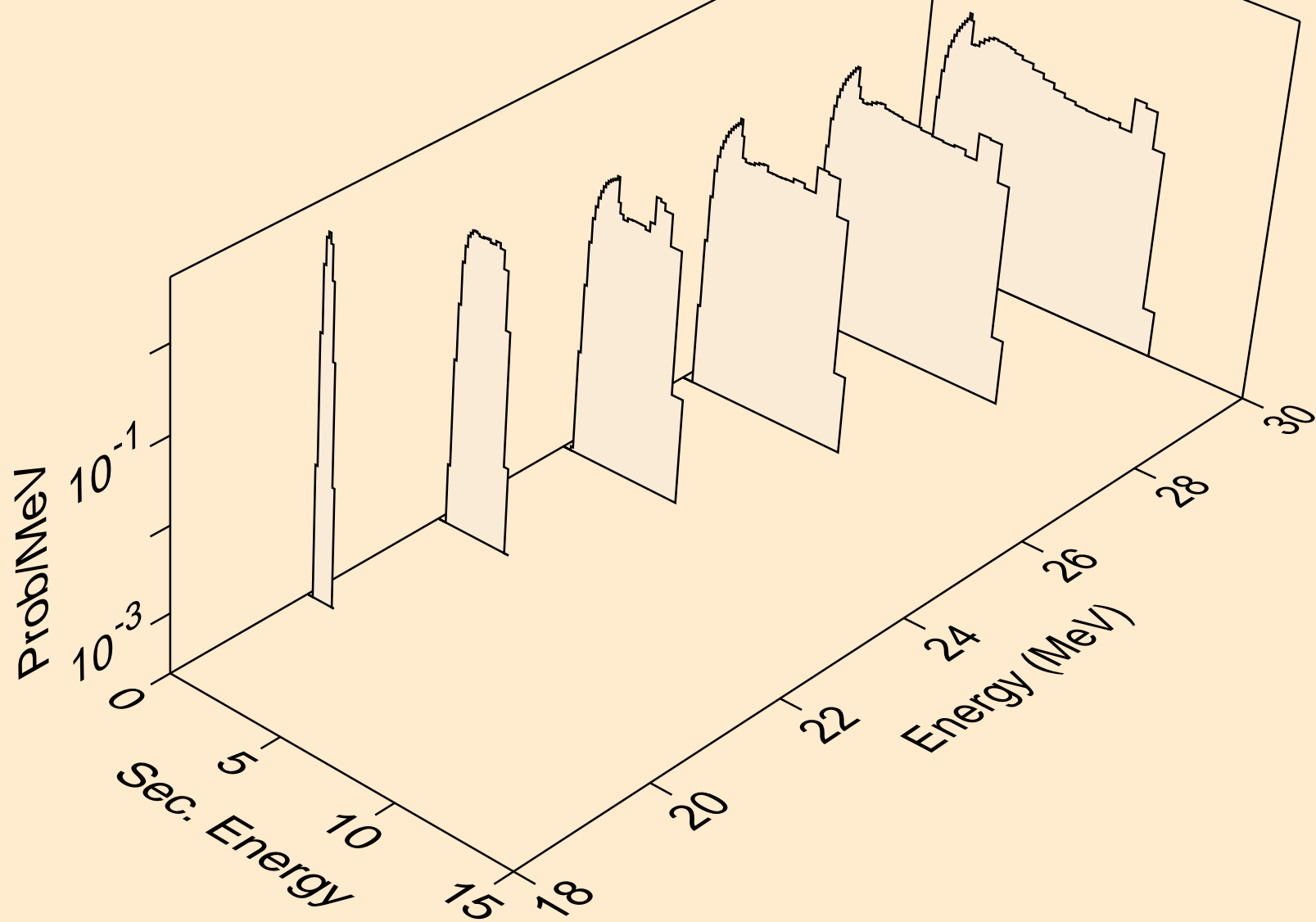

AR038 PHOTON ACER TENDL-2024 LIBRARY; T=0.K
protons from (g,pa)

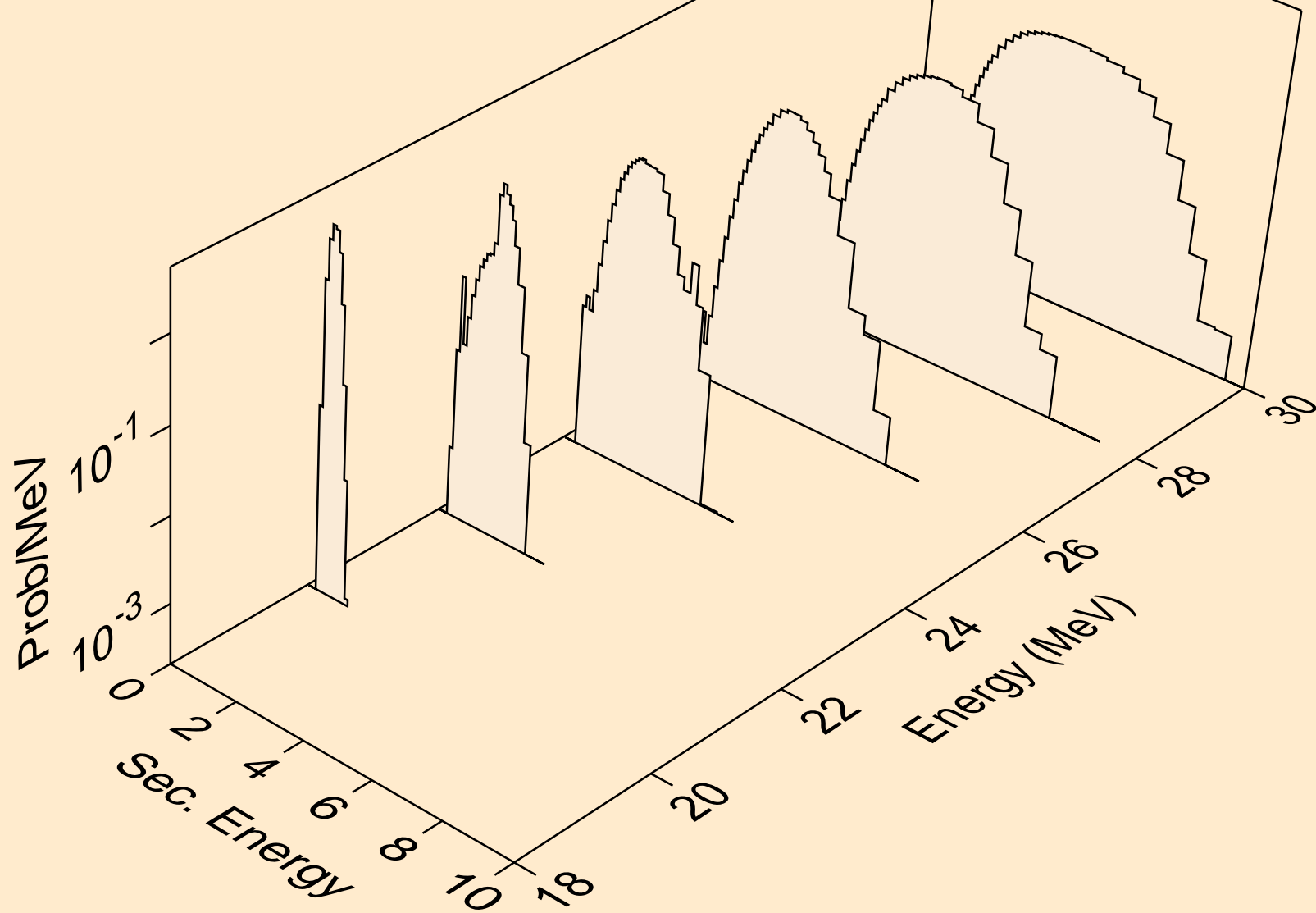

AR038 PHOTON ACER TENDL-2024 LIBRARY; T=0.K
protons from (g,pd)

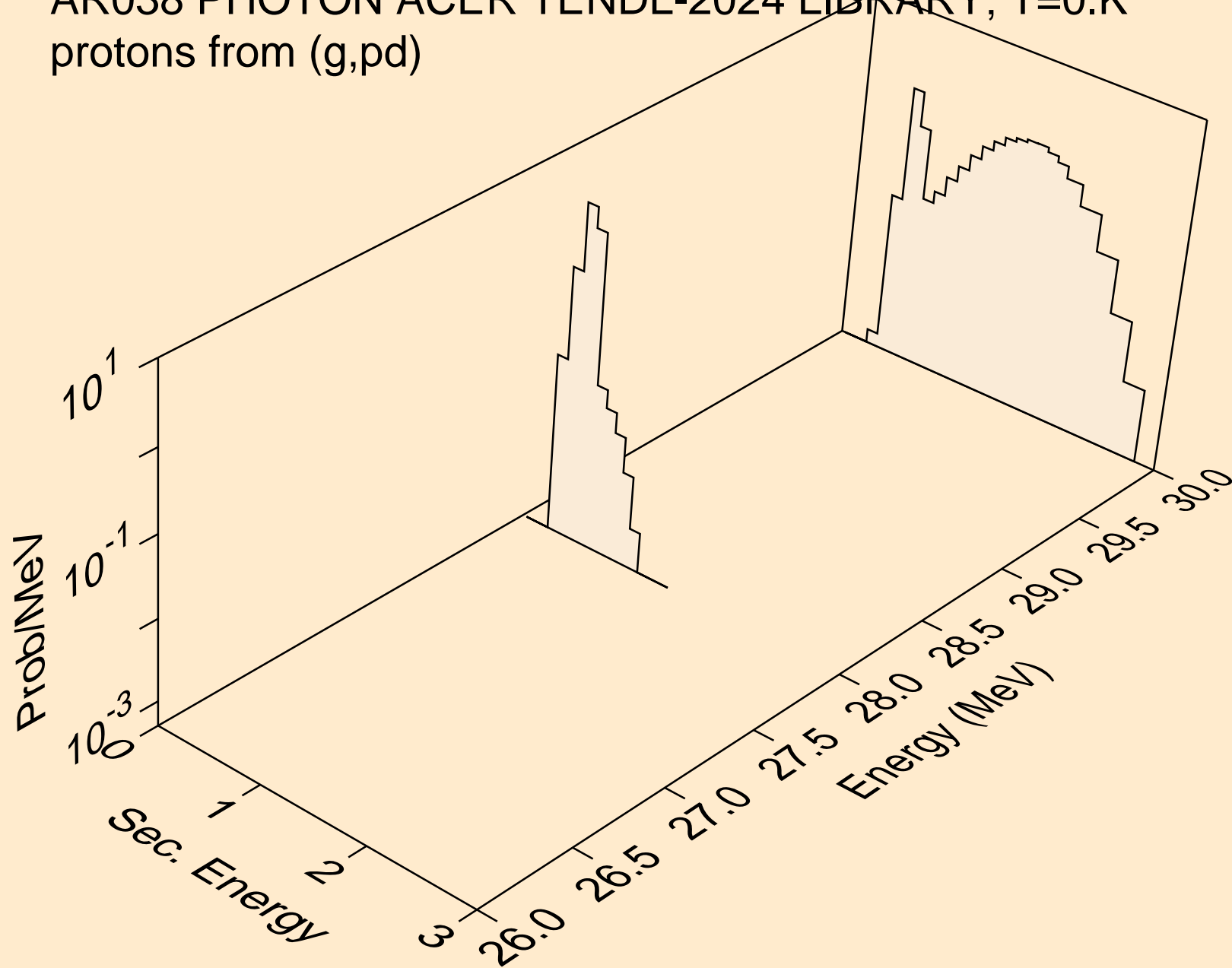

AR038 PHOTON ACER TENDL-2024 LIBRARY; T=0.K
protons from (g,pt)

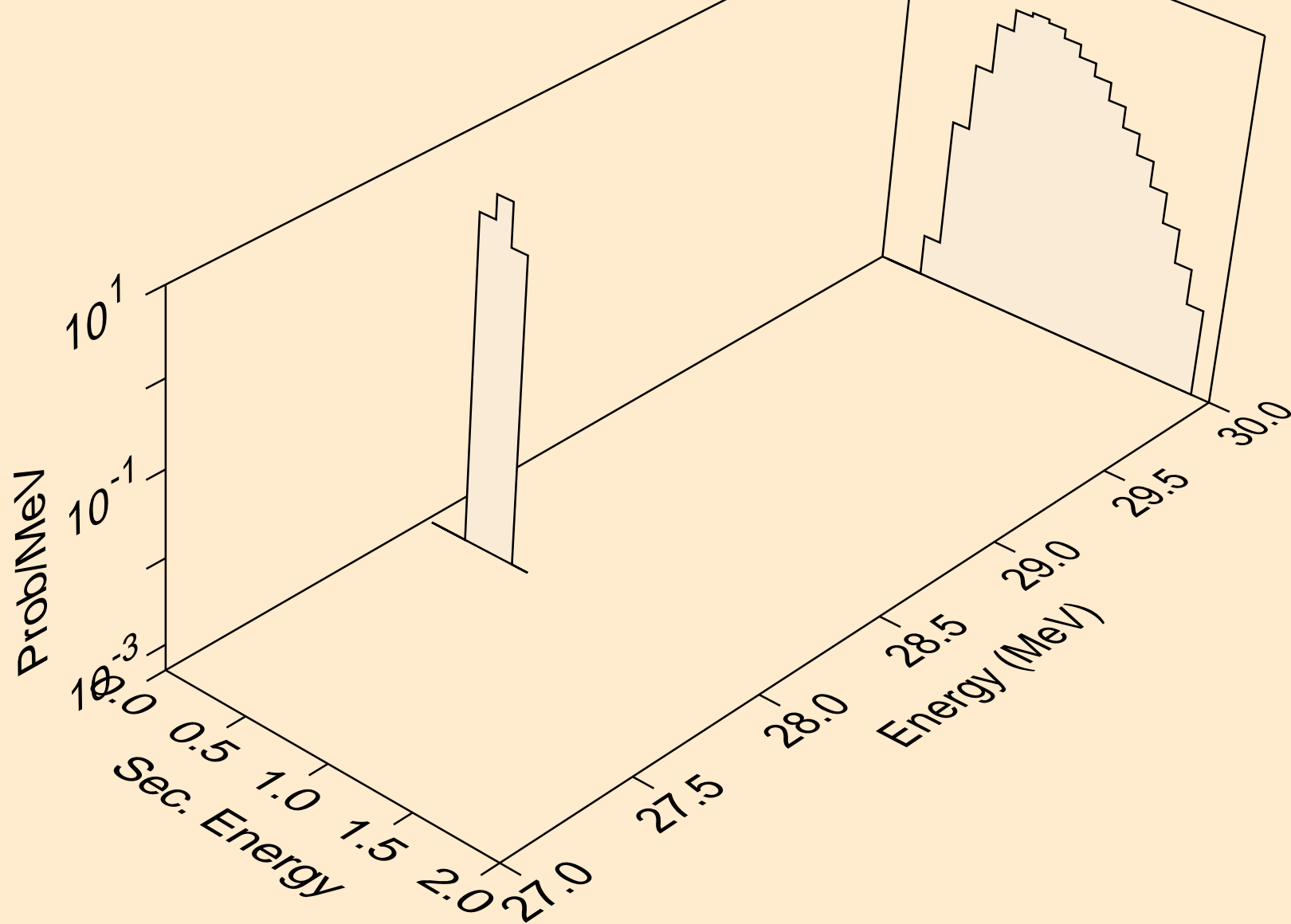

AR038 PHOTON ACER TENDL-2024 LIBRARY; T=0.K
deuterons from (g,x)

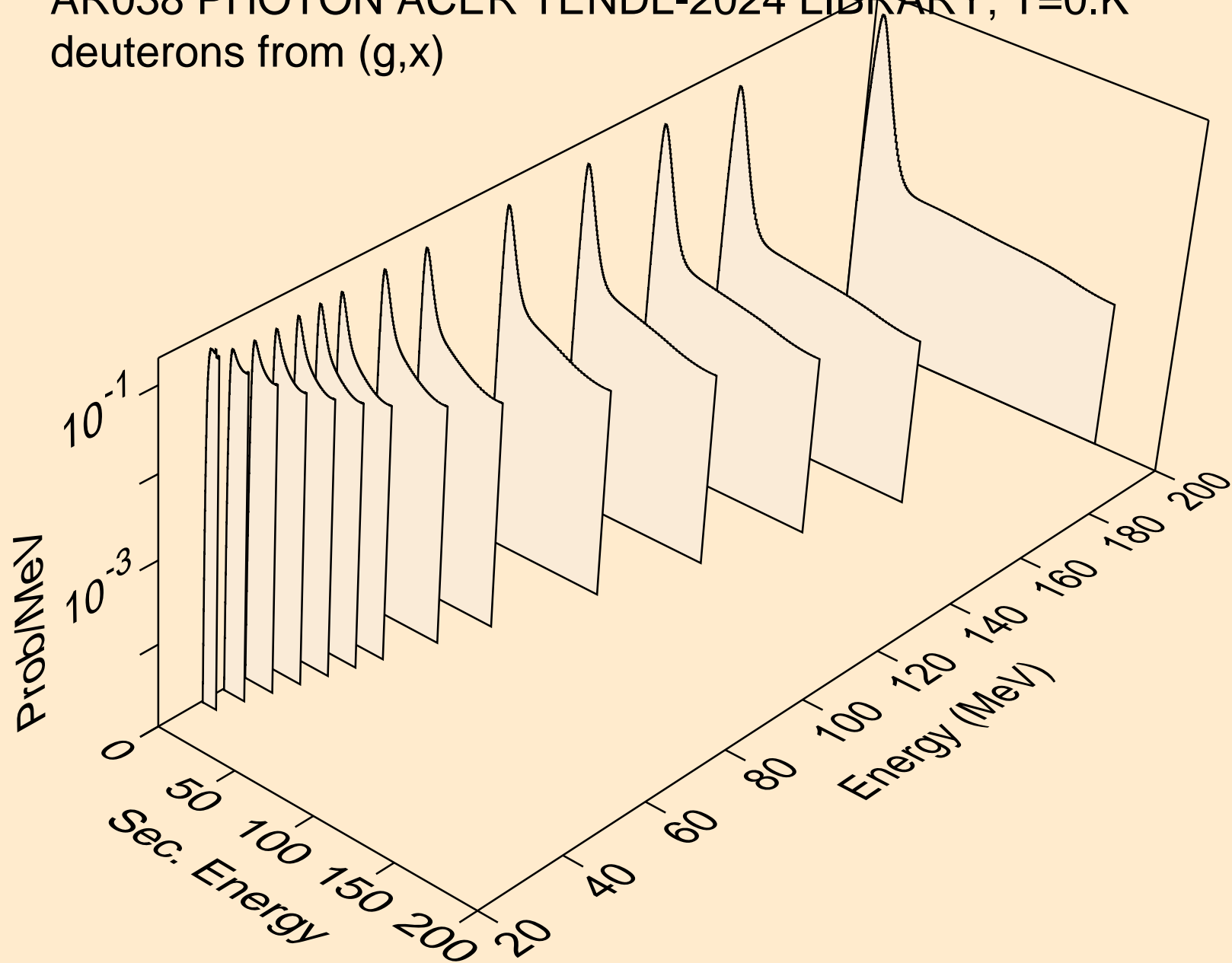

AR038 PHOTON ACER TENDL-2024 LIBRARY; T=0.K
deuterons from (g,n*)d

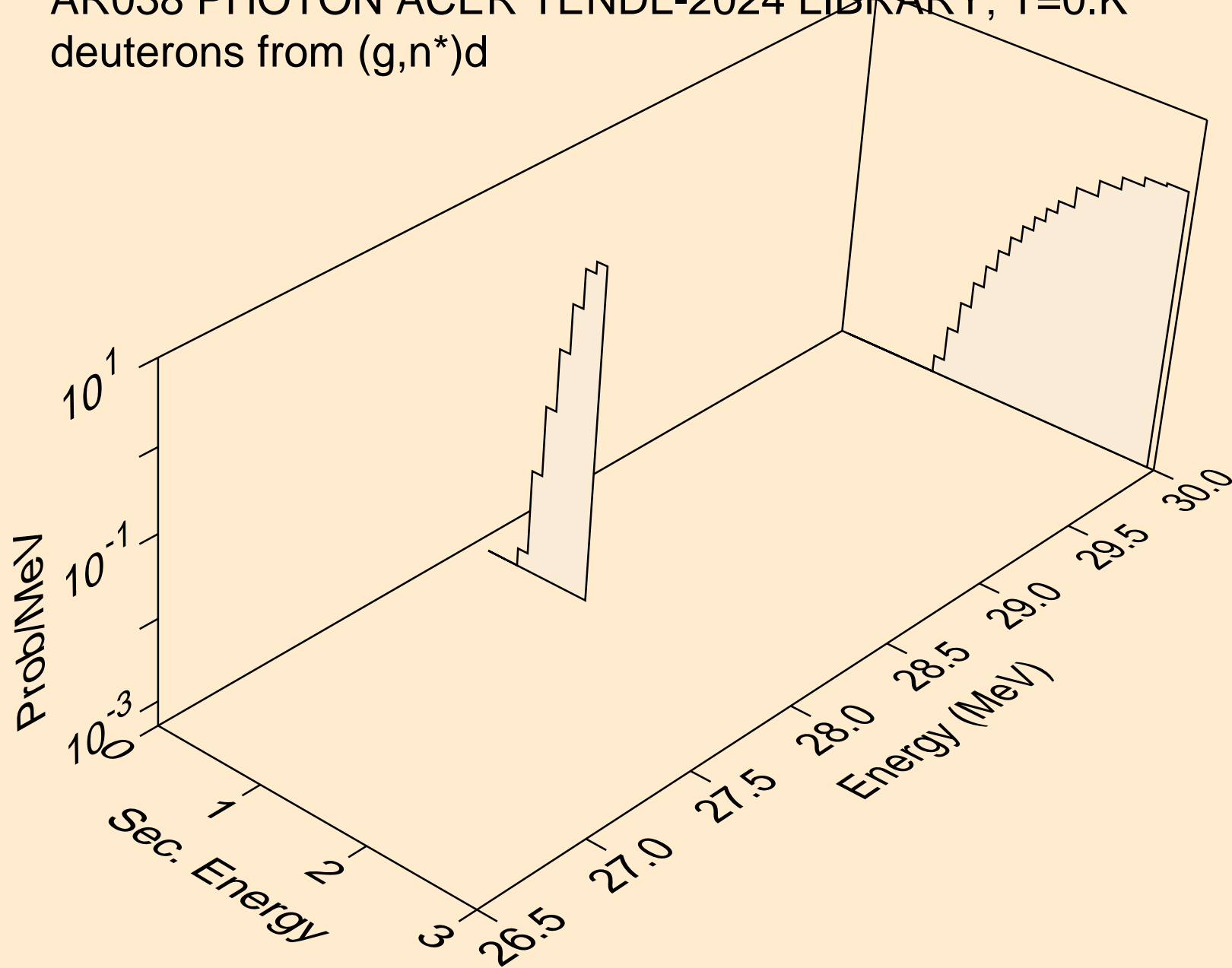

AR038 PHOTON ACER TENDL-2024 LIBRARY; T=0.K
deuterons from (g,d)

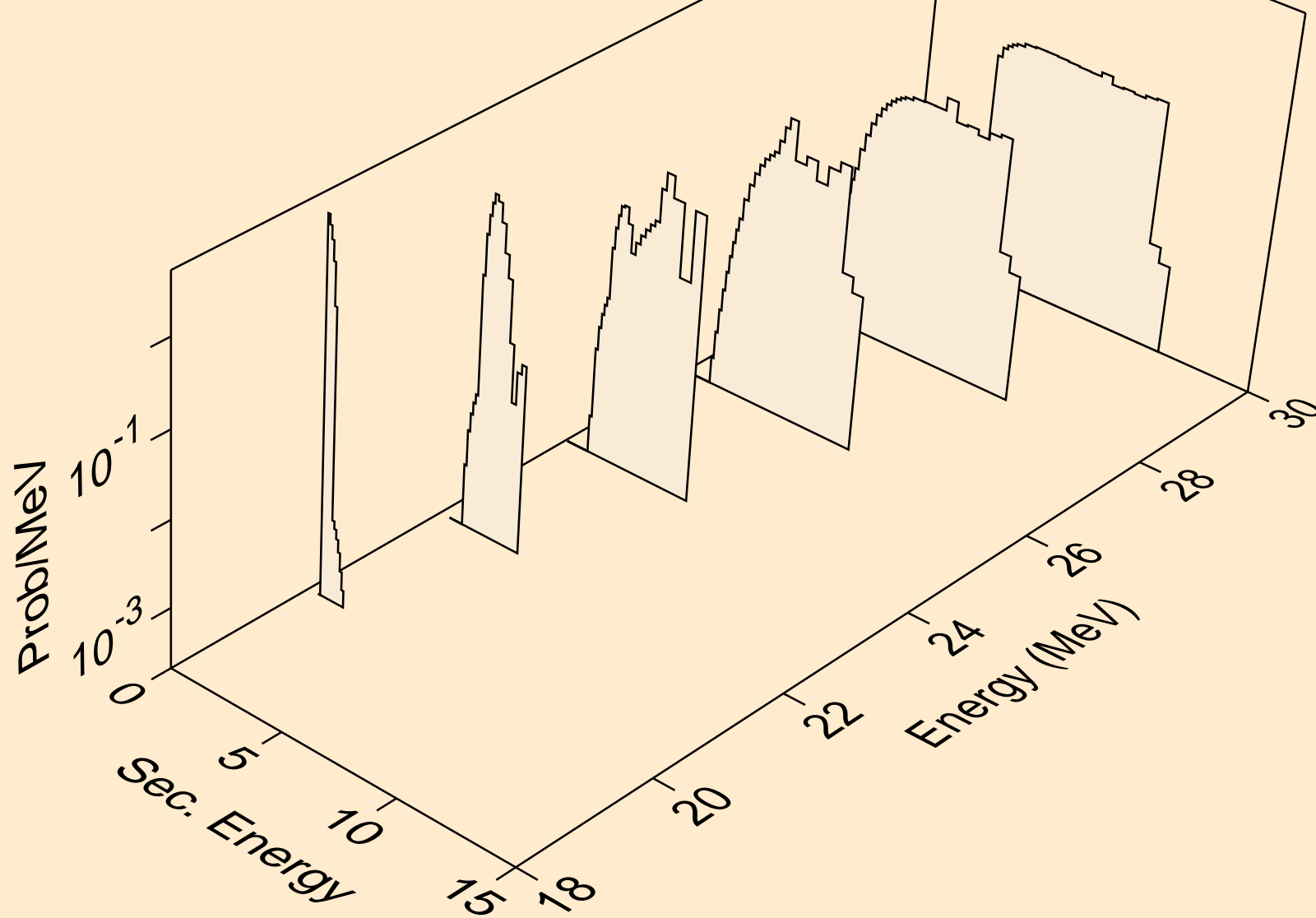

AR038 PHOTON ACER TENDL-2024 LIBRARY; T=0.K
deuterons from (g,pd)

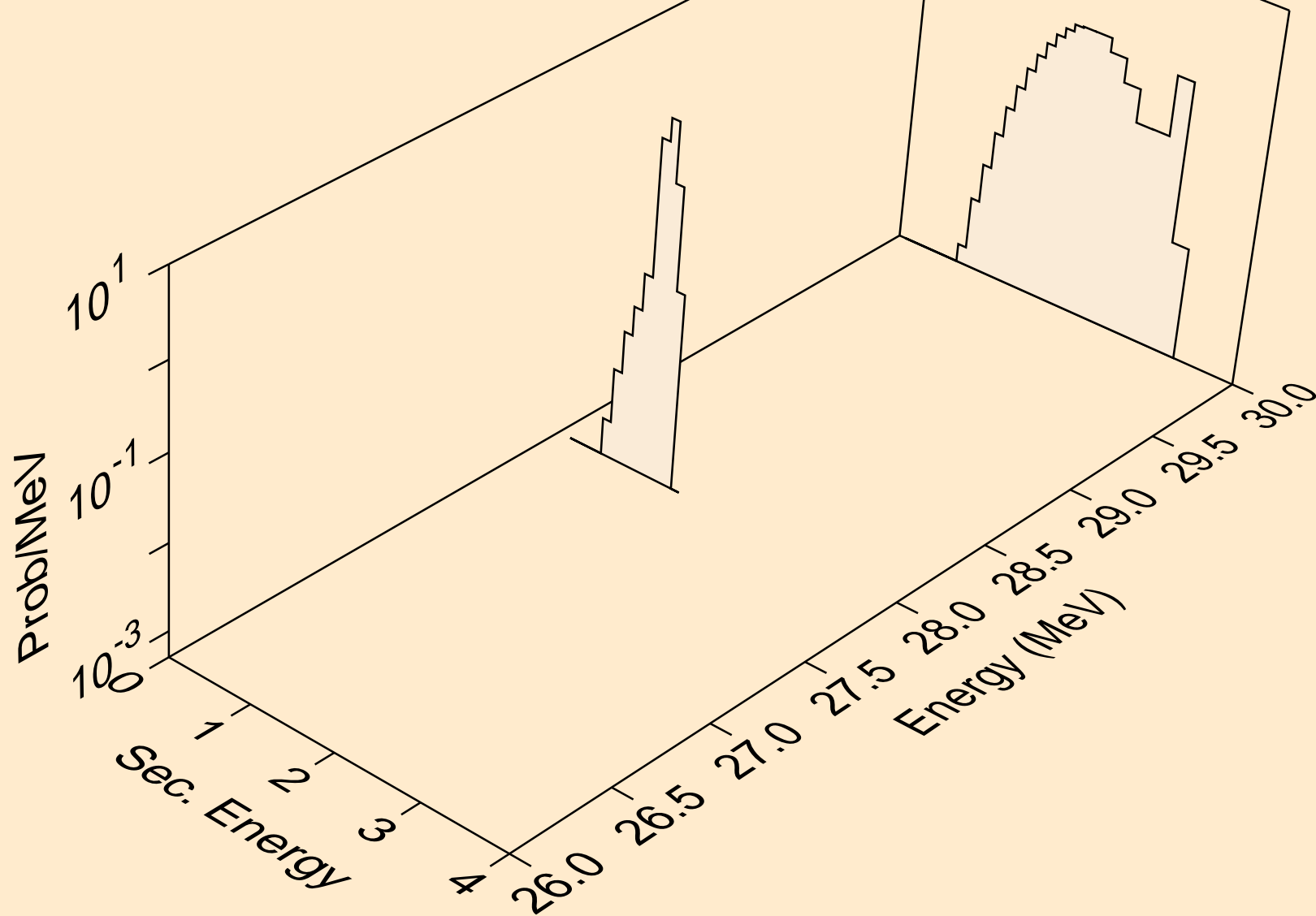

AR038 PHOTON ACER TENDL-2024 LIBRARY; T=0.K
tritons from (g,x)

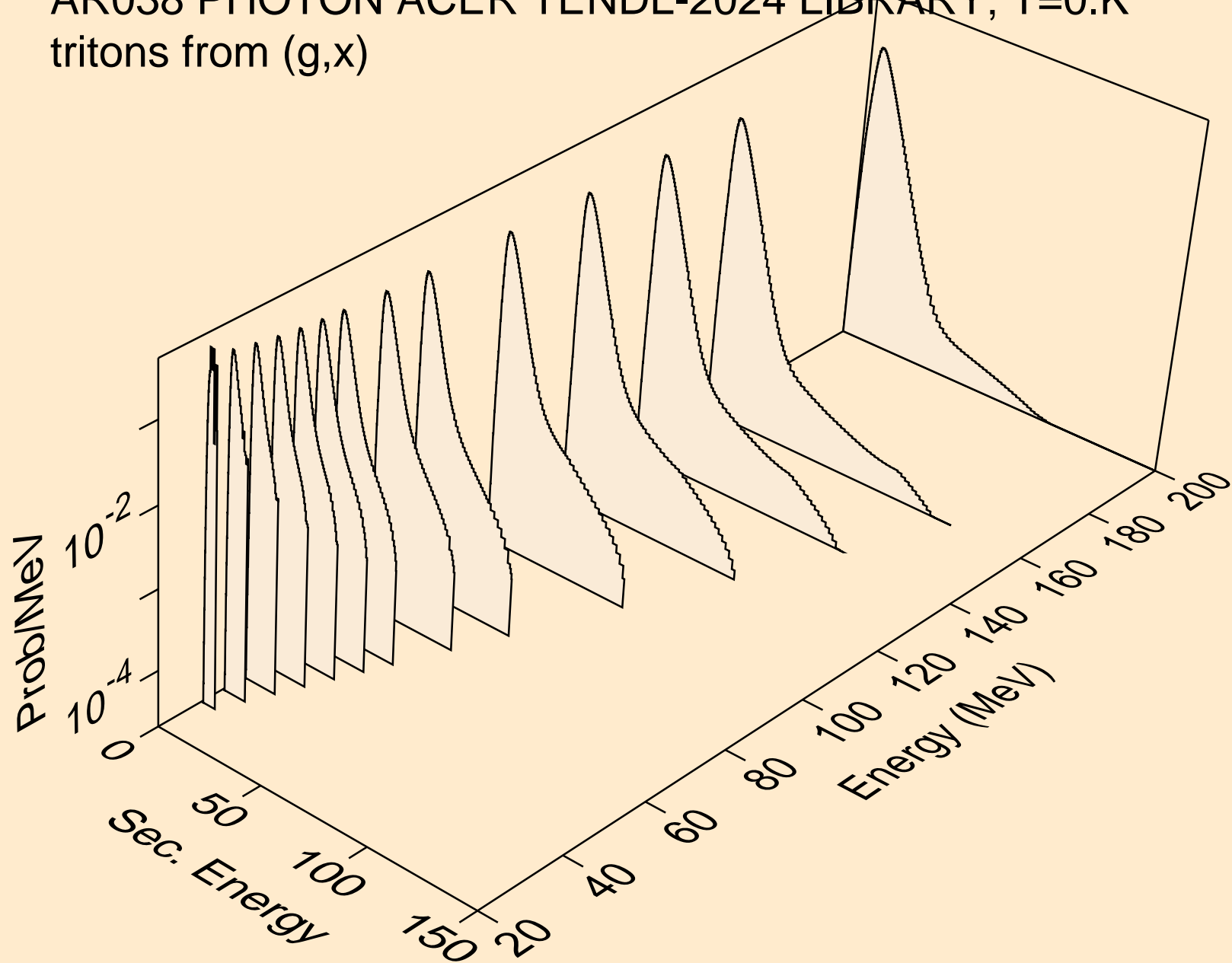

AR038 PHOTON ACER TENDL-2024 LIBRARY; T=0.K
tritons from (g,t)

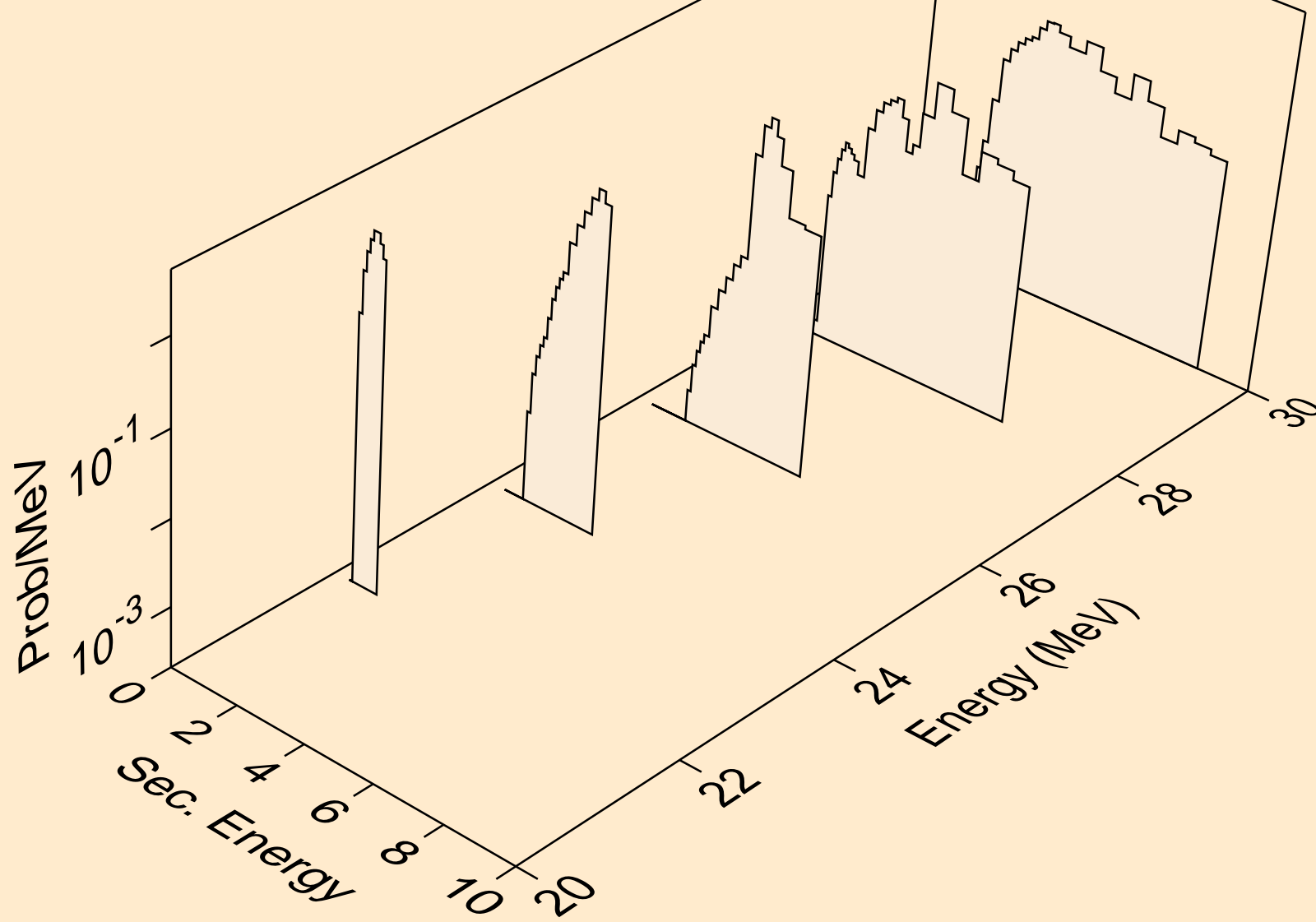

AR038 PHOTON ACER TENDL-2024 LIBRARY; T=0.K
tritons from (g,pt)

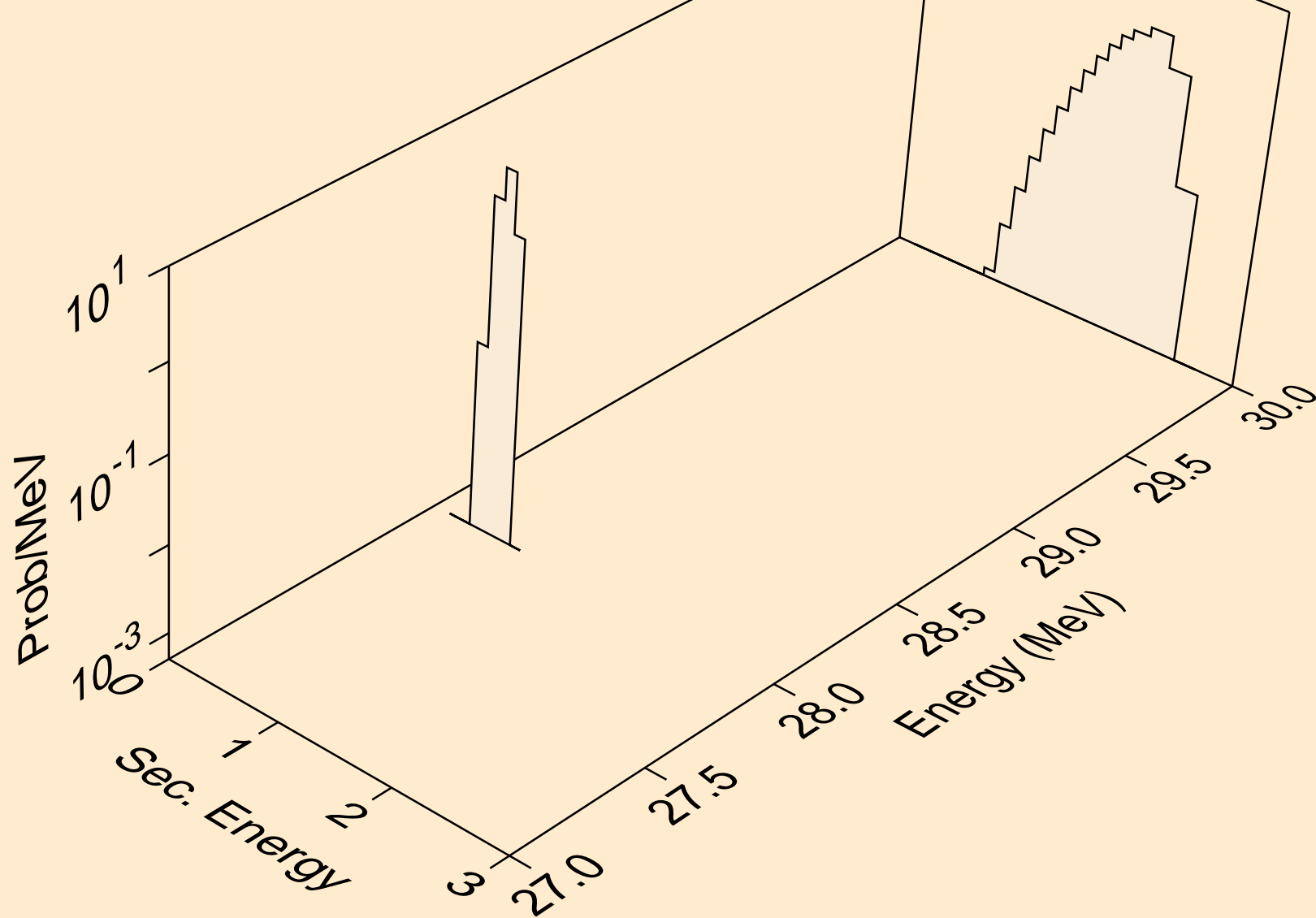

AR038 PHOTON ACER TENDL-2024 LIBRARY; T=0.K
he3s from (g,x)

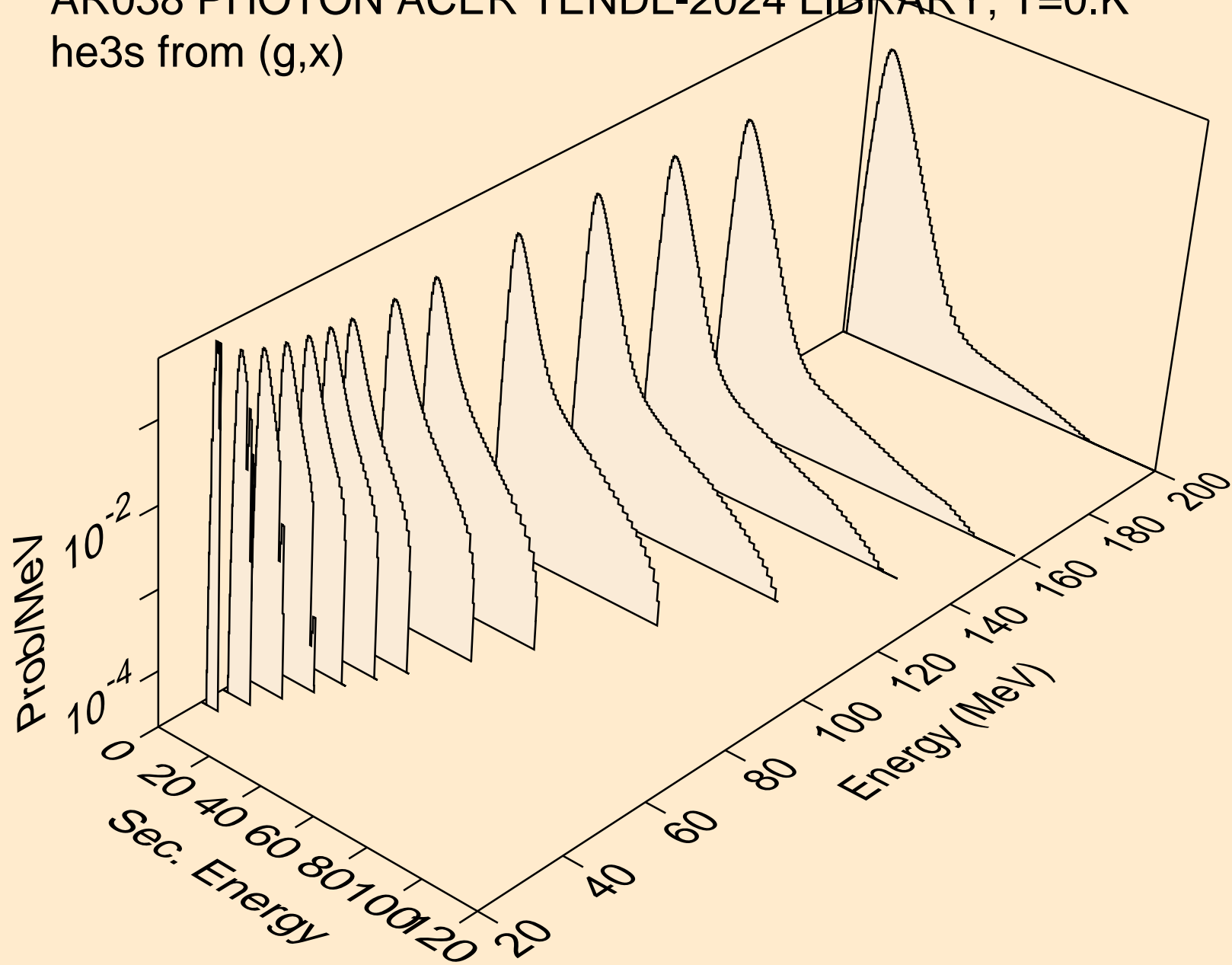

AR038 PHOTON ACER TENDL-2024 LIBRARY; T=0.K
he3s from (g,he3)

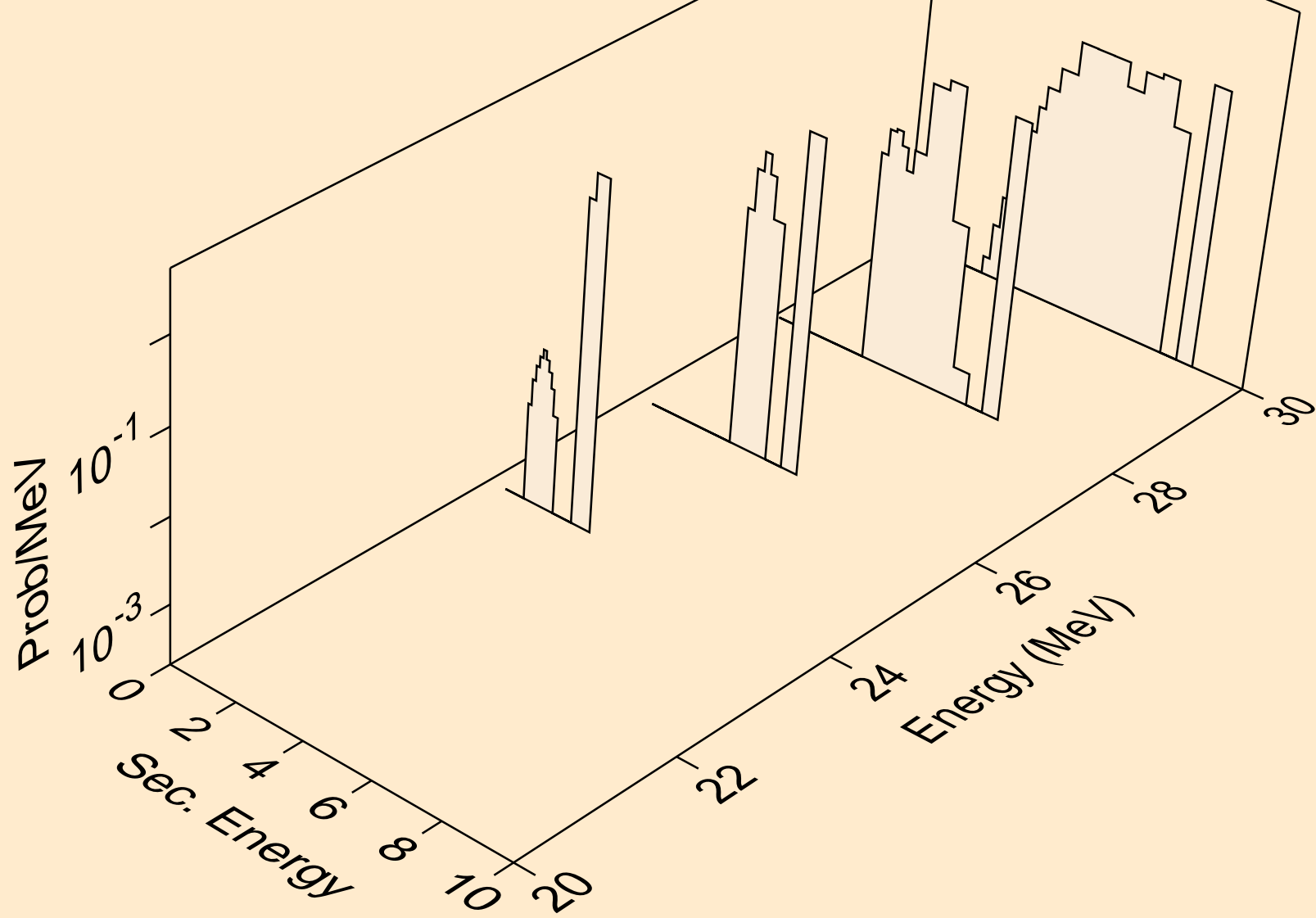

AR038 PHOTON ACER TENDL-2024 LIBRARY; T=0.K
alphas from (g,x)

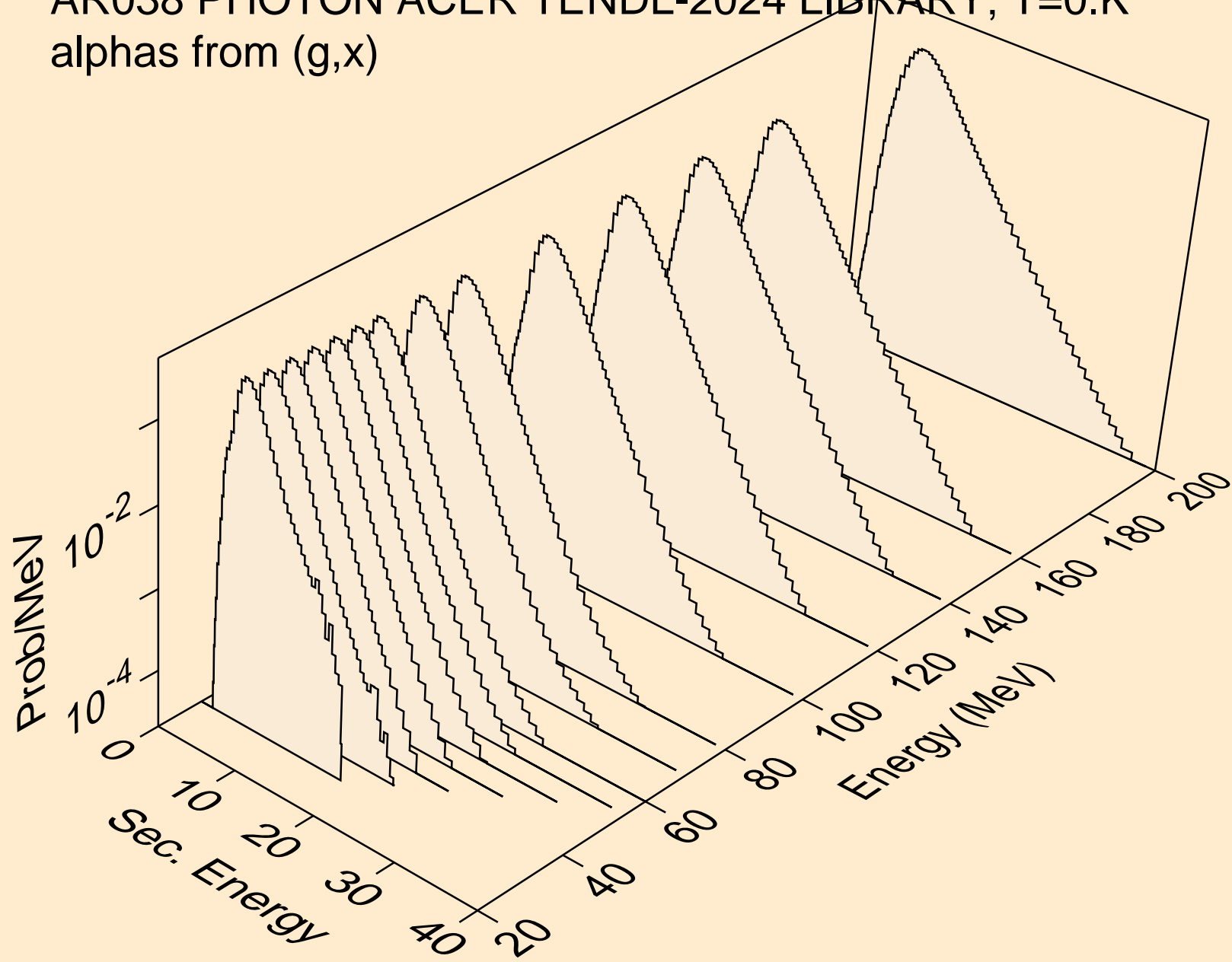

AR038 PHOTON ACER TENDL-2024 LIBRARY; T=0.K
alphas from (g,n*)a

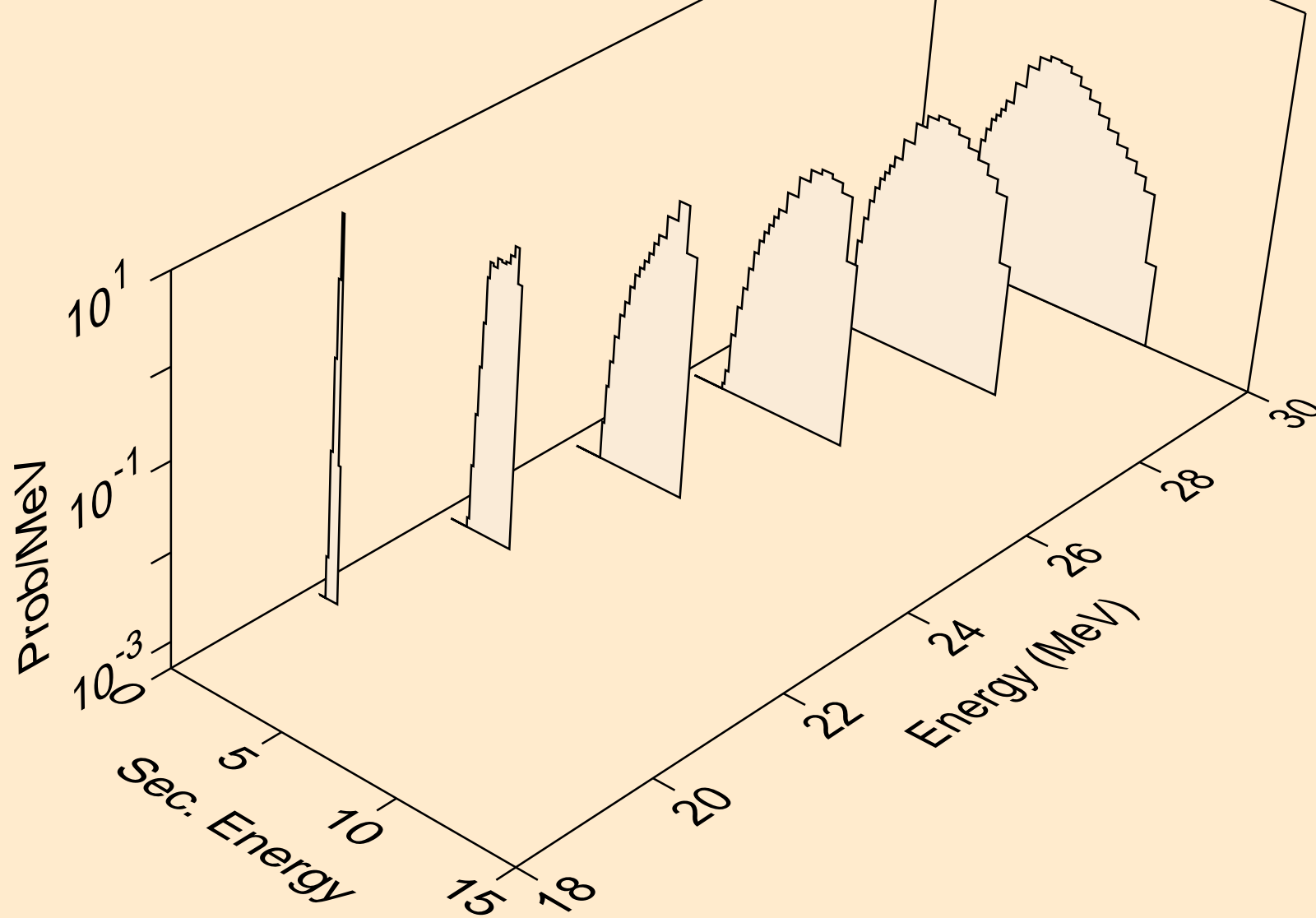

AR038 PHOTON ACER TENDL-2024 LIBRARY; T=0.K
alphas from (g,a)

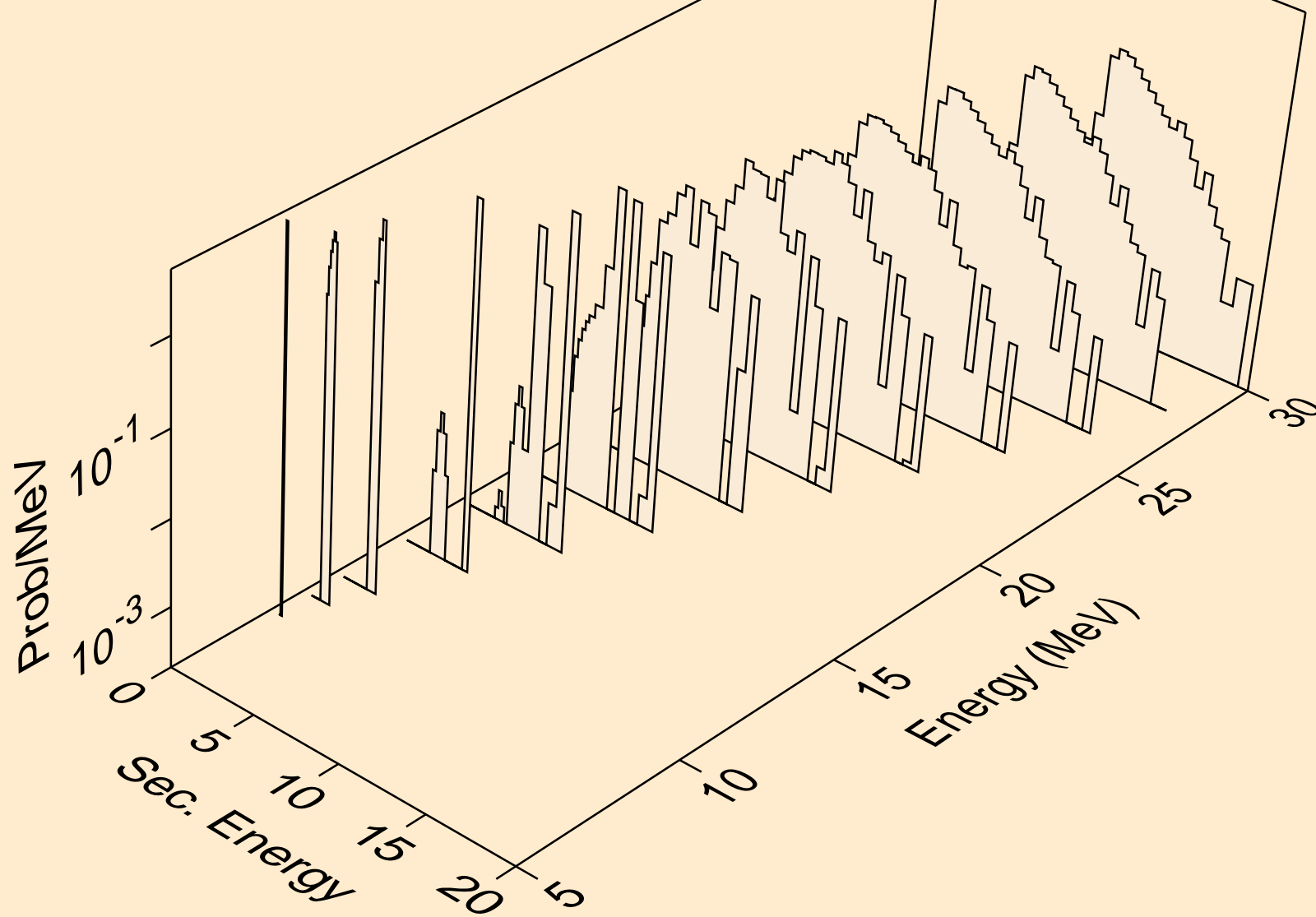

AR038 PHOTON ACER TENDL-2024 LIBRARY; T=0.K
alphas from (g,2a)

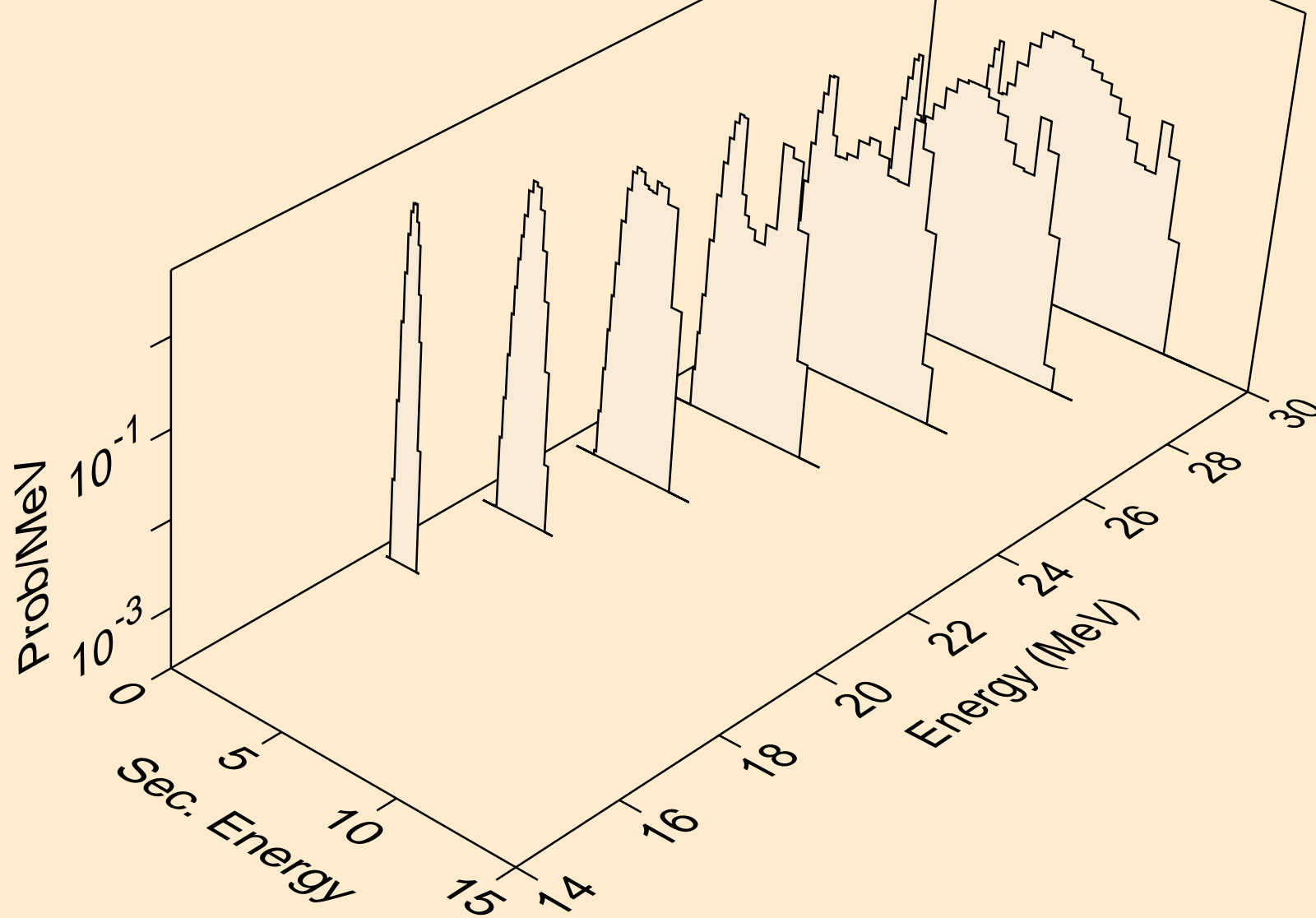

AR038 PHOTON ACER TENDL-2024 LIBRARY; T=0.K
alphas from (g,pa)

