

C011 PHOTON ACER TENDL-2024 LIBRARY; T=0.K  
Principal cross sections

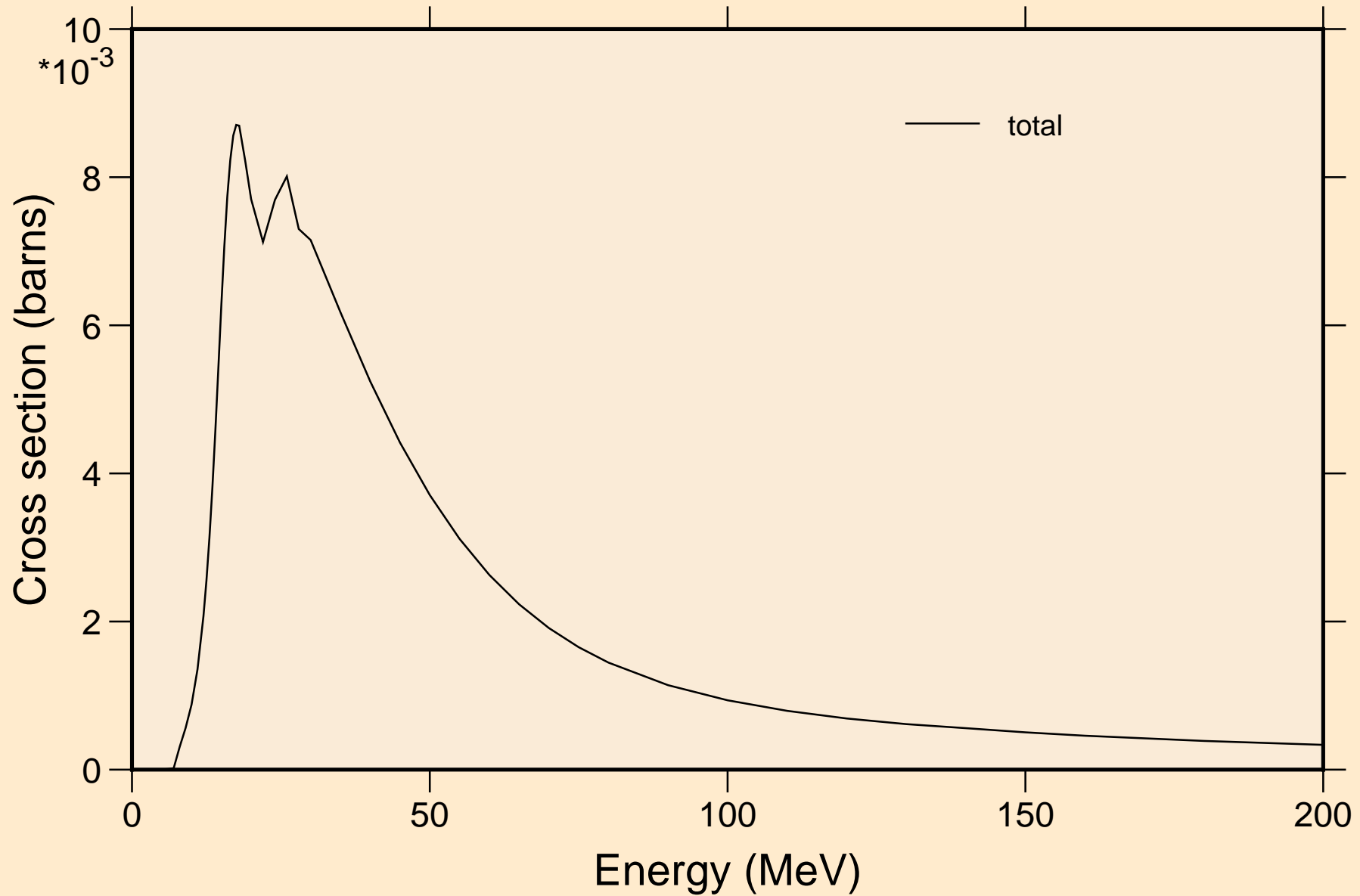

# C011 PHOTON ACER TENDL-2024 LIBRARY; T=0.K

## Partial cross sections

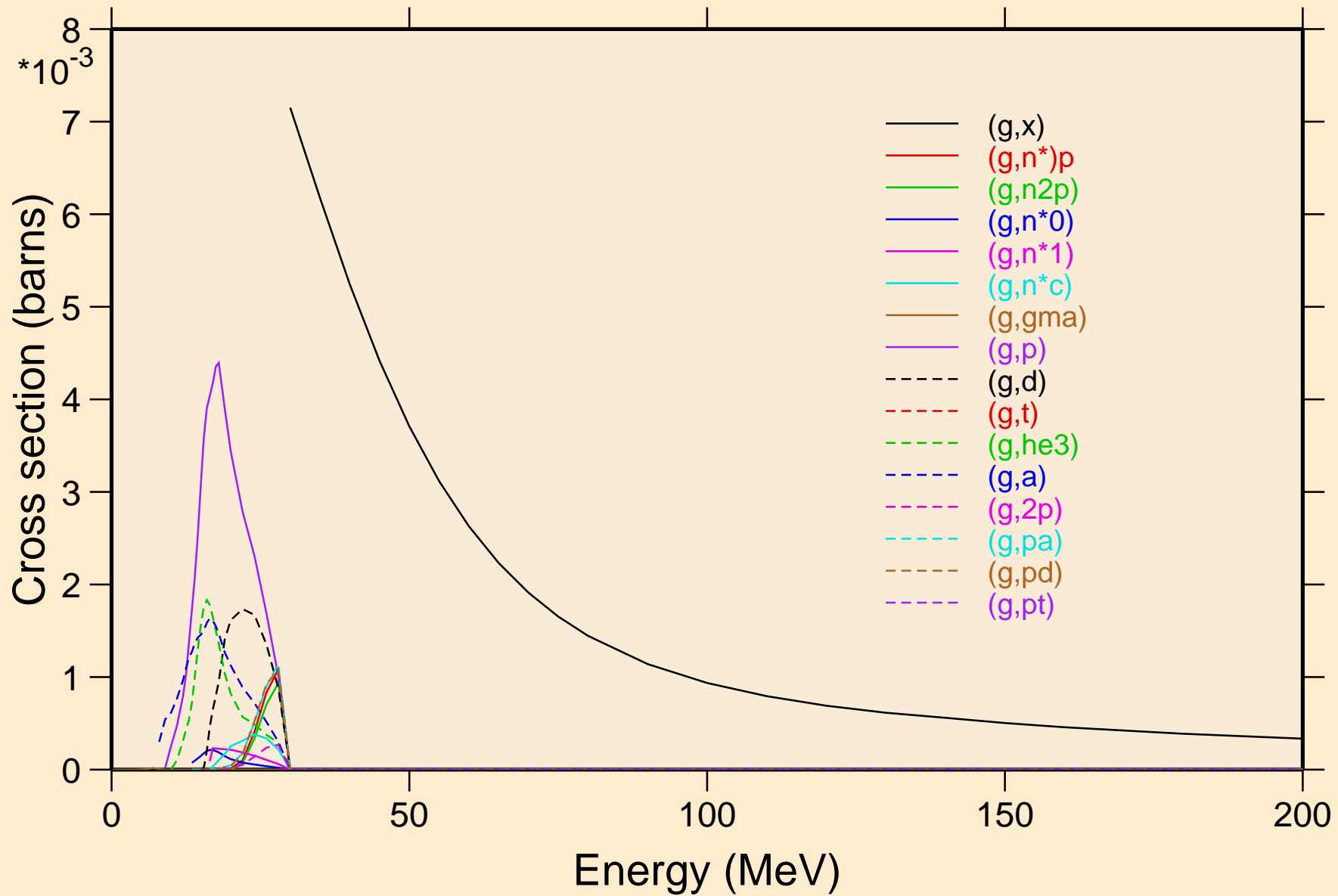

# C011 PHOTON ACER TENDL-2024 LIBRARY; T=0.K

## Heating

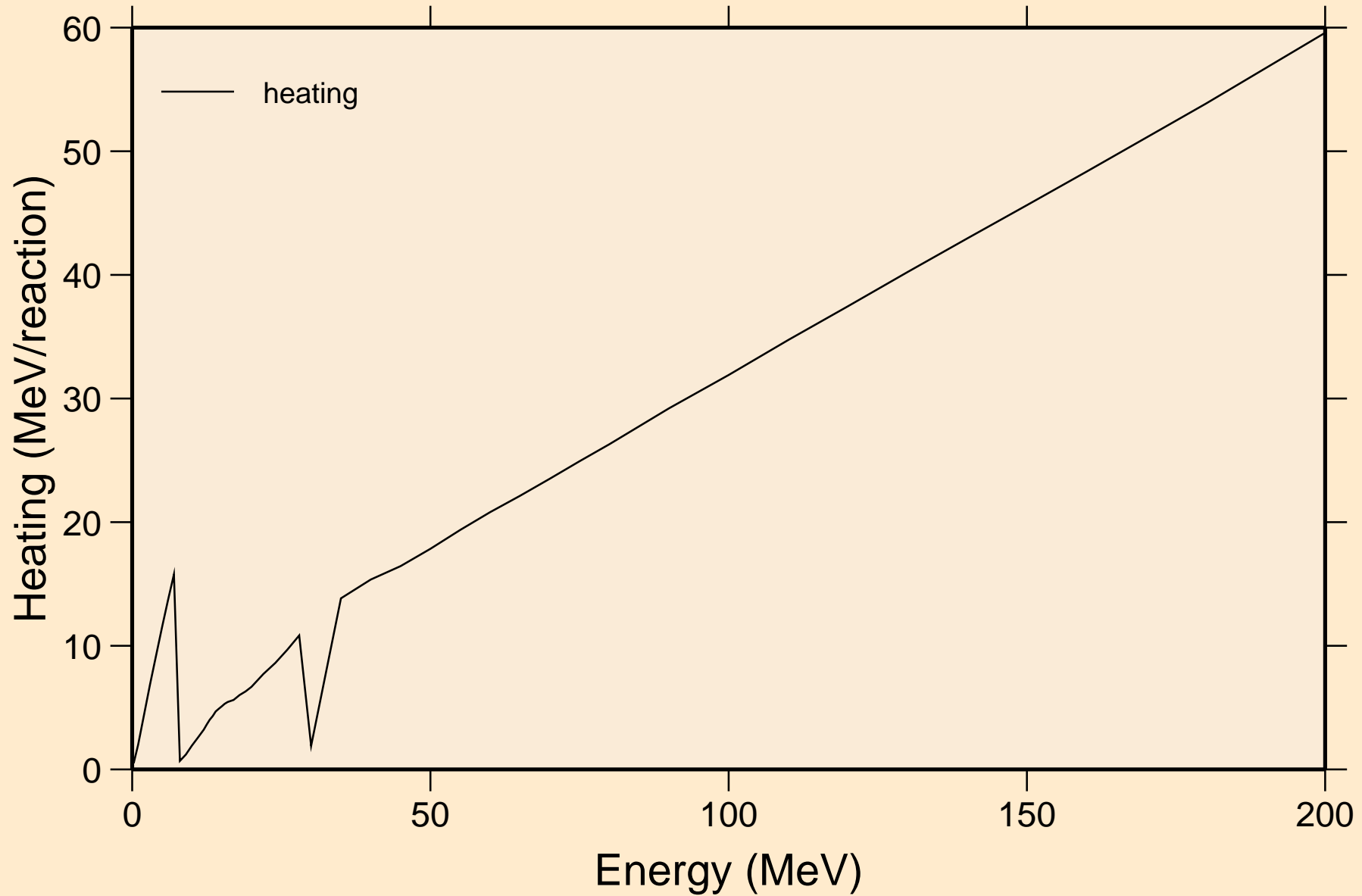

# C011 PHOTON ACER TENDL-2024 LIBRARY; T=0.K

## Particle heating contributions

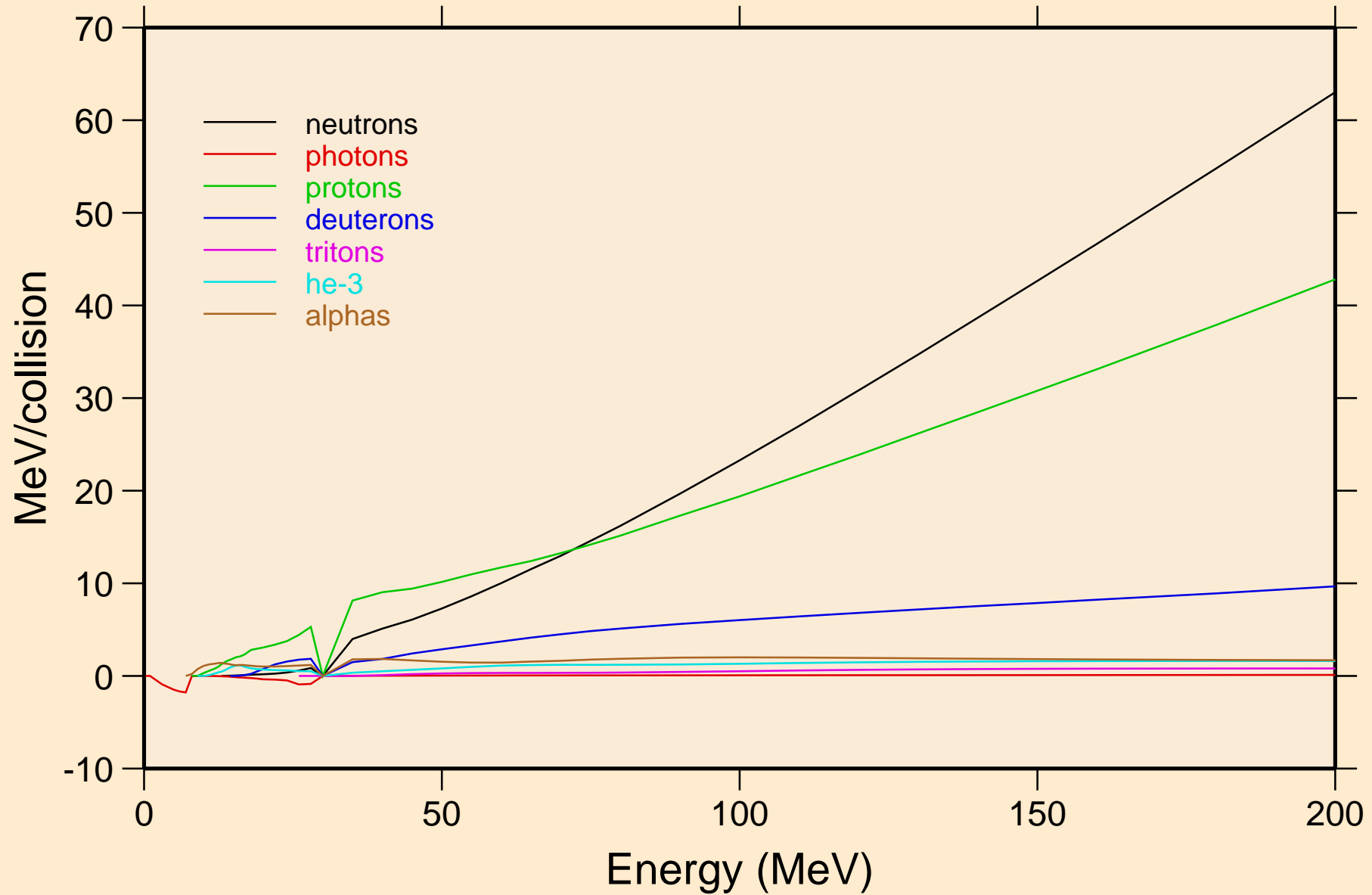

C011 PHOTON ACER TENDL-2024 LIBRARY; T=0.K  
Particle production cross sections

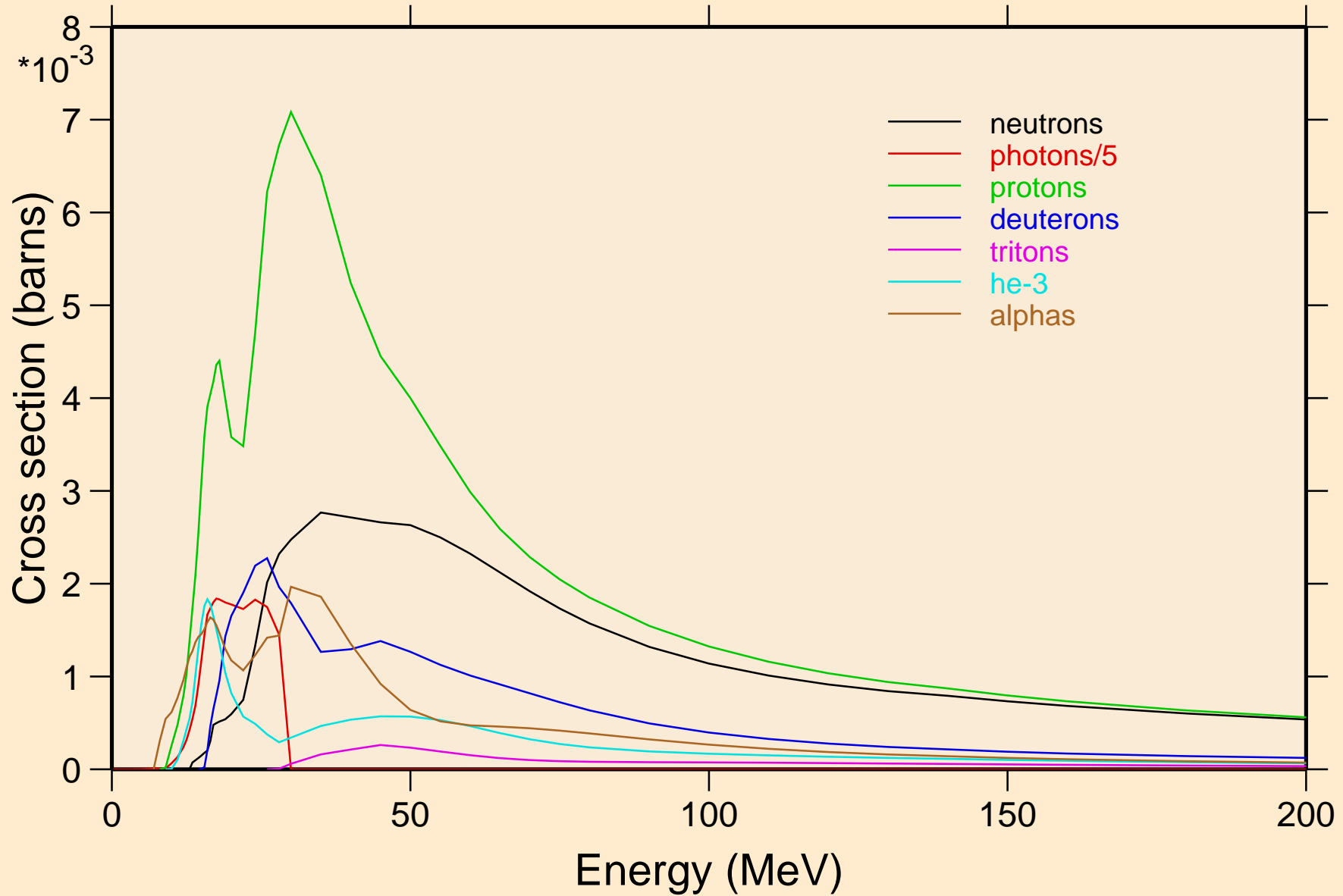

C011 PHOTON ACER TENDL-2024 LIBRARY; T=0.K  
neutrons from (g,x)

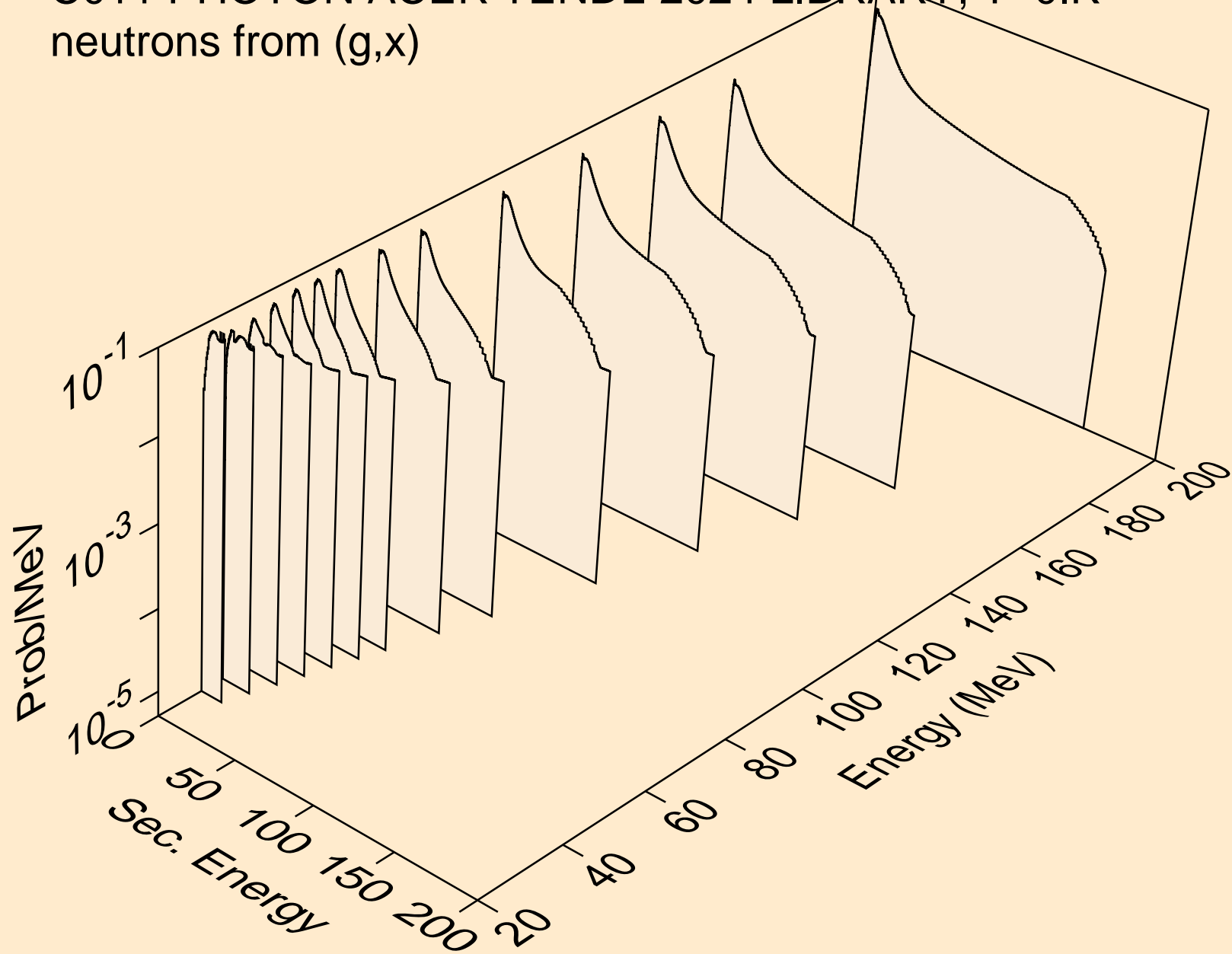

C011 PHOTON ACER TENDL-2024 LIBRARY; T=0.K  
neutrons from (g,n\*)p

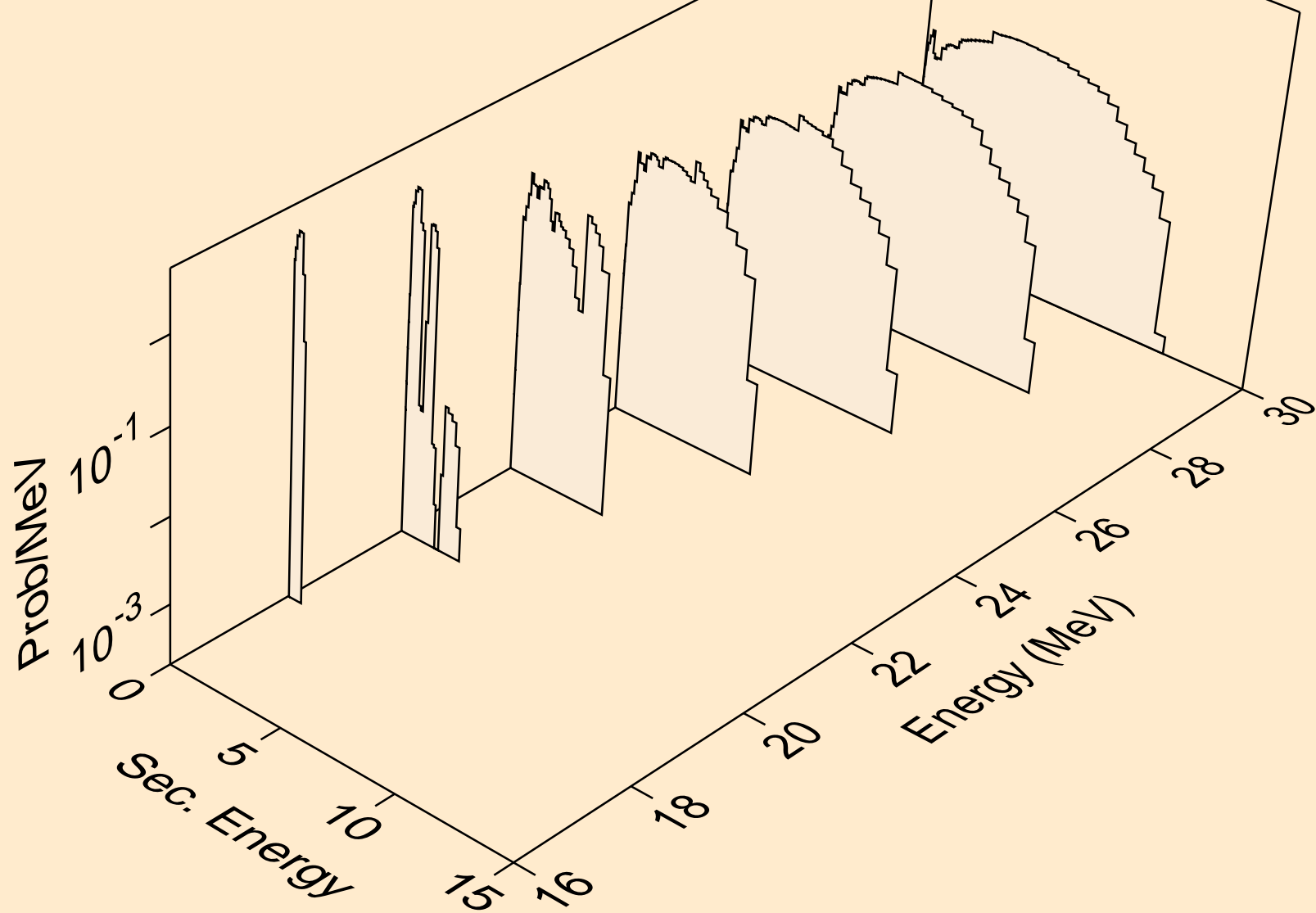

C011 PHOTON ACER TENDL-2024 LIBRARY; T=0.K  
neutrons from (g,n2p)

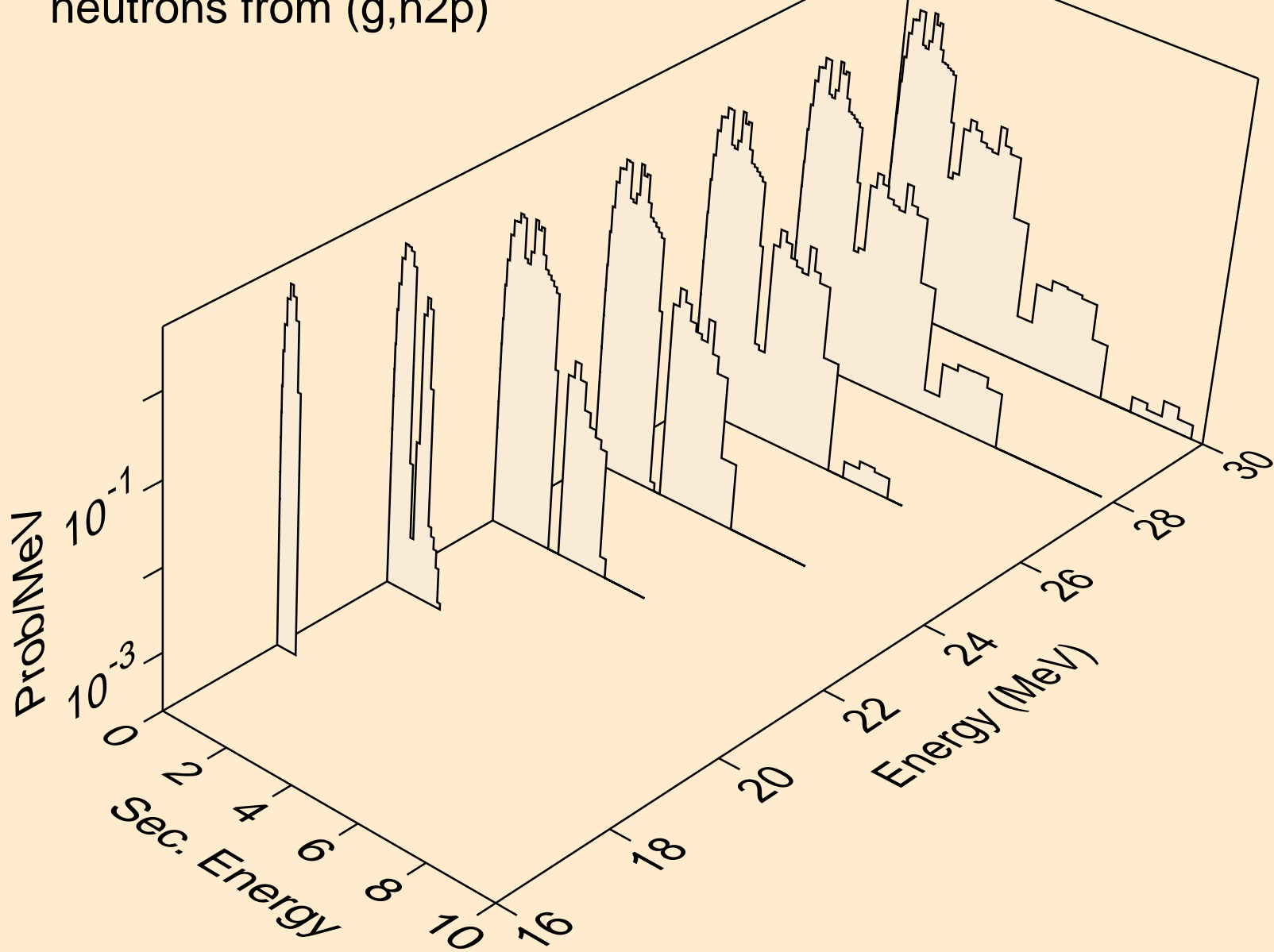

C011 PHOTON ACER TENDL-2024 LIBRARY; T=0.K  
angular distribution for (g,n\*0) neutron

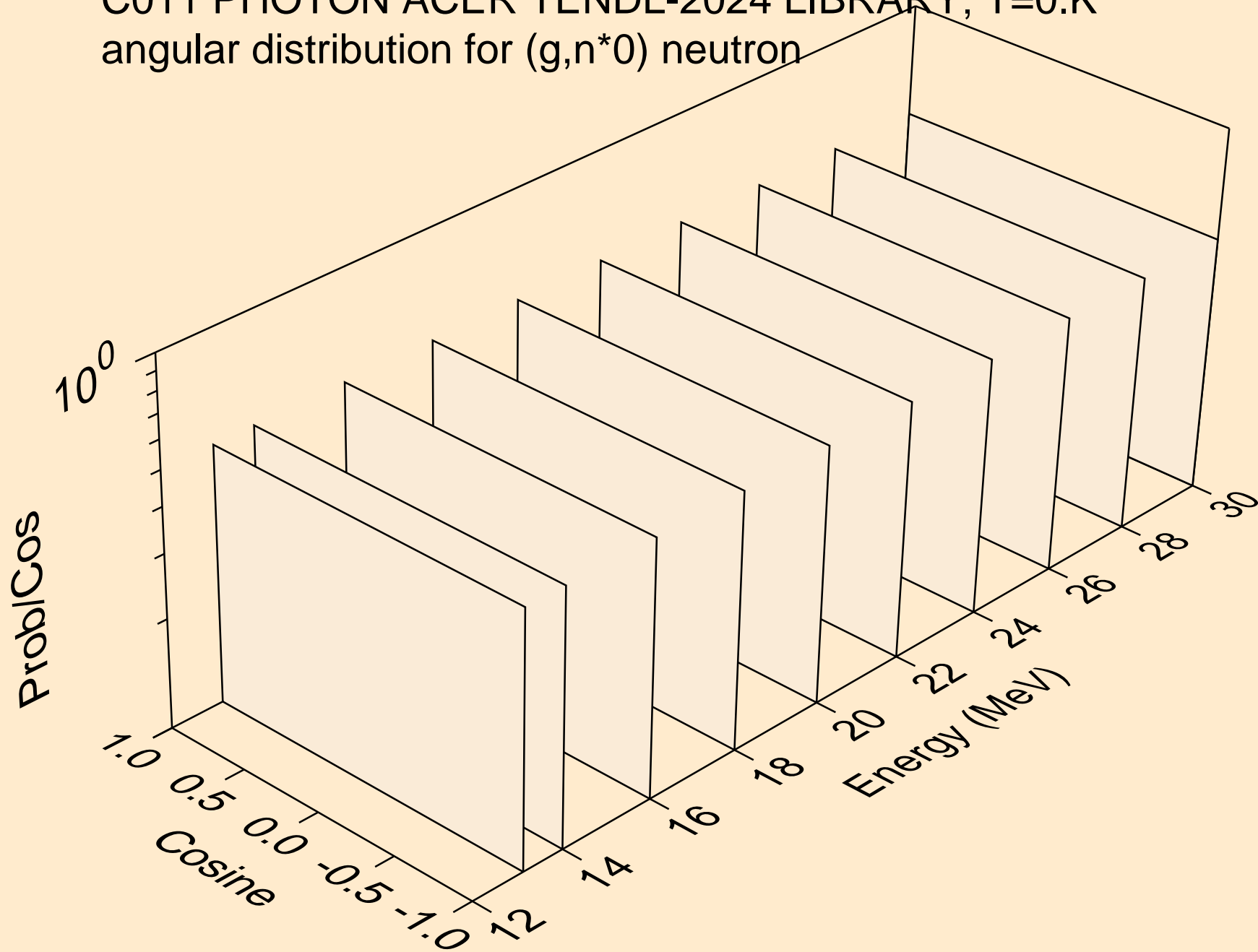

C011 PHOTON ACER TENDL-2024 LIBRARY; T=0.K  
angular distribution for (g,n\*1) neutron

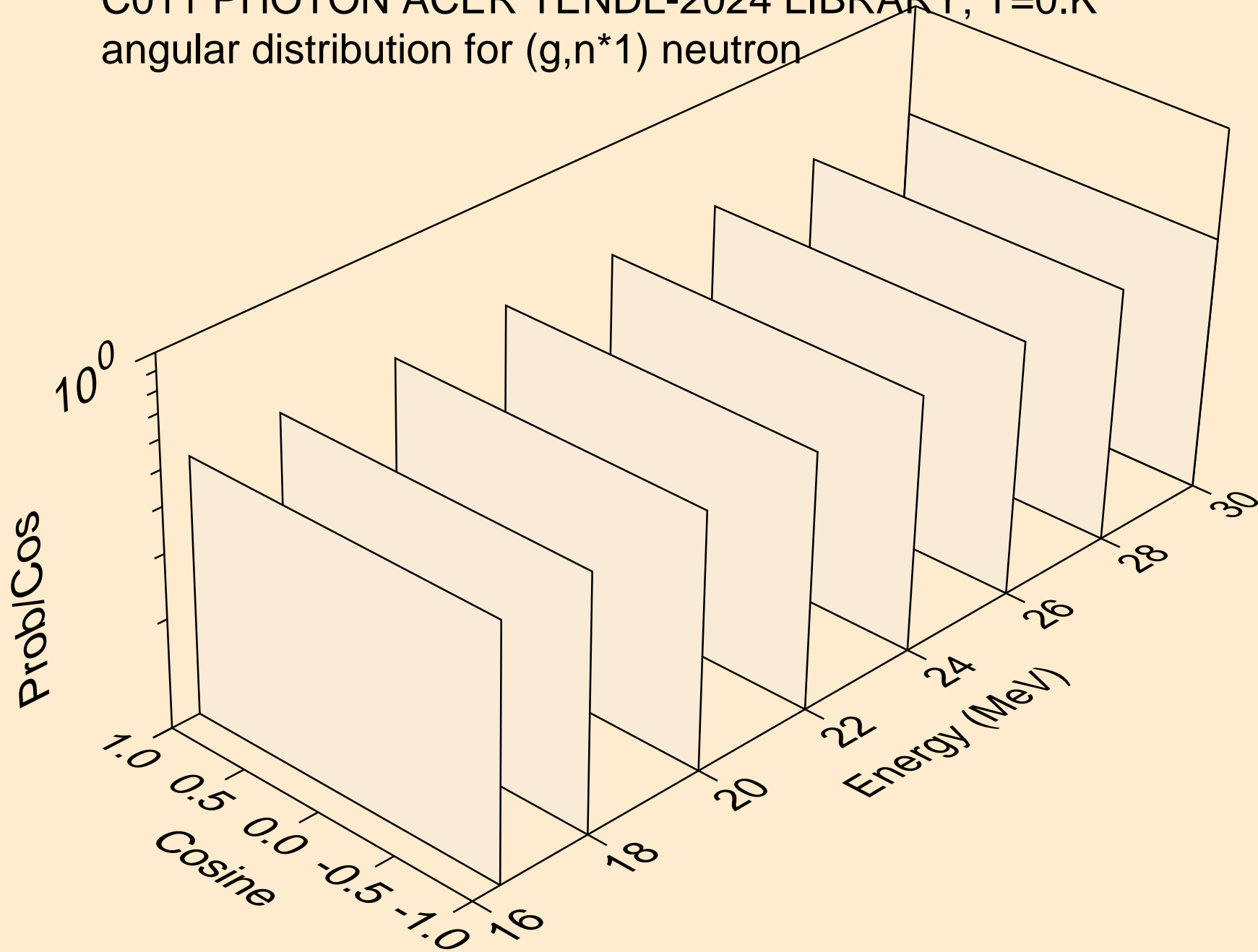

C011 PHOTON ACER TENDL-2024 LIBRARY; T=0.K  
neutrons from (g,n\*c)

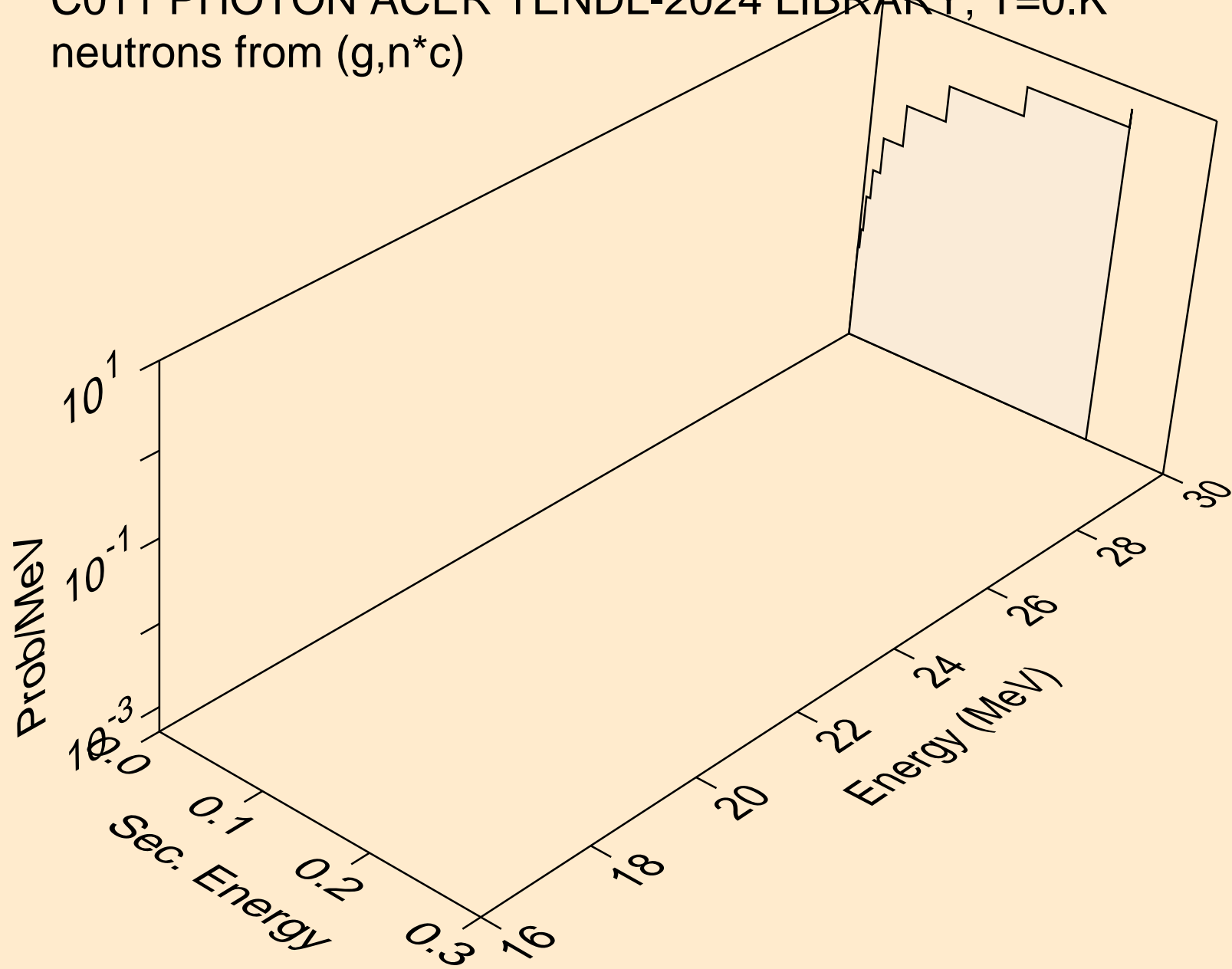

C011 PHOTON ACER TENDL-2024 LIBRARY; T=0.K  
photons from (g,x)

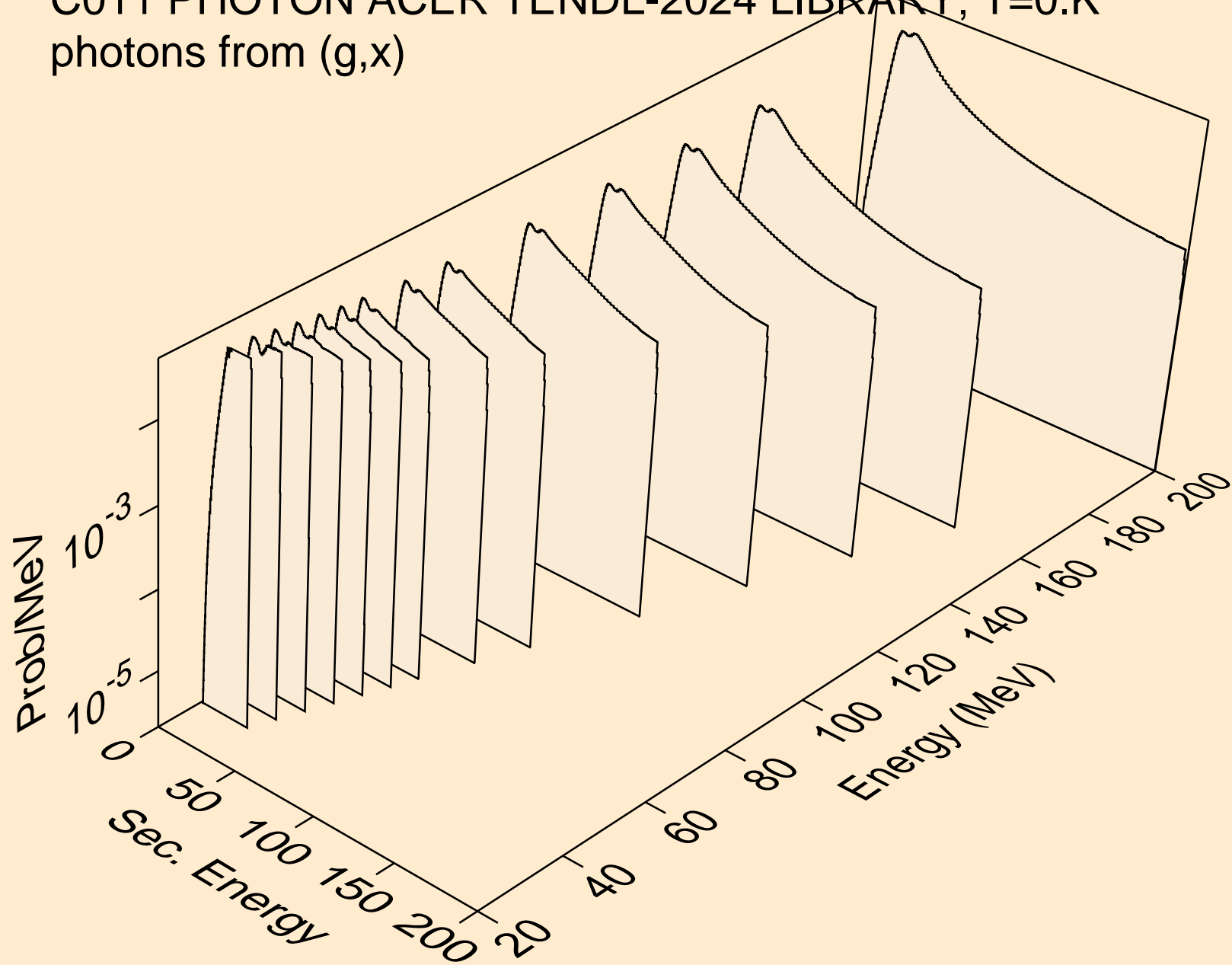

C011 PHOTON ACER TENDL-2024 LIBRARY; T=0.K  
photons from (g,n\*)p

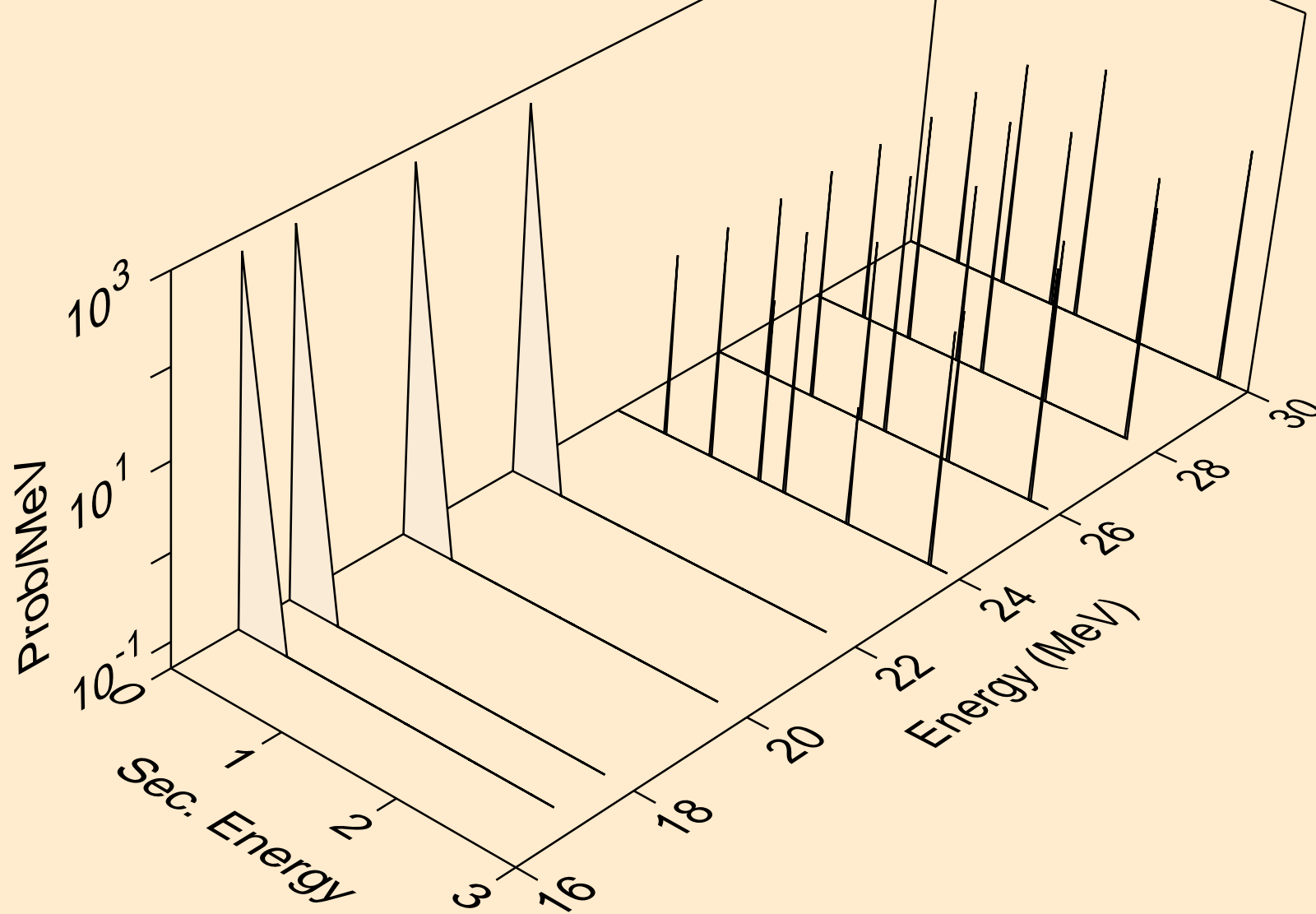

C011 PHOTON ACER TENDL-2024 LIBRARY; T=0.K  
photons from (g,n2p)

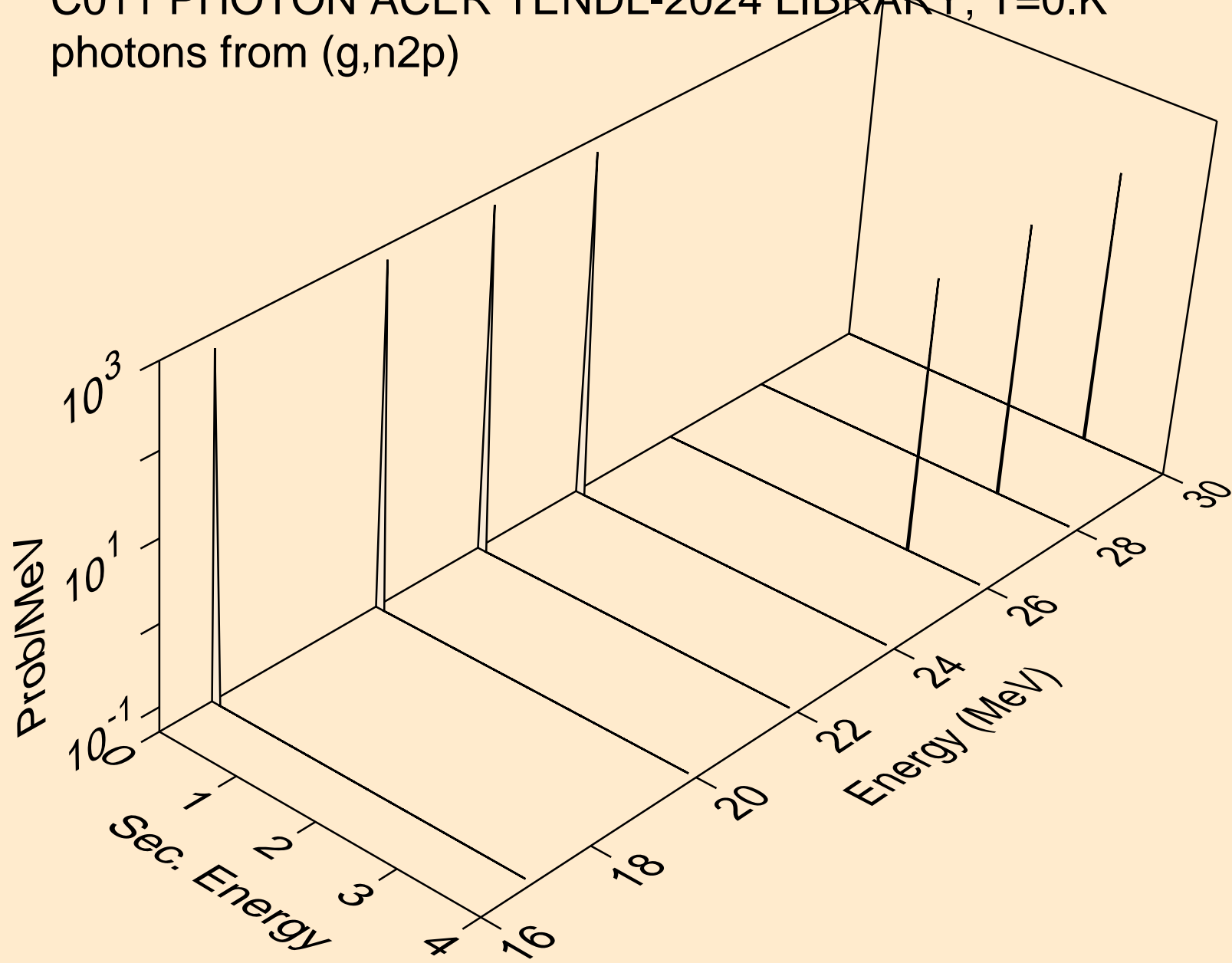

C011 PHOTON ACER TENDL-2024 LIBRARY; T=0.K  
photons from (g,n\*c)

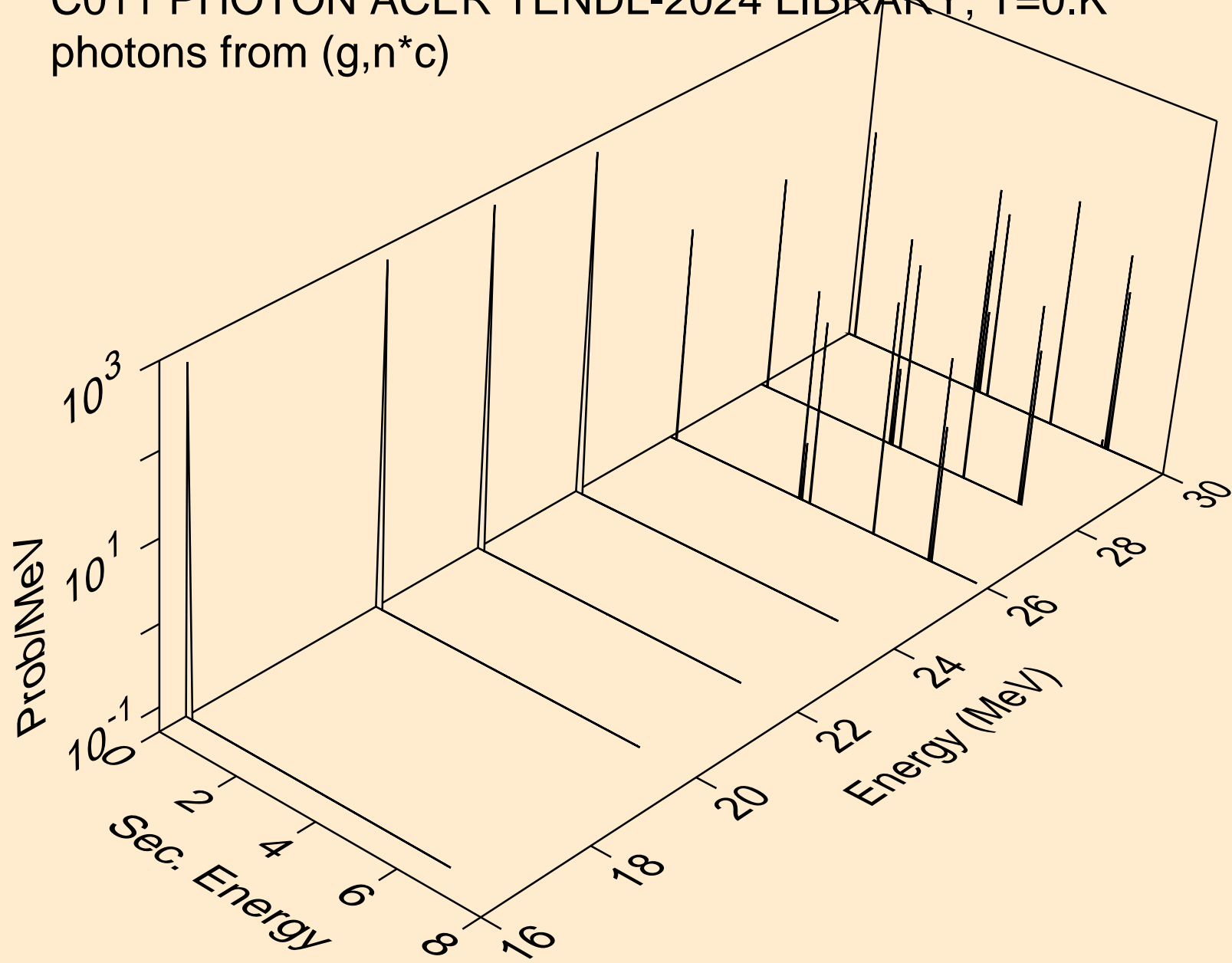

C011 PHOTON ACER TENDL-2024 LIBRARY; T=0.K  
photons from (g,gma)

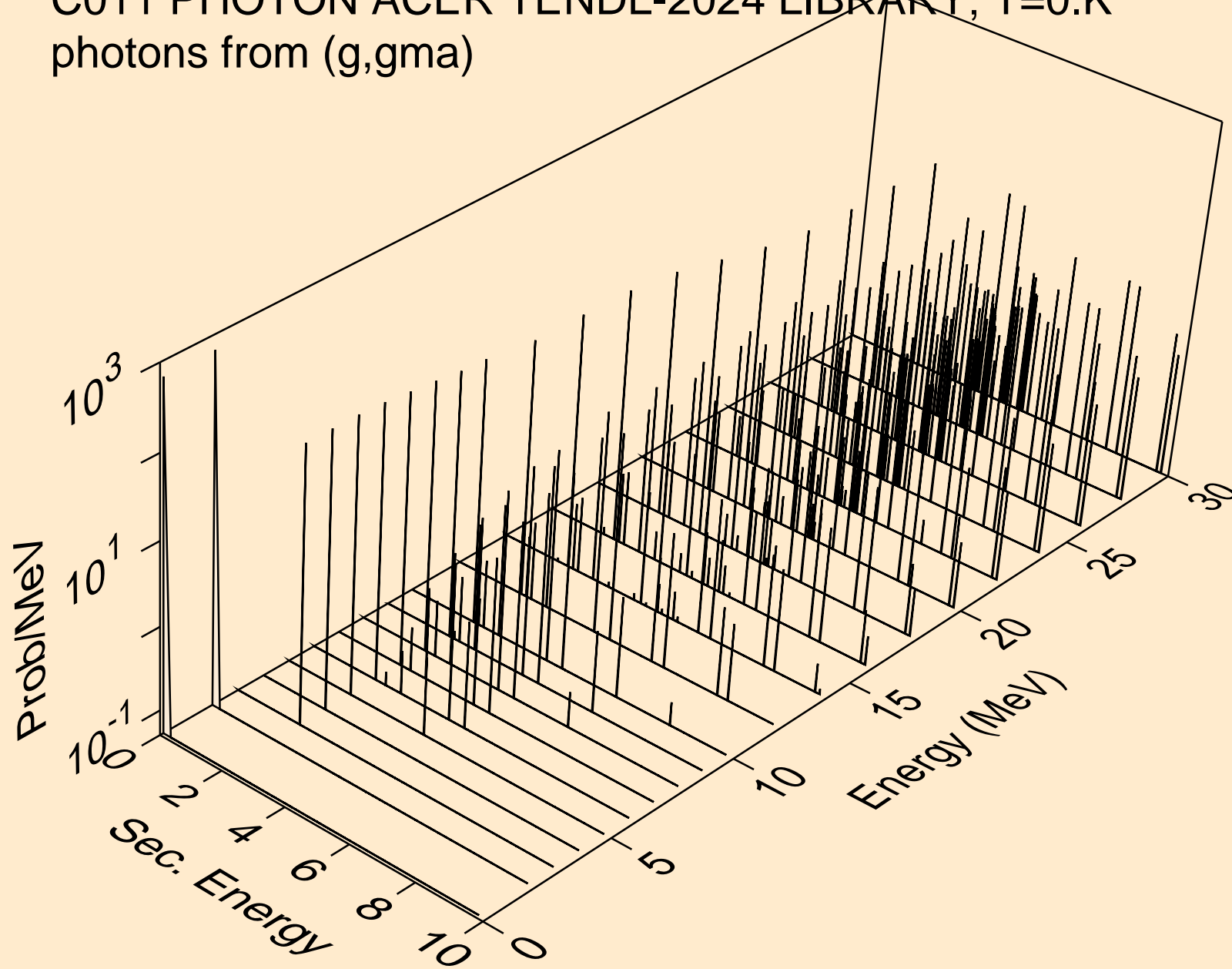

C011 PHOTON ACER TENDL-2024 LIBRARY; T=0.K  
photons from (g,p)

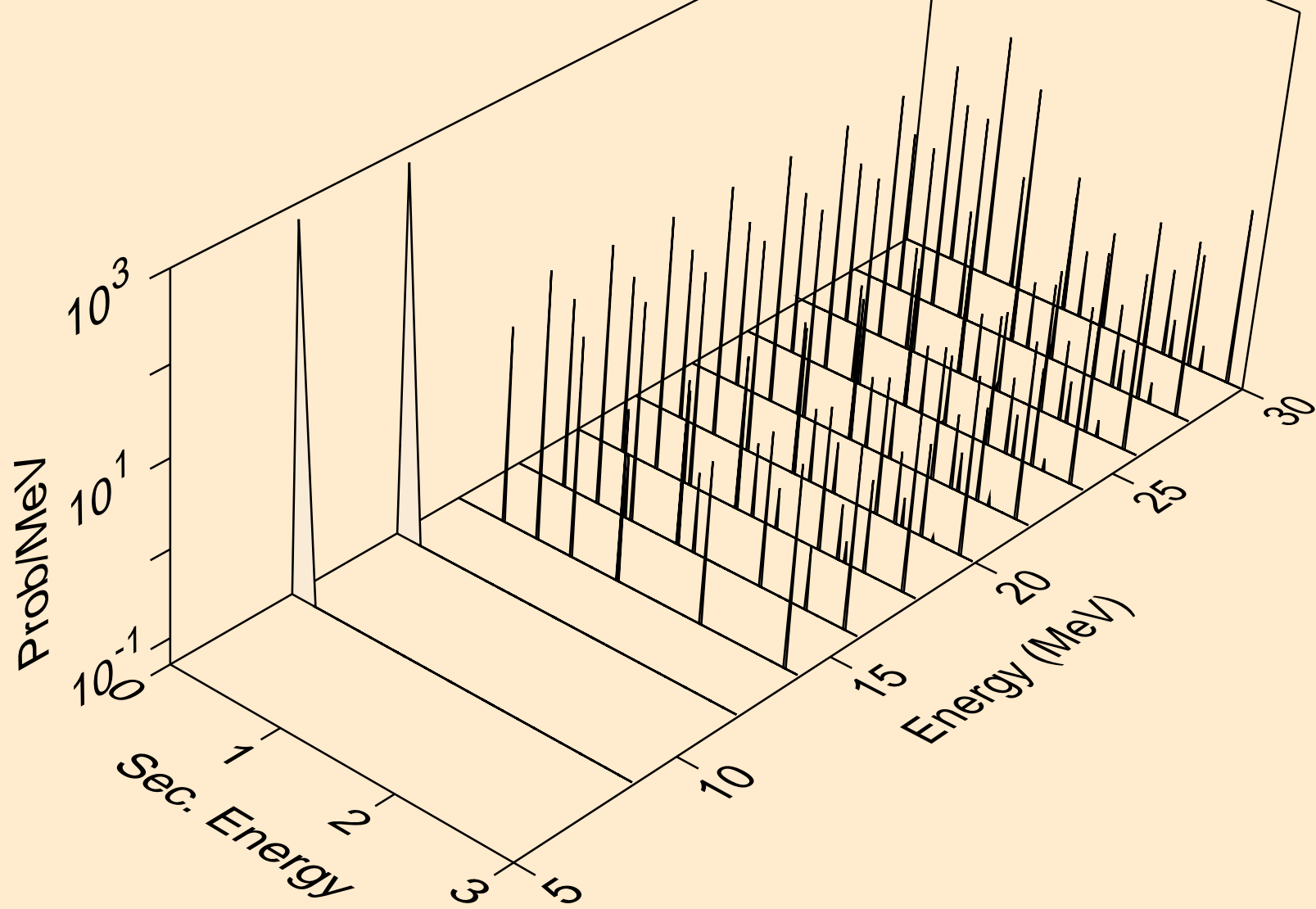

C011 PHOTON ACER TENDL-2024 LIBRARY; T=0.K  
photons from (g,d)

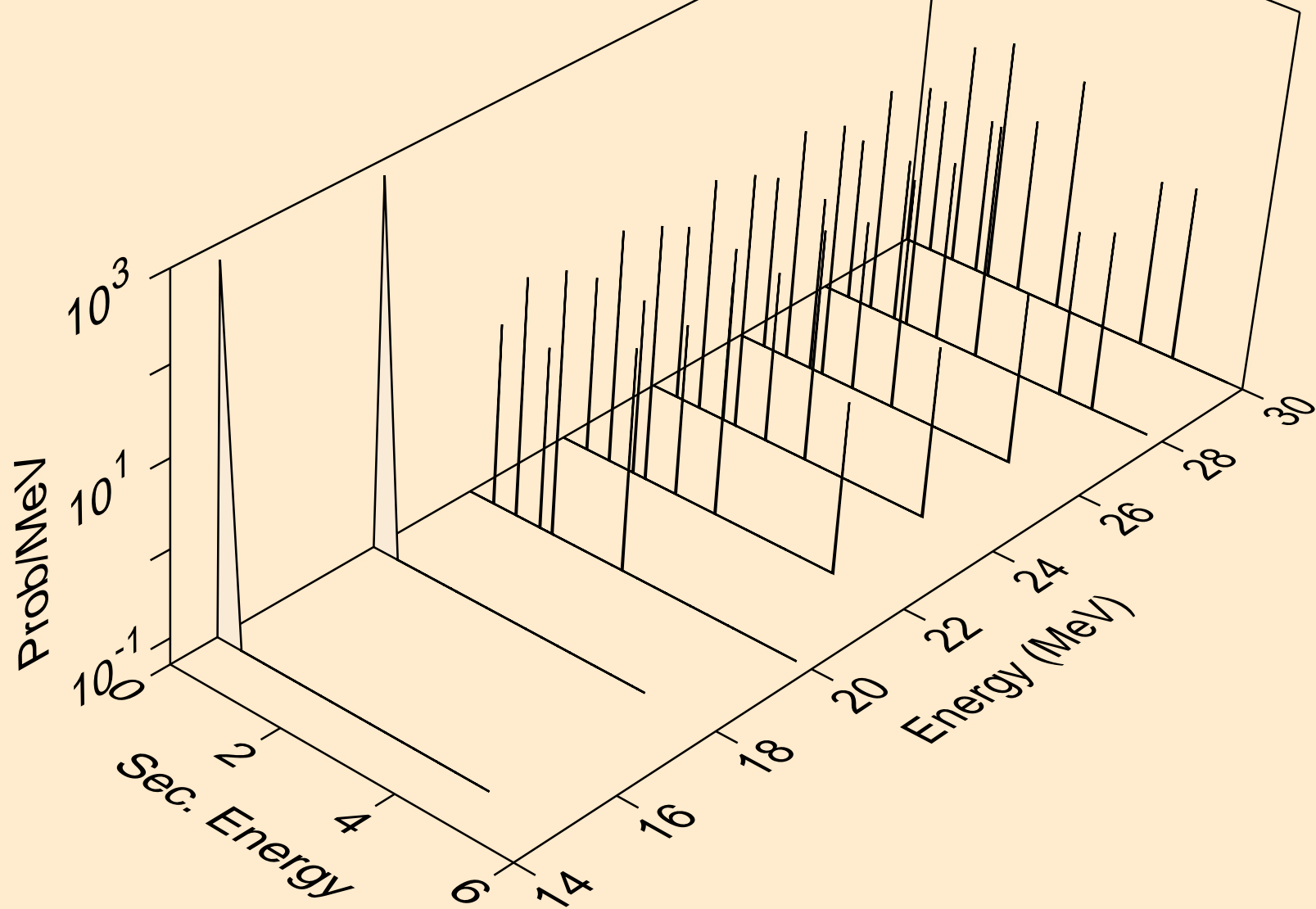

C011 PHOTON ACER TENDL-2024 LIBRARY; T=0.K  
photons from (g,t)

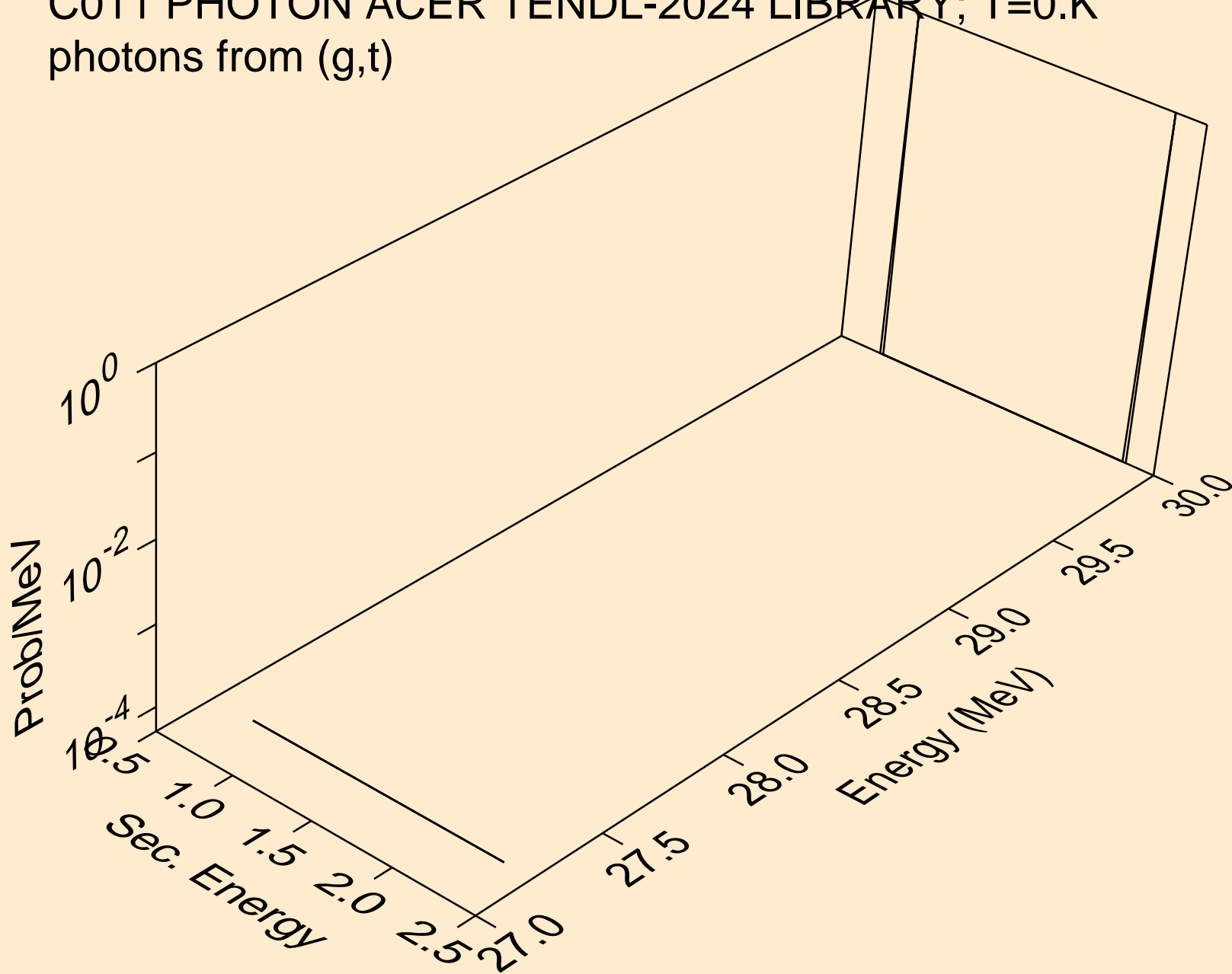

C011 PHOTON ACER TENDL-2024 LIBRARY; T=0.K  
photons from (g,he3)

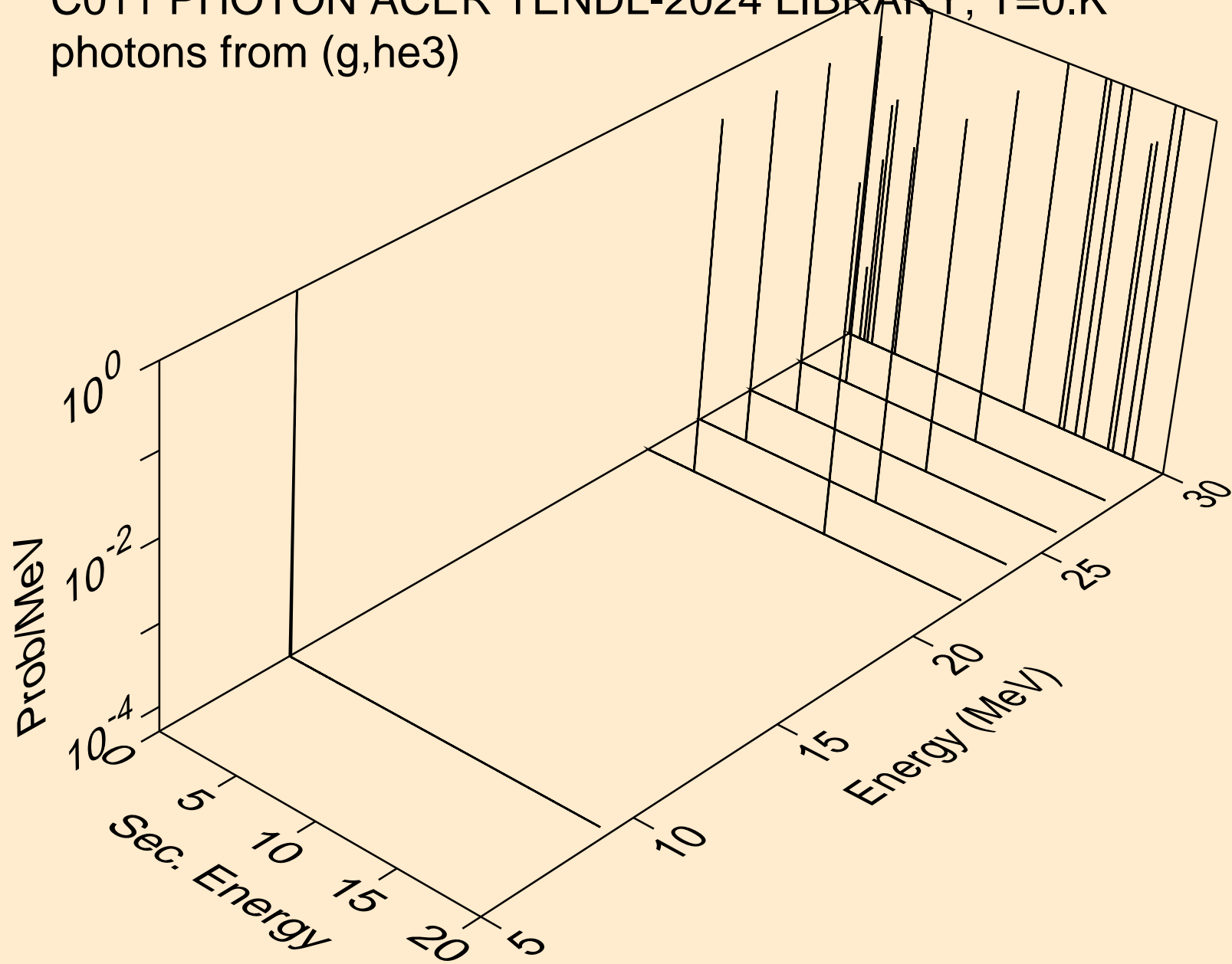

C011 PHOTON ACER TENDL-2024 LIBRARY; T=0.K  
photons from (g,a)

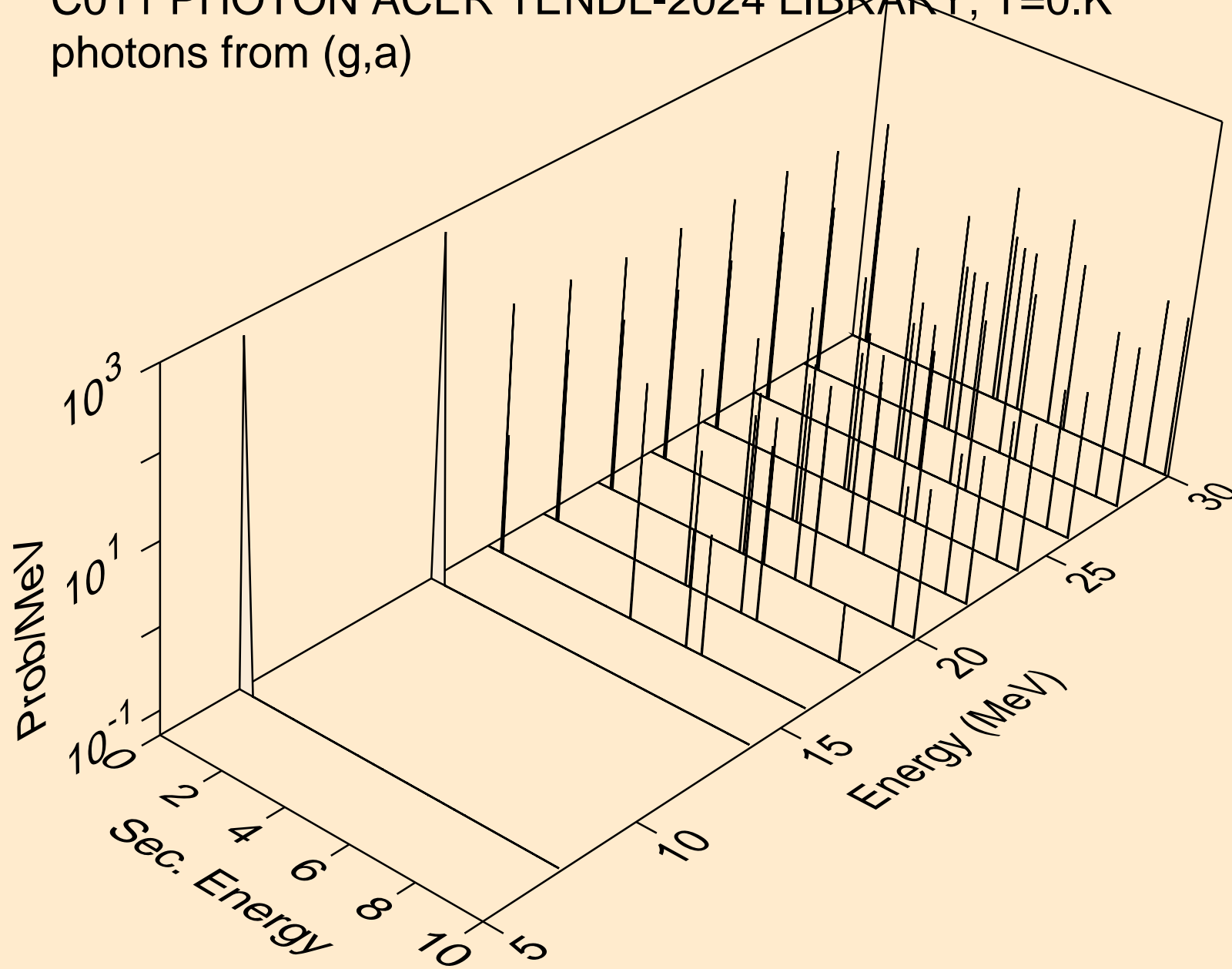

C011 PHOTON ACER TENDL-2024 LIBRARY; T=0.K  
photons from (g,2p)

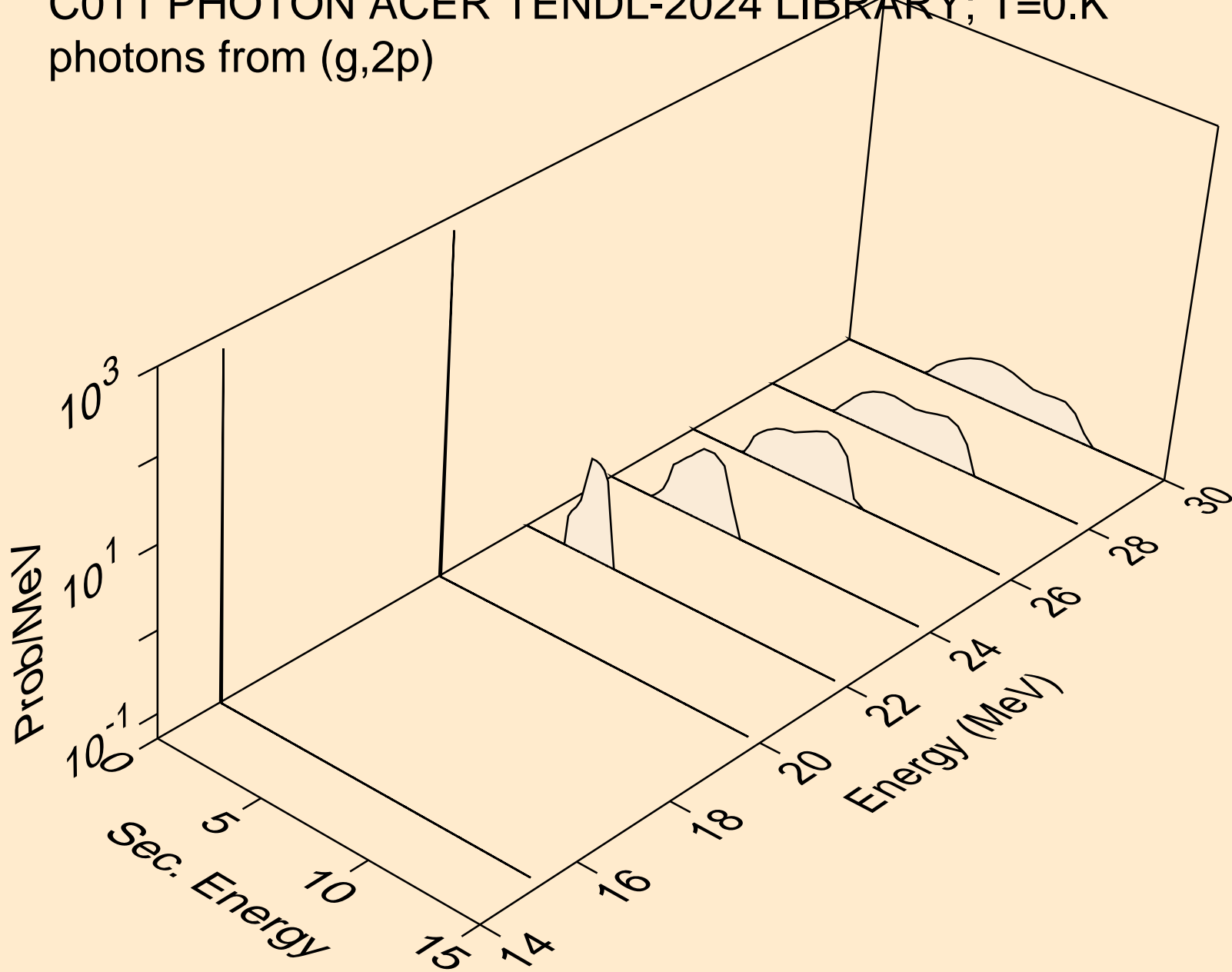

C011 PHOTON ACER TENDL-2024 LIBRARY; T=0.K  
photons from (g,pa)

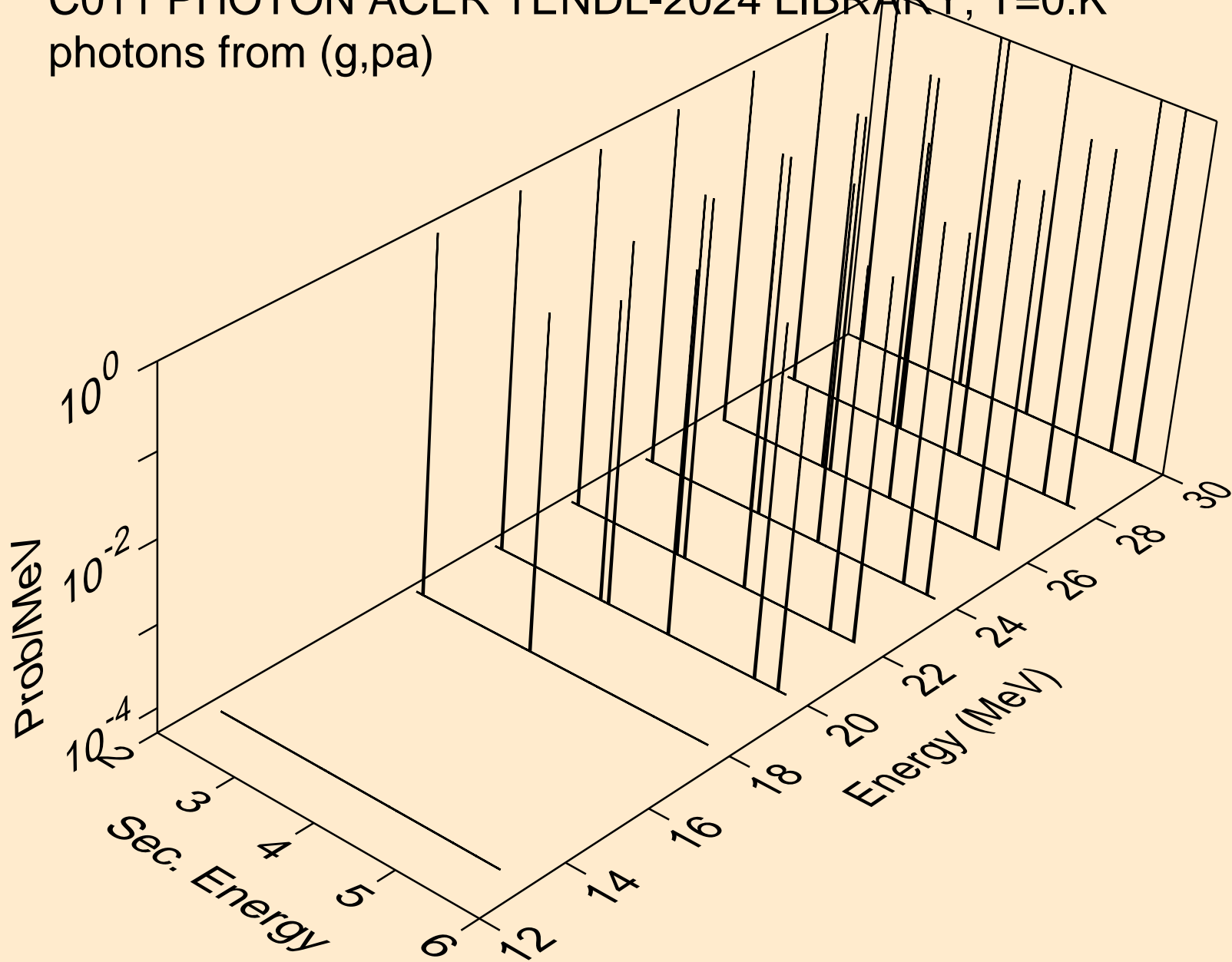

C011 PHOTON ACER TENDL-2024 LIBRARY; T=0.K  
photons from (g,pd)

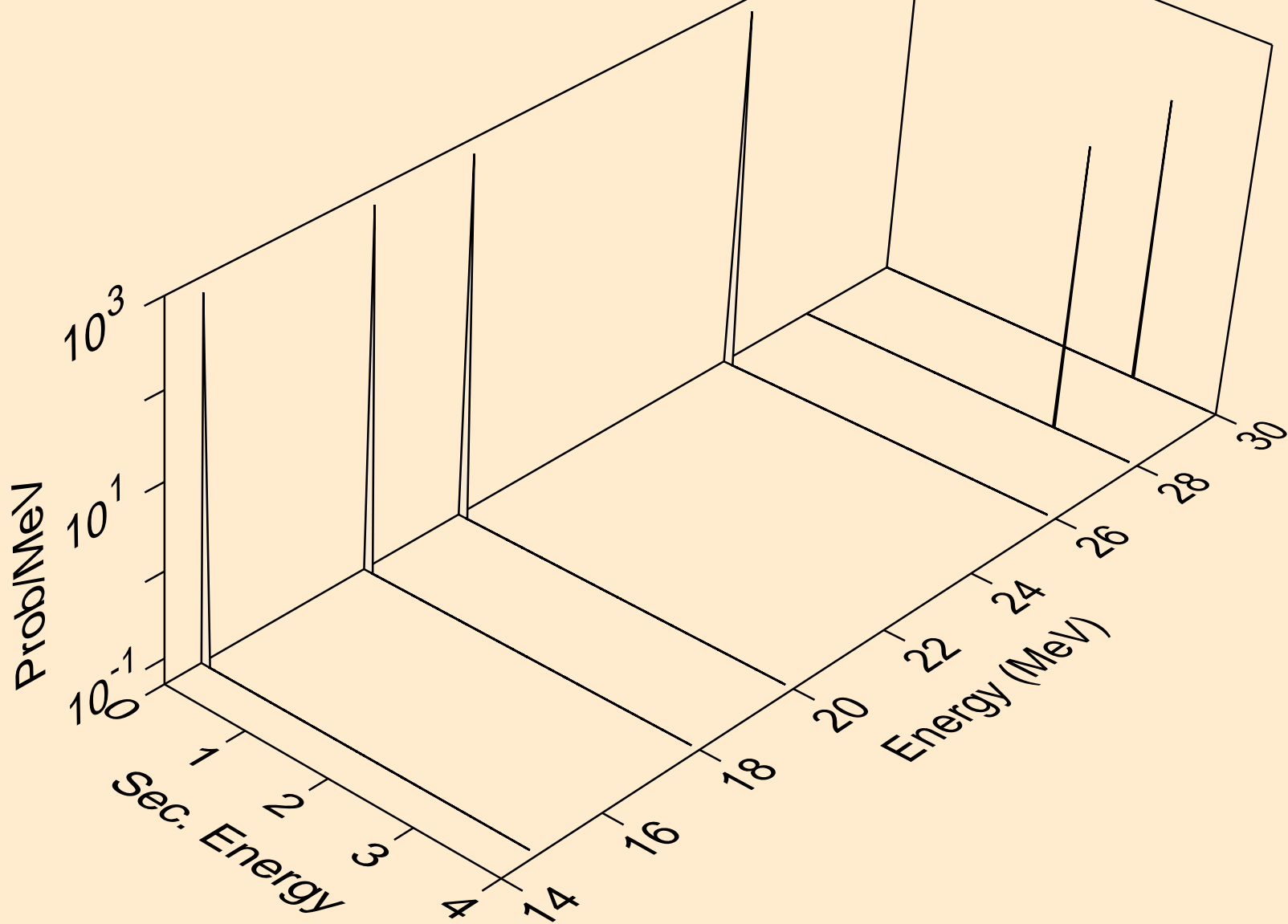

C011 PHOTON ACER TENDL-2024 LIBRARY; T=0.K  
photons from (g,pt)

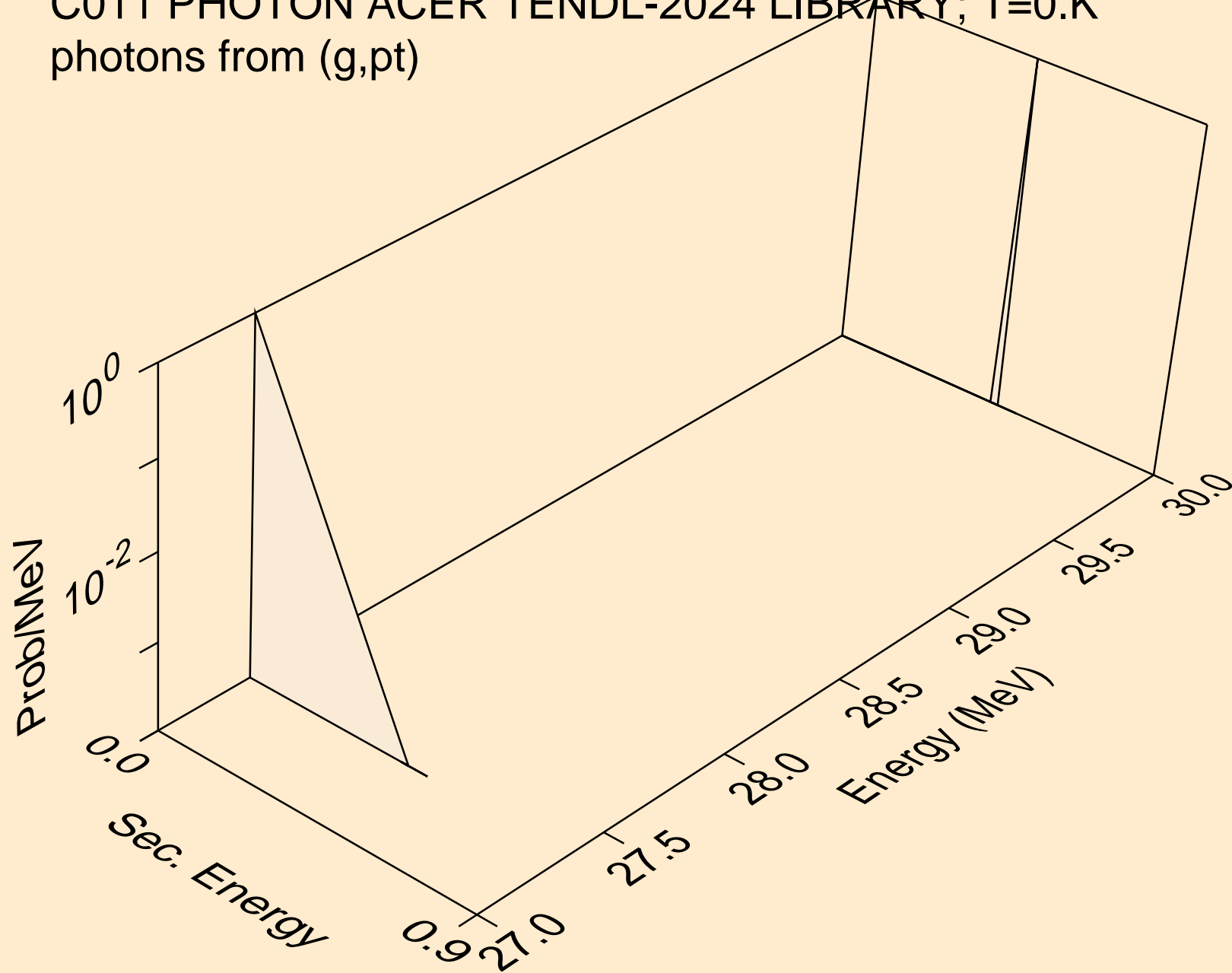

C011 PHOTON ACER TENDL-2024 LIBRARY; T=0.K  
protons from (g,x)

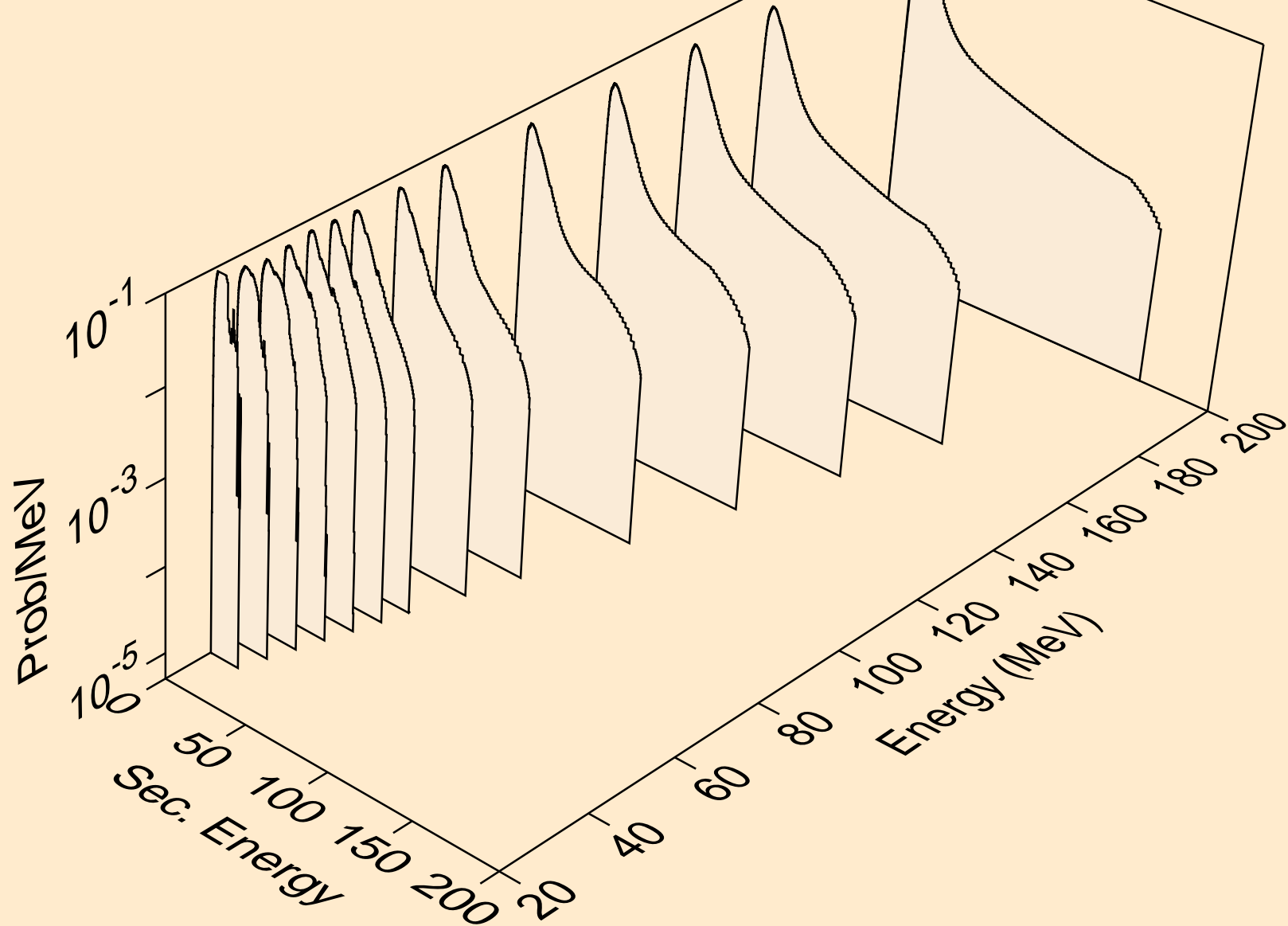

C011 PHOTON ACER TENDL-2024 LIBRARY; T=0.K  
protons from (g,n\*)p

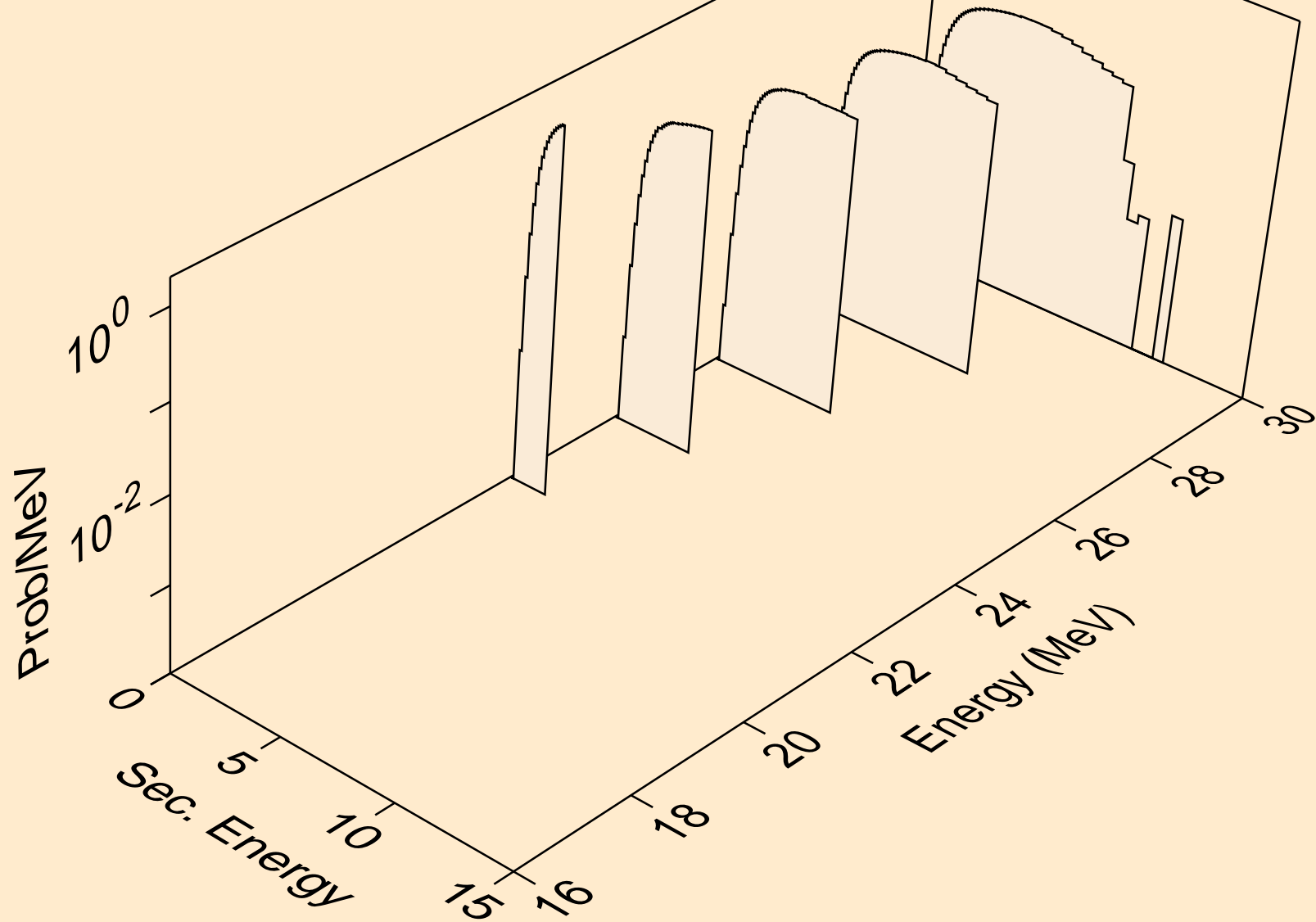

C011 PHOTON ACER TENDL-2024 LIBRARY; T=0.K  
protons from (g,n2p)

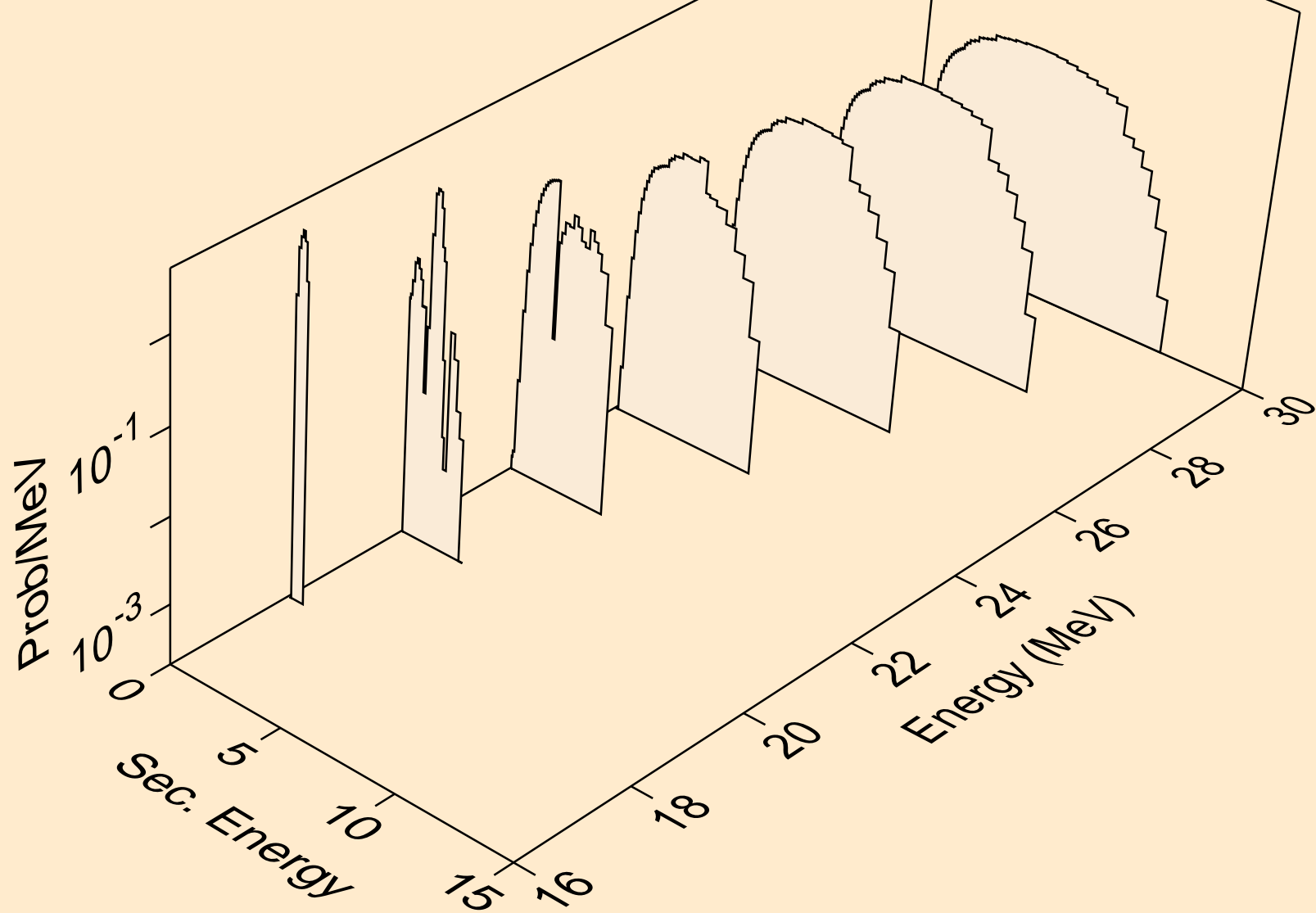

C011 PHOTON ACER TENDL-2024 LIBRARY; T=0.K  
protons from (g,p)

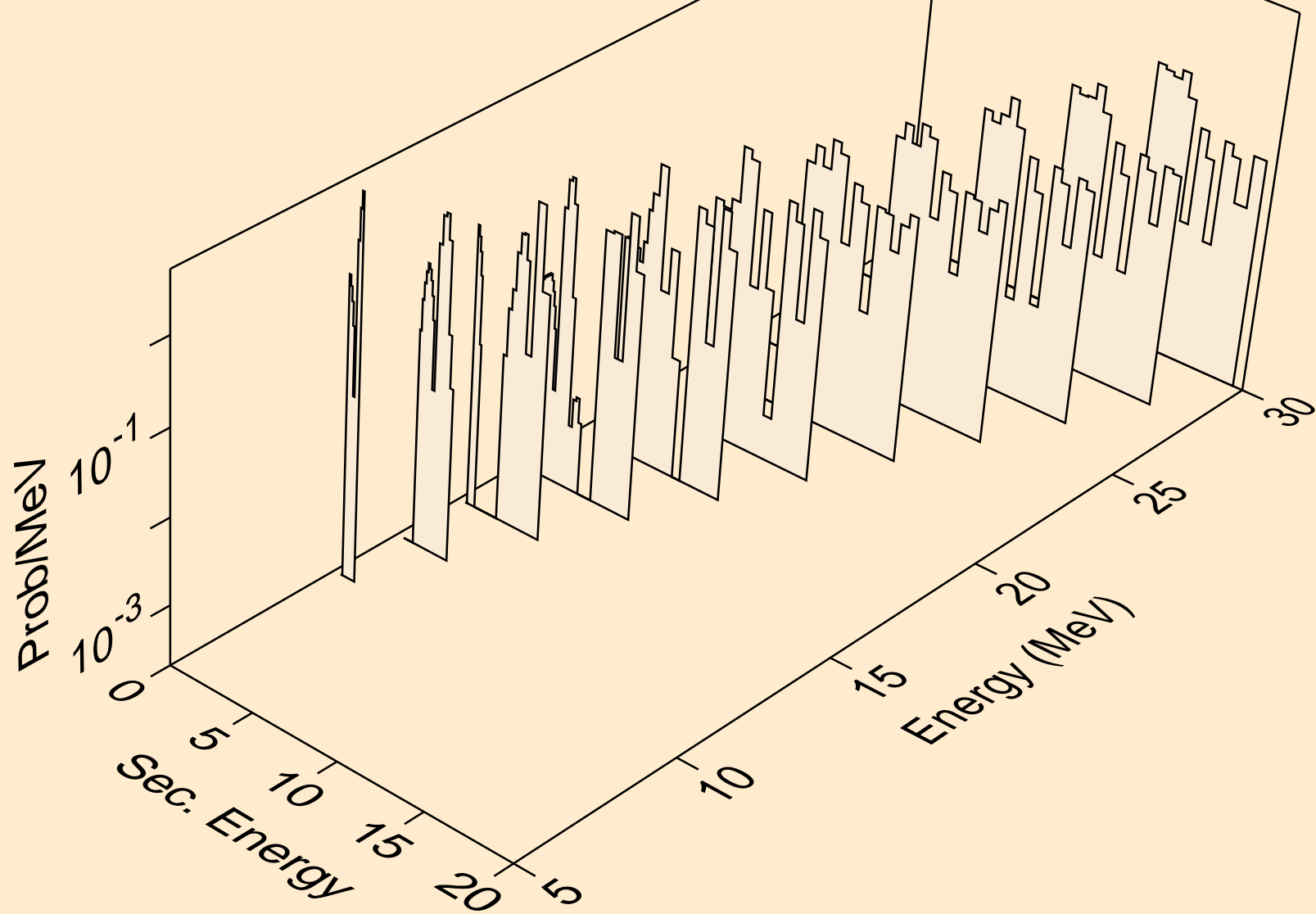

C011 PHOTON ACER TENDL-2024 LIBRARY; T=0.K  
protons from (g,2p)

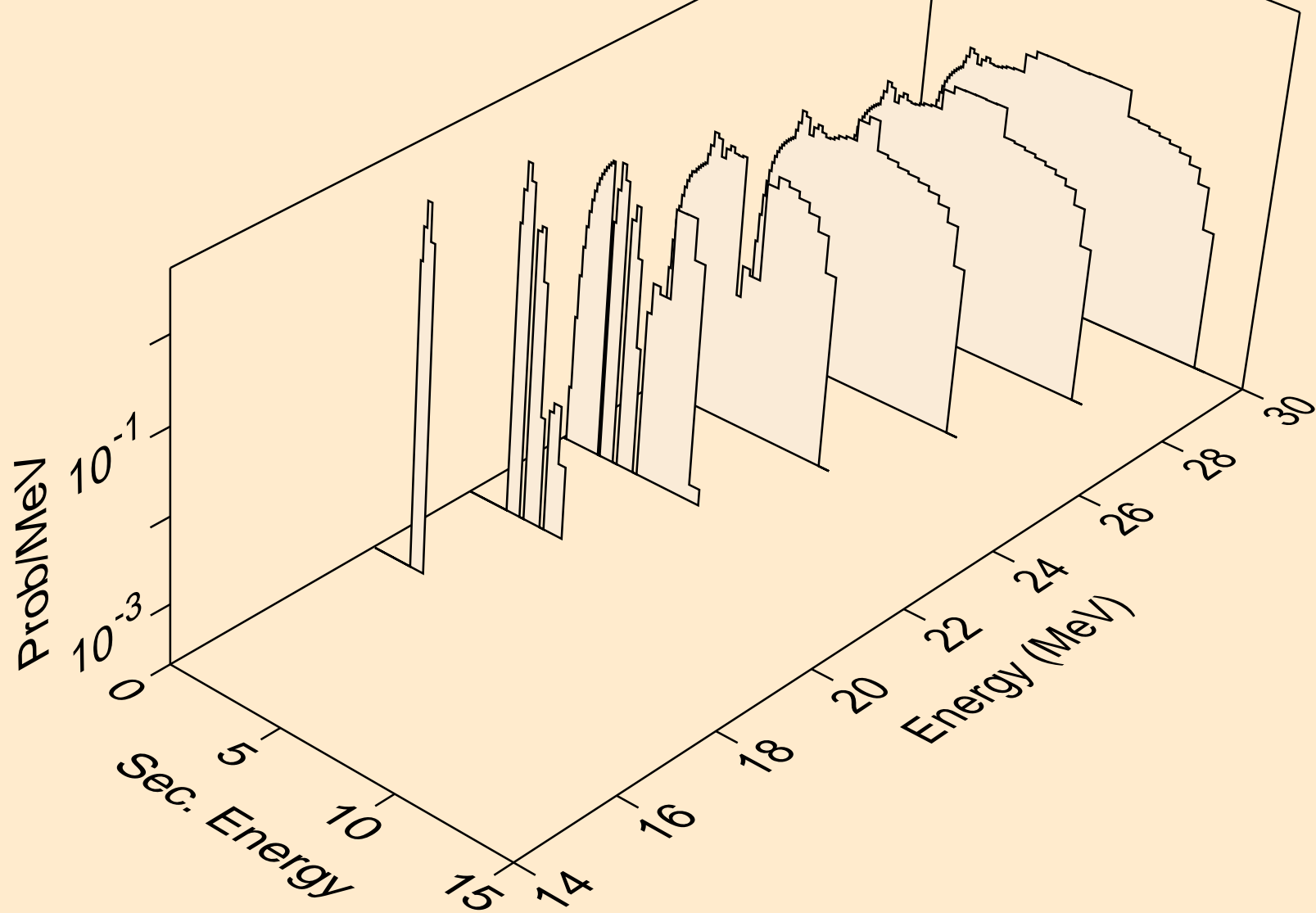

C011 PHOTON ACER TENDL-2024 LIBRARY; T=0.K  
protons from (g,pa)

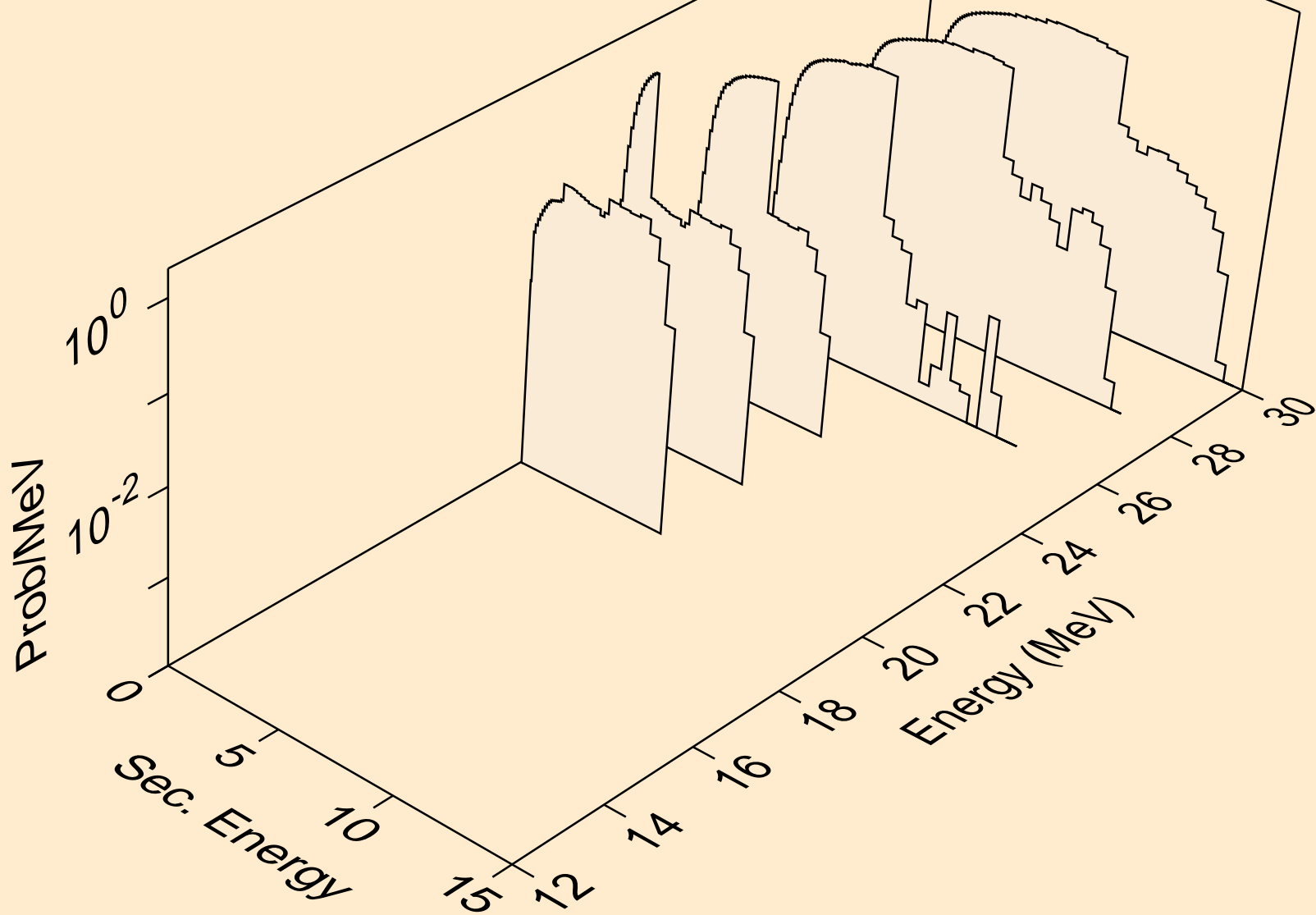

C011 PHOTON ACER TENDL-2024 LIBRARY; T=0.K  
protons from (g,pd)

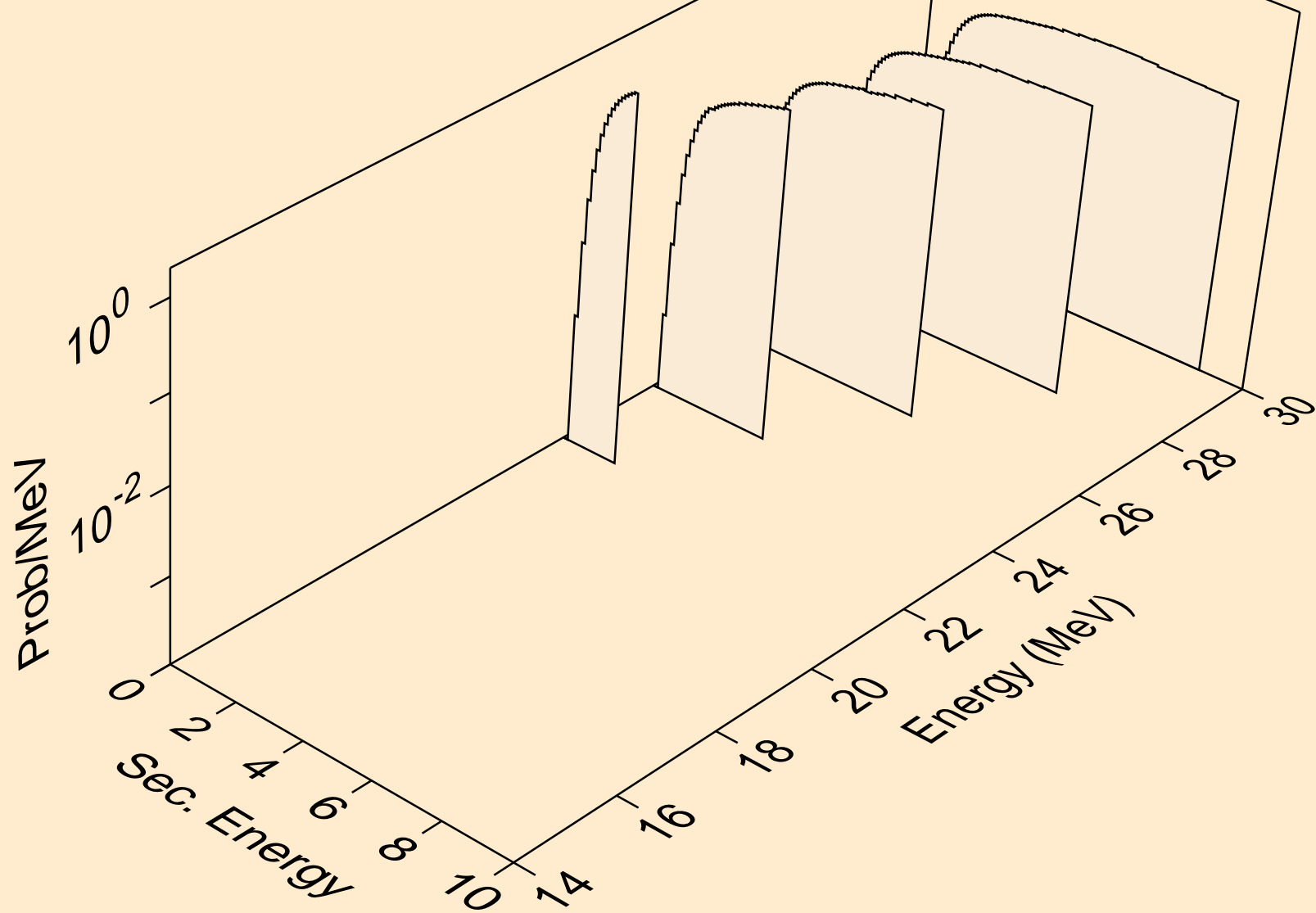

C011 PHOTON ACER TENDL-2024 LIBRARY; T=0.K  
protons from (g,pt)

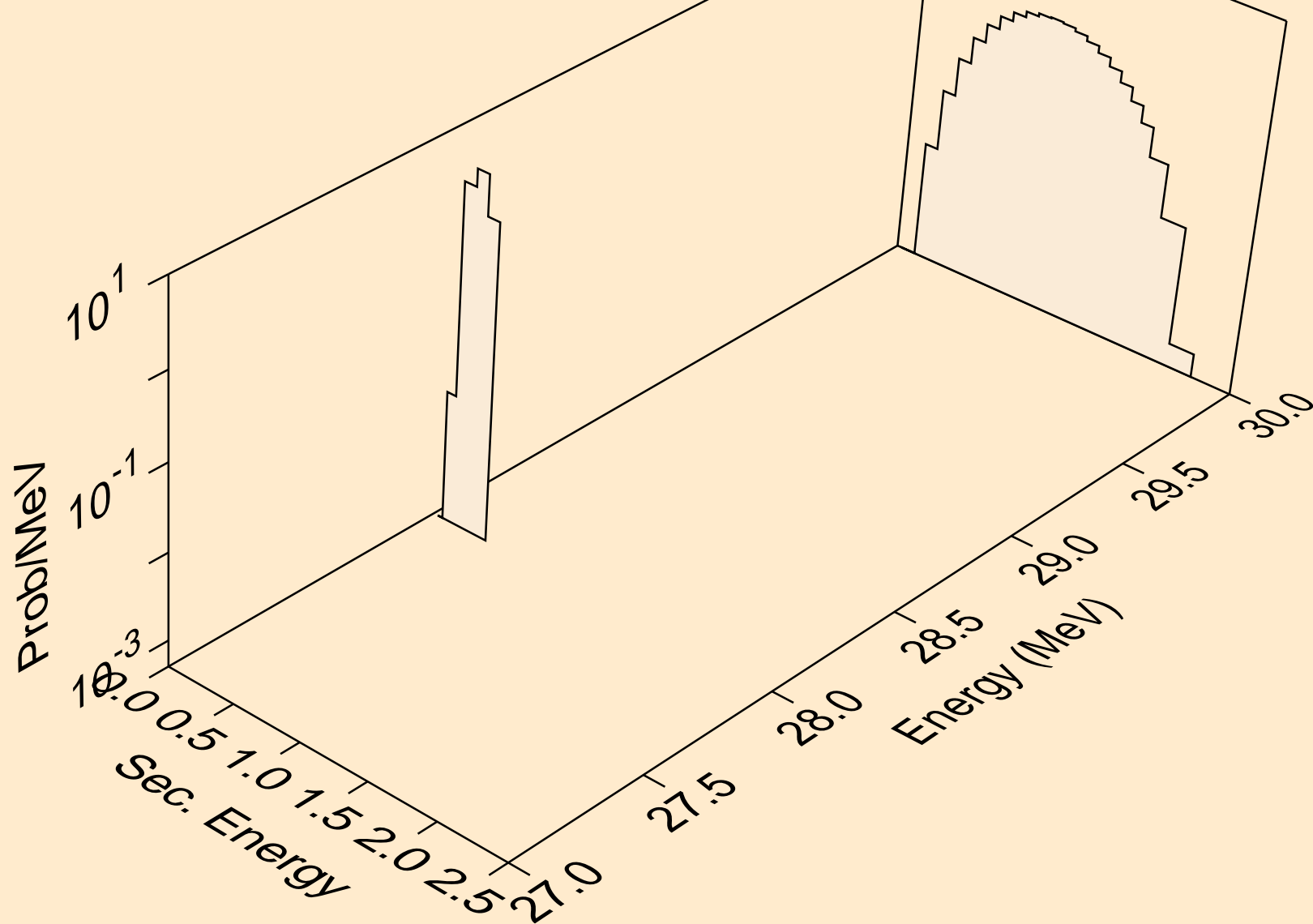

C011 PHOTON ACER TENDL-2024 LIBRARY; T=0.K  
deuterons from (g,x)

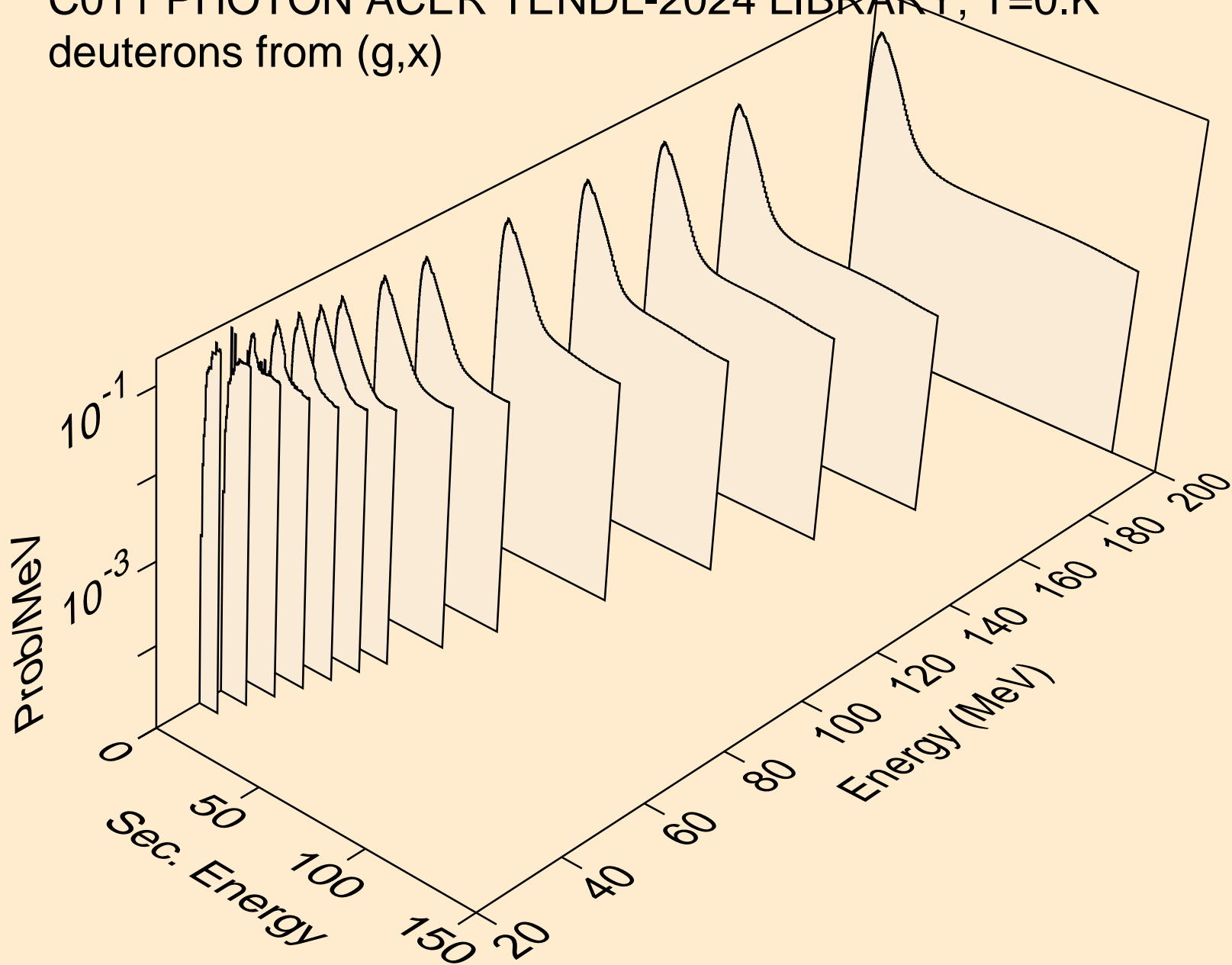

C011 PHOTON ACER TENDL-2024 LIBRARY; T=0.K  
deuterons from (g,d)

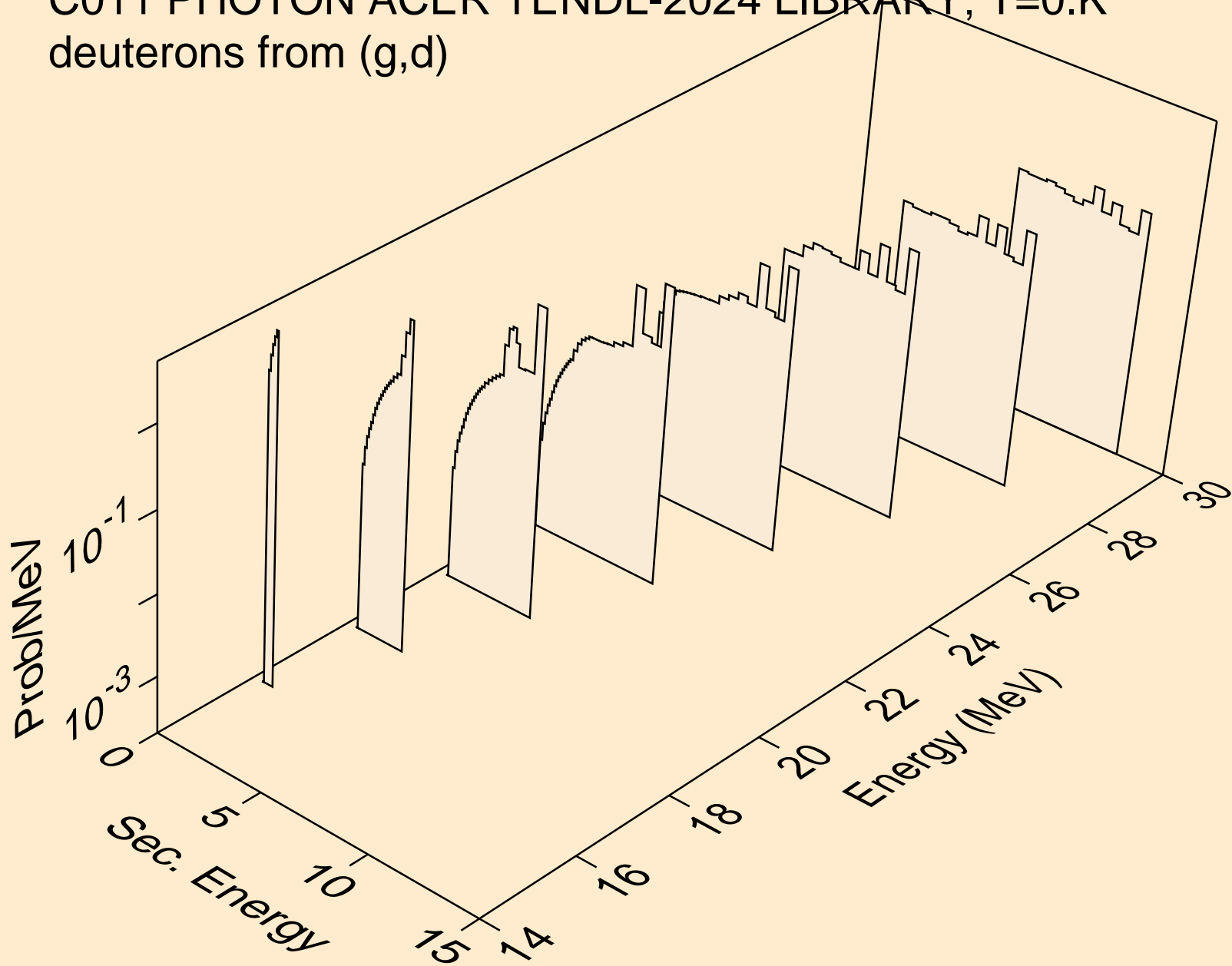

C011 PHOTON ACER TENDL-2024 LIBRARY; T=0.K  
deuterons from (g,pd)

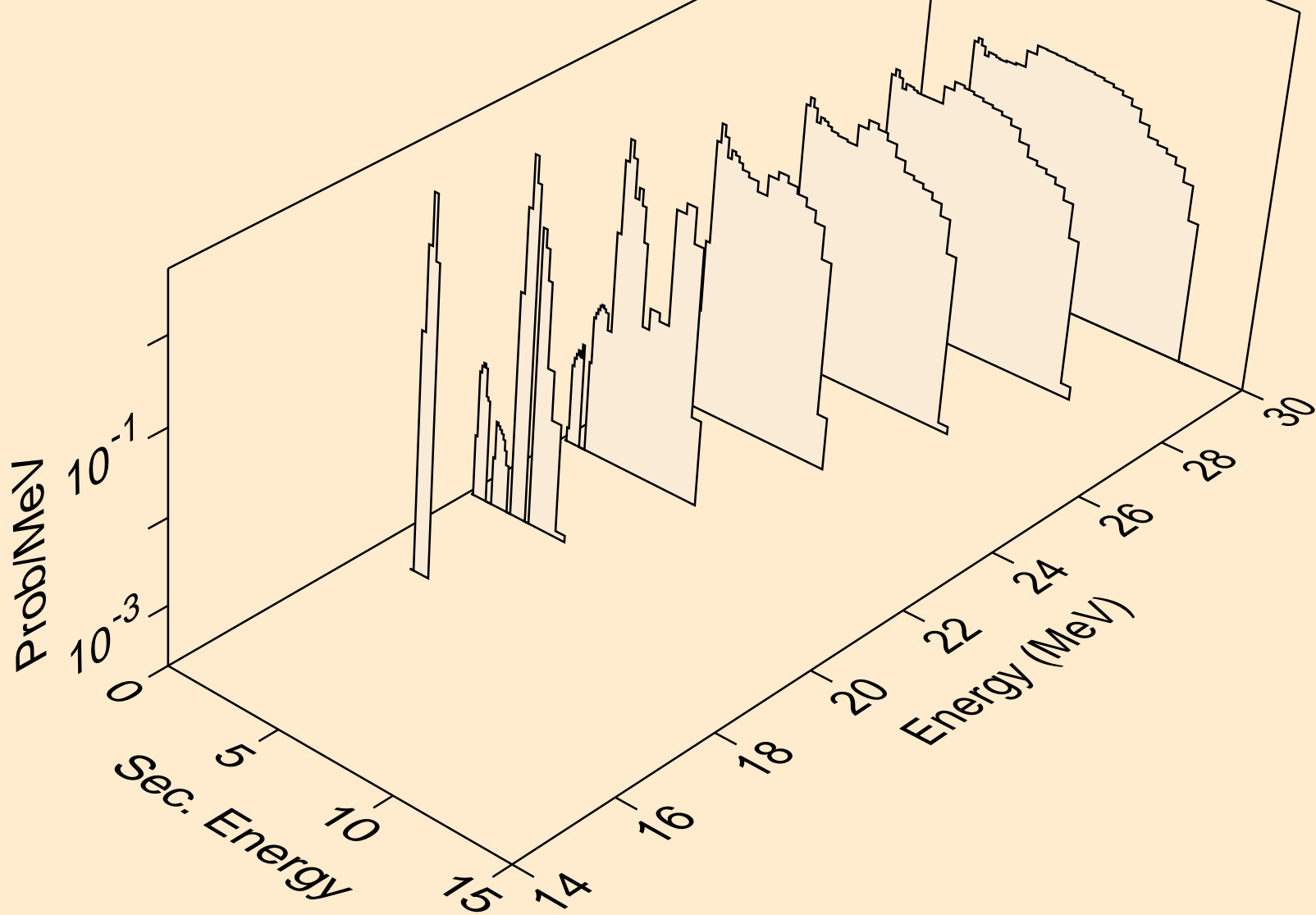

C011 PHOTON ACER TENDL-2024 LIBRARY; T=0.K  
tritons from (g,x)

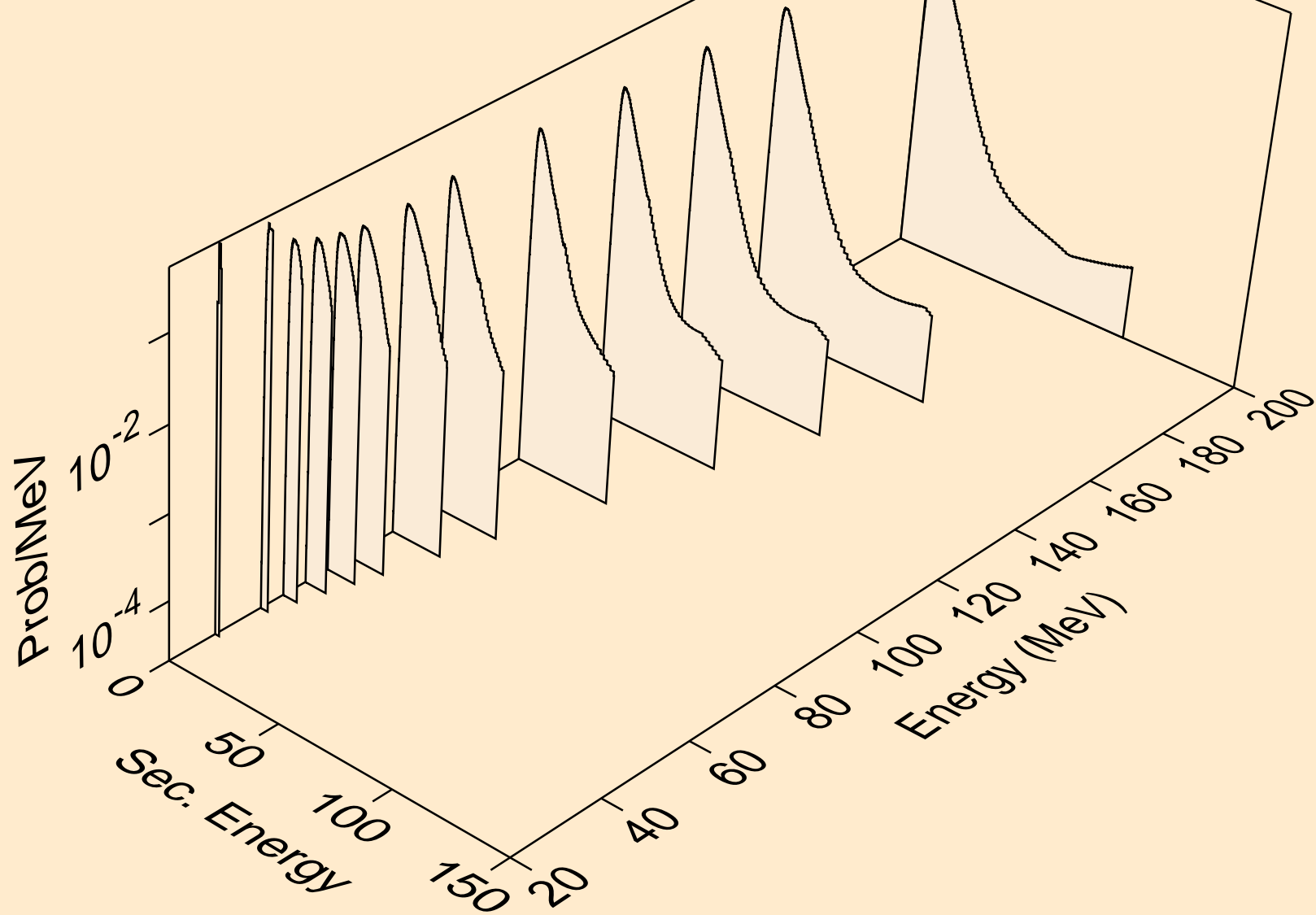

C011 PHOTON ACER TENDL-2024 LIBRARY; T=0.K  
tritons from (g,t)

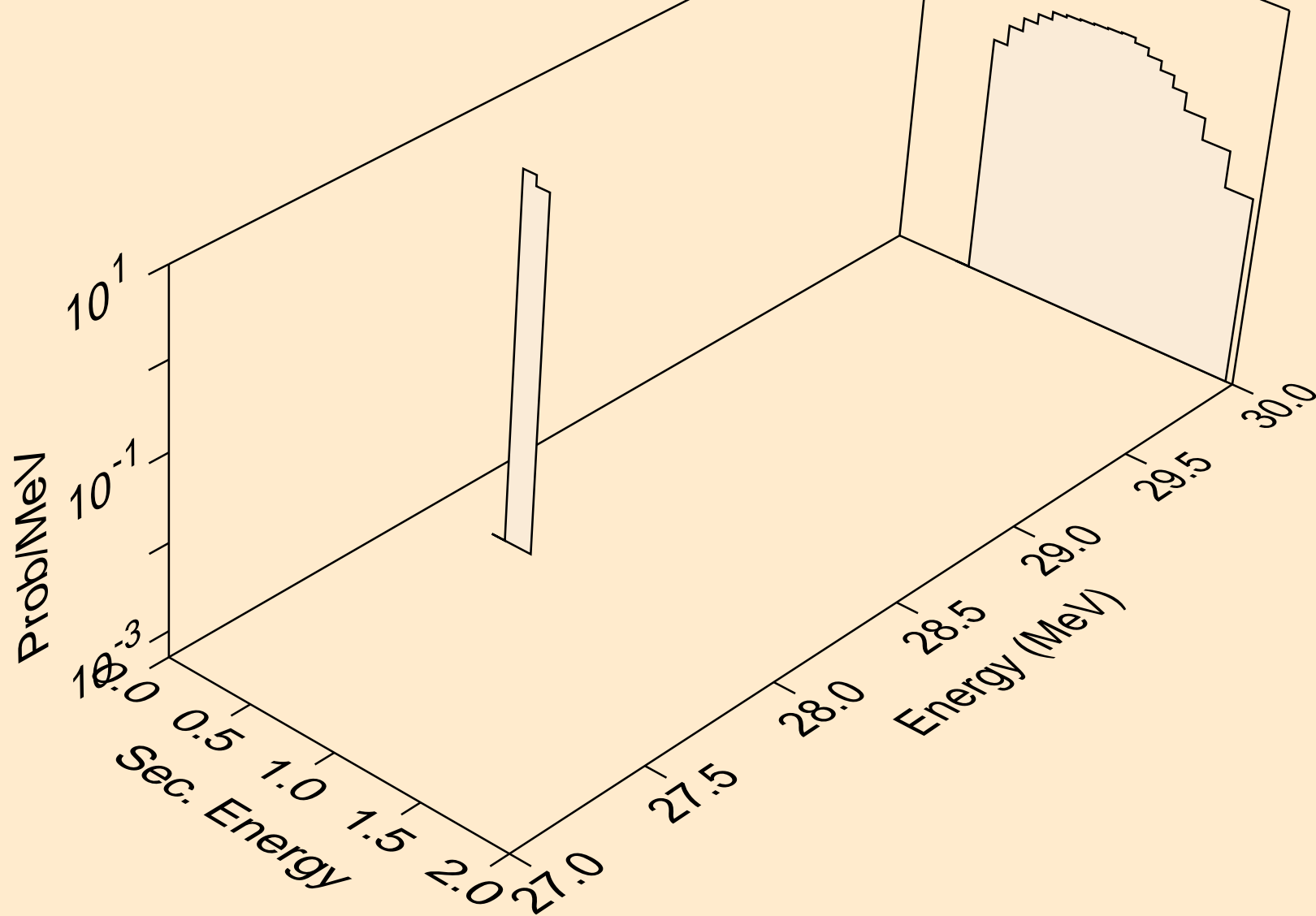

C011 PHOTON ACER TENDL-2024 LIBRARY; T=0.K  
tritons from (g,pt)

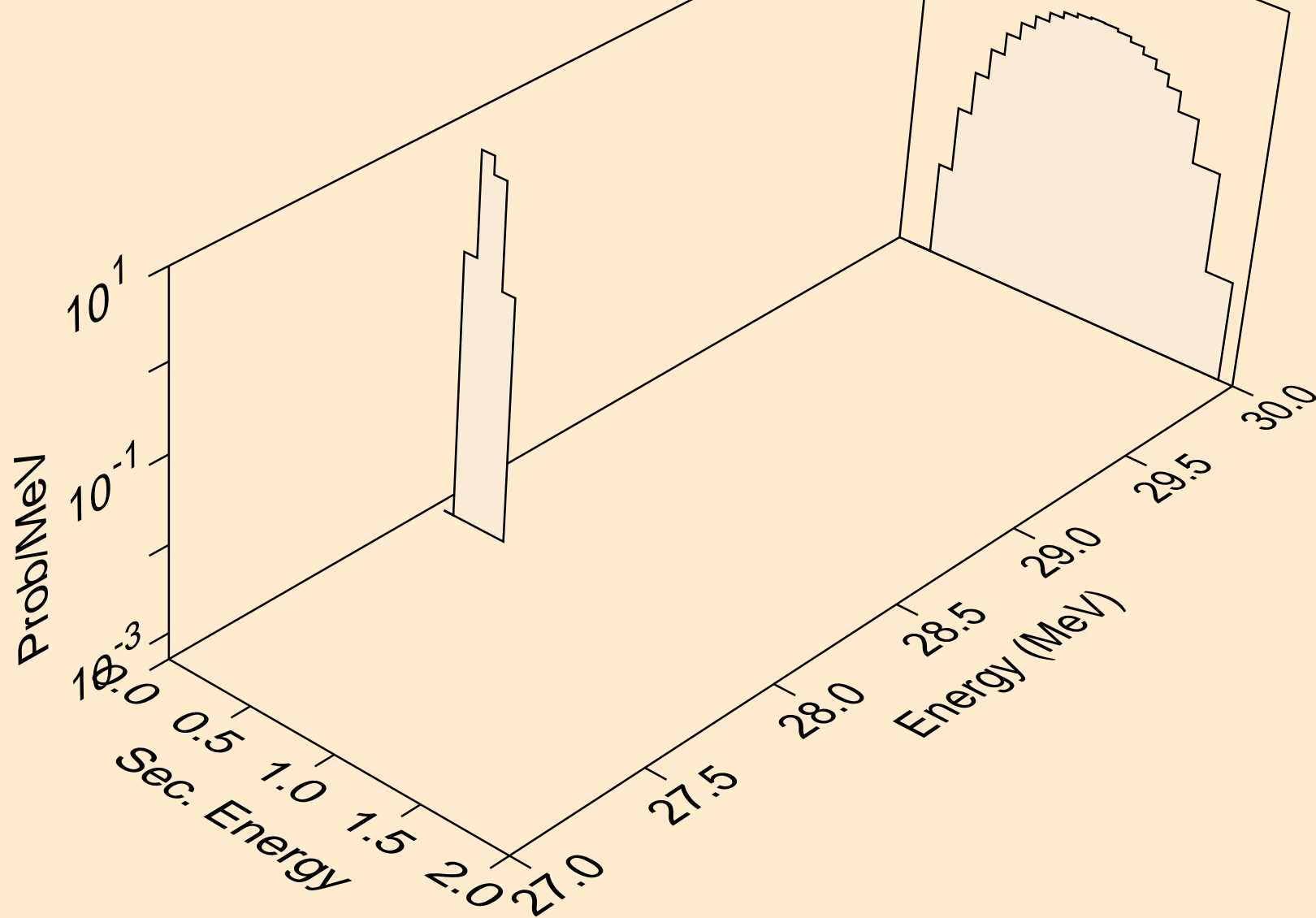

C011 PHOTON ACER TENDL-2024 LIBRARY; T=0.K  
he3s from (g,x)

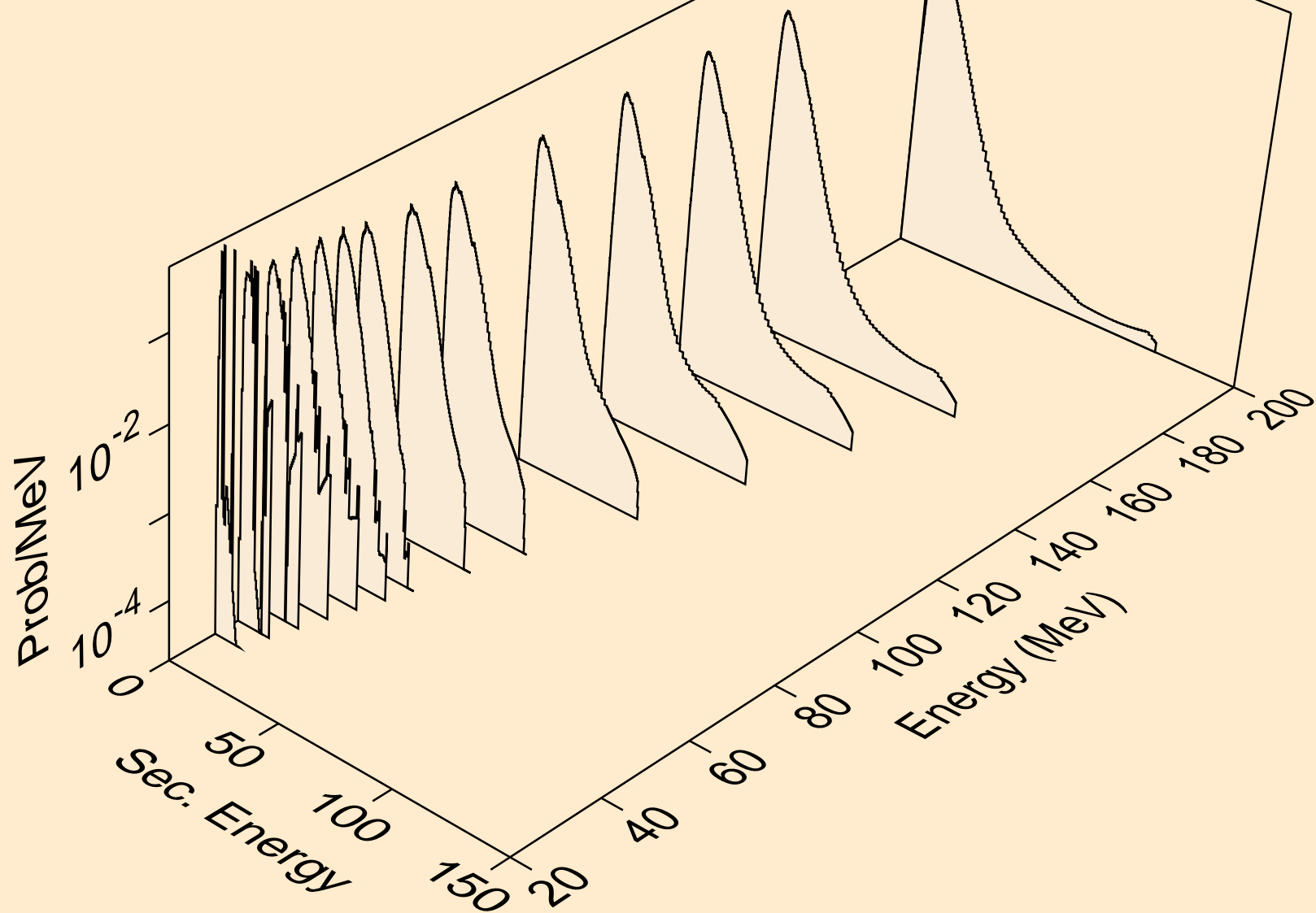

C011 PHOTON ACER TENDL-2024 LIBRARY; T=0.K  
he3s from (g,he3)

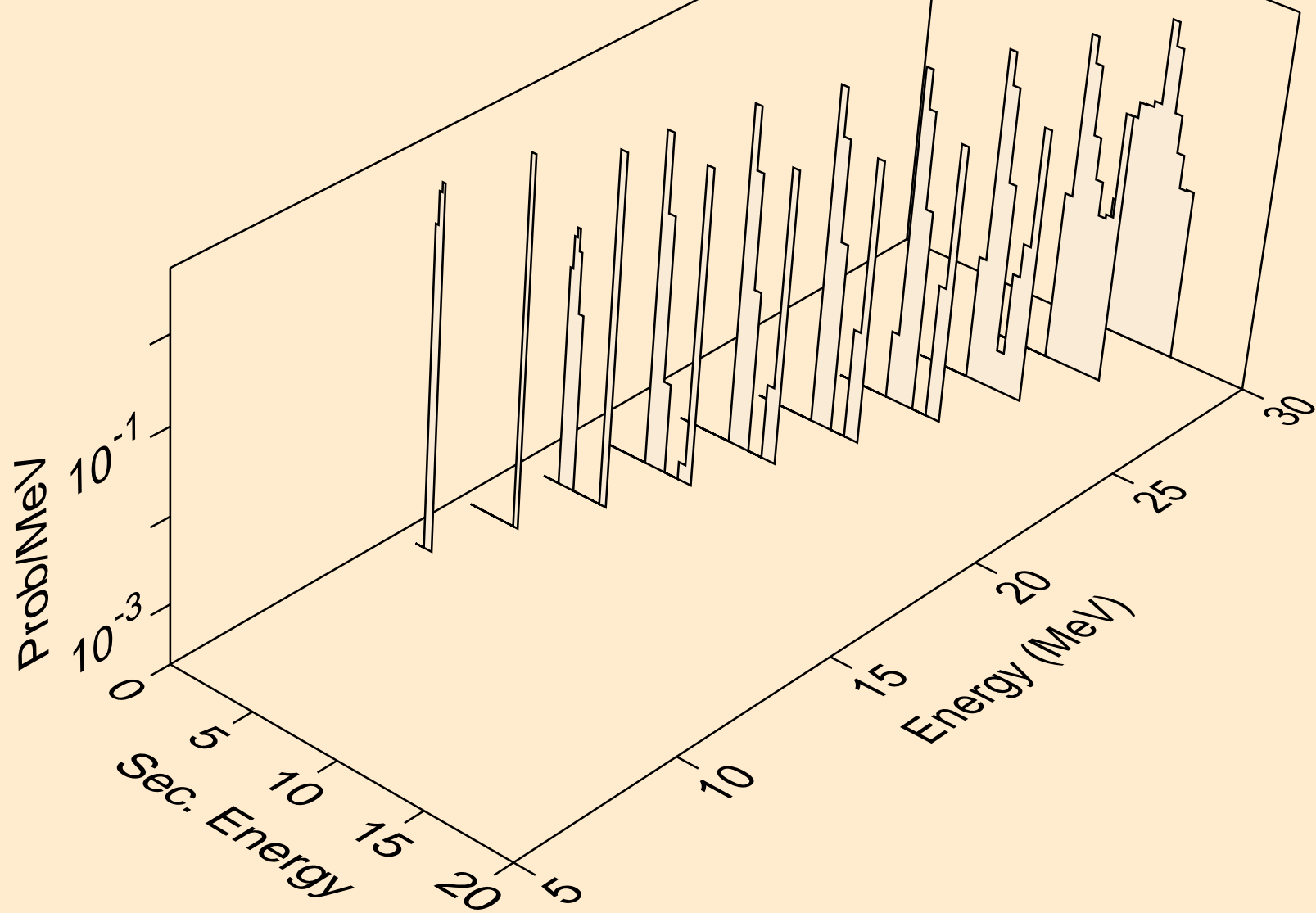

C011 PHOTON ACER TENDL-2024 LIBRARY; T=0.K  
alphas from (g,x)

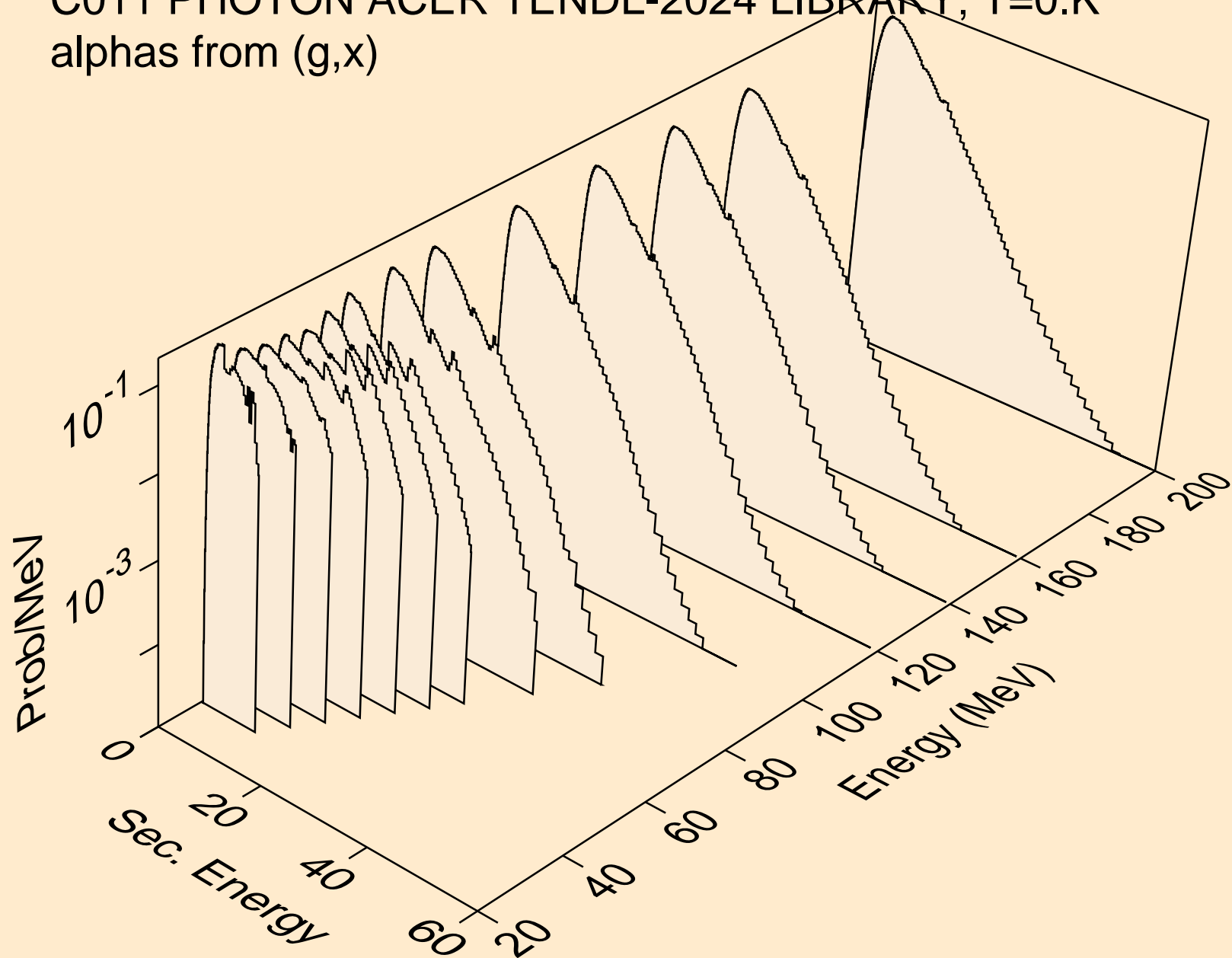

C011 PHOTON ACER TENDL-2024 LIBRARY; T=0.K  
alphas from (g,a)

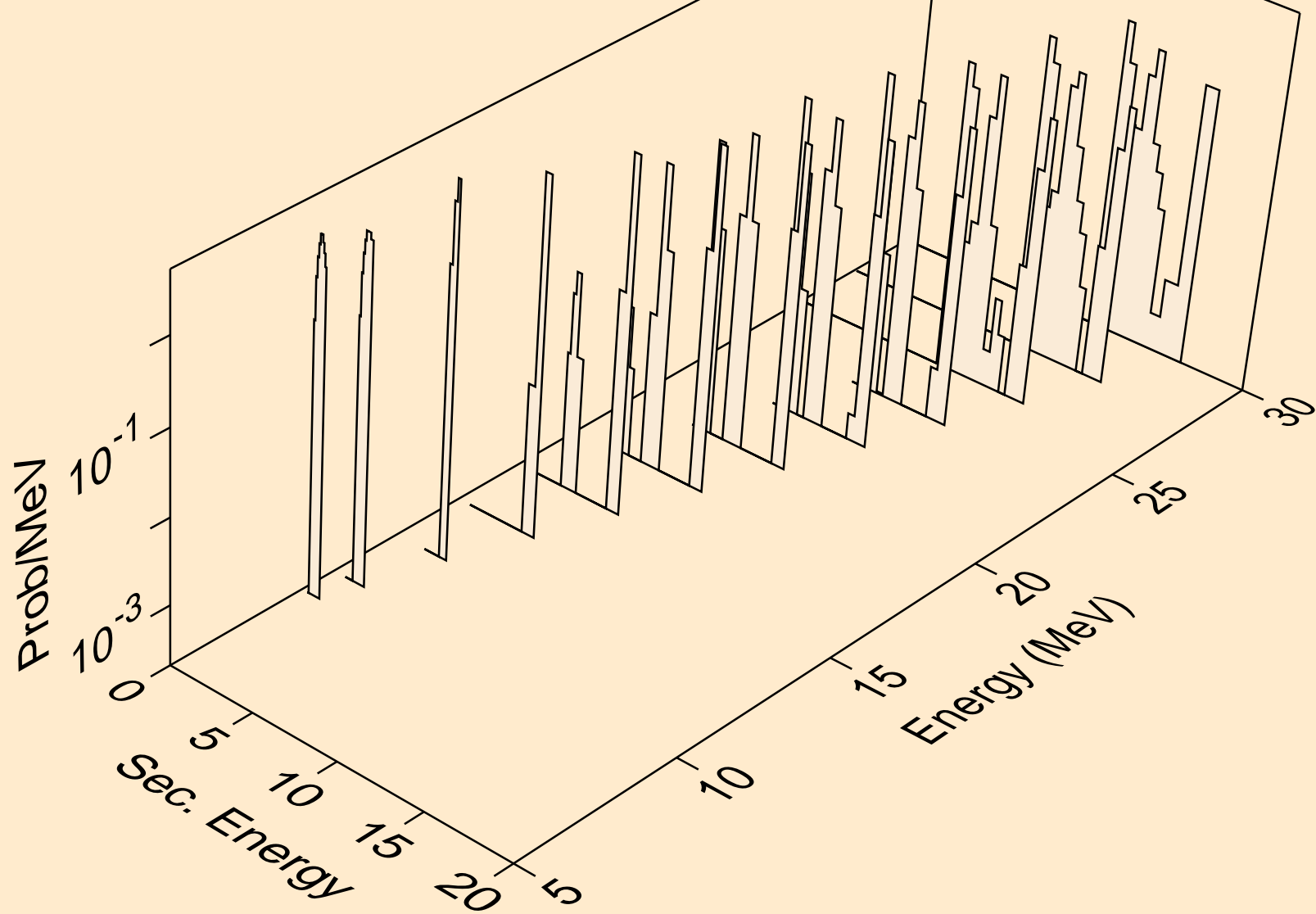

C011 PHOTON ACER TENDL-2024 LIBRARY; T=0.K  
alphas from (g,pa)

