

CA050 PHOTON ACER TENDL-2024 LIBRARY; T=0.K

Principal cross sections

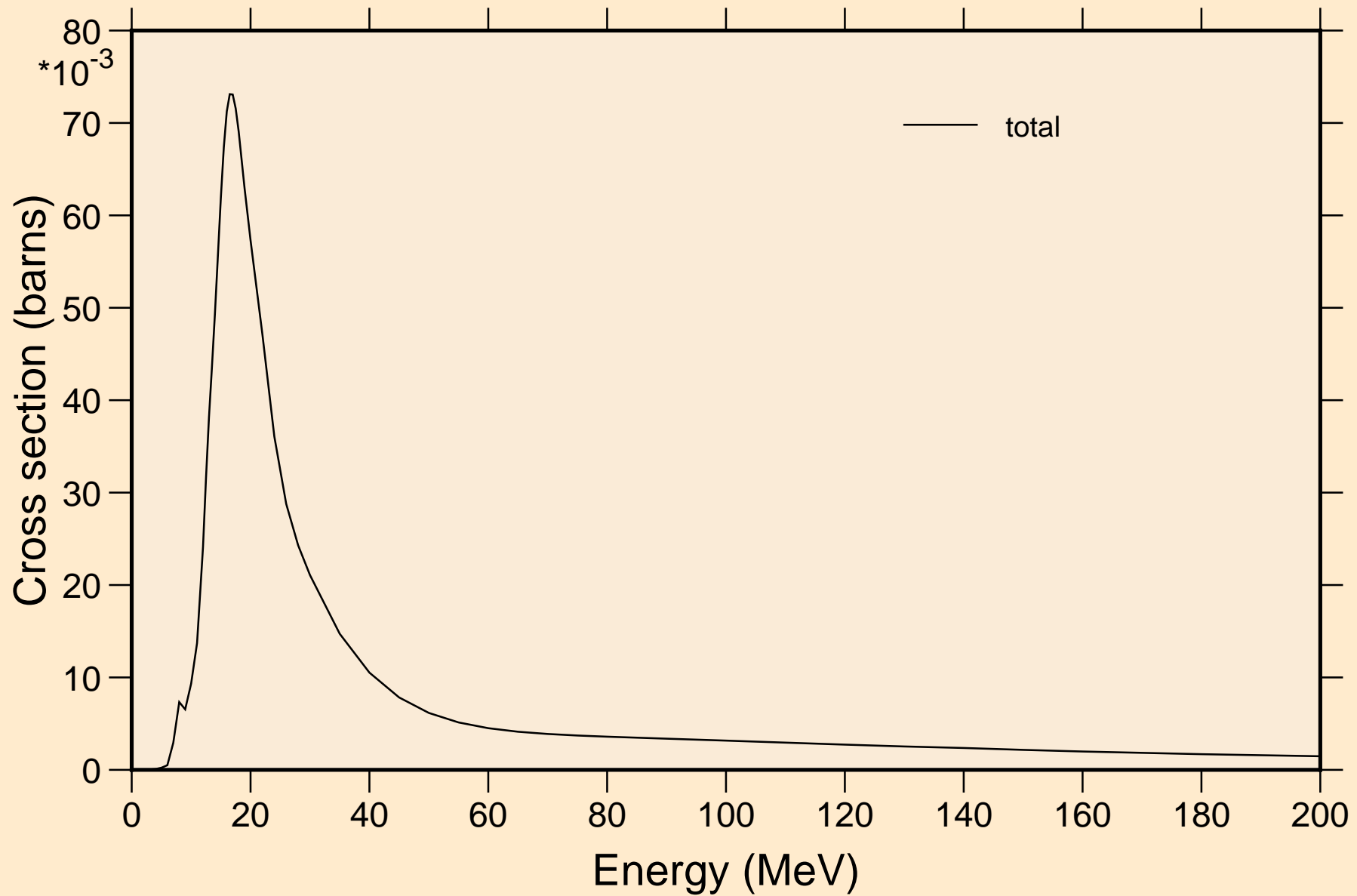

CA050 PHOTON ACER TENDL-2024 LIBRARY; T=0.K

Partial cross sections

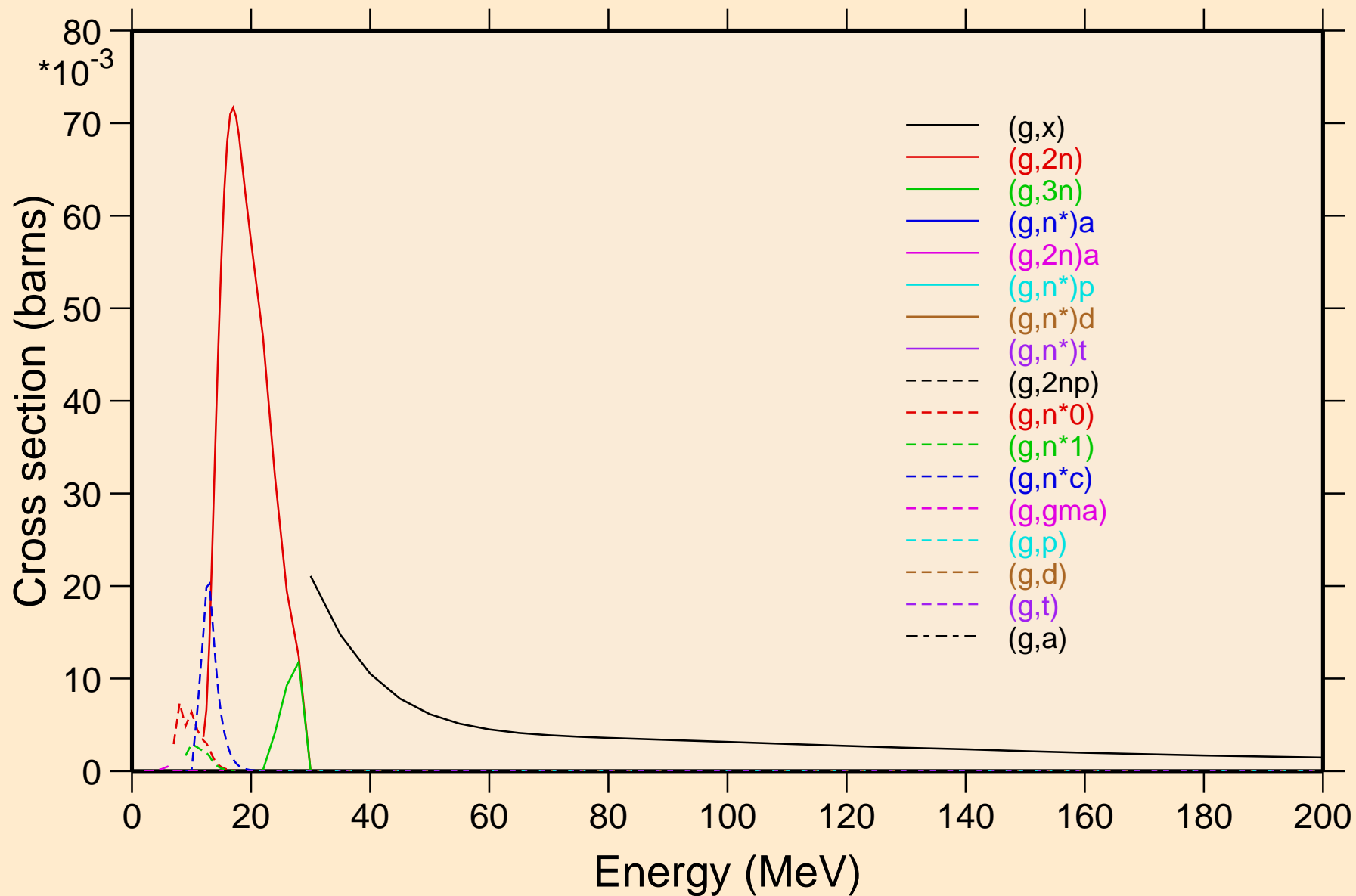

CA050 PHOTON ACER TENDL-2024 LIBRARY; T=0.K

Heating

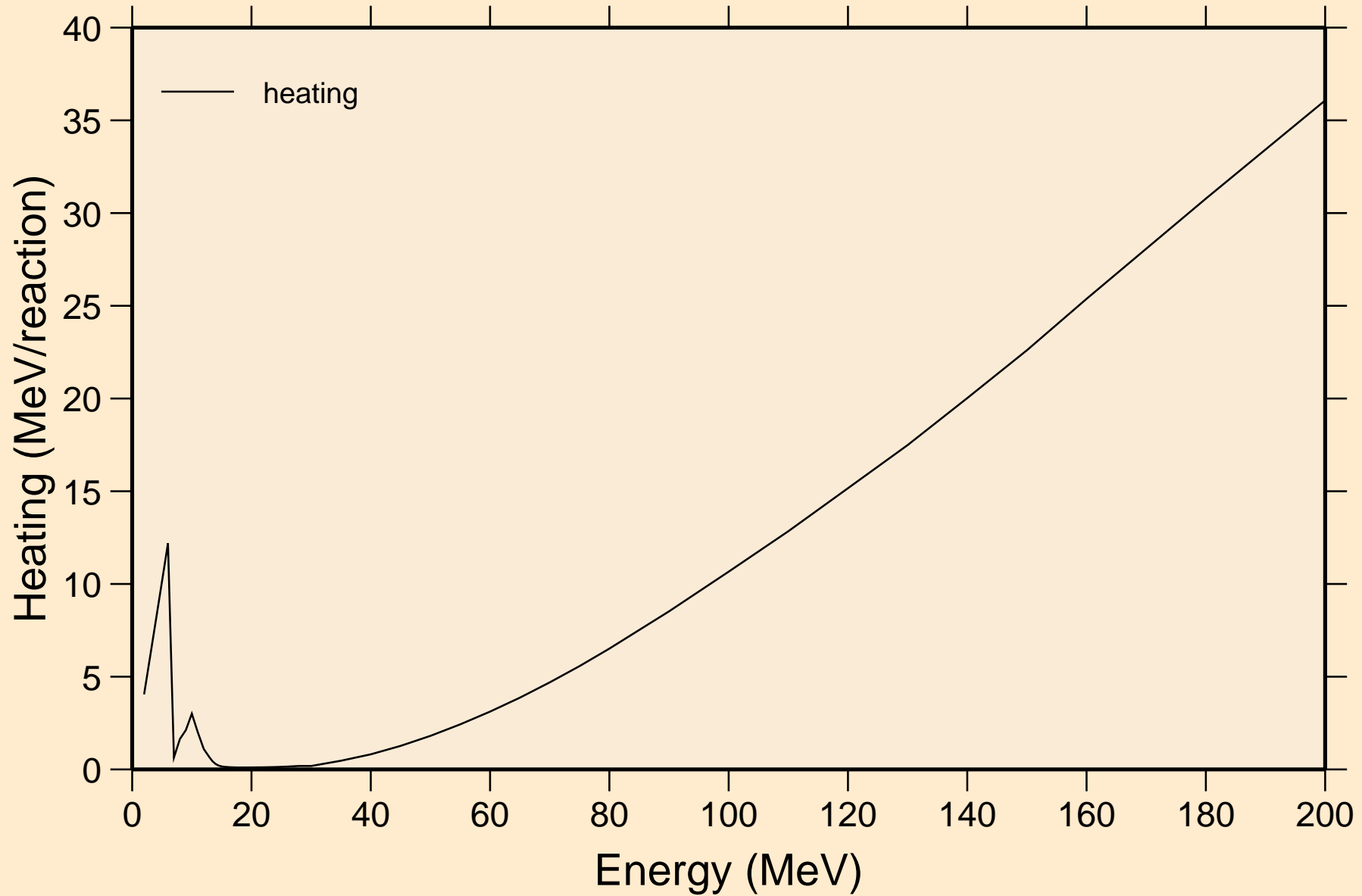

CA050 PHOTON ACER TENDL-2024 LIBRARY; T=0.K

Particle heating contributions

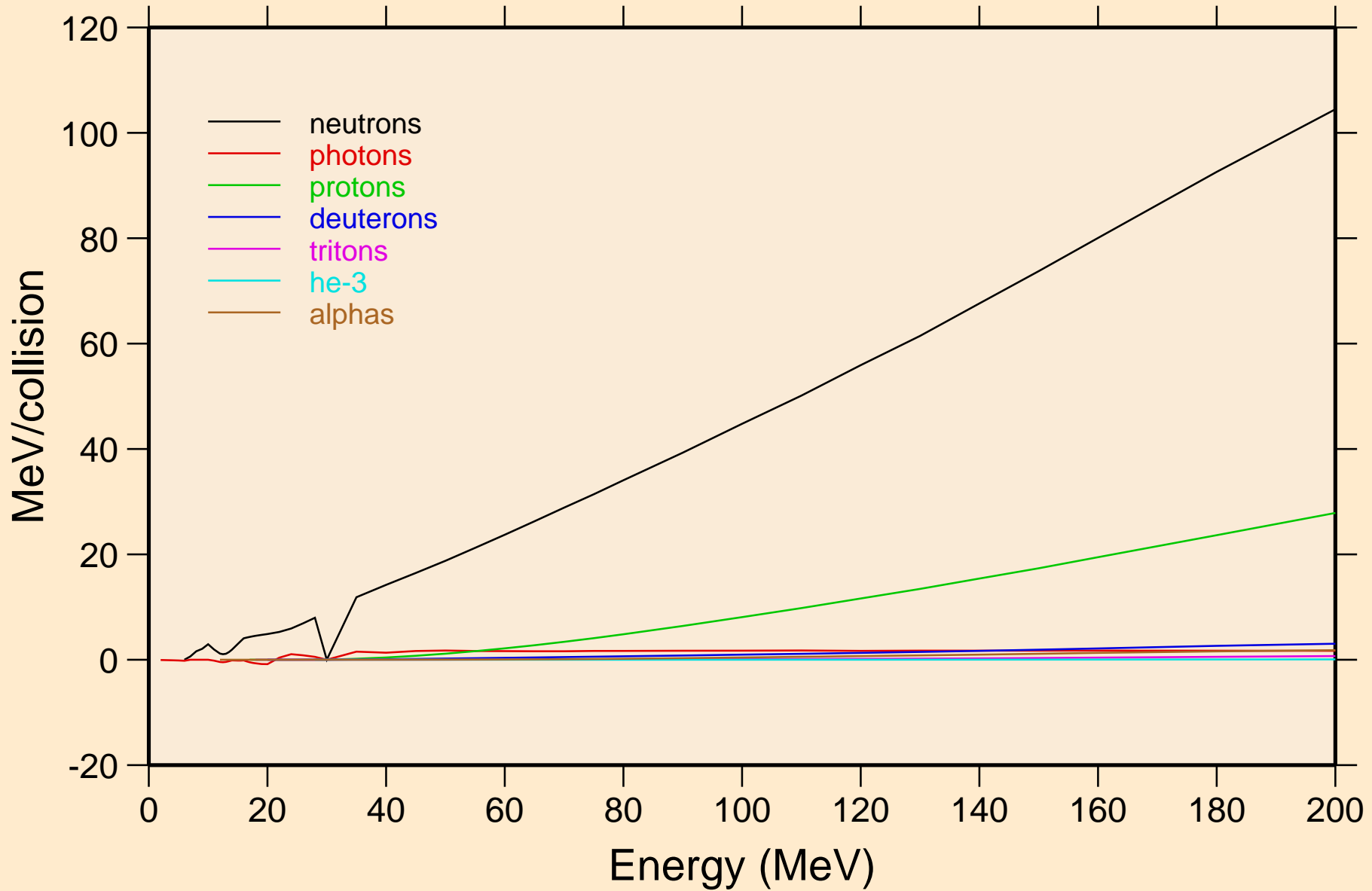

CA050 PHOTON ACER TENDL-2024 LIBRARY; T=0.K

Particle production cross sections

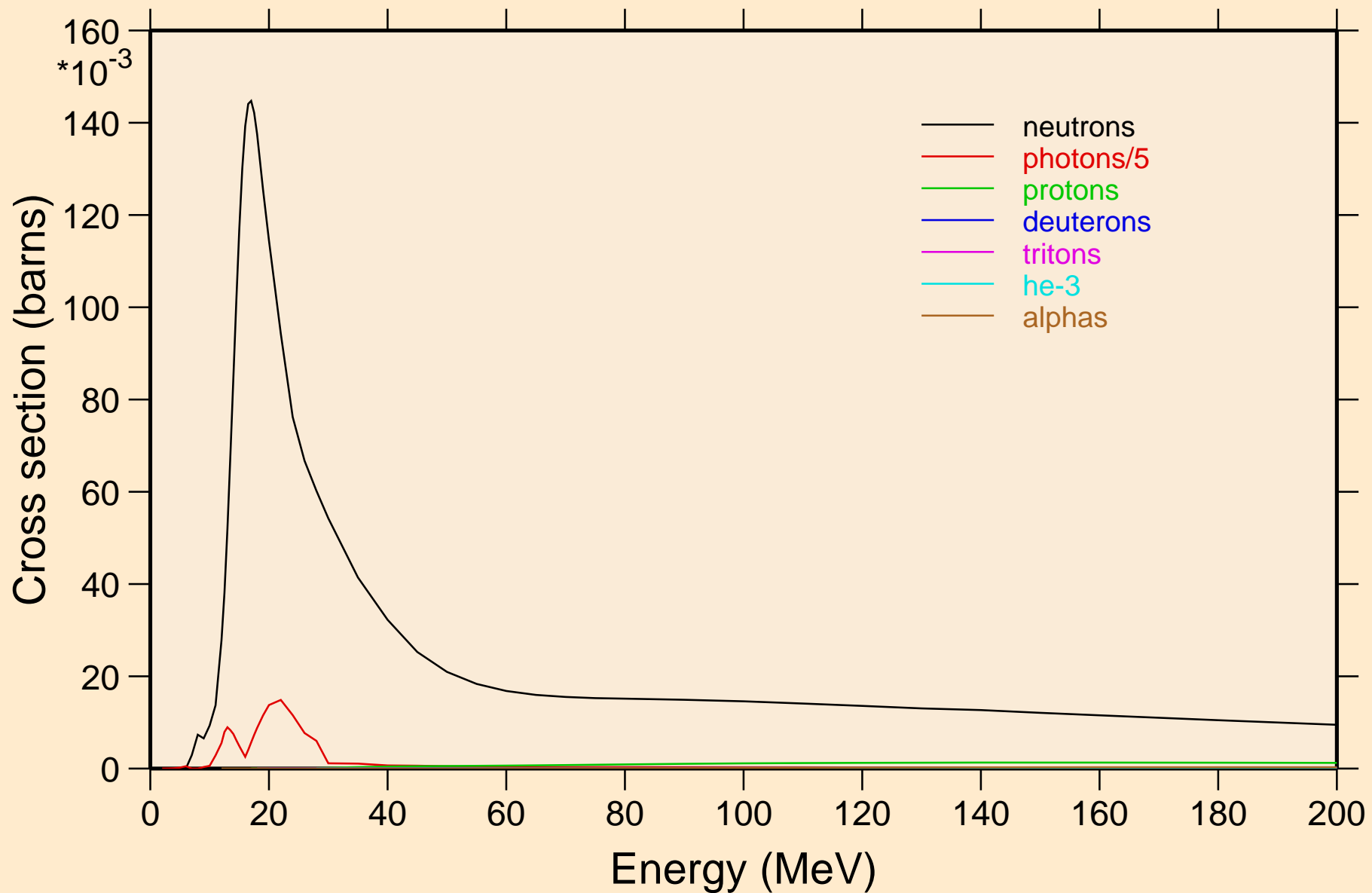

CA050 PHOTON ACER TENDL-2024 LIBRARY; T=0.K
neutrons from (g,x)

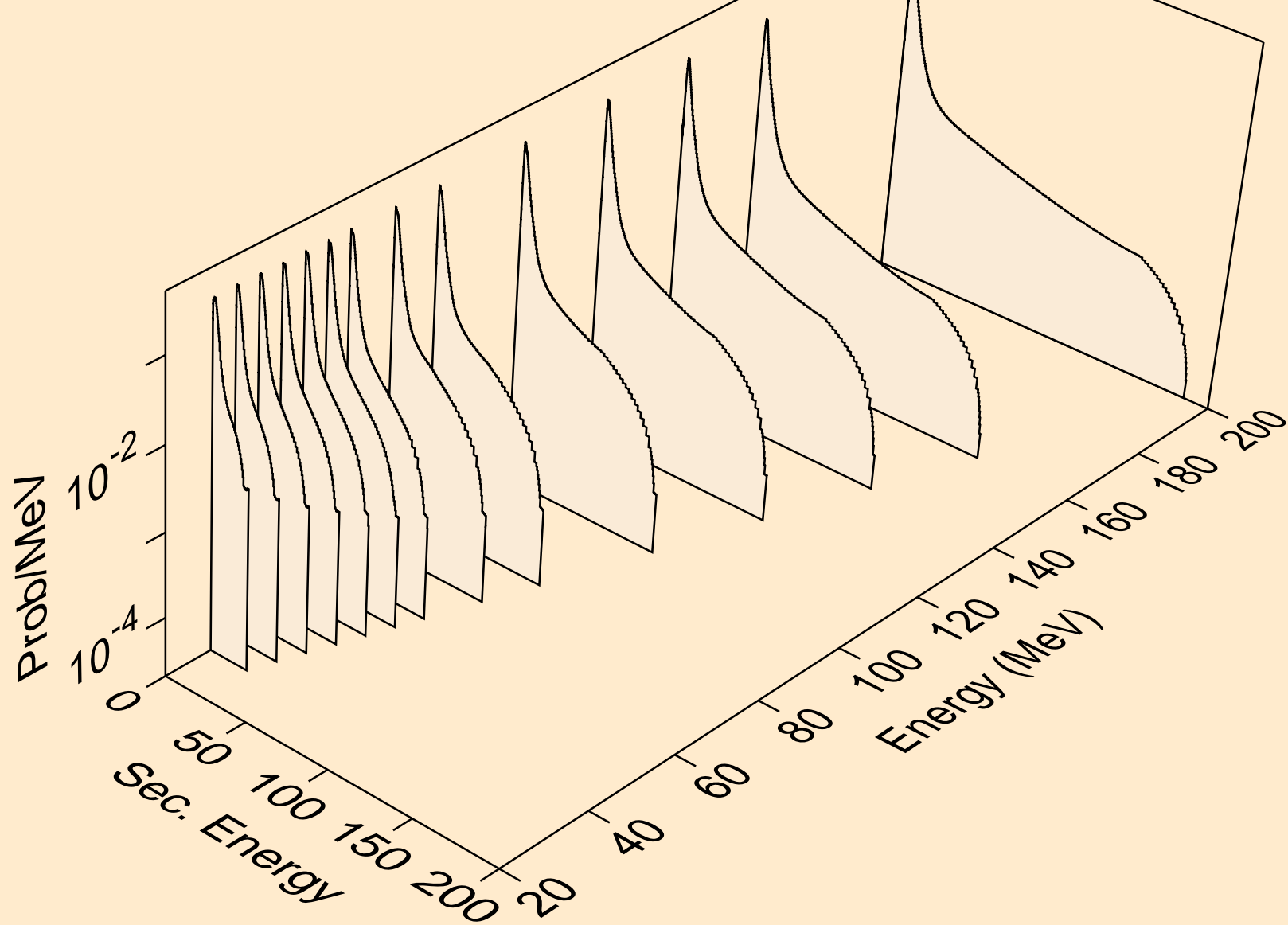

CA050 PHOTON ACER TENDL-2024 LIBRARY; T=0.K
neutrons from (g,2n)

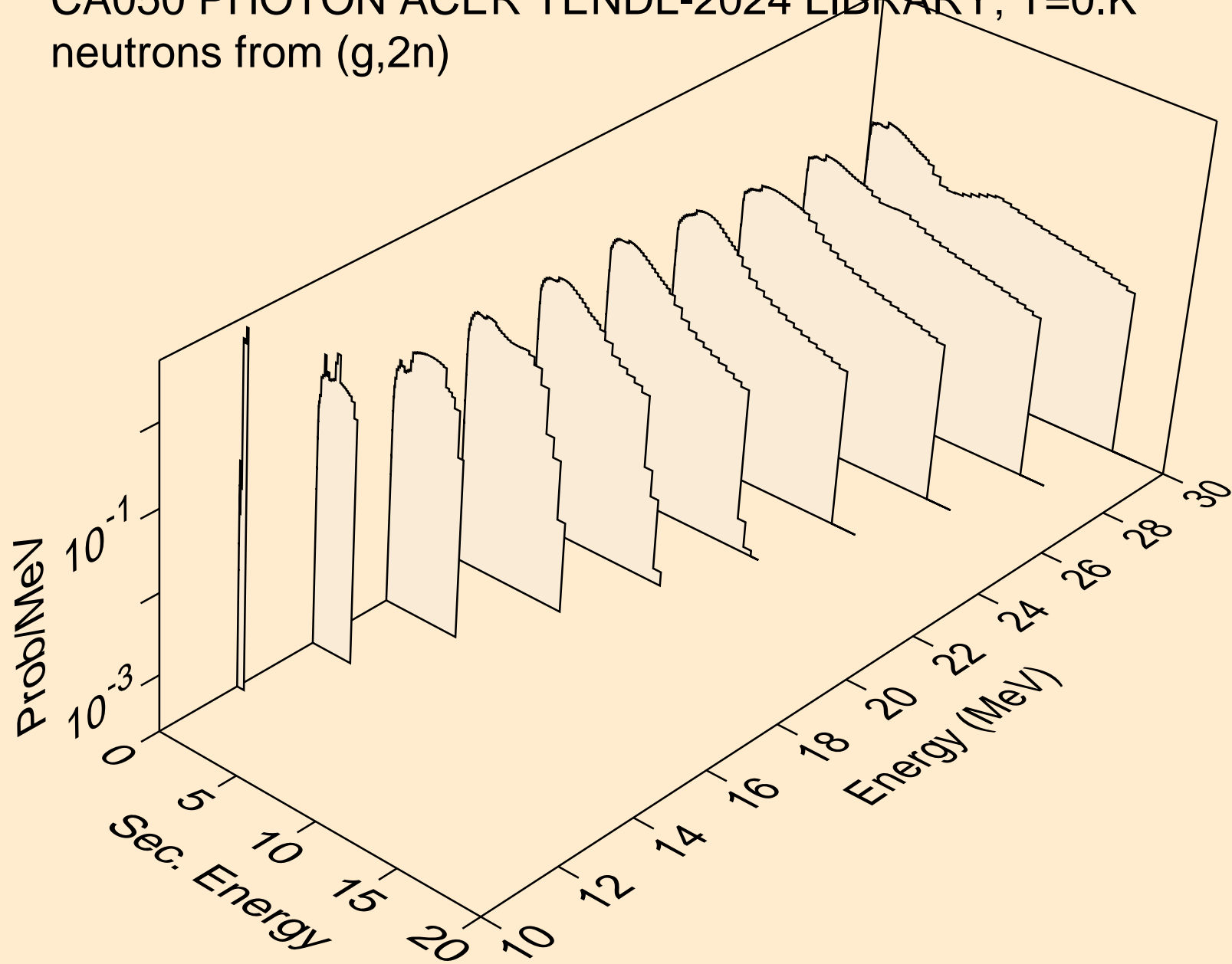

CA050 PHOTON ACER TENDL-2024 LIBRARY; T=0.K
neutrons from (g,3n)

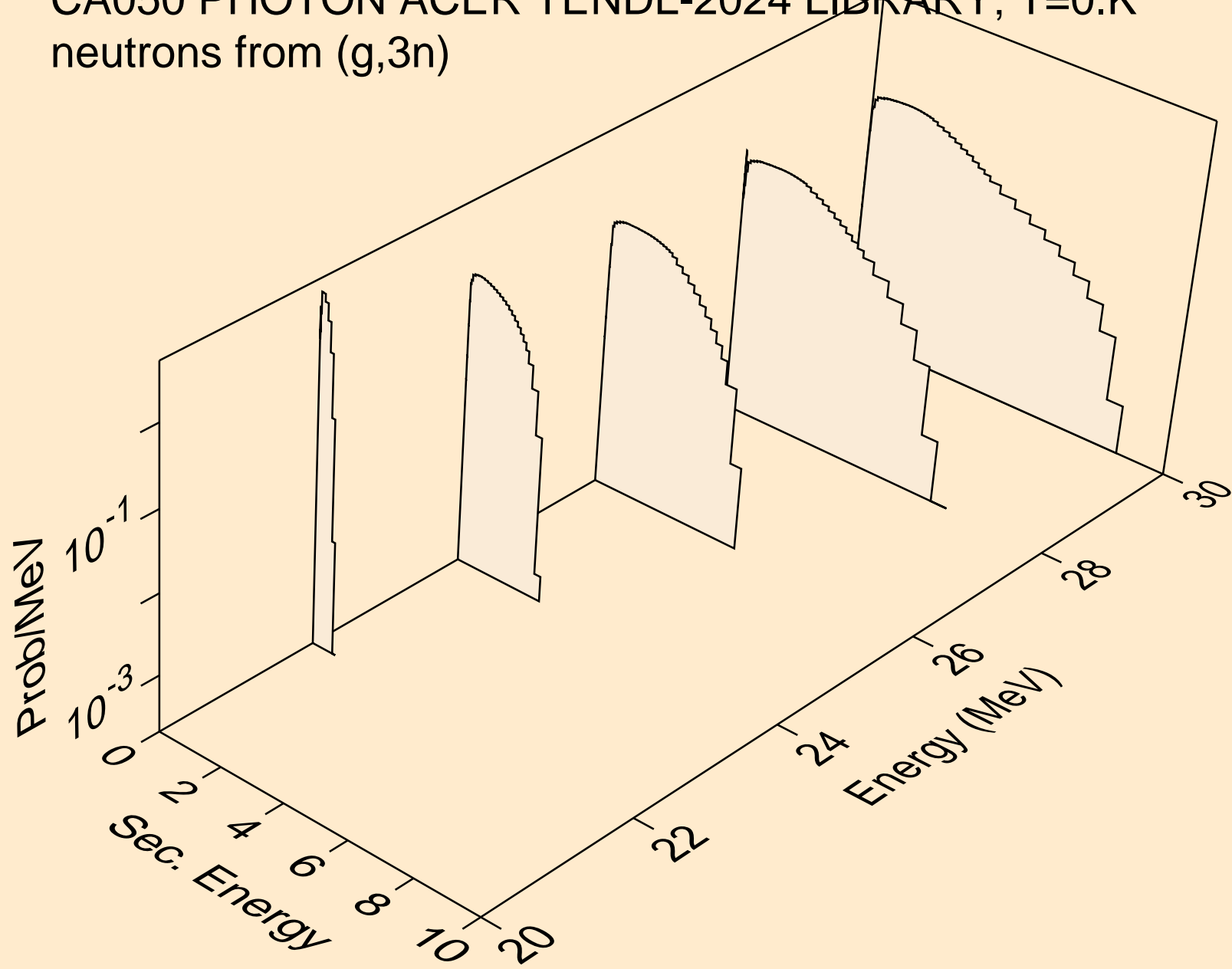

CA050 PHOTON ACER TENDL-2024 LIBRARY; T=0.K
neutrons from (g,n*)a

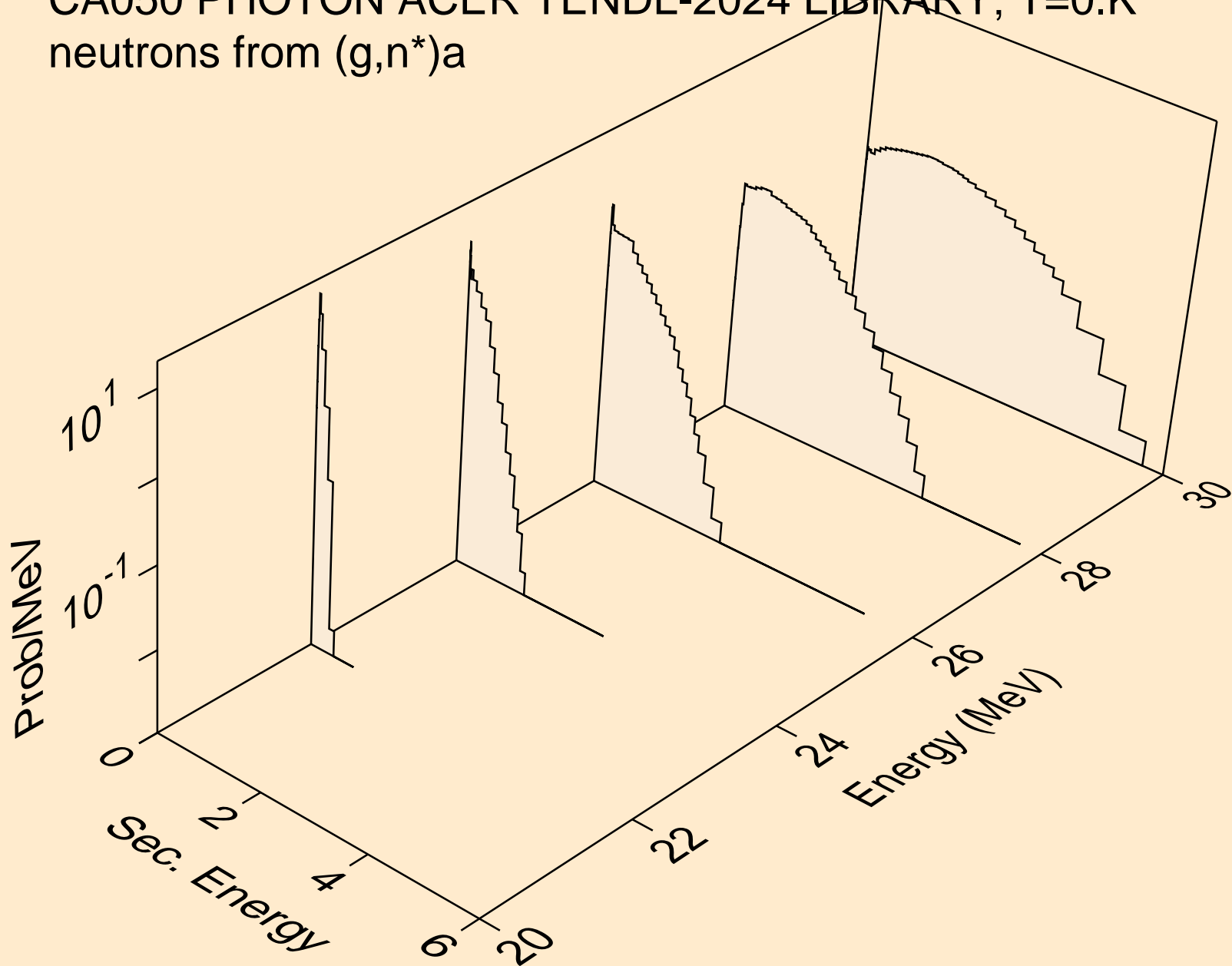

CA050 PHOTON ACER TENDL-2024 LIBRARY; T=0.K
neutrons from (g,2n)a

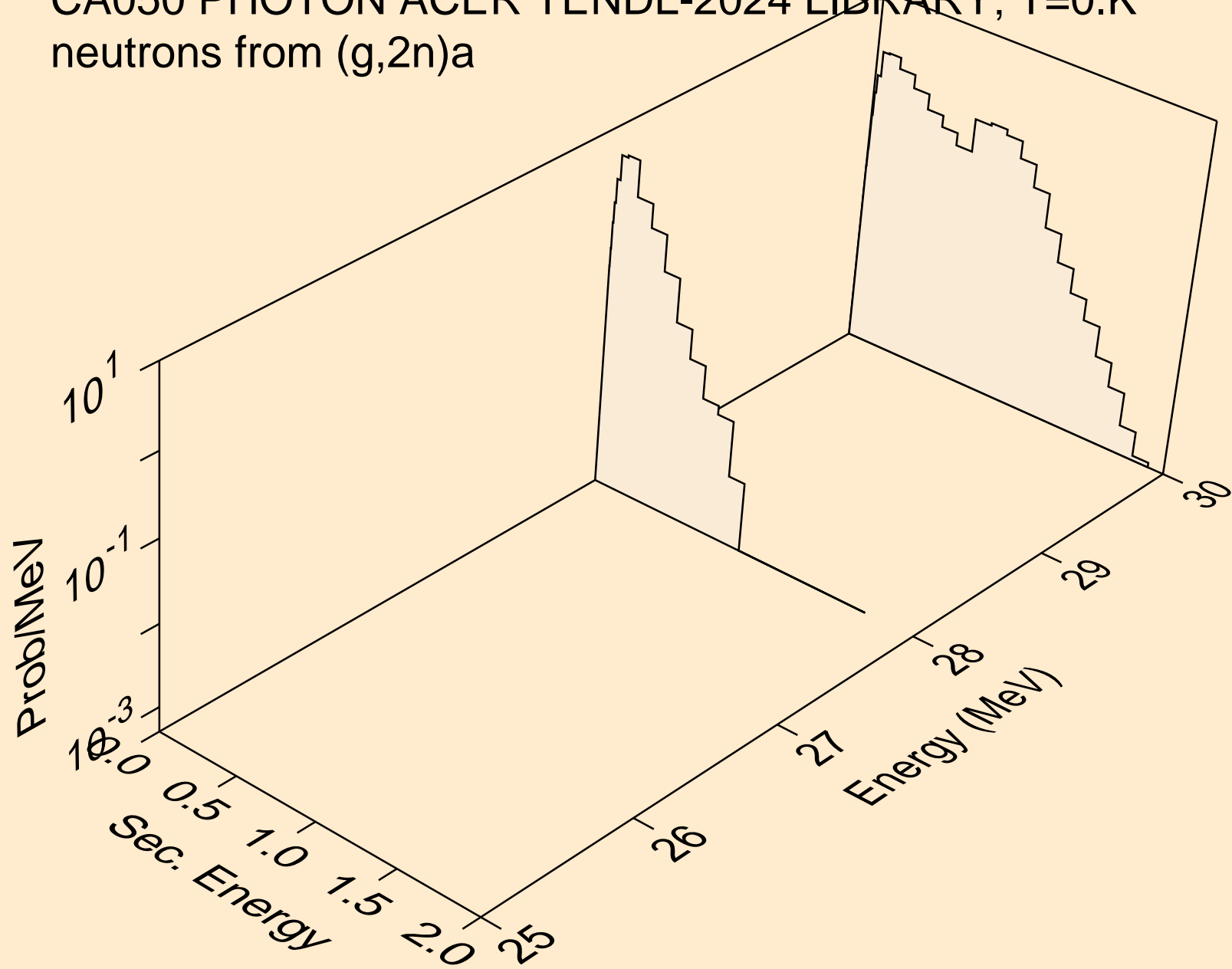

CA050 PHOTON ACER TENDL-2024 LIBRARY; T=0.K
neutrons from (g,n*)p

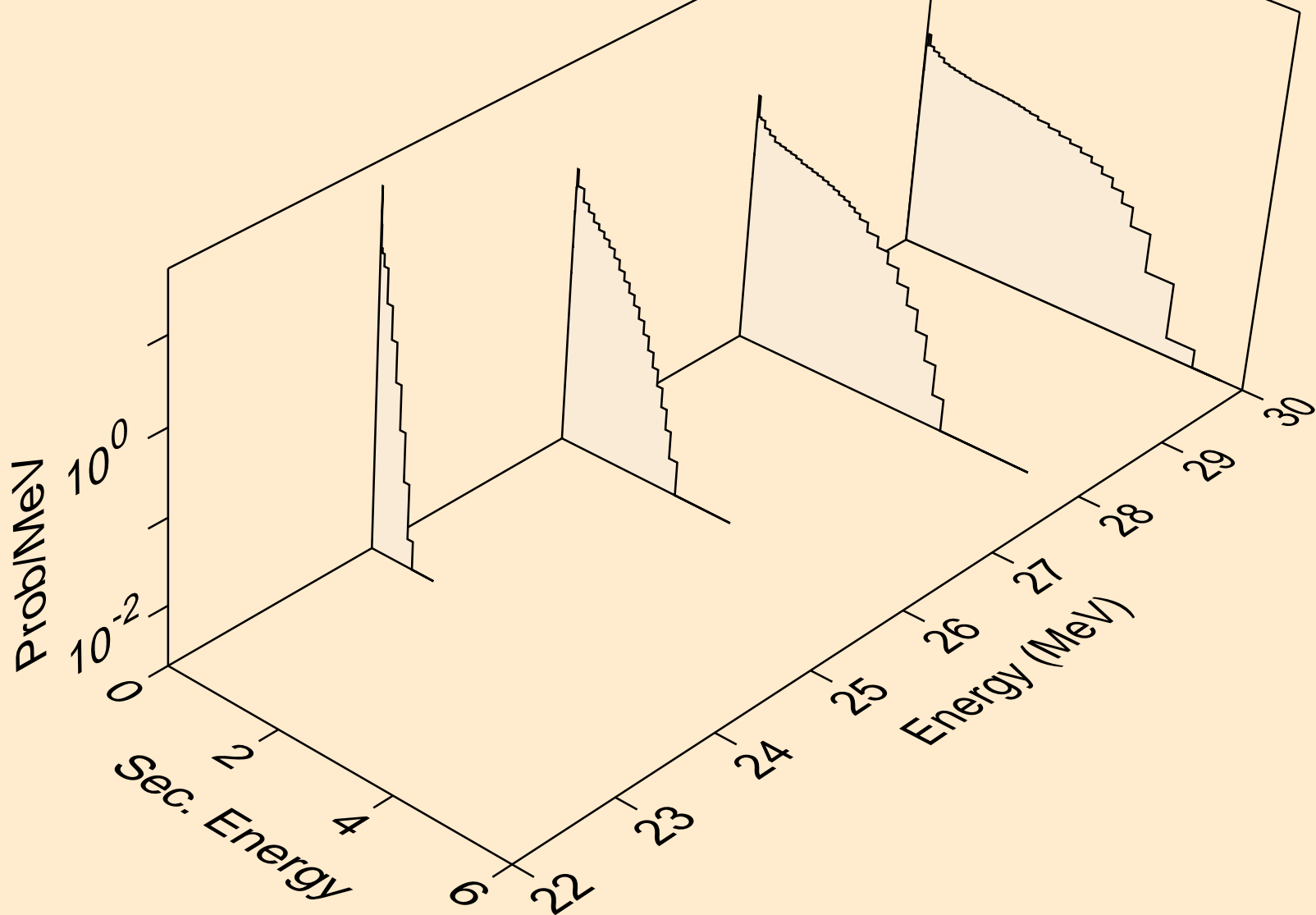

CA050 PHOTON ACER TENDL-2024 LIBRARY; T=0.K
neutrons from (g,n*)d

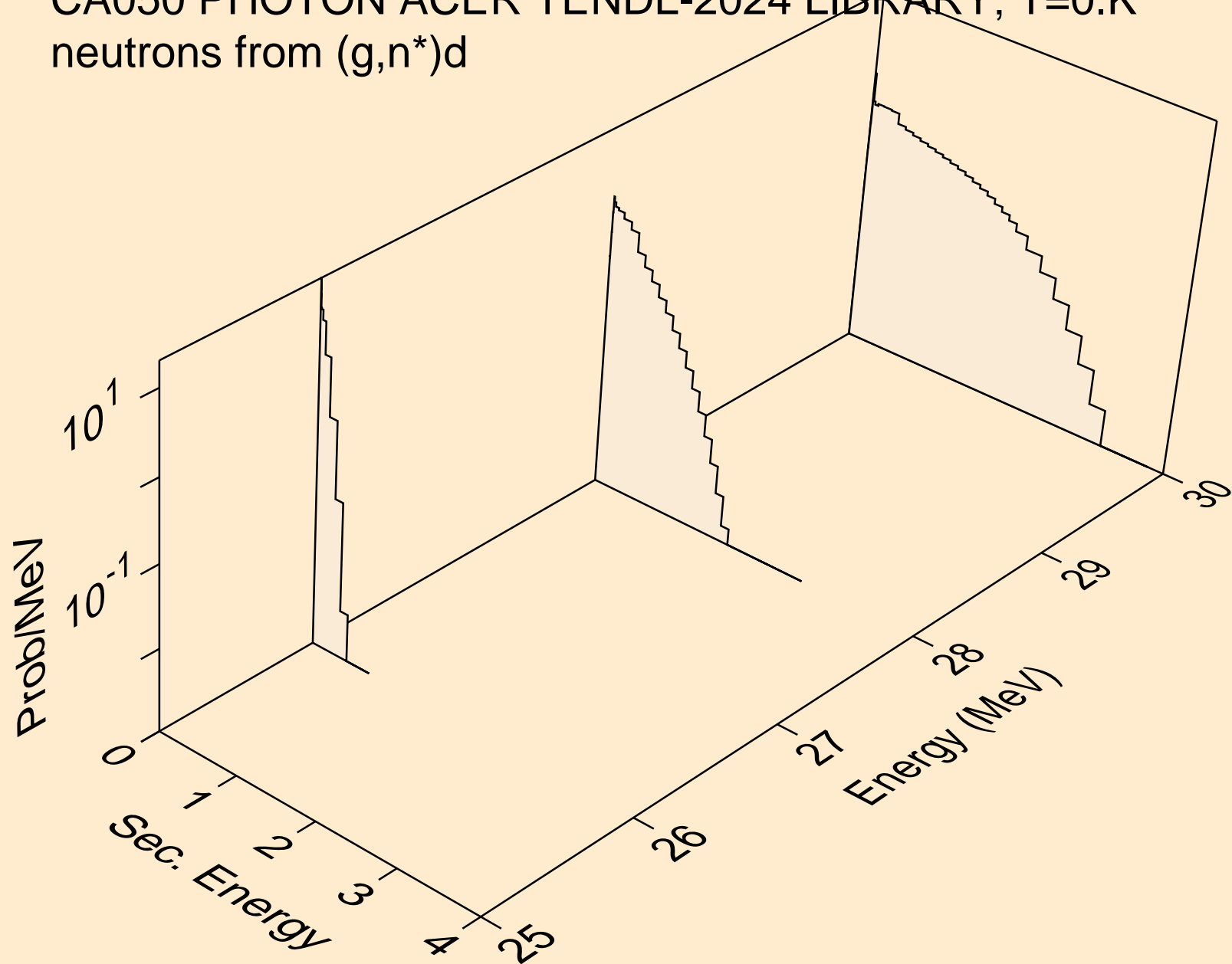

CA050 PHOTON ACER TENDL-2024 LIBRARY; T=0.K
neutrons from (g,n*)t

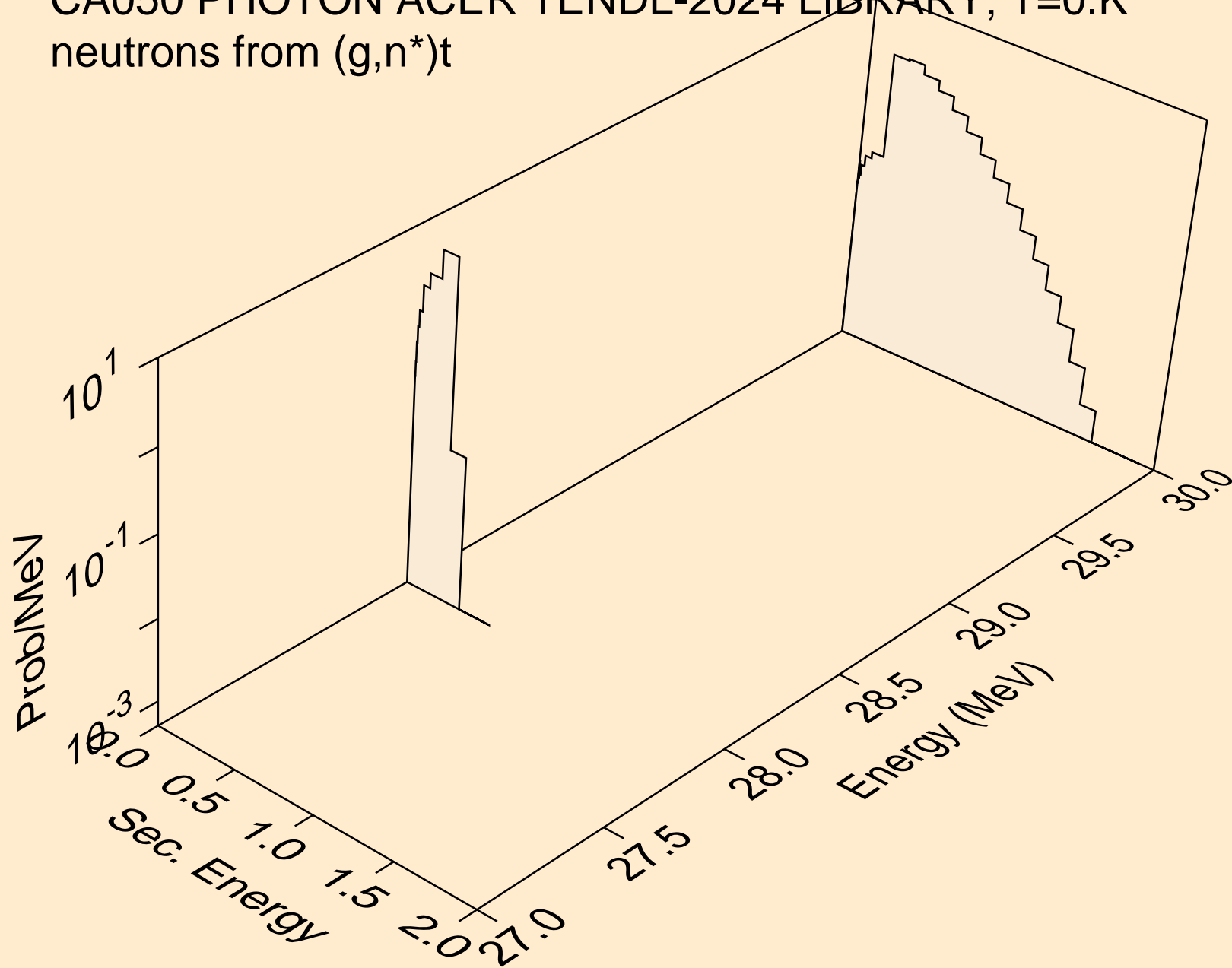

CA050 PHOTON ACER TENDL-2024 LIBRARY; T=0.K
neutrons from (g,2np)

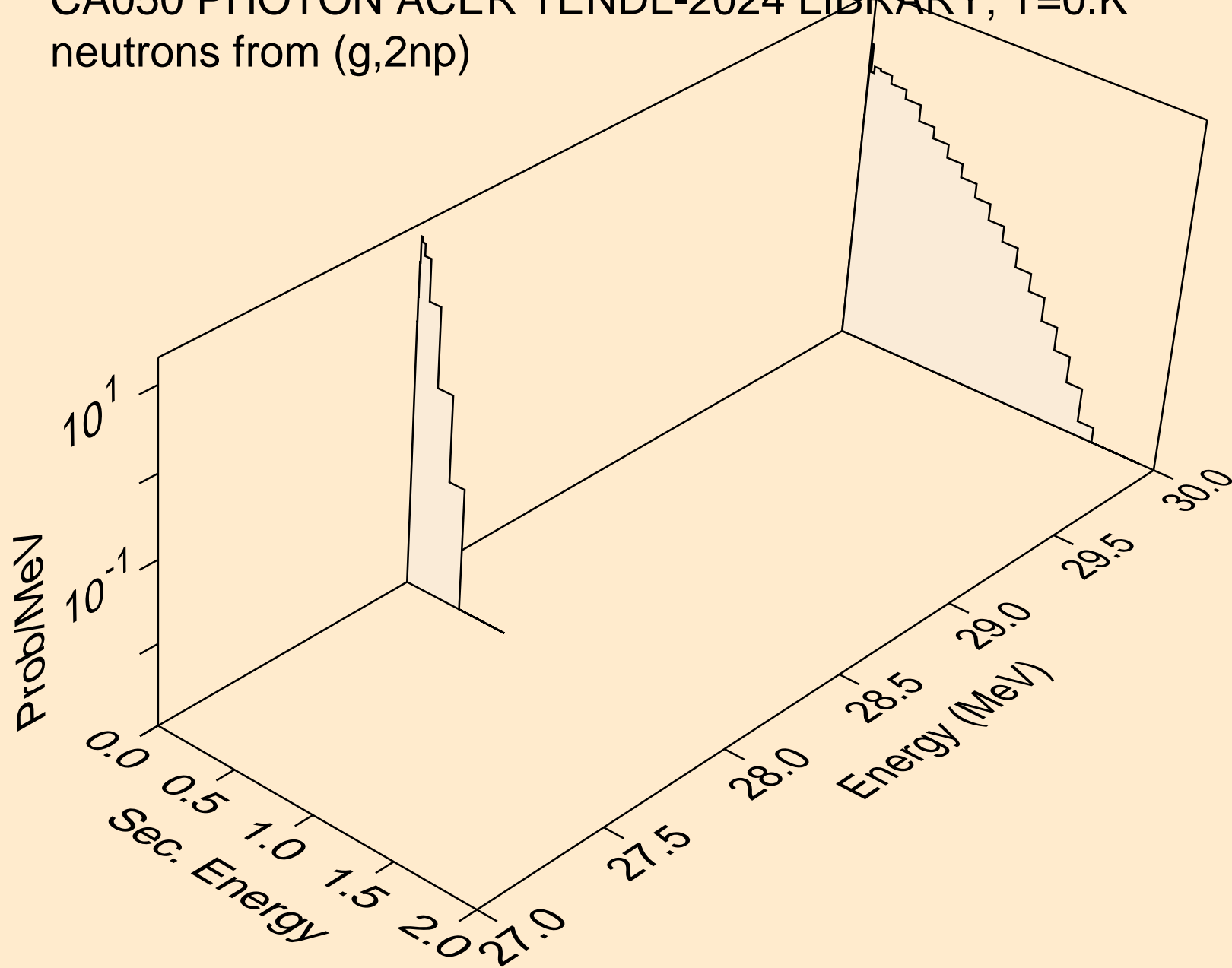

CA050 PHOTON ACER TENDL-2024 LIBRARY; T=0.K
angular distribution for (g,n*0) neutron

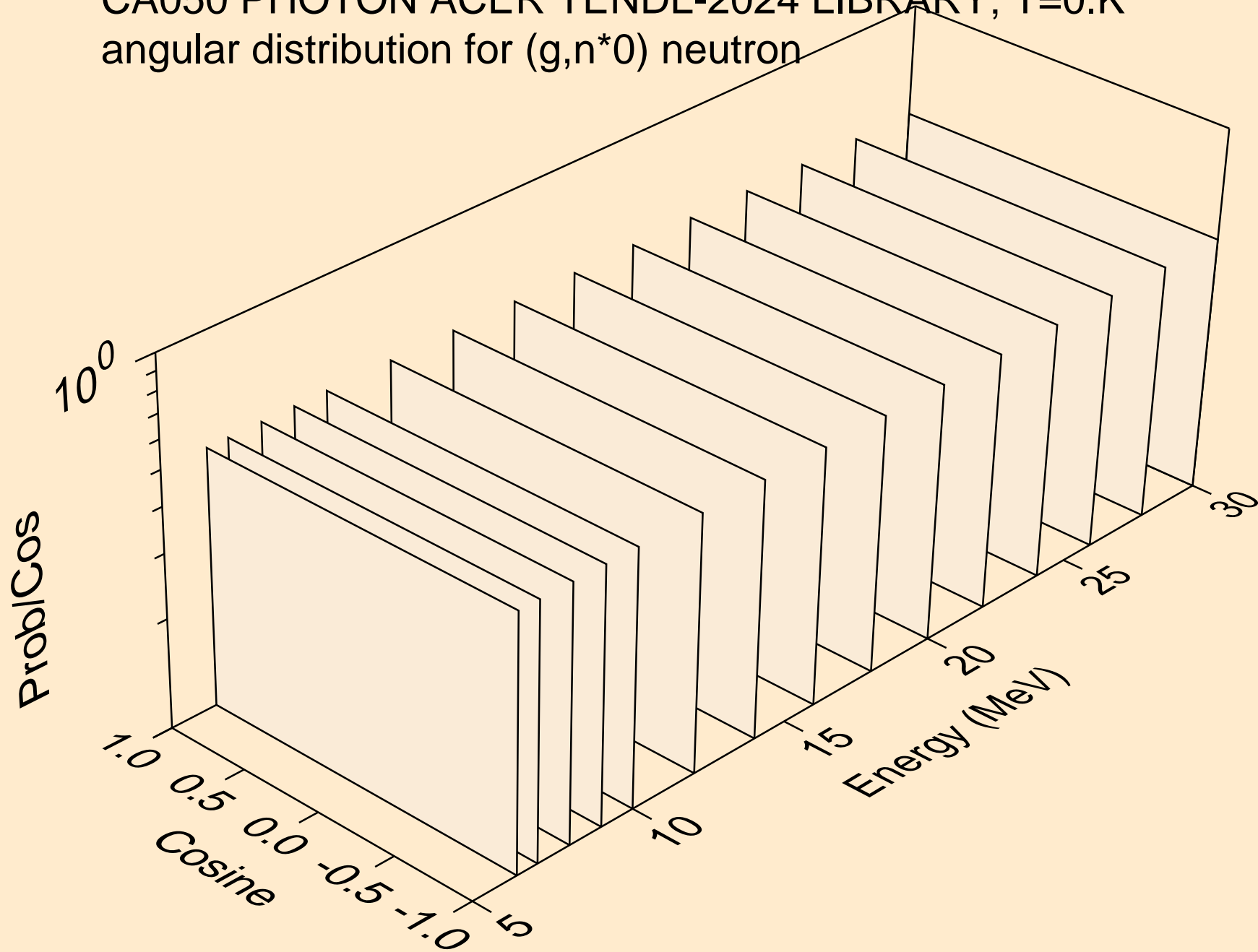

CA050 PHOTON ACER TENDL-2024 LIBRARY; T=0.K
angular distribution for (g,n*1) neutron

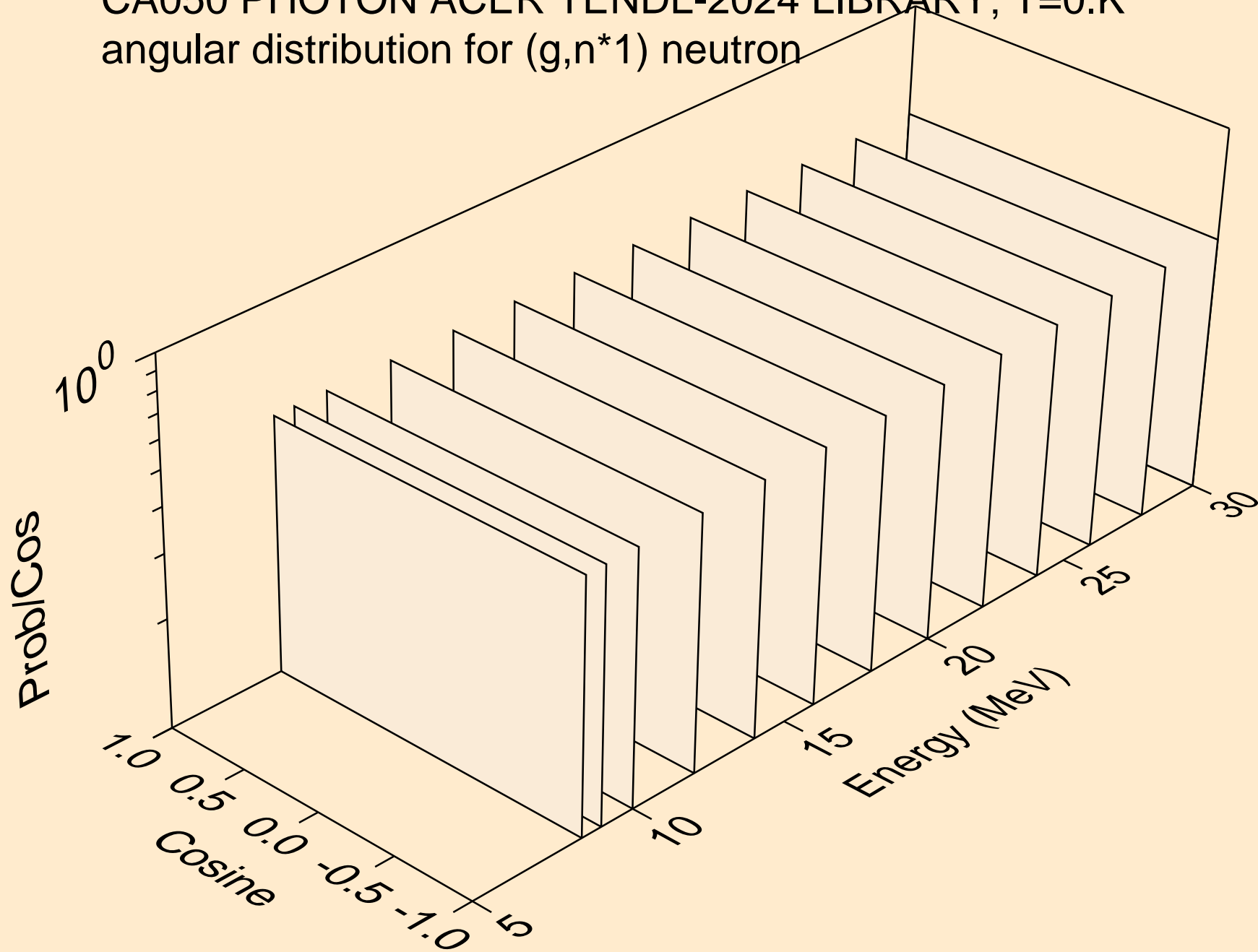

CA050 PHOTON ACER TENDL-2024 LIBRARY; T=0.K
neutrons from (g,n*c)

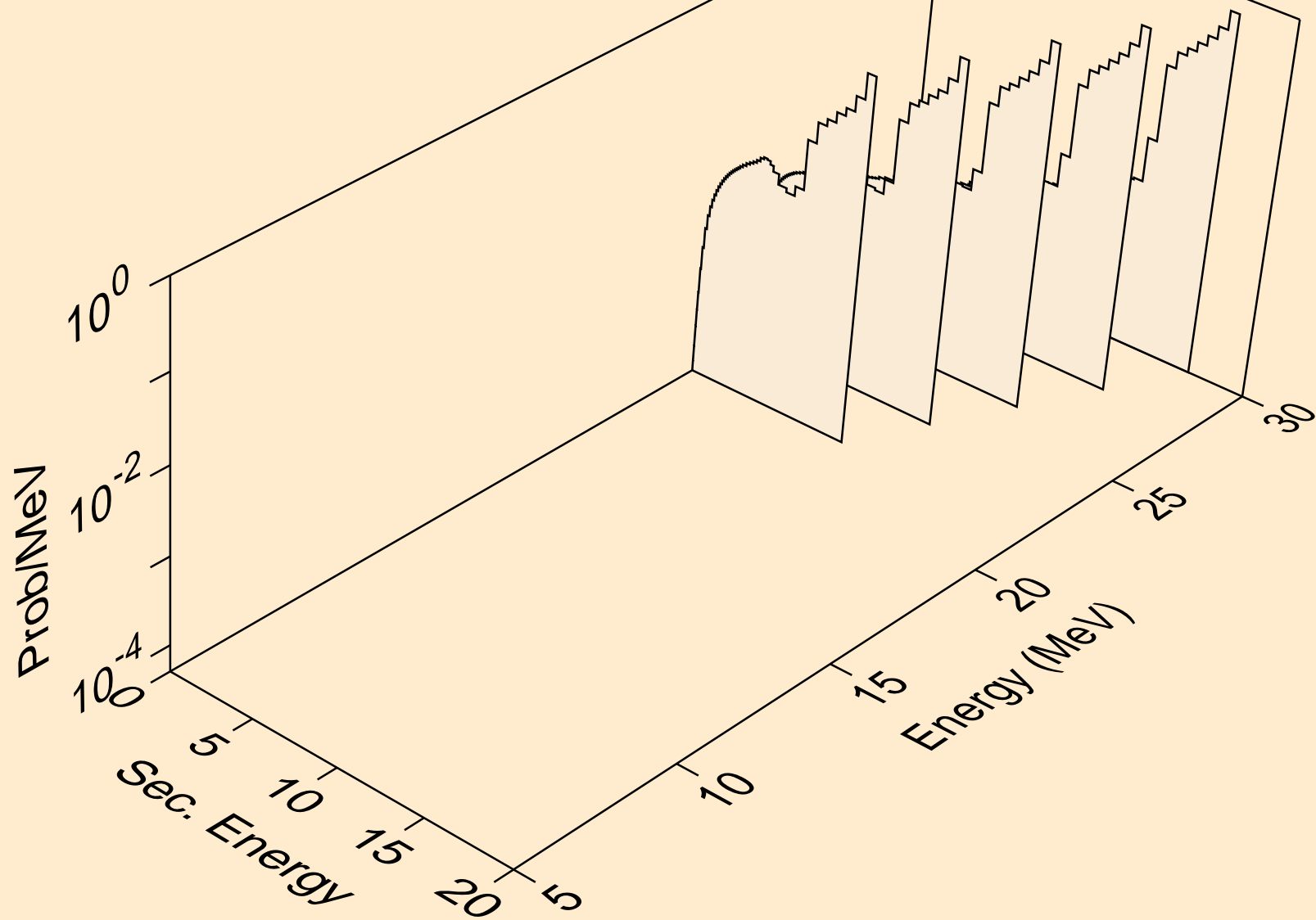

CA050 PHOTON ACER TENDL-2024 LIBRARY; T=0.K
photons from (g,x)

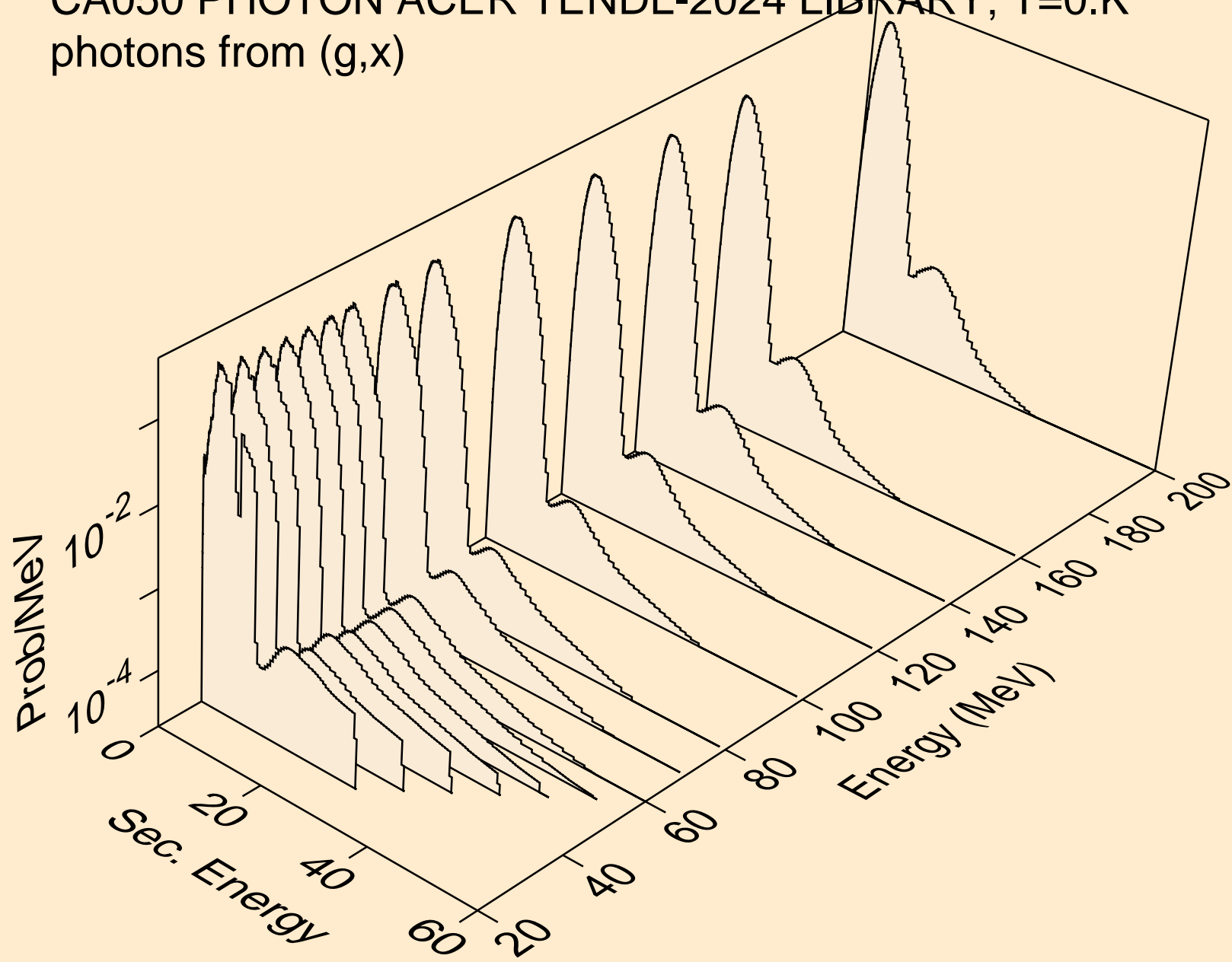

CA050 PHOTON ACER TENDL-2024 LIBRARY; T=0.K
photons from (g,2n)

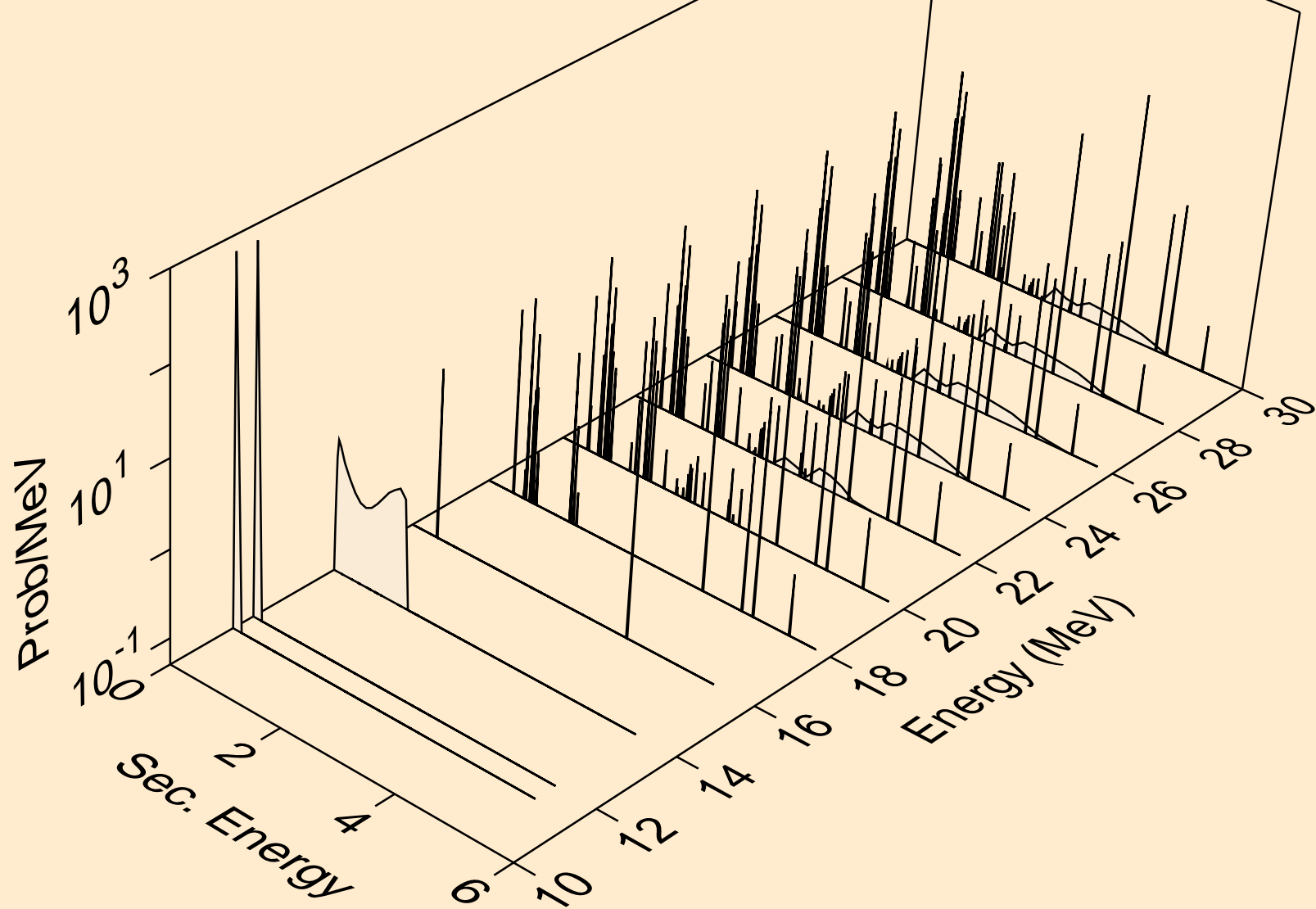

CA050 PHOTON ACER TENDL-2024 LIBRARY; T=0.K
photons from (g,3n)

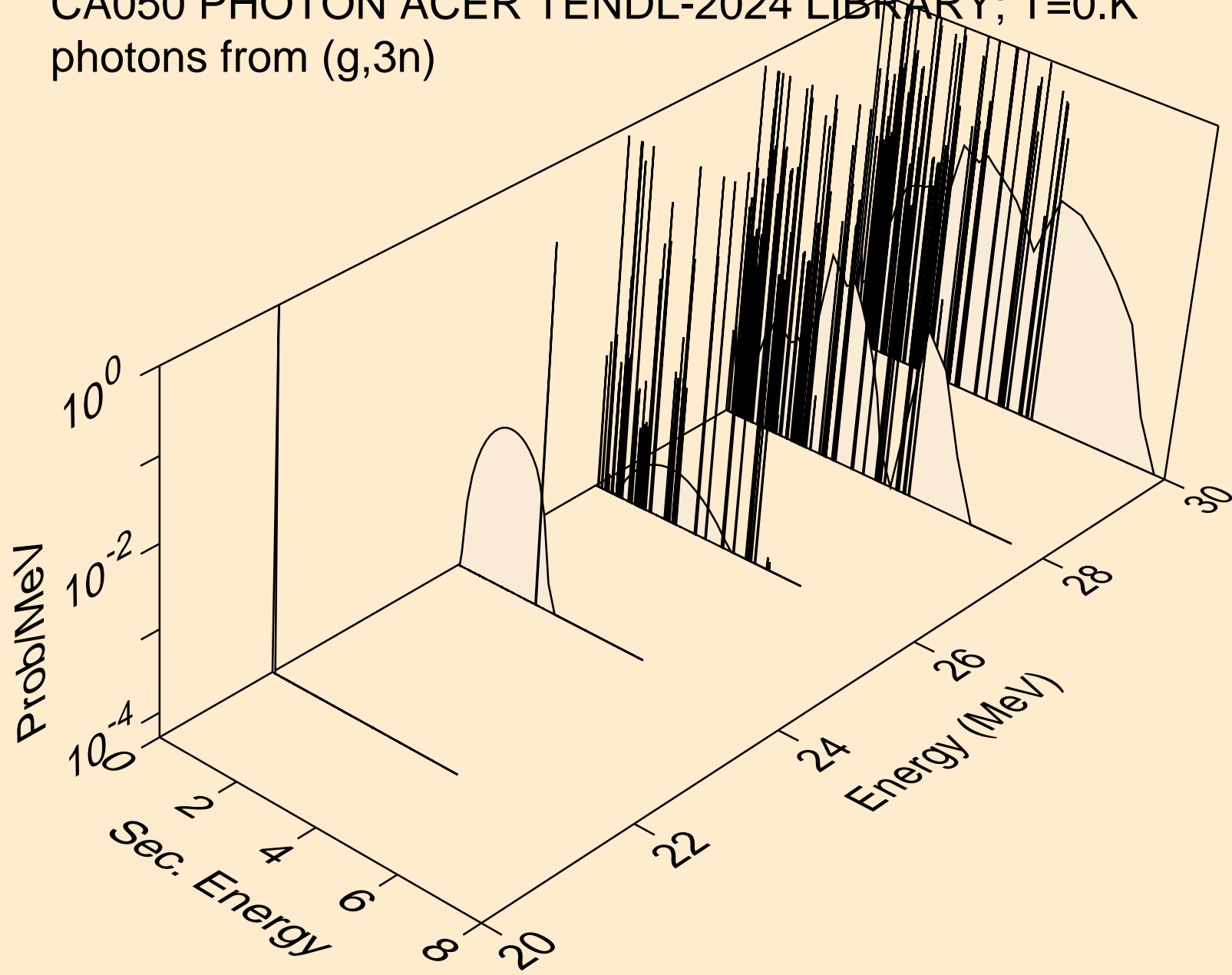

CA050 PHOTON ACER TENDL-2024 LIBRARY; T=0.K
photons from (g,n*)a

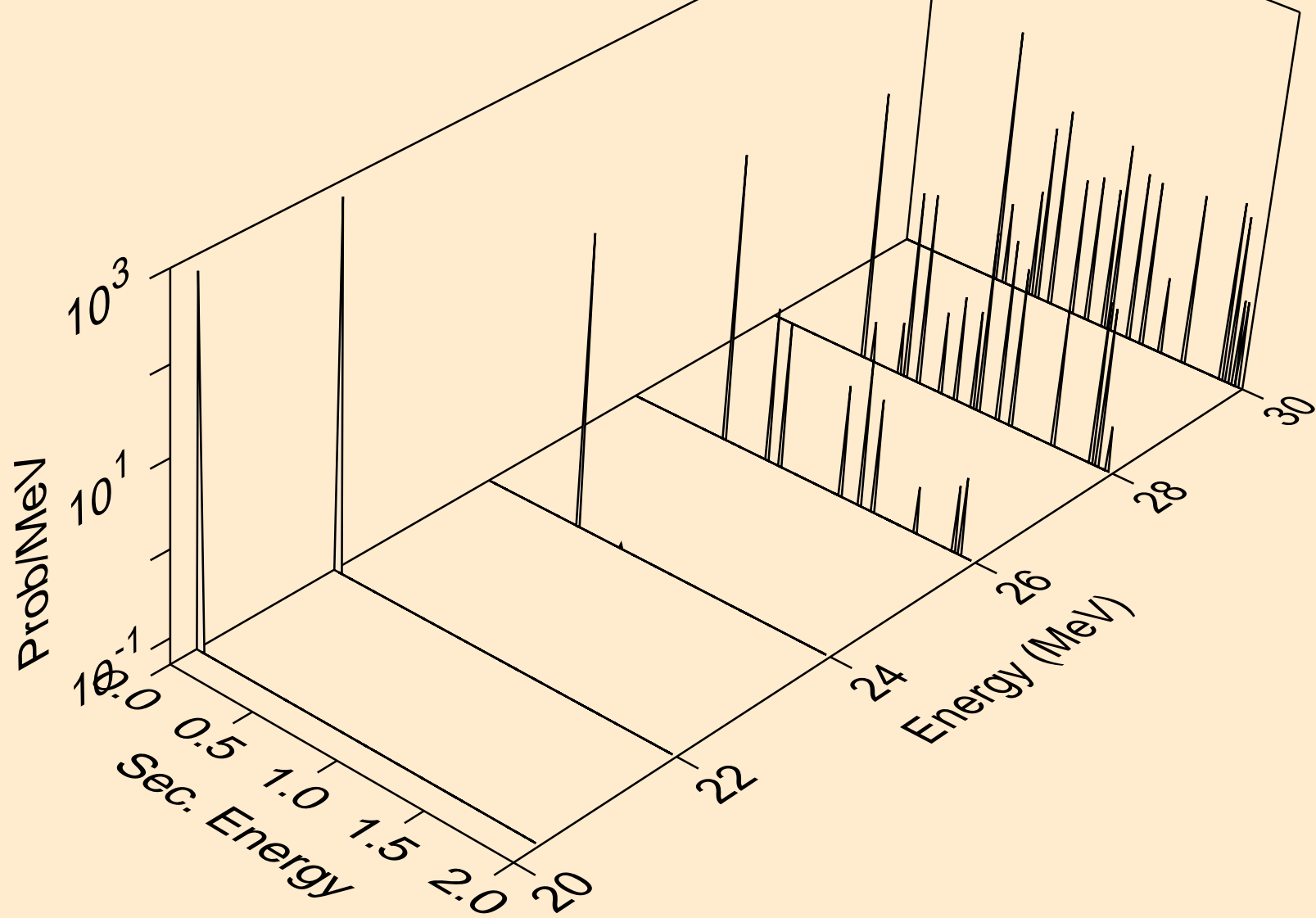

CA050 PHOTON ACER TENDL-2024 LIBRARY; T=0.K
photons from (g,2n)a

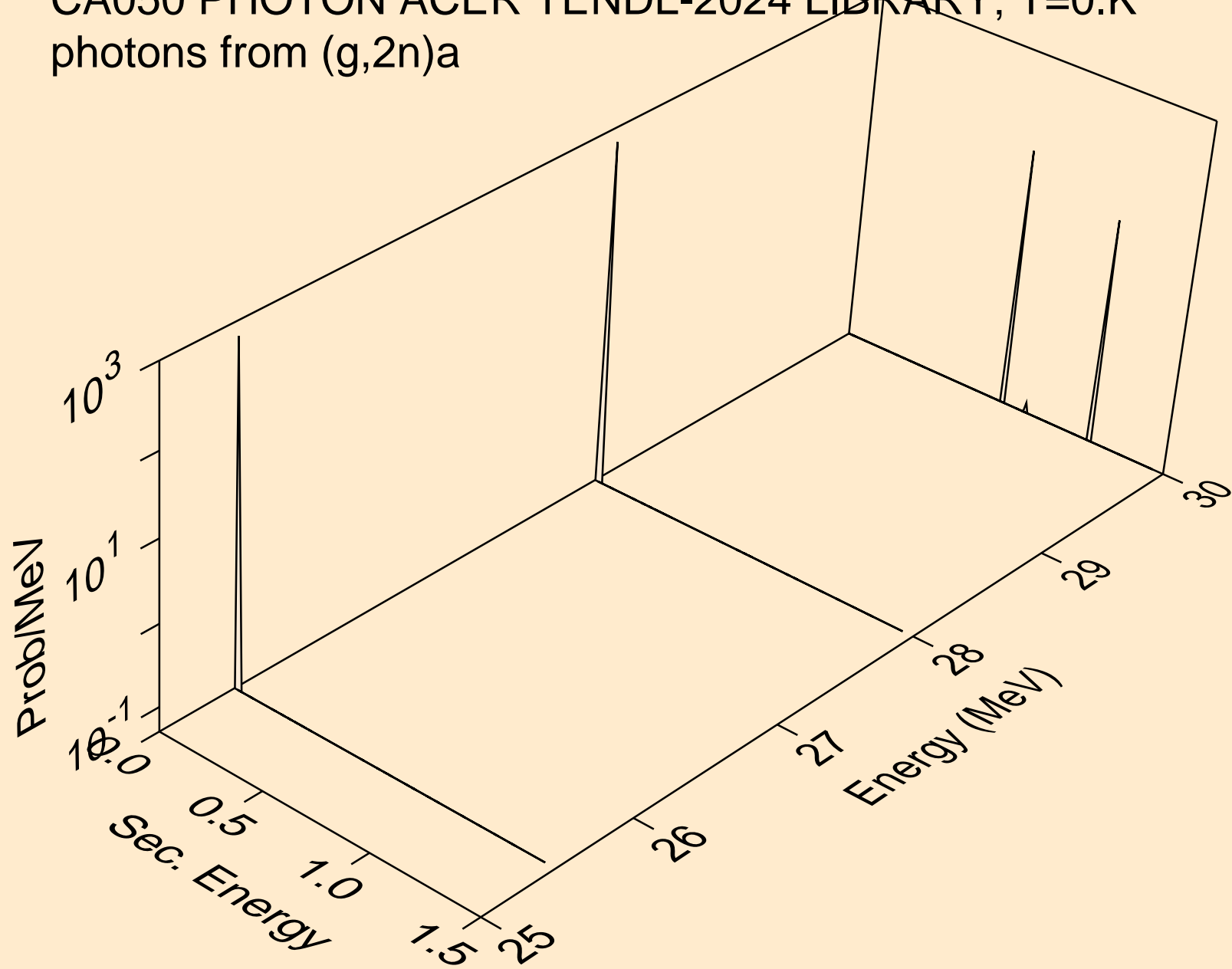

CA050 PHOTON ACER TENDL-2024 LIBRARY; T=0.K
photons from (g,n*)p

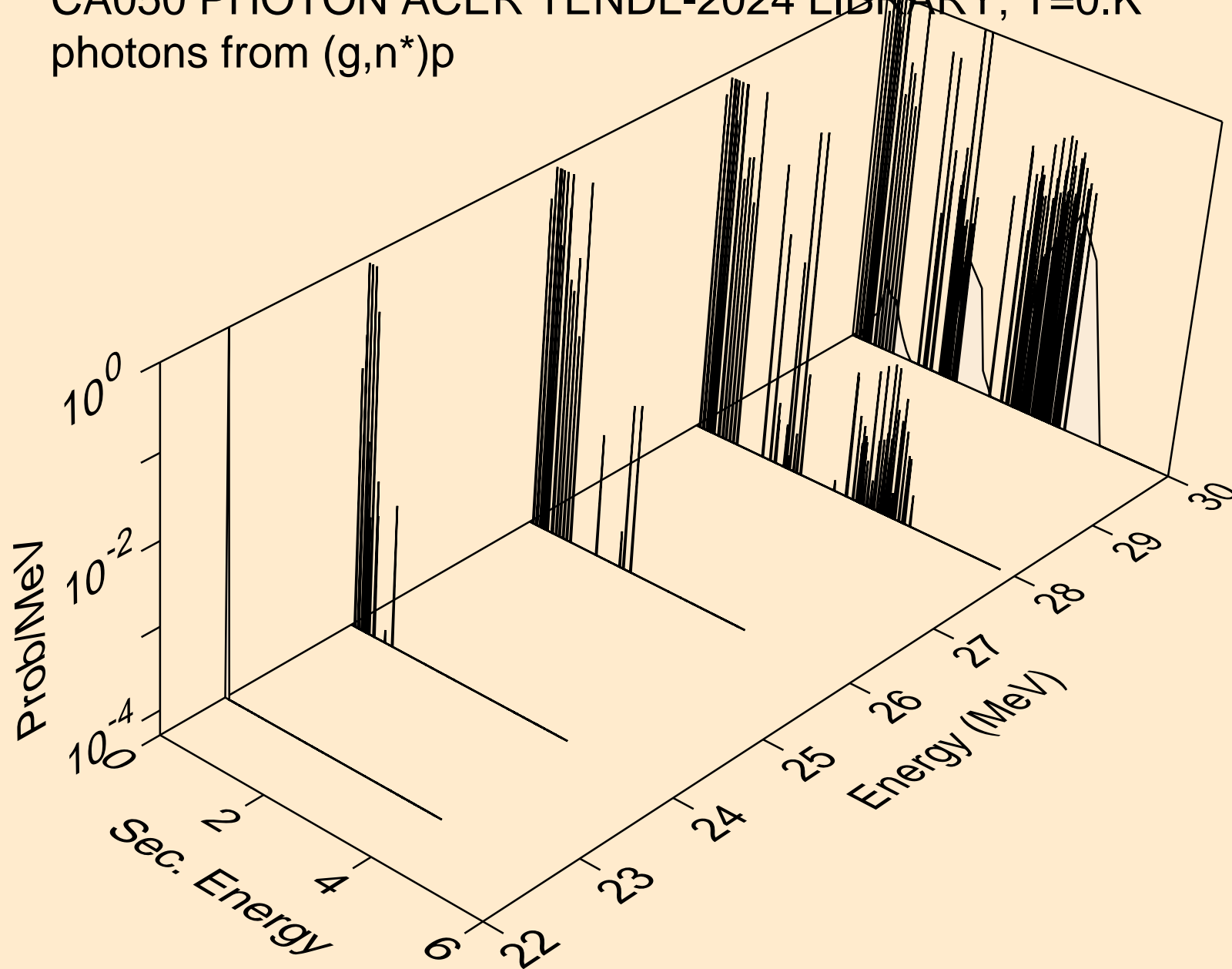

CA050 PHOTON ACER TENDL-2024 LIBRARY; T=0.K
photons from (g,n*)d

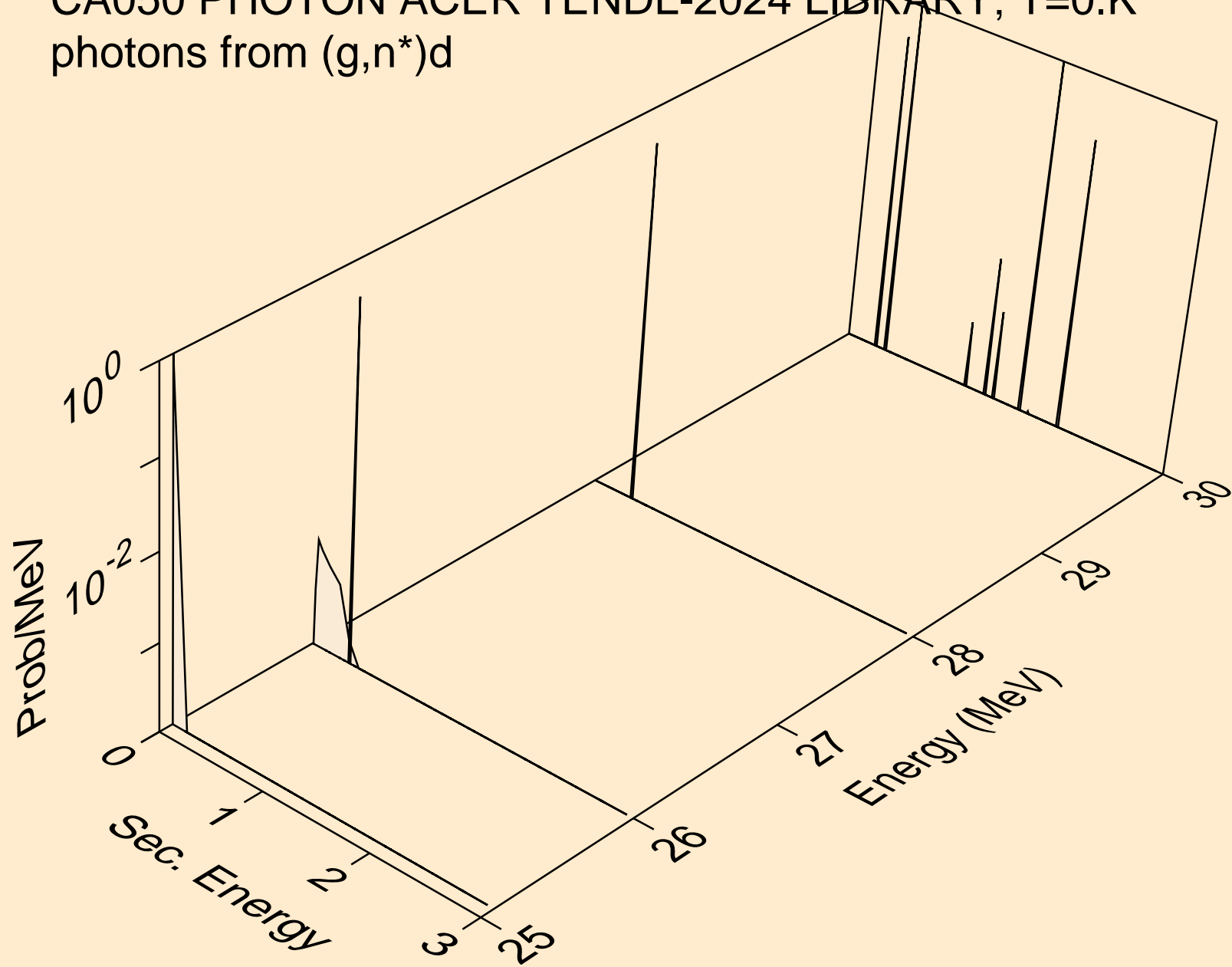

CA050 PHOTON ACER TENDL-2024 LIBRARY; T=0.K
photons from (g,n*)t

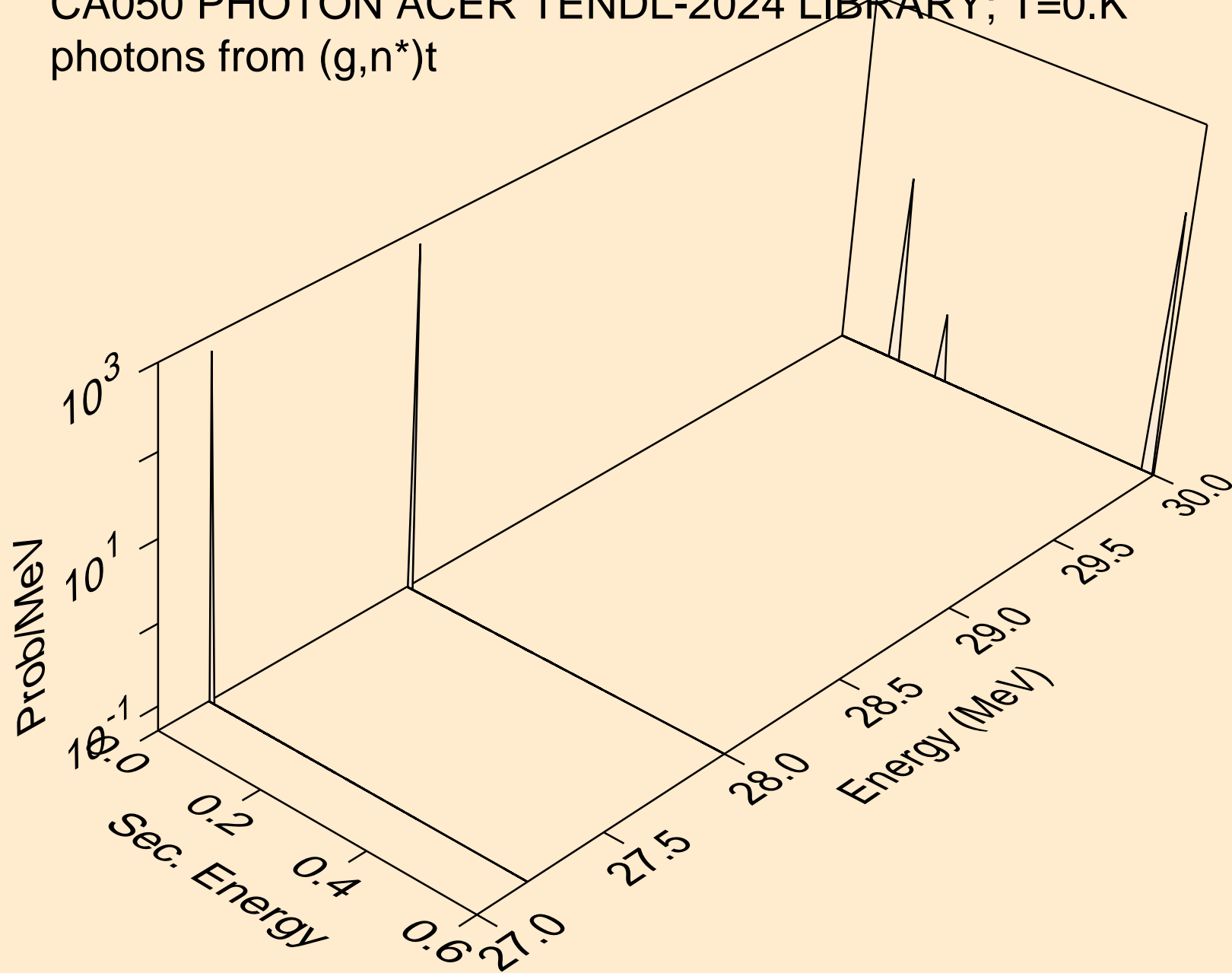

CA050 PHOTON ACER TENDL-2024 LIBRARY; T=0.K
photons from (g,2np)

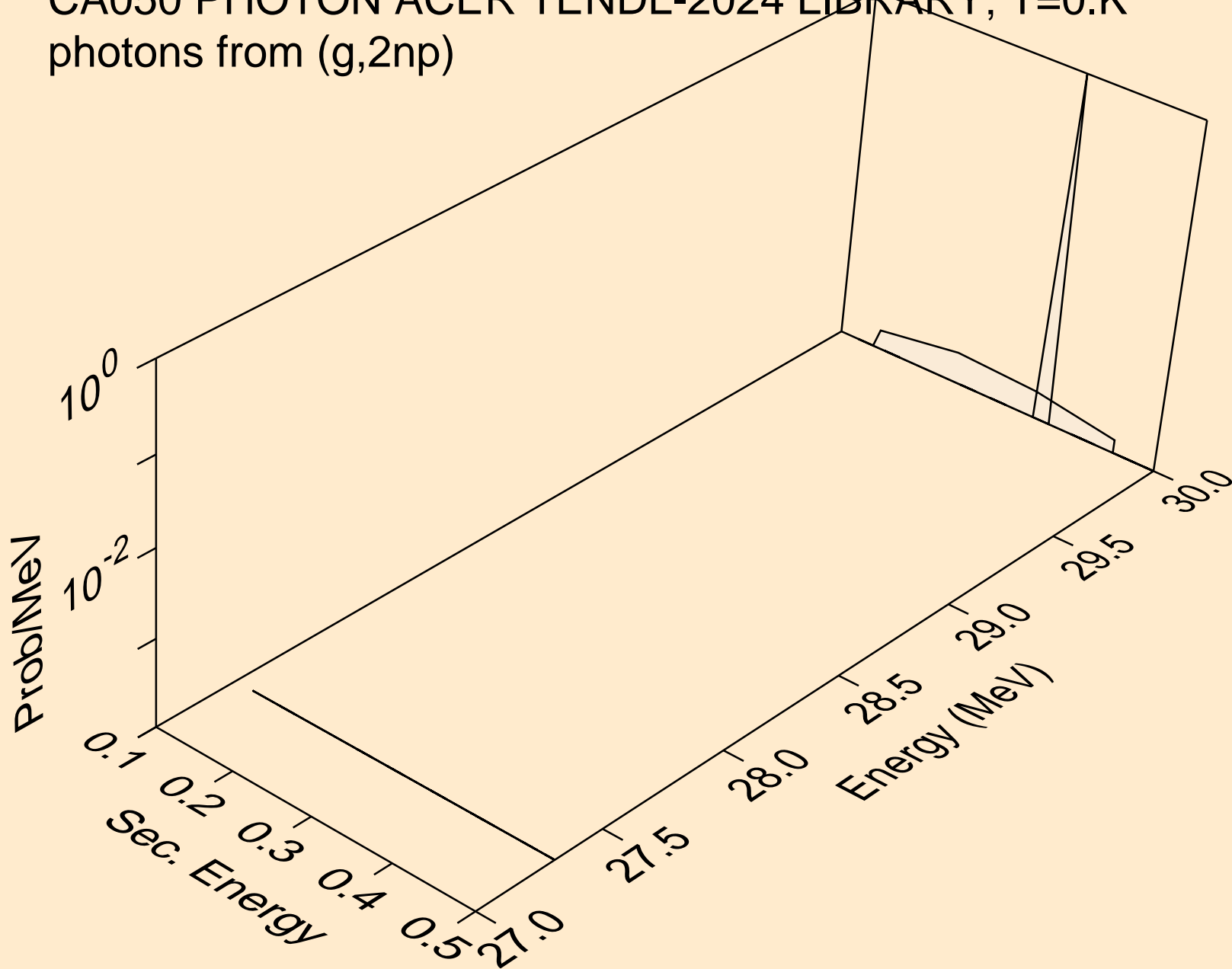

CA050 PHOTON ACER TENDL-2024 LIBRARY; T=0.K
photons from (g,n*c)

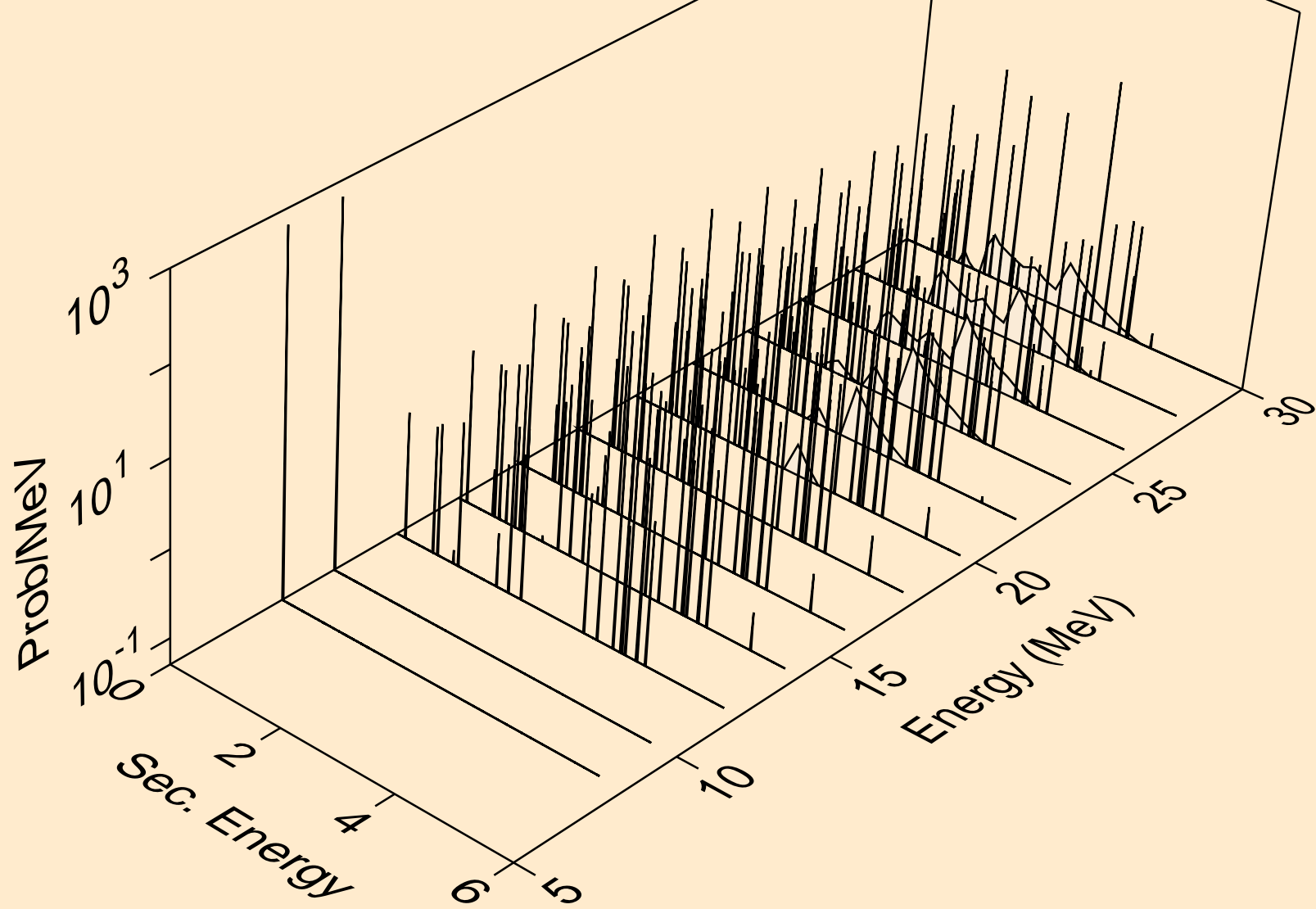

CA050 PHOTON ACER TENDL-2024 LIBRARY; T=0.K
photons from (g,gma)

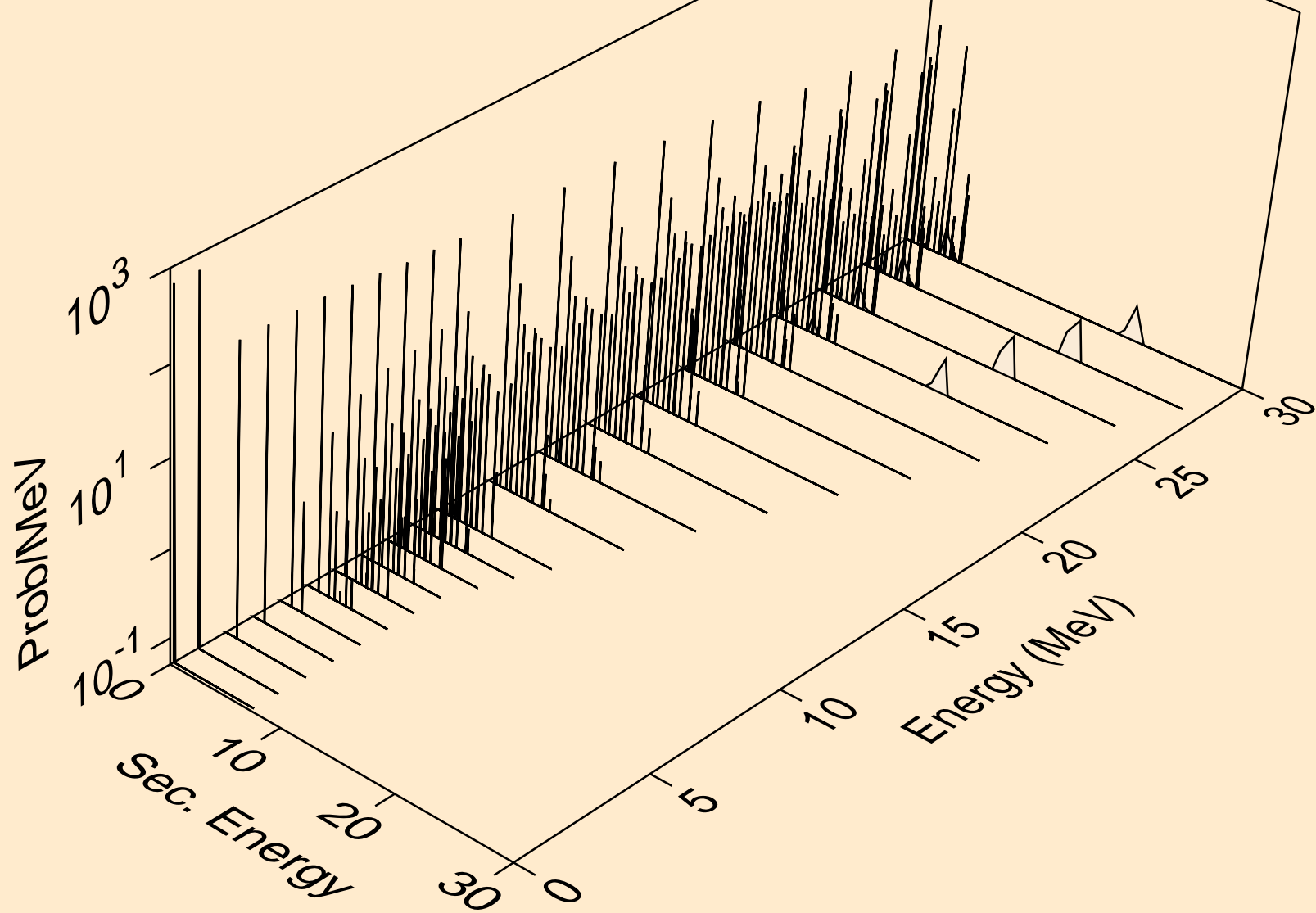

CA050 PHOTON ACER TENDL-2024 LIBRARY; T=0.K
photons from (g,p)

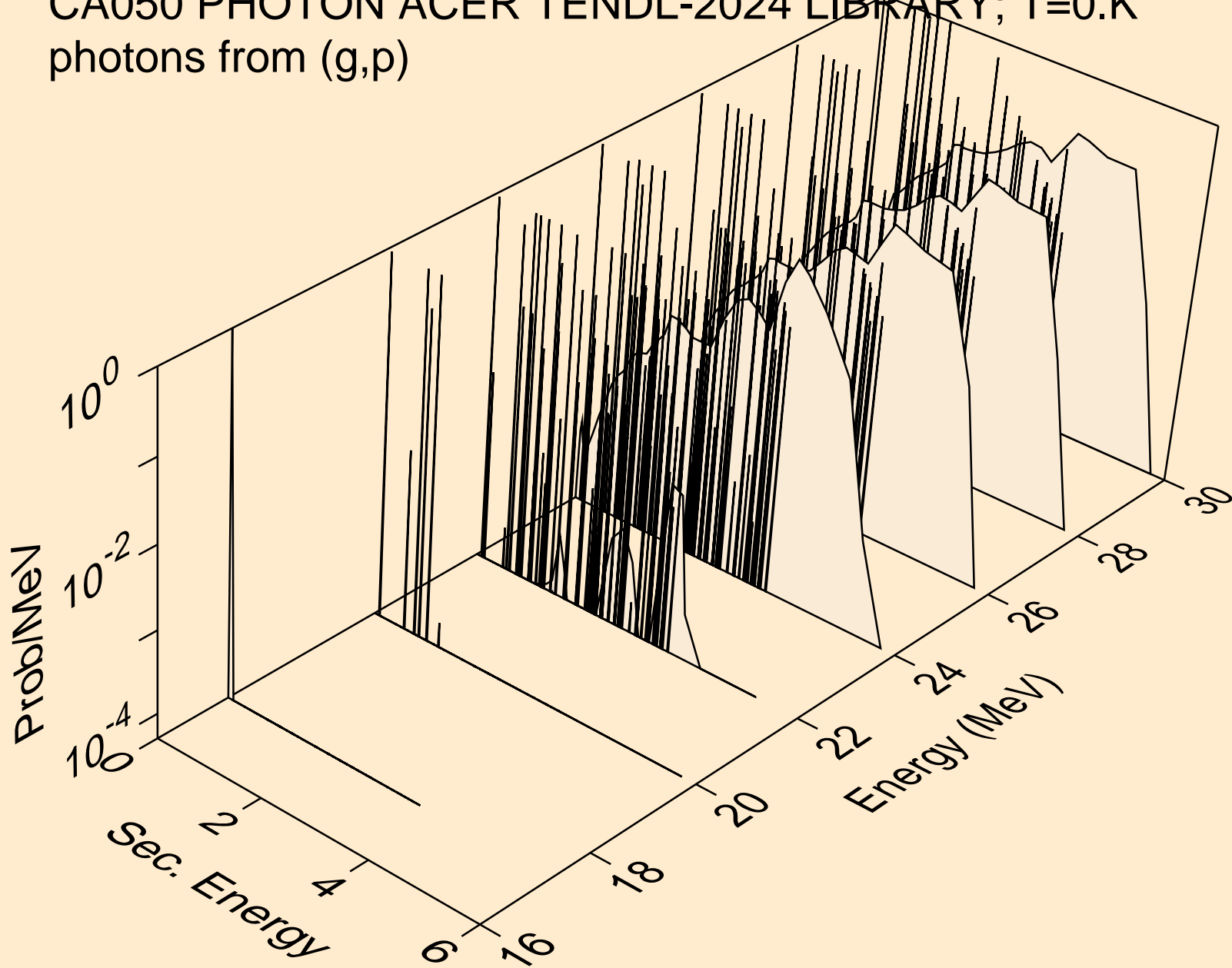

CA050 PHOTON ACER TENDL-2024 LIBRARY; T=0.K
photons from (g,d)

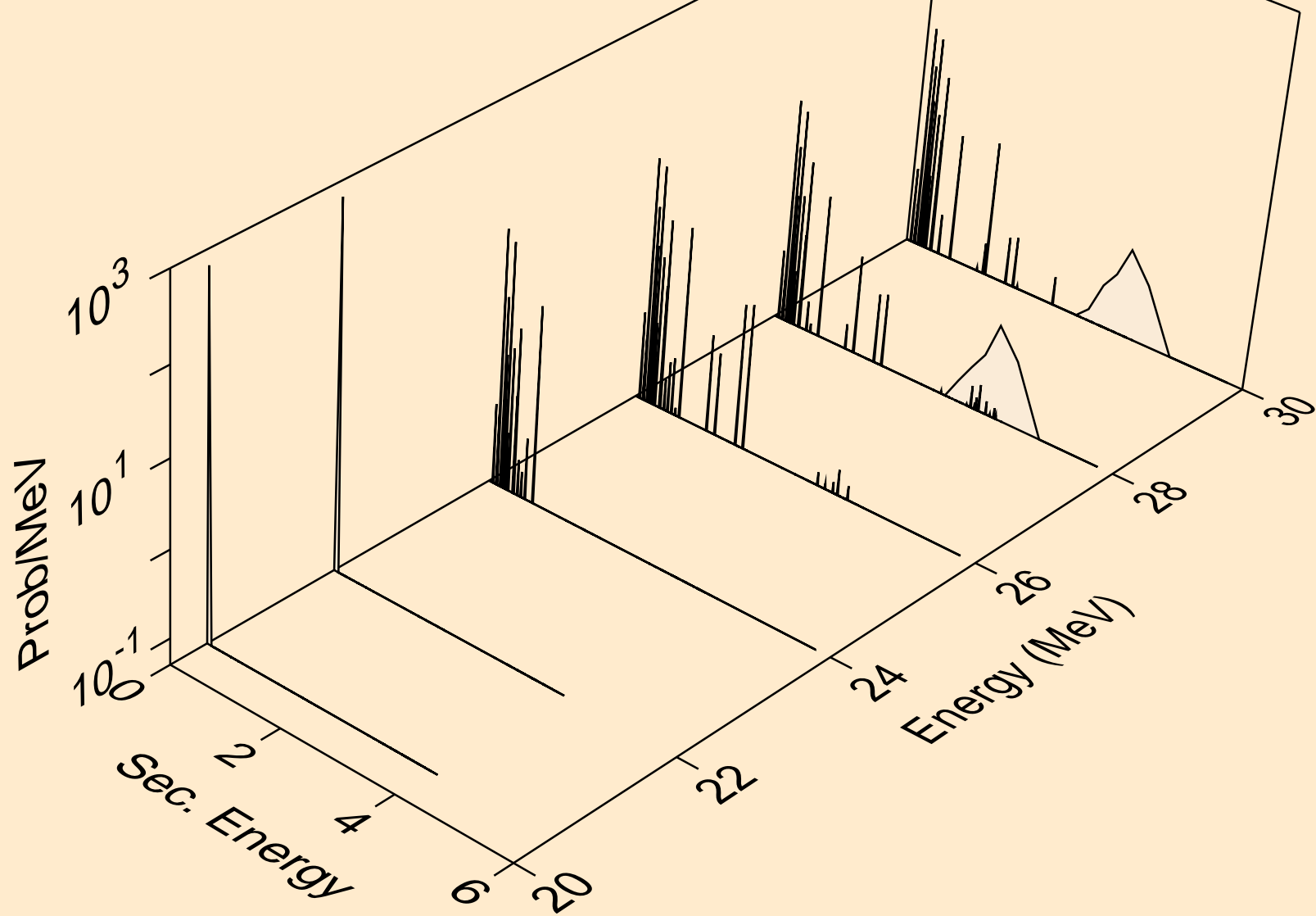

CA050 PHOTON ACER TENDL-2024 LIBRARY; T=0.K
photons from (g,t)

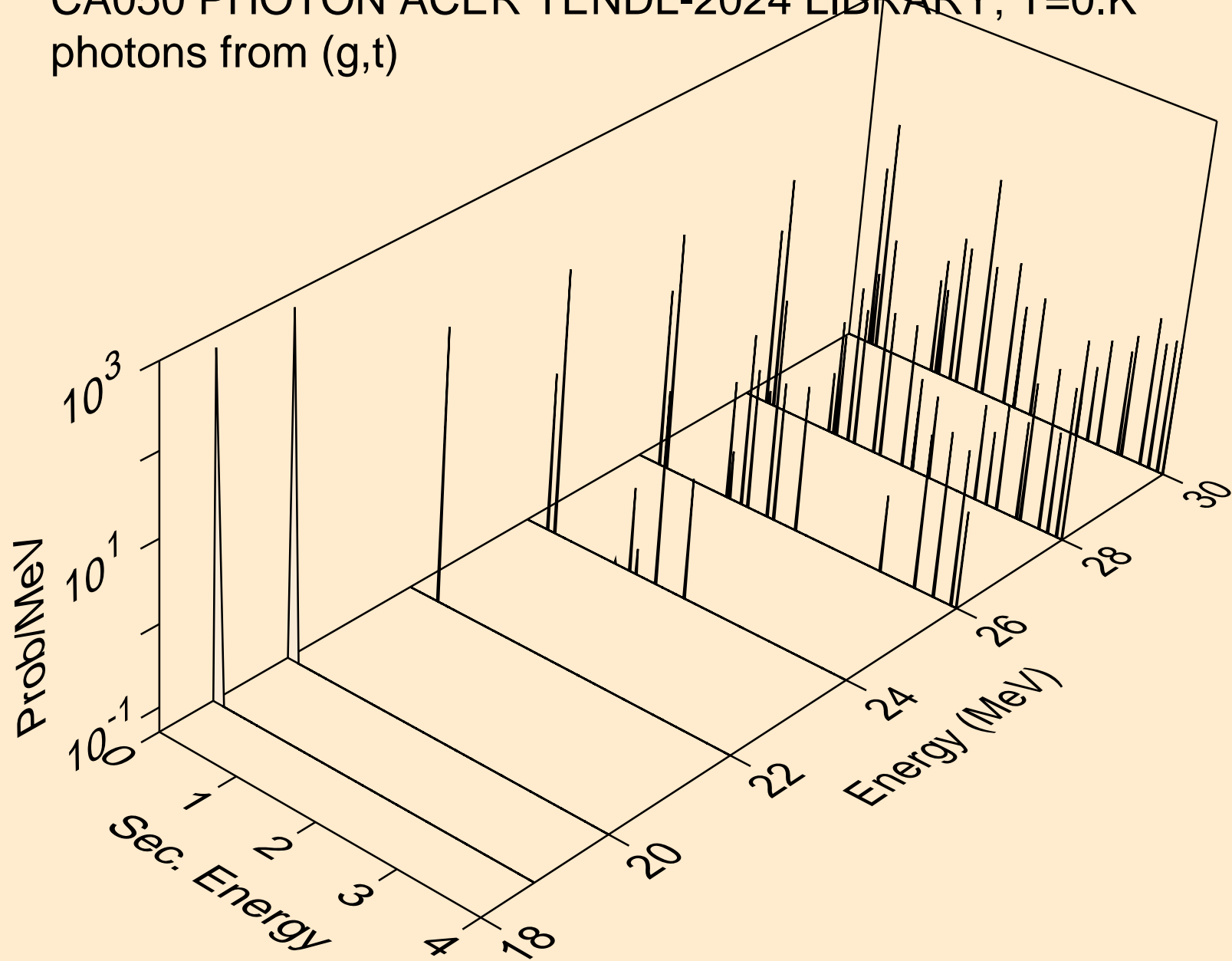

CA050 PHOTON ACER TENDL-2024 LIBRARY; T=0.K
photons from (g,a)

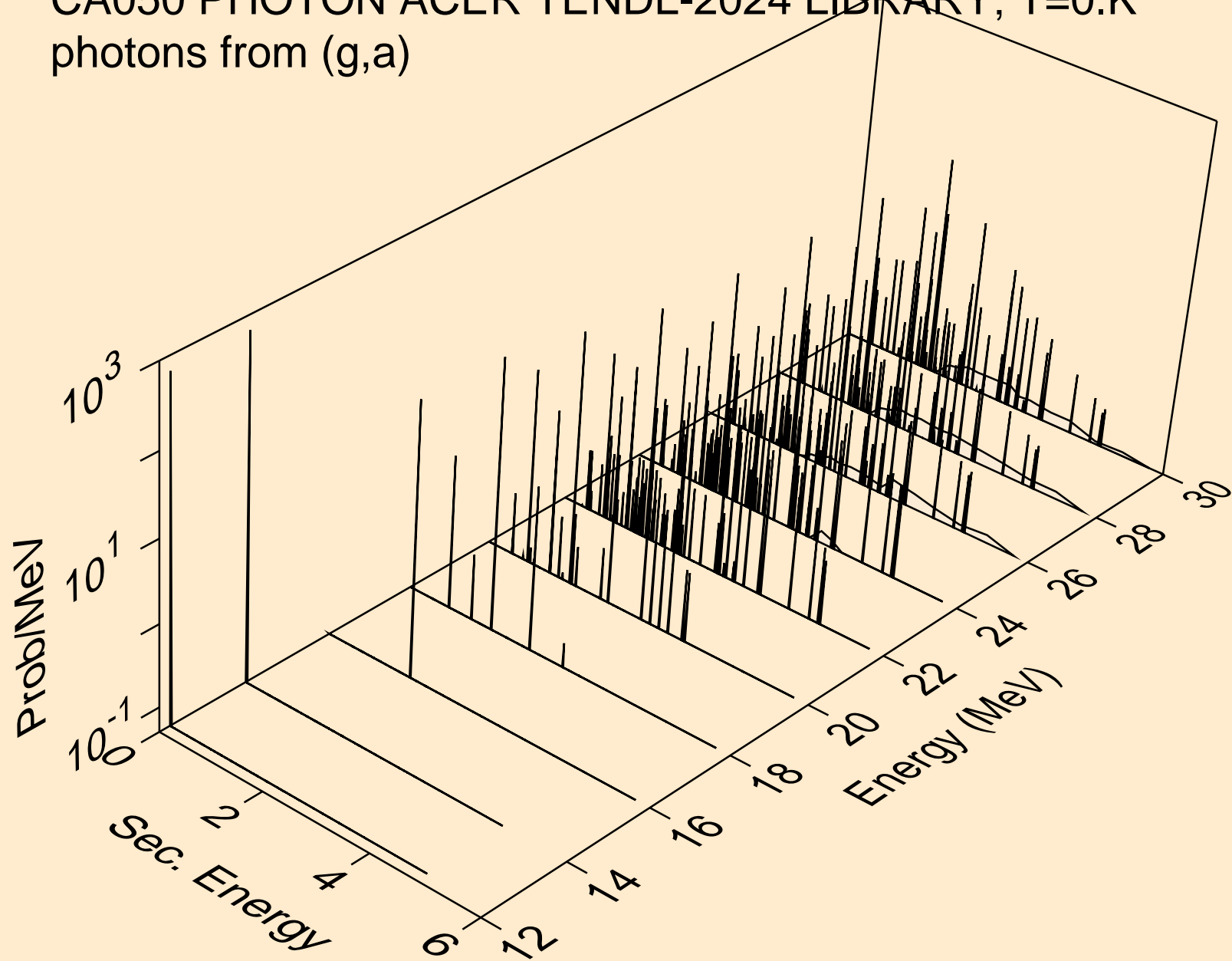

CA050 PHOTON ACER TENDL-2024 LIBRARY; T=0.K
protons from (g,x)

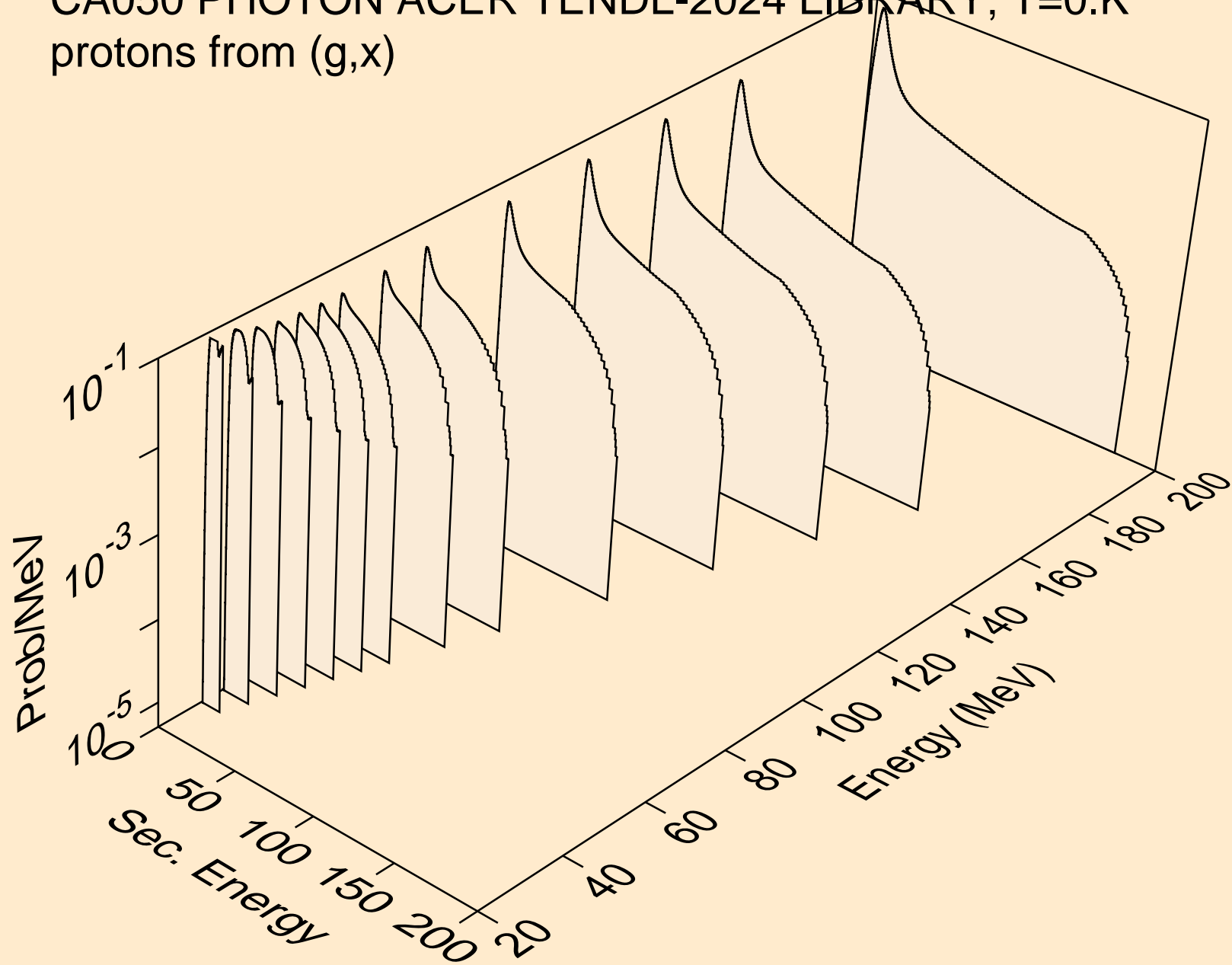

CA050 PHOTON ACER TENDL-2024 LIBRARY; T=0.K
protons from (g,n*)p

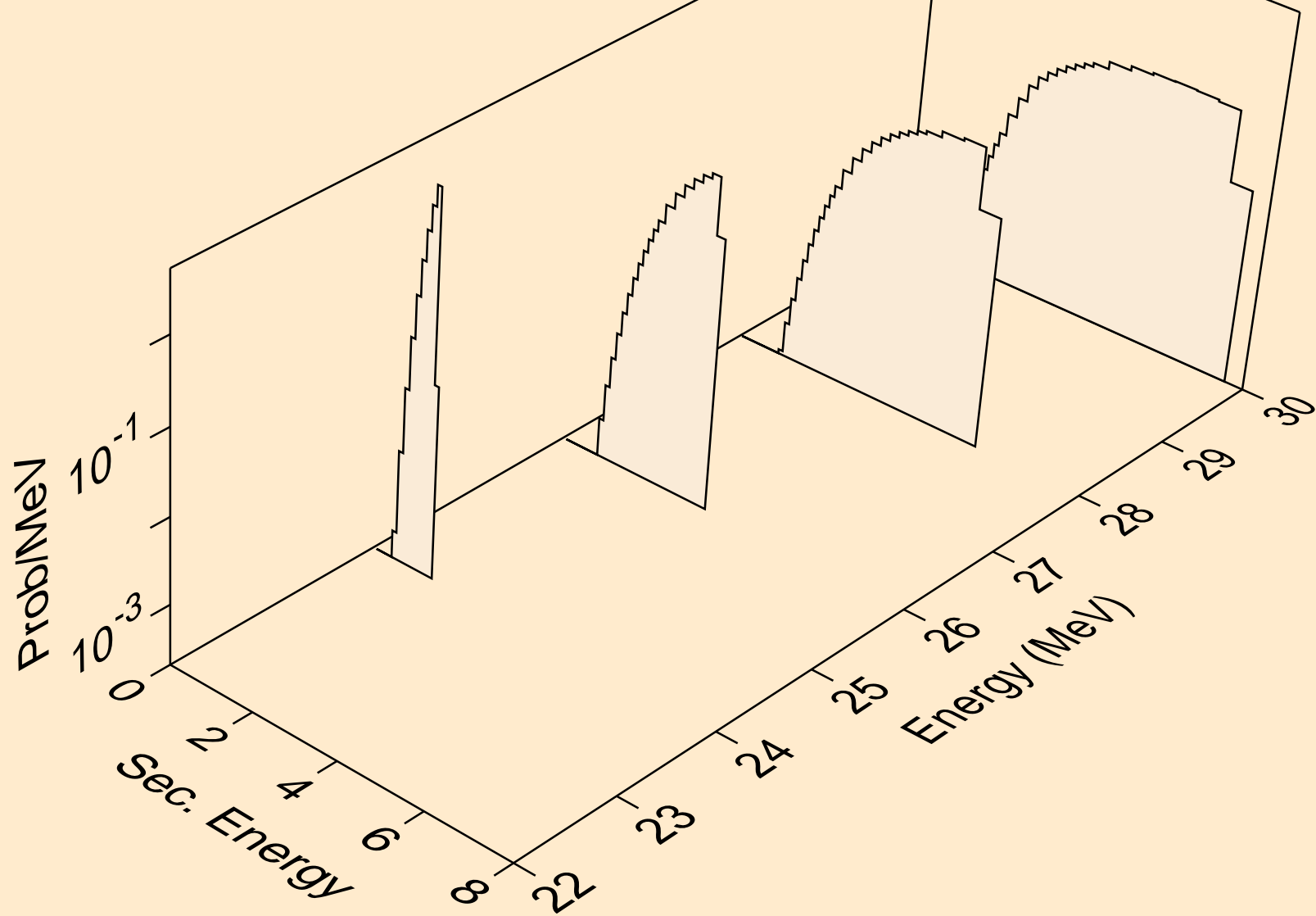

CA050 PHOTON ACER TENDL-2024 LIBRARY; T=0.K
protons from (g,2np)

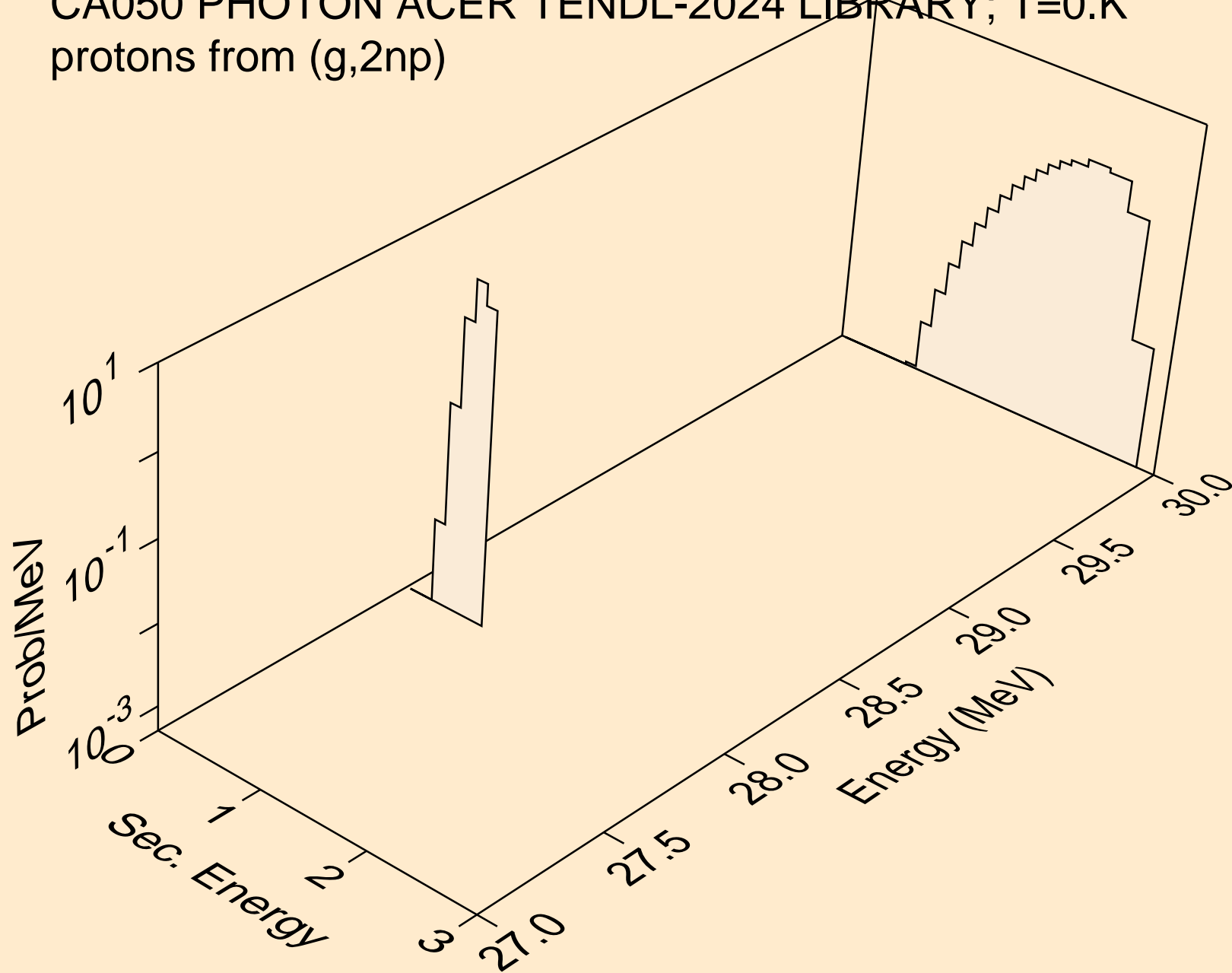

CA050 PHOTON ACER TENDL-2024 LIBRARY; T=0.K
protons from (g,p)

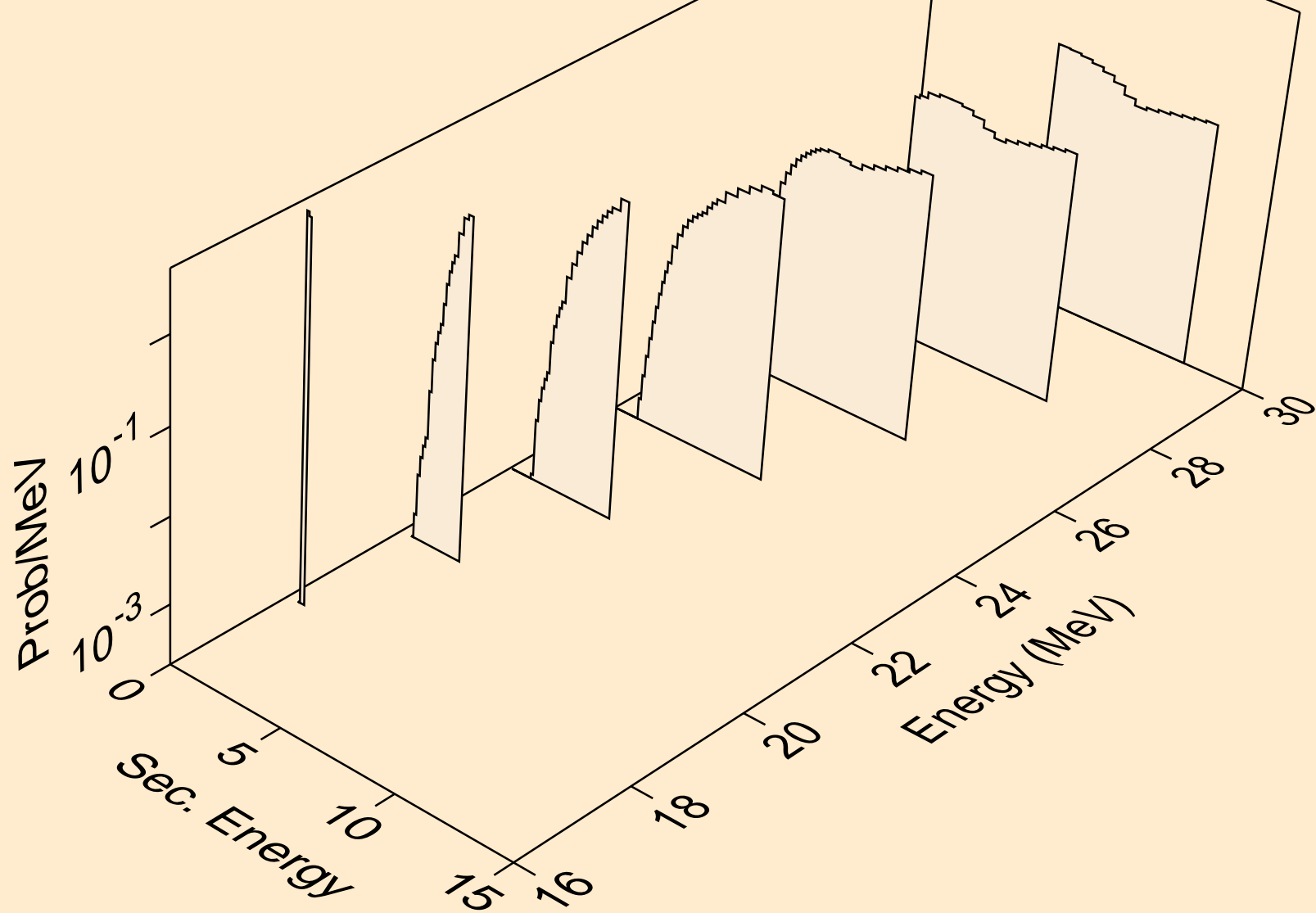

CA050 PHOTON ACER TENDL-2024 LIBRARY; T=0.K
deuterons from (g,x)

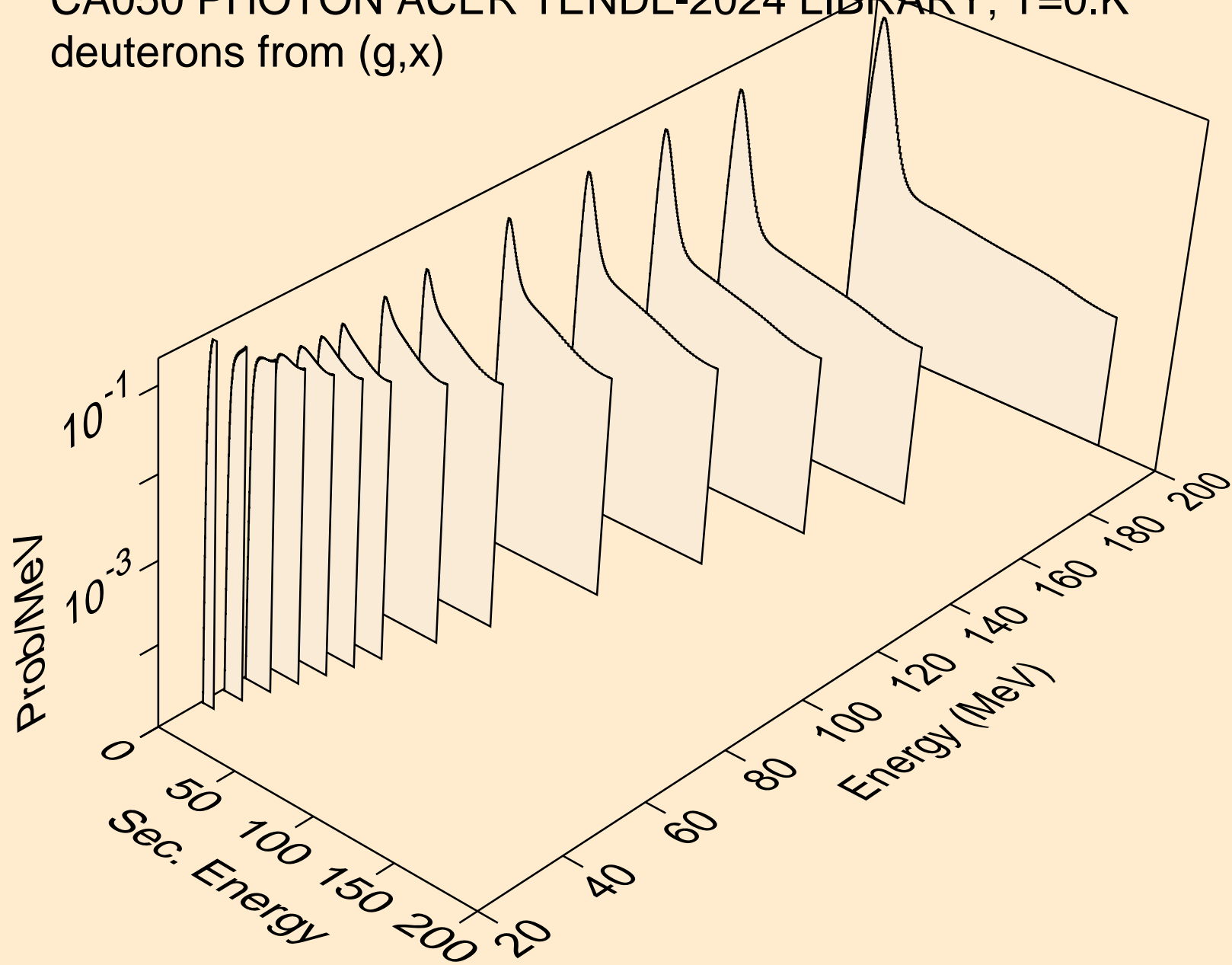

CA050 PHOTON ACER TENDL-2024 LIBRARY; T=0.K
deuterons from (g,n*)d

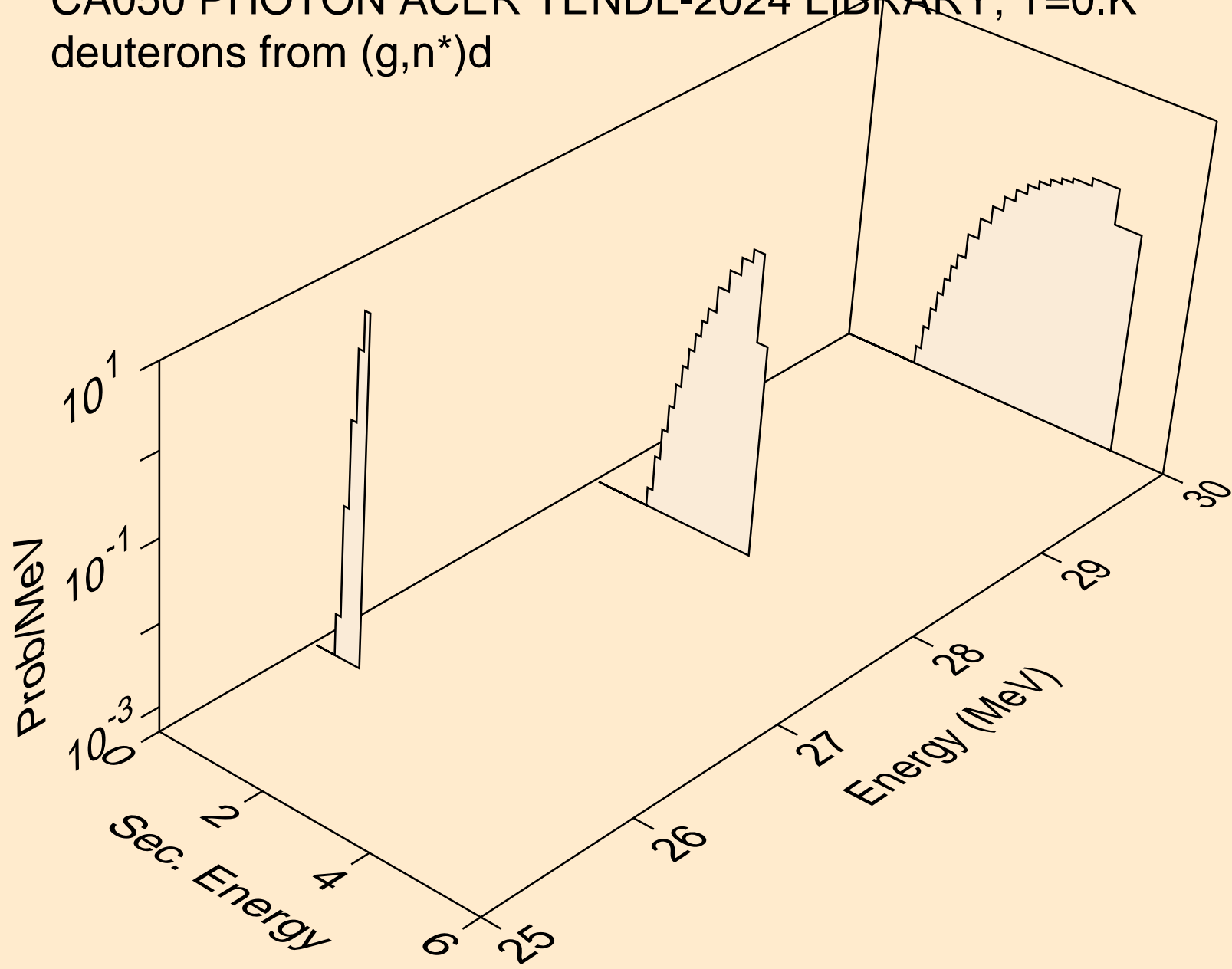

CA050 PHOTON ACER TENDL-2024 LIBRARY; T=0.K
deuterons from (g,d)

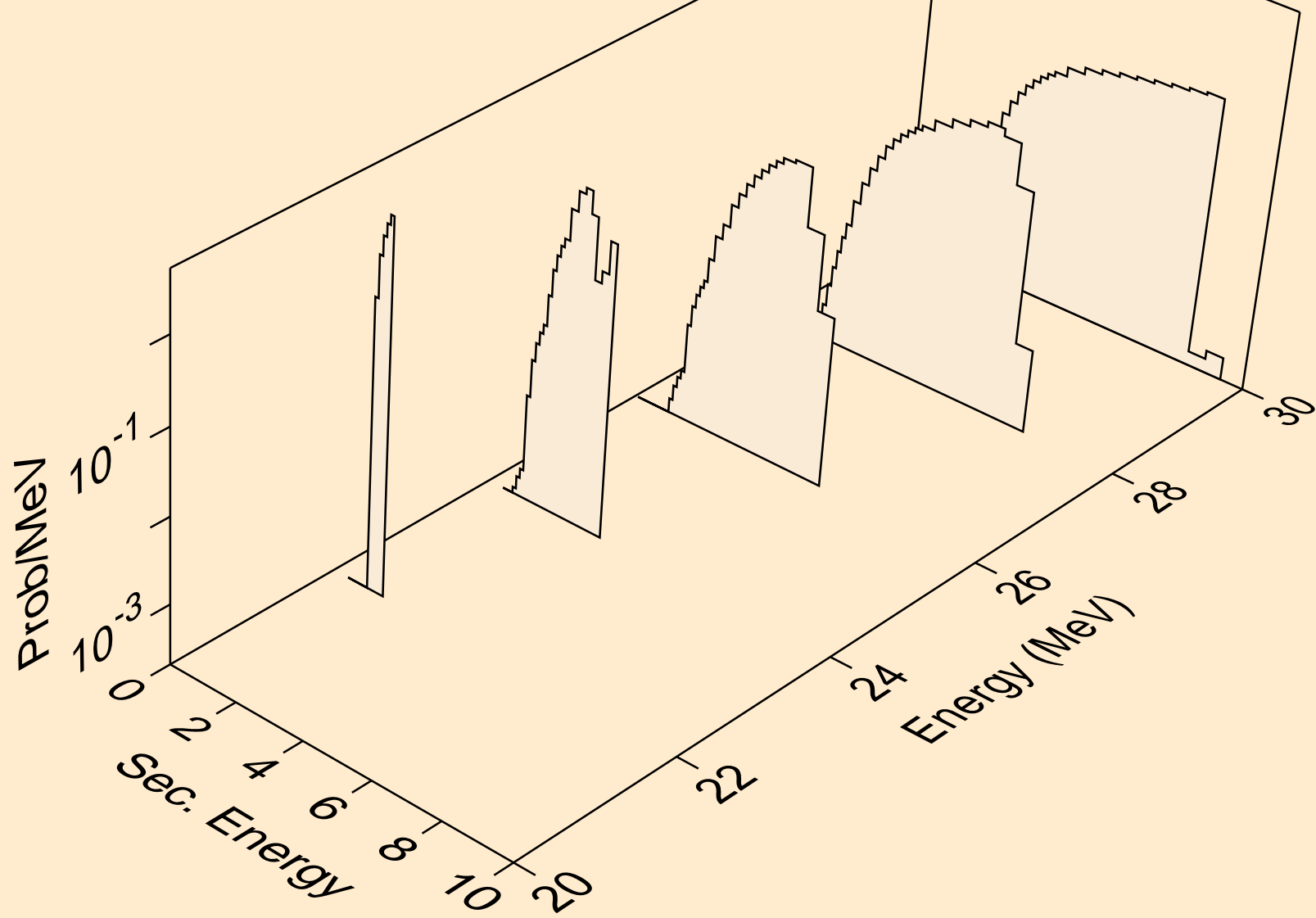

CA050 PHOTON ACER TENDL-2024 LIBRARY; T=0.K
tritons from (g,x)

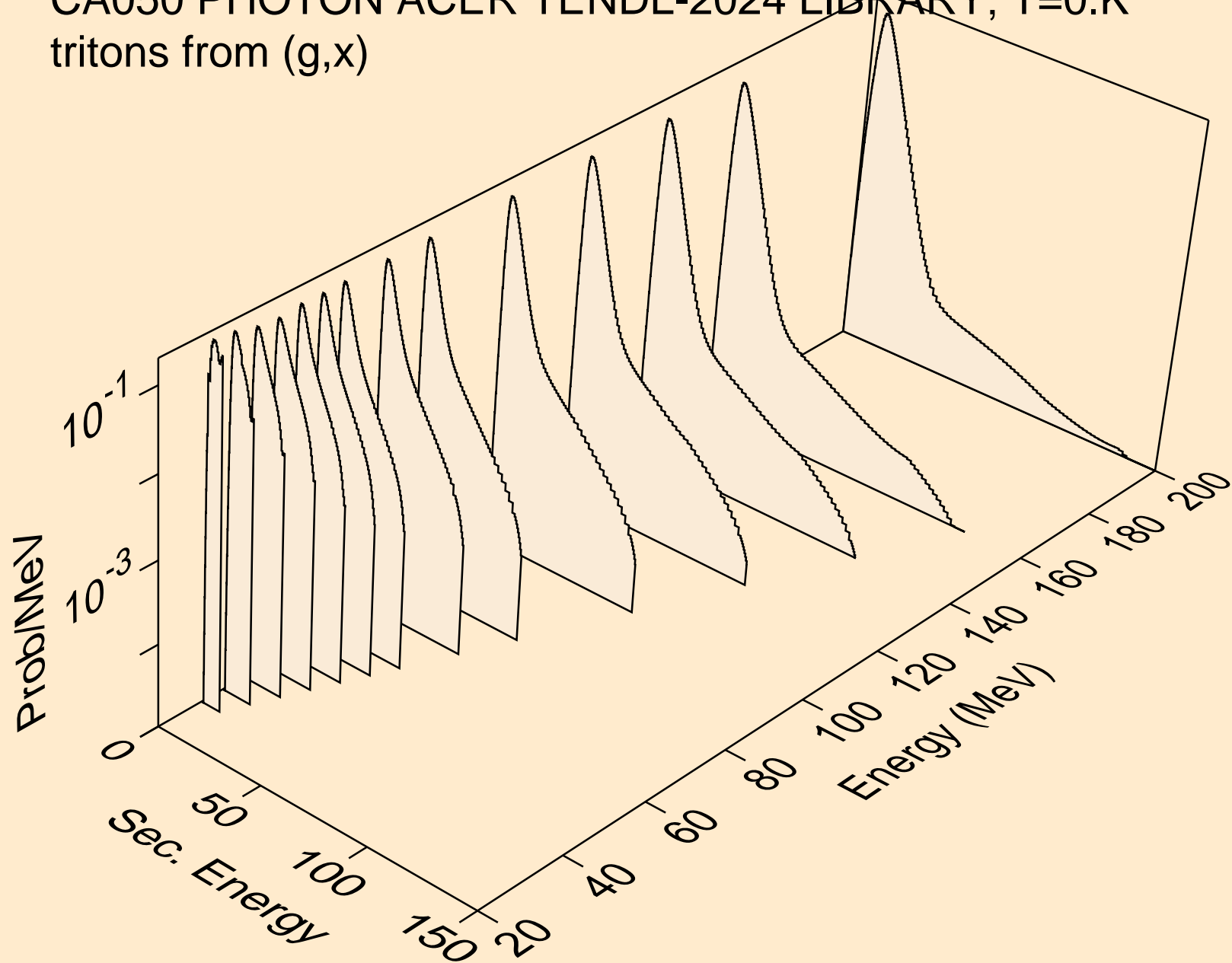

CA050 PHOTON ACER TENDL-2024 LIBRARY; T=0.K
tritons from (g,n*)t

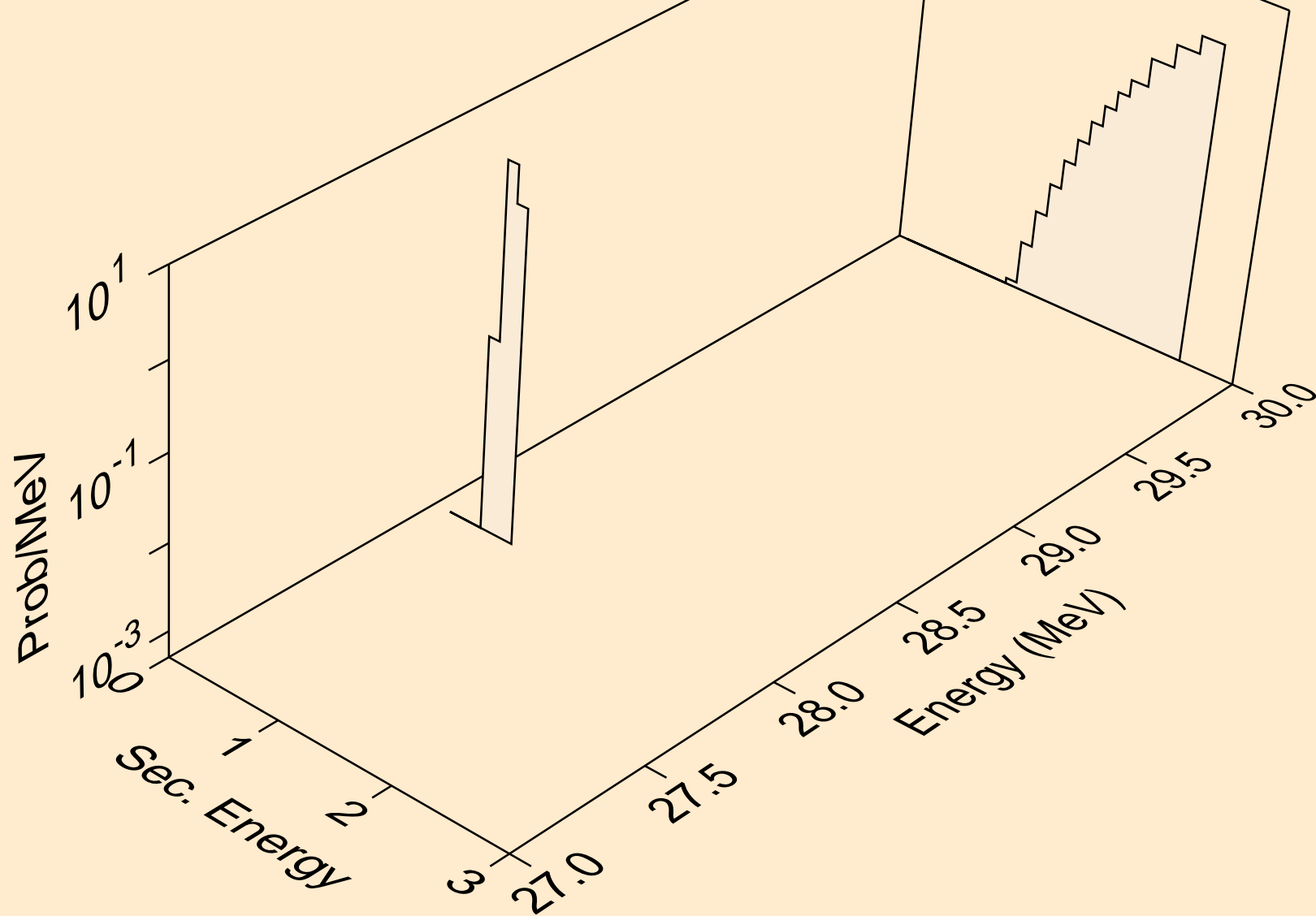

CA050 PHOTON ACER TENDL-2024 LIBRARY; T=0.K
tritons from (g,t)

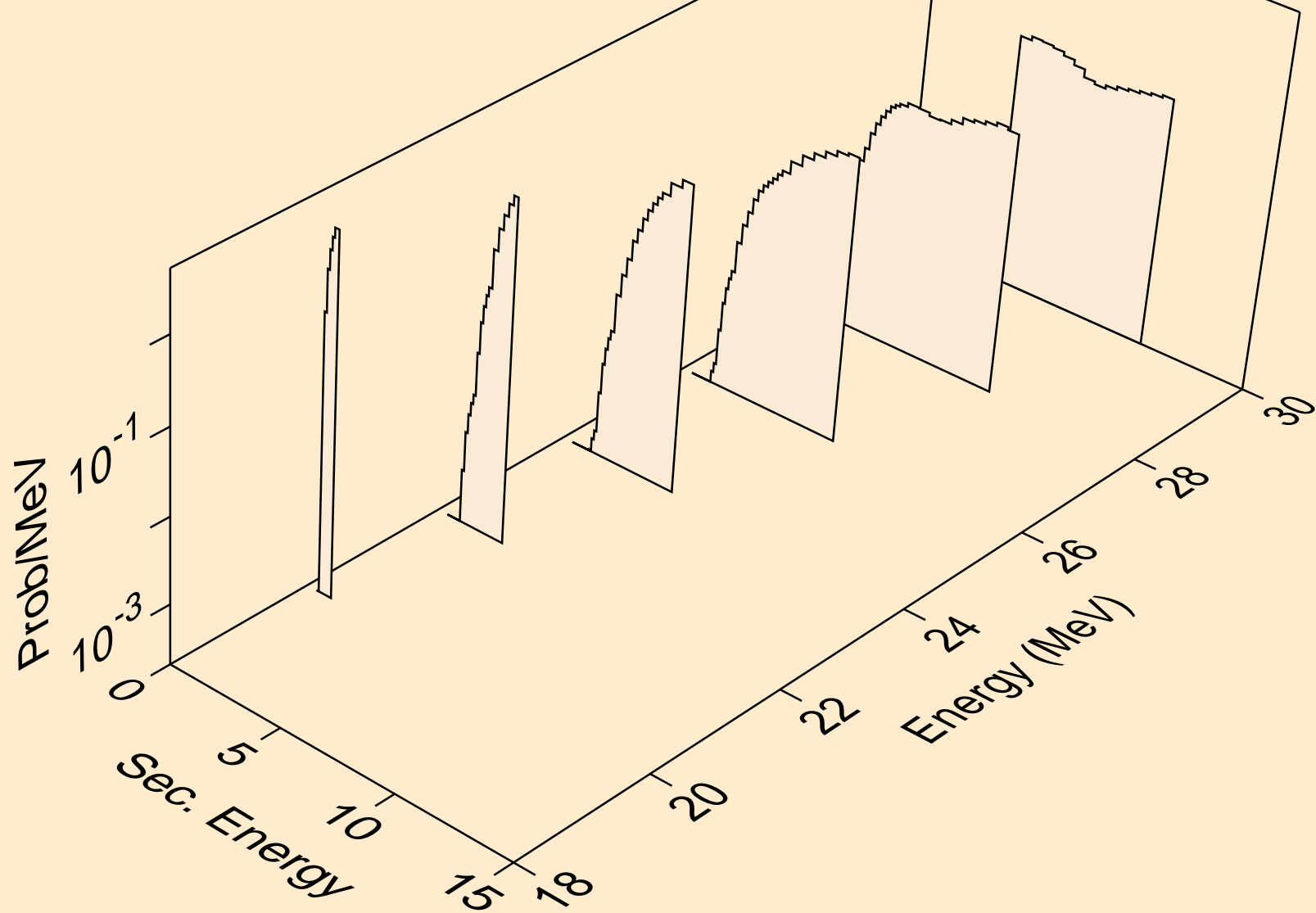

CA050 PHOTON ACER TENDL-2024 LIBRARY; T=0.K
he3s from (g,x)

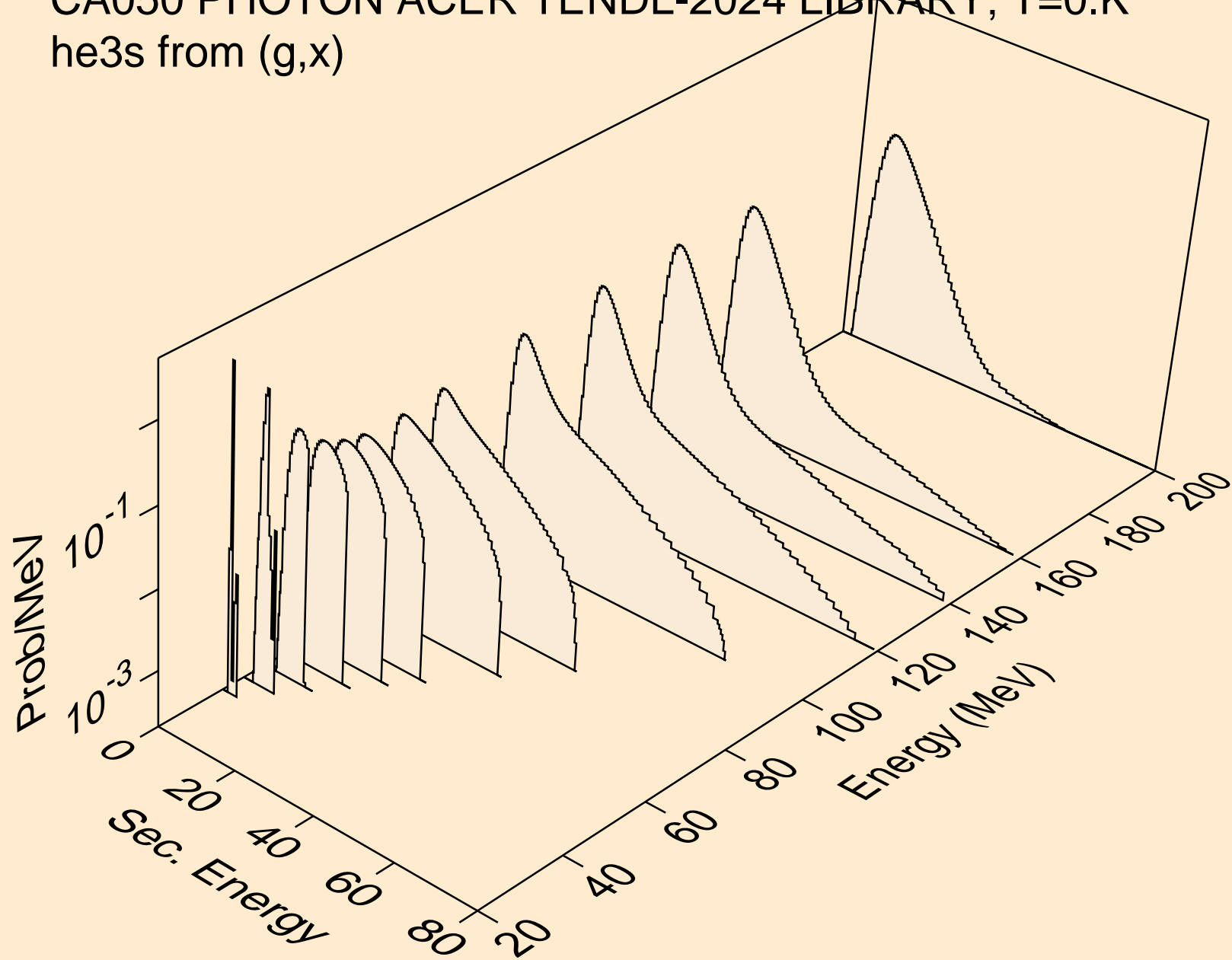

CA050 PHOTON ACER TENDL-2024 LIBRARY; T=0.K
alphas from (g,x)

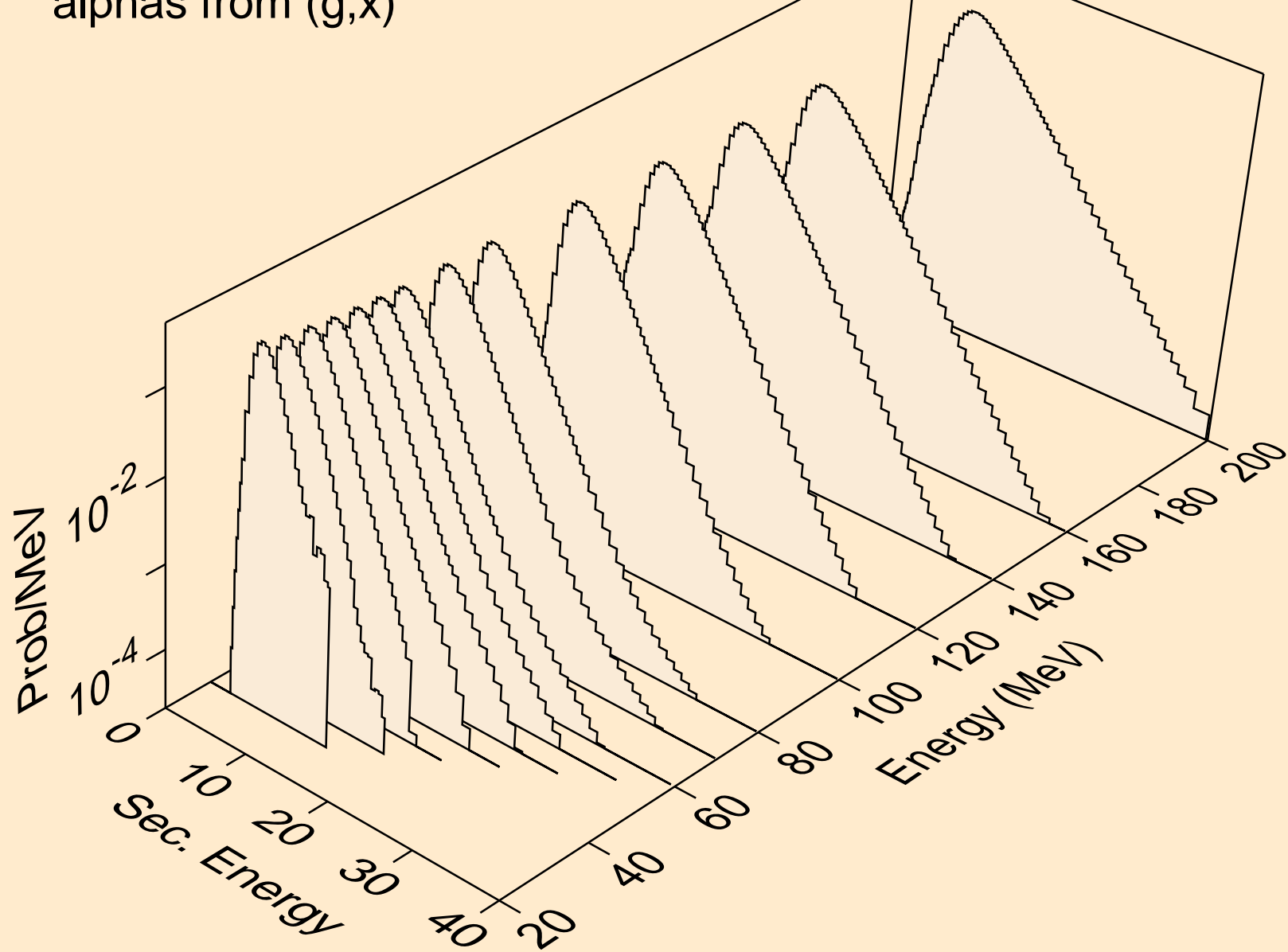

CA050 PHOTON ACER TENDL-2024 LIBRARY; T=0.K
alphas from (g,n*)a

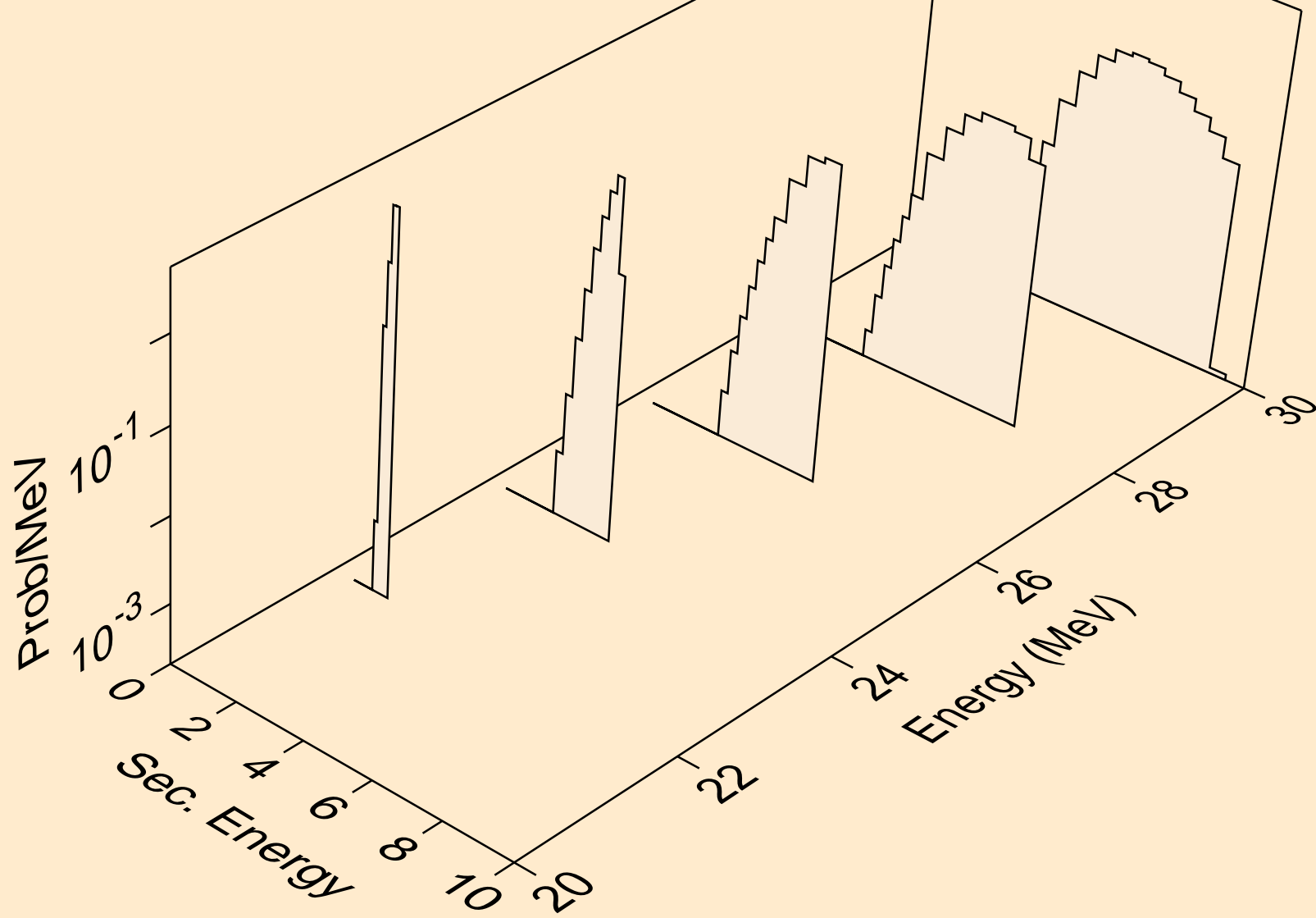

CA050 PHOTON ACER TENDL-2024 LIBRARY; T=0.K
alphas from (g,2n)a

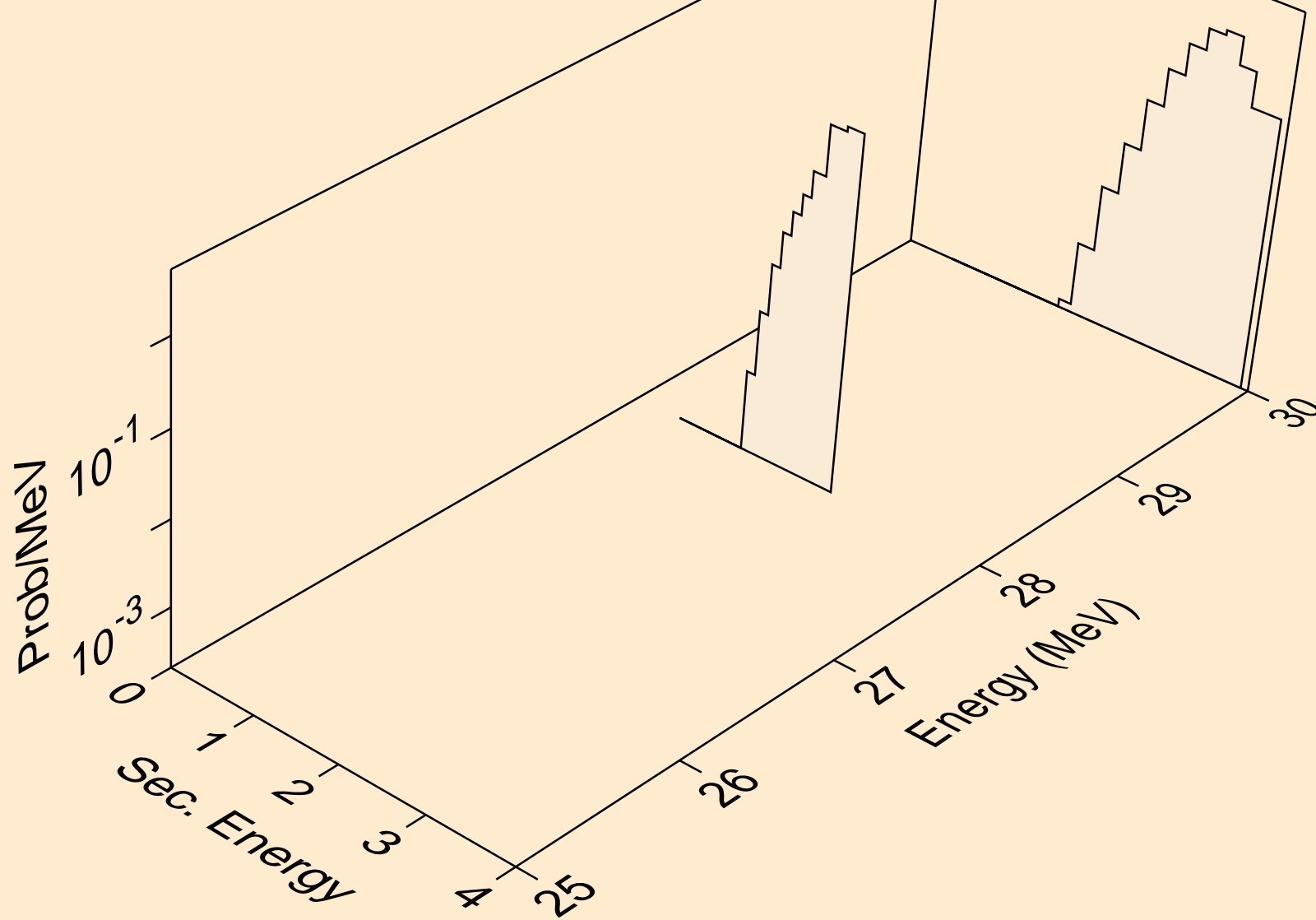

CA050 PHOTON ACER TENDL-2024 LIBRARY; T=0.K
alphas from (g,a)

