

CM232 PHOTON ACER TENDL-2024 LIBRARY; T=0.K
Principal cross sections

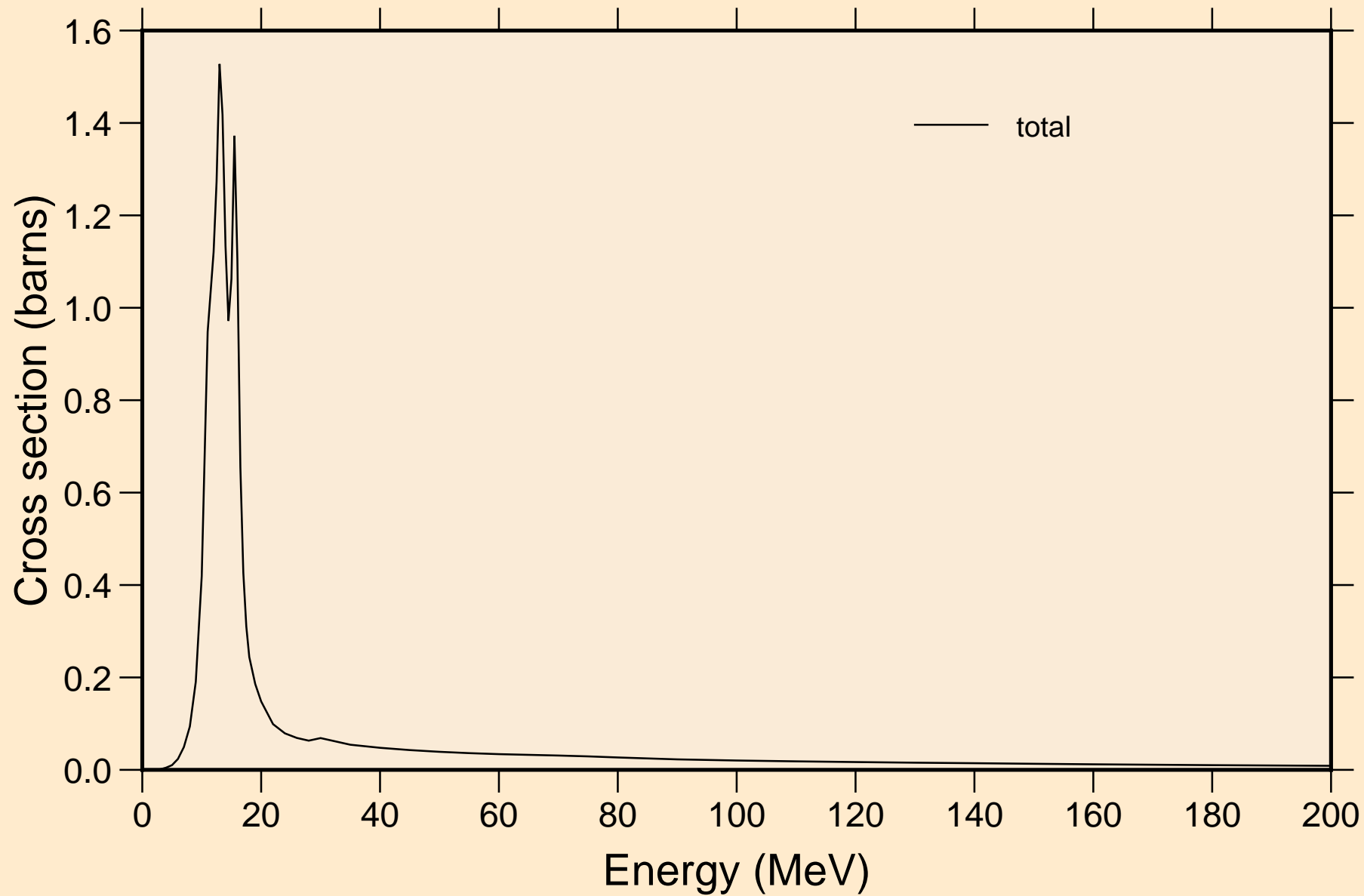

CM232 PHOTON ACER TENDL-2024 LIBRARY; T=0.K

Partial cross sections

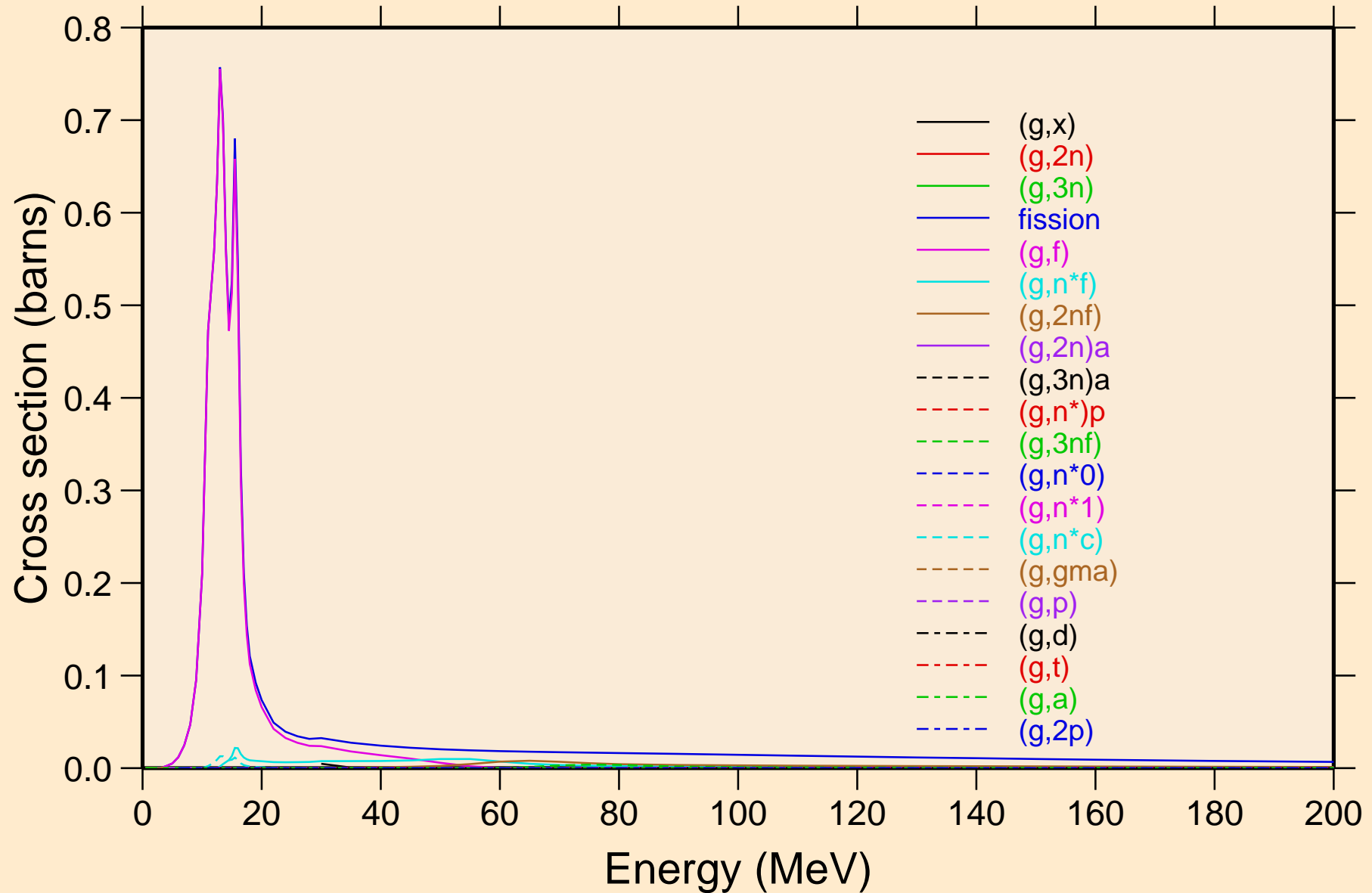

CM232 PHOTON ACER TENDL-2024 LIBRARY; T=0.K

Heating

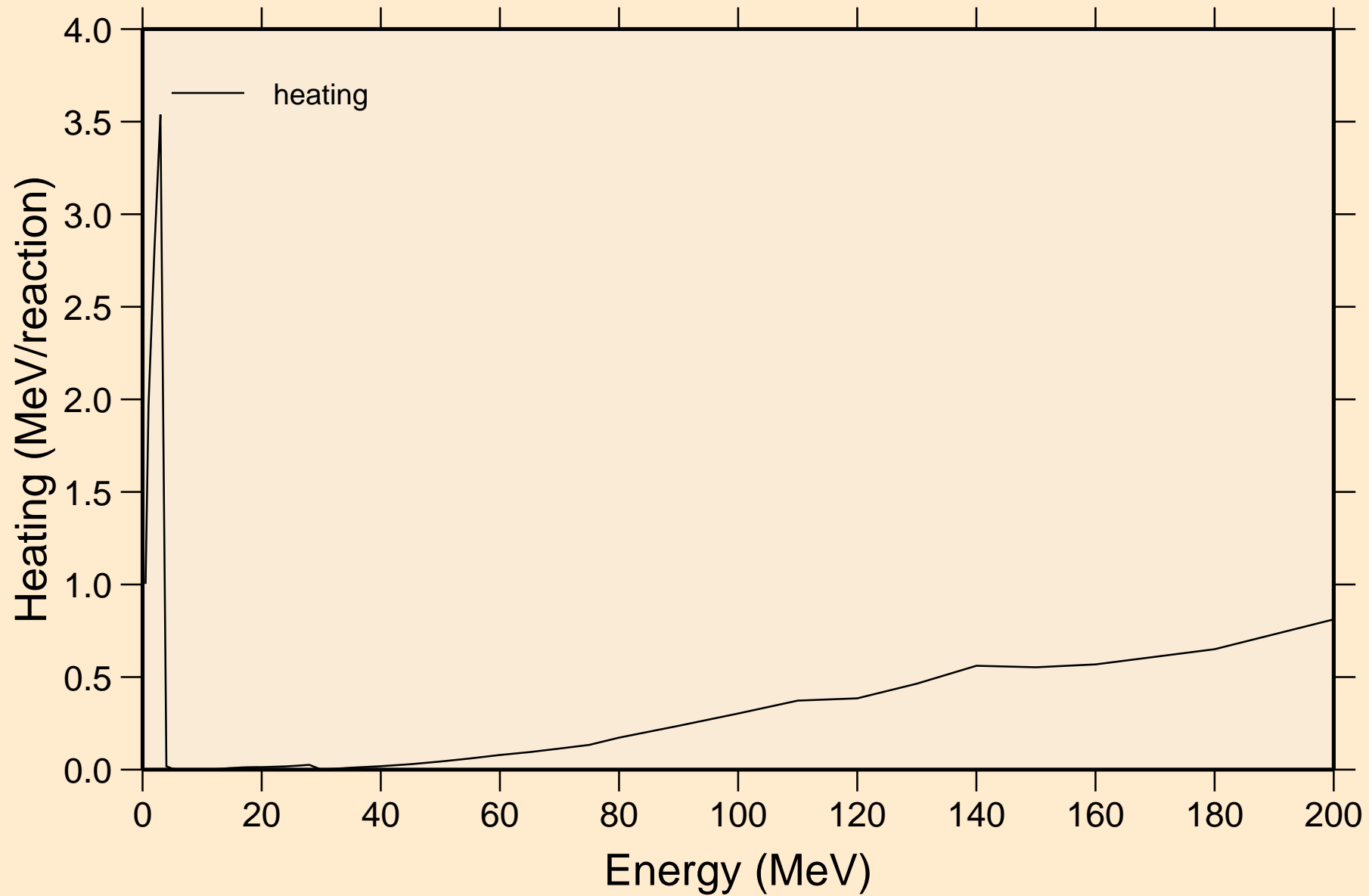

CM232 PHOTON ACER TENDL-2024 LIBRARY; T=0.K

Particle heating contributions

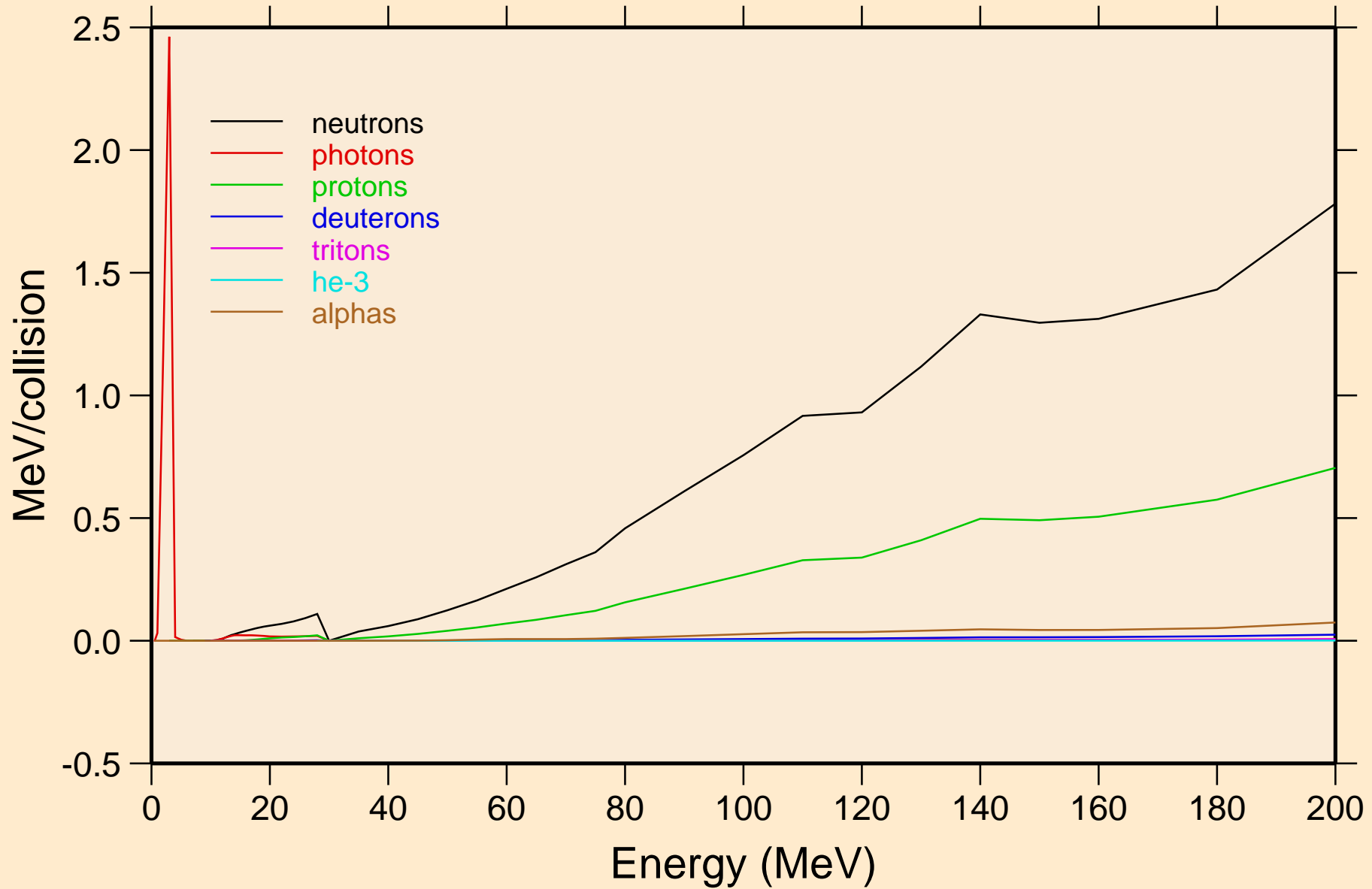

CM232 PHOTON ACER TENDL-2024 LIBRARY; T=0.K

Particle production cross sections

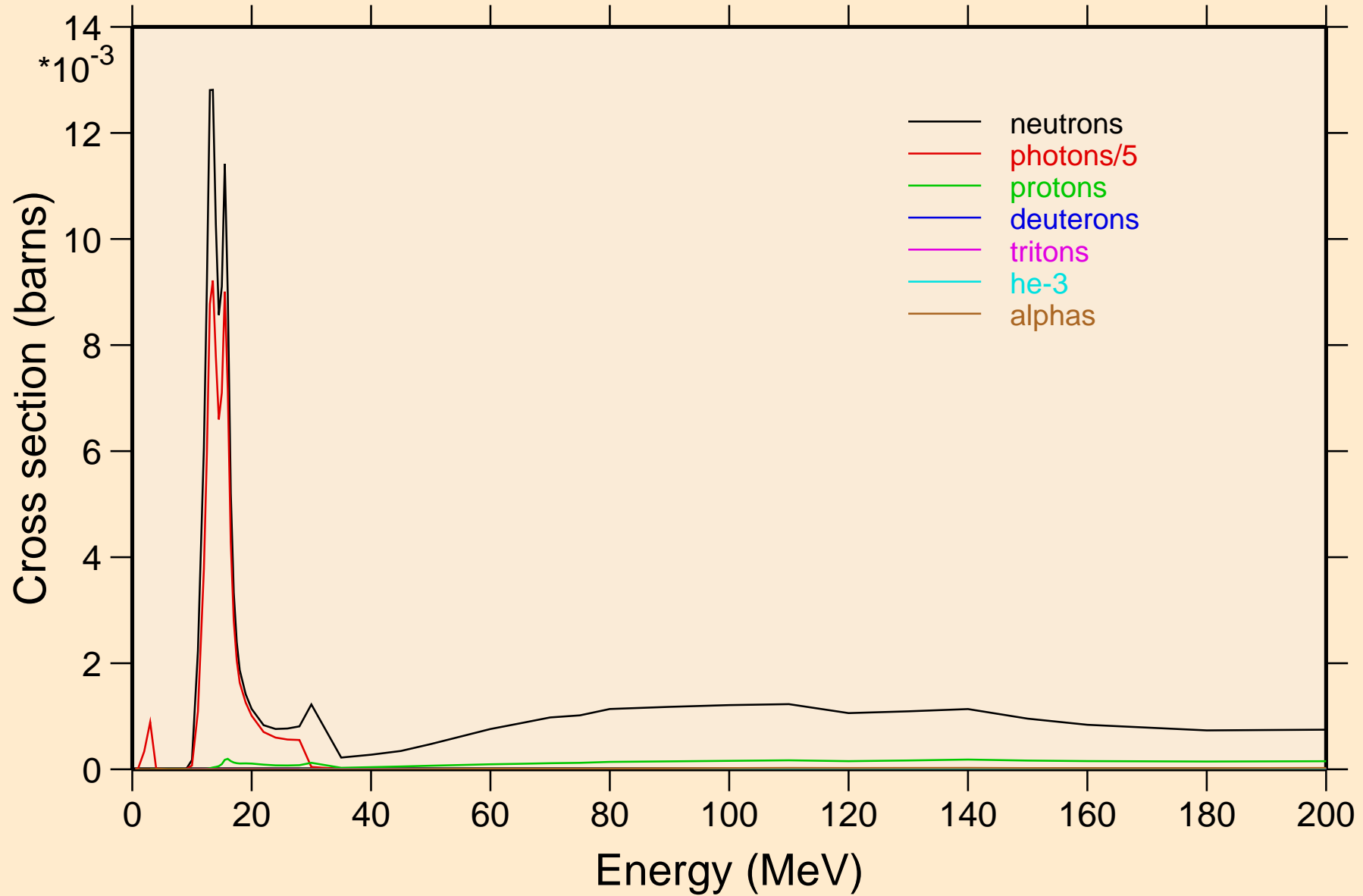

CM232 PHOTON ACER TENDL-2024 LIBRARY; T=0.K
neutrons from (g,x)

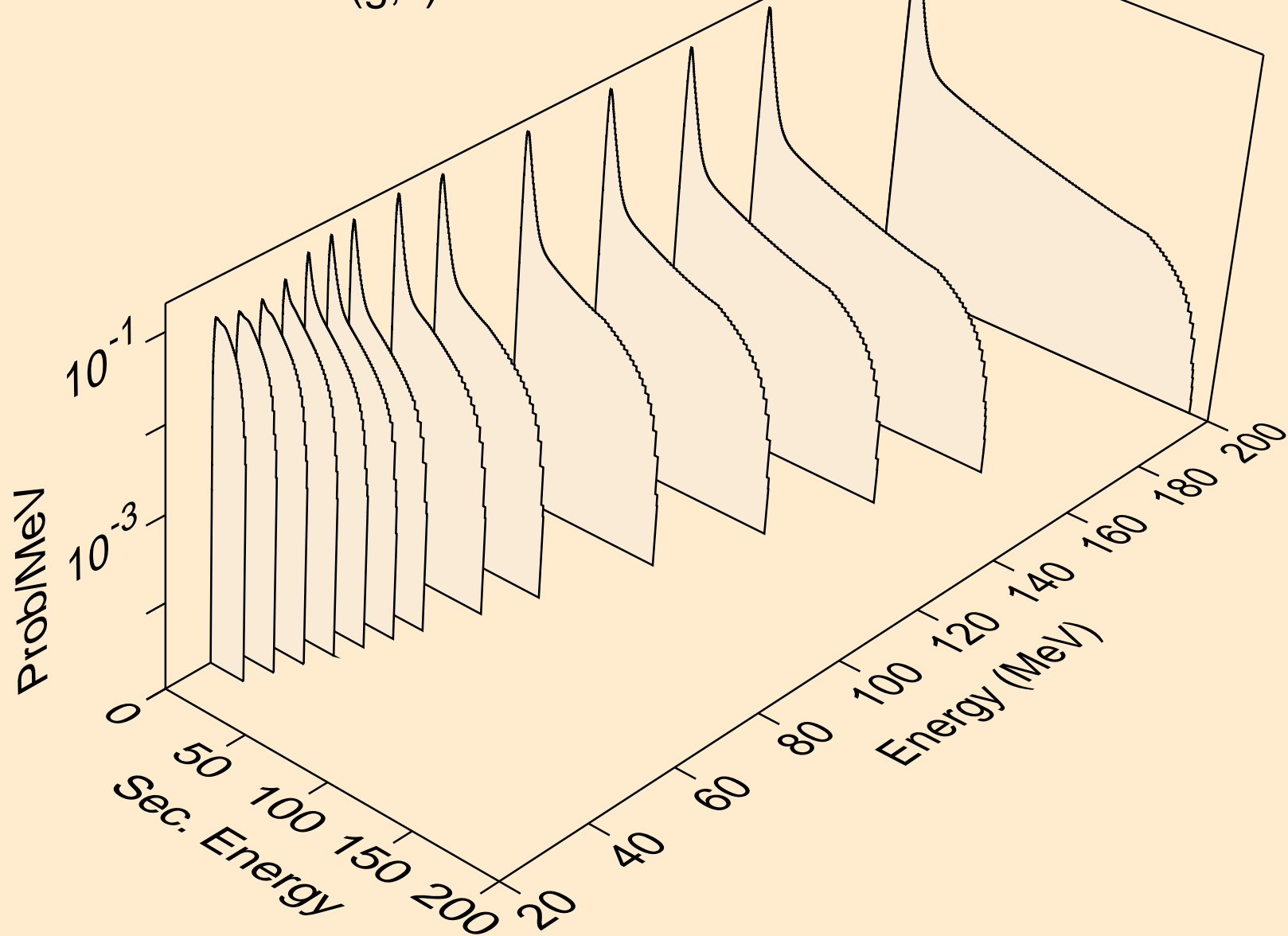

CM232 PHOTON ACER TENDL-2024 LIBRARY; T=0.K
neutrons from (g,2n)

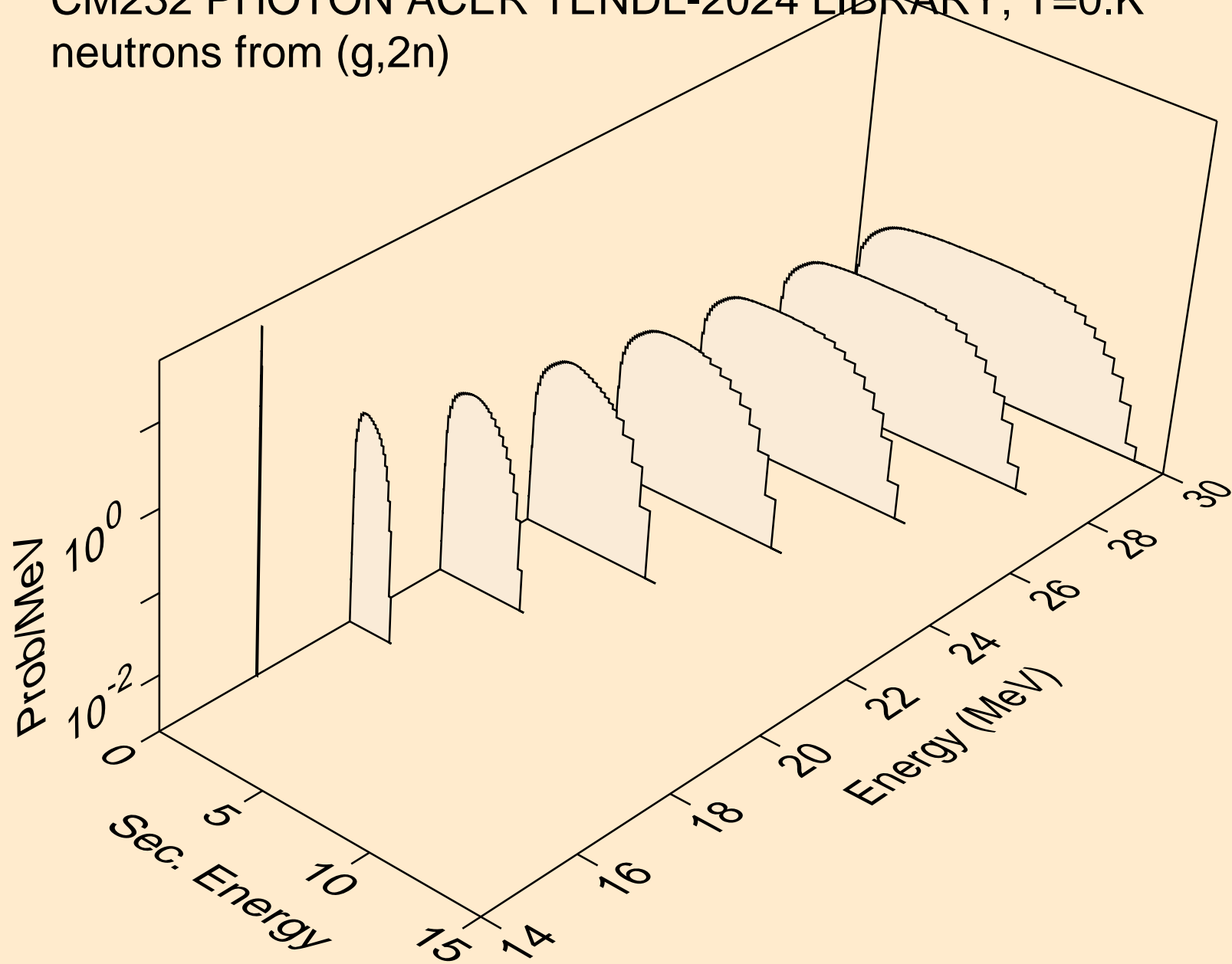

CM232 PHOTON ACER TENDL-2024 LIBRARY; T=0.K
neutrons from (g,3n)

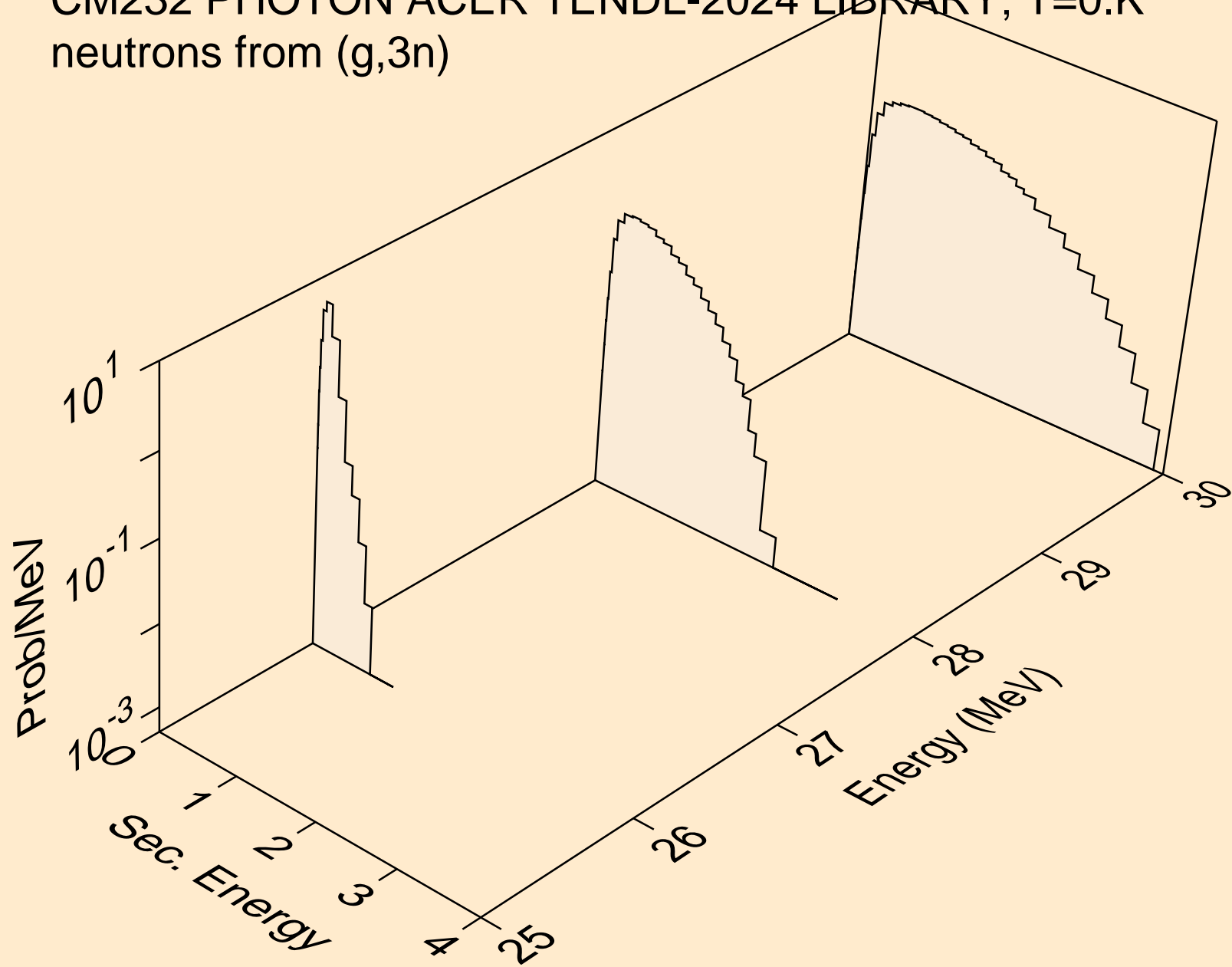

CM232 PHOTON ACER TENDL-2024 LIBRARY; T=0.K
neutrons from (g,2n)a

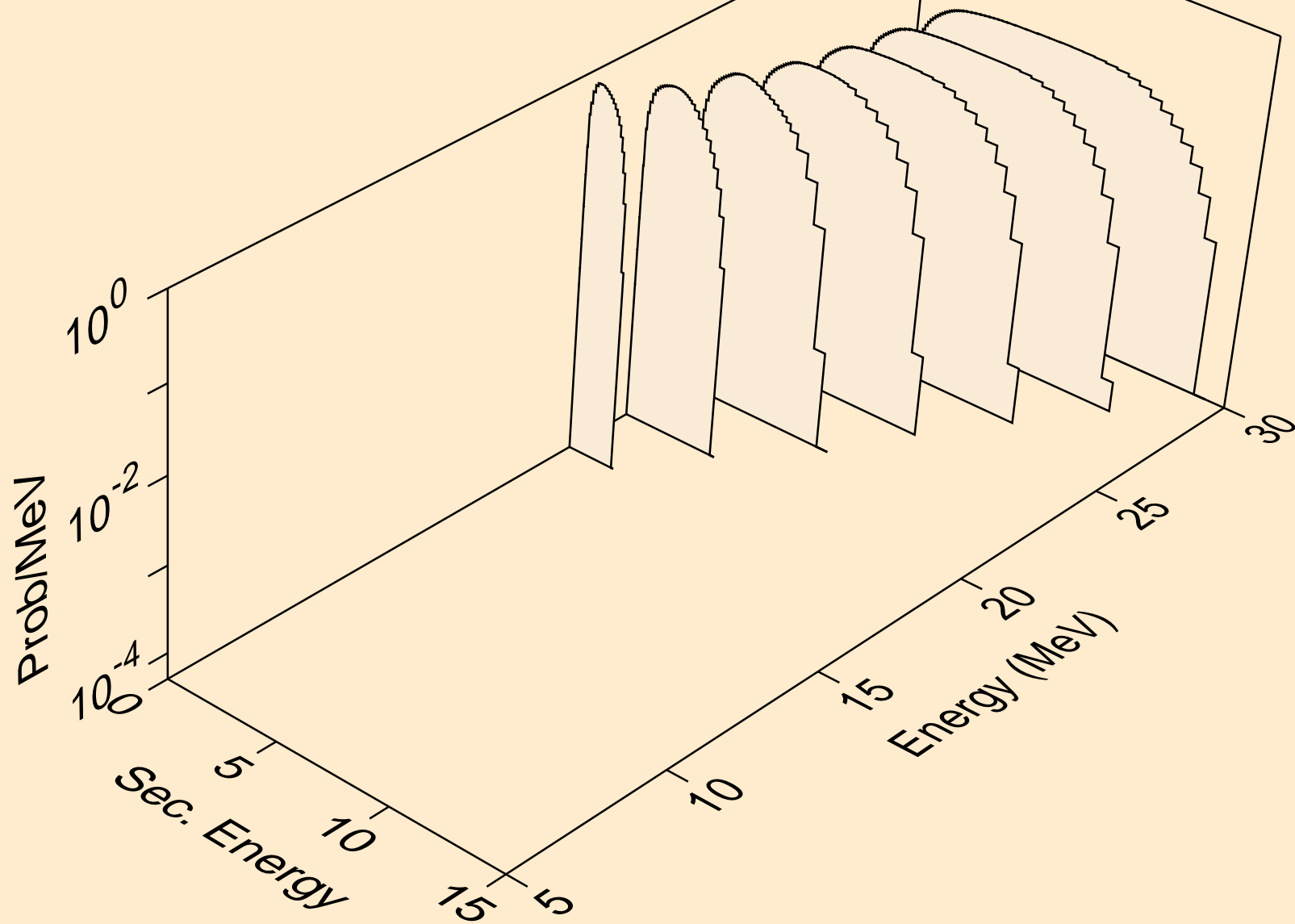

CM232 PHOTON ACER TENDL-2024 LIBRARY; T=0.K
neutrons from (g,3n)a

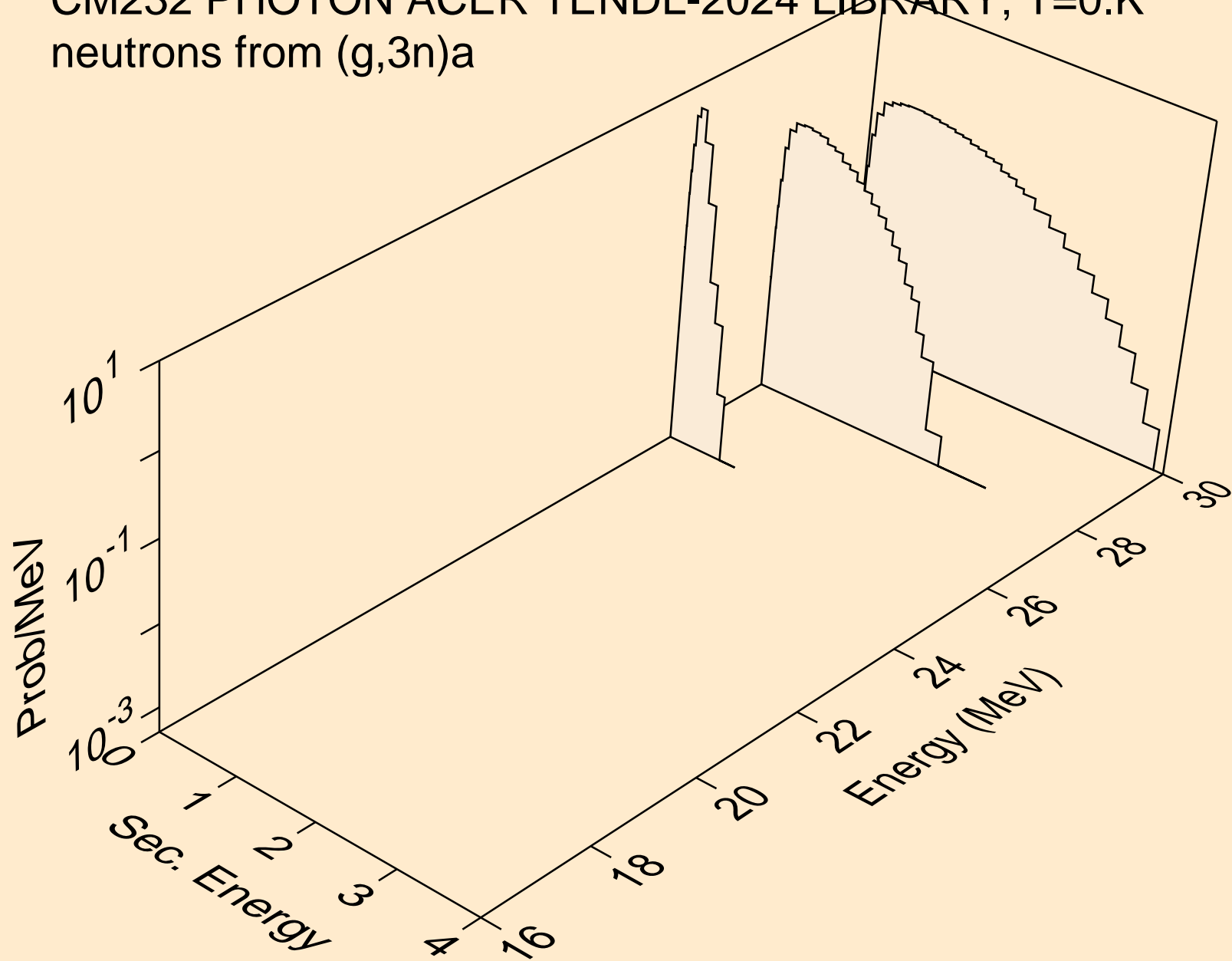

CM232 PHOTON ACER TENDL-2024 LIBRARY; T=0.K
neutrons from (g,n*)p

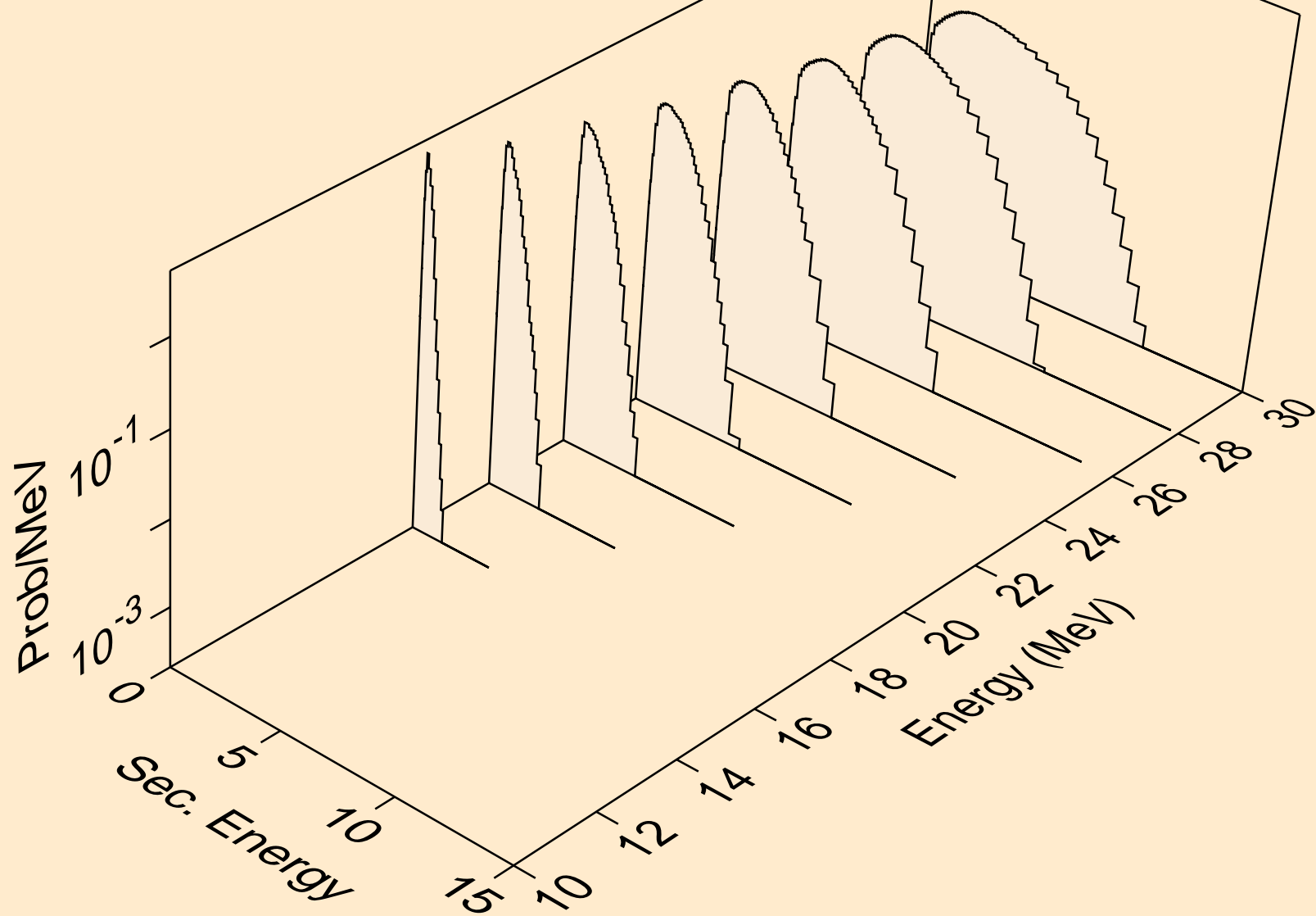

CM232 PHOTON ACER TENDL-2024 LIBRARY; T=0.K
angular distribution for (g,n*0) neutron

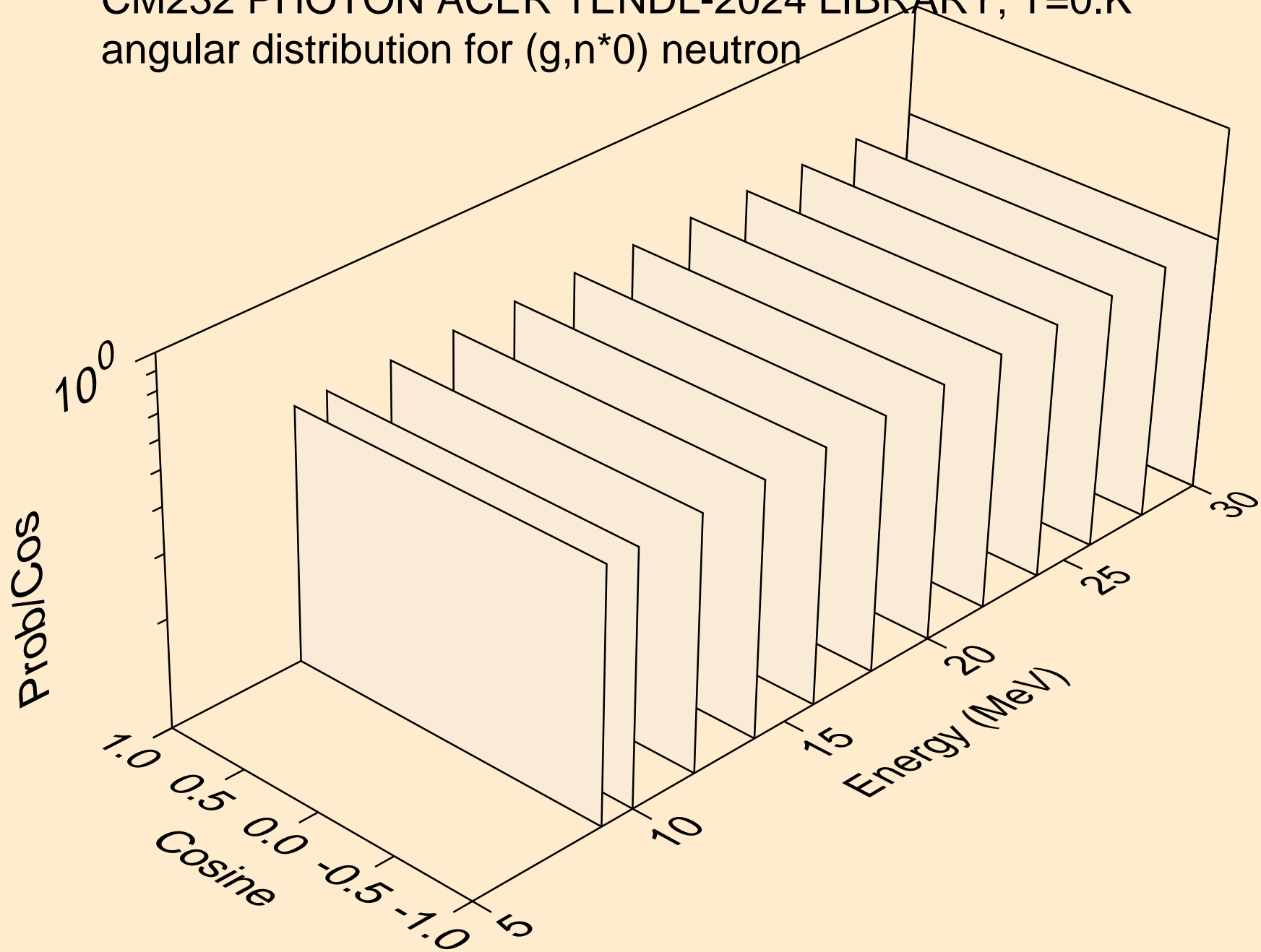

CM232 PHOTON ACER TENDL-2024 LIBRARY; T=0.K
angular distribution for (g,n*1) neutron

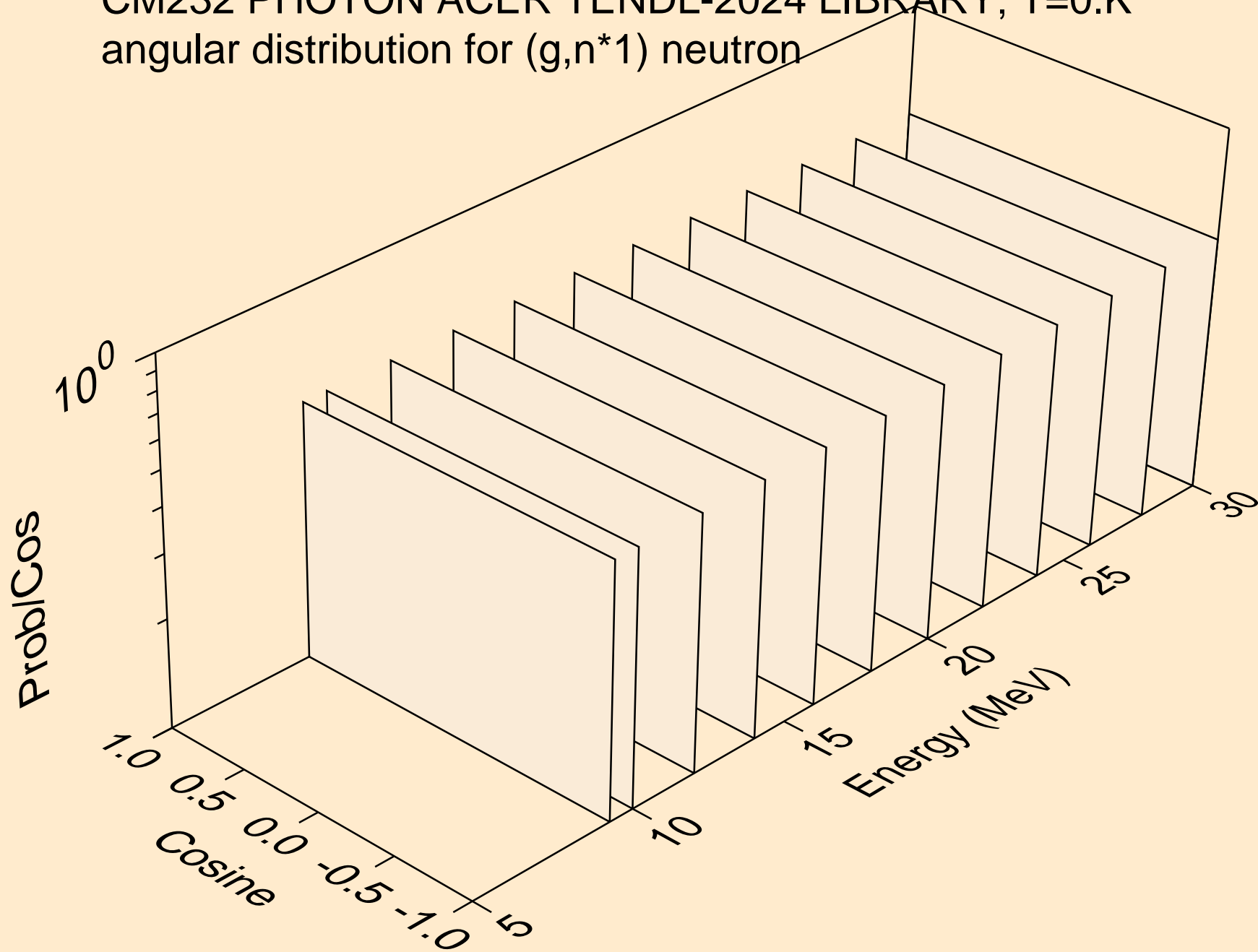

CM232 PHOTON ACER TENDL-2024 LIBRARY; T=0.K
neutrons from (g,n*c)

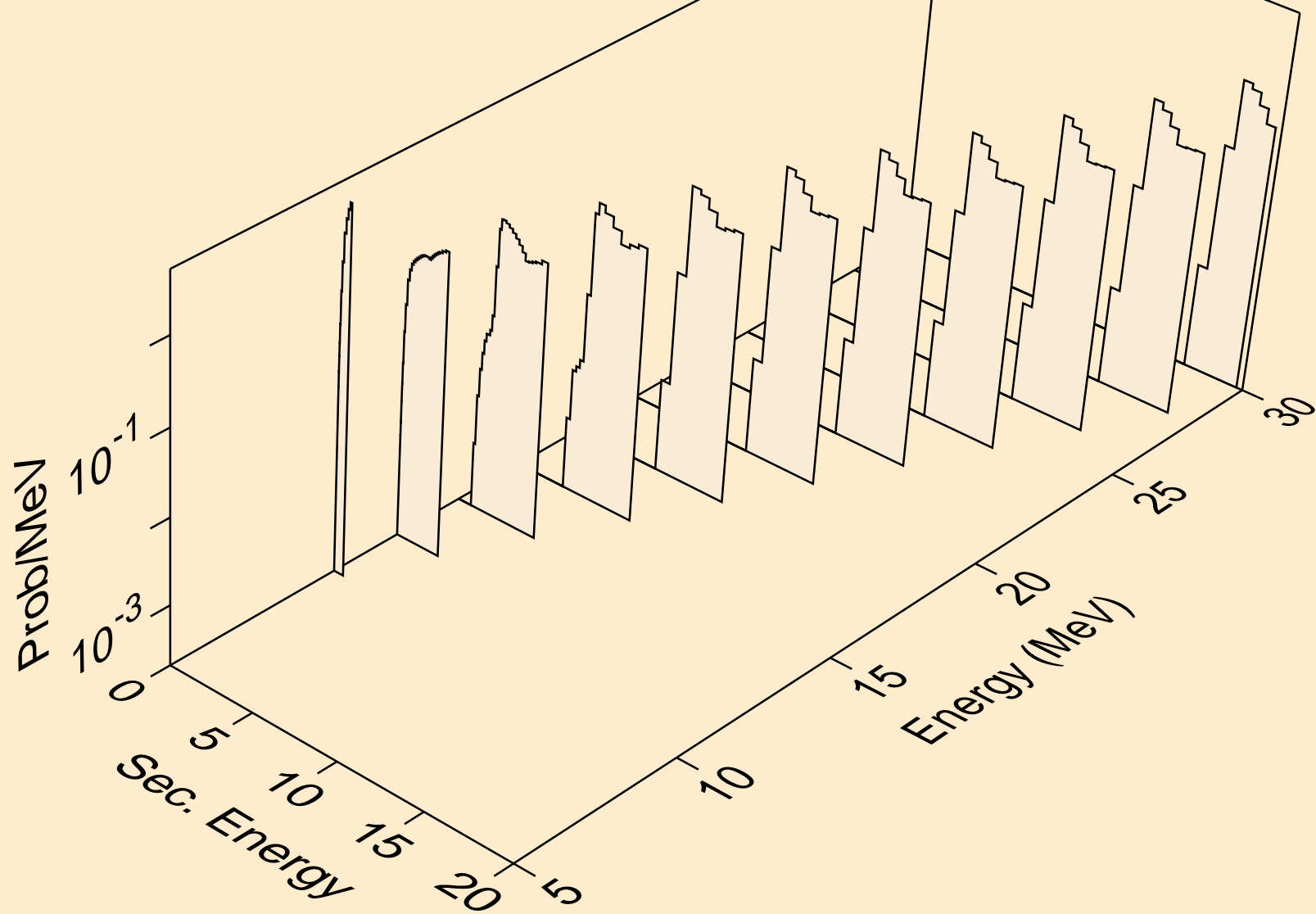

CM232 PHOTON ACER TENDL-2024 LIBRARY; T=0.K
photons from (g,x)

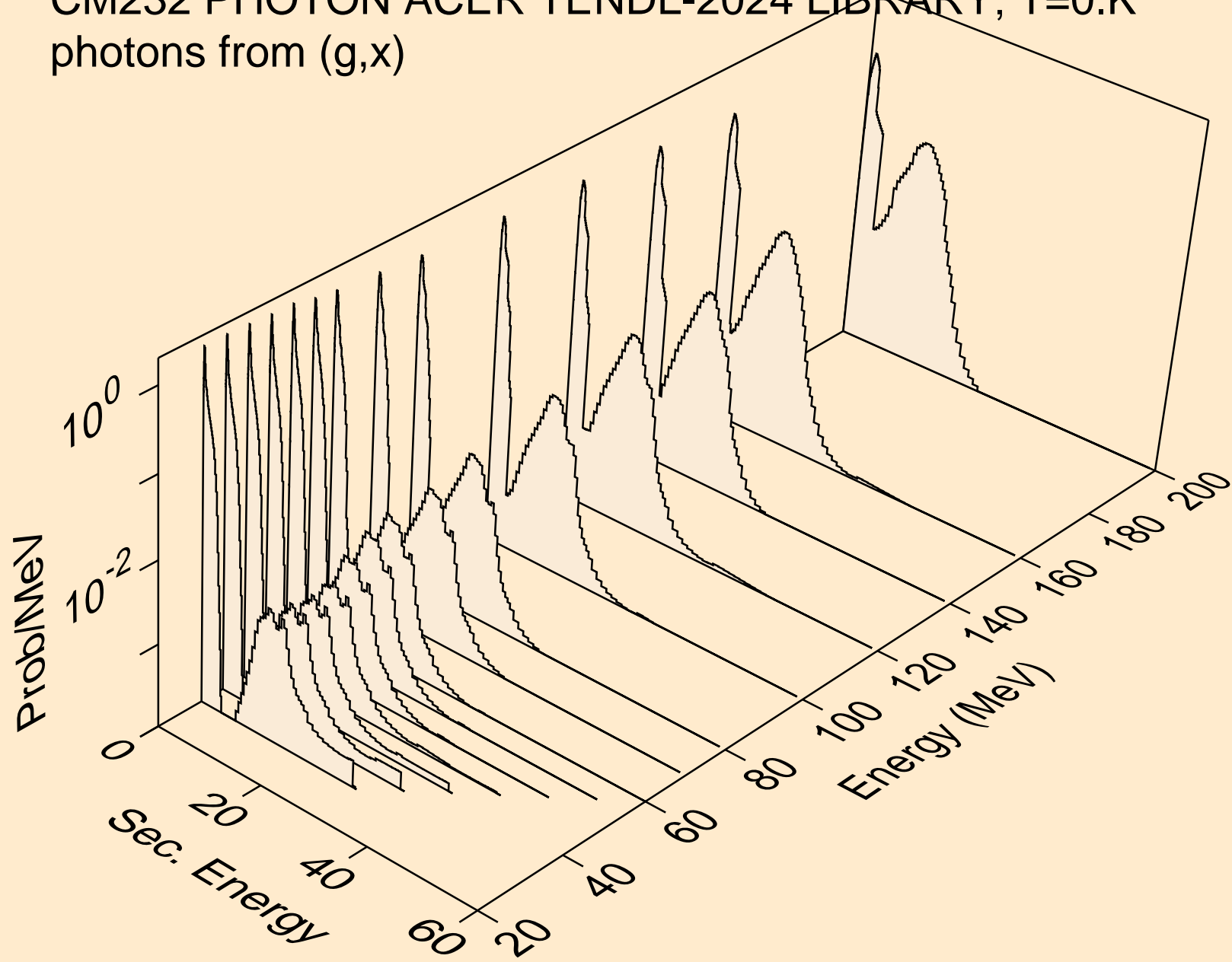

CM232 PHOTON ACER TENDL-2024 LIBRARY; T=0.K
photons from (g,2n)

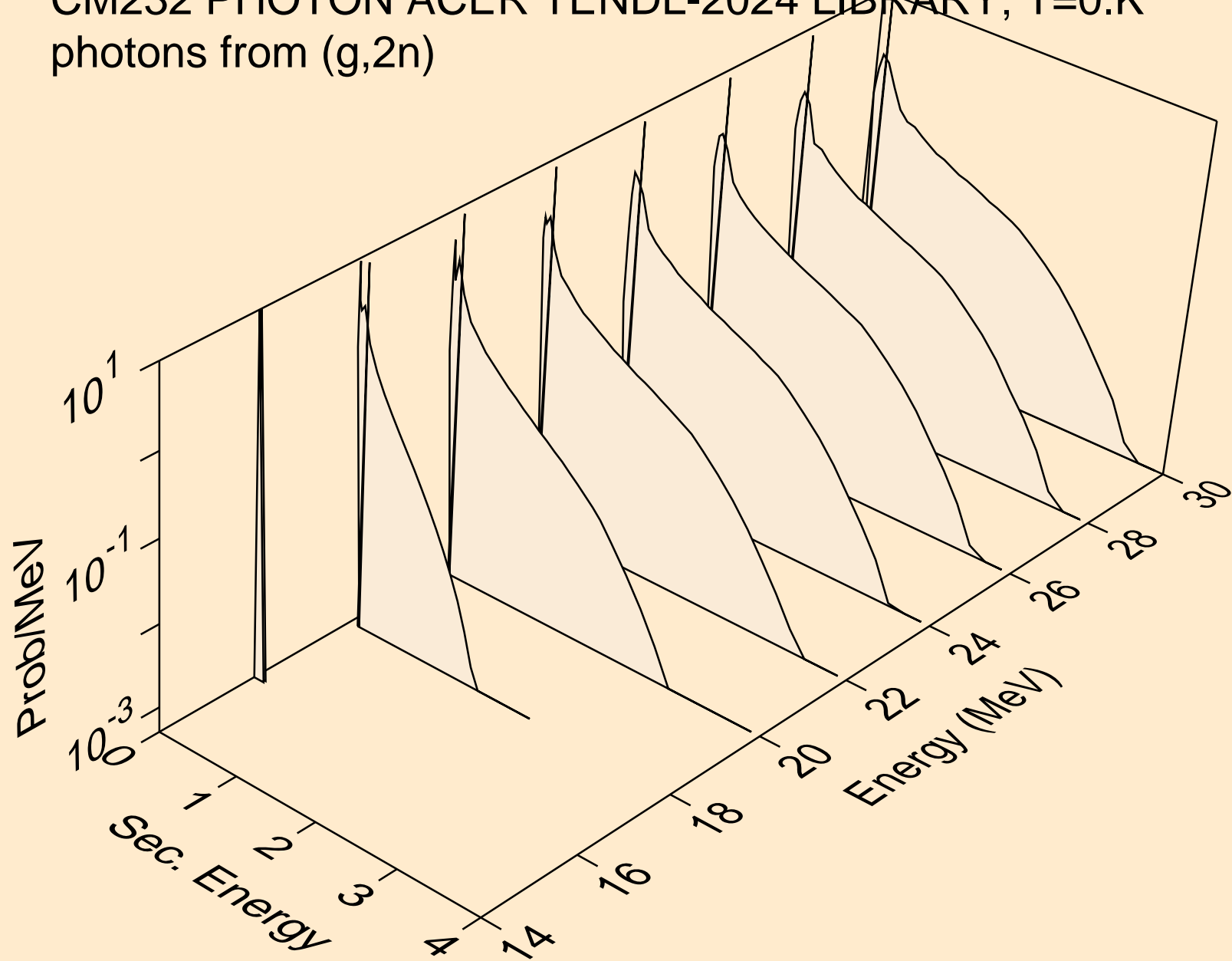

CM232 PHOTON ACER TENDL-2024 LIBRARY; T=0.K
photons from (g,3n)

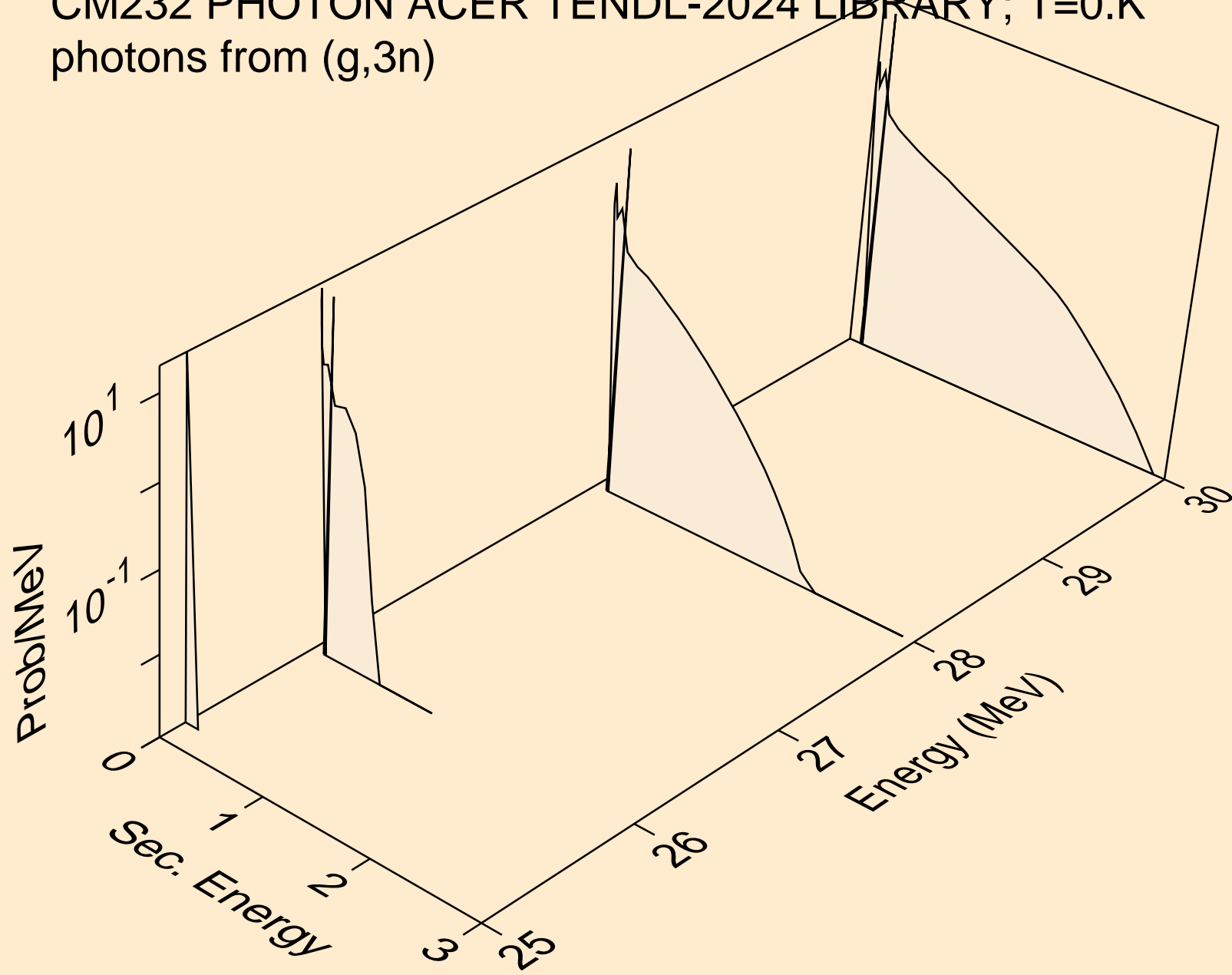

CM232 PHOTON ACER TENDL-2024 LIBRARY; T=0.K
photons from (g,2n)a

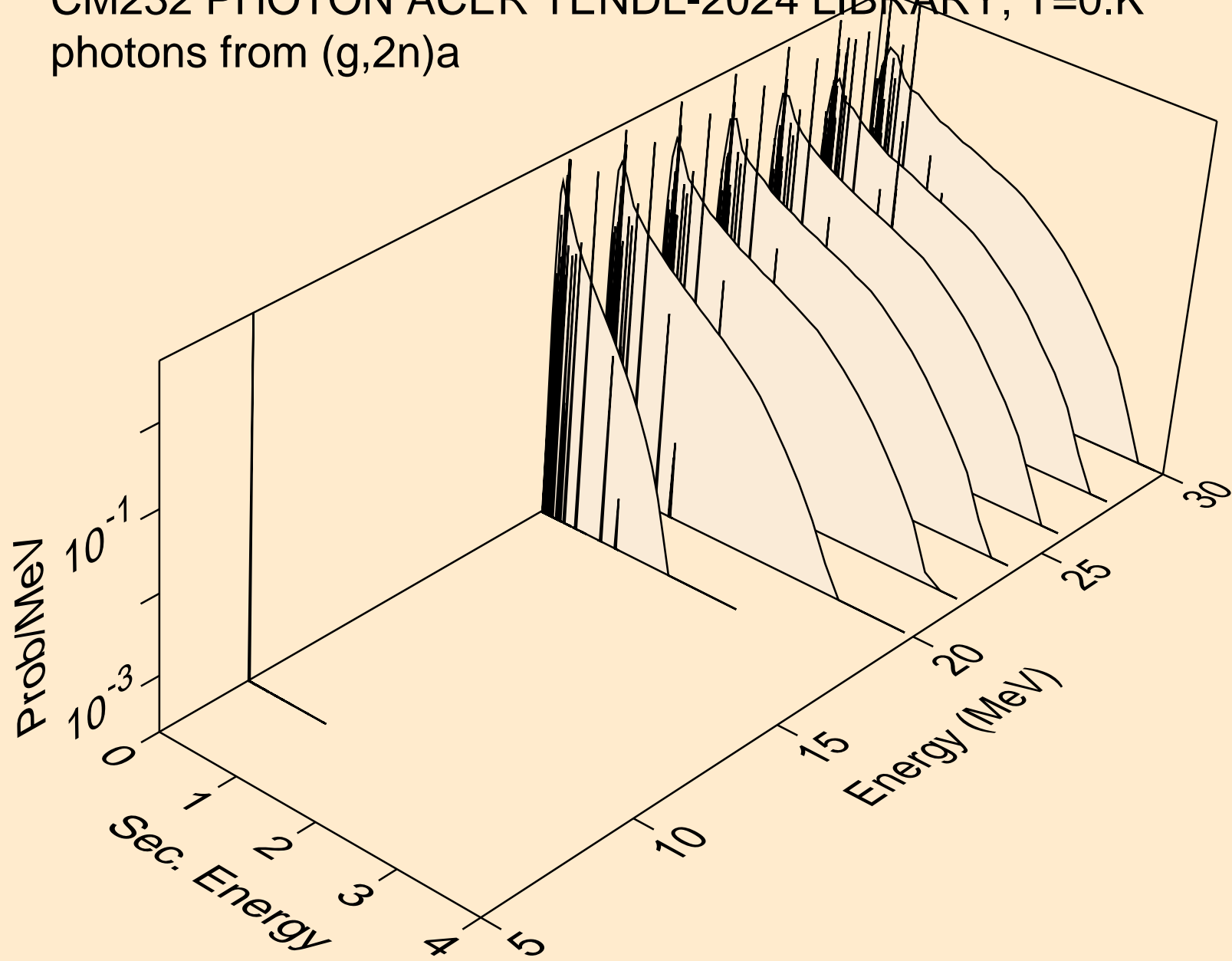

CM232 PHOTON ACER TENDL-2024 LIBRARY; T=0.K
photons from (g,3n)a

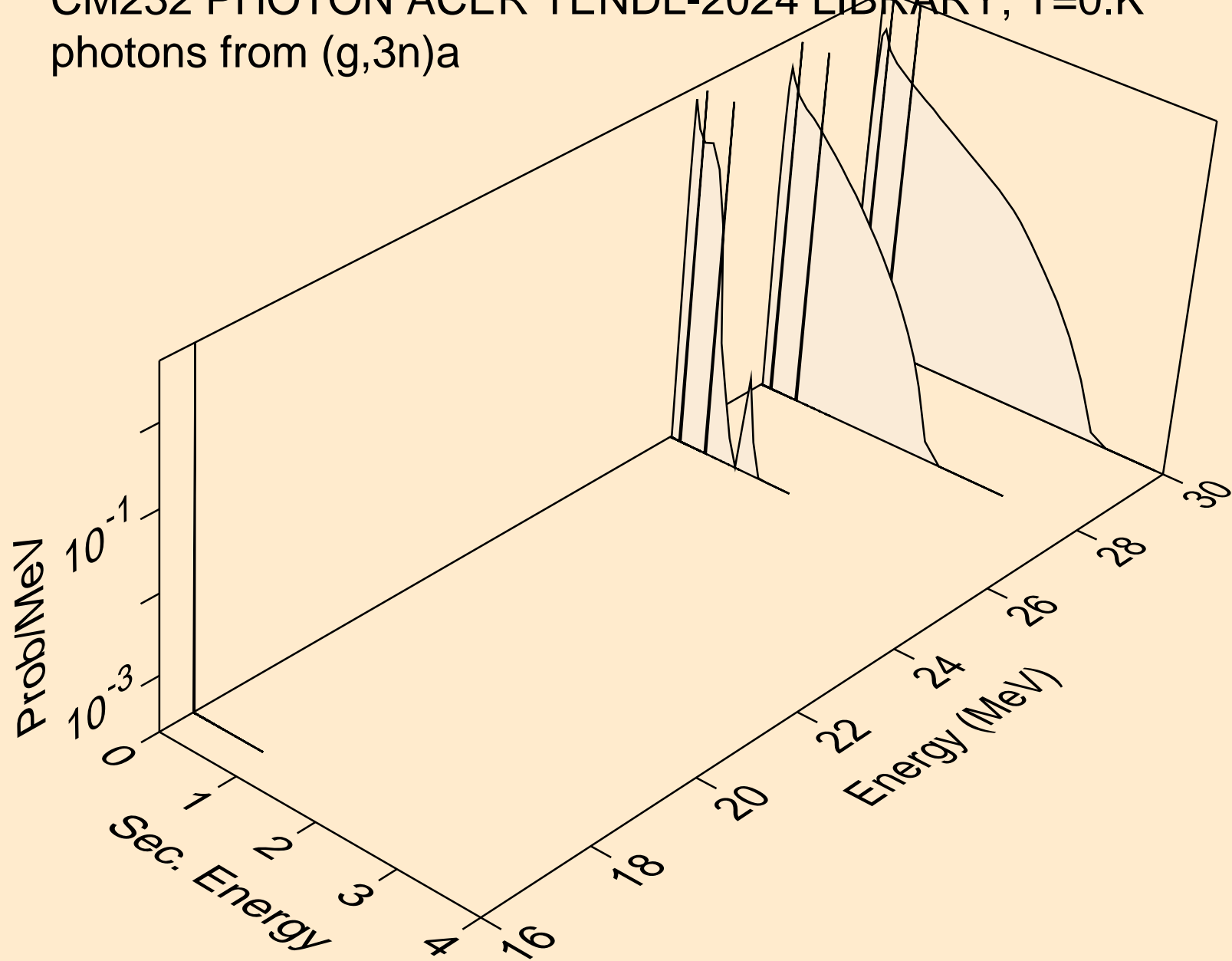

CM232 PHOTON ACER TENDL-2024 LIBRARY; T=0.K
photons from (g,n*)p

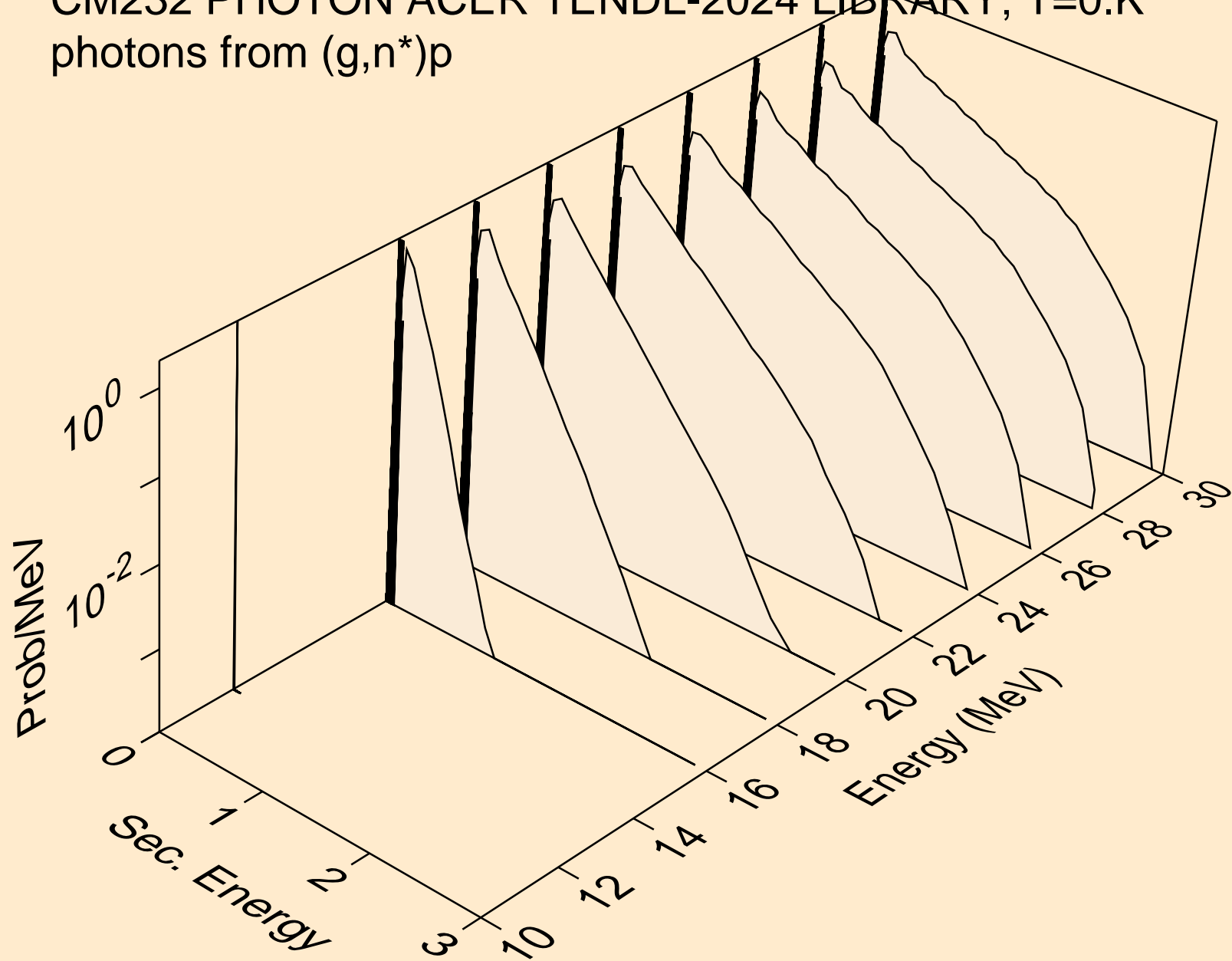

CM232 PHOTON ACER TENDL-2024 LIBRARY; T=0.K
photons from (g,n*c)

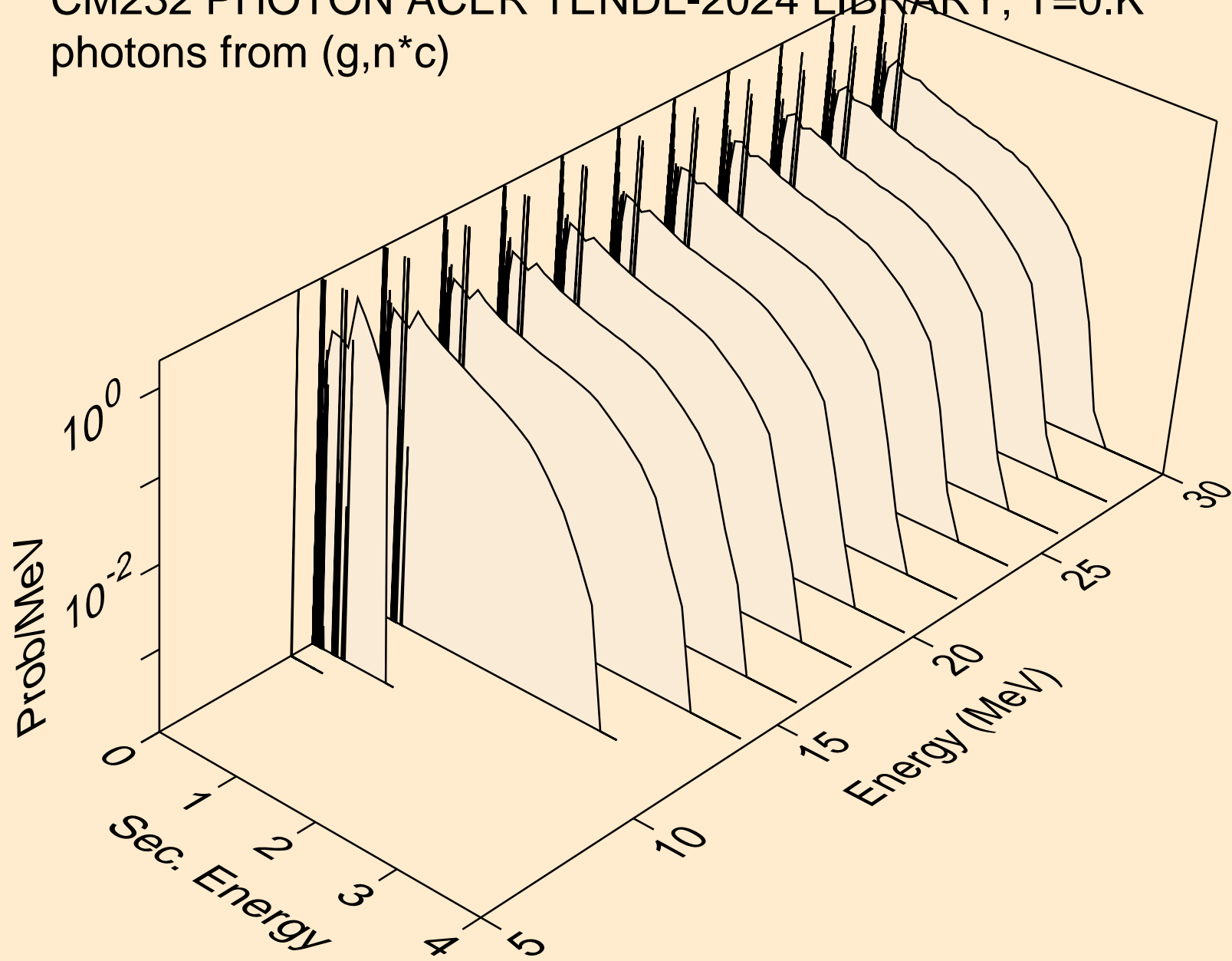

CM232 PHOTON ACER TENDL-2024 LIBRARY; T=0.K
photons from (g,gma)

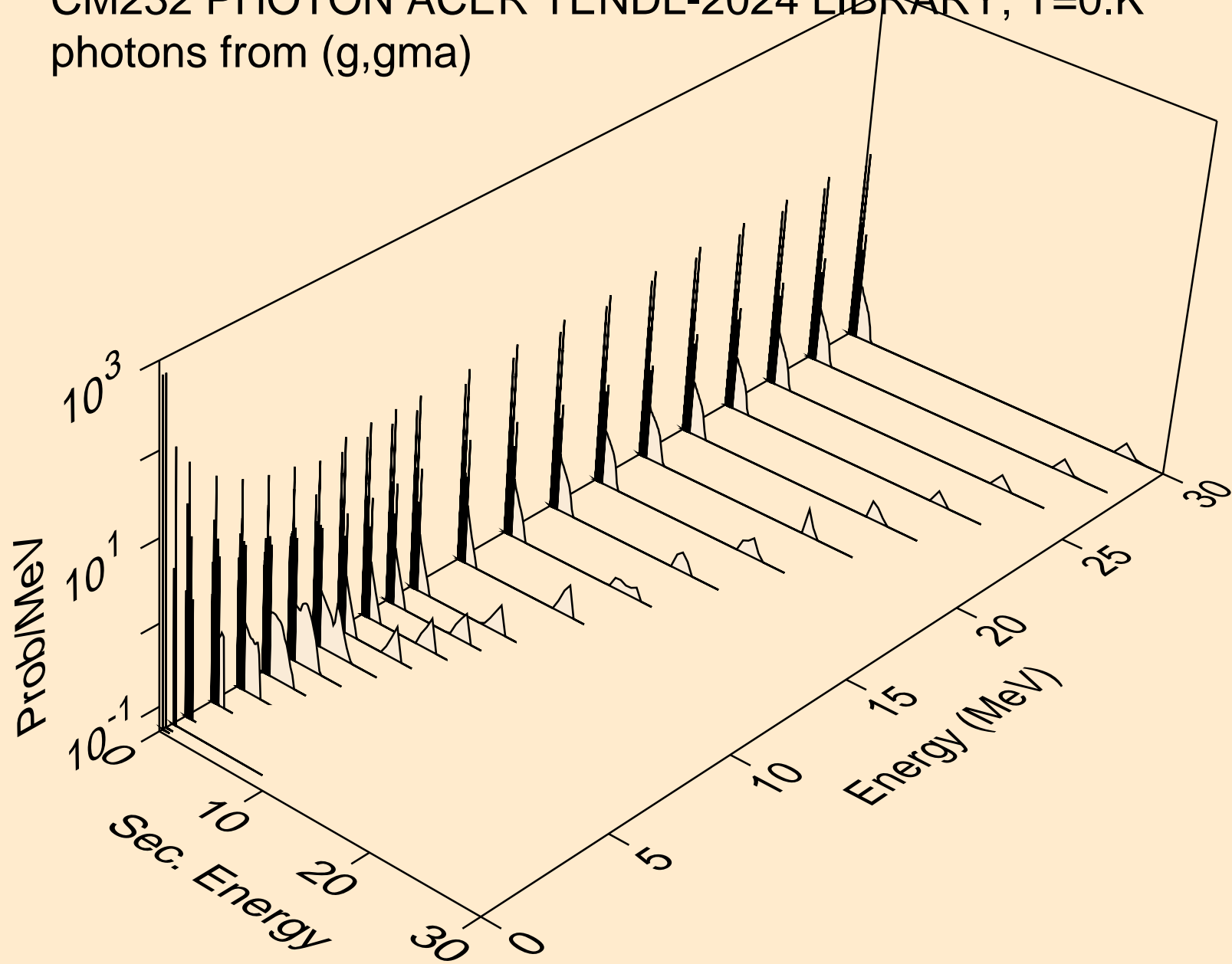

CM232 PHOTON ACER TENDL-2024 LIBRARY; T=0.K
photons from (g,p)

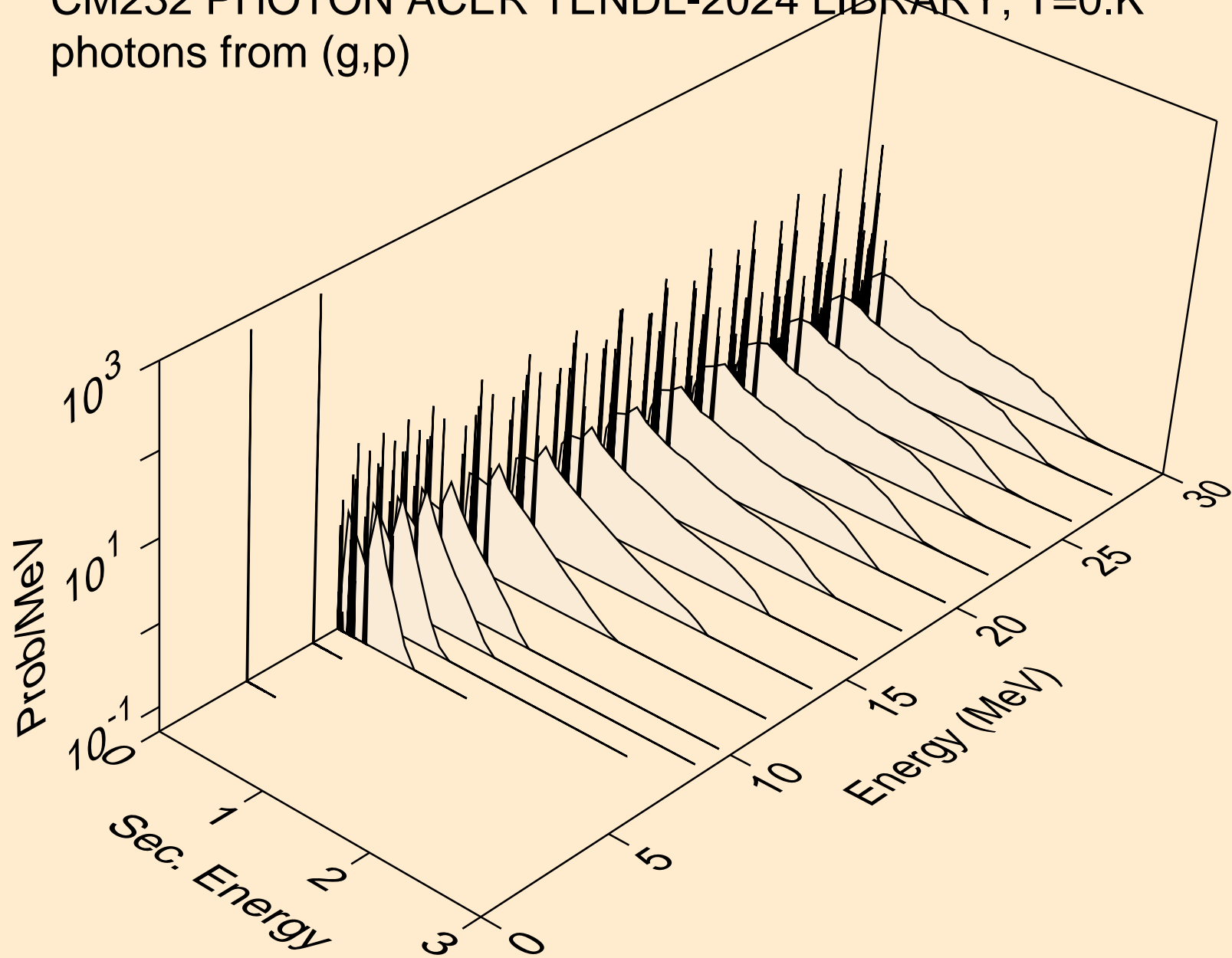

CM232 PHOTON ACER TENDL-2024 LIBRARY; T=0.K
photons from (g,d)

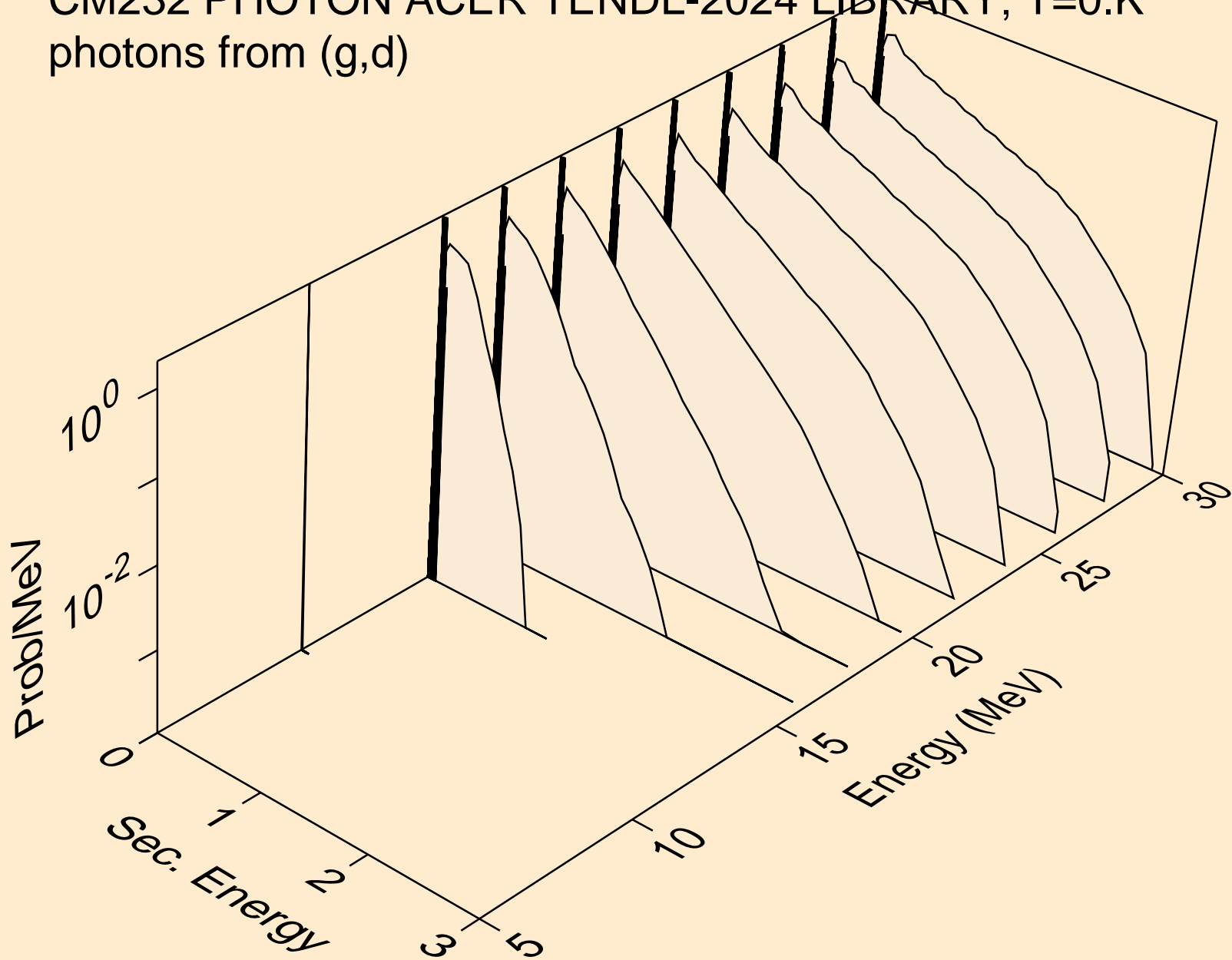

CM232 PHOTON ACER TENDL-2024 LIBRARY; T=0.K
photons from (g,t)

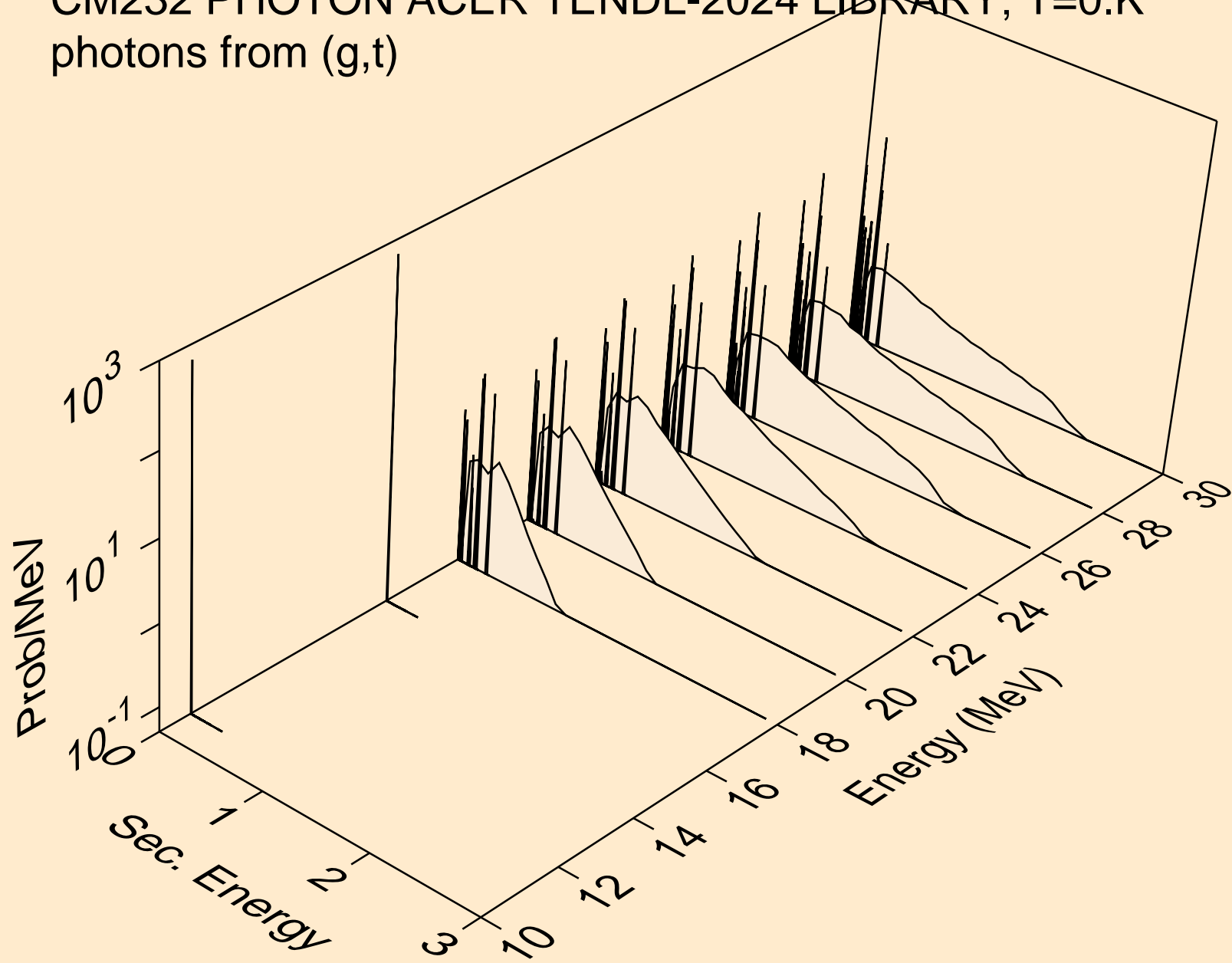

CM232 PHOTON ACER TENDL-2024 LIBRARY; T=0.K
photons from (g,a)

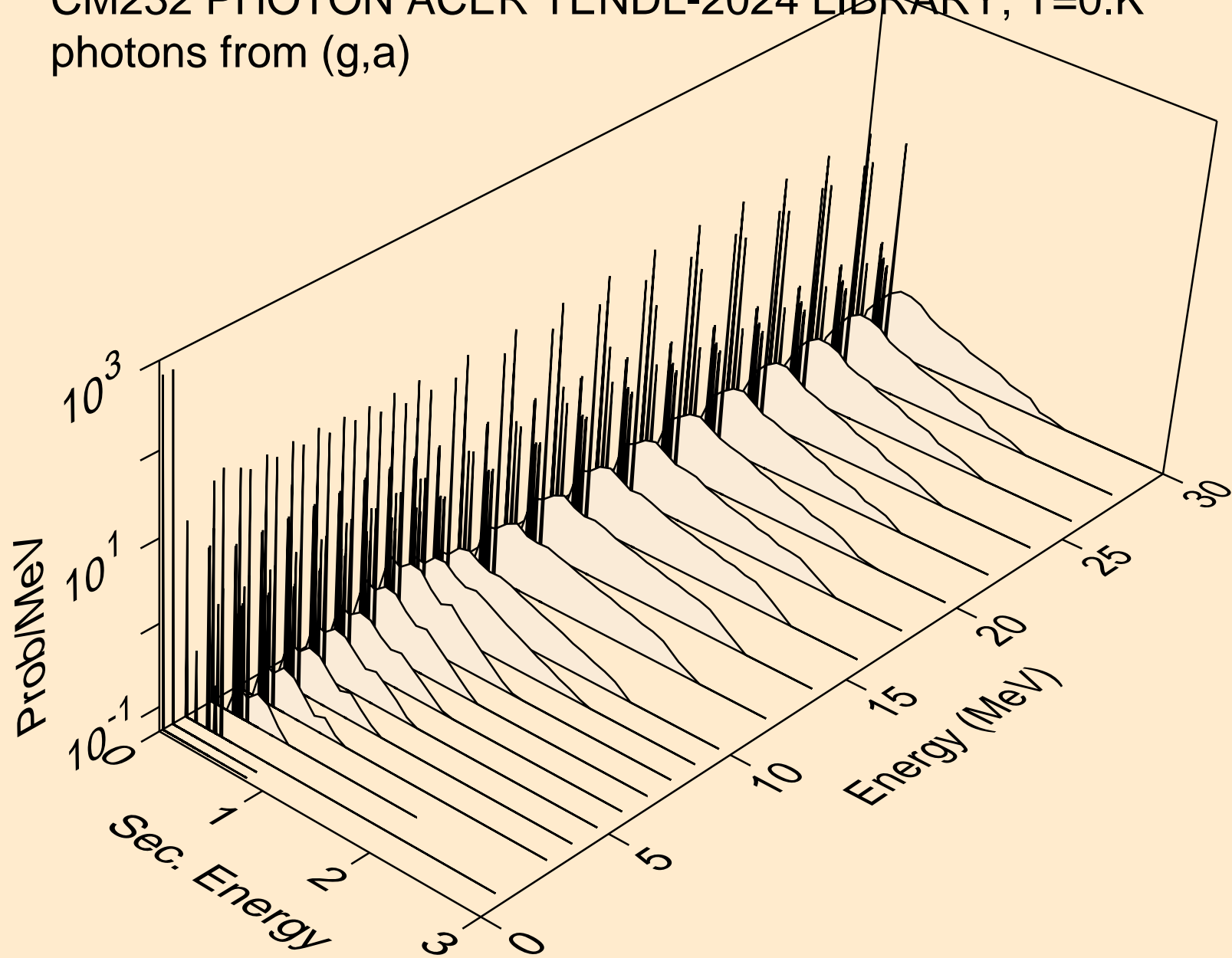

CM232 PHOTON ACER TENDL-2024 LIBRARY; T=0.K
photons from (g,2p)

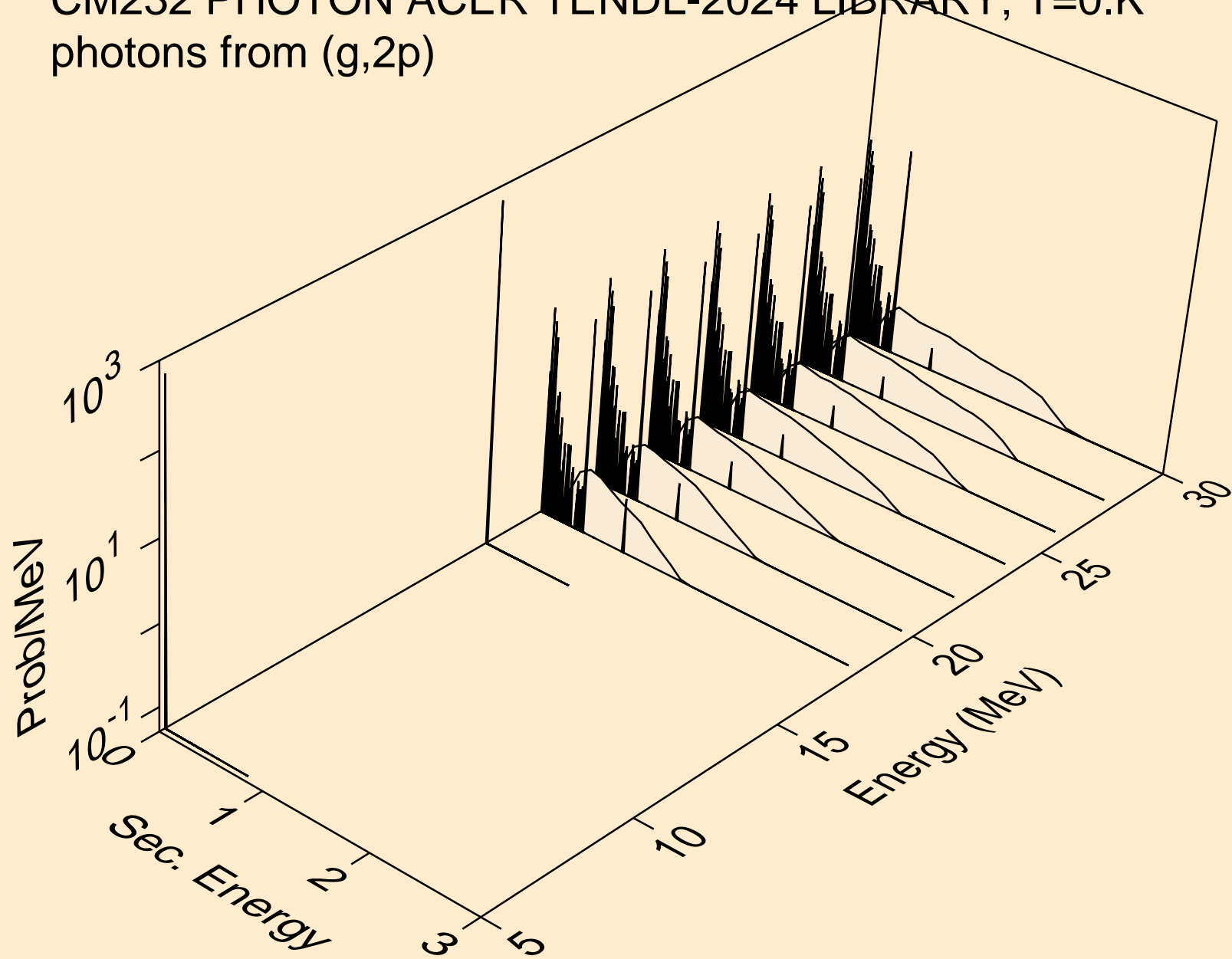

CM232 PHOTON ACER TENDL-2024 LIBRARY; T=0.K
protons from (g,x)

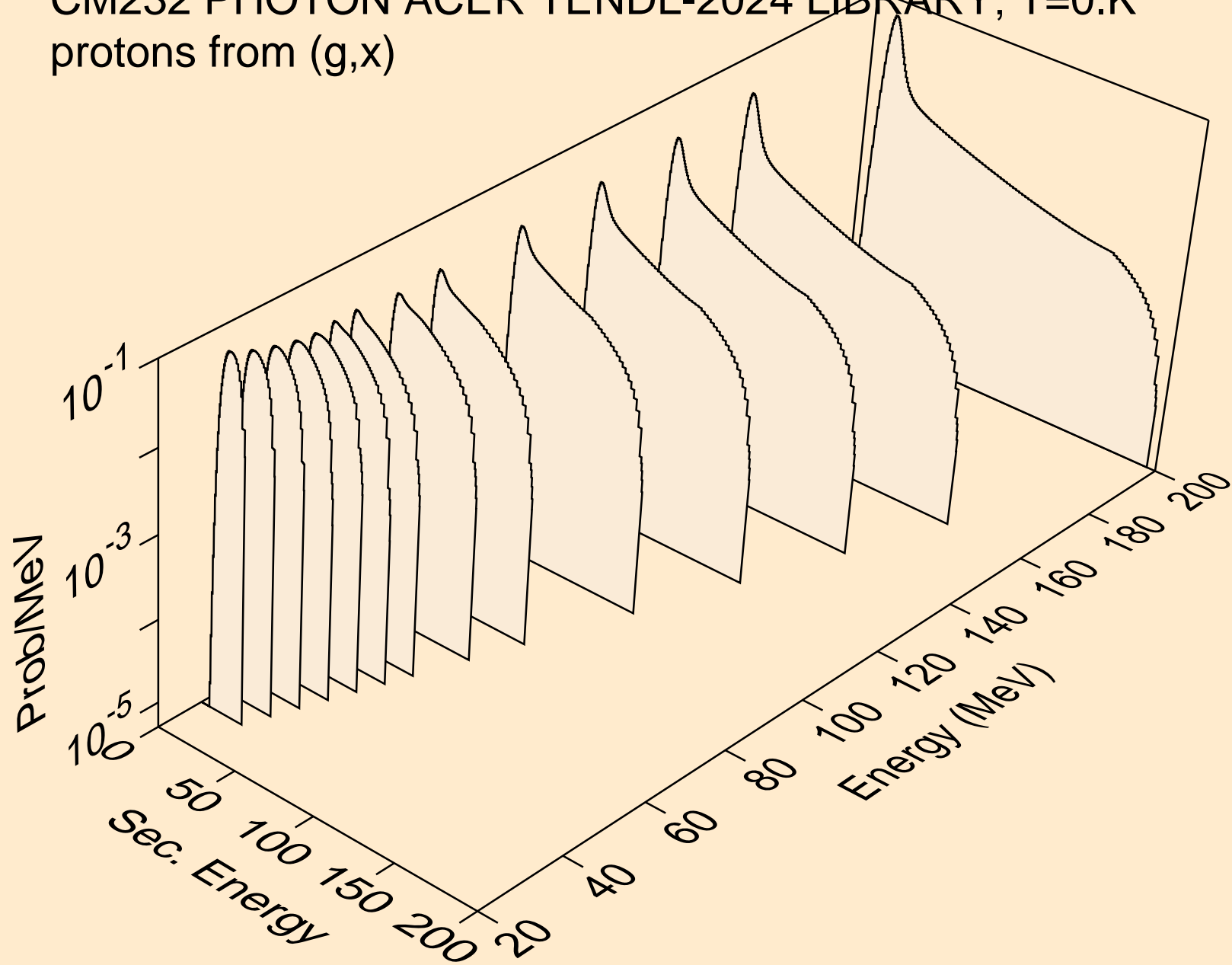

CM232 PHOTON ACER TENDL-2024 LIBRARY; T=0.K
protons from (g,n*)p

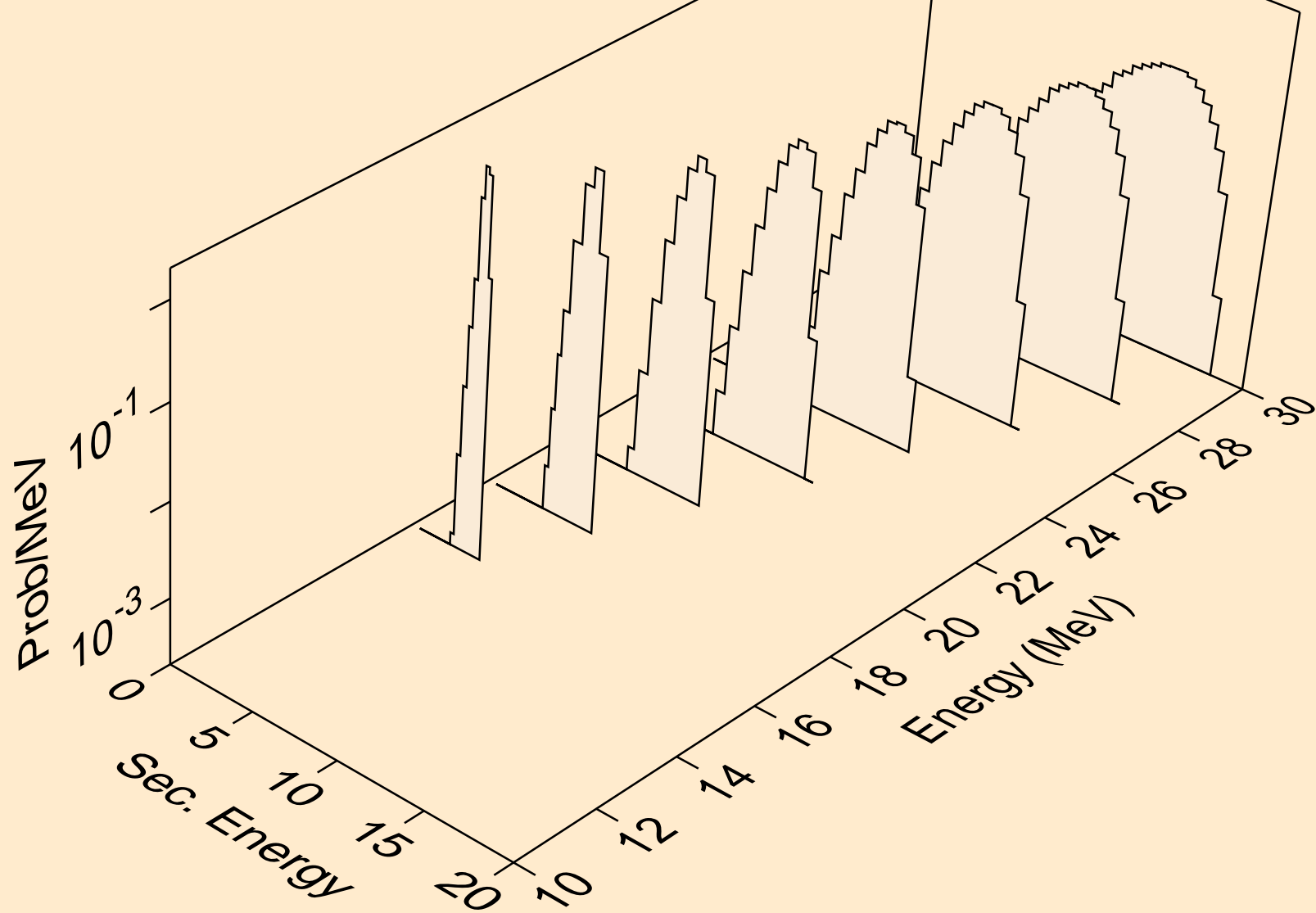

CM232 PHOTON ACER TENDL-2024 LIBRARY; T=0.K
protons from (g,p)

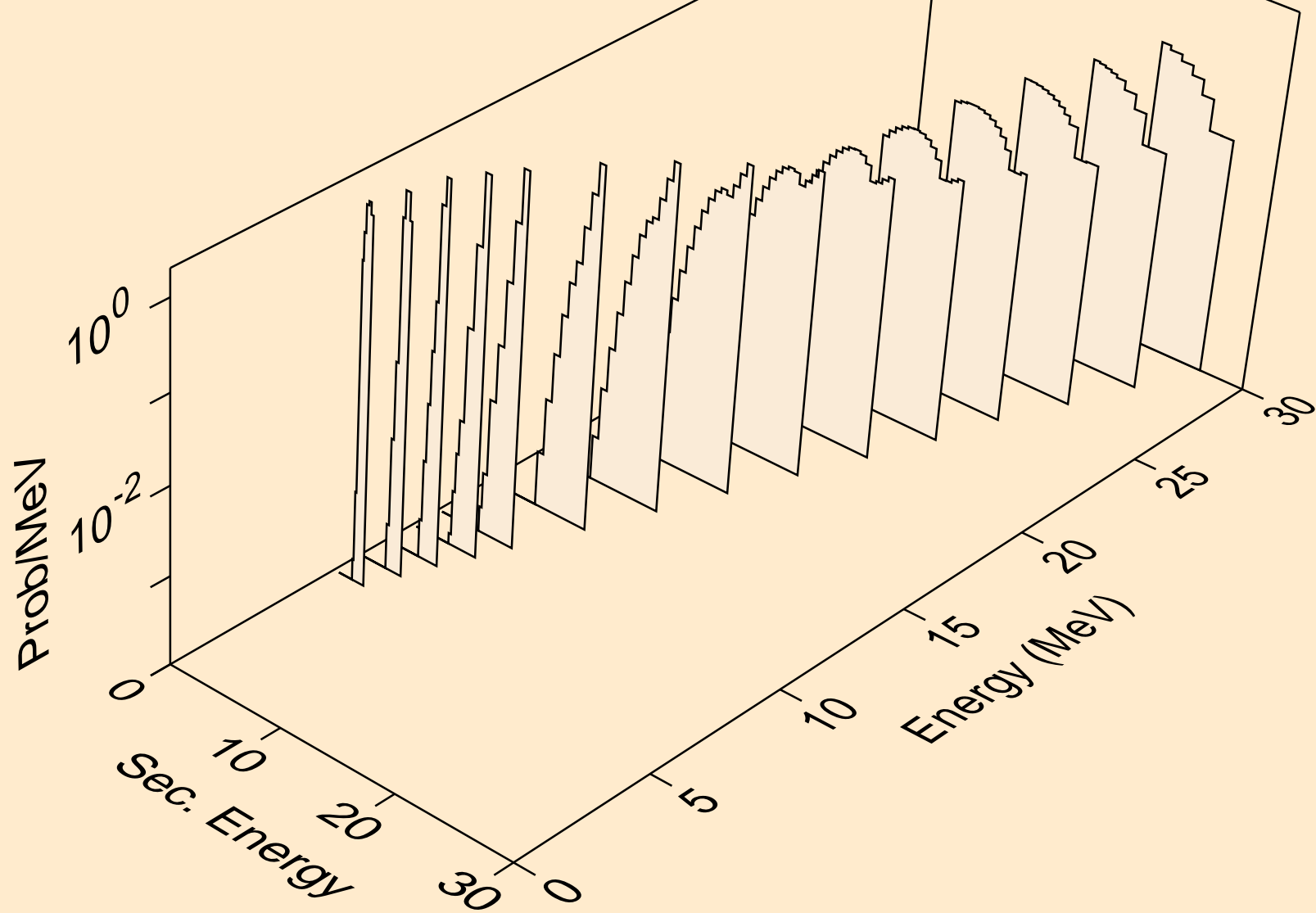

CM232 PHOTON ACER TENDL-2024 LIBRARY; T=0.K
protons from (g,2p)

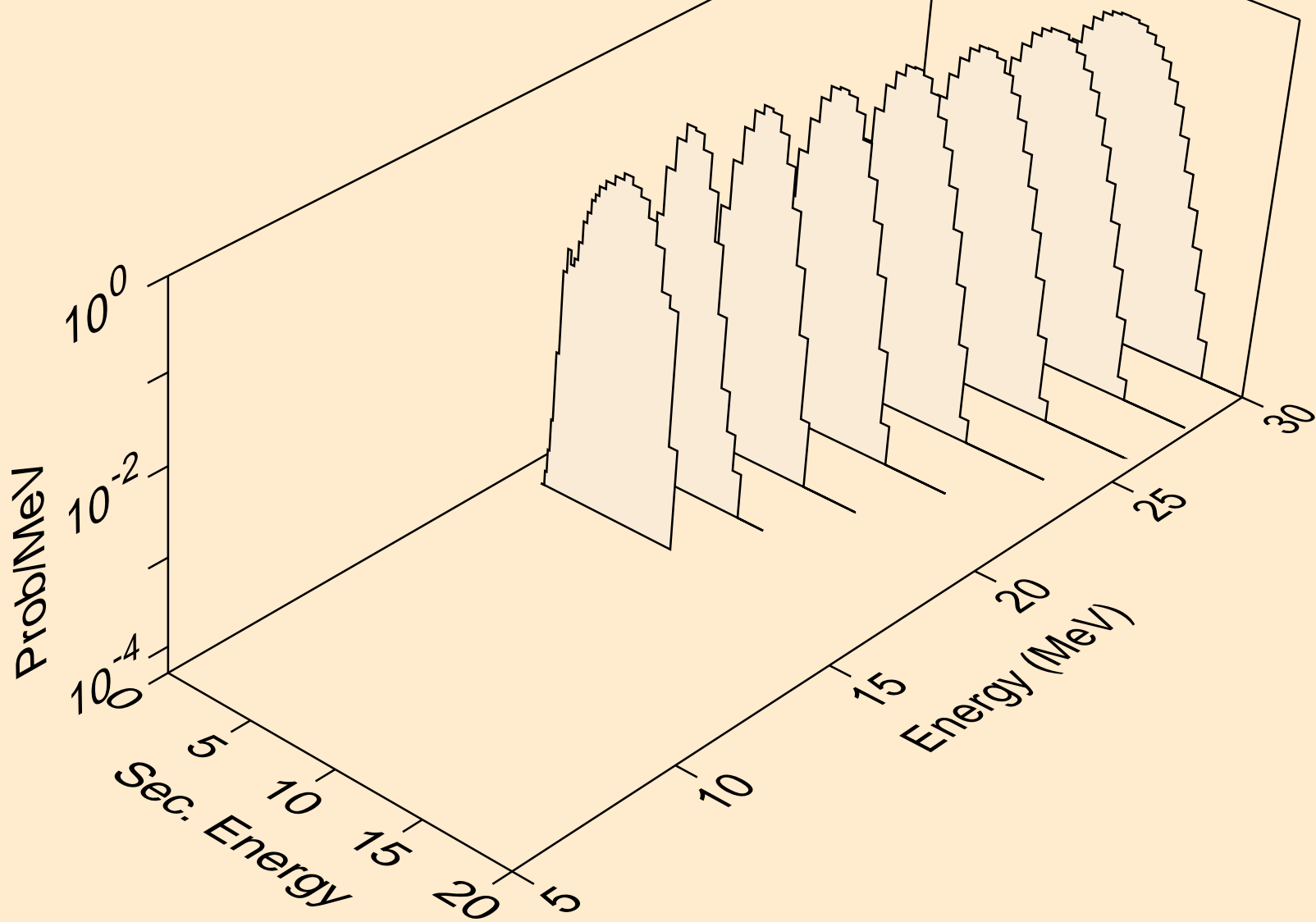

CM232 PHOTON ACER TENDL-2024 LIBRARY; T=0.K
deuterons from (g,x)

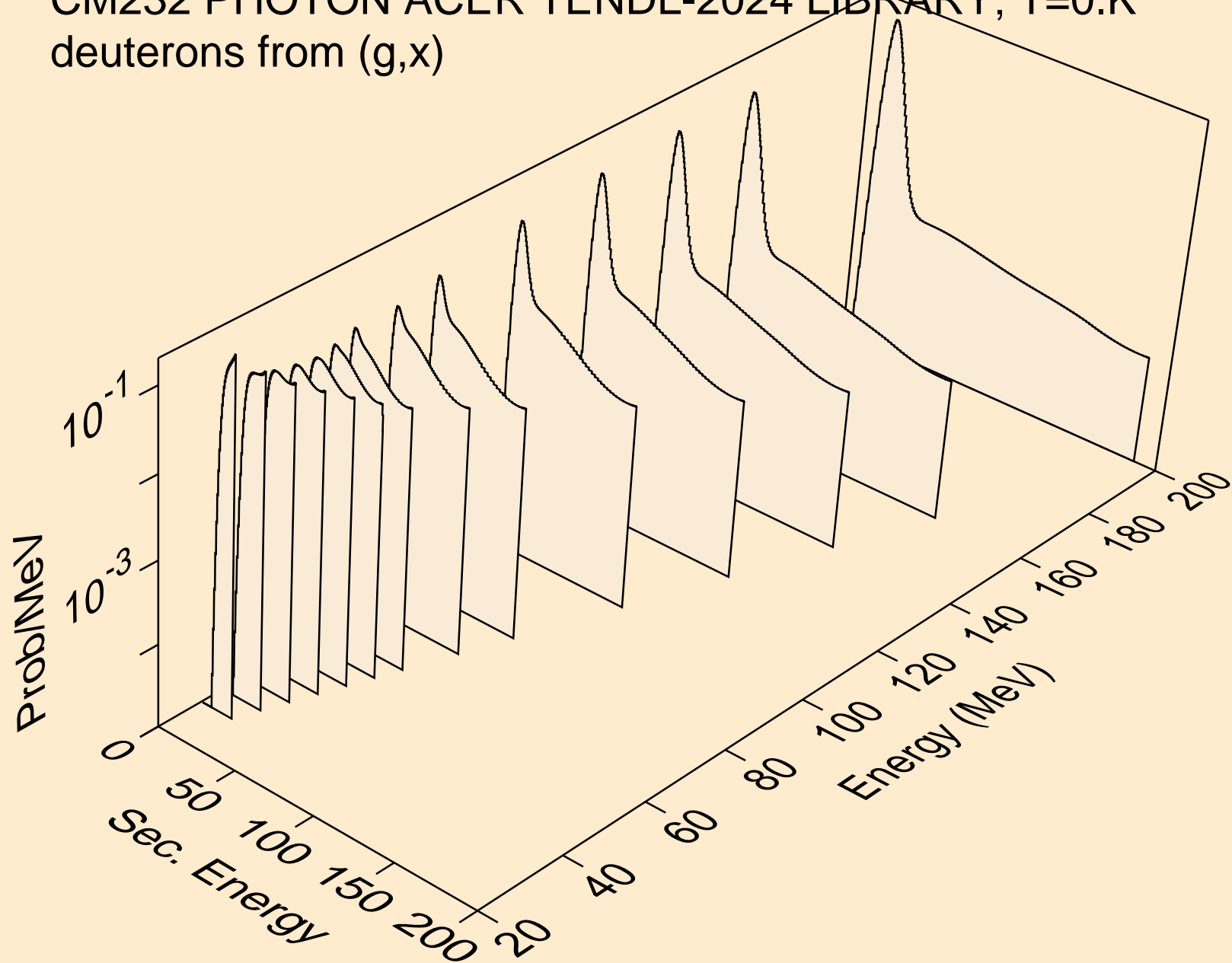

CM232 PHOTON ACER TENDL-2024 LIBRARY; T=0.K
deuterons from (g,d)

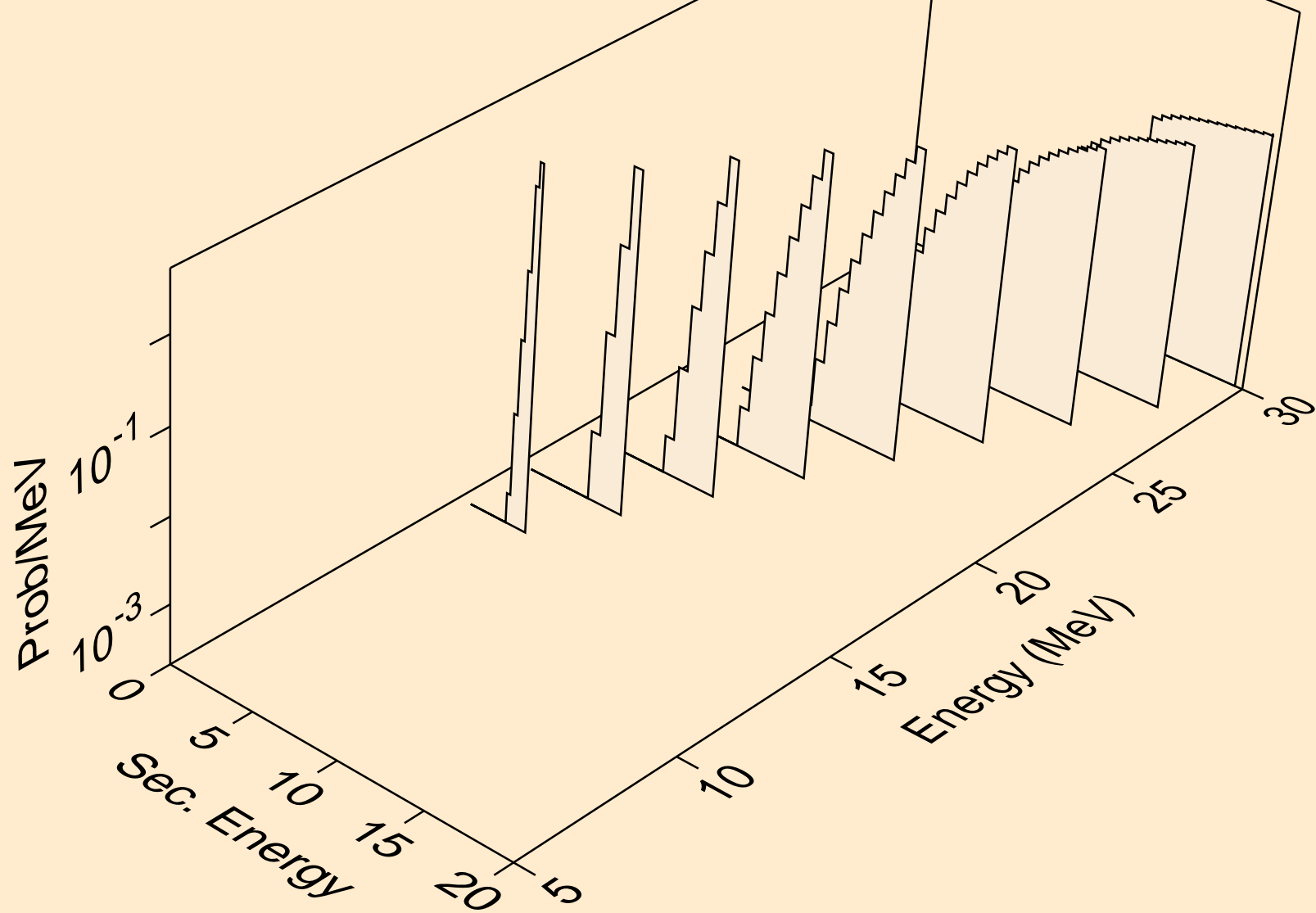

CM232 PHOTON ACER TENDL-2024 LIBRARY; T=0.K
tritons from (g,x)

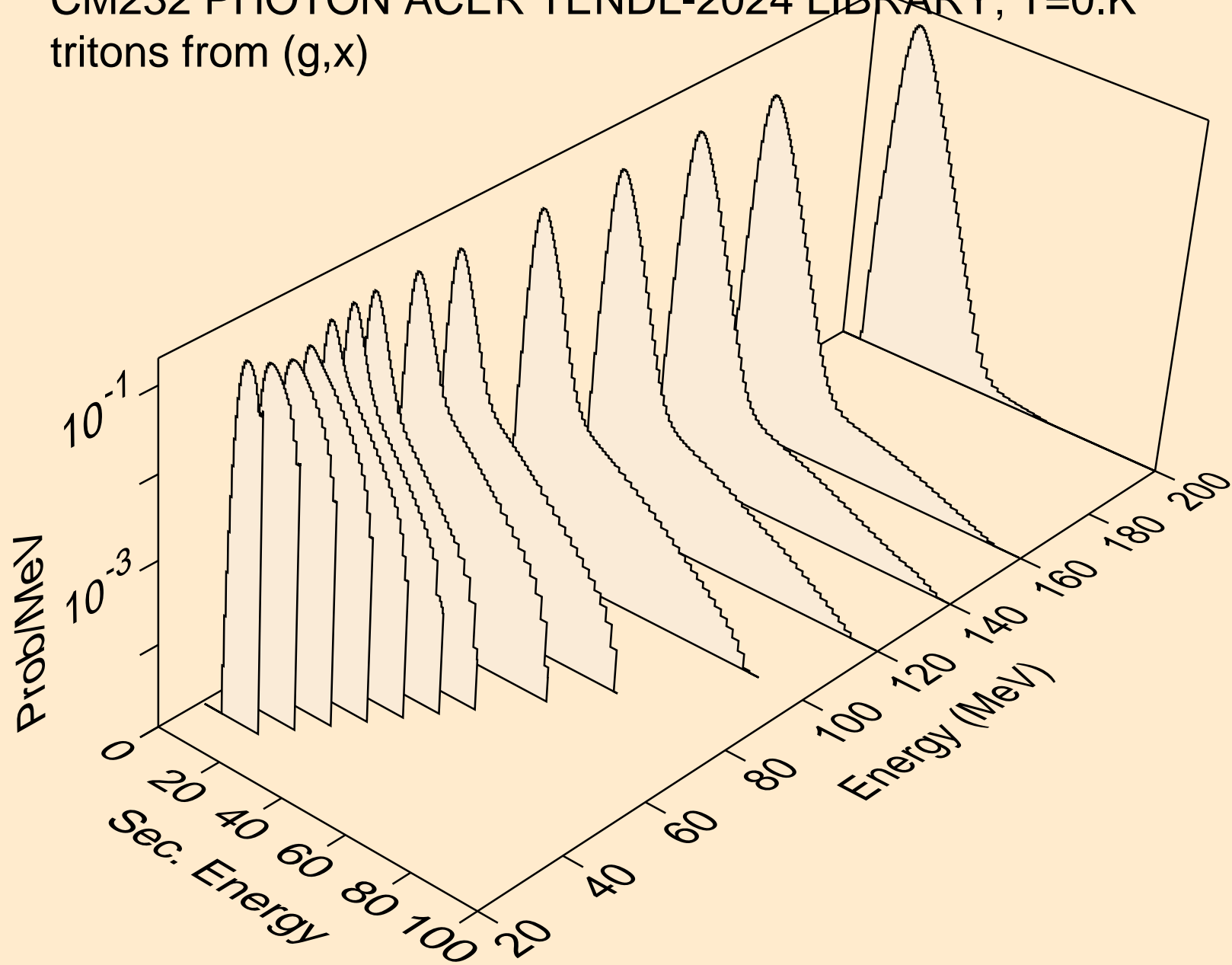

CM232 PHOTON ACER TENDL-2024 LIBRARY; T=0.K
tritons from (g,t)

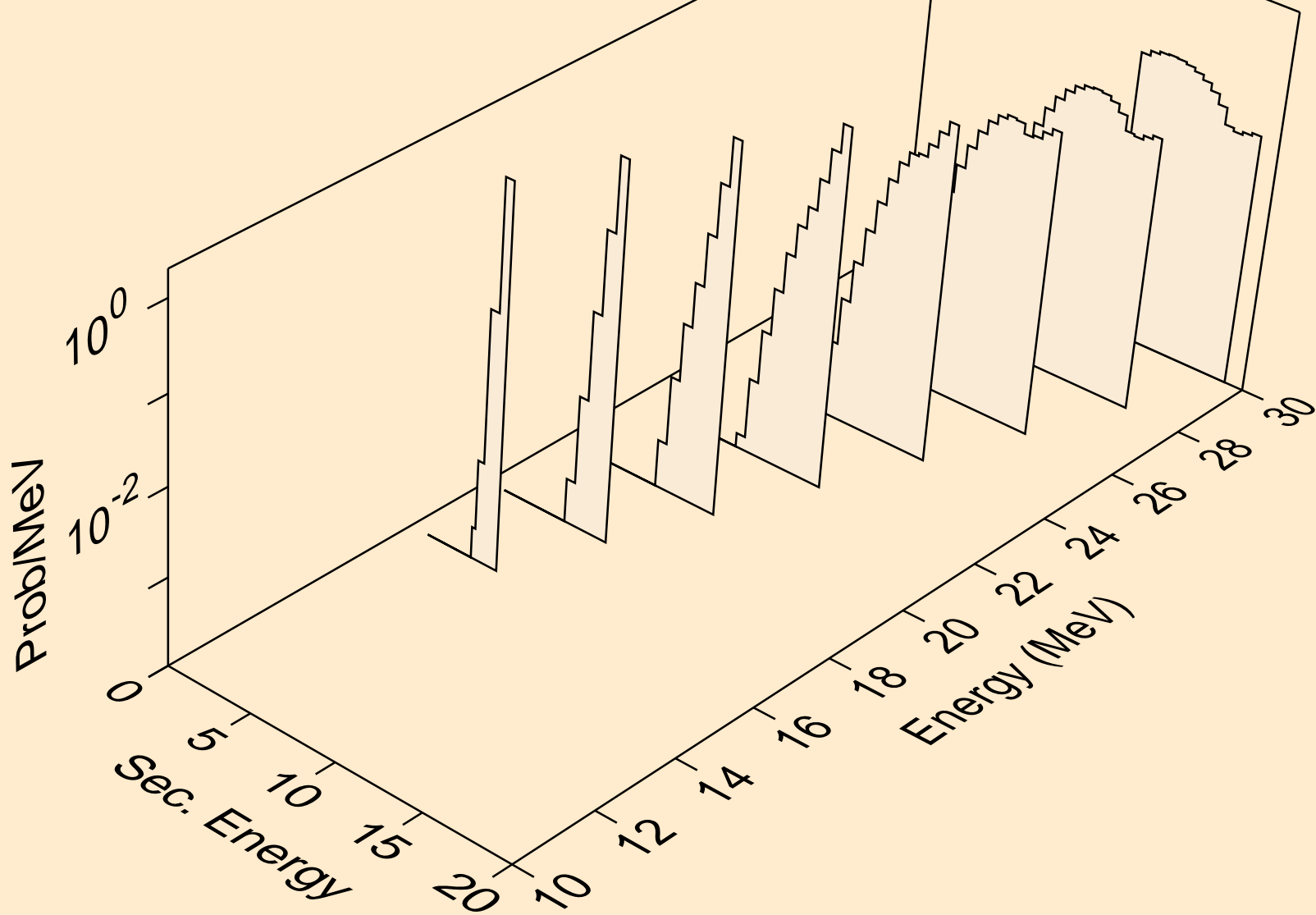

CM232 PHOTON ACER TENDL-2024 LIBRARY; T=0.K
he3s from (g,x)

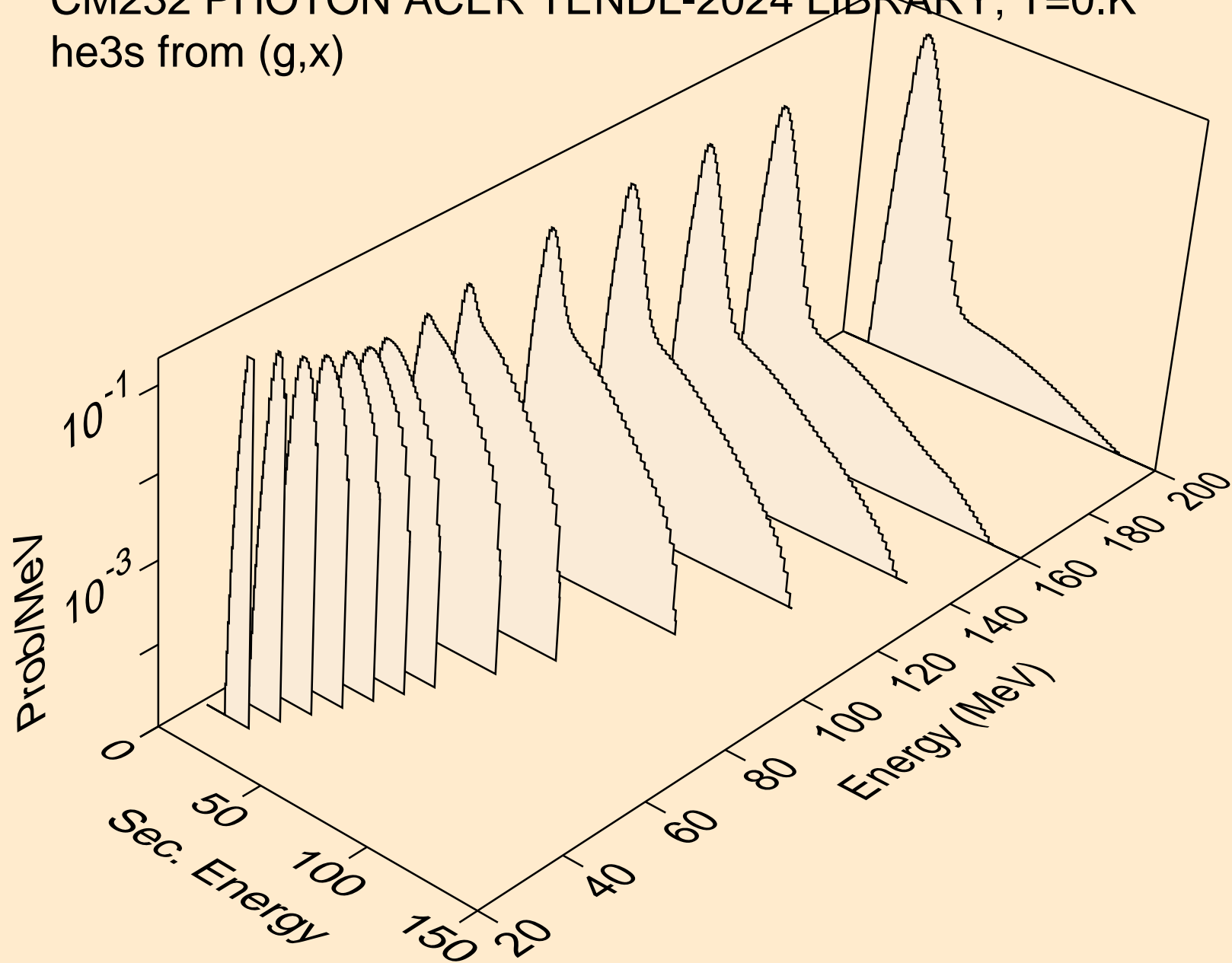

CM232 PHOTON ACER TENDL-2024 LIBRARY; T=0.K
alphas from (g,x)

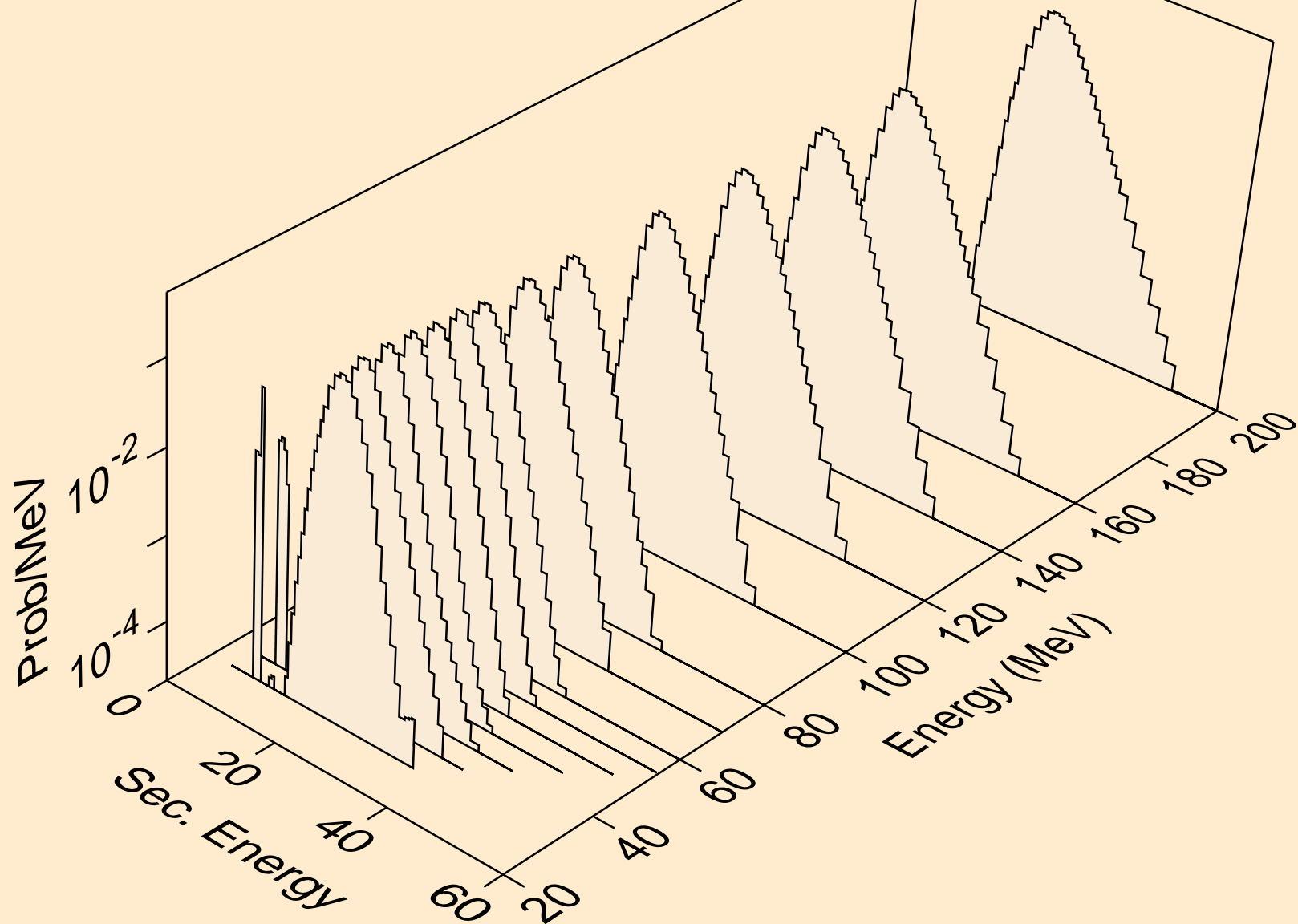

CM232 PHOTON ACER TENDL-2024 LIBRARY; T=0.K
alphas from (g,2n)a

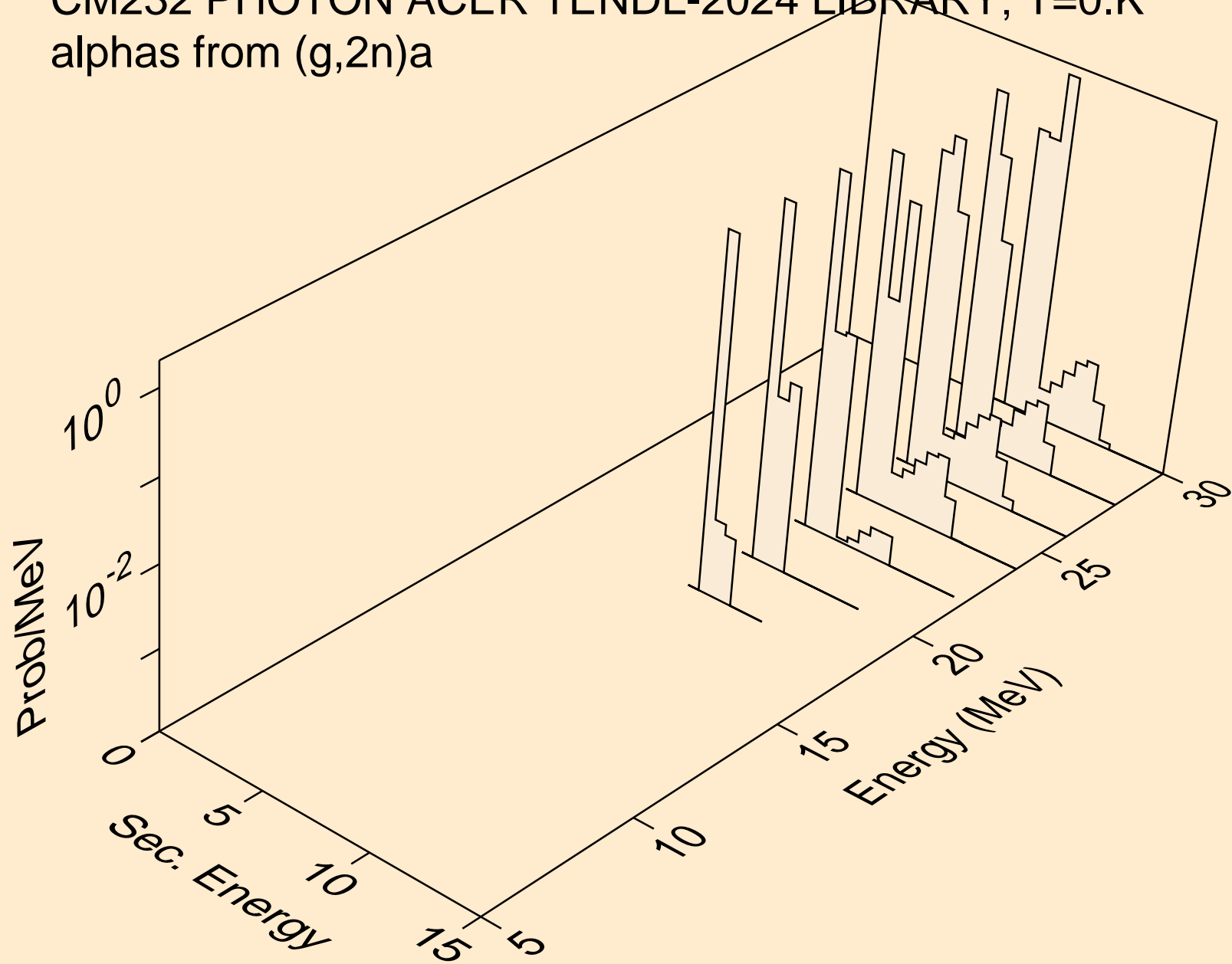

CM232 PHOTON ACER TENDL-2024 LIBRARY; T=0.K
alphas from (g,3n)a

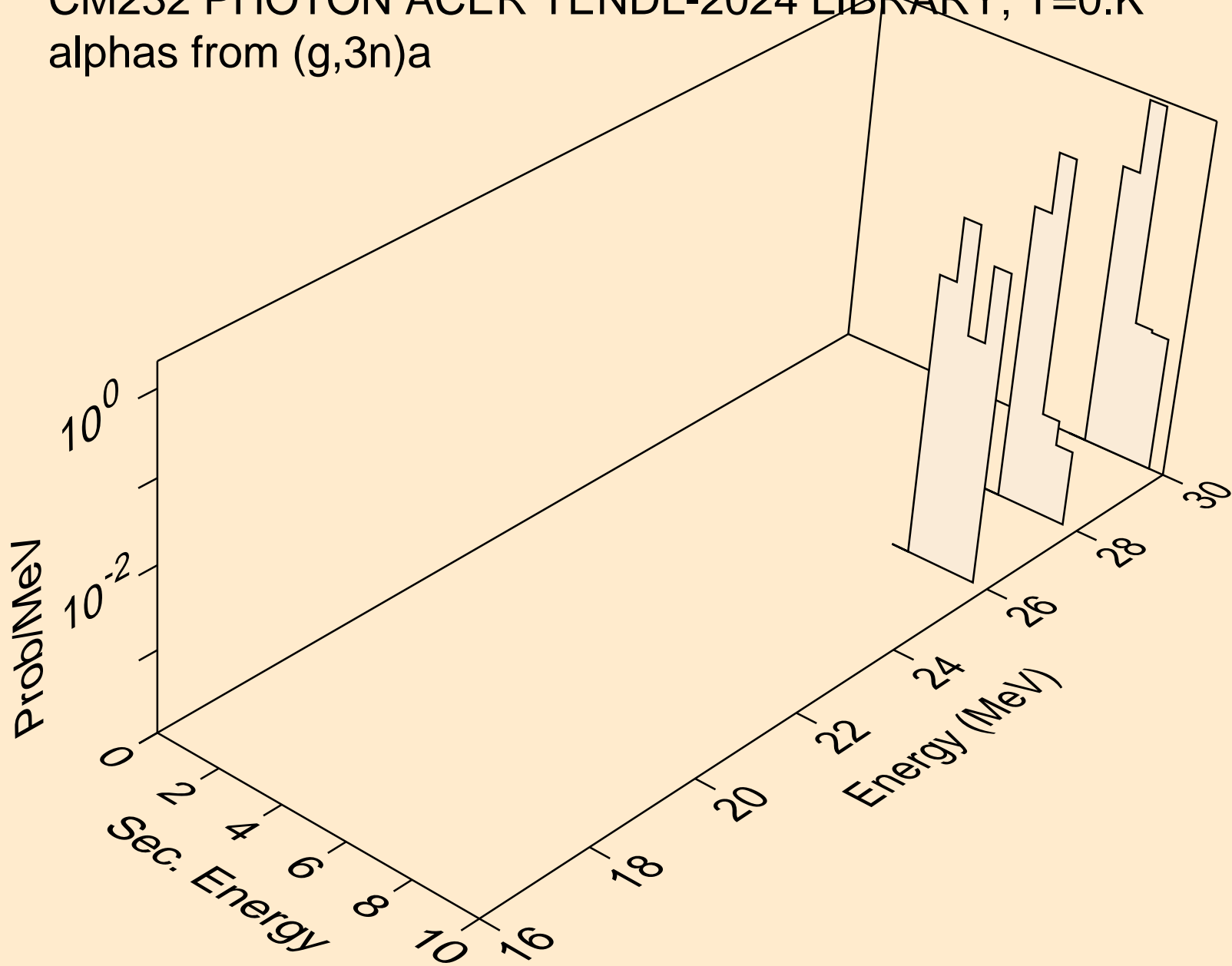

CM232 PHOTON ACER TENDL-2024 LIBRARY; T=0.K
alphas from (g,a)

