

HF163 PHOTON ACER TENDL-2024 LIBRARY; T=0.K  
Principal cross sections

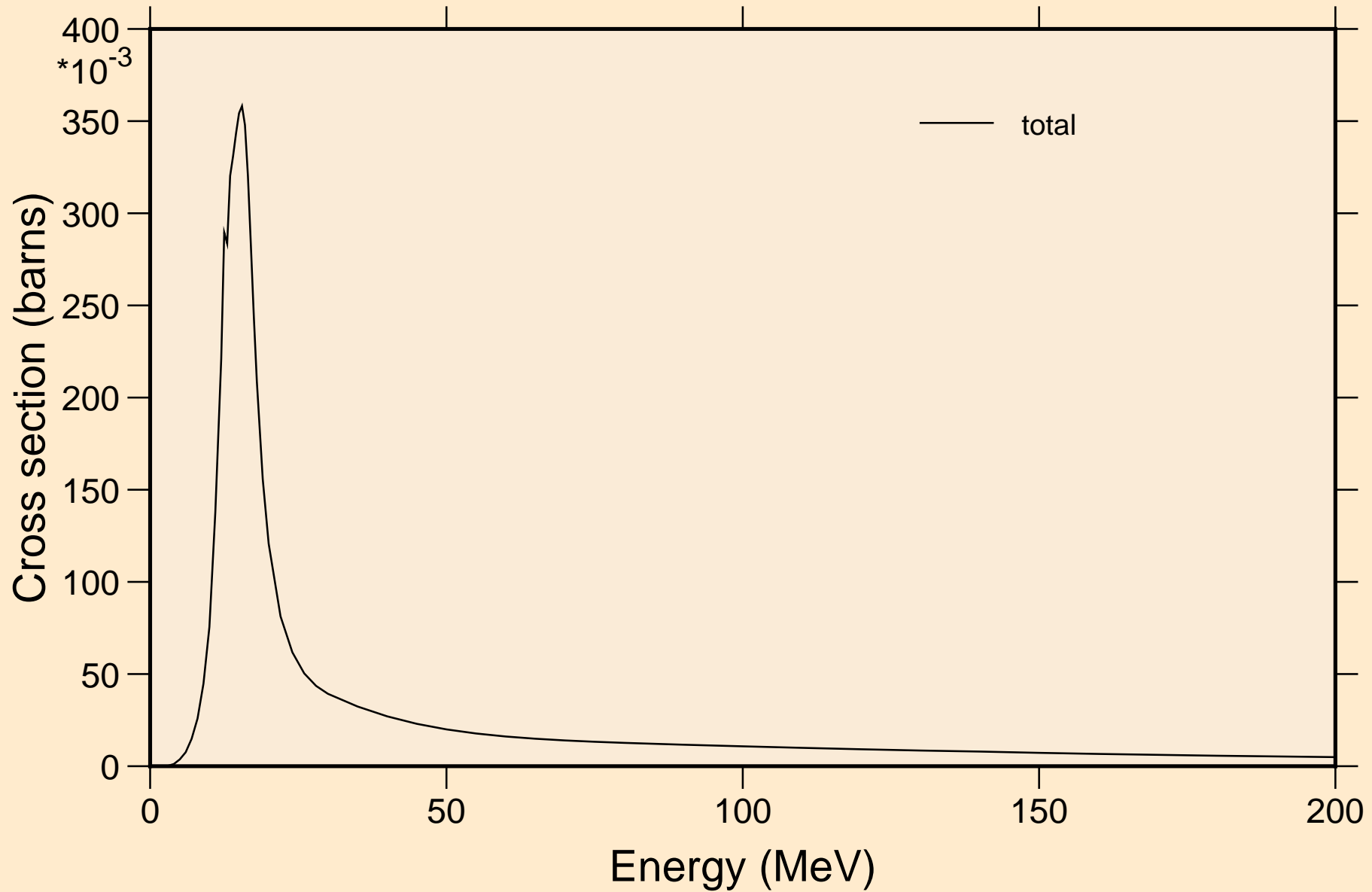

# HF163 PHOTON ACER TENDL-2024 LIBRARY; T=0.K

## Partial cross sections

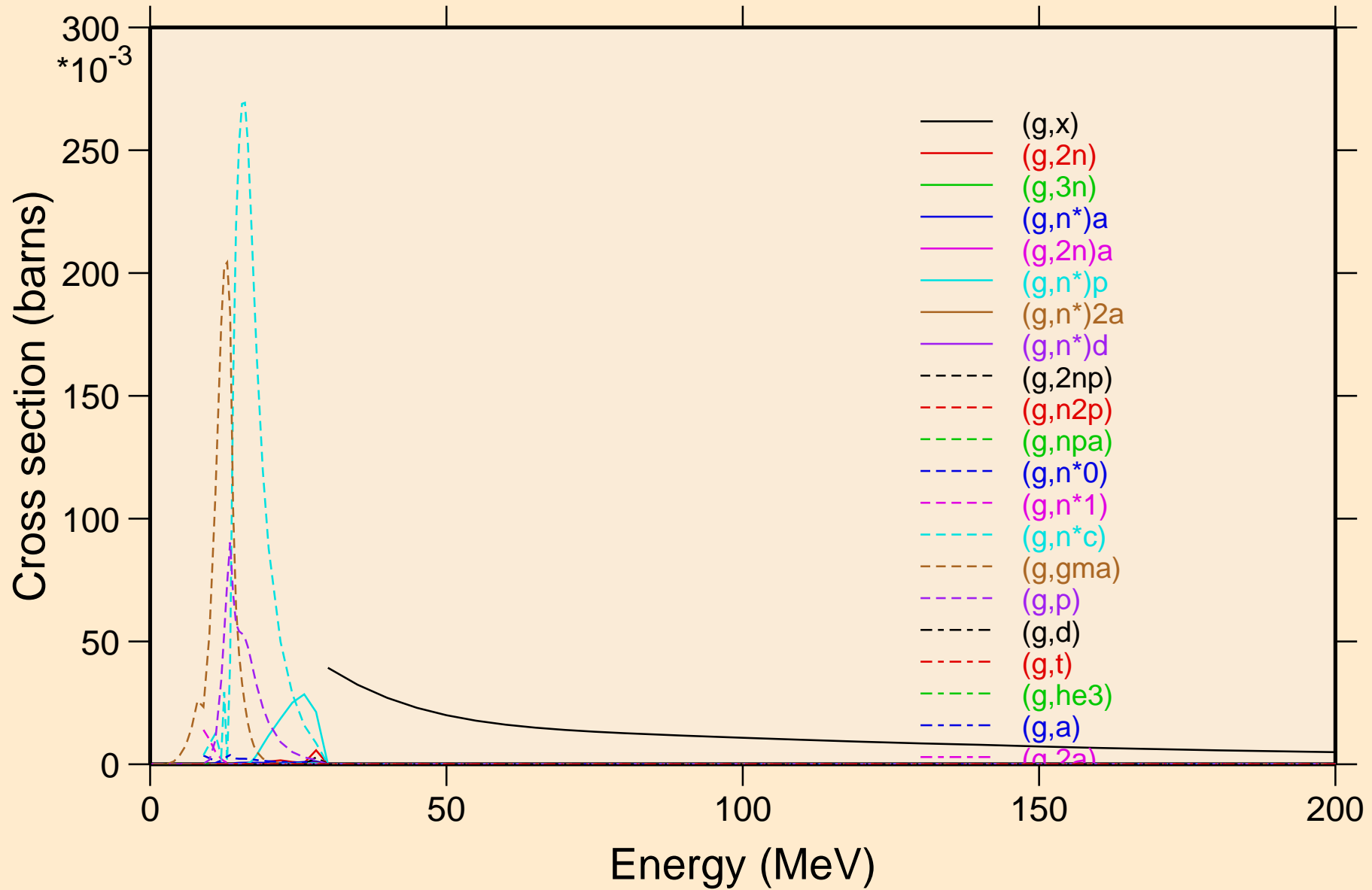

# HF163 PHOTON ACER TENDL-2024 LIBRARY; T=0.K

## Heating

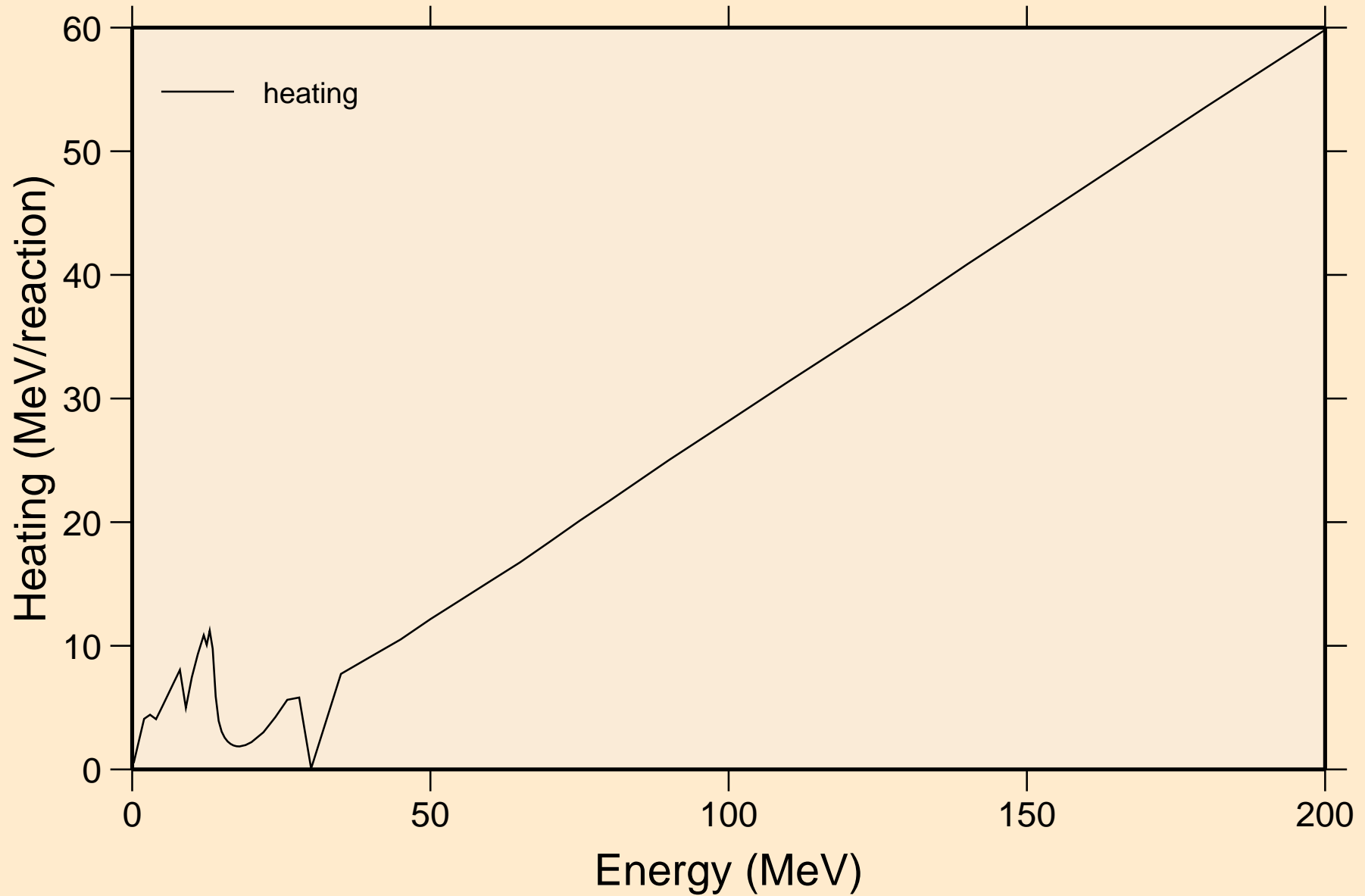

# HF163 PHOTON ACER TENDL-2024 LIBRARY; T=0.K

## Particle heating contributions

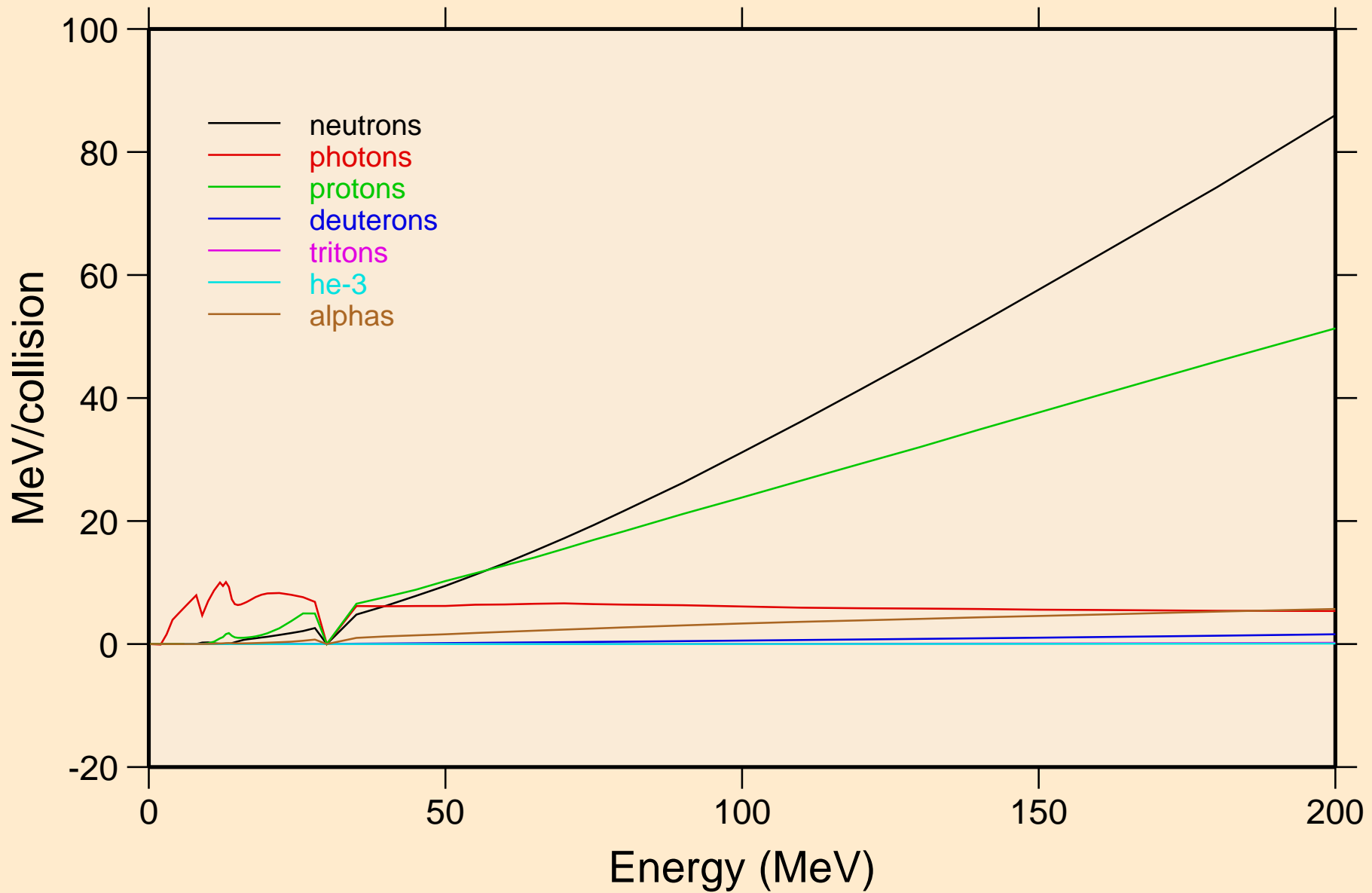

# HF163 PHOTON ACER TENDL-2024 LIBRARY; T=0.K

## Particle production cross sections

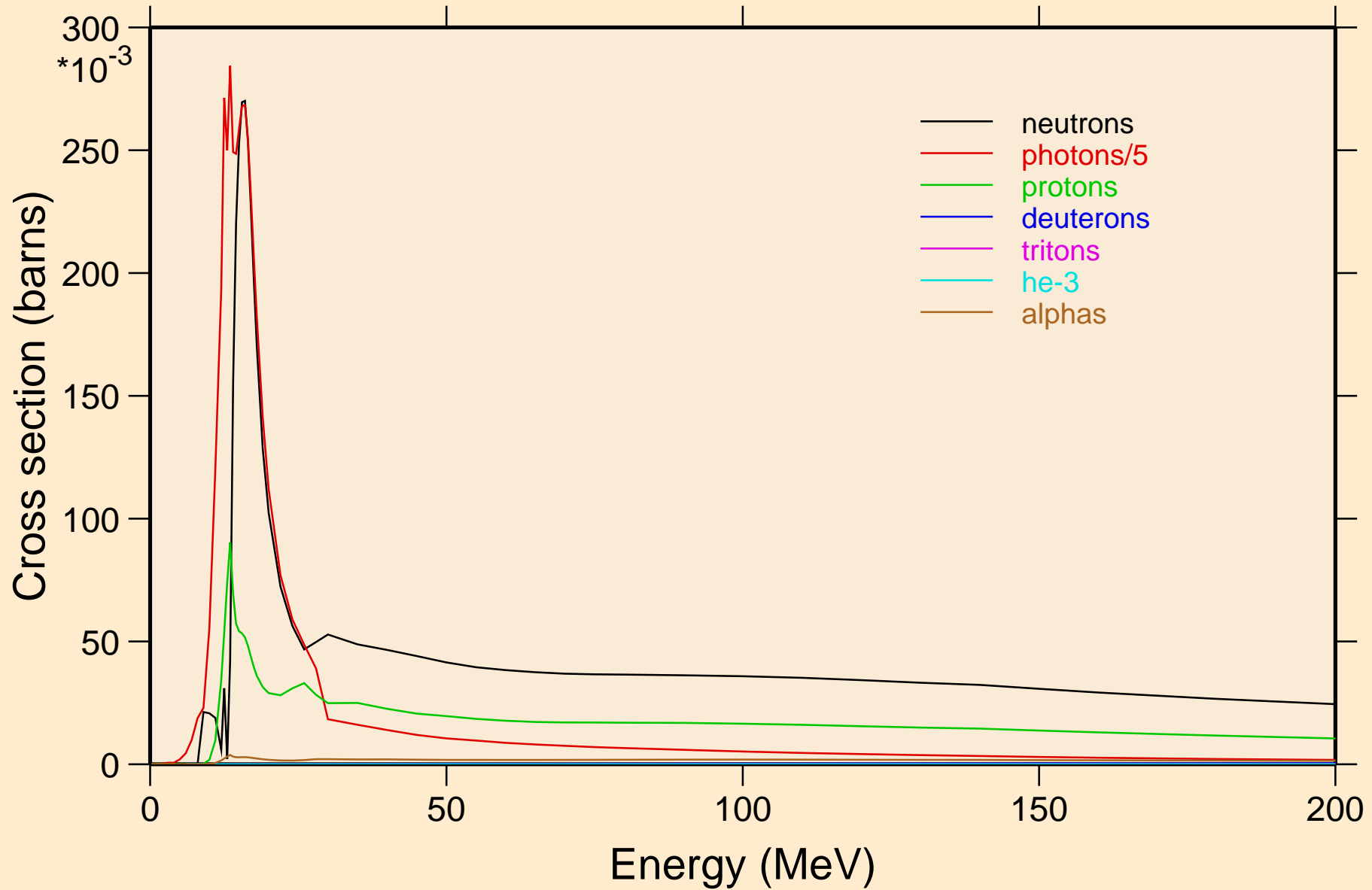

HF163 PHOTON ACER TENDL-2024 LIBRARY; T=0.K  
neutrons from (g,x)

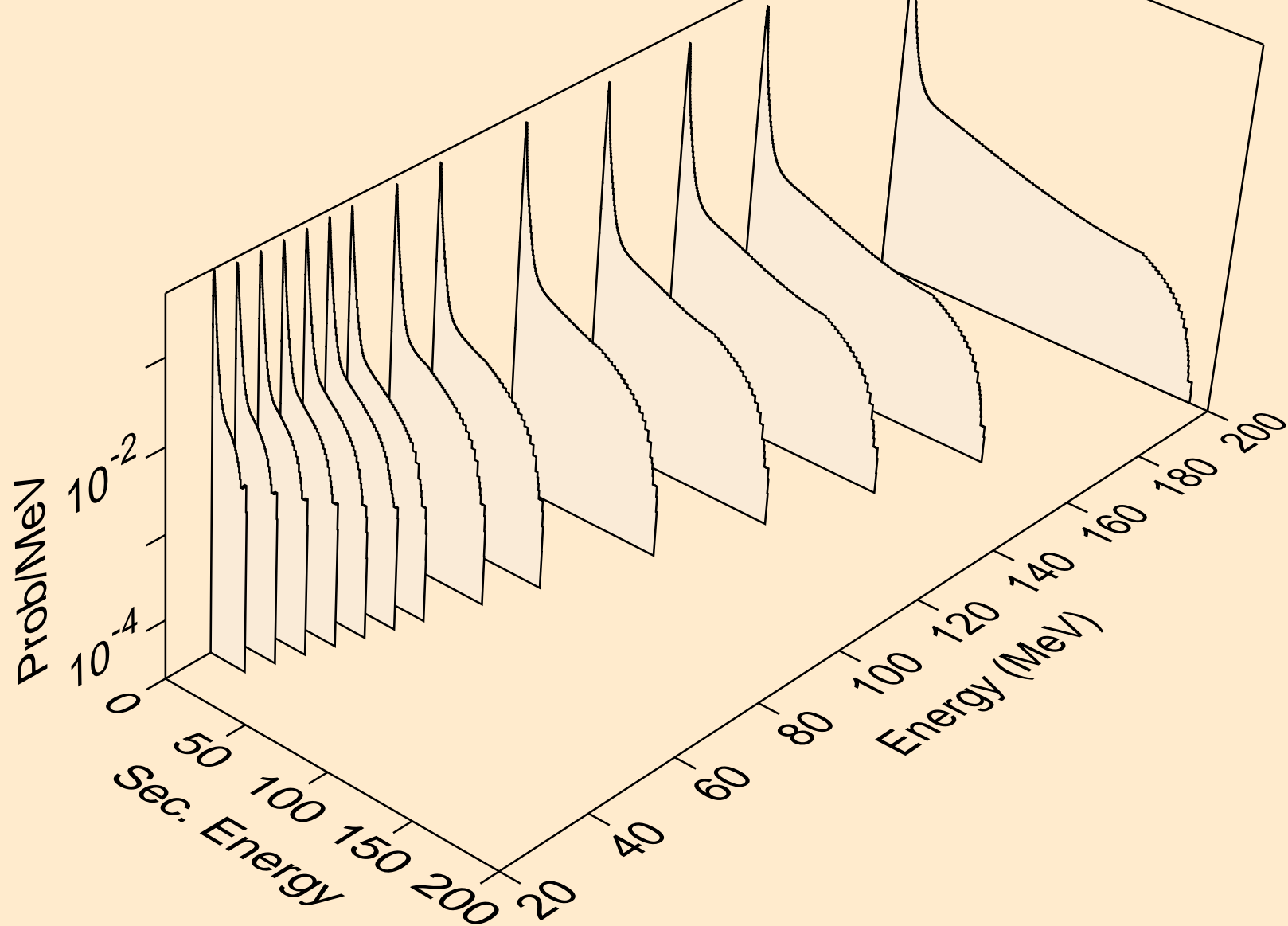

HF163 PHOTON ACER TENDL-2024 LIBRARY; T=0.K  
neutrons from (g,2n)

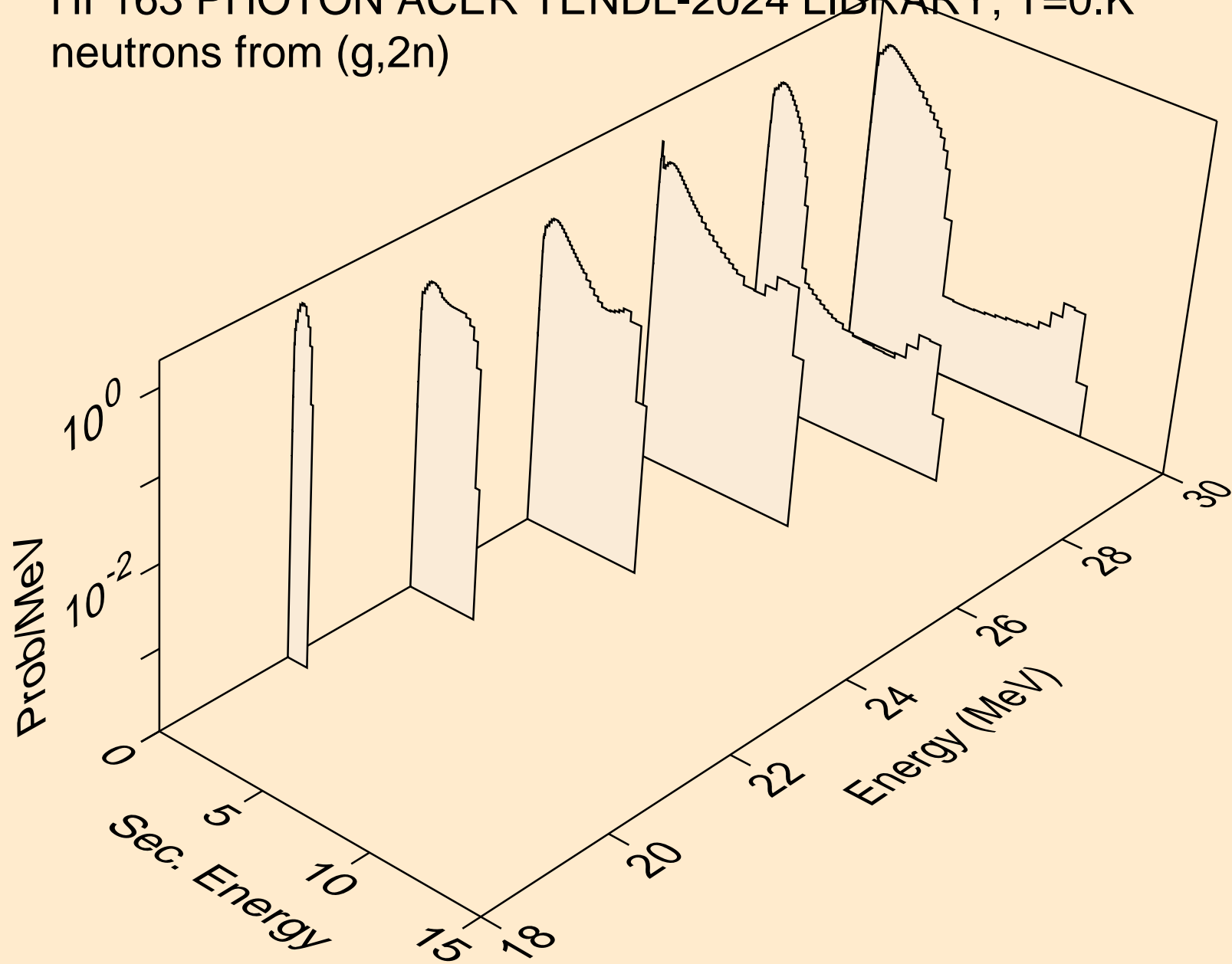

HF163 PHOTON ACER TENDL-2024 LIBRARY; T=0.K  
neutrons from (g,3n)

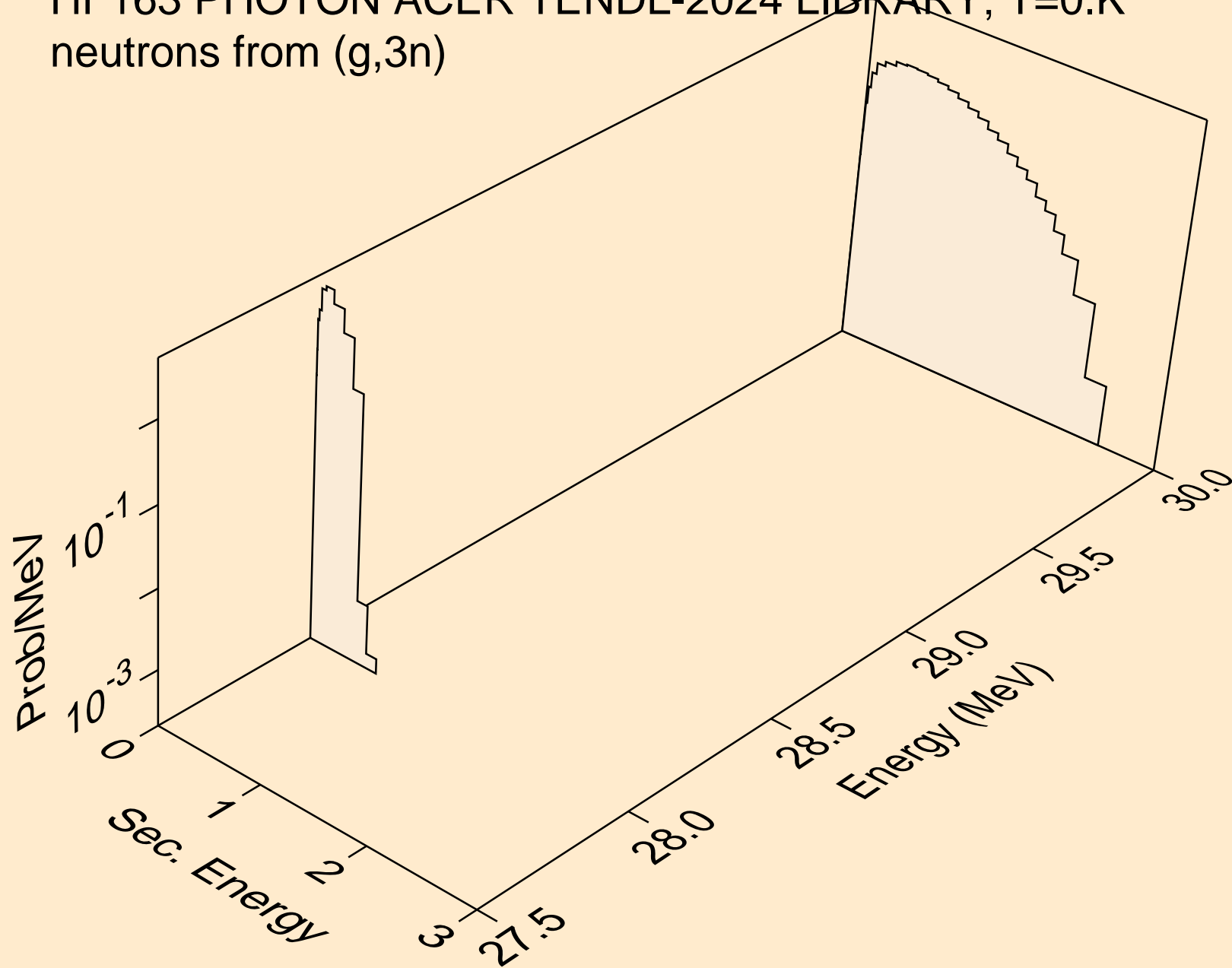

HF163 PHOTON ACER TENDL-2024 LIBRARY; T=0.K  
neutrons from (g,n\*)a

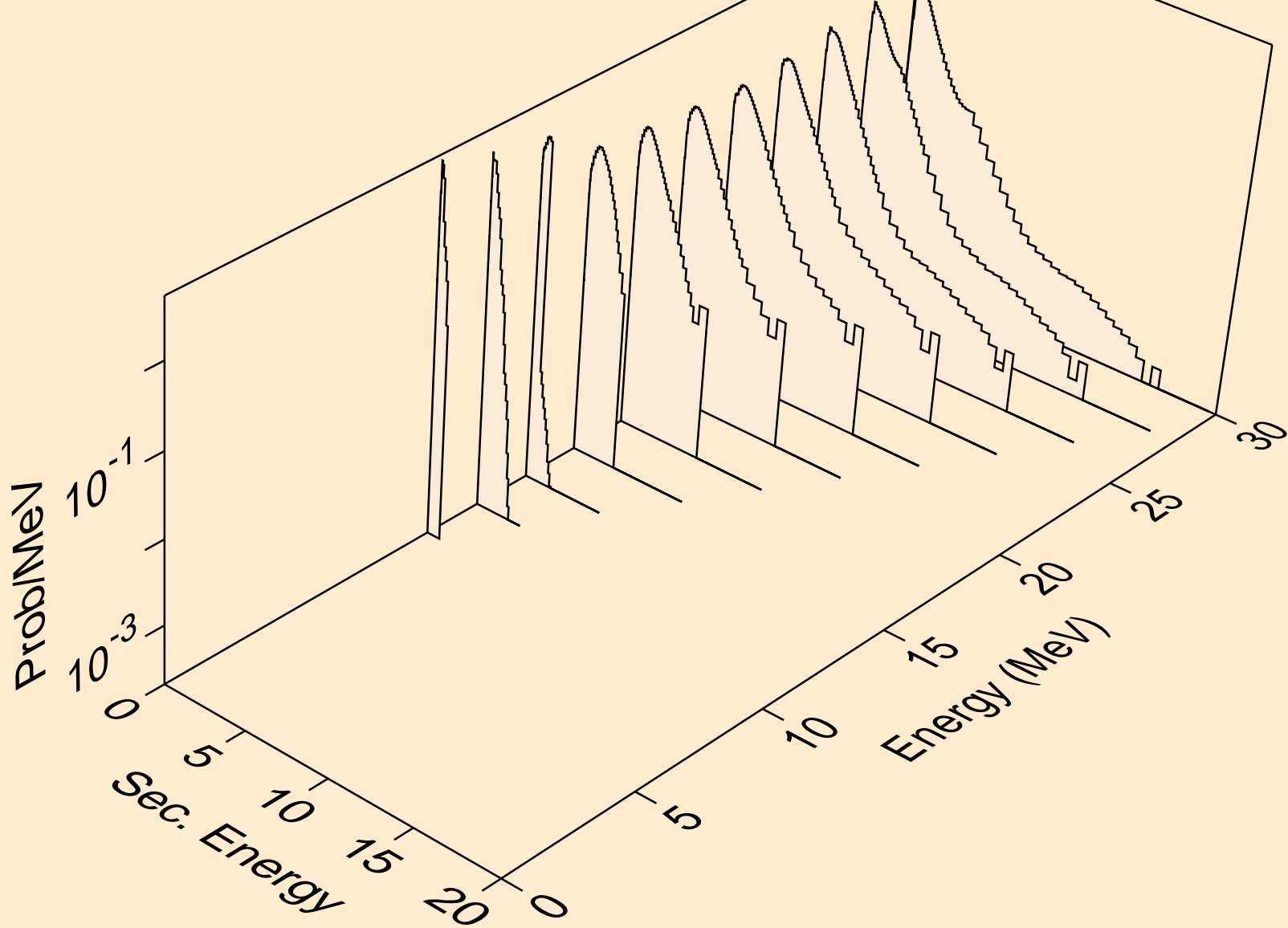

HF163 PHOTON ACER TENDL-2024 LIBRARY; T=0.K  
neutrons from (g,2n)a

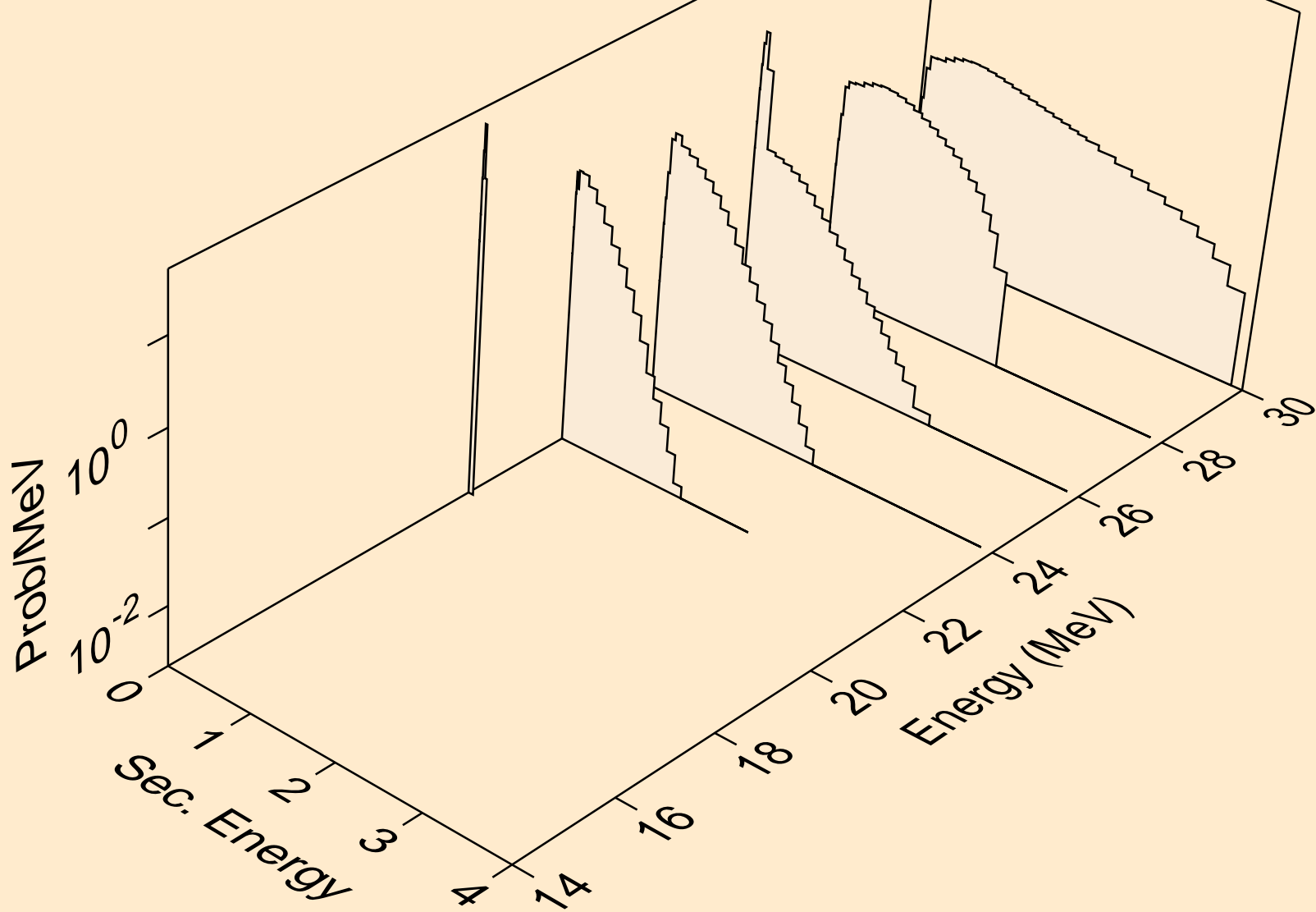

HF163 PHOTON ACER TENDL-2024 LIBRARY; T=0.K  
neutrons from (g,n\*)p

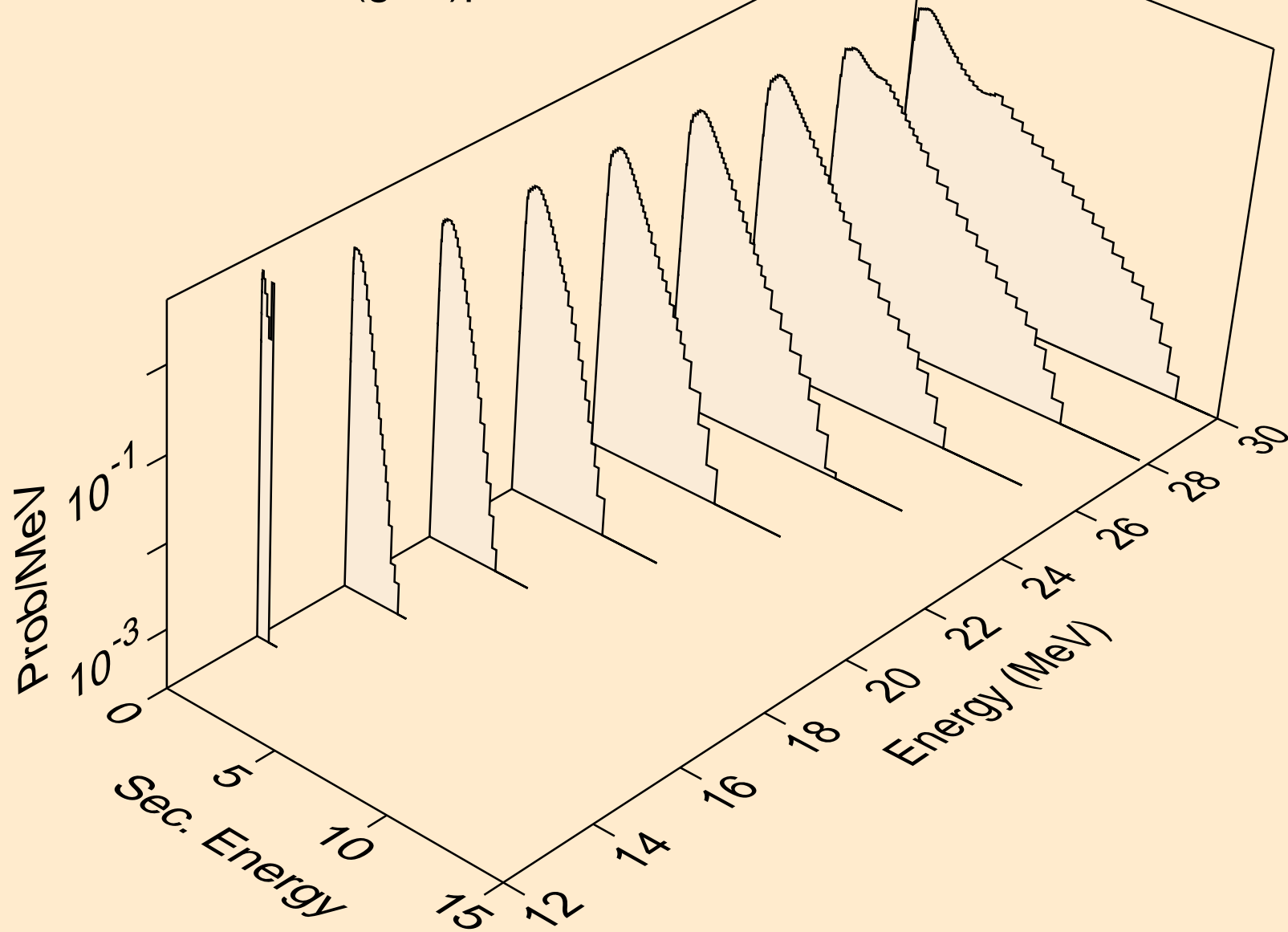

HF163 PHOTON ACER TENDL-2024 LIBRARY; T=0.K  
neutrons from (g,n\*)2a

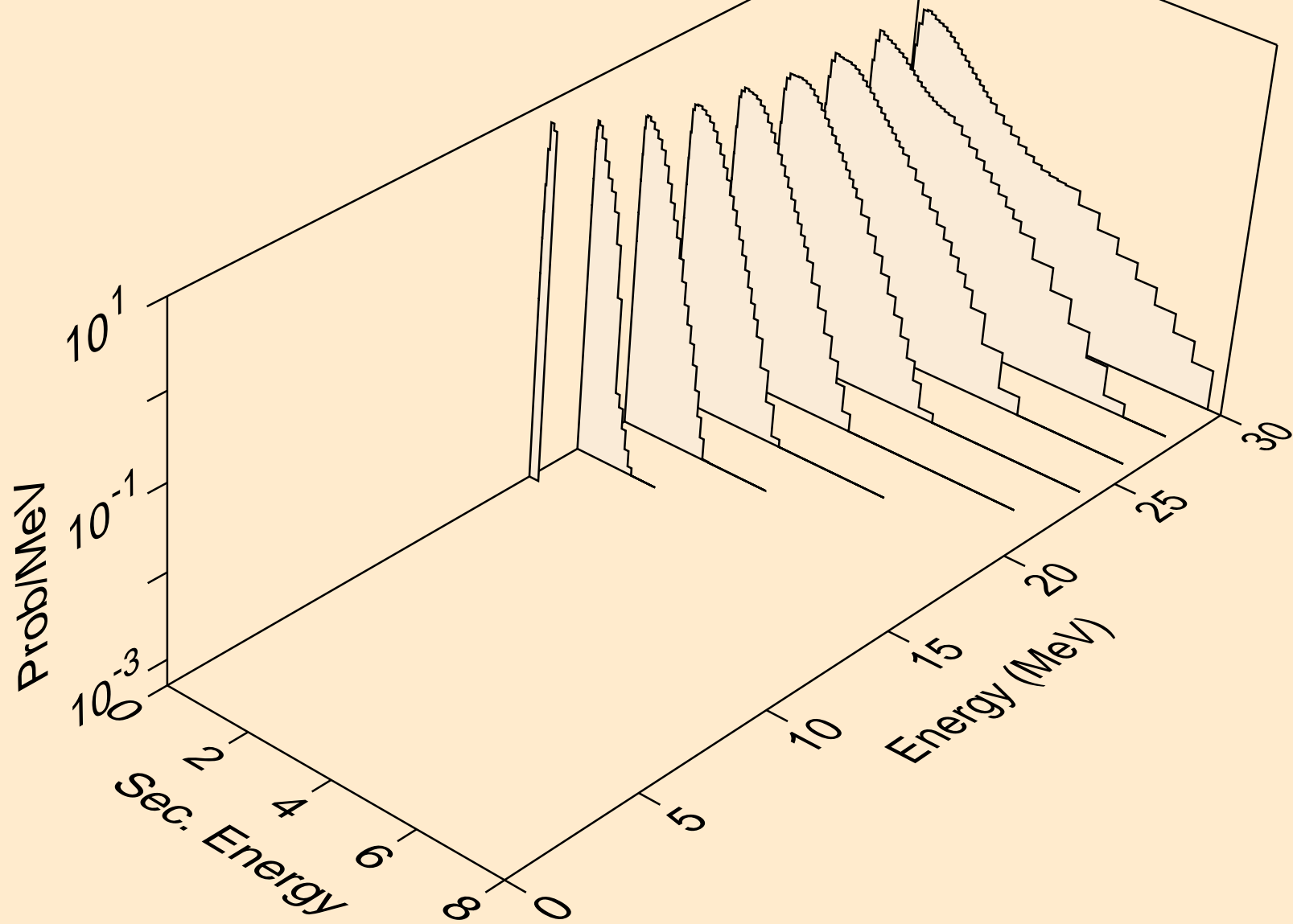

HF163 PHOTON ACER TENDL-2024 LIBRARY; T=0.K  
neutrons from (g,n\*)d

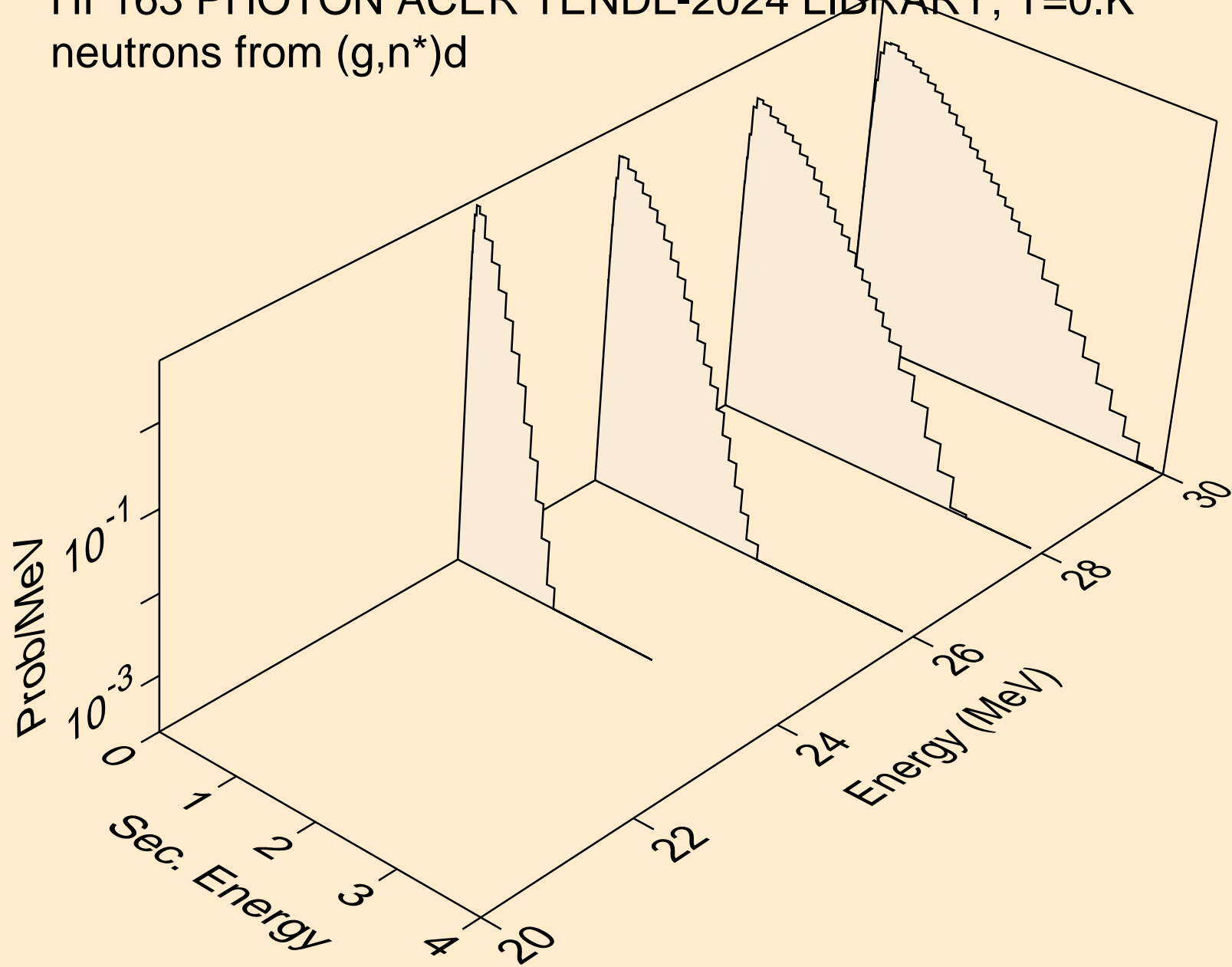

HF163 PHOTON ACER TENDL-2024 LIBRARY; T=0.K  
neutrons from (g,2np)

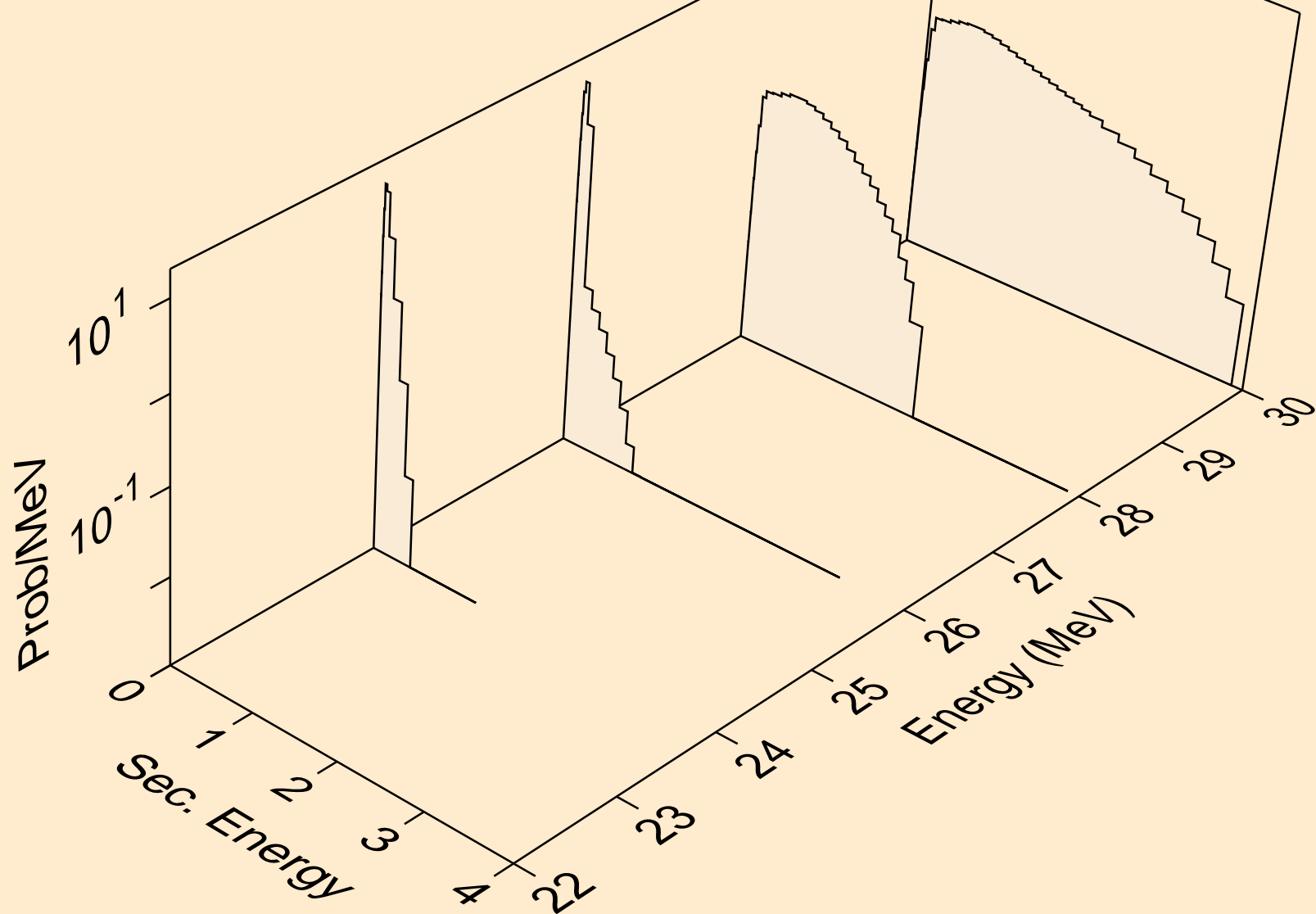

HF163 PHOTON ACER TENDL-2024 LIBRARY; T=0.K  
neutrons from (g,n2p)

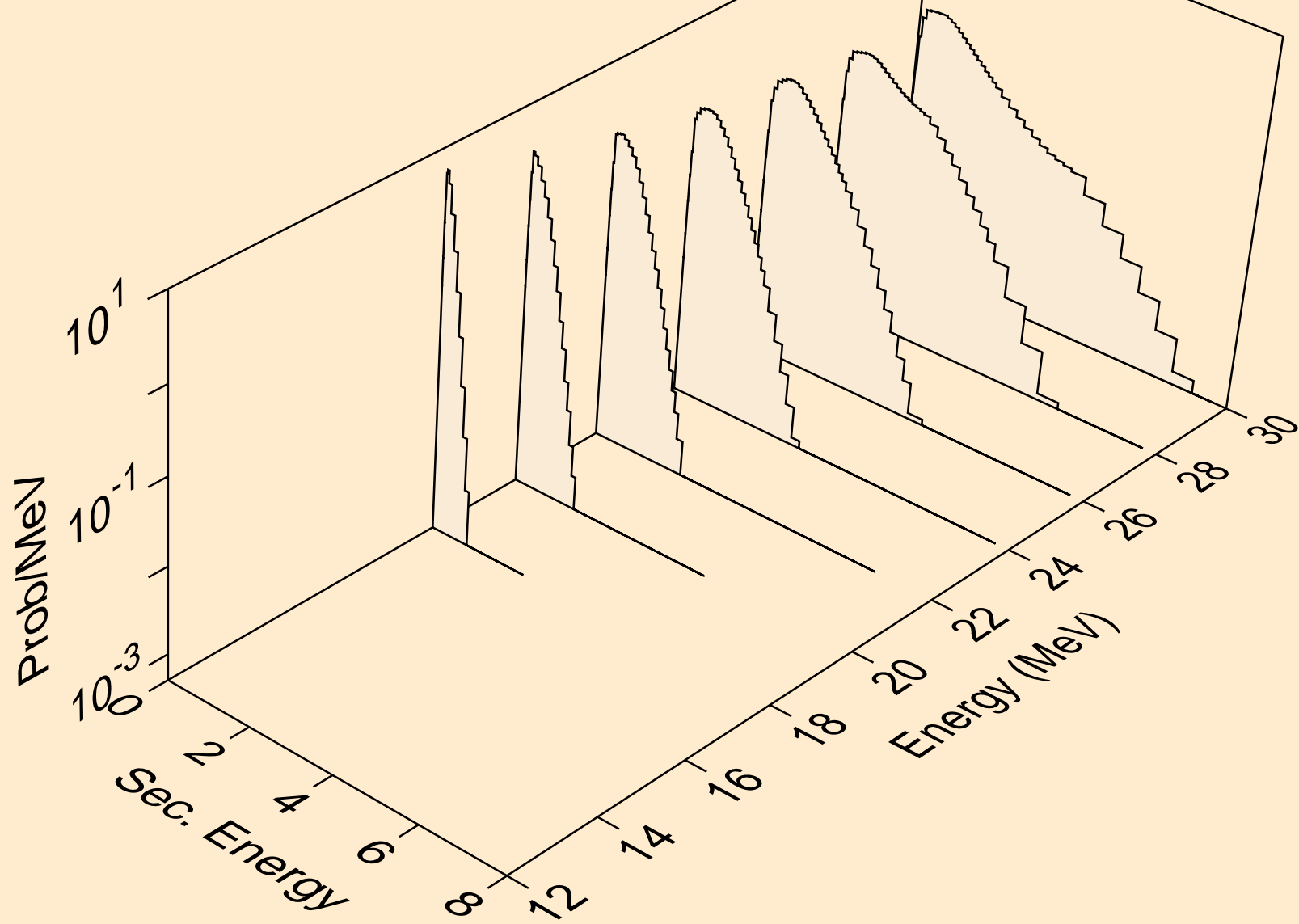

HF163 PHOTON ACER TENDL-2024 LIBRARY; T=0.K  
neutrons from (g,npa)

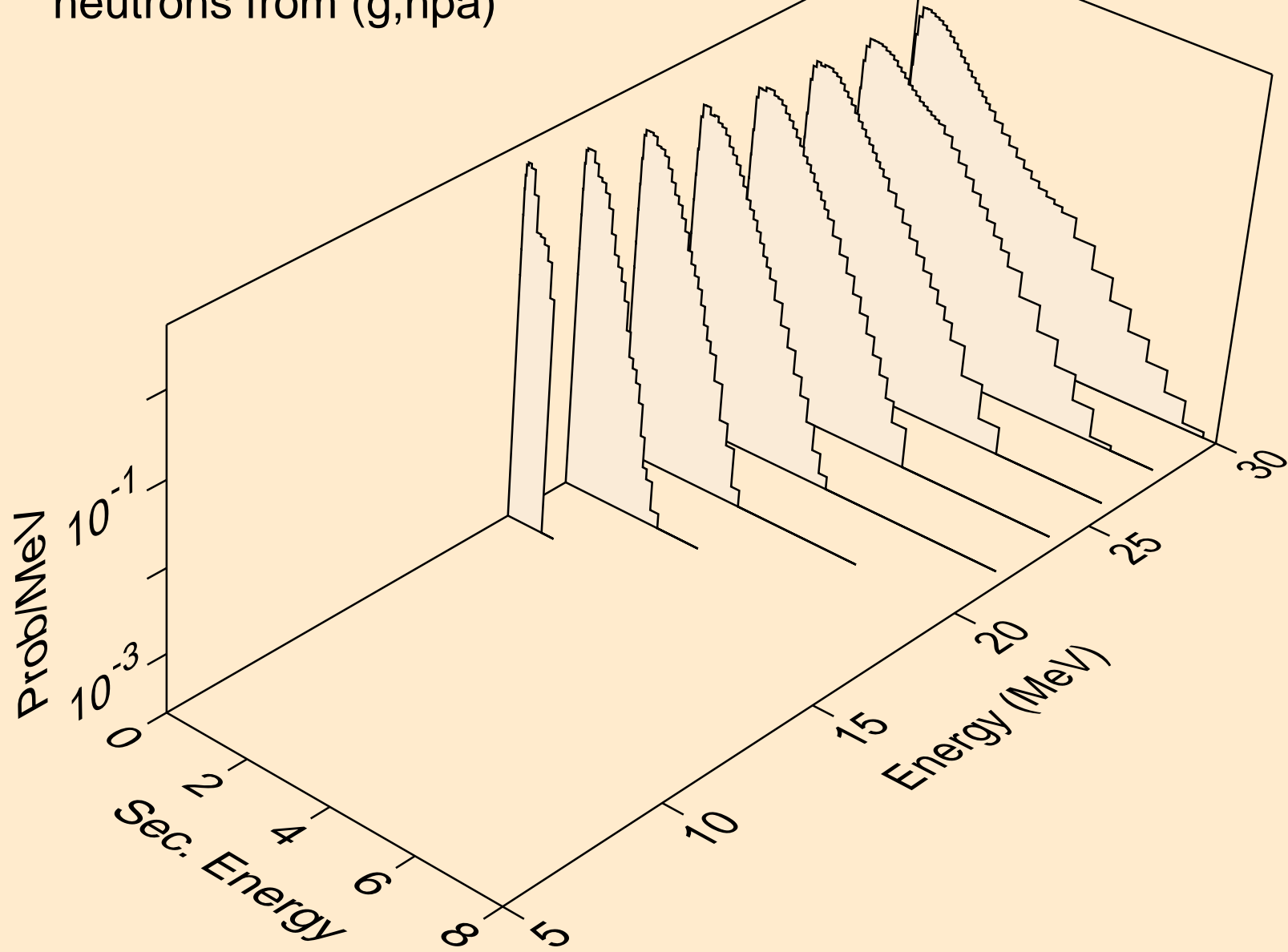

HF163 PHOTON ACER TENDL-2024 LIBRARY; T=0.K  
angular distribution for (g,n\*0) neutron

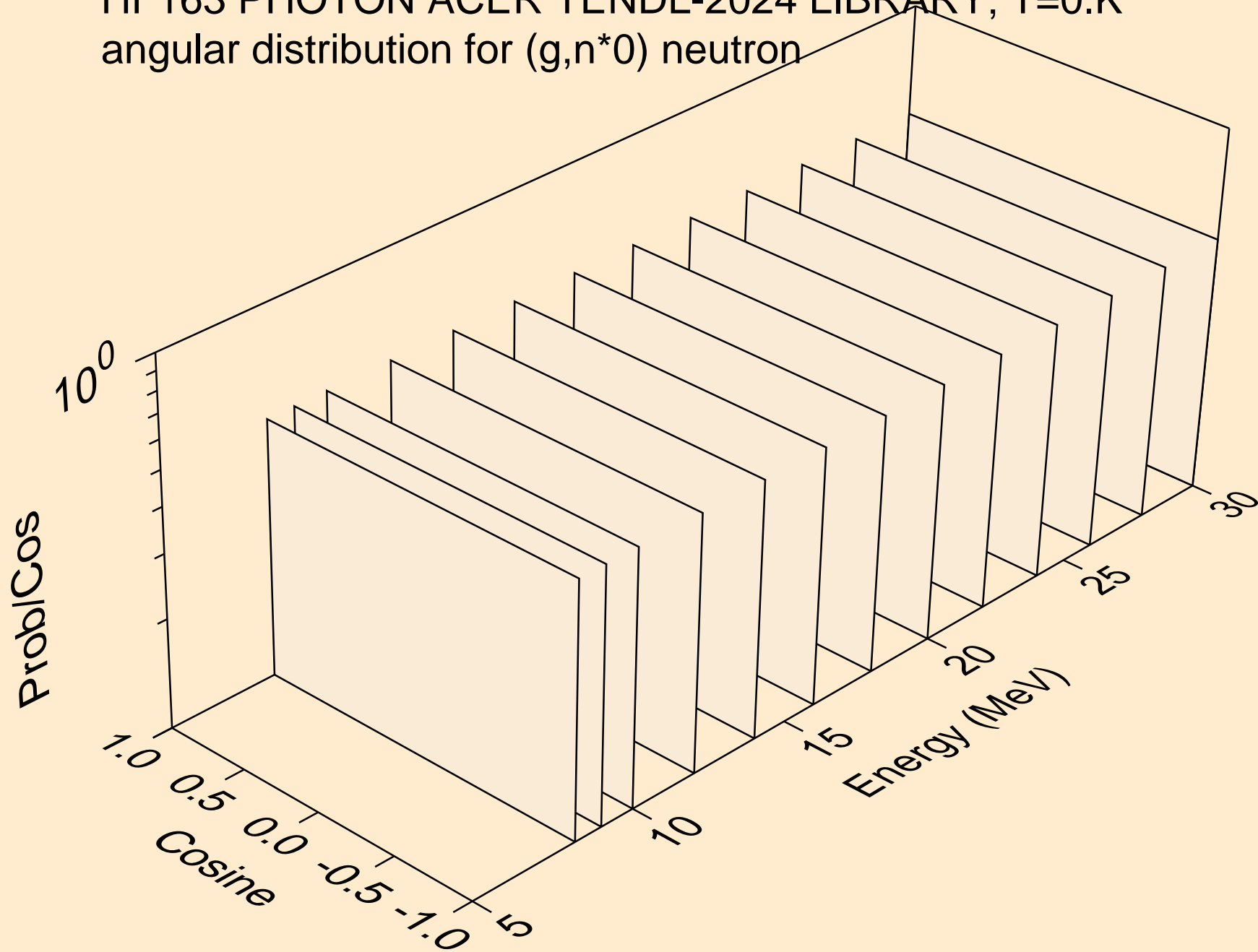

HF163 PHOTON ACER TENDL-2024 LIBRARY; T=0.K  
angular distribution for (g,n\*1) neutron

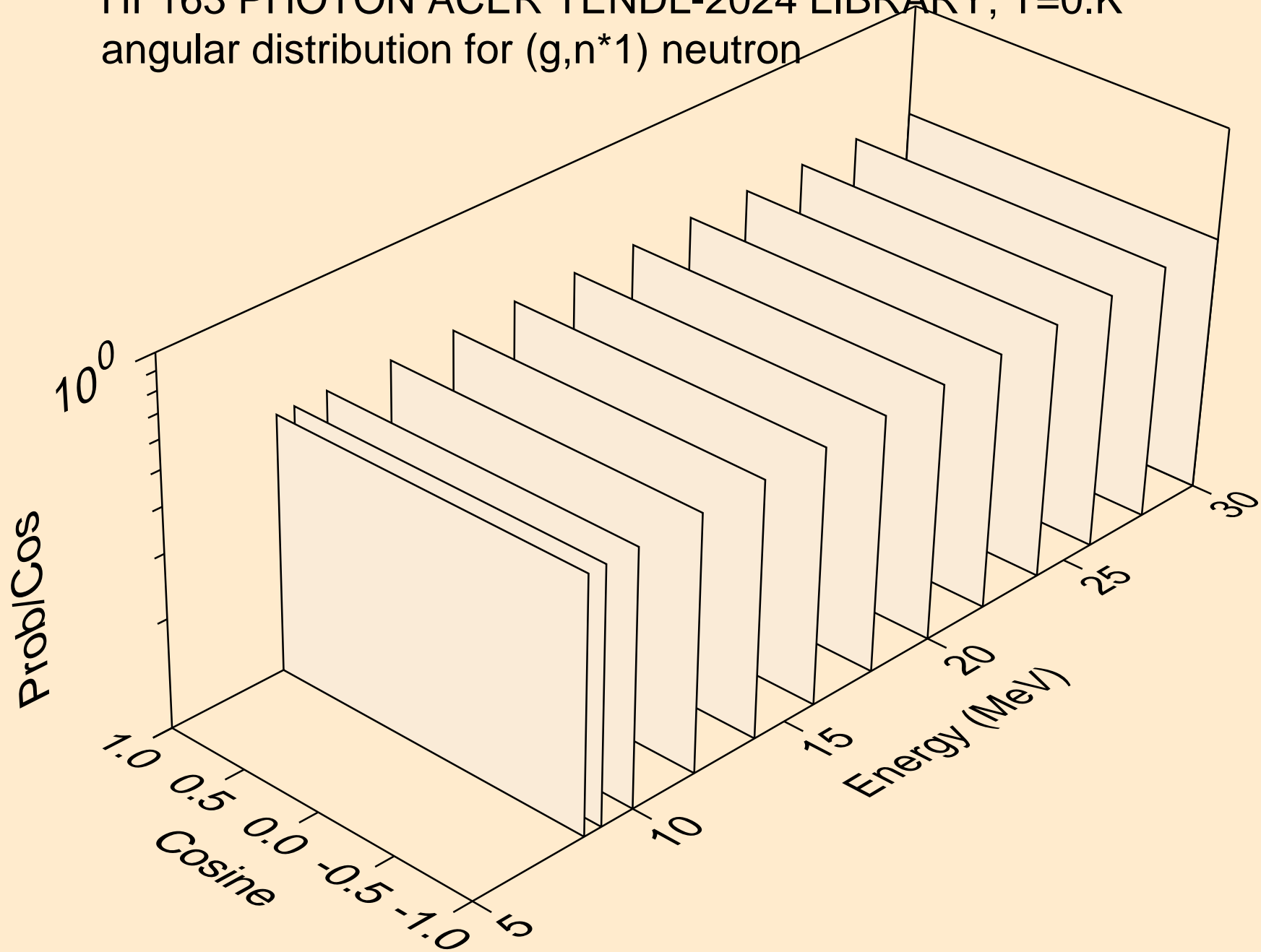

HF163 PHOTON ACER TENDL-2024 LIBRARY; T=0.K  
neutrons from (g,n\*c)

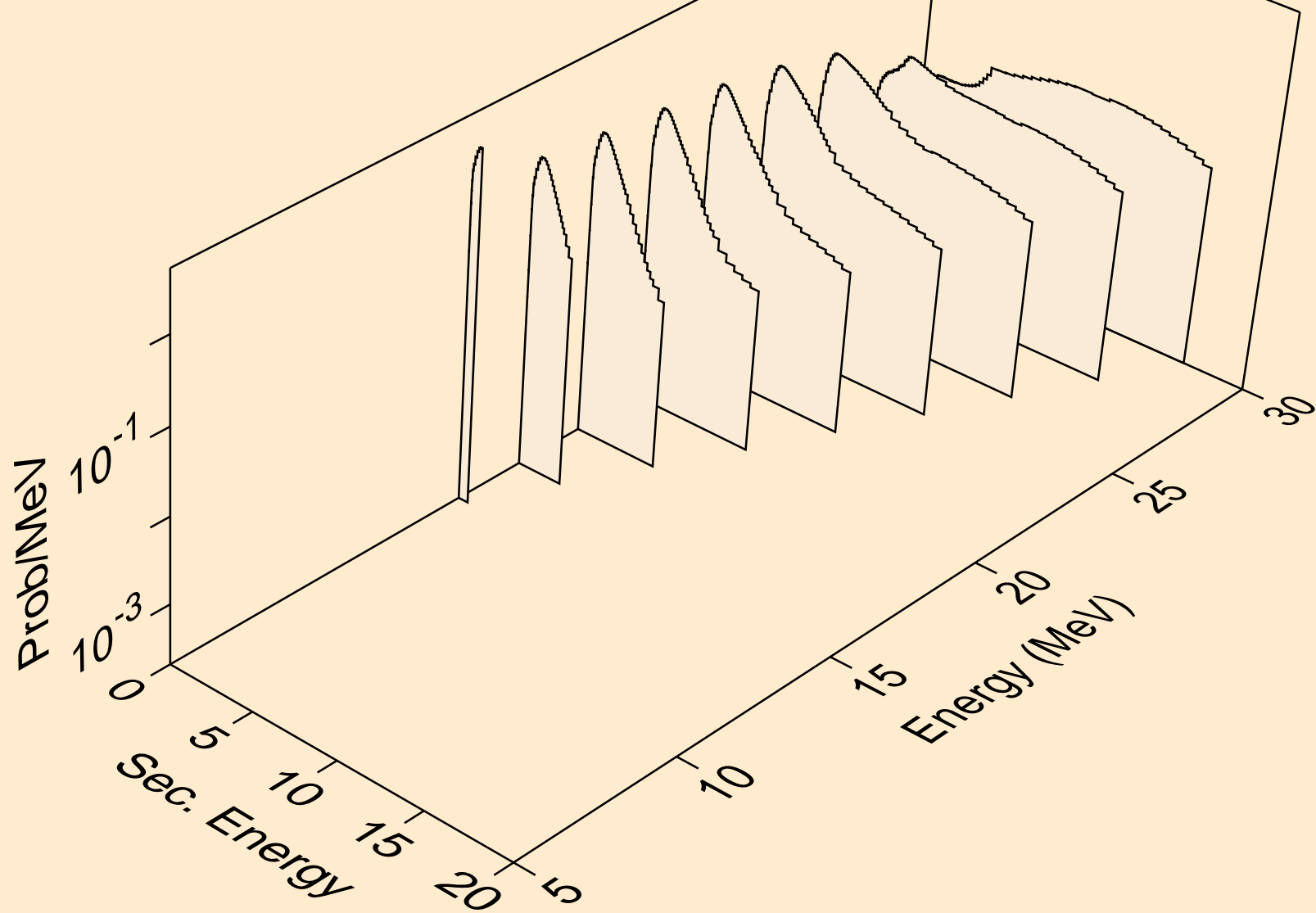

HF163 PHOTON ACER TENDL-2024 LIBRARY; T=0.K  
photons from (g,x)

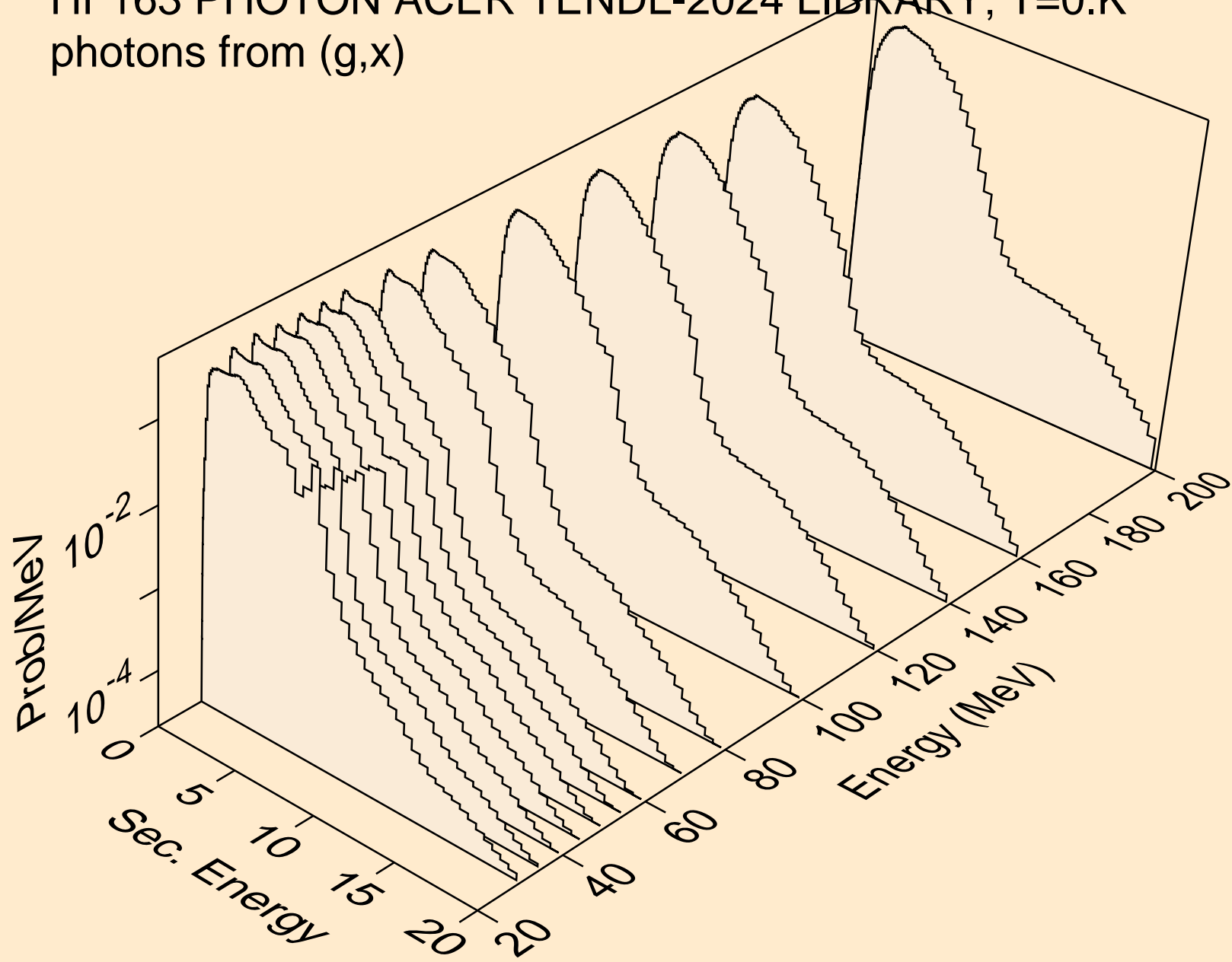

HF163 PHOTON ACER TENDL-2024 LIBRARY; T=0.K  
photons from (g,2n)

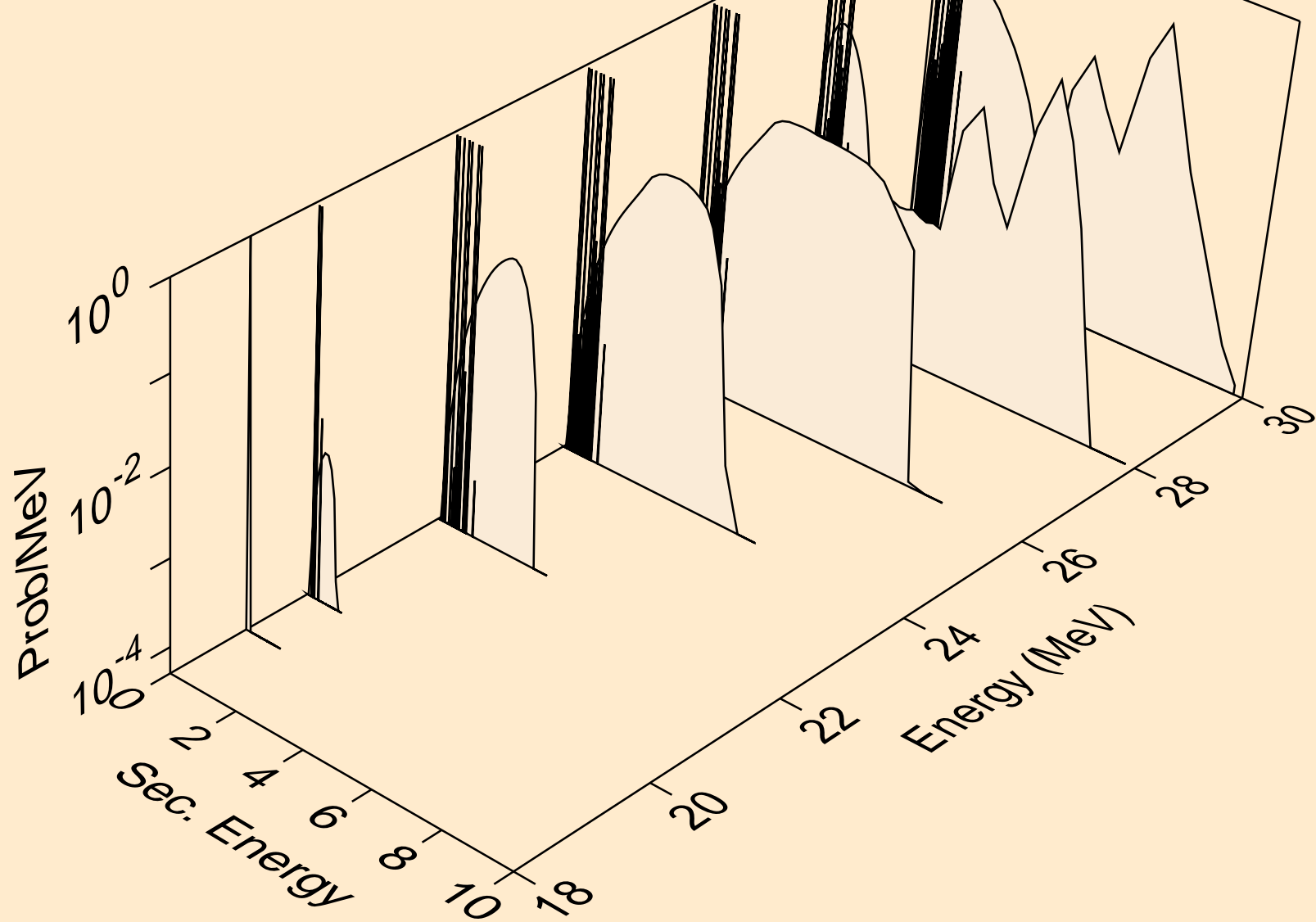

HF163 PHOTON ACER TENDL-2024 LIBRARY; T=0.K  
photons from (g,3n)

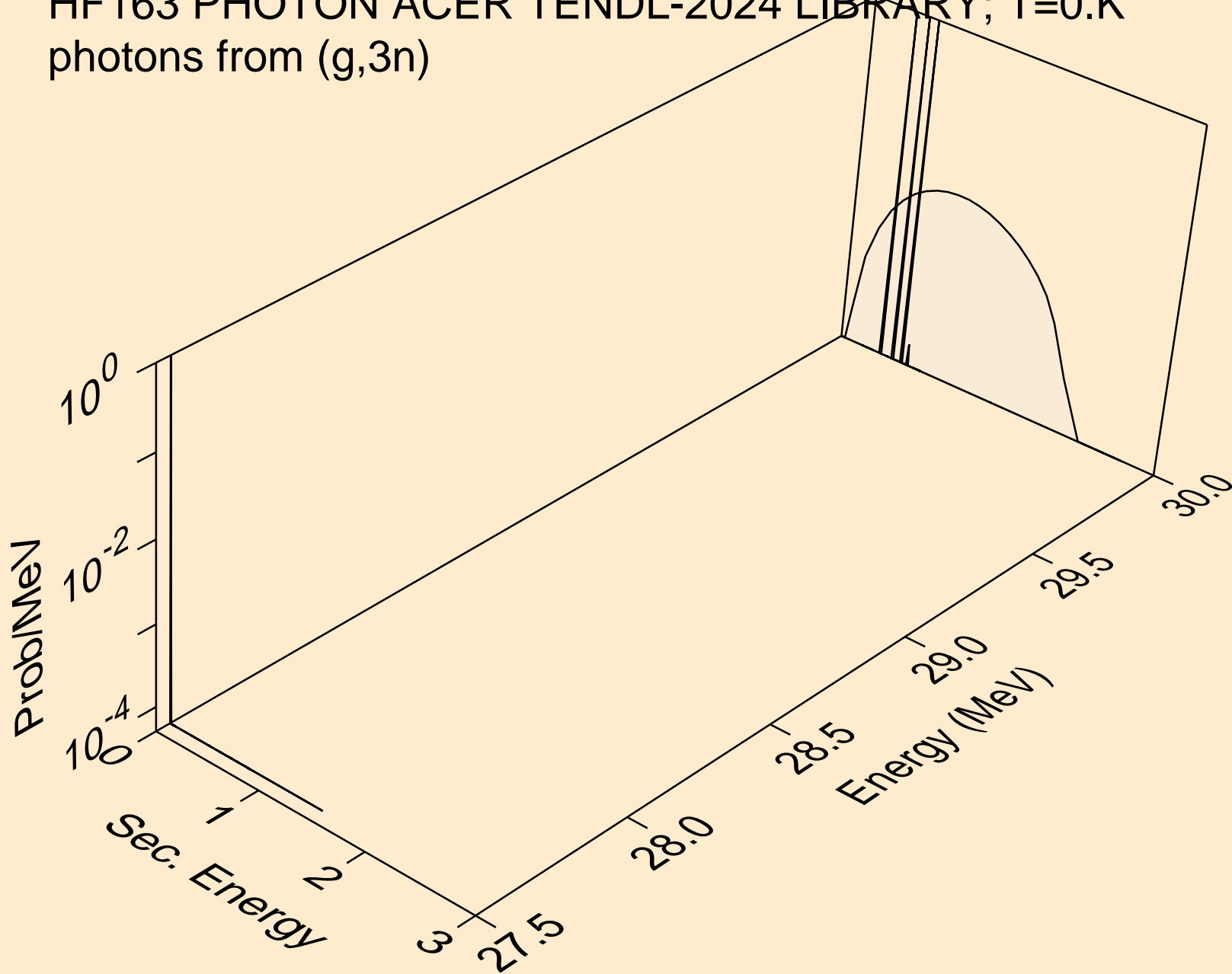

HF163 PHOTON ACER TENDL-2024 LIBRARY; T=0.K  
photons from (g,n\*)a

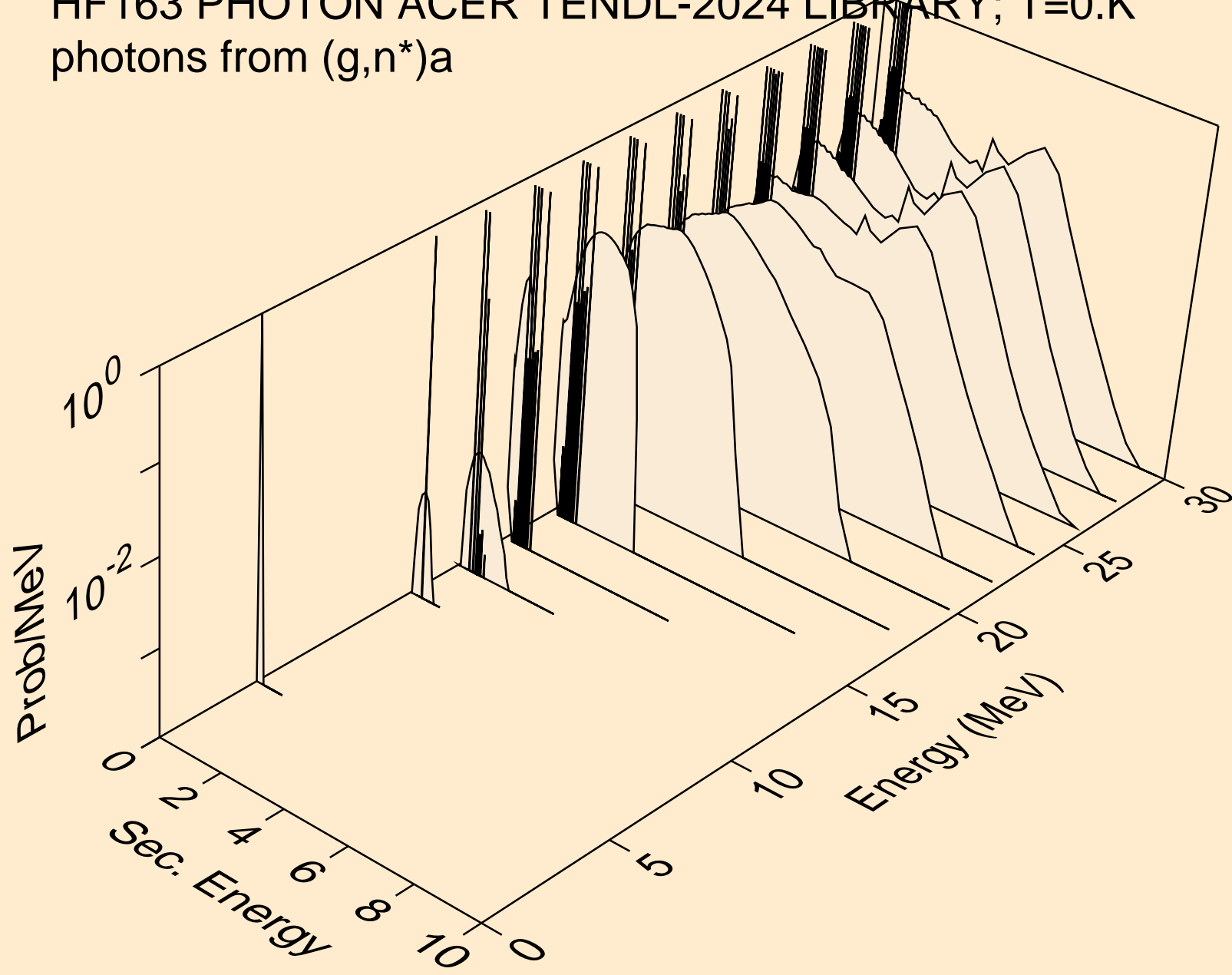

HF163 PHOTON ACER TENDL-2024 LIBRARY; T=0.K  
photons from (g,2n)a

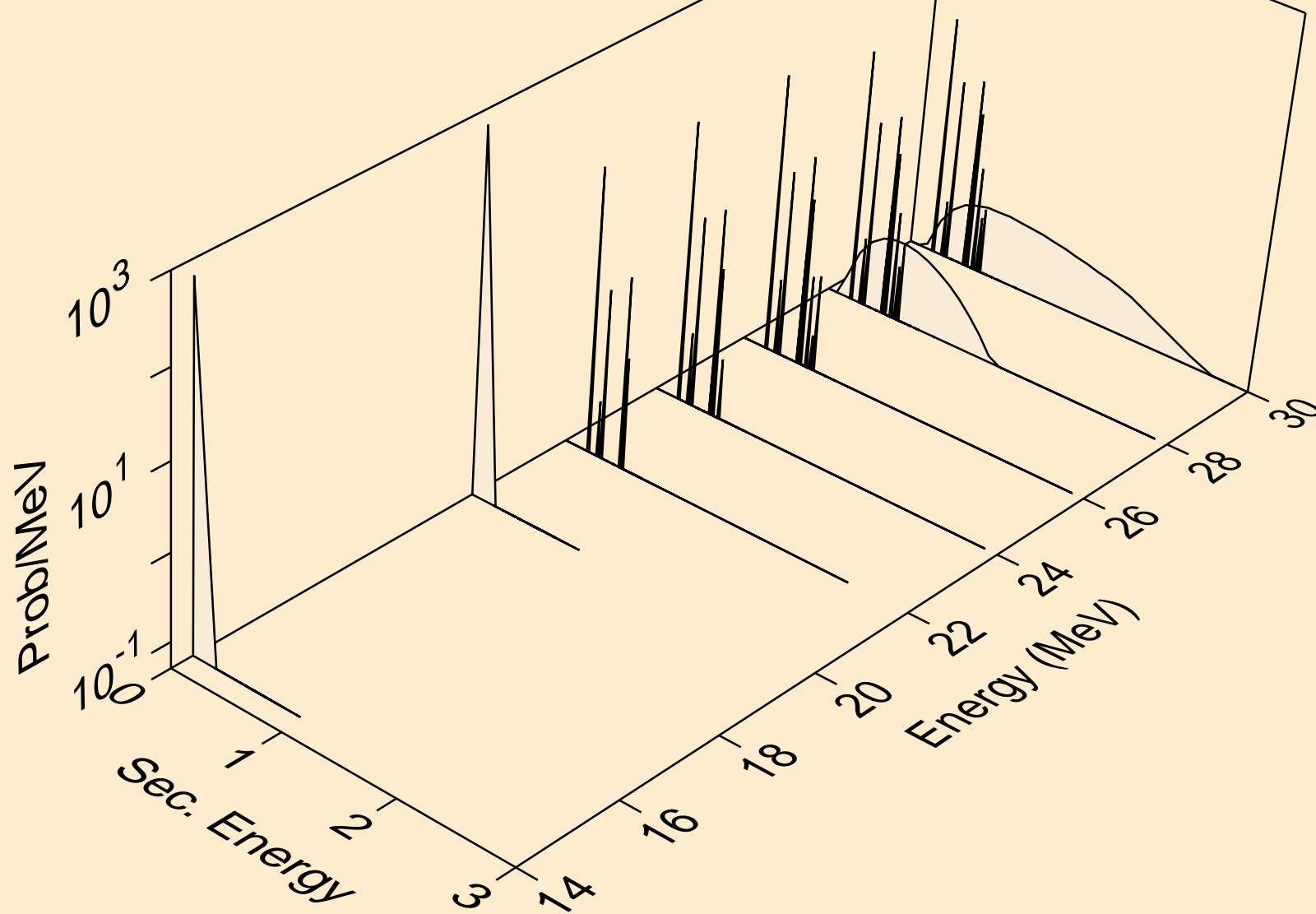

HF163 PHOTON ACER TENDL-2024 LIBRARY; T=0.K  
photons from (g,n\*)p

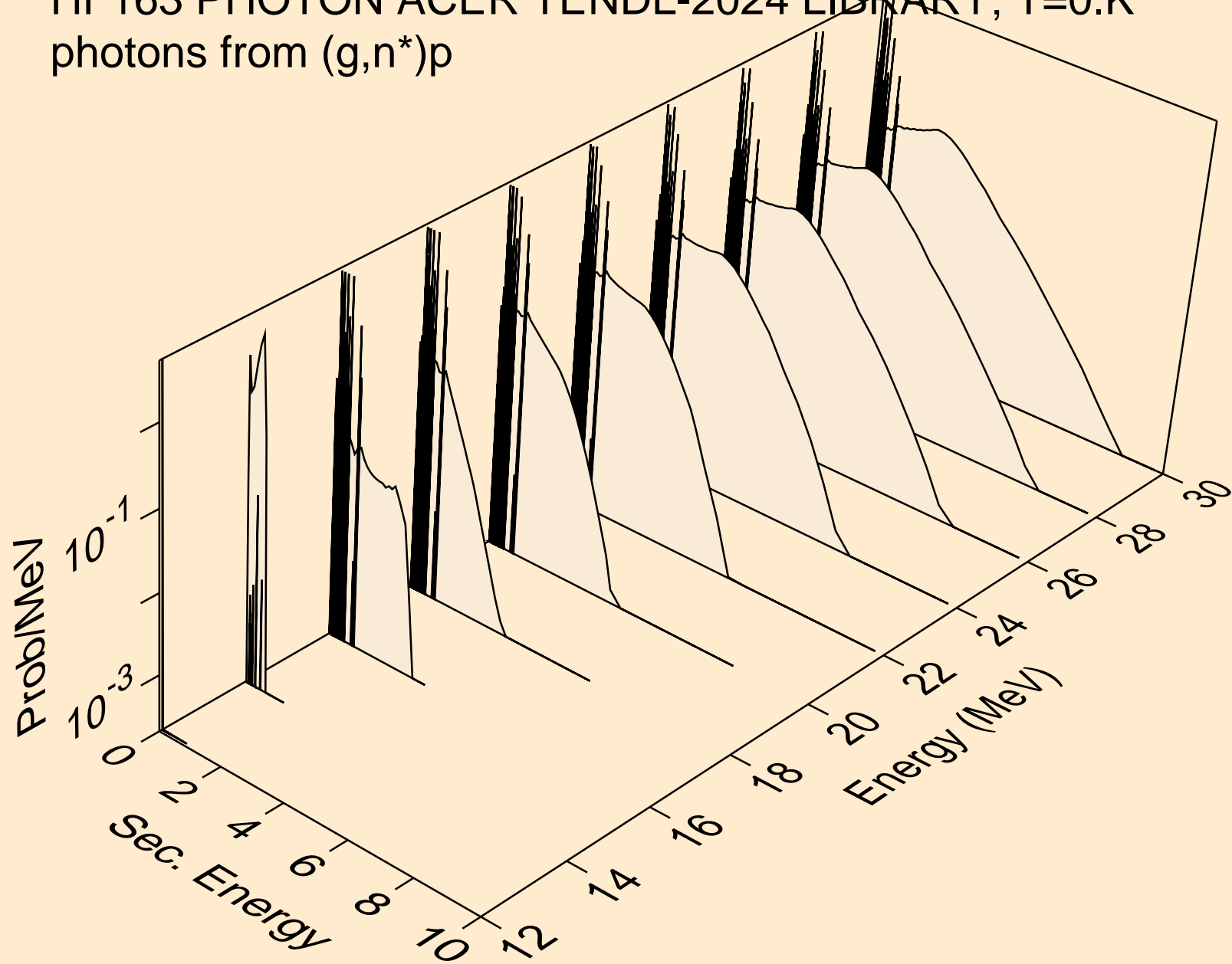

HF163 PHOTON ACER TENDL-2024 LIBRARY; T=0.K  
photons from (g,n\*)2a

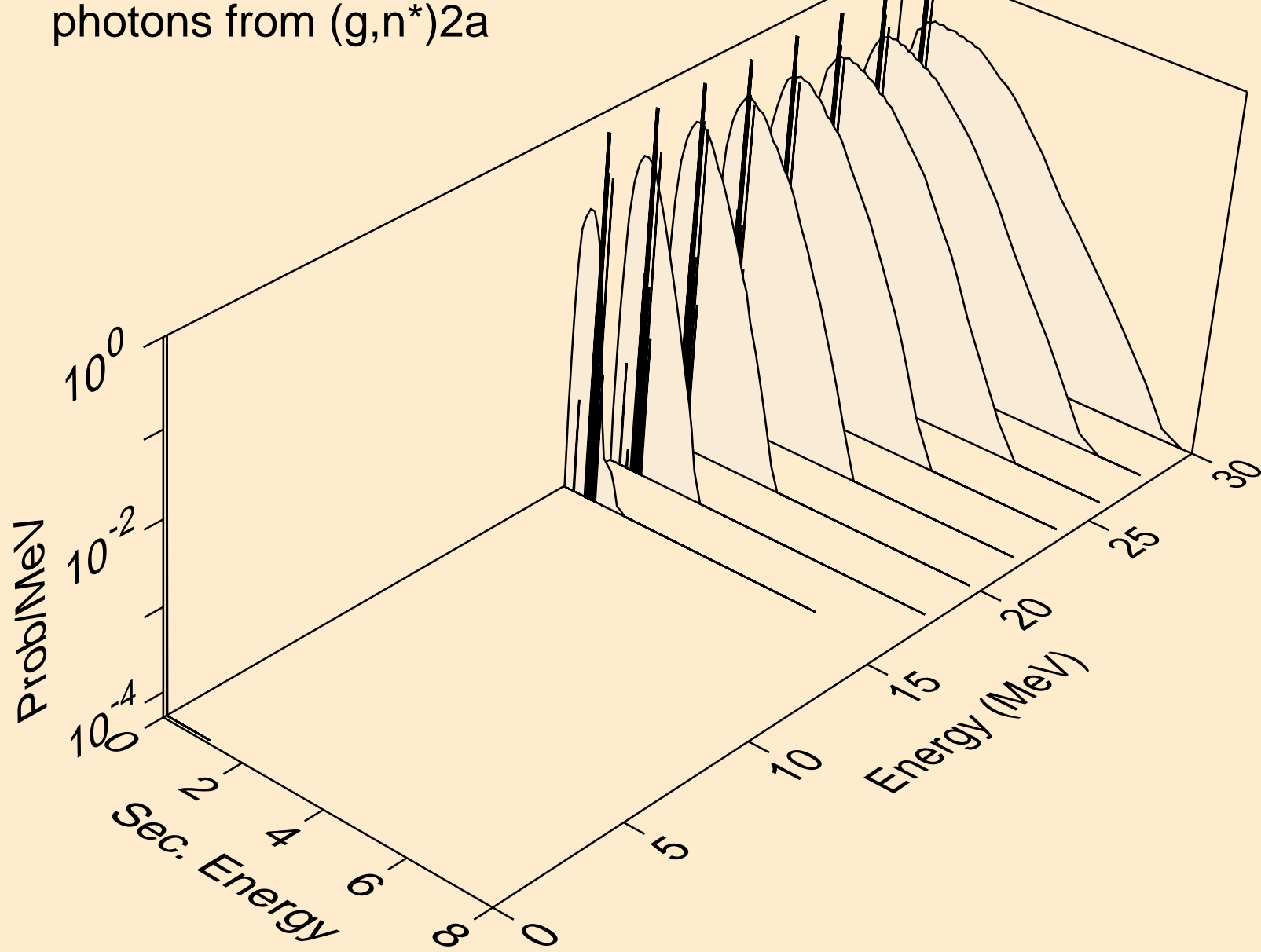

HF163 PHOTON ACER TENDL-2024 LIBRARY; T=0.K  
photons from (g,n\*)d

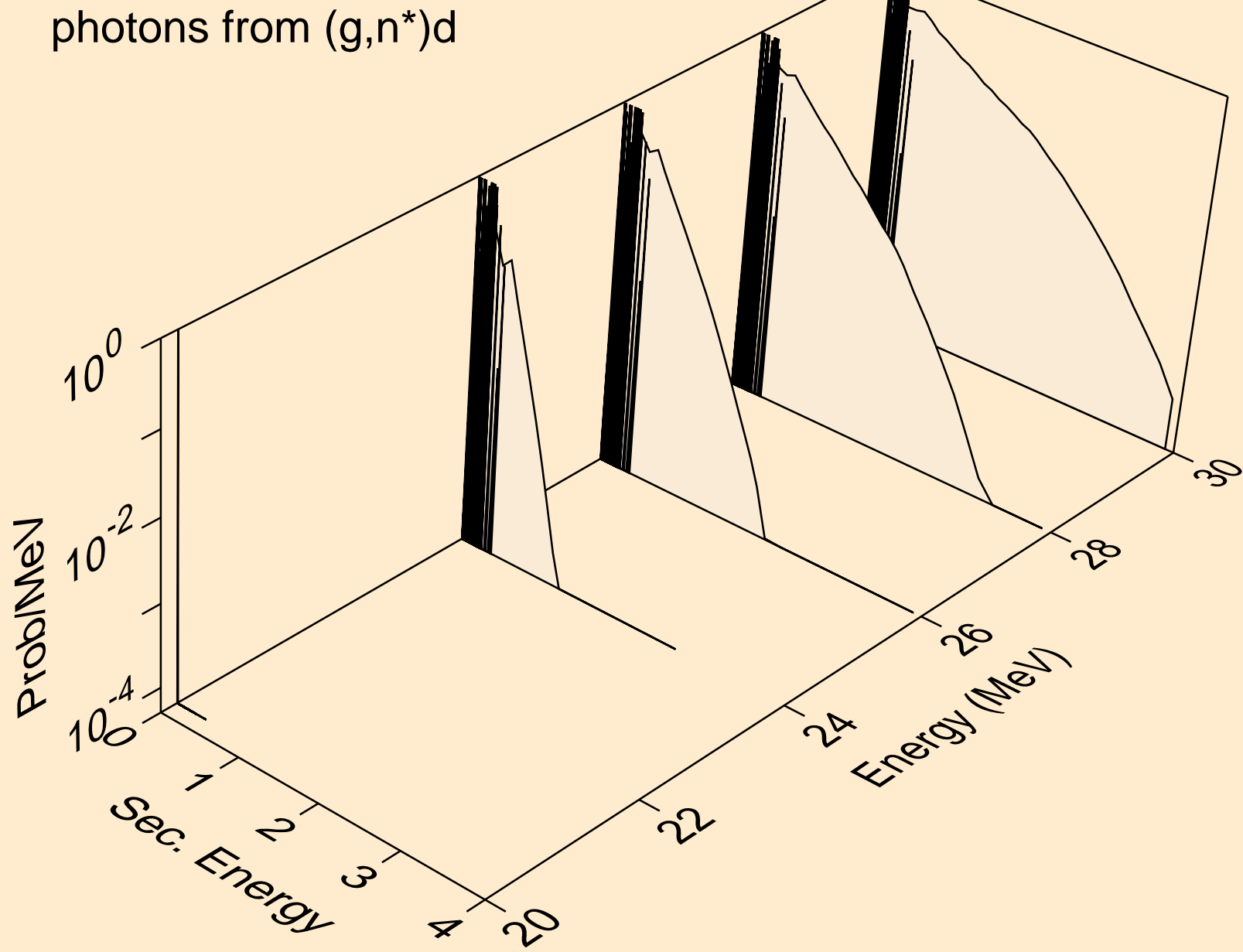

HF163 PHOTON ACER TENDL-2024 LIBRARY; T=0.K  
photons from (g,2np)

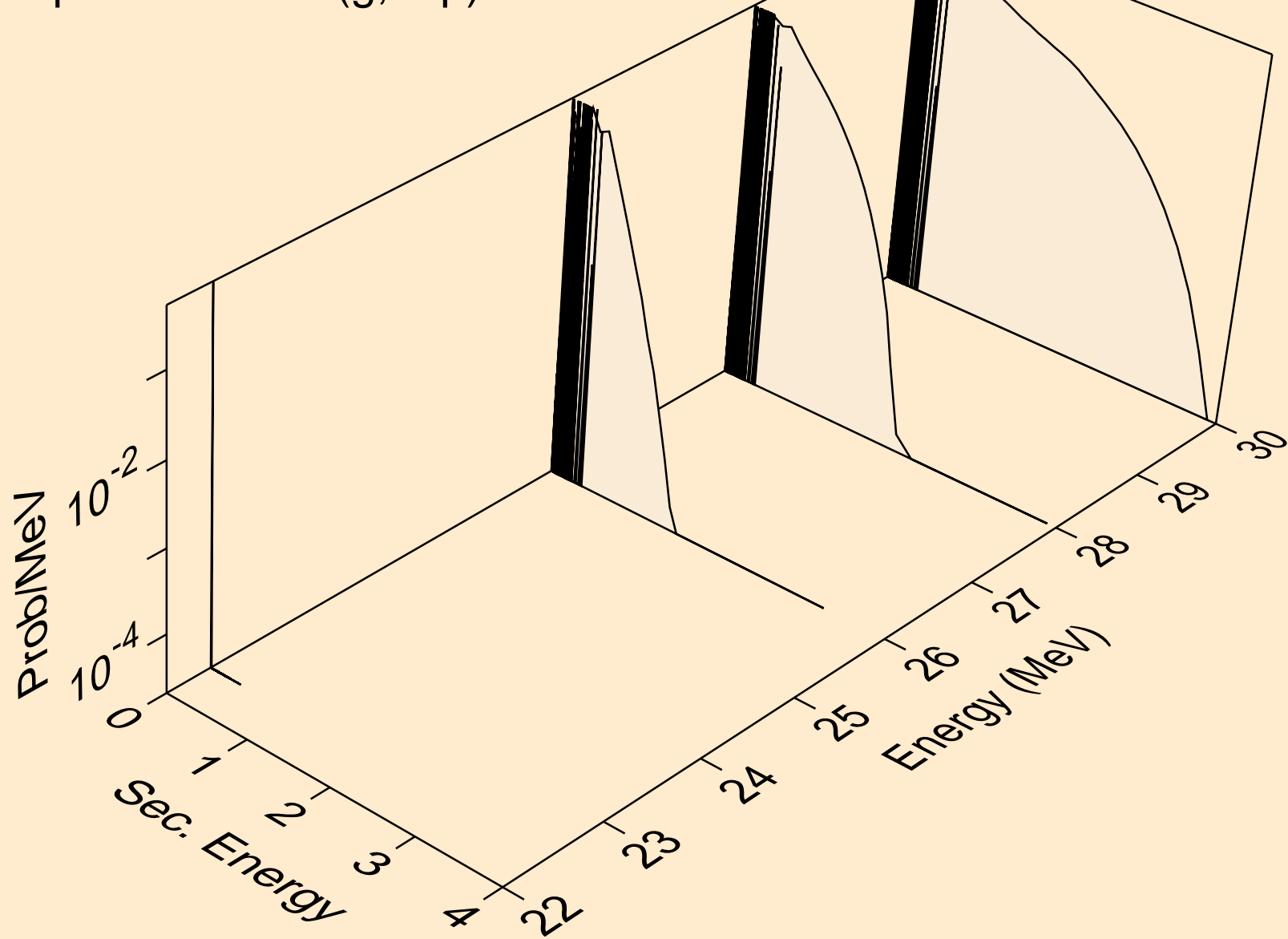

HF163 PHOTON ACER TENDL-2024 LIBRARY; T=0.K  
photons from (g,n2p)

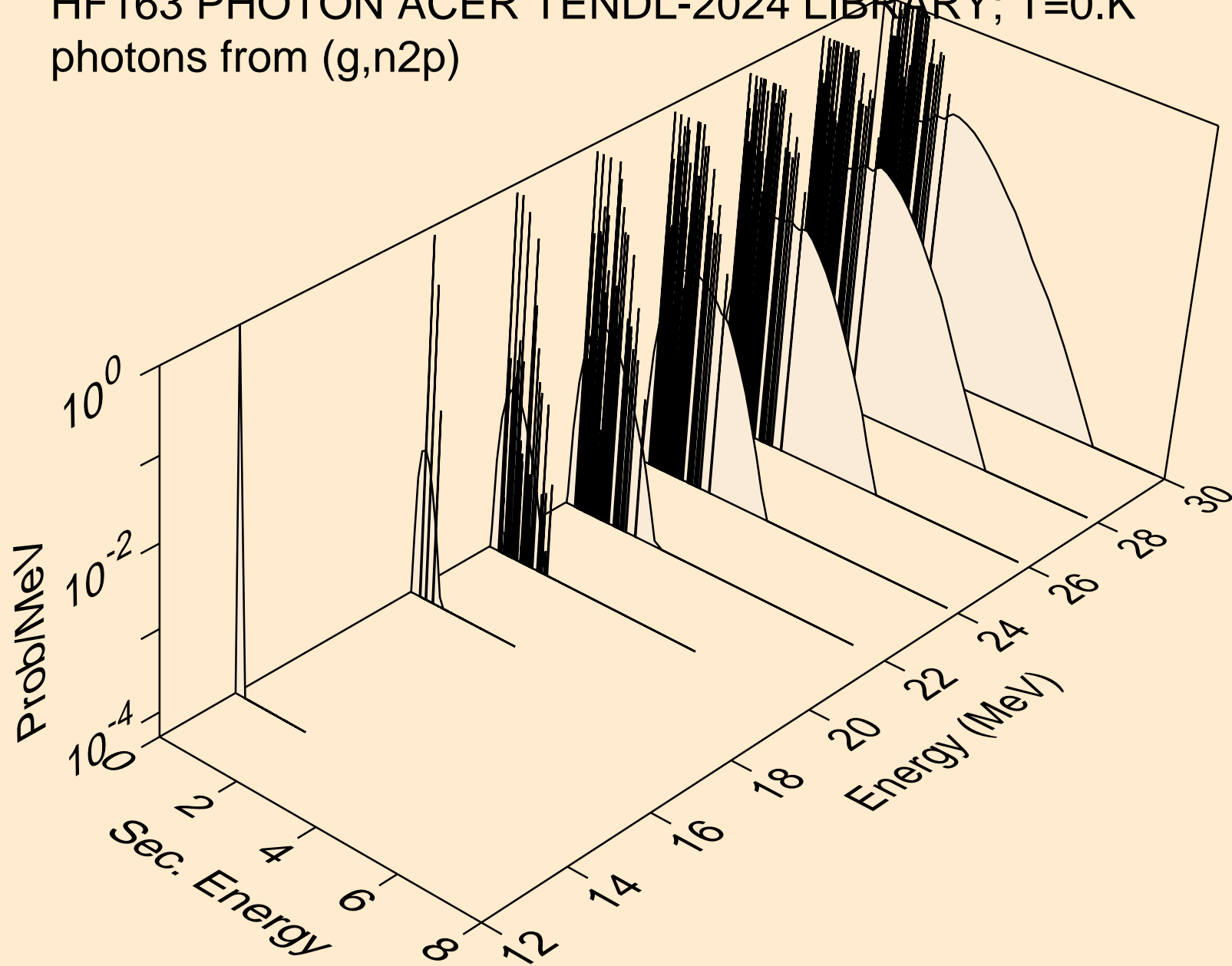

HF163 PHOTON ACER TENDL-2024 LIBRARY; T=0.K  
photons from (g,npa)

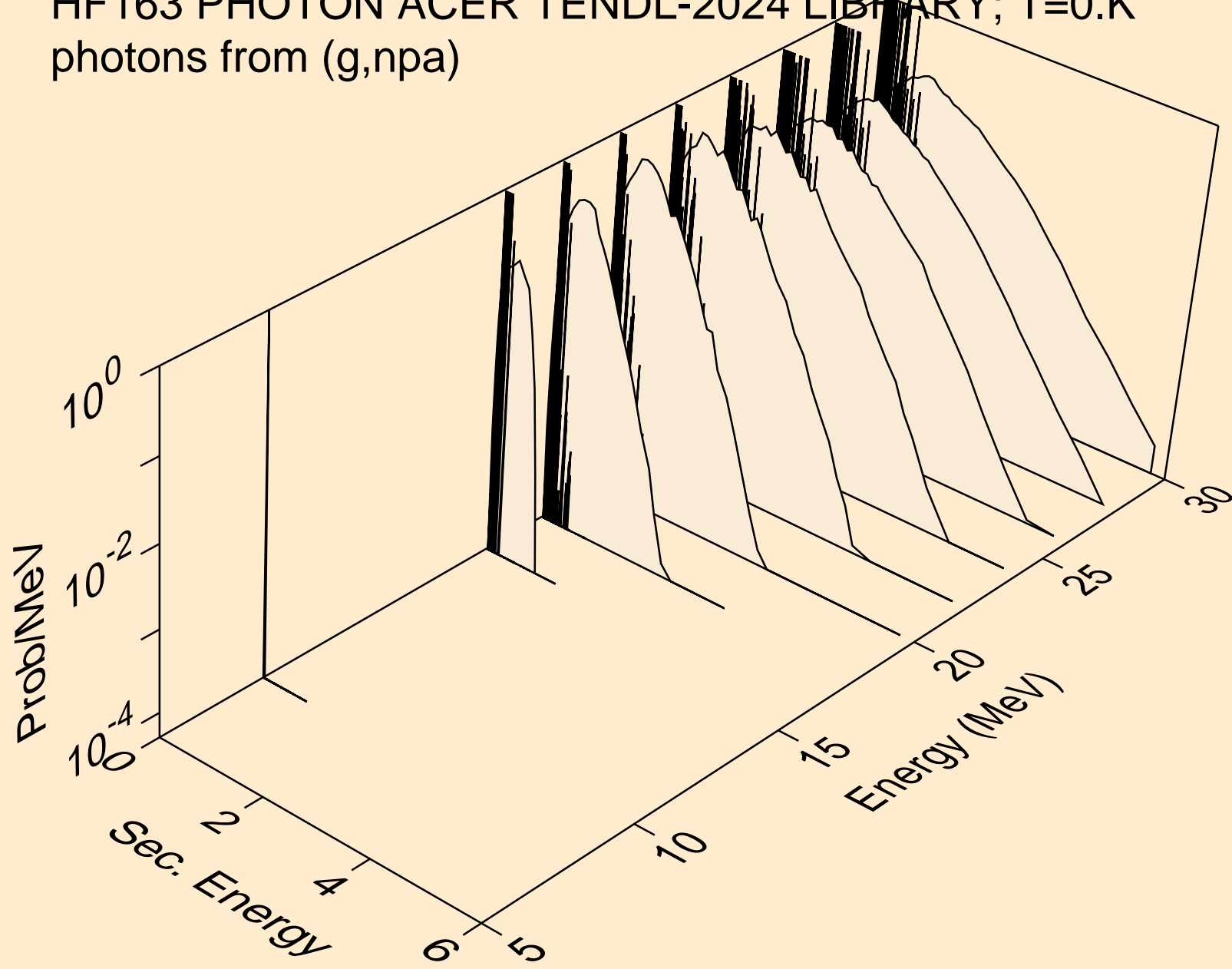

HF163 PHOTON ACER TENDL-2024 LIBRARY; T=0.K  
photons from (g,n\*c)

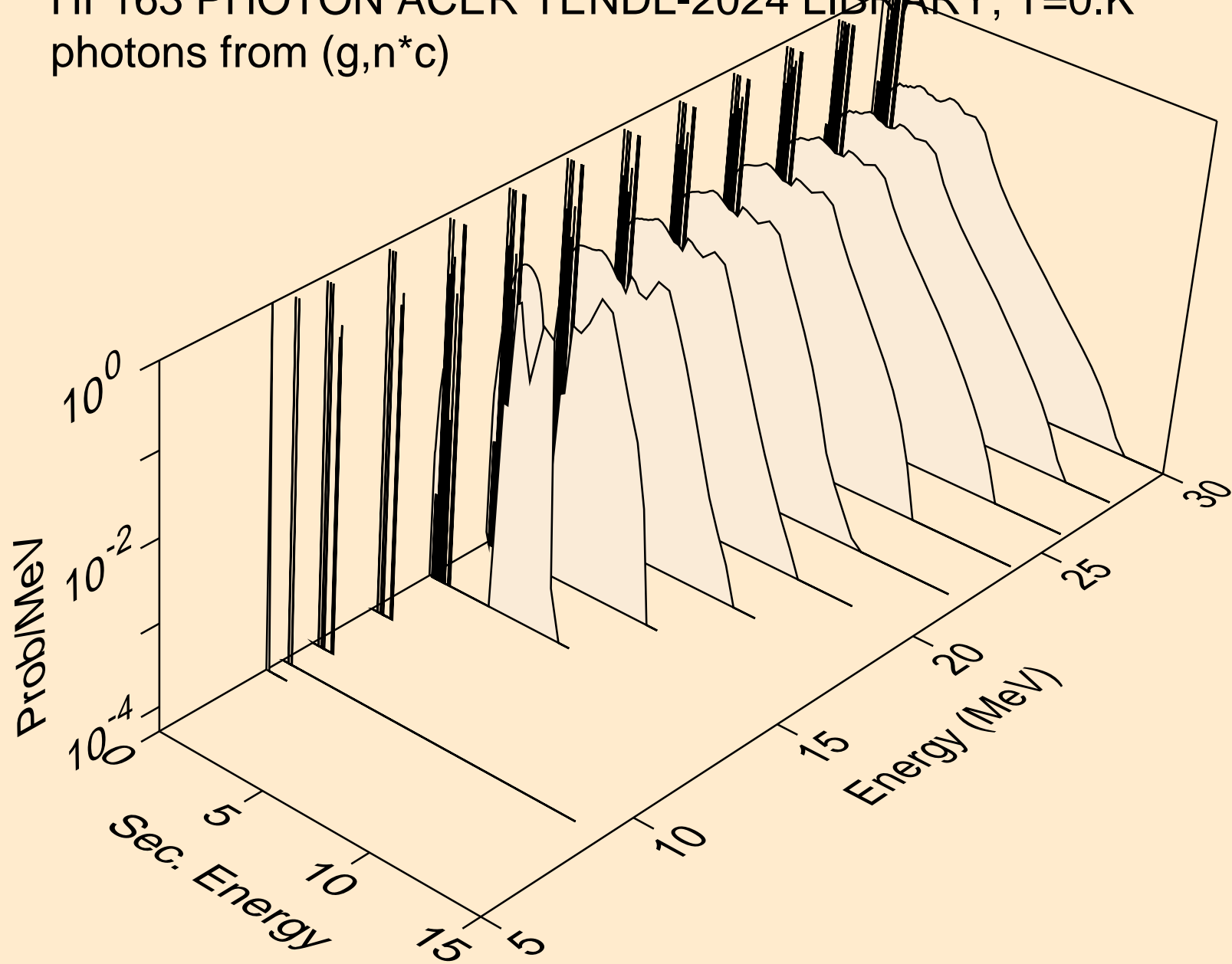

HF163 PHOTON ACER TENDL-2024 LIBRARY; T=0.K  
photons from (g,gma)

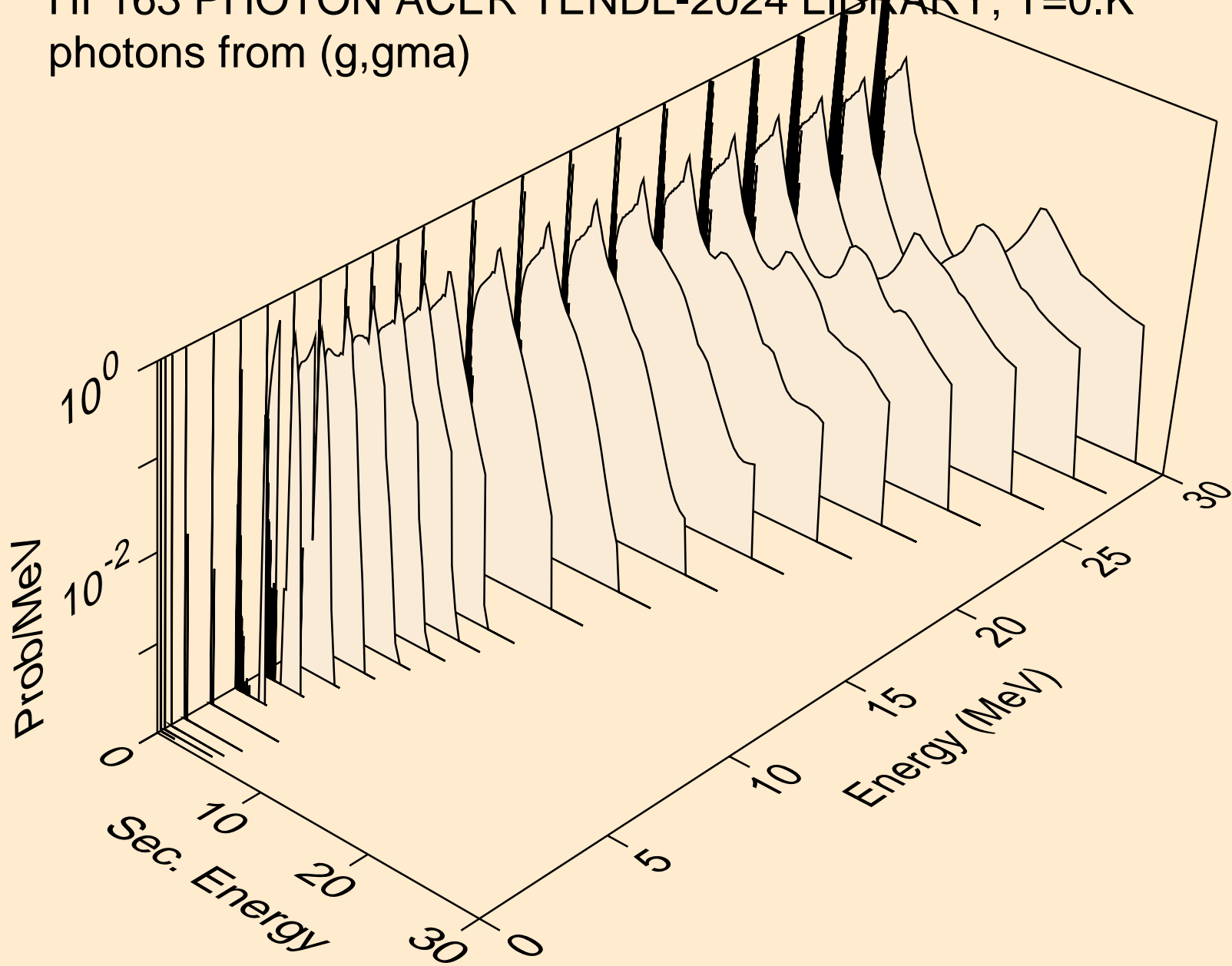

HF163 PHOTON ACER TENDL-2024 LIBRARY; T=0.K  
photons from (g,p)

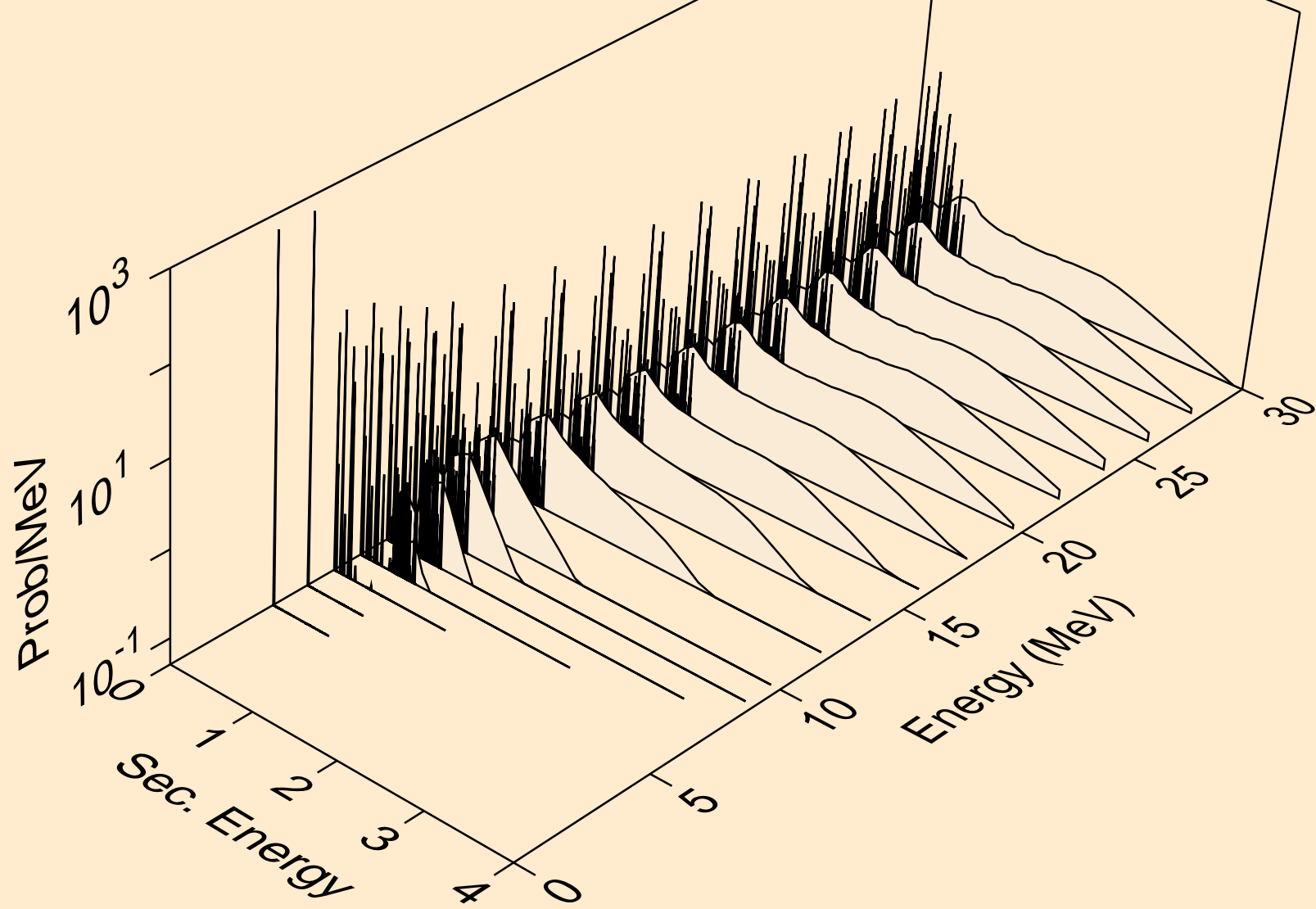

HF163 PHOTON ACER TENDL-2024 LIBRARY; T=0.K  
photons from (g,d)

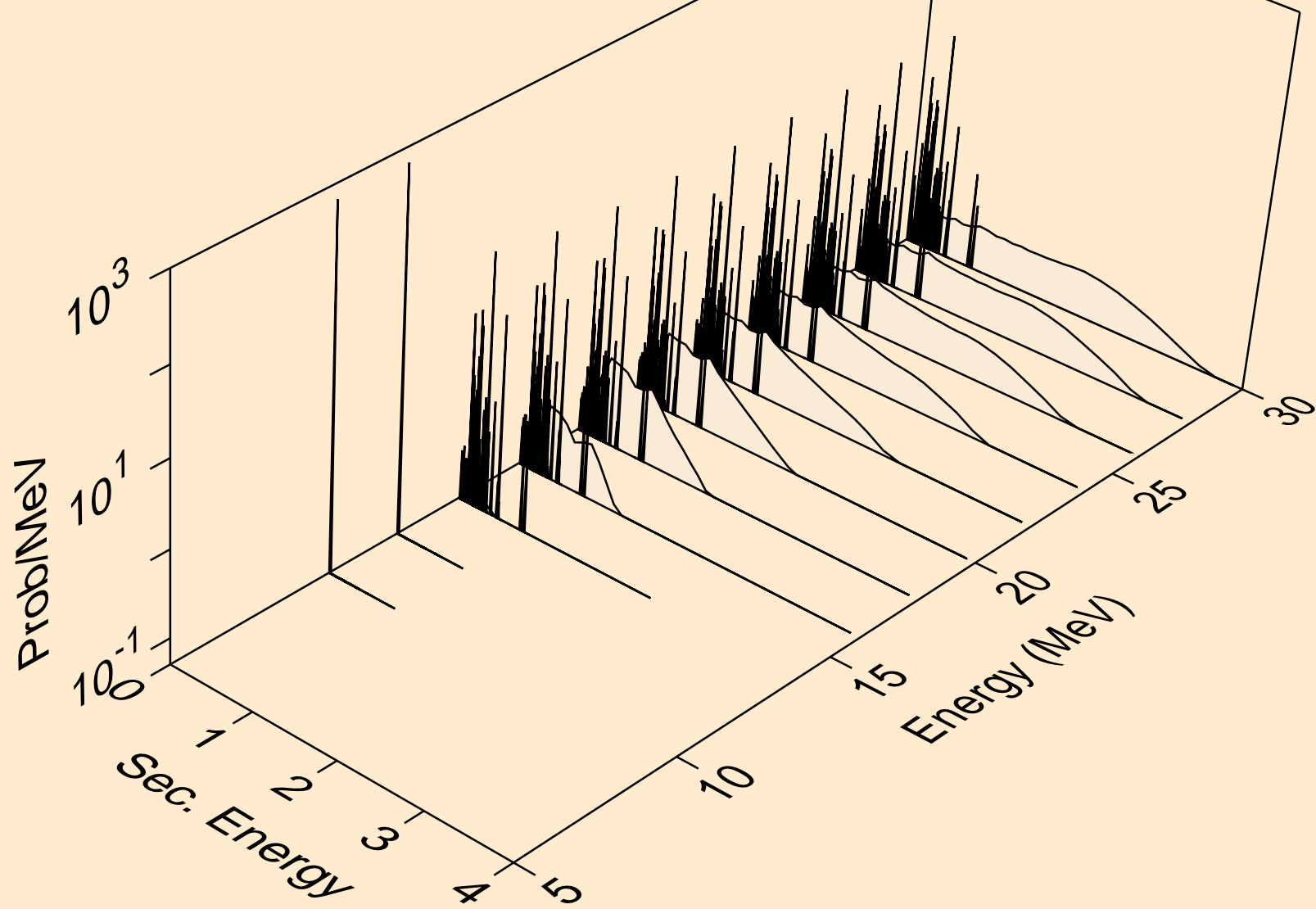

HF163 PHOTON ACER TENDL-2024 LIBRARY; T=0.K  
photons from (g,t)

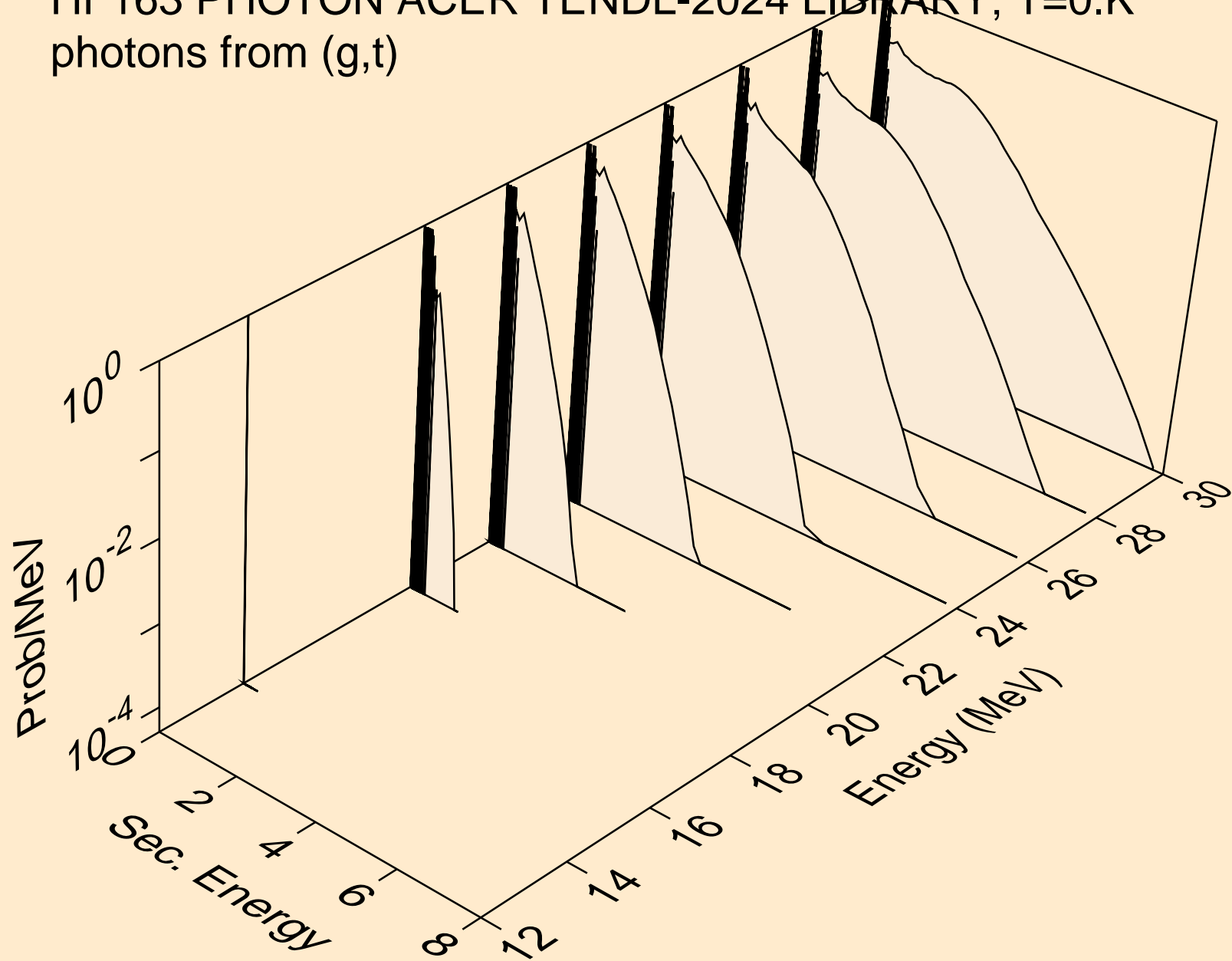

HF163 PHOTON ACER TENDL-2024 LIBRARY; T=0.K  
photons from (g,he3)

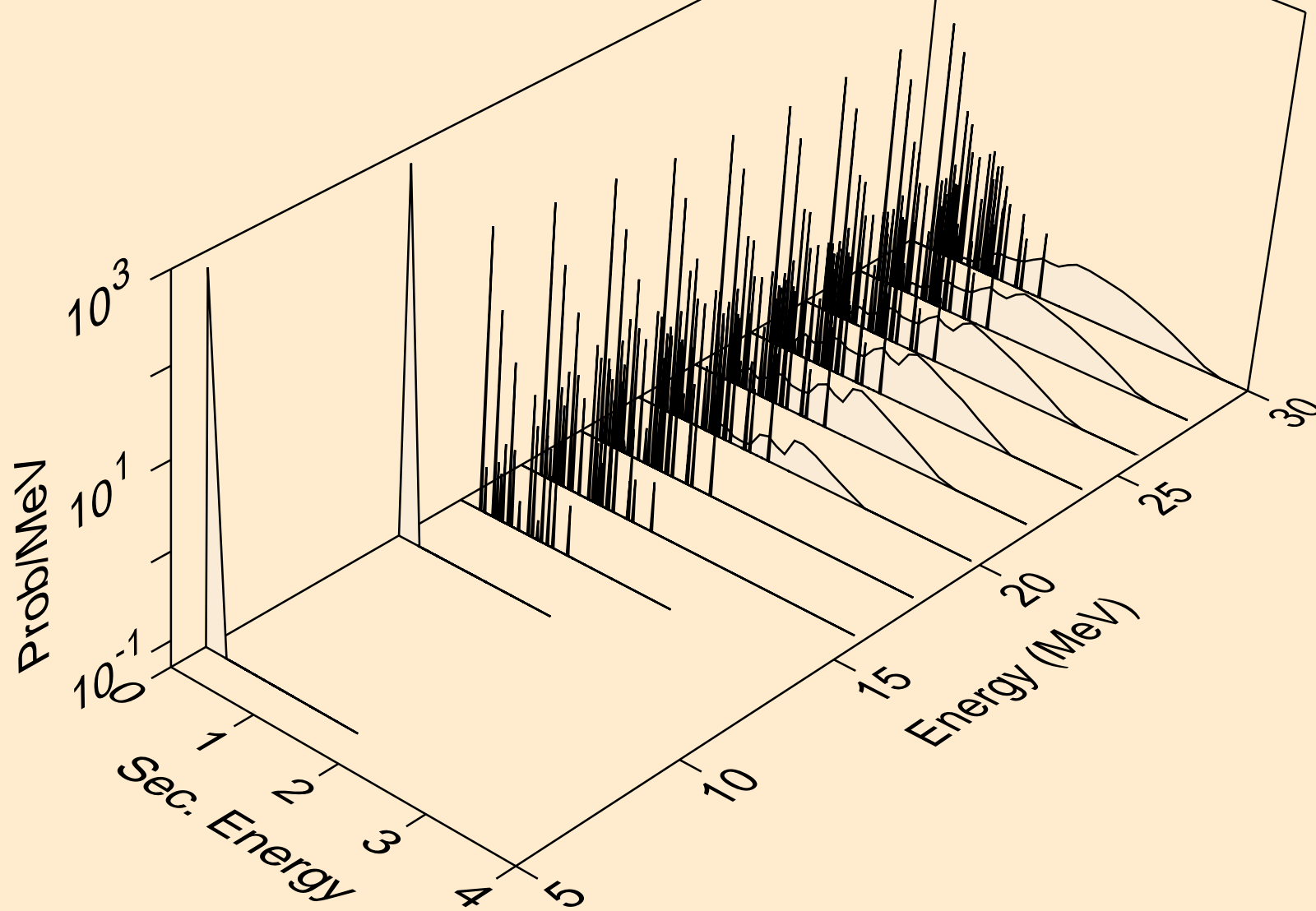

HF163 PHOTON ACER TENDL-2024 LIBRARY; T=0.K  
photons from (g,a)

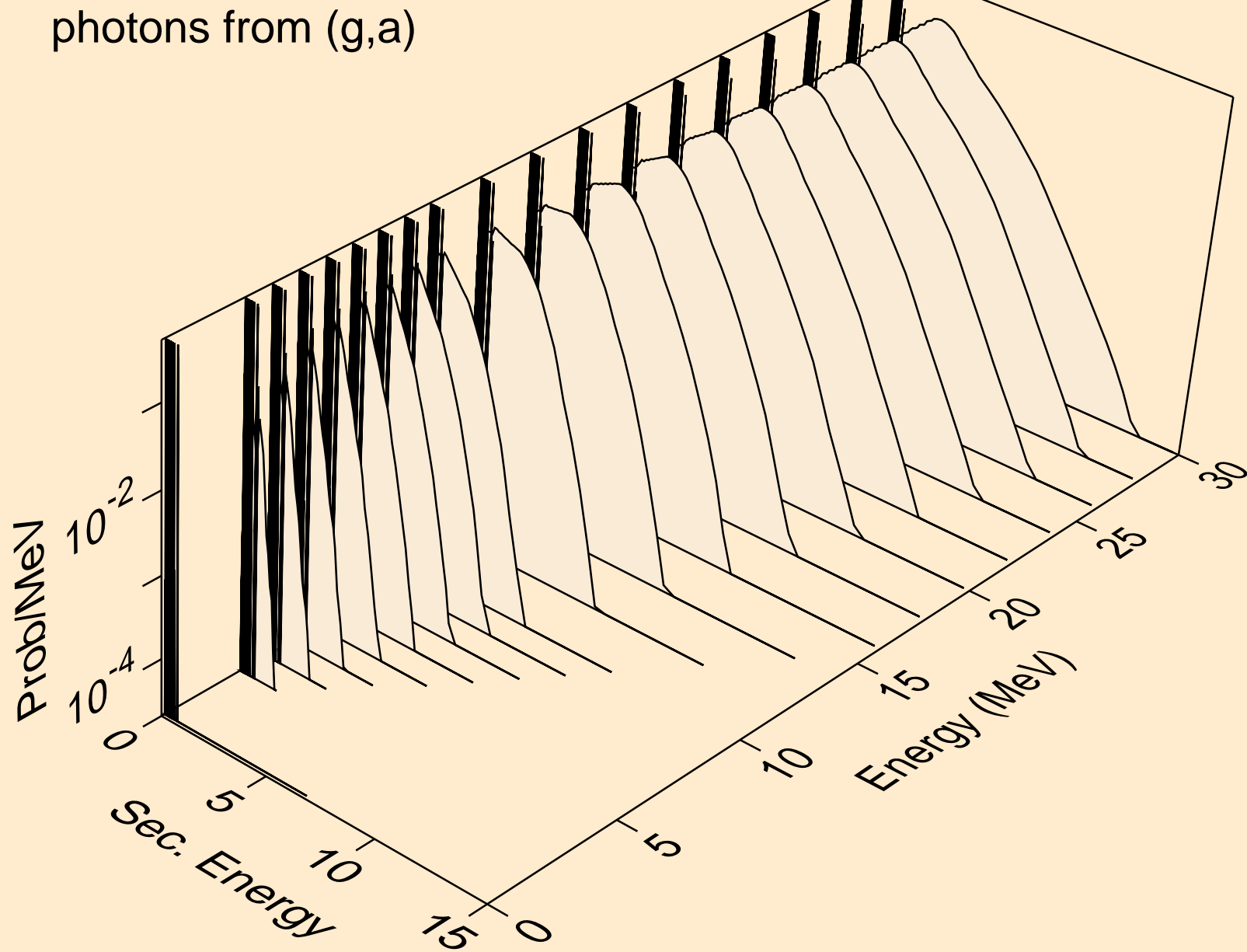

HF163 PHOTON ACER TENDL-2024 LIBRARY; T=0.K  
photons from (g,2a)

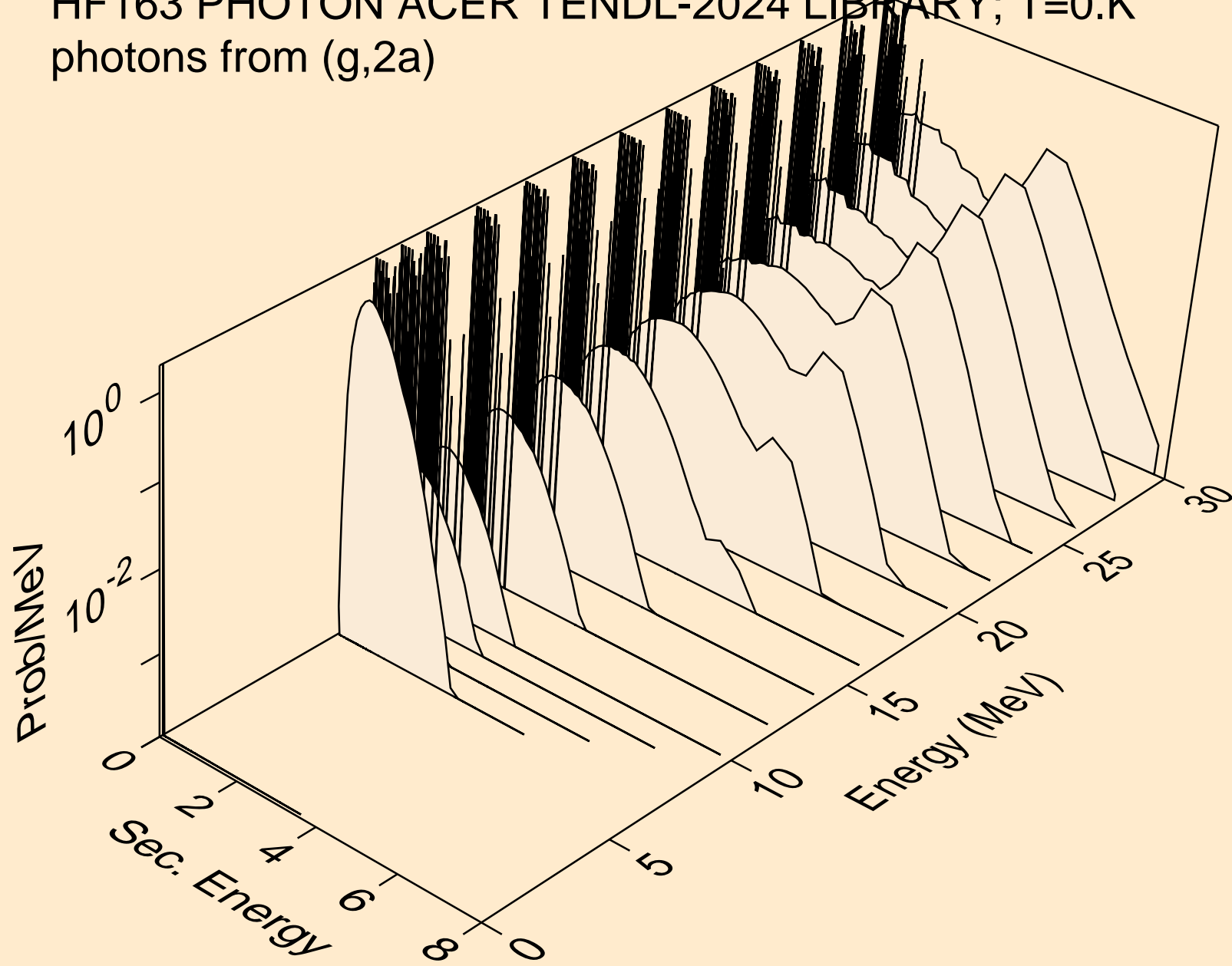

HF163 PHOTON ACER TENDL-2024 LIBRARY; T=0.K  
photons from (g,2p)

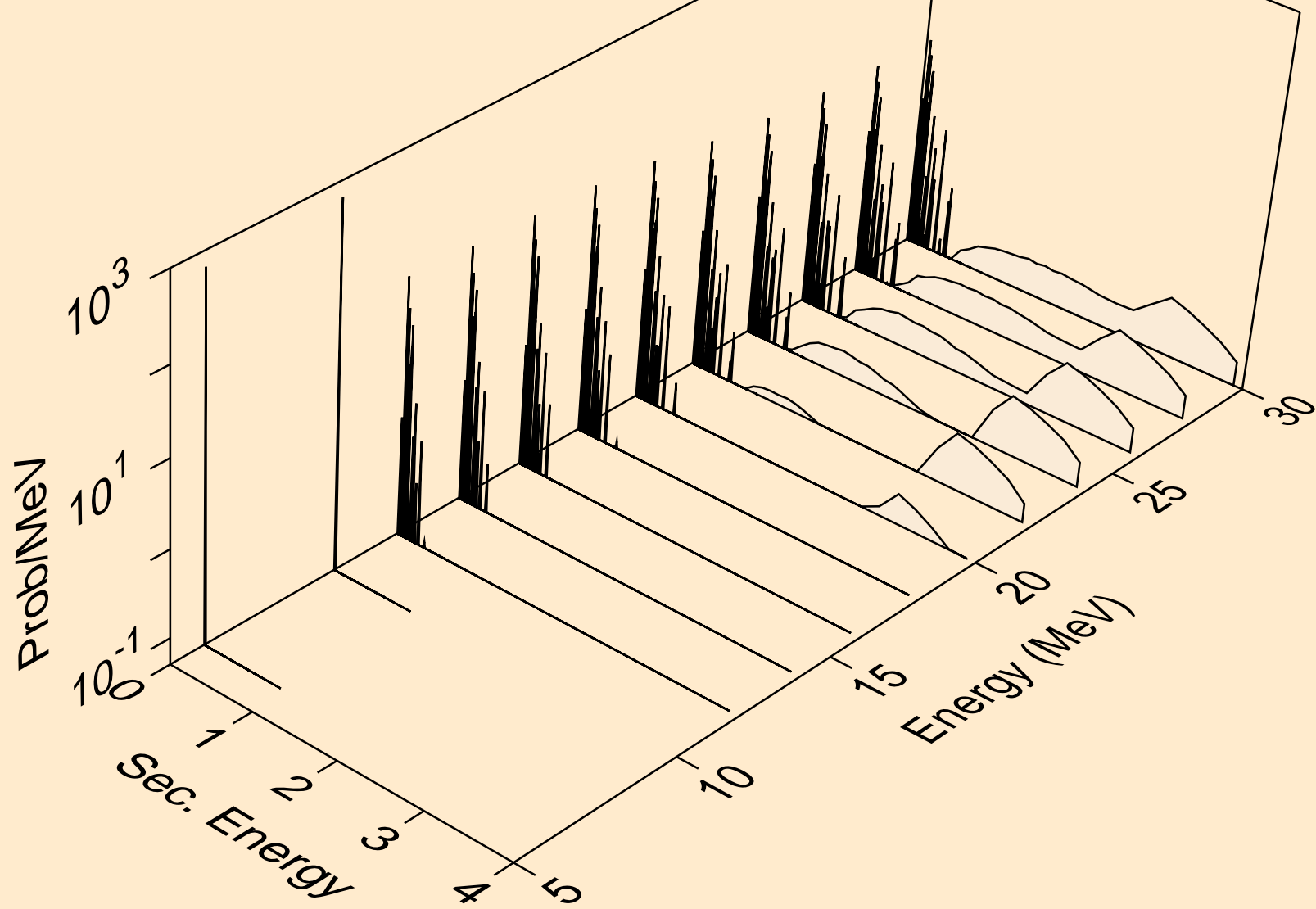

HF163 PHOTON ACER TENDL-2024 LIBRARY; T=0.K  
photons from (g,pa)

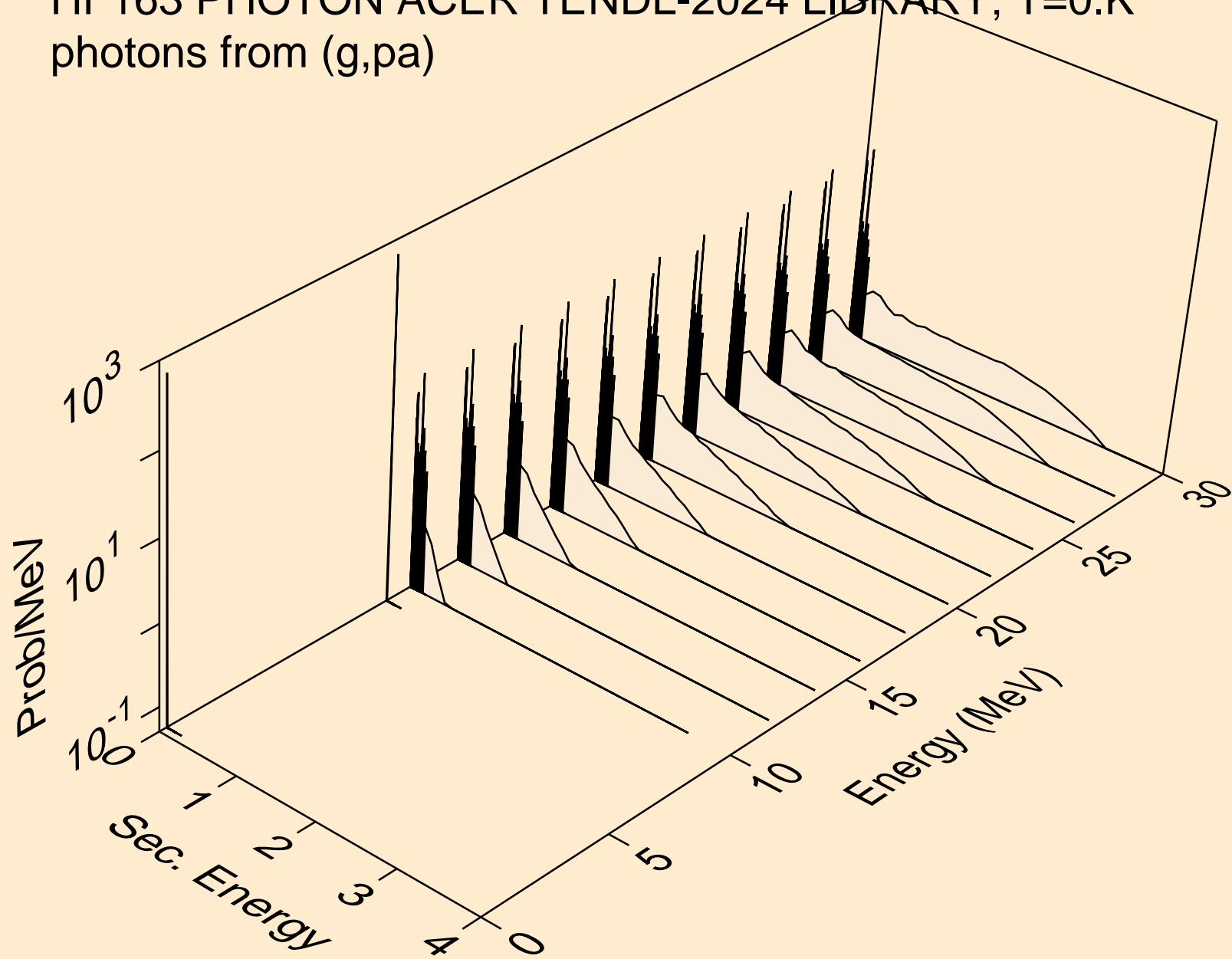

HF163 PHOTON ACER TENDL-2024 LIBRARY; T=0.K  
photons from (g,pd)

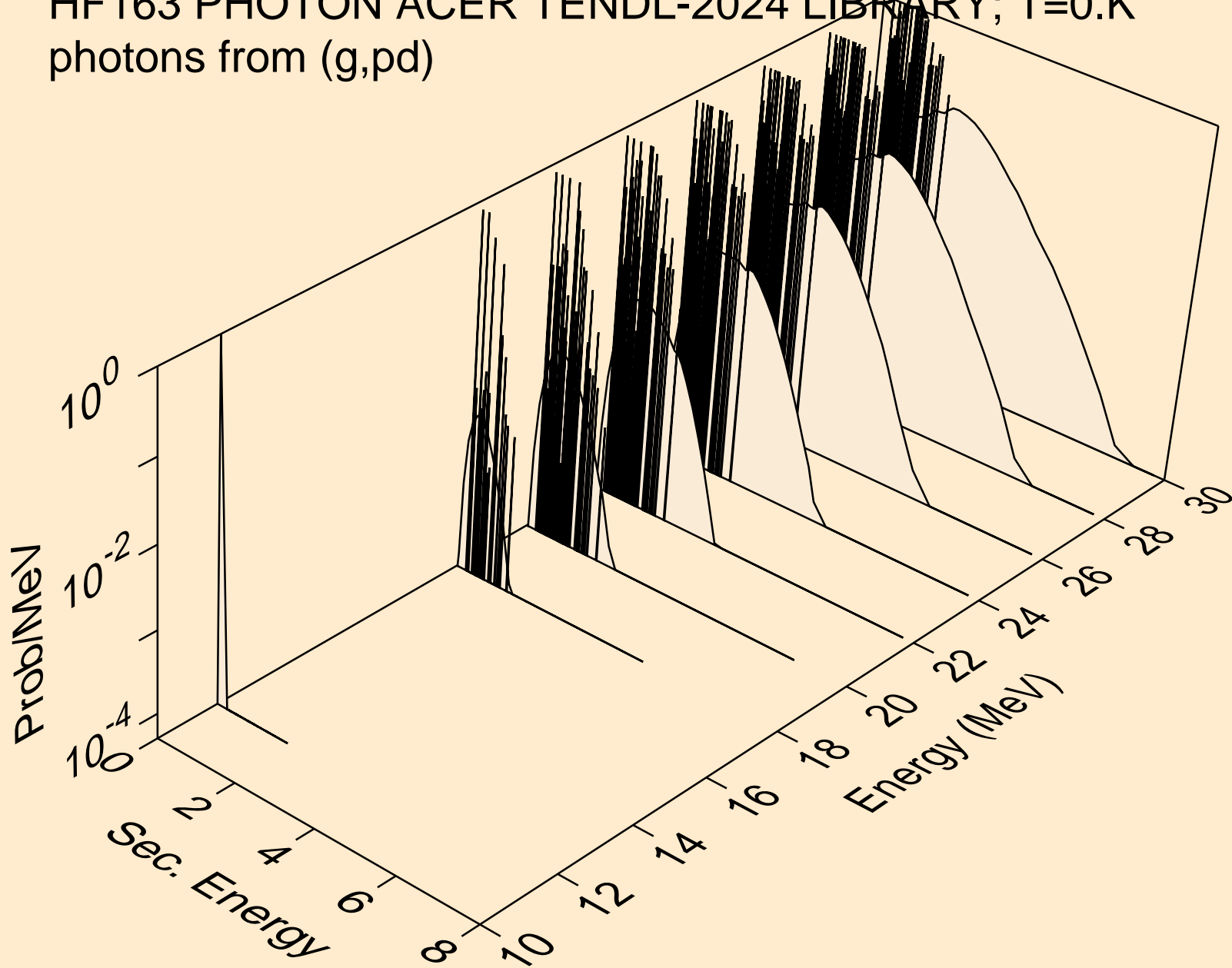

HF163 PHOTON ACER TENDL-2024 LIBRARY; T=0.K  
photons from (g,pt)

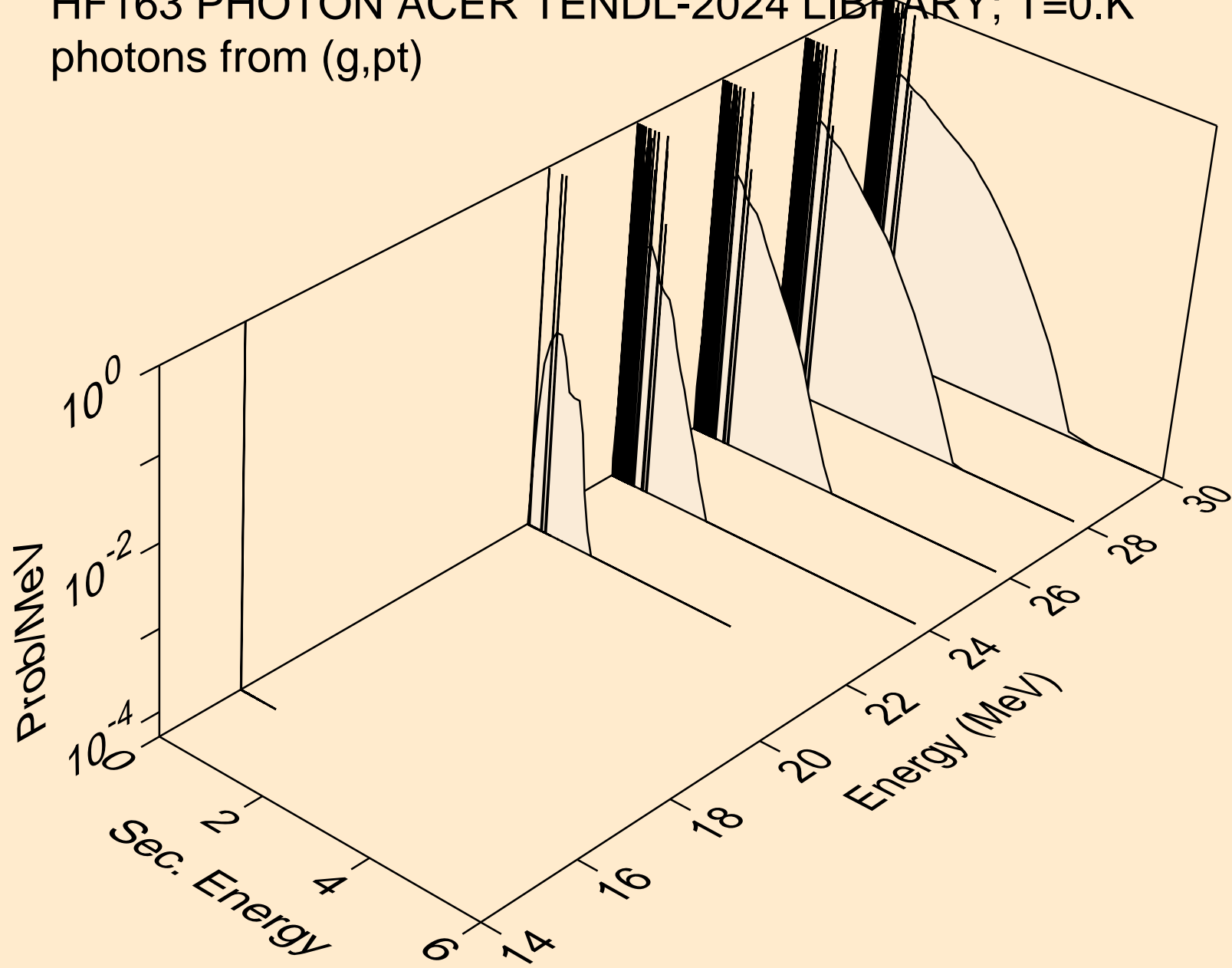

HF163 PHOTON ACER TENDL-2024 LIBRARY; T=0.K  
photons from (g,da)

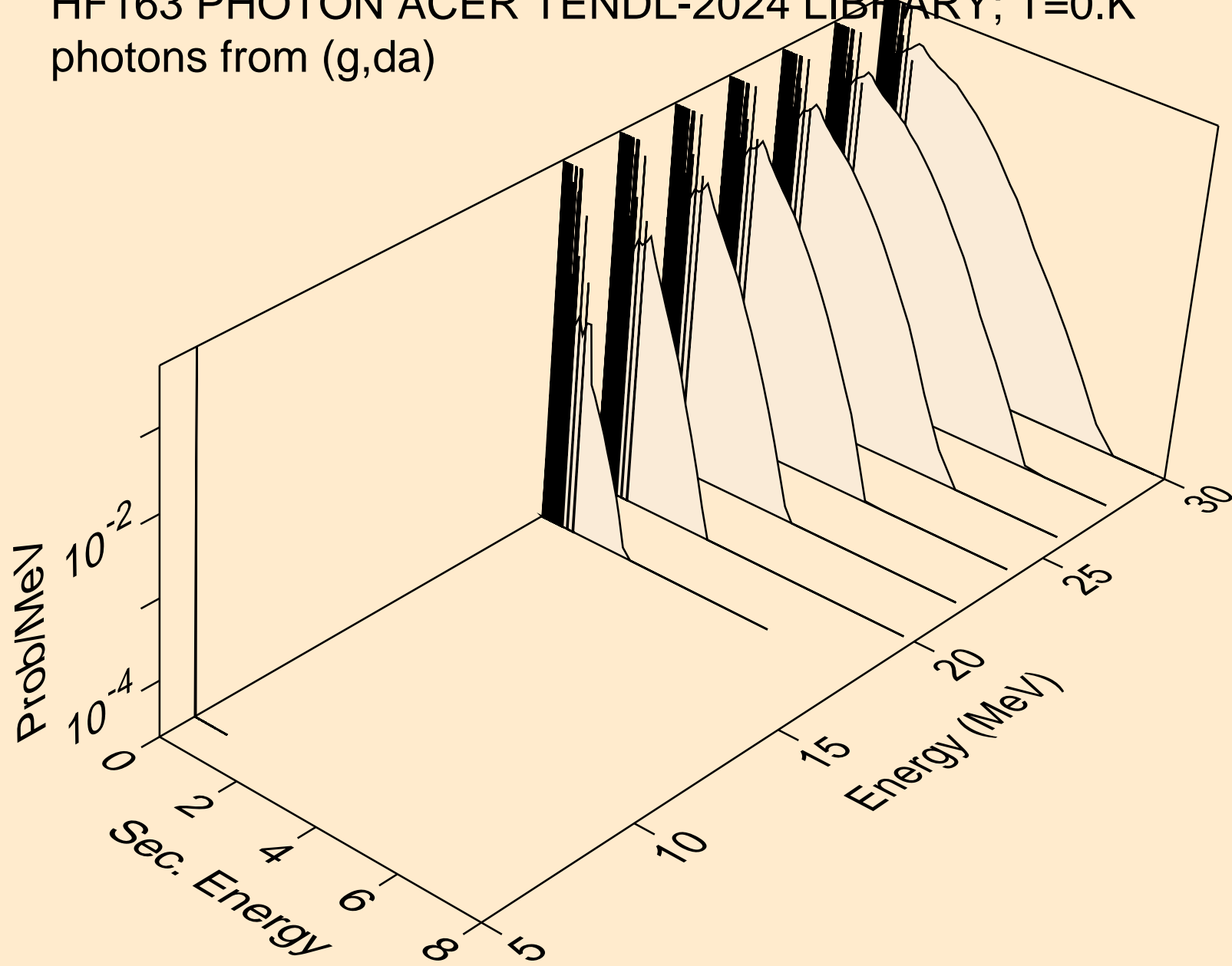

HF163 PHOTON ACER TENDL-2024 LIBRARY; T=0.K  
protons from (g,x)

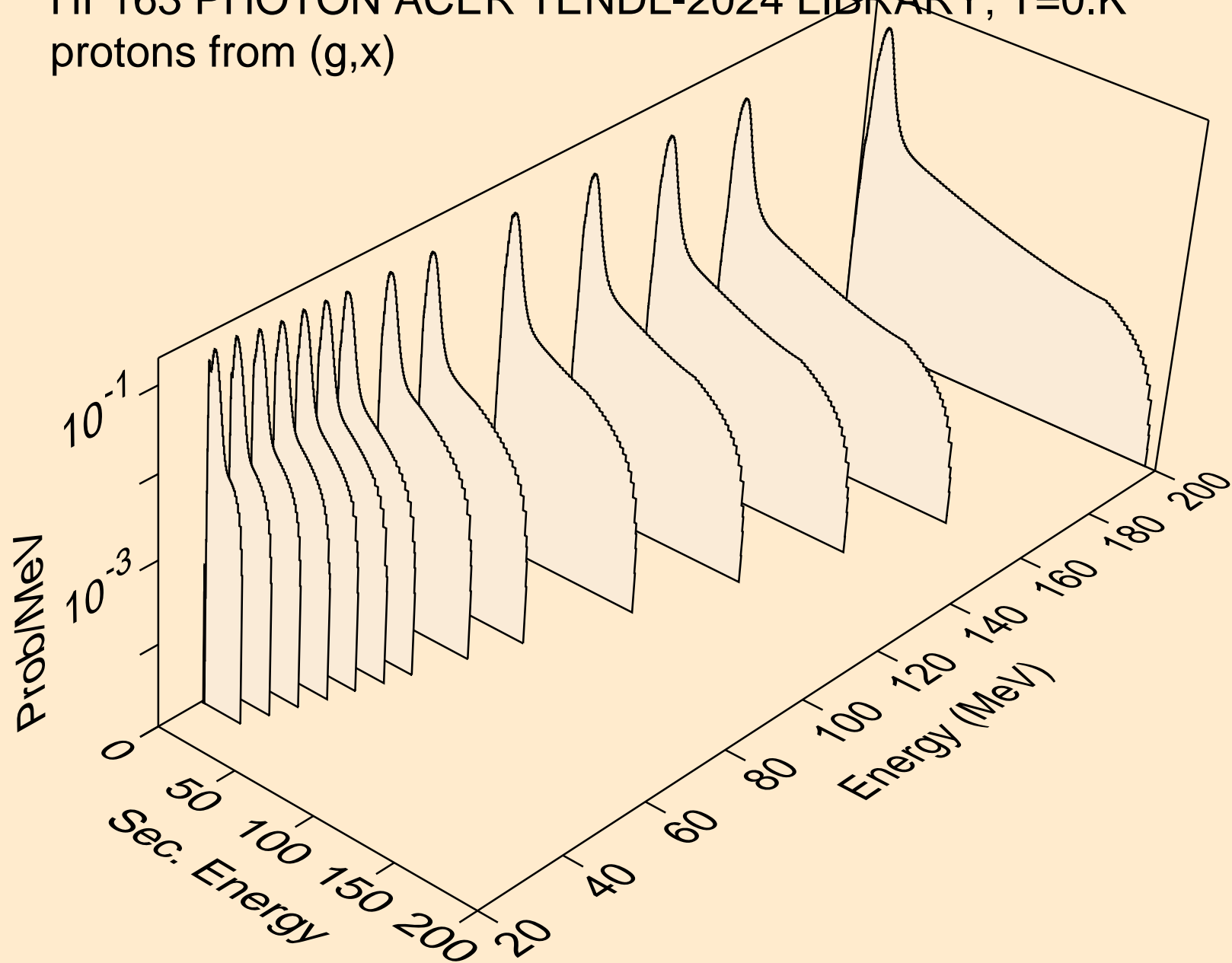

HF163 PHOTON ACER TENDL-2024 LIBRARY; T=0.K  
protons from (g,n\*)p

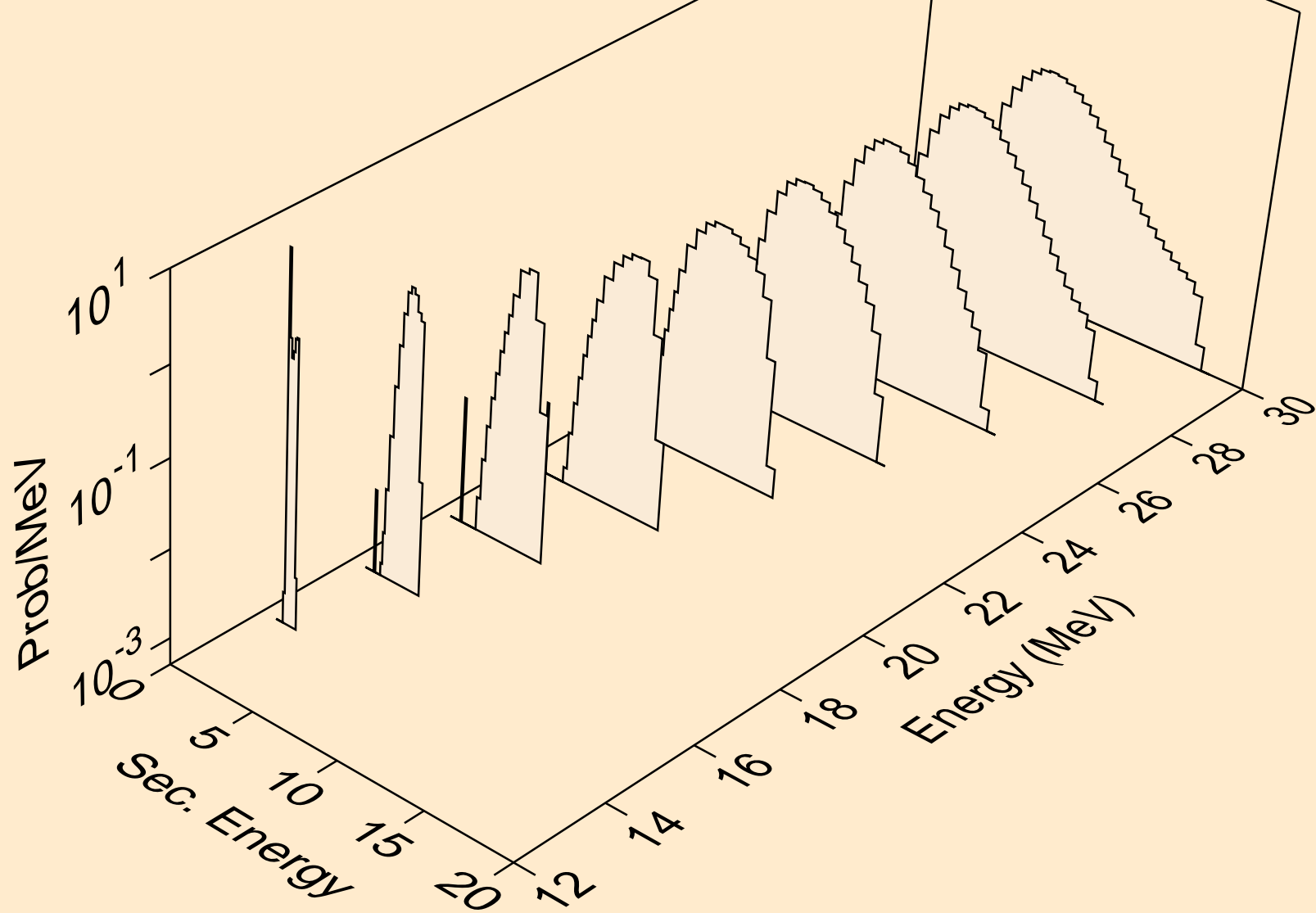

HF163 PHOTON ACER TENDL-2024 LIBRARY; T=0.K  
protons from (g,2np)

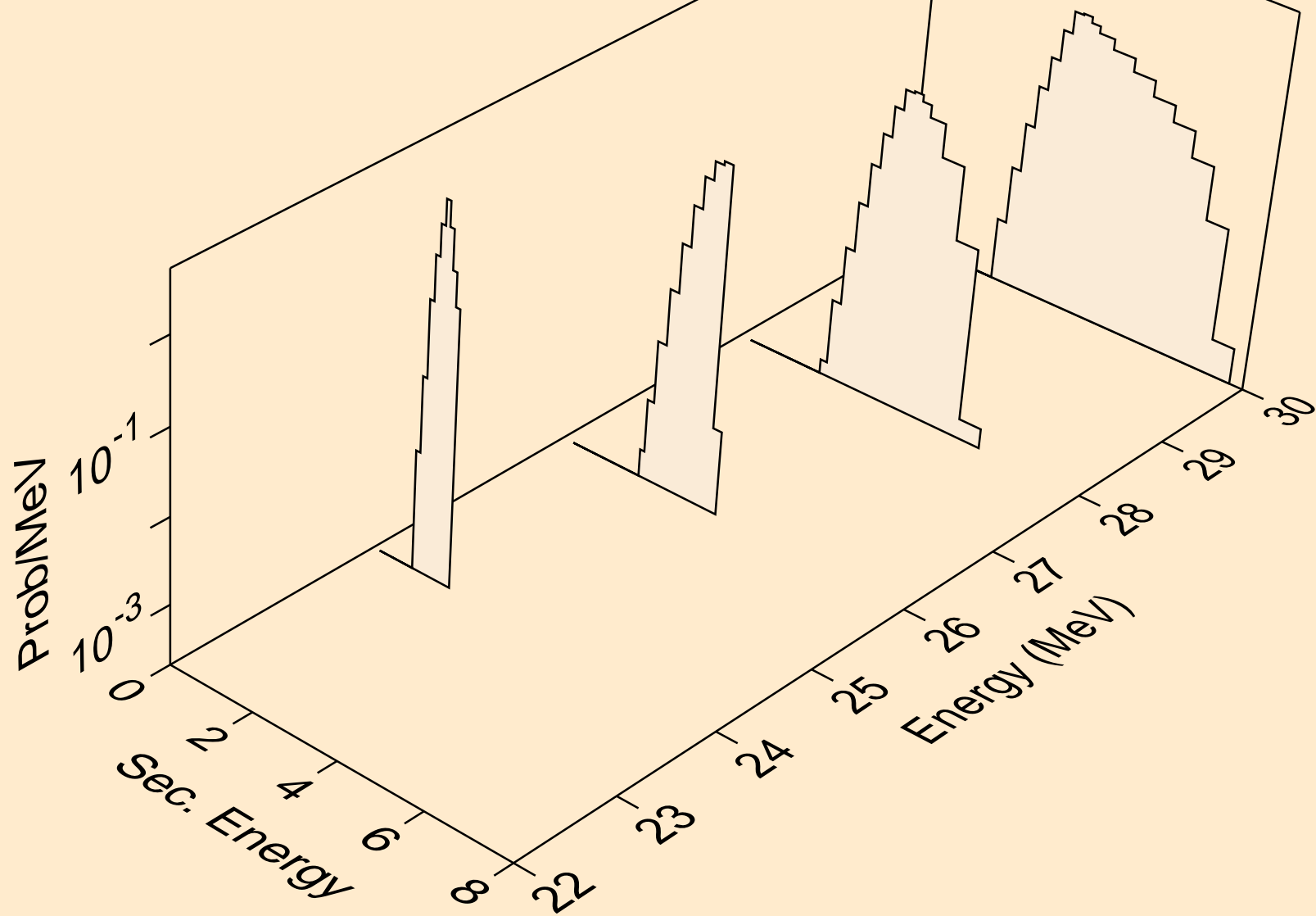

HF163 PHOTON ACER TENDL-2024 LIBRARY; T=0.K  
protons from (g,n2p)

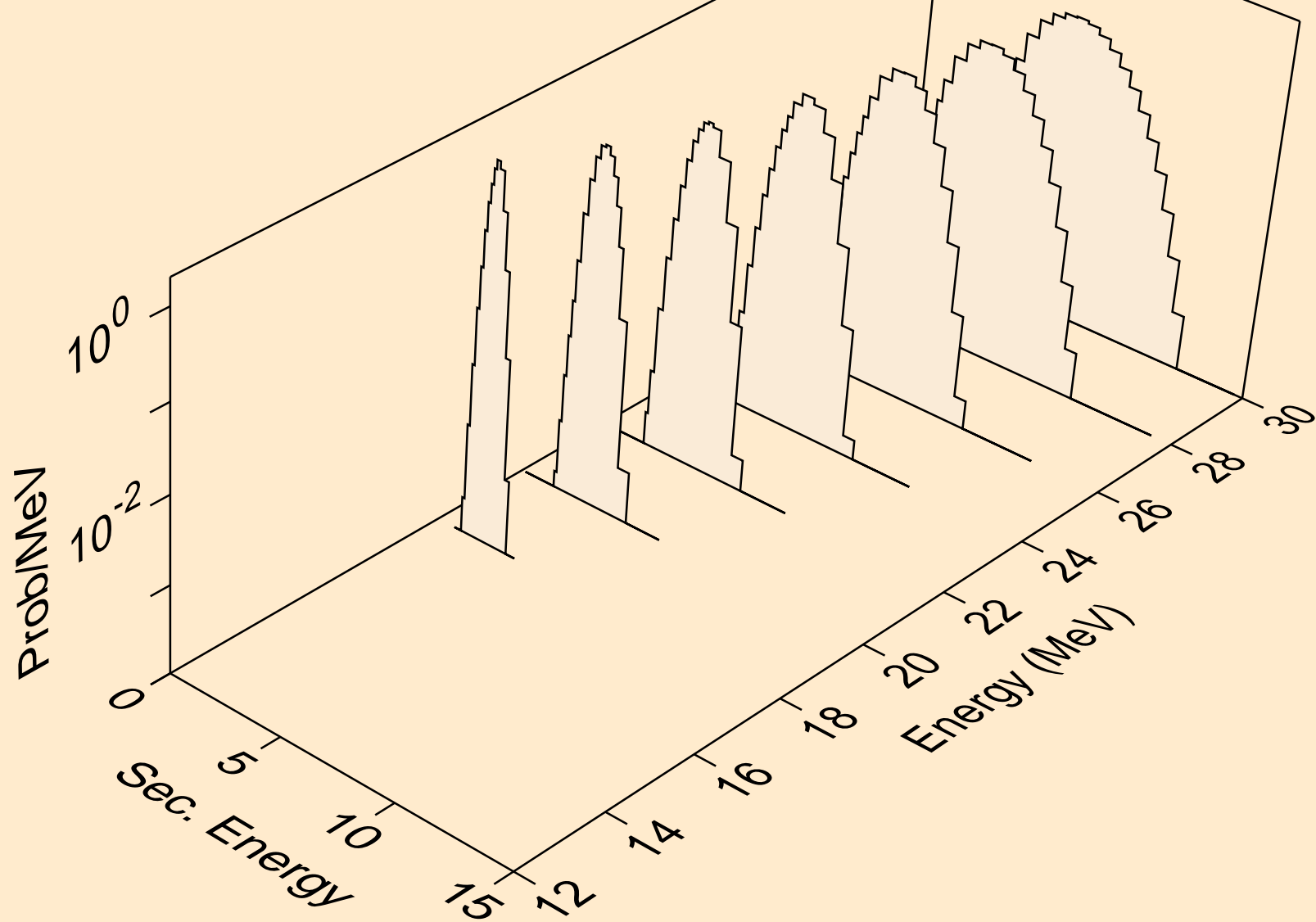

HF163 PHOTON ACER TENDL-2024 LIBRARY; T=0.K  
protons from (g,npa)

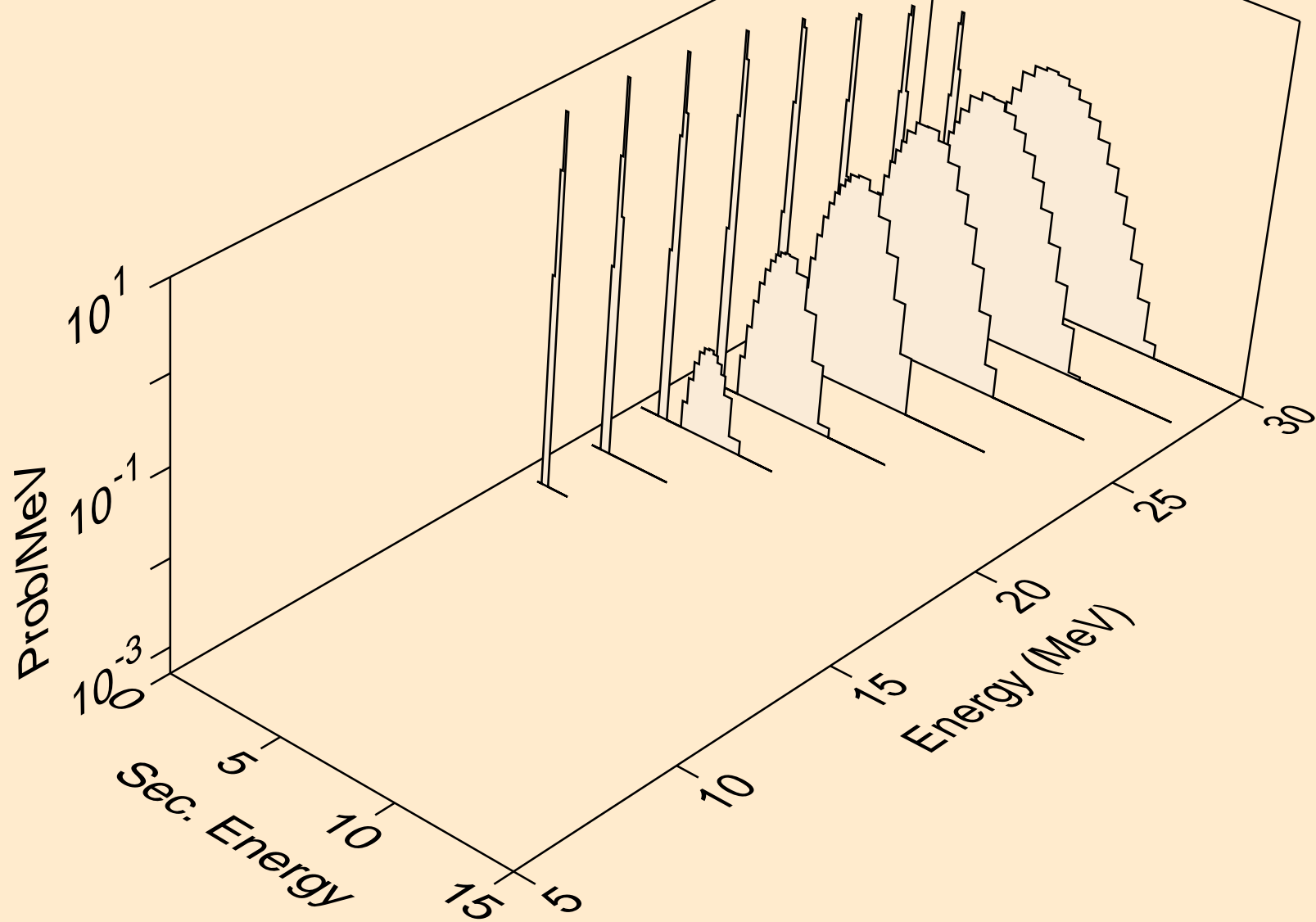

HF163 PHOTON ACER TENDL-2024 LIBRARY; T=0.K  
protons from (g,p)

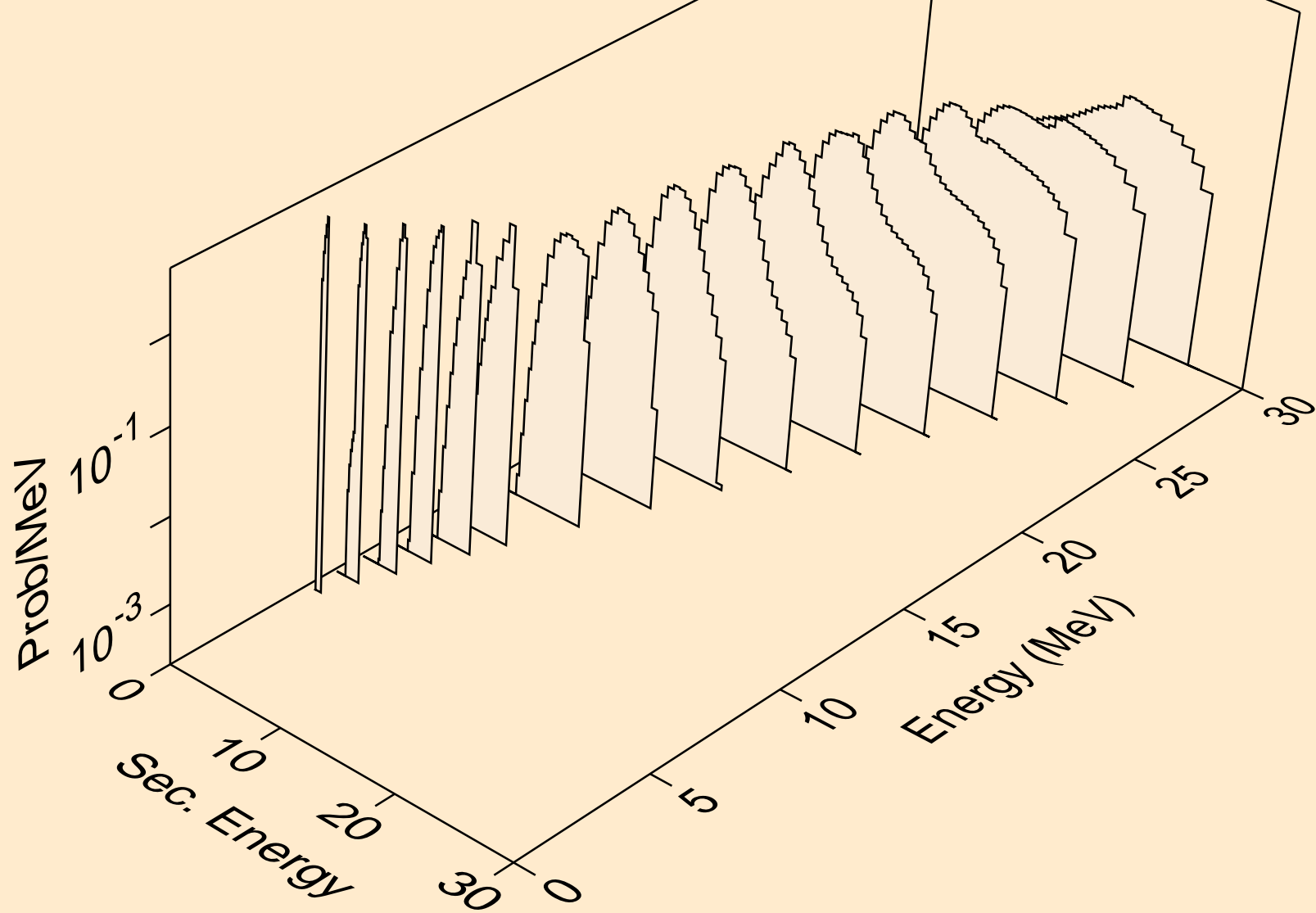

HF163 PHOTON ACER TENDL-2024 LIBRARY; T=0.K  
protons from (g,2p)

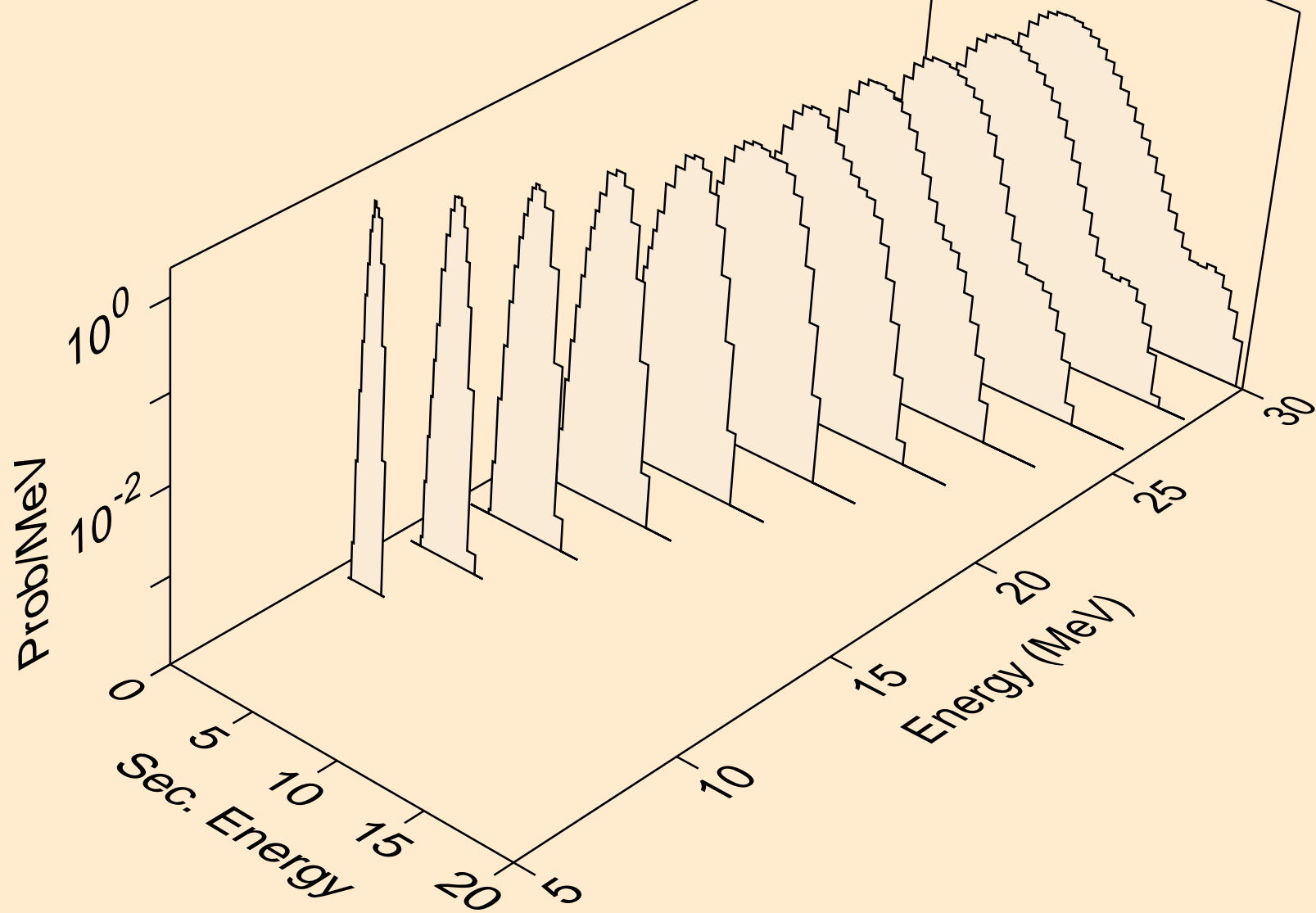

HF163 PHOTON ACER TENDL-2024 LIBRARY; T=0.K  
protons from (g,pa)

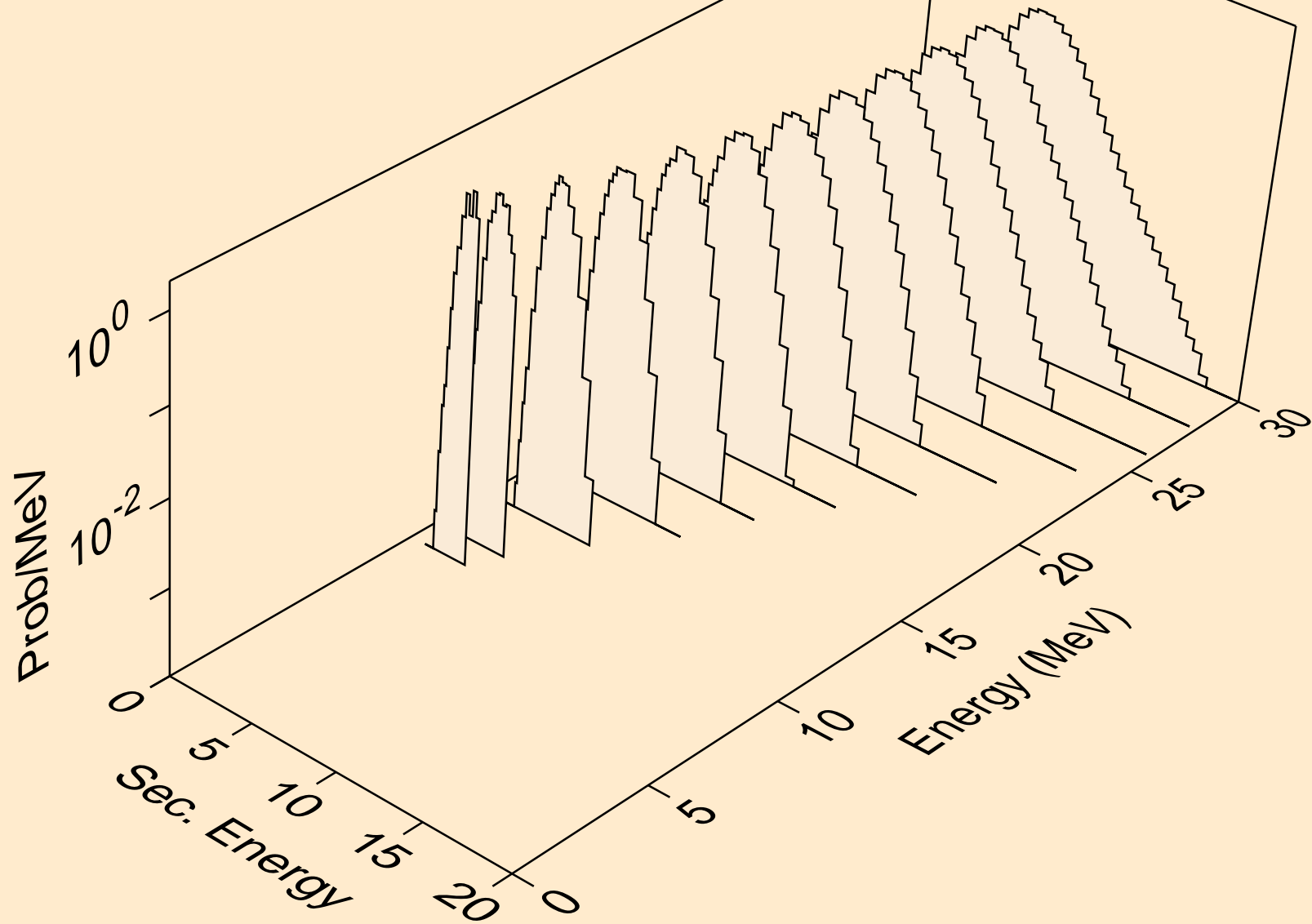

HF163 PHOTON ACER TENDL-2024 LIBRARY; T=0.K  
protons from (g,pd)

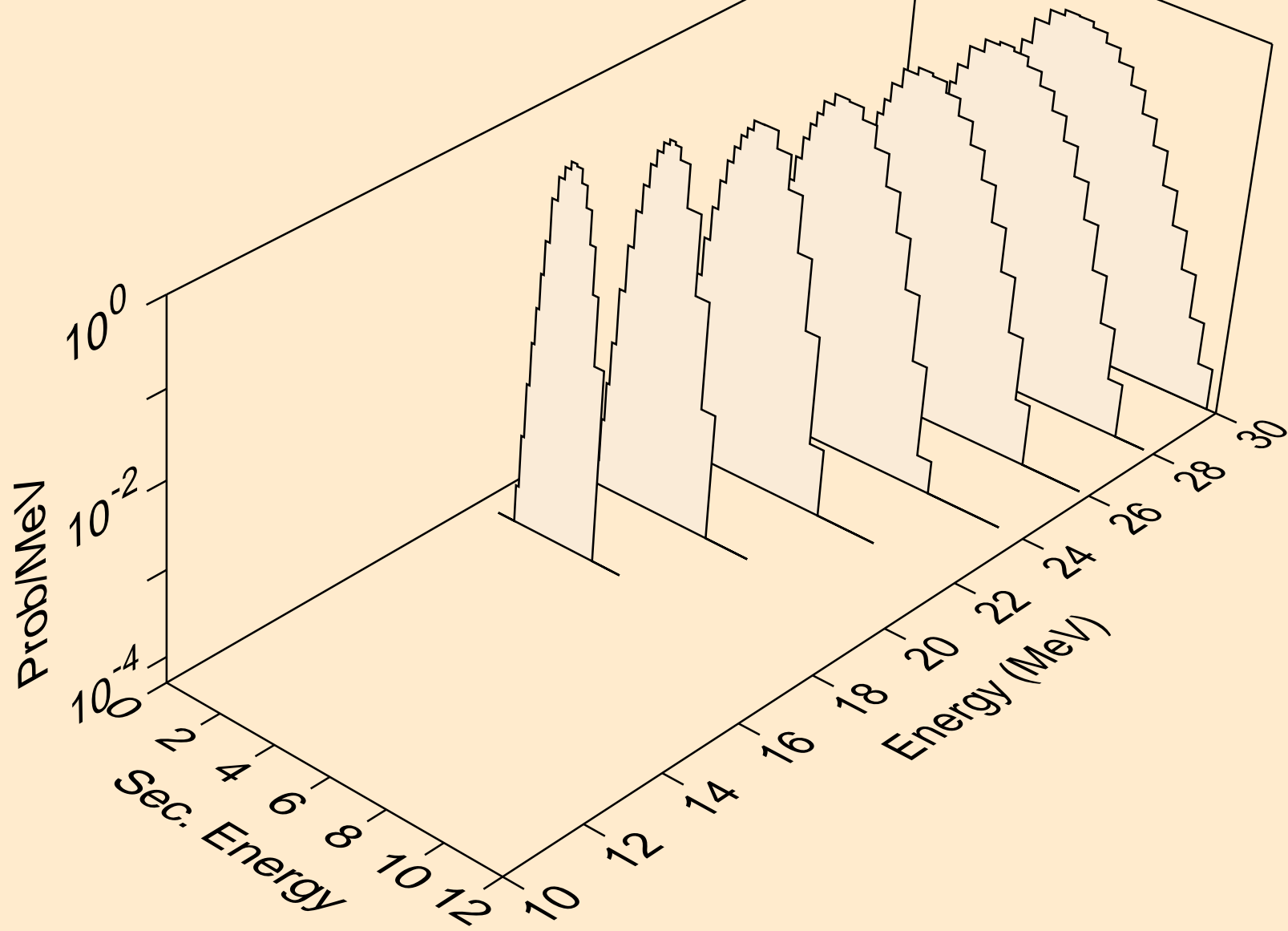

HF163 PHOTON ACER TENDL-2024 LIBRARY; T=0.K  
protons from (g,pt)

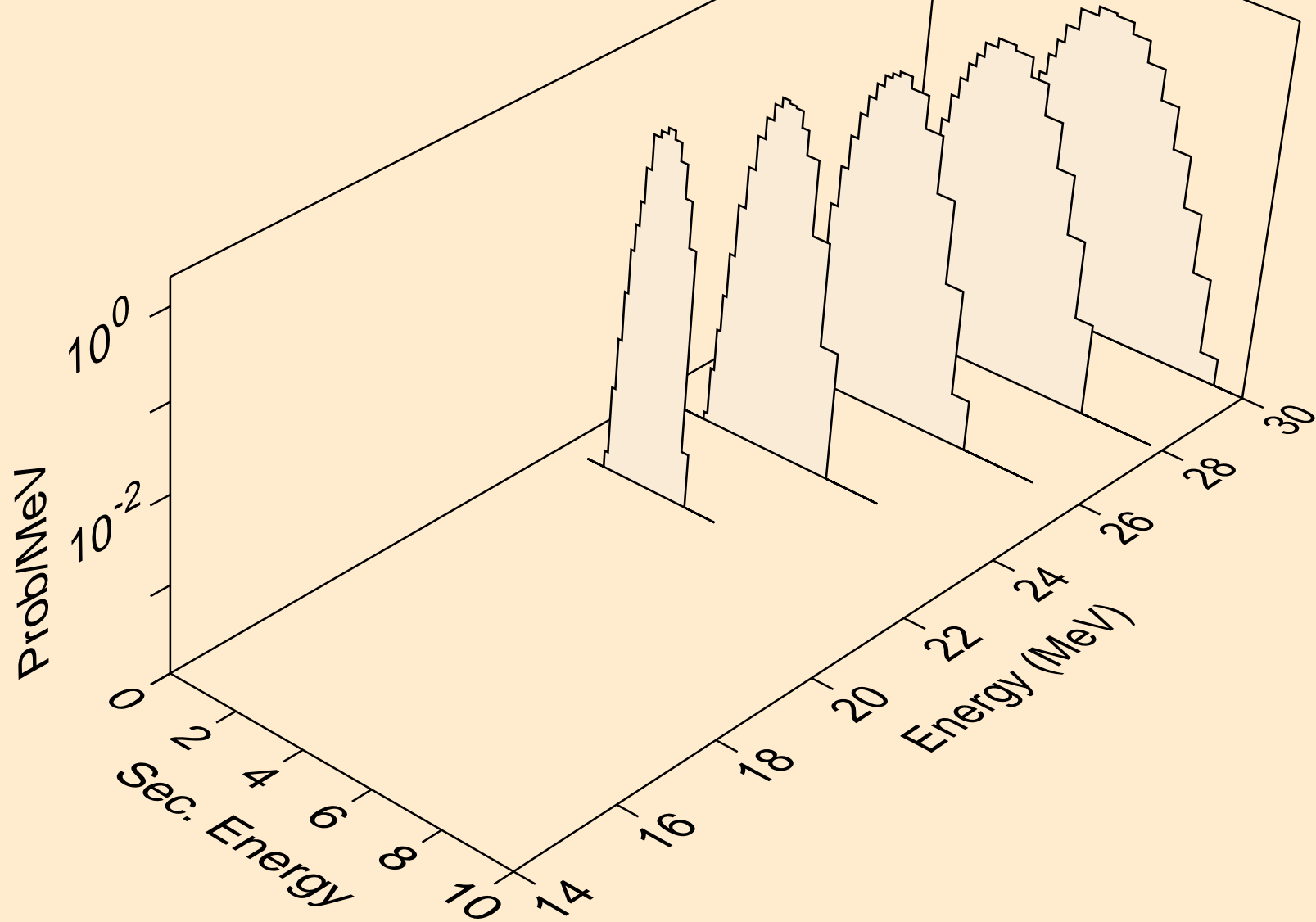

HF163 PHOTON ACER TENDL-2024 LIBRARY; T=0.K  
deuterons from (g,x)

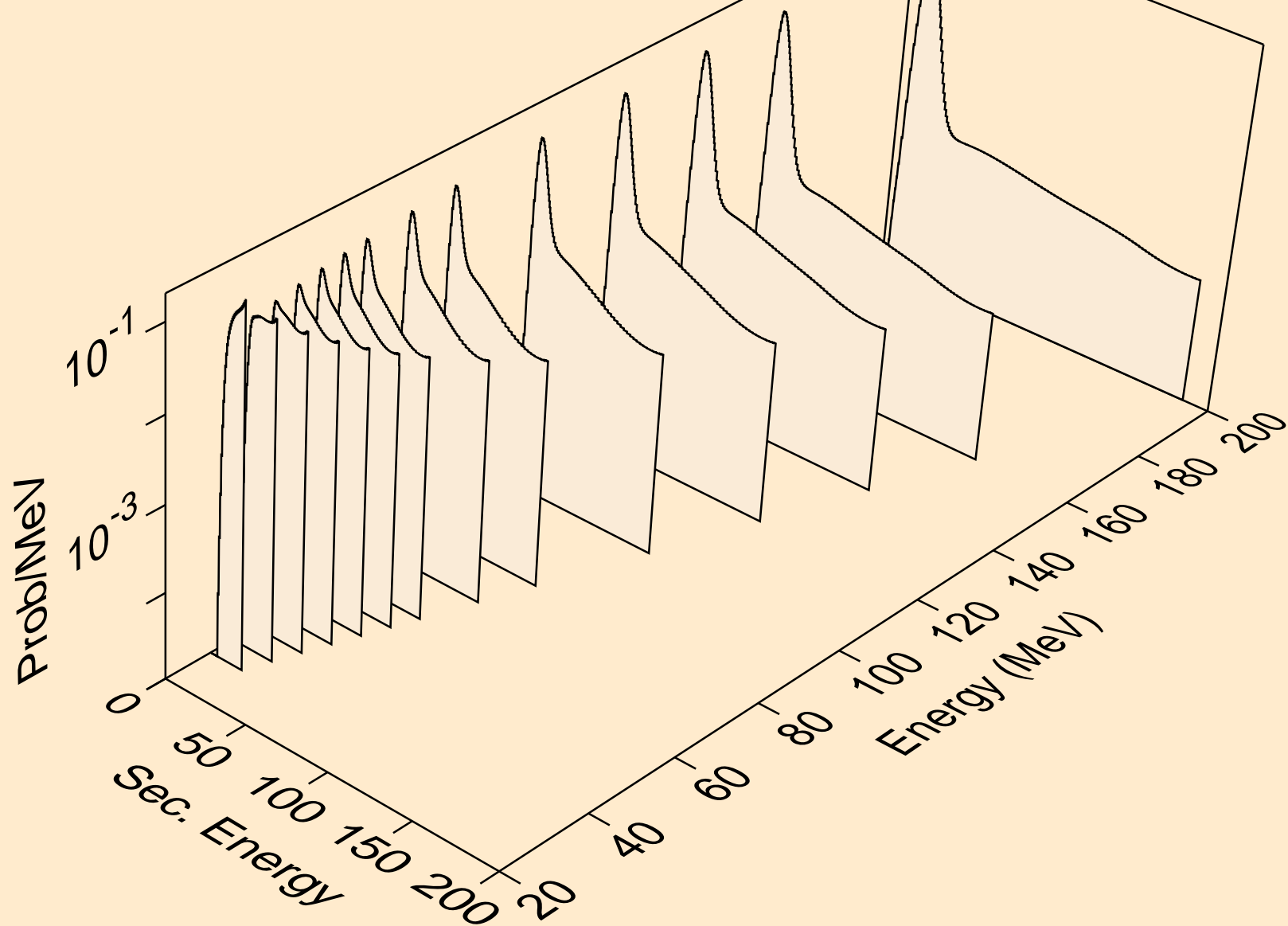

HF163 PHOTON ACER TENDL-2024 LIBRARY; T=0.K  
deuterons from (g,n\*)d

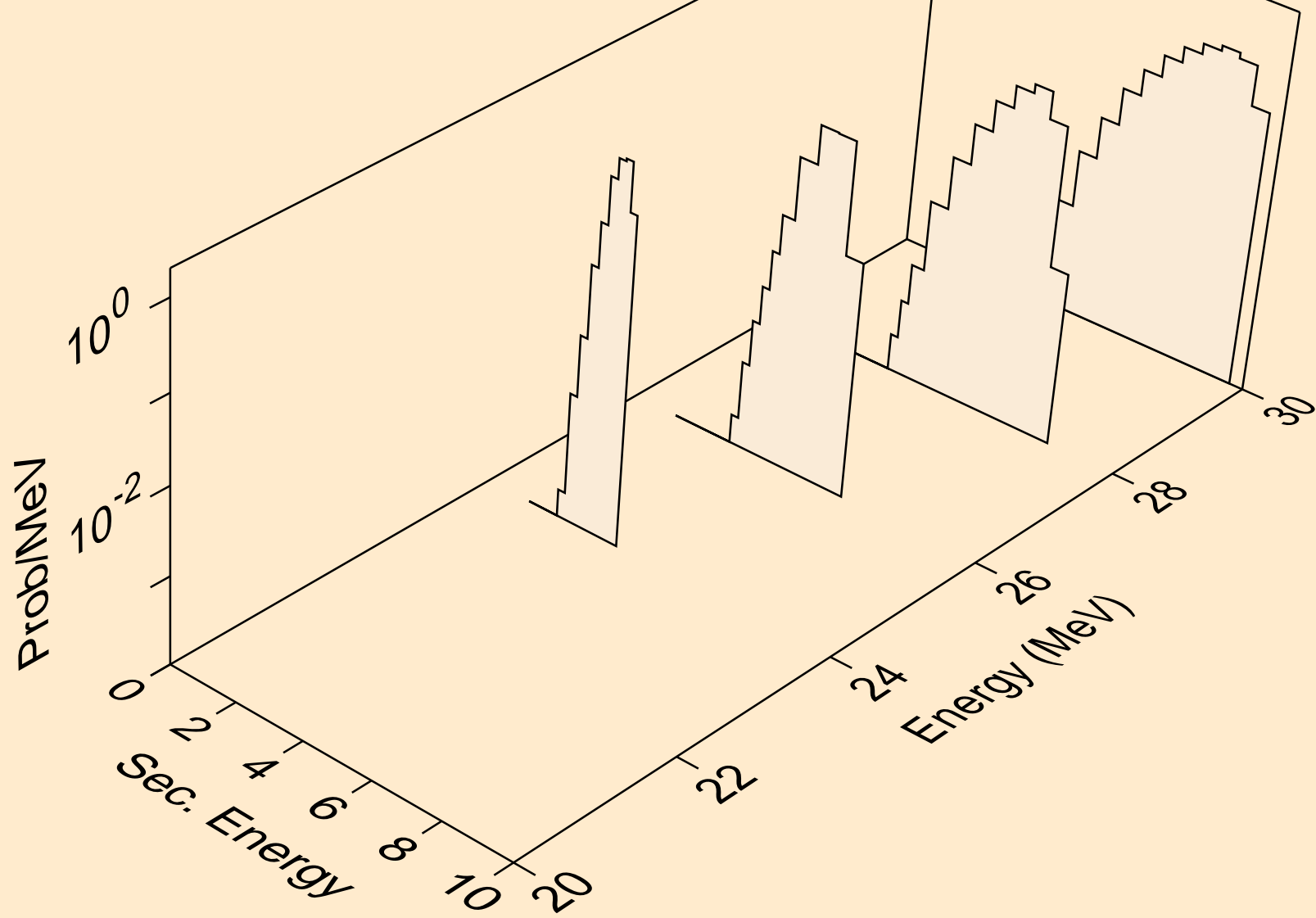

HF163 PHOTON ACER TENDL-2024 LIBRARY; T=0.K  
deuterons from (g,d)

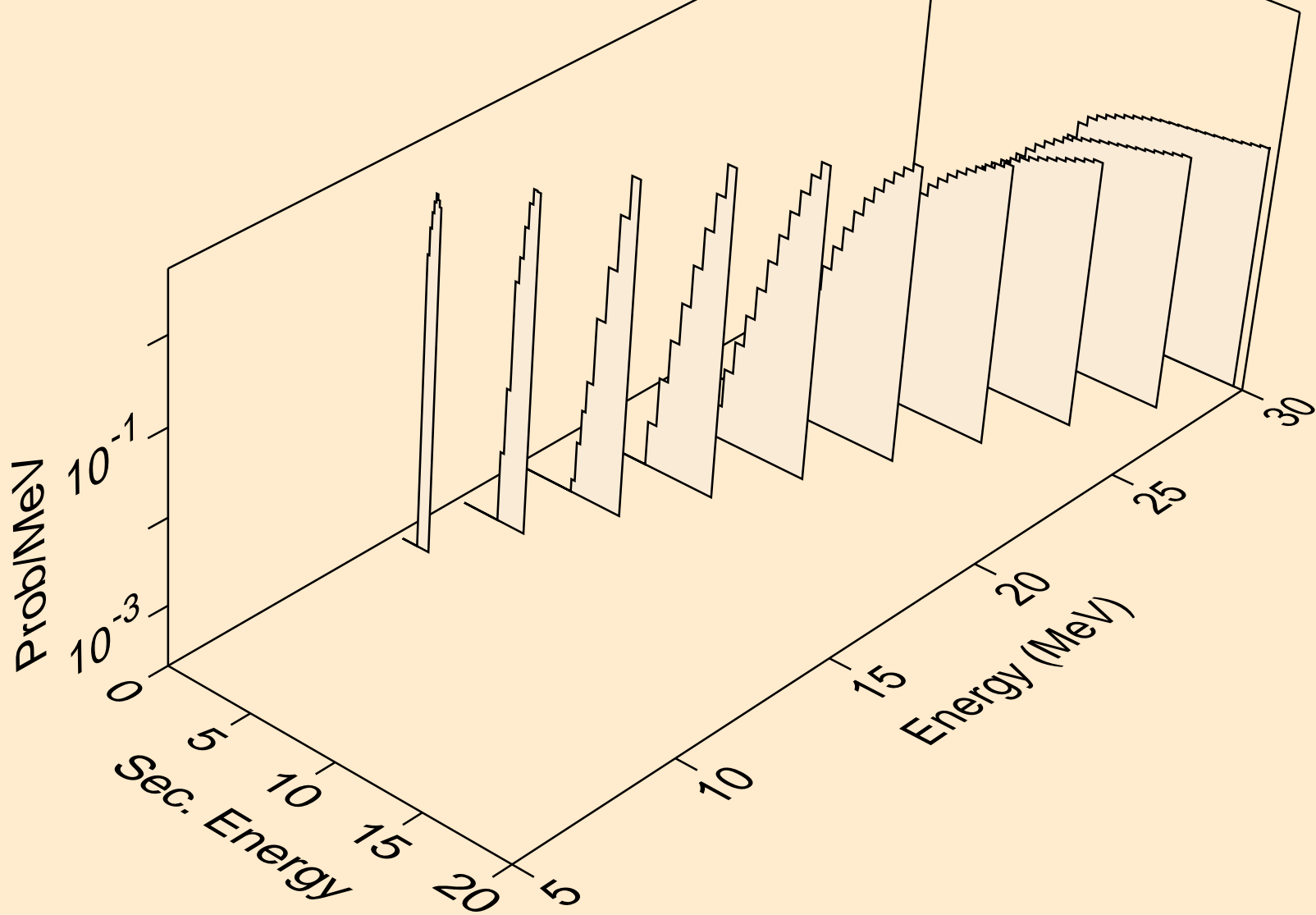

HF163 PHOTON ACER TENDL-2024 LIBRARY; T=0.K  
deuterons from (g,pd)

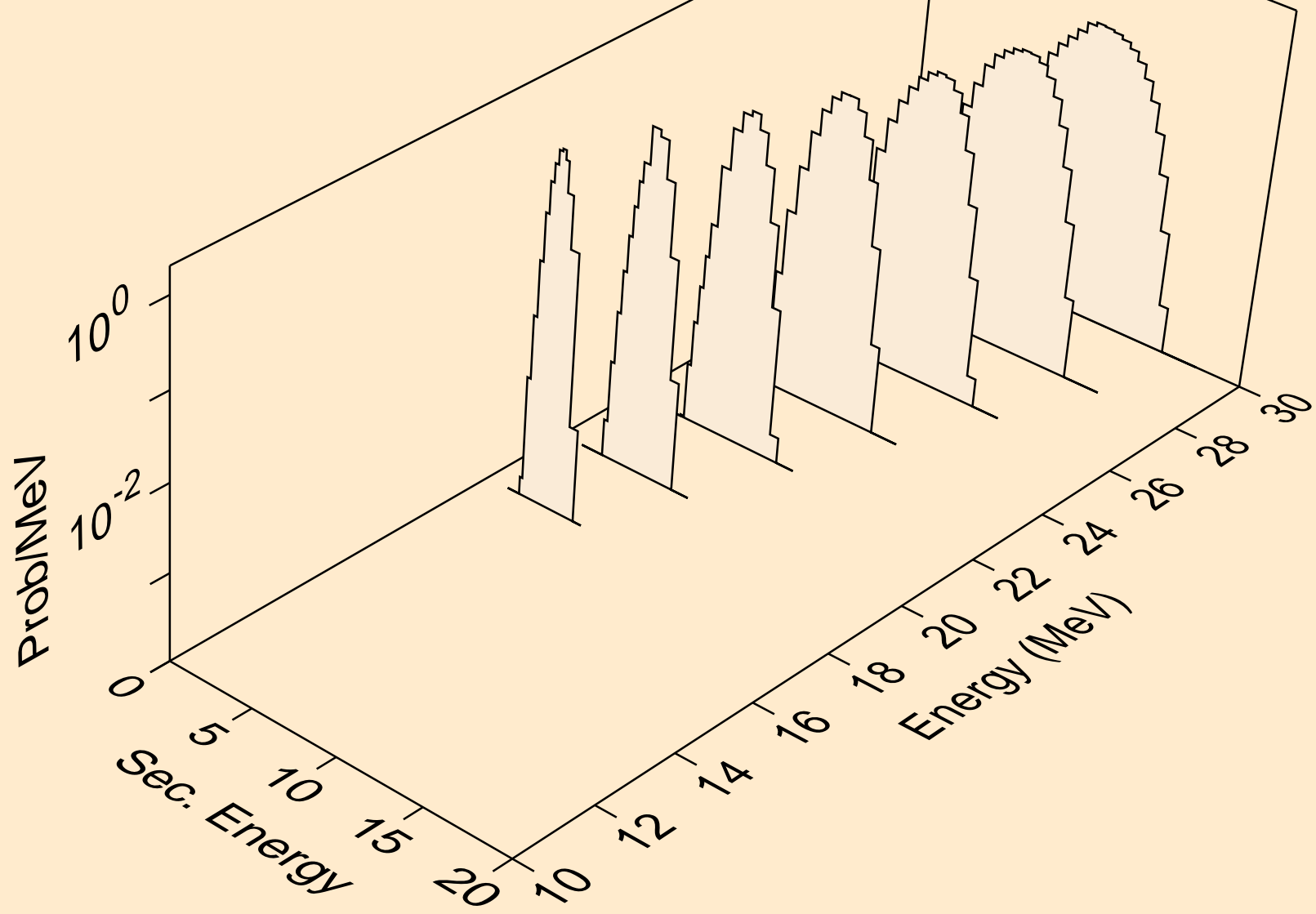

HF163 PHOTON ACER TENDL-2024 LIBRARY; T=0.K  
deuterons from (g,da)

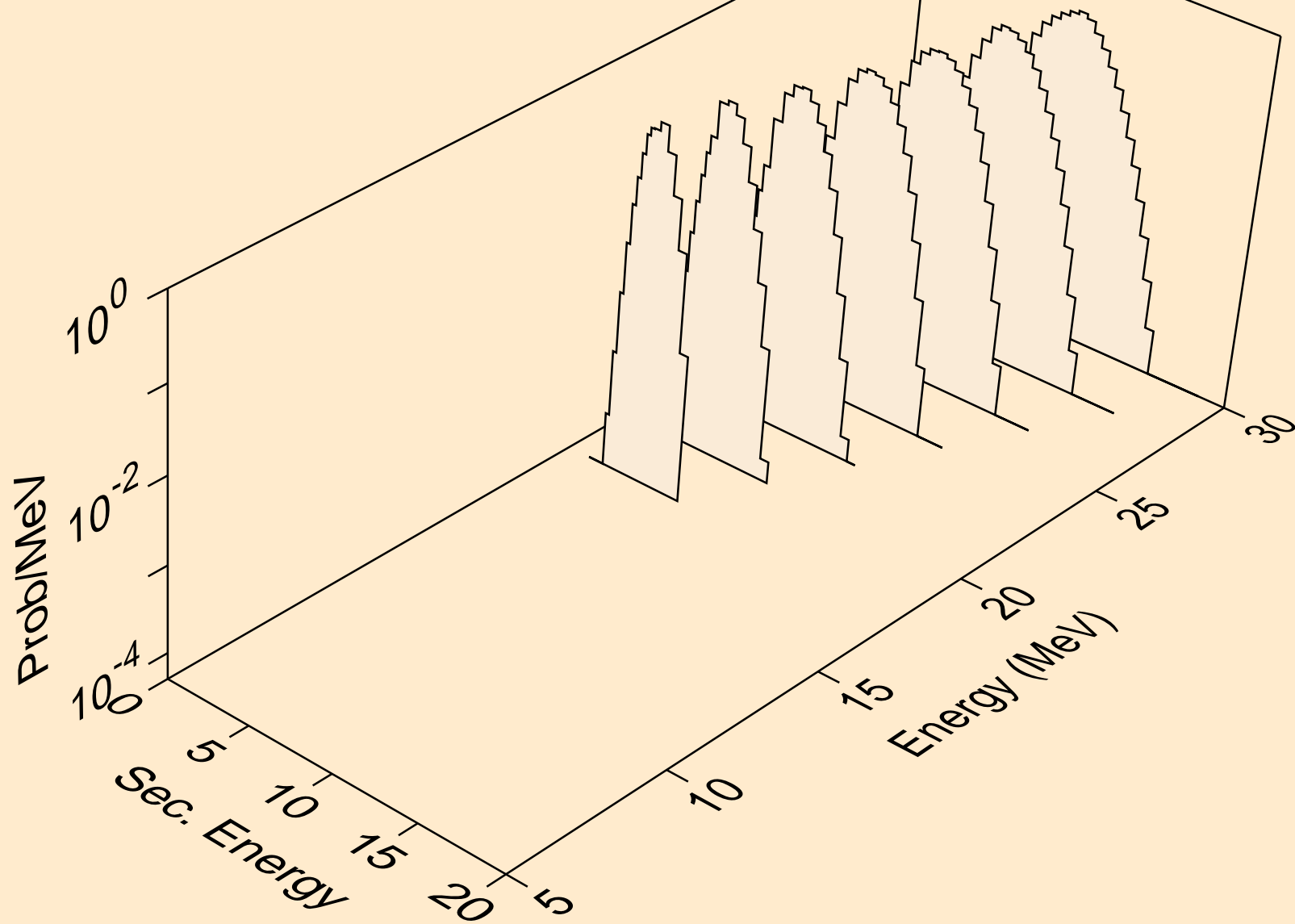

HF163 PHOTON ACER TENDL-2024 LIBRARY; T=0.K  
tritons from (g,x)

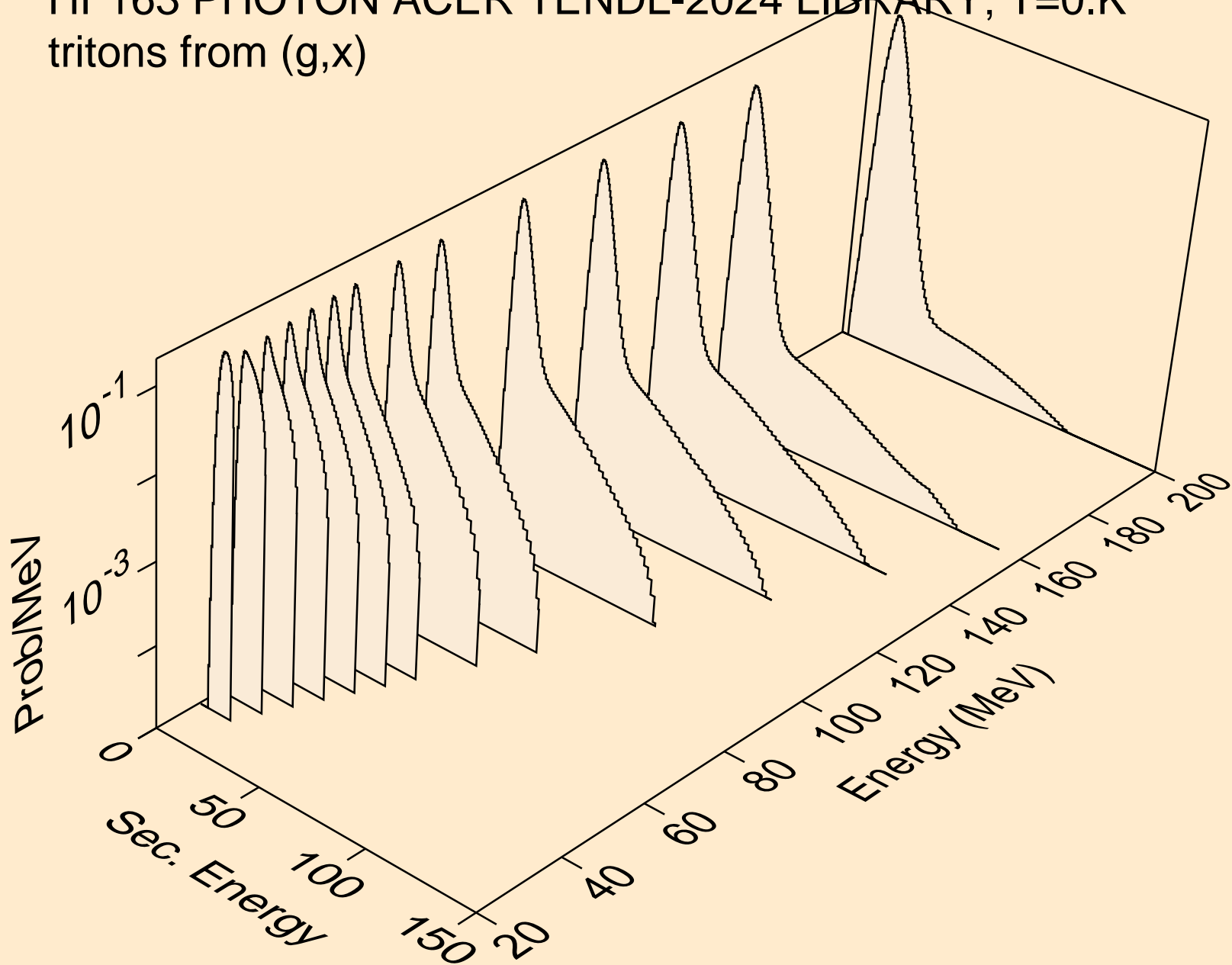

HF163 PHOTON ACER TENDL-2024 LIBRARY; T=0.K  
tritons from (g,t)

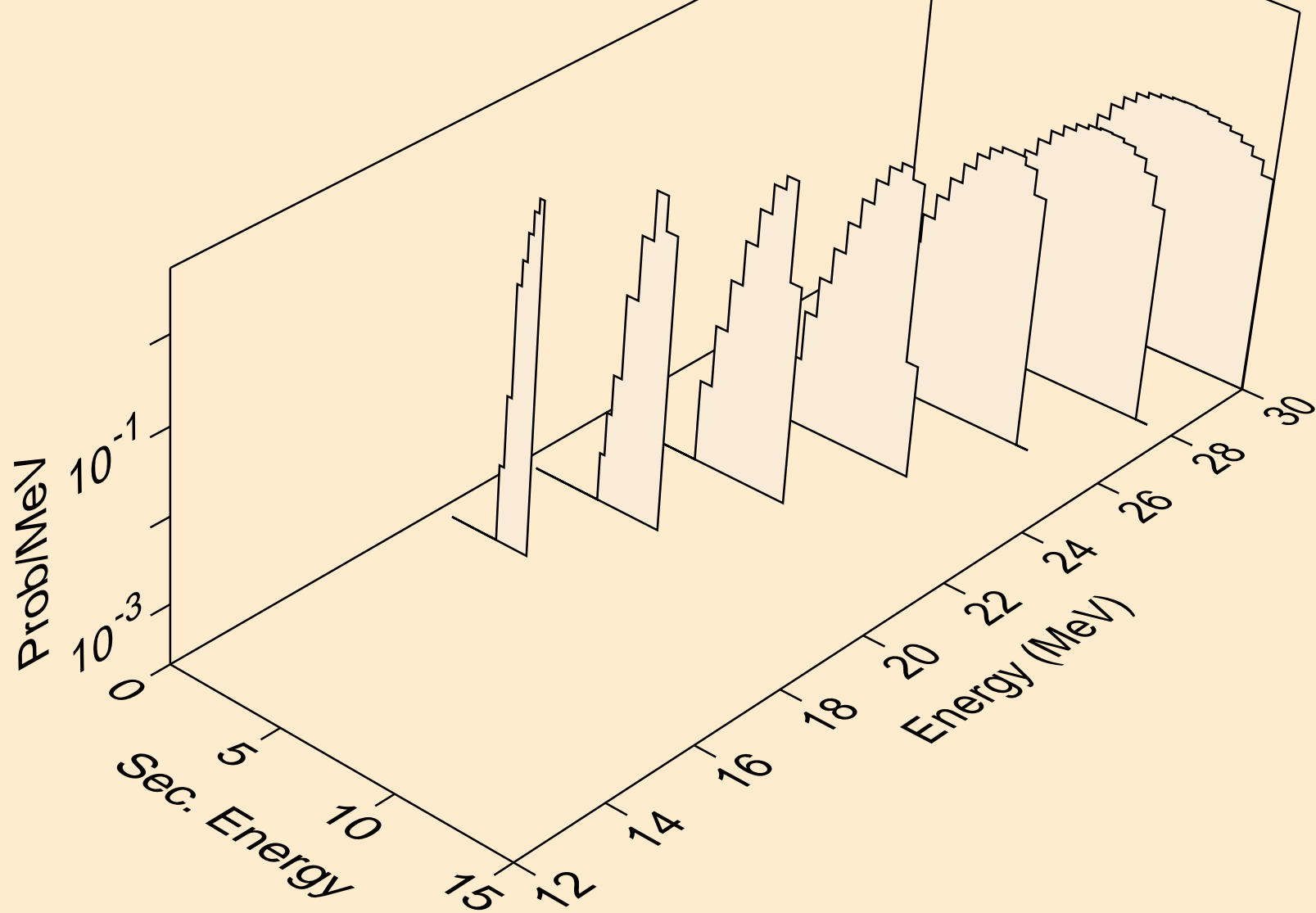

HF163 PHOTON ACER TENDL-2024 LIBRARY; T=0.K  
tritons from (g,pt)

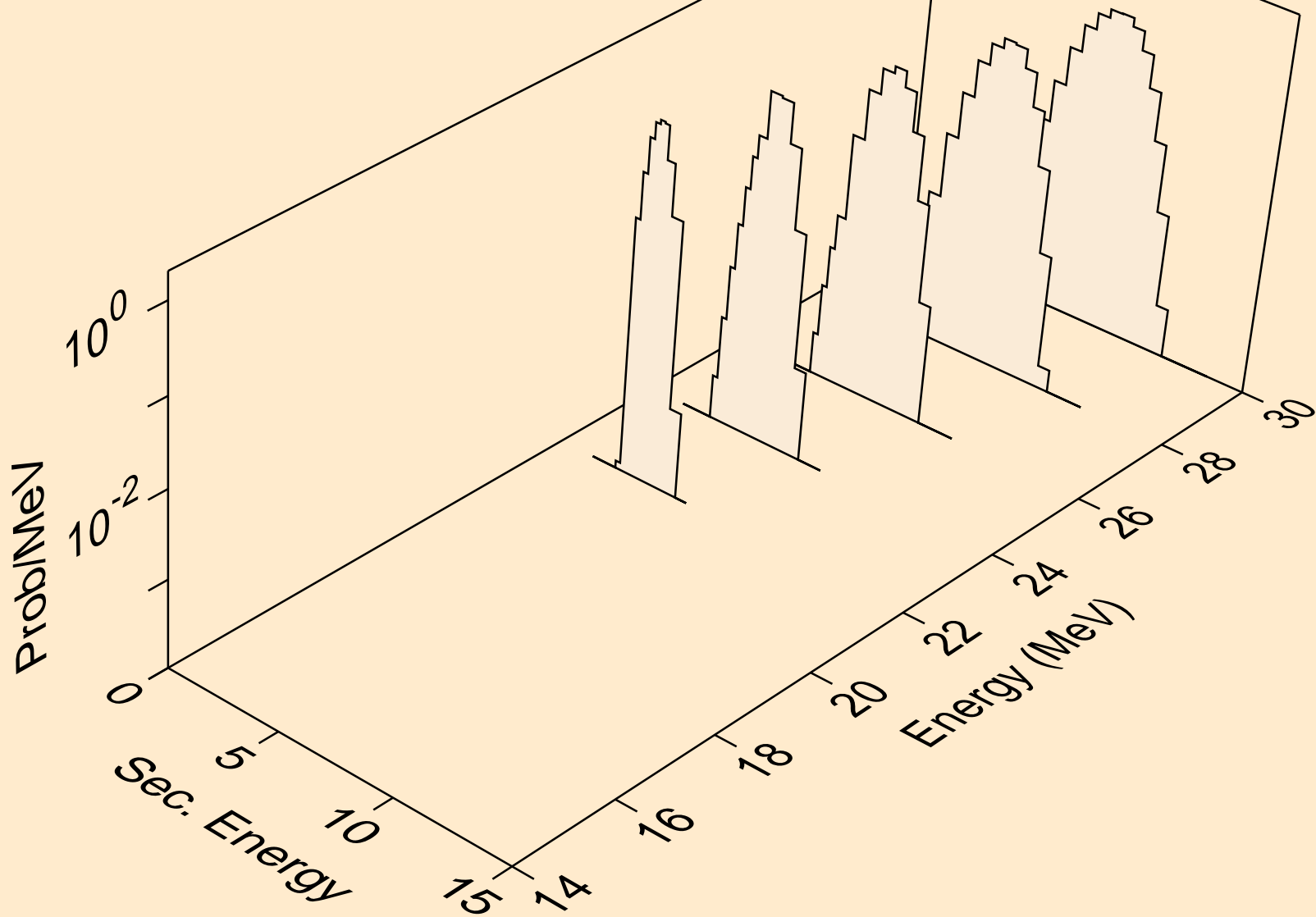

HF163 PHOTON ACER TENDL-2024 LIBRARY; T=0.K  
he3s from (g,x)

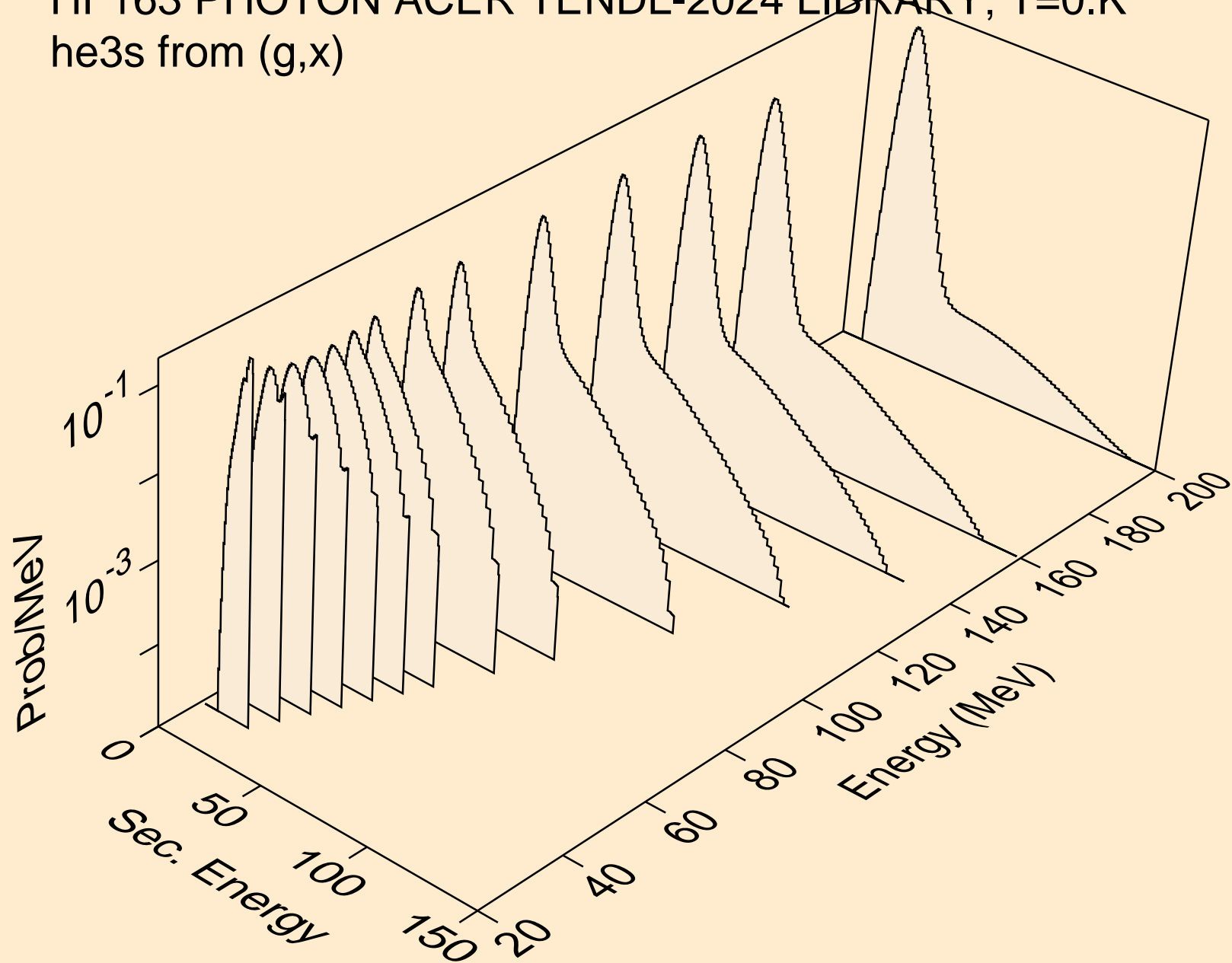

HF163 PHOTON ACER TENDL-2024 LIBRARY; T=0.K  
he3s from (g,he3)

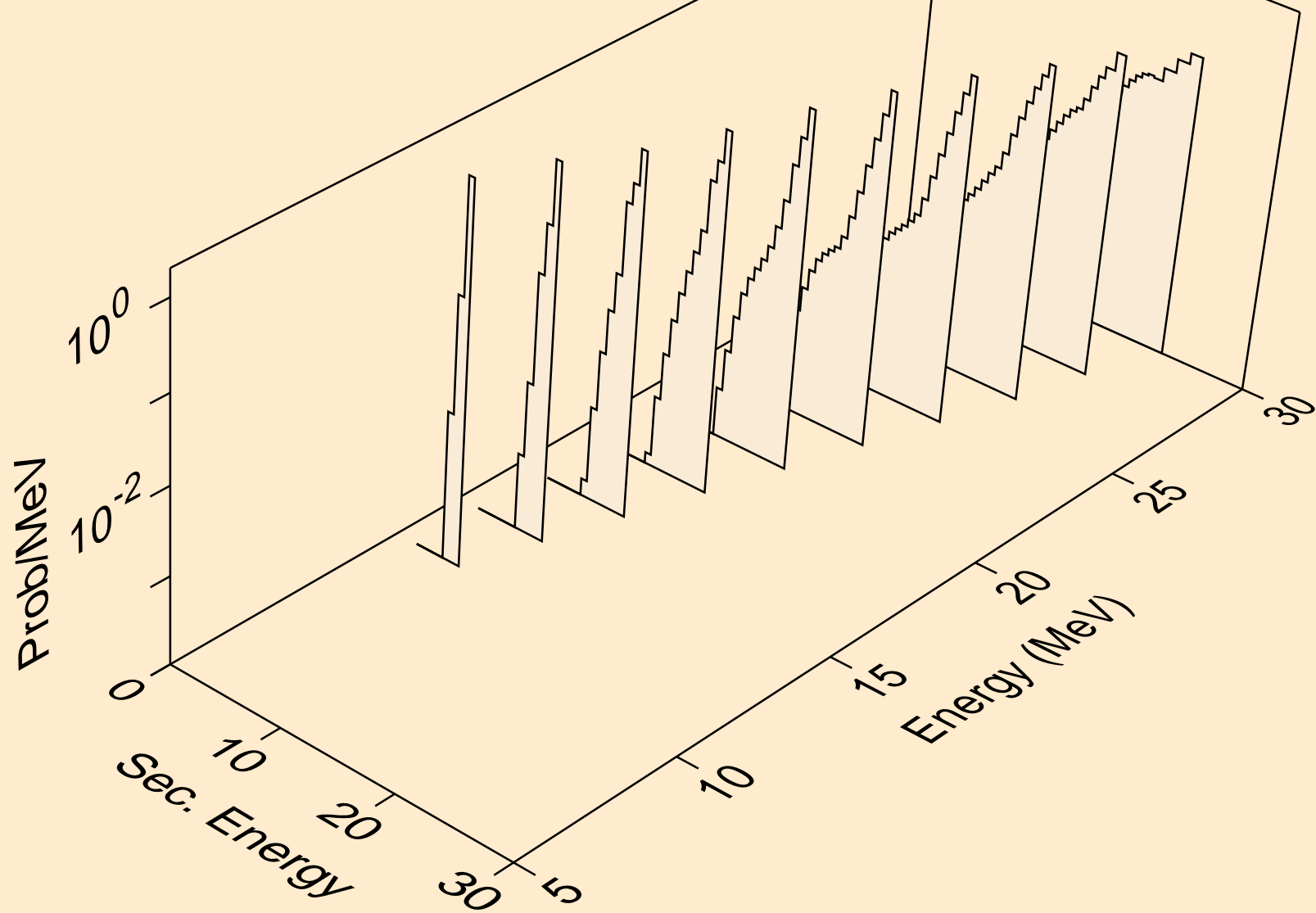

HF163 PHOTON ACER TENDL-2024 LIBRARY; T=0.K  
alphas from (g,x)

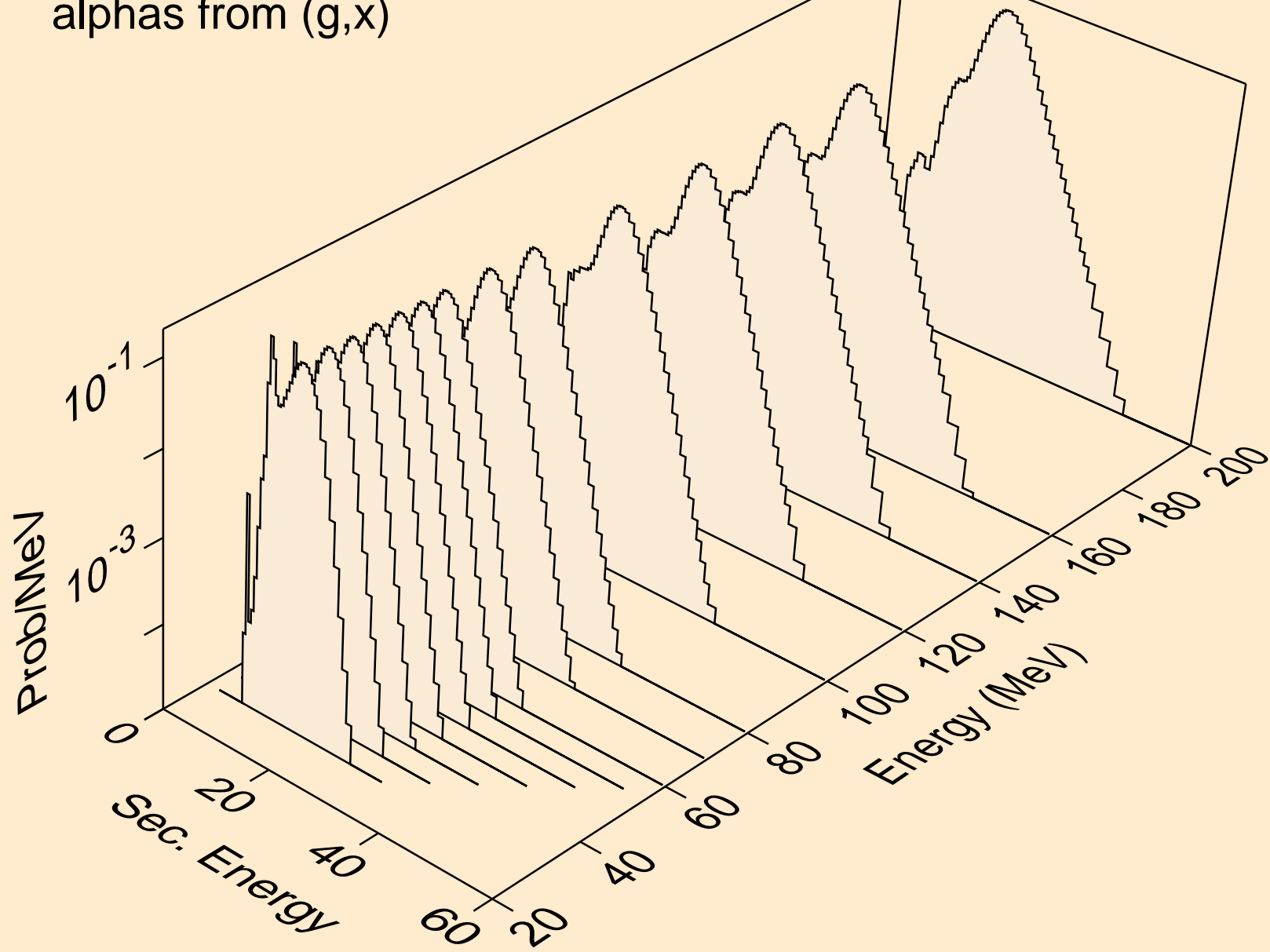

HF163 PHOTON ACER TENDL-2024 LIBRARY; T=0.K  
alphas from (g,n\*)a

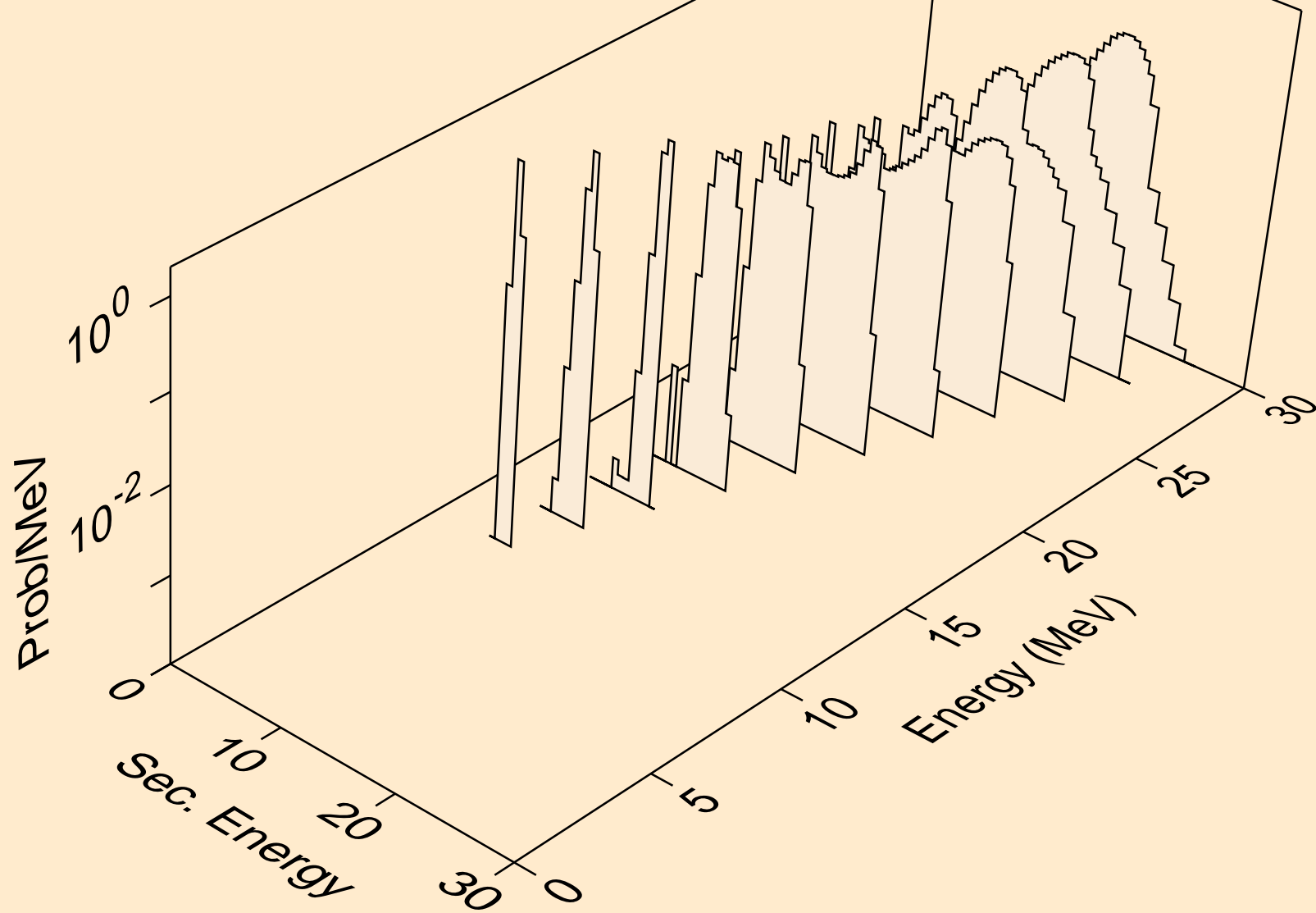

HF163 PHOTON ACER TENDL-2024 LIBRARY; T=0.K  
alphas from (g,2n)a

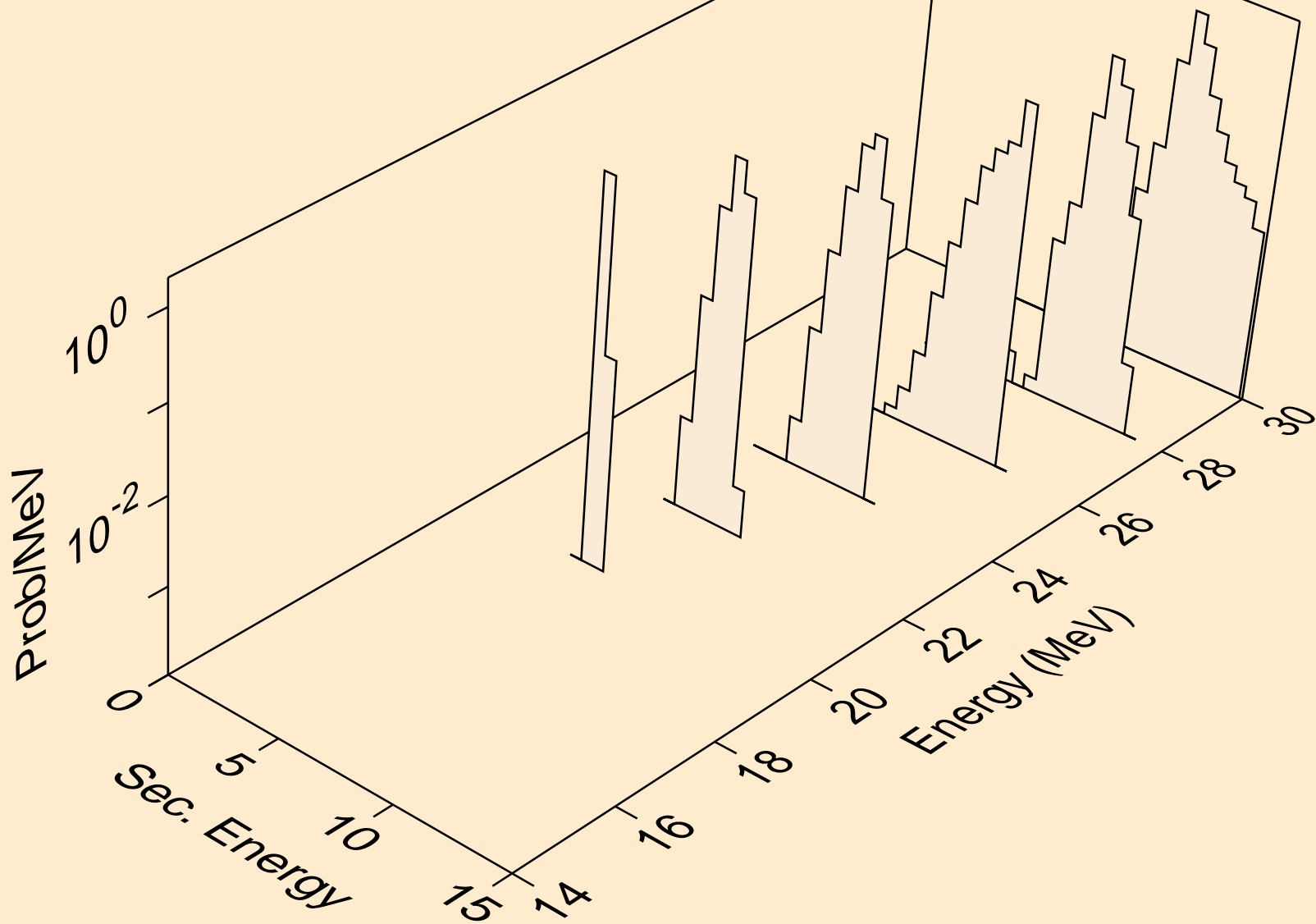

HF163 PHOTON ACER TENDL-2024 LIBRARY; T=0.K  
alphas from (g,n\*)2a

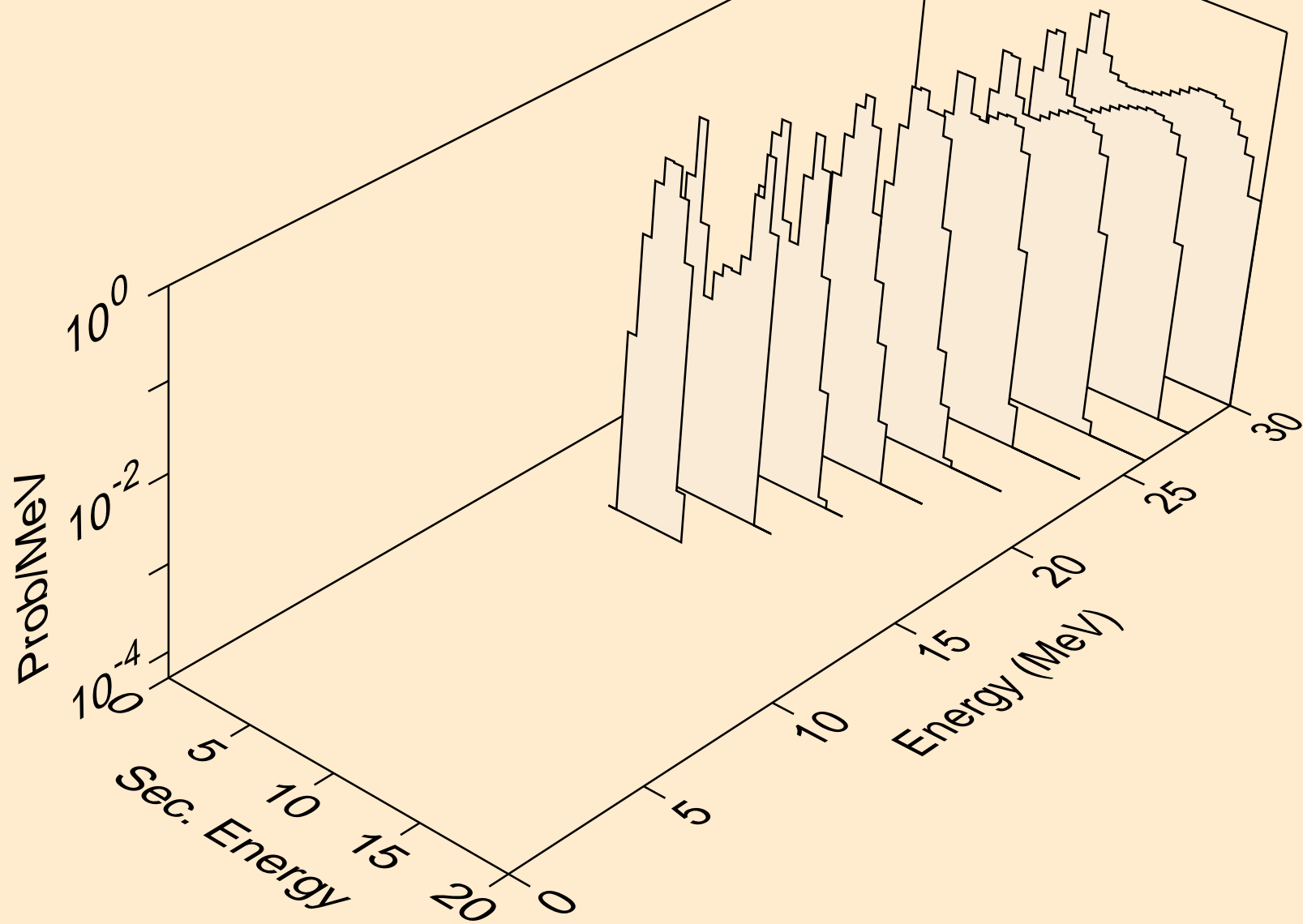

HF163 PHOTON ACER TENDL-2024 LIBRARY; T=0.K  
alphas from (g,npa)

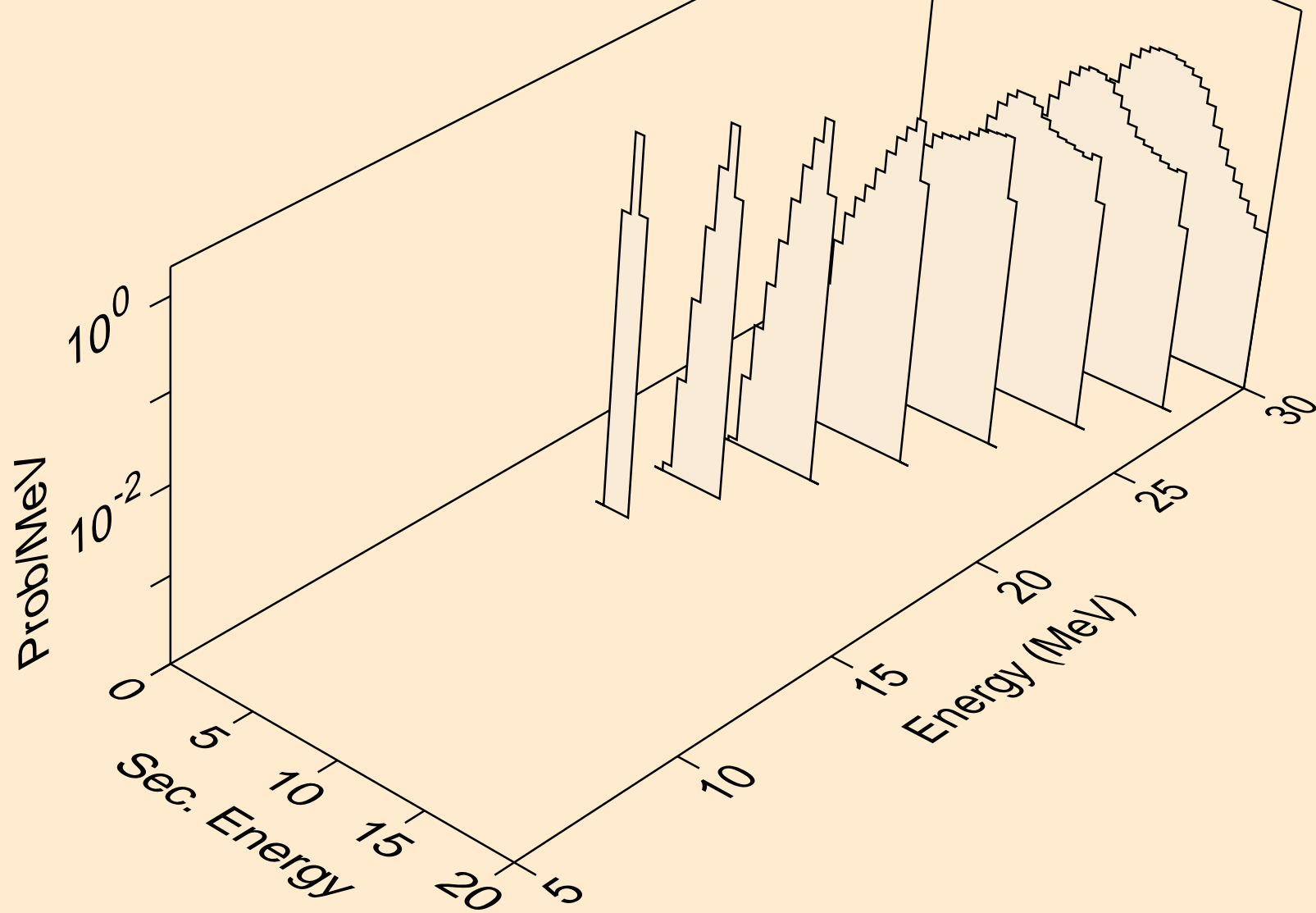

HF163 PHOTON ACER TENDL-2024 LIBRARY; T=0.K  
alphas from (g,a)

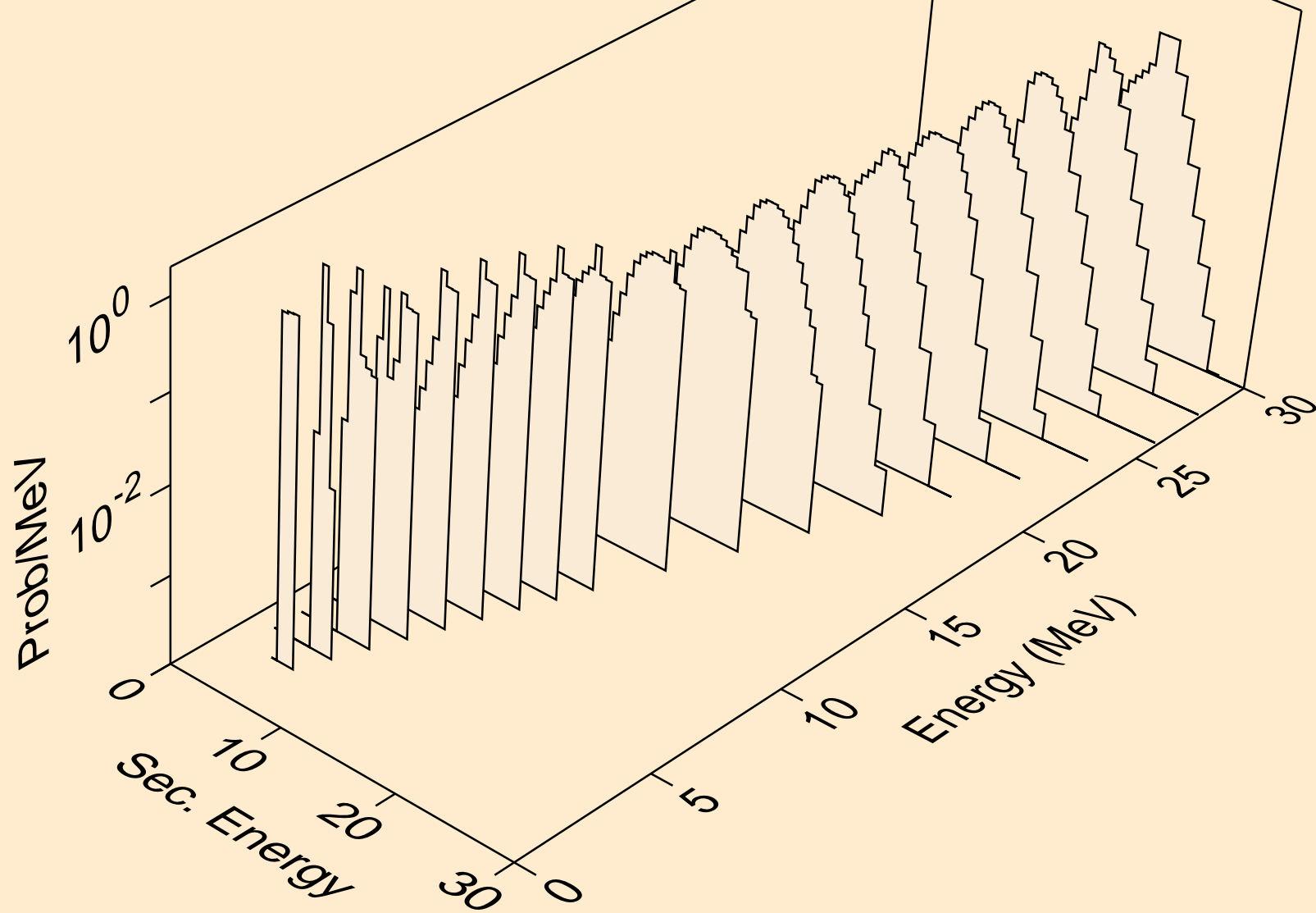

HF163 PHOTON ACER TENDL-2024 LIBRARY; T=0.K  
alphas from (g,2a)

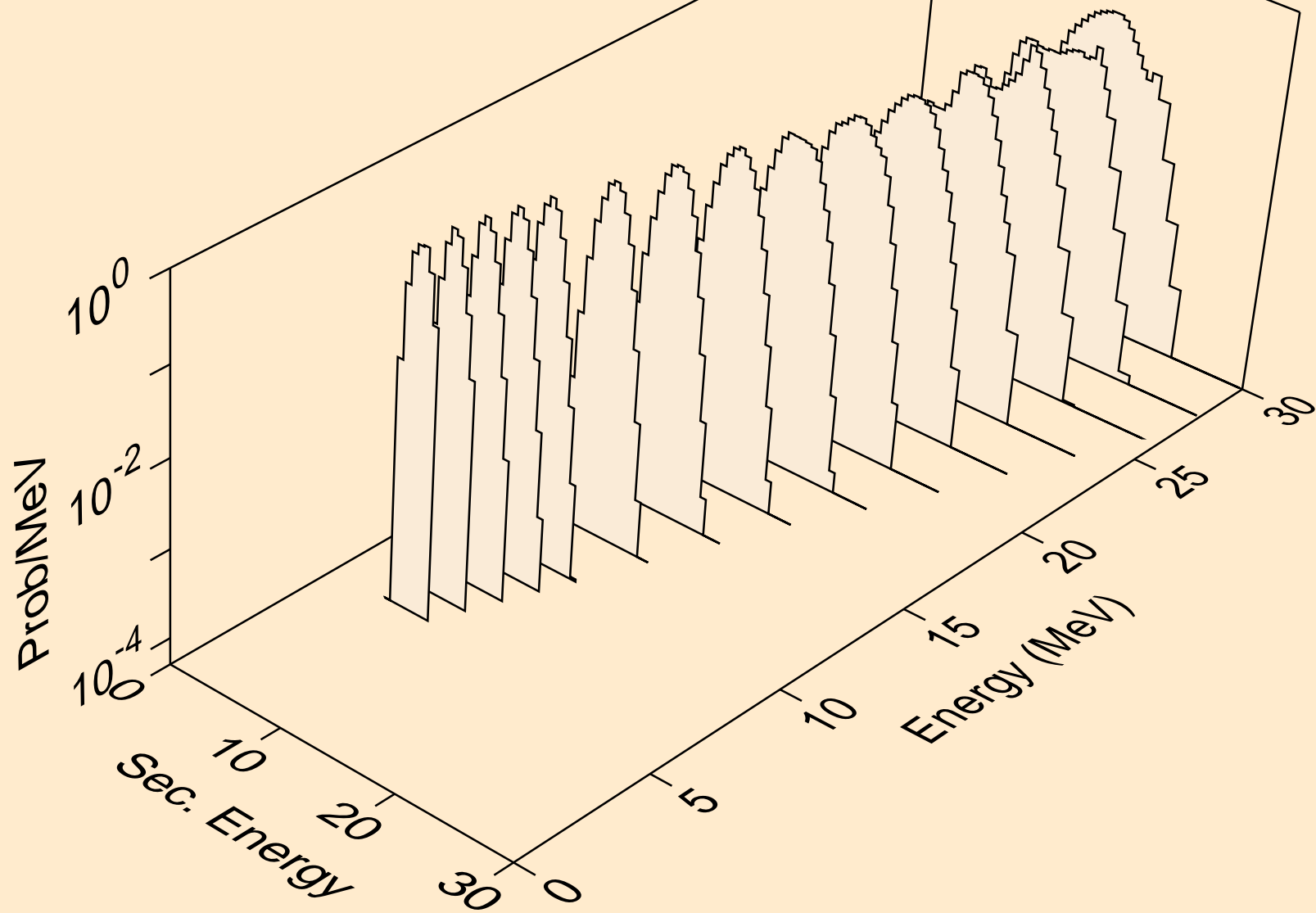

HF163 PHOTON ACER TENDL-2024 LIBRARY; T=0.K  
alphas from (g,pa)

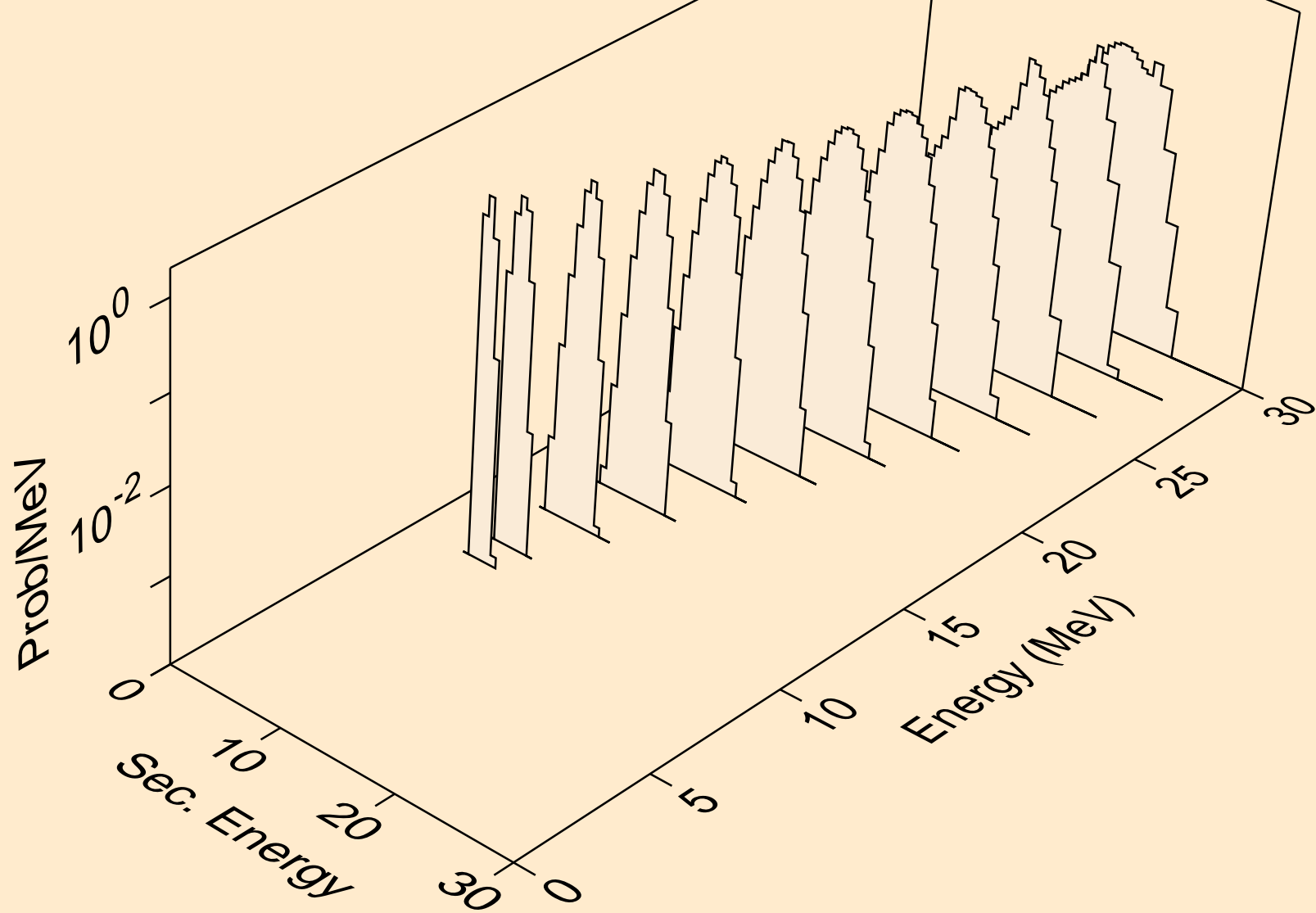

HF163 PHOTON ACER TENDL-2024 LIBRARY; T=0.K  
alphas from (g,da)

