

O016 PHOTON ACER TENDL-2024 LIBRARY; T=0.K  
Principal cross sections

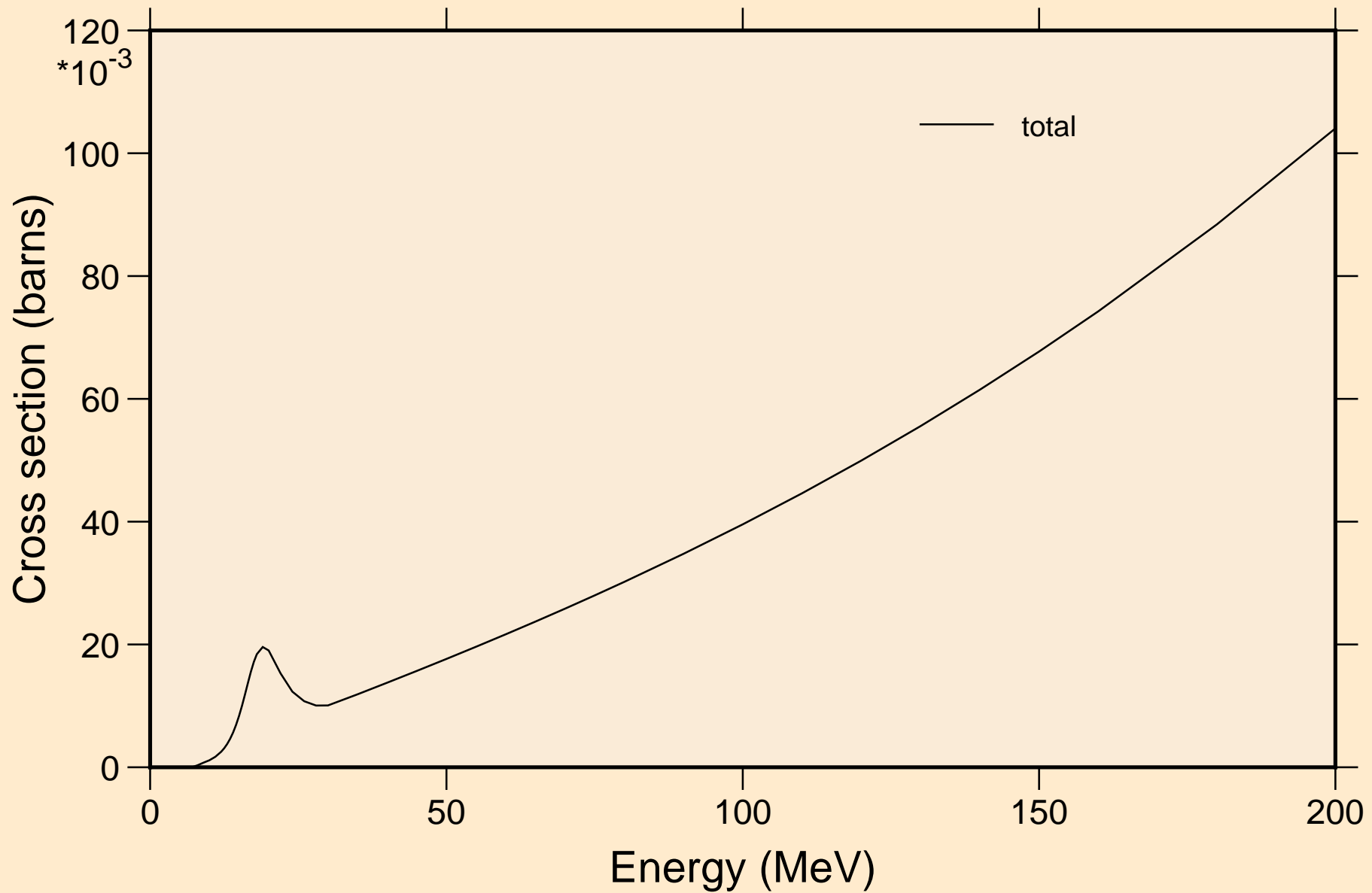



# O016 PHOTON ACER TENDL-2024 LIBRARY; T=0.K

## Heating

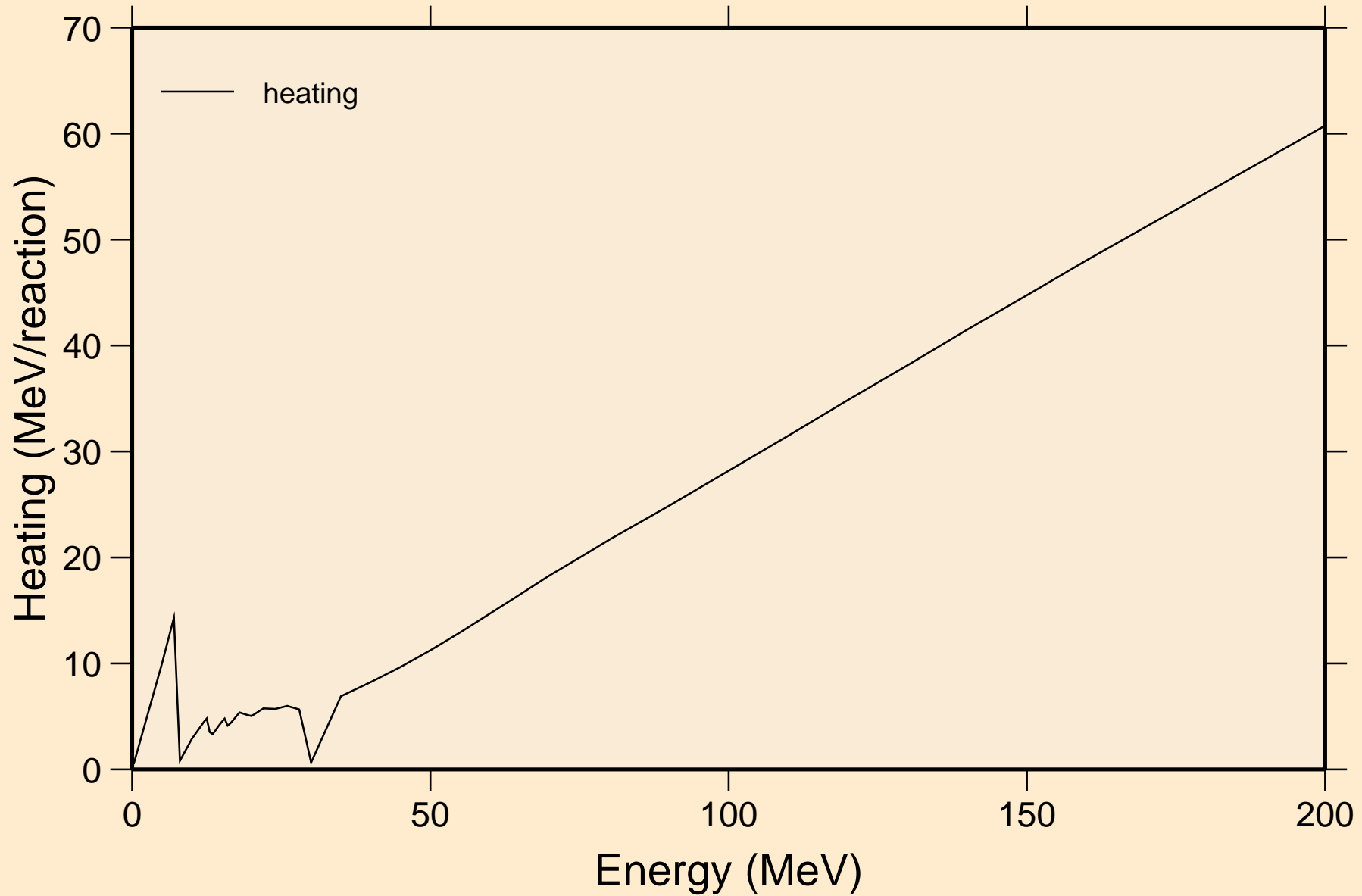

O016 PHOTON ACER TENDL-2024 LIBRARY; T=0.K  
Particle heating contributions

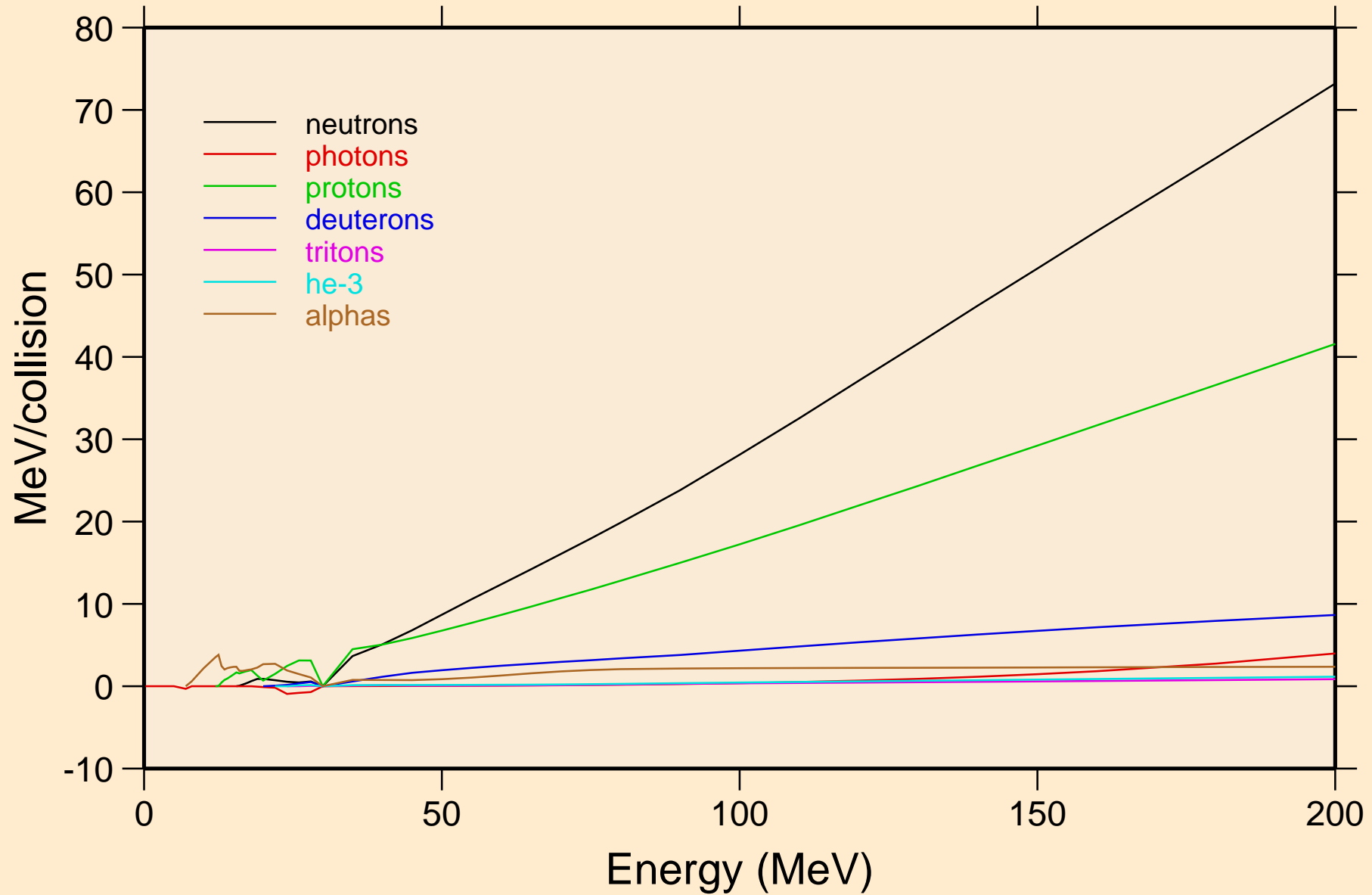

O016 PHOTON ACER TENDL-2024 LIBRARY; T=0.K  
Particle production cross sections

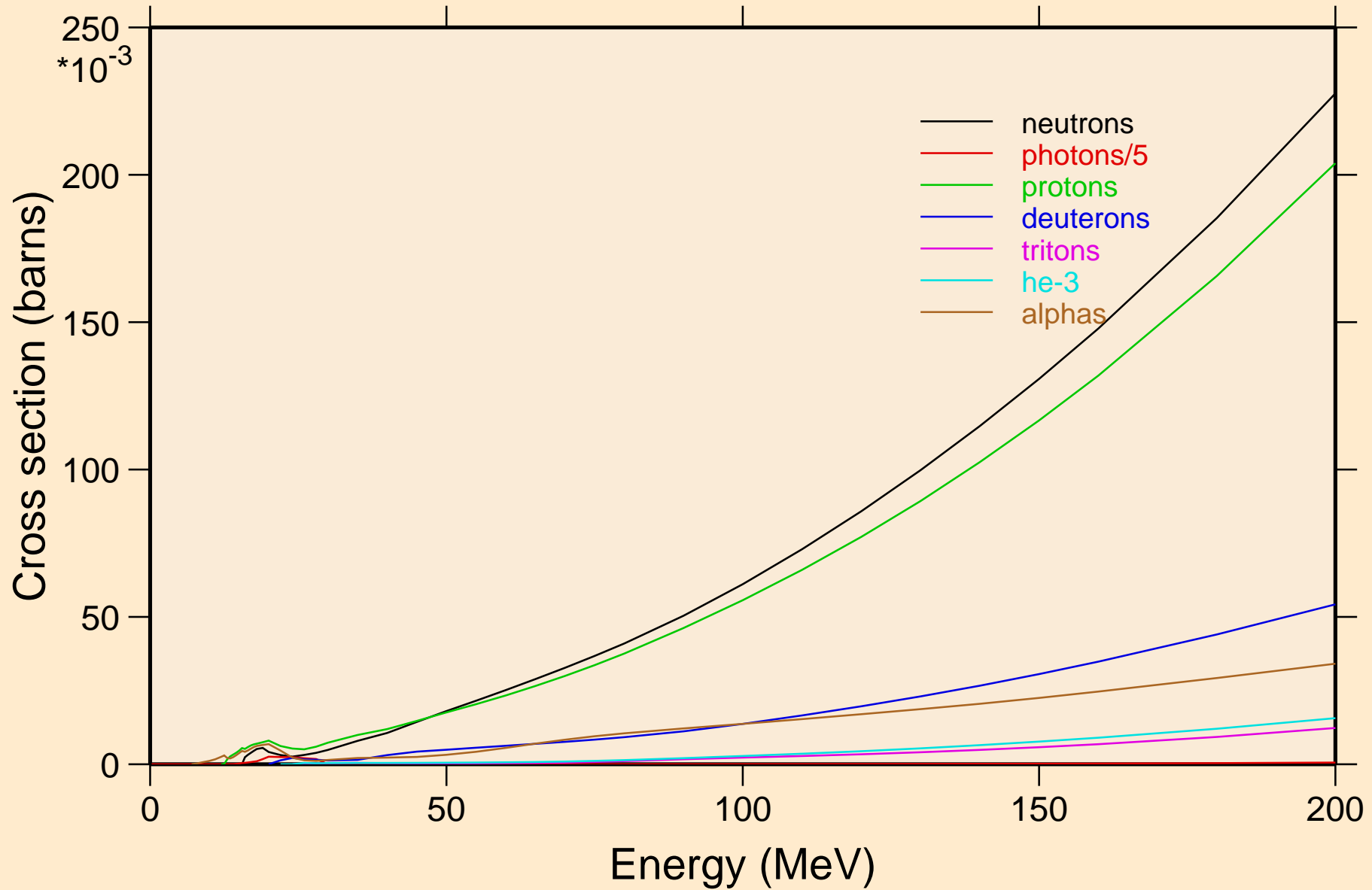

O016 PHOTON ACER TENDL-2024 LIBRARY; T=0.K  
neutrons from (g,x)

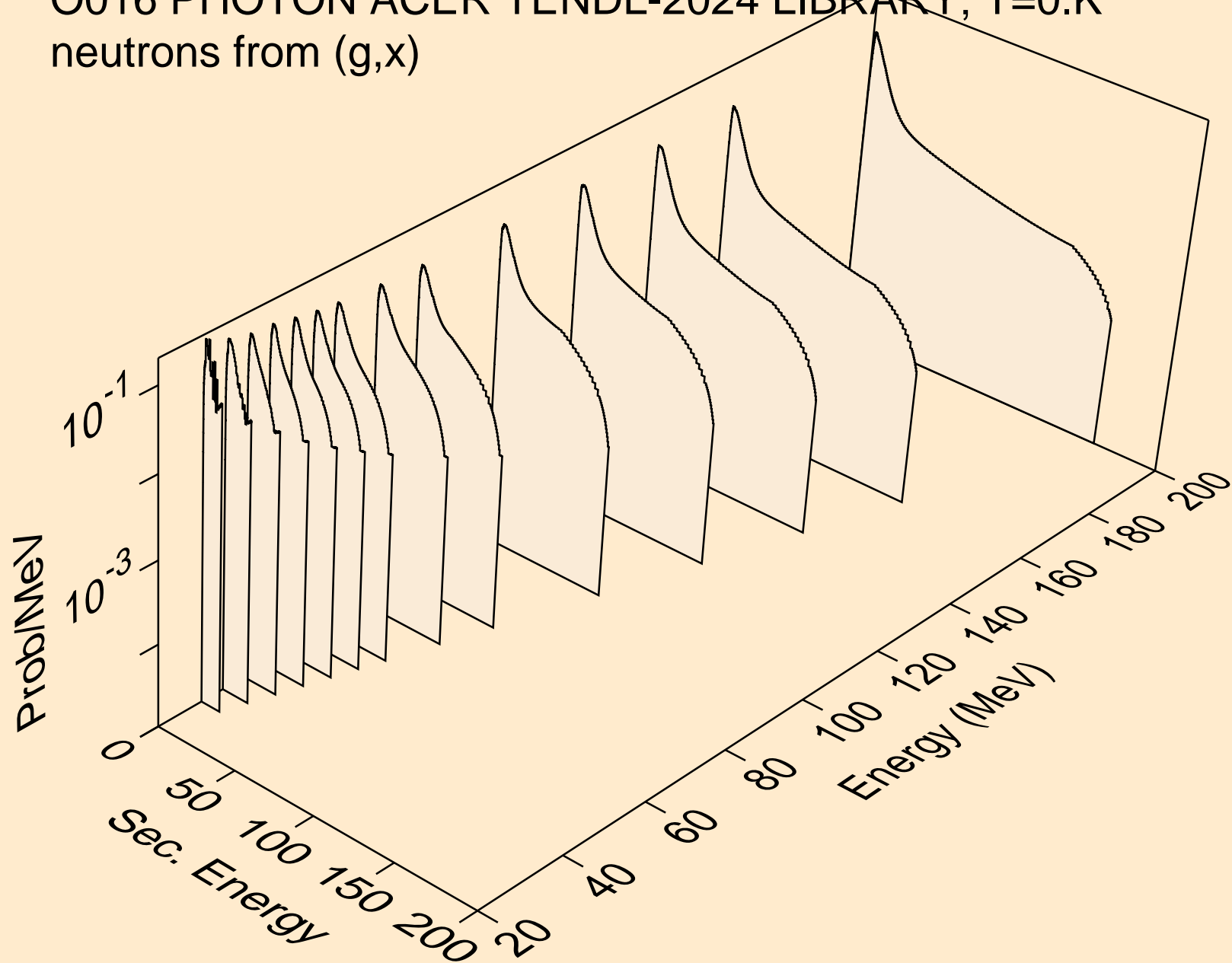

O016 PHOTON ACER TENDL-2024 LIBRARY; T=0.K  
neutrons from (g,n\*)a

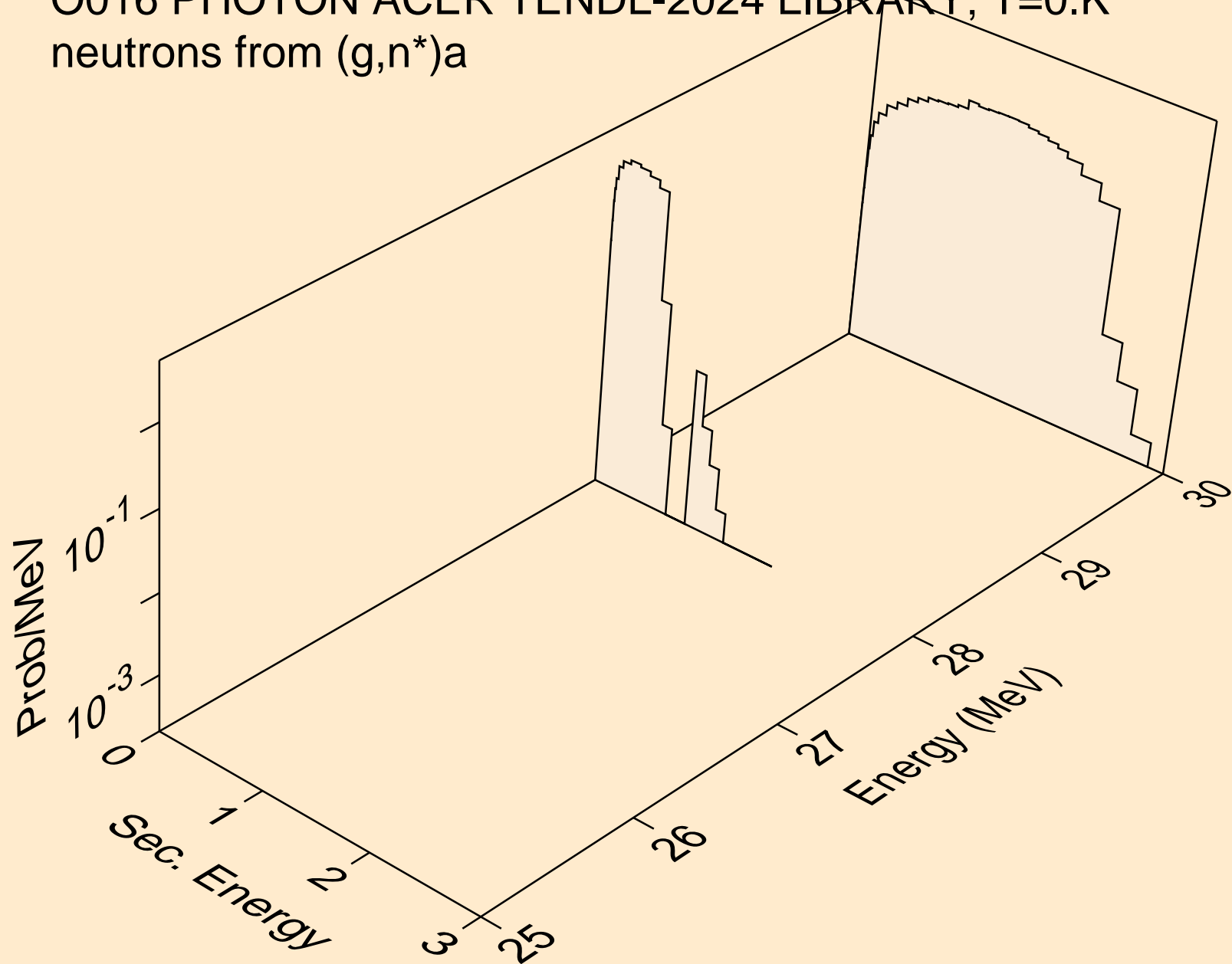

O016 PHOTON ACER TENDL-2024 LIBRARY; T=0.K  
neutrons from (g,n\*)p

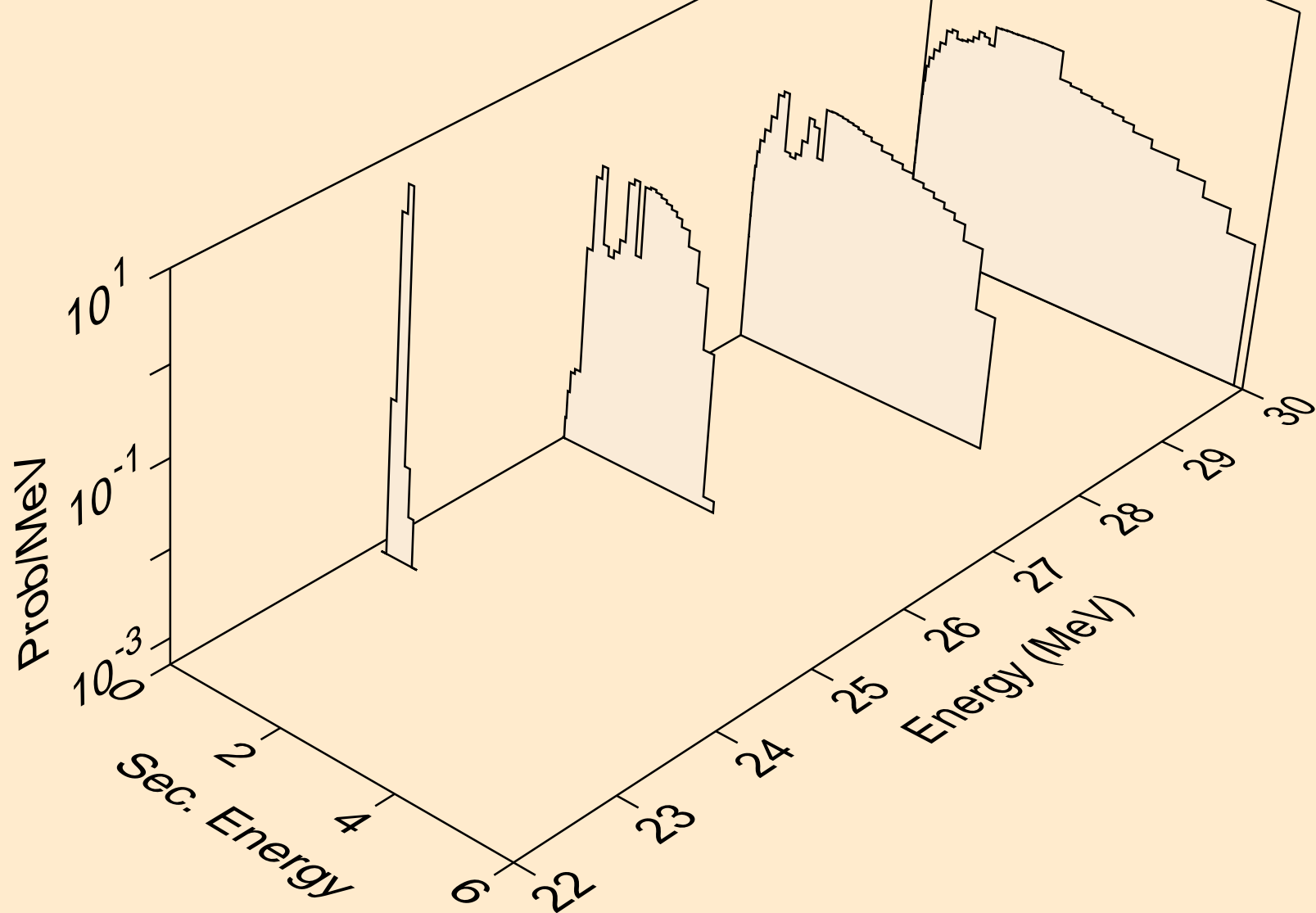

O016 PHOTON ACER TENDL-2024 LIBRARY; T=0.K  
angular distribution for (g,n\*0) neutron

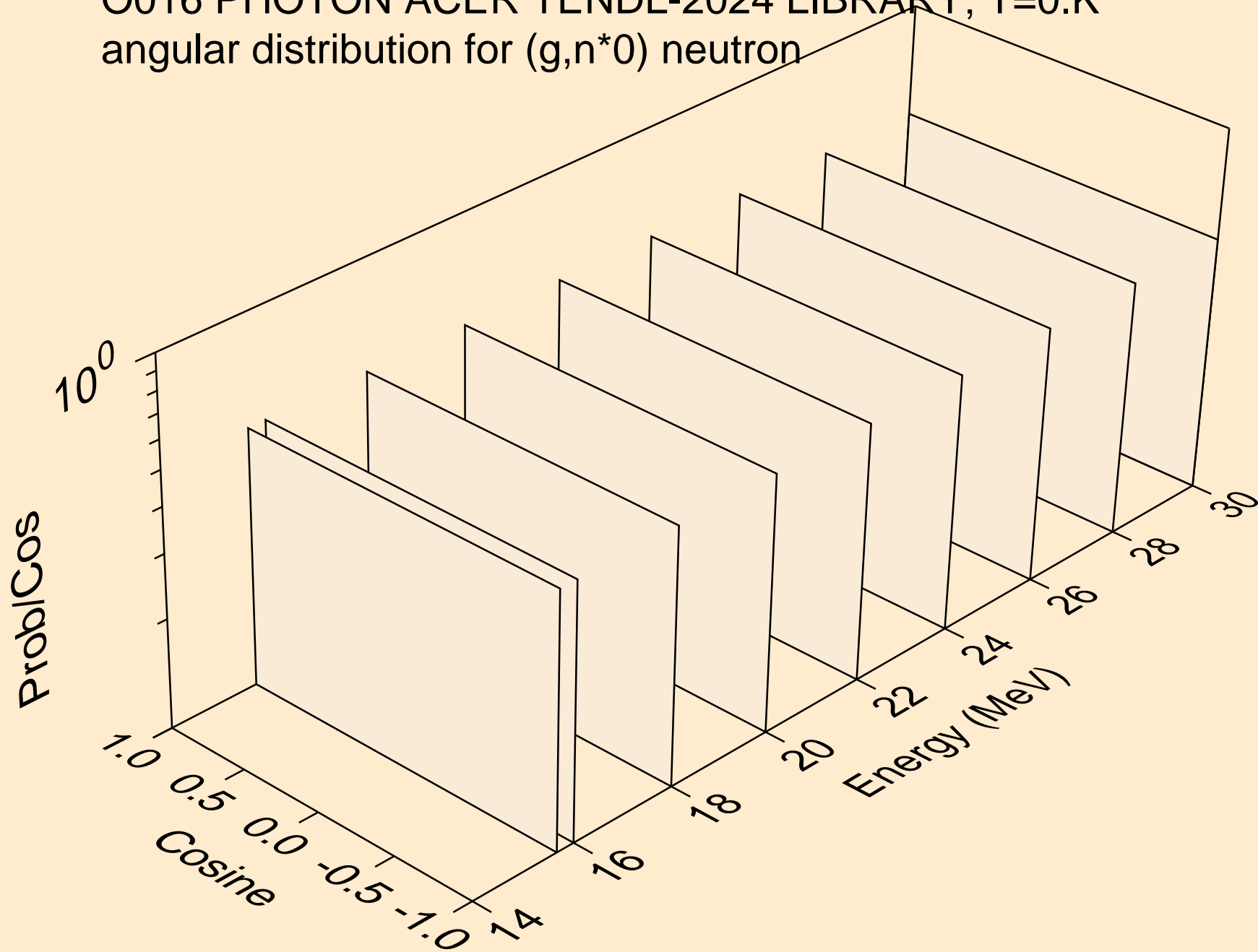

O016 PHOTON ACER TENDL-2024 LIBRARY; T=0.K  
angular distribution for (g,n\*1) neutron

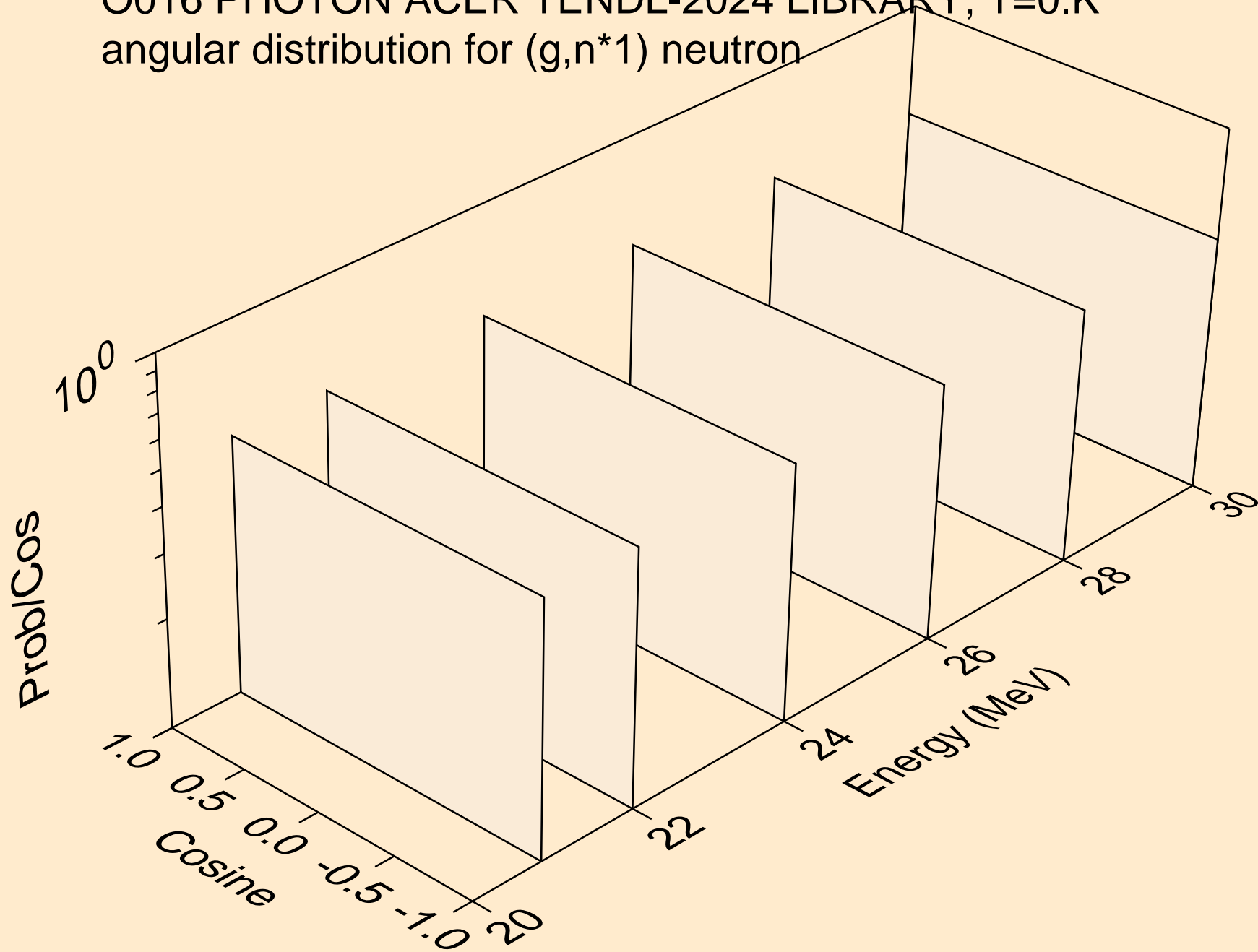

O016 PHOTON ACER TENDL-2024 LIBRARY; T=0.K  
photons from (g,x)

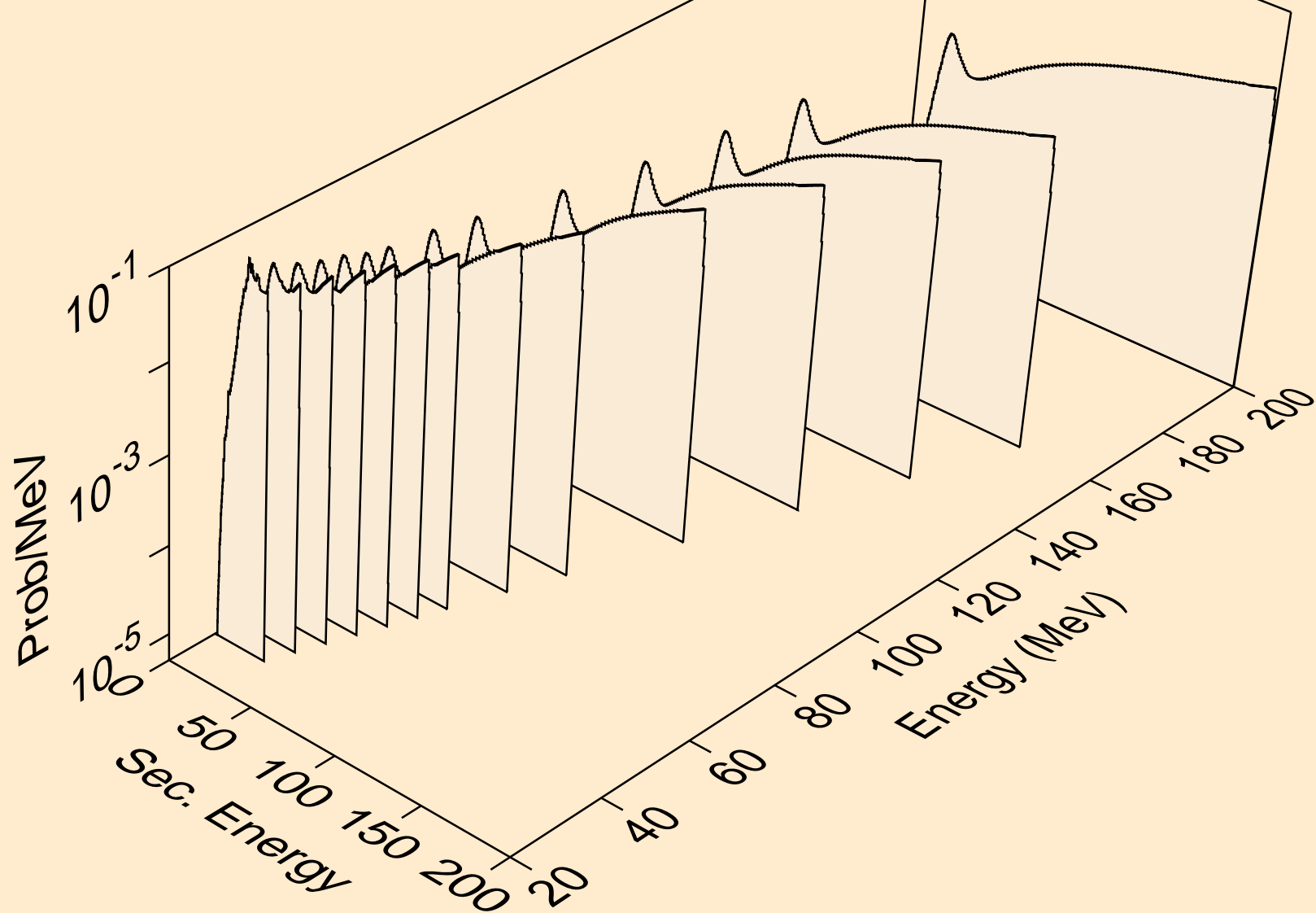

O016 PHOTON ACER TENDL-2024 LIBRARY; T=0.K  
photons from (g,n\*)a

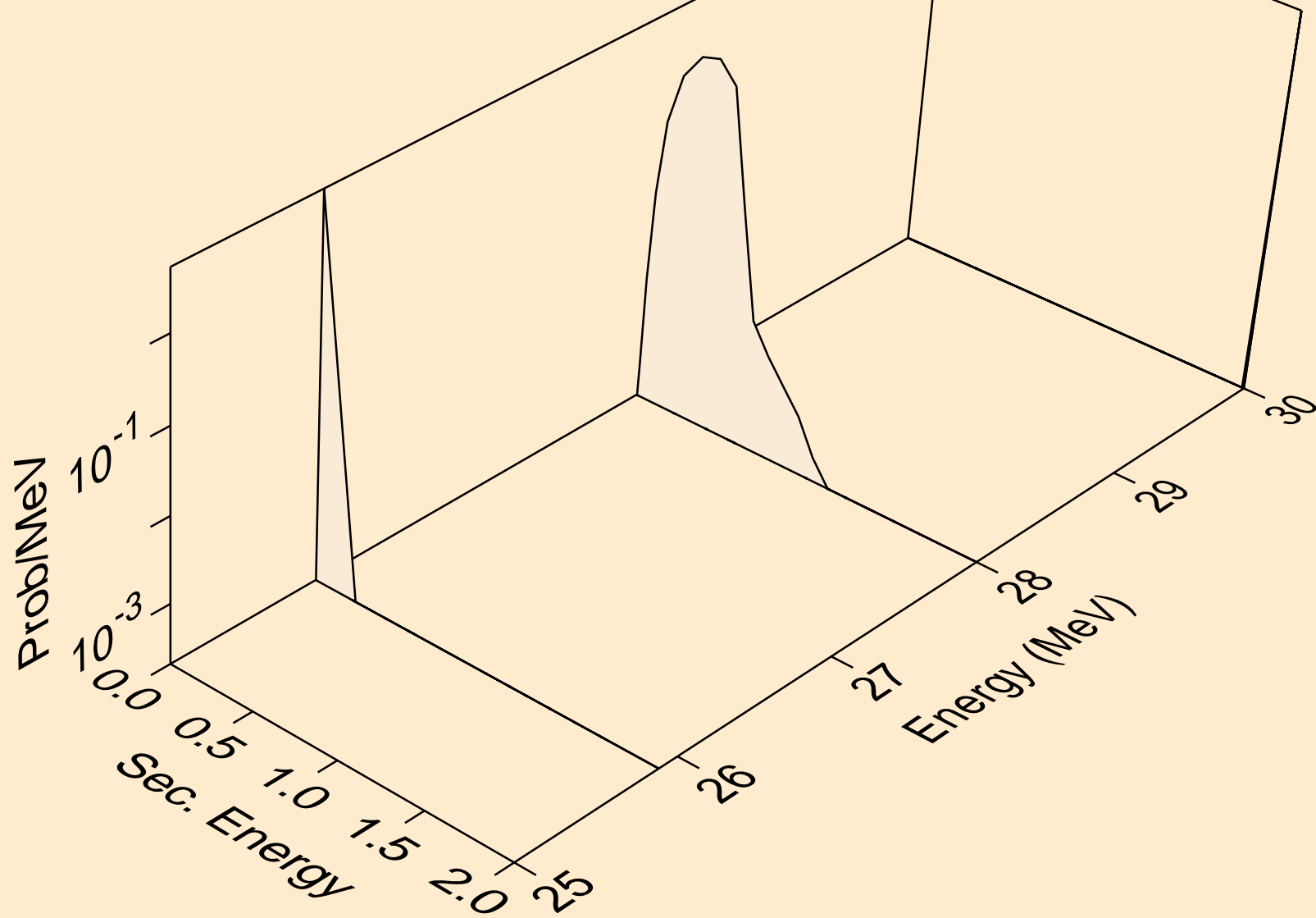

O016 PHOTON ACER TENDL-2024 LIBRARY; T=0.K  
photons from (g,n\*)p

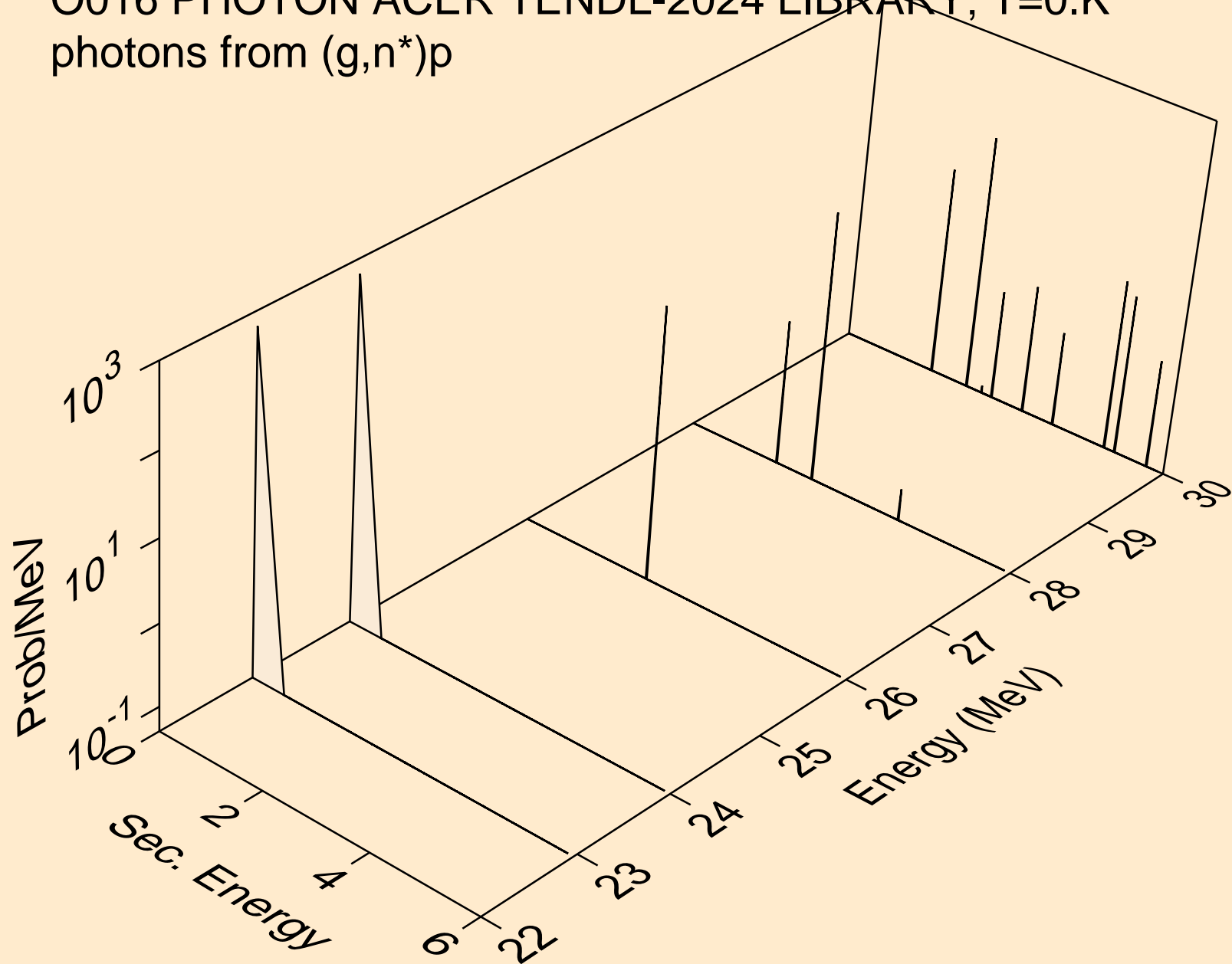

O016 PHOTON ACER TENDL-2024 LIBRARY; T=0.K  
photons from (g,n\*c)

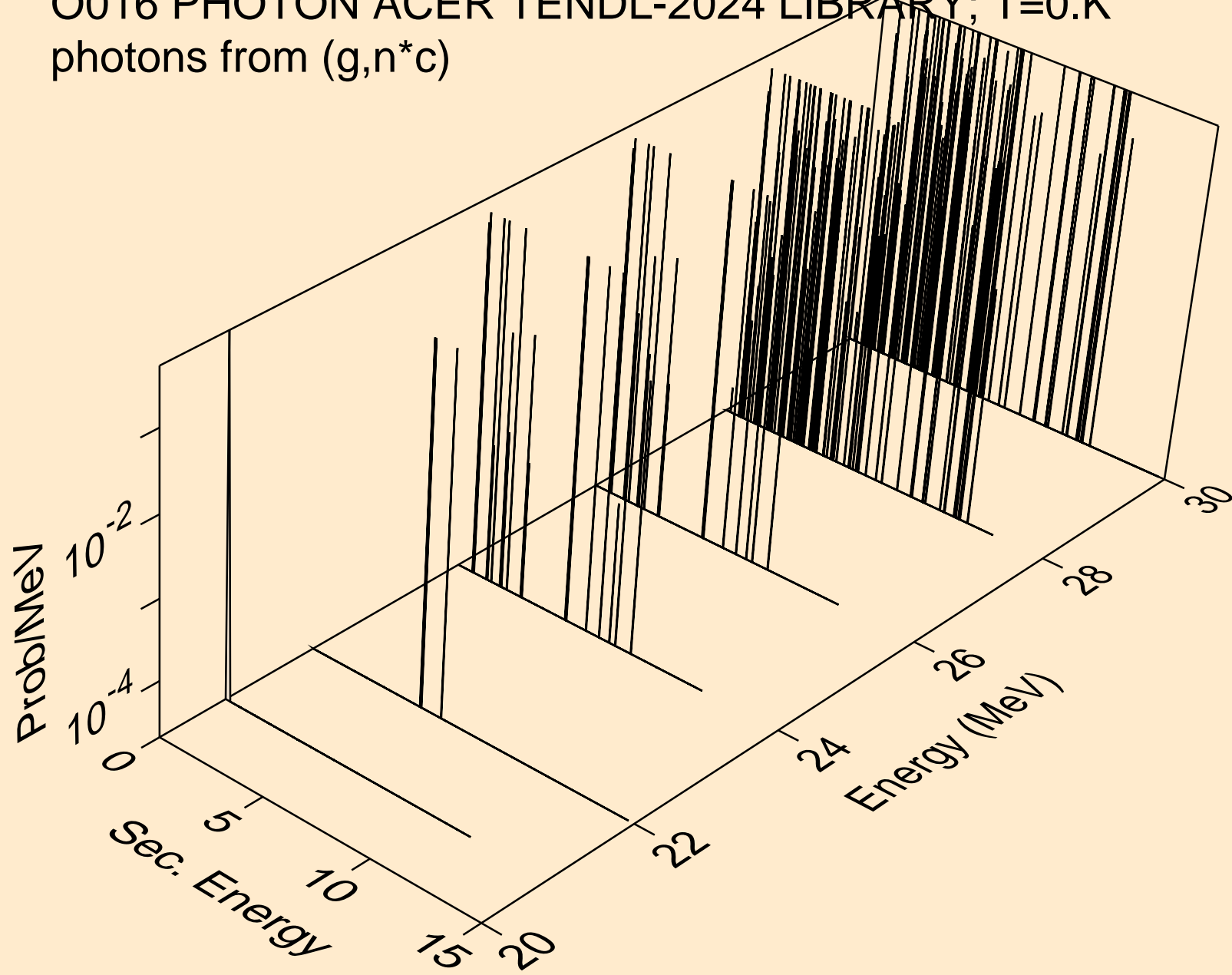

O016 PHOTON ACER TENDL-2024 LIBRARY; T=0.K  
photons from (g,gma)

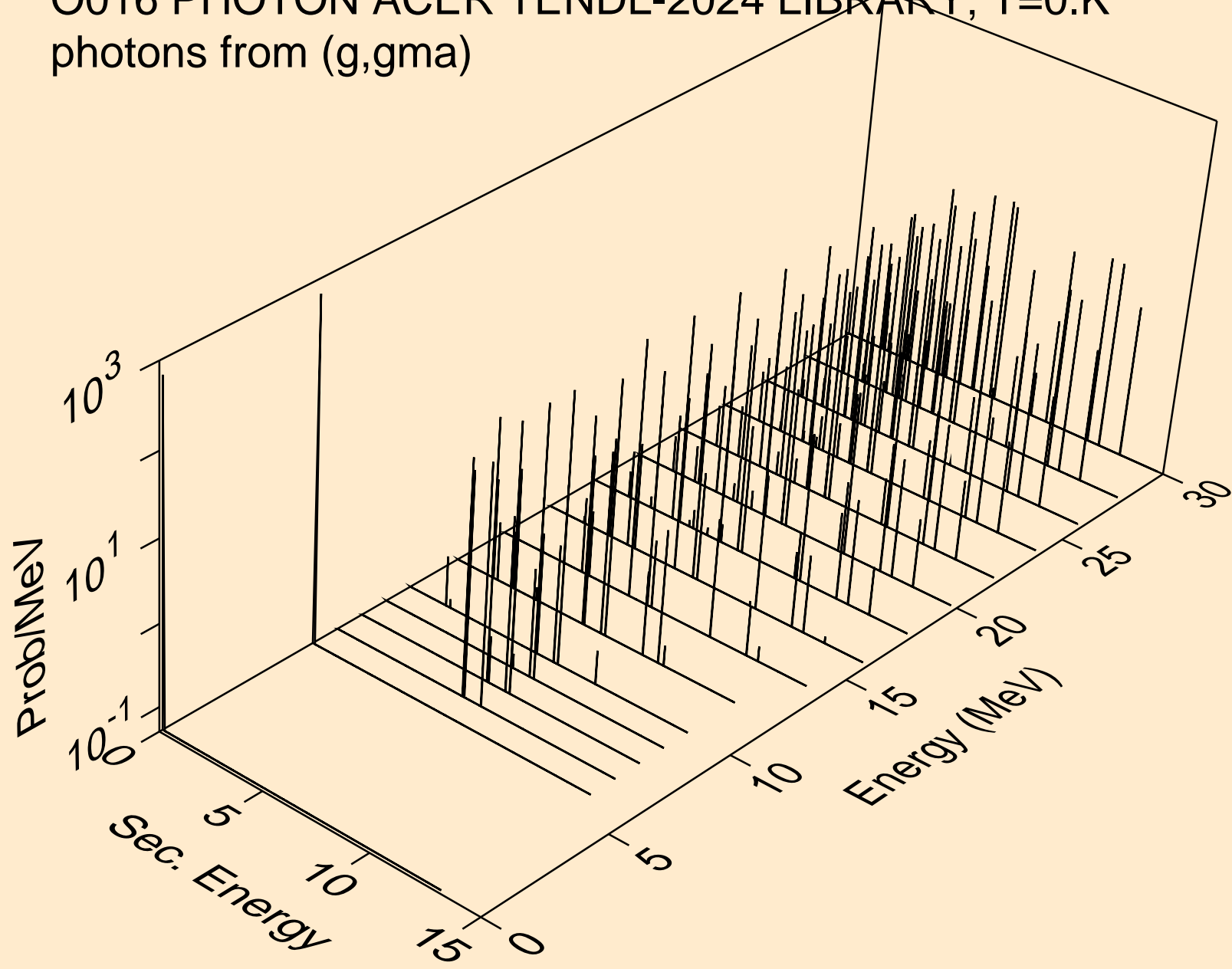

O016 PHOTON ACER TENDL-2024 LIBRARY; T=0.K  
photons from (g,p)

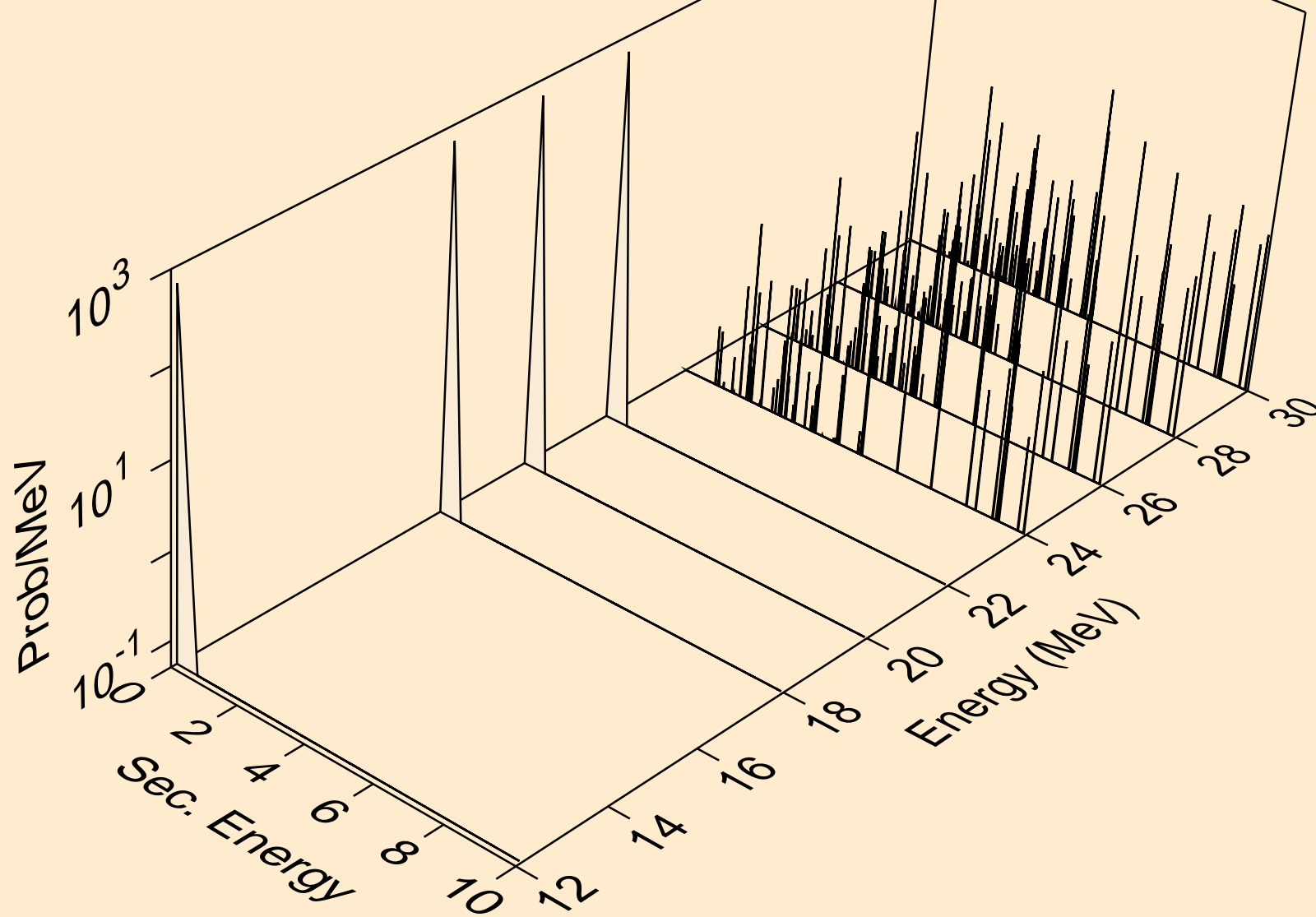

O016 PHOTON ACER TENDL-2024 LIBRARY; T=0.K  
photons from (g,d)

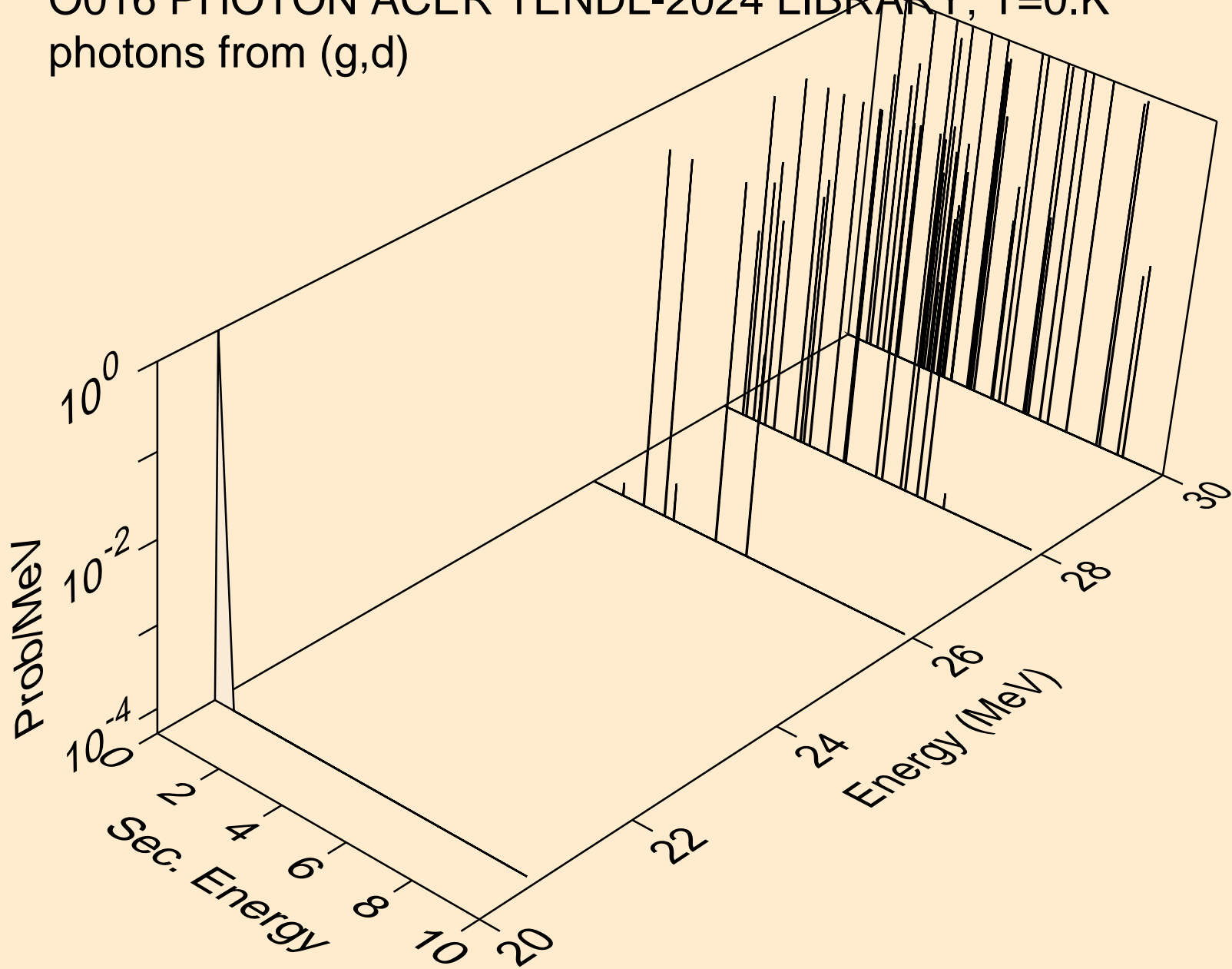

O016 PHOTON ACER TENDL-2024 LIBRARY; T=0.K  
photons from (g,t)

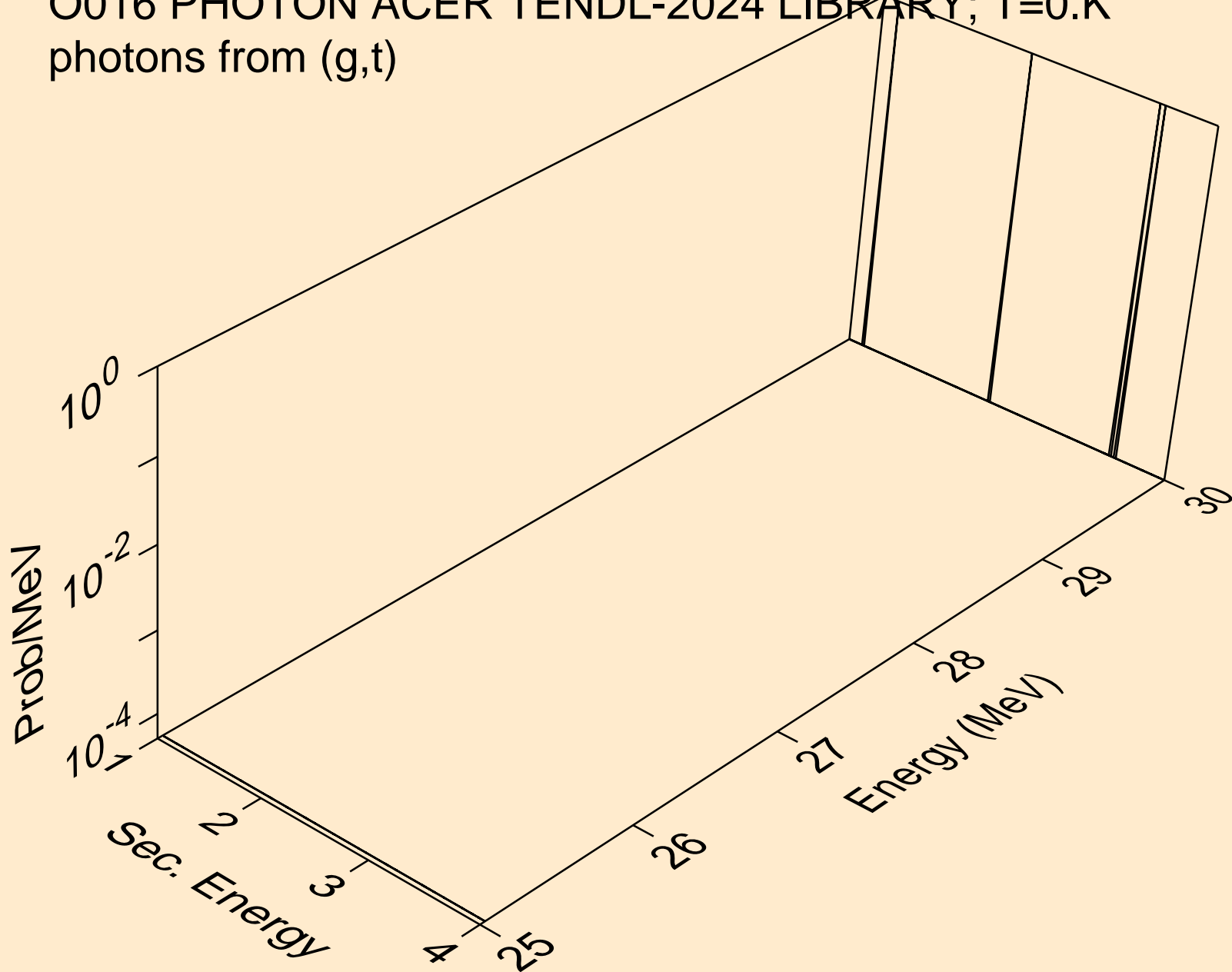

O016 PHOTON ACER TENDL-2024 LIBRARY; T=0.K  
photons from (g,he3)

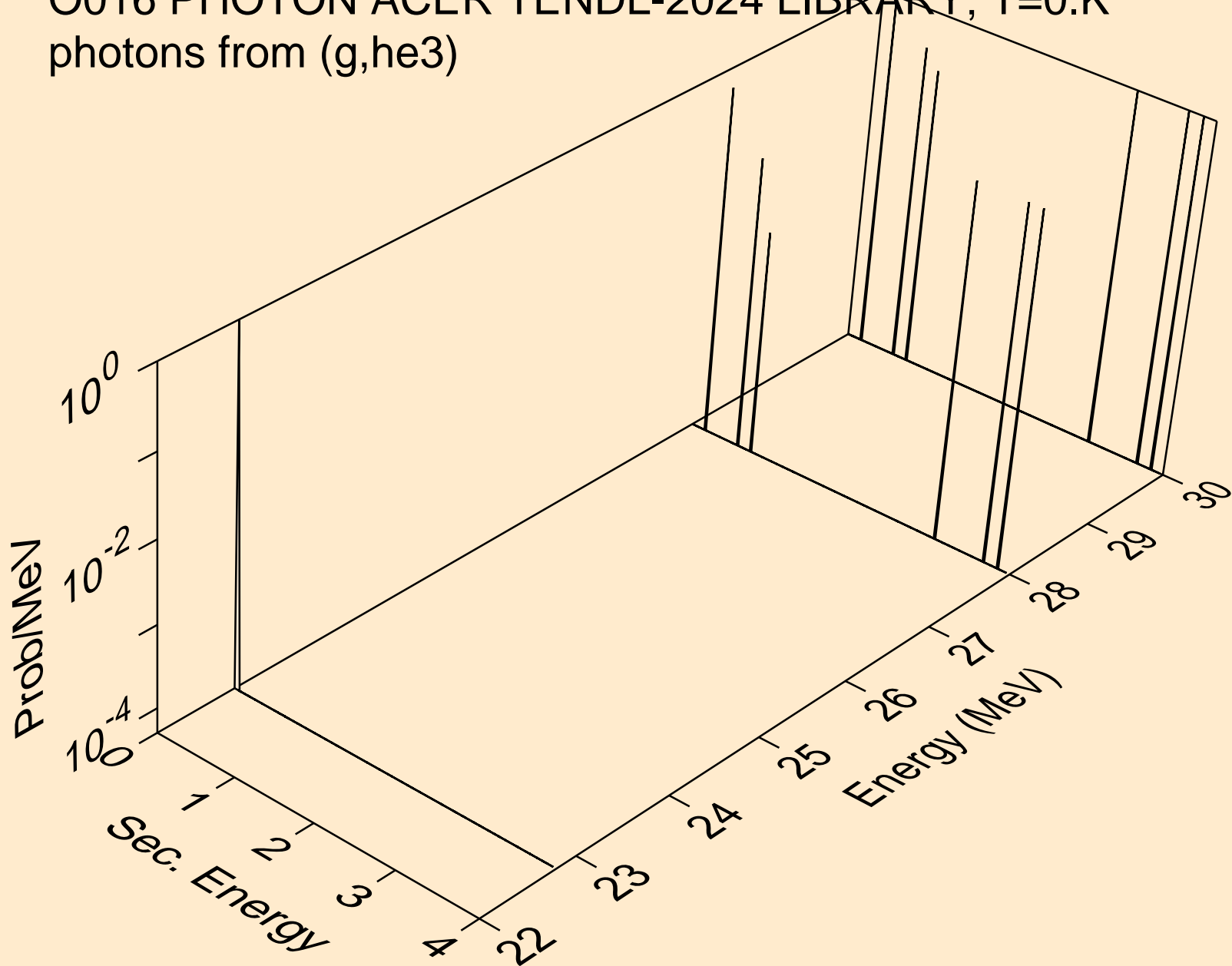

O016 PHOTON ACER TENDL-2024 LIBRARY; T=0.K  
photons from (g,a)

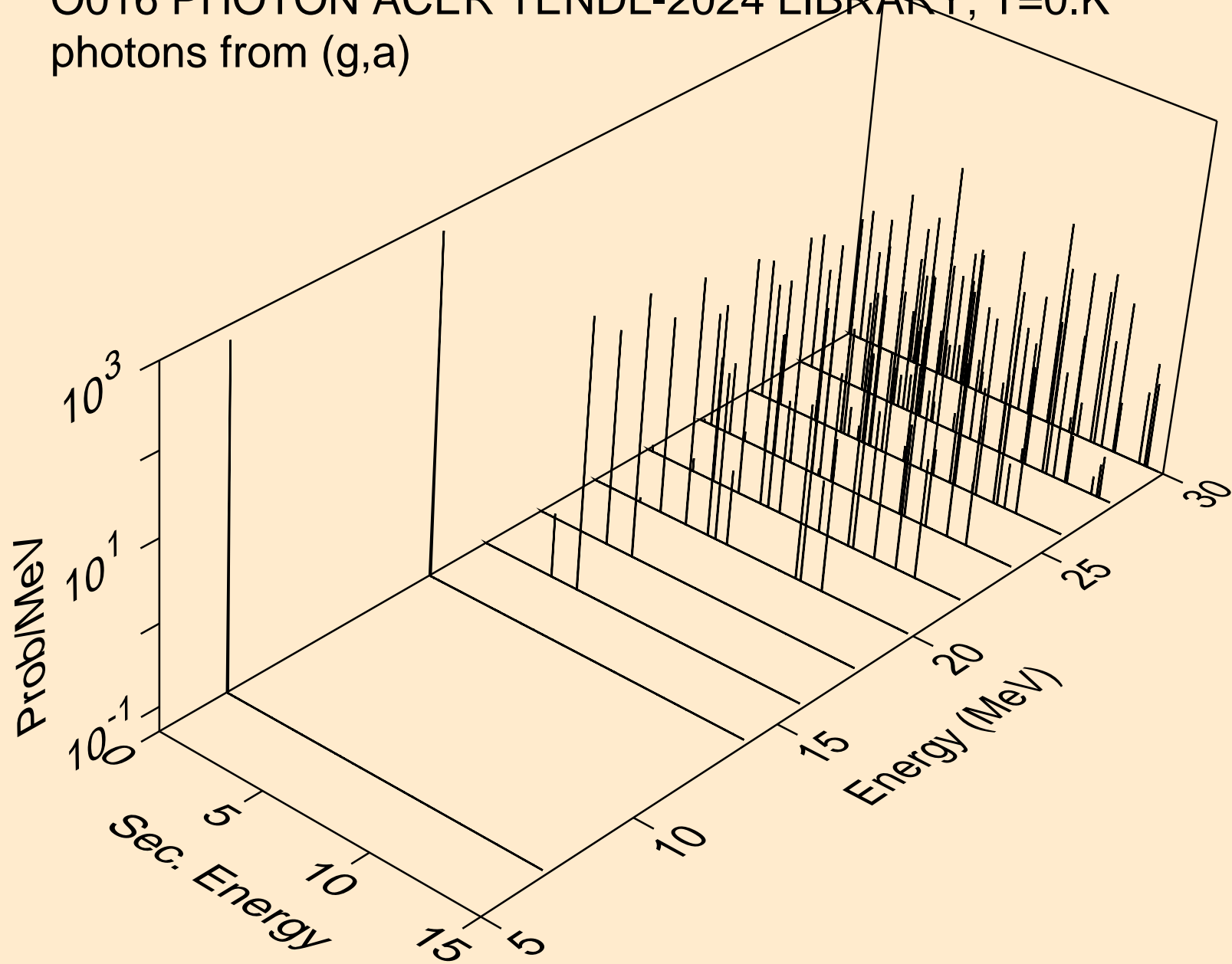

O016 PHOTON ACER TENDL-2024 LIBRARY; T=0.K  
photons from (g,2a)

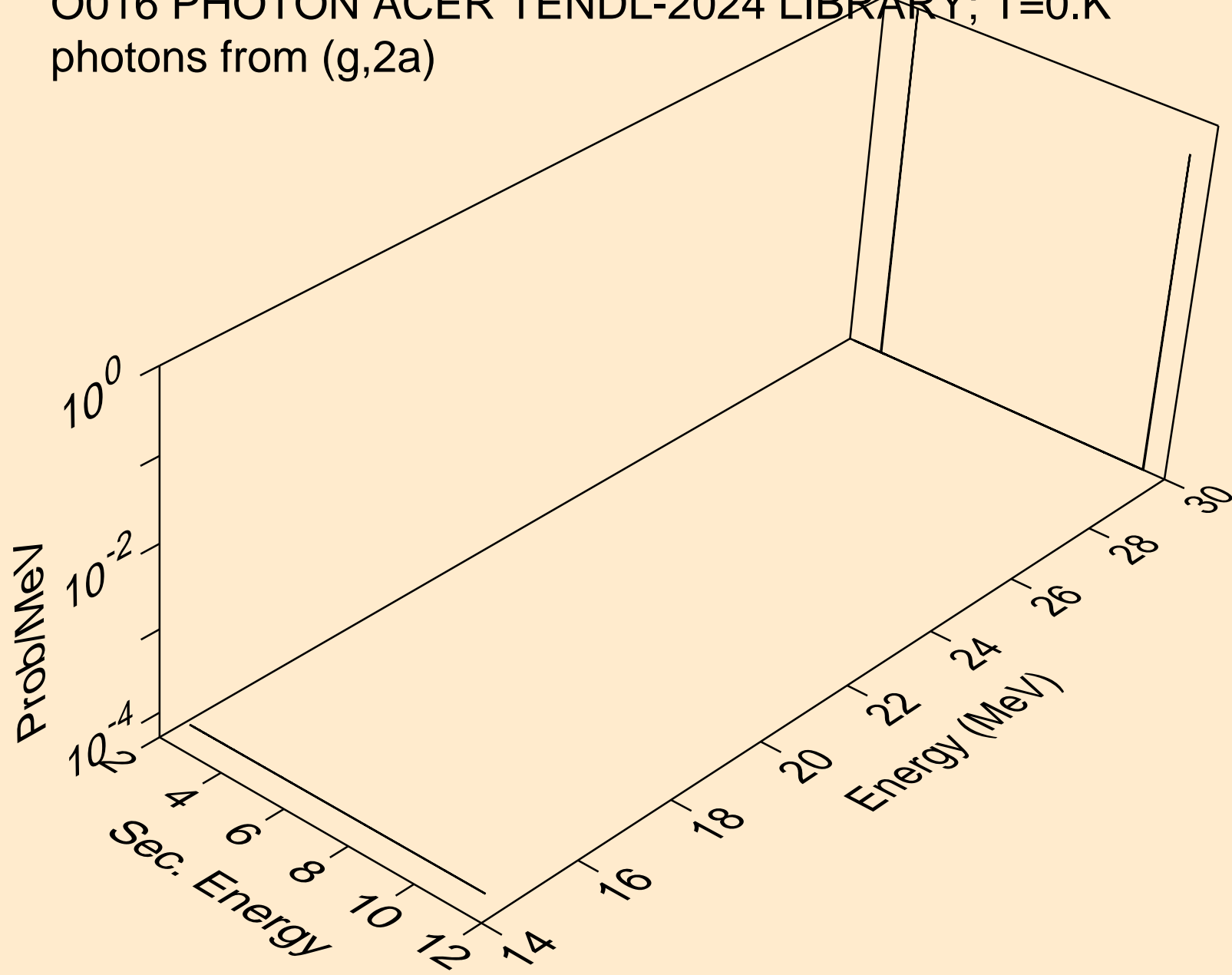

O016 PHOTON ACER TENDL-2024 LIBRARY; T=0.K  
photons from (g,2p)

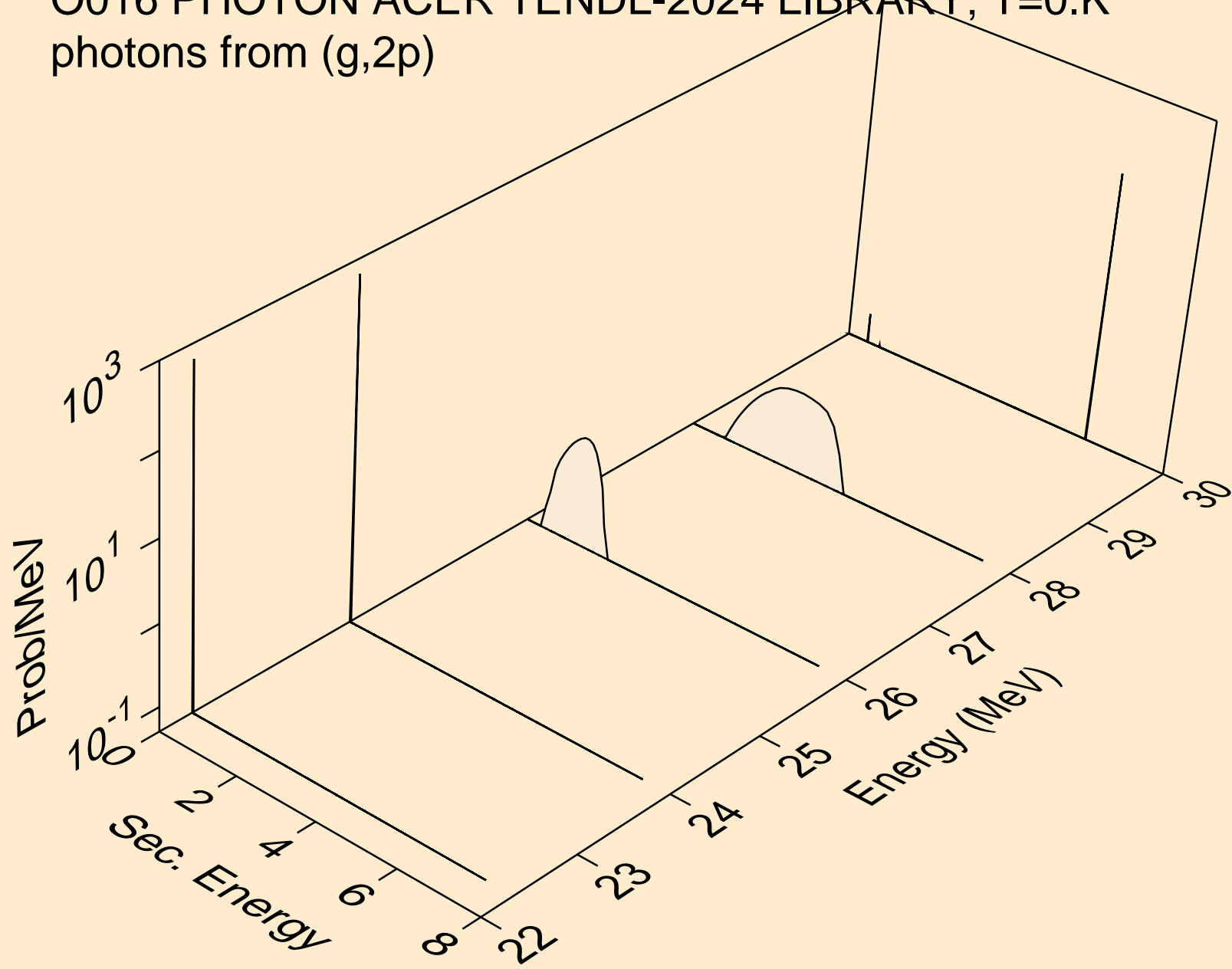

O016 PHOTON ACER TENDL-2024 LIBRARY; T=0.K  
photons from (g,pa)

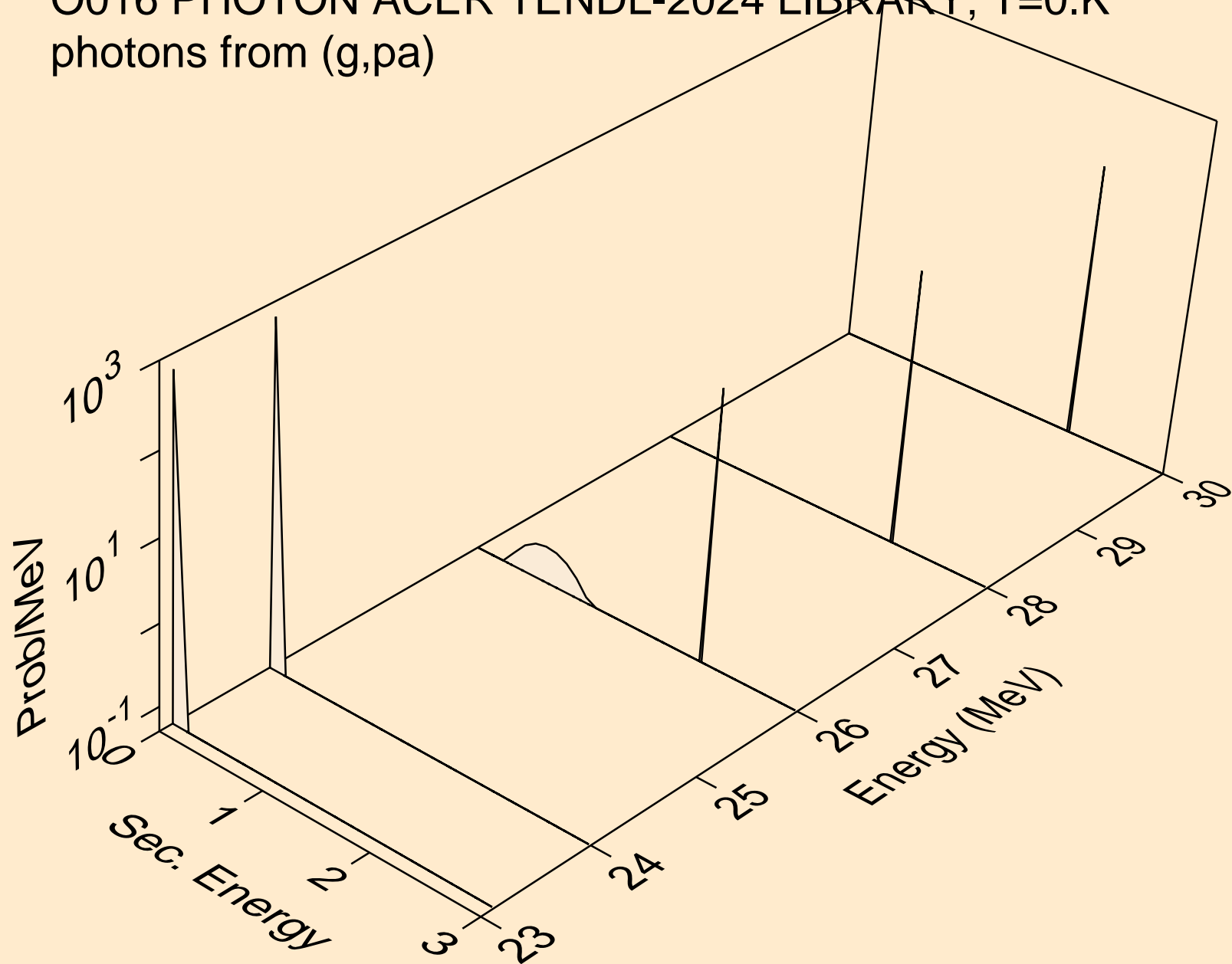

O016 PHOTON ACER TENDL-2024 LIBRARY; T=0.K  
photons from (g,pt)

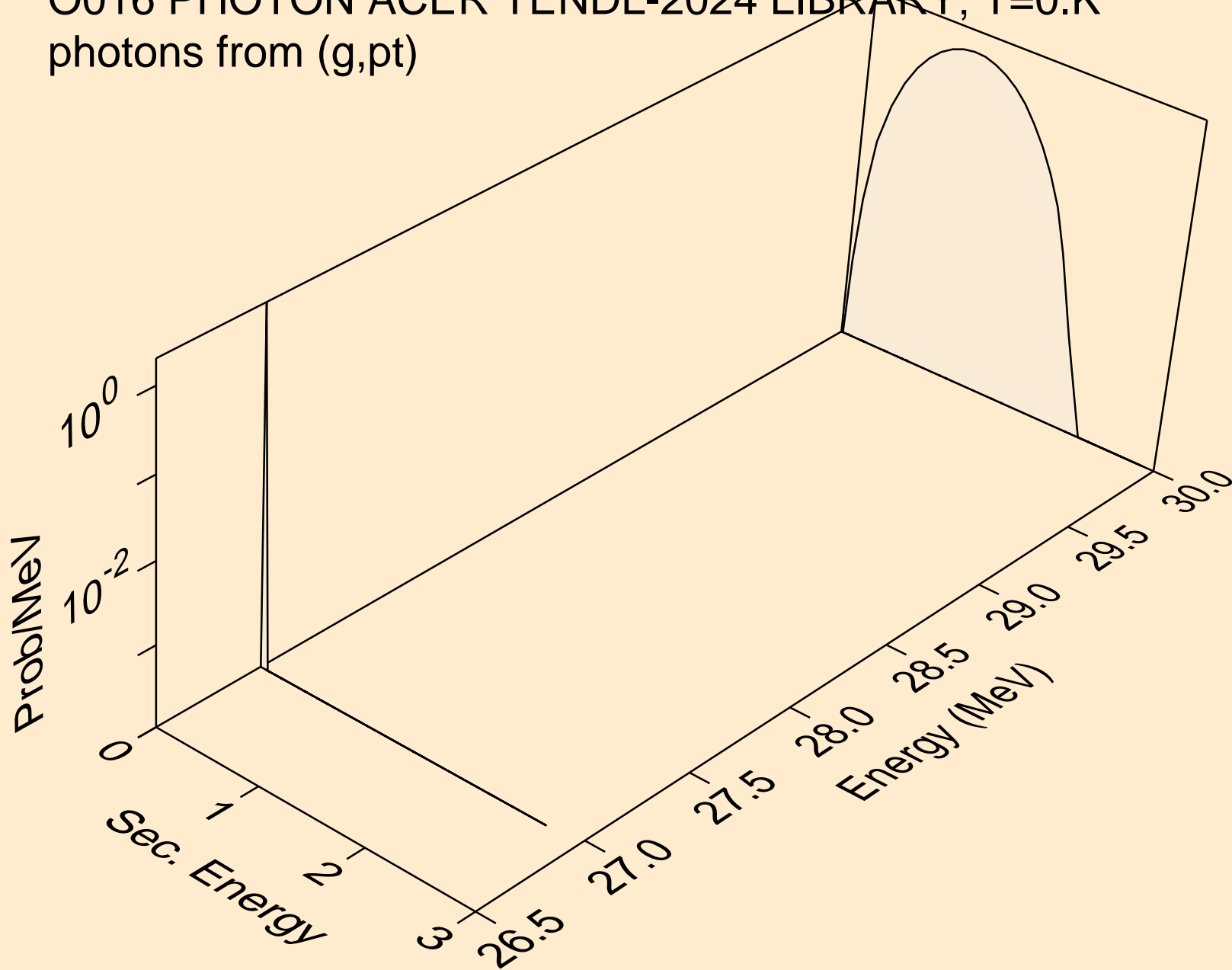

O016 PHOTON ACER TENDL-2024 LIBRARY; T=0.K  
protons from (g,x)

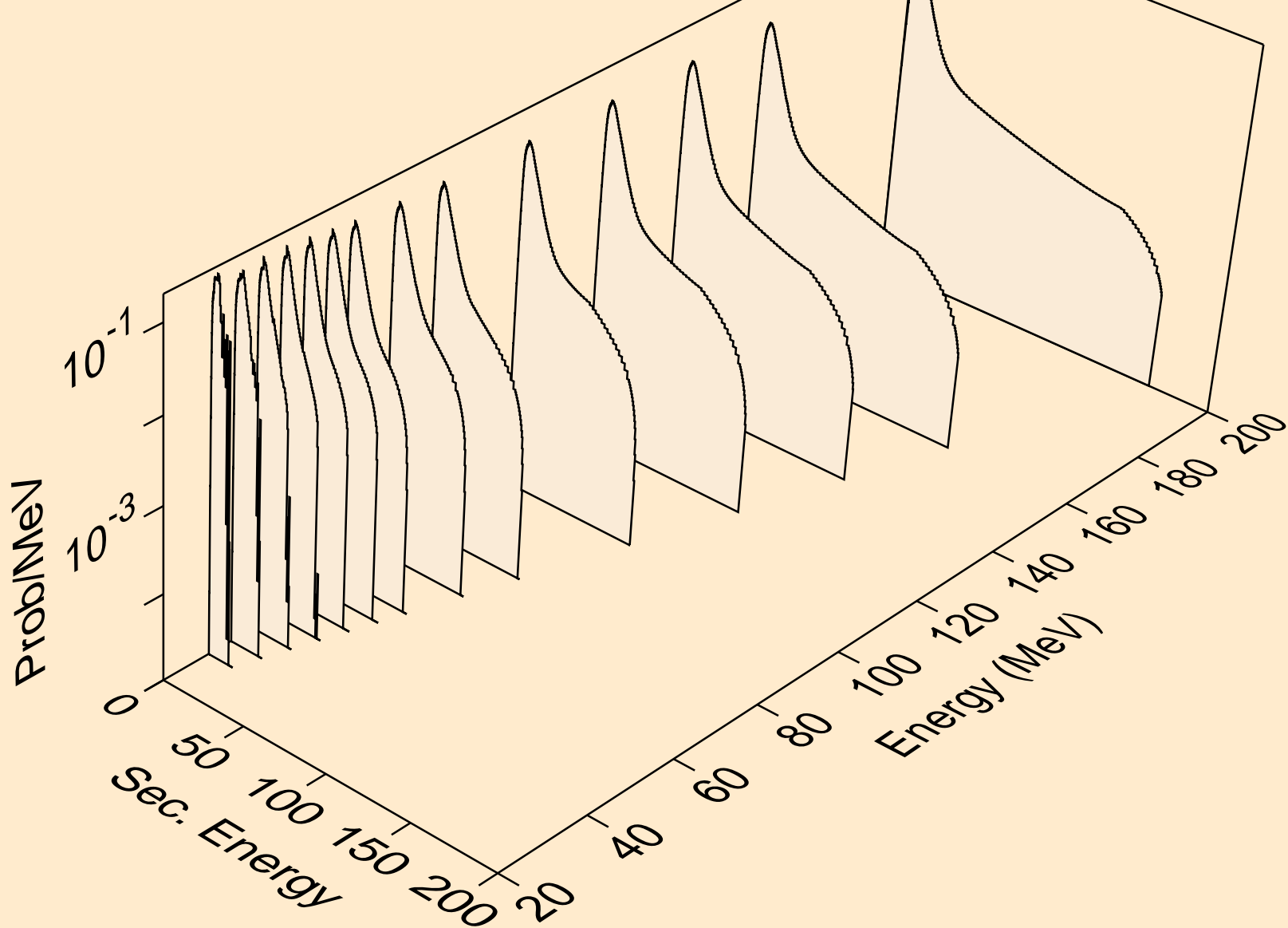

O016 PHOTON ACER TENDL-2024 LIBRARY; T=0.K  
protons from (g,n\*)p

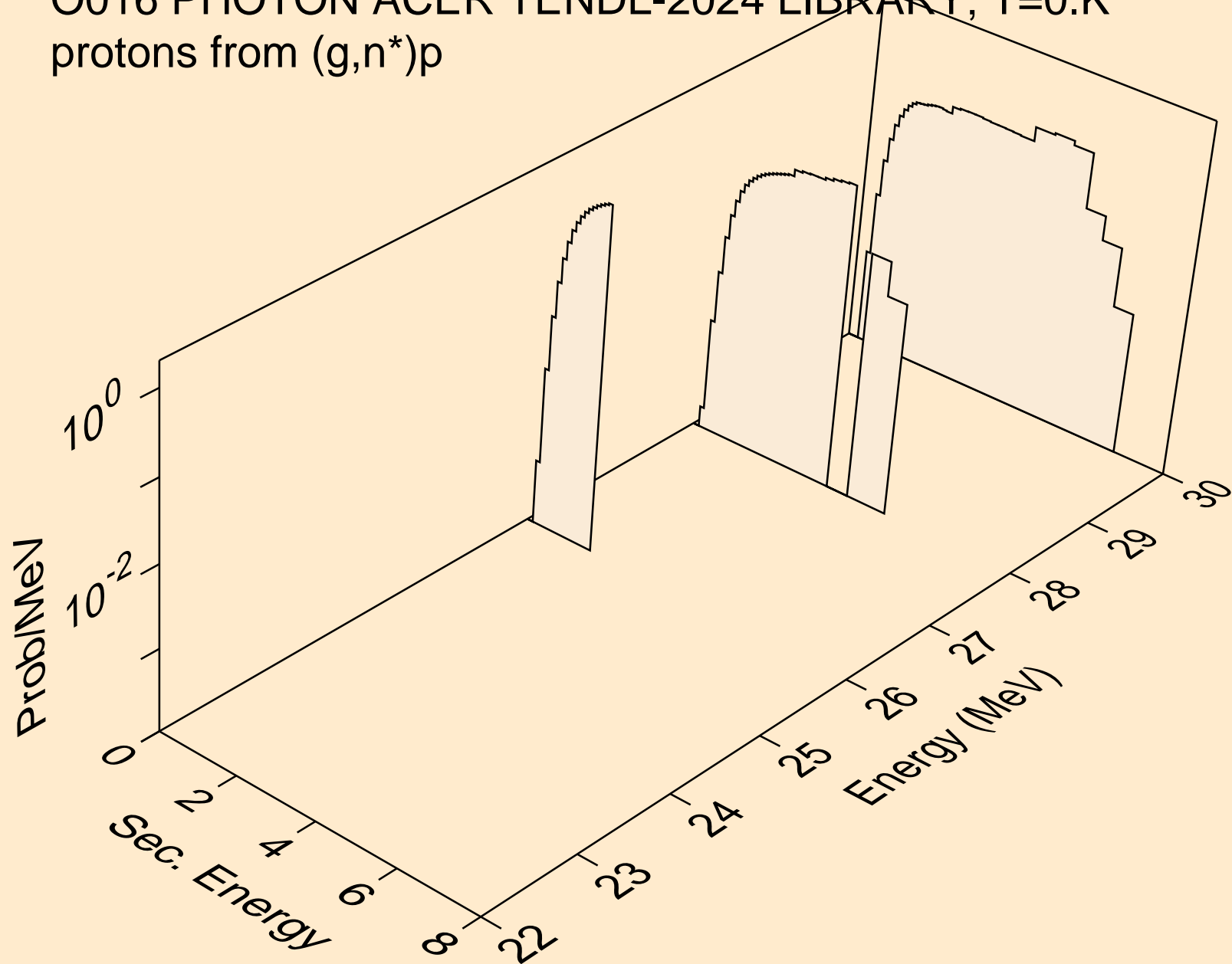

O016 PHOTON ACER TENDL-2024 LIBRARY; T=0.K  
protons from (g,p)

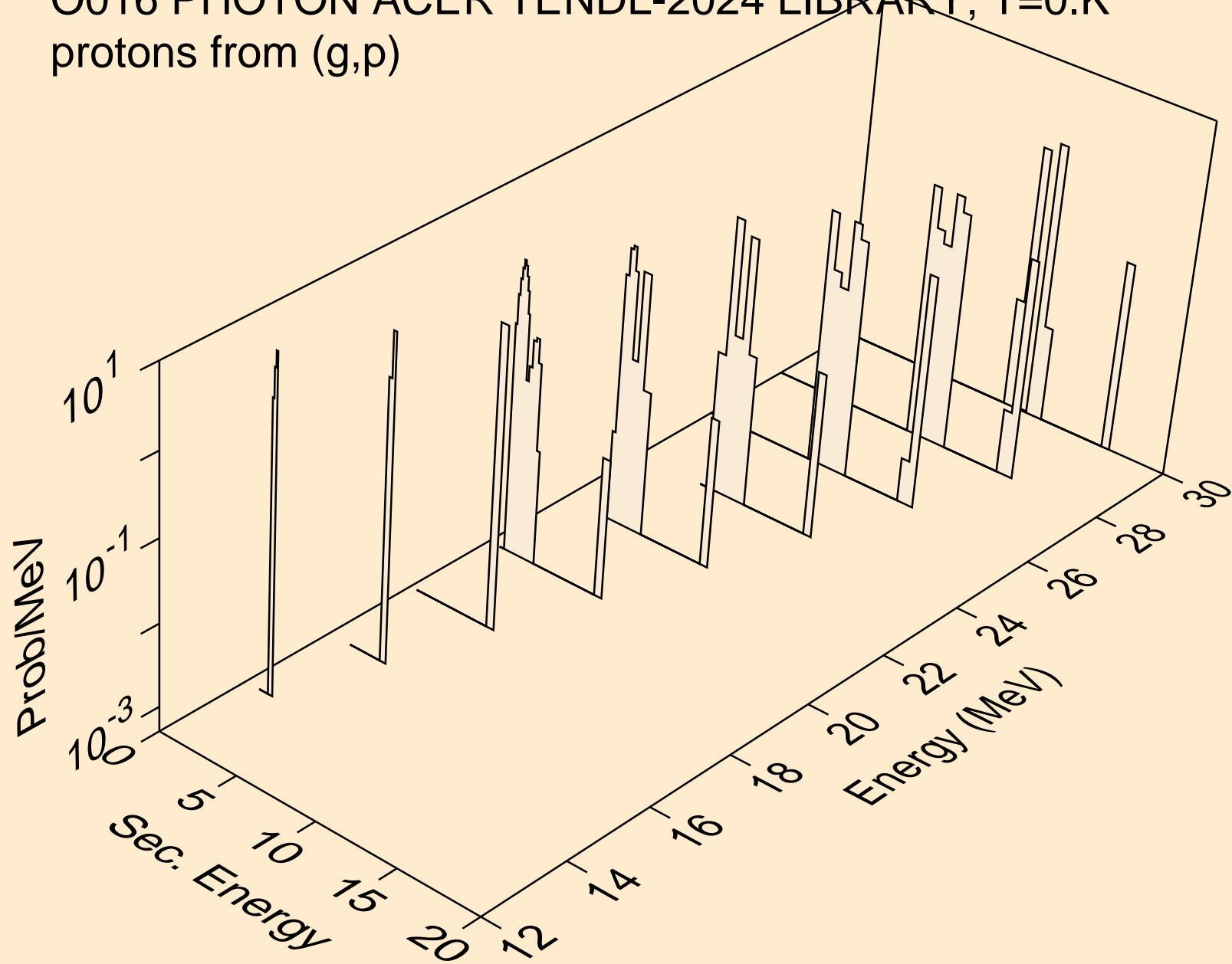

O016 PHOTON ACER TENDL-2024 LIBRARY; T=0.K  
protons from (g,2p)

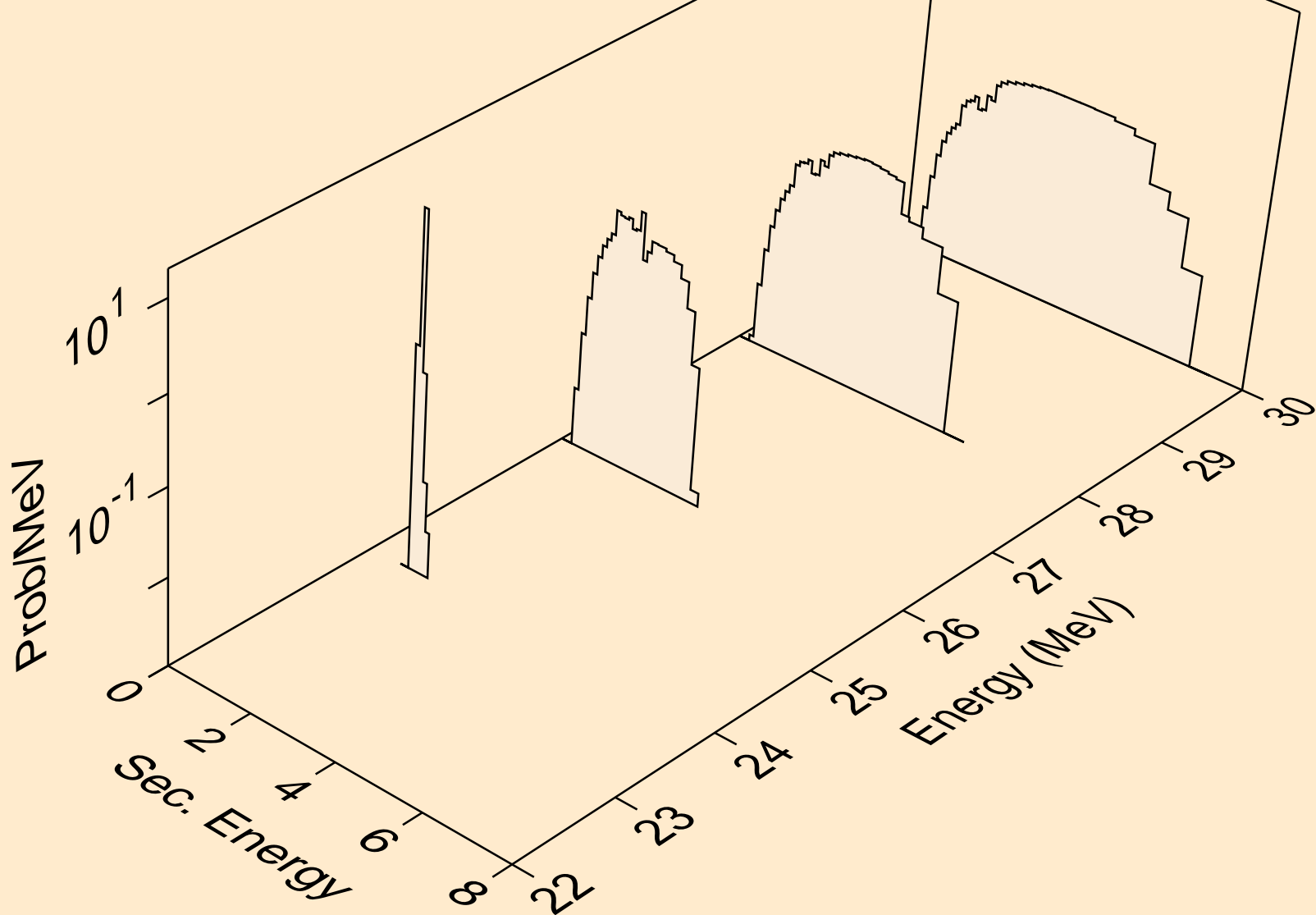

O016 PHOTON ACER TENDL-2024 LIBRARY; T=0.K  
protons from (g,pa)

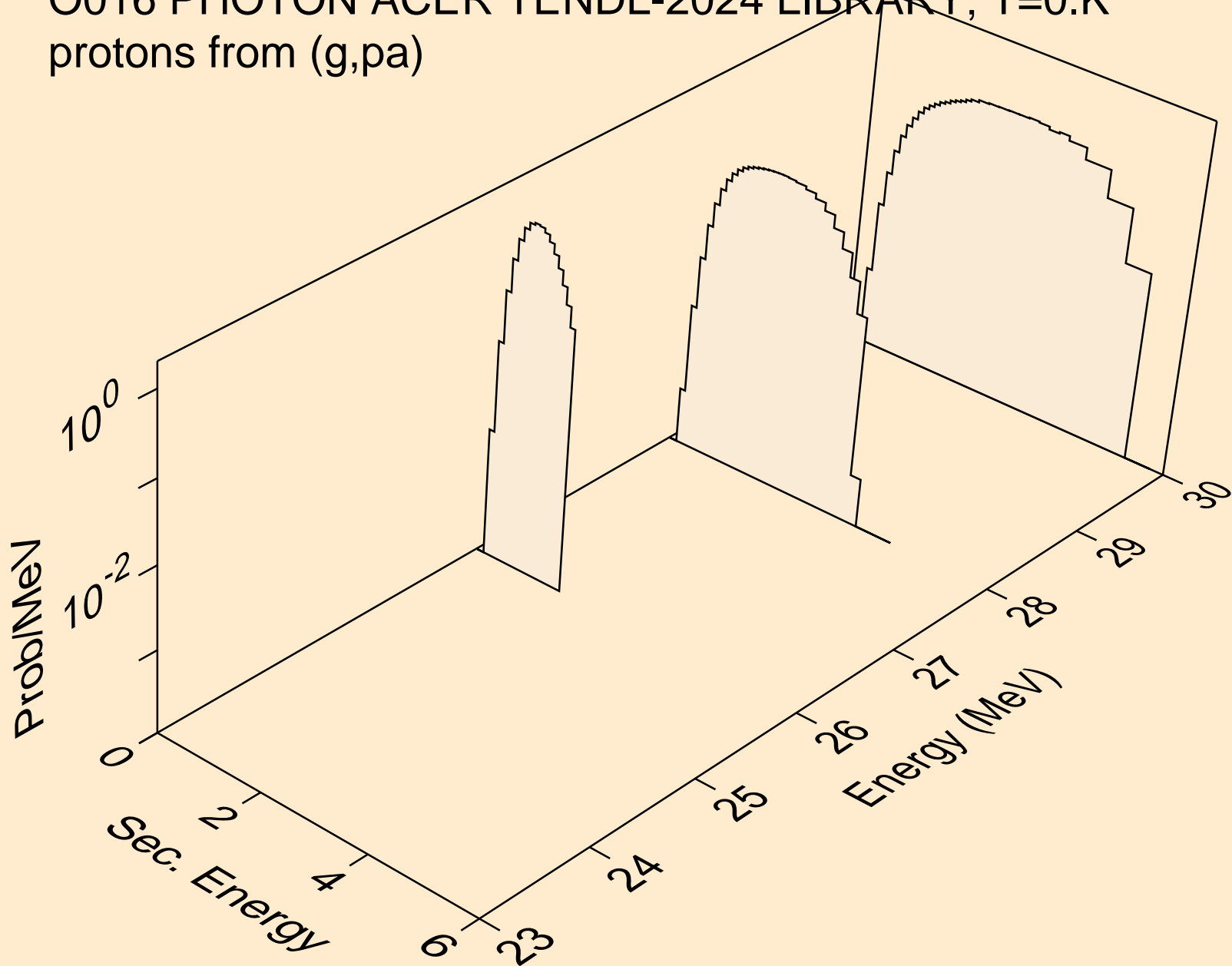

O016 PHOTON ACER TENDL-2024 LIBRARY; T=0.K  
protons from (g,pt)

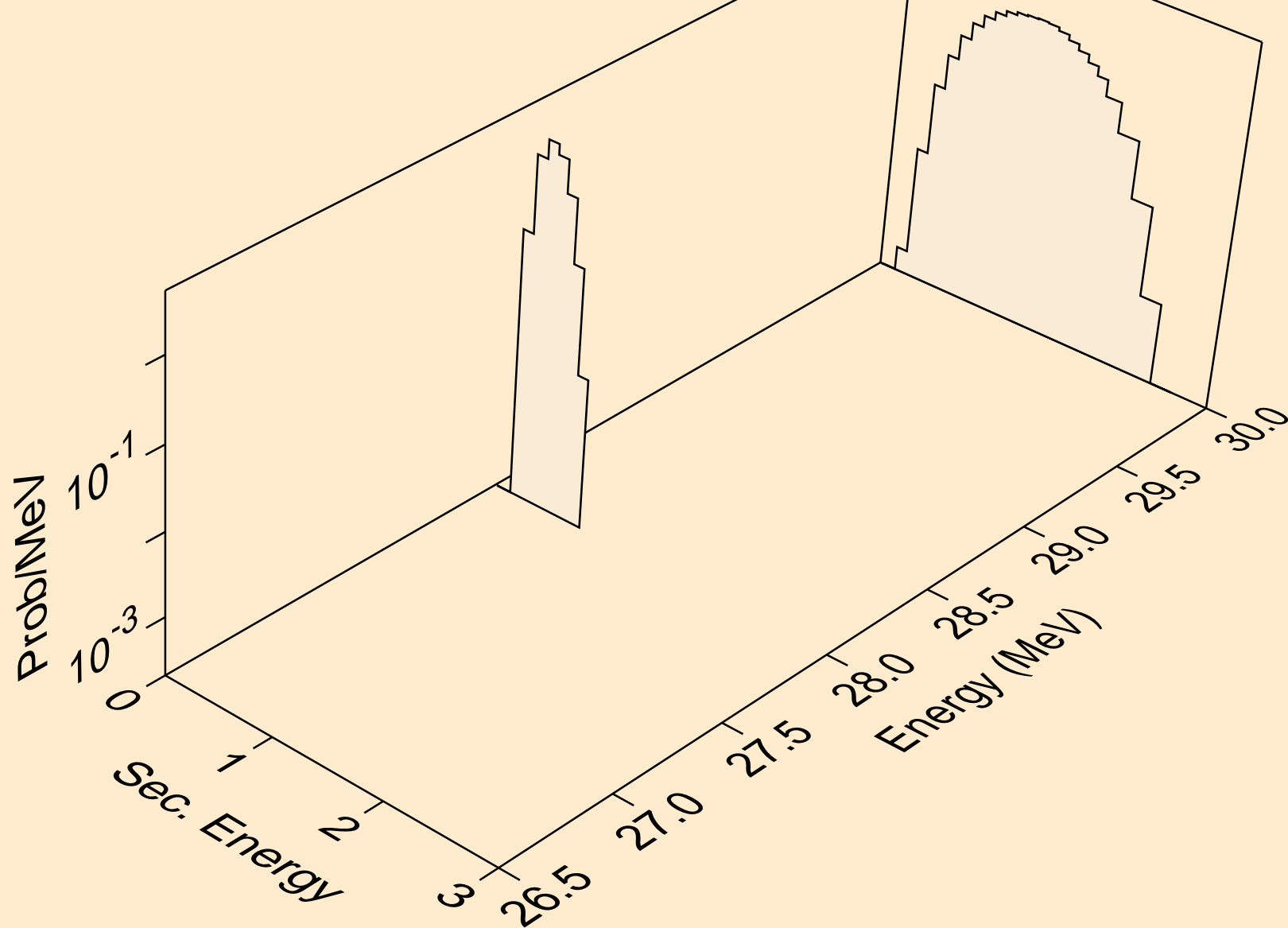

O016 PHOTON ACER TENDL-2024 LIBRARY; T=0.K  
deuterons from (g,x)

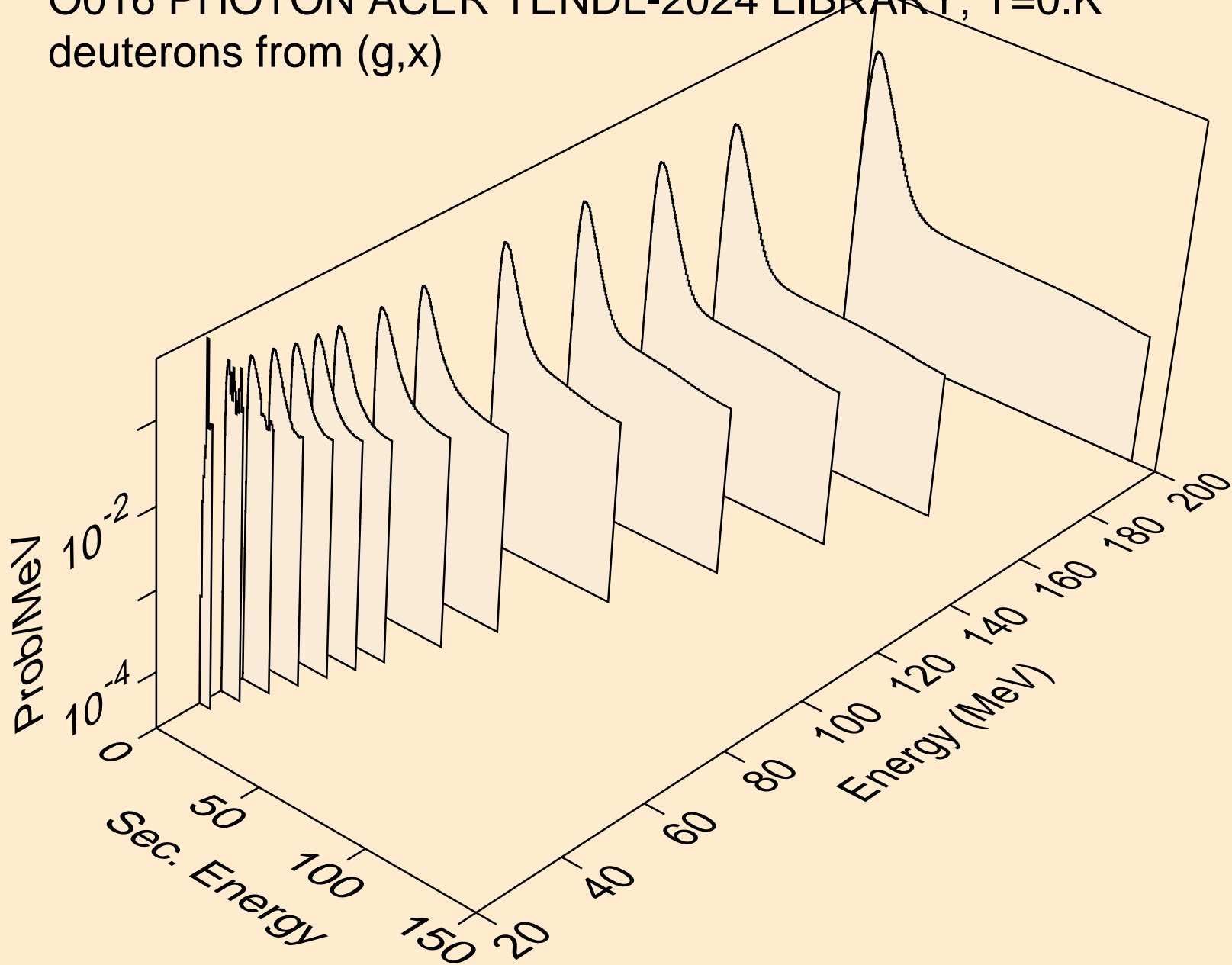

O016 PHOTON ACER TENDL-2024 LIBRARY; T=0.K  
deuterons from (g,d)

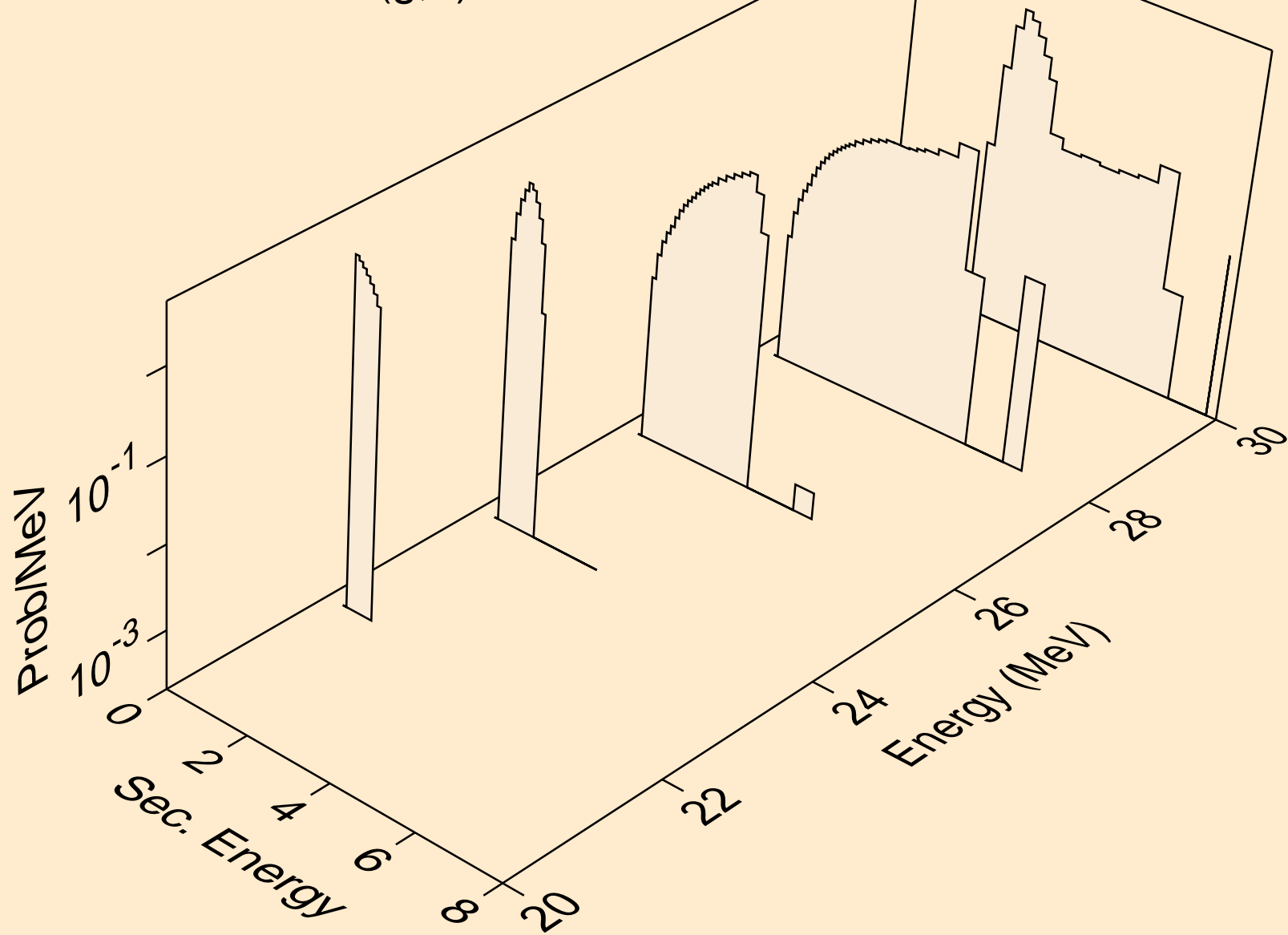

O016 PHOTON ACER TENDL-2024 LIBRARY; T=0.K  
tritons from (g,x)

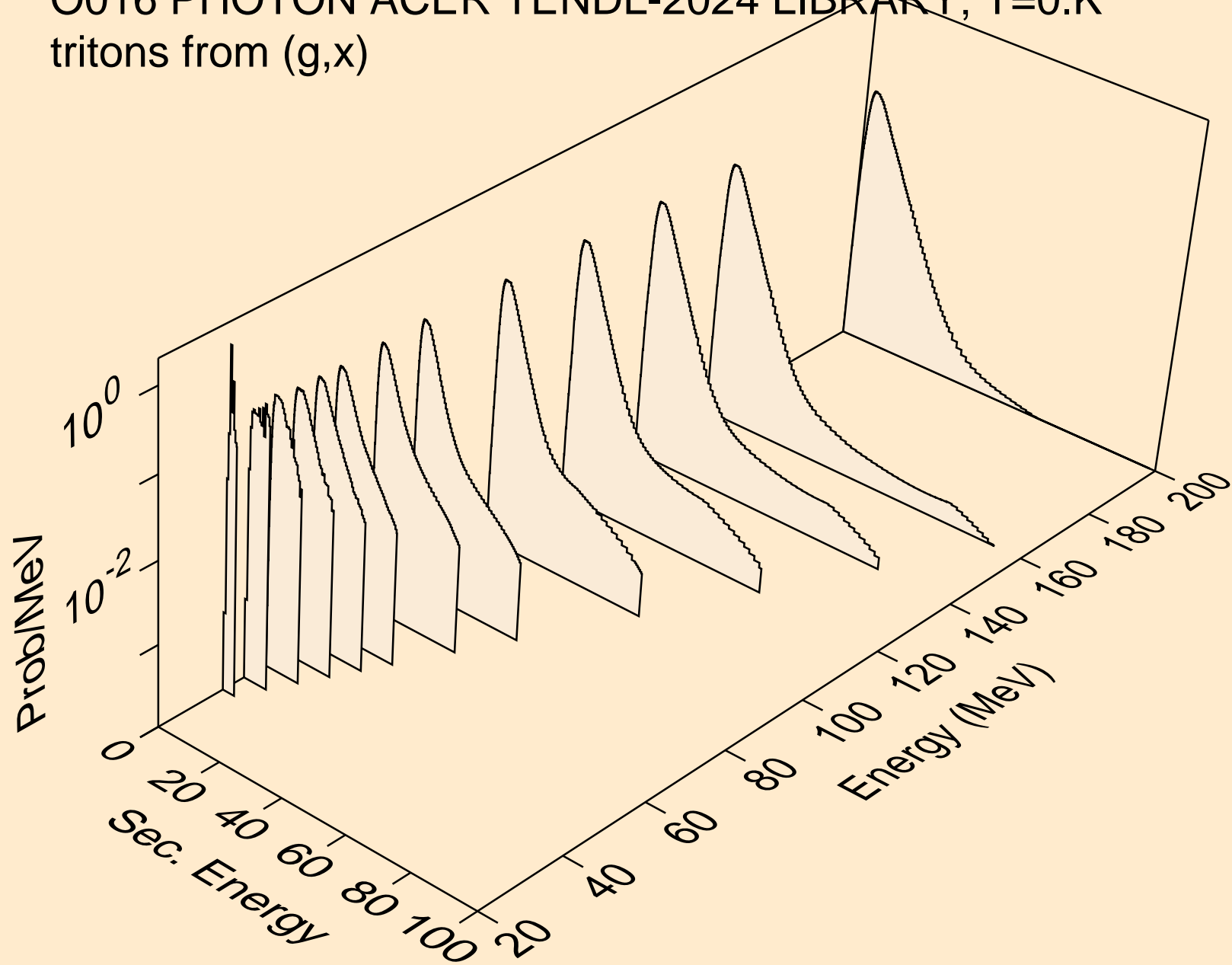

O016 PHOTON ACER TENDL-2024 LIBRARY; T=0.K  
tritons from (g,t)

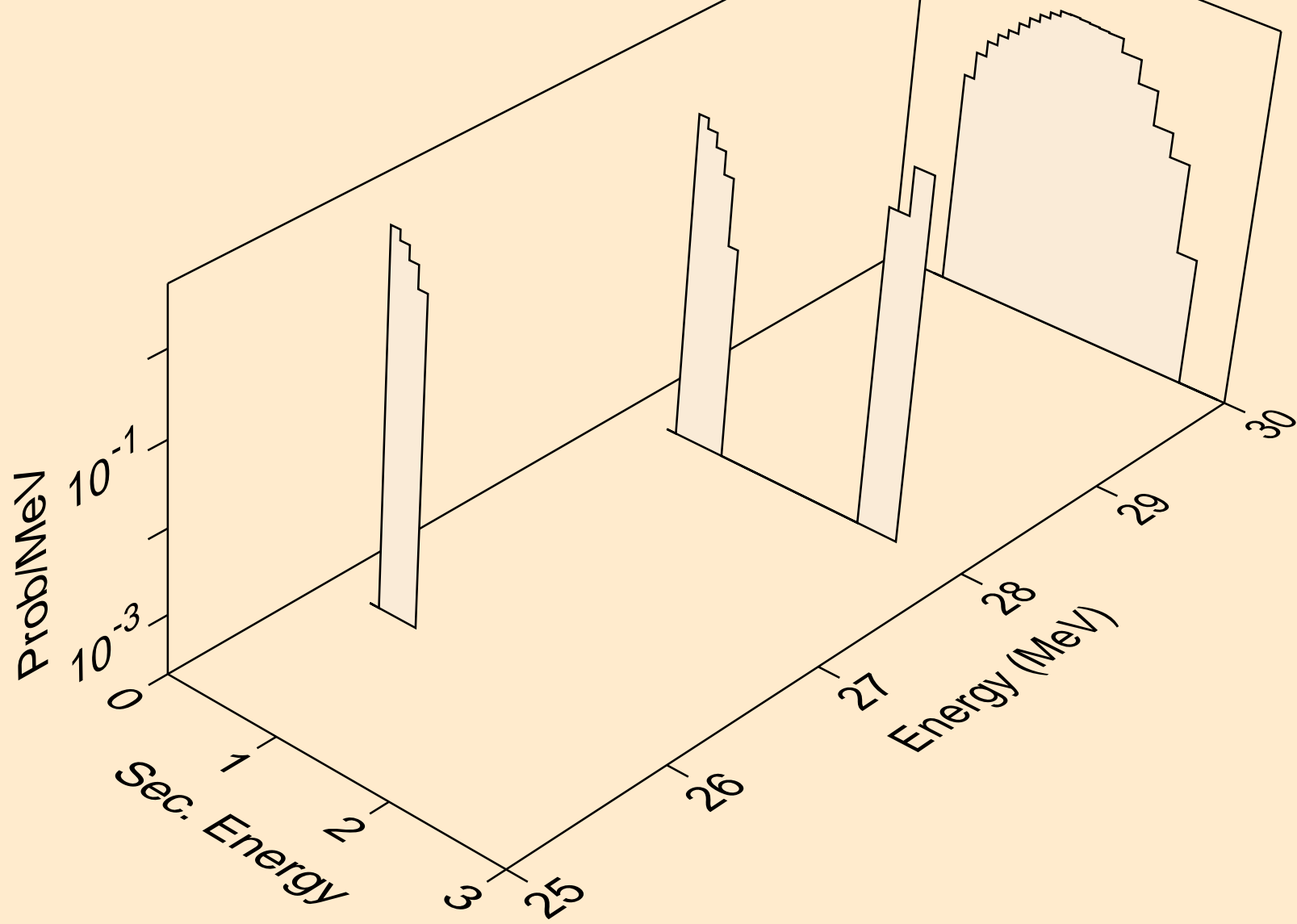

O016 PHOTON ACER TENDL-2024 LIBRARY; T=0.K  
tritons from (g,pt)

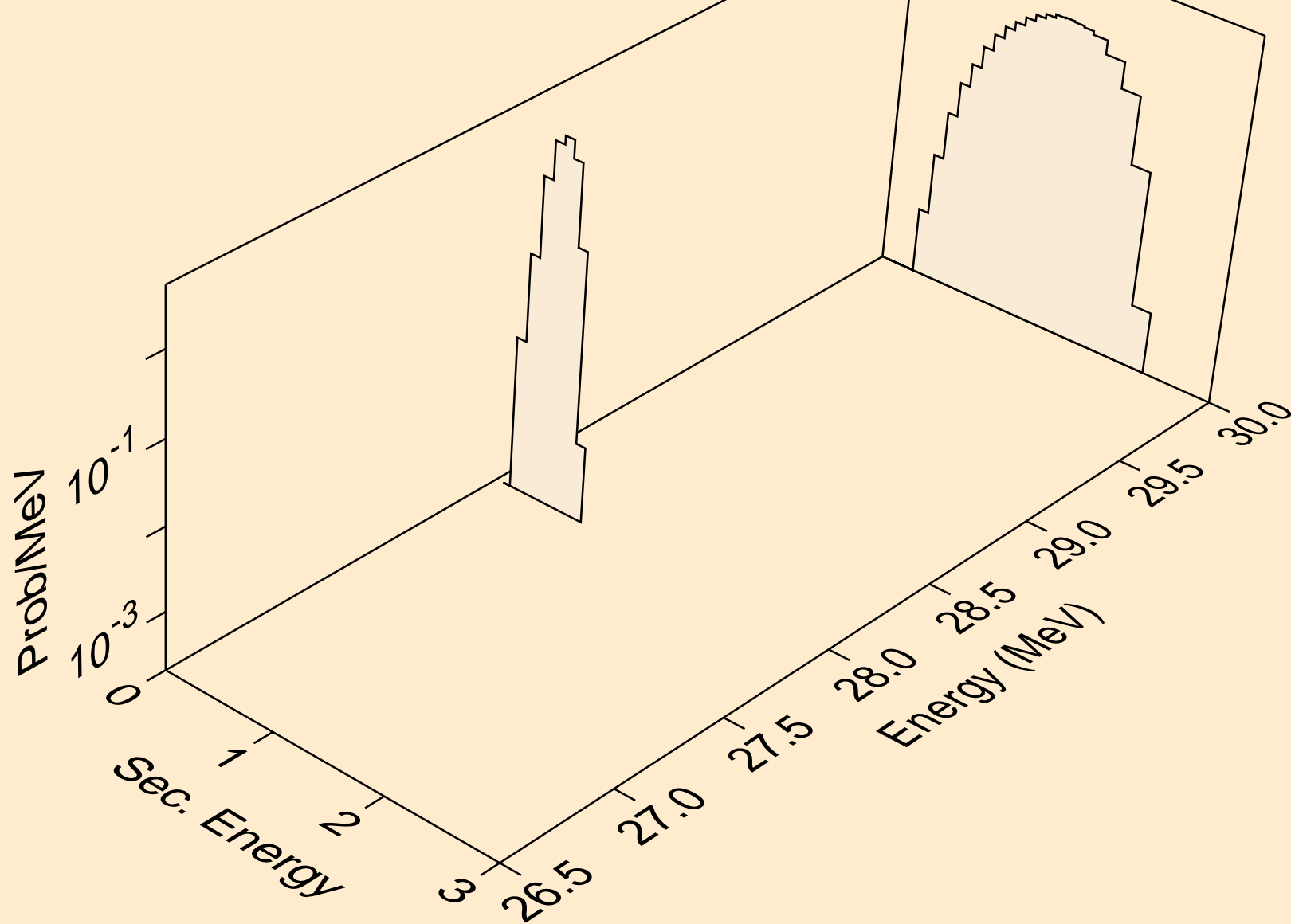

O016 PHOTON ACER TENDL-2024 LIBRARY; T=0.K  
he3s from (g,x)

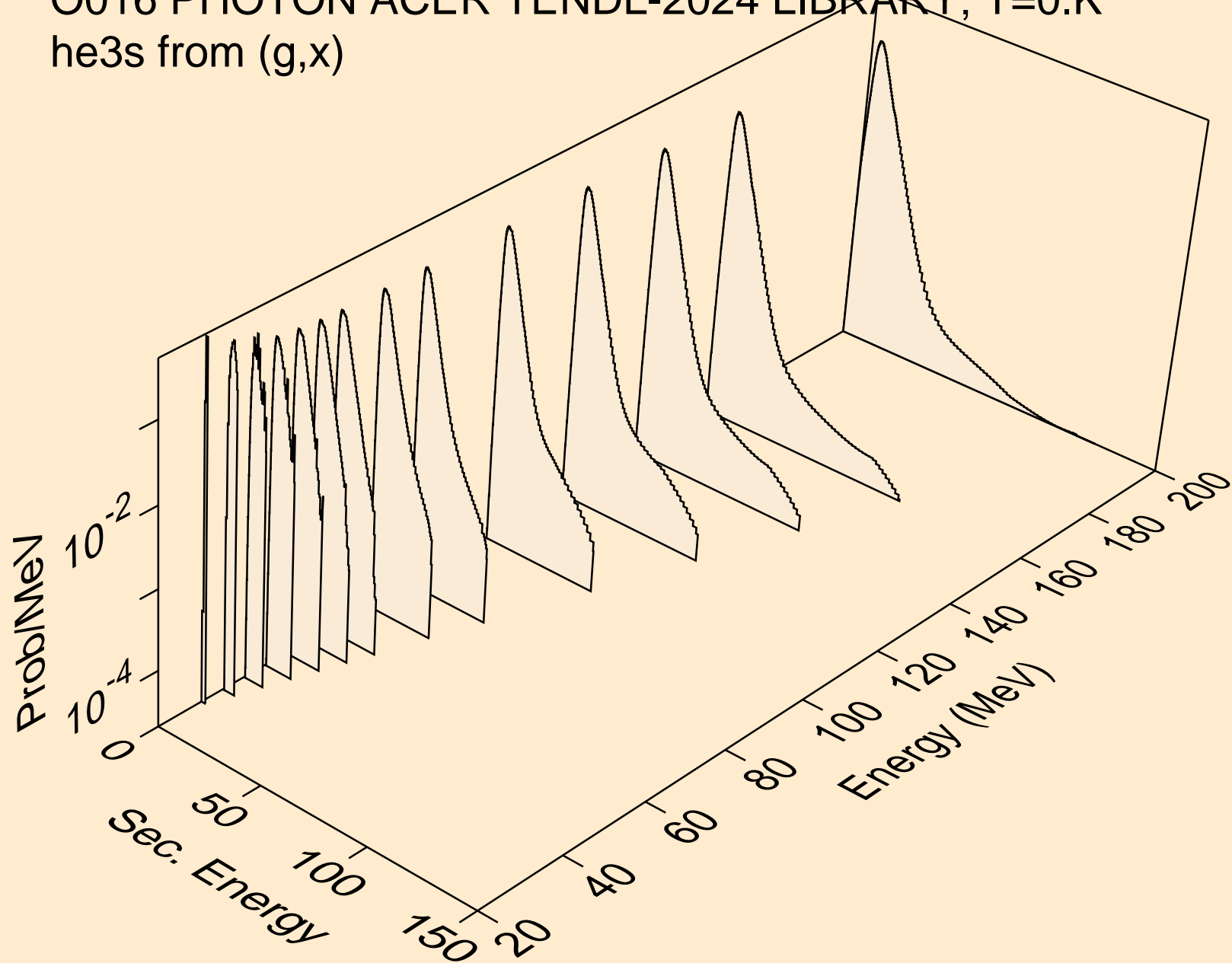

O016 PHOTON ACER TENDL-2024 LIBRARY; T=0.K  
he3s from (g,he3)

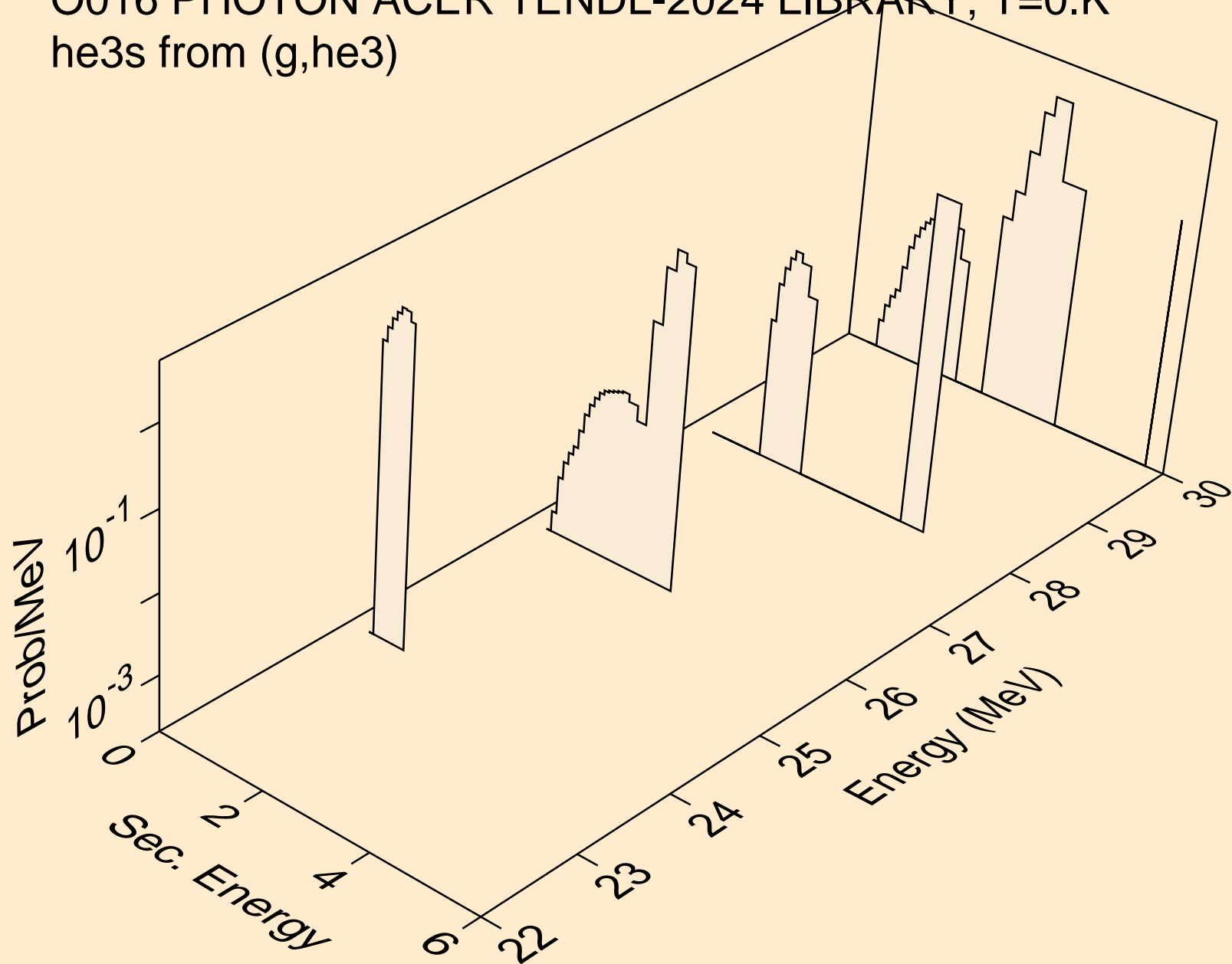

O016 PHOTON ACER TENDL-2024 LIBRARY; T=0.K  
alphas from (g,x)

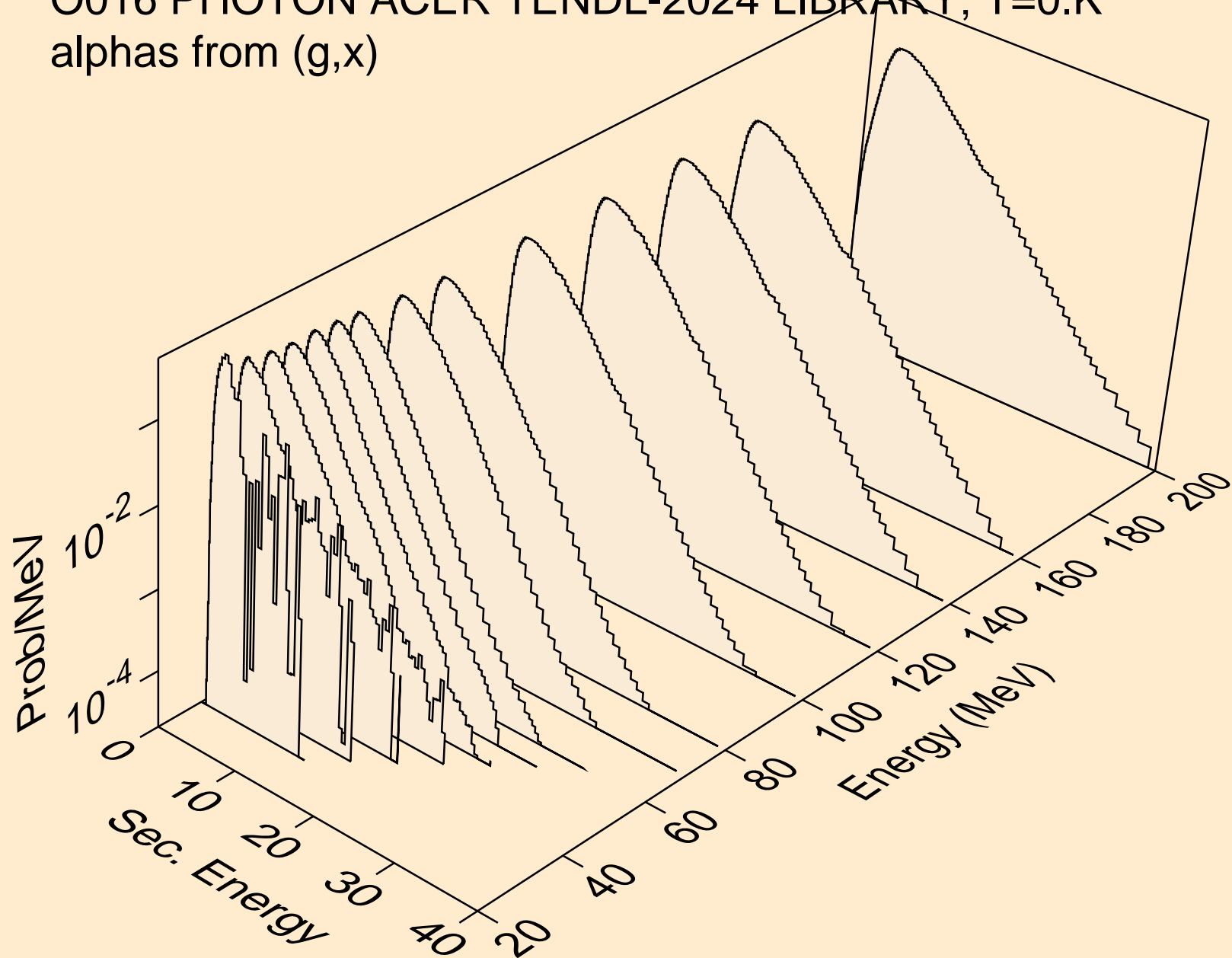

O016 PHOTON ACER TENDL-2024 LIBRARY; T=0.K  
alphas from (g,n\*)a

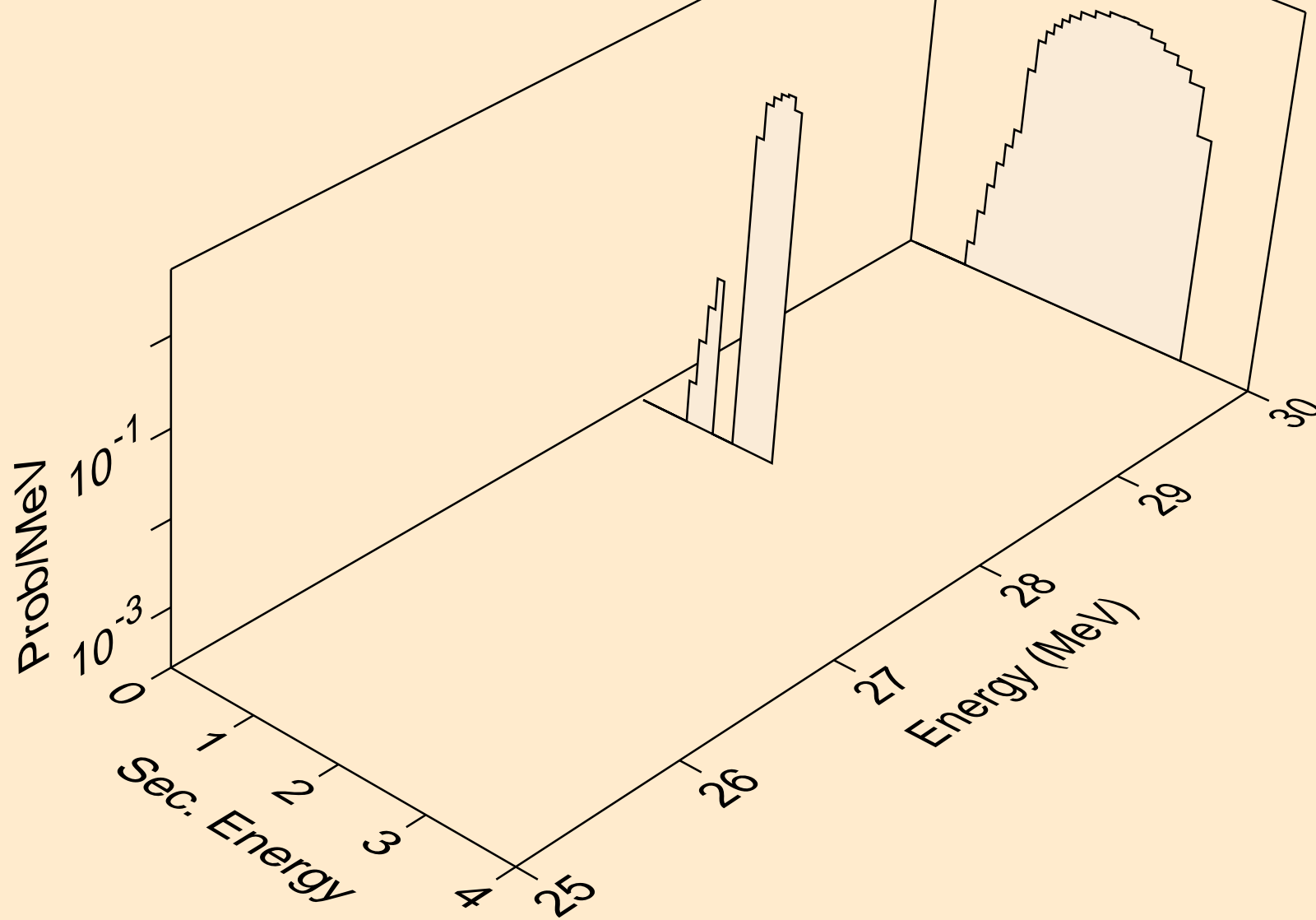

O016 PHOTON ACER TENDL-2024 LIBRARY; T=0.K  
alphas from (g,a)

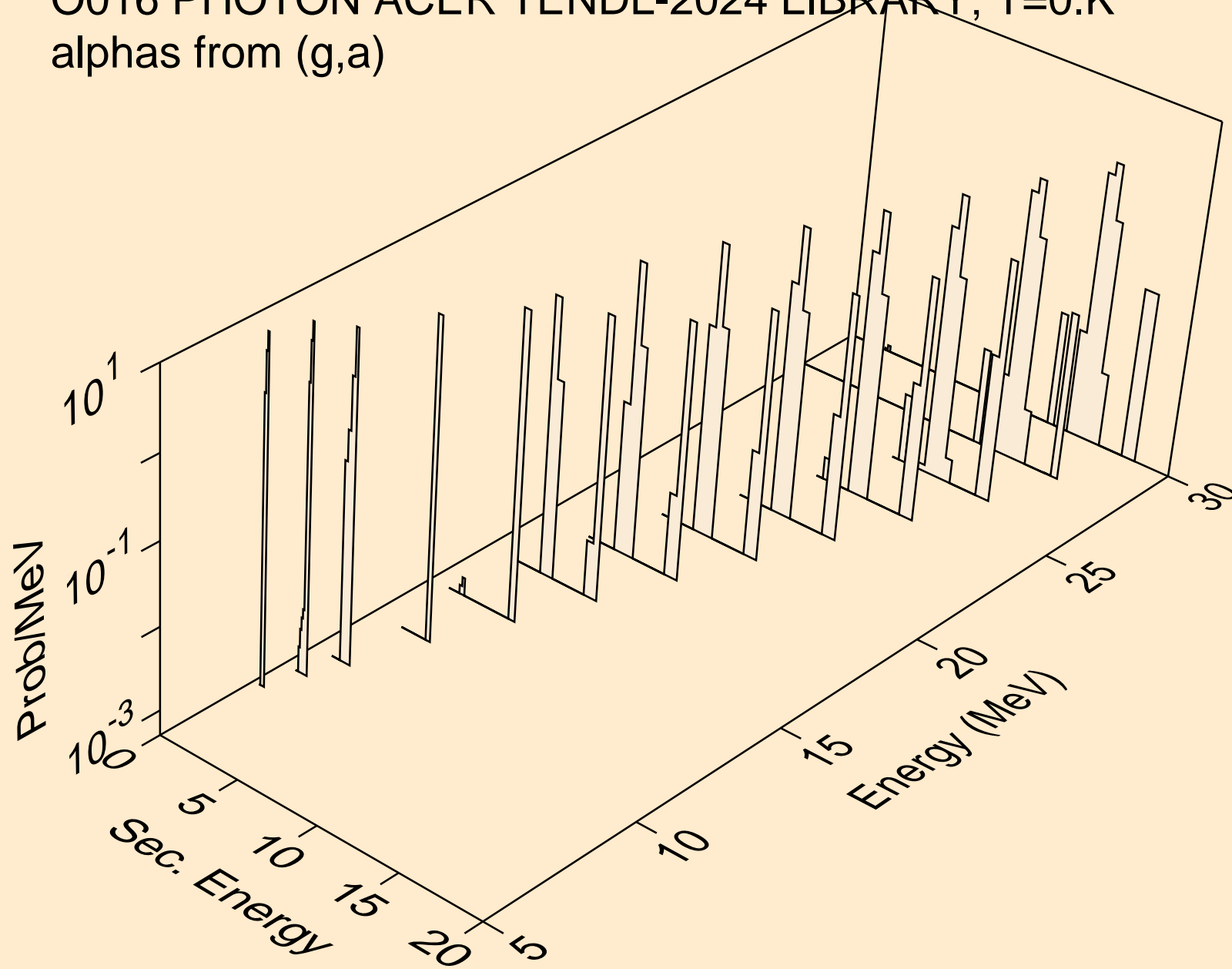

O016 PHOTON ACER TENDL-2024 LIBRARY; T=0.K  
alphas from (g,2a)

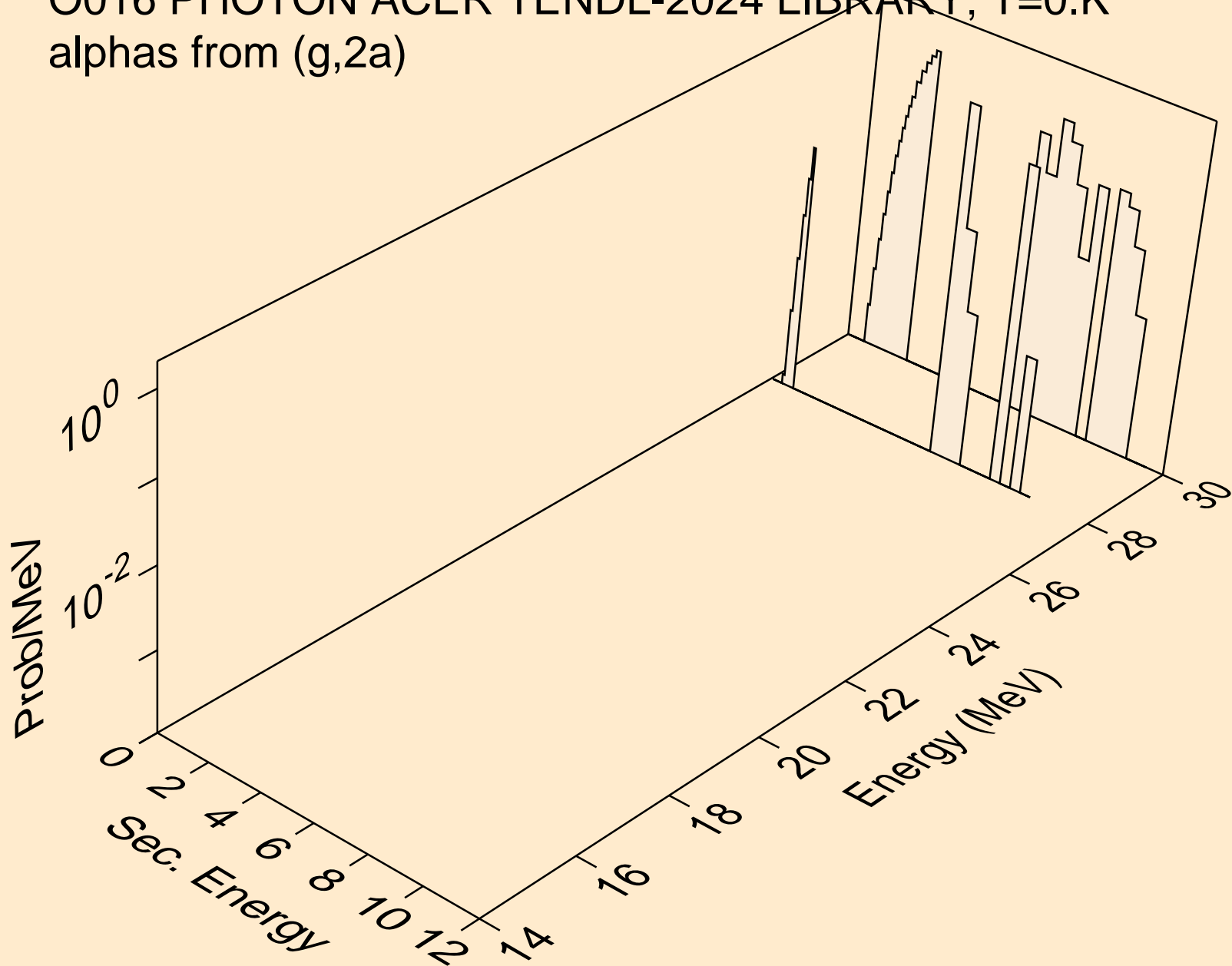

O016 PHOTON ACER TENDL-2024 LIBRARY; T=0.K  
alphas from (g,pa)

