

PD103 PHOTON ACER TENDL-2024 LIBRARY; T=0.K  
Principal cross sections

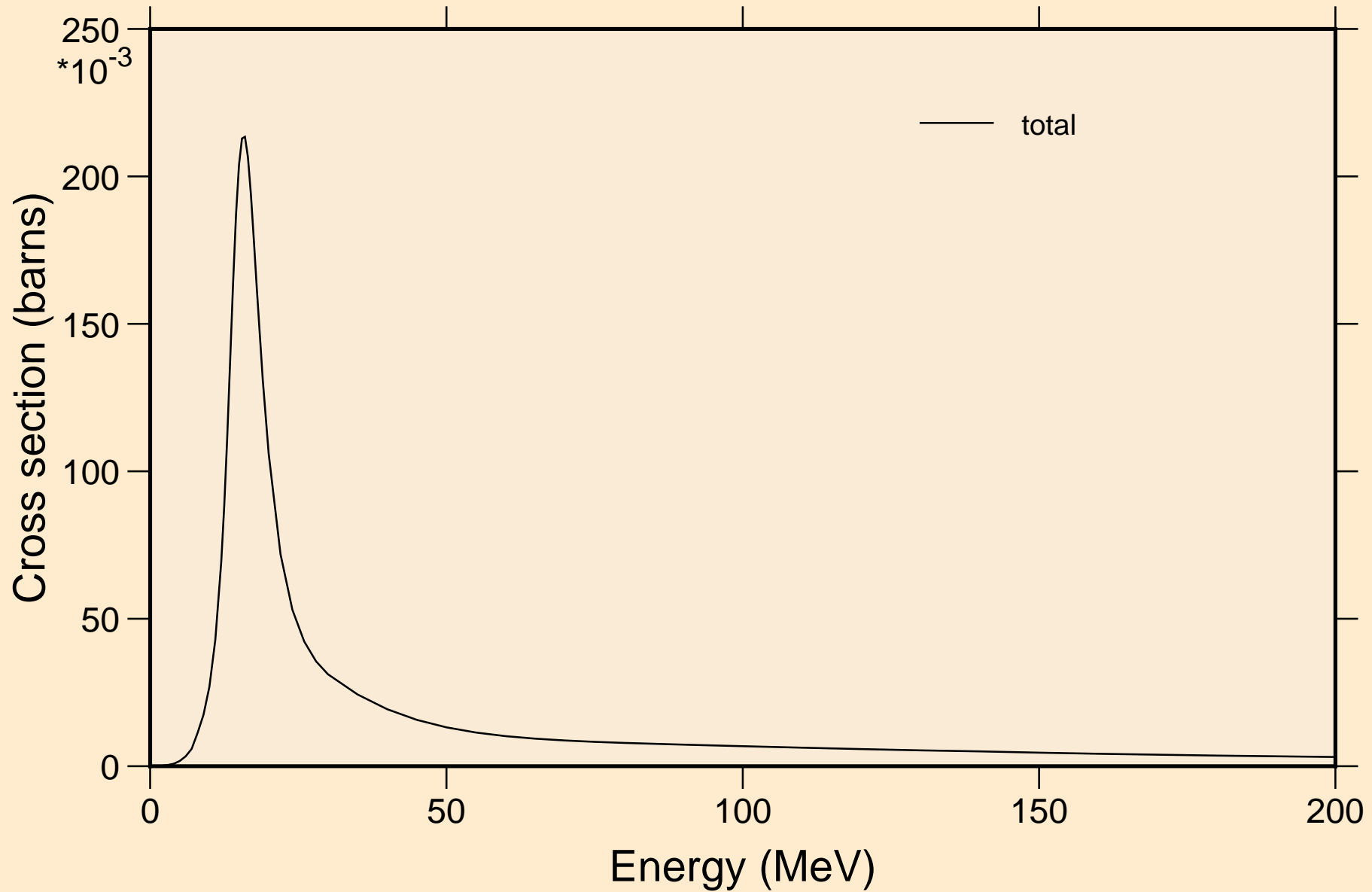

# PD103 PHOTON ACER TENDL-2024 LIBRARY; T=0.K

## Partial cross sections

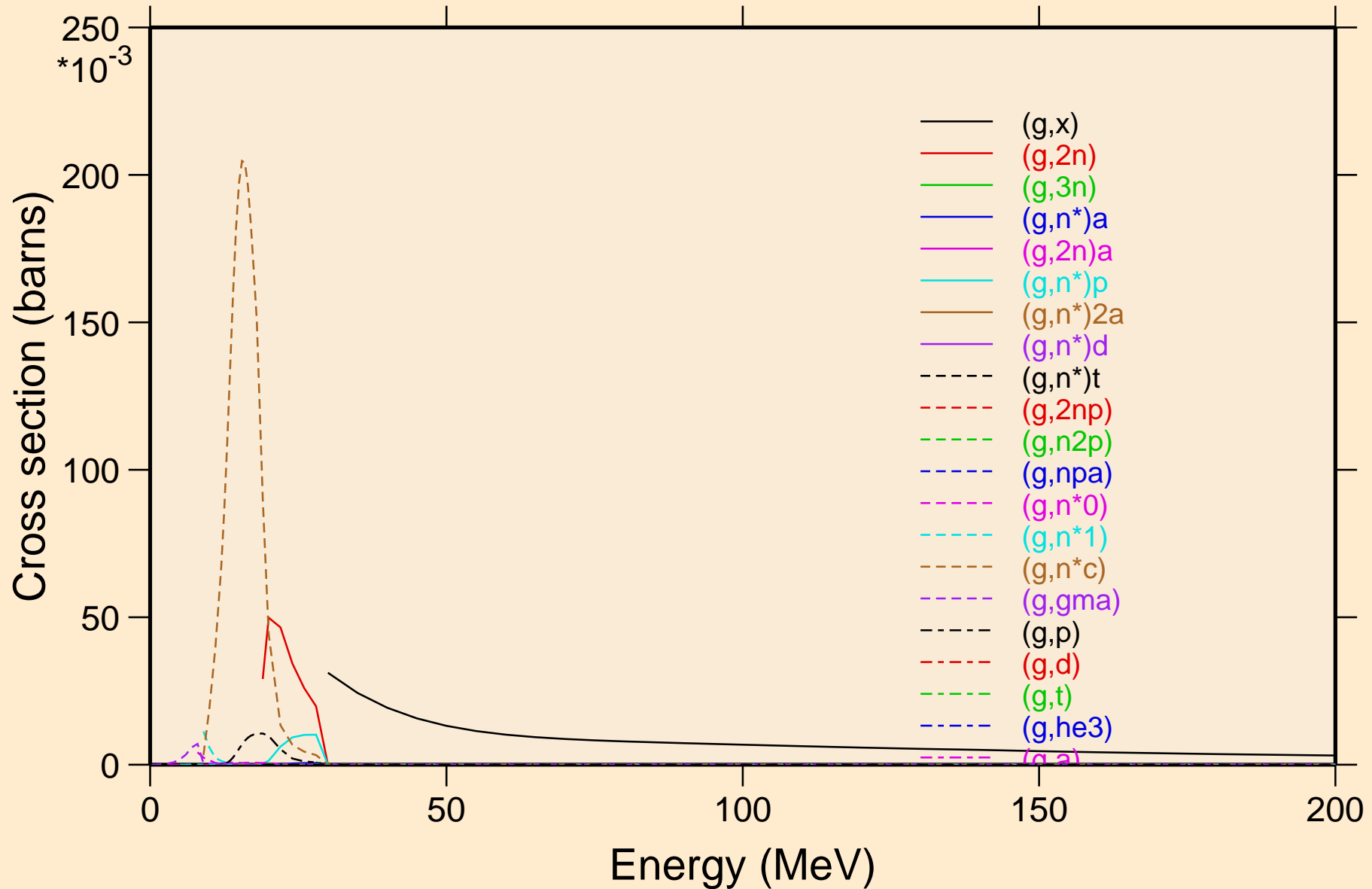

PD103 PHOTON ACER TENDL-2024 LIBRARY; T=0.K

Heating

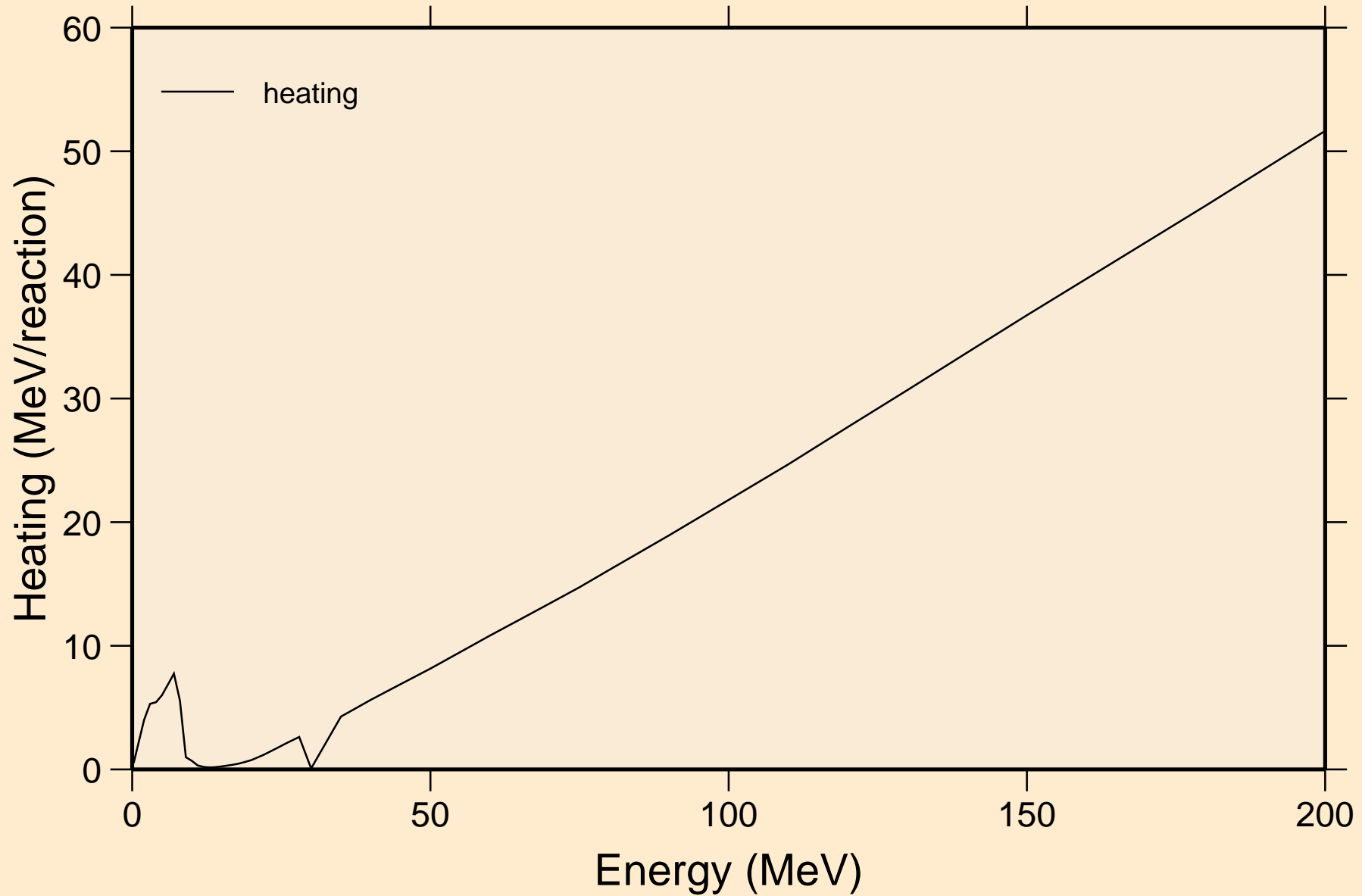

# PD103 PHOTON ACER TENDL-2024 LIBRARY; T=0.K

## Particle heating contributions

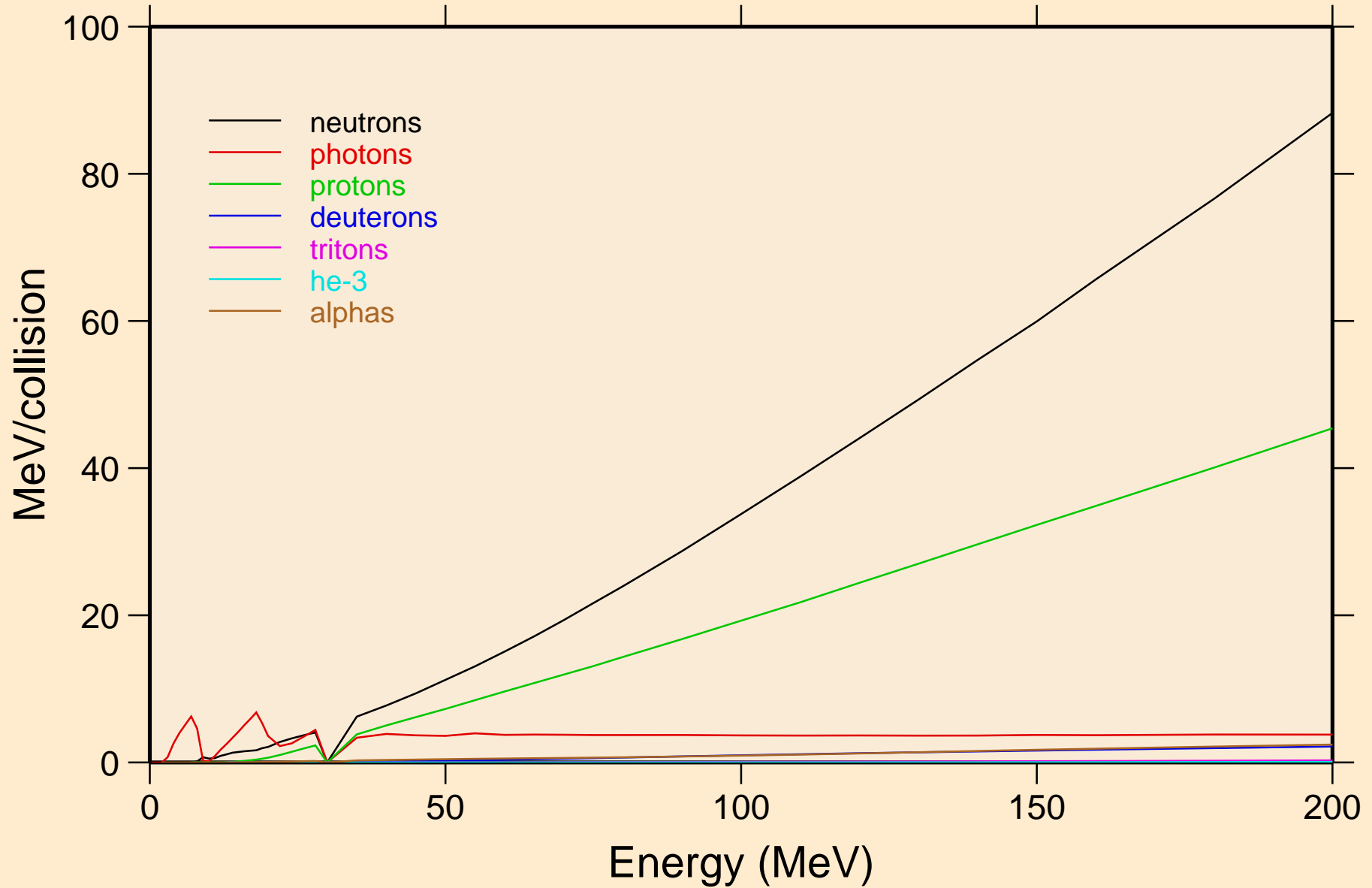

PD103 PHOTON ACER TENDL-2024 LIBRARY; T=0.K  
Particle production cross sections

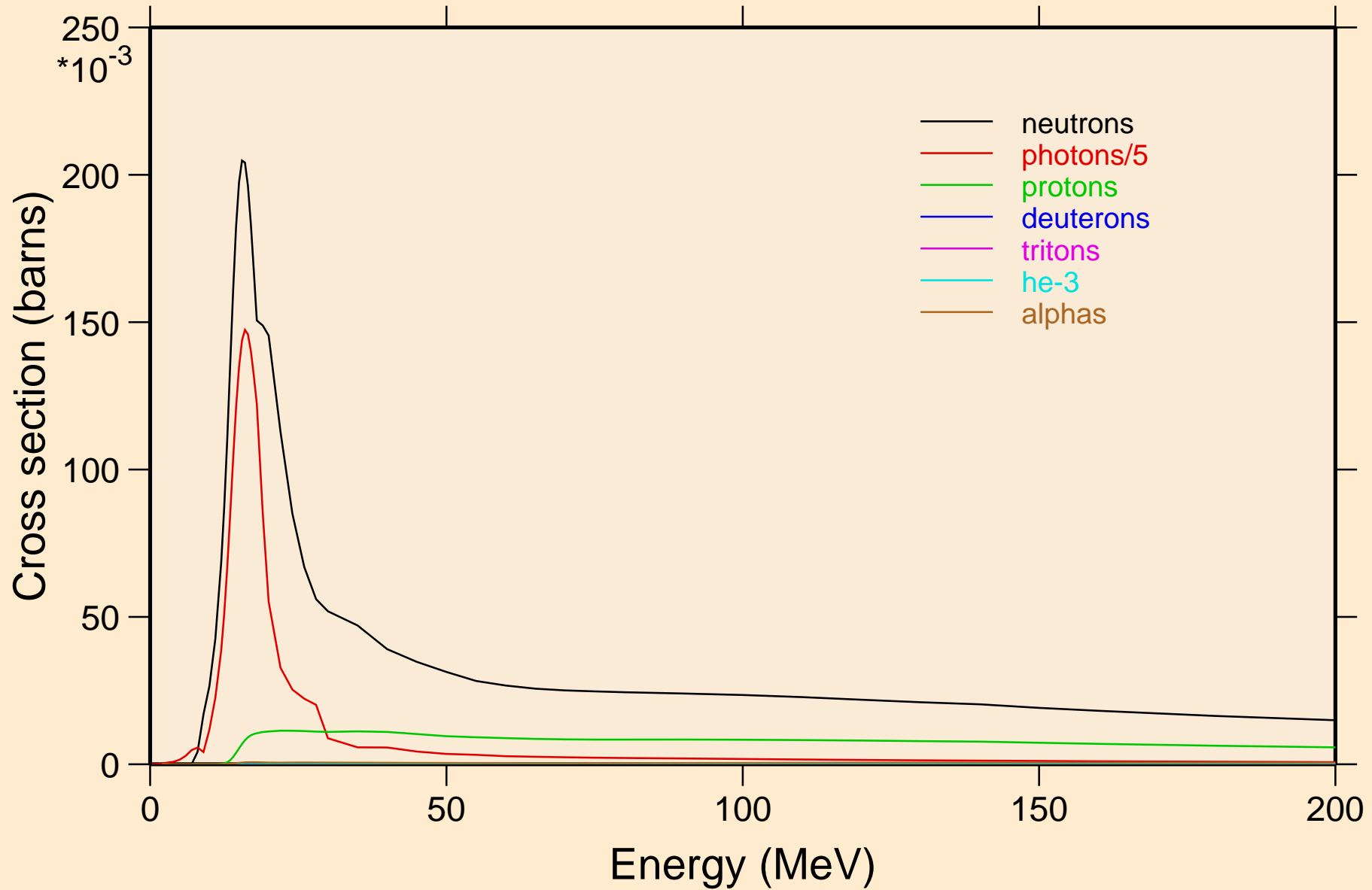

PD103 PHOTON ACER TENDL-2024 LIBRARY; T=0.K  
neutrons from (g,x)

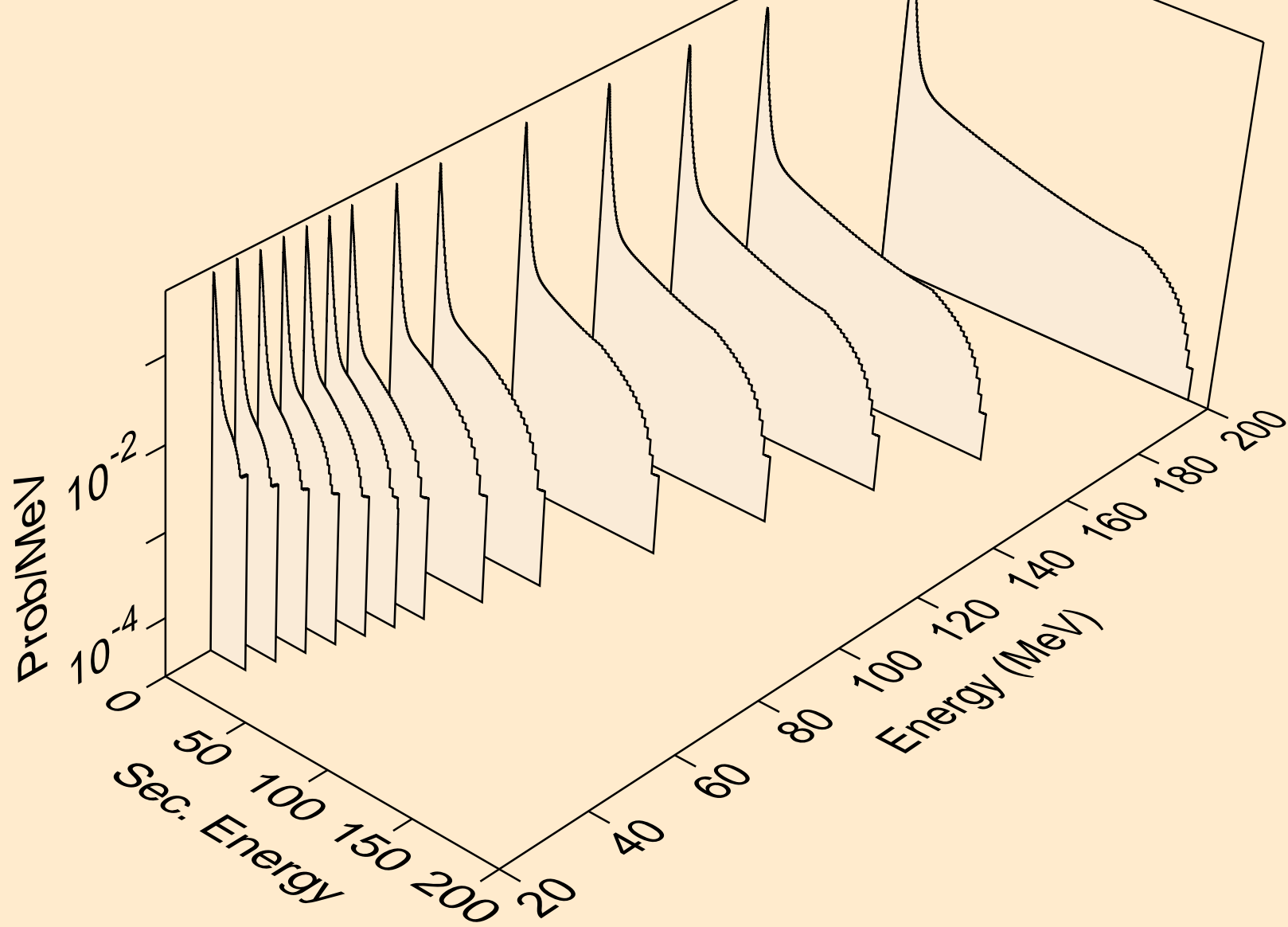

PD103 PHOTON ACER TENDL-2024 LIBRARY; T=0.K  
neutrons from (g,2n)

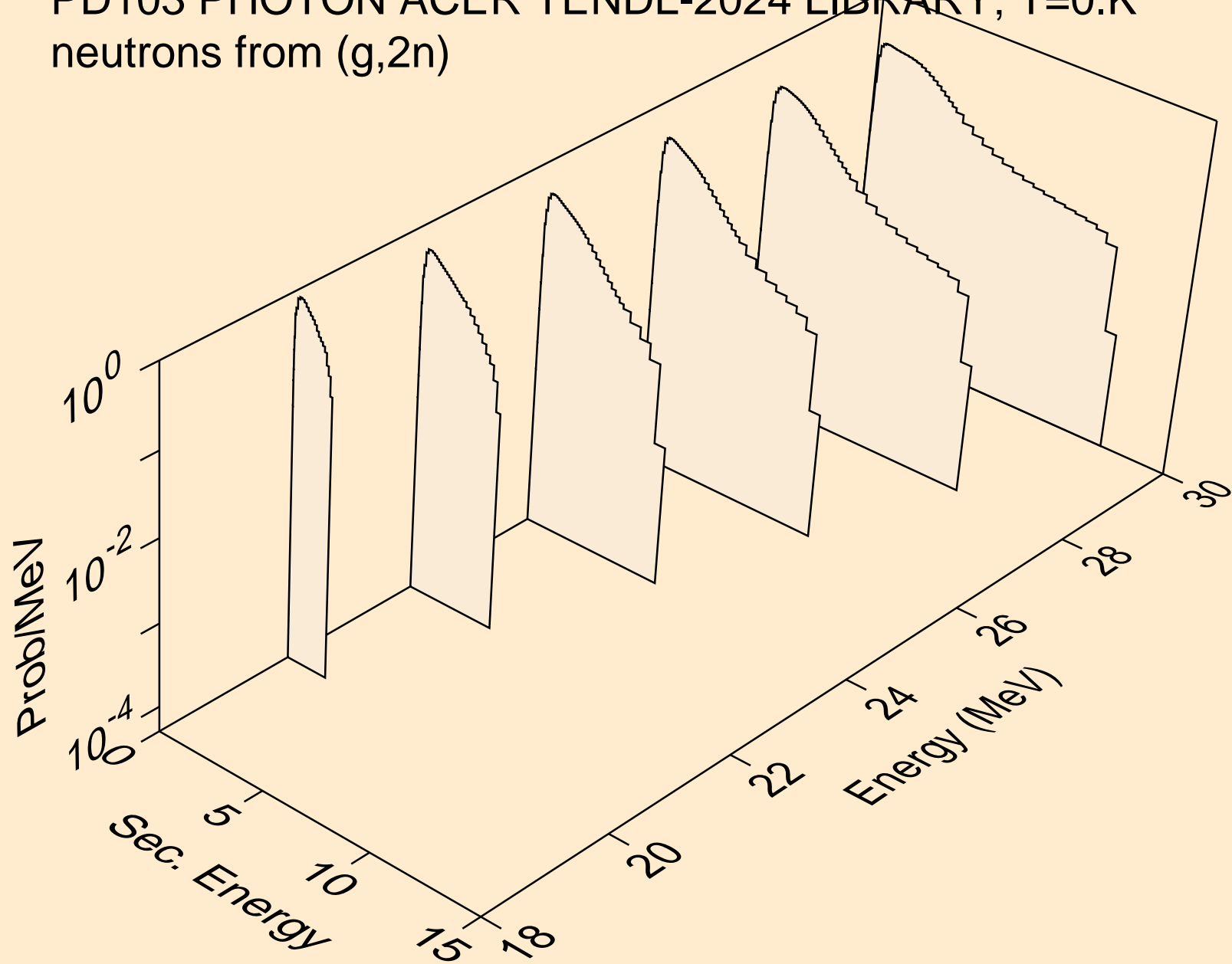

PD103 PHOTON ACER TENDL-2024 LIBRARY; T=0.K  
neutrons from (g,3n)

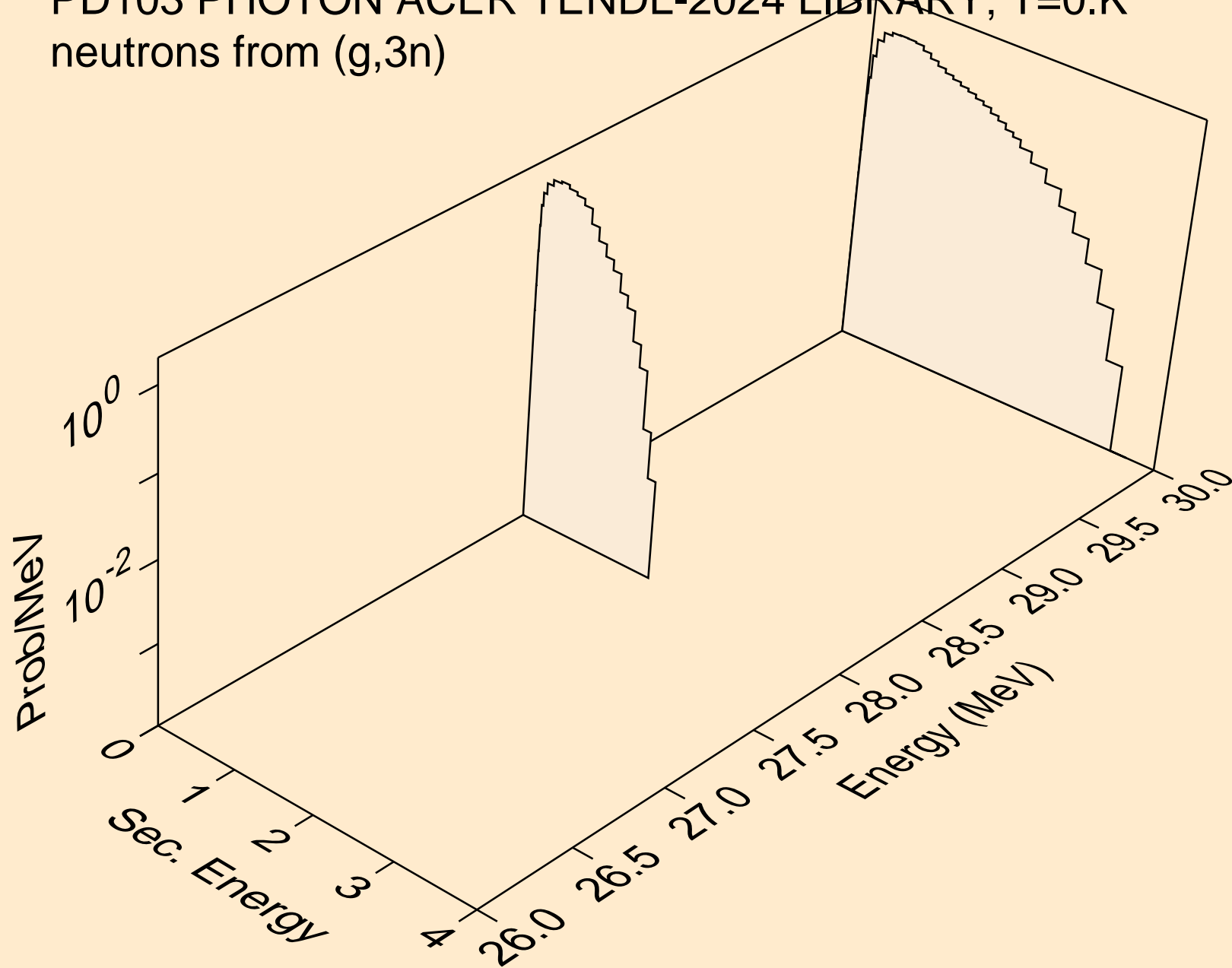

PD103 PHOTON ACER TENDL-2024 LIBRARY; T=0.K  
neutrons from (g,n\*)a

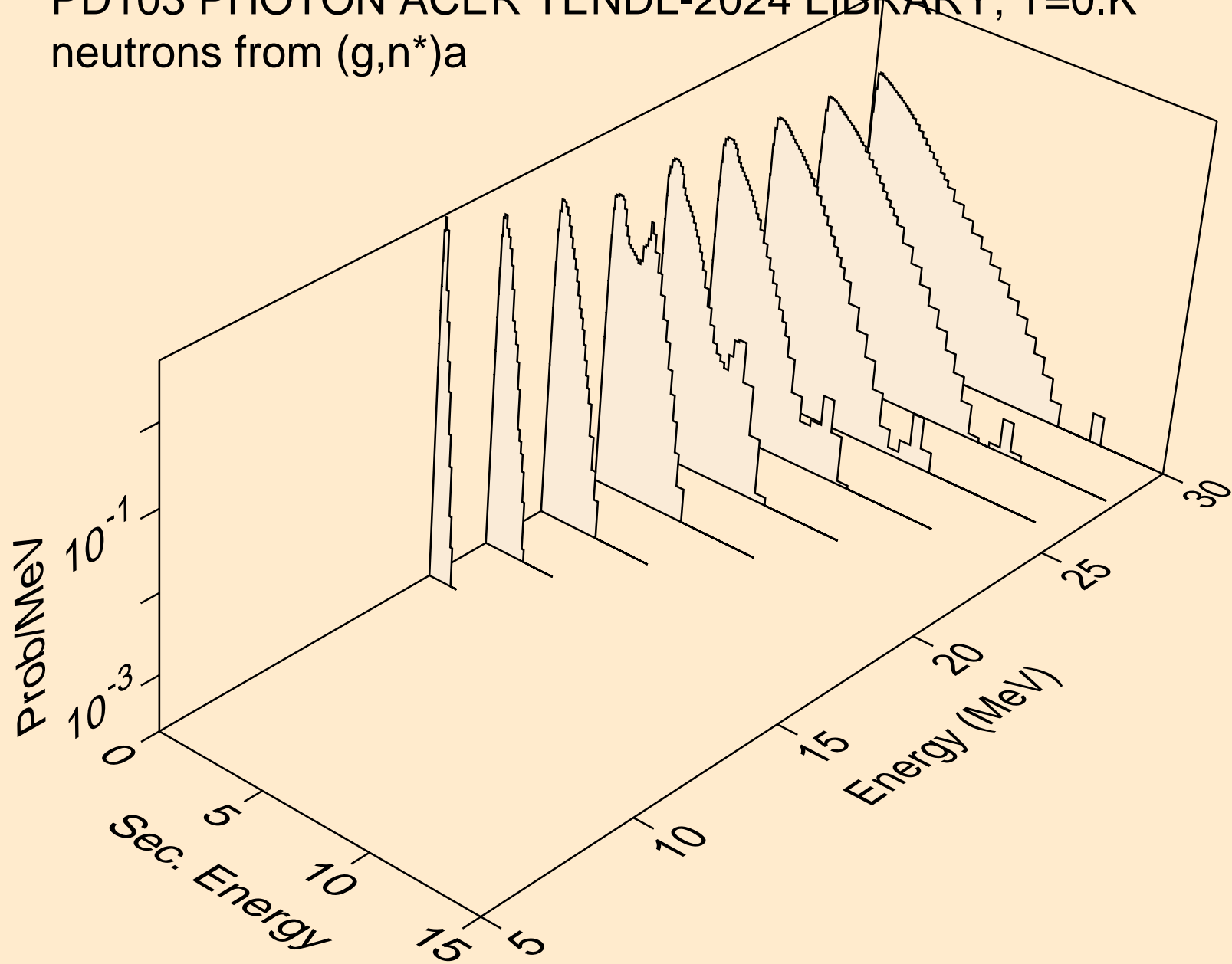

PD103 PHOTON ACER TENDL-2024 LIBRARY; T=0.K  
neutrons from (g,2n)a

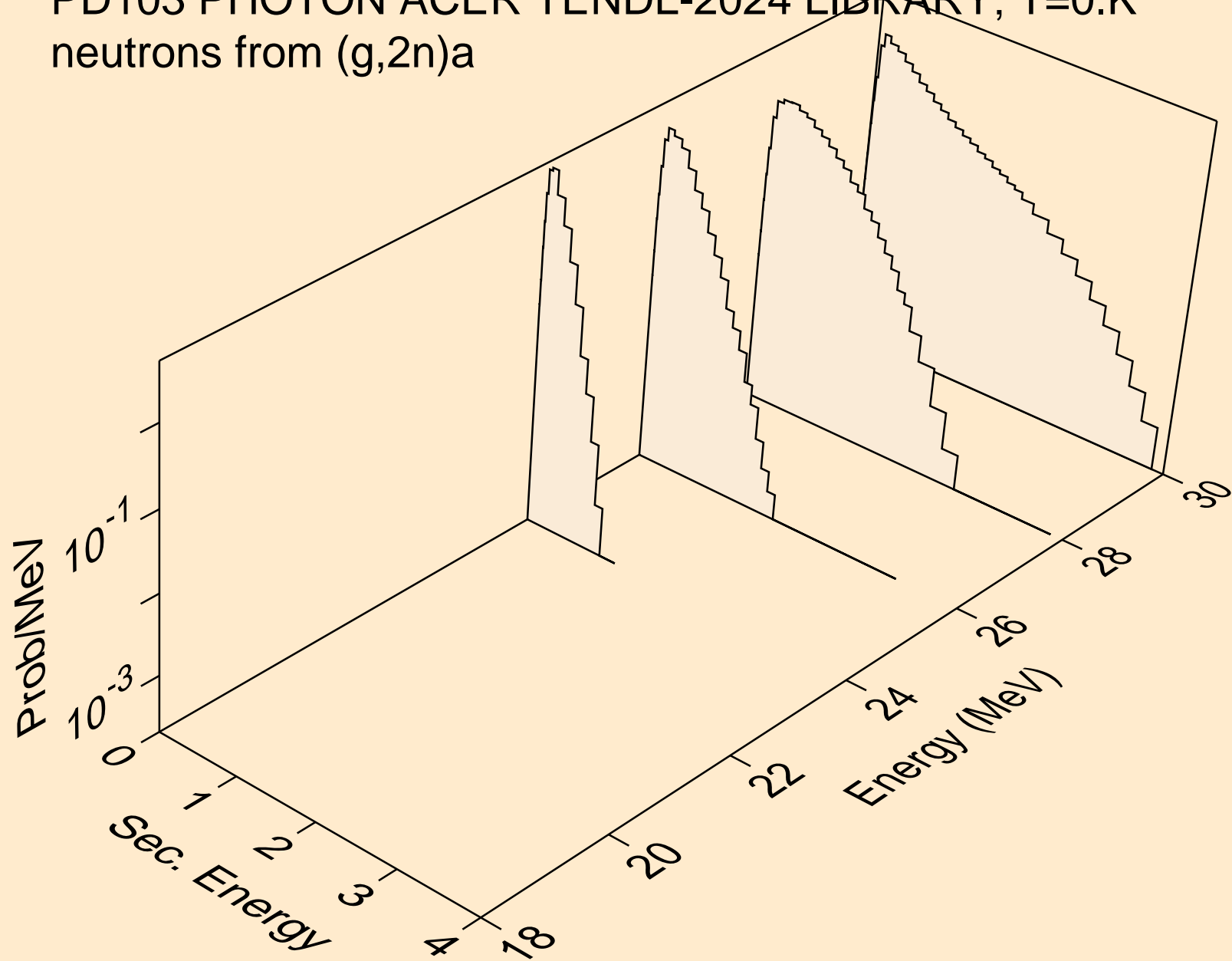

PD103 PHOTON ACER TENDL-2024 LIBRARY; T=0.K  
neutrons from (g,n\*)p

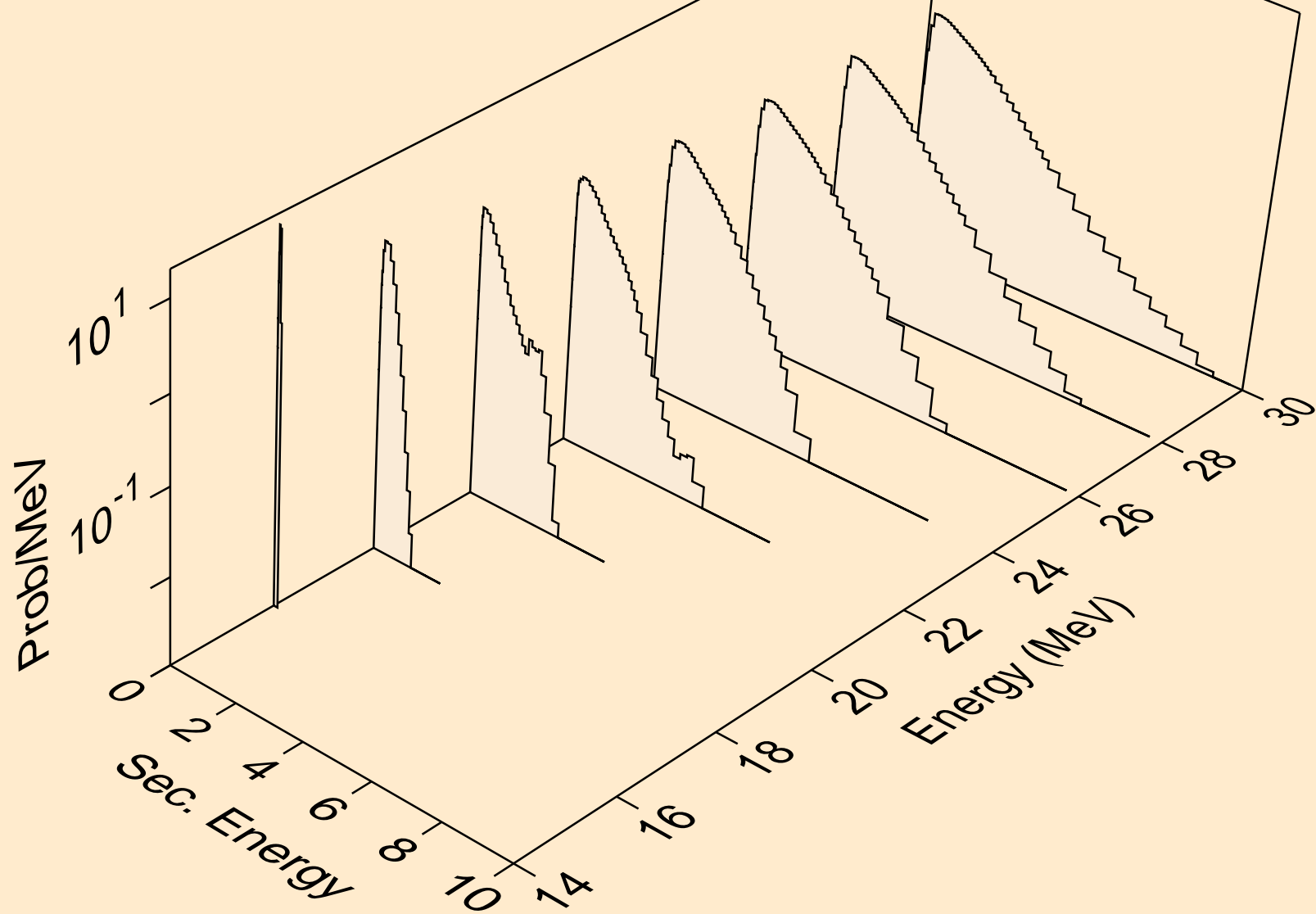

PD103 PHOTON ACER TENDL-2024 LIBRARY; T=0.K  
neutrons from (g,n\*)2a

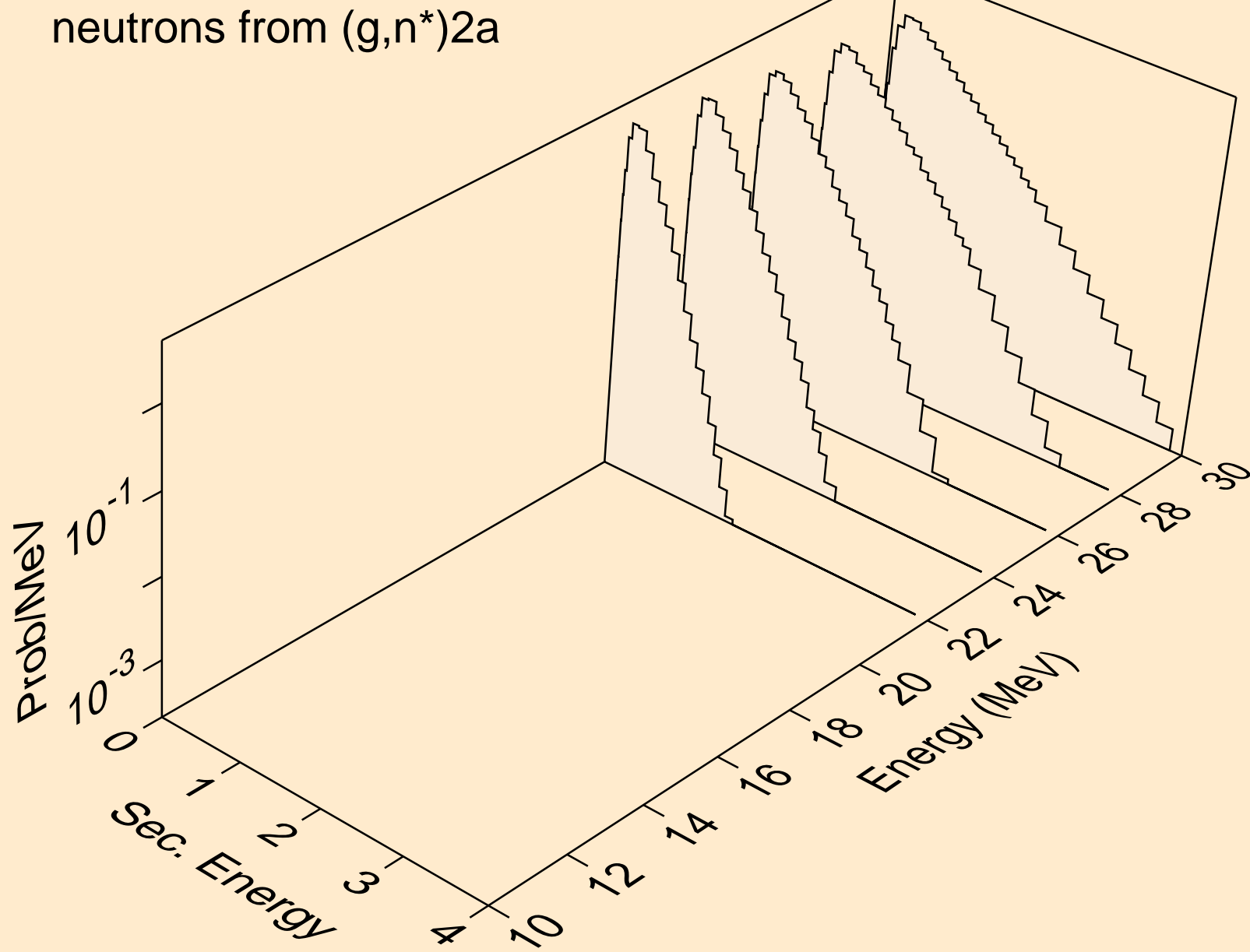

PD103 PHOTON ACER TENDL-2024 LIBRARY; T=0.K  
neutrons from (g,n\*)d

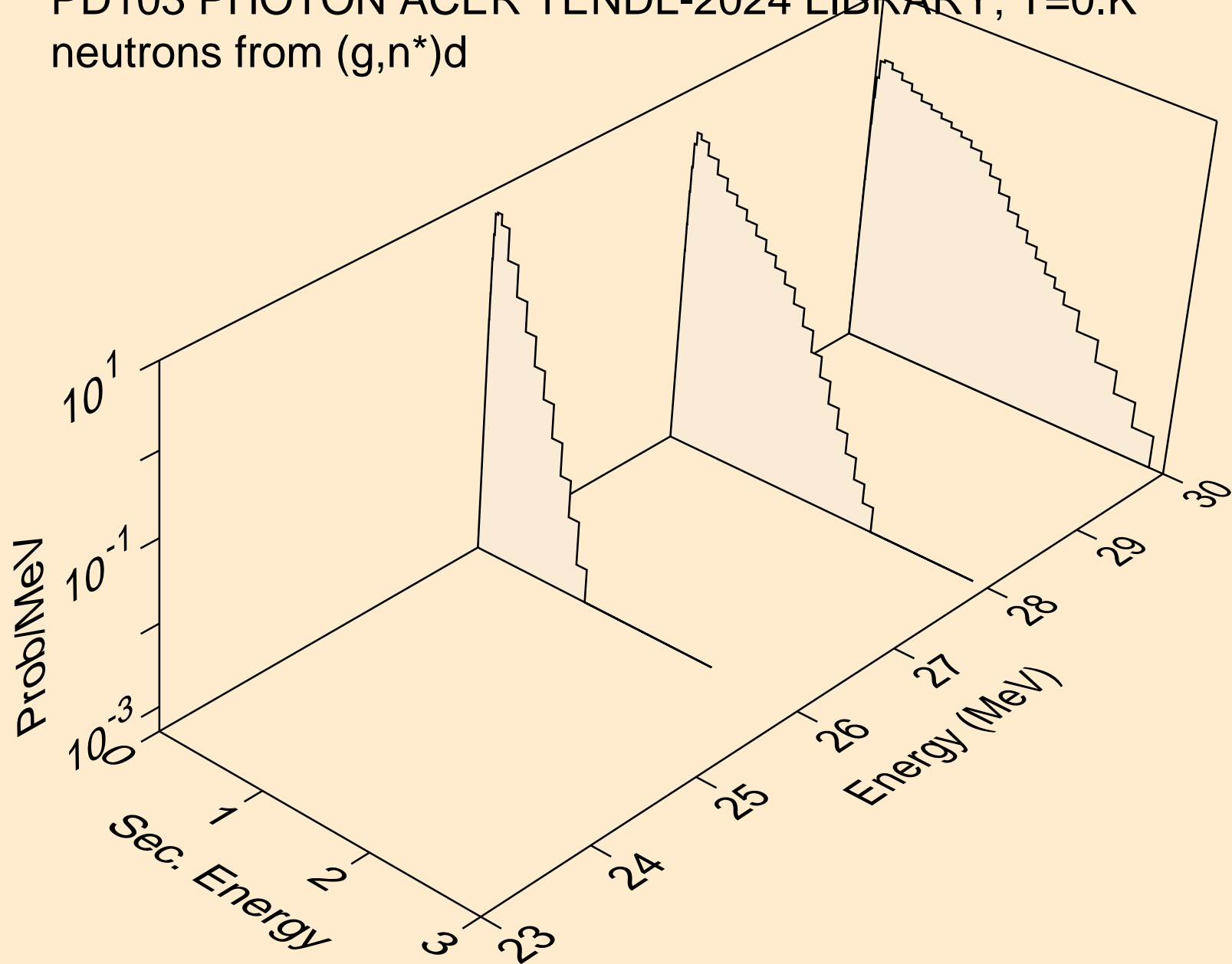

PD103 PHOTON ACER TENDL-2024 LIBRARY; T=0.K  
neutrons from (g,n\*)t

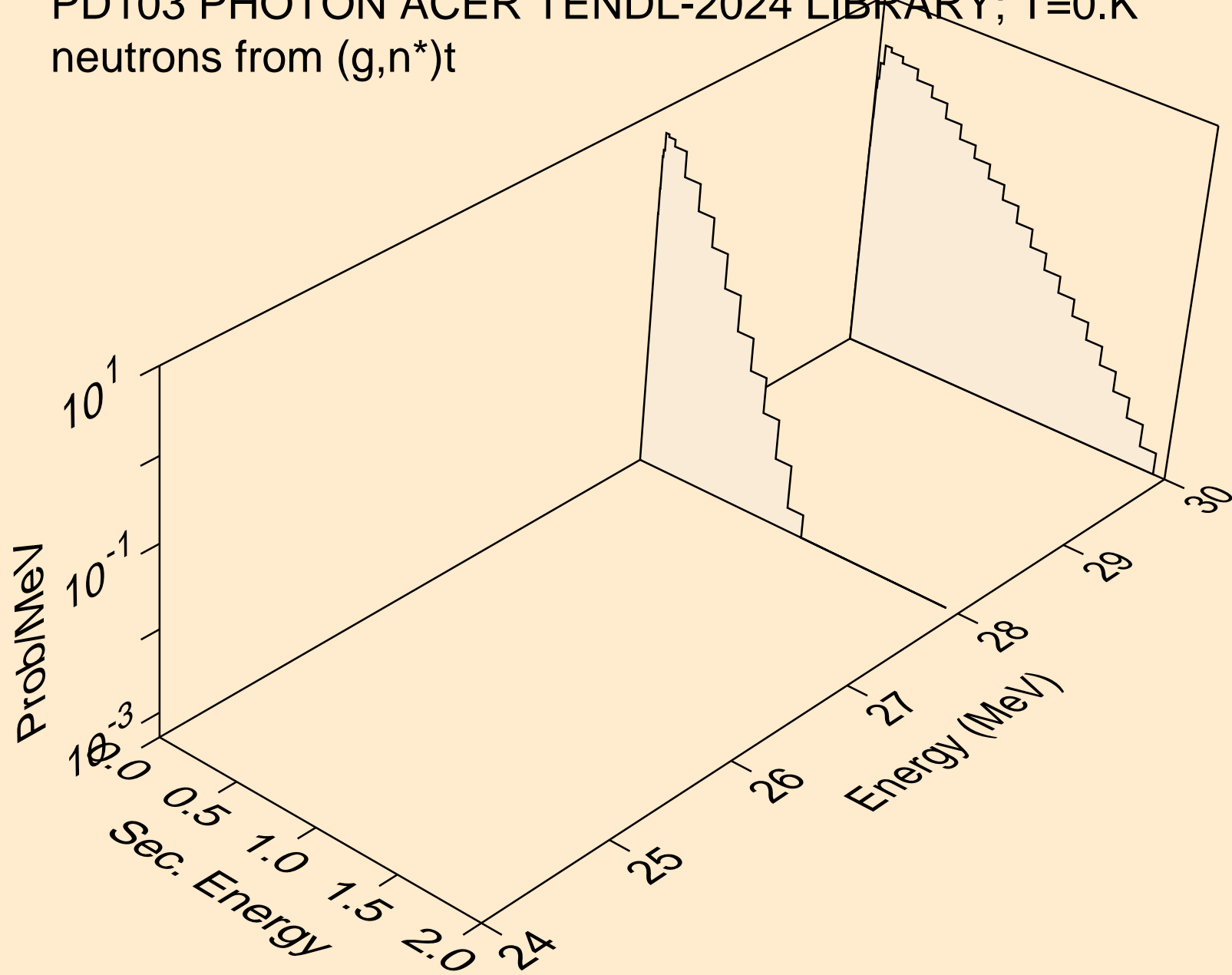

PD103 PHOTON ACER TENDL-2024 LIBRARY; T=0.K  
neutrons from (g,2np)

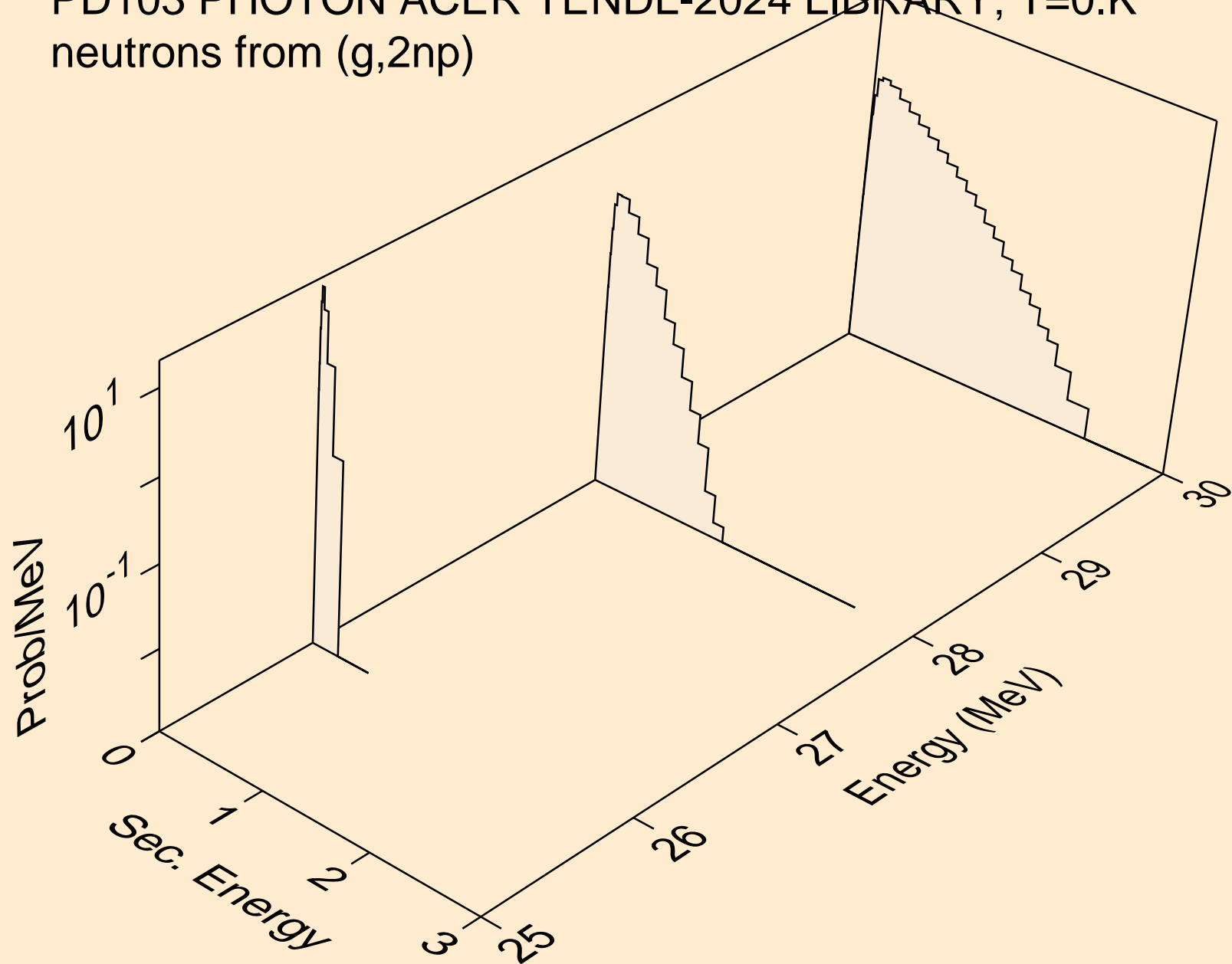

PD103 PHOTON ACER TENDL-2024 LIBRARY; T=0.K  
neutrons from (g,n2p)

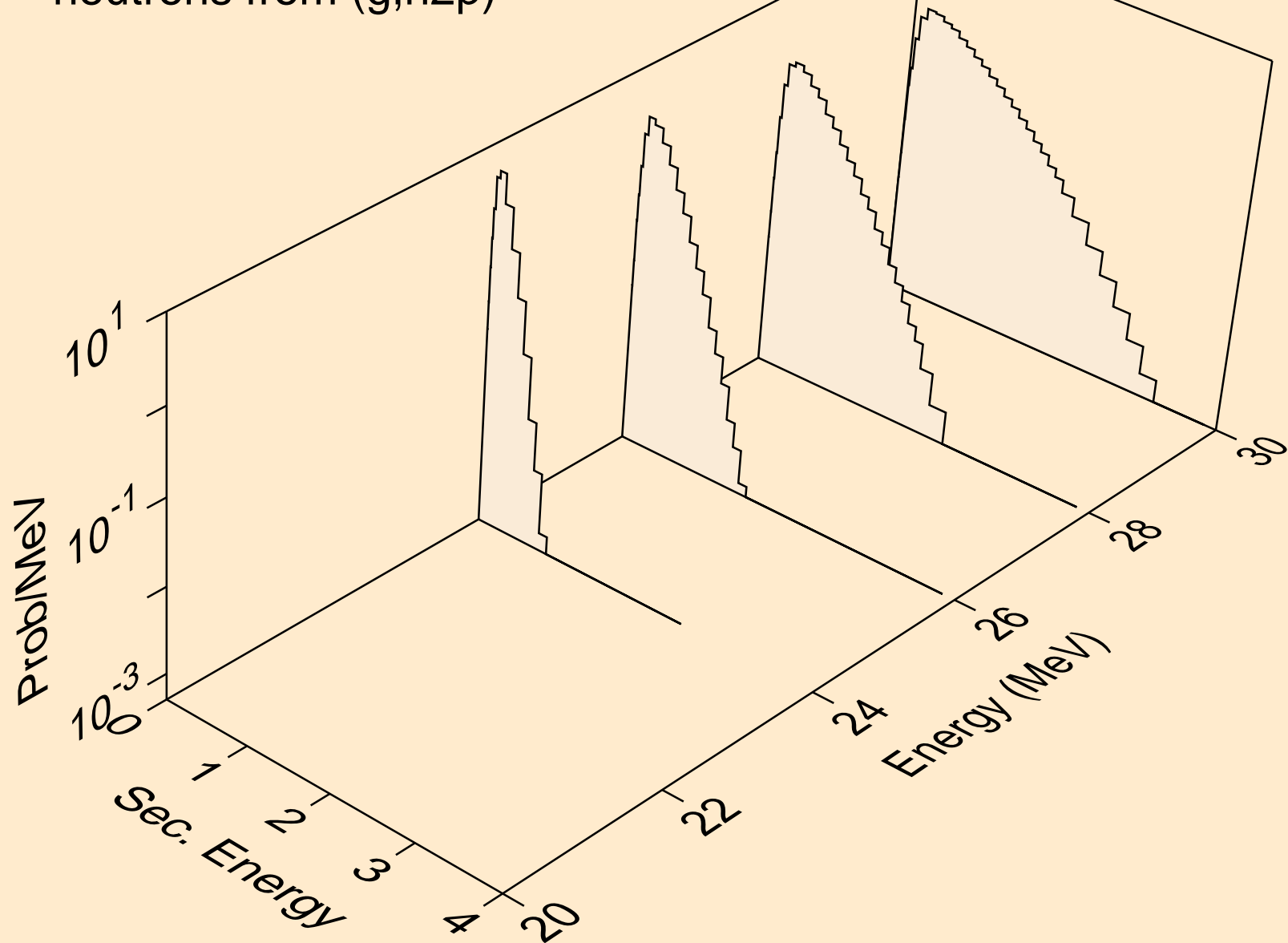

PD103 PHOTON ACER TENDL-2024 LIBRARY; T=0.K  
neutrons from (g,npa)

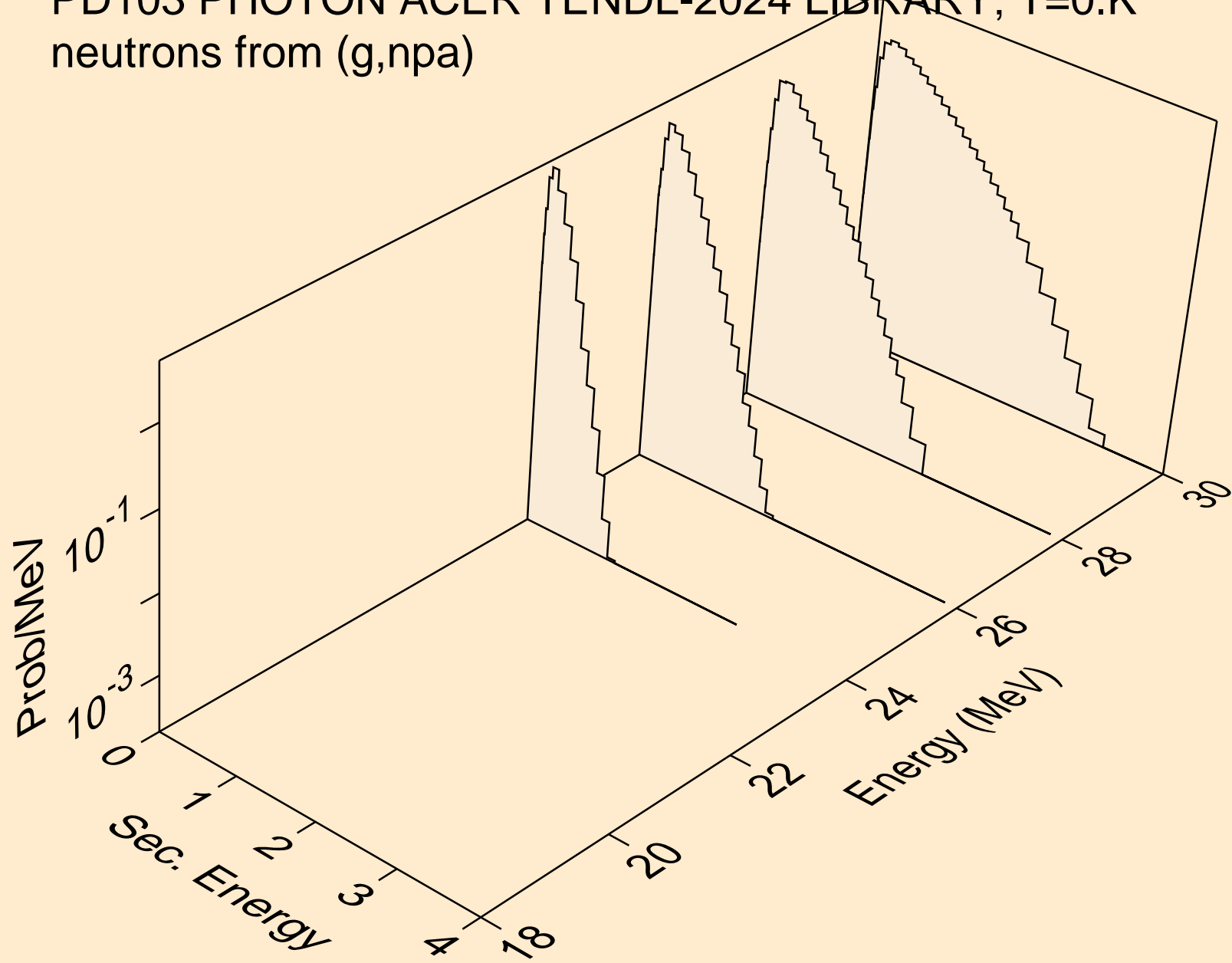

PD103 PHOTON ACER TENDL-2024 LIBRARY; T=0.K  
angular distribution for (g,n\*0) neutron

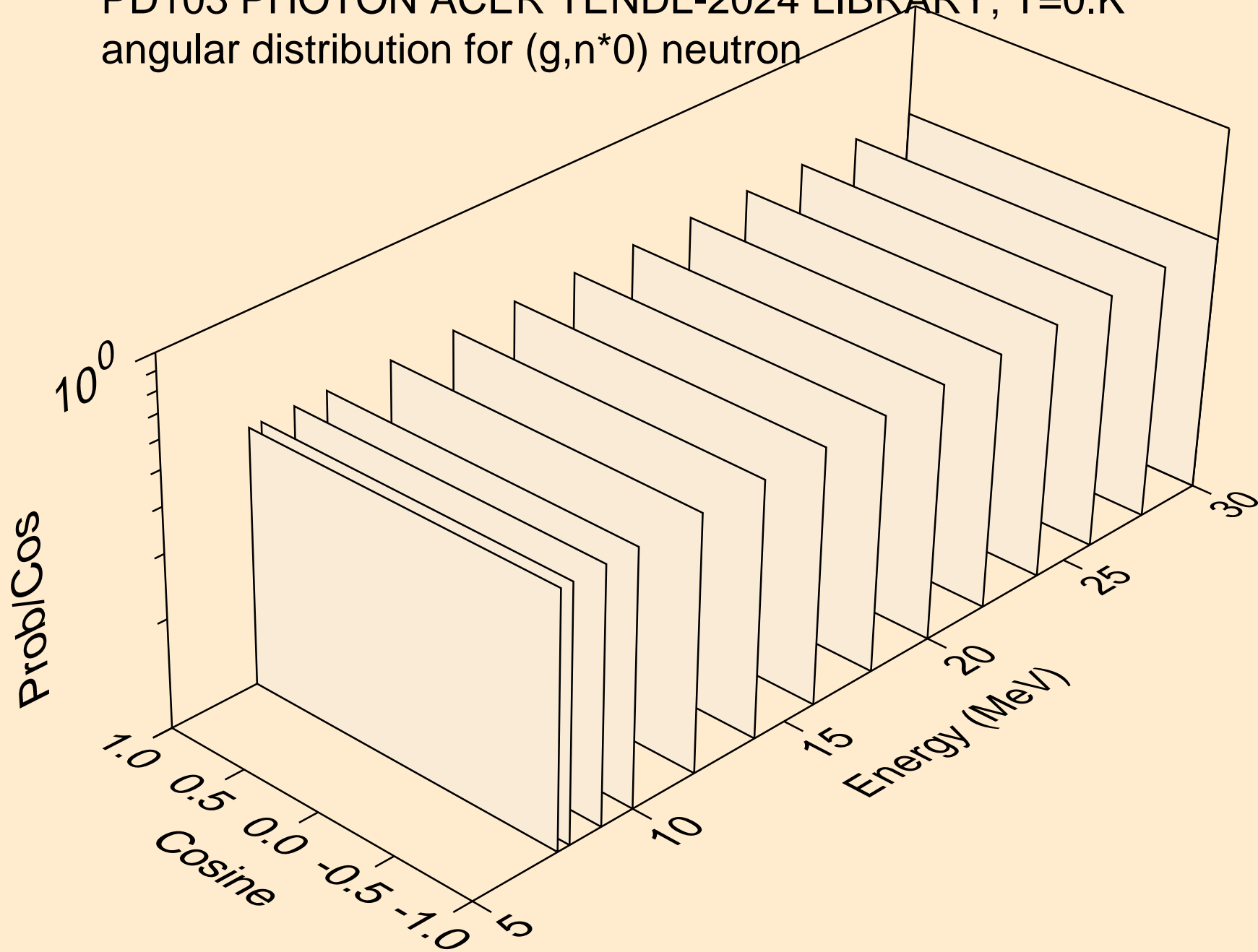

PD103 PHOTON ACER TENDL-2024 LIBRARY; T=0.K  
angular distribution for (g,n\*1) neutron

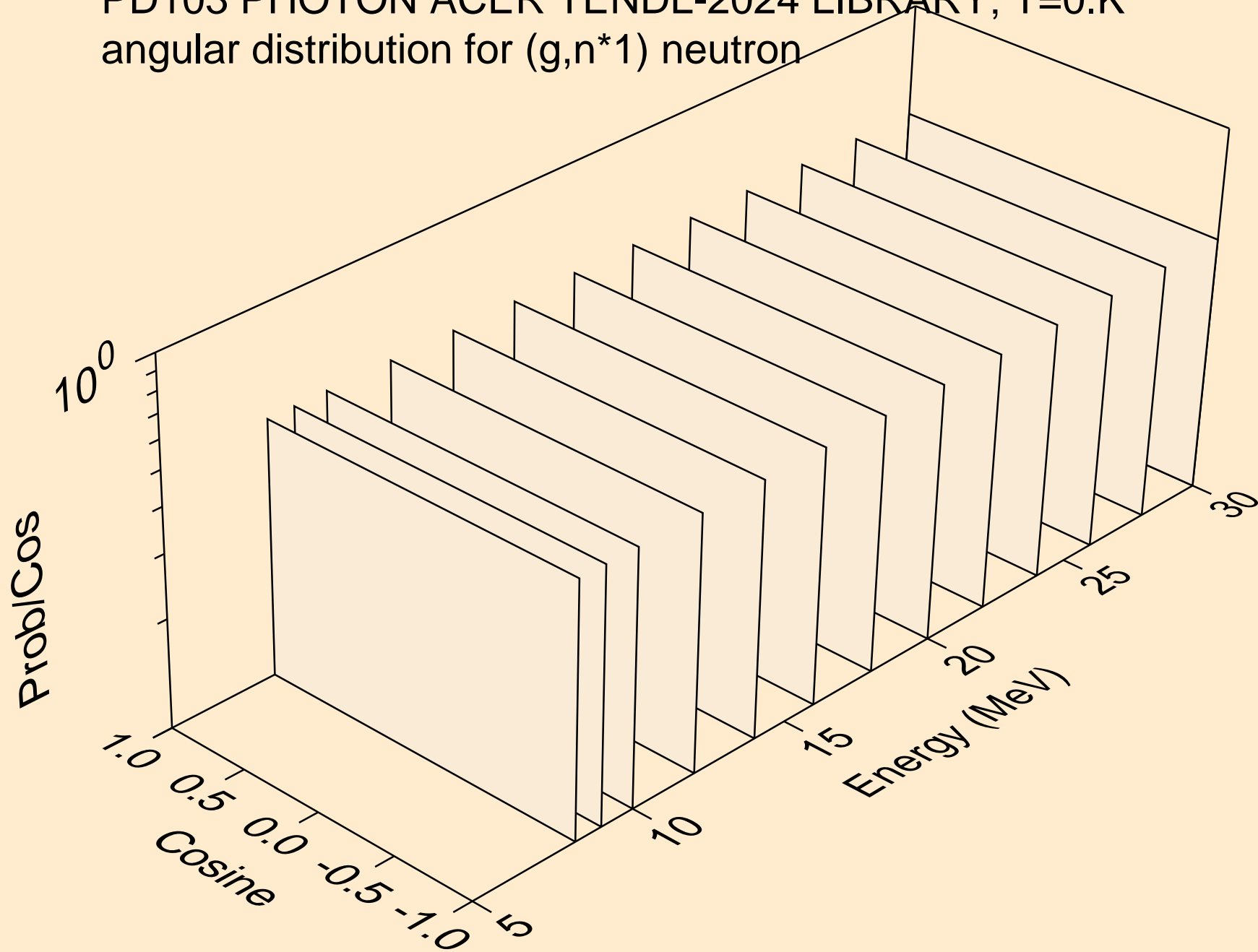

PD103 PHOTON ACER TENDL-2024 LIBRARY; T=0.K  
neutrons from (g,n\*c)

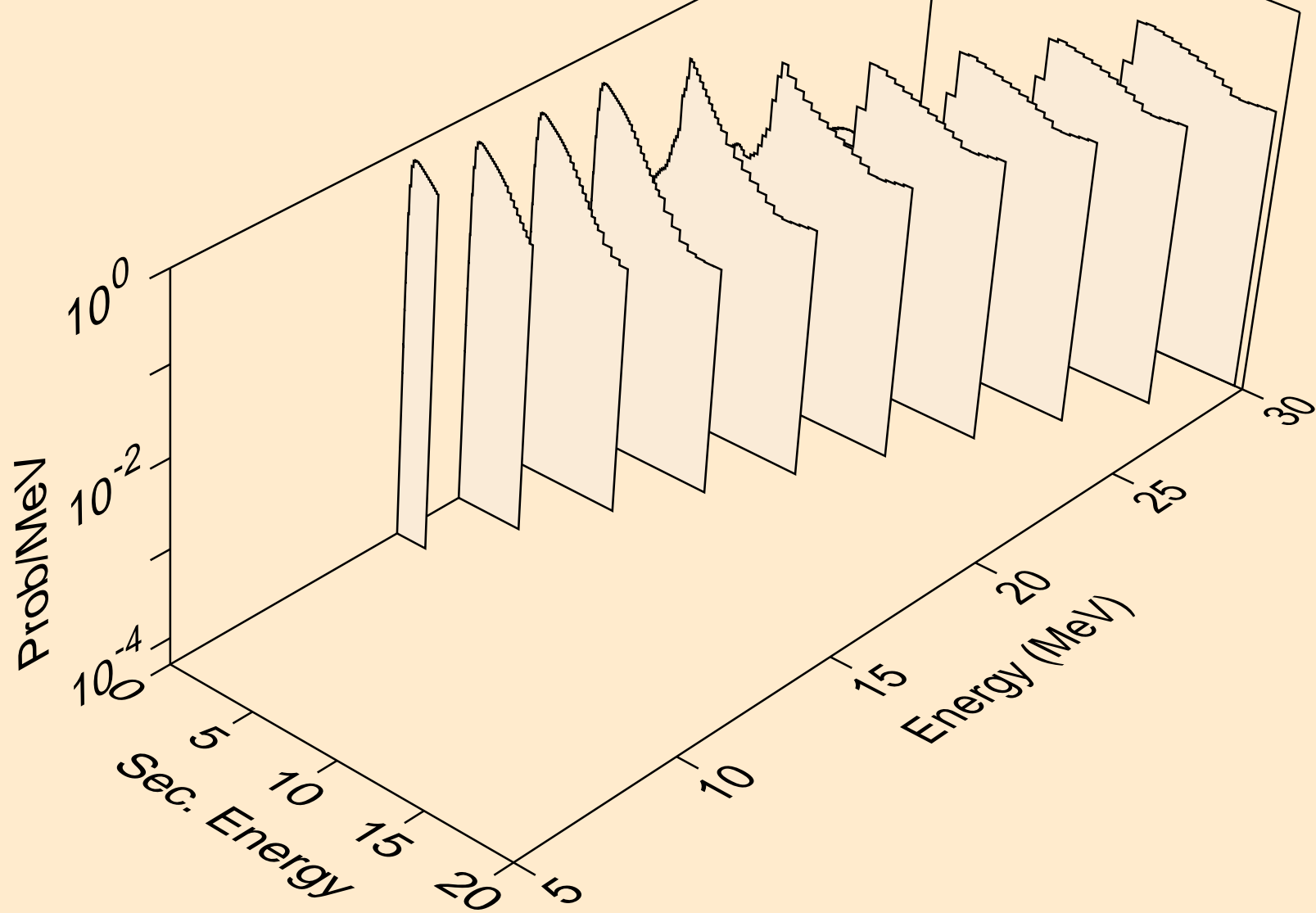

PD103 PHOTON ACER TENDL-2024 LIBRARY; T=0.K  
photons from (g,x)

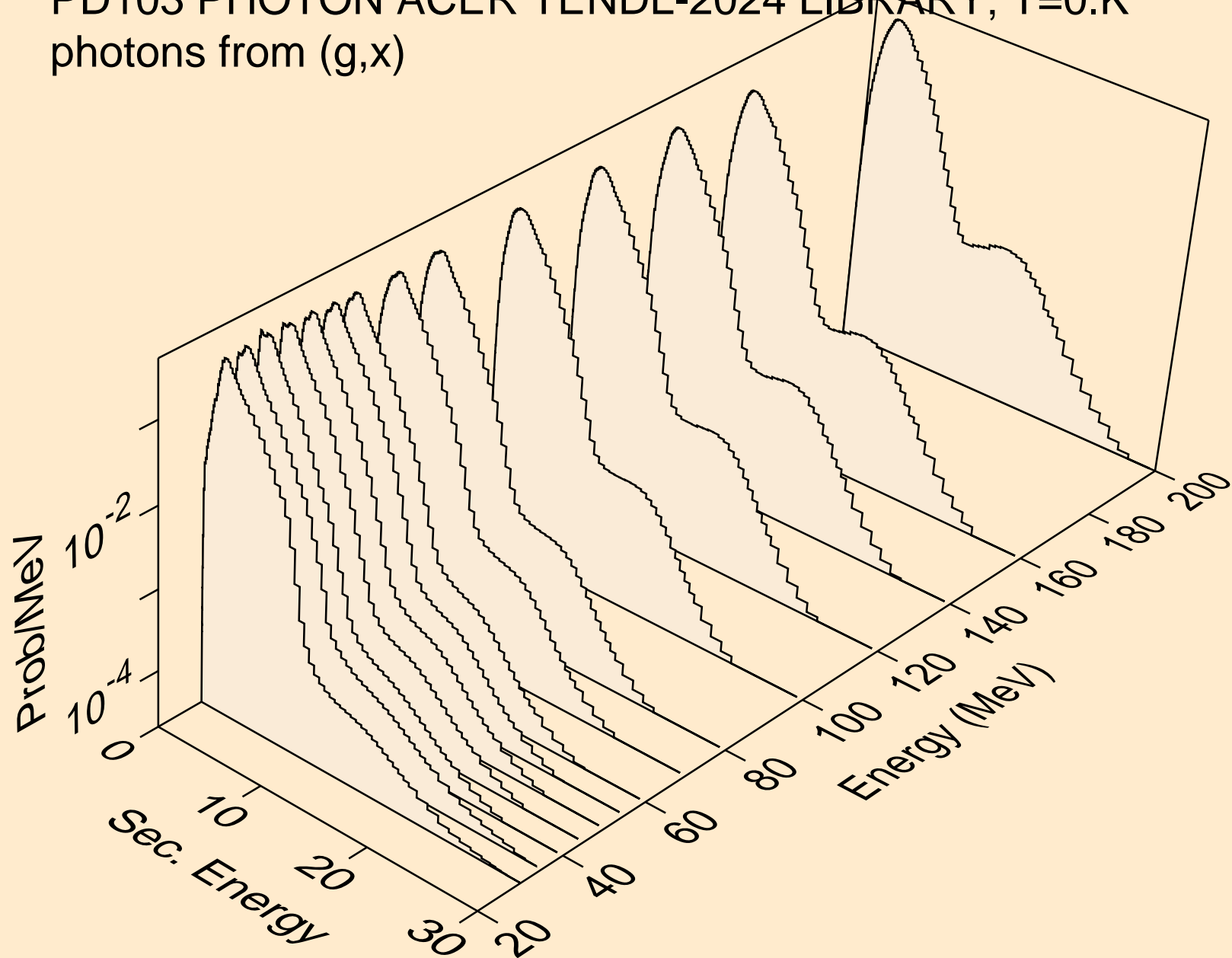

PD103 PHOTON ACER TENDL-2024 LIBRARY; T=0.K  
photons from (g,2n)

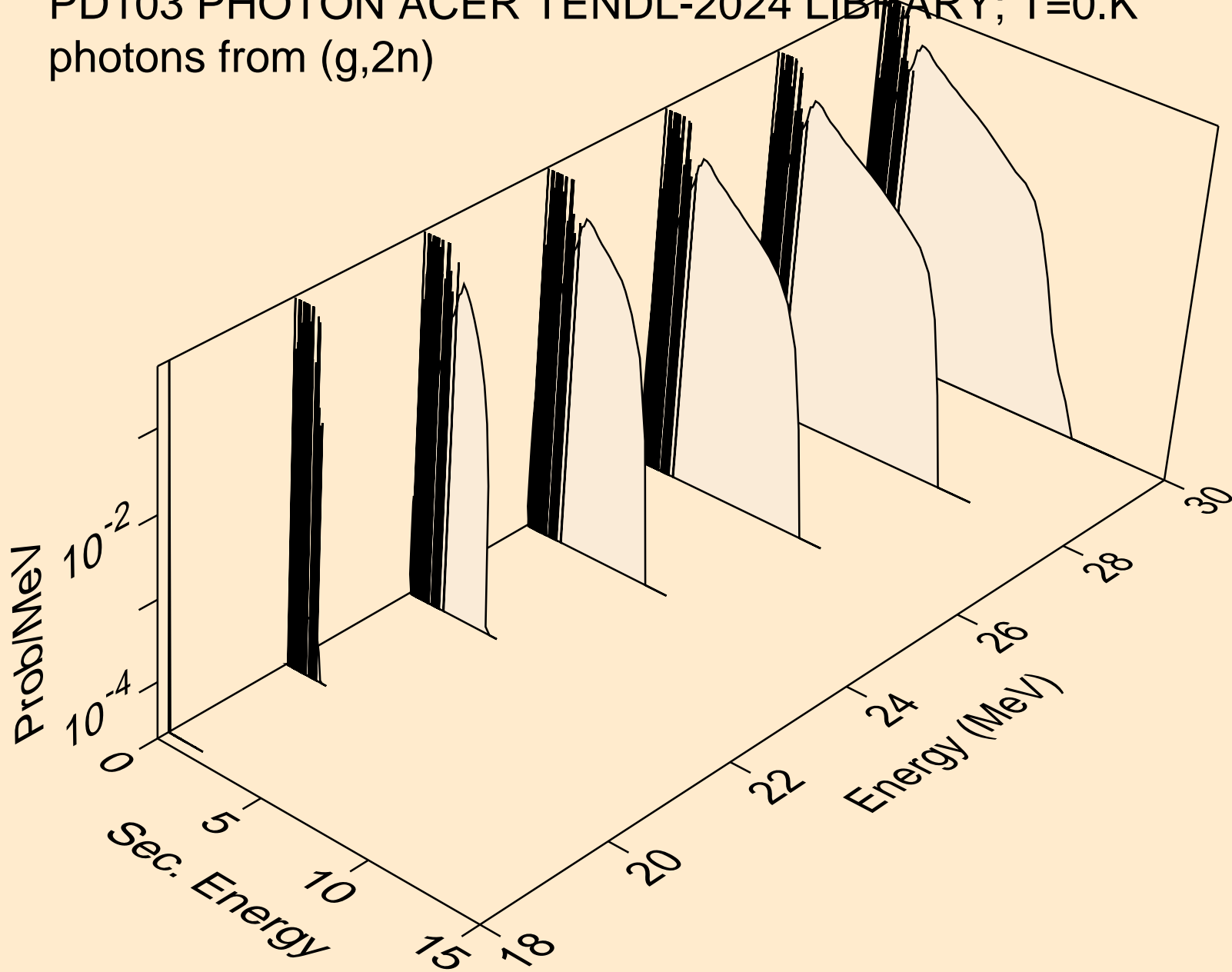

PD103 PHOTON ACER TENDL-2024 LIBRARY; T=0.K  
photons from (g,3n)

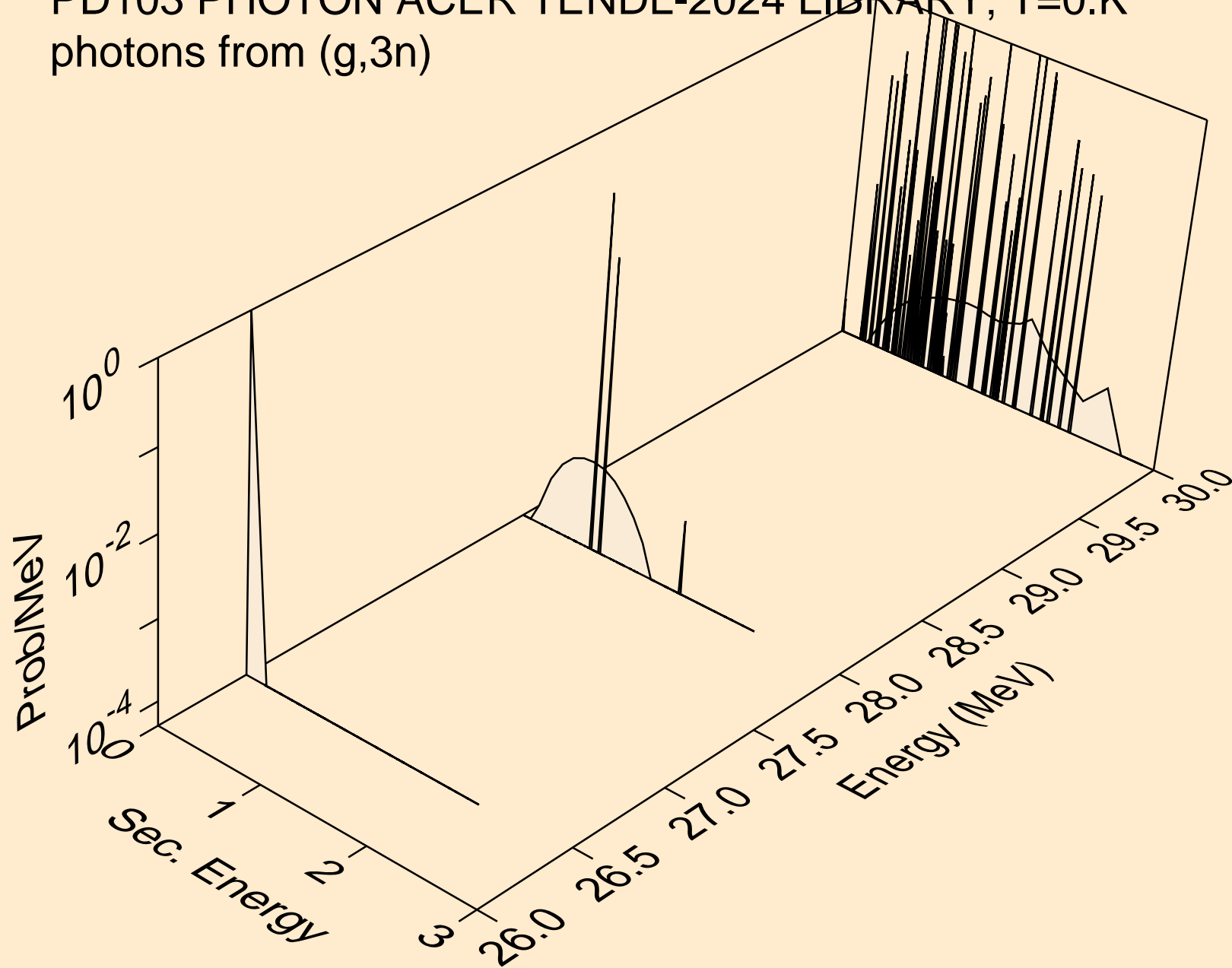

PD103 PHOTON ACER TENDL-2024 LIBRARY; T=0.K  
photons from (g,n\*)a

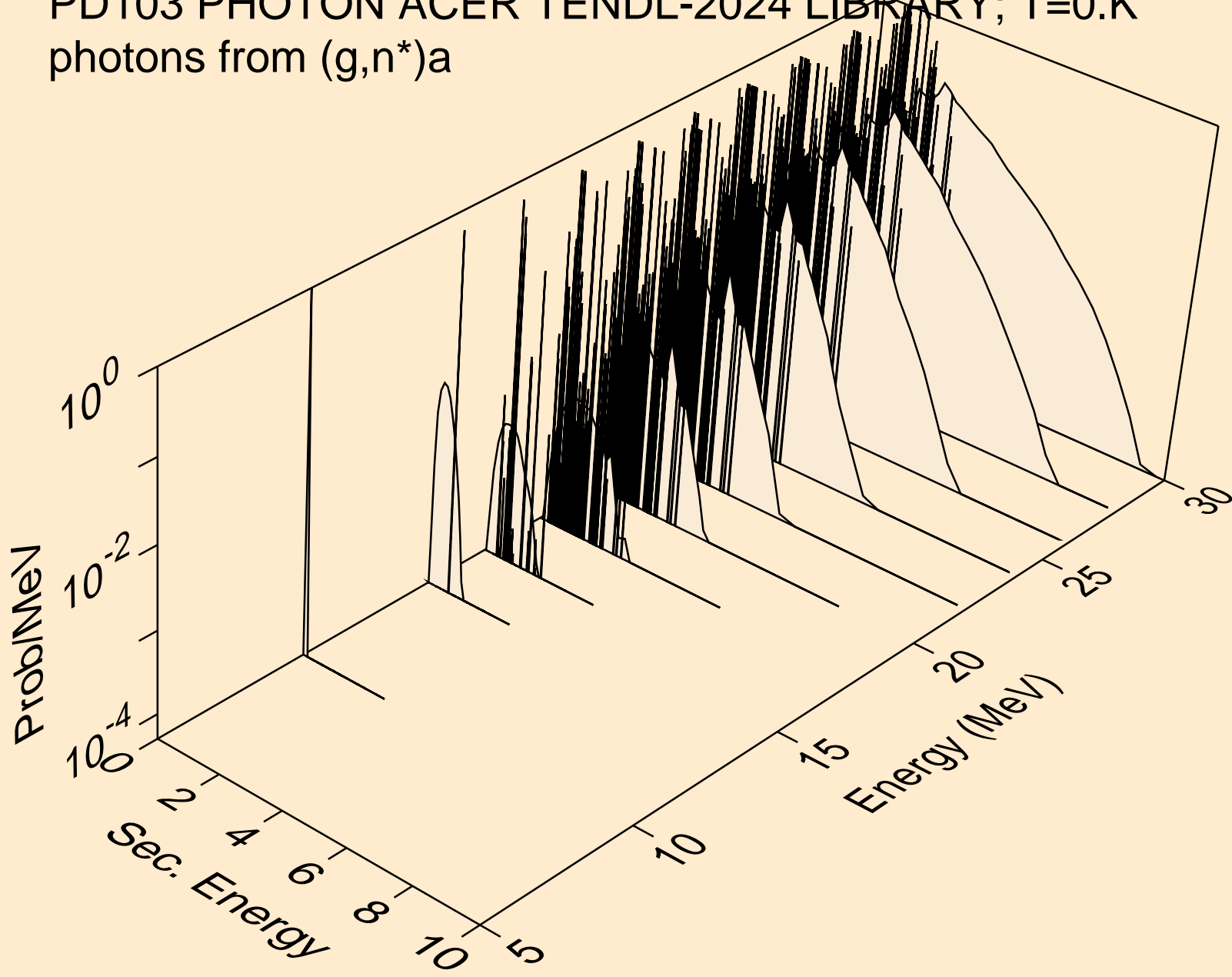

PD103 PHOTON ACER TENDL-2024 LIBRARY; T=0.K  
photons from (g,2n)a

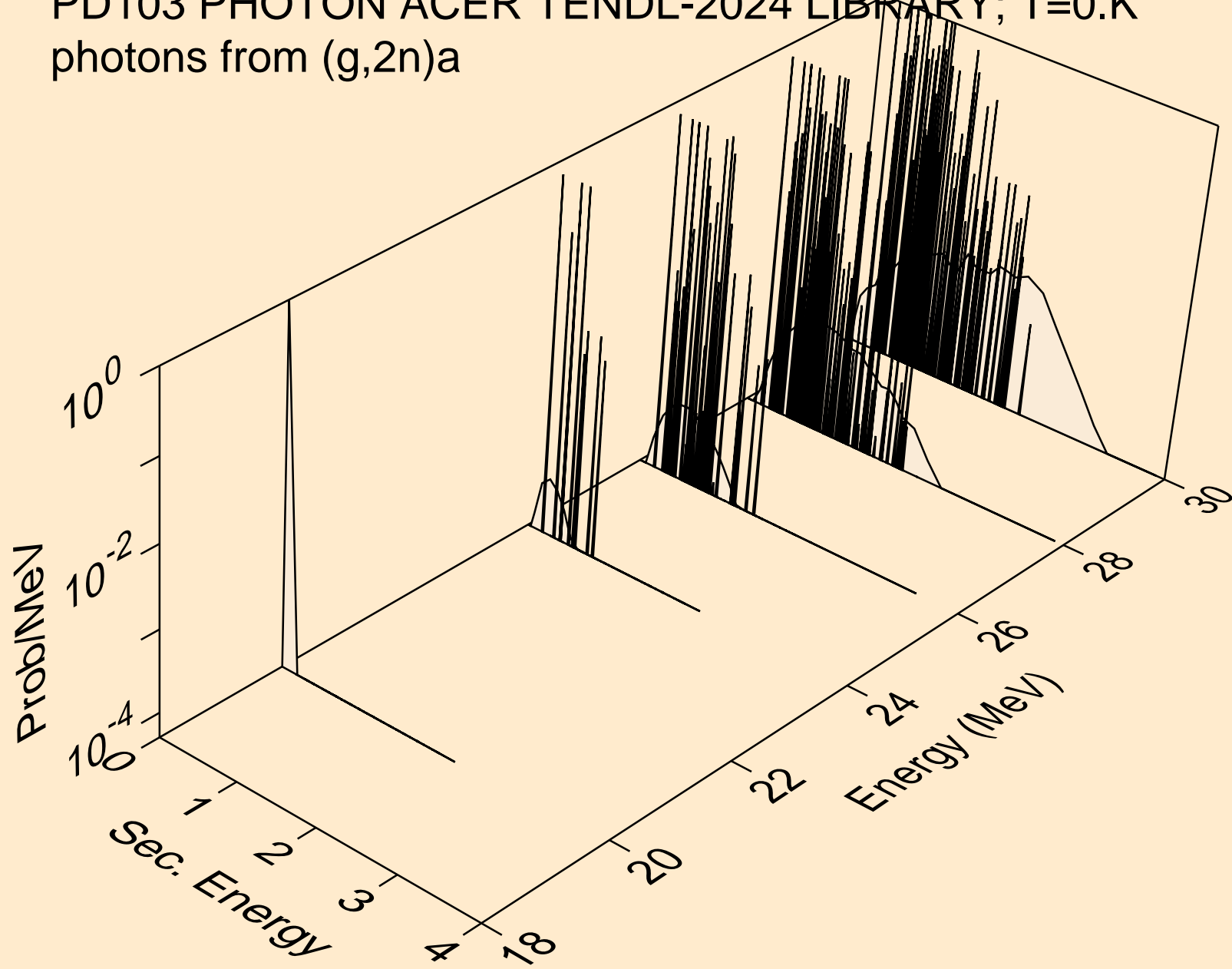

PD103 PHOTON ACER TENDL-2024 LIBRARY; T=0.K  
photons from (g,n\*)p

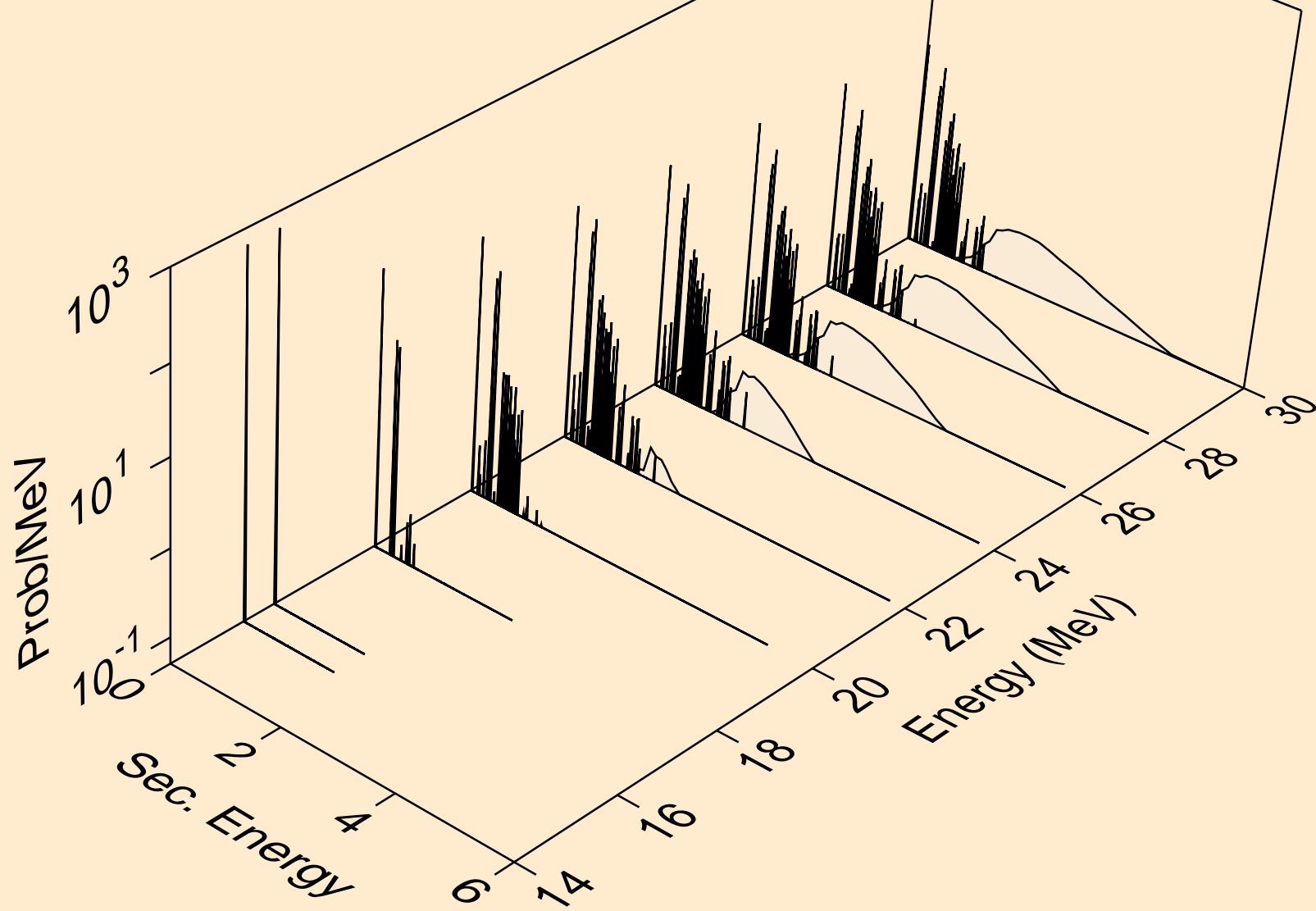

PD103 PHOTON ACER TENDL-2024 LIBRARY; T=0.K  
photons from (g,n\*)2a

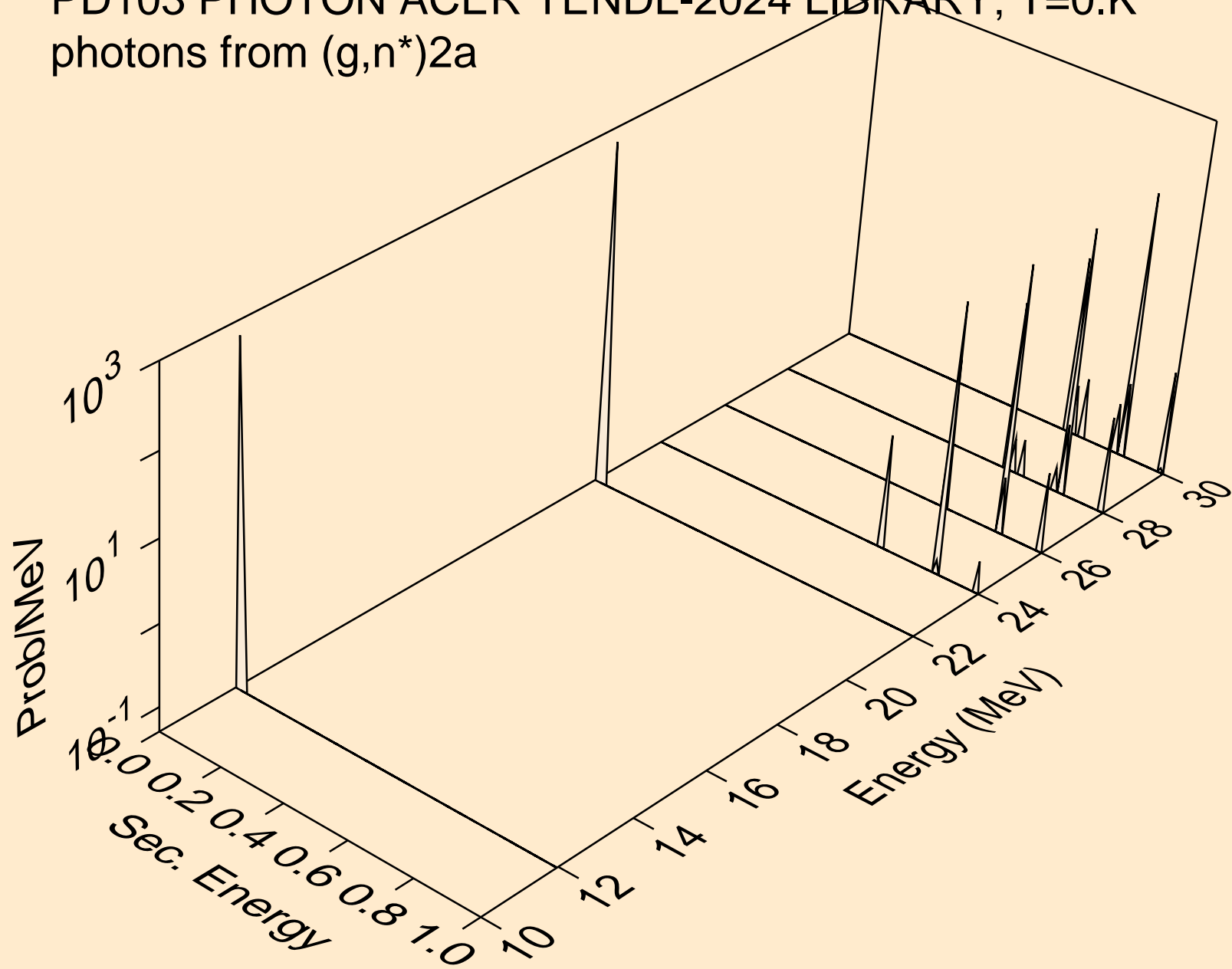

PD103 PHOTON ACER TENDL-2024 LIBRARY; T=0.K  
photons from (g,n\*)d

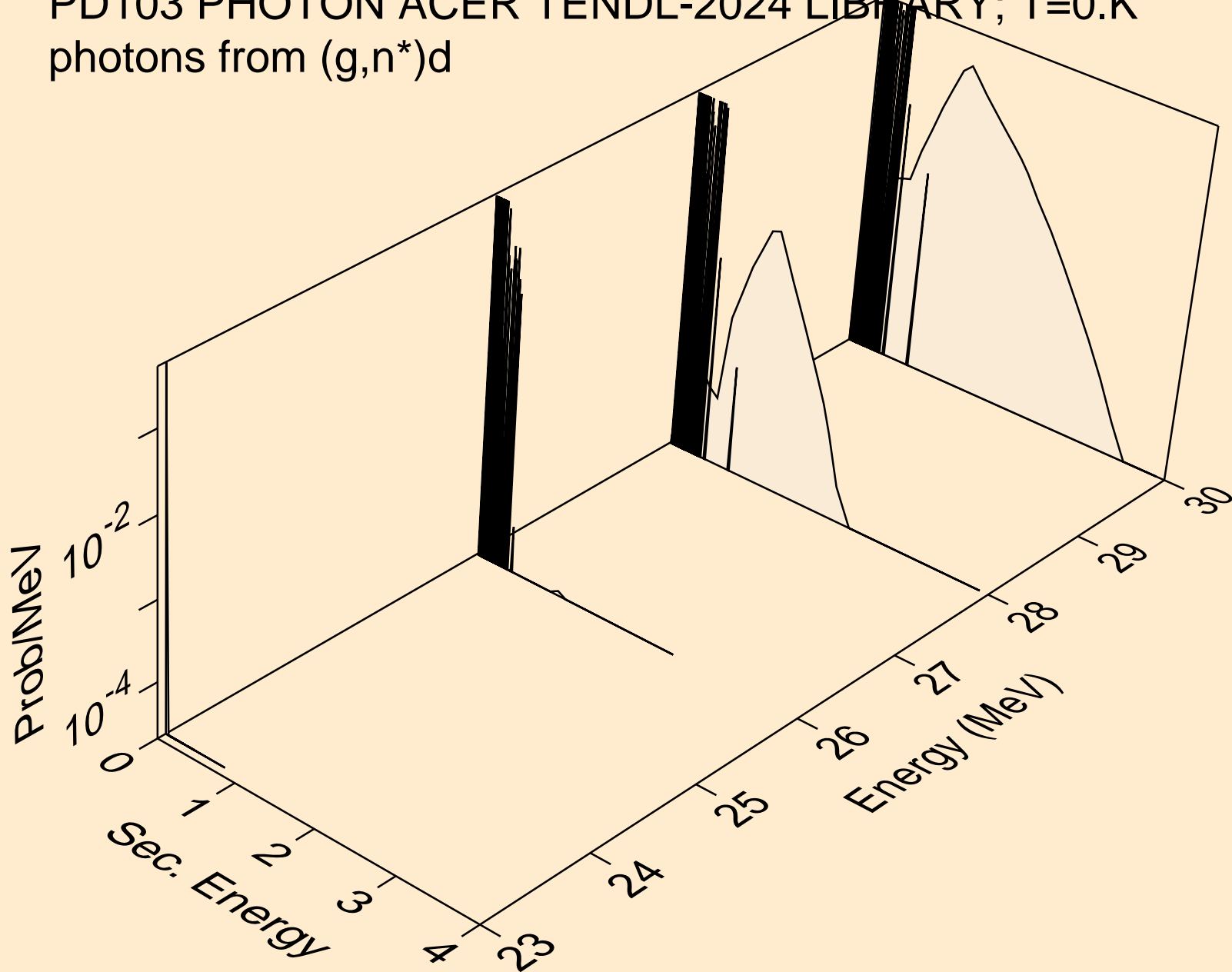

PD103 PHOTON ACER TENDL-2024 LIBRARY; T=0.K  
photons from (g,n\*)t

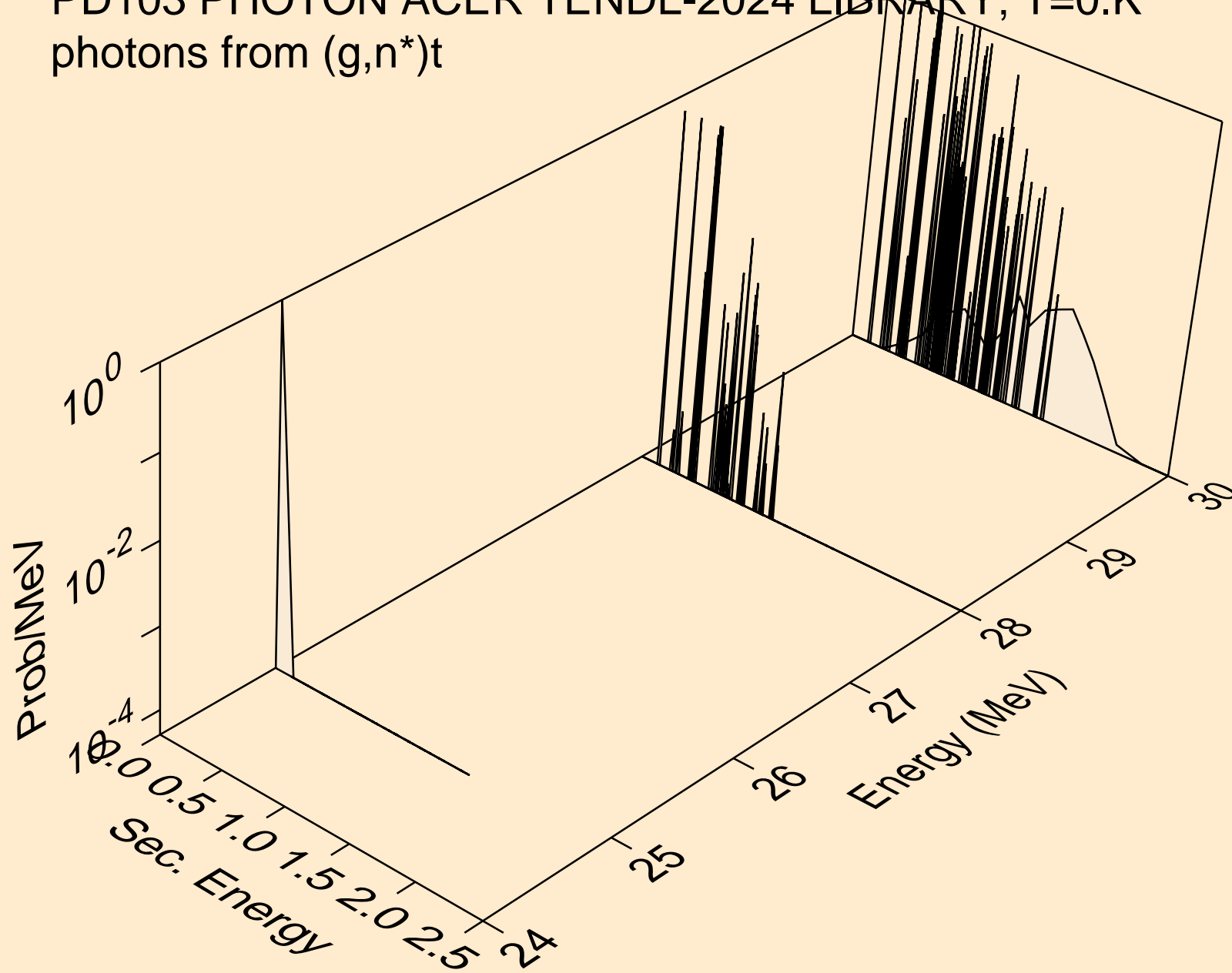

PD103 PHOTON ACER TENDL-2024 LIBRARY; T=0.K  
photons from (g,2np)

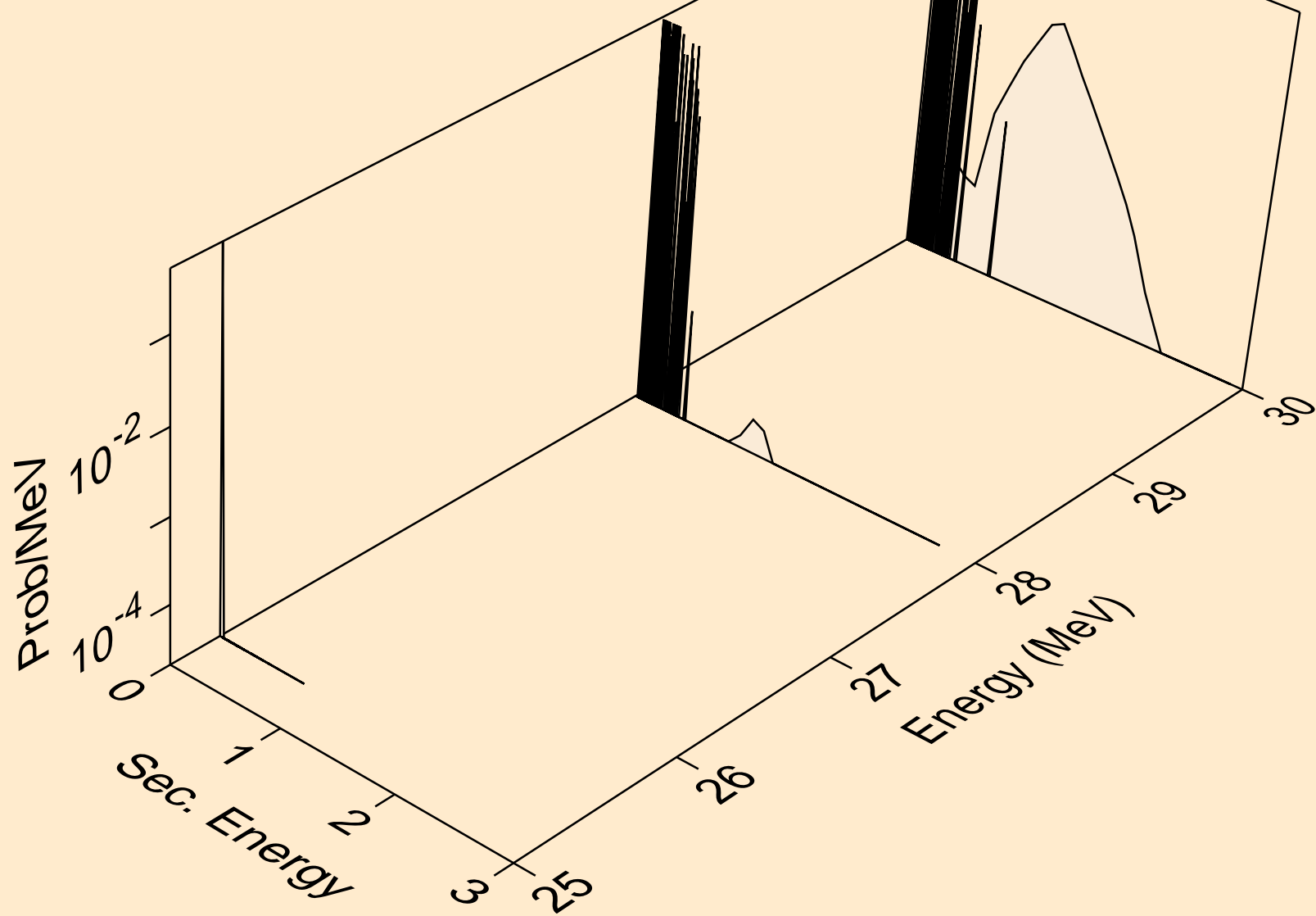

PD103 PHOTON ACER TENDL-2024 LIBRARY; T=0.K  
photons from (g,n2p)

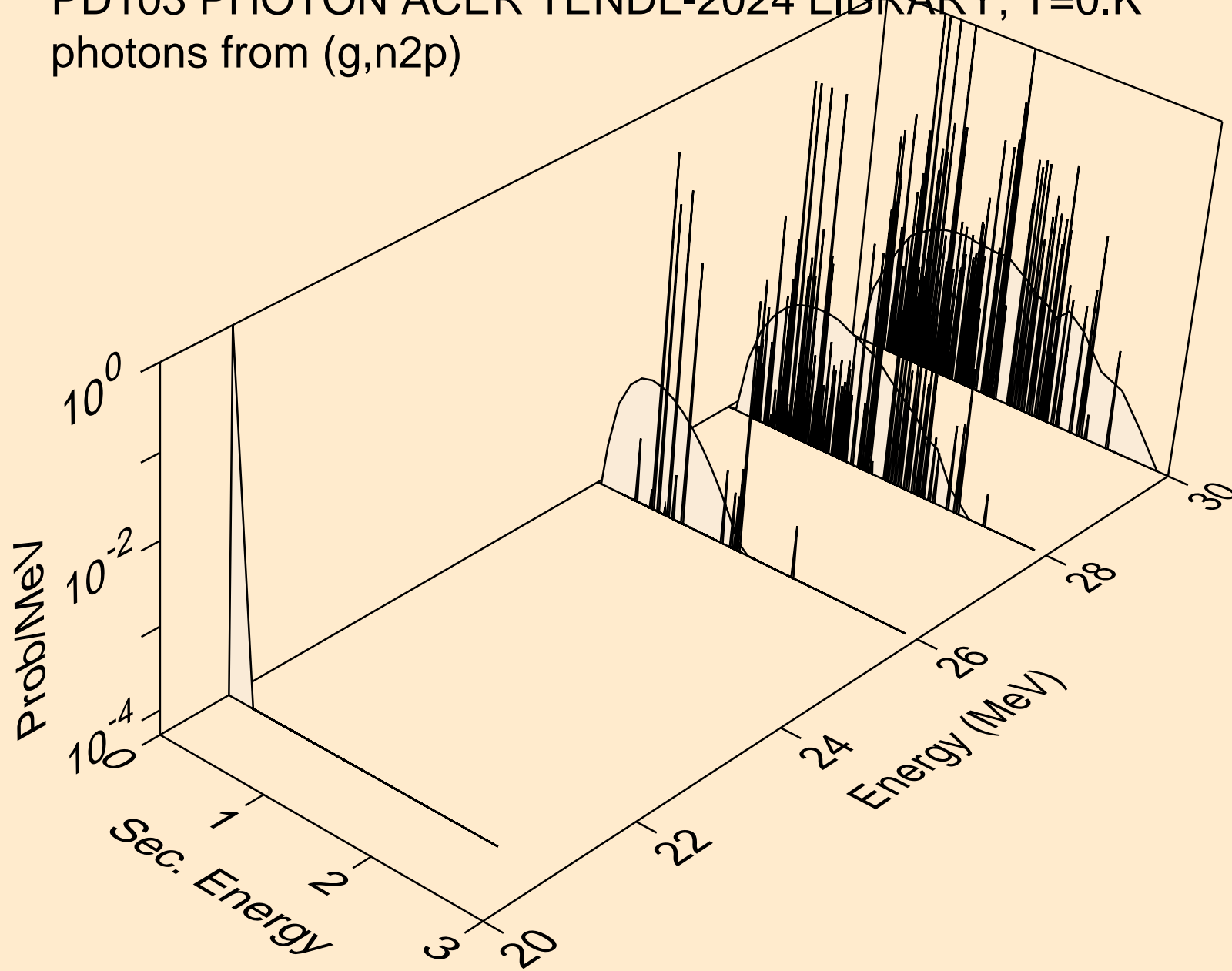

PD103 PHOTON ACER TENDL-2024 LIBRARY; T=0.K  
photons from (g,npa)

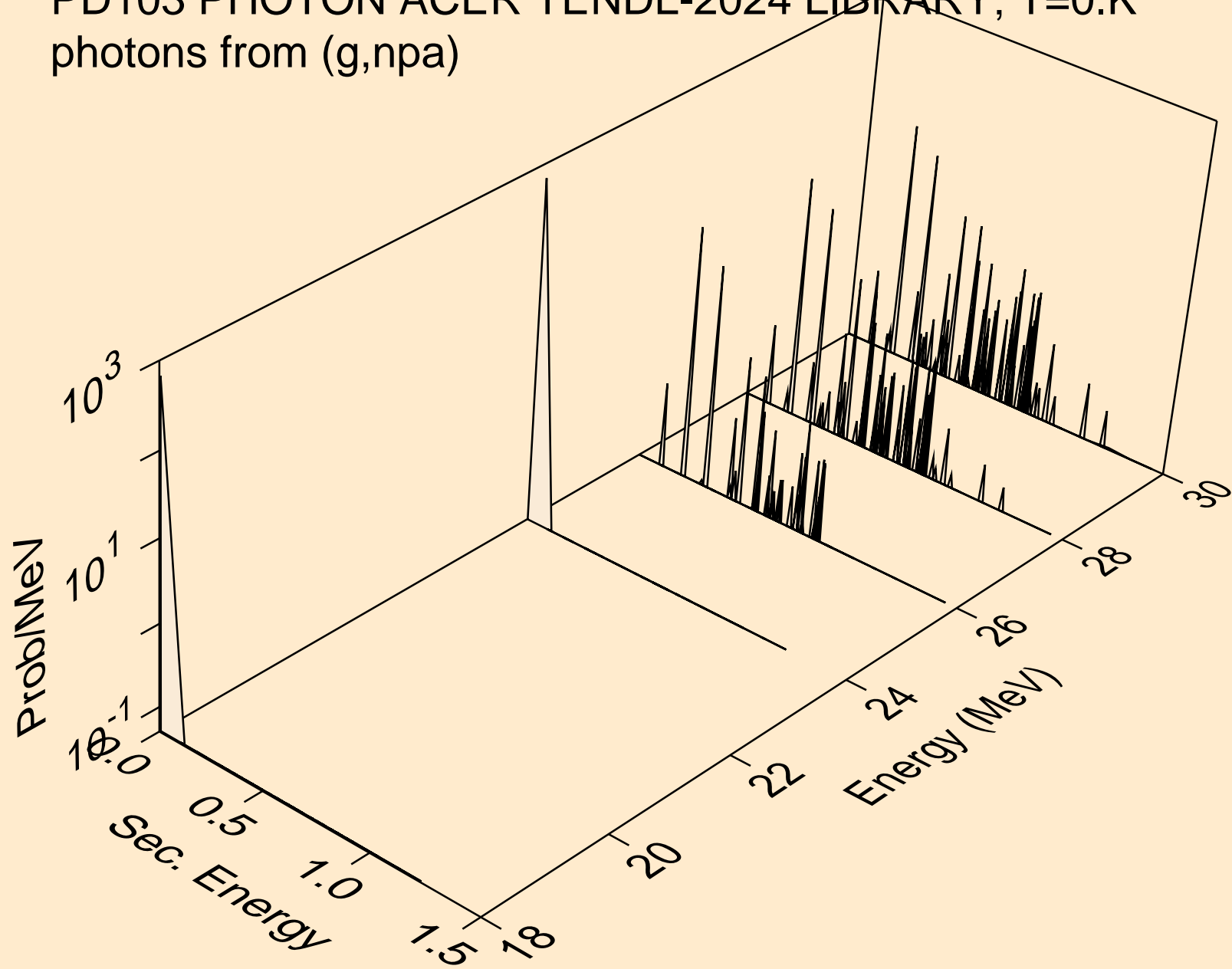

PD103 PHOTON ACER TENDL-2024 LIBRARY; T=0.K  
photons from (g,n\*c)

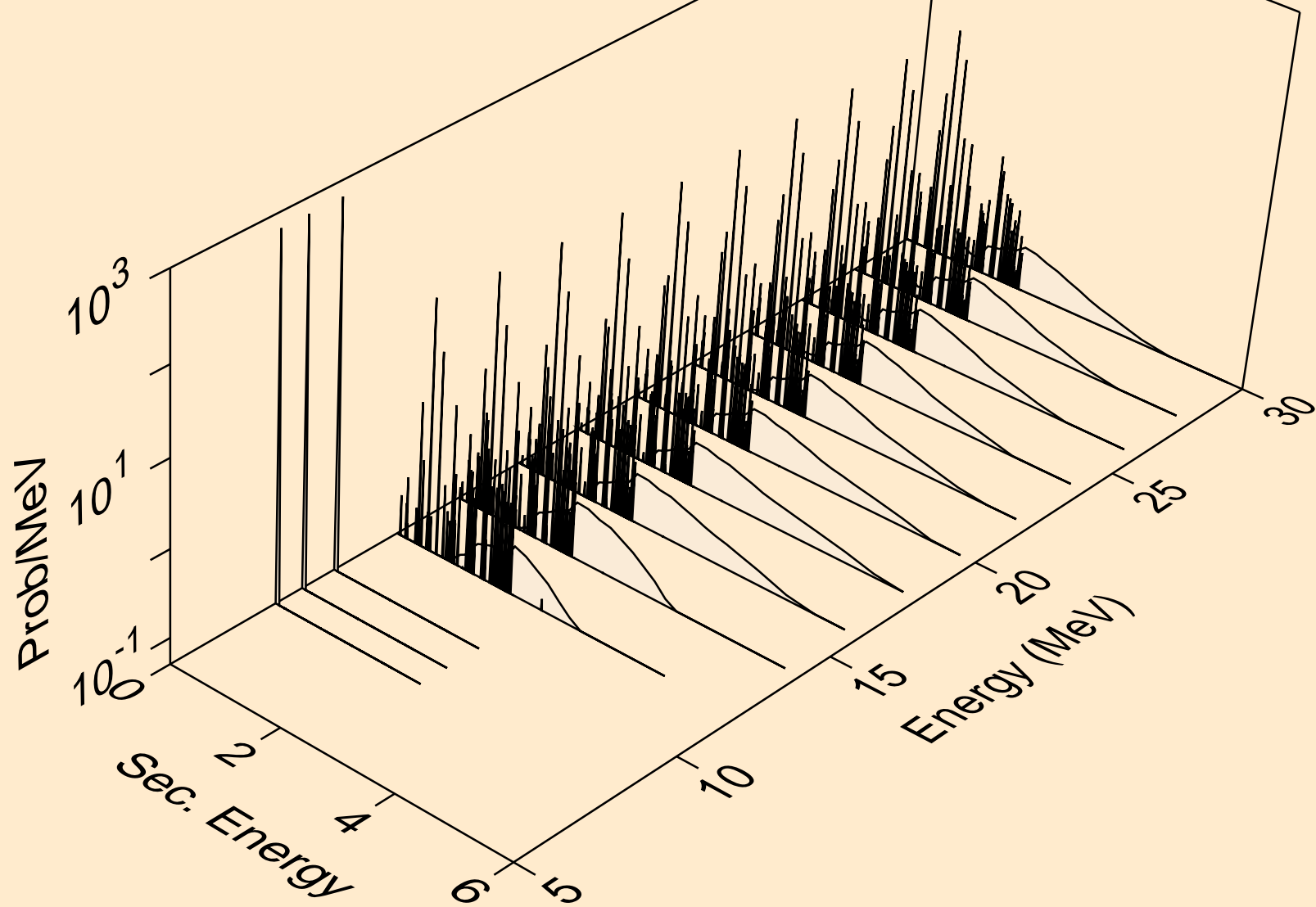

PD103 PHOTON ACER TENDL-2024 LIBRARY; T=0.K  
photons from (g,gma)

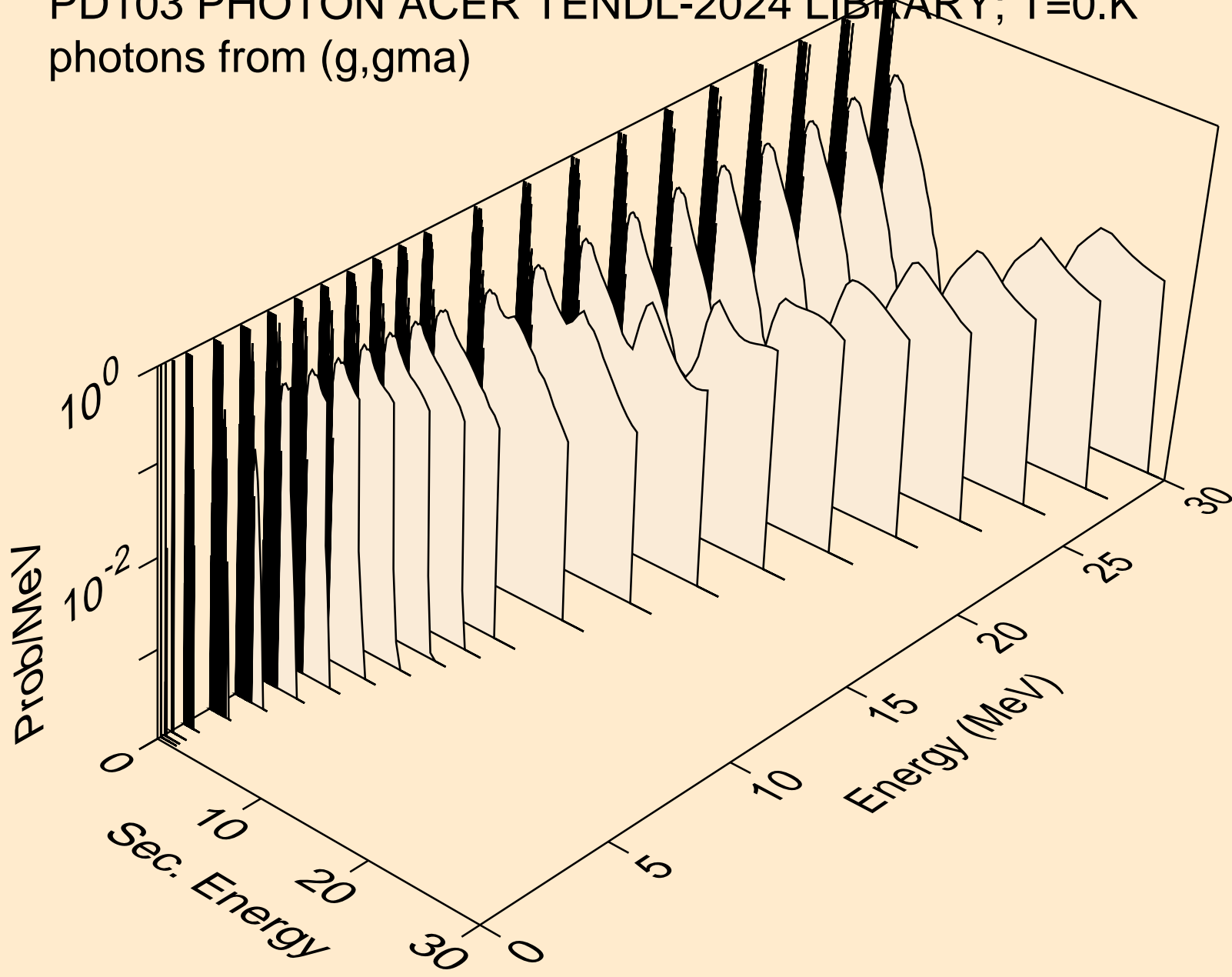

PD103 PHOTON ACER TENDL-2024 LIBRARY; T=0.K  
photons from (g,p)

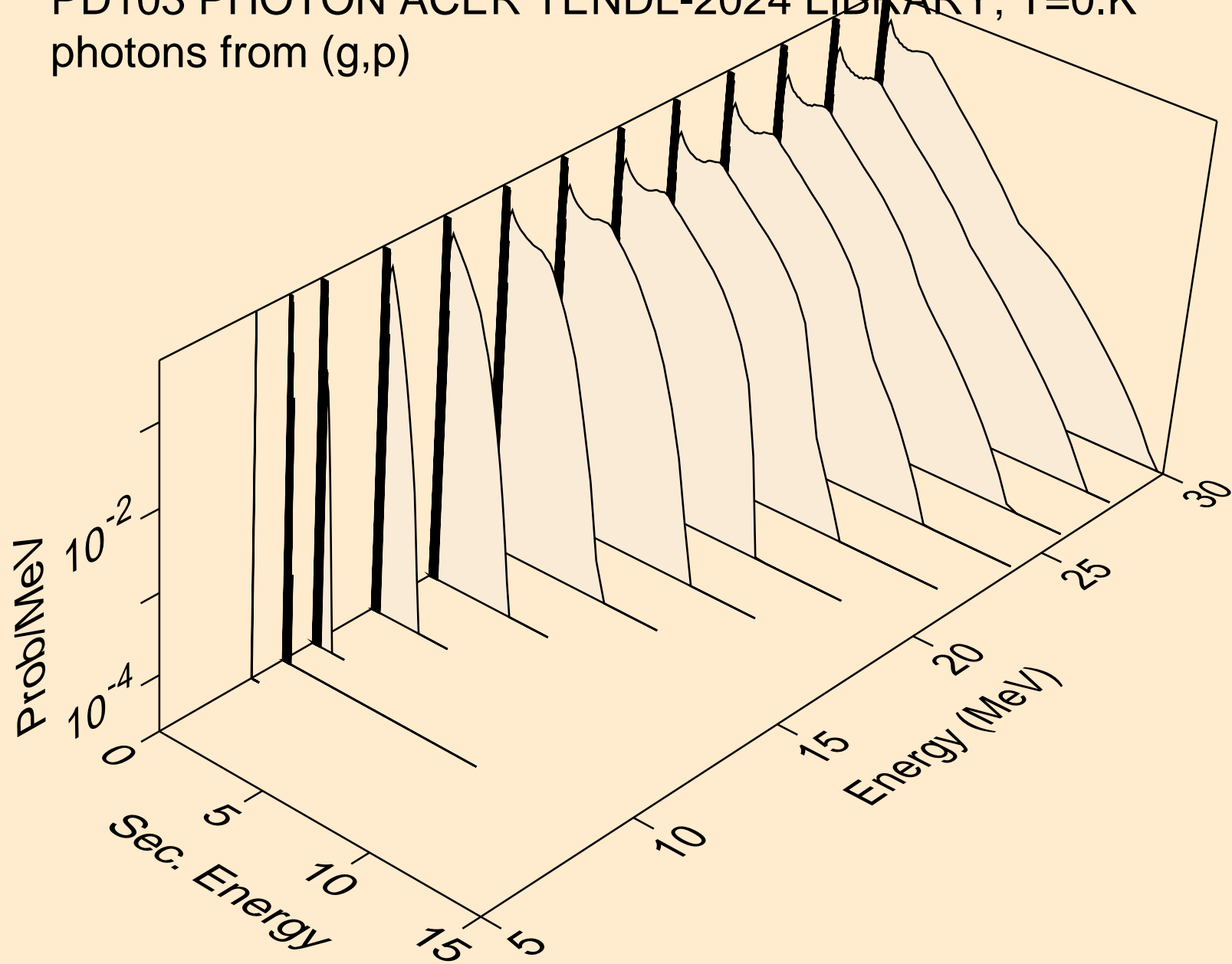

PD103 PHOTON ACER TENDL-2024 LIBRARY; T=0.K  
photons from (g,d)

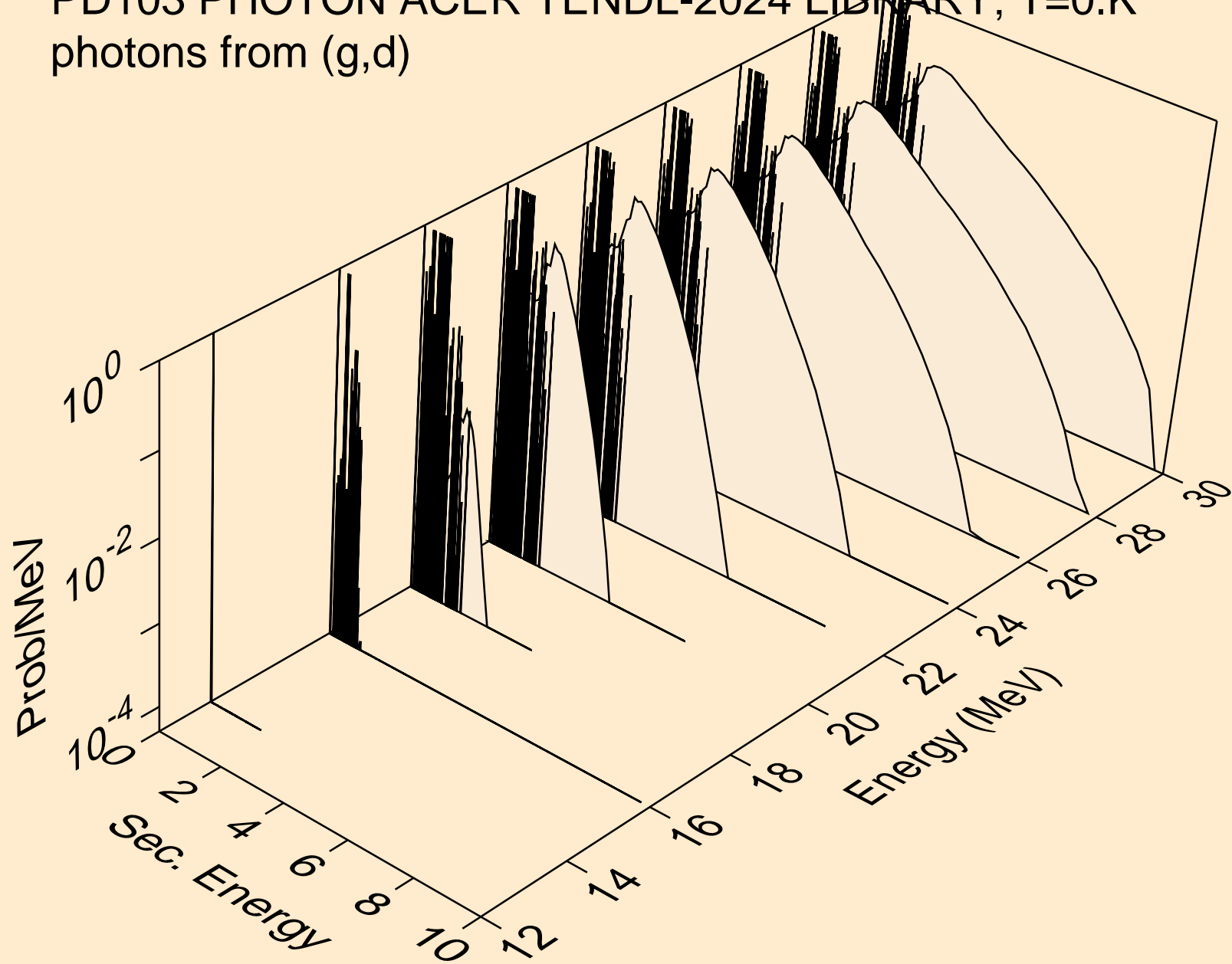

PD103 PHOTON ACER TENDL-2024 LIBRARY; T=0.K  
photons from (g,t)

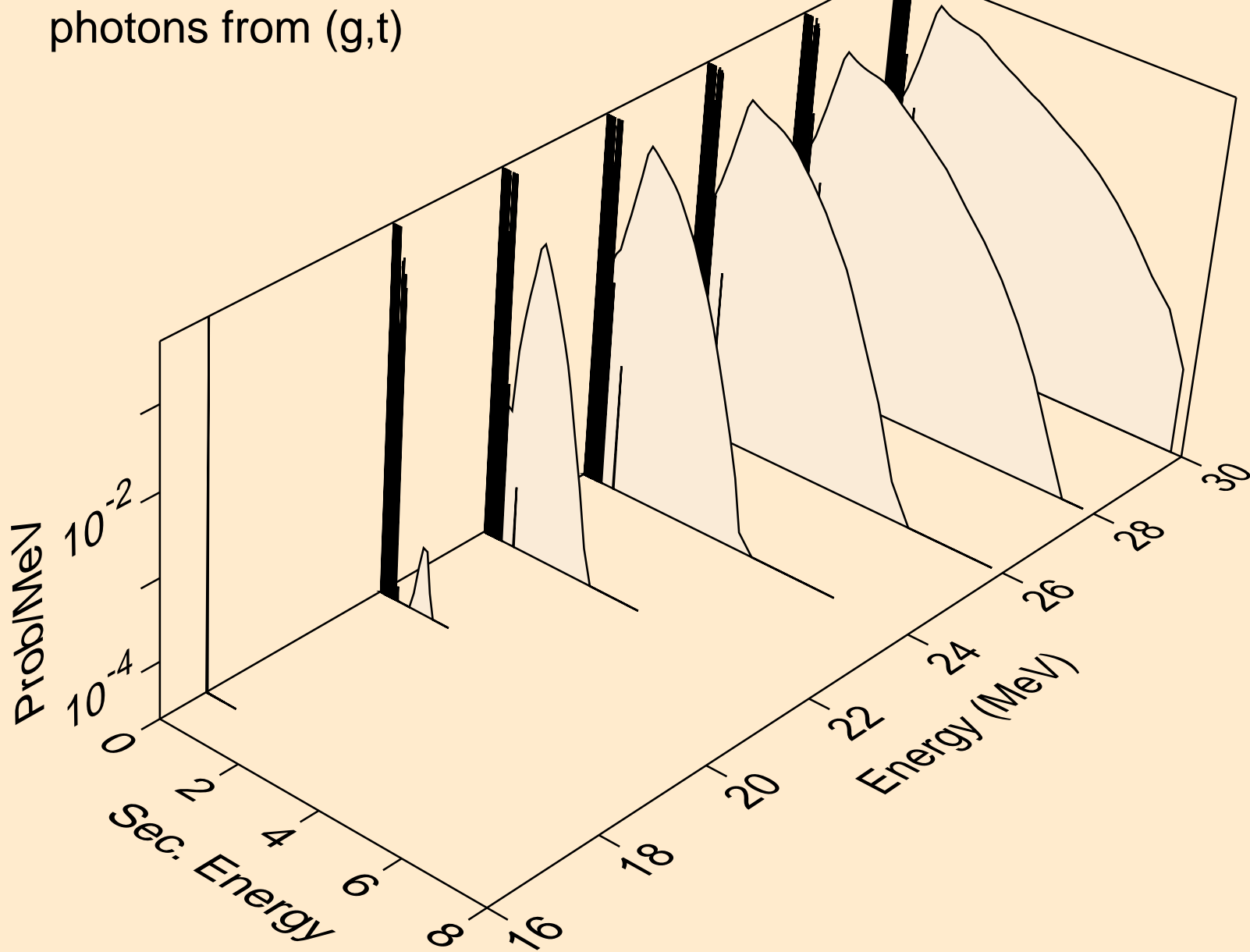

PD103 PHOTON ACER TENDL-2024 LIBRARY; T=0.K  
photons from (g,he3)

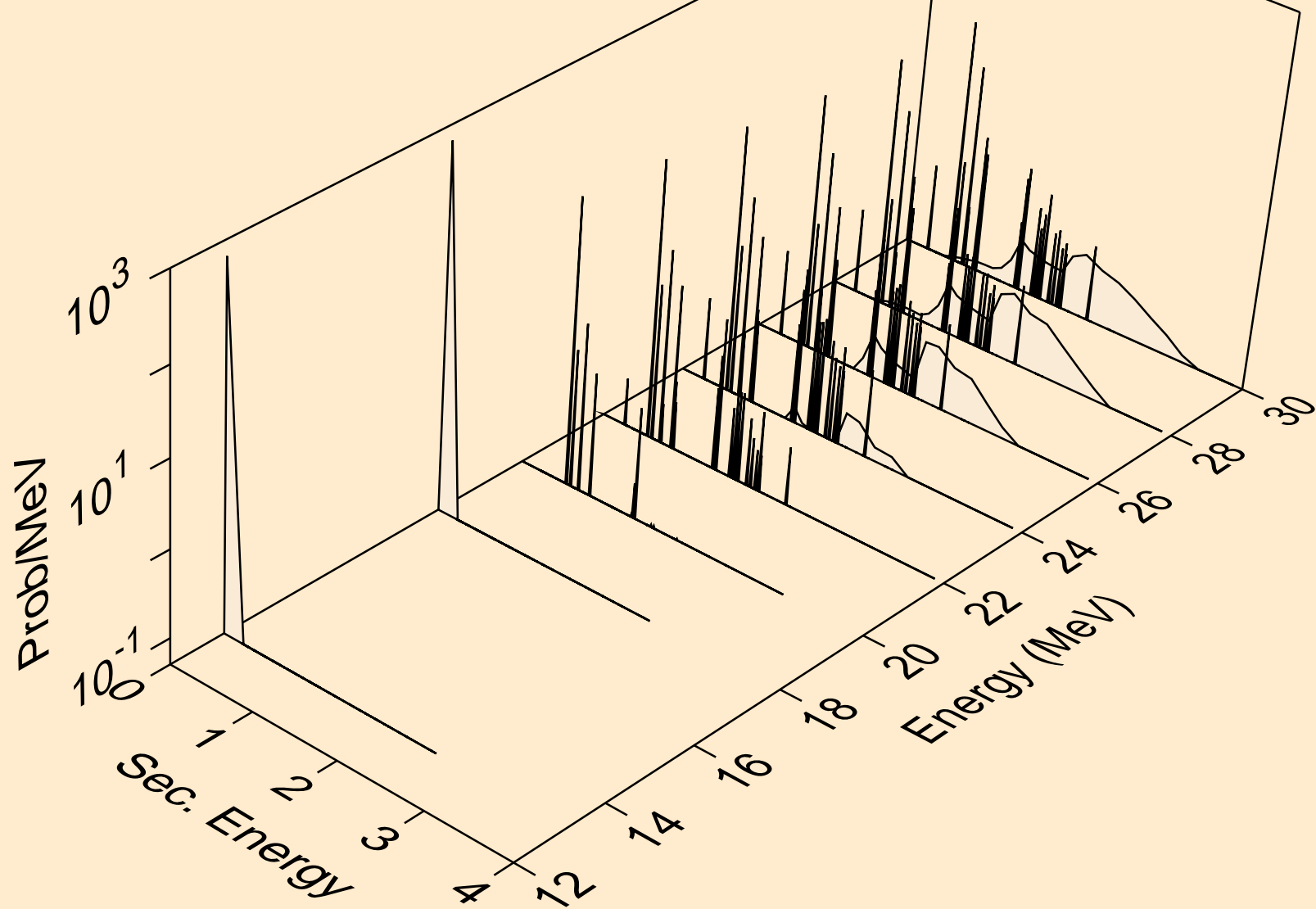

PD103 PHOTON ACER TENDL-2024 LIBRARY; T=0.K  
photons from (g,a)

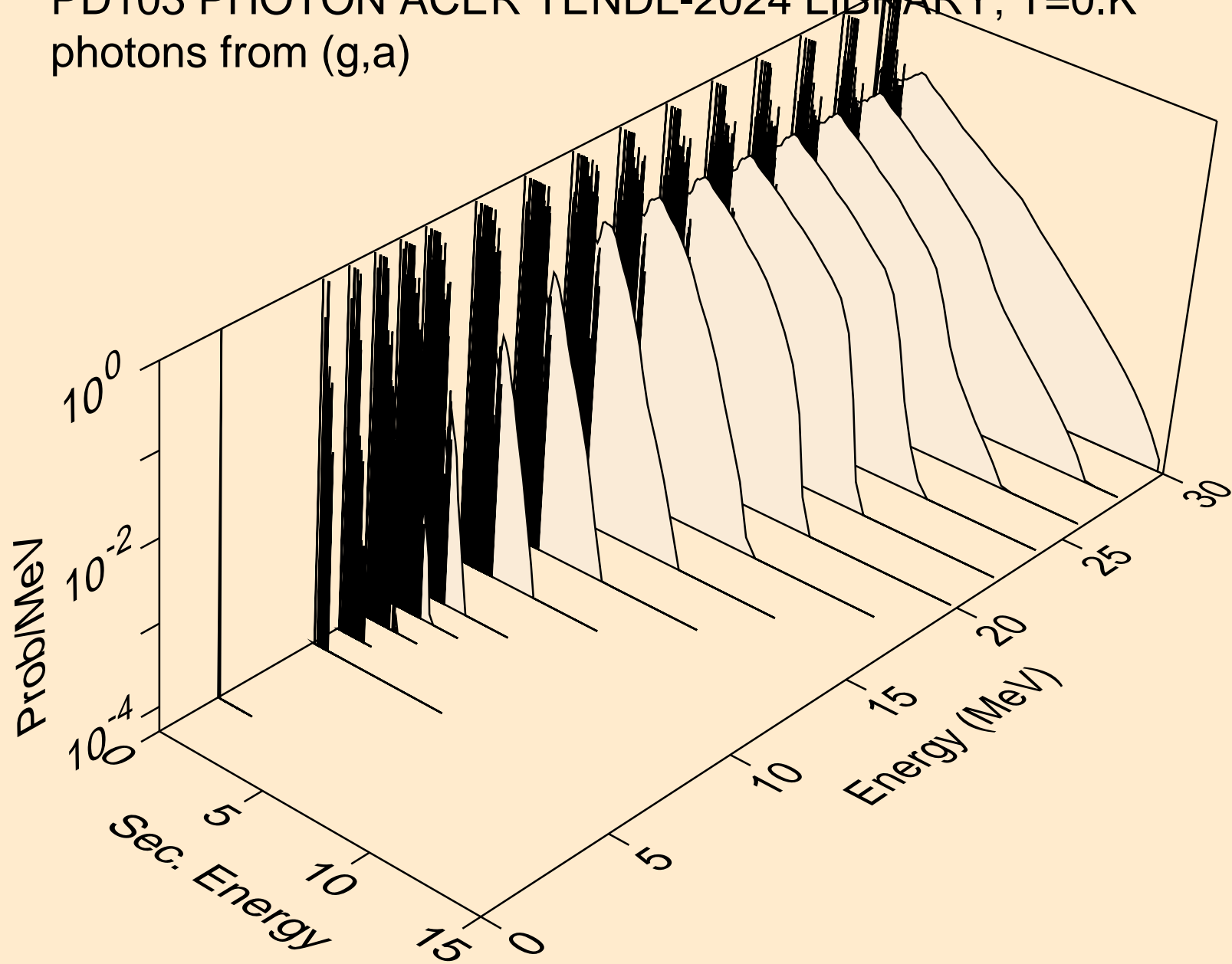

PD103 PHOTON ACER TENDL-2024 LIBRARY; T=0.K  
photons from (g,2a)

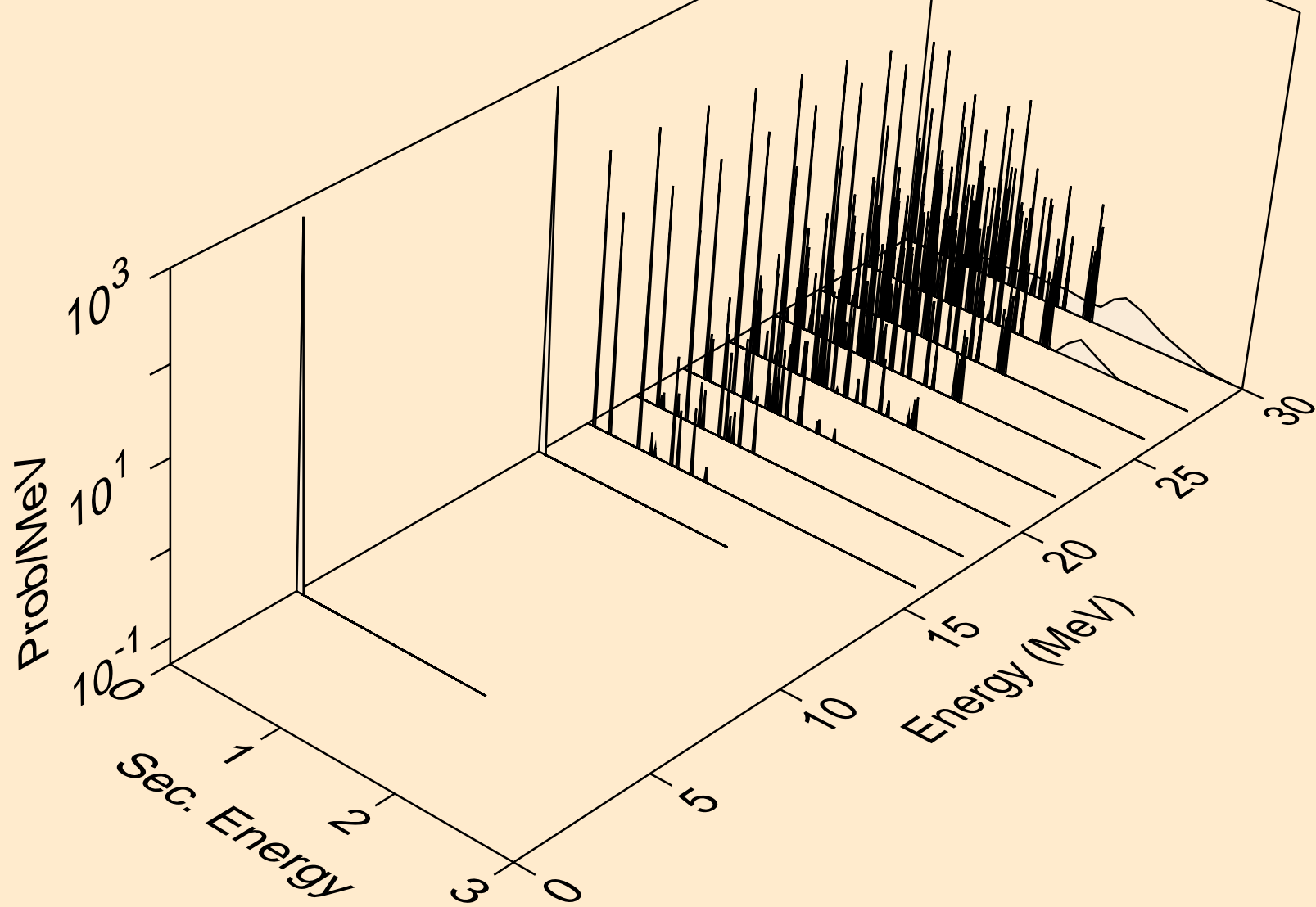

PD103 PHOTON ACER TENDL-2024 LIBRARY; T=0.K  
photons from (g,2p)

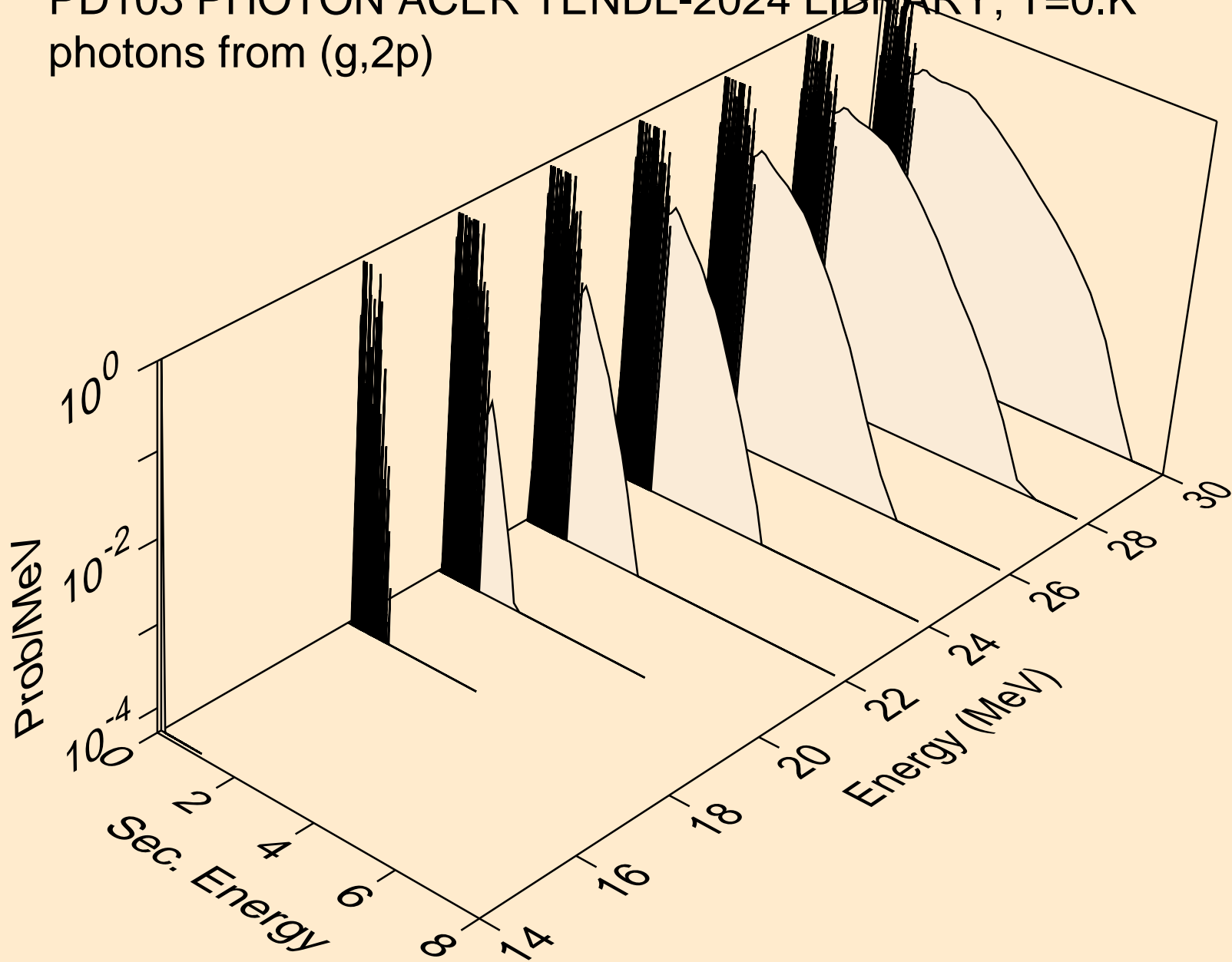

PD103 PHOTON ACER TENDL-2024 LIBRARY; T=0.K  
photons from (g,pa)

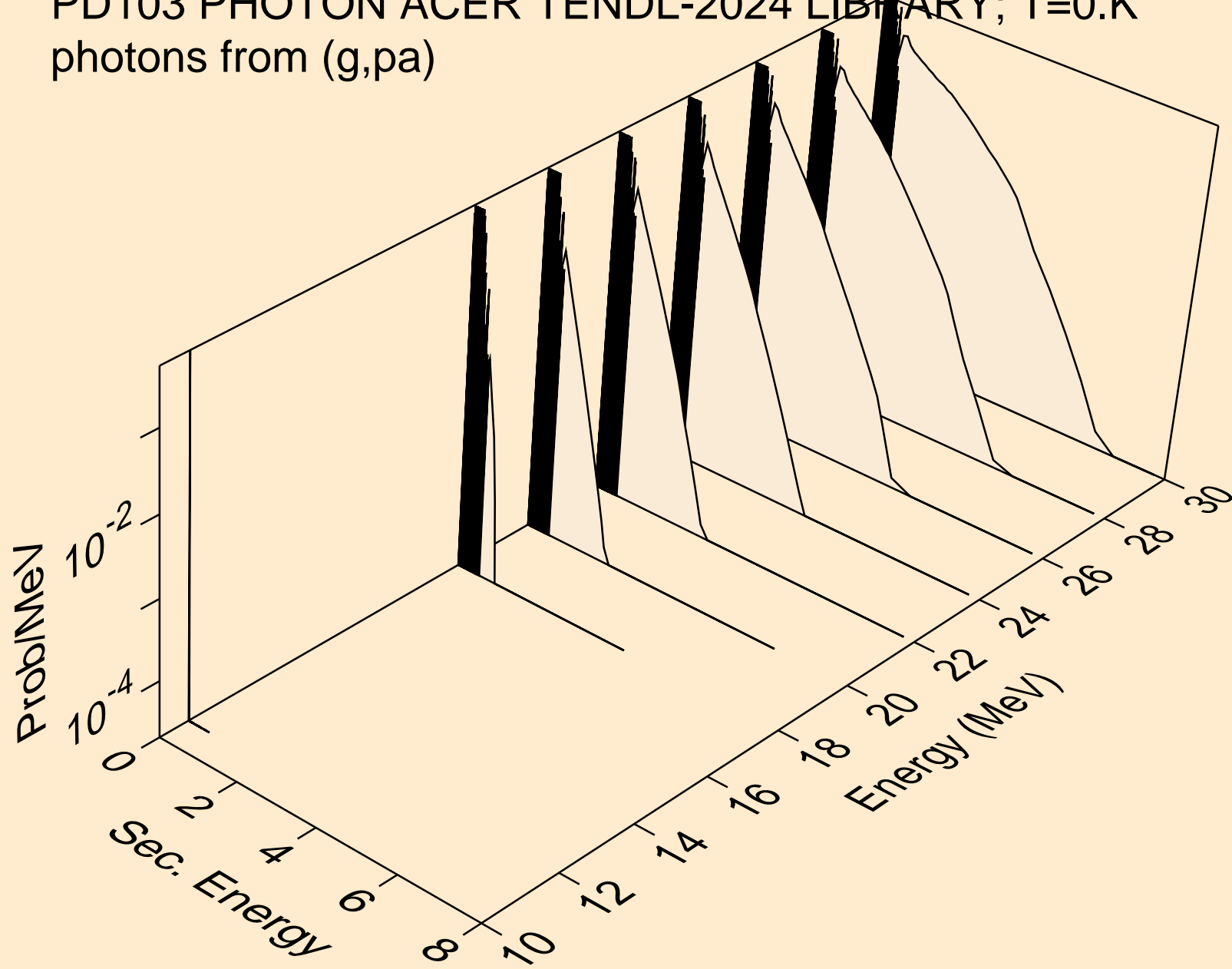

PD103 PHOTON ACER TENDL-2024 LIBRARY; T=0.K  
photons from (g,pd)

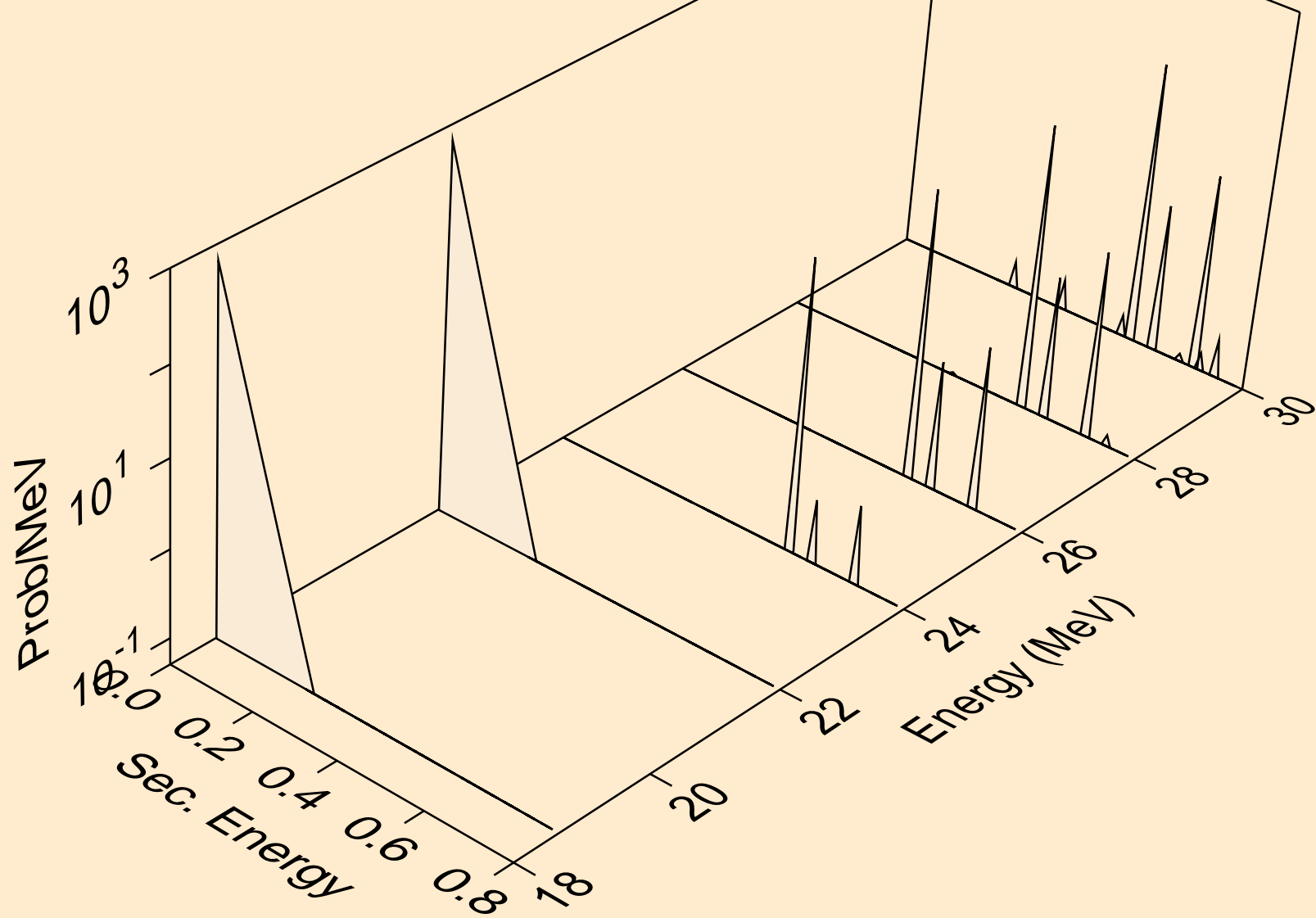

PD103 PHOTON ACER TENDL-2024 LIBRARY; T=0.K  
protons from (g,x)

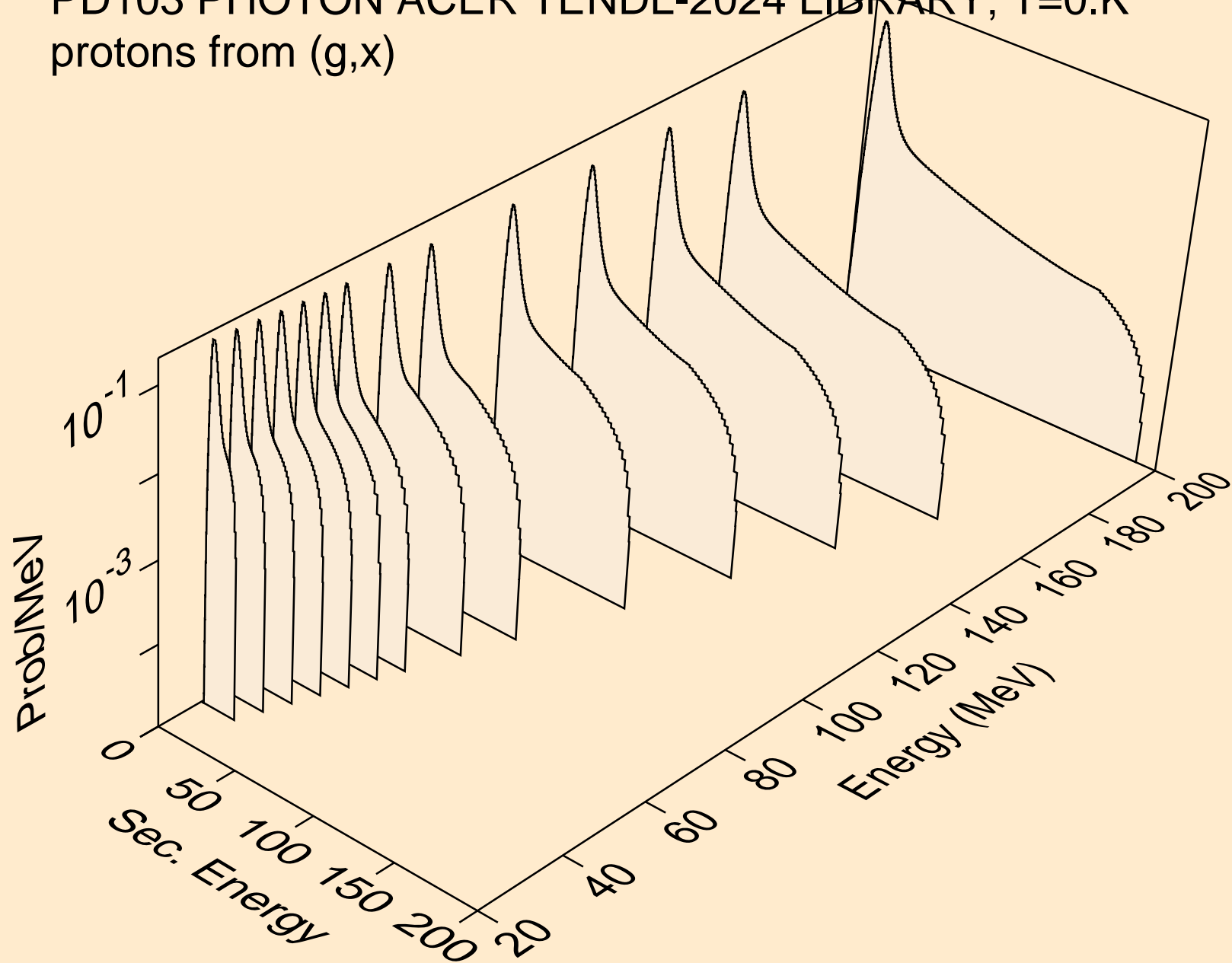

PD103 PHOTON ACER TENDL-2024 LIBRARY; T=0.K  
protons from (g,n\*)p

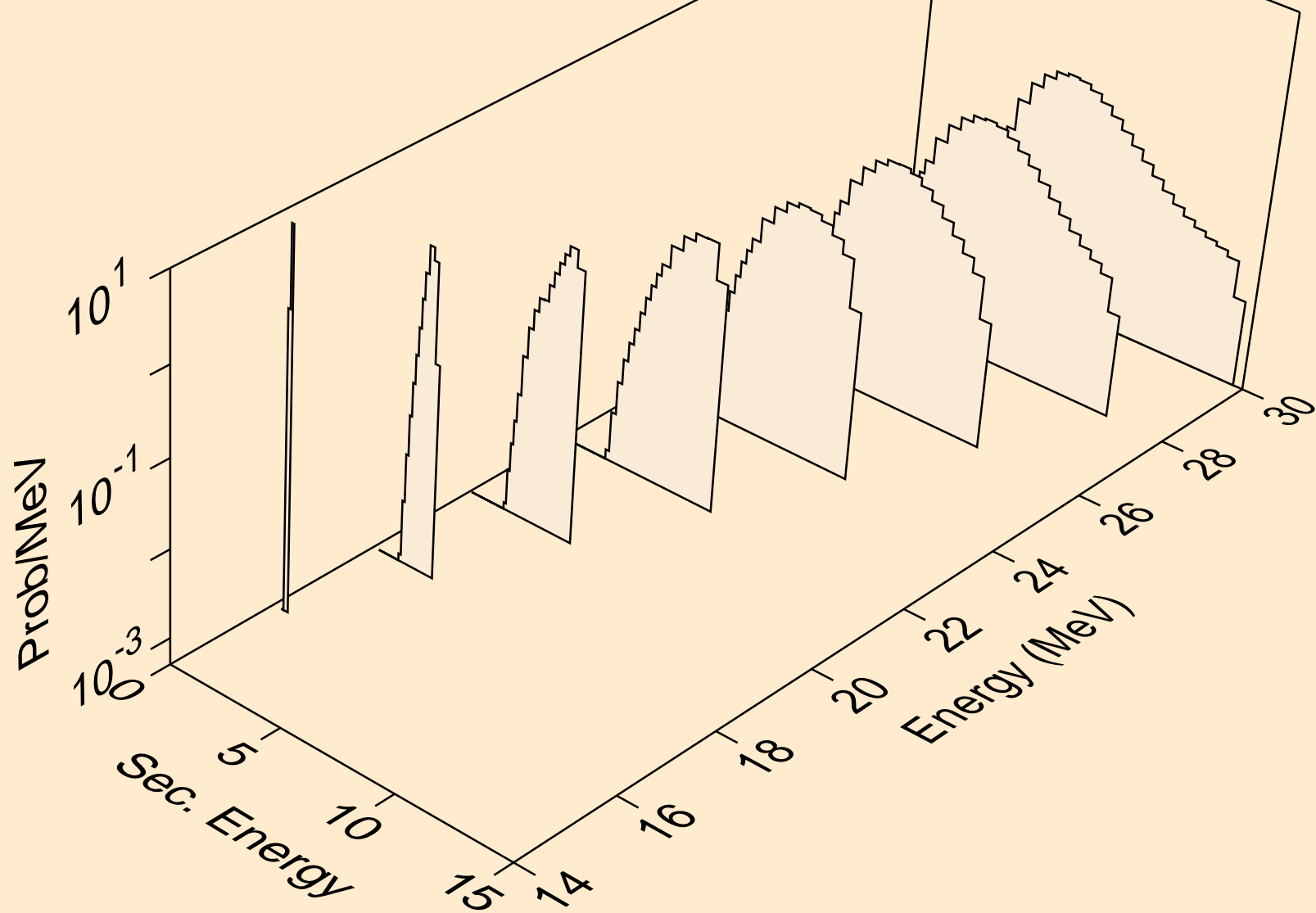

PD103 PHOTON ACER TENDL-2024 LIBRARY; T=0.K  
protons from (g,2np)

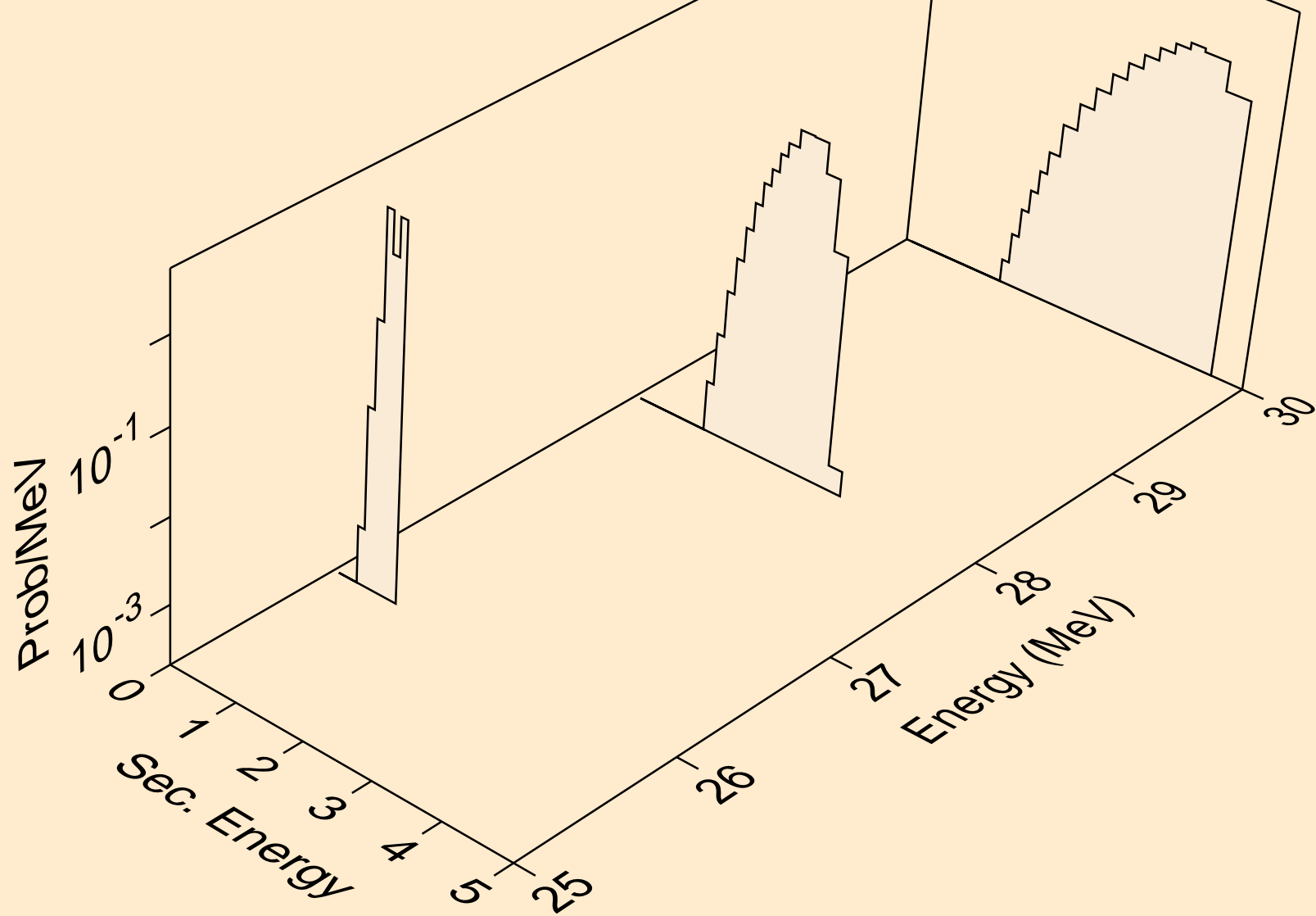

PD103 PHOTON ACER TENDL-2024 LIBRARY; T=0.K  
protons from (g,n2p)

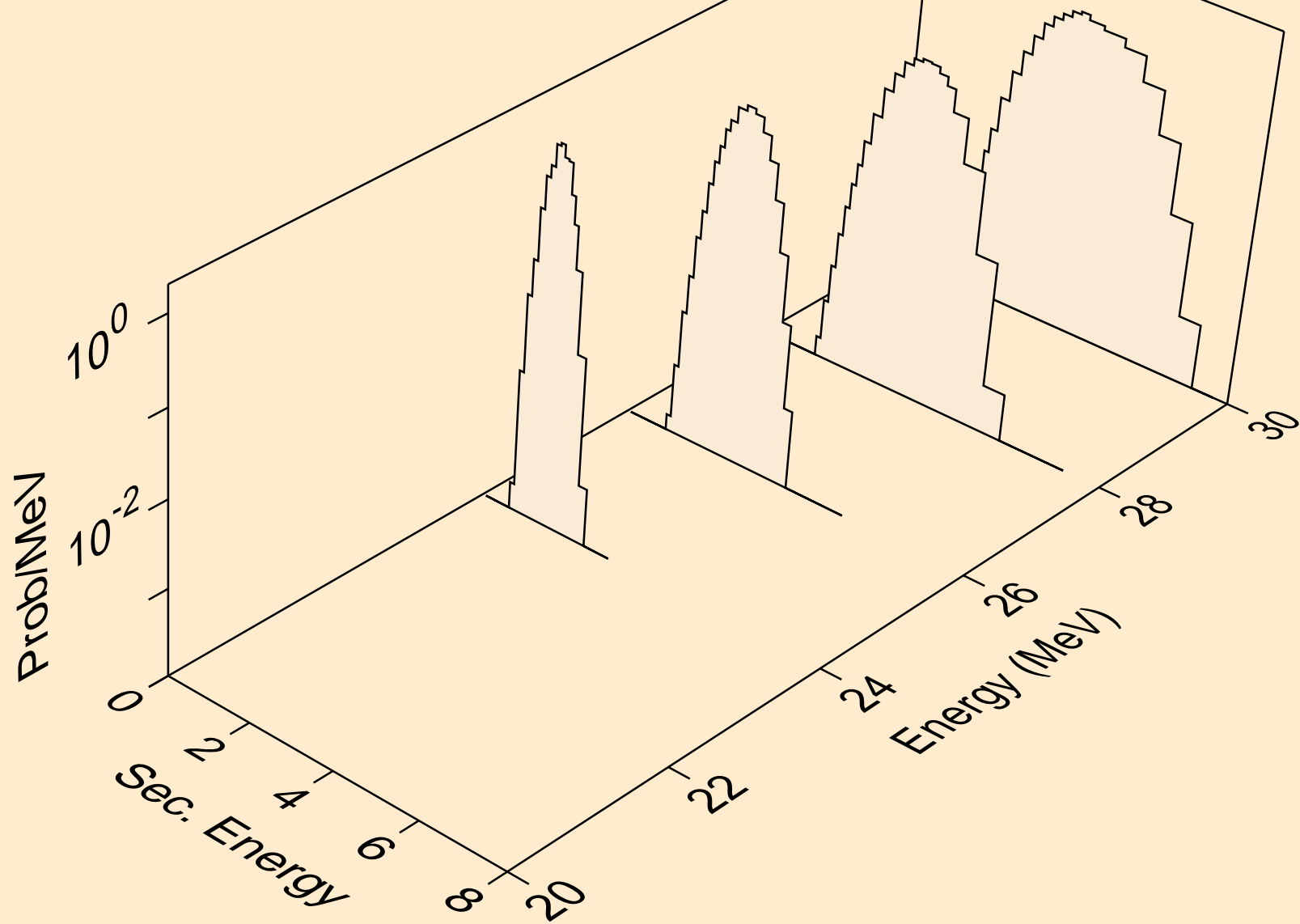

PD103 PHOTON ACER TENDL-2024 LIBRARY; T=0.K  
protons from (g,npa)

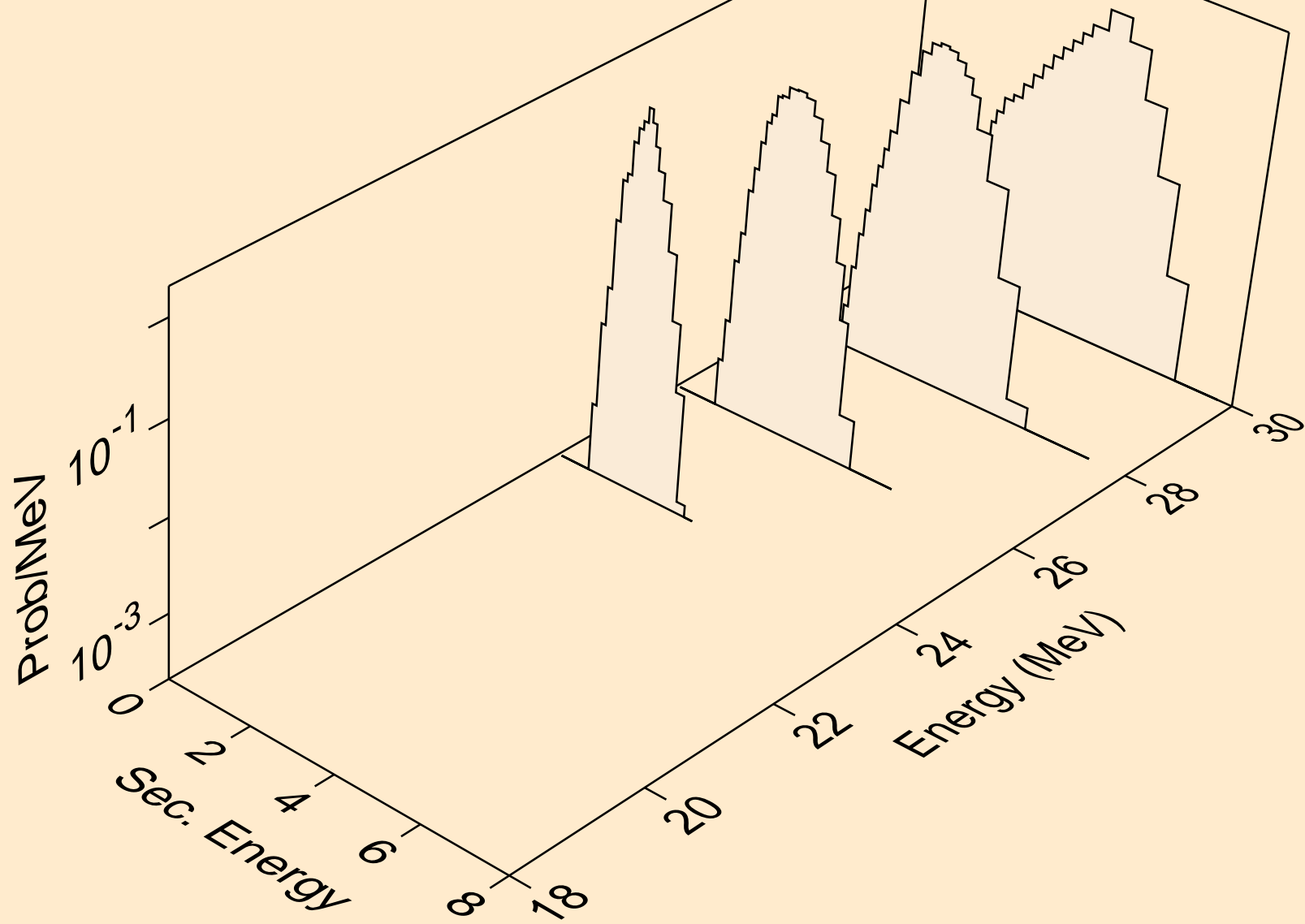

PD103 PHOTON ACER TENDL-2024 LIBRARY; T=0.K  
protons from (g,p)

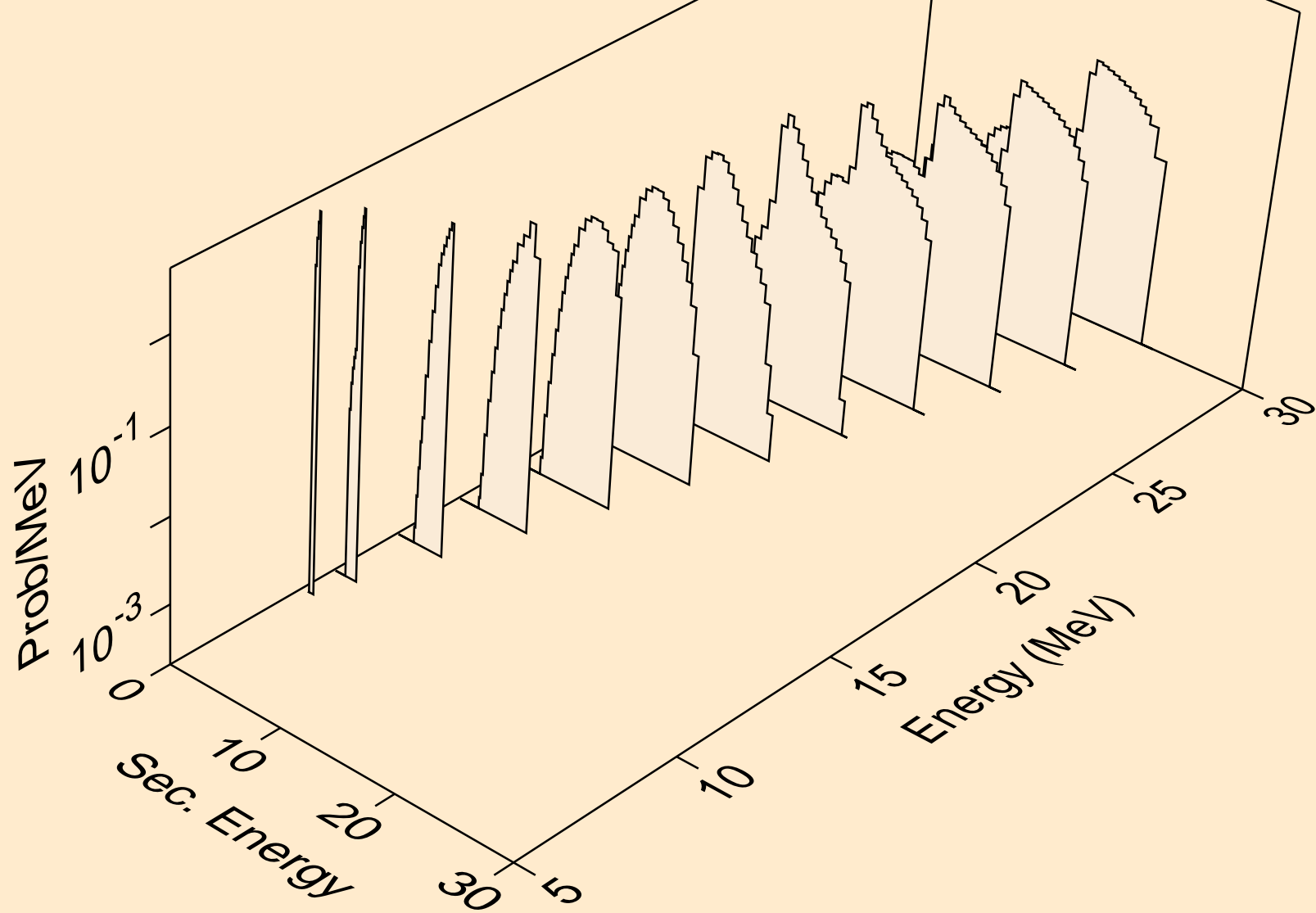

PD103 PHOTON ACER TENDL-2024 LIBRARY; T=0.K  
protons from (g,2p)

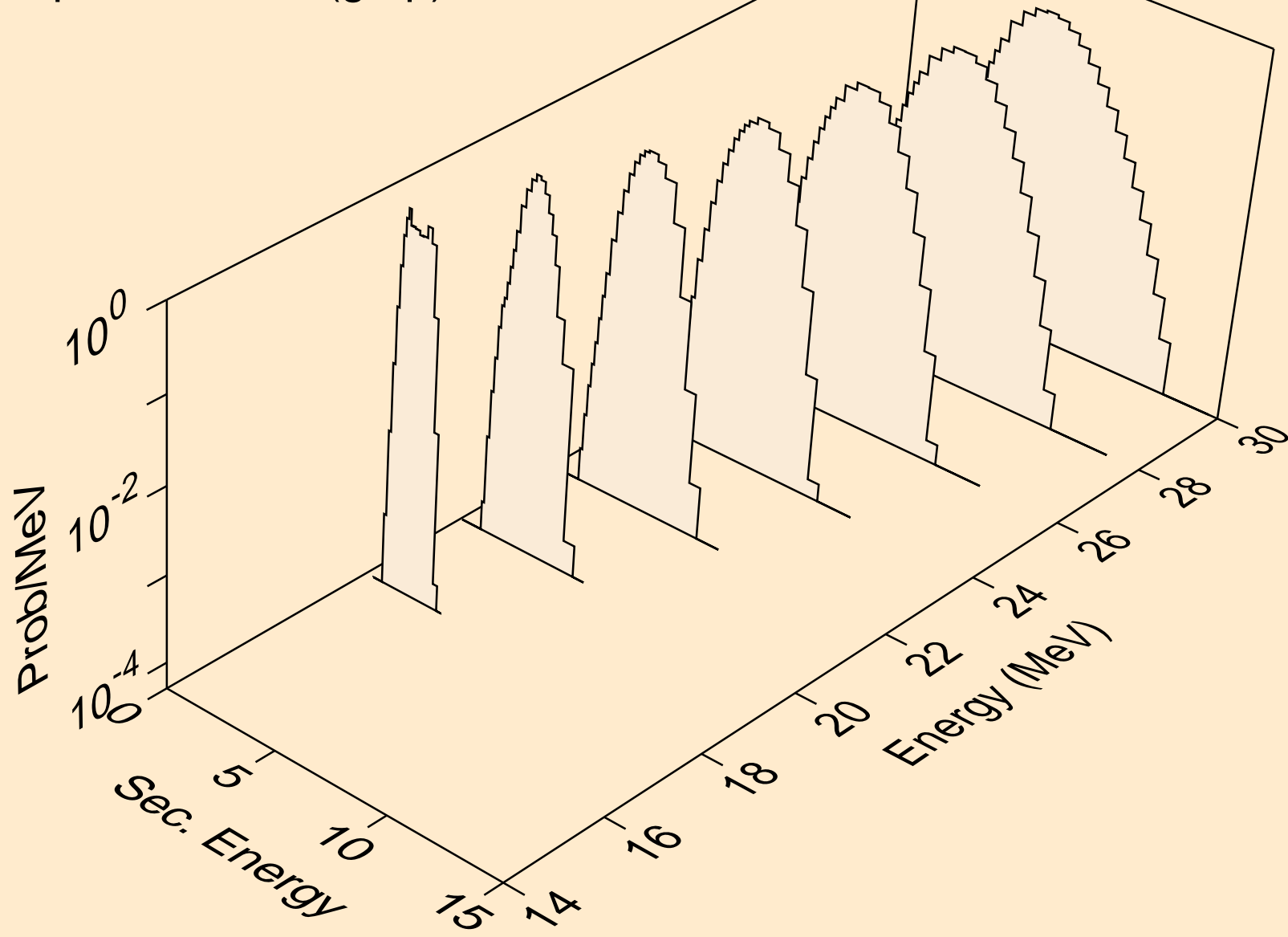

PD103 PHOTON ACER TENDL-2024 LIBRARY; T=0.K  
protons from (g,pa)

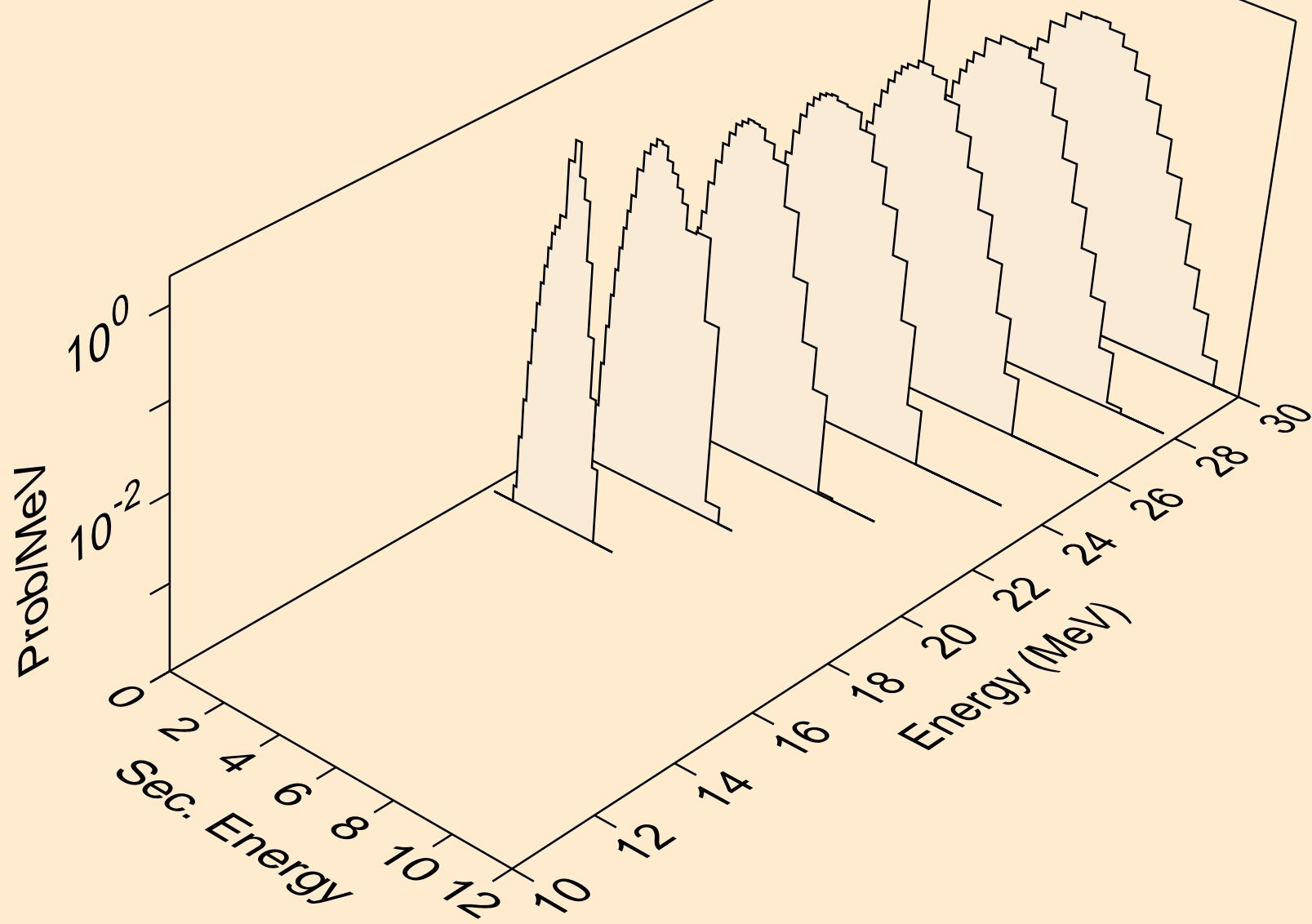

PD103 PHOTON ACER TENDL-2024 LIBRARY; T=0.K  
protons from (g,pd)

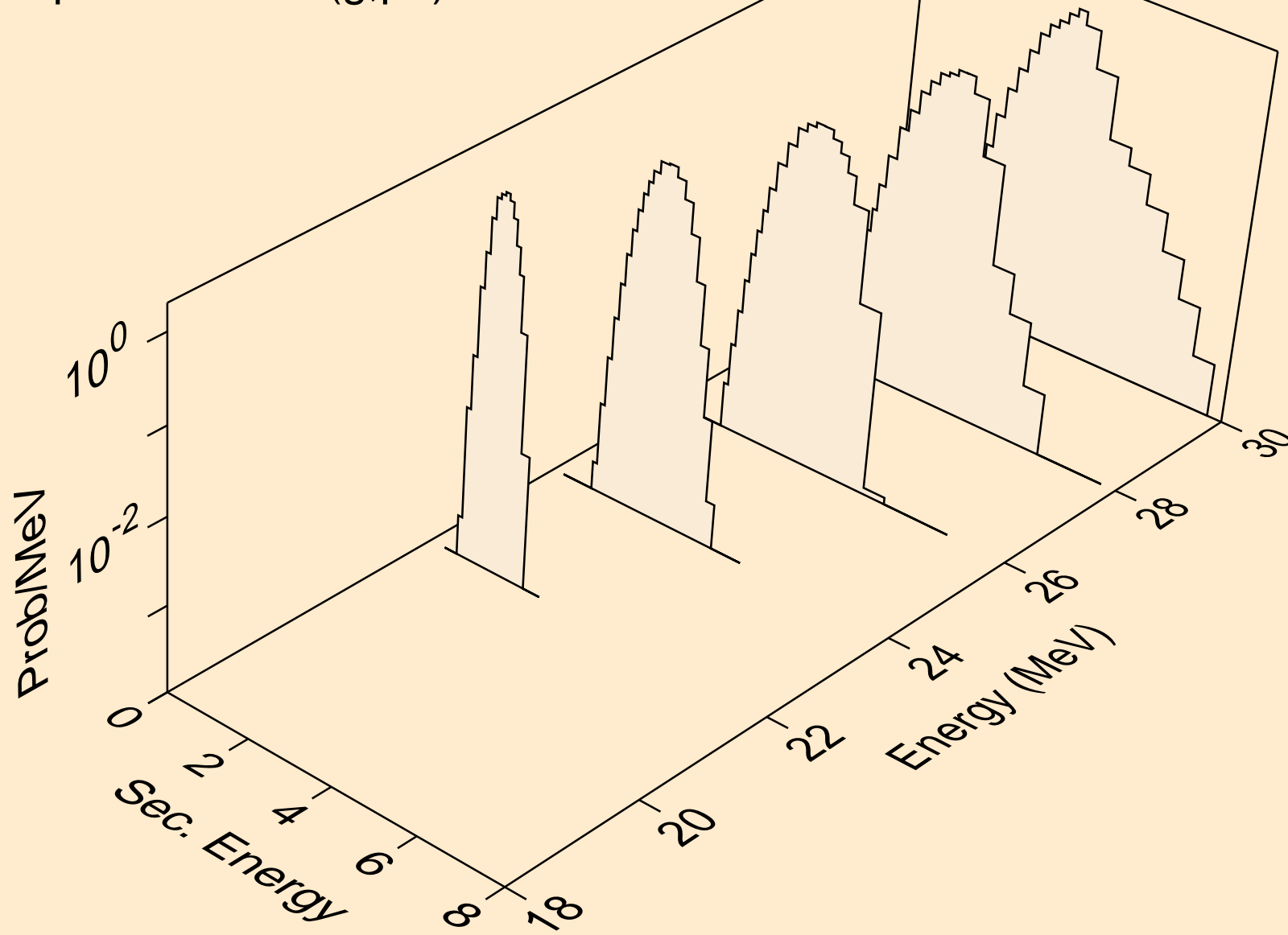

PD103 PHOTON ACER TENDL-2024 LIBRARY; T=0.K  
deuterons from (g,x)

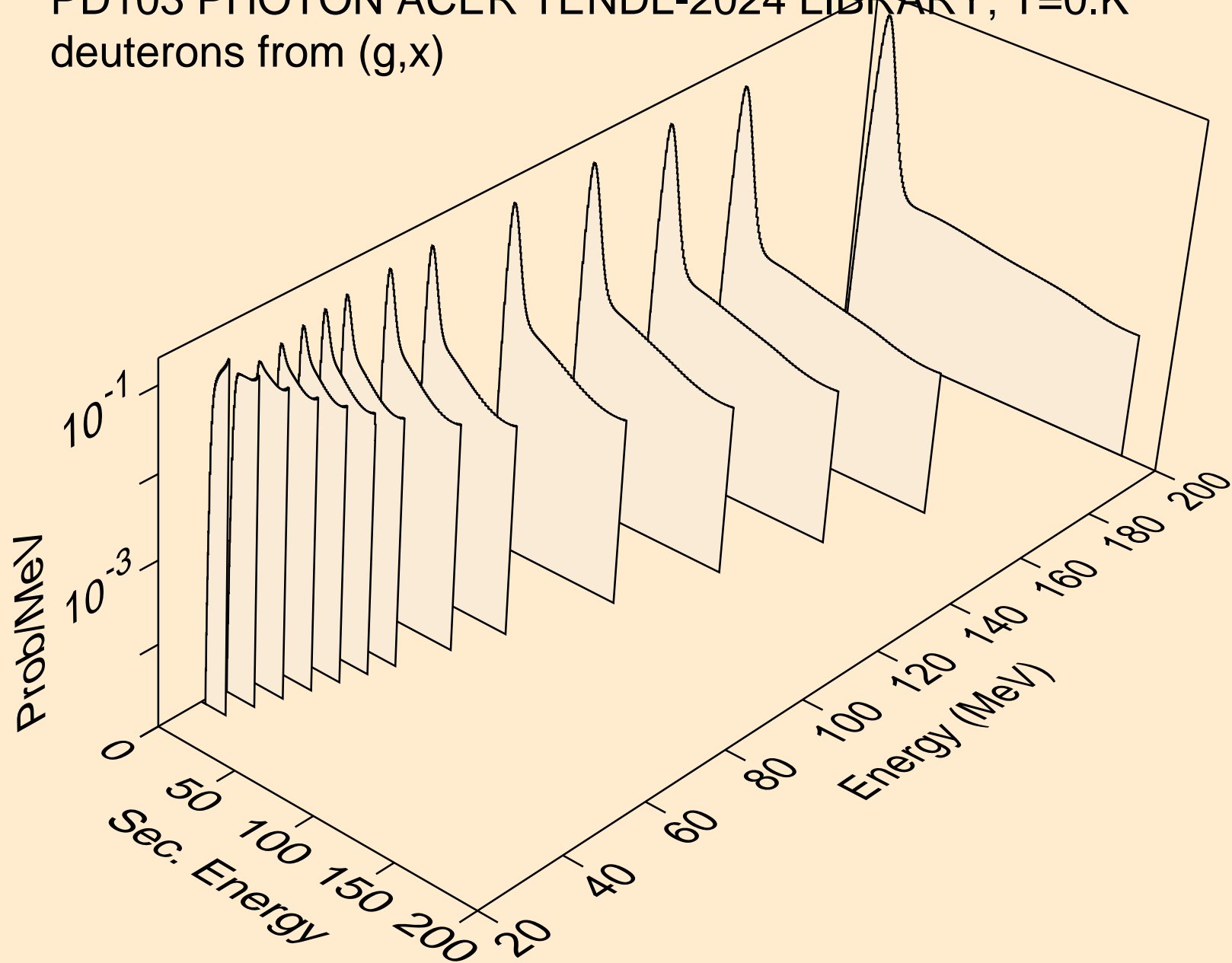

PD103 PHOTON ACER TENDL-2024 LIBRARY; T=0.K  
deuterons from (g,n\*)d

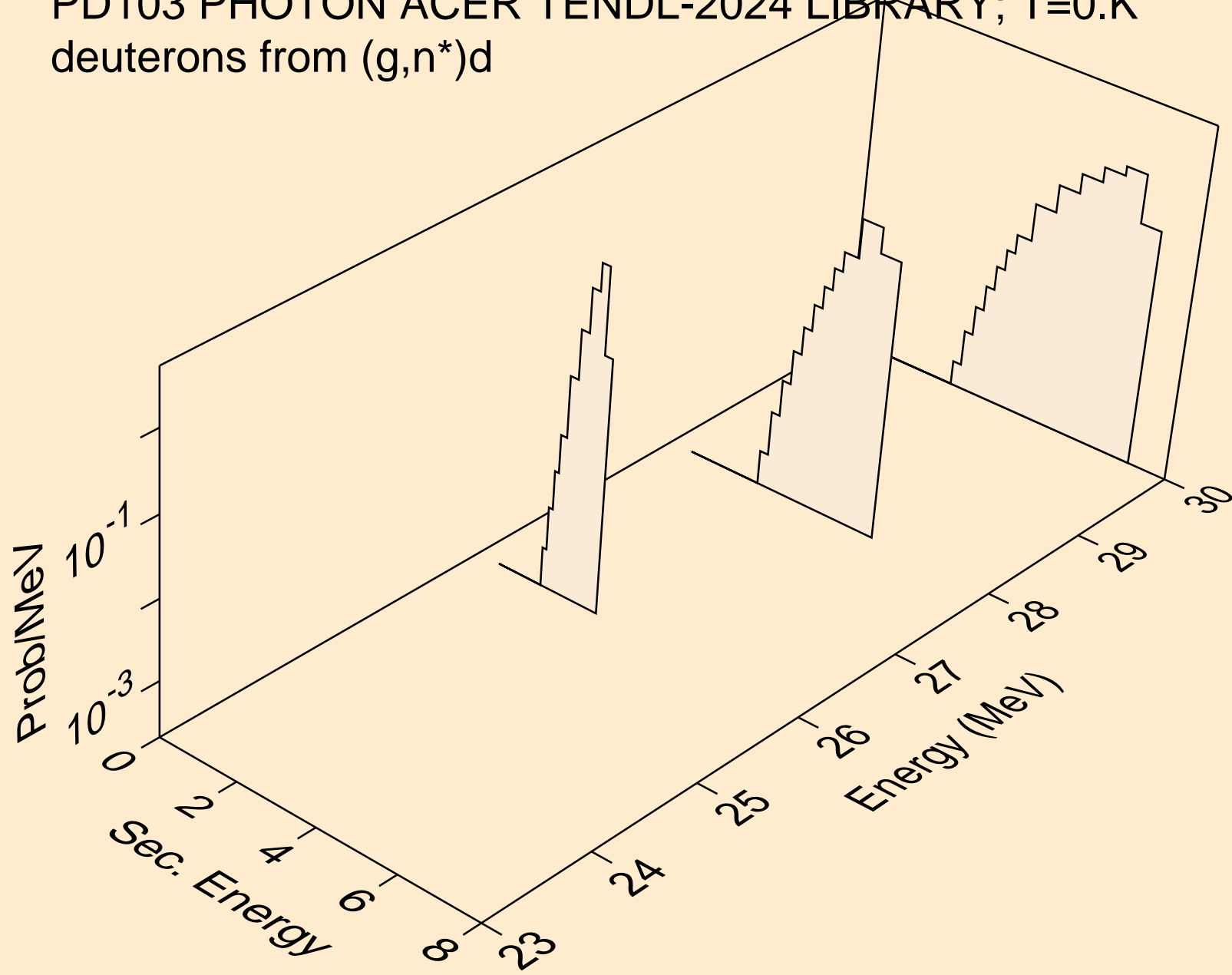

PD103 PHOTON ACER TENDL-2024 LIBRARY; T=0.K  
deuterons from (g,d)

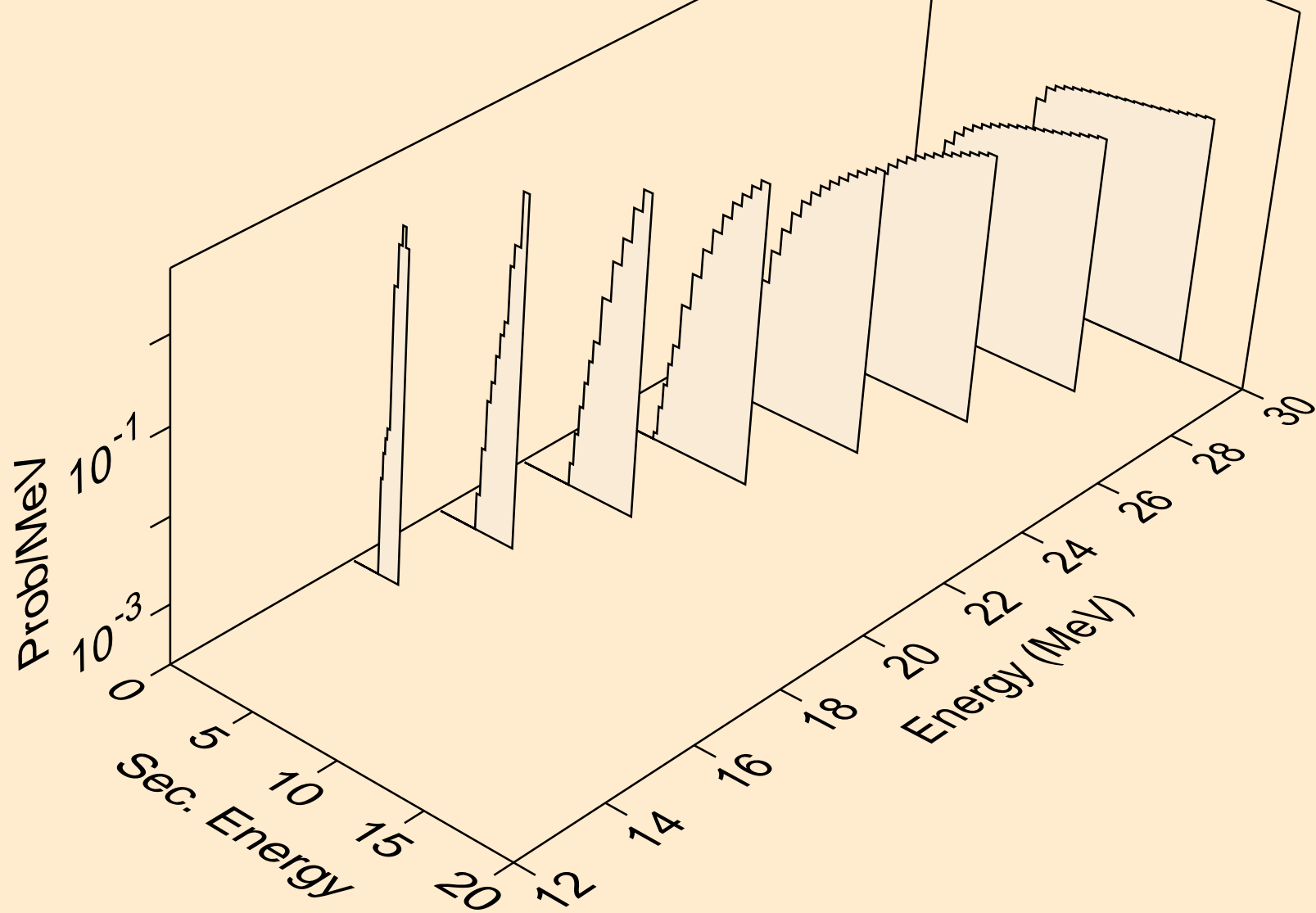

PD103 PHOTON ACER TENDL-2024 LIBRARY; T=0.K  
deuterons from (g,pd)

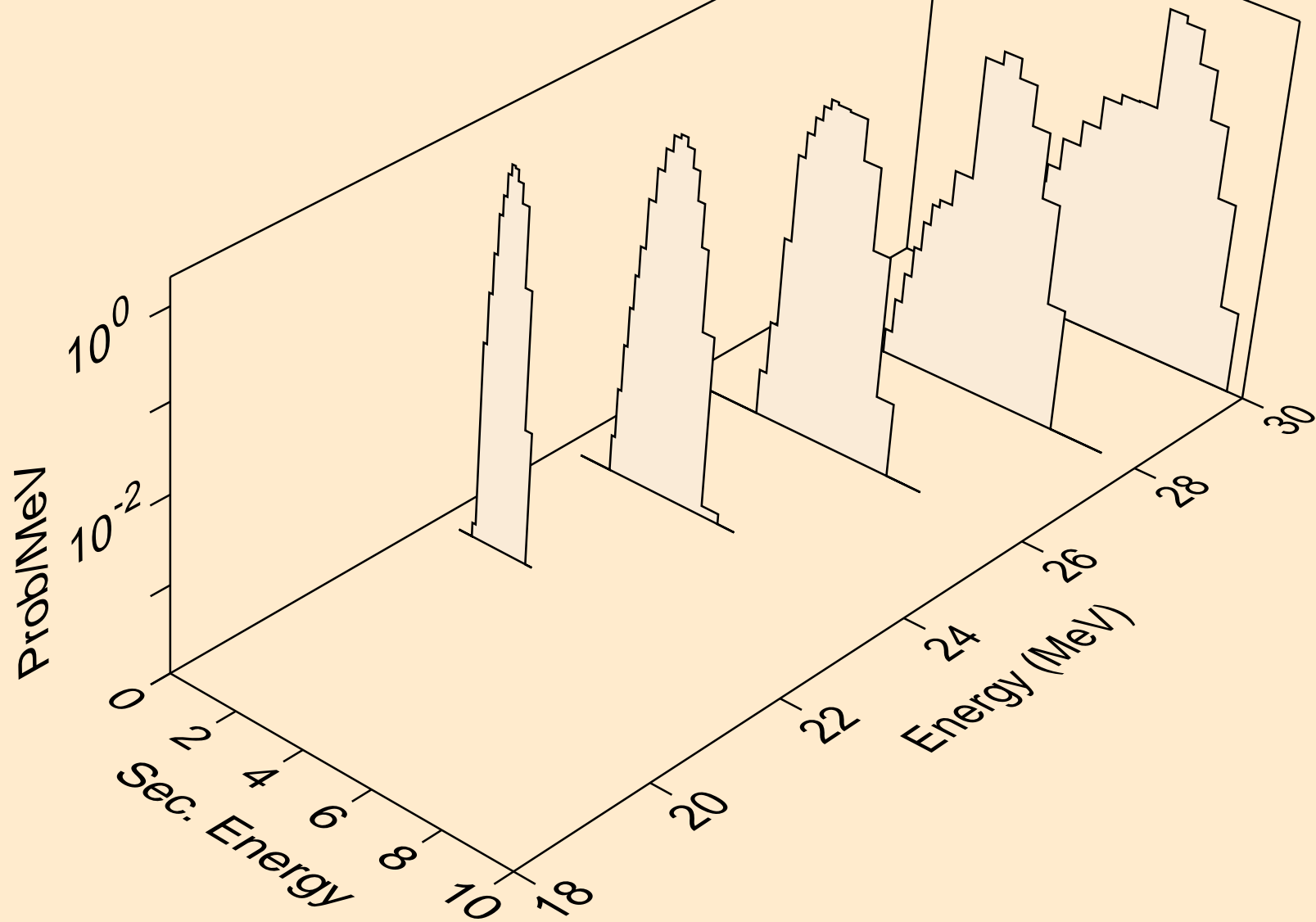

PD103 PHOTON ACER TENDL-2024 LIBRARY; T=0.K  
tritons from (g,x)

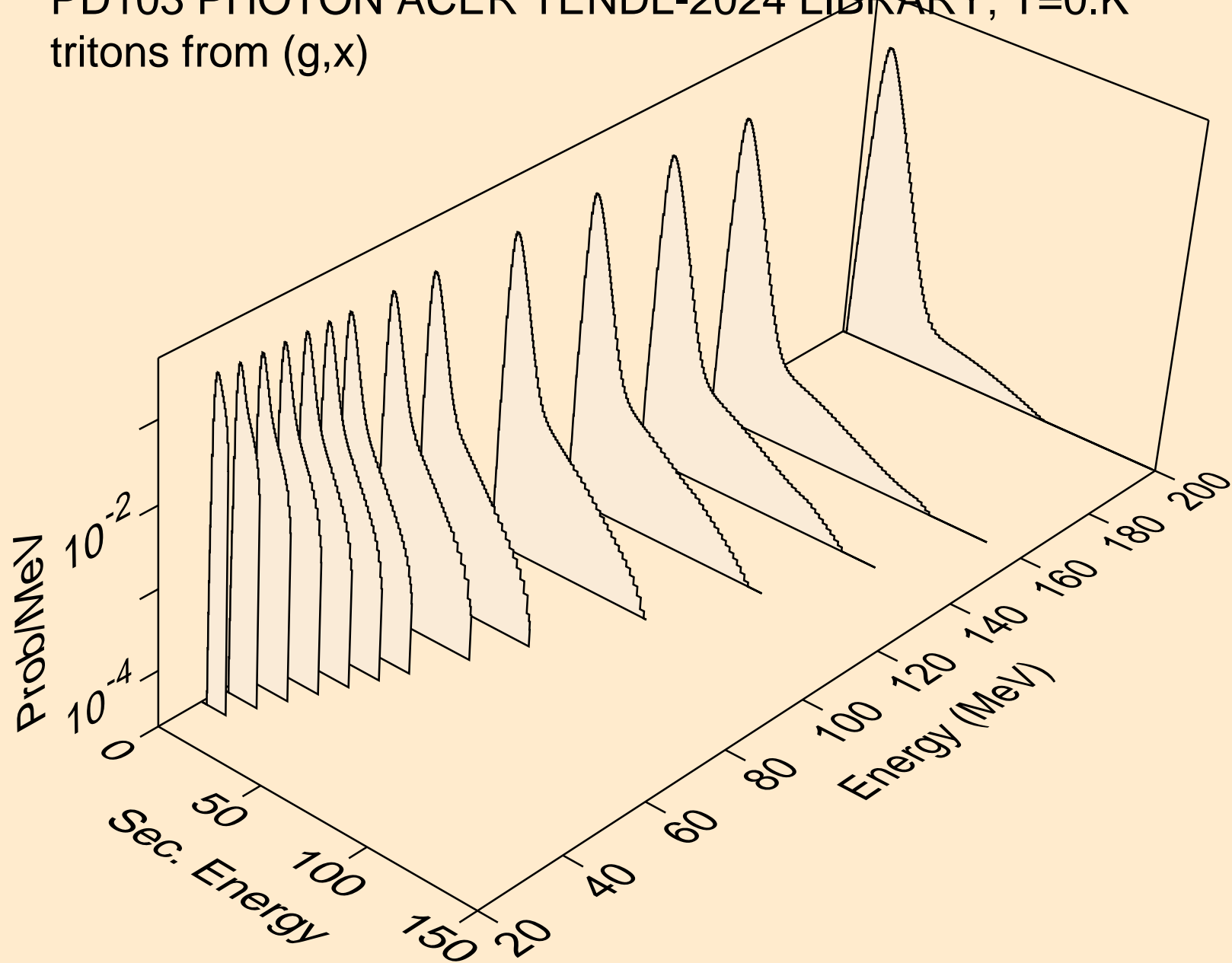

PD103 PHOTON ACER TENDL-2024 LIBRARY; T=0.K  
tritons from (g,n\*)t

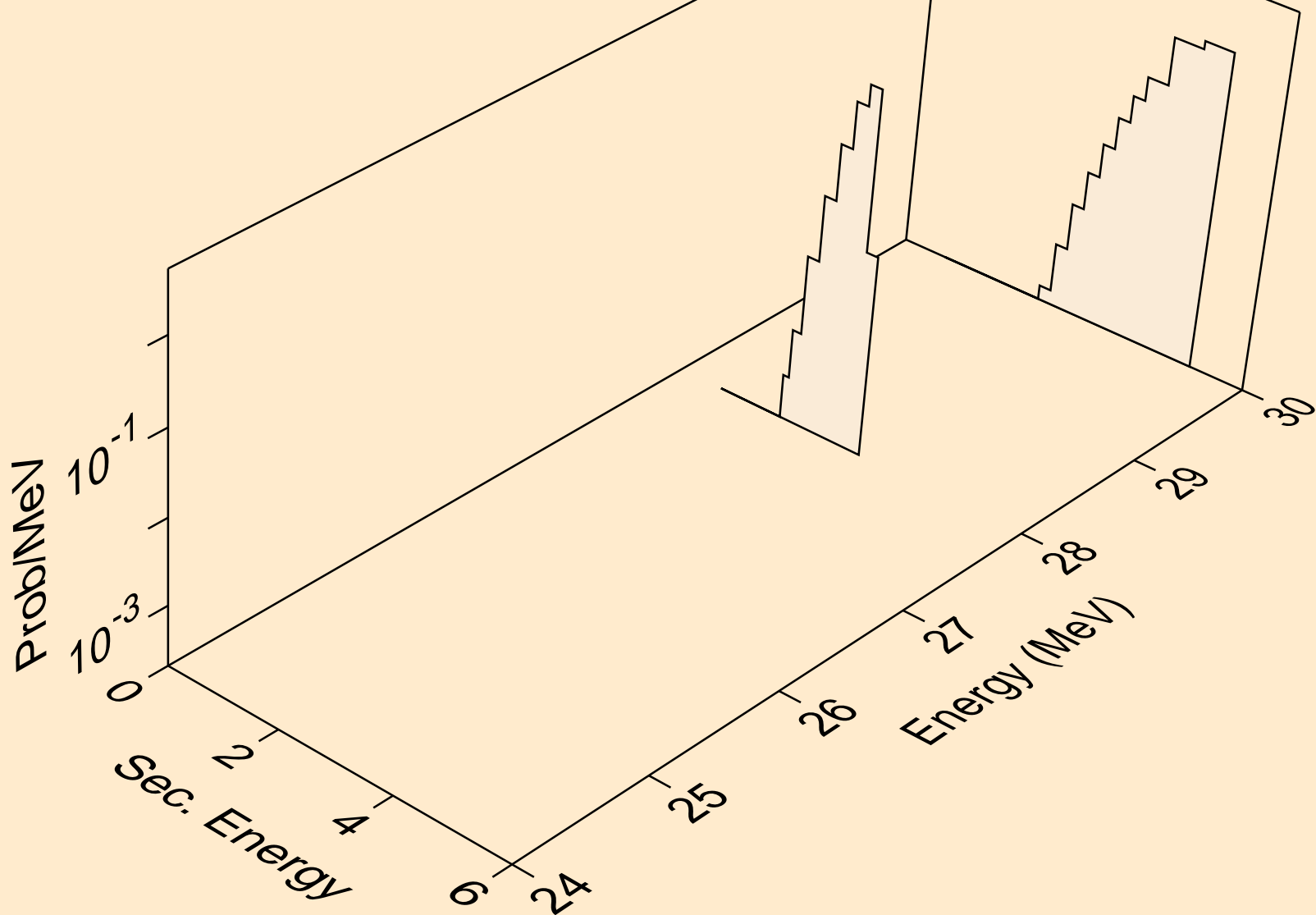

PD103 PHOTON ACER TENDL-2024 LIBRARY; T=0.K  
tritons from (g,t)

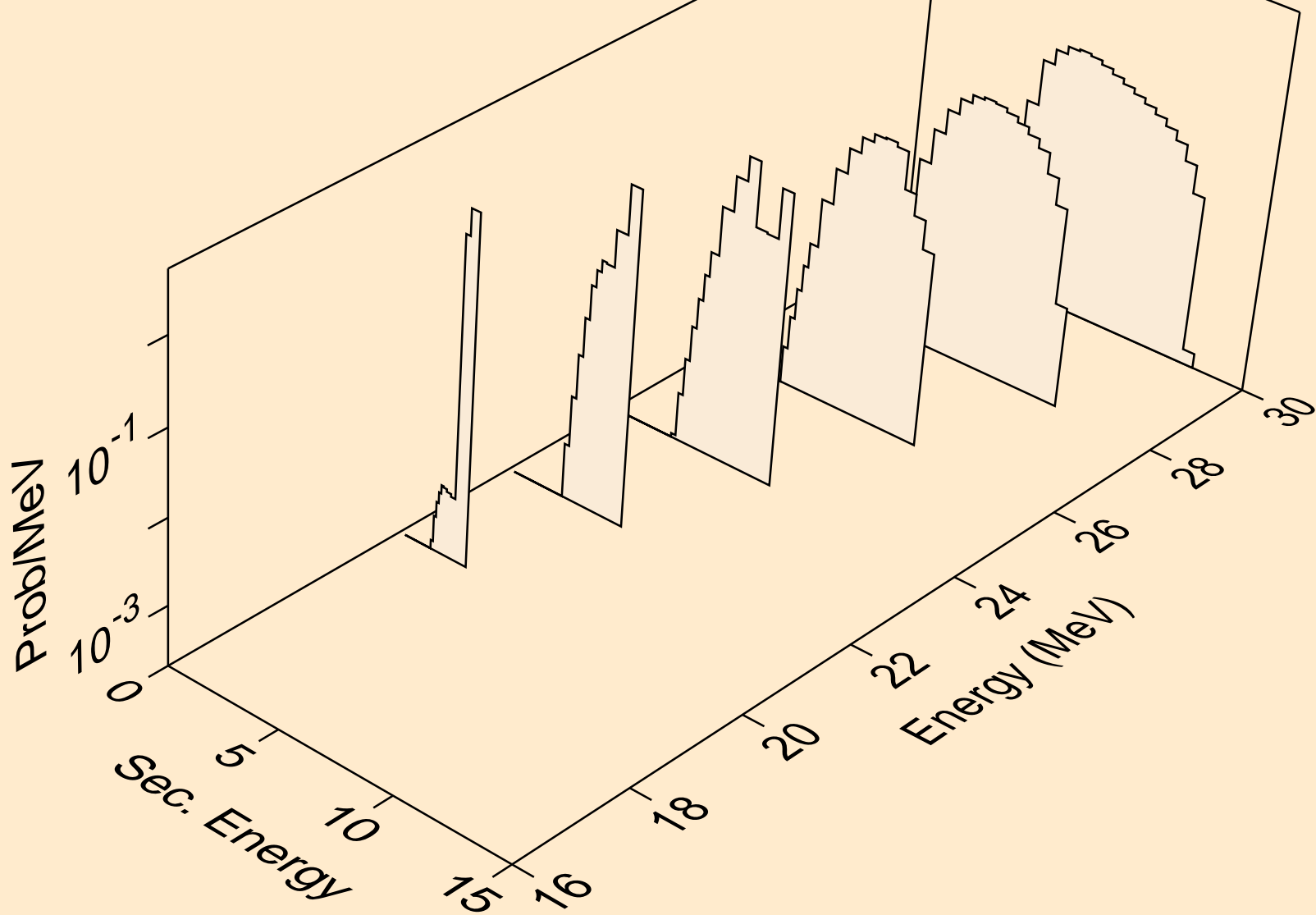

PD103 PHOTON ACER TENDL-2024 LIBRARY; T=0.K  
he3s from (g,x)

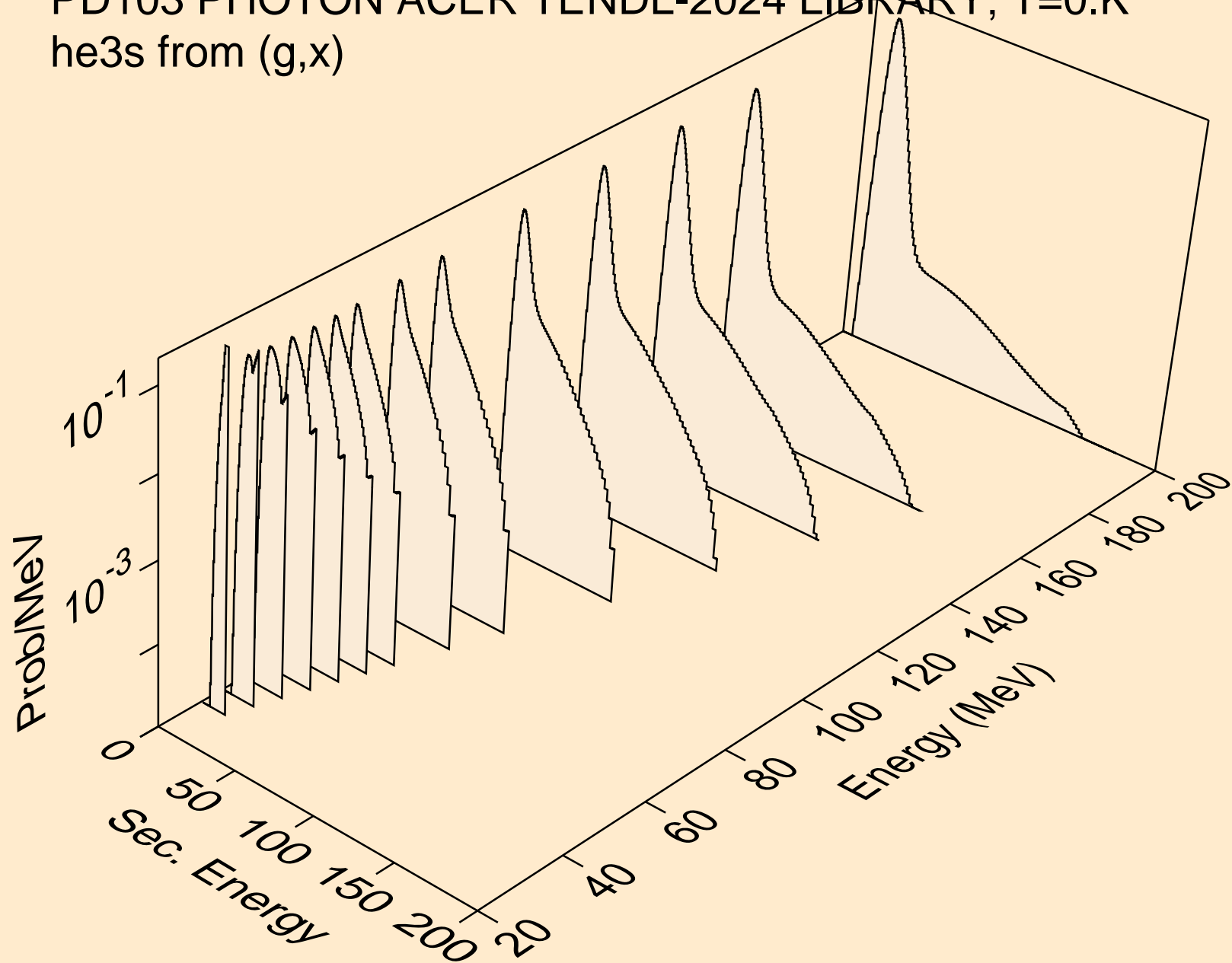

PD103 PHOTON ACER TENDL-2024 LIBRARY; T=0.K  
he3s from (g,he3)

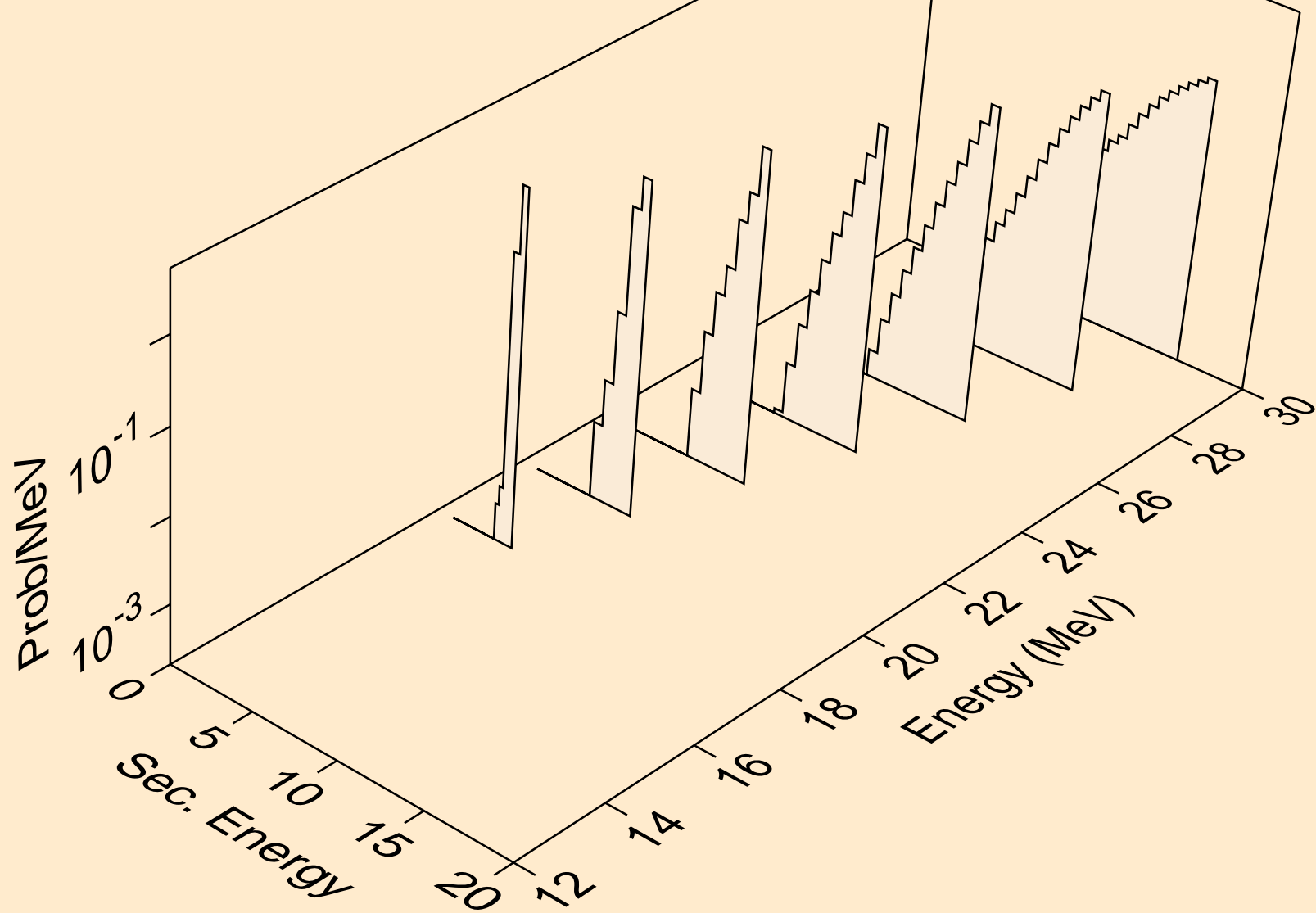

PD103 PHOTON ACER TENDL-2024 LIBRARY; T=0.K  
alphas from (g,x)

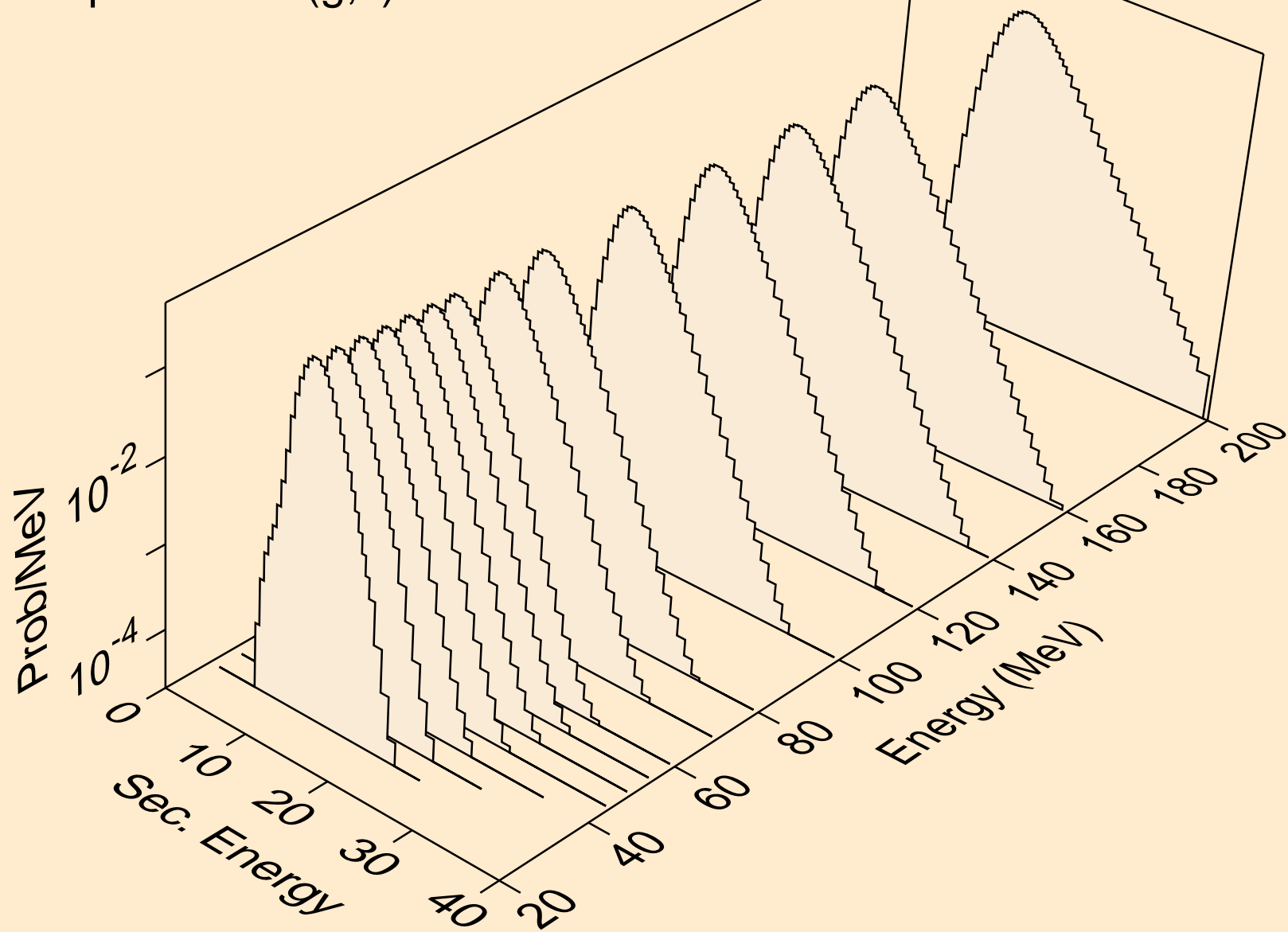

PD103 PHOTON ACER TENDL-2024 LIBRARY; T=0.K  
alphas from (g,n\*)a

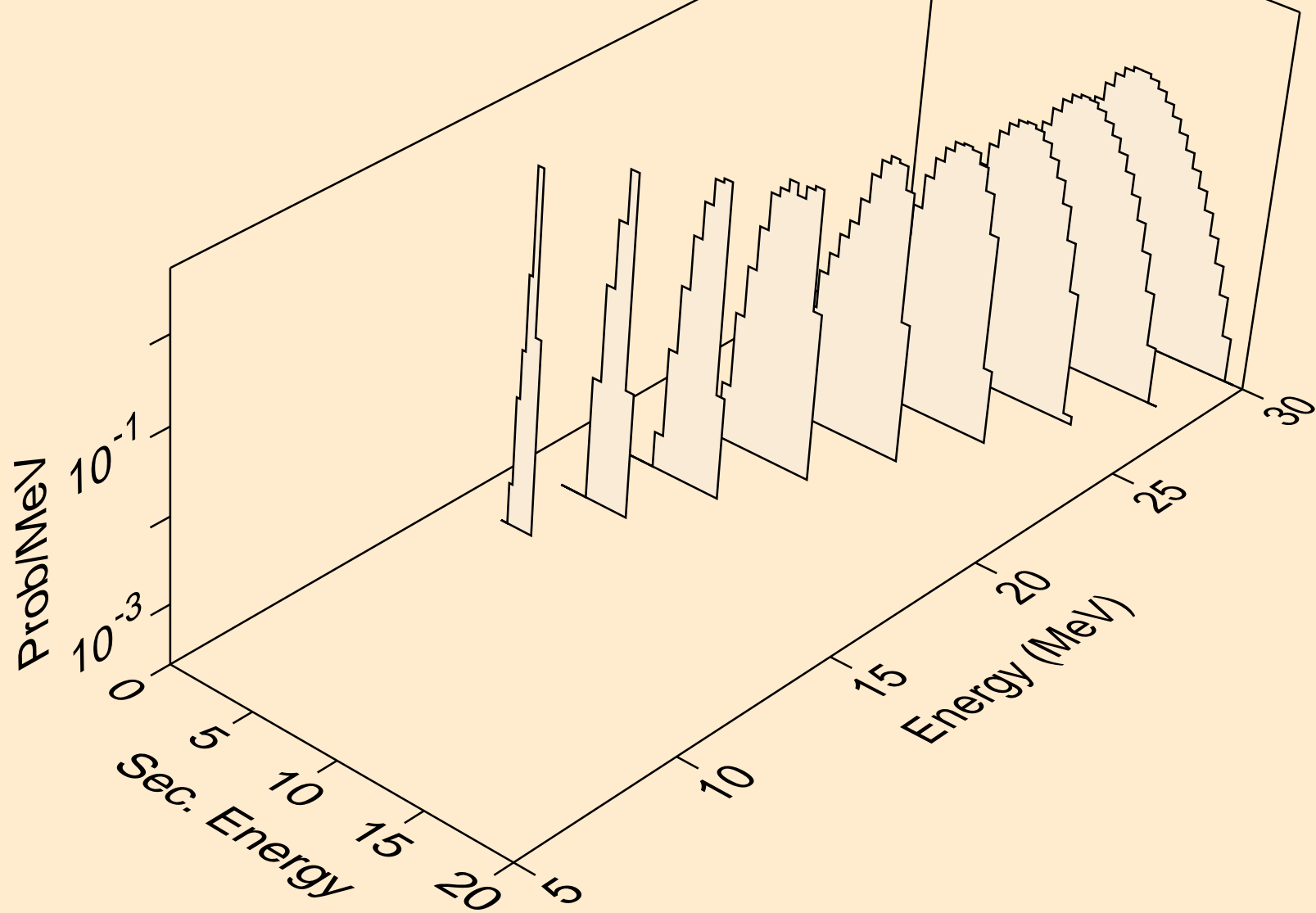

PD103 PHOTON ACER TENDL-2024 LIBRARY; T=0.K  
alphas from (g,2n)a

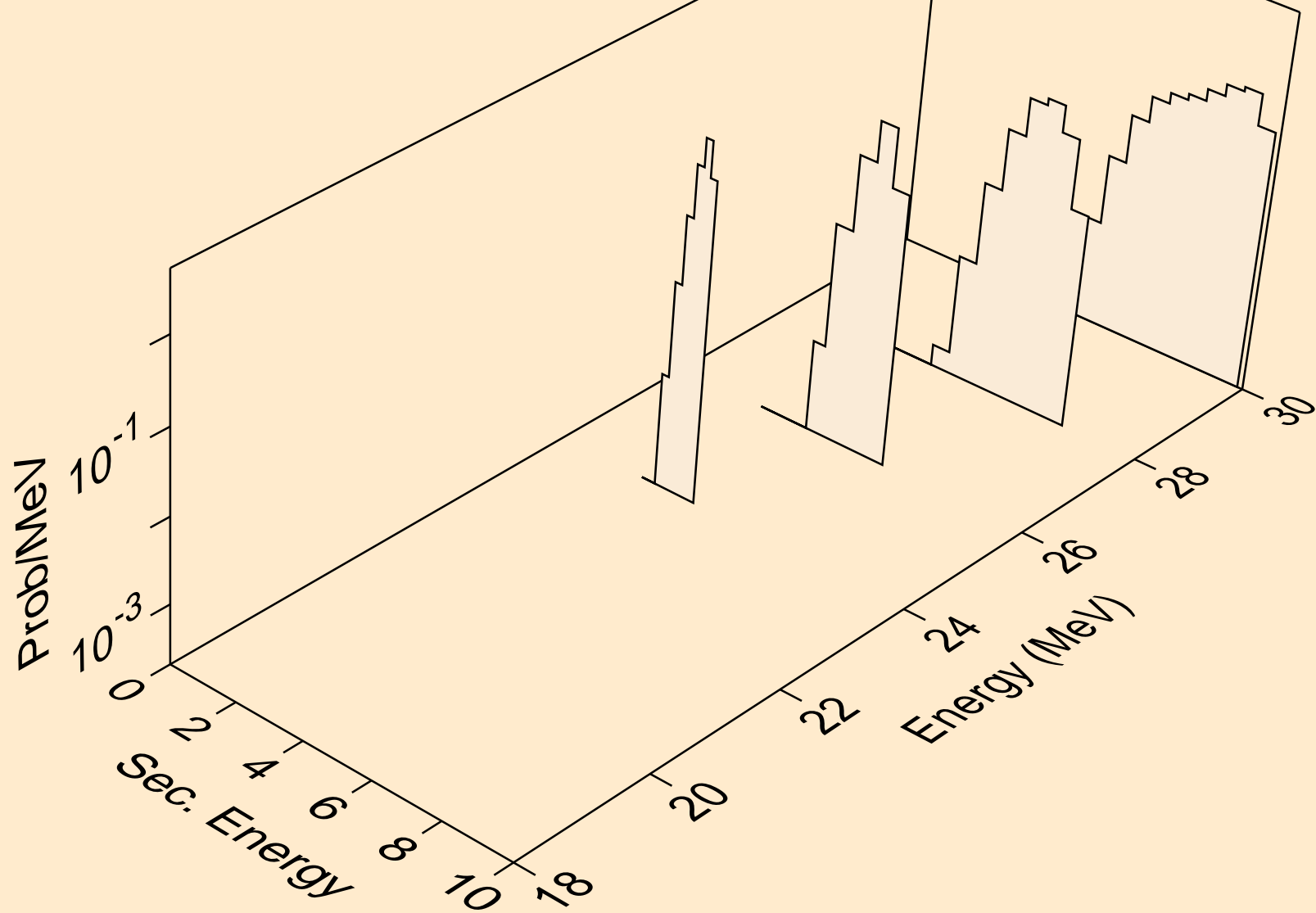

PD103 PHOTON ACER TENDL-2024 LIBRARY; T=0.K  
alphas from (g,n\*)2a

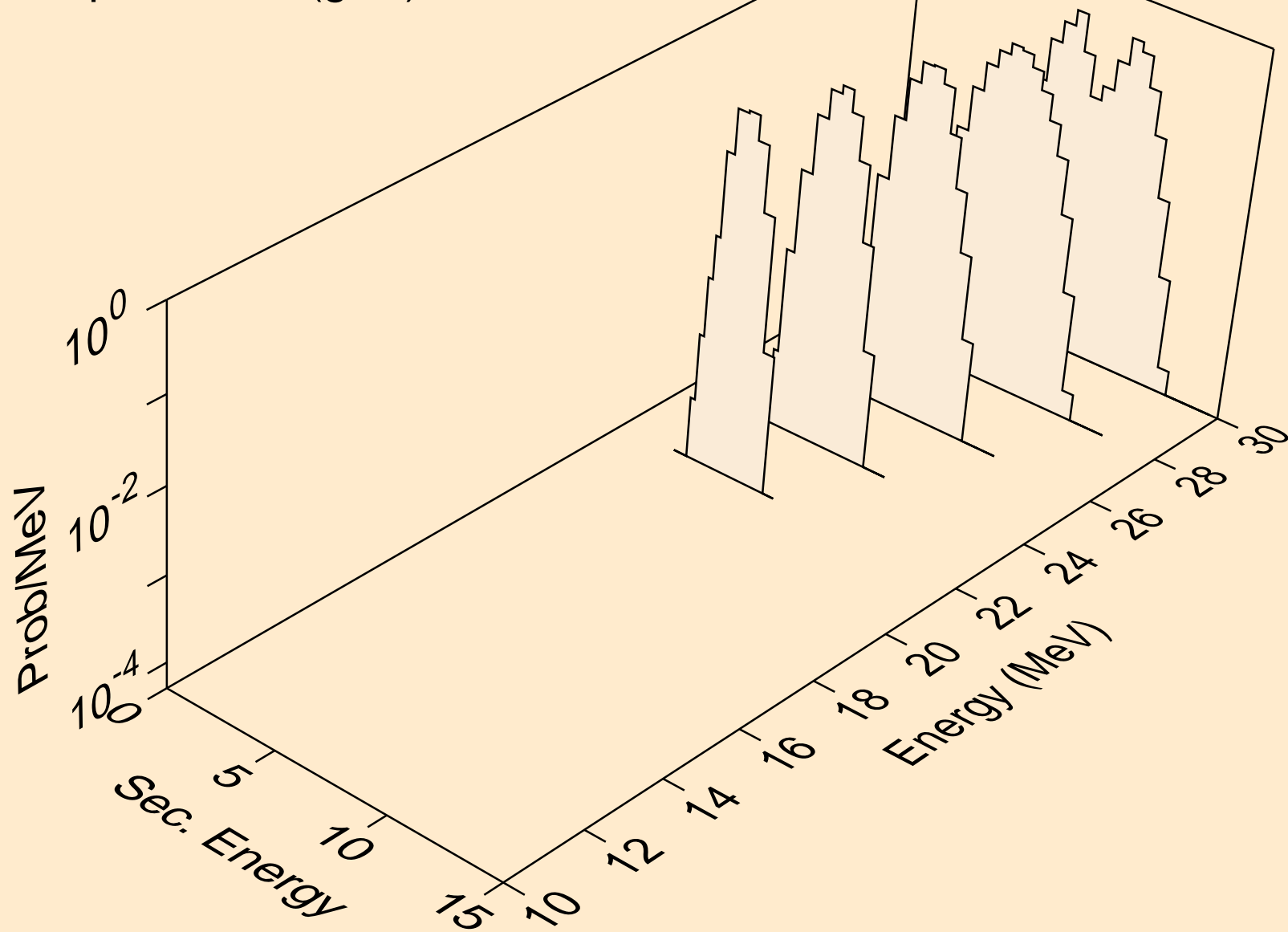

PD103 PHOTON ACER TENDL-2024 LIBRARY; T=0.K  
alphas from (g,npa)

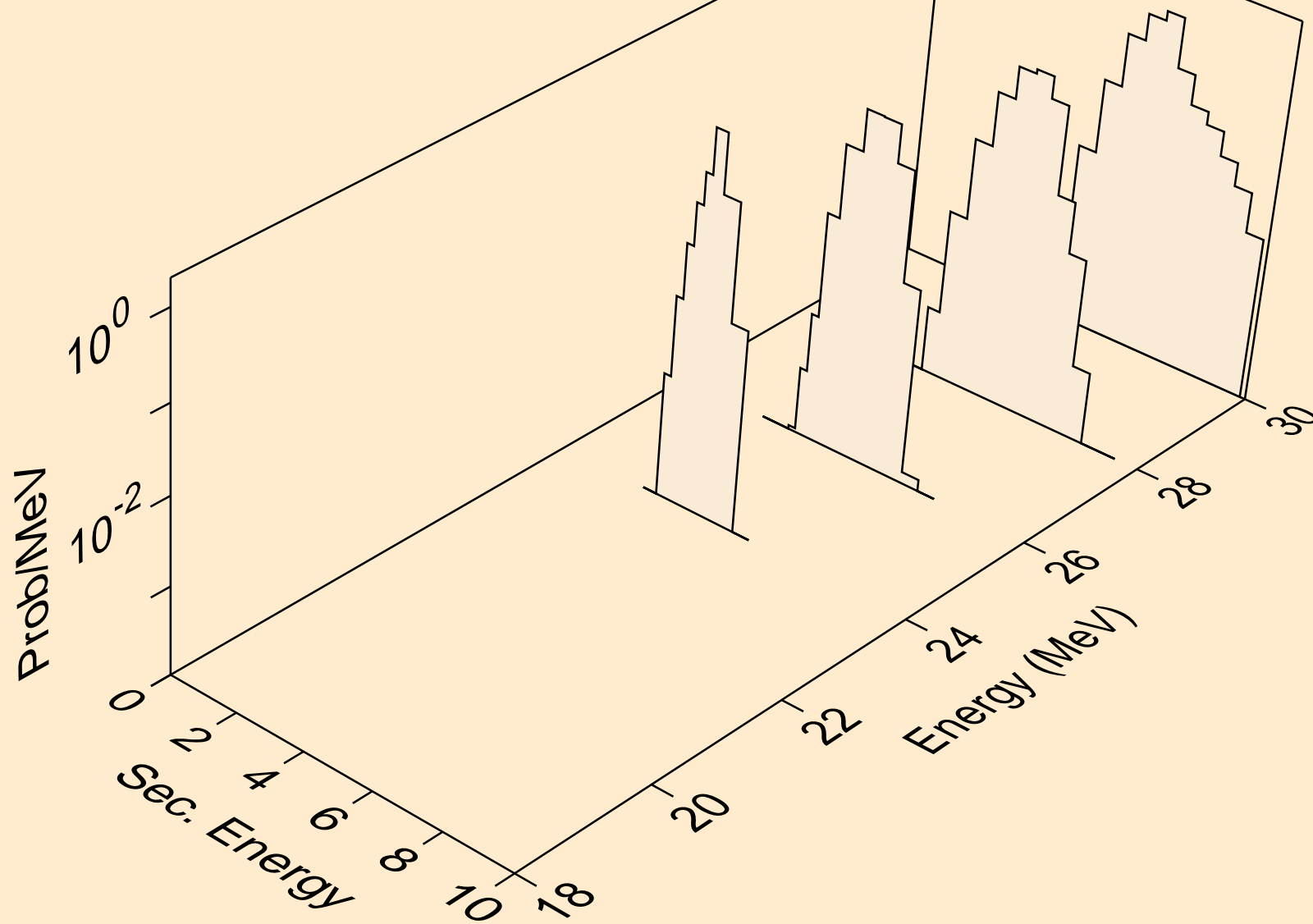

PD103 PHOTON ACER TENDL-2024 LIBRARY; T=0.K  
alphas from (g,a)

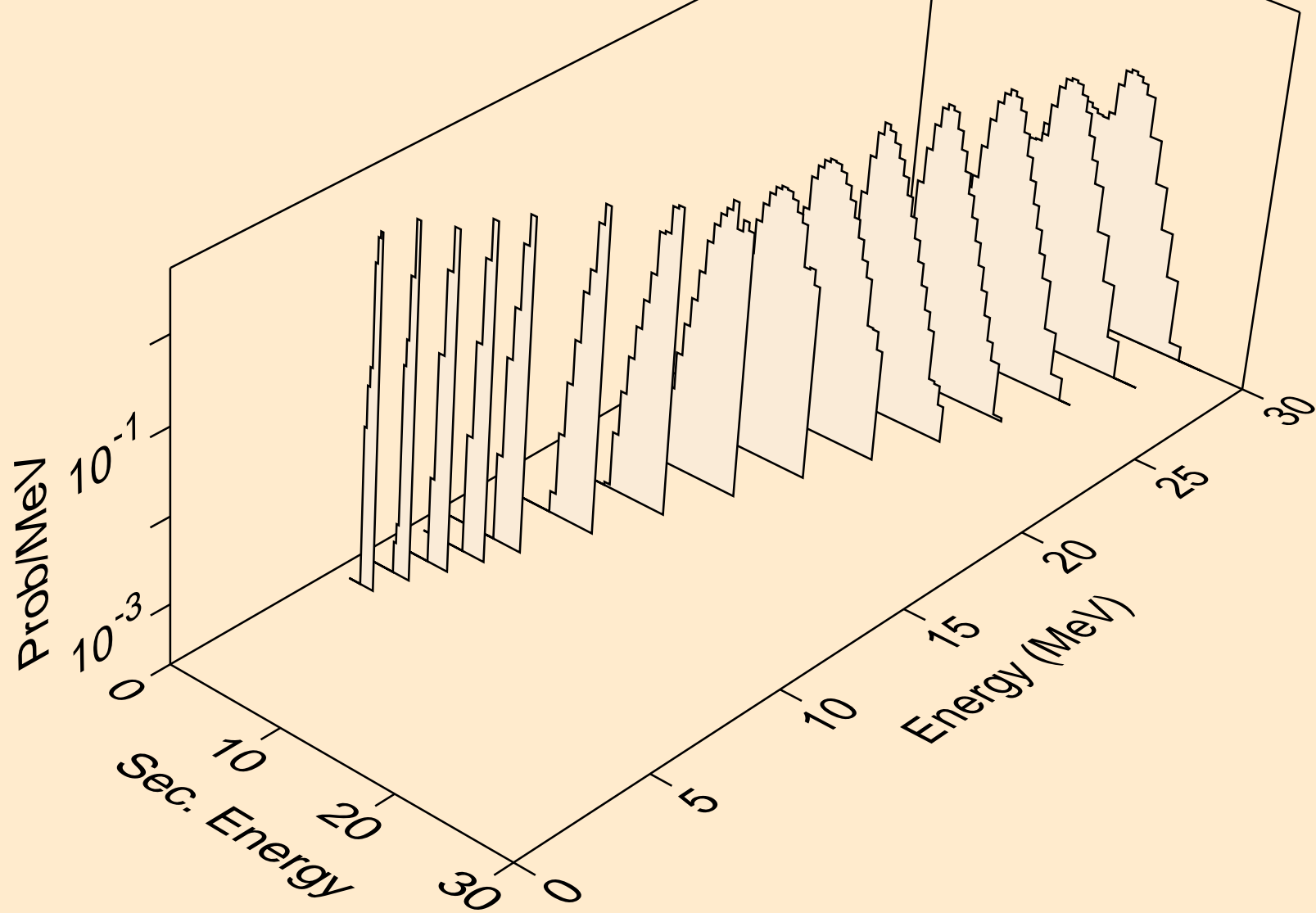

PD103 PHOTON ACER TENDL-2024 LIBRARY; T=0.K  
alphas from (g,2a)

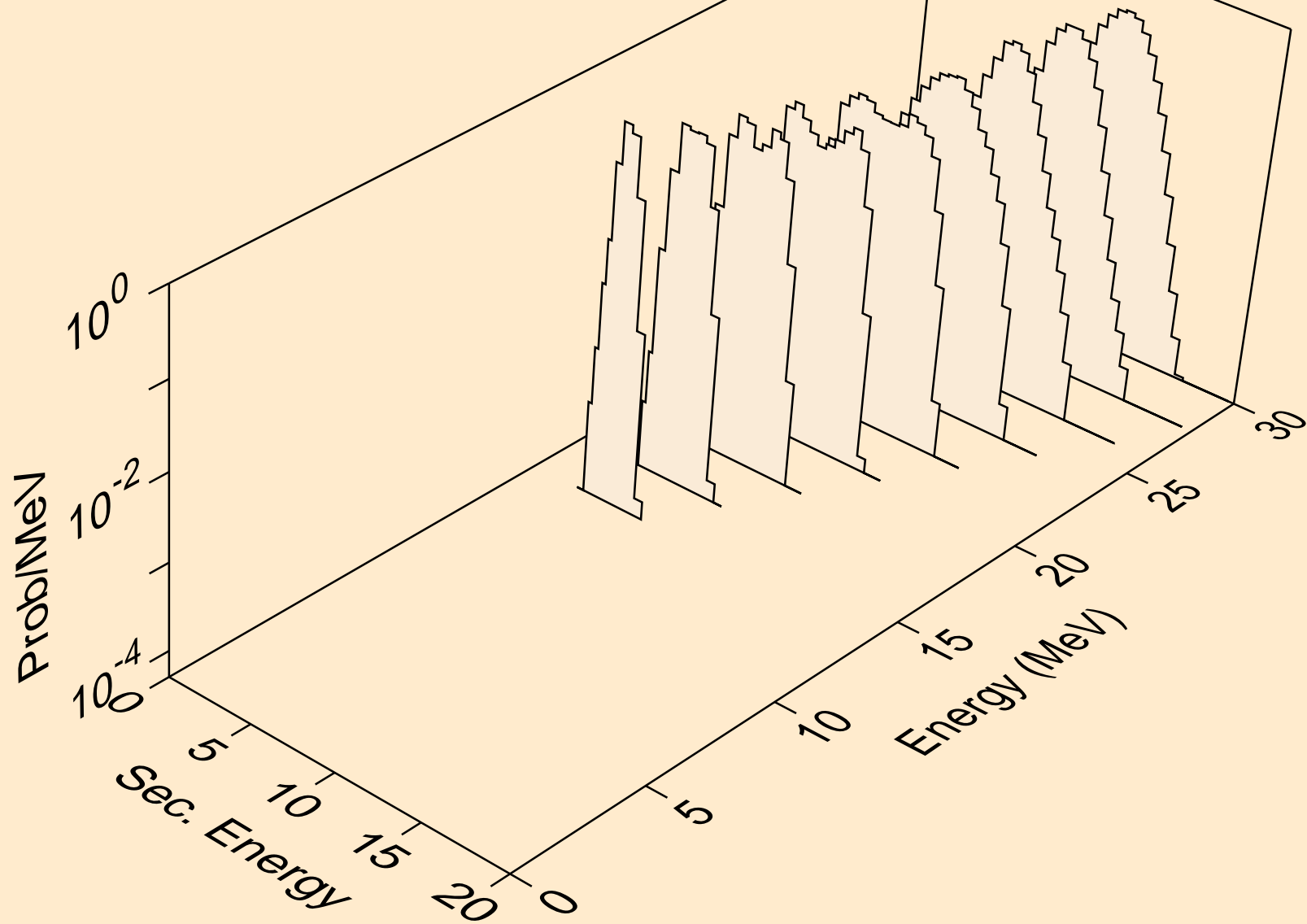

PD103 PHOTON ACER TENDL-2024 LIBRARY; T=0.K  
alphas from (g,pa)

