

SC044M PHOTON ACER TENDL-2024 LIBRARY; T=0.K

Principal cross sections

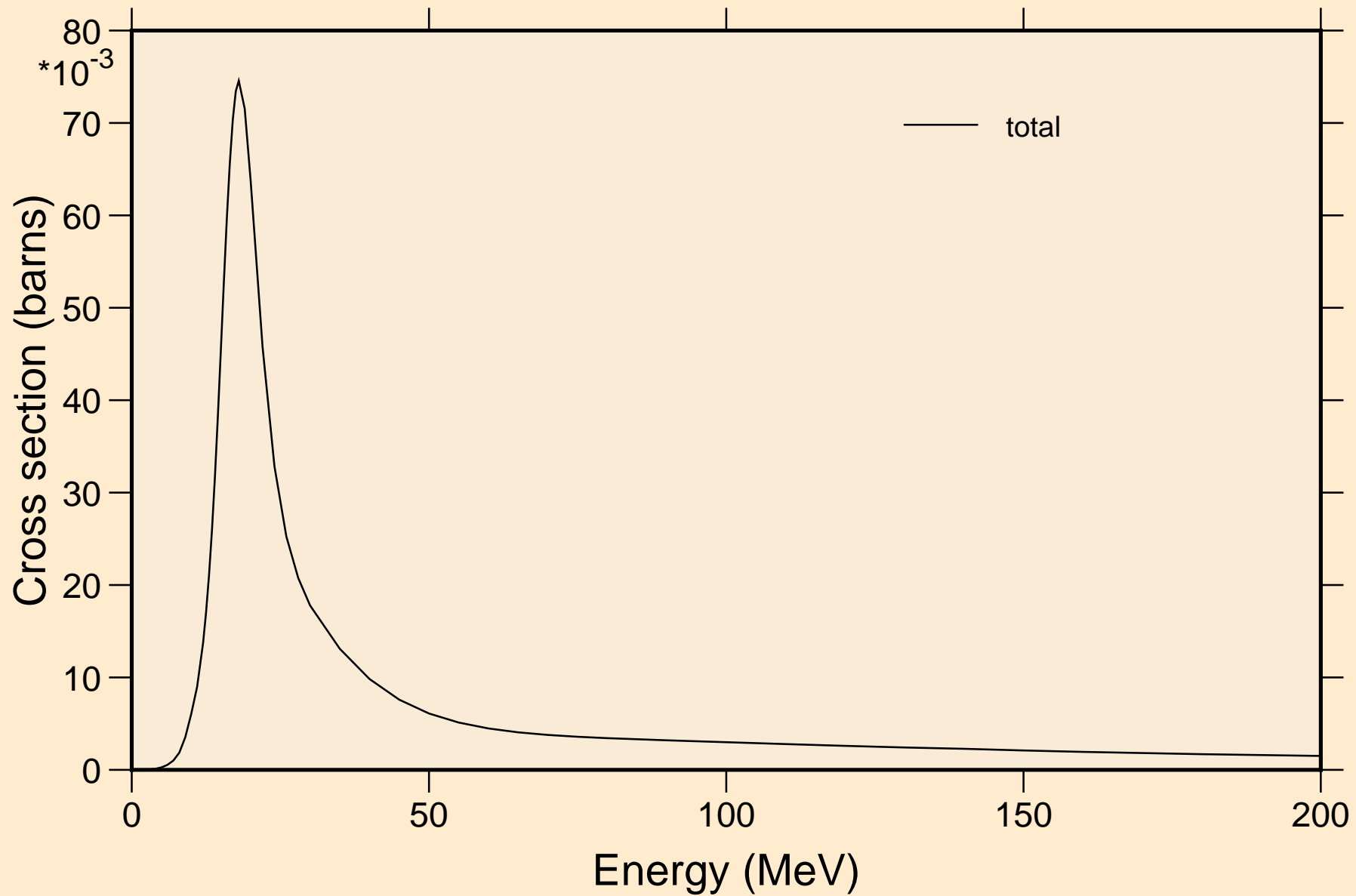

SC044M PHOTON ACER TENDL-2024 LIBRARY; T=0.K

Heating

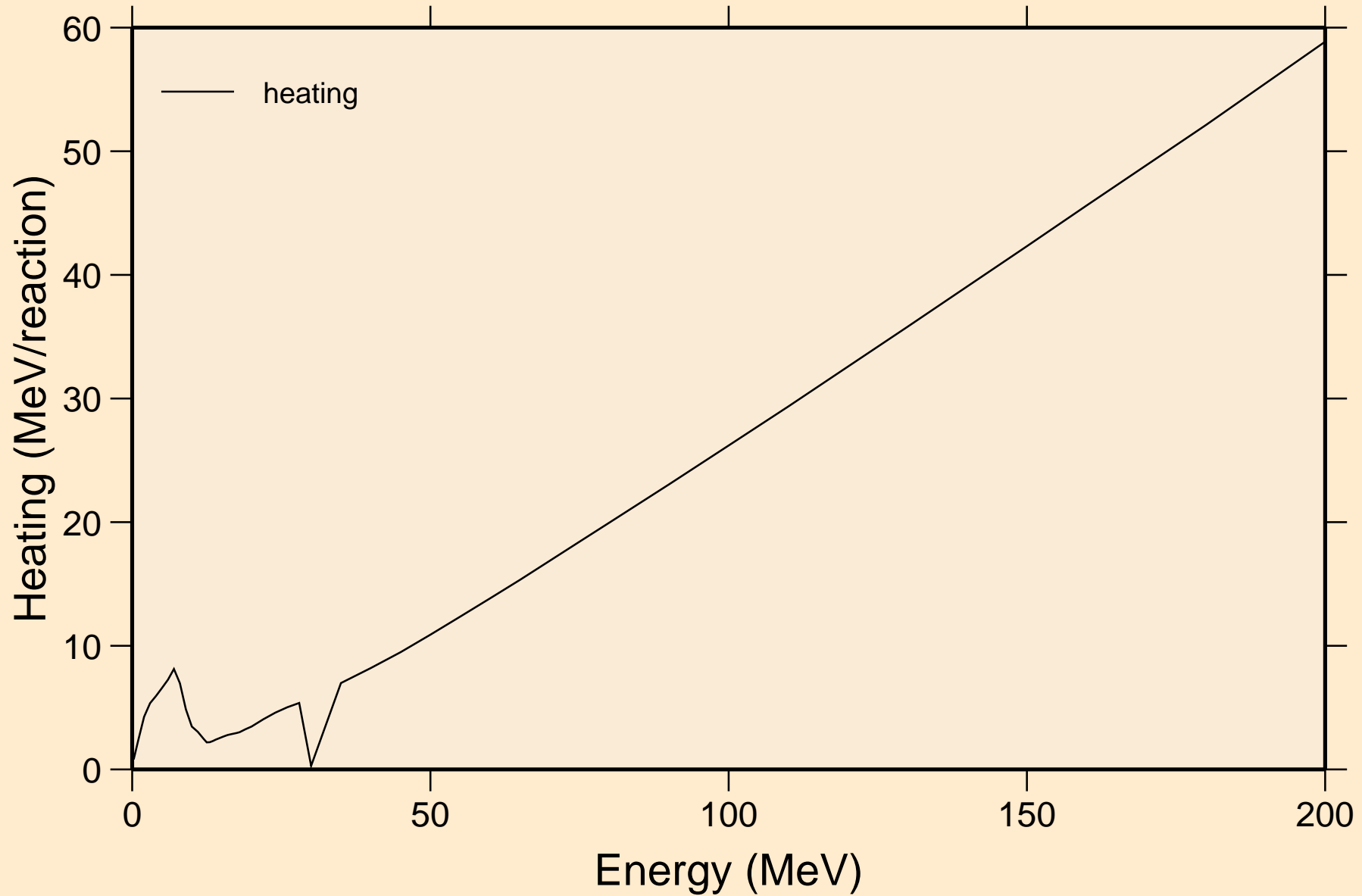

SC044M PHOTON ACER TENDL-2024 LIBRARY; T=0.K

Particle heating contributions

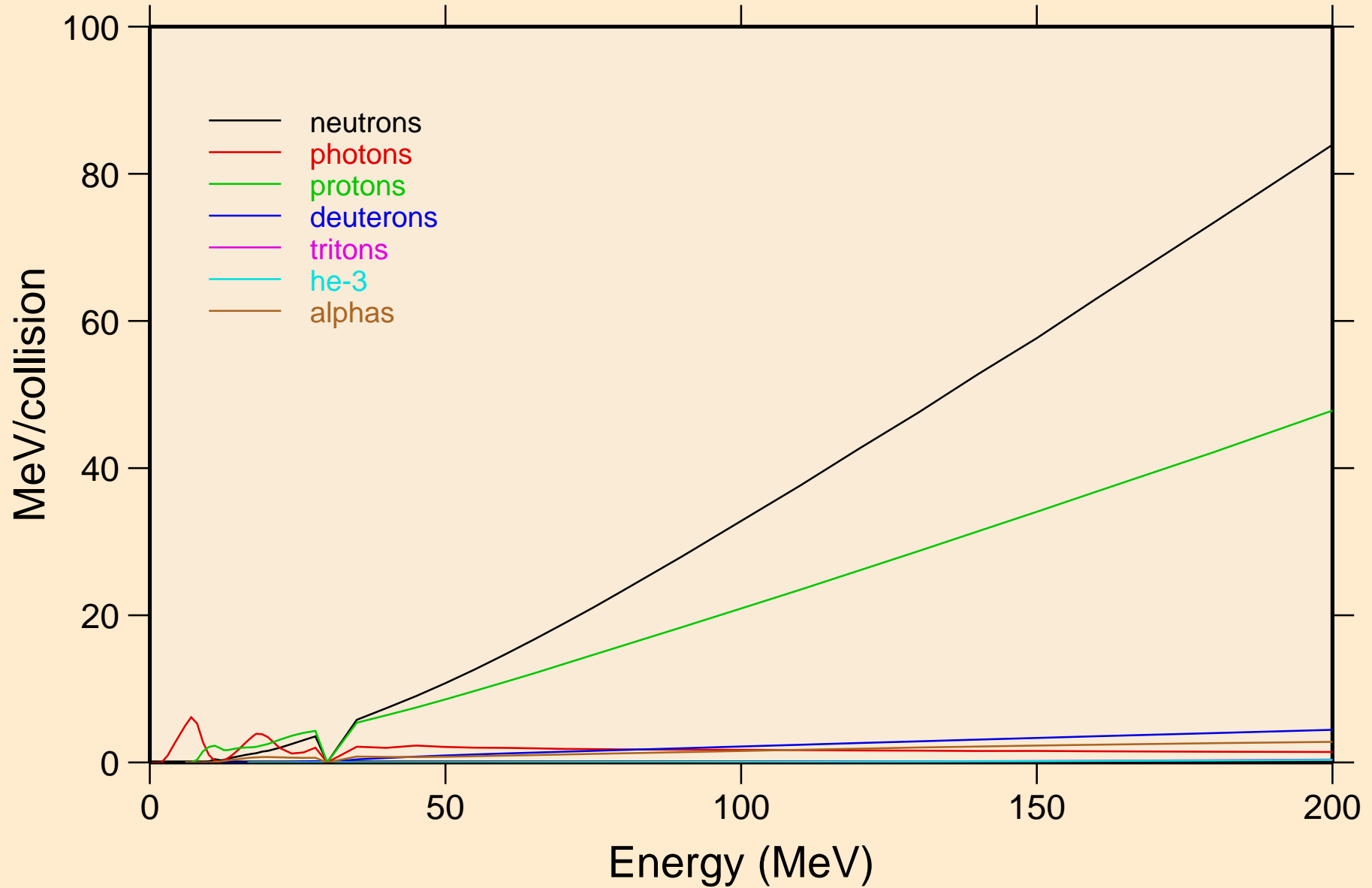

SC044M PHOTON ACER TENDL-2024 LIBRARY; T=0.K

Particle production cross sections

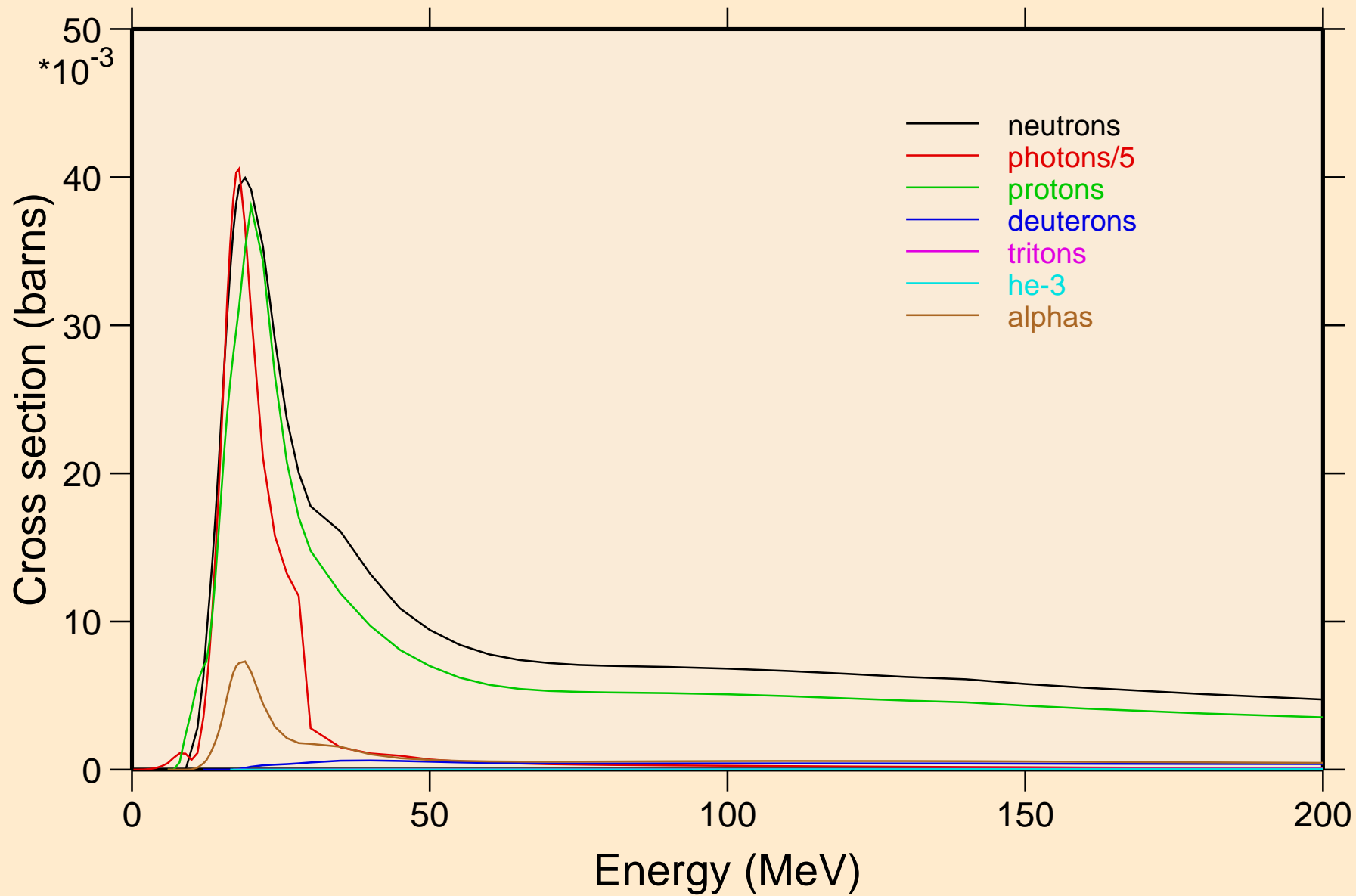

SC044M PHOTON ACER TENDL-2024 LIBRARY; T=0.K
neutrons from (g,x)

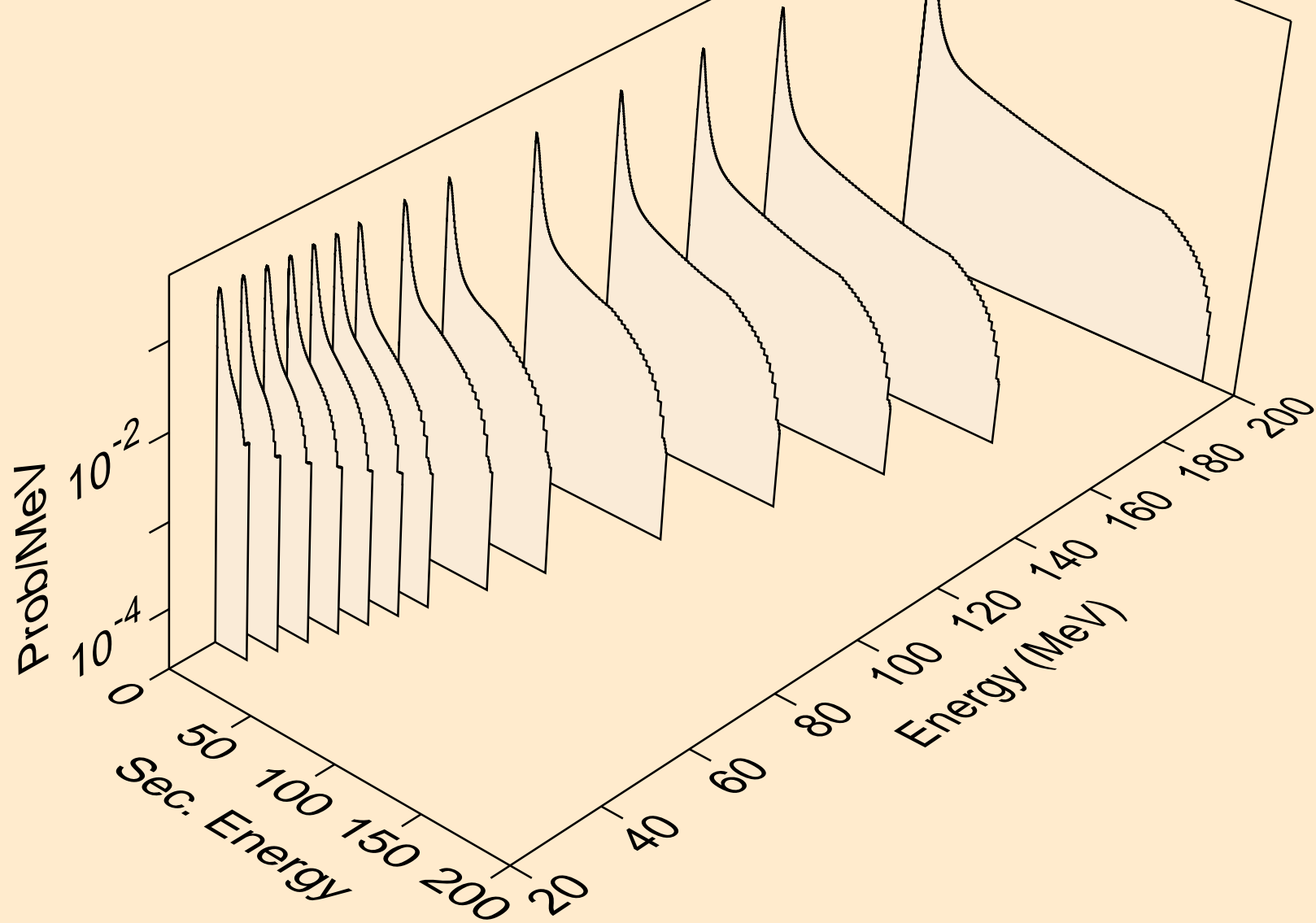

SC044M PHOTON ACER TENDL-2024 LIBRARY; T=0.K
neutrons from (g,2n)

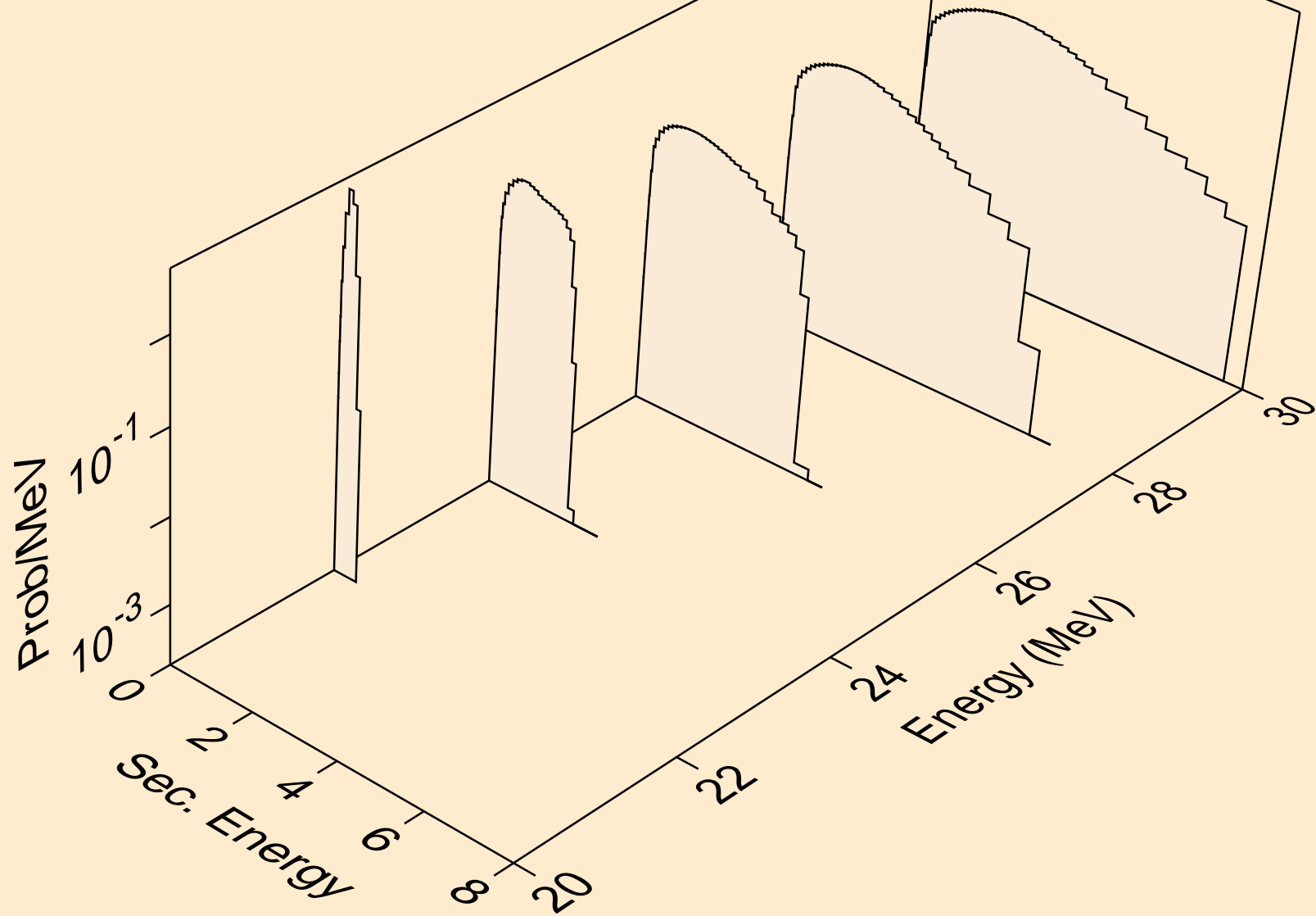

SC044M PHOTON ACER TENDL-2024 LIBRARY; T=0.K
neutrons from (g,n*)a

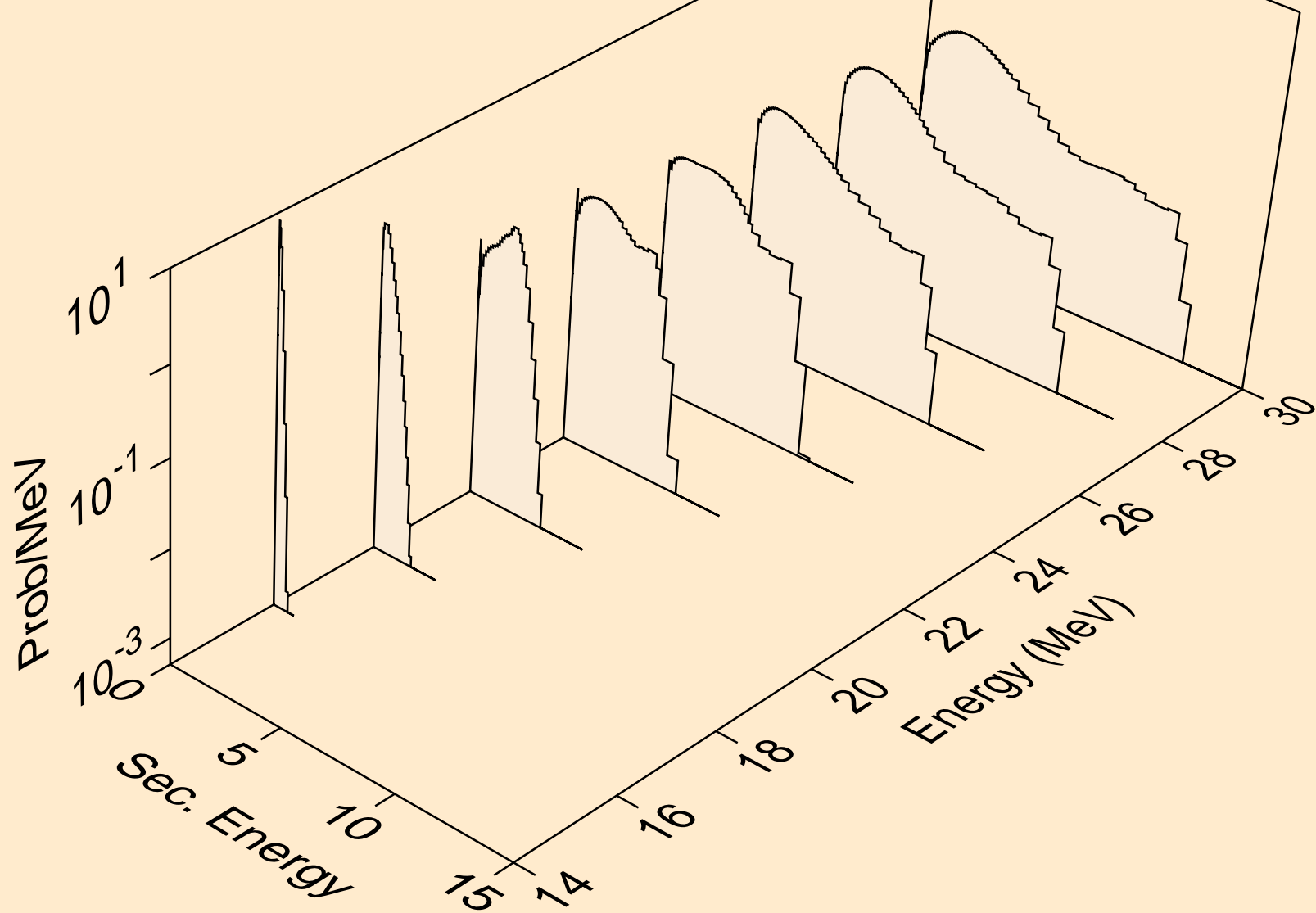

SC044M PHOTON ACER TENDL-2024 LIBRARY; T=0.K
neutrons from (g,n*)p

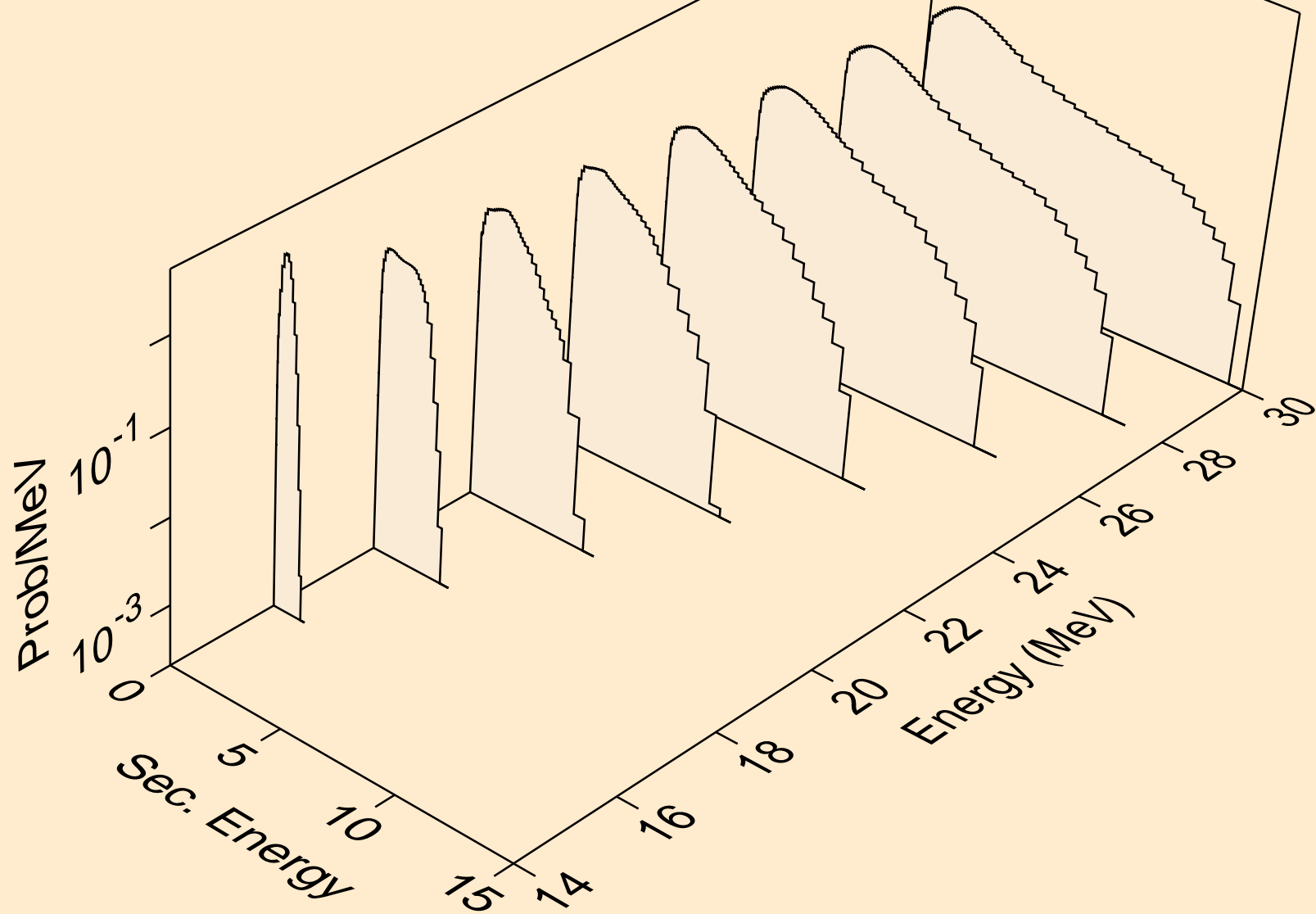

SC044M PHOTON ACER TENDL-2024 LIBRARY; T=0.K
neutrons from (g,n*)2a

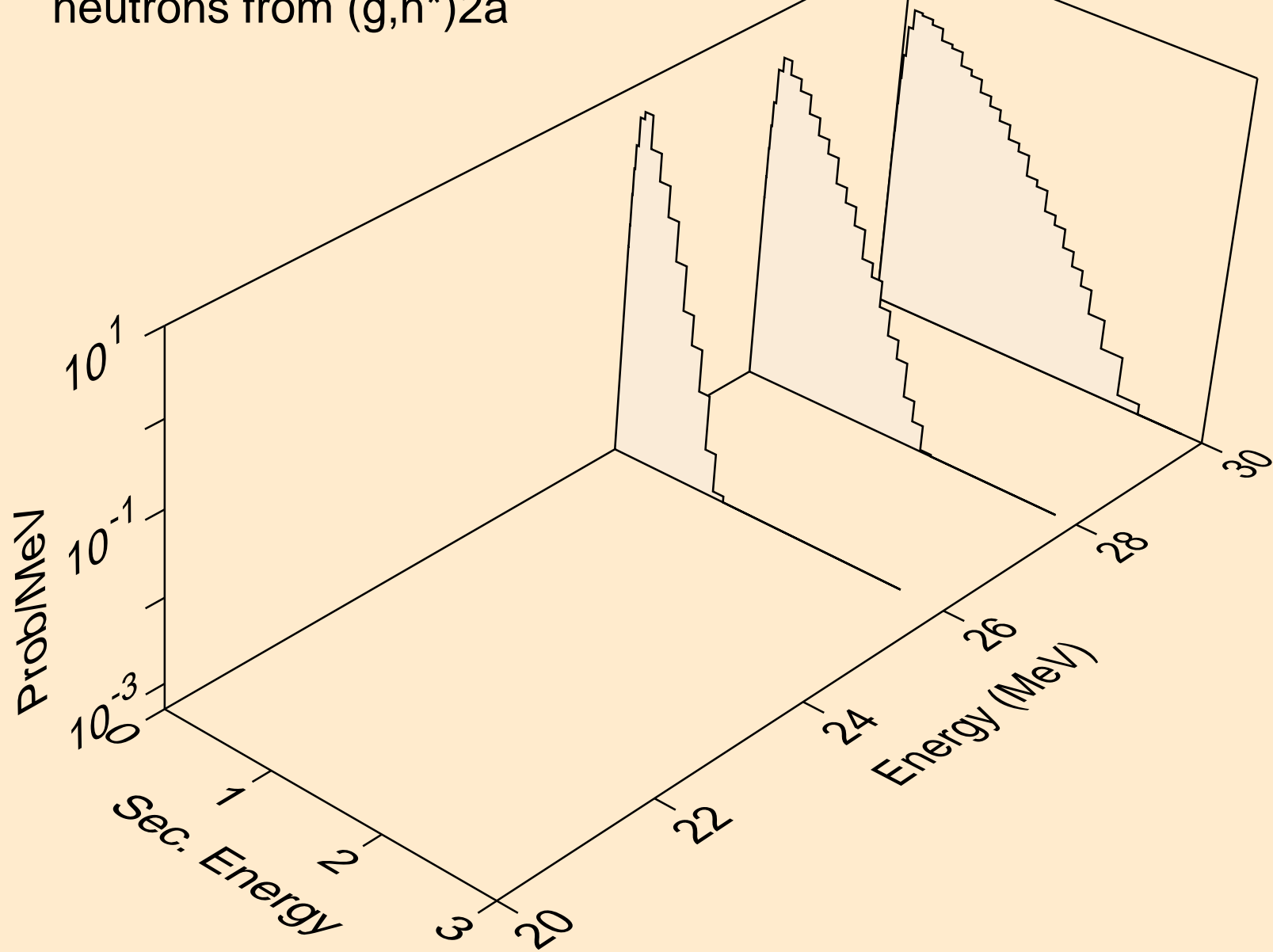

SC044M PHOTON ACER TENDL-2024 LIBRARY; T=0.K
neutrons from (g,n*)d

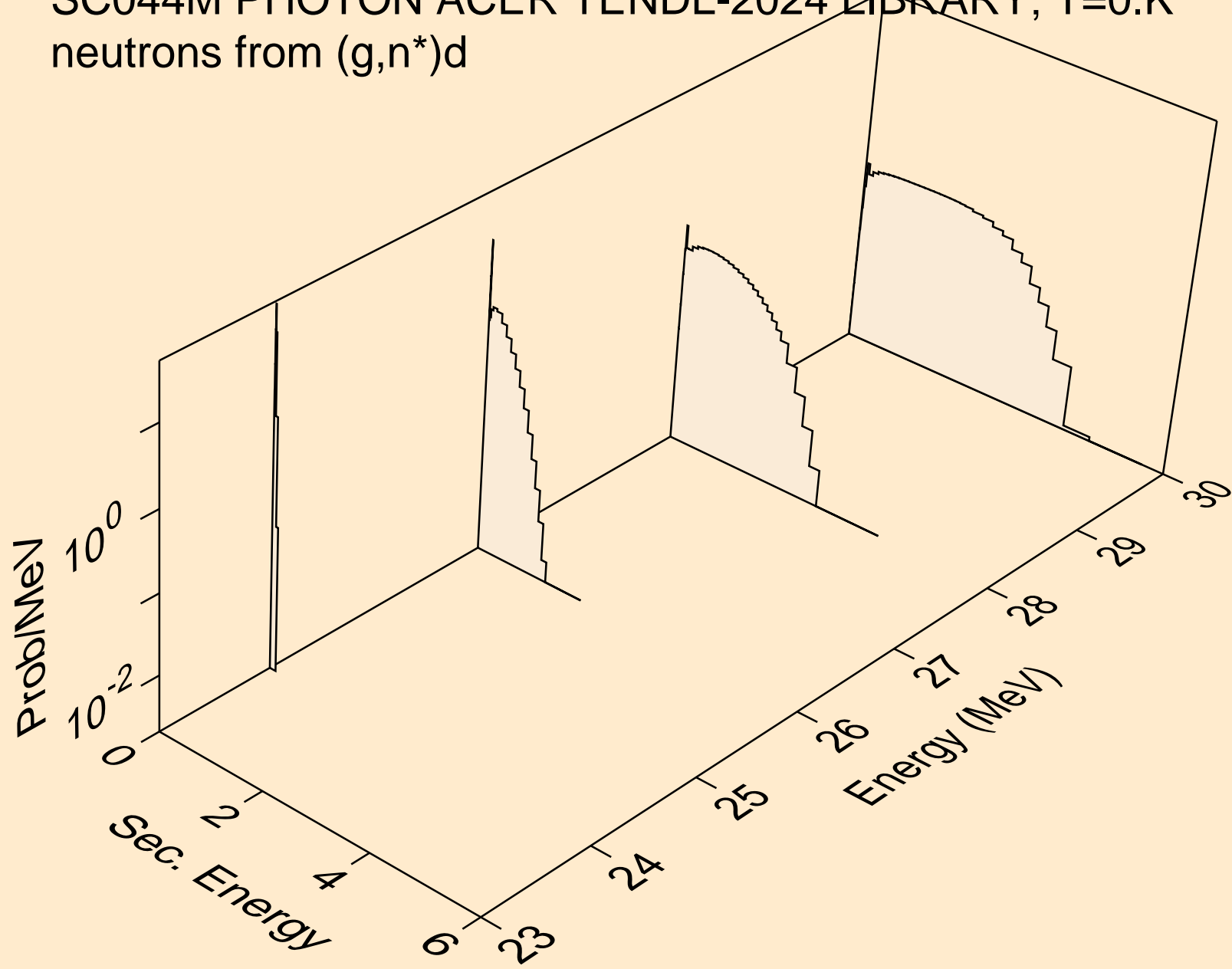

SC044M PHOTON ACER TENDL-2024 LIBRARY; T=0.K
neutrons from (g,n*)t

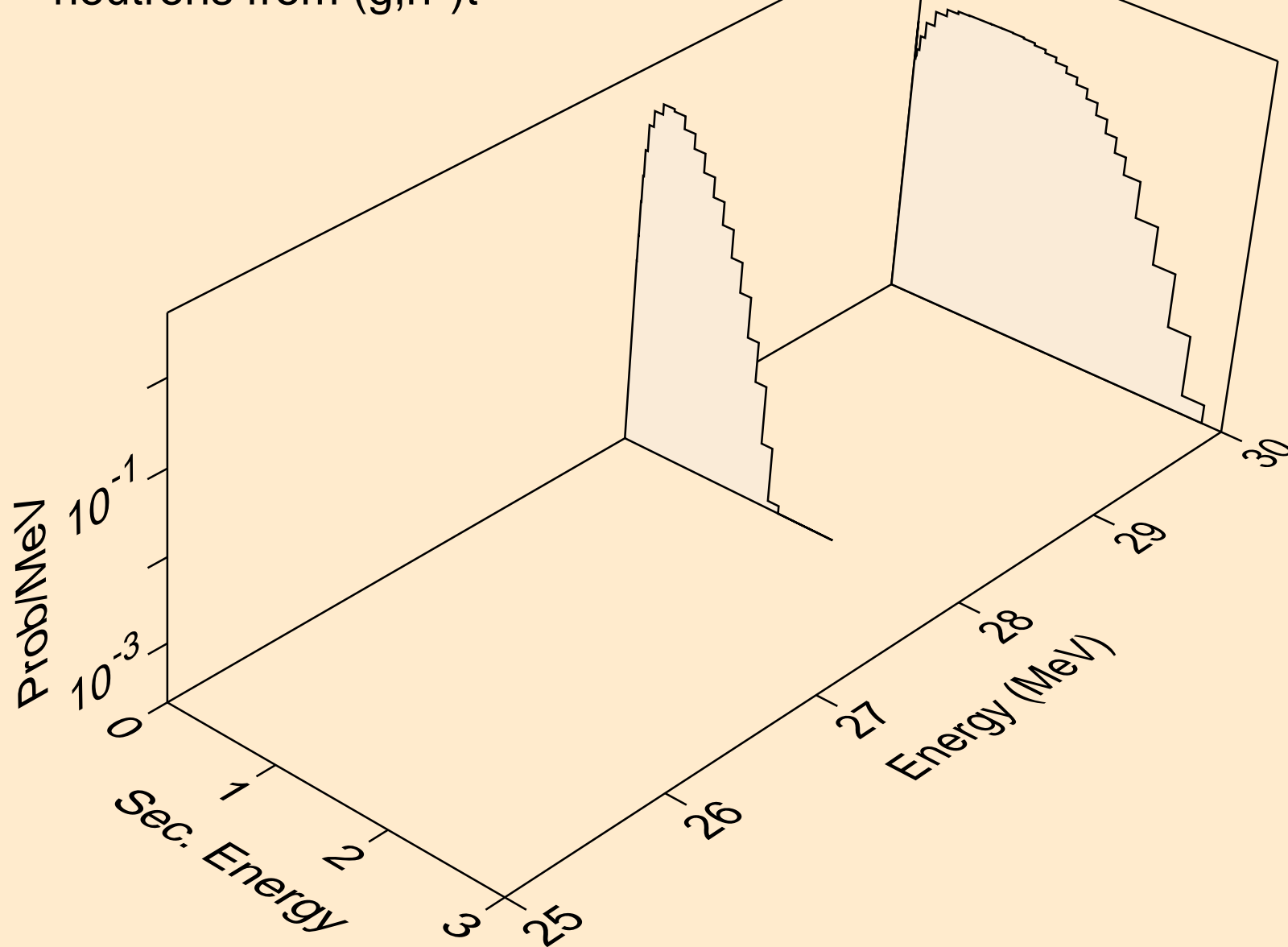

SC044M PHOTON ACER TENDL-2024 LIBRARY; T=0.K
neutrons from (g,2np)

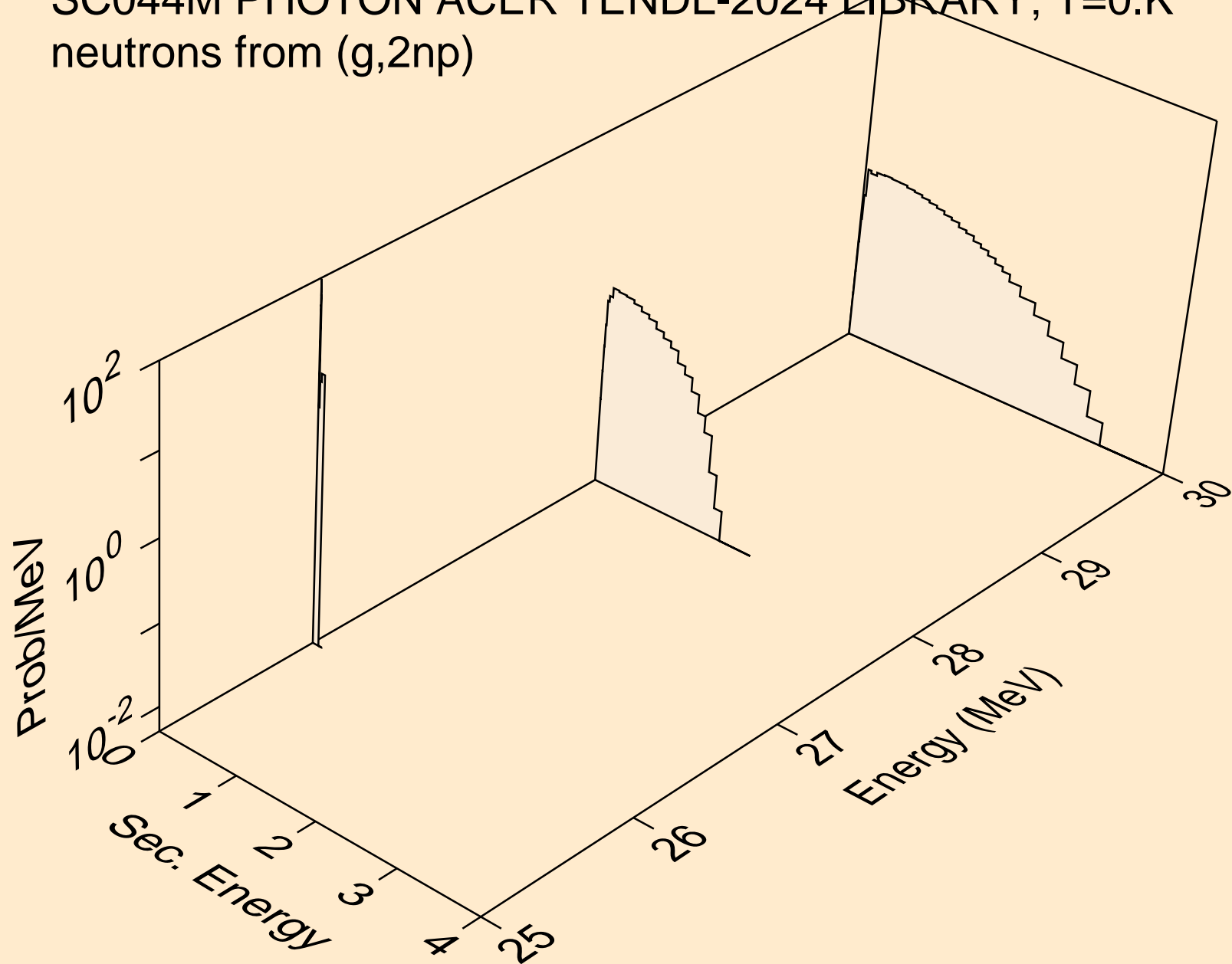

SC044M PHOTON ACER TENDL-2024 LIBRARY; T=0.K
neutrons from (g,n2p)

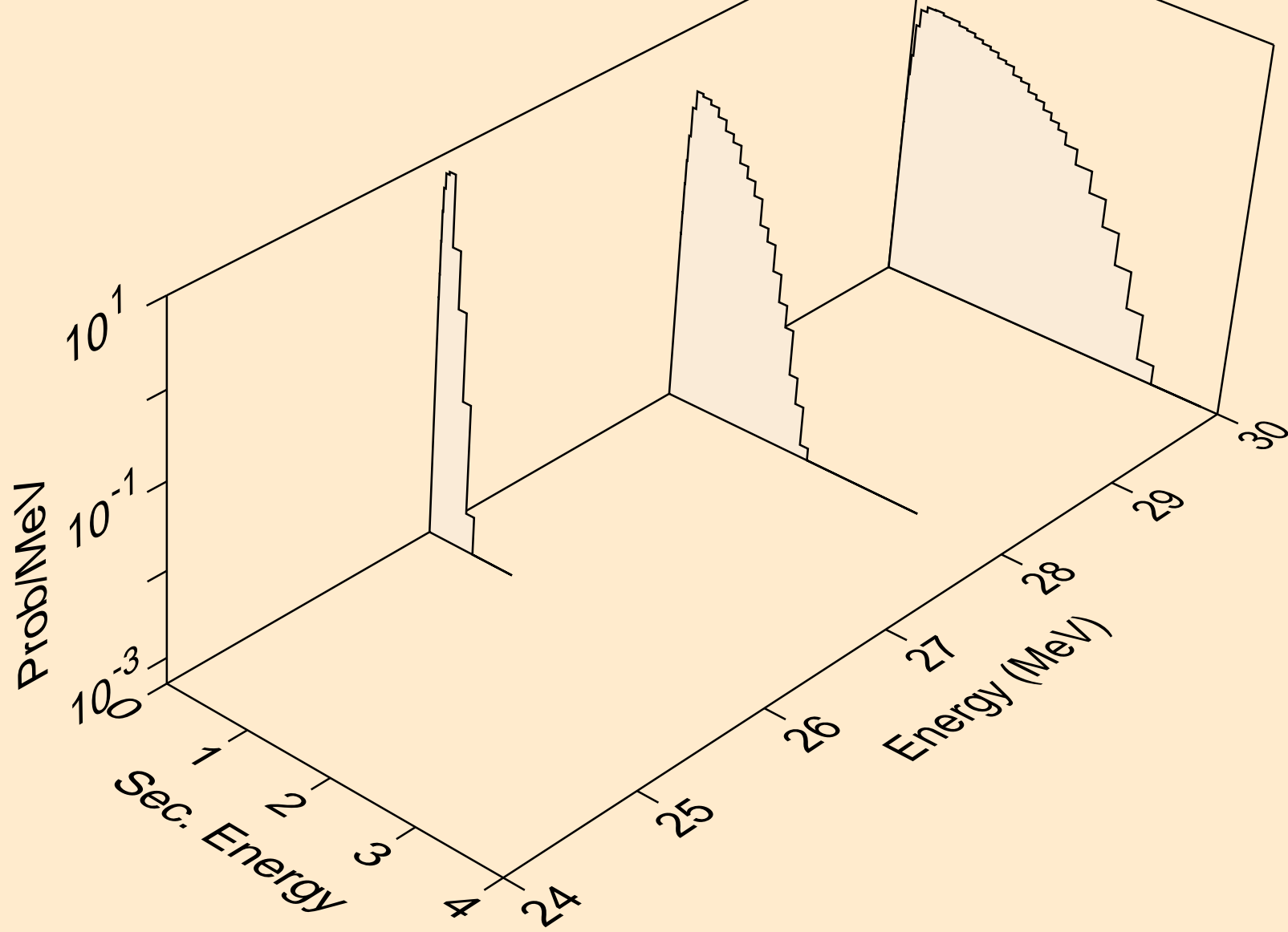

SC044M PHOTON ACER TENDL-2024 LIBRARY; T=0.K
neutrons from (g,npa)

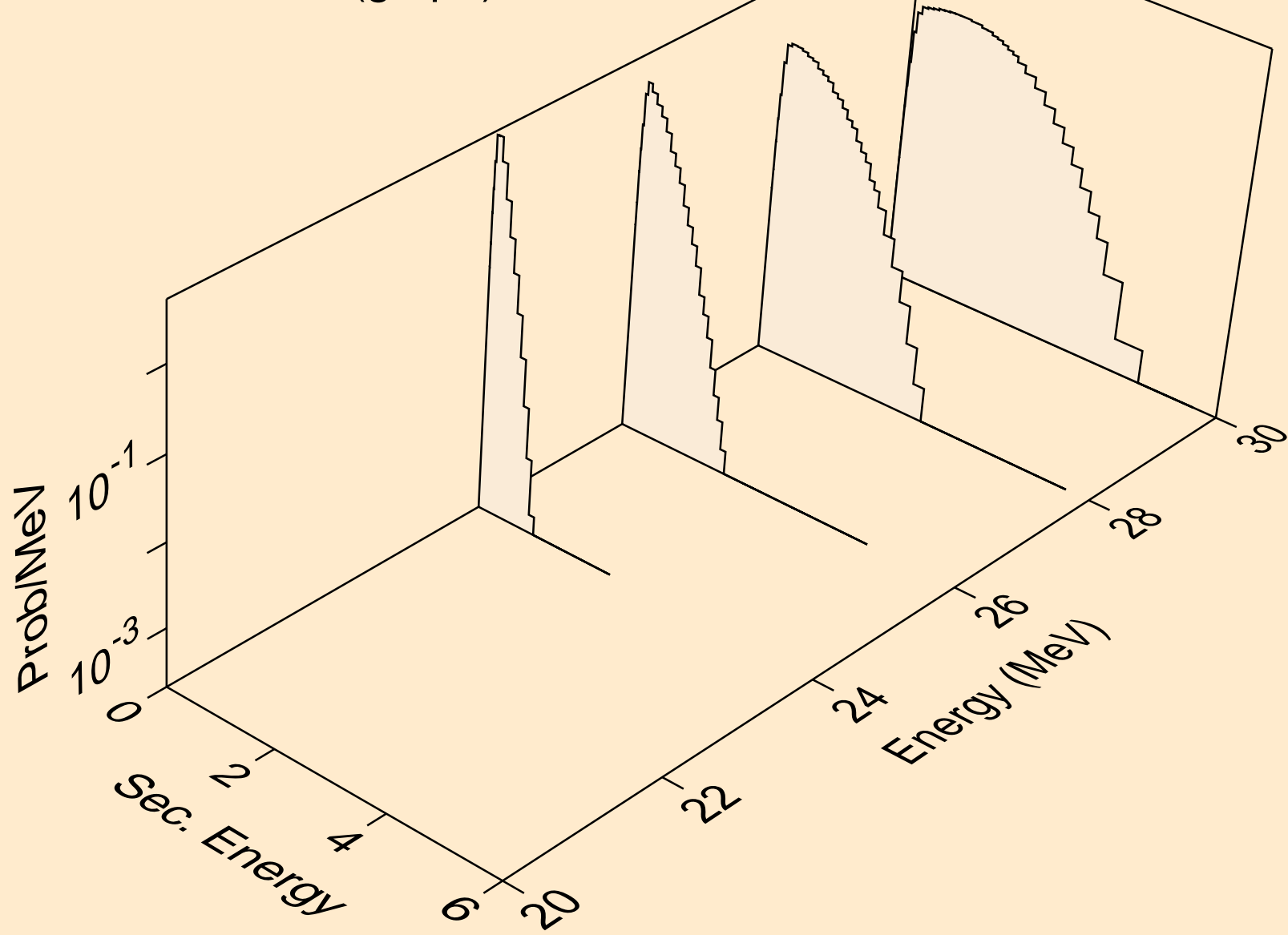

SC044M PHOTON ACER TENDL-2024 LIBRARY; T=0.K
angular distribution for (g,n*0) neutron

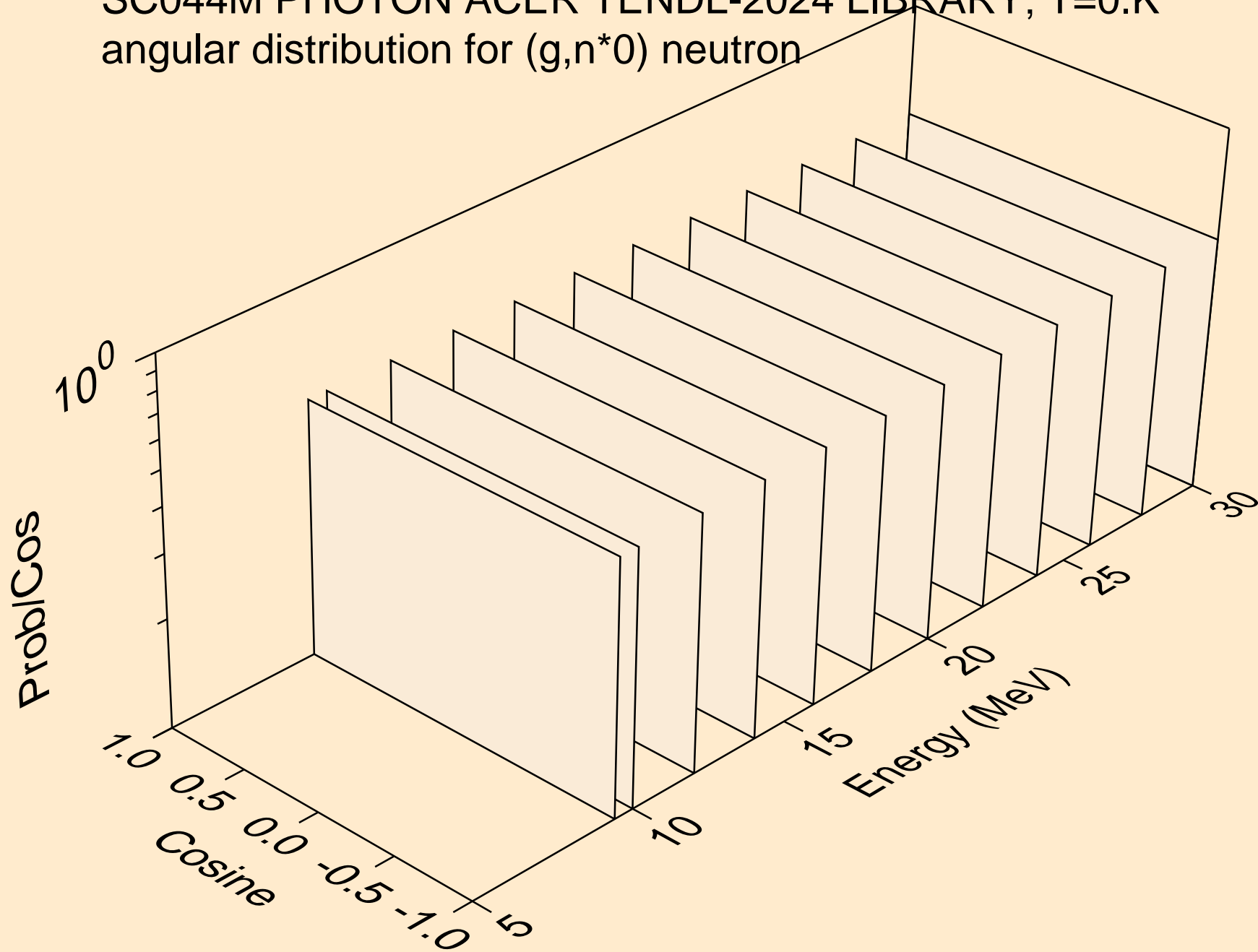

SC044M PHOTON ACER TENDL-2024 LIBRARY; T=0.K
angular distribution for (g,n*1) neutron

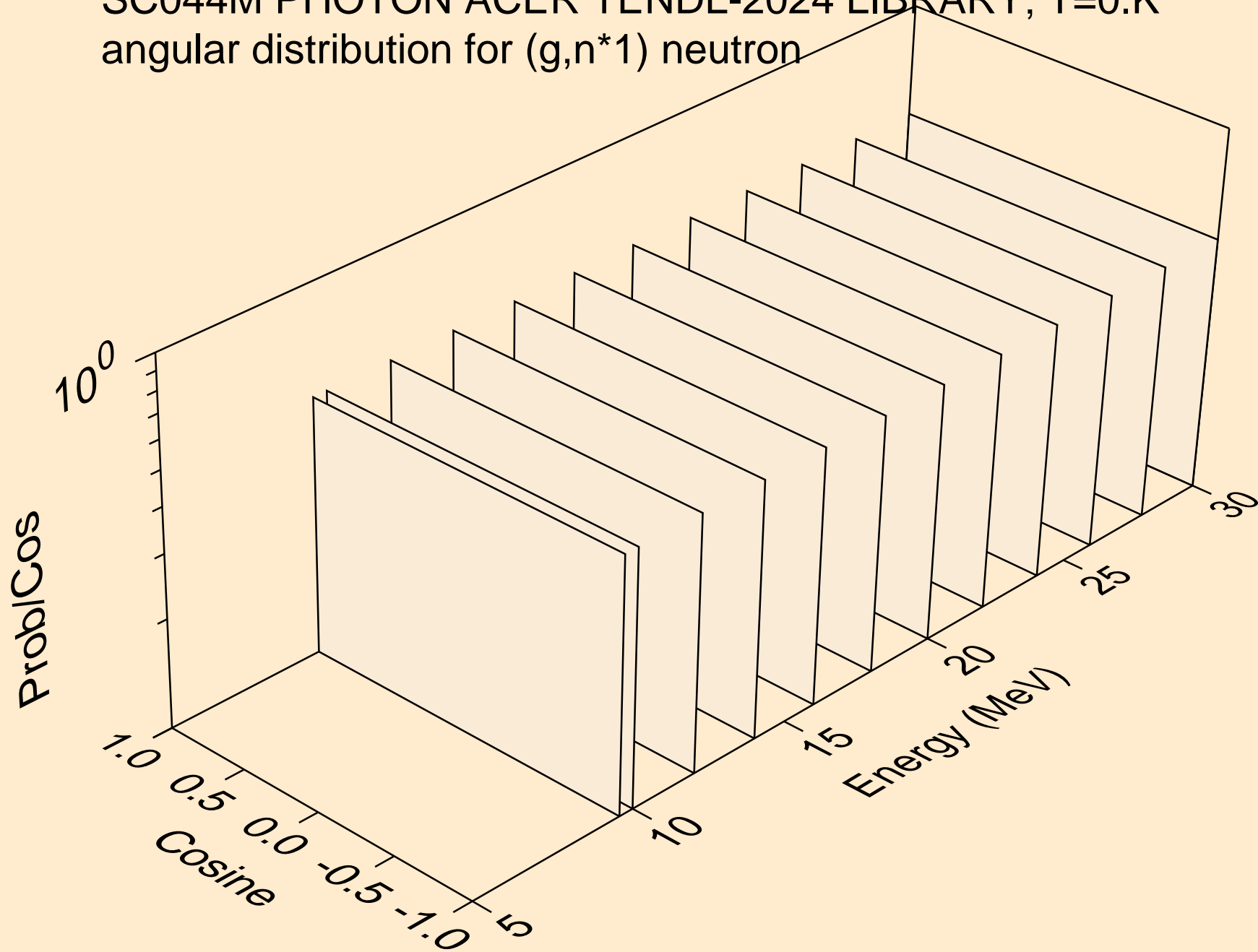

SC044M PHOTON ACER TENDL-2024 LIBRARY; T=0.K
neutrons from (g,n*c)

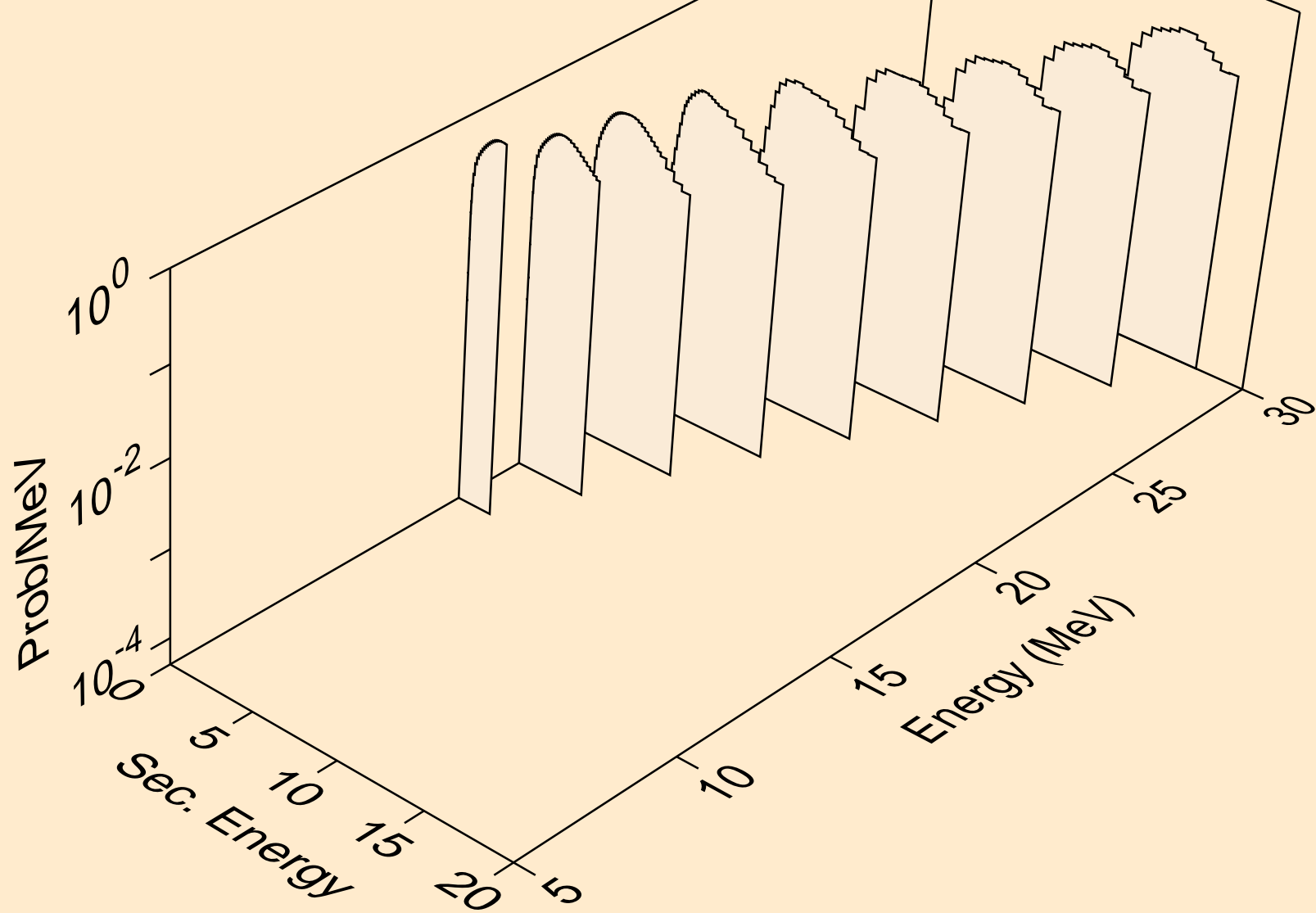

SC044M PHOTON ACER TENDL-2024 LIBRARY; T=0.K
photons from (g,x)

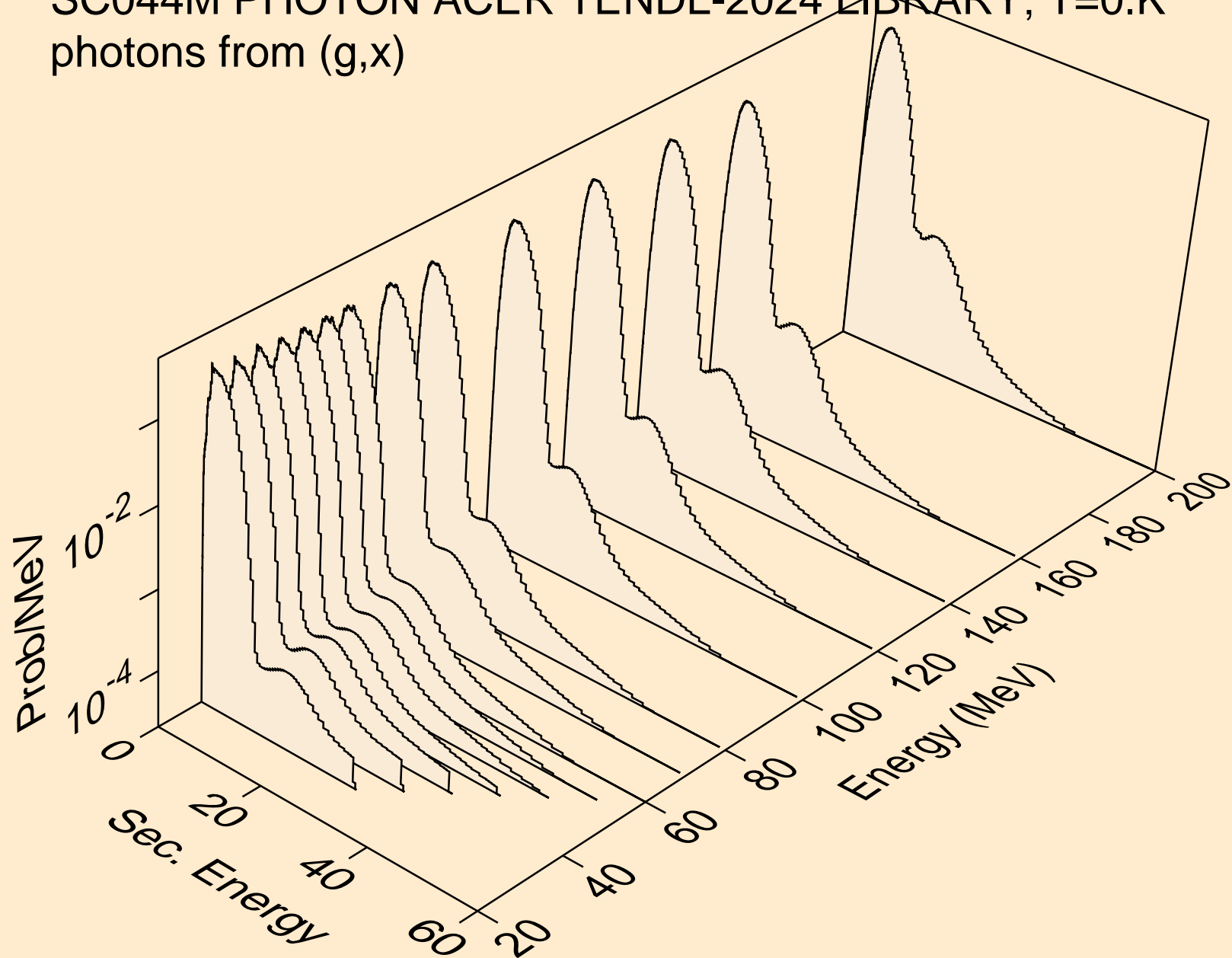

SC044M PHOTON ACER TENDL-2024 LIBRARY; T=0.K
photons from (g,2n)

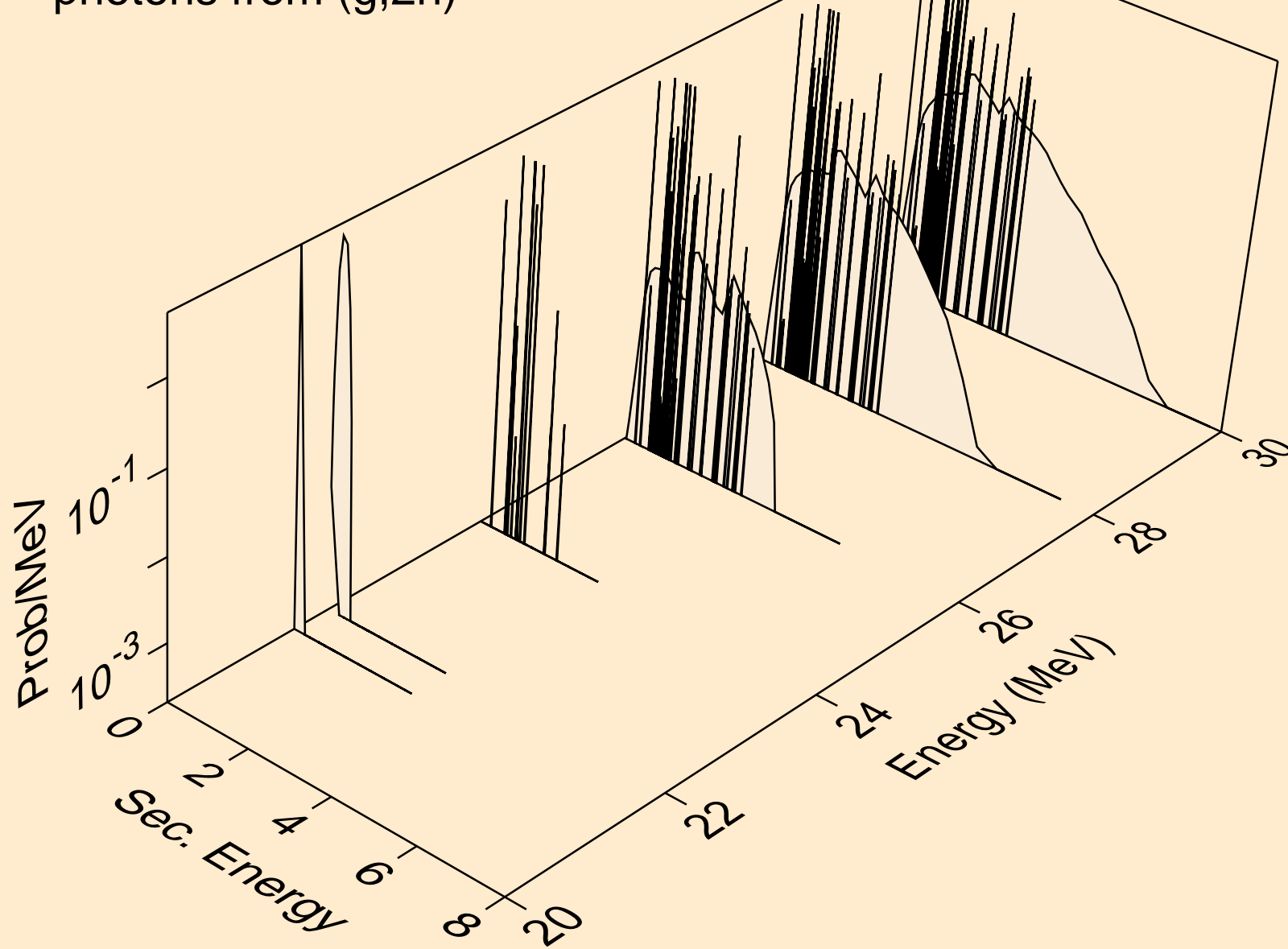

SC044M PHOTON ACER TENDL-2024 LIBRARY; T=0.K
photons from (g,n*)a

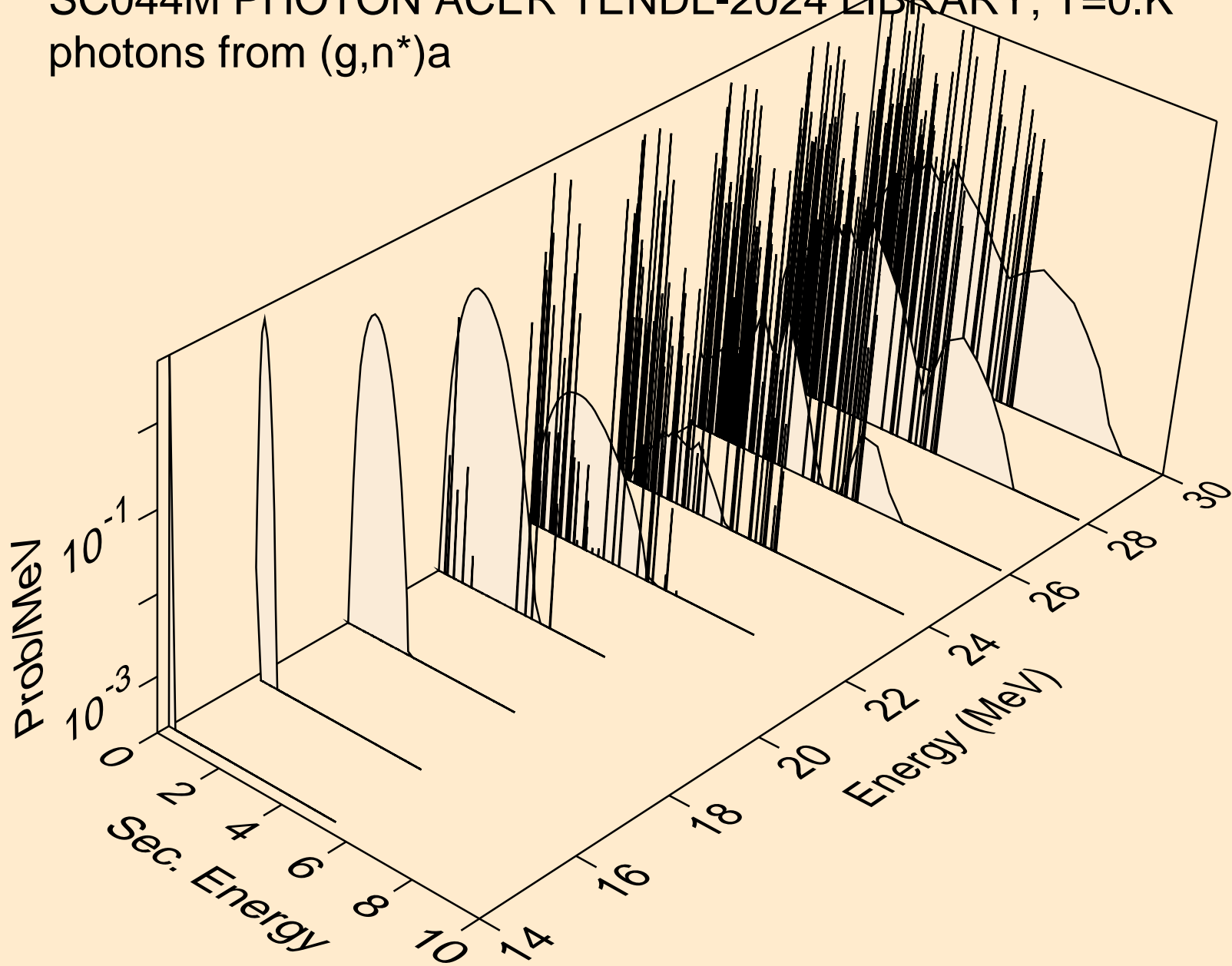

SC044M PHOTON ACER TENDL-2024 LIBRARY; T=0.K
photons from (g,n*)p

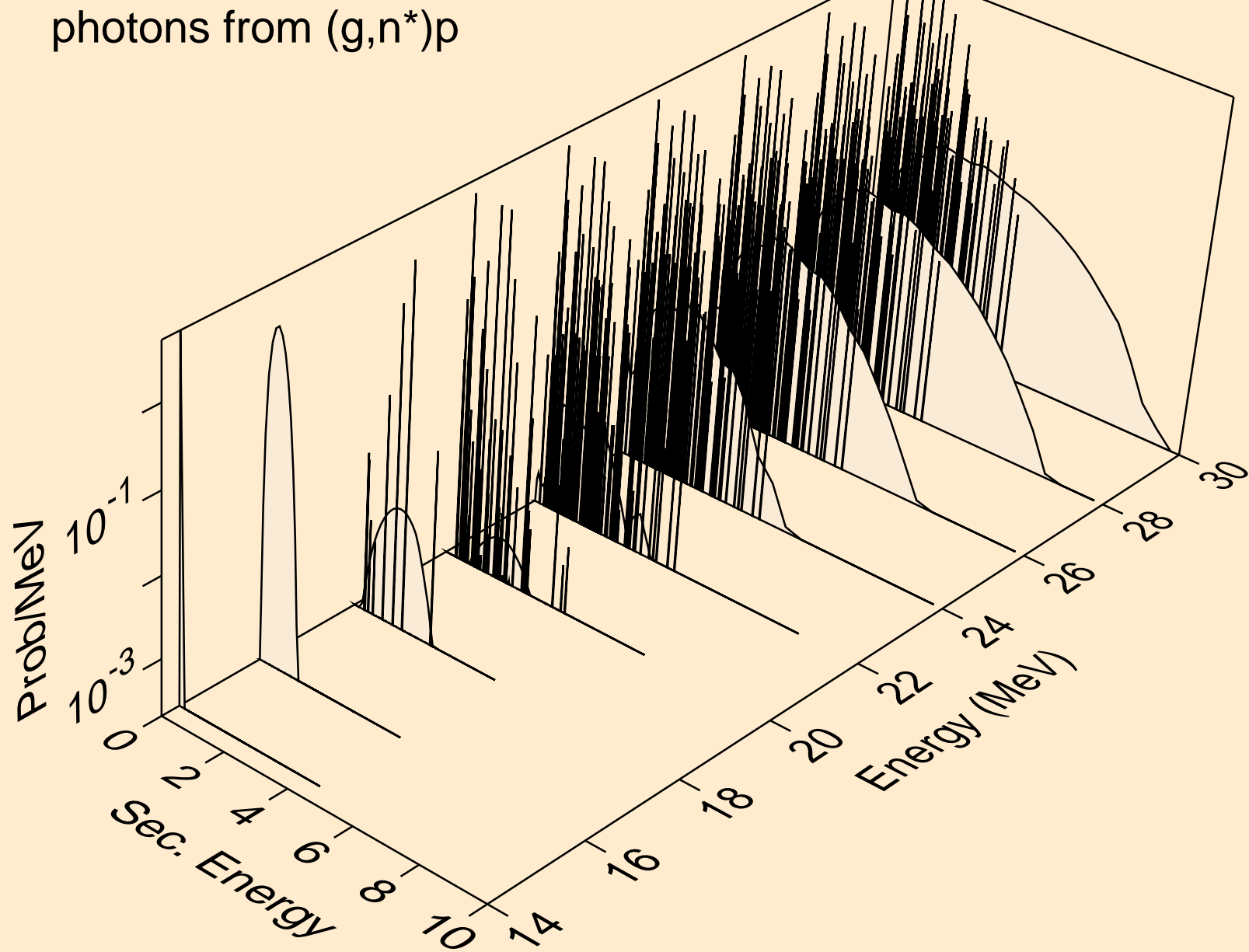

SC044M PHOTON ACER TENDL-2024 LIBRARY; T=0.K
photons from (g,n*)2a

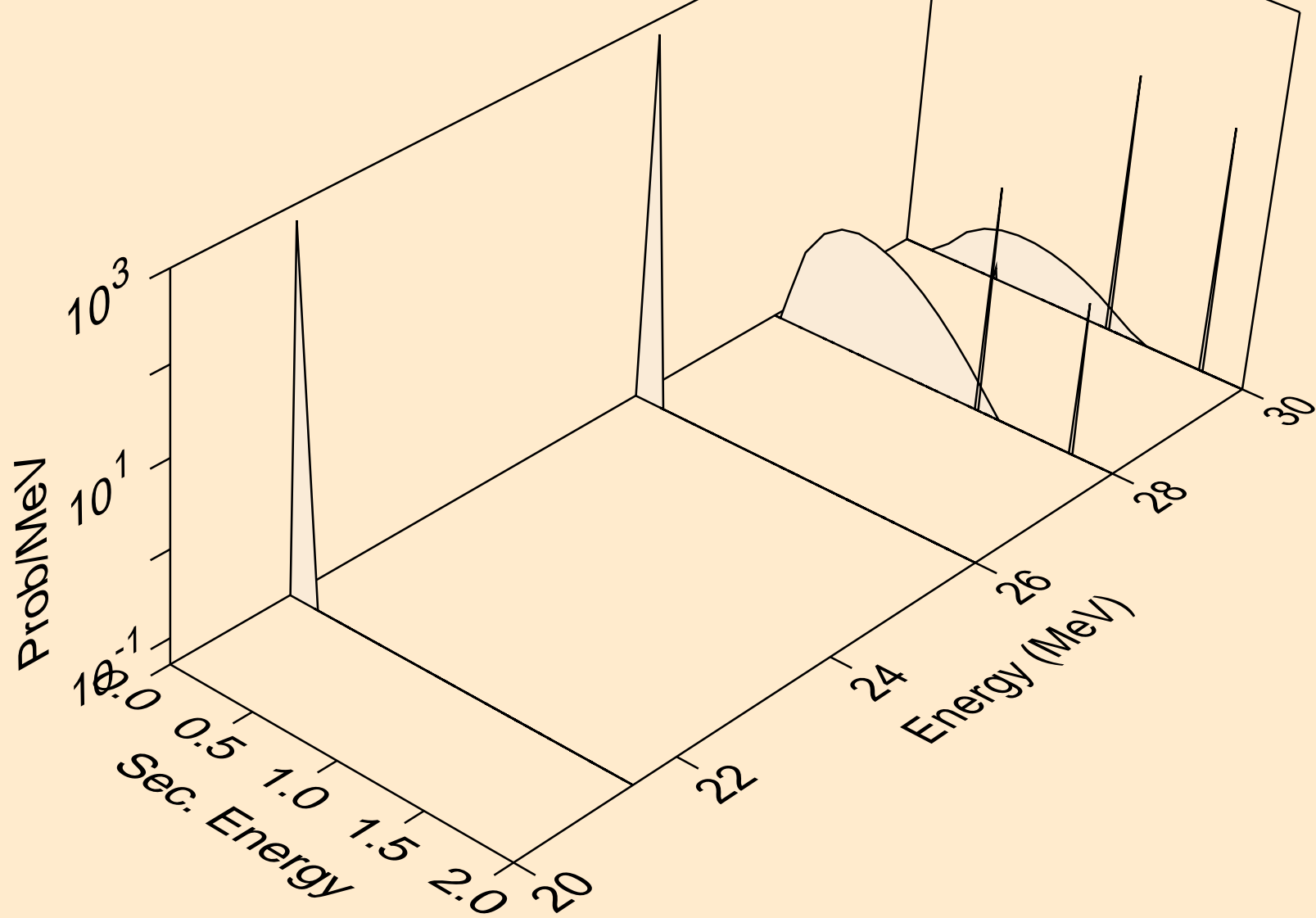

SC044M PHOTON ACER TENDL-2024 LIBRARY; T=0.K
photons from (g,n*)d

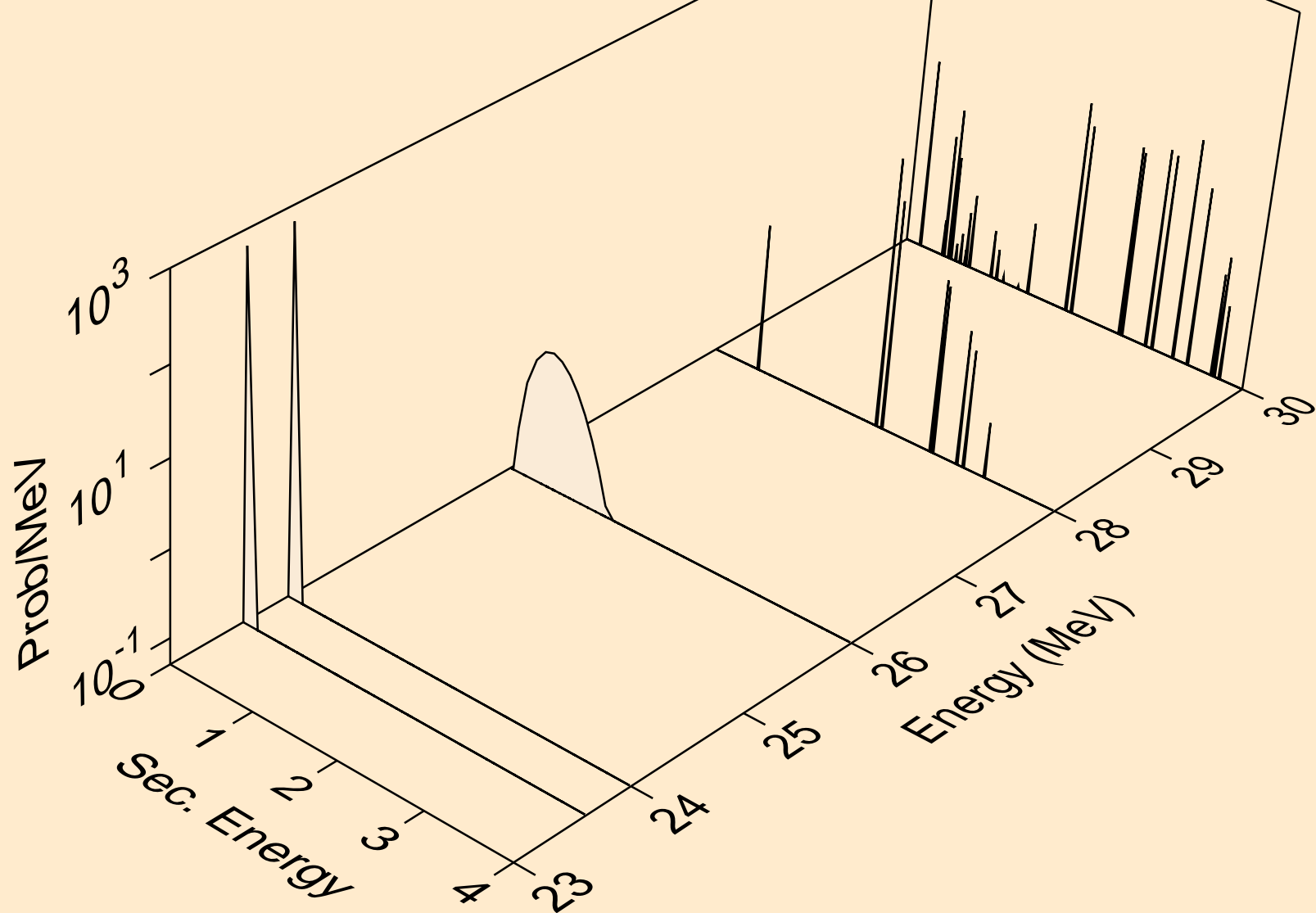

SC044M PHOTON ACER TENDL-2024 LIBRARY; T=0.K
photons from (g,n*)t

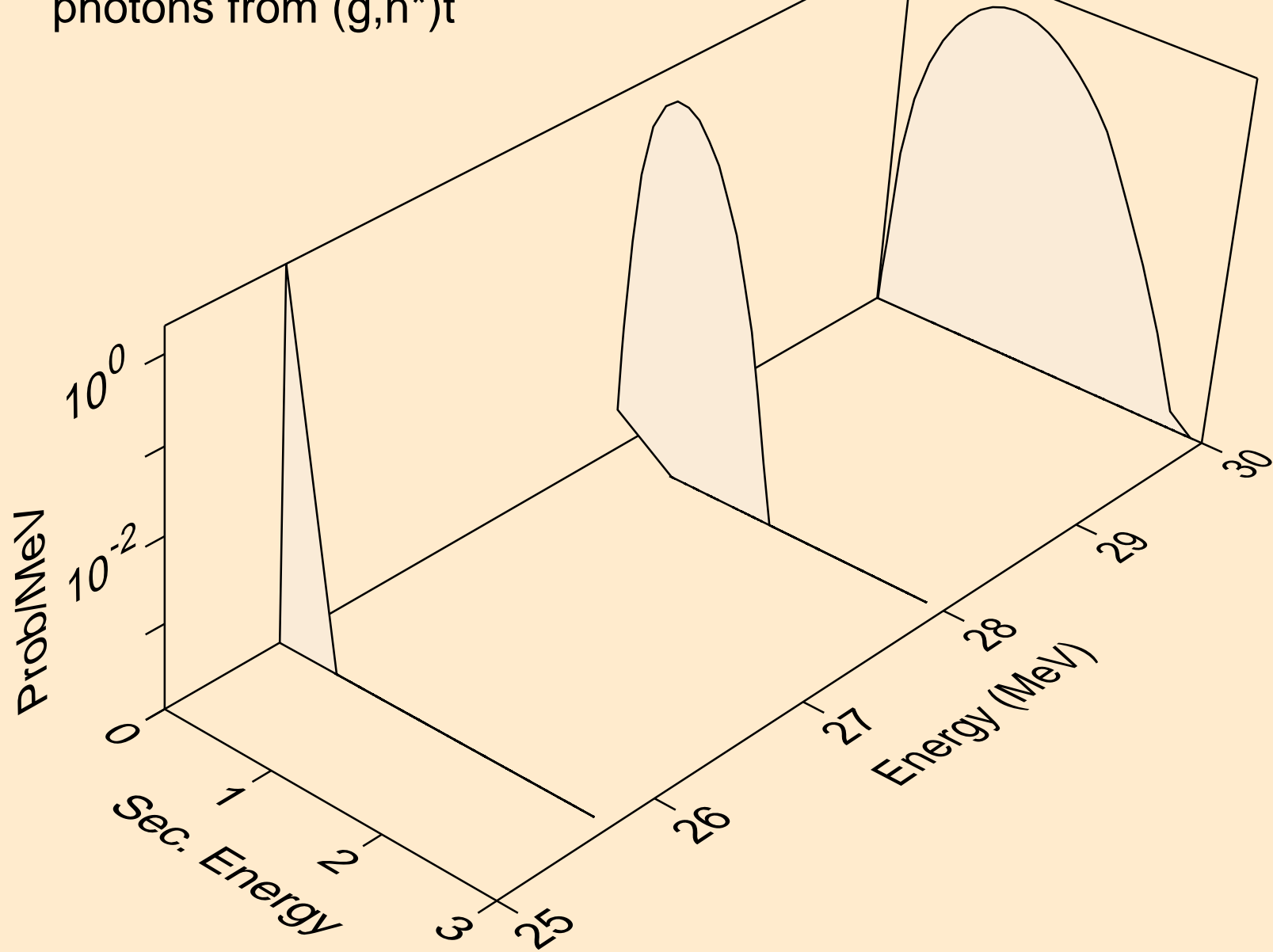

SC044M PHOTON ACER TENDL-2024 LIBRARY; T=0.K
photons from (g,2np)

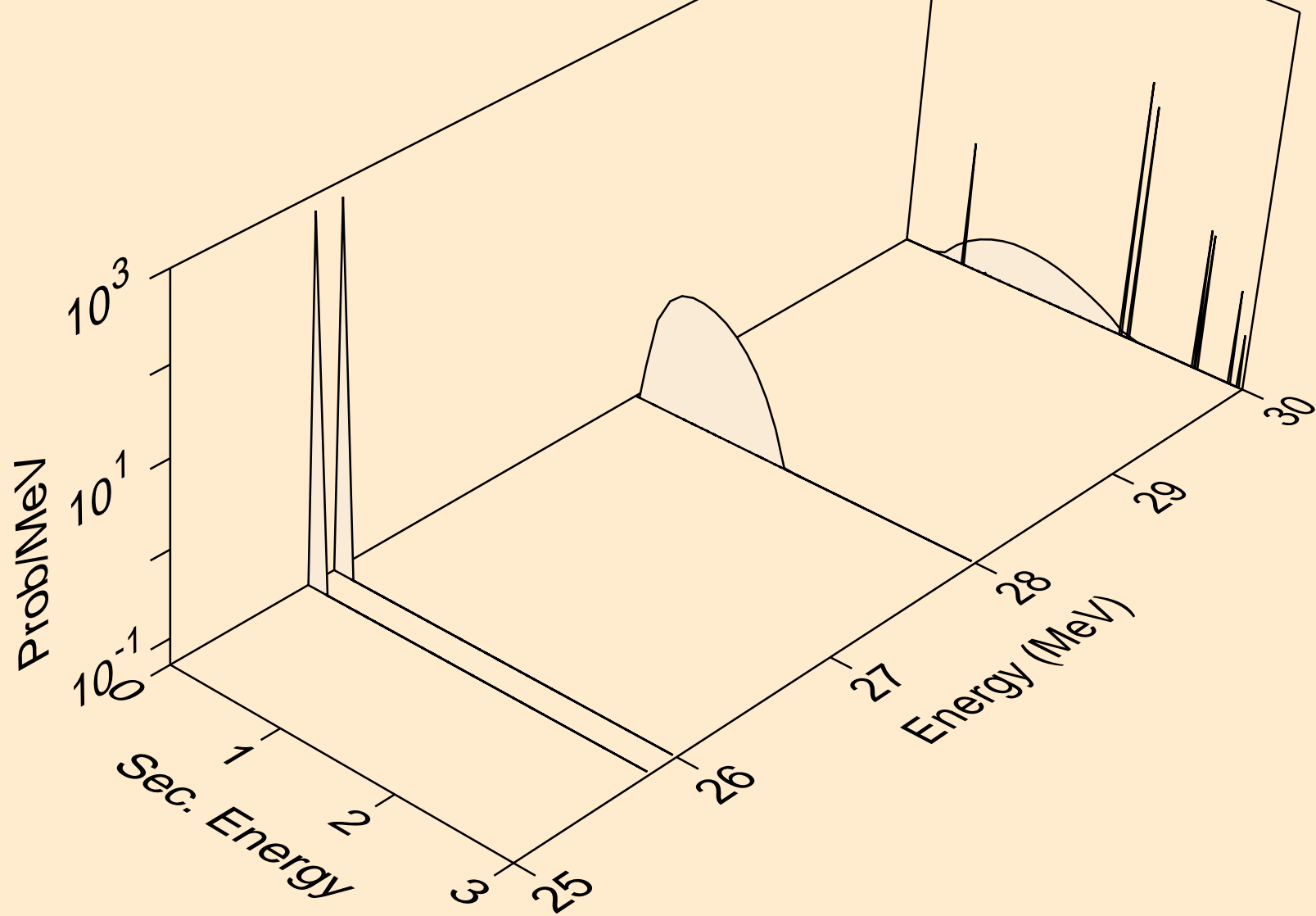

SC044M PHOTON ACER TENDL-2024 LIBRARY; T=0.K
photons from (g,n2p)

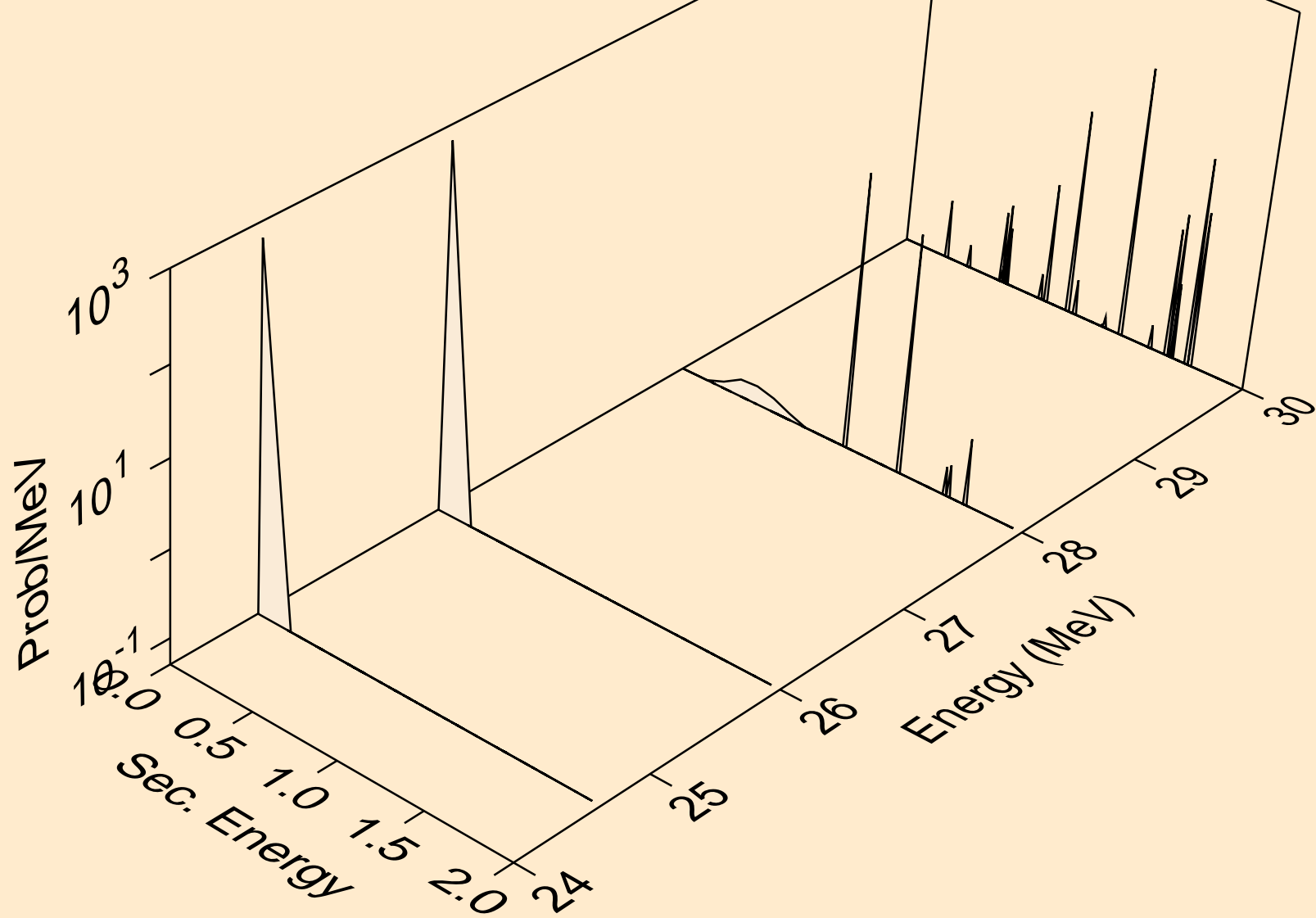

SC044M PHOTON ACER TENDL-2024 LIBRARY; T=0.K
photons from (g,npa)

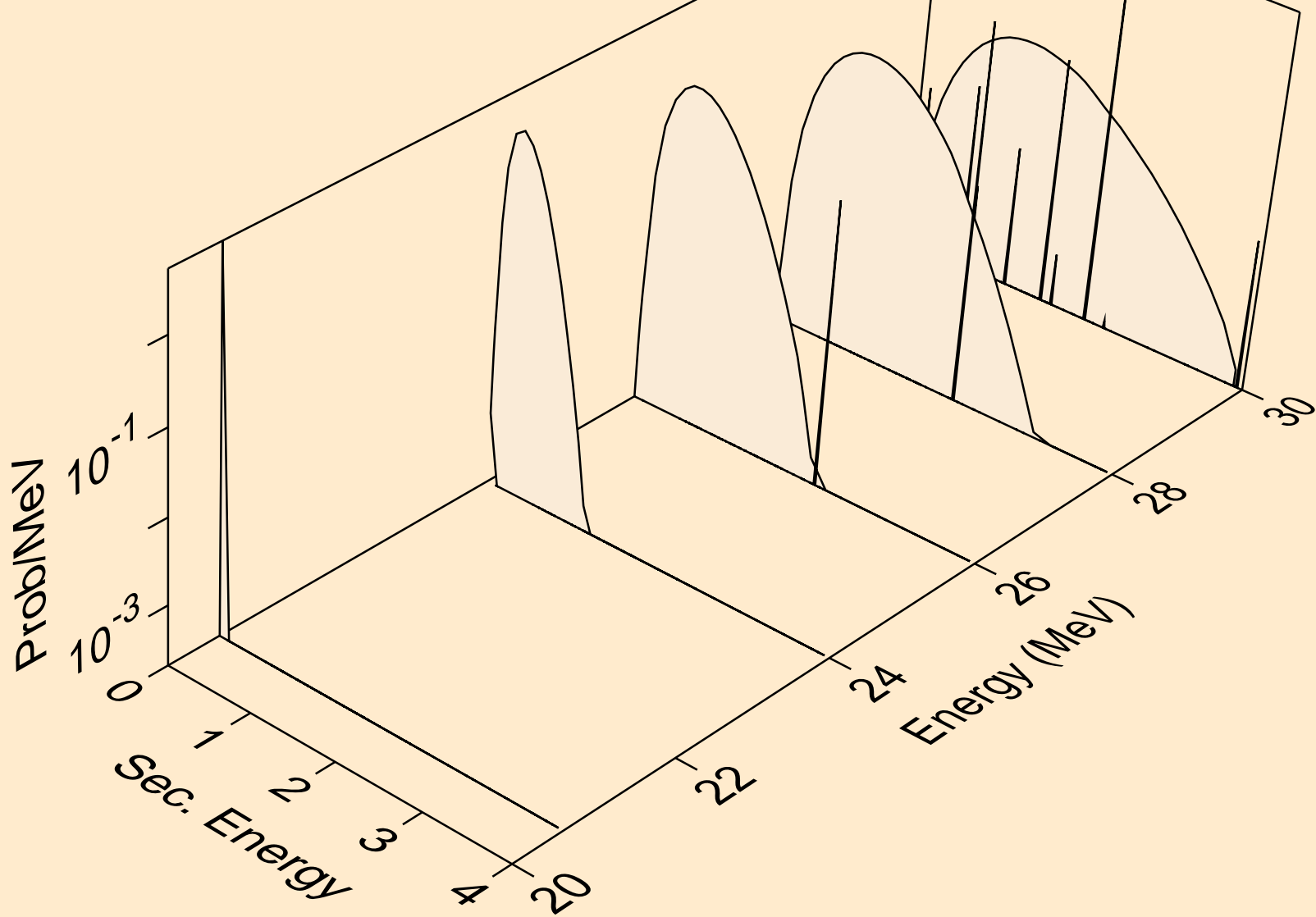

SC044M PHOTON ACER TENDL-2024 LIBRARY; T=0.K
photons from (g,n*c)

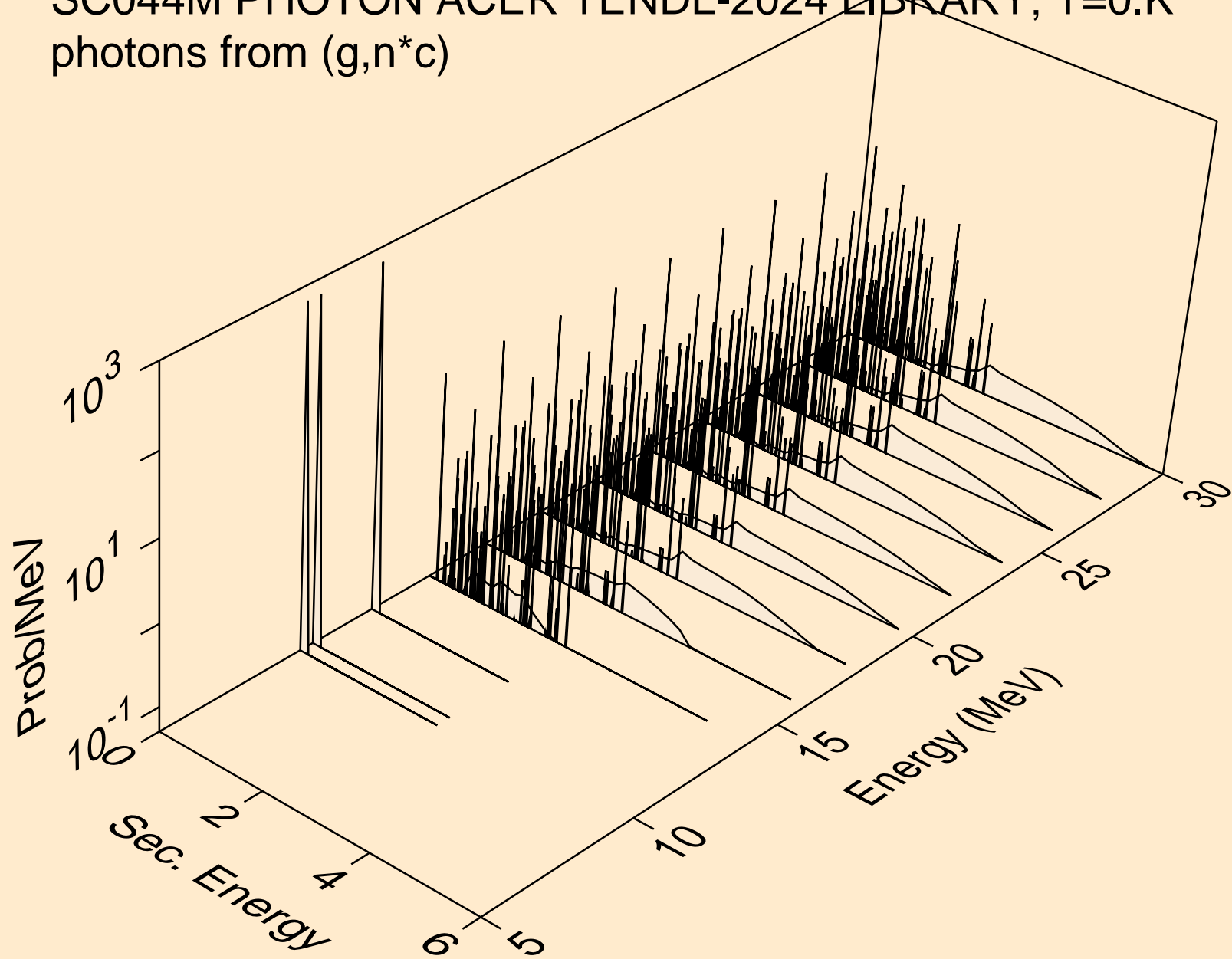

SC044M PHOTON ACER TENDL-2024 LIBRARY; T=0.K
photons from (g,gma)

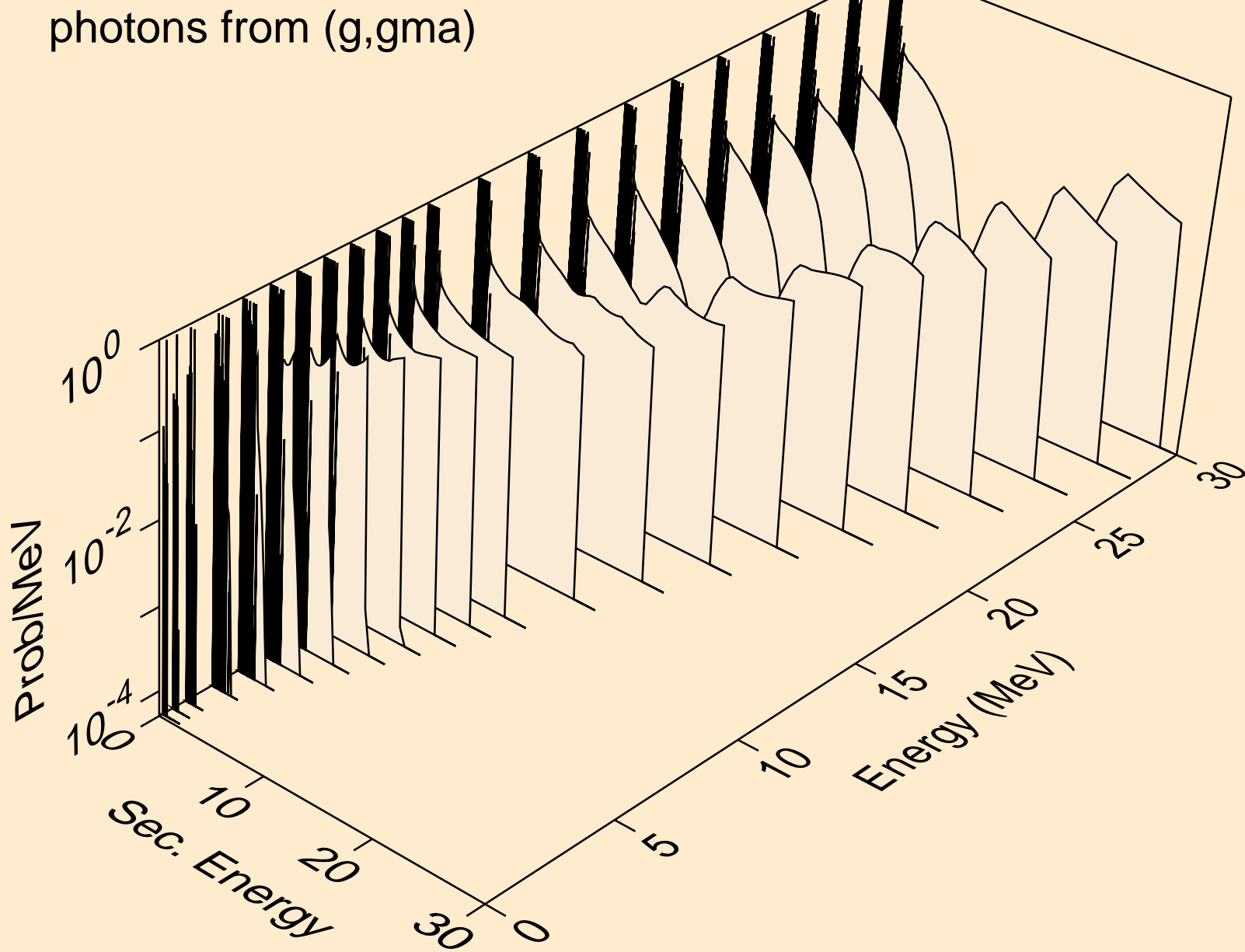

SC044M PHOTON ACER TENDL-2024 LIBRARY; T=0.K
photons from (g,p)

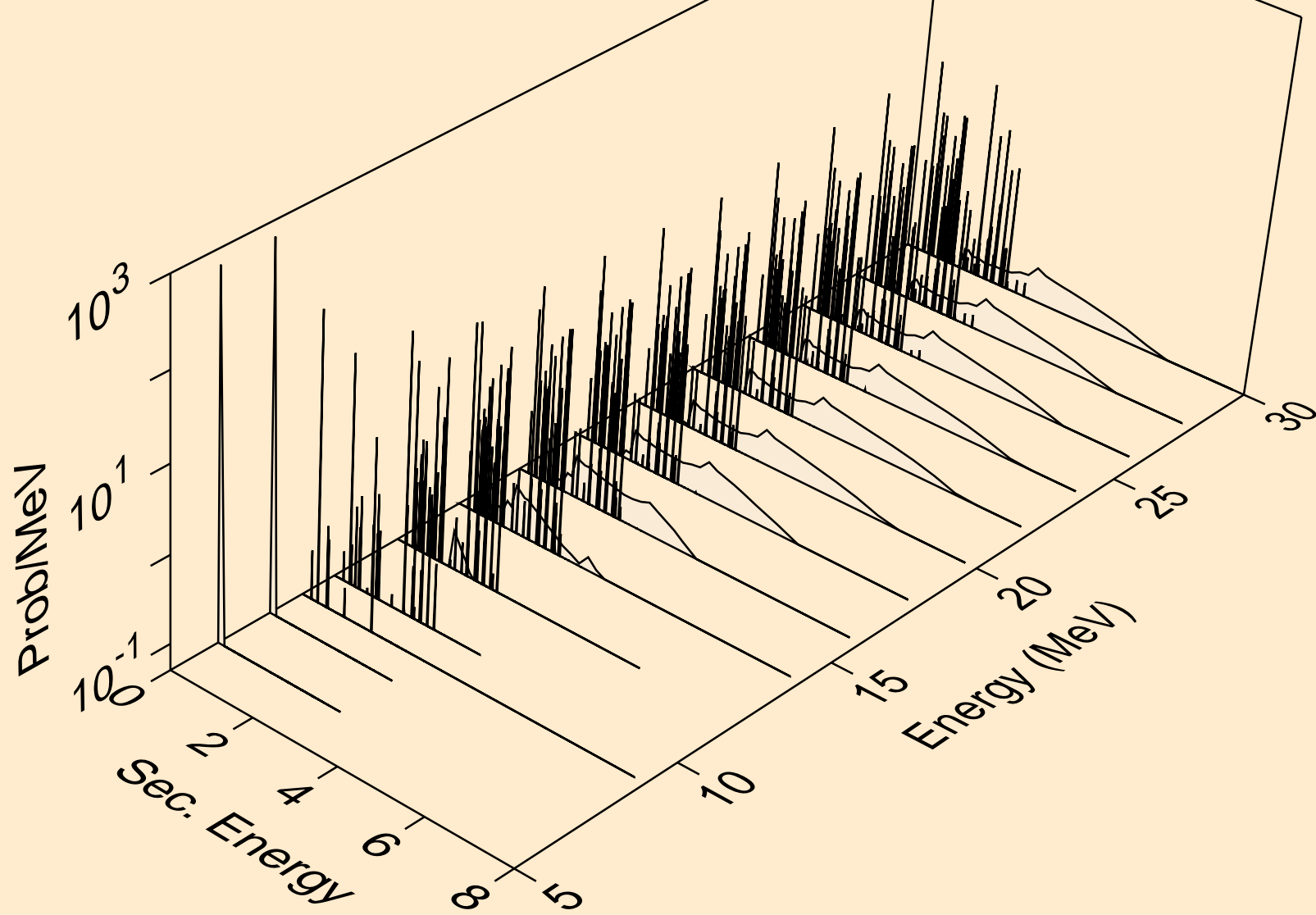

SC044M PHOTON ACER TENDL-2024 LIBRARY; T=0.K
photons from (g,d)

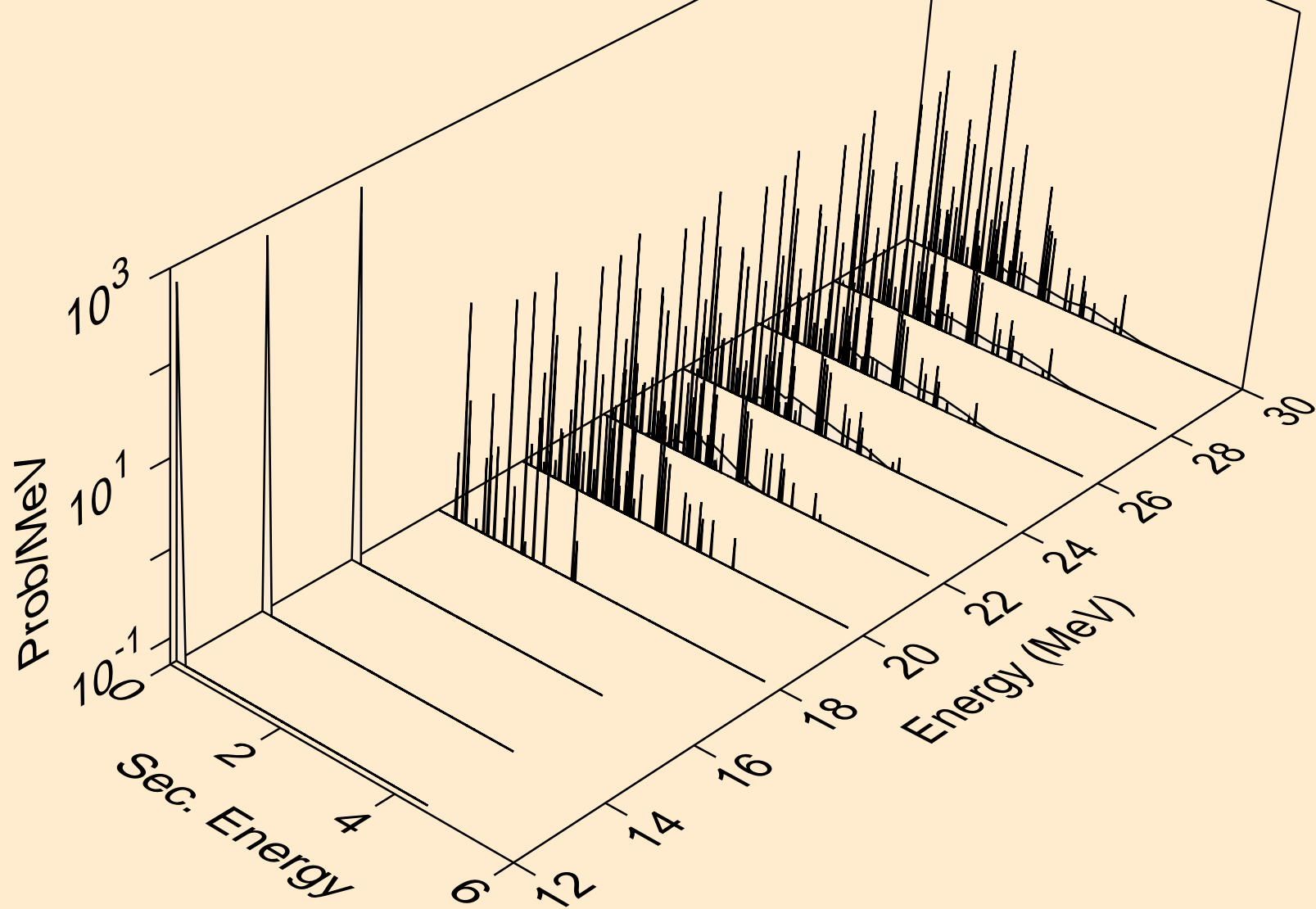

SC044M PHOTON ACER TENDL-2024 LIBRARY; T=0.K
photons from (g,t)

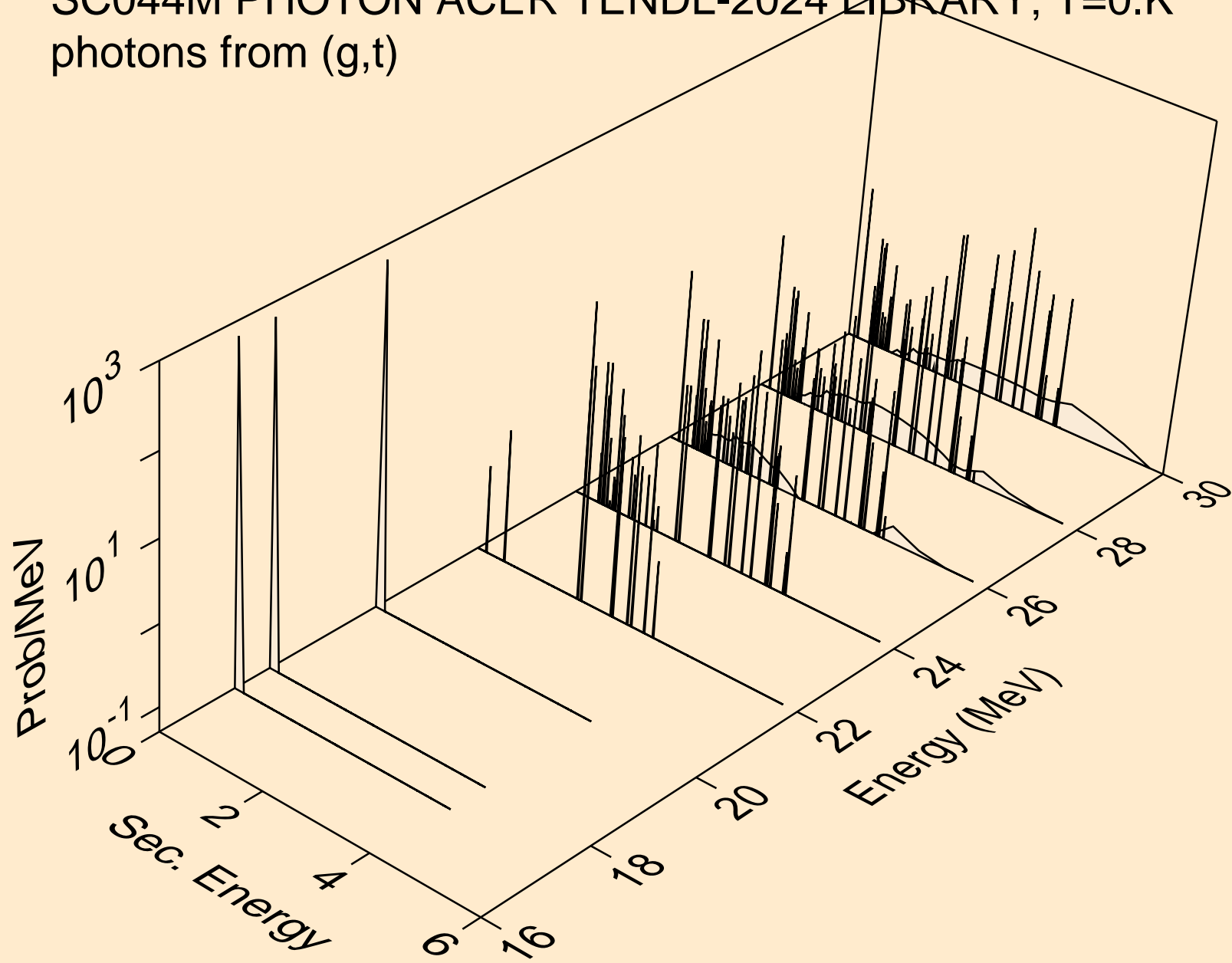

SC044M PHOTON ACER TENDL-2024 LIBRARY; T=0.K
photons from (g,he3)

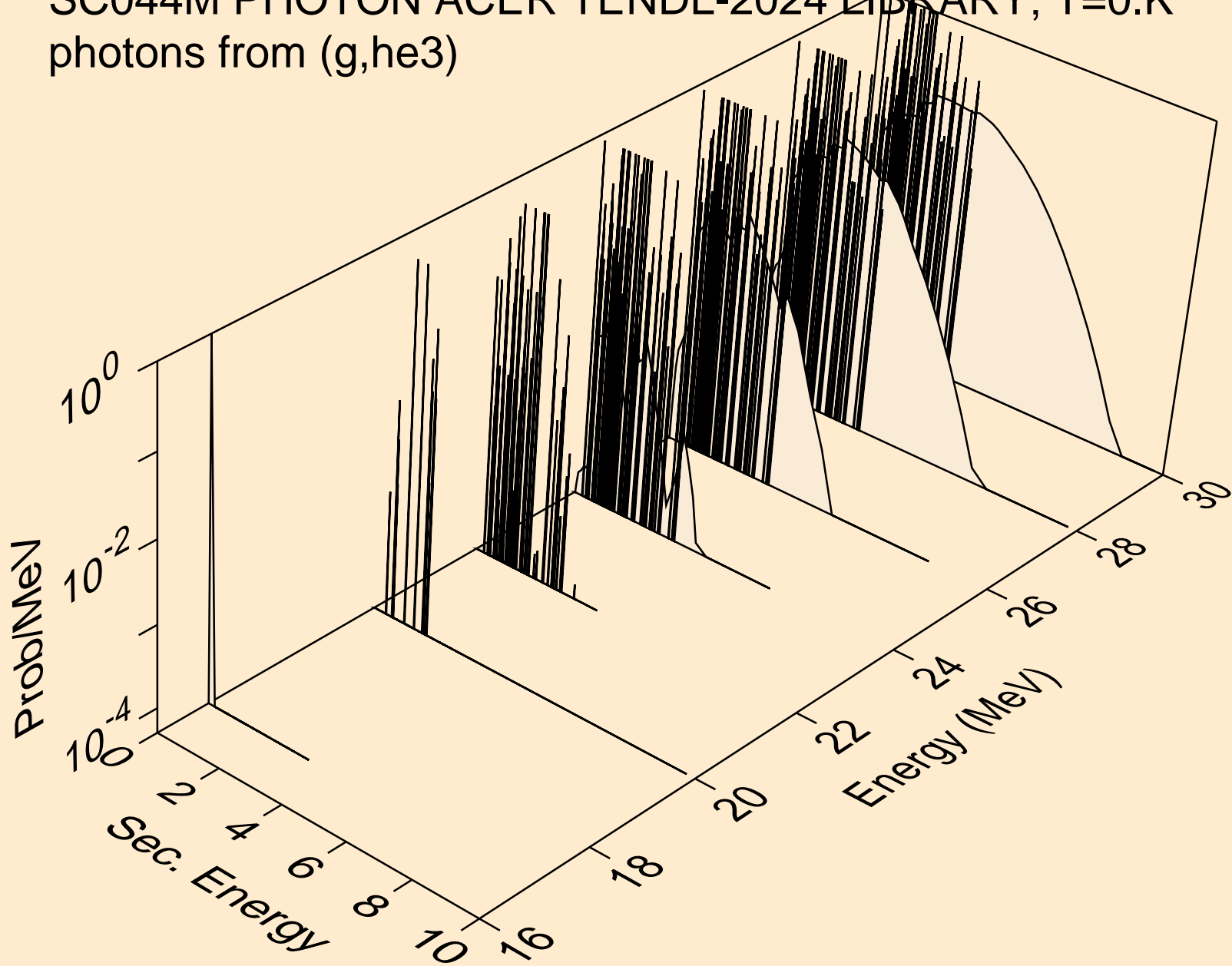

SC044M PHOTON ACER TENDL-2024 LIBRARY; T=0.K
photons from (g,a)

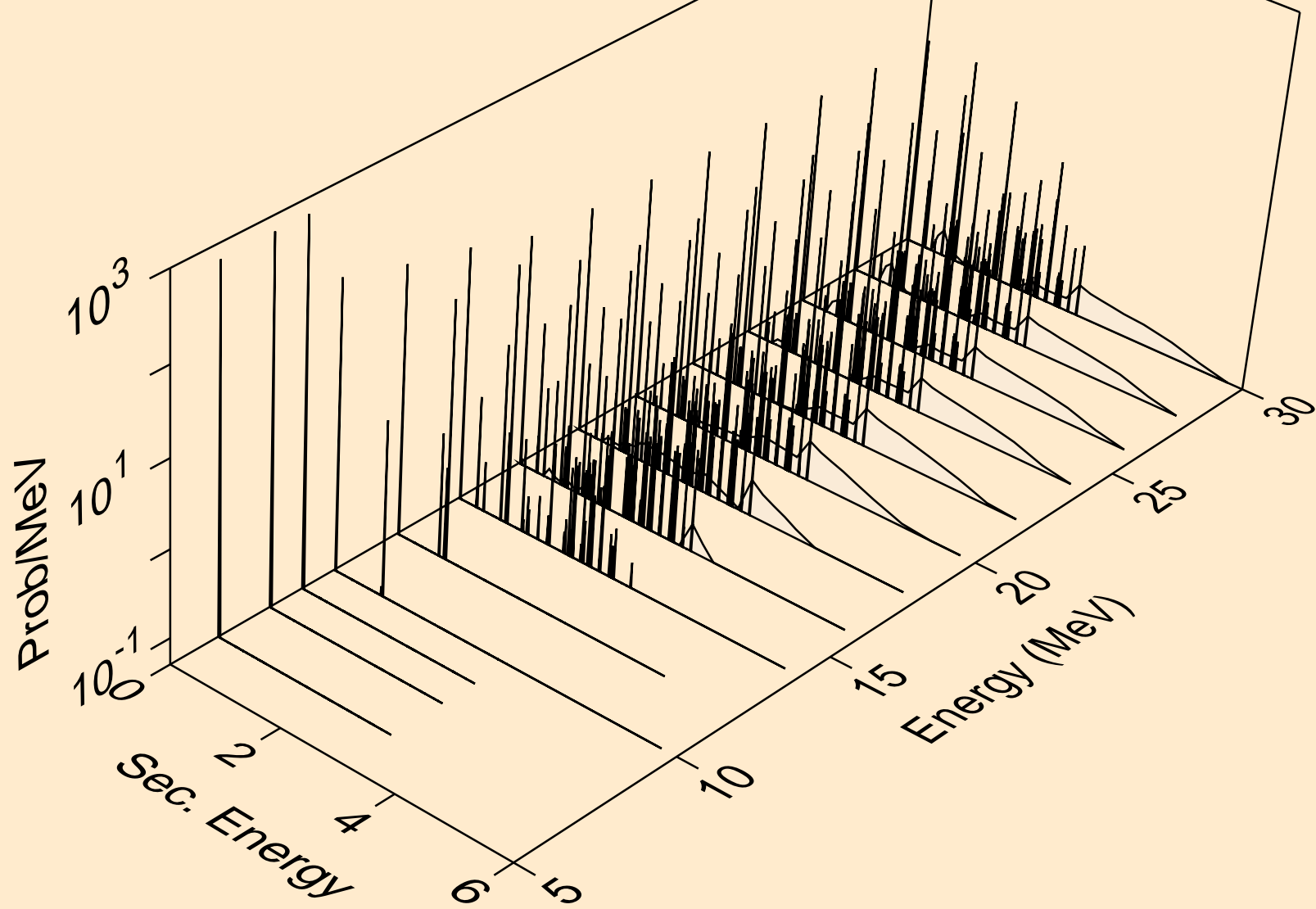

SC044M PHOTON ACER TENDL-2024 LIBRARY; T=0.K
photons from (g,2a)

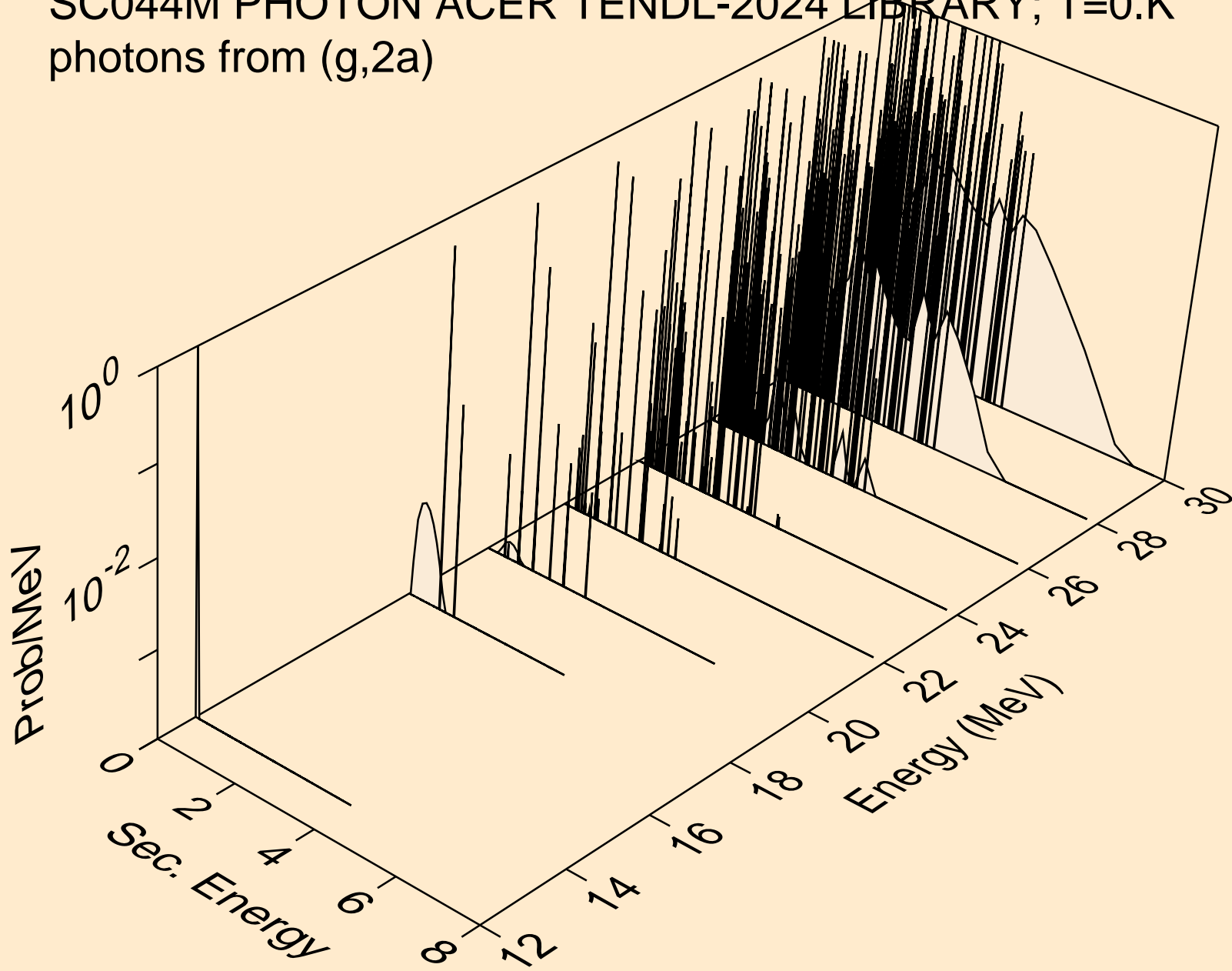

SC044M PHOTON ACER TENDL-2024 LIBRARY; T=0.K
photons from (g,2p)

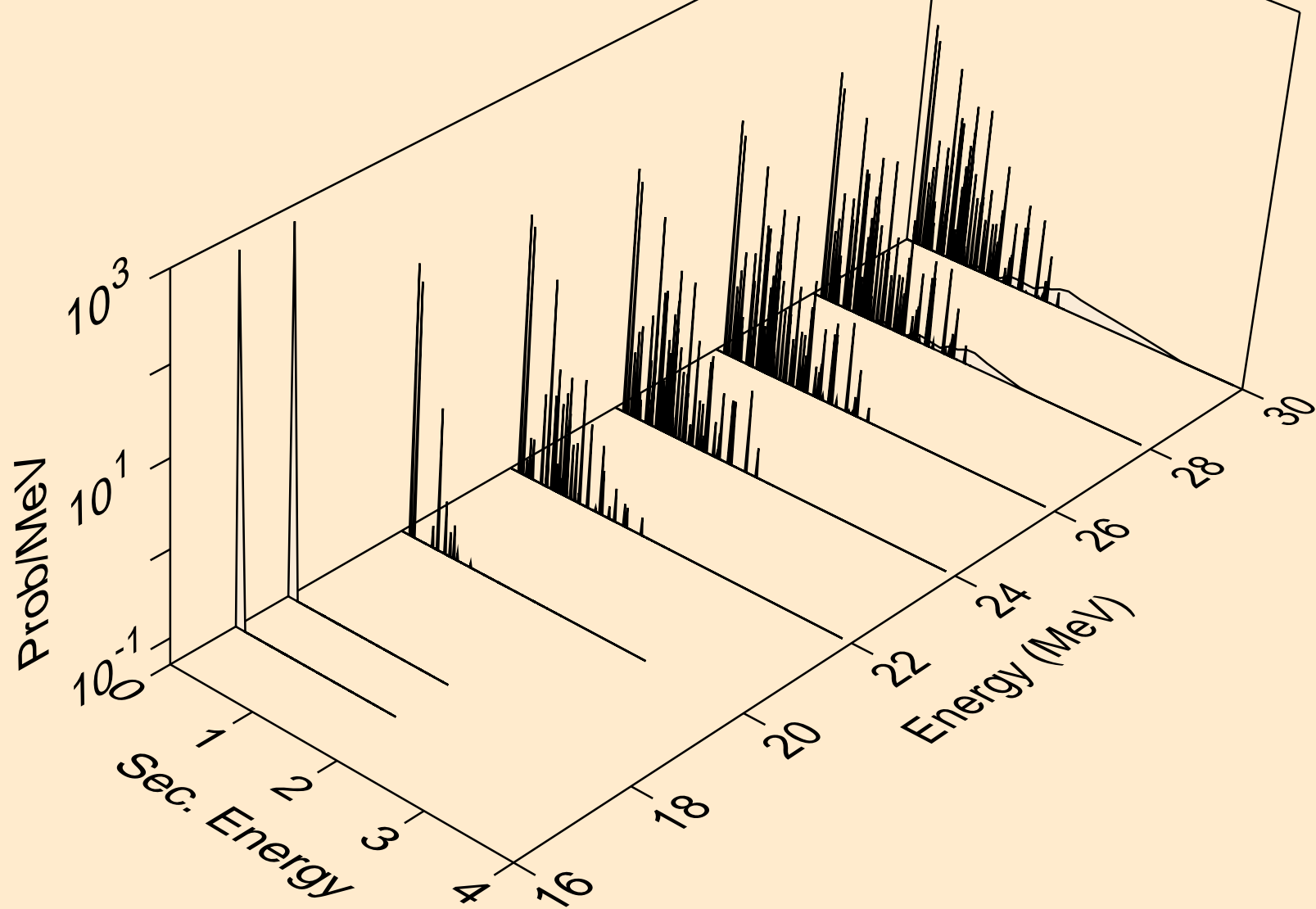

SC044M PHOTON ACER TENDL-2024 LIBRARY; T=0.K
photons from (g,pa)

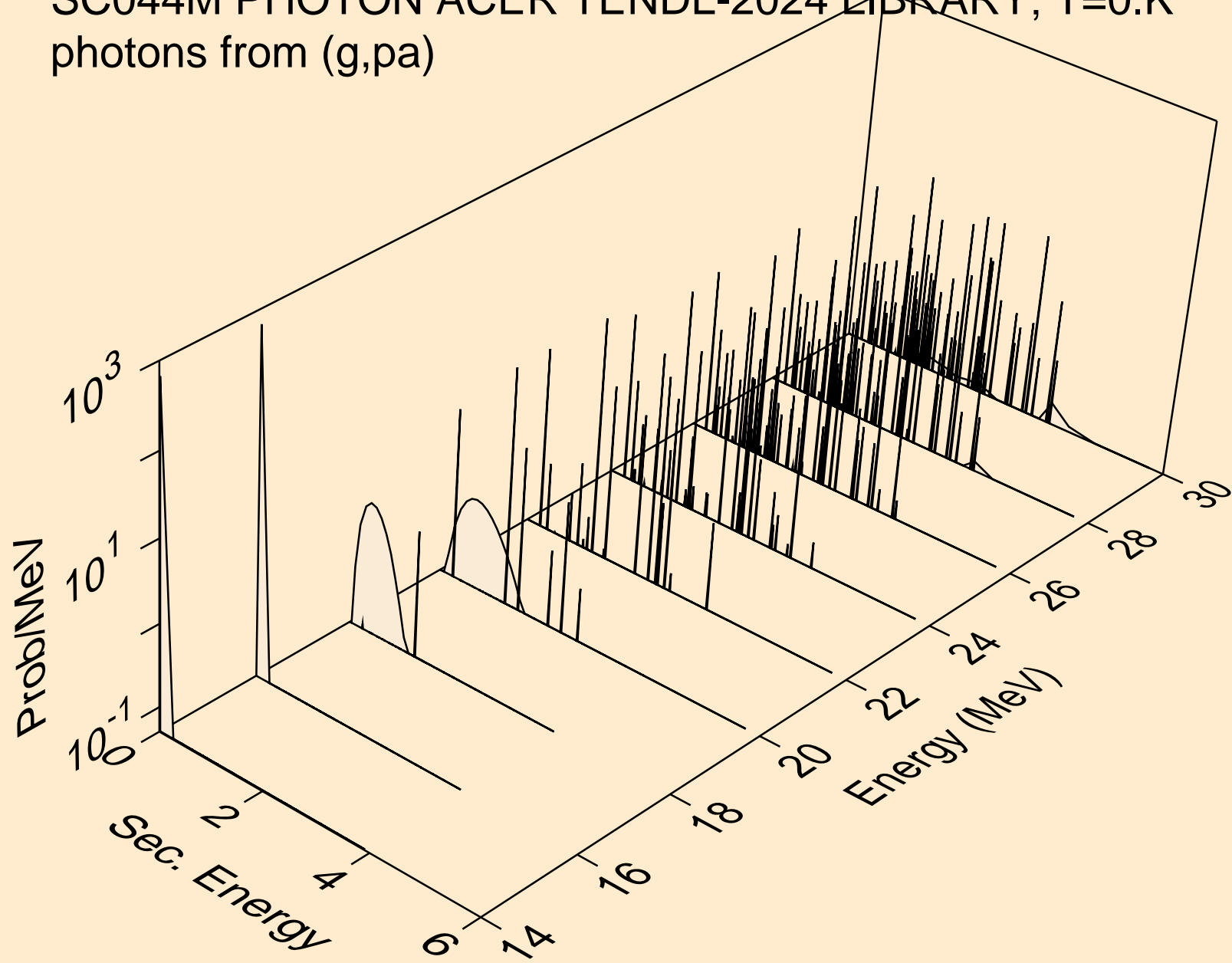

SC044M PHOTON ACER TENDL-2024 LIBRARY; T=0.K
photons from (g,pd)

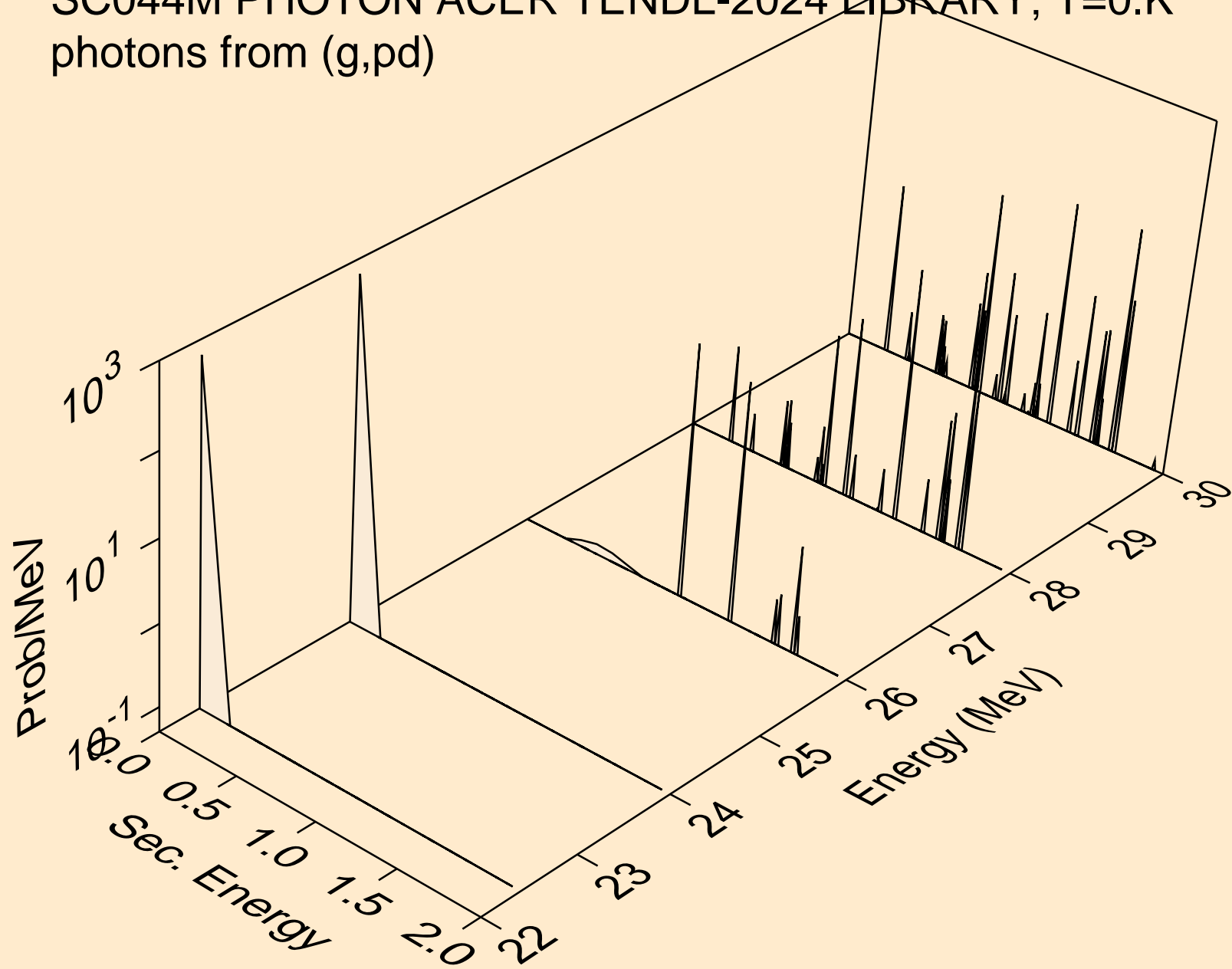

SC044M PHOTON ACER TENDL-2024 LIBRARY; T=0.K
photons from (g,pt)

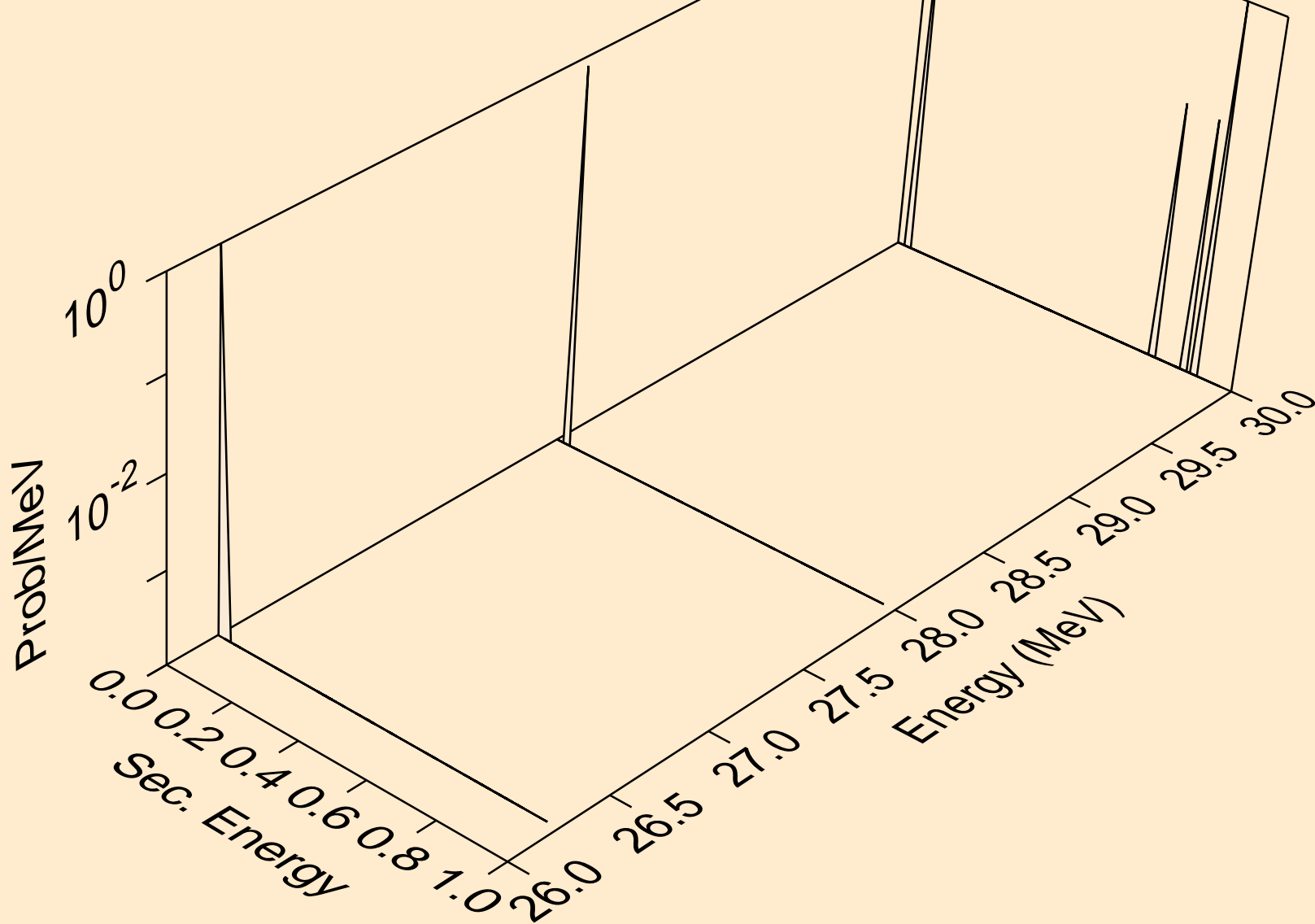

SC044M PHOTON ACER TENDL-2024 LIBRARY; T=0.K
photons from (g,da)

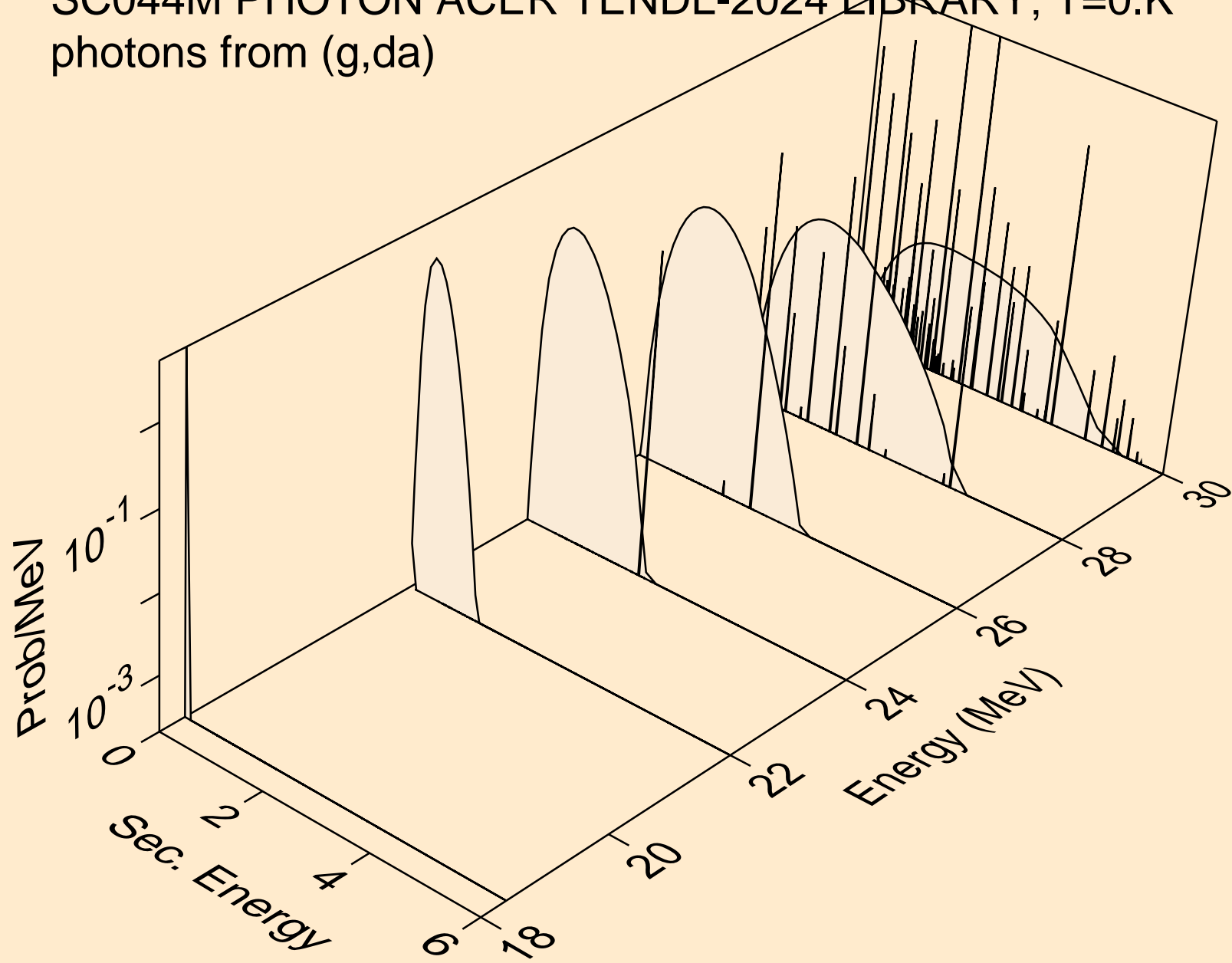

SC044M PHOTON ACER TENDL-2024 LIBRARY; T=0.K
protons from (g,x)

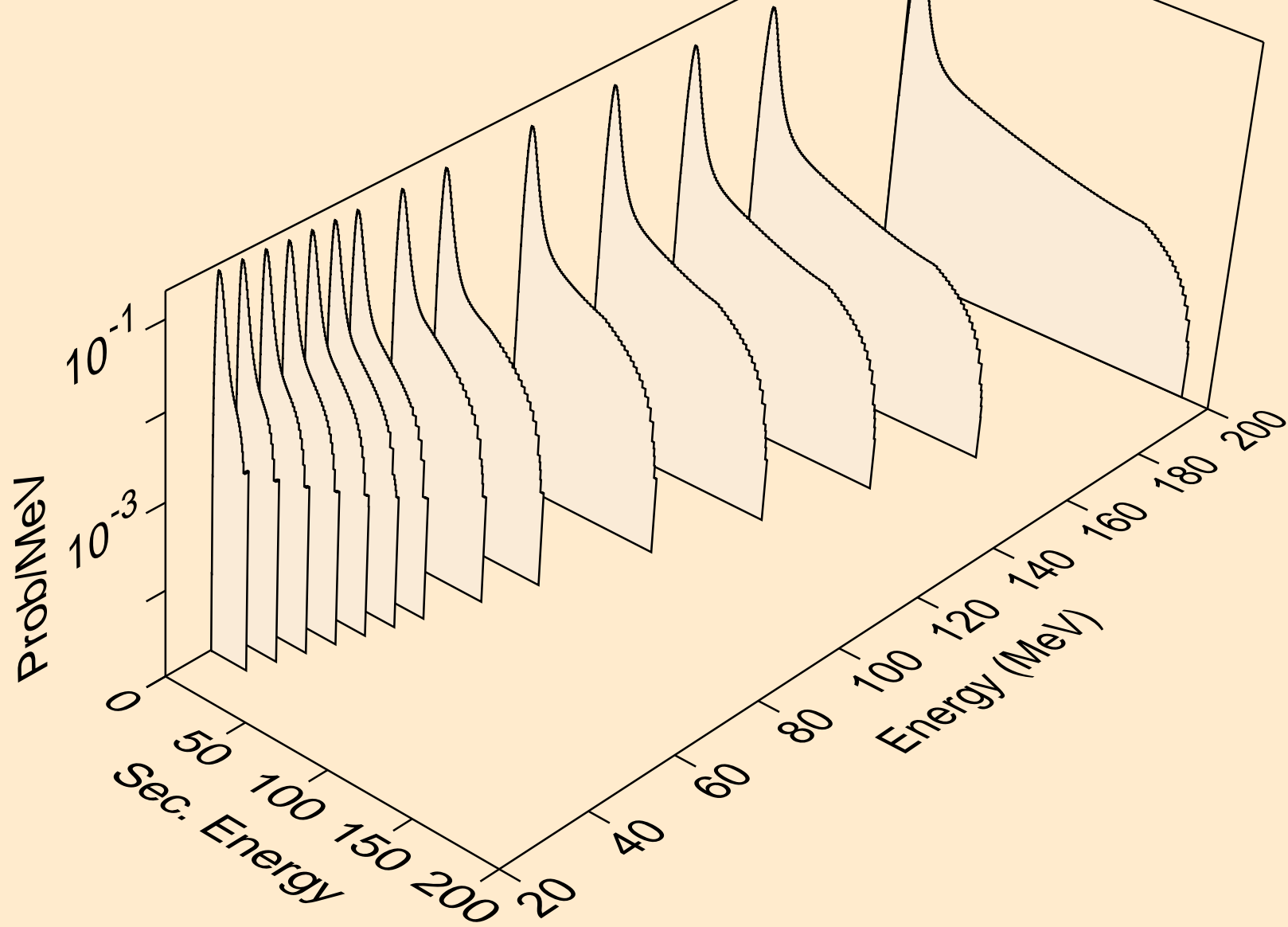

SC044M PHOTON ACER TENDL-2024 LIBRARY; T=0.K
protons from (g,n*)p

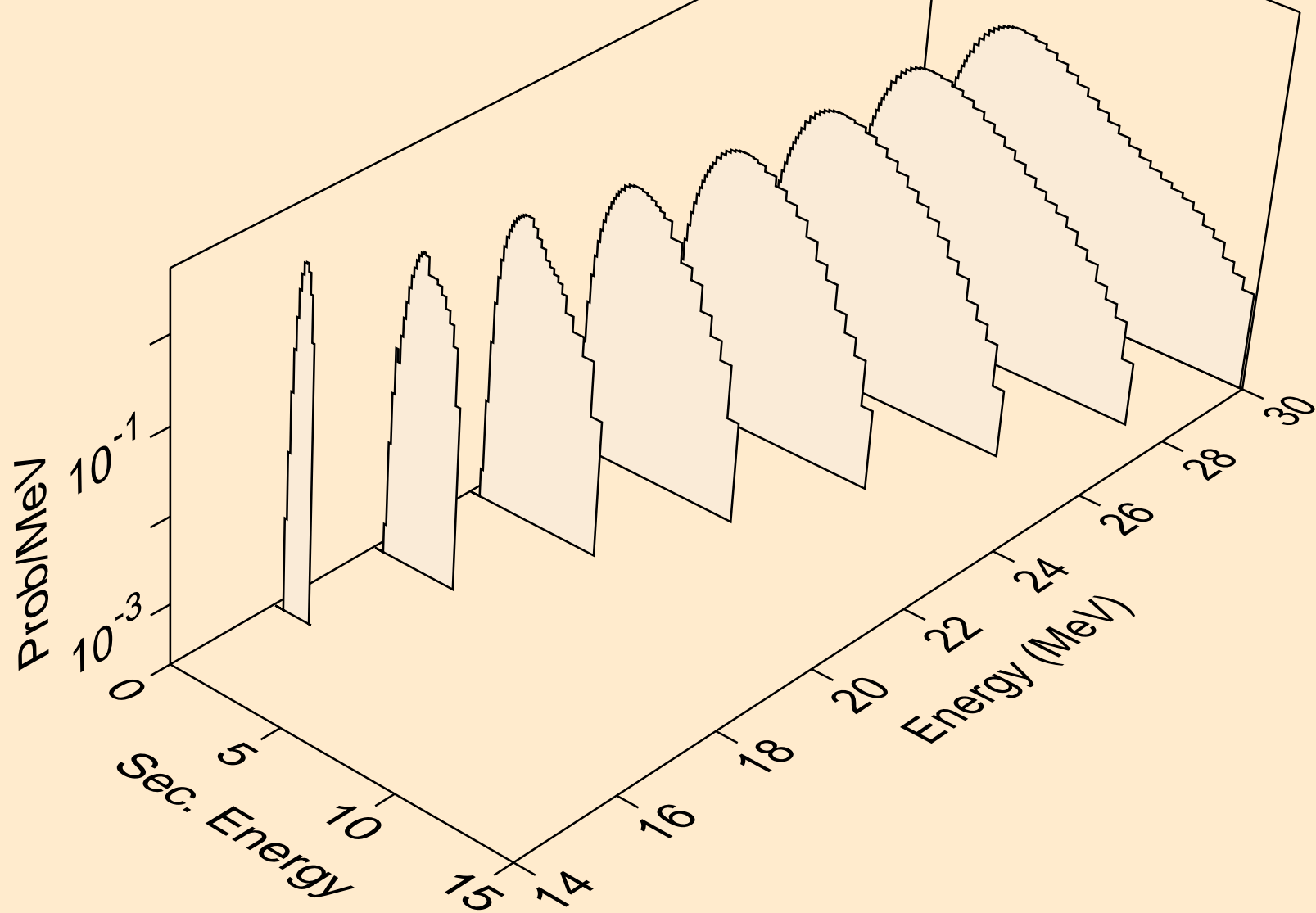

SC044M PHOTON ACER TENDL-2024 LIBRARY; T=0.K
protons from (g,2np)

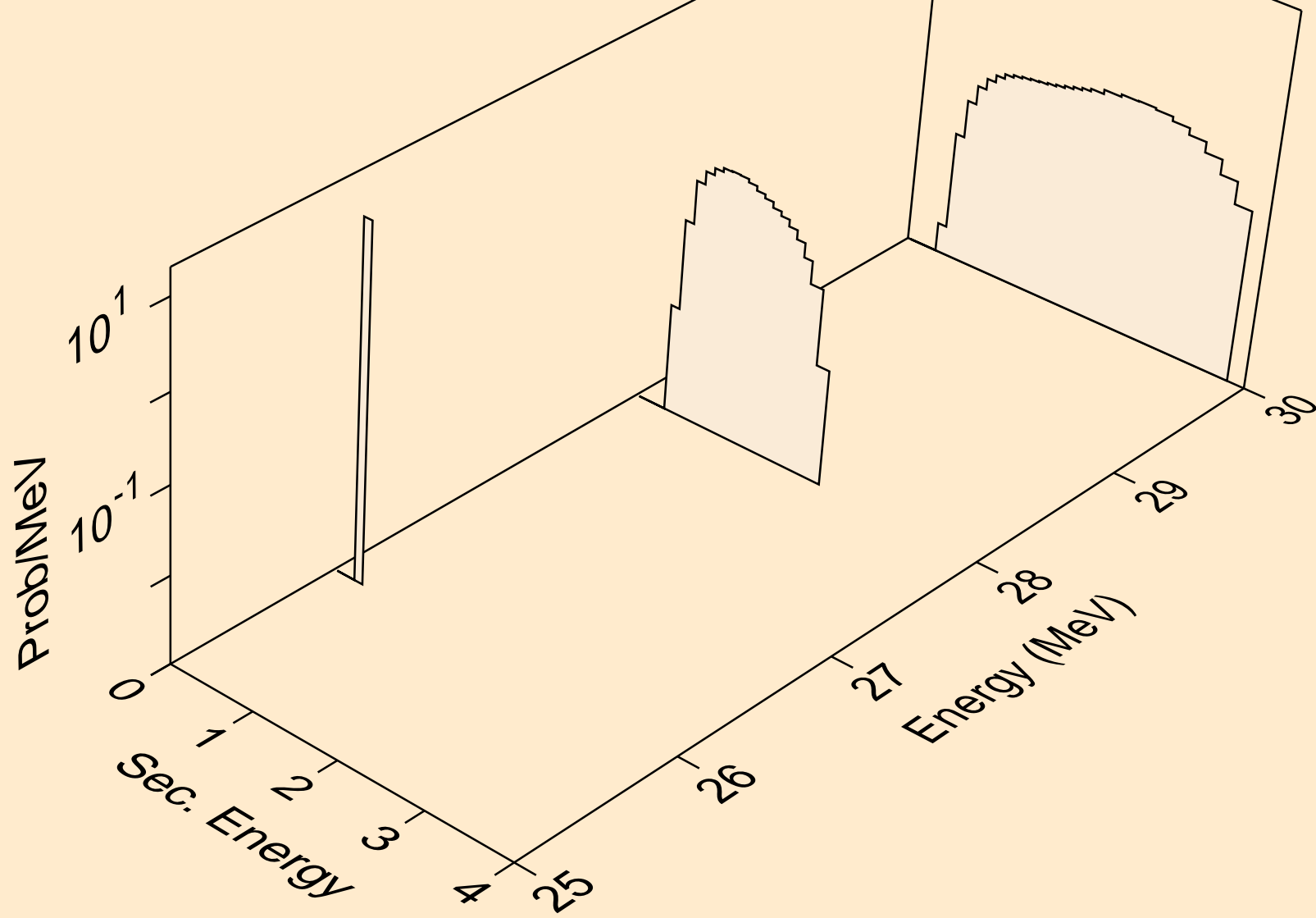

SC044M PHOTON ACER TENDL-2024 LIBRARY; T=0.K
protons from (g,n2p)

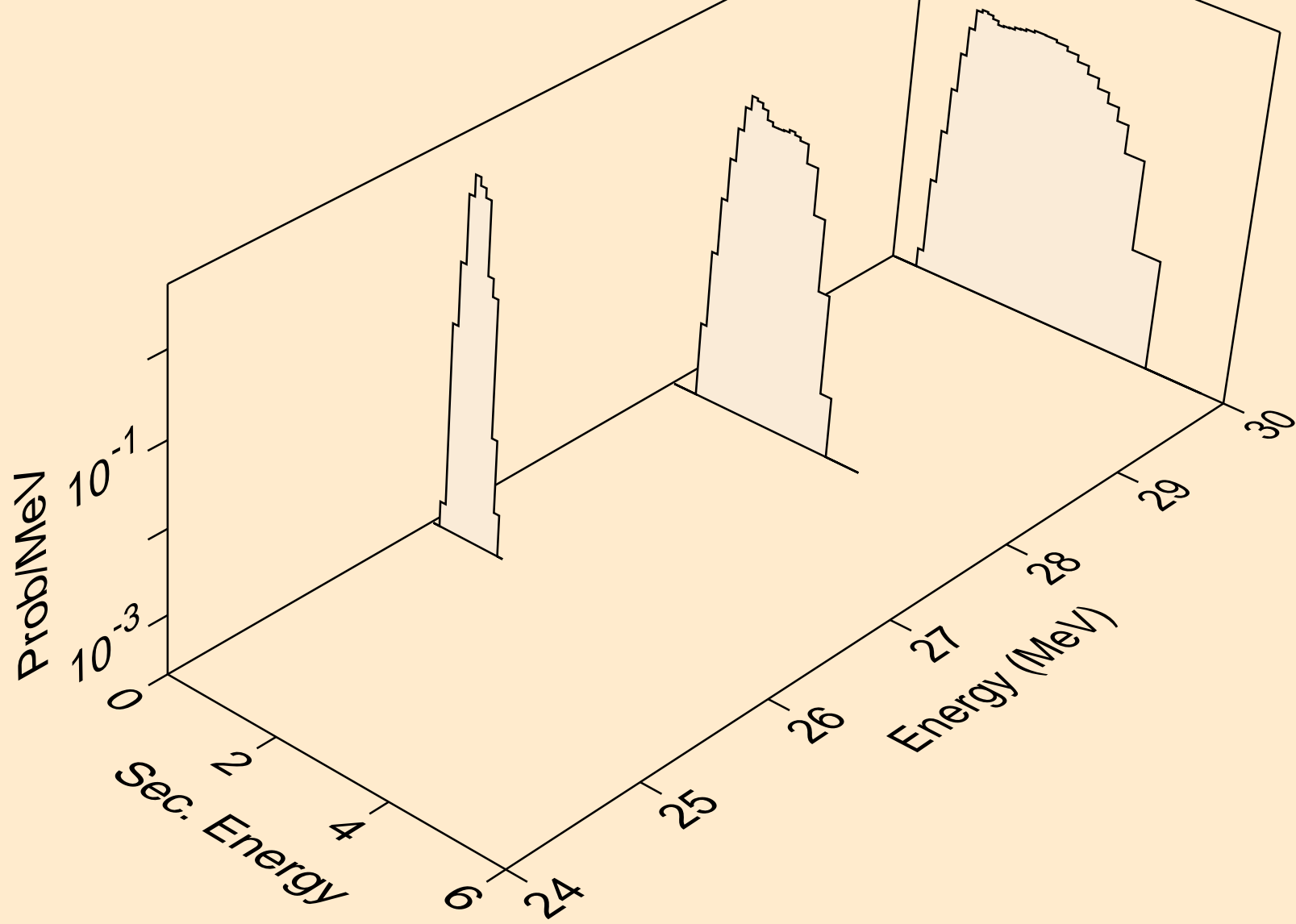

SC044M PHOTON ACER TENDL-2024 LIBRARY; T=0.K
protons from (g,npa)

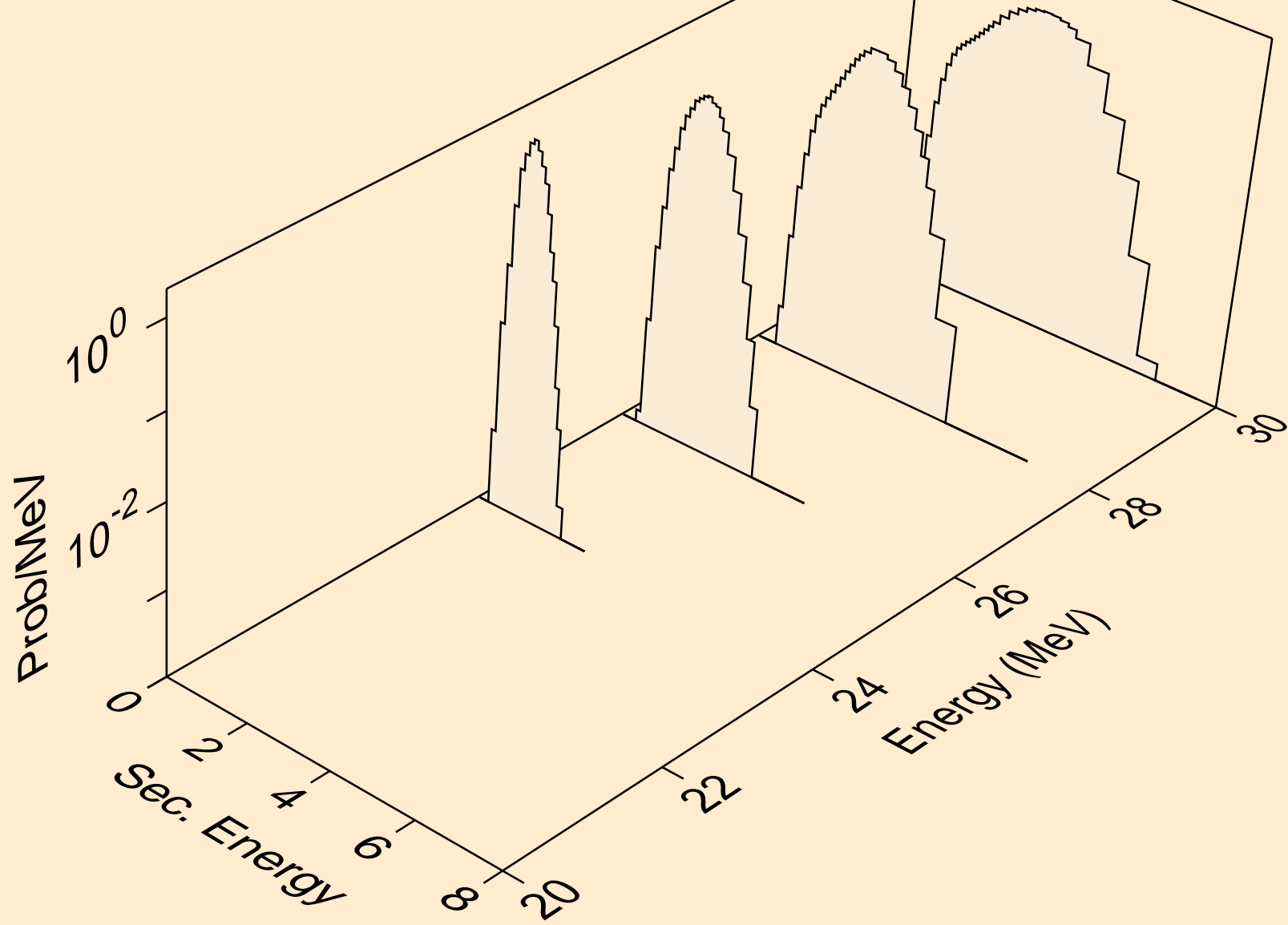

SC044M PHOTON ACER TENDL-2024 LIBRARY; T=0.K
protons from (g,p)

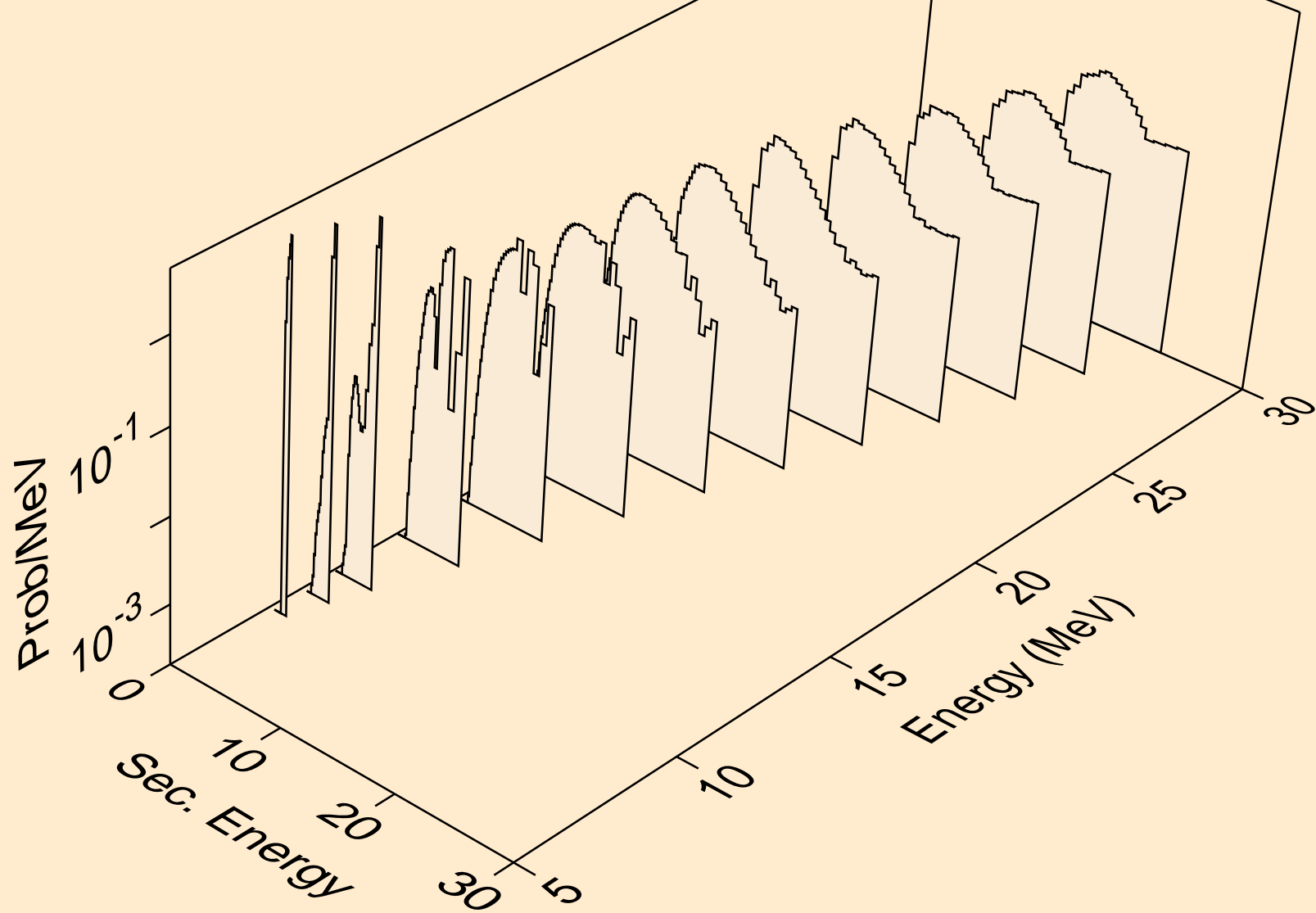

SC044M PHOTON ACER TENDL-2024 LIBRARY; T=0.K
protons from (g,2p)

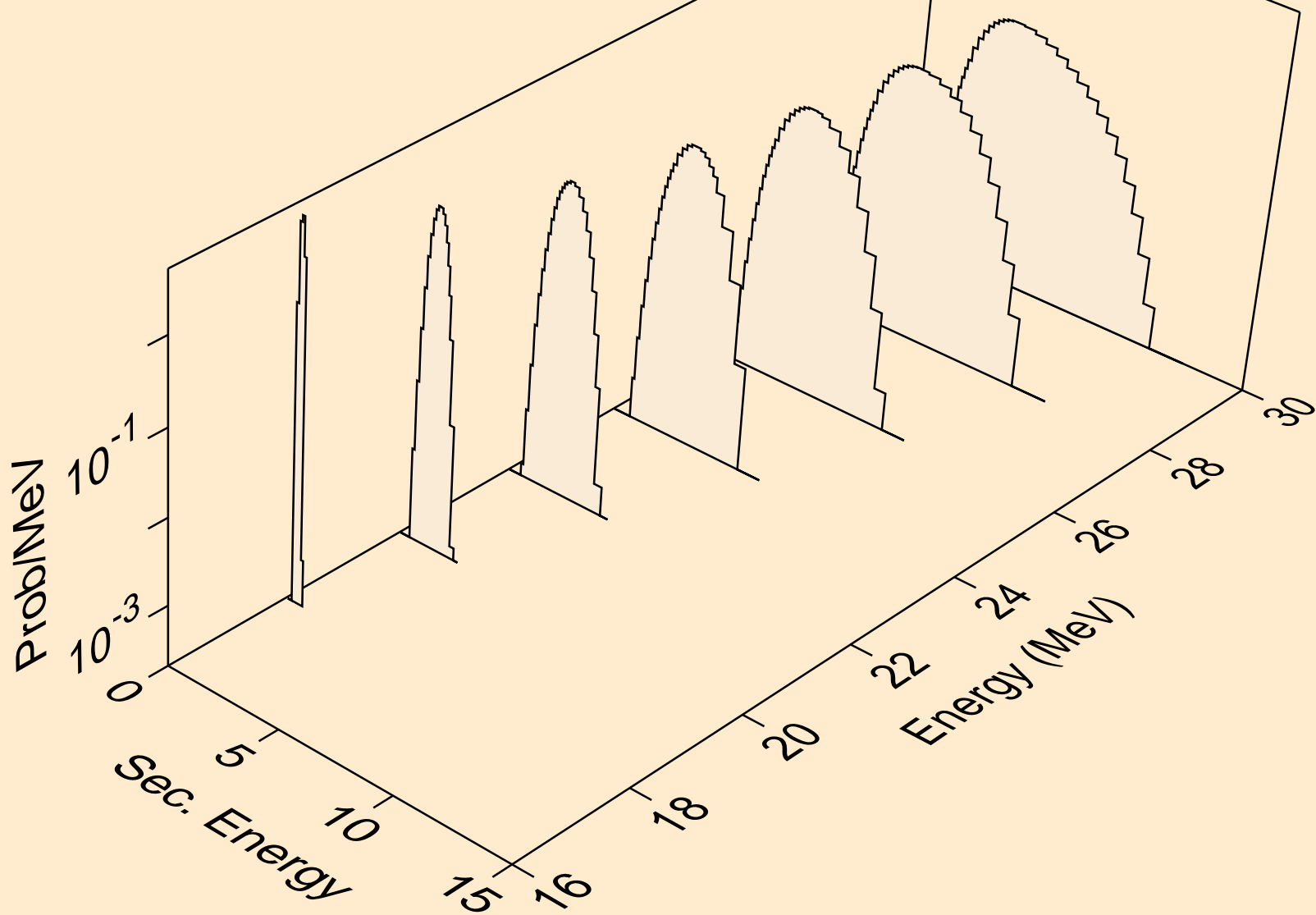

SC044M PHOTON ACER TENDL-2024 LIBRARY; T=0.K
protons from (g,pa)

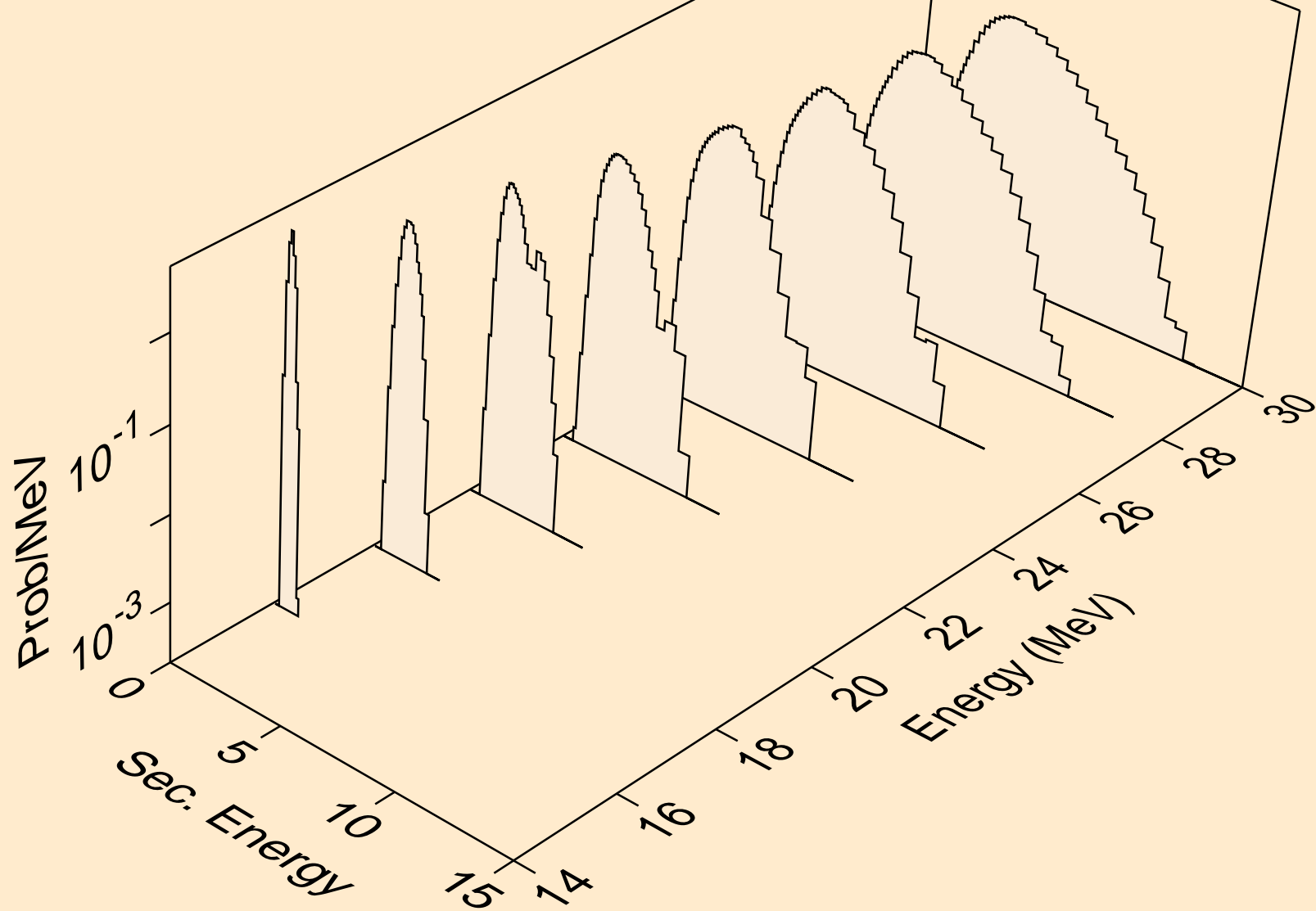

SC044M PHOTON ACER TENDL-2024 LIBRARY; T=0.K
protons from (g,pd)

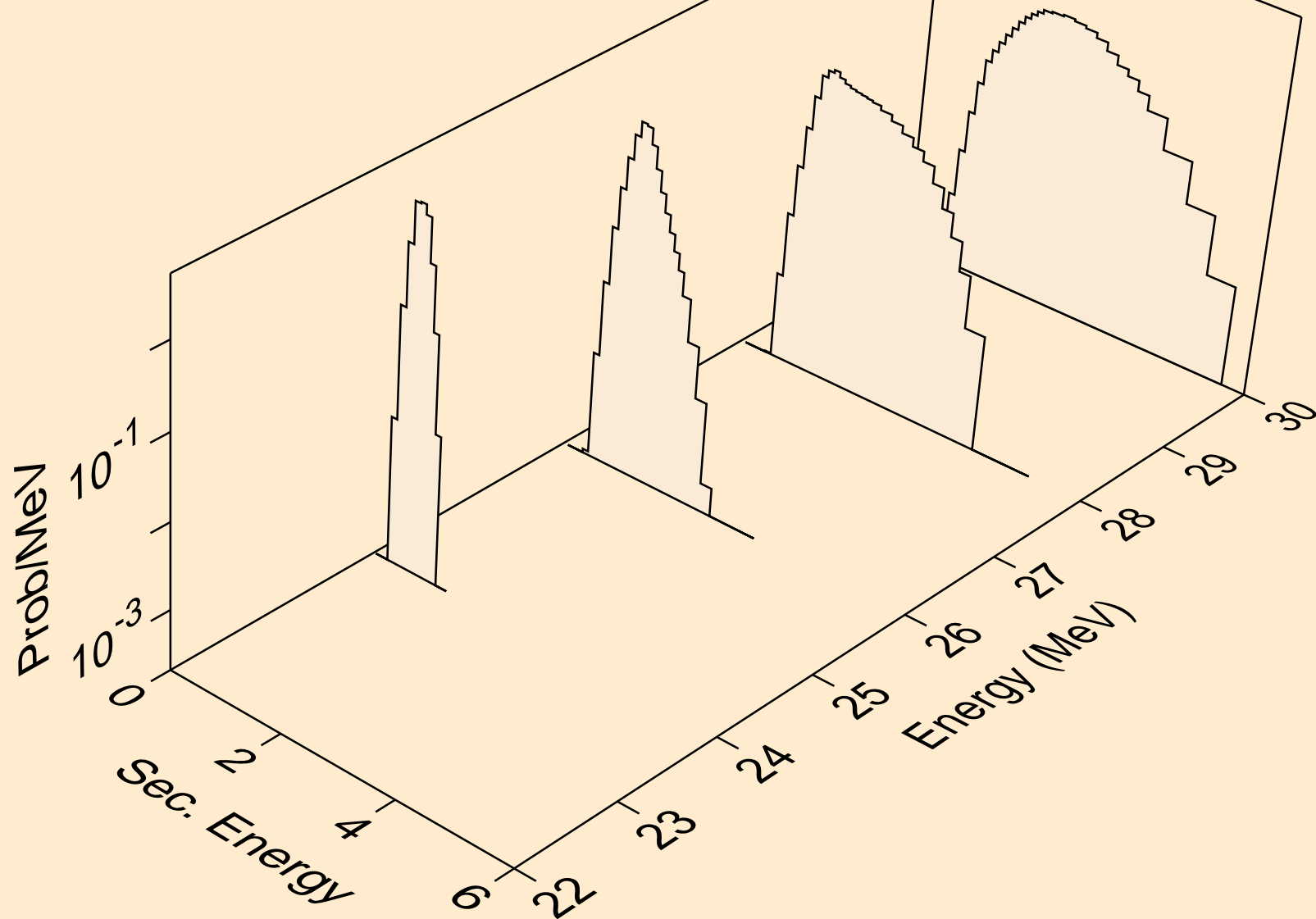

SC044M PHOTON ACER TENDL-2024 LIBRARY; T=0.K
protons from (g,pt)

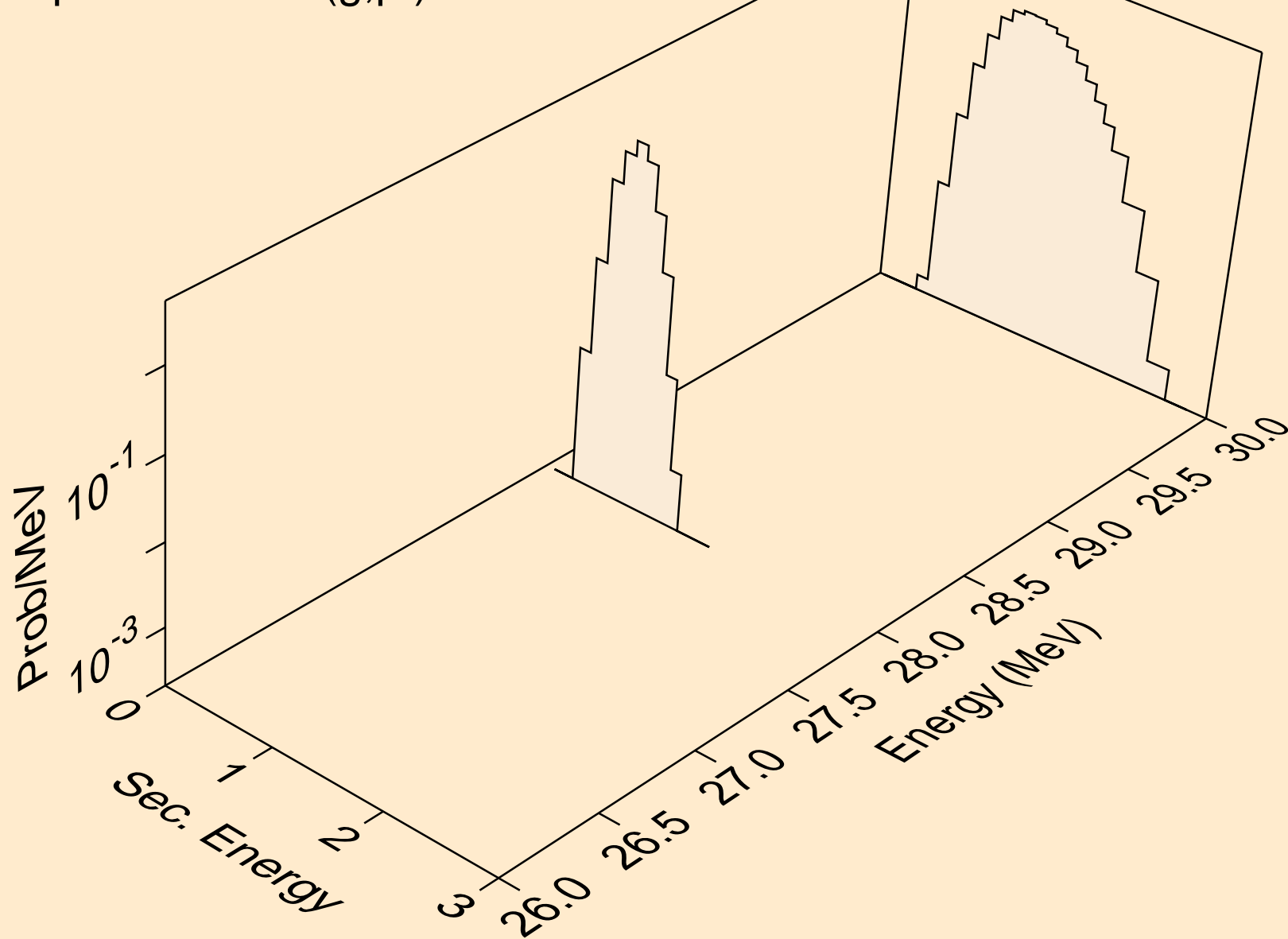

SC044M PHOTON ACER TENDL-2024 LIBRARY; T=0.K
deuterons from (g,x)

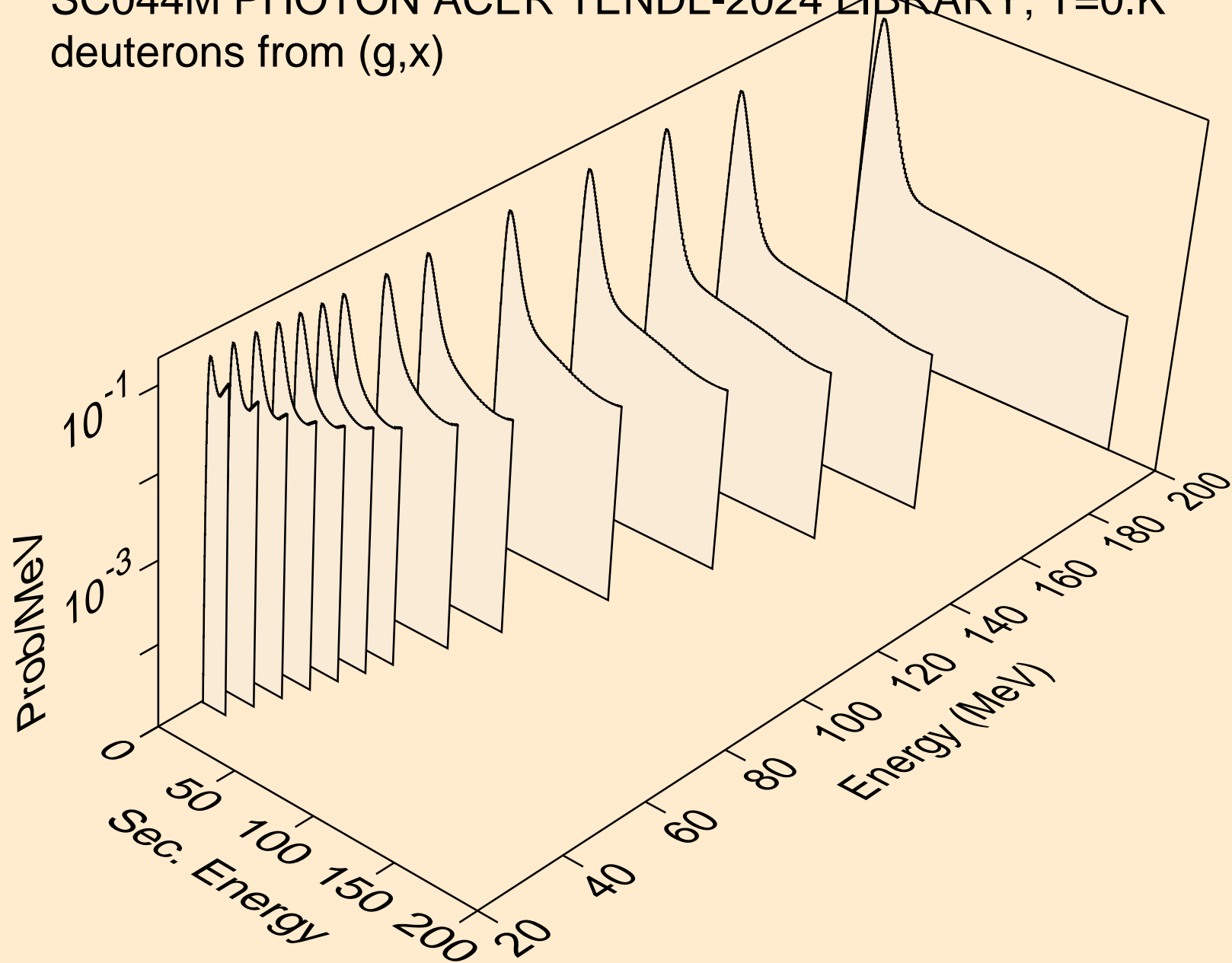

SC044M PHOTON ACER TENDL-2024 LIBRARY; T=0.K
deuterons from (g,n*)d

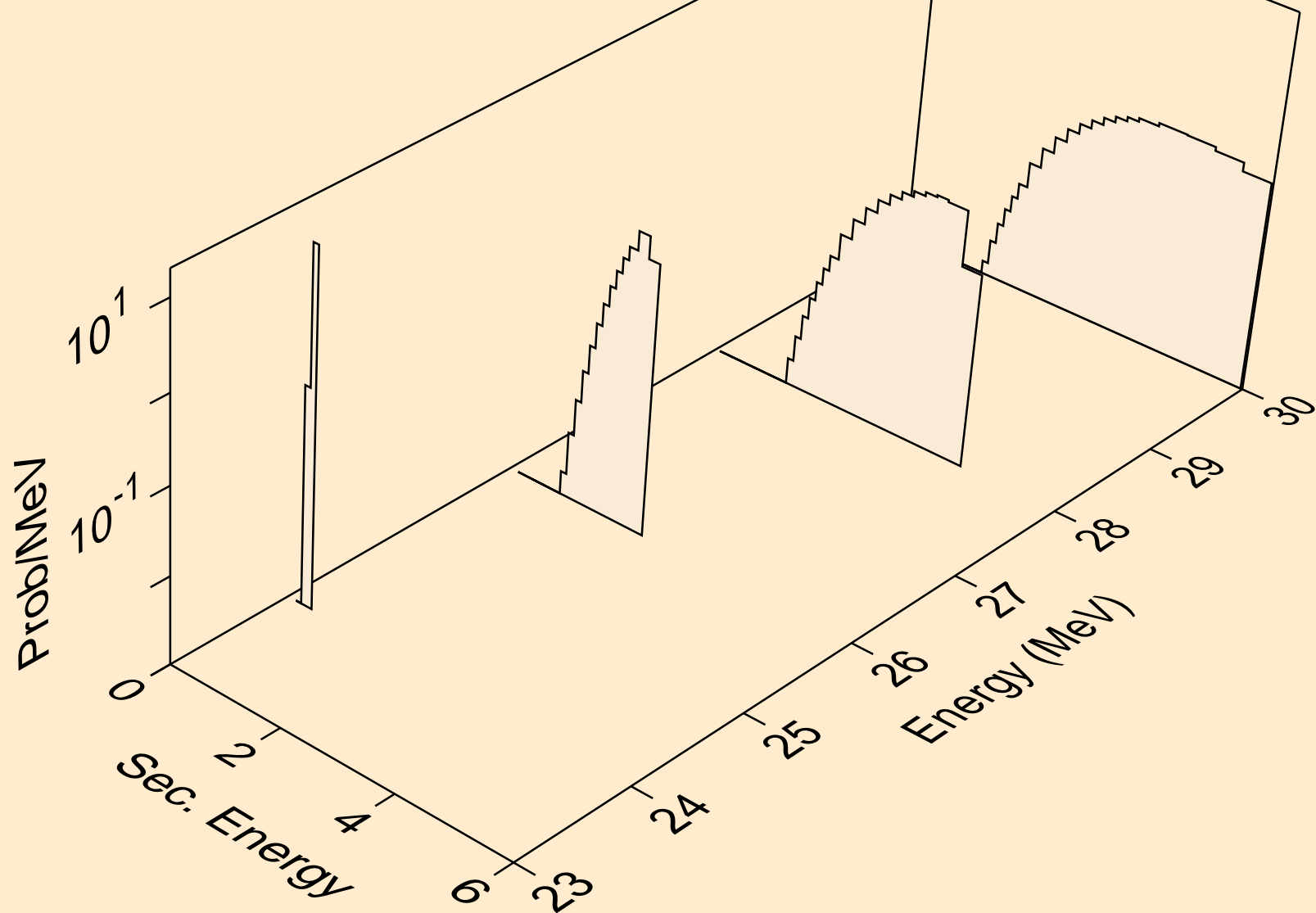

SC044M PHOTON ACER TENDL-2024 LIBRARY; T=0.K
deuterons from (g,d)

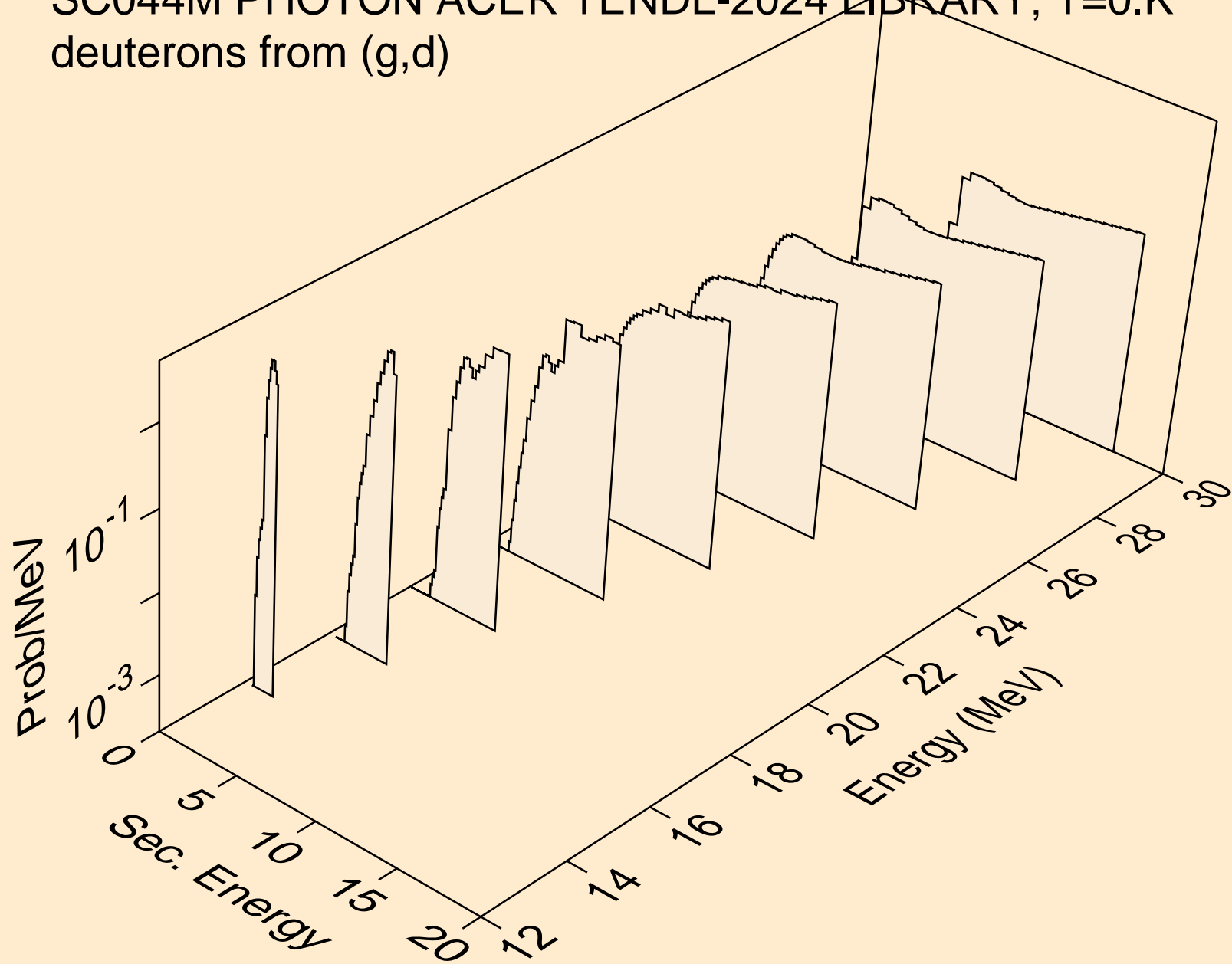

SC044M PHOTON ACER TENDL-2024 LIBRARY; T=0.K
deuterons from (g,pd)

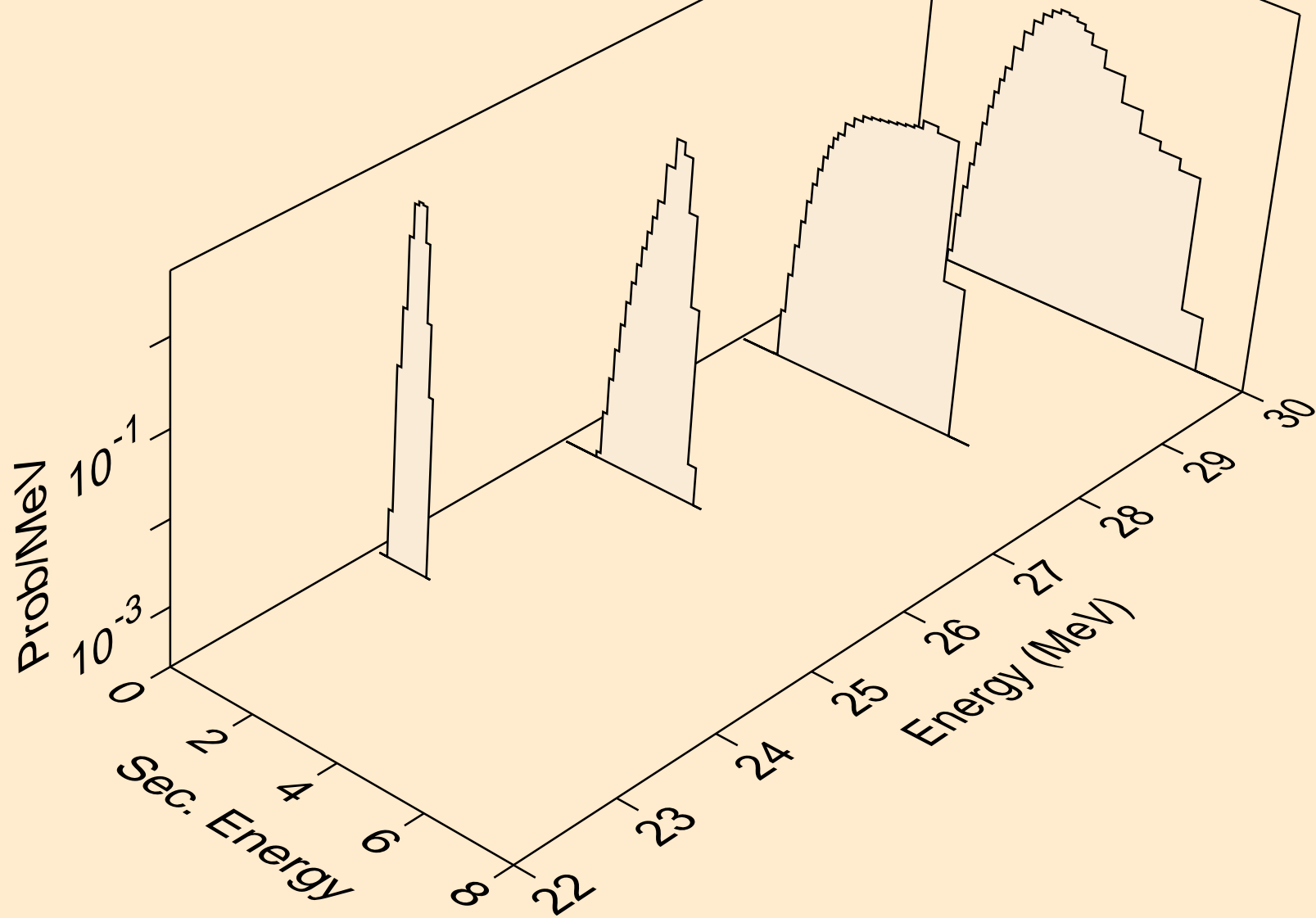

SC044M PHOTON ACER TENDL-2024 LIBRARY; T=0.K
deuterons from (g,da)

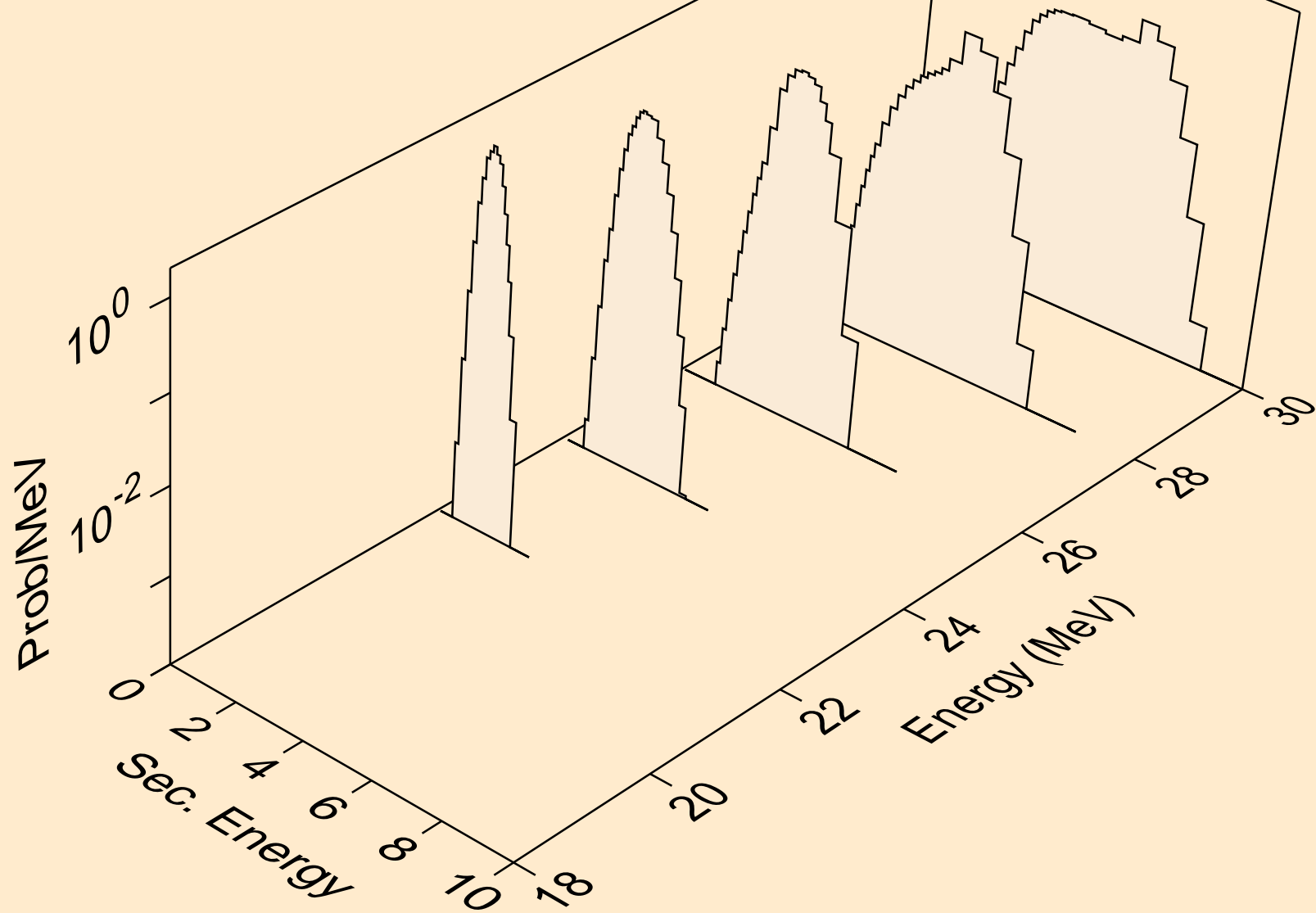

SC044M PHOTON ACER TENDL-2024 LIBRARY; T=0.K
tritons from (g,x)

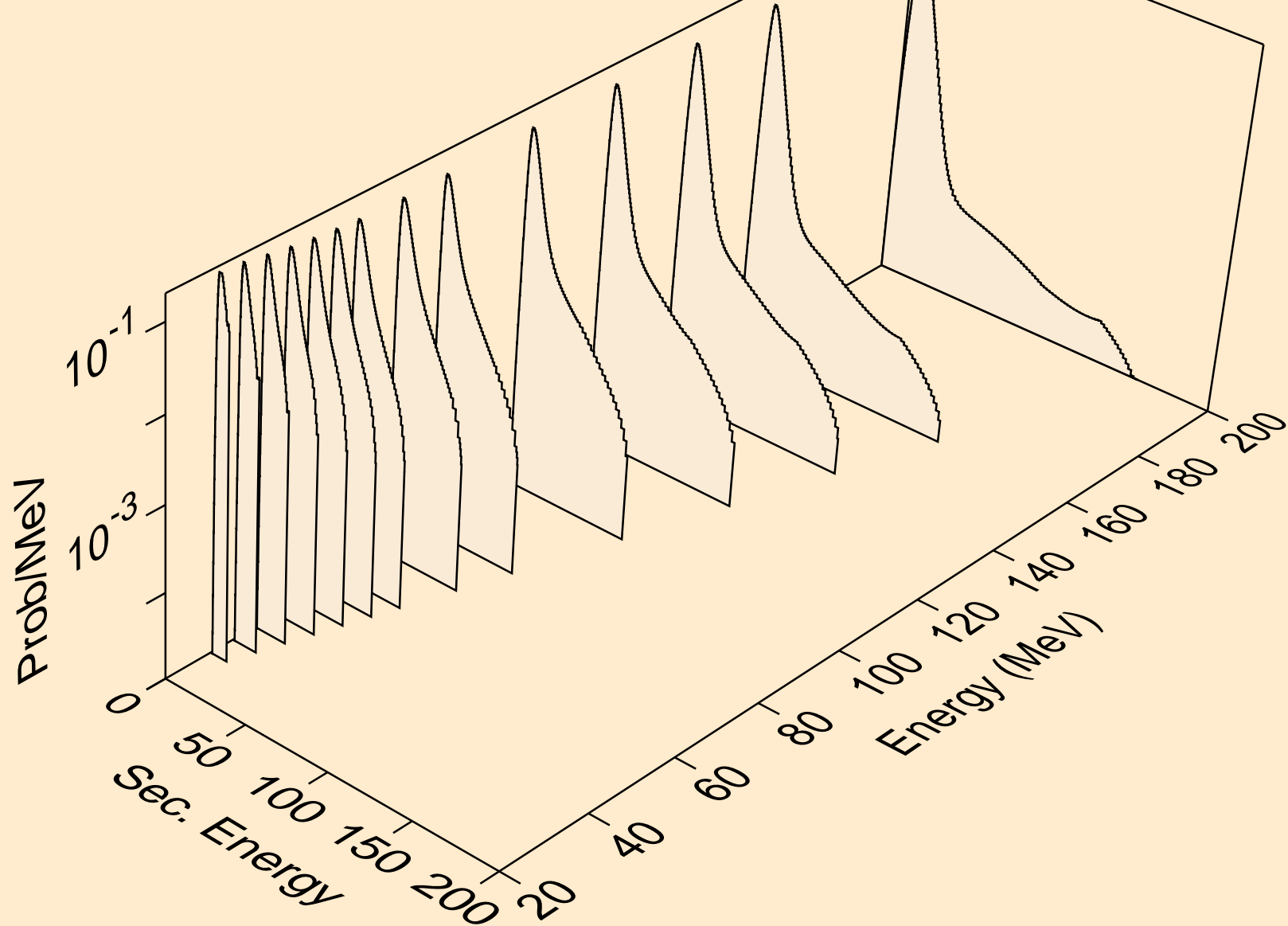

SC044M PHOTON ACER TENDL-2024 LIBRARY; T=0.K
tritons from (g,n*)t

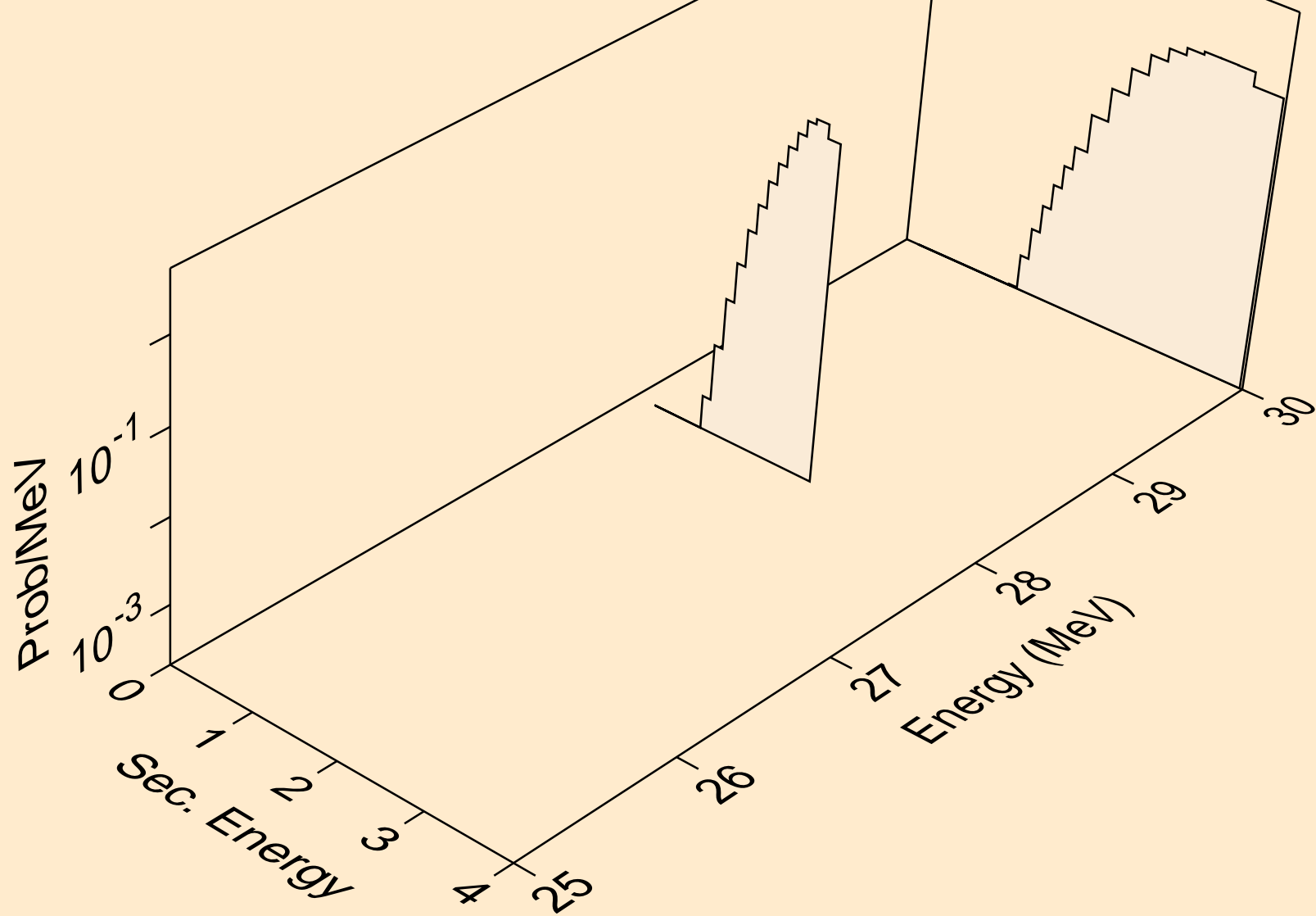

SC044M PHOTON ACER TENDL-2024 LIBRARY; T=0.K
tritons from (g,t)

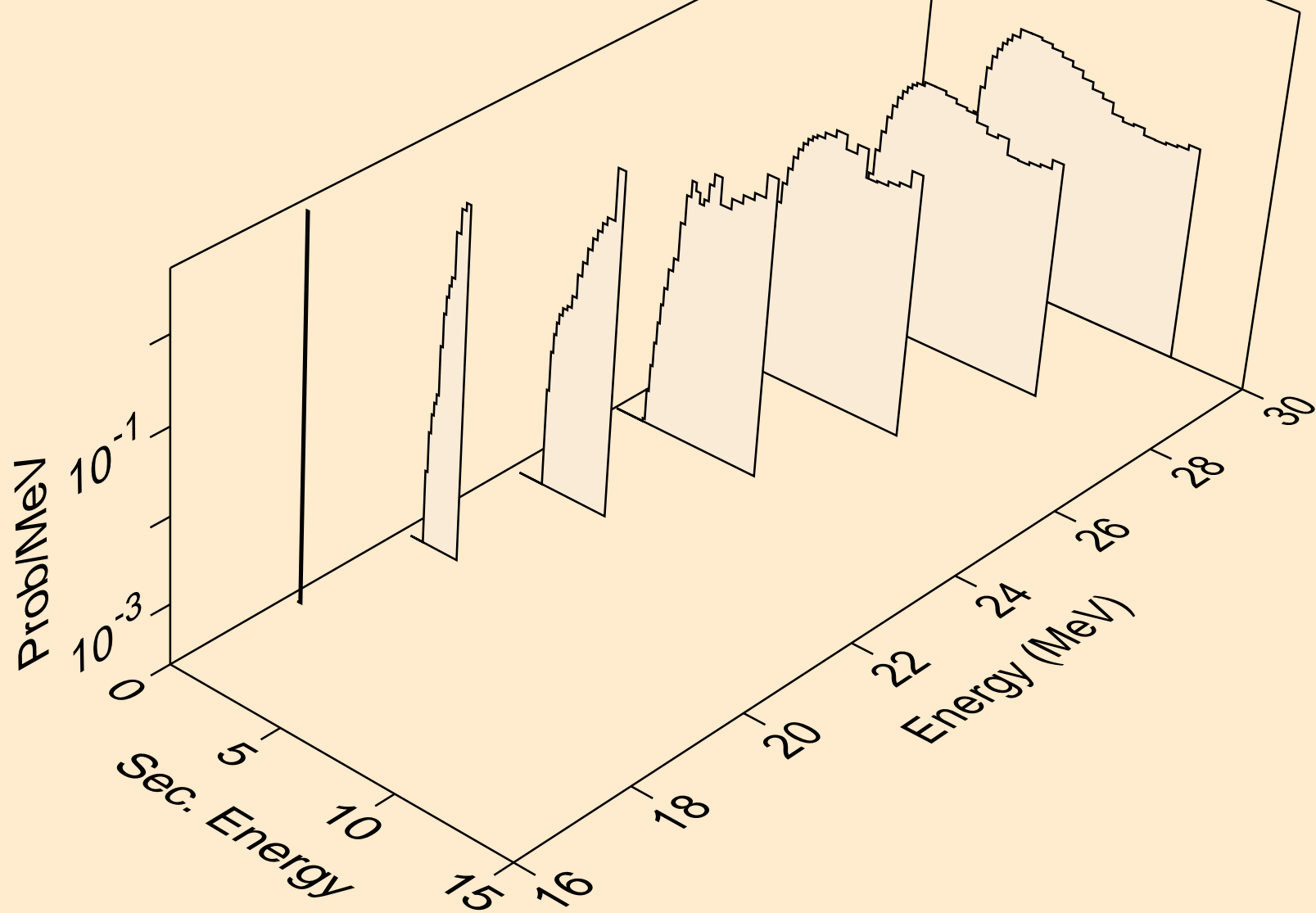

SC044M PHOTON ACER TENDL-2024 LIBRARY; T=0.K
tritons from (g,pt)

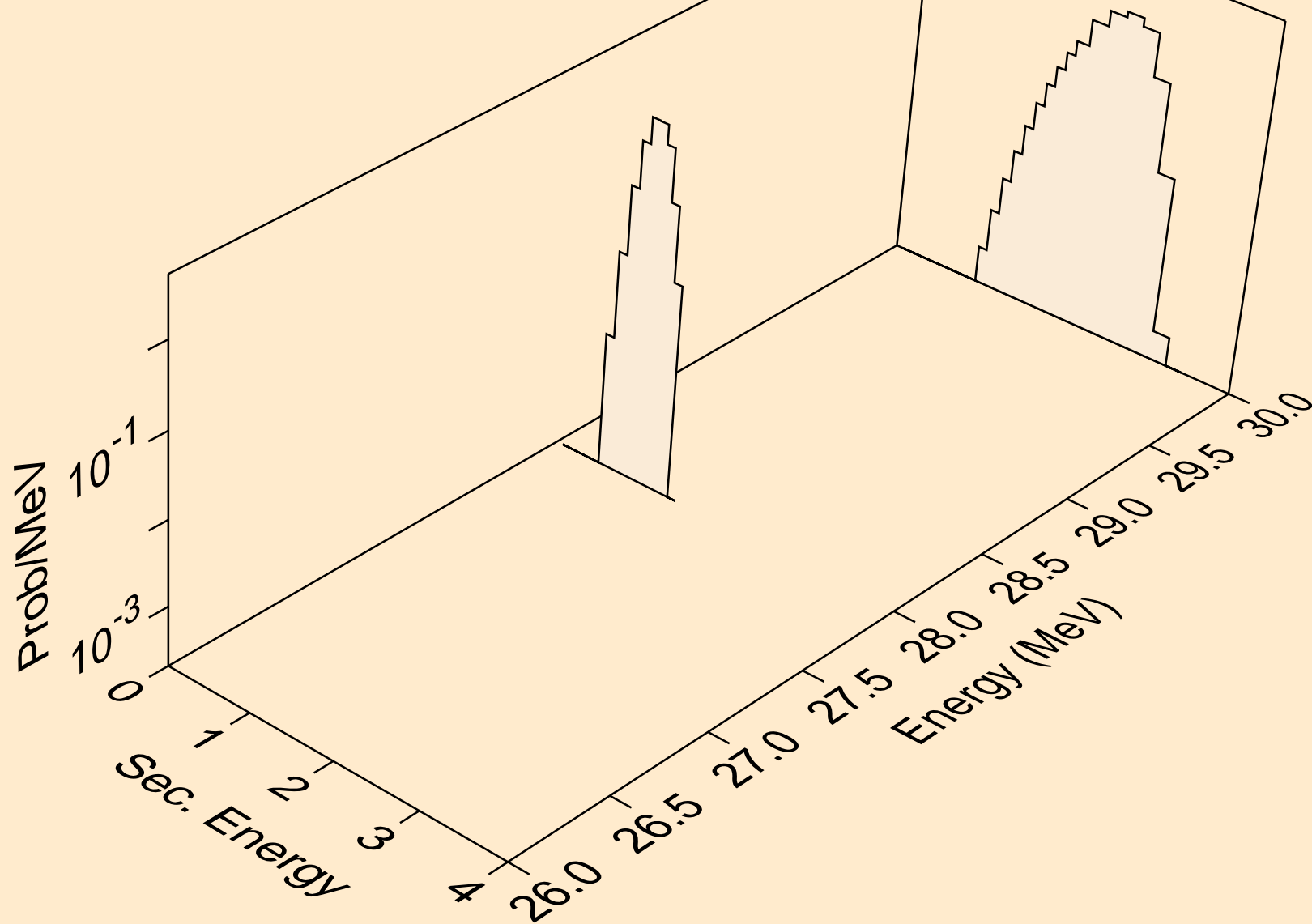

SC044M PHOTON ACER TENDL-2024 LIBRARY; T=0.K
he3s from (g,x)

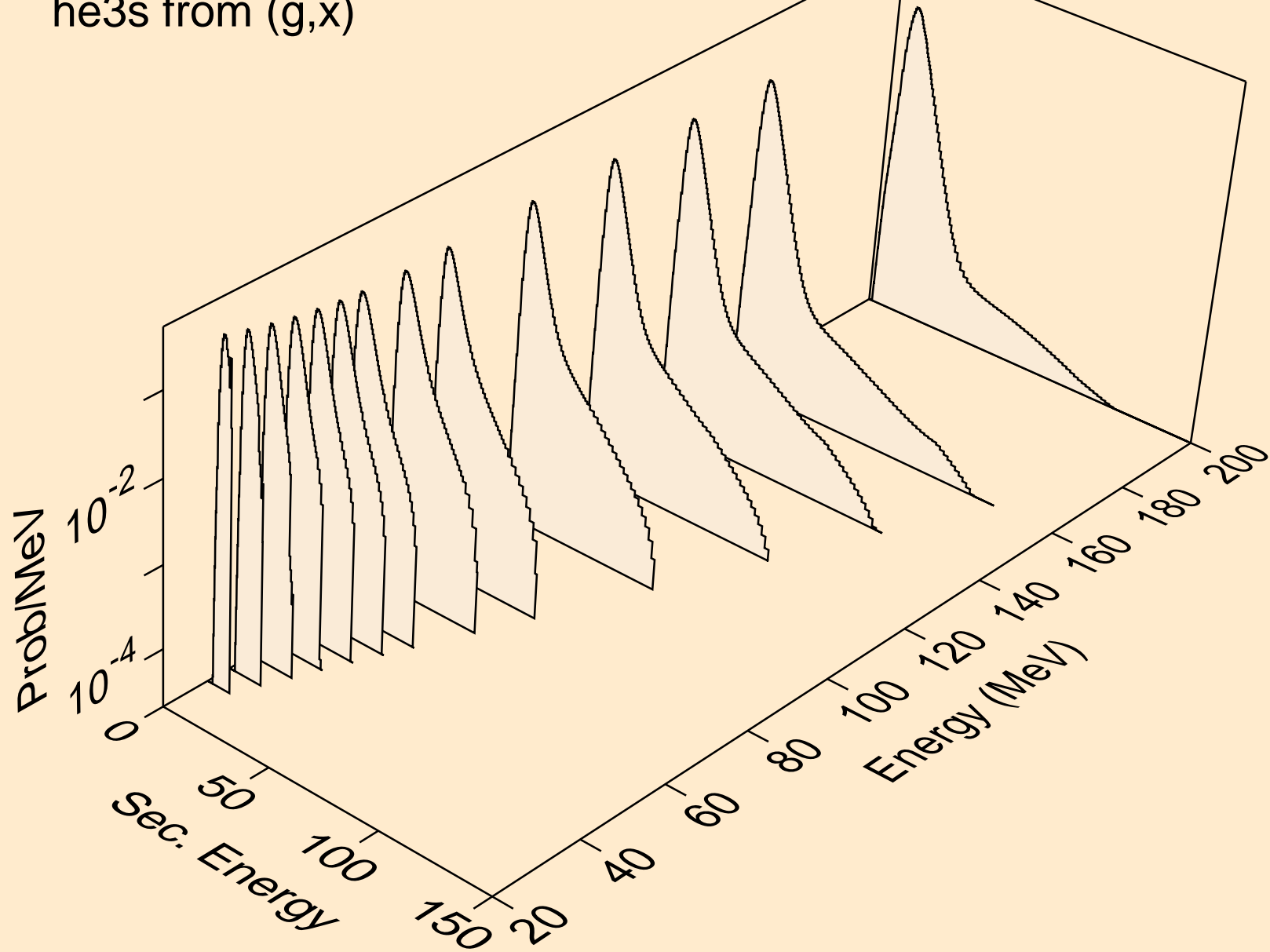

SC044M PHOTON ACER TENDL-2024 LIBRARY; T=0.K
he3s from (g,he3)

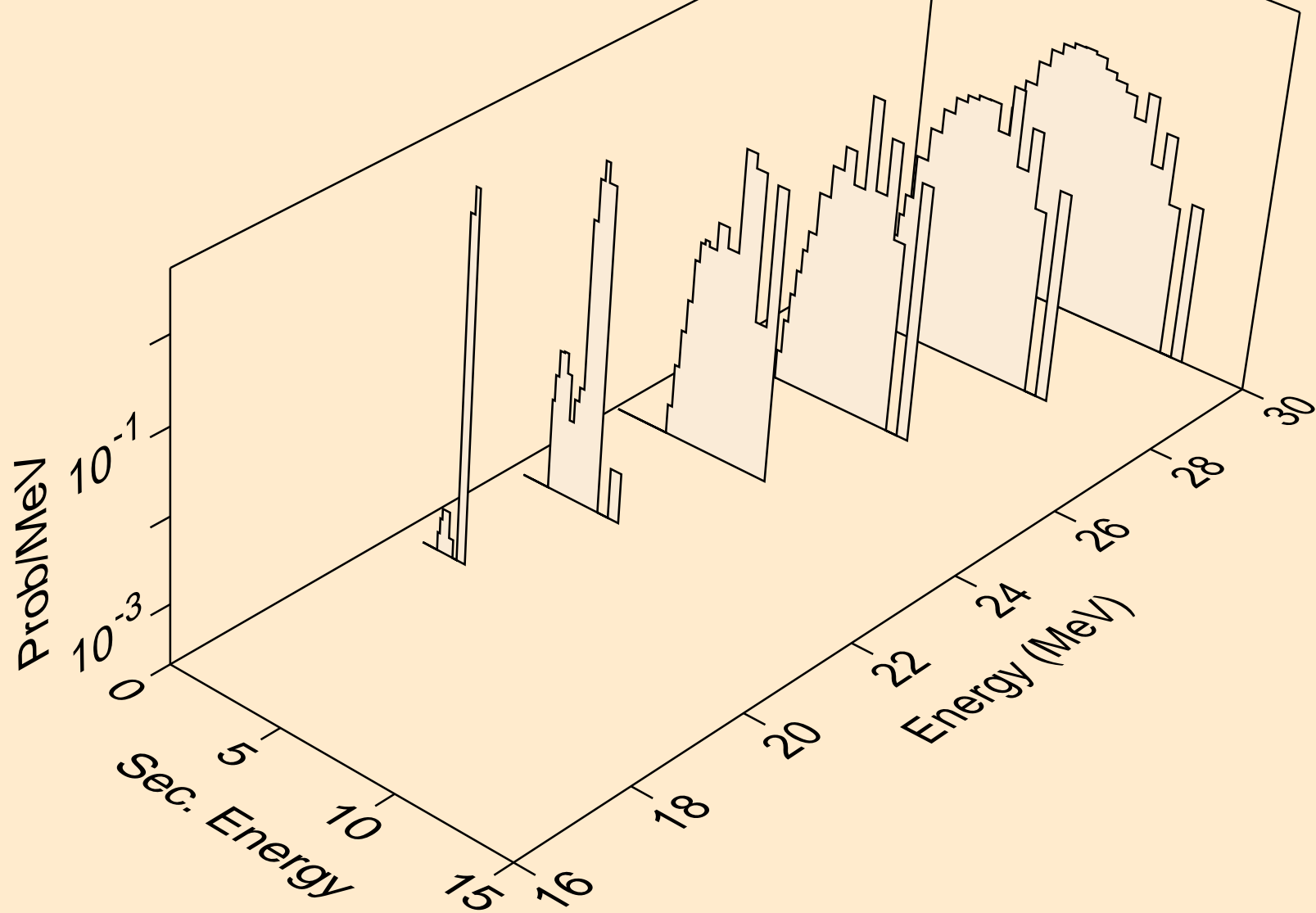

SC044M PHOTON ACER TENDL-2024 LIBRARY; T=0.K
alphas from (g,x)

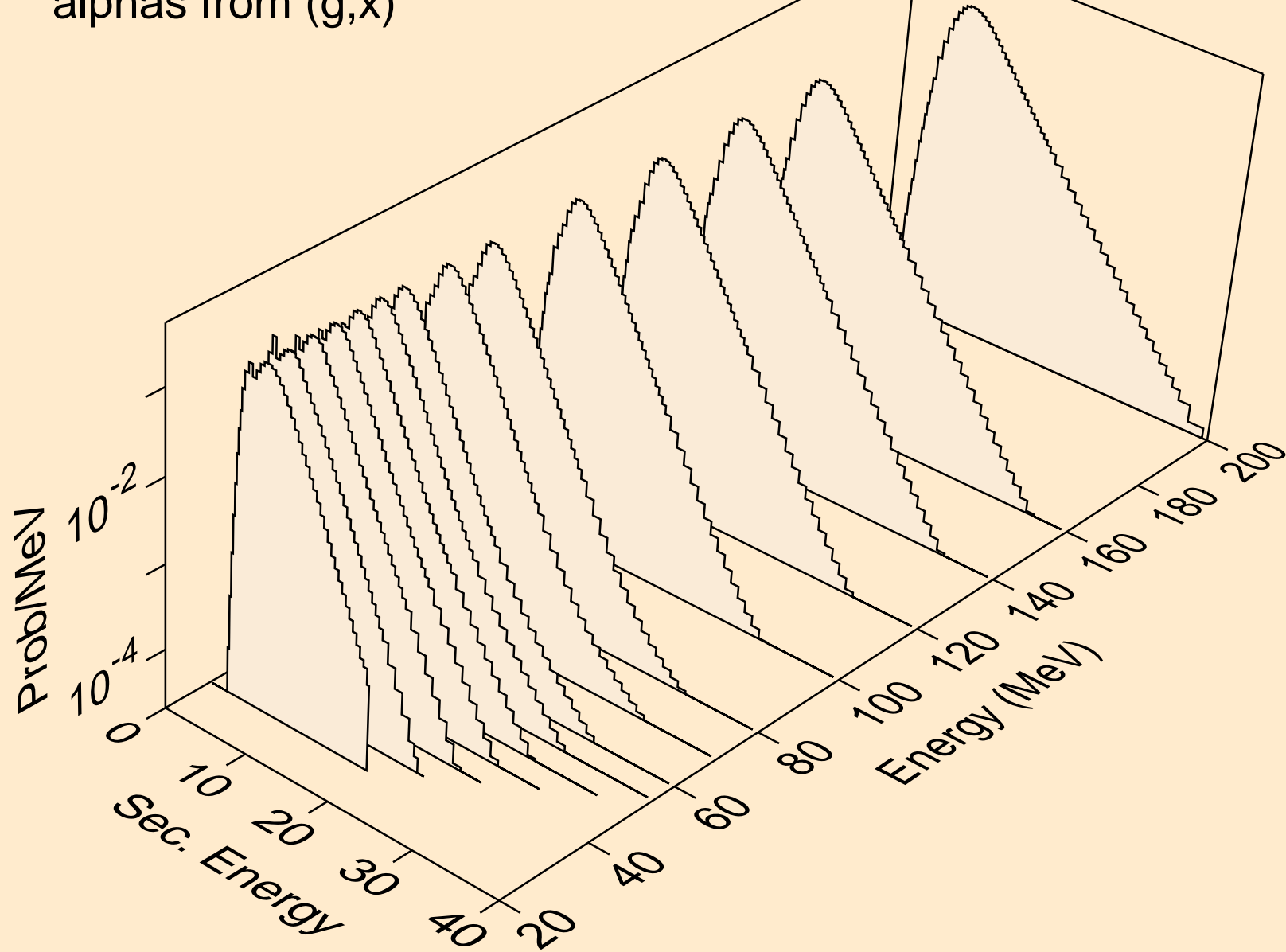

SC044M PHOTON ACER TENDL-2024 LIBRARY; T=0.K
alphas from (g,n*)a

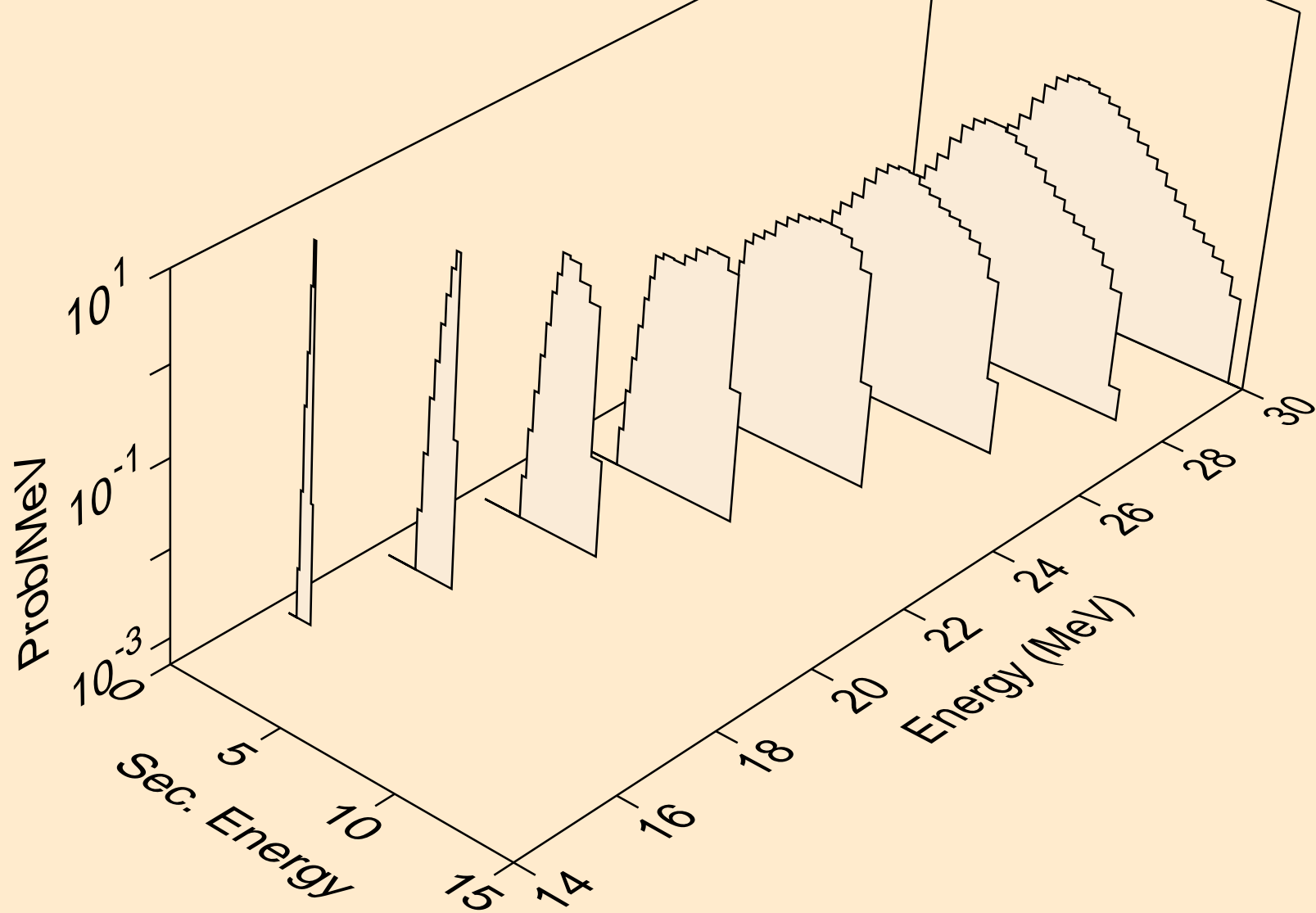

SC044M PHOTON ACER TENDL-2024 LIBRARY; T=0.K
alphas from (g,n*)2a

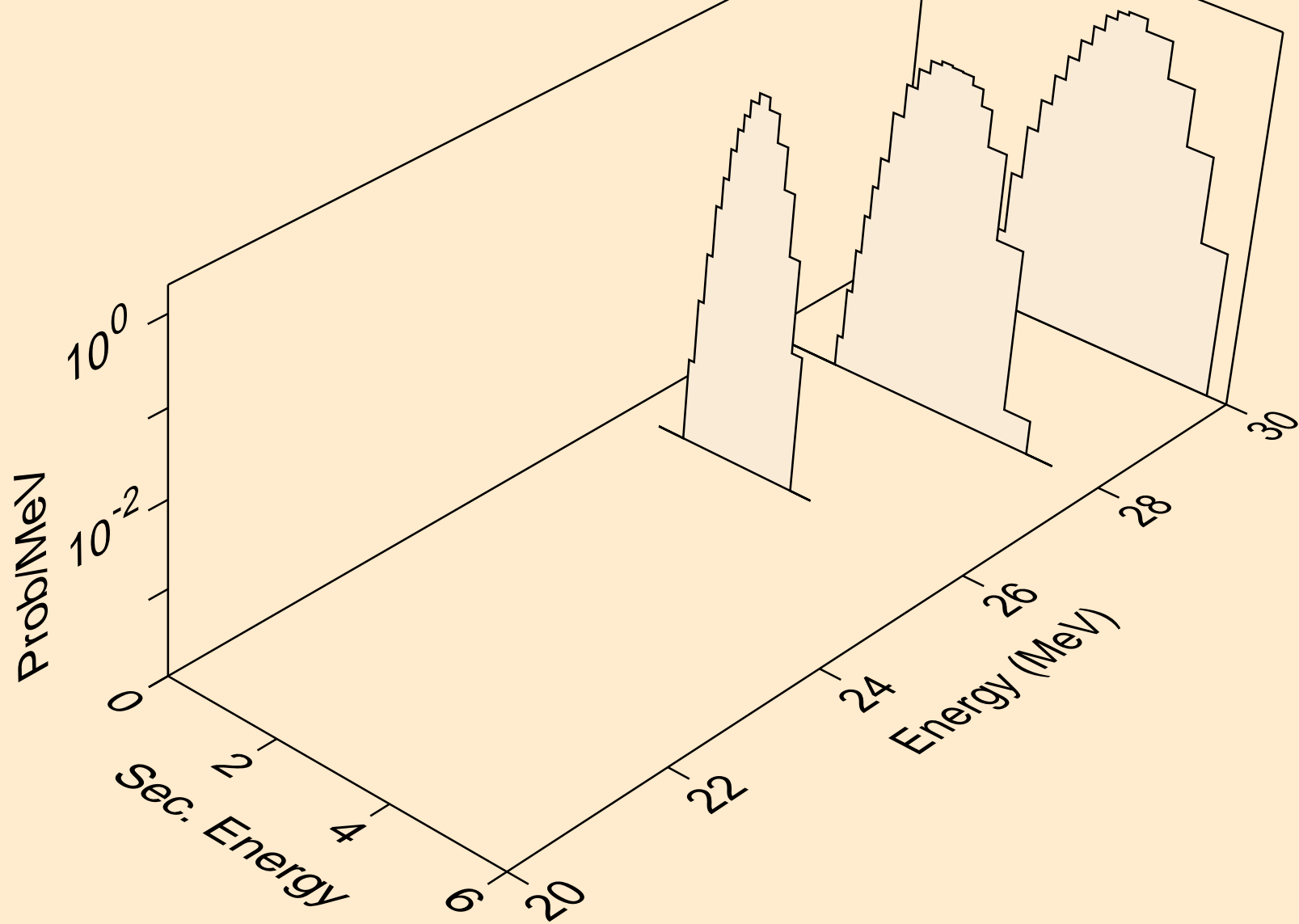

SC044M PHOTON ACER TENDL-2024 LIBRARY; T=0.K
alphas from (g,npa)

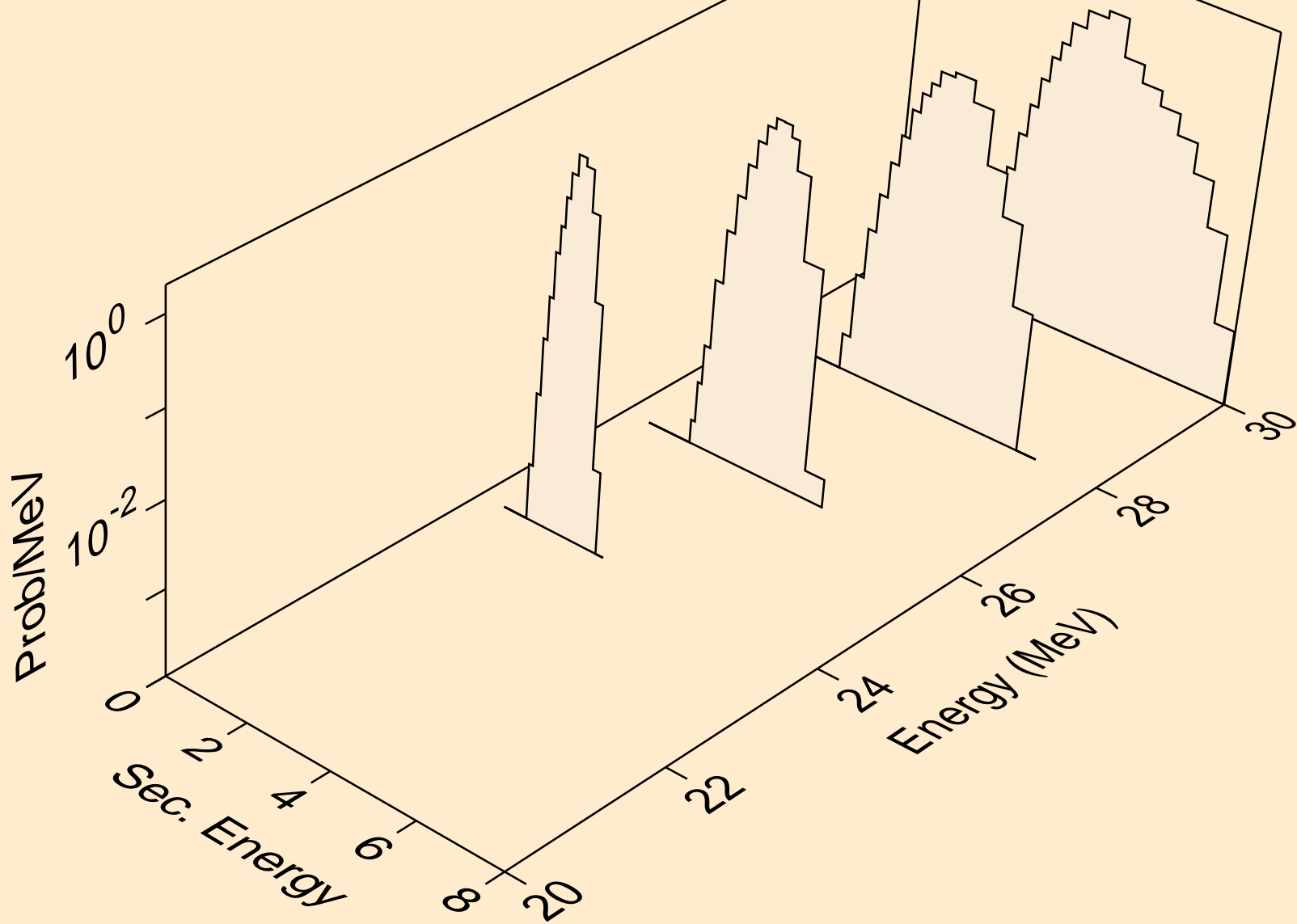

SC044M PHOTON ACER TENDL-2024 LIBRARY; T=0.K
alphas from (g,a)

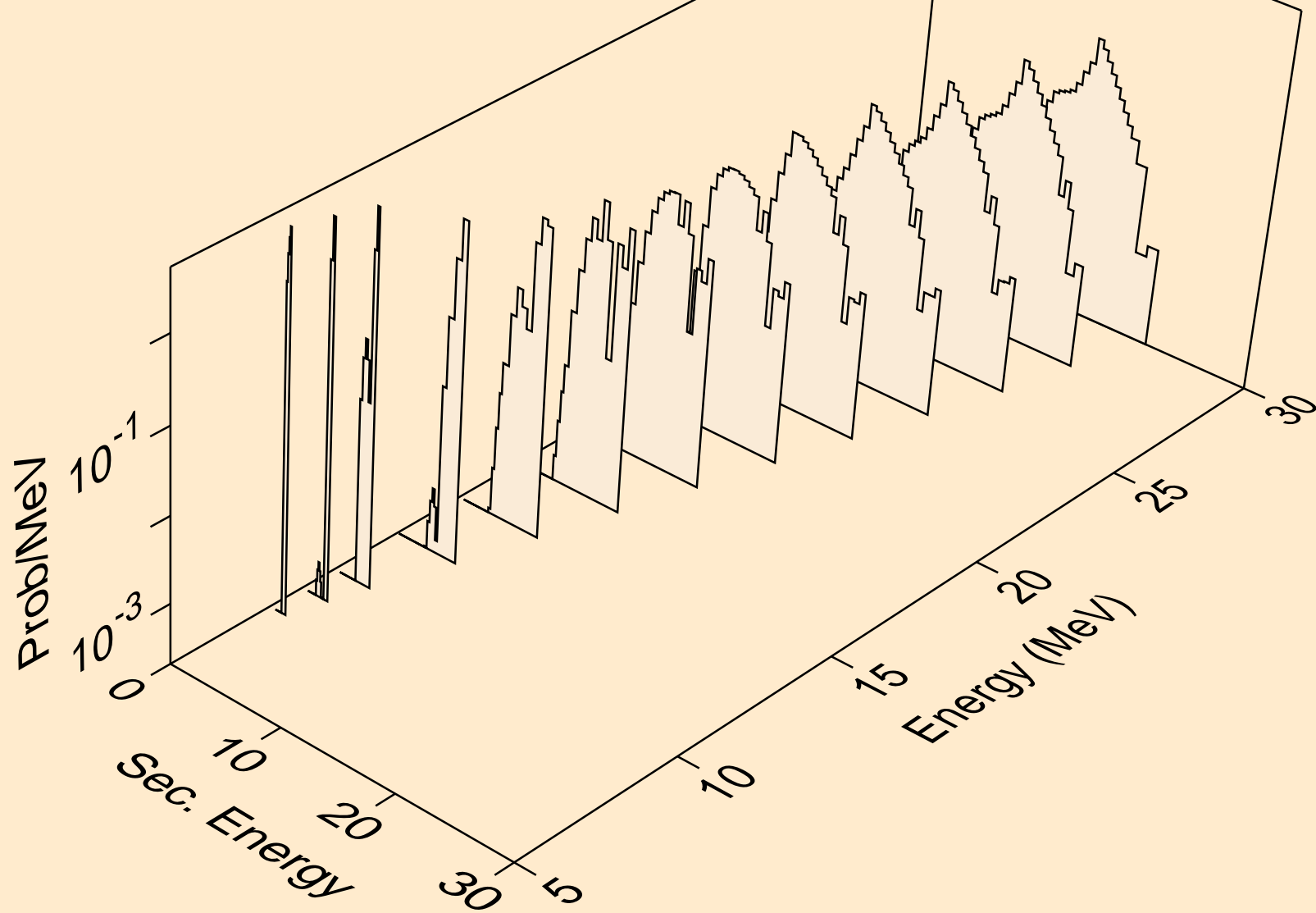

SC044M PHOTON ACER TENDL-2024 LIBRARY; T=0.K
alphas from (g,2a)

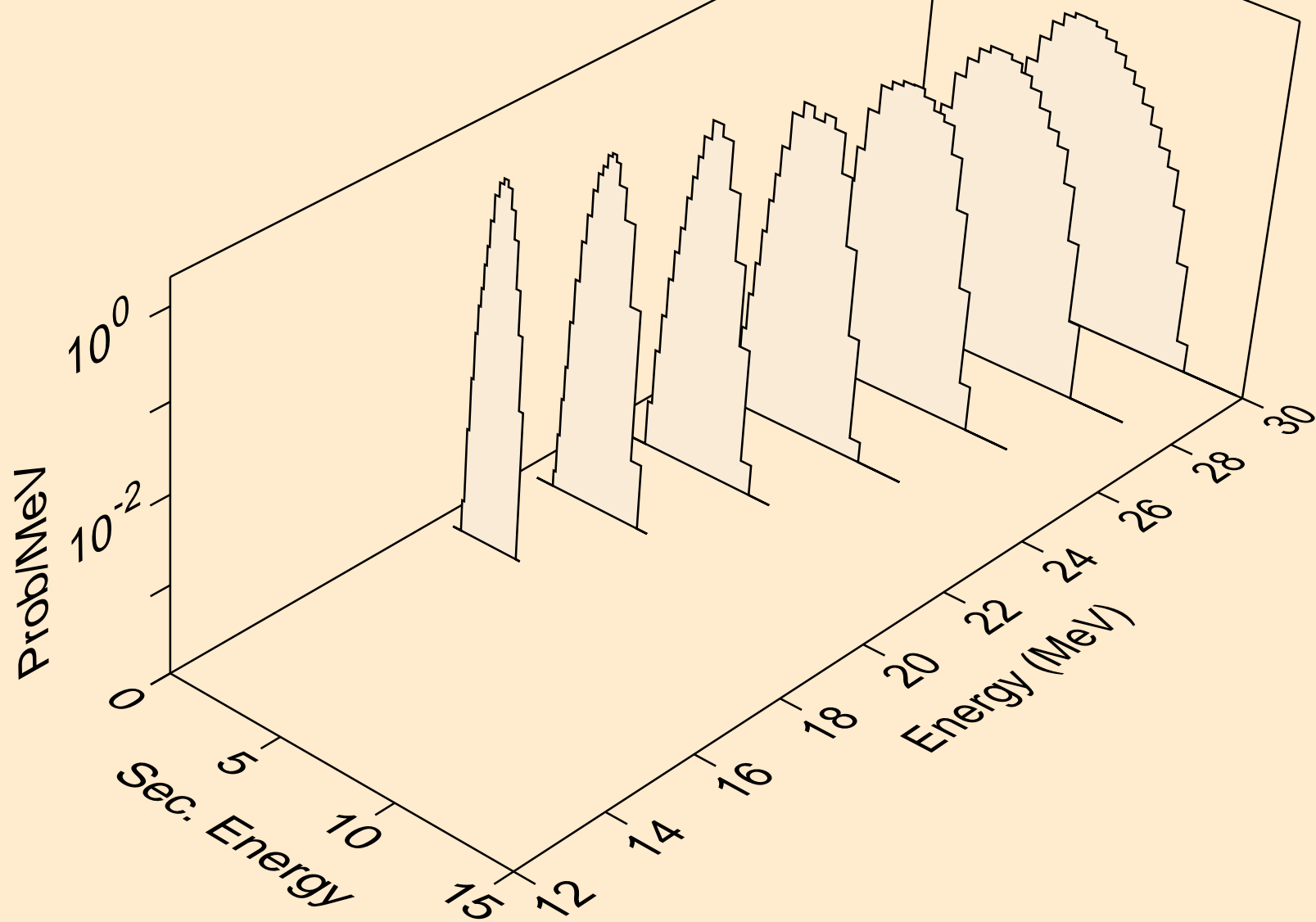

SC044M PHOTON ACER TENDL-2024 LIBRARY; T=0.K
alphas from (g,pa)

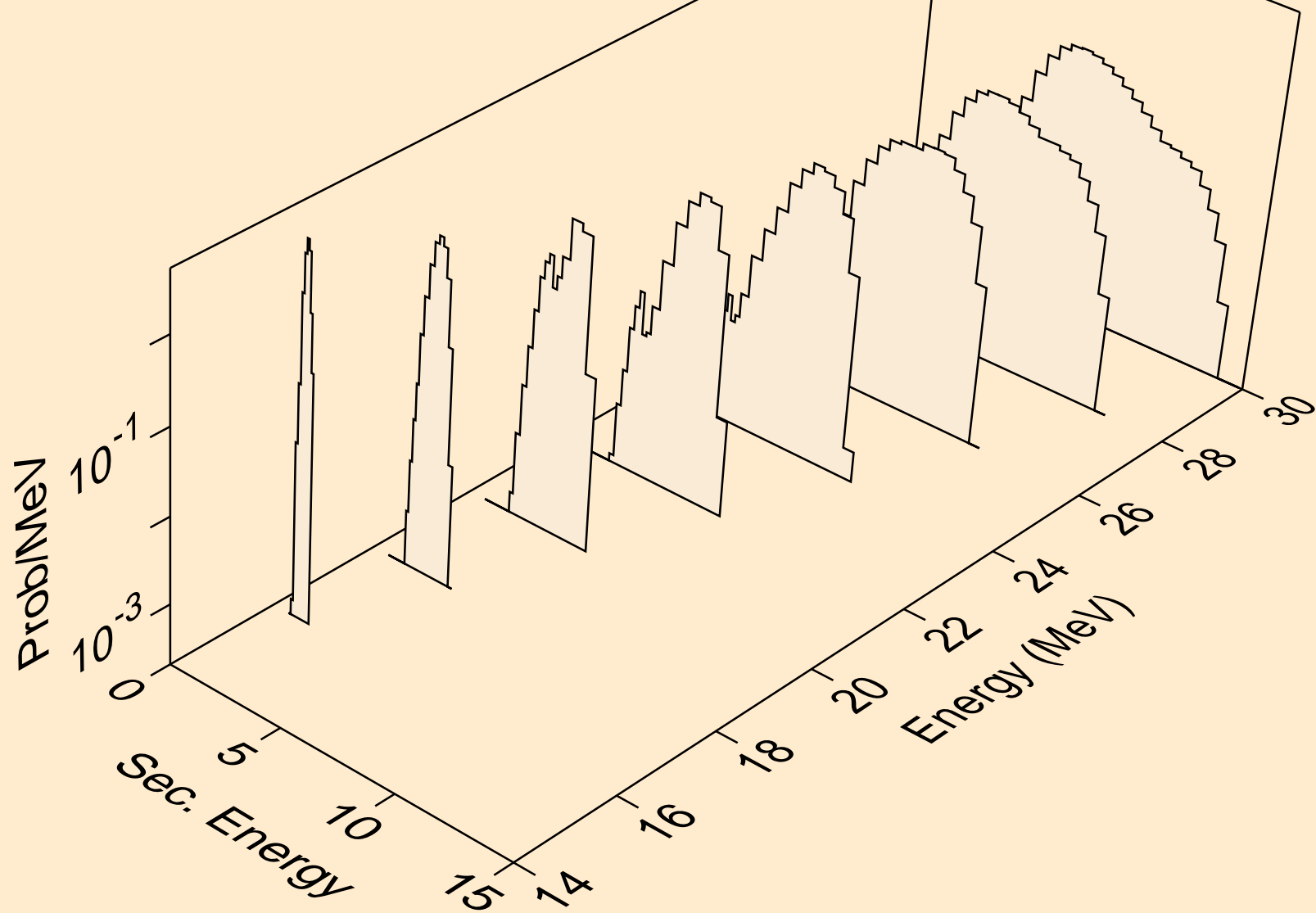

SC044M PHOTON ACER TENDL-2024 LIBRARY; T=0.K
alphas from (g,da)

