

SN131M PHOTON ACER TENDL-2024 LIBRARY; T=0.K

Principal cross sections

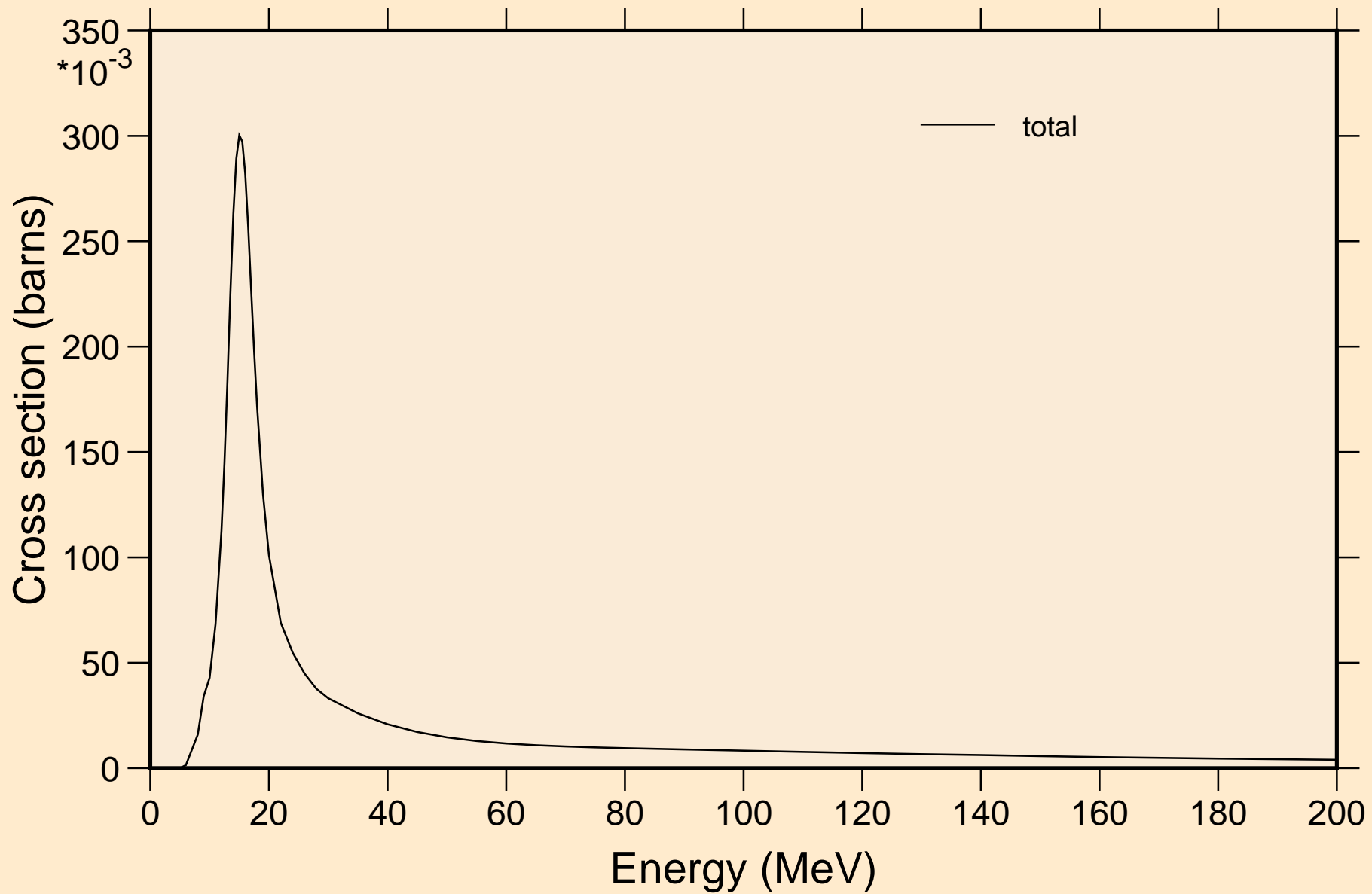

SN131M PHOTON ACER TENDL-2024 LIBRARY; T=0.K

Partial cross sections

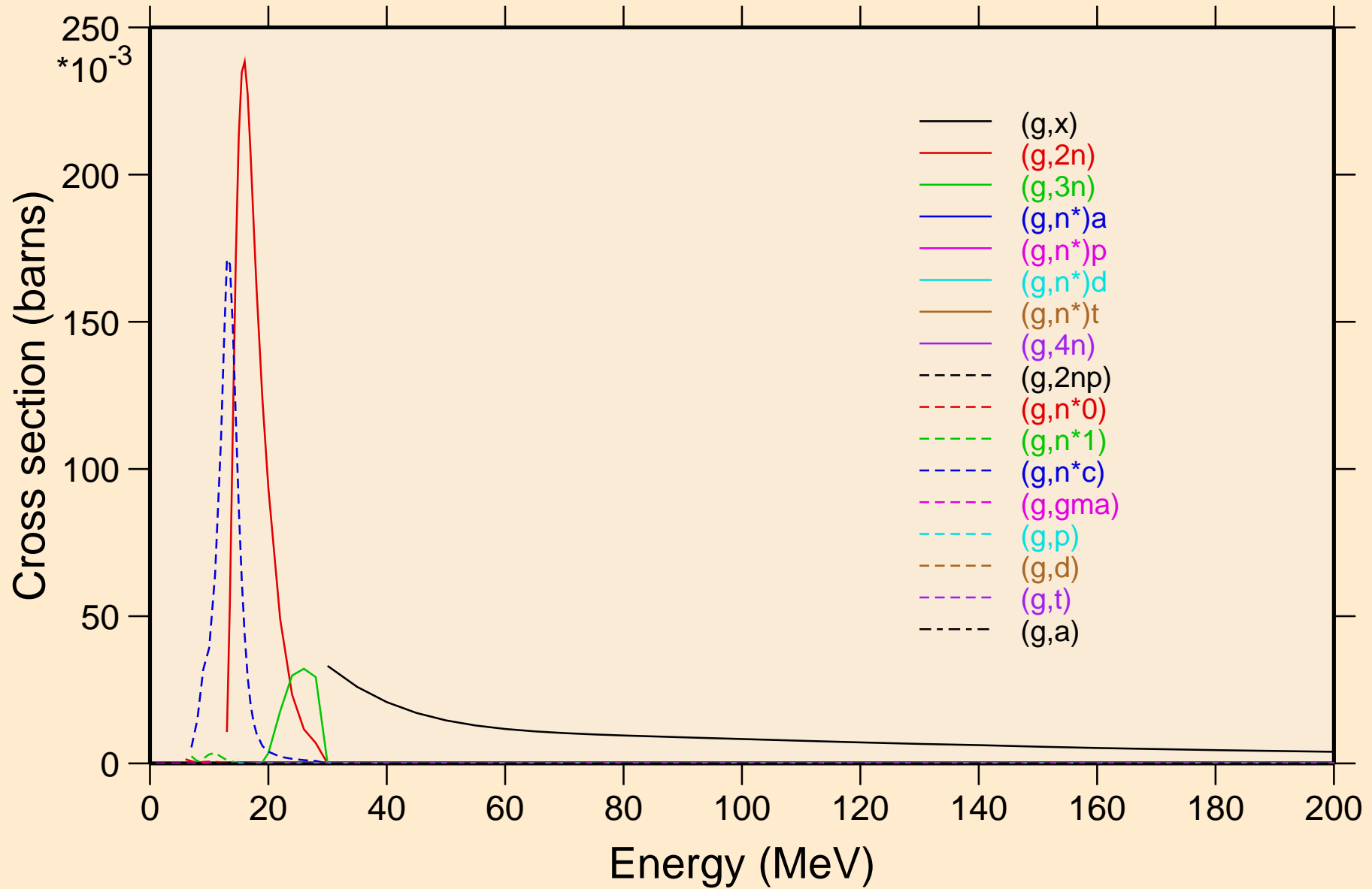

SN131M PHOTON ACER TENDL-2024 LIBRARY; T=0.K

Heating

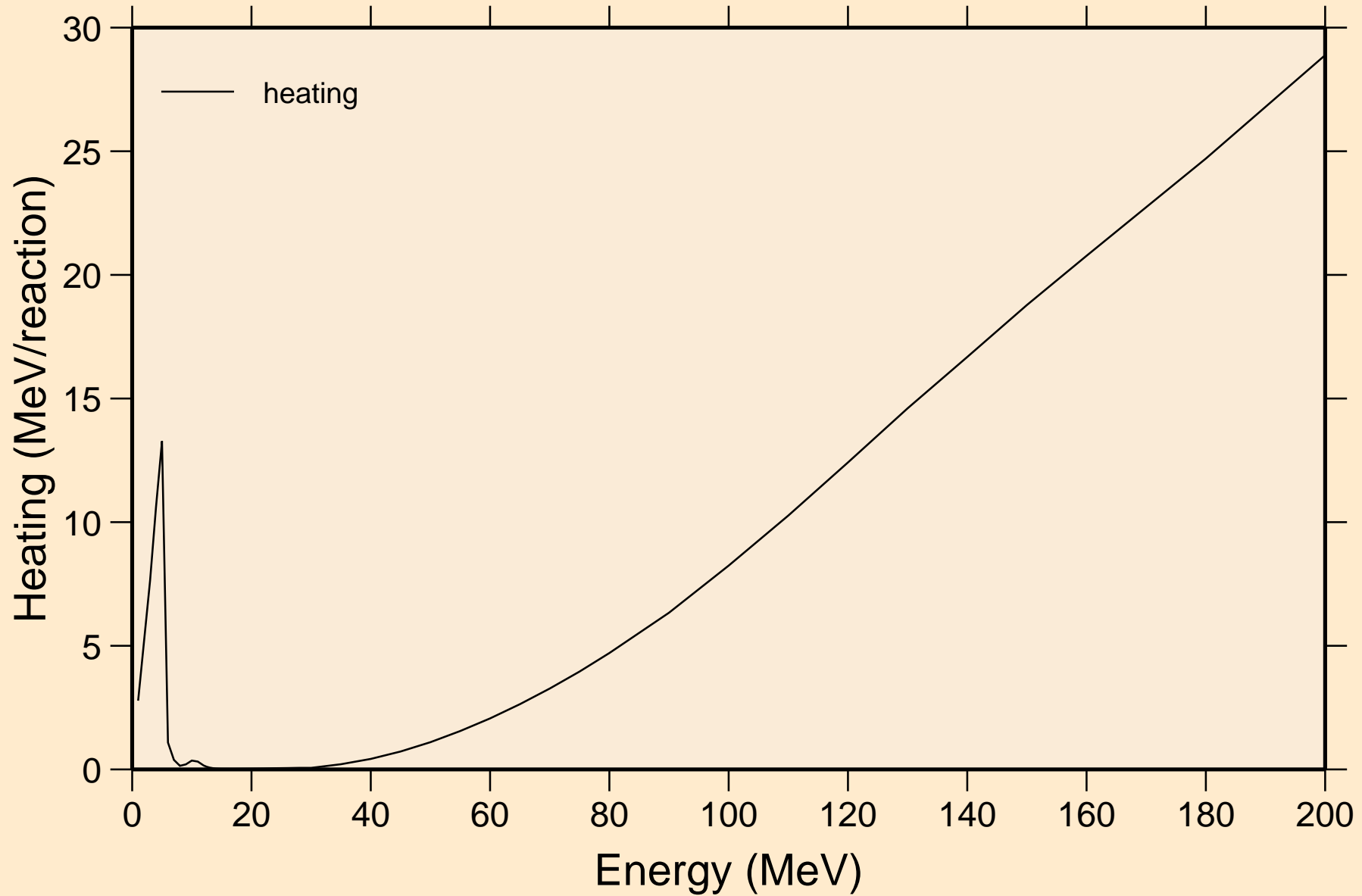

SN131M PHOTON ACER TENDL-2024 LIBRARY; T=0.K

Particle heating contributions

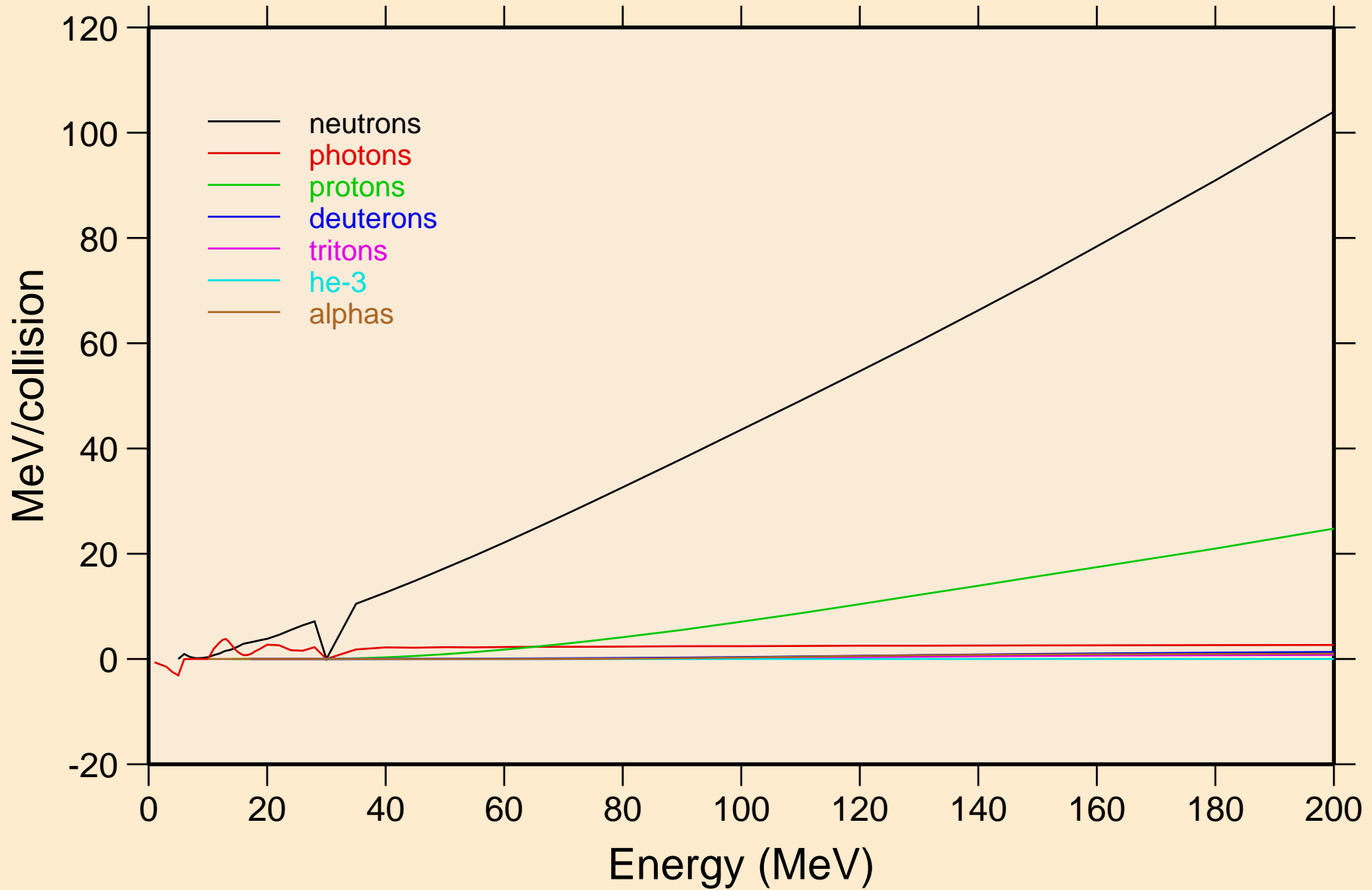

SN131M PHOTON ACER TENDL-2024 LIBRARY; T=0.K

Particle production cross sections

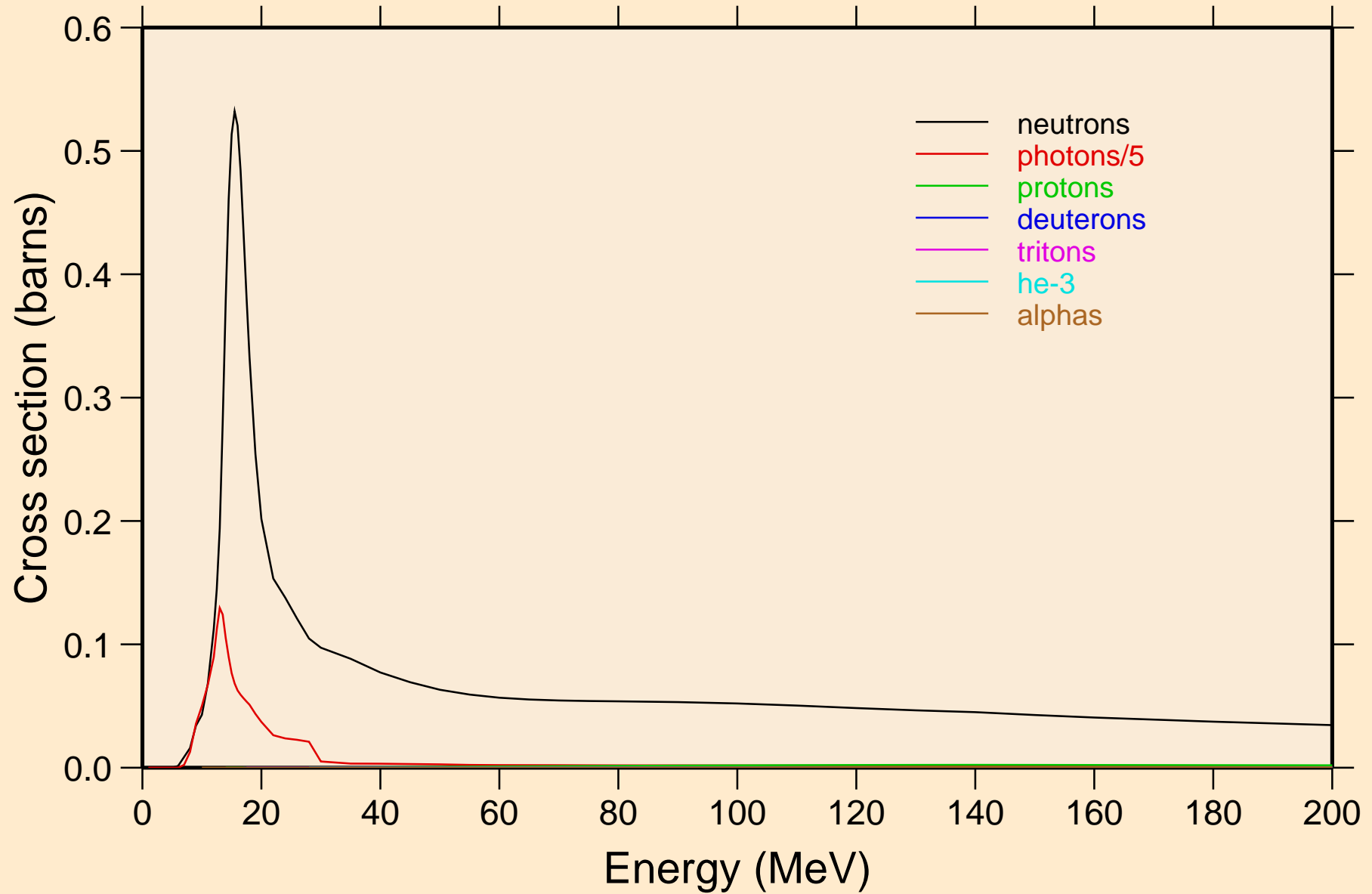

SN131M PHOTON ACER TENDL-2024 LIBRARY; T=0.K
neutrons from (g,x)

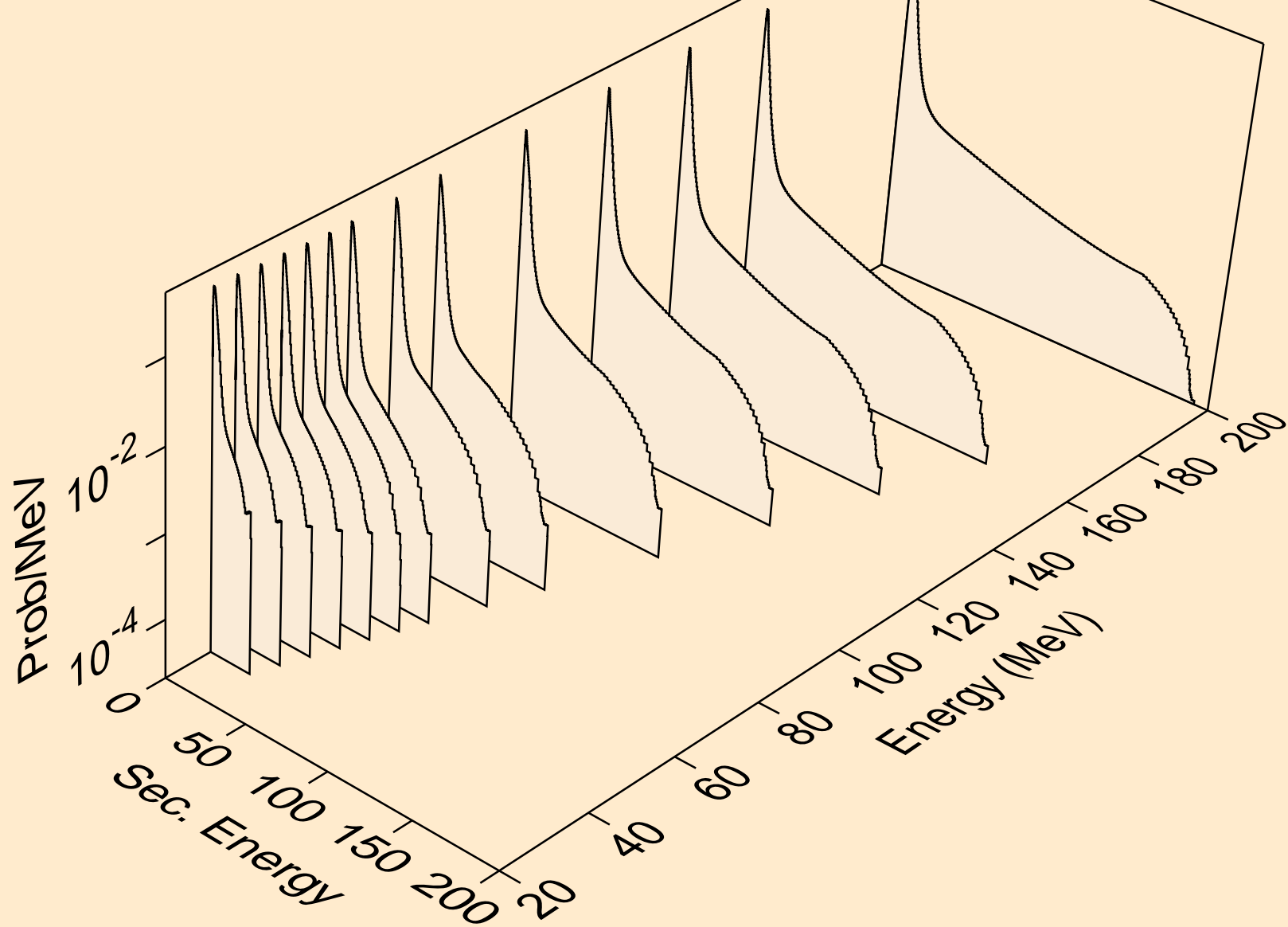

SN131M PHOTON ACER TENDL-2024 LIBRARY; T=0.K
neutrons from (g,2n)

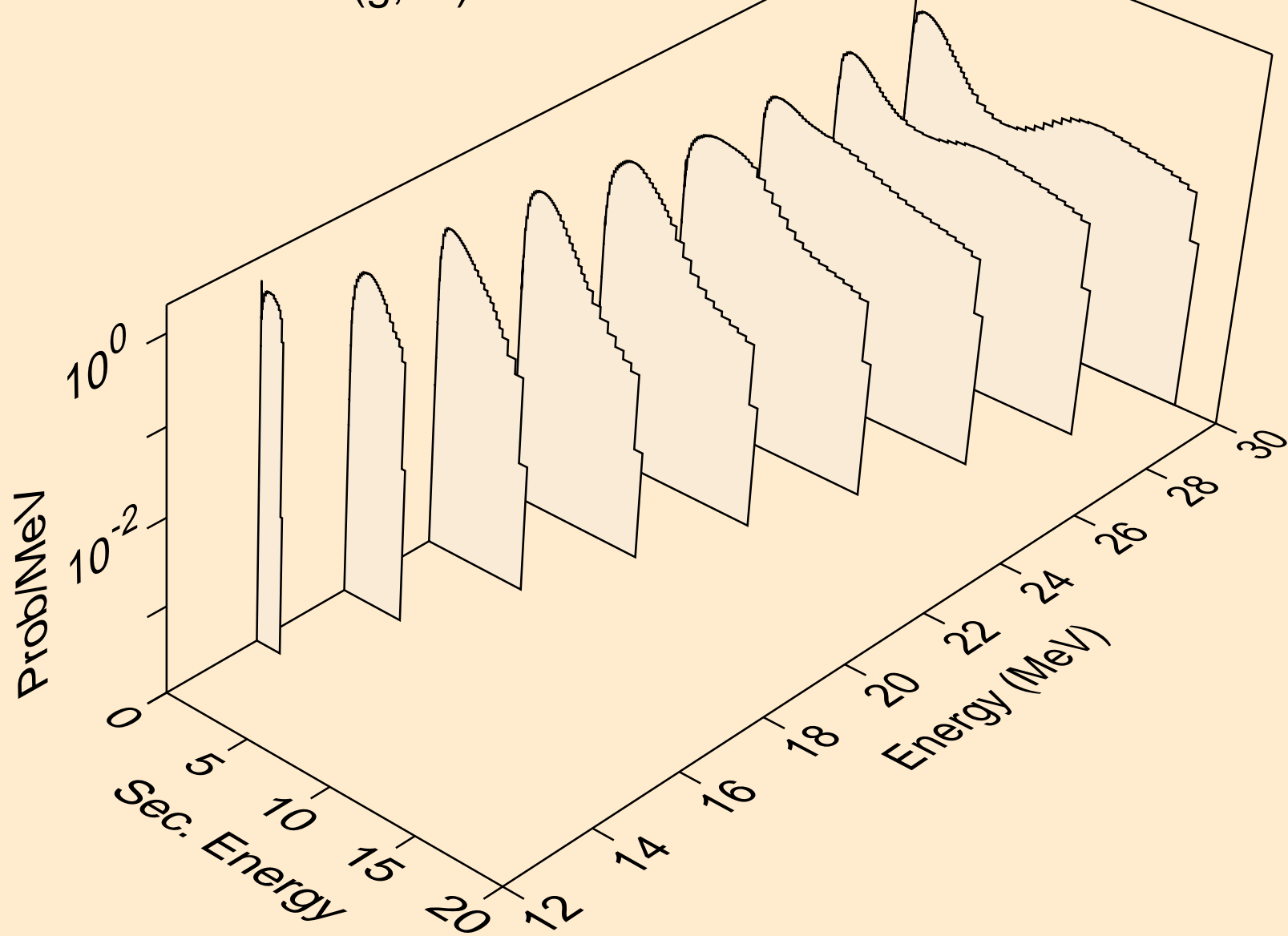

SN131M PHOTON ACER TENDL-2024 LIBRARY; T=0.K
neutrons from (g,3n)

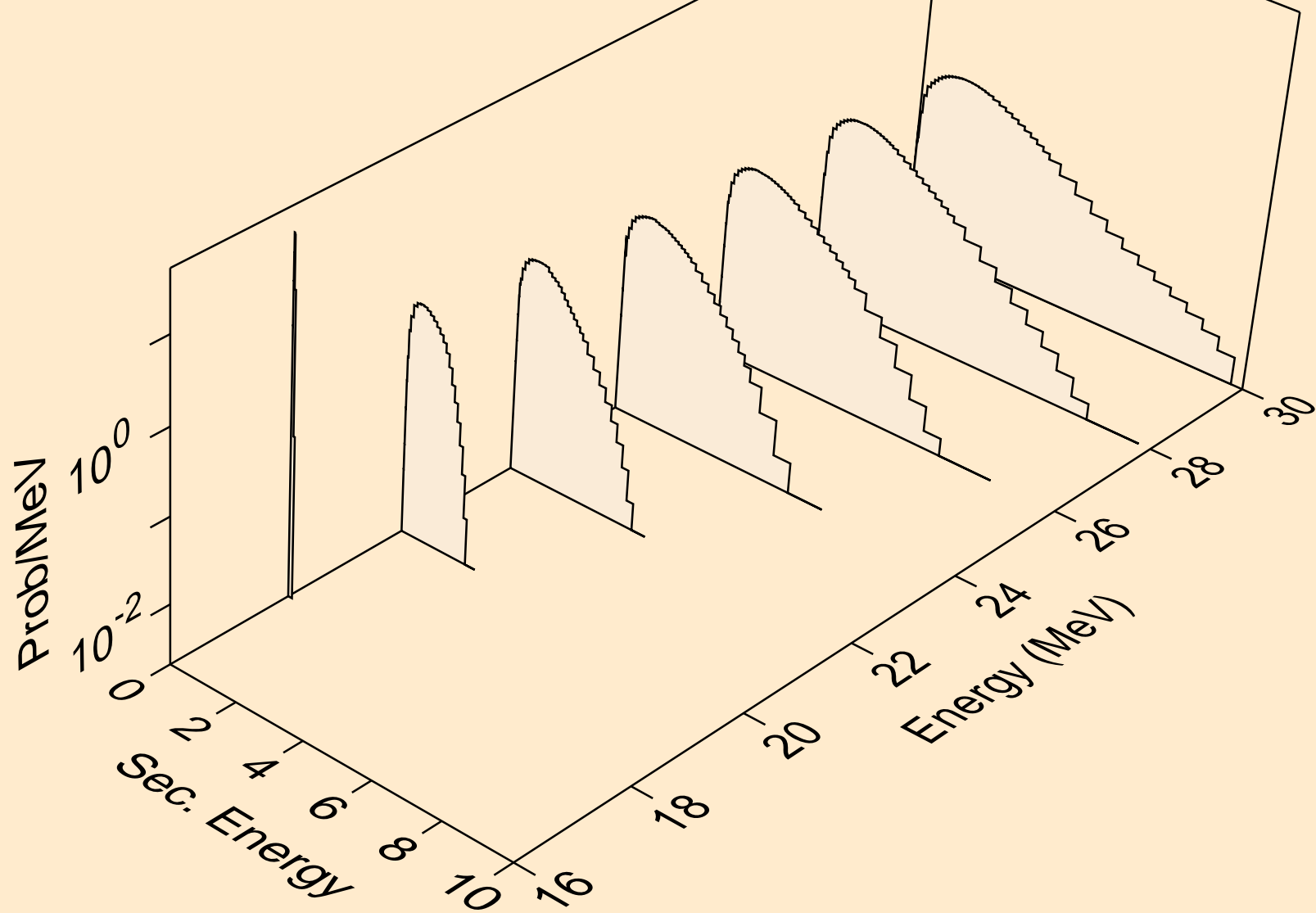

SN131M PHOTON ACER TENDL-2024 LIBRARY; T=0.K
neutrons from (g,n*)a

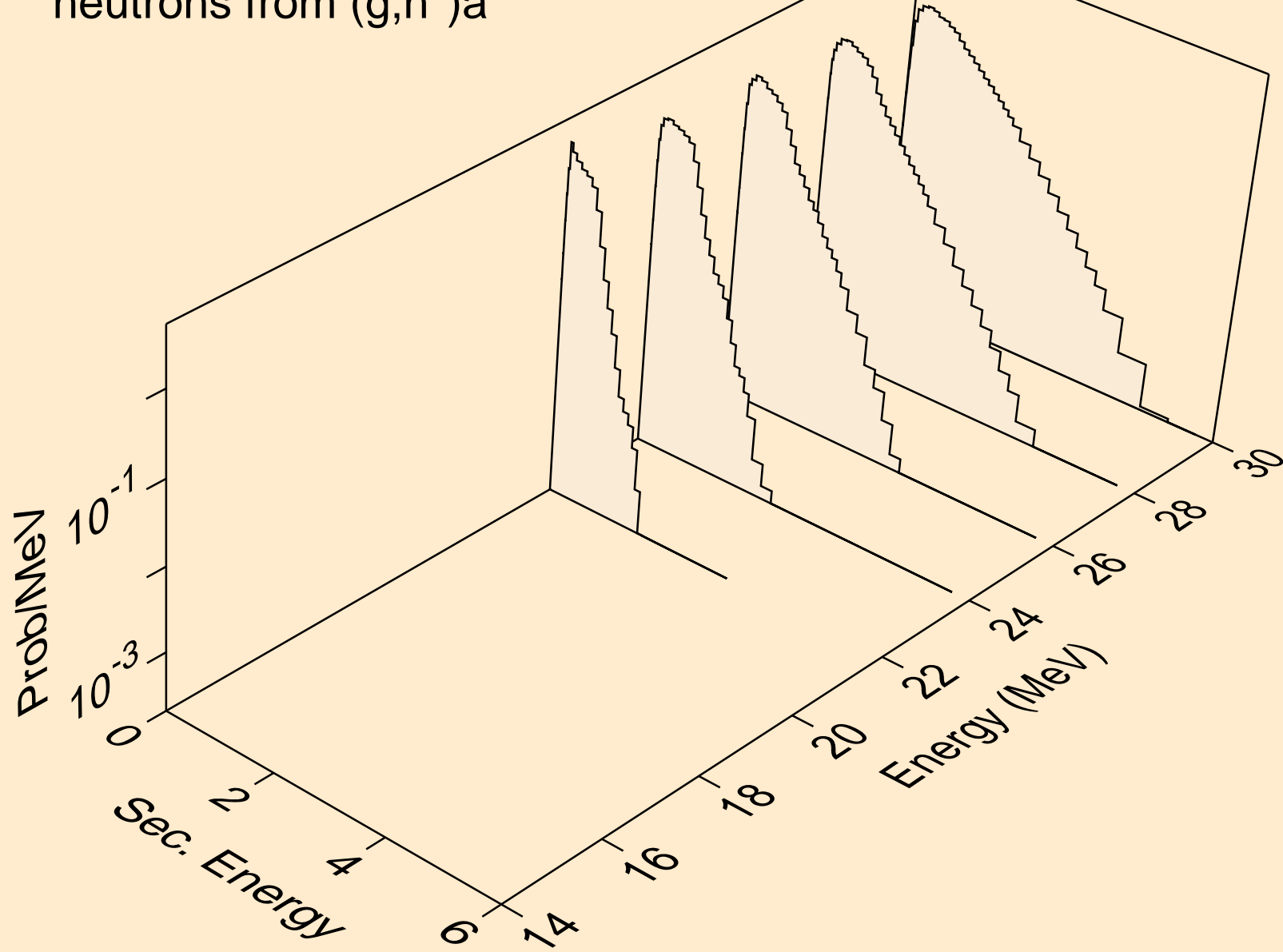

SN131M PHOTON ACER TENDL-2024 LIBRARY; T=0.K
neutrons from (g,n*)p

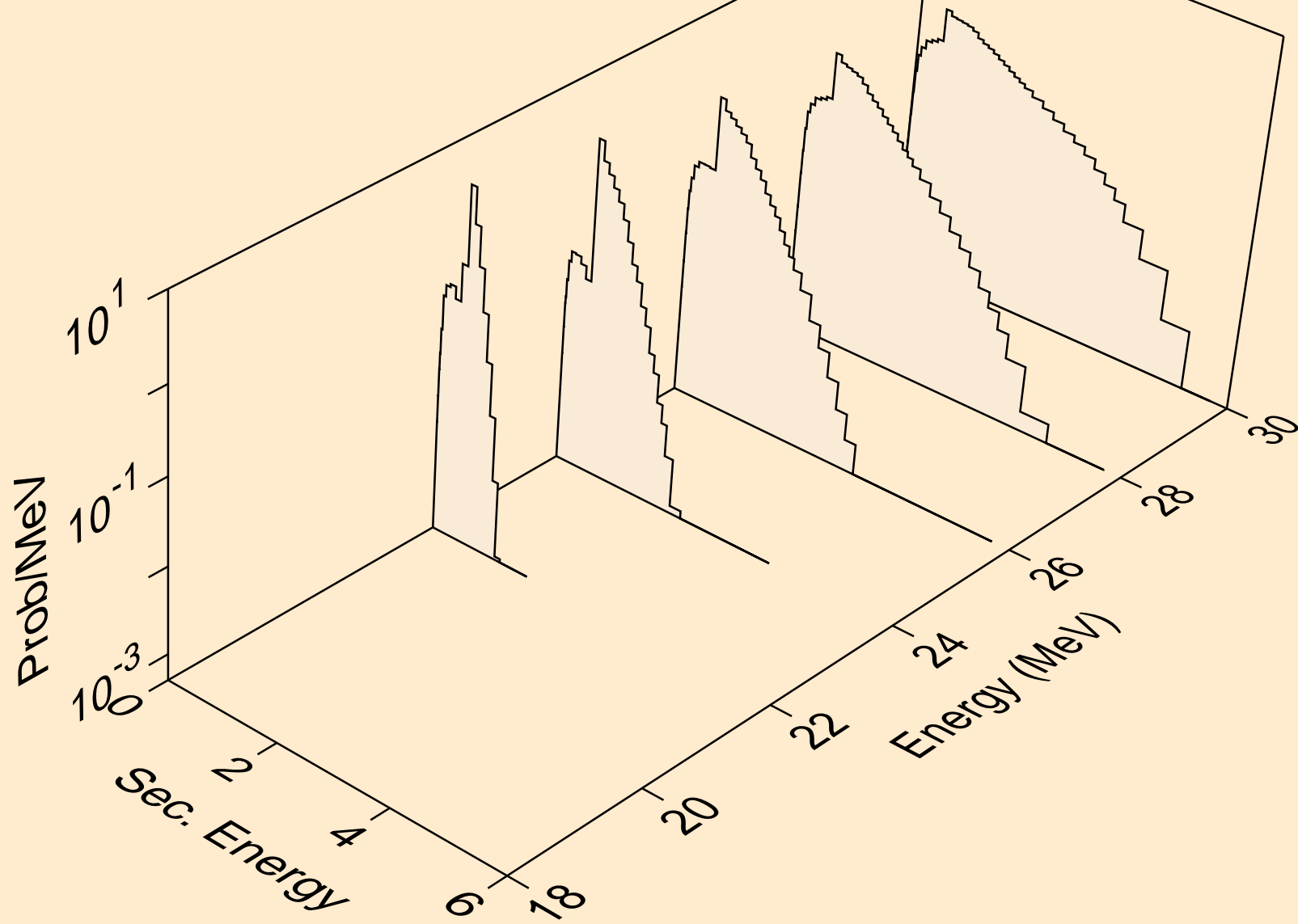

SN131M PHOTON ACER TENDL-2024 LIBRARY; T=0.K
neutrons from (g,n*)d

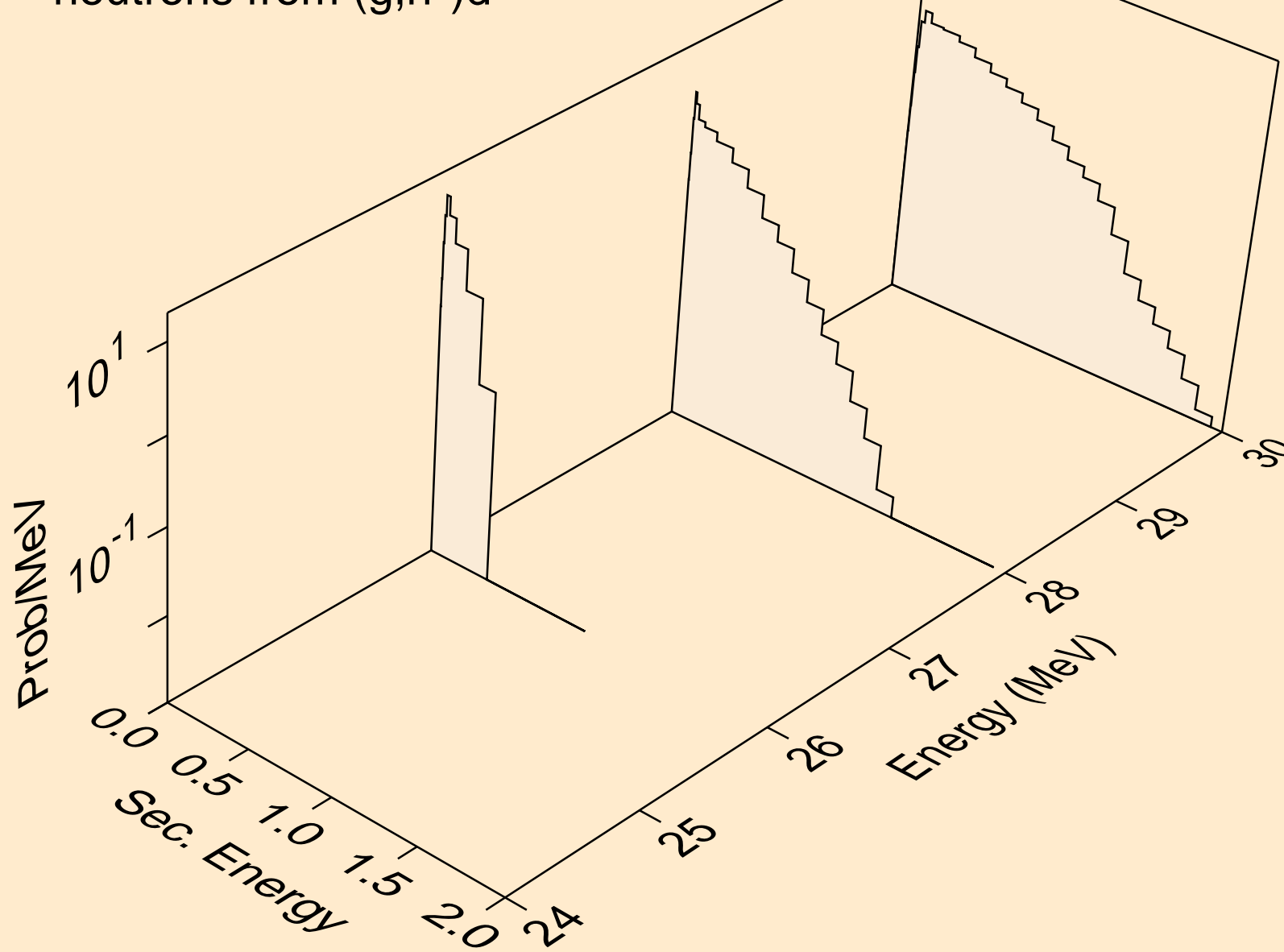

SN131M PHOTON ACER TENDL-2024 LIBRARY; T=0.K
neutrons from (g,n*)t

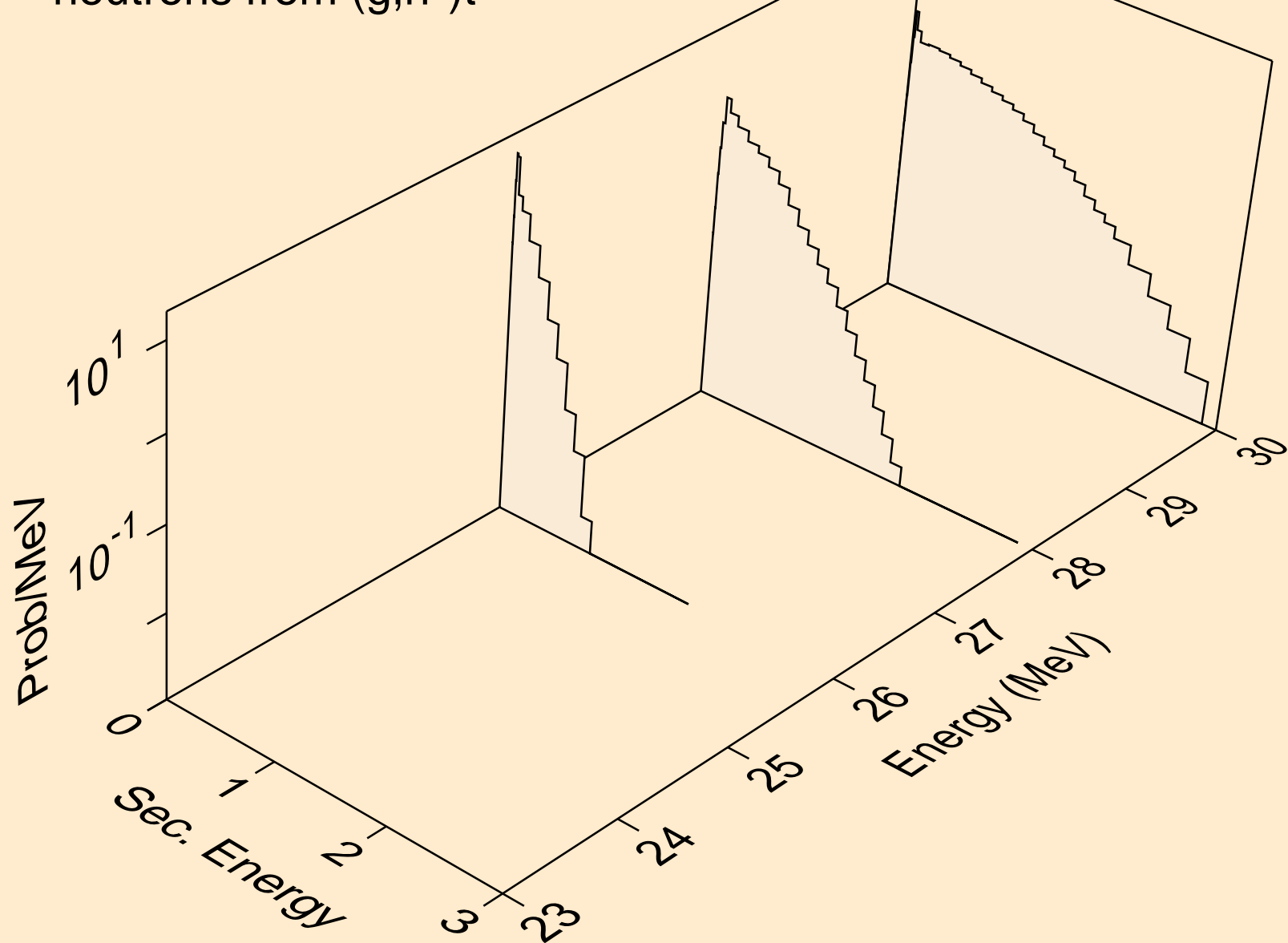

SN131M PHOTON ACER TENDL-2024 LIBRARY; T=0.K
neutrons from (g,4n)

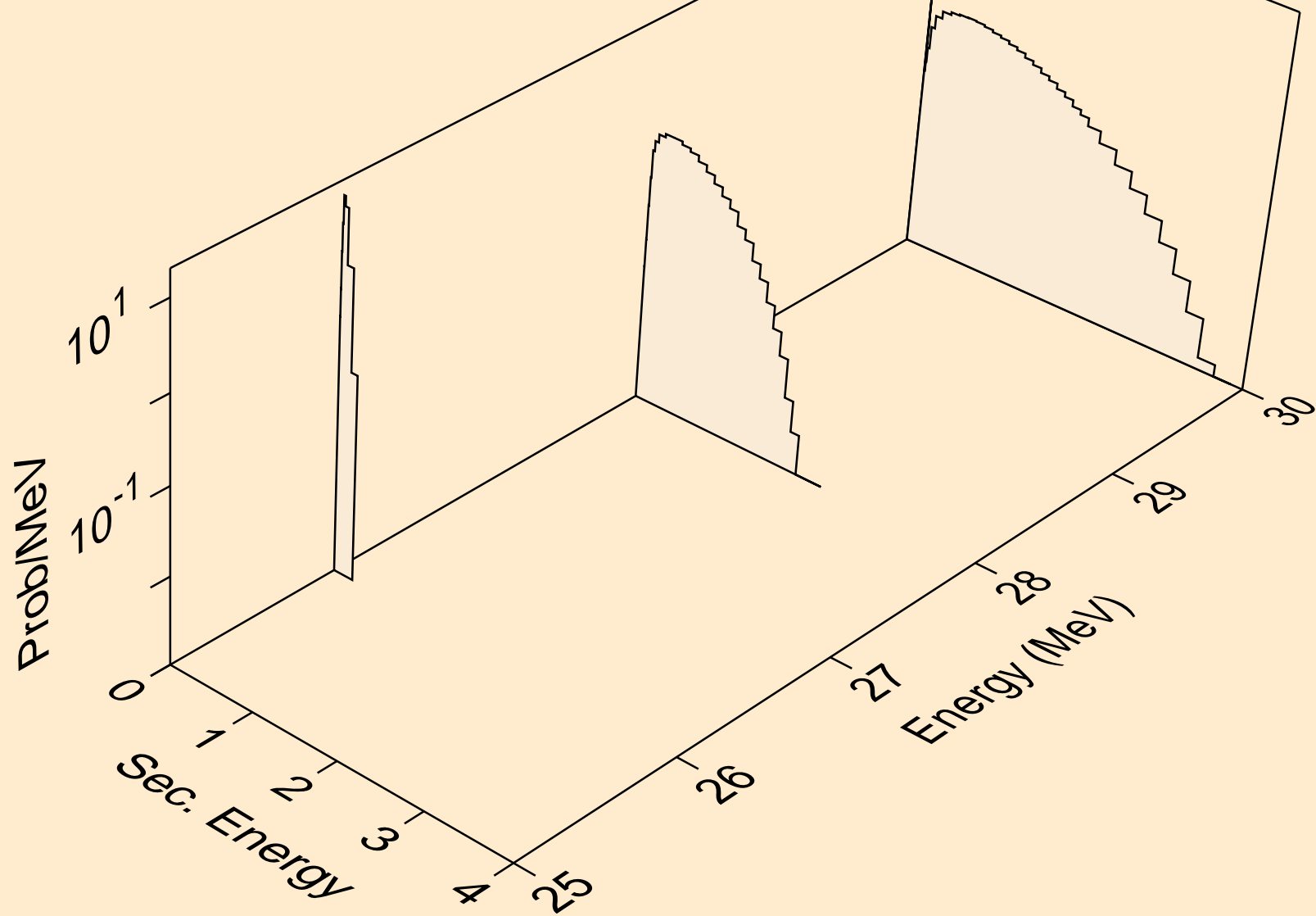

SN131M PHOTON ACER TENDL-2024 LIBRARY; T=0.K
neutrons from (g,2np)

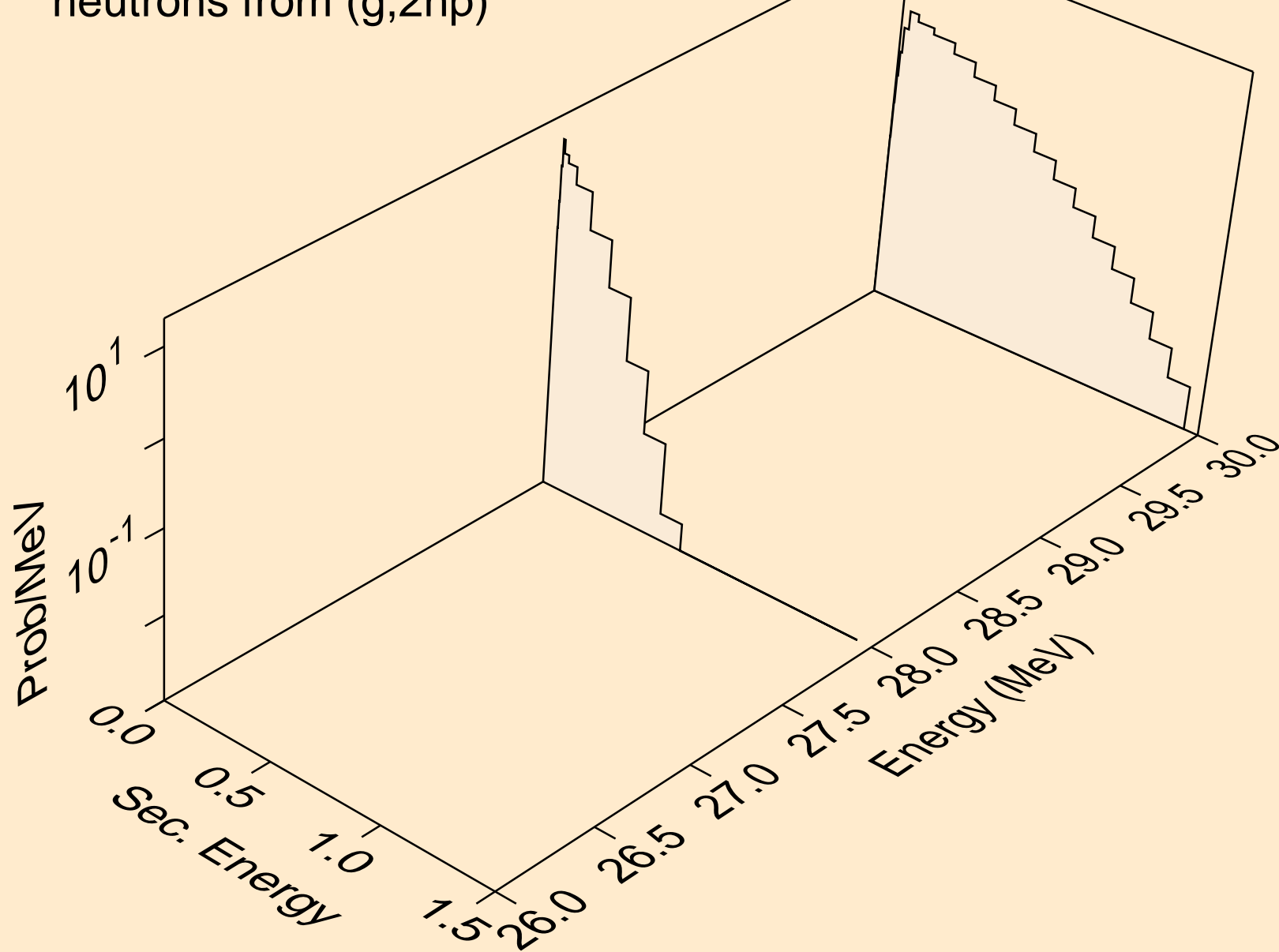

SN131M PHOTON ACER TENDL-2024 LIBRARY; T=0.K
angular distribution for (g,n*0) neutron

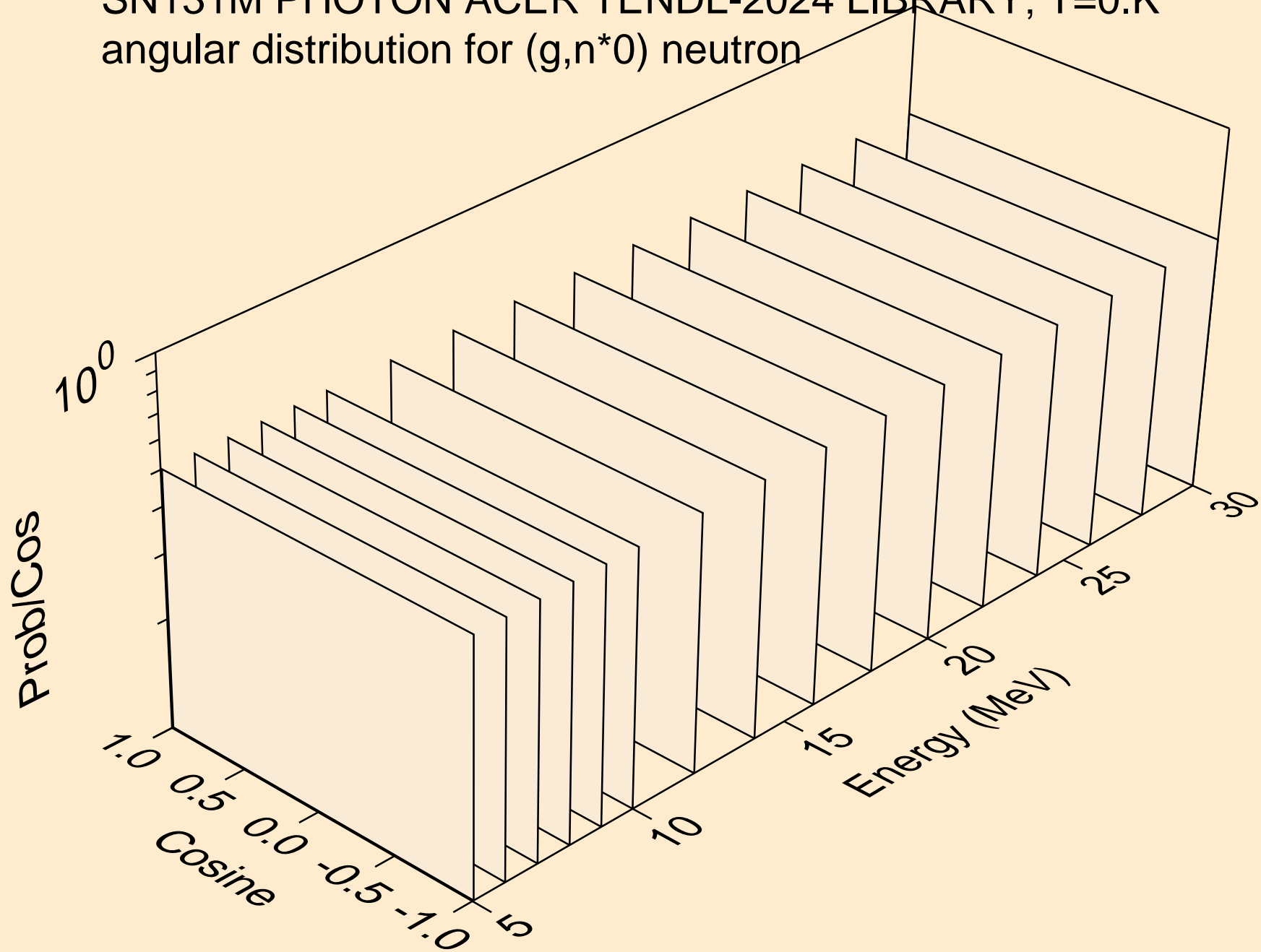

SN131M PHOTON ACER TENDL-2024 LIBRARY; T=0.K
angular distribution for (g,n*1) neutron

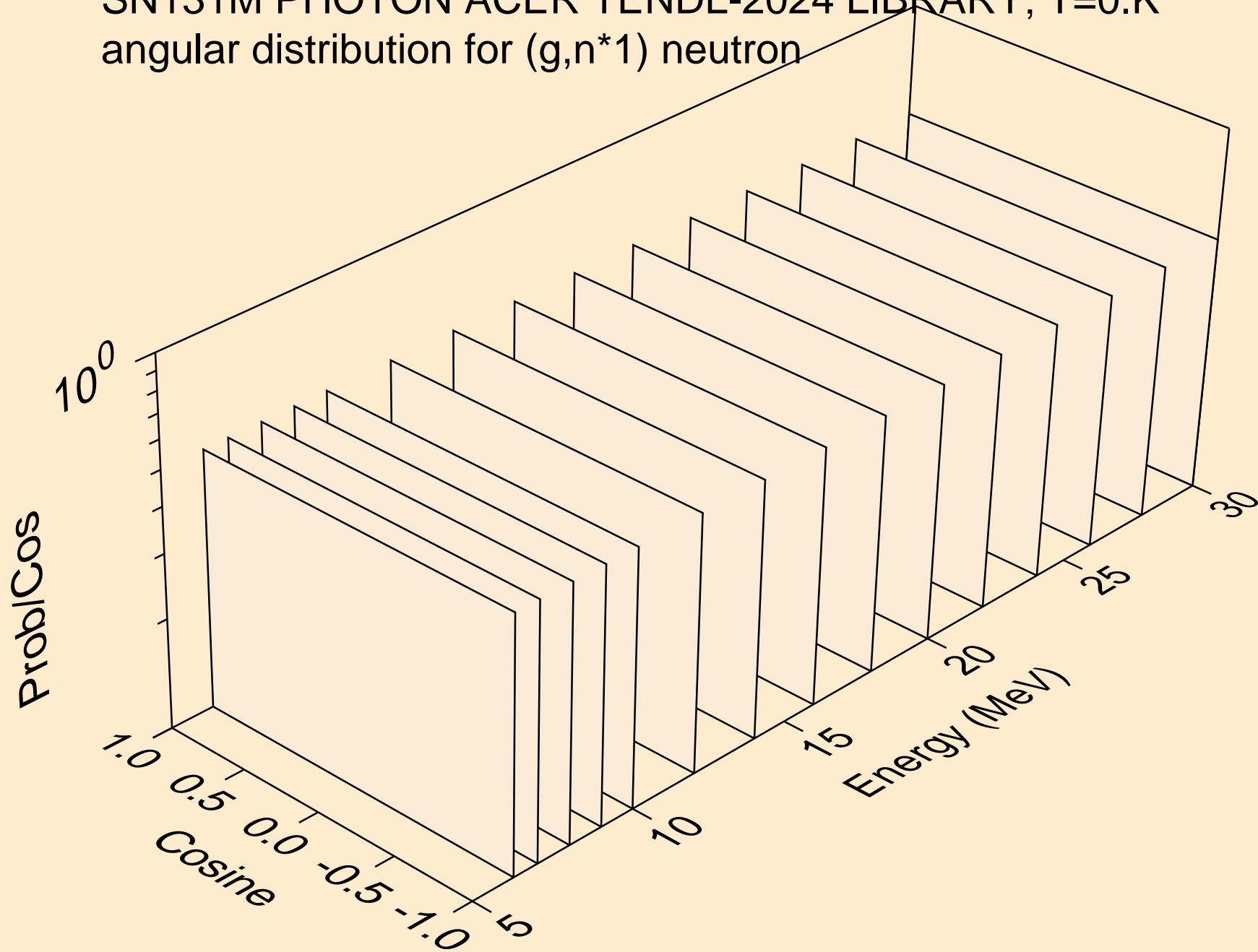

SN131M PHOTON ACER TENDL-2024 LIBRARY; T=0.K
neutrons from (g,n*c)

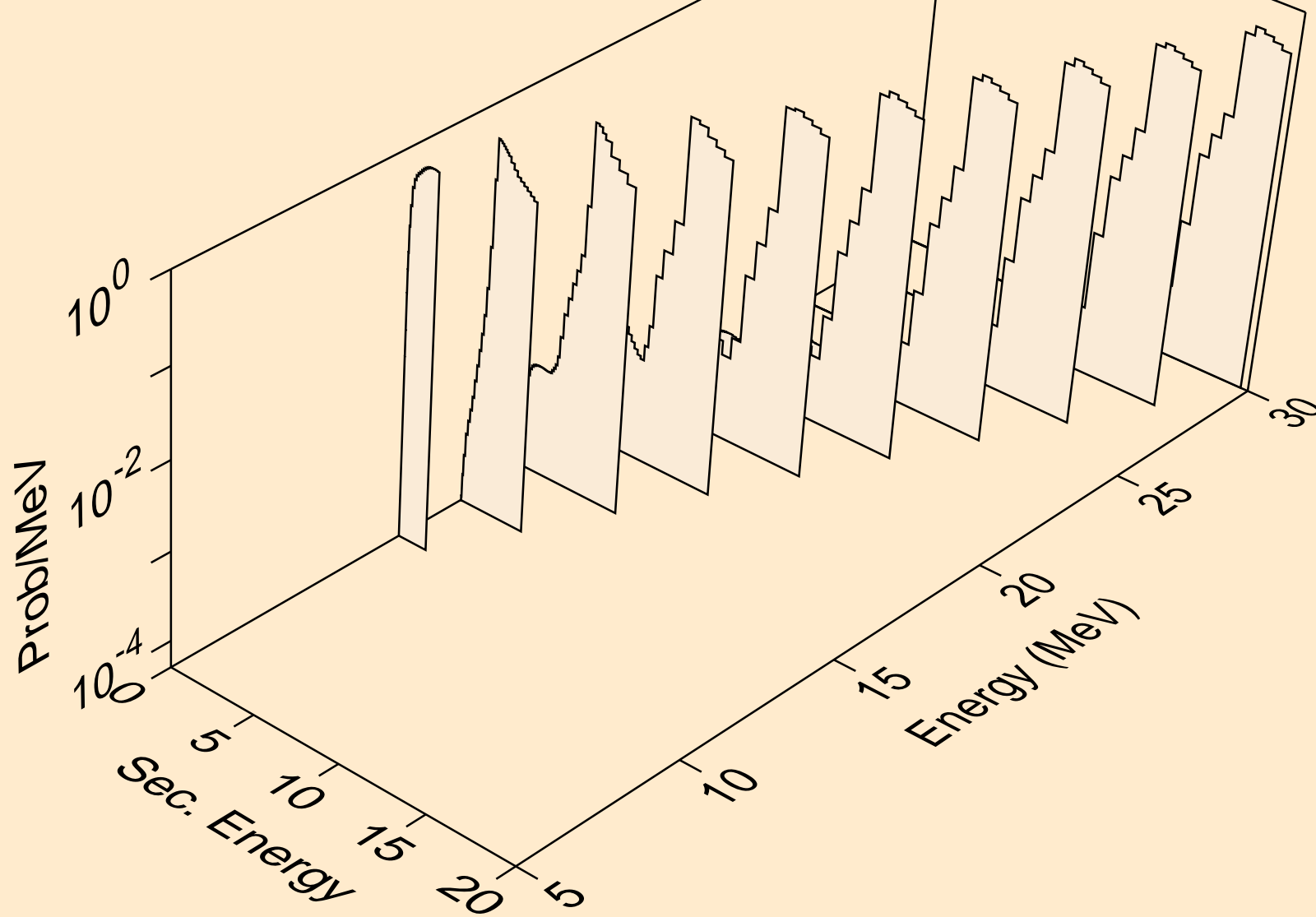

SN131M PHOTON ACER TENDL-2024 LIBRARY; T=0.K
photons from (g,x)

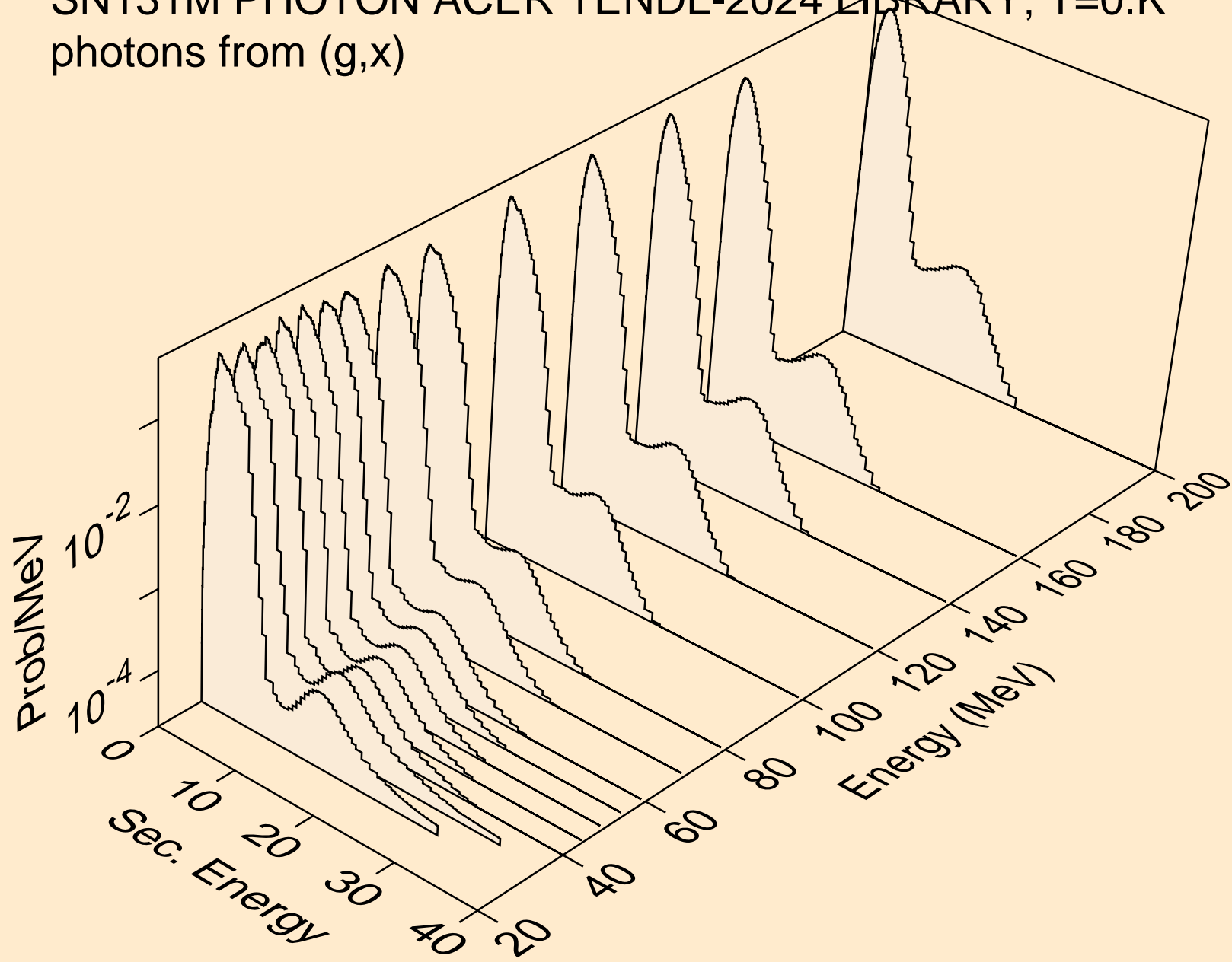

SN131M PHOTON ACER TENDL-2024 LIBRARY; T=0.K
photons from (g,2n)

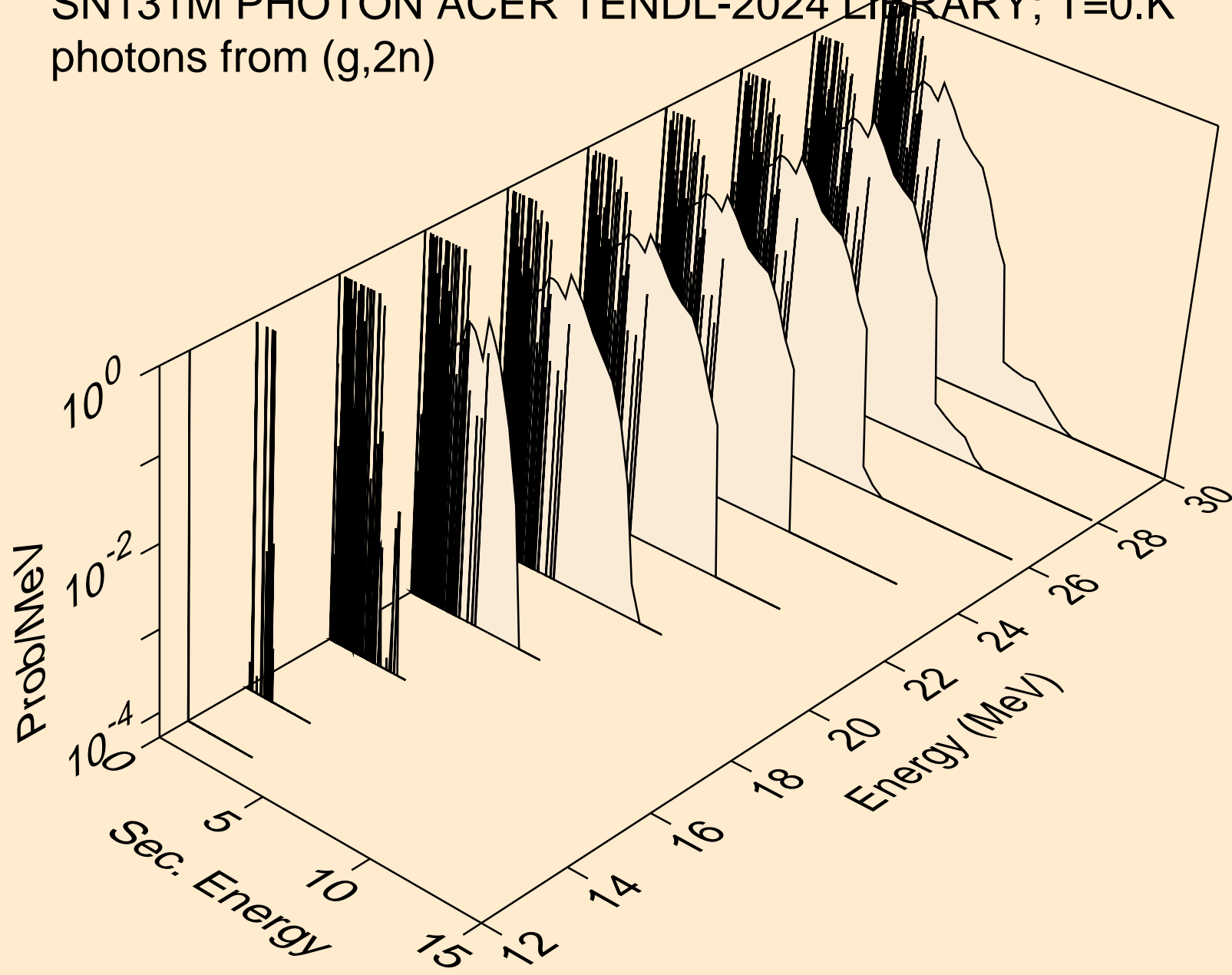

SN131M PHOTON ACER TENDL-2024 LIBRARY; T=0.K
photons from (g,3n)

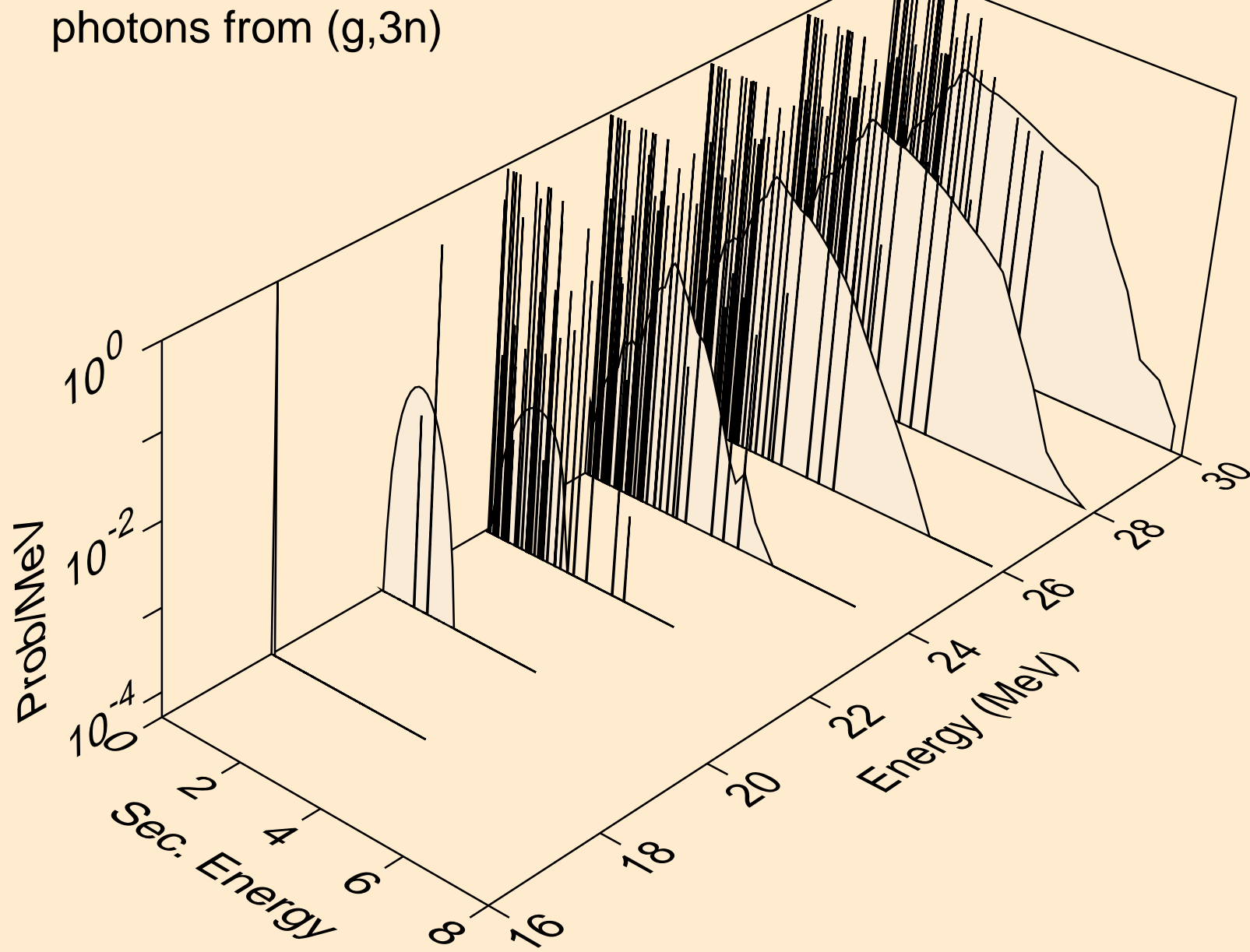

SN131M PHOTON ACER TENDL-2024 LIBRARY; T=0.K
photons from (g,n*)a

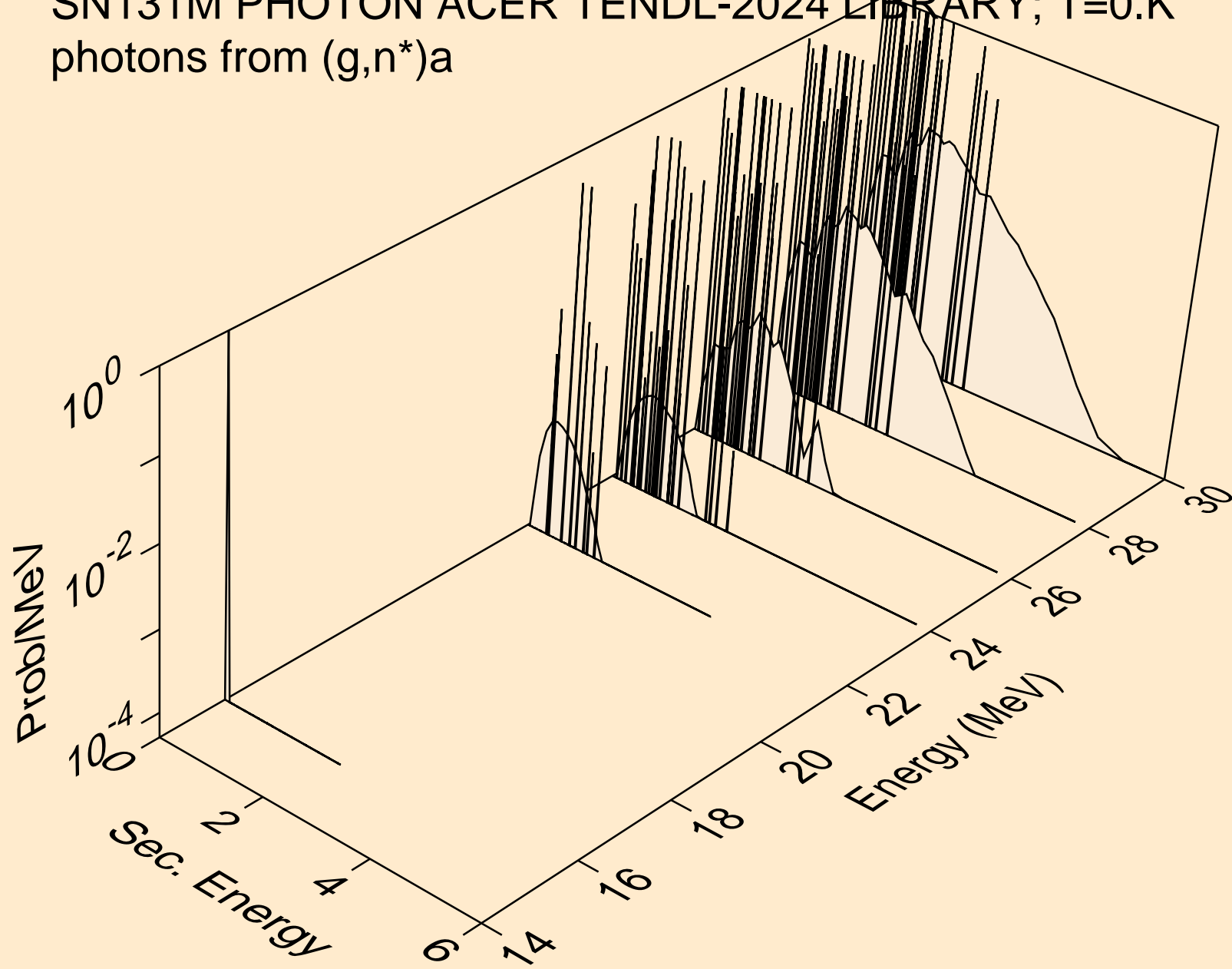

SN131M PHOTON ACER TENDL-2024 LIBRARY; T=0.K
photons from (g,n*)p

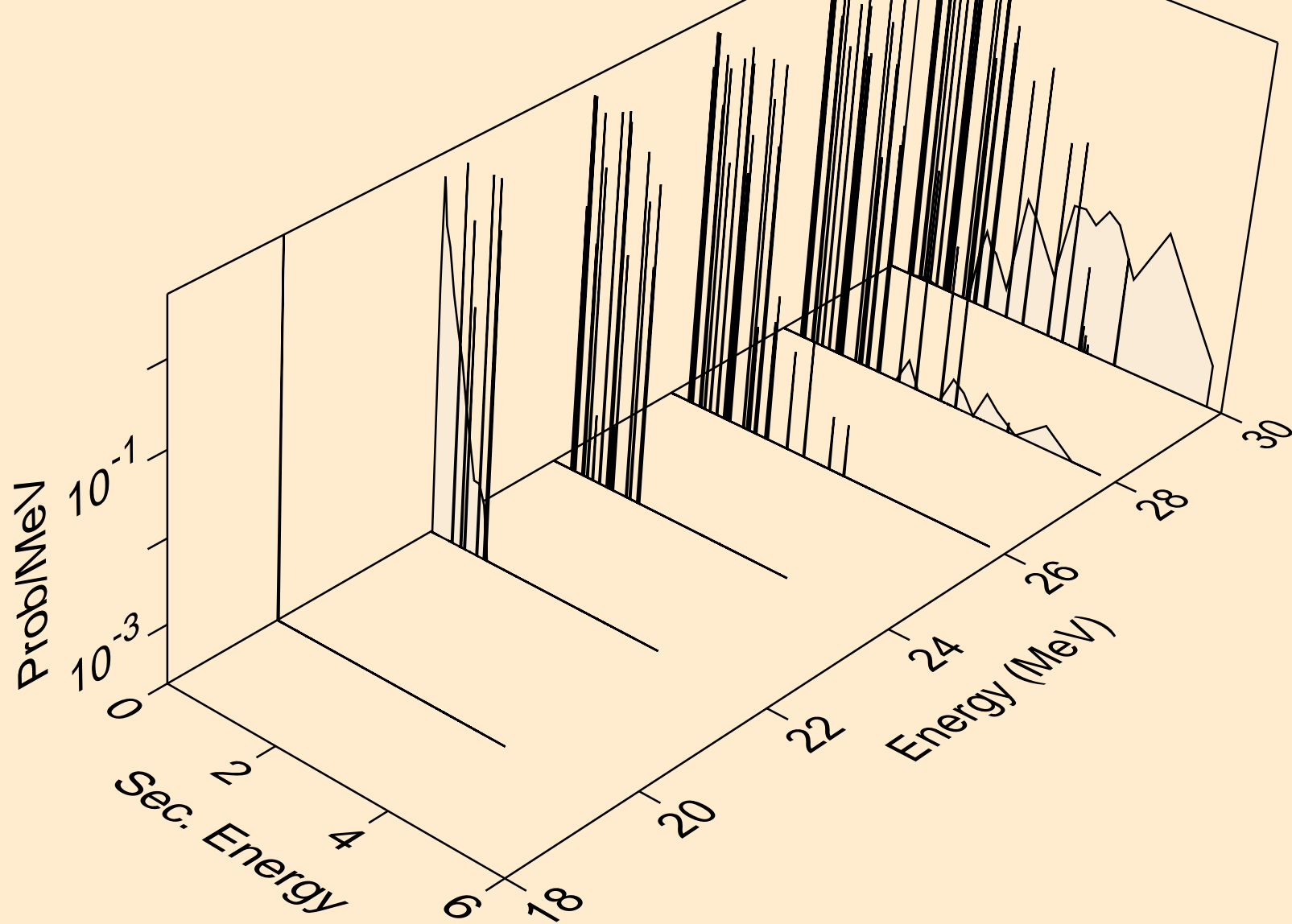

SN131M PHOTON ACER TENDL-2024 LIBRARY; T=0.K
photons from (g,n*)d

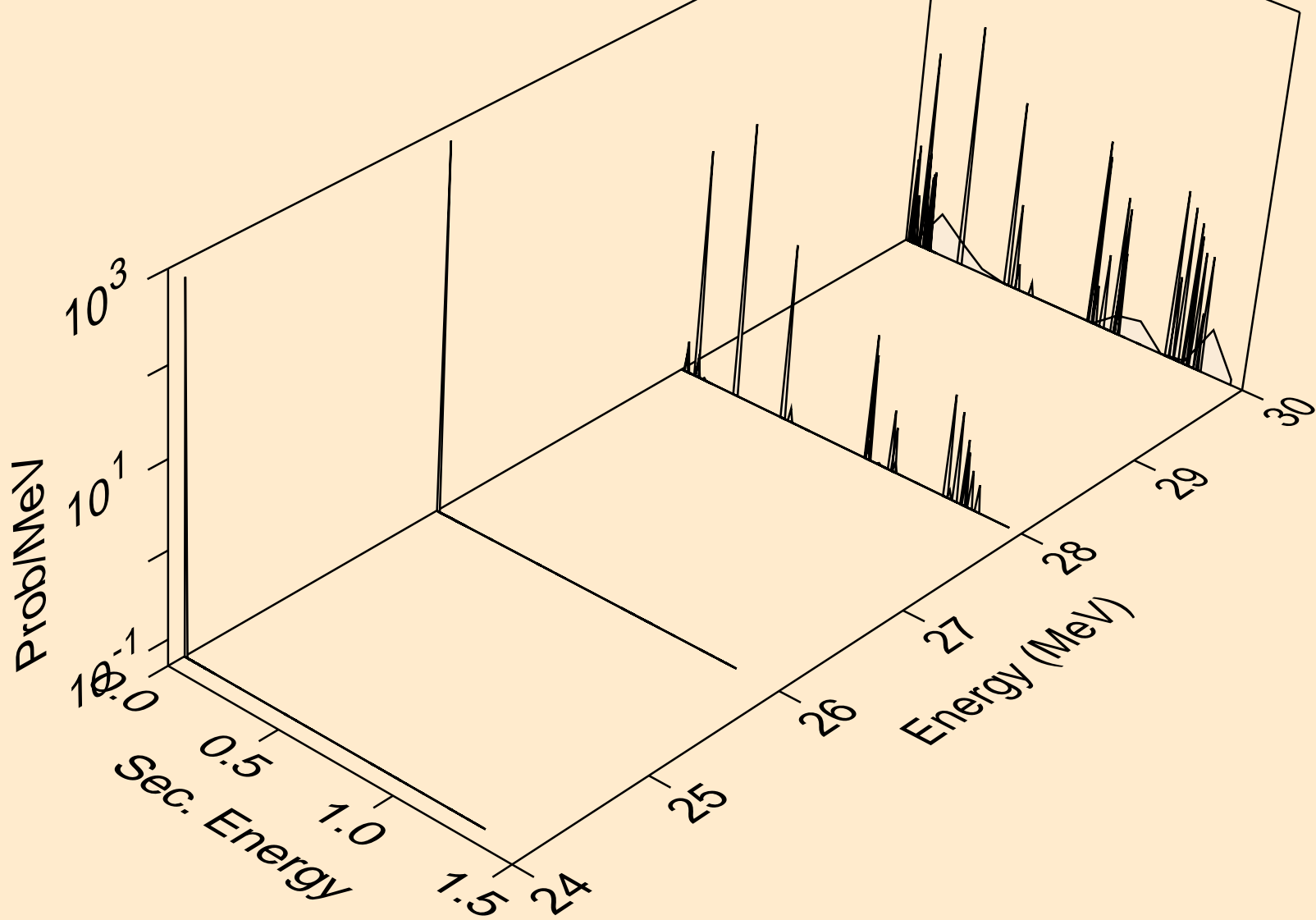

SN131M PHOTON ACER TENDL-2024 LIBRARY; T=0.K
photons from (g,n*)t

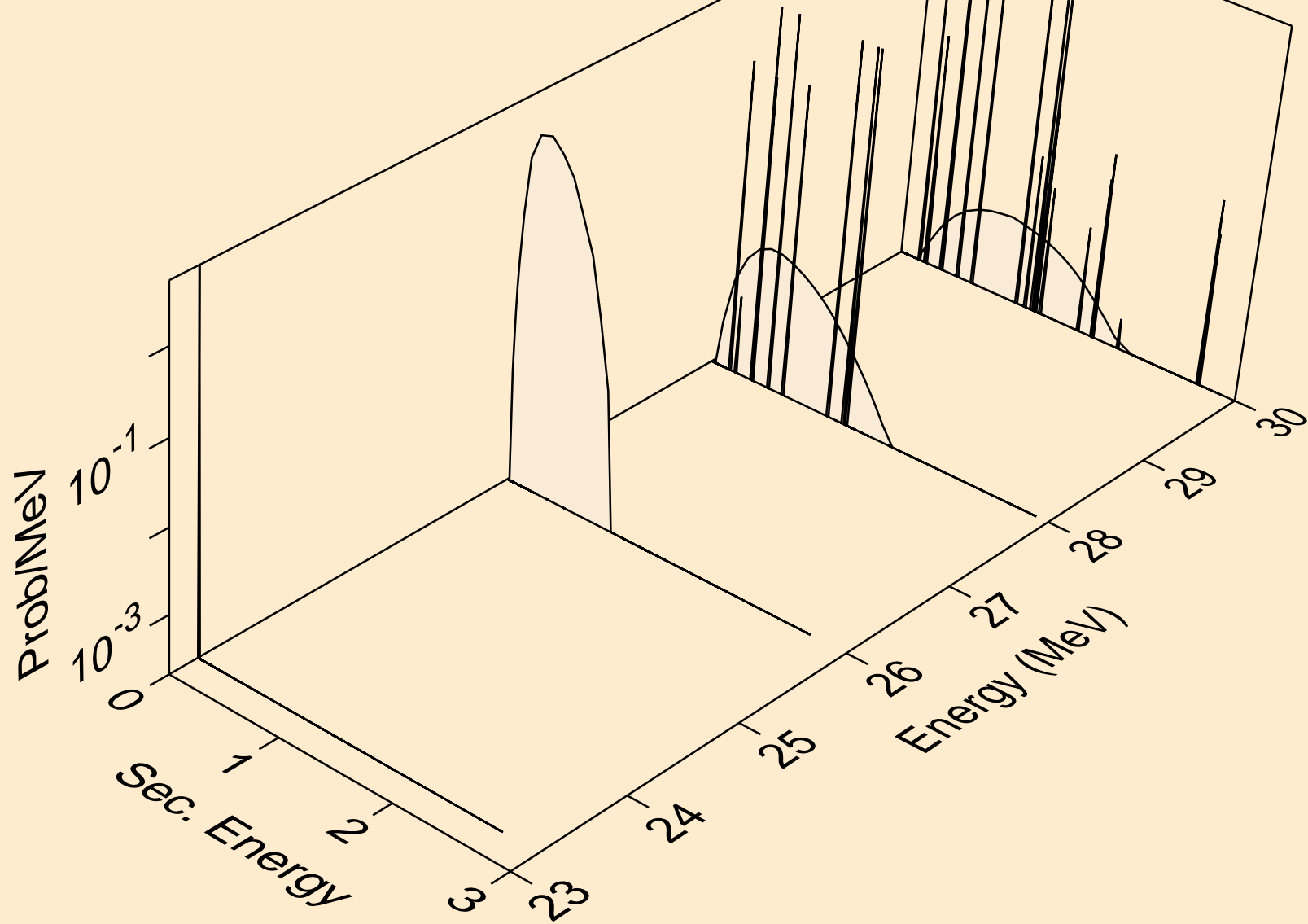

SN131M PHOTON ACER TENDL-2024 LIBRARY; T=0.K
photons from (g,4n)

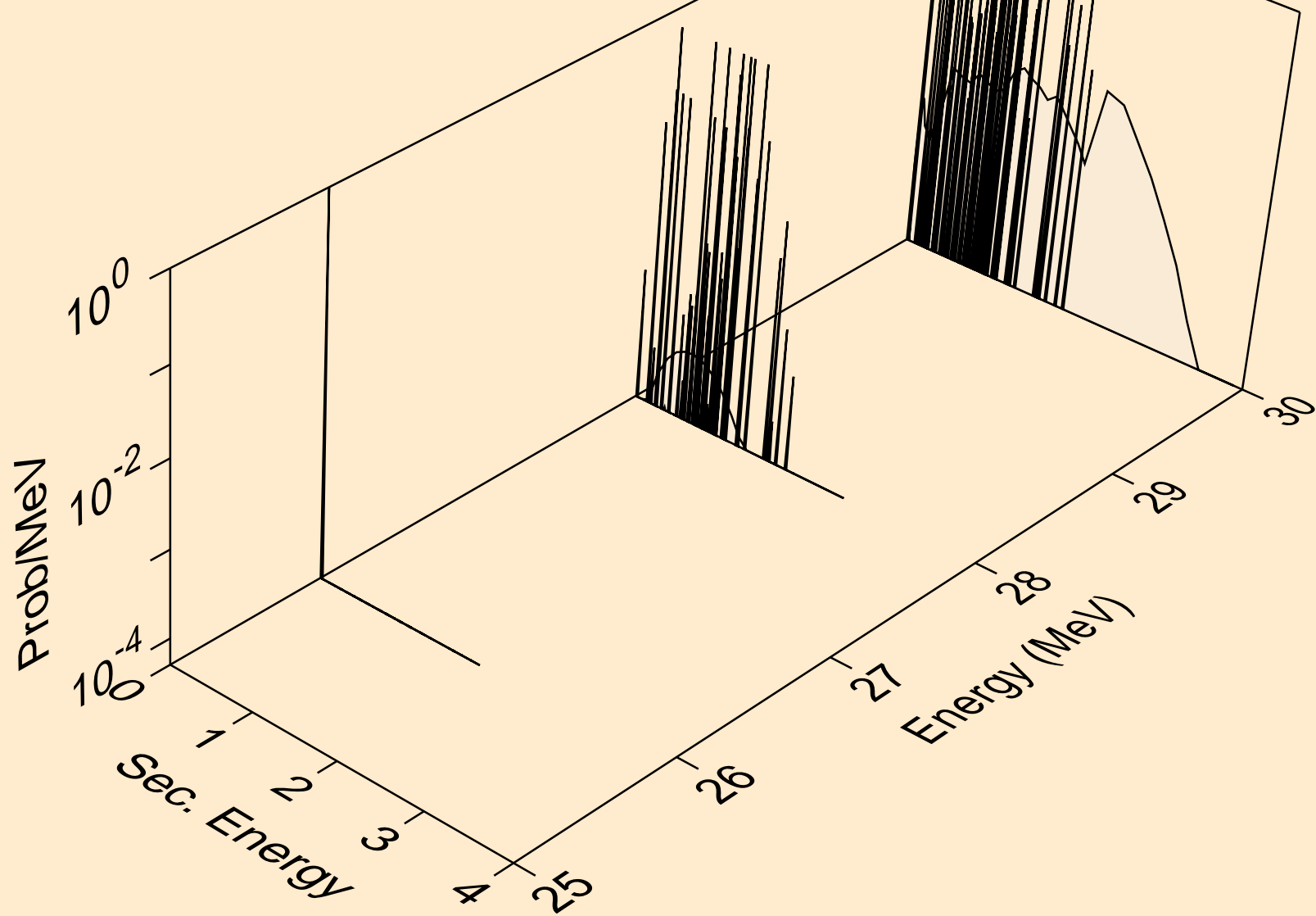

SN131M PHOTON ACER TENDL-2024 LIBRARY; T=0.K
photons from (g,2np)

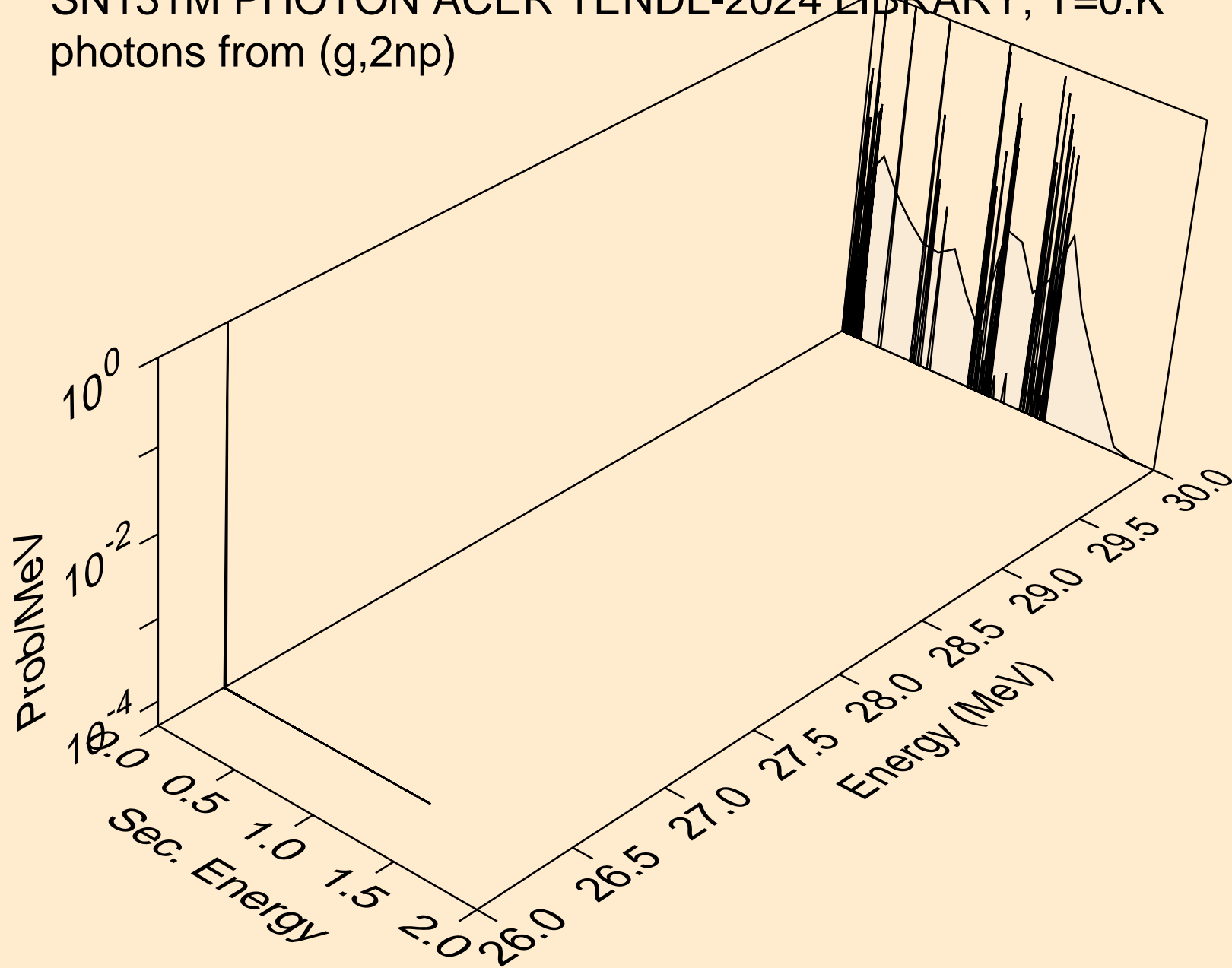

SN131M PHOTON ACER TENDL-2024 LIBRARY; T=0.K
photons from (g,n*c)

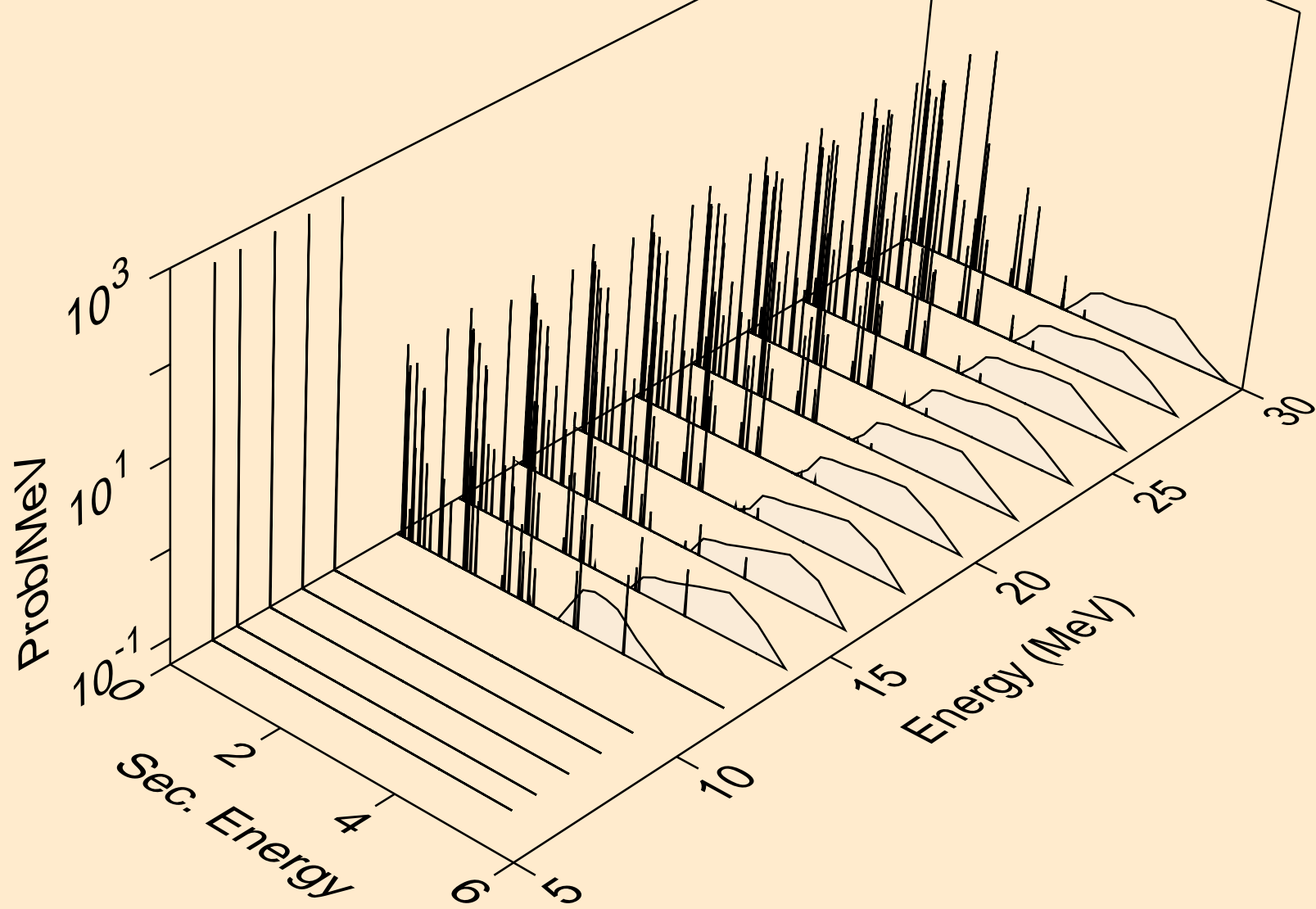

SN131M PHOTON ACER TENDL-2024 LIBRARY; T=0.K
photons from (g,gma)

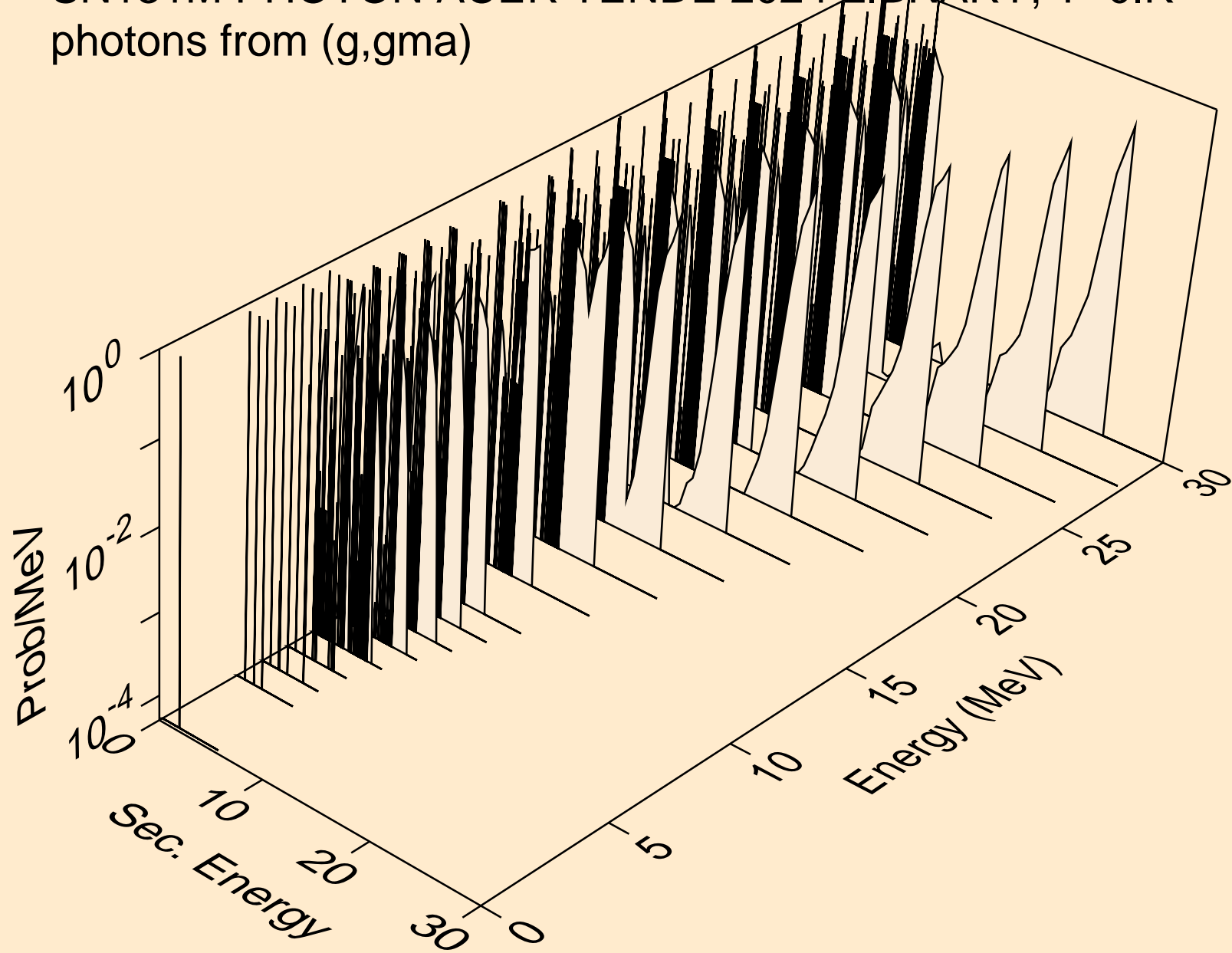

SN131M PHOTON ACER TENDL-2024 LIBRARY; T=0.K
photons from (g,p)

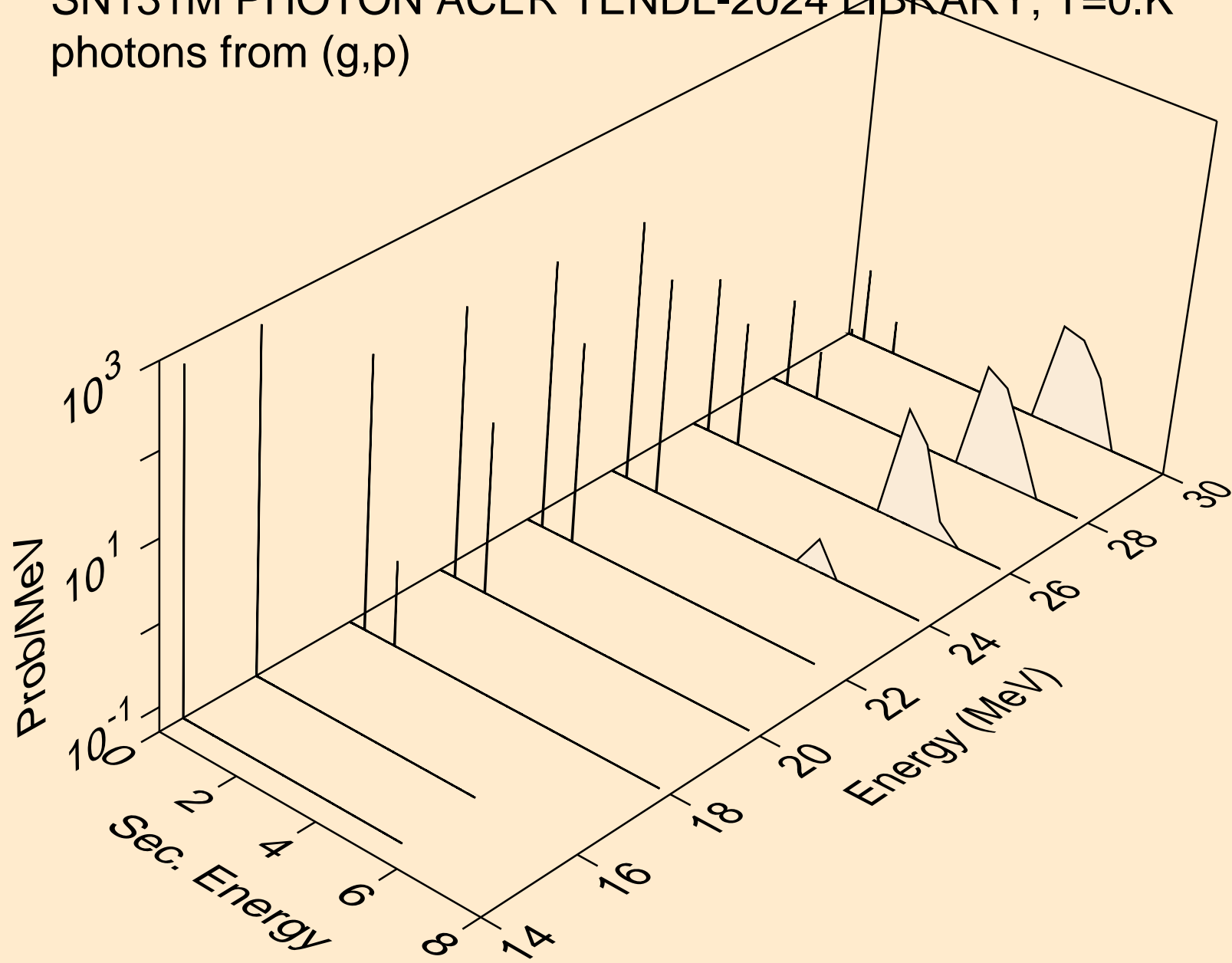

SN131M PHOTON ACER TENDL-2024 LIBRARY; T=0.K
photons from (g,d)

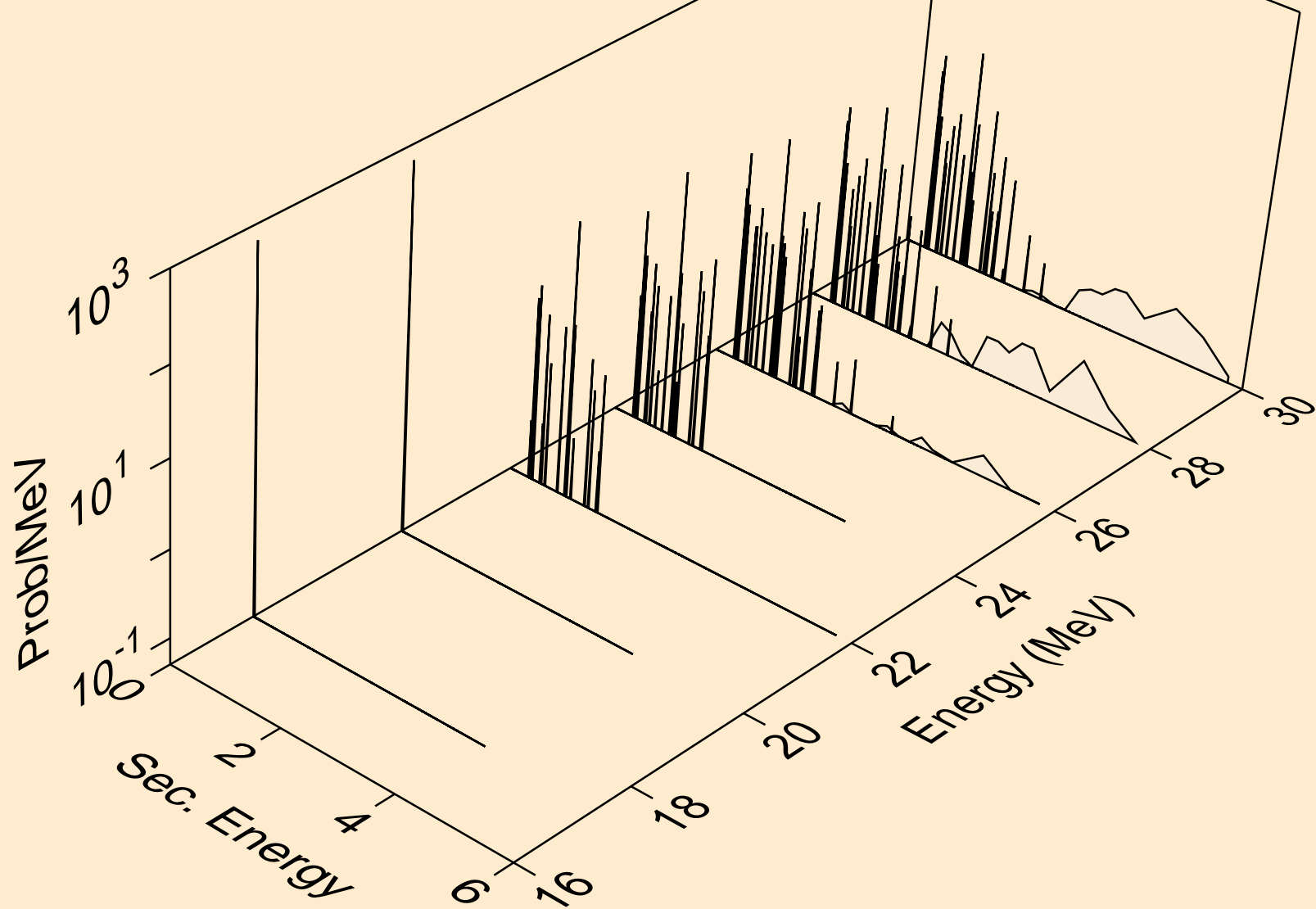

SN131M PHOTON ACER TENDL-2024 LIBRARY; T=0.K
photons from (g,t)

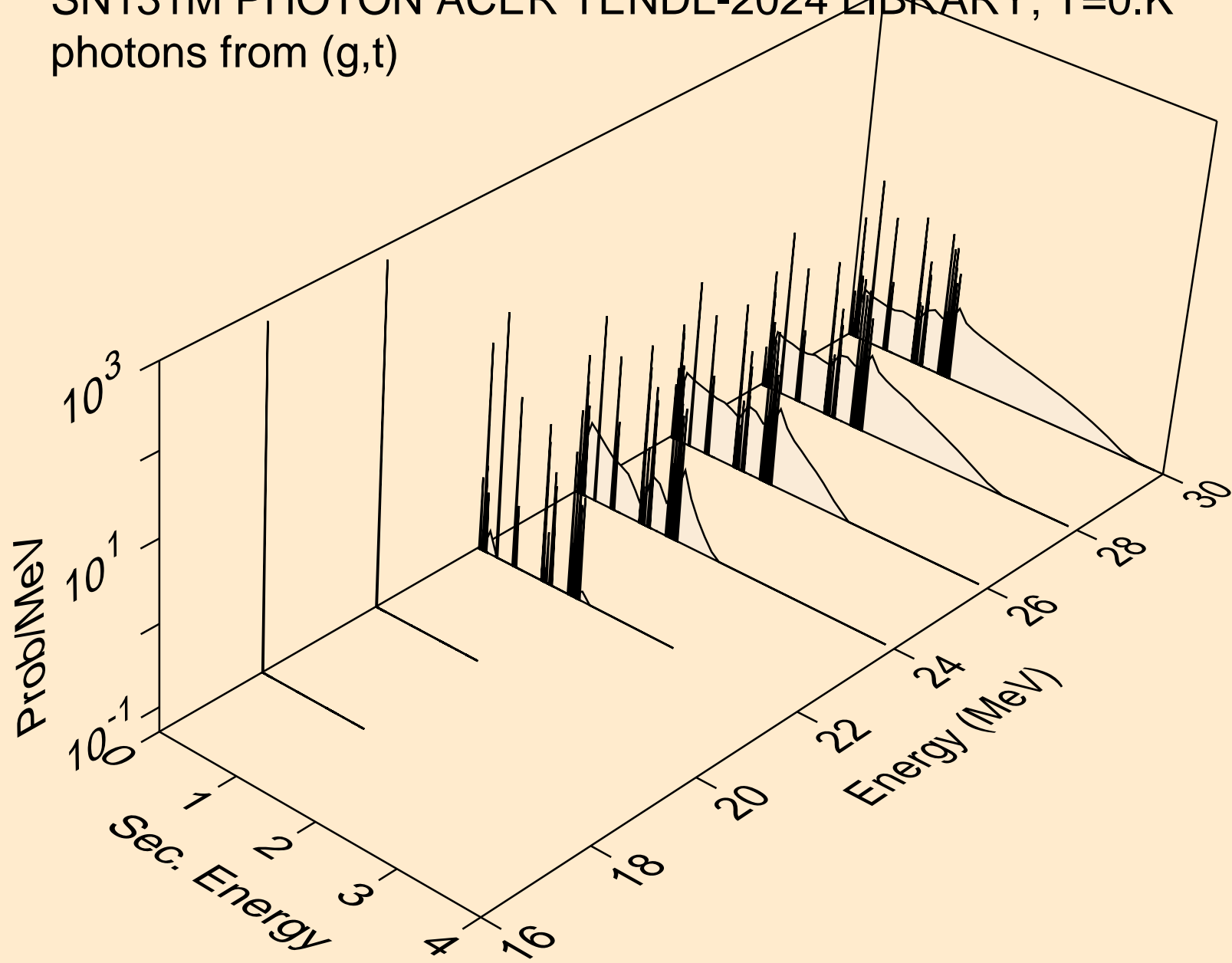

SN131M PHOTON ACER TENDL-2024 LIBRARY; T=0.K
photons from (g,a)

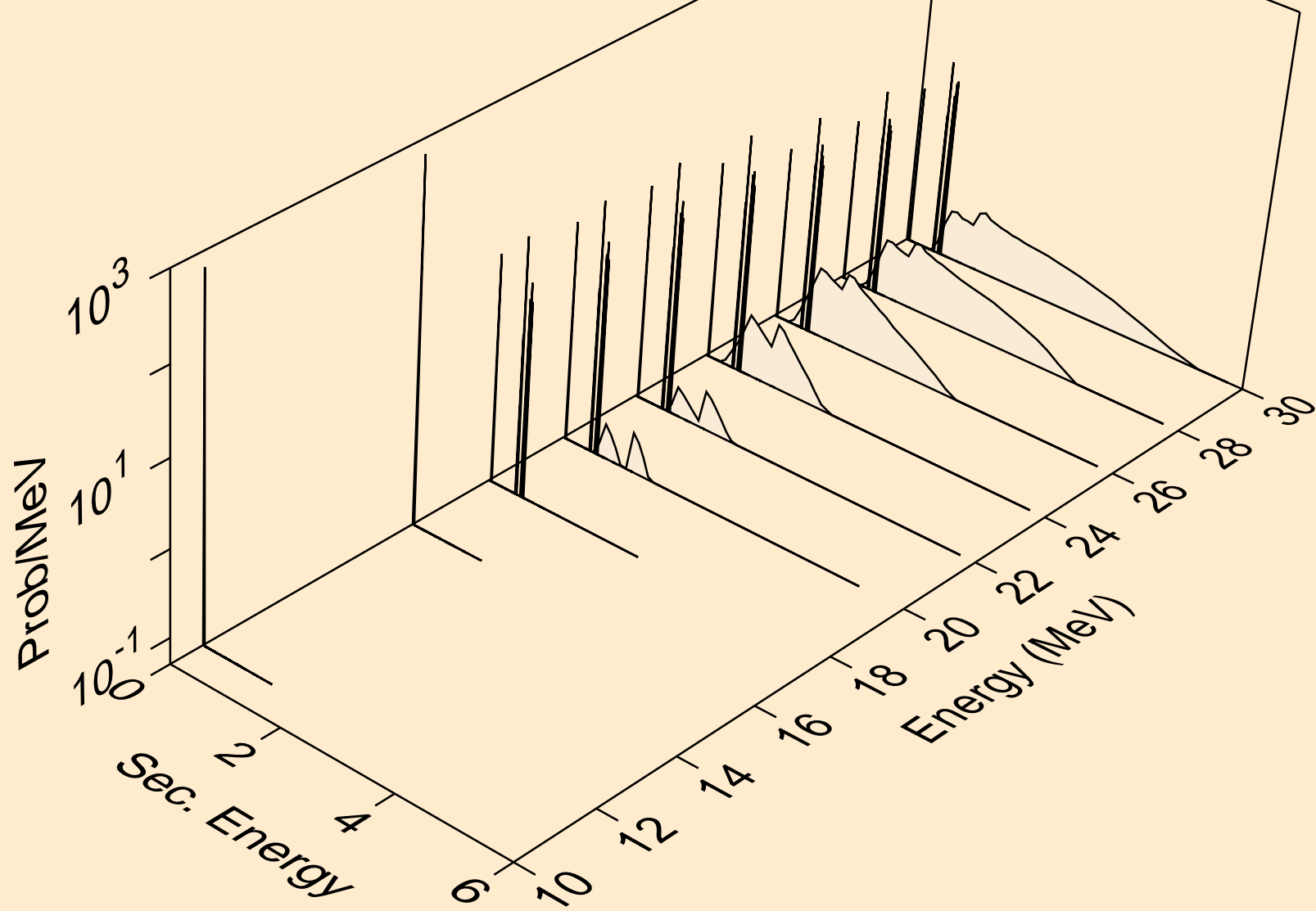

SN131M PHOTON ACER TENDL-2024 LIBRARY; T=0.K
protons from (g,x)

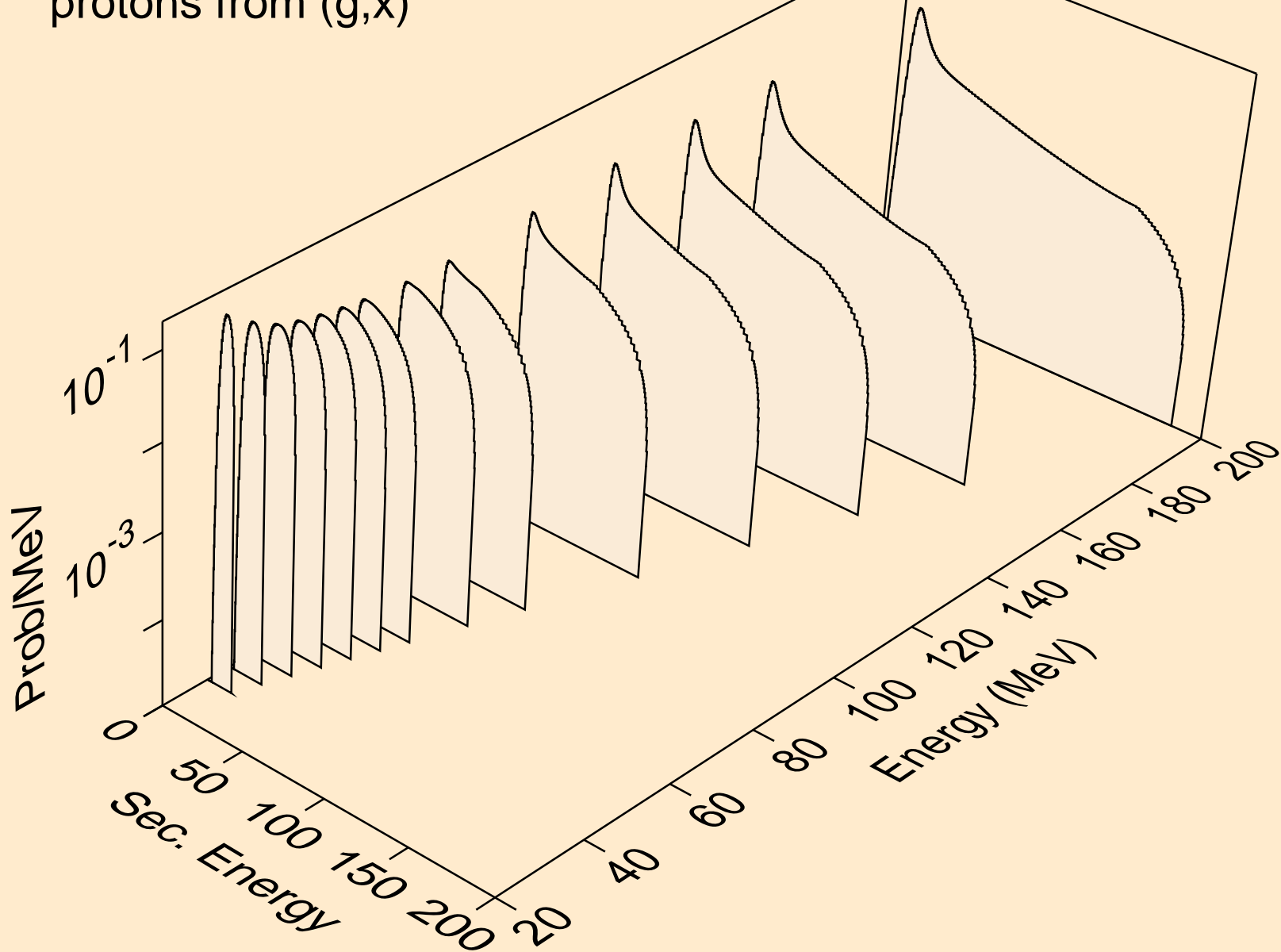

SN131M PHOTON ACER TENDL-2024 LIBRARY; T=0.K
protons from (g,n*)p

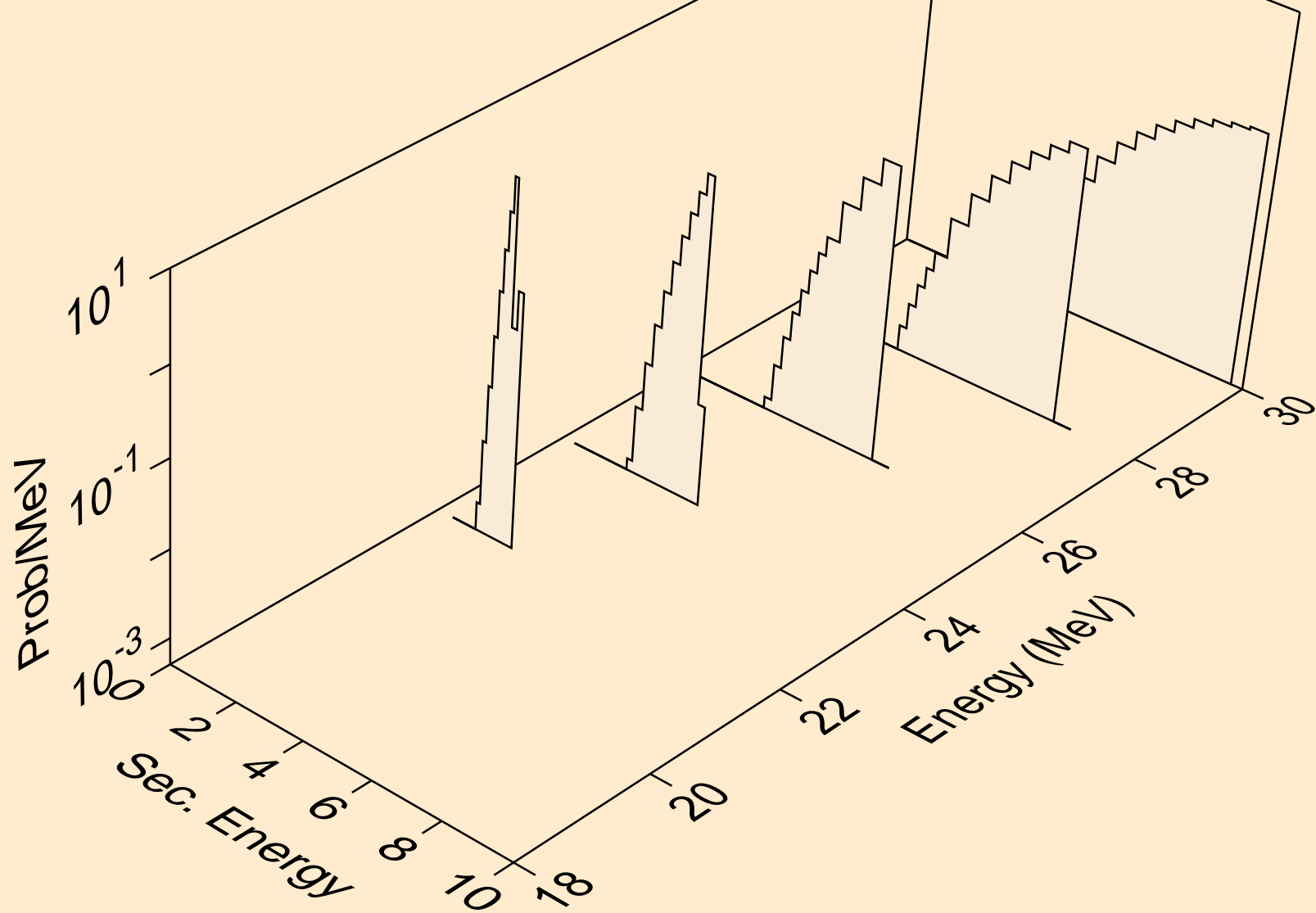

SN131M PHOTON ACER TENDL-2024 LIBRARY; T=0.K
protons from (g,2np)

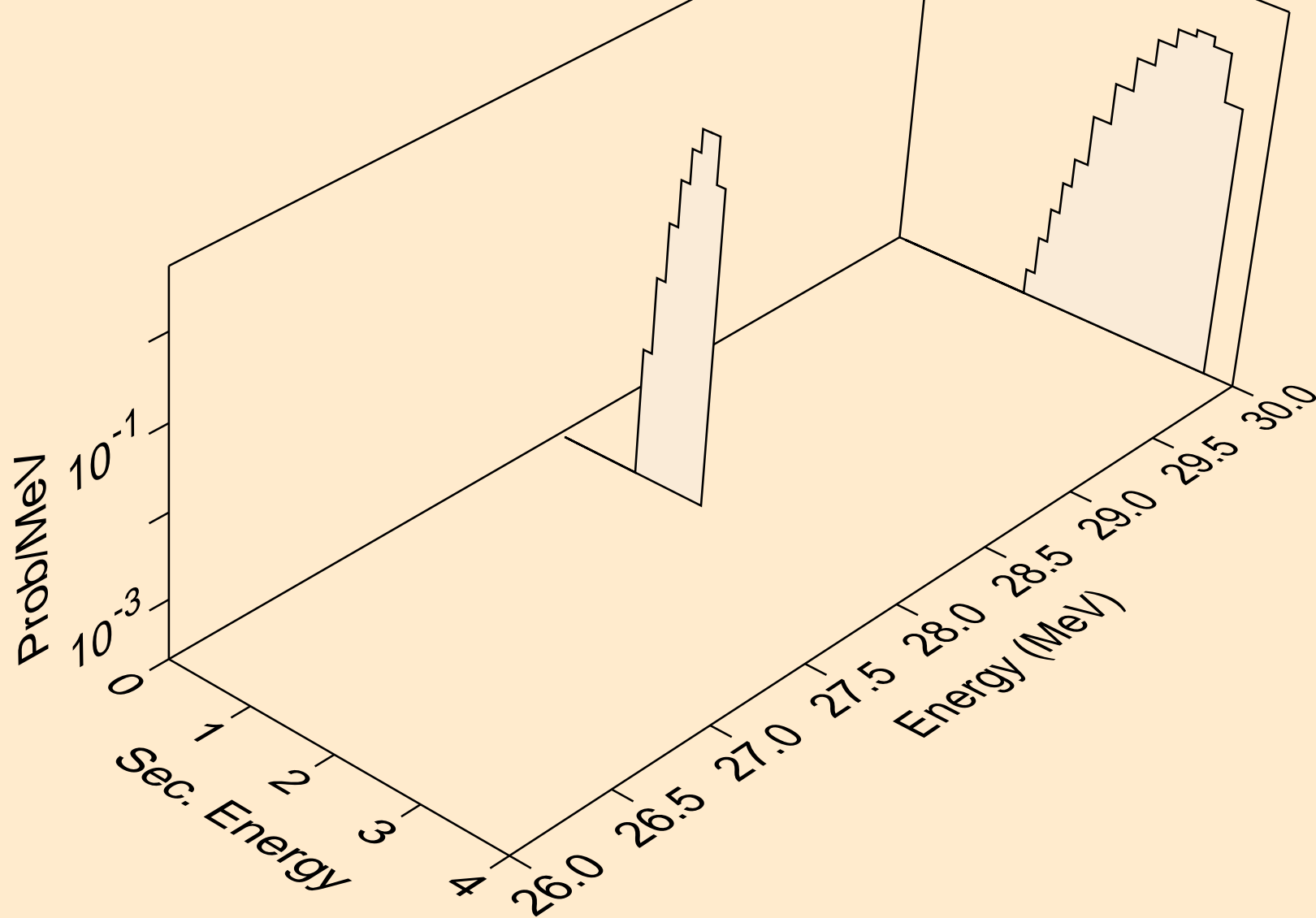

SN131M PHOTON ACER TENDL-2024 LIBRARY; T=0.K
protons from (g,p)

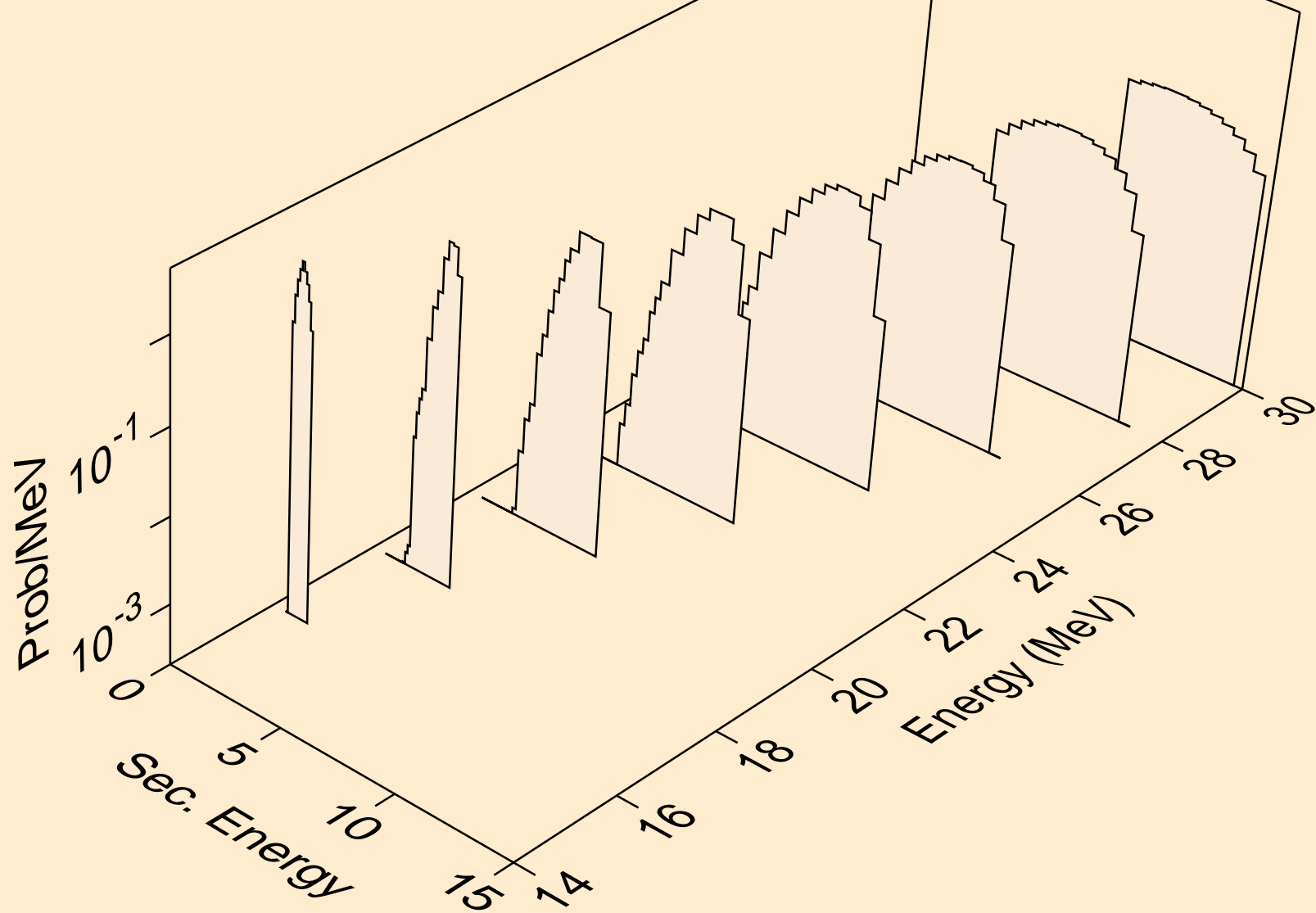

SN131M PHOTON ACER TENDL-2024 LIBRARY; T=0.K
deuterons from (g,x)

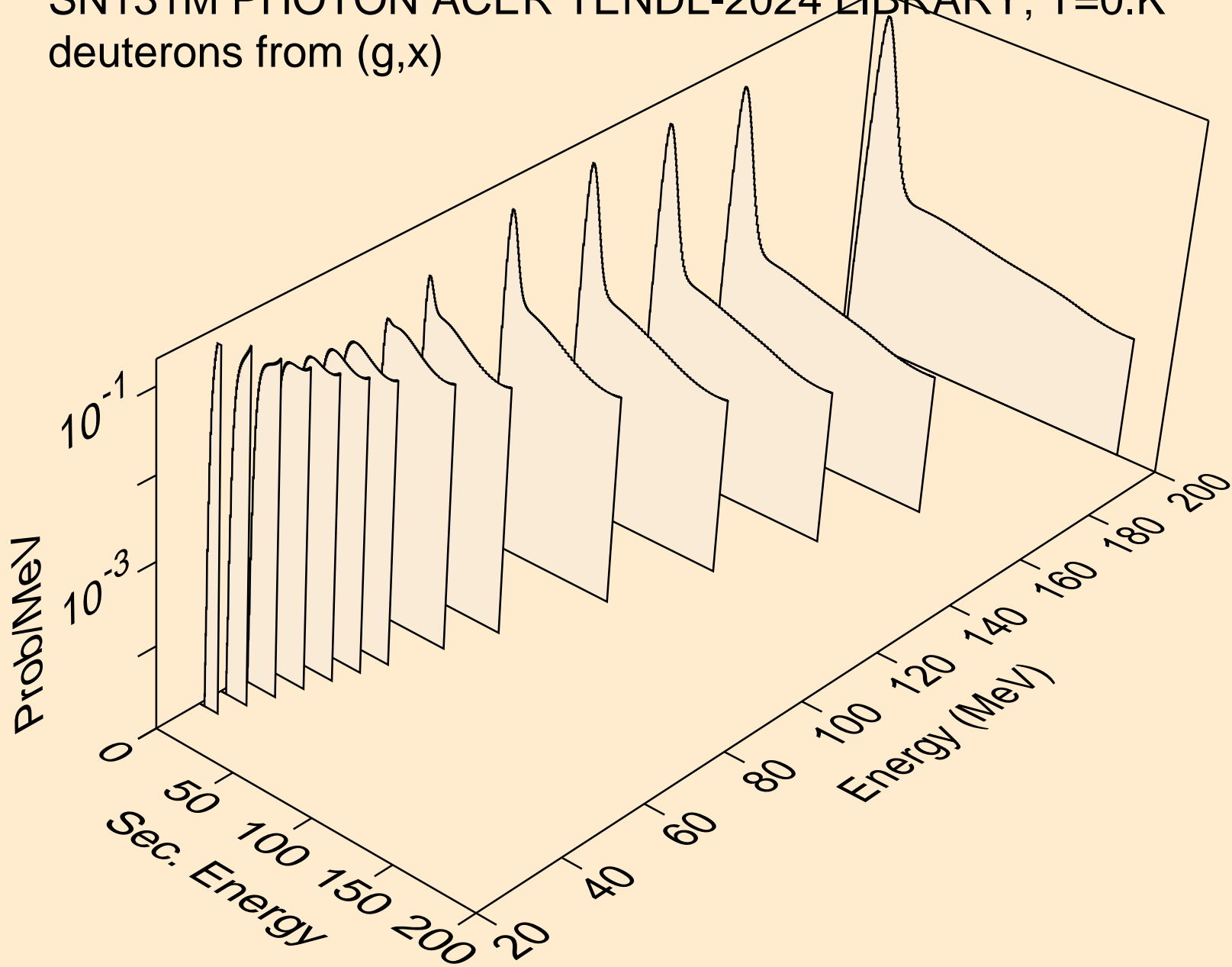

SN131M PHOTON ACER TENDL-2024 LIBRARY; T=0.K
deuterons from (g,n*)d

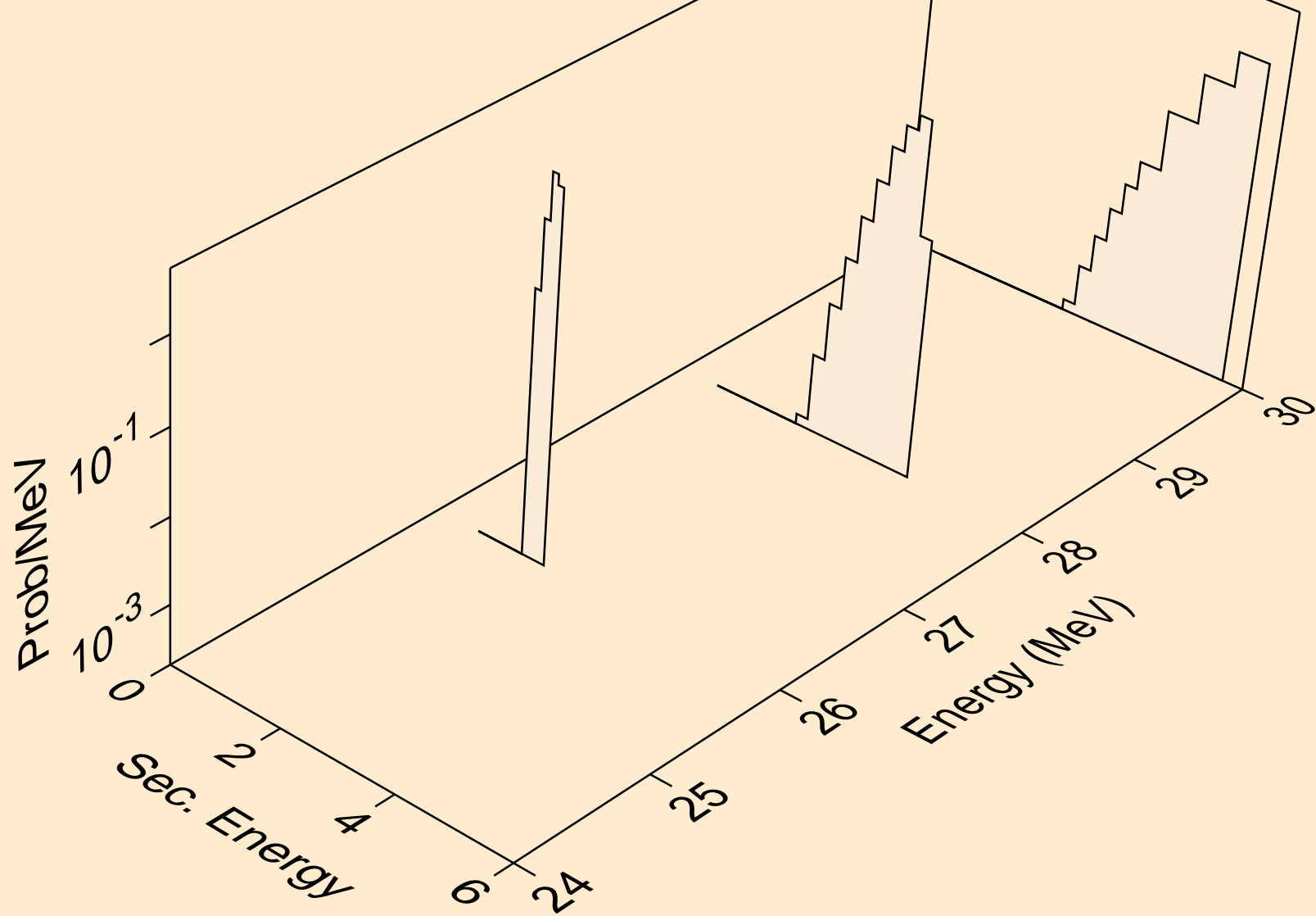

SN131M PHOTON ACER TENDL-2024 LIBRARY; T=0.K
deuterons from (g,d)

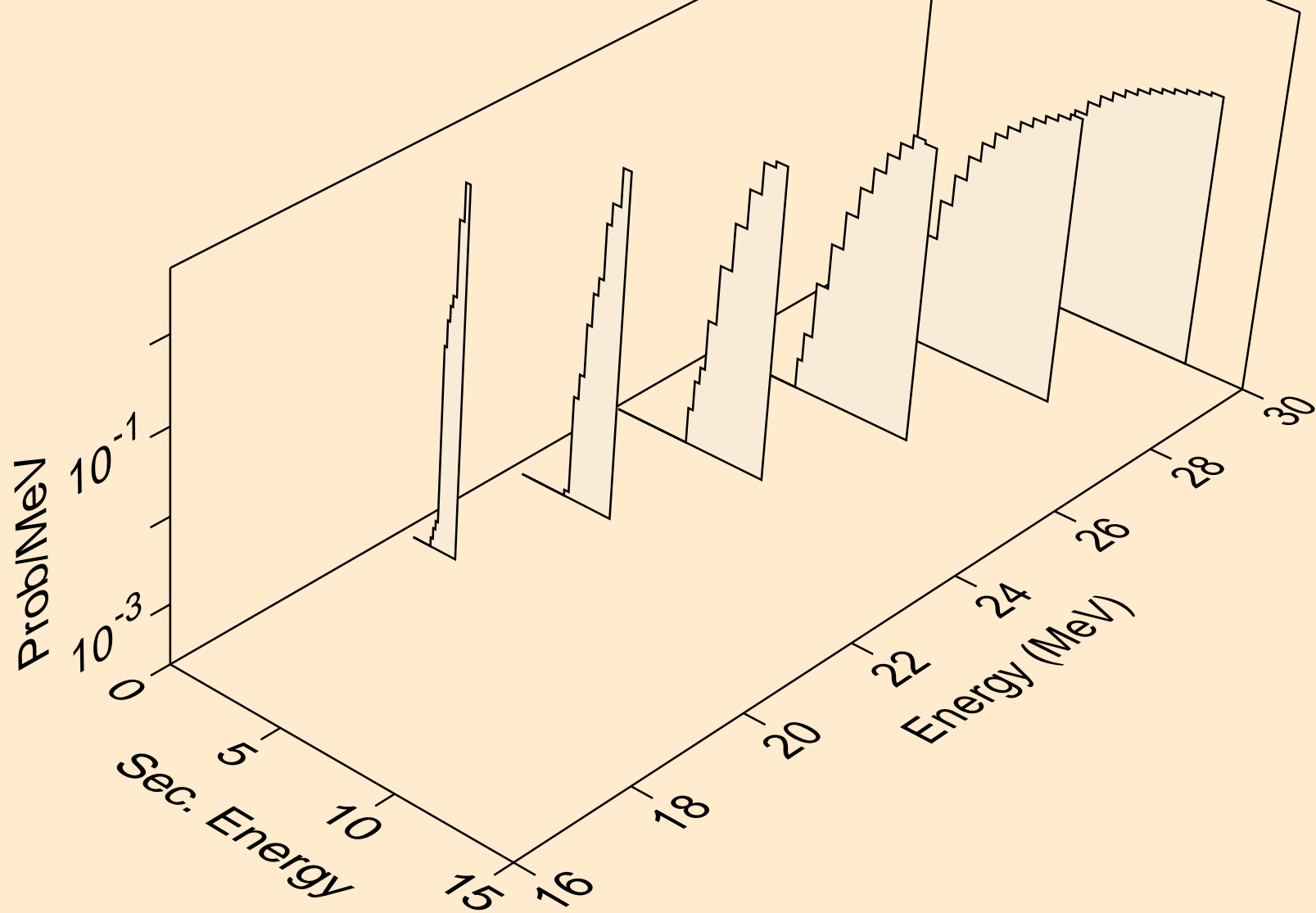

SN131M PHOTON ACER TENDL-2024 LIBRARY; T=0.K
tritons from (g,x)

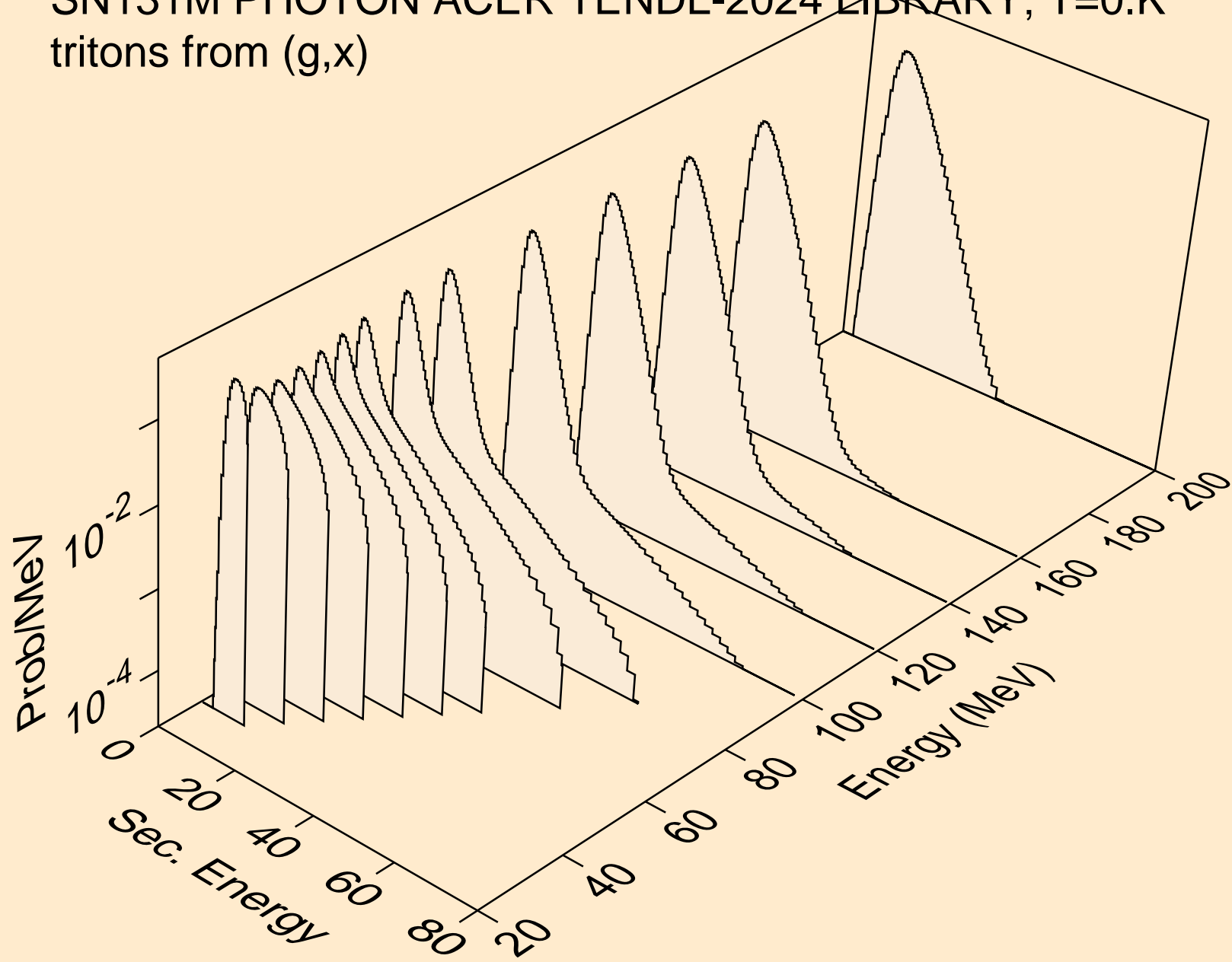

SN131M PHOTON ACER TENDL-2024 LIBRARY; T=0.K
tritons from (g,n*)t

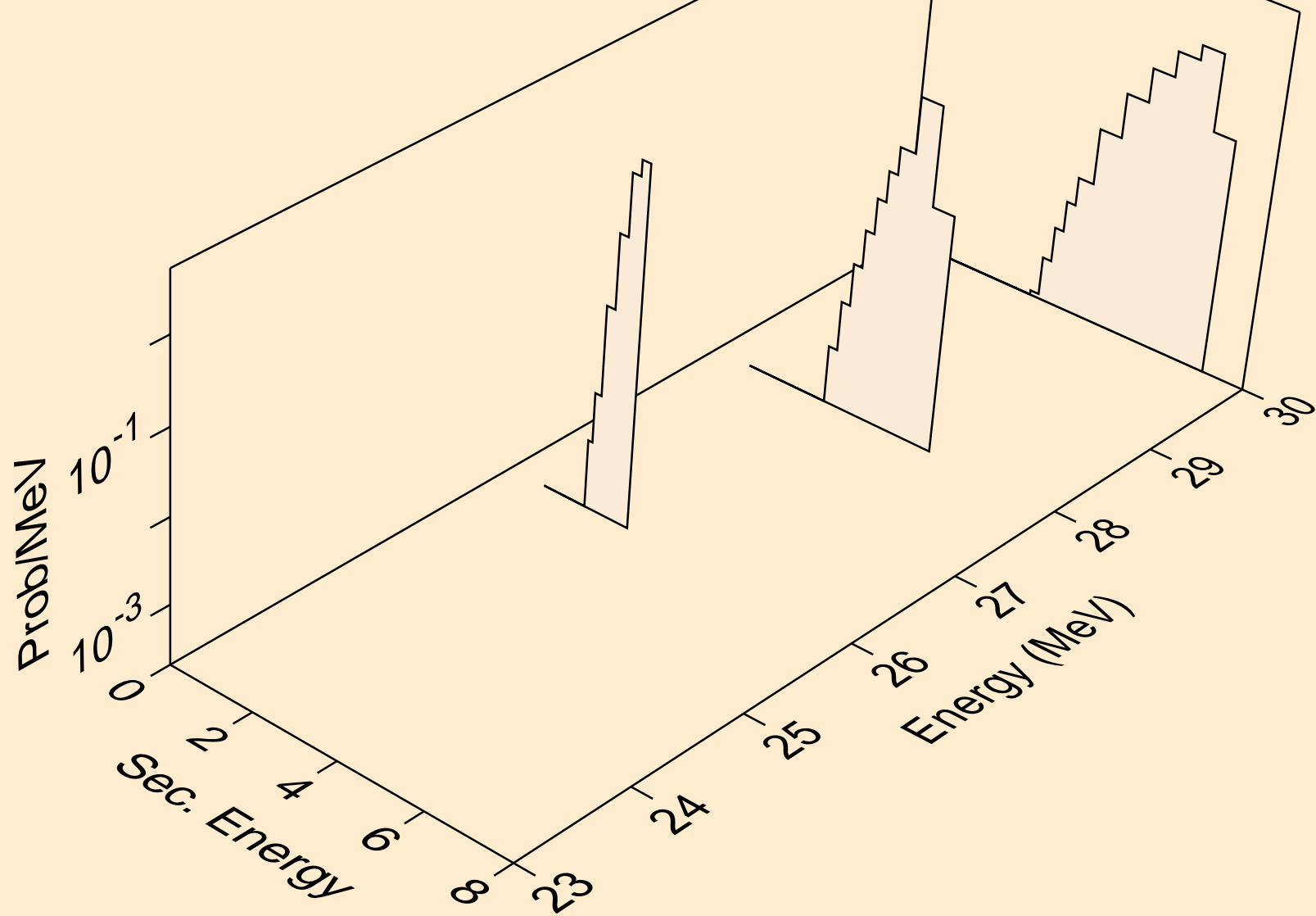

SN131M PHOTON ACER TENDL-2024 LIBRARY; T=0.K
tritons from (g,t)

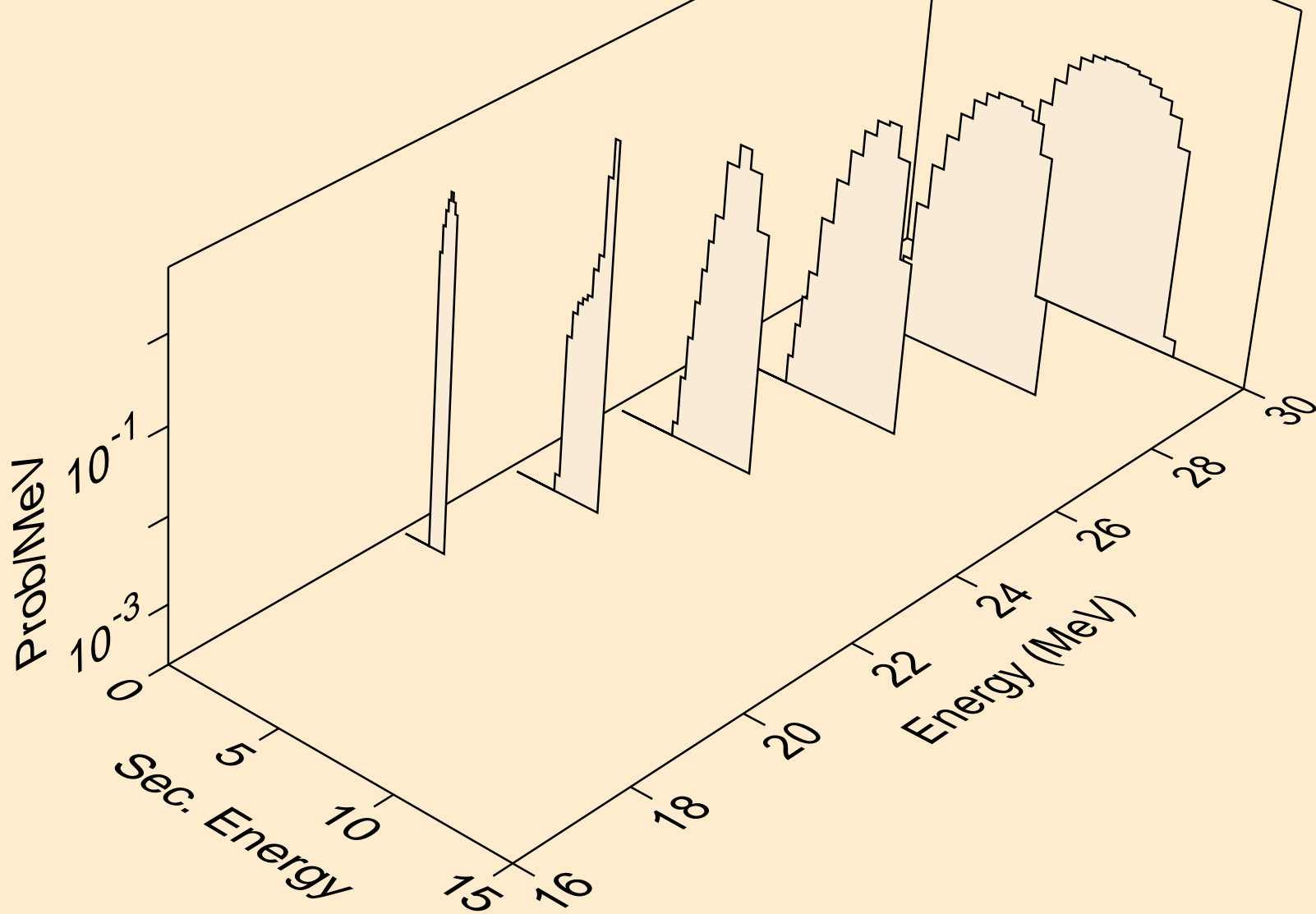

SN131M PHOTON ACER TENDL-2024 LIBRARY; T=0.K
he3s from (g,x)

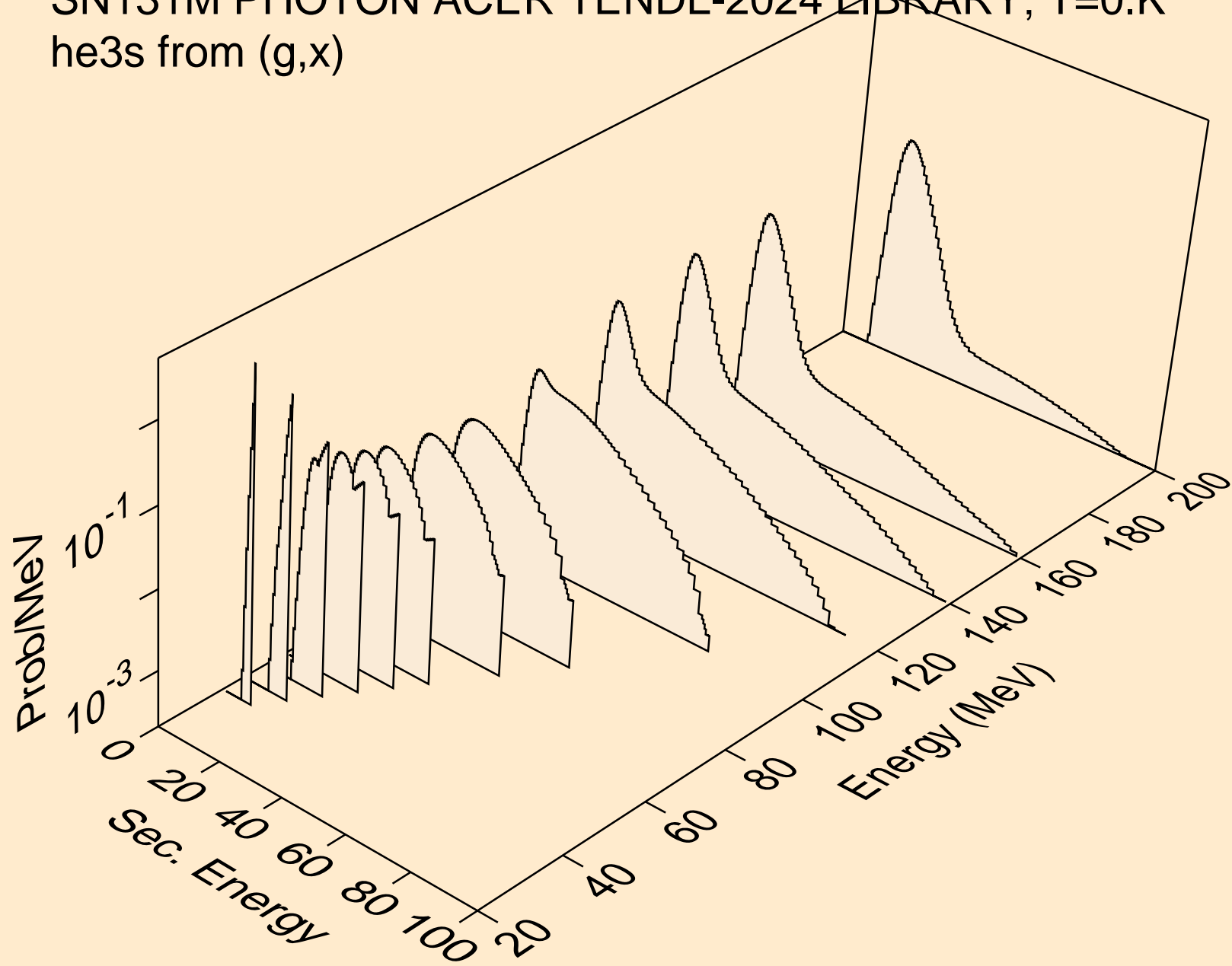

SN131M PHOTON ACER TENDL-2024 LIBRARY; T=0.K
alphas from (g,x)

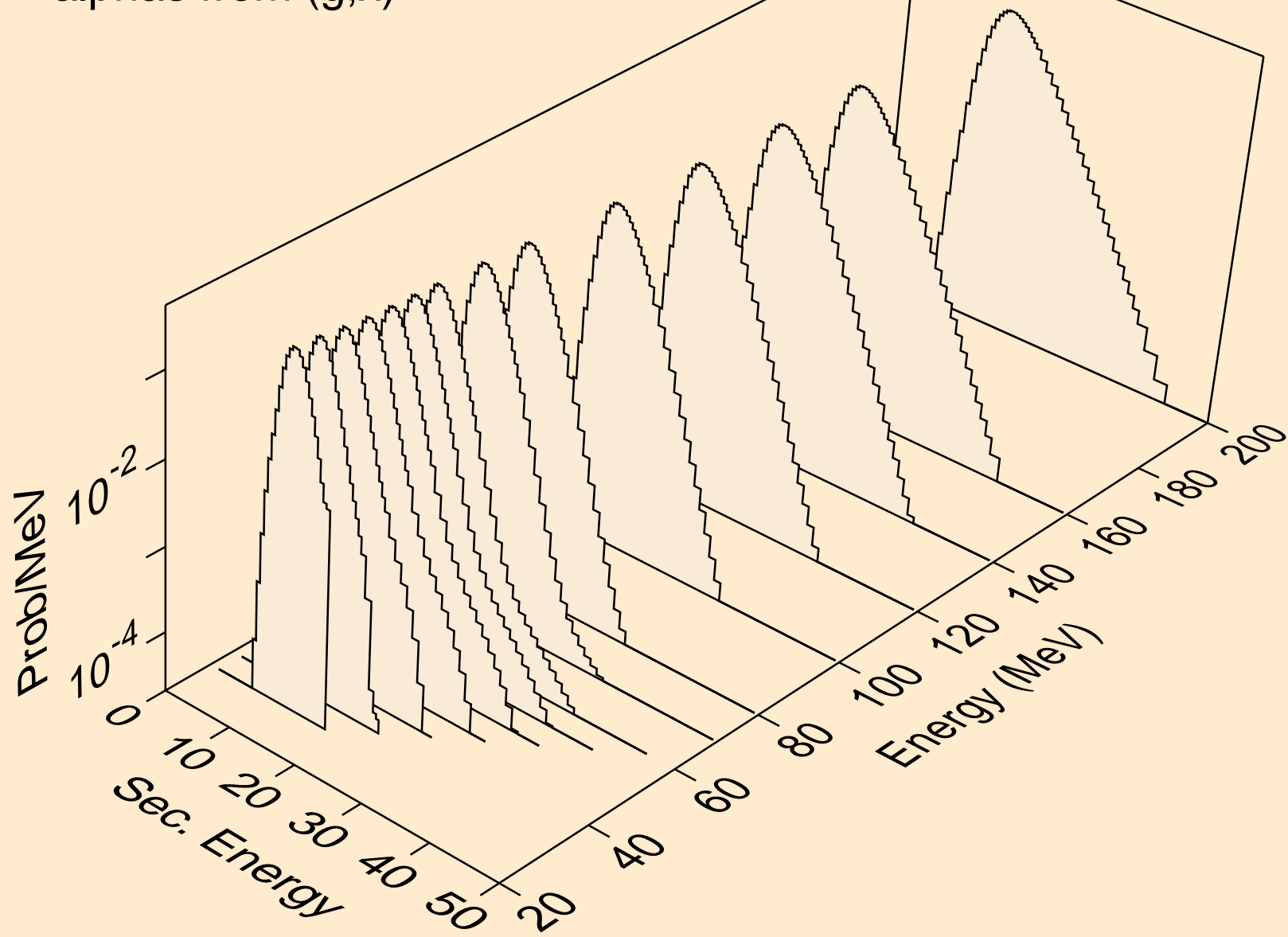

SN131M PHOTON ACER TENDL-2024 LIBRARY; T=0.K
alphas from (g,n*)a

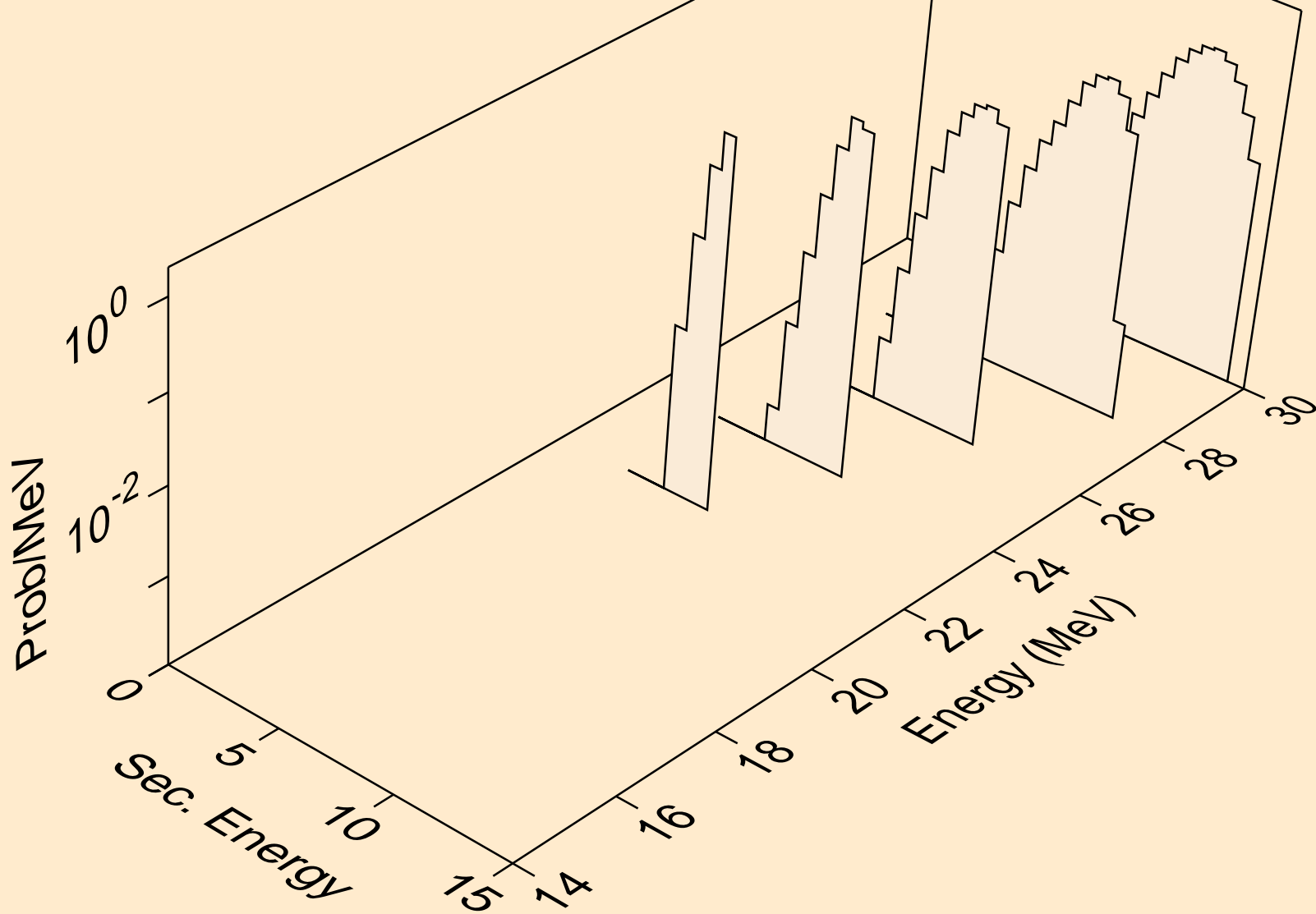

SN131M PHOTON ACER TENDL-2024 LIBRARY; T=0.K
alphas from (g,a)

