

TH228 PHOTON ACER TENDL-2024 LIBRARY; T=0.K

Principal cross sections

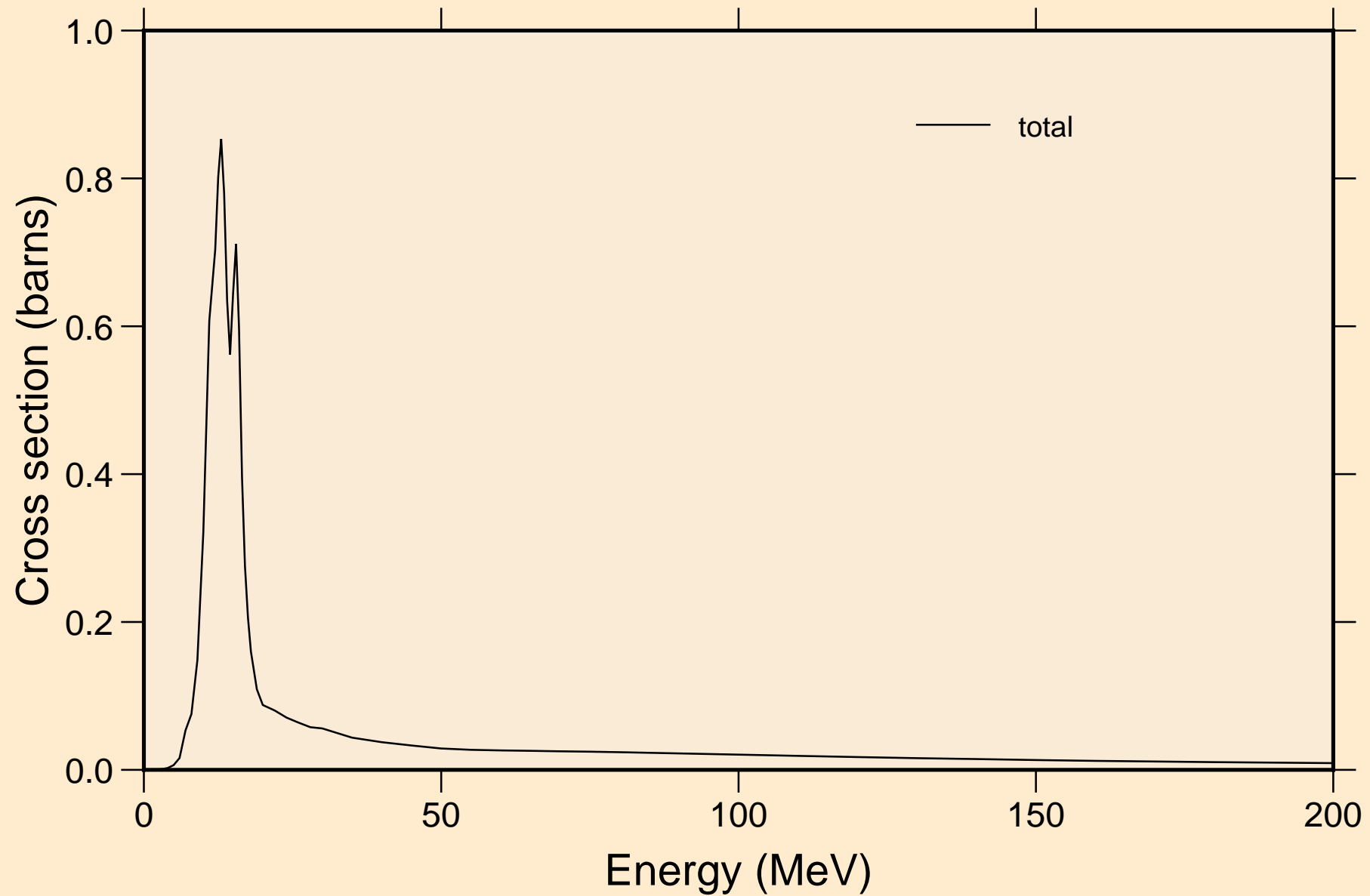

TH228 PHOTON ACER TENDL-2024 LIBRARY; T=0.K

Partial cross sections

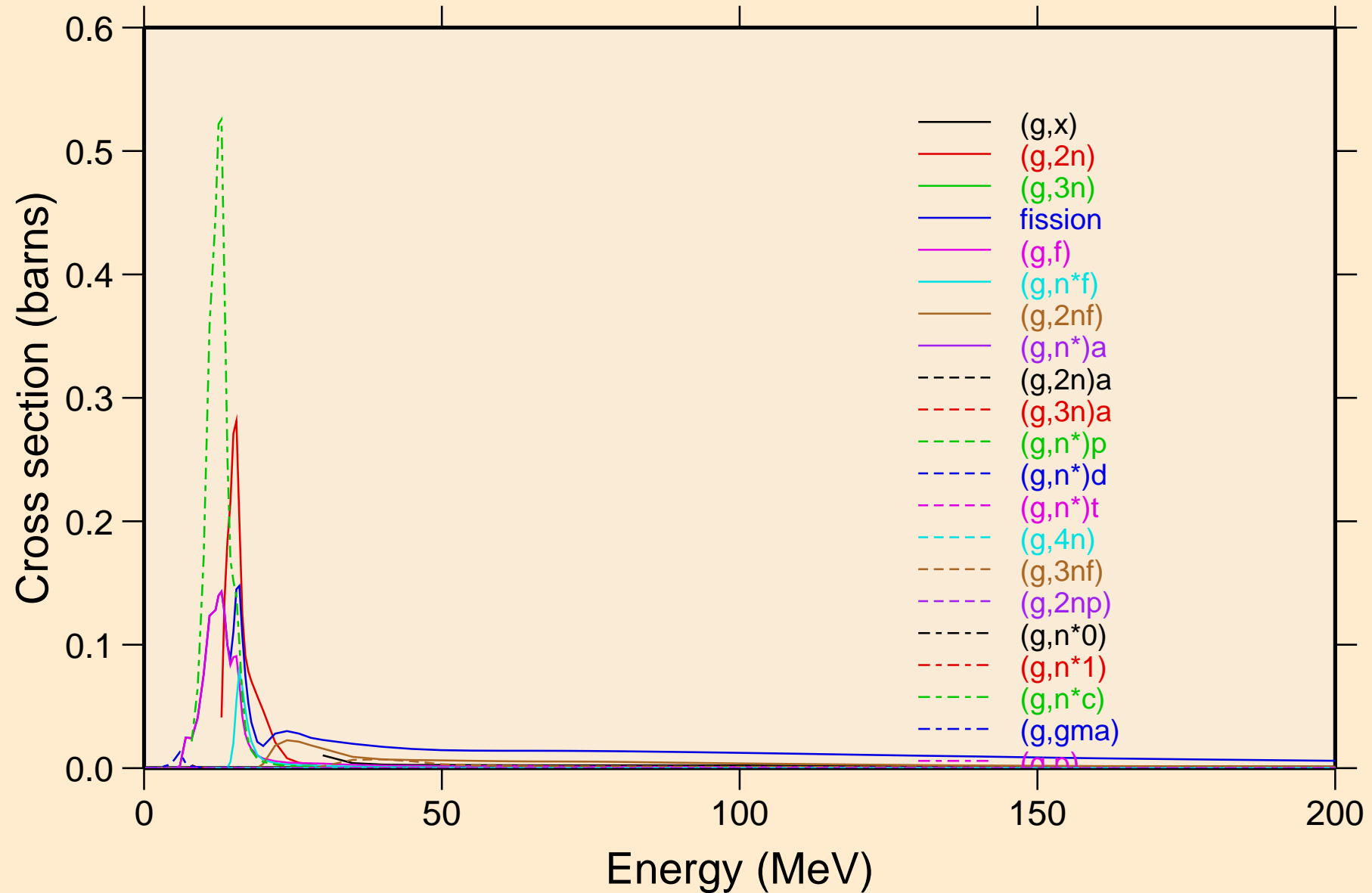

TH228 PHOTON ACER TENDL-2024 LIBRARY; T=0.K

Heating

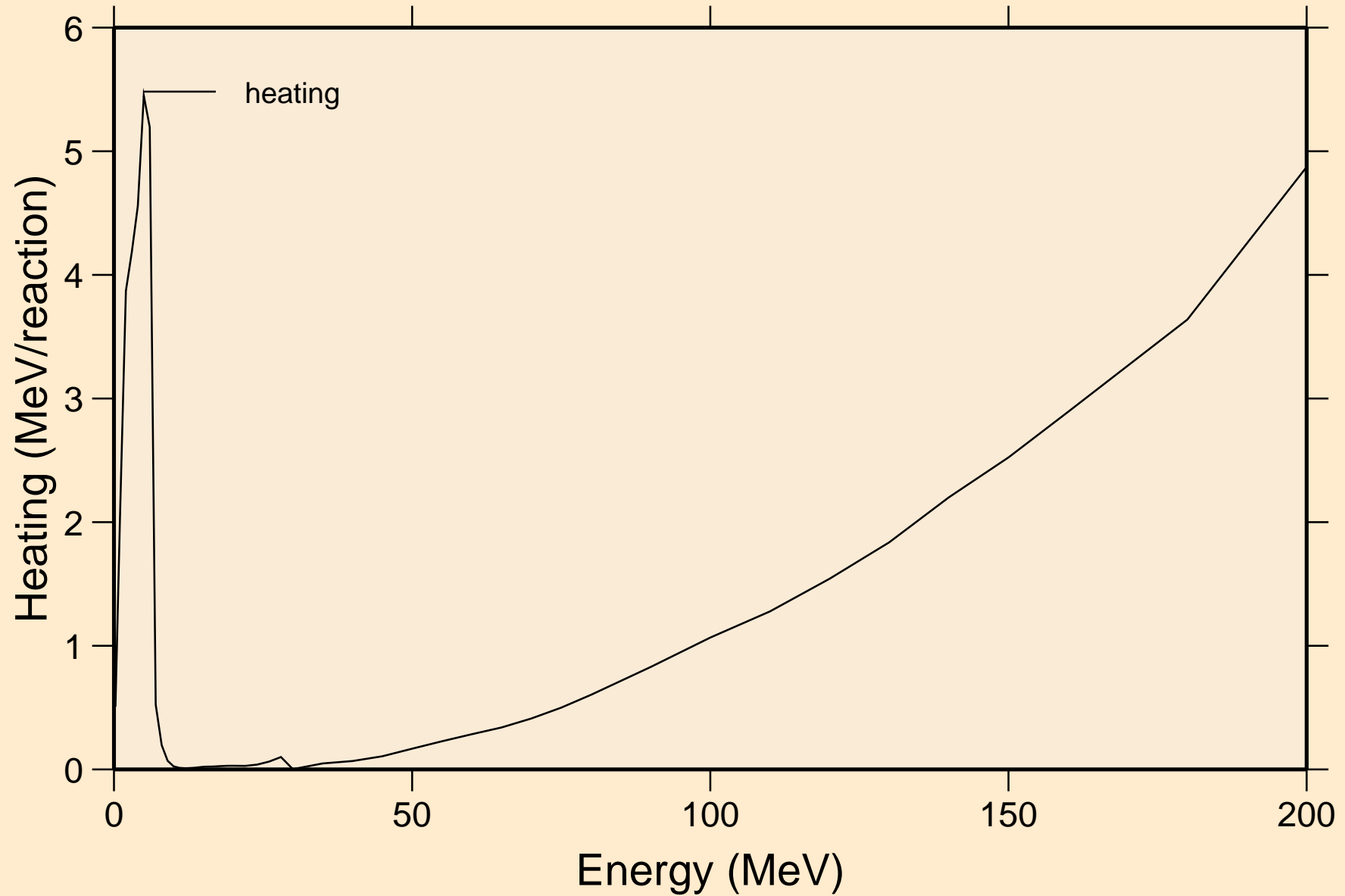

TH228 PHOTON ACER TENDL-2024 LIBRARY; T=0.K

Particle heating contributions

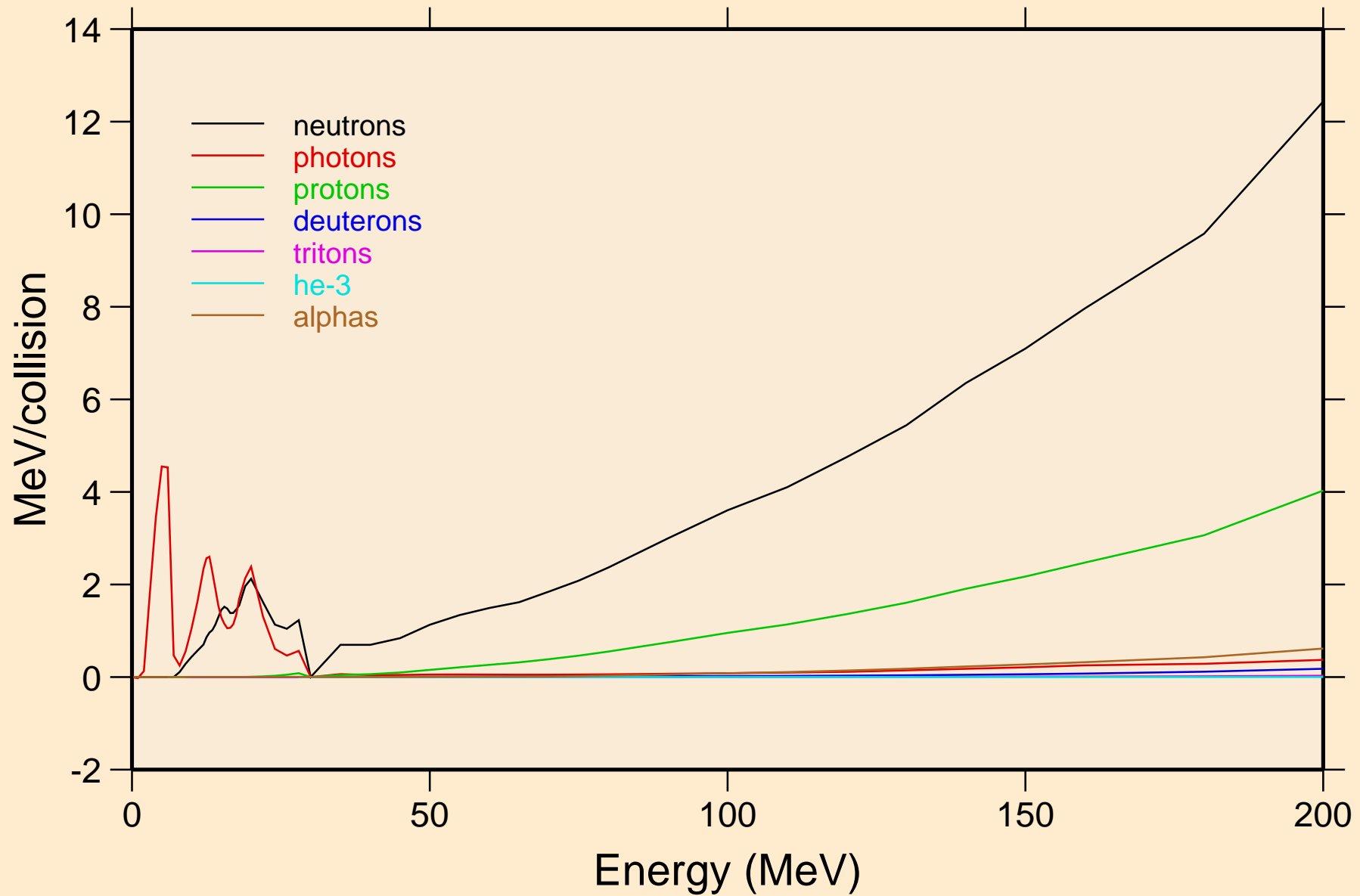

TH228 PHOTON ACER TENDL-2024 LIBRARY; T=0.K
Particle production cross sections

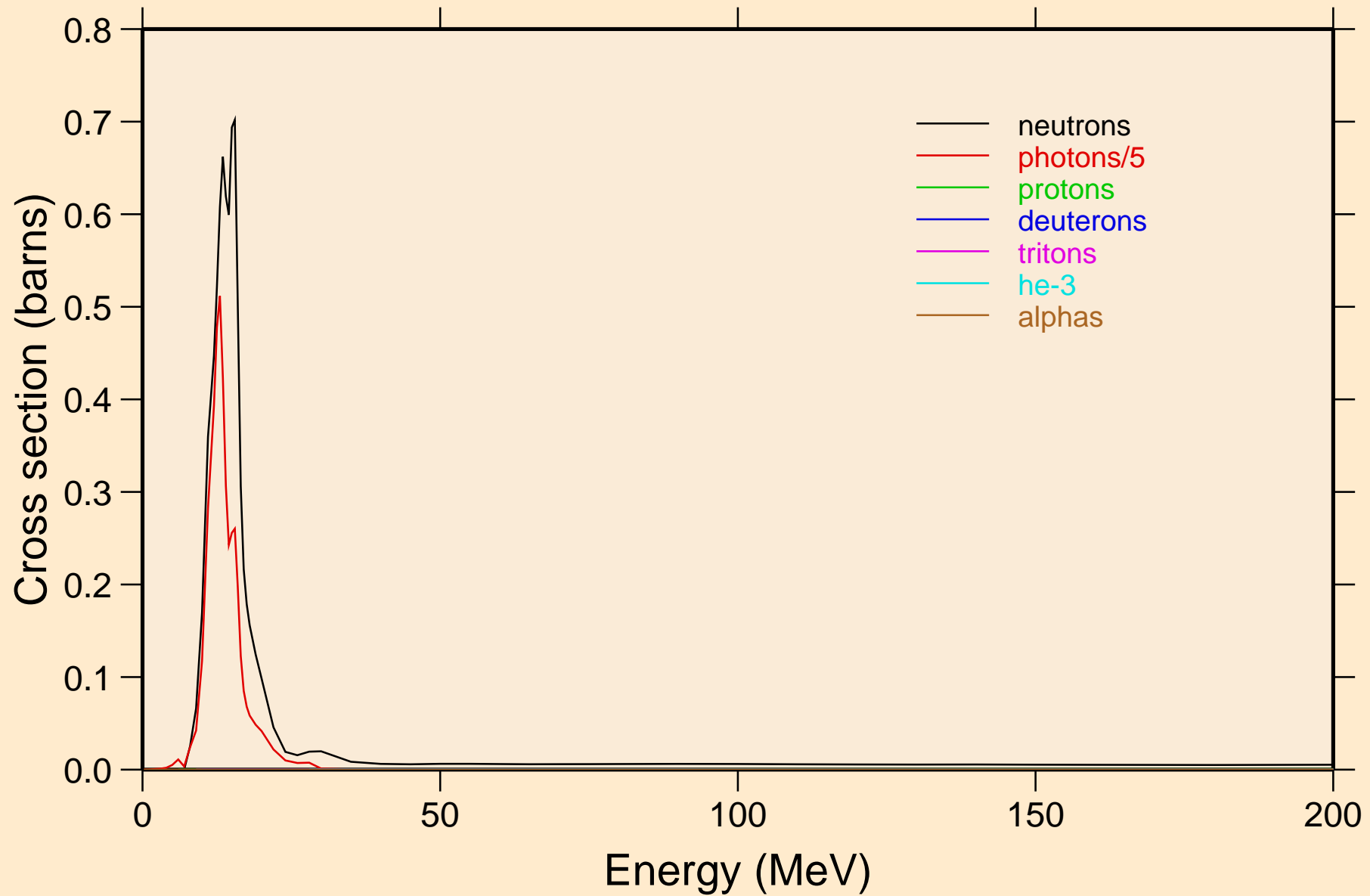

TH228 PHOTON ACER TENDL-2024 LIBRARY; T=0.K
neutrons from (g,x)

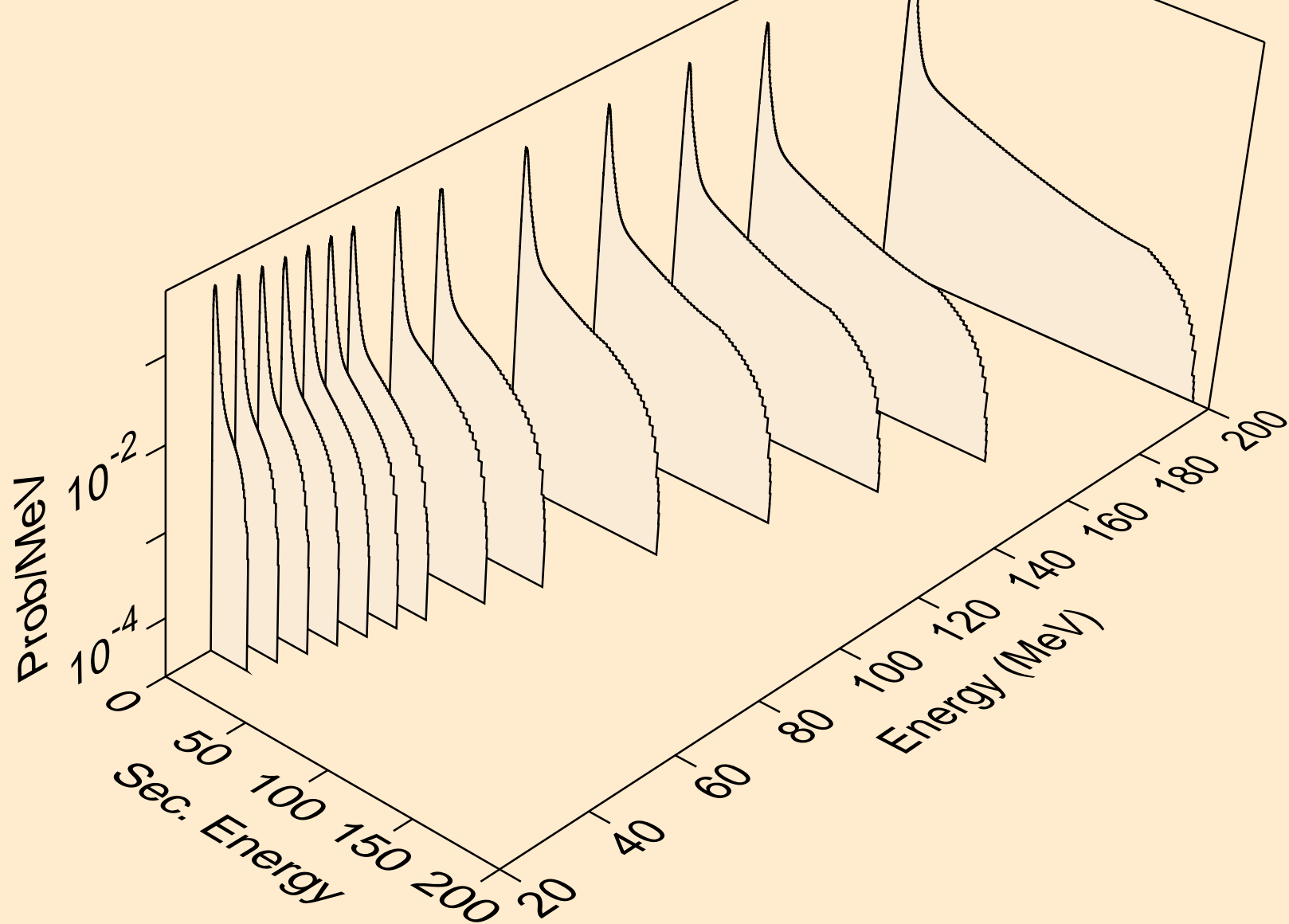

TH228 PHOTON ACER TENDL-2024 LIBRARY; T=0.K
neutrons from (g,2n)

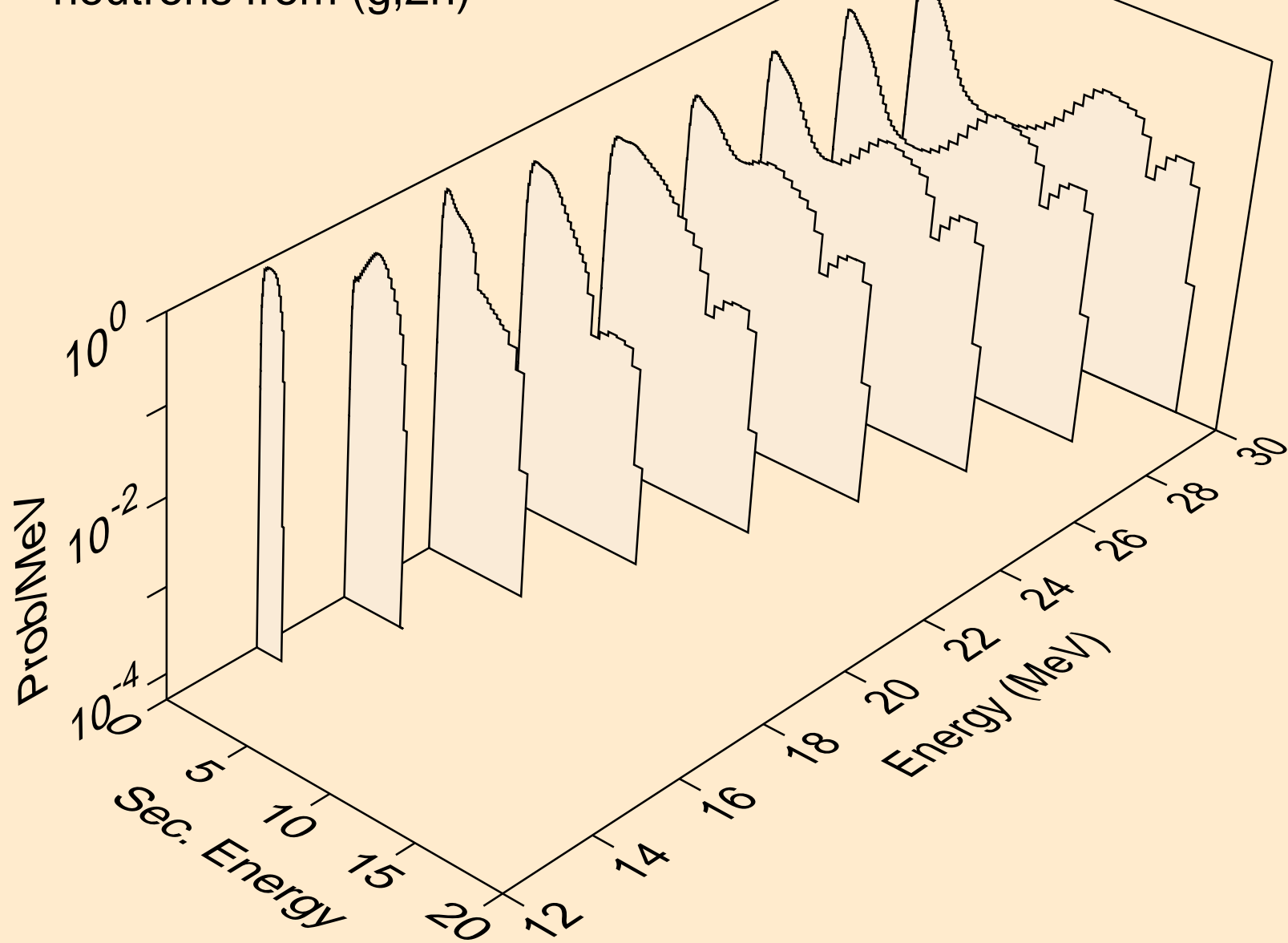

TH228 PHOTON ACER TENDL-2024 LIBRARY; T=0.K
neutrons from (g,3n)

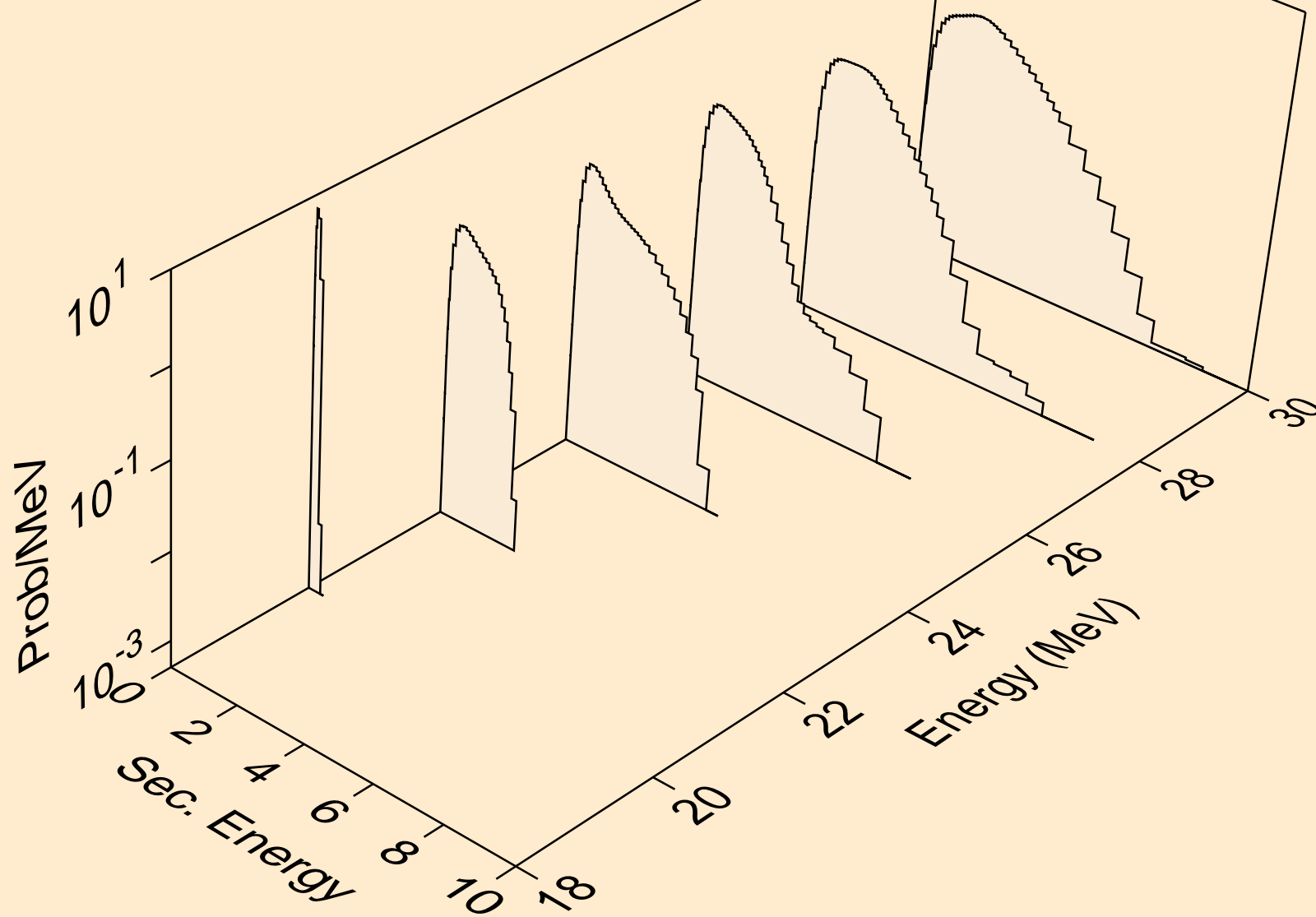

TH228 PHOTON ACER TENDL-2024 LIBRARY; T=0.K
neutrons from (g,n*)a

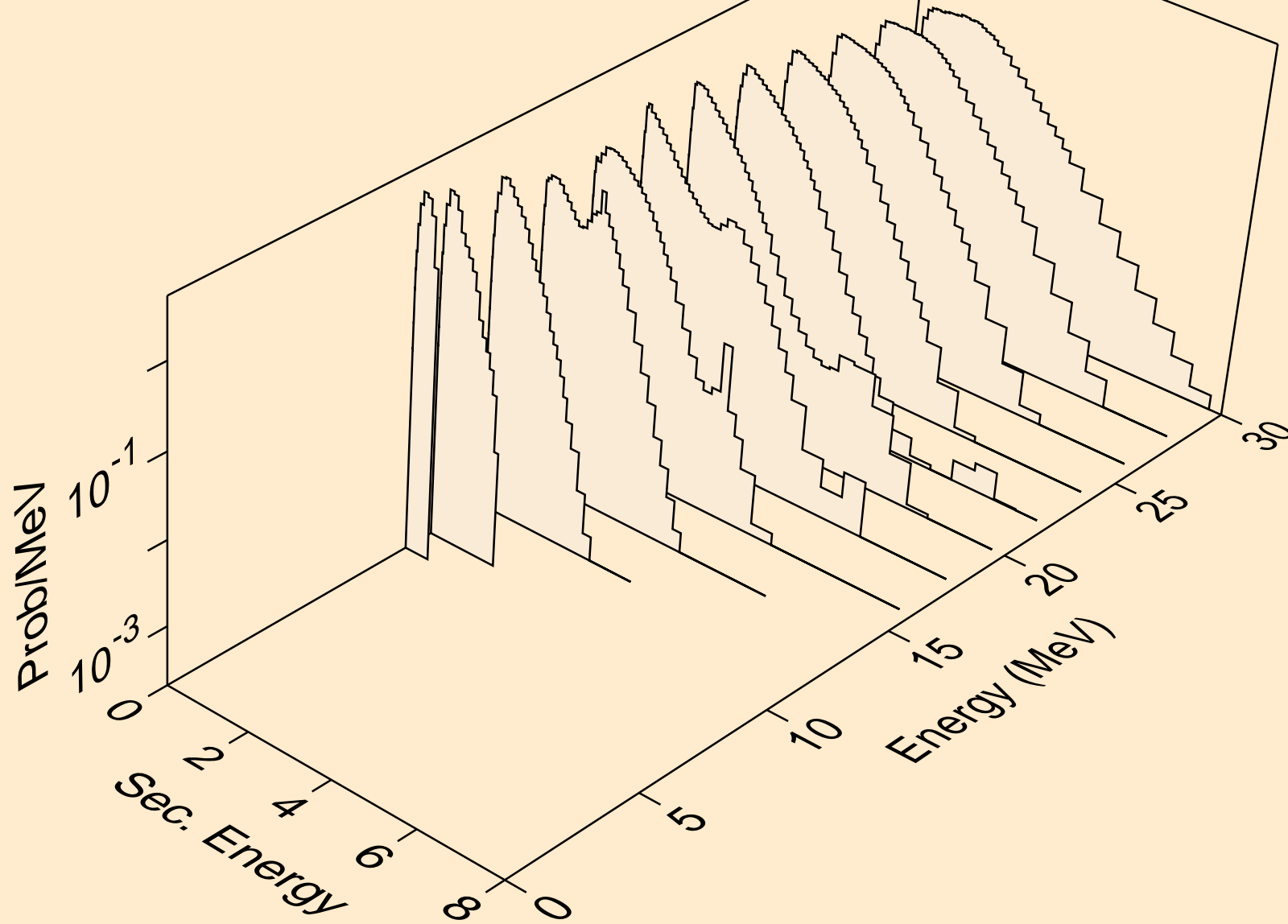

TH228 PHOTON ACER TENDL-2024 LIBRARY; T=0.K
neutrons from (g,2n)a

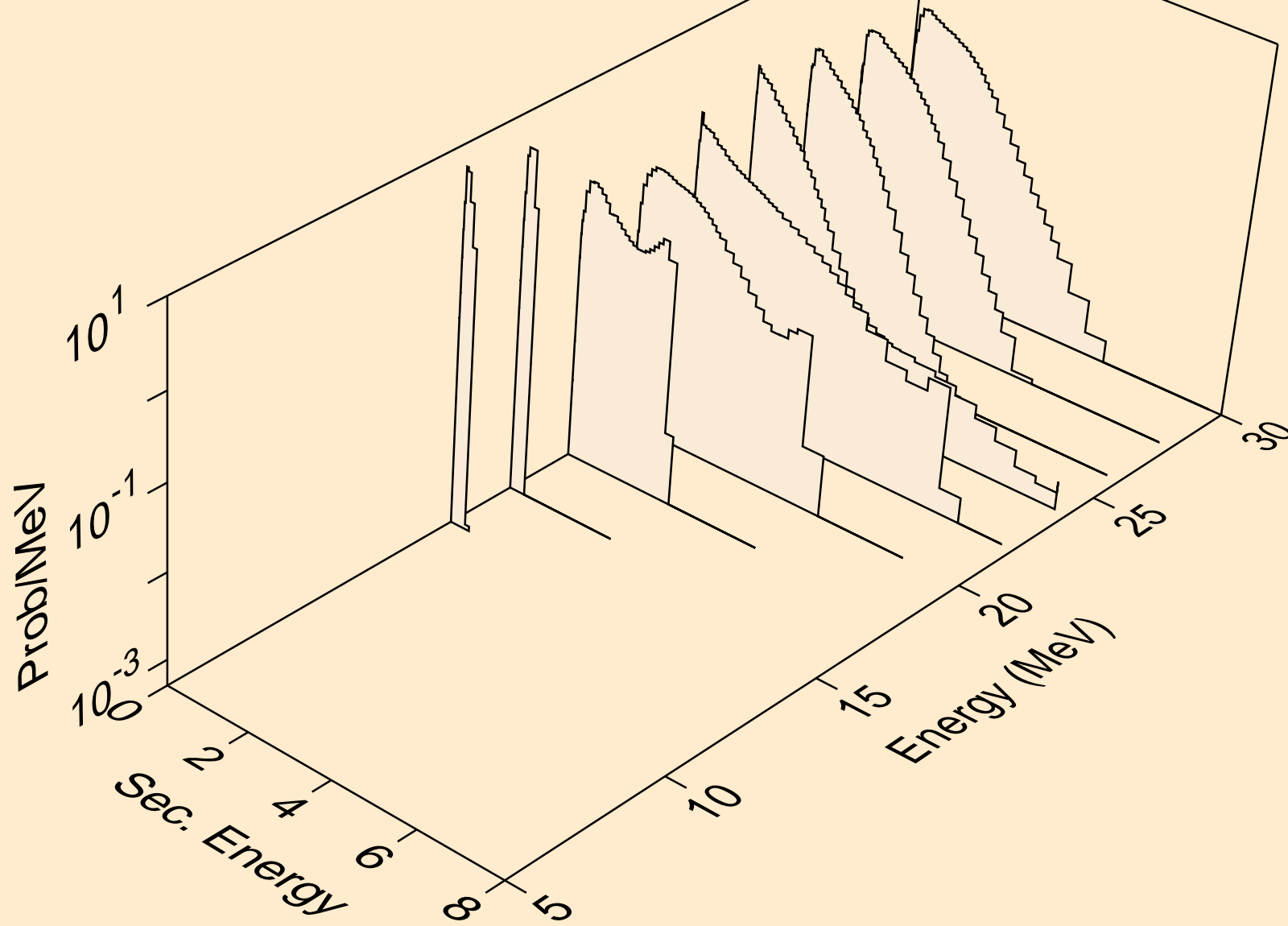

TH228 PHOTON ACER TENDL-2024 LIBRARY; T=0.K
neutrons from (g,3n)a

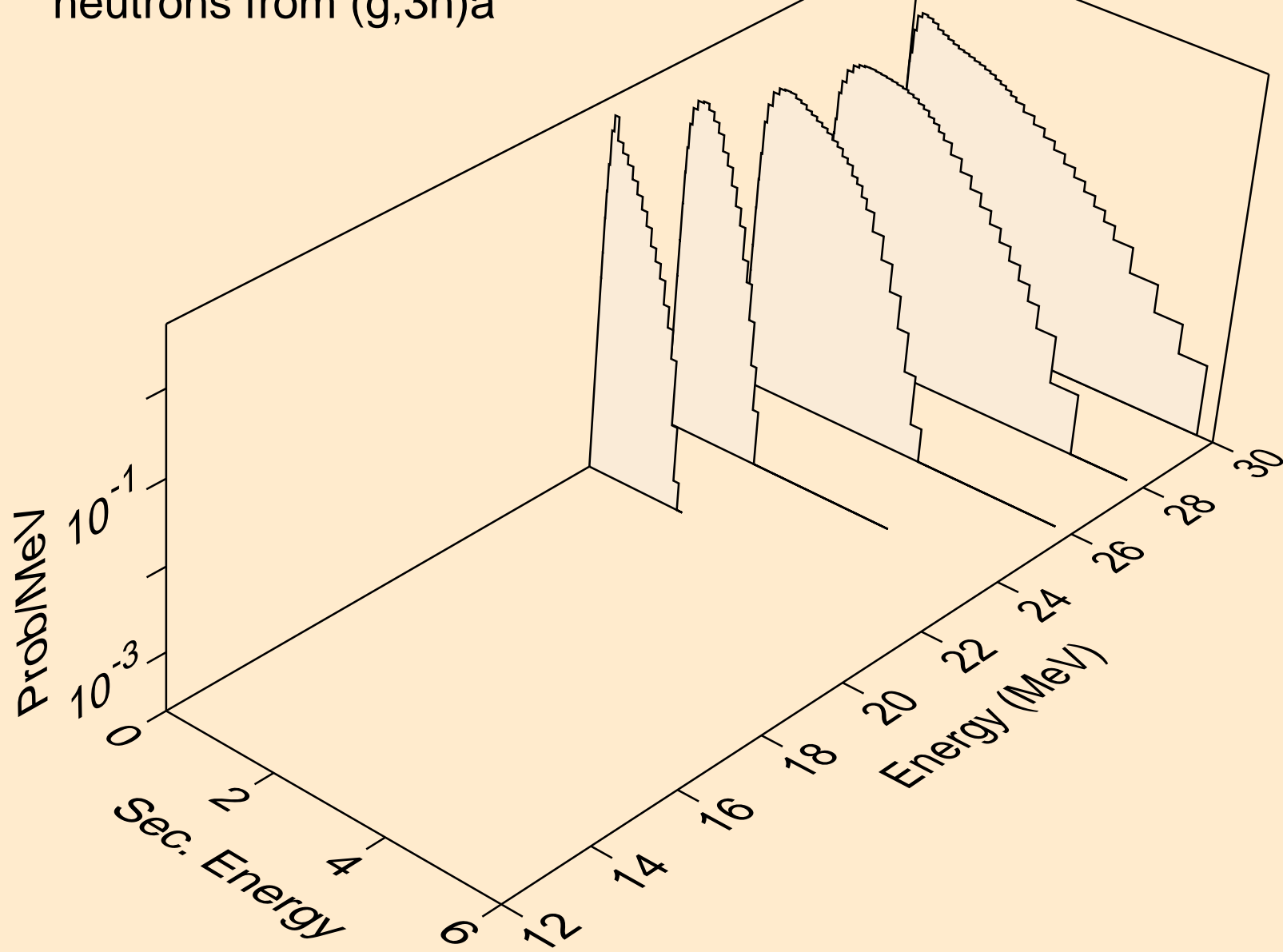

TH228 PHOTON ACER TENDL-2024 LIBRARY; T=0.K
neutrons from (g,n*)p

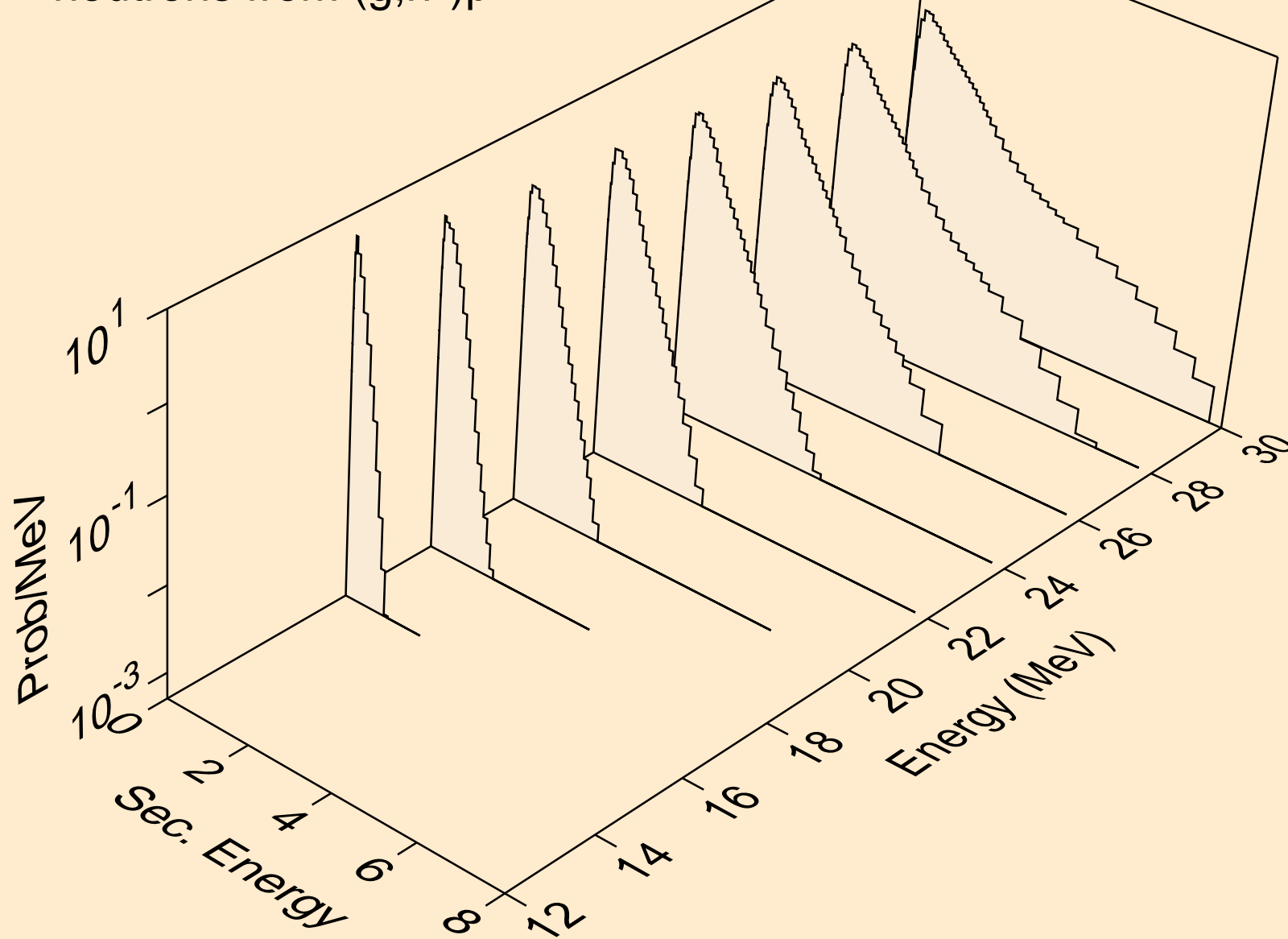

TH228 PHOTON ACER TENDL-2024 LIBRARY; T=0.K
neutrons from (g,n*)d

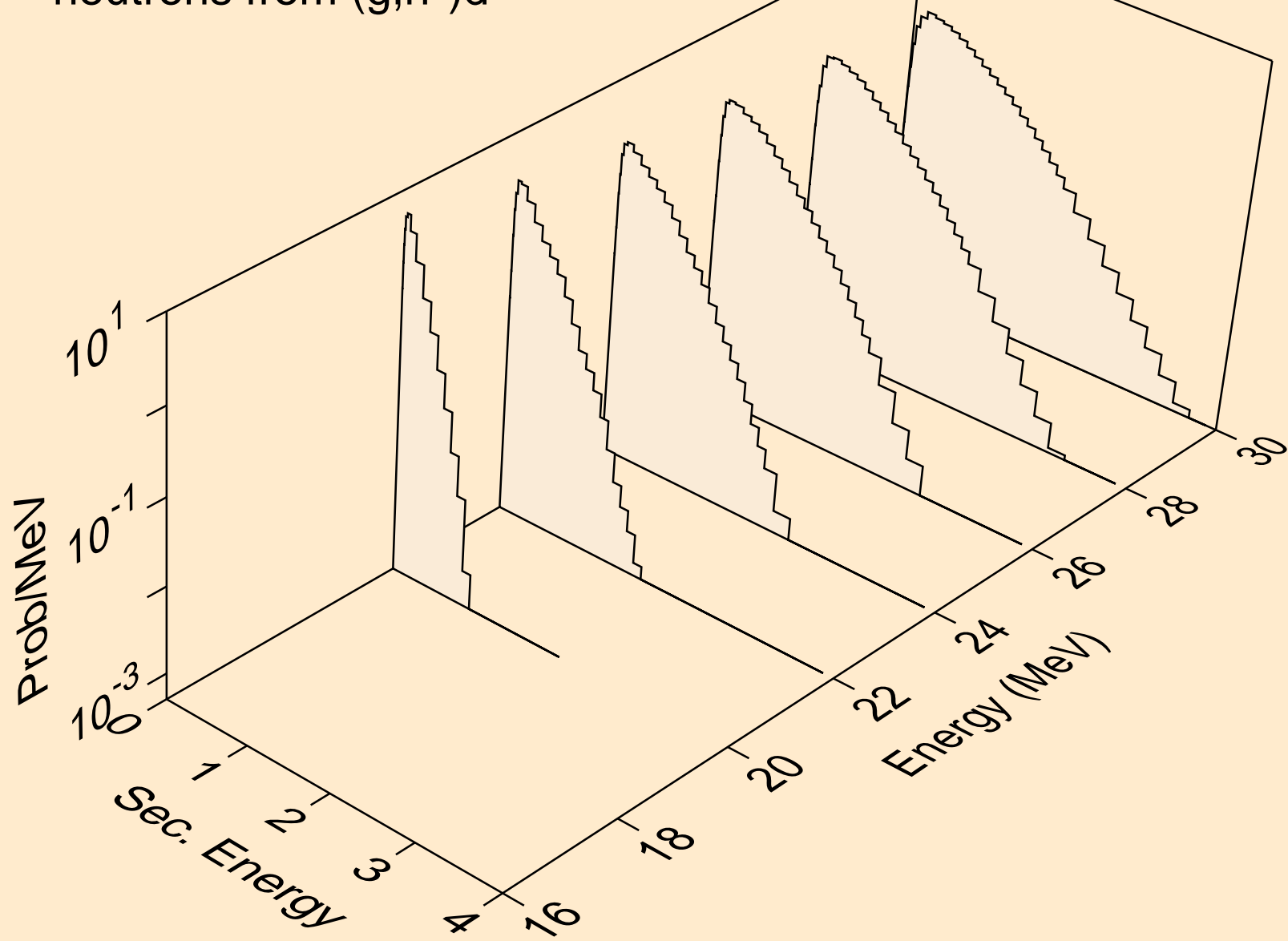

TH228 PHOTON ACER TENDL-2024 LIBRARY; T=0.K
neutrons from (g,n*)t

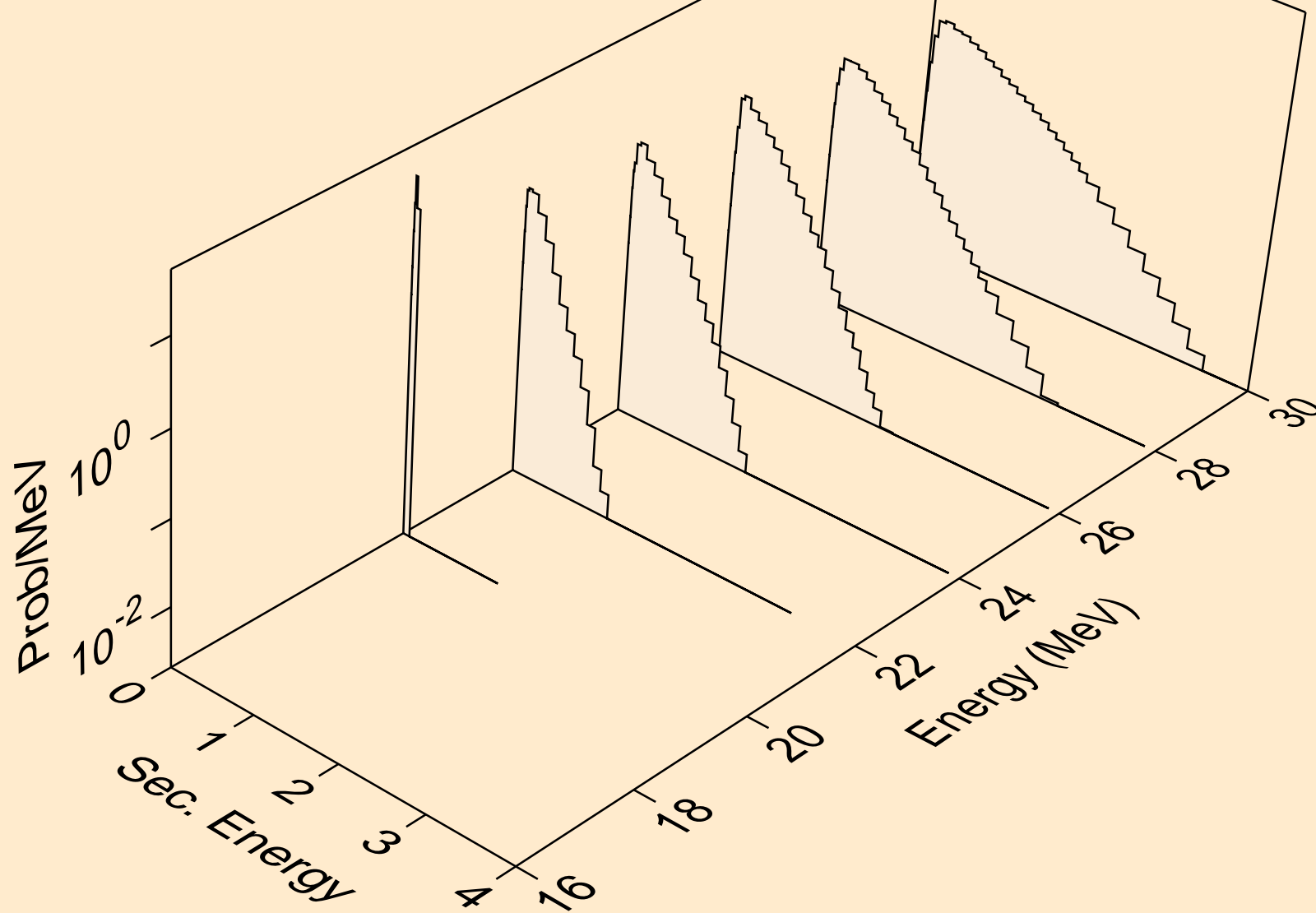

TH228 PHOTON ACER TENDL-2024 LIBRARY; T=0.K
neutrons from (g,4n)

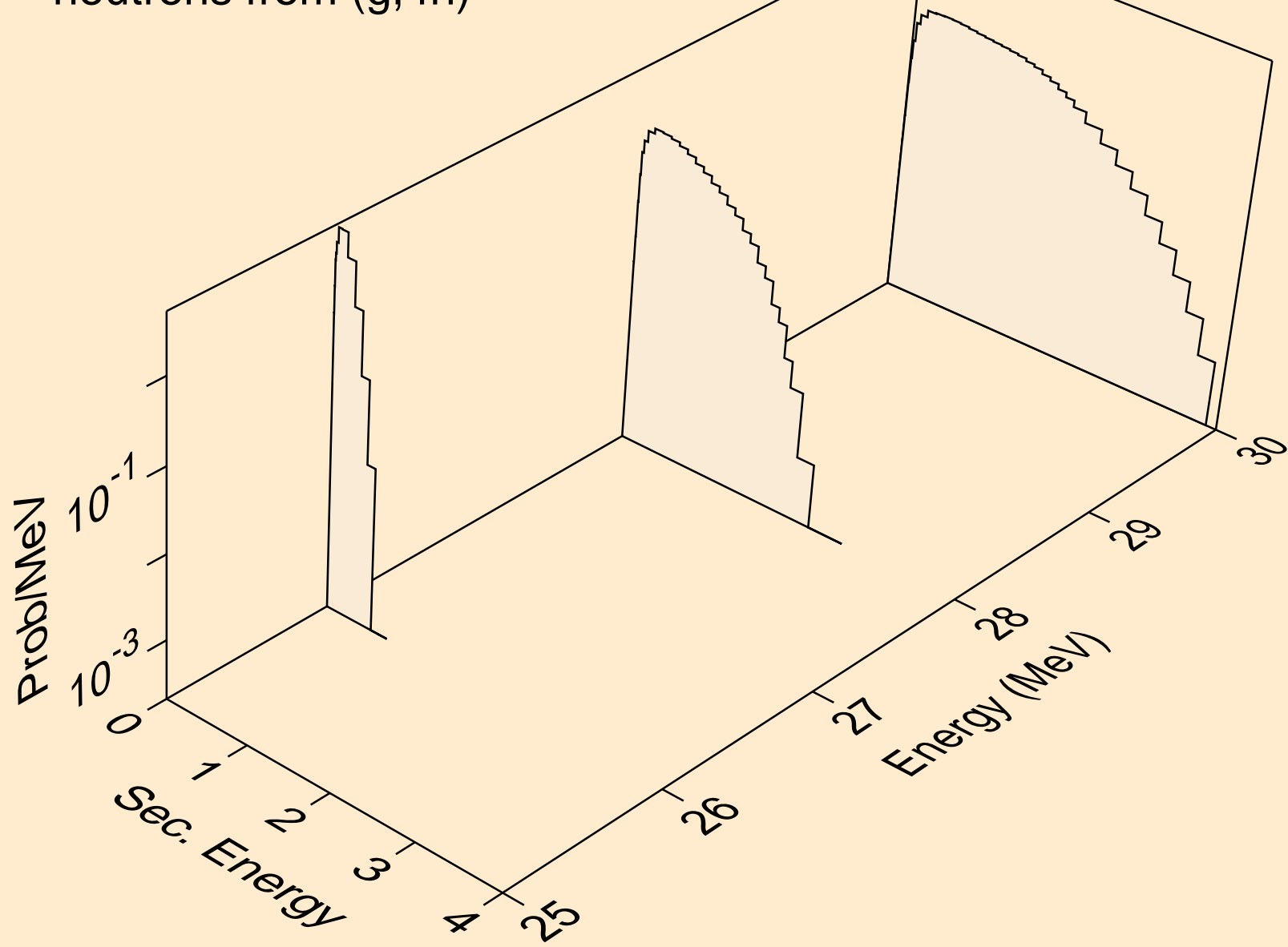

TH228 PHOTON ACER TENDL-2024 LIBRARY; T=0.K
neutrons from (g,2np)

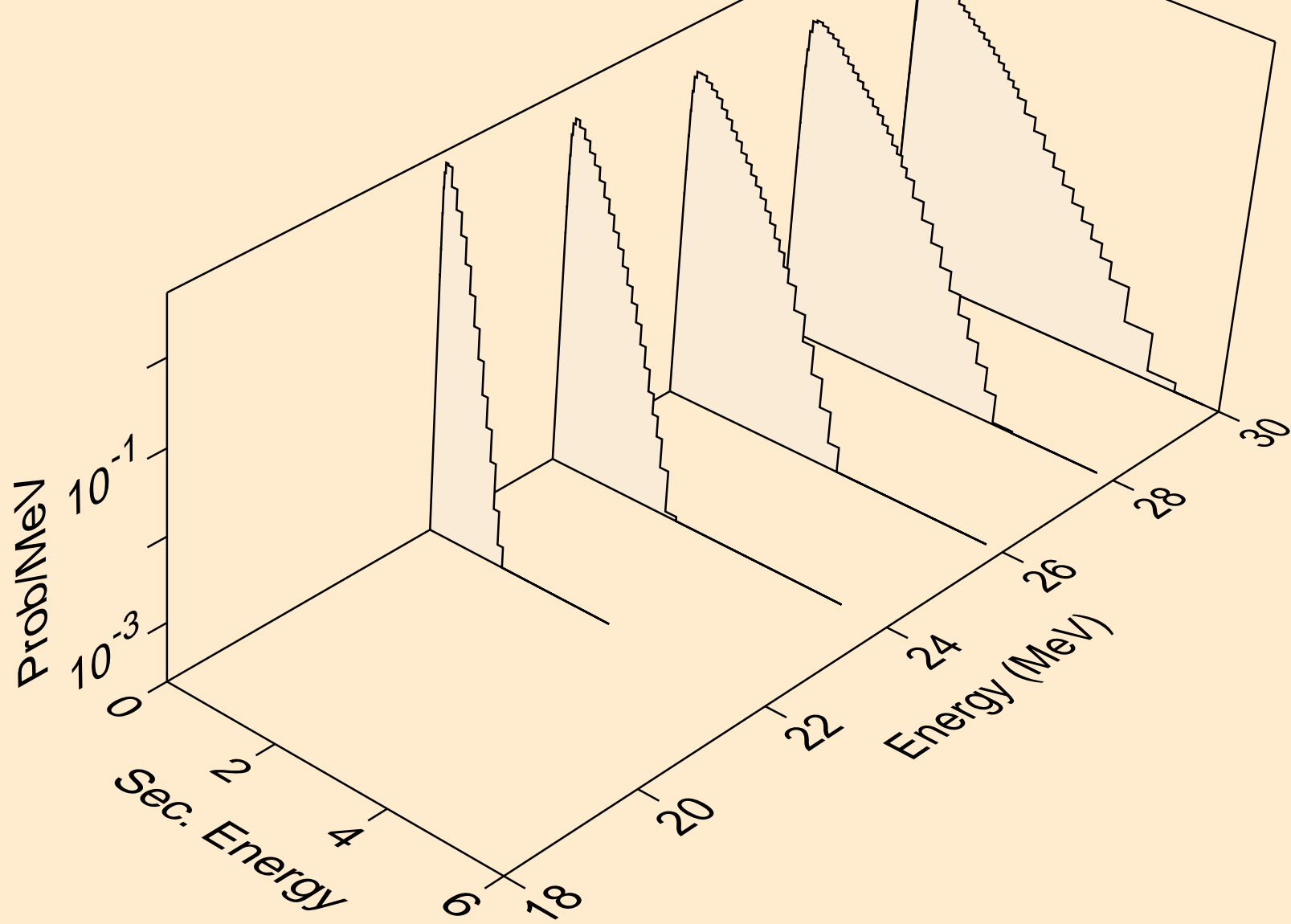

TH228 PHOTON ACER TENDL-2024 LIBRARY; T=0.K
angular distribution for (g,n*0) neutron

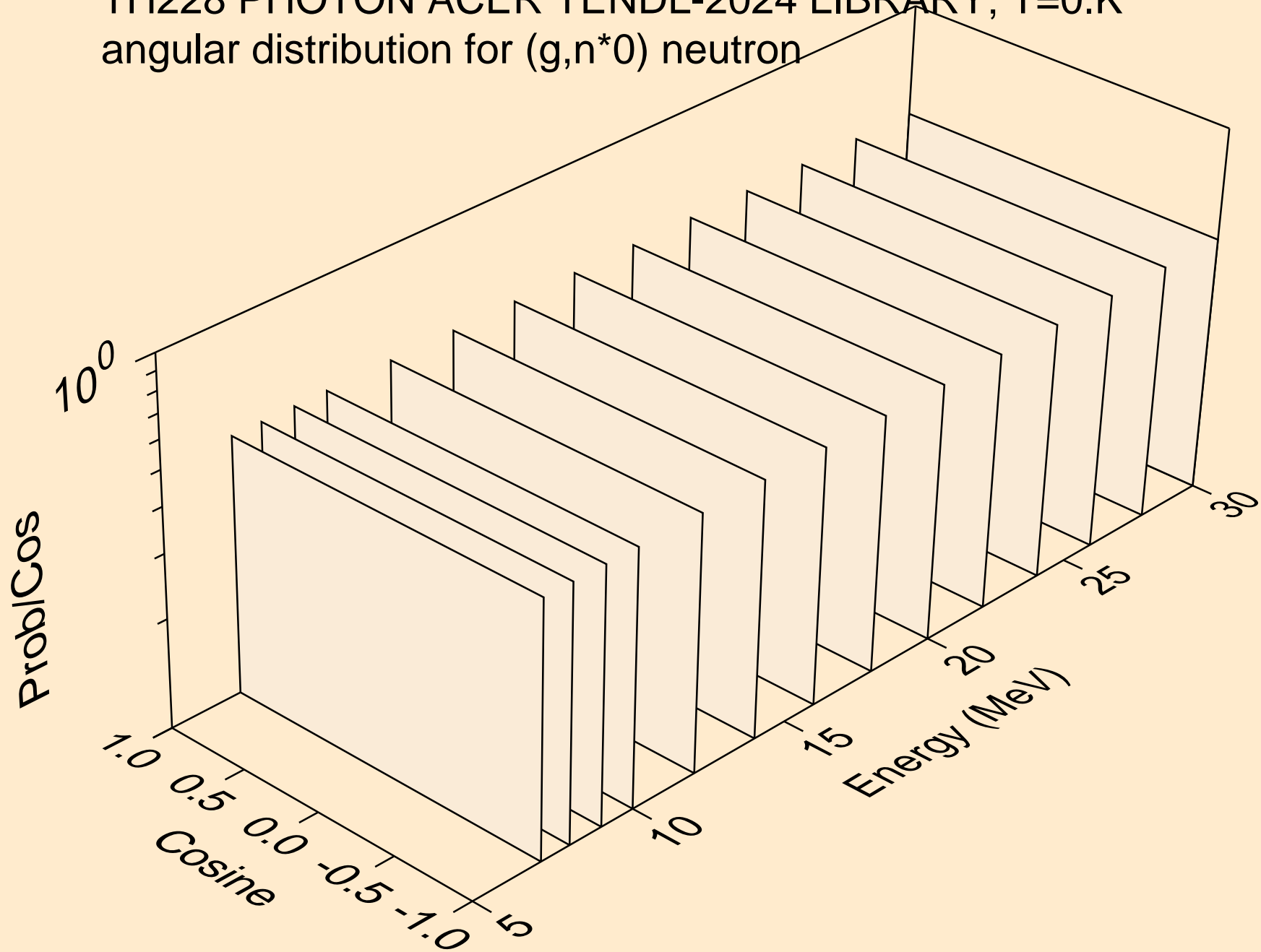

TH228 PHOTON ACER TENDL-2024 LIBRARY; T=0.K
angular distribution for (g,n*1) neutron

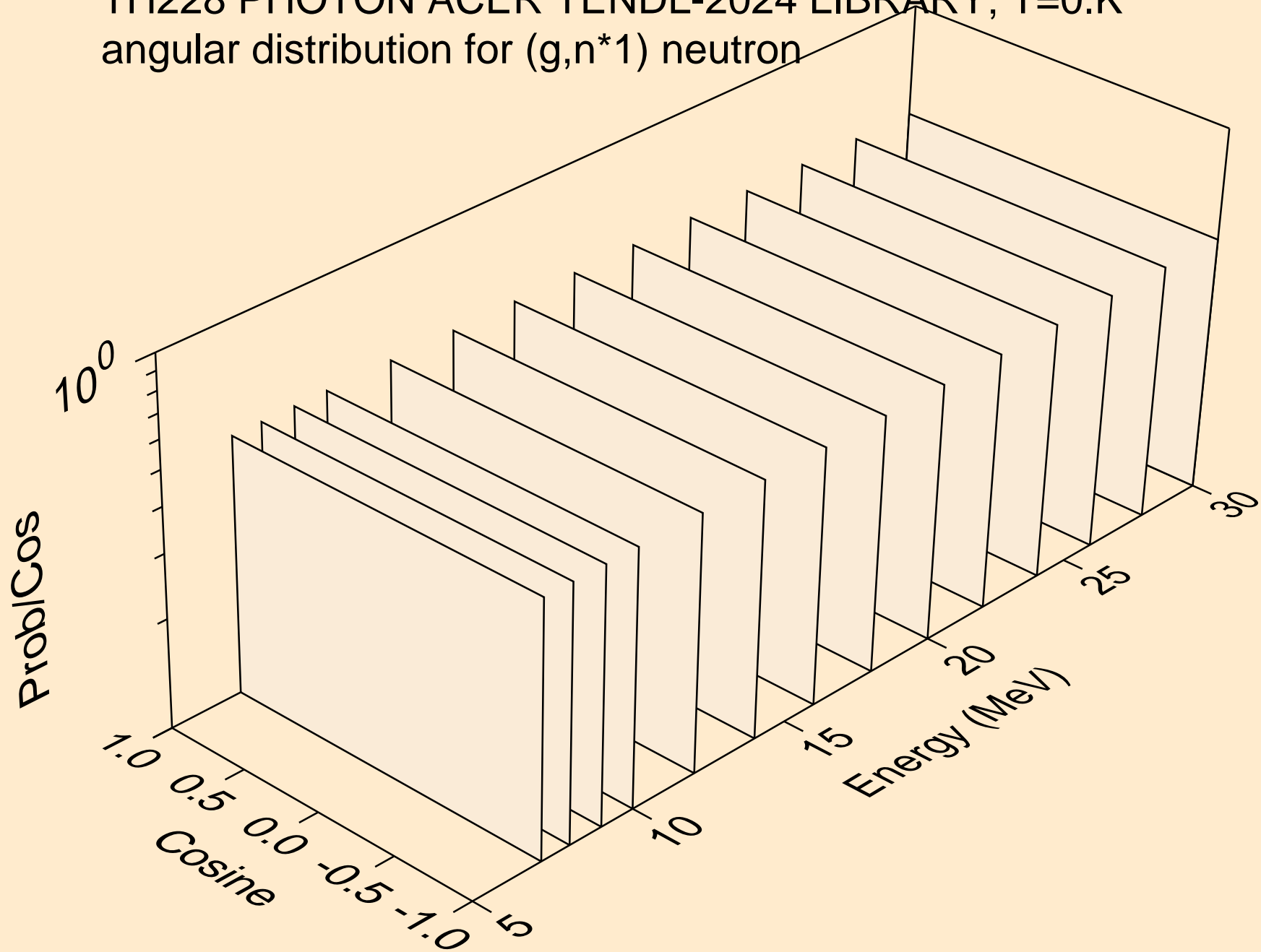

TH228 PHOTON ACER TENDL-2024 LIBRARY; T=0.K
neutrons from (g,n*c)

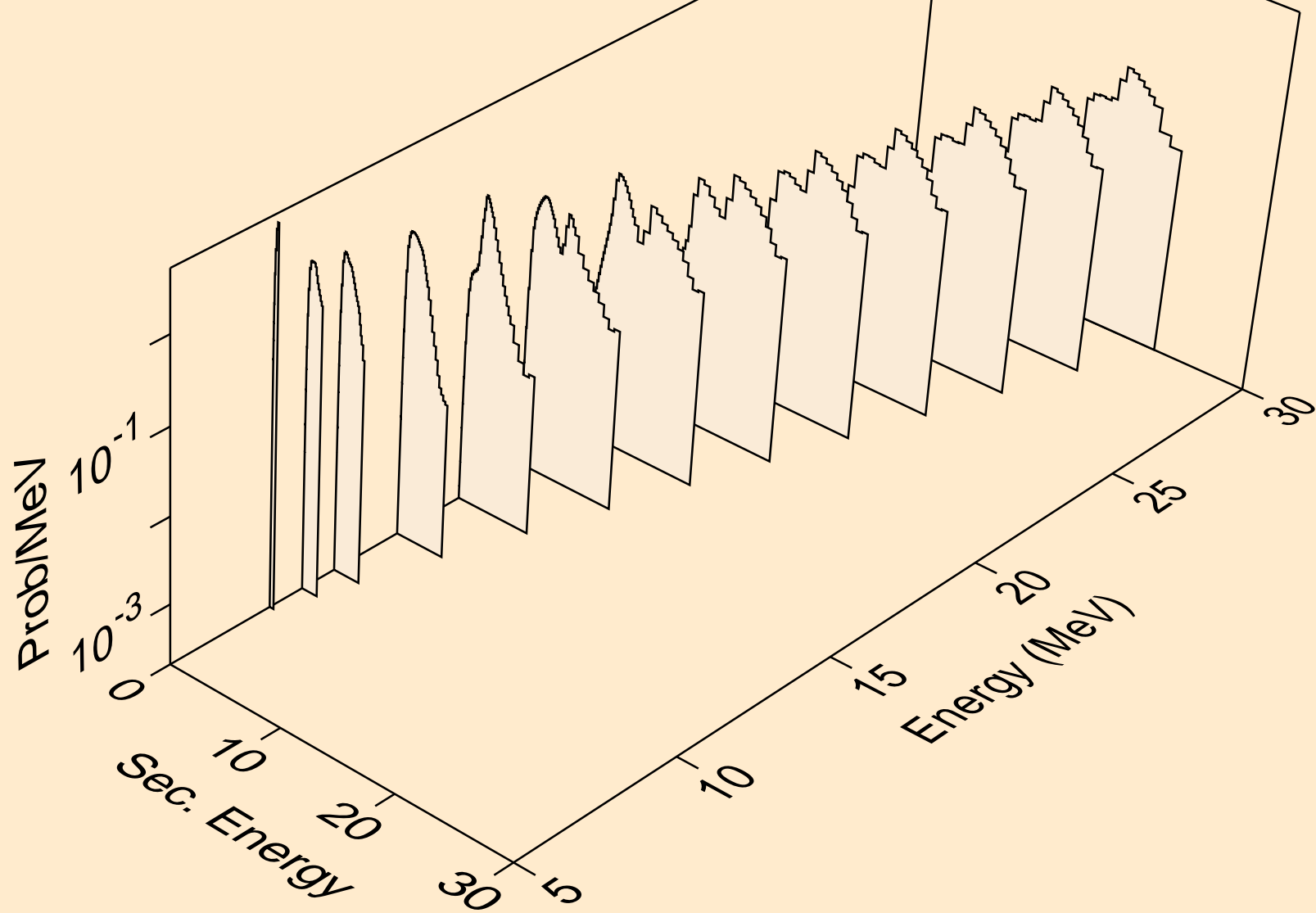

TH228 PHOTON ACER TENDL-2024 LIBRARY; T=0.K
photons from (g,x)

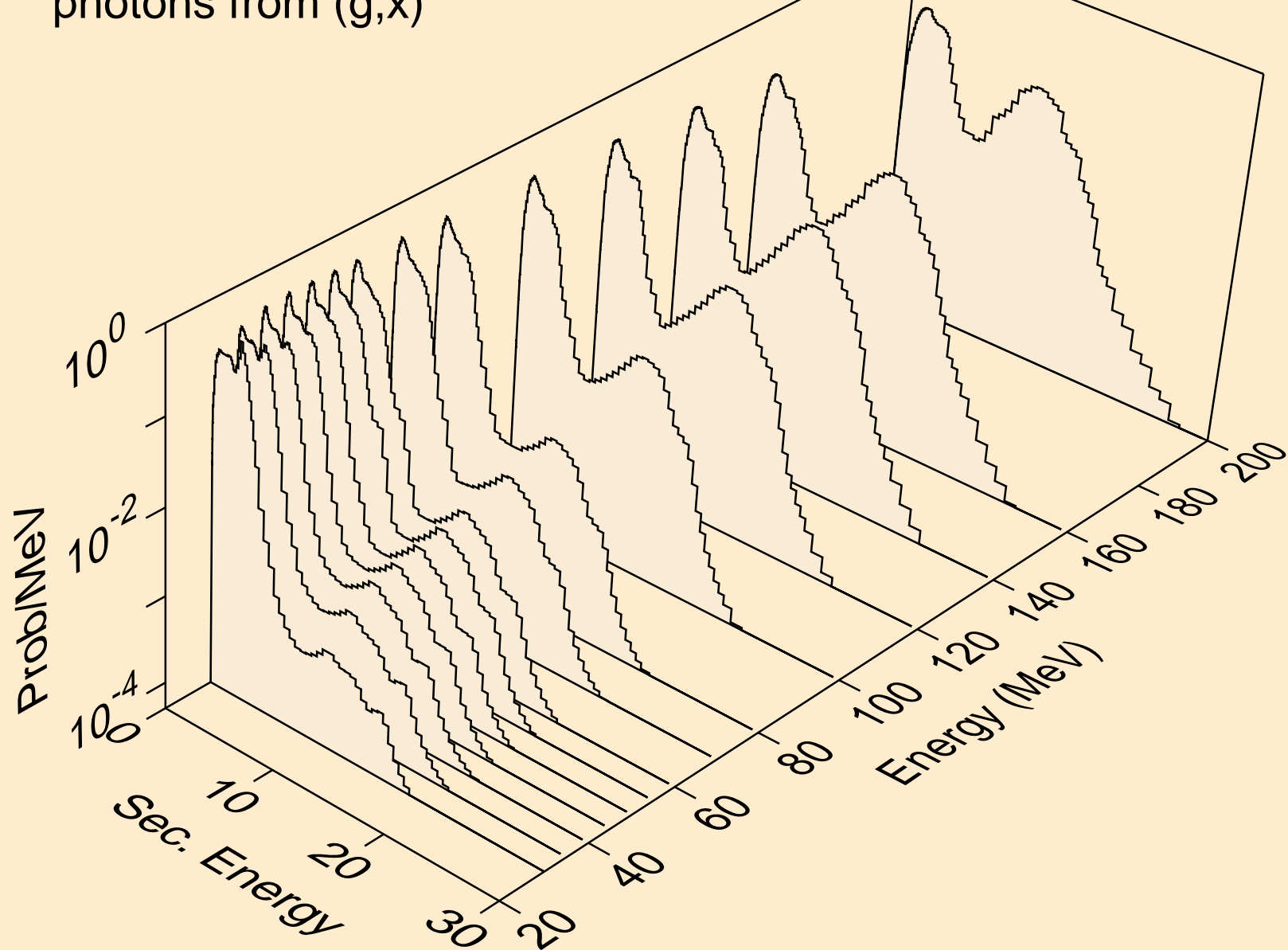

TH228 PHOTON ACER TENDL-2024 LIBRARY; T=0.K
photons from (g,2n)

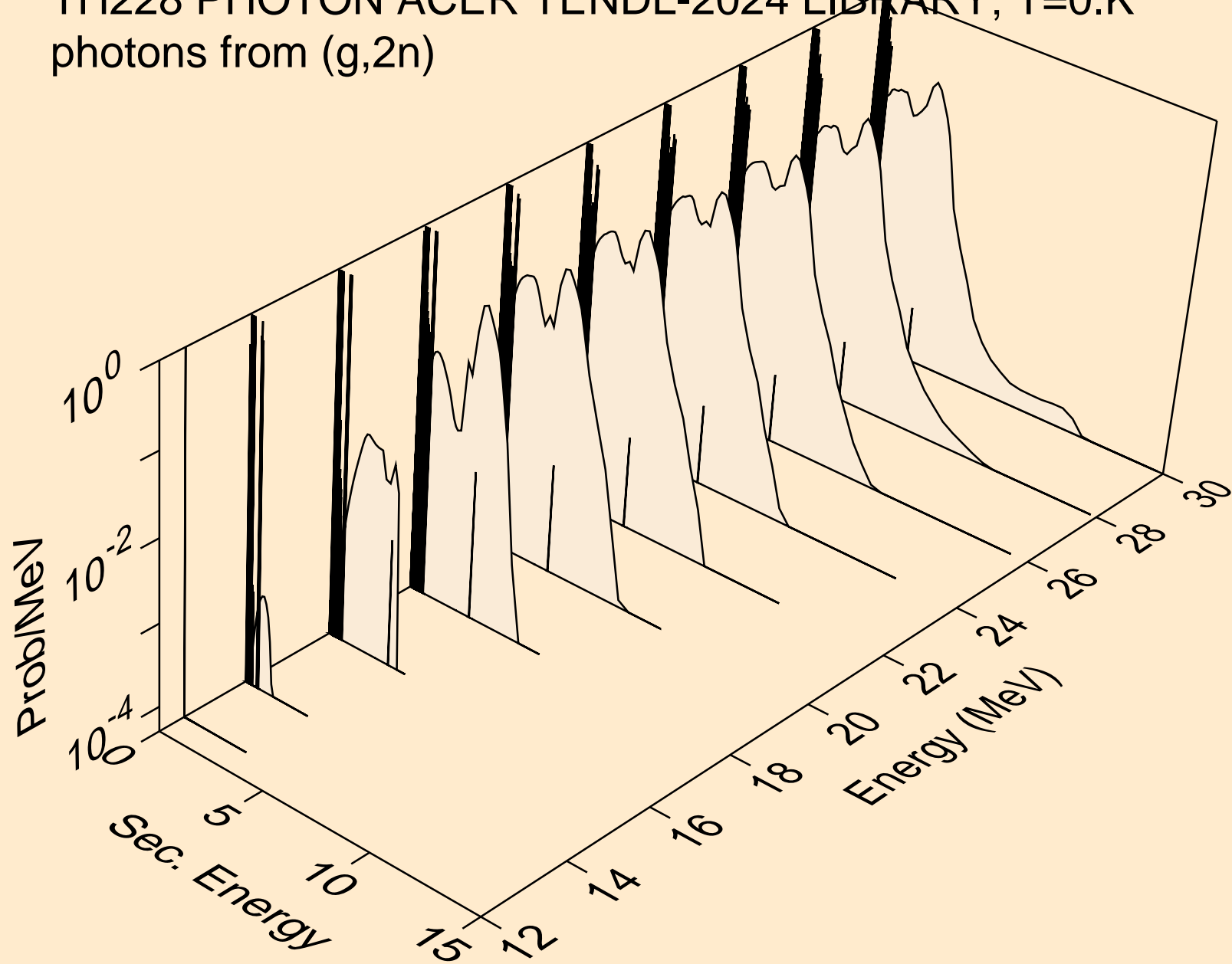

TH228 PHOTON ACER TENDL-2024 LIBRARY; T=0.K
photons from (g,3n)

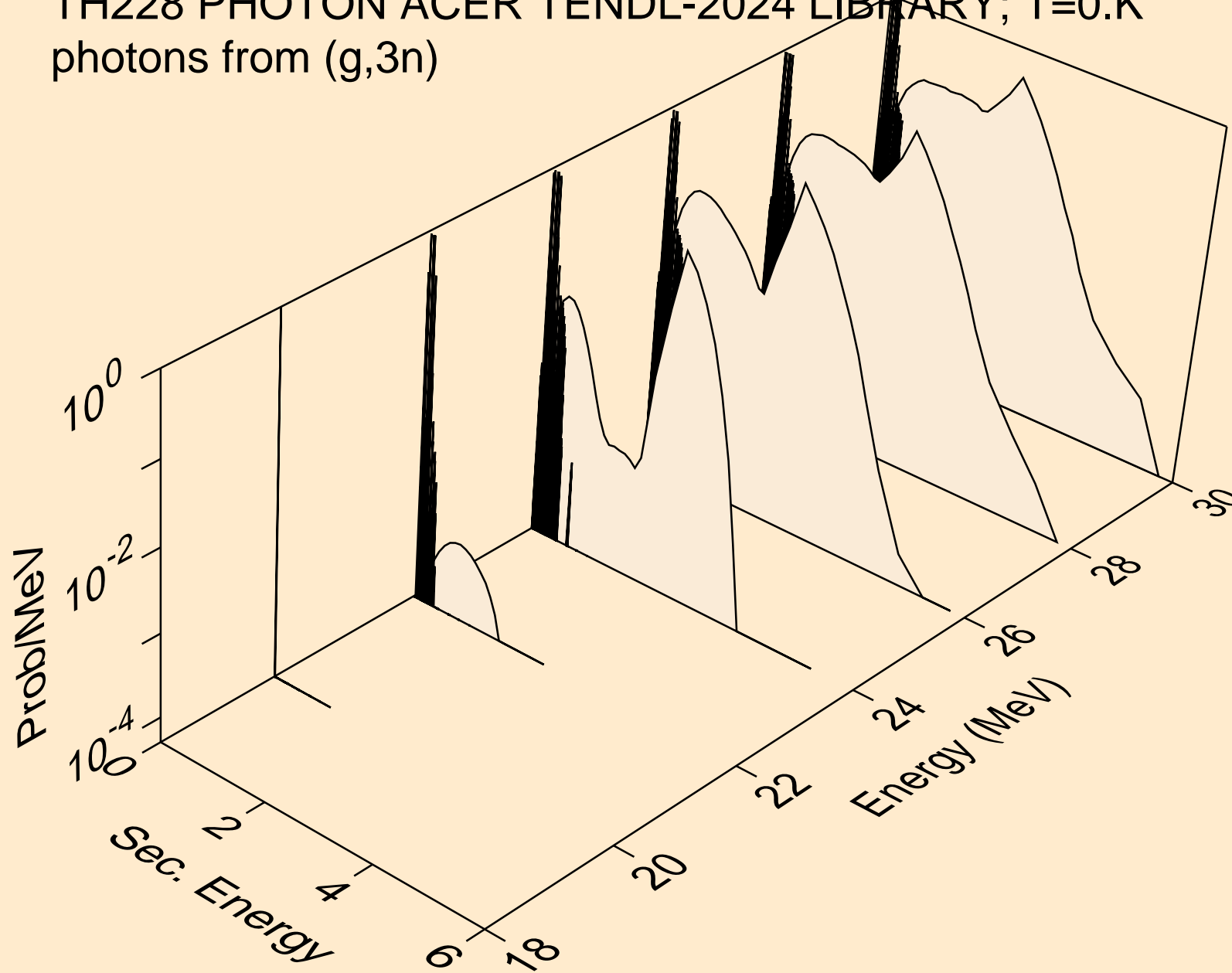

TH228 PHOTON ACER TENDL-2024 LIBRARY; T=0.K
photons from (g,n*)a

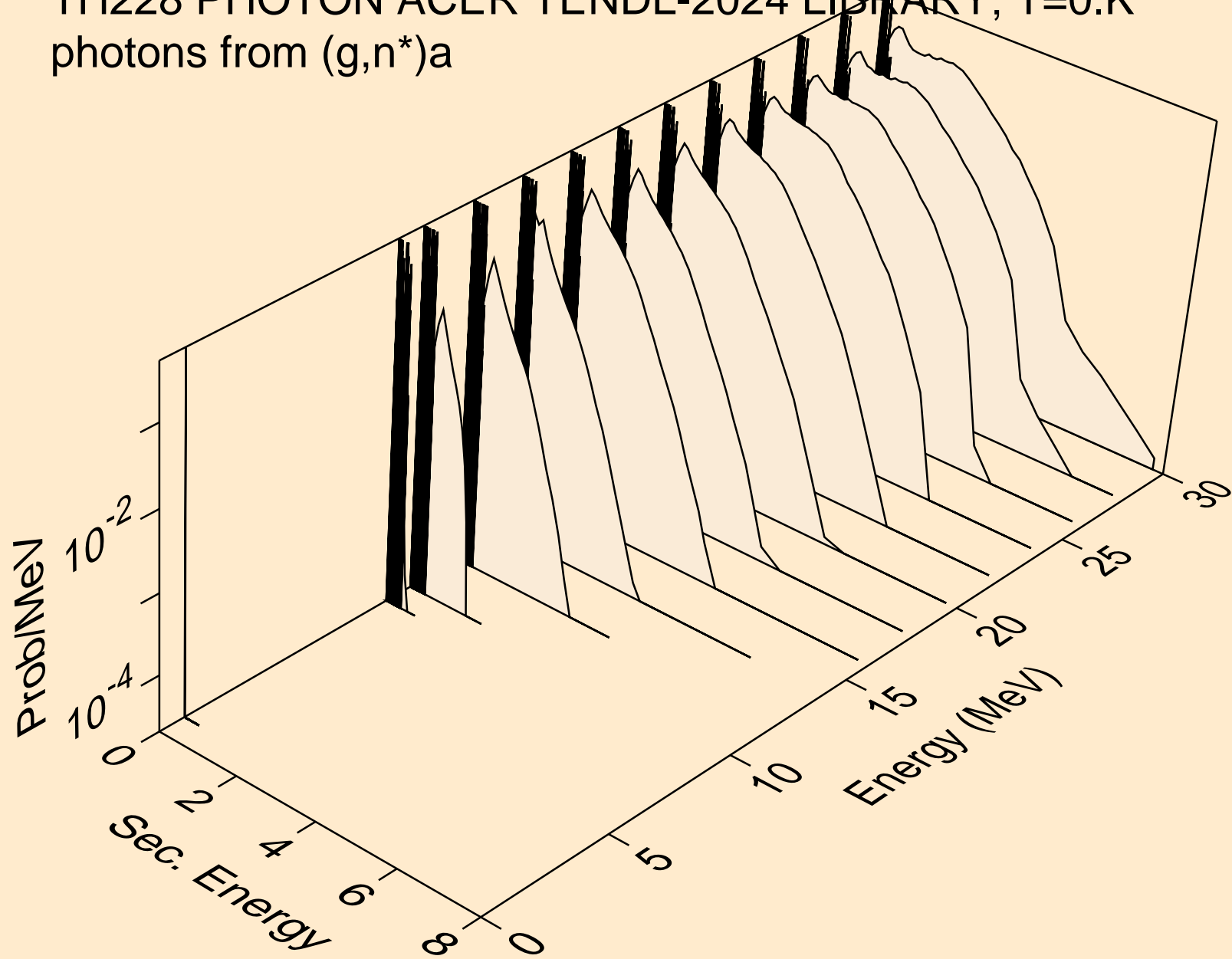

TH228 PHOTON ACER TENDL-2024 LIBRARY; T=0.K
photons from (g,2n)a

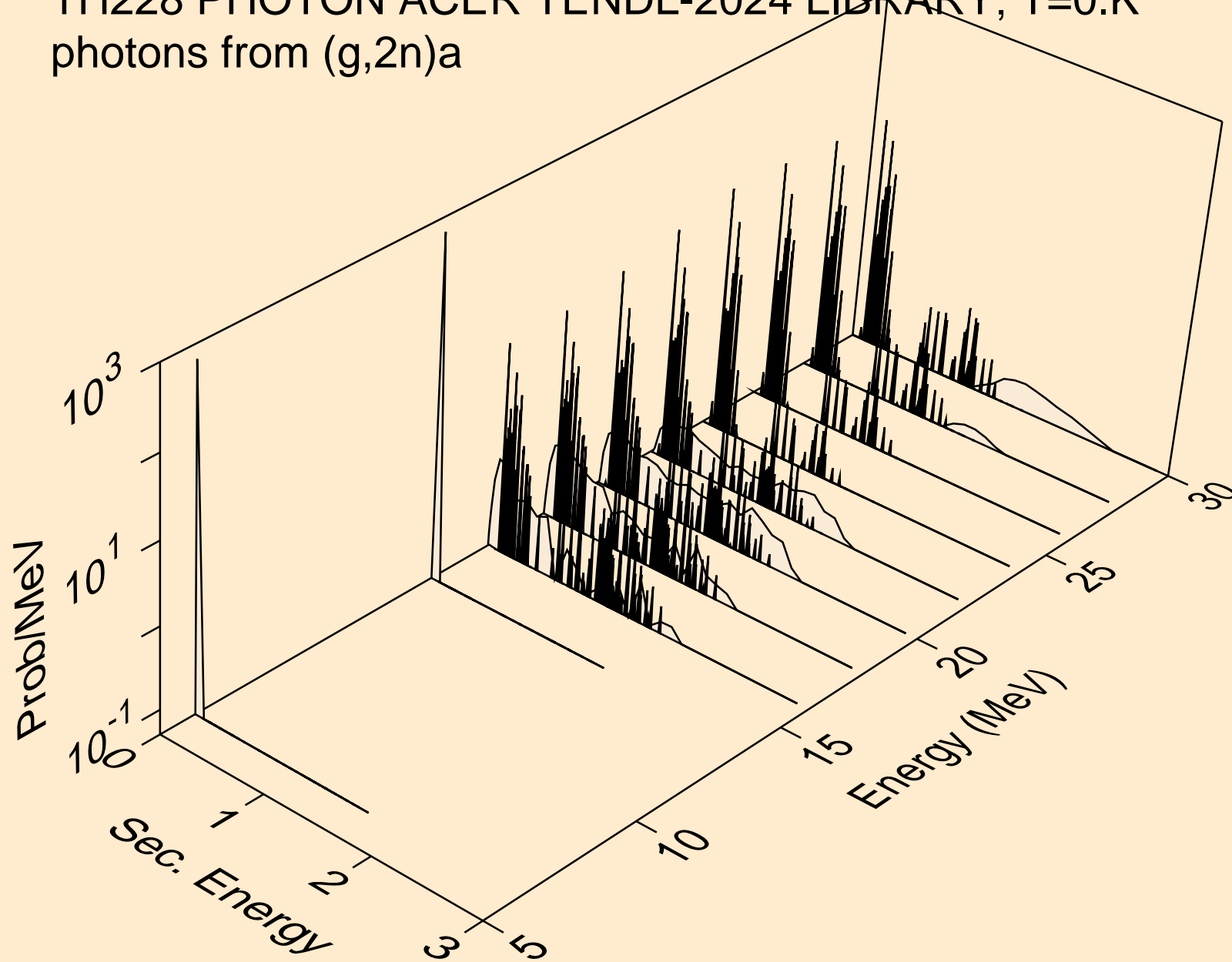

TH228 PHOTON ACER TENDL-2024 LIBRARY; T=0.K
photons from (g,3n)a

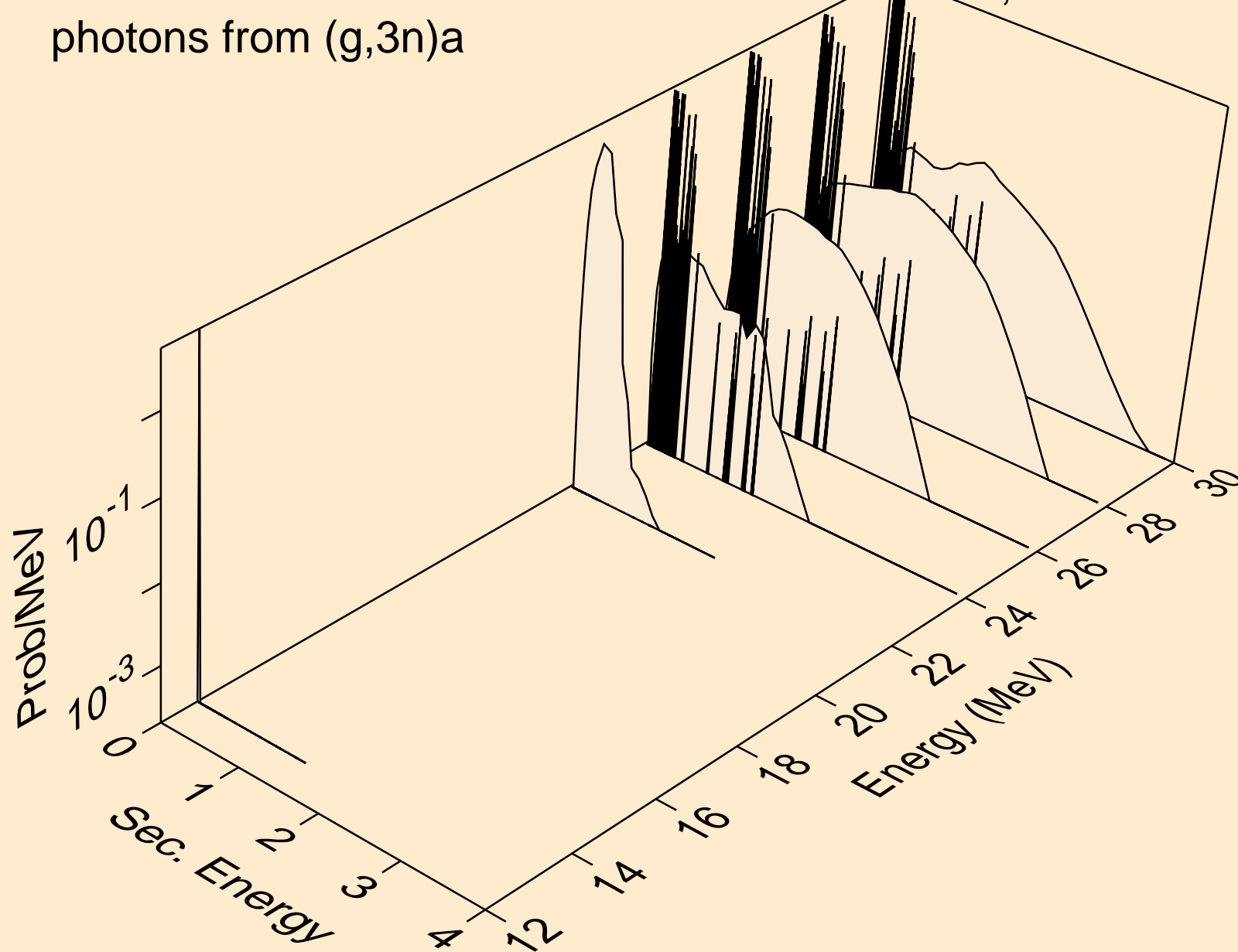

TH228 PHOTON ACER TENDL-2024 LIBRARY; T=0.K
photons from (g,n*)p

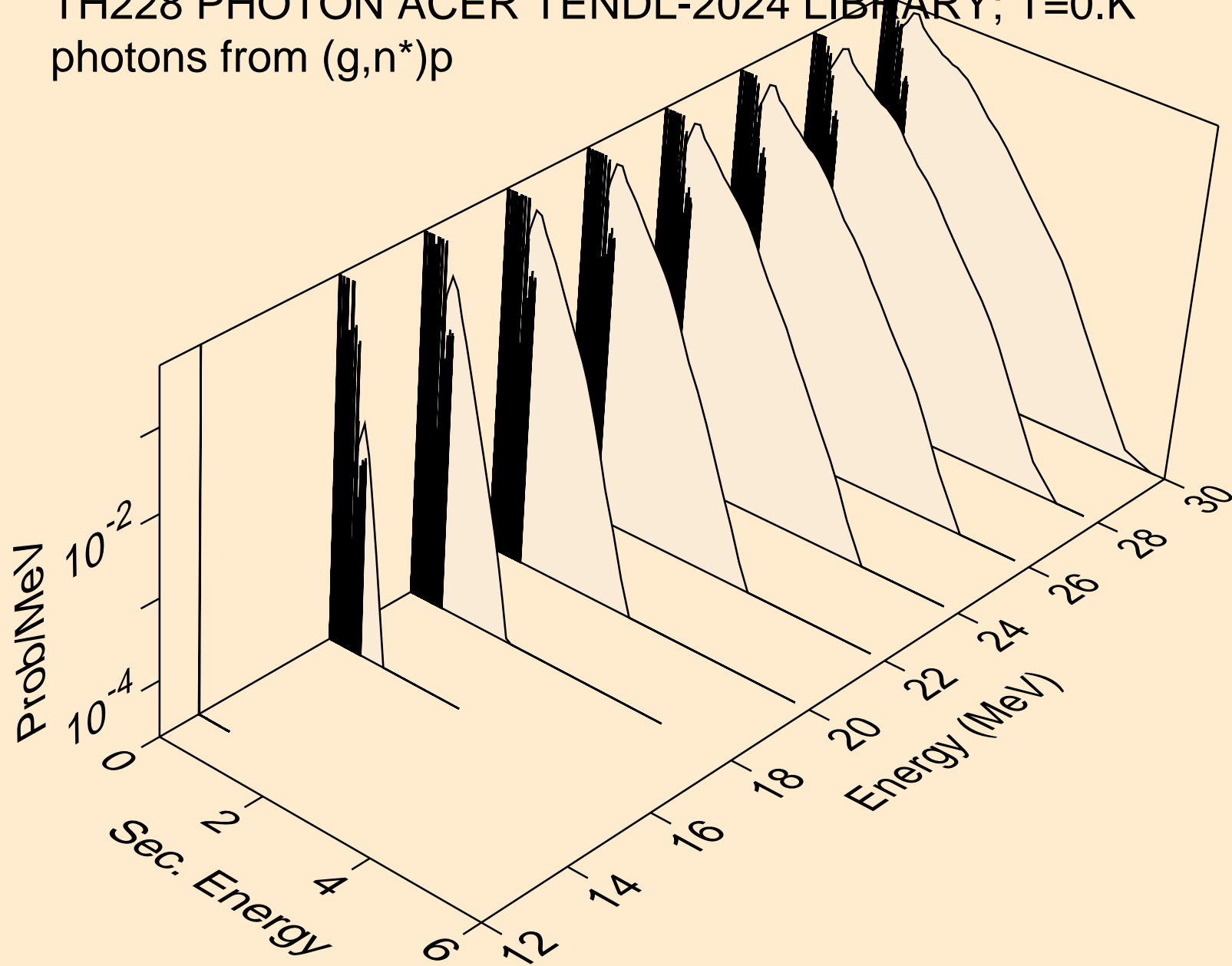

TH228 PHOTON ACER TENDL-2024 LIBRARY; T=0.K
photons from (g,n*)d

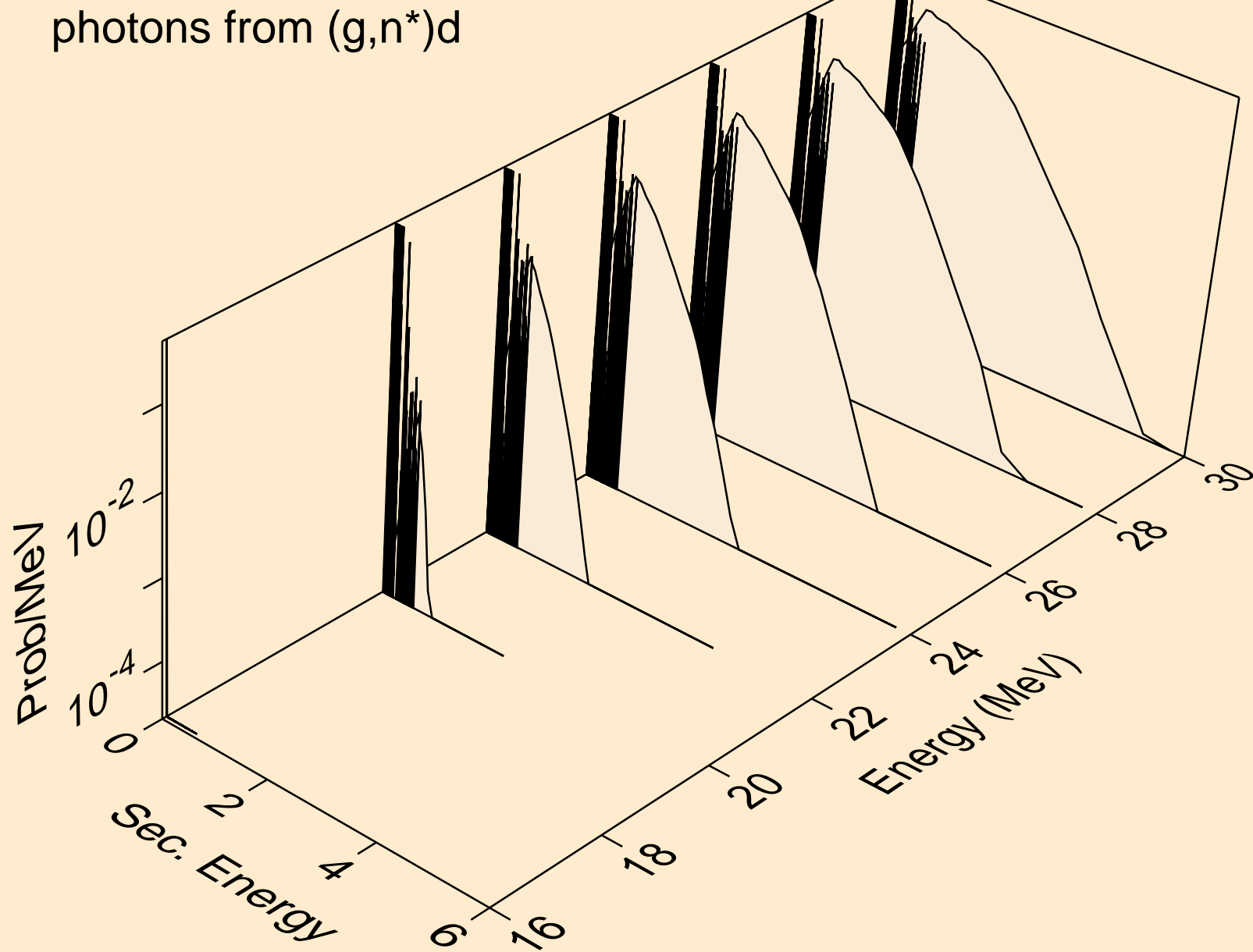

TH228 PHOTON ACER TENDL-2024 LIBRARY; T=0.K
photons from (g,n*)t

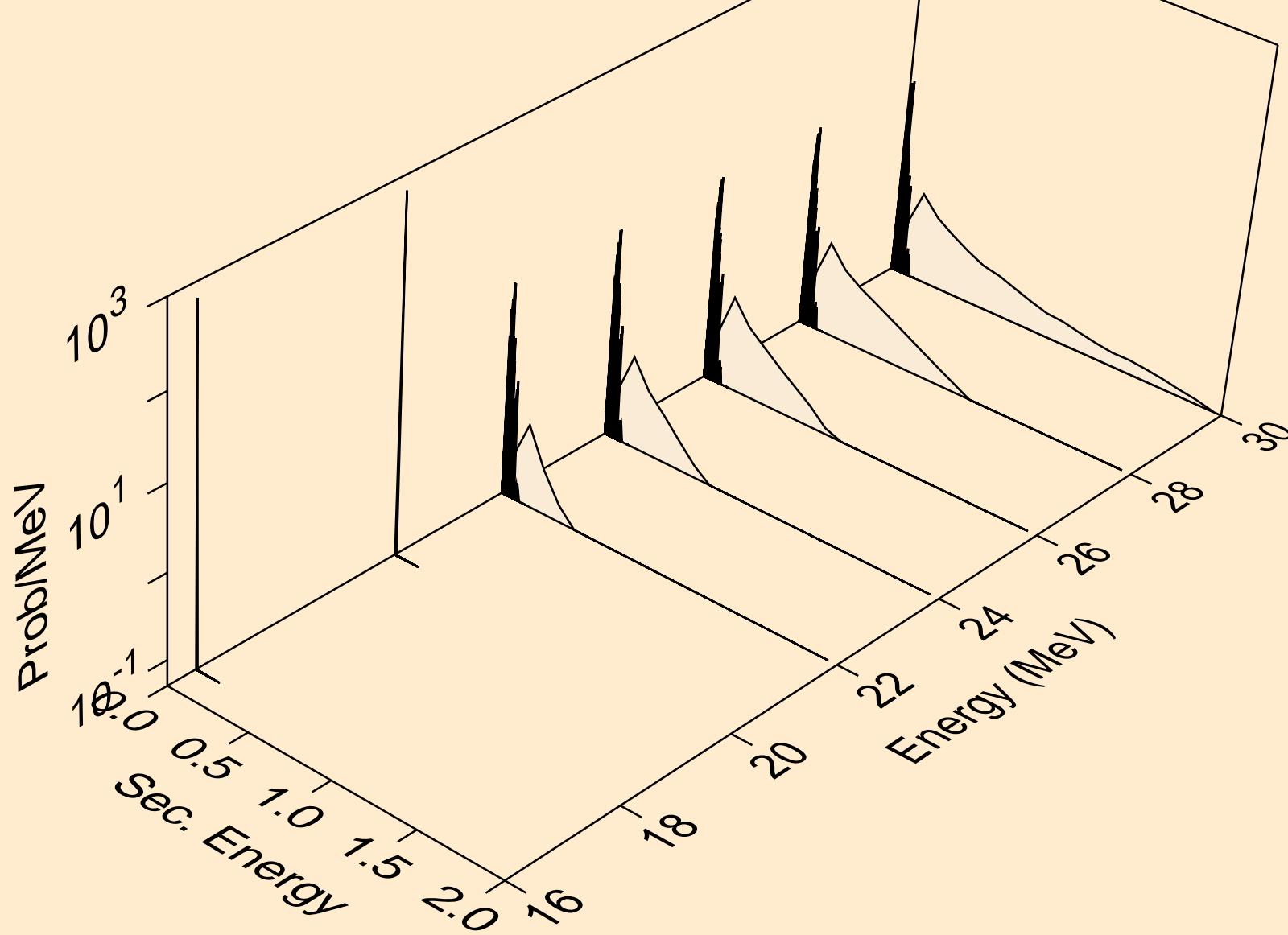

TH228 PHOTON ACER TENDL-2024 LIBRARY; T=0.K
photons from (g,4n)

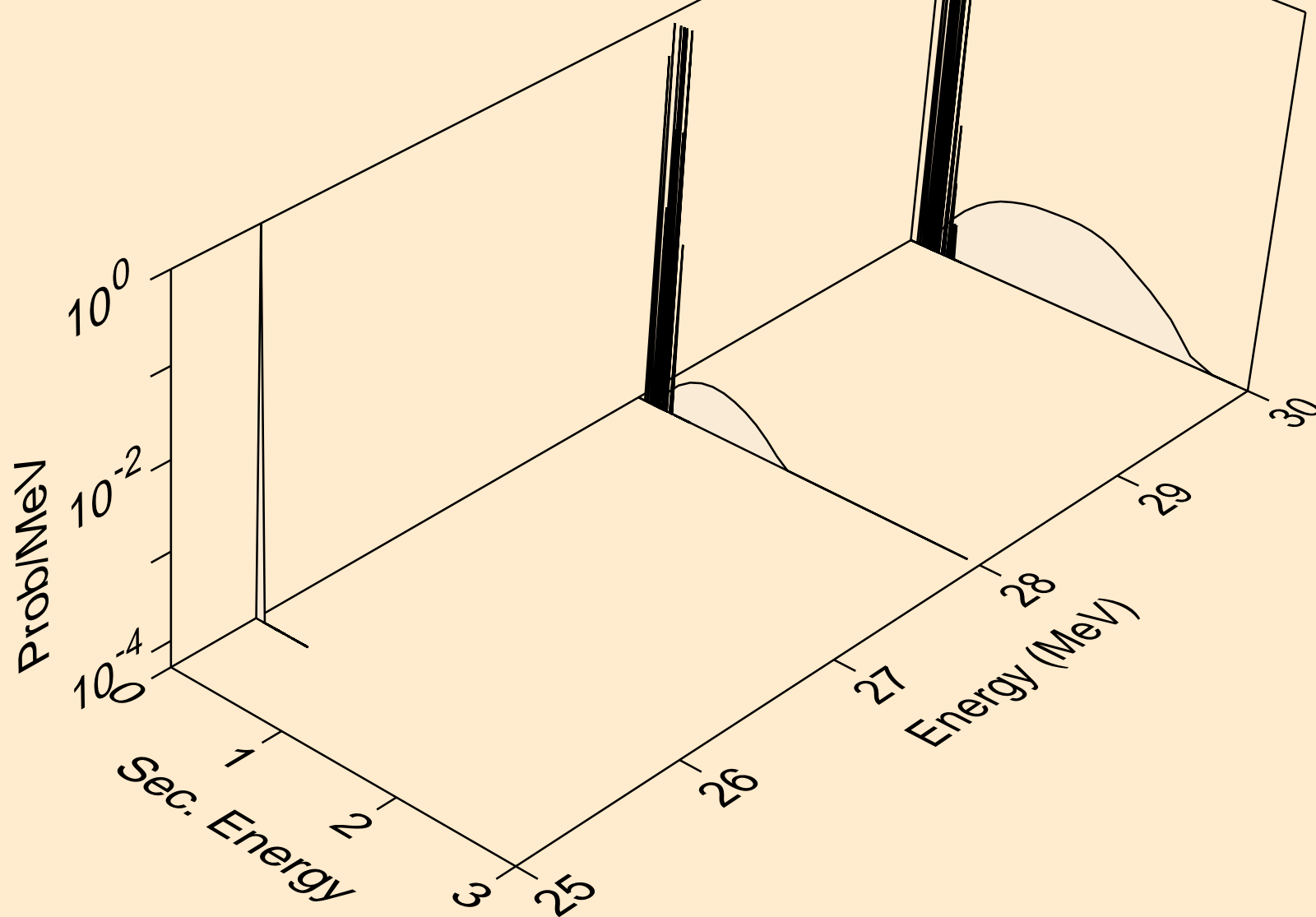

TH228 PHOTON ACER TENDL-2024 LIBRARY; T=0.K
photons from (g,2np)

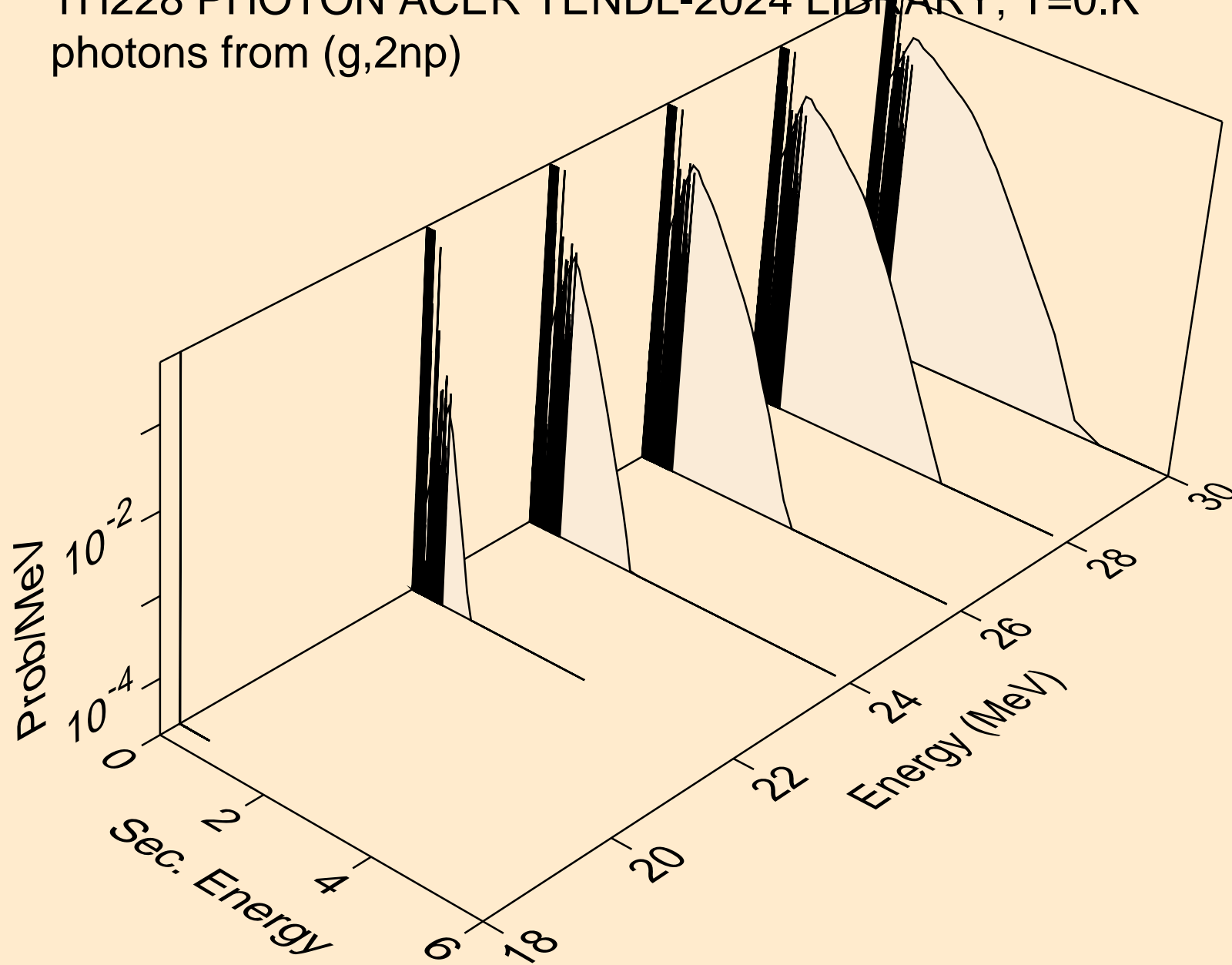

TH228 PHOTON ACER TENDL-2024 LIBRARY; T=0.K
photons from (g,n*c)

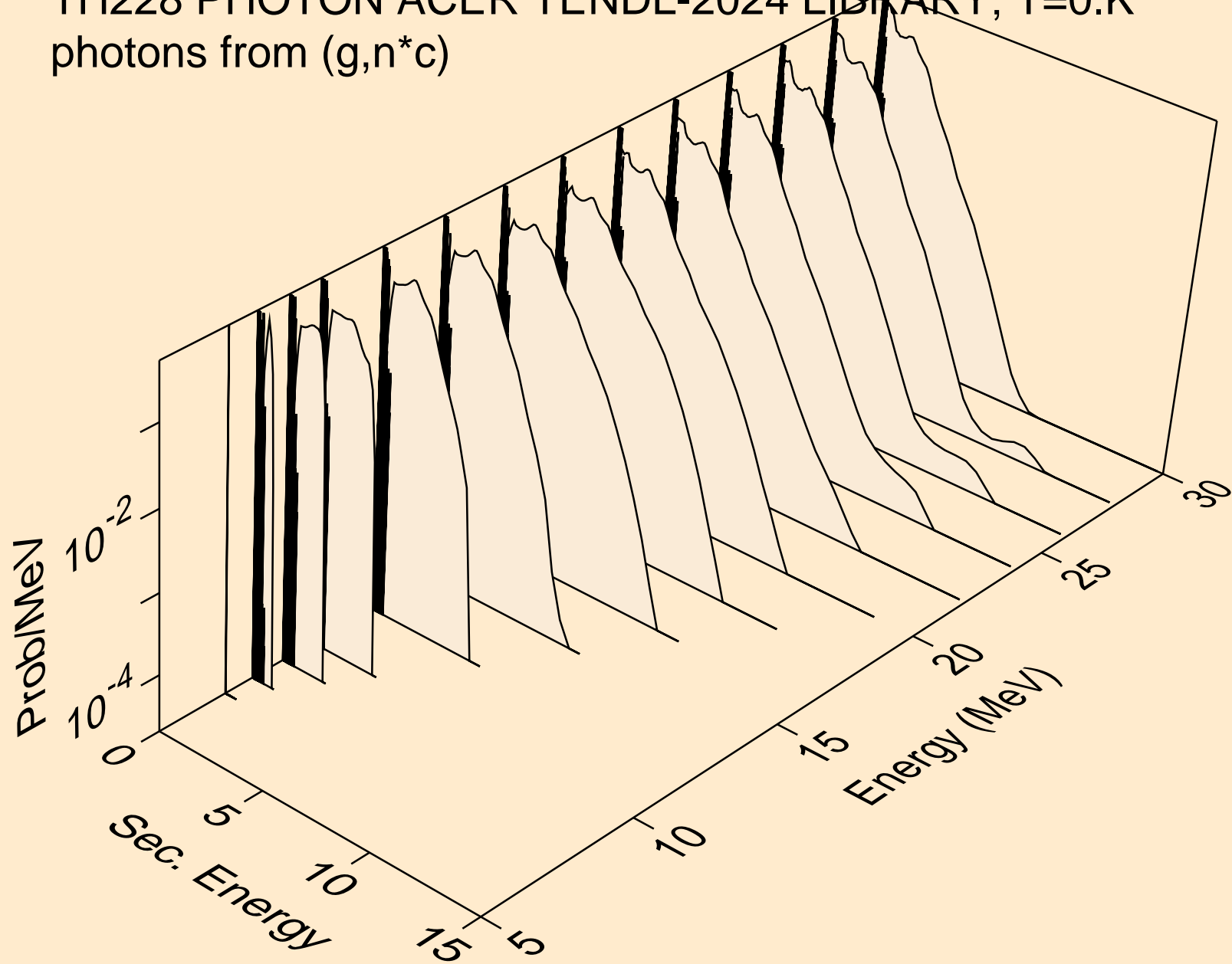

TH228 PHOTON ACER TENDL-2024 LIBRARY; T=0.K
photons from (g,gma)

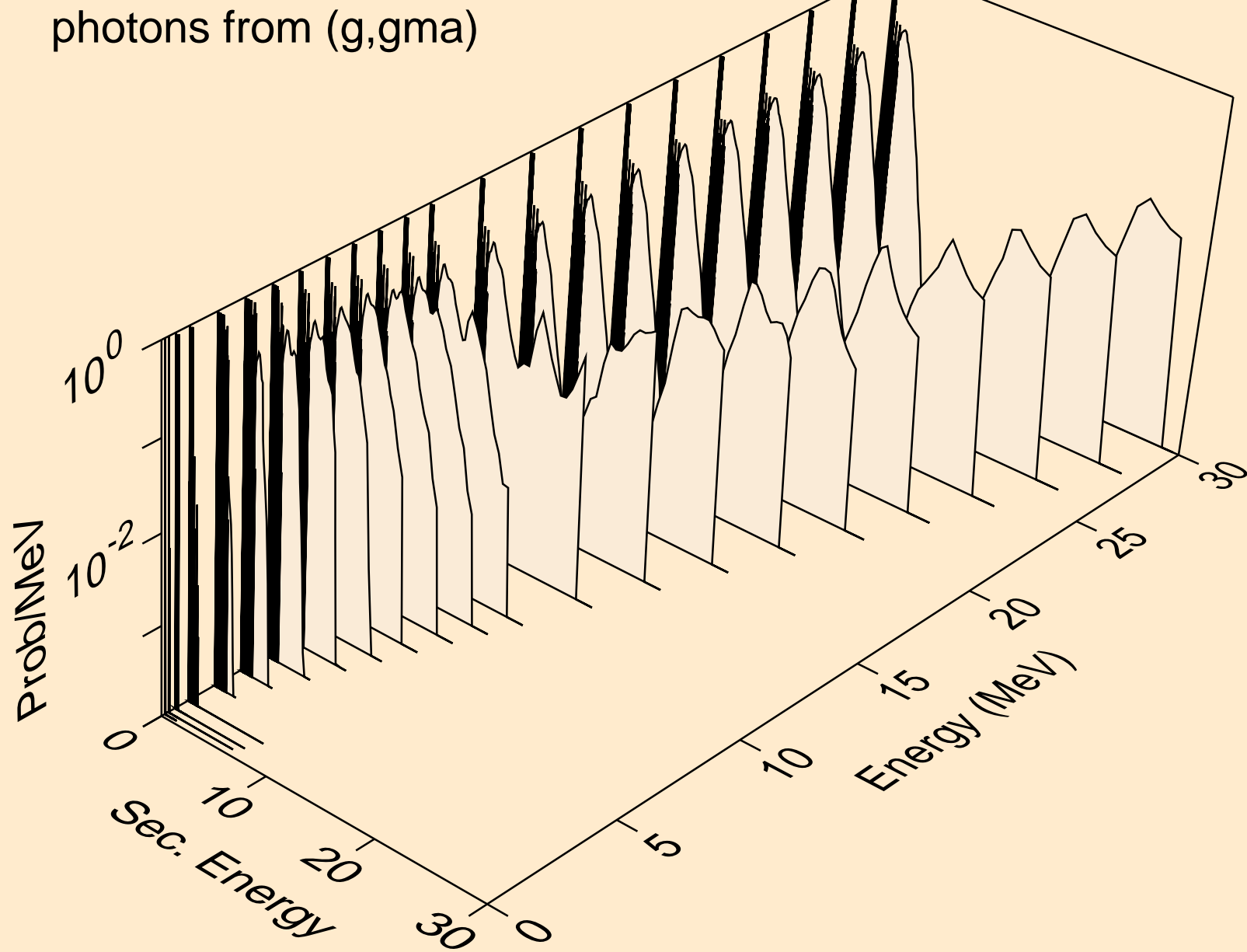

TH228 PHOTON ACER TENDL-2024 LIBRARY; T=0.K
photons from (g,p)

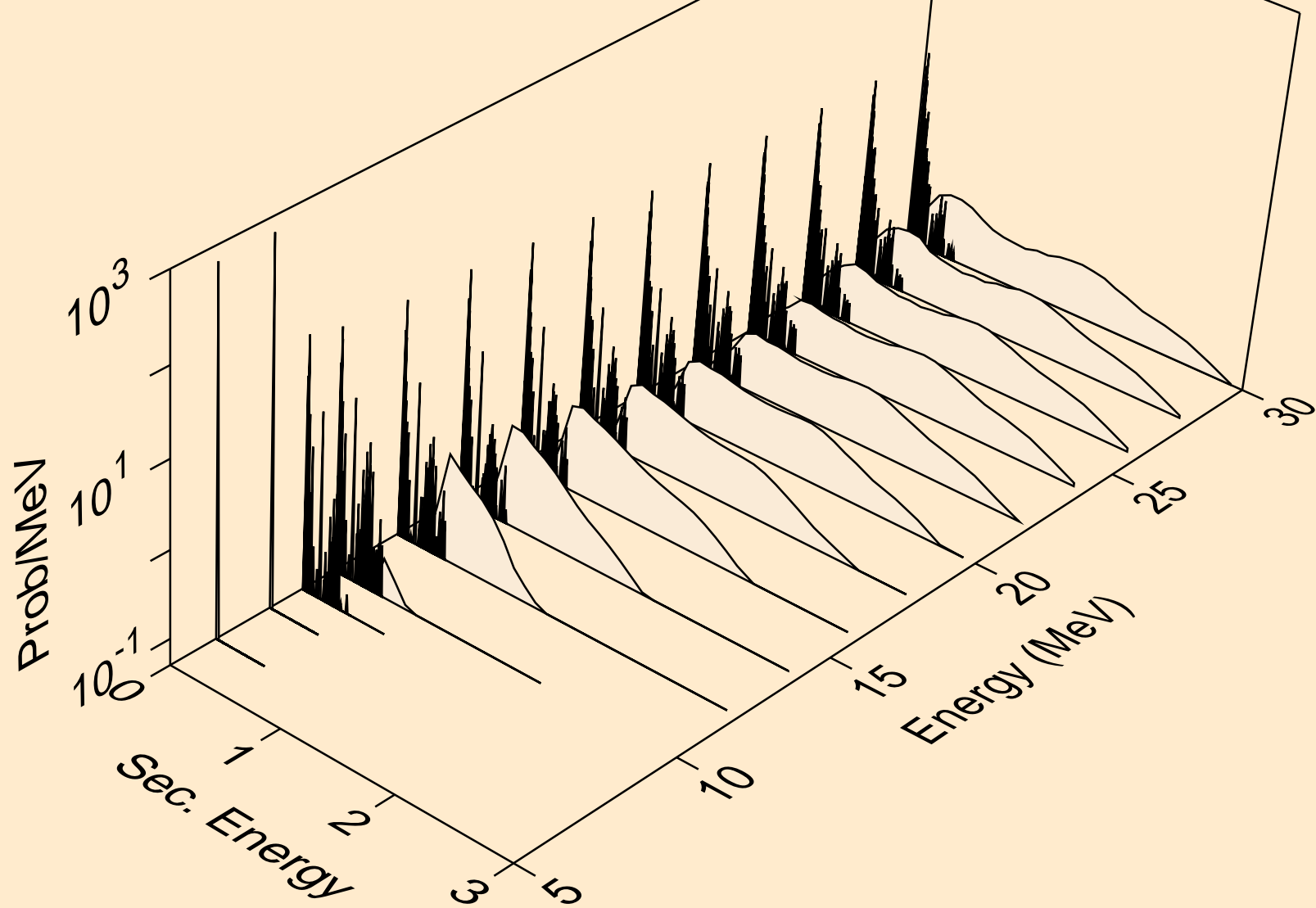

TH228 PHOTON ACER TENDL-2024 LIBRARY; T=0.K
photons from (g,d)

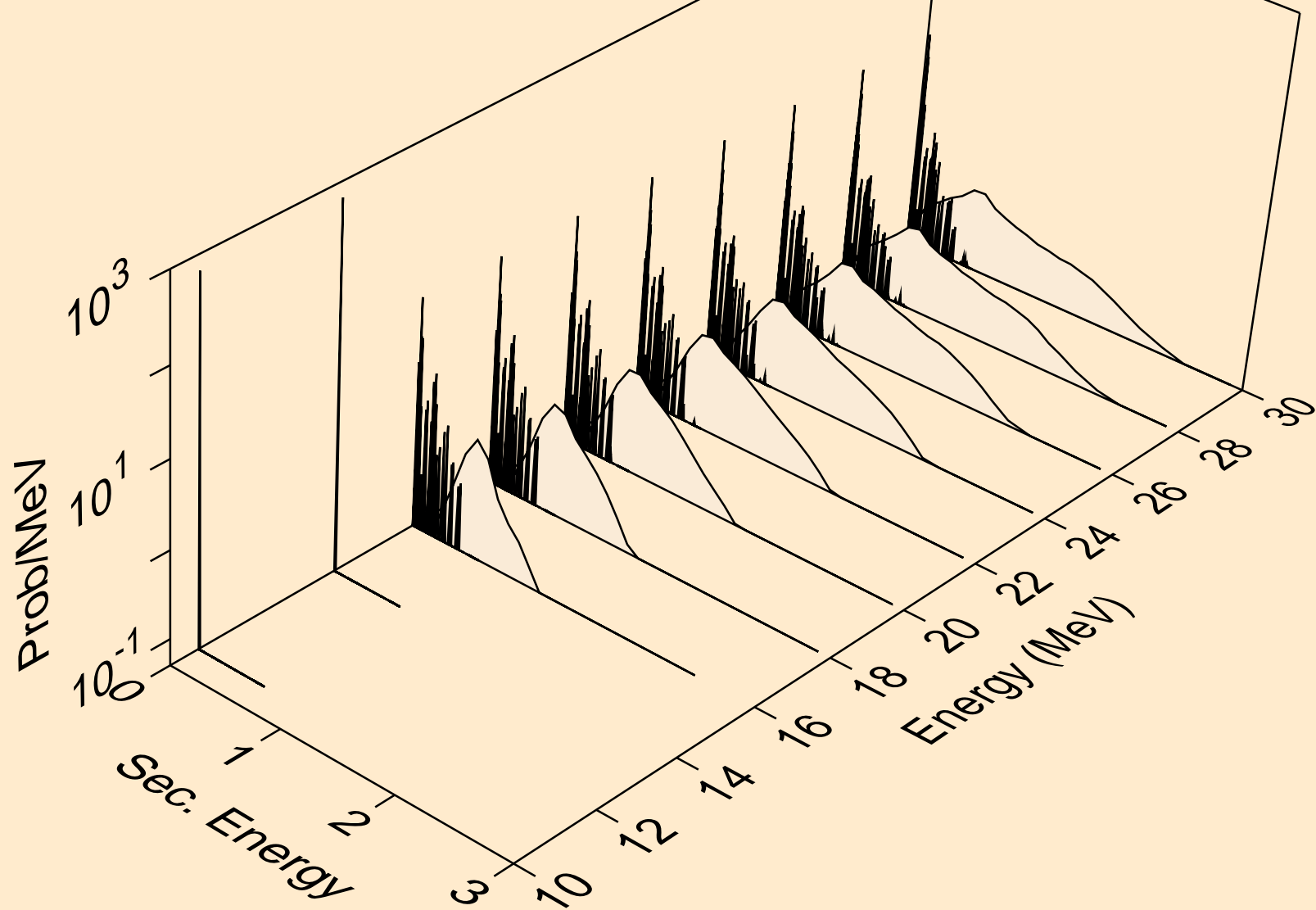

TH228 PHOTON ACER TENDL-2024 LIBRARY; T=0.K
photons from (g,t)

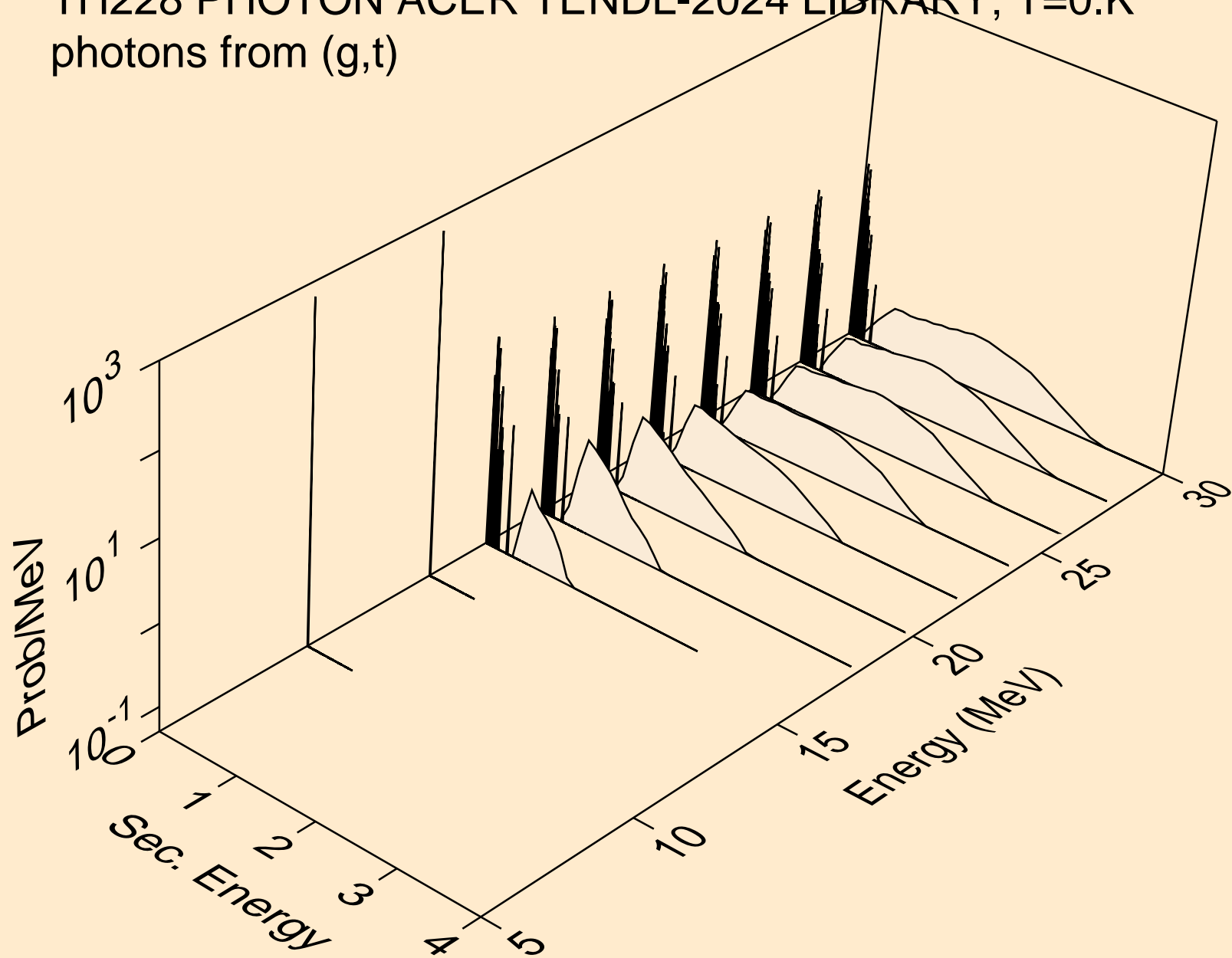

TH228 PHOTON ACER TENDL-2024 LIBRARY; T=0.K
photons from (g,a)

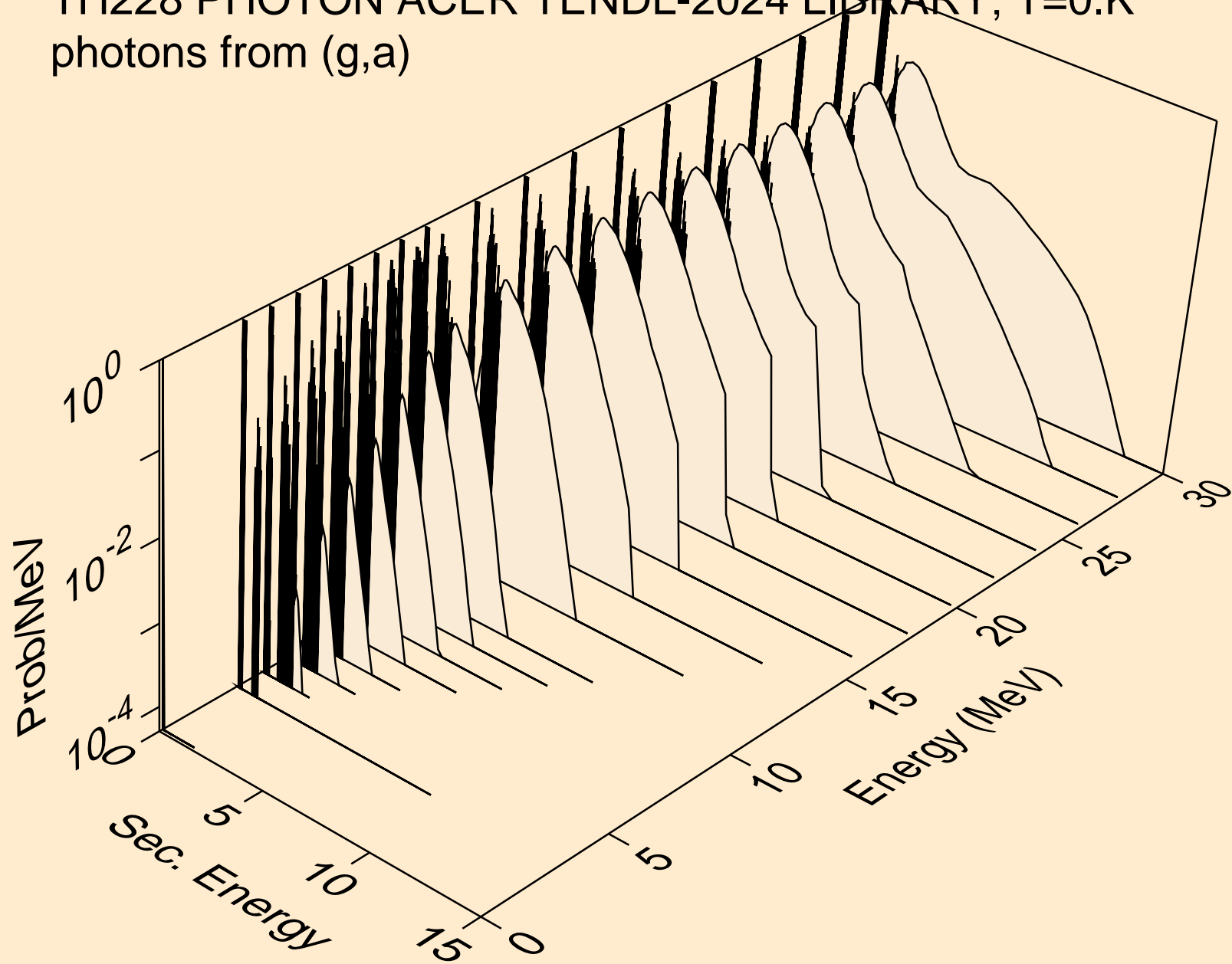

TH228 PHOTON ACER TENDL-2024 LIBRARY; T=0.K
protons from (g,x)

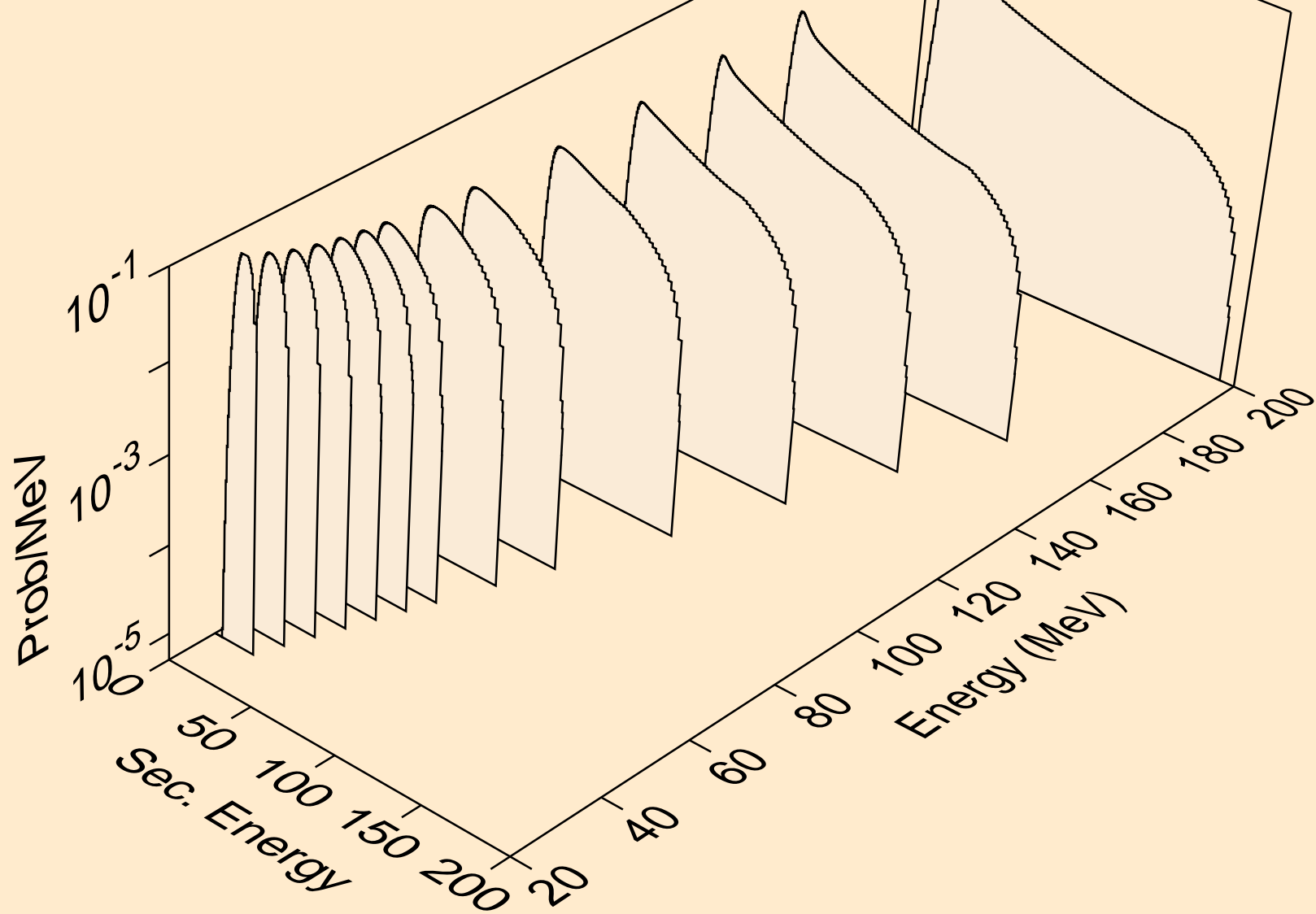

TH228 PHOTON ACER TENDL-2024 LIBRARY; T=0.K
protons from (g,n*)p

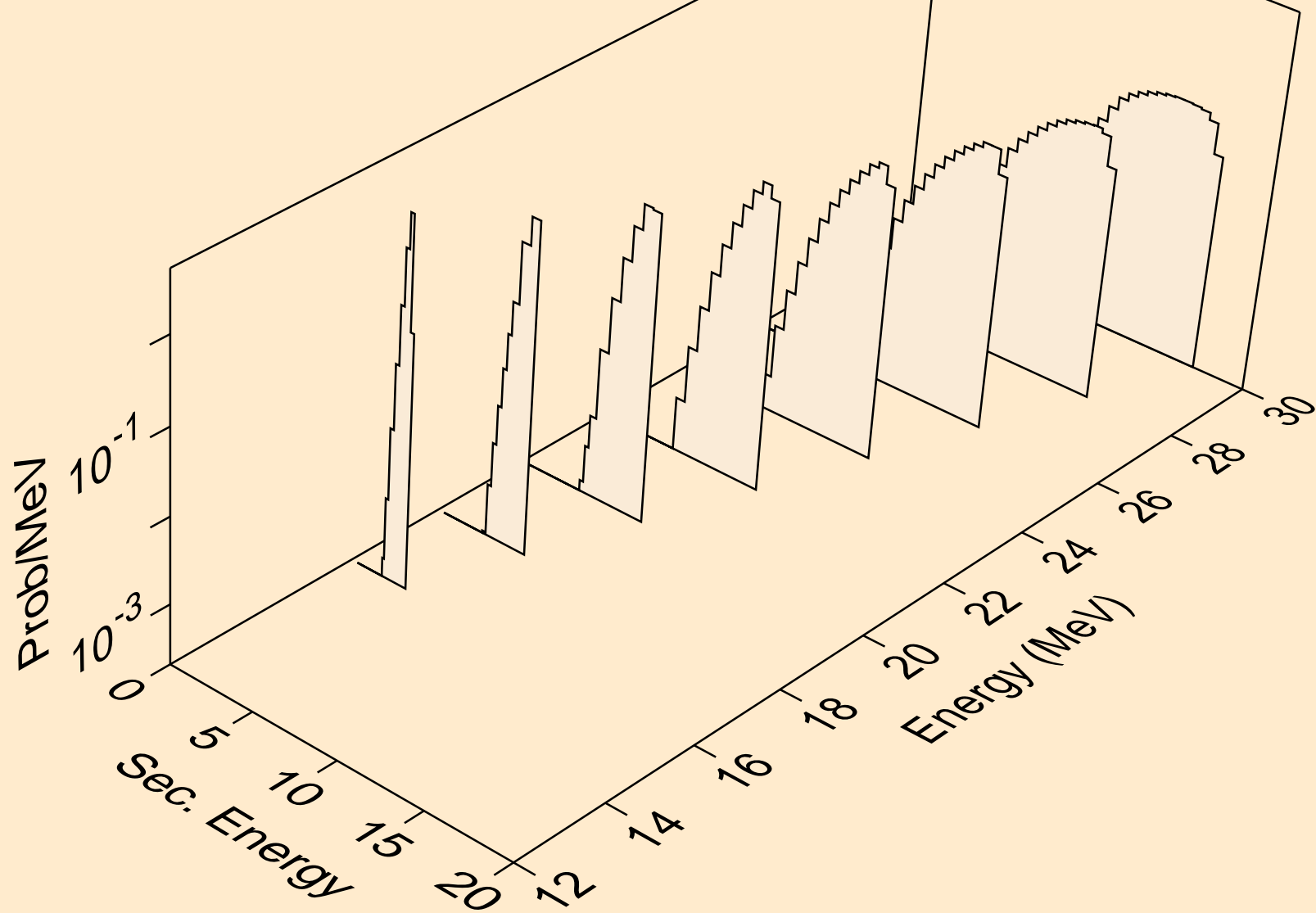

TH228 PHOTON ACER TENDL-2024 LIBRARY; T=0.K
protons from (g,2np)

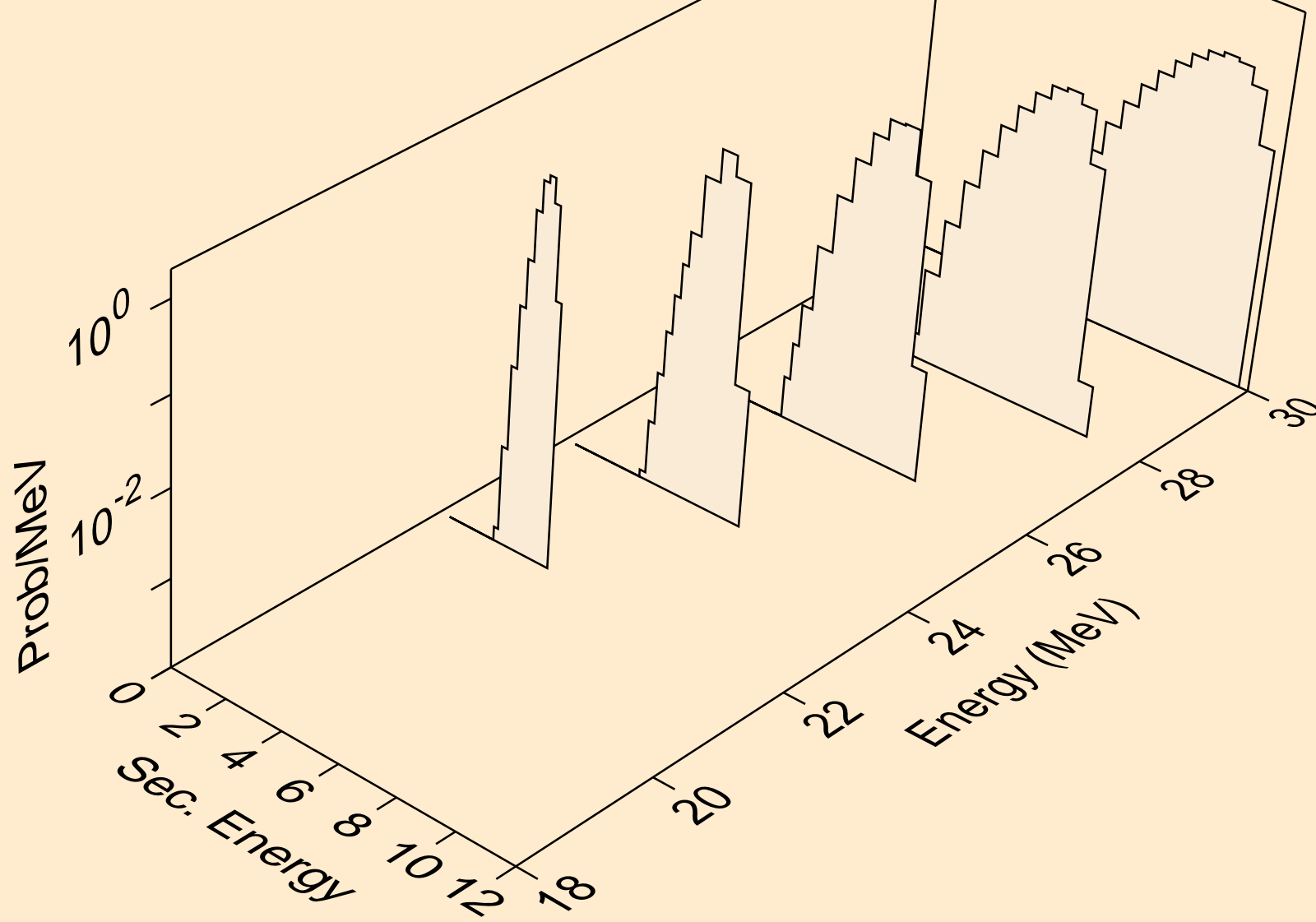

TH228 PHOTON ACER TENDL-2024 LIBRARY; T=0.K
protons from (g,p)

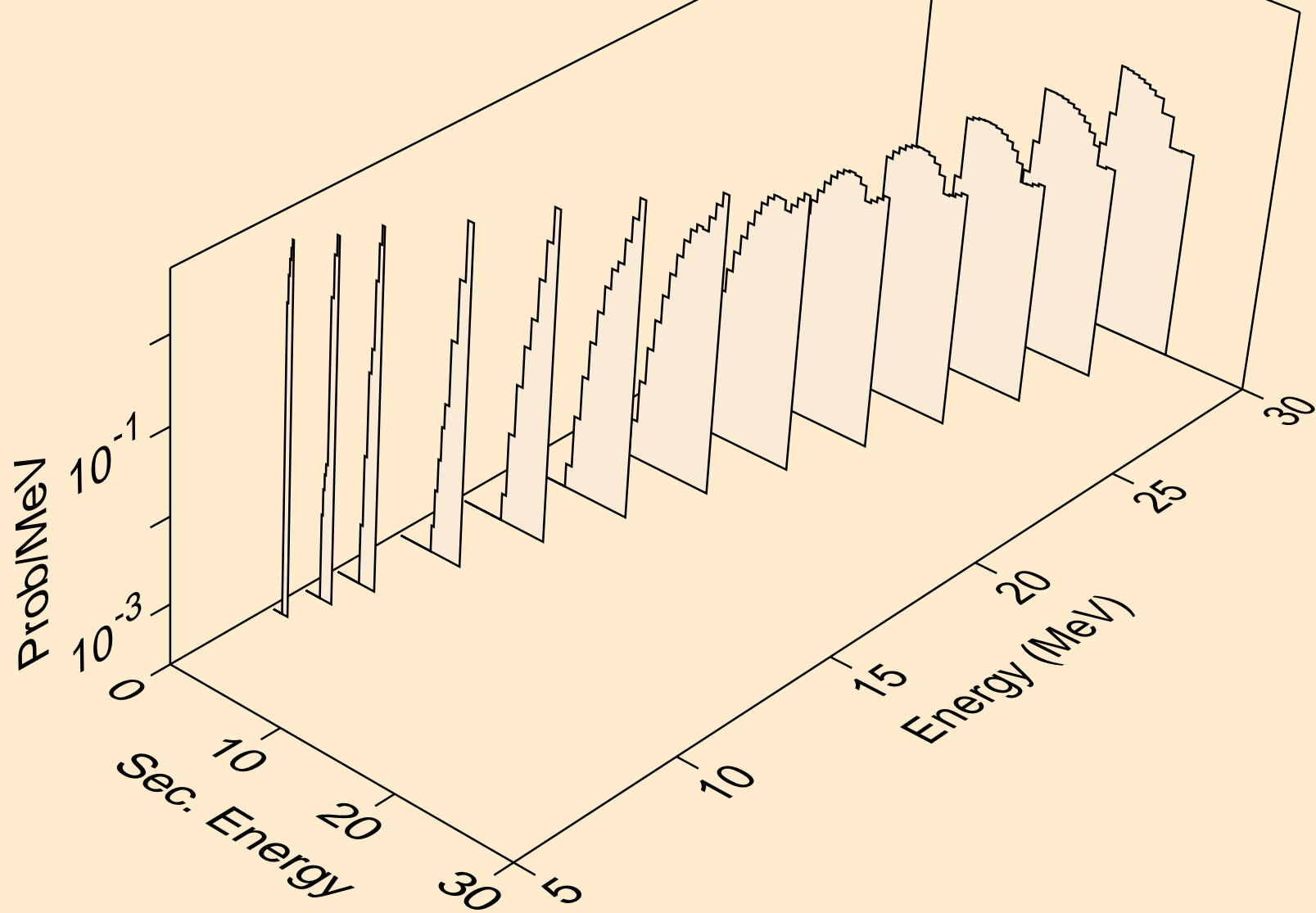

TH228 PHOTON ACER TENDL-2024 LIBRARY; T=0.K
deuterons from (g,x)

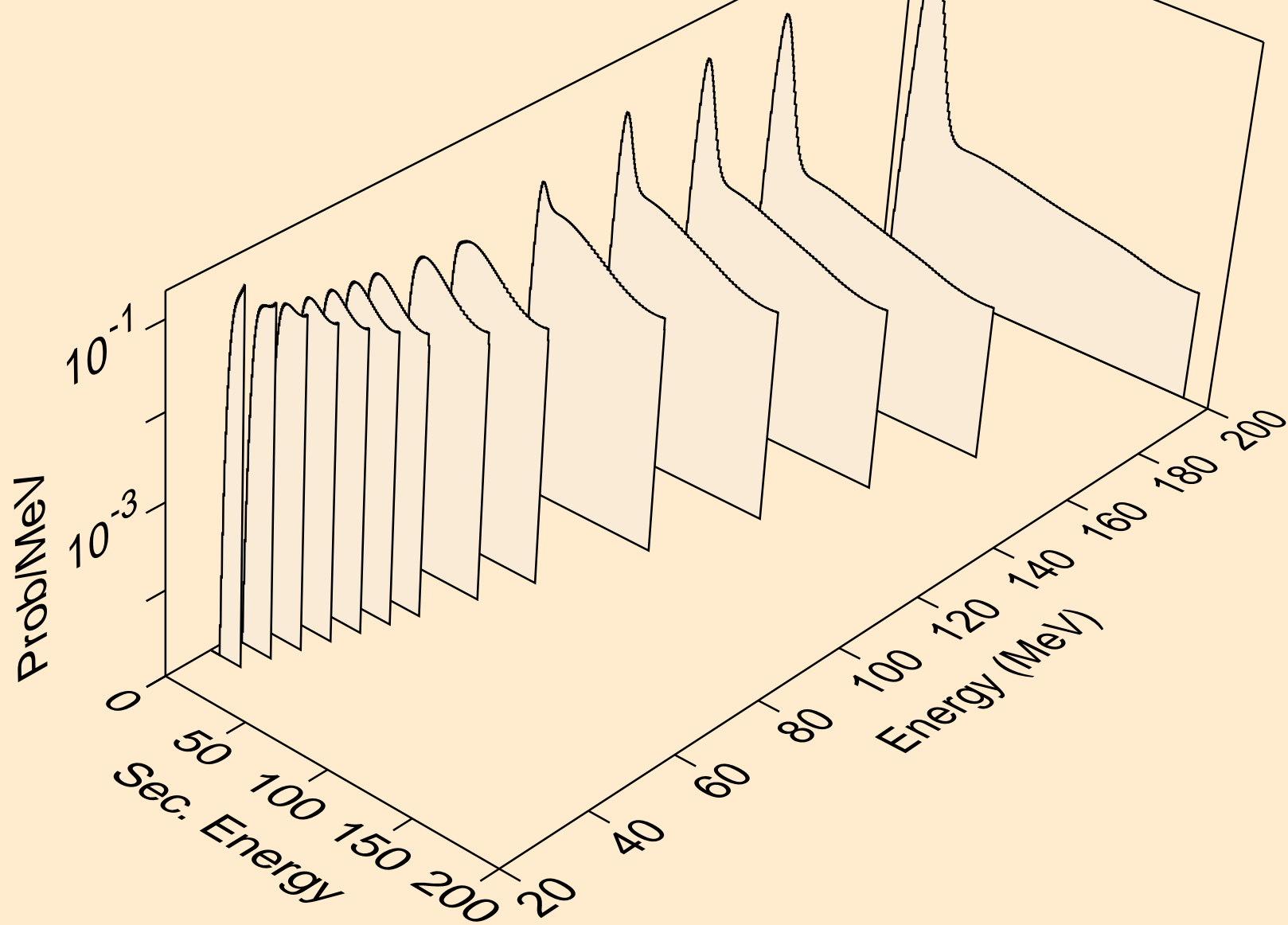

TH228 PHOTON ACER TENDL-2024 LIBRARY; T=0.K
deuterons from (g,n*)d

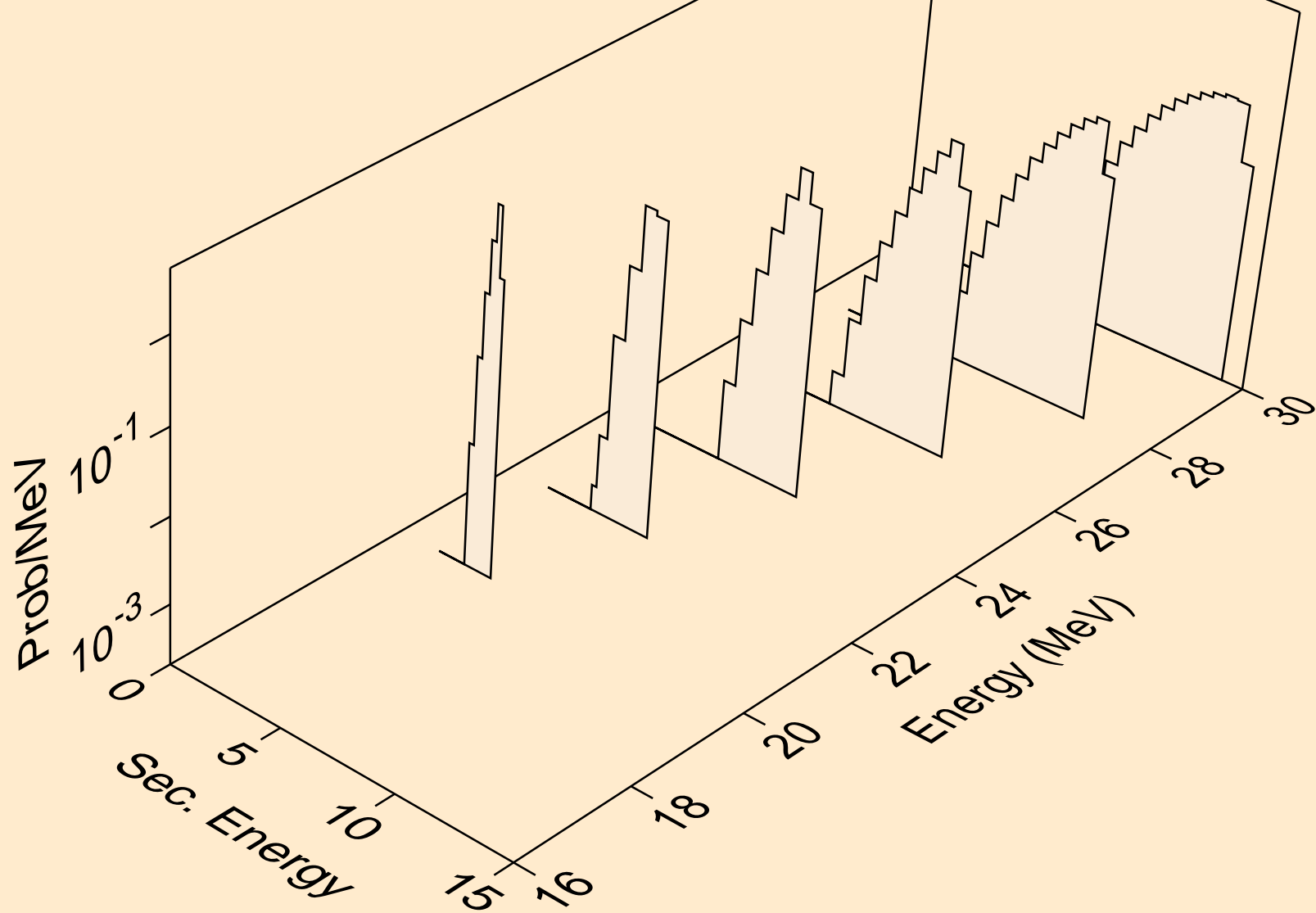

TH228 PHOTON ACER TENDL-2024 LIBRARY; T=0.K
deuterons from (g,d)

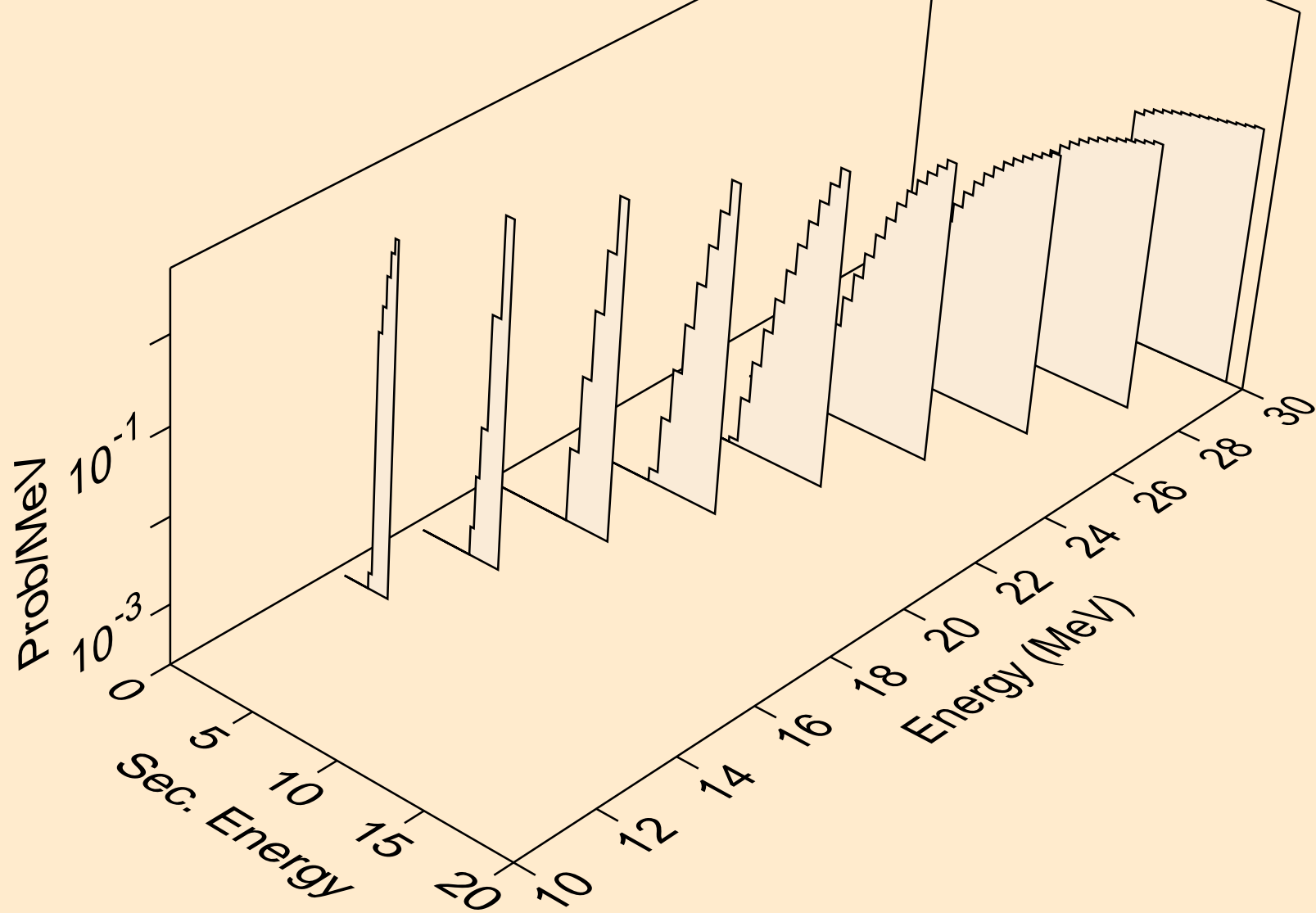

TH228 PHOTON ACER TENDL-2024 LIBRARY; T=0.K
tritons from (g,x)

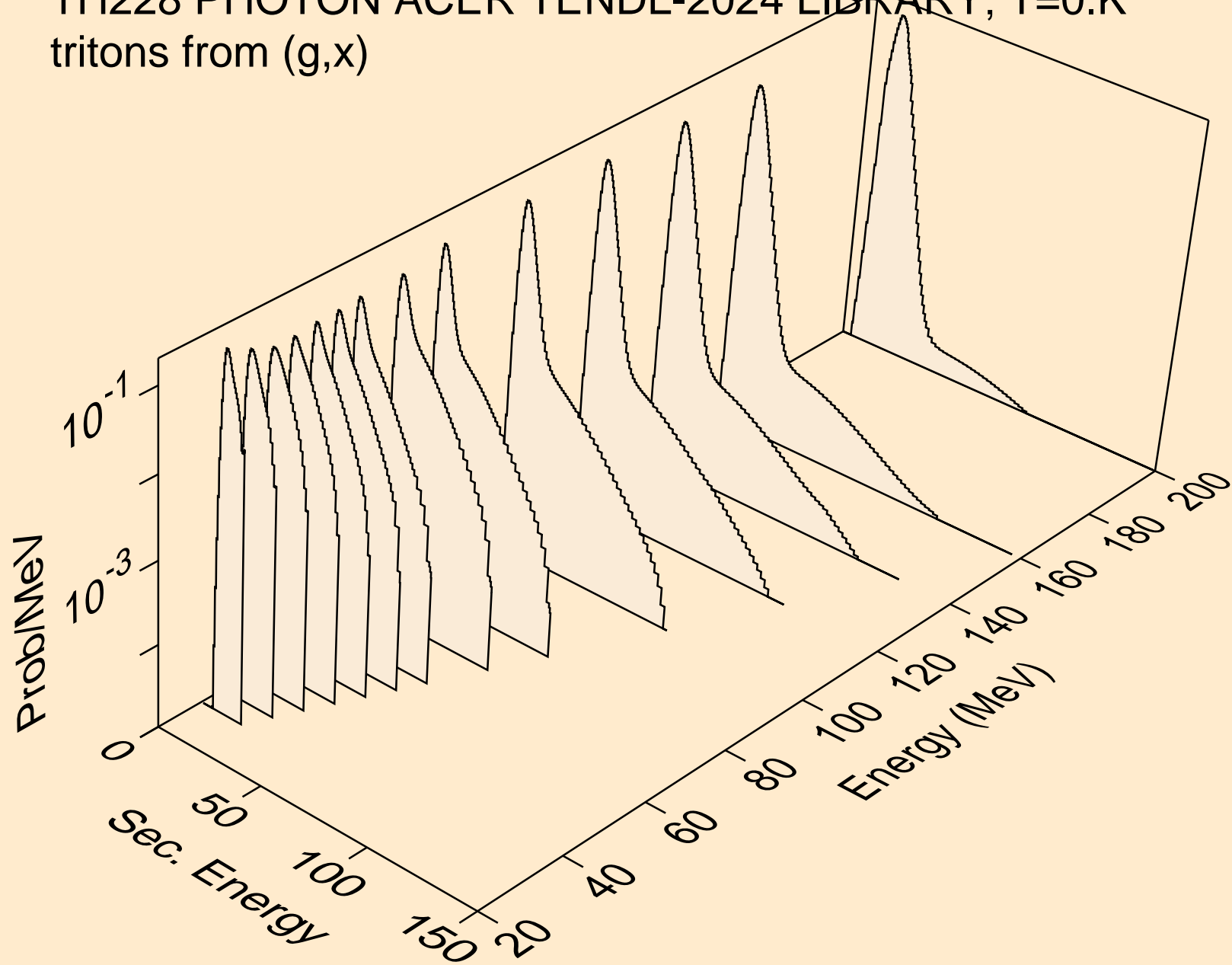

TH228 PHOTON ACER TENDL-2024 LIBRARY; T=0.K
tritons from (g,n*)t

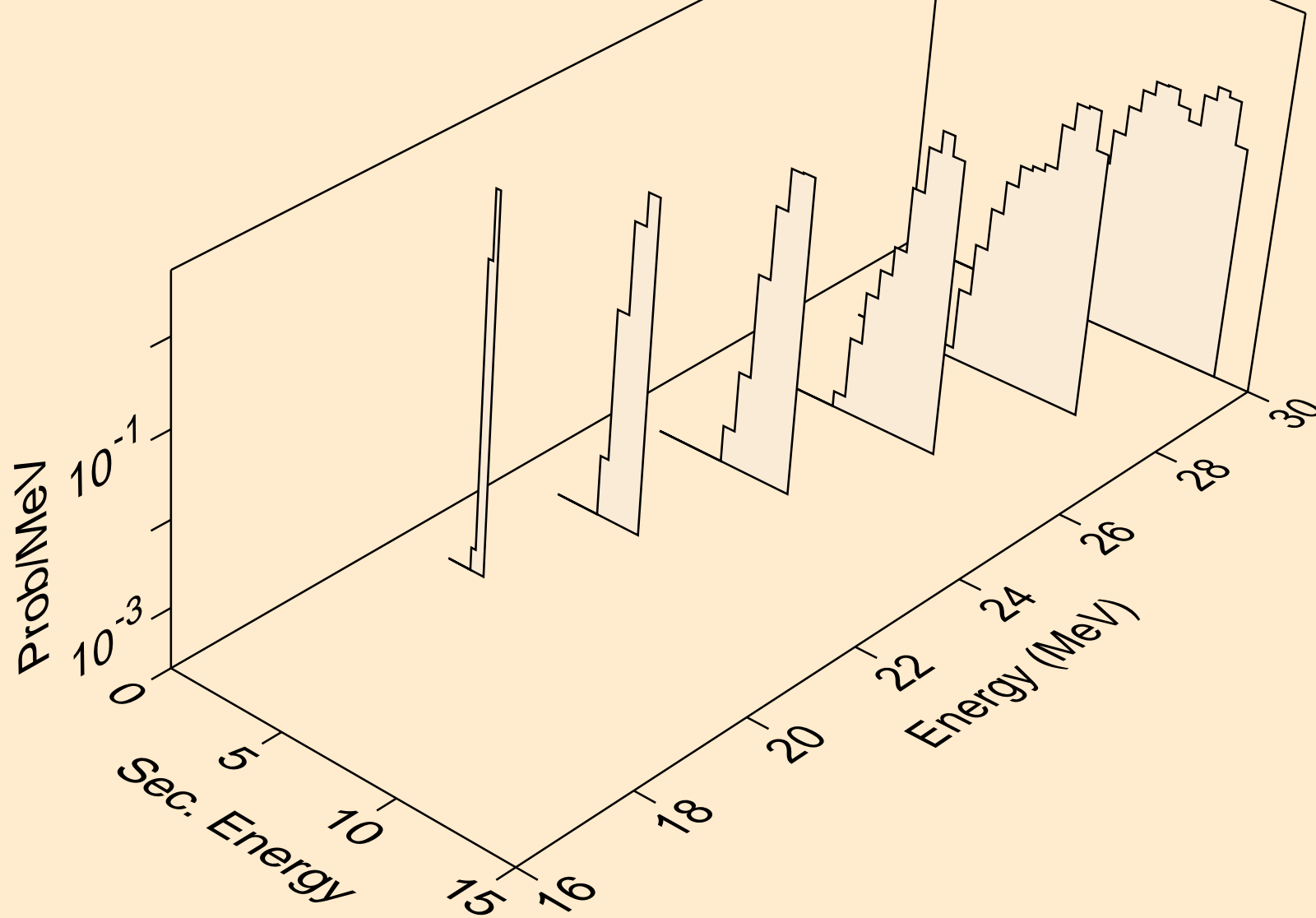

TH228 PHOTON ACER TENDL-2024 LIBRARY; T=0.K
tritons from (g,t)

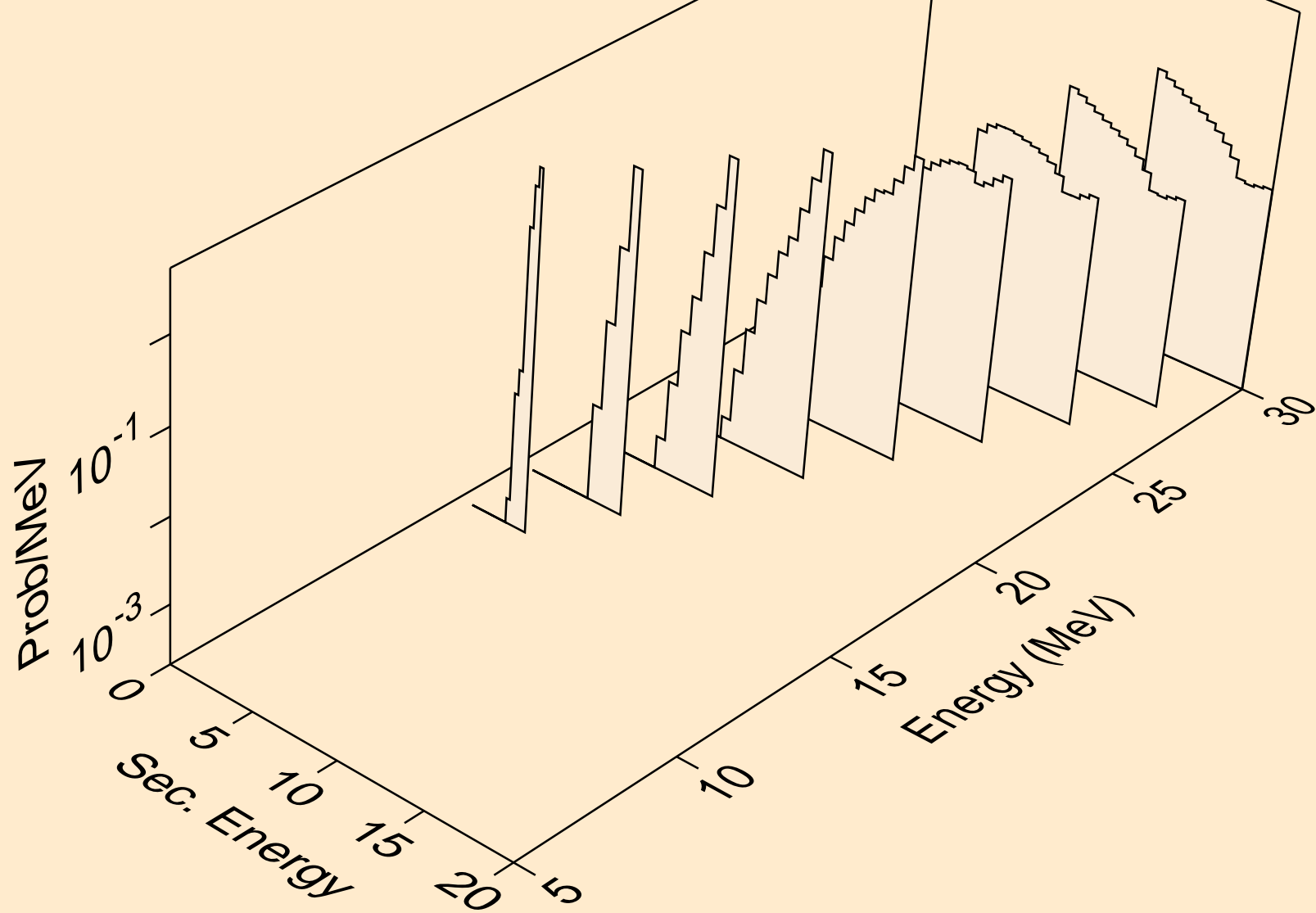

TH228 PHOTON ACER TENDL-2024 LIBRARY; T=0.K
he3s from (g,x)

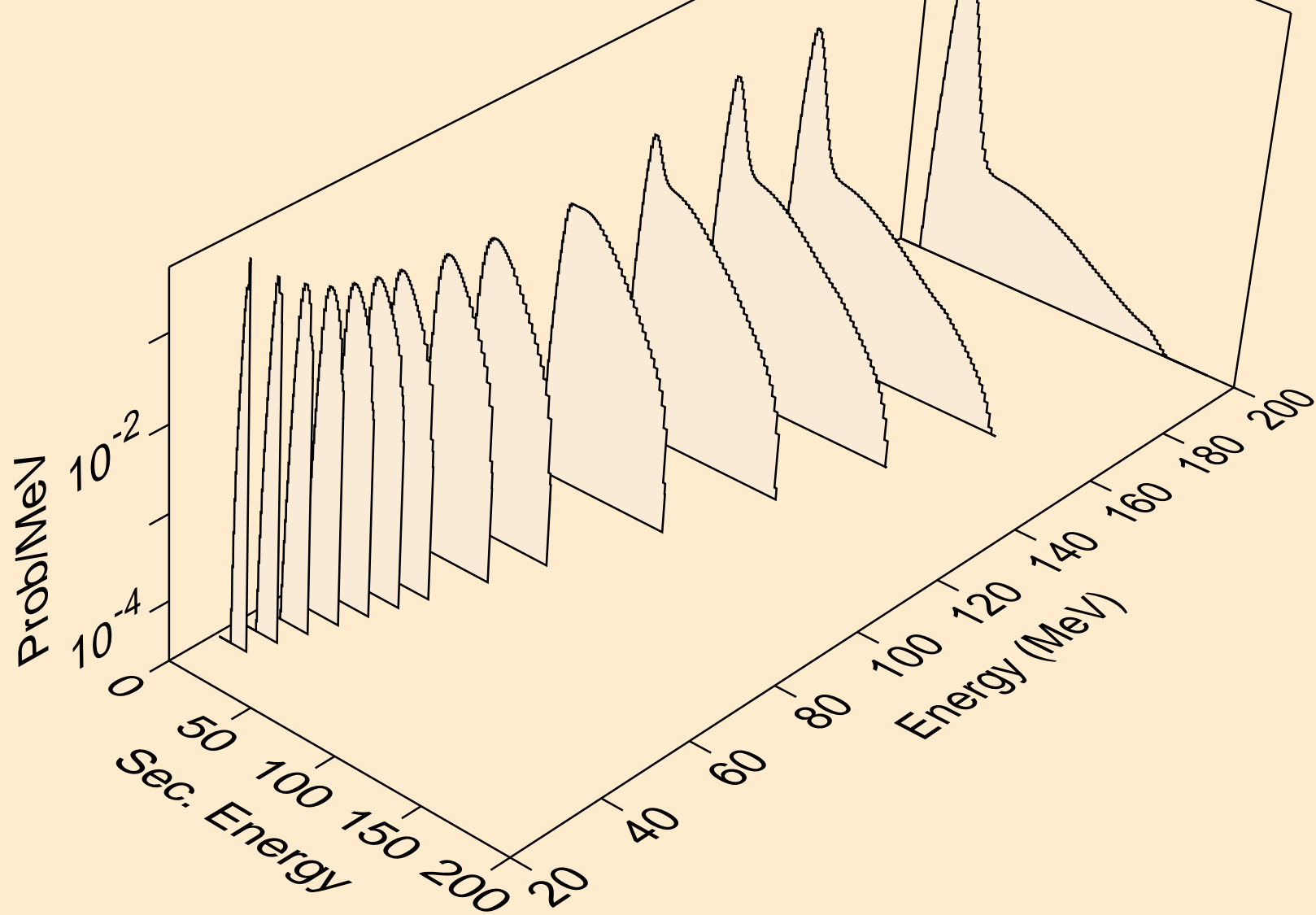

TH228 PHOTON ACER TENDL-2024 LIBRARY; T=0.K
alphas from (g,x)

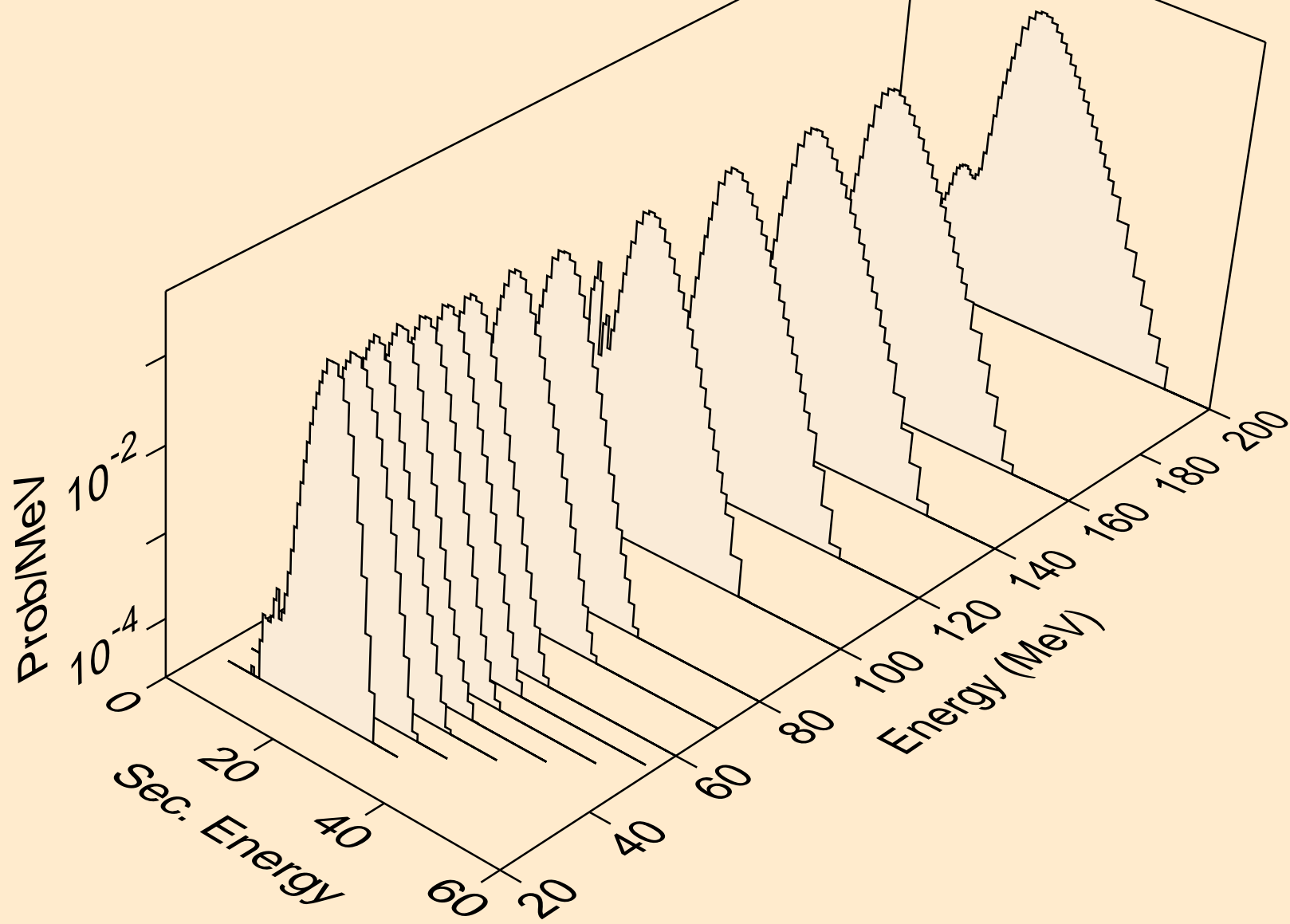

TH228 PHOTON ACER TENDL-2024 LIBRARY; T=0.K
alphas from (g,n*)a

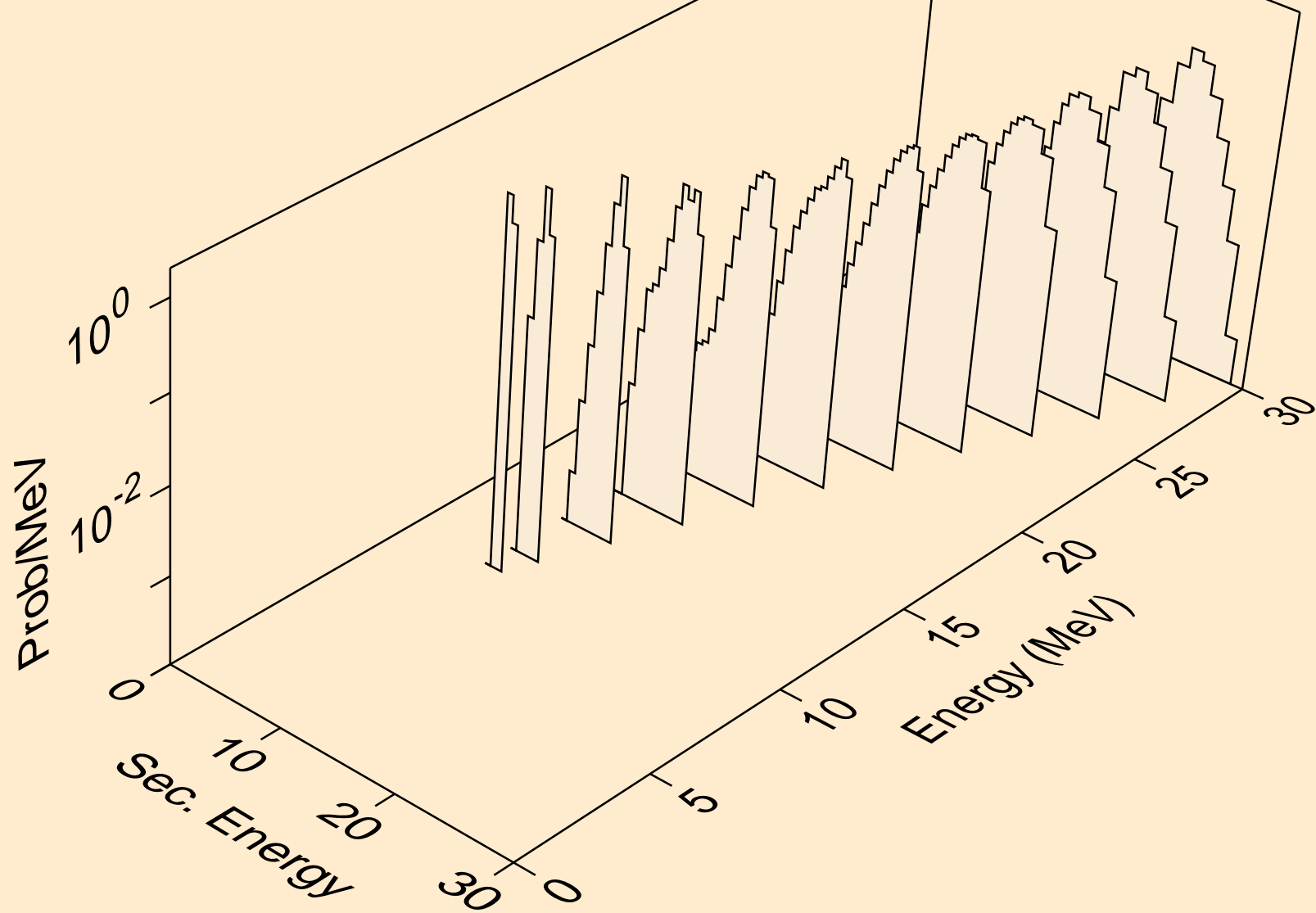

TH228 PHOTON ACER TENDL-2024 LIBRARY; T=0.K
alphas from (g,2n)a

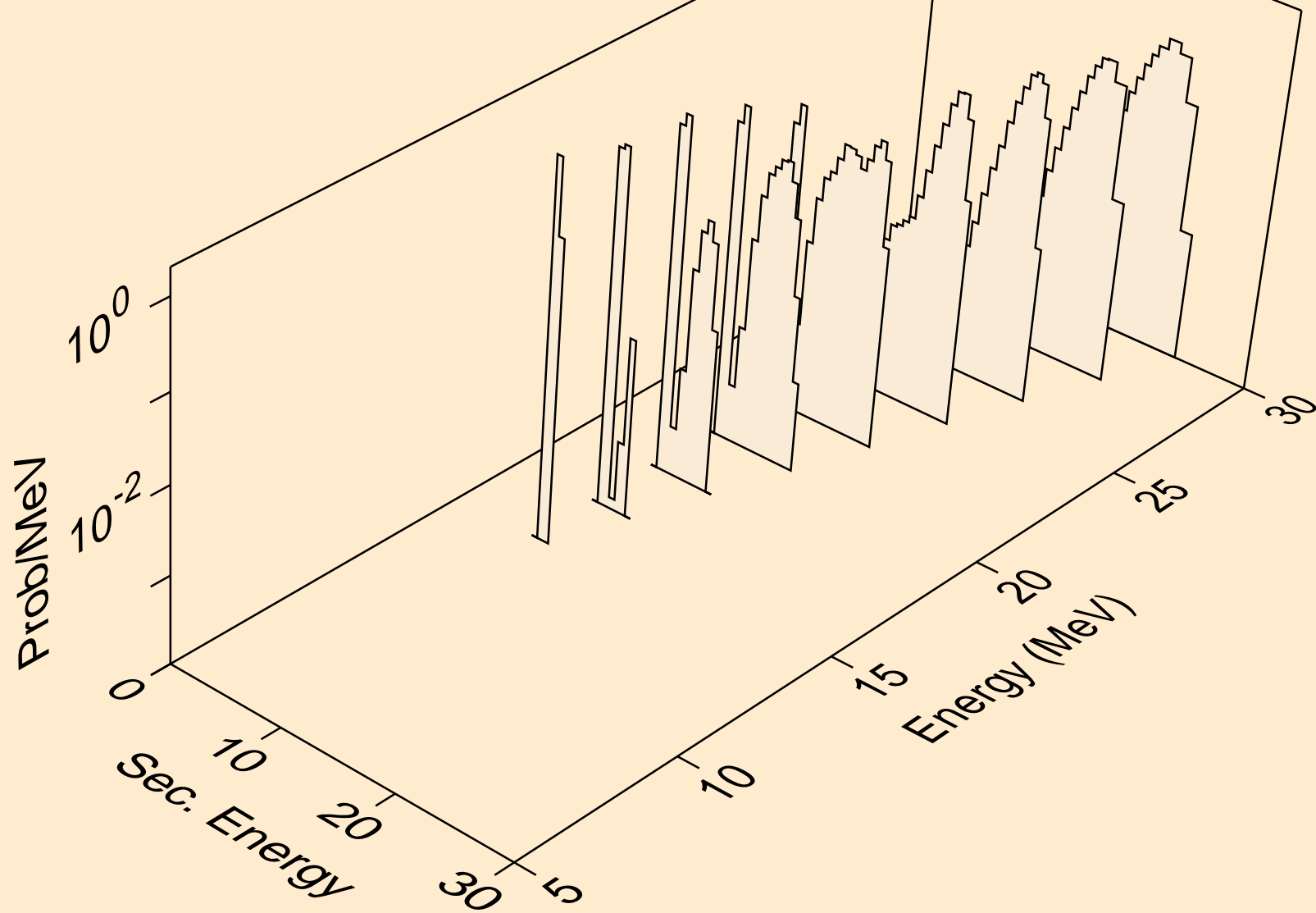

TH228 PHOTON ACER TENDL-2024 LIBRARY; T=0.K
alphas from (g,3n)a

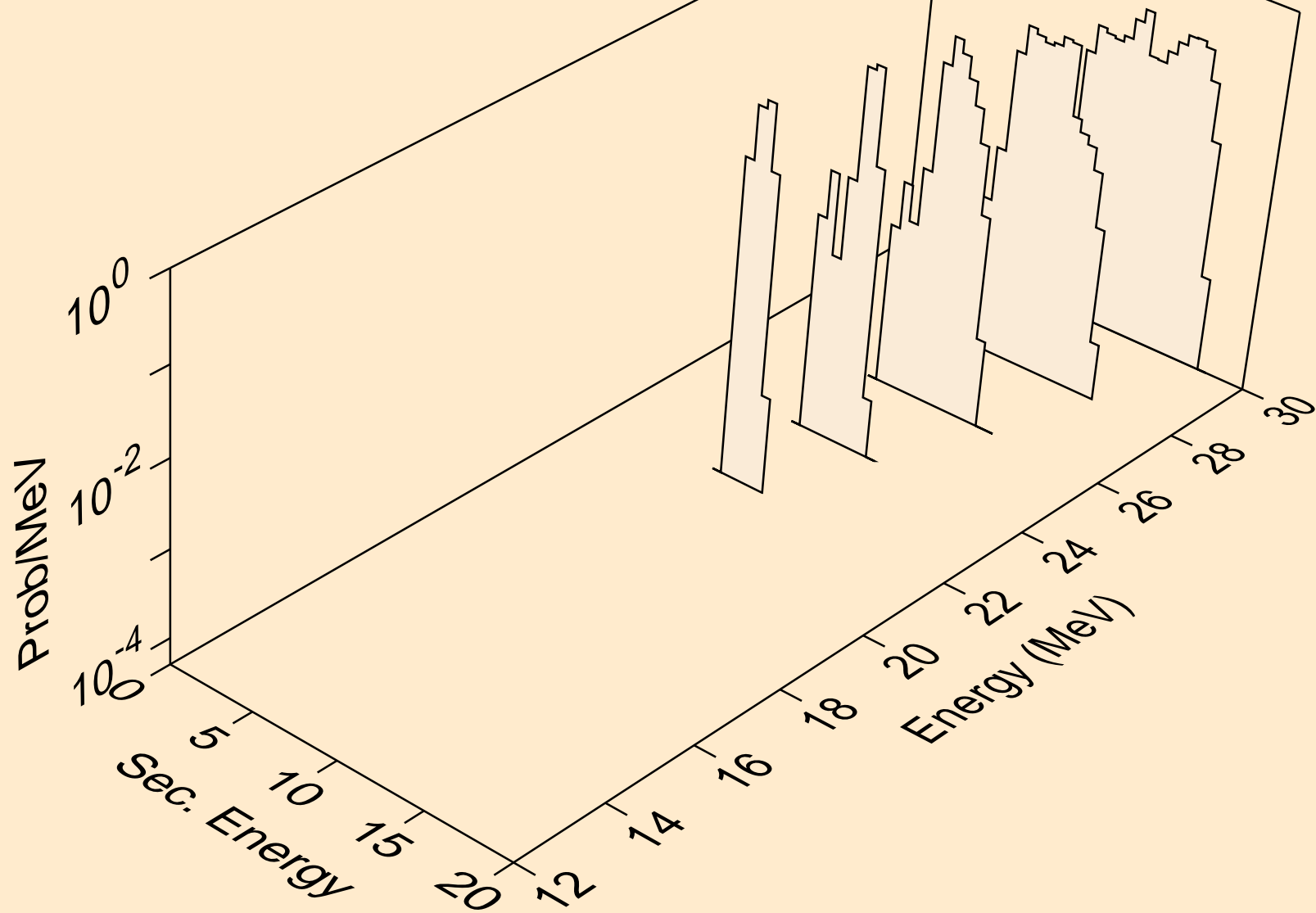

TH228 PHOTON ACER TENDL-2024 LIBRARY; T=0.K
alphas from (g,a)

