

TM154 PHOTON ACER TENDL-2024 LIBRARY; T=0.K
Principal cross sections

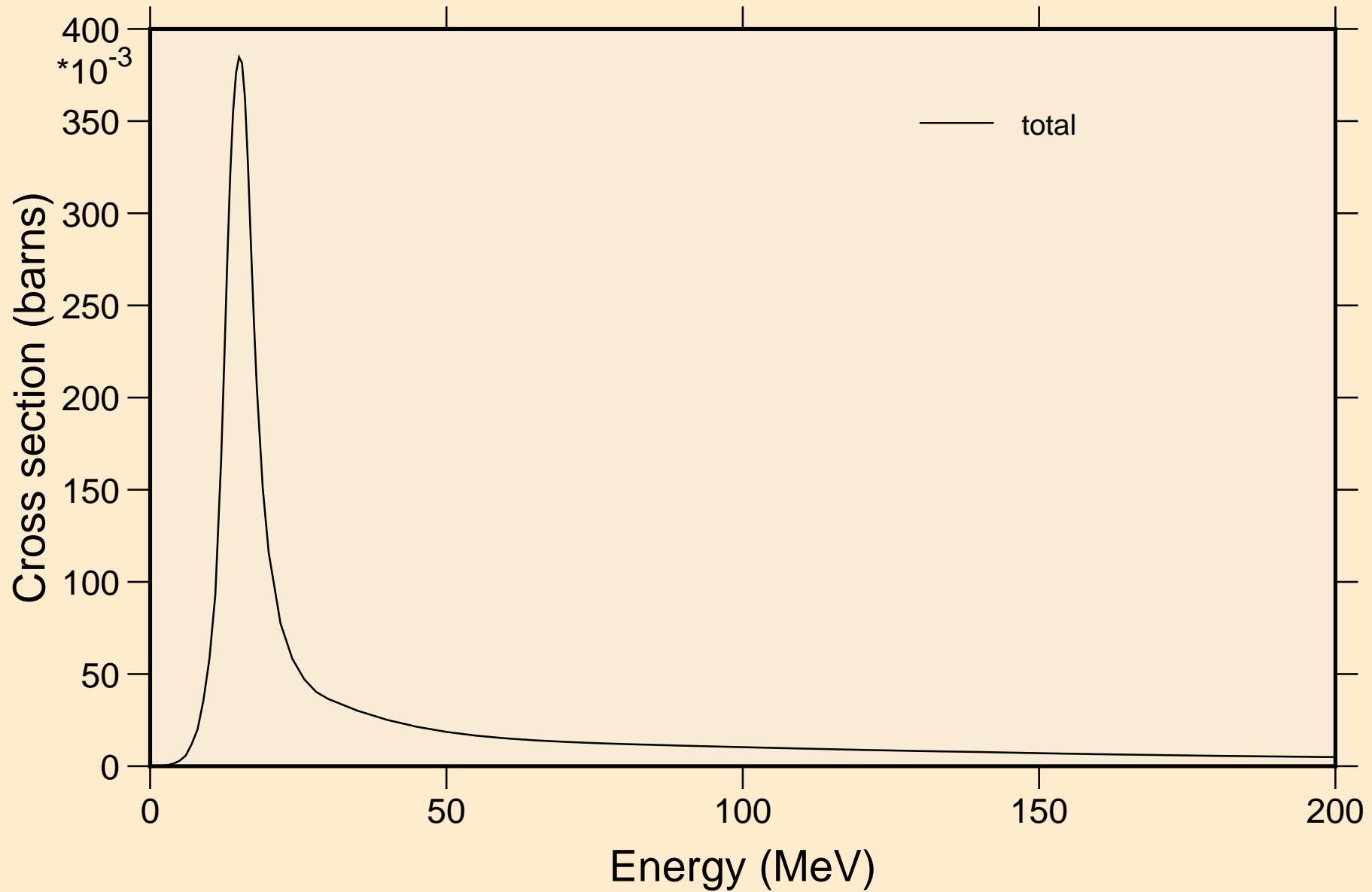

TM154 PHOTON ACER TENDL-2024 LIBRARY; T=0.K

Partial cross sections

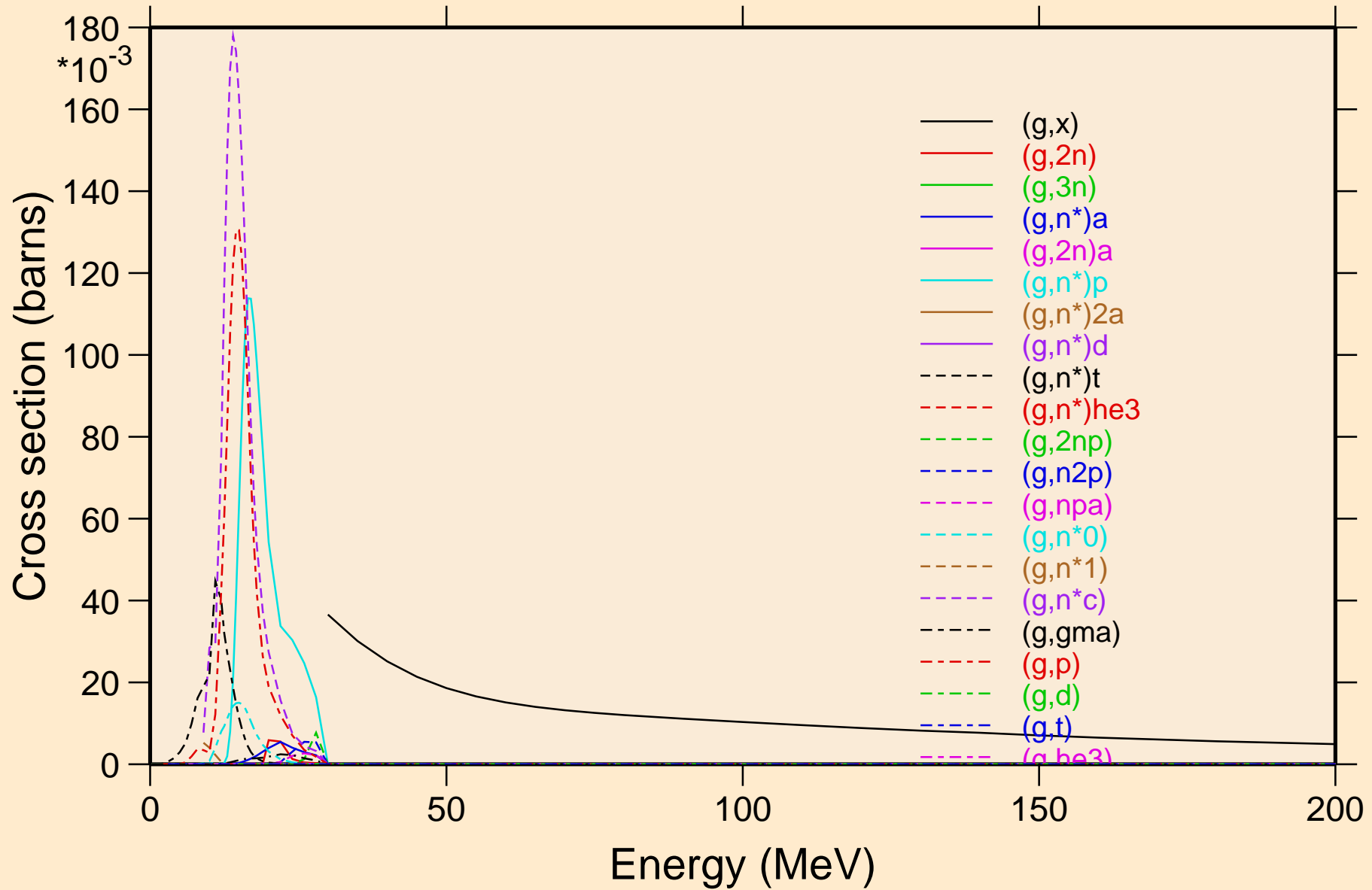

TM154 PHOTON ACER TENDL-2024 LIBRARY; T=0.K

Heating

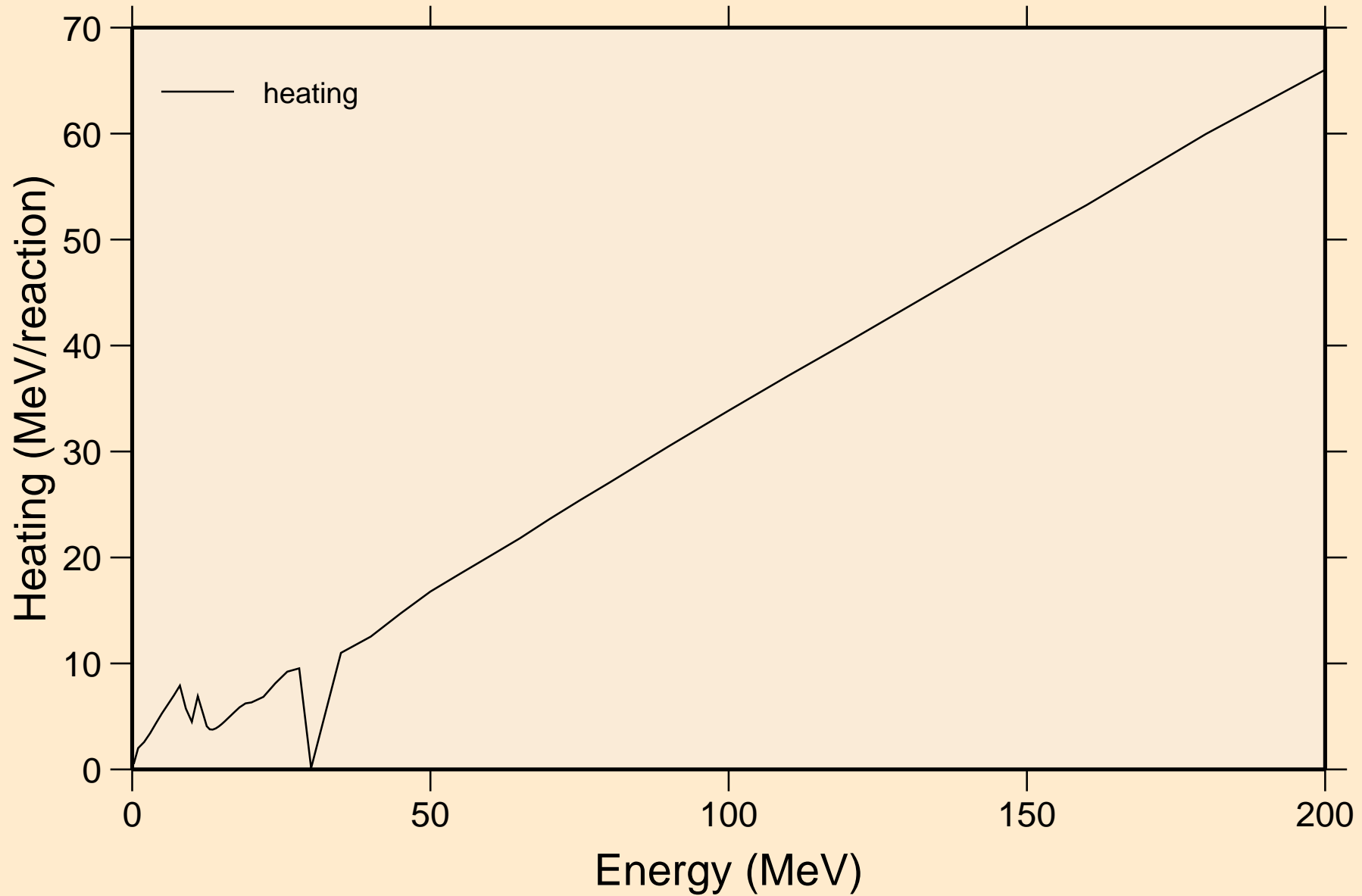

TM154 PHOTON ACER TENDL-2024 LIBRARY; T=0.K

Particle heating contributions

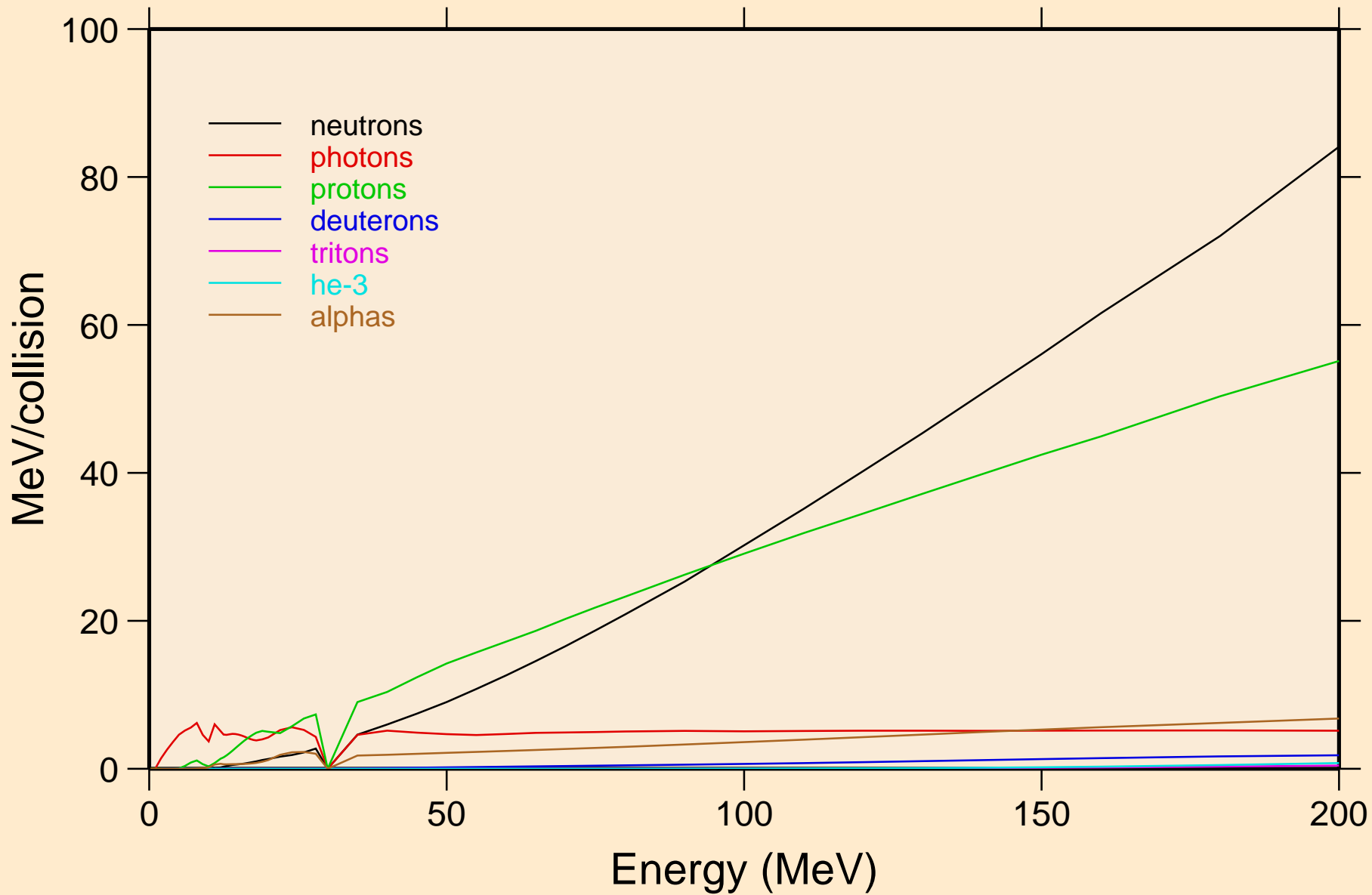

TM154 PHOTON ACER TENDL-2024 LIBRARY; T=0.K

Particle production cross sections

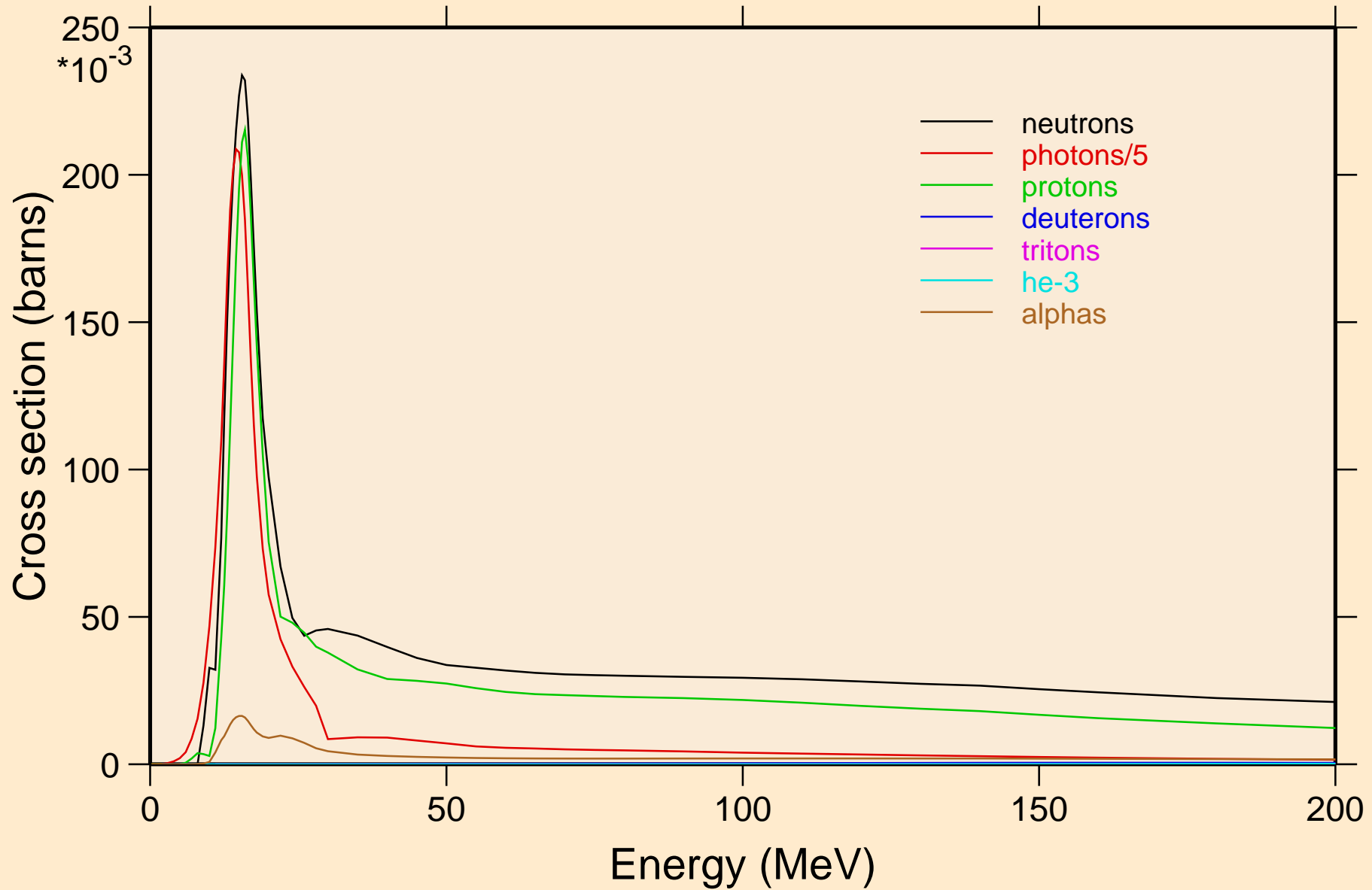

TM154 PHOTON ACER TENDL-2024 LIBRARY; T=0.K
neutrons from (g,x)

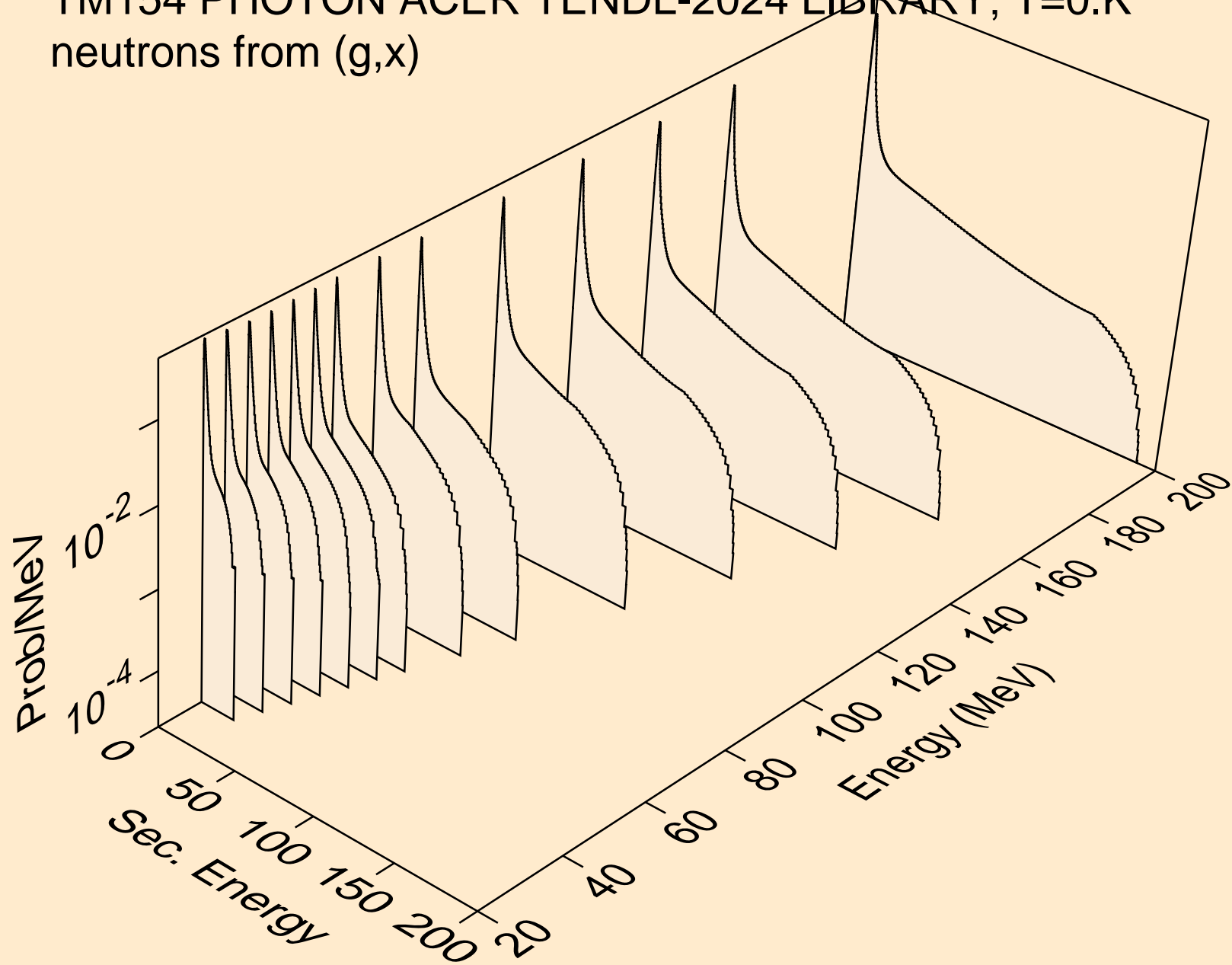

TM154 PHOTON ACER TENDL-2024 LIBRARY; T=0.K
neutrons from (g,2n)

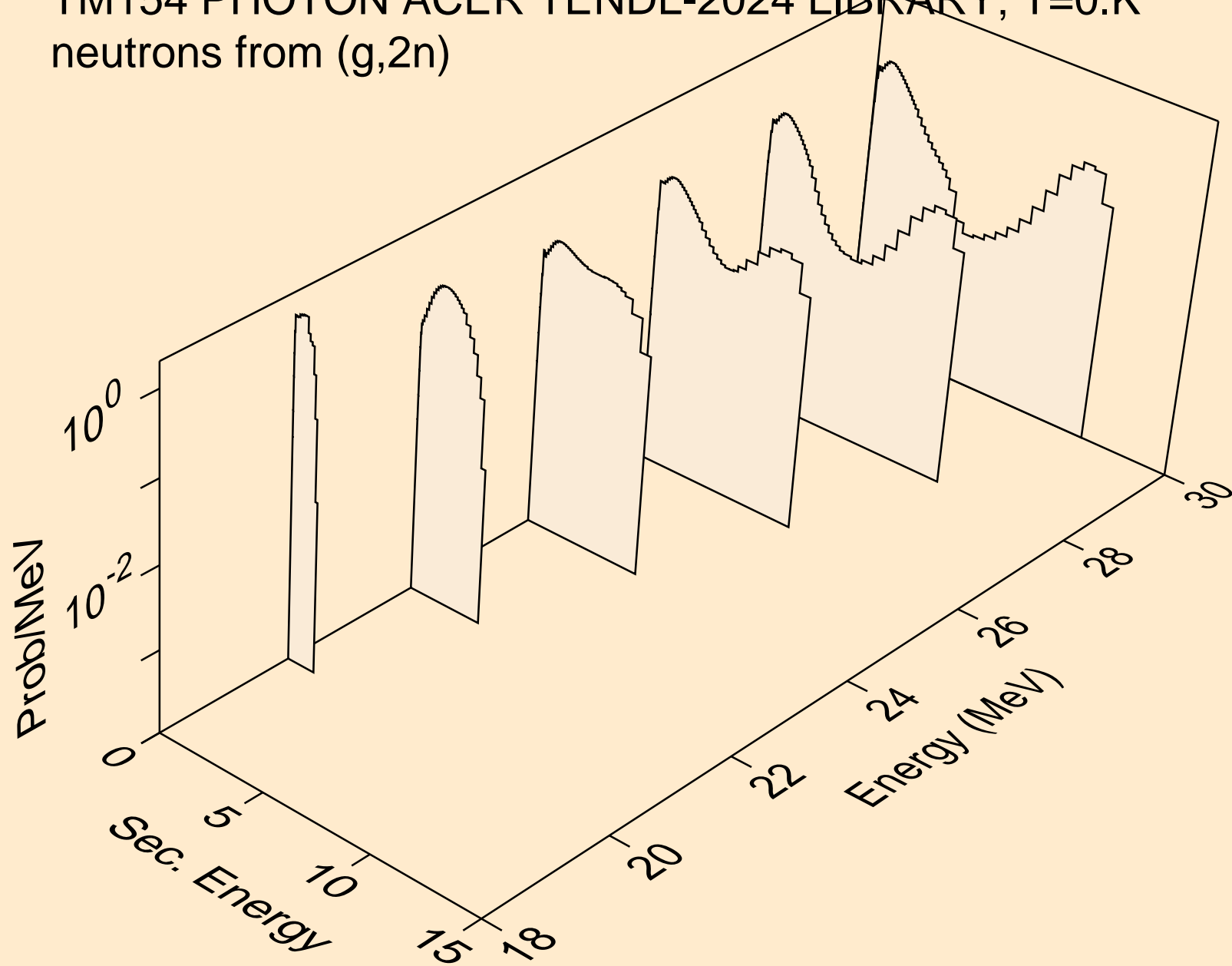

TM154 PHOTON ACER TENDL-2024 LIBRARY; T=0.K
neutrons from (g,3n)

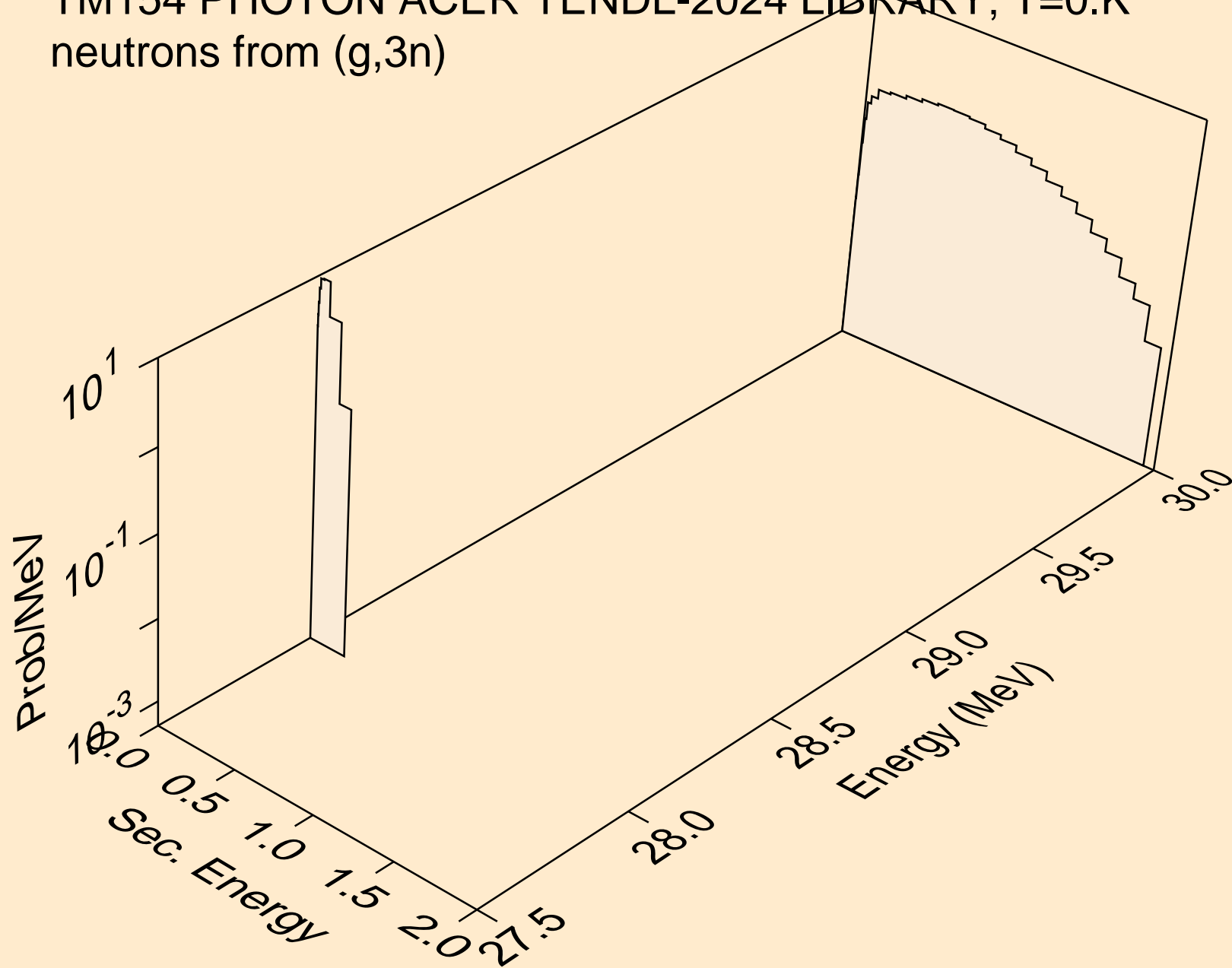

TM154 PHOTON ACER TENDL-2024 LIBRARY; T=0.K
neutrons from (g,n*)a

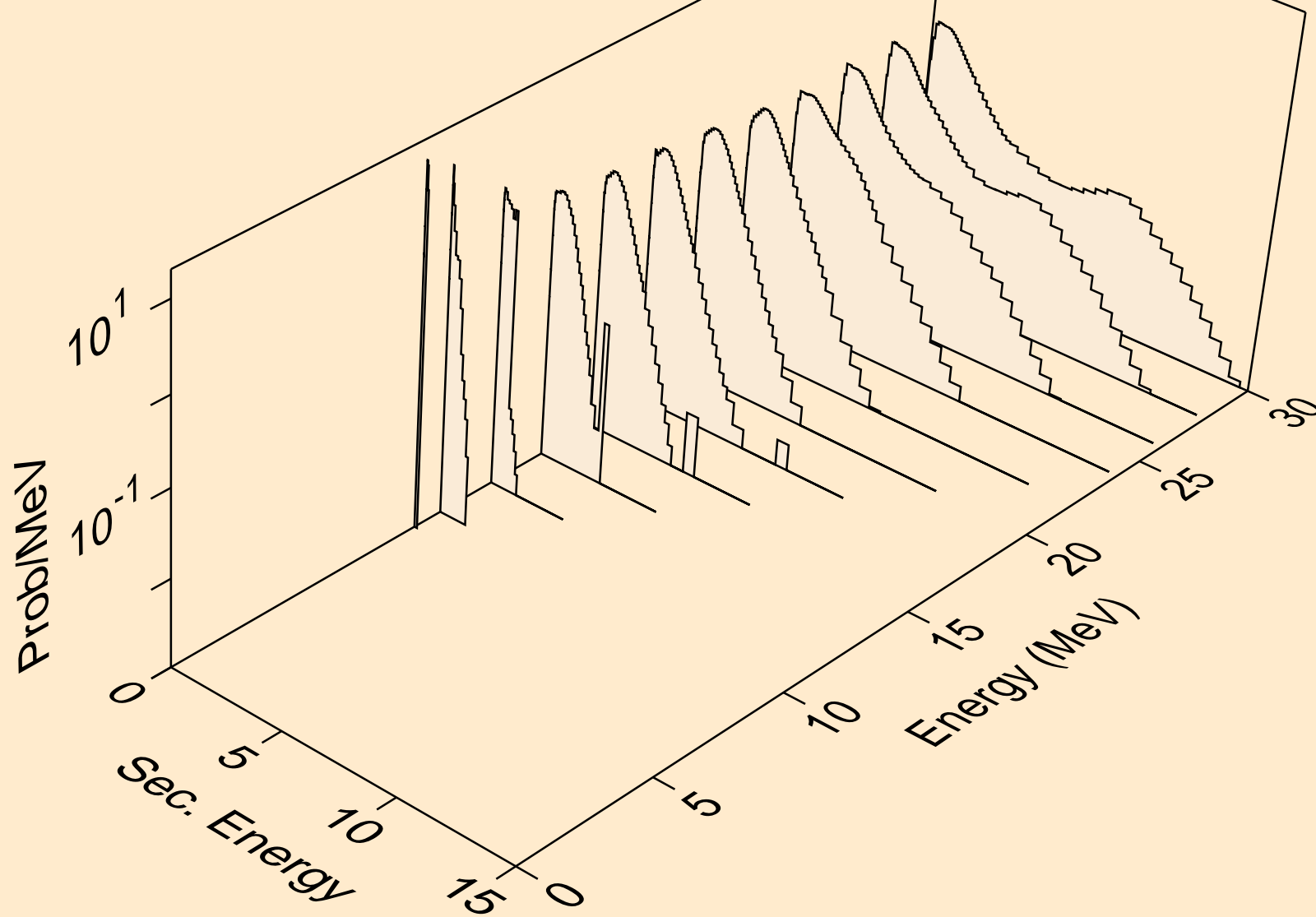

TM154 PHOTON ACER TENDL-2024 LIBRARY; T=0.K
neutrons from (g,2n)a

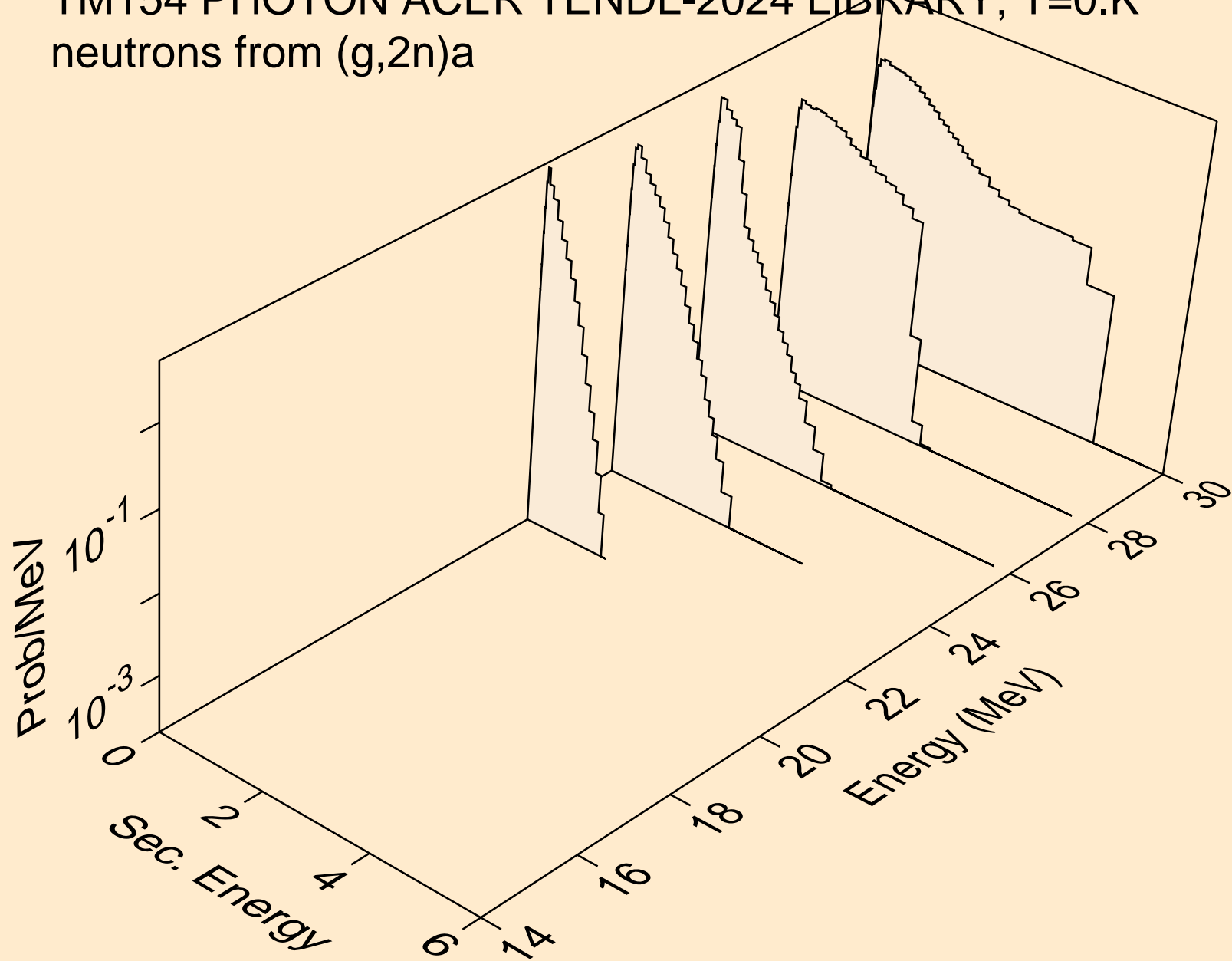

TM154 PHOTON ACER TENDL-2024 LIBRARY; T=0.K
neutrons from (g,n*)p

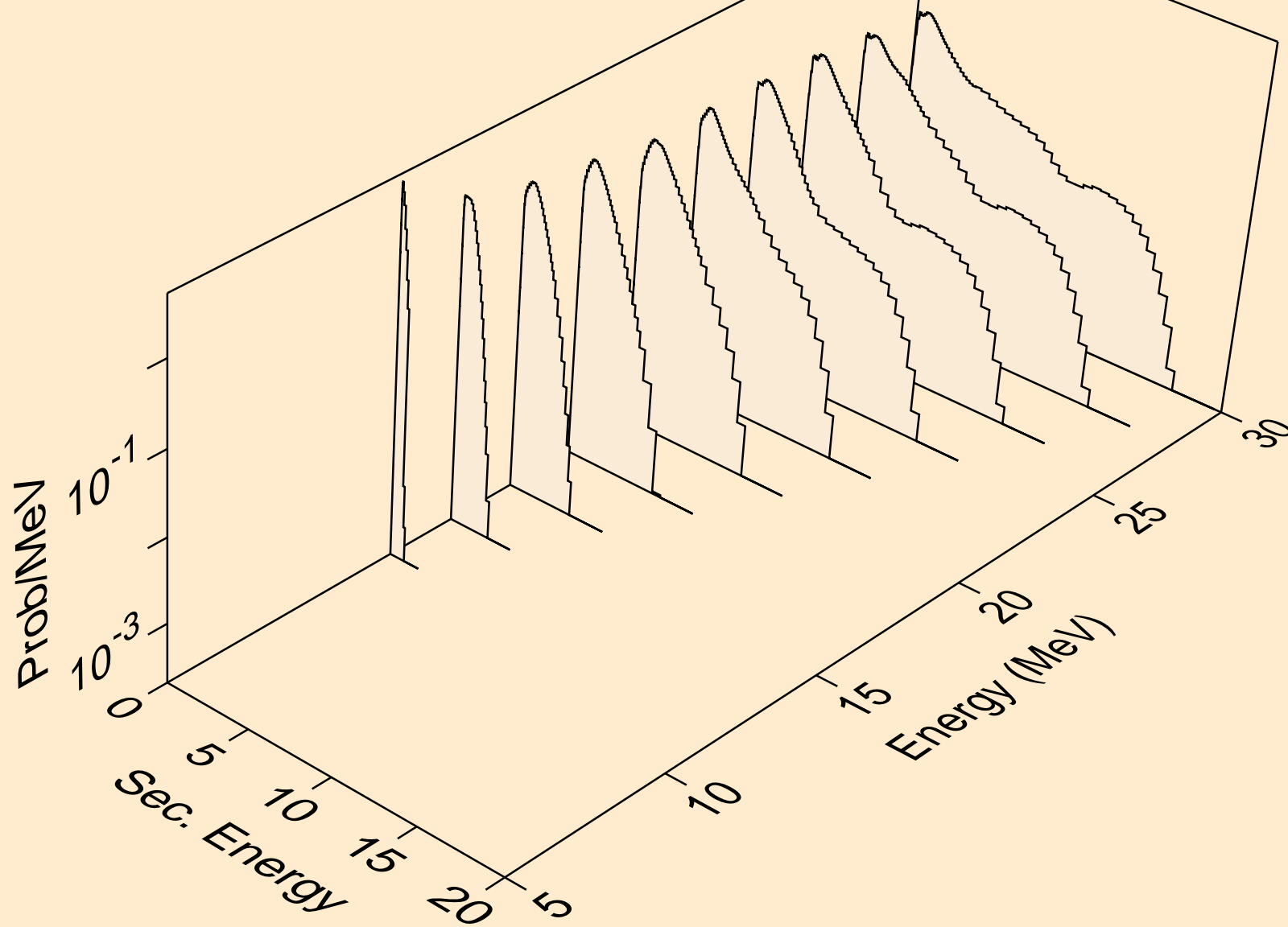

TM154 PHOTON ACER TENDL-2024 LIBRARY; T=0.K
neutrons from (g,n*)2a

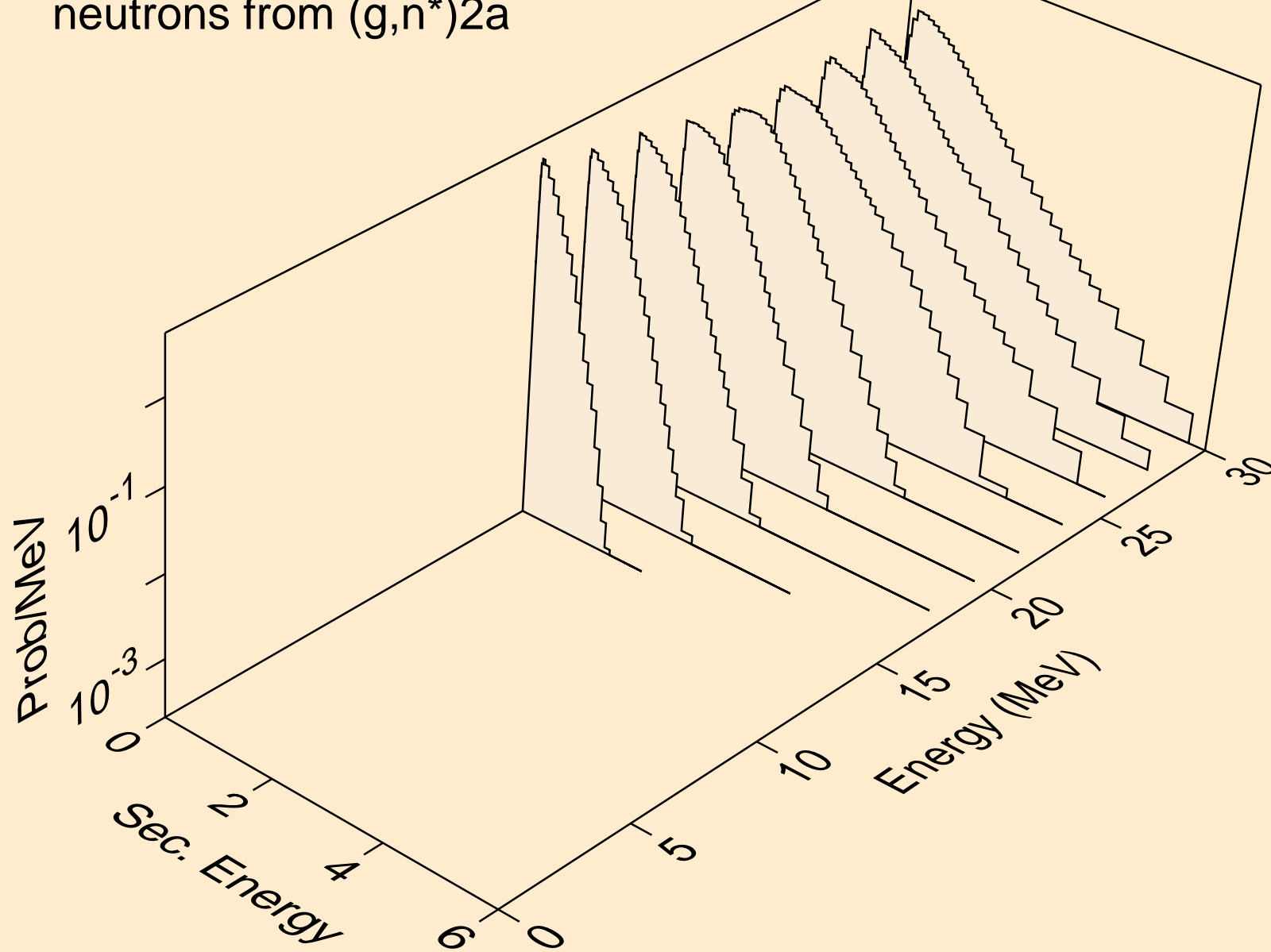

TM154 PHOTON ACER TENDL-2024 LIBRARY; T=0.K
neutrons from (g,n*)d

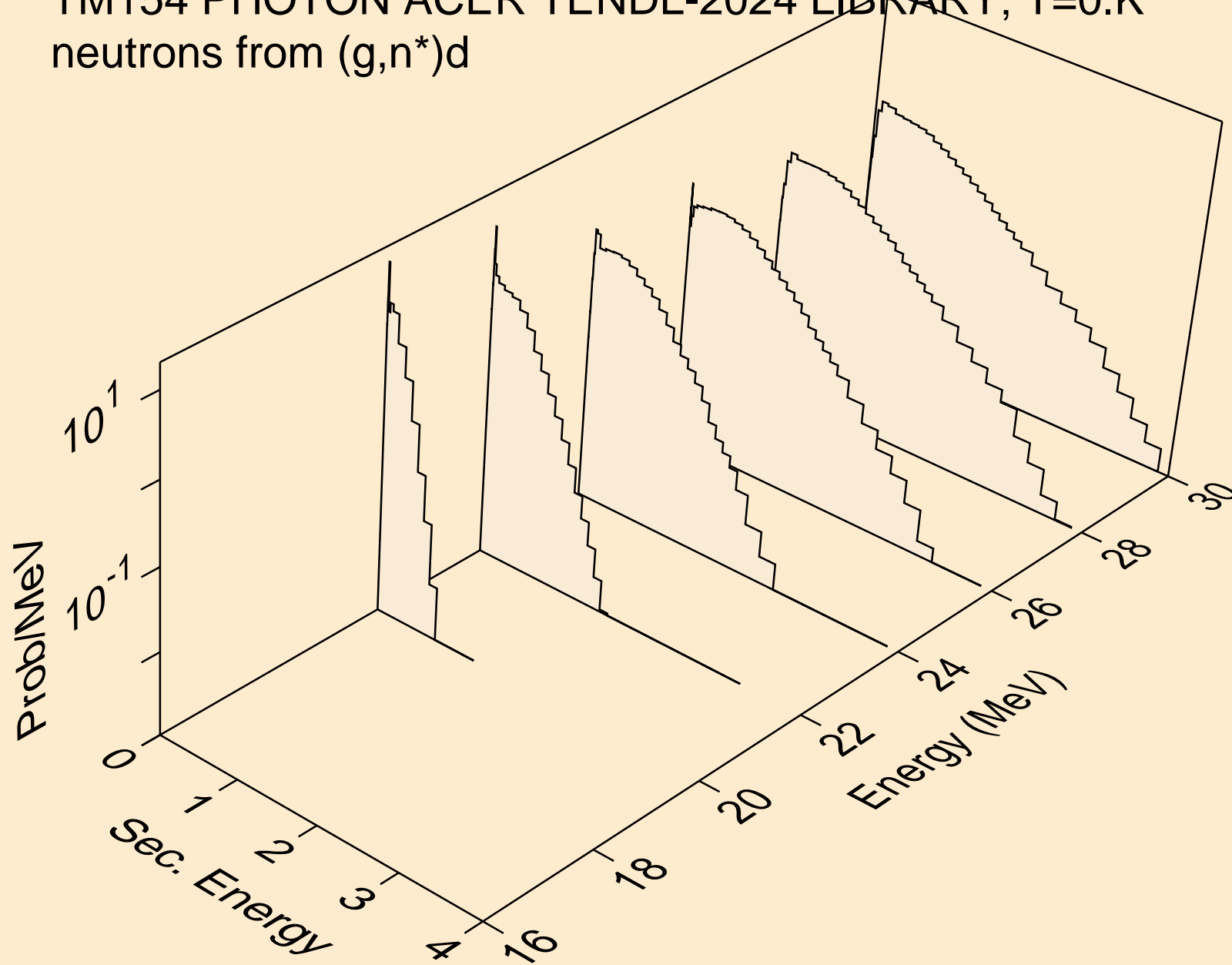

TM154 PHOTON ACER TENDL-2024 LIBRARY; T=0.K
neutrons from (g,n*)t

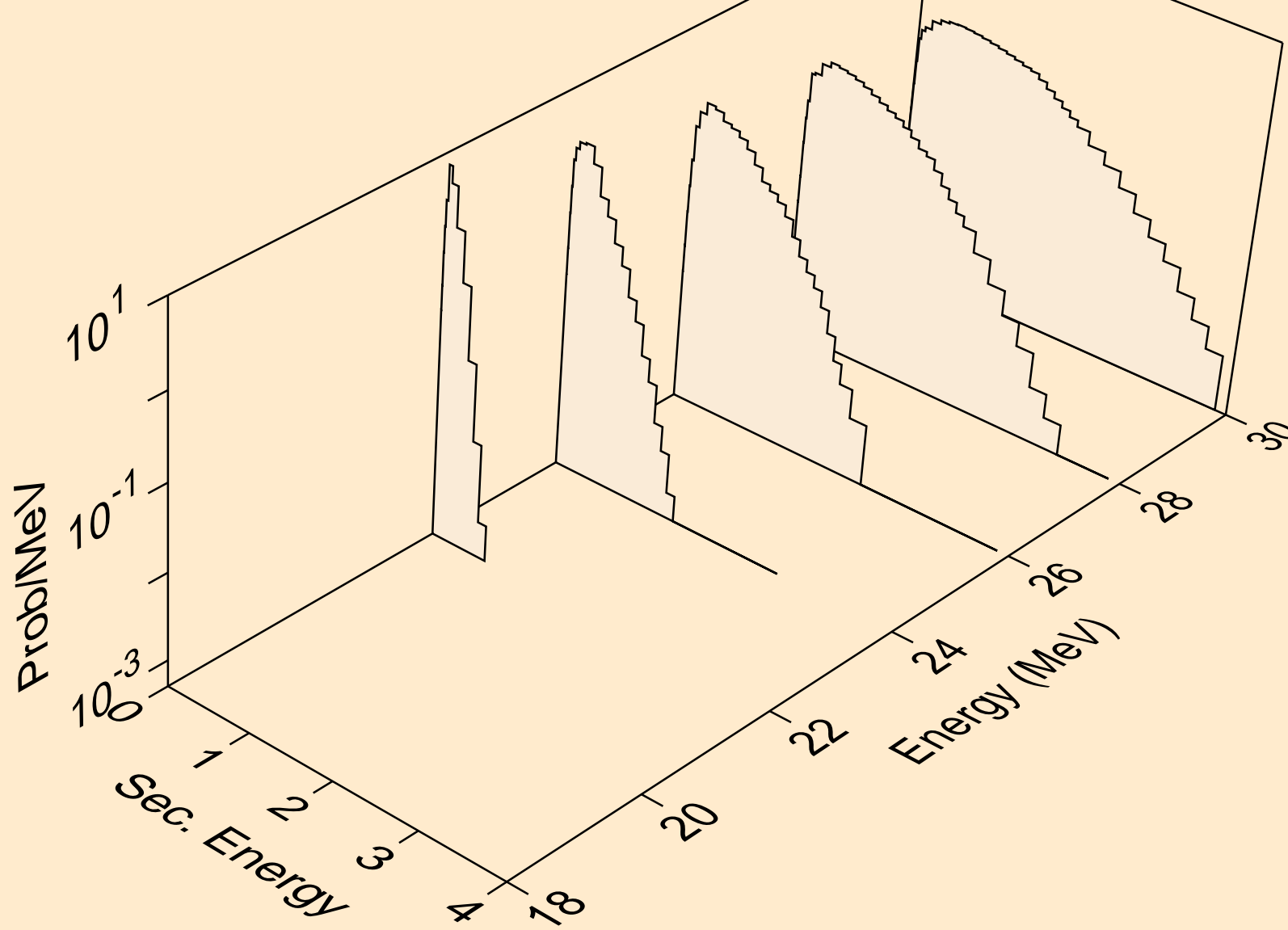

TM154 PHOTON ACER TENDL-2024 LIBRARY; T=0.K
neutrons from (g,n*)he3

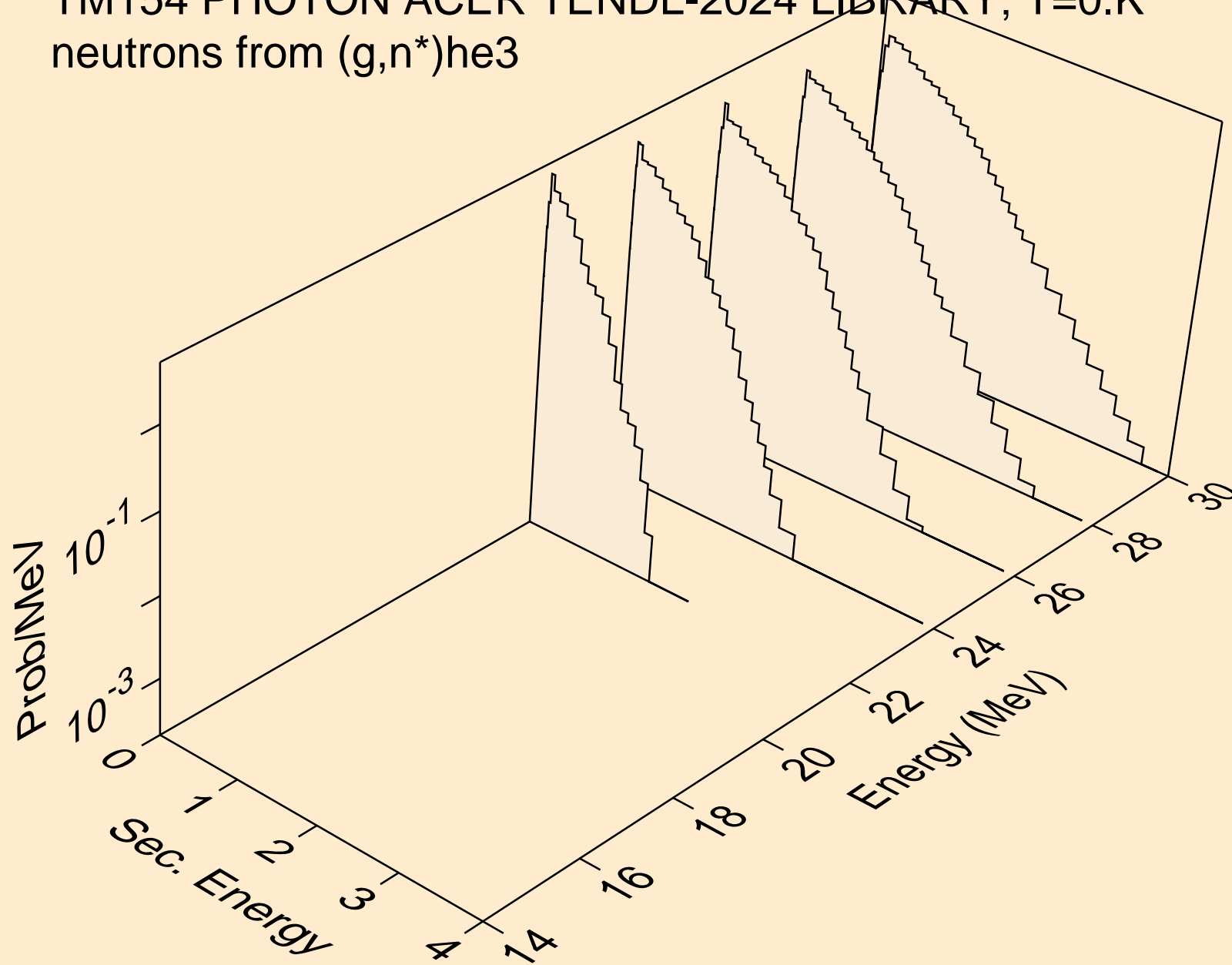

TM154 PHOTON ACER TENDL-2024 LIBRARY; T=0.K
neutrons from (g,2np)

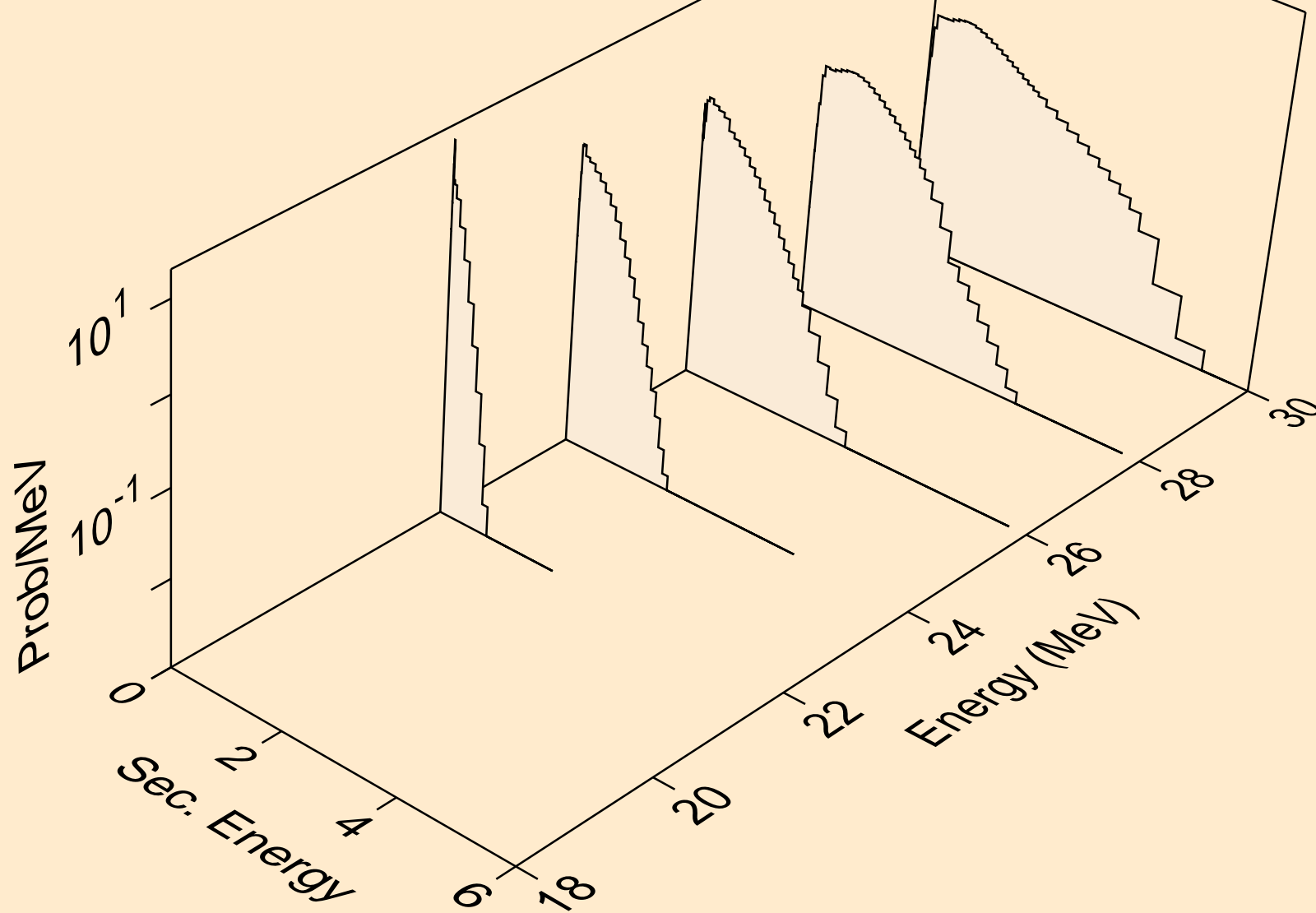

TM154 PHOTON ACER TENDL-2024 LIBRARY; T=0.K
neutrons from (g,n2p)

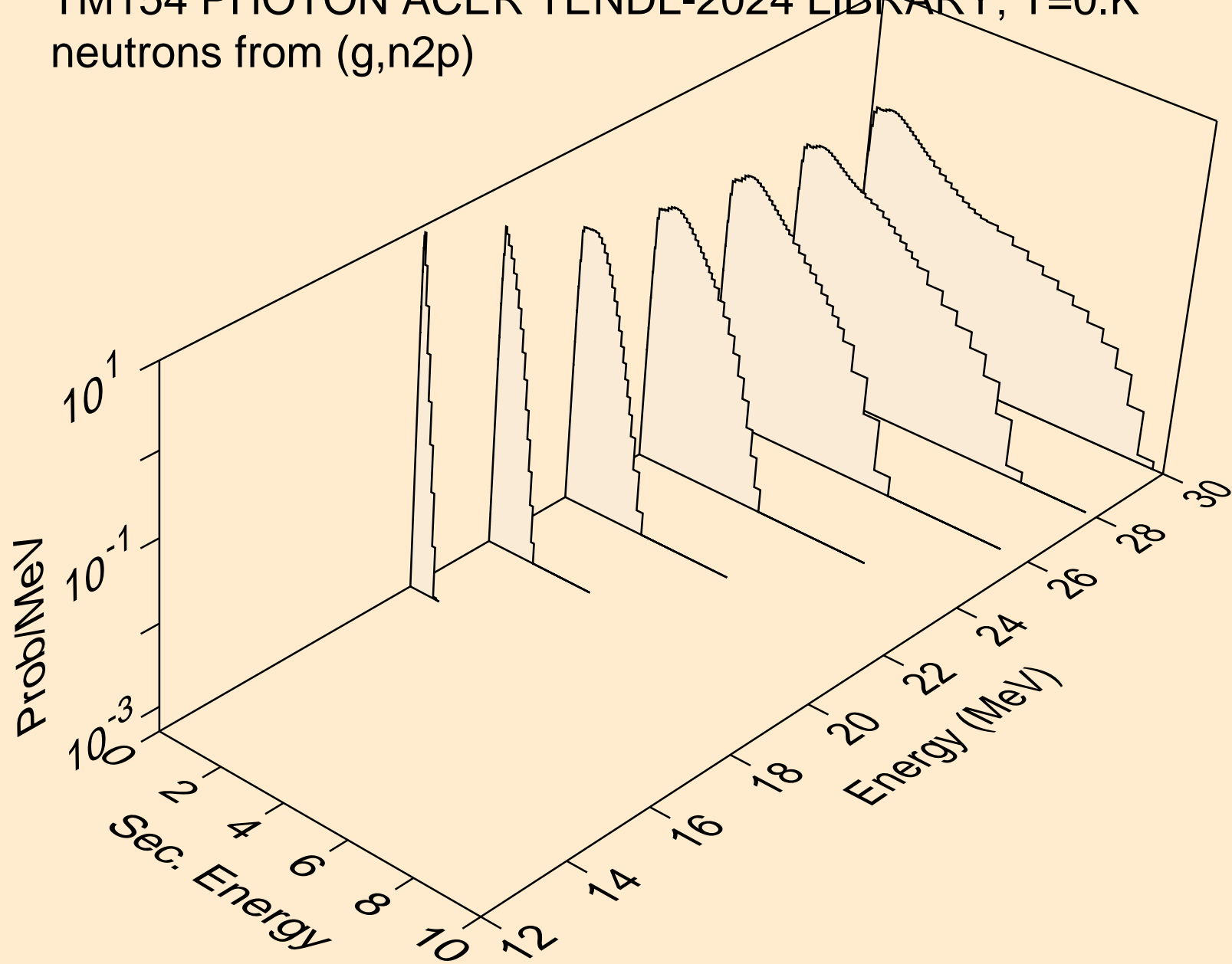

TM154 PHOTON ACER TENDL-2024 LIBRARY; T=0.K
neutrons from (g,npa)

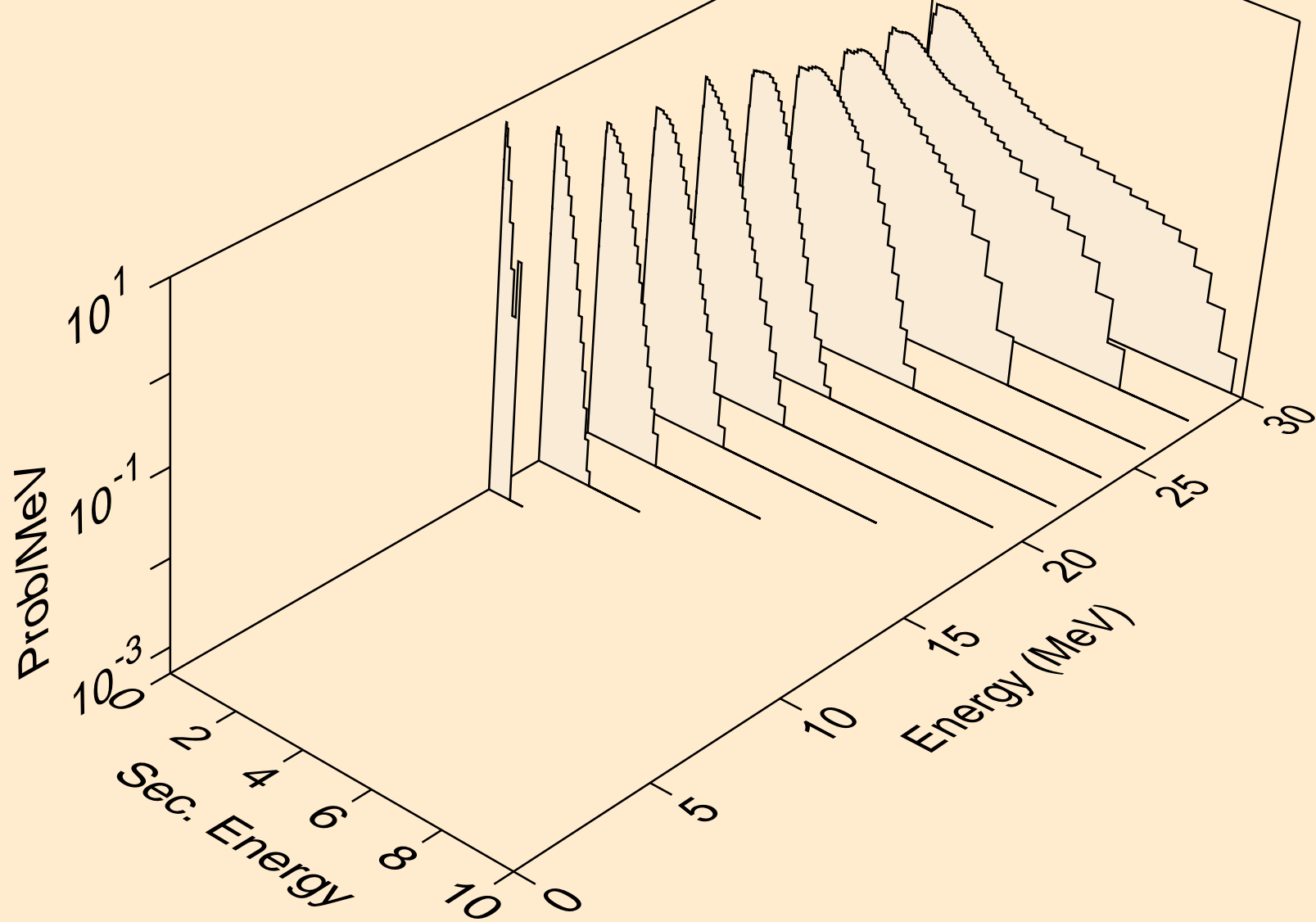

TM154 PHOTON ACER TENDL-2024 LIBRARY; T=0.K
angular distribution for (g,n*0) neutron

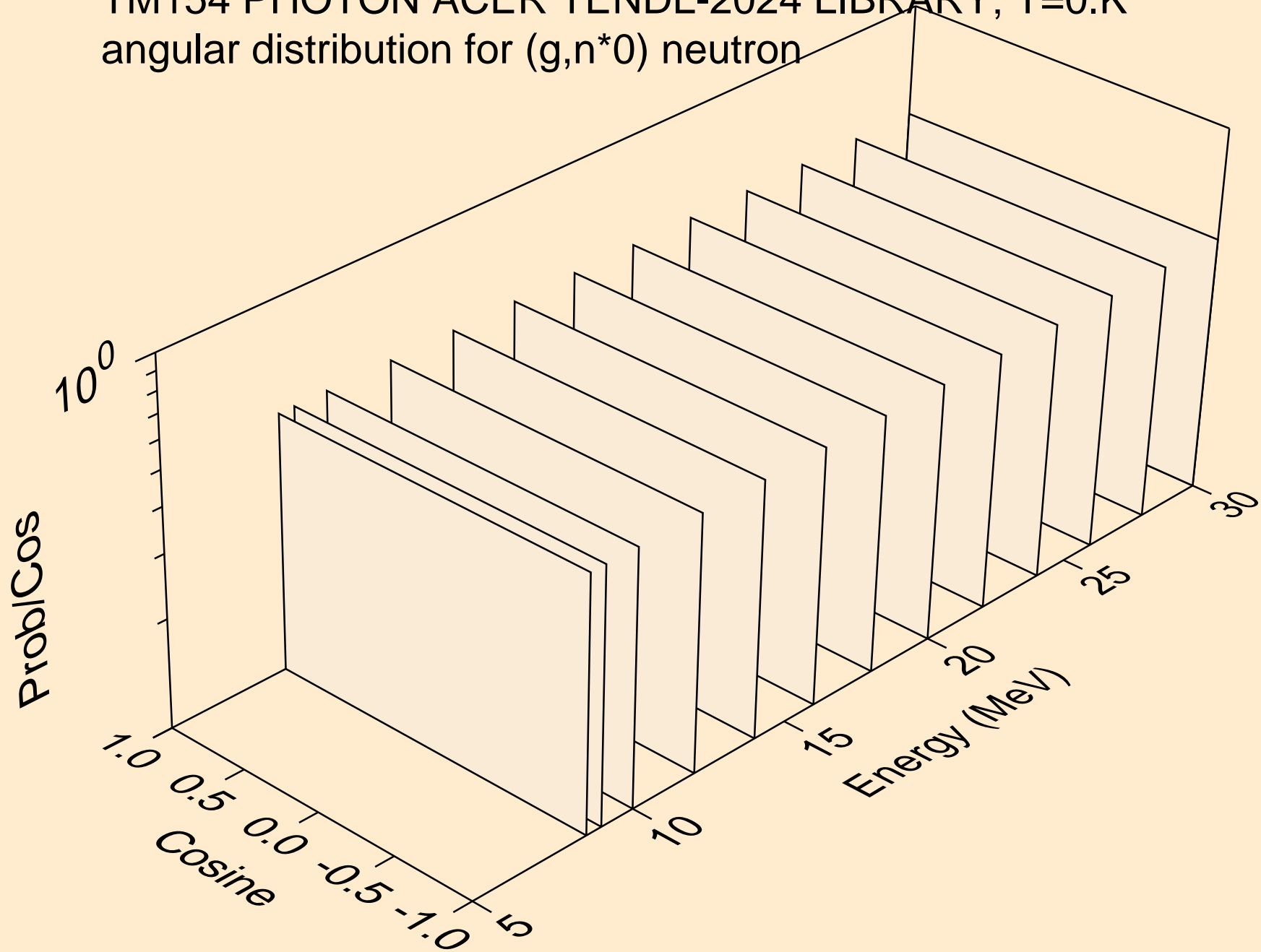

TM154 PHOTON ACER TENDL-2024 LIBRARY; T=0.K
angular distribution for (g,n*1) neutron

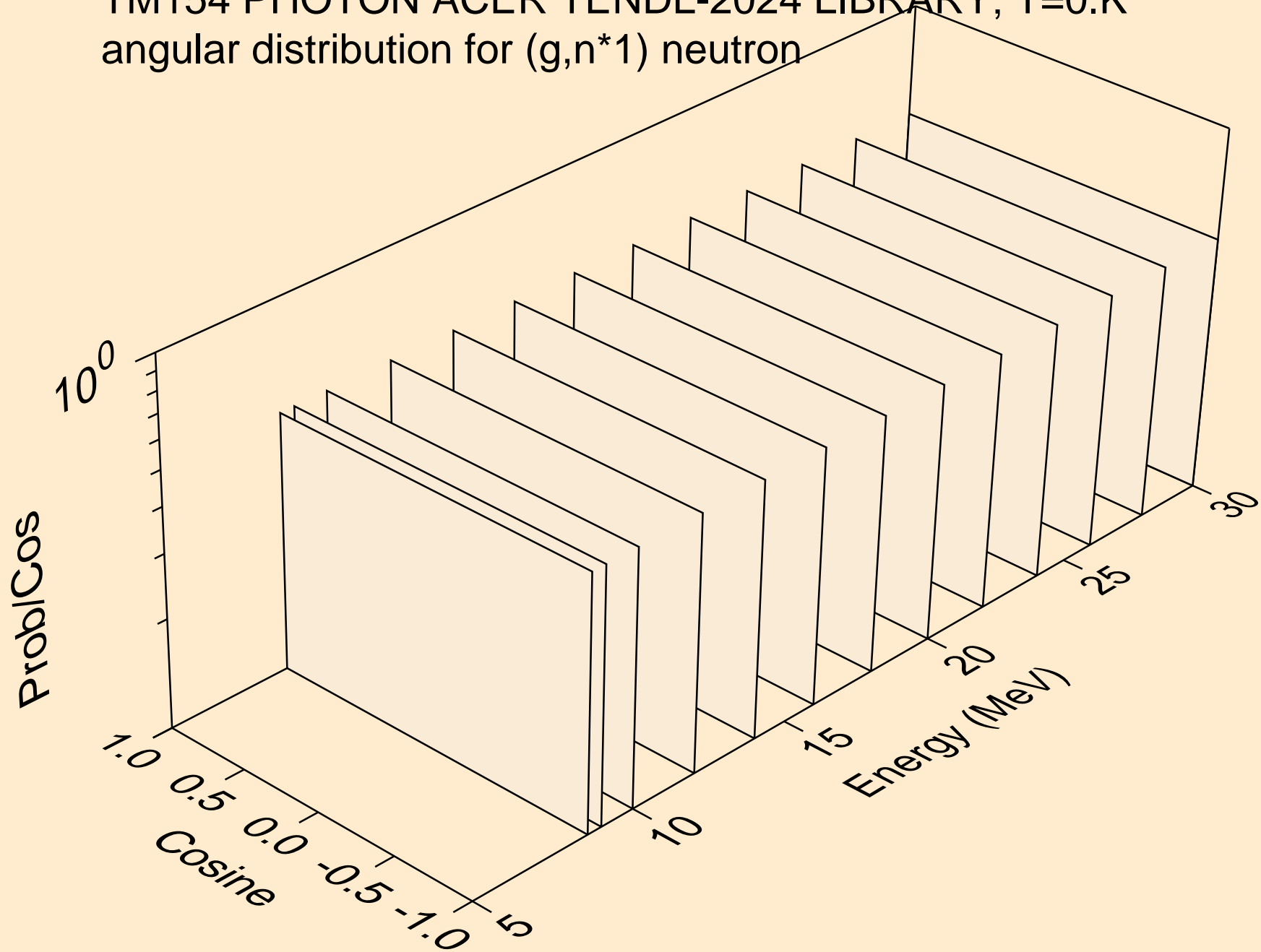

TM154 PHOTON ACER TENDL-2024 LIBRARY; T=0.K
neutrons from (g,n*c)

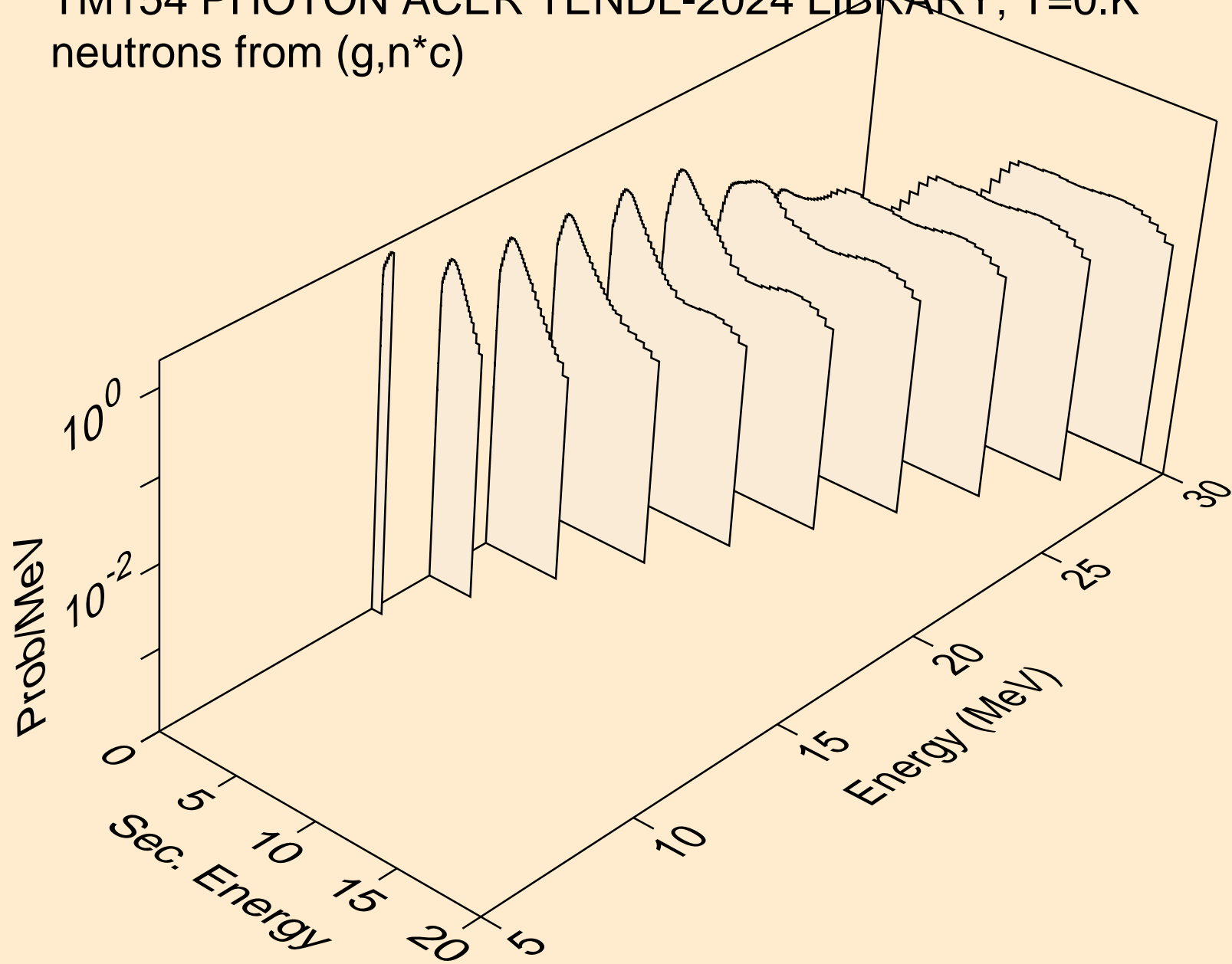

TM154 PHOTON ACER TENDL-2024 LIBRARY; T=0.K
photons from (g,x)

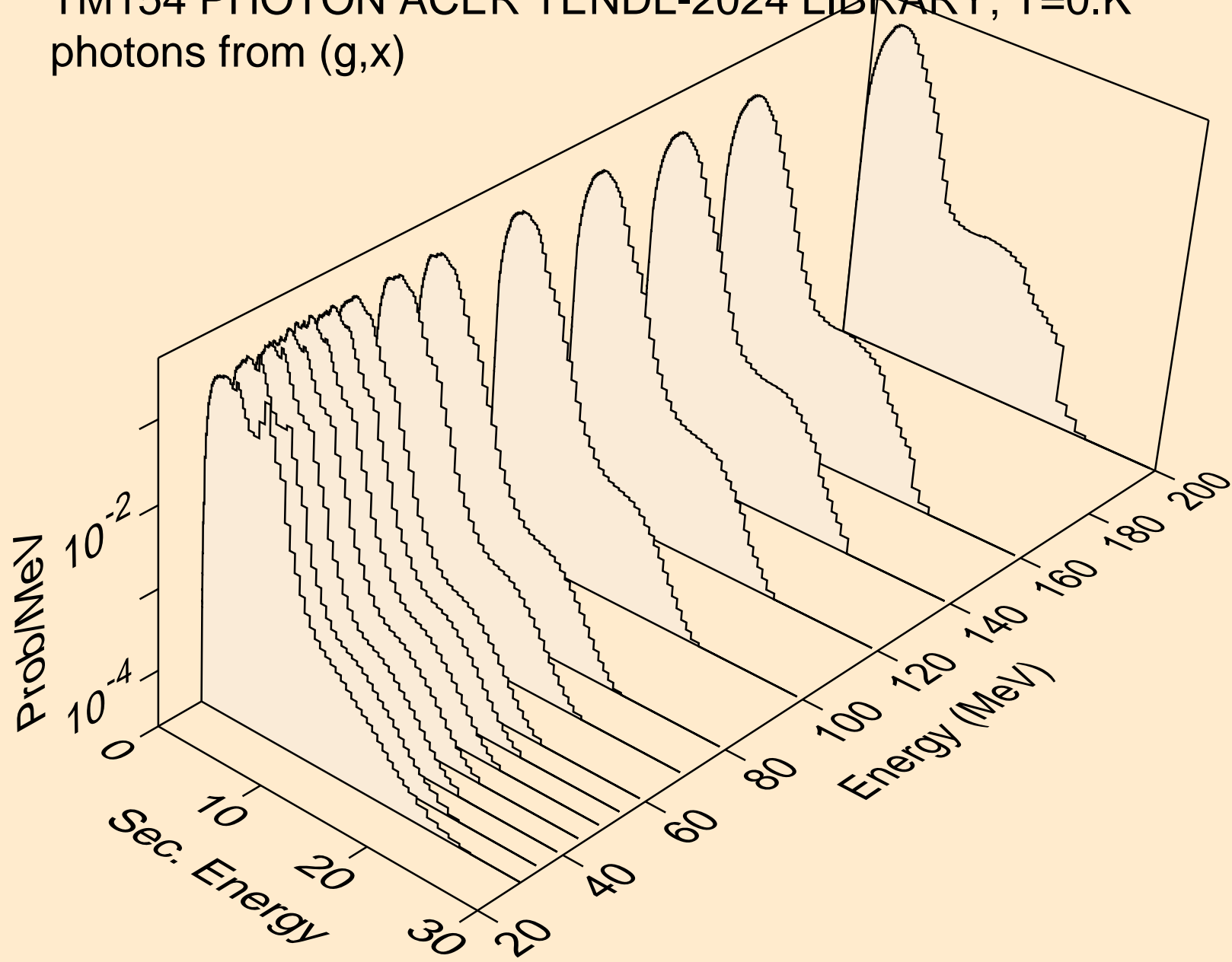

TM154 PHOTON ACER TENDL-2024 LIBRARY; T=0.K
photons from (g,2n)

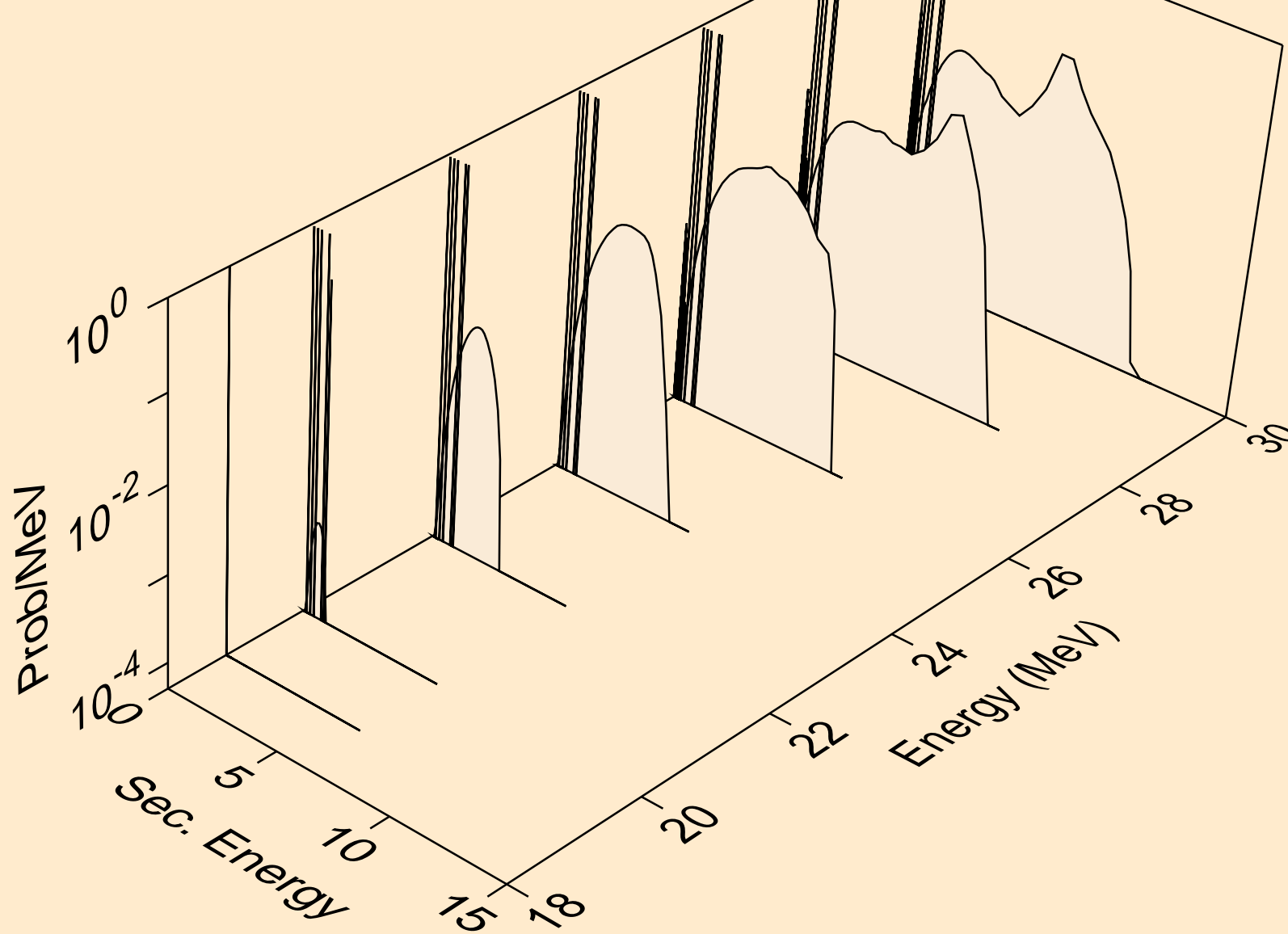

TM154 PHOTON ACER TENDL-2024 LIBRARY; T=0.K
photons from (g,3n)

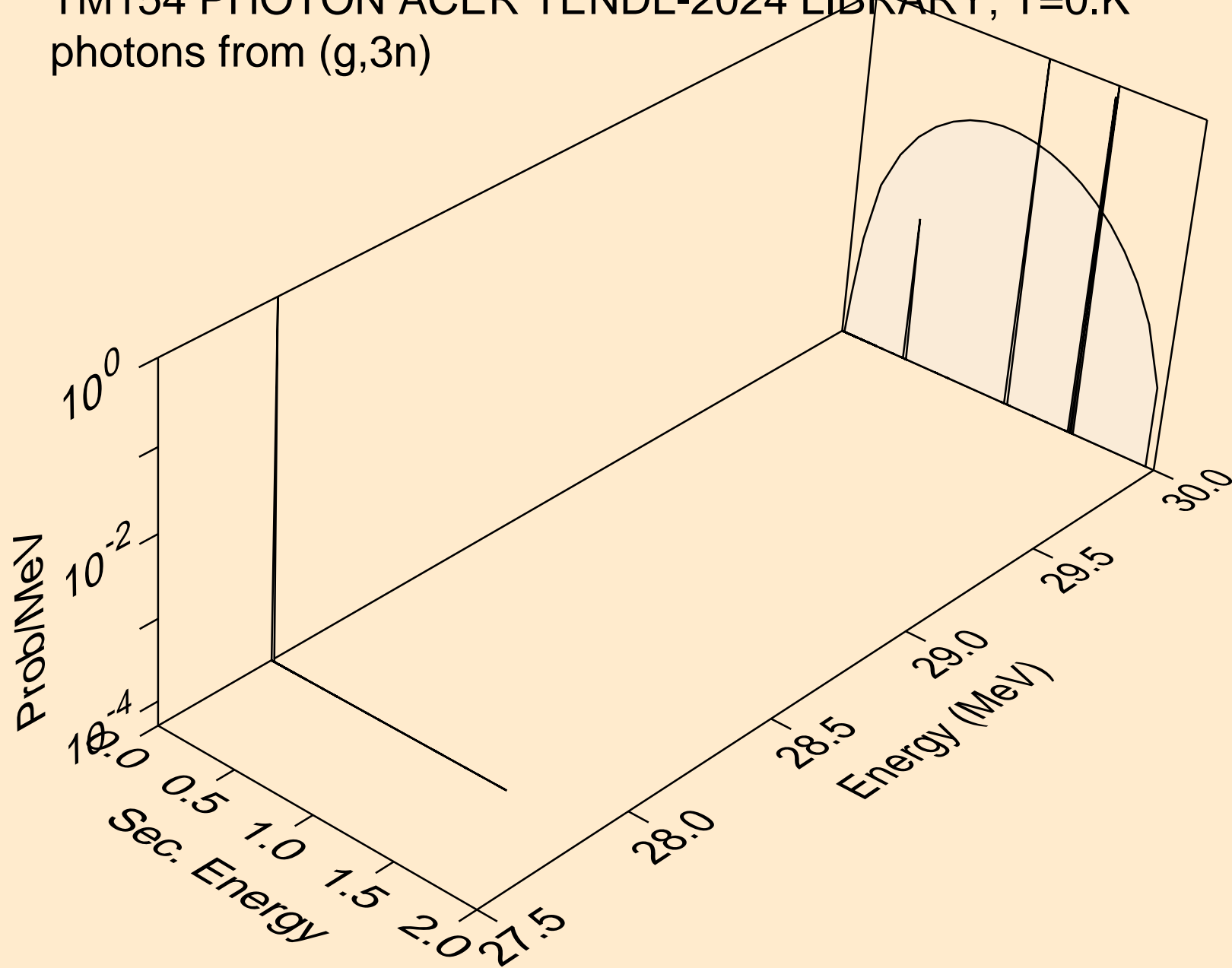

TM154 PHOTON ACER TENDL-2024 LIBRARY; T=0.K
photons from (g,n*)a

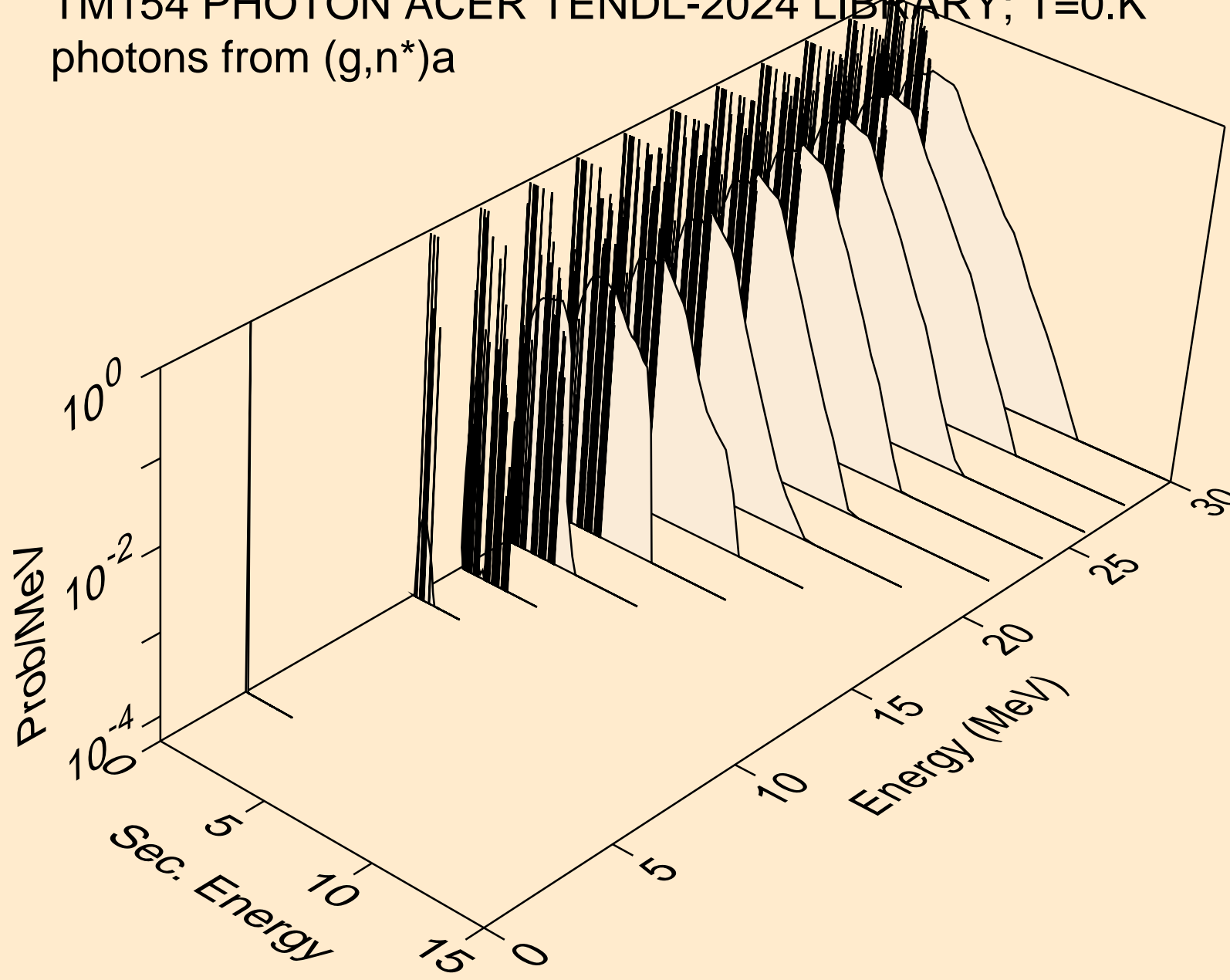

TM154 PHOTON ACER TENDL-2024 LIBRARY; T=0.K
photons from (g,2n)a

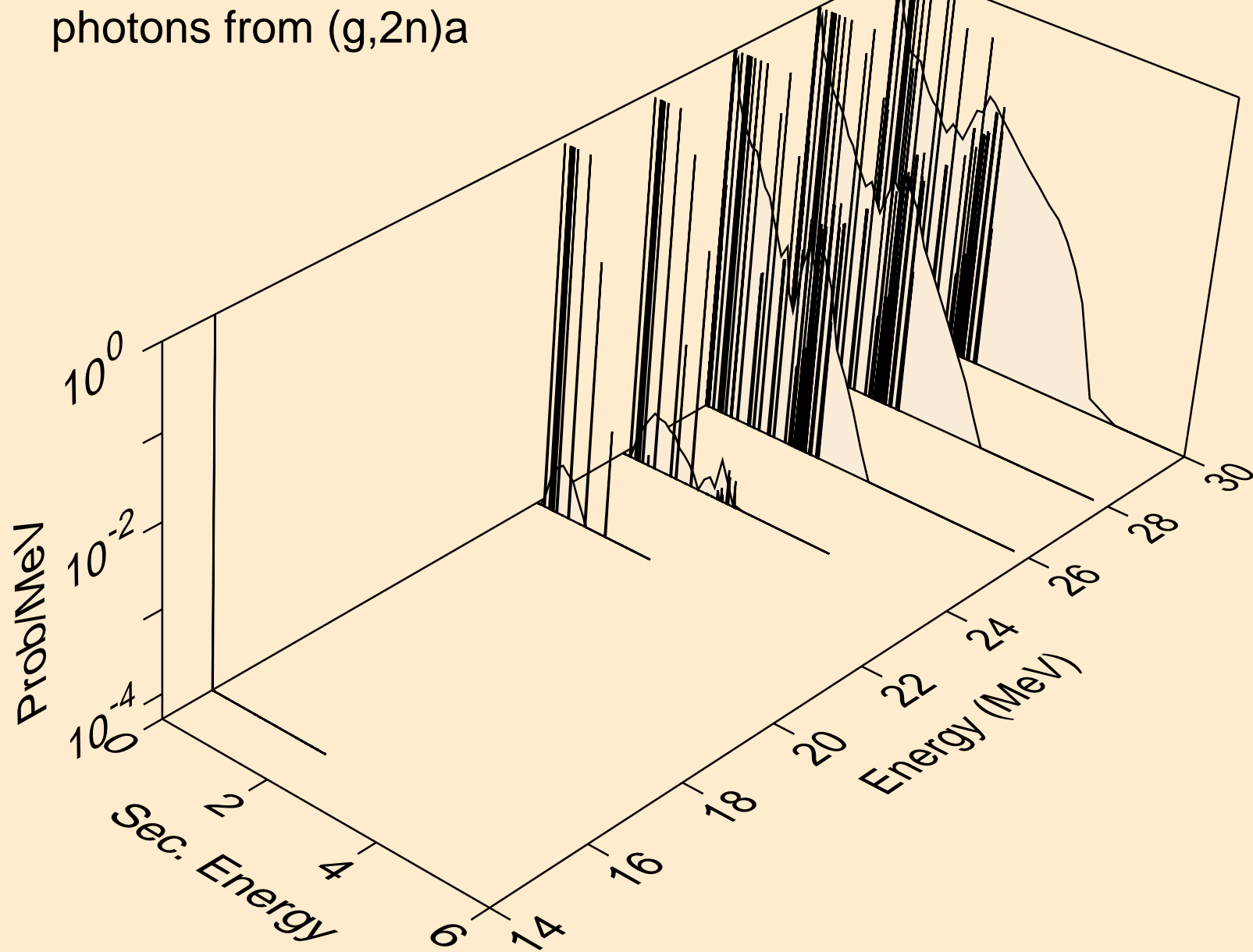

TM154 PHOTON ACER TENDL-2024 LIBRARY; T=0.K
photons from (g,n*)p

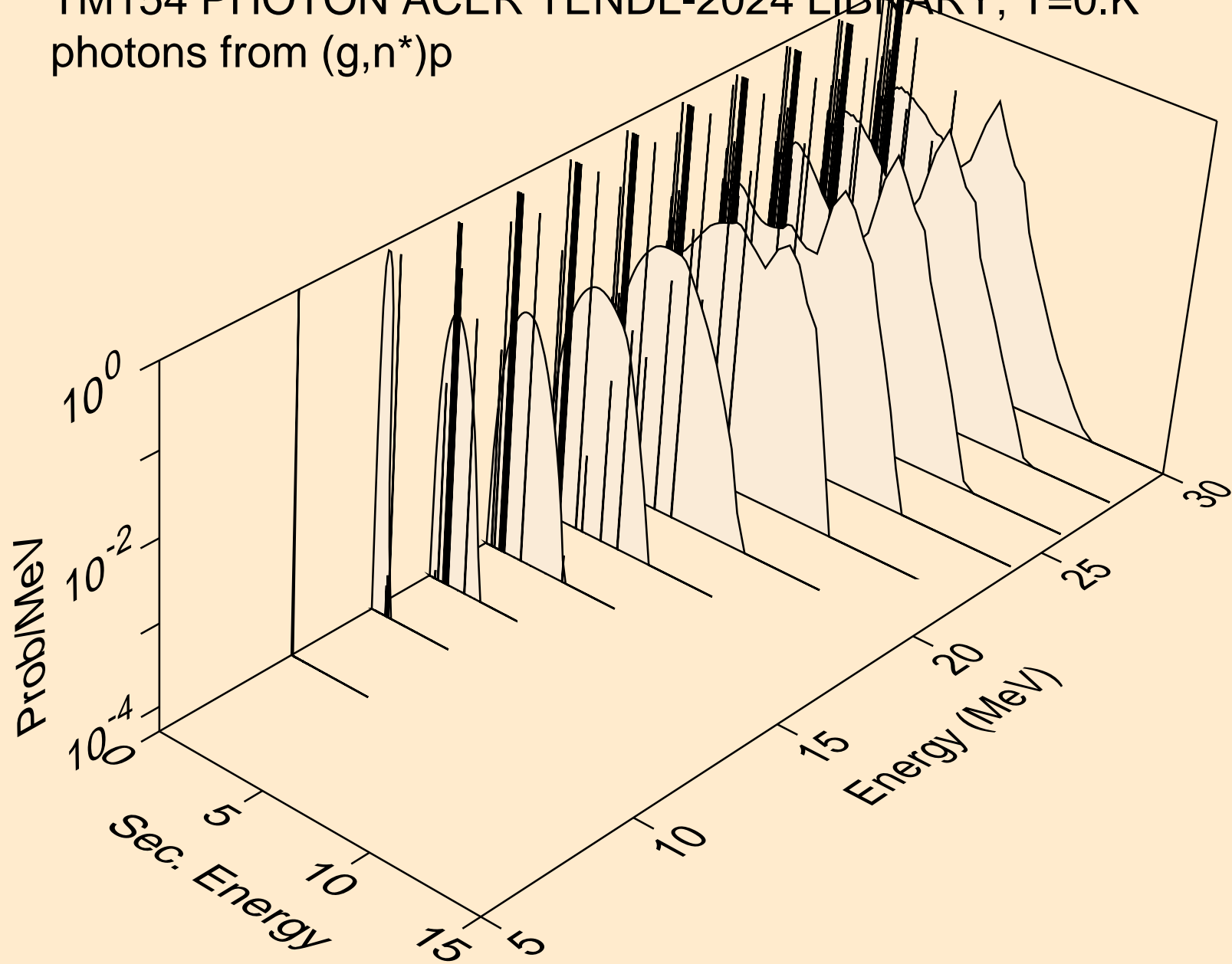

TM154 PHOTON ACER TENDL-2024 LIBRARY; T=0.K
photons from (g,n*)2a

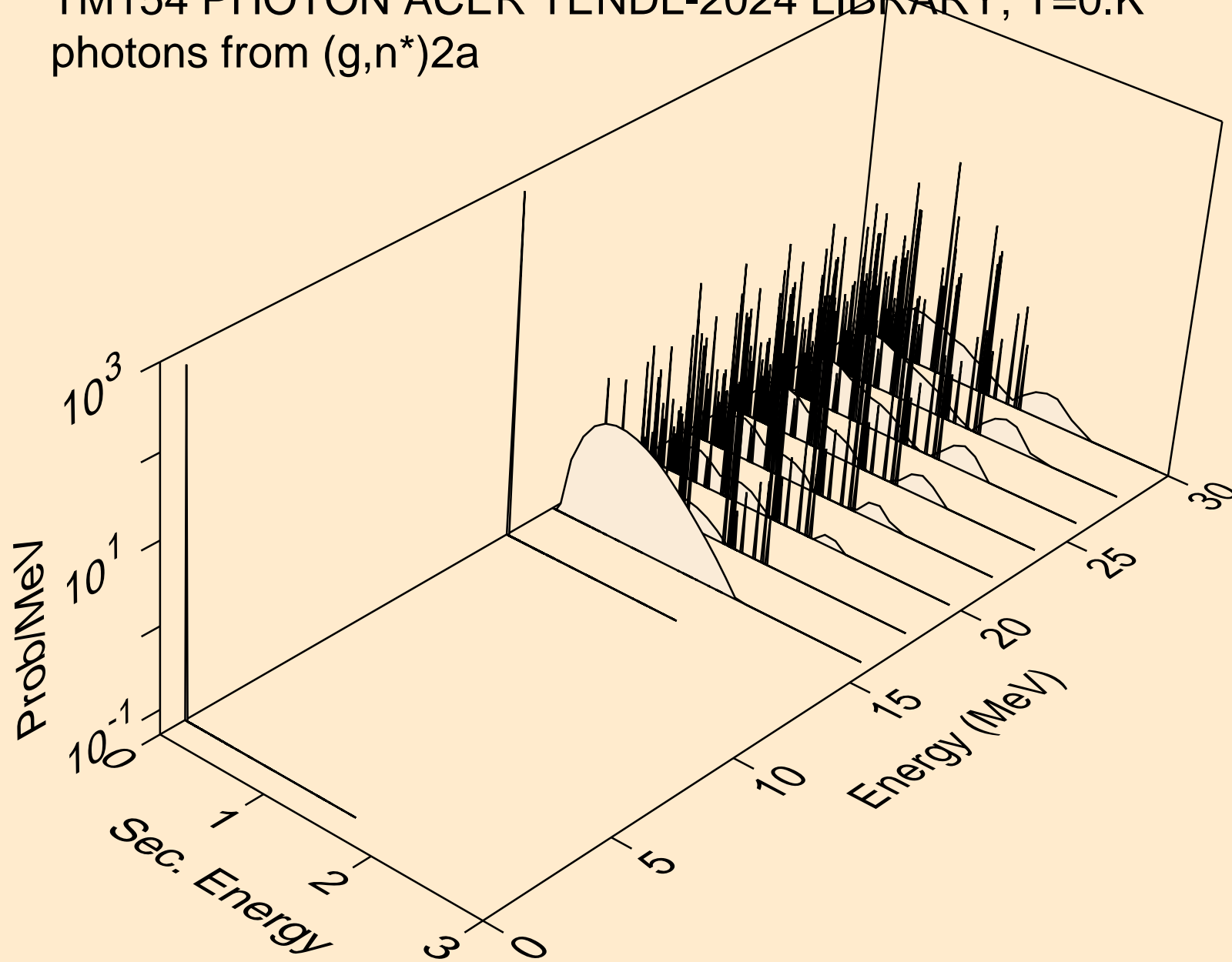

TM154 PHOTON ACER TENDL-2024 LIBRARY; T=0.K
photons from (g,n*)d

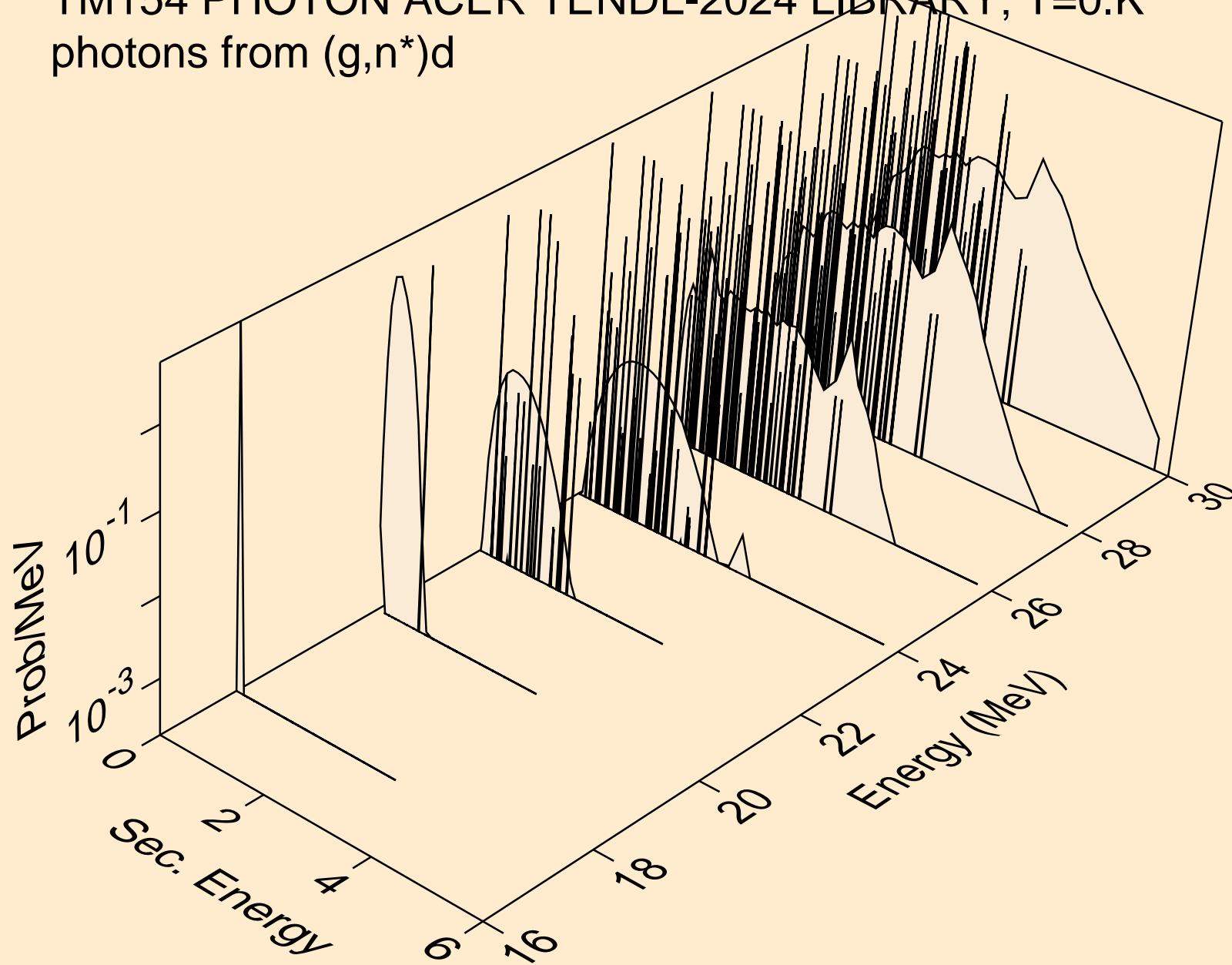

TM154 PHOTON ACER TENDL-2024 LIBRARY; T=0.K
photons from (g,n*)t

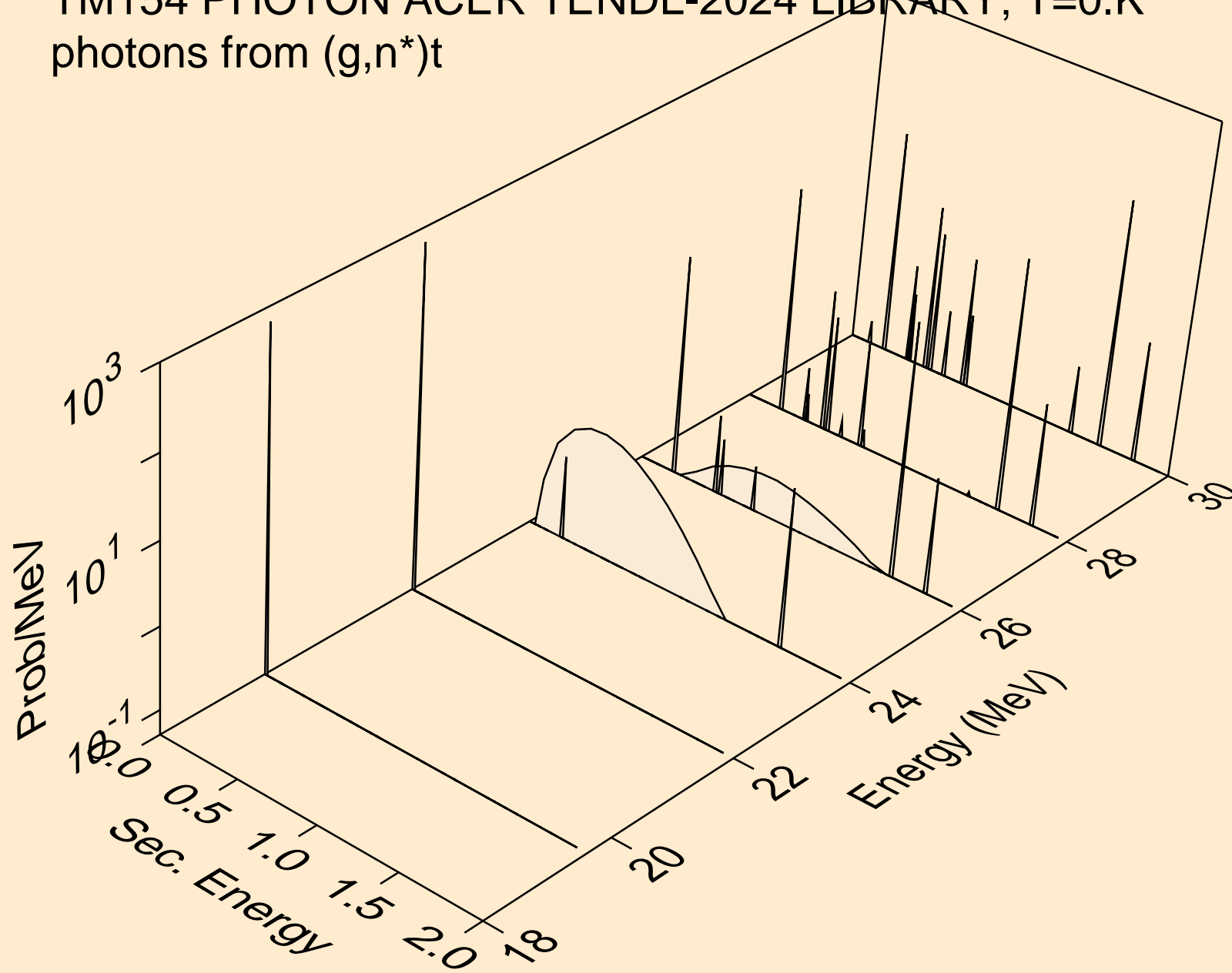

TM154 PHOTON ACER TENDL-2024 LIBRARY; T=0.K
photons from (g,n*)he3

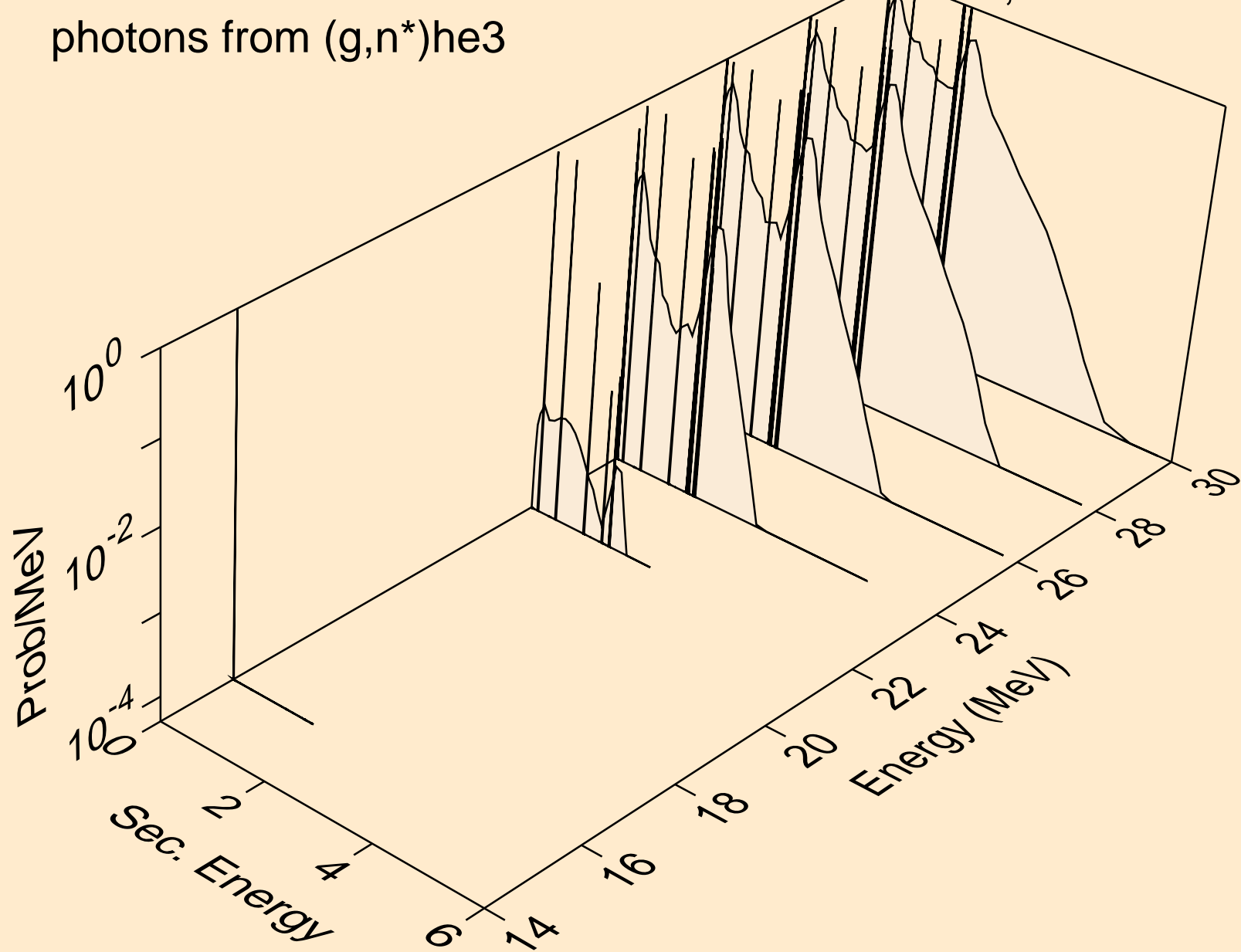

TM154 PHOTON ACER TENDL-2024 LIBRARY; T=0.K
photons from (g,2np)

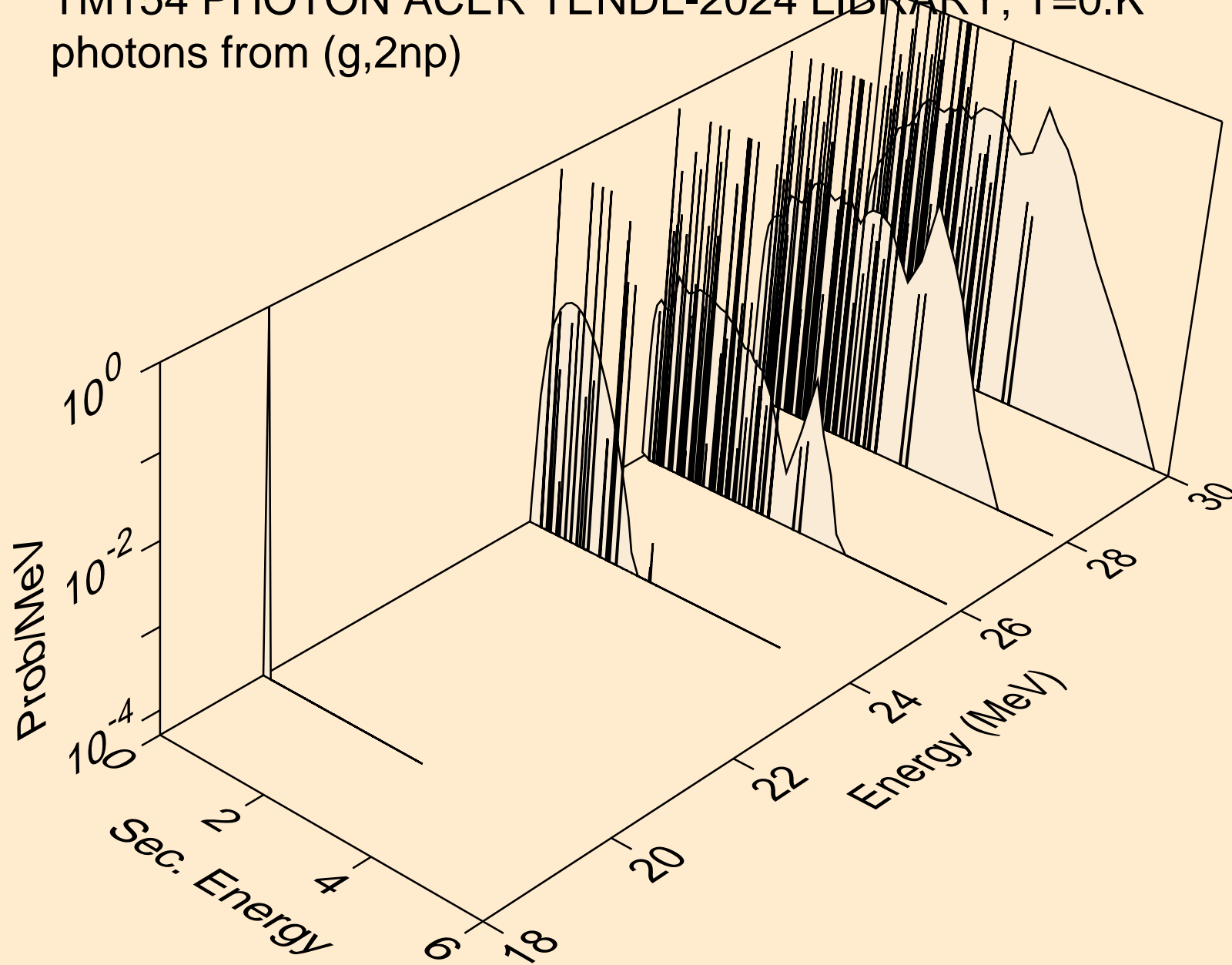

TM154 PHOTON ACER TENDL-2024 LIBRARY; T=0.K
photons from (g,n2p)

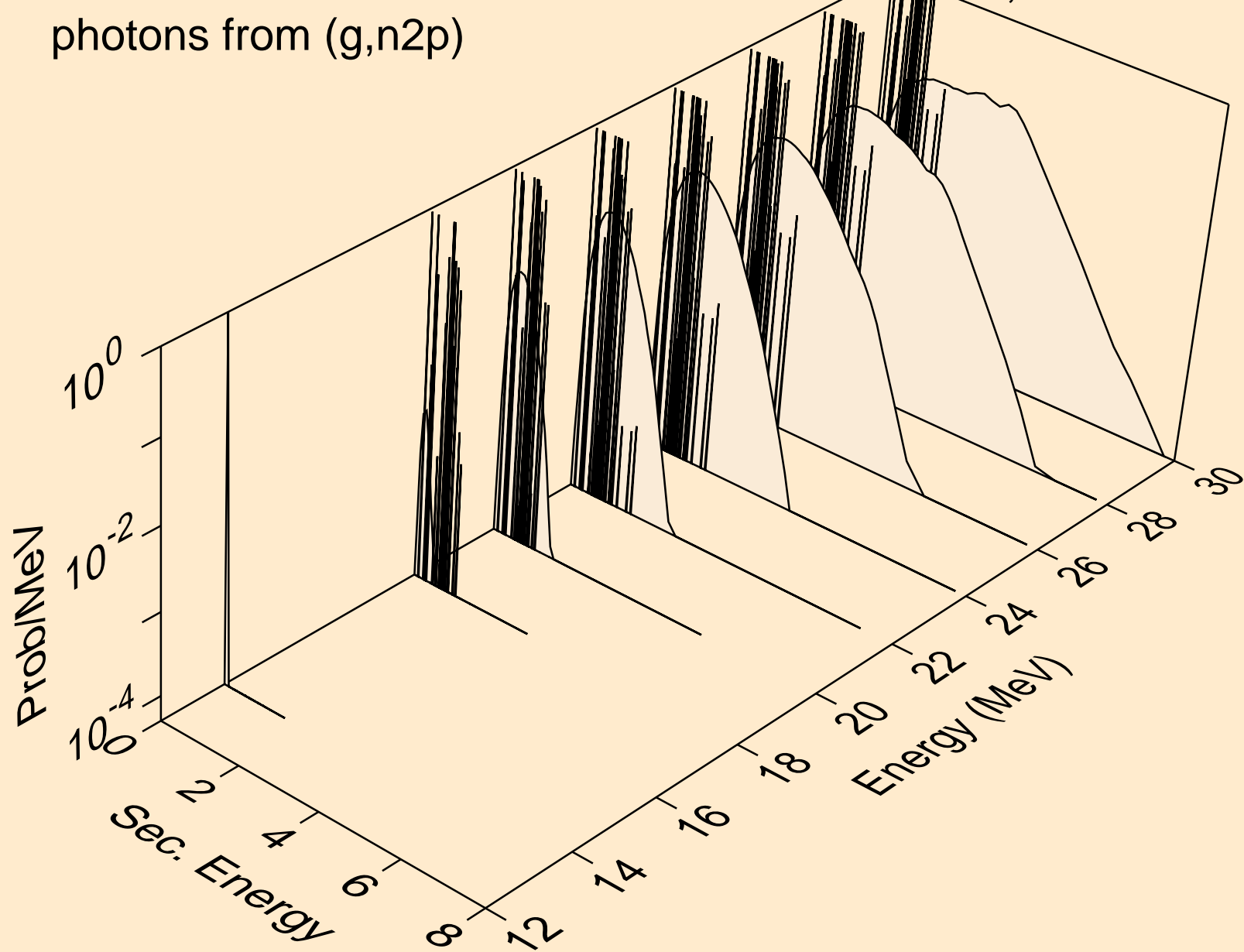

TM154 PHOTON ACER TENDL-2024 LIBRARY; T=0.K
photons from (g,npa)

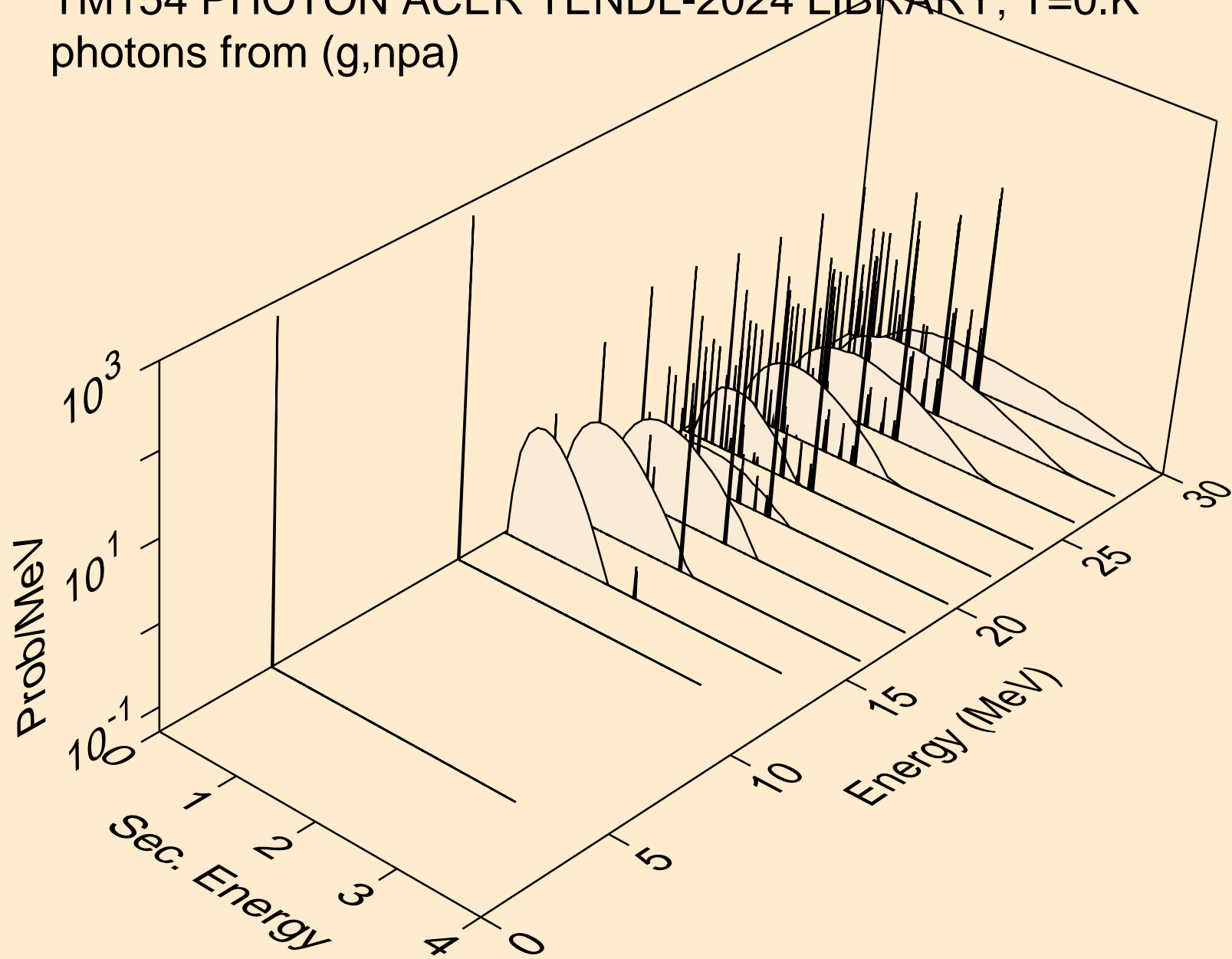

TM154 PHOTON ACER TENDL-2024 LIBRARY; T=0.K
photons from (g,n*c)

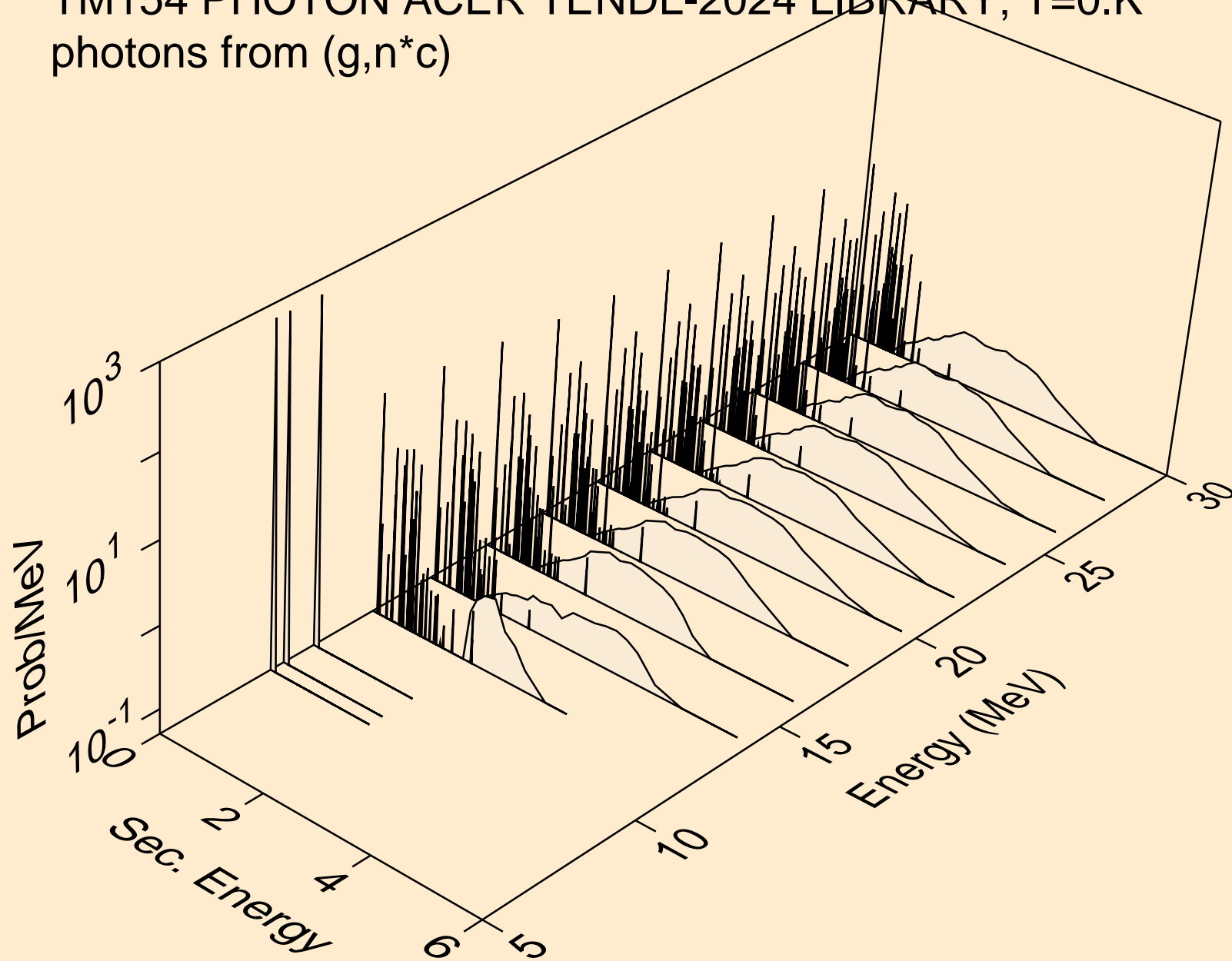

TM154 PHOTON ACER TENDL-2024 LIBRARY; T=0.K
photons from (g,gma)

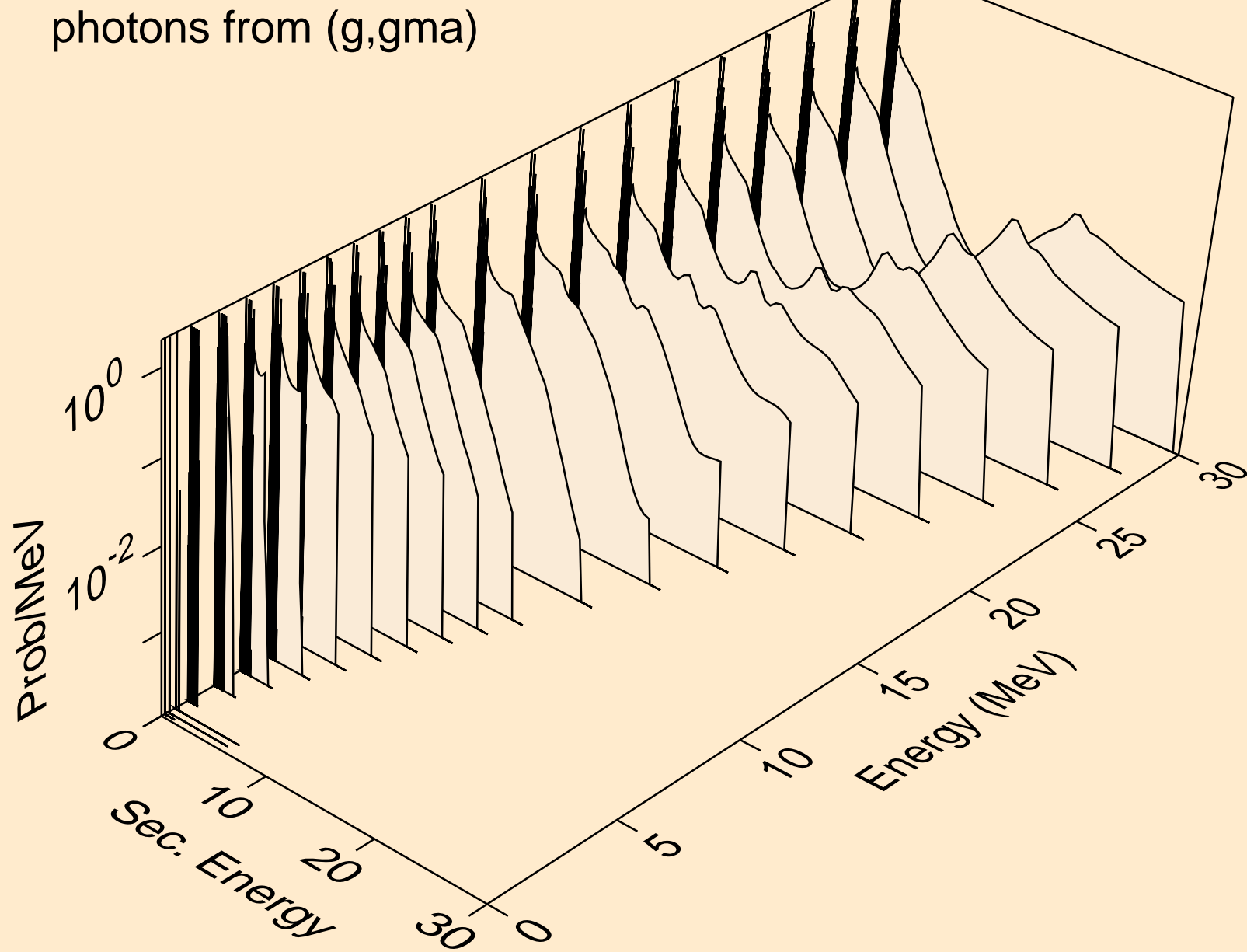

TM154 PHOTON ACER TENDL-2024 LIBRARY; T=0.K
photons from (g,p)

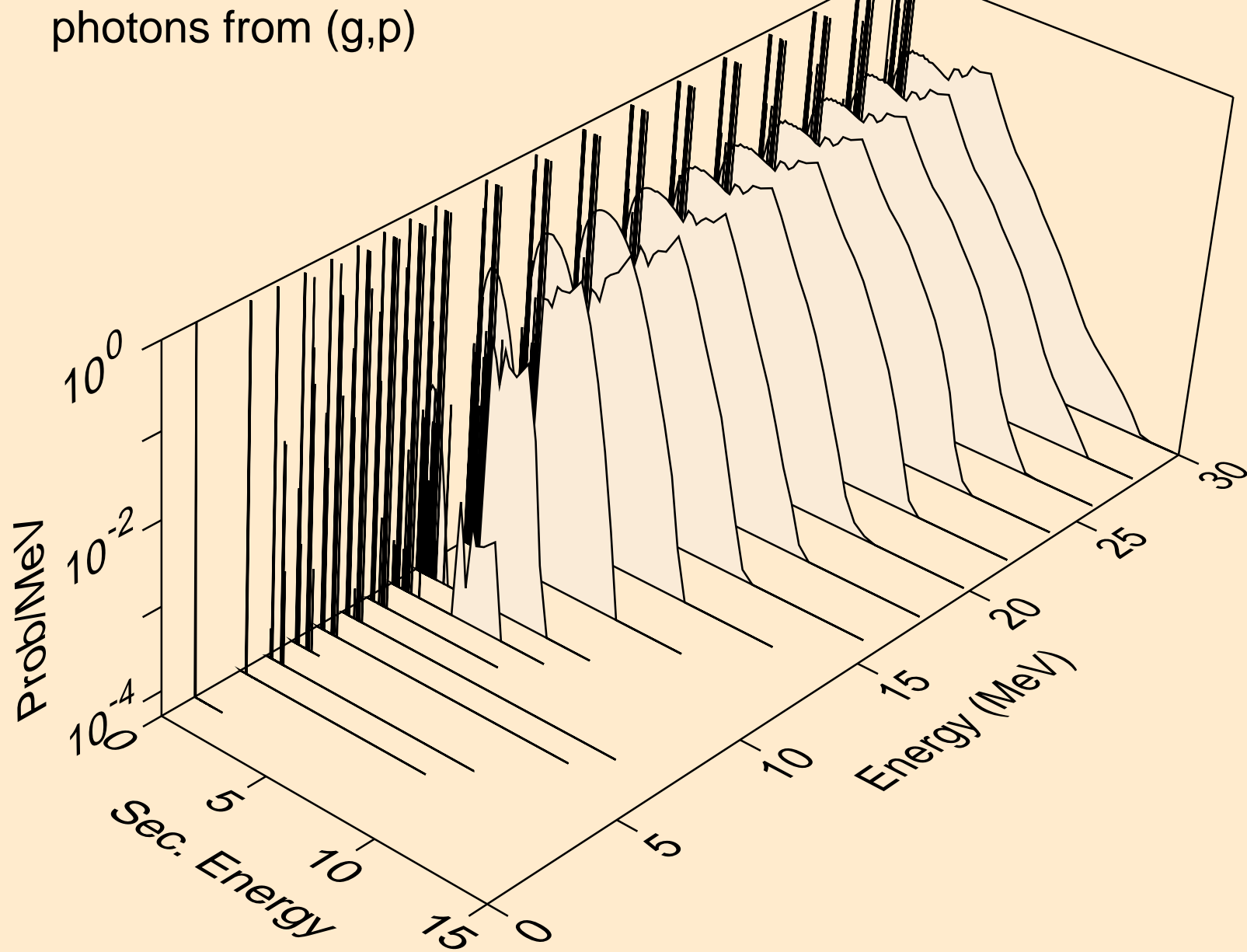

TM154 PHOTON ACER TENDL-2024 LIBRARY; T=0.K
photons from (g,d)

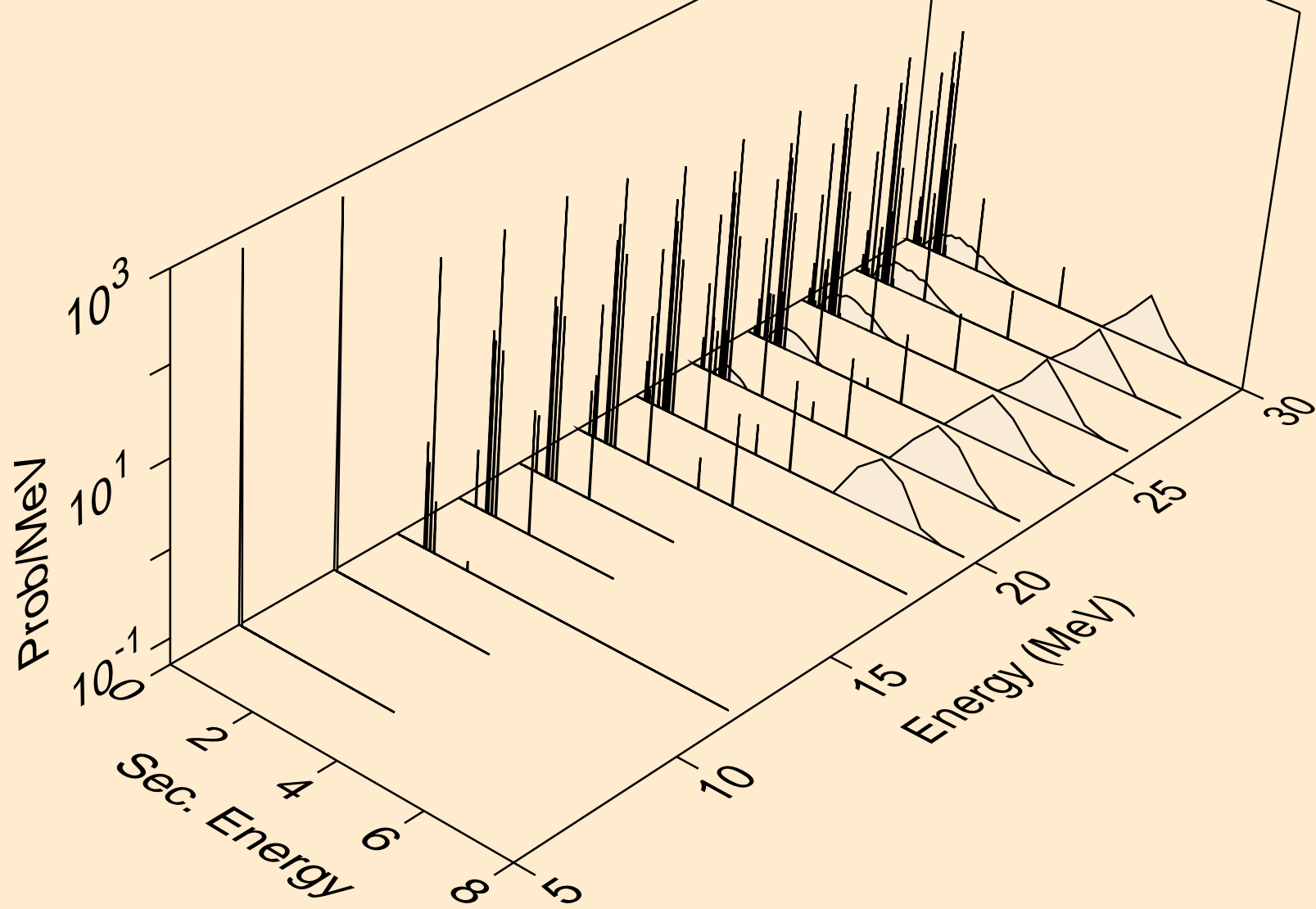

TM154 PHOTON ACER TENDL-2024 LIBRARY; T=0.K
photons from (g,t)

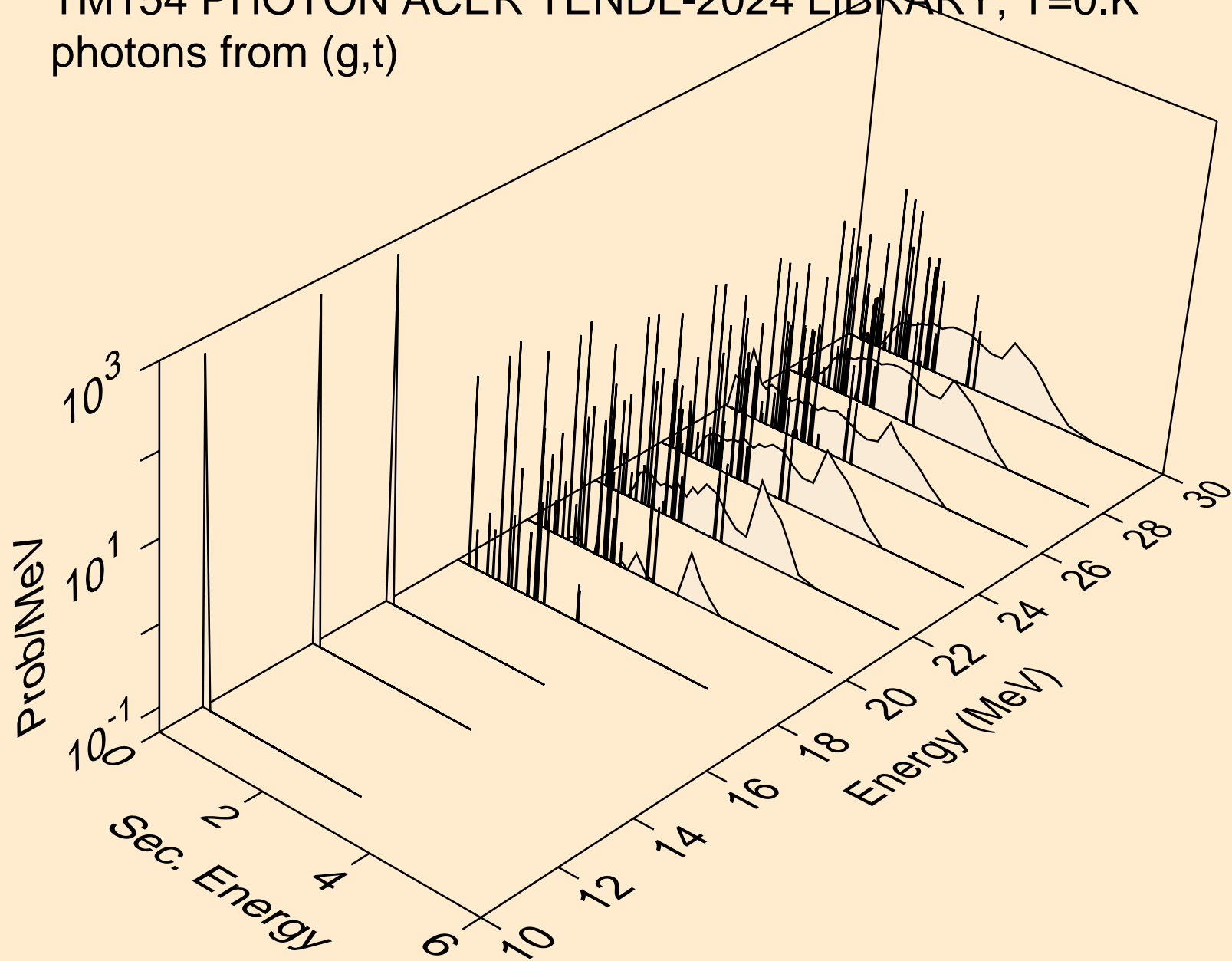

TM154 PHOTON ACER TENDL-2024 LIBRARY; T=0.K
photons from (g,he3)

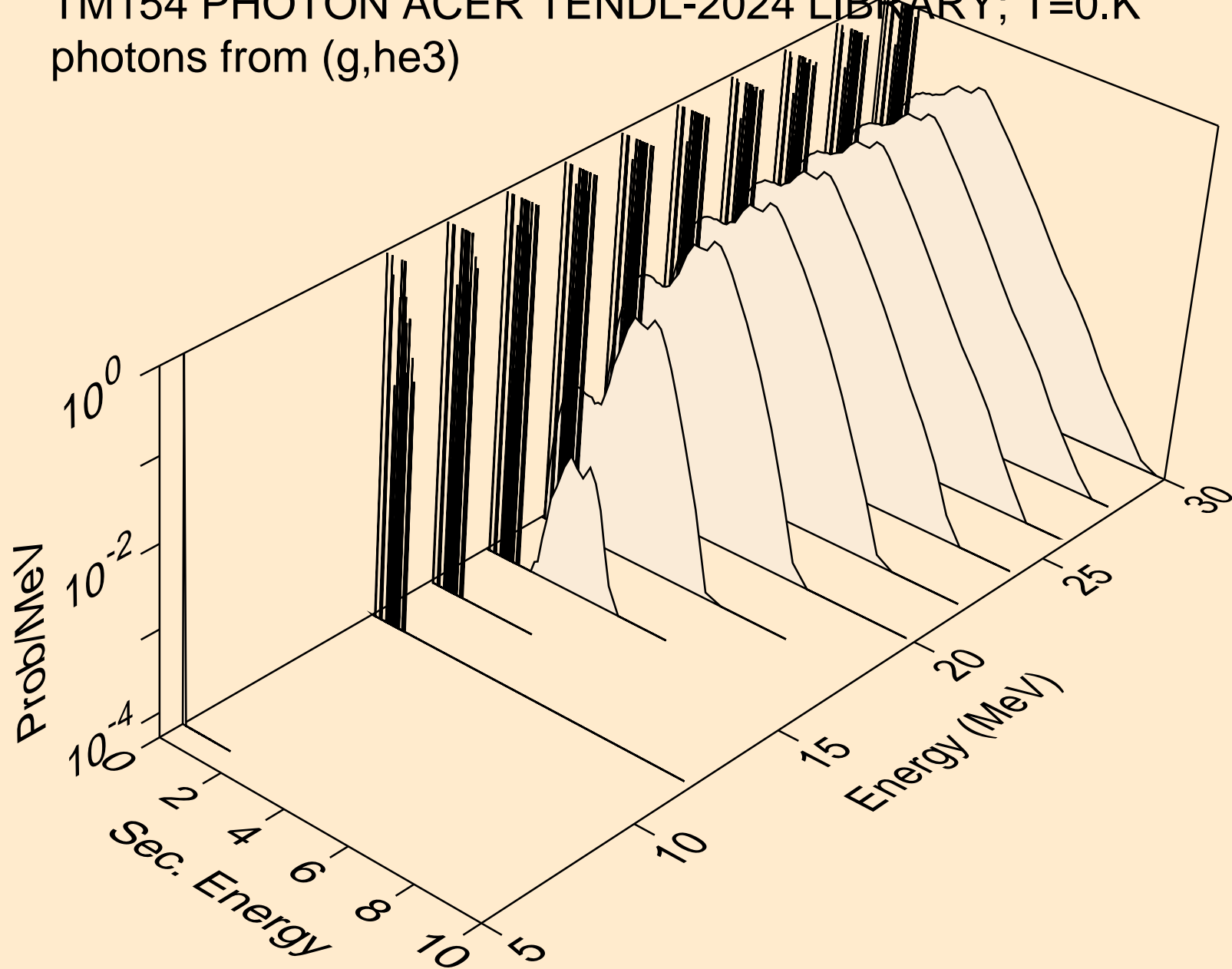

TM154 PHOTON ACER TENDL-2024 LIBRARY; T=0.K
photons from (g,a)

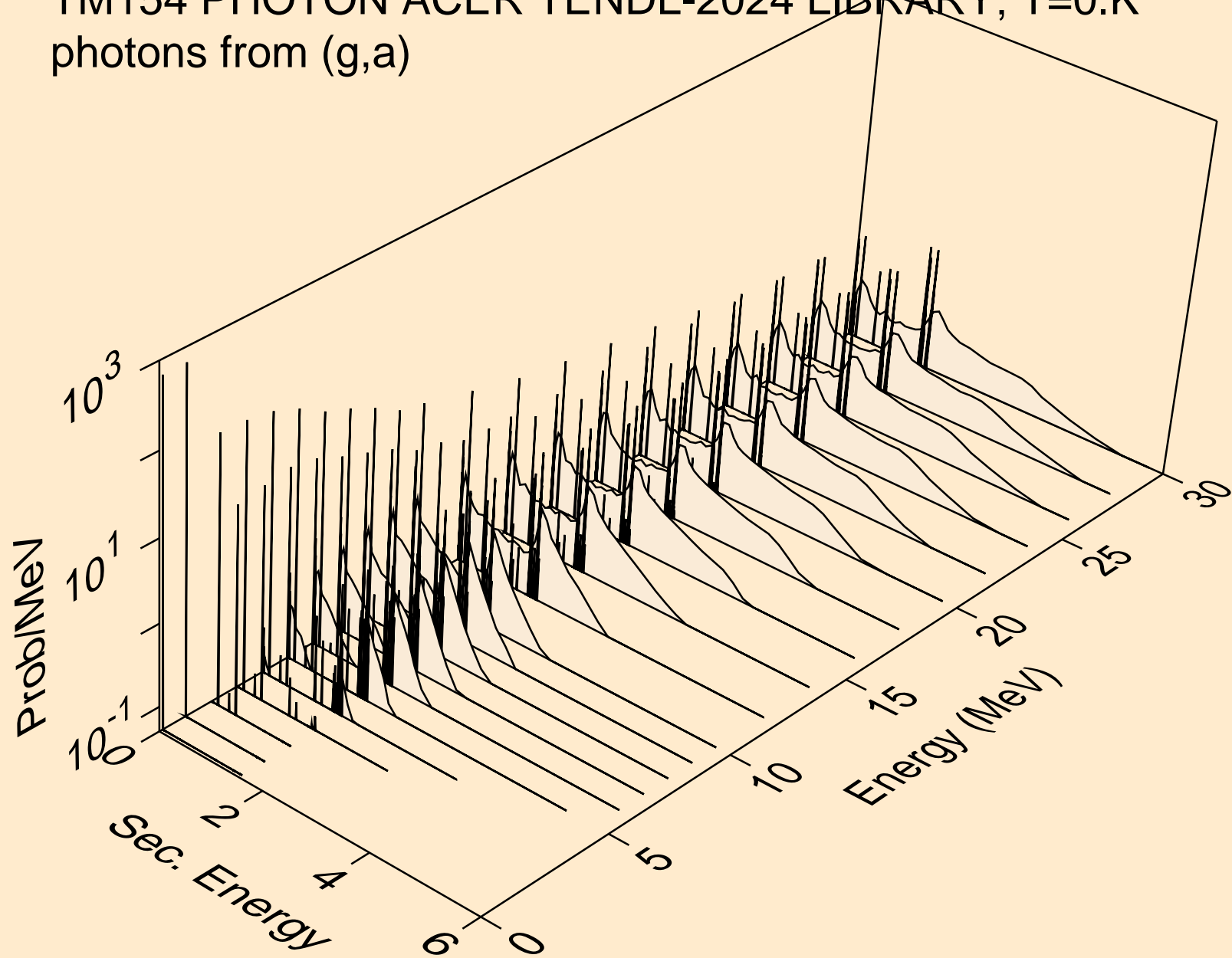

TM154 PHOTON ACER TENDL-2024 LIBRARY; T=0.K
photons from (g,2a)

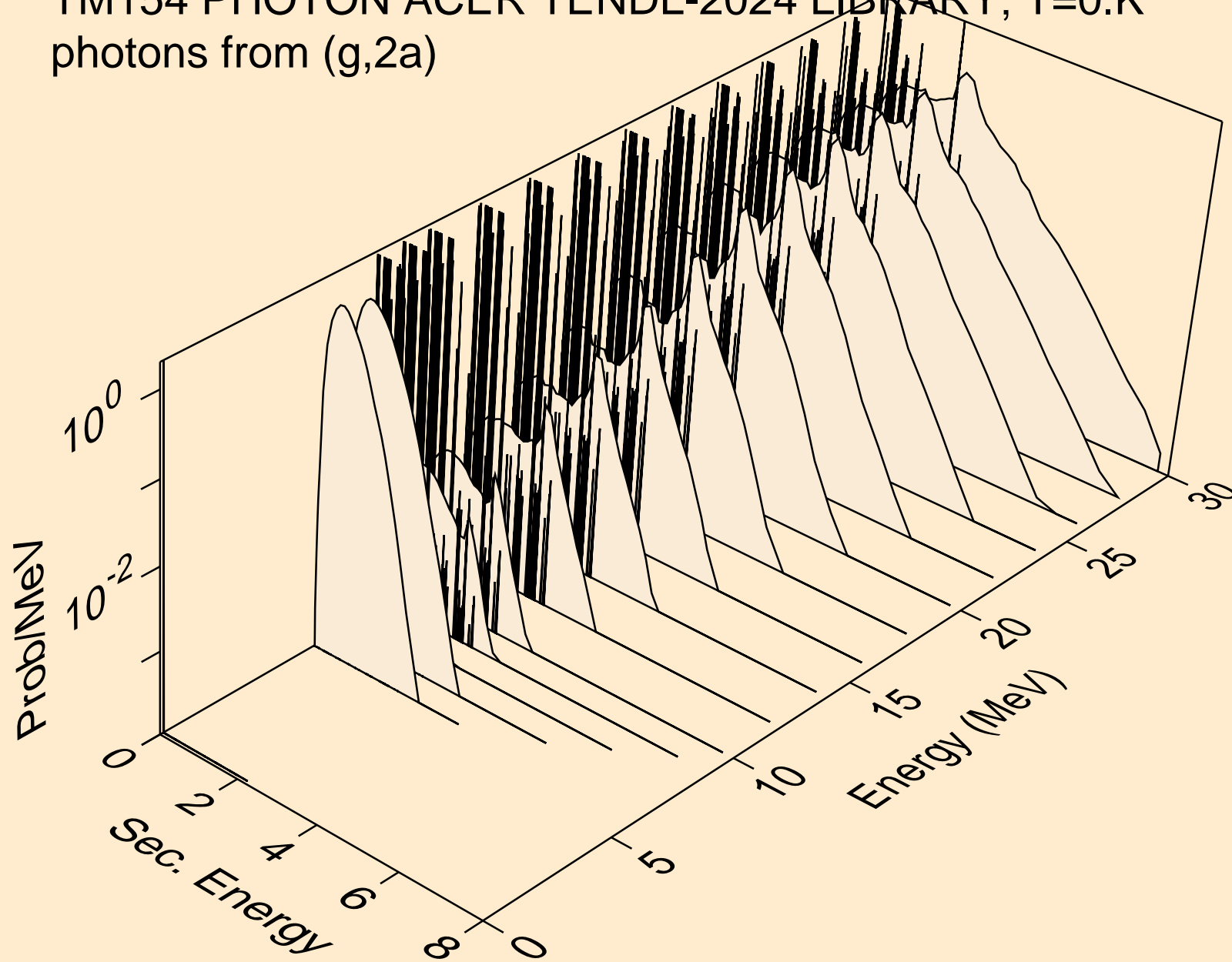

TM154 PHOTON ACER TENDL-2024 LIBRARY; T=0.K
photons from (g,2p)

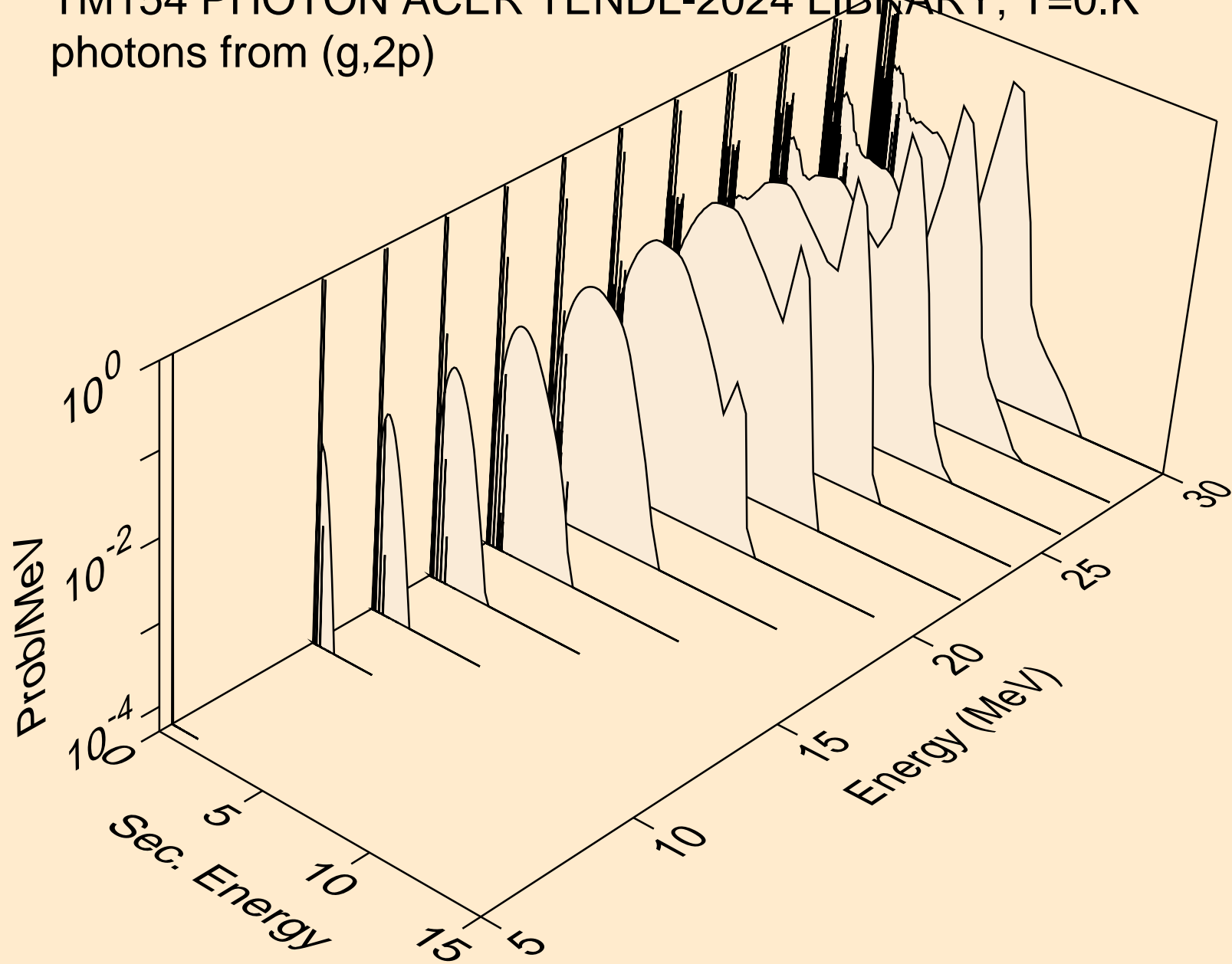

TM154 PHOTON ACER TENDL-2024 LIBRARY; T=0.K
photons from (g,pa)

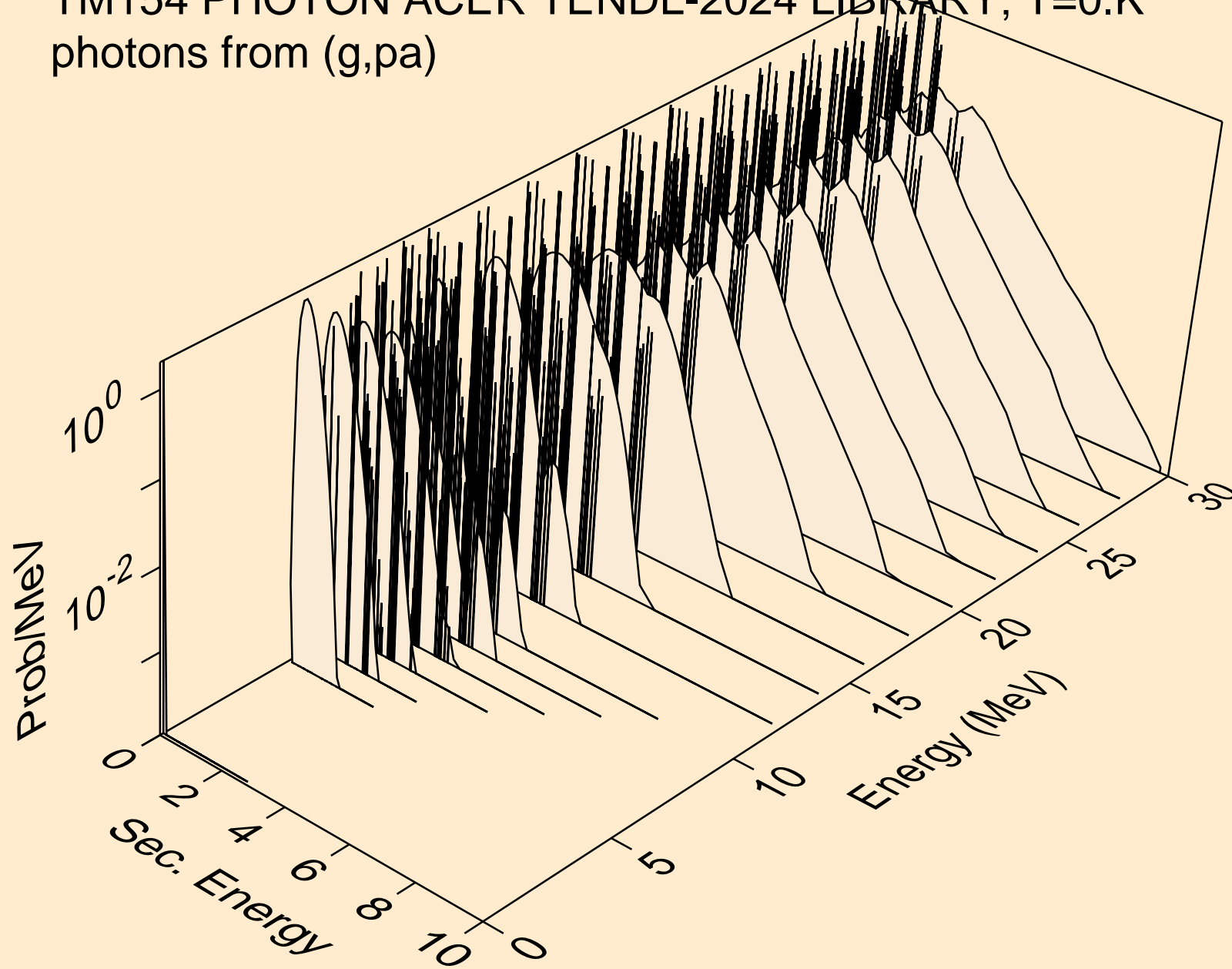

TM154 PHOTON ACER TENDL-2024 LIBRARY; T=0.K
photons from (g,pd)

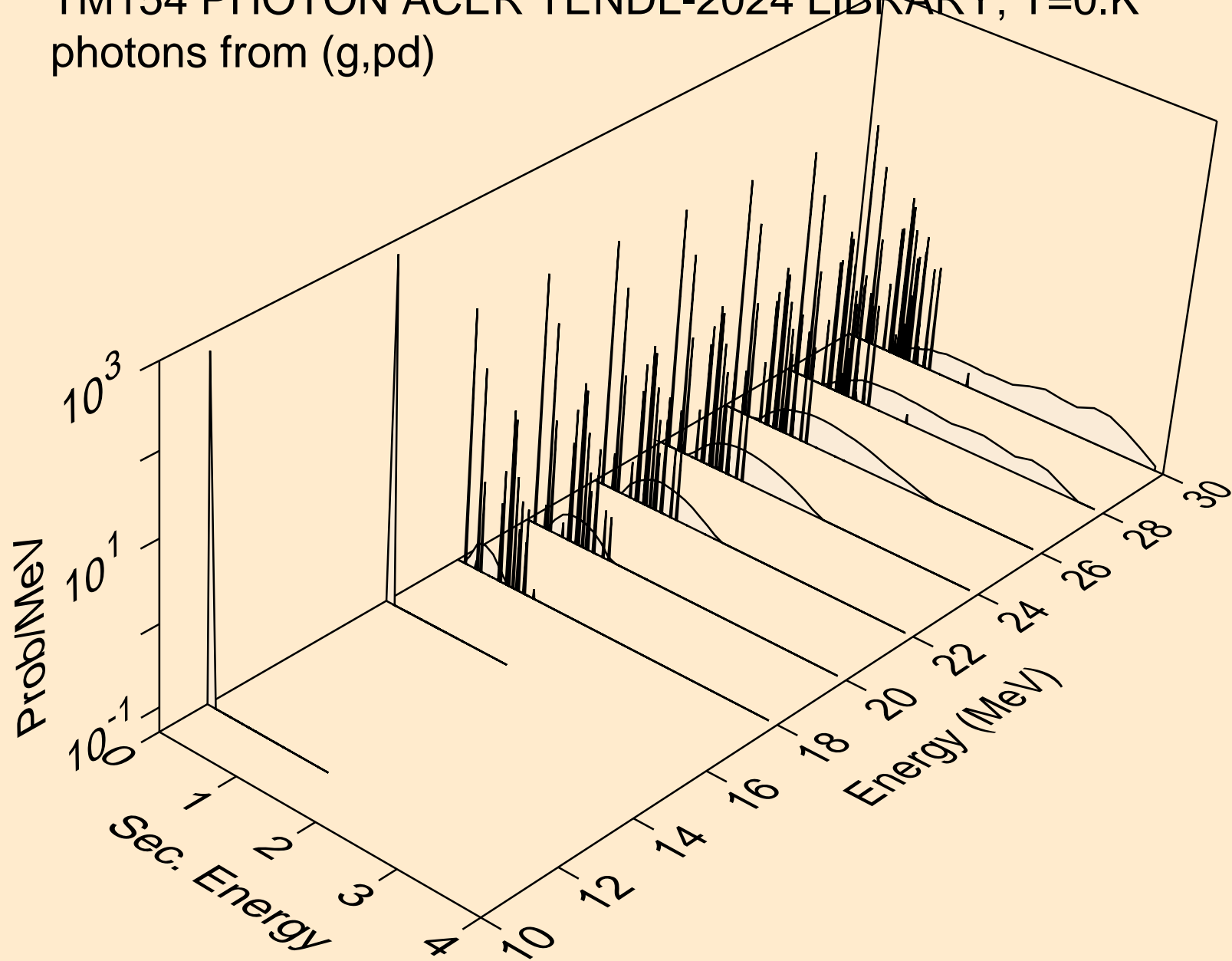

TM154 PHOTON ACER TENDL-2024 LIBRARY; T=0.K
photons from (g,pt)

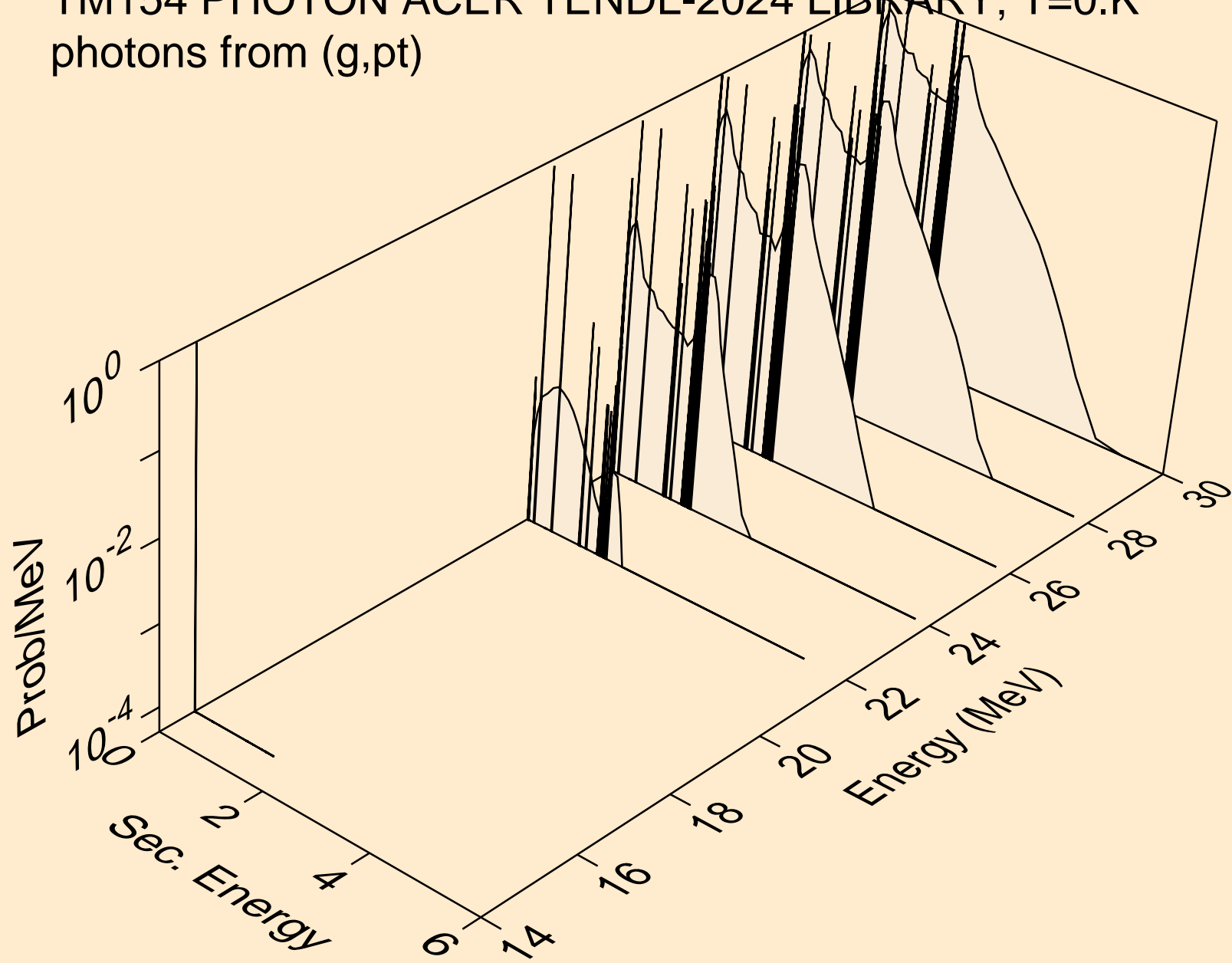

TM154 PHOTON ACER TENDL-2024 LIBRARY; T=0.K
photons from (g,da)

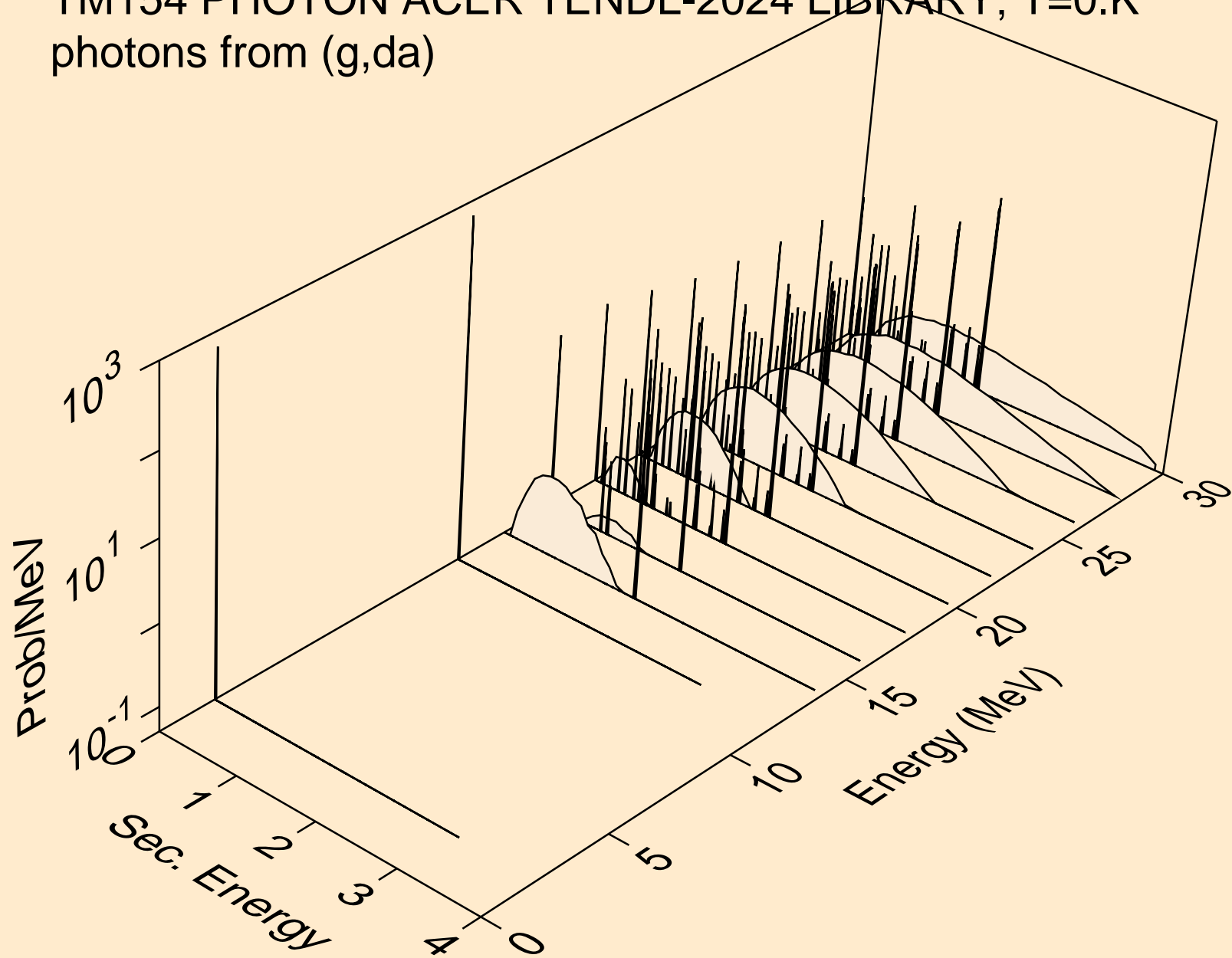

TM154 PHOTON ACER TENDL-2024 LIBRARY; T=0.K
protons from (g,x)

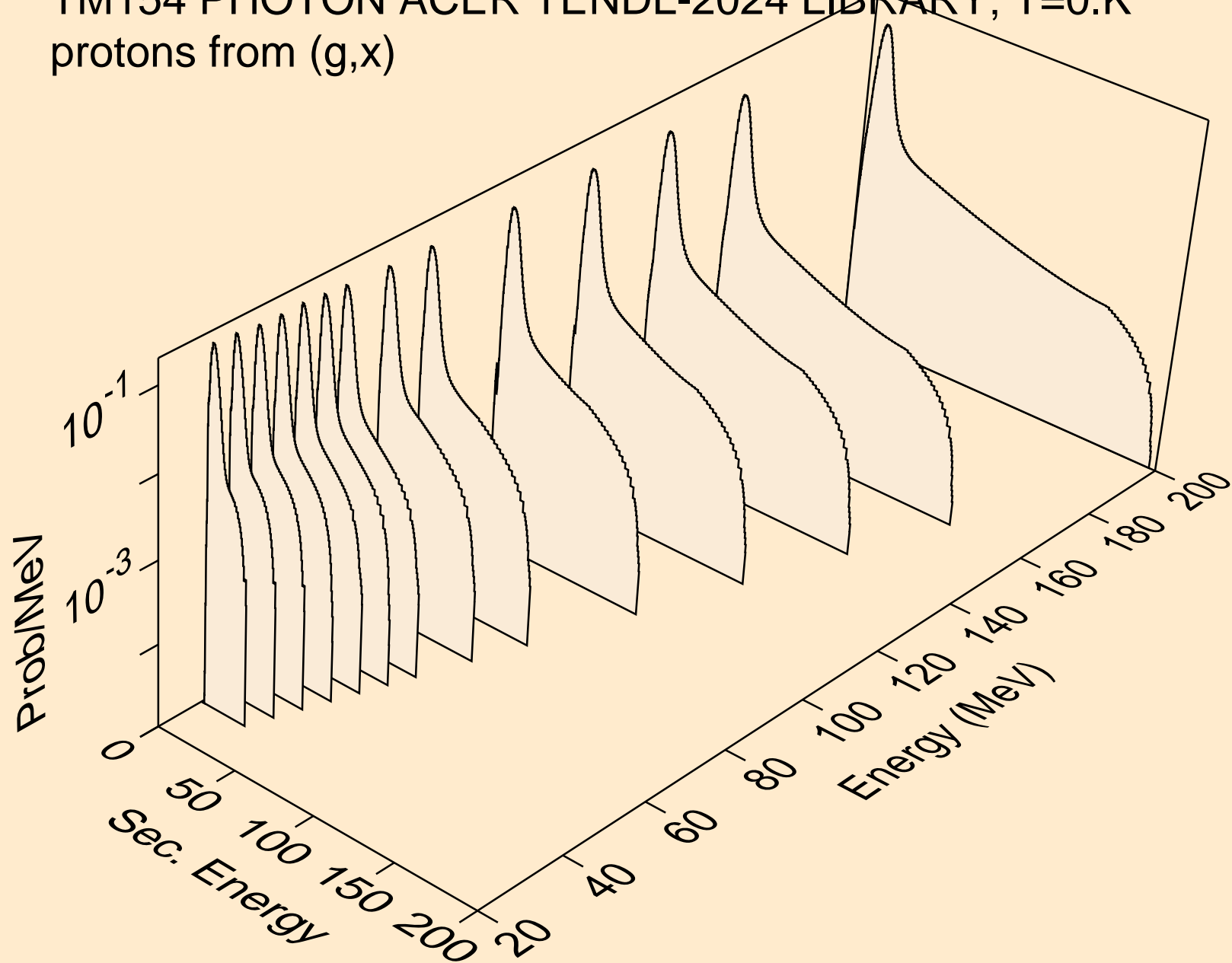

TM154 PHOTON ACER TENDL-2024 LIBRARY; T=0.K
protons from (g,n*)p

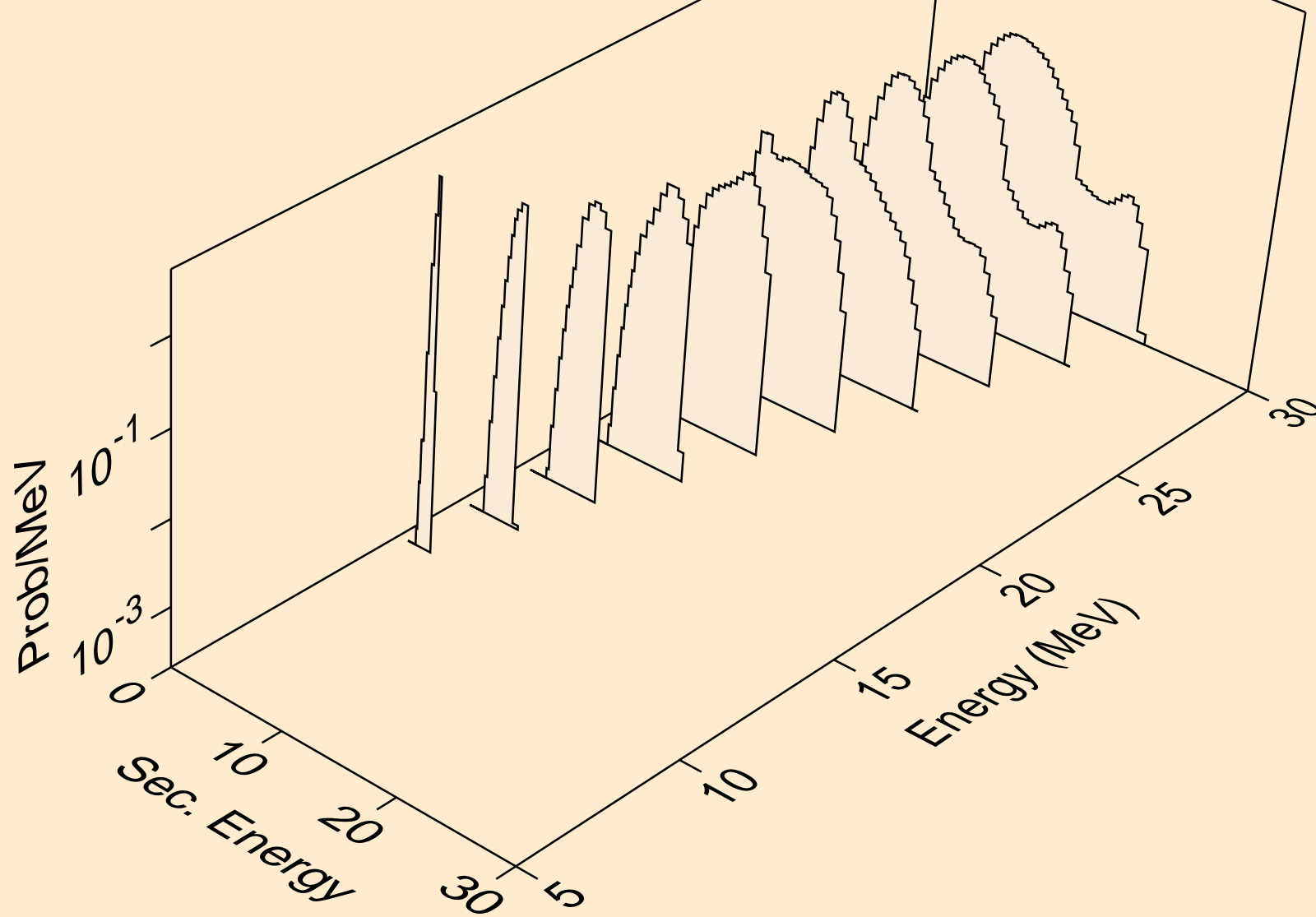

TM154 PHOTON ACER TENDL-2024 LIBRARY; T=0.K
protons from (g,2np)

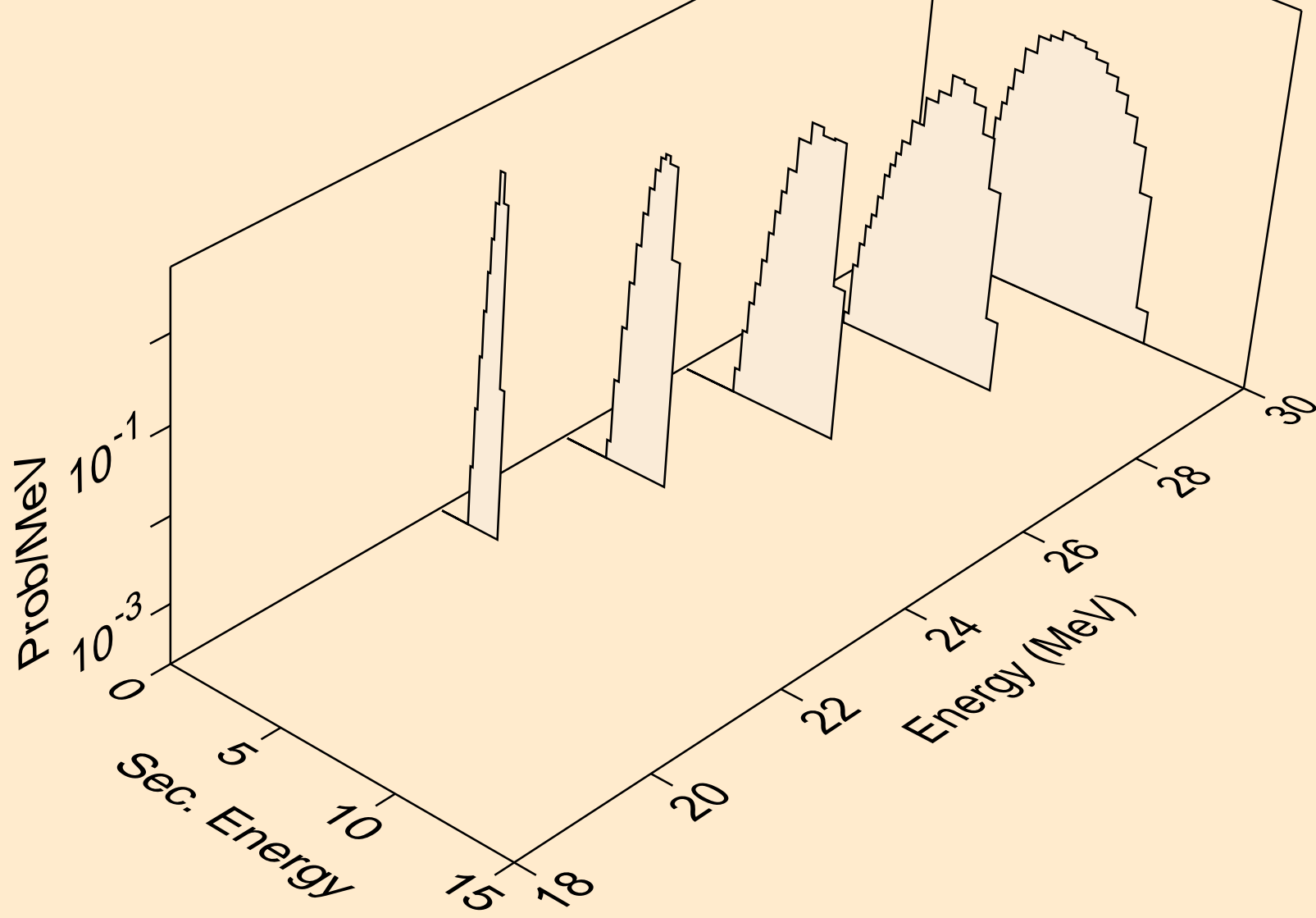

TM154 PHOTON ACER TENDL-2024 LIBRARY; T=0.K
protons from (g,n2p)

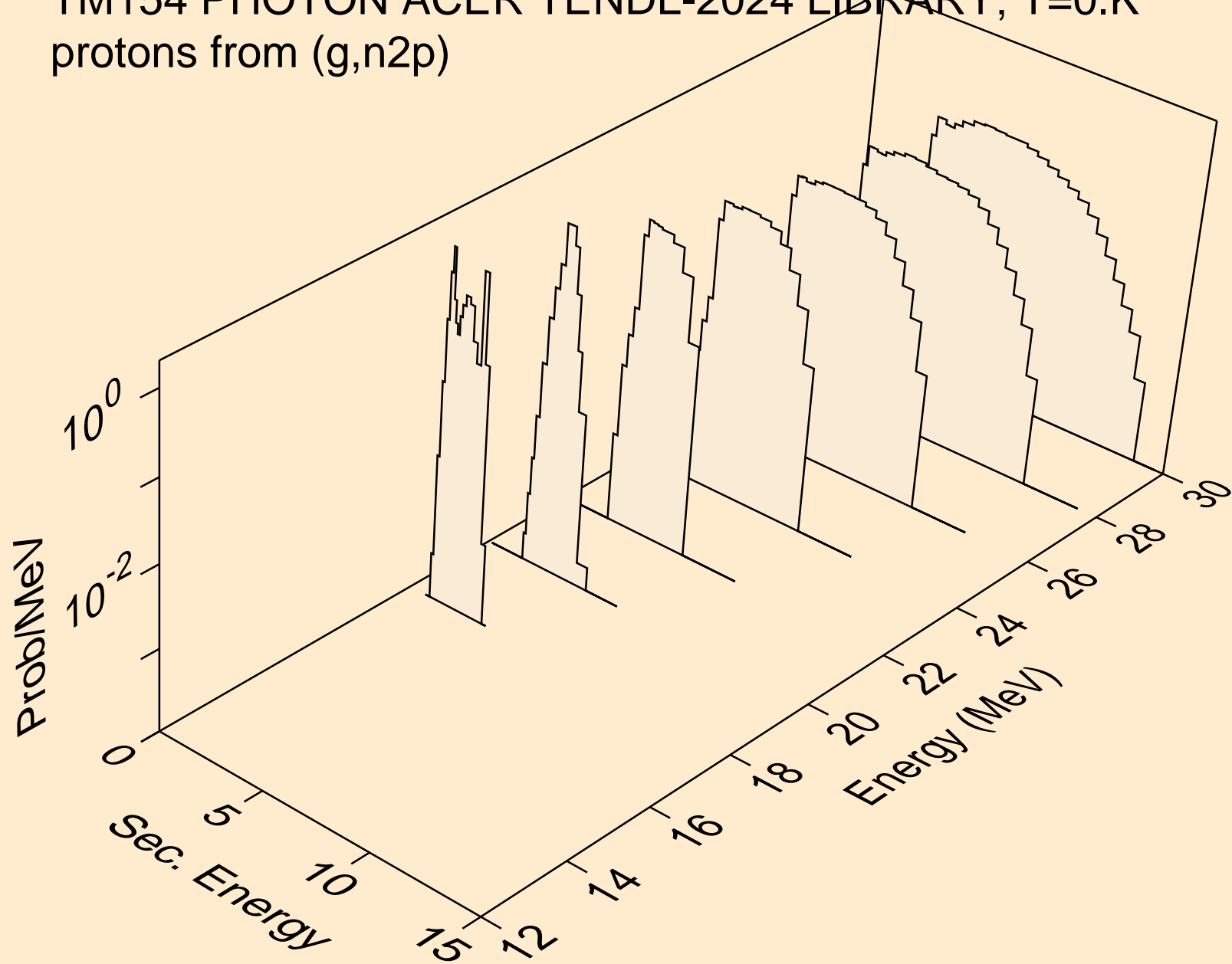

TM154 PHOTON ACER TENDL-2024 LIBRARY; T=0.K
protons from (g,npa)

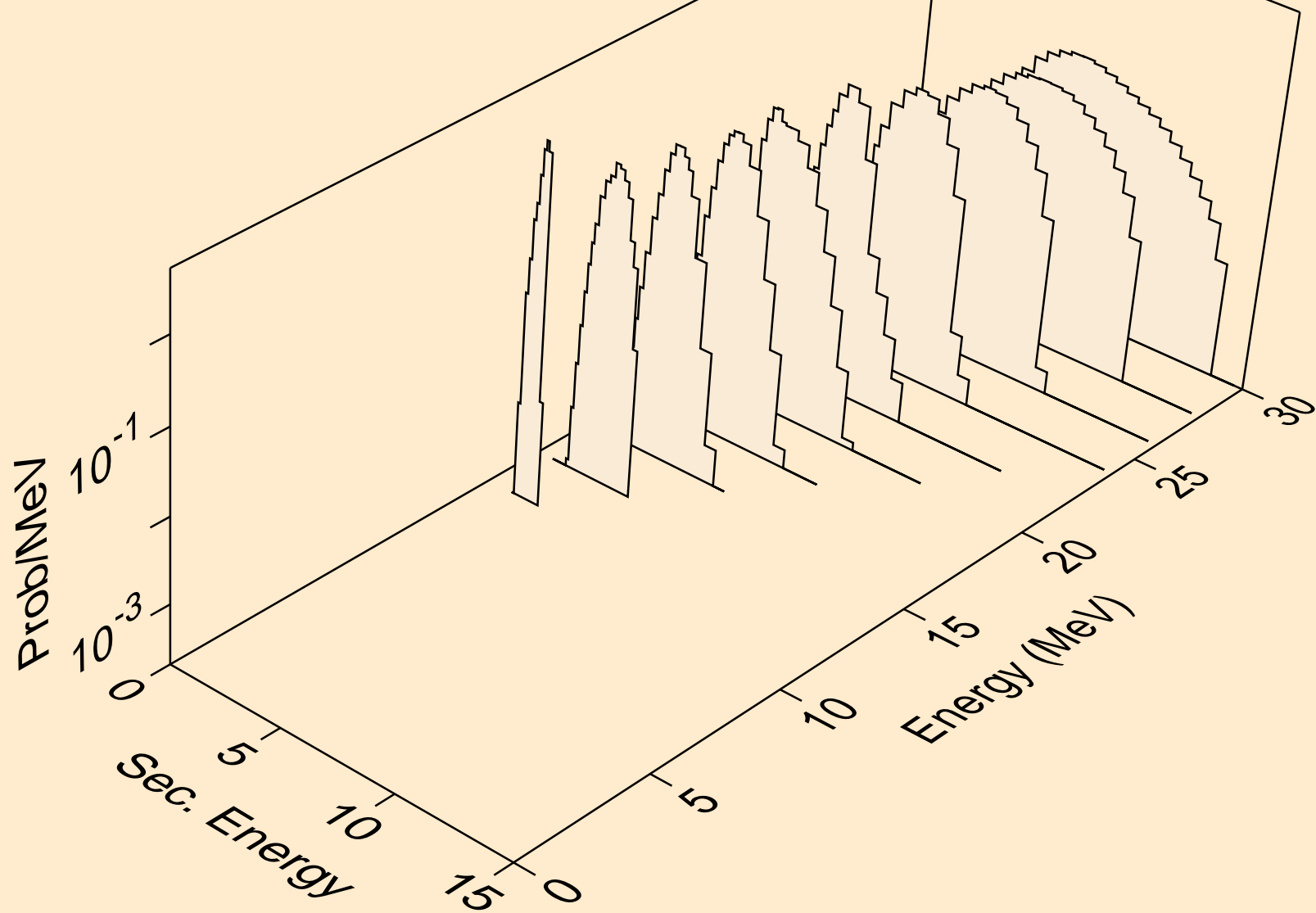

TM154 PHOTON ACER TENDL-2024 LIBRARY; T=0.K
protons from (g,p)

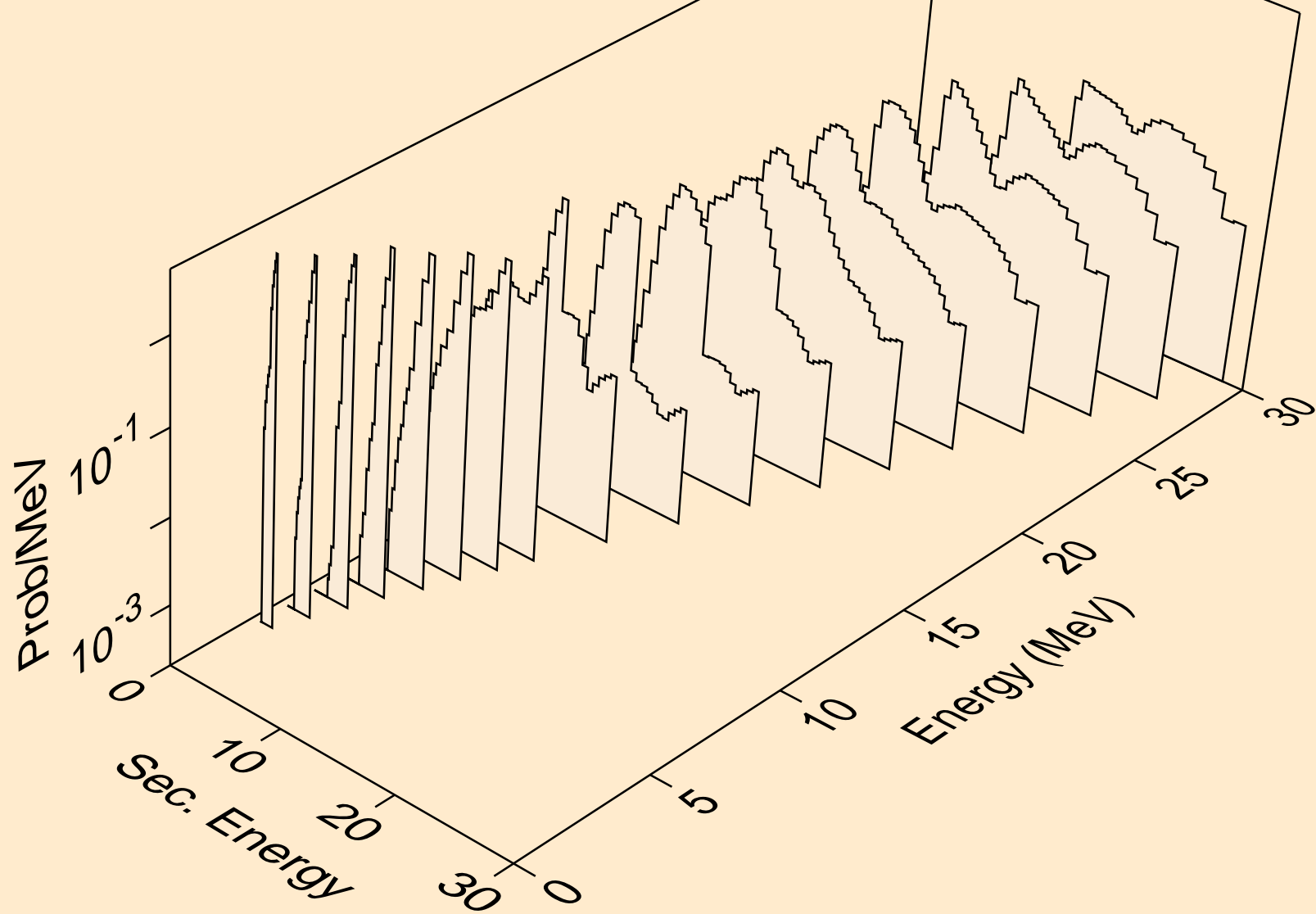

TM154 PHOTON ACER TENDL-2024 LIBRARY; T=0.K
protons from (g,2p)

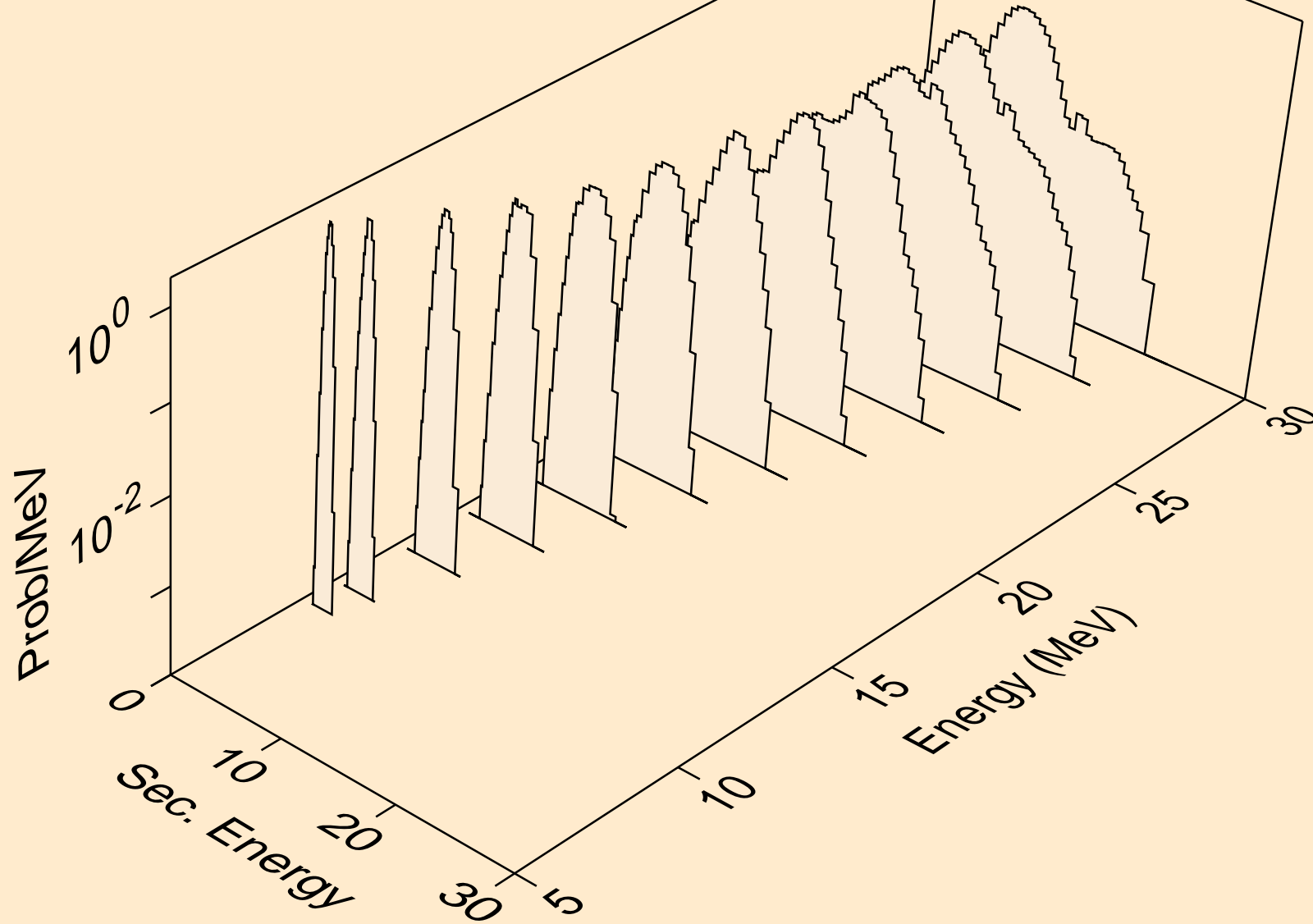

TM154 PHOTON ACER TENDL-2024 LIBRARY; T=0.K
protons from (g,pa)

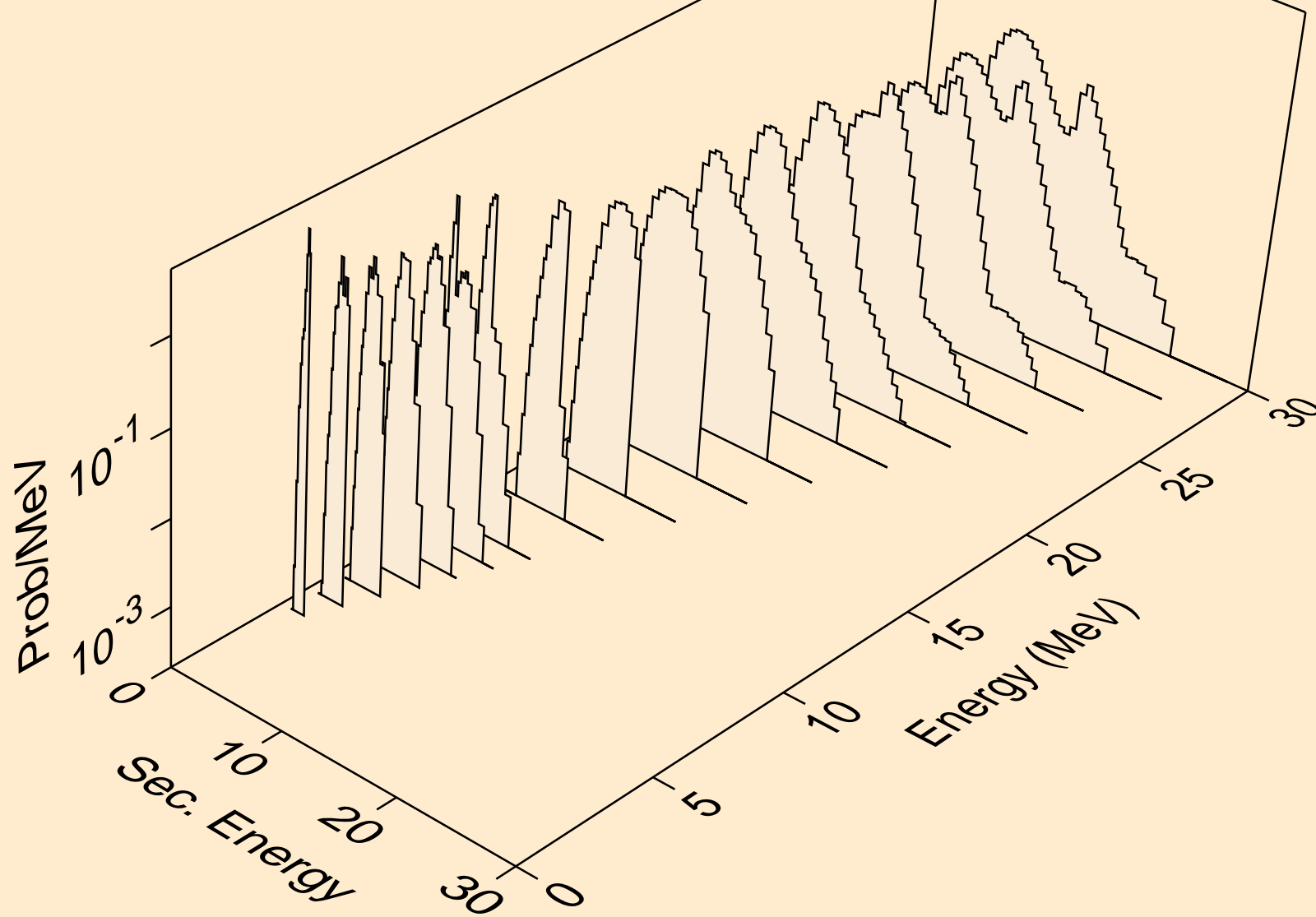

TM154 PHOTON ACER TENDL-2024 LIBRARY; T=0.K
protons from (g,pd)

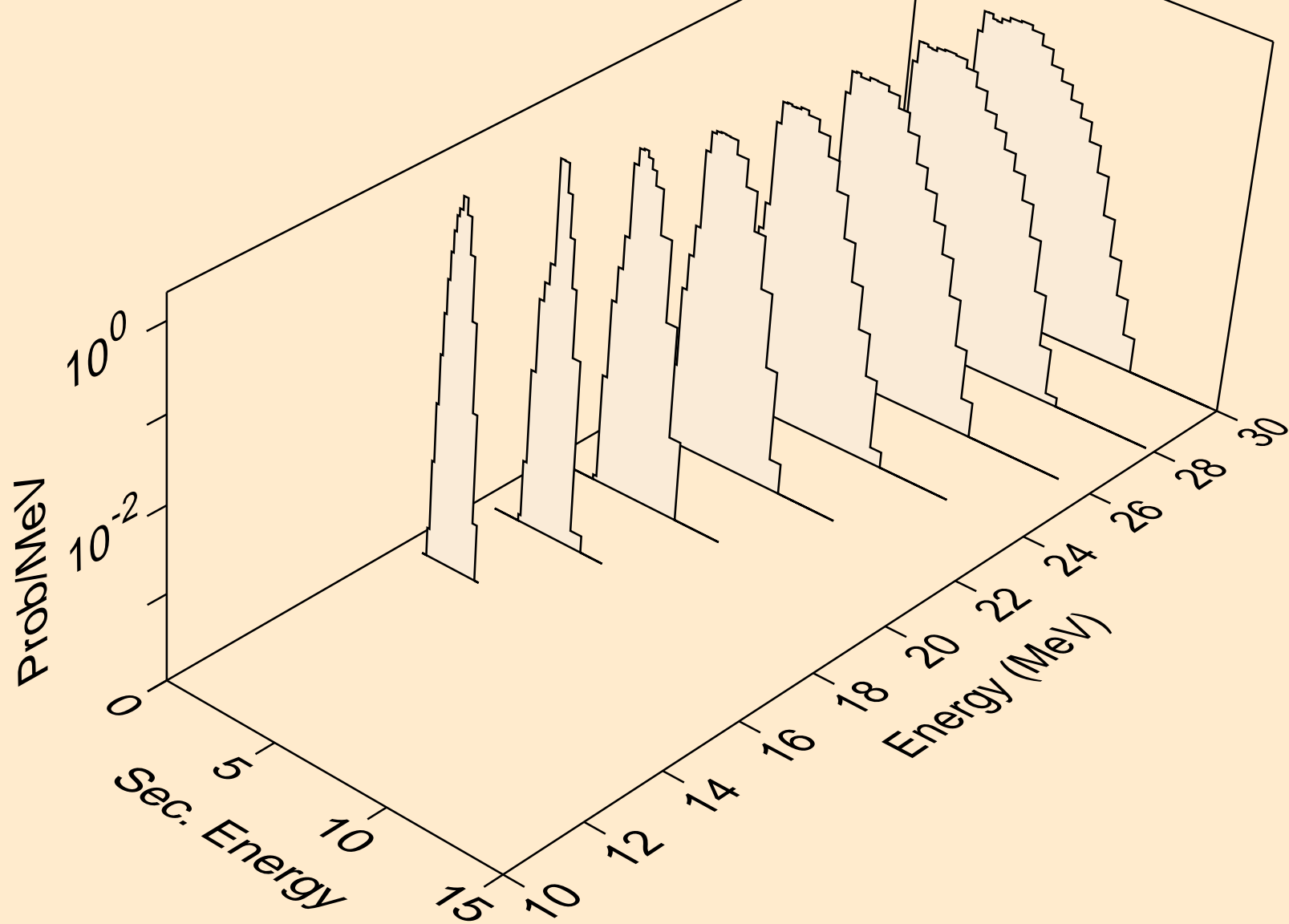

TM154 PHOTON ACER TENDL-2024 LIBRARY; T=0.K
protons from (g,pt)

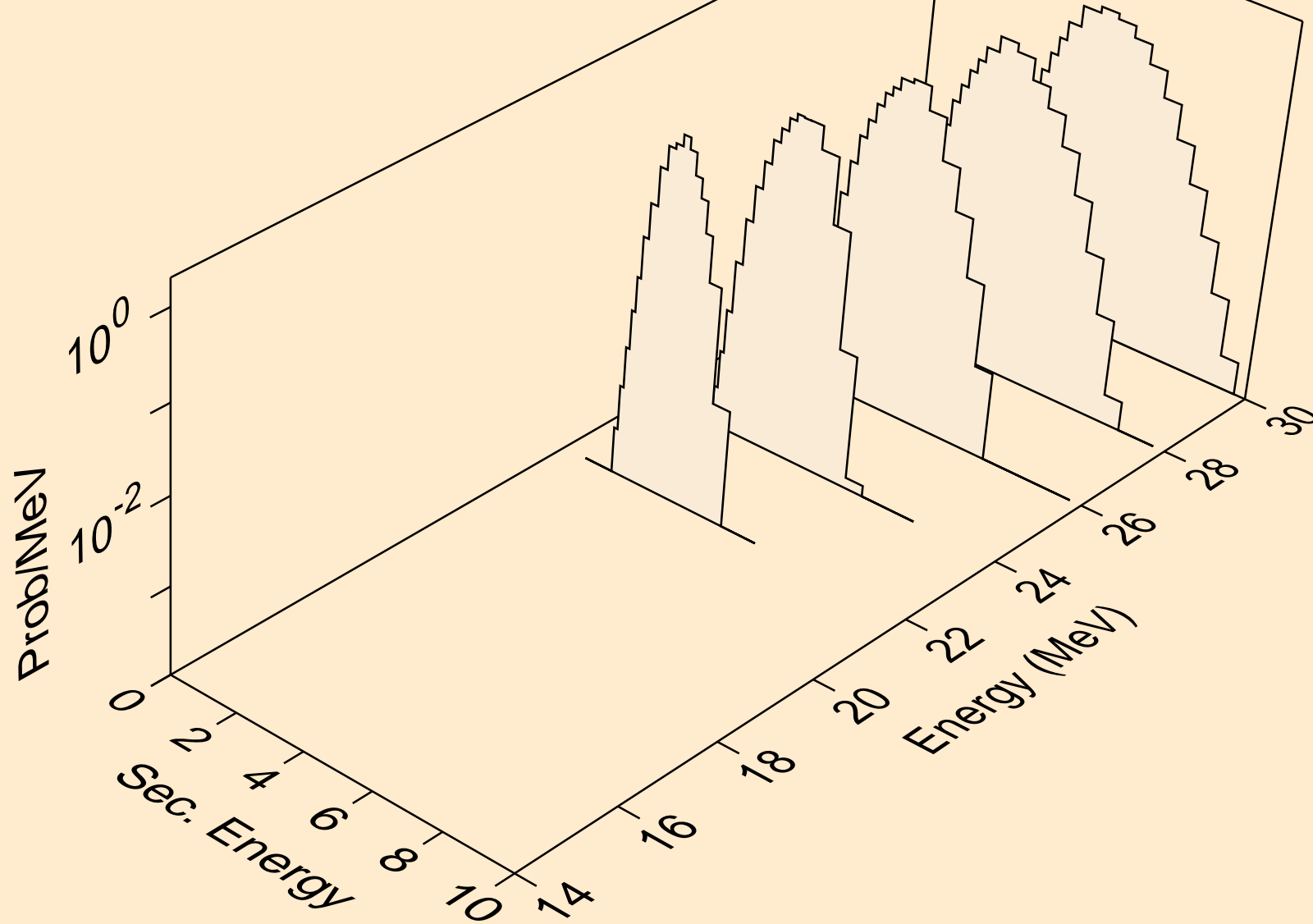

TM154 PHOTON ACER TENDL-2024 LIBRARY; T=0.K
deuterons from (g,x)

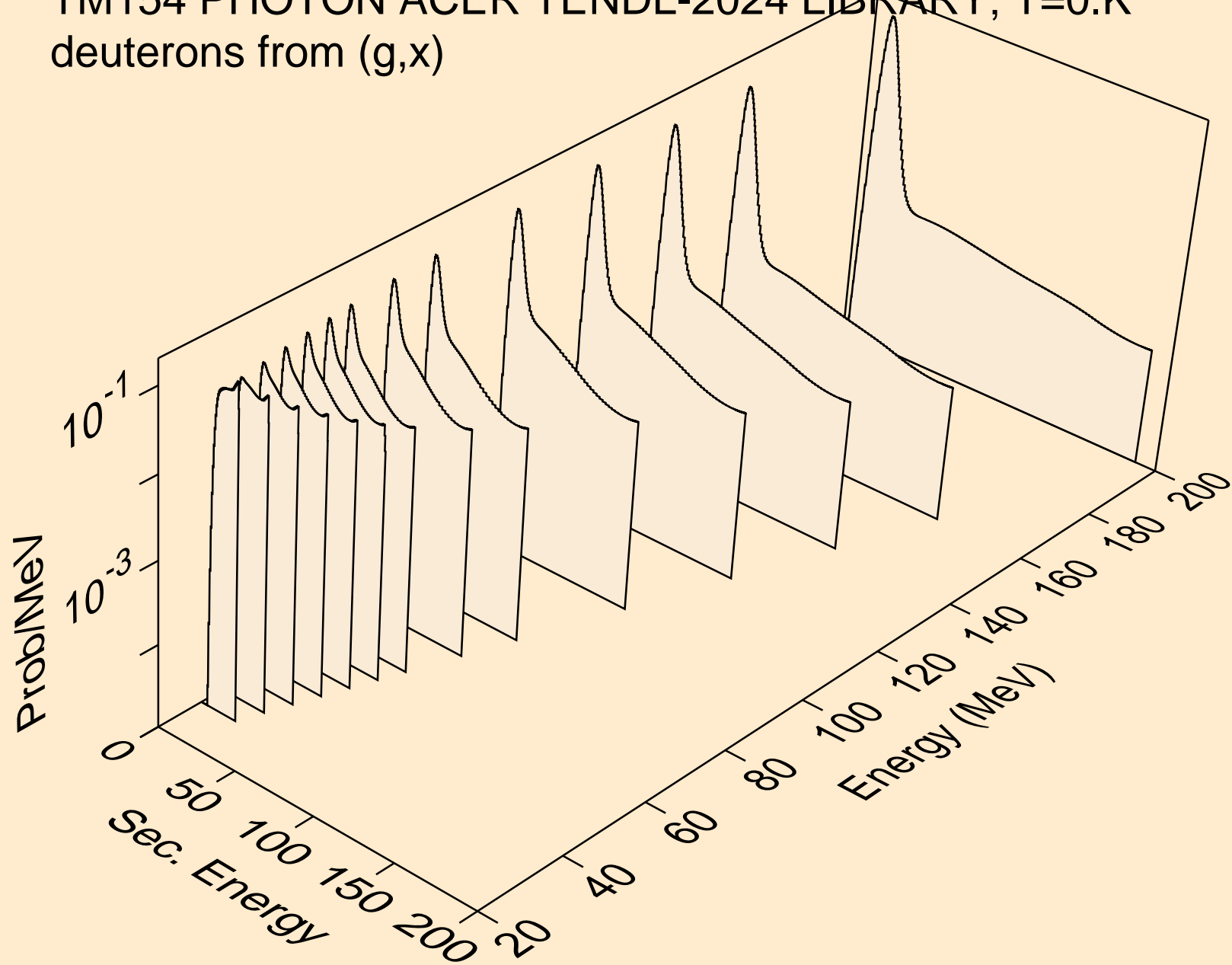

TM154 PHOTON ACER TENDL-2024 LIBRARY; T=0.K
deuterons from (g,n*)d

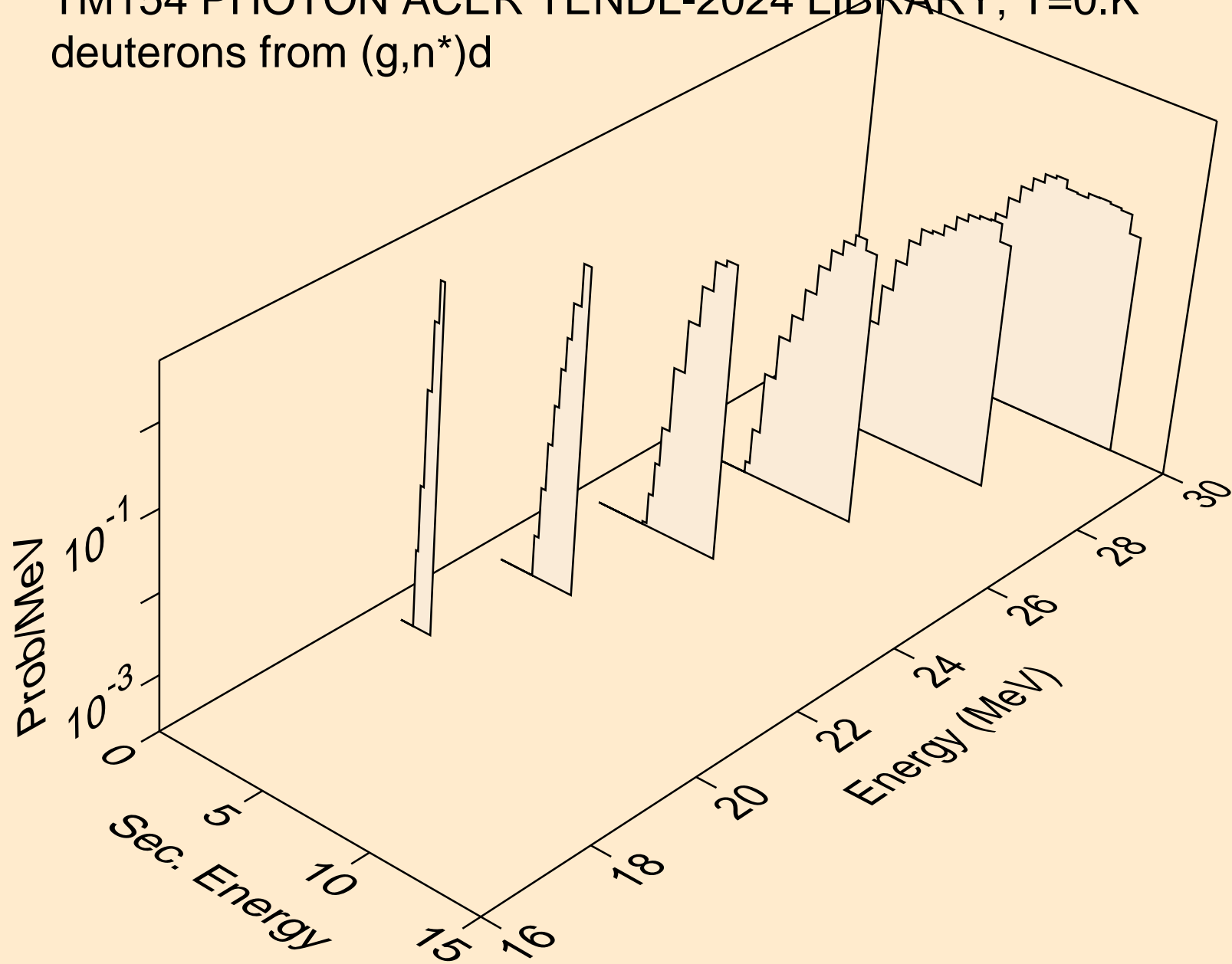

TM154 PHOTON ACER TENDL-2024 LIBRARY; T=0.K
deuterons from (g,d)

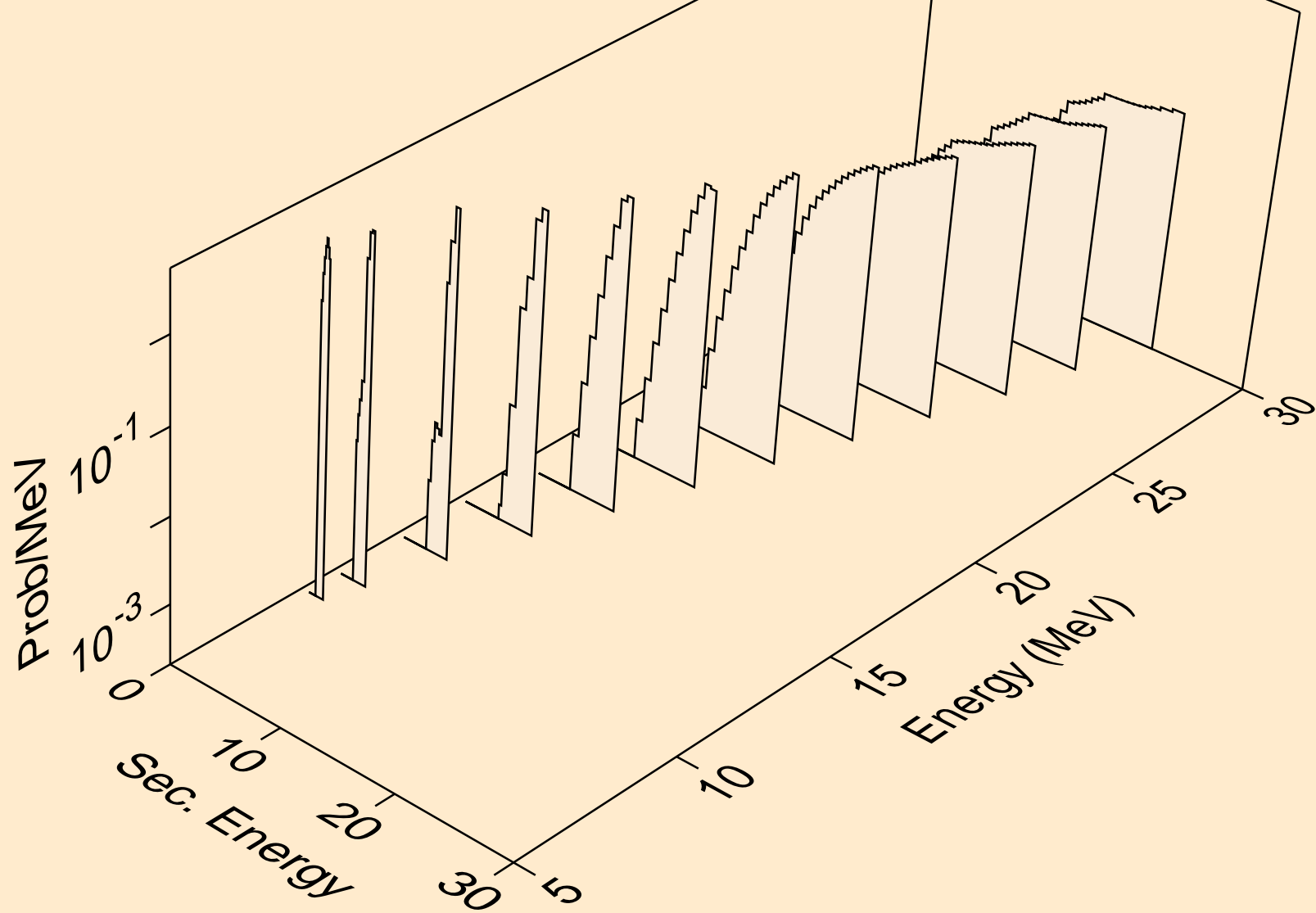

TM154 PHOTON ACER TENDL-2024 LIBRARY; T=0.K
deuterons from (g,pd)

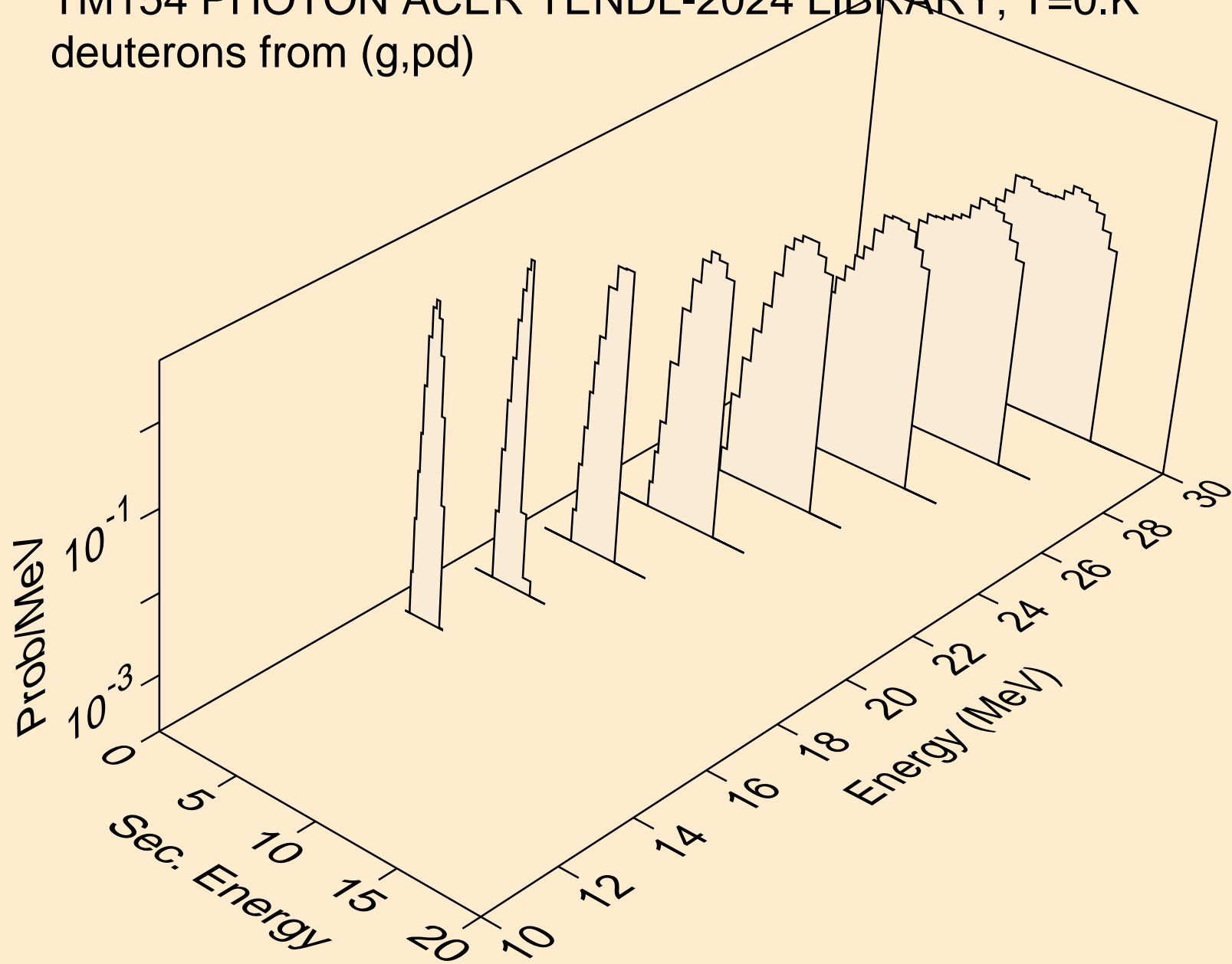

TM154 PHOTON ACER TENDL-2024 LIBRARY; T=0.K
deuterons from (g,da)

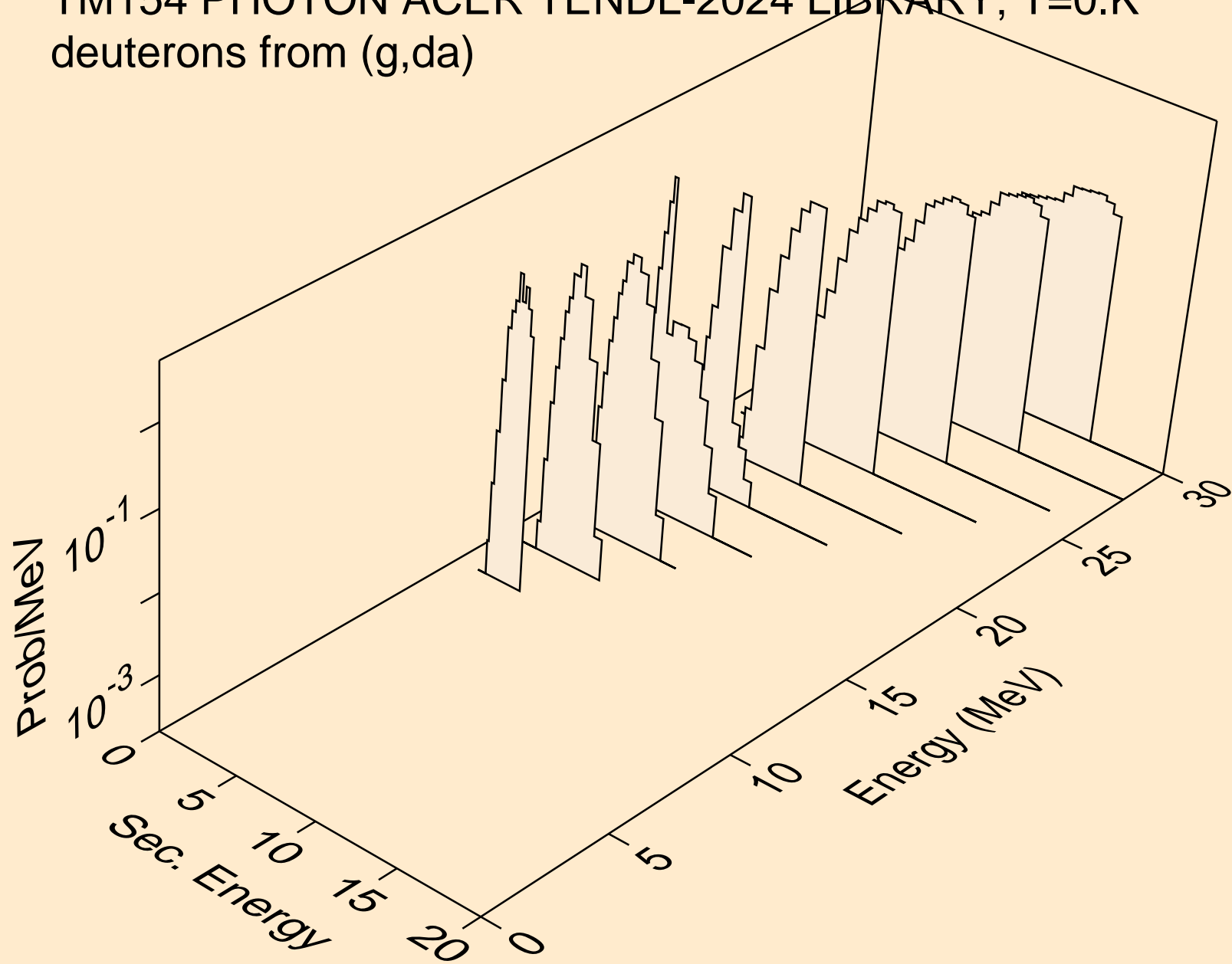

TM154 PHOTON ACER TENDL-2024 LIBRARY; T=0.K
tritons from (g,x)

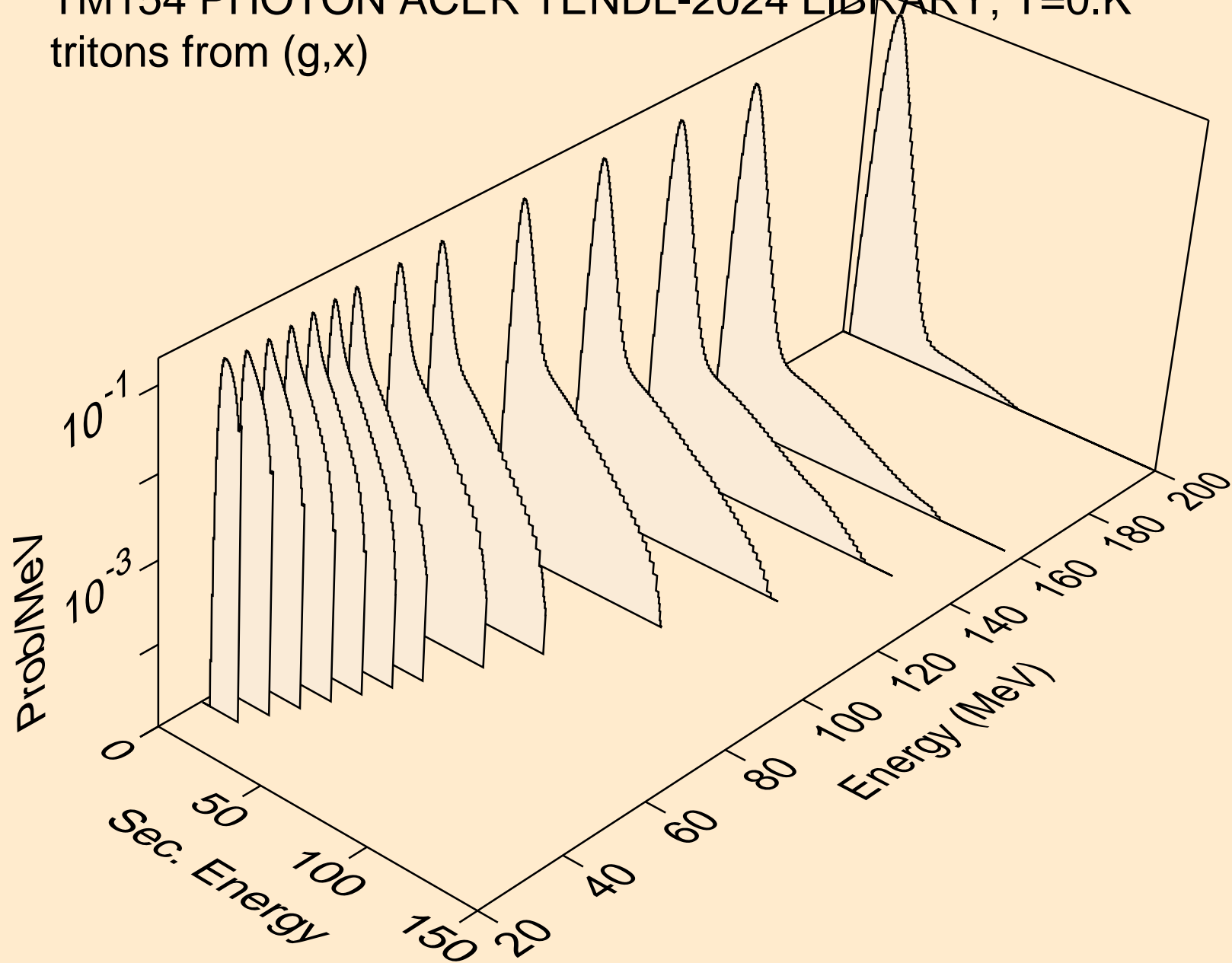

TM154 PHOTON ACER TENDL-2024 LIBRARY; T=0.K
tritons from (g,n*)t

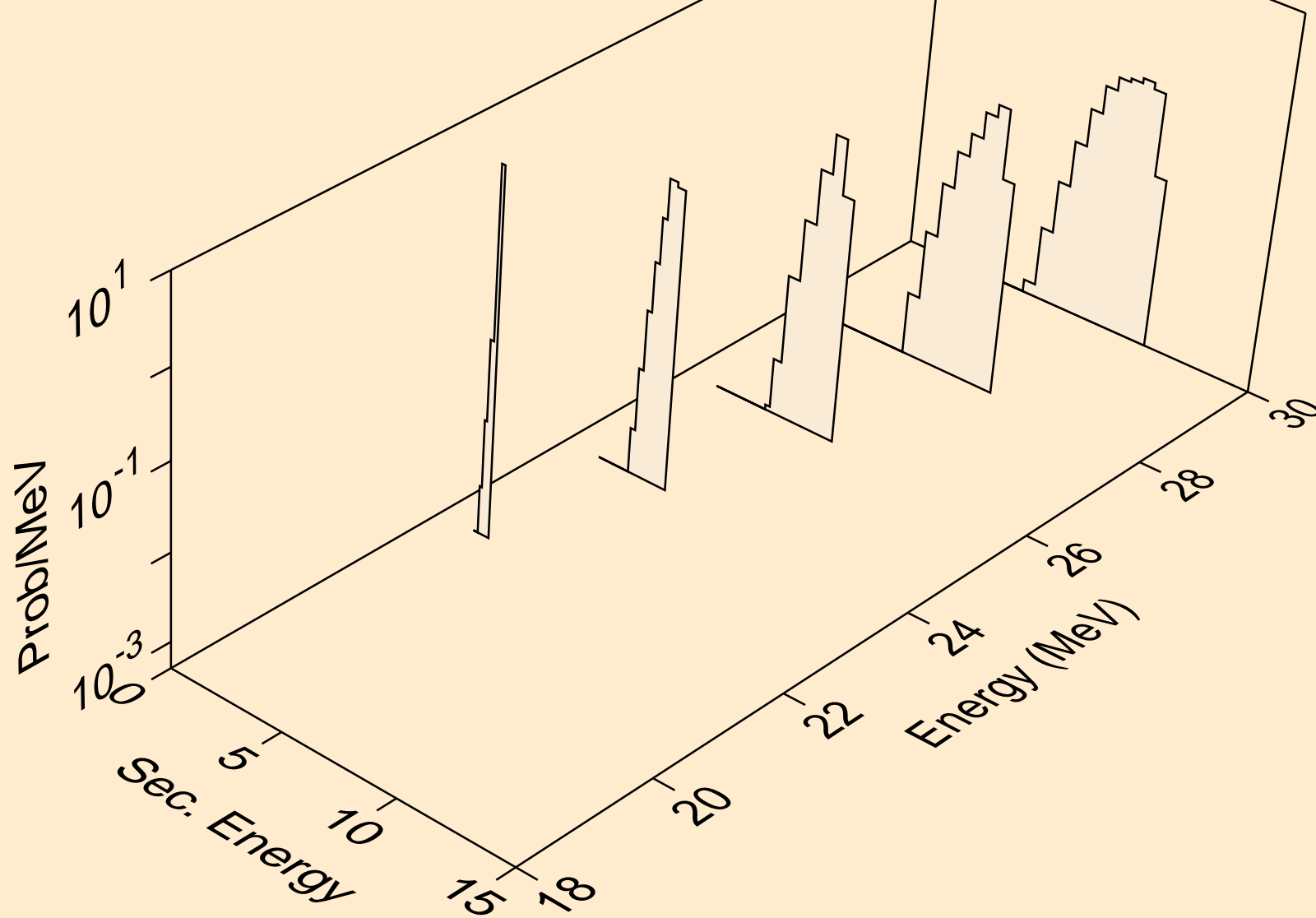

TM154 PHOTON ACER TENDL-2024 LIBRARY; T=0.K
tritons from (g,t)

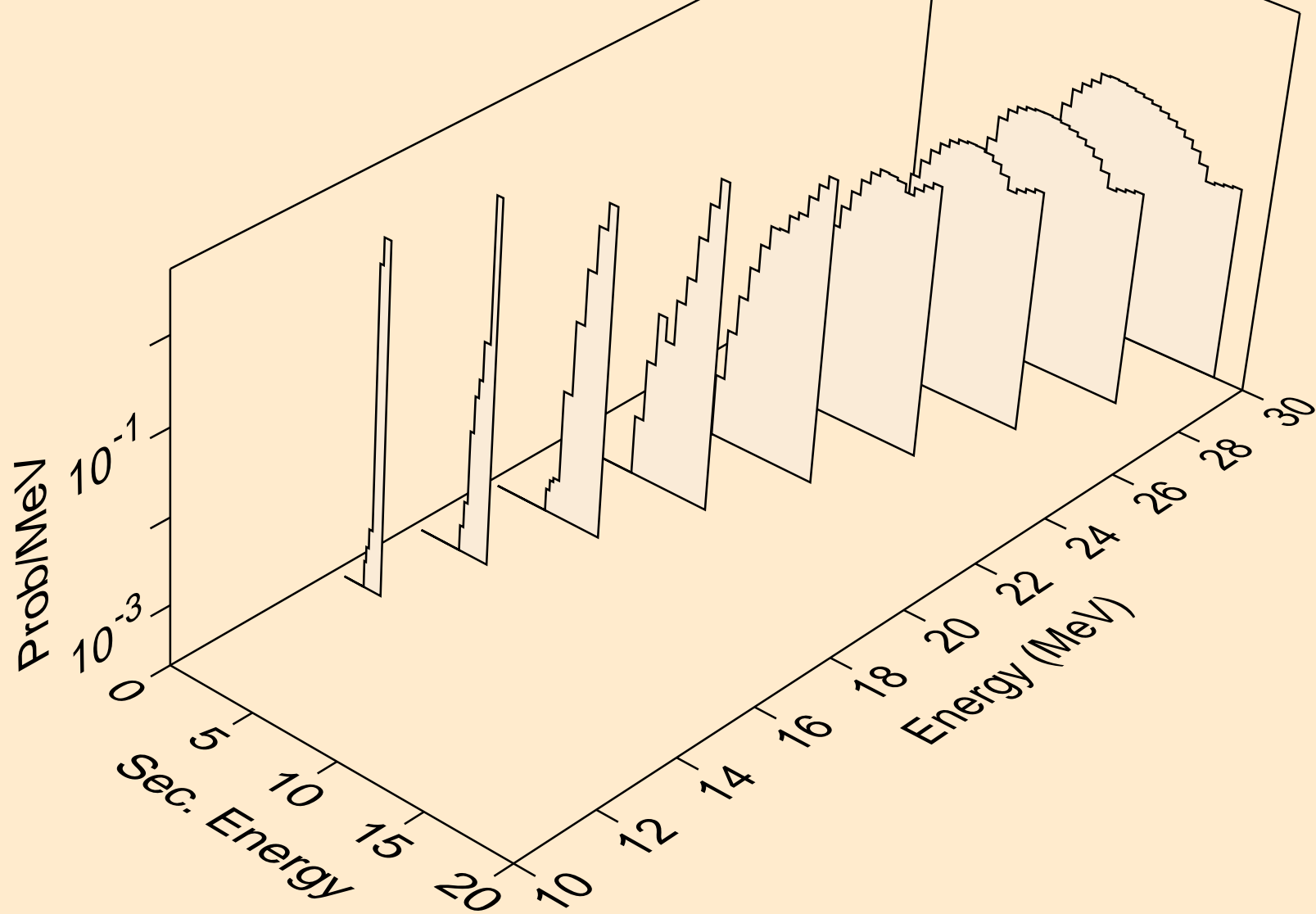

TM154 PHOTON ACER TENDL-2024 LIBRARY; T=0.K
tritons from (g,pt)

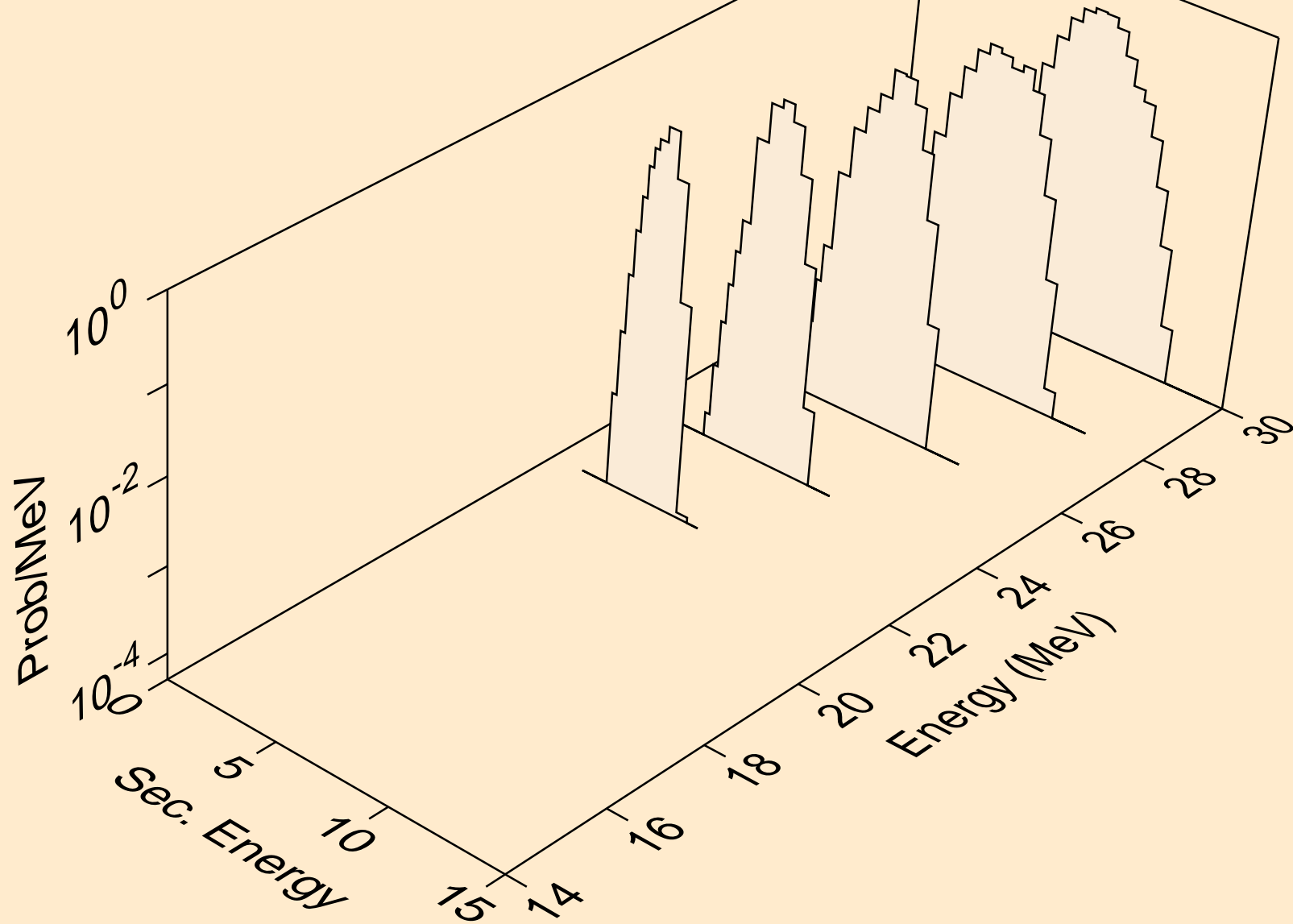

TM154 PHOTON ACER TENDL-2024 LIBRARY; T=0.K
he3s from (g,x)

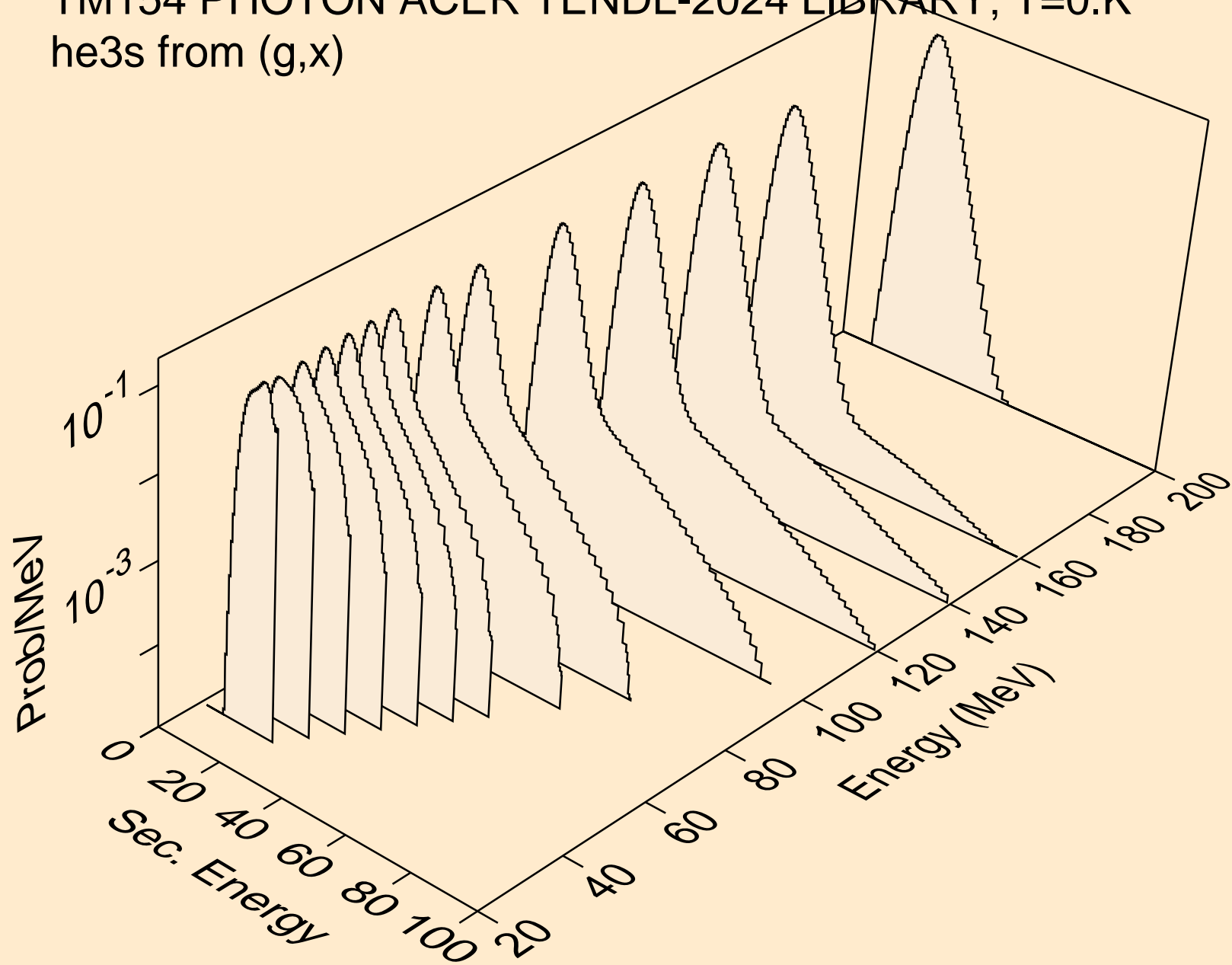

TM154 PHOTON ACER TENDL-2024 LIBRARY; T=0.K
he3s from (g,n*)he3

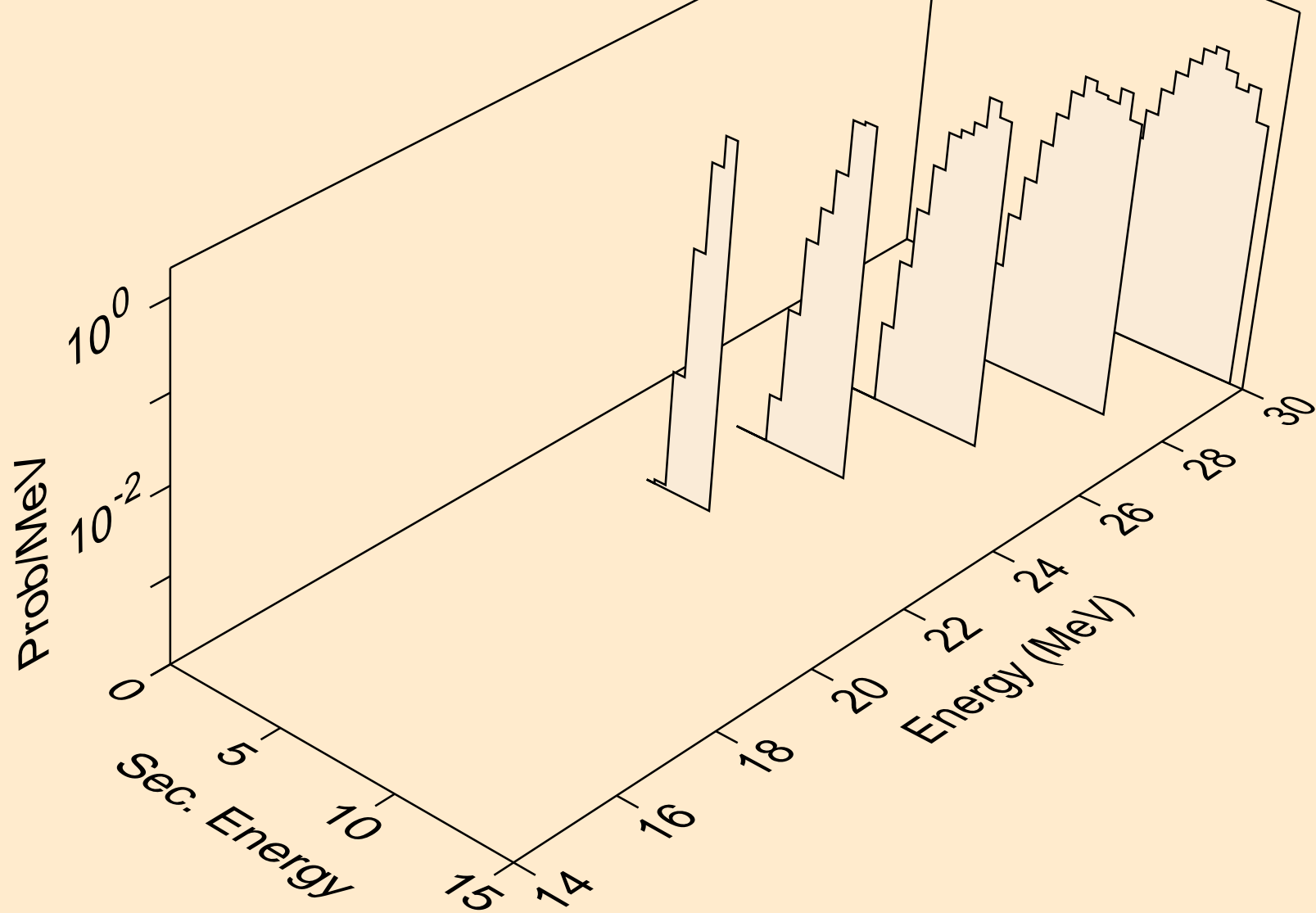

TM154 PHOTON ACER TENDL-2024 LIBRARY; T=0.K
he3s from (g,he3)

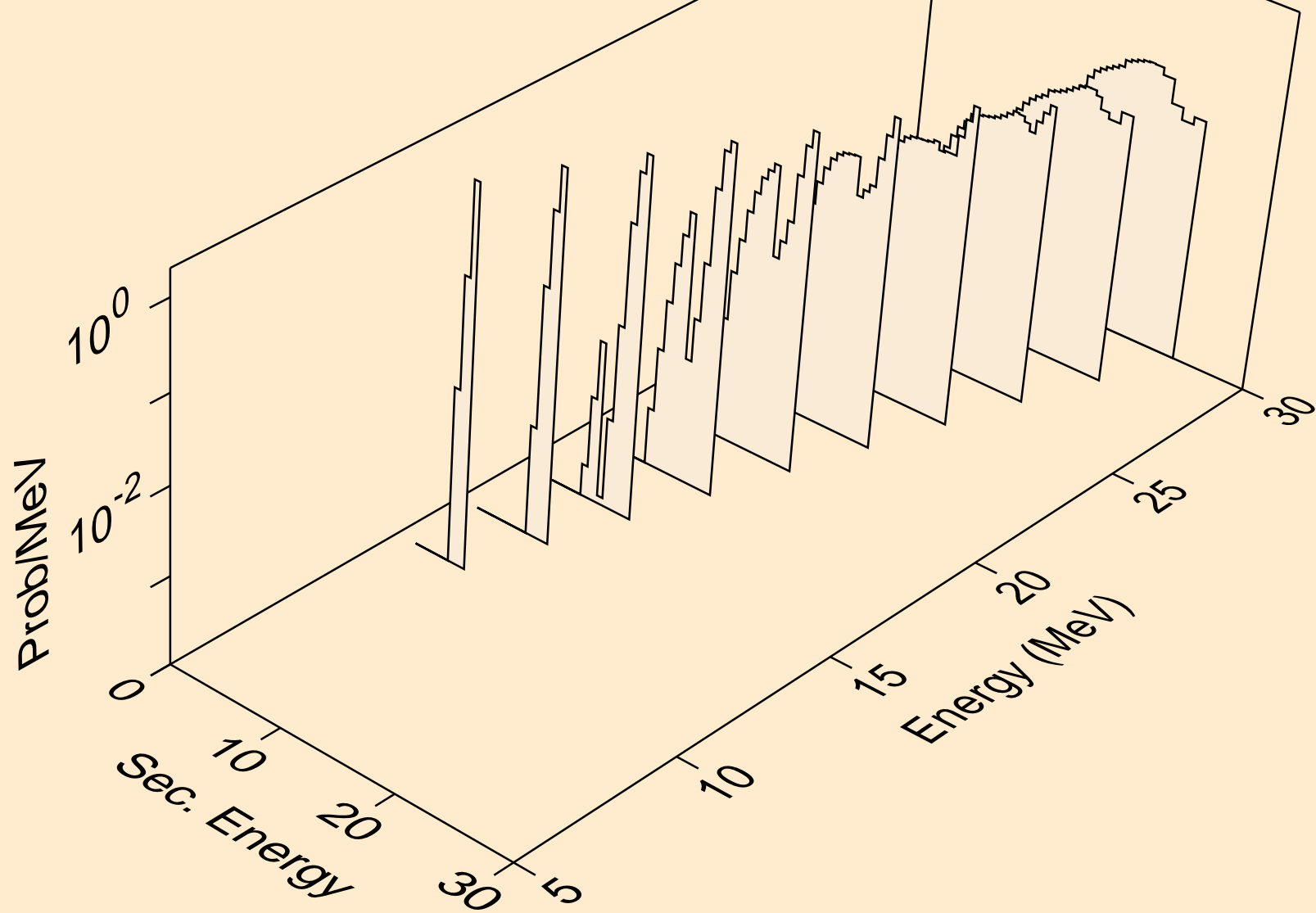

TM154 PHOTON ACER TENDL-2024 LIBRARY; T=0.K
alphas from (g,x)

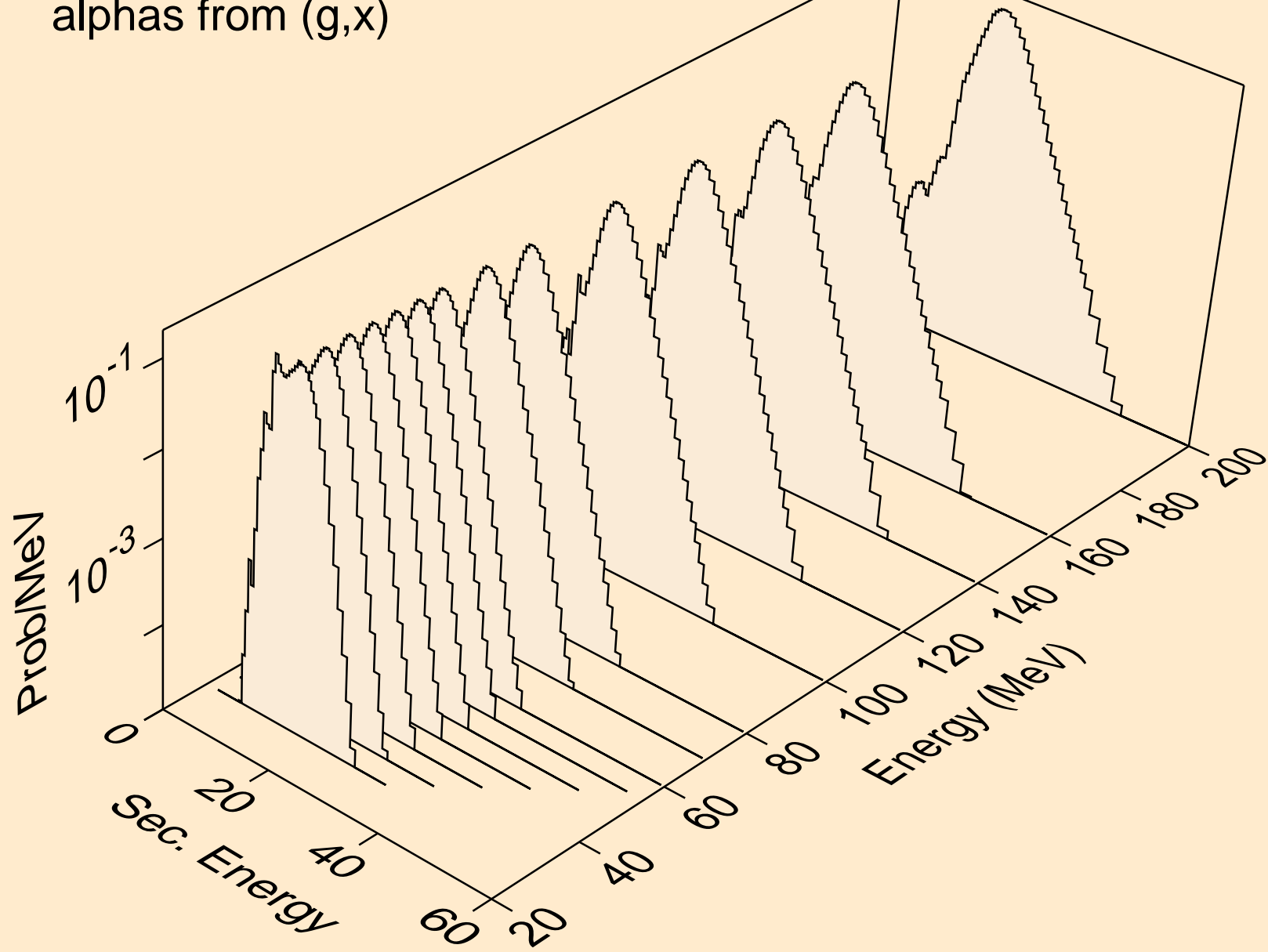

TM154 PHOTON ACER TENDL-2024 LIBRARY; T=0.K
alphas from (g,n*)a

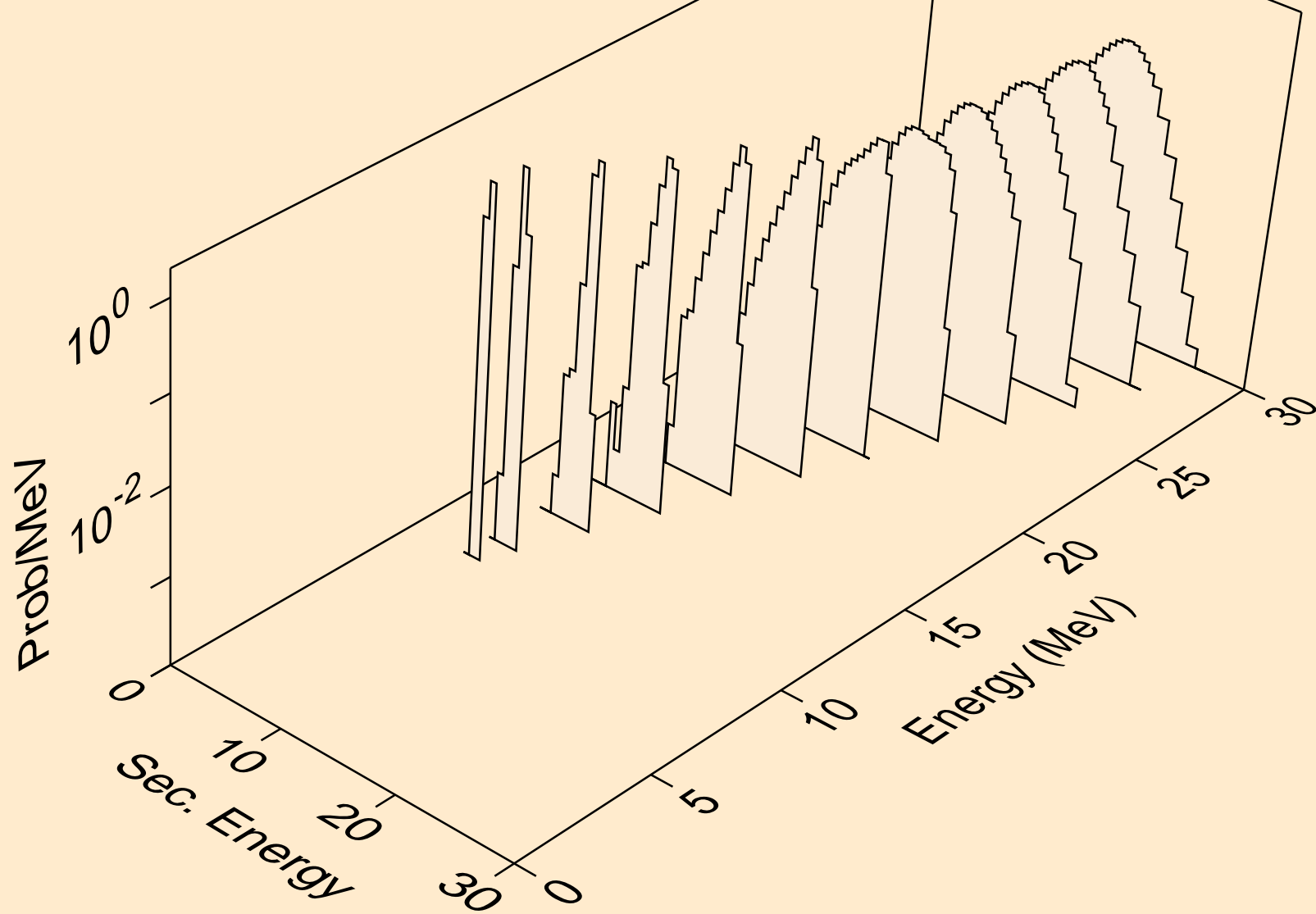

TM154 PHOTON ACER TENDL-2024 LIBRARY; T=0.K
alphas from (g,2n)a

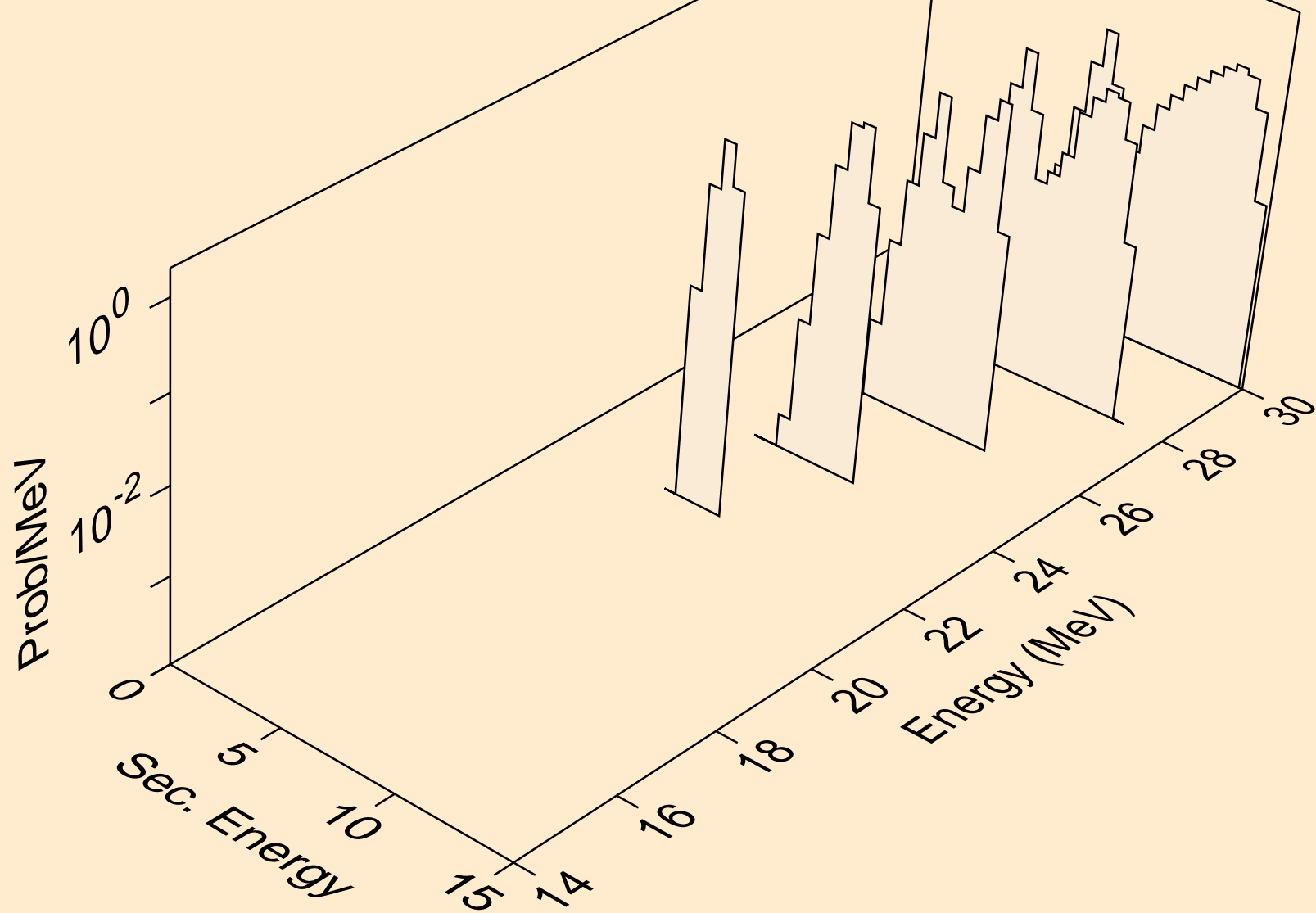

TM154 PHOTON ACER TENDL-2024 LIBRARY; T=0.K
alphas from (g,n*)2a

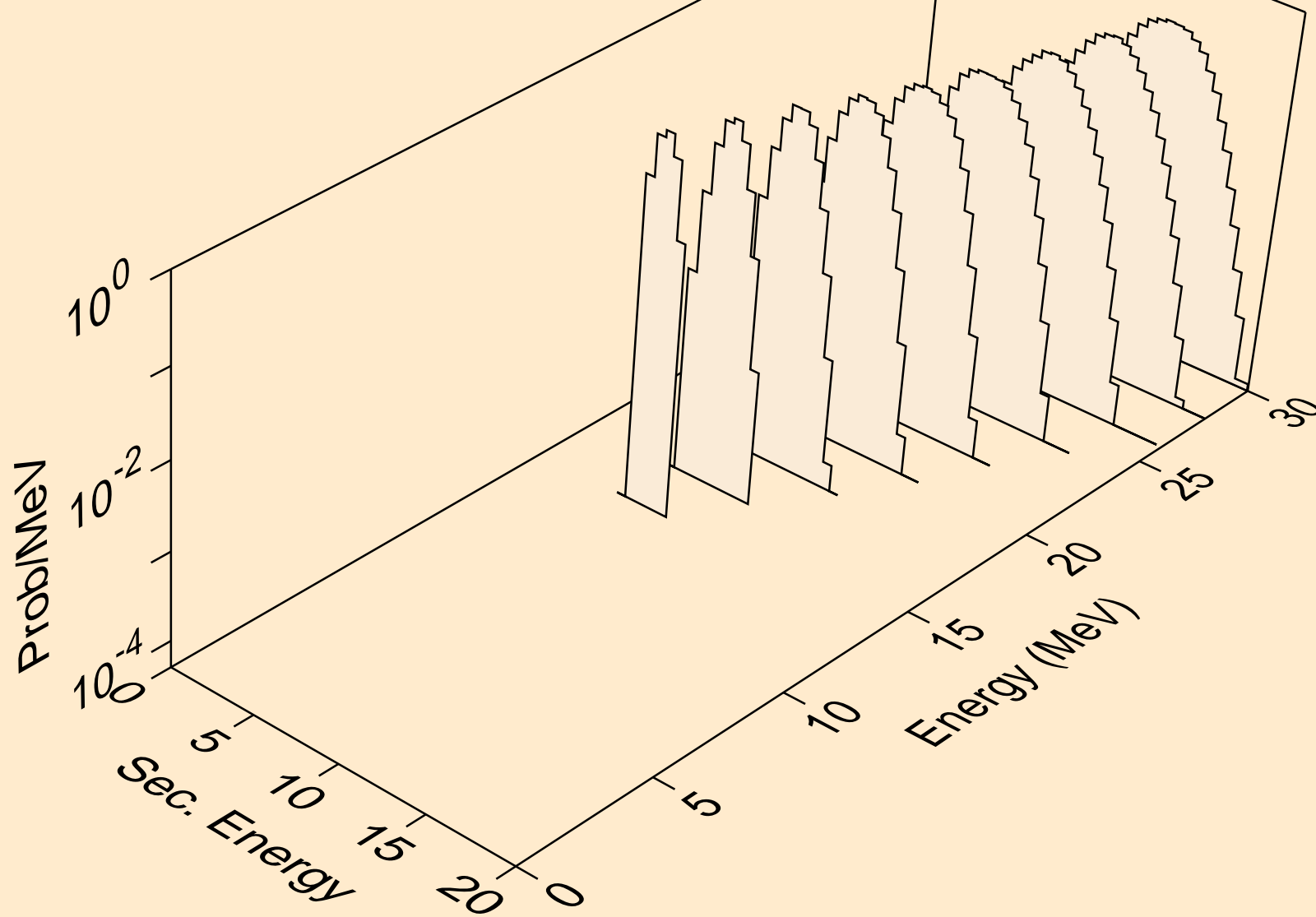

TM154 PHOTON ACER TENDL-2024 LIBRARY; T=0.K
alphas from (g,npa)

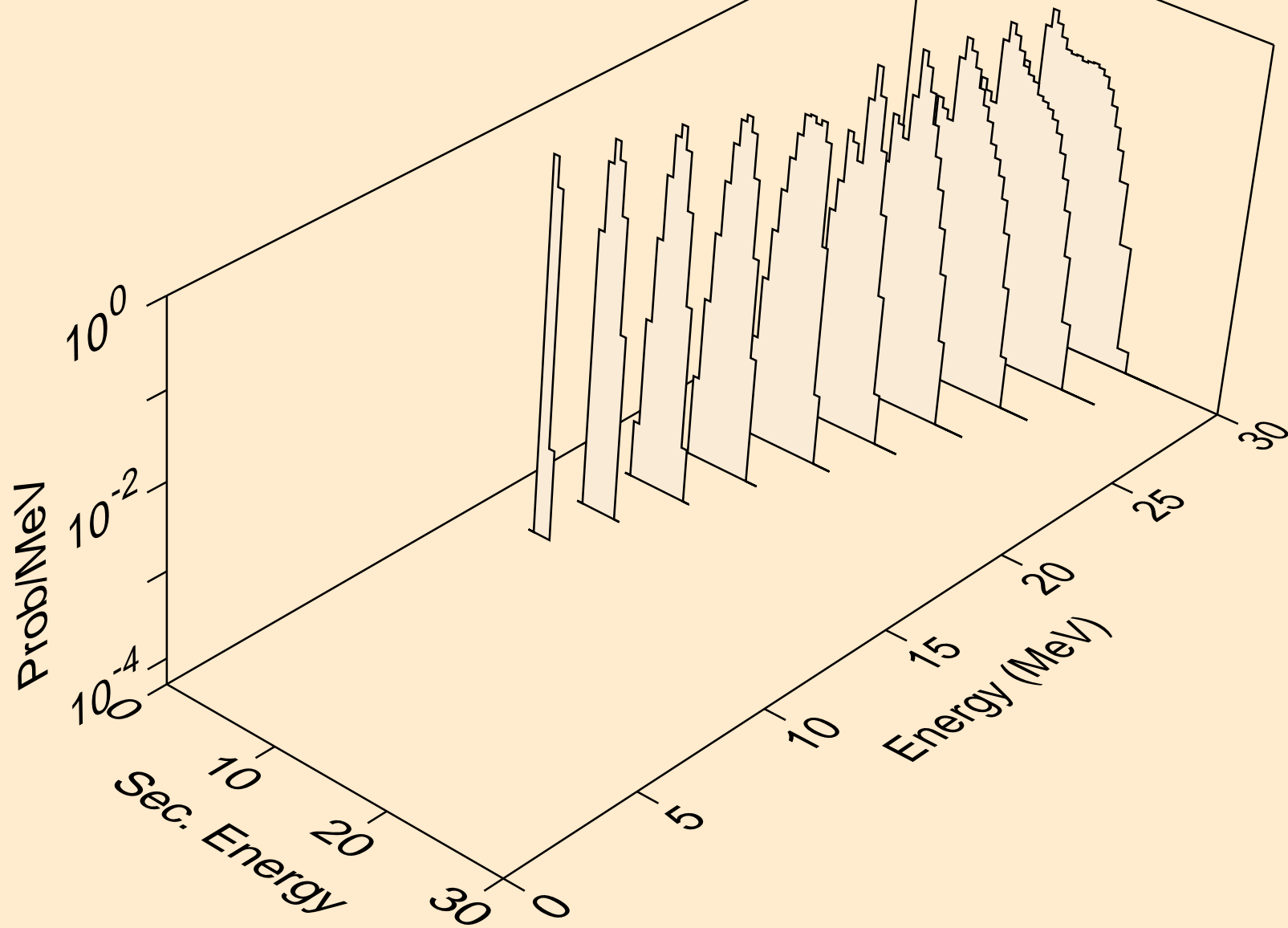

TM154 PHOTON ACER TENDL-2024 LIBRARY; T=0.K
alphas from (g,a)

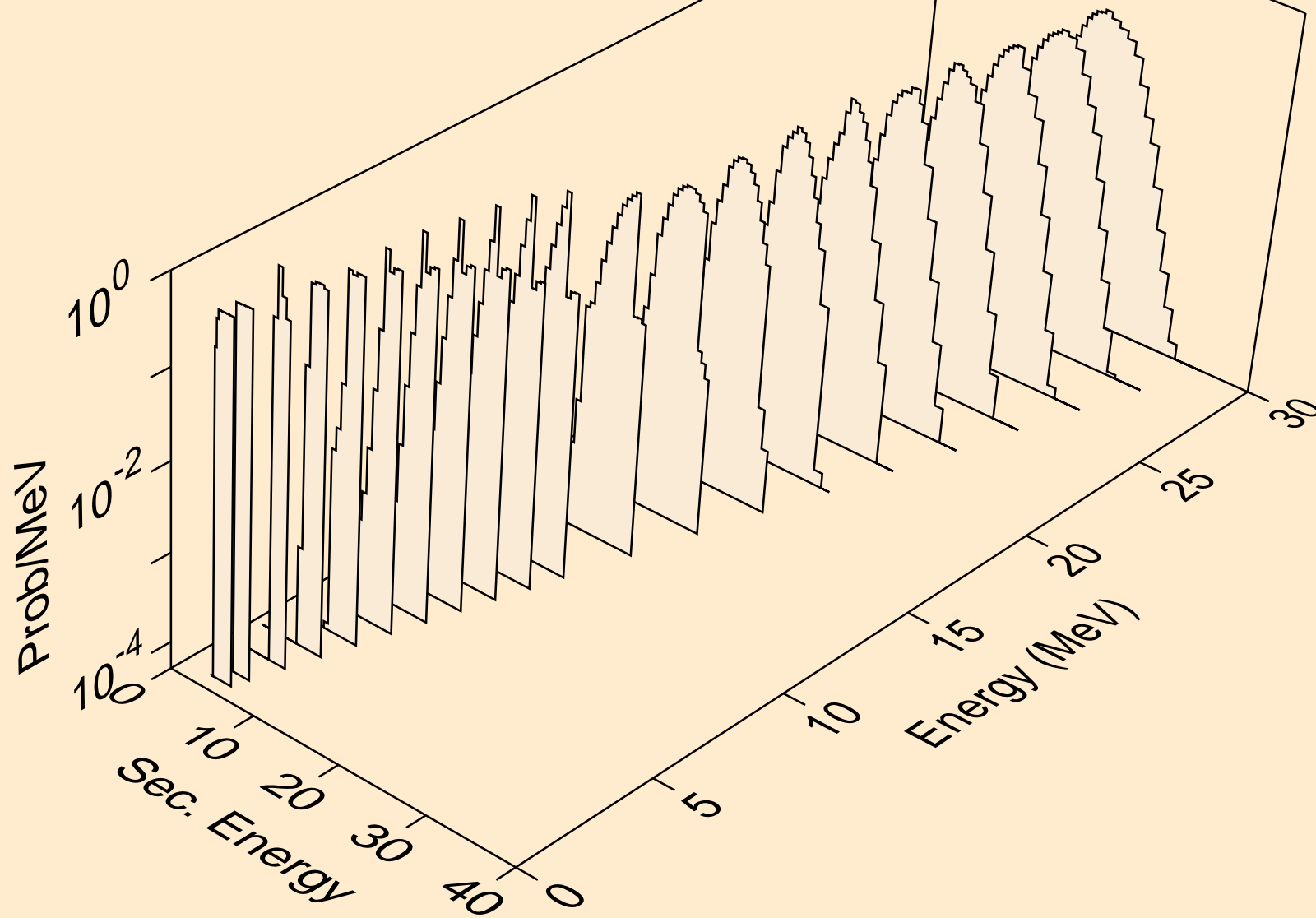

TM154 PHOTON ACER TENDL-2024 LIBRARY; T=0.K
alphas from (g,2a)

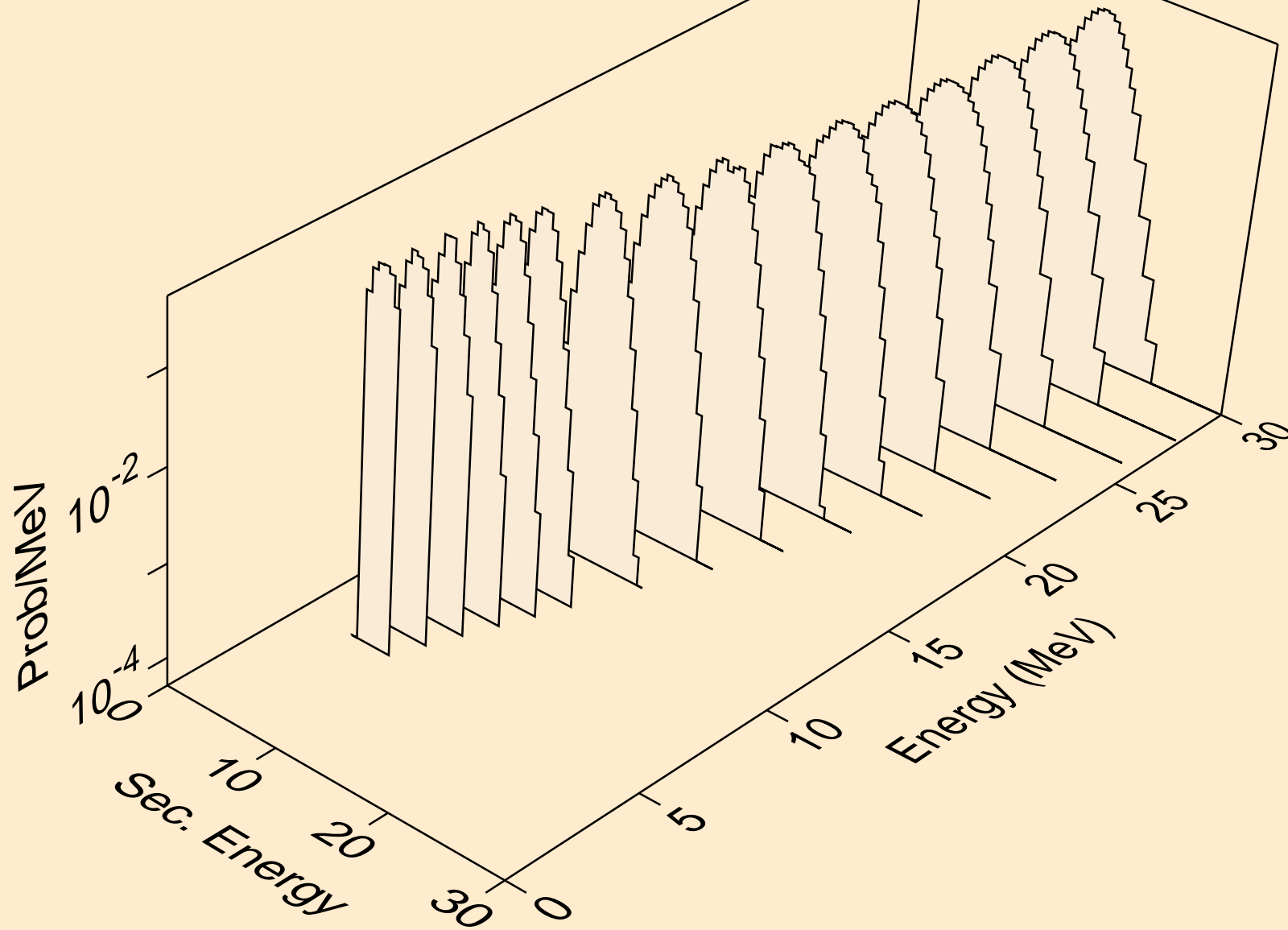

TM154 PHOTON ACER TENDL-2024 LIBRARY; T=0.K
alphas from (g,pa)

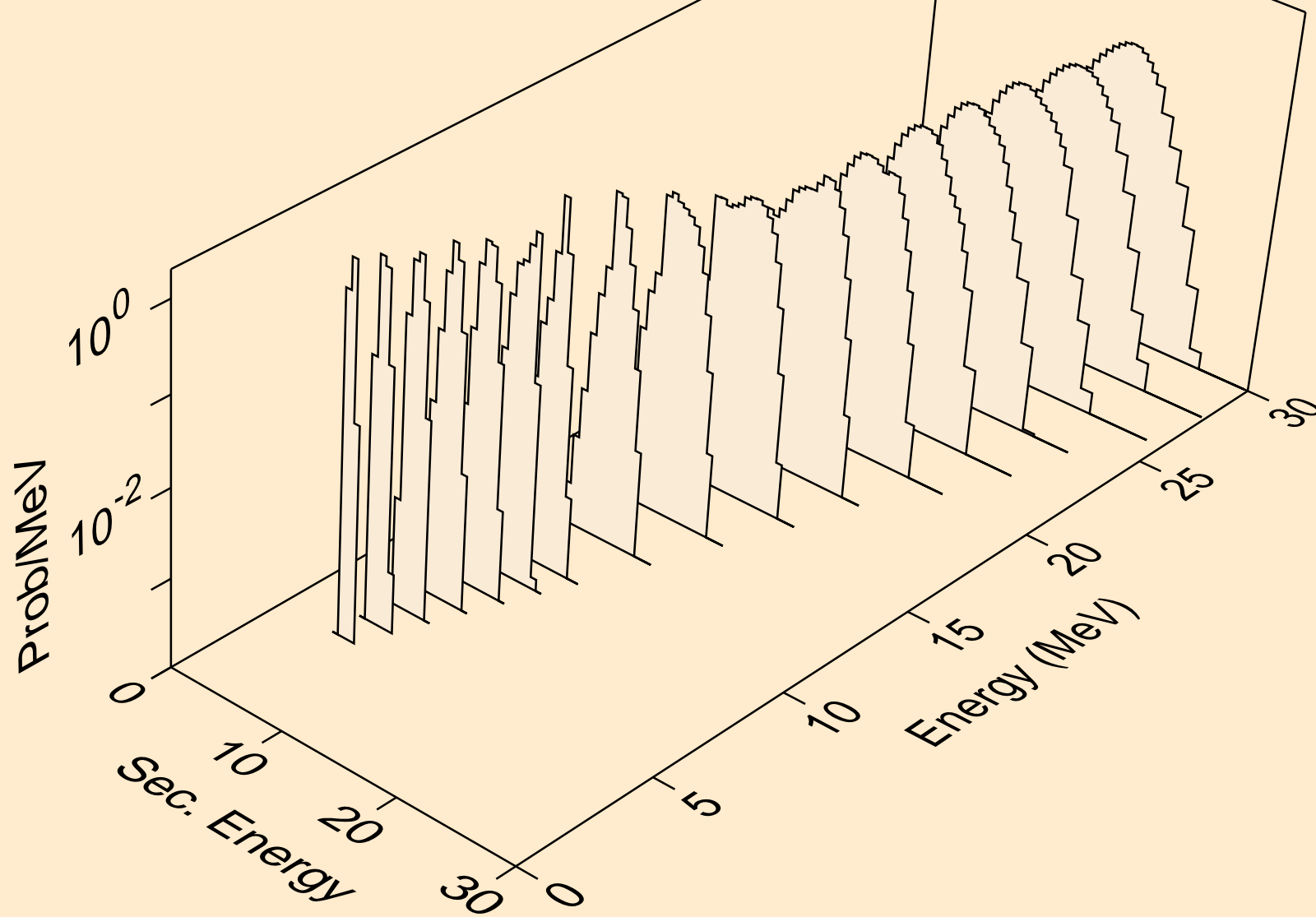

TM154 PHOTON ACER TENDL-2024 LIBRARY; T=0.K
alphas from (g,da)

