

YB157 PHOTON ACER TENDL-2024 LIBRARY; T=0.K
Principal cross sections

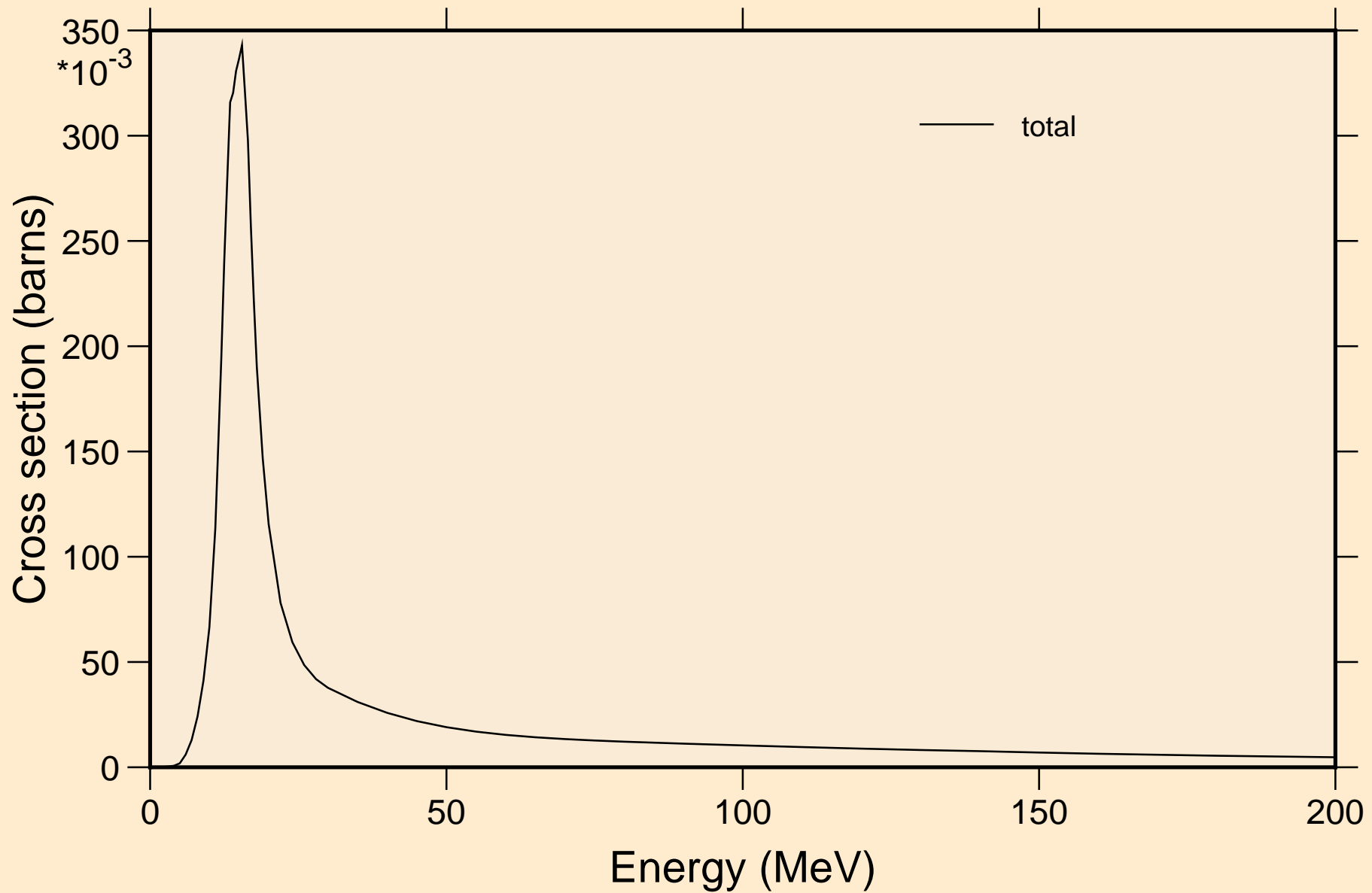

YB157 PHOTON ACER TENDL-2024 LIBRARY; T=0.K

Partial cross sections

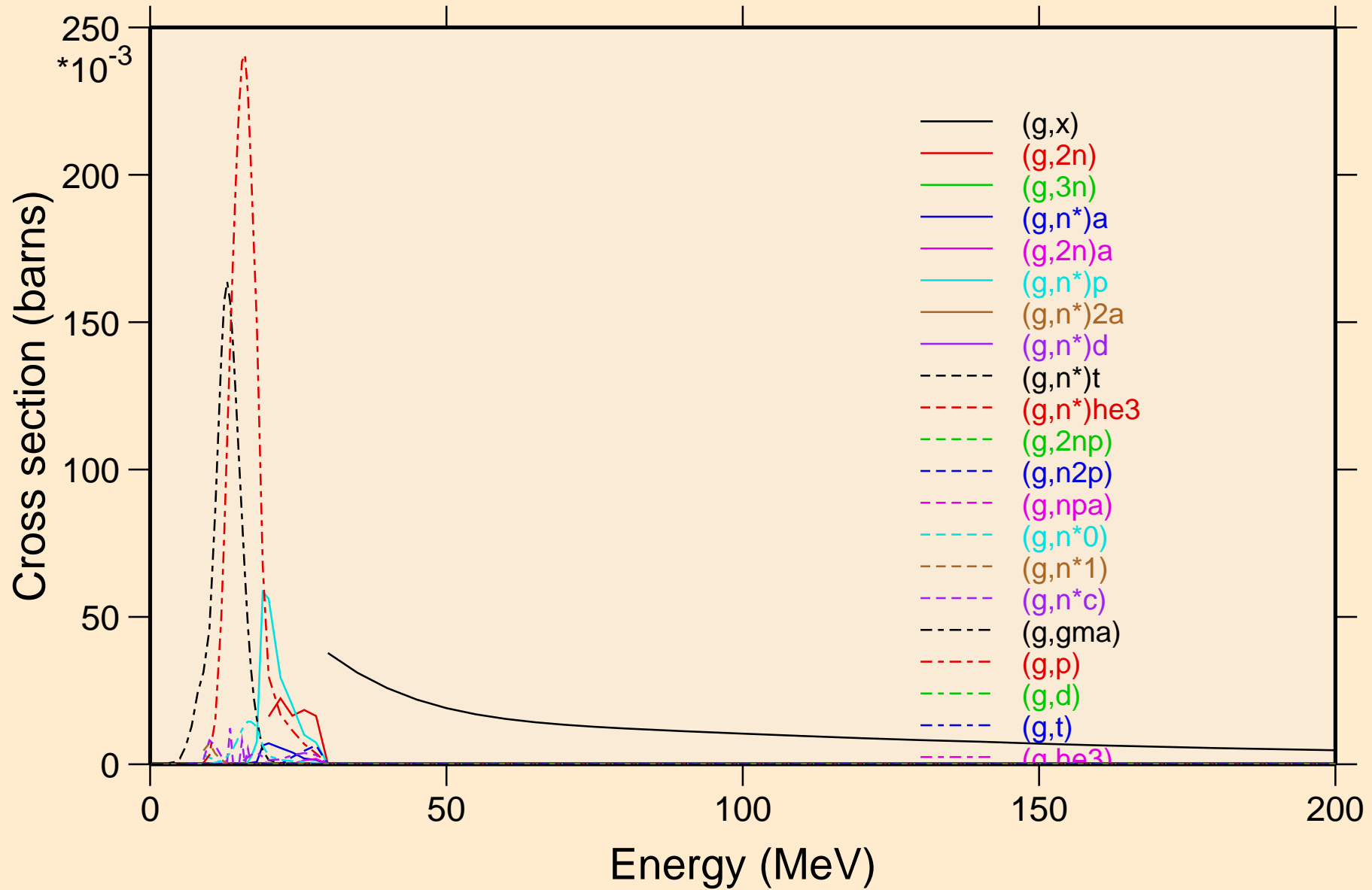

YB157 PHOTON ACER TENDL-2024 LIBRARY; T=0.K

Heating

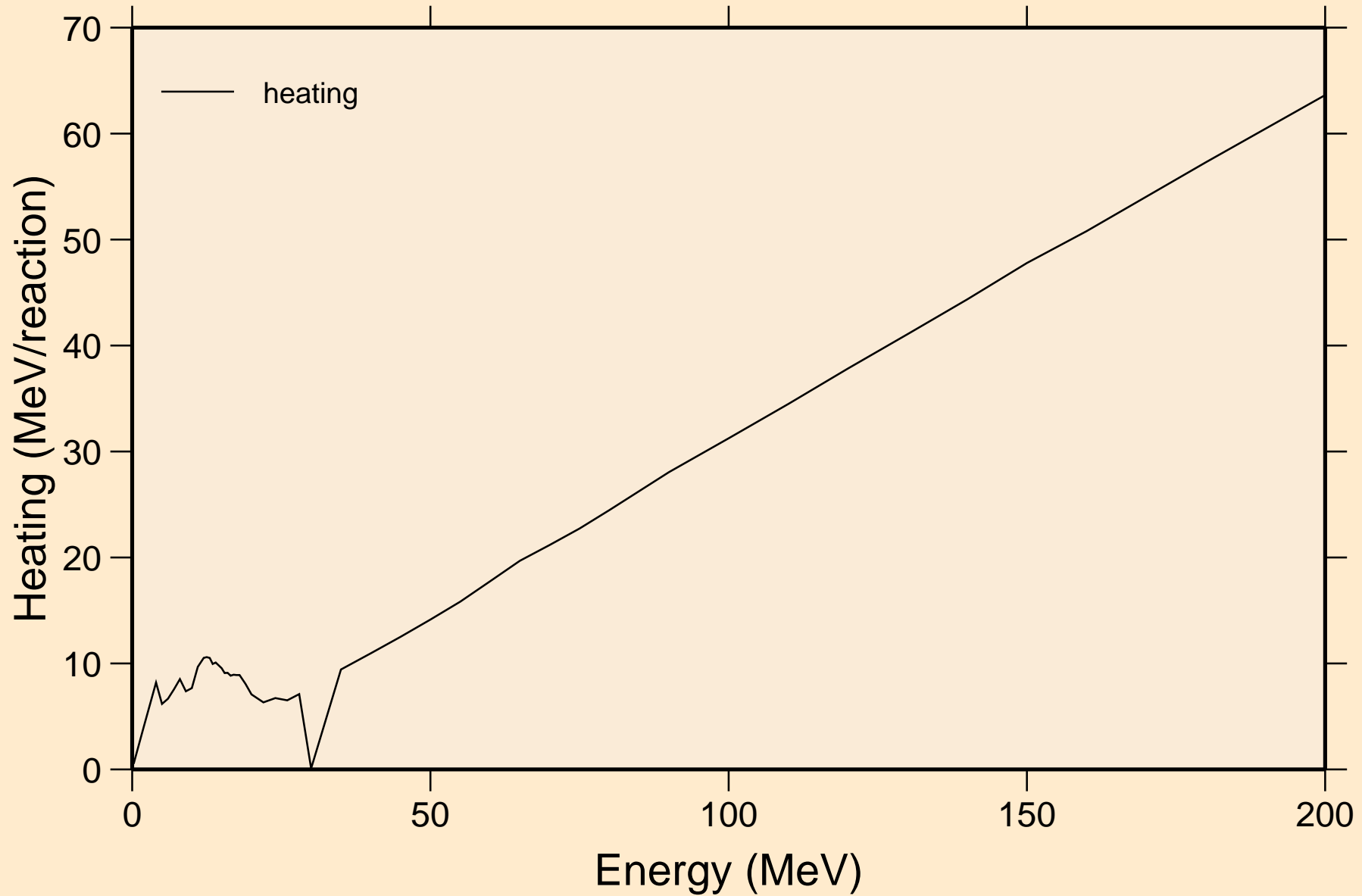

YB157 PHOTON ACER TENDL-2024 LIBRARY; T=0.K

Particle heating contributions

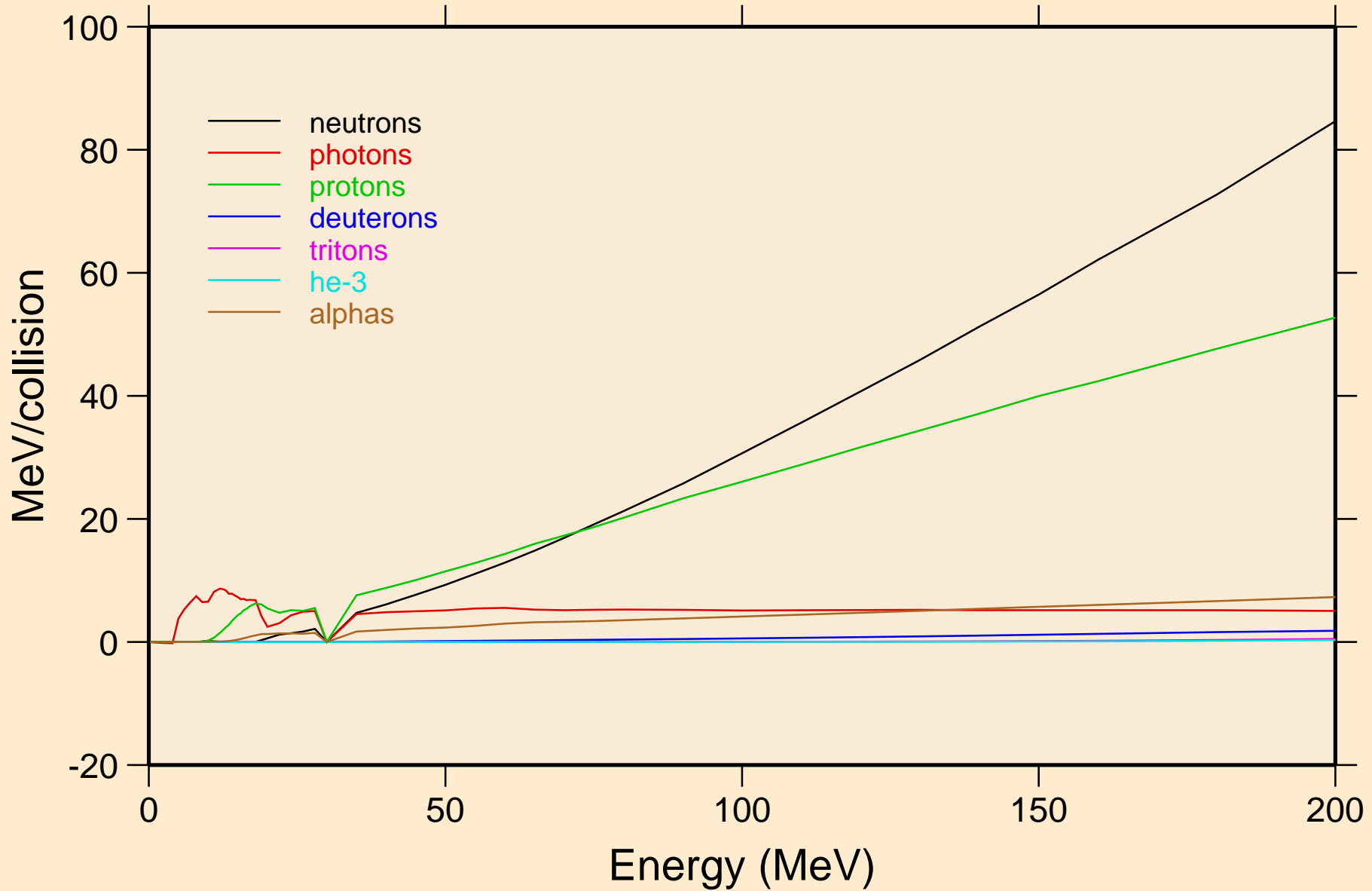

YB157 PHOTON ACER TENDL-2024 LIBRARY; T=0.K

Particle production cross sections

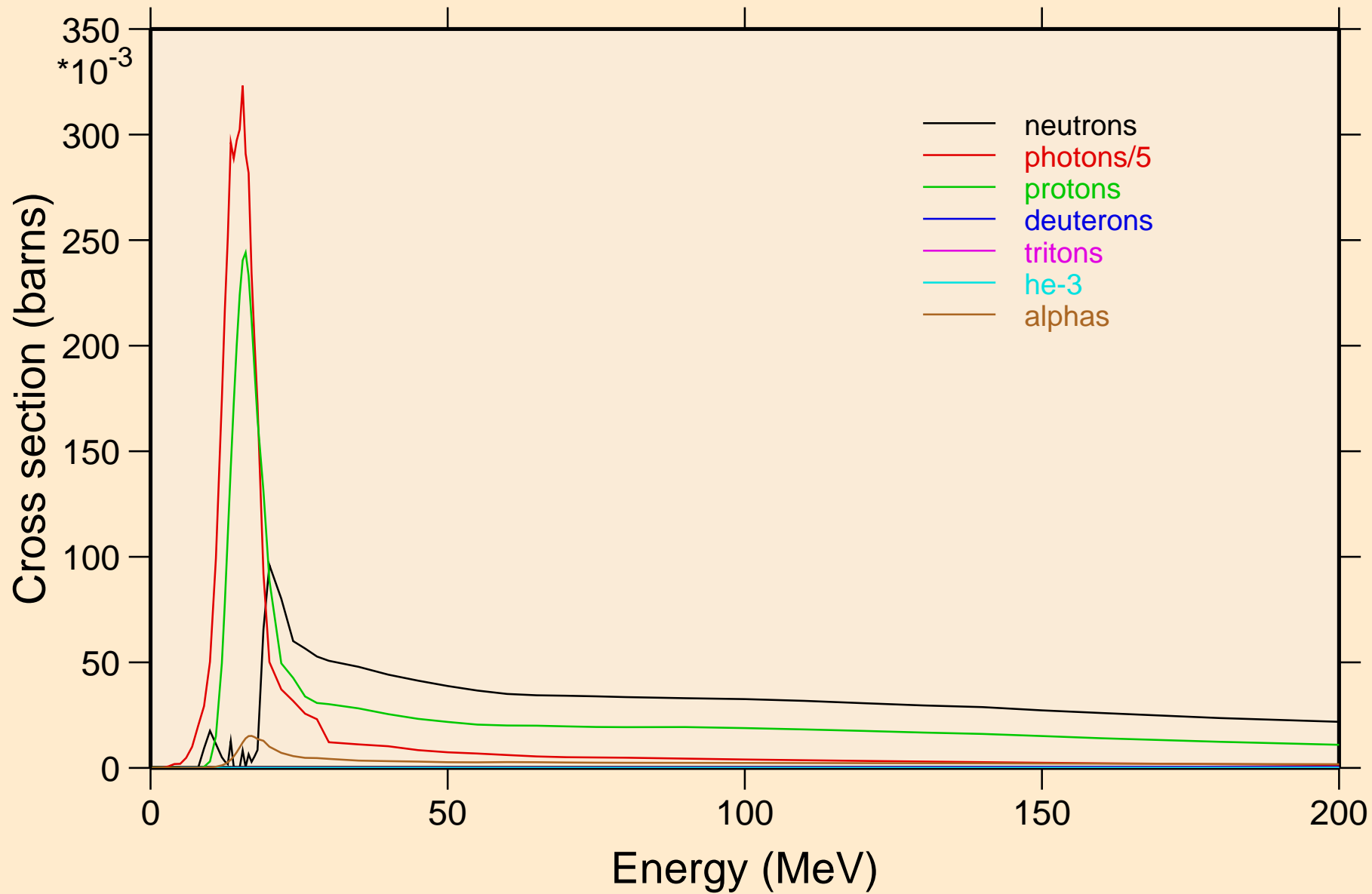

YB157 PHOTON ACER TENDL-2024 LIBRARY; T=0.K
neutrons from (g,x)

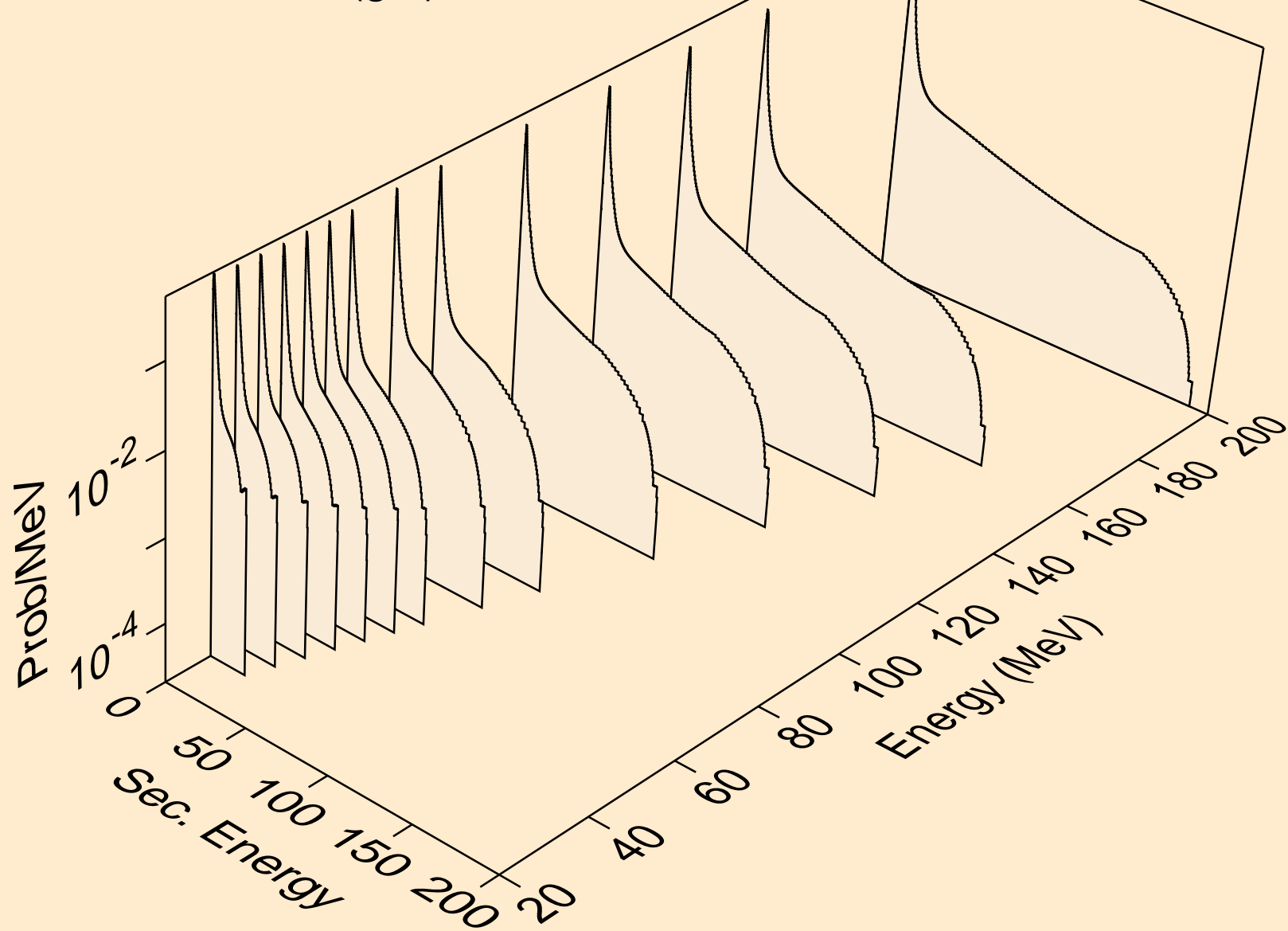

YB157 PHOTON ACER TENDL-2024 LIBRARY; T=0.K
neutrons from (g,2n)

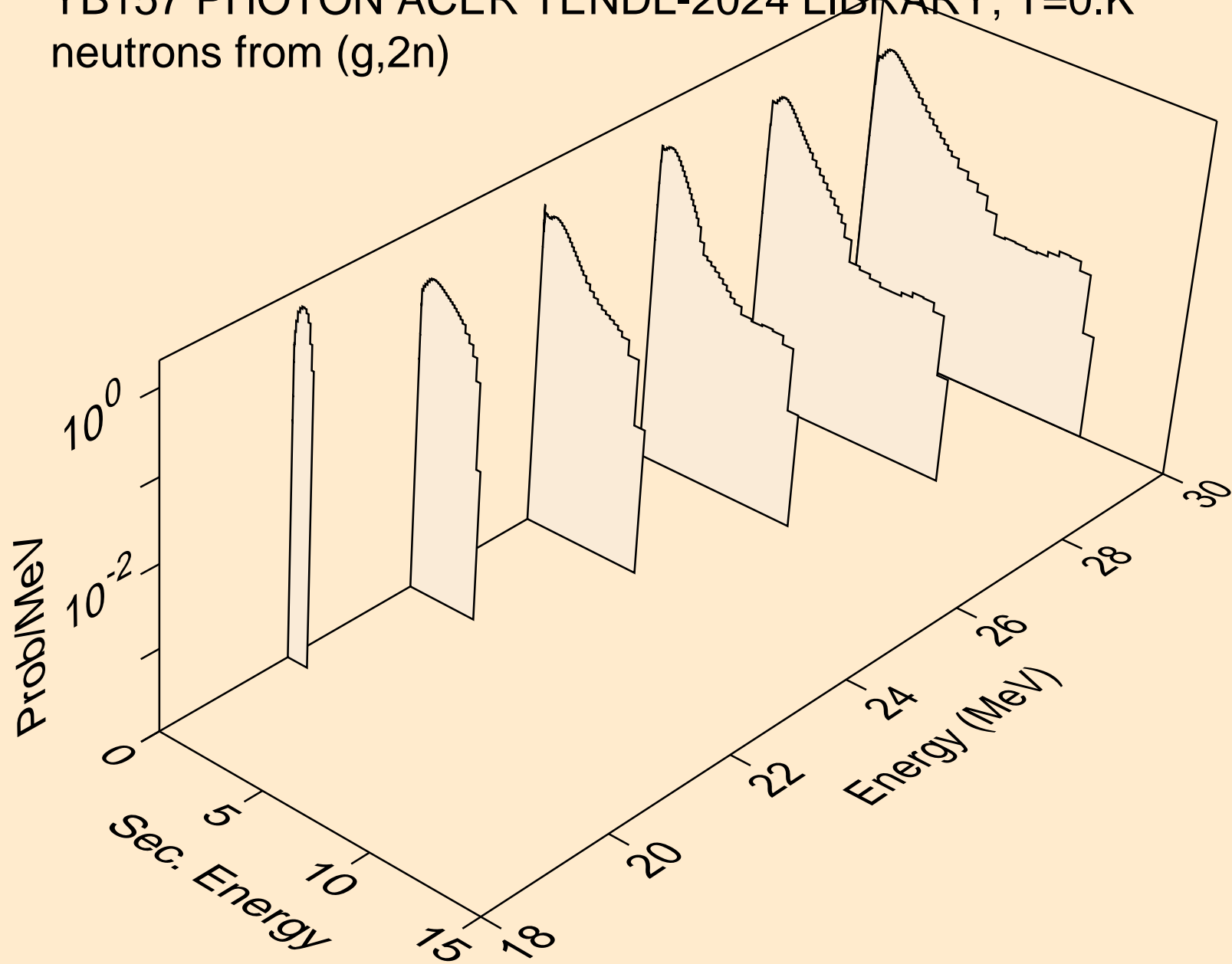

YB157 PHOTON ACER TENDL-2024 LIBRARY; T=0.K
neutrons from (g,3n)

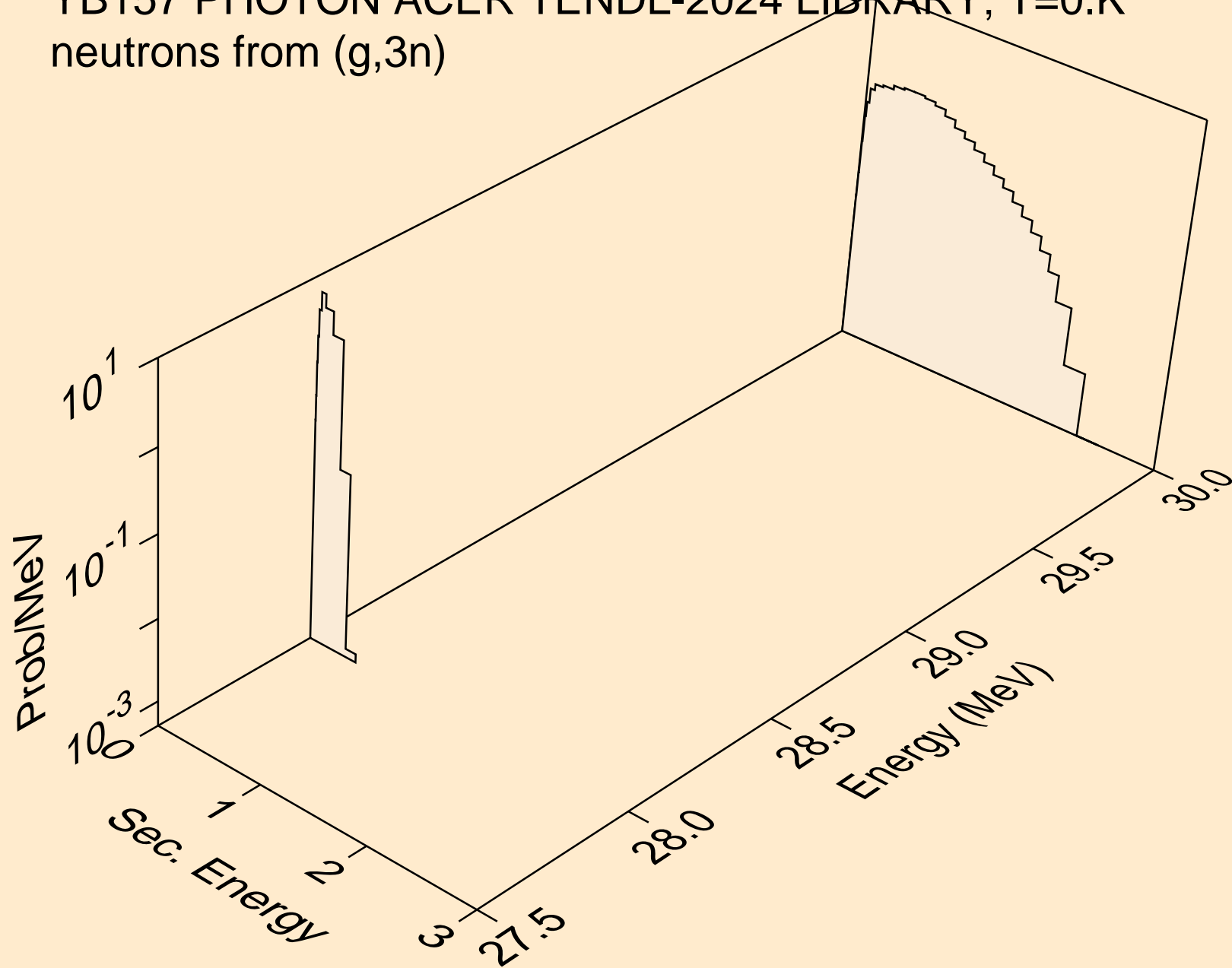

YB157 PHOTON ACER TENDL-2024 LIBRARY; T=0.K
neutrons from (g,n*)a

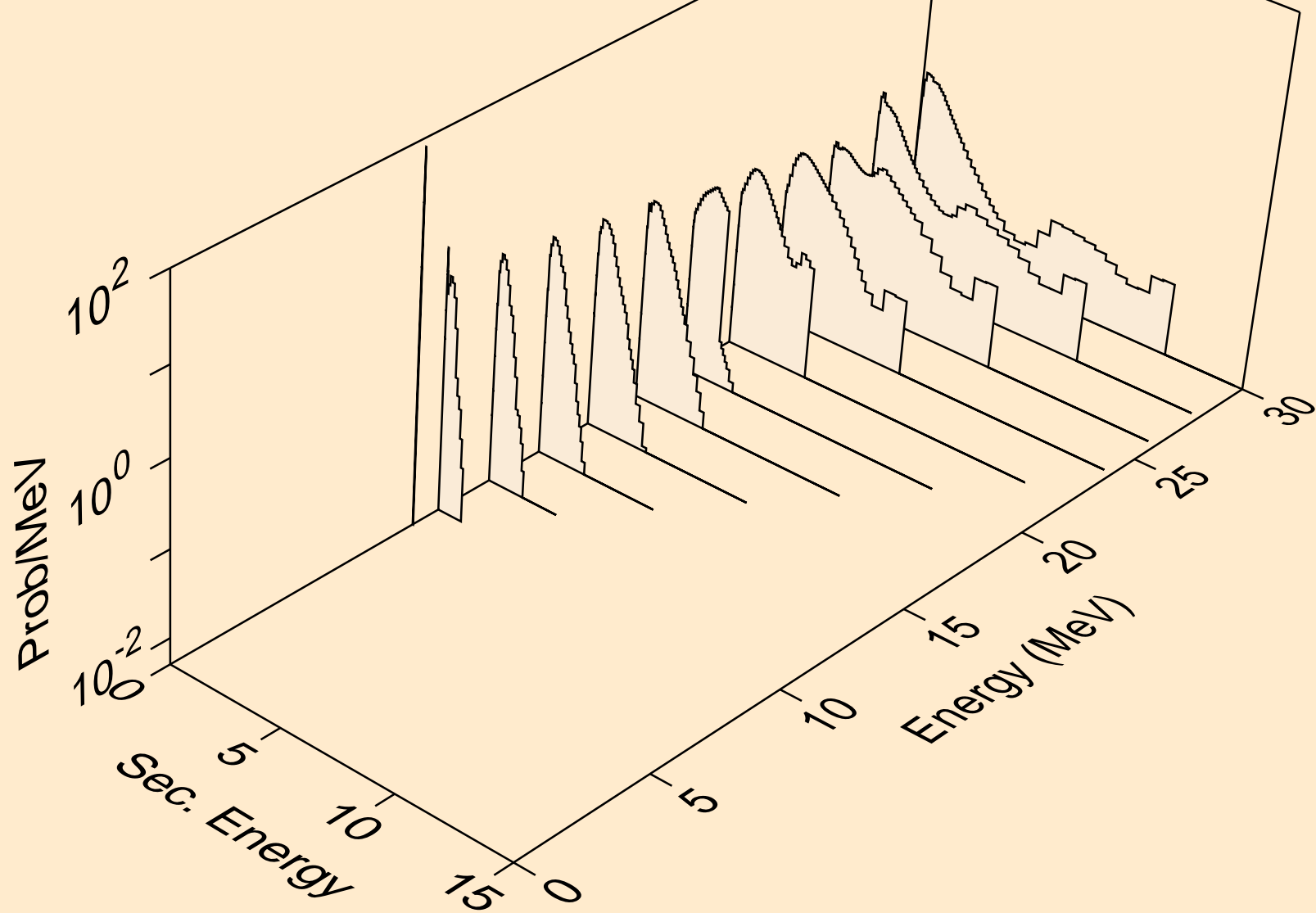

YB157 PHOTON ACER TENDL-2024 LIBRARY; T=0.K
neutrons from (g,2n)a

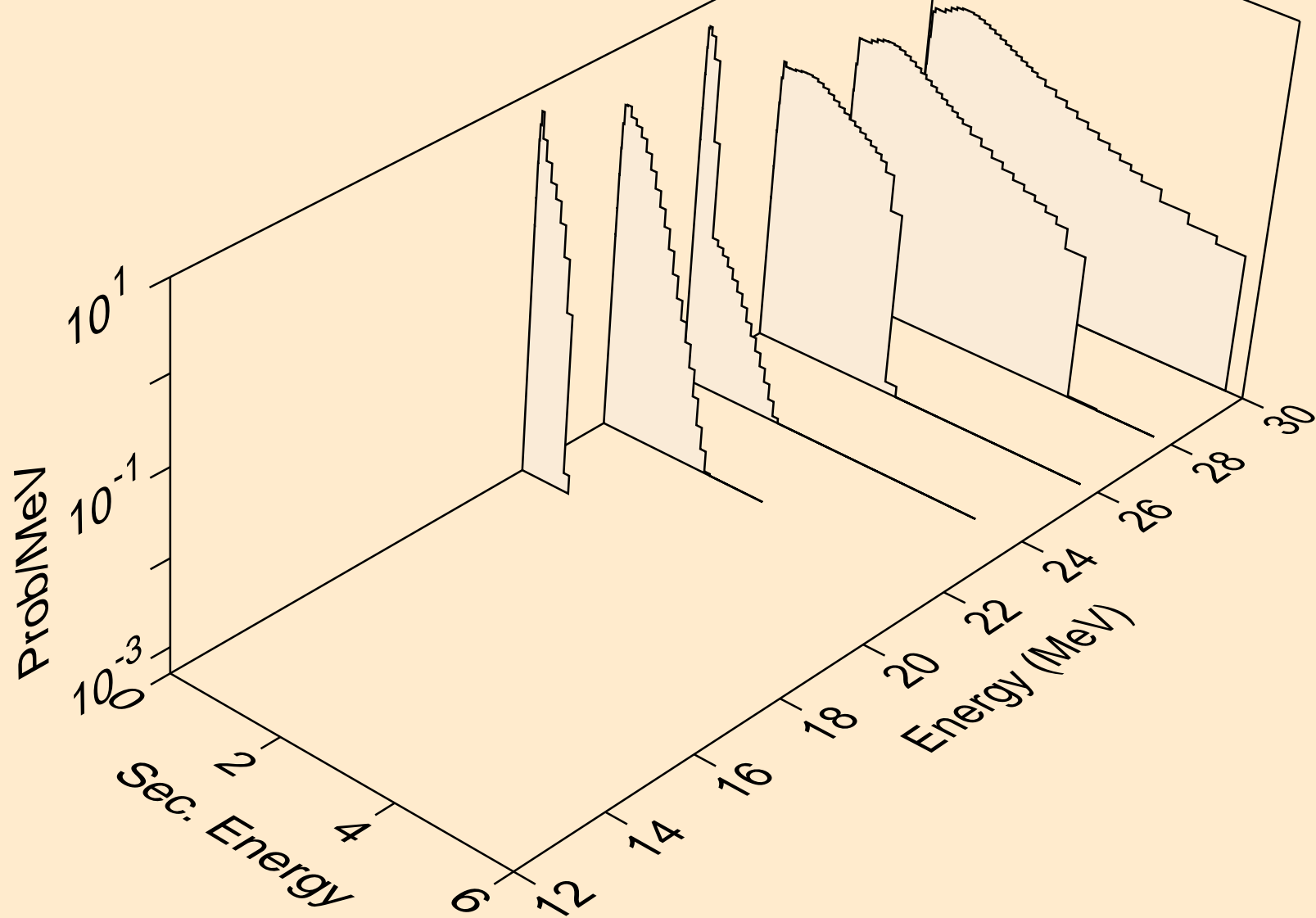

YB157 PHOTON ACER TENDL-2024 LIBRARY; T=0.K
neutrons from (g,n*)p

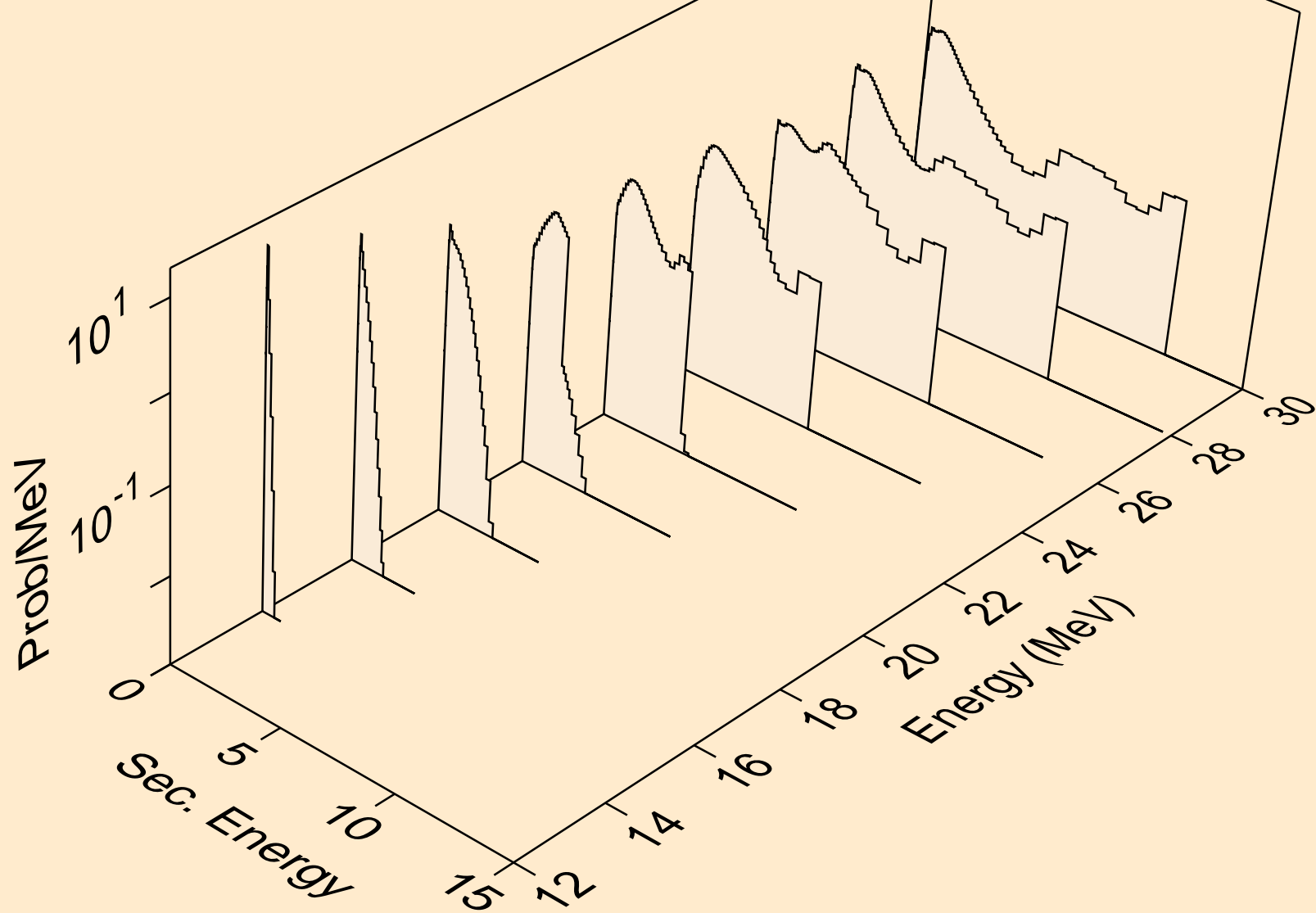

YB157 PHOTON ACER TENDL-2024 LIBRARY; T=0.K
neutrons from (g,n*)2a

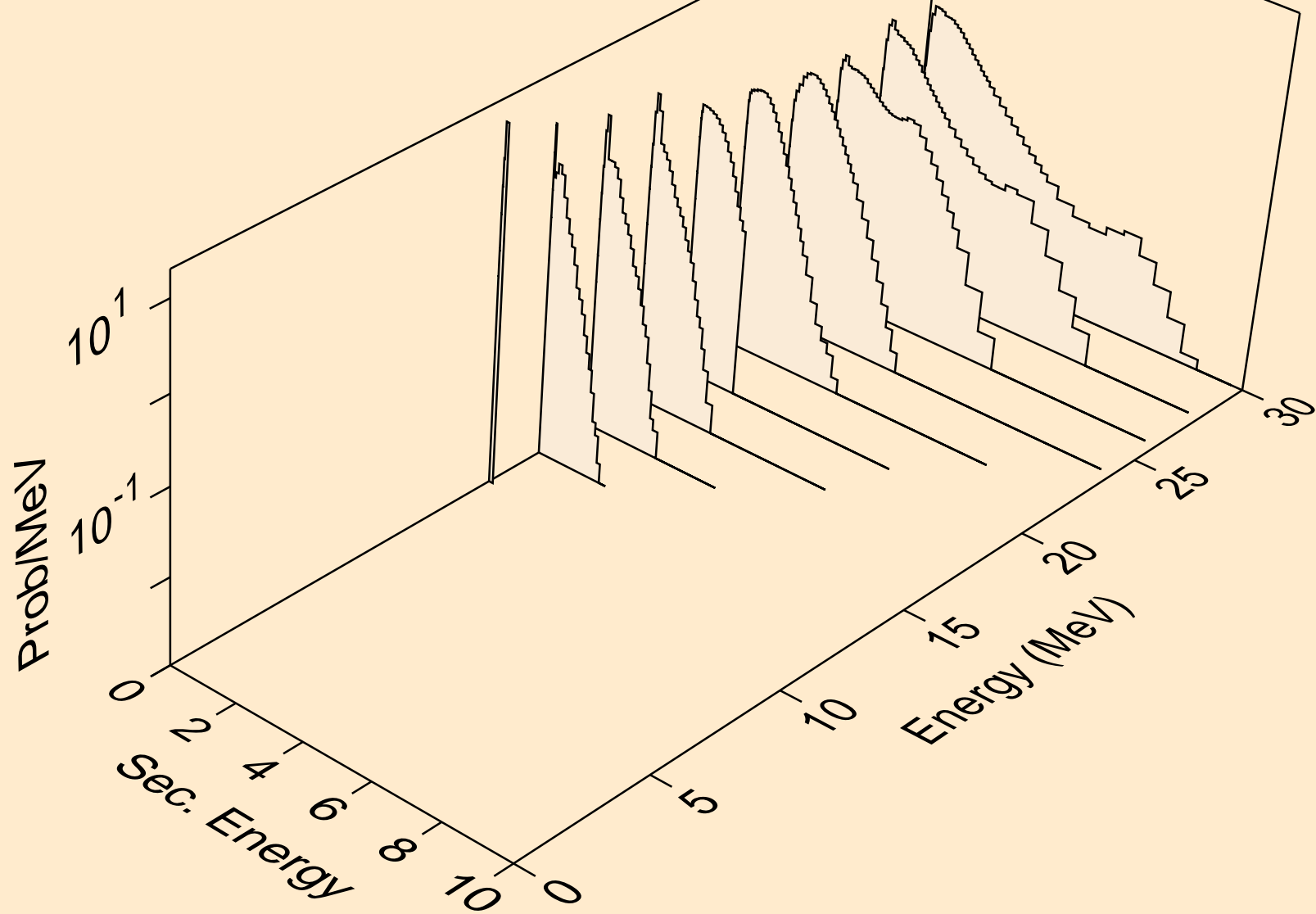

YB157 PHOTON ACER TENDL-2024 LIBRARY; T=0.K
neutrons from (g,n*)d

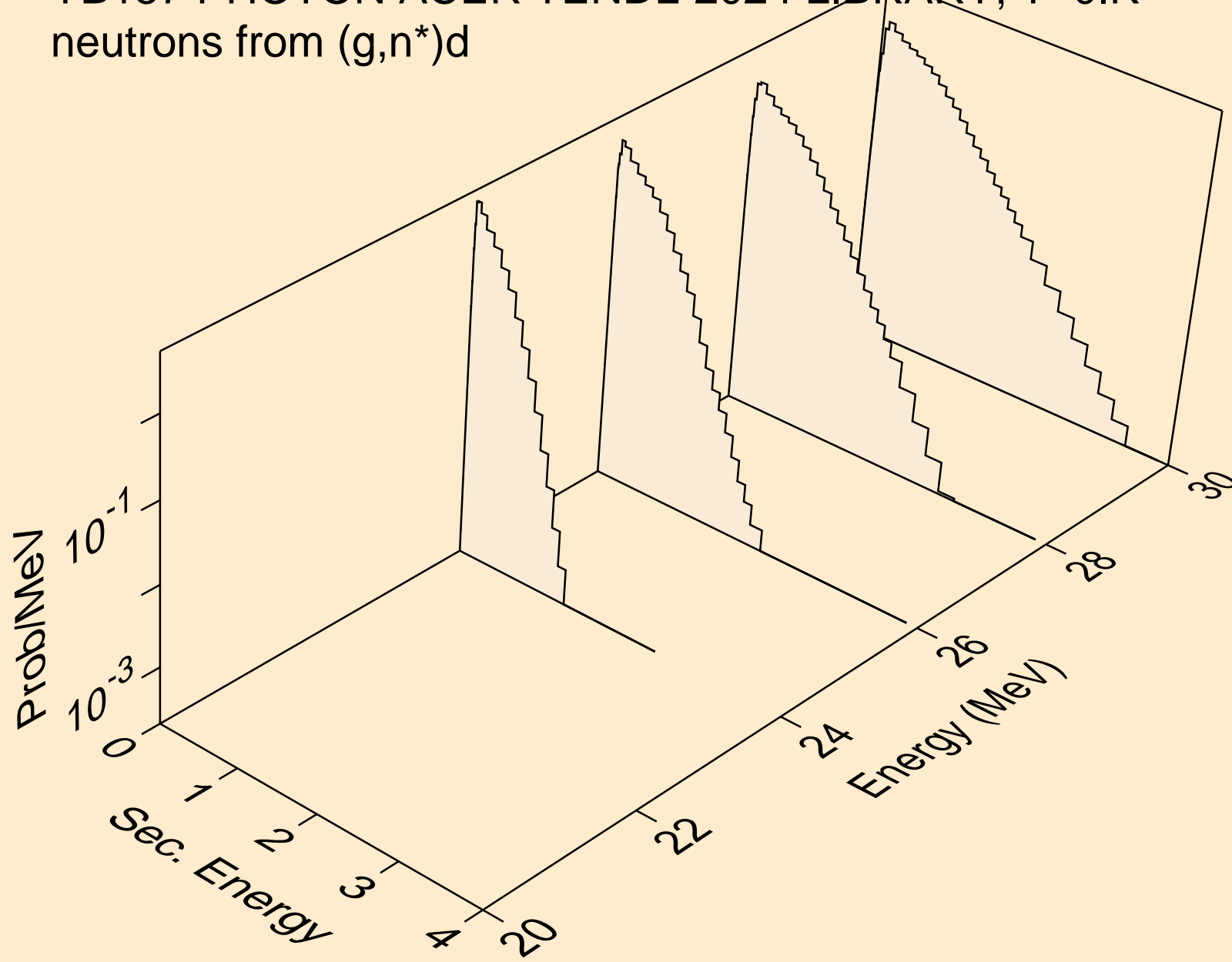

YB157 PHOTON ACER TENDL-2024 LIBRARY; T=0.K
neutrons from (g,n*)t

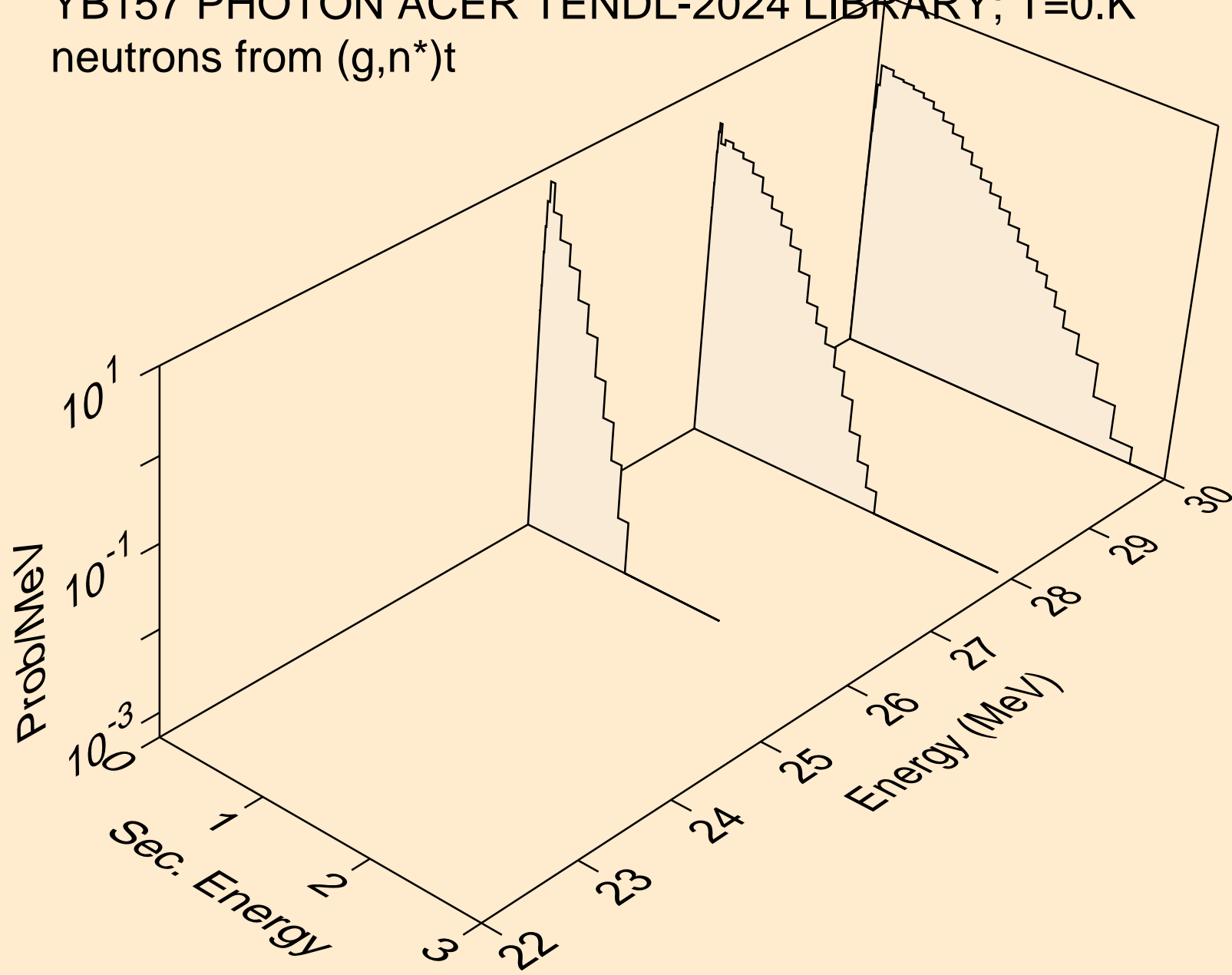

YB157 PHOTON ACER TENDL-2024 LIBRARY; T=0.K
neutrons from (g,n*)he3

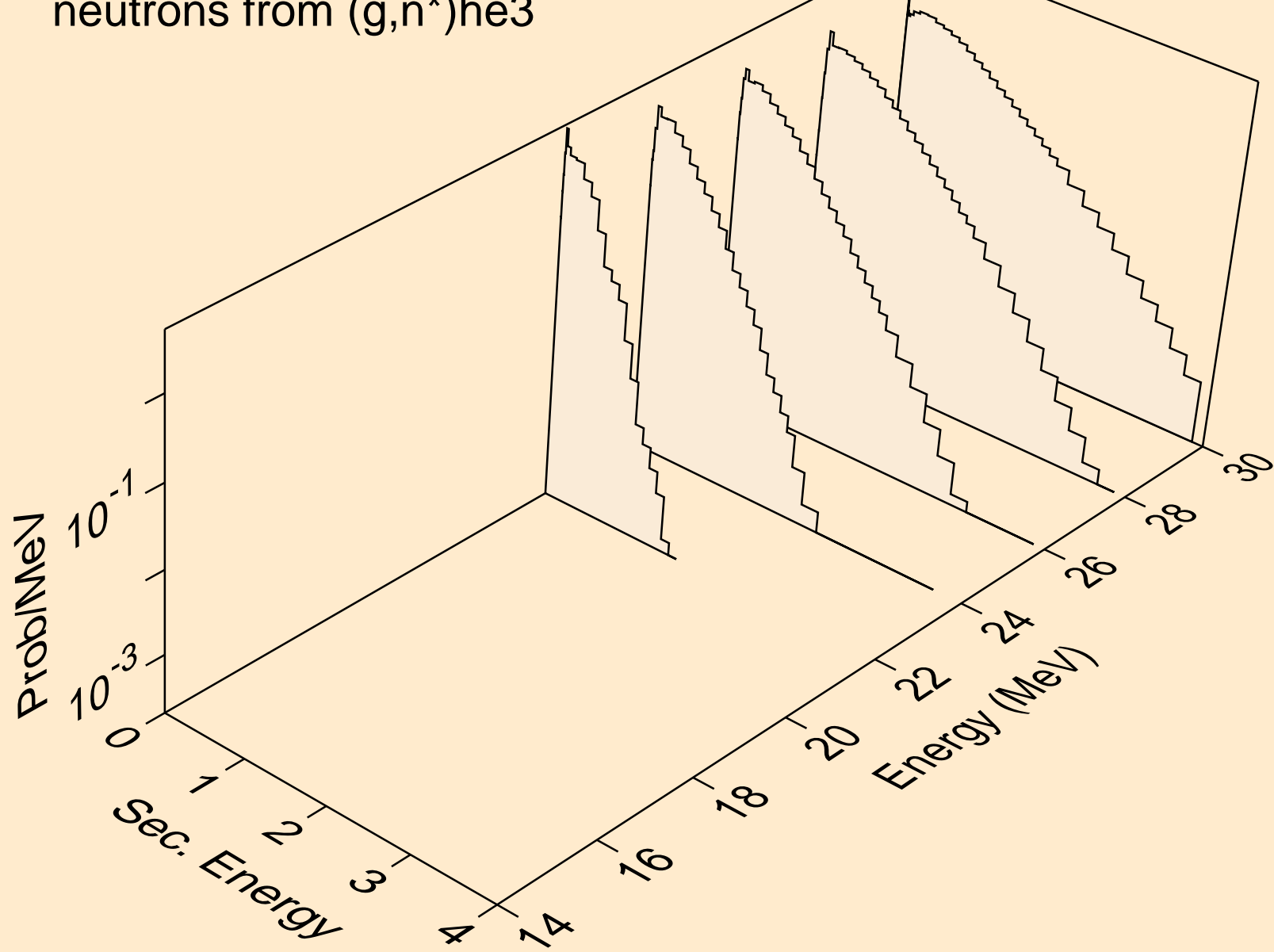

YB157 PHOTON ACER TENDL-2024 LIBRARY; T=0.K
neutrons from (g,2np)

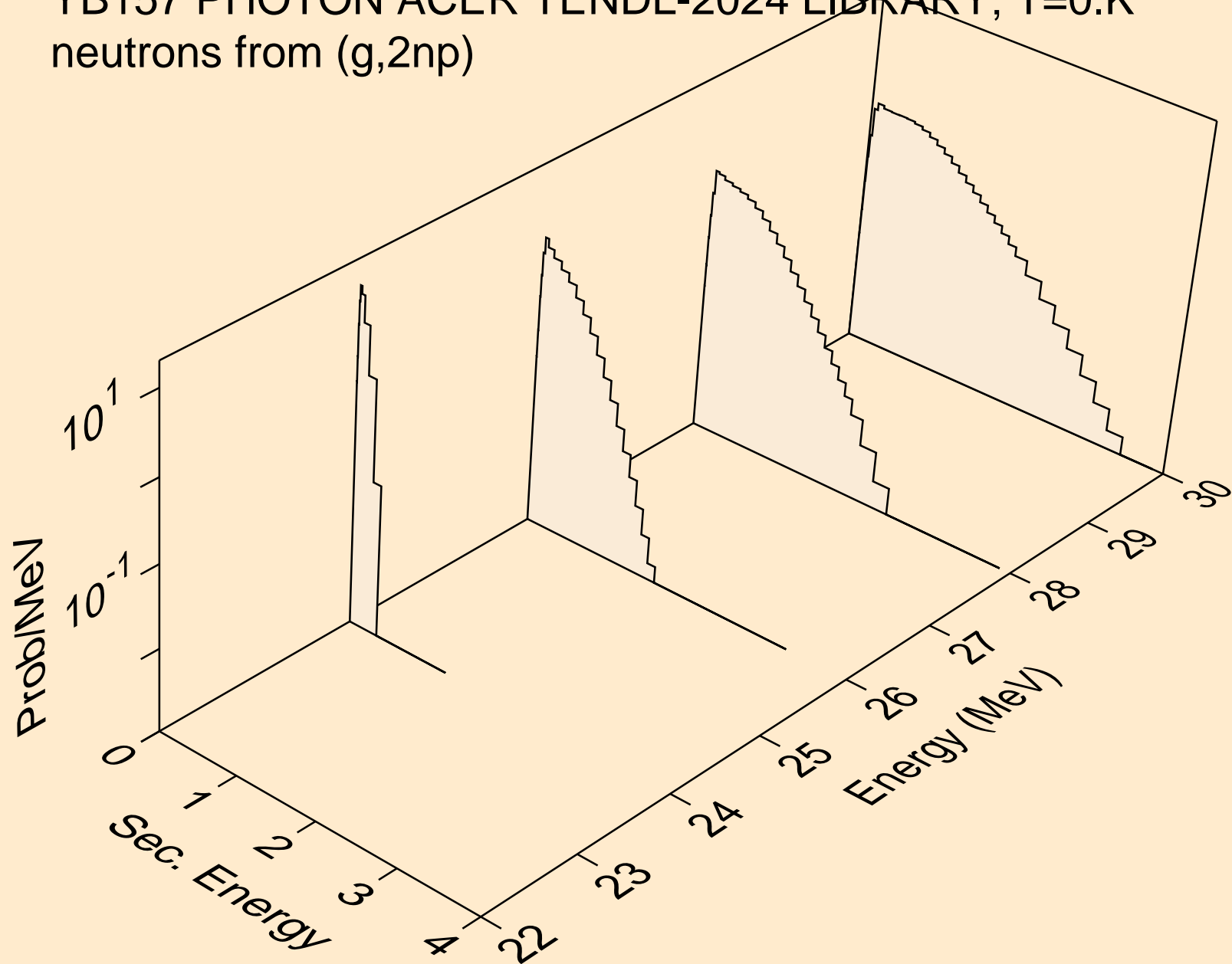

YB157 PHOTON ACER TENDL-2024 LIBRARY; T=0.K
neutrons from (g,n2p)

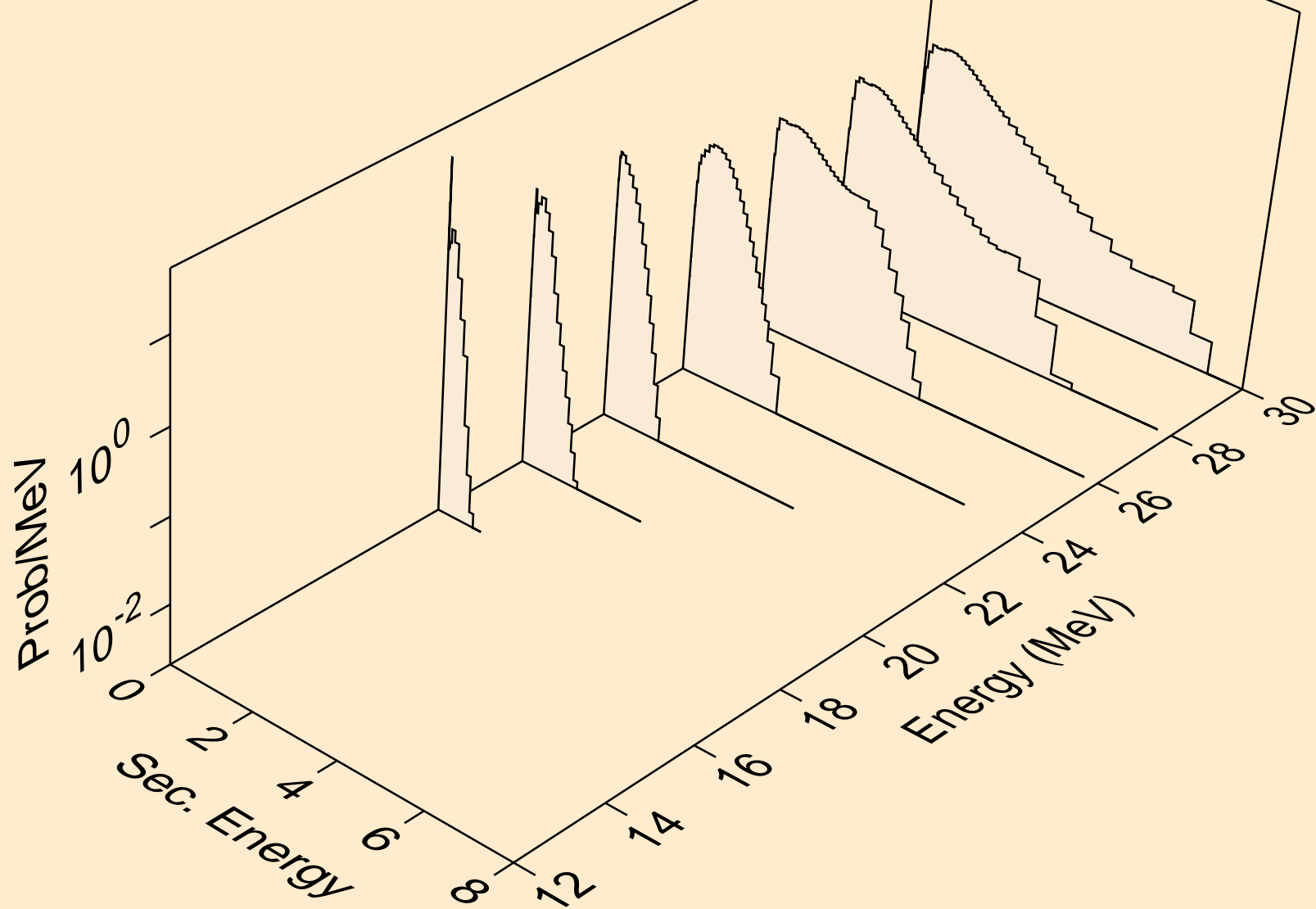

YB157 PHOTON ACER TENDL-2024 LIBRARY; T=0.K
neutrons from (g,npa)

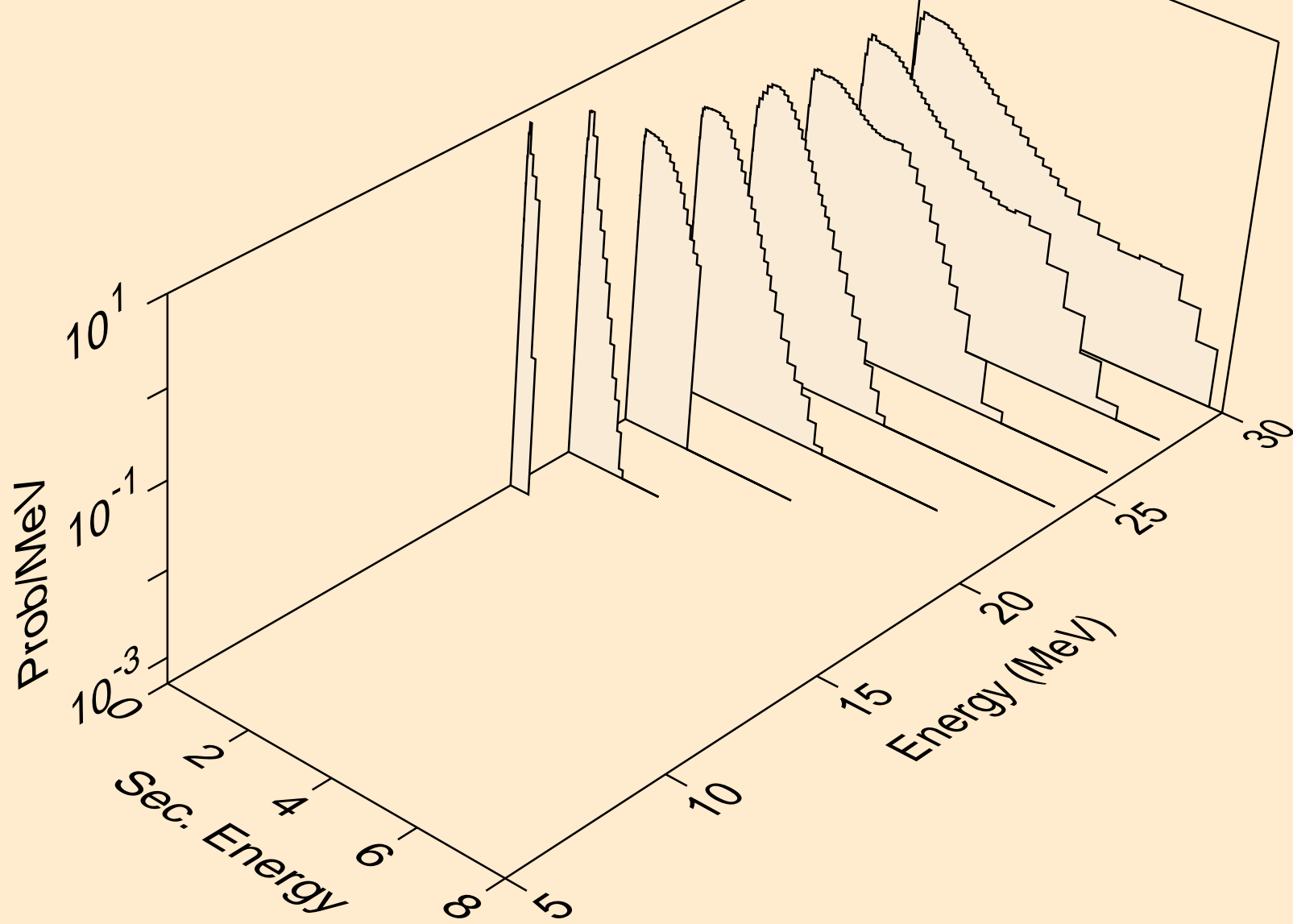

YB157 PHOTON ACER TENDL-2024 LIBRARY; T=0.K
angular distribution for (g,n*0) neutron

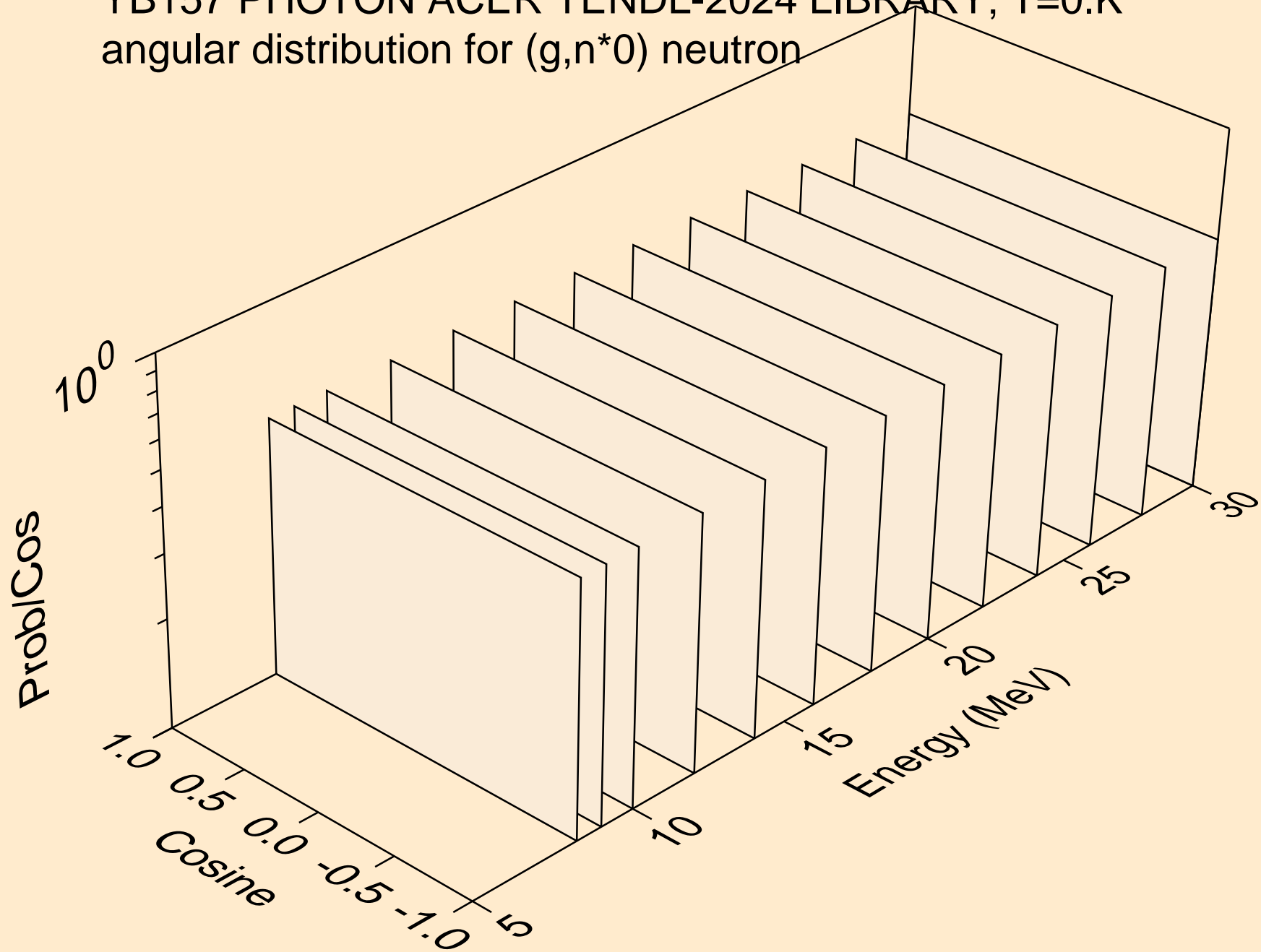

YB157 PHOTON ACER TENDL-2024 LIBRARY; T=0.K
angular distribution for (g,n*1) neutron

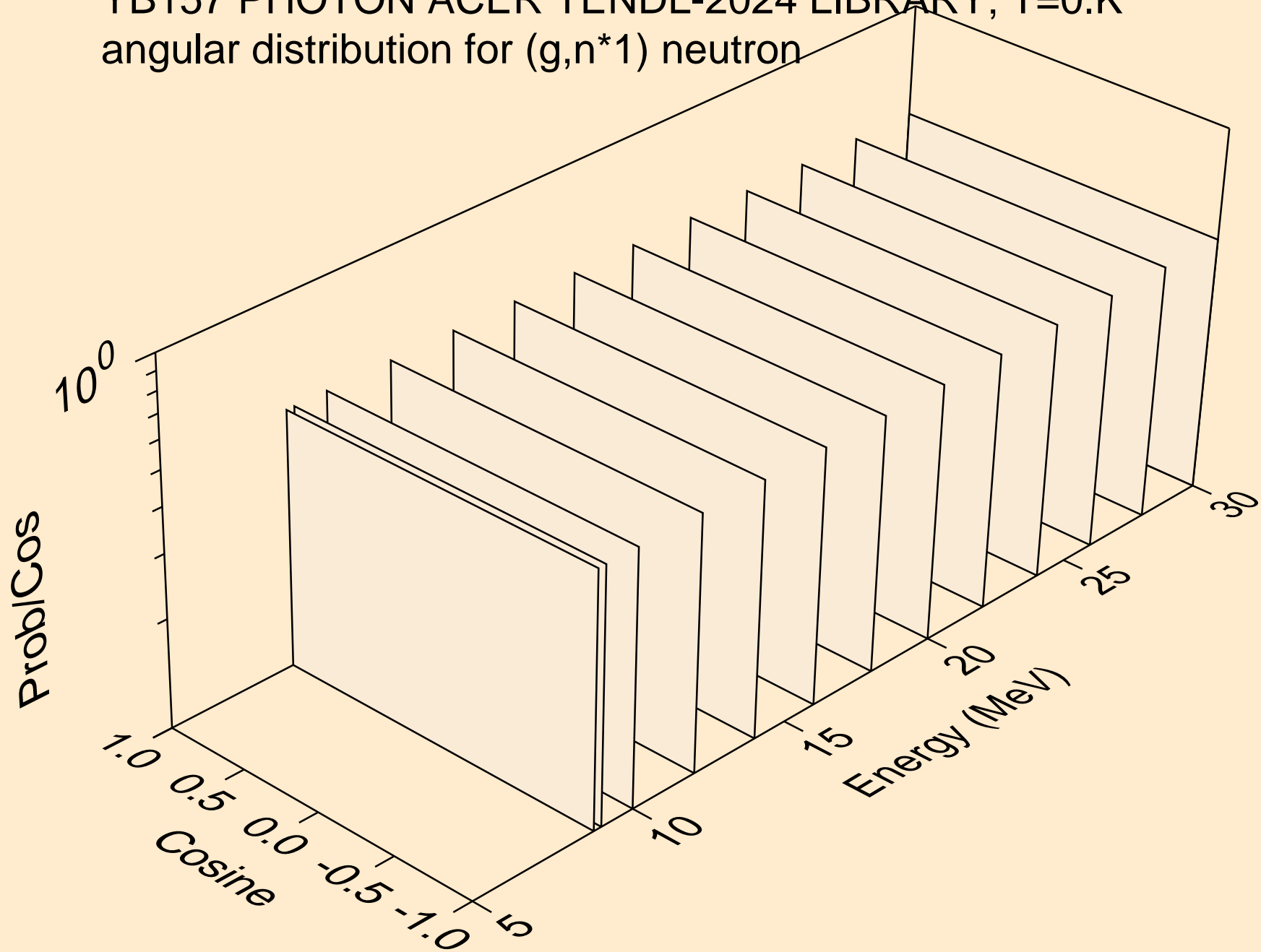

YB157 PHOTON ACER TENDL-2024 LIBRARY; T=0.K
neutrons from (g,n*c)

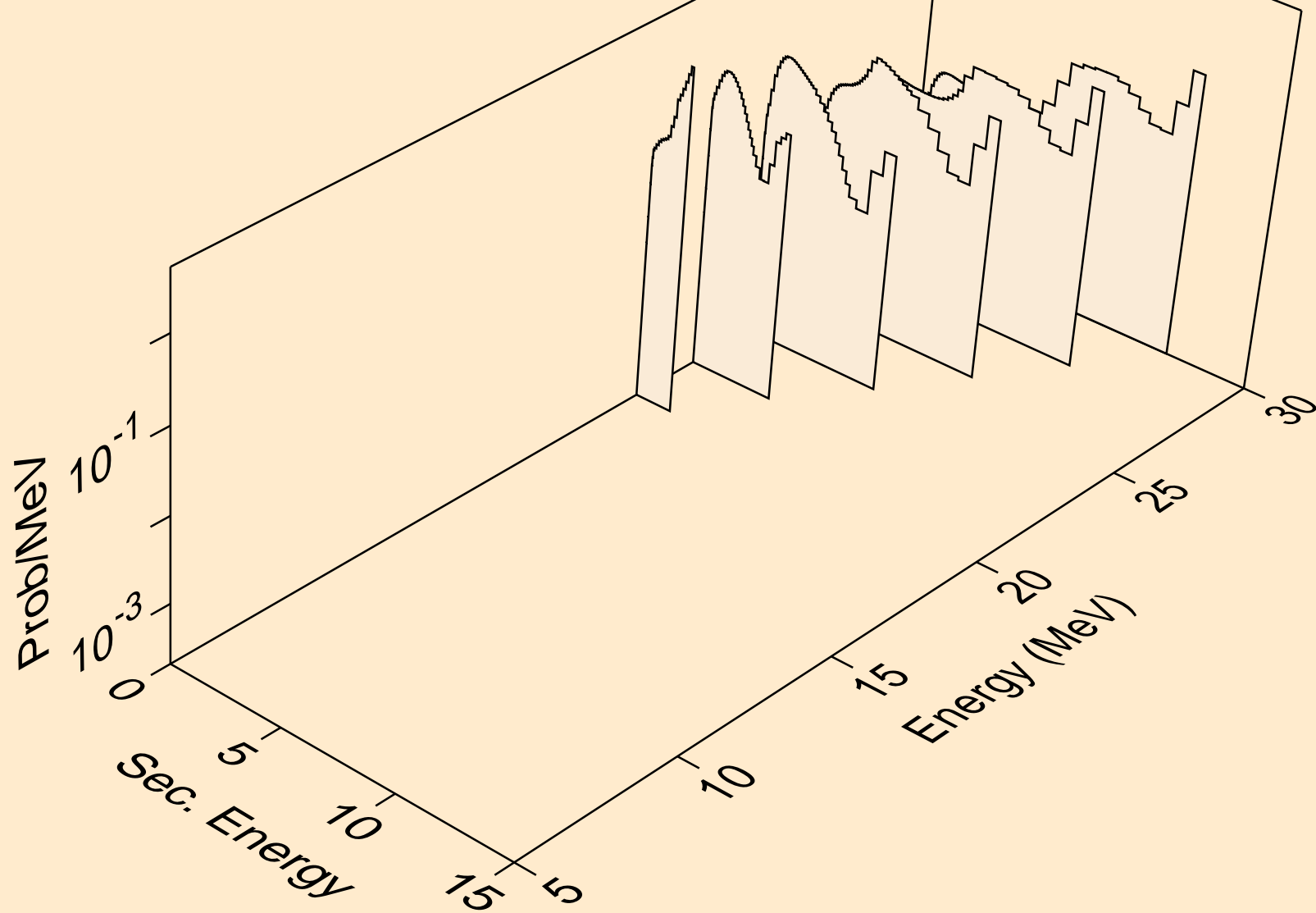

YB157 PHOTON ACER TENDL-2024 LIBRARY; T=0.K
photons from (g,x)

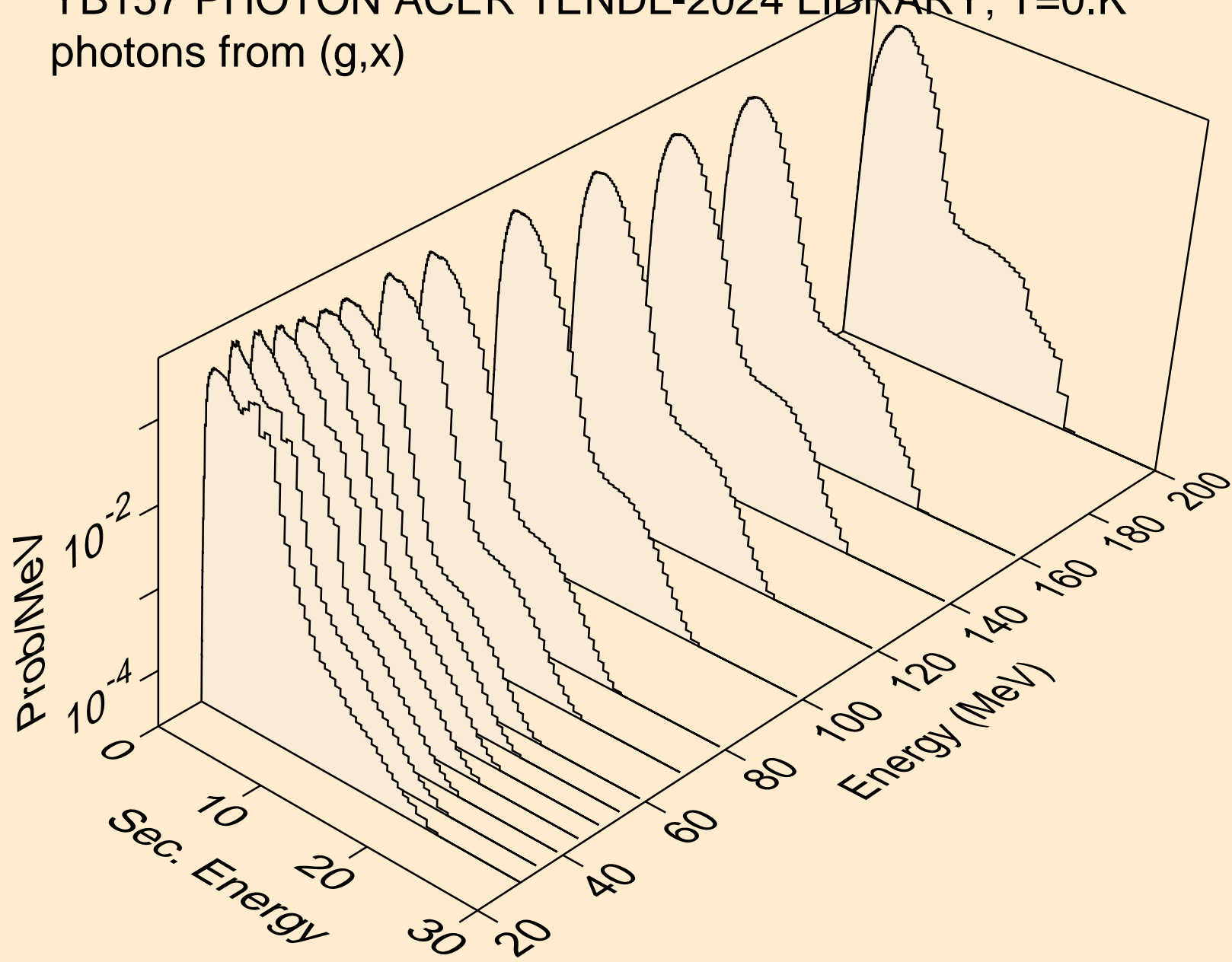

YB157 PHOTON ACER TENDL-2024 LIBRARY; T=0.K
photons from (g,2n)

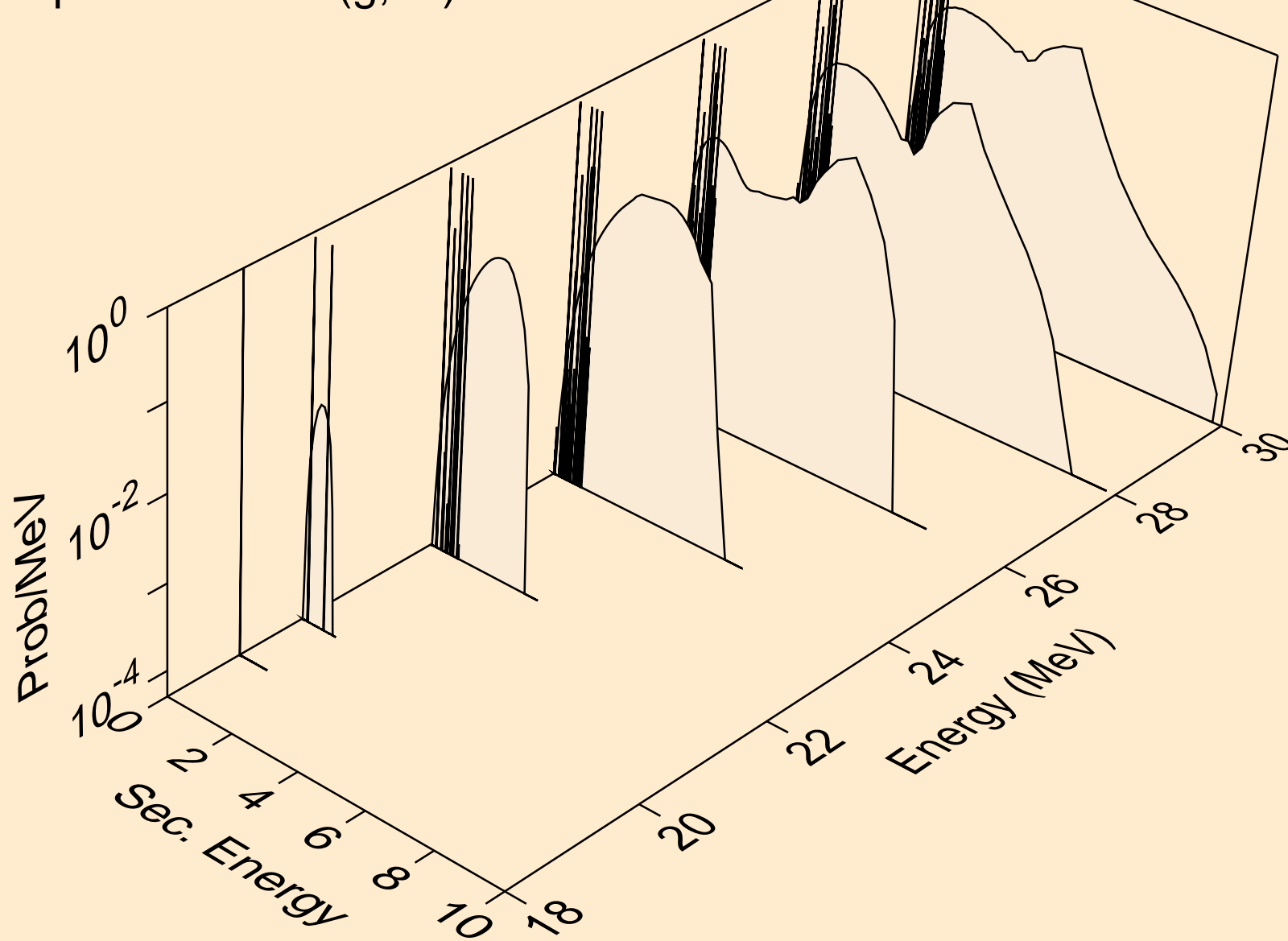

YB157 PHOTON ACER TENDL-2024 LIBRARY; T=0.K
photons from (g,3n)

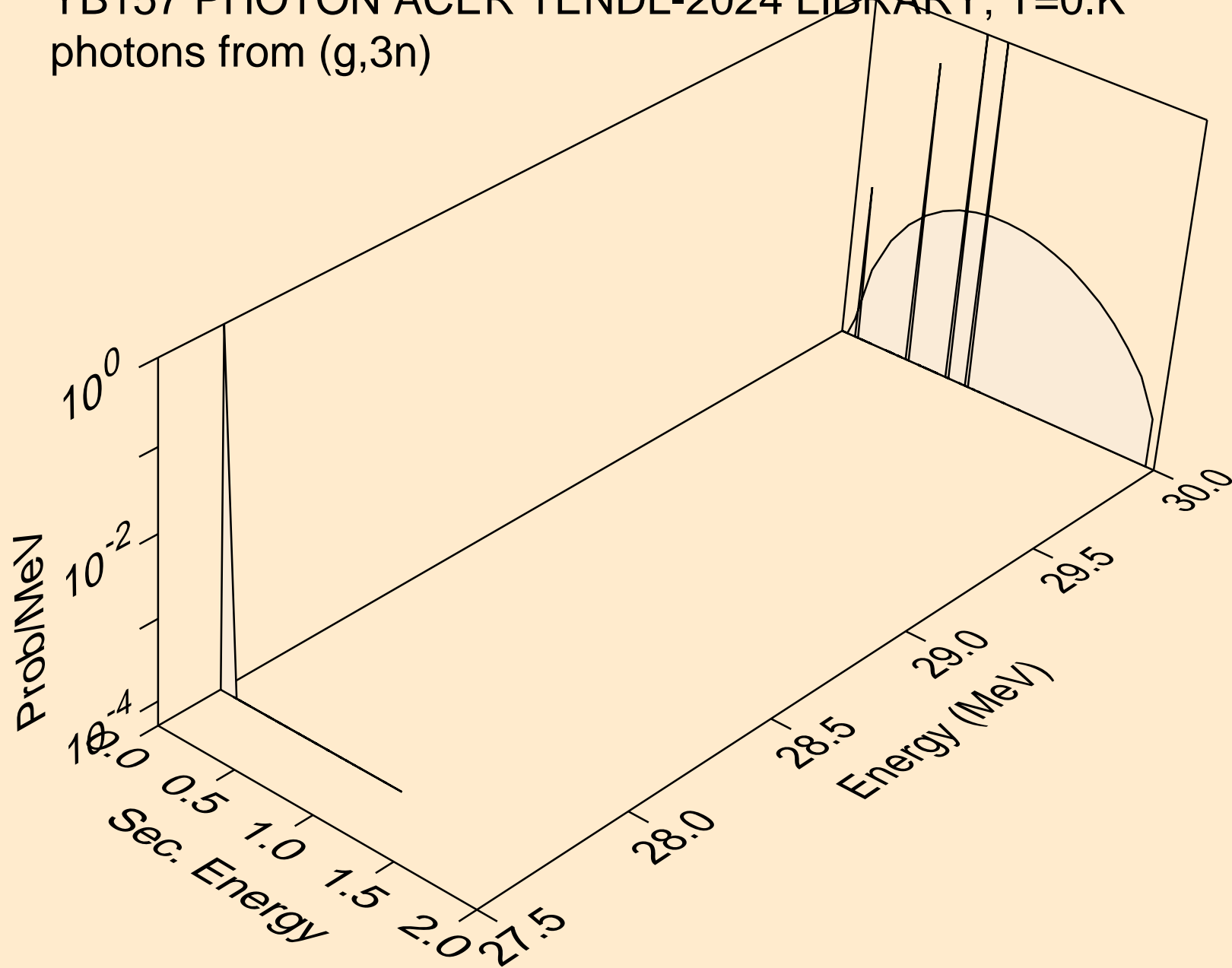

YB157 PHOTON ACER TENDL-2024 LIBRARY; T=0.K
photons from (g,n*)a

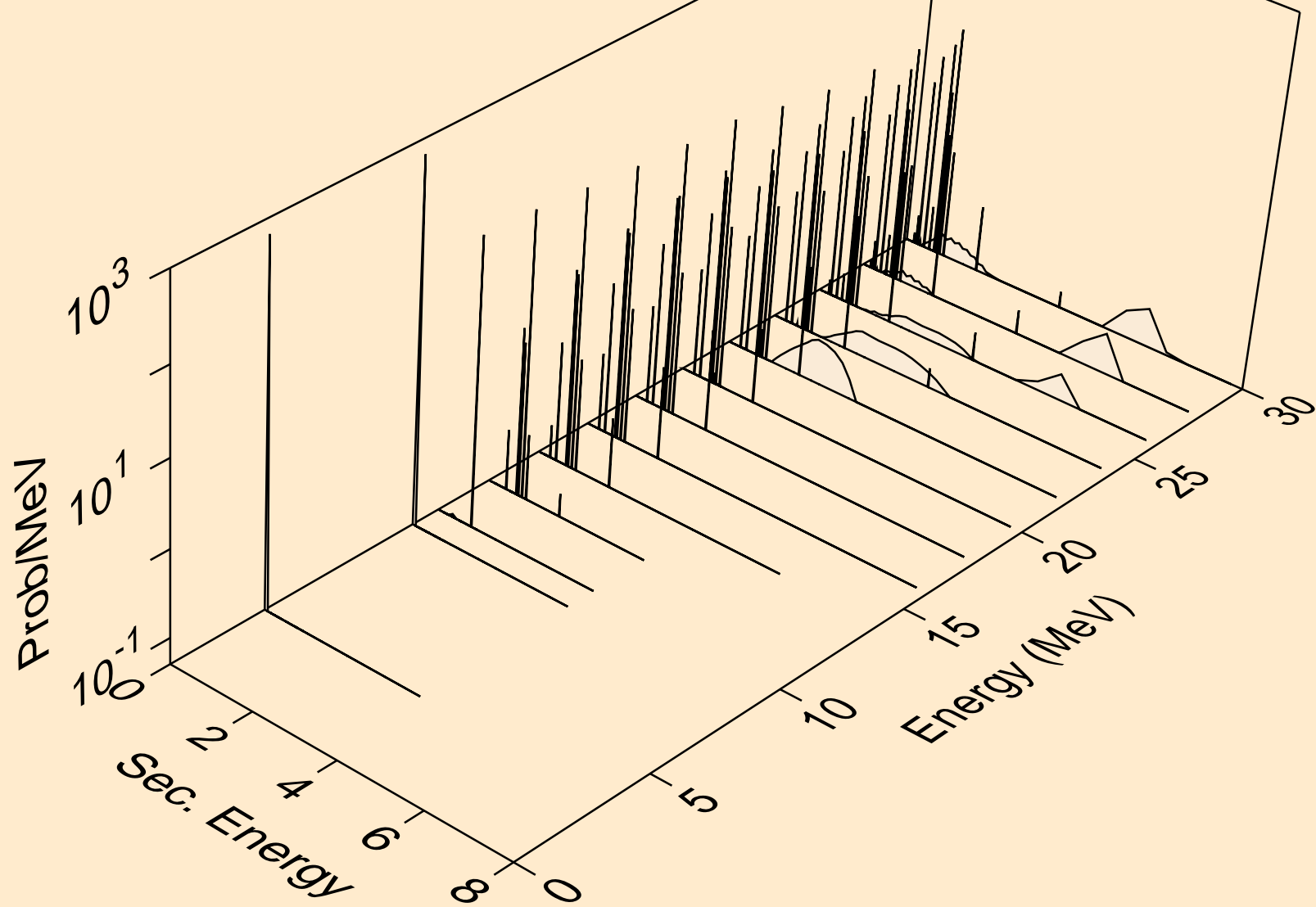

YB157 PHOTON ACER TENDL-2024 LIBRARY; T=0.K
photons from (g,2n)a

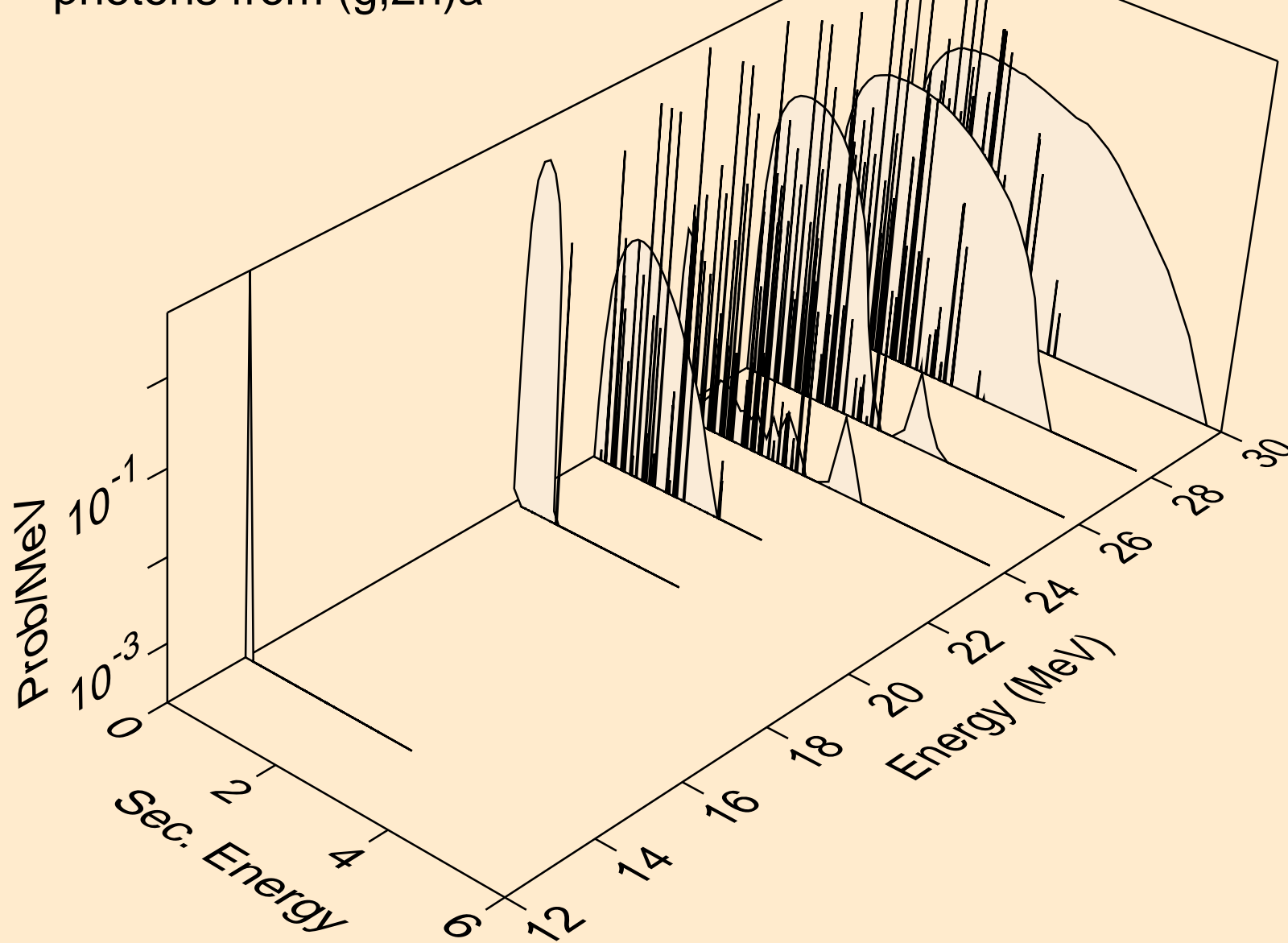

YB157 PHOTON ACER TENDL-2024 LIBRARY; T=0.K
photons from (g,n*)p

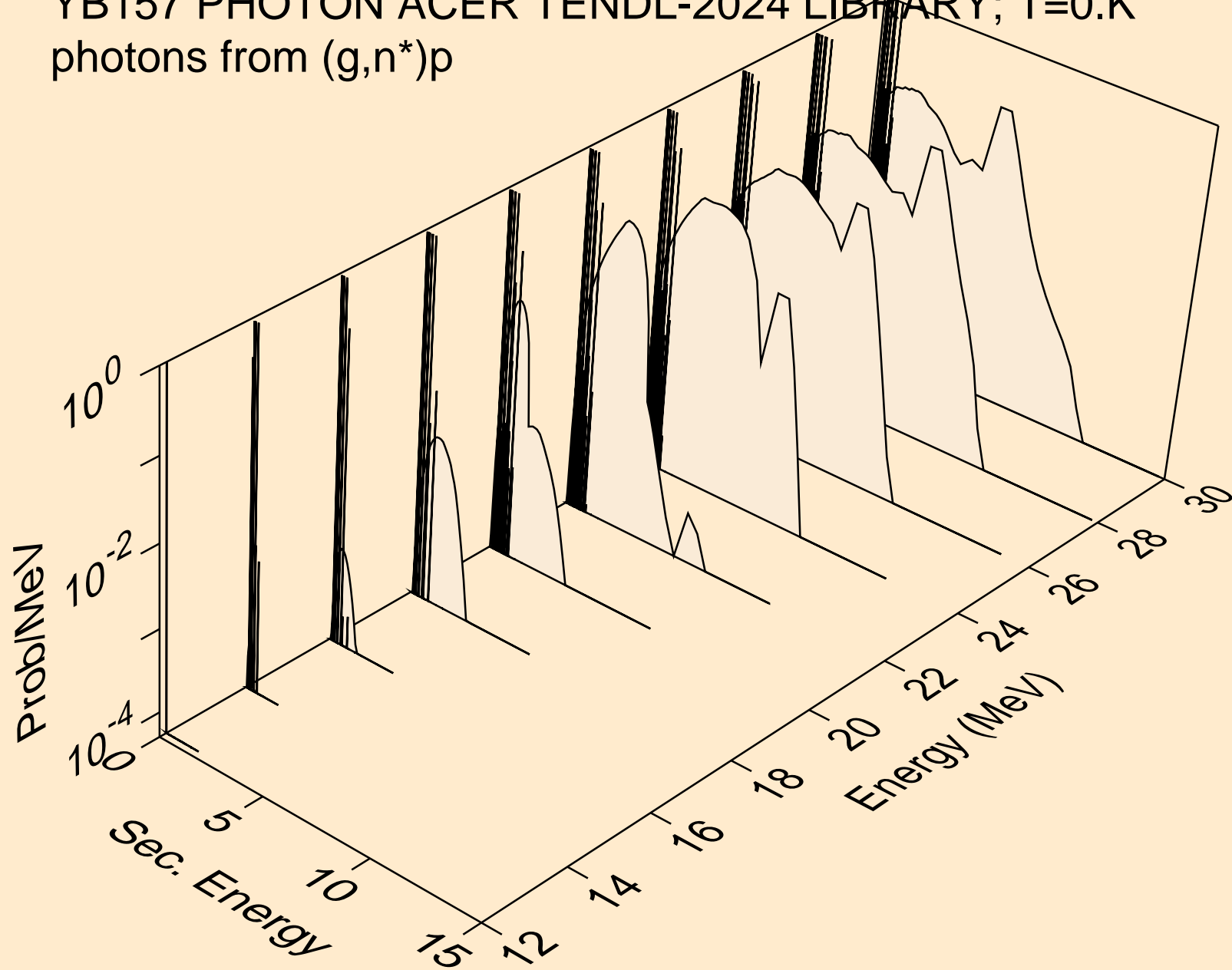

YB157 PHOTON ACER TENDL-2024 LIBRARY; T=0.K
photons from (g,n*)2a

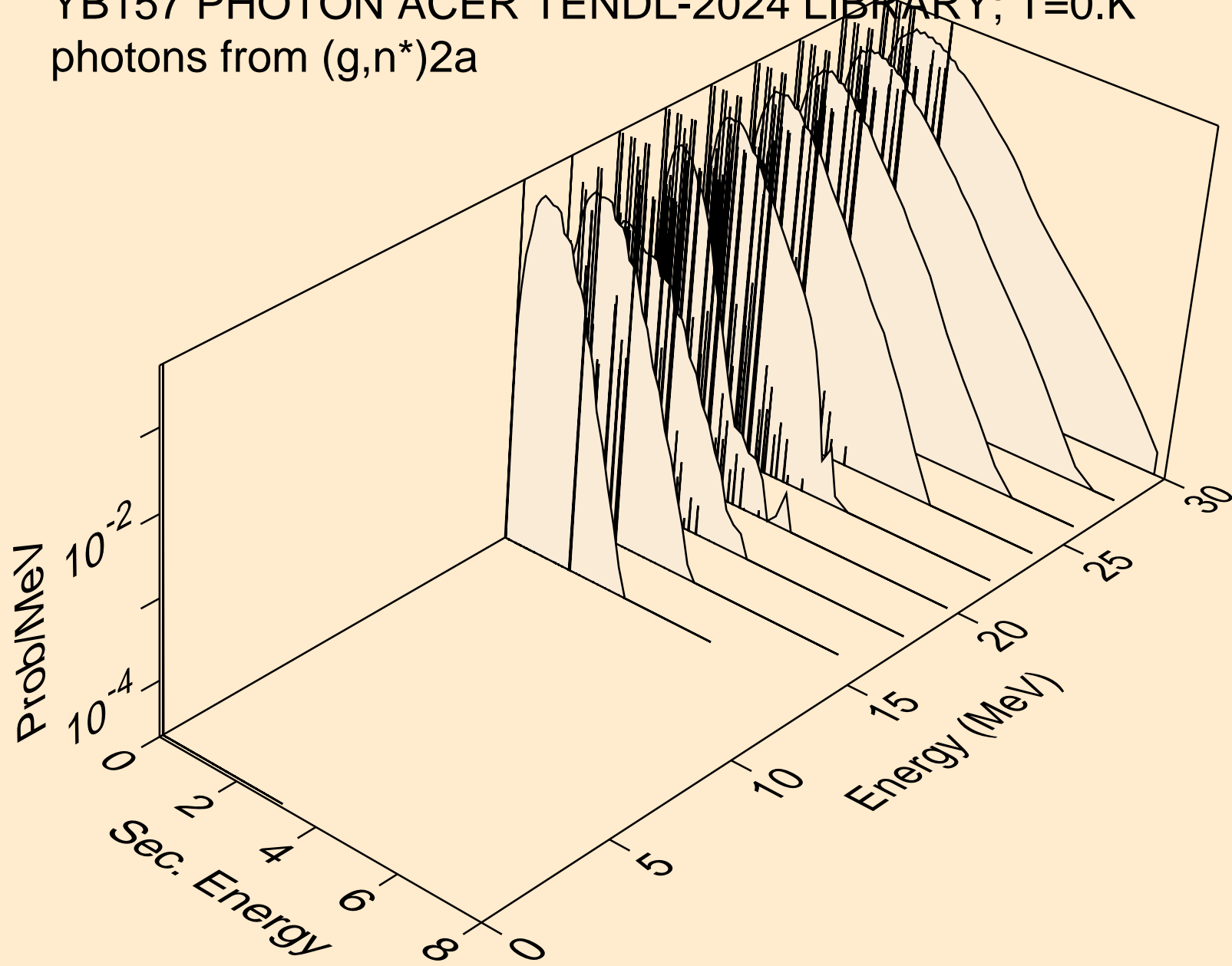

YB157 PHOTON ACER TENDL-2024 LIBRARY; T=0.K
photons from (g,n*)d

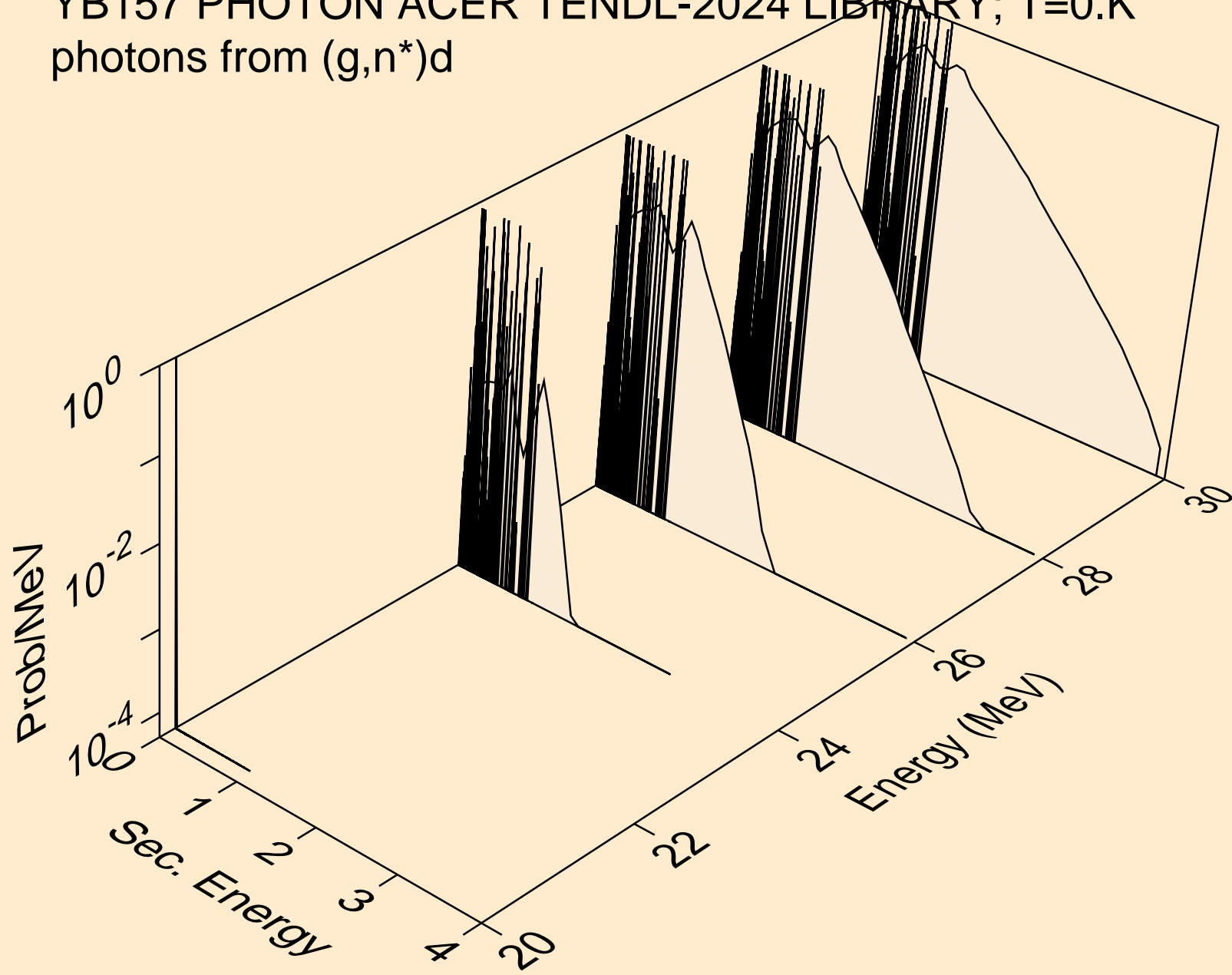

YB157 PHOTON ACER TENDL-2024 LIBRARY; T=0.K
photons from (g,n*)t

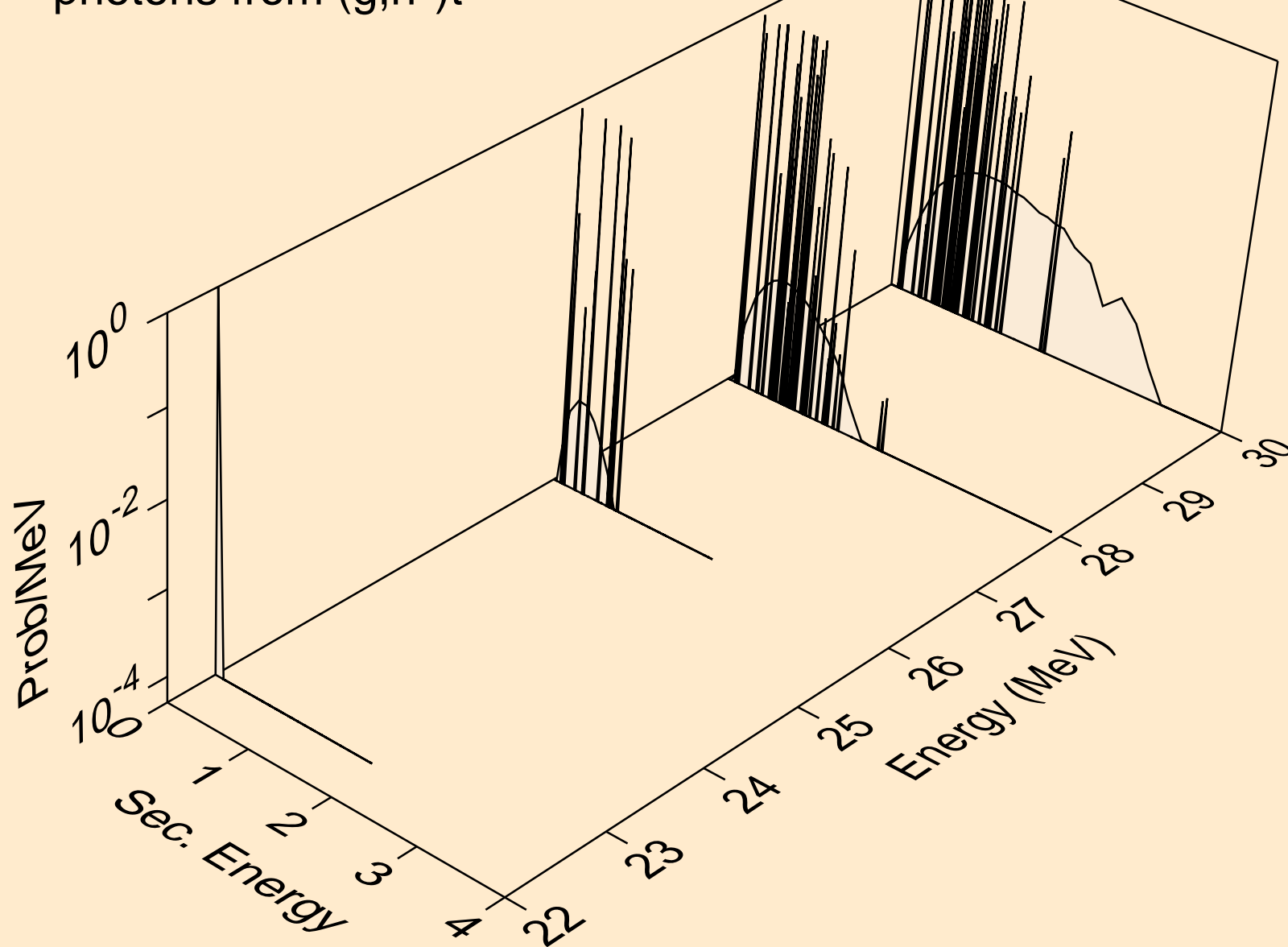

YB157 PHOTON ACER TENDL-2024 LIBRARY; T=0.K
photons from (g,n*)he3

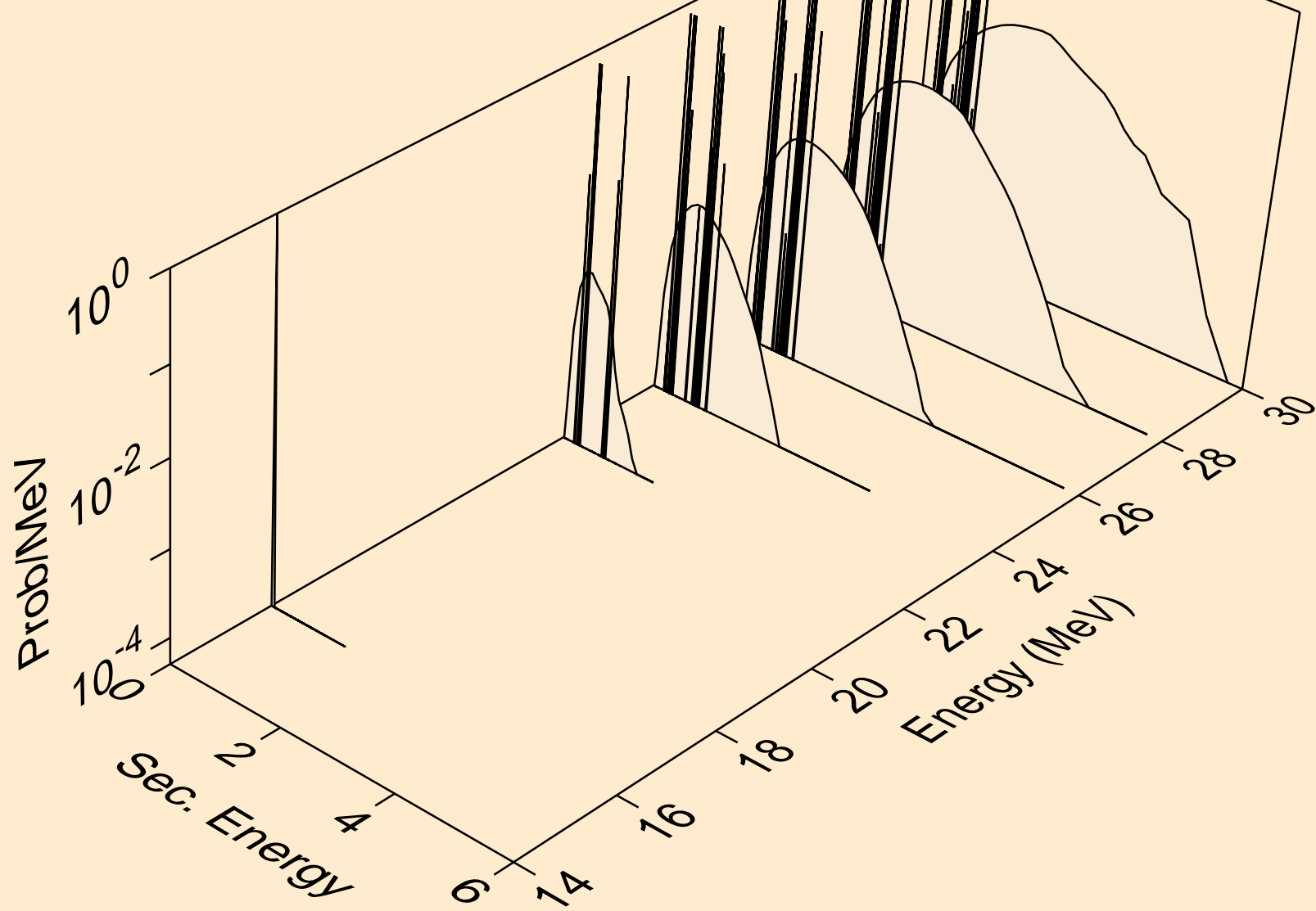

YB157 PHOTON ACER TENDL-2024 LIBRARY; T=0.K
photons from (g,2np)

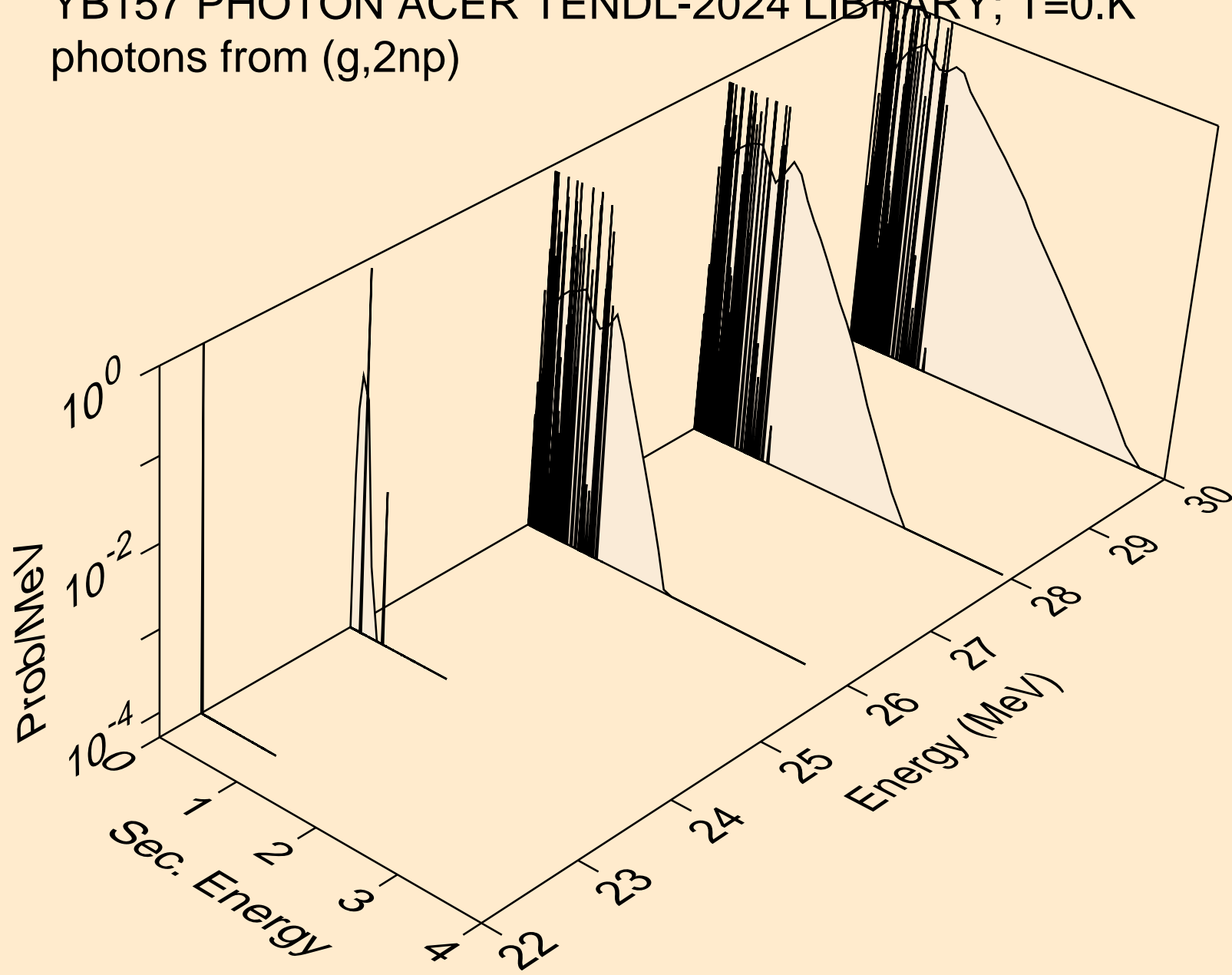

YB157 PHOTON ACER TENDL-2024 LIBRARY; T=0.K
photons from (g,n2p)

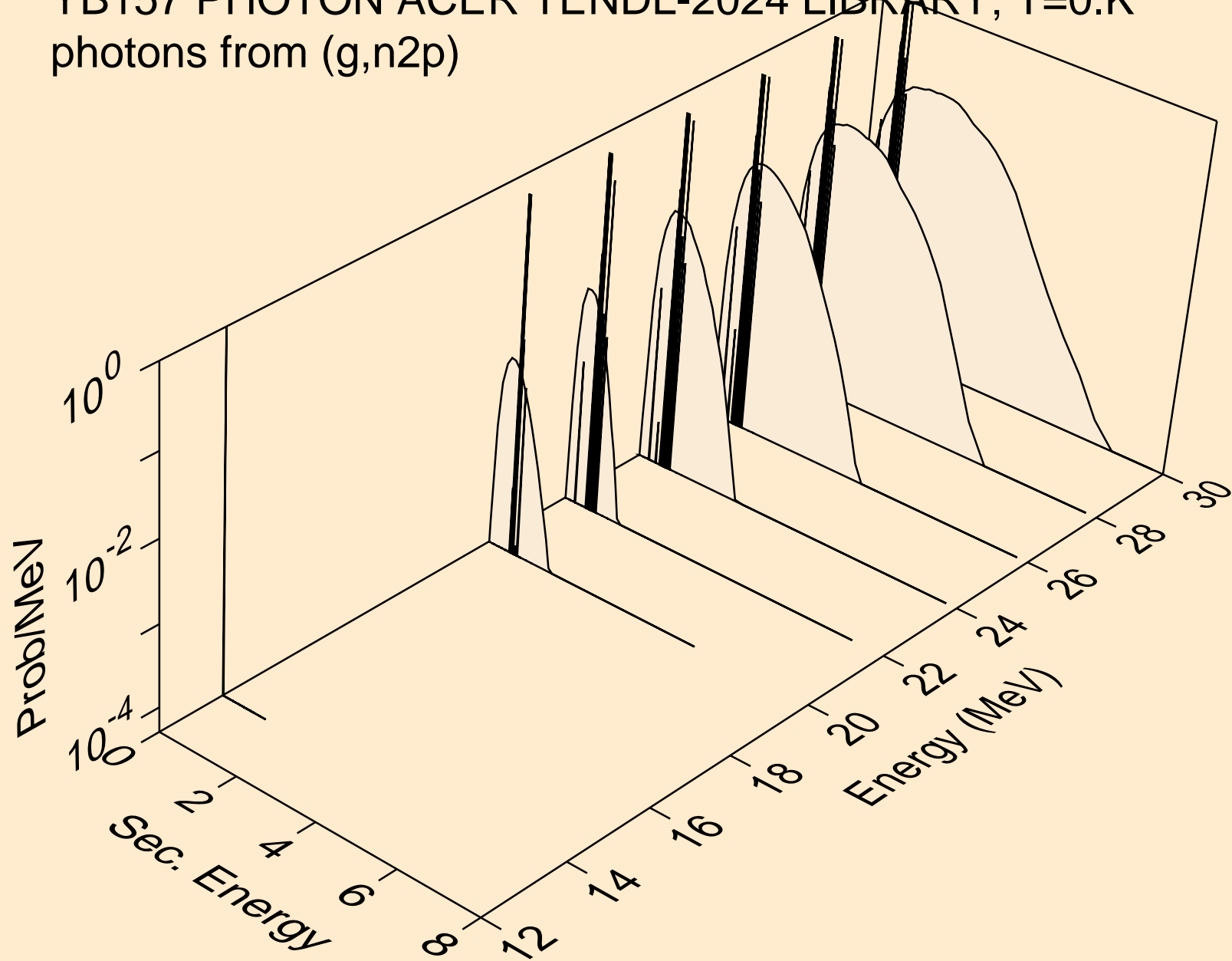

YB157 PHOTON ACER TENDL-2024 LIBRARY; T=0.K
photons from (g,npa)

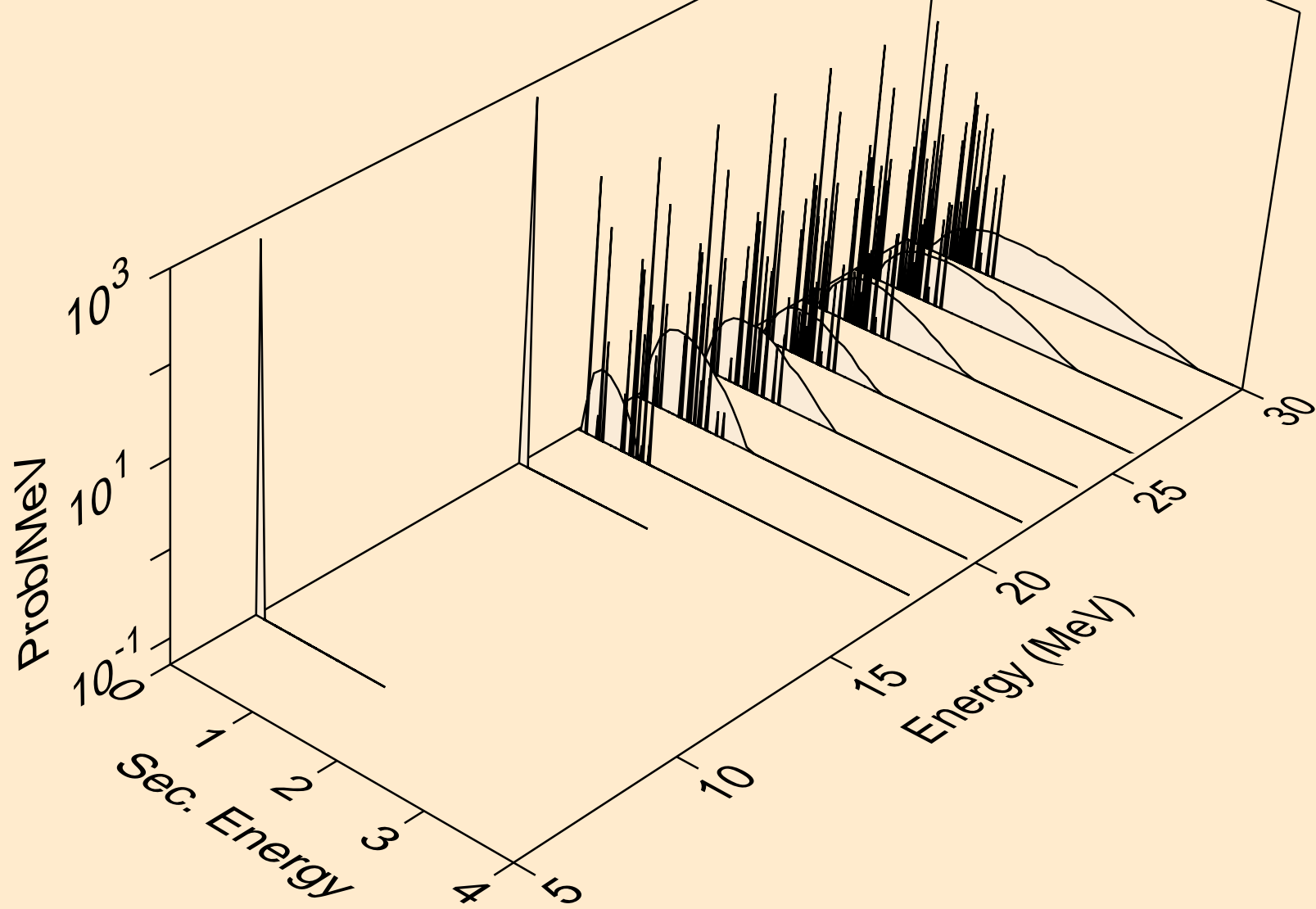

YB157 PHOTON ACER TENDL-2024 LIBRARY; T=0.K
photons from (g,n*c)

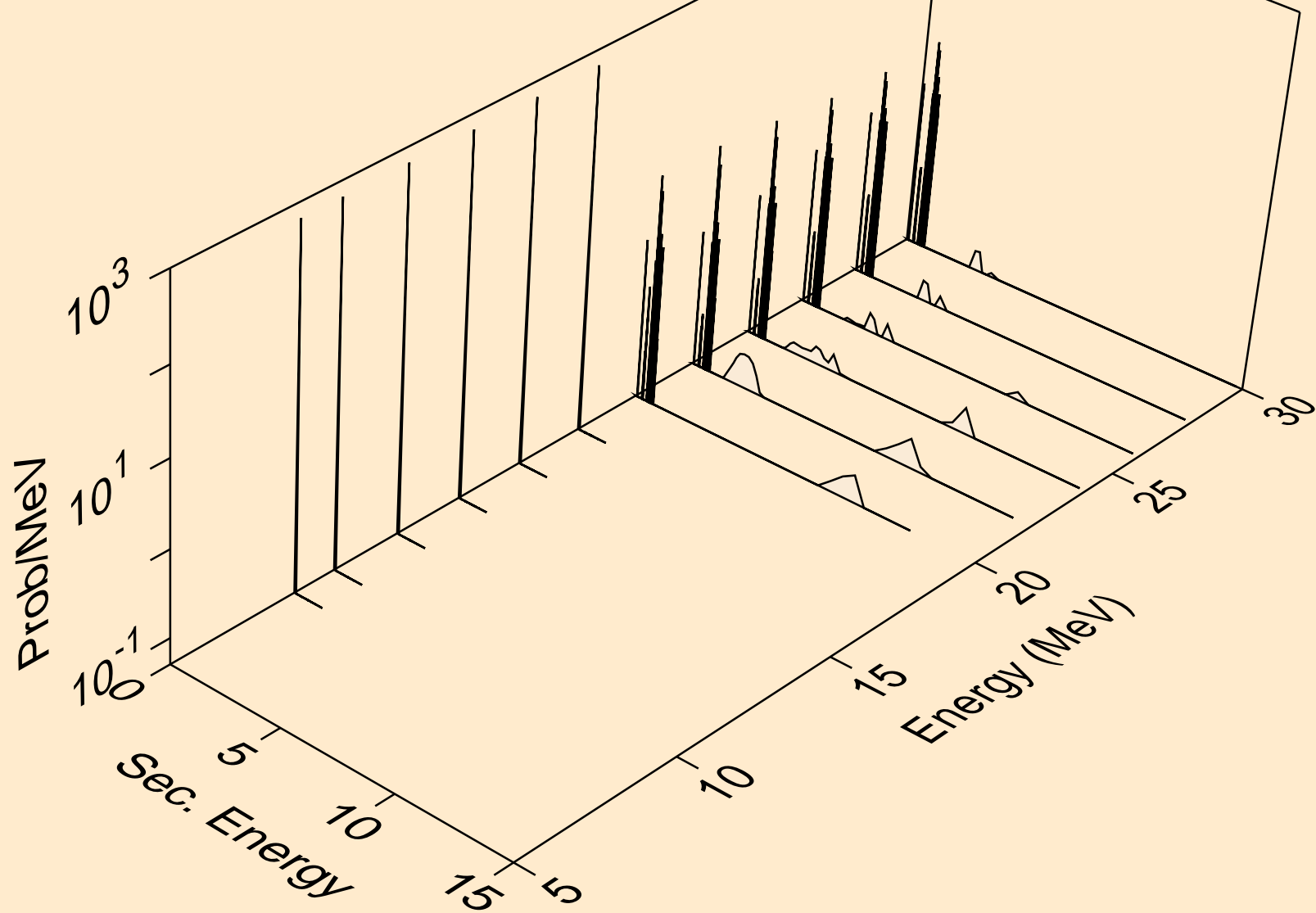

YB157 PHOTON ACER TENDL-2024 LIBRARY; T=0.K
photons from (g,gma)

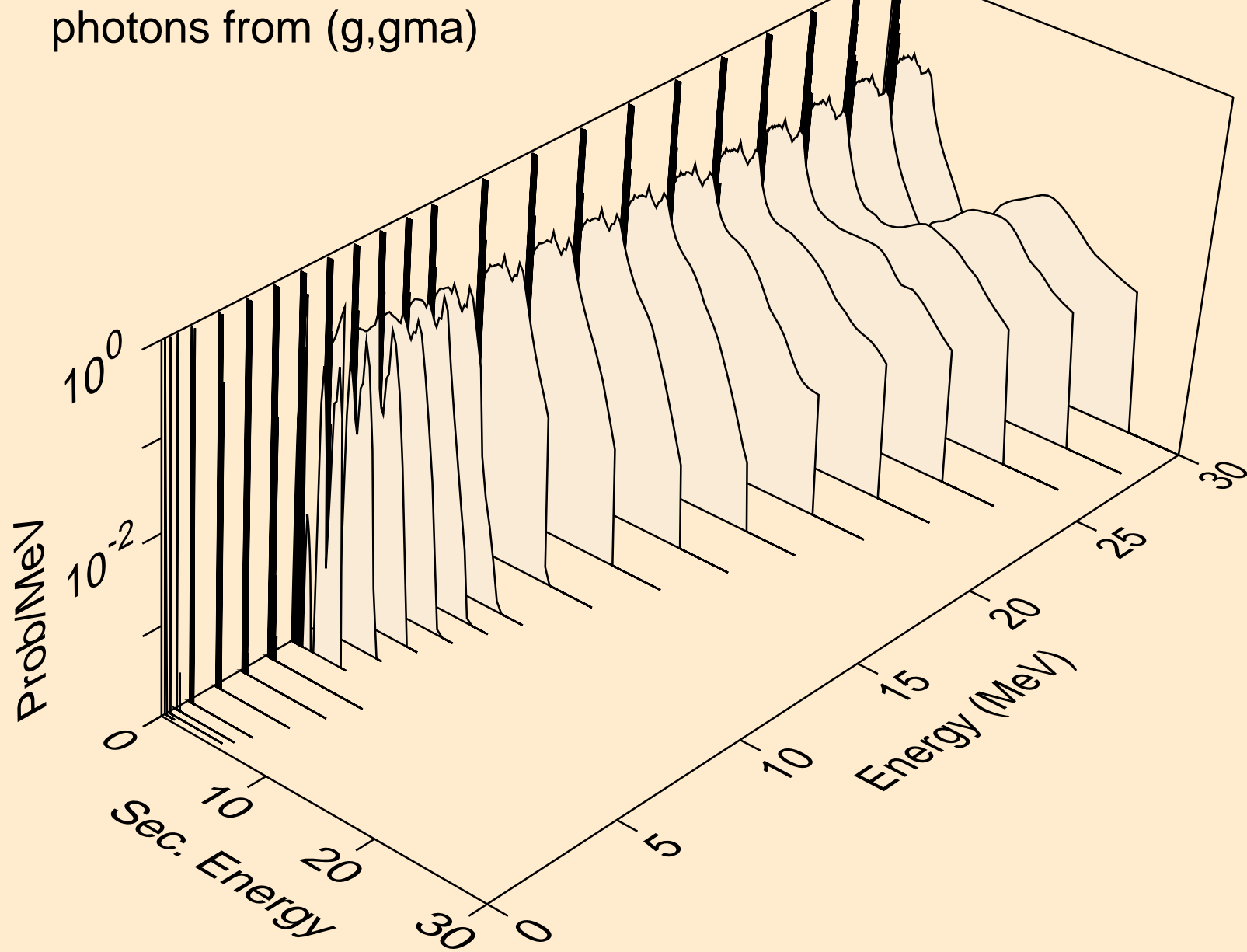

YB157 PHOTON ACER TENDL-2024 LIBRARY; T=0.K
photons from (g,p)

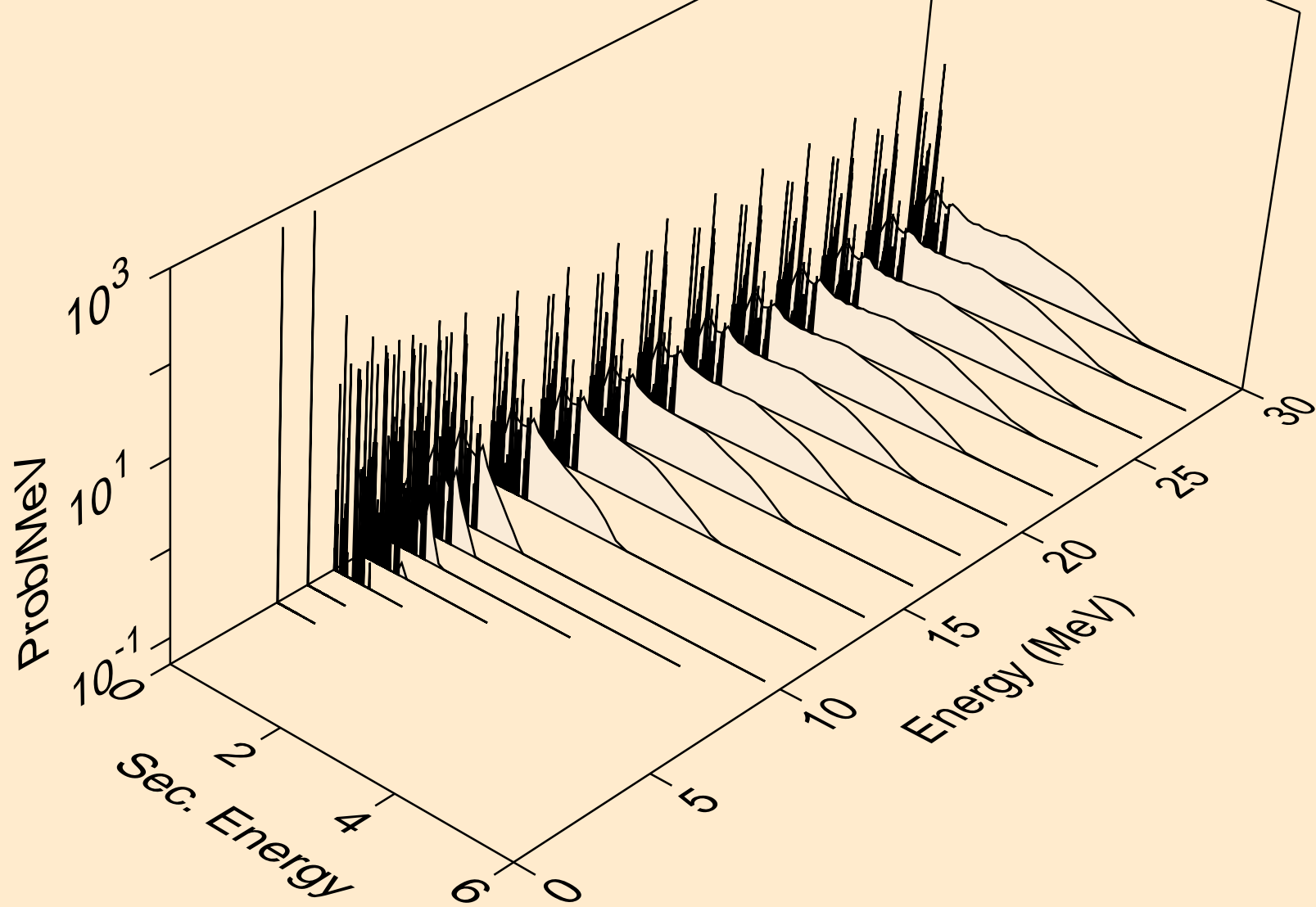

YB157 PHOTON ACER TENDL-2024 LIBRARY; T=0.K
photons from (g,d)

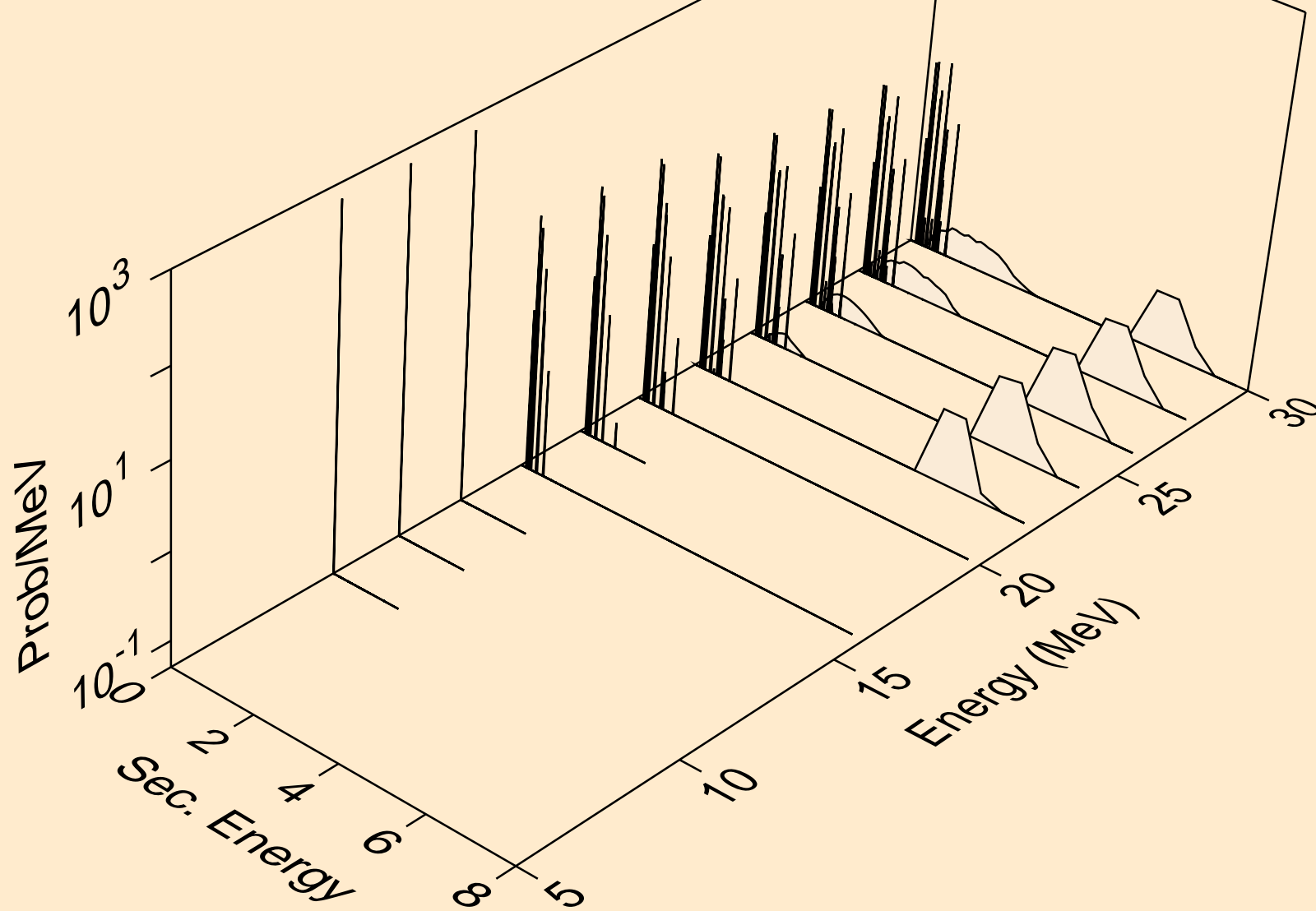

YB157 PHOTON ACER TENDL-2024 LIBRARY; T=0.K
photons from (g,t)

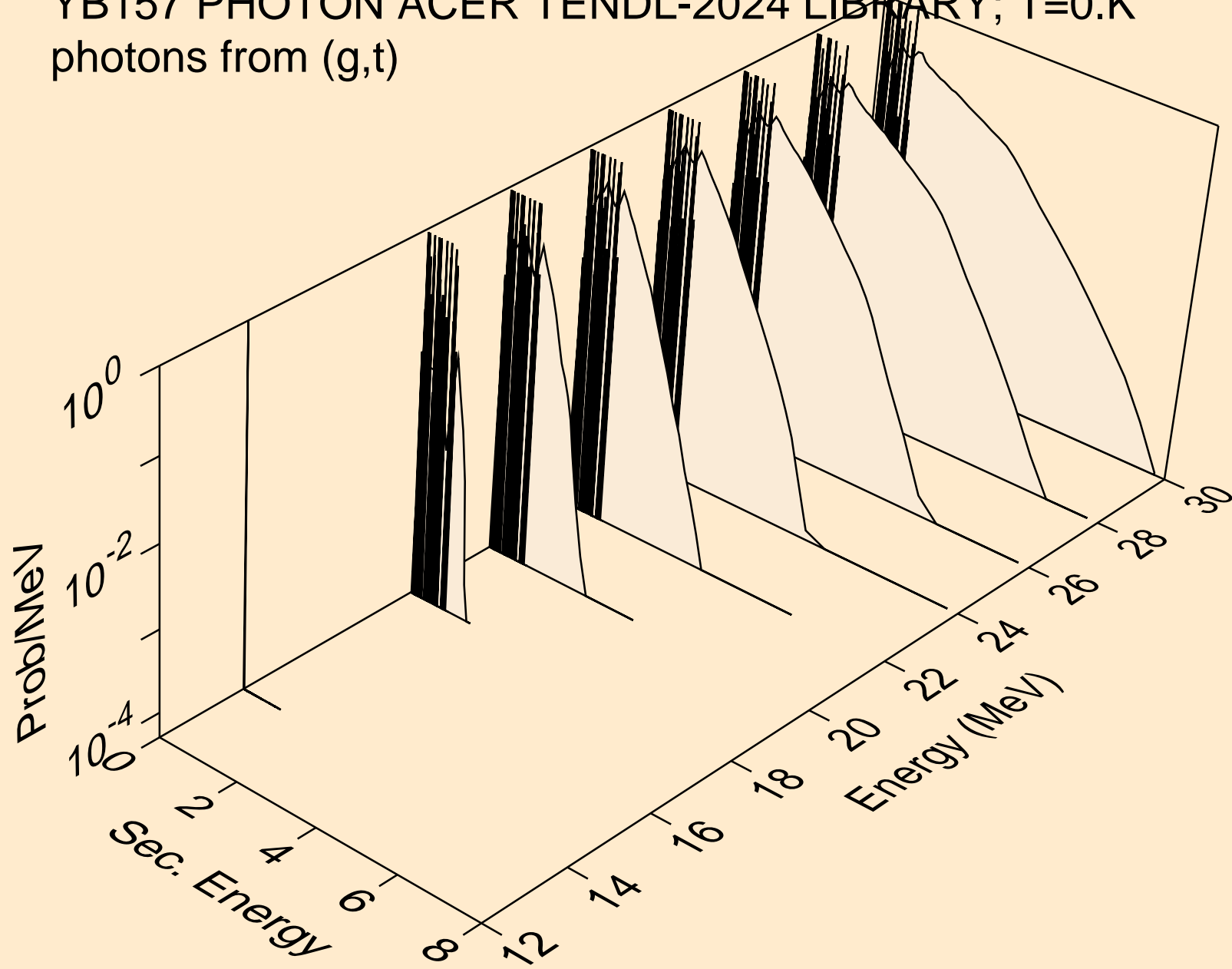

YB157 PHOTON ACER TENDL-2024 LIBRARY; T=0.K
photons from (g,he3)

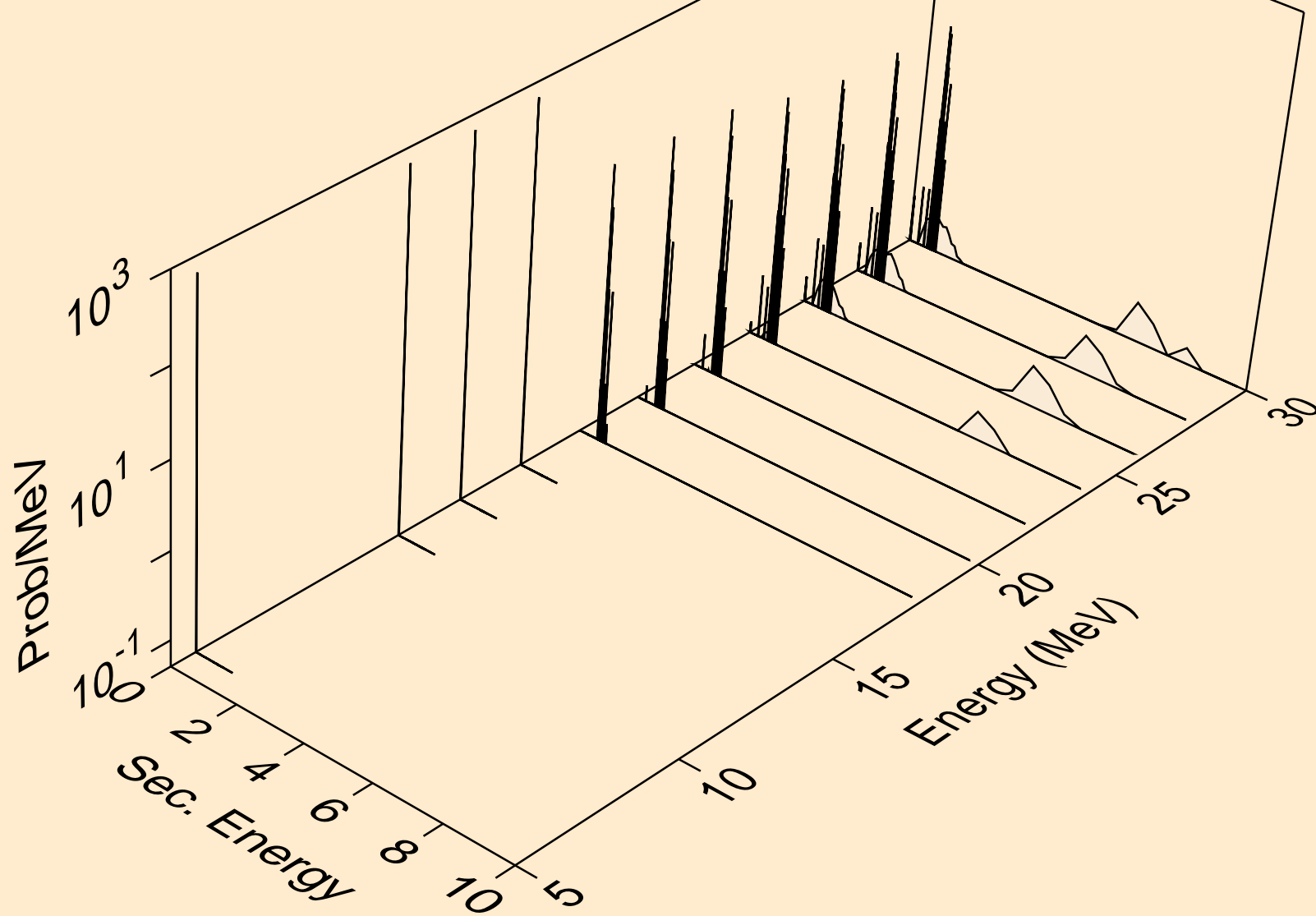

YB157 PHOTON ACER TENDL-2024 LIBRARY; T=0.K
photons from (g,a)

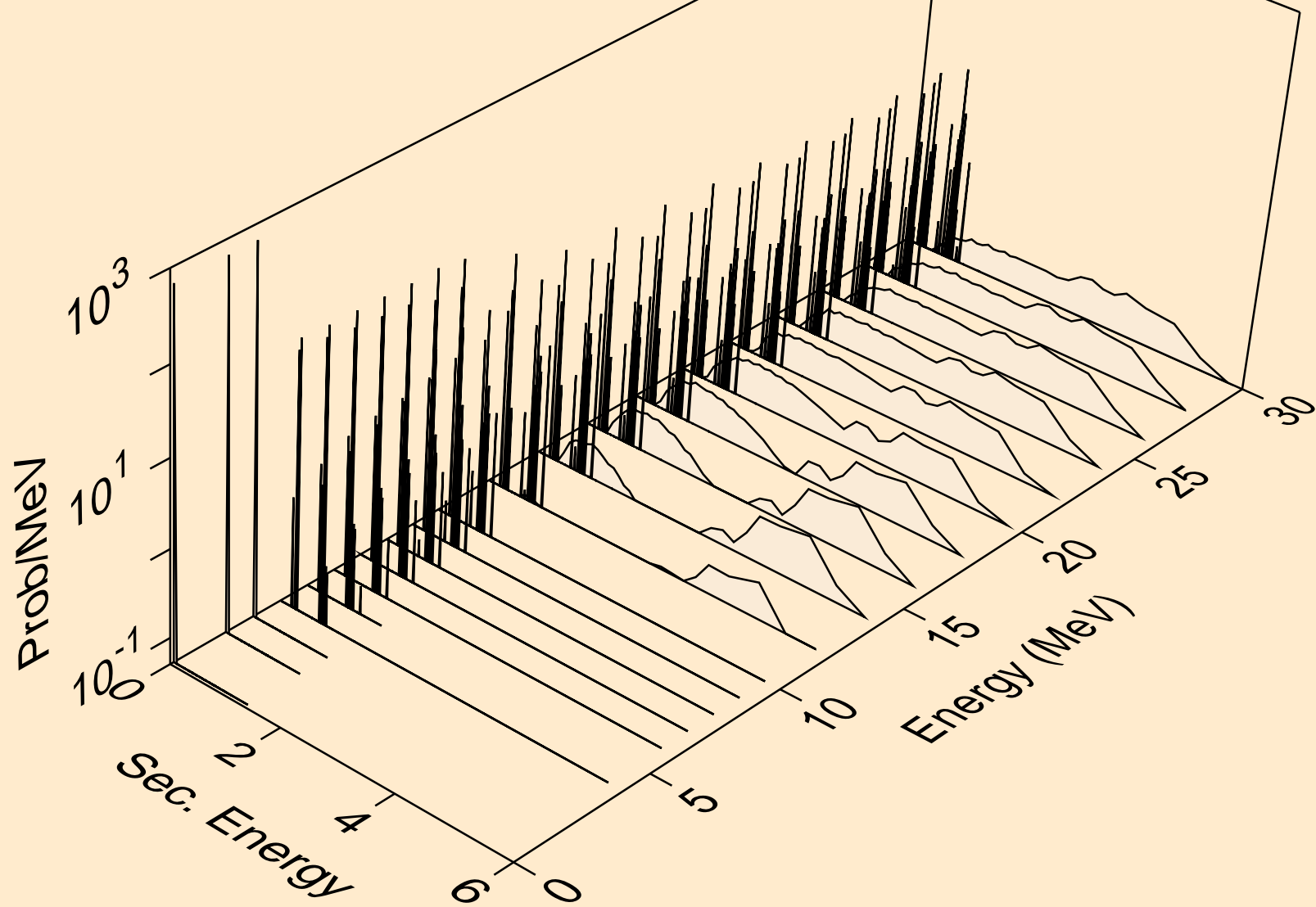

YB157 PHOTON ACER TENDL-2024 LIBRARY; T=0.K
photons from (g,2a)

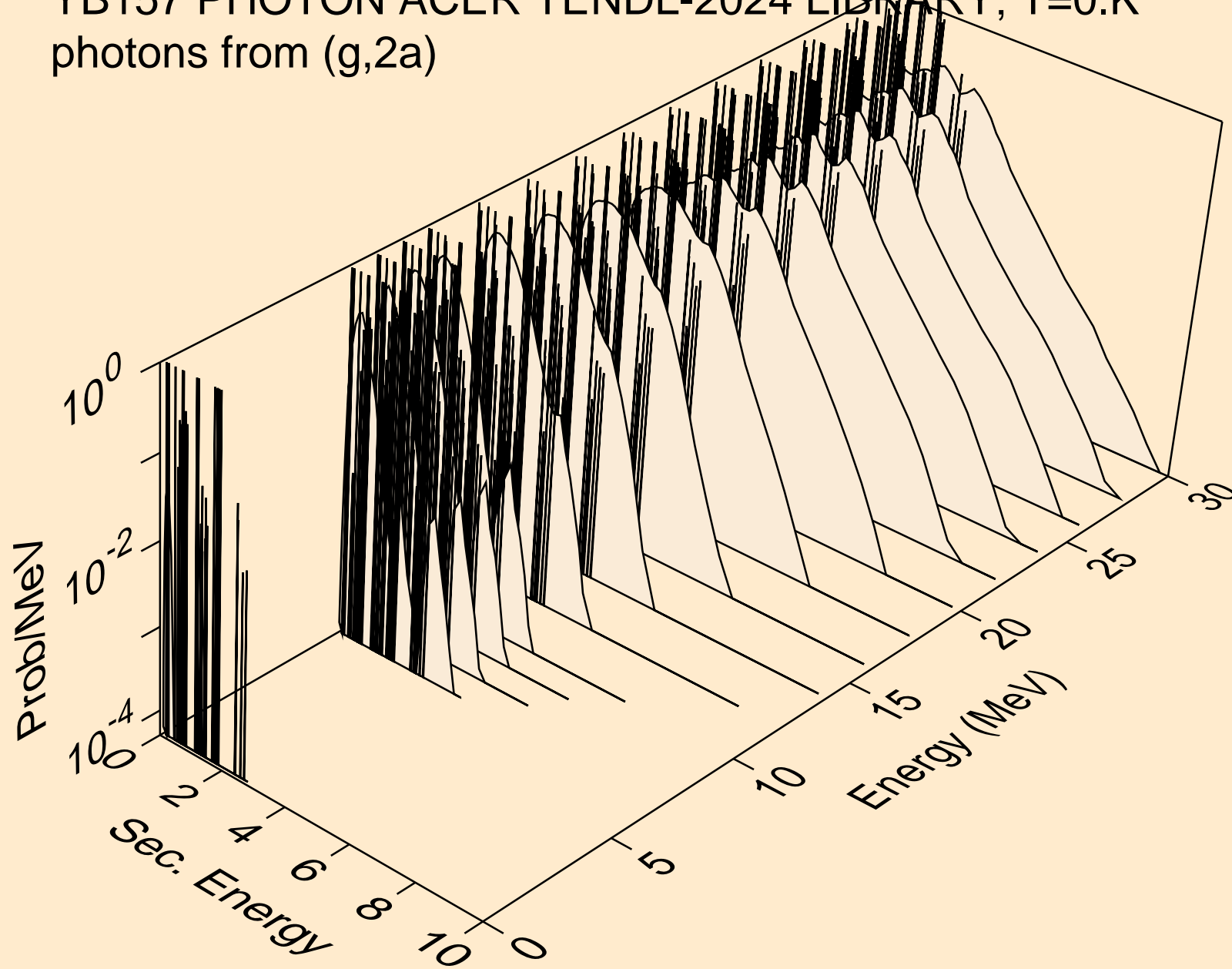

YB157 PHOTON ACER TENDL-2024 LIBRARY; T=0.K
photons from (g,2p)

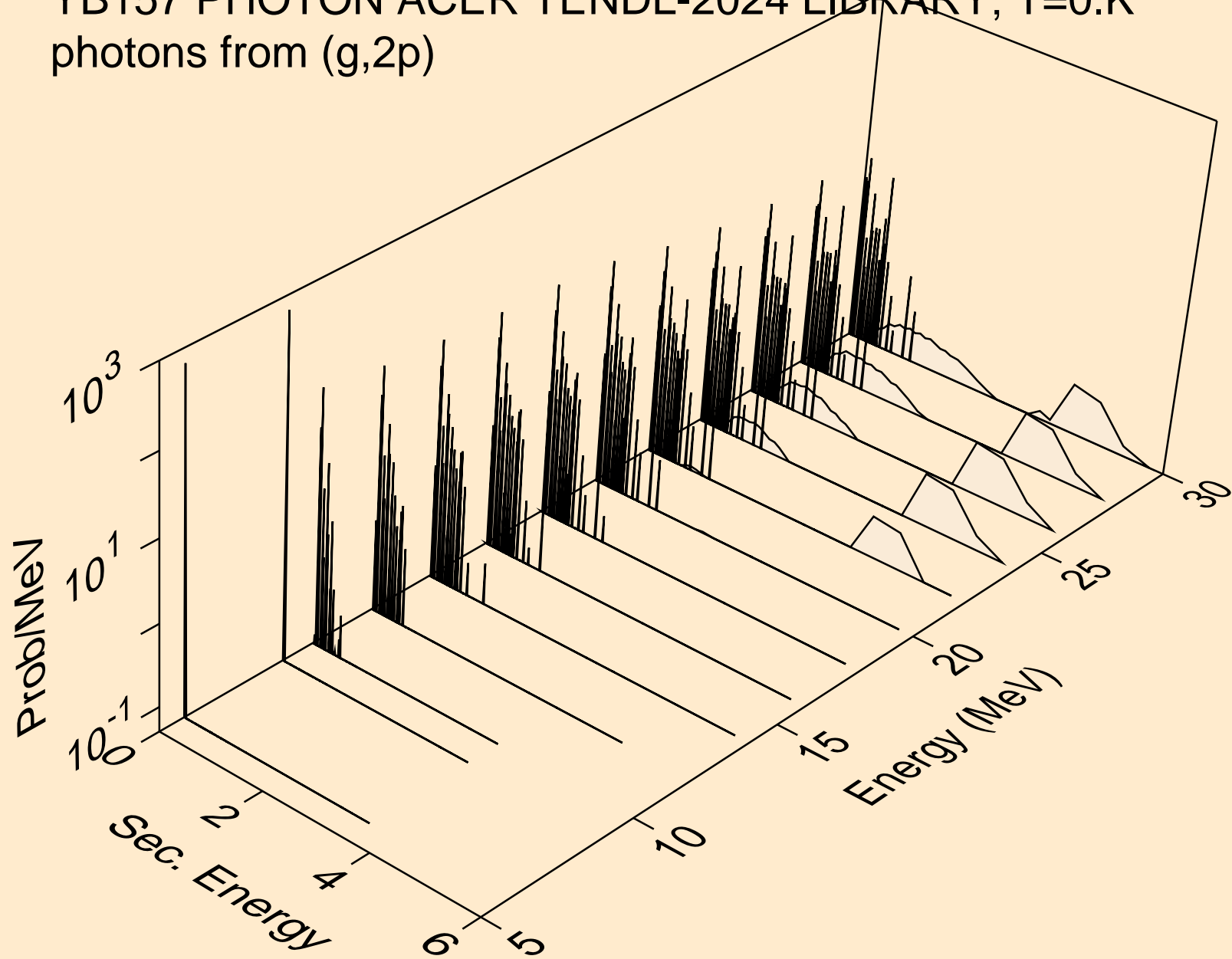

YB157 PHOTON ACER TENDL-2024 LIBRARY; T=0.K
photons from (g,pa)

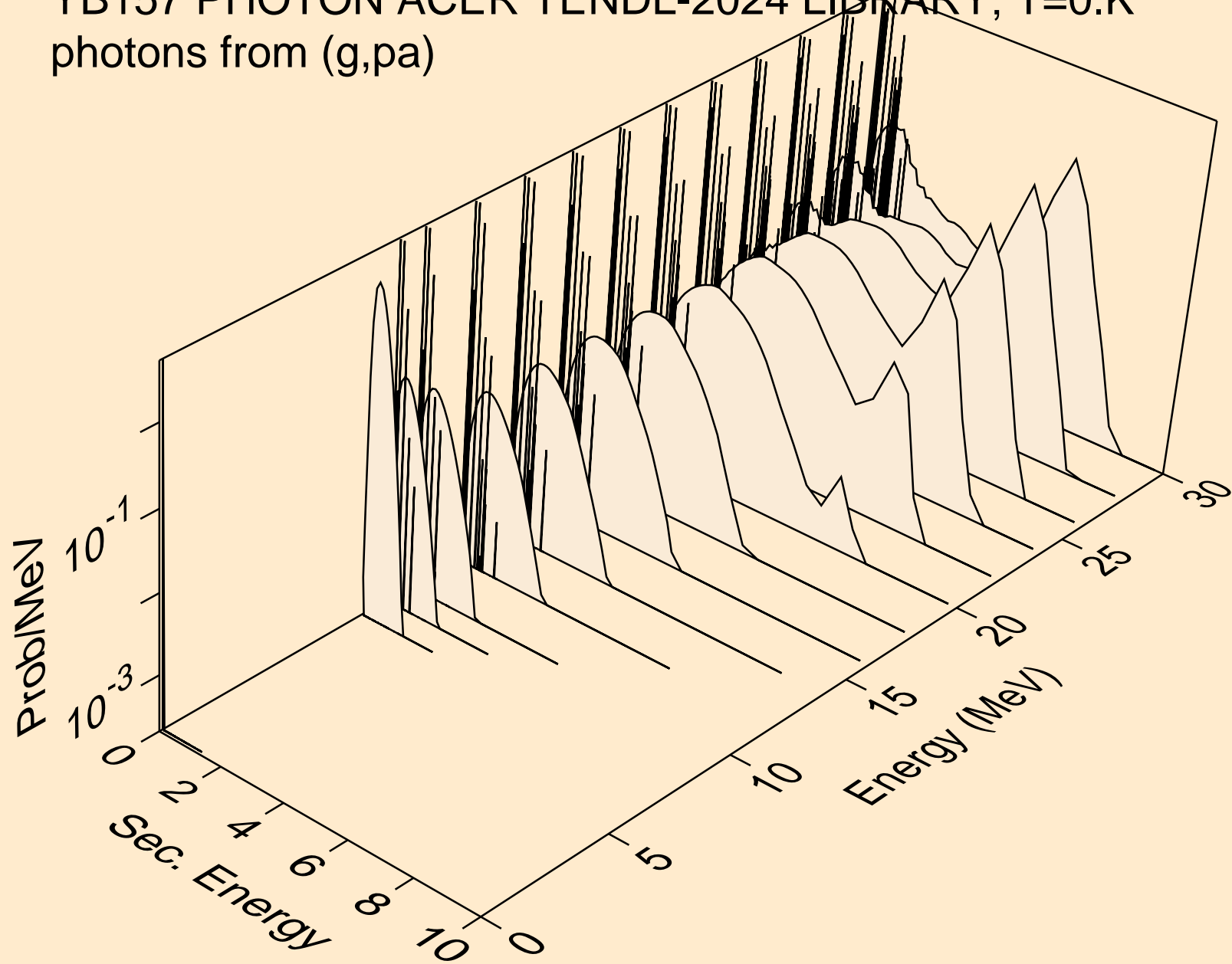

YB157 PHOTON ACER TENDL-2024 LIBRARY; T=0.K
photons from (g,pd)

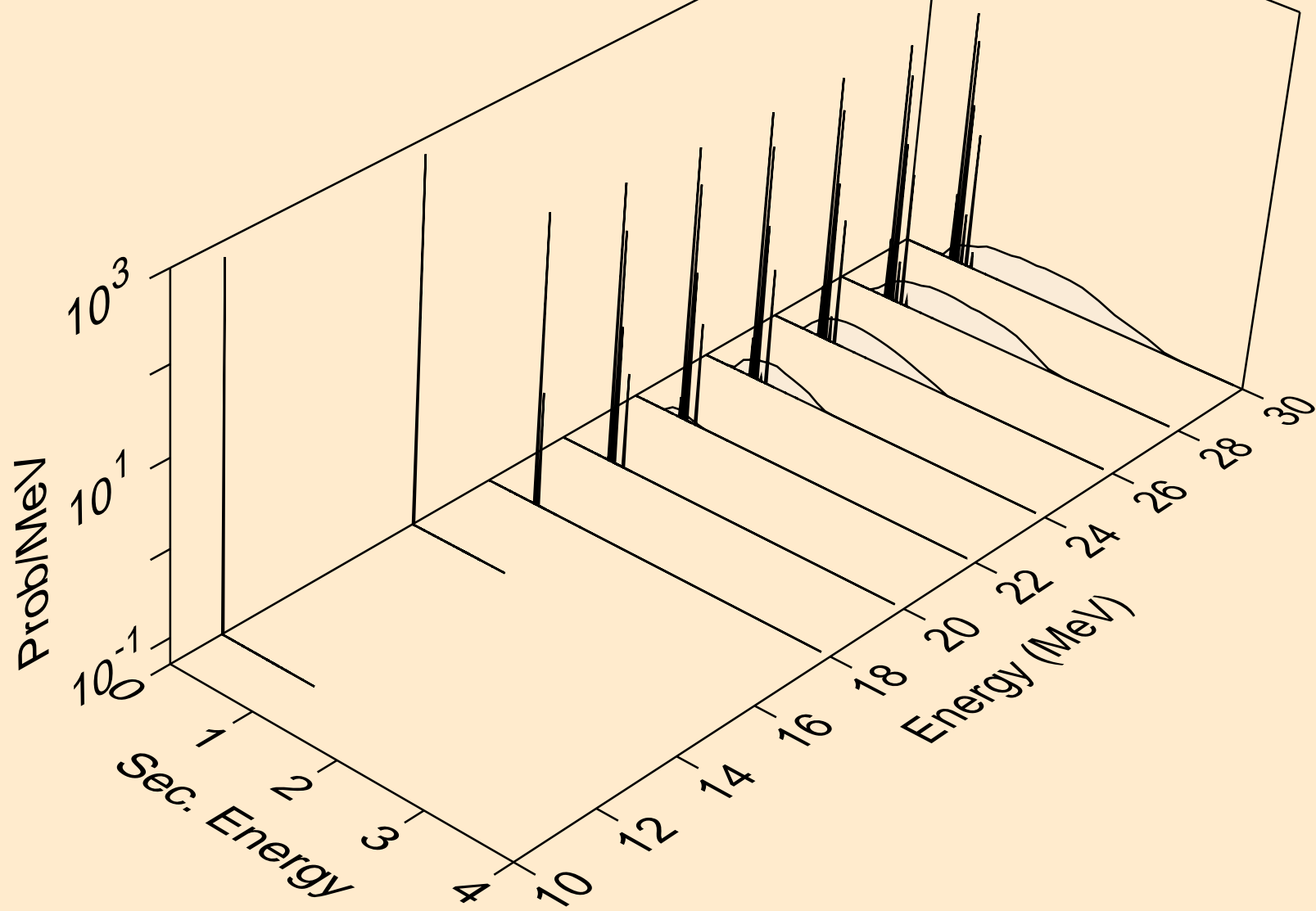

YB157 PHOTON ACER TENDL-2024 LIBRARY; T=0.K
photons from (g,pt)

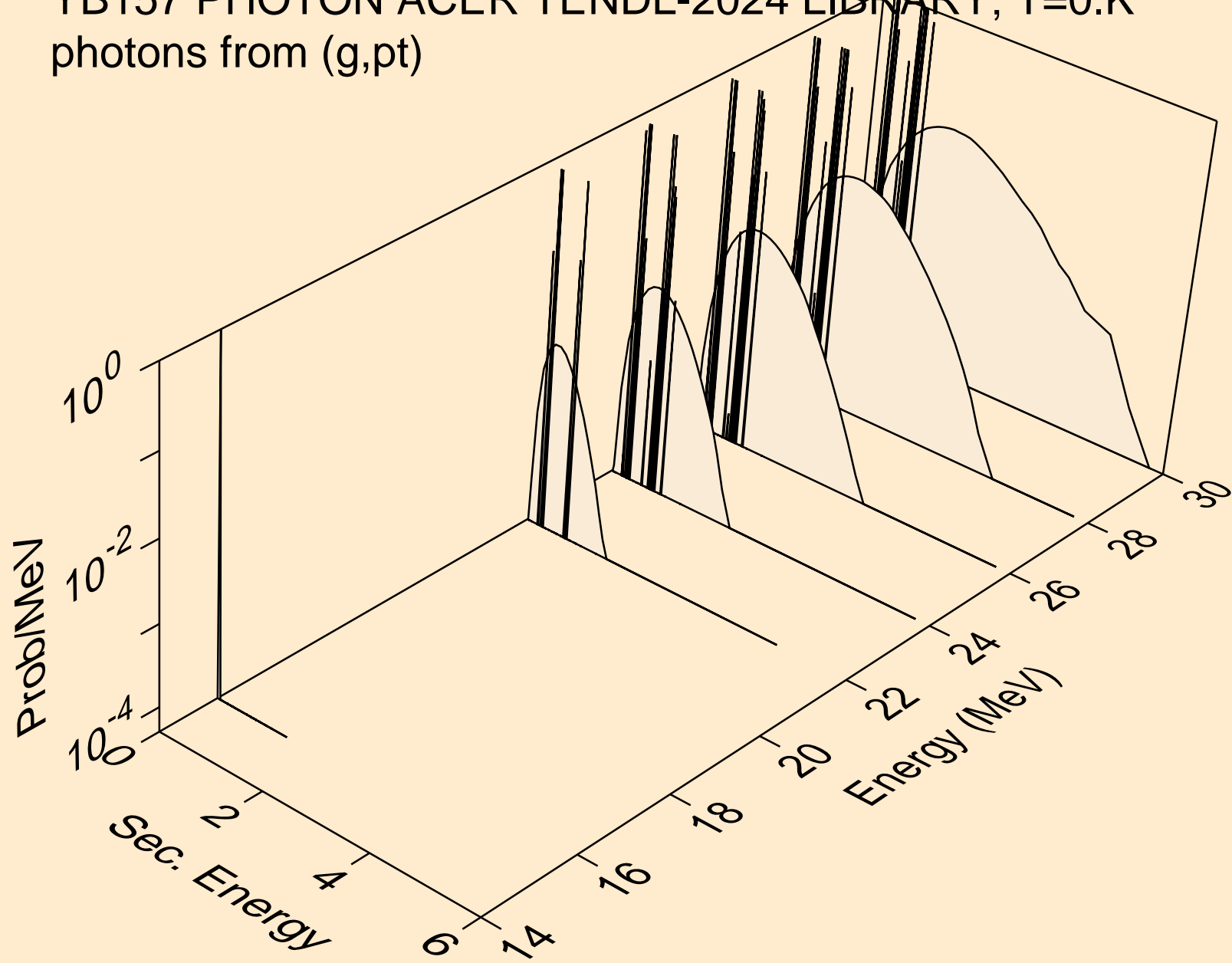

YB157 PHOTON ACER TENDL-2024 LIBRARY; T=0.K
photons from (g,da)

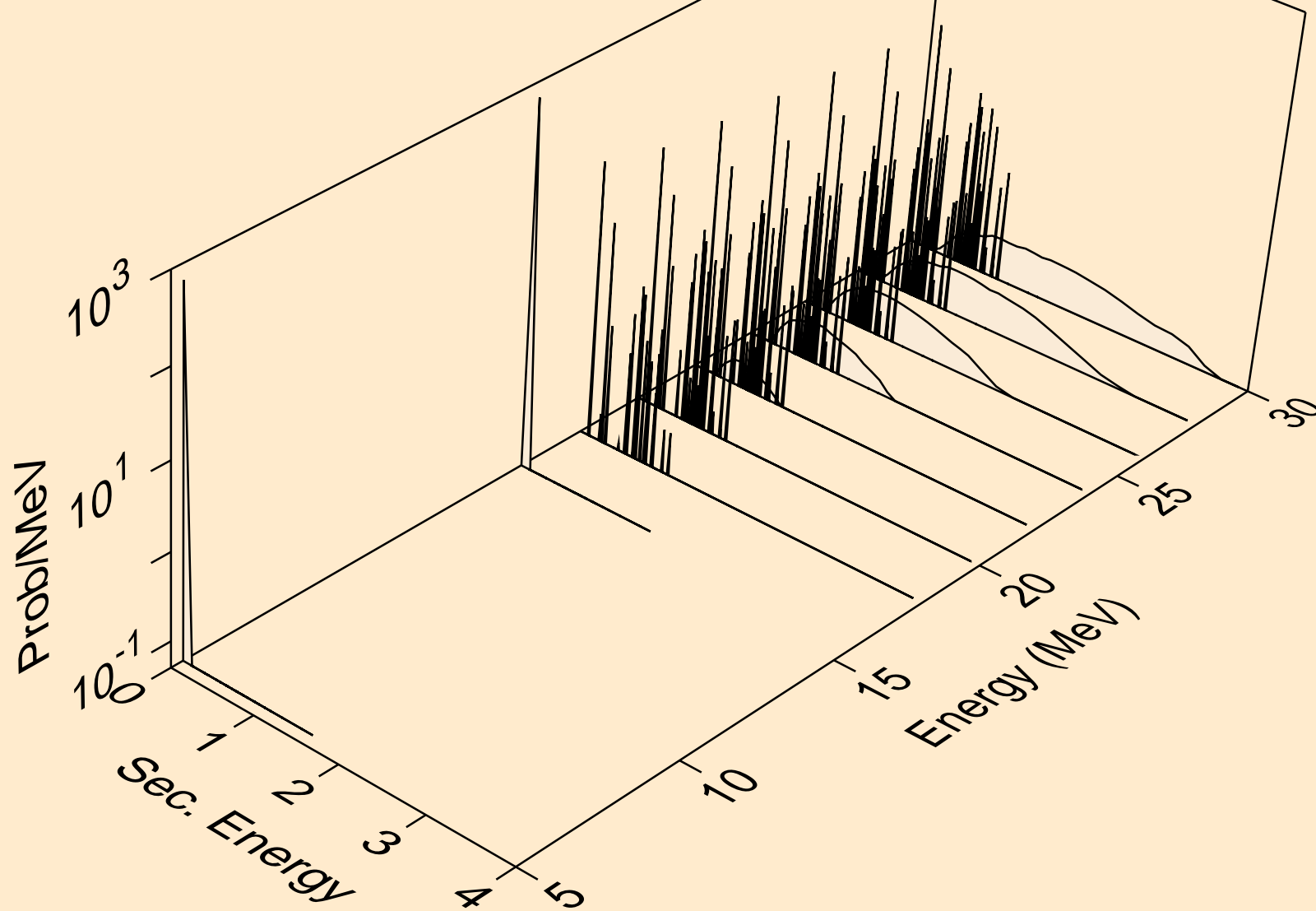

YB157 PHOTON ACER TENDL-2024 LIBRARY; T=0.K
protons from (g,x)

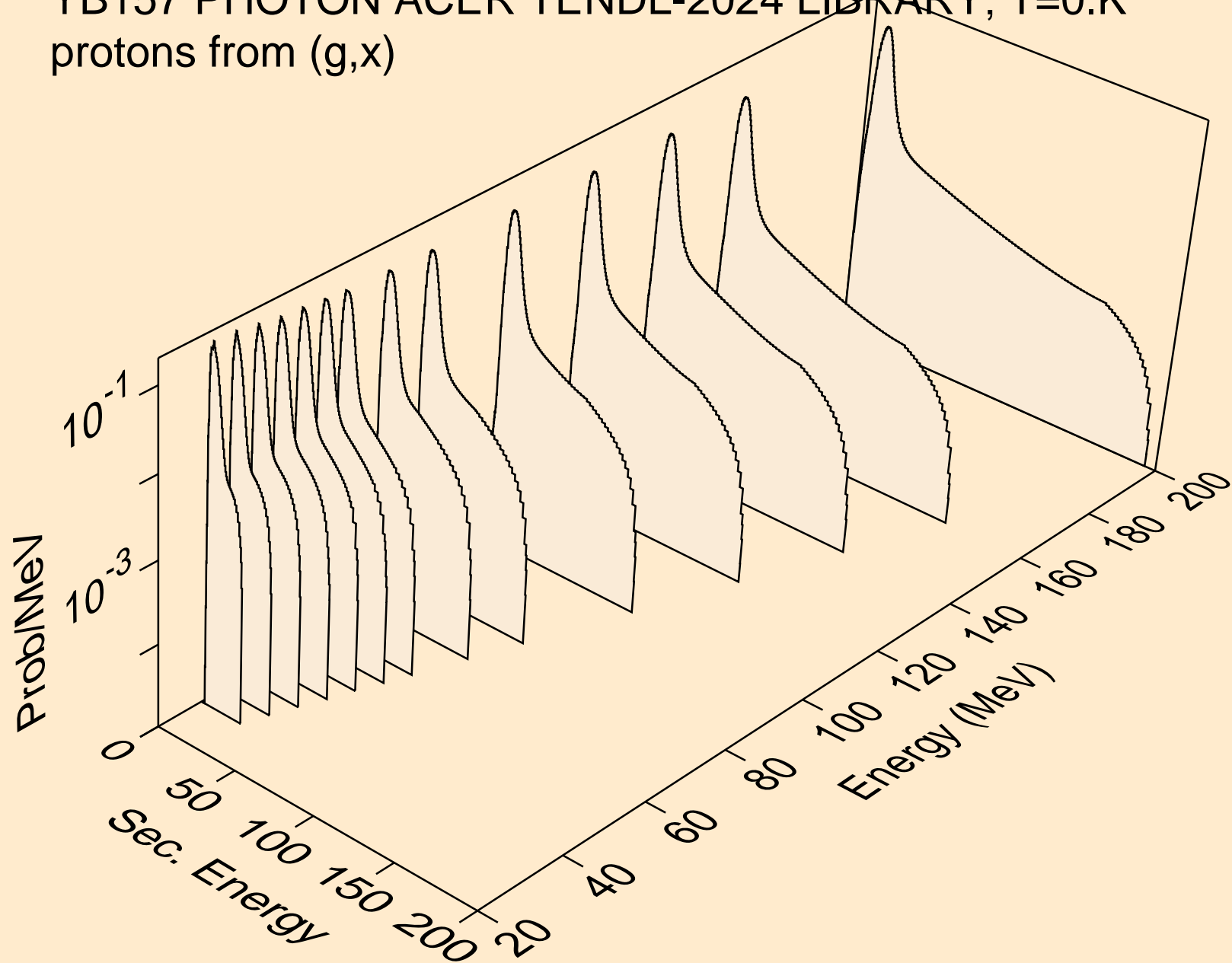

YB157 PHOTON ACER TENDL-2024 LIBRARY; T=0.K
protons from (g,n*)p

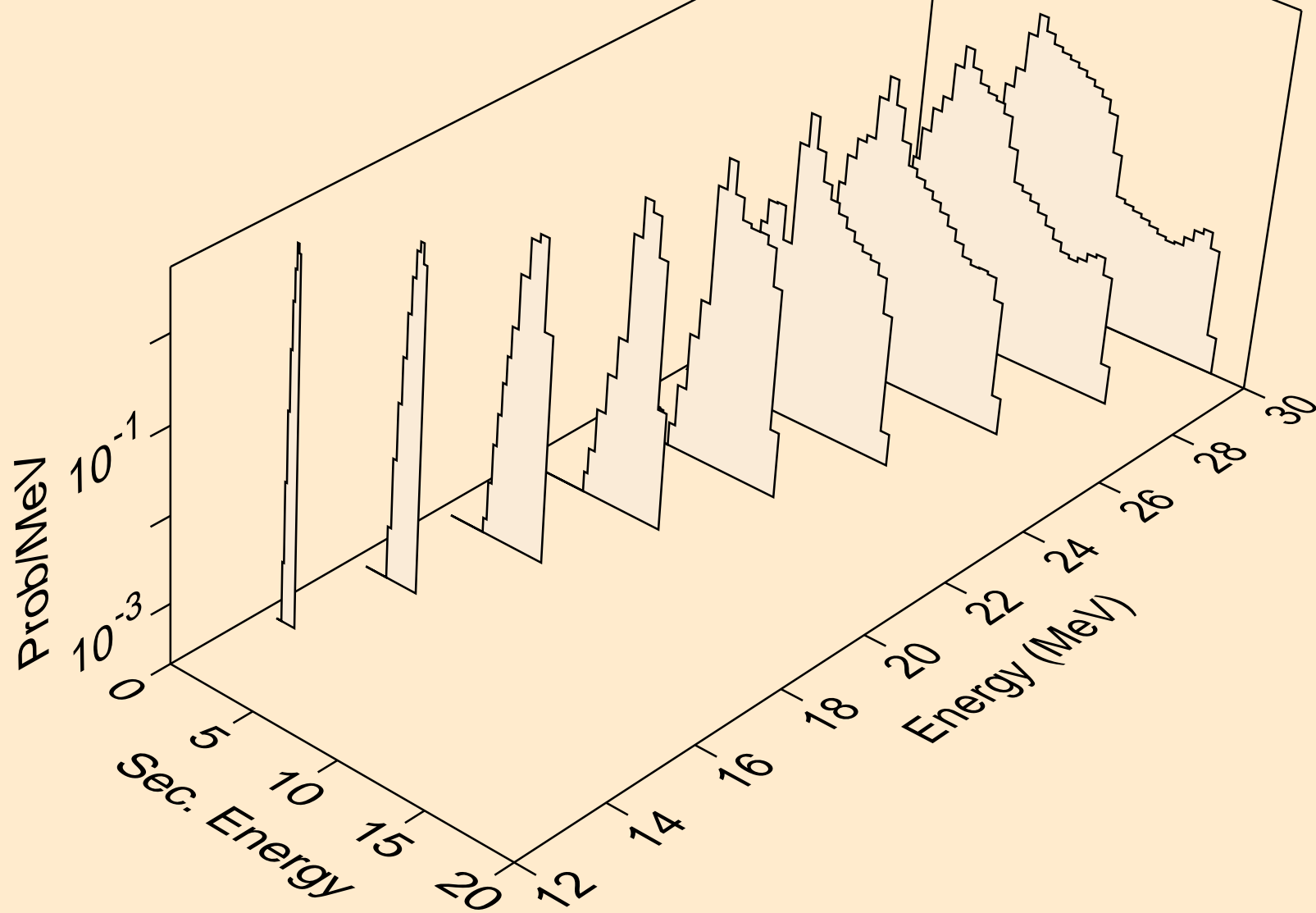

YB157 PHOTON ACER TENDL-2024 LIBRARY; T=0.K
protons from (g,2np)

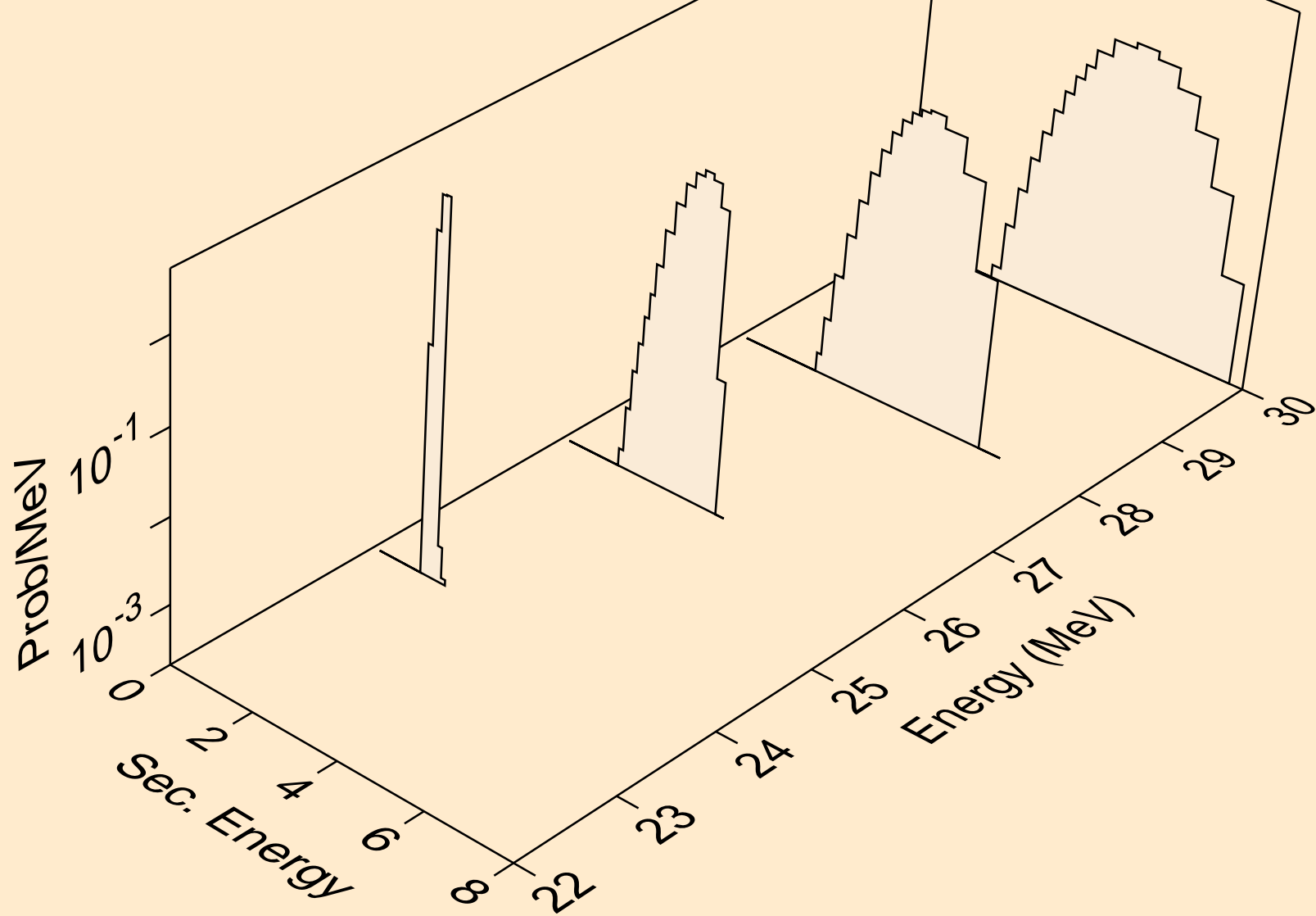

YB157 PHOTON ACER TENDL-2024 LIBRARY; T=0.K
protons from (g,n2p)

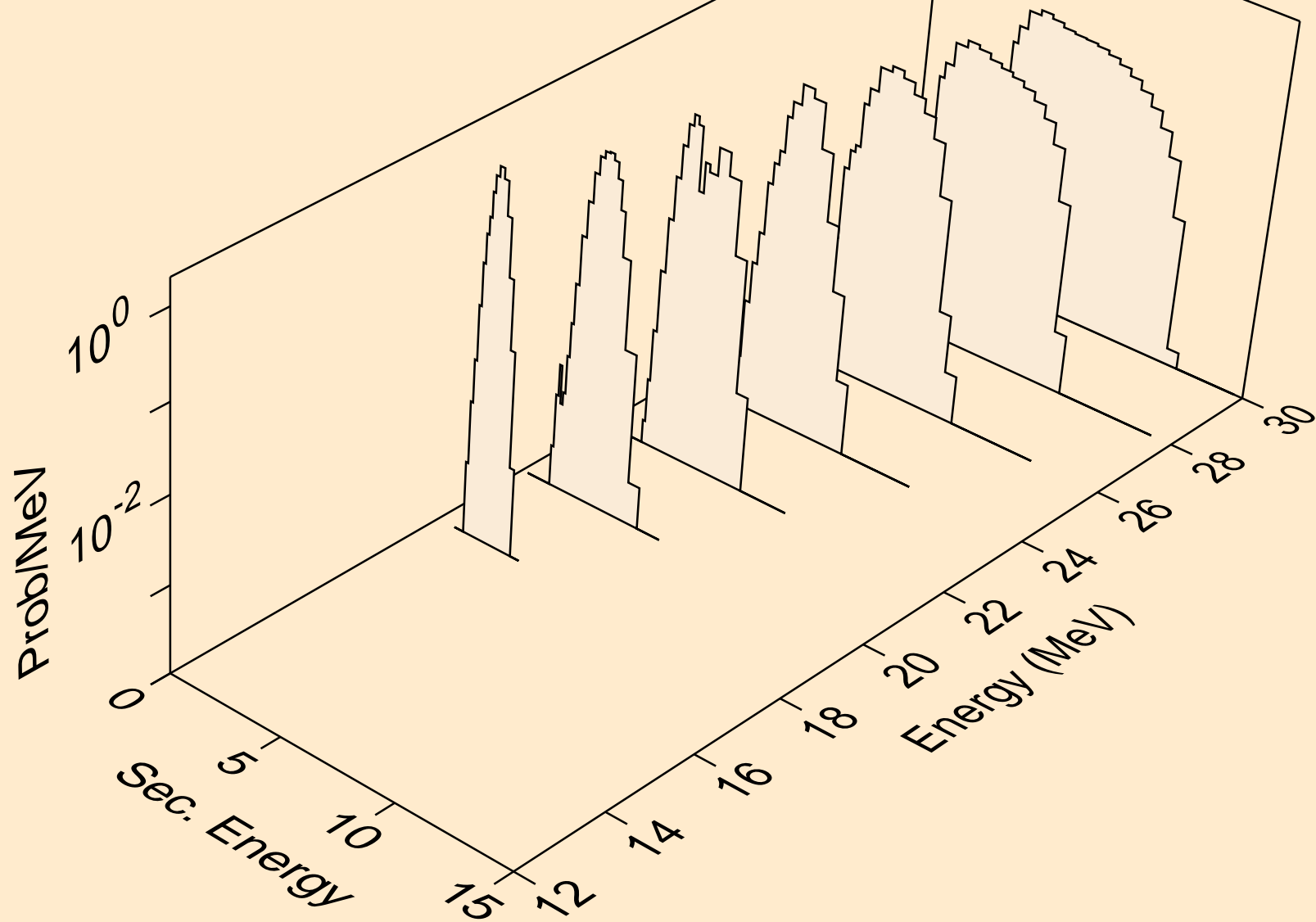

YB157 PHOTON ACER TENDL-2024 LIBRARY; T=0.K
protons from (g,npa)

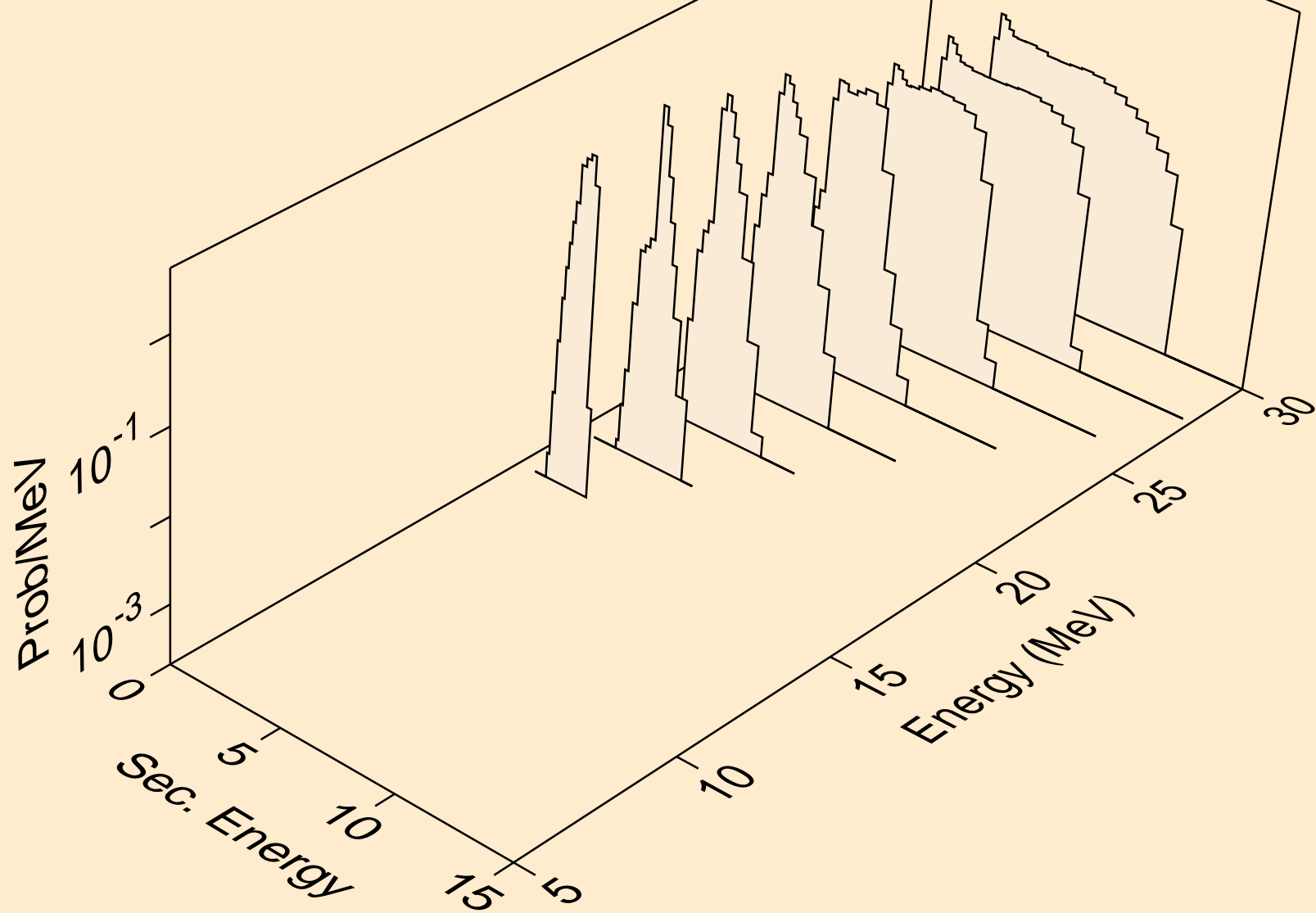

YB157 PHOTON ACER TENDL-2024 LIBRARY; T=0.K
protons from (g,p)

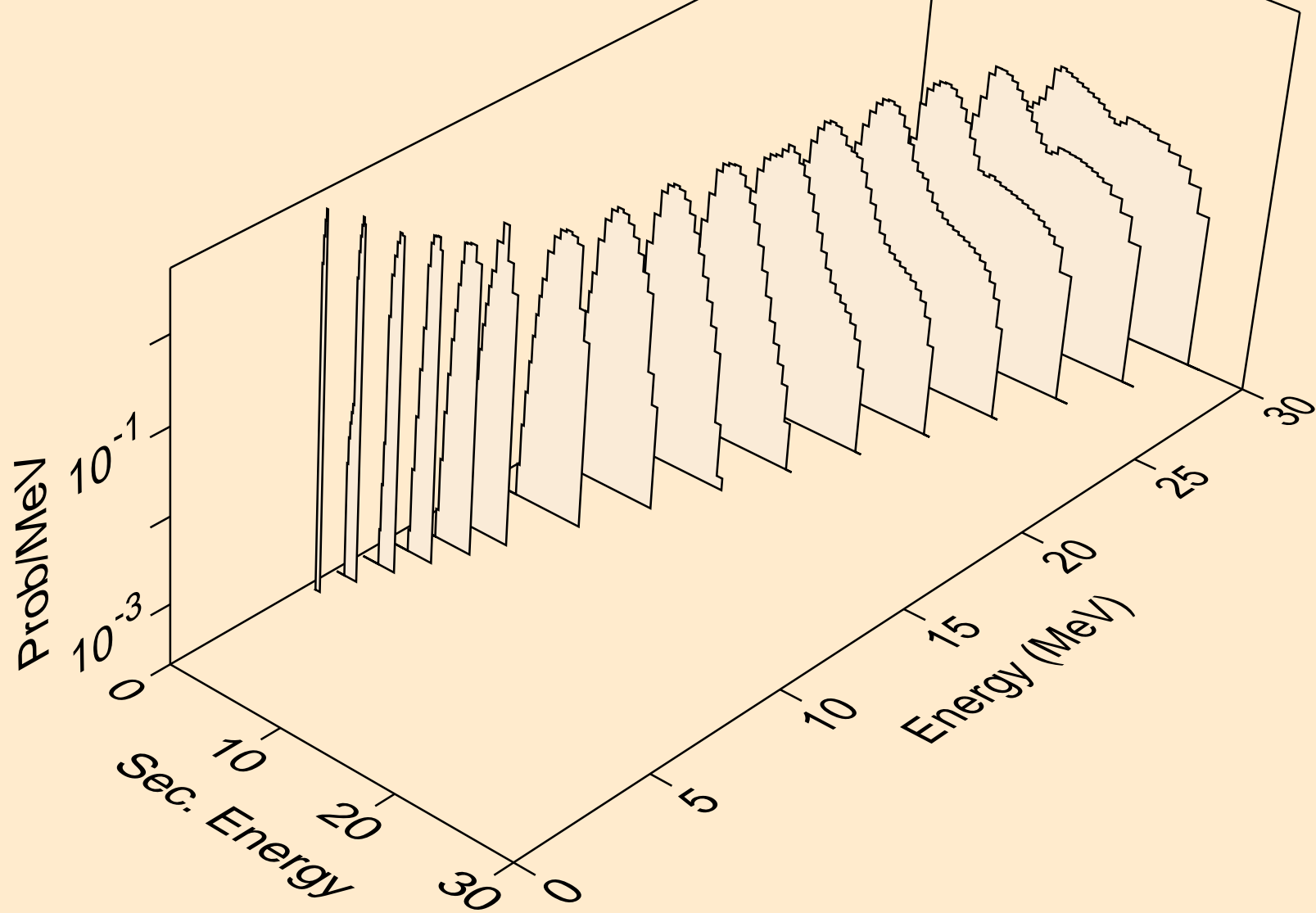

YB157 PHOTON ACER TENDL-2024 LIBRARY; T=0.K
protons from (g,2p)

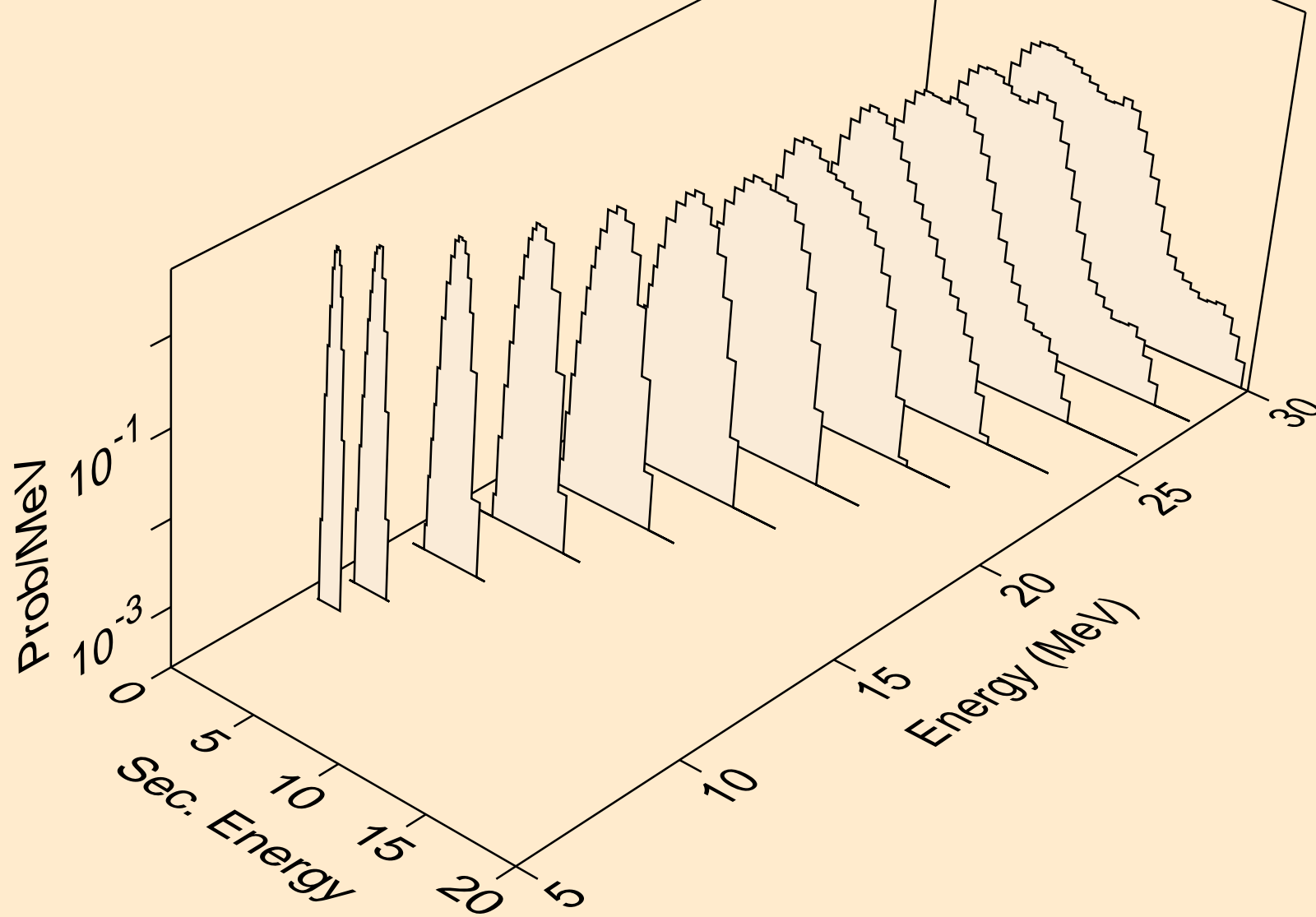

YB157 PHOTON ACER TENDL-2024 LIBRARY; T=0.K
protons from (g,pa)

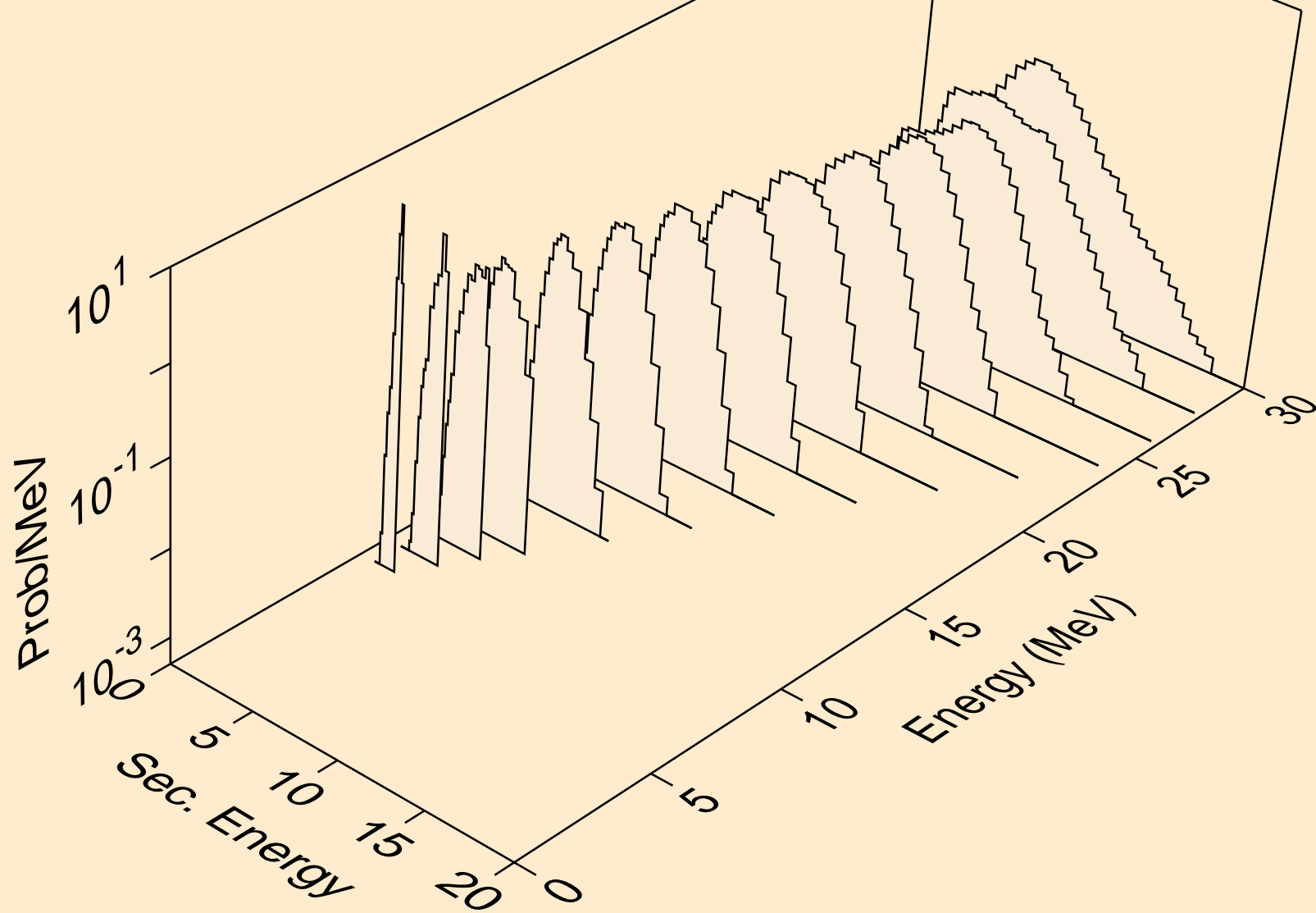

YB157 PHOTON ACER TENDL-2024 LIBRARY; T=0.K
protons from (g,pd)

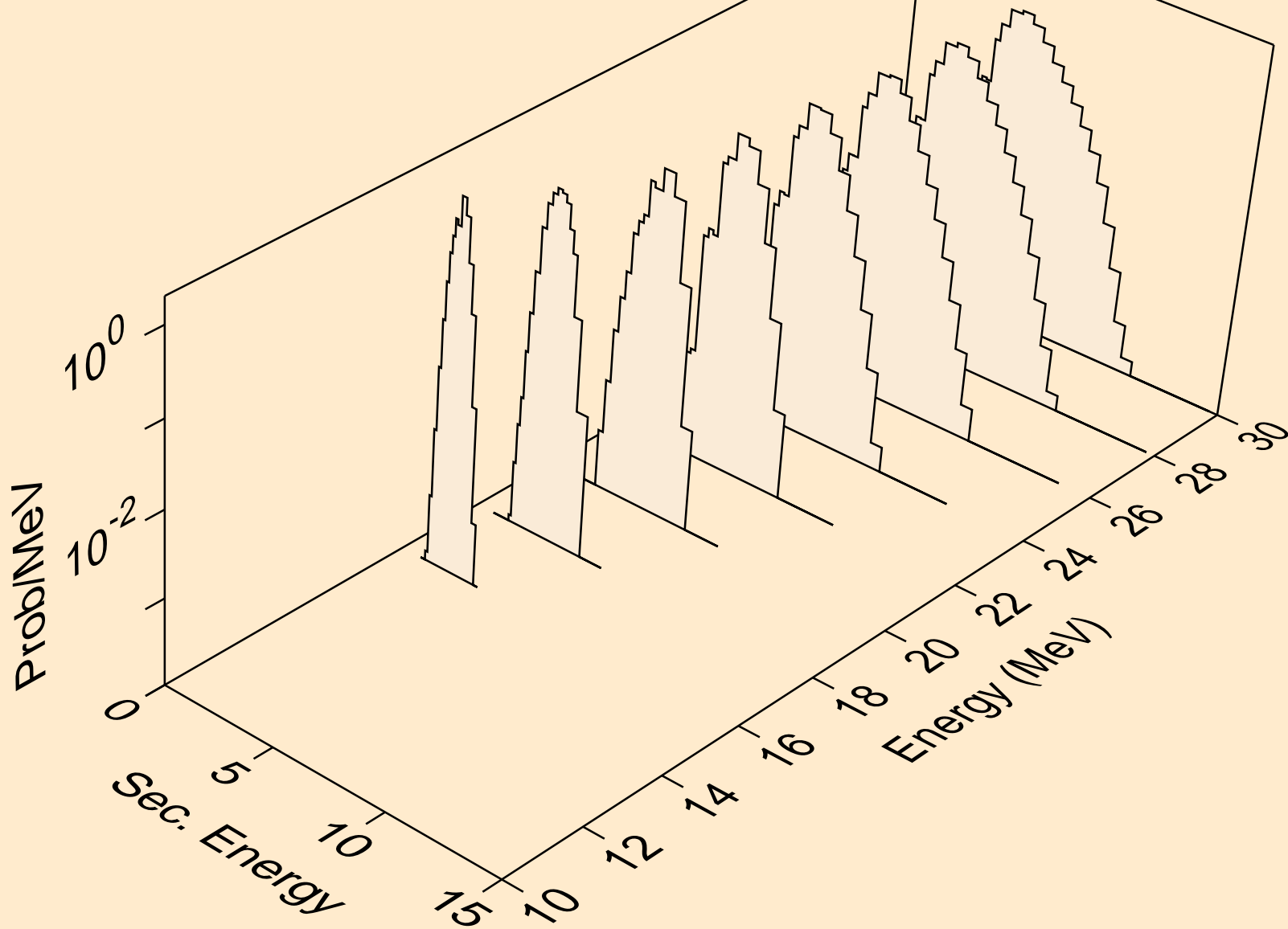

YB157 PHOTON ACER TENDL-2024 LIBRARY; T=0.K
protons from (g,pt)

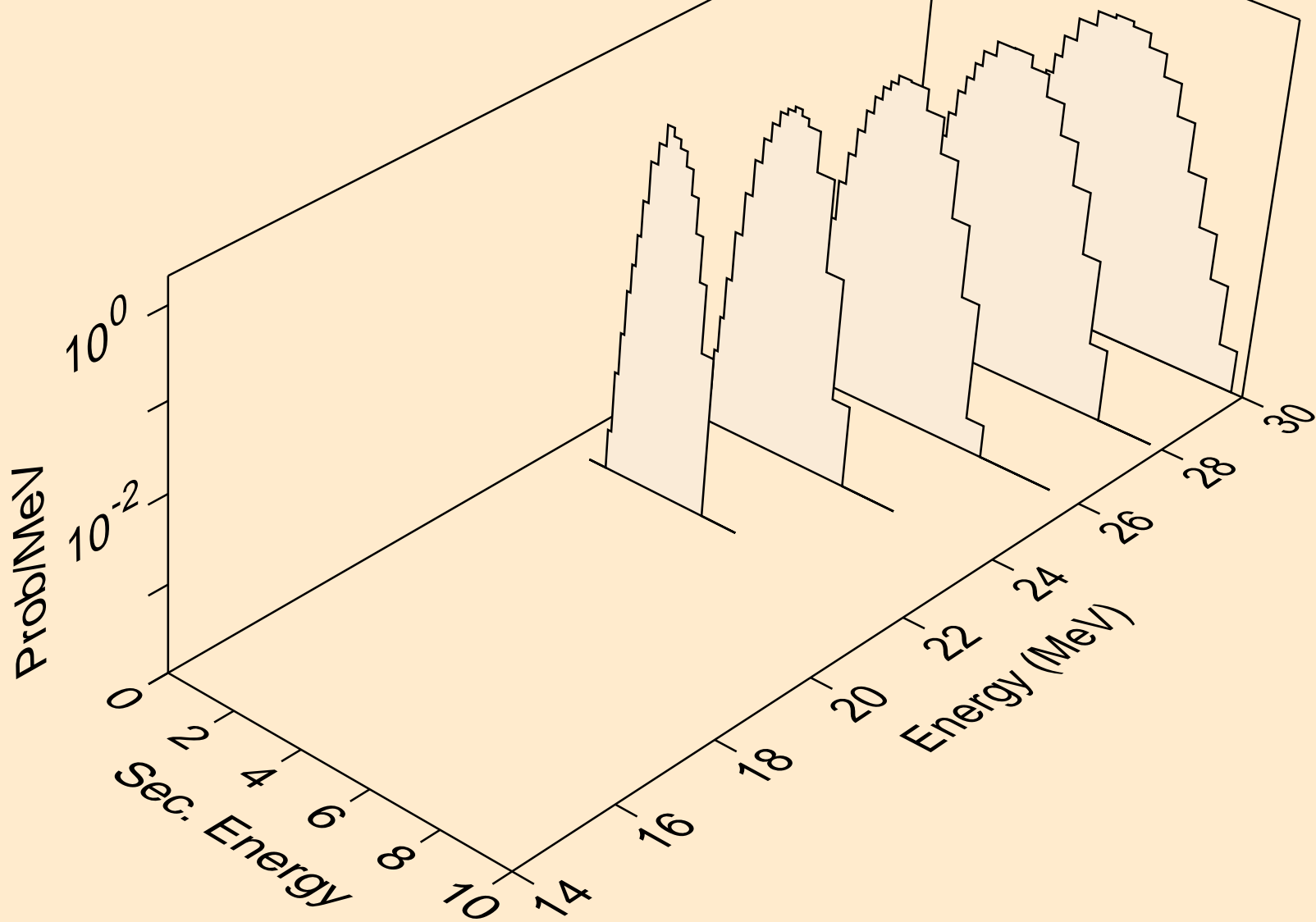

YB157 PHOTON ACER TENDL-2024 LIBRARY; T=0.K
deuterons from (g,x)

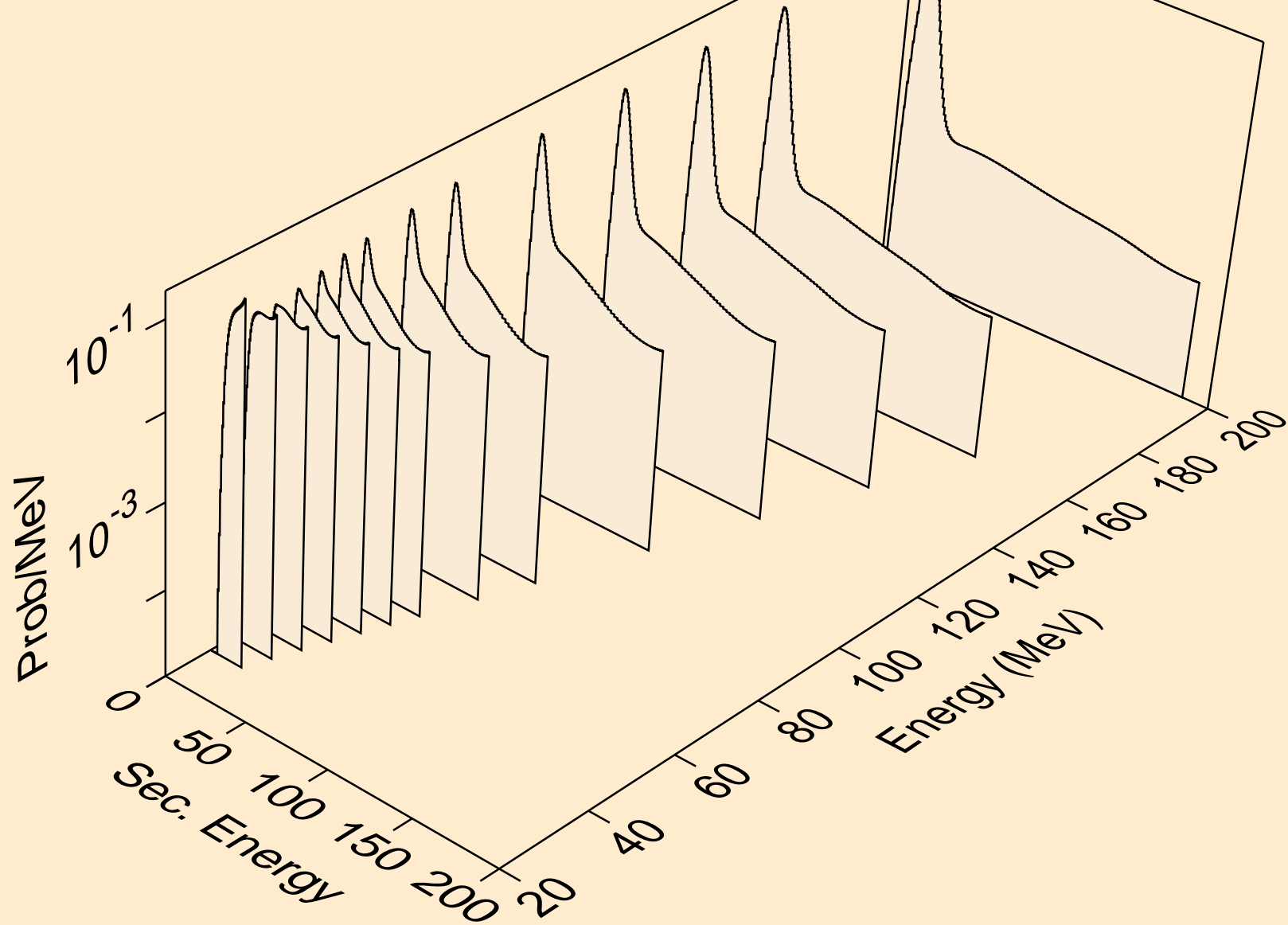

YB157 PHOTON ACER TENDL-2024 LIBRARY; T=0.K
deuterons from (g,n*)d

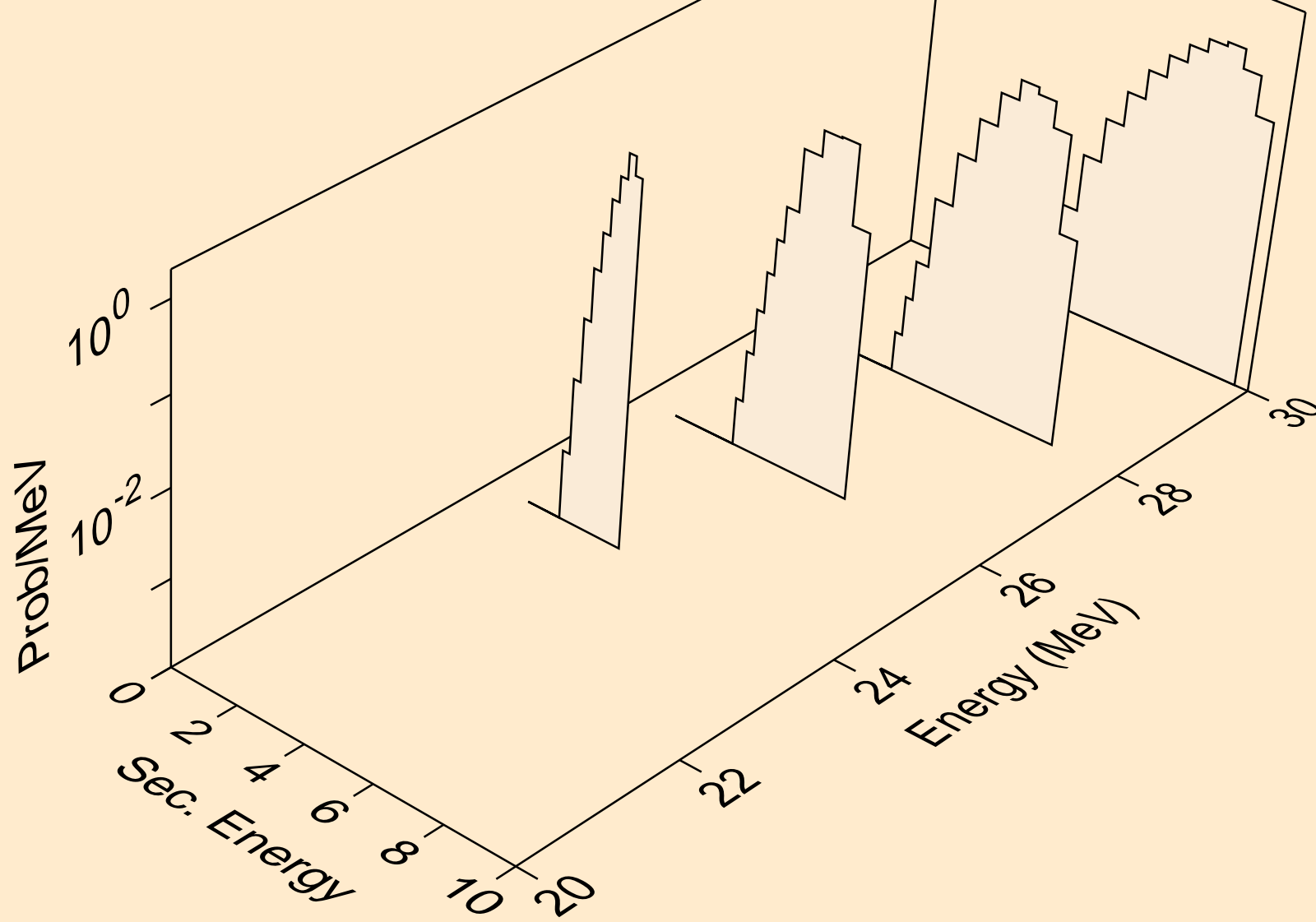

YB157 PHOTON ACER TENDL-2024 LIBRARY; T=0.K
deuterons from (g,d)

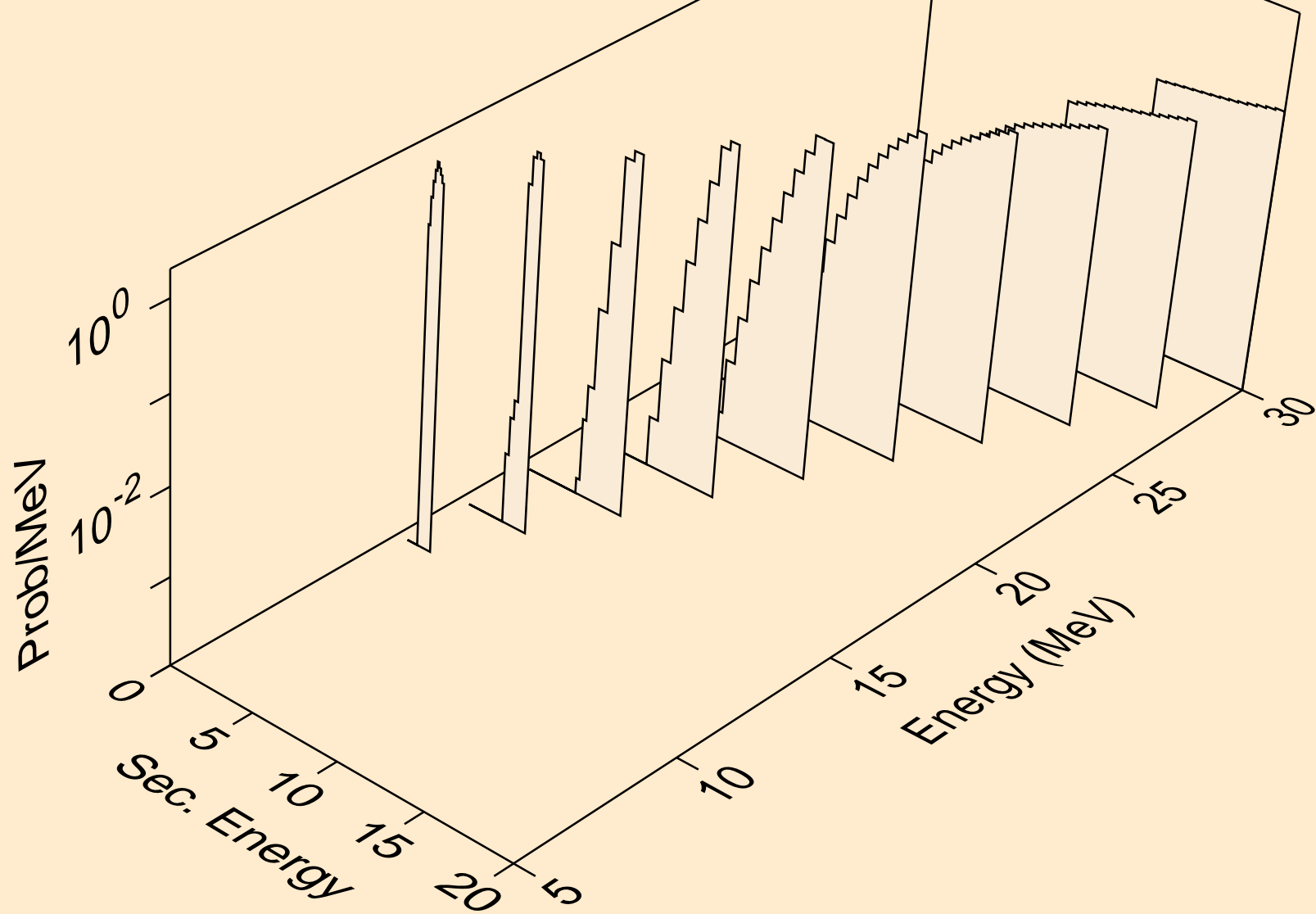

YB157 PHOTON ACER TENDL-2024 LIBRARY; T=0.K
deuterons from (g,pd)

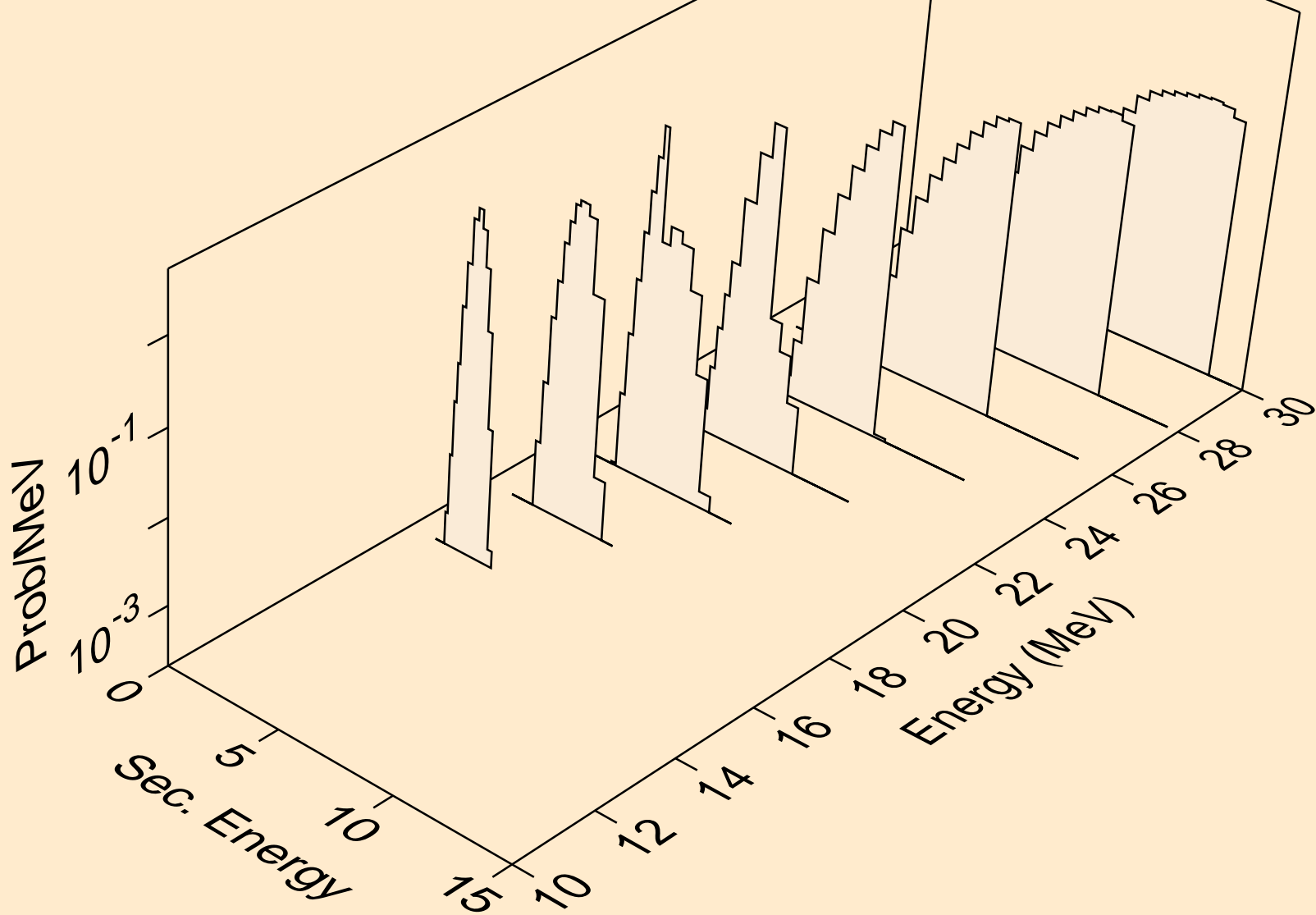

YB157 PHOTON ACER TENDL-2024 LIBRARY; T=0.K
deuterons from (g,da)

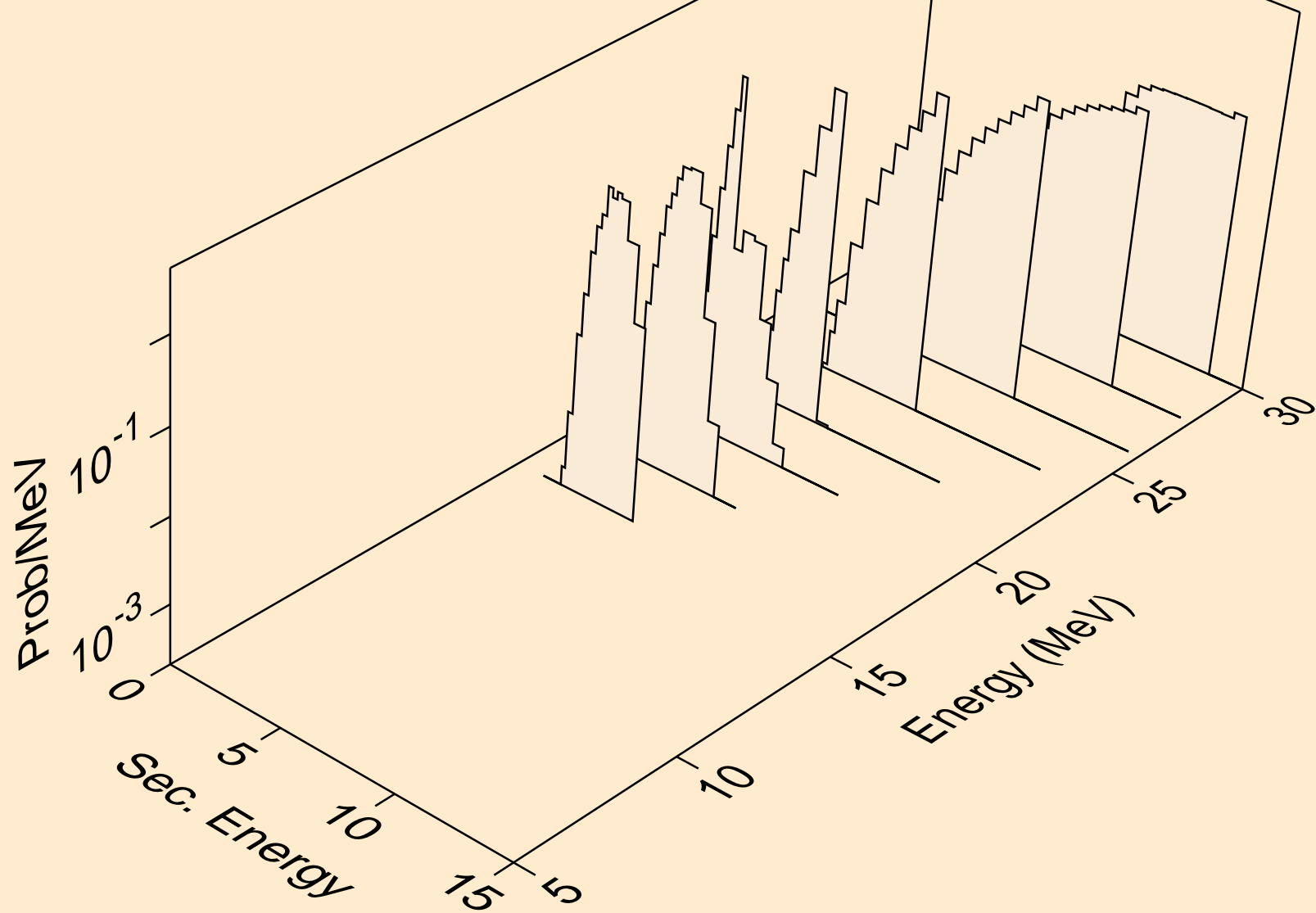

YB157 PHOTON ACER TENDL-2024 LIBRARY; T=0.K
tritons from (g,x)

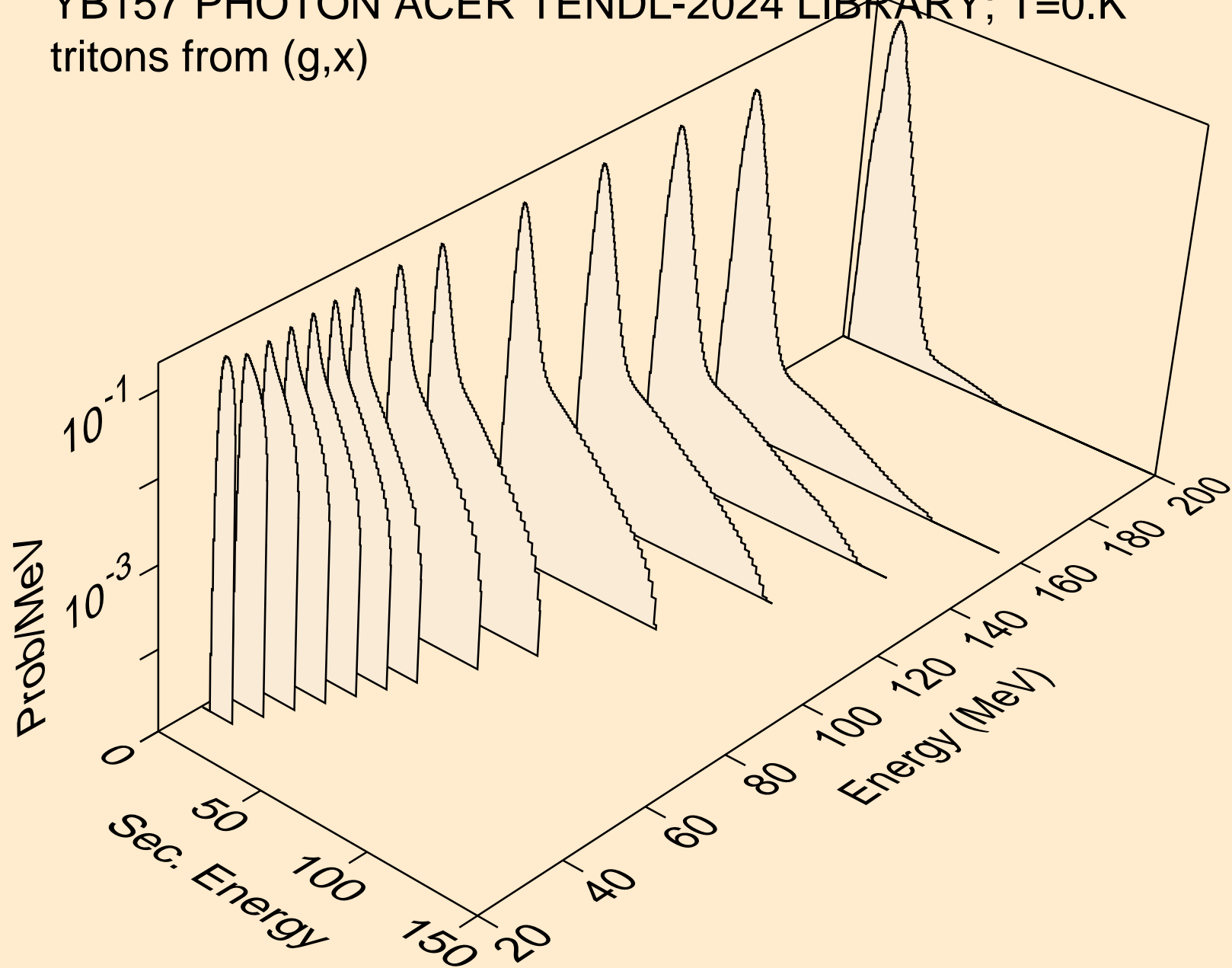

YB157 PHOTON ACER TENDL-2024 LIBRARY; T=0.K
tritons from (g,n*)t

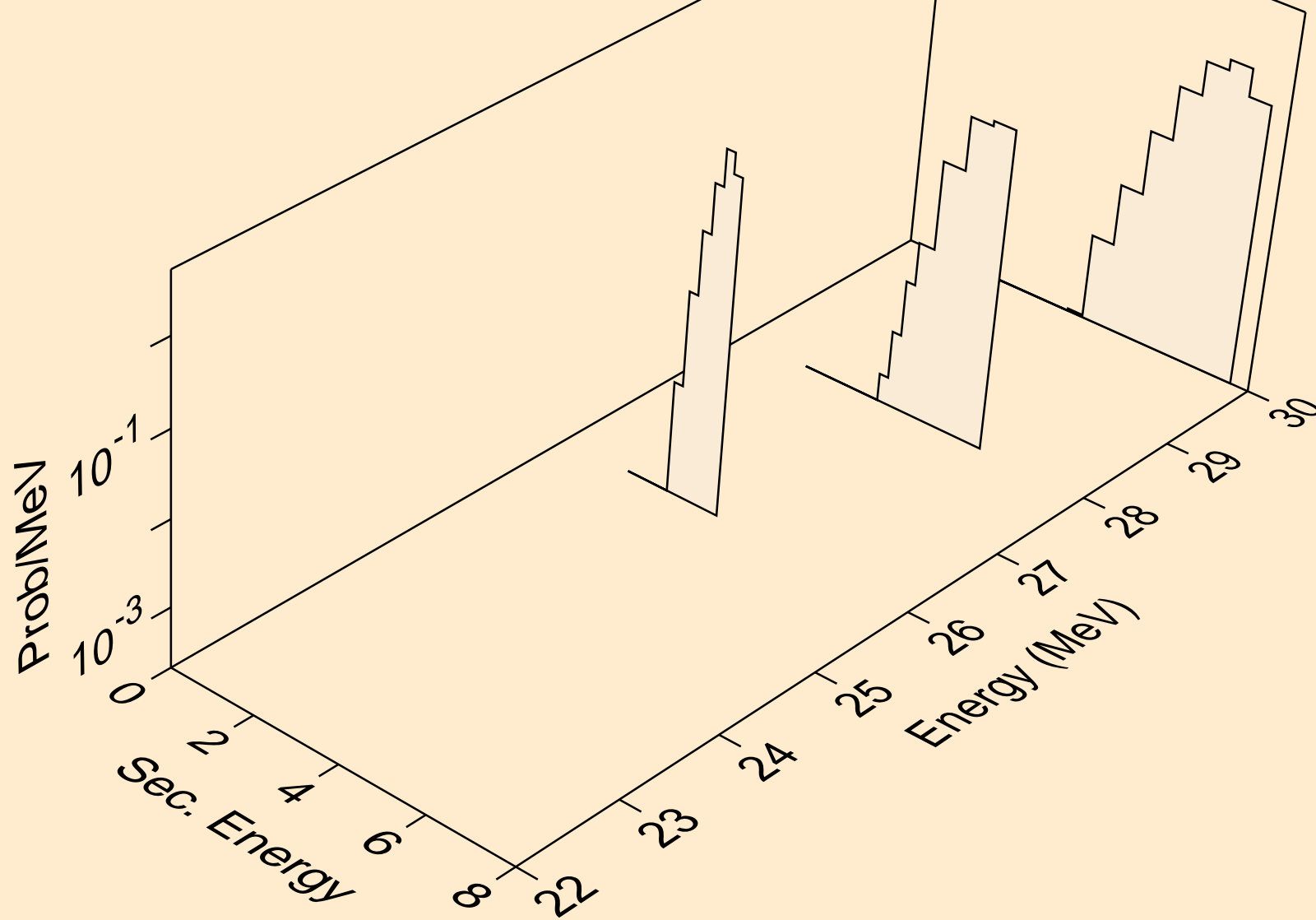

YB157 PHOTON ACER TENDL-2024 LIBRARY; T=0.K
tritons from (g,t)

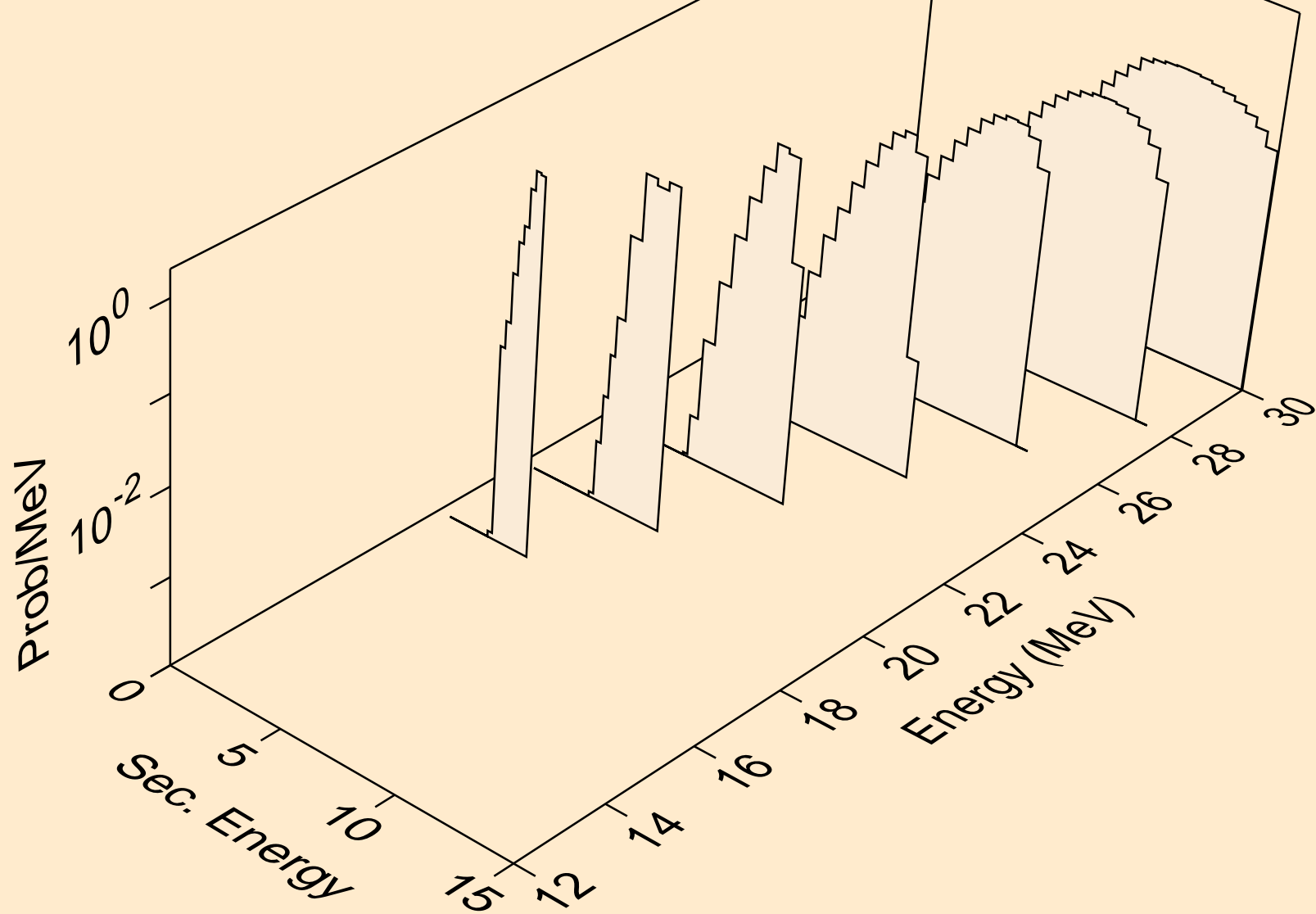

YB157 PHOTON ACER TENDL-2024 LIBRARY; T=0.K
tritons from (g,pt)

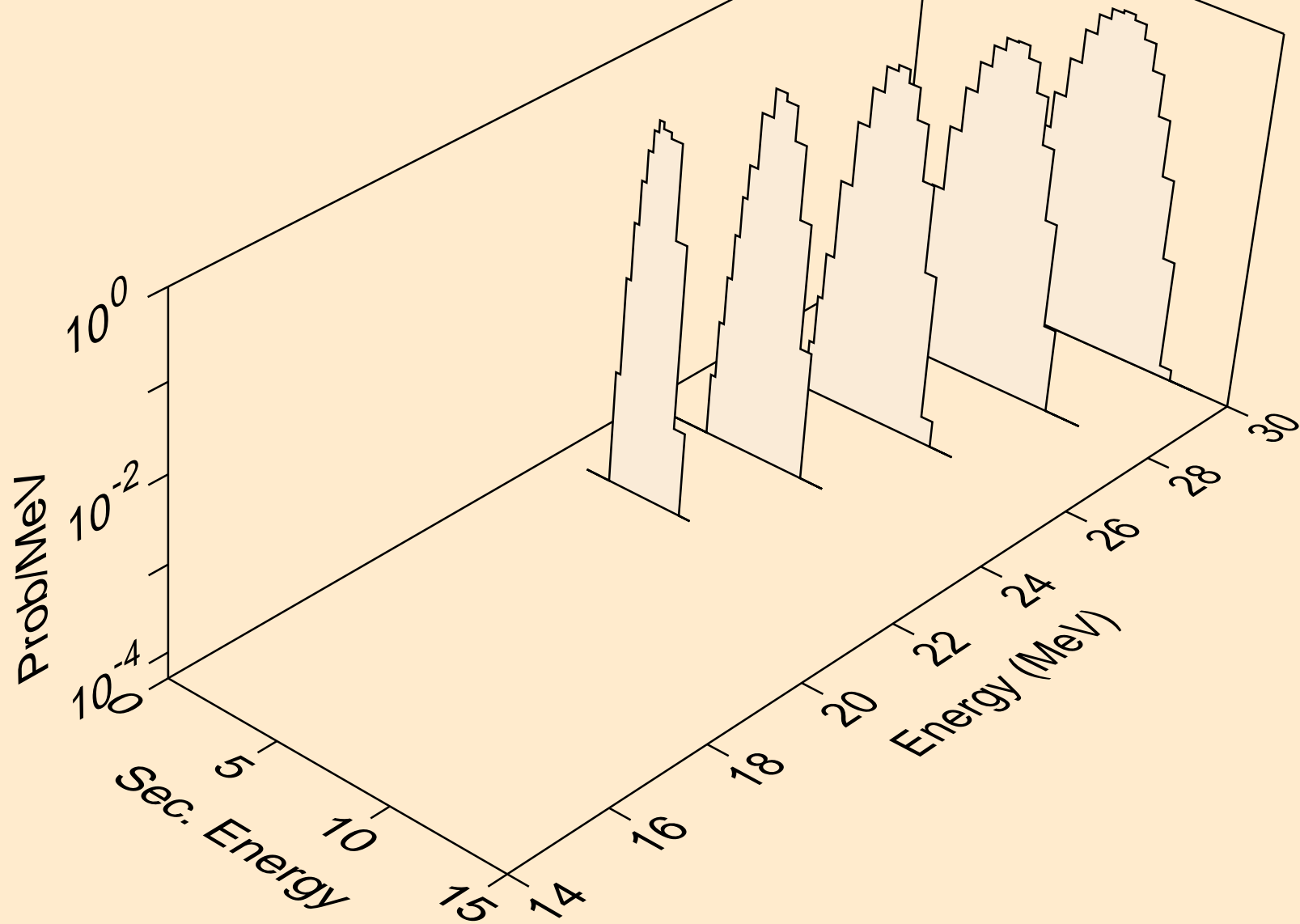

YB157 PHOTON ACER TENDL-2024 LIBRARY; T=0.K
he3s from (g,x)

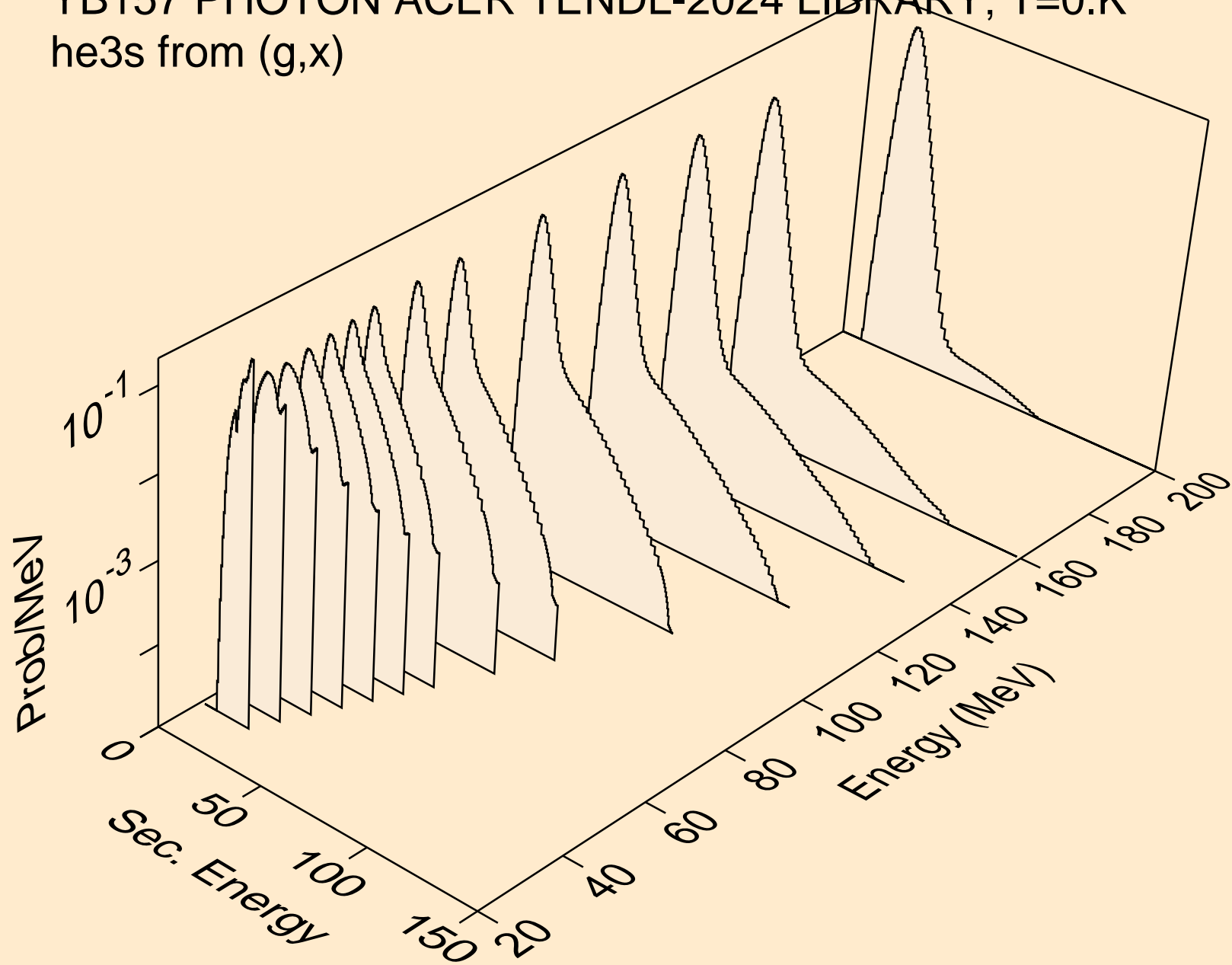

YB157 PHOTON ACER TENDL-2024 LIBRARY; T=0.K
he3s from (g,n*)he3

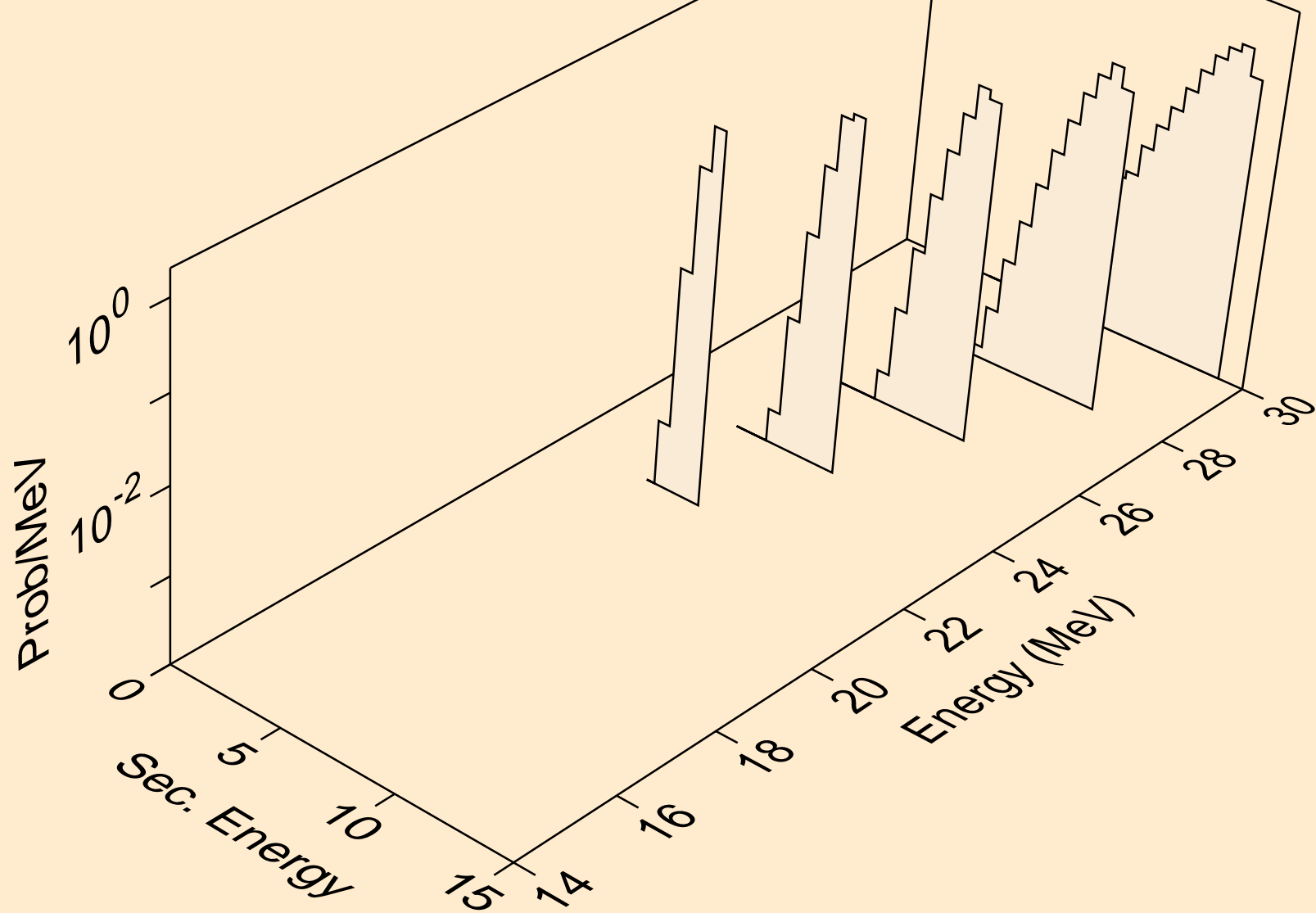

YB157 PHOTON ACER TENDL-2024 LIBRARY; T=0.K
he3s from (g,he3)

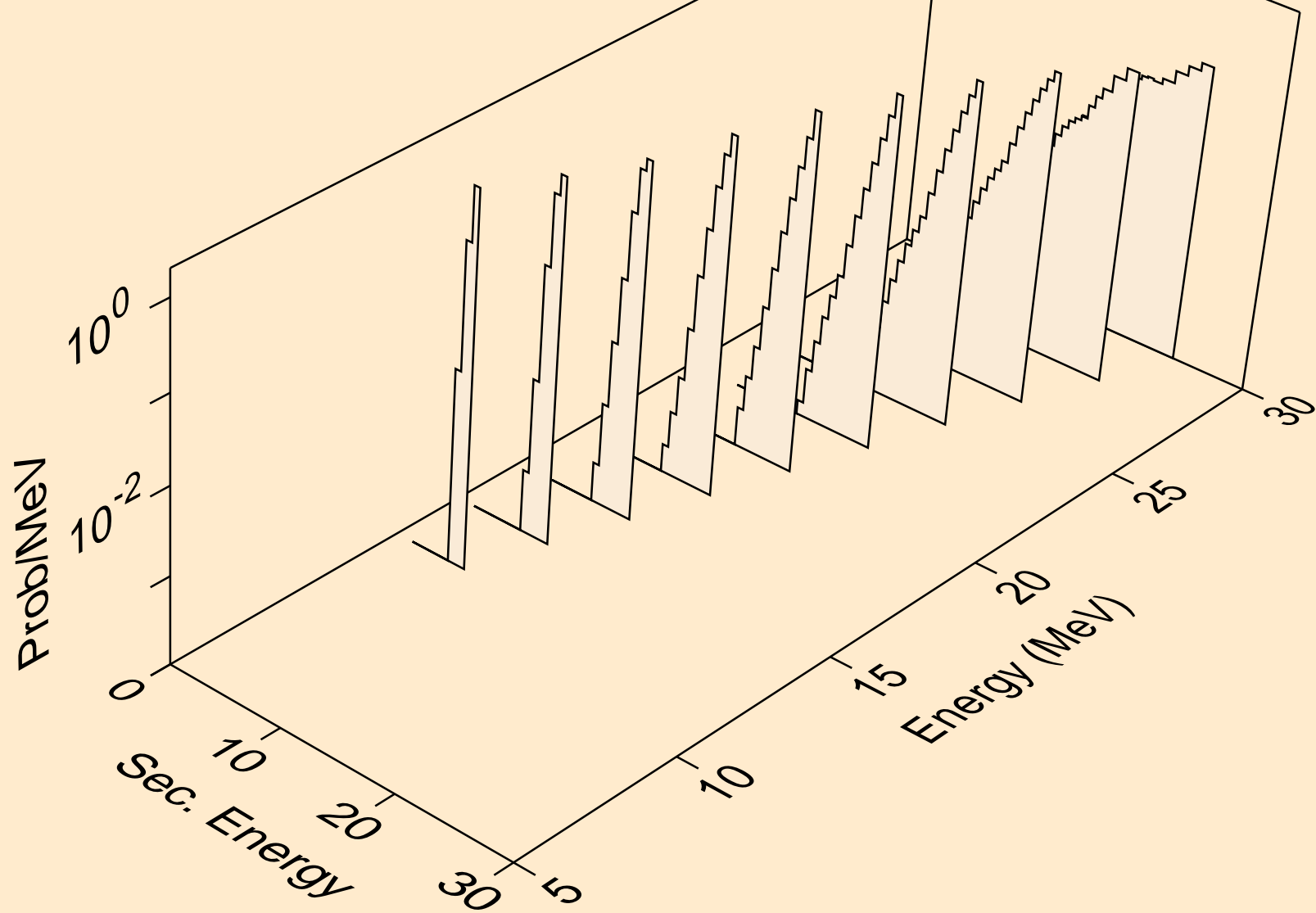

YB157 PHOTON ACER TENDL-2024 LIBRARY; T=0.K
alphas from (g,x)

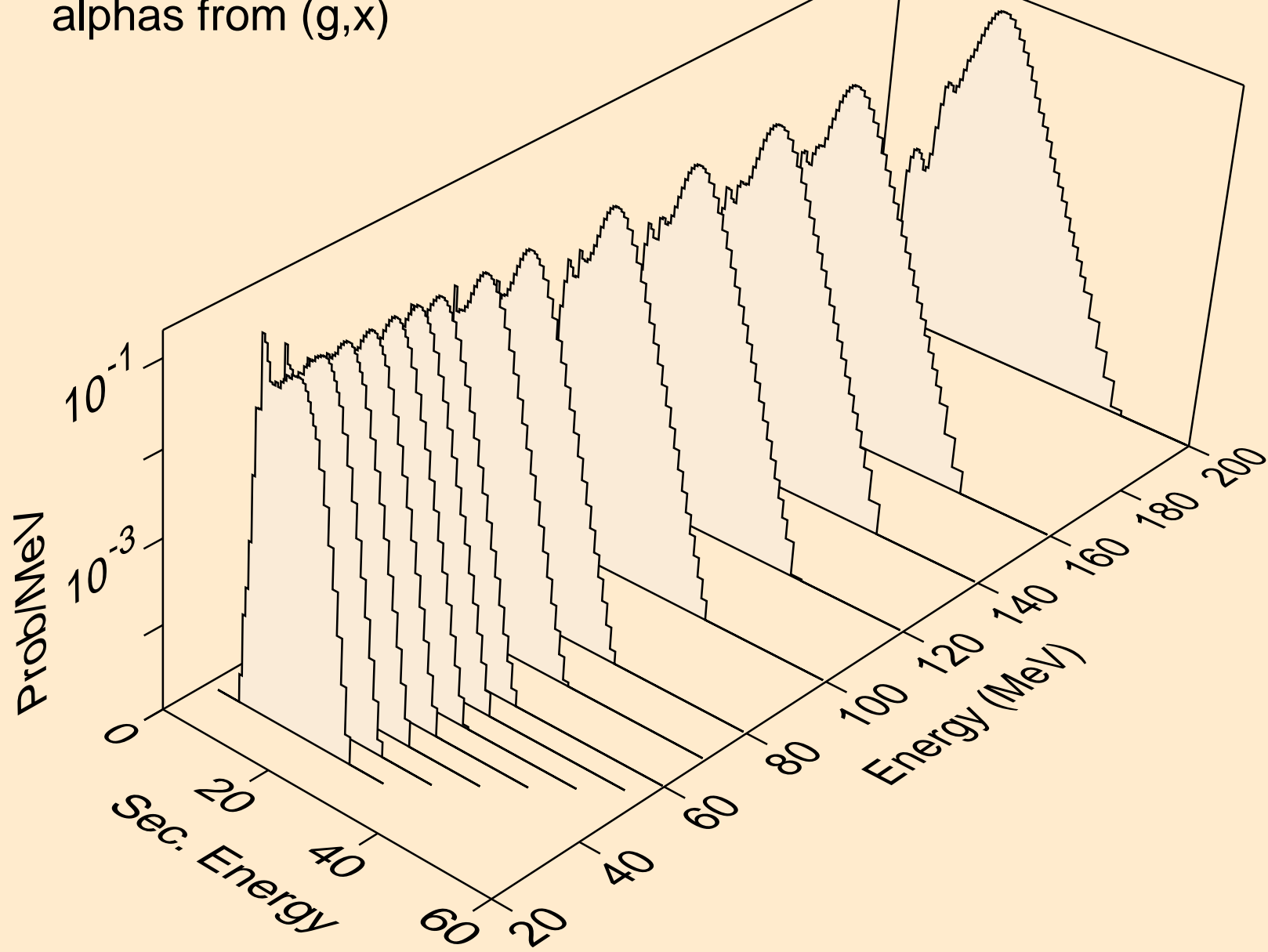

YB157 PHOTON ACER TENDL-2024 LIBRARY; T=0.K
alphas from (g,n*)a

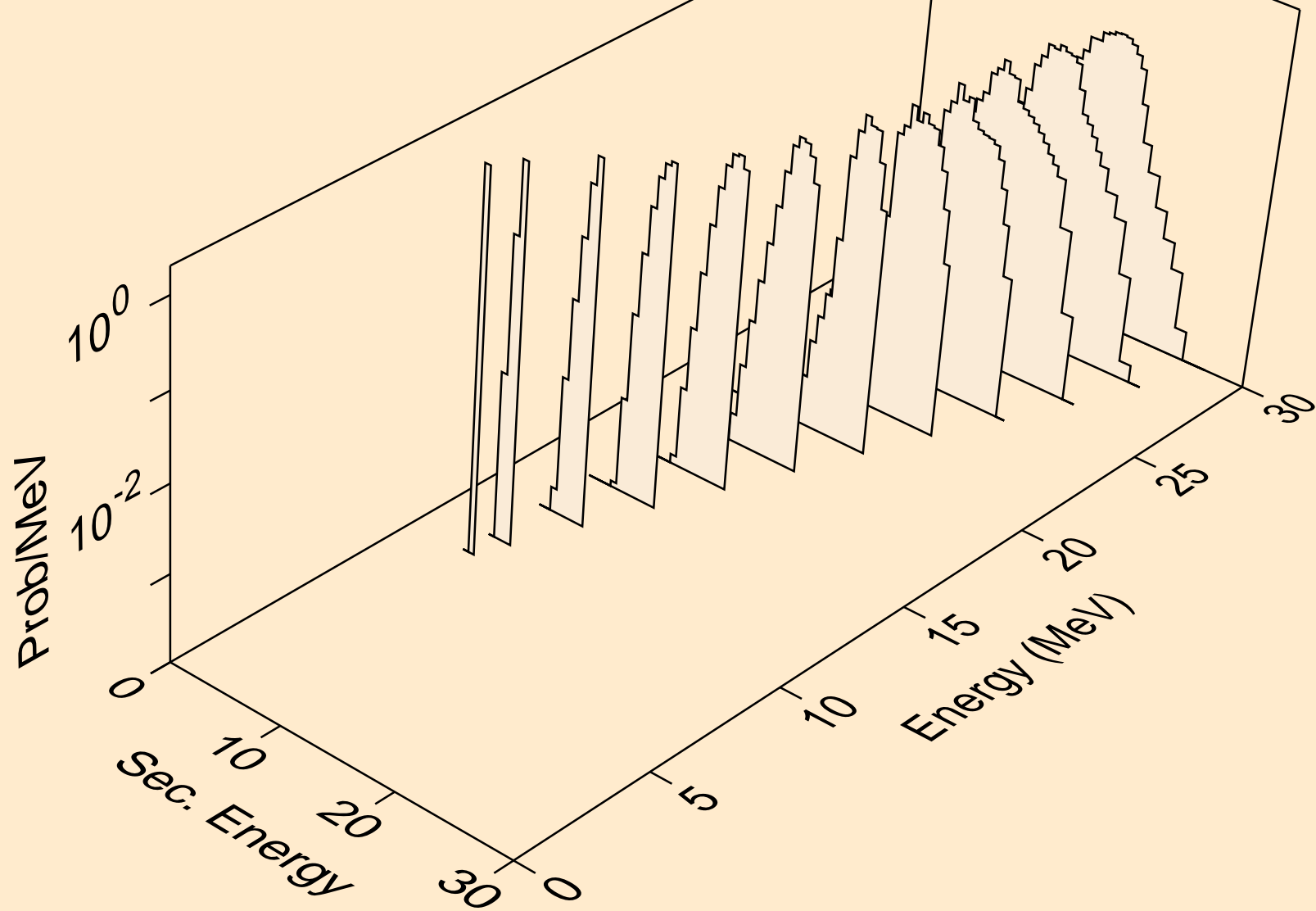

YB157 PHOTON ACER TENDL-2024 LIBRARY; T=0.K
alphas from (g,2n)a

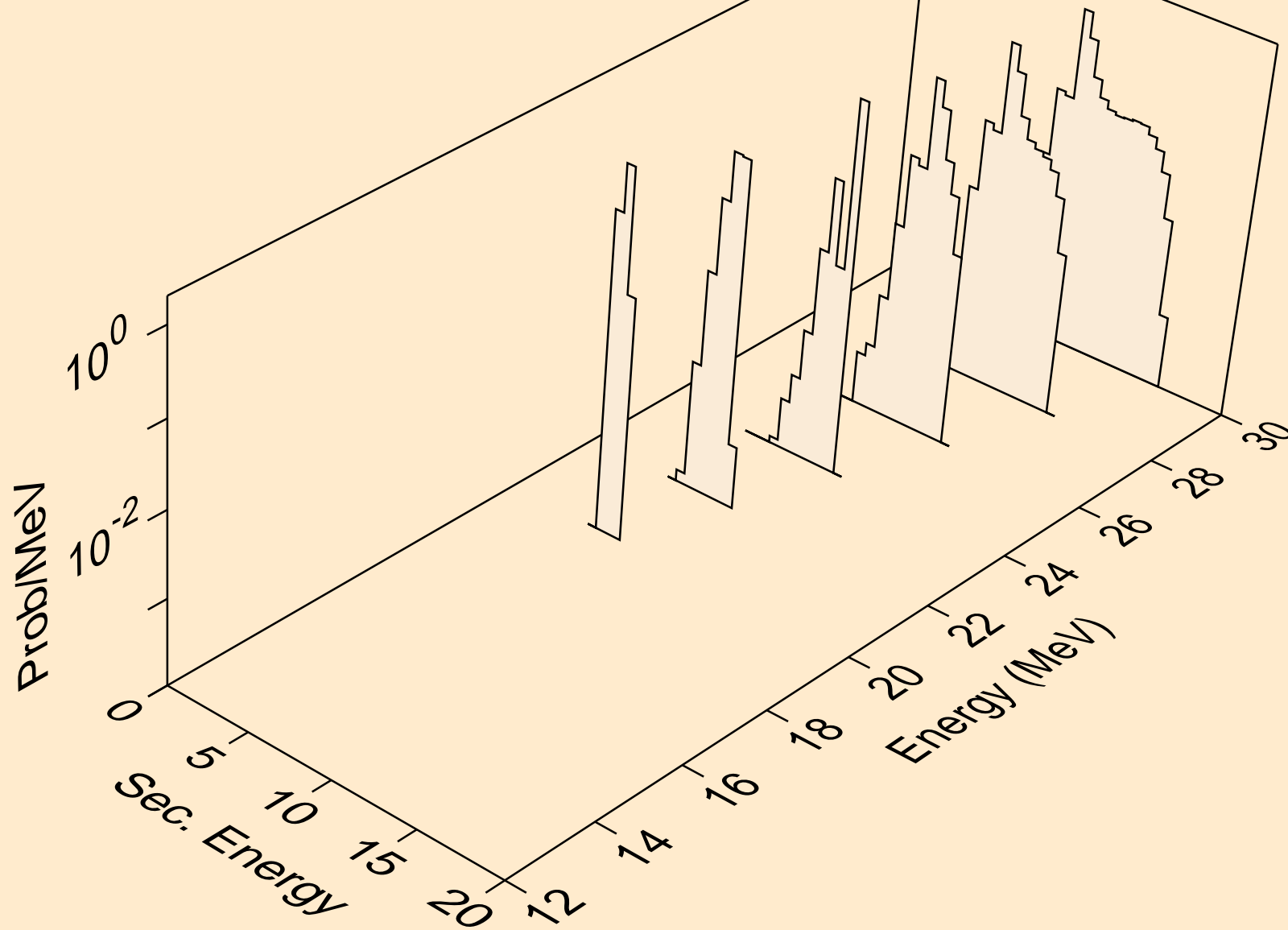

YB157 PHOTON ACER TENDL-2024 LIBRARY; T=0.K
alphas from (g,n*)2a

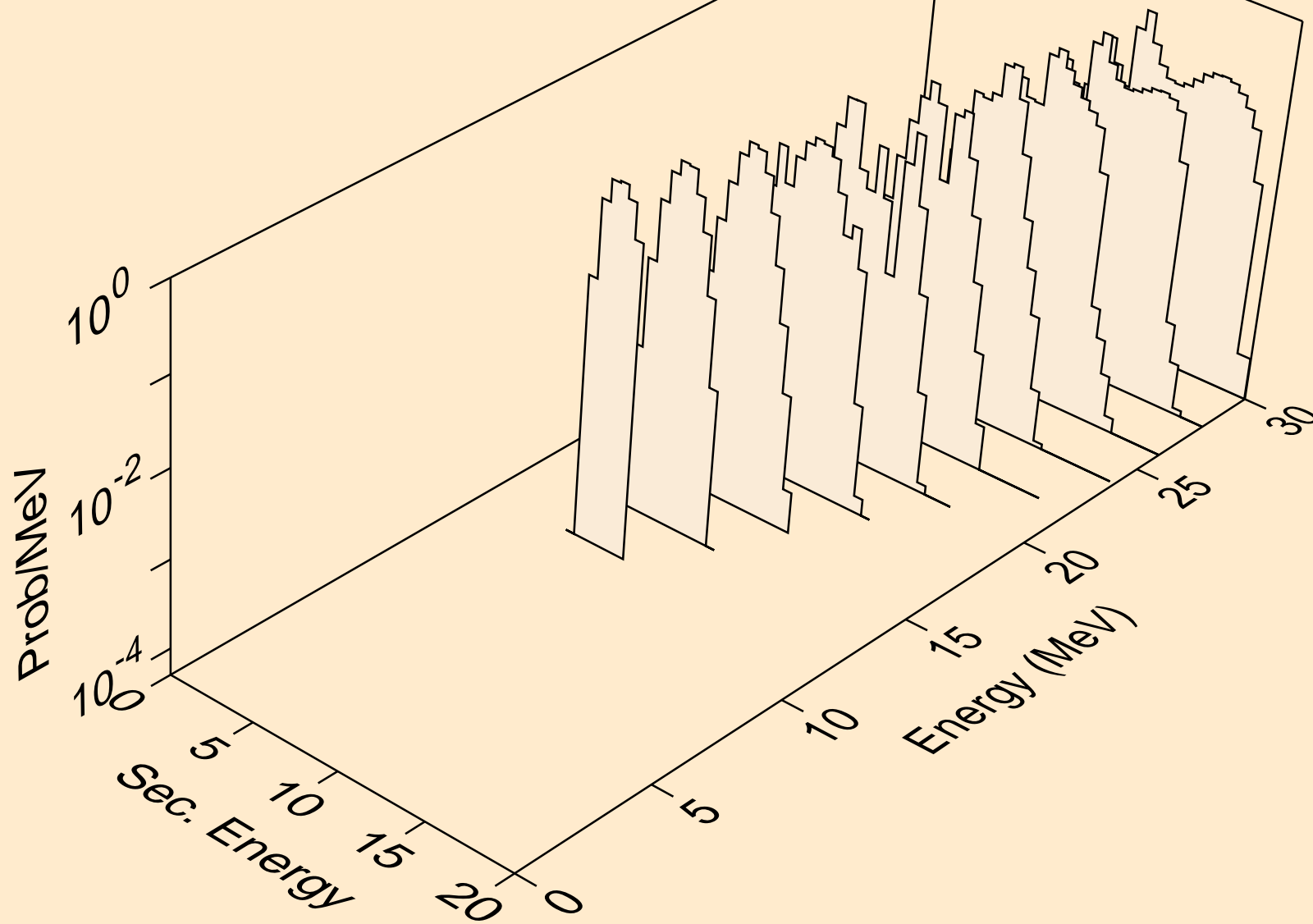

YB157 PHOTON ACER TENDL-2024 LIBRARY; T=0.K
alphas from (g,npa)

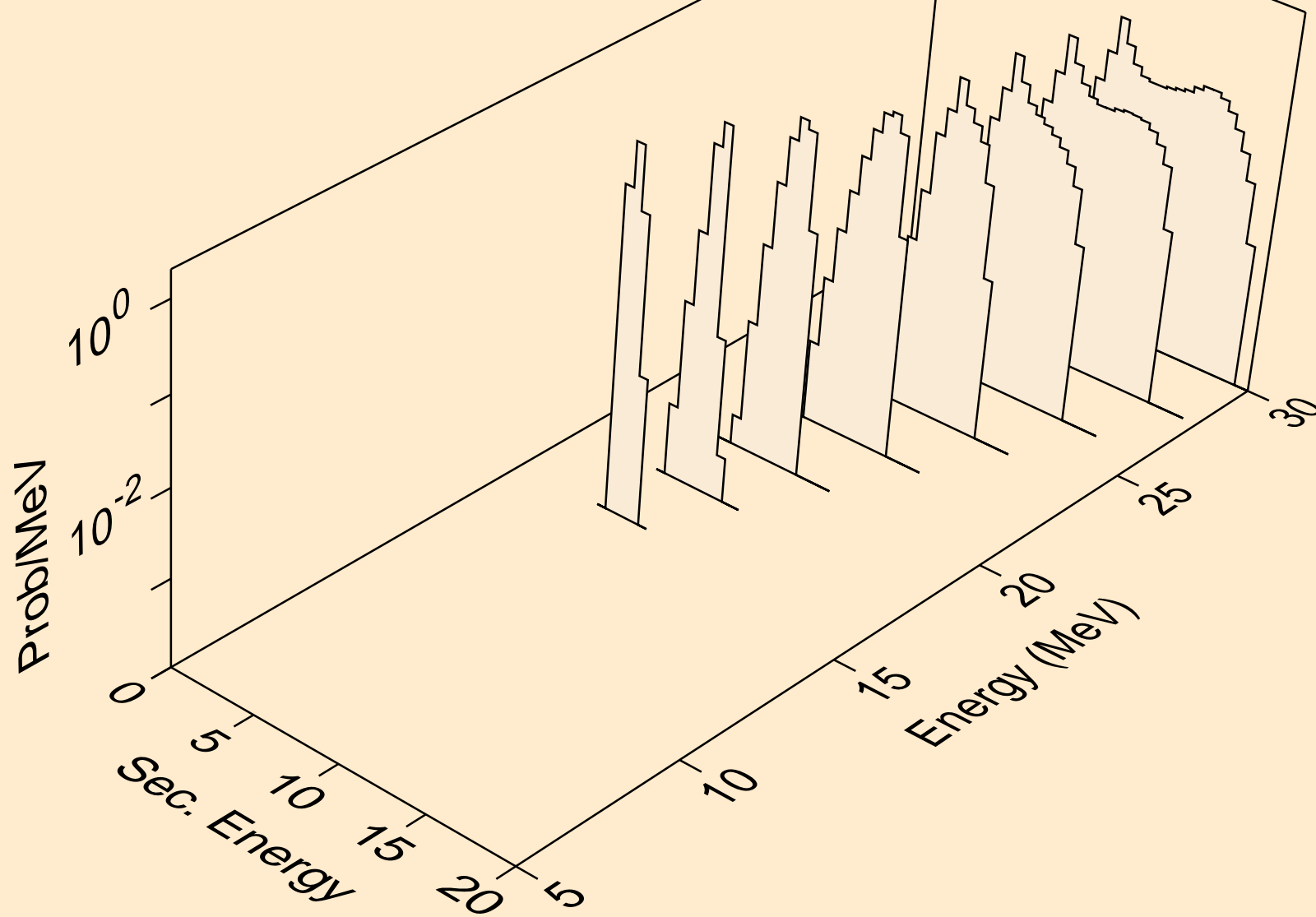

YB157 PHOTON ACER TENDL-2024 LIBRARY; T=0.K
alphas from (g,a)

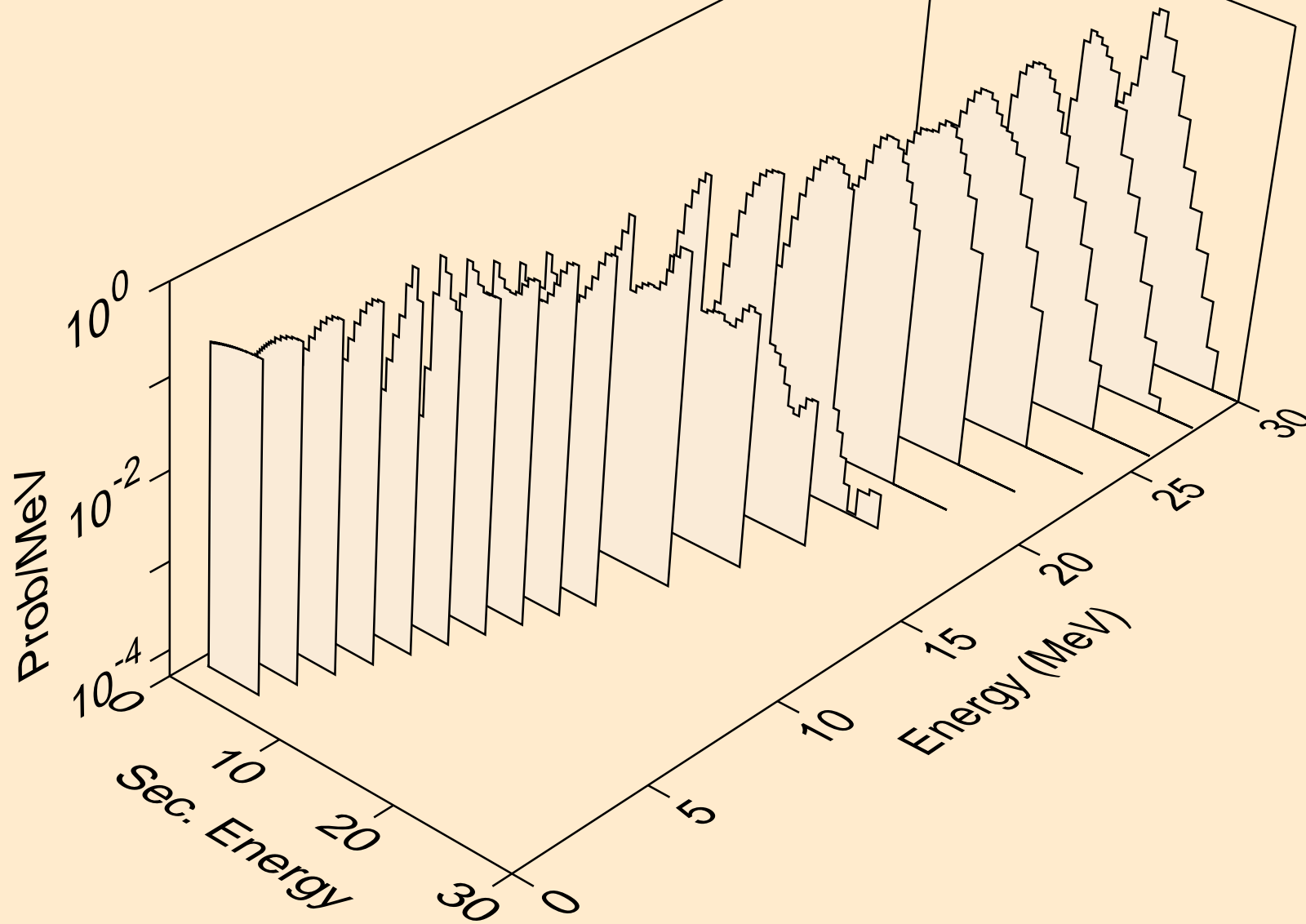

YB157 PHOTON ACER TENDL-2024 LIBRARY; T=0.K
alphas from (g,2a)

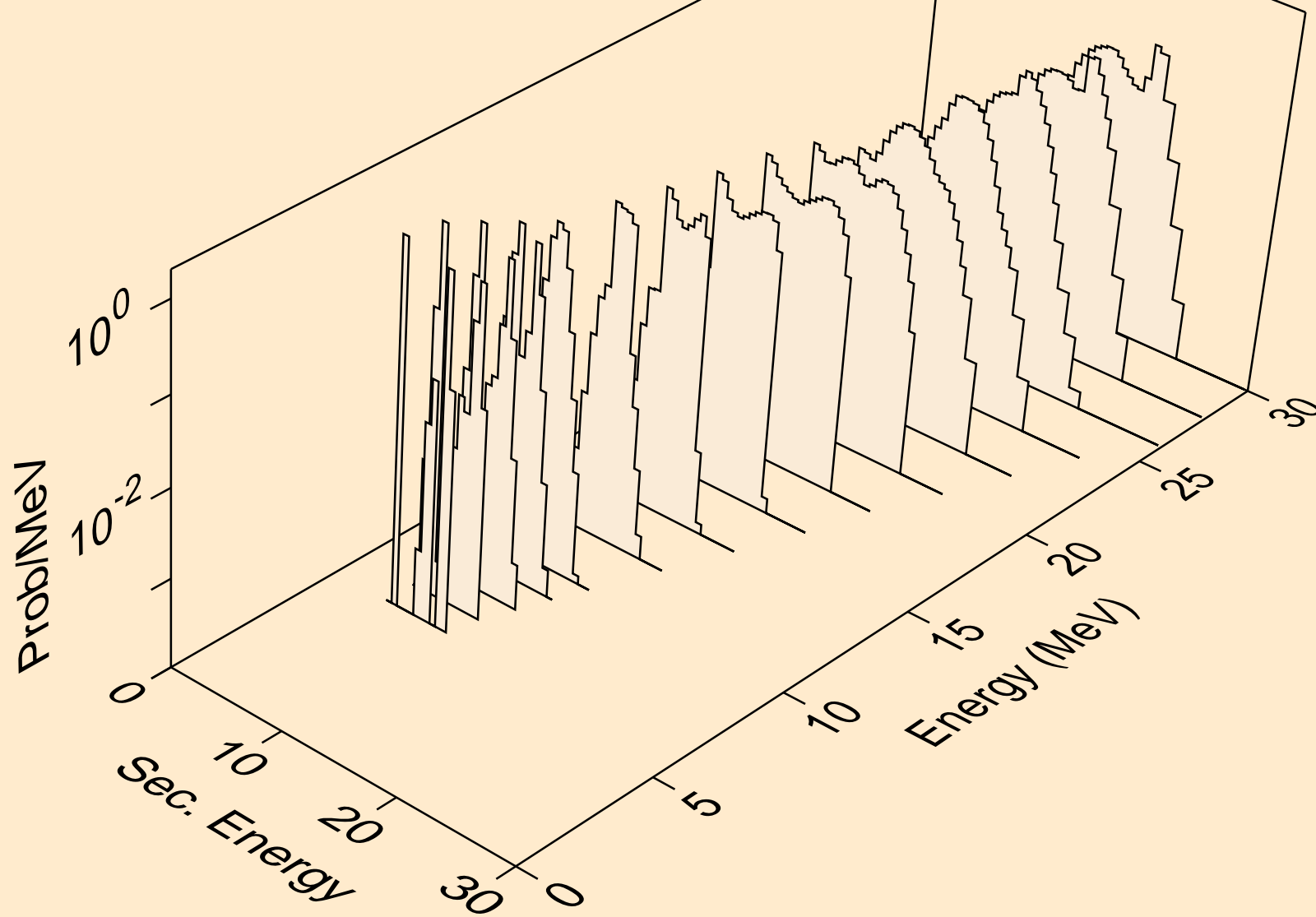

YB157 PHOTON ACER TENDL-2024 LIBRARY; T=0.K
alphas from (g,pa)

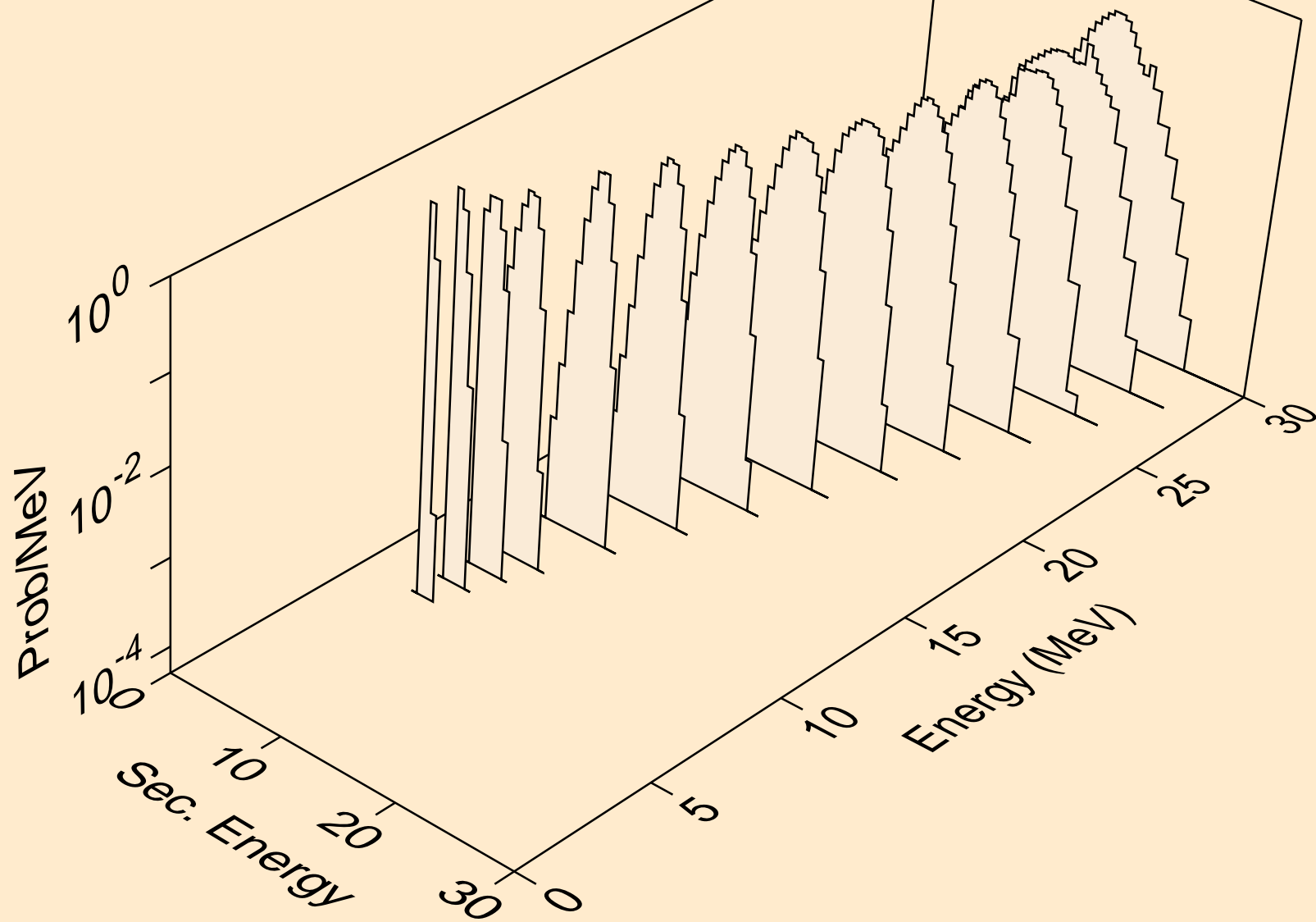

YB157 PHOTON ACER TENDL-2024 LIBRARY; T=0.K
alphas from (g,da)

