

AM236M HELION ACER TENDL-2024 LIBRARY; T=0.K
Principal cross sections

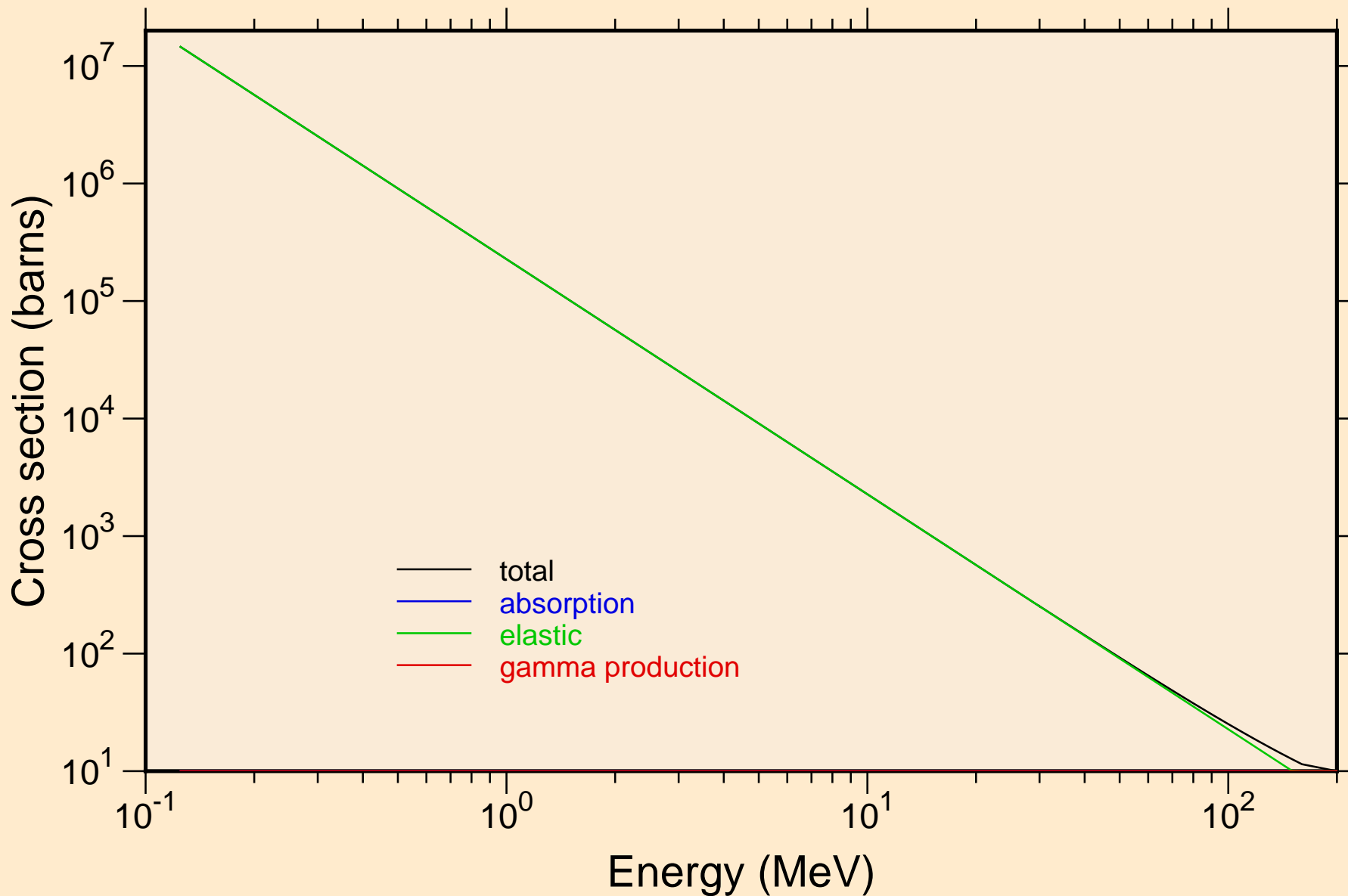

AM236M HELION ACER TENDL-2024 LIBRARY; T=0.K

Heating

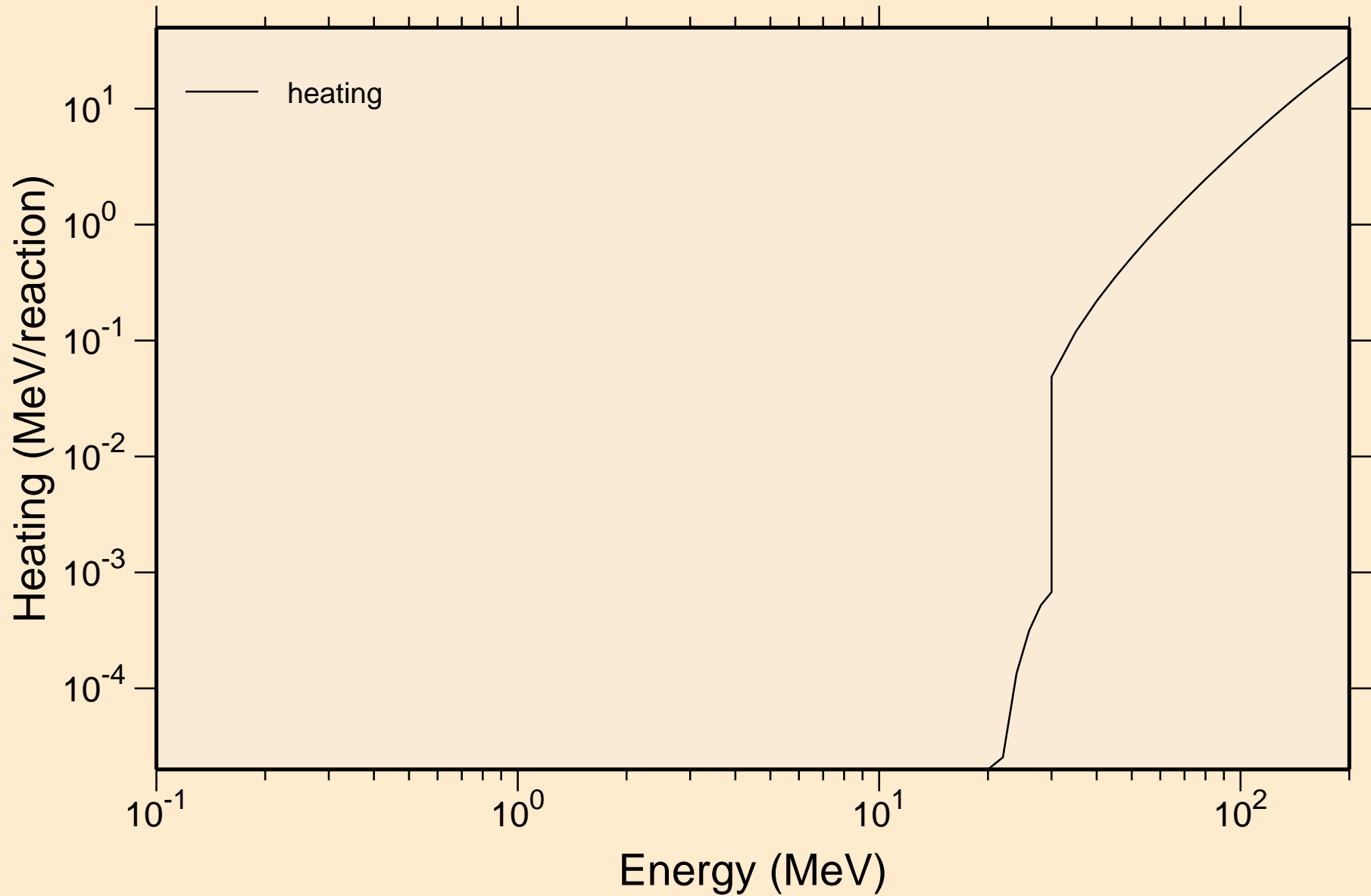

AM236M HELION ACER TENDL-2024 LIBRARY; T=0.K

Principal cross sections

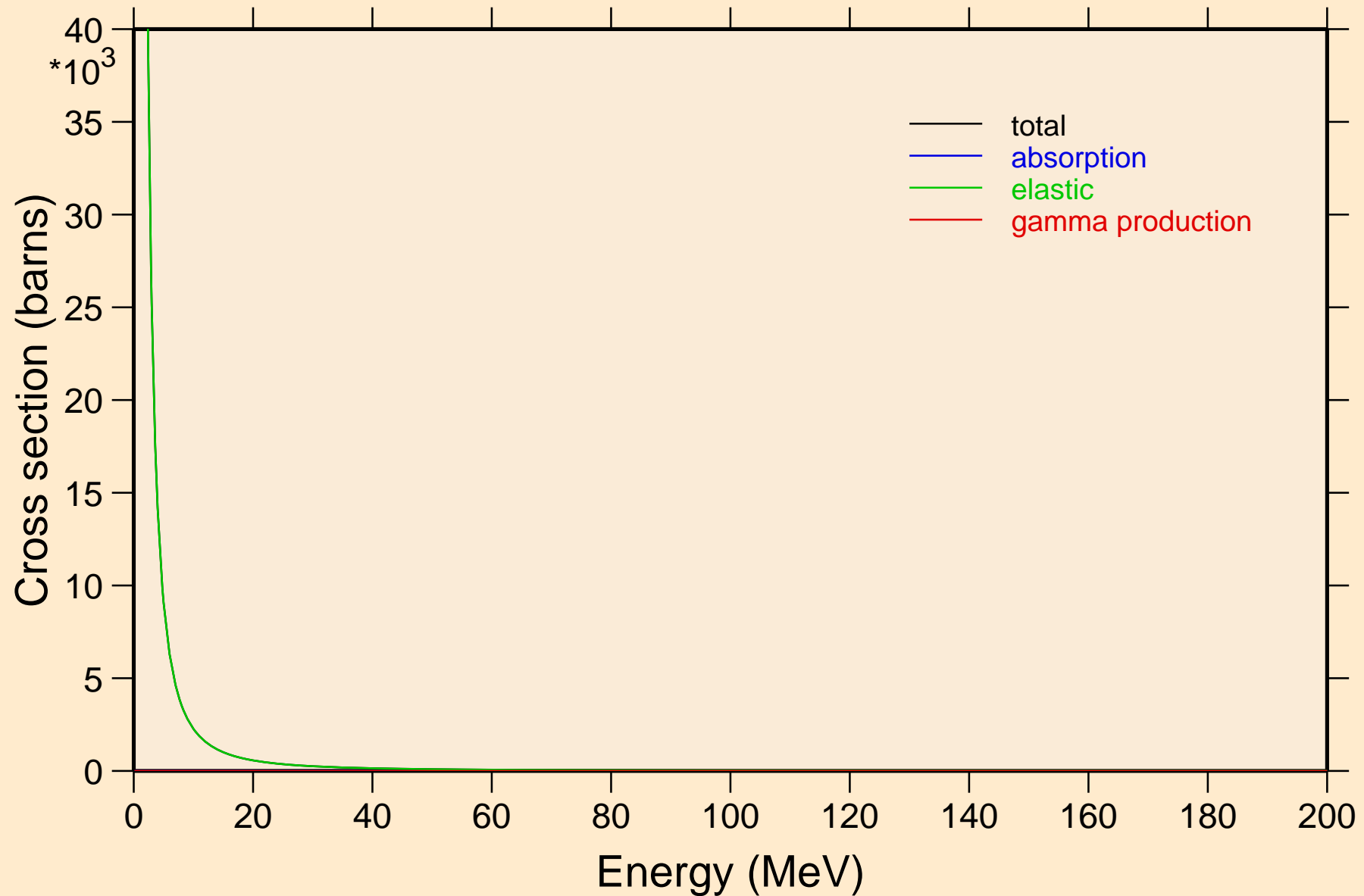

AM236M HELION ACER TENDL-2024 LIBRARY; T=0.K

Heating

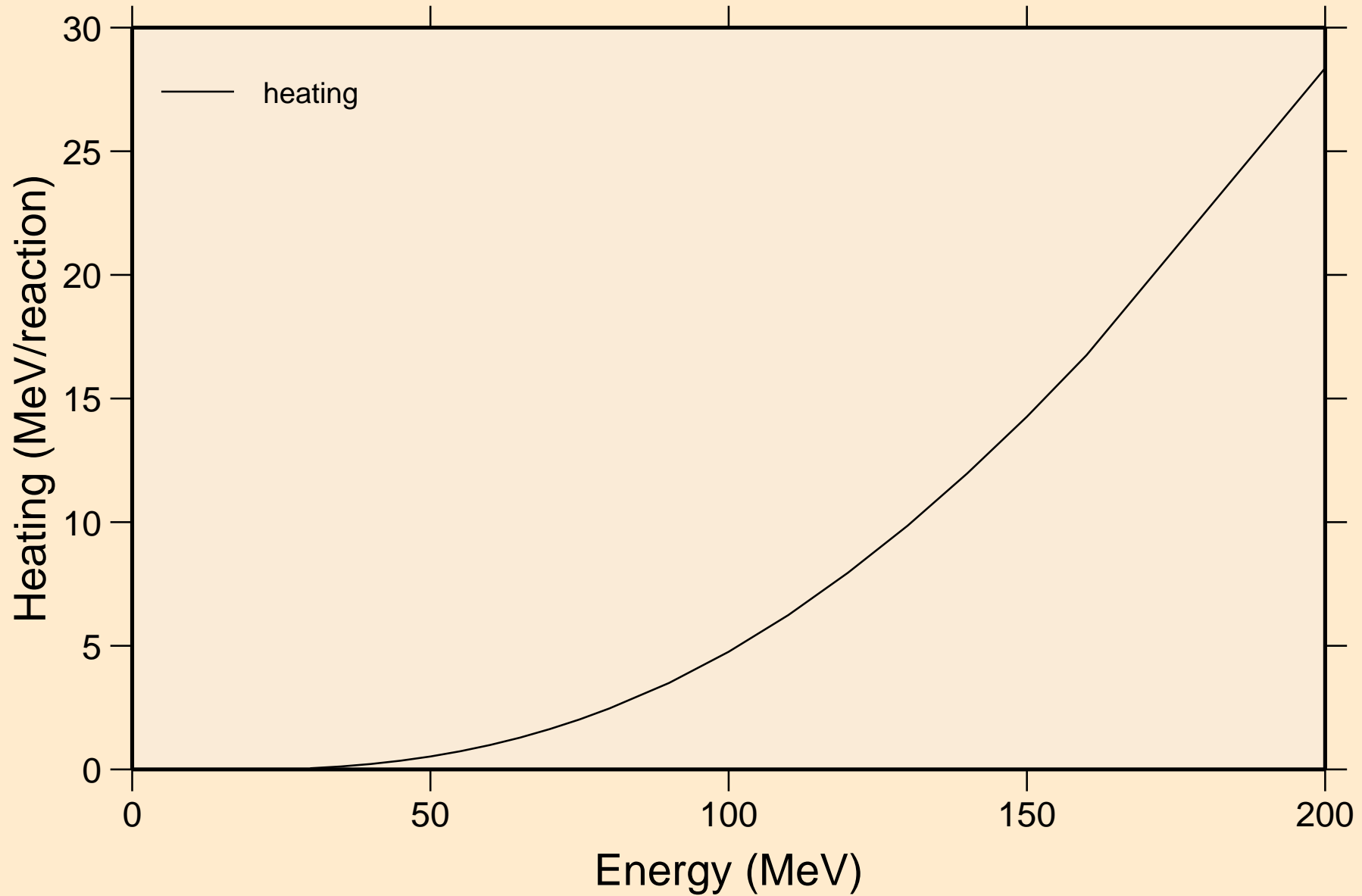

AM236M HELION ACER TENDL-2024 LIBRARY; T=0.K
Threshold reactions

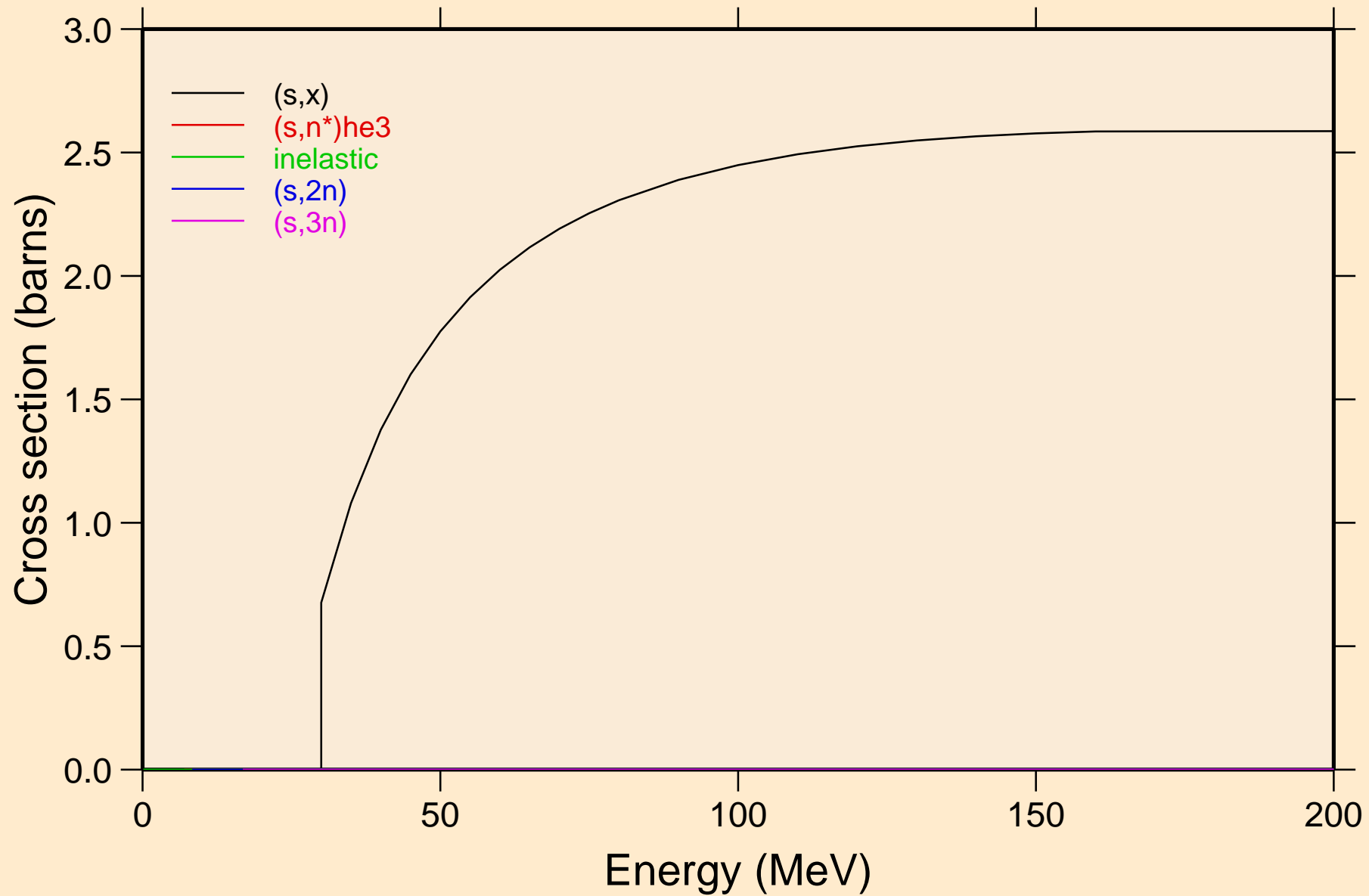

AM236M HELION ACER TENDL-2024 LIBRARY; T=0.K
Threshold reactions

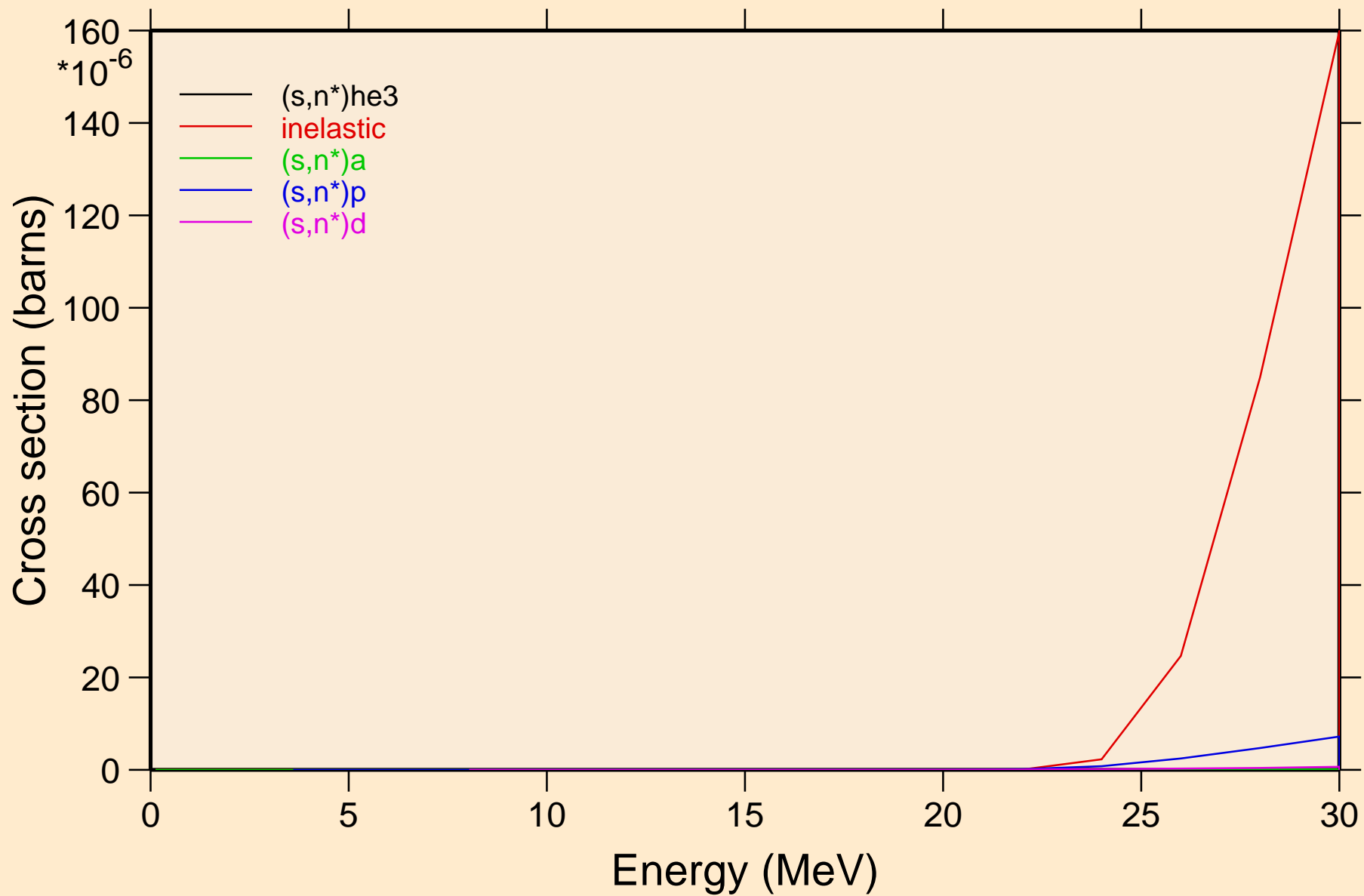

AM236M HELION ACER TENDL-2024 LIBRARY; T=0.K
Threshold reactions

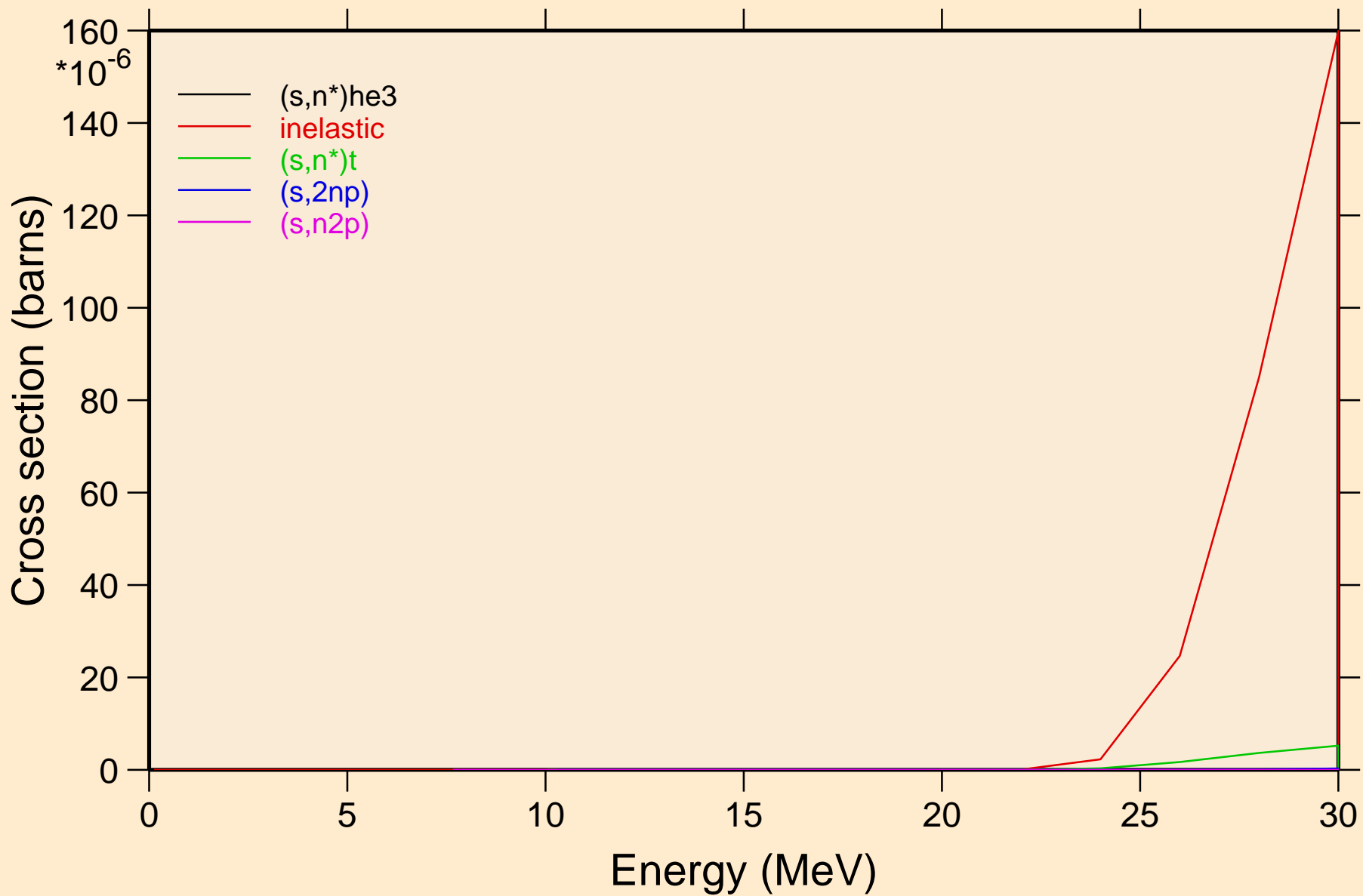

AM236M HELION ACER TENDL-2024 LIBRARY; T=0.K
Threshold reactions

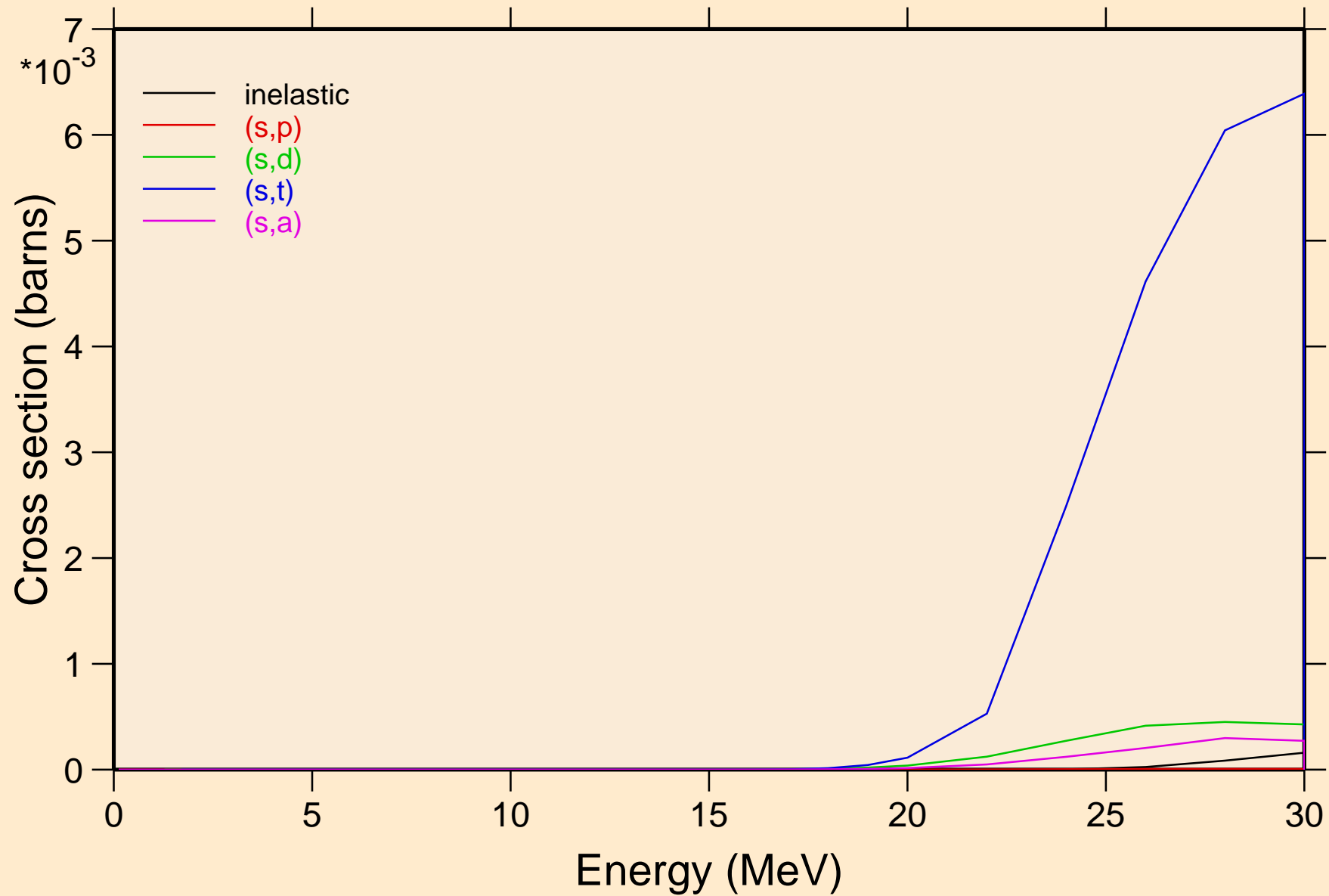

AM236M HELION ACER TENDL-2024 LIBRARY; T=0.K
Threshold reactions

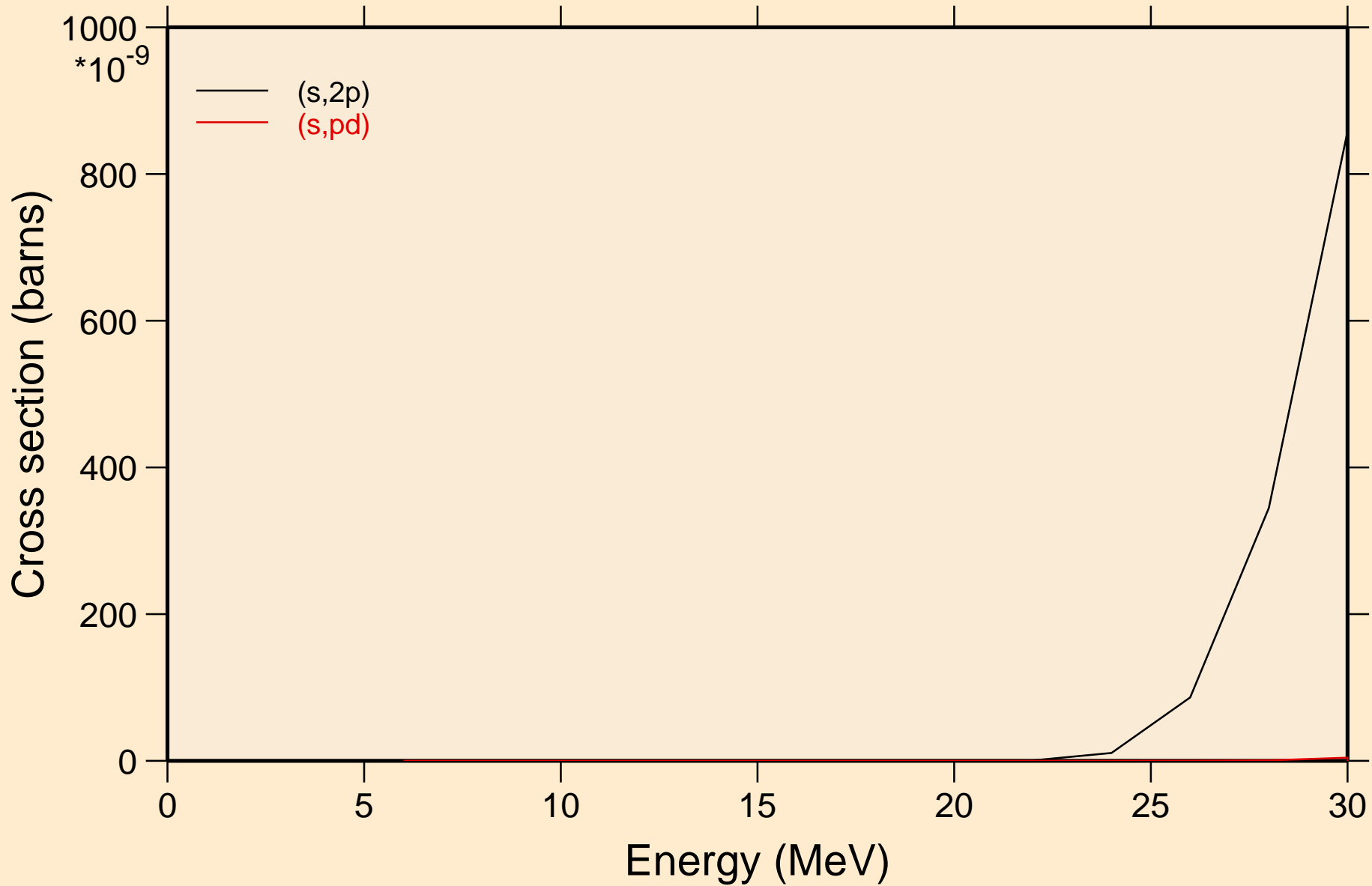

AM236M HELION ACER TENDL-2024 LIBRARY; T=0.K
angular distribution for elastic

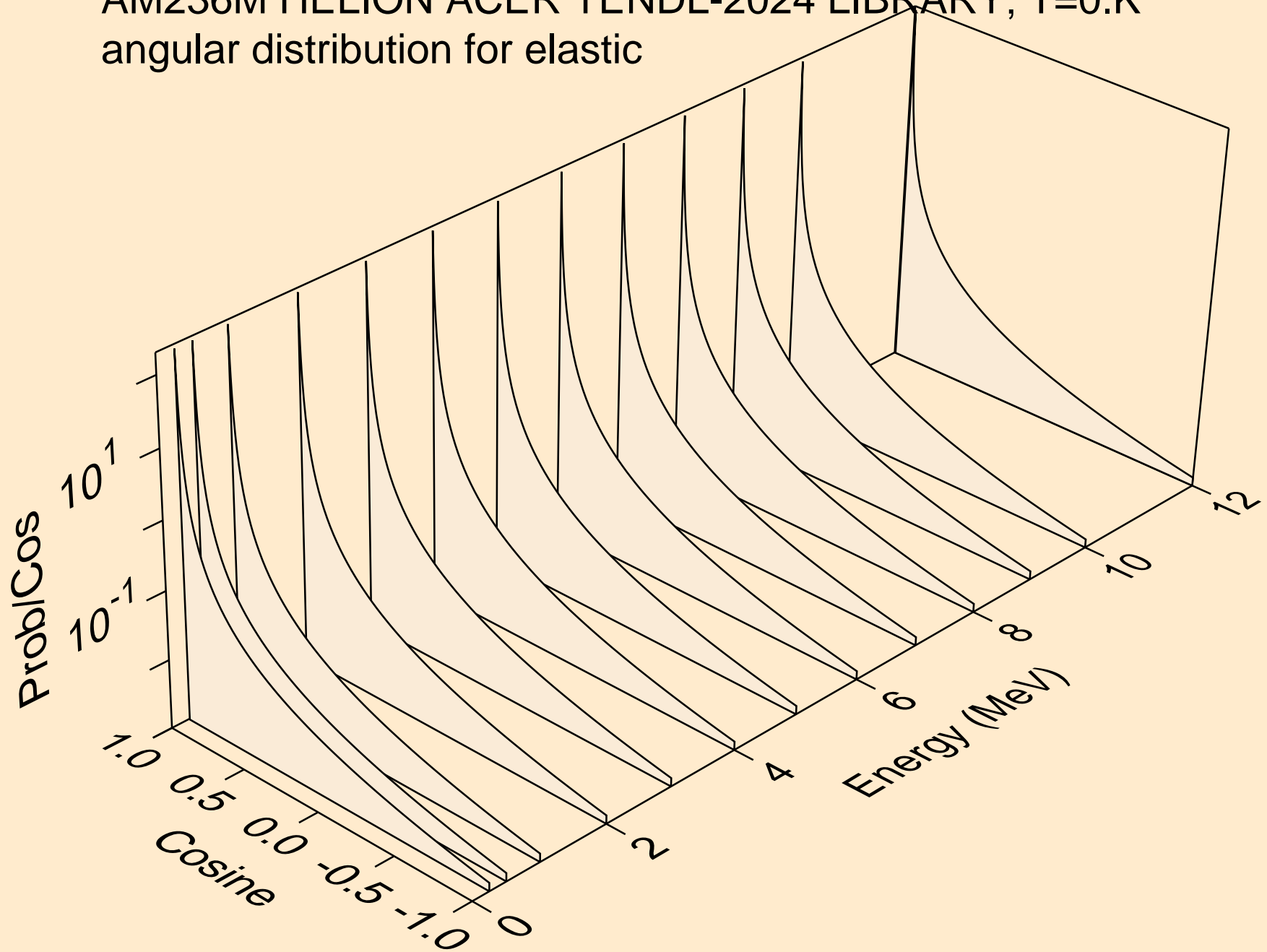

AM236M HELION ACER TENDL-2024 LIBRARY; T=0.K
He-3 emission for (s,x)

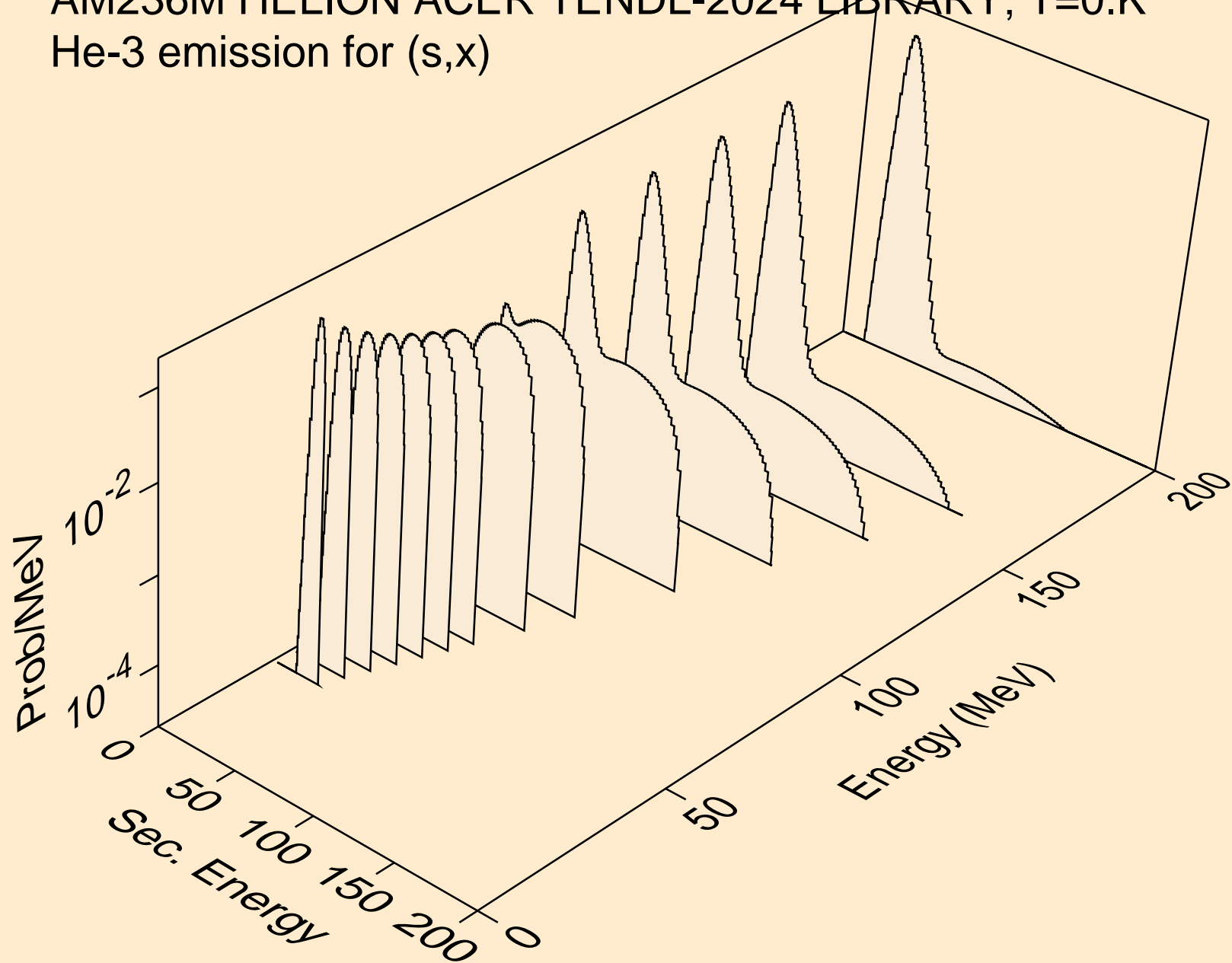

AM236M HELION ACER TENDL-2024 LIBRARY; T=0.K
He-3 emission for (s,n*)he3

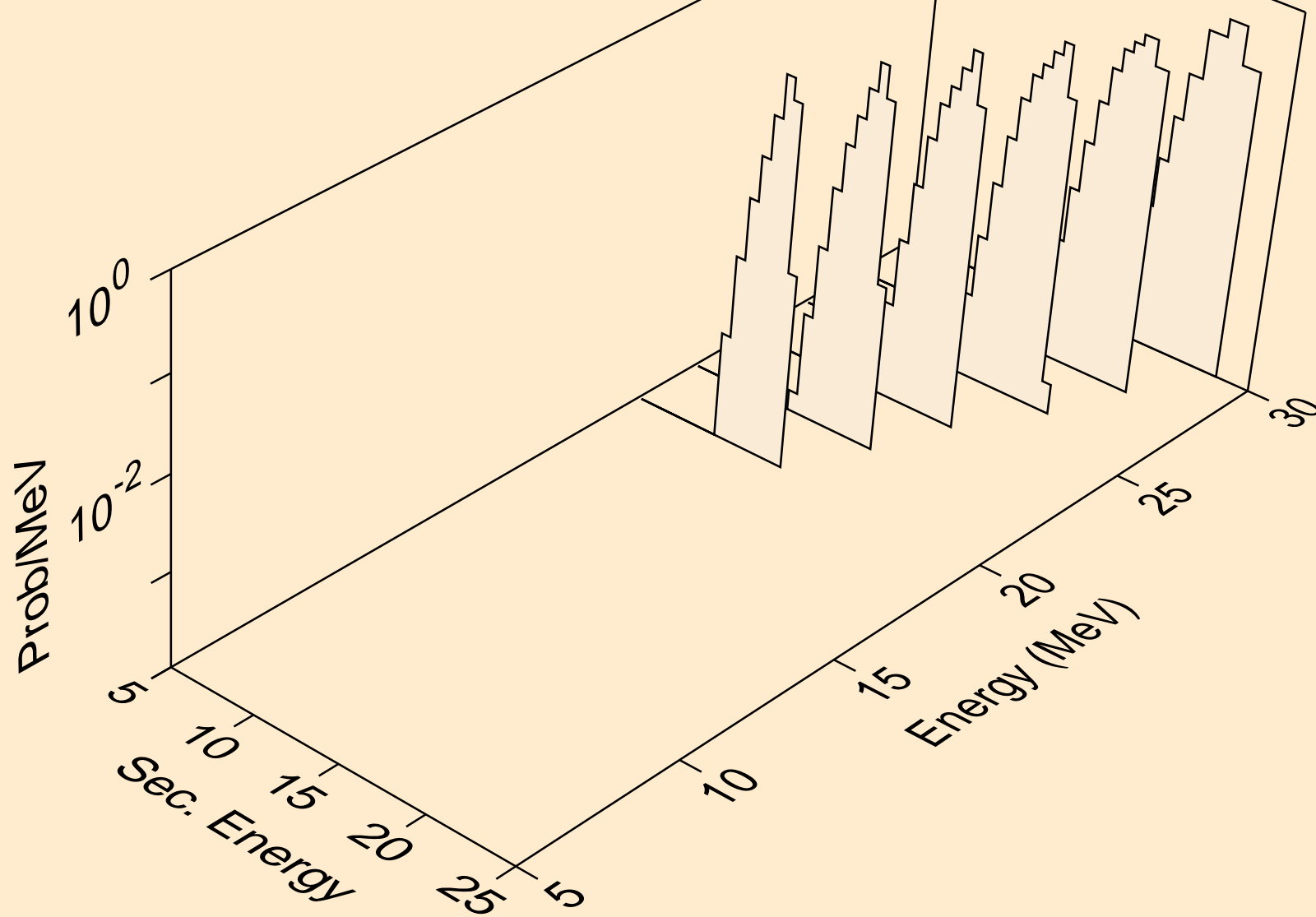

AM236M HELION ACER TENDL-2024 LIBRARY; T=0.K
He-3 emission for inelastic

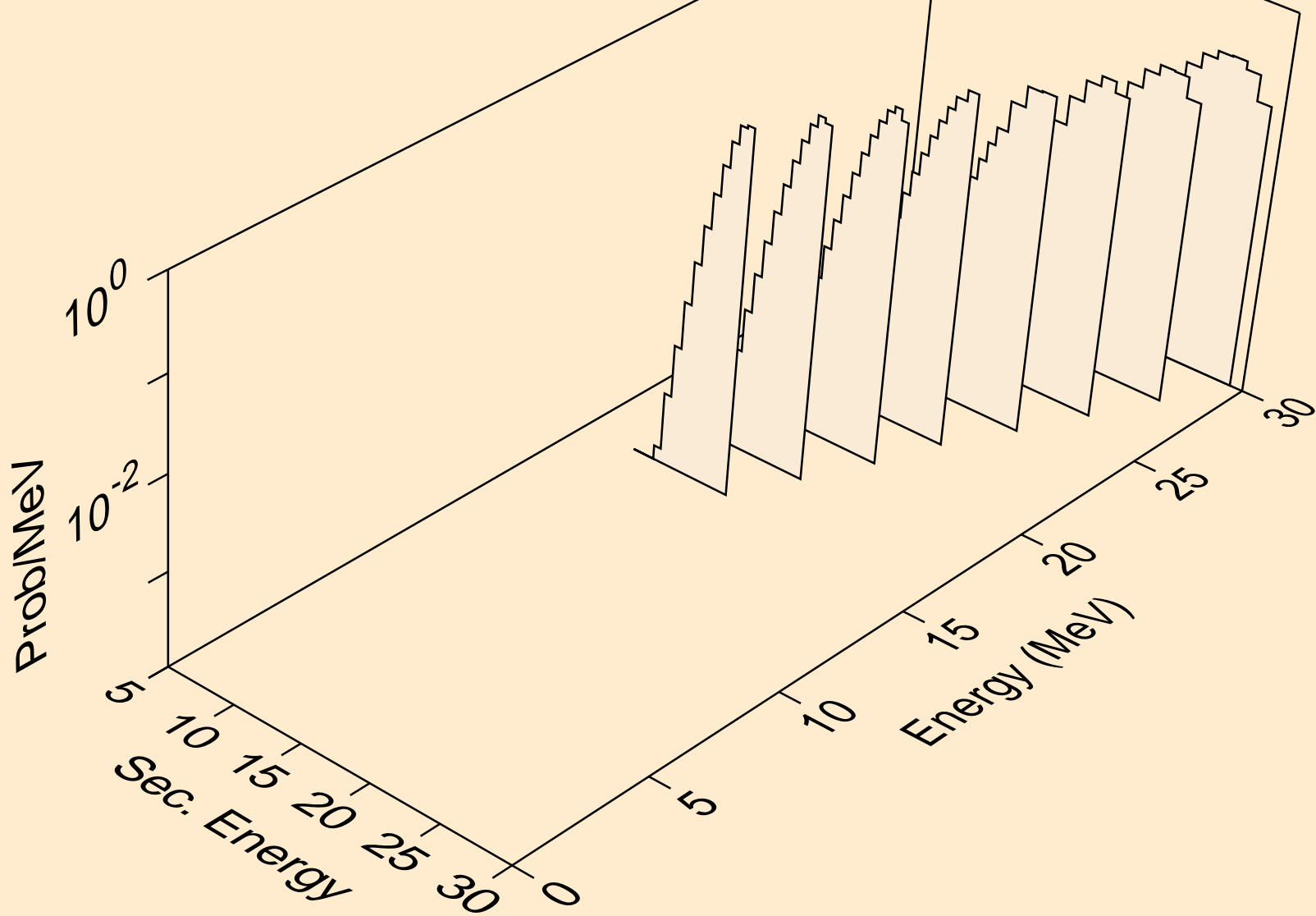

AM236M HELION ACER TENDL-2024 LIBRARY; T=0.K
Photon emission for (z,n)

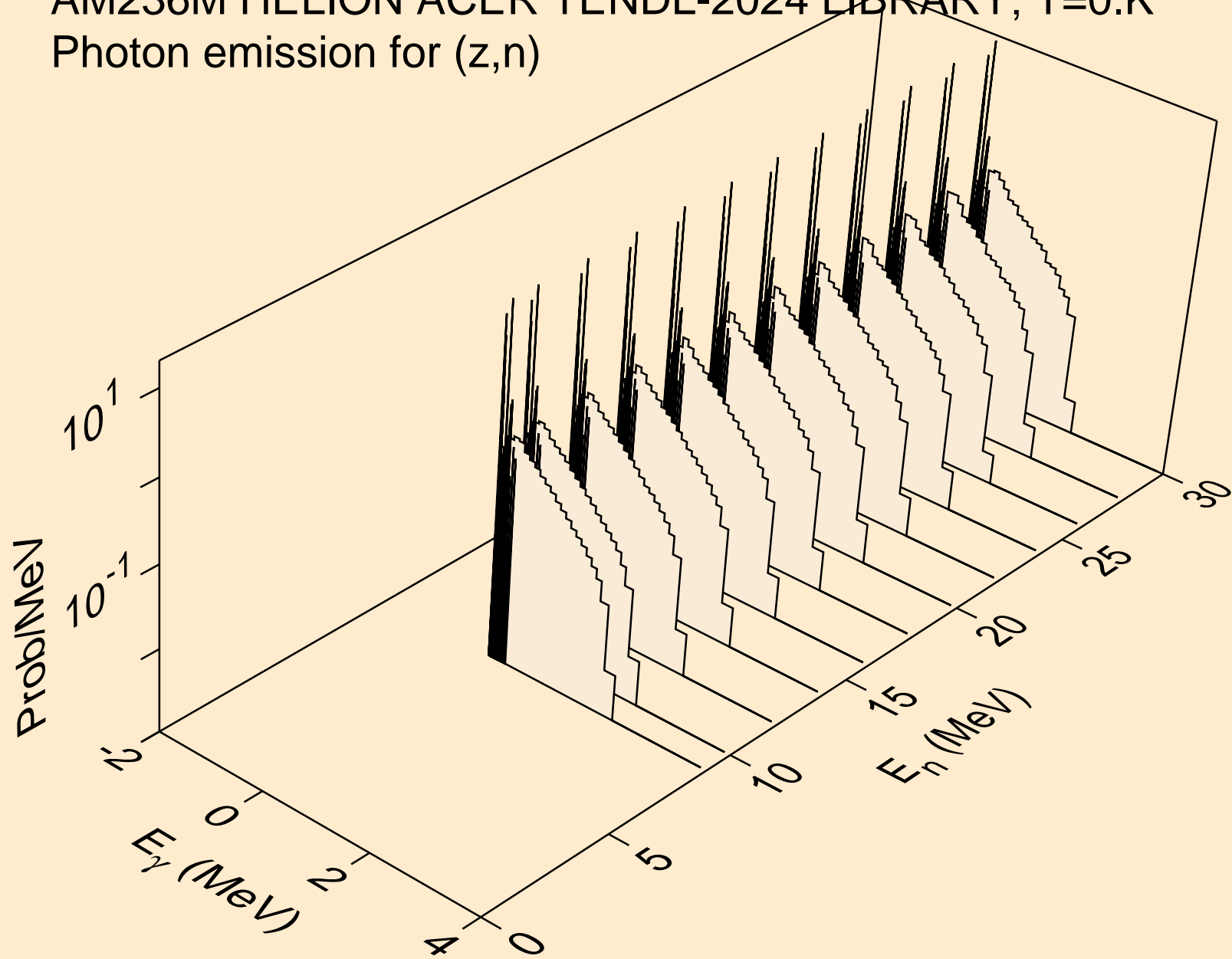

AM236M HELION ACER TENDL-2024 LIBRARY; T=0.K
Photon emission for (z,x)

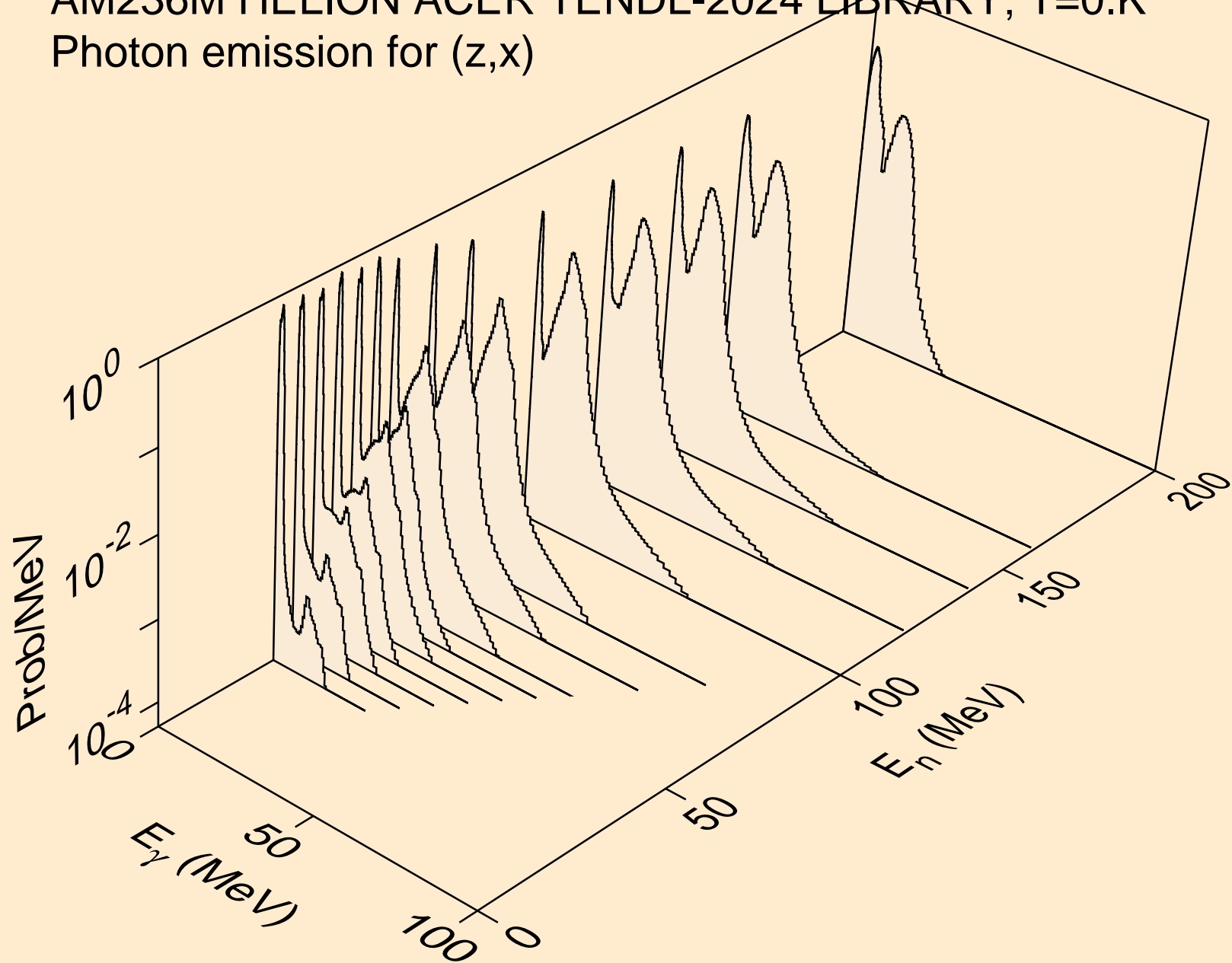

AM236M HELION ACER TENDL-2024 LIBRARY; T=0.K
Photon emission for (n,2n)

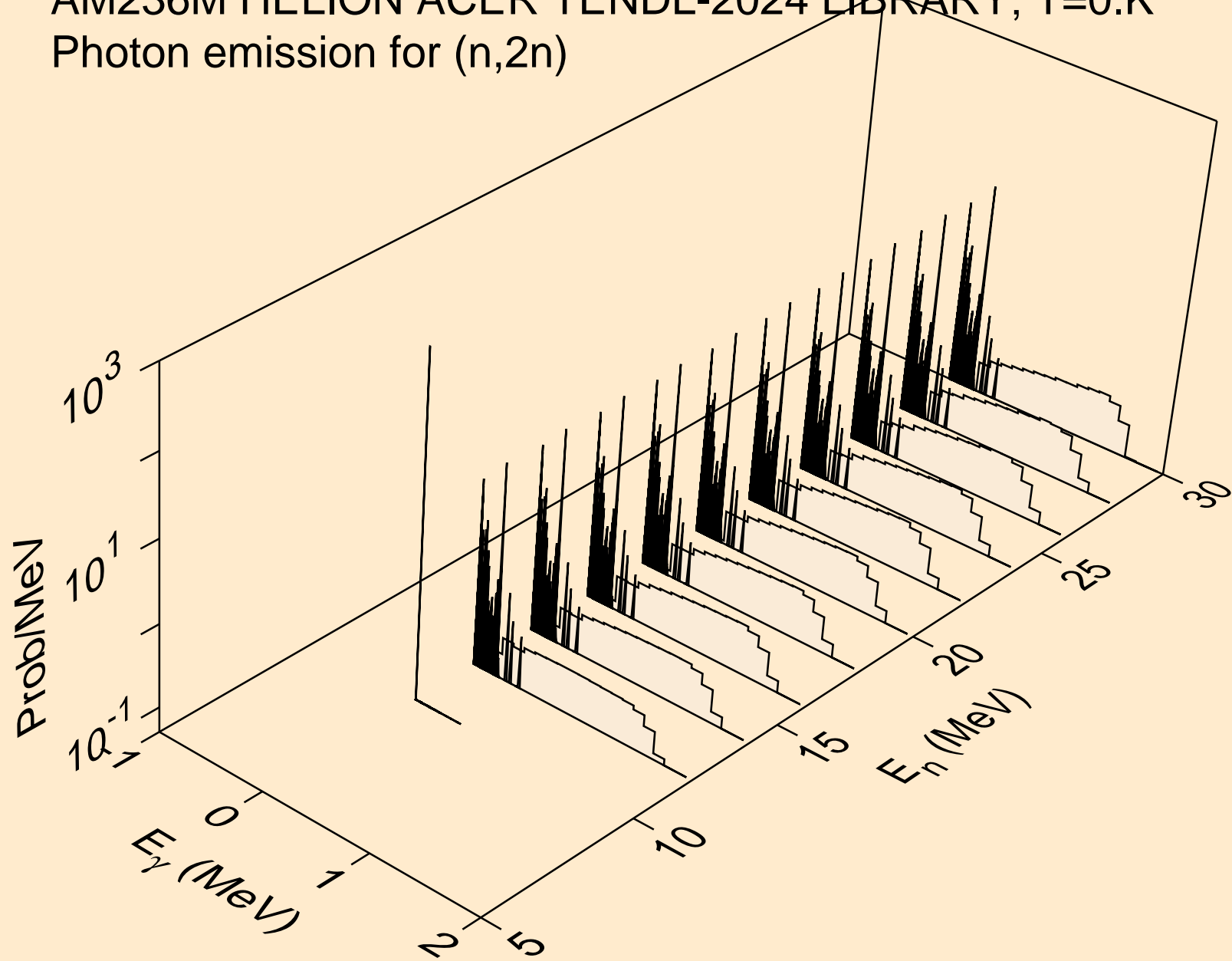

AM236M HELION ACER TENDL-2024 LIBRARY; T=0.K
Photon emission for (n,3n)

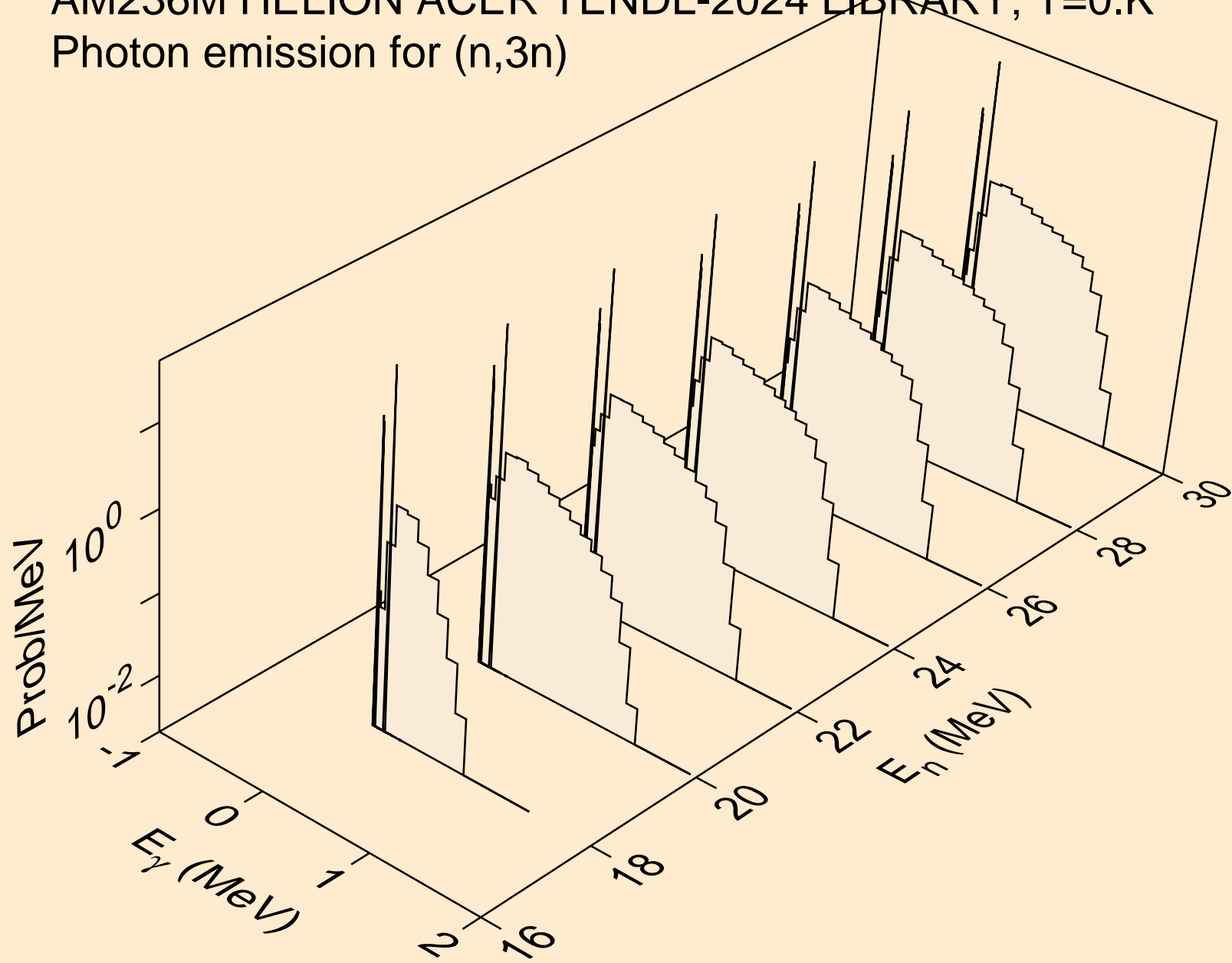

AM236M HELION ACER TENDL-2024 LIBRARY; T=0.K
Photon emission for (n,n*)a

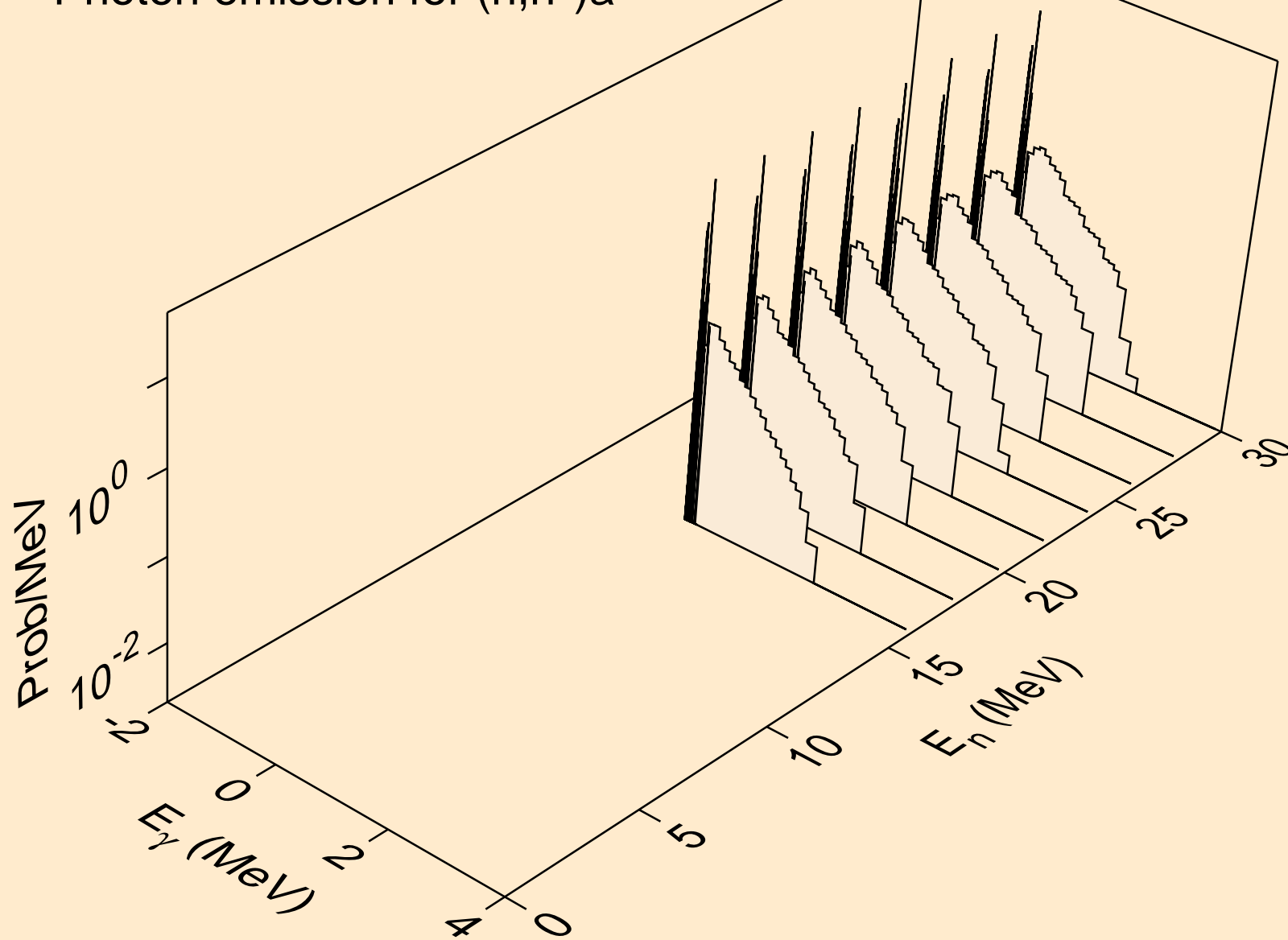

AM236M HELION ACER TENDL-2024 LIBRARY; T=0.K
Photon emission for (n,n*)p

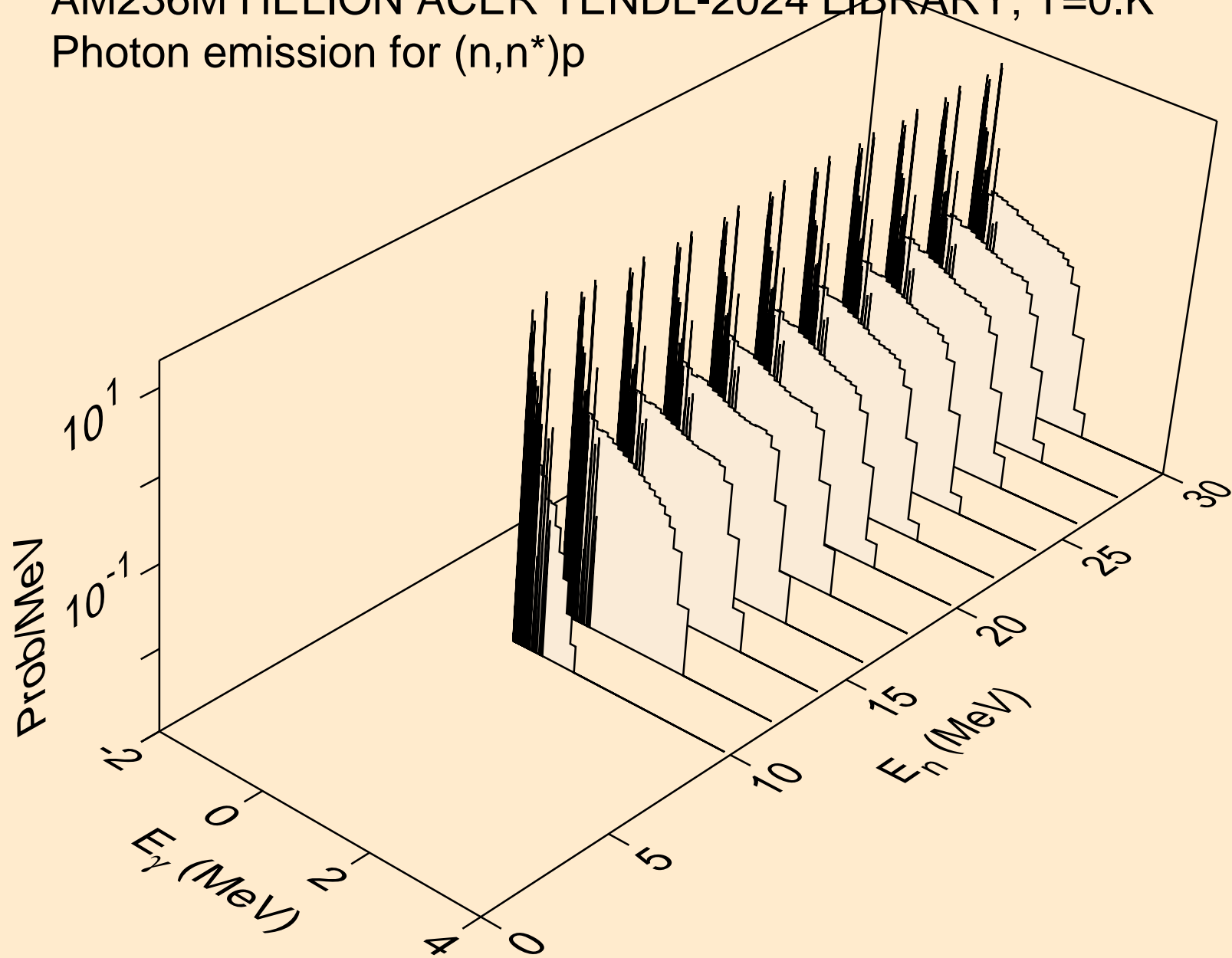

AM236M HELION ACER TENDL-2024 LIBRARY; T=0.K
Photon emission for (n,n*)d

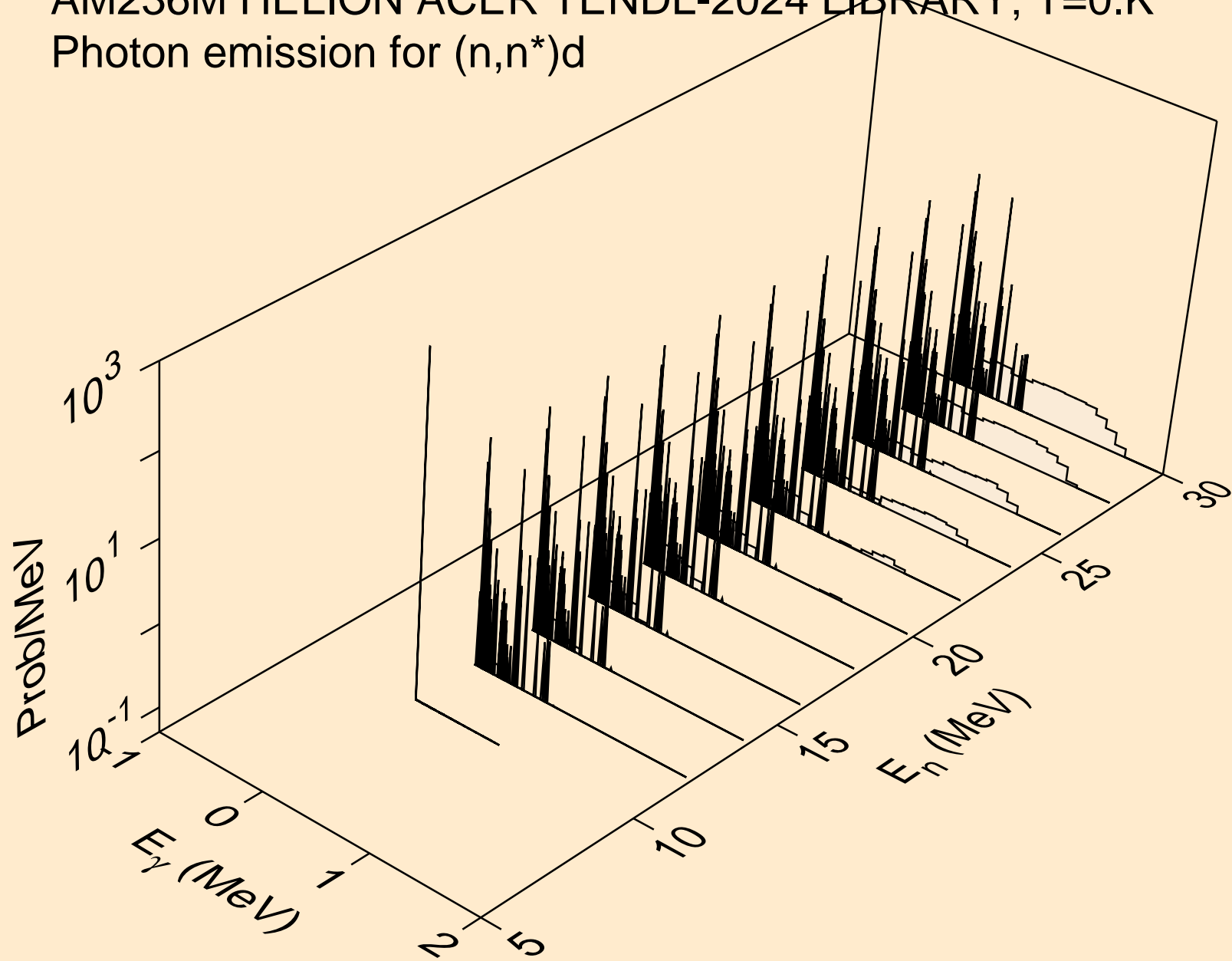

AM236M HELION ACER TENDL-2024 LIBRARY; T=0.K
Photon emission for (n,n*)t

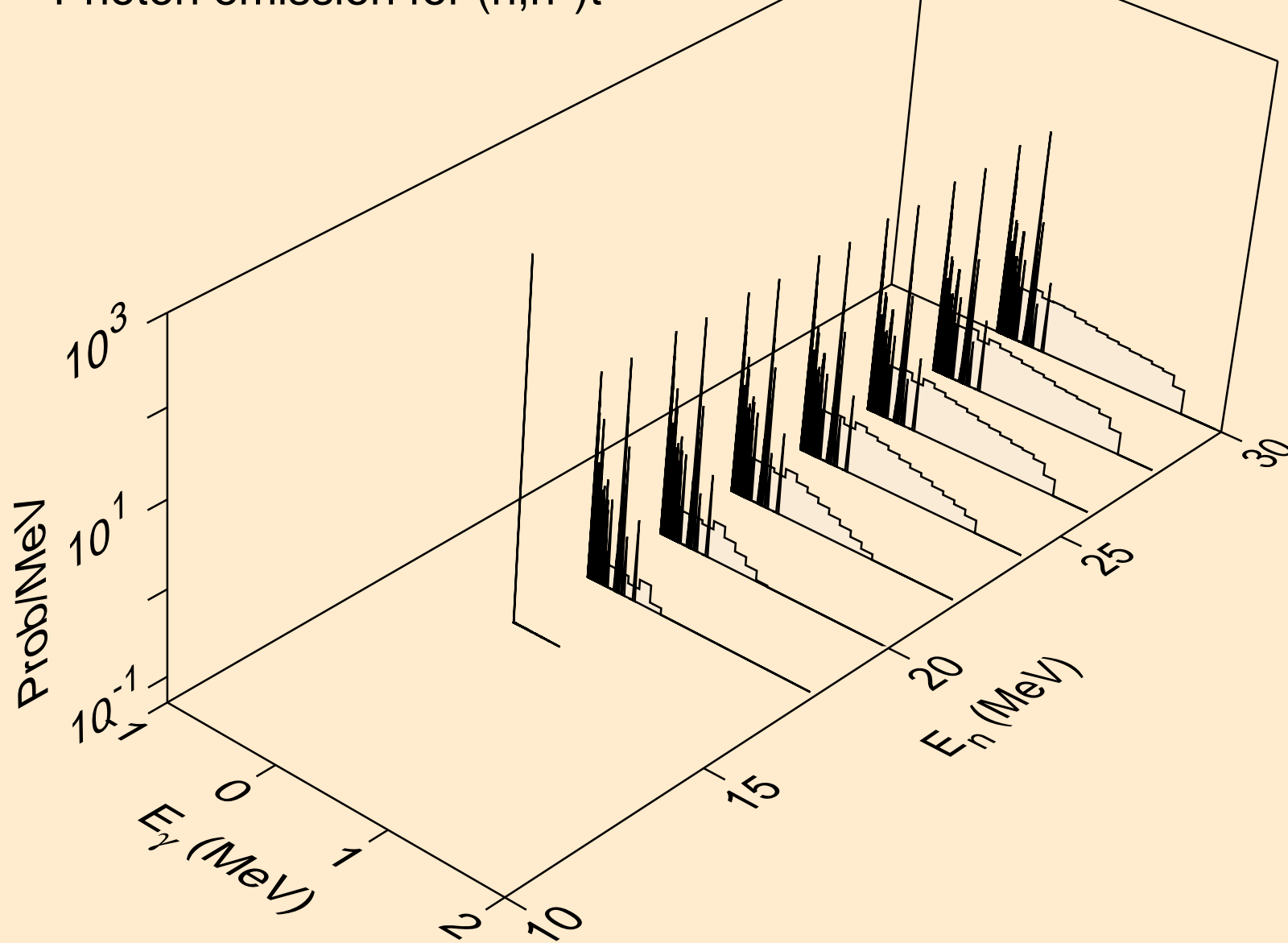

AM236M HELION ACER TENDL-2024 LIBRARY; T=0.K
Photon emission for (n,n*)he3

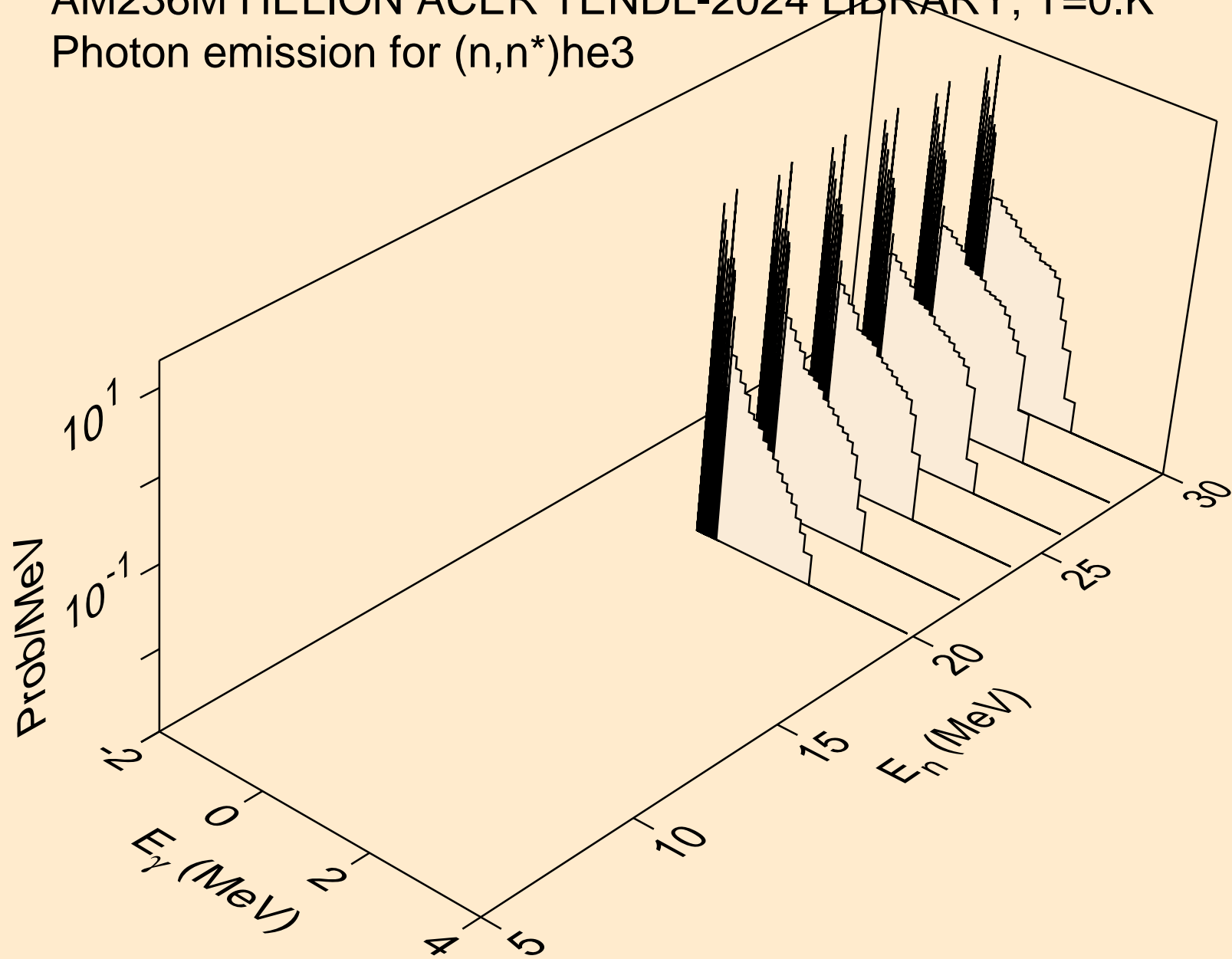

AM236M HELION ACER TENDL-2024 LIBRARY; T=0.K
Photon emission for (n,2np)

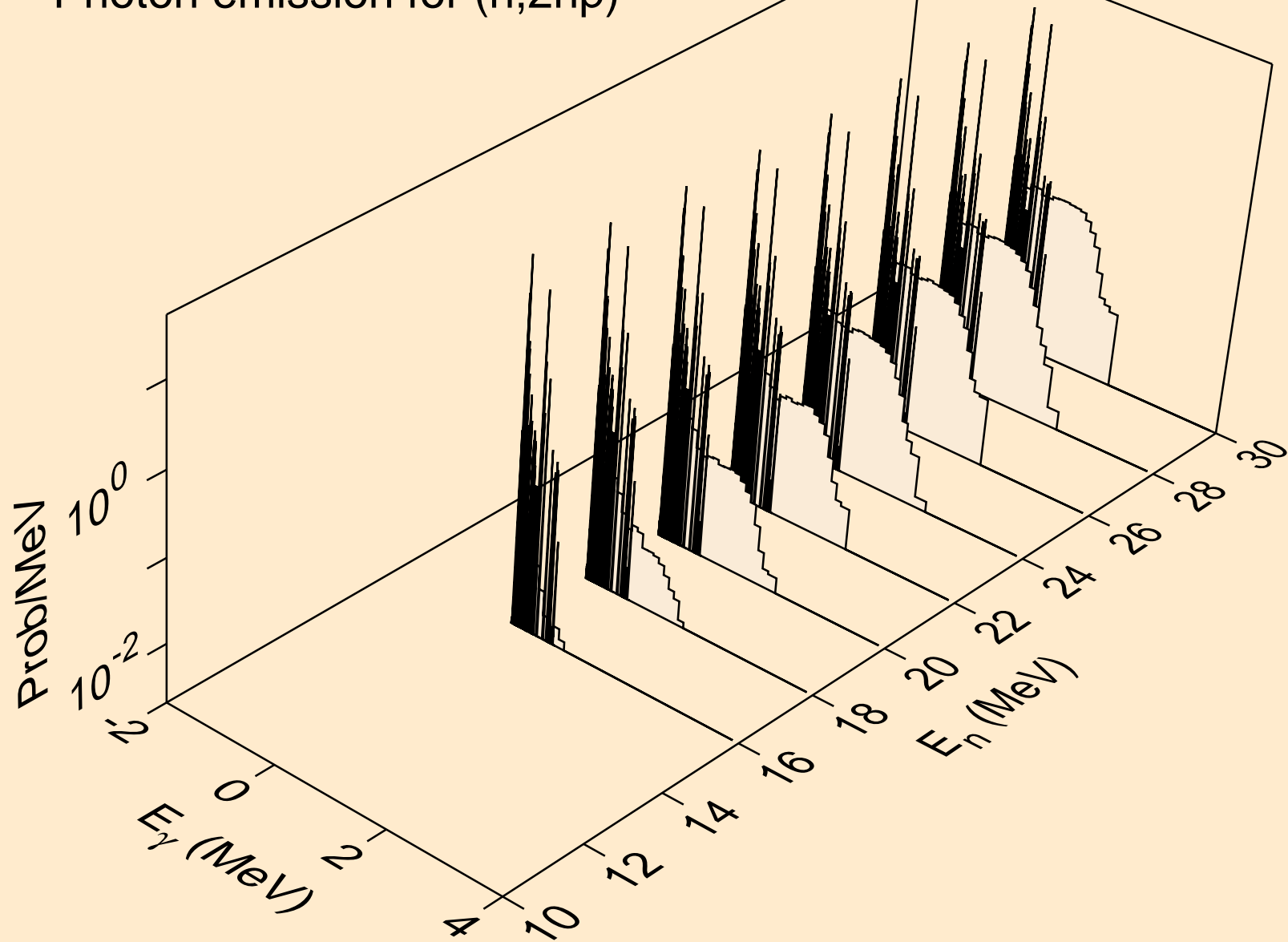

AM236M HELION ACER TENDL-2024 LIBRARY; T=0.K
Photon emission for (n,n2p)

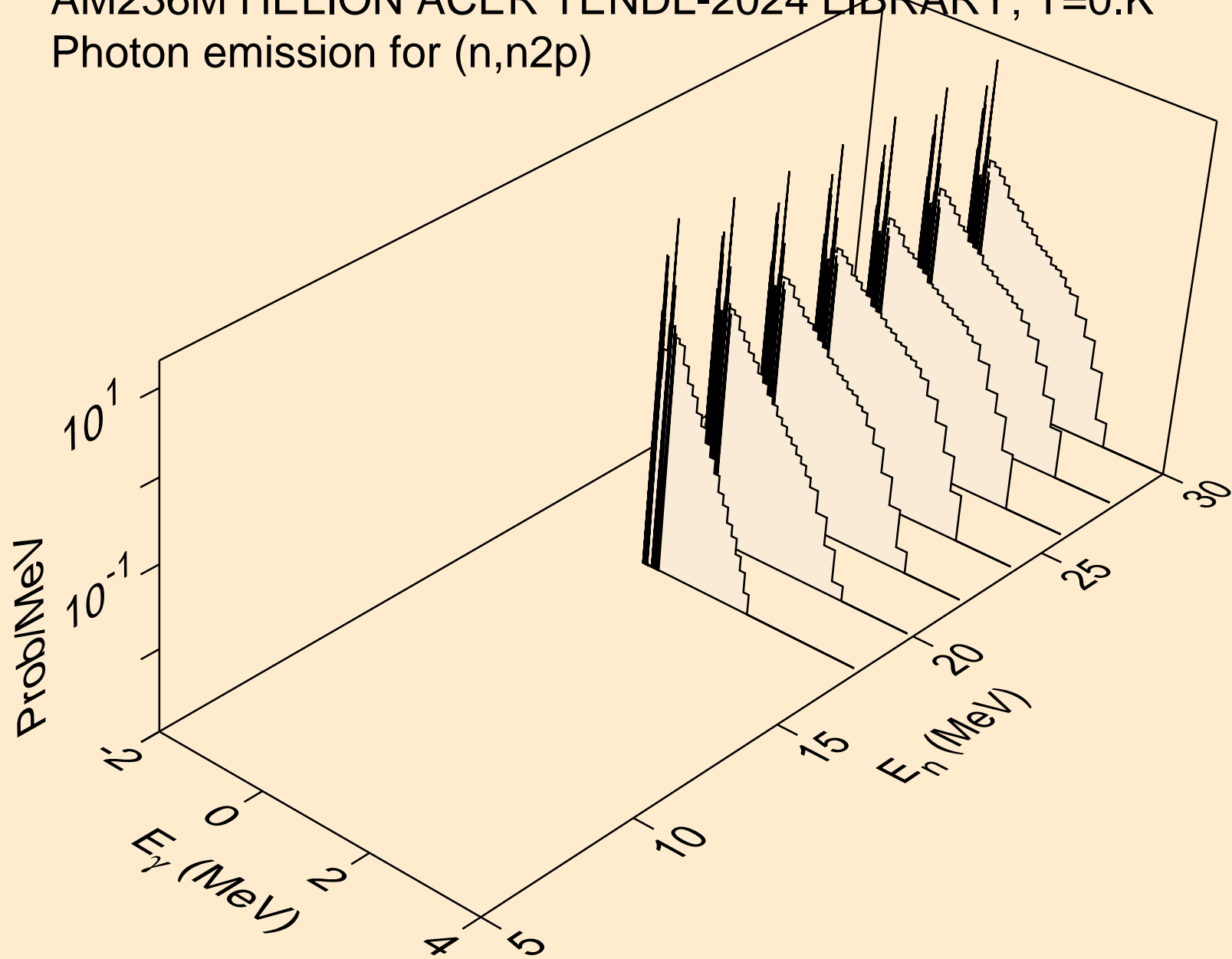

AM236M HELION ACER TENDL-2024 LIBRARY; T=0.K
Photon emission for (n,p)

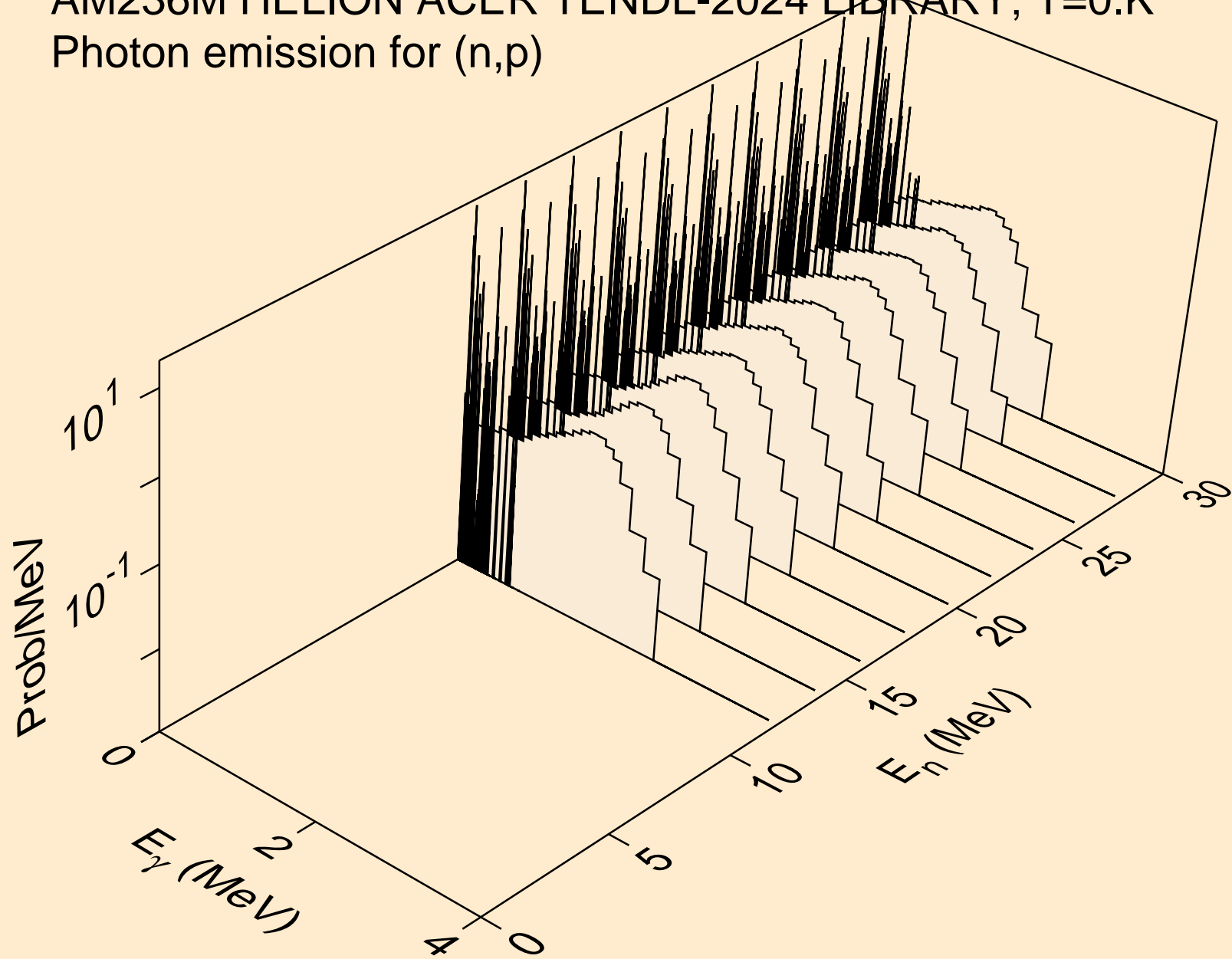

AM236M HELION ACER TENDL-2024 LIBRARY; T=0.K
Photon emission for (n,d)

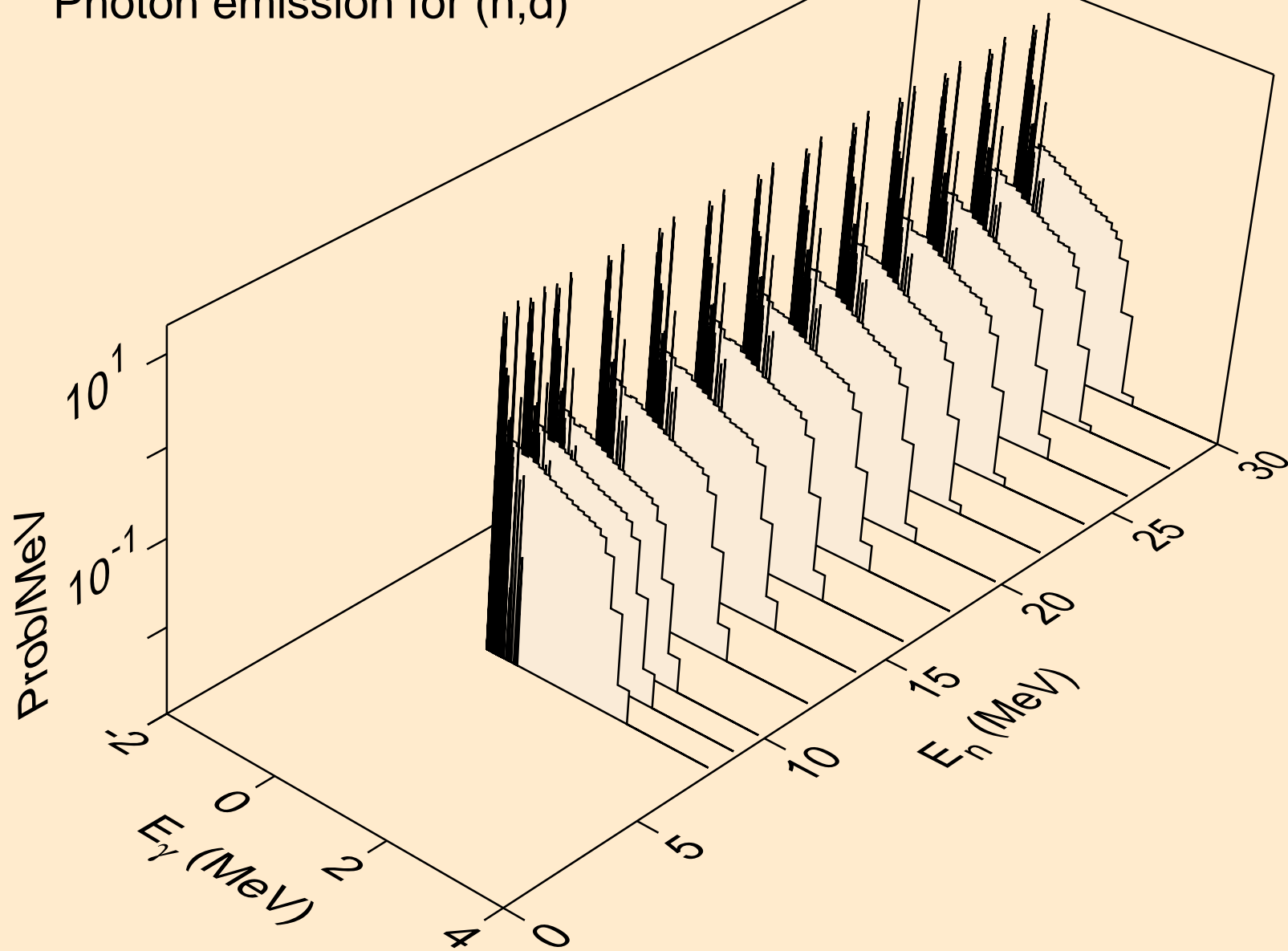

AM236M HELION ACER TENDL-2024 LIBRARY; T=0.K
Photon emission for (n,t)

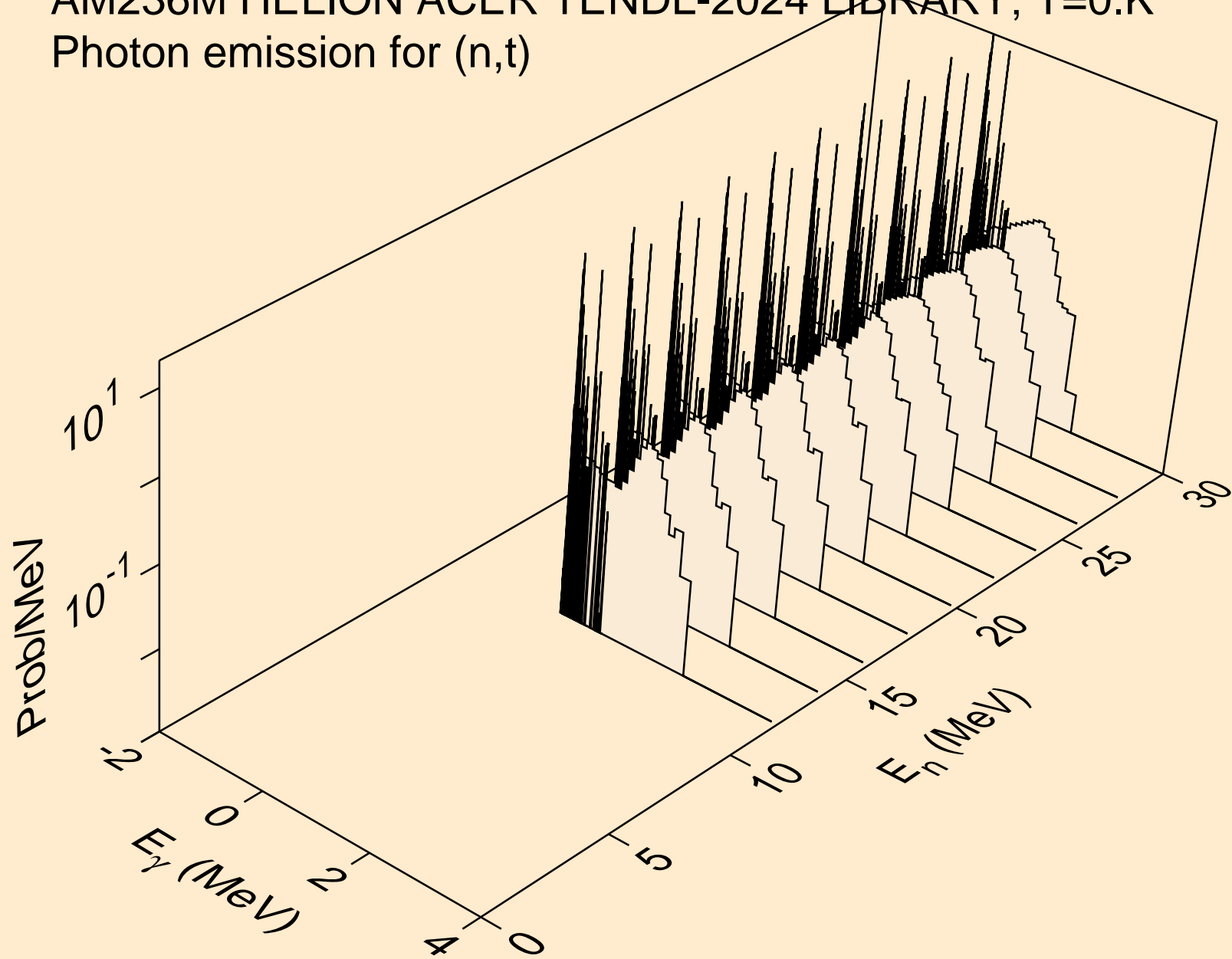

AM236M HELION ACER TENDL-2024 LIBRARY; T=0.K
Photon emission for inelastic

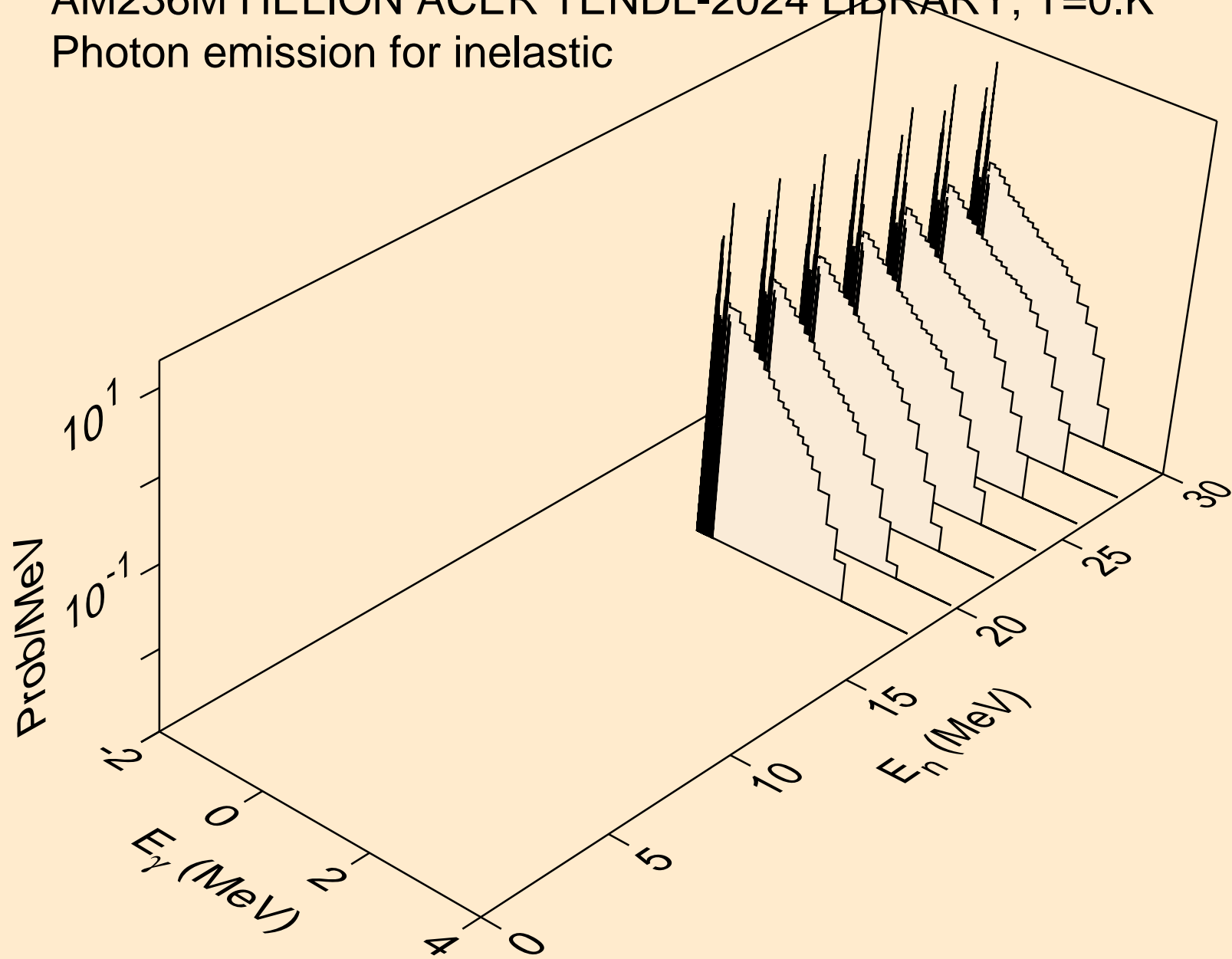

AM236M HELION ACER TENDL-2024 LIBRARY; T=0.K
Photon emission for (n,a)

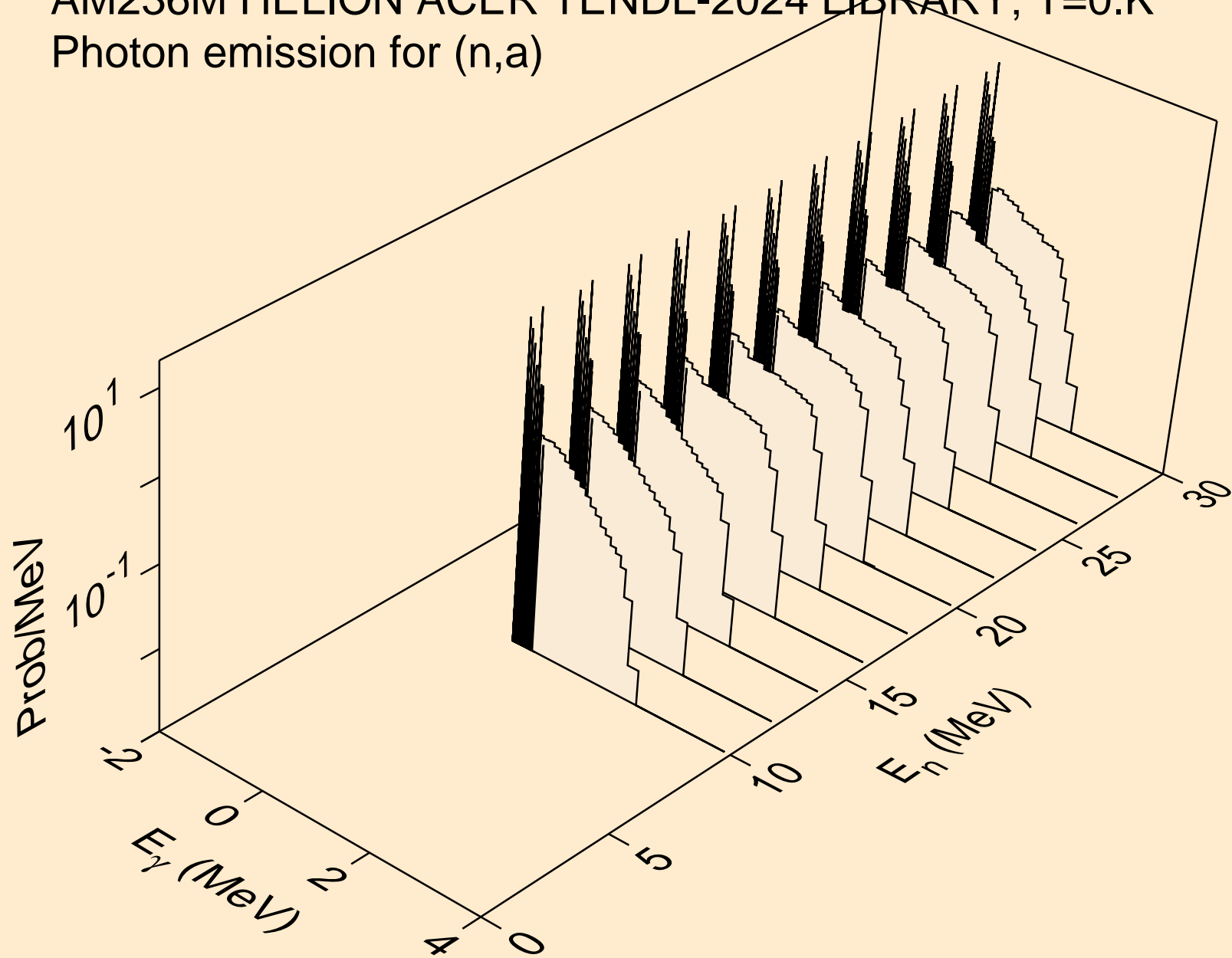

AM236M HELION ACER TENDL-2024 LIBRARY; T=0.K
Photon emission for (n,2p)

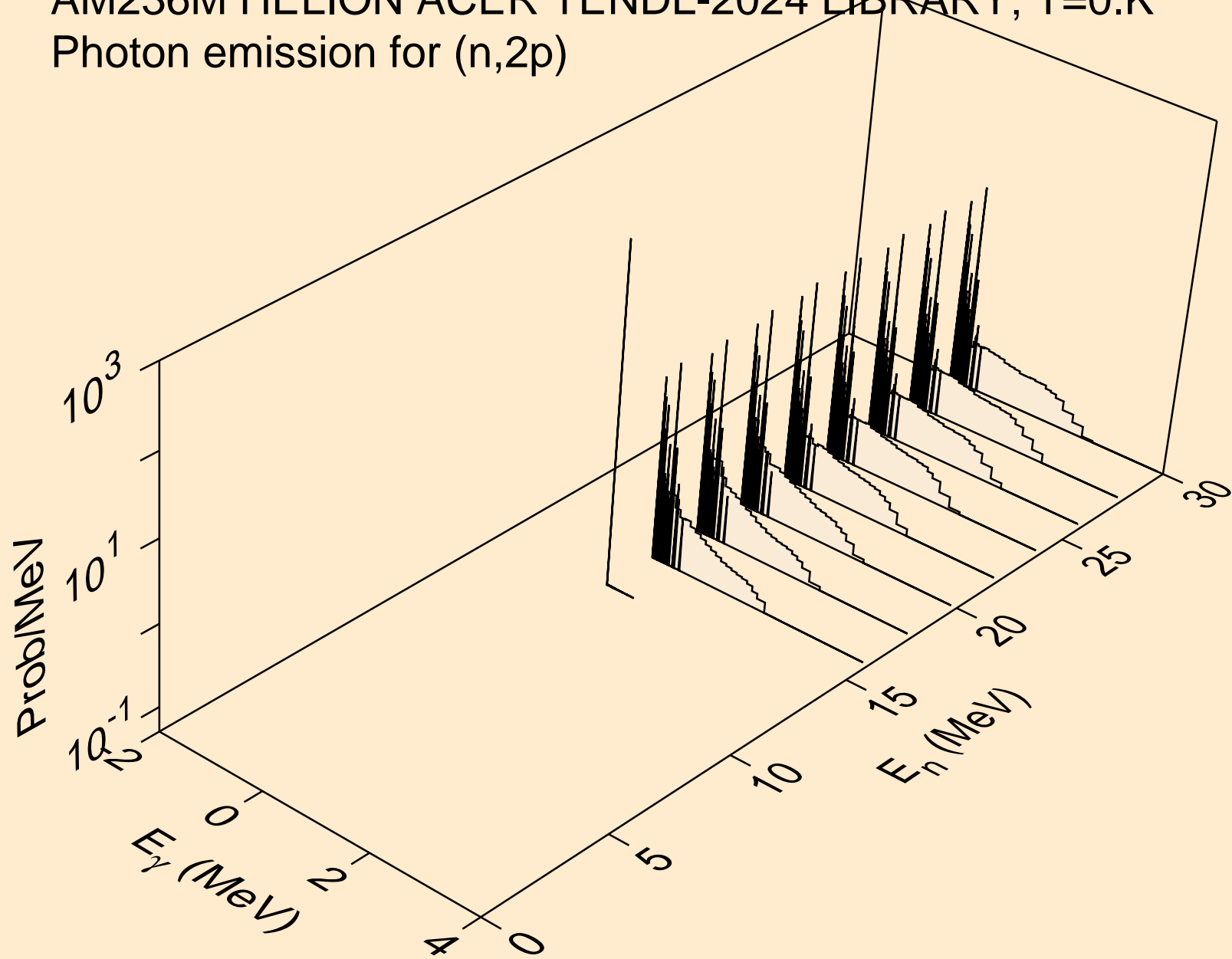

AM236M HELION ACER TENDL-2024 LIBRARY; T=0.K
Photon emission for (n,pd)

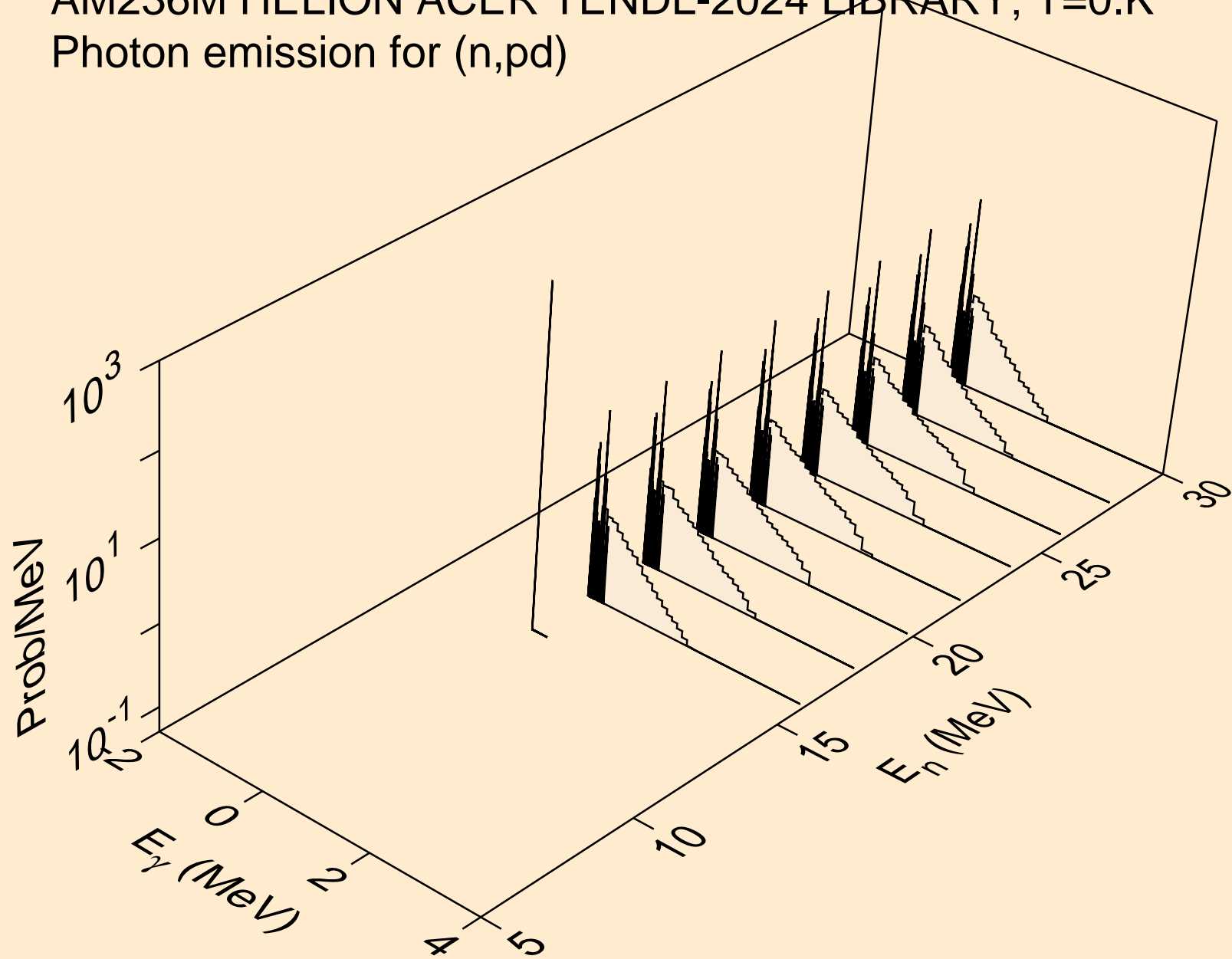

AM236M HELION ACER TENDL-2024 LIBRARY; T=0.K
Particle heating contributions

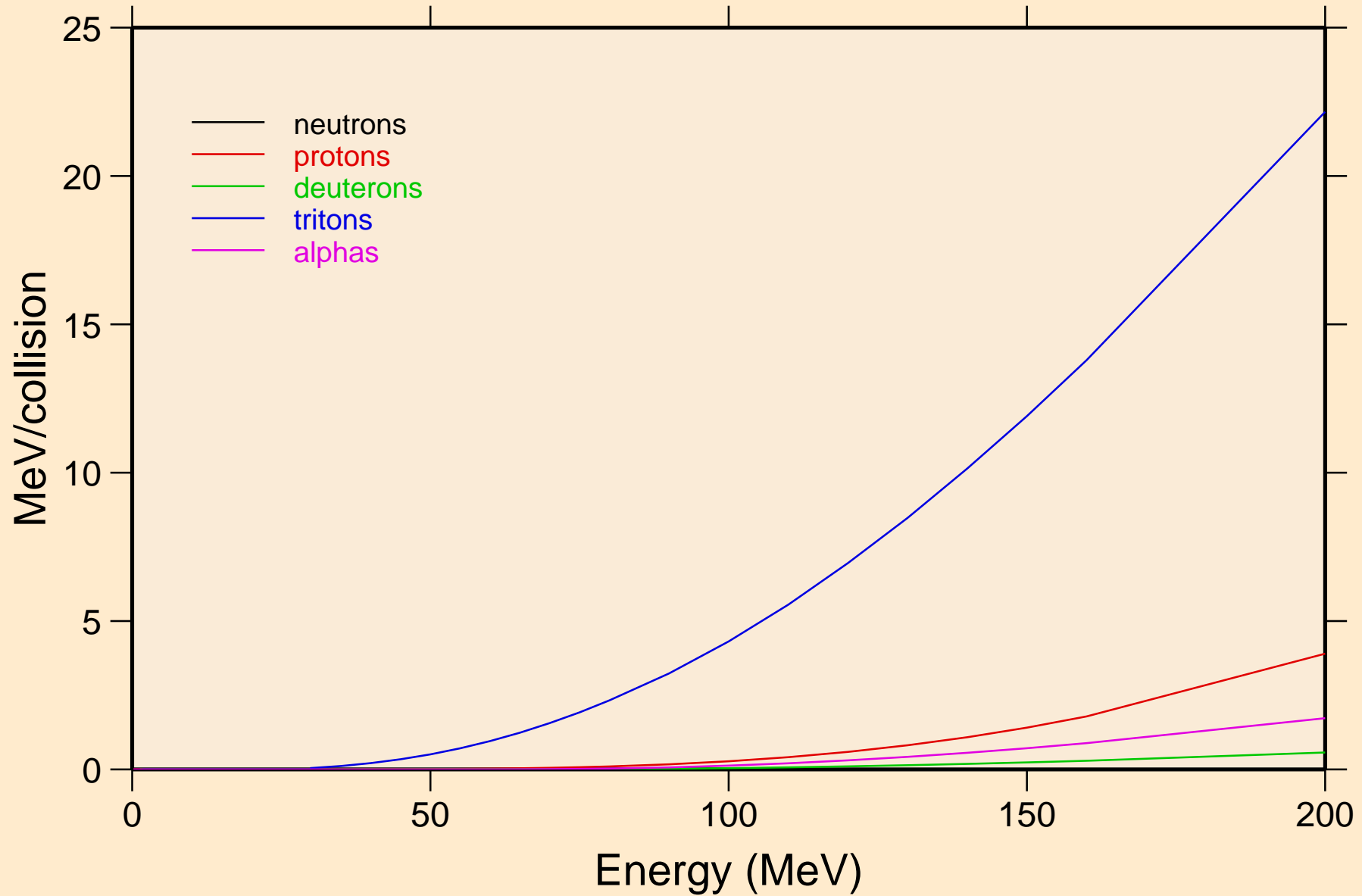

AM236M HELION ACER TENDL-2024 LIBRARY; T=0.K
Recoil Heating

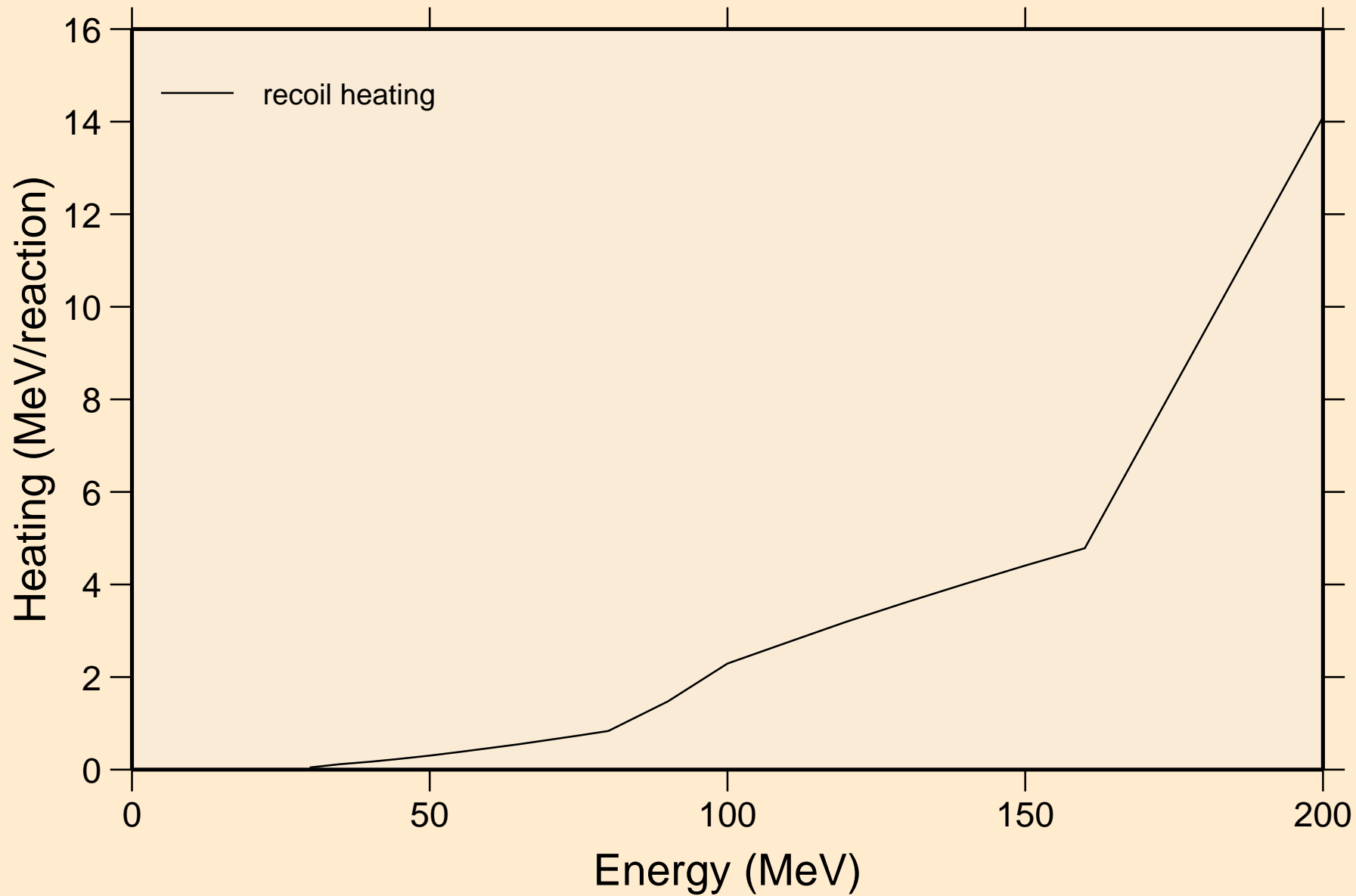

AM236M HELION ACER TENDL-2024 LIBRARY; T=0.K
Particle production cross sections

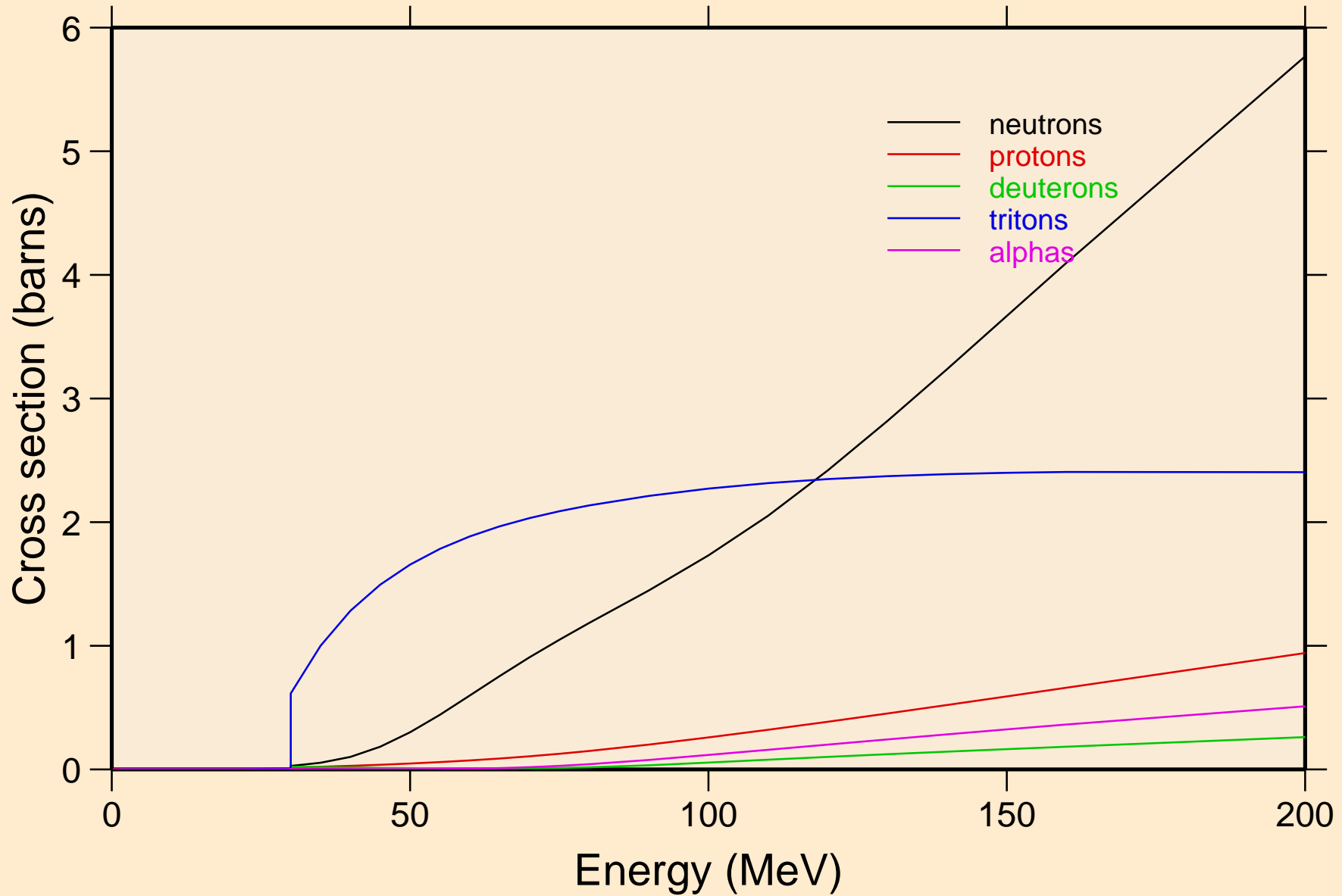

AM236M HELION ACER TENDL-2024 LIBRARY; T=0.K
neutrons from (s,n)

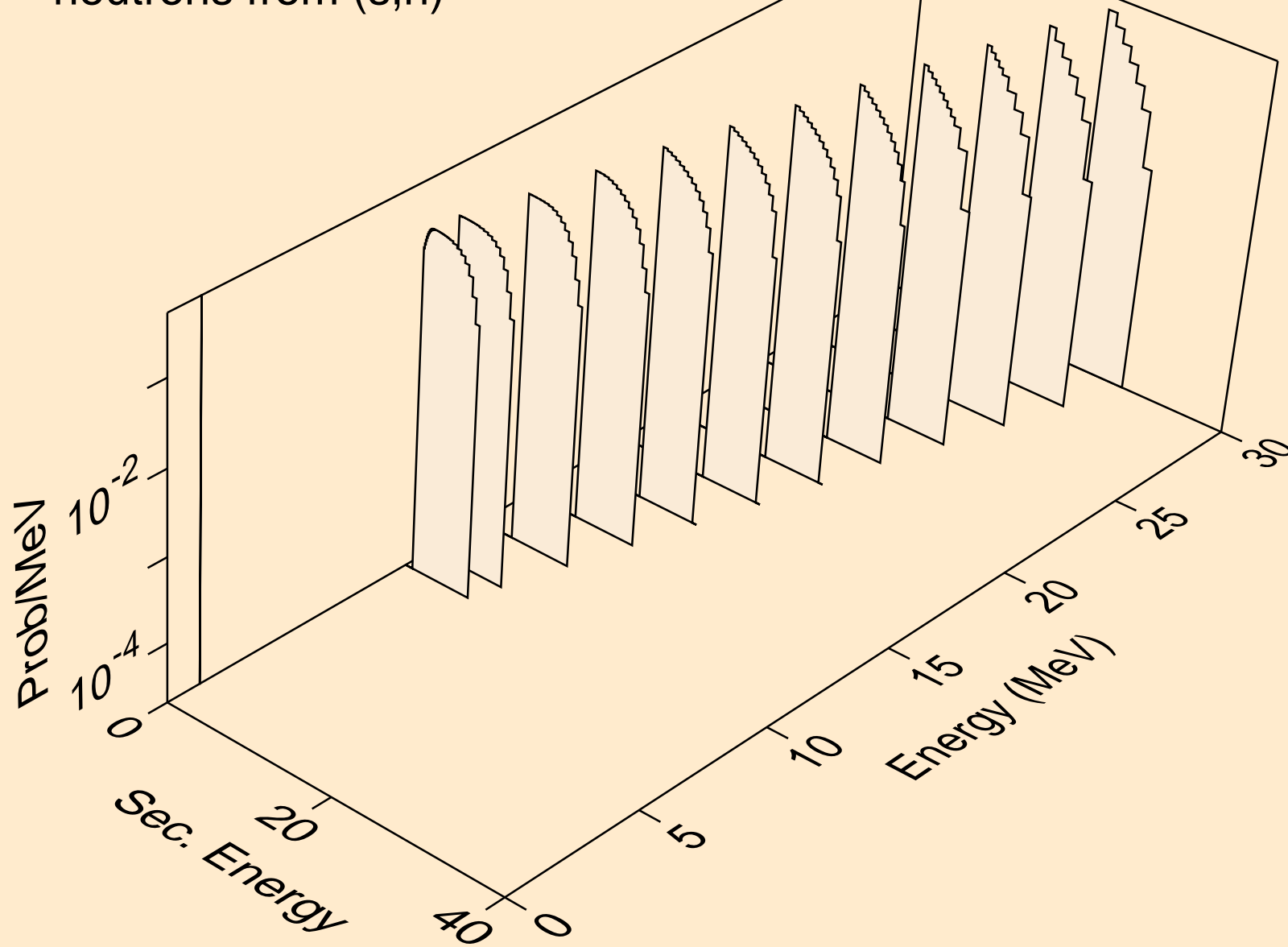

AM236M HELION ACER TENDL-2024 LIBRARY; T=0.K
neutrons from (s,x)

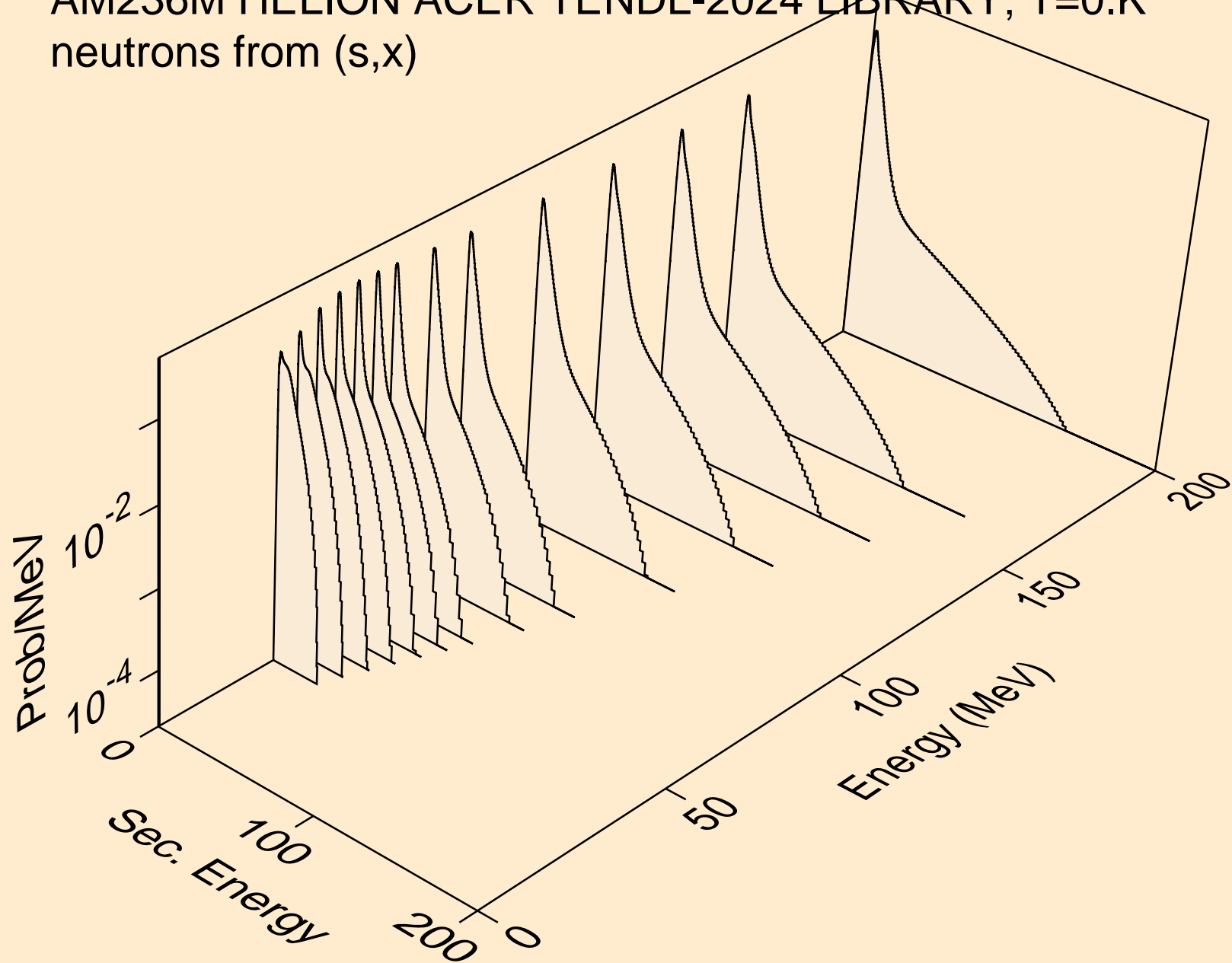

AM236M HELION ACER TENDL-2024 LIBRARY; T=0.K
neutrons from (s,2n)

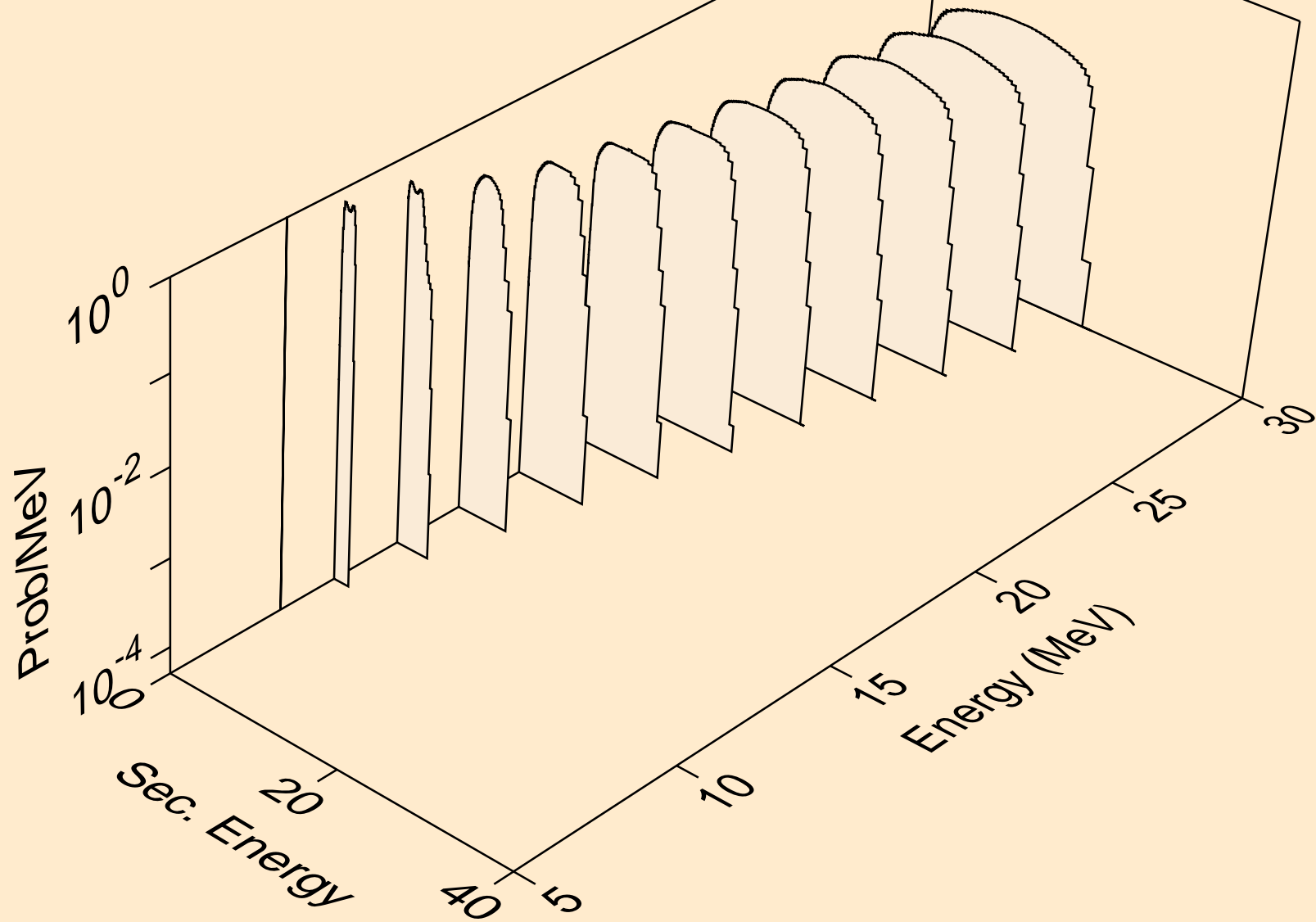

AM236M HELION ACER TENDL-2024 LIBRARY; T=0.K
neutrons from (s,3n)

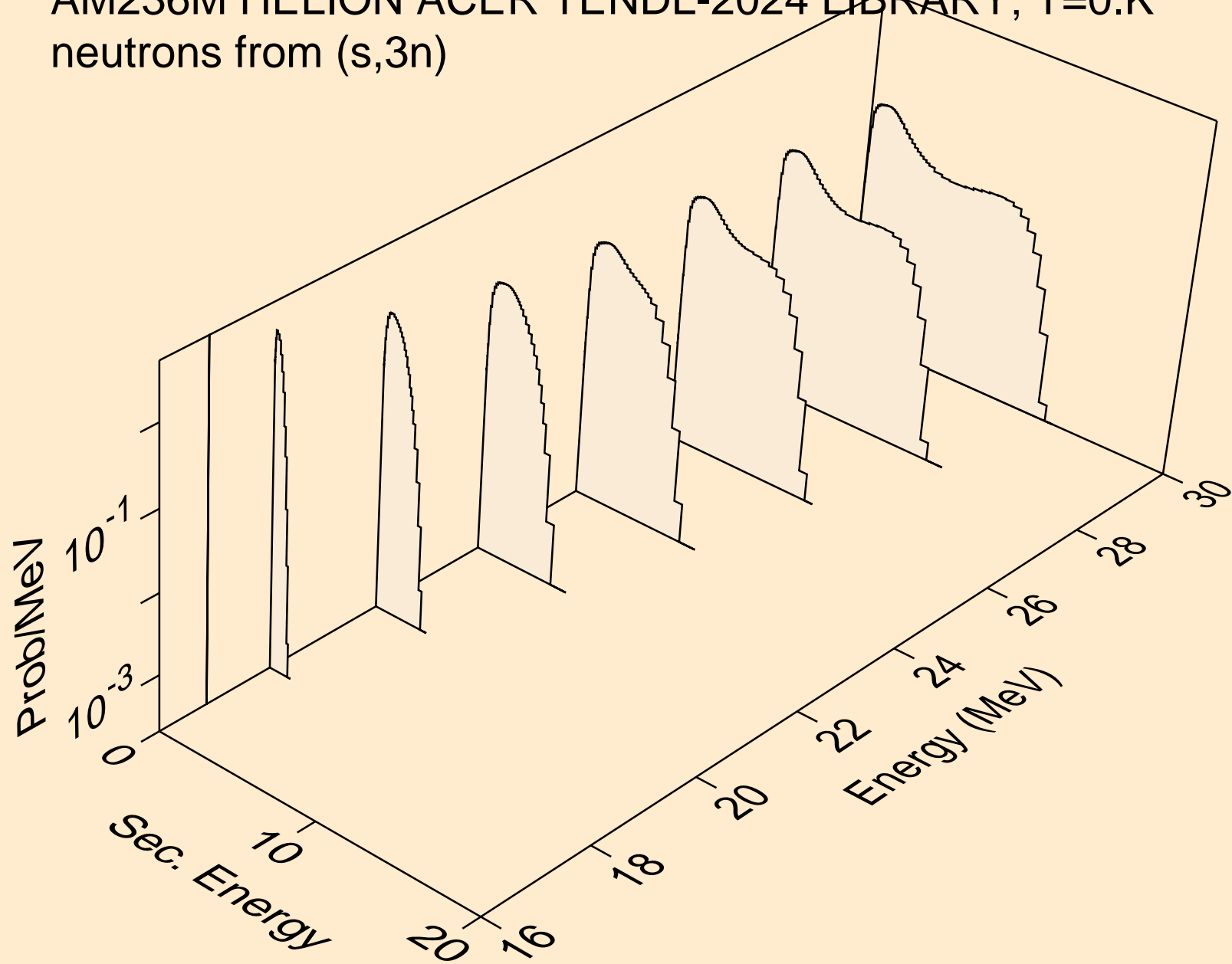

AM236M HELION ACER TENDL-2024 LIBRARY; T=0.K
neutrons from (s,n*)a

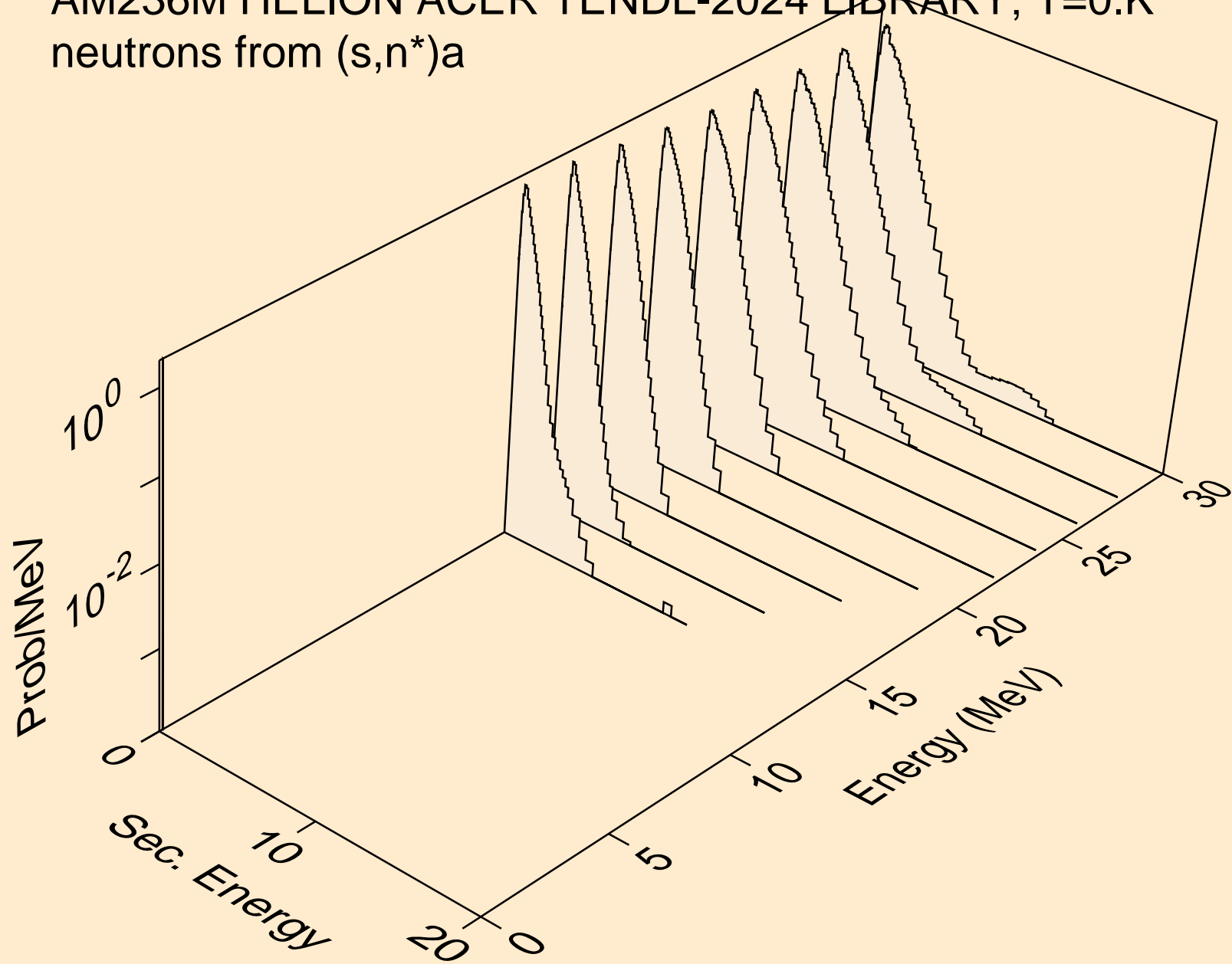

AM236M HELION ACER TENDL-2024 LIBRARY; T=0.K
neutrons from (s,n*)p

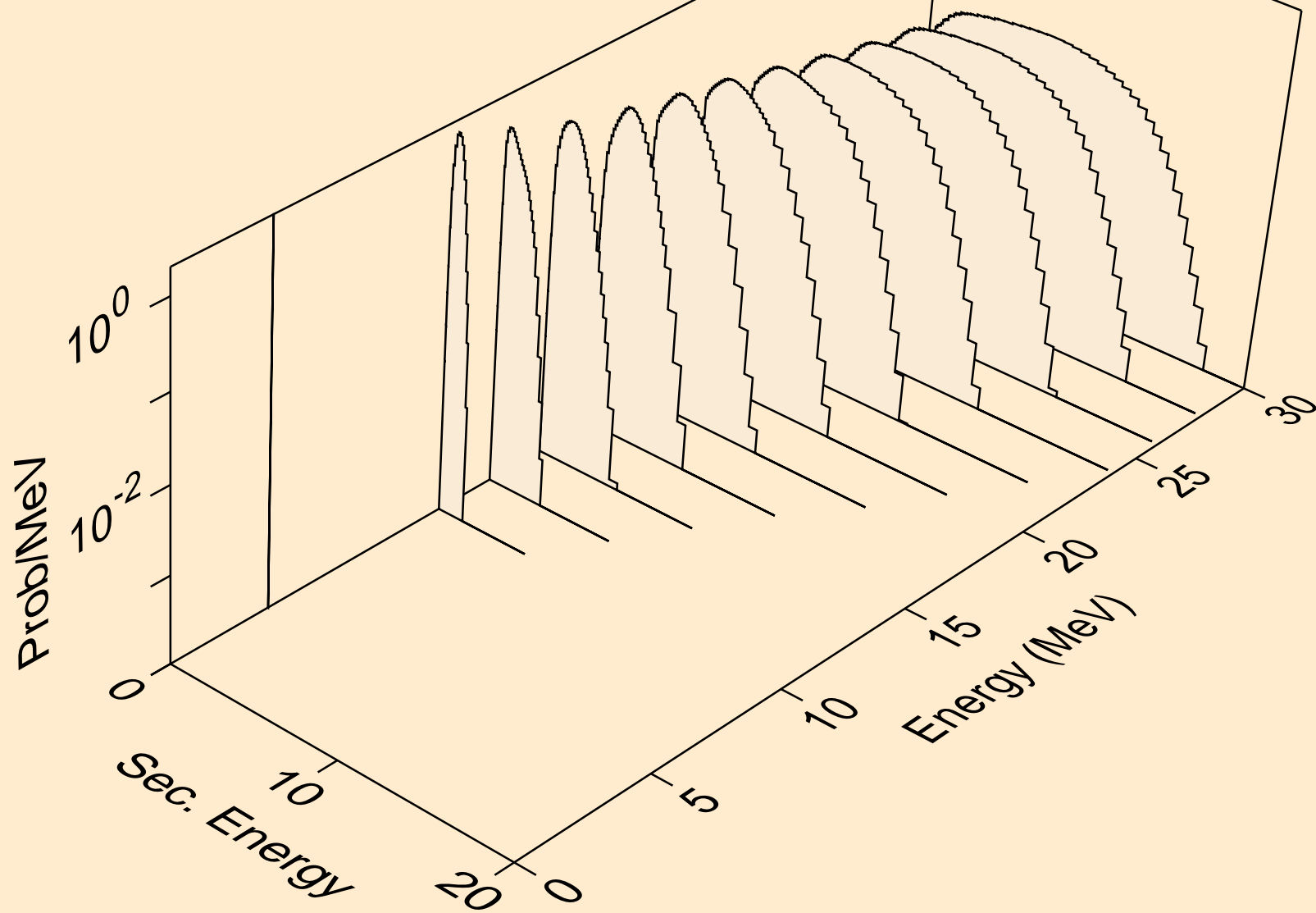

AM236M HELION ACER TENDL-2024 LIBRARY; T=0.K
neutrons from (s,n*)d

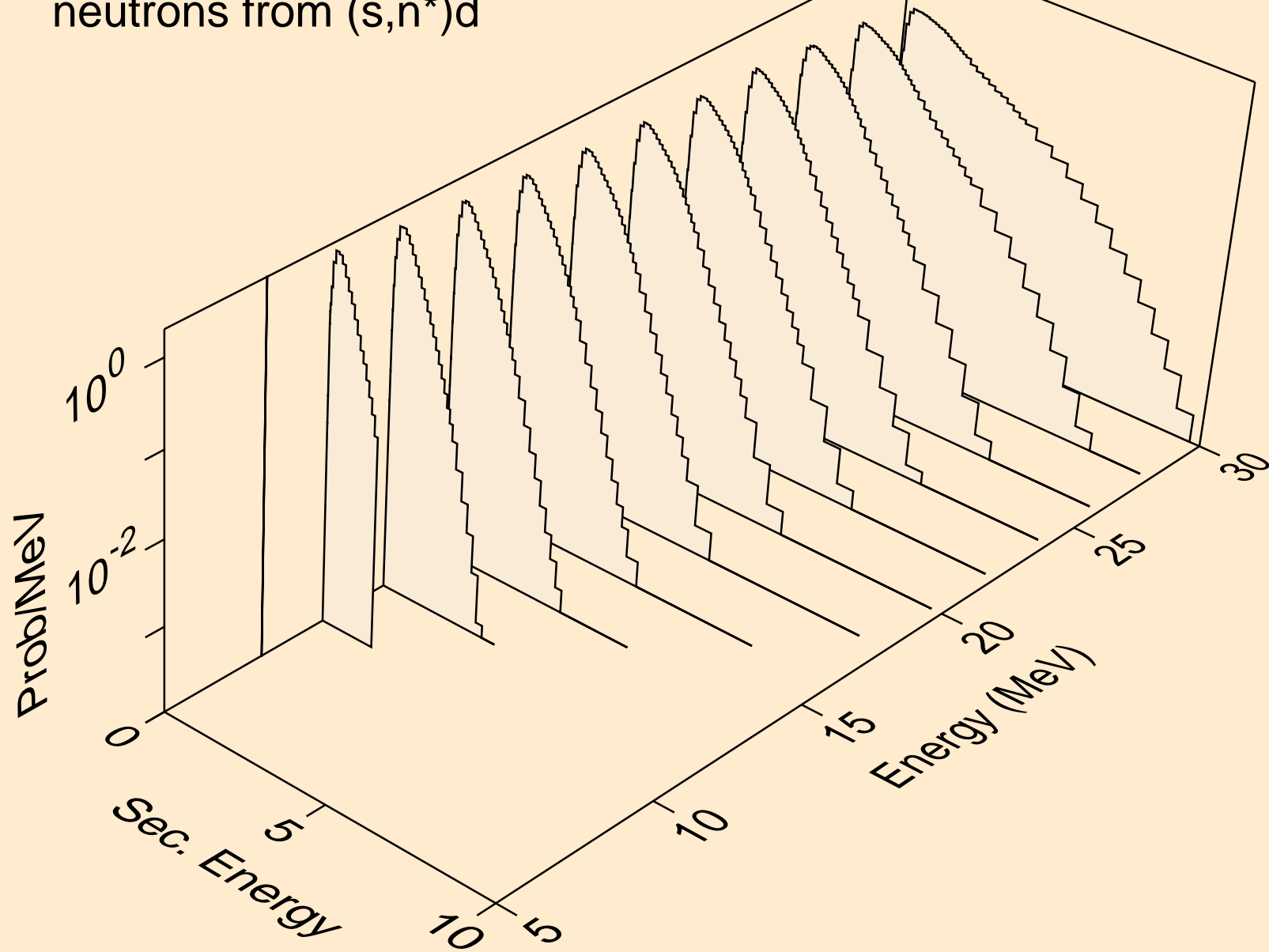

AM236M HELION ACER TENDL-2024 LIBRARY; T=0.K
neutrons from (s,n*)t

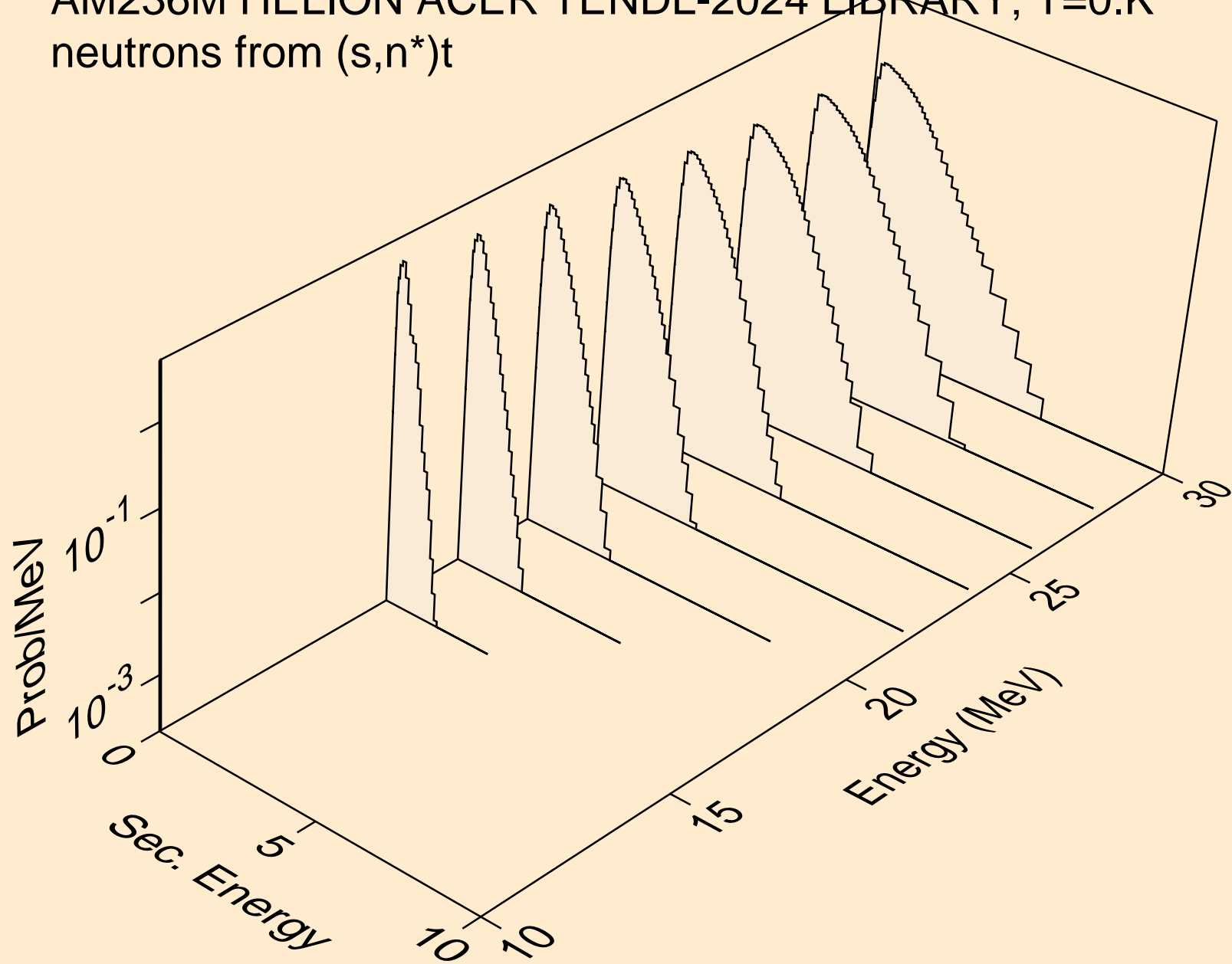

AM236M HELION ACER TENDL-2024 LIBRARY; T=0.K
neutrons from (s,n*)he3

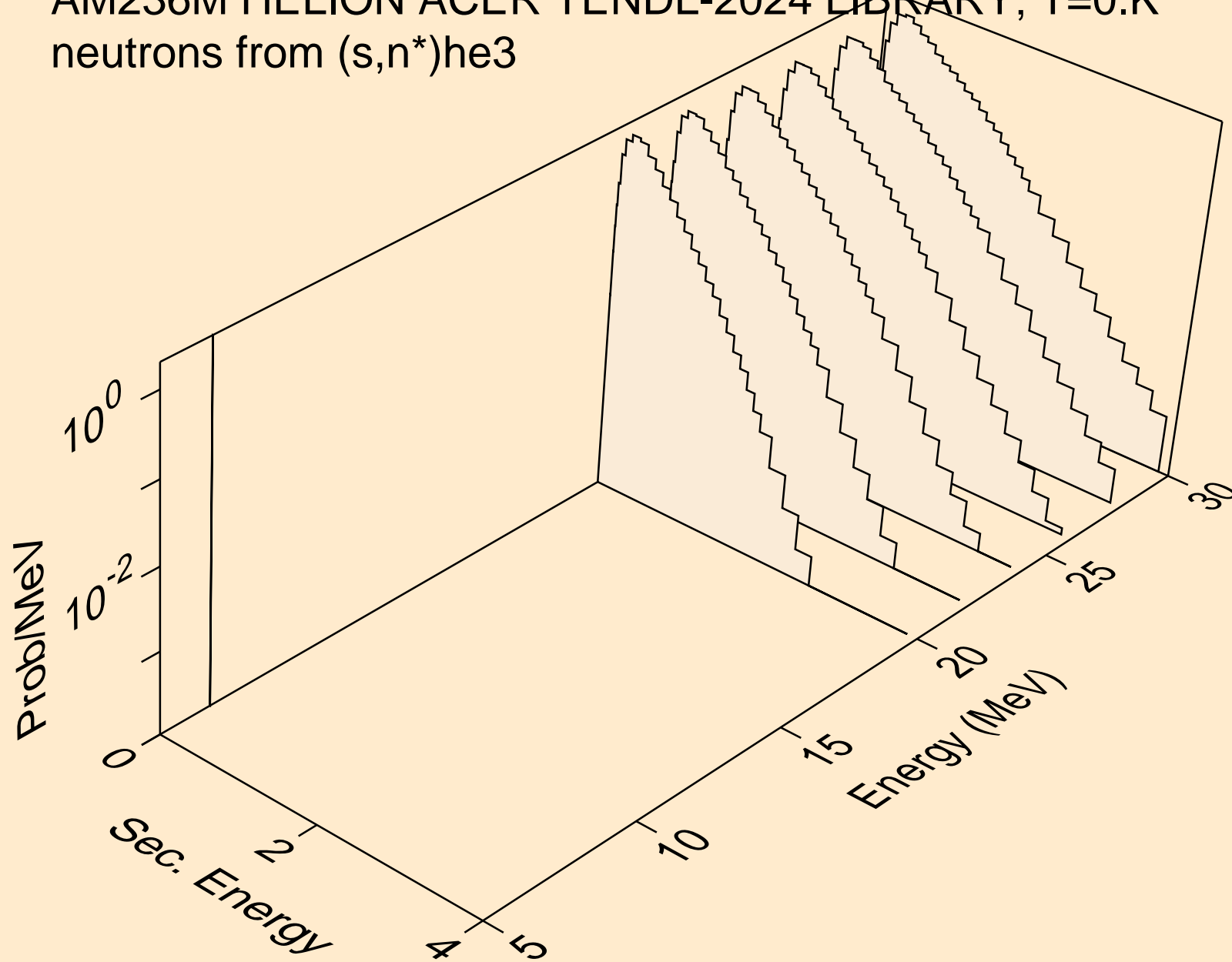

AM236M HELION ACER TENDL-2024 LIBRARY; T=0.K
neutrons from (s,2np)

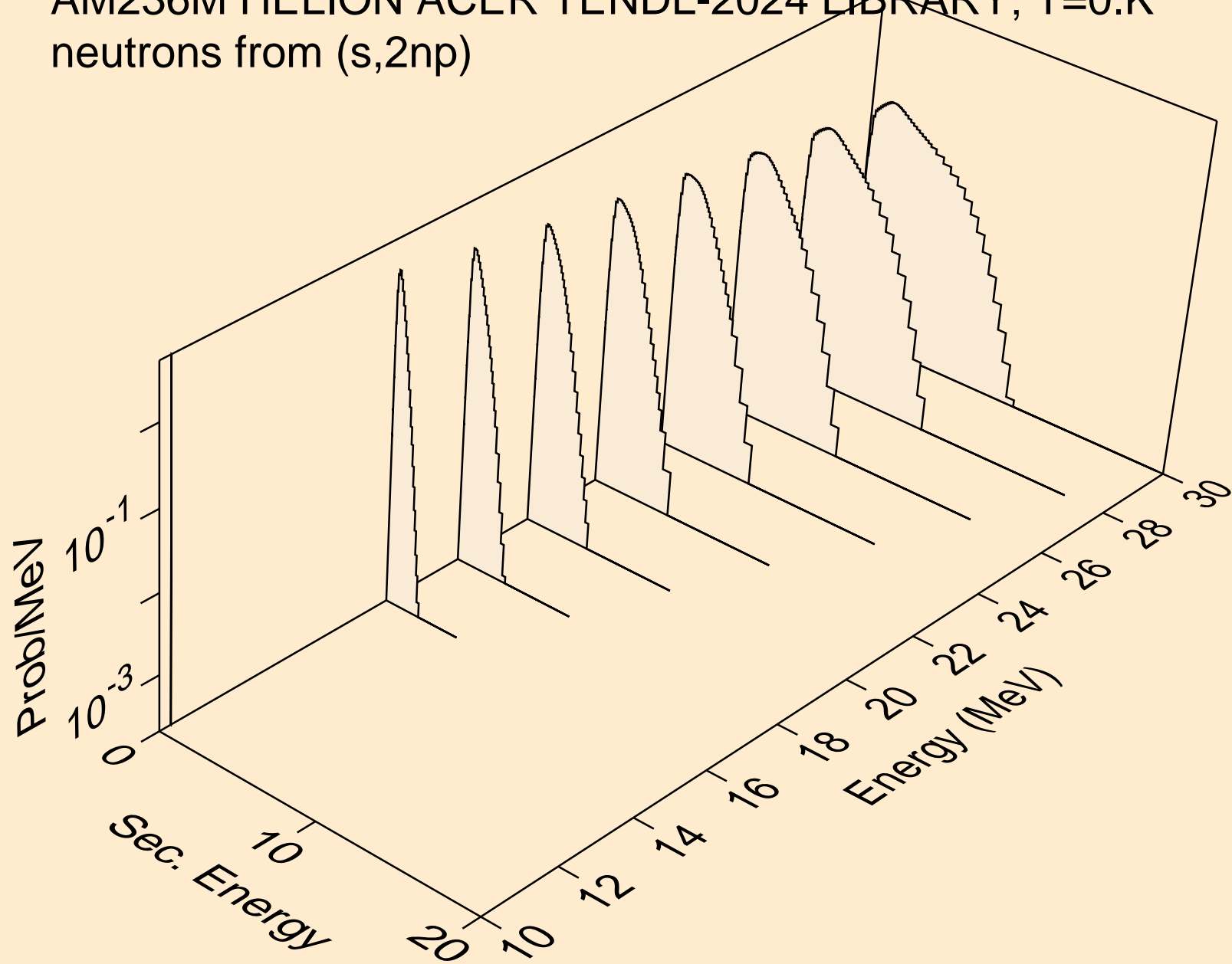

AM236M HELION ACER TENDL-2024 LIBRARY; T=0.K
neutrons from (s,n2p)

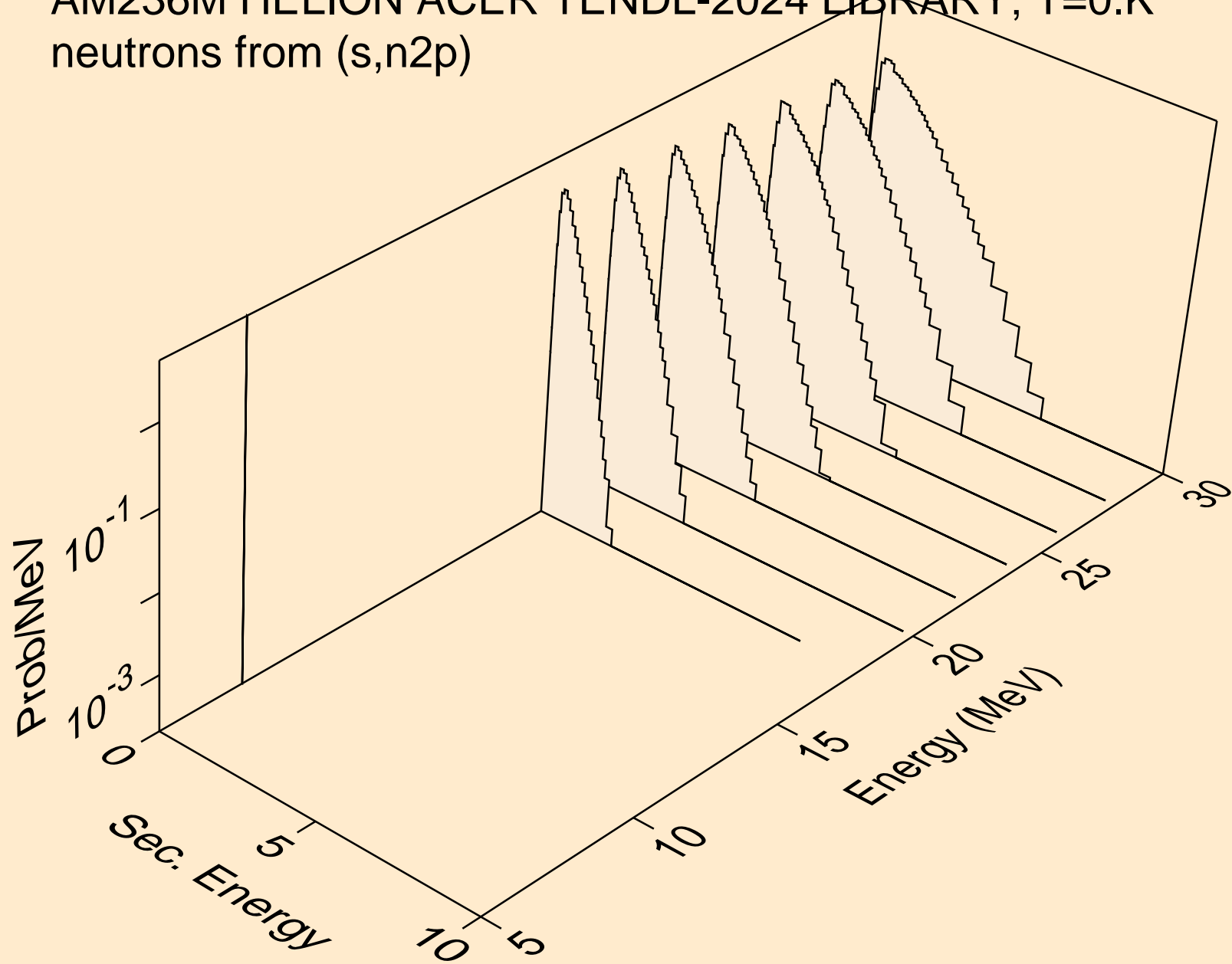

AM236M HELION ACER TENDL-2024 LIBRARY; T=0.K
protons from (s,x)

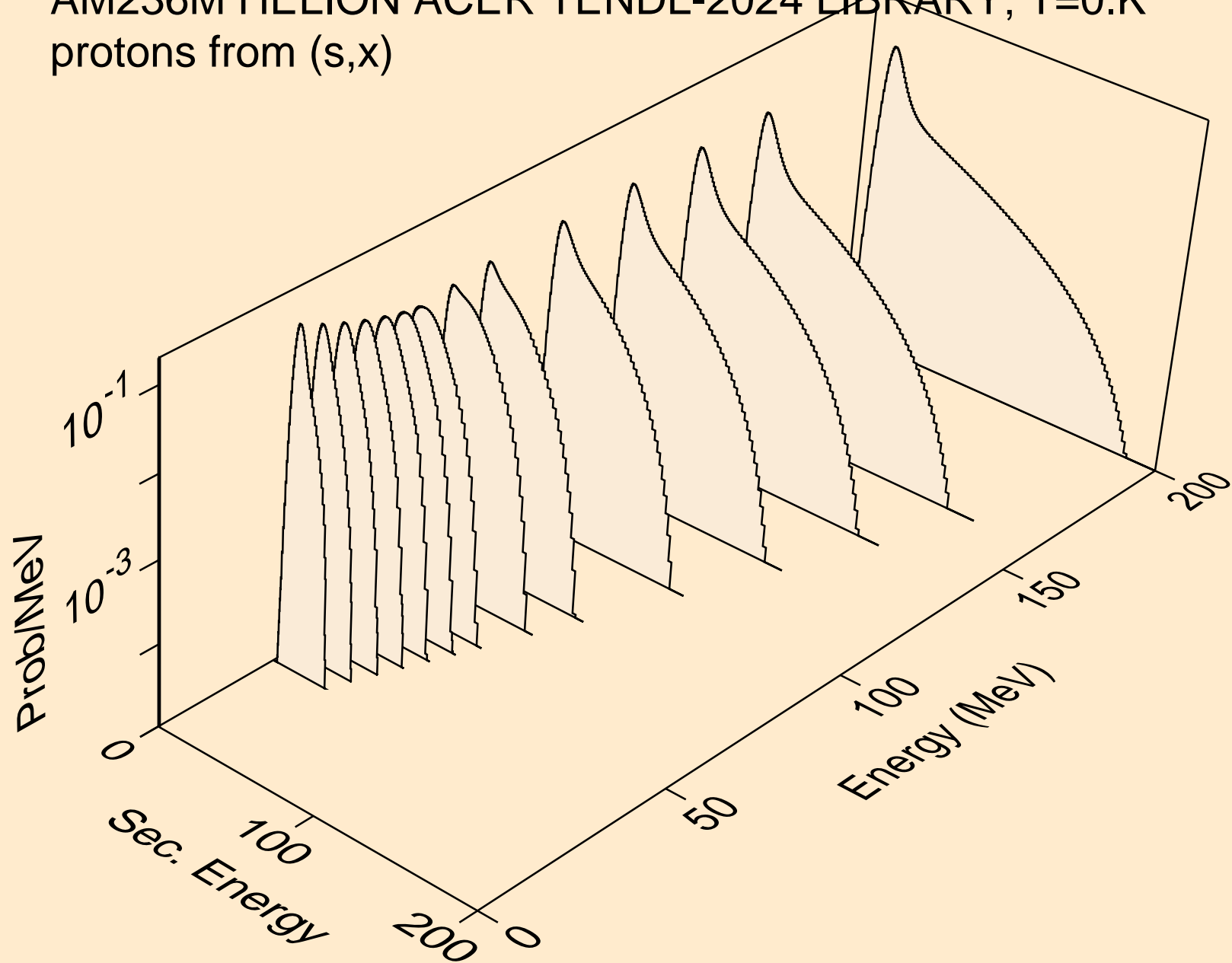

AM236M HELION ACER TENDL-2024 LIBRARY; T=0.K
protons from (s,n*)p

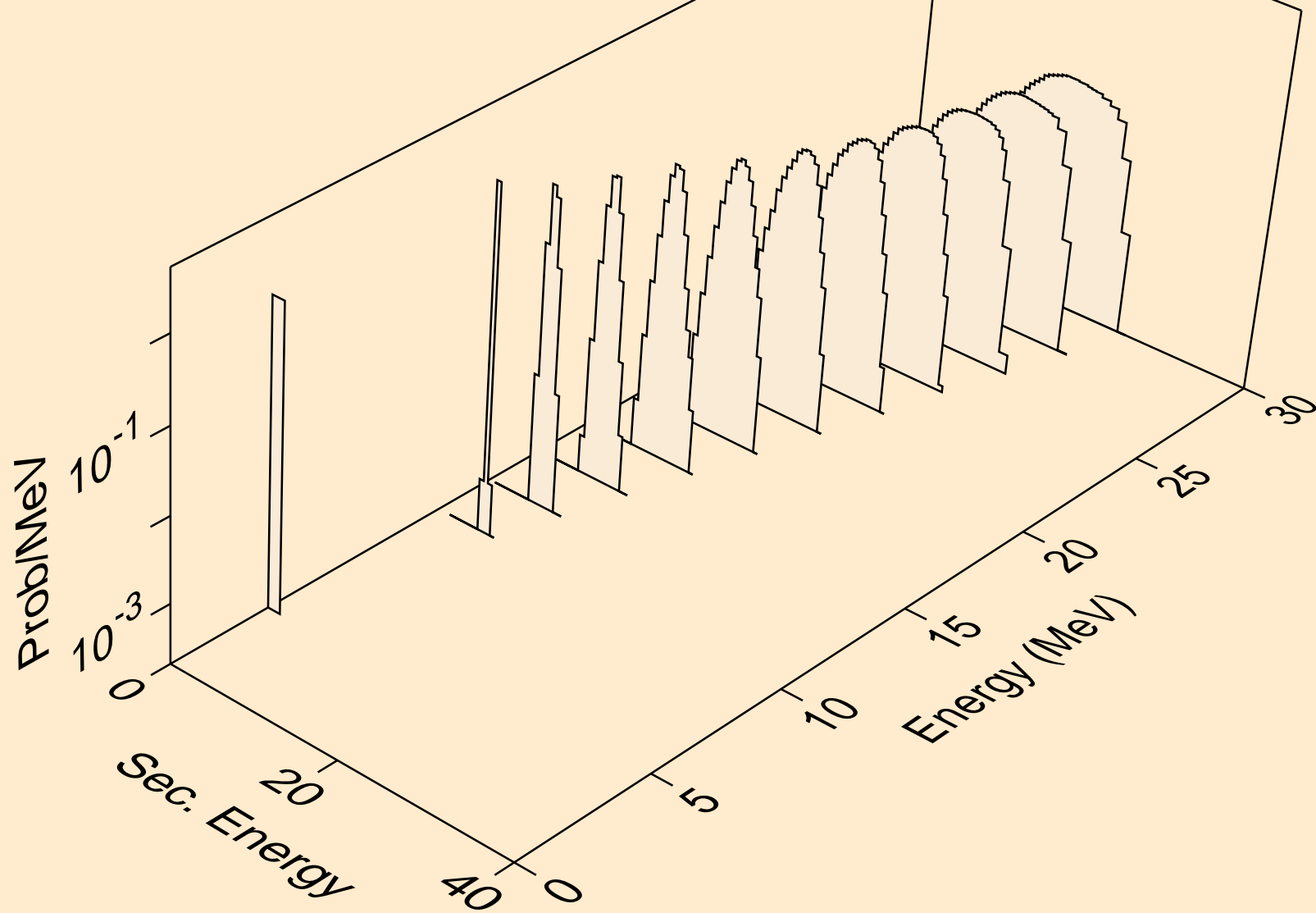

AM236M HELION ACER TENDL-2024 LIBRARY; T=0.K
protons from (s,2np)

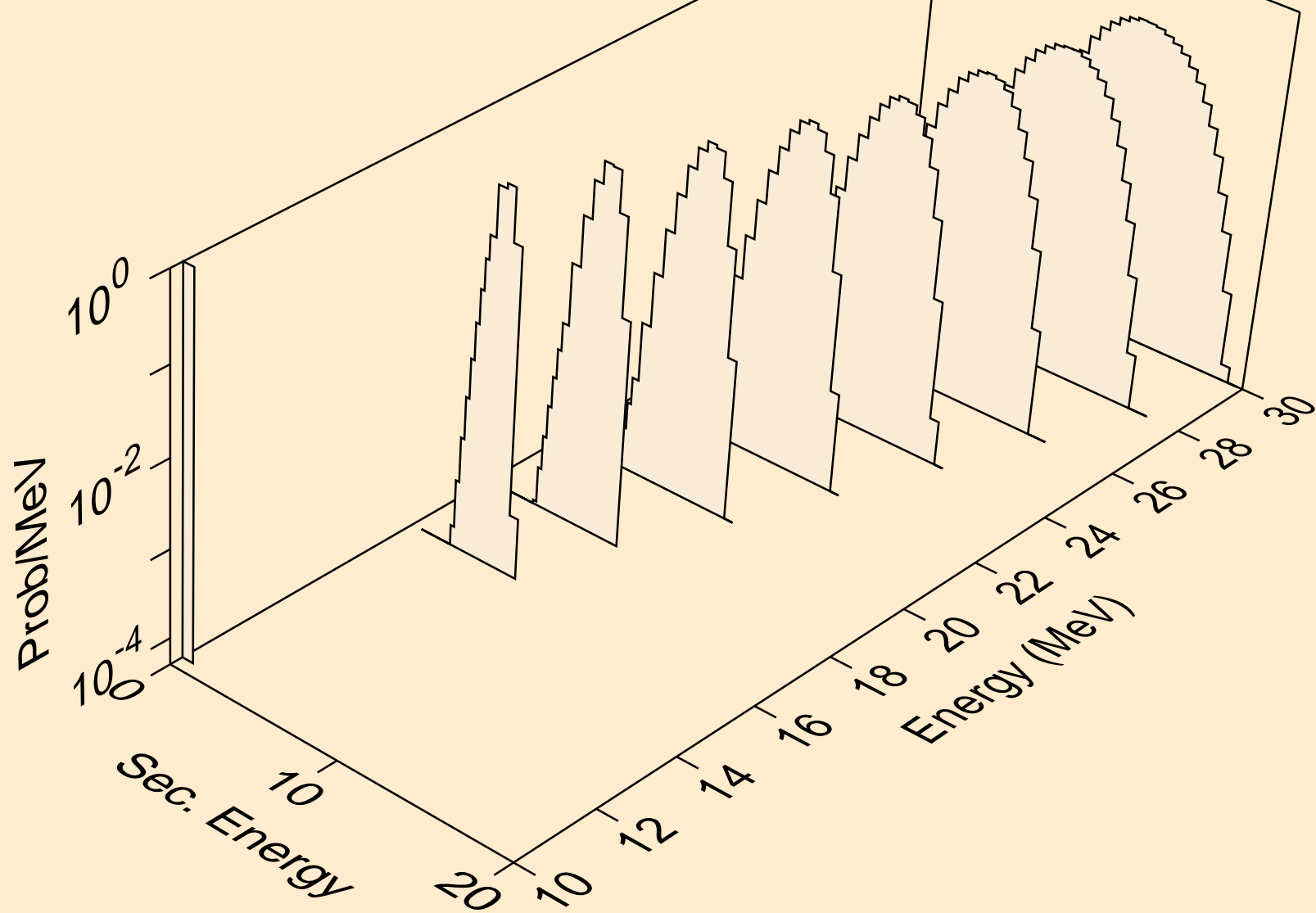

AM236M HELION ACER TENDL-2024 LIBRARY; T=0.K
protons from (s,n2p)

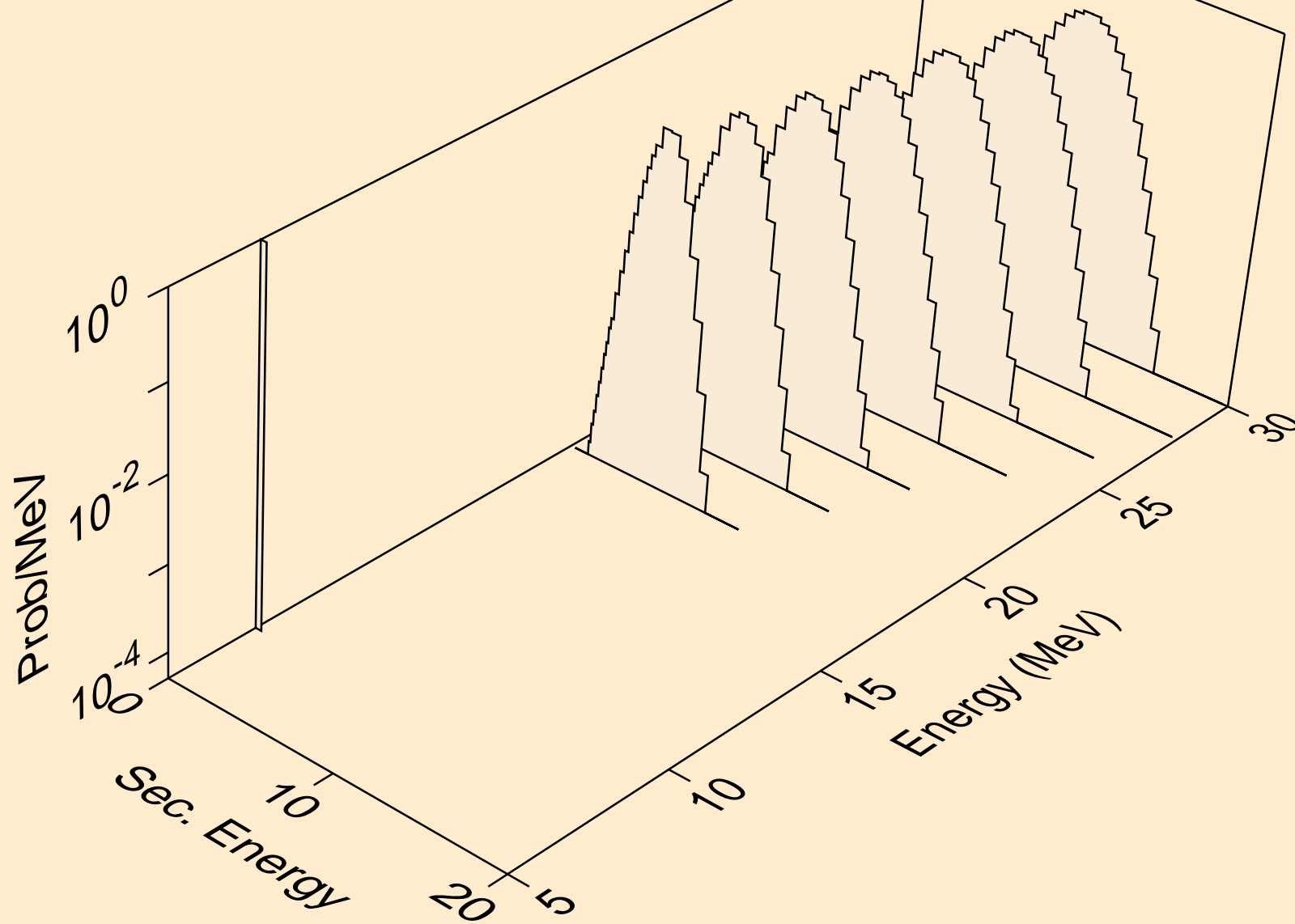

AM236M HELION ACER TENDL-2024 LIBRARY; T=0.K
protons from (s,p)

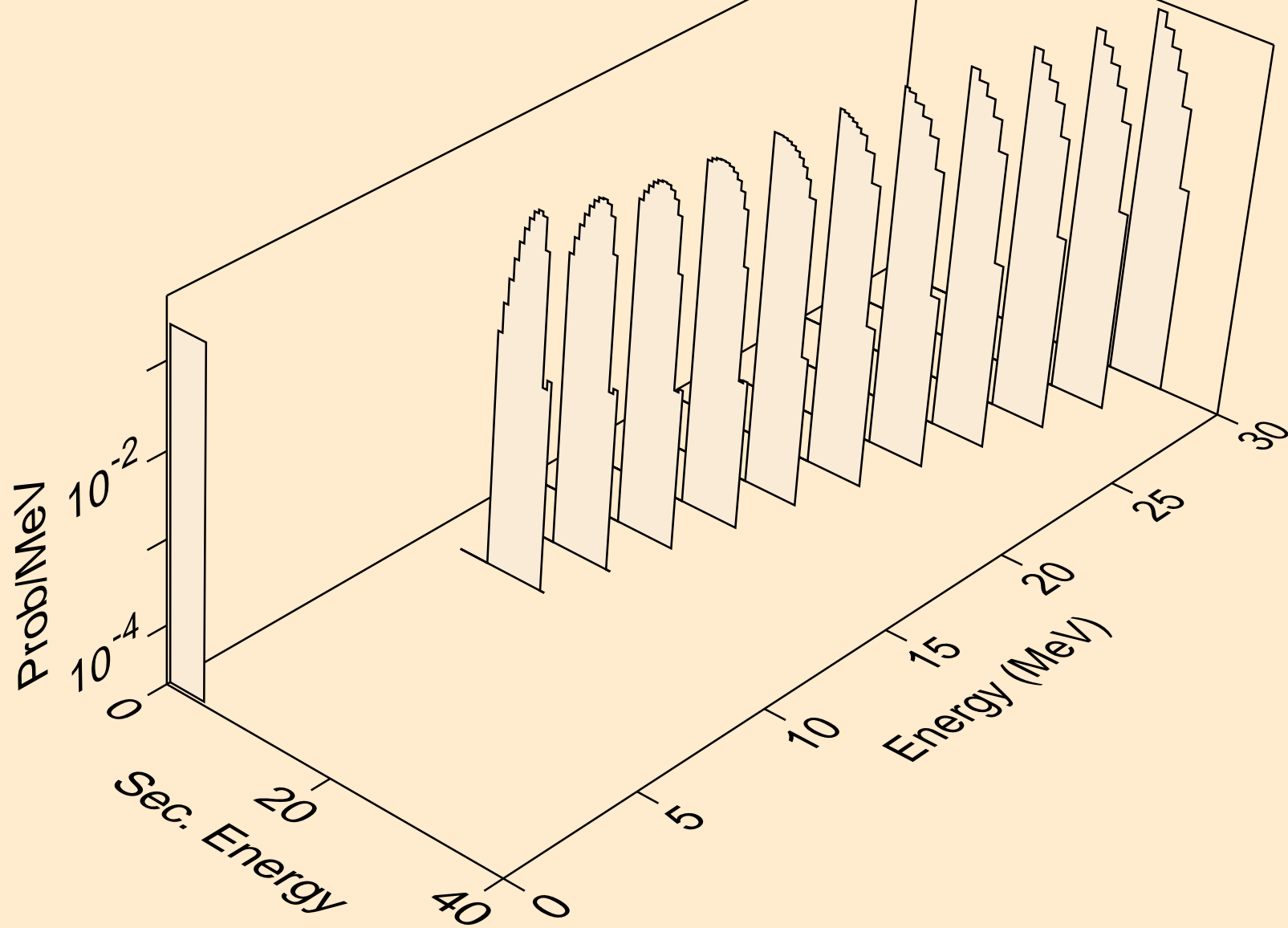

AM236M HELION ACER TENDL-2024 LIBRARY; T=0.K
protons from (s,2p)

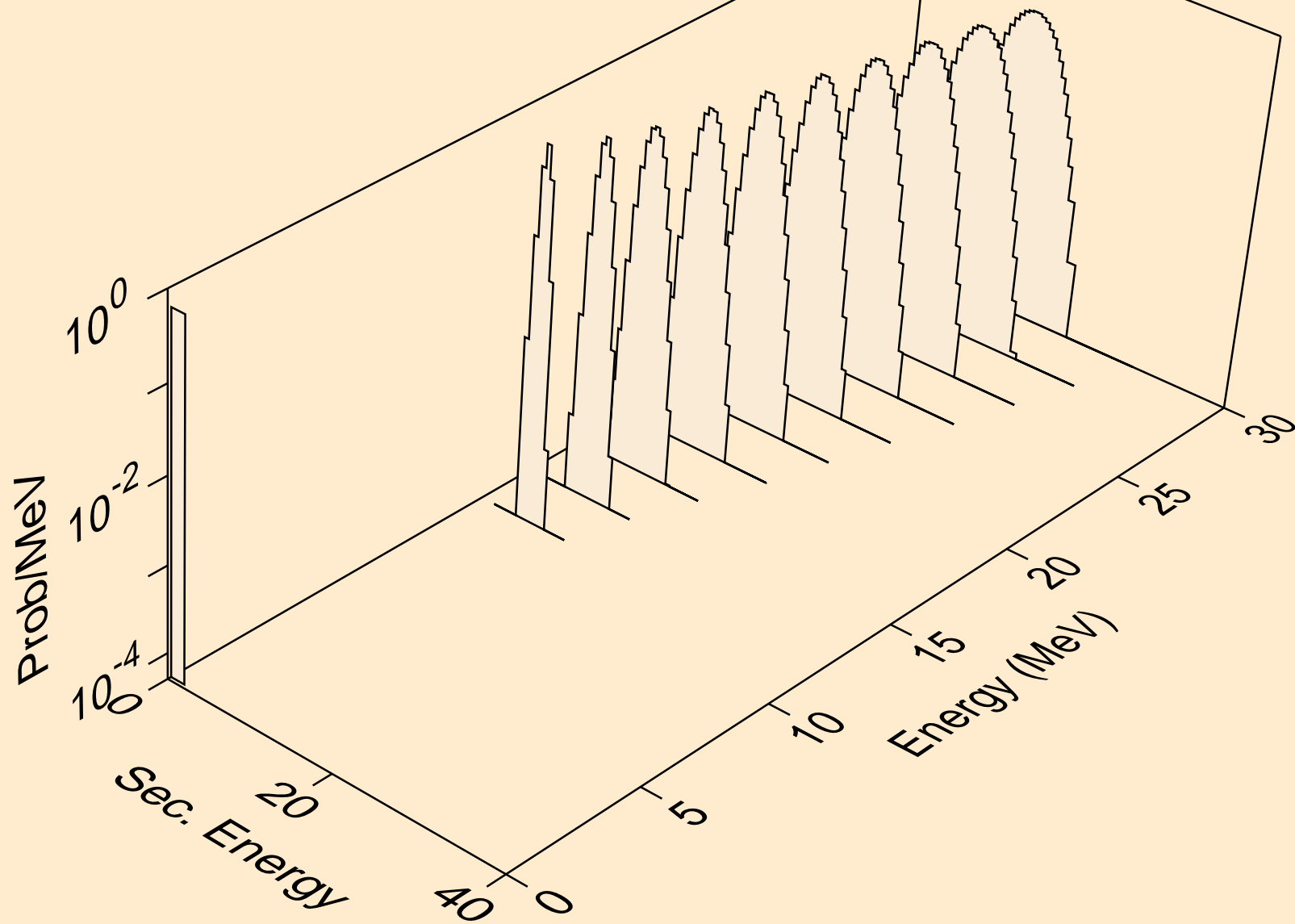

AM236M HELION ACER TENDL-2024 LIBRARY; T=0.K
protons from (s,pd)

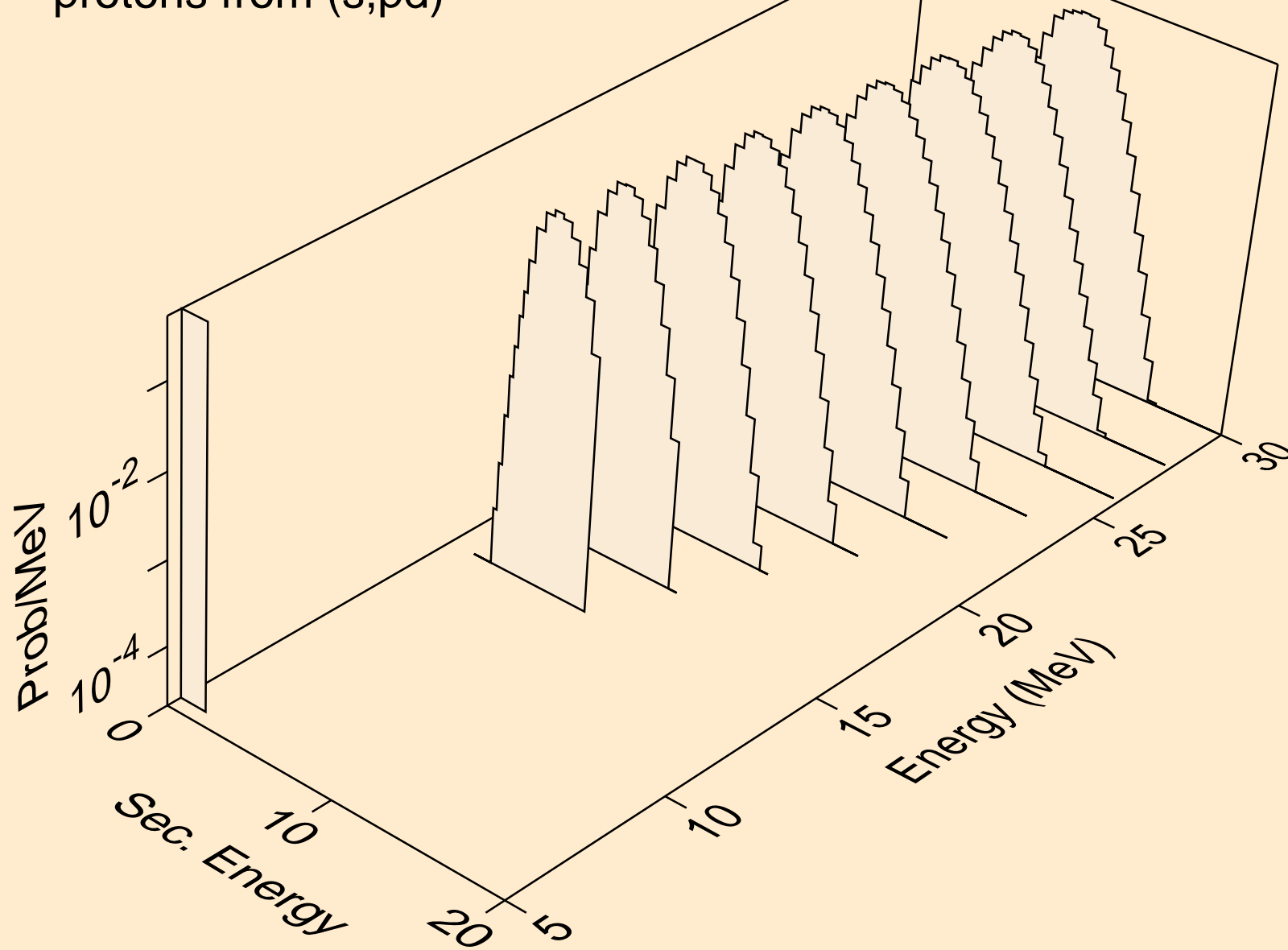

AM236M HELION ACER TENDL-2024 LIBRARY; T=0.K
deuterons from (s,x)

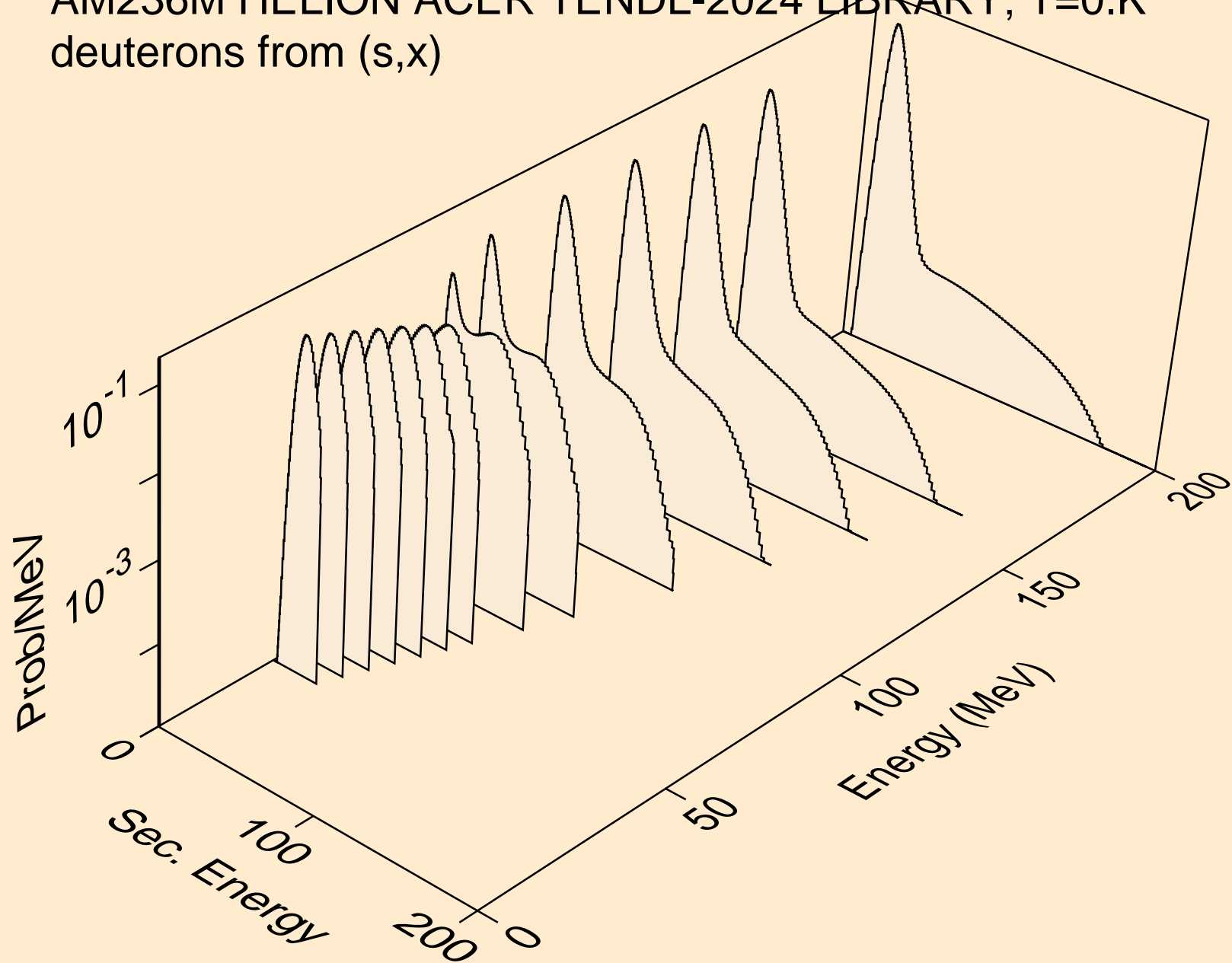

AM236M HELION ACER TENDL-2024 LIBRARY; T=0.K
deuterons from (s,n*)d

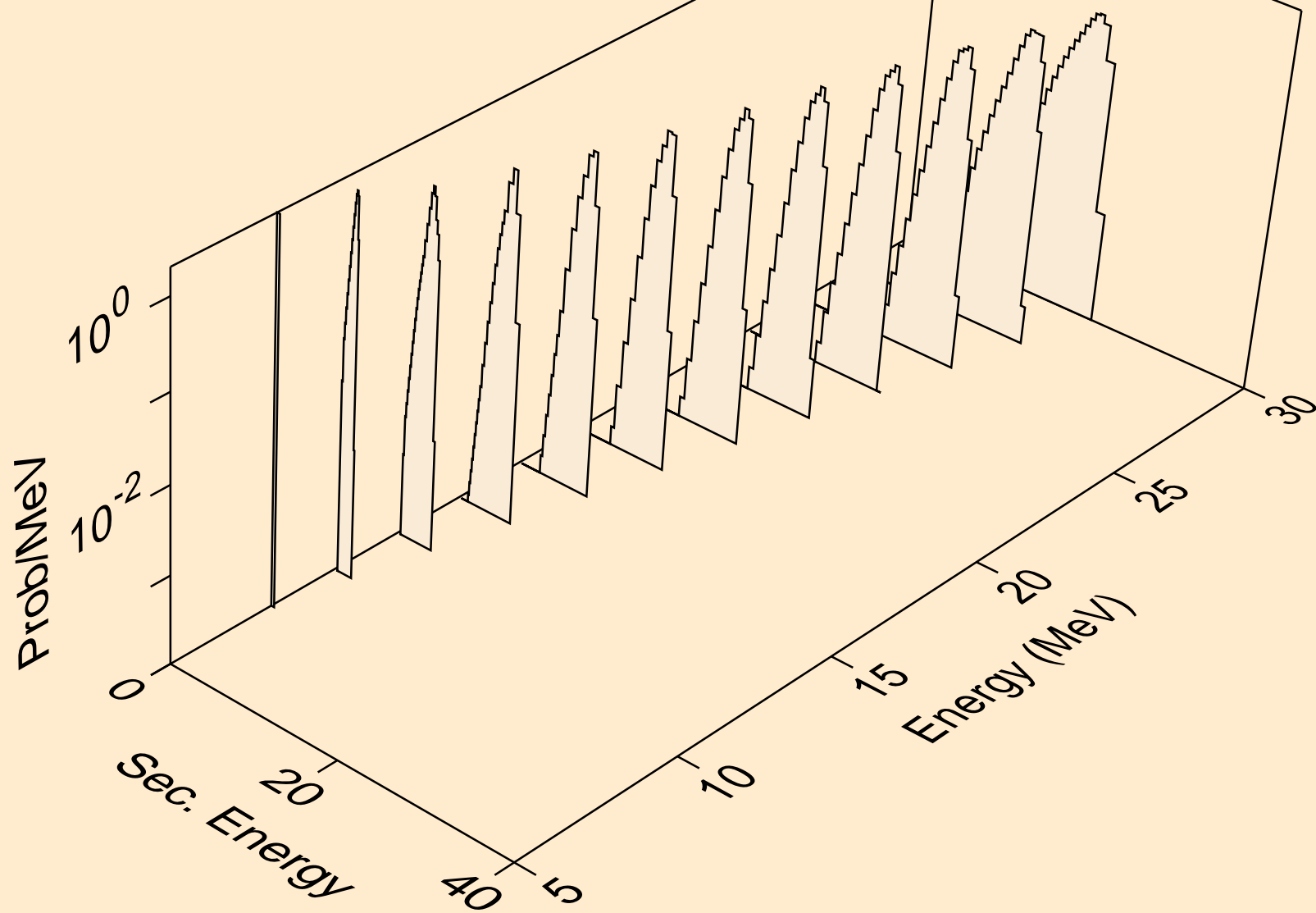

AM236M HELION ACER TENDL-2024 LIBRARY; T=0.K
deuterons from (s,d)

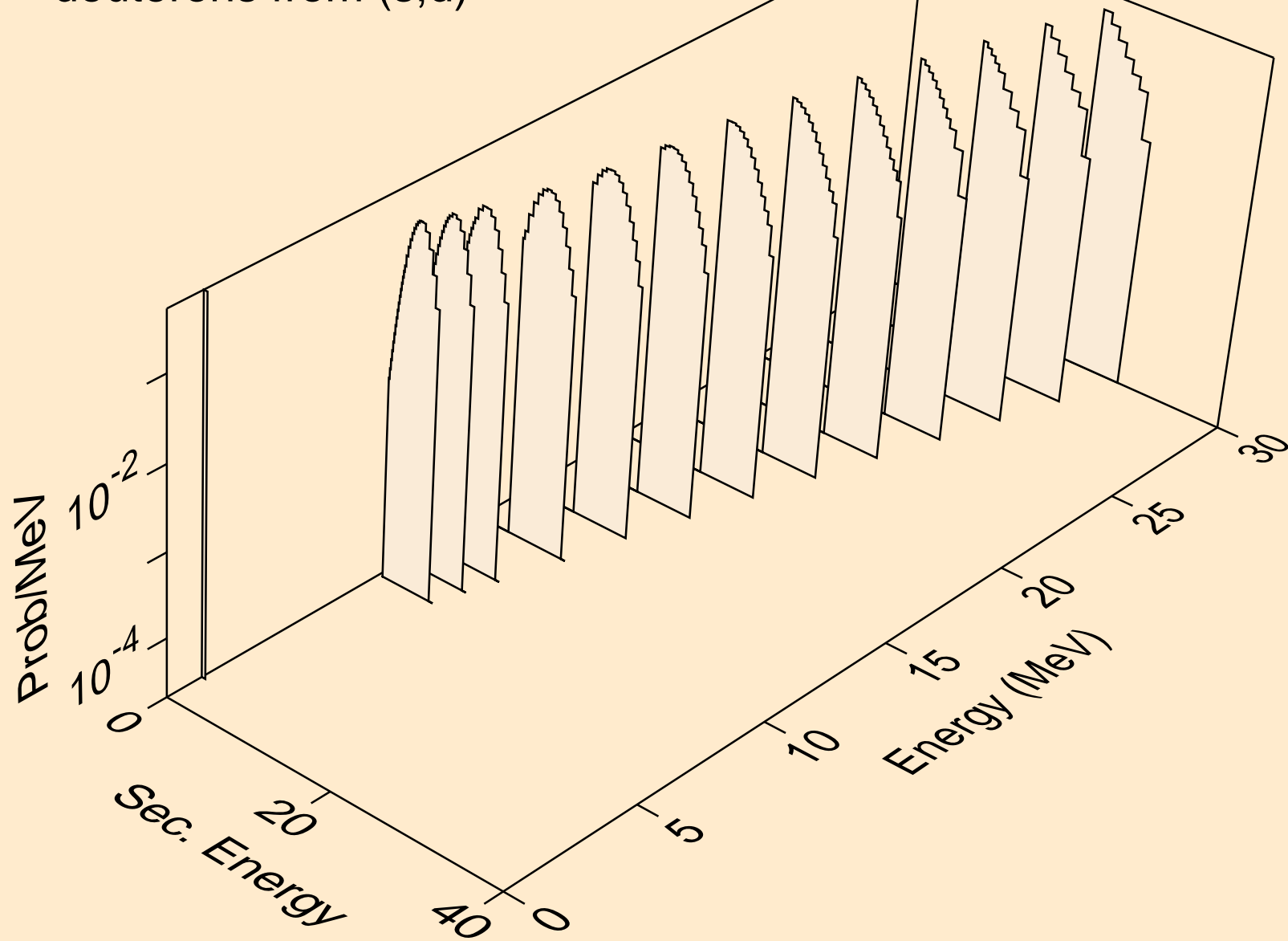

AM236M HELION ACER TENDL-2024 LIBRARY; T=0.K
deuterons from (s,pd)

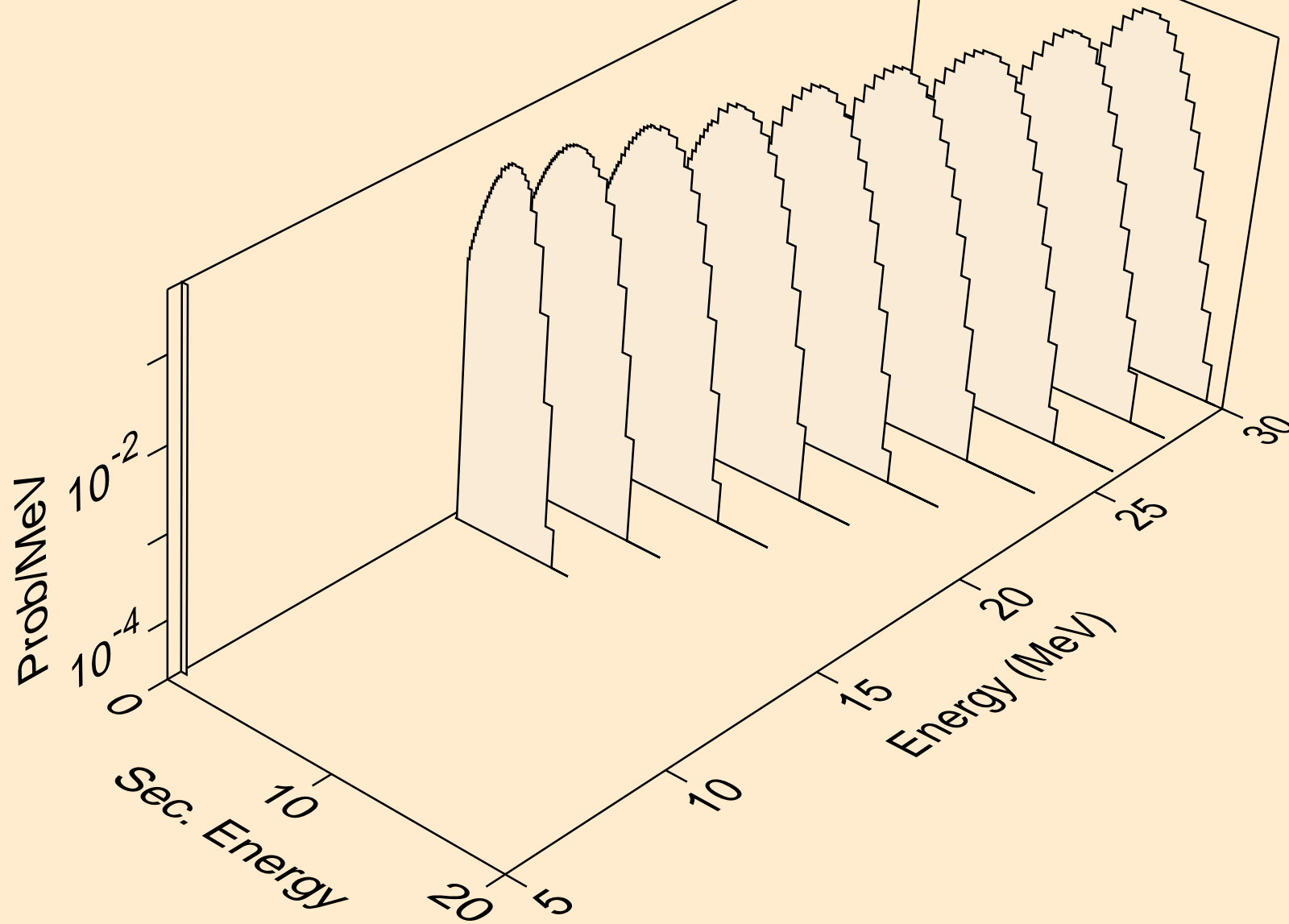

AM236M HELION ACER TENDL-2024 LIBRARY; T=0.K
tritons from (s,x)

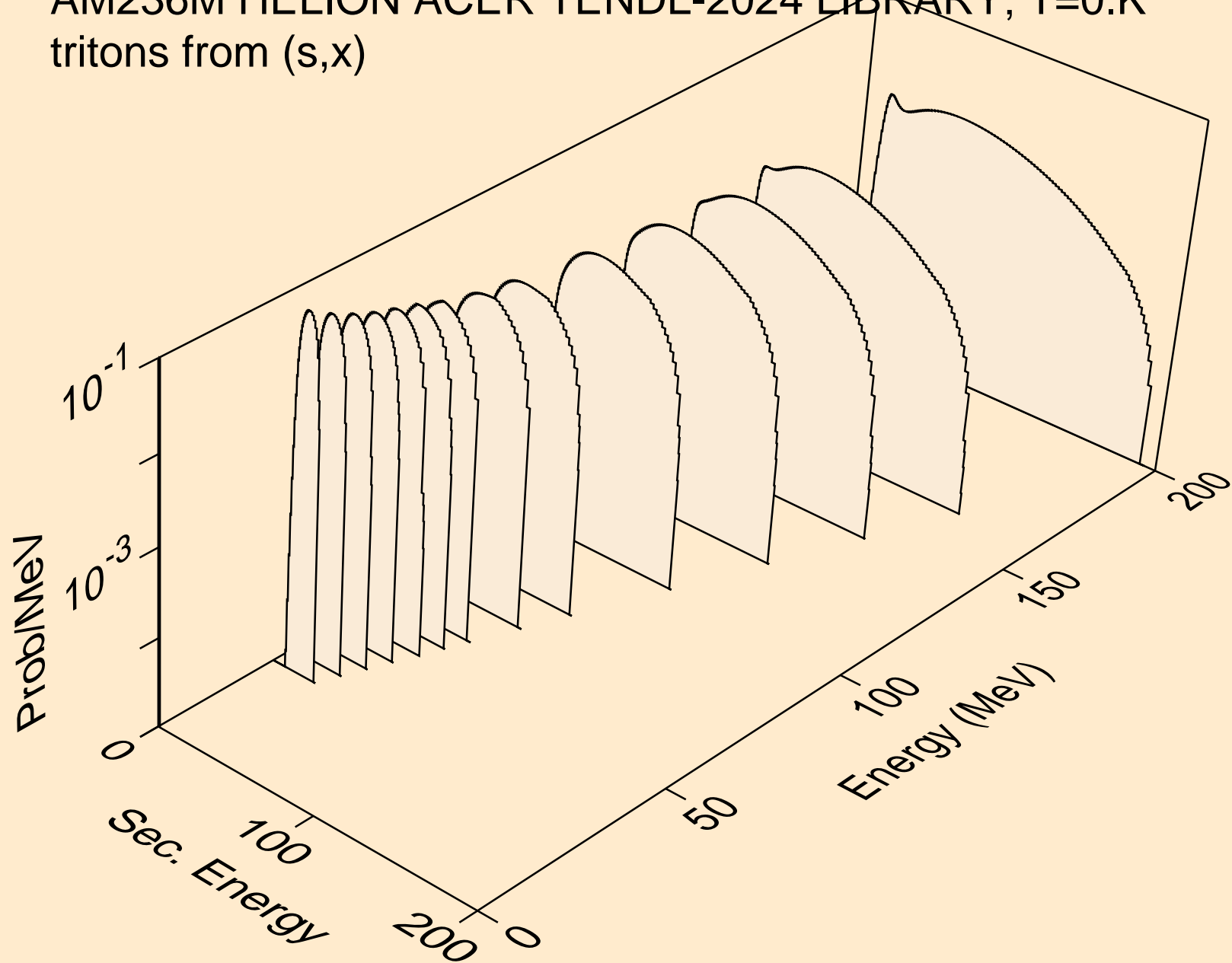

AM236M HELION ACER TENDL-2024 LIBRARY; T=0.K
tritons from (s,n*)t

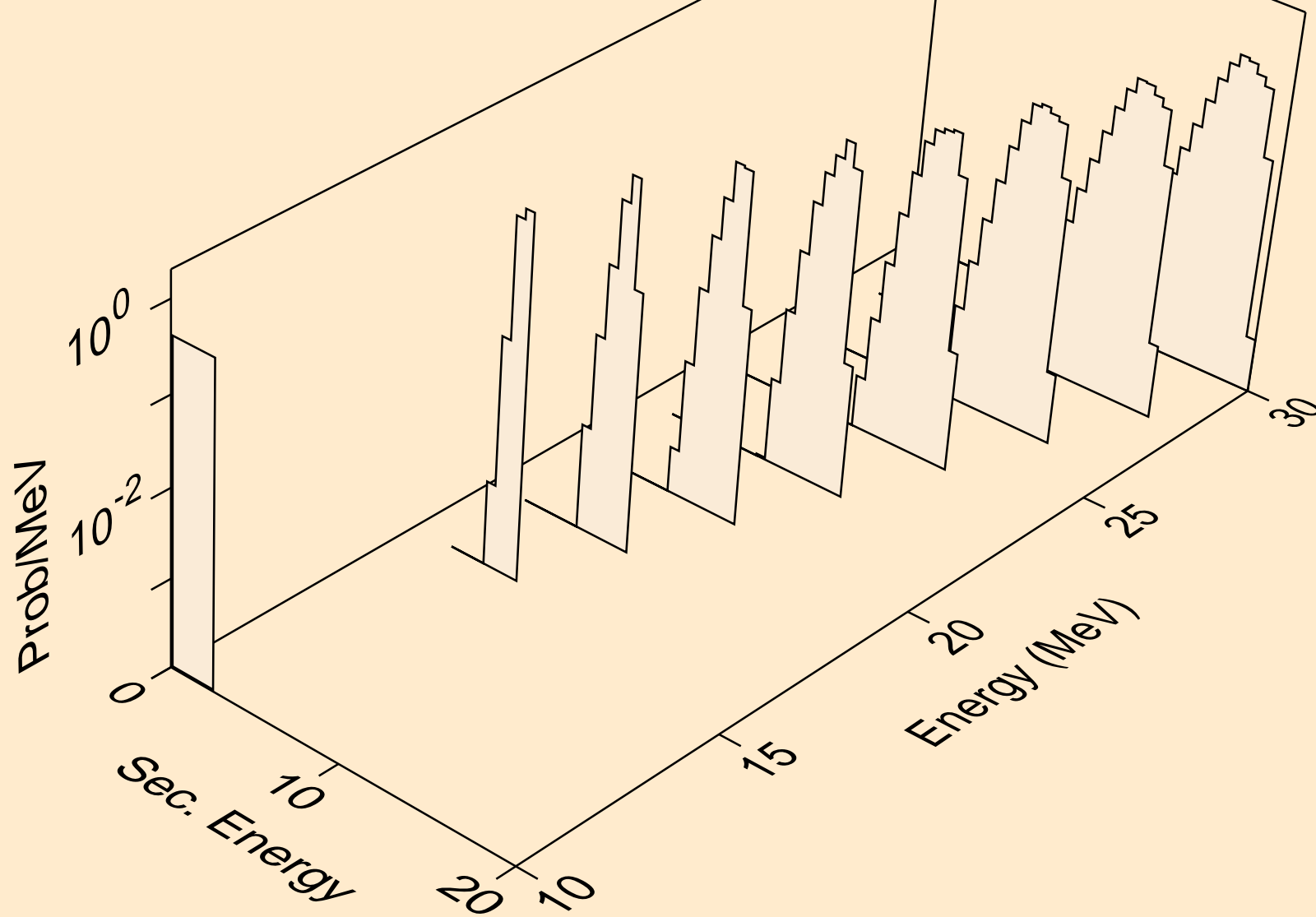

AM236M HELION ACER TENDL-2024 LIBRARY; T=0.K
tritons from (s,t)

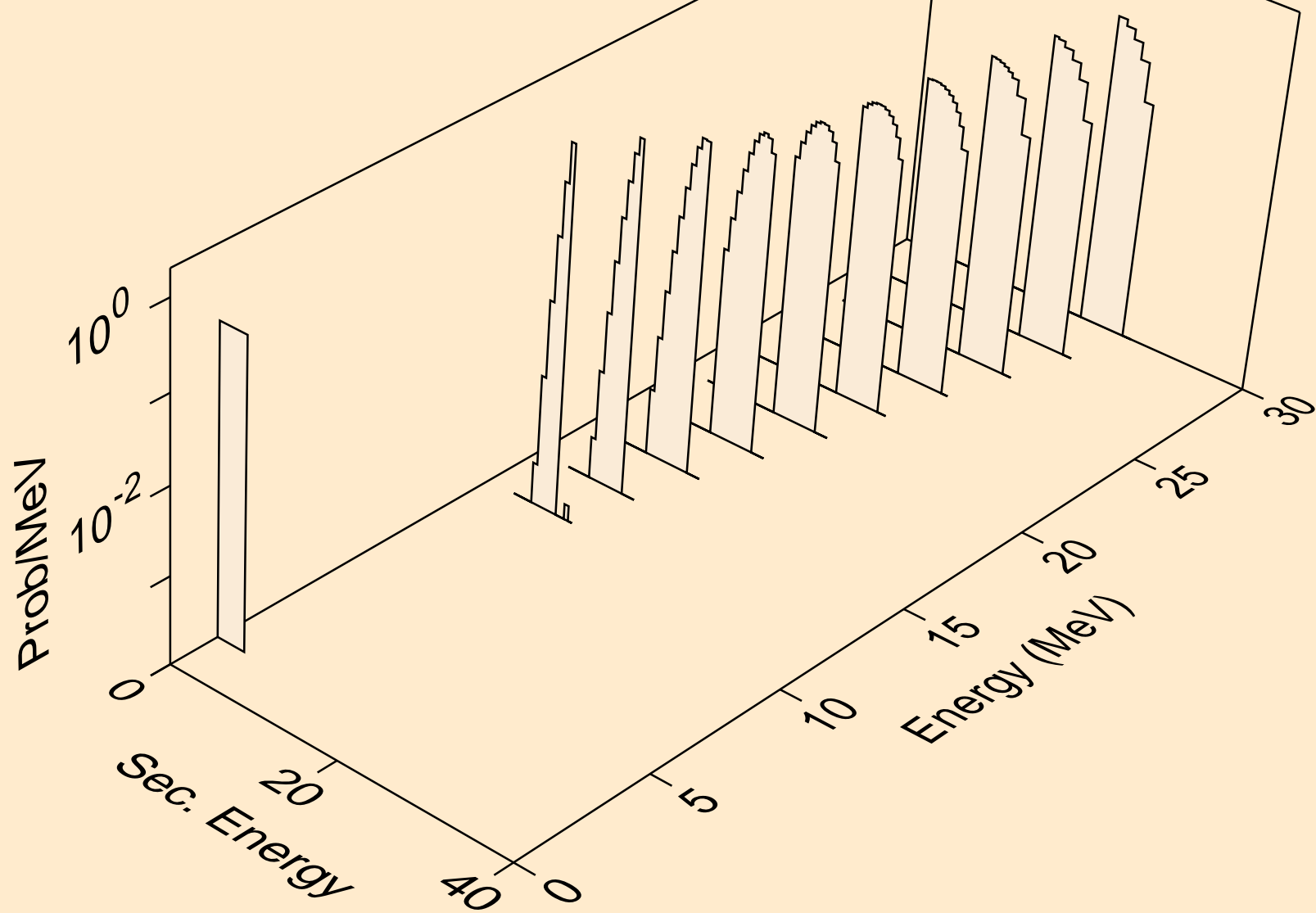

AM236M HELION ACER TENDL-2024 LIBRARY; T=0.K
alphas from (s,x)

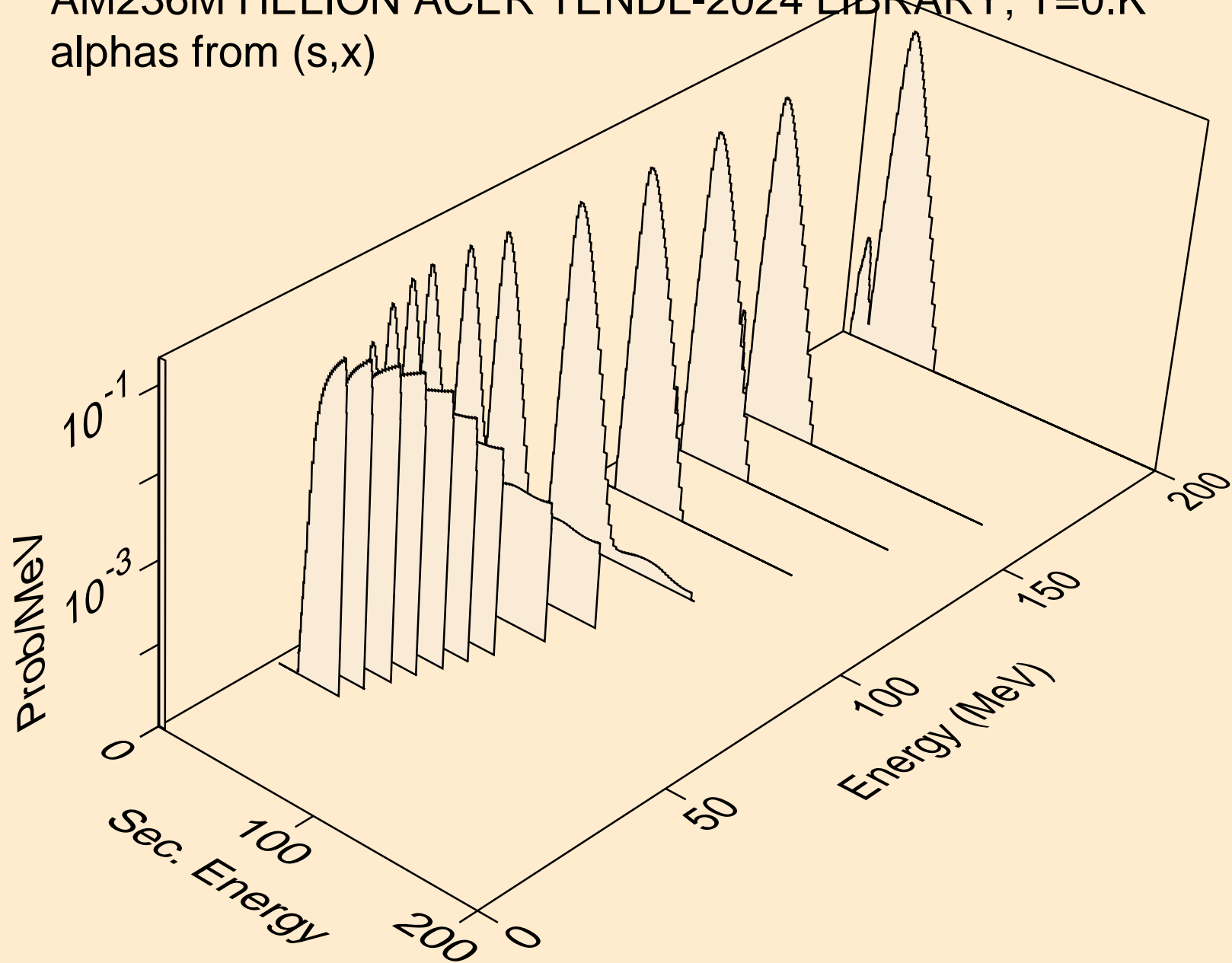

AM236M HELION ACER TENDL-2024 LIBRARY; T=0.K
alphas from (s,n*)a

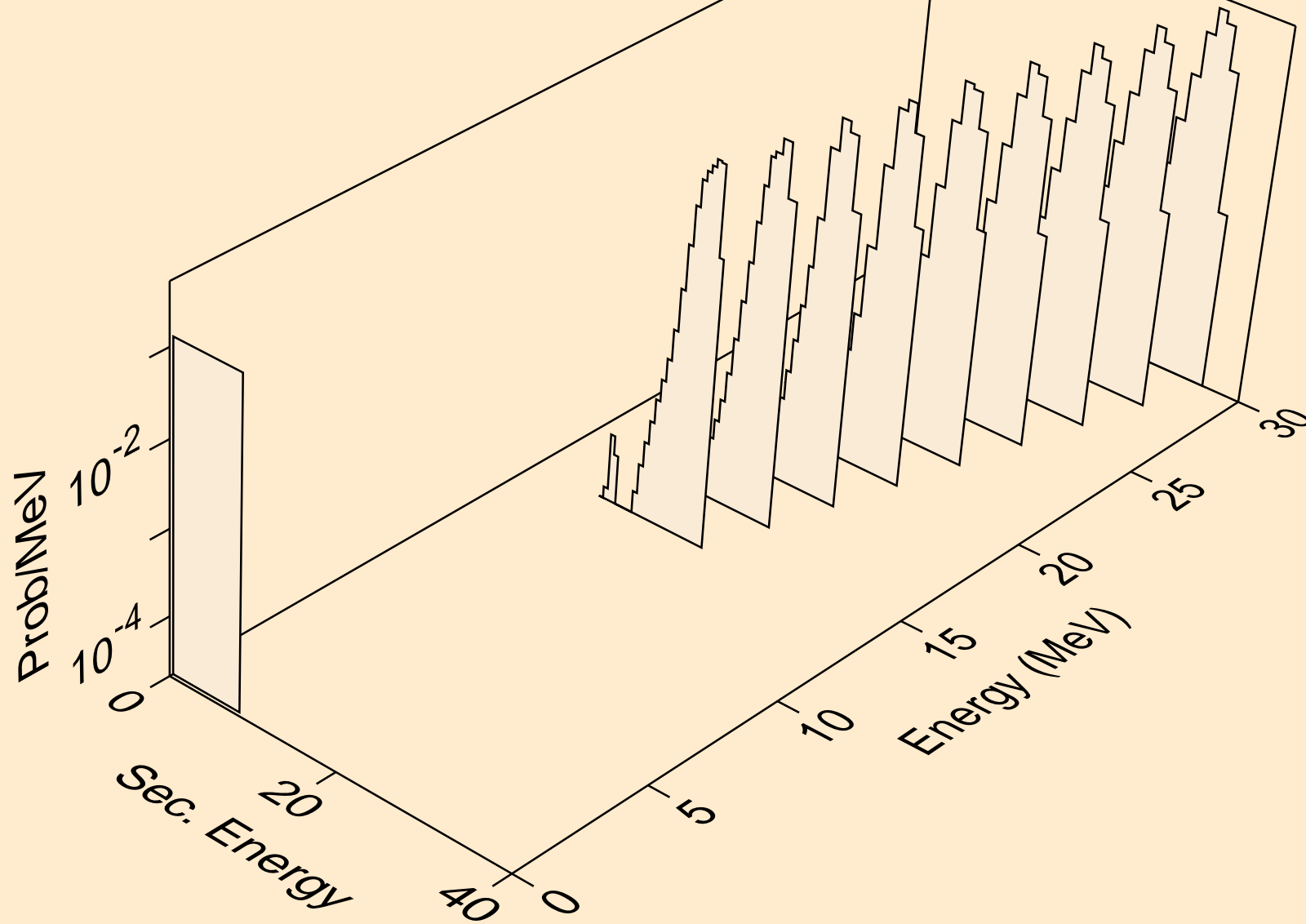

AM236M HELION ACER TENDL-2024 LIBRARY; T=0.K
alphas from (s,a)

