

AR041 HELION ACER TENDL-2024 LIBRARY; T=0.K
Principal cross sections

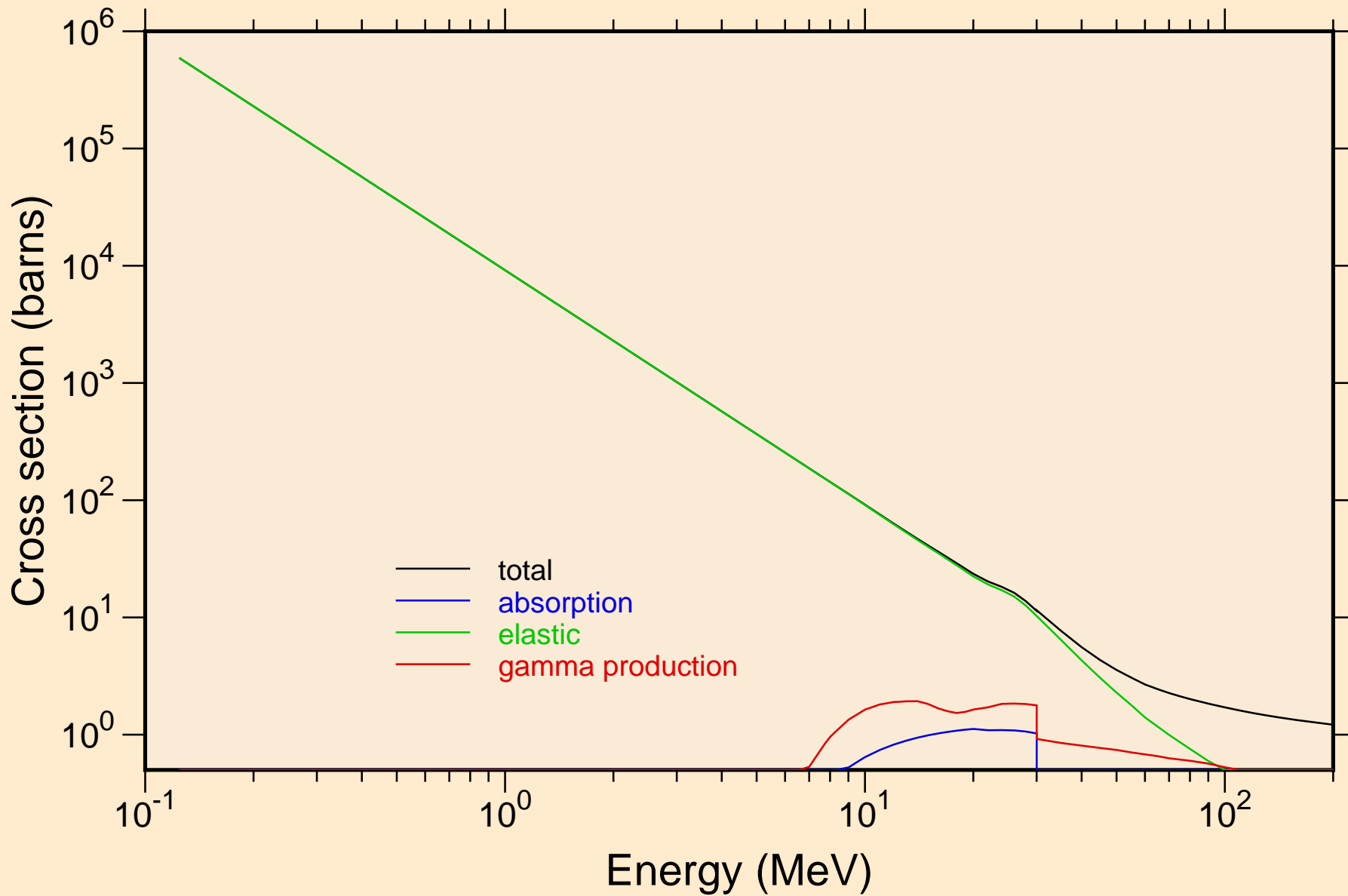

AR041 HELION ACER TENDL-2024 LIBRARY; T=0.K

Heating

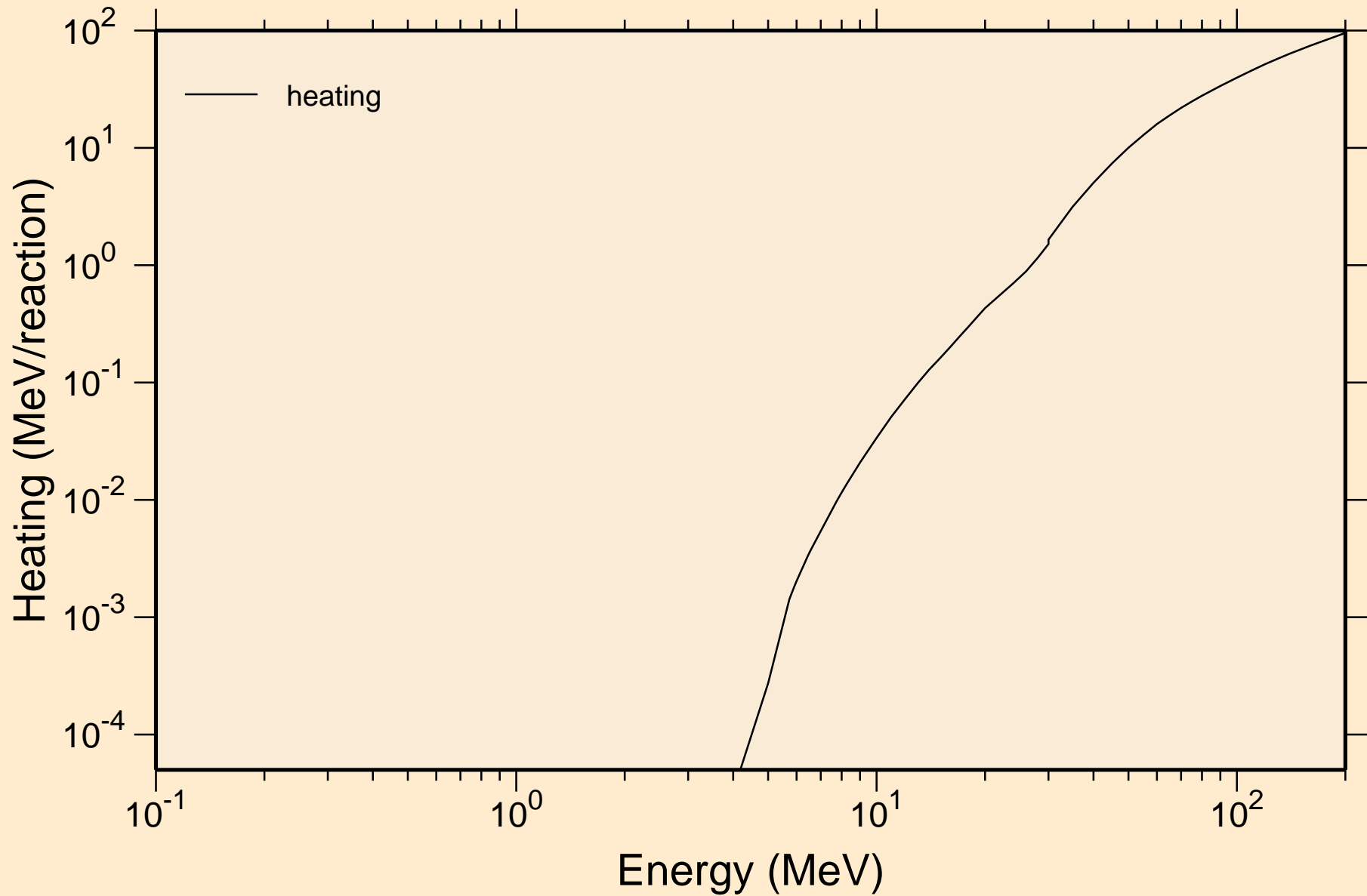

AR041 HELION ACER TENDL-2024 LIBRARY; T=0.K

Principal cross sections

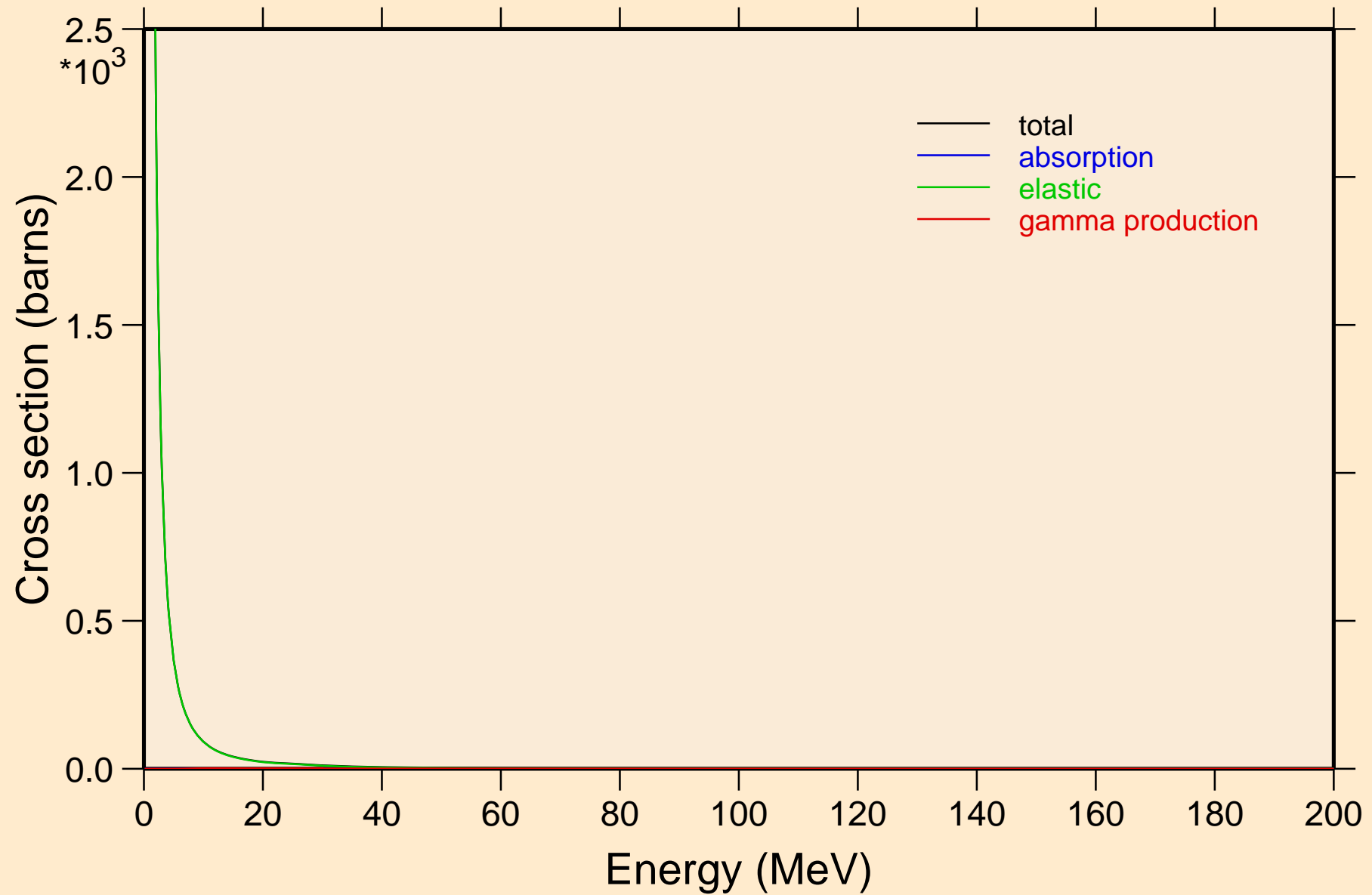

AR041 HELION ACER TENDL-2024 LIBRARY; T=0.K

Heating

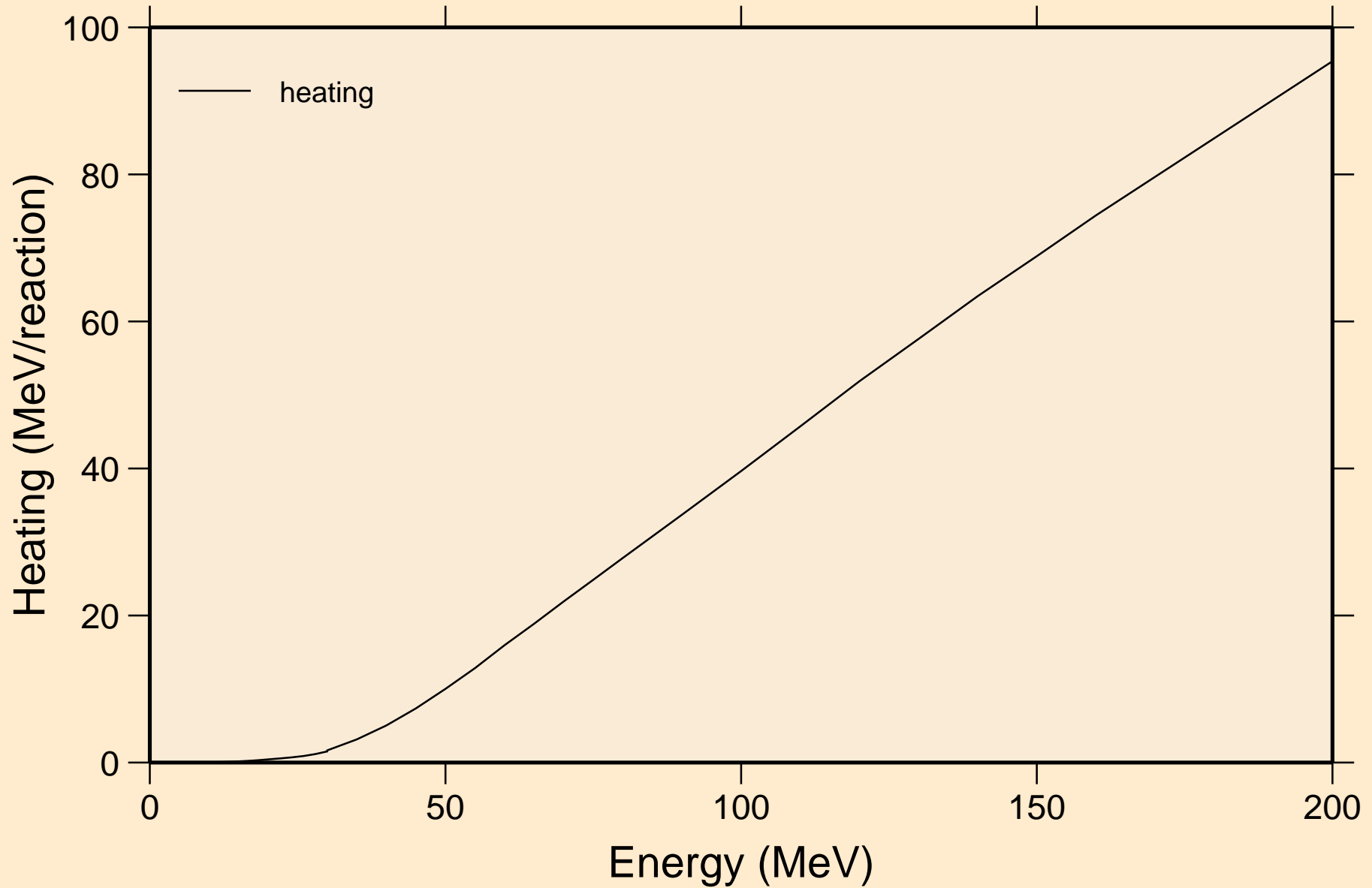

AR041 HELION ACER TENDL-2024 LIBRARY; T=0.K
Threshold reactions

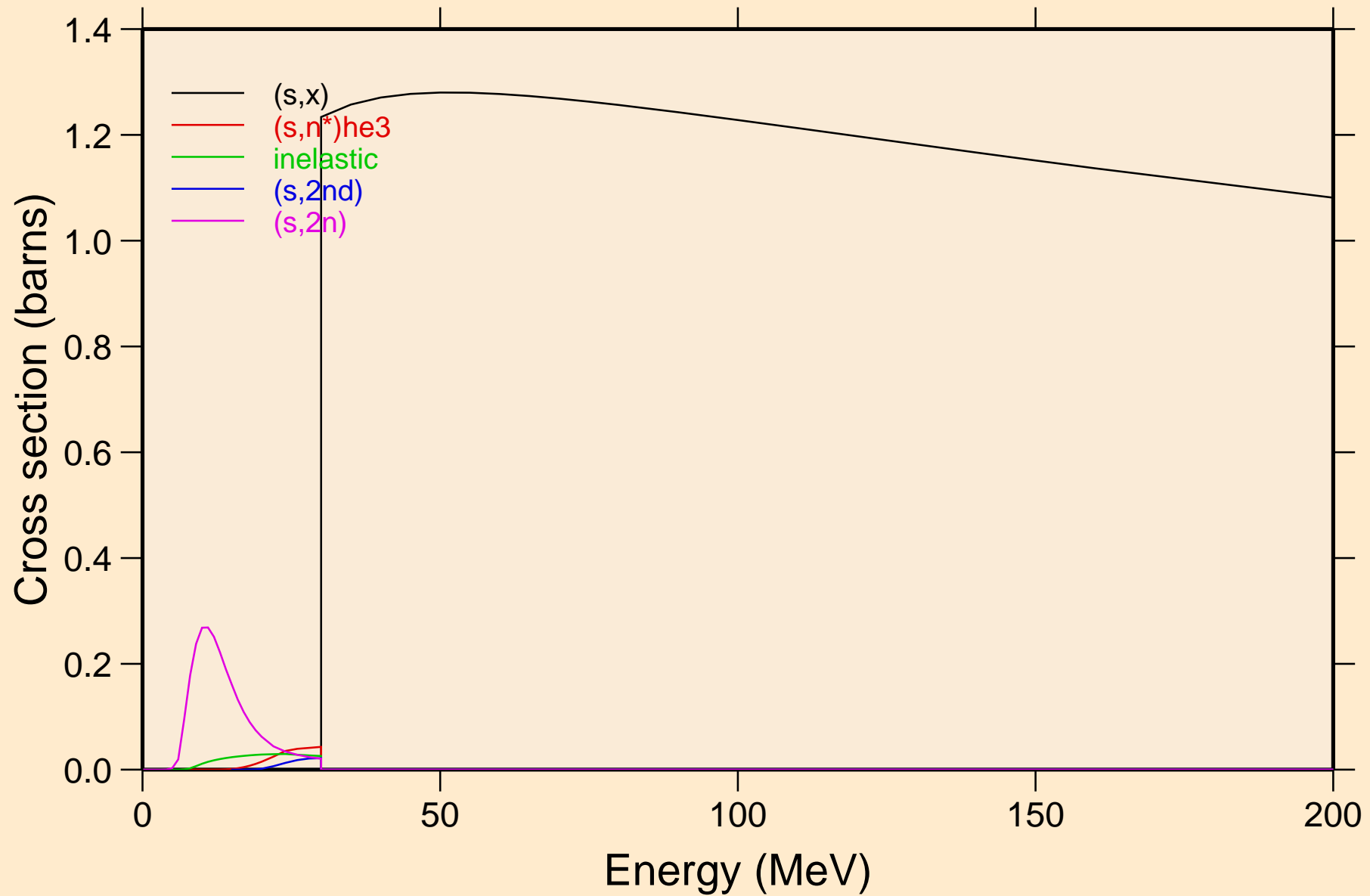

AR041 HELION ACER TENDL-2024 LIBRARY; T=0.K
Threshold reactions

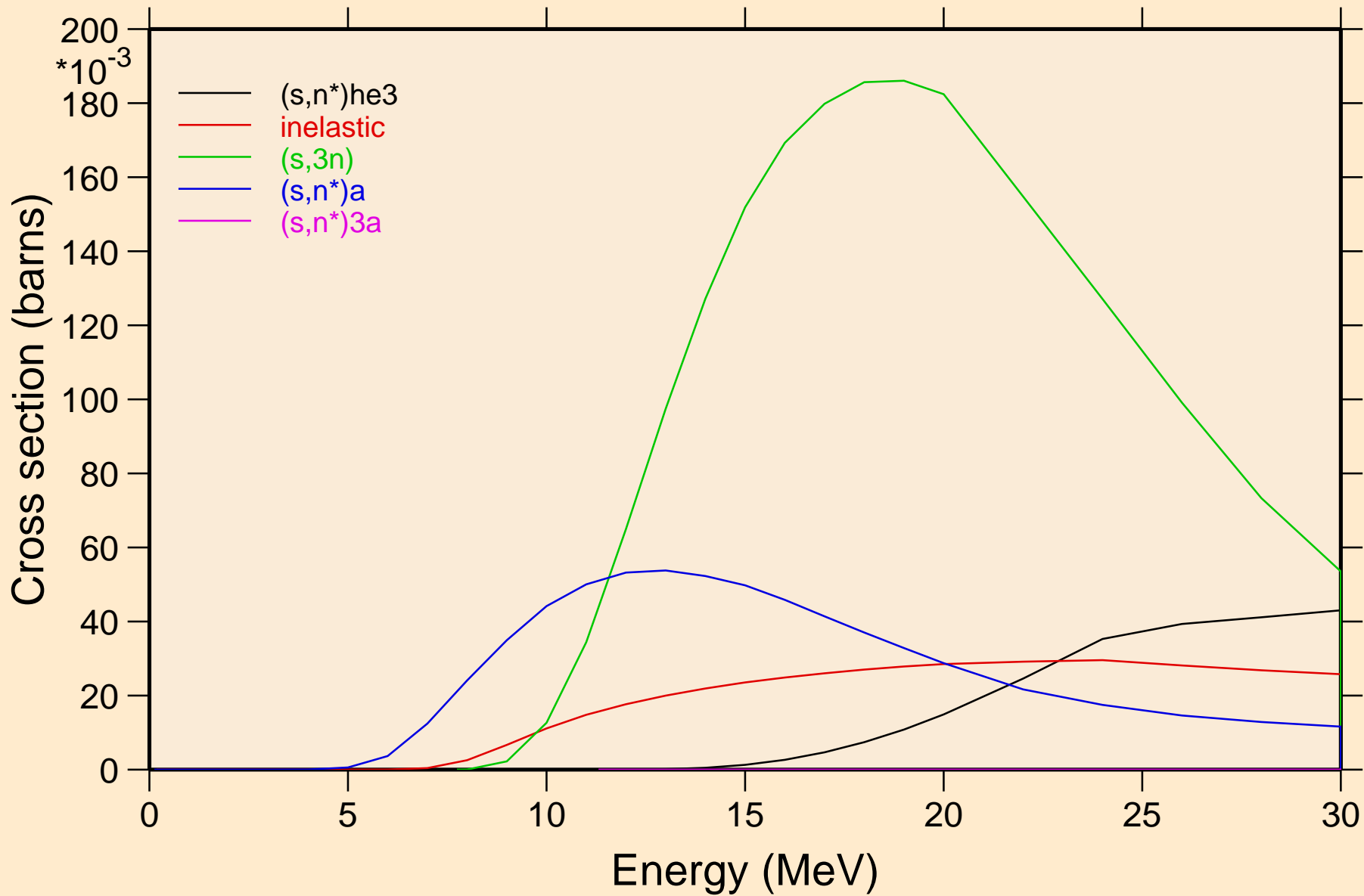

AR041 HELION ACER TENDL-2024 LIBRARY; T=0.K
Threshold reactions

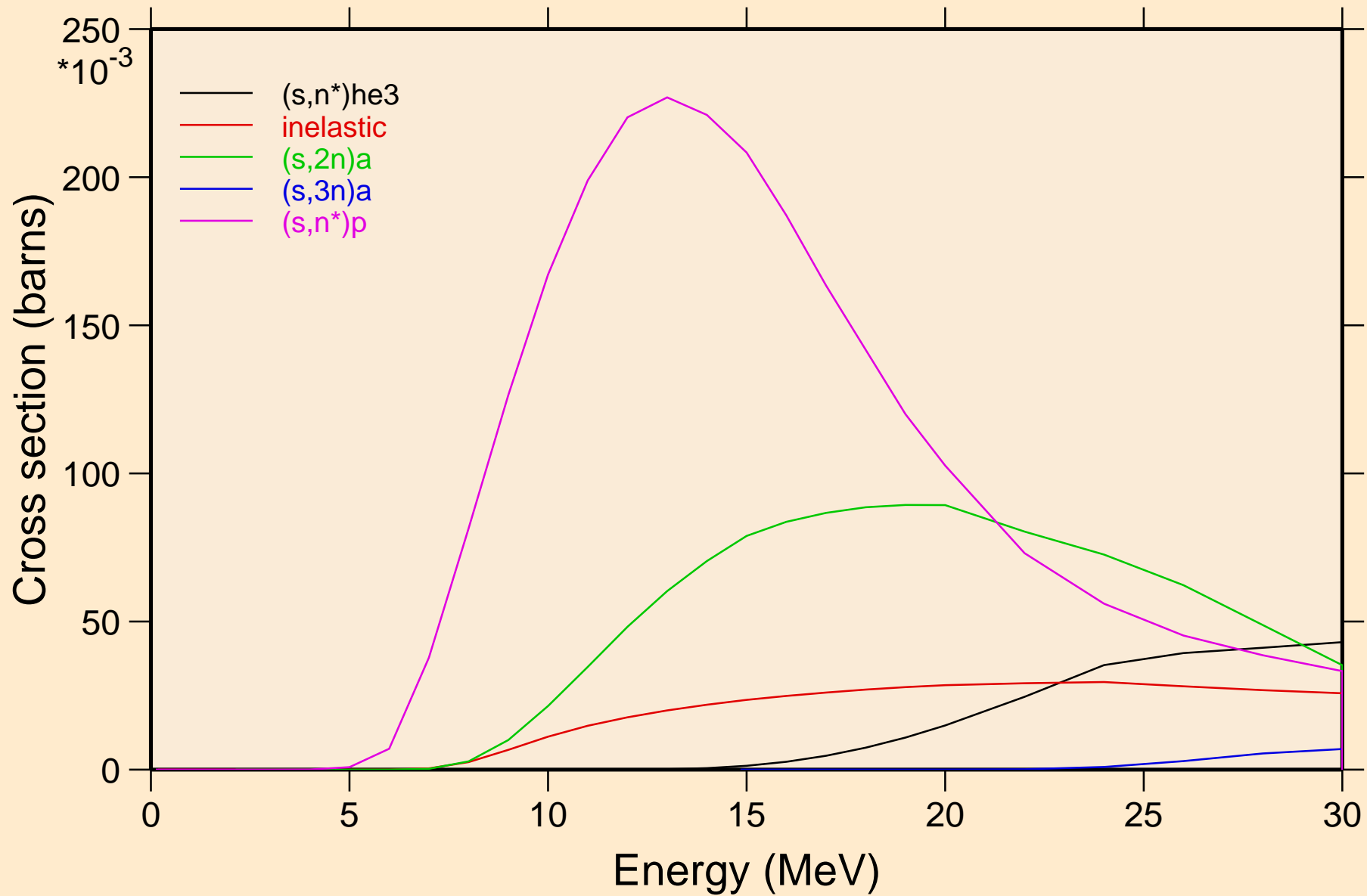

AR041 HELION ACER TENDL-2024 LIBRARY; T=0.K
Threshold reactions

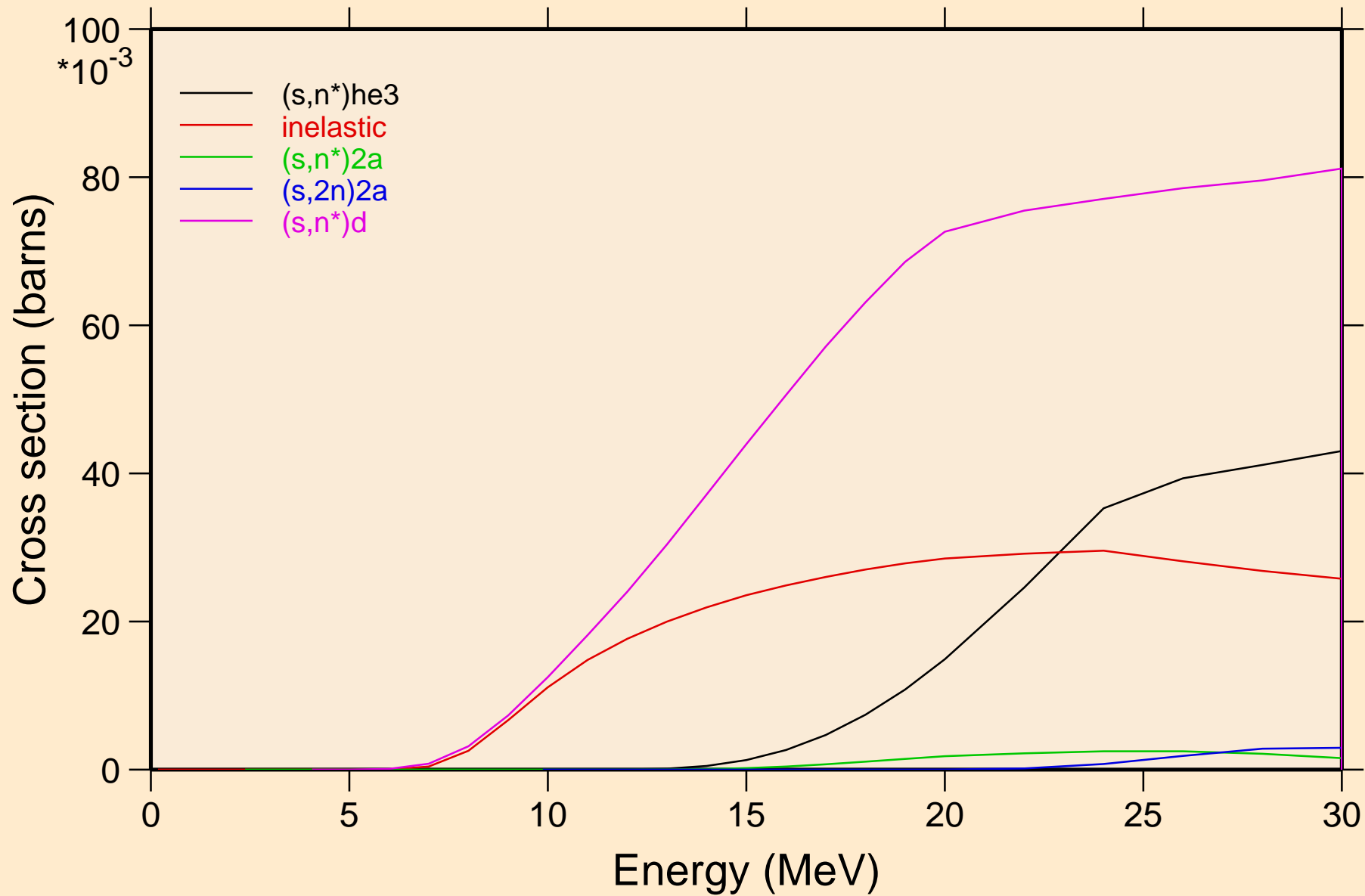

AR041 HELION ACER TENDL-2024 LIBRARY; T=0.K
Threshold reactions

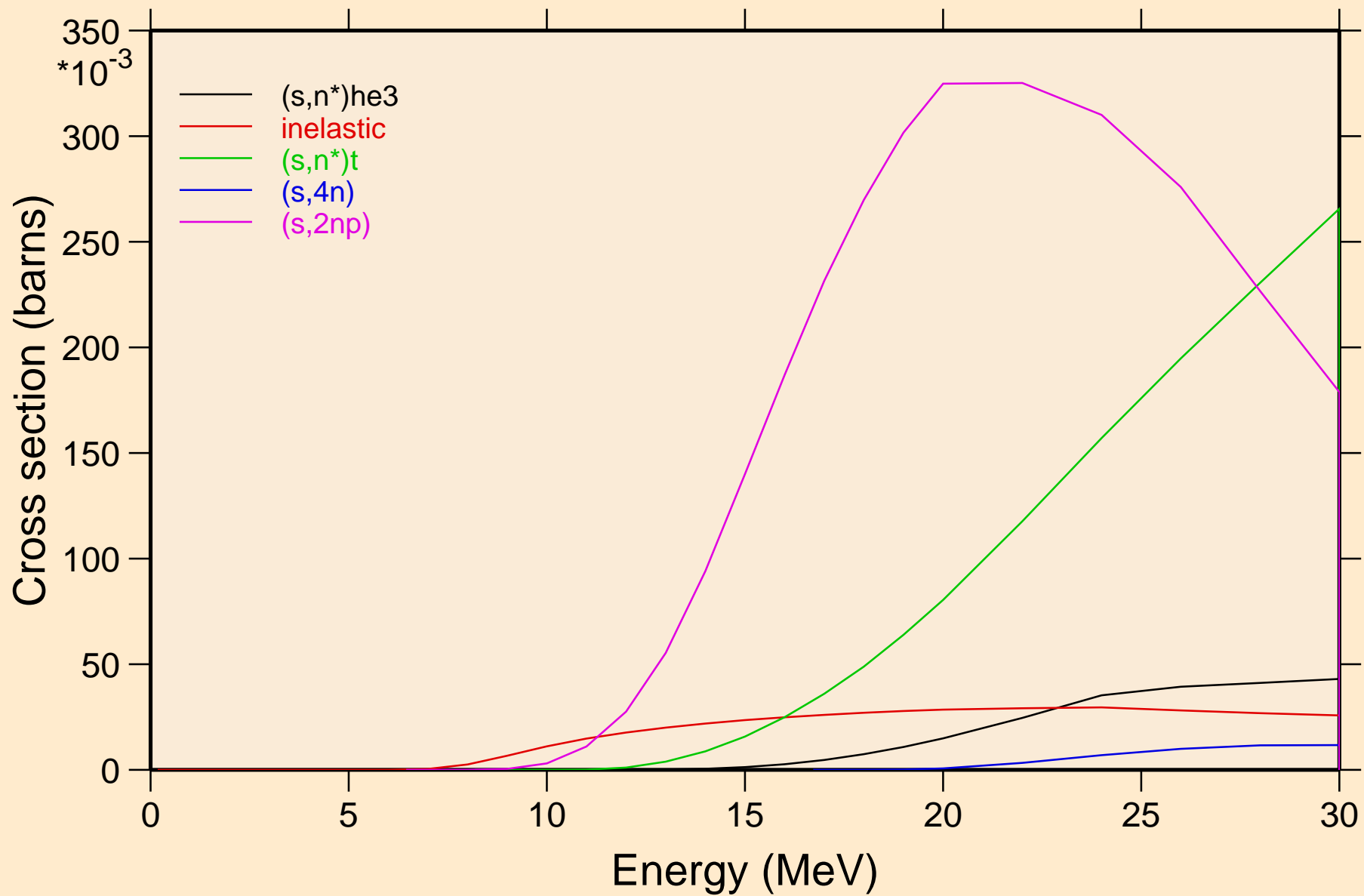

AR041 HELION ACER TENDL-2024 LIBRARY; T=0.K
Threshold reactions

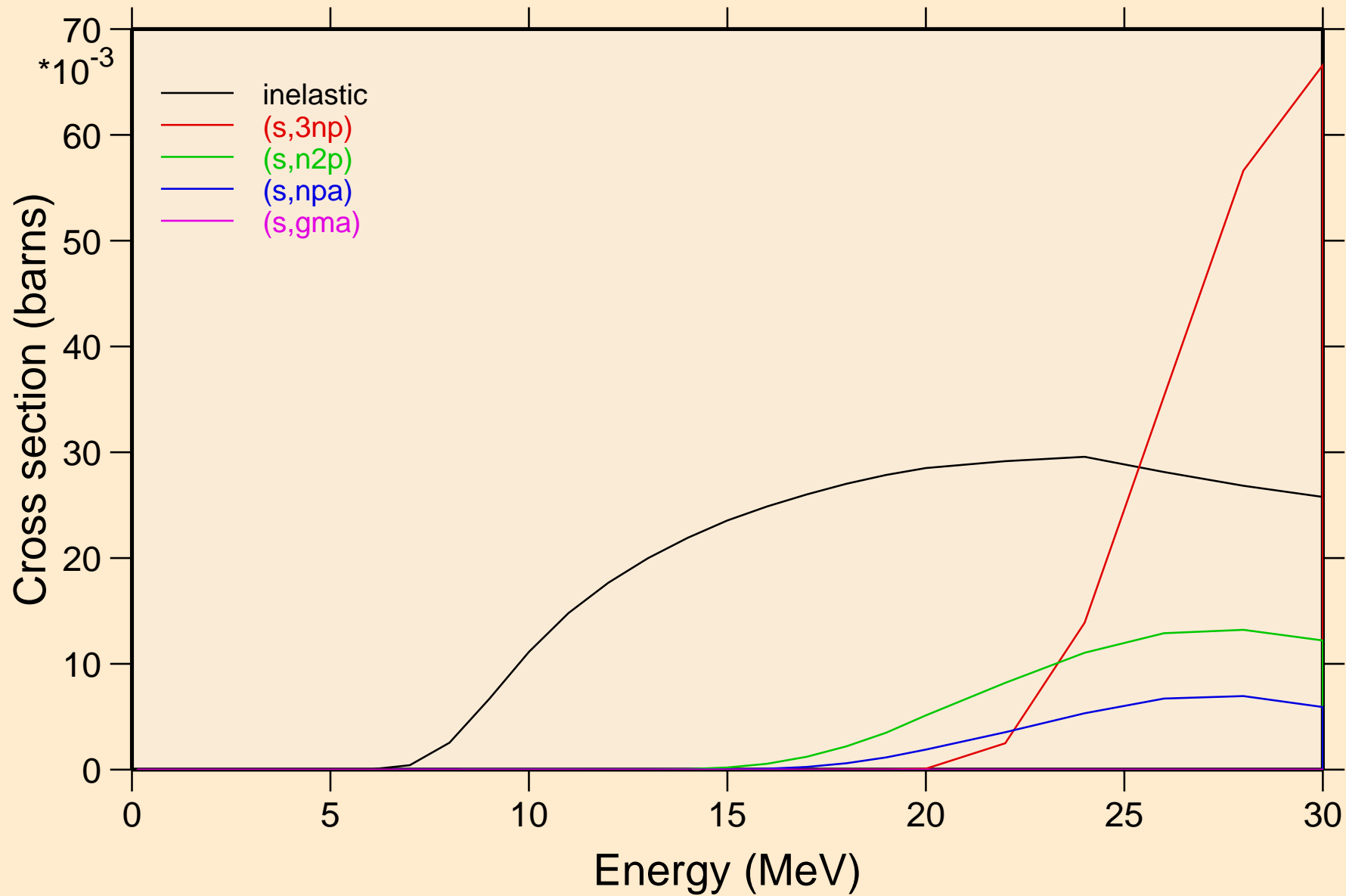

AR041 HELION ACER TENDL-2024 LIBRARY; T=0.K
Threshold reactions

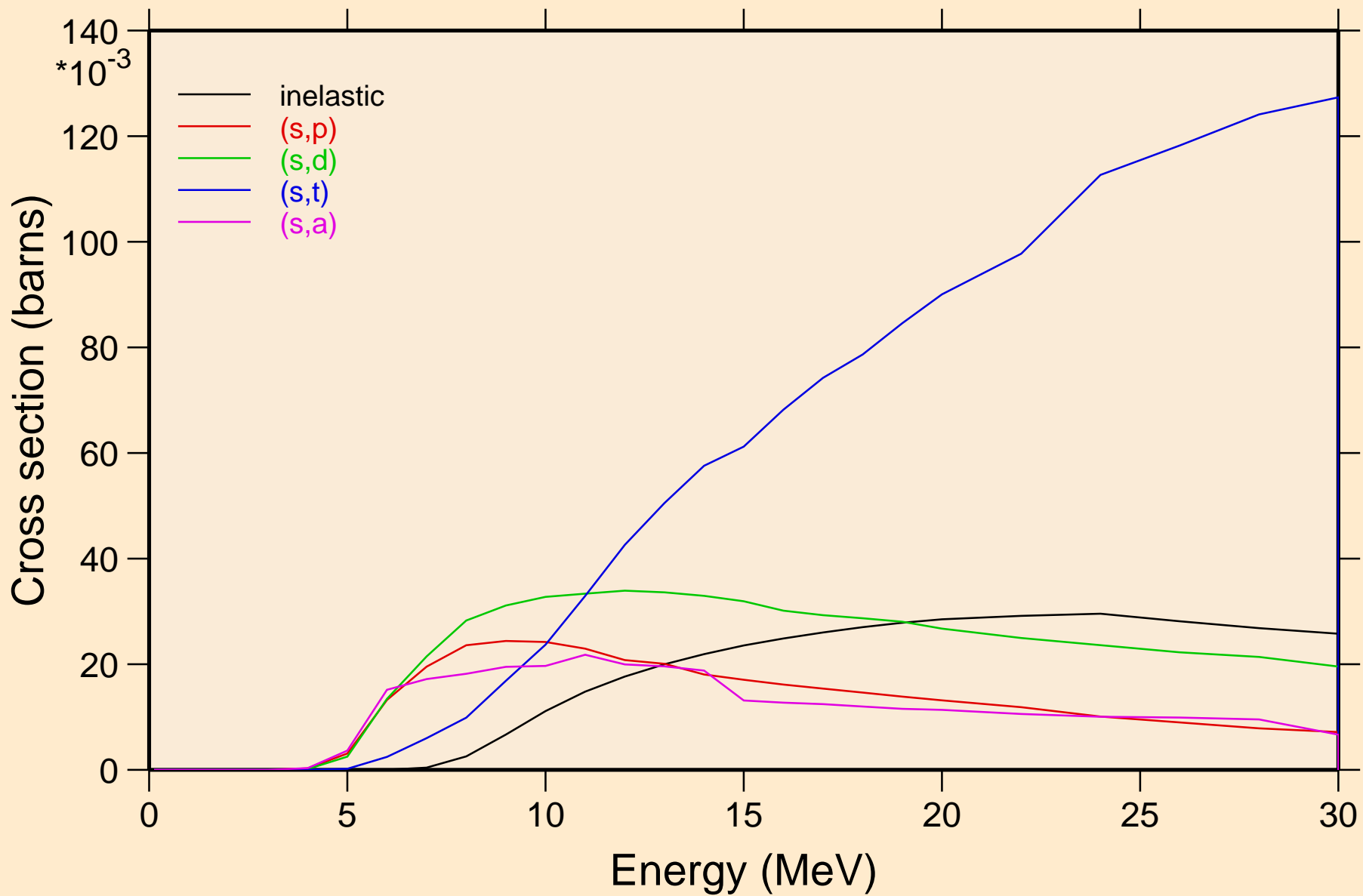

AR041 HELION ACER TENDL-2024 LIBRARY; T=0.K
Threshold reactions

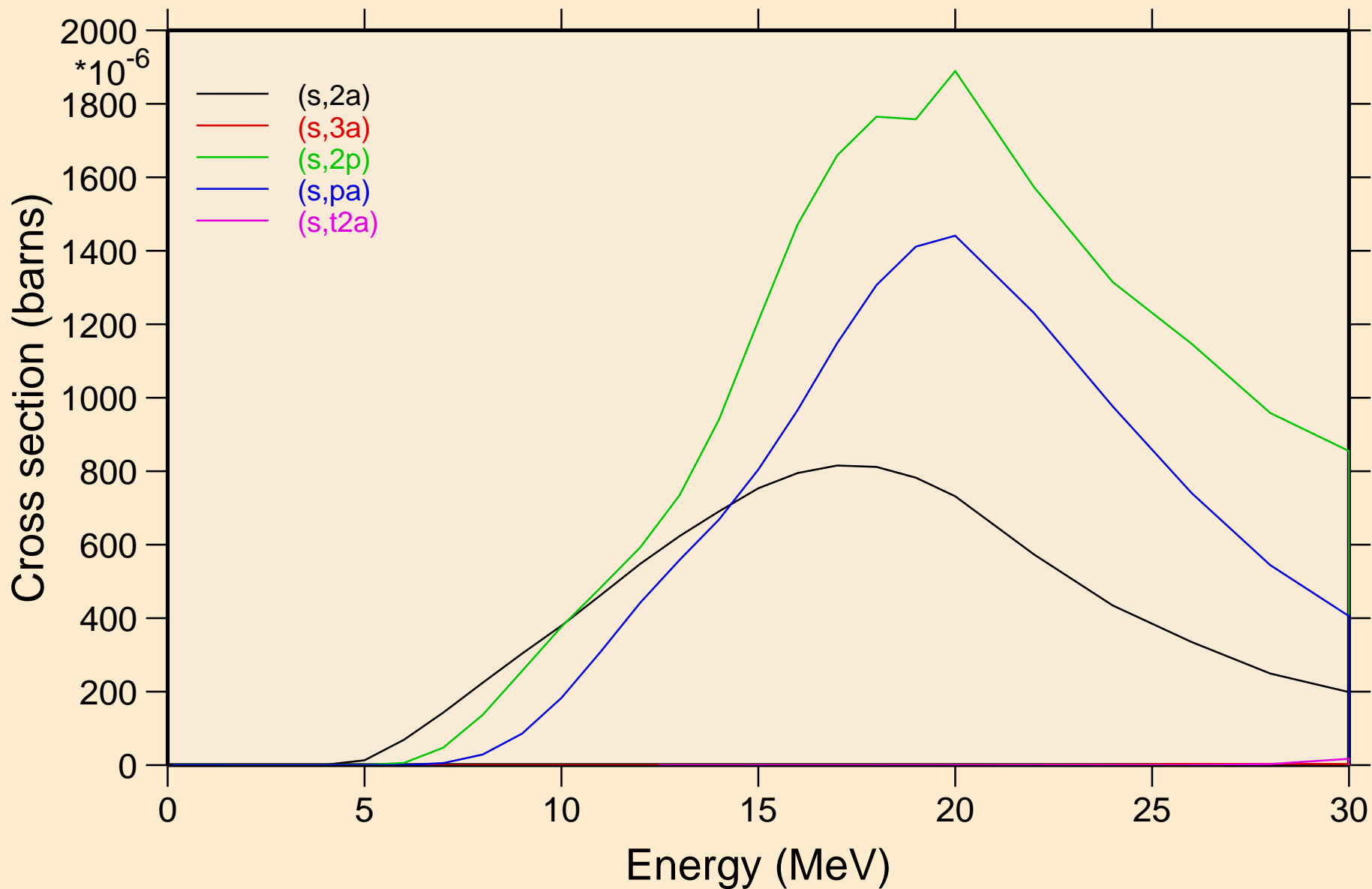

AR041 HELION ACER TENDL-2024 LIBRARY; T=0.K
Threshold reactions

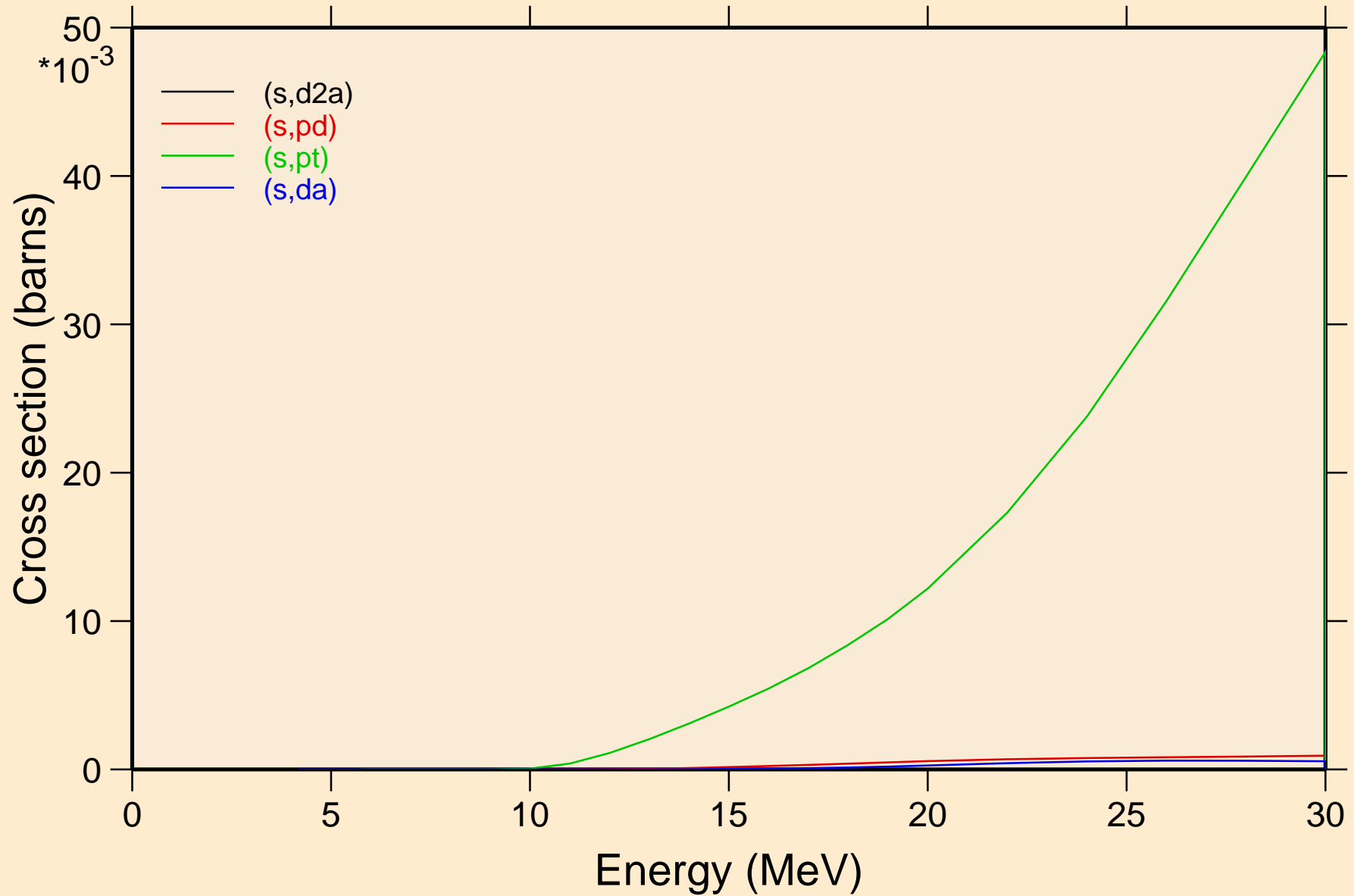

AR041 HELION ACER TENDL-2024 LIBRARY; T=0.K
angular distribution for elastic

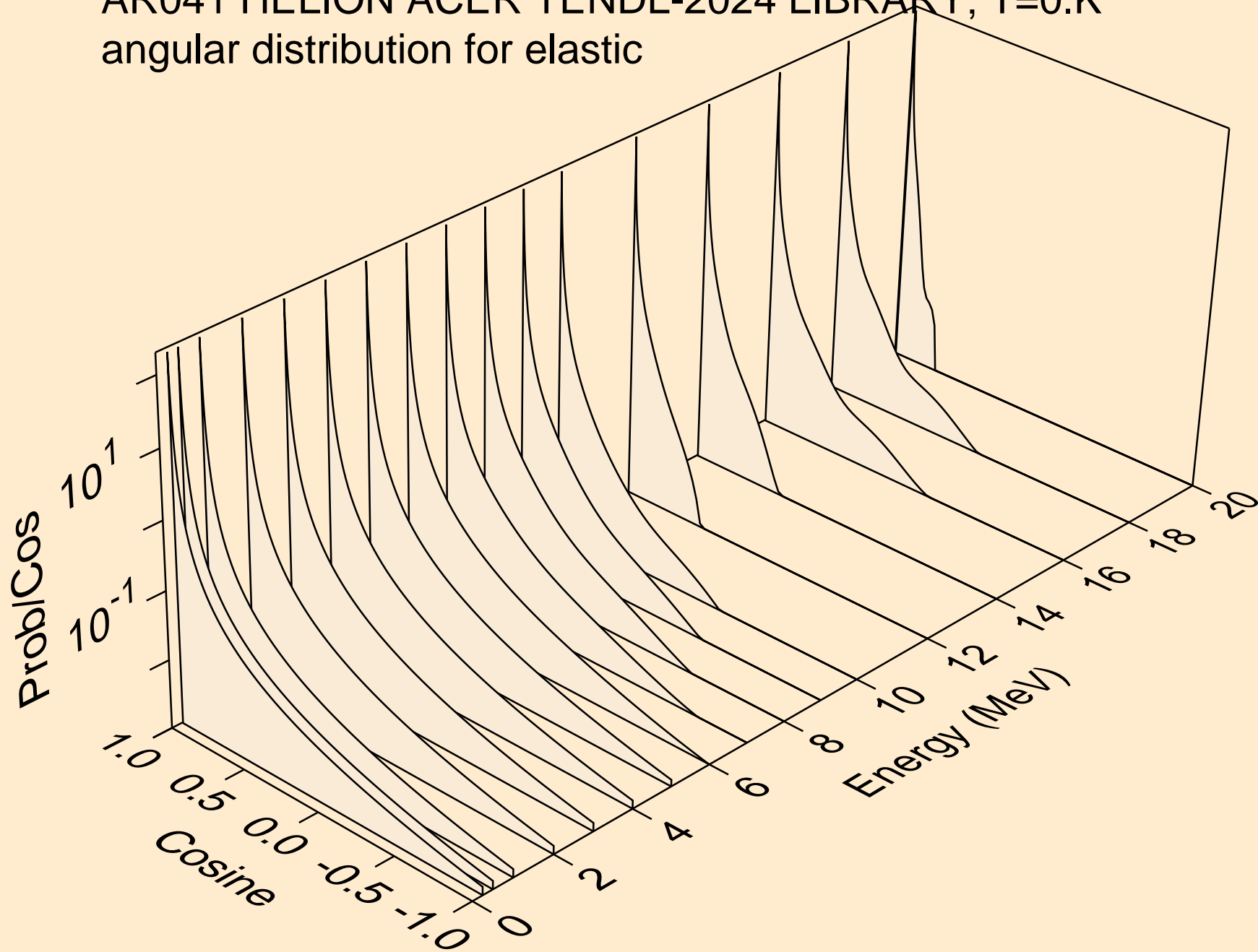

AR041 HELION ACER TENDL-2024 LIBRARY; T=0.K
angular distribution for elastic

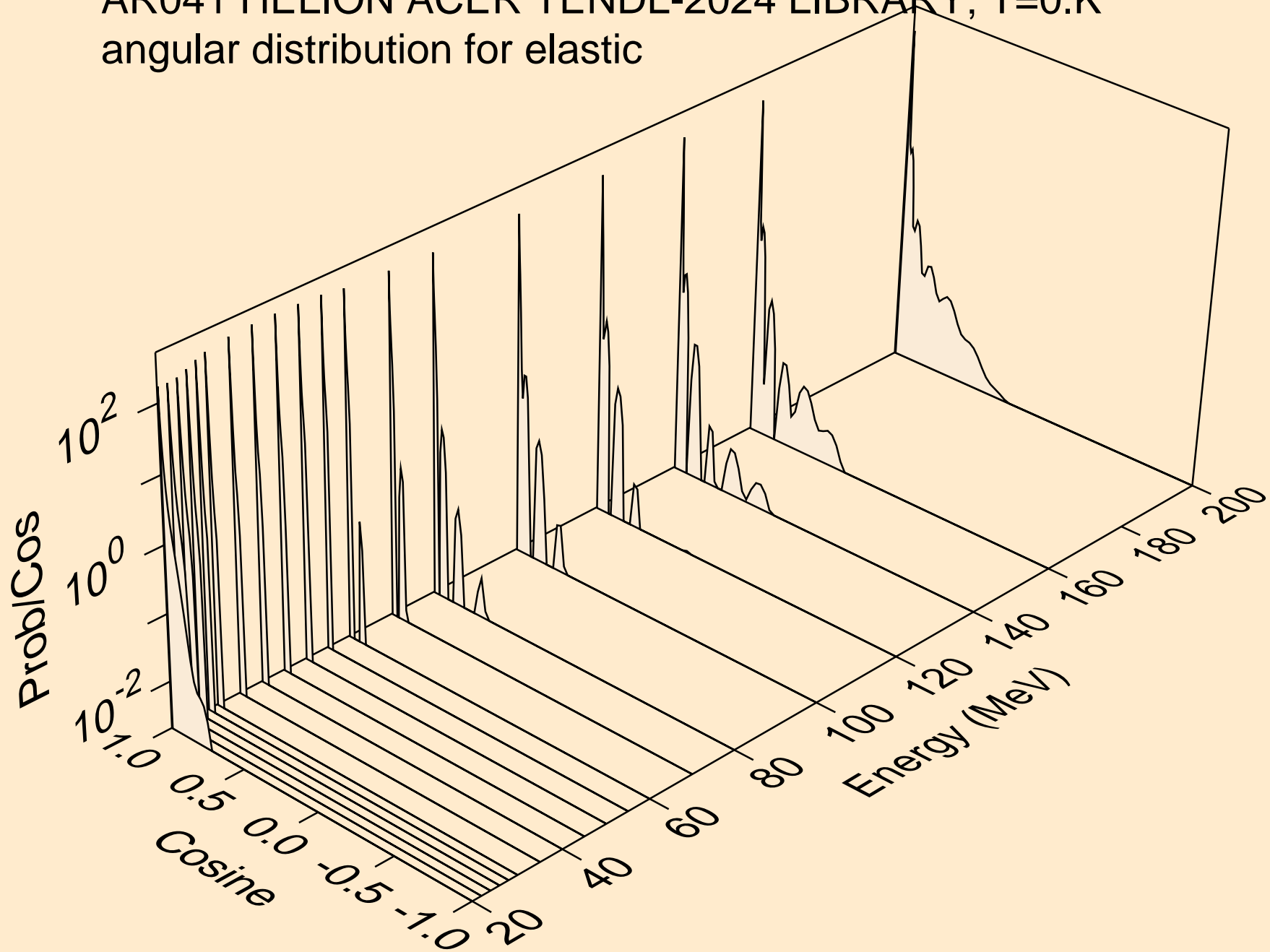

AR041 HELION ACER TENDL-2024 LIBRARY; T=0.K
He-3 emission for (s,x)

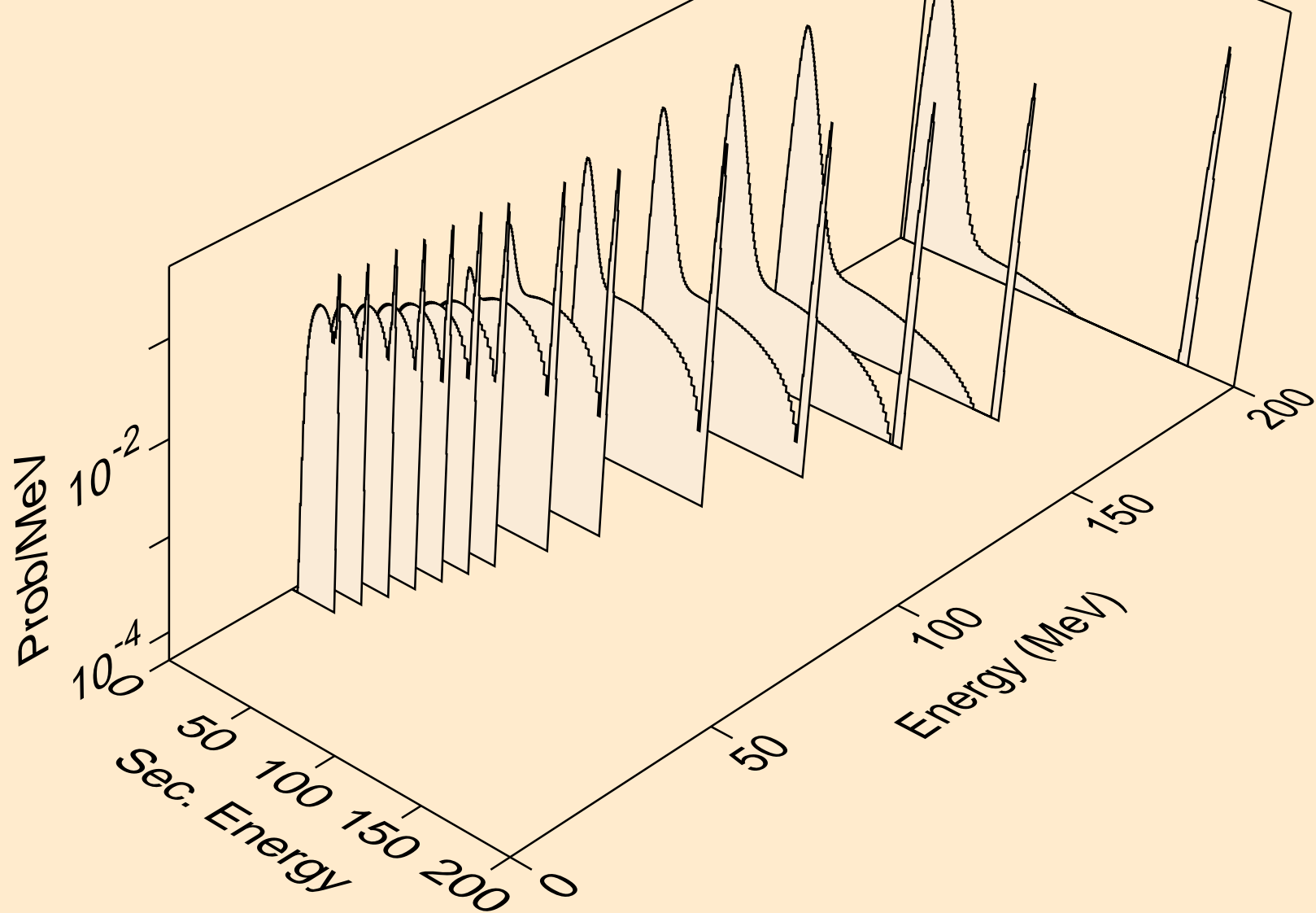

AR041 HELION ACER TENDL-2024 LIBRARY; T=0.K
He-3 emission for (s,n*)he3

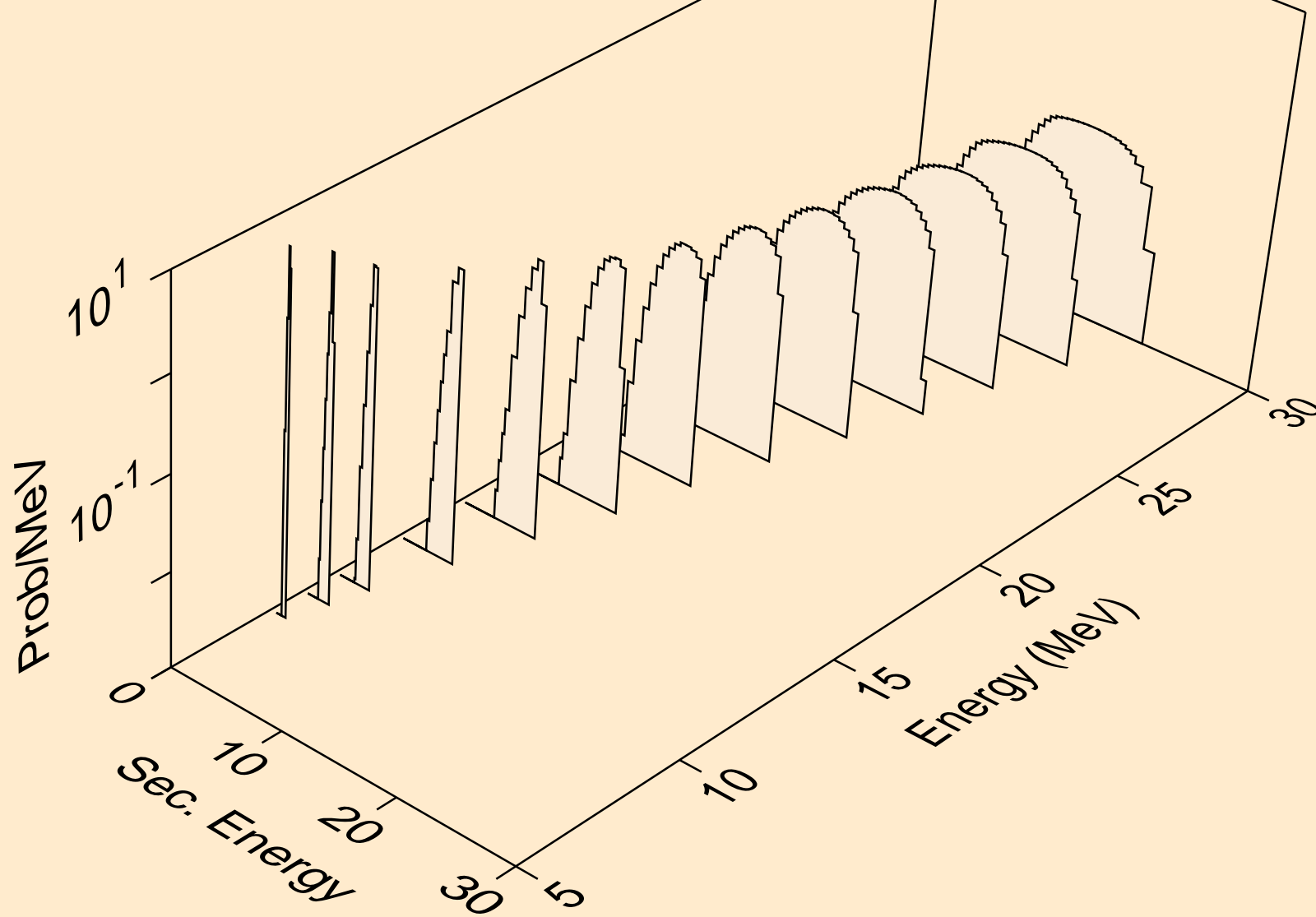

AR041 HELION ACER TENDL-2024 LIBRARY; T=0.K
He-3 emission for inelastic

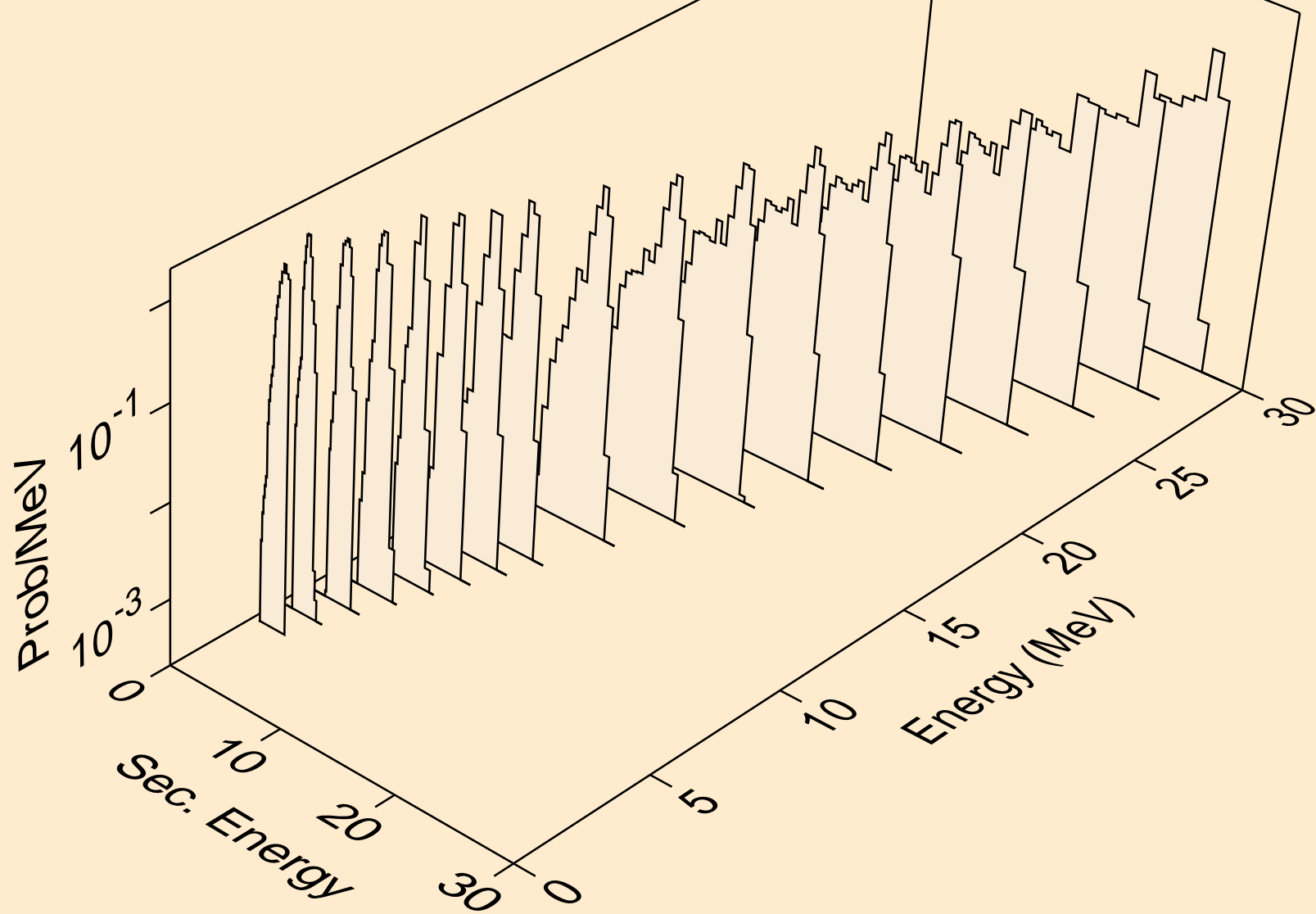

AR041 HELION ACER TENDL-2024 LIBRARY; T=0.K
Photon emission for (z,n)

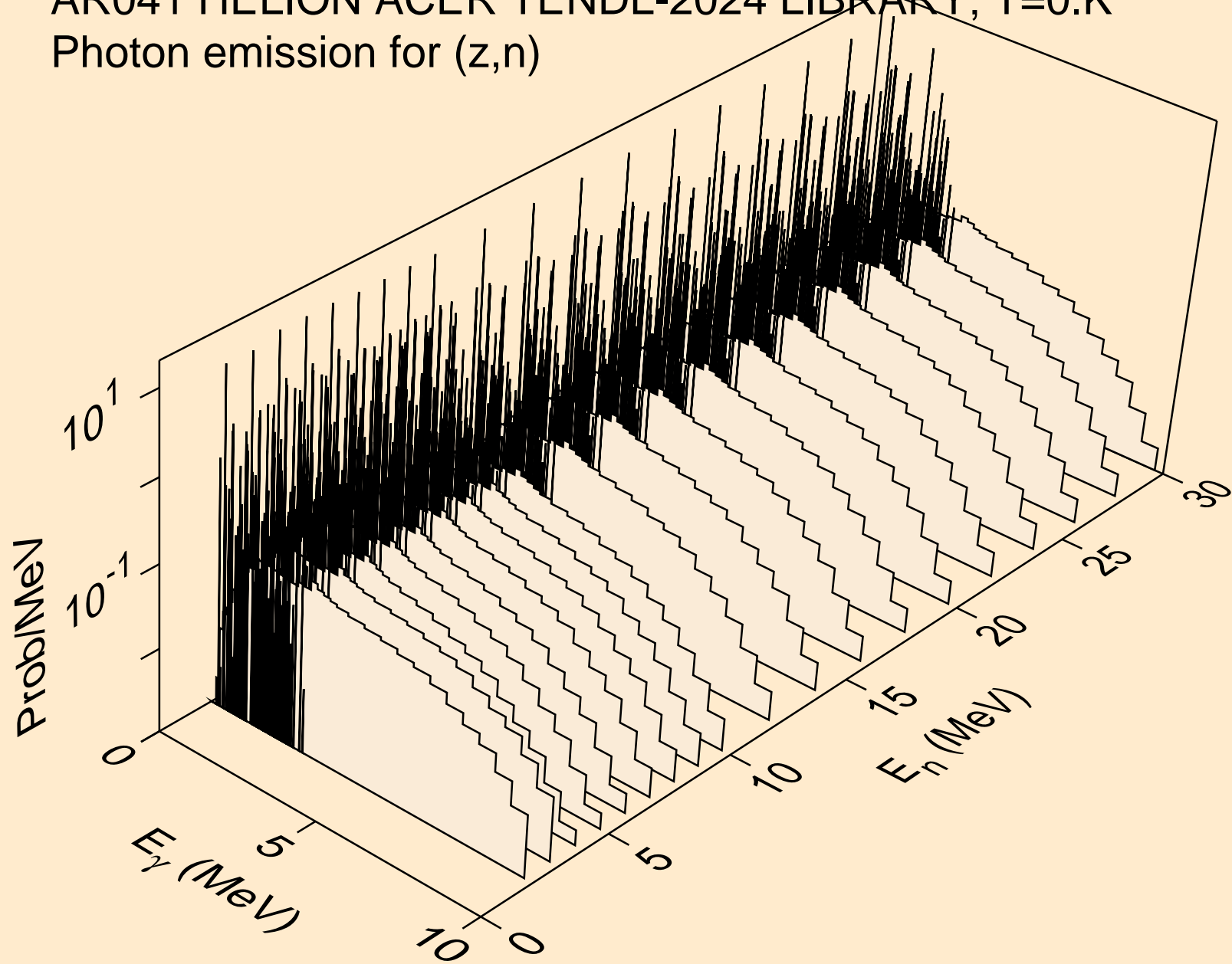

AR041 HELION ACER TENDL-2024 LIBRARY; T=0.K
Photon emission for (z,x)

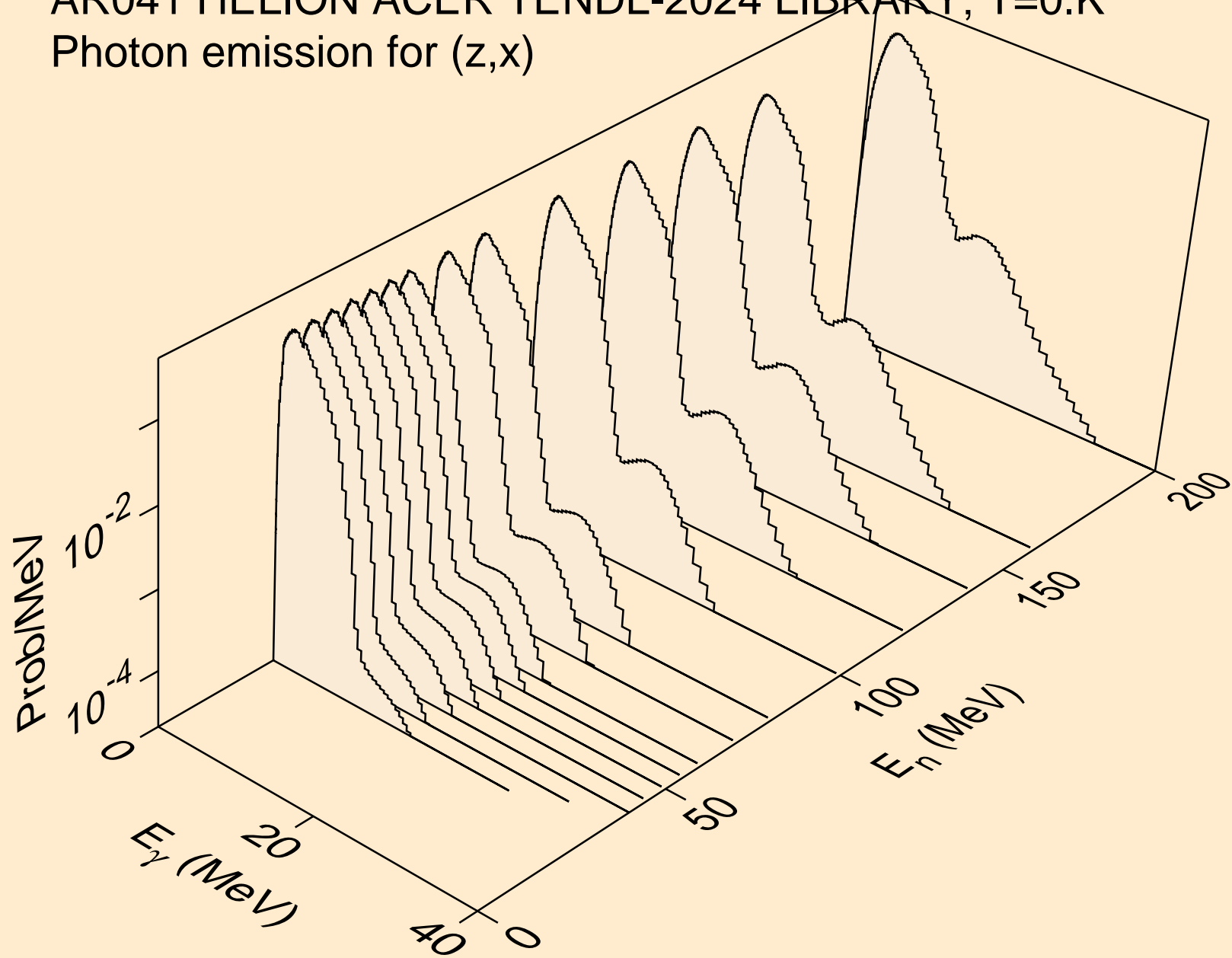

AR041 HELION ACER TENDL-2024 LIBRARY; T=0.K
Photon emission for (n,2nd)

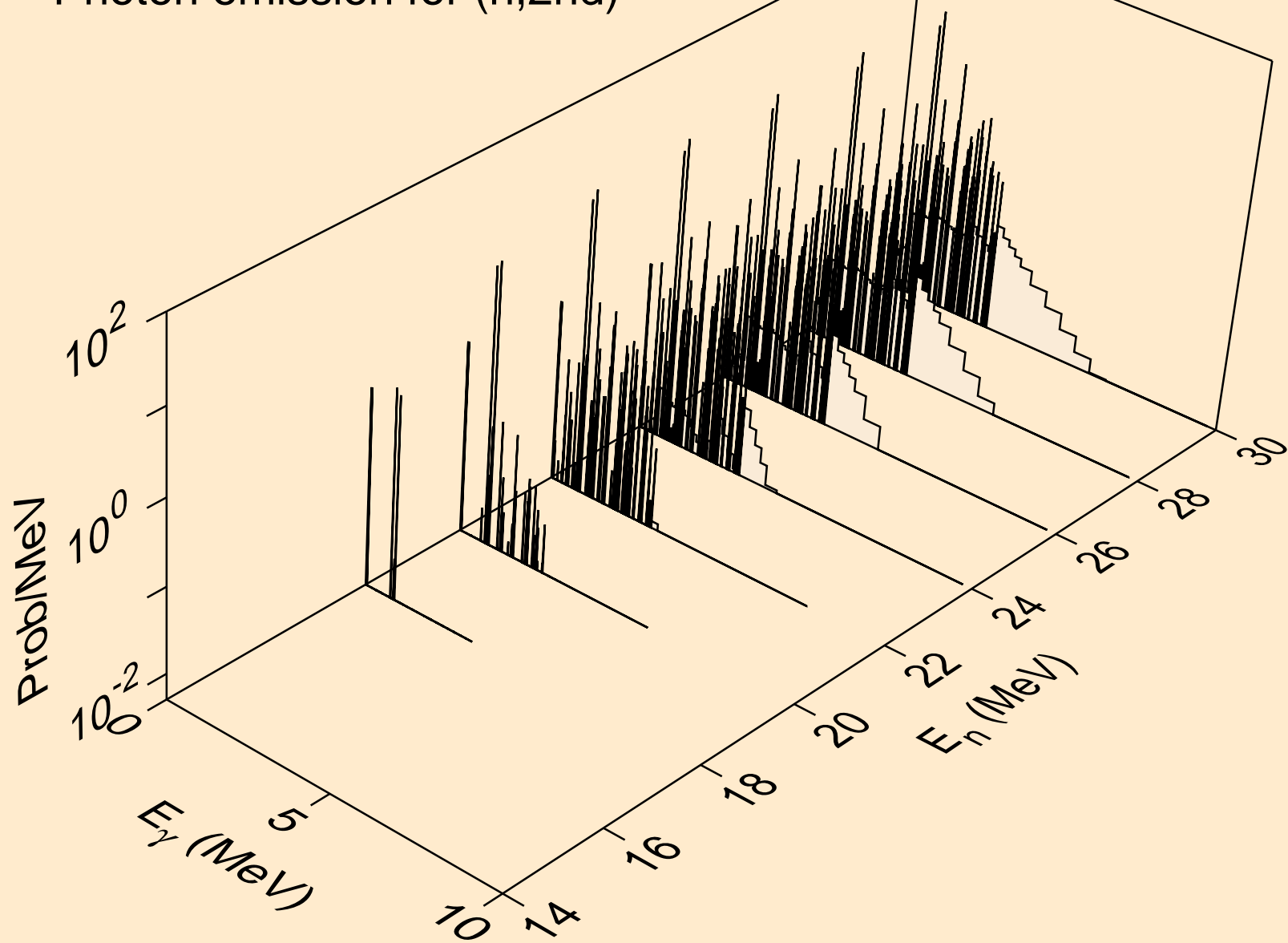

AR041 HELION ACER TENDL-2024 LIBRARY; T=0.K
Photon emission for (n,2n)

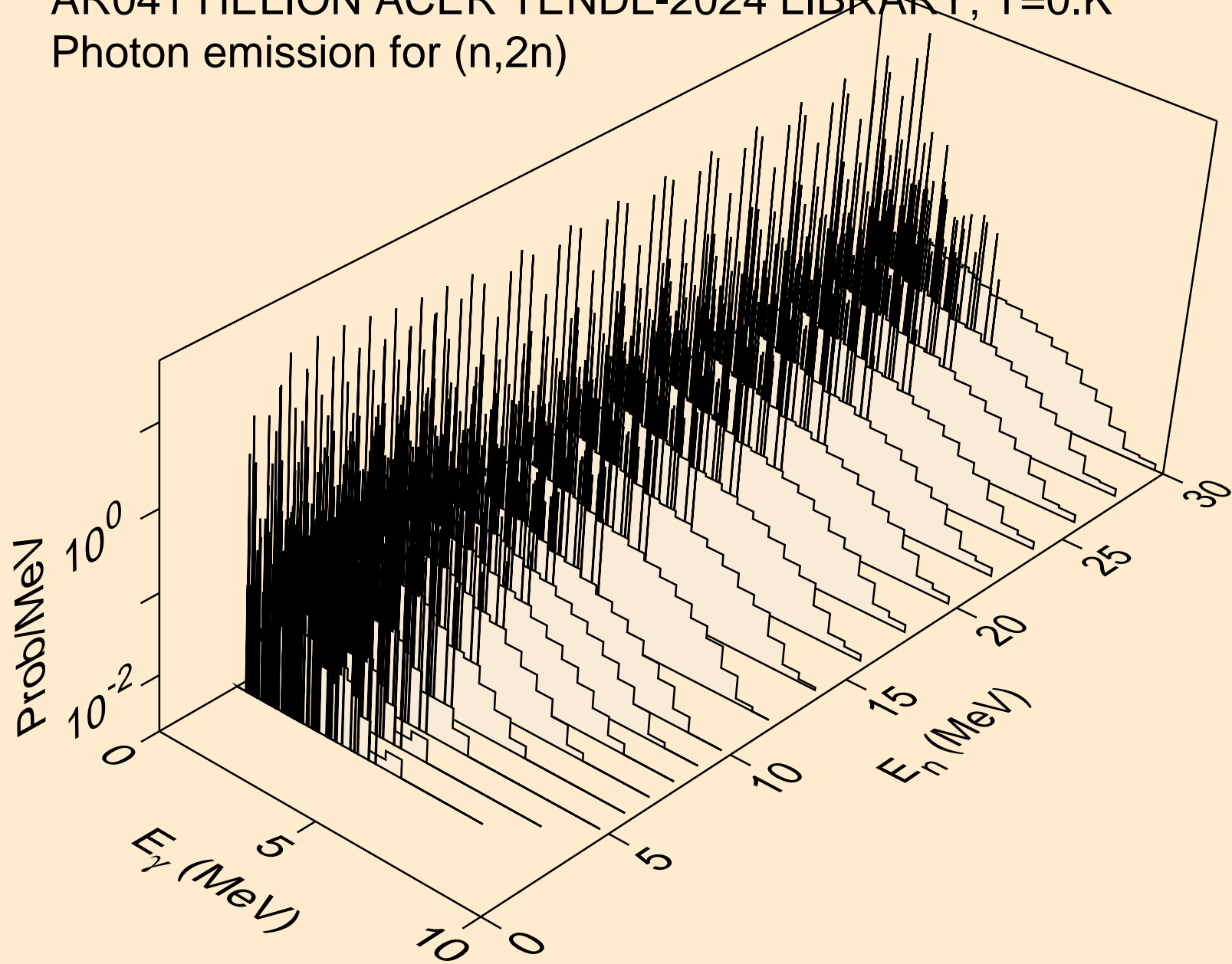

AR041 HELION ACER TENDL-2024 LIBRARY; T=0.K
Photon emission for (n,3n)

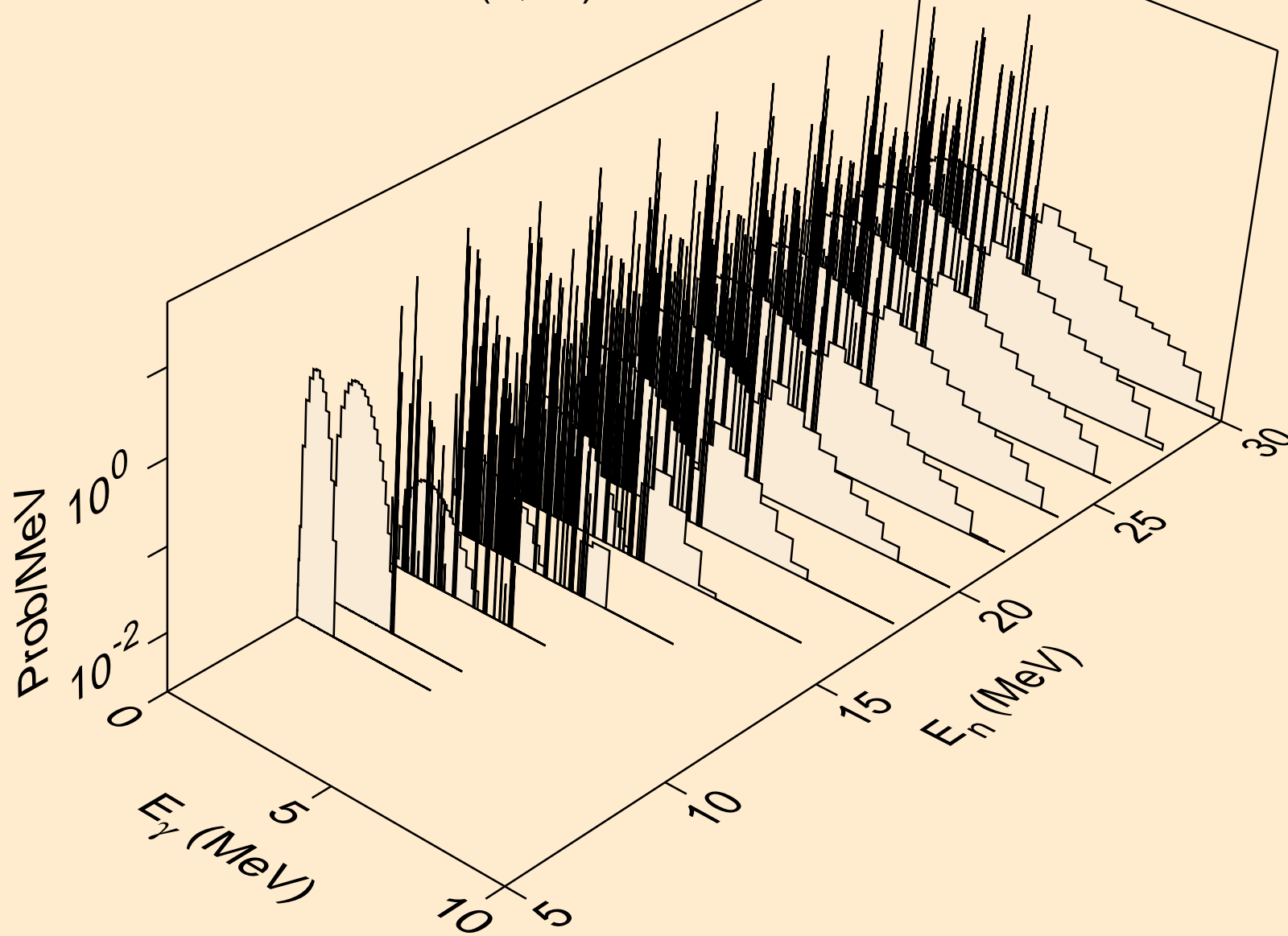

AR041 HELION ACER TENDL-2024 LIBRARY; T=0.K
Photon emission for (n,n*)a

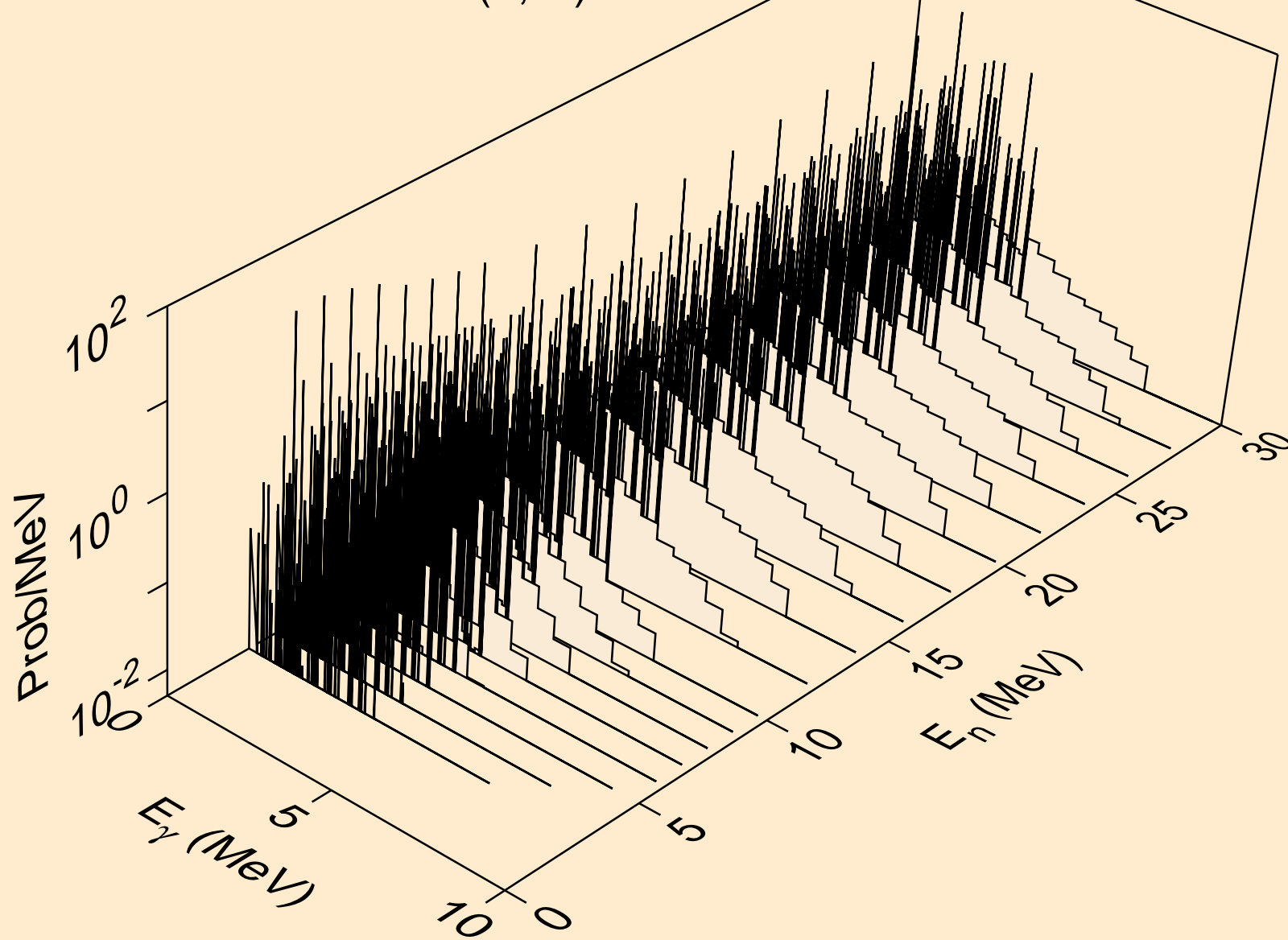

AR041 HELION ACER TENDL-2024 LIBRARY; T=0.K
Photon emission for (n,n*)3a

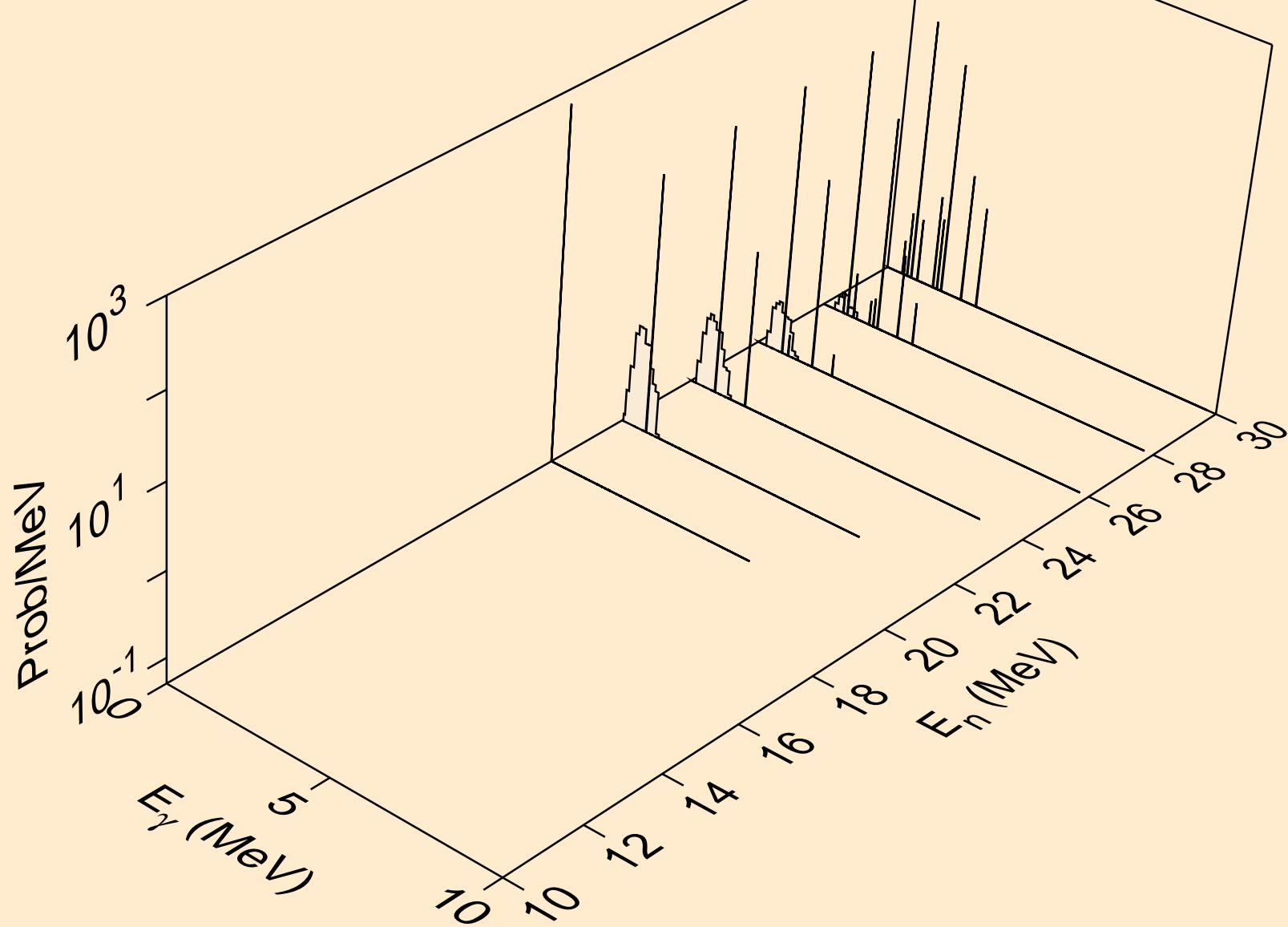

AR041 HELION ACER TENDL-2024 LIBRARY; T=0.K
Photon emission for (n,2n)a

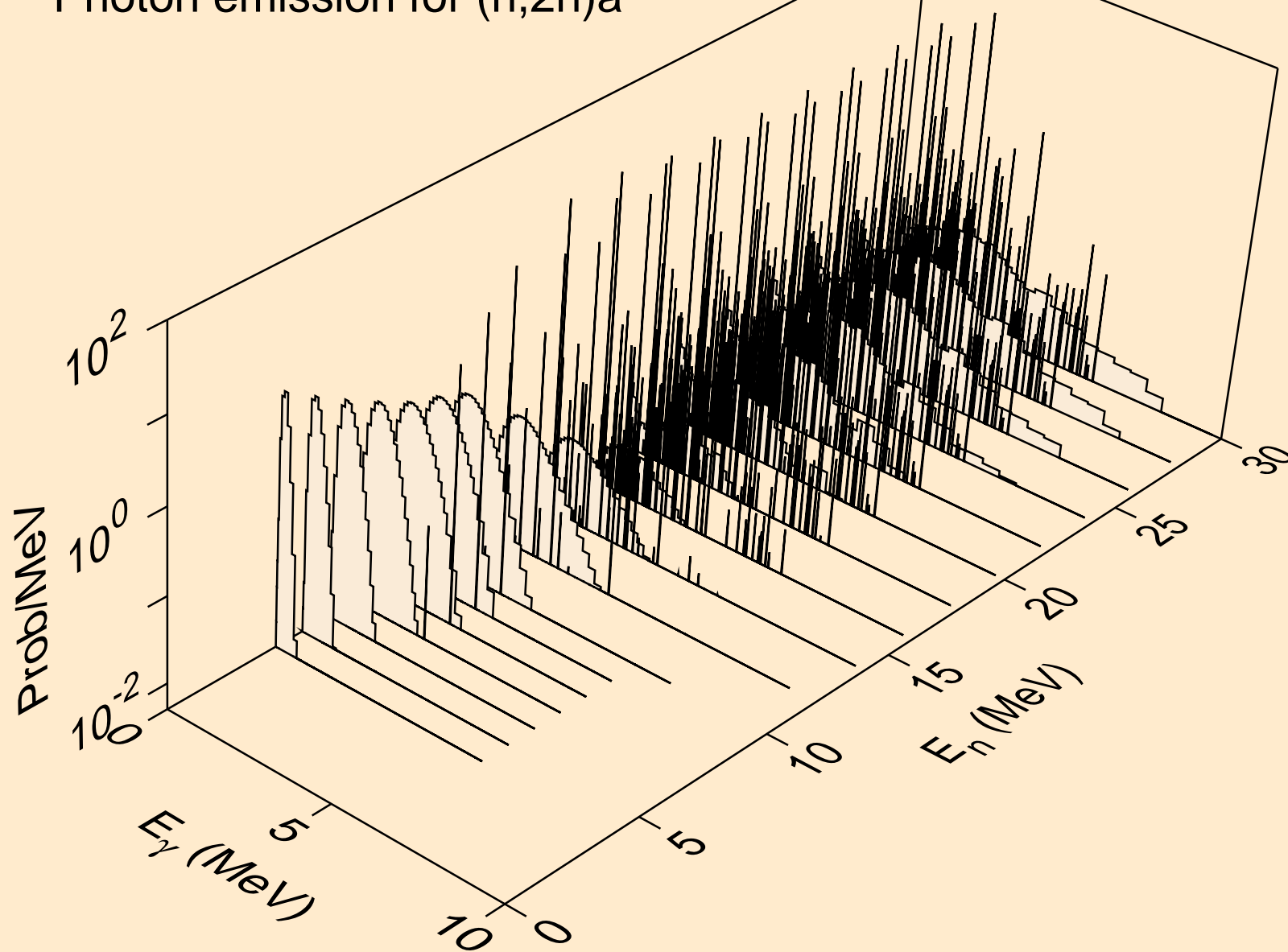

AR041 HELION ACER TENDL-2024 LIBRARY; T=0.K
Photon emission for (n,3n)a

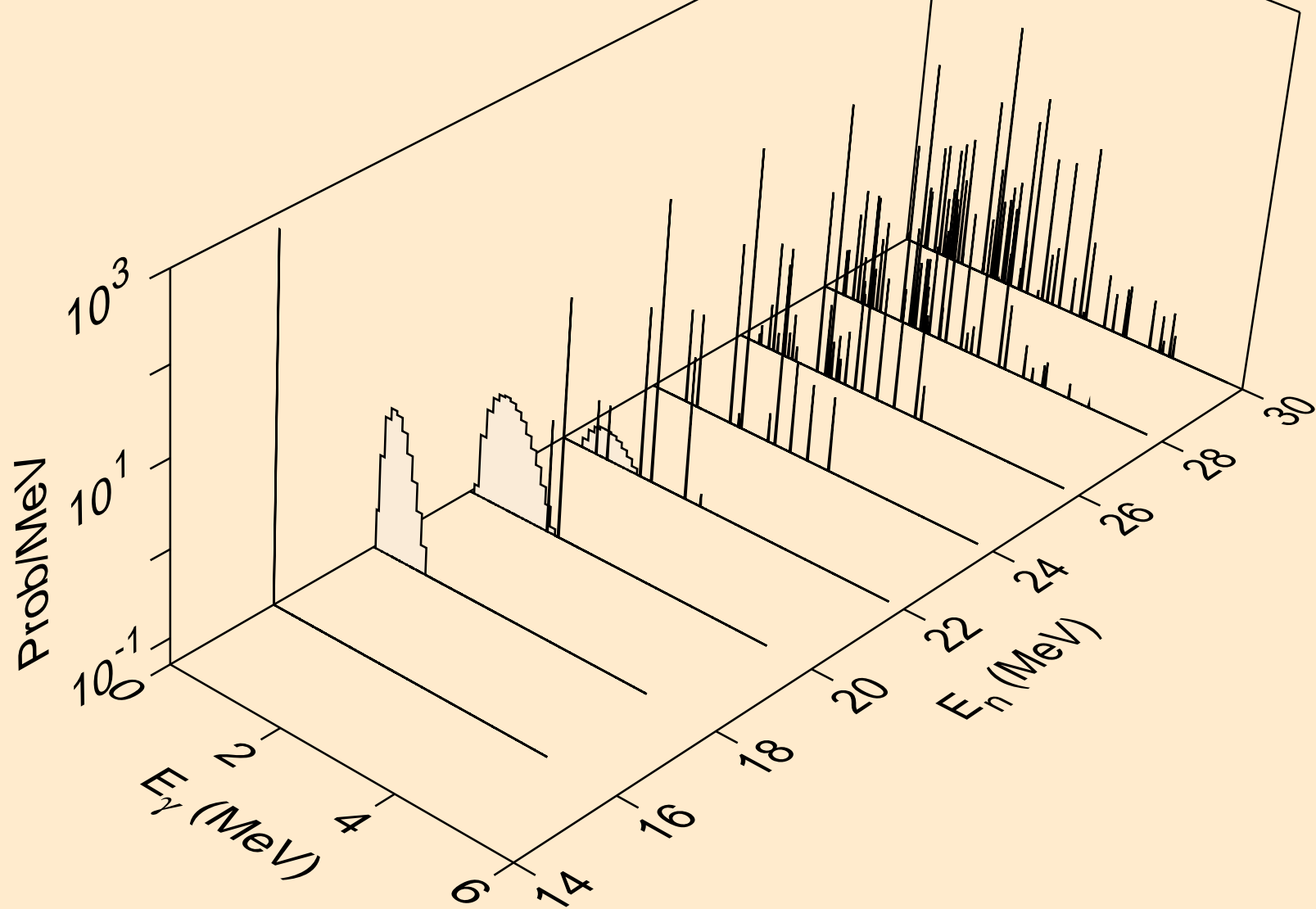

AR041 HELION ACER TENDL-2024 LIBRARY; T=0.K
Photon emission for (n,n*)p

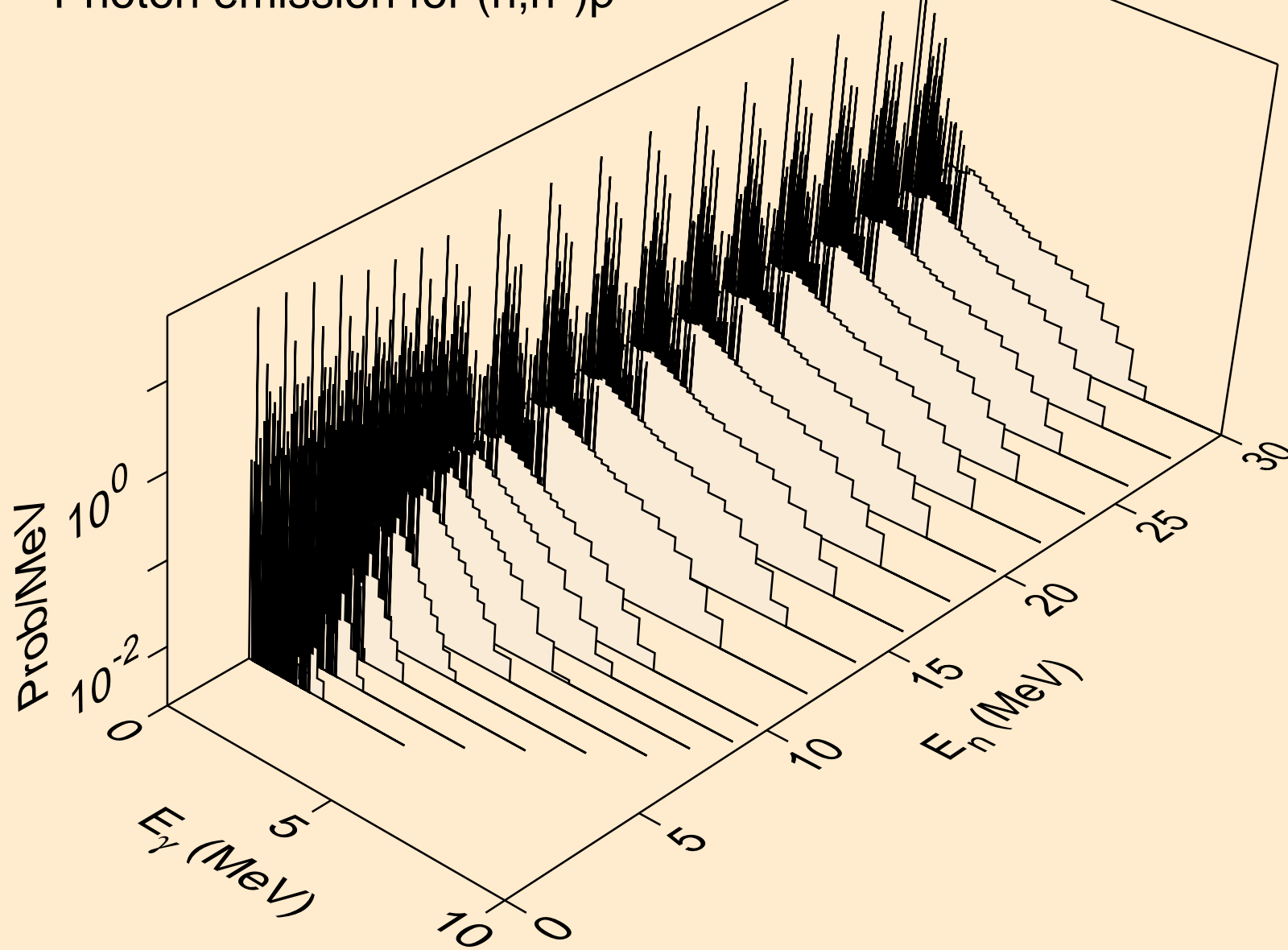

AR041 HELION ACER TENDL-2024 LIBRARY; T=0.K
Photon emission for (n,n*)2a

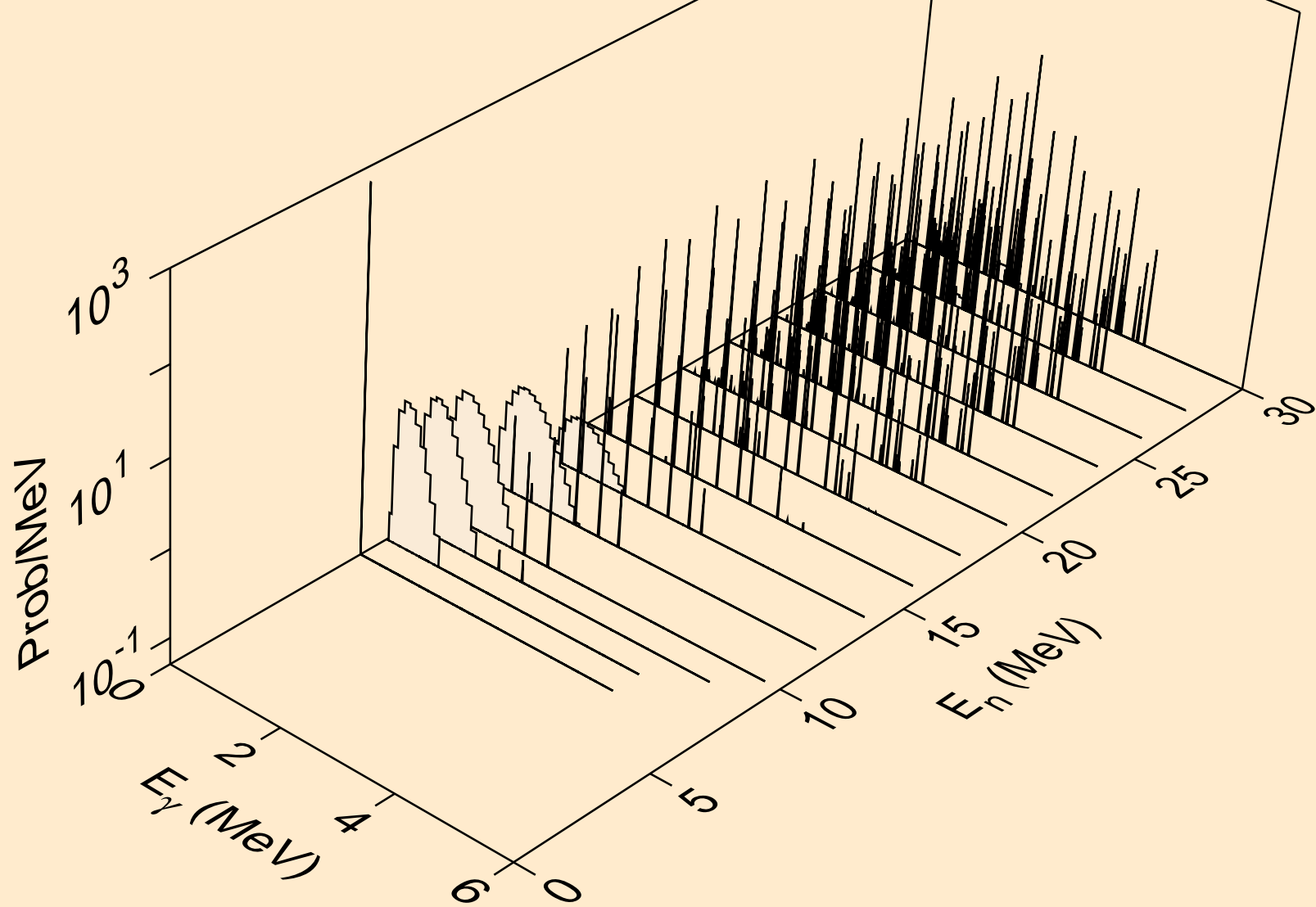

AR041 HELION ACER TENDL-2024 LIBRARY; T=0.K
Photon emission for (n,2n)2a

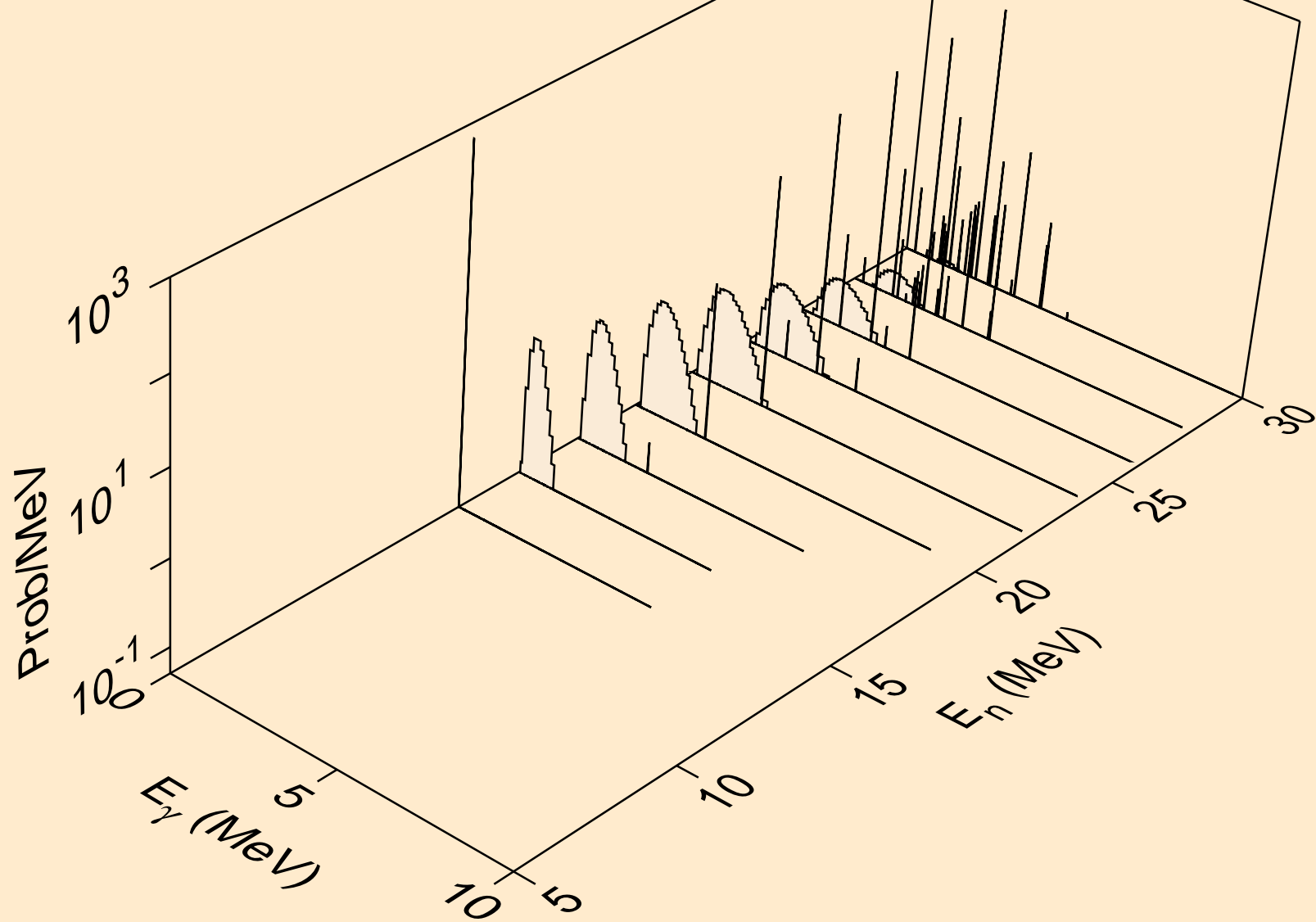

AR041 HELION ACER TENDL-2024 LIBRARY; T=0.K
Photon emission for (n,n*)d

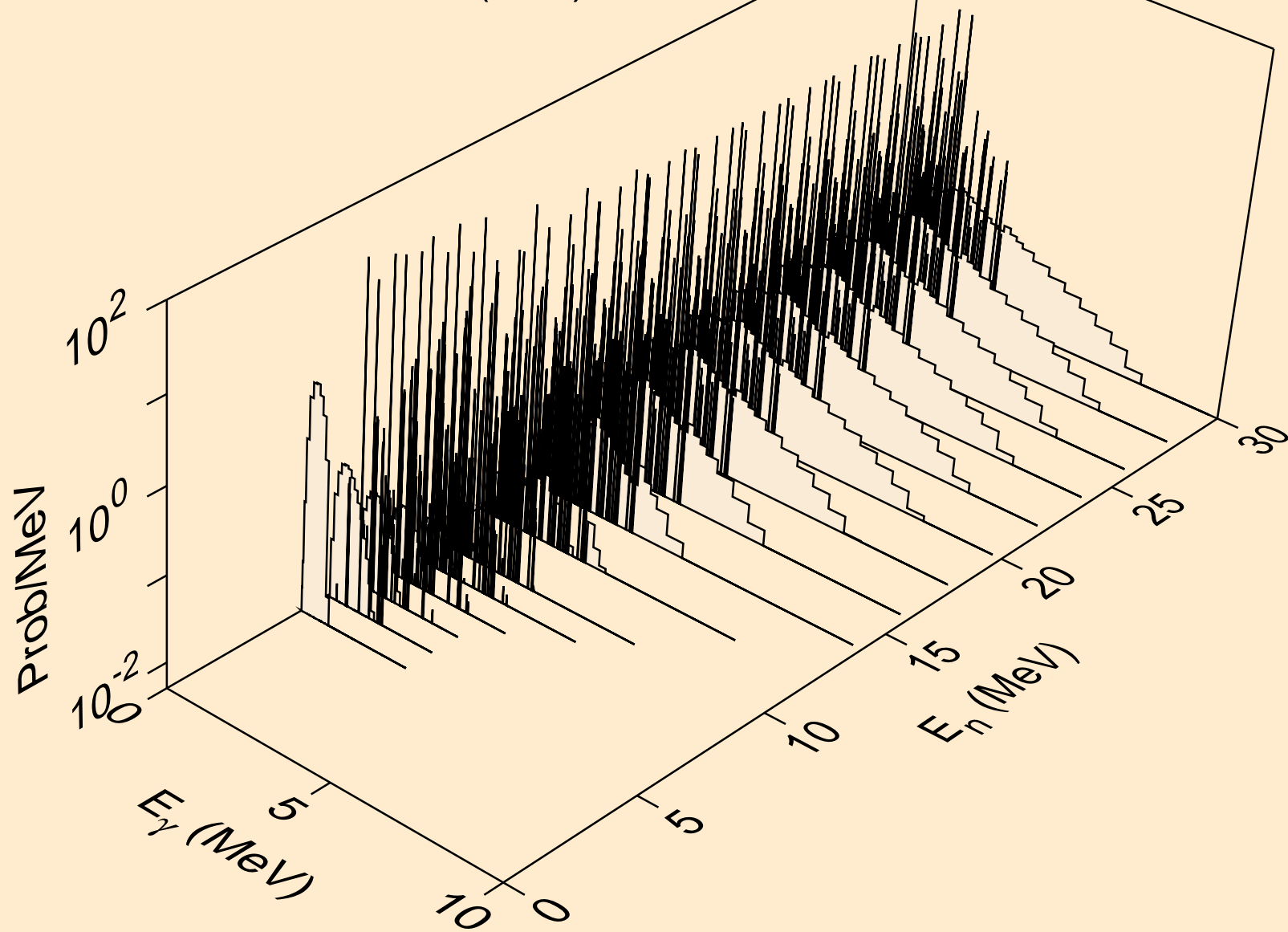

AR041 HELION ACER TENDL-2024 LIBRARY; T=0.K
Photon emission for (n,n*)t

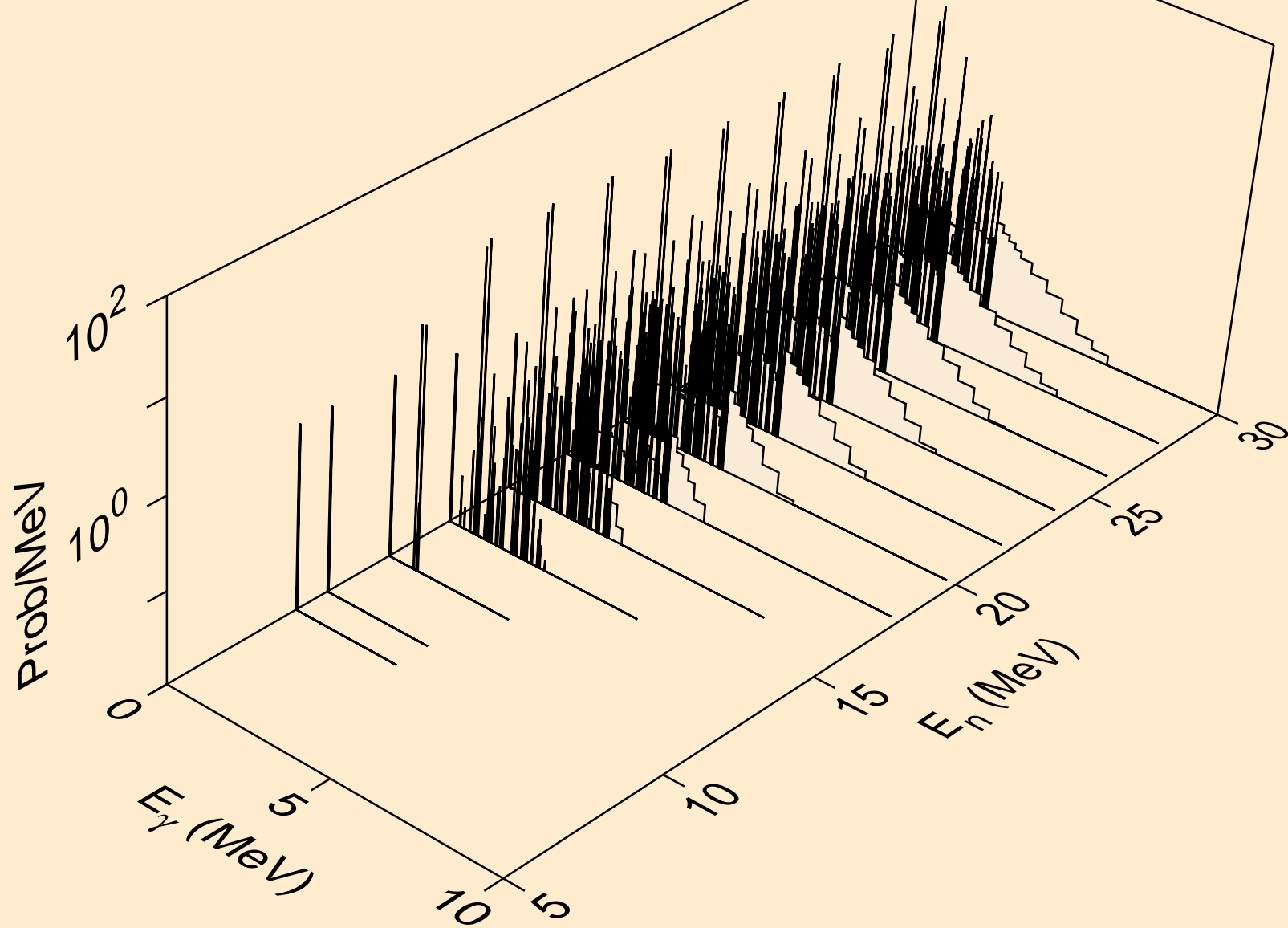

AR041 HELION ACER TENDL-2024 LIBRARY; T=0.K
Photon emission for (n,n*)he3

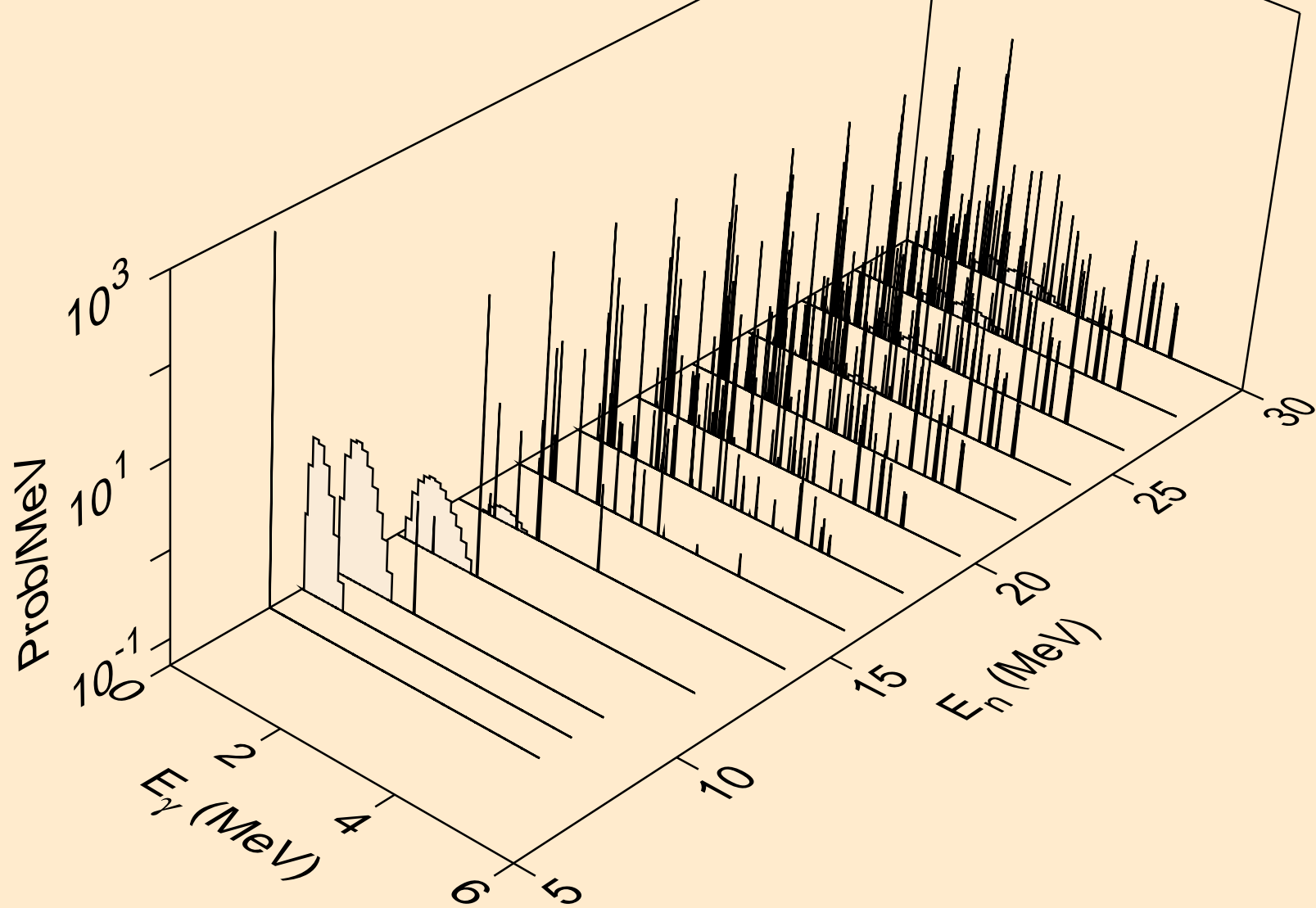

AR041 HELION ACER TENDL-2024 LIBRARY; T=0.K
Photon emission for (n,4n)

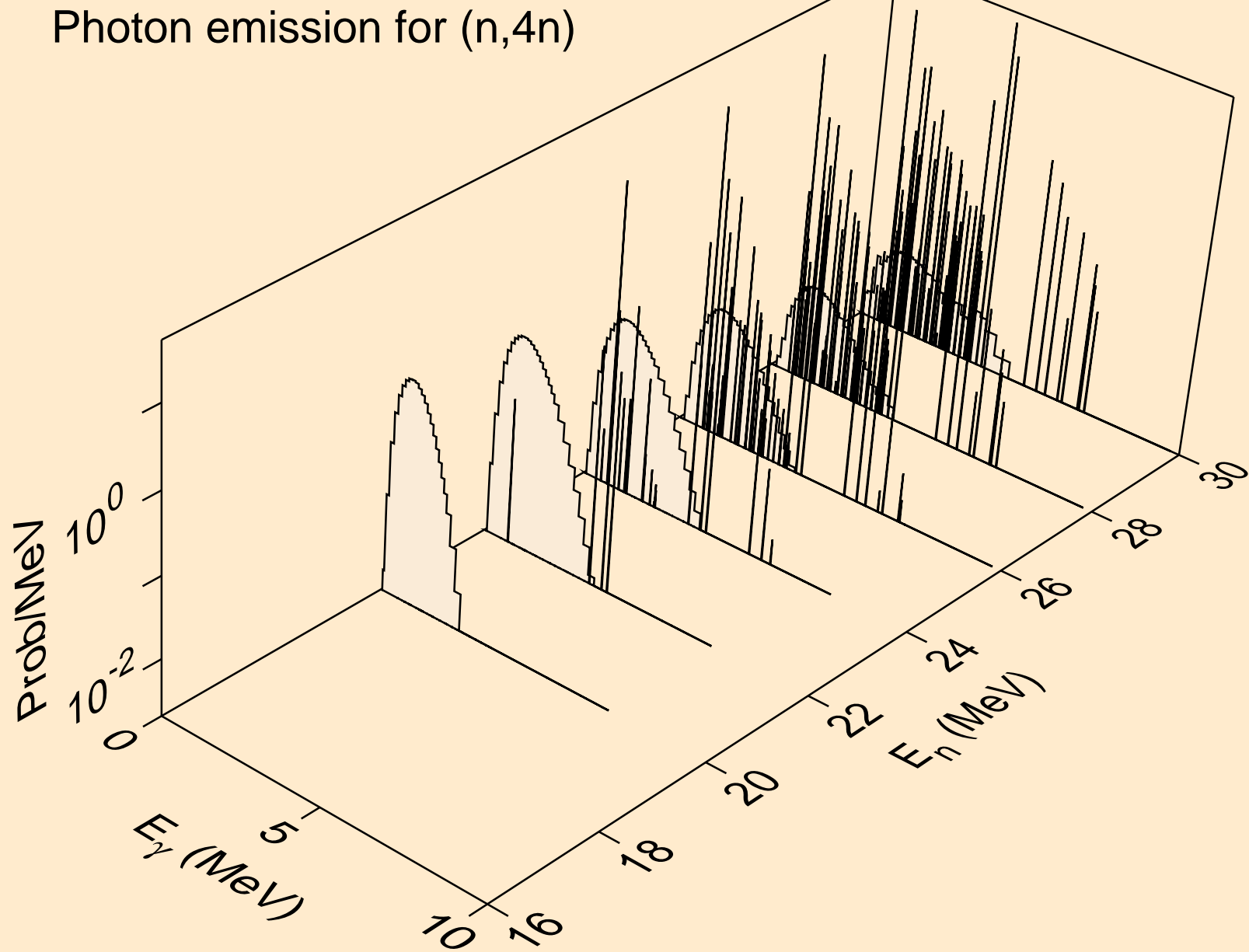

AR041 HELION ACER TENDL-2024 LIBRARY; T=0.K
Photon emission for (n,2np)

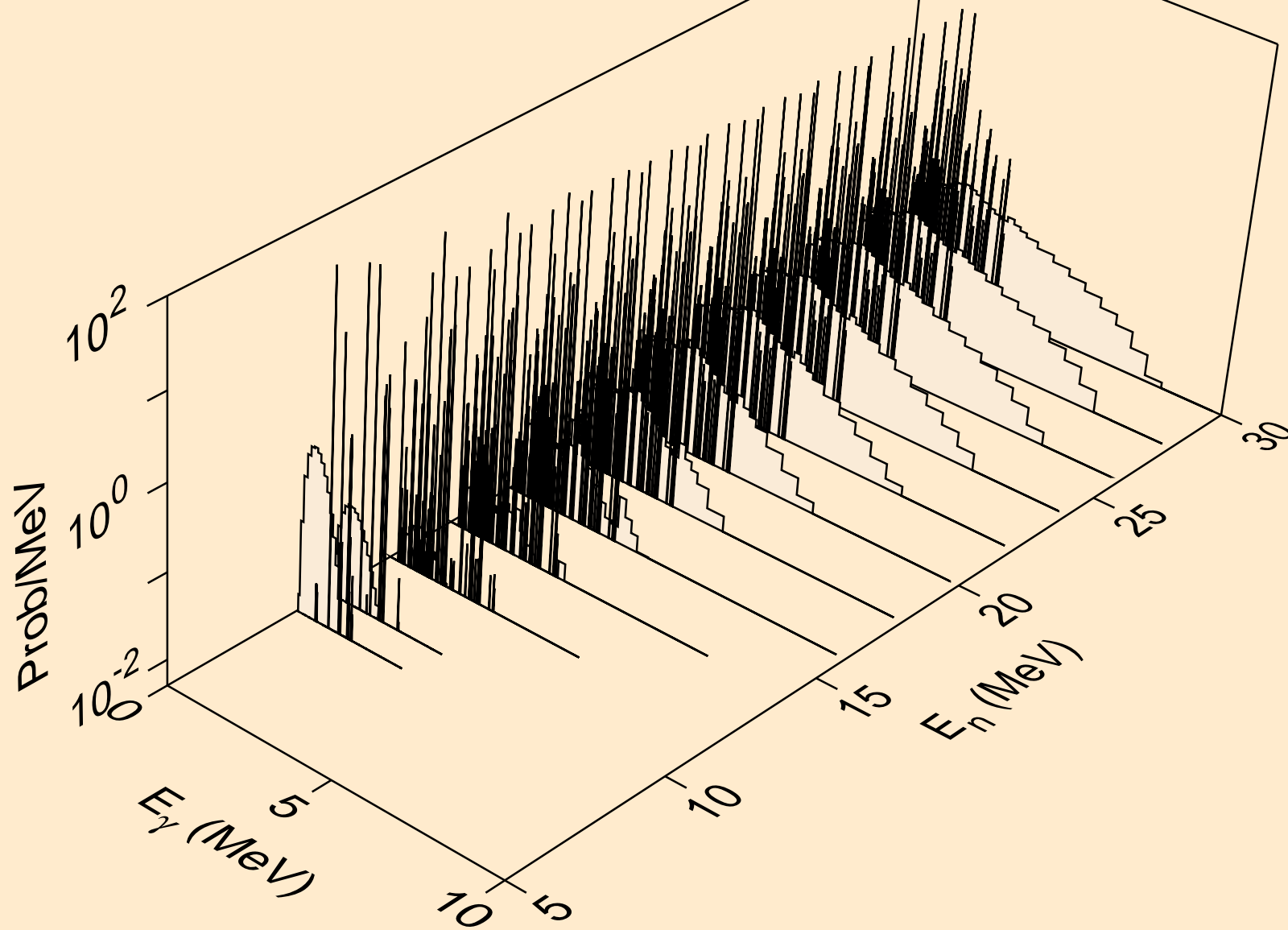

AR041 HELION ACER TENDL-2024 LIBRARY; T=0.K
Photon emission for (n,3np)

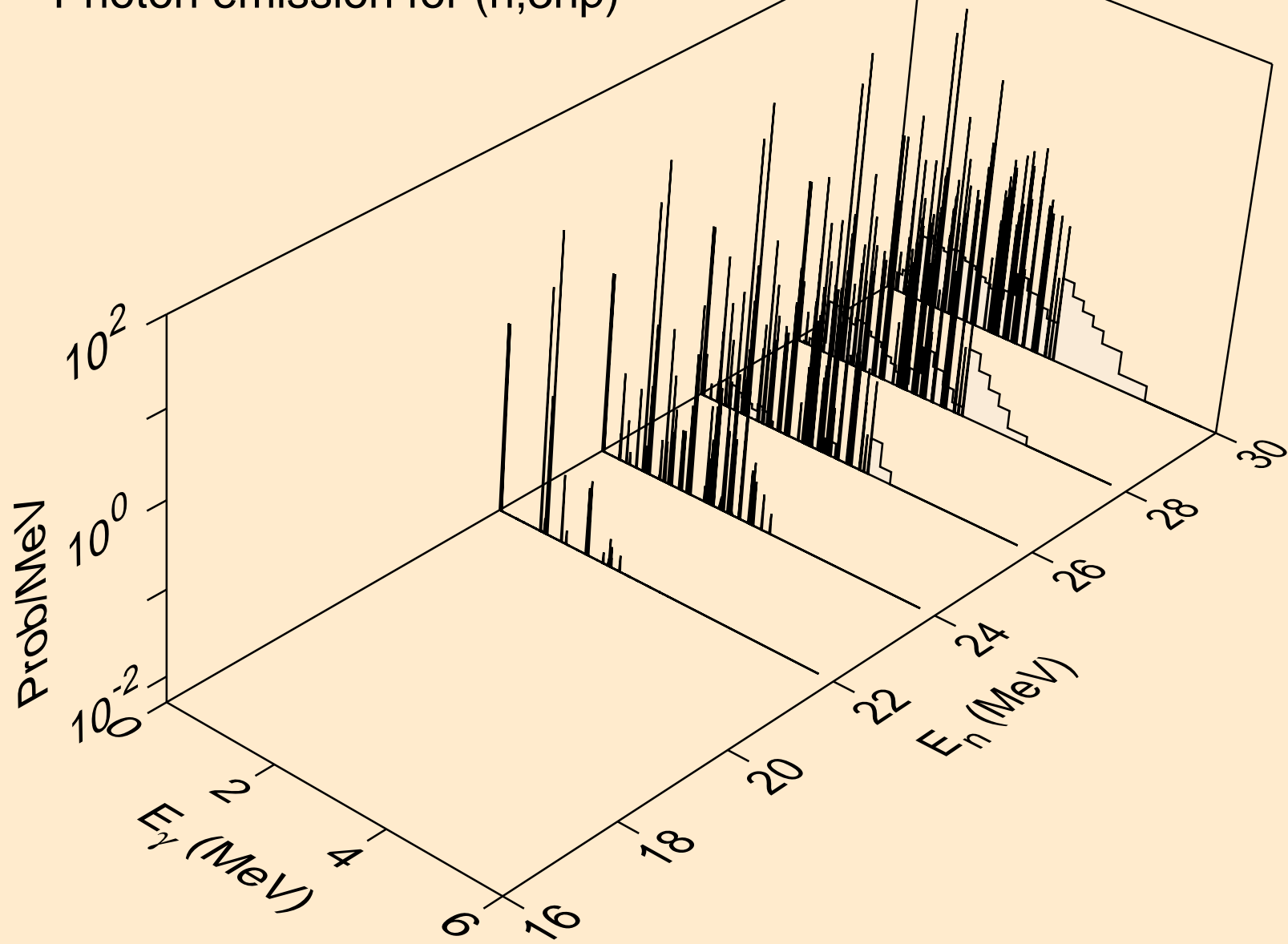

AR041 HELION ACER TENDL-2024 LIBRARY; T=0.K
Photon emission for (n,n2p)

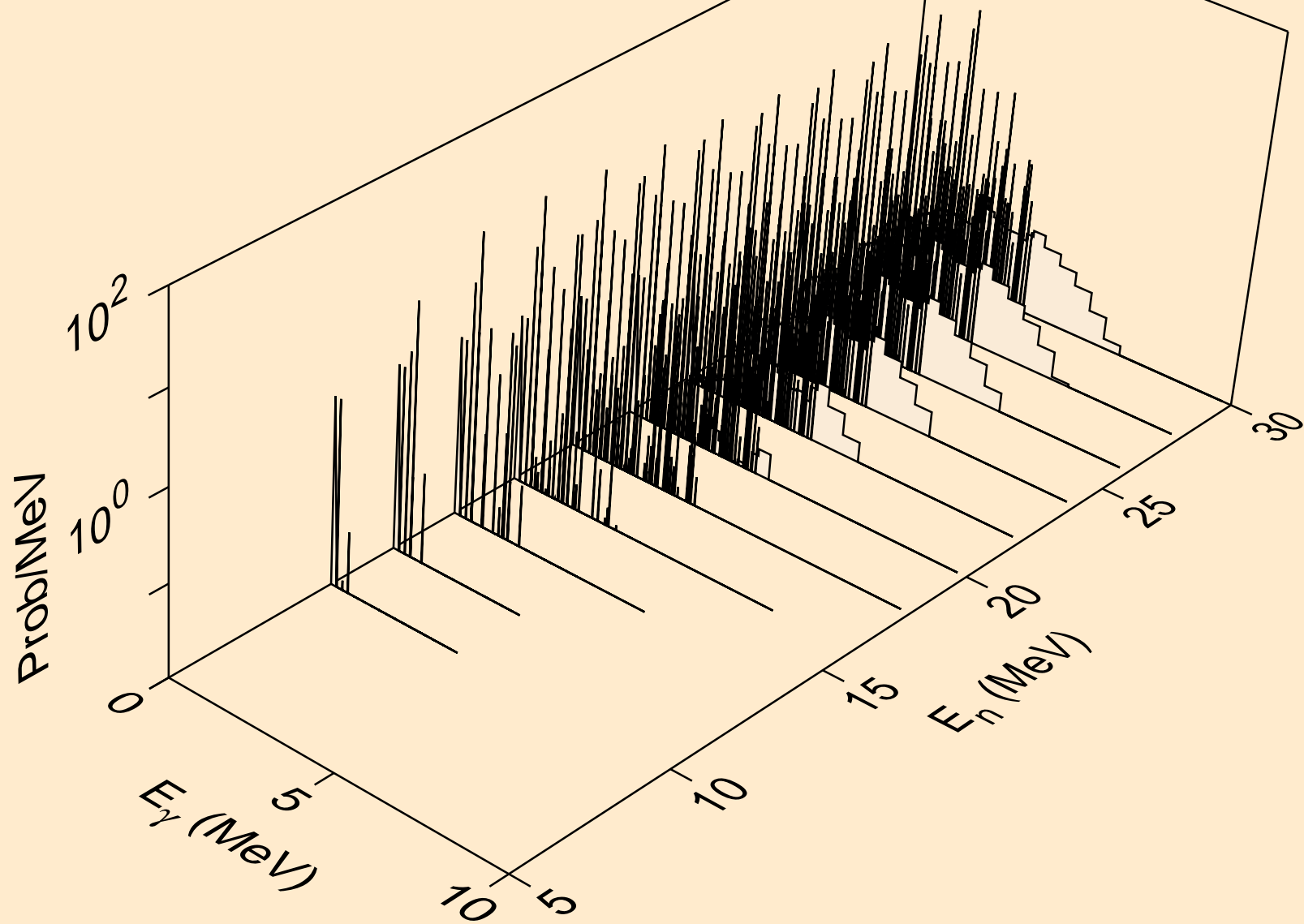

AR041 HELION ACER TENDL-2024 LIBRARY; T=0.K
Photon emission for (n,npa)

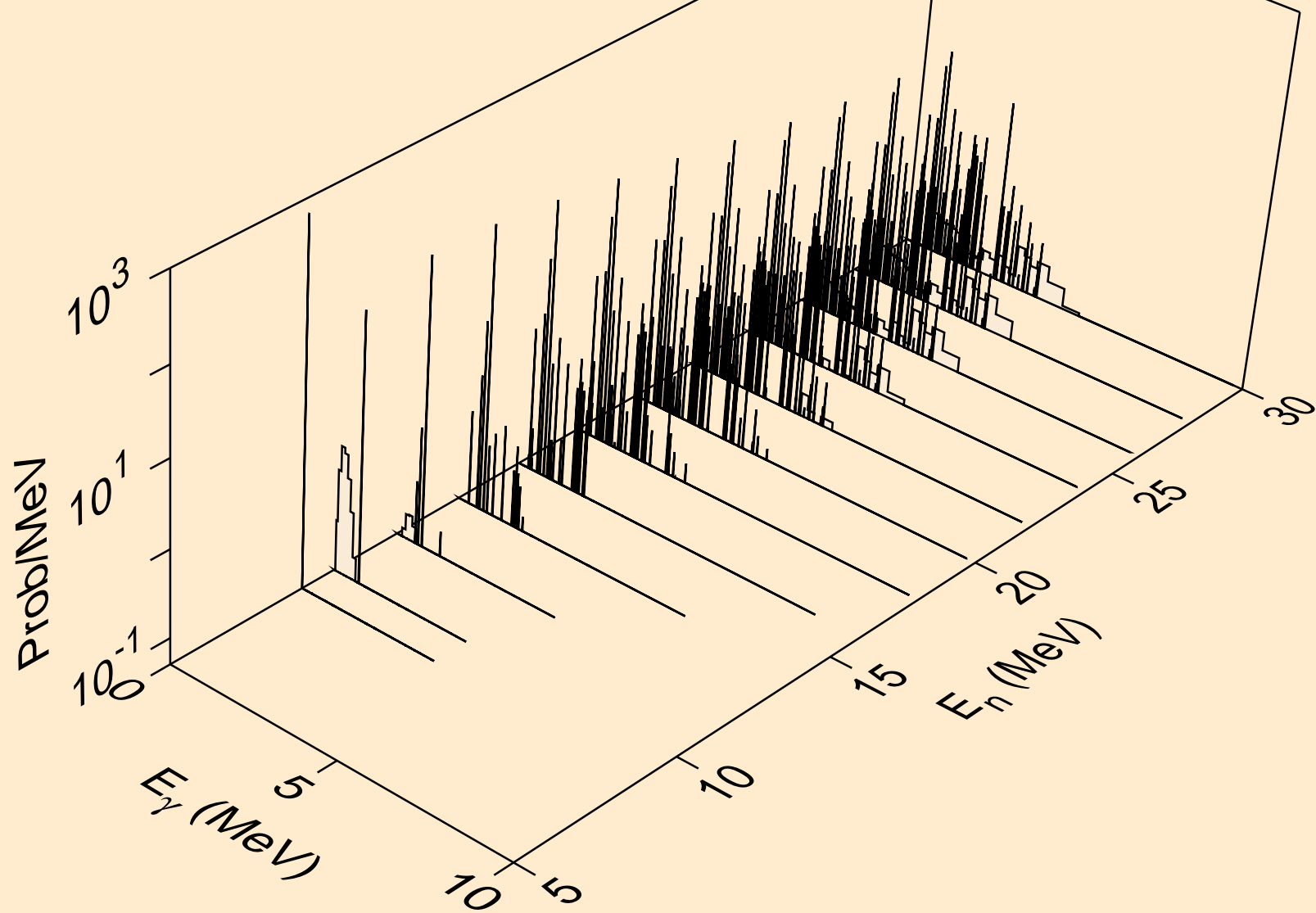

AR041 HELION ACER TENDL-2024 LIBRARY; T=0.K
Photon emission for (n,gma)

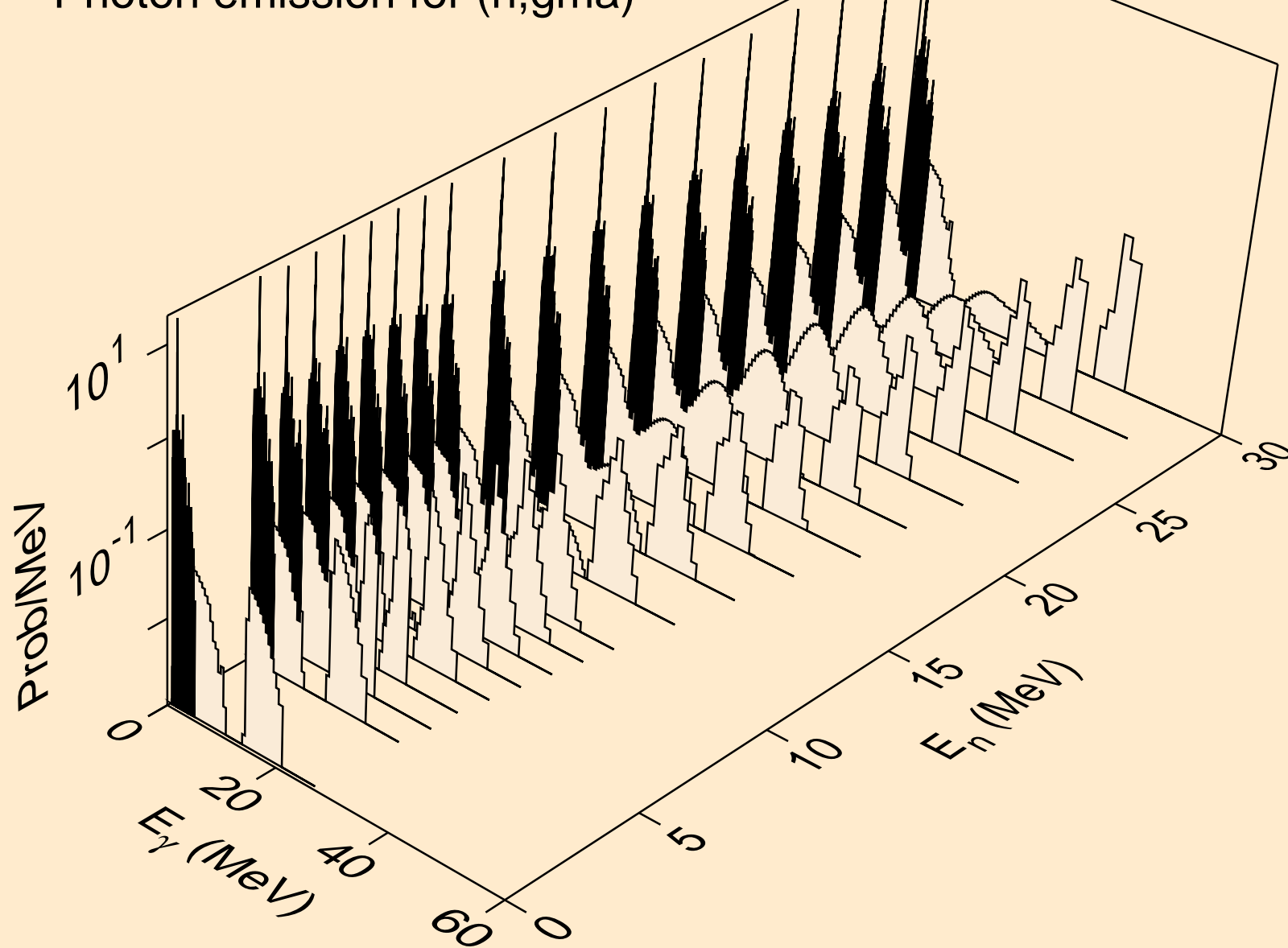

AR041 HELION ACER TENDL-2024 LIBRARY; T=0.K
Photon emission for (n,p)

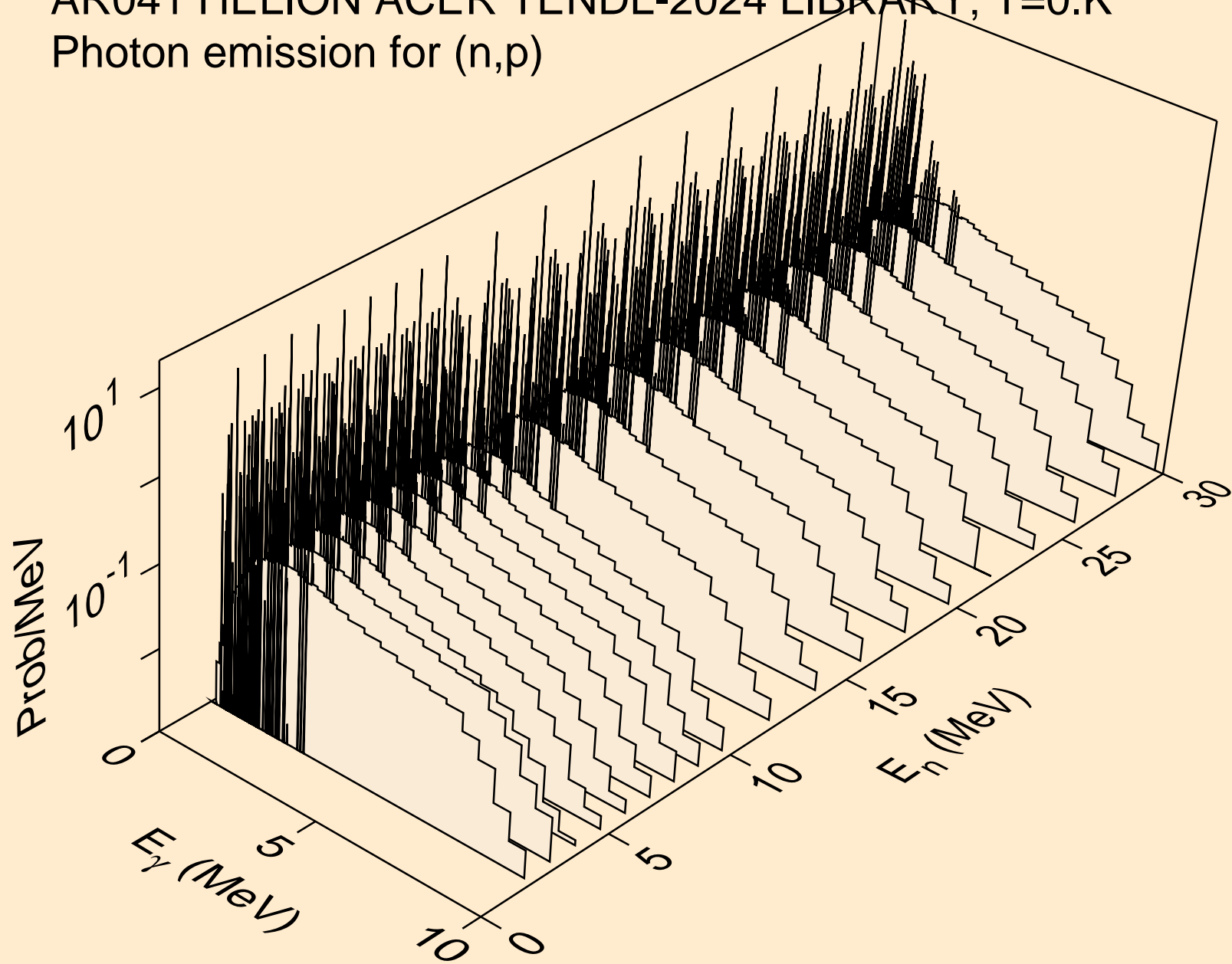

AR041 HELION ACER TENDL-2024 LIBRARY; T=0.K
Photon emission for (n,d)

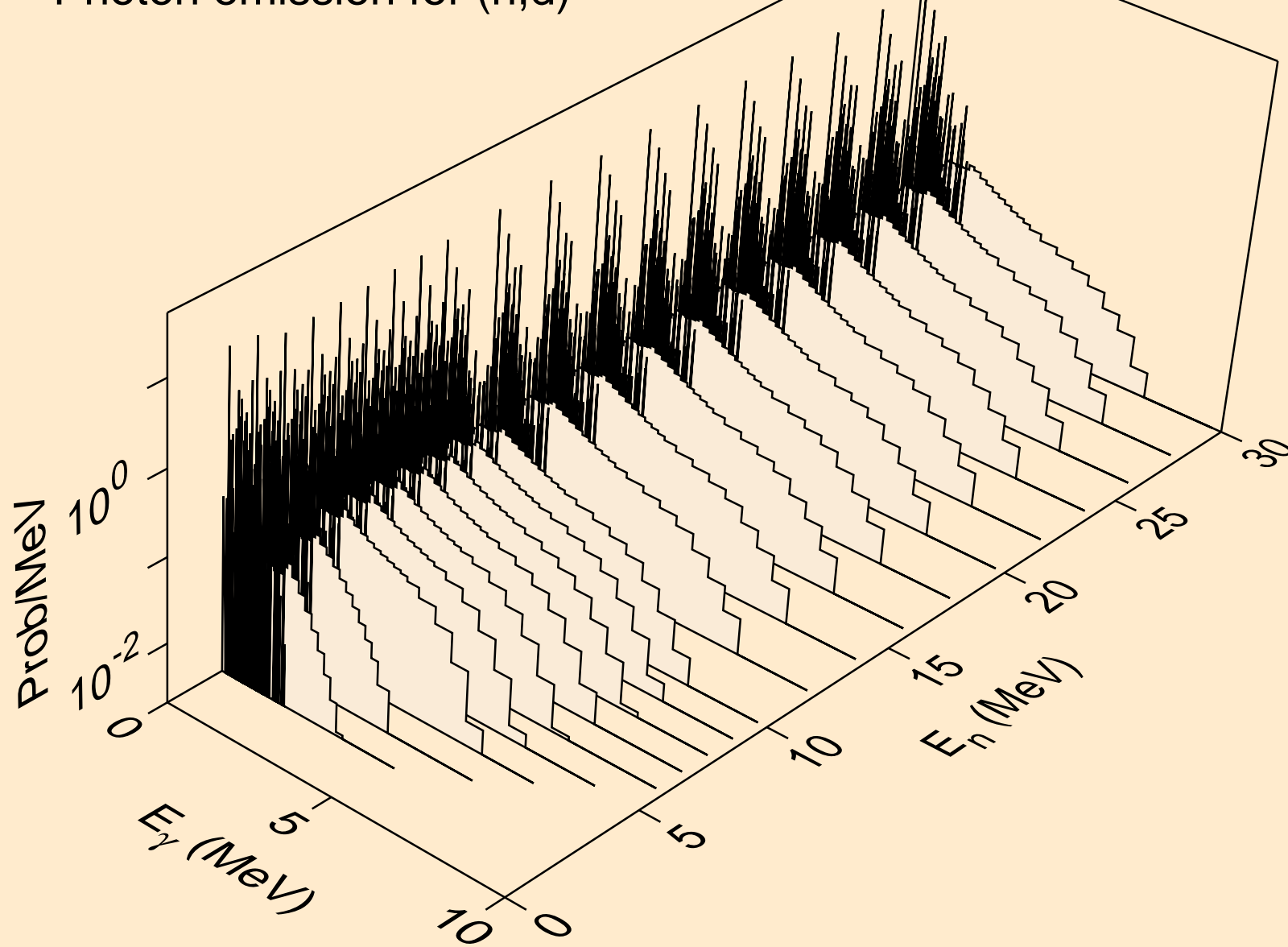

AR041 HELION ACER TENDL-2024 LIBRARY; T=0.K
Photon emission for (n,t)

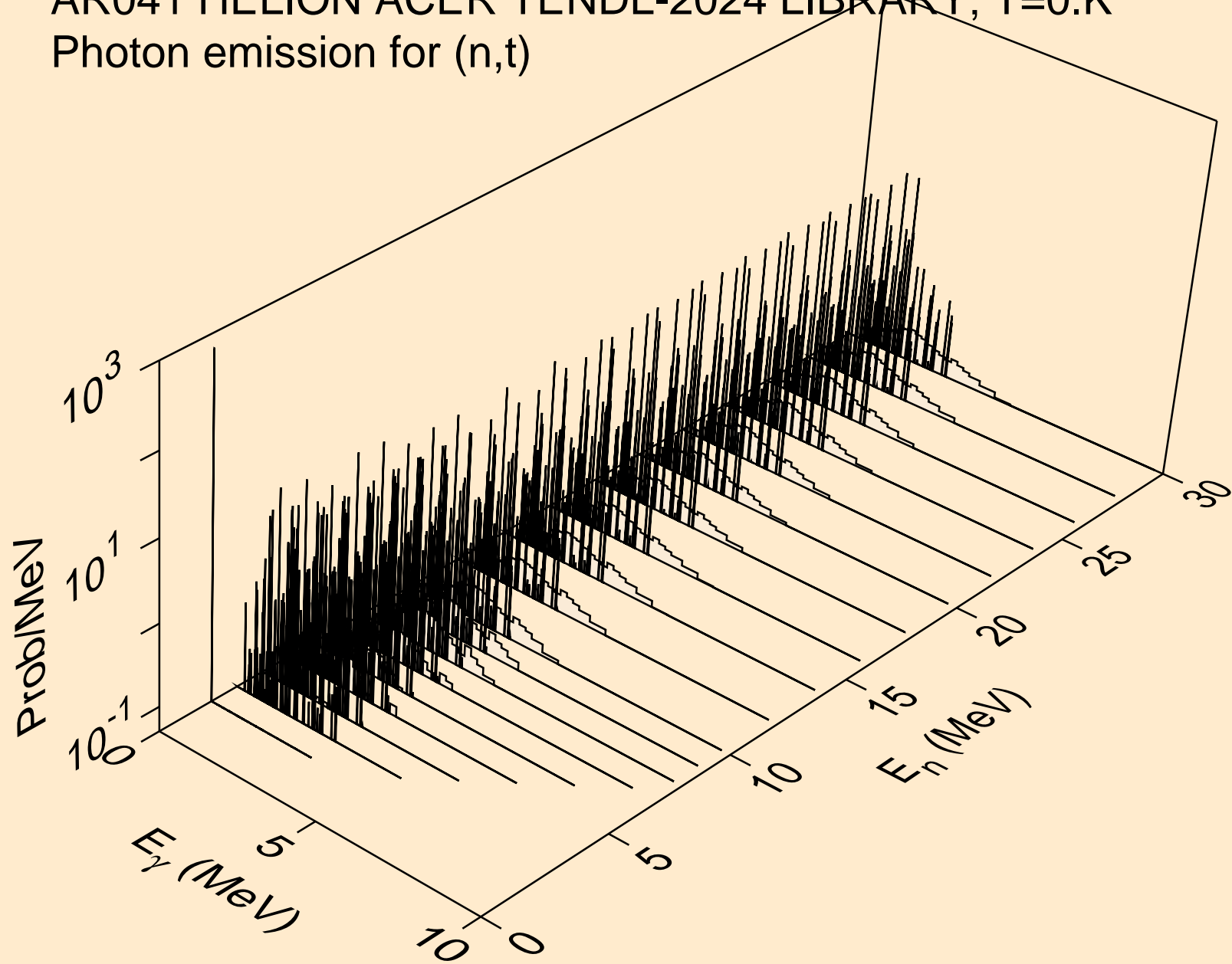

AR041 HELION ACER TENDL-2024 LIBRARY; T=0.K
Photon emission for inelastic

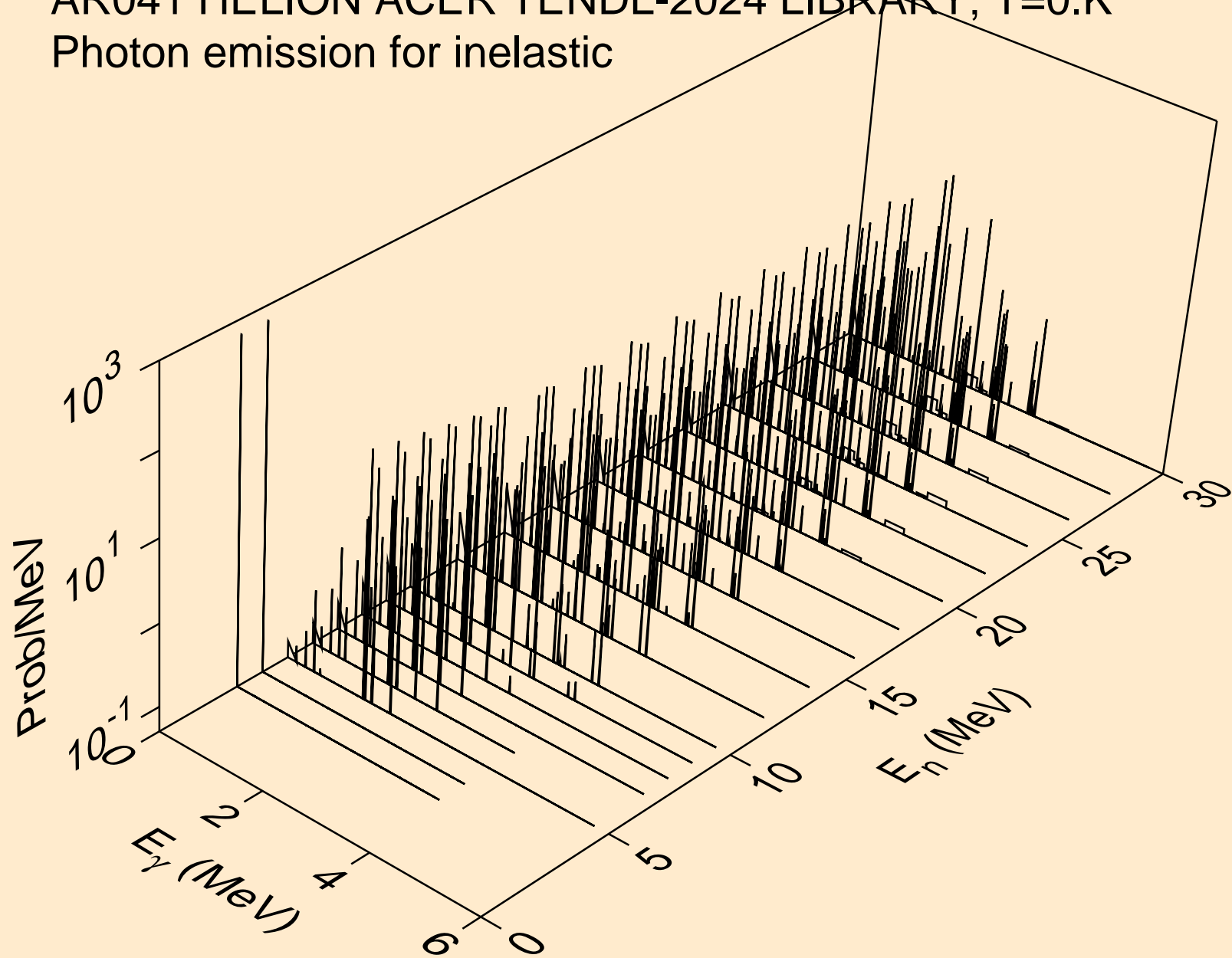

AR041 HELION ACER TENDL-2024 LIBRARY; T=0.K
Photon emission for (n,a)

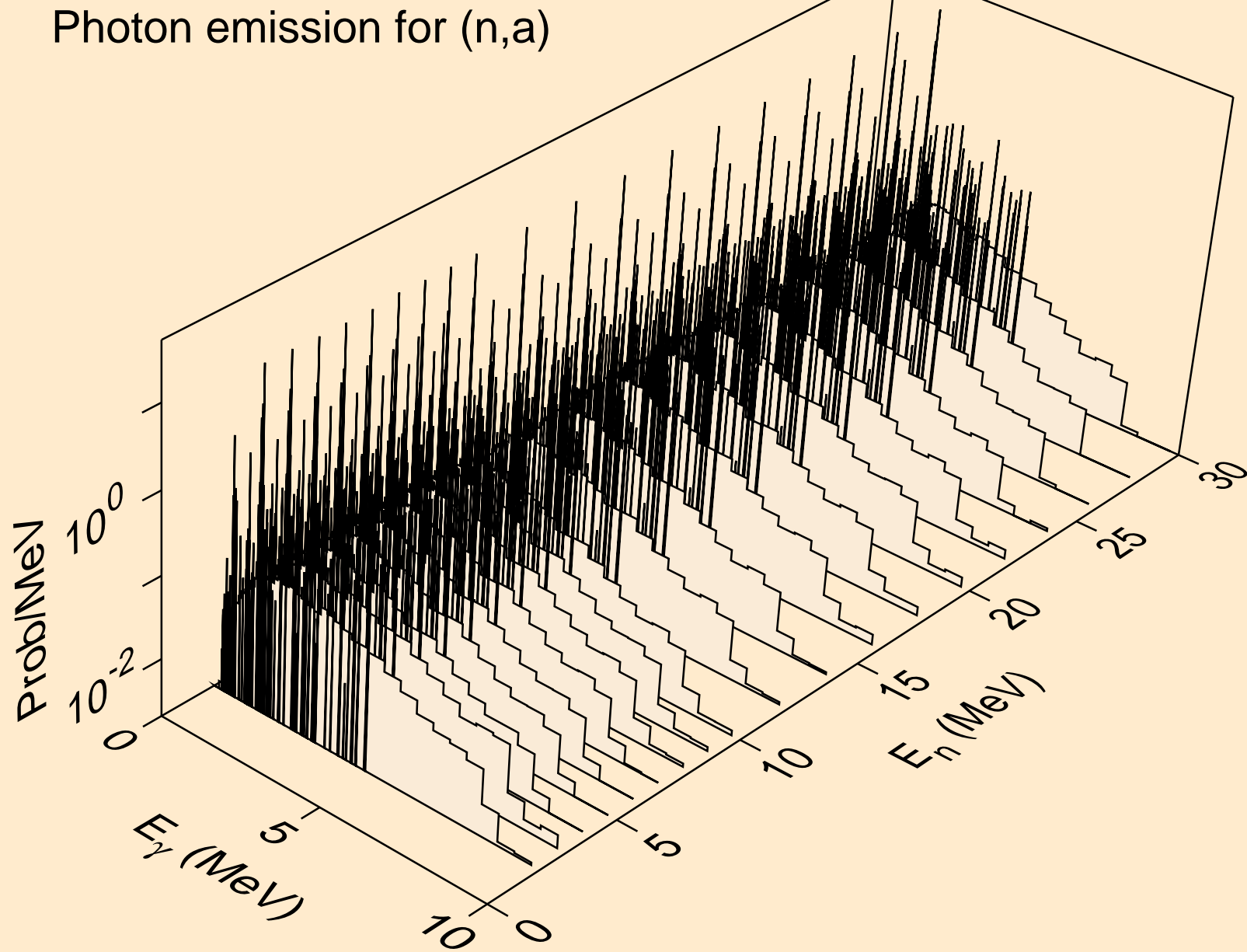

AR041 HELION ACER TENDL-2024 LIBRARY; T=0.K
Photon emission for (n,2a)

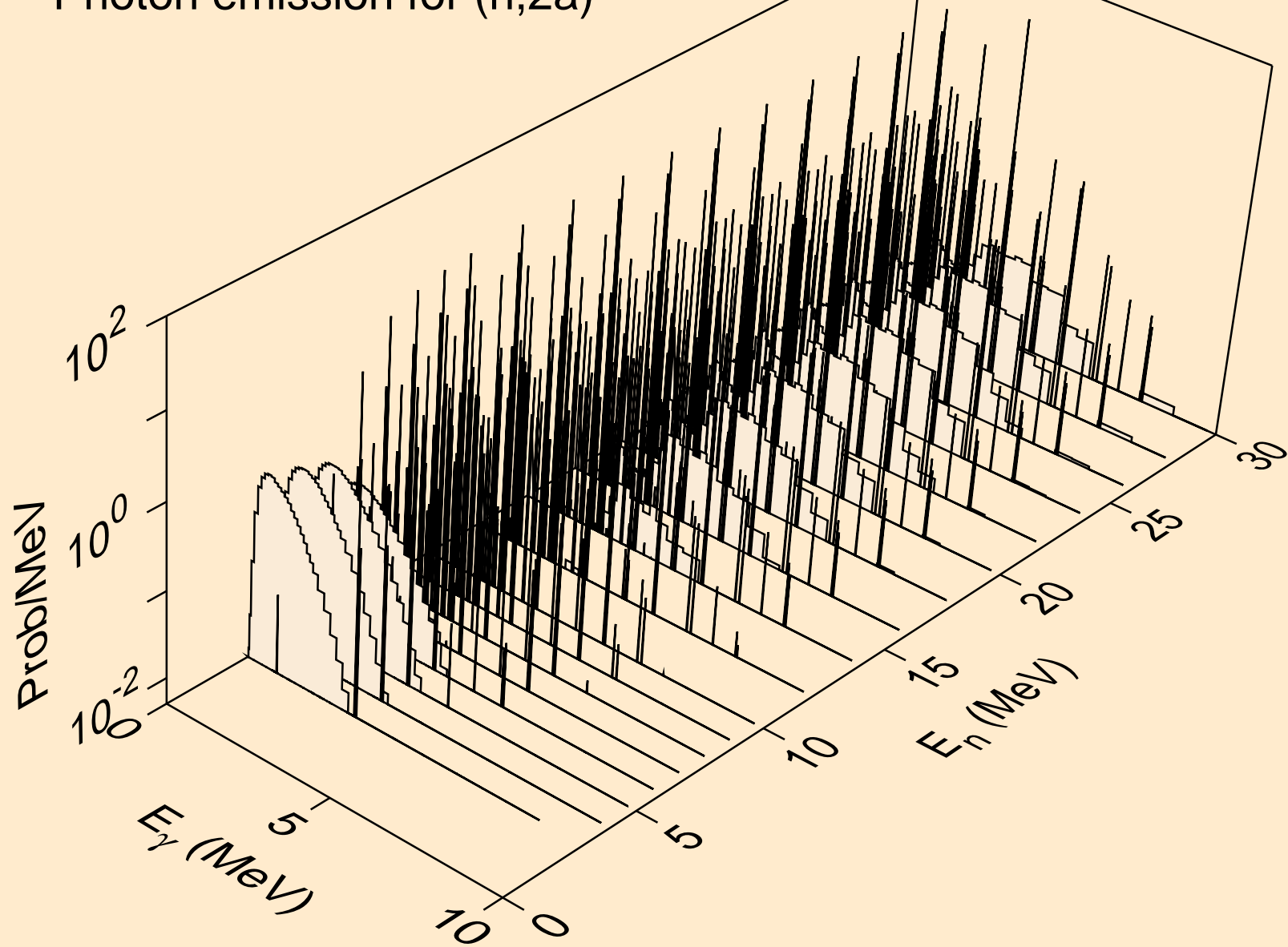

AR041 HELION ACER TENDL-2024 LIBRARY; T=0.K
Photon emission for (n,3a)

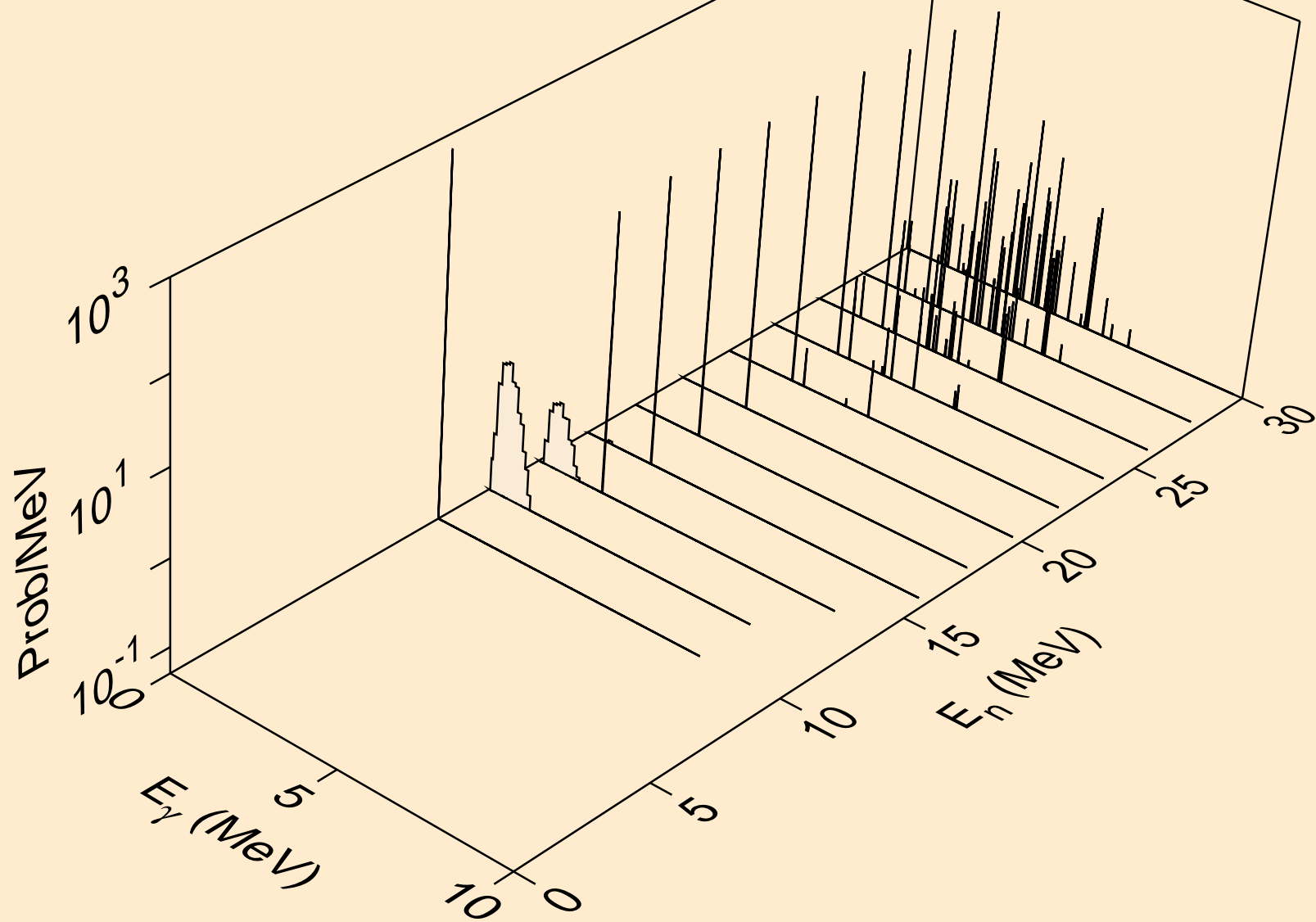

AR041 HELION ACER TENDL-2024 LIBRARY; T=0.K
Photon emission for (n,2p)

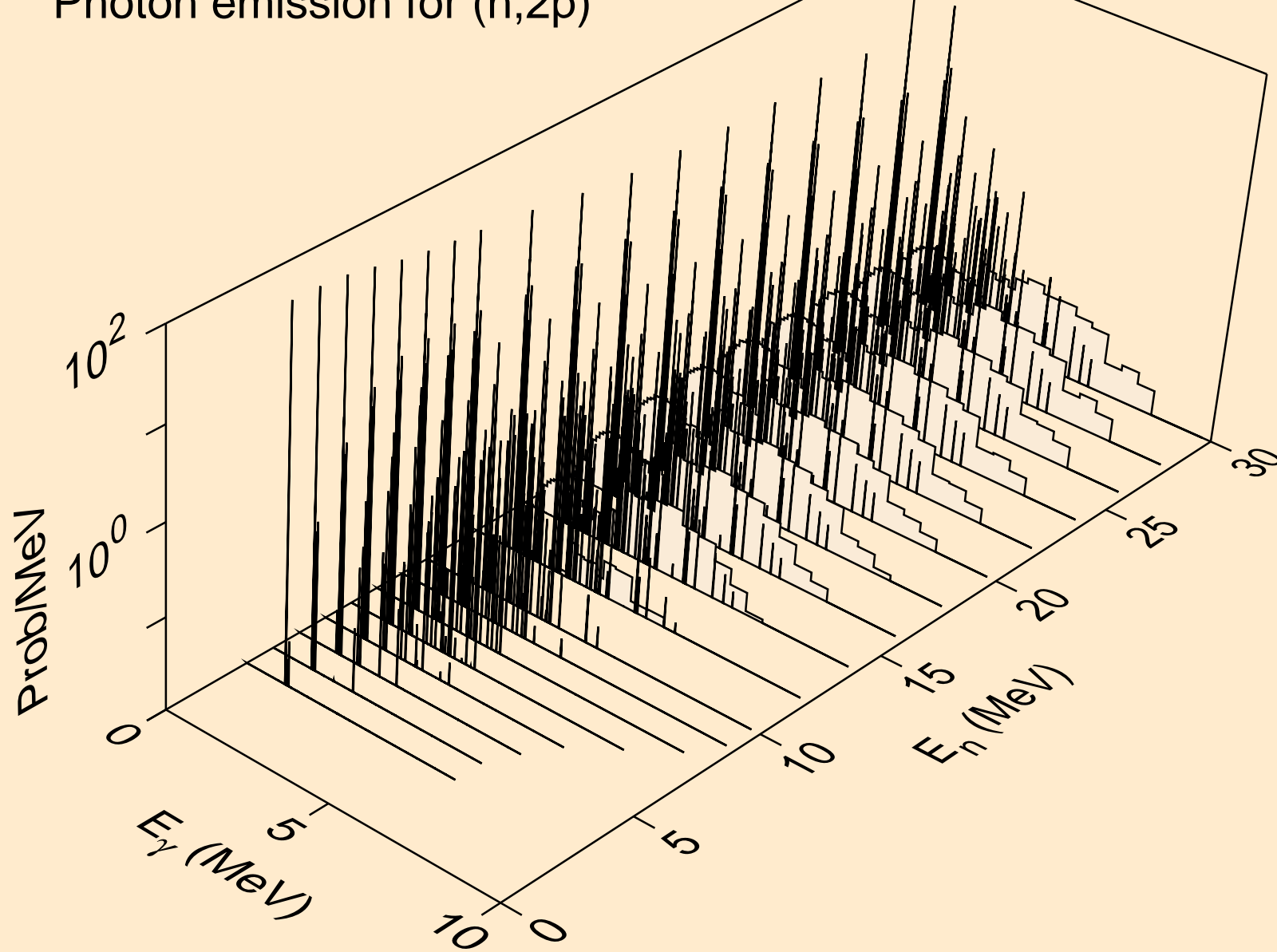

AR041 HELION ACER TENDL-2024 LIBRARY; T=0.K
Photon emission for (n,pa)

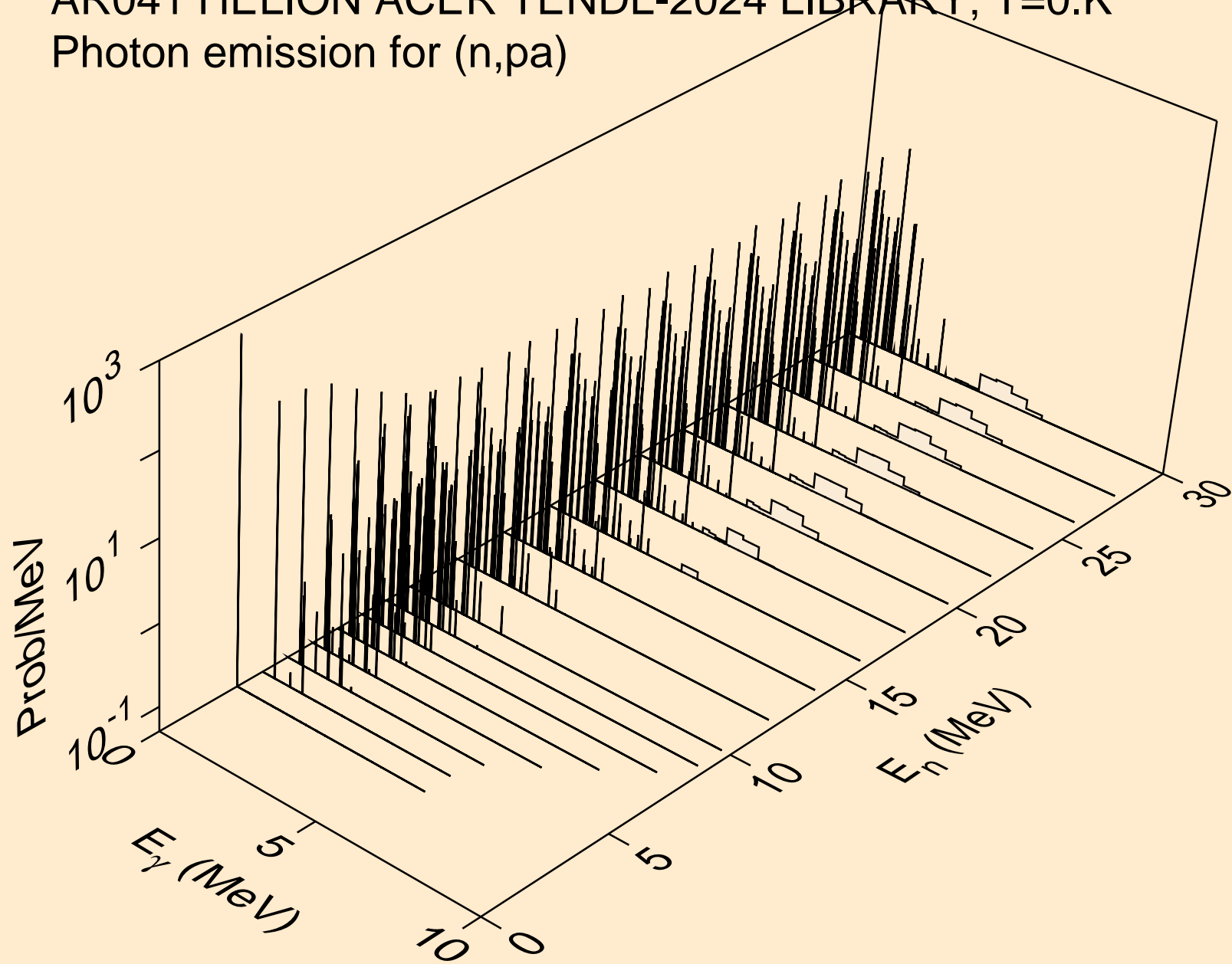

AR041 HELION ACER TENDL-2024 LIBRARY; T=0.K
Photon emission for (n,t2a)

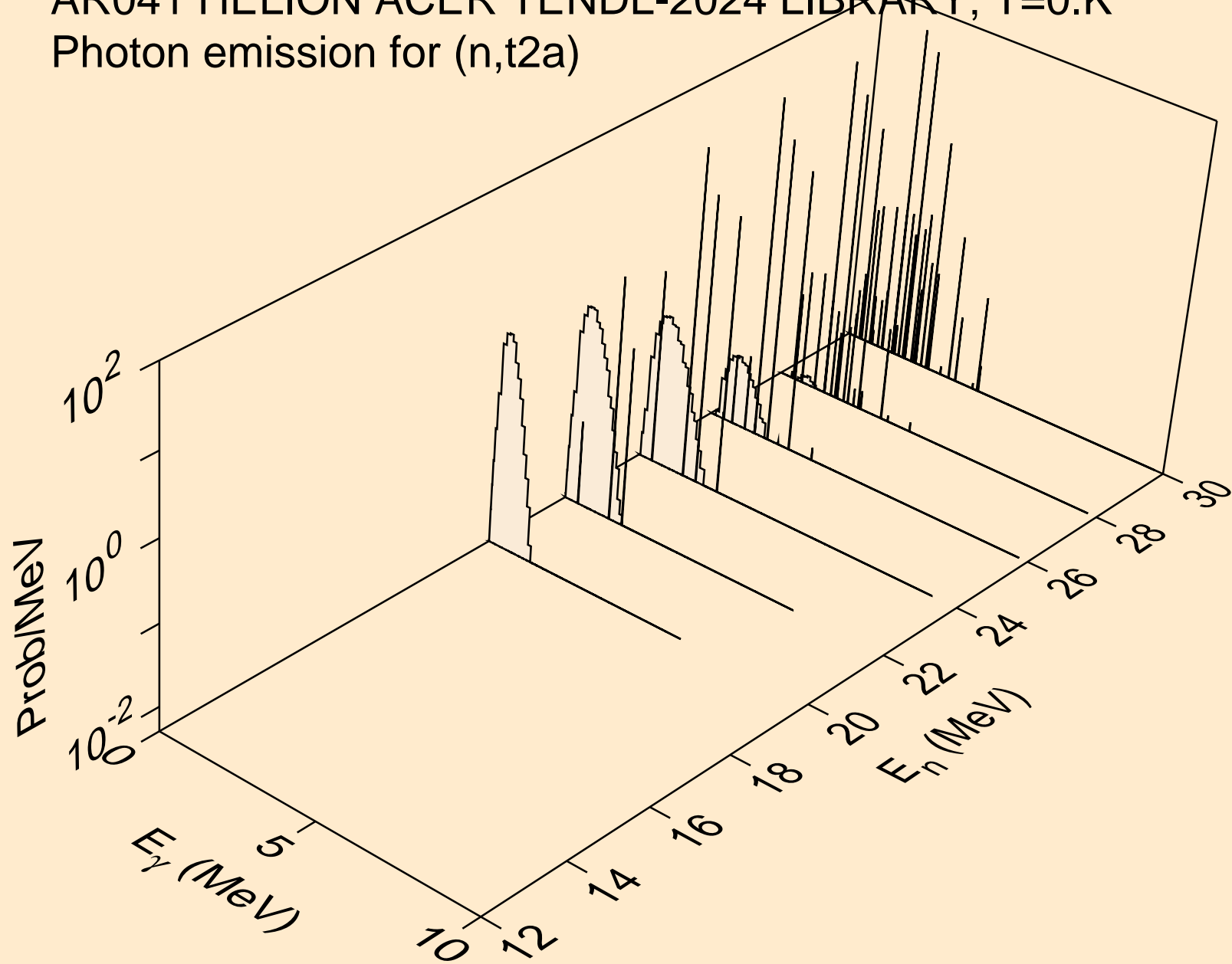

AR041 HELION ACER TENDL-2024 LIBRARY; T=0.K
Photon emission for (n,d2a)

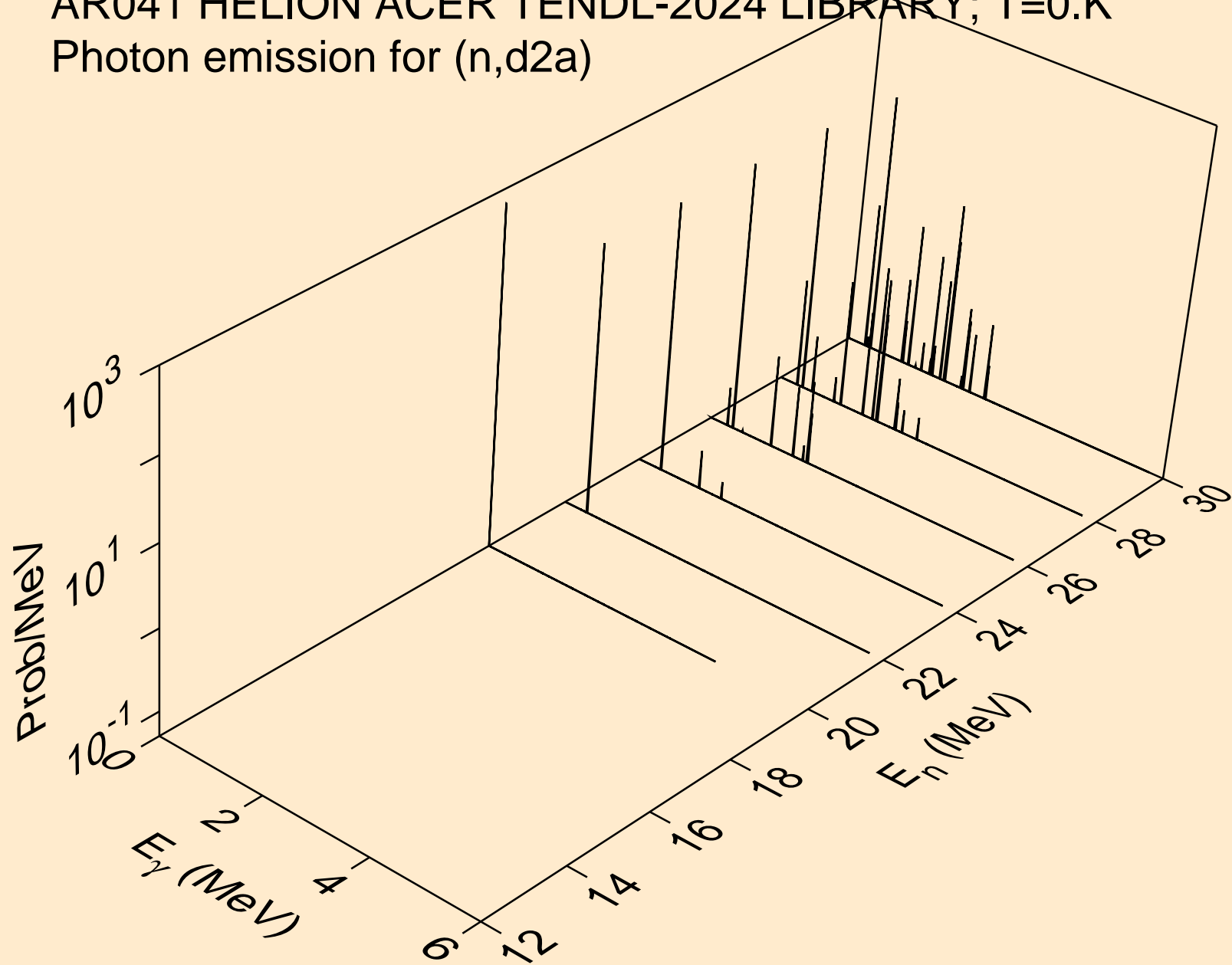

AR041 HELION ACER TENDL-2024 LIBRARY; T=0.K
Photon emission for (n,pd)

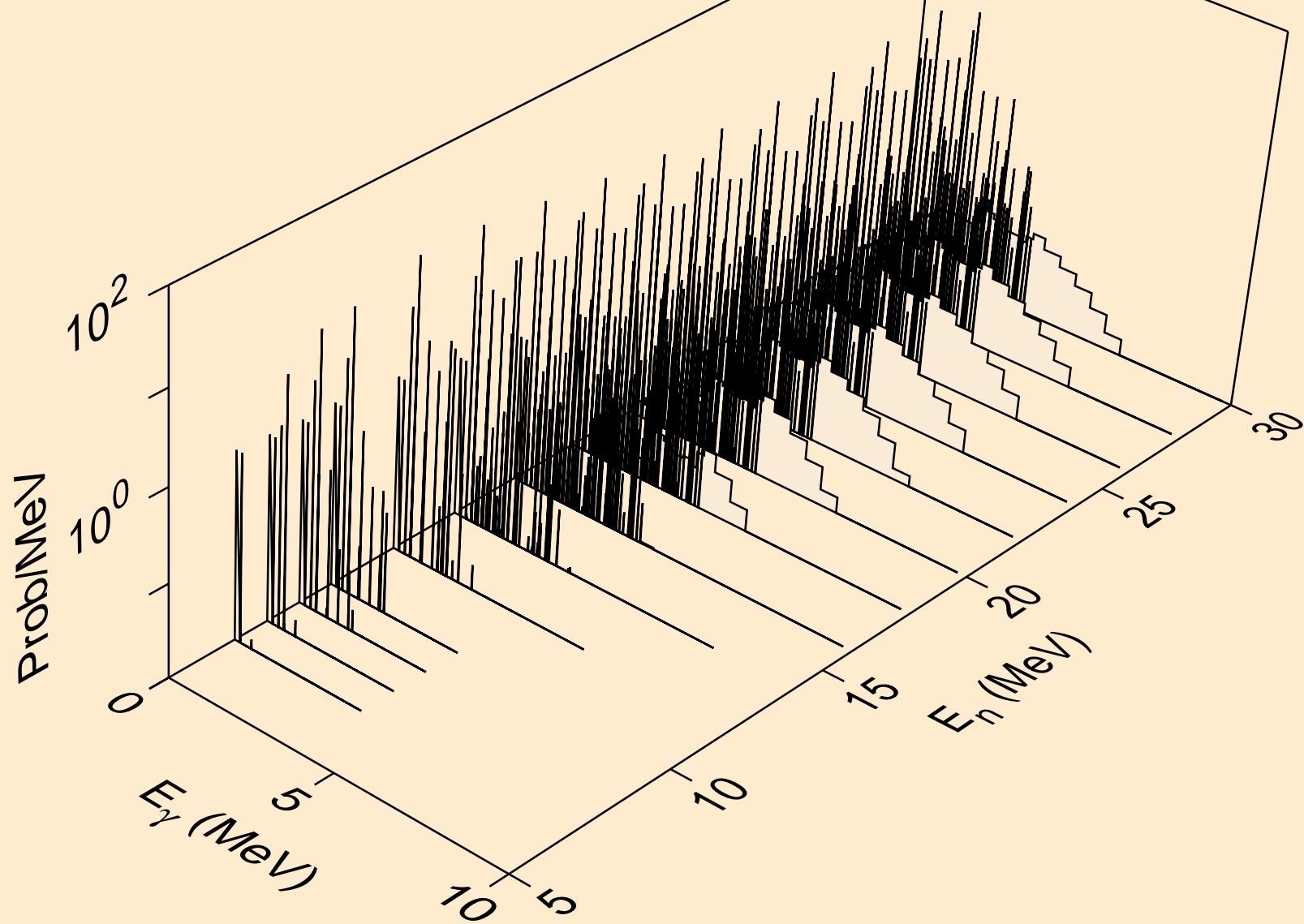

AR041 HELION ACER TENDL-2024 LIBRARY; T=0.K
Photon emission for (n,pt)

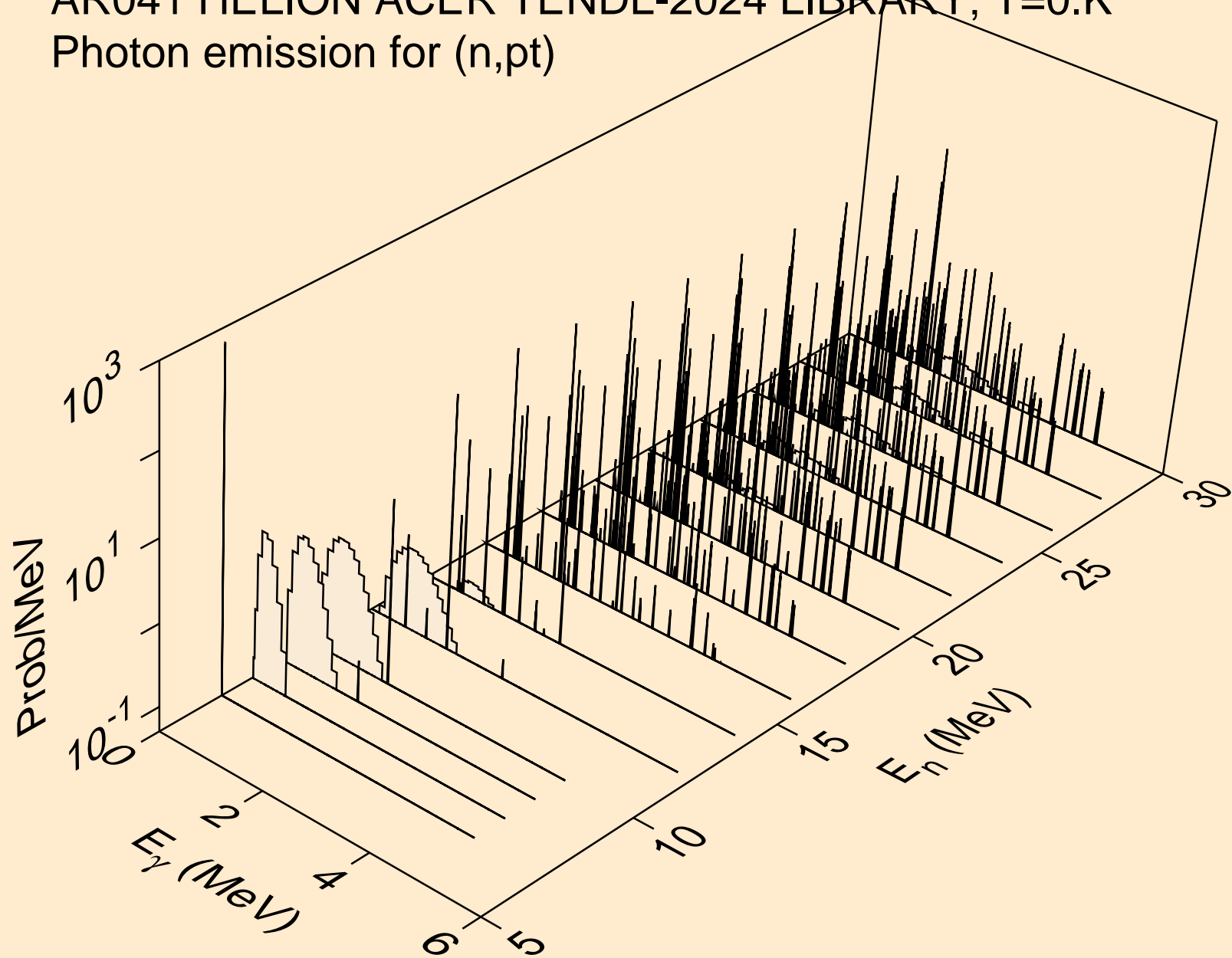

AR041 HELION ACER TENDL-2024 LIBRARY; T=0.K
Photon emission for (n,da)

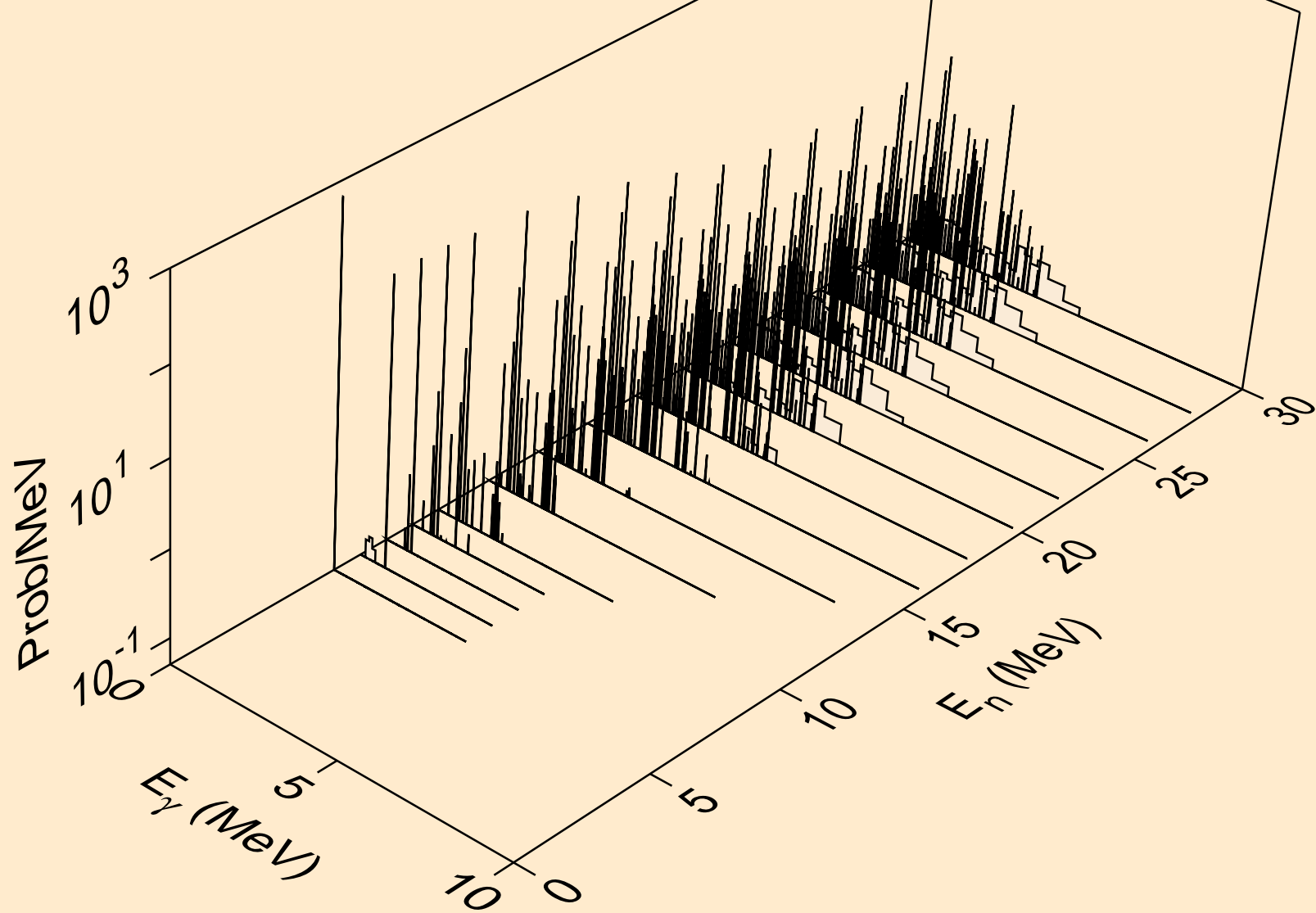

AR041 HELION ACER TENDL-2024 LIBRARY; T=0.K
Particle heating contributions

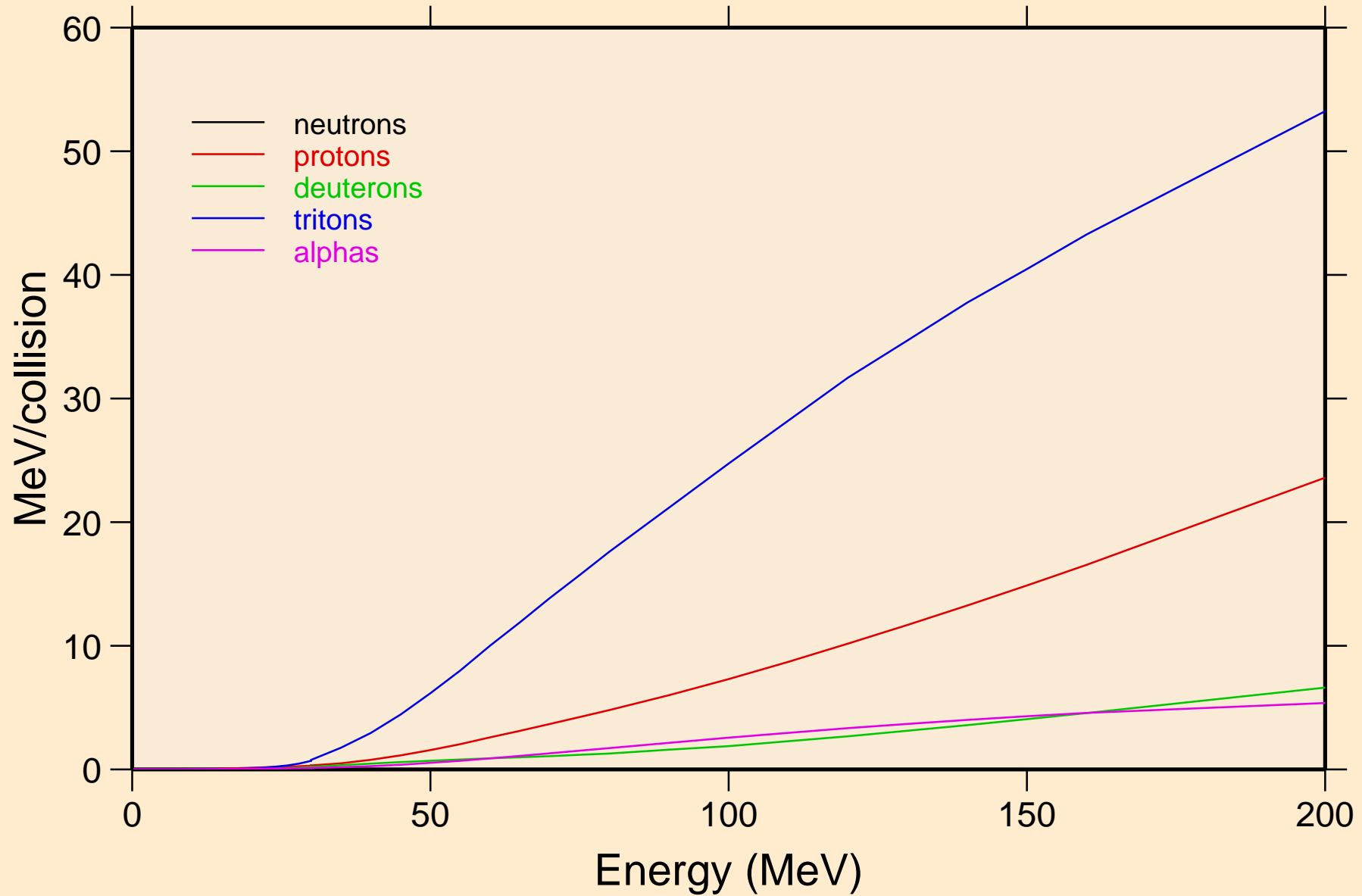

AR041 HELION ACER TENDL-2024 LIBRARY; T=0.K
Recoil Heating

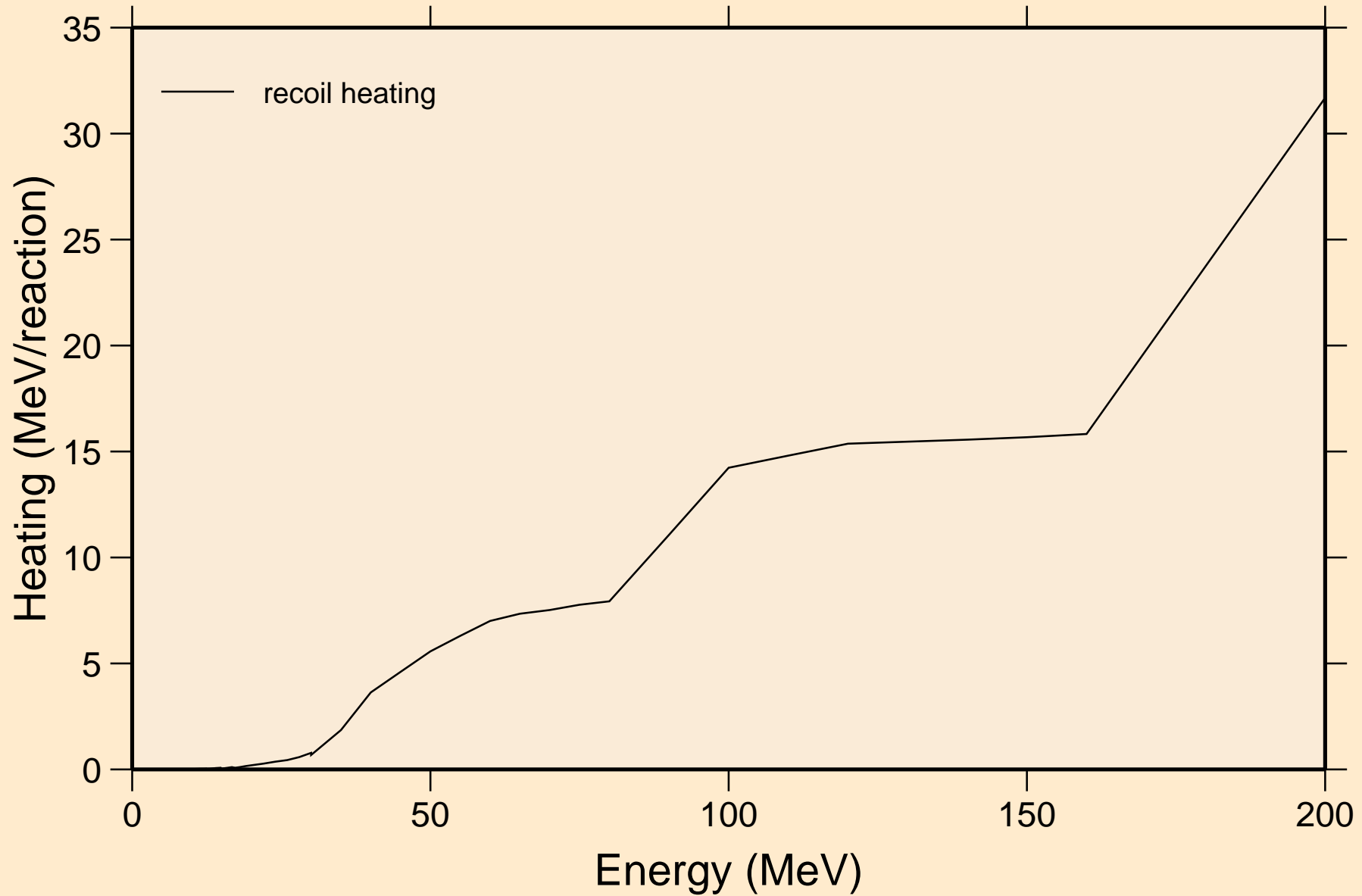

AR041 HELION ACER TENDL-2024 LIBRARY; T=0.K
Particle production cross sections

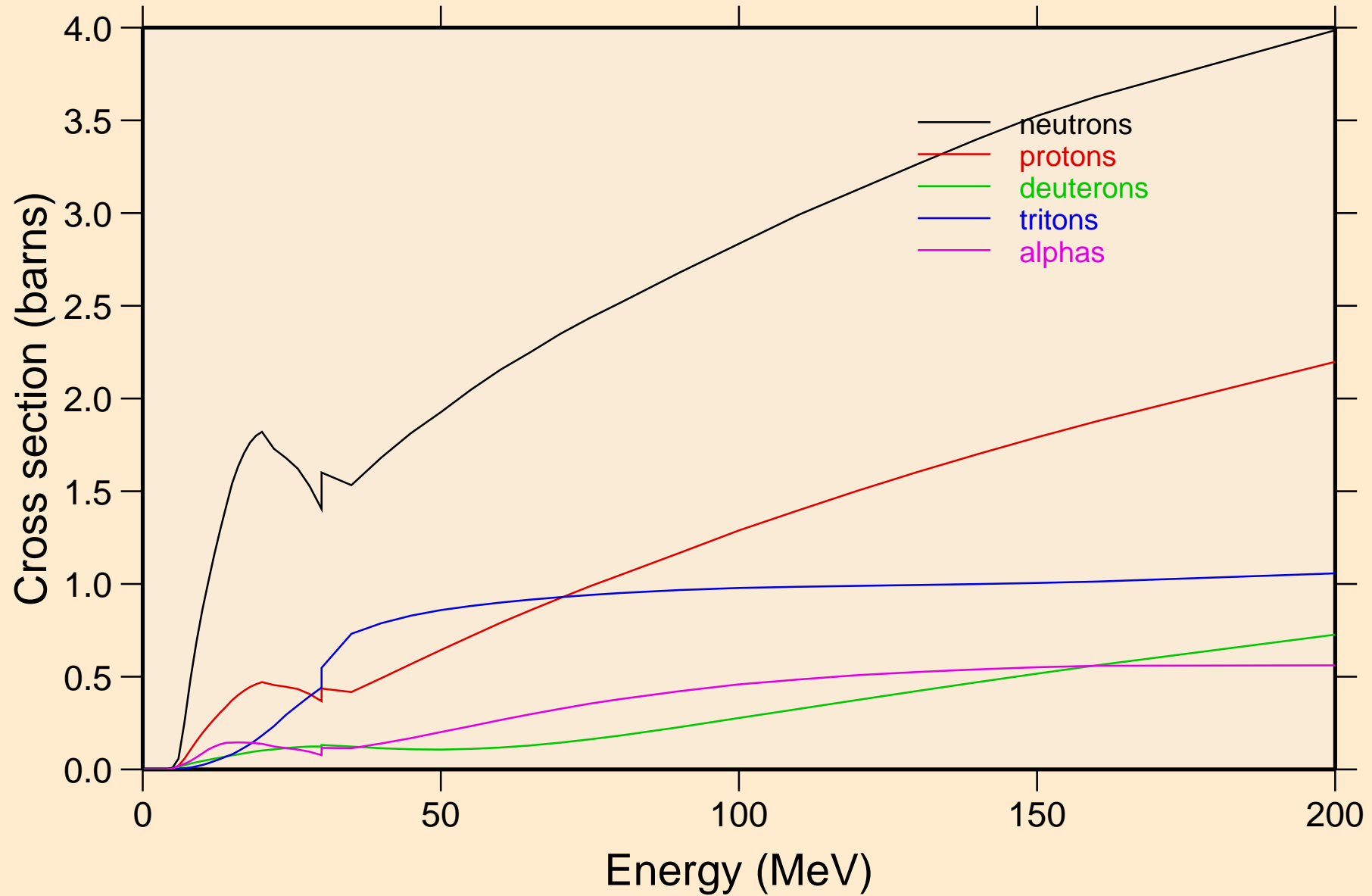

AR041 HELION ACER TENDL-2024 LIBRARY; T=0.K
neutrons from (s,n)

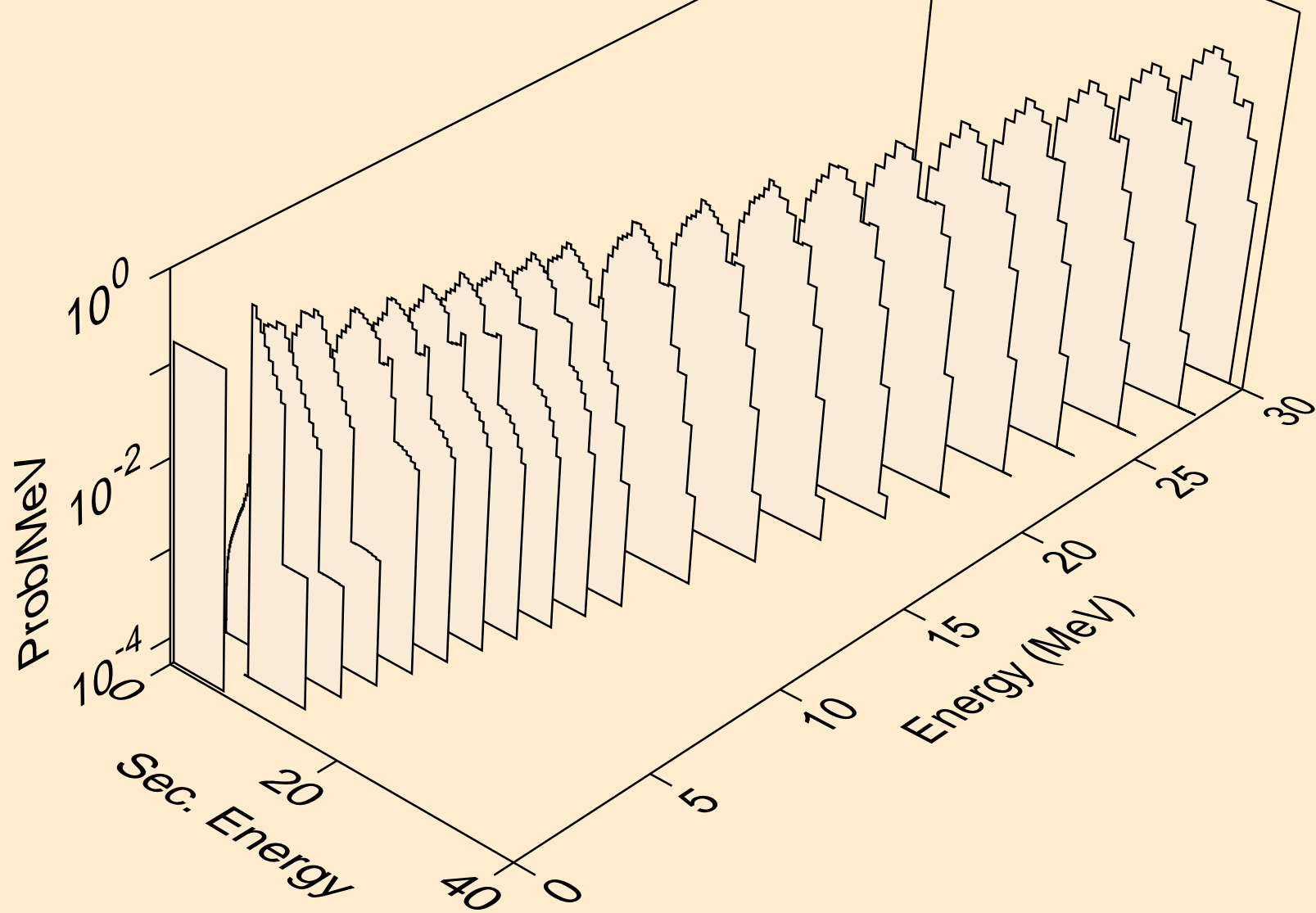

AR041 HELION ACER TENDL-2024 LIBRARY; T=0.K
neutrons from (s,x)

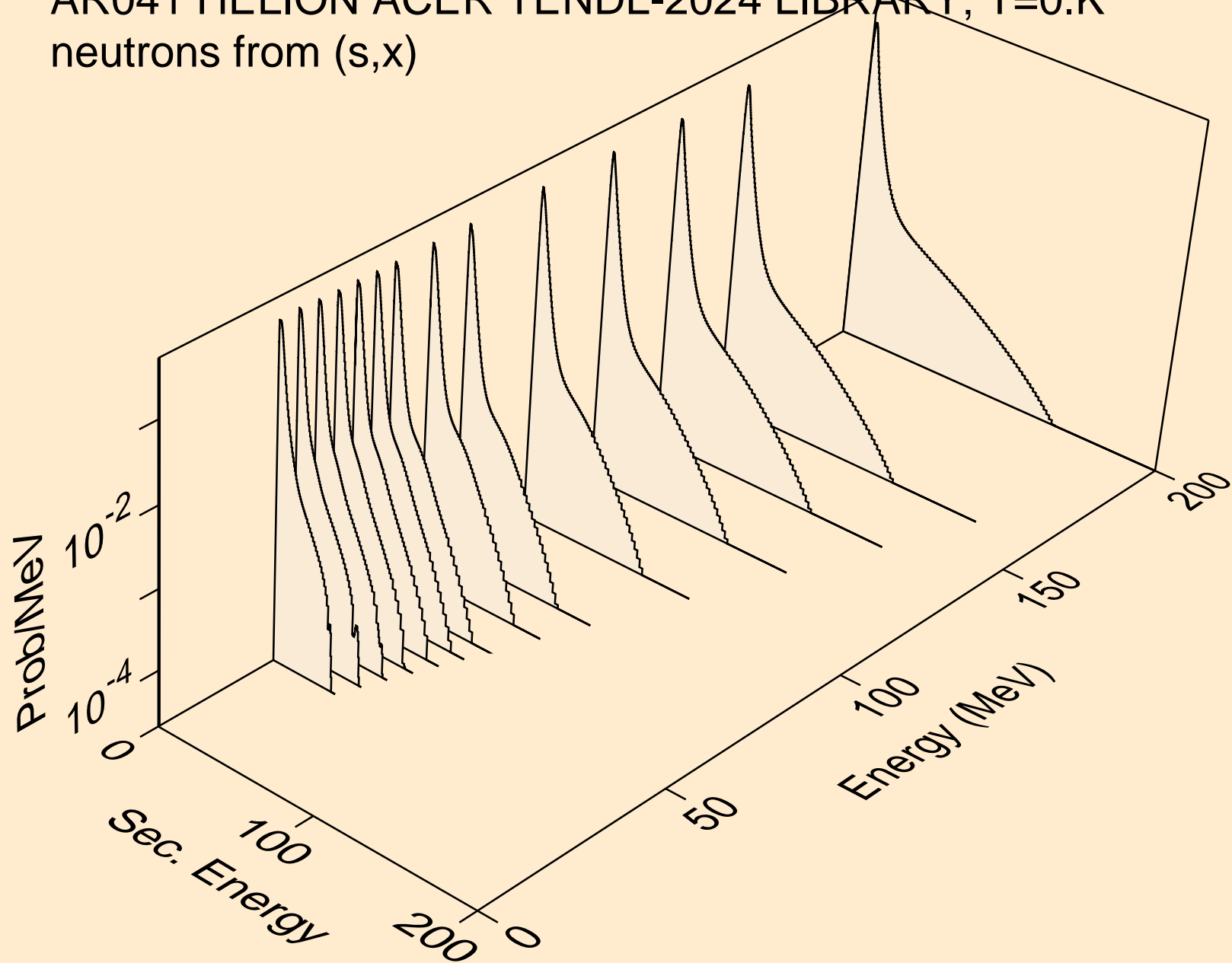

AR041 HELION ACER TENDL-2024 LIBRARY; T=0.K
neutrons from (s,2nd)

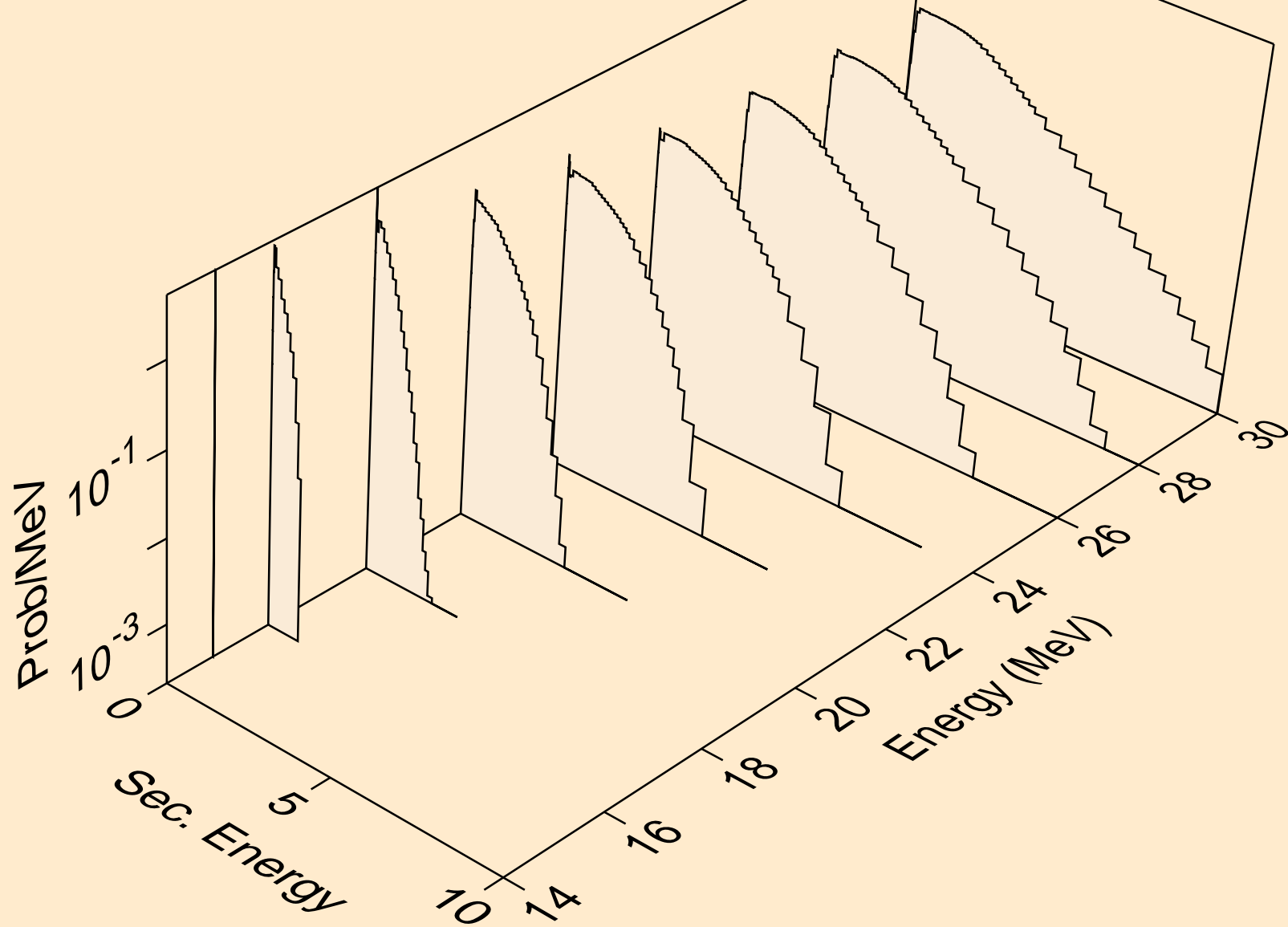

AR041 HELION ACER TENDL-2024 LIBRARY; T=0.K
neutrons from (s,2n)

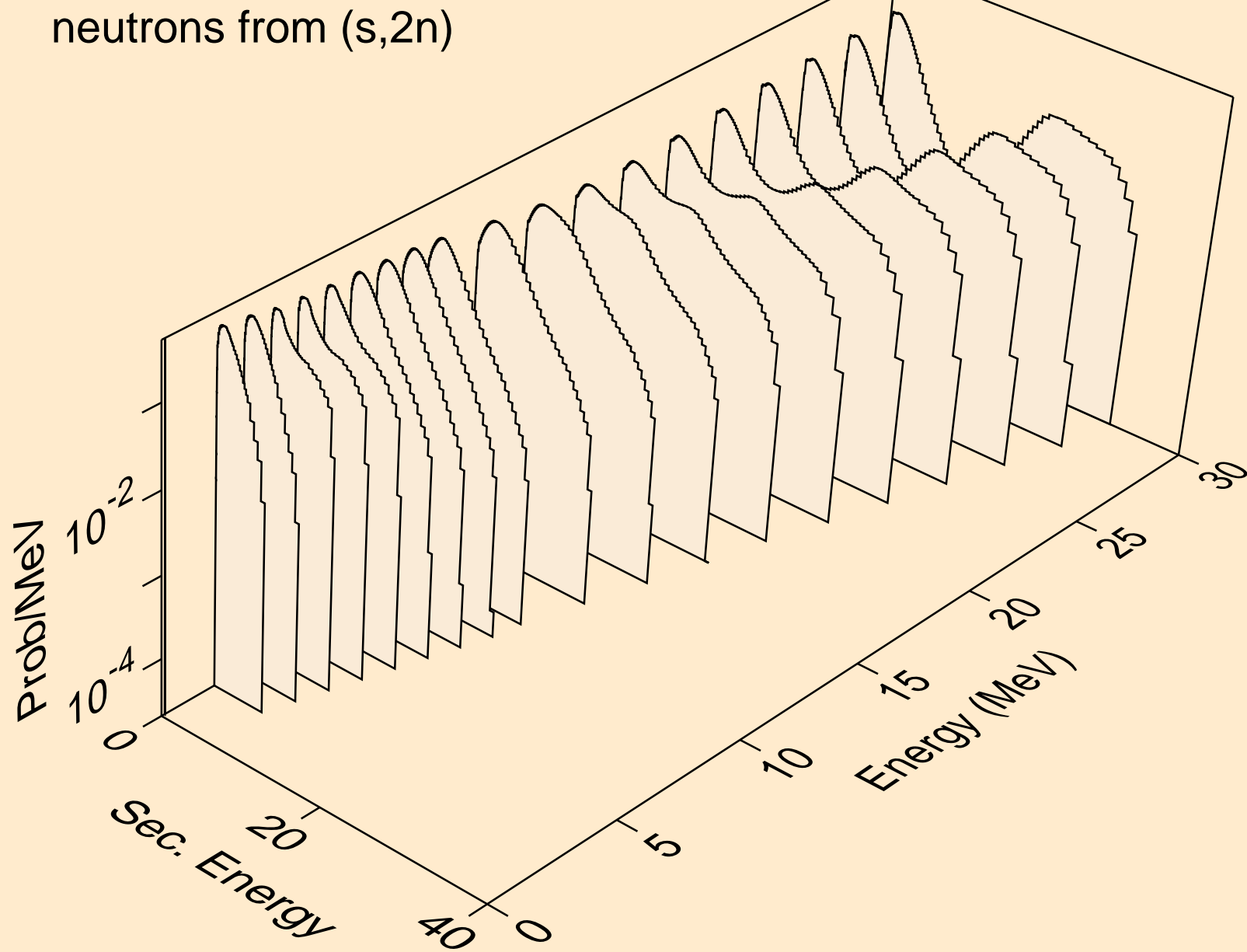

AR041 HELION ACER TENDL-2024 LIBRARY; T=0.K
neutrons from (s,3n)

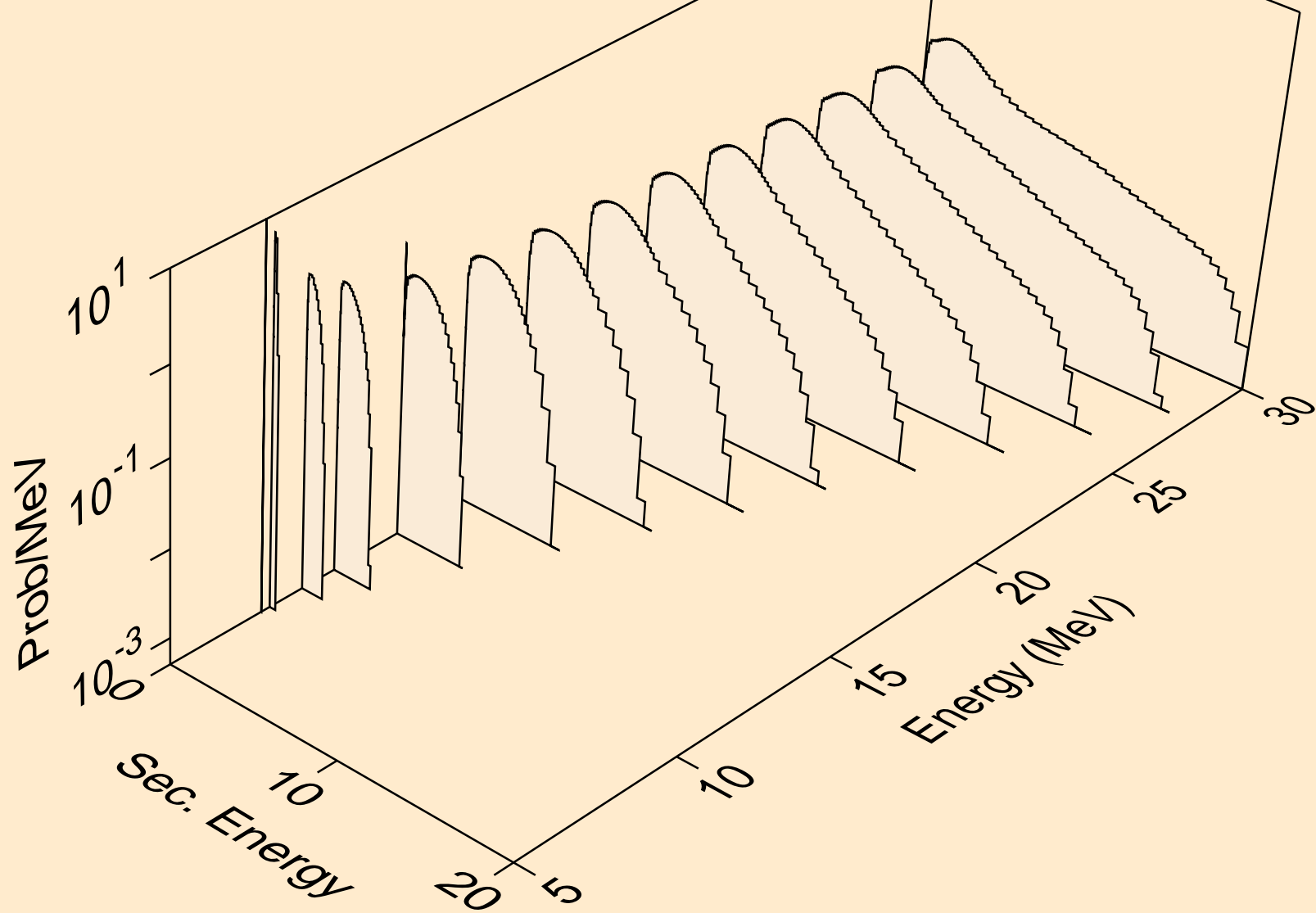

AR041 HELION ACER TENDL-2024 LIBRARY; T=0.K
neutrons from (s,n*)a

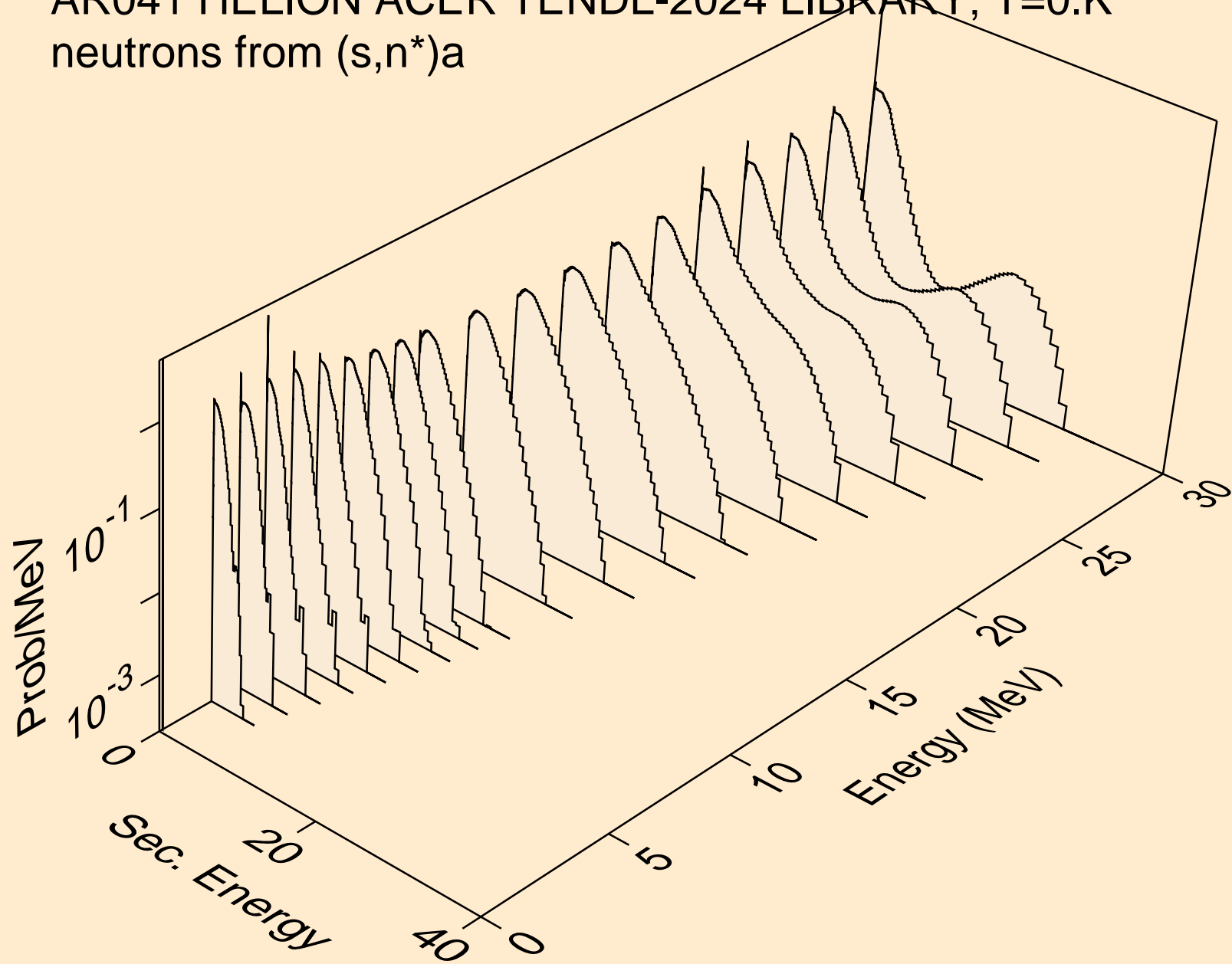

AR041 HELION ACER TENDL-2024 LIBRARY; T=0.K
neutrons from (s,n*)3a

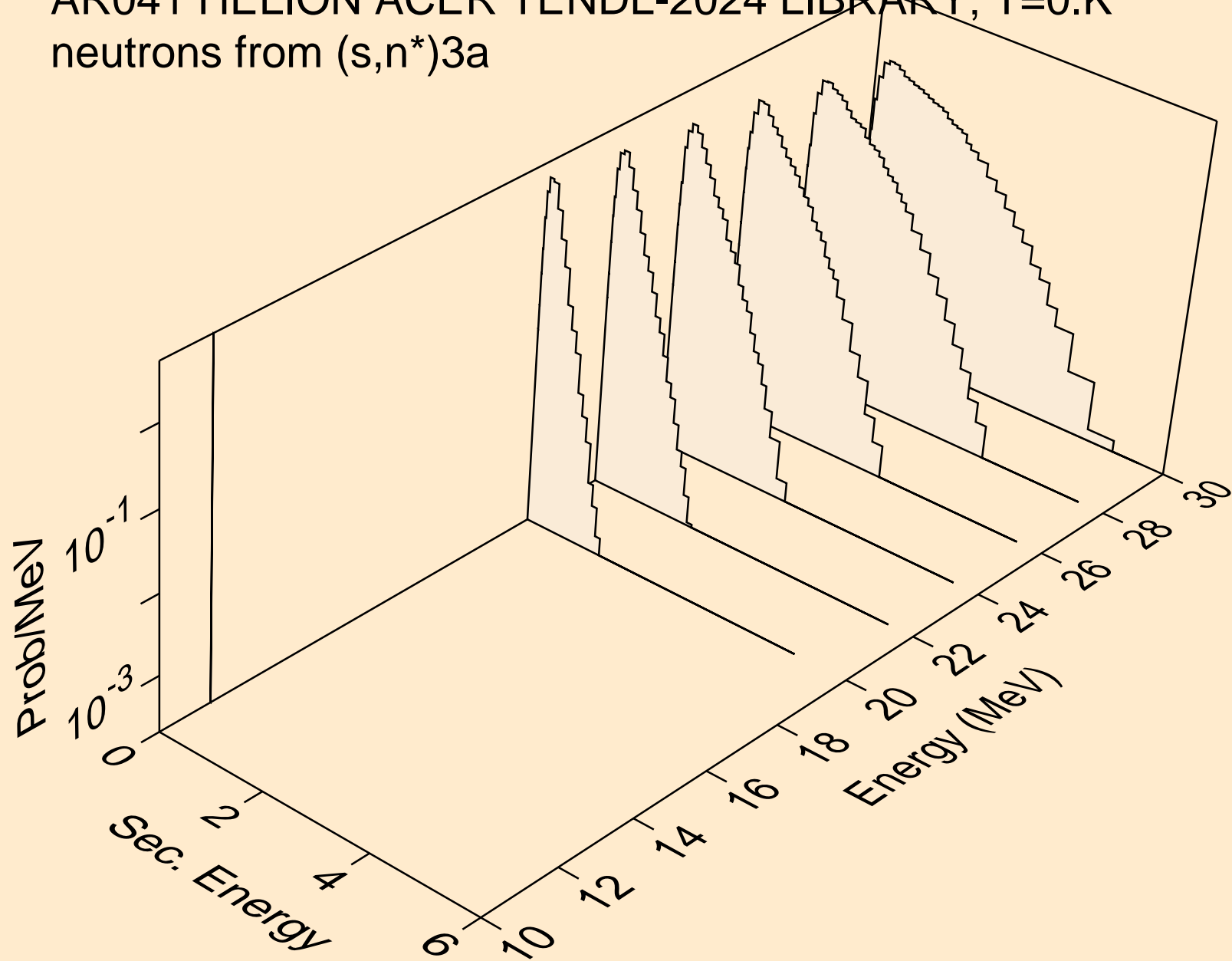

AR041 HELION ACER TENDL-2024 LIBRARY; T=0.K
neutrons from (s,2n)a

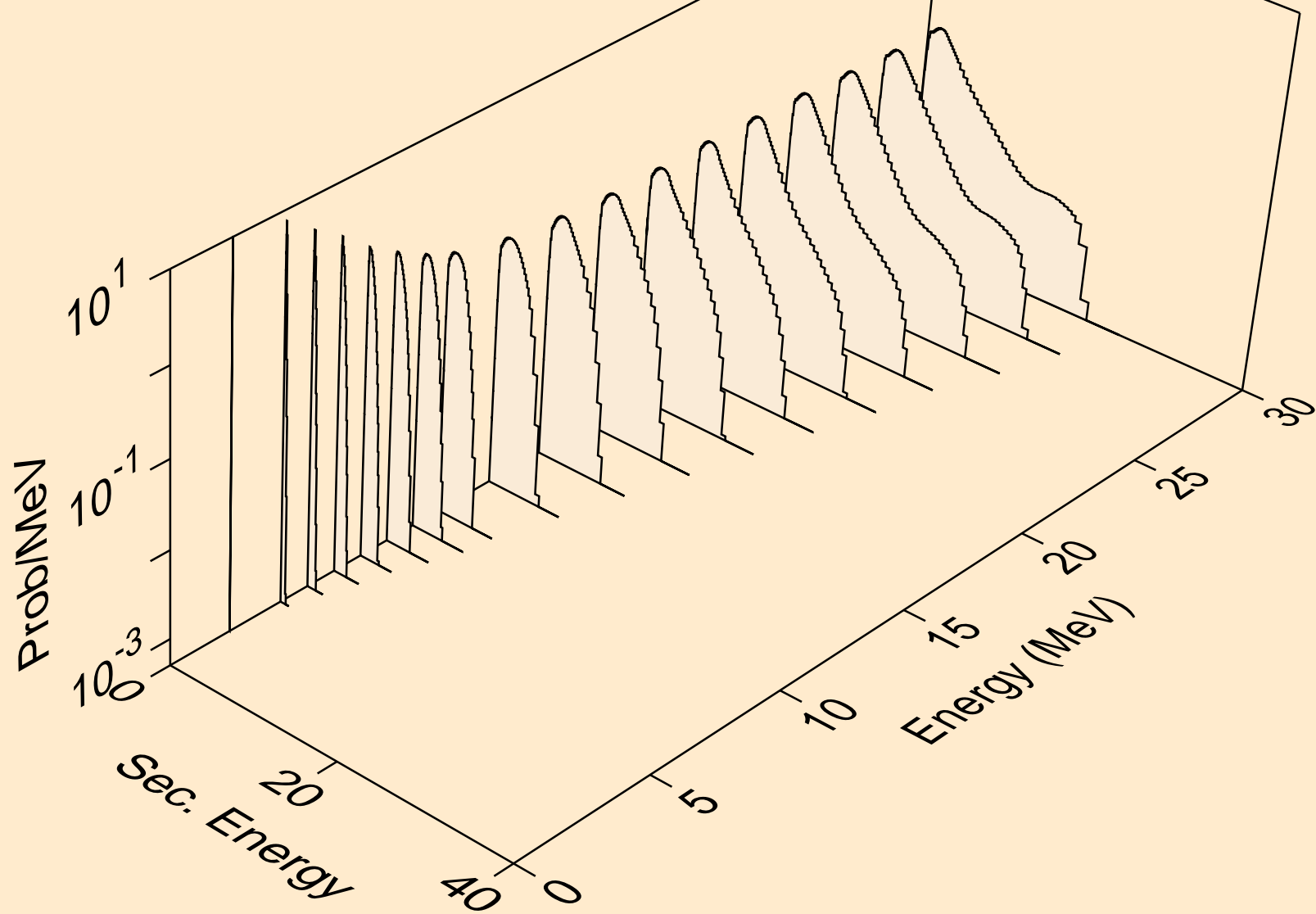

AR041 HELION ACER TENDL-2024 LIBRARY; T=0.K
neutrons from (s,3n)a

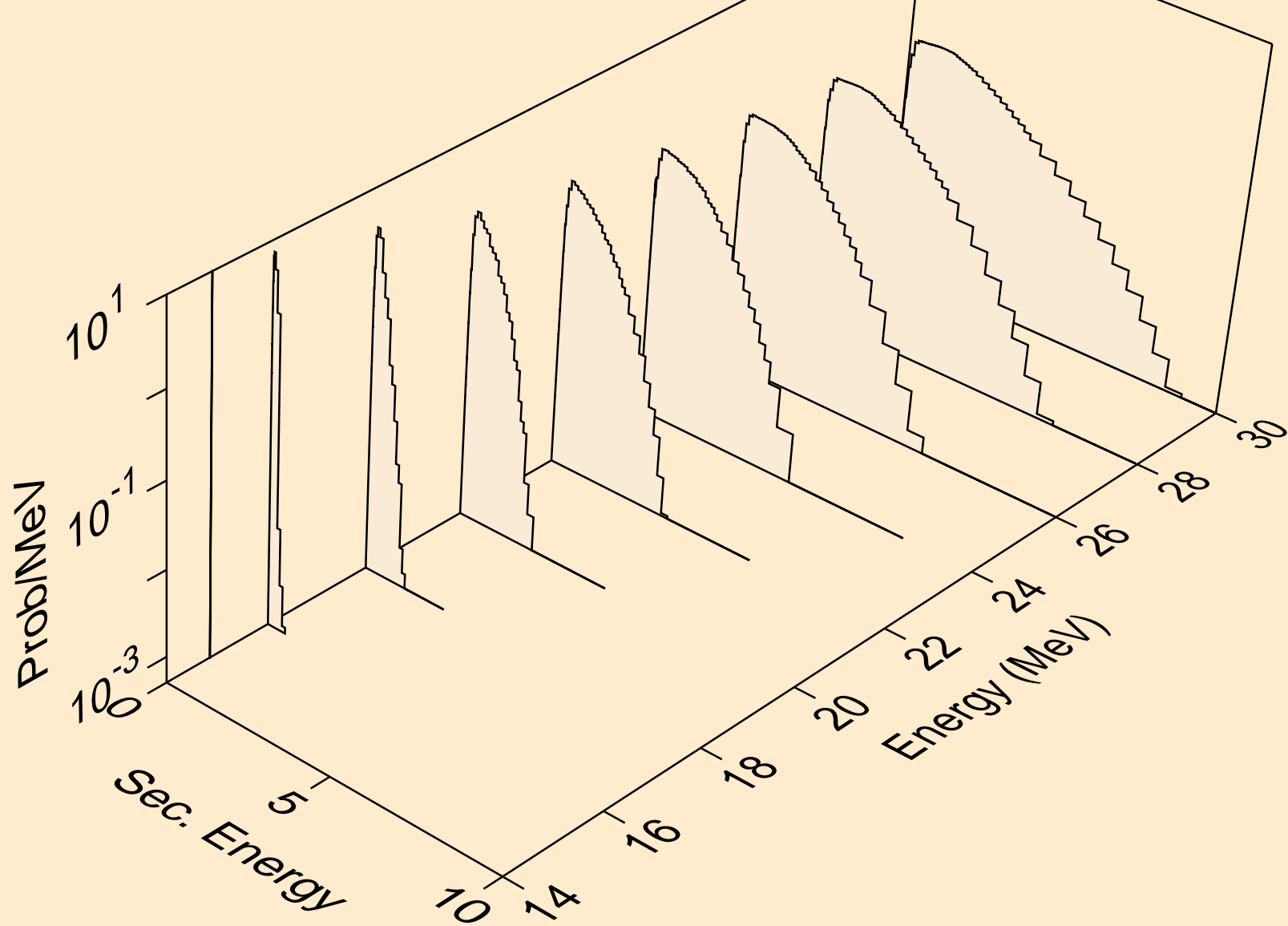

AR041 HELION ACER TENDL-2024 LIBRARY; T=0.K
neutrons from (s,n*)p

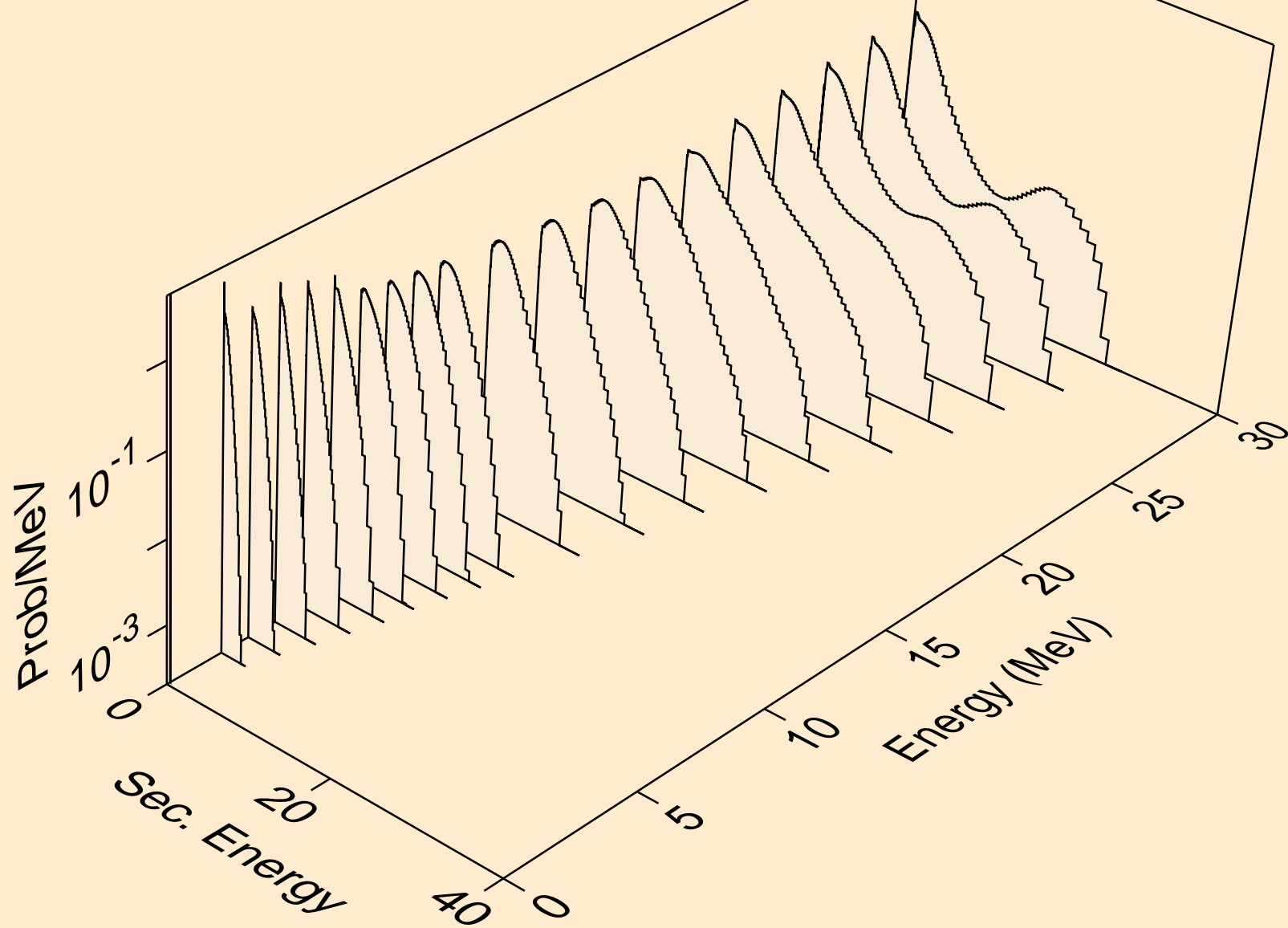

AR041 HELION ACER TENDL-2024 LIBRARY; T=0.K
neutrons from (s,n*)2a

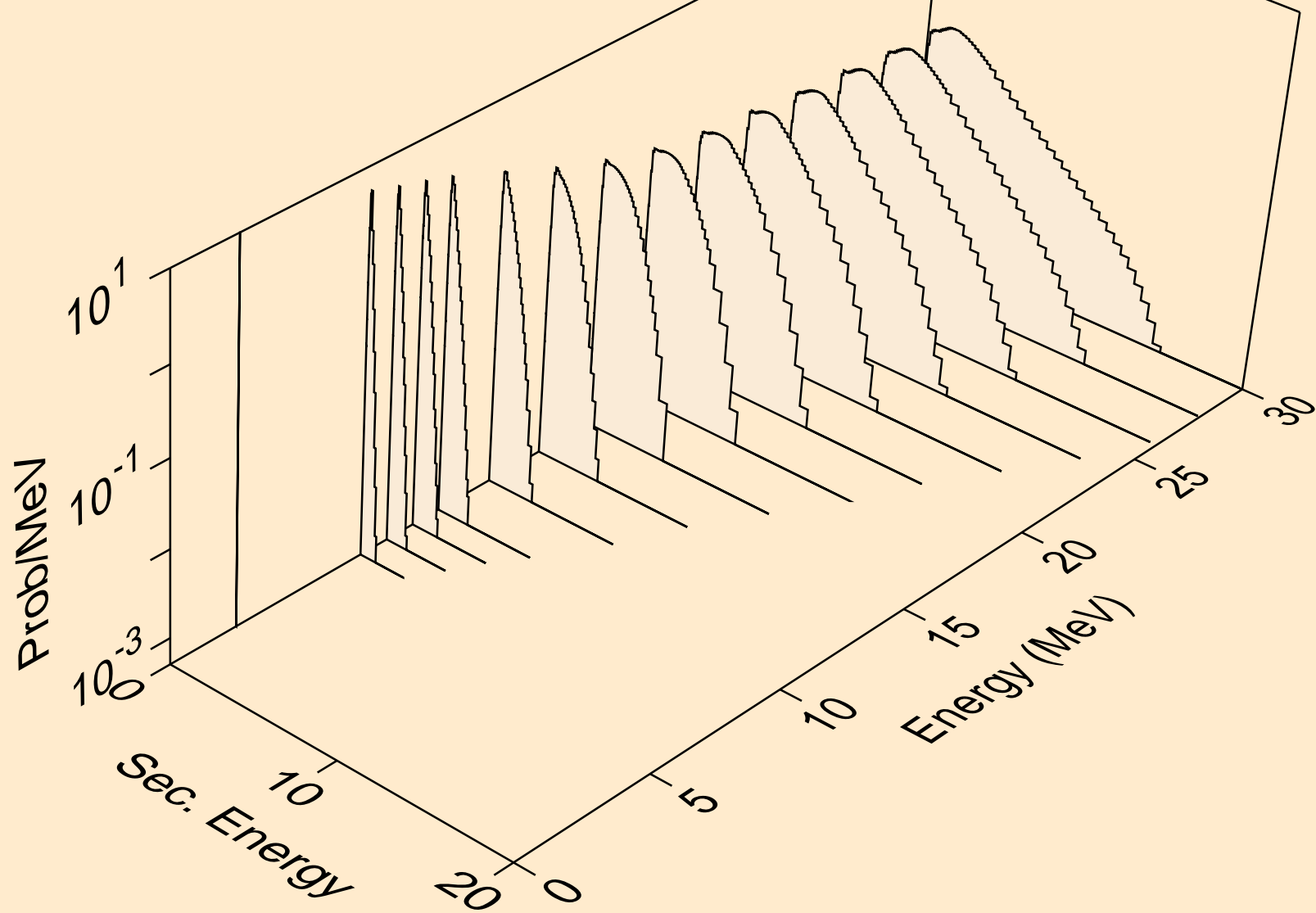

AR041 HELION ACER TENDL-2024 LIBRARY; T=0.K
neutrons from (s,2n)2a

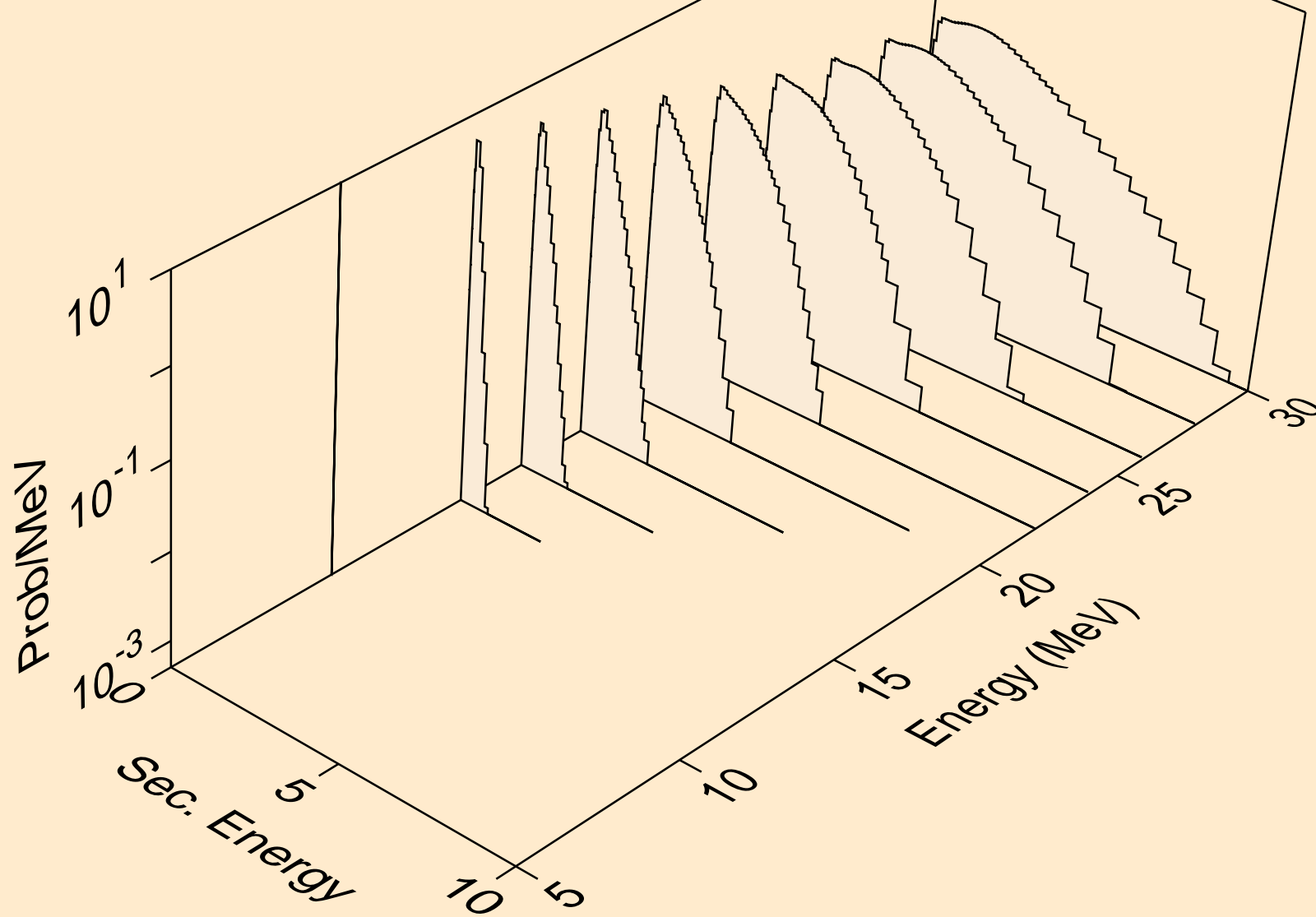

AR041 HELION ACER TENDL-2024 LIBRARY; T=0.K
neutrons from (s,n*)d

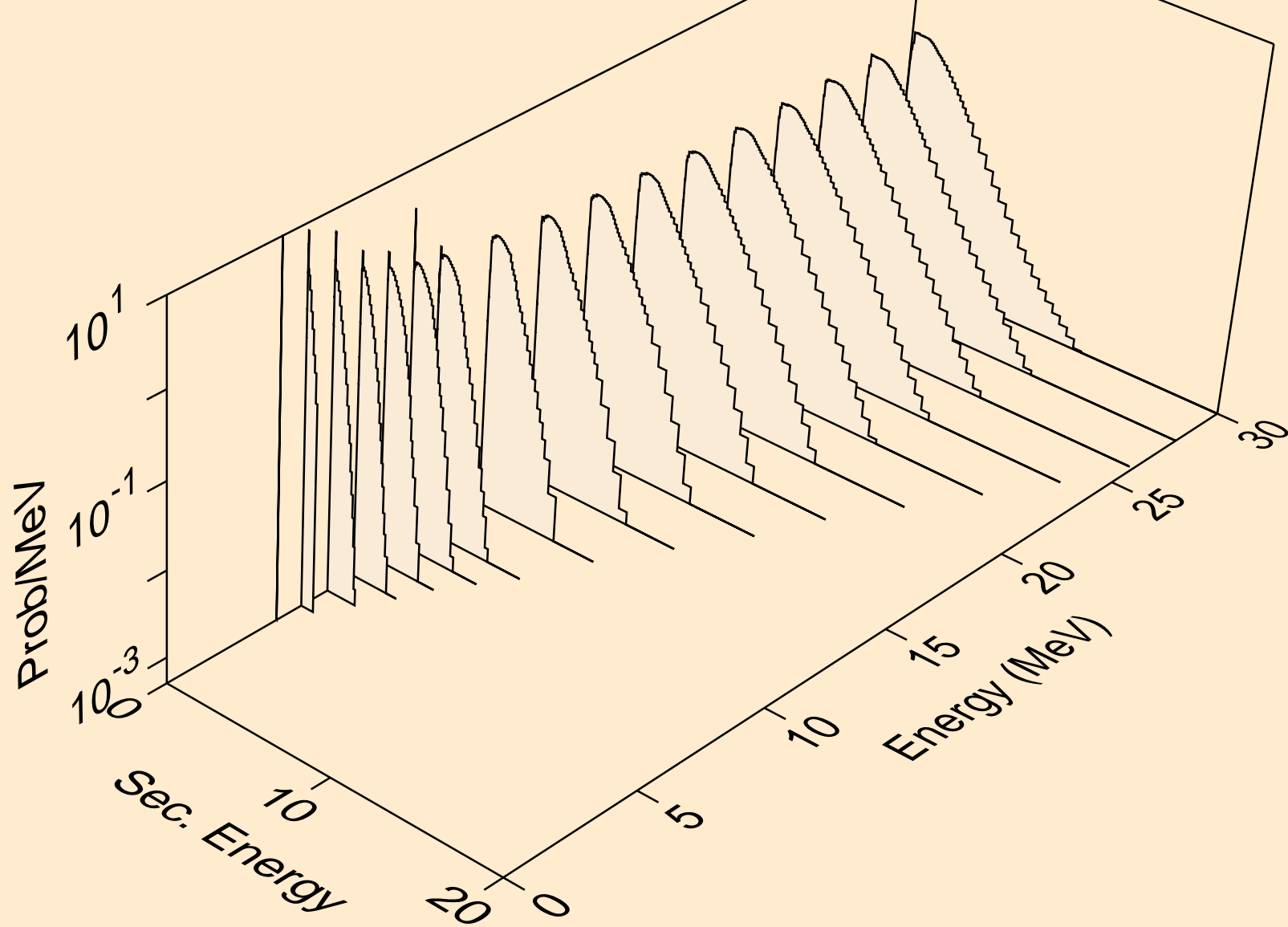

AR041 HELION ACER TENDL-2024 LIBRARY; T=0.K
neutrons from (s,n*)t

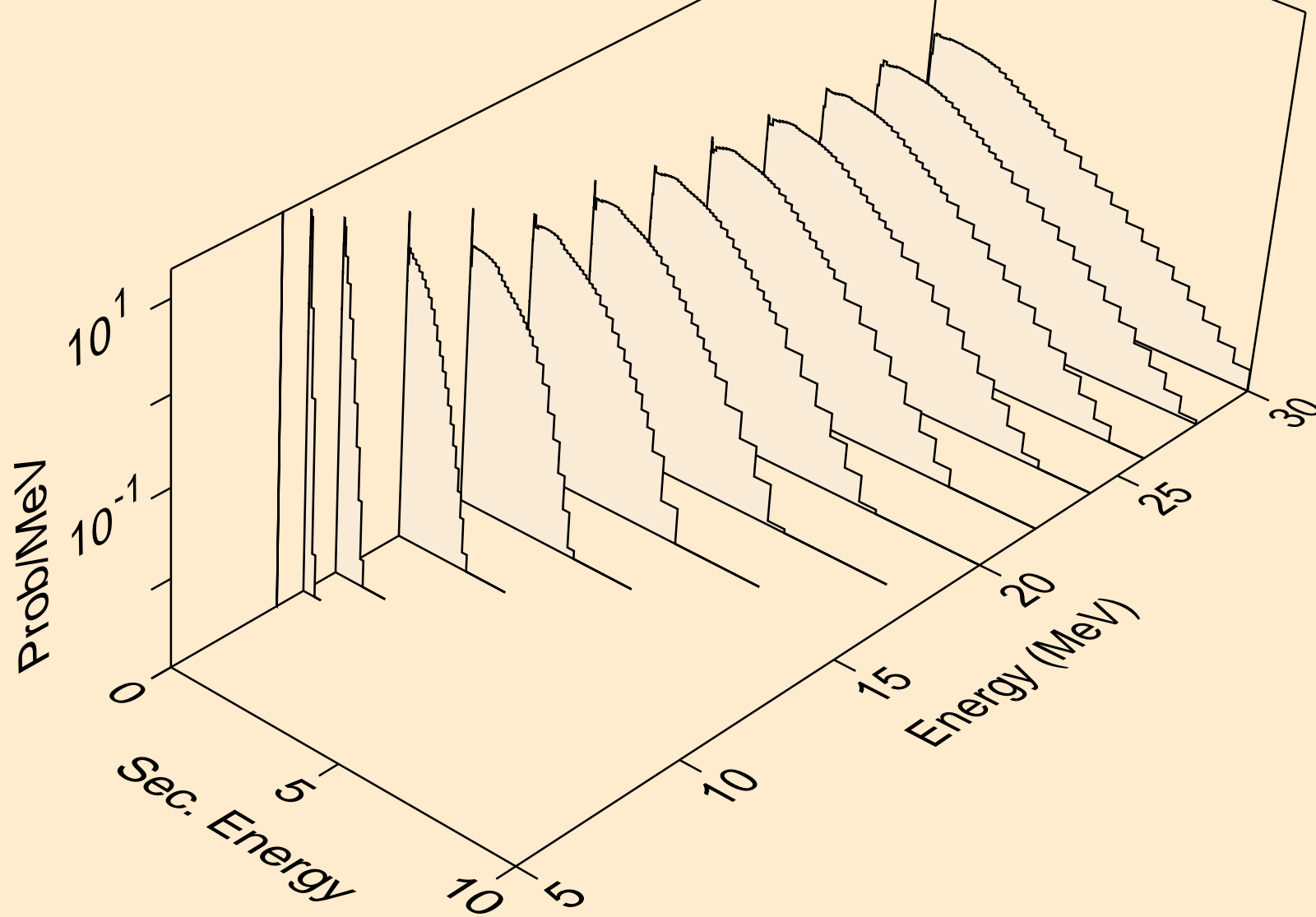

AR041 HELION ACER TENDL-2024 LIBRARY; T=0.K
neutrons from (s,n*)he3

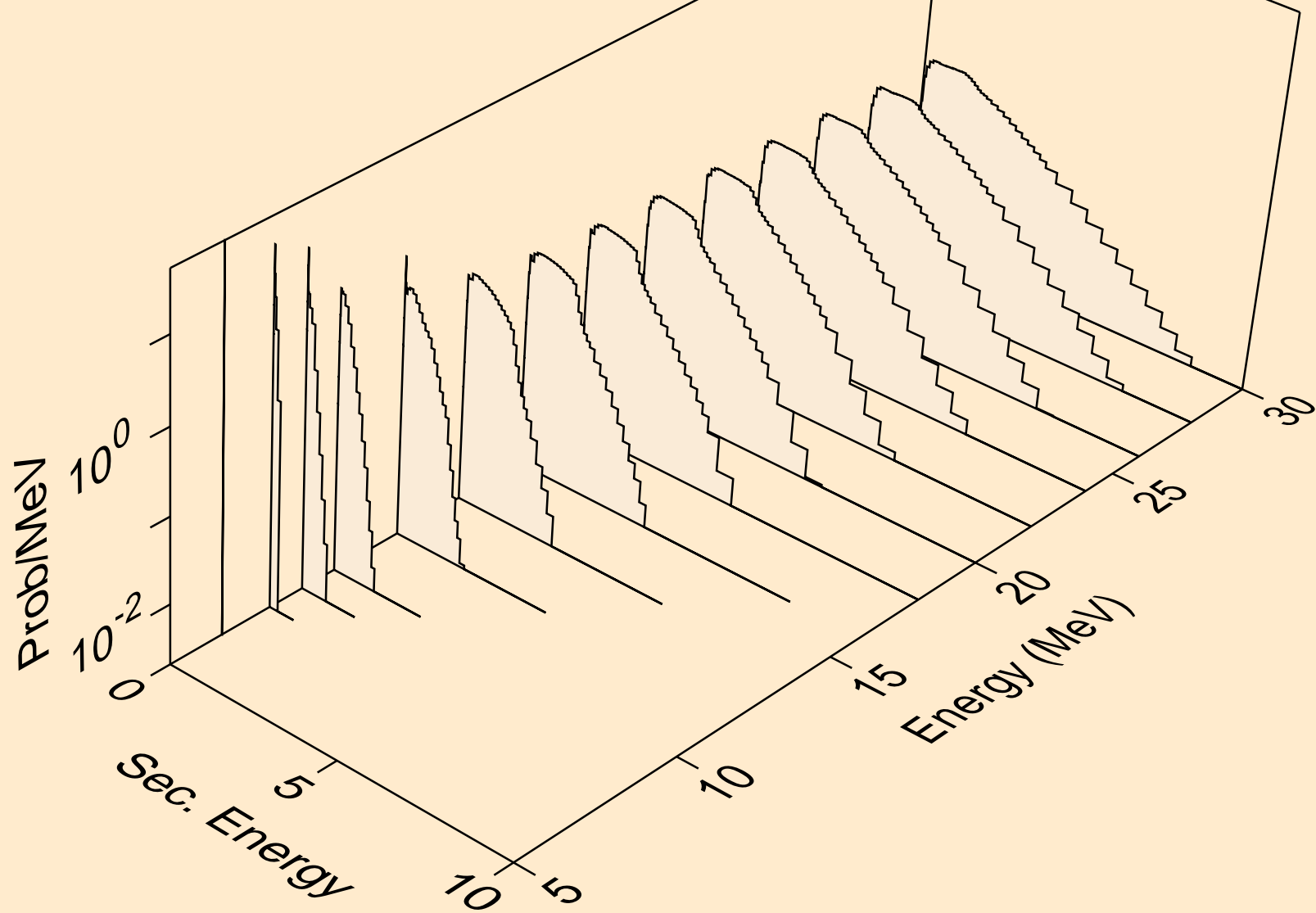

AR041 HELION ACER TENDL-2024 LIBRARY; T=0.K
neutrons from (s,4n)

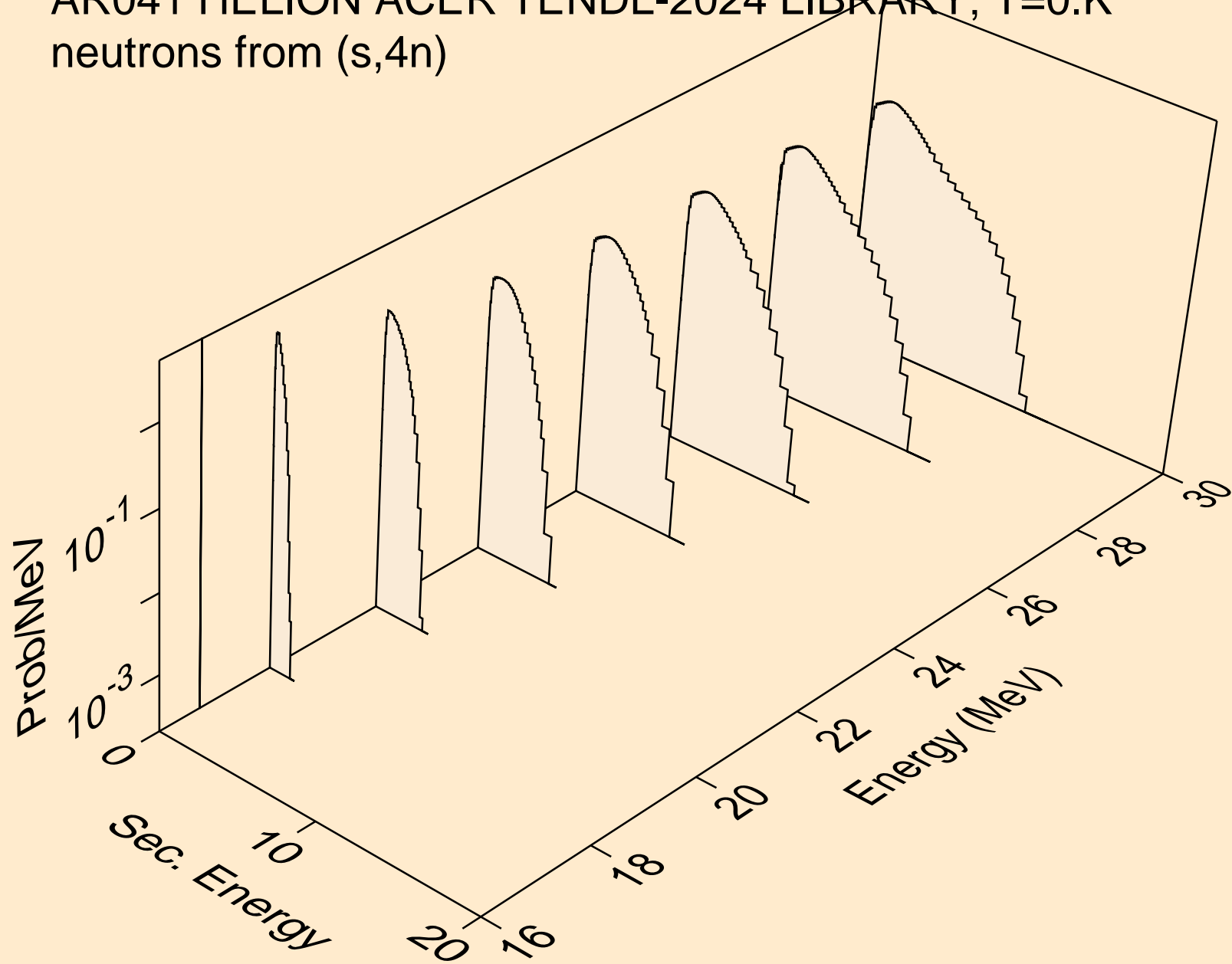

AR041 HELION ACER TENDL-2024 LIBRARY; T=0.K
neutrons from (s,2np)

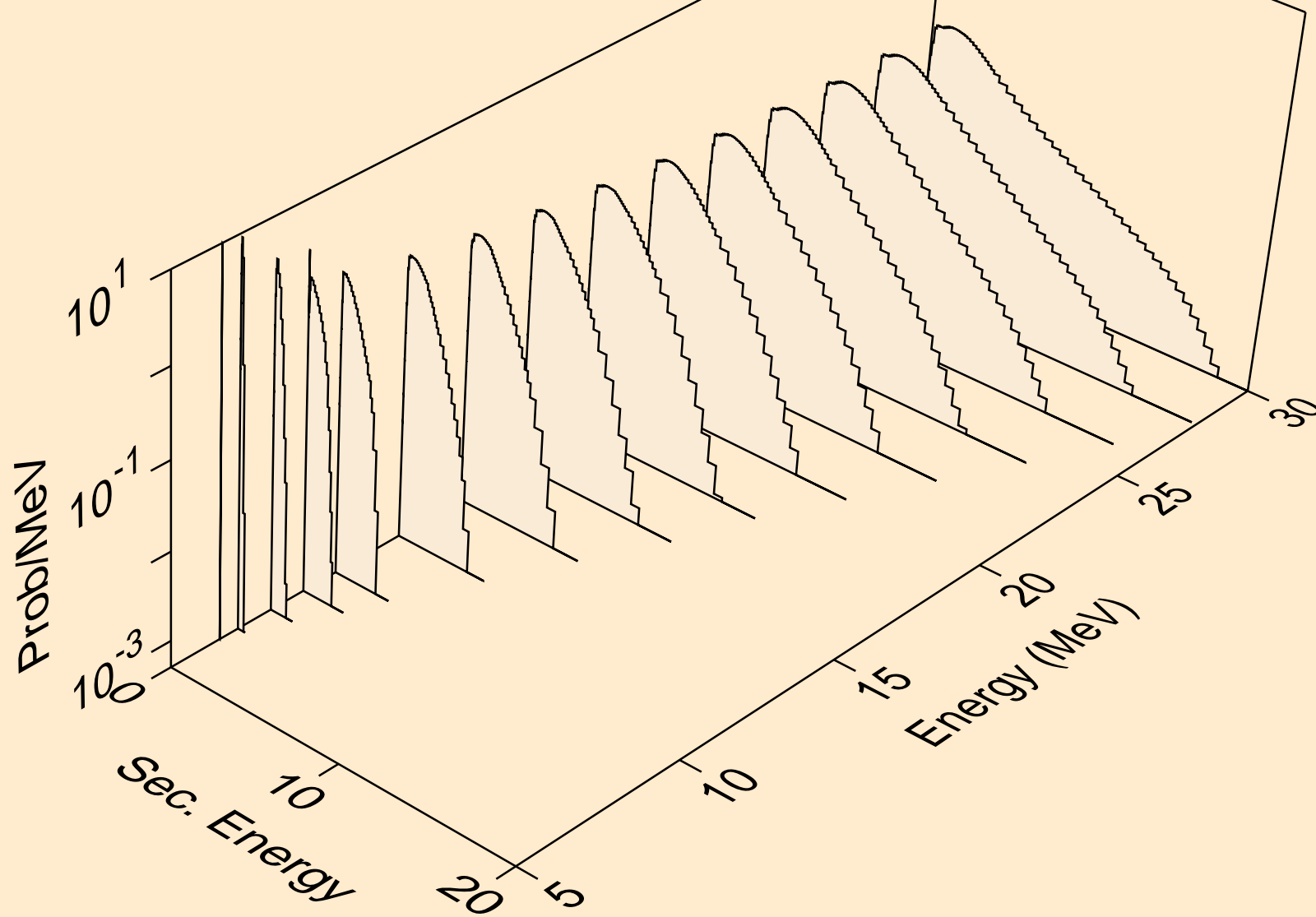

AR041 HELION ACER TENDL-2024 LIBRARY; T=0.K
neutrons from (s,3np)

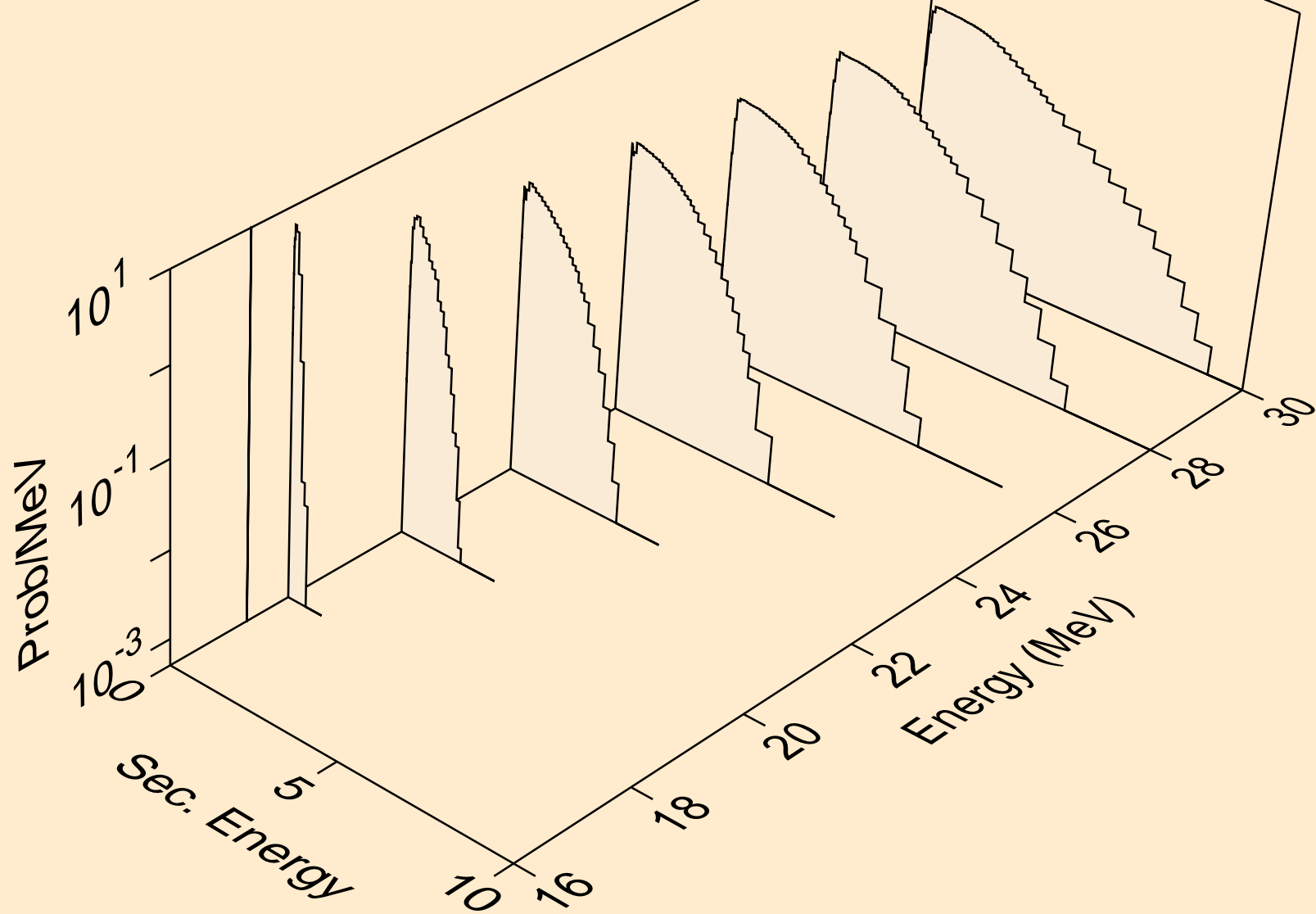

AR041 HELION ACER TENDL-2024 LIBRARY; T=0.K
neutrons from (s,n2p)

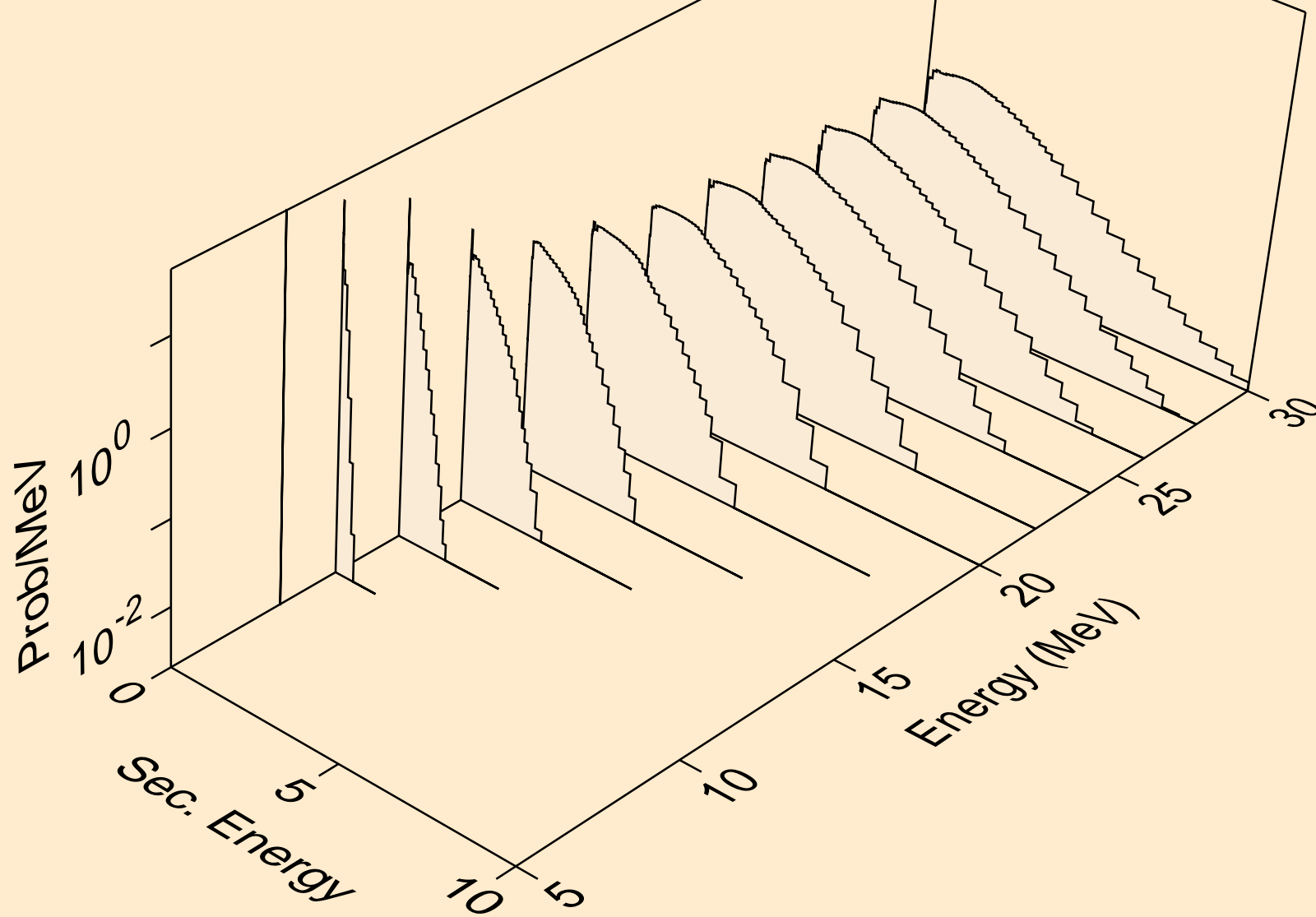

AR041 HELION ACER TENDL-2024 LIBRARY; T=0.K
neutrons from (s,npa)

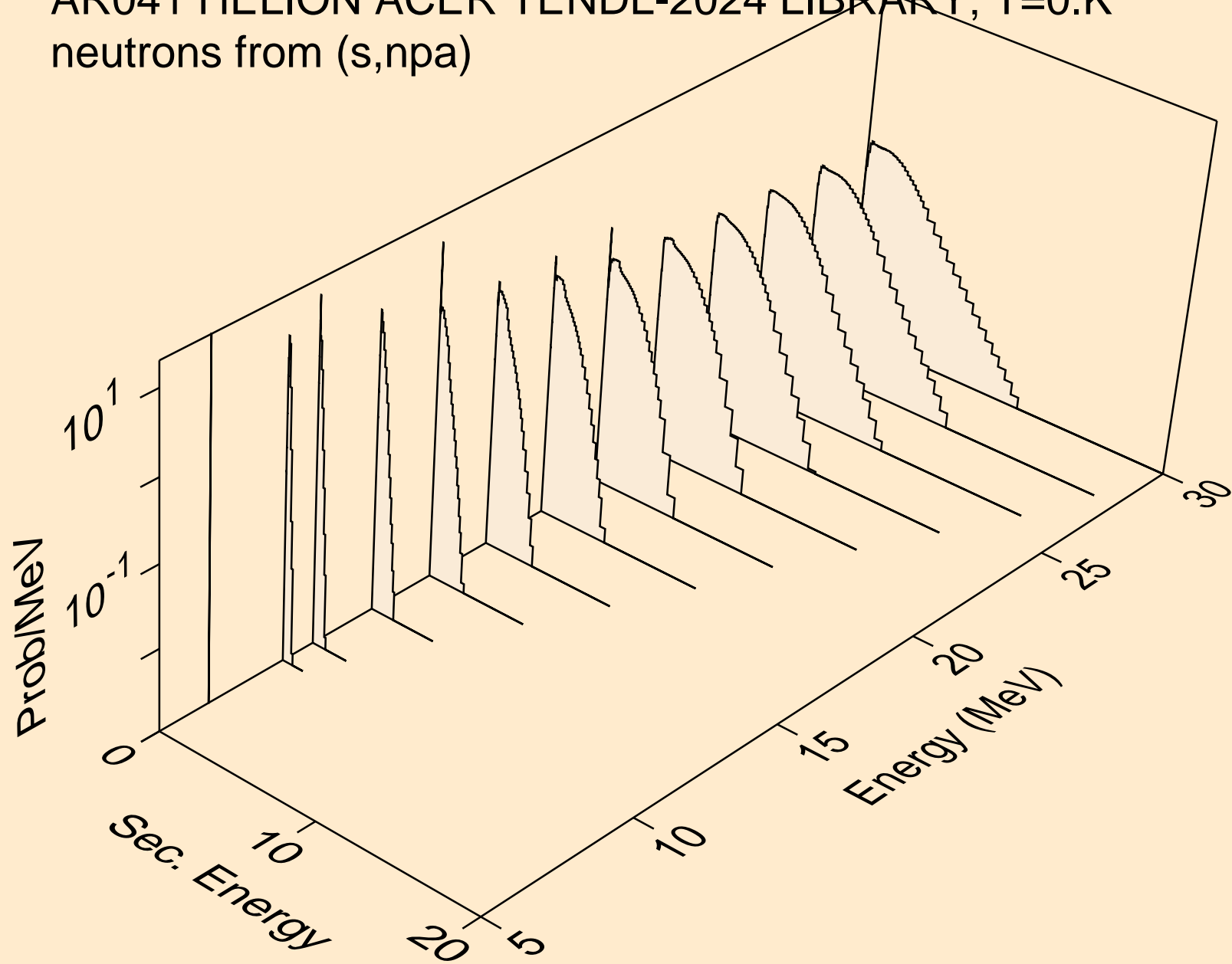

AR041 HELION ACER TENDL-2024 LIBRARY; T=0.K
protons from (s,x)

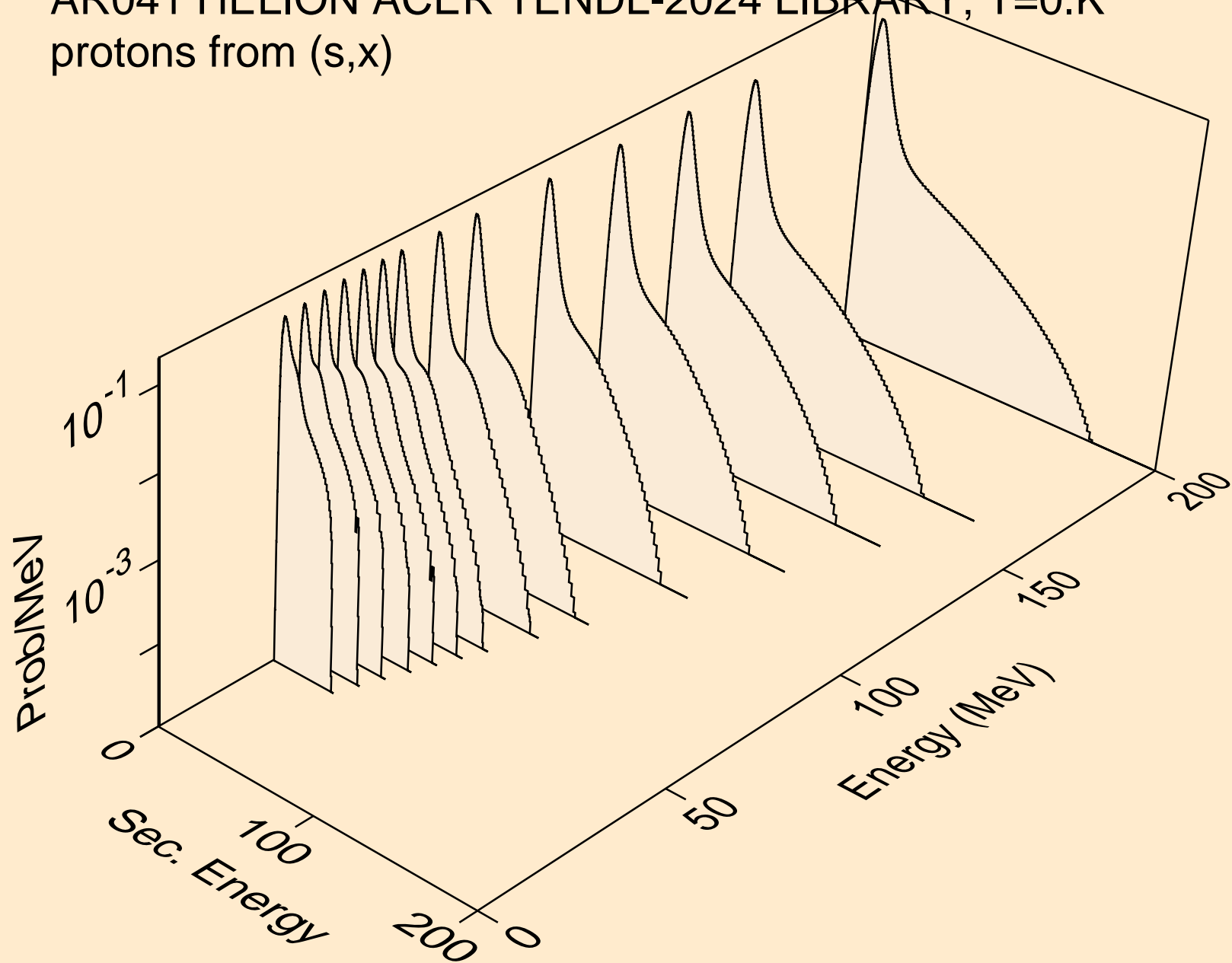

AR041 HELION ACER TENDL-2024 LIBRARY; T=0.K
protons from (s,n*)p

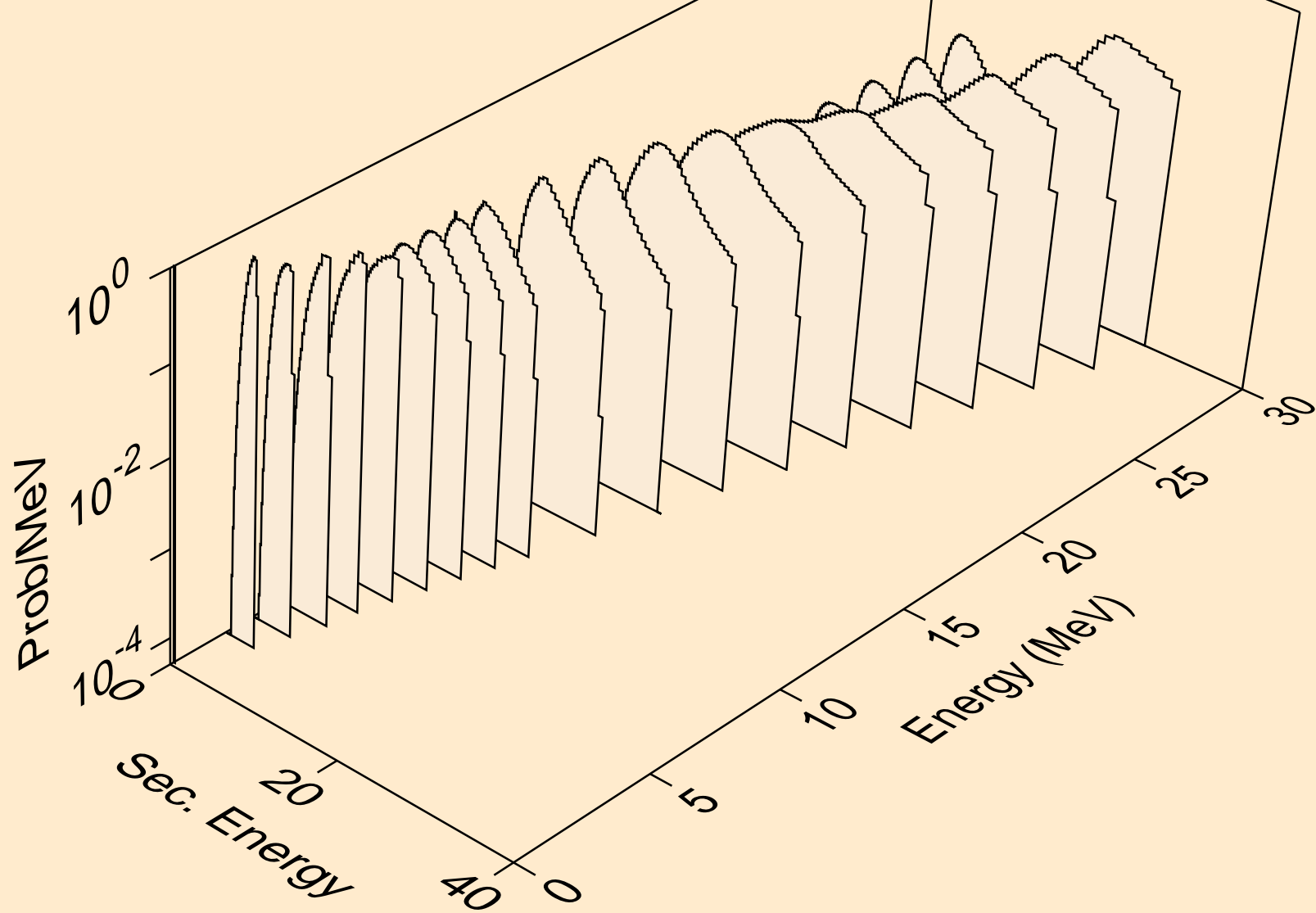

AR041 HELION ACER TENDL-2024 LIBRARY; T=0.K
protons from (s,2np)

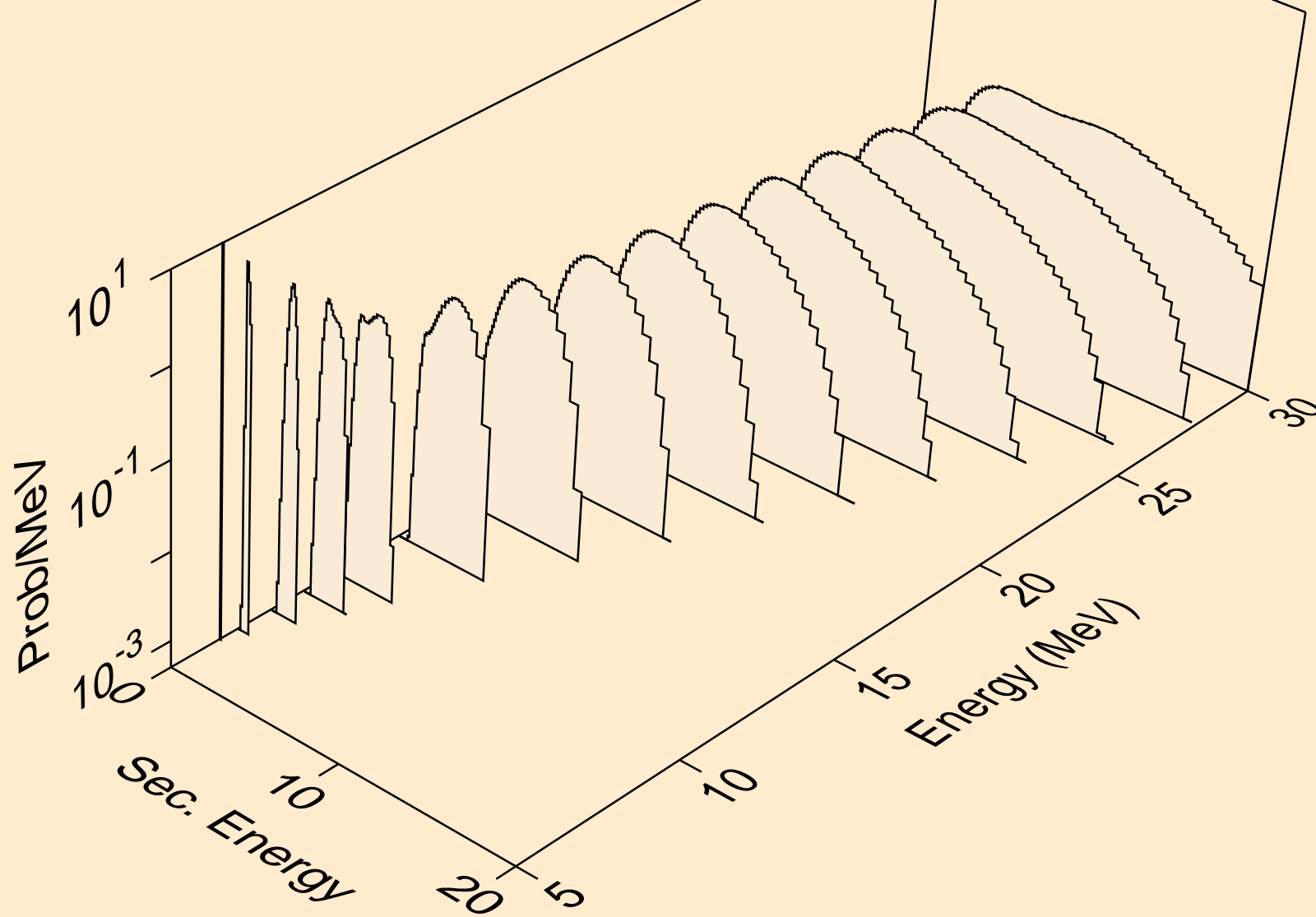

AR041 HELION ACER TENDL-2024 LIBRARY; T=0.K
protons from (s,3np)

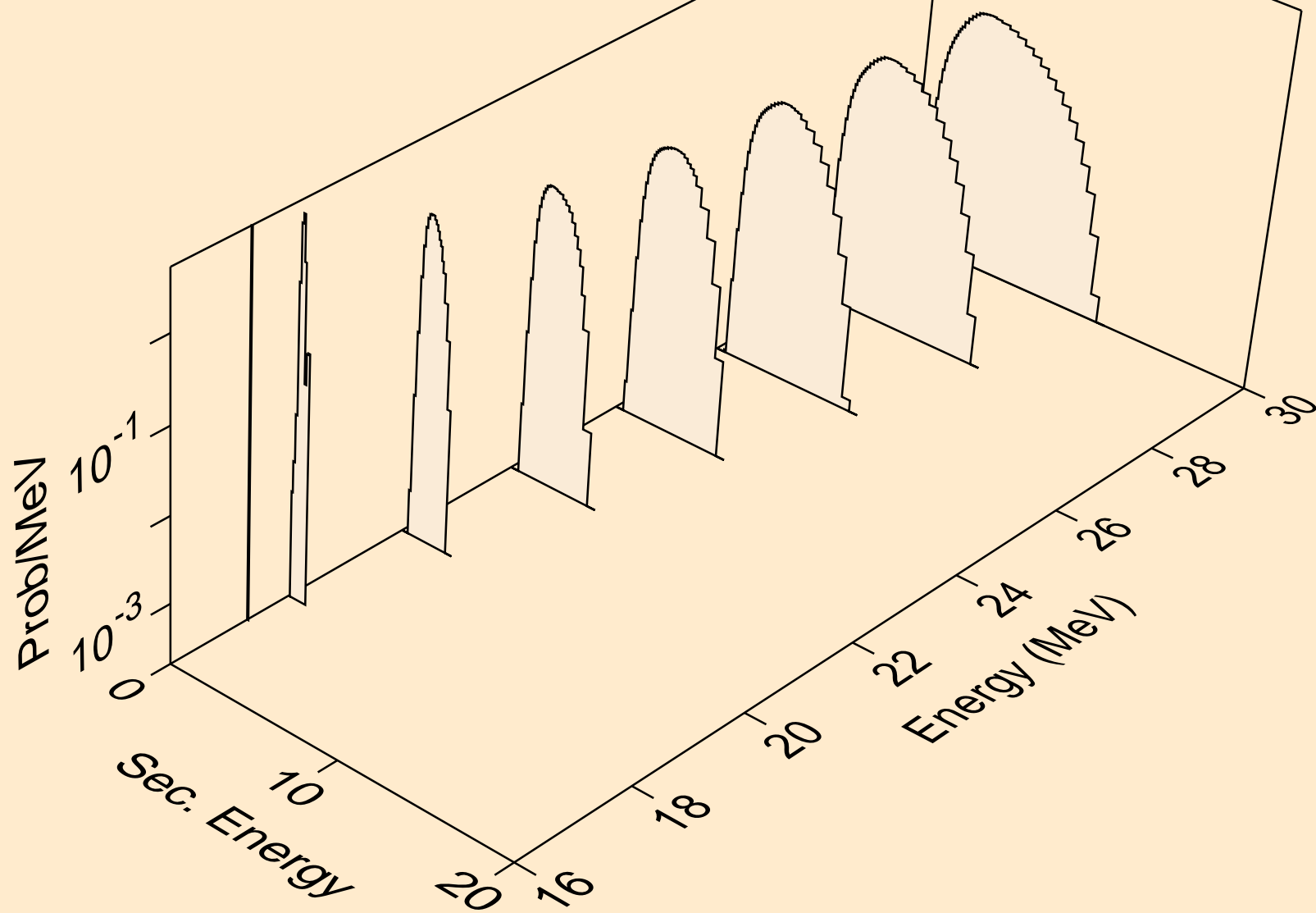

AR041 HELION ACER TENDL-2024 LIBRARY; T=0.K
protons from (s,n2p)

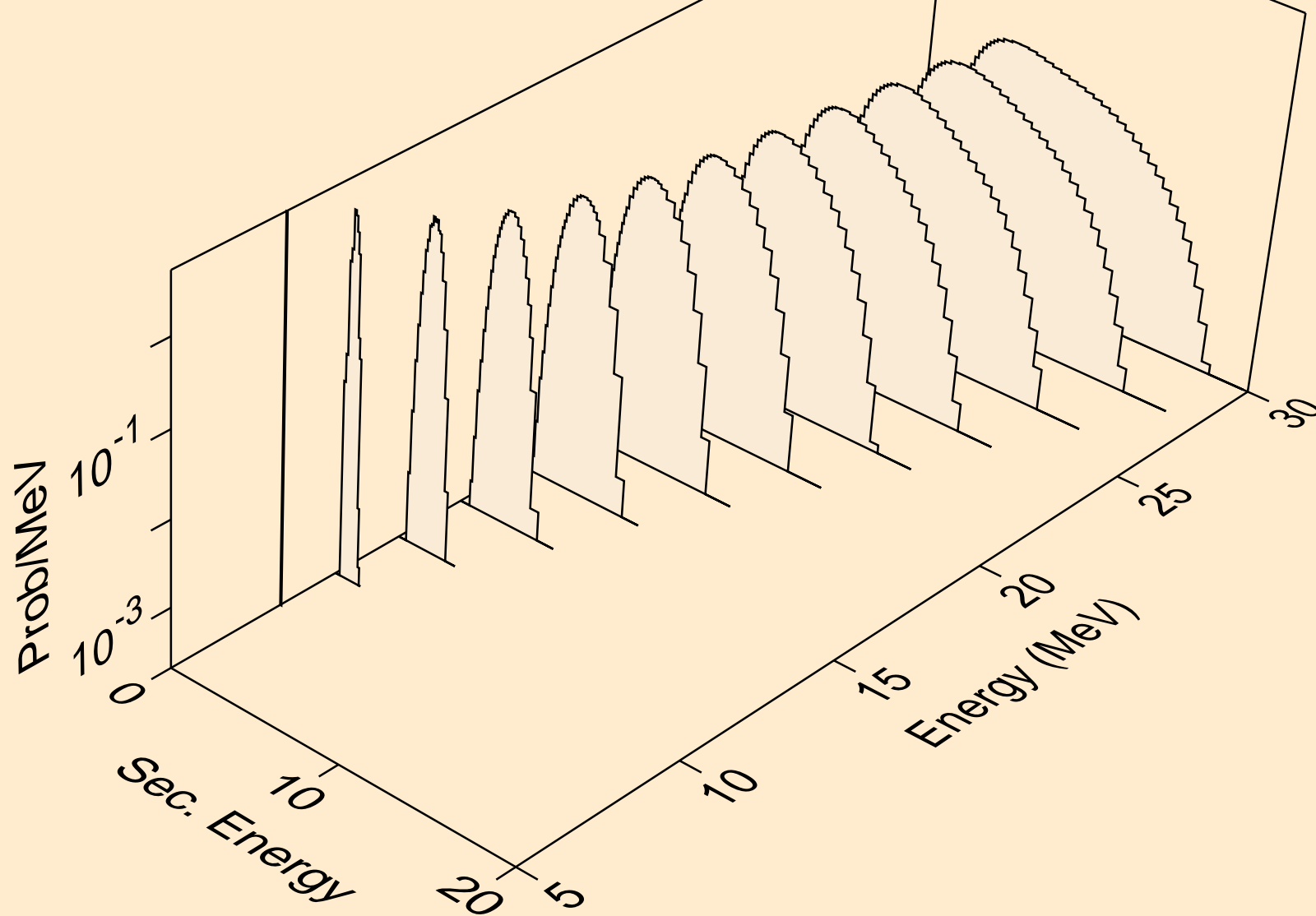

AR041 HELION ACER TENDL-2024 LIBRARY; T=0.K
protons from (s,npa)

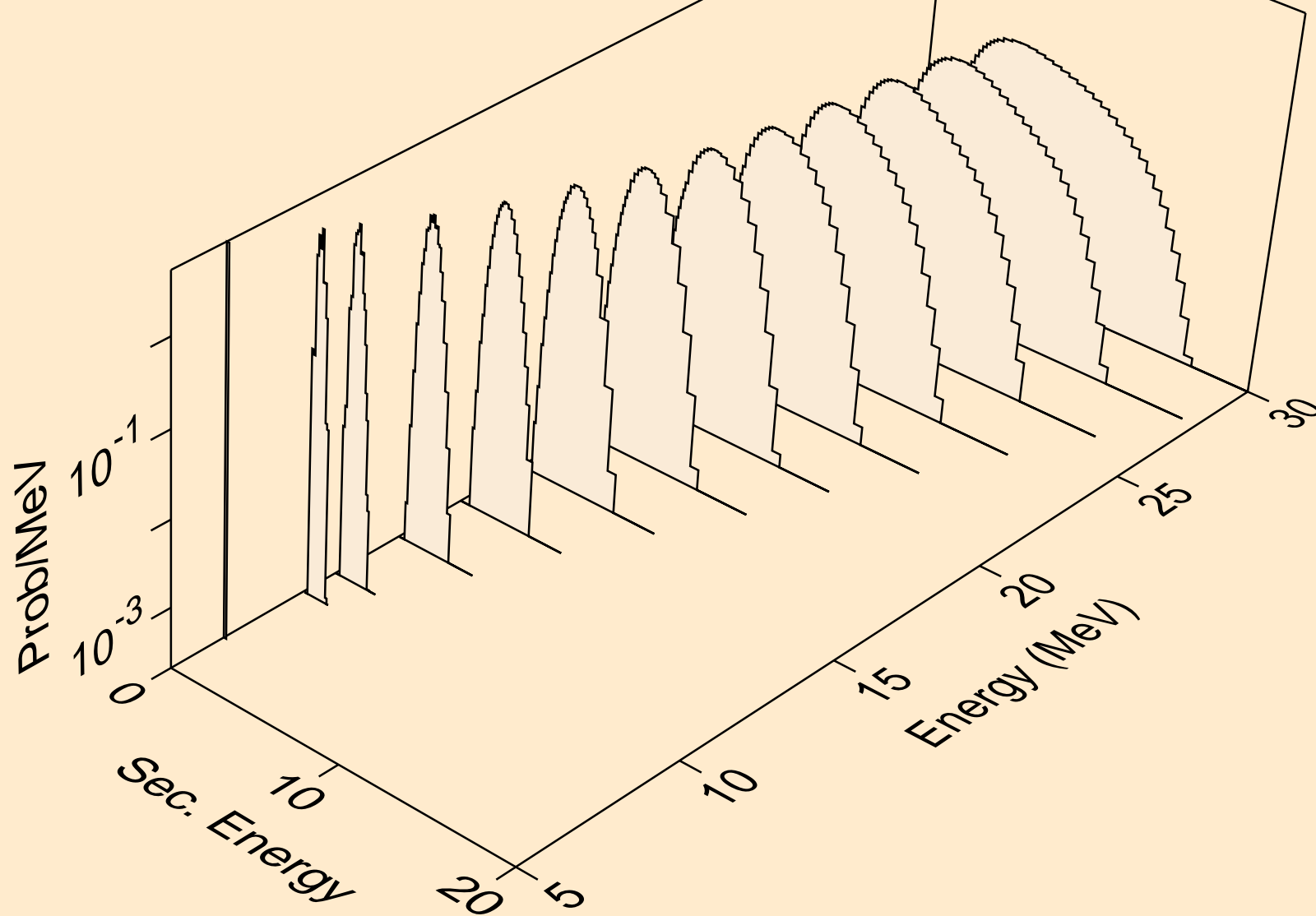

AR041 HELION ACER TENDL-2024 LIBRARY; T=0.K
protons from (s,p)

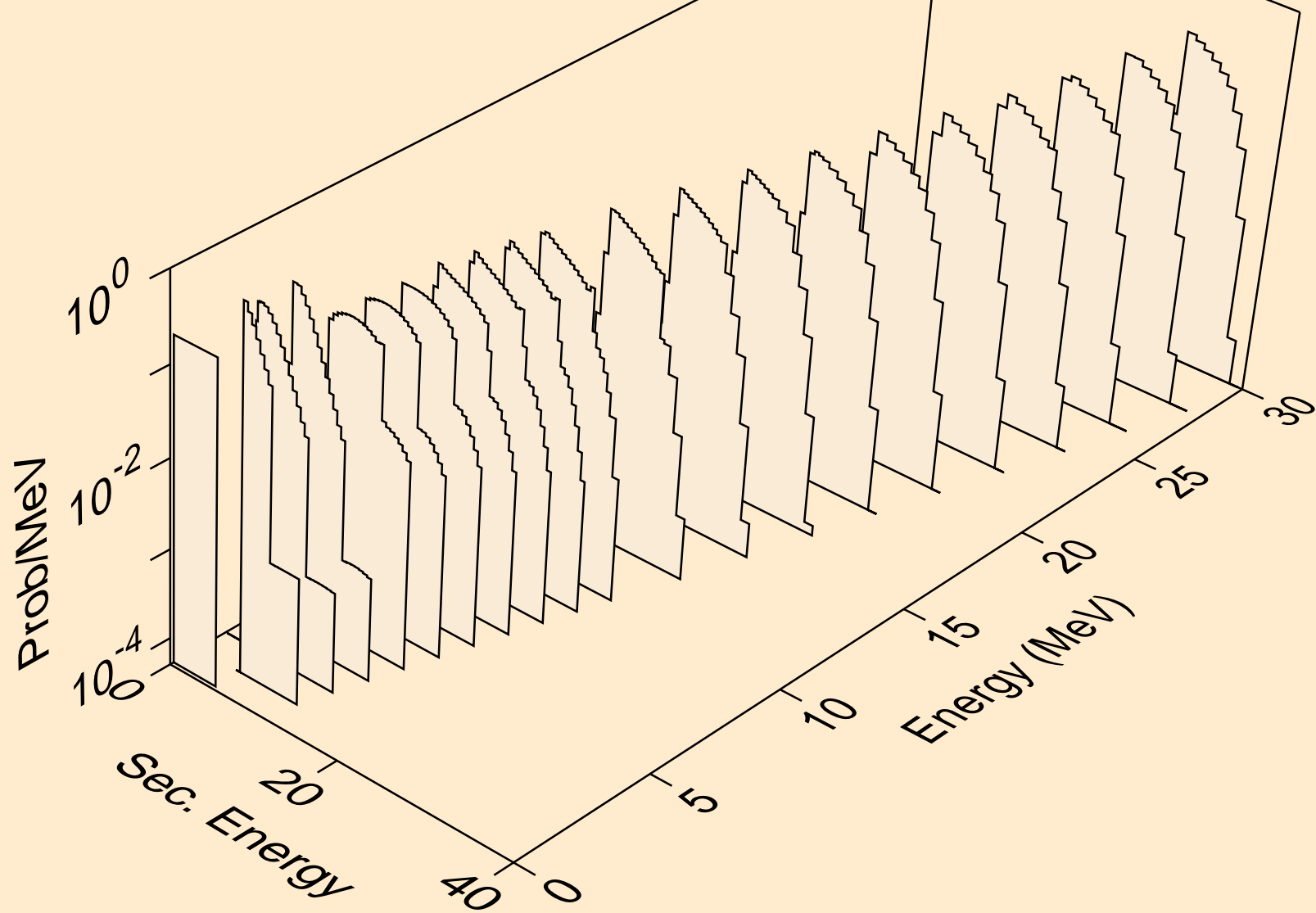

AR041 HELION ACER TENDL-2024 LIBRARY; T=0.K
protons from (s,2p)

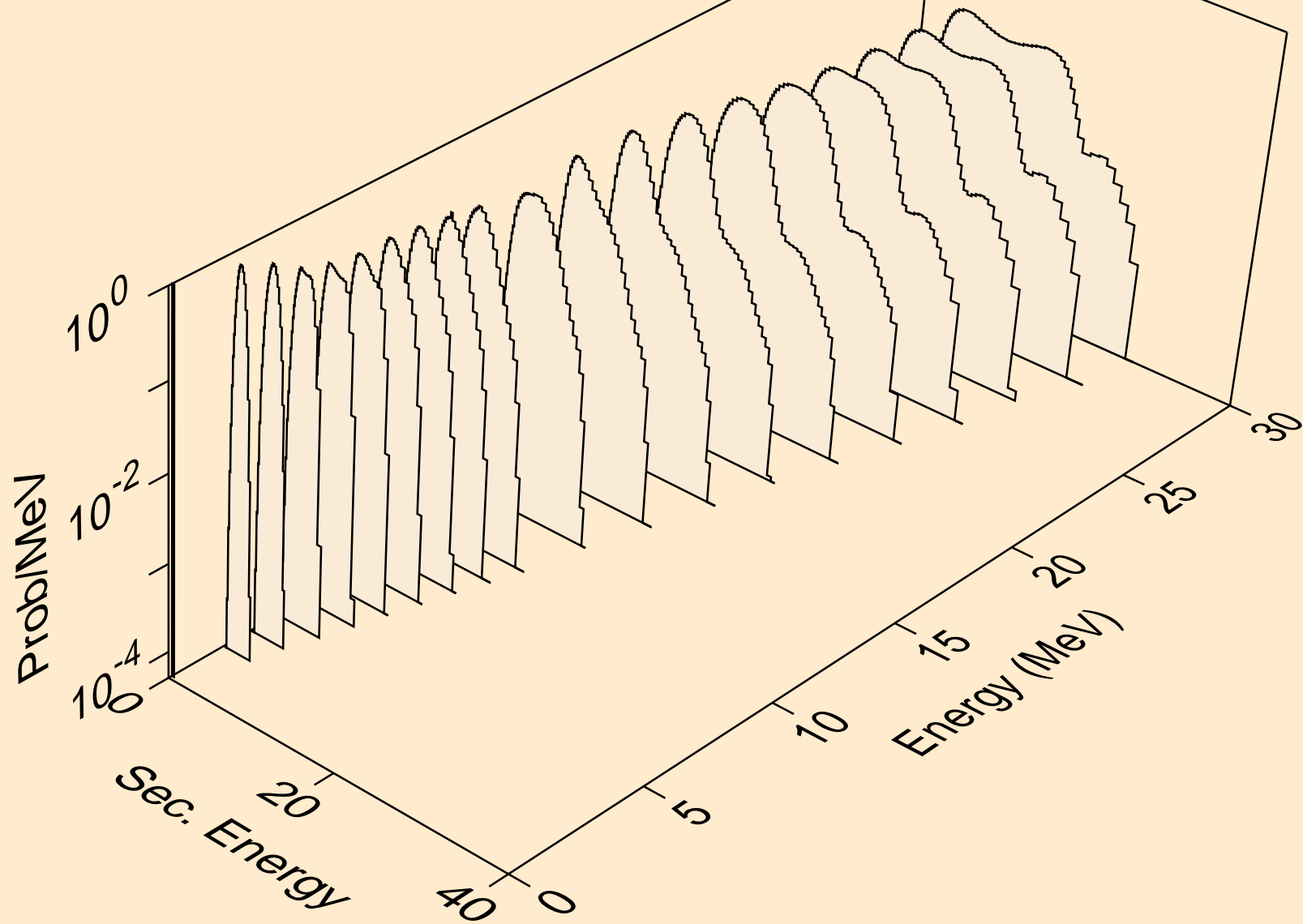

AR041 HELION ACER TENDL-2024 LIBRARY; T=0.K
protons from (s,pa)

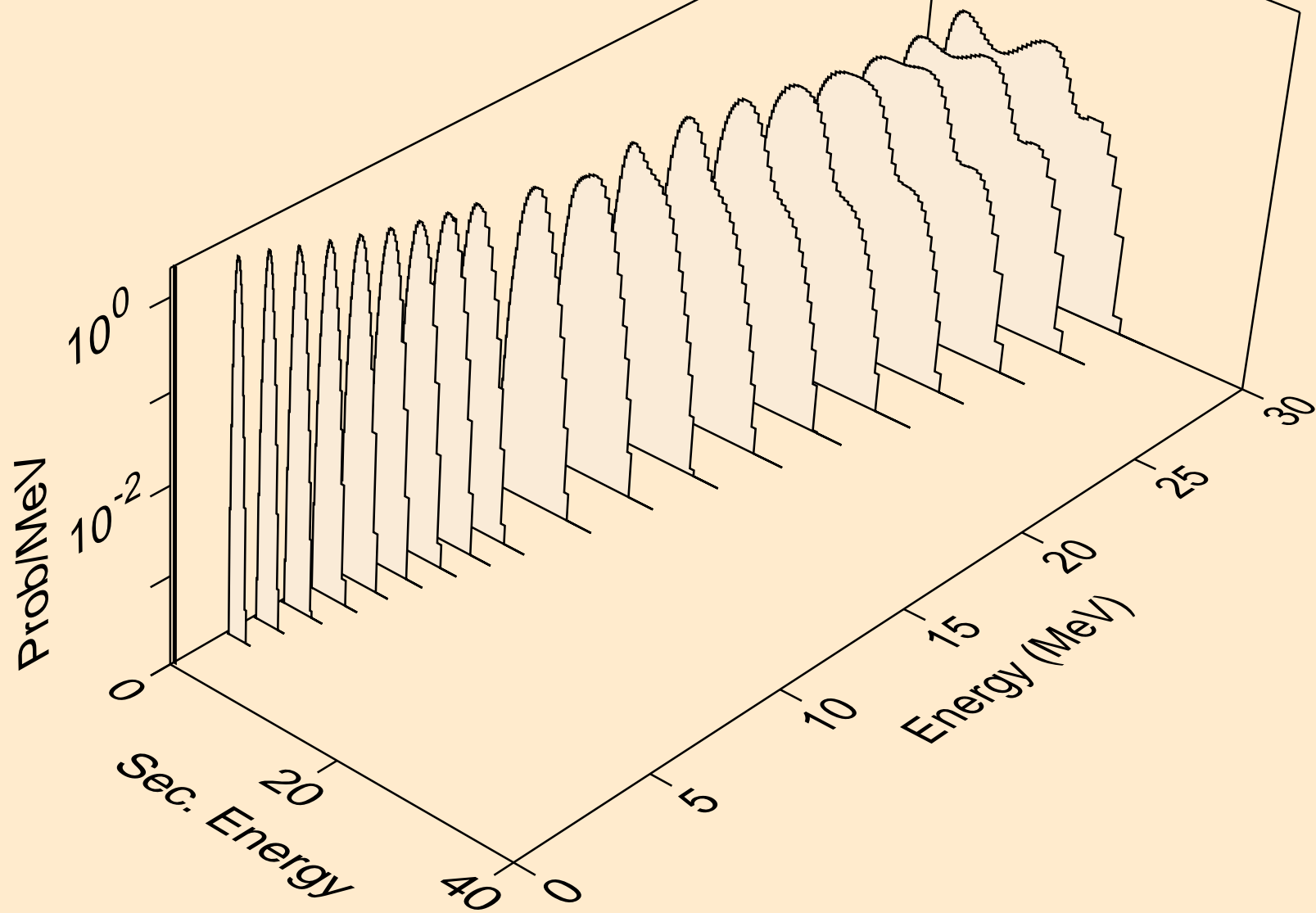

AR041 HELION ACER TENDL-2024 LIBRARY; T=0.K
protons from (s,pd)

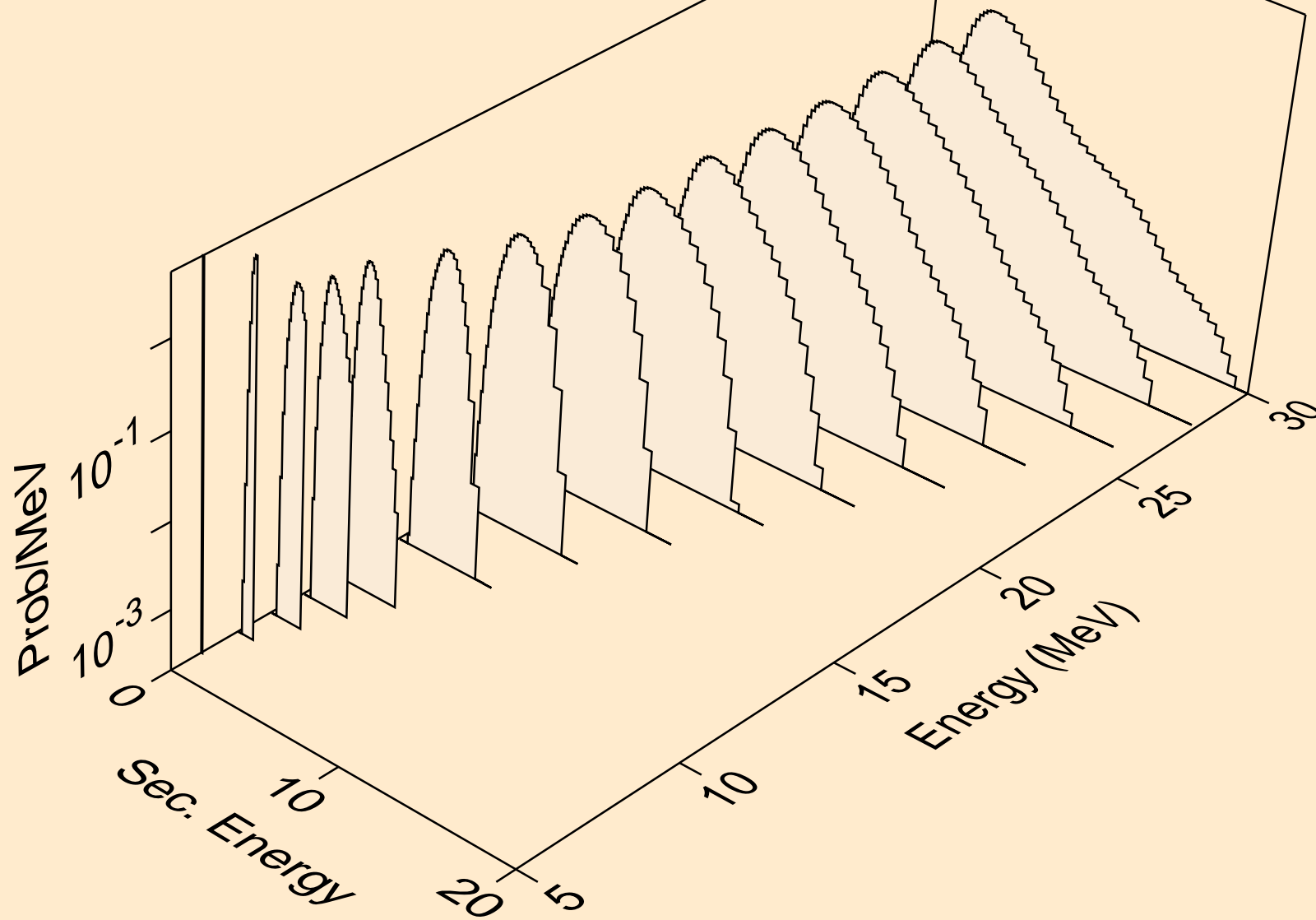

AR041 HELION ACER TENDL-2024 LIBRARY; T=0.K
protons from (s,pt)

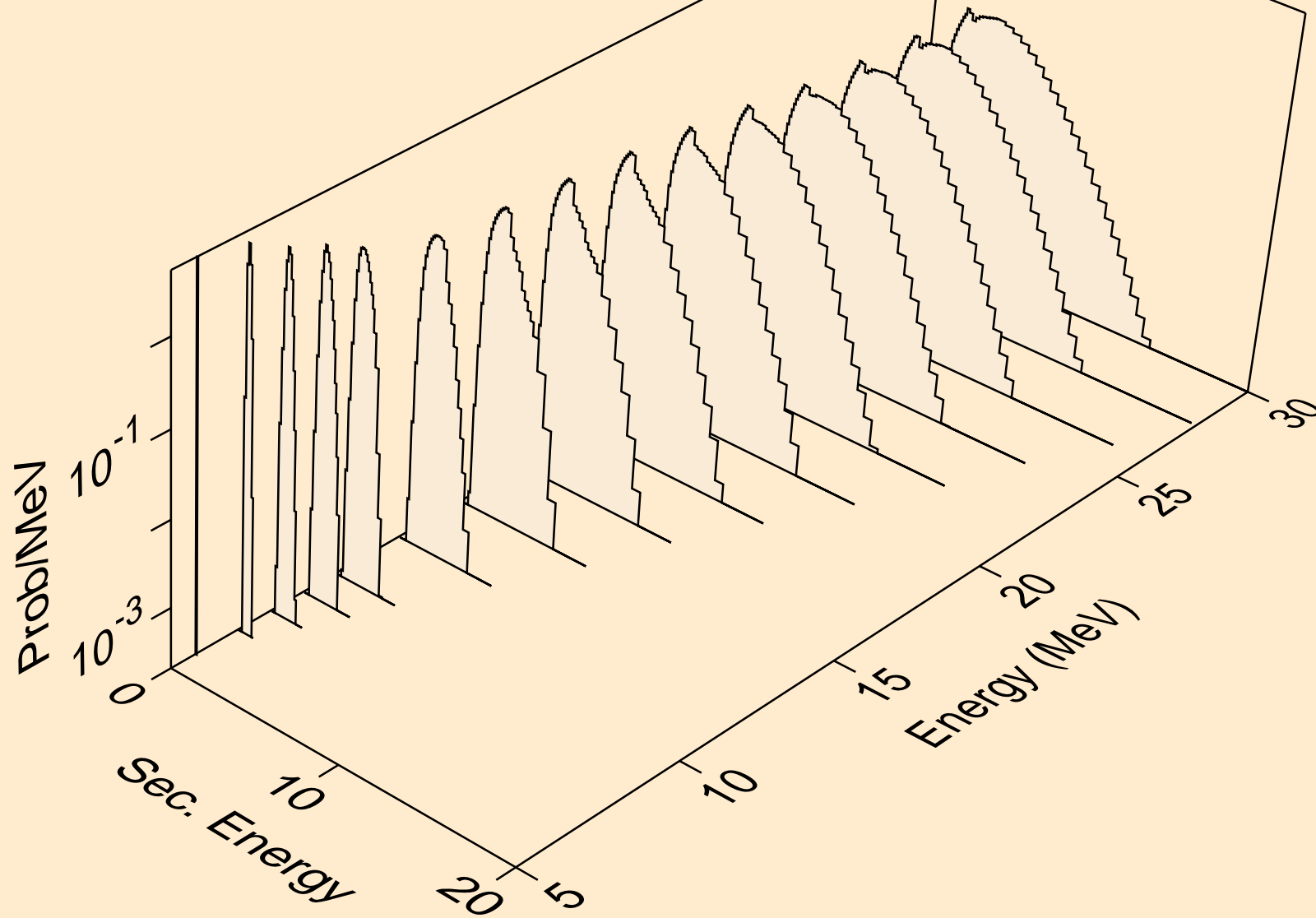

AR041 HELION ACER TENDL-2024 LIBRARY; T=0.K
deuterons from (s,x)

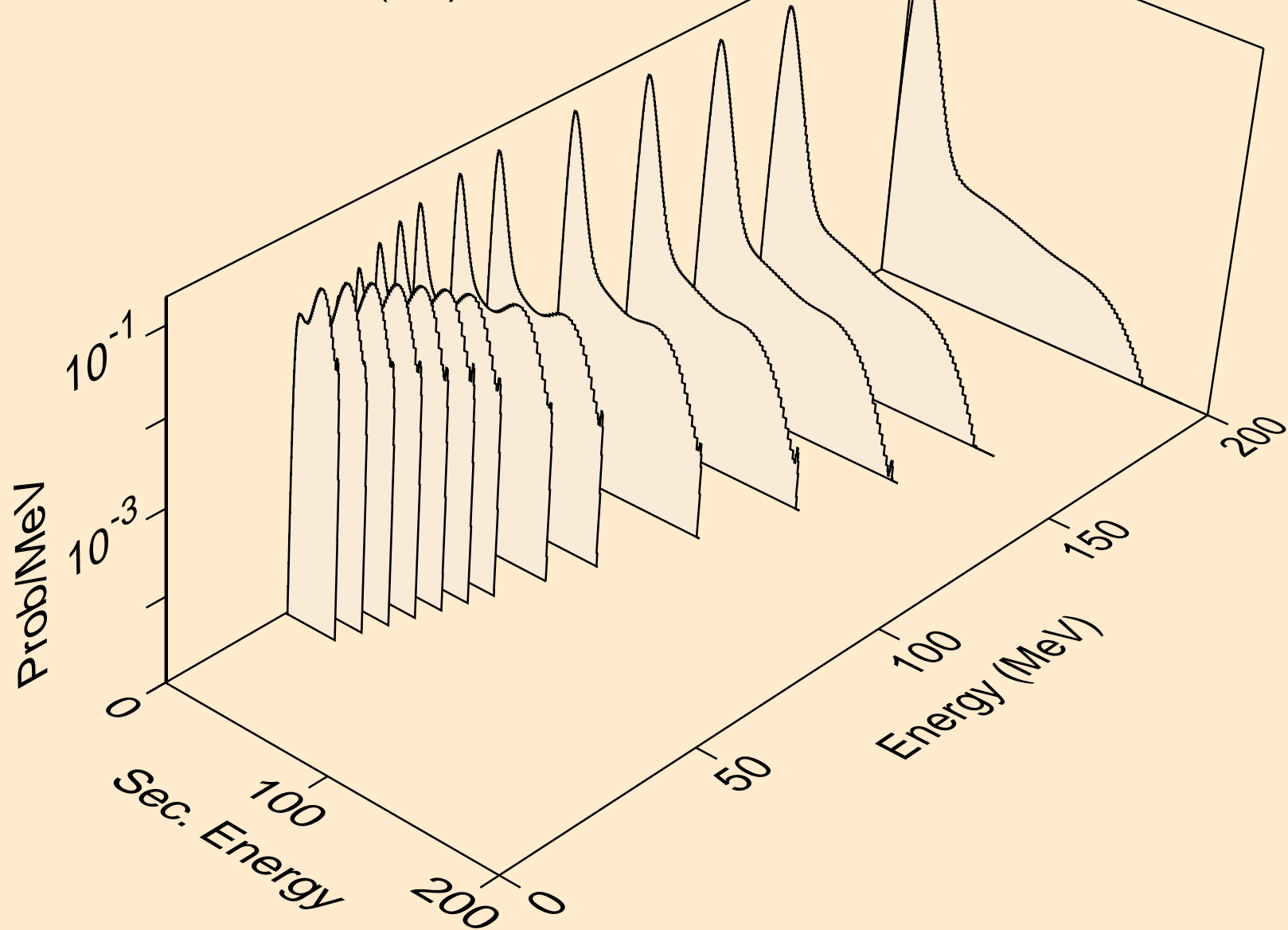

AR041 HELION ACER TENDL-2024 LIBRARY; T=0.K
deuterons from (s,2nd)

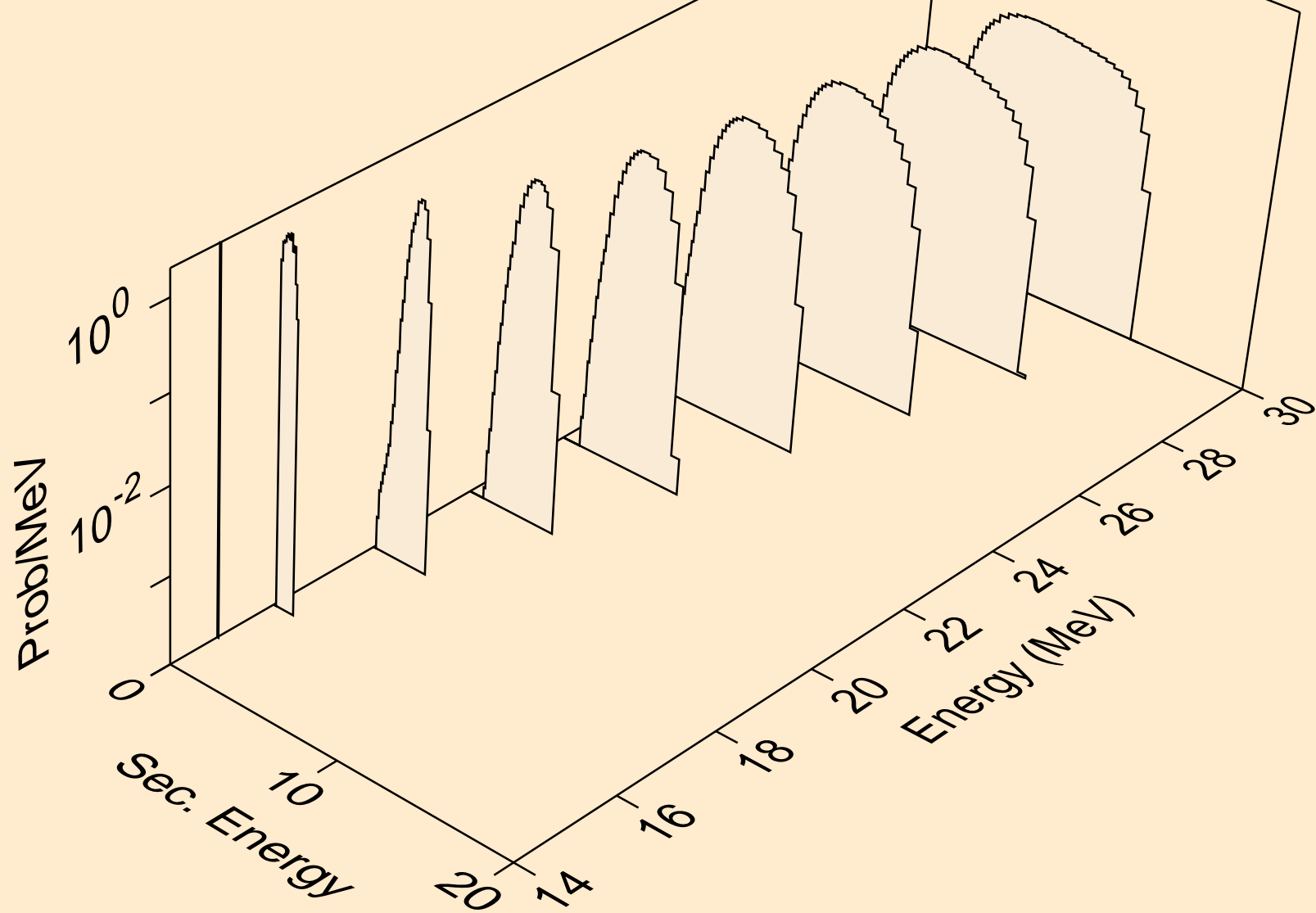

AR041 HELION ACER TENDL-2024 LIBRARY; T=0.K
deuterons from (s,n*)d

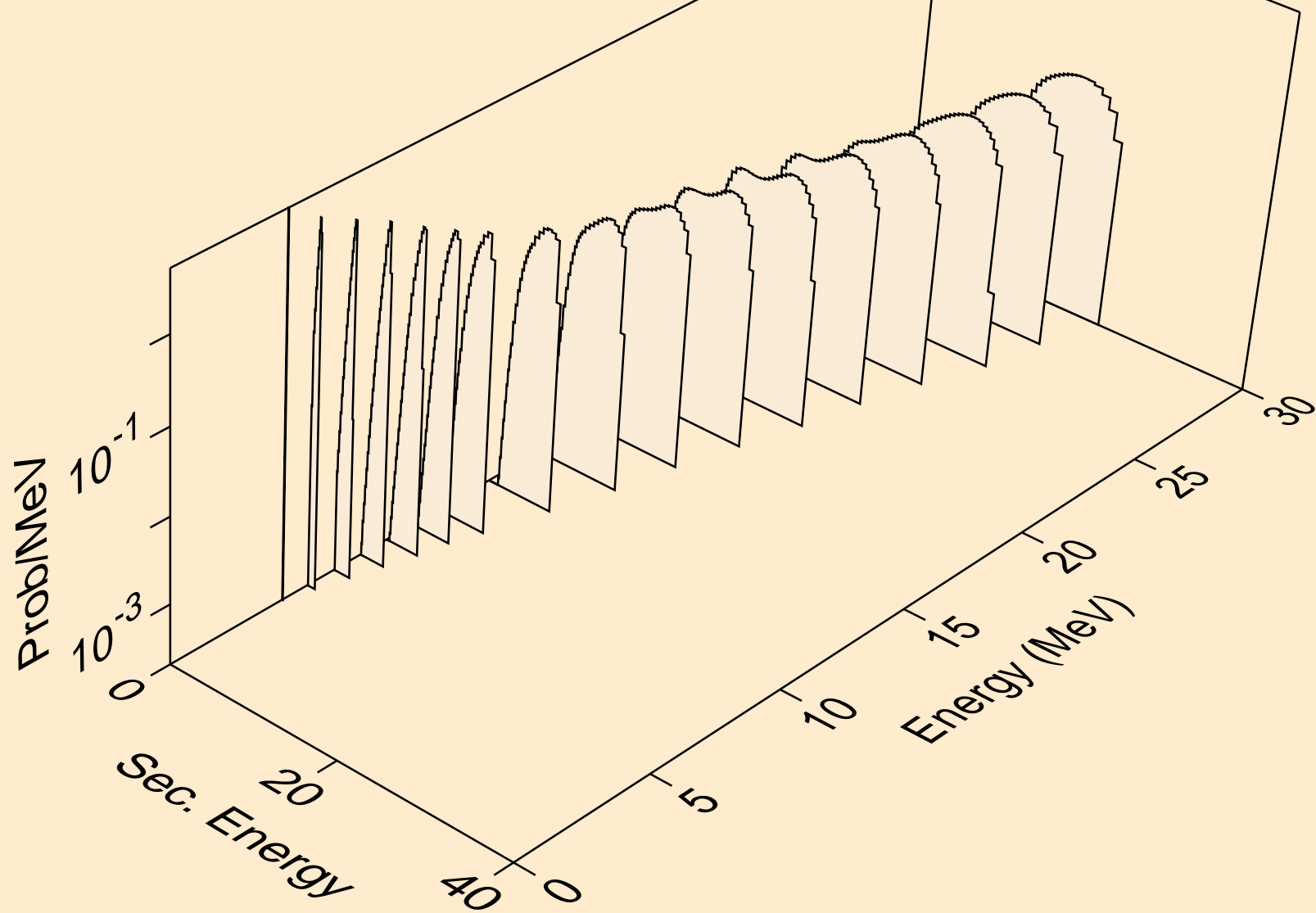

AR041 HELION ACER TENDL-2024 LIBRARY; T=0.K
deuterons from (s,d)

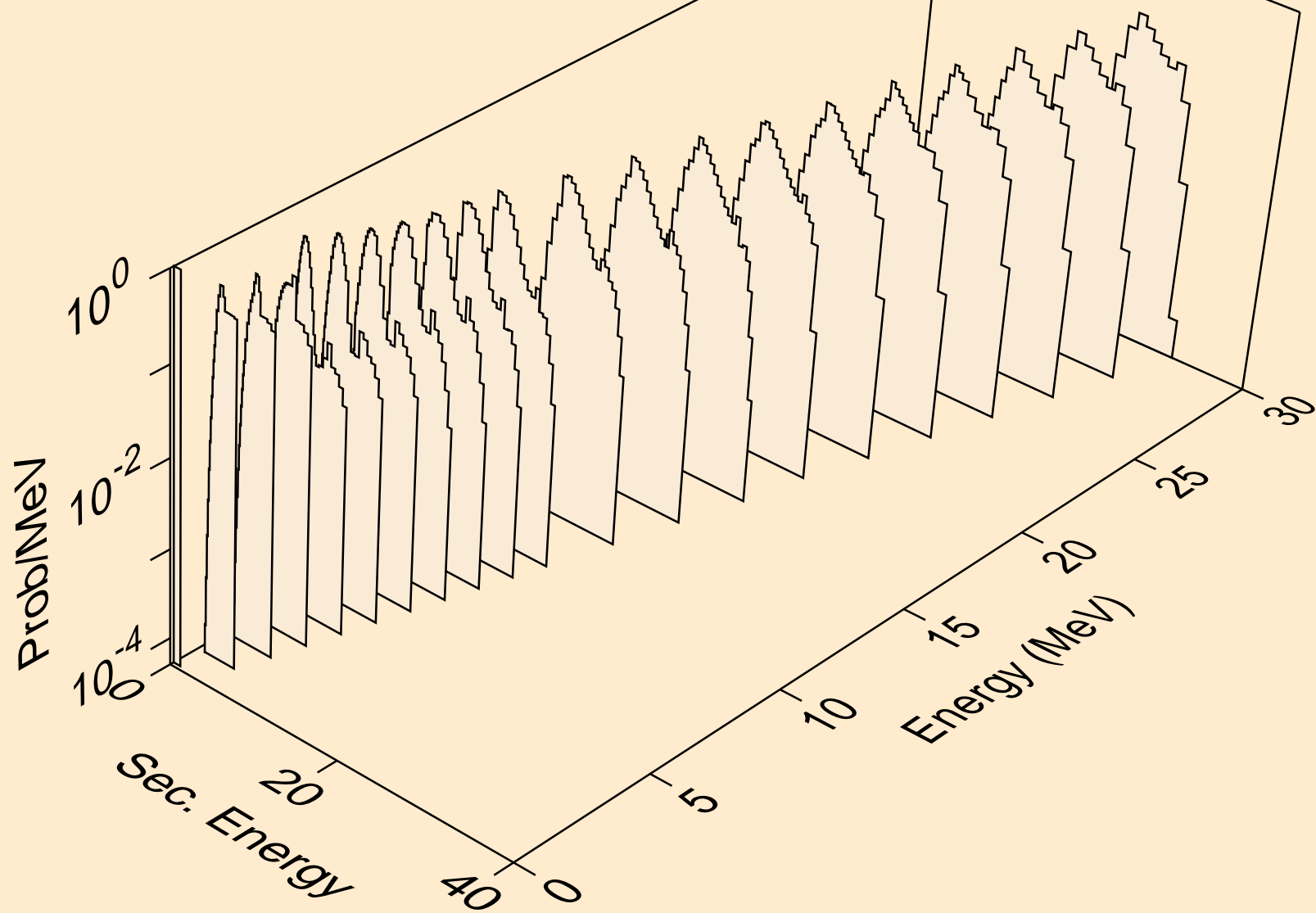

AR041 HELION ACER TENDL-2024 LIBRARY; T=0.K
deuterons from (s,d2a)

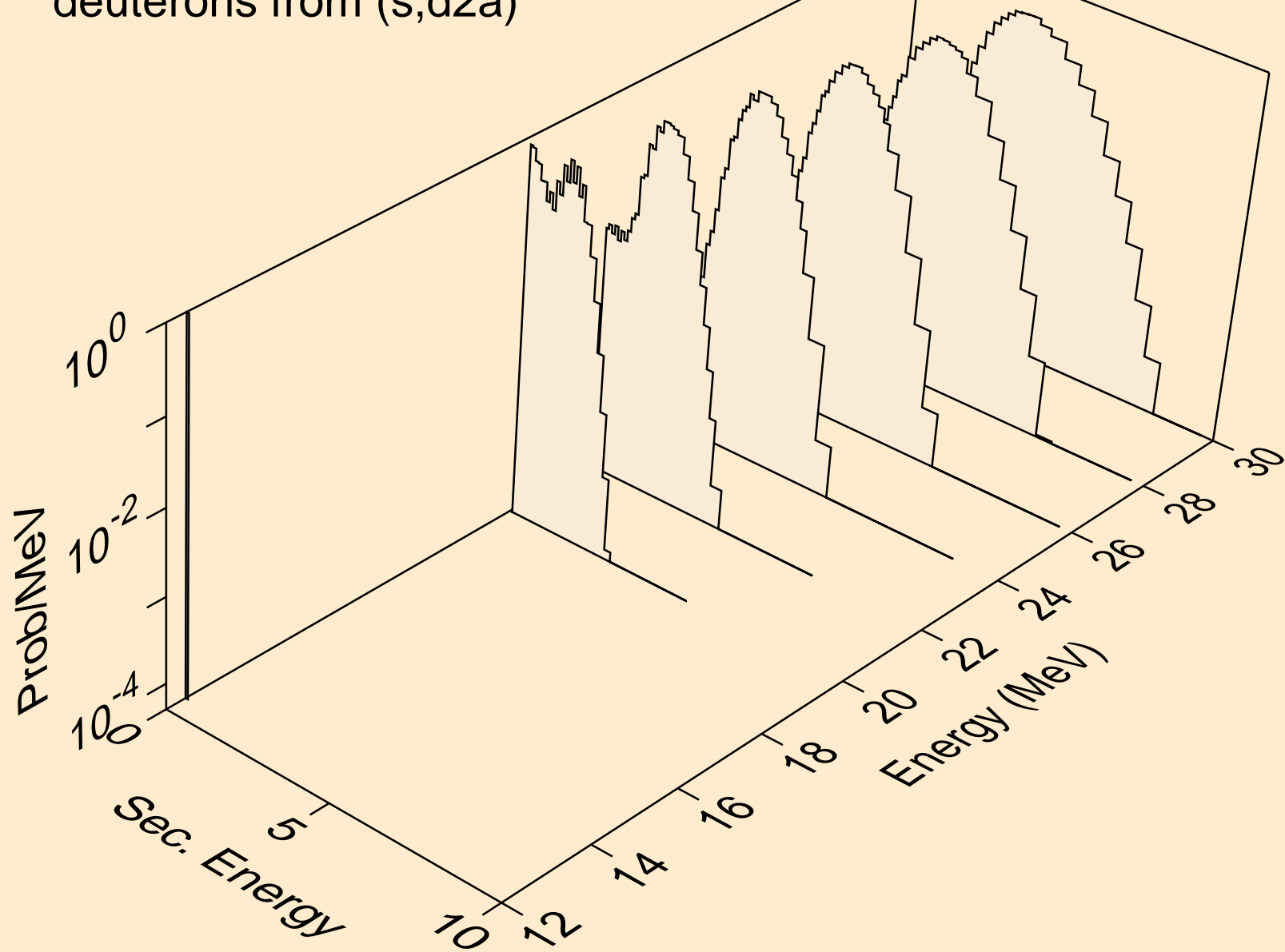

AR041 HELION ACER TENDL-2024 LIBRARY; T=0.K
deuterons from (s,pd)

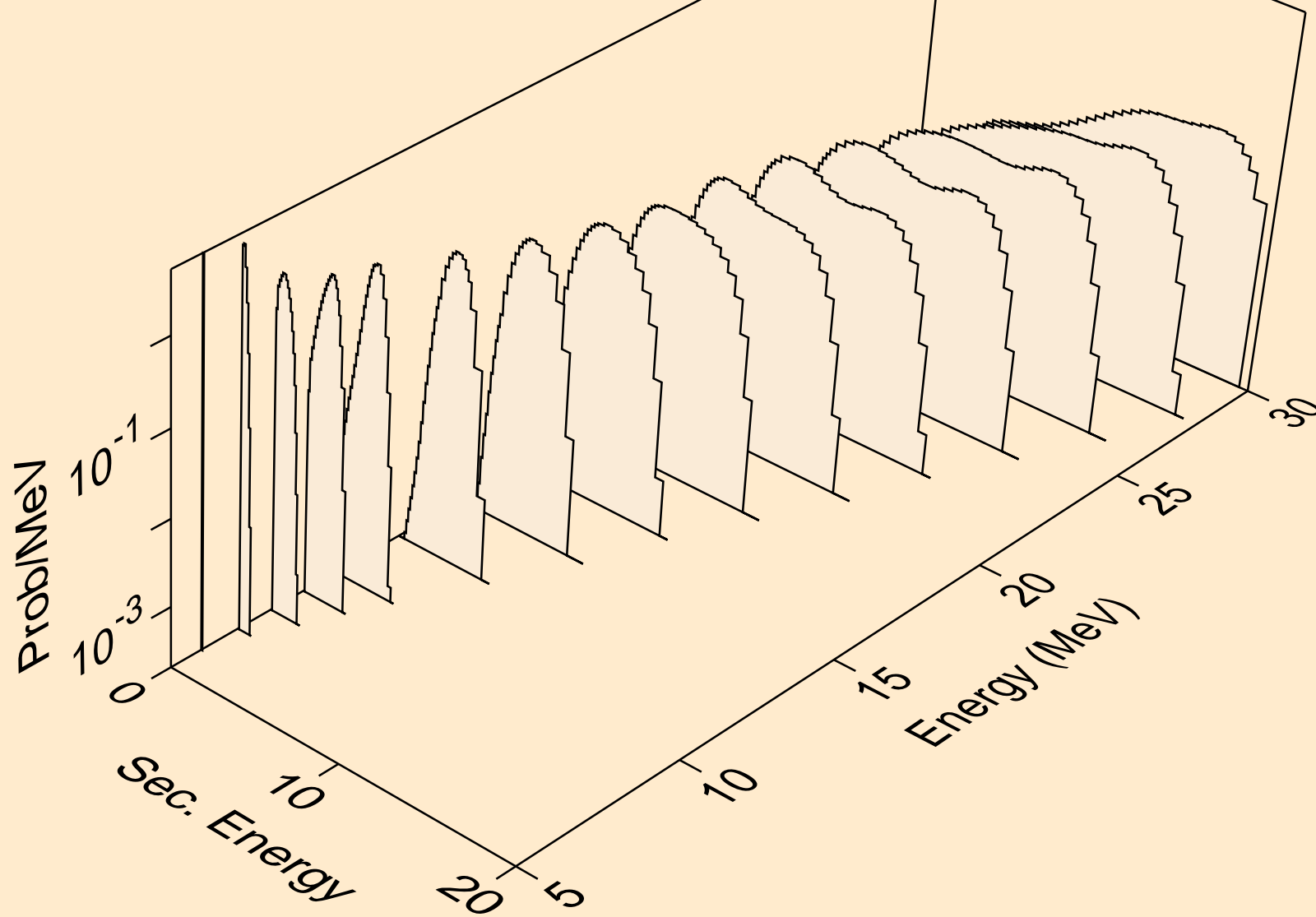

AR041 HELION ACER TENDL-2024 LIBRARY; T=0.K
deuterons from (s,da)

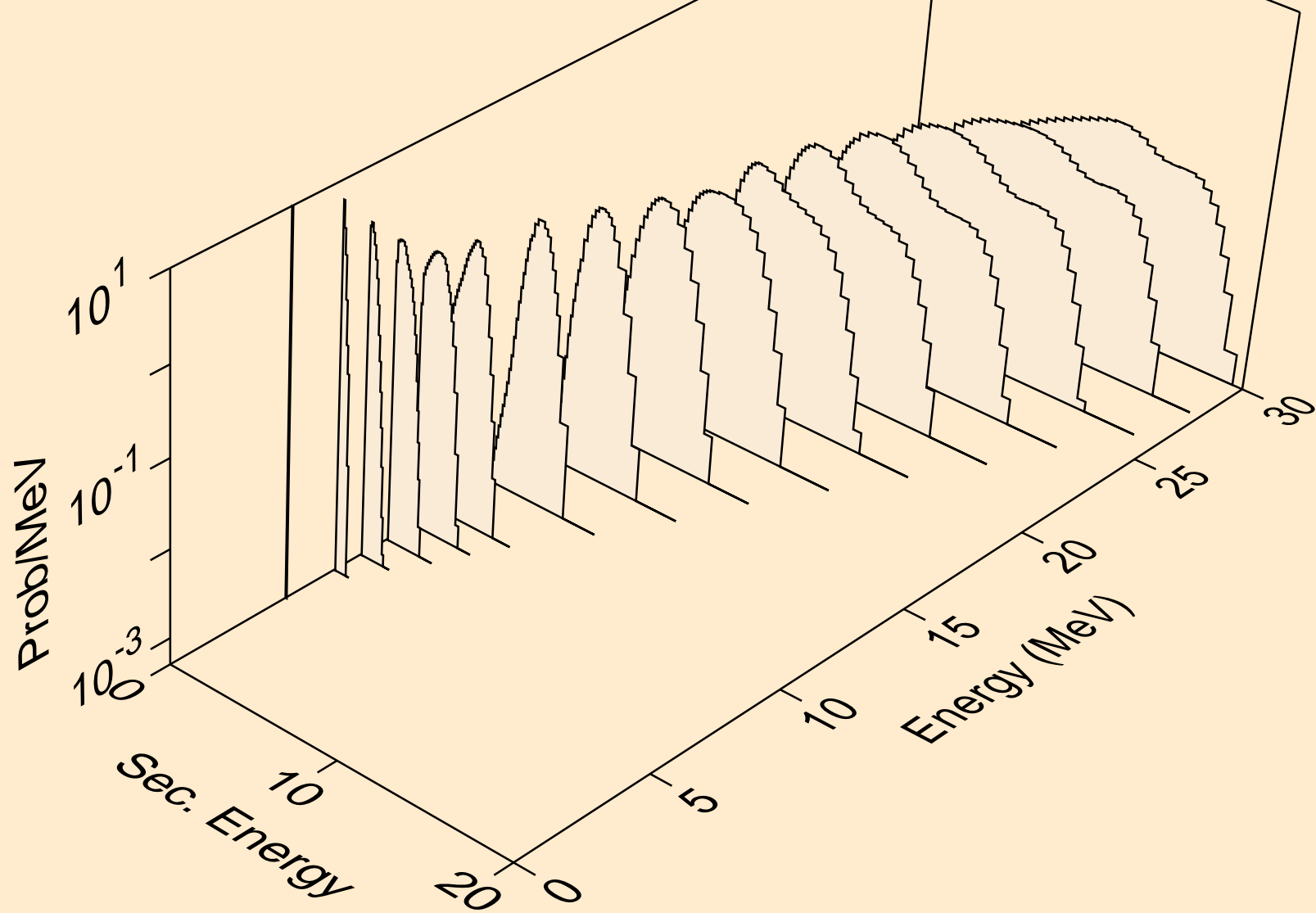

AR041 HELION ACER TENDL-2024 LIBRARY; T=0.K
tritons from (s,x)

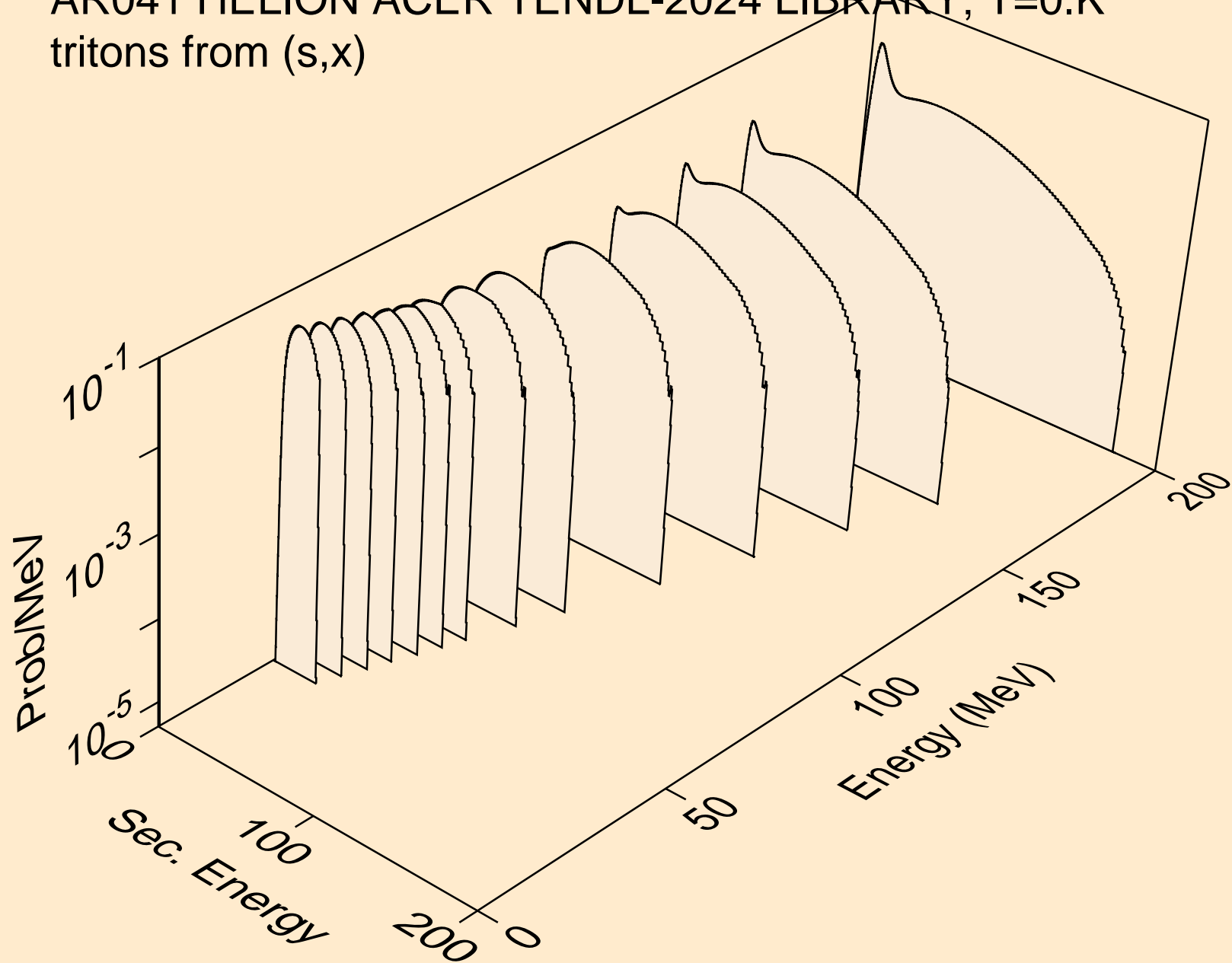

AR041 HELION ACER TENDL-2024 LIBRARY; T=0.K
tritons from (s,n*)t

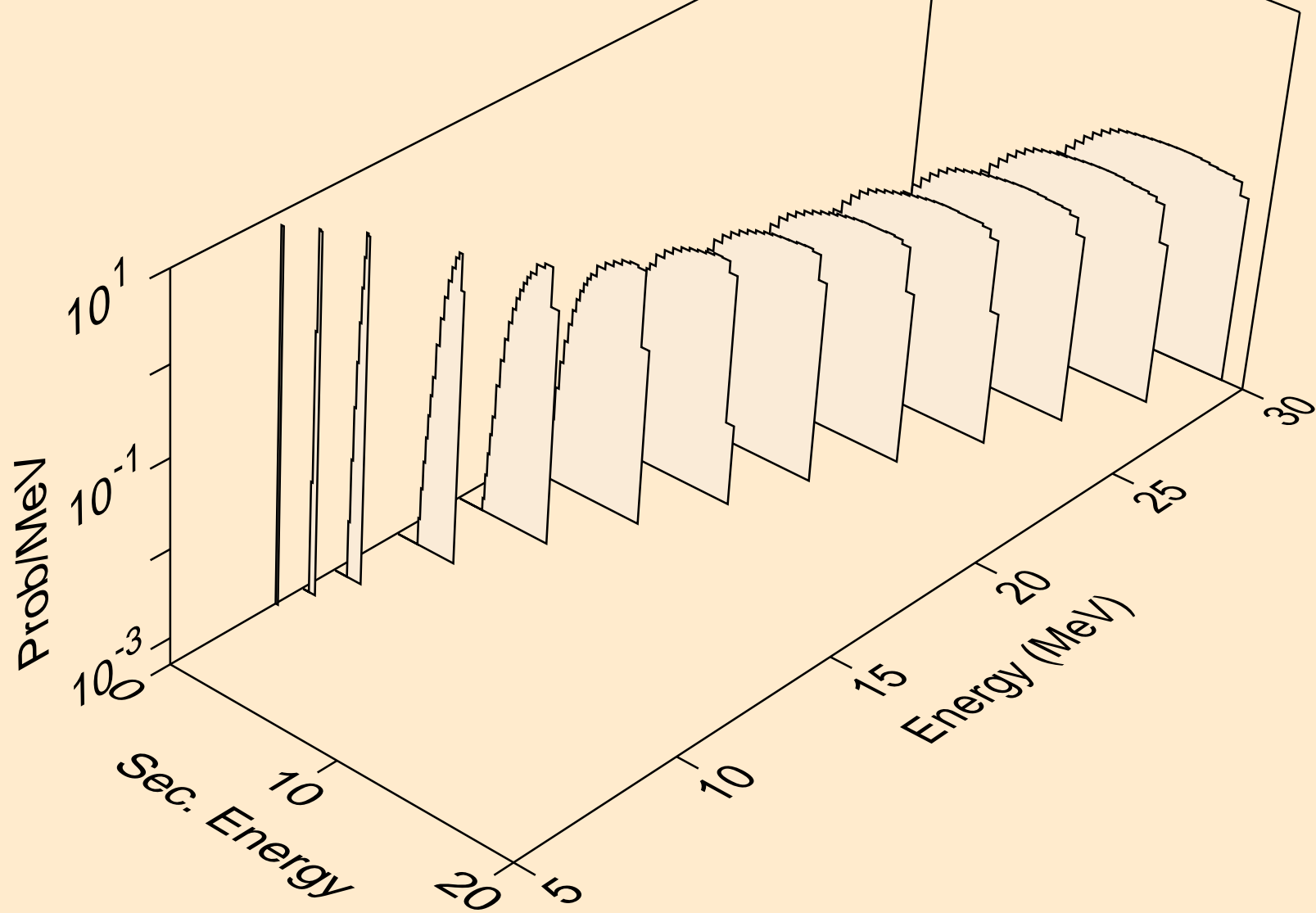

AR041 HELION ACER TENDL-2024 LIBRARY; T=0.K
tritons from (s,t)

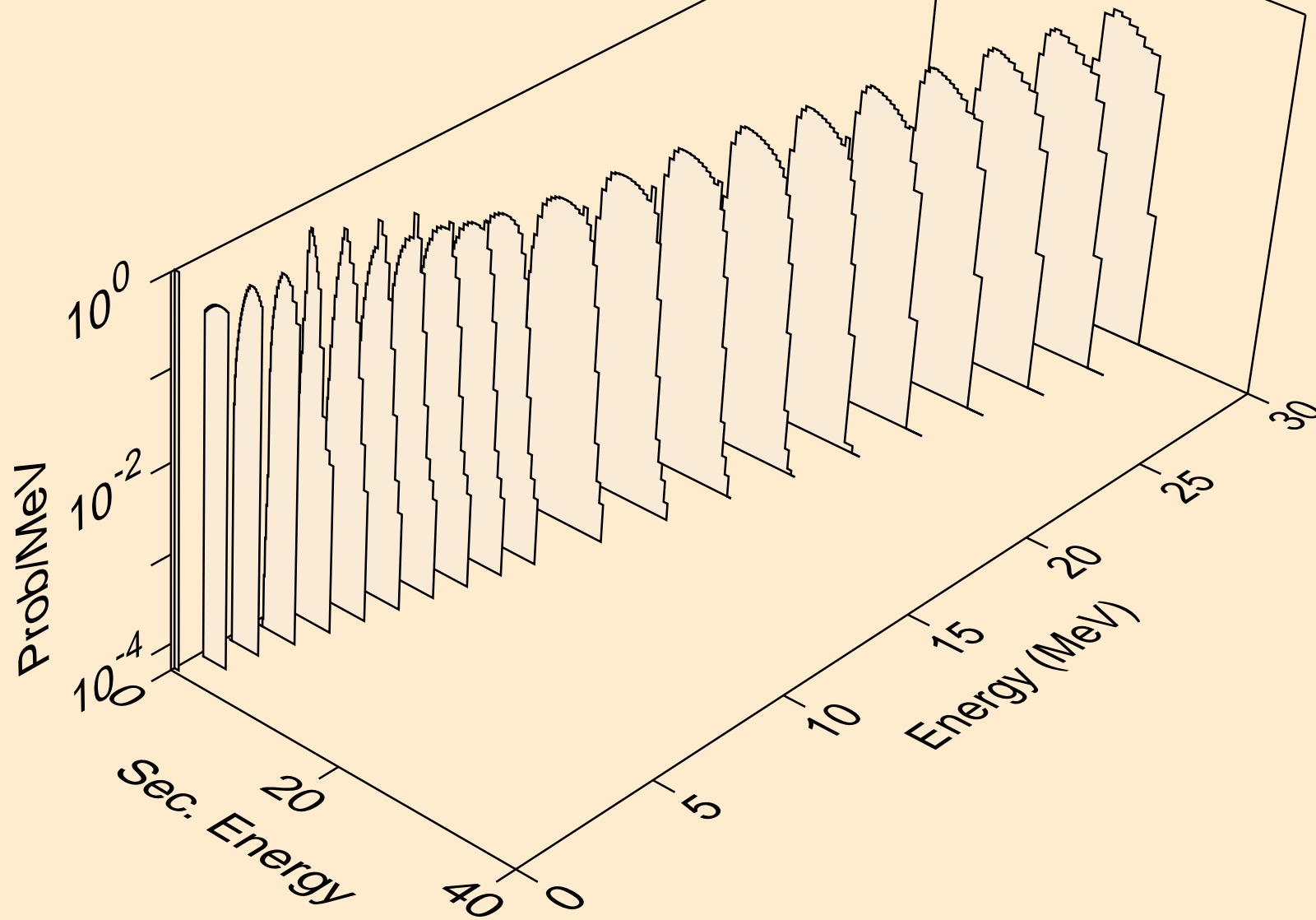

AR041 HELION ACER TENDL-2024 LIBRARY; T=0.K
tritons from (s,t2a)

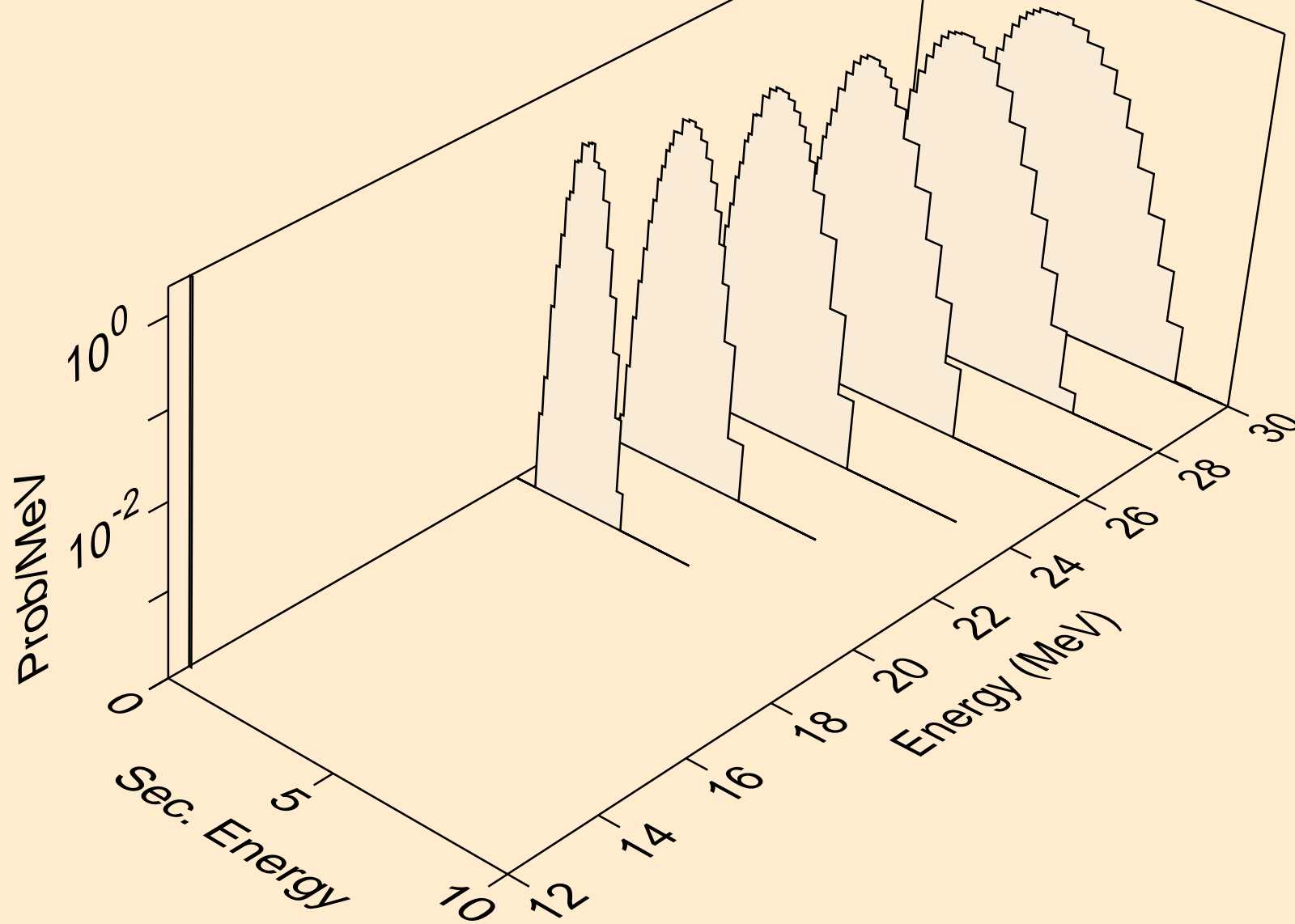

AR041 HELION ACER TENDL-2024 LIBRARY; T=0.K
tritons from (s,pt)

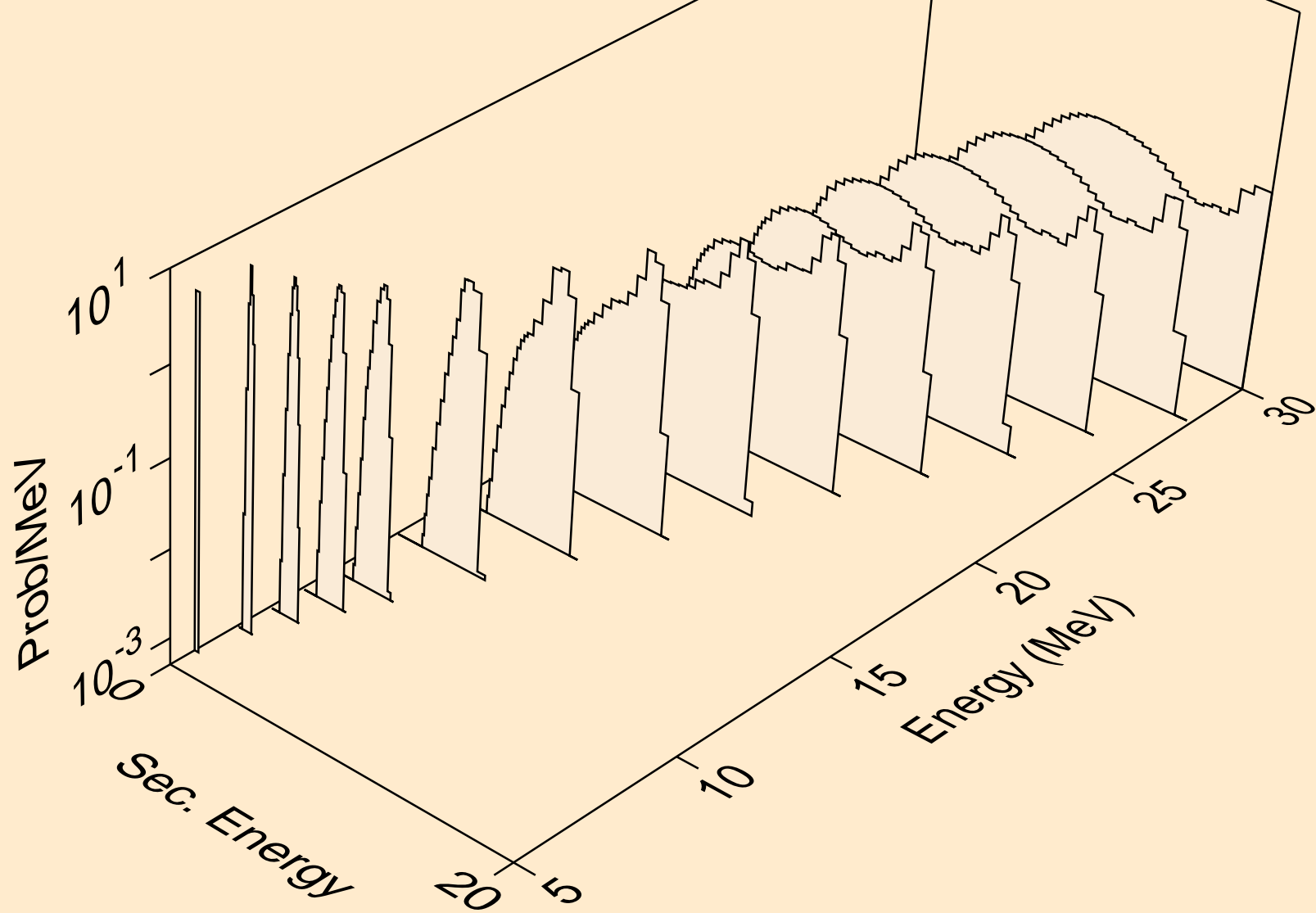

AR041 HELION ACER TENDL-2024 LIBRARY; T=0.K
alphas from (s,x)

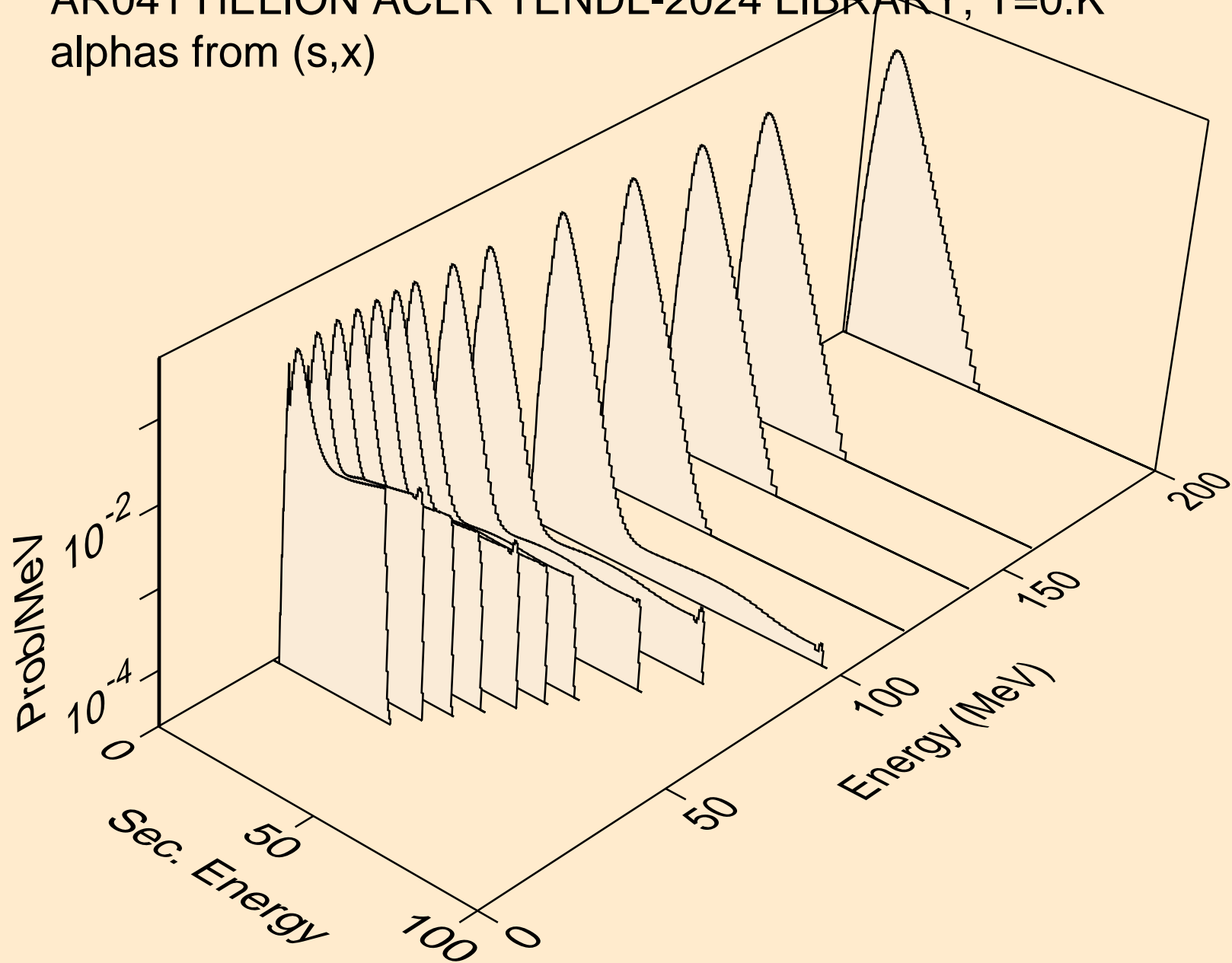

AR041 HELION ACER TENDL-2024 LIBRARY; T=0.K
alphas from (s,n*)a

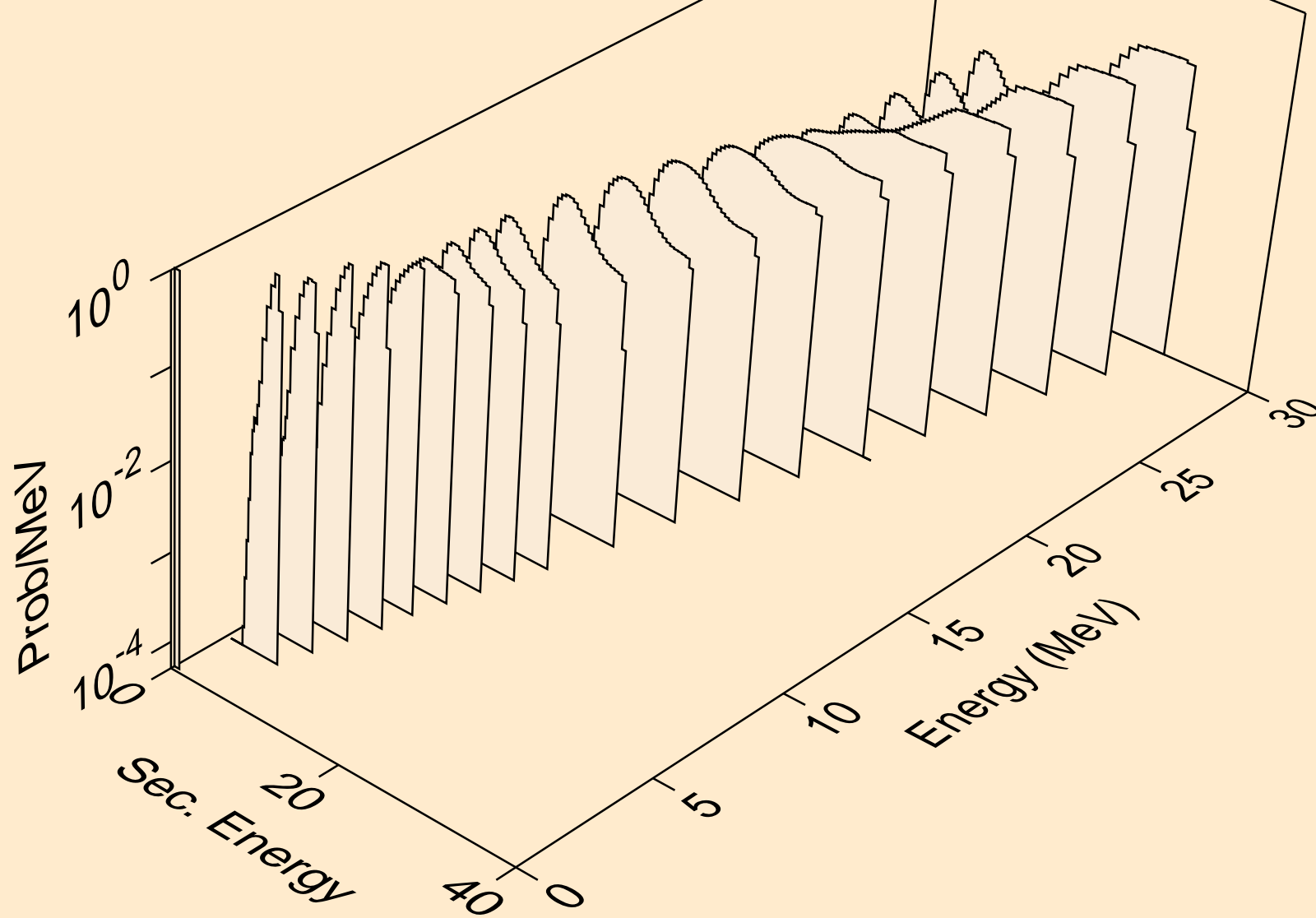

AR041 HELION ACER TENDL-2024 LIBRARY; T=0.K
alphas from (s,n*)3a

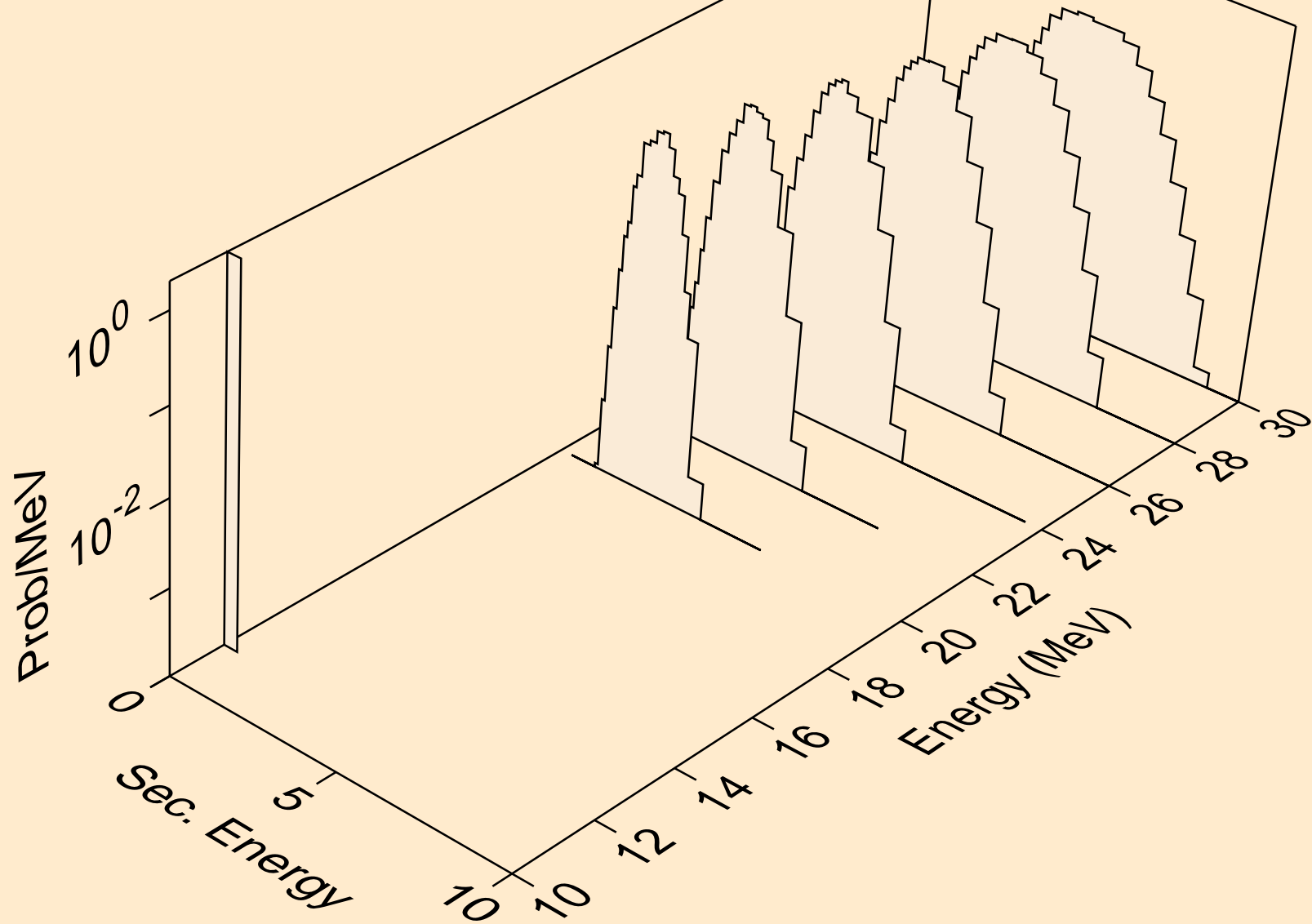

AR041 HELION ACER TENDL-2024 LIBRARY; T=0.K
alphas from (s,2n)a

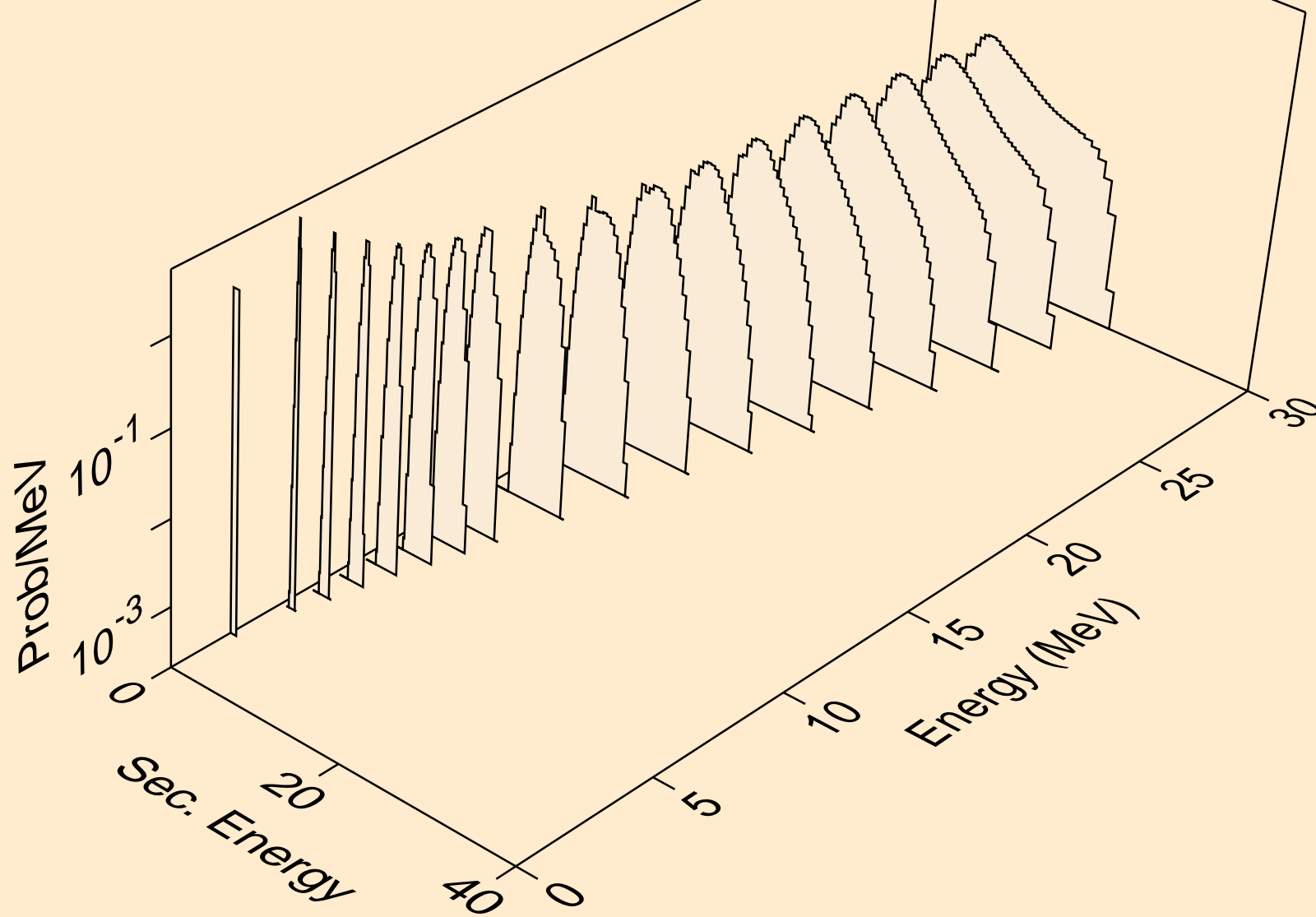

AR041 HELION ACER TENDL-2024 LIBRARY; T=0.K
alphas from (s,3n)a

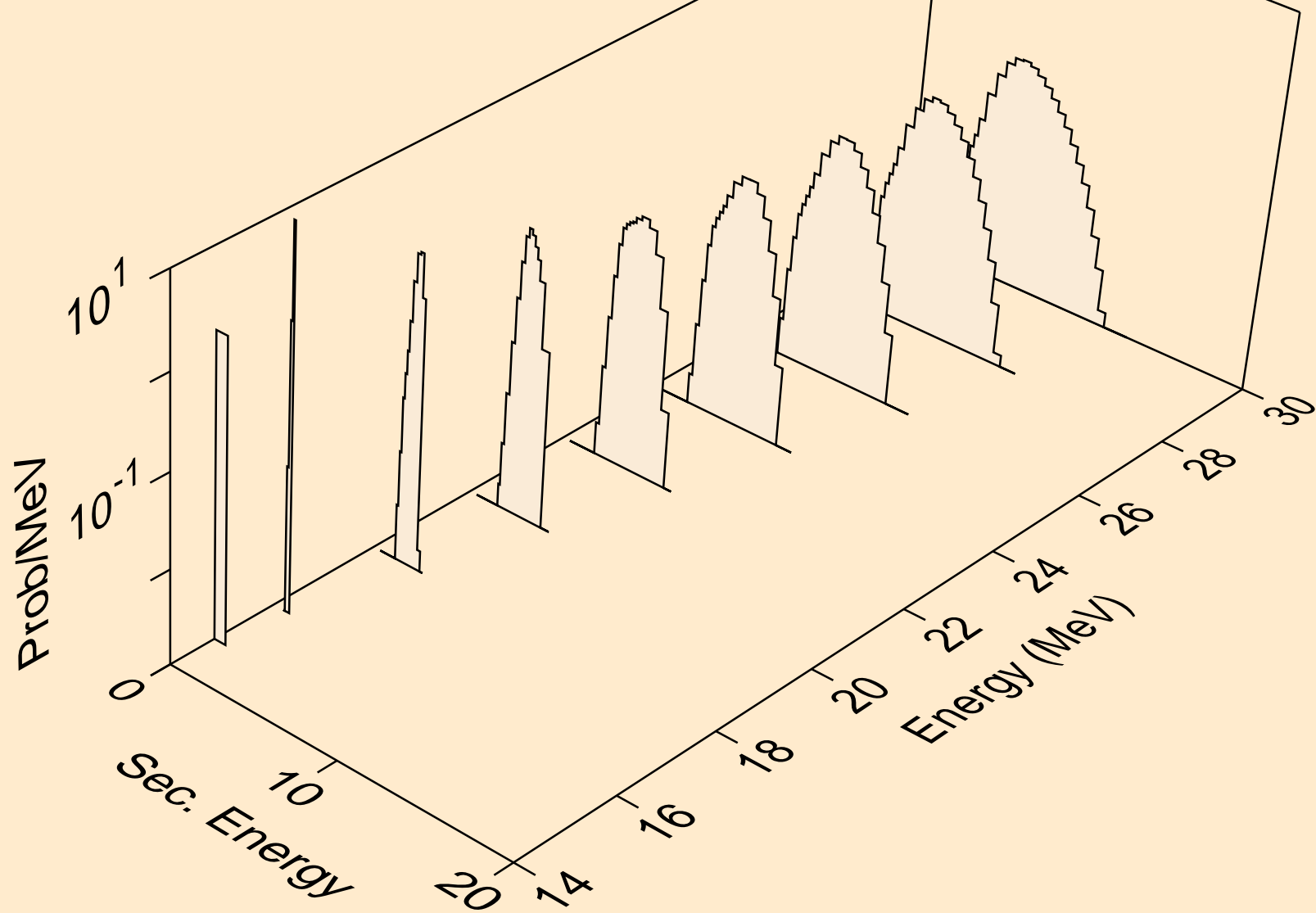

AR041 HELION ACER TENDL-2024 LIBRARY; T=0.K
alphas from (s,n*)2a

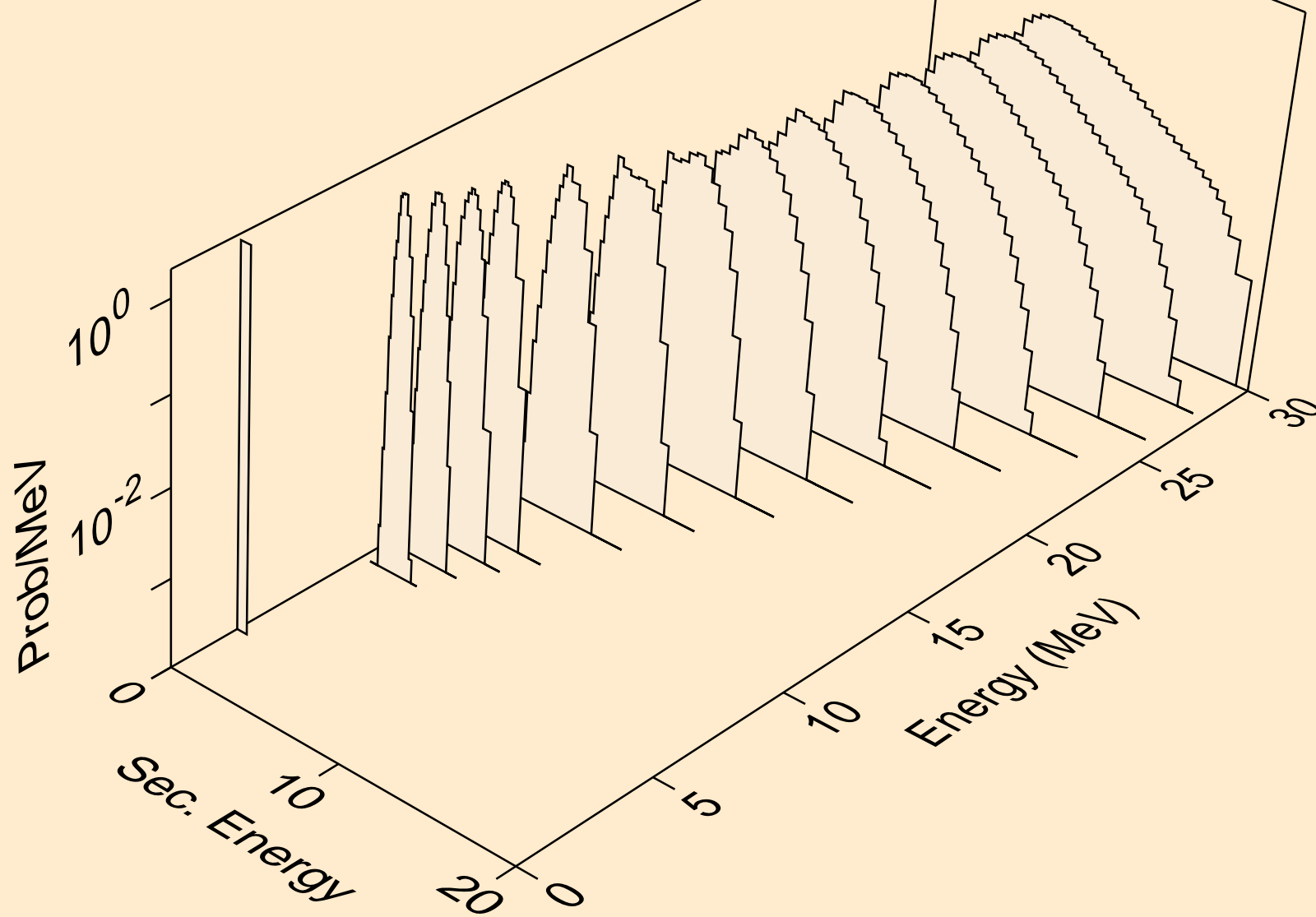

AR041 HELION ACER TENDL-2024 LIBRARY; T=0.K
alphas from (s,2n)2a

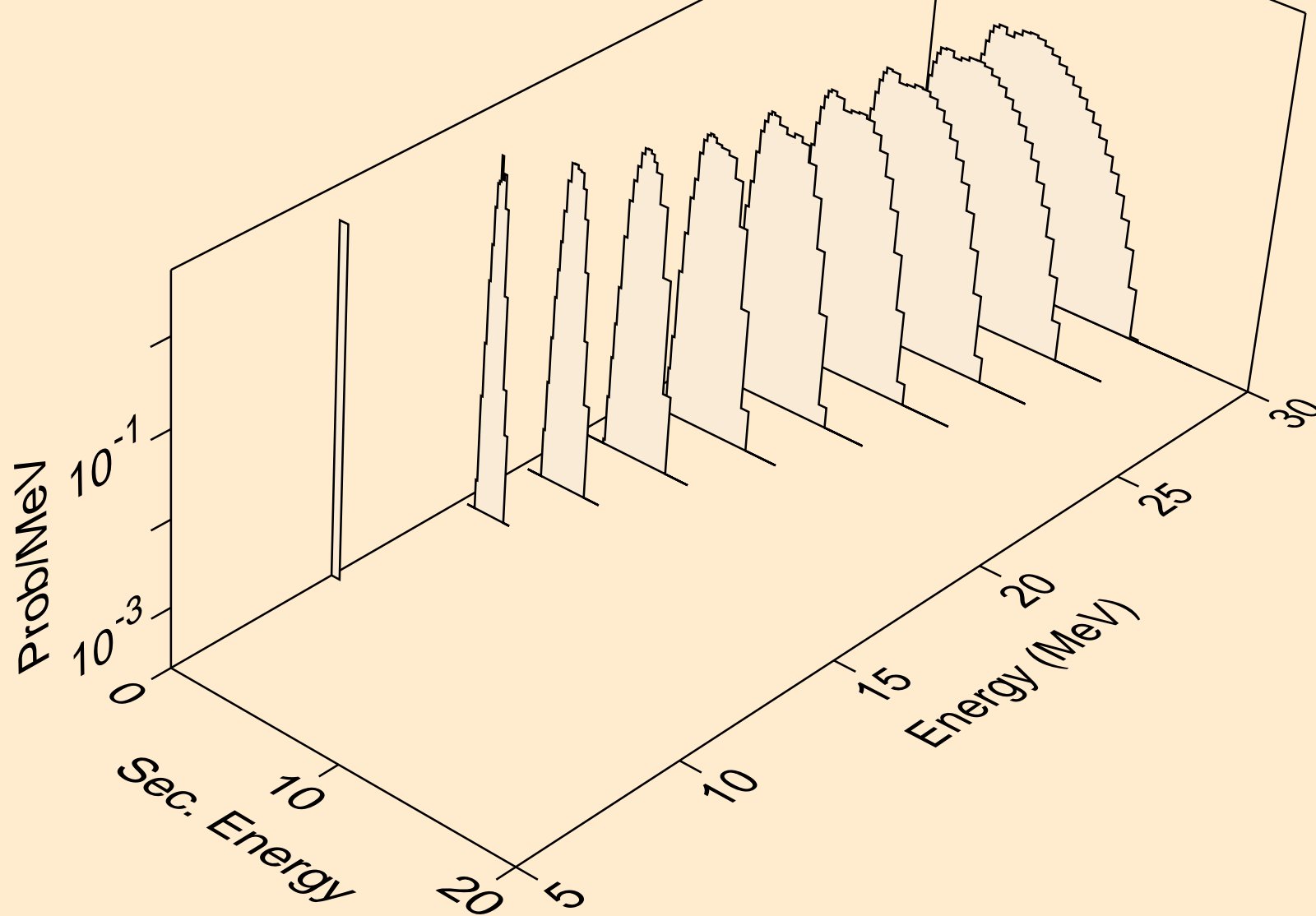

AR041 HELION ACER TENDL-2024 LIBRARY; T=0.K
alphas from (s,npa)

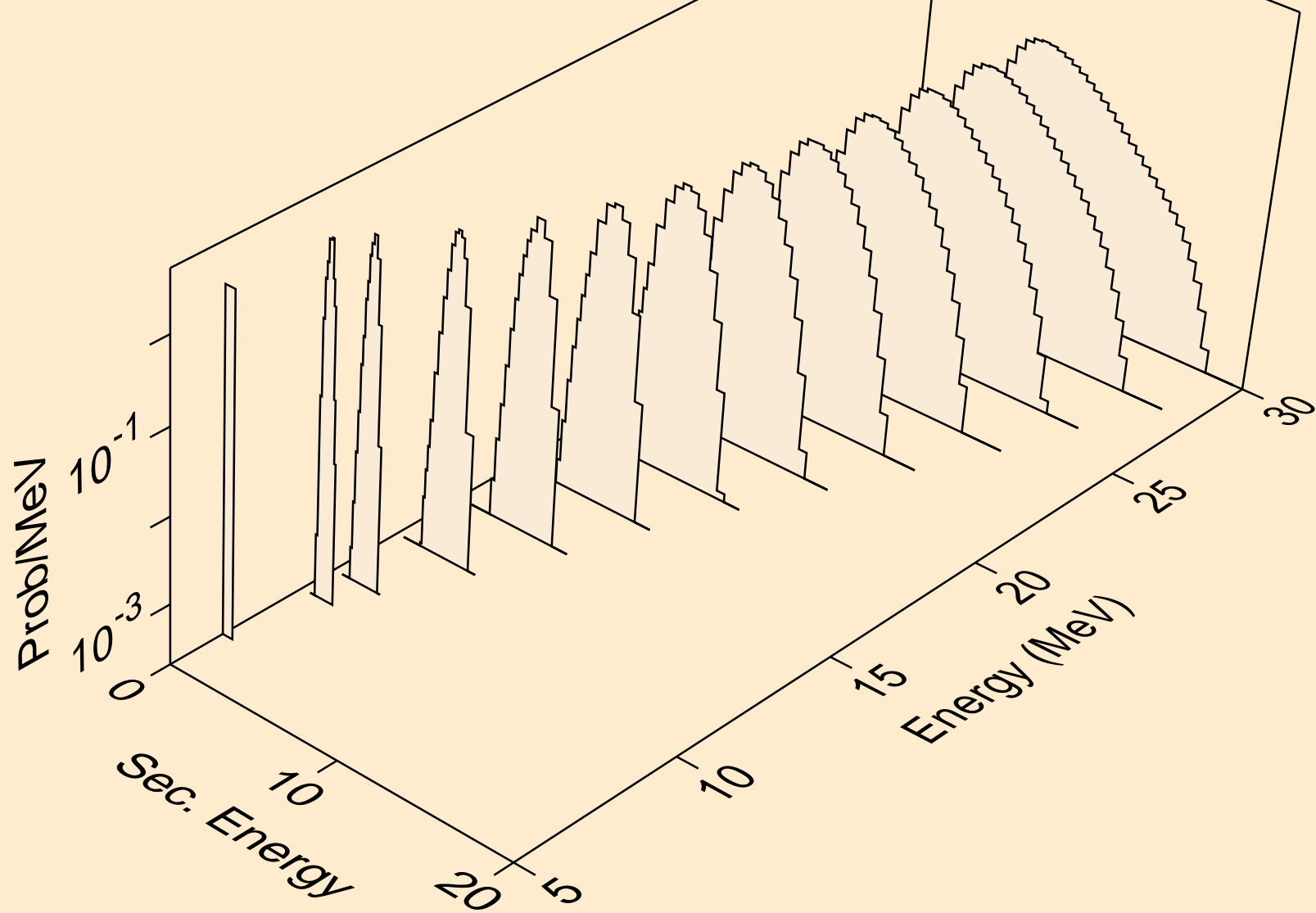

AR041 HELION ACER TENDL-2024 LIBRARY; T=0.K
alphas from (s,a)

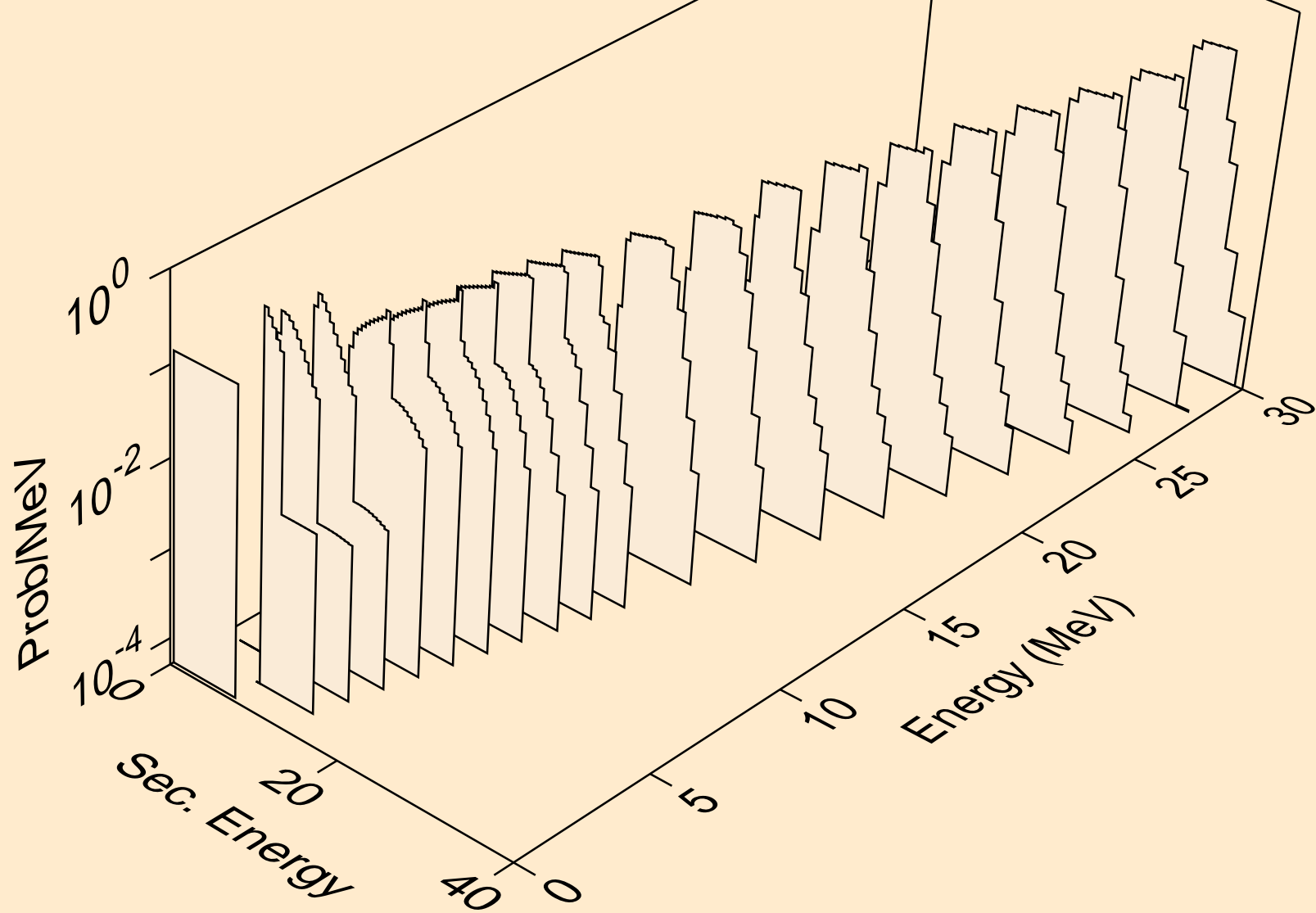

AR041 HELION ACER TENDL-2024 LIBRARY; T=0.K
alphas from (s,2a)

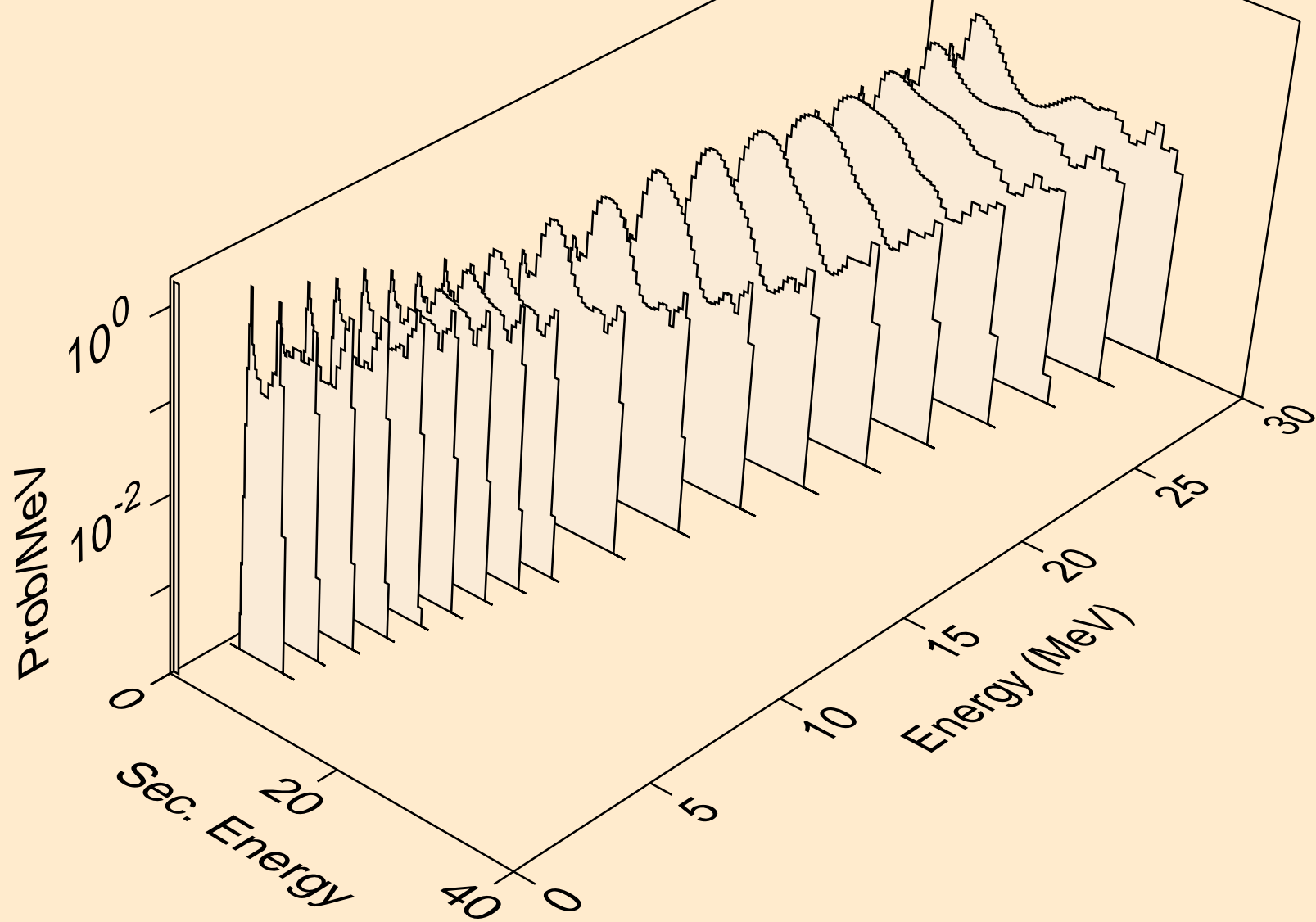

AR041 HELION ACER TENDL-2024 LIBRARY; T=0.K
alphas from (s,3a)

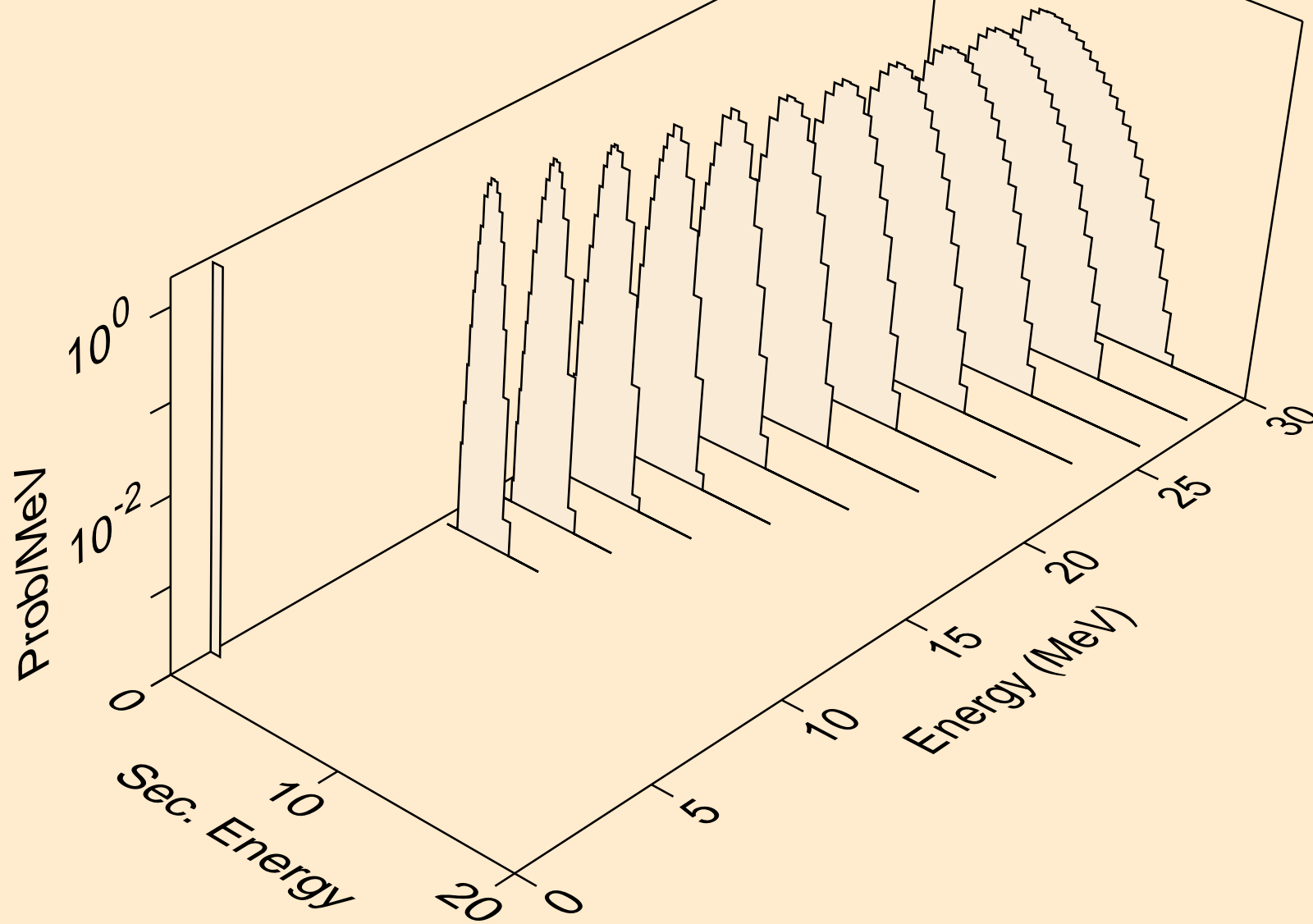

AR041 HELION ACER TENDL-2024 LIBRARY; T=0.K
alphas from (s,pa)

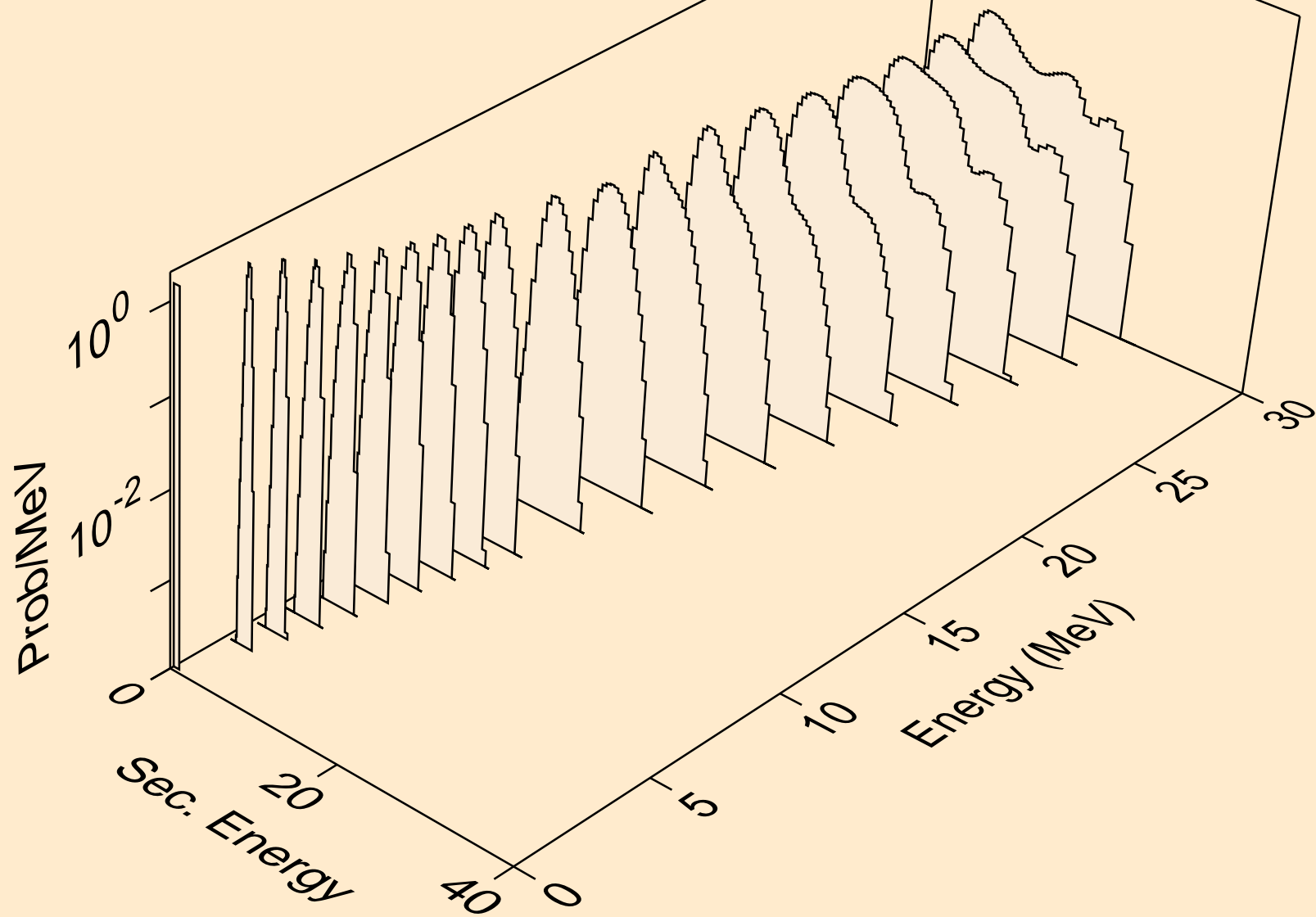

AR041 HELION ACER TENDL-2024 LIBRARY; T=0.K
alphas from (s,t2a)

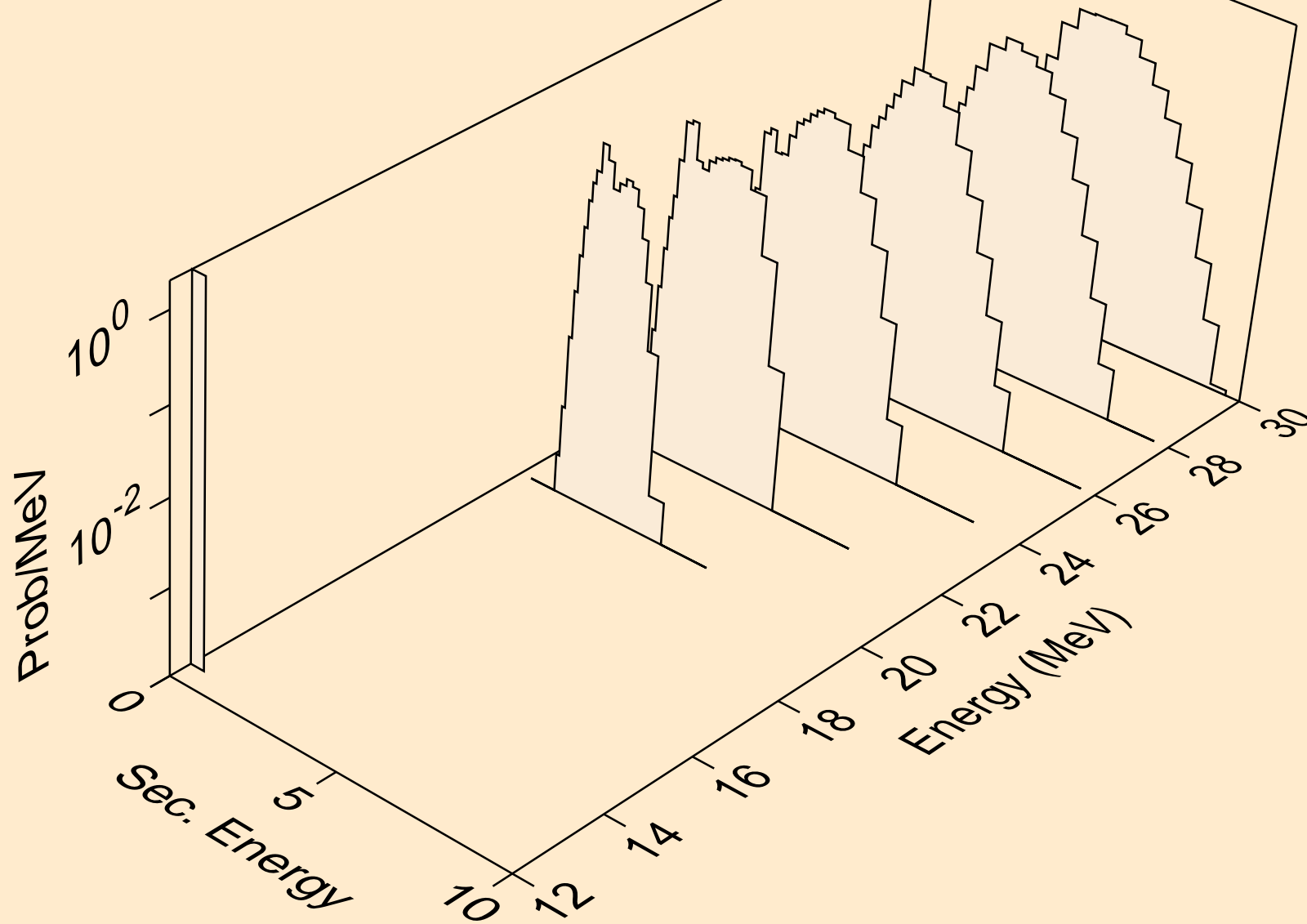

AR041 HELION ACER TENDL-2024 LIBRARY; T=0.K
alphas from (s,d2a)

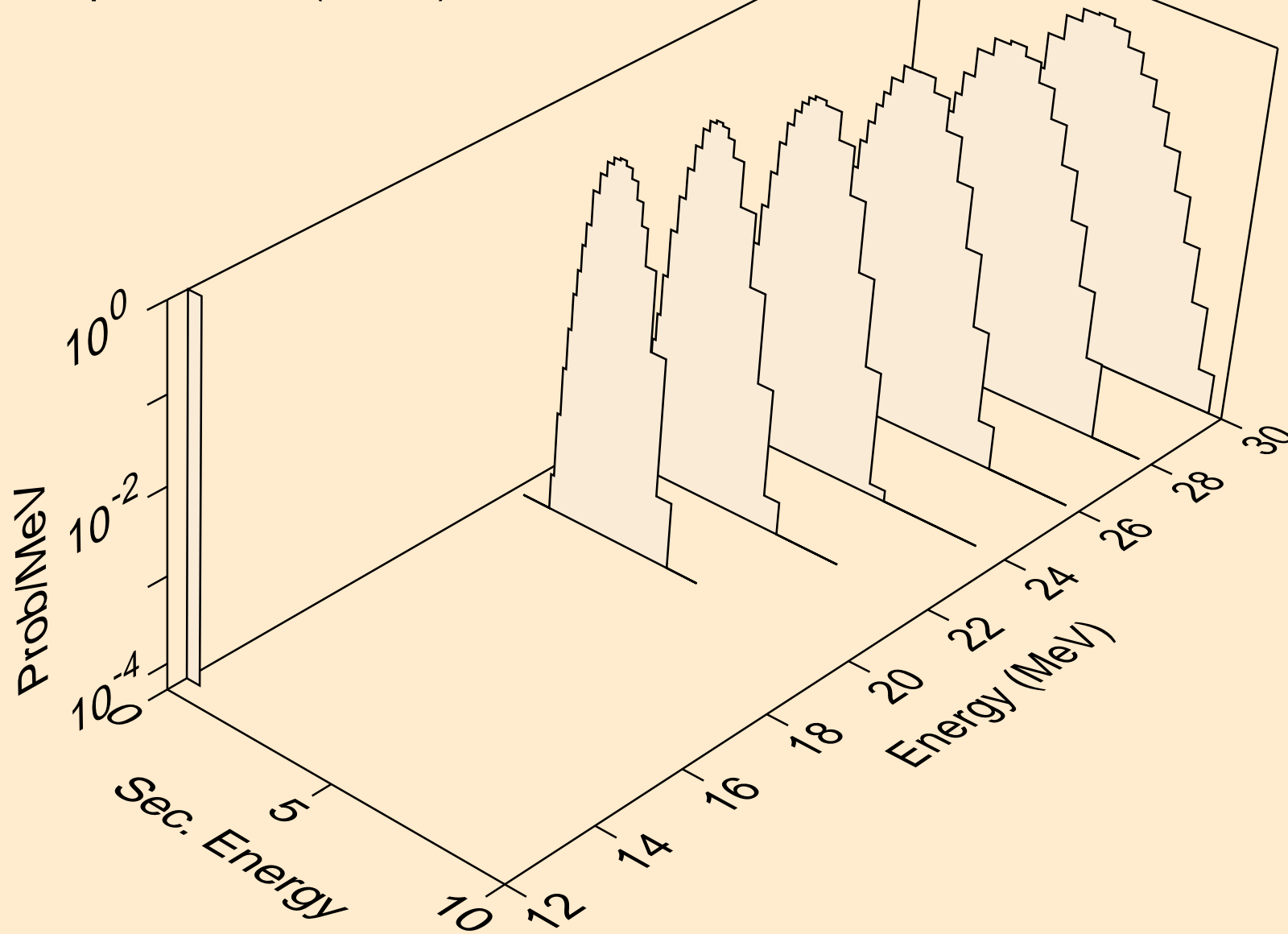

AR041 HELION ACER TENDL-2024 LIBRARY; T=0.K
alphas from (s,da)

