

BK235 HELION ACER TENDL-2024 LIBRARY; T=0.K
Principal cross sections

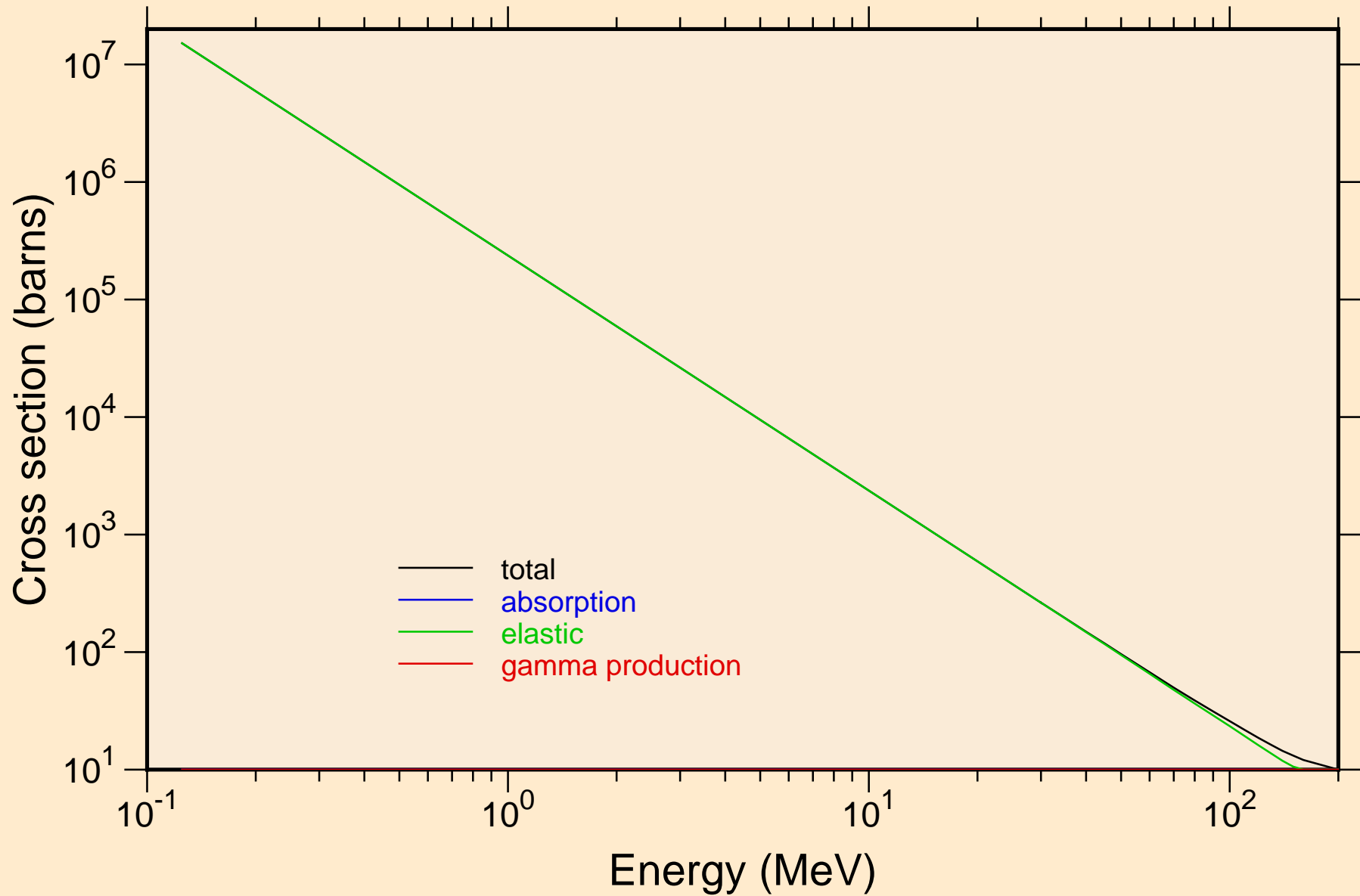

BK235 HELION ACER TENDL-2024 LIBRARY; T=0.K

Heating

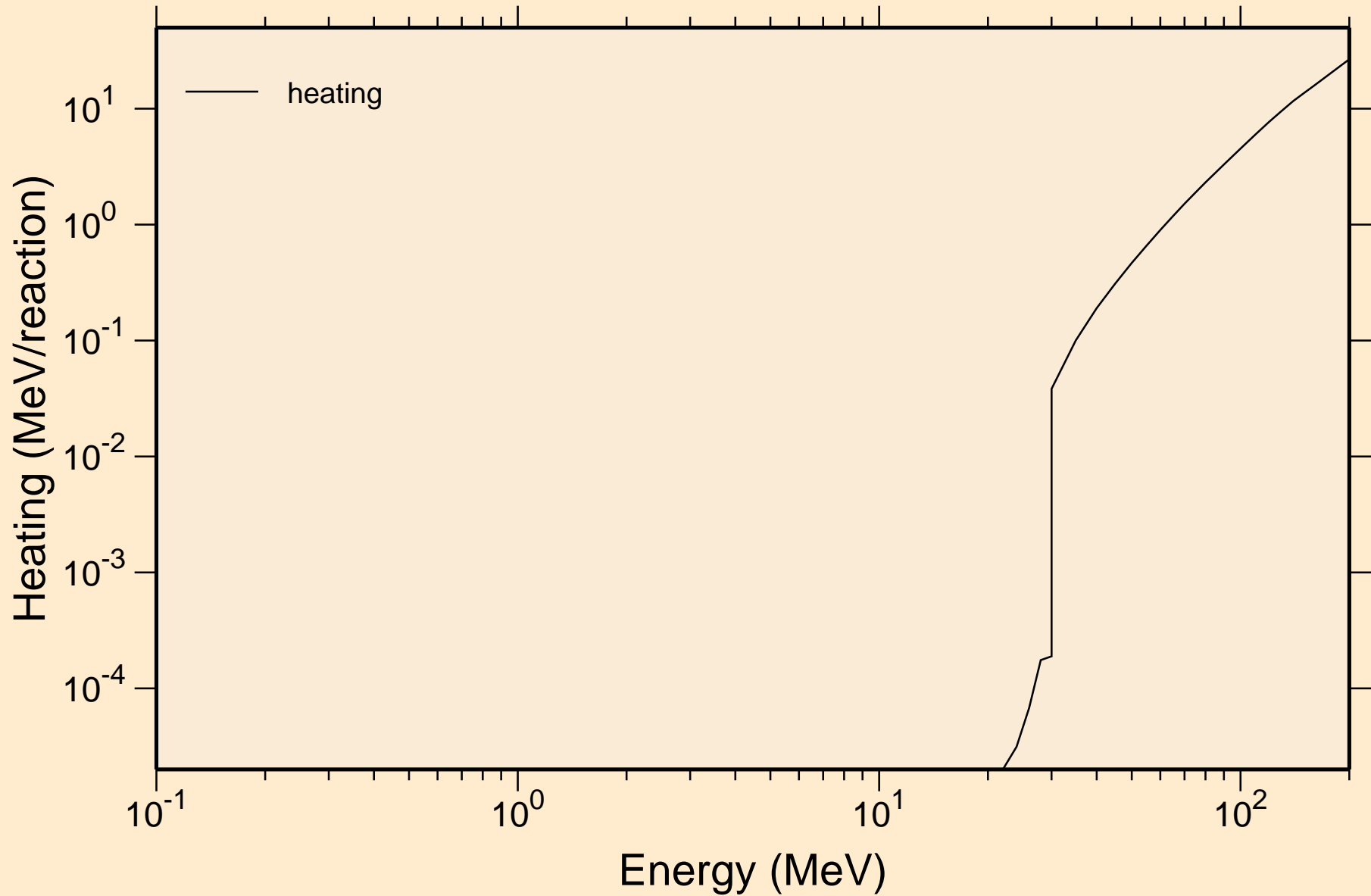

BK235 HELION ACER TENDL-2024 LIBRARY; T=0.K

Principal cross sections

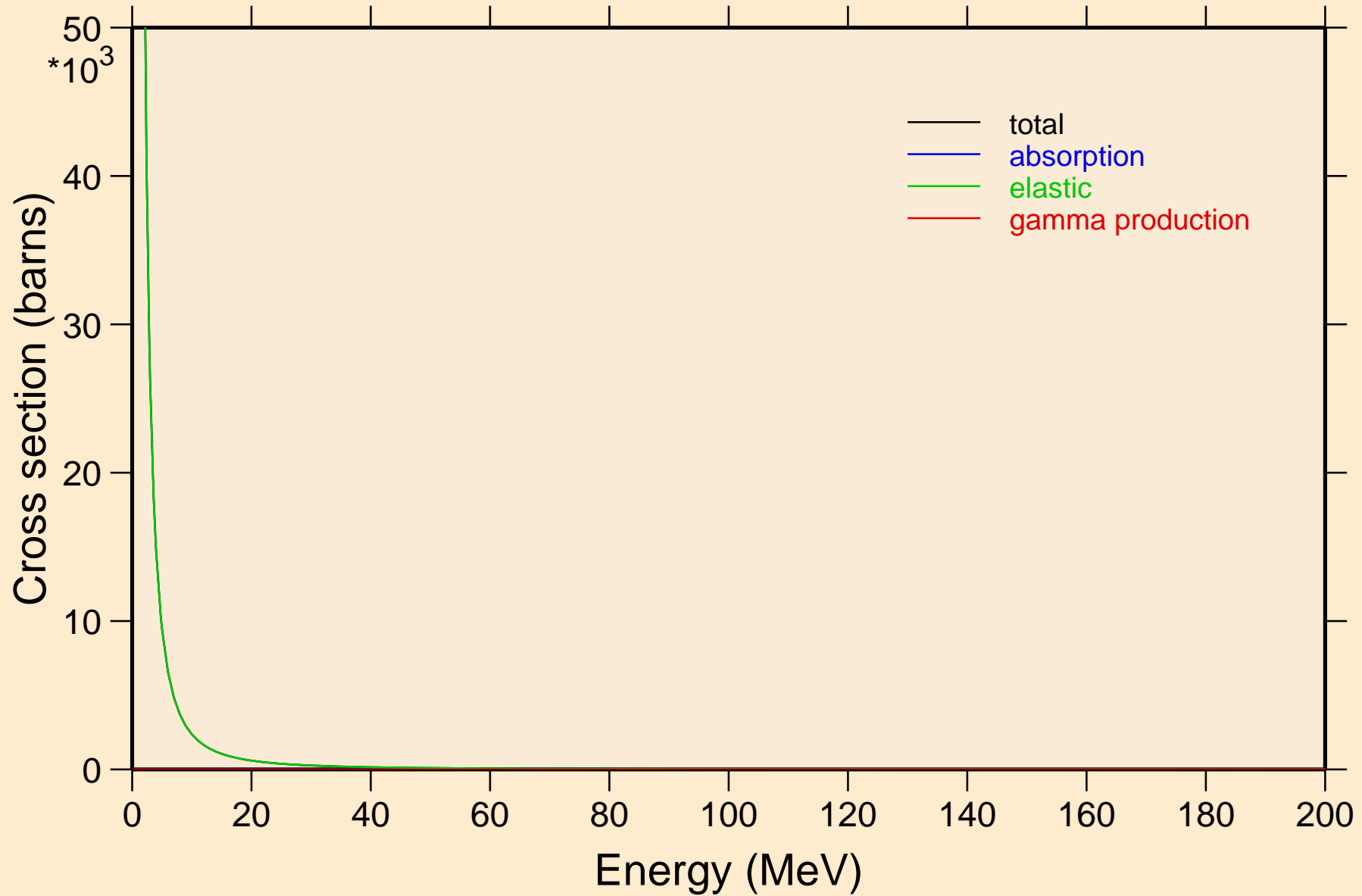

BK235 HELION ACER TENDL-2024 LIBRARY; T=0.K

Heating

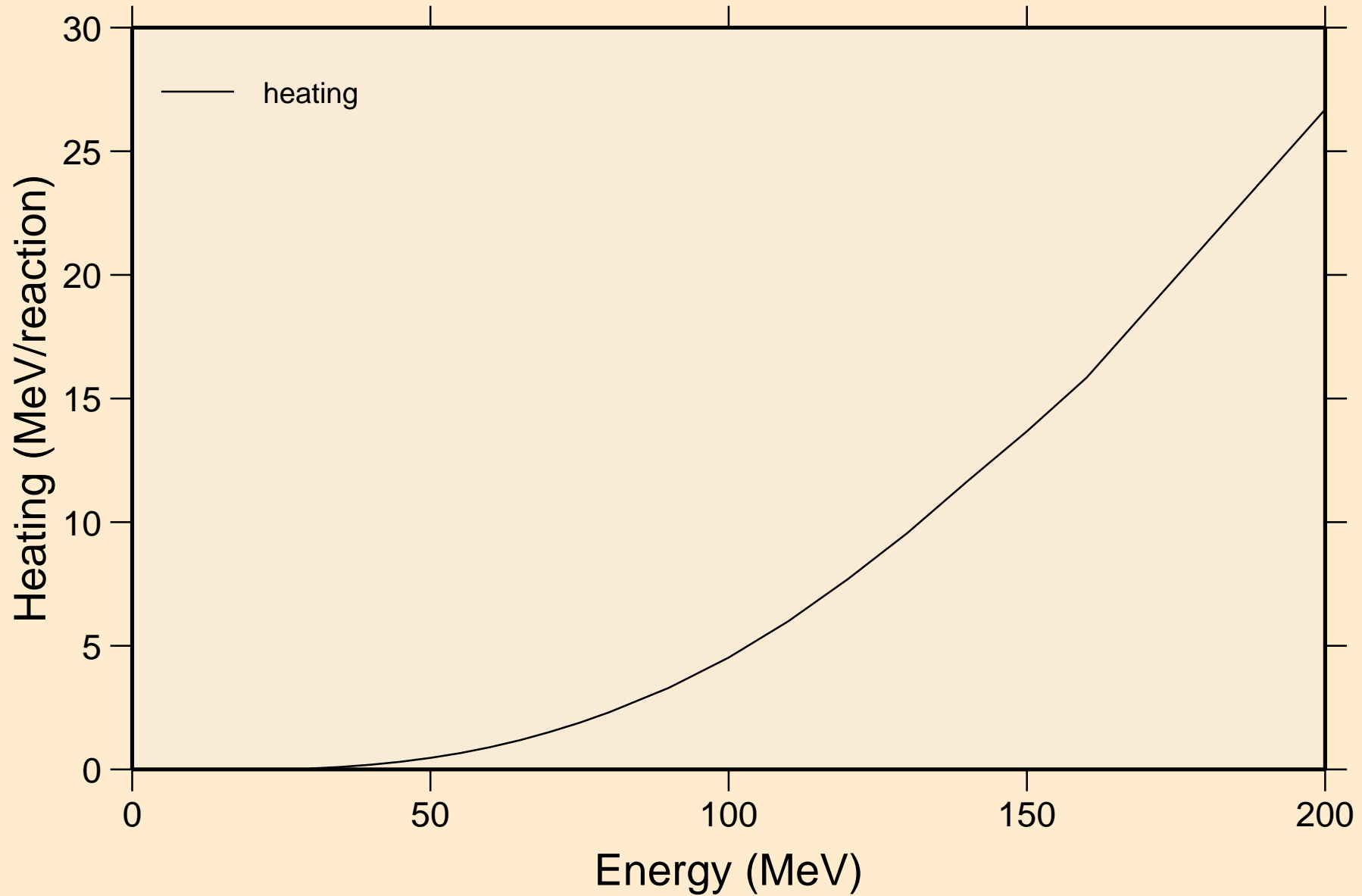

BK235 HELION ACER TENDL-2024 LIBRARY; T=0.K
Threshold reactions

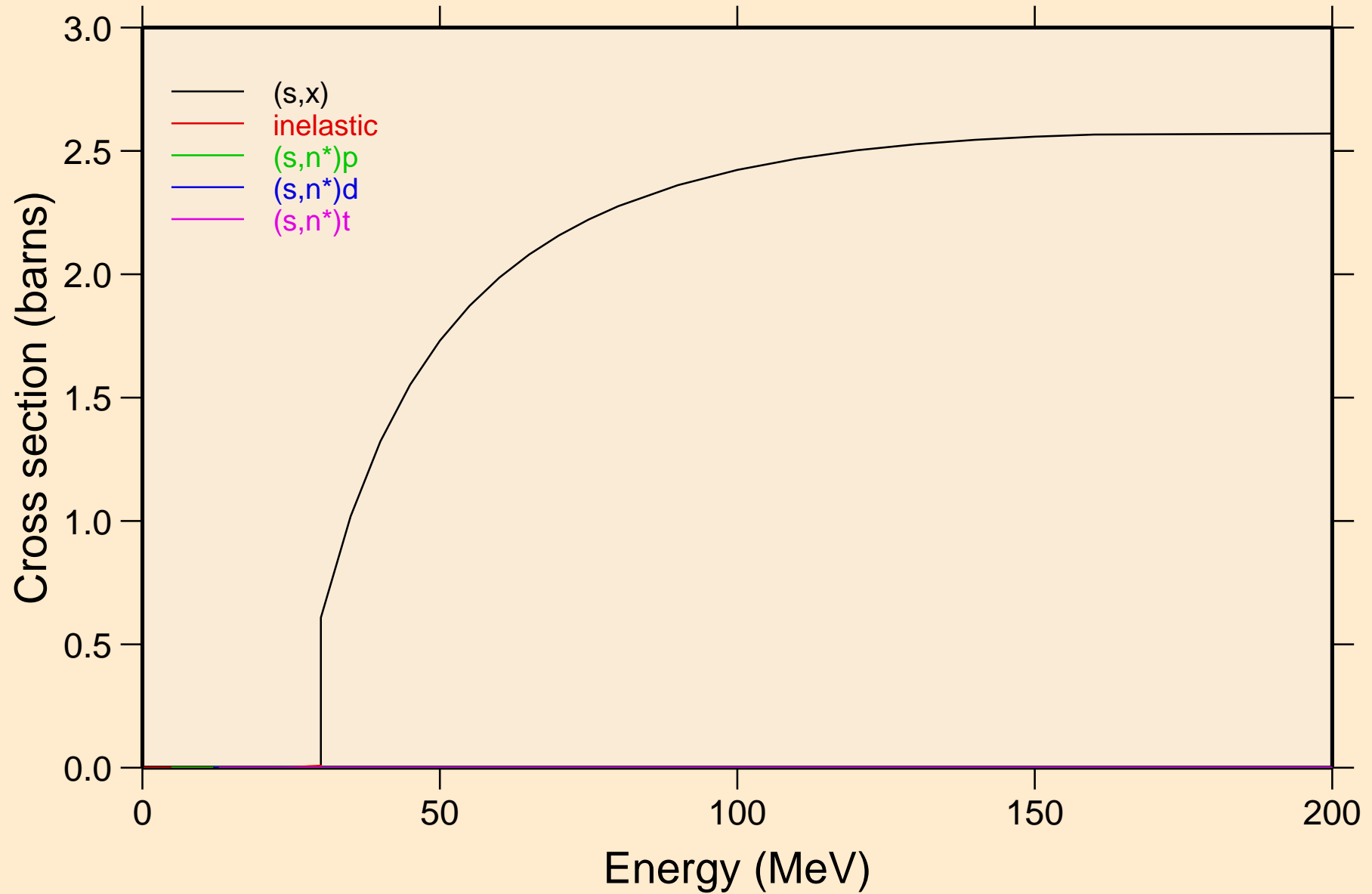

BK235 HELION ACER TENDL-2024 LIBRARY; T=0.K
Threshold reactions

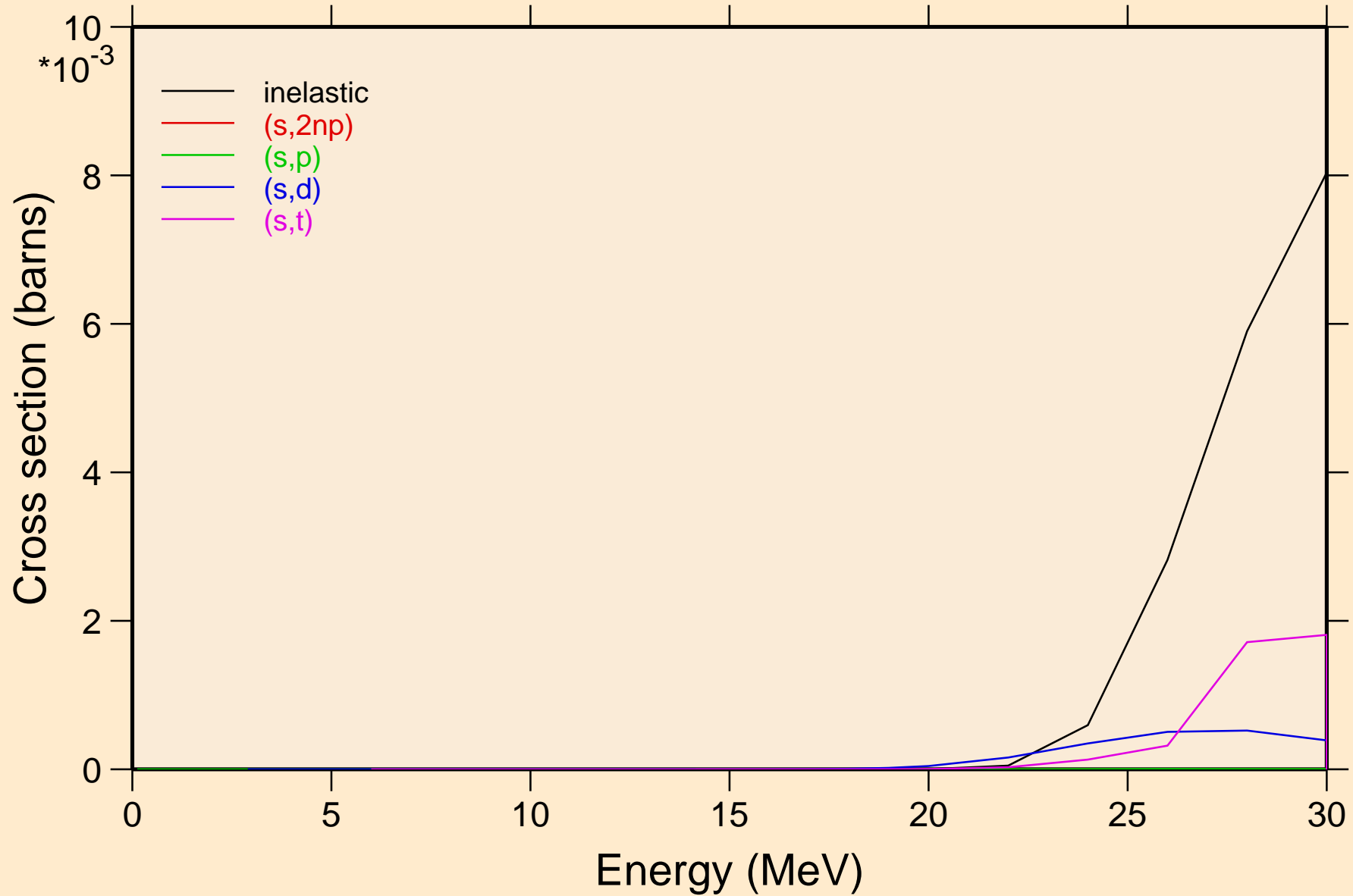

BK235 HELION ACER TENDL-2024 LIBRARY; T=0.K
Threshold reactions

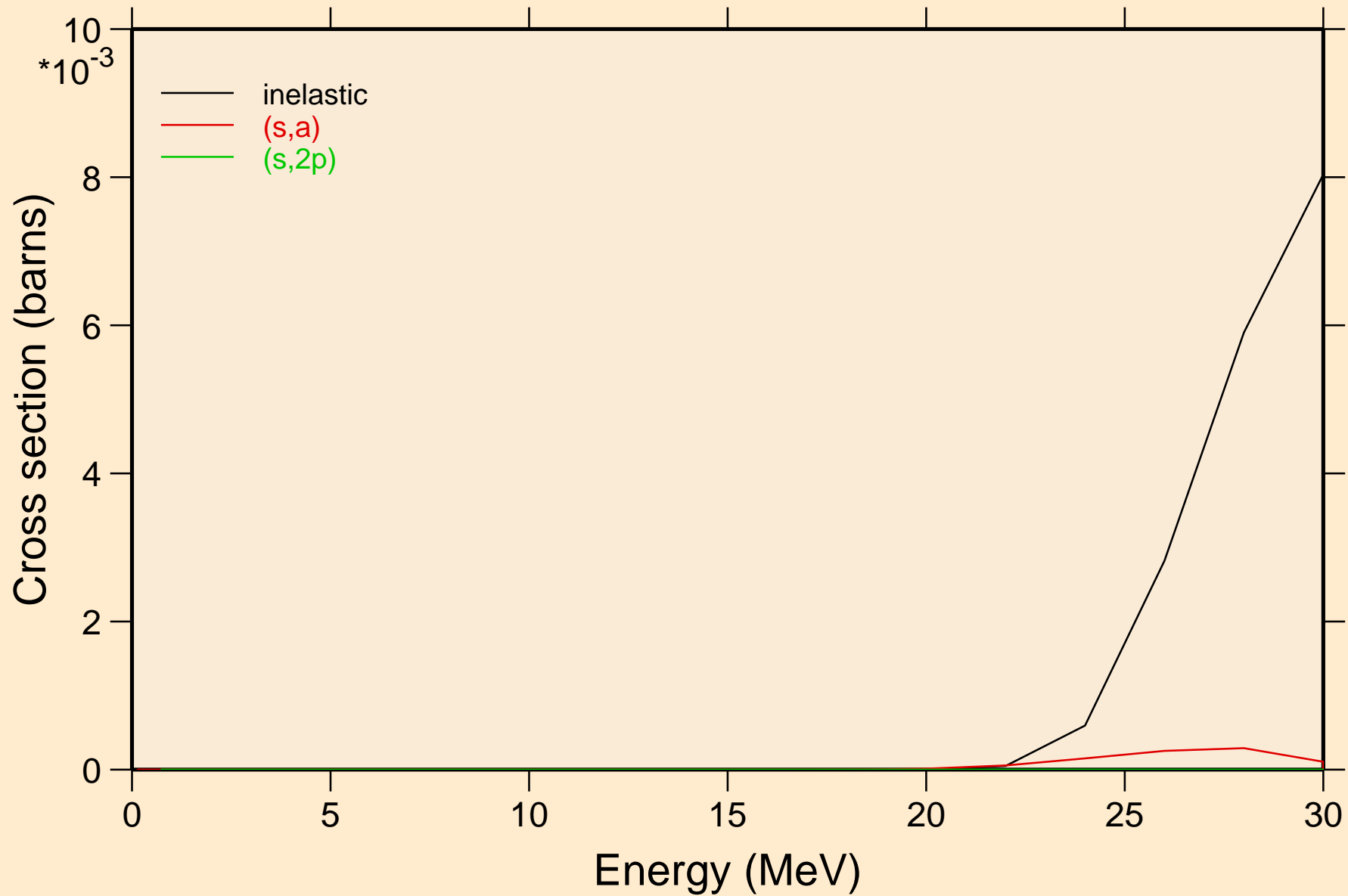

BK235 HELION ACER TENDL-2024 LIBRARY; T=0.K
angular distribution for elastic

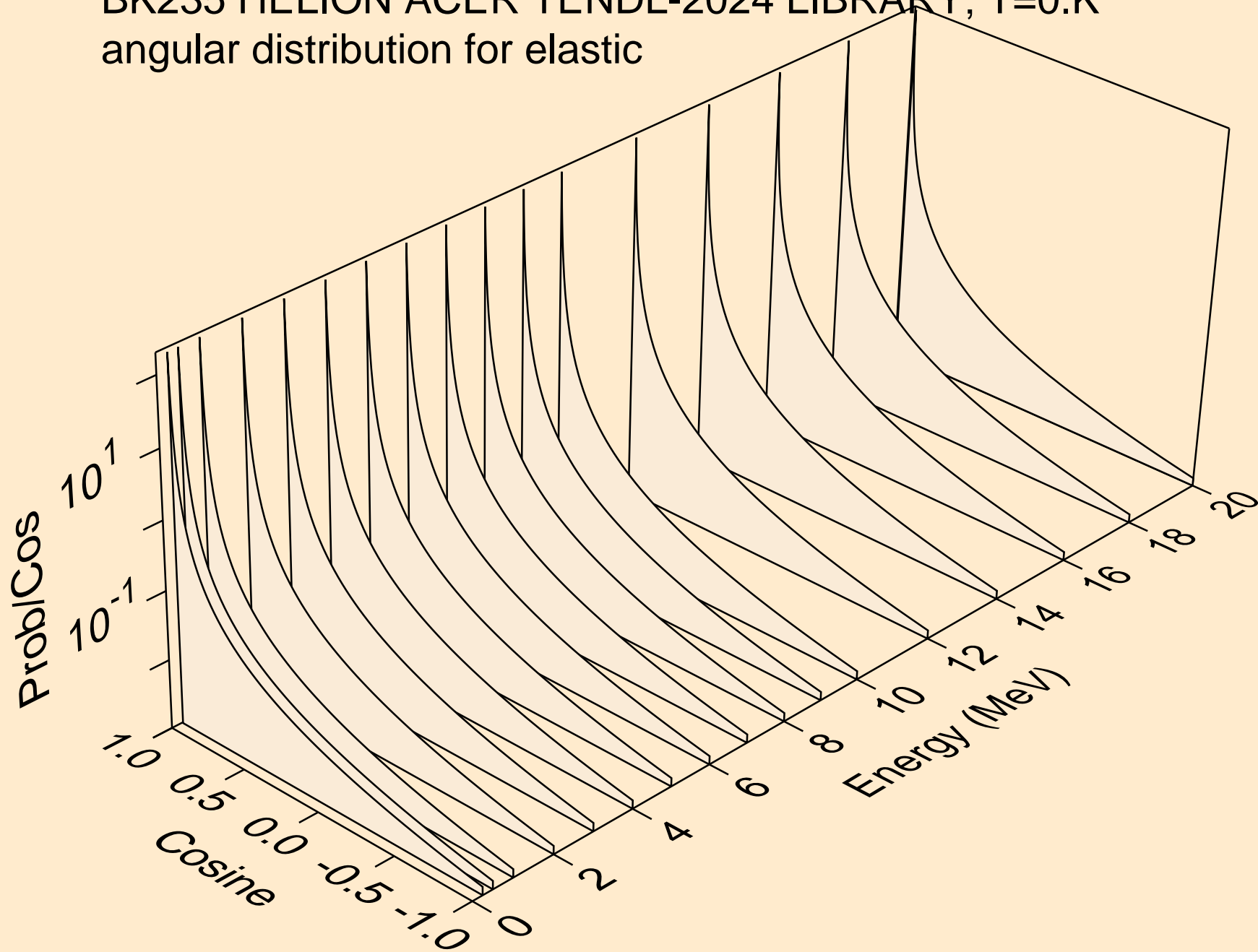

BK235 HELION ACER TENDL-2024 LIBRARY; T=0.K
angular distribution for elastic

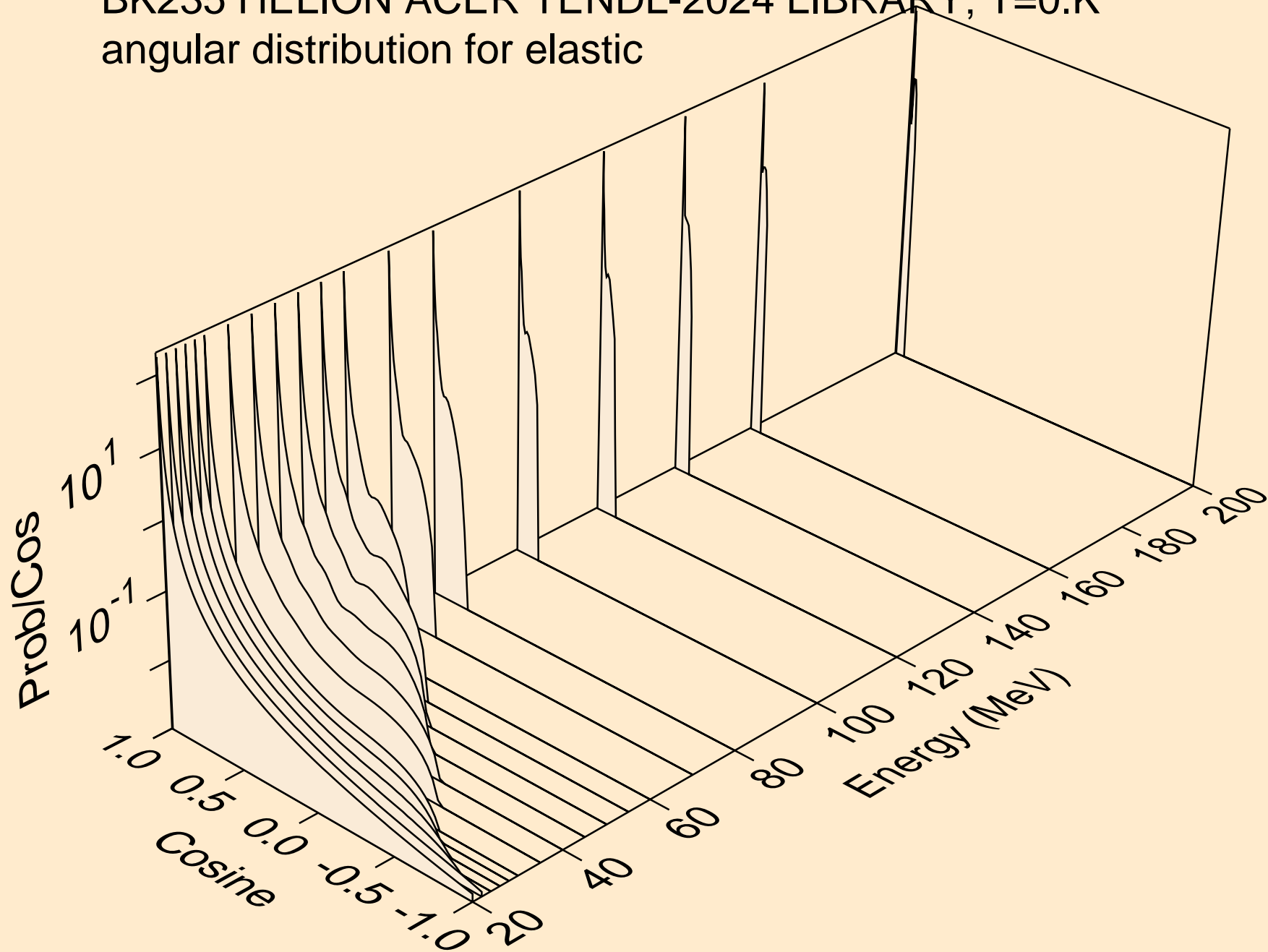

BK235 HELION ACER TENDL-2024 LIBRARY; T=0.K
He-3 emission for (s,x)

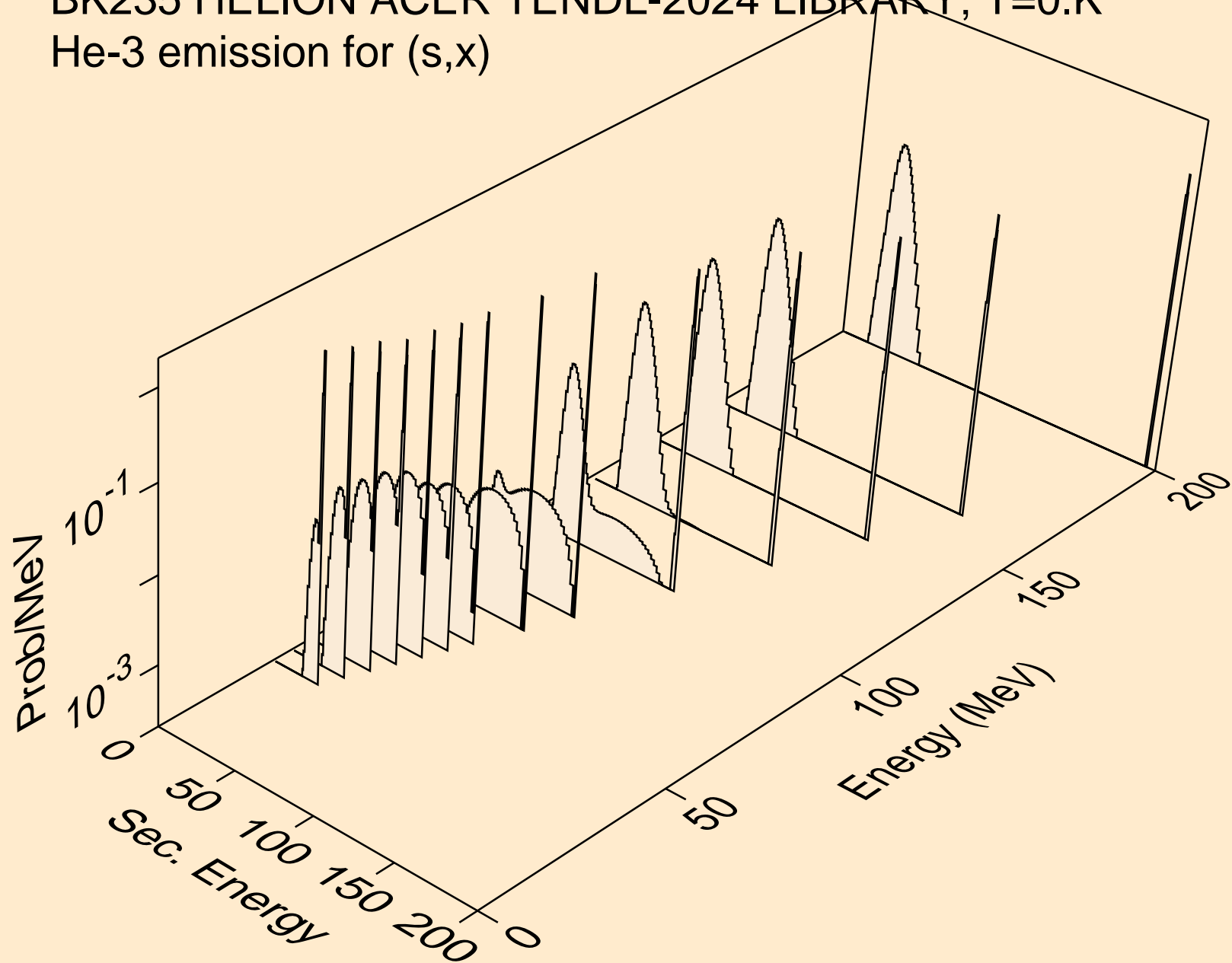

BK235 HELION ACER TENDL-2024 LIBRARY; T=0.K
He-3 emission for inelastic

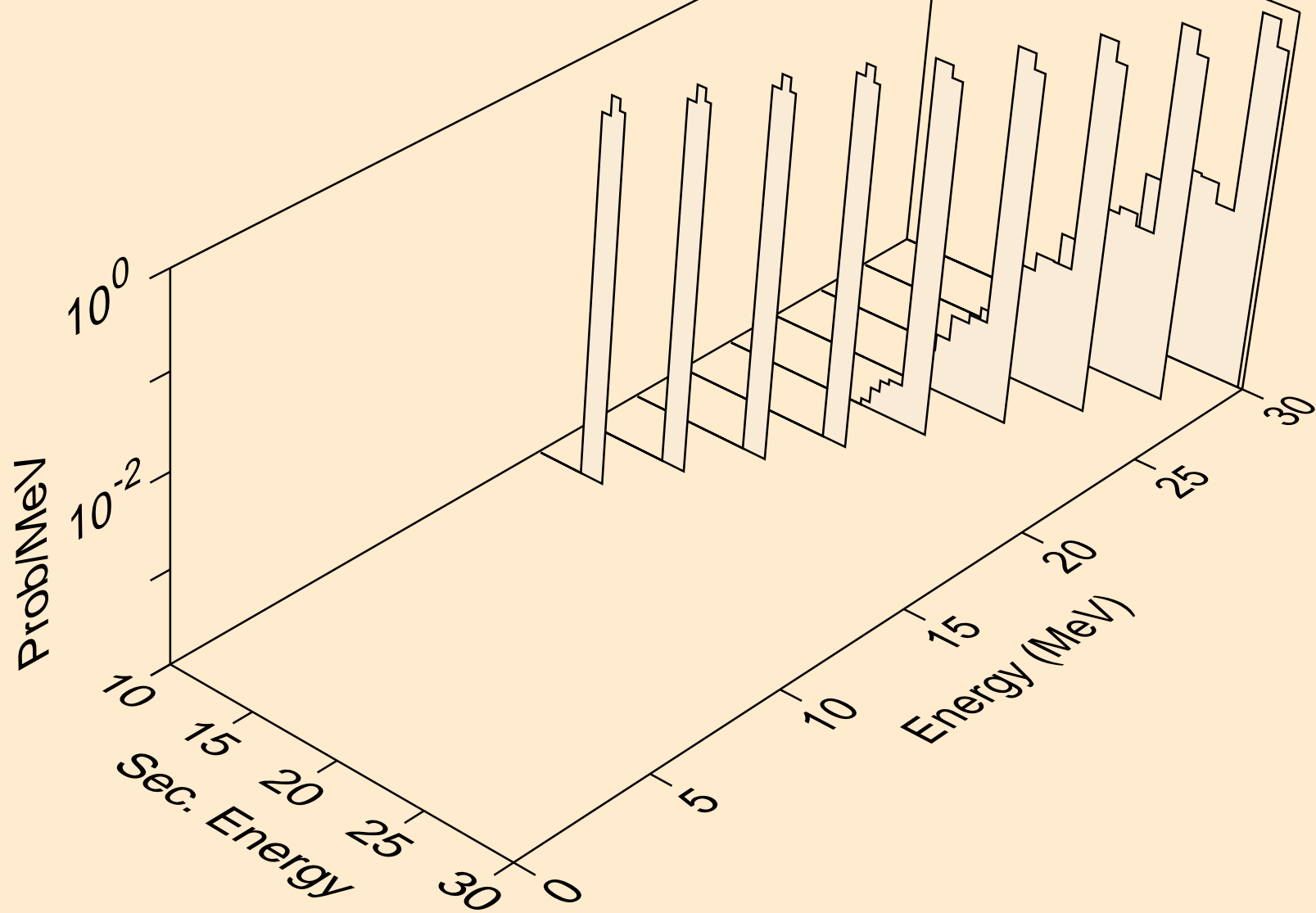

BK235 HELION ACER TENDL-2024 LIBRARY; T=0.K
Photon emission for (z,n)

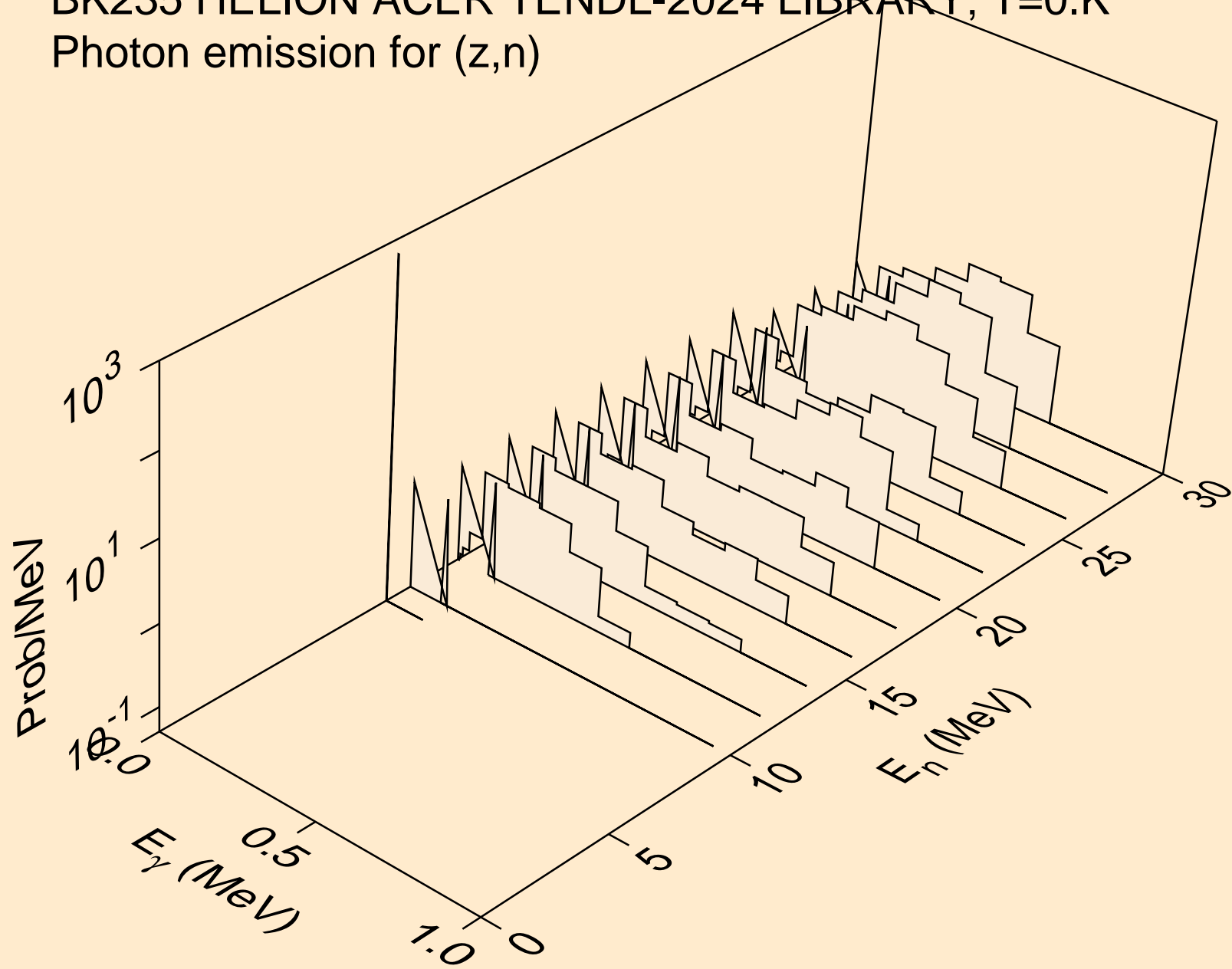

BK235 HELION ACER TENDL-2024 LIBRARY; T=0.K
Photon emission for (z,x)

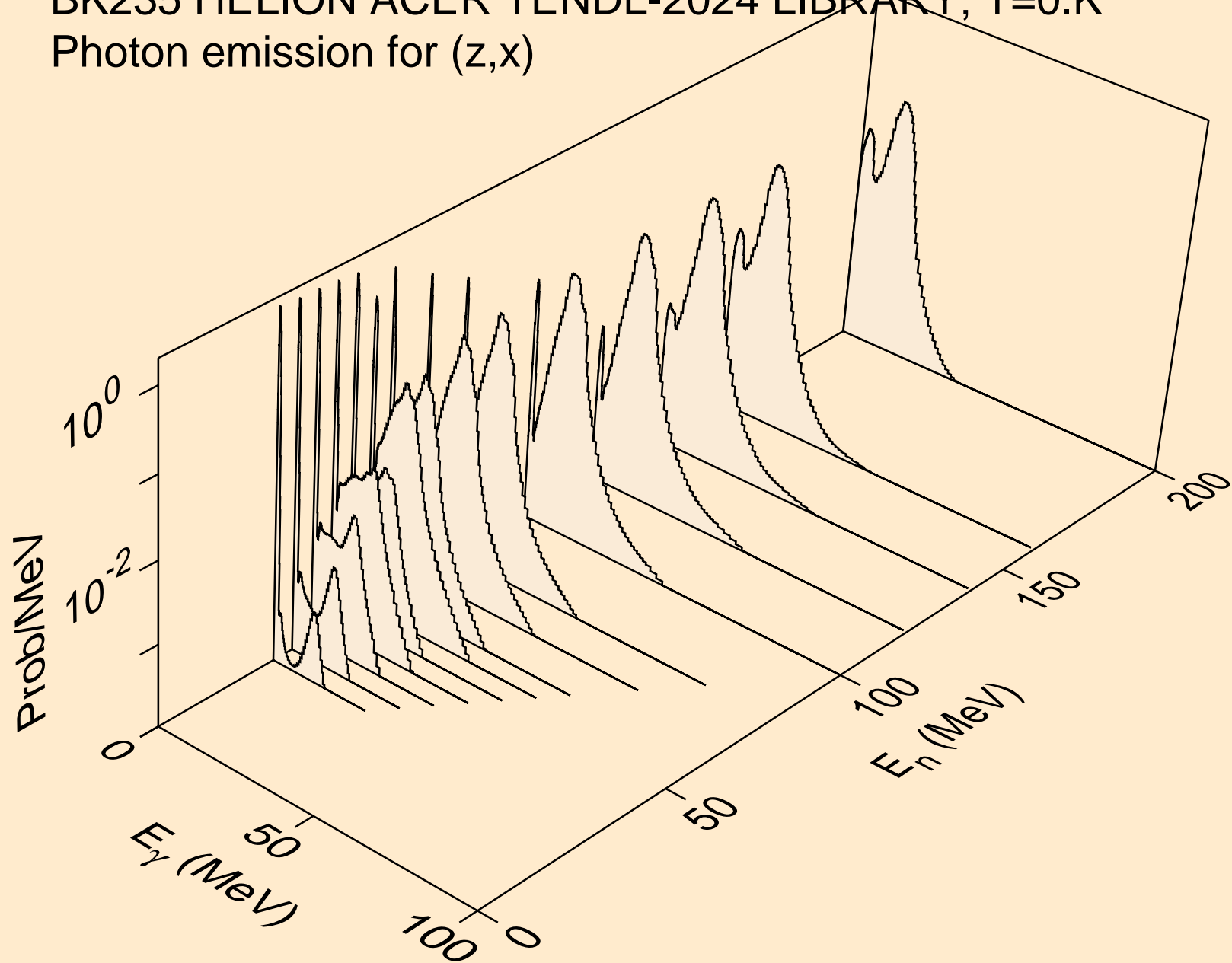

BK235 HELION ACER TENDL-2024 LIBRARY; T=0.K
Photon emission for (n,n*)p

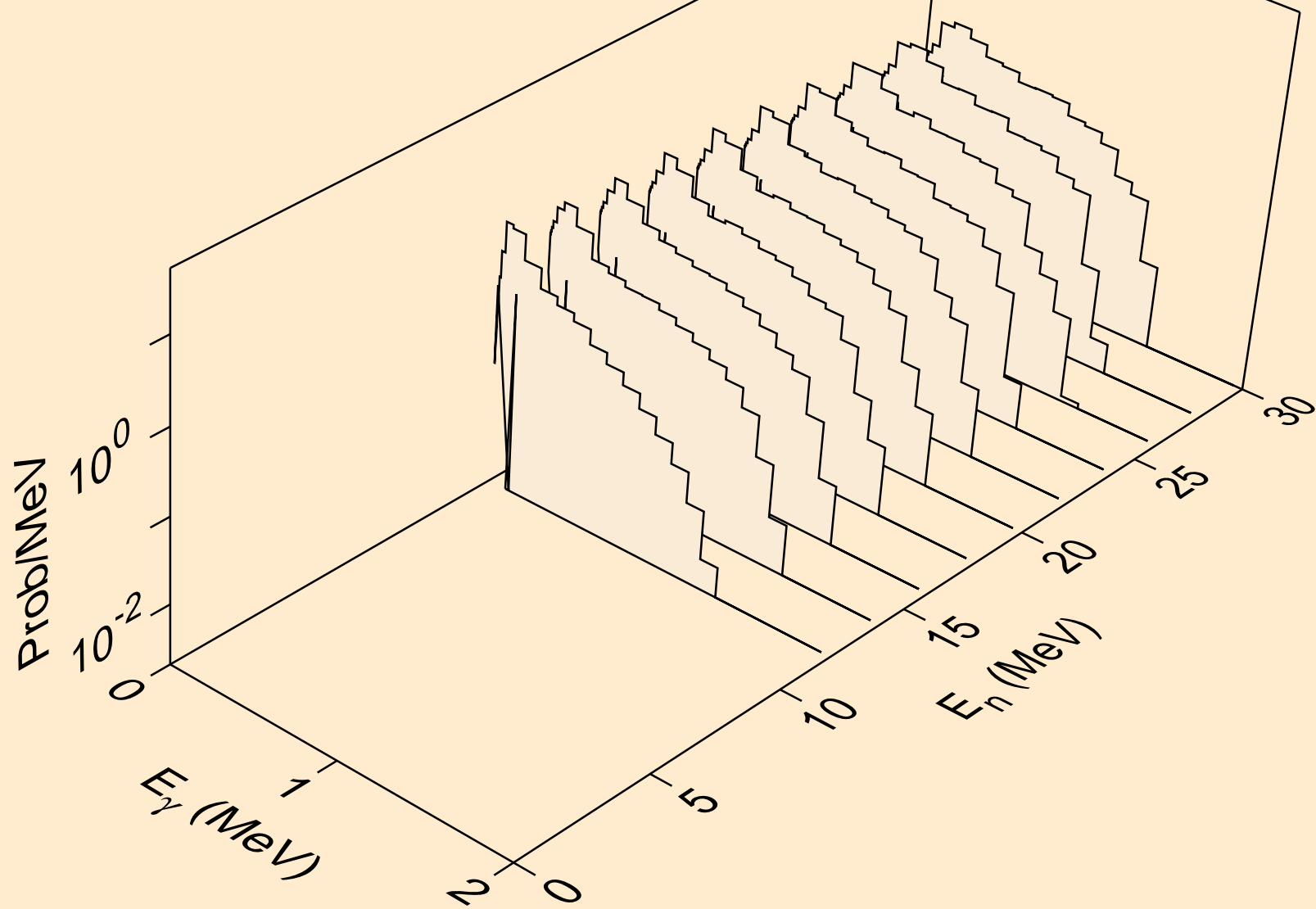

BK235 HELION ACER TENDL-2024 LIBRARY; T=0.K
Photon emission for (n,n*)d

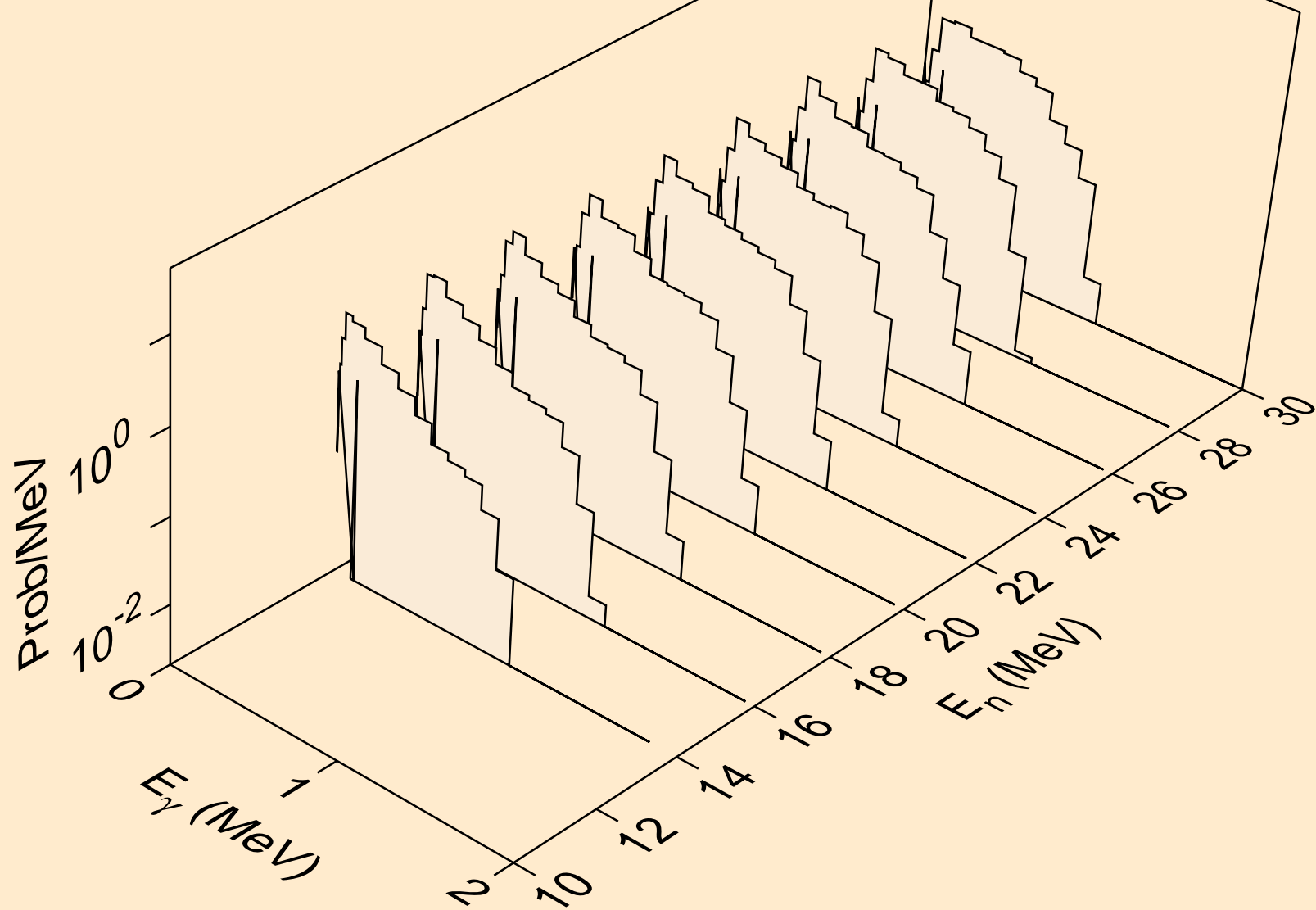

BK235 HELION ACER TENDL-2024 LIBRARY; T=0.K
Photon emission for (n,n*)t

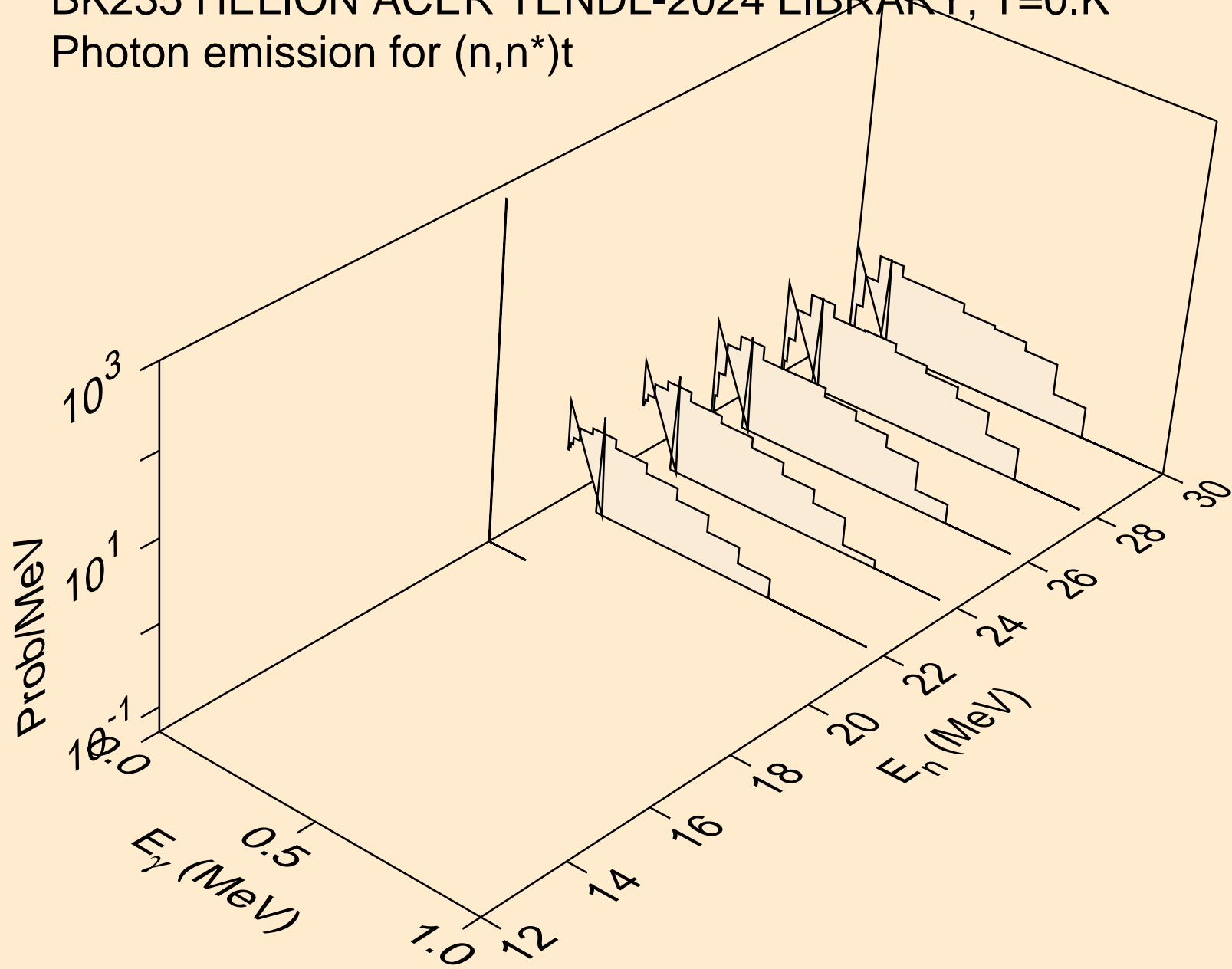

BK235 HELION ACER TENDL-2024 LIBRARY; T=0.K
Photon emission for (n,2np)

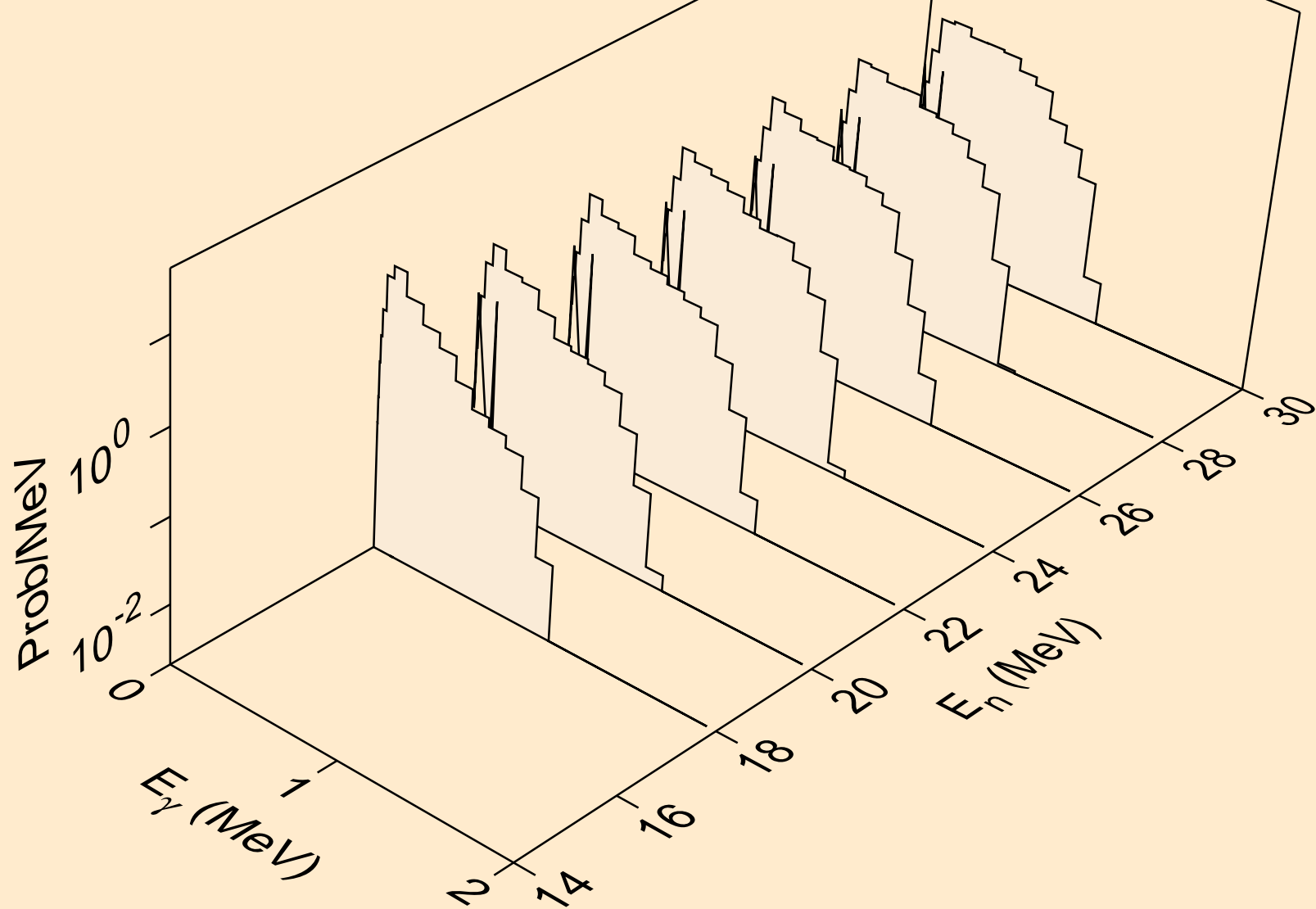

BK235 HELION ACER TENDL-2024 LIBRARY; T=0.K
Photon emission for (n,p)

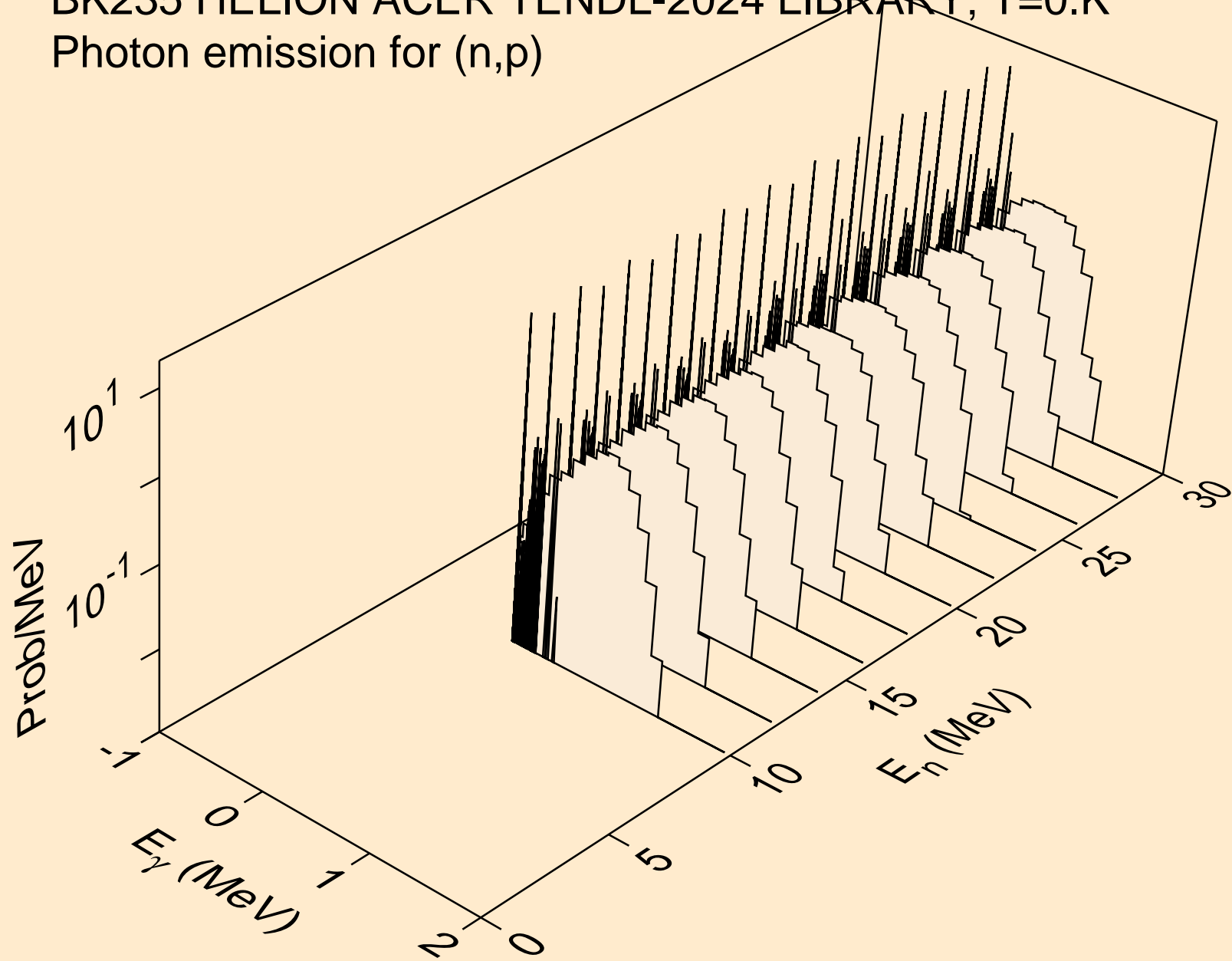

BK235 HELION ACER TENDL-2024 LIBRARY; T=0.K
Photon emission for (n,d)

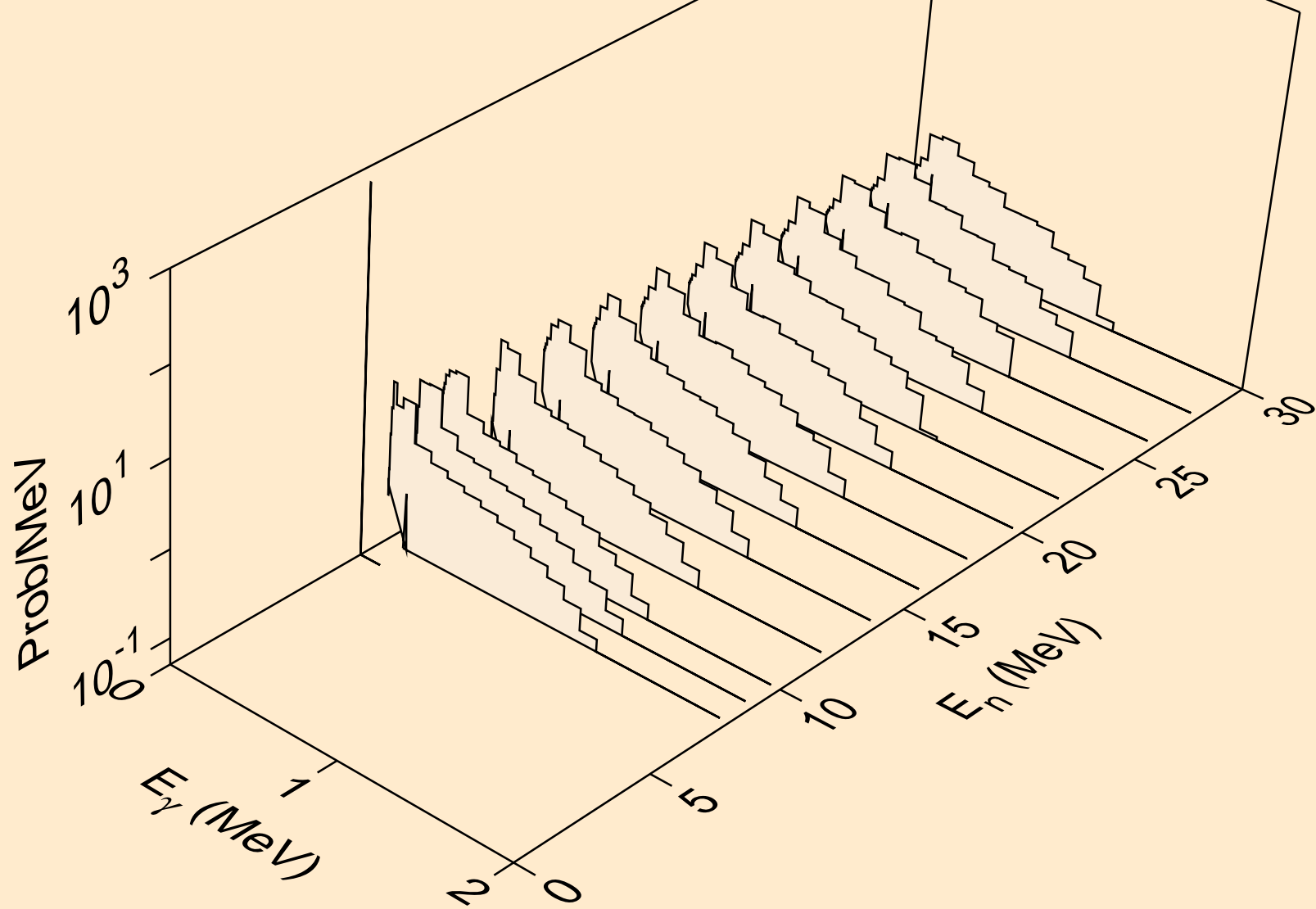

BK235 HELION ACER TENDL-2024 LIBRARY; T=0.K
Photon emission for (n,t)

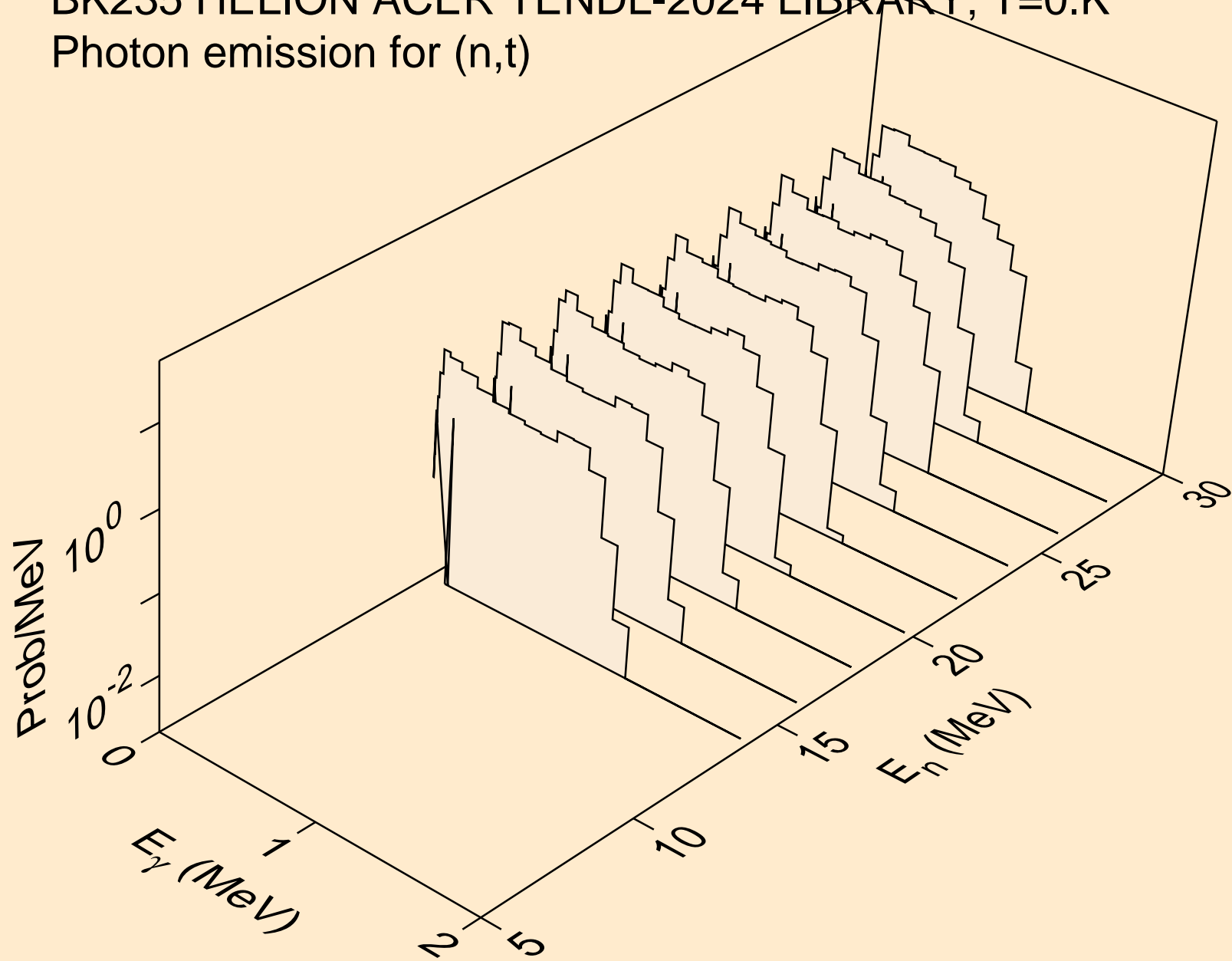

BK235 HELION ACER TENDL-2024 LIBRARY; T=0.K
Photon emission for inelastic

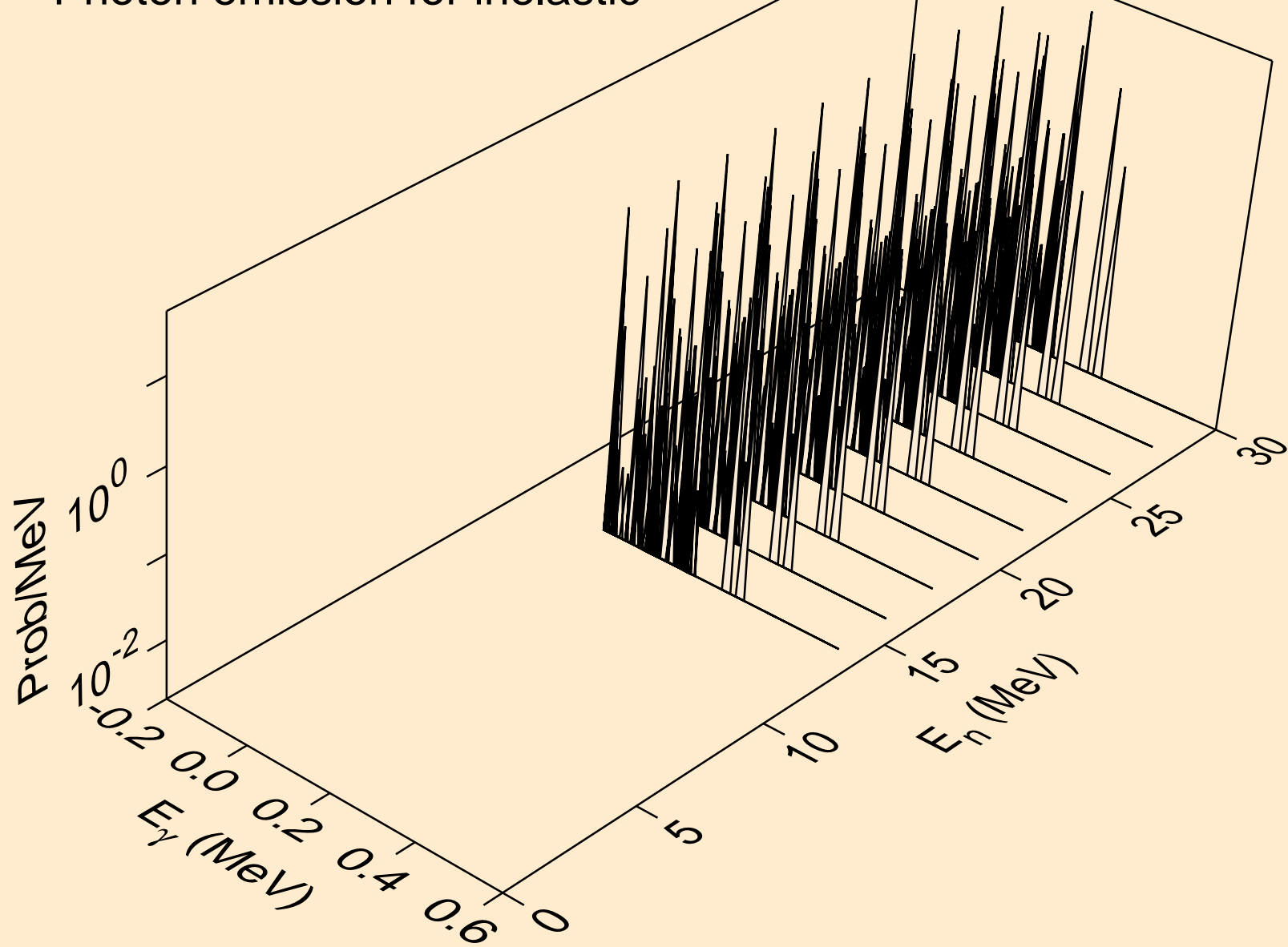

BK235 HELION ACER TENDL-2024 LIBRARY; T=0.K
Photon emission for (n,a)

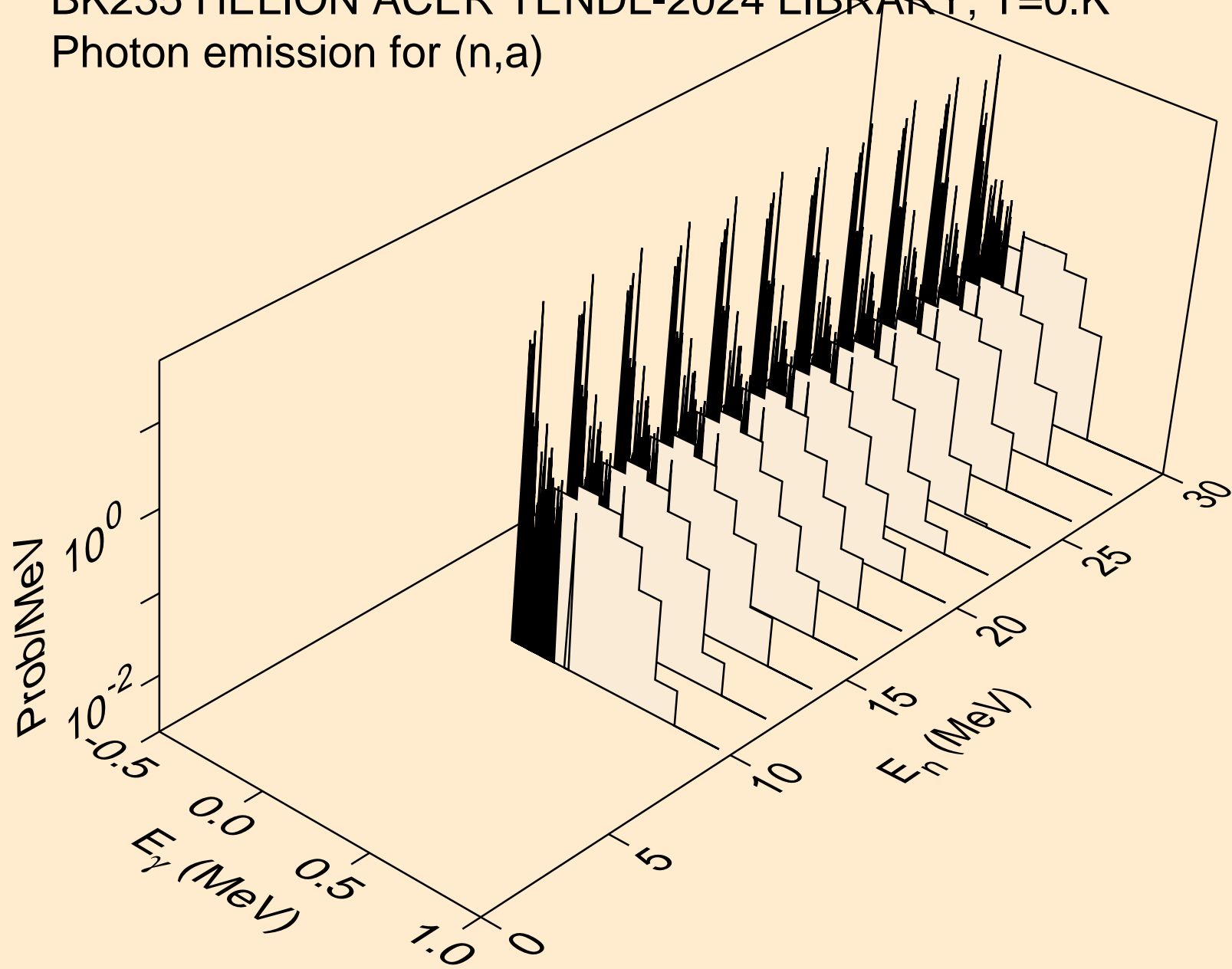

BK235 HELION ACER TENDL-2024 LIBRARY; T=0.K
Photon emission for (n,2p)

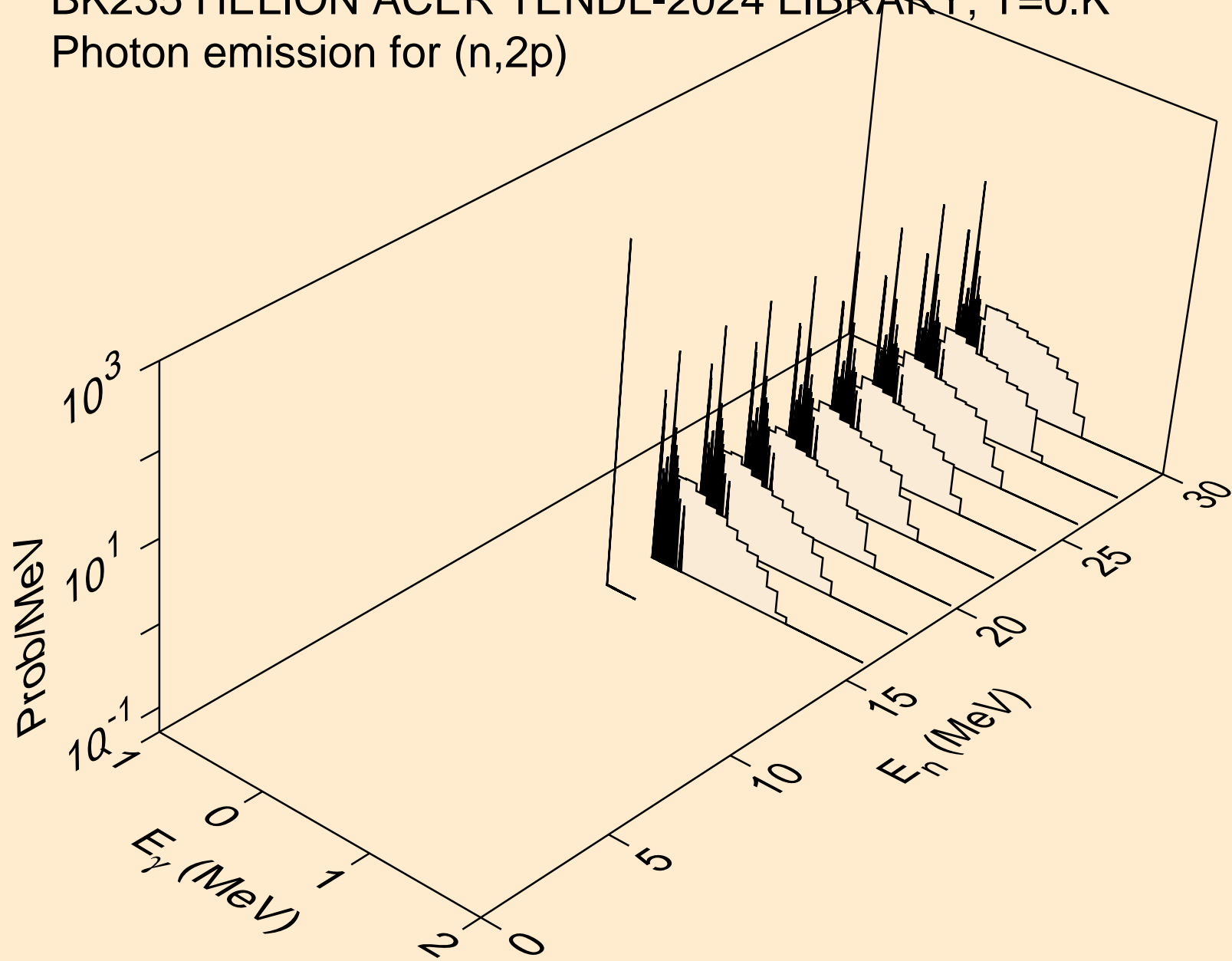

BK235 HELION ACER TENDL-2024 LIBRARY; T=0.K
Particle heating contributions

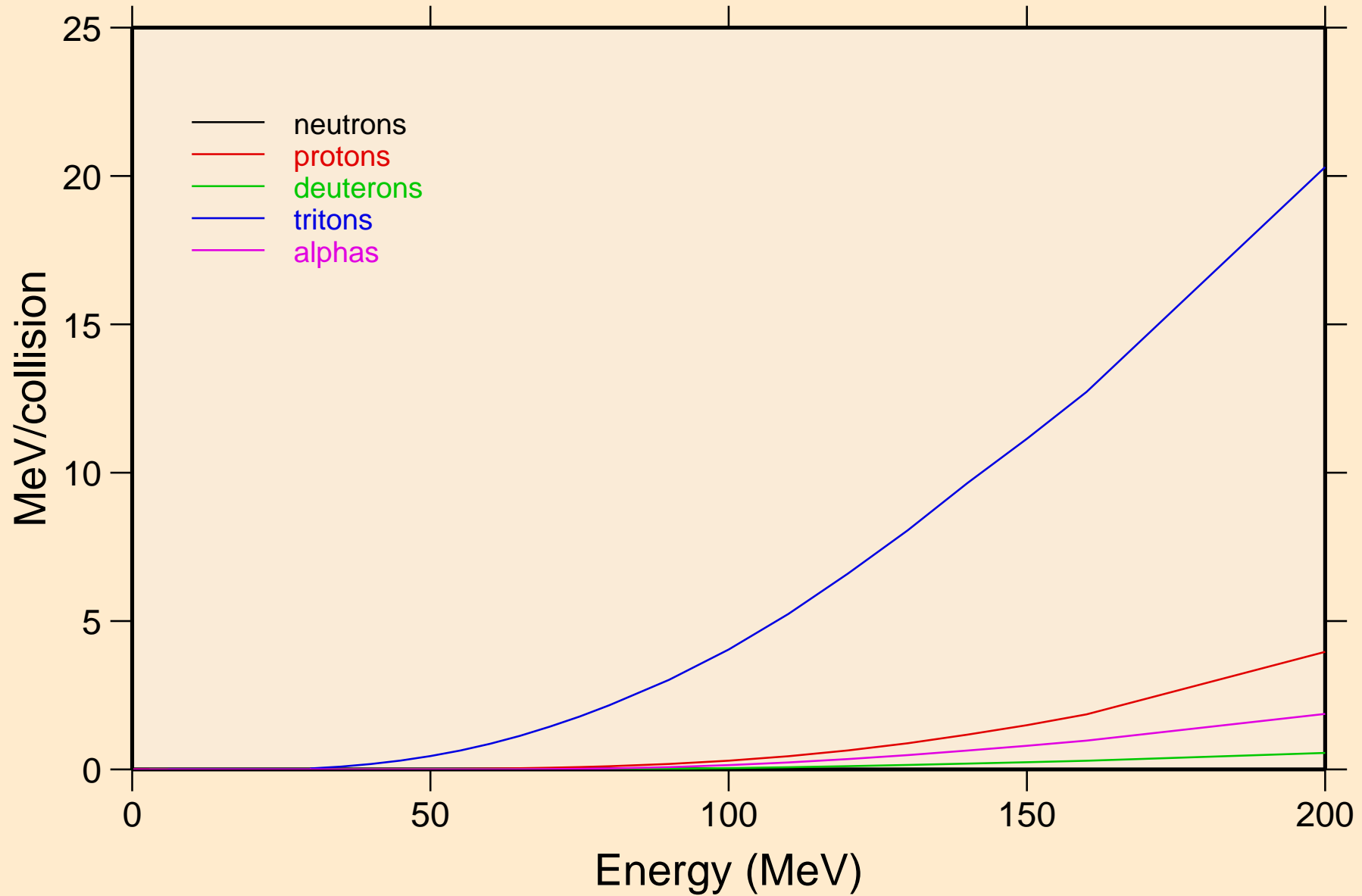

BK235 HELION ACER TENDL-2024 LIBRARY; T=0.K
Recoil Heating

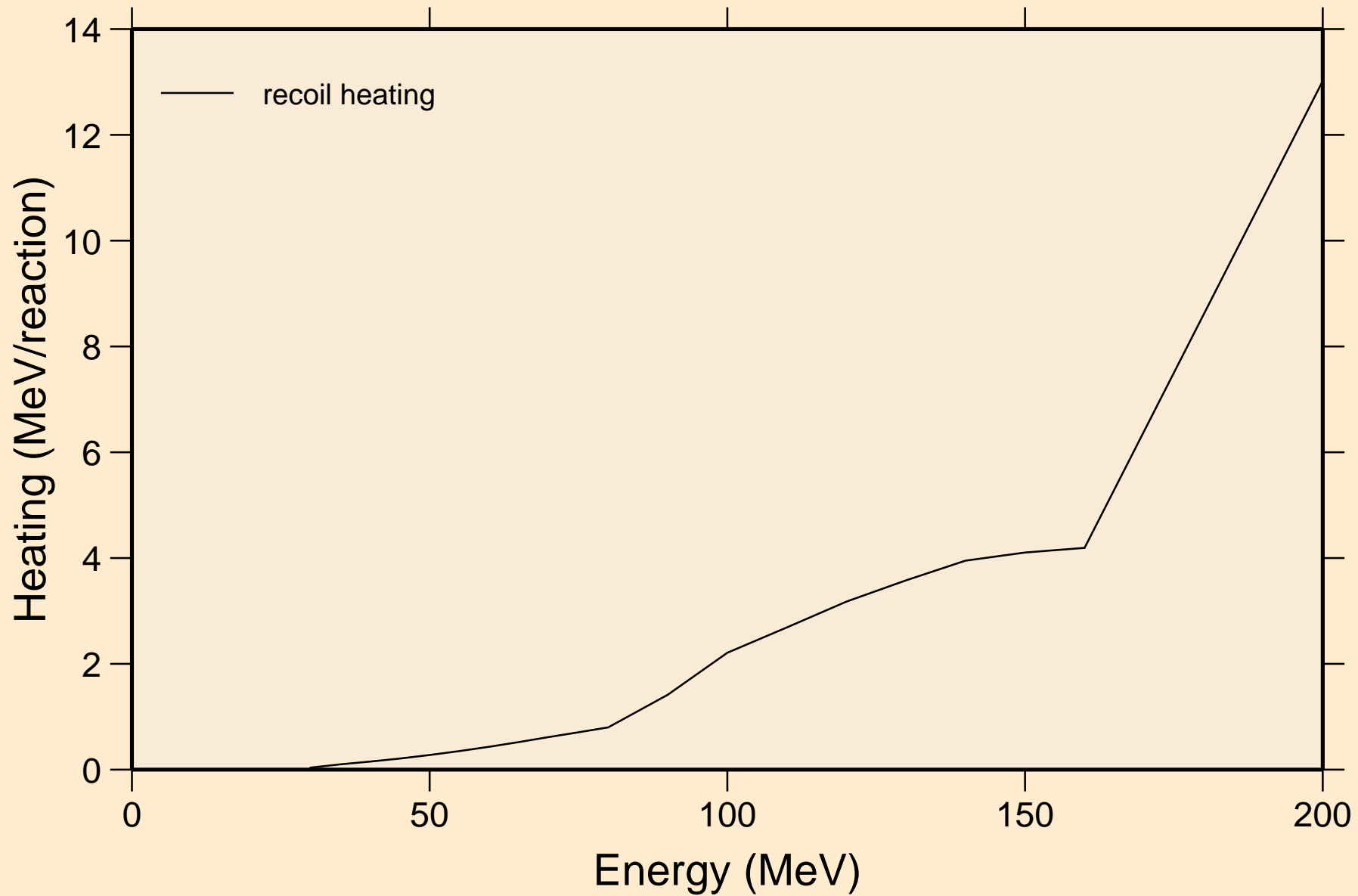

BK235 HELION ACER TENDL-2024 LIBRARY; T=0.K
Particle production cross sections

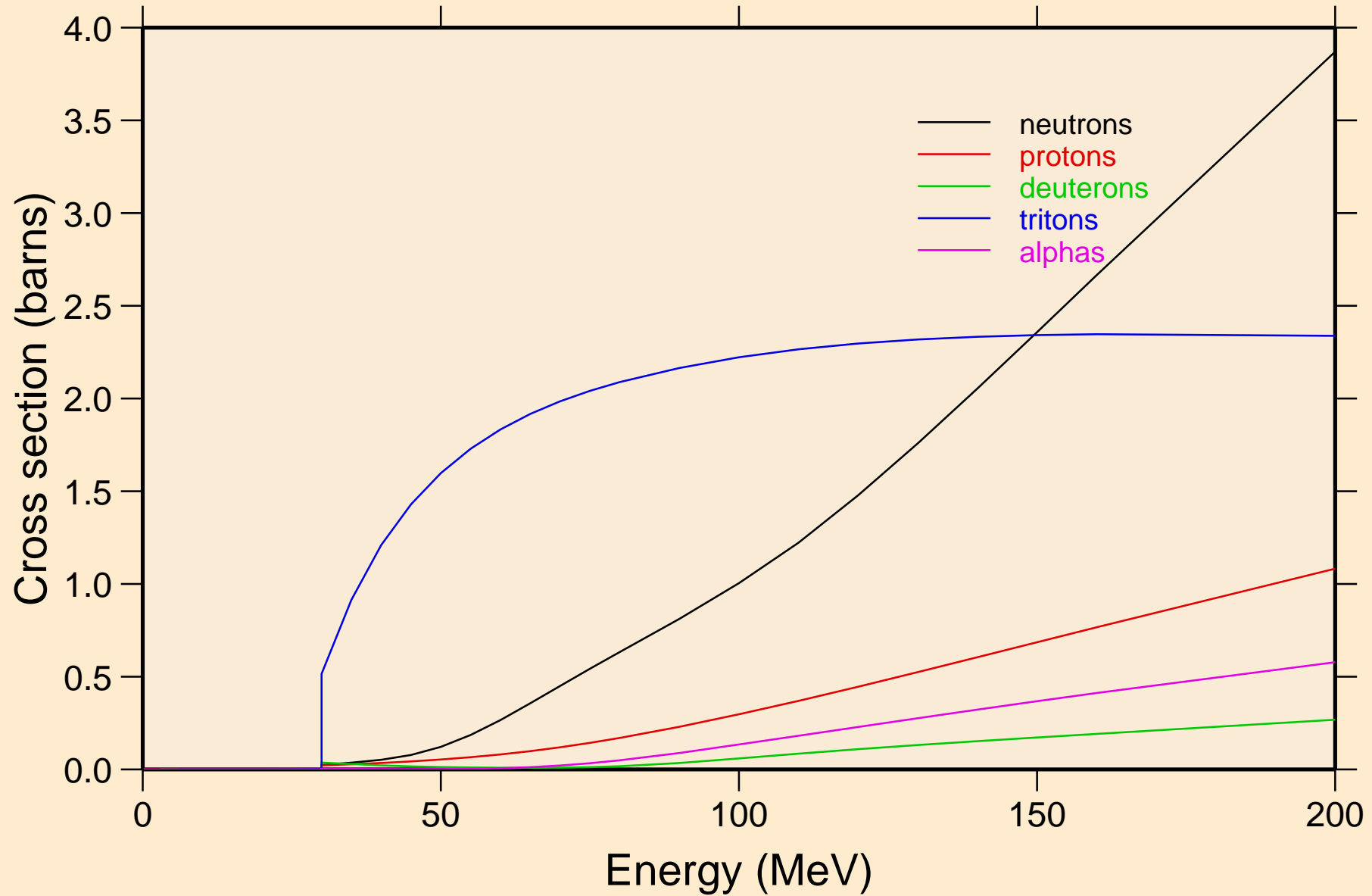

BK235 HELION ACER TENDL-2024 LIBRARY; T=0.K
neutrons from (s,n)

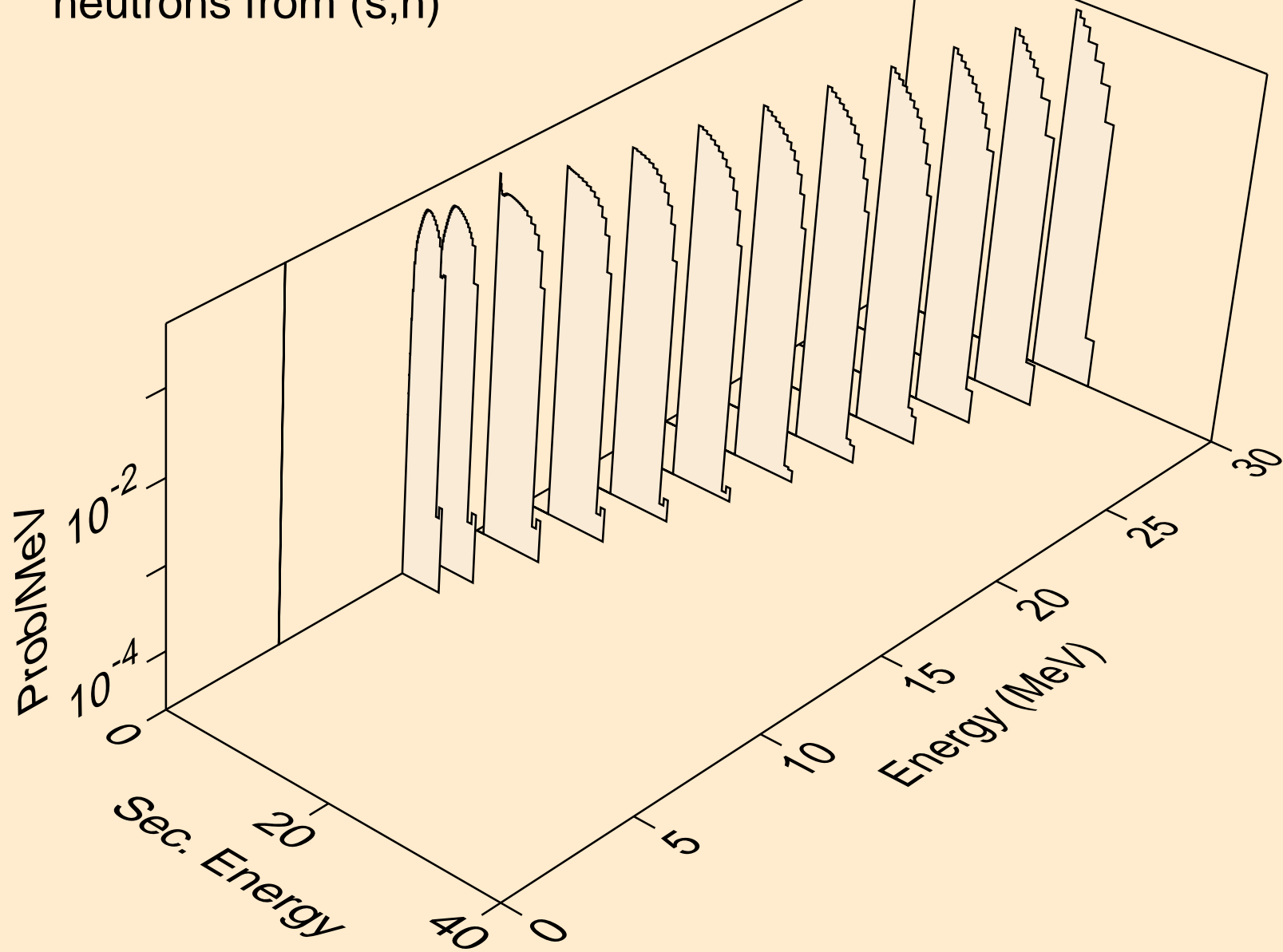

BK235 HELION ACER TENDL-2024 LIBRARY; T=0.K
neutrons from (s,x)

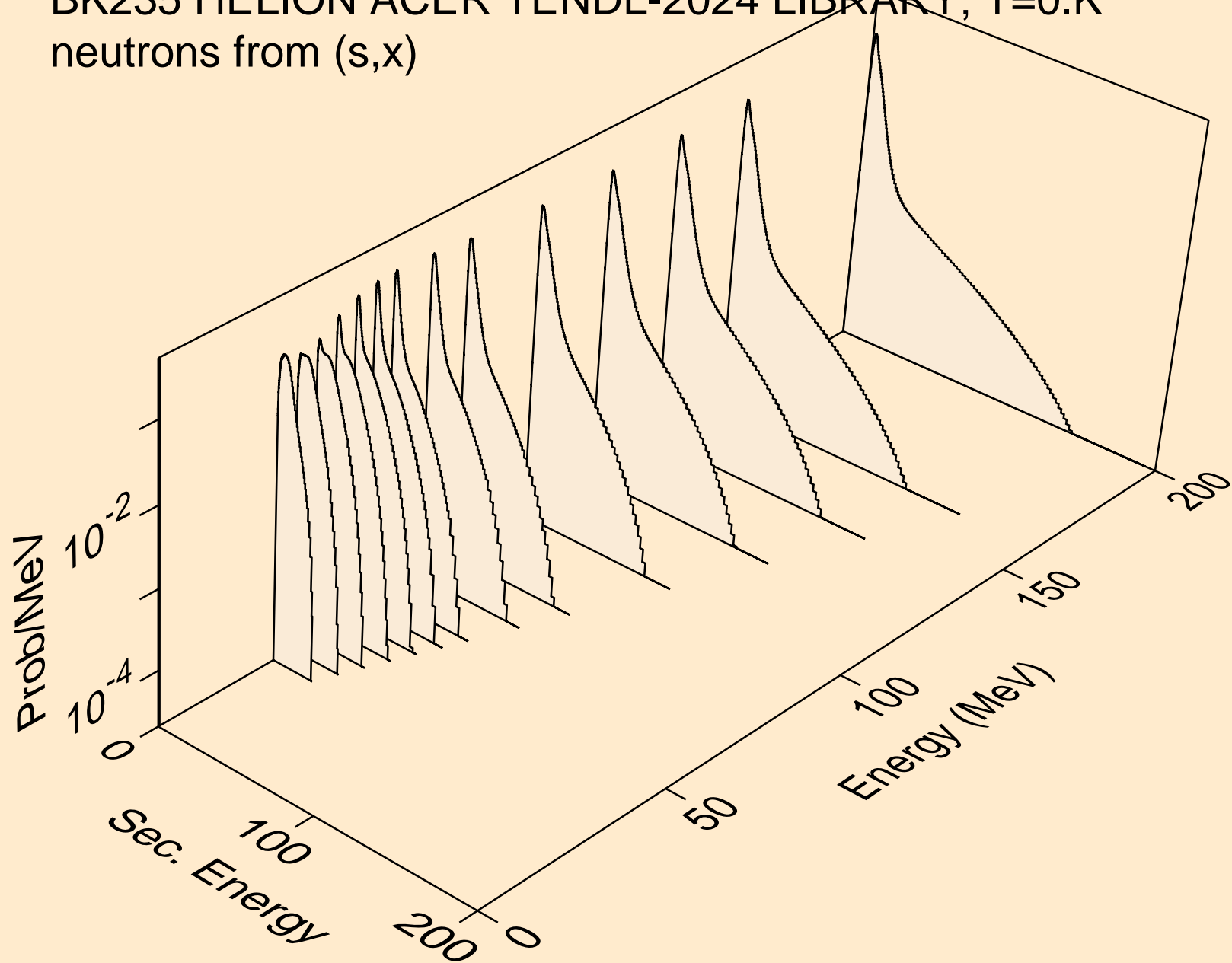

BK235 HELION ACER TENDL-2024 LIBRARY; T=0.K
neutrons from (s,n*)p

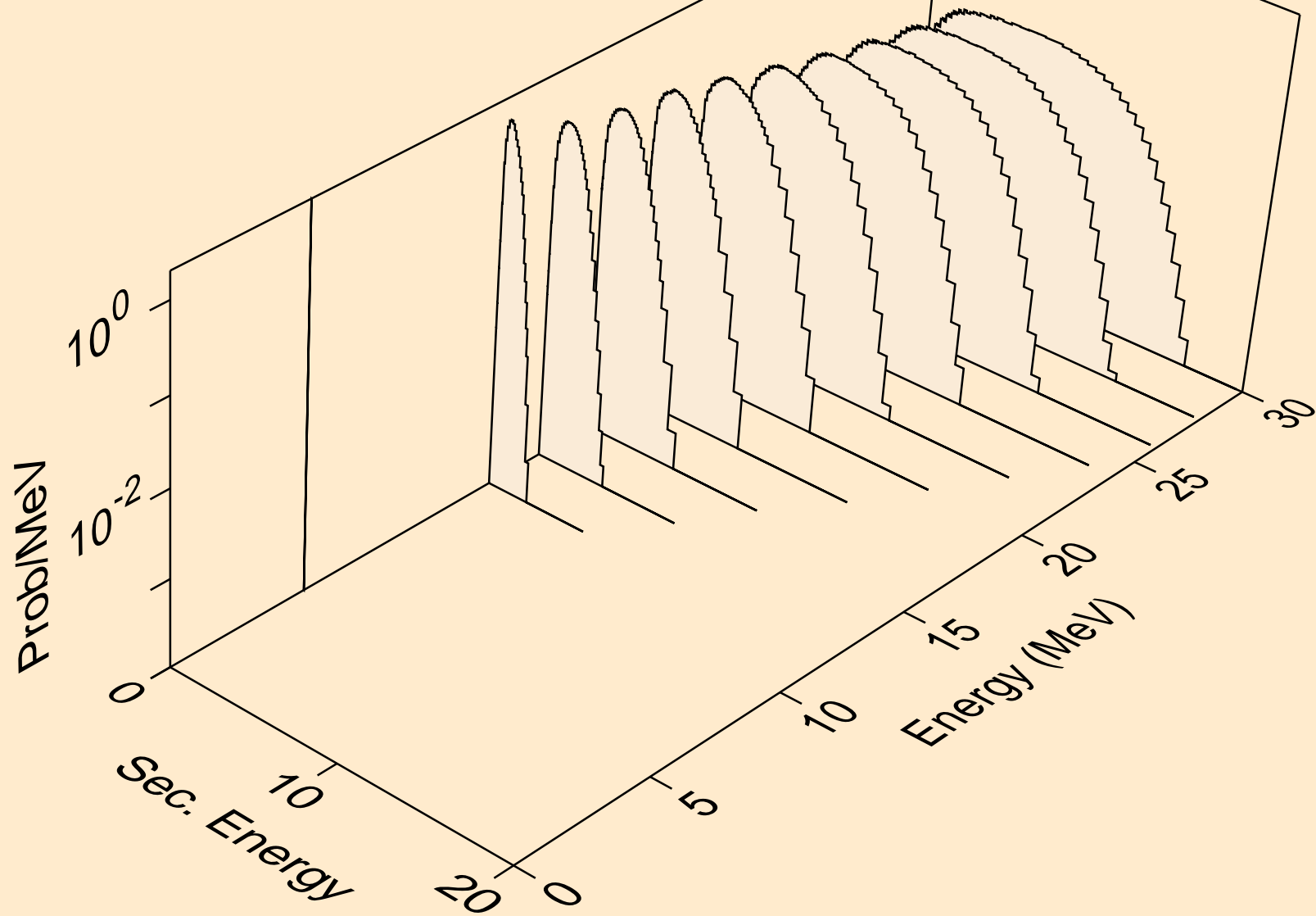

BK235 HELION ACER TENDL-2024 LIBRARY; T=0.K
neutrons from (s,n*)d

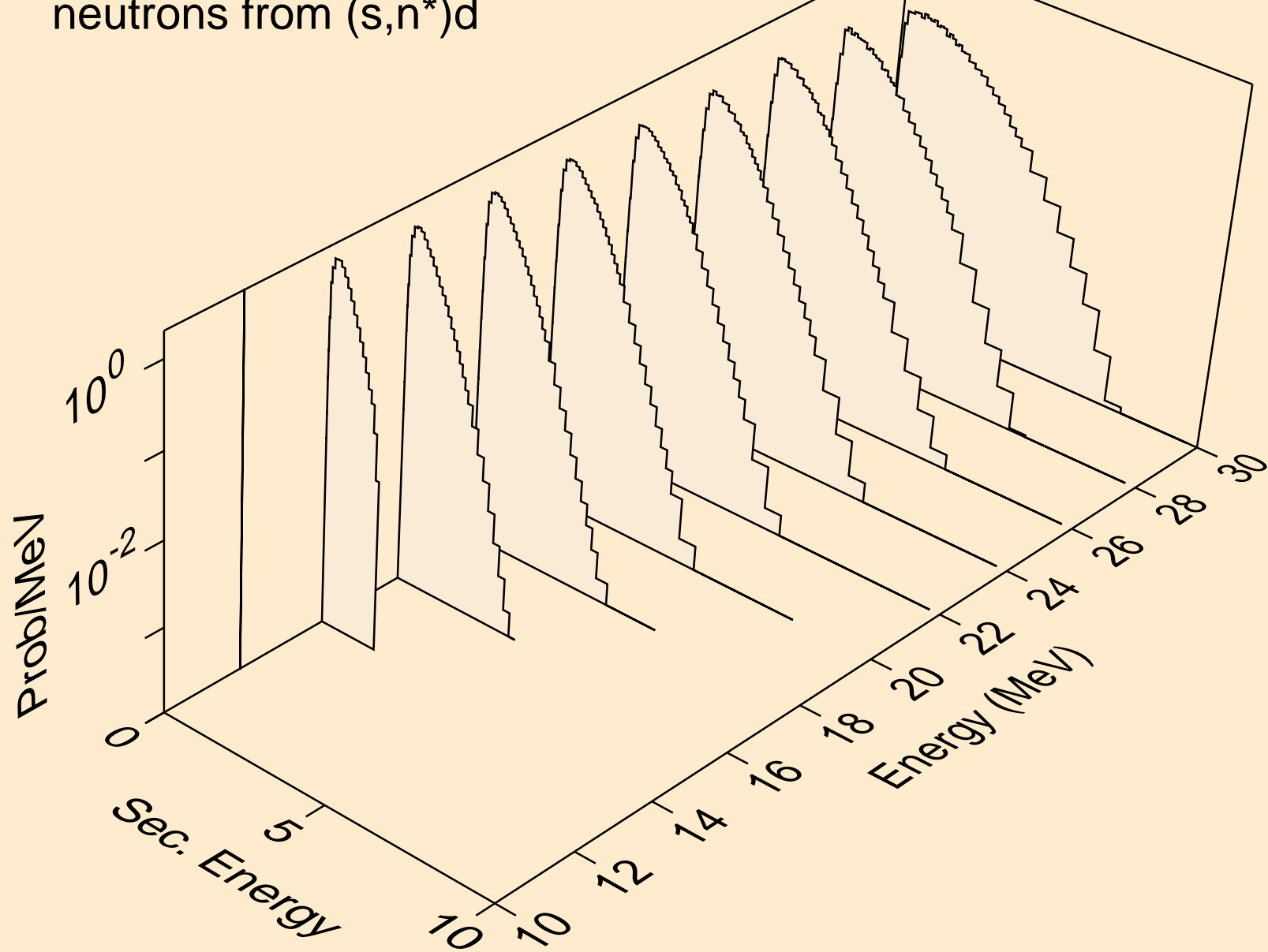

BK235 HELION ACER TENDL-2024 LIBRARY; T=0.K
neutrons from (s,n*)t

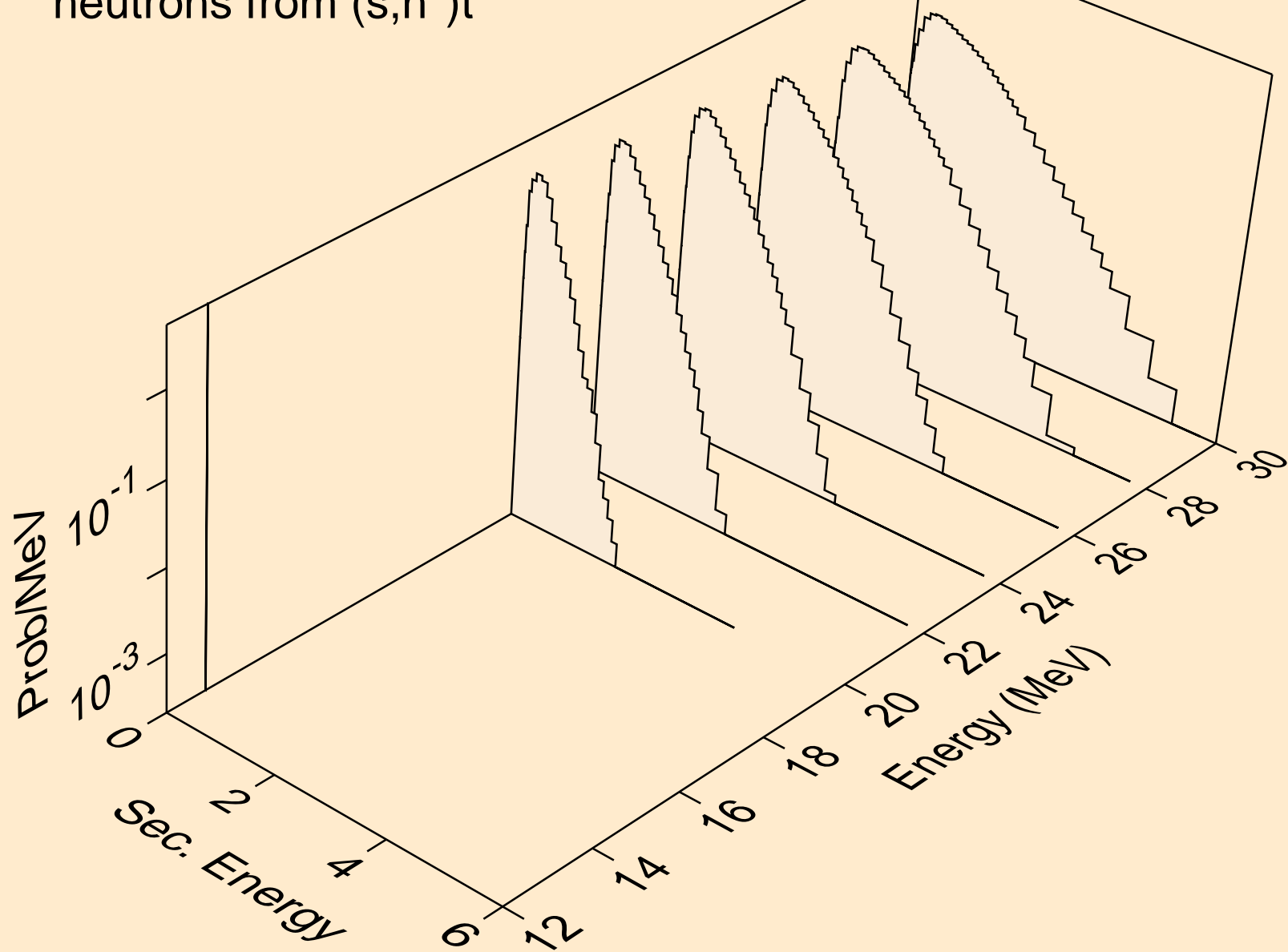

BK235 HELION ACER TENDL-2024 LIBRARY; T=0.K
neutrons from (s,2np)

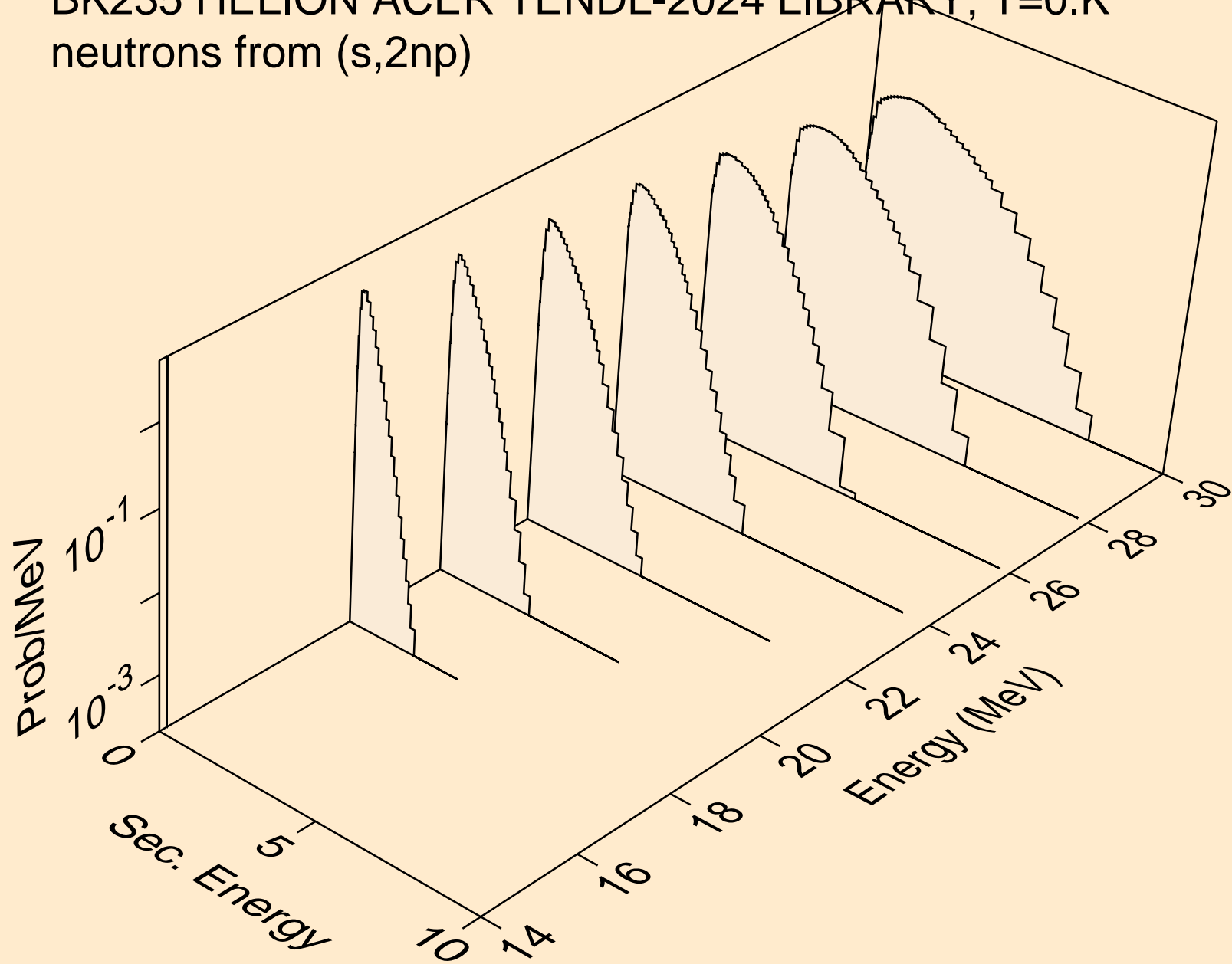

BK235 HELION ACER TENDL-2024 LIBRARY; T=0.K
protons from (s,x)

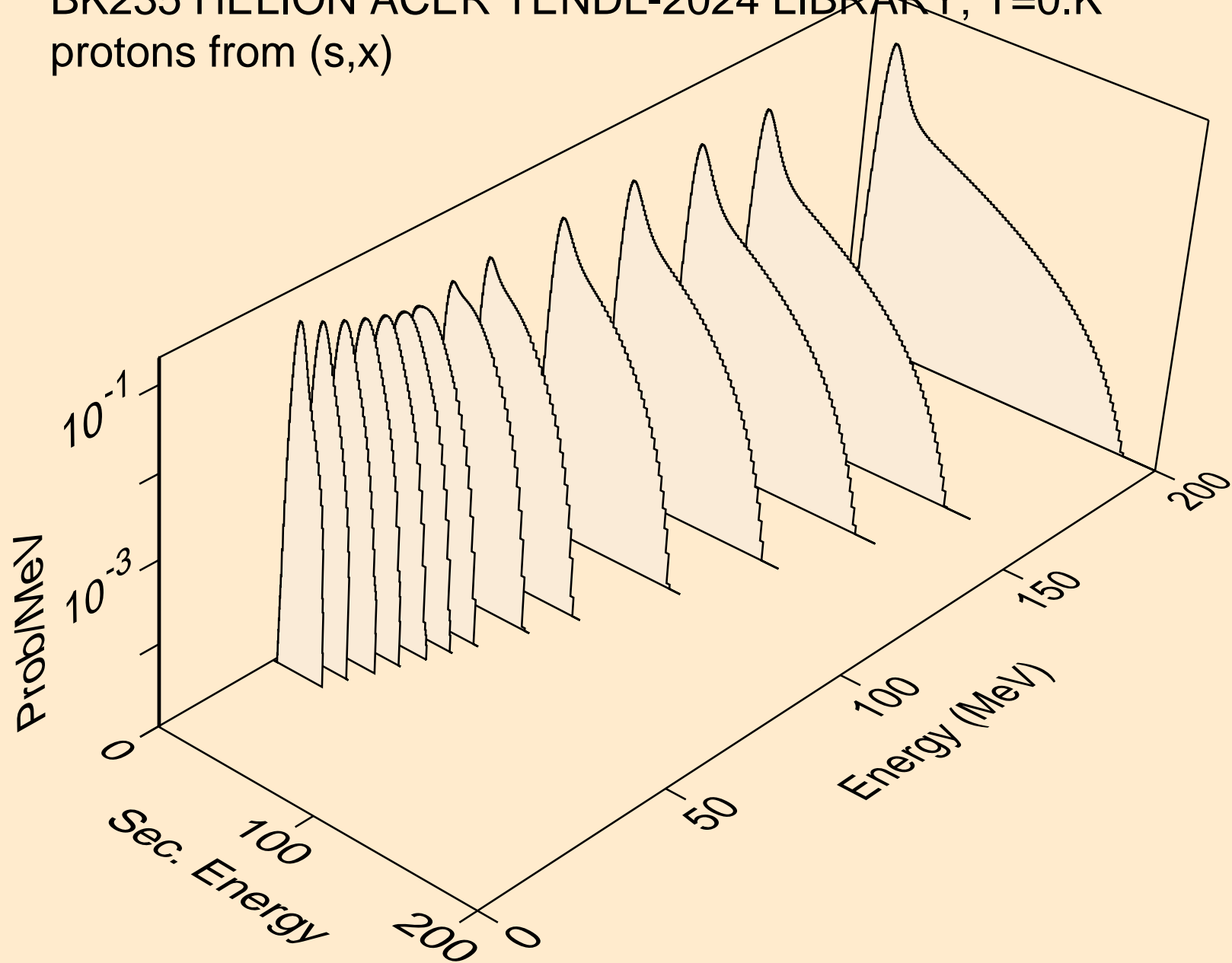

BK235 HELION ACER TENDL-2024 LIBRARY; T=0.K
protons from (s,n*)p

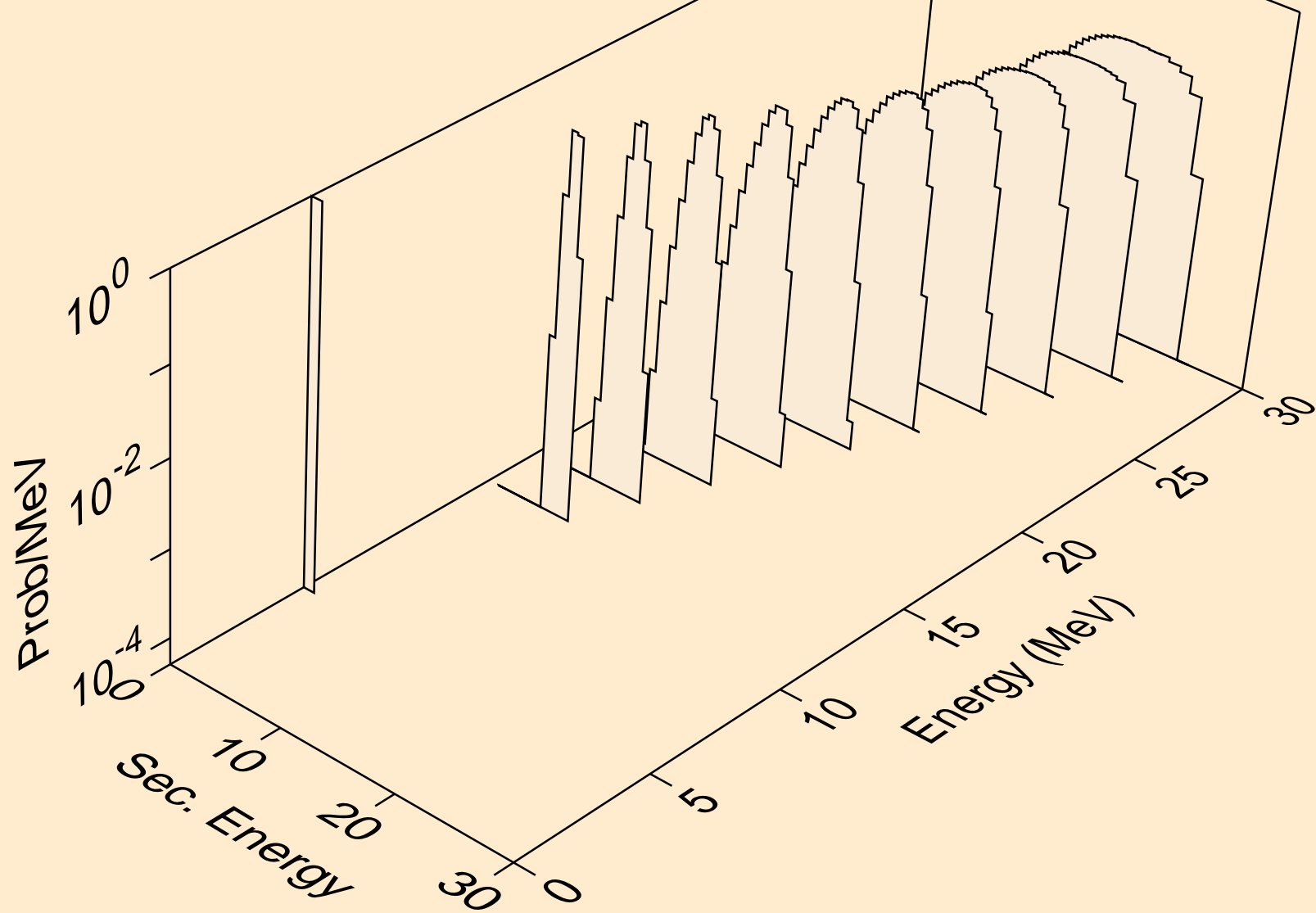

BK235 HELION ACER TENDL-2024 LIBRARY; T=0.K
protons from (s,2np)

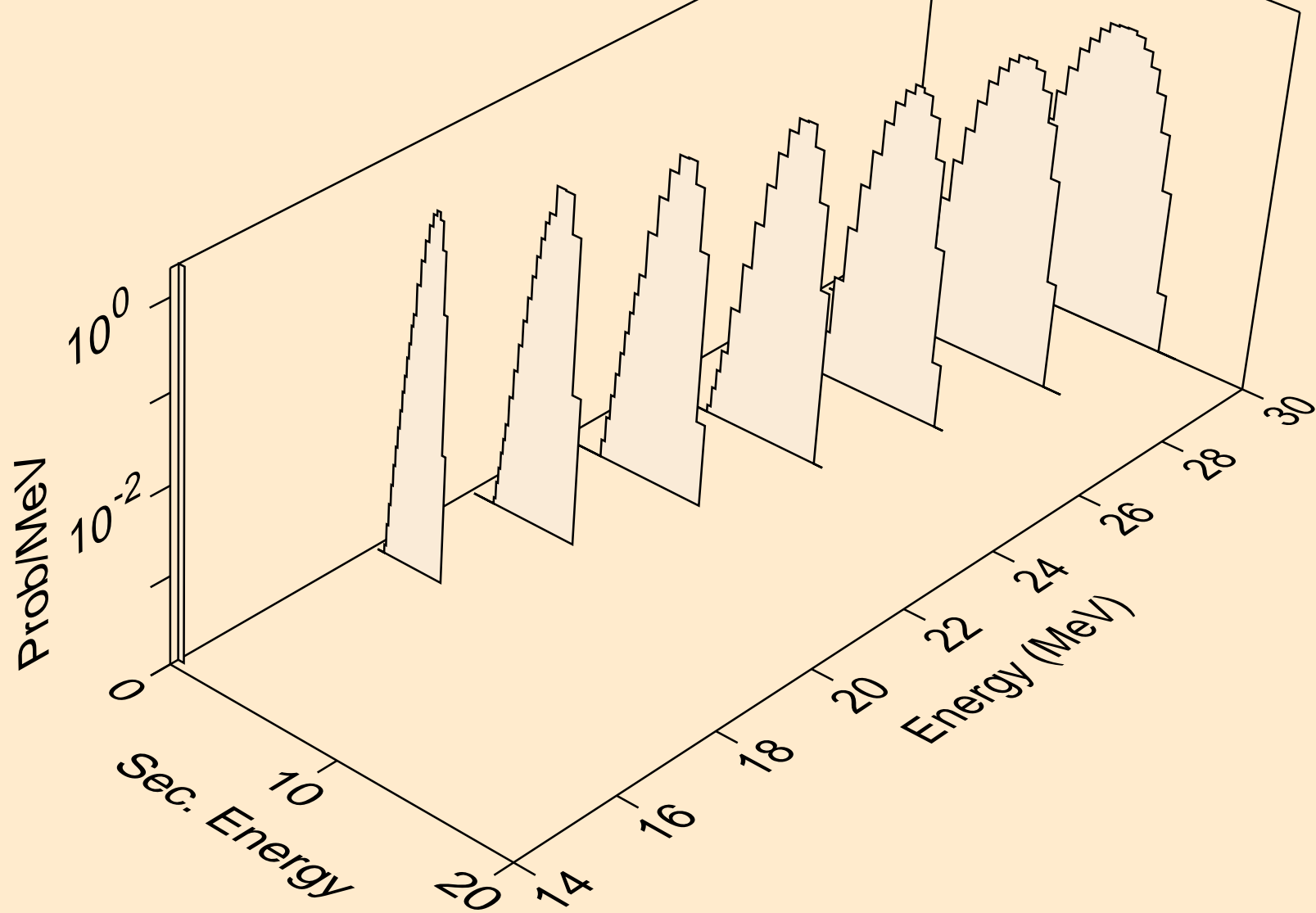

BK235 HELION ACER TENDL-2024 LIBRARY; T=0.K
protons from (s,p)

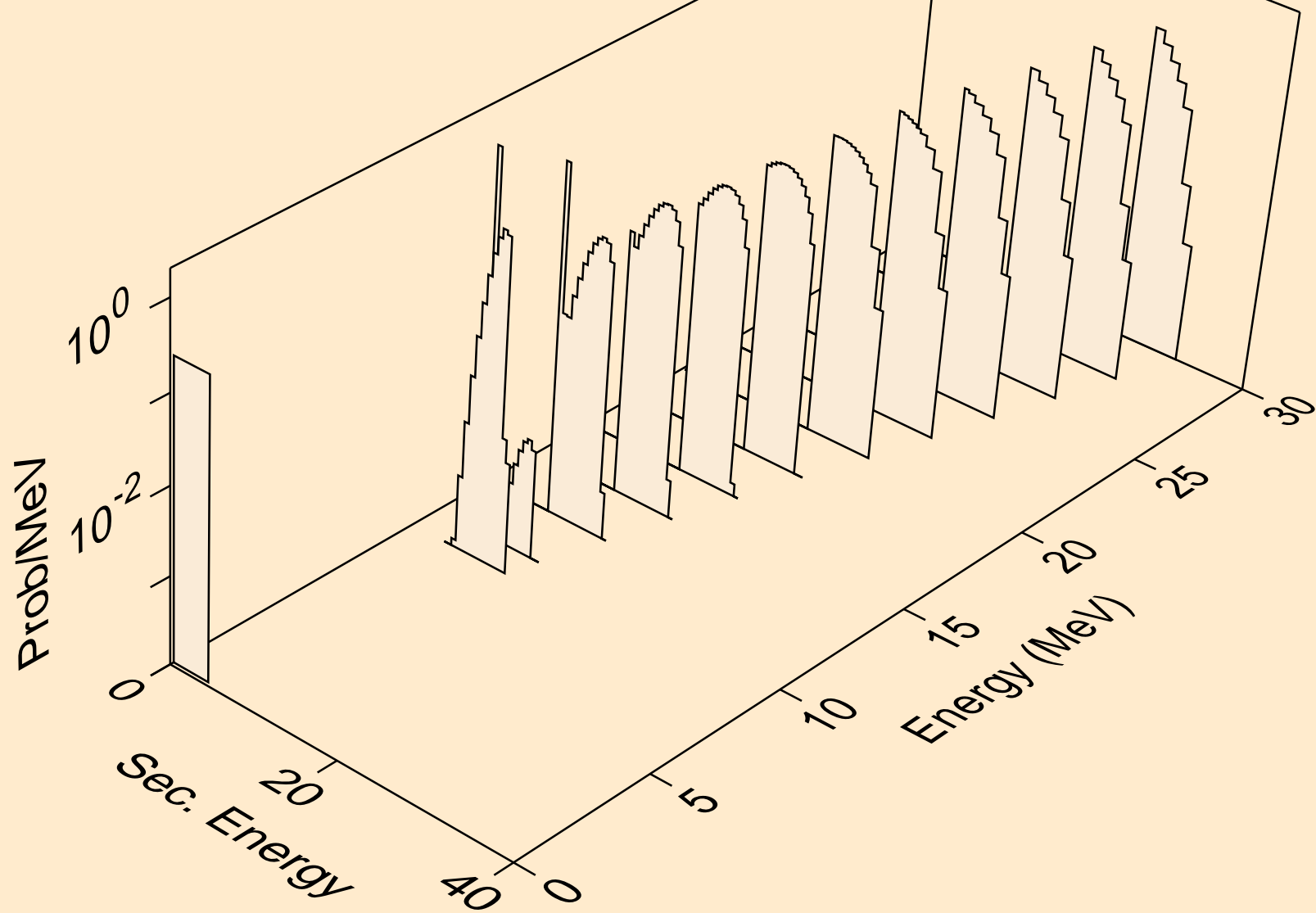

BK235 HELION ACER TENDL-2024 LIBRARY; T=0.K
protons from (s,2p)

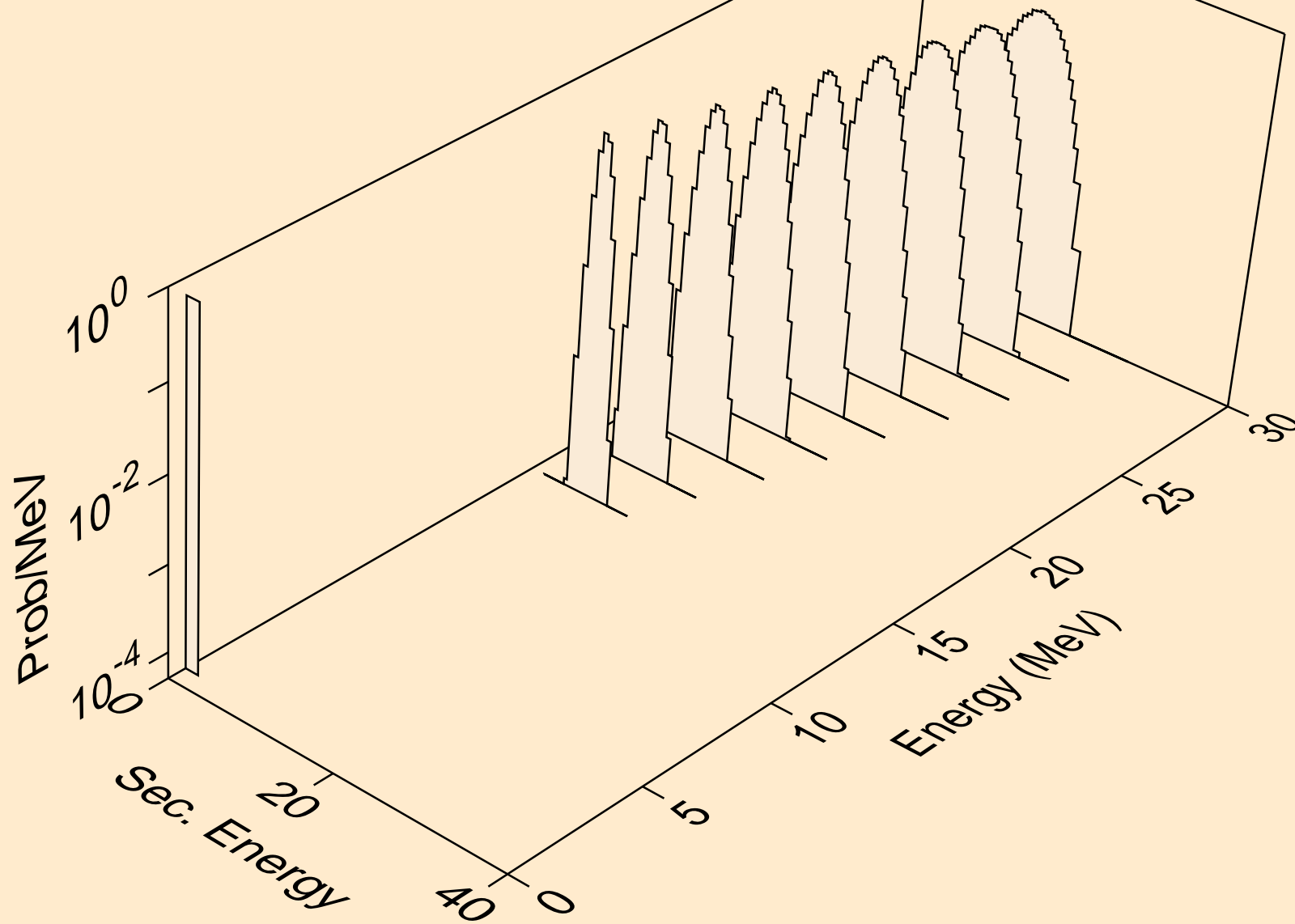

BK235 HELION ACER TENDL-2024 LIBRARY; T=0.K
deuterons from (s,x)

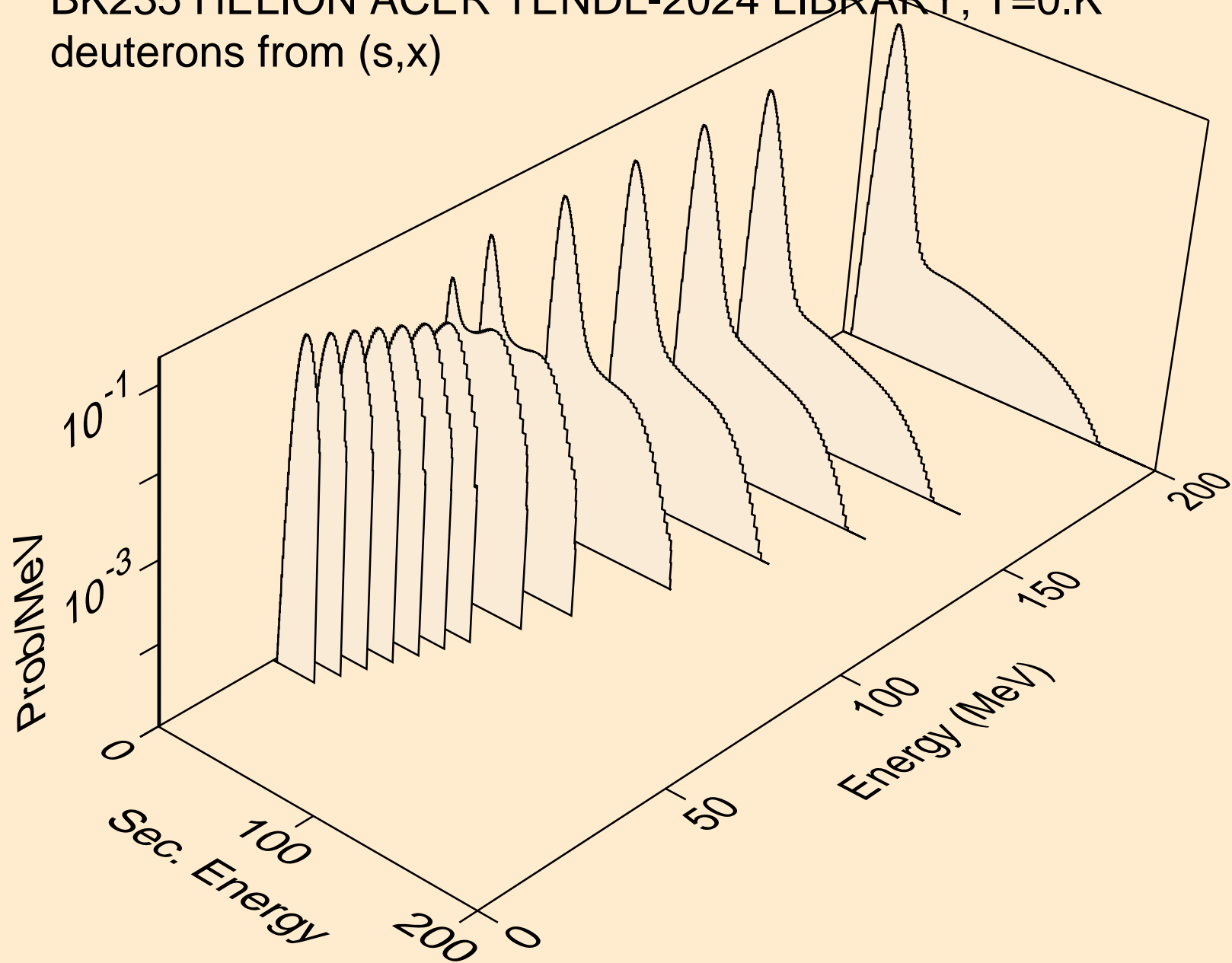

BK235 HELION ACER TENDL-2024 LIBRARY; T=0.K
deuterons from (s,n*)d

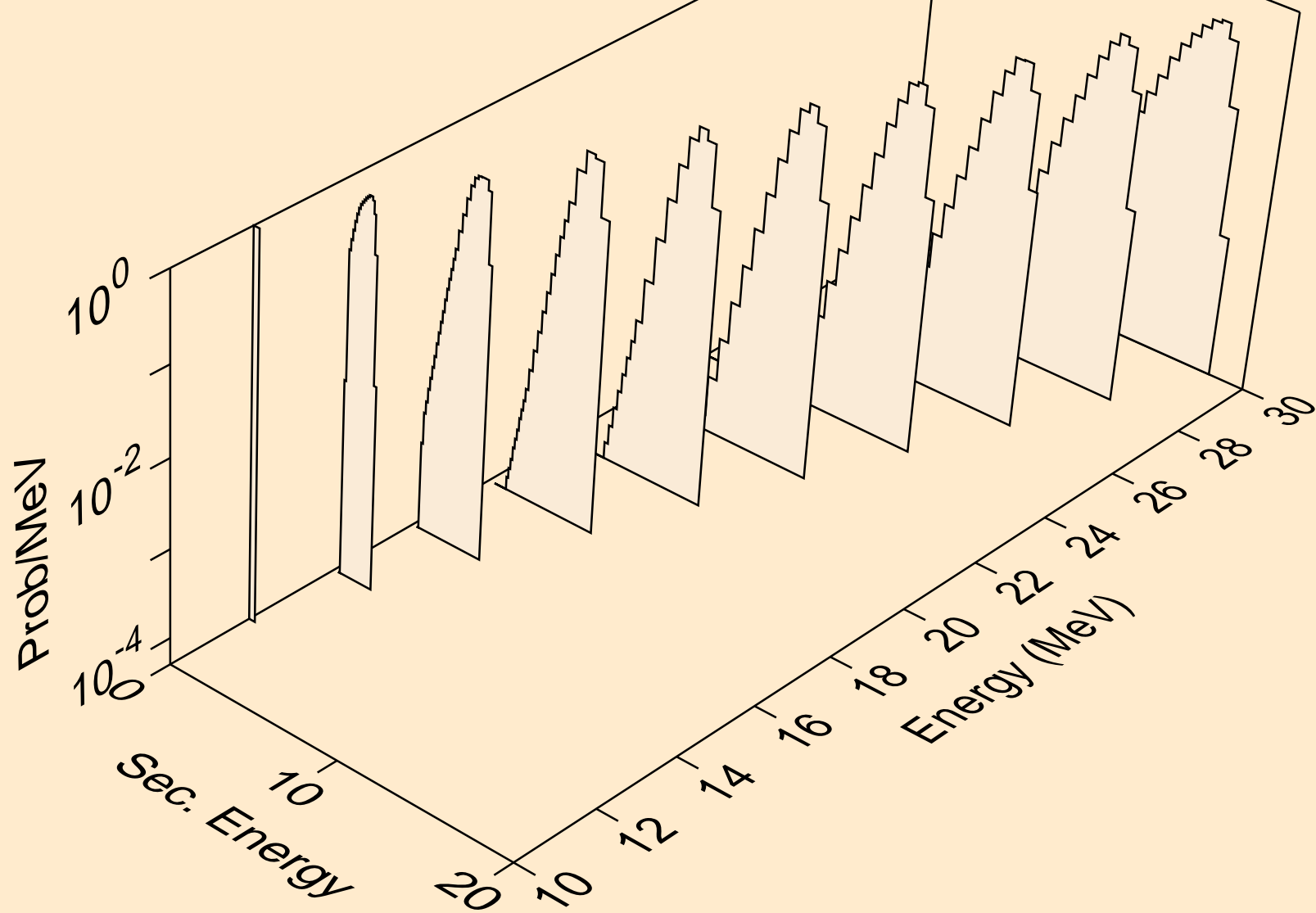

BK235 HELION ACER TENDL-2024 LIBRARY; T=0.K
deuterons from (s,d)

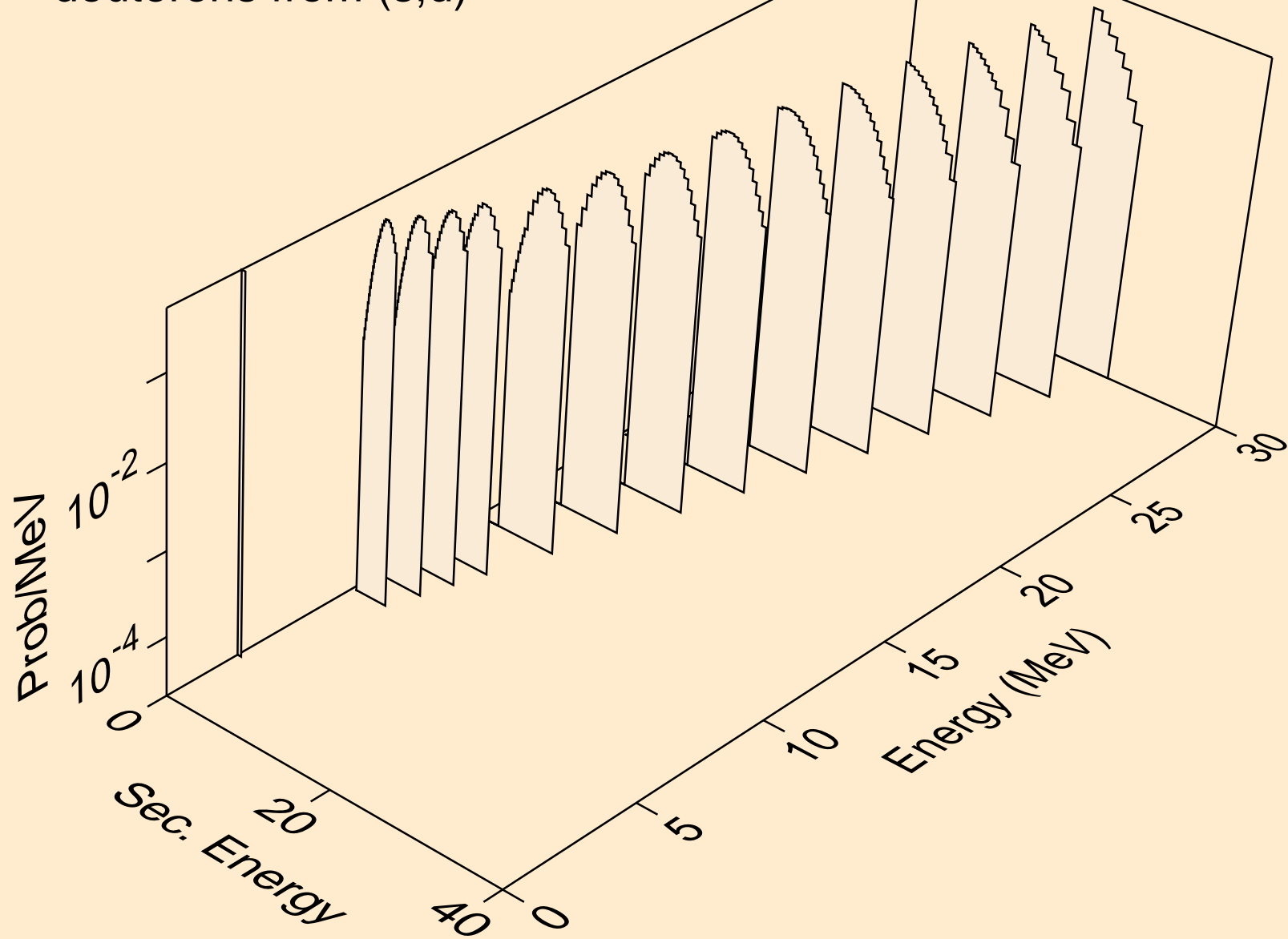

BK235 HELION ACER TENDL-2024 LIBRARY; T=0.K
tritons from (s,x)

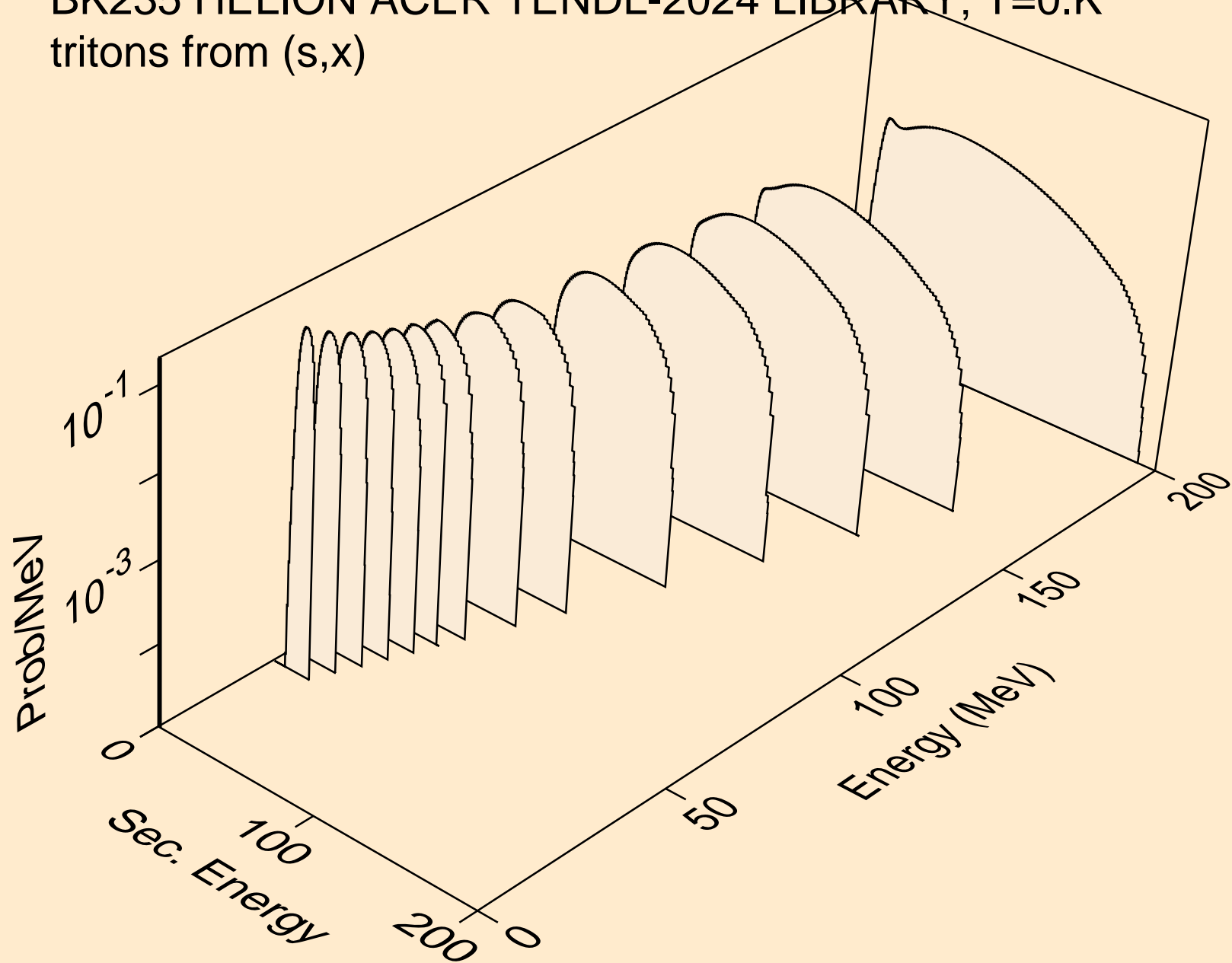

BK235 HELION ACER TENDL-2024 LIBRARY; T=0.K
tritons from (s,n*)t

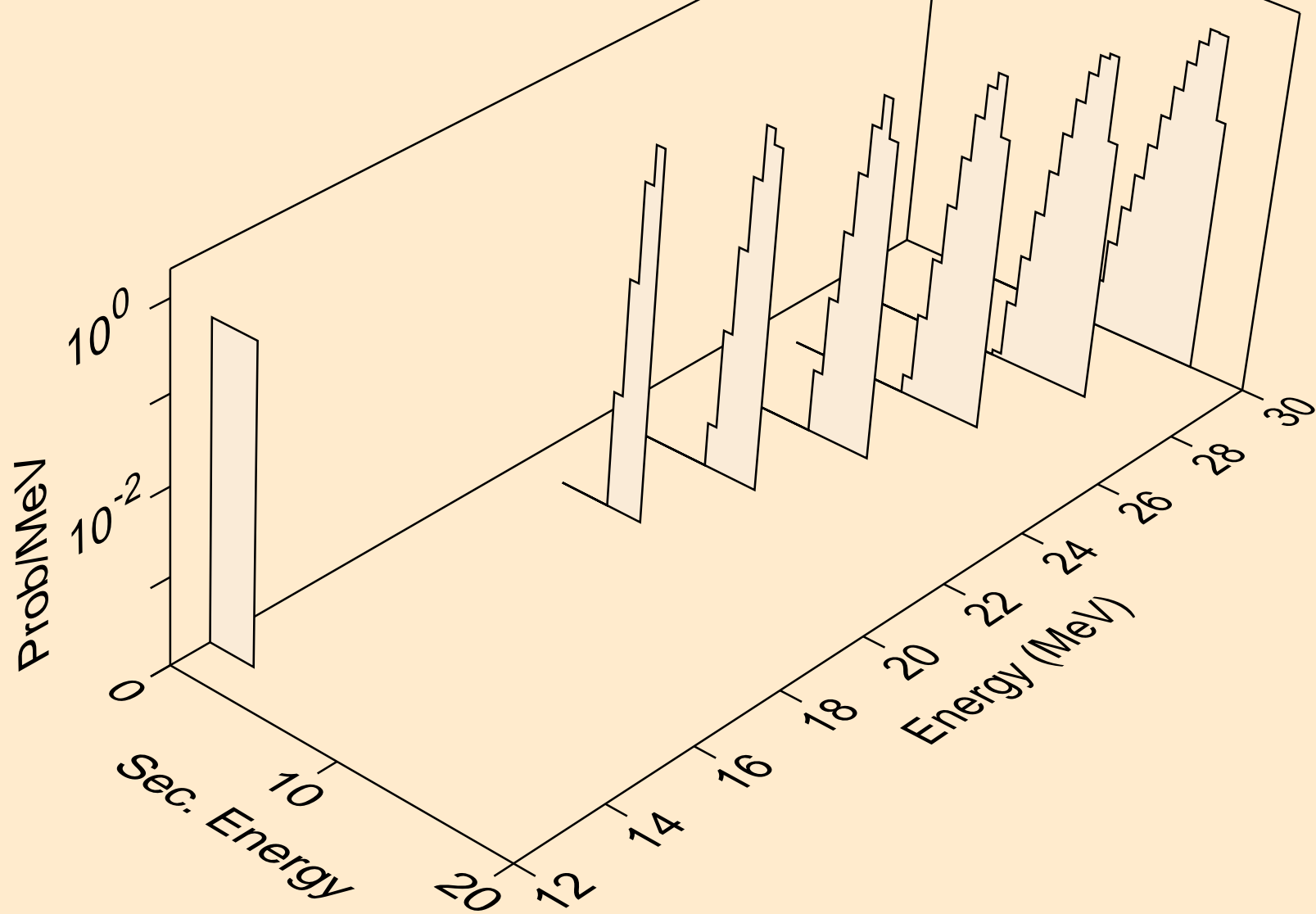

BK235 HELION ACER TENDL-2024 LIBRARY; T=0.K
tritons from (s,t)

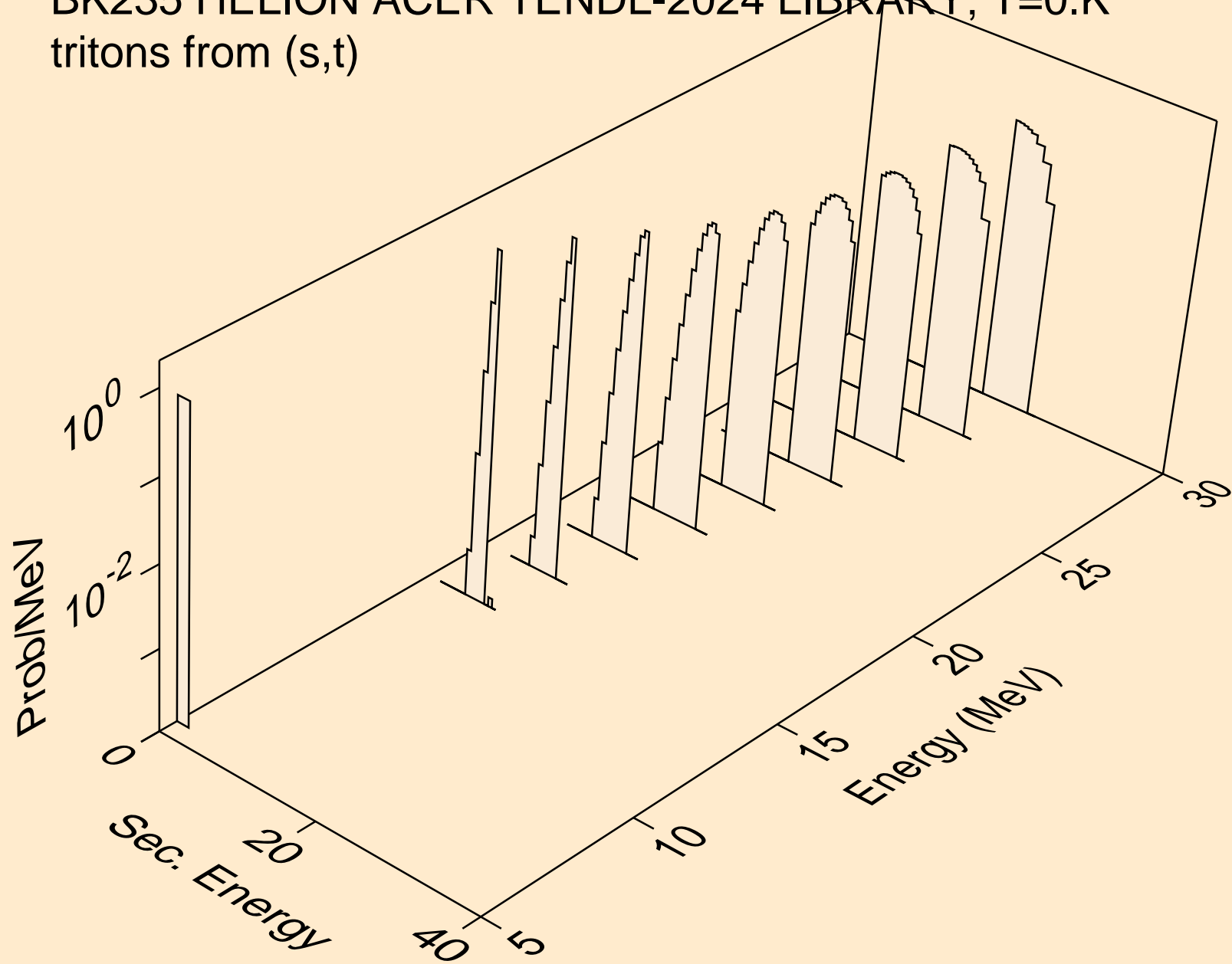

BK235 HELION ACER TENDL-2024 LIBRARY; T=0.K
alphas from (s,x)

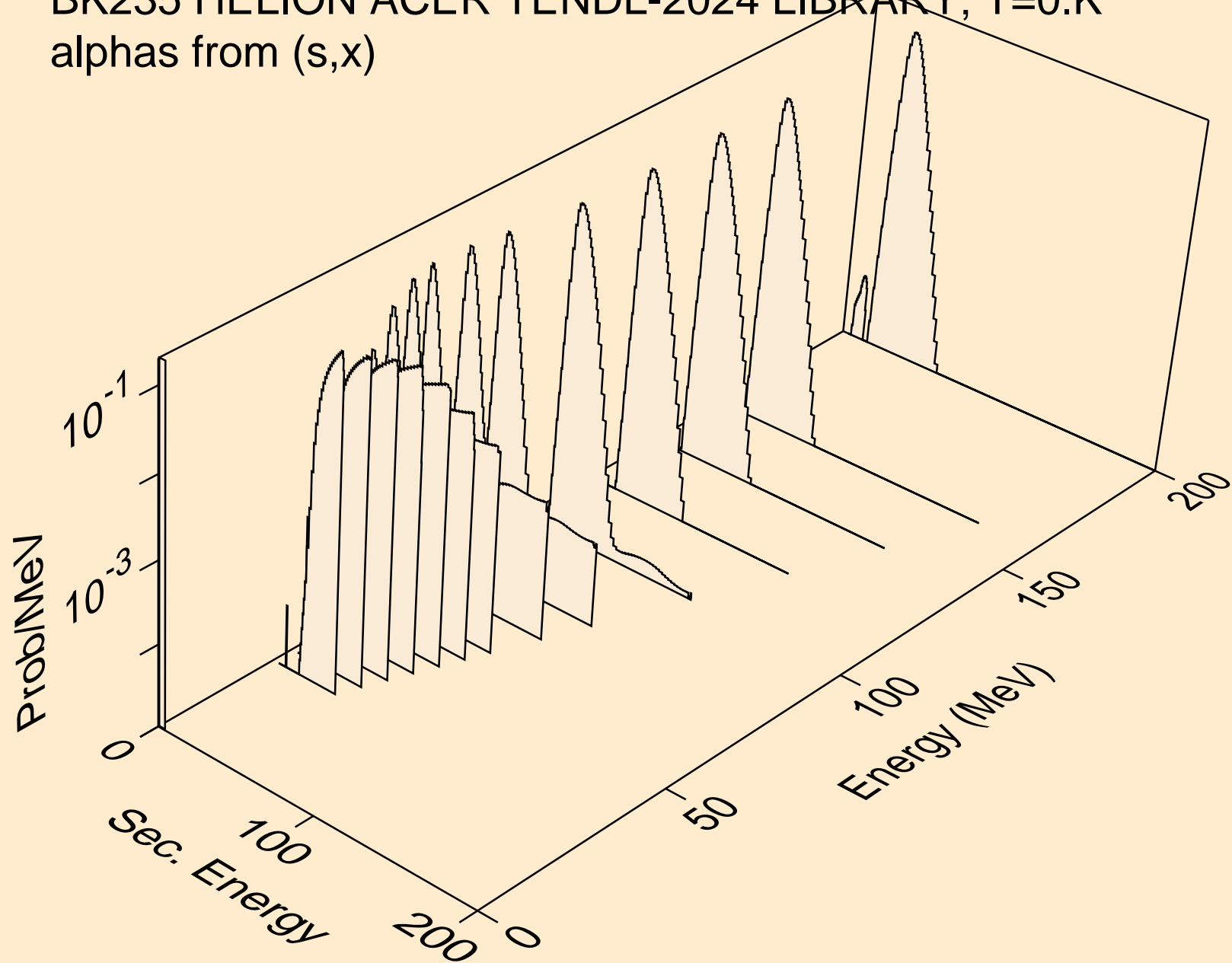

BK235 HELION ACER TENDL-2024 LIBRARY; T=0.K
alphas from (s,a)

