

# CD123 HELION ACER TENDL-2024 LIBRARY; T=0.K

## Principal cross sections

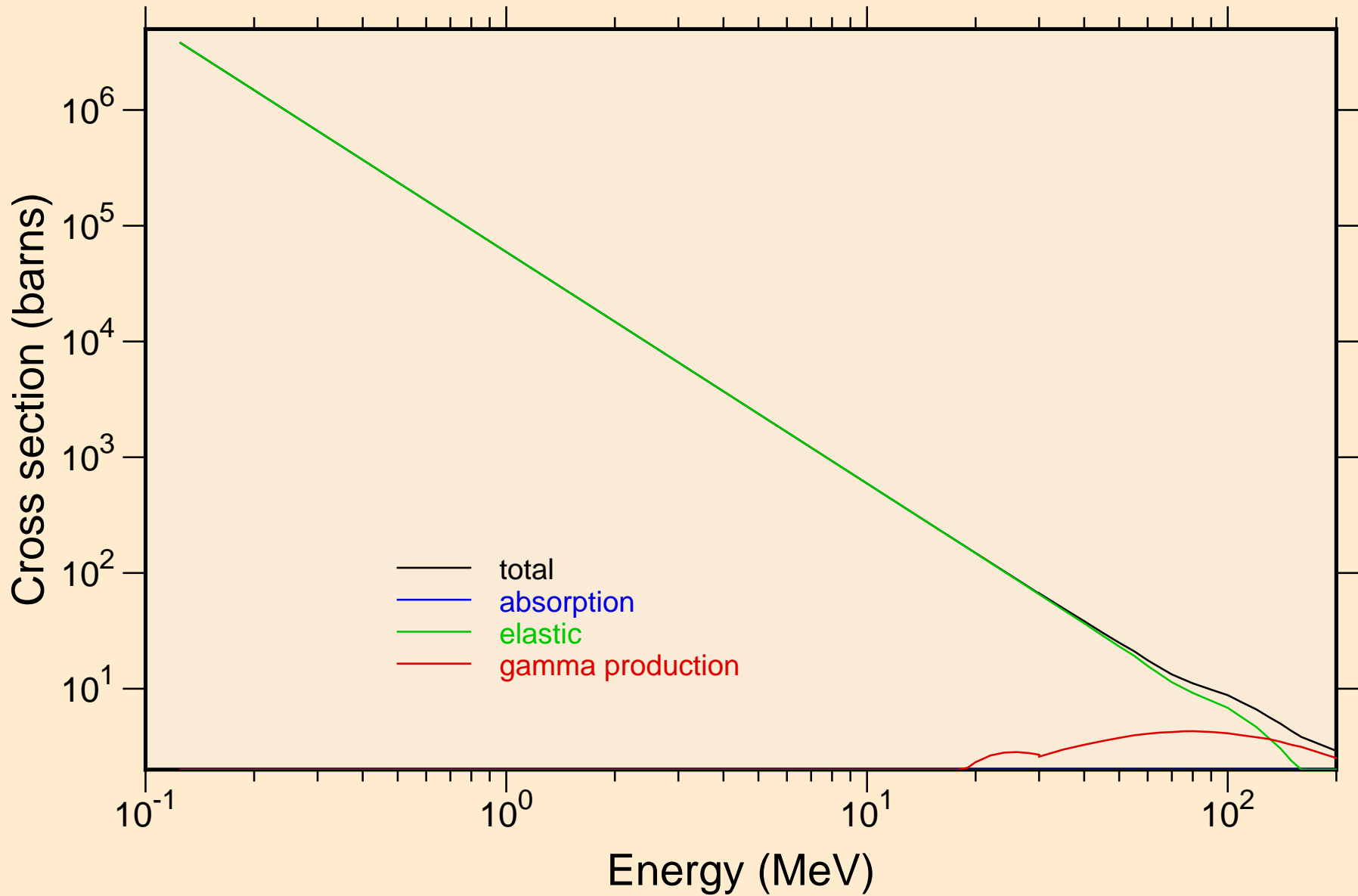

# CD123 HELION ACER TENDL-2024 LIBRARY; T=0.K

## Heating

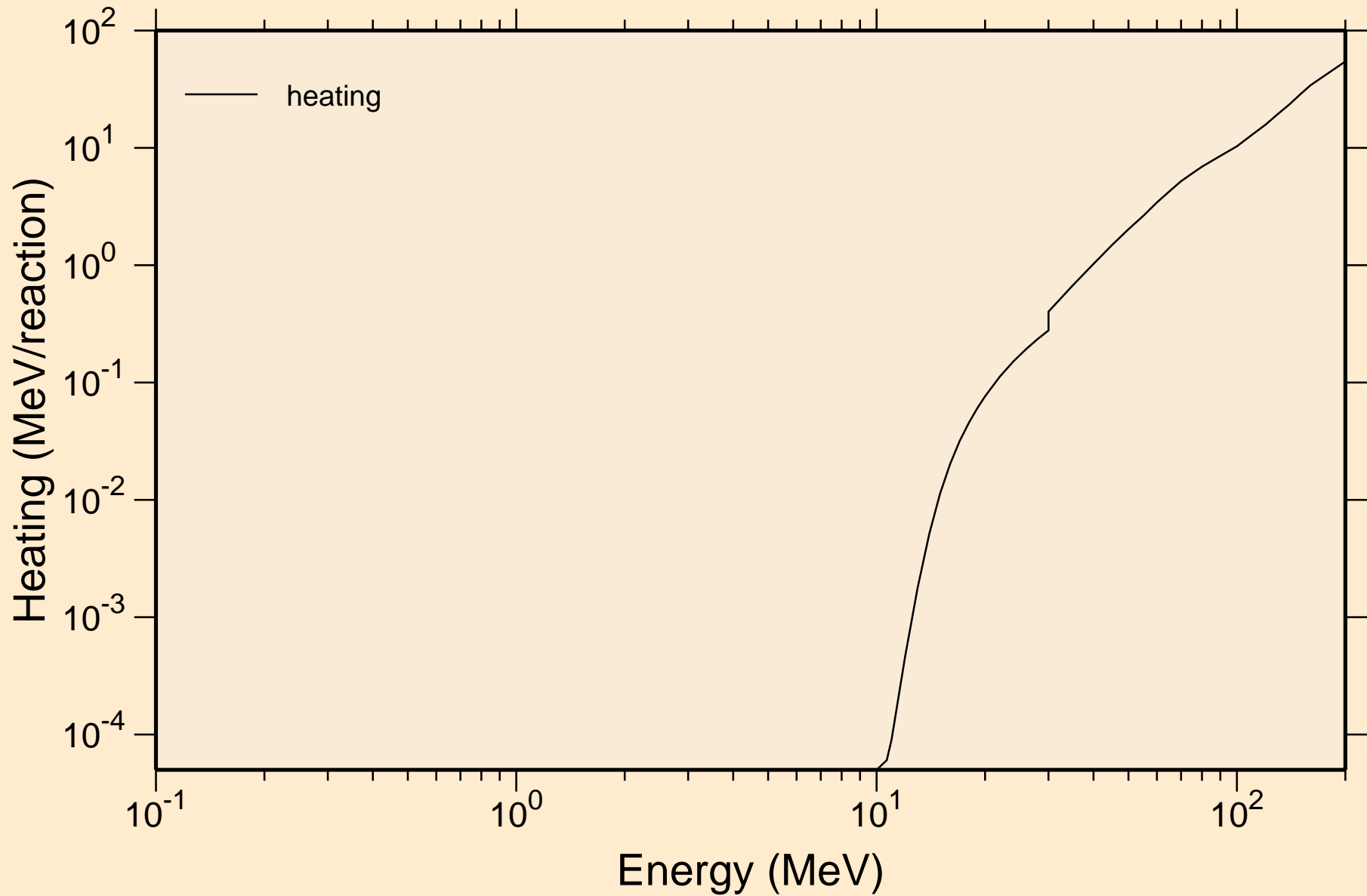

# CD123 HELION ACER TENDL-2024 LIBRARY; T=0.K

## Principal cross sections

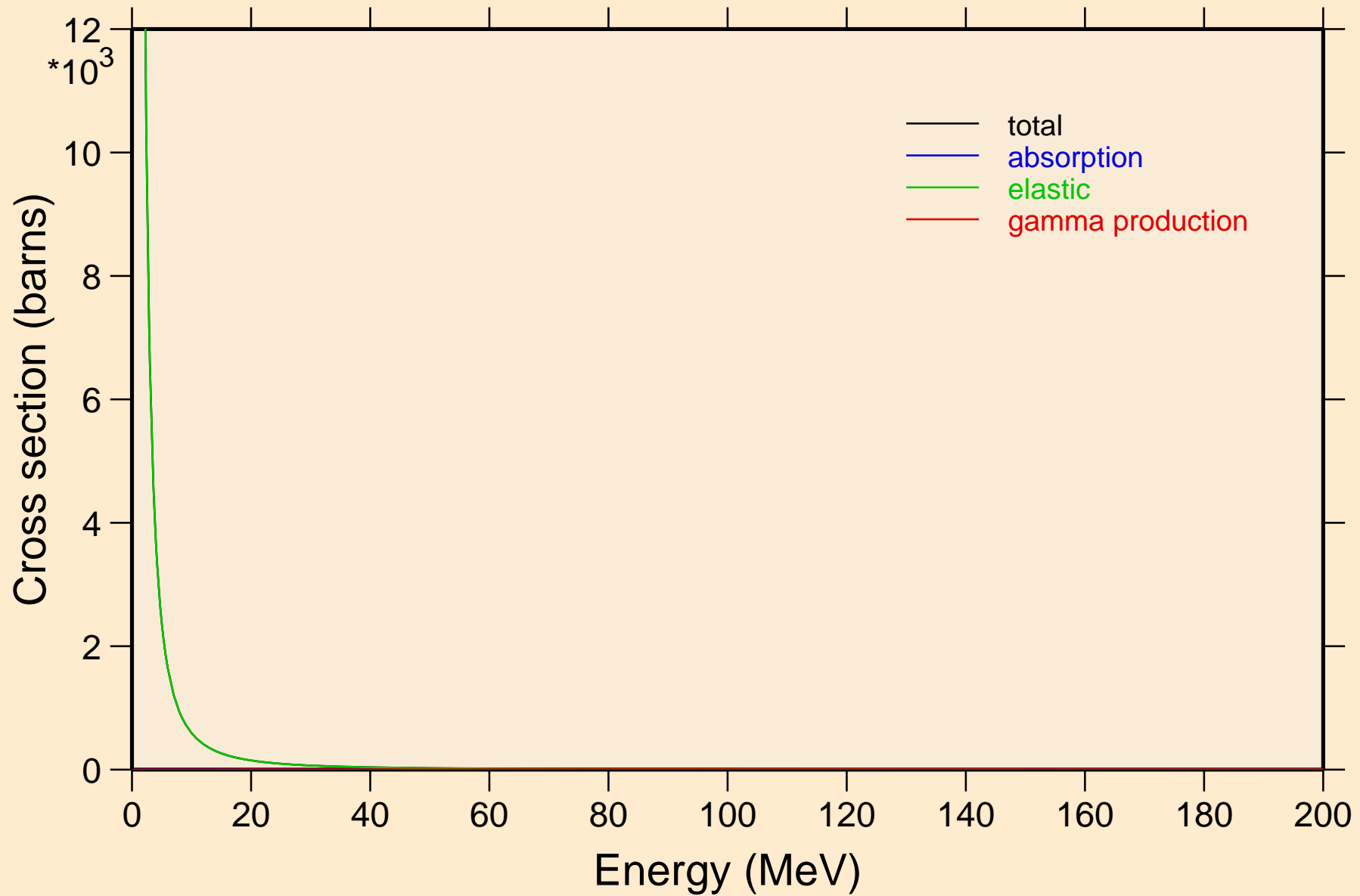

# CD123 HELION ACER TENDL-2024 LIBRARY; T=0.K

## Heating

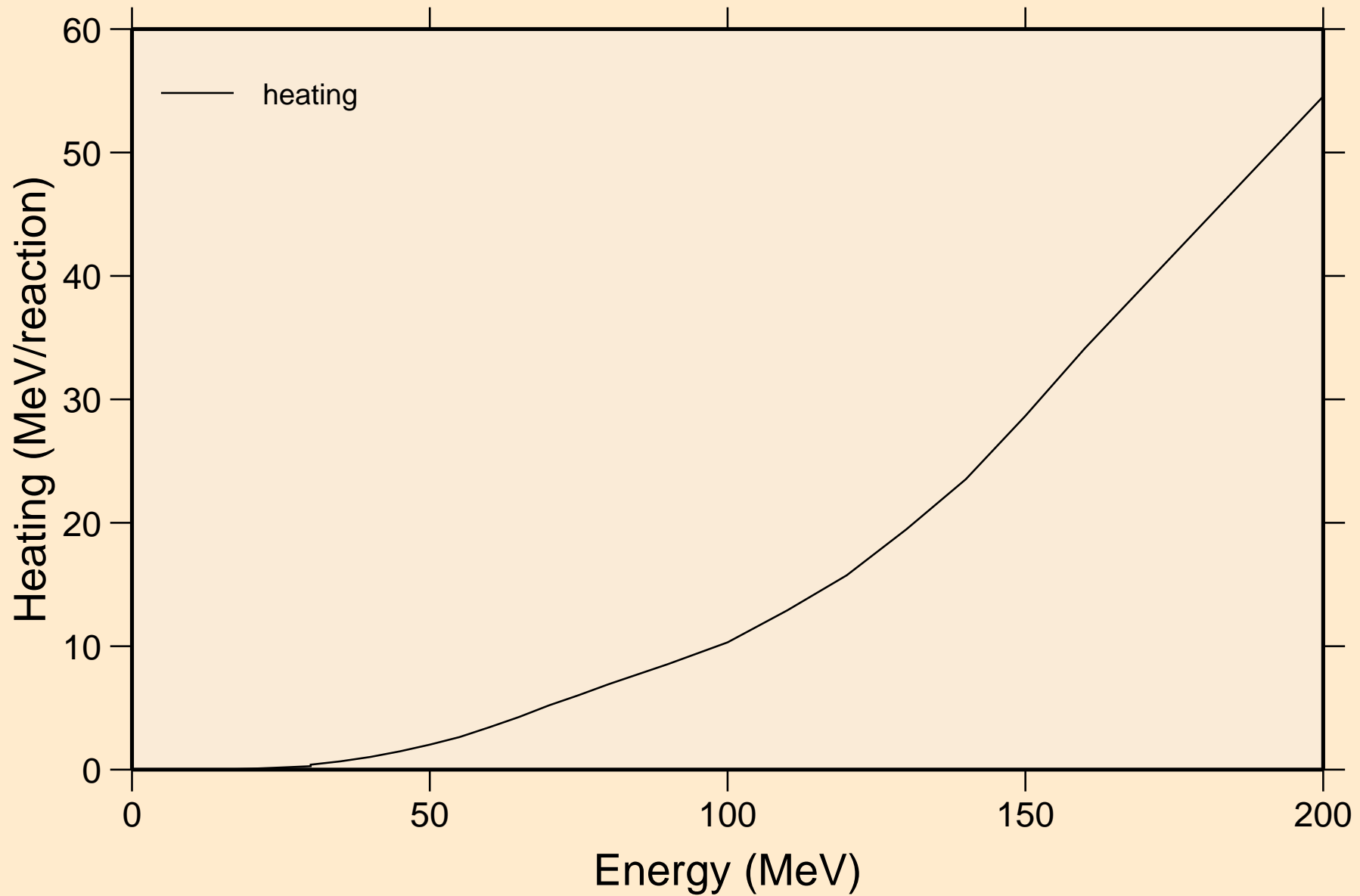

# CD123 HELION ACER TENDL-2024 LIBRARY; T=0.K

## Threshold reactions

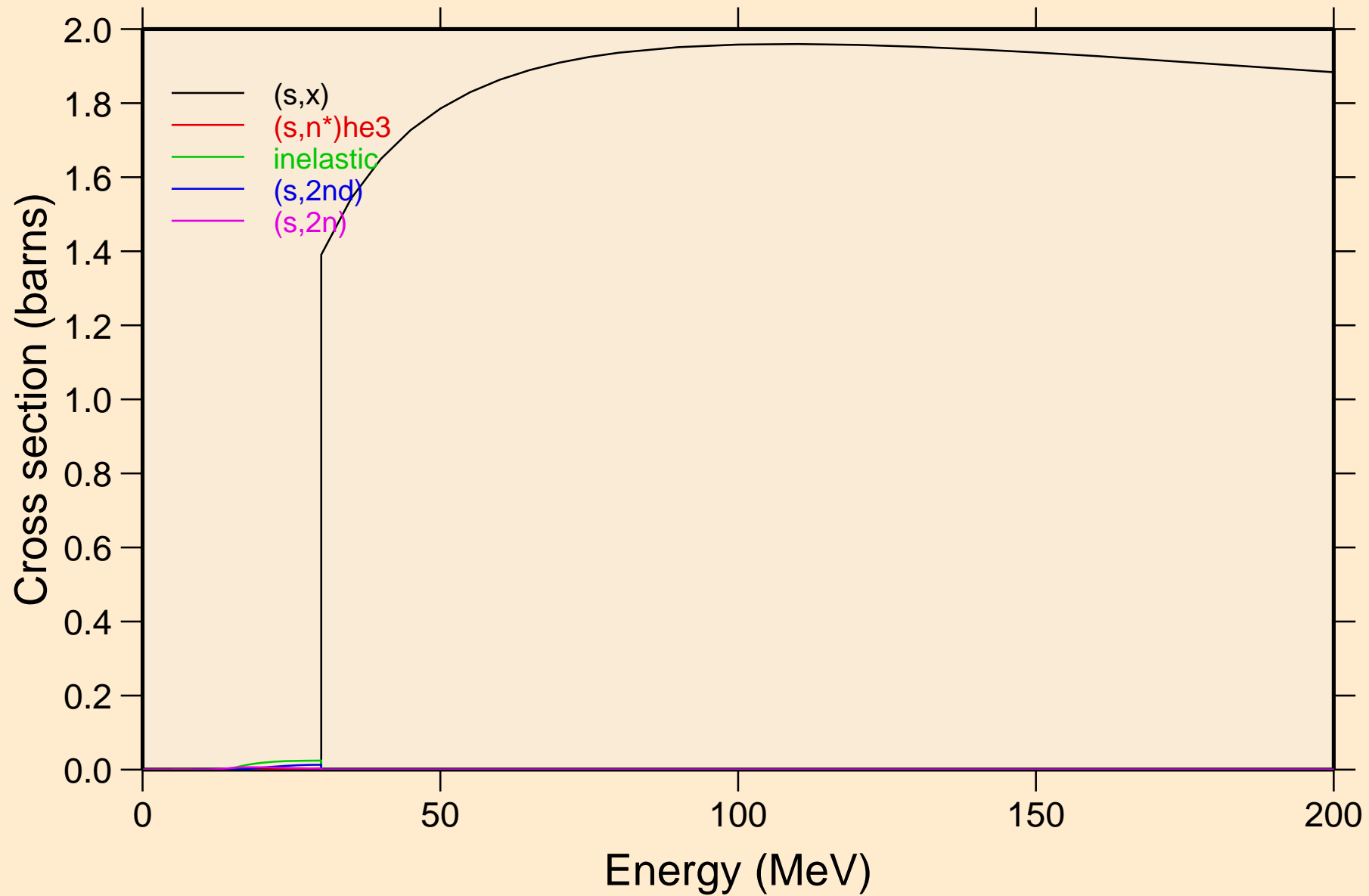

# CD123 HELION ACER TENDL-2024 LIBRARY; T=0.K

## Threshold reactions

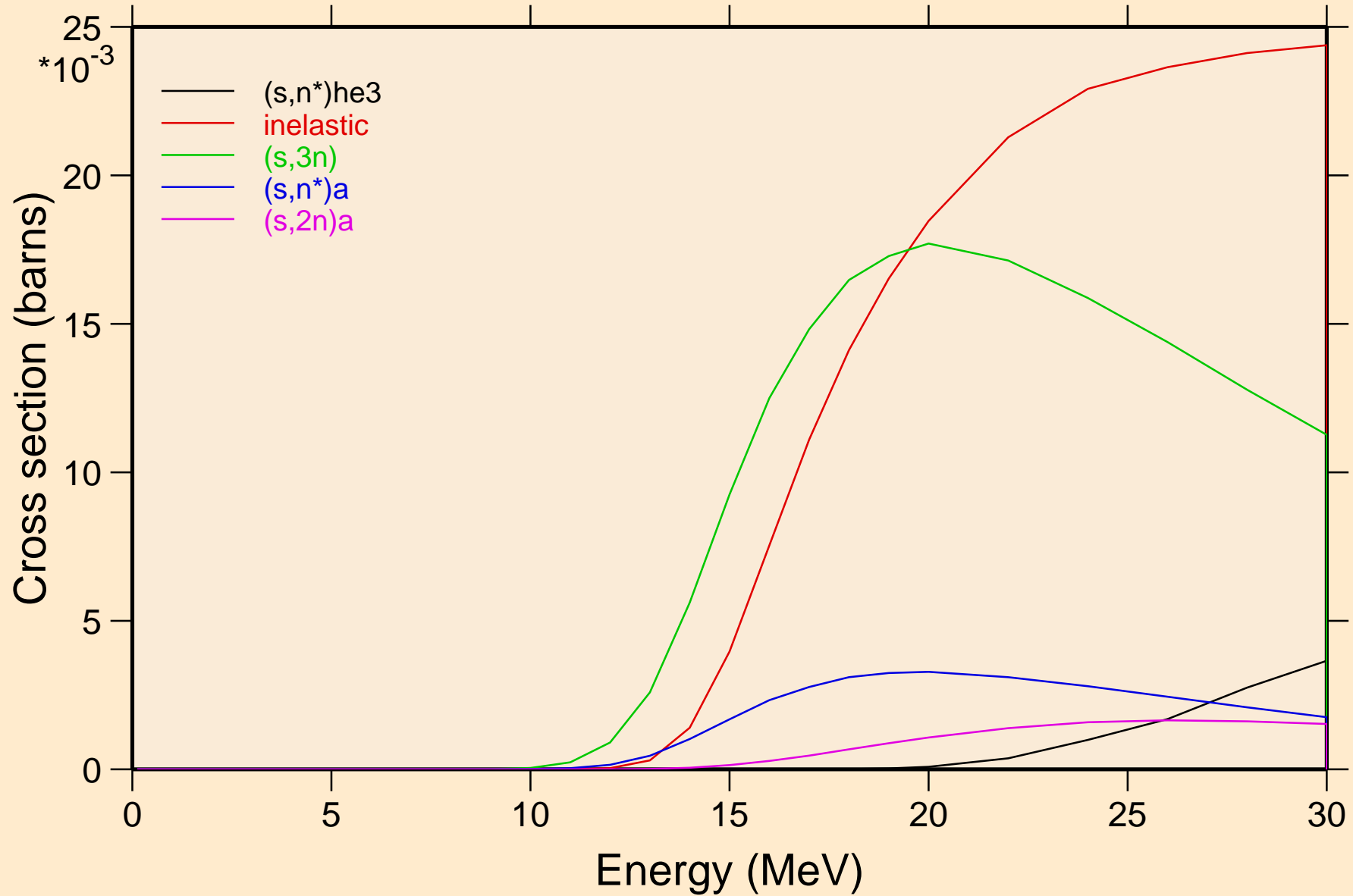

# CD123 HELION ACER TENDL-2024 LIBRARY; T=0.K

## Threshold reactions

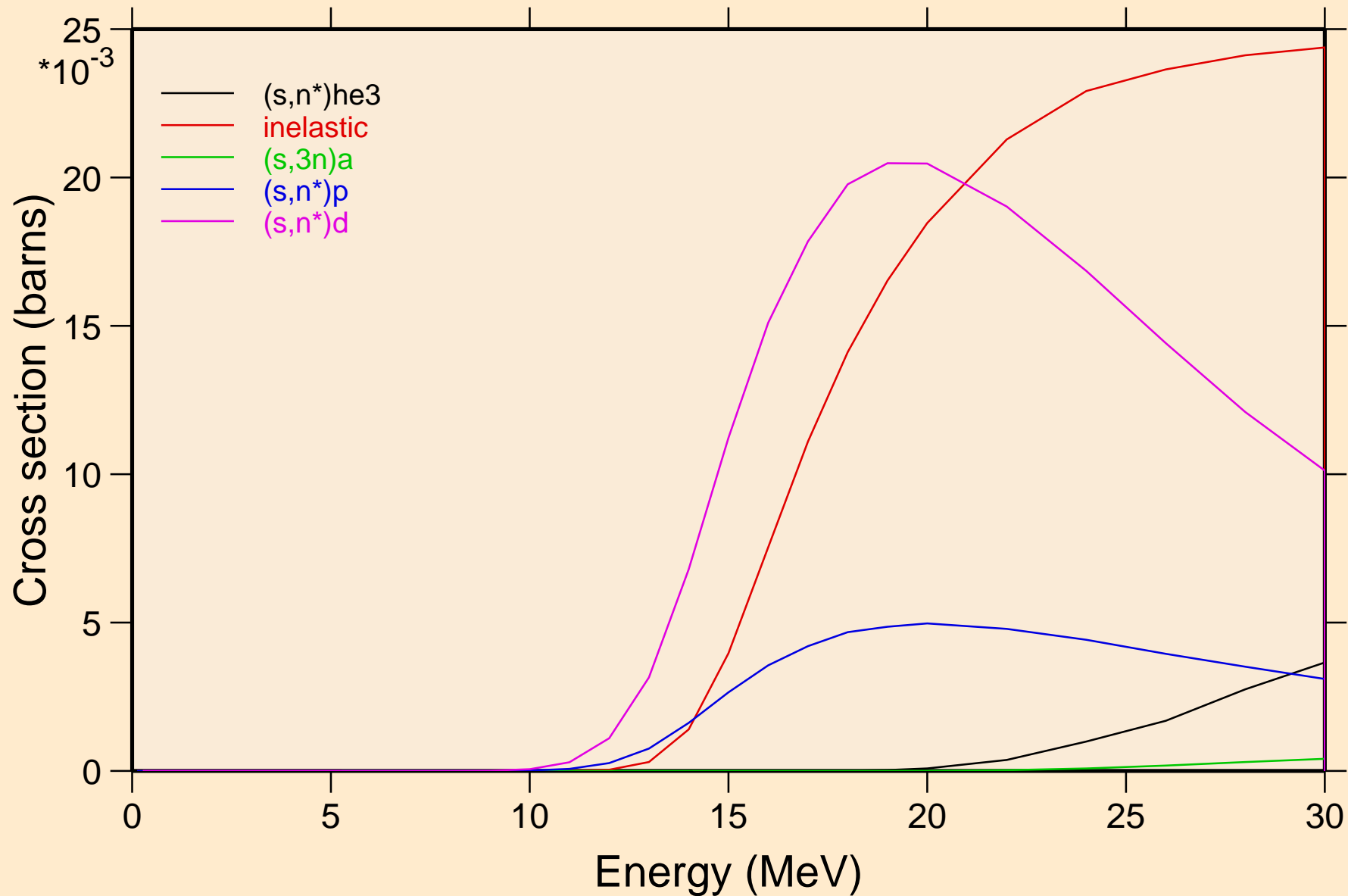

# CD123 HELION ACER TENDL-2024 LIBRARY; T=0.K

## Threshold reactions

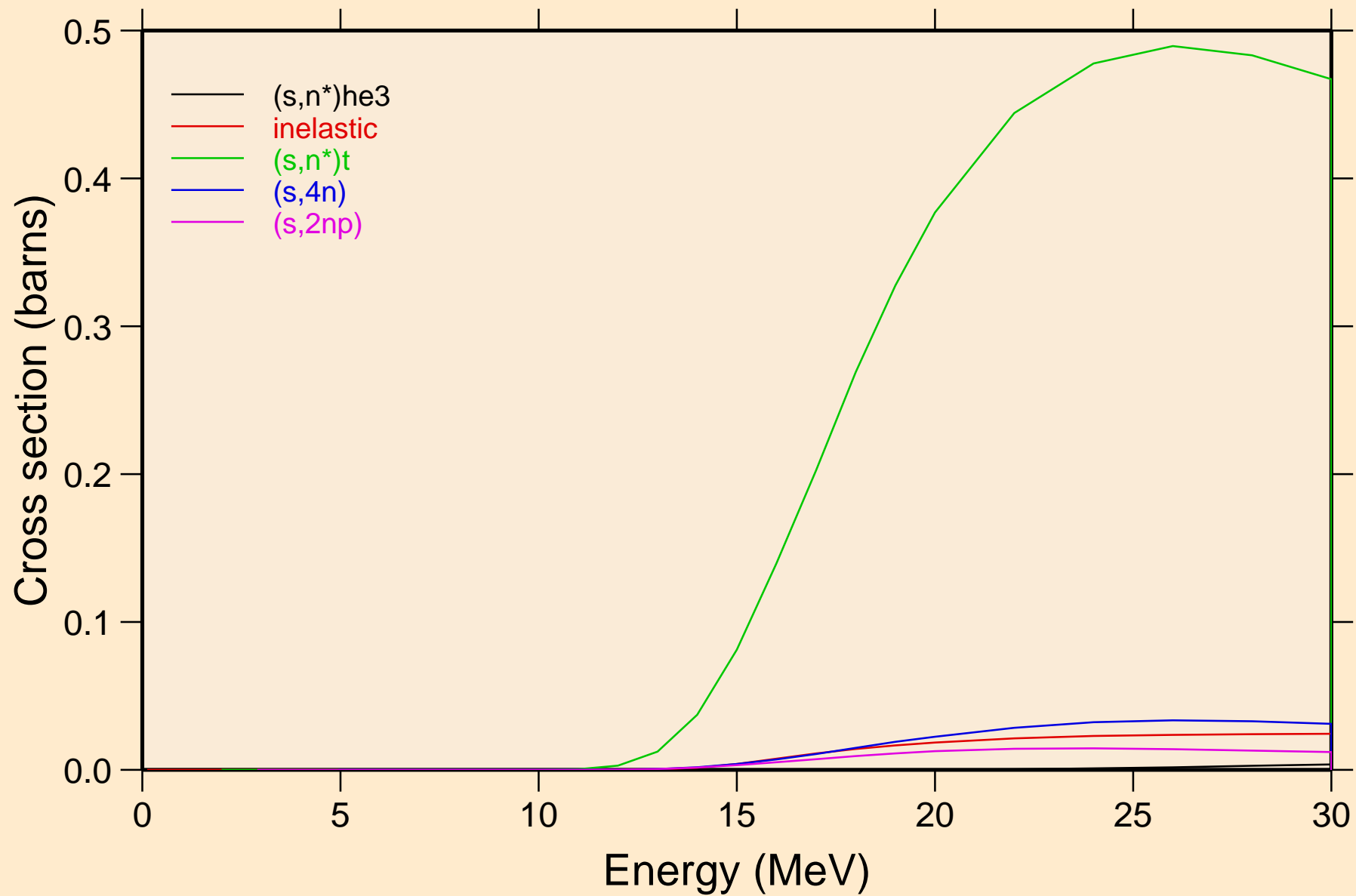

# CD123 HELION ACER TENDL-2024 LIBRARY; T=0.K

## Threshold reactions

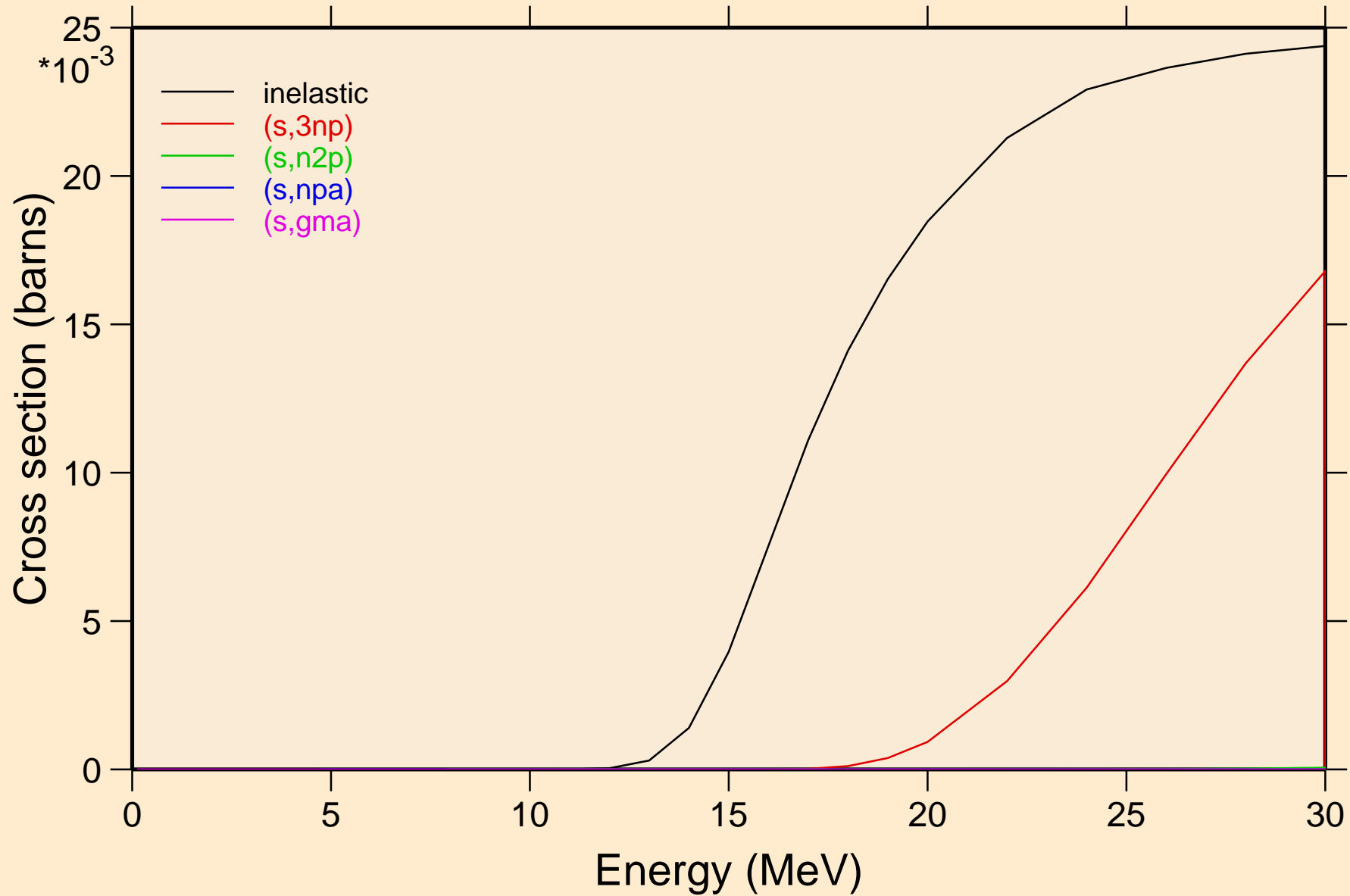

# CD123 HELION ACER TENDL-2024 LIBRARY; T=0.K

## Threshold reactions

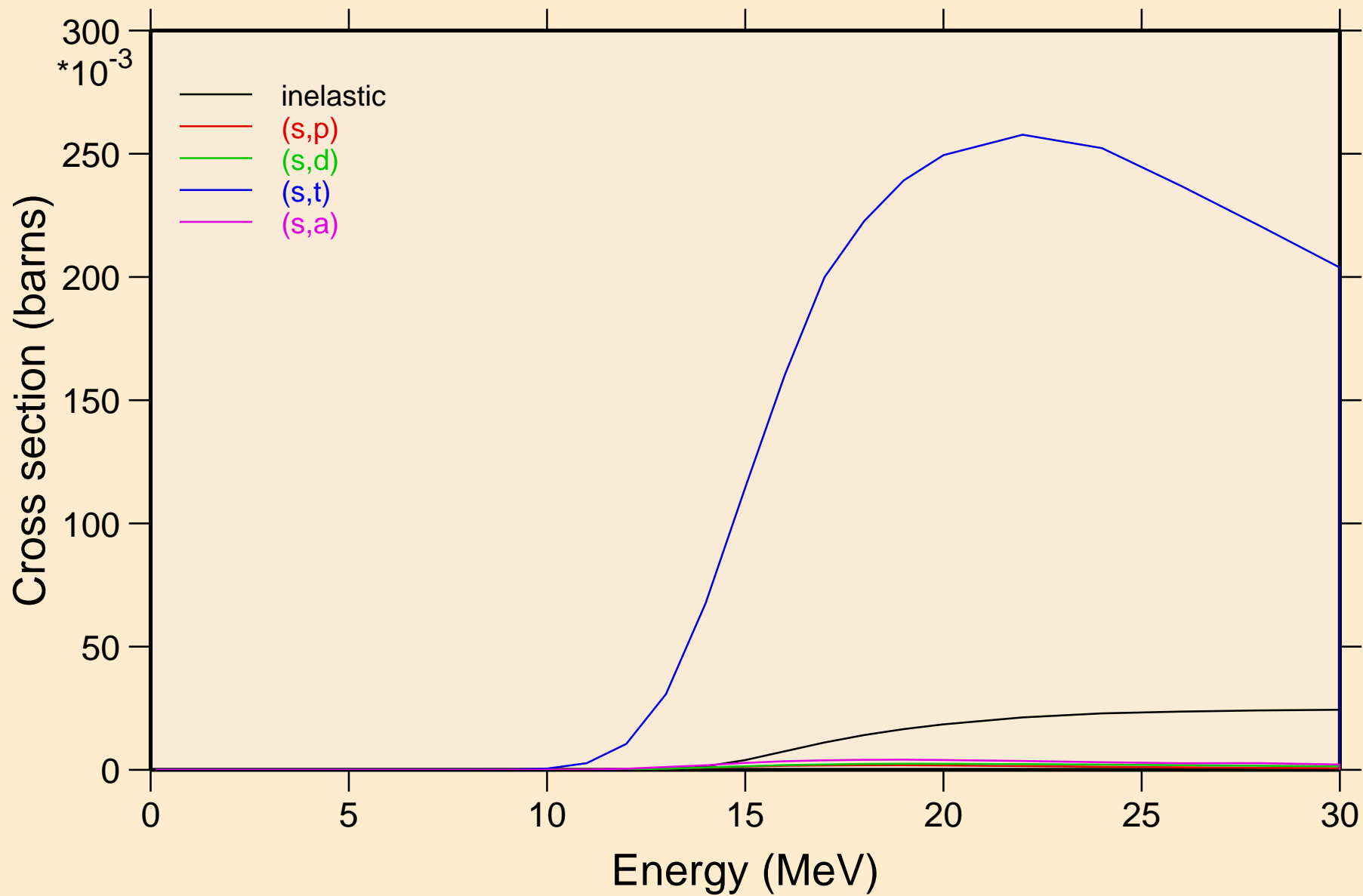

# CD123 HELION ACER TENDL-2024 LIBRARY; T=0.K

## Threshold reactions

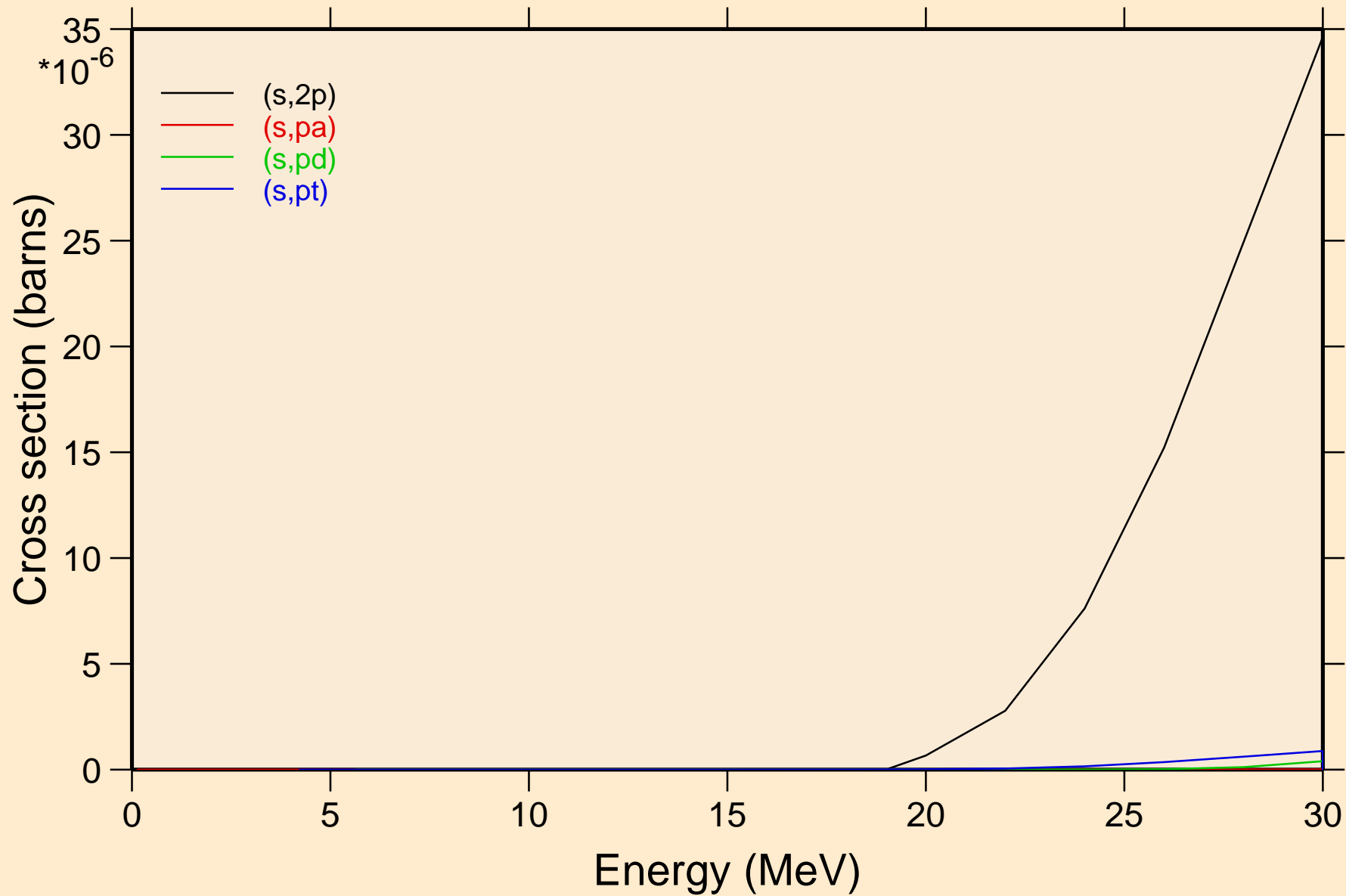

CD123 HELION ACER TENDL-2024 LIBRARY; T=0.K  
angular distribution for elastic

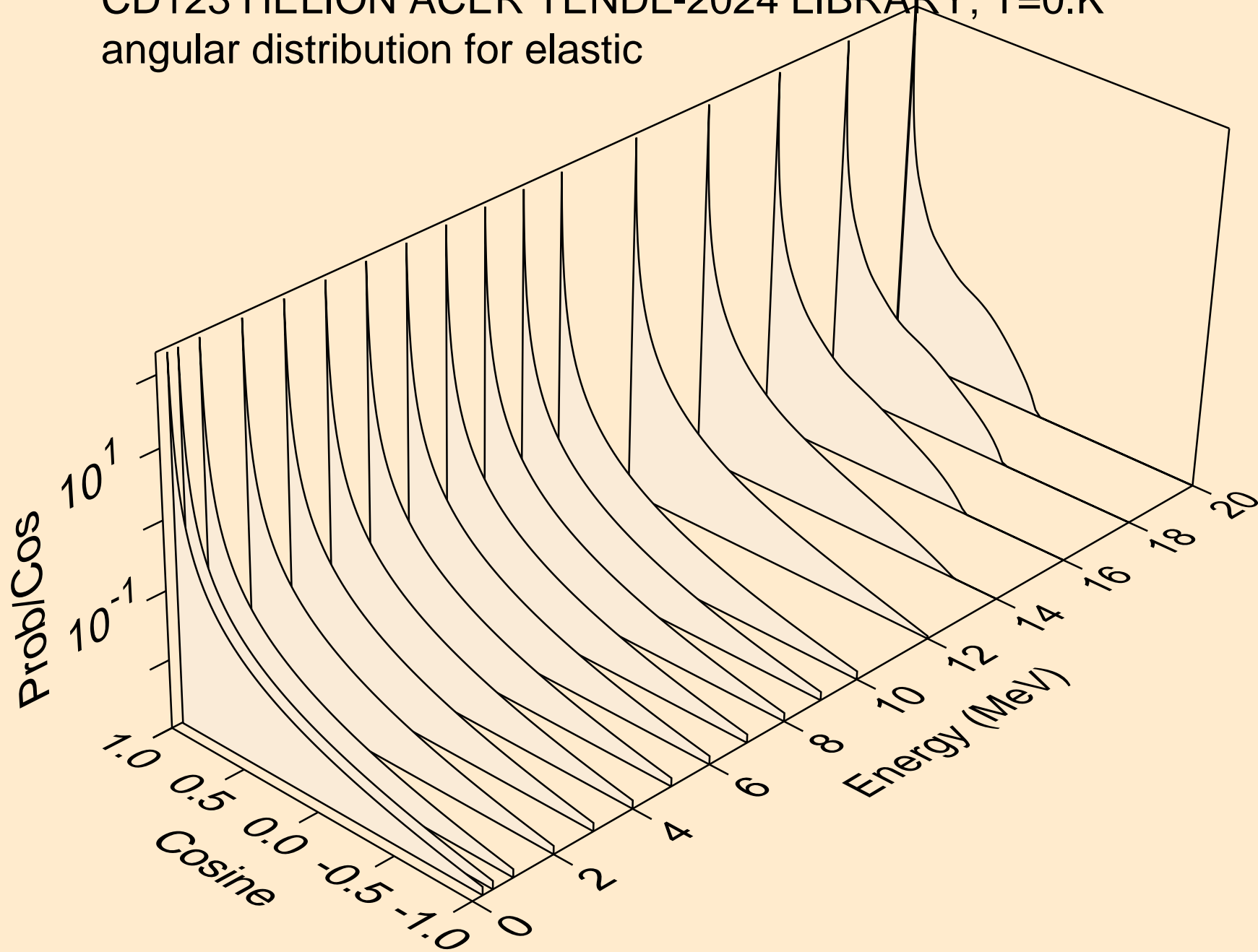

CD123 HELION ACER TENDL-2024 LIBRARY; T=0.K  
angular distribution for elastic

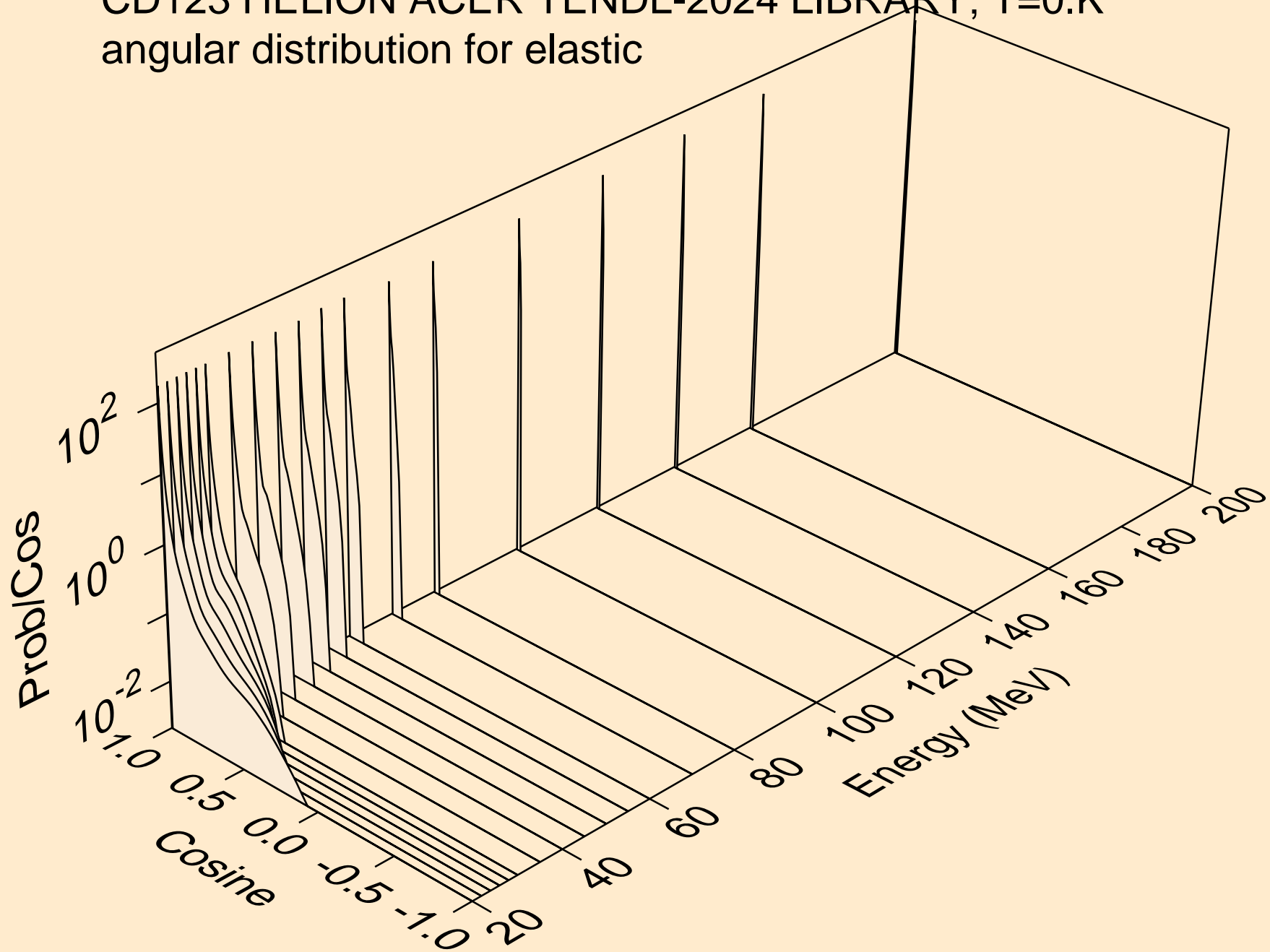

CD123 HELION ACER TENDL-2024 LIBRARY; T=0.K  
He-3 emission for (s,x)

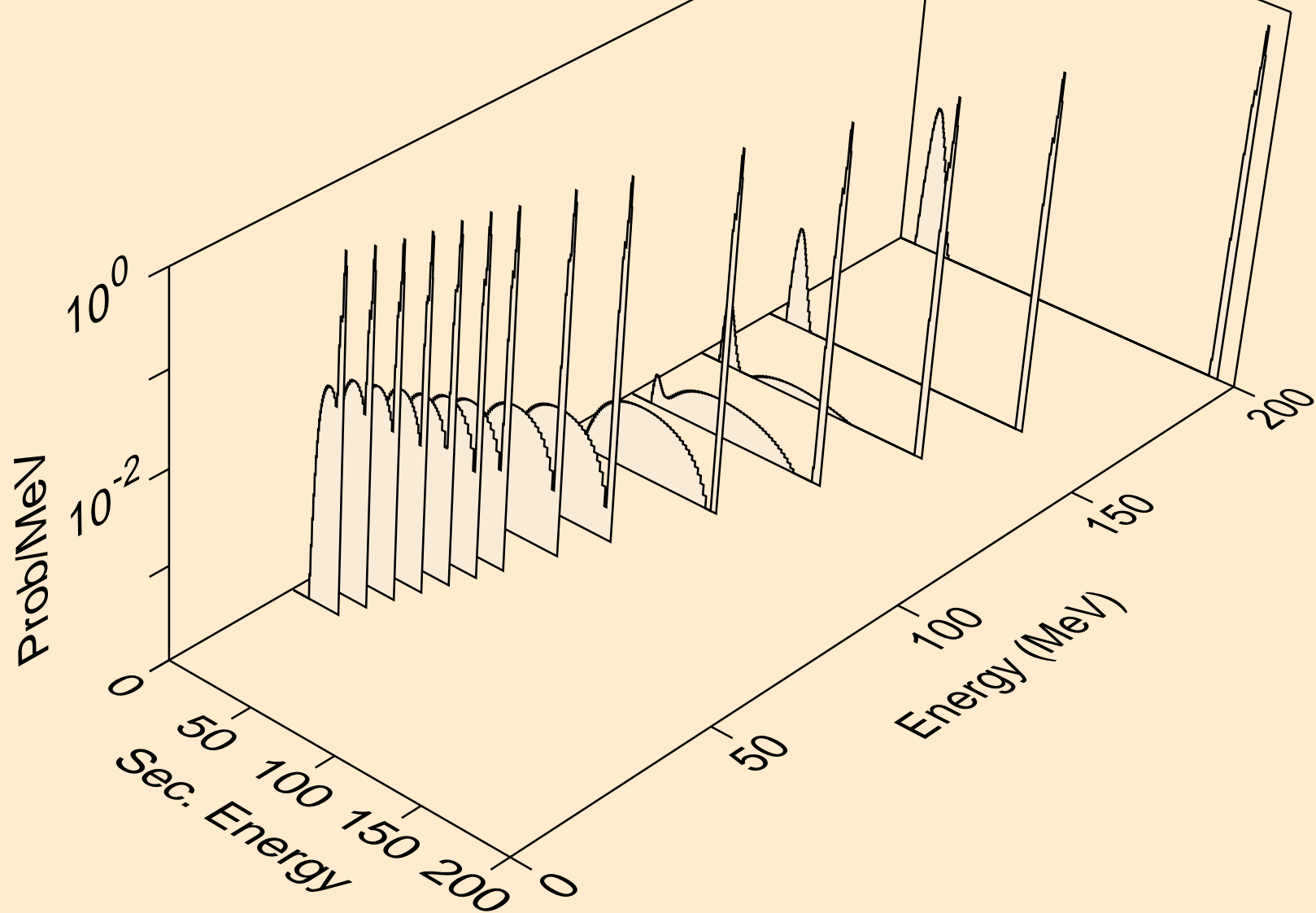

CD123 HELION ACER TENDL-2024 LIBRARY; T=0.K  
He-3 emission for (s,n\*)he3

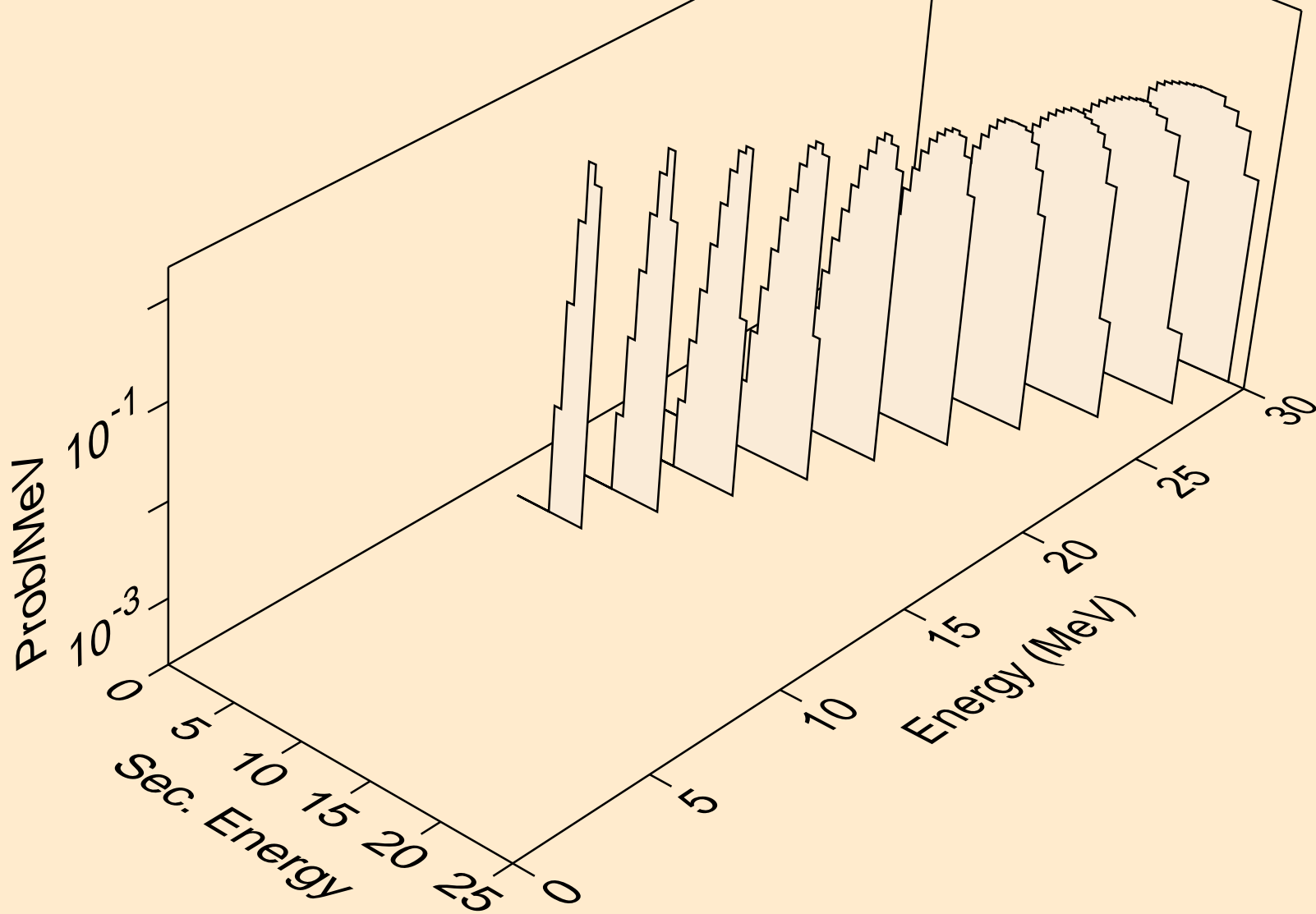

CD123 HELION ACER TENDL-2024 LIBRARY; T=0.K  
He-3 emission for inelastic

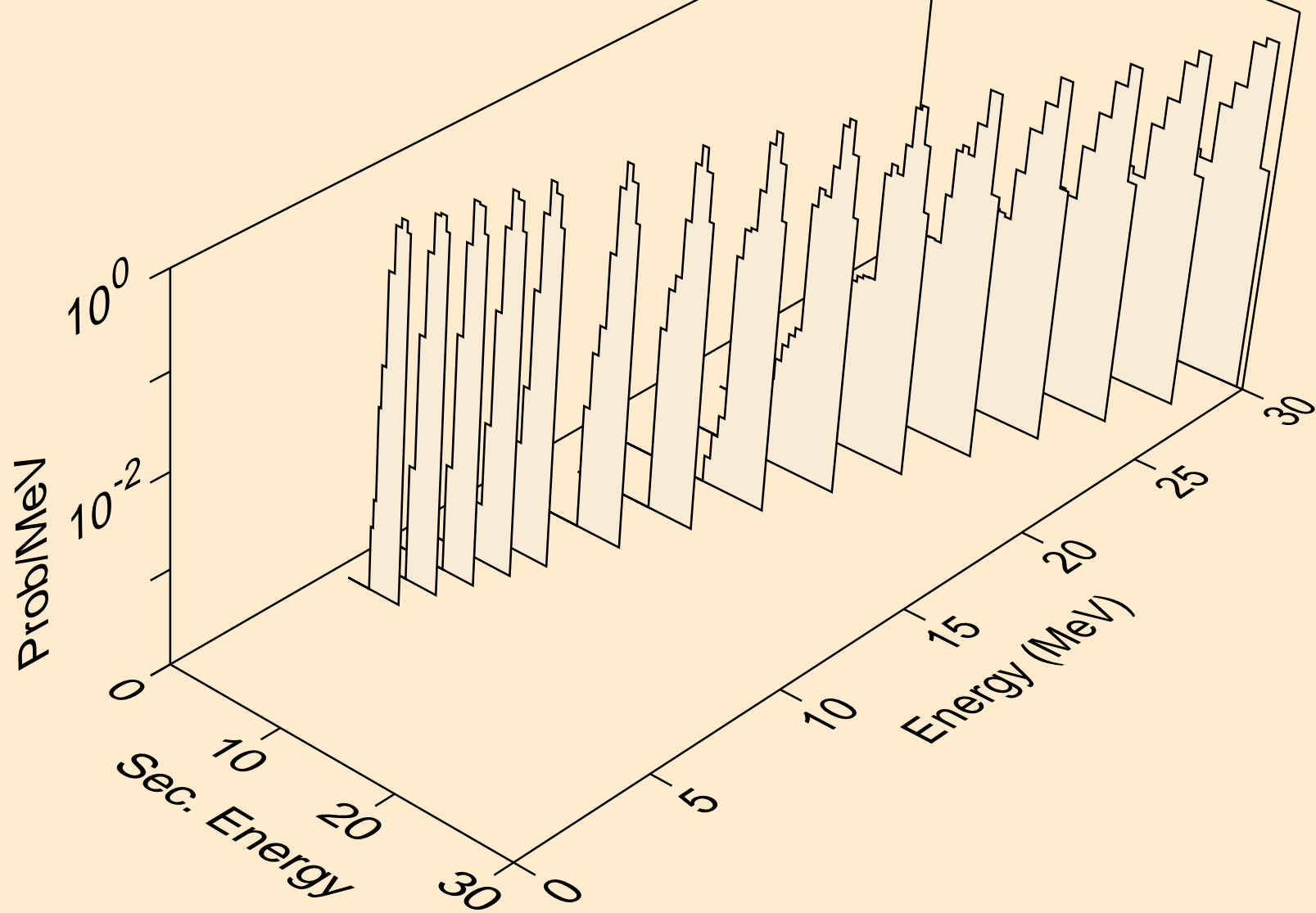

CD123 HELION ACER TENDL-2024 LIBRARY; T=0.K  
Photon emission for (z,n)

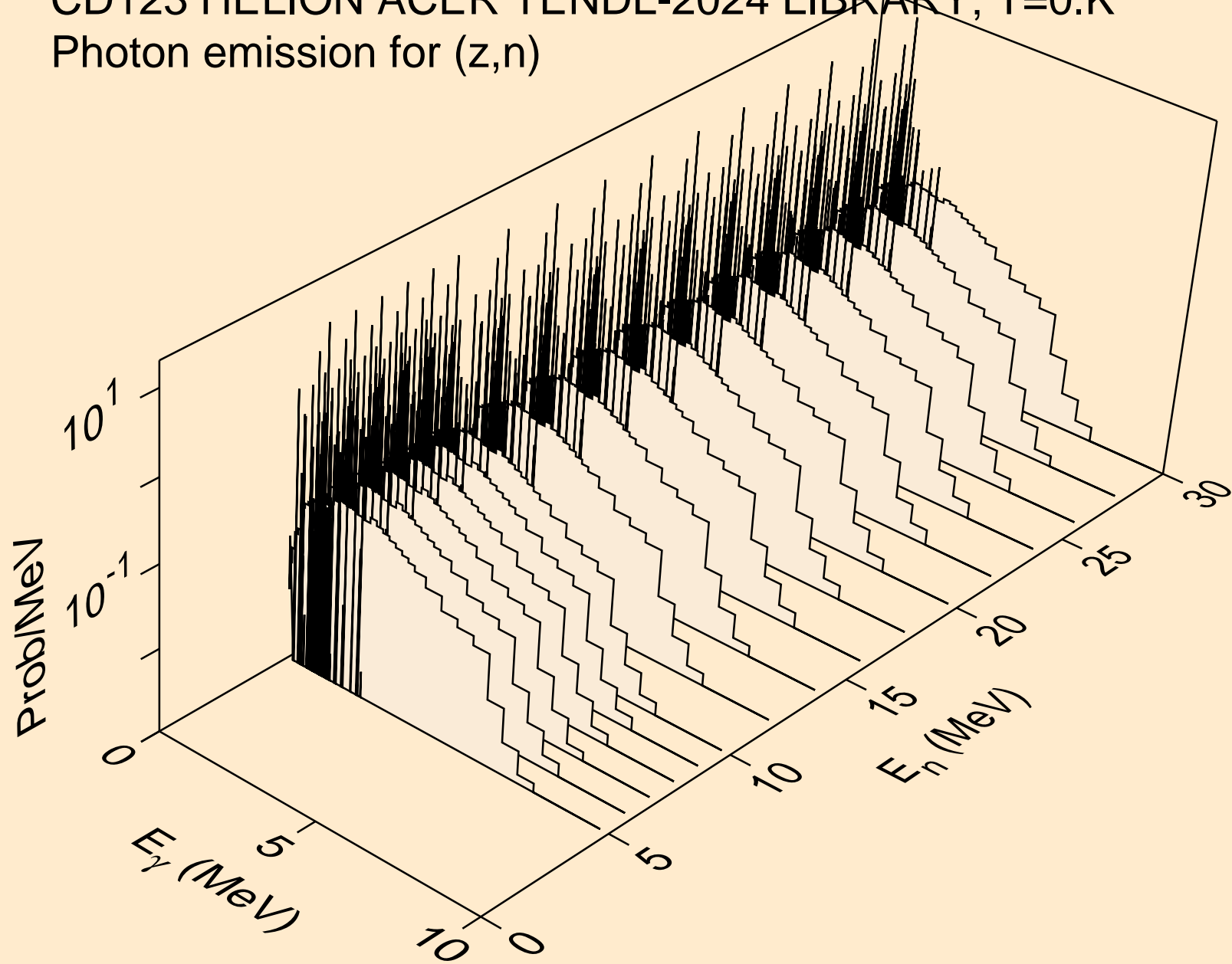

CD123 HELION ACER TENDL-2024 LIBRARY; T=0.K  
Photon emission for (z,x)

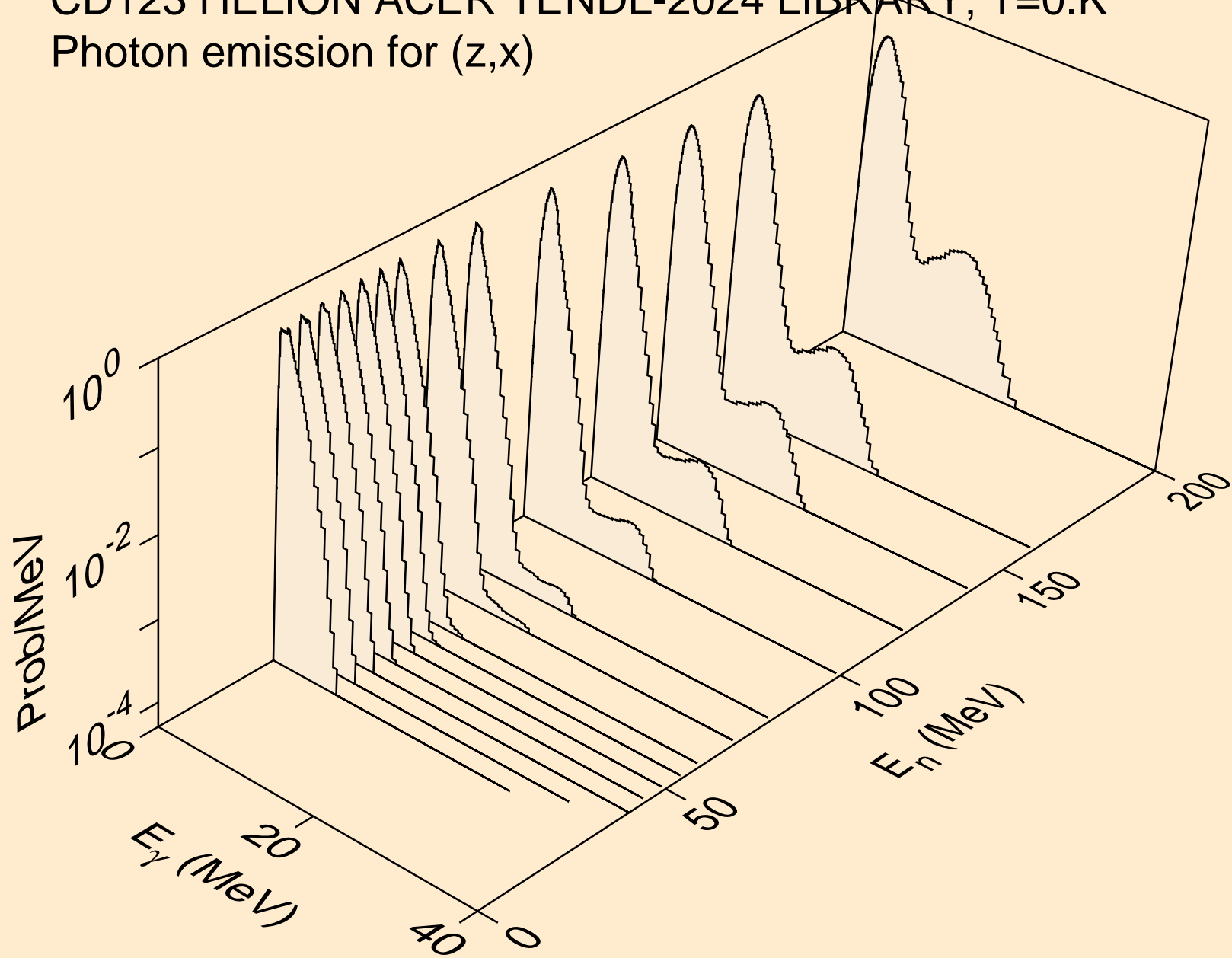

CD123 HELION ACER TENDL-2024 LIBRARY; T=0.K  
Photon emission for (n,2nd)

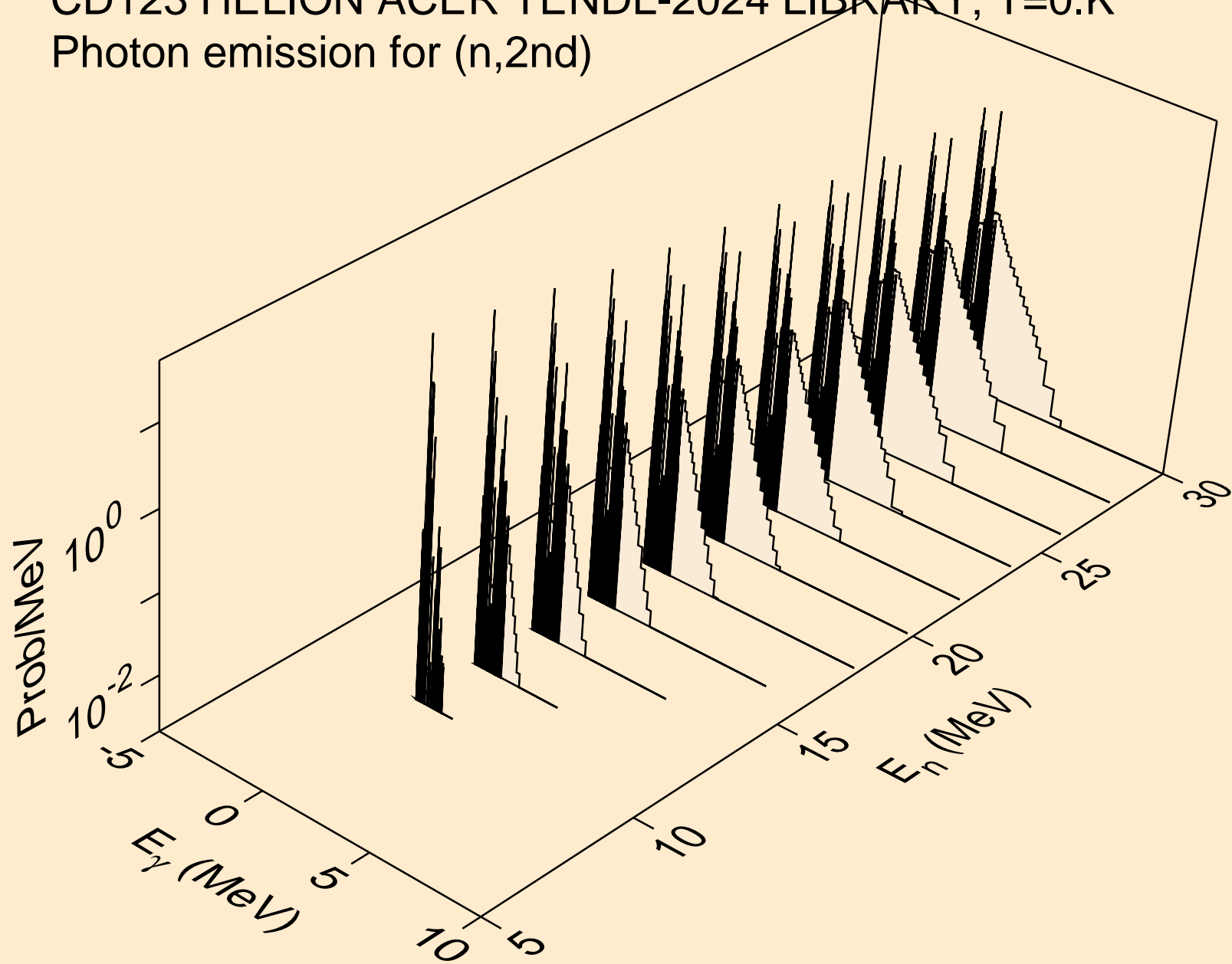

CD123 HELION ACER TENDL-2024 LIBRARY; T=0.K  
Photon emission for (n,2n)

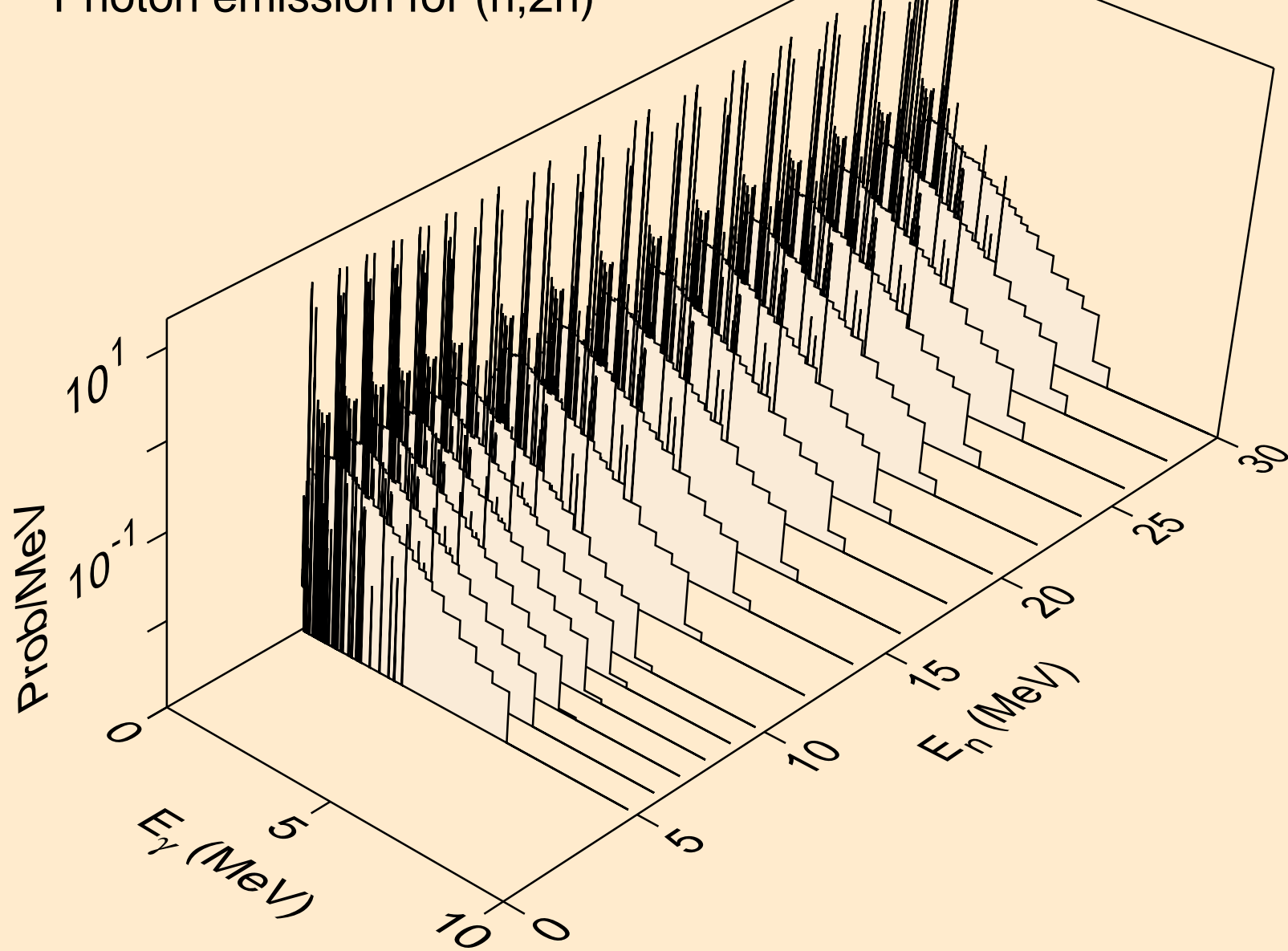

CD123 HELION ACER TENDL-2024 LIBRARY; T=0.K  
Photon emission for (n,3n)

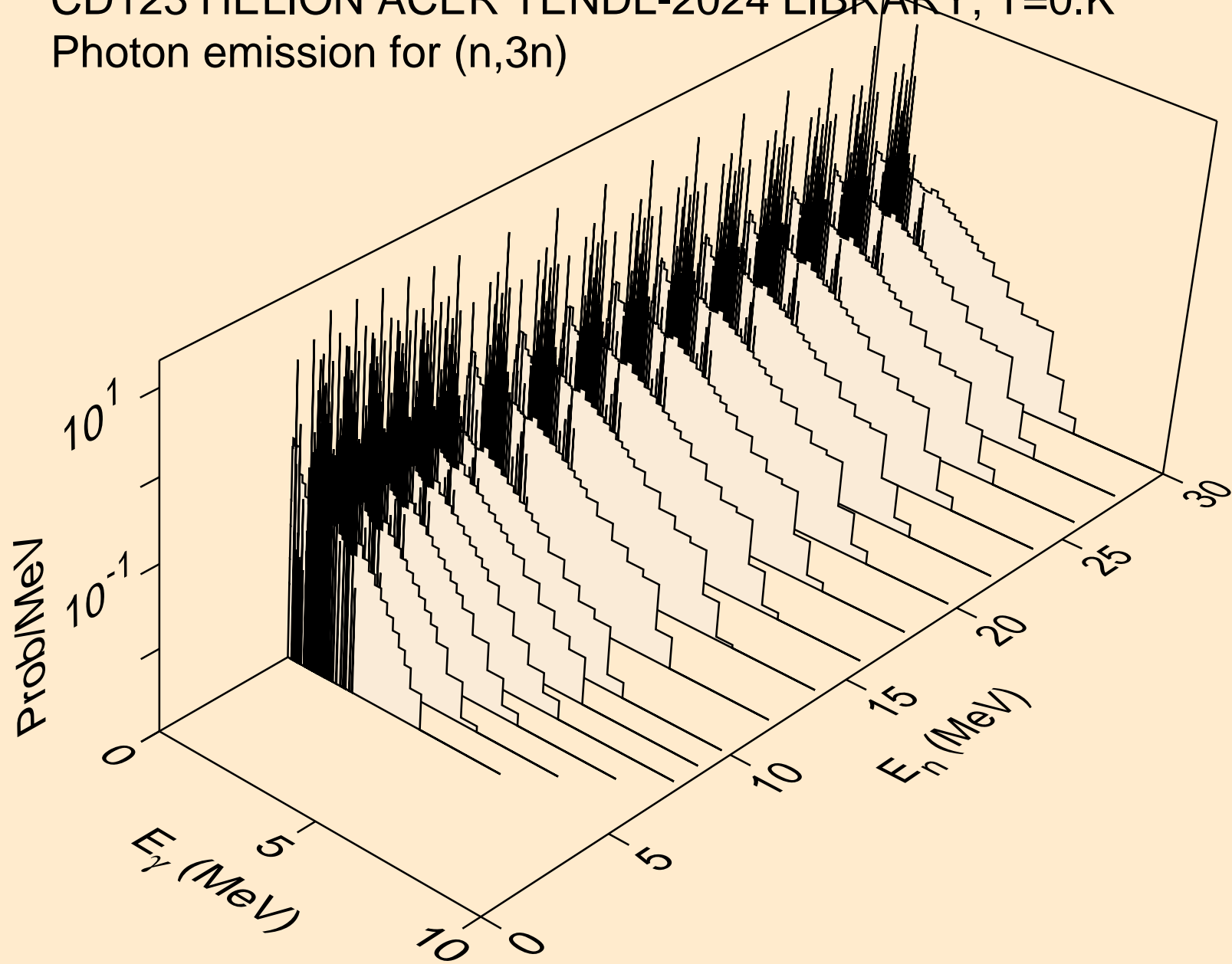

CD123 HELION ACER TENDL-2024 LIBRARY; T=0.K  
Photon emission for (n,n\*)a

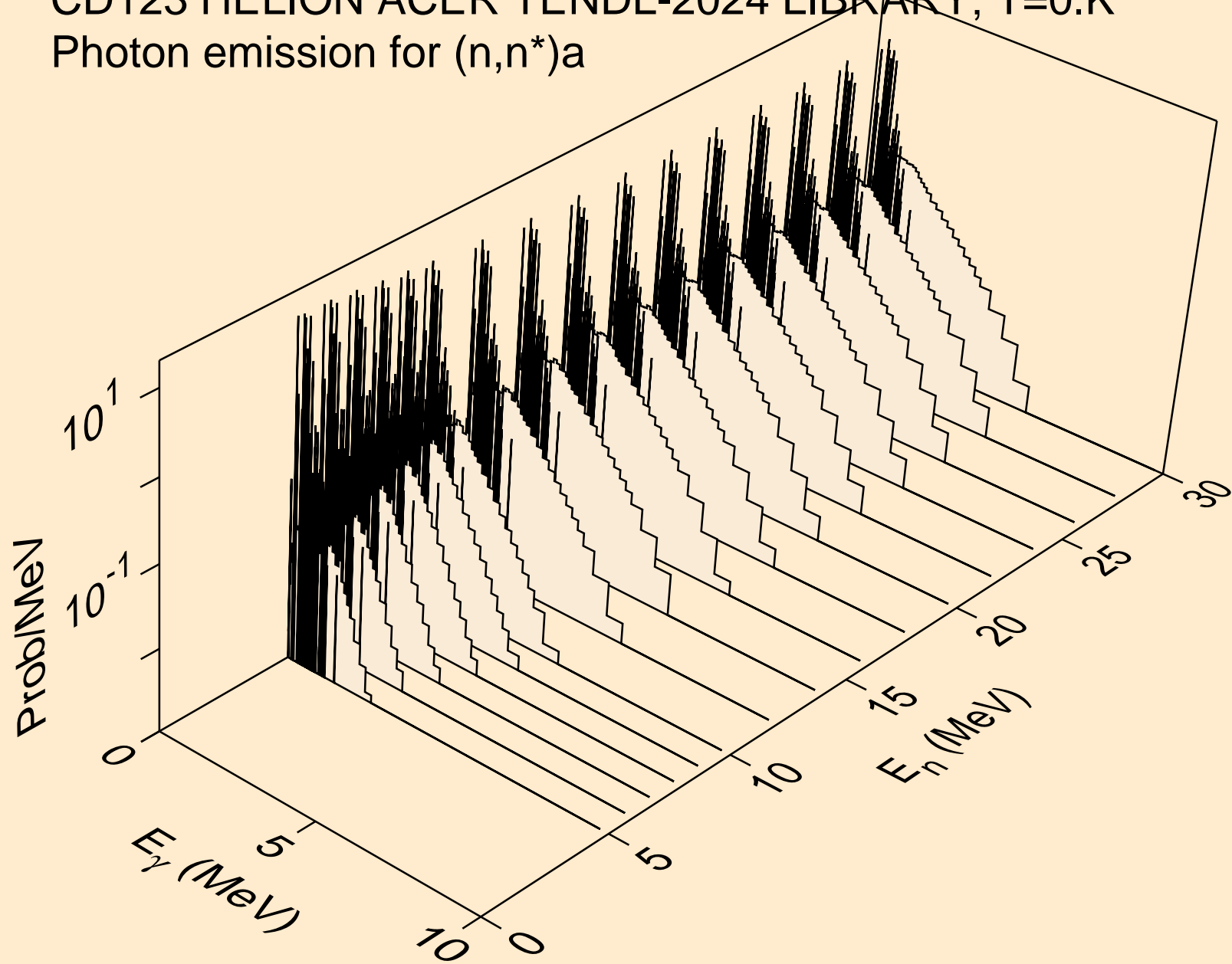

CD123 HELION ACER TENDL-2024 LIBRARY; T=0.K  
Photon emission for (n,2n)a

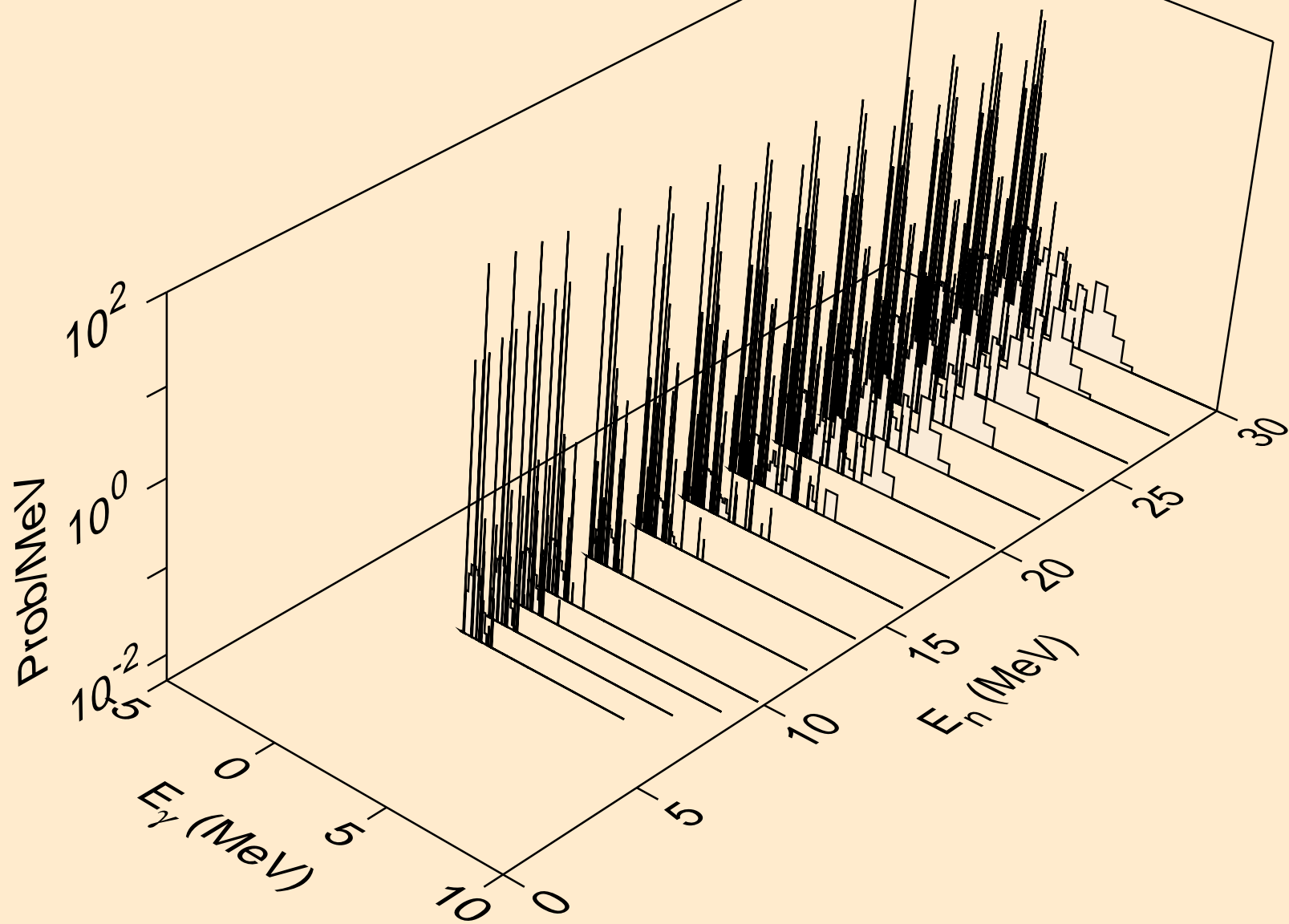

CD123 HELION ACER TENDL-2024 LIBRARY; T=0.K  
Photon emission for (n,3n)a

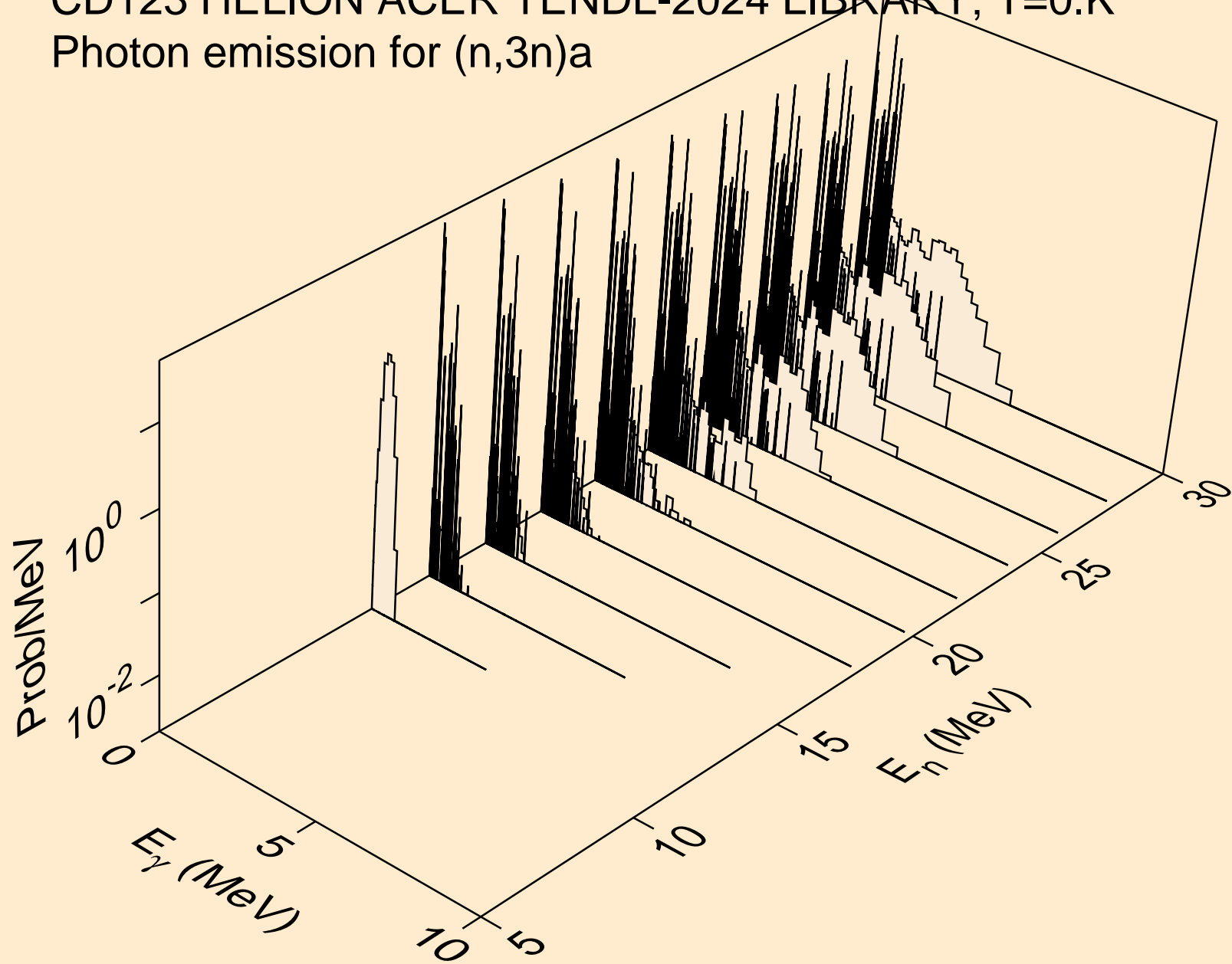

CD123 HELION ACER TENDL-2024 LIBRARY; T=0.K  
Photon emission for (n,n\*)p

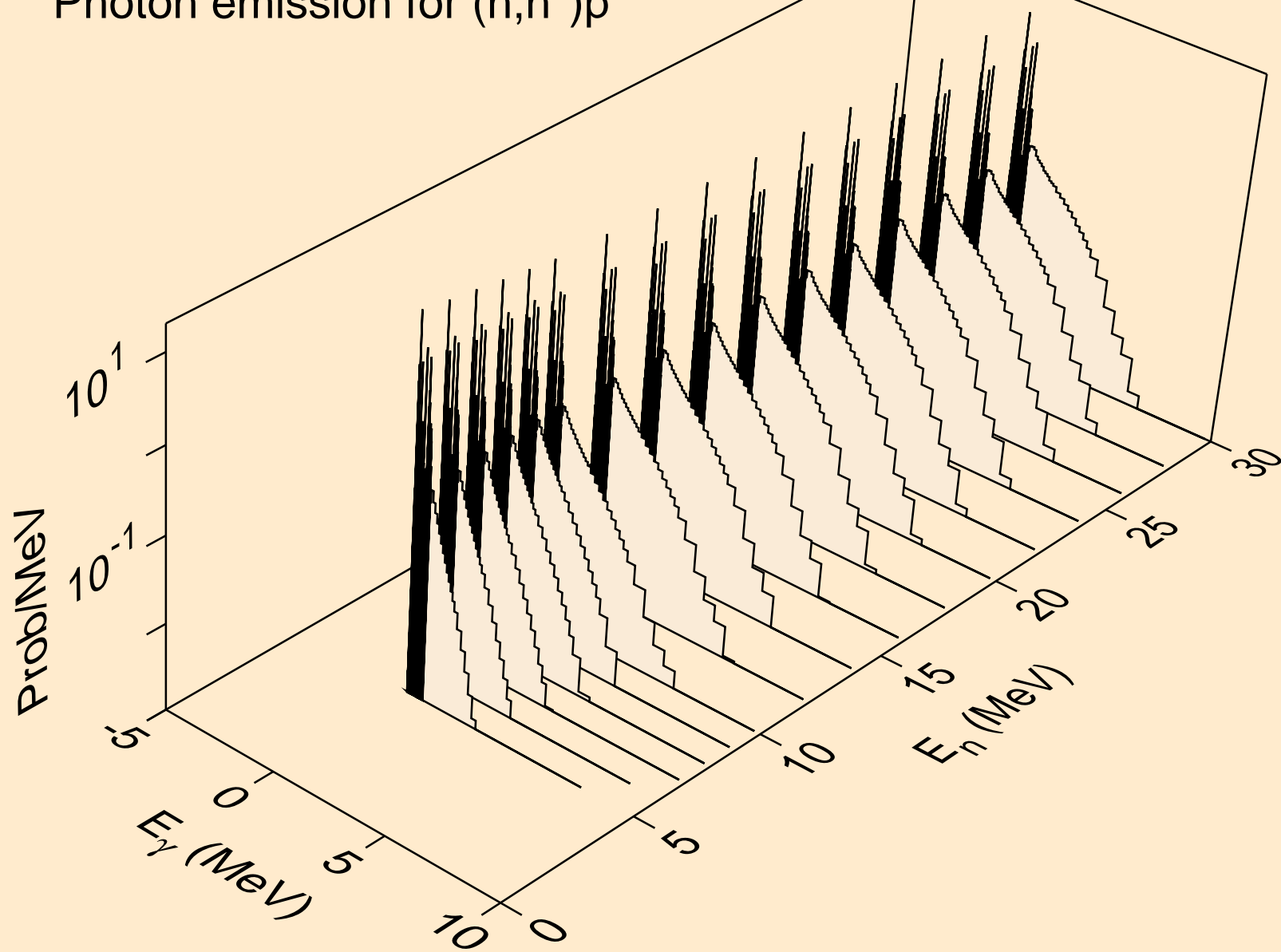

CD123 HELION ACER TENDL-2024 LIBRARY; T=0.K  
Photon emission for (n,n\*)d

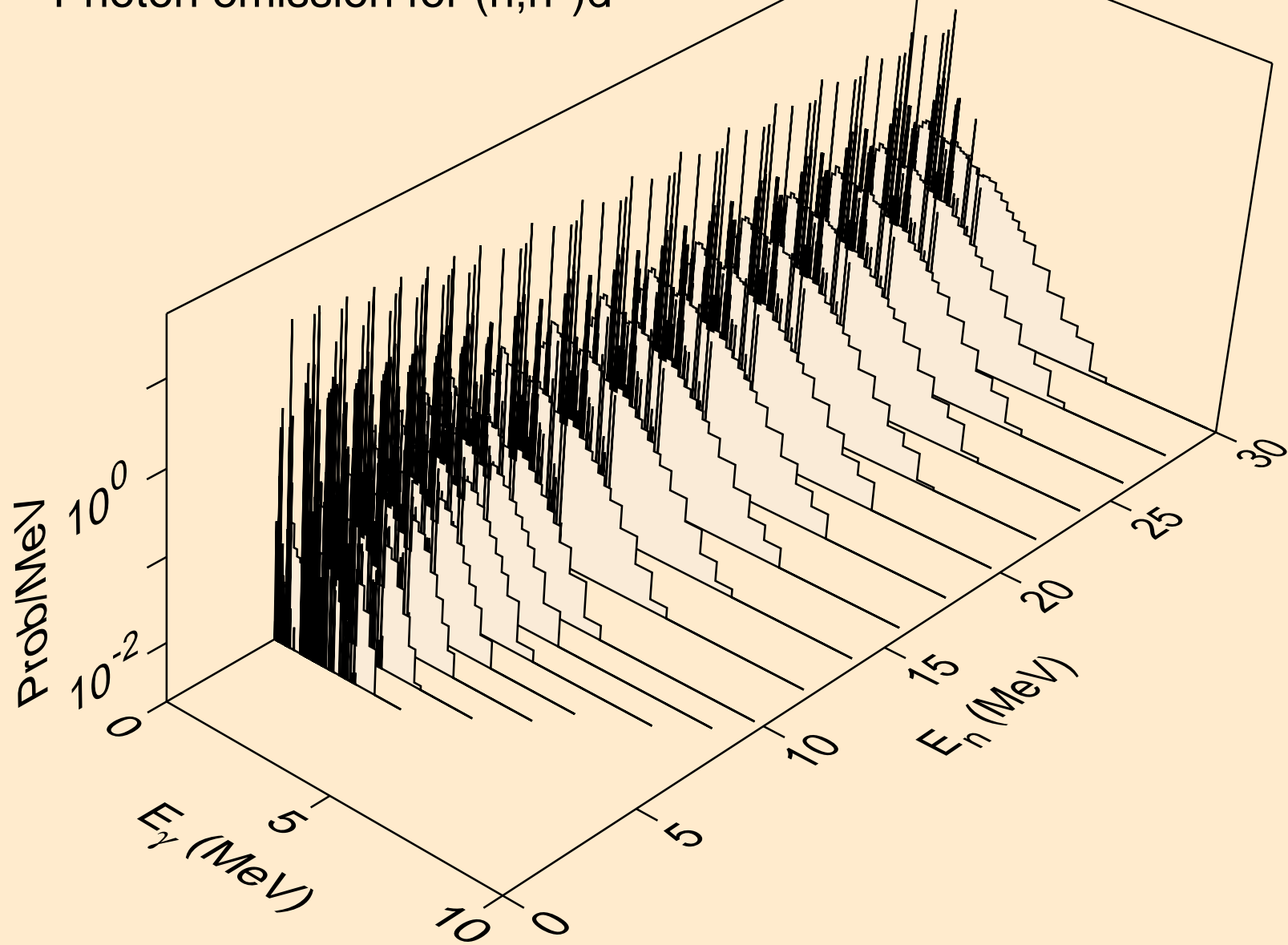

CD123 HELION ACER TENDL-2024 LIBRARY; T=0.K  
Photon emission for (n,n\*)t

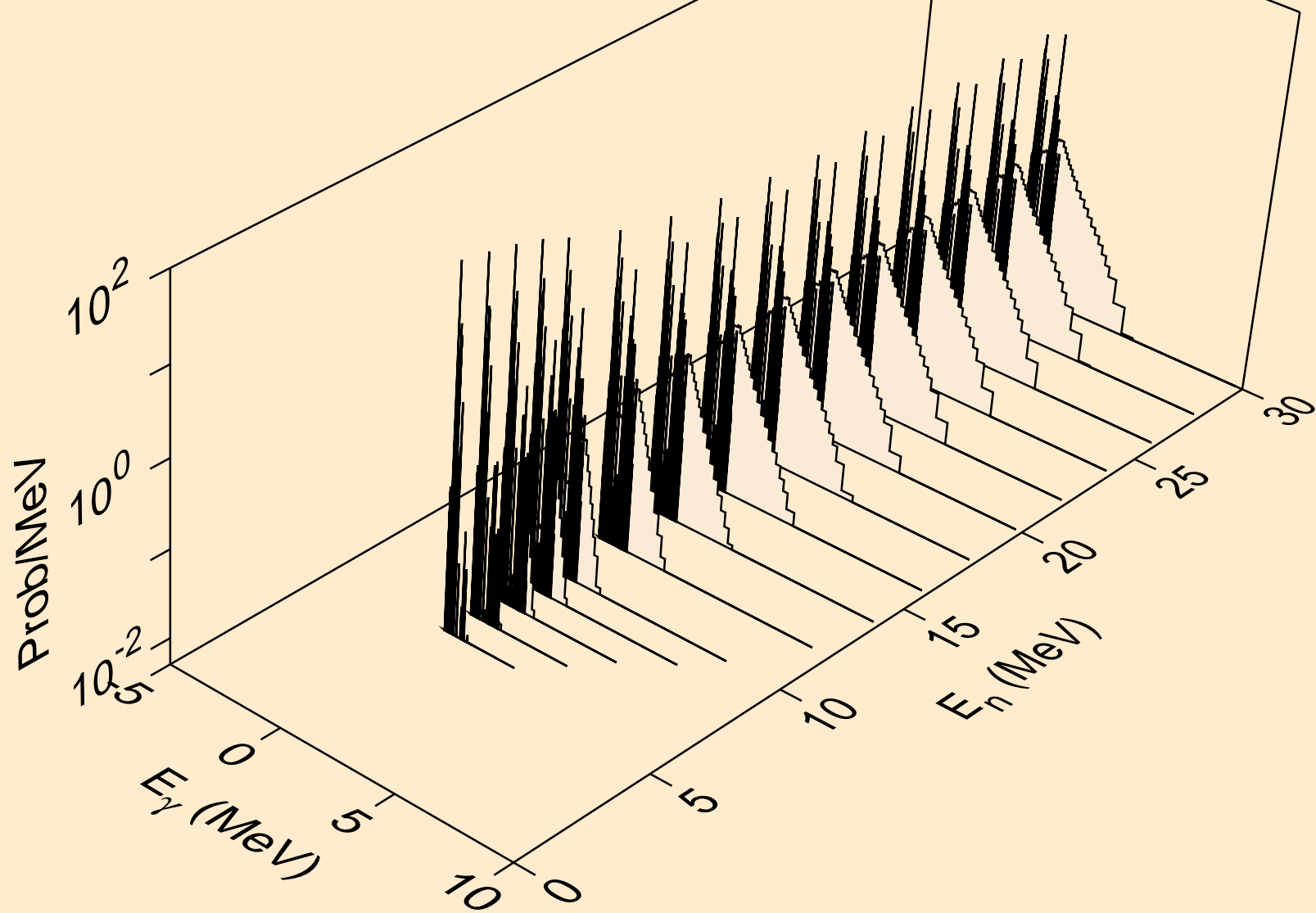

CD123 HELION ACER TENDL-2024 LIBRARY; T=0.K  
Photon emission for (n,n\*)he3

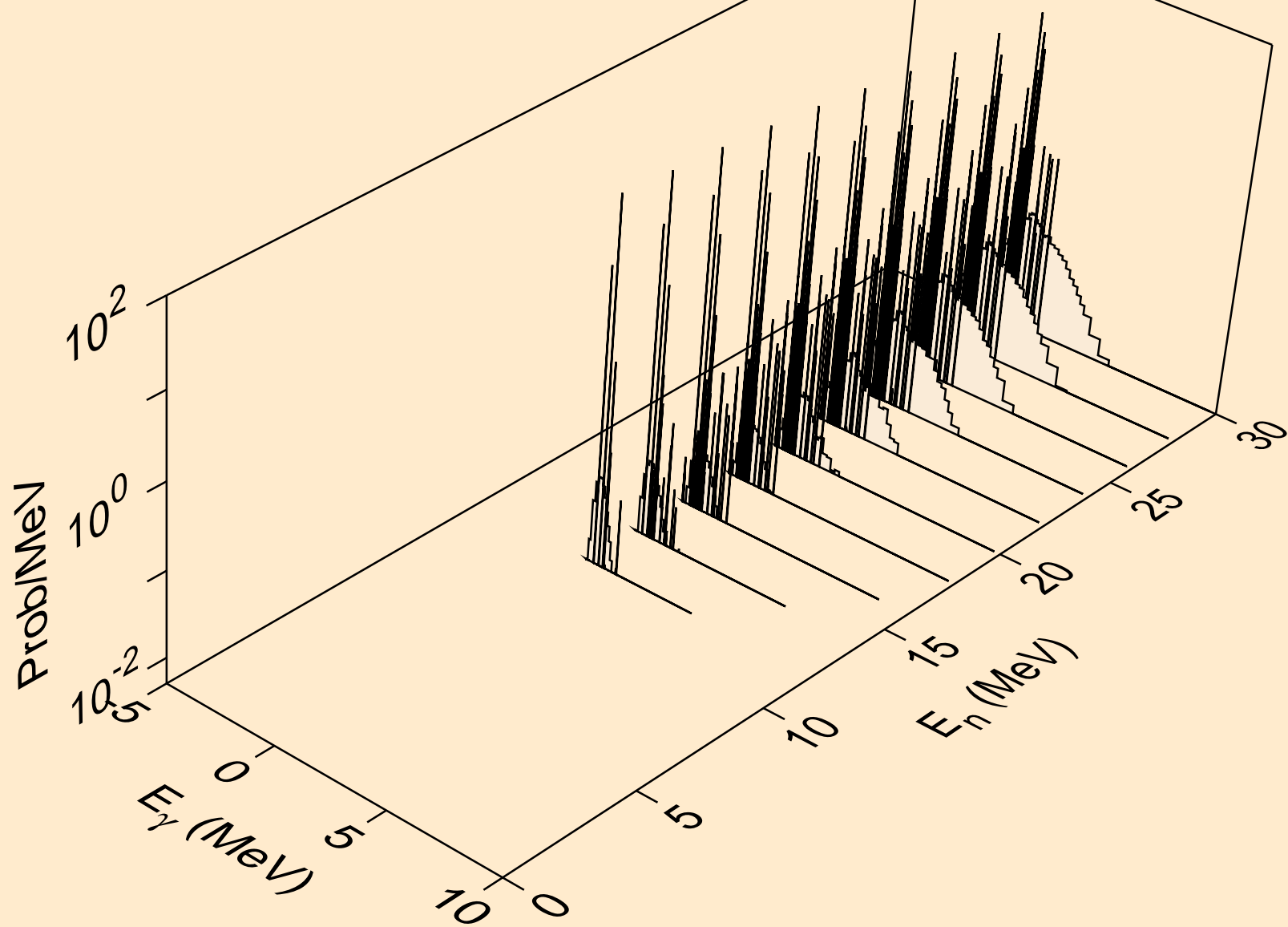

CD123 HELION ACER TENDL-2024 LIBRARY; T=0.K  
Photon emission for (n,4n)

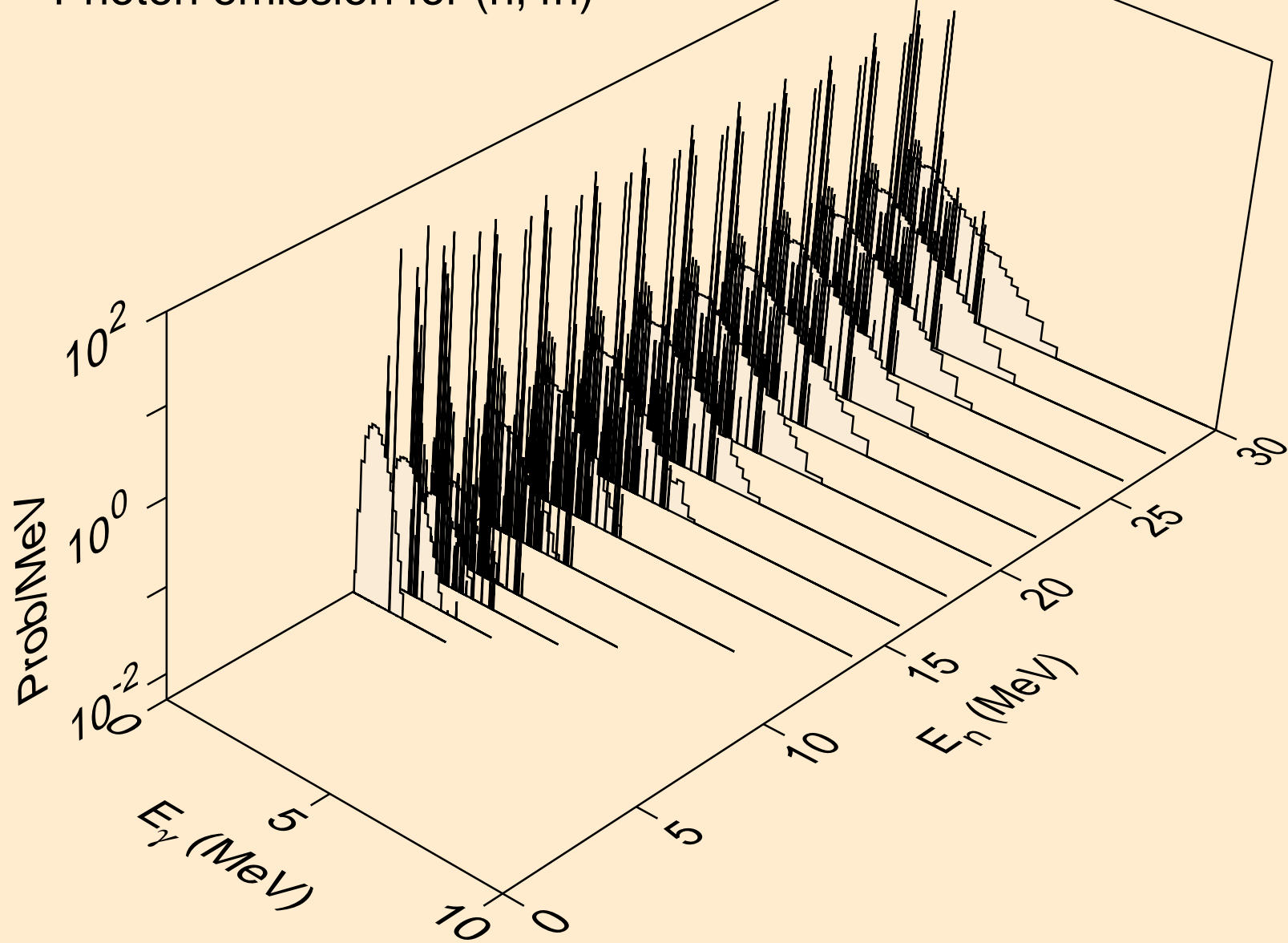

CD123 HELION ACER TENDL-2024 LIBRARY; T=0.K  
Photon emission for (n,2np)

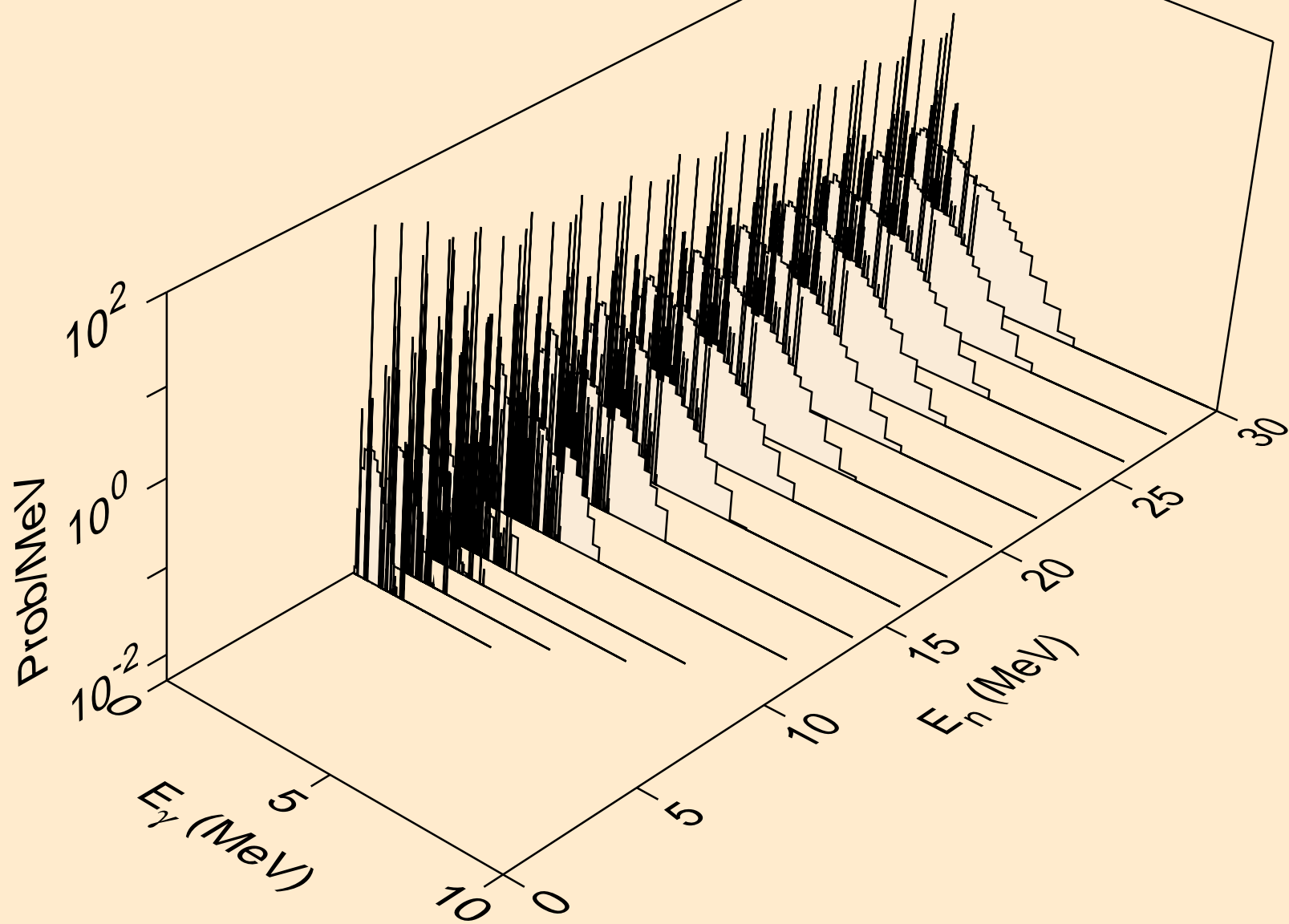

CD123 HELION ACER TENDL-2024 LIBRARY; T=0.K  
Photon emission for (n,3np)

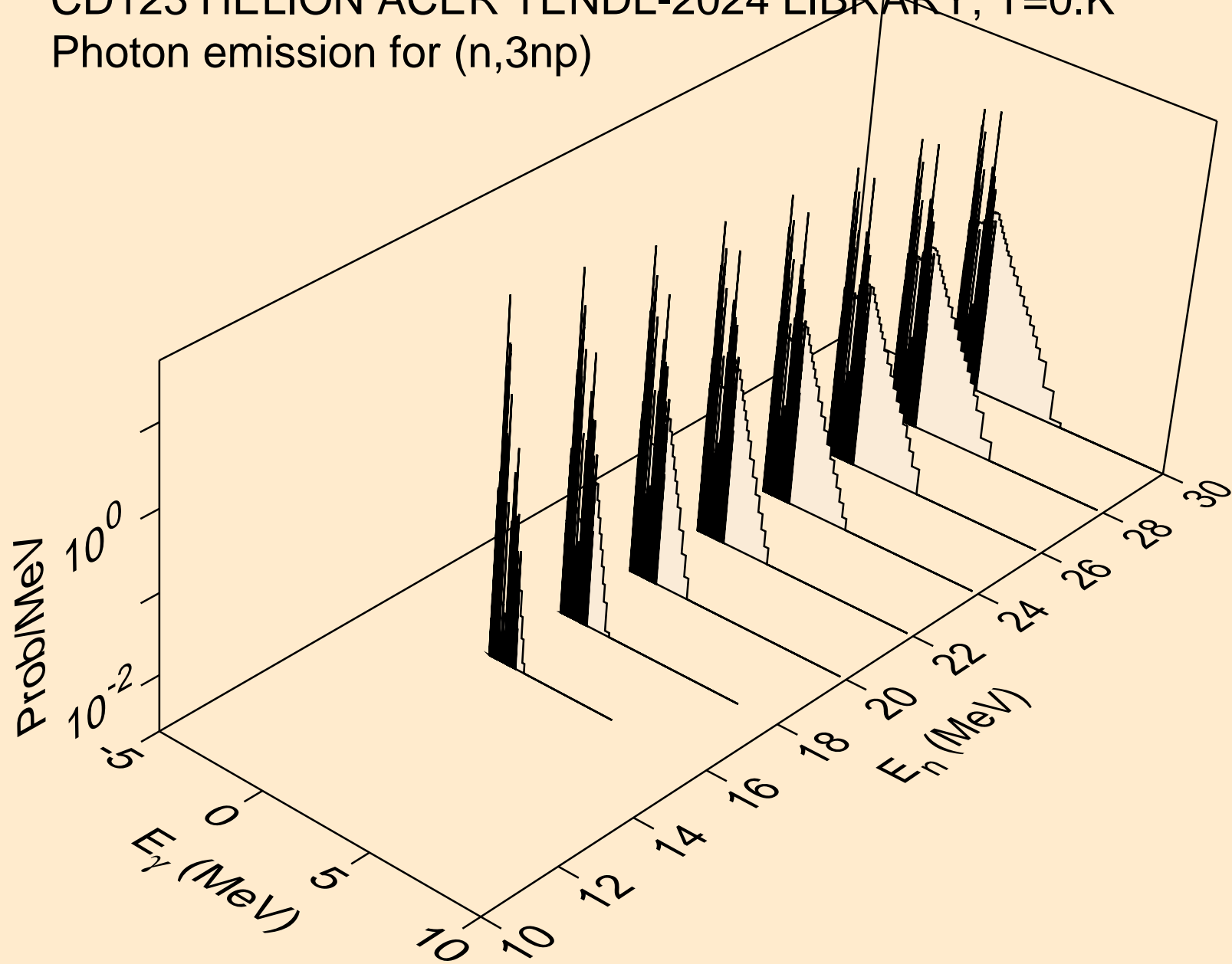

CD123 HELION ACER TENDL-2024 LIBRARY; T=0.K  
Photon emission for (n,n2p)

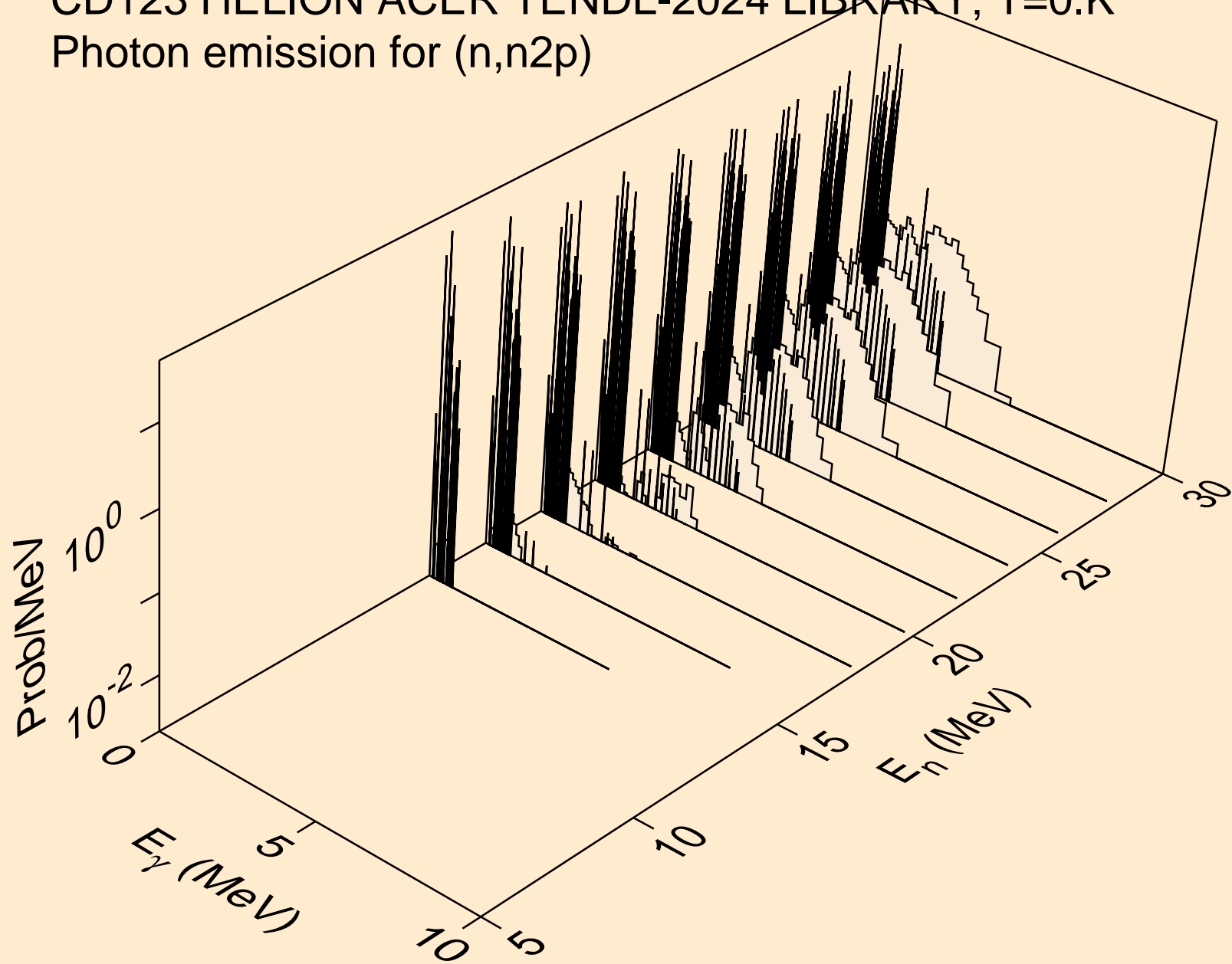

CD123 HELION ACER TENDL-2024 LIBRARY; T=0.K  
Photon emission for (n,npa)

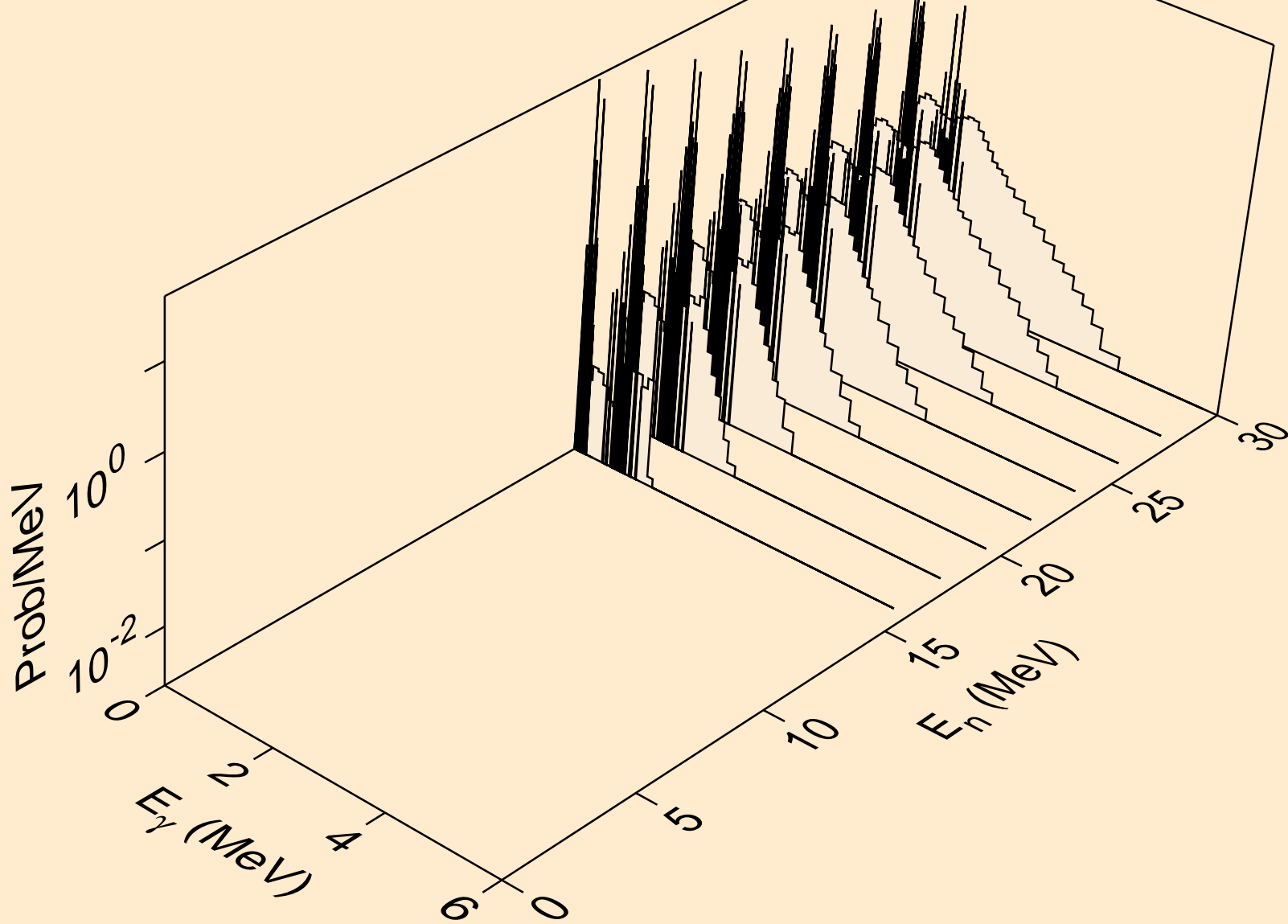

CD123 HELION ACER TENDL-2024 LIBRARY; T=0.K  
Photon emission for (n,gma)

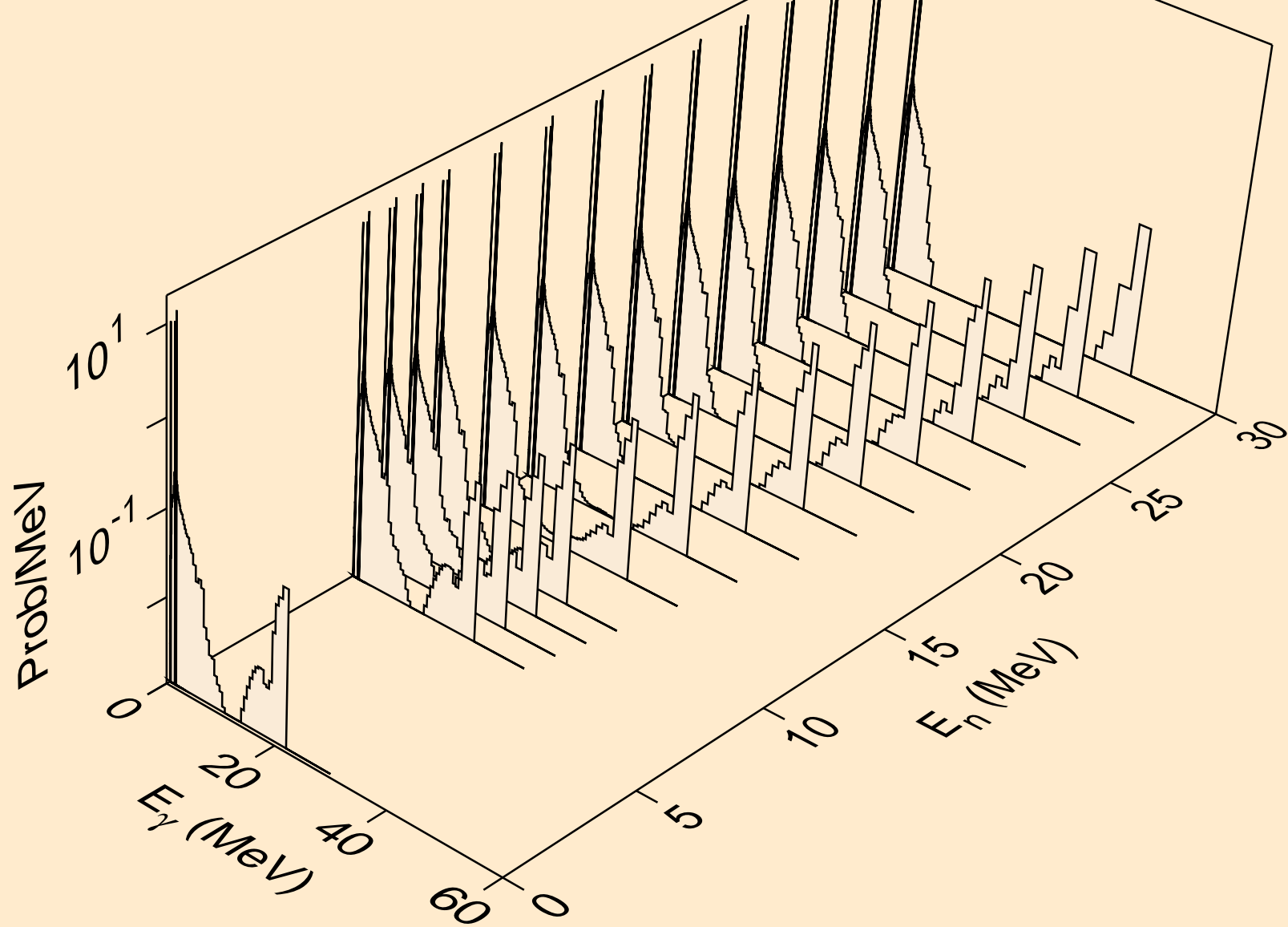

CD123 HELION ACER TENDL-2024 LIBRARY; T=0.K  
Photon emission for (n,p)

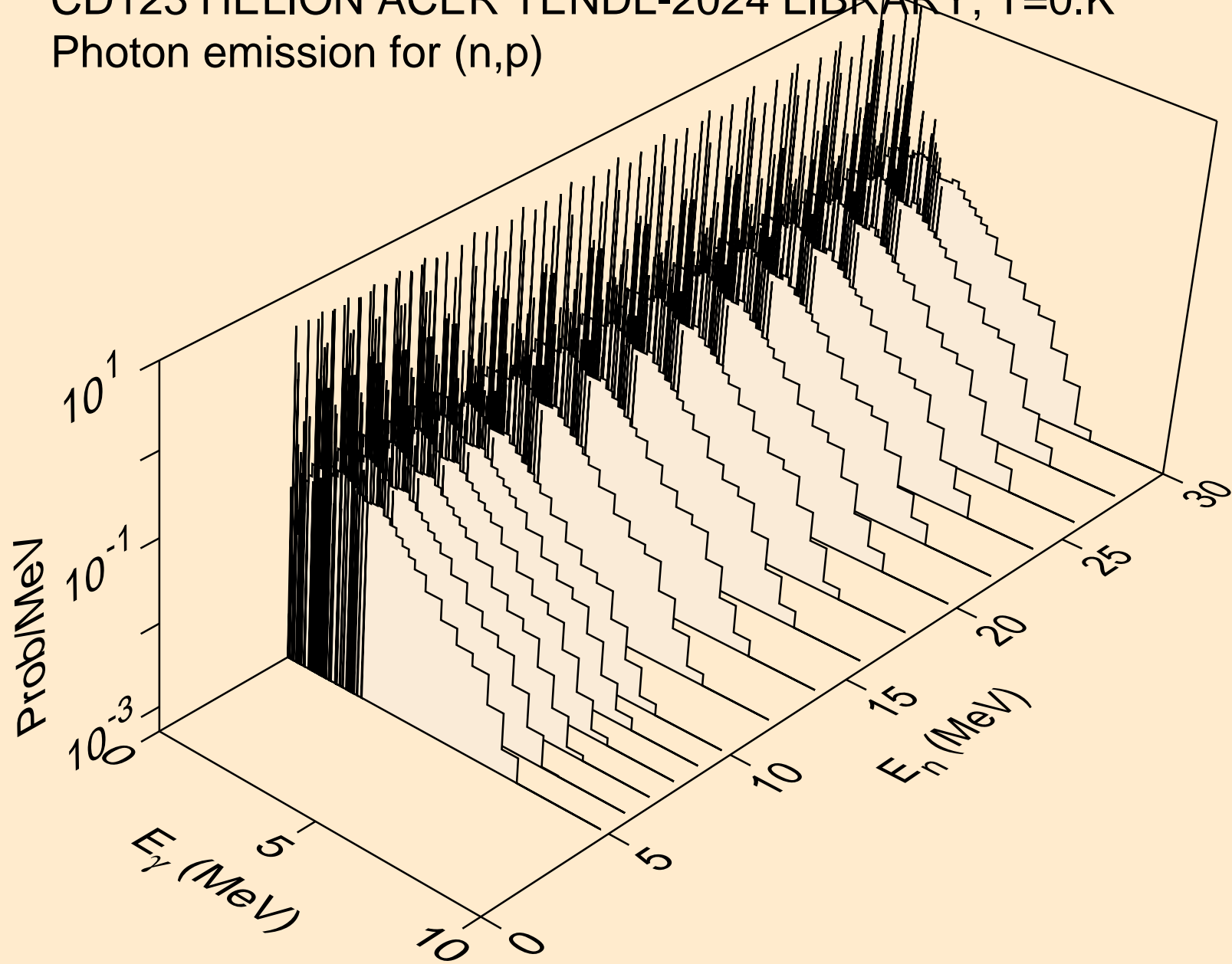

CD123 HELION ACER TENDL-2024 LIBRARY; T=0.K  
Photon emission for (n,d)

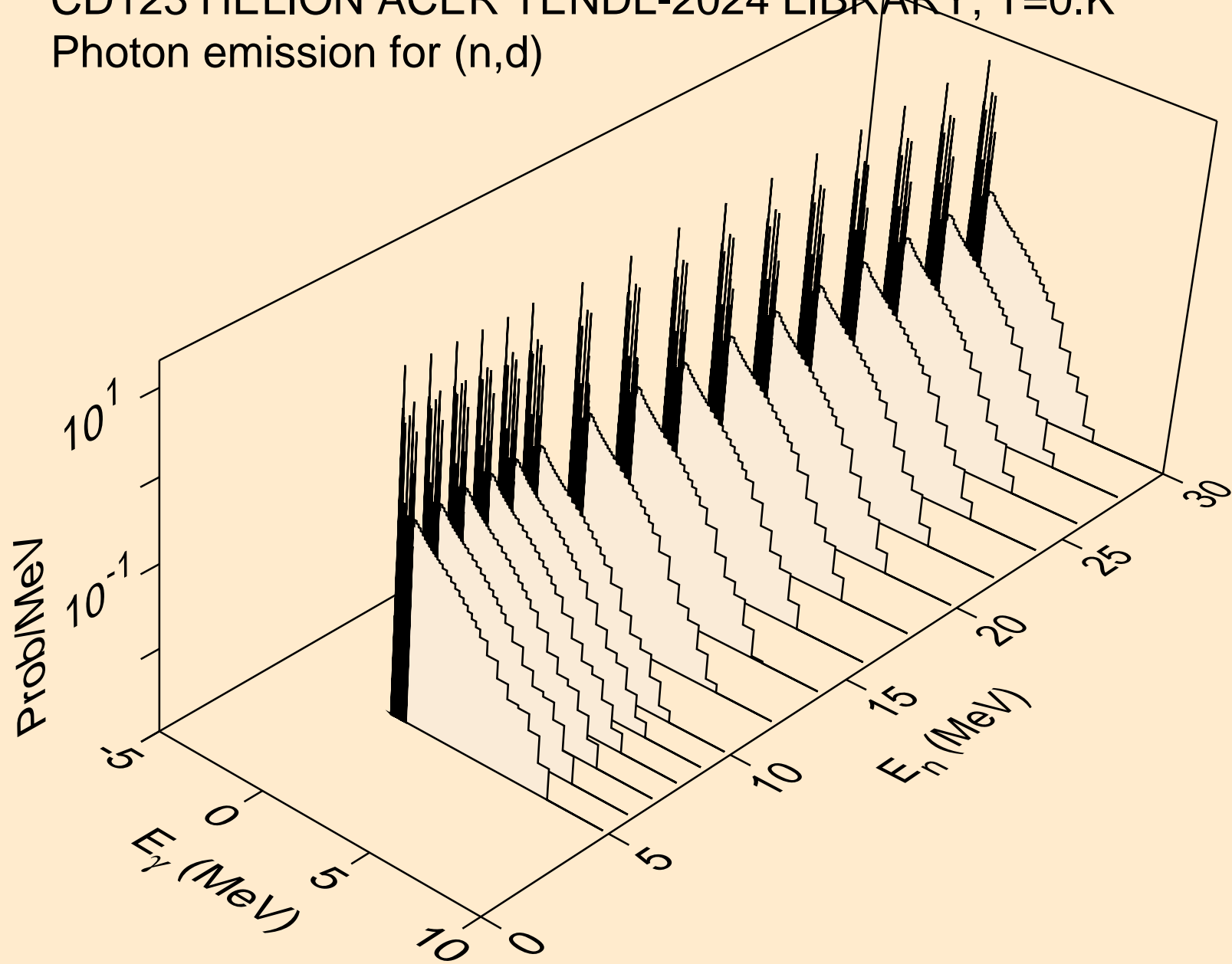

CD123 HELION ACER TENDL-2024 LIBRARY; T=0.K  
Photon emission for (n,t)

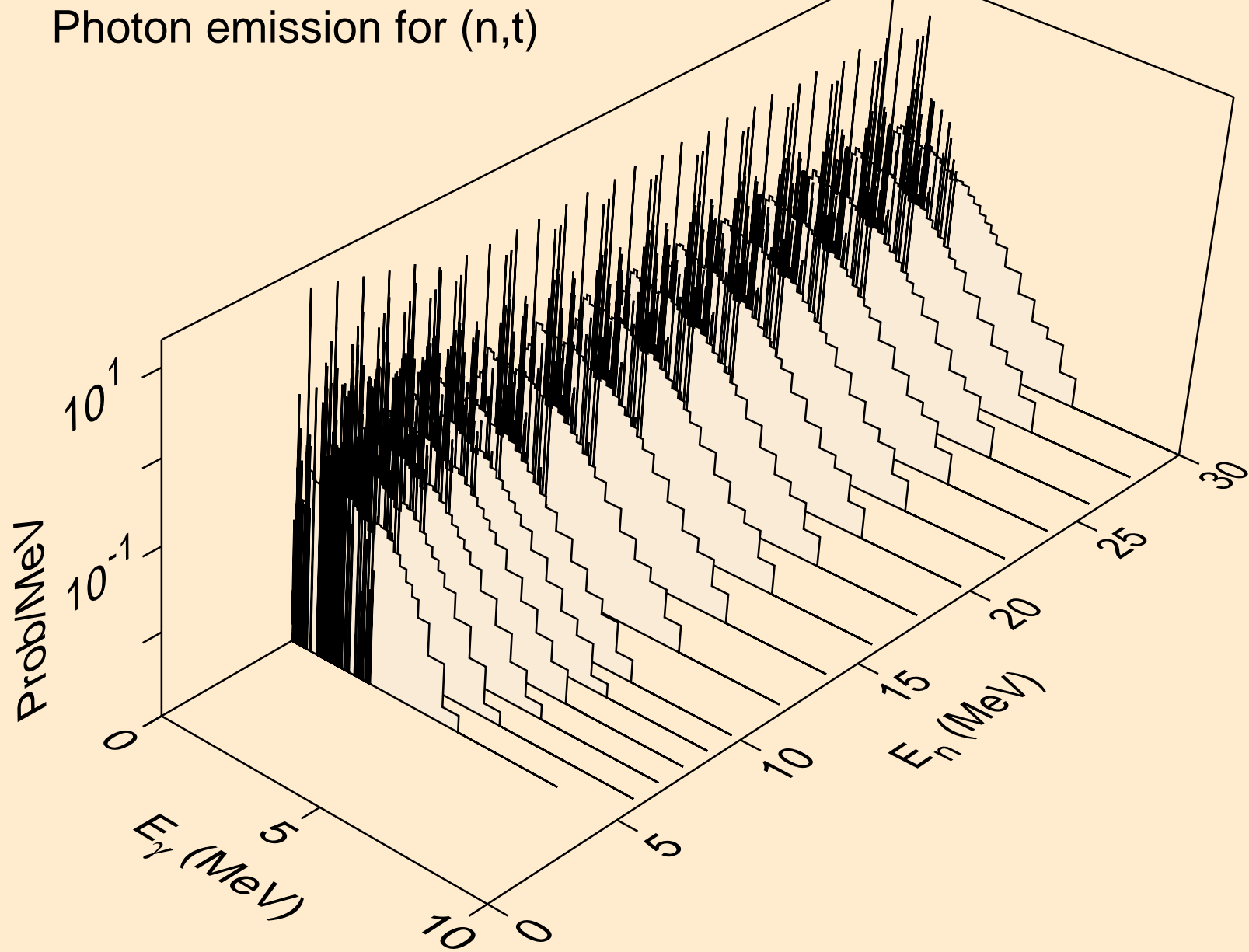

CD123 HELION ACER TENDL-2024 LIBRARY; T=0.K  
Photon emission for inelastic

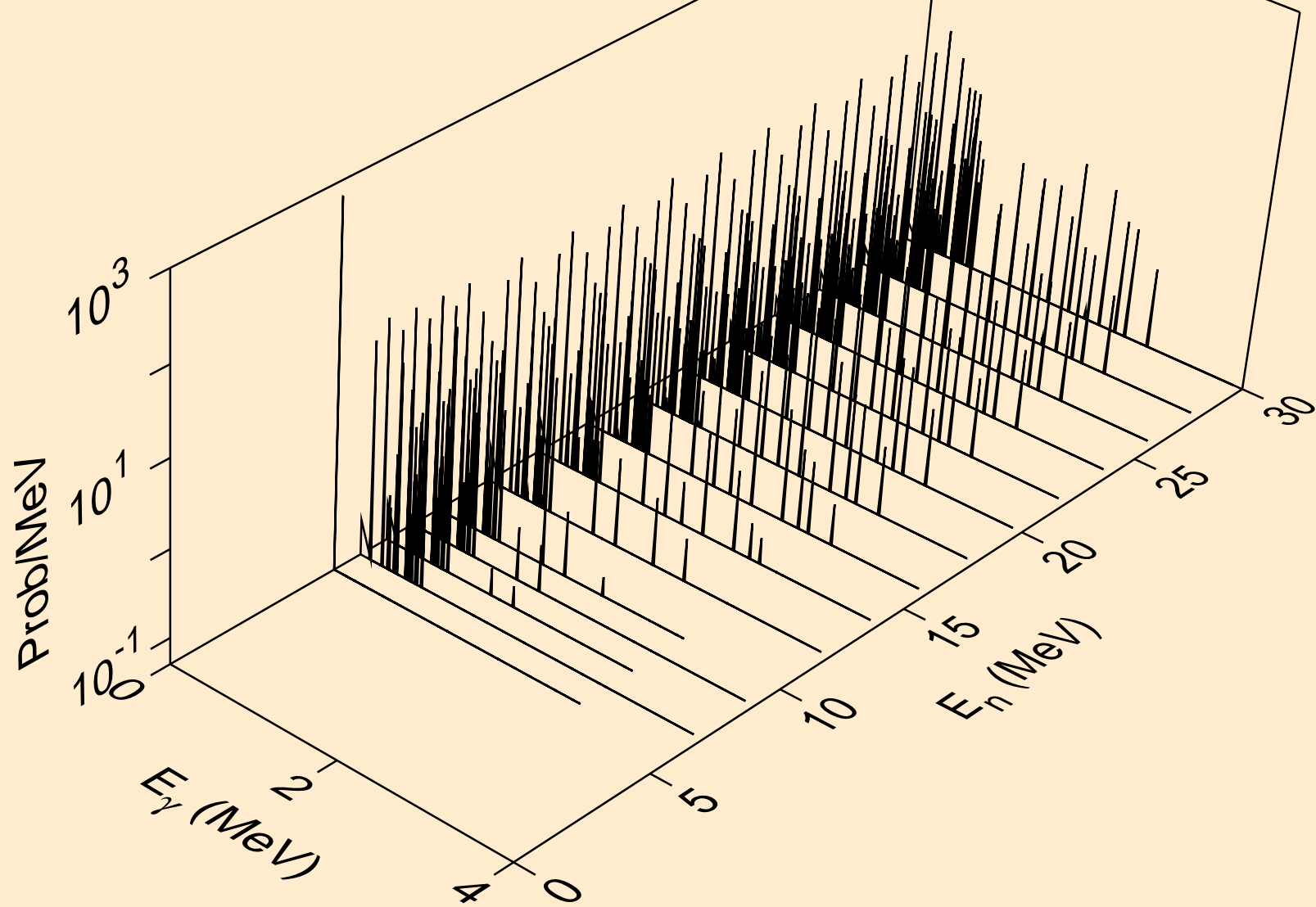

CD123 HELION ACER TENDL-2024 LIBRARY; T=0.K  
Photon emission for (n,a)

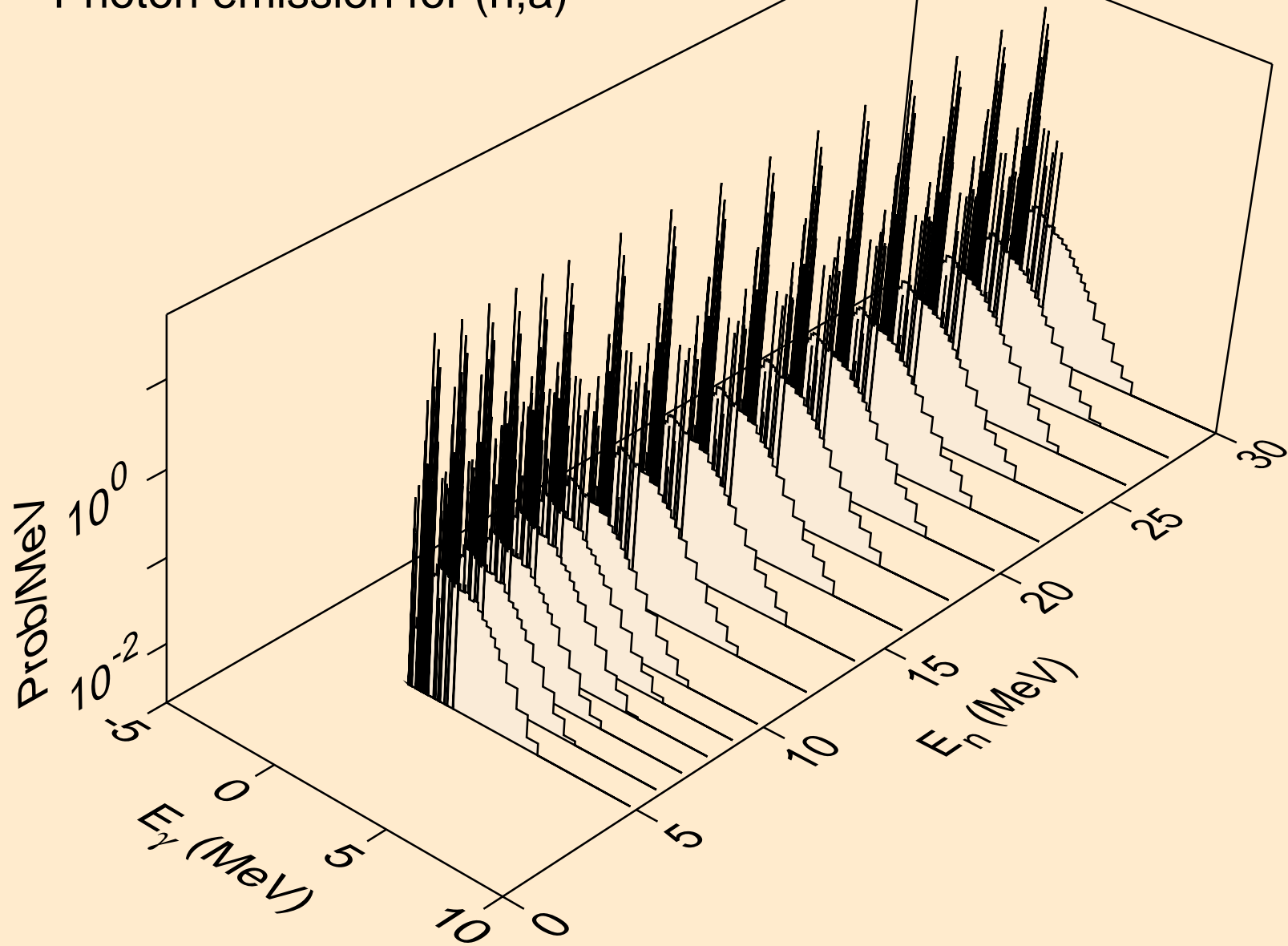

CD123 HELION ACER TENDL-2024 LIBRARY; T=0.K  
Photon emission for (n,2p)

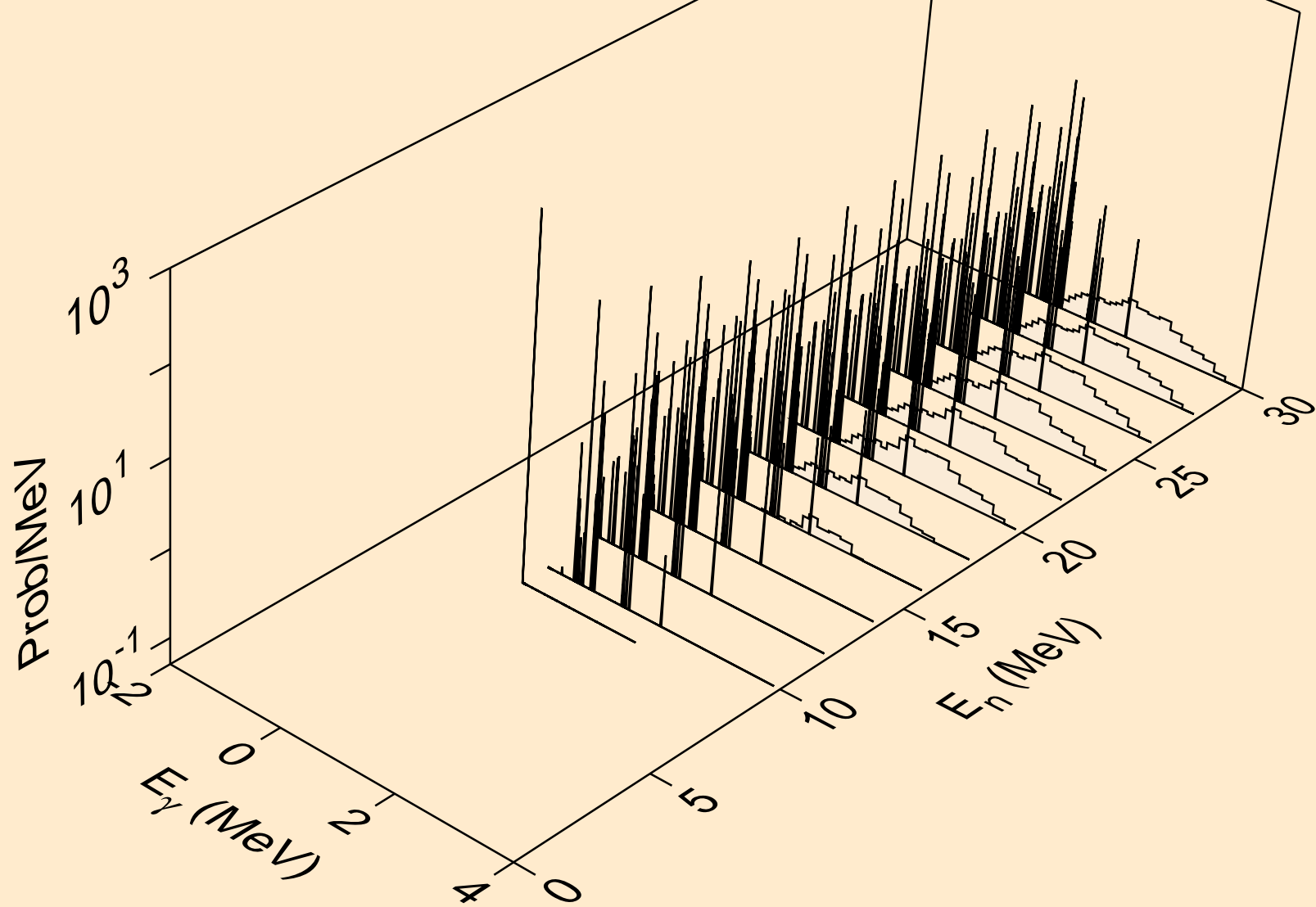

CD123 HELION ACER TENDL-2024 LIBRARY; T=0.K  
Photon emission for (n,pa)

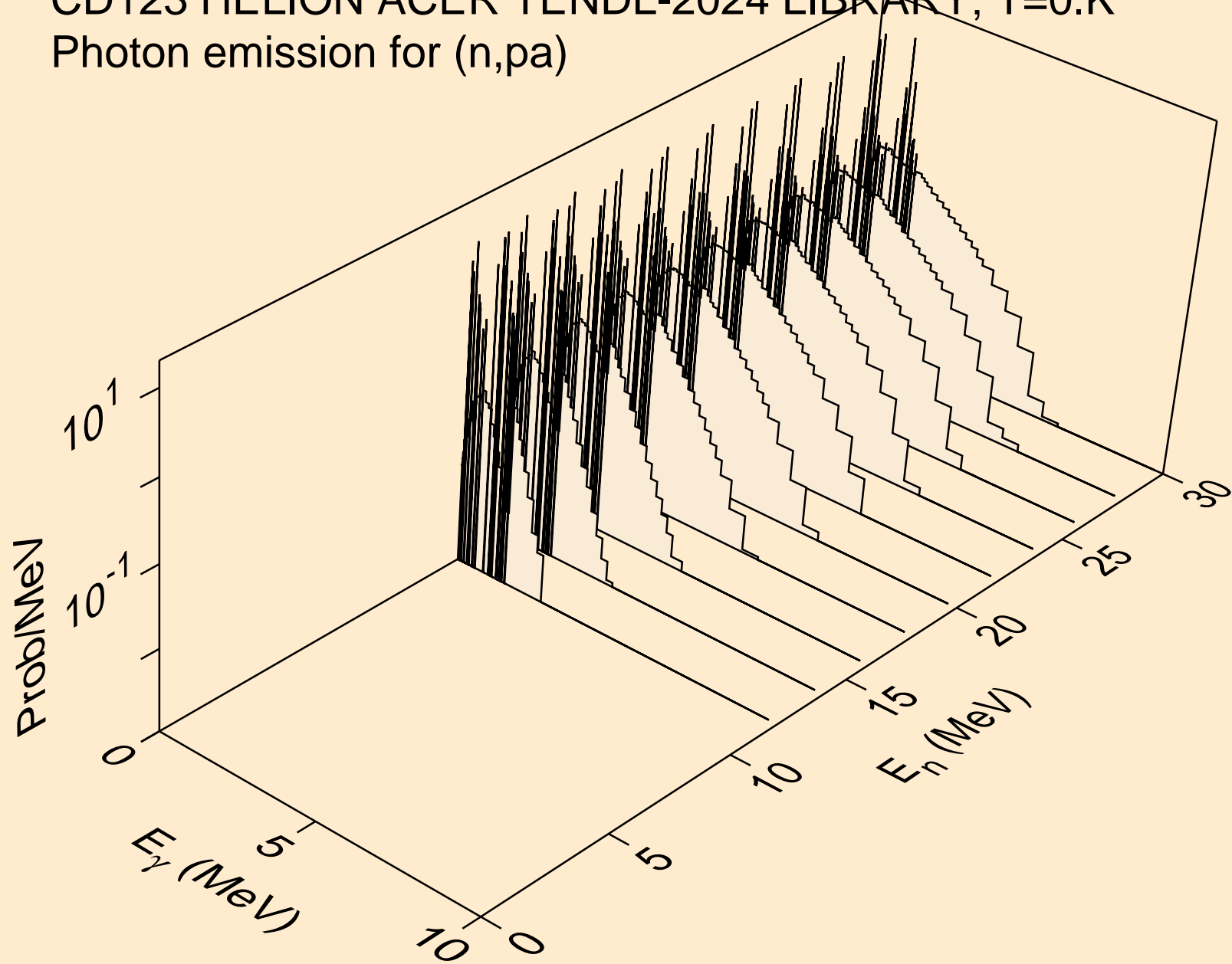

CD123 HELION ACER TENDL-2024 LIBRARY; T=0.K  
Photon emission for (n,pd)

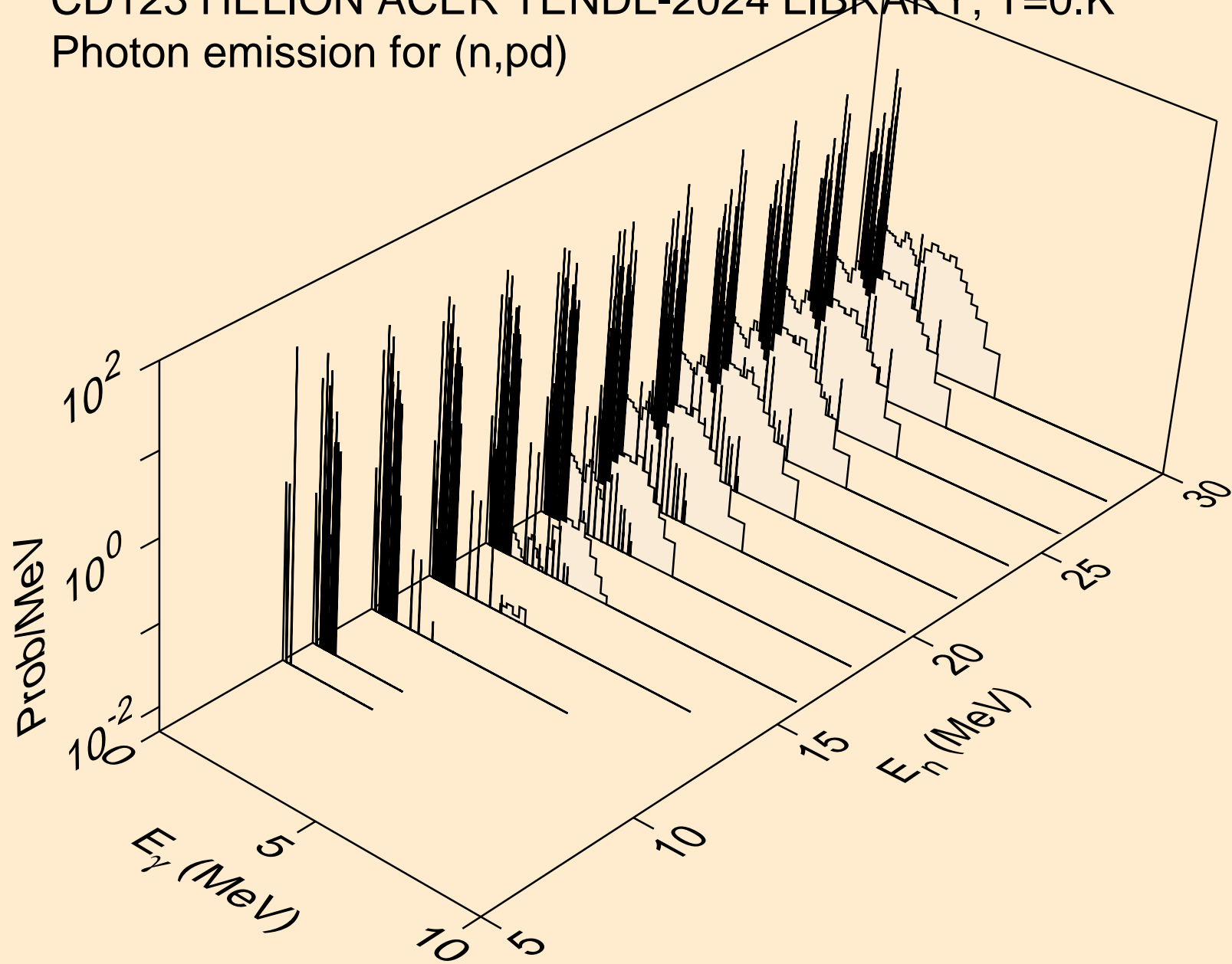

CD123 HELION ACER TENDL-2024 LIBRARY; T=0.K  
Photon emission for (n,pt)

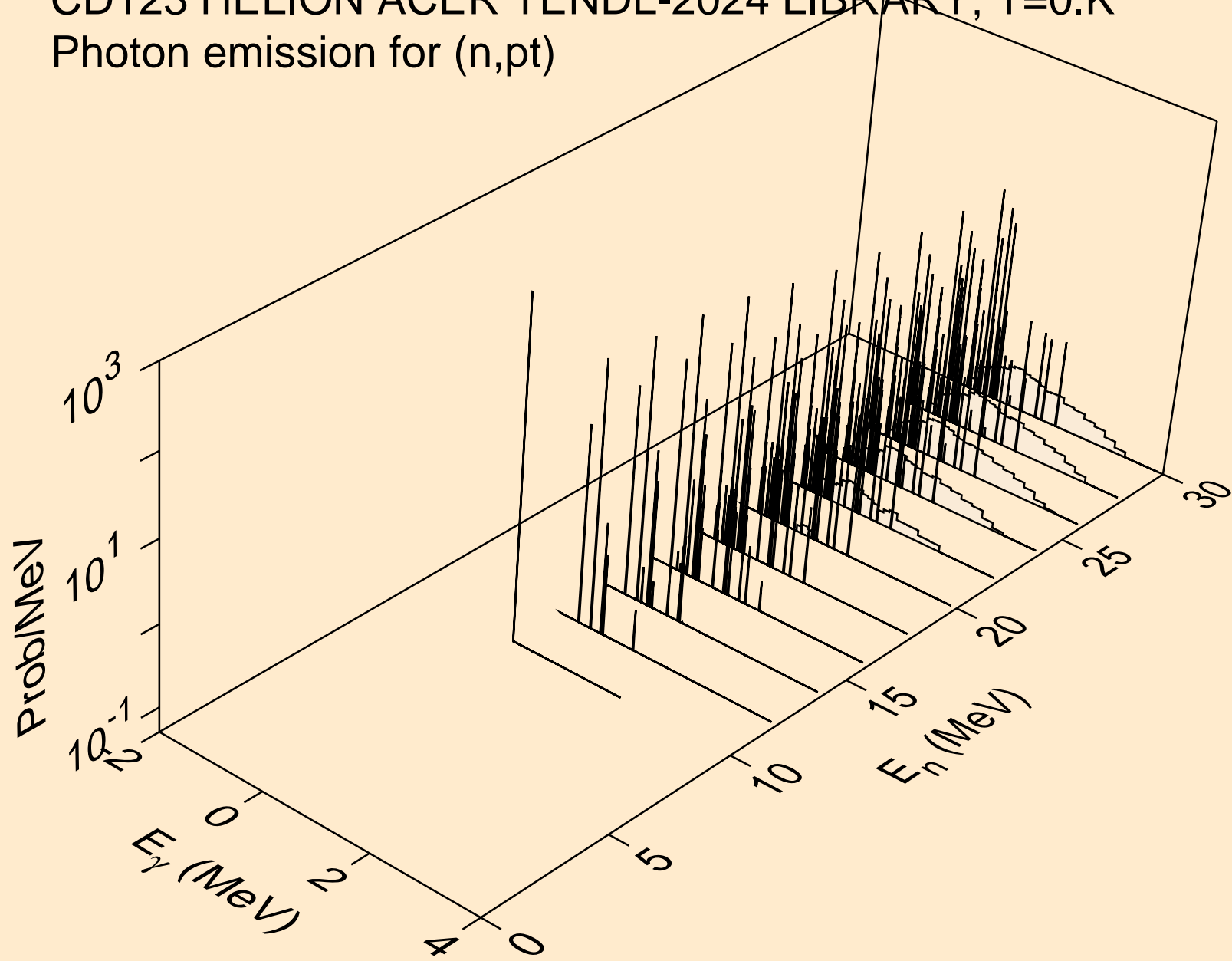

# CD123 HELION ACER TENDL-2024 LIBRARY; T=0.K

## Particle heating contributions

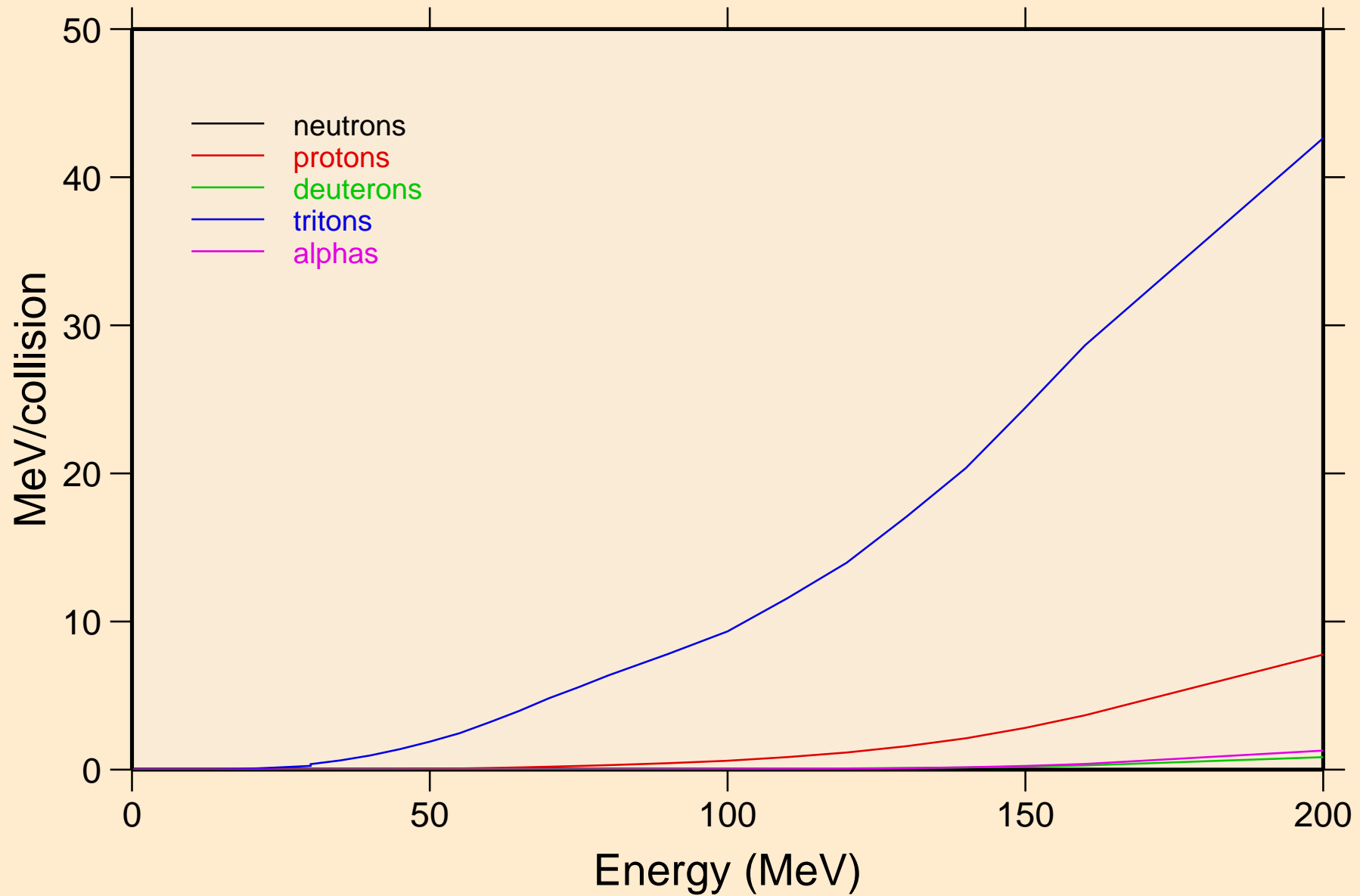

CD123 HELION ACER TENDL-2024 LIBRARY; T=0.K  
Recoil Heating

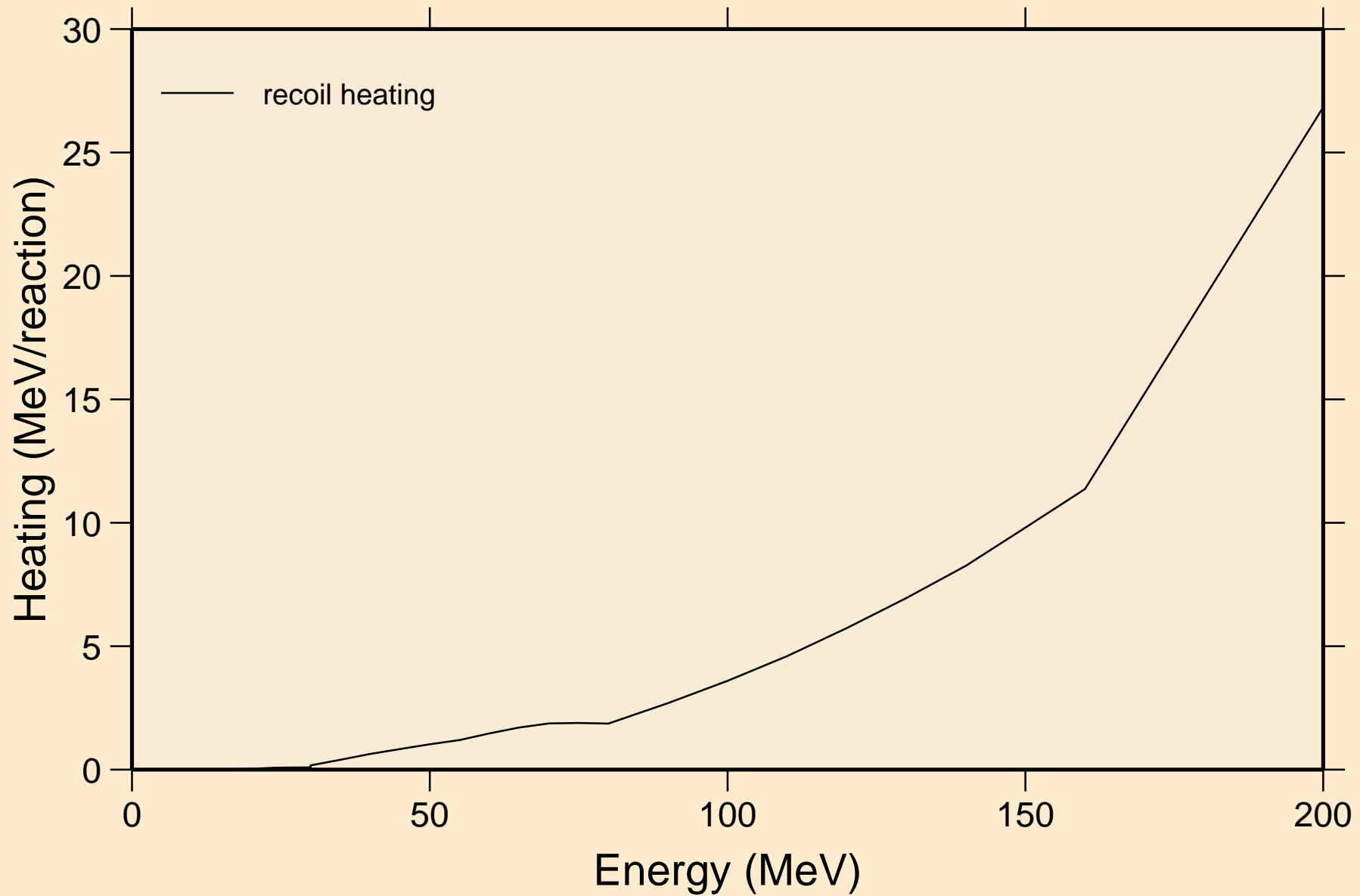

CD123 HELION ACER TENDL-2024 LIBRARY; T=0.K  
Particle production cross sections

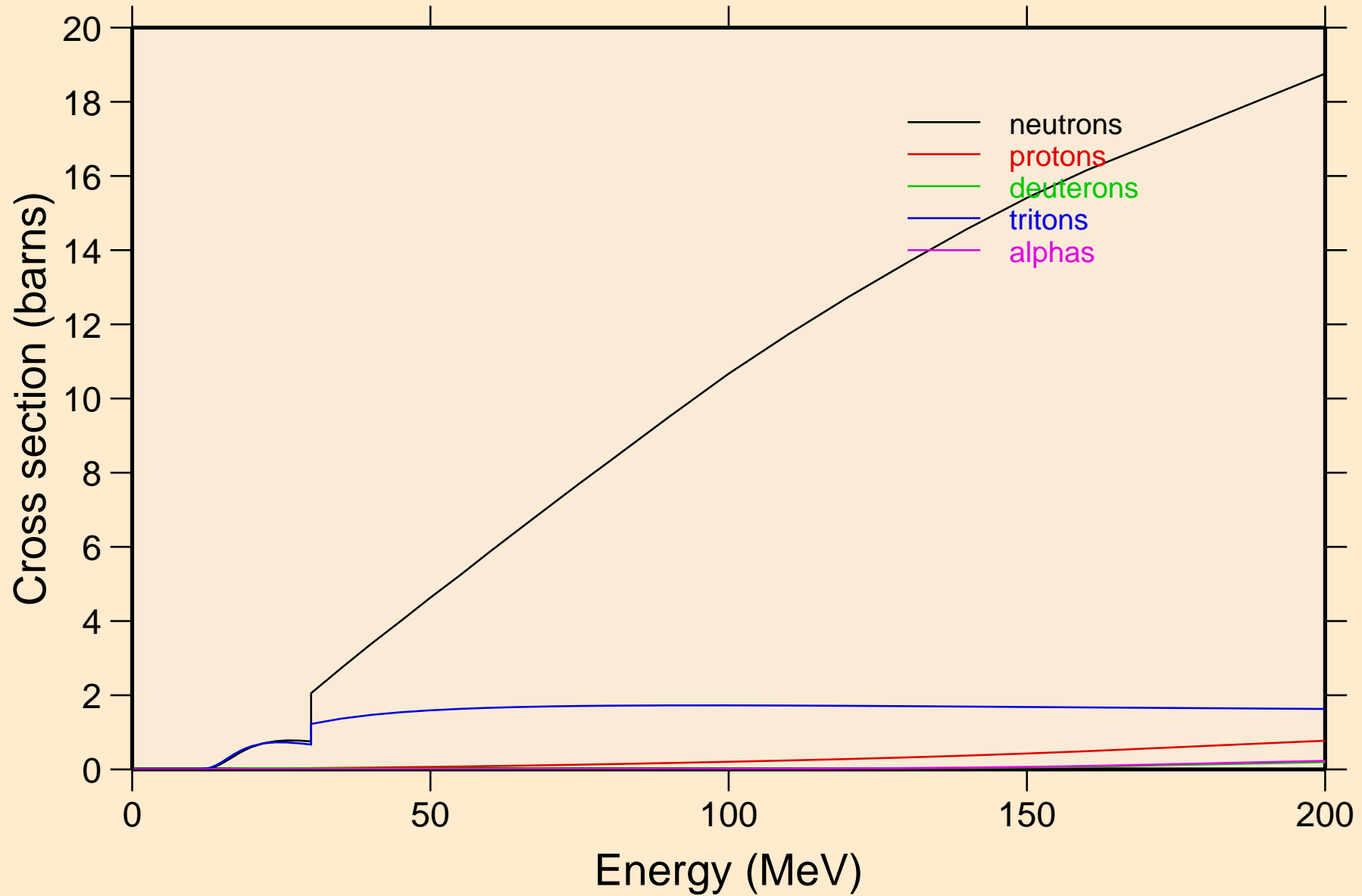

CD123 HELION ACER TENDL-2024 LIBRARY; T=0.K  
neutrons from (s,n)

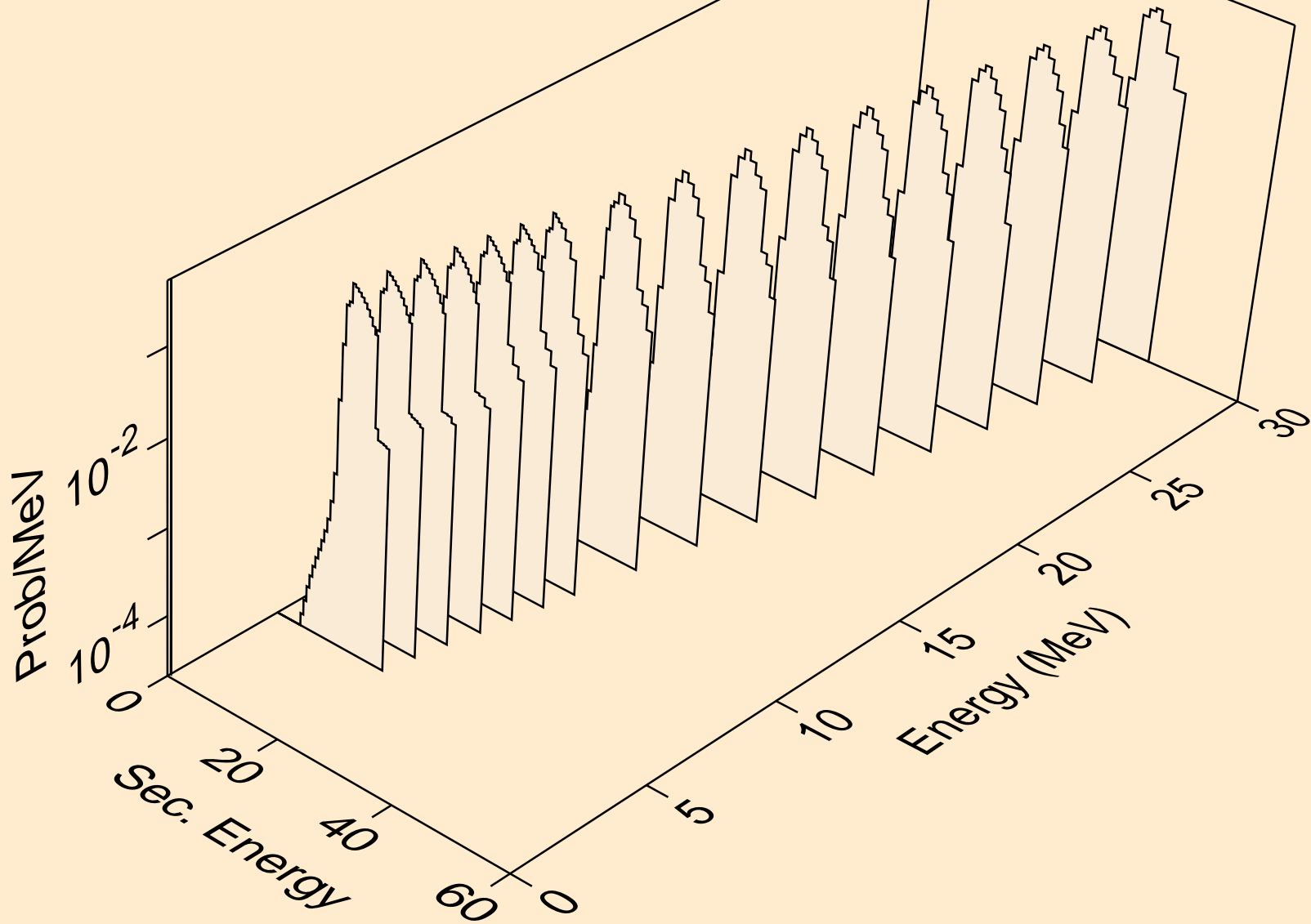

CD123 HELION ACER TENDL-2024 LIBRARY; T=0.K  
neutrons from (s,x)

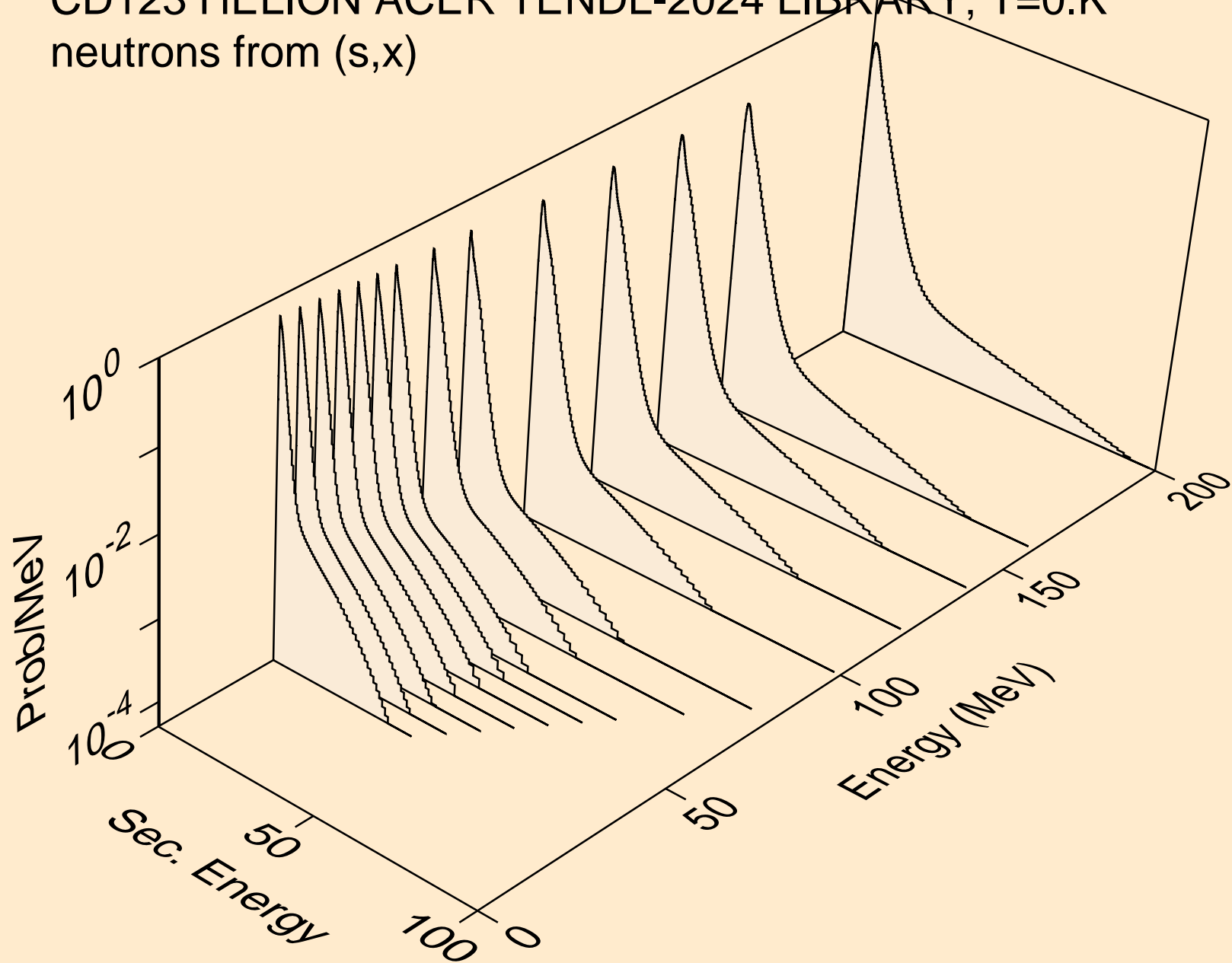

CD123 HELION ACER TENDL-2024 LIBRARY; T=0.K  
neutrons from (s,2nd)

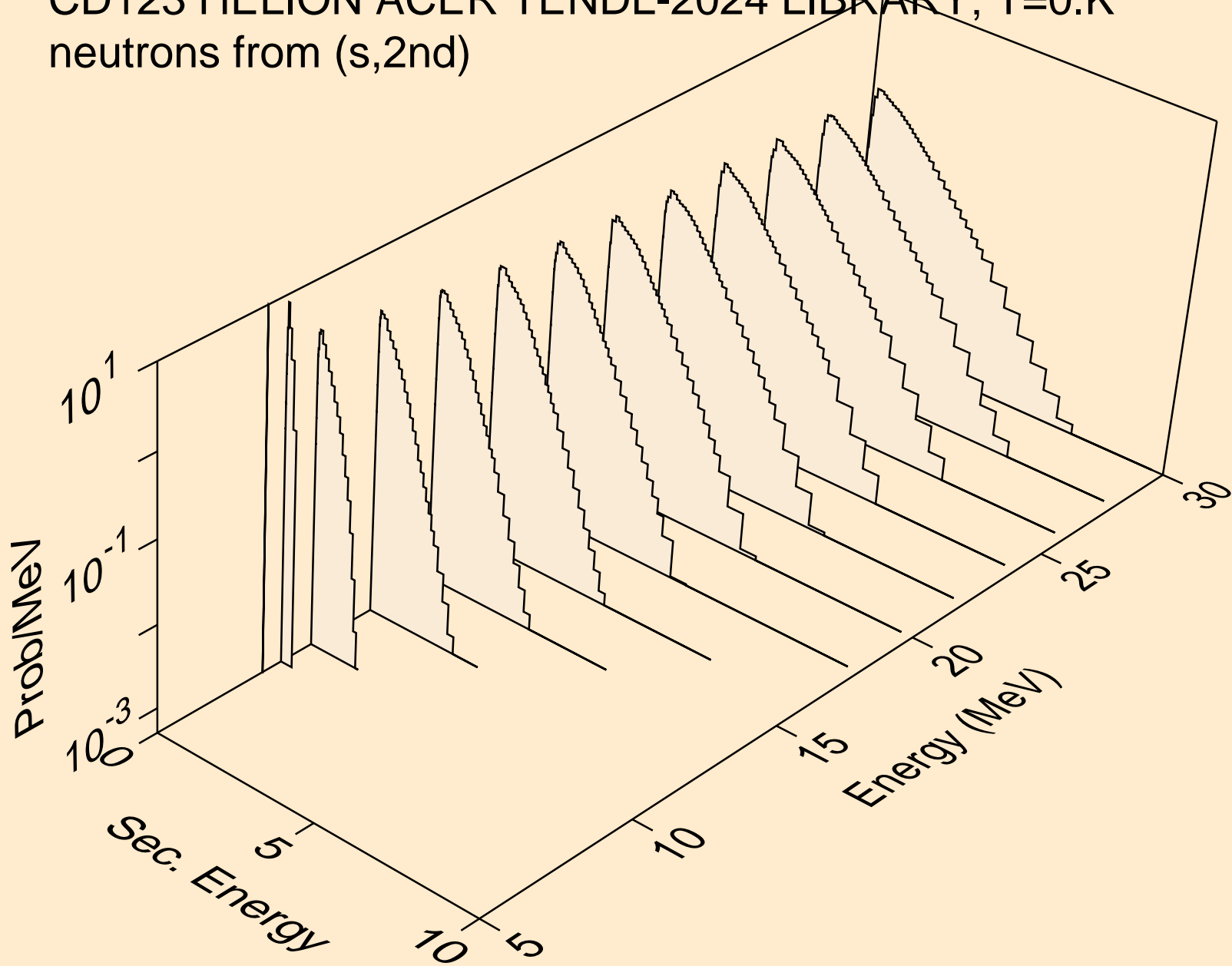

CD123 HELION ACER TENDL-2024 LIBRARY; T=0.K  
neutrons from (s,2n)

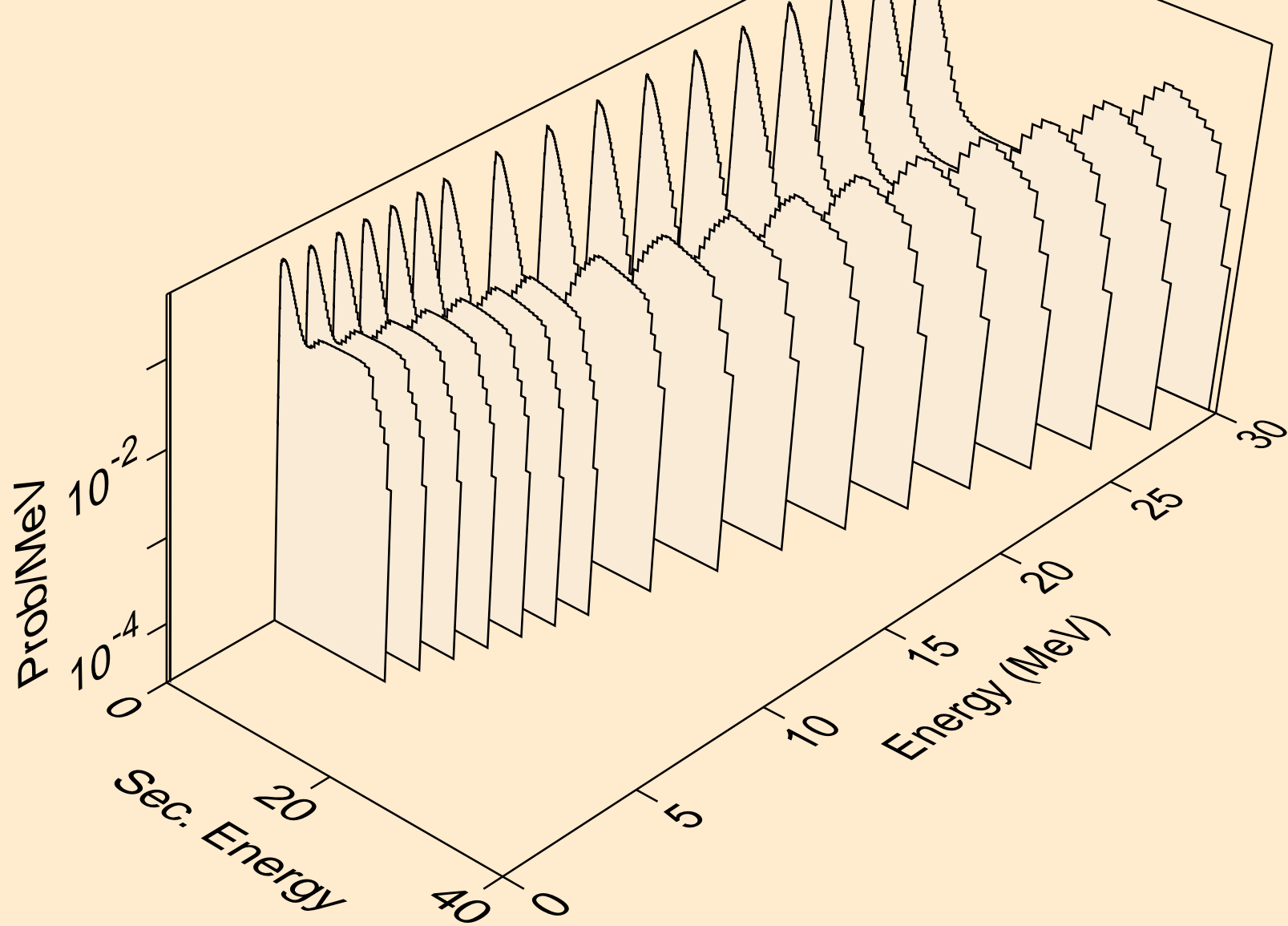

CD123 HELION ACER TENDL-2024 LIBRARY; T=0.K  
neutrons from (s,3n)

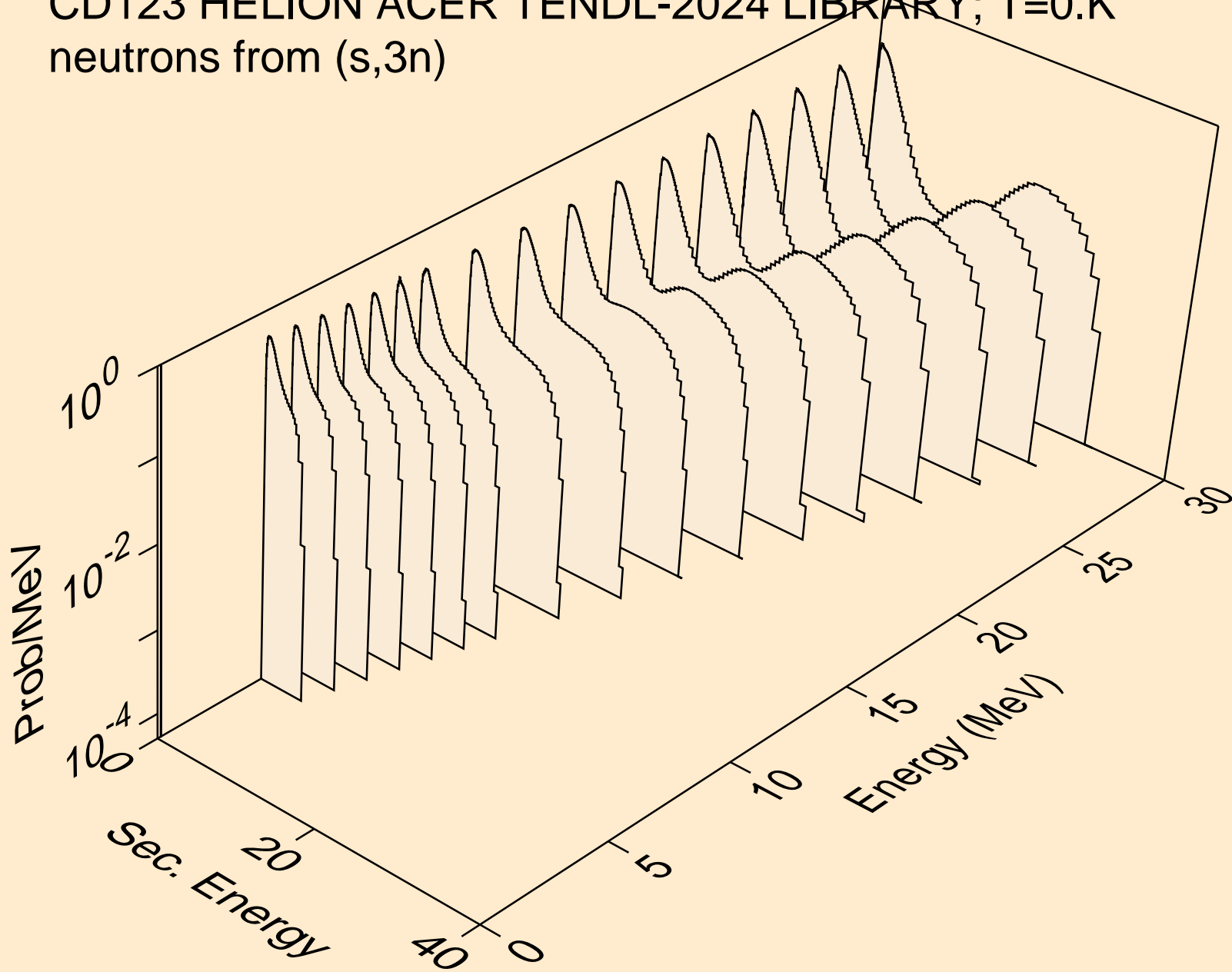

CD123 HELION ACER TENDL-2024 LIBRARY; T=0.K  
neutrons from (s,n\*)a

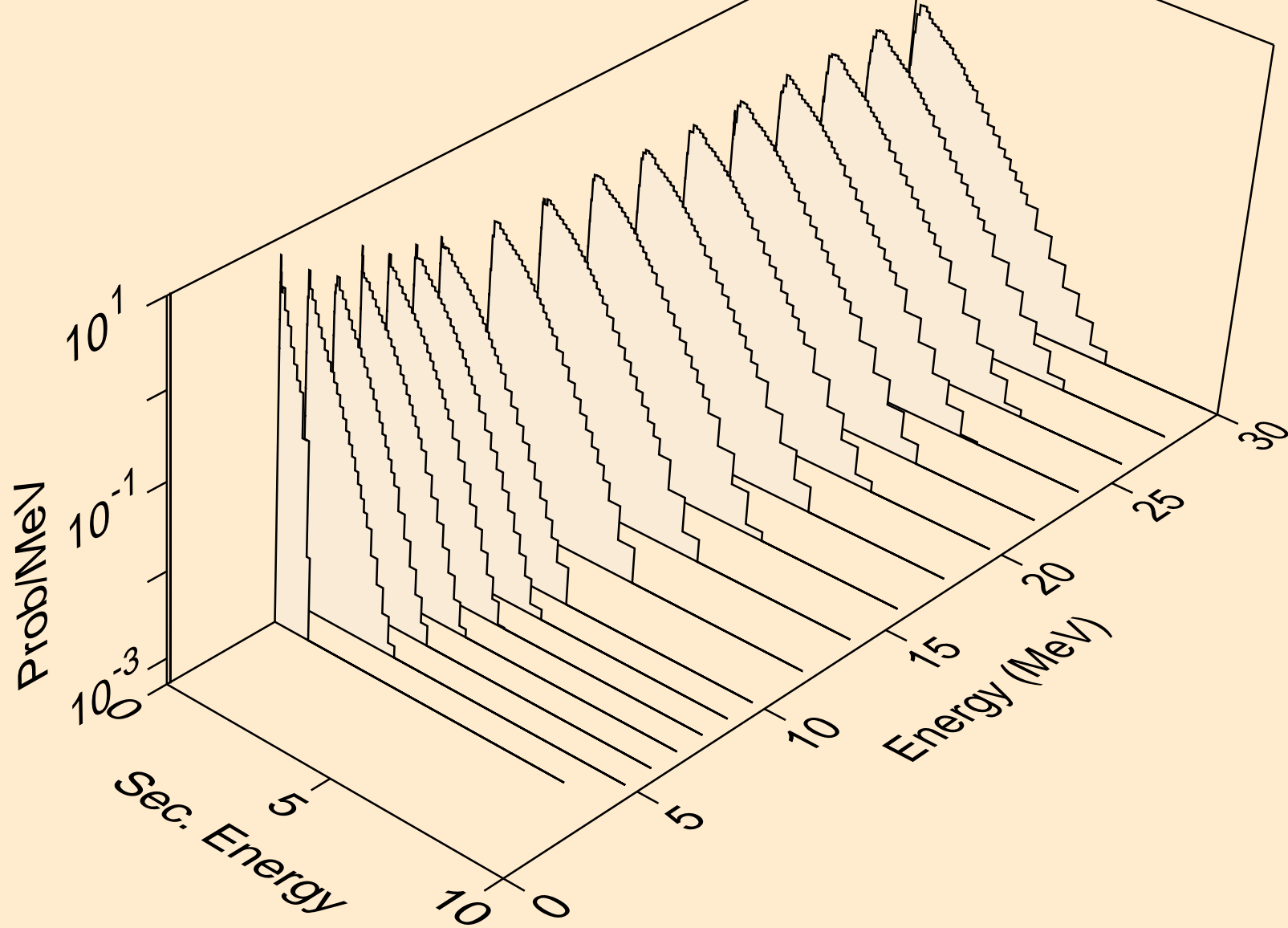

CD123 HELION ACER TENDL-2024 LIBRARY; T=0.K  
neutrons from (s,2n)a

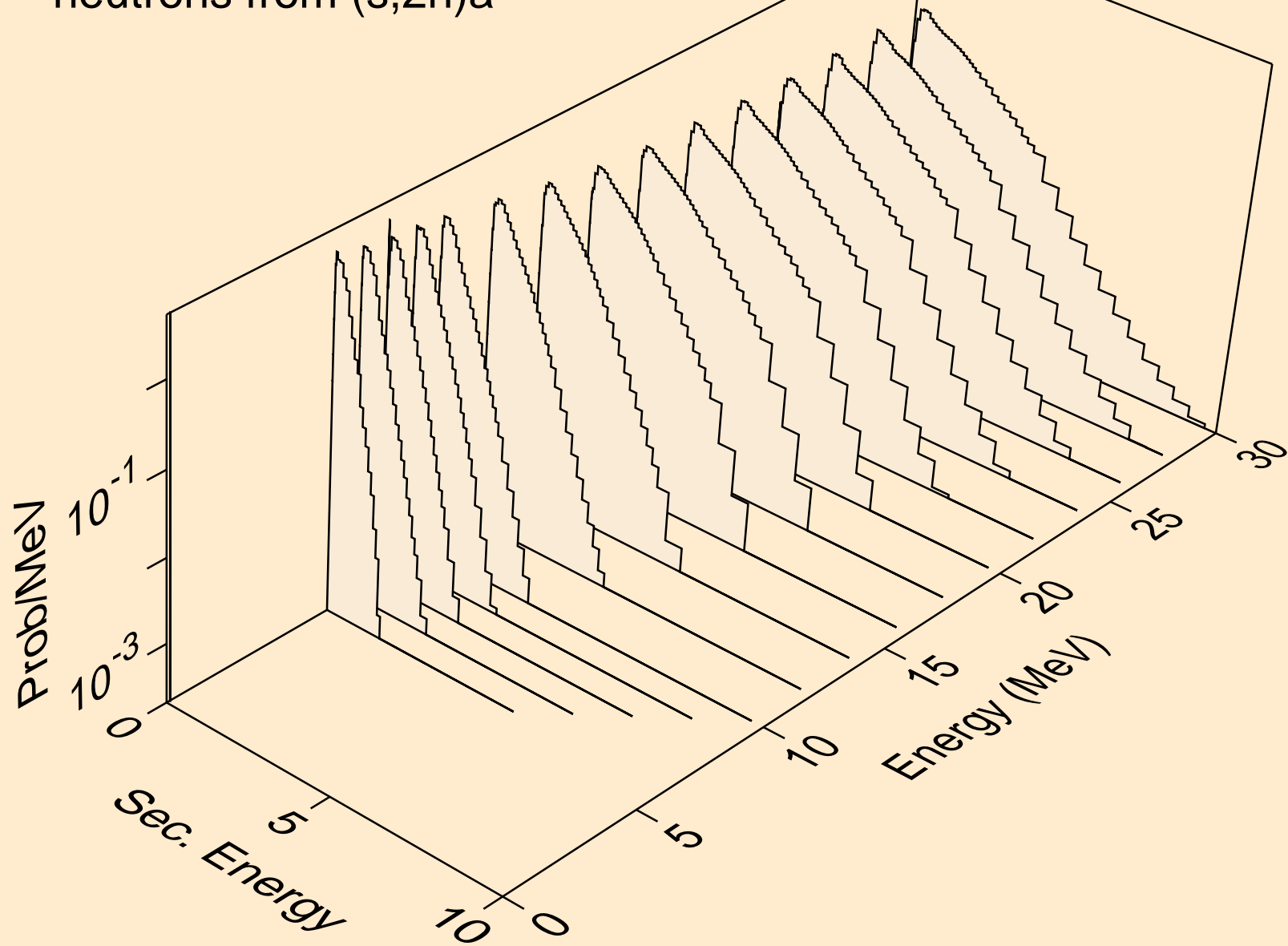

CD123 HELION ACER TENDL-2024 LIBRARY; T=0.K  
neutrons from (s,3n)a

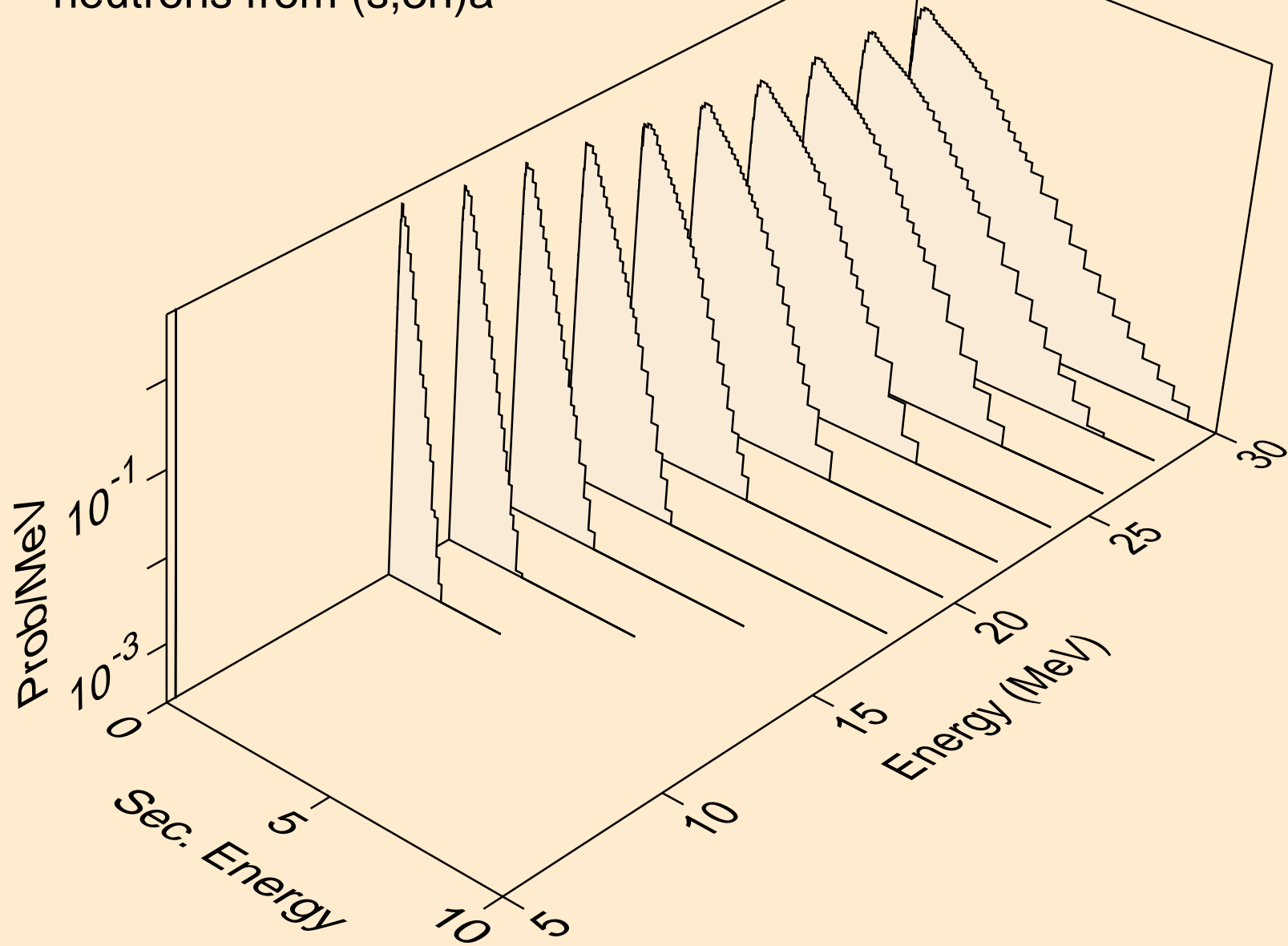

CD123 HELION ACER TENDL-2024 LIBRARY; T=0.K  
neutrons from (s,n\*)p

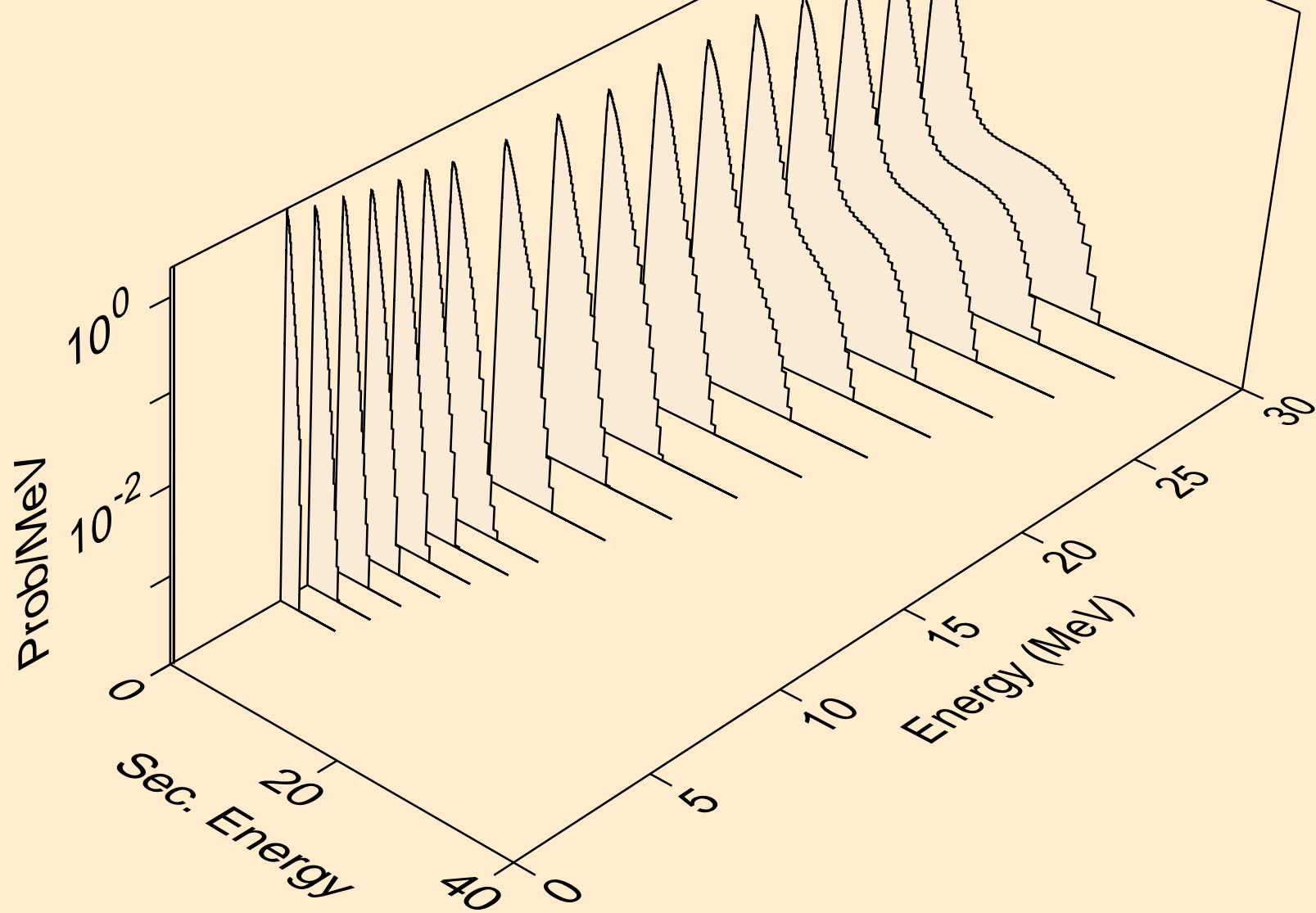

CD123 HELION ACER TENDL-2024 LIBRARY; T=0.K  
neutrons from (s,n\*)d

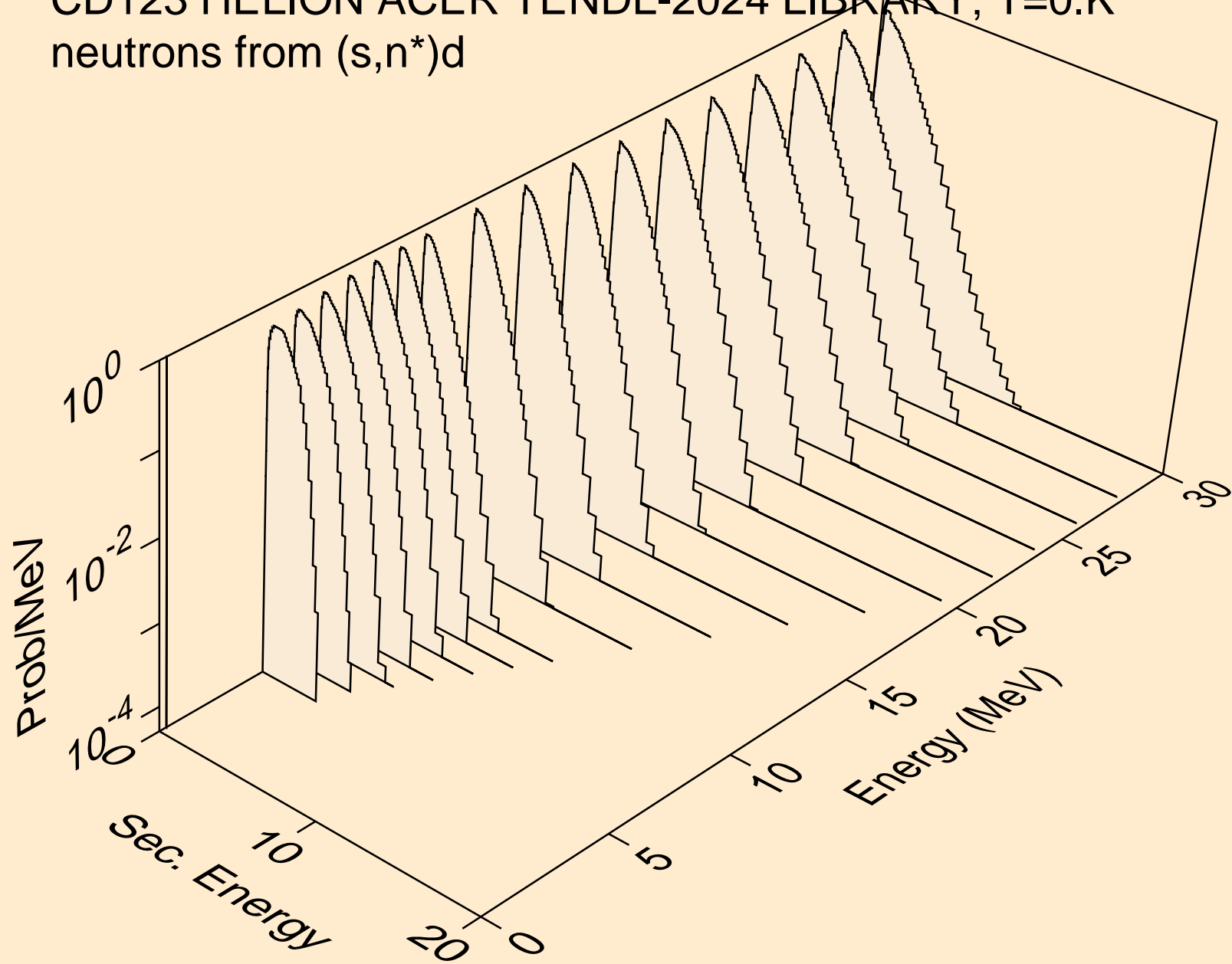

CD123 HELION ACER TENDL-2024 LIBRARY; T=0.K  
neutrons from (s,n\*)t

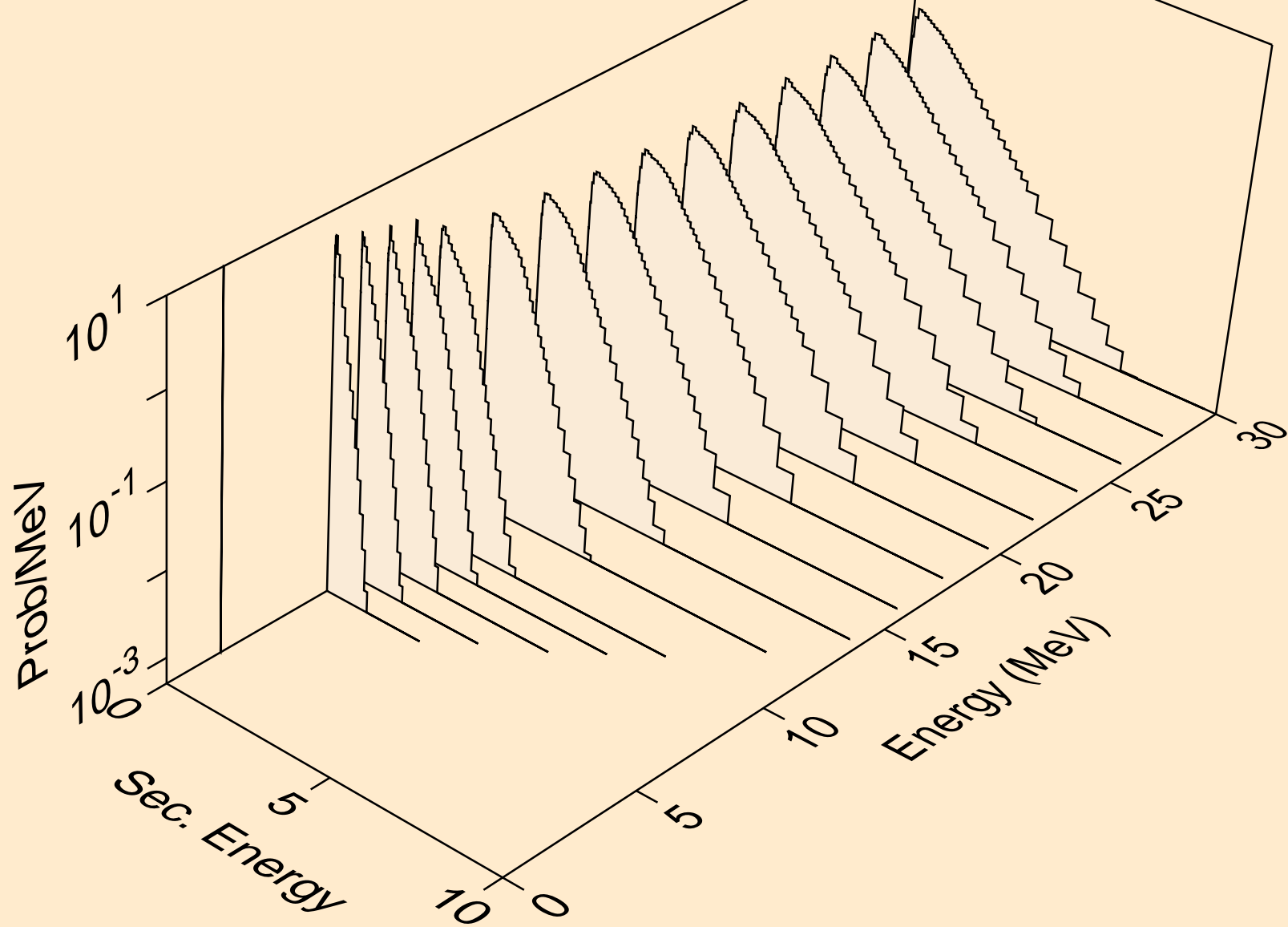

CD123 HELION ACER TENDL-2024 LIBRARY; T=0.K  
neutrons from (s,n\*)he3

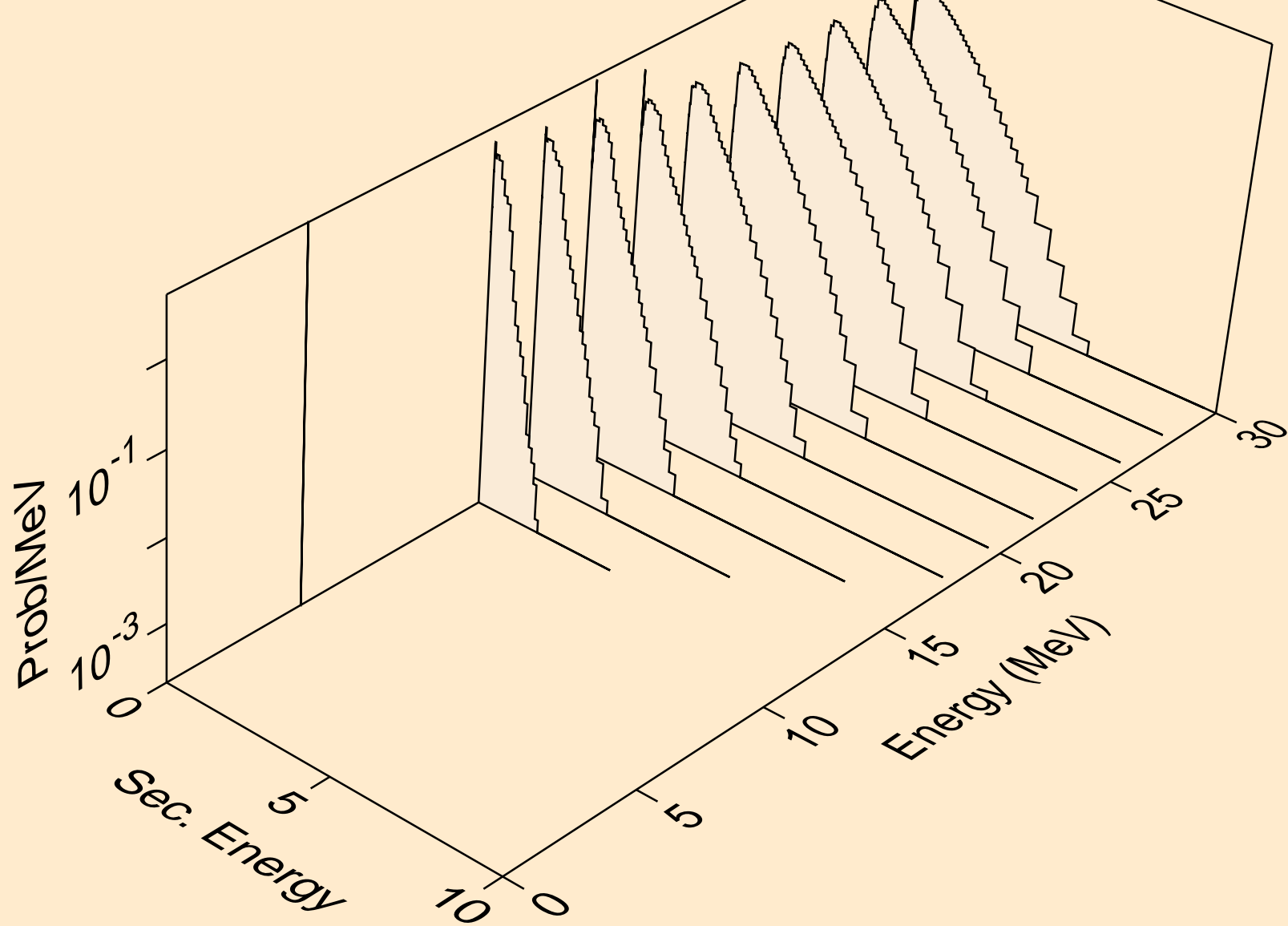

CD123 HELION ACER TENDL-2024 LIBRARY; T=0.K  
neutrons from (s,4n)

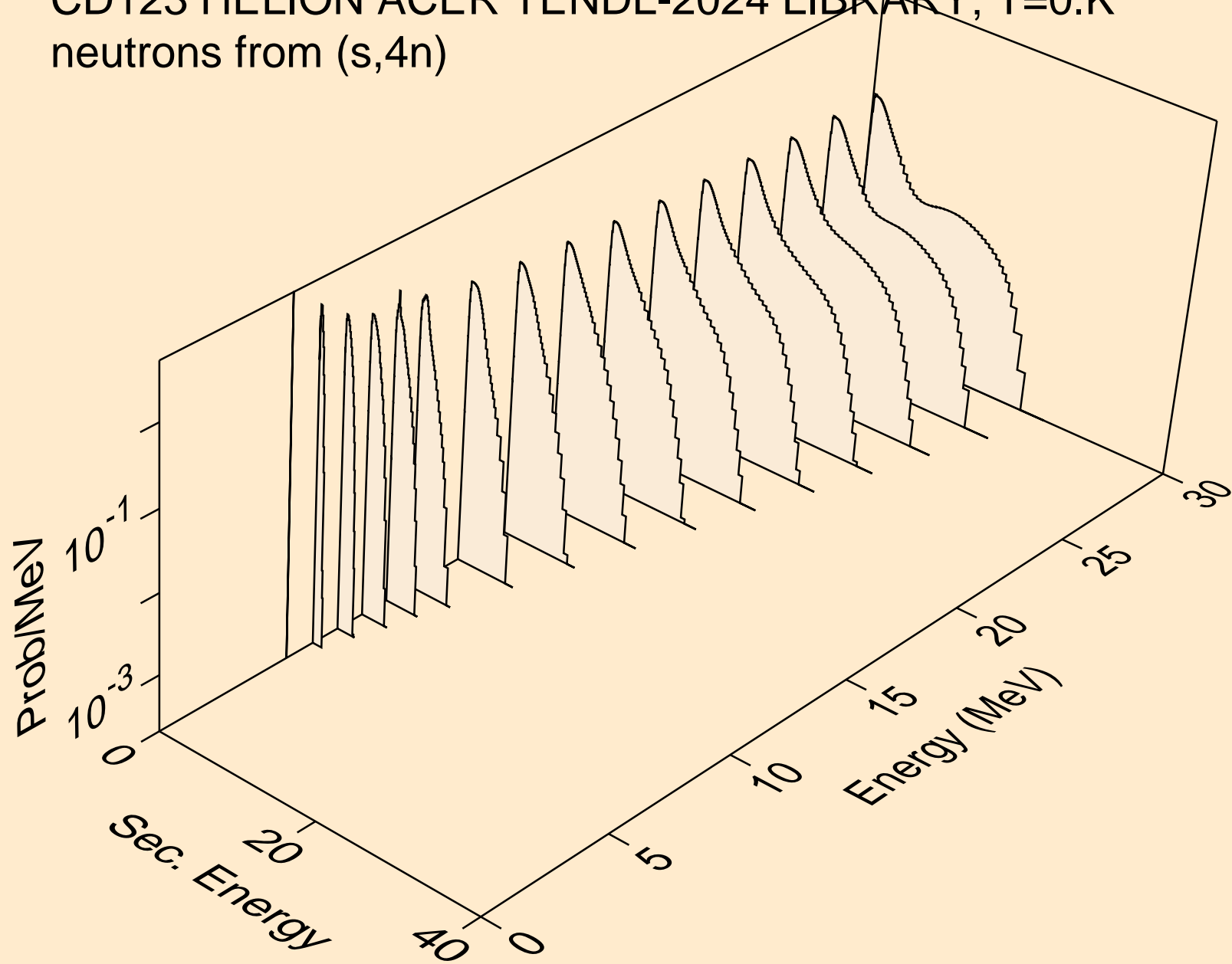

CD123 HELION ACER TENDL-2024 LIBRARY; T=0.K  
neutrons from (s,2np)

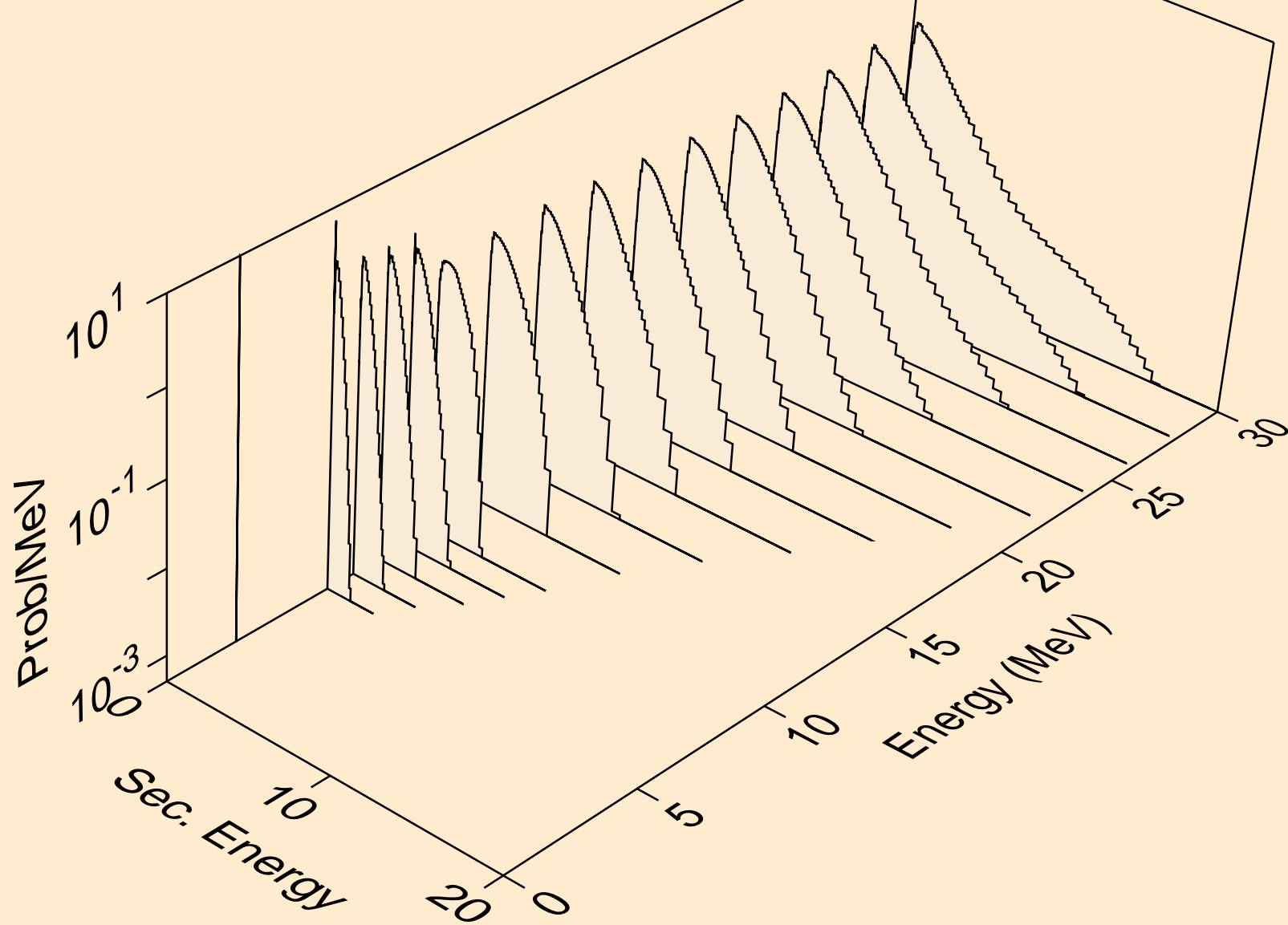

CD123 HELION ACER TENDL-2024 LIBRARY; T=0.K  
neutrons from (s,3np)

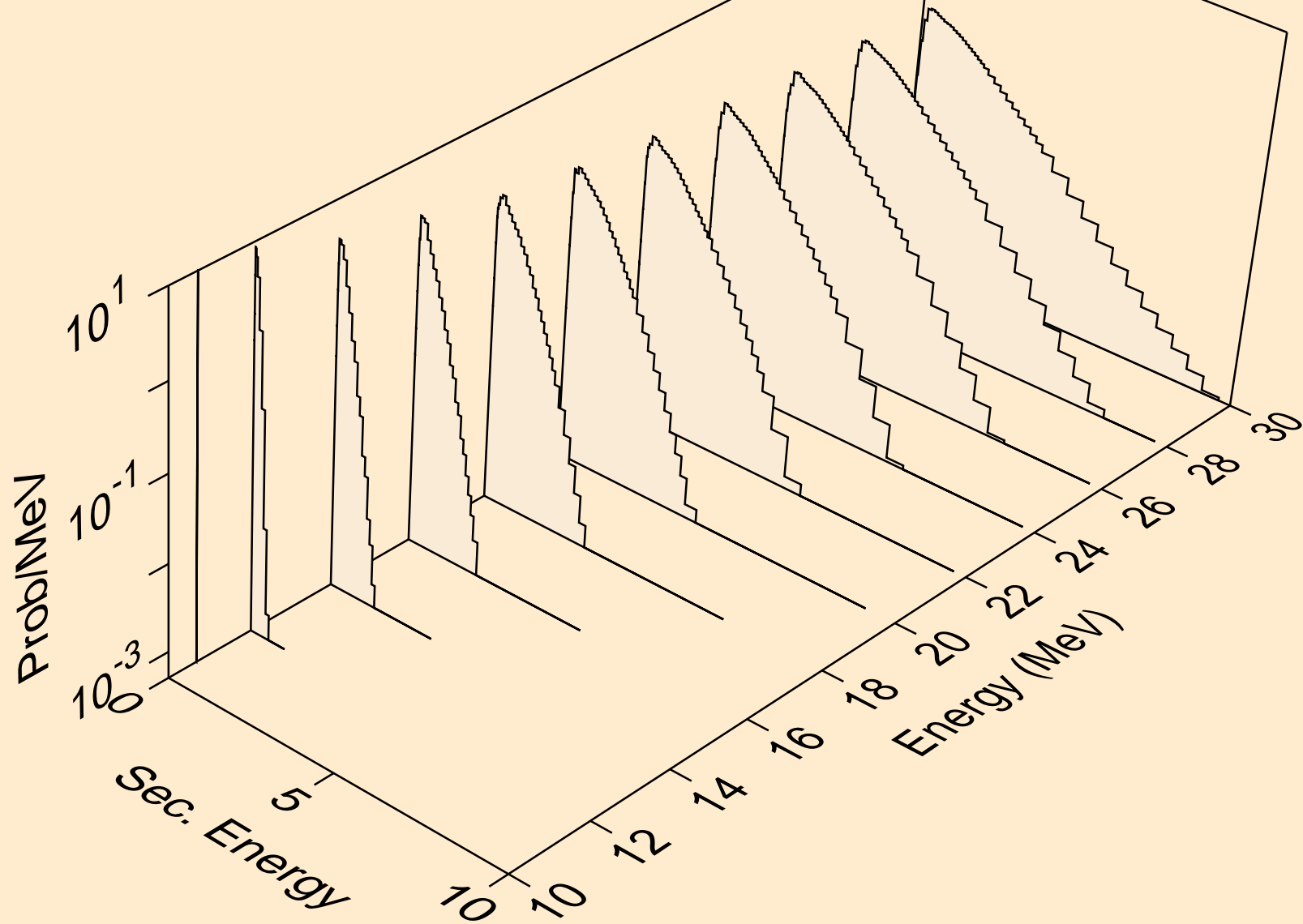

CD123 HELION ACER TENDL-2024 LIBRARY; T=0.K  
neutrons from (s,n2p)

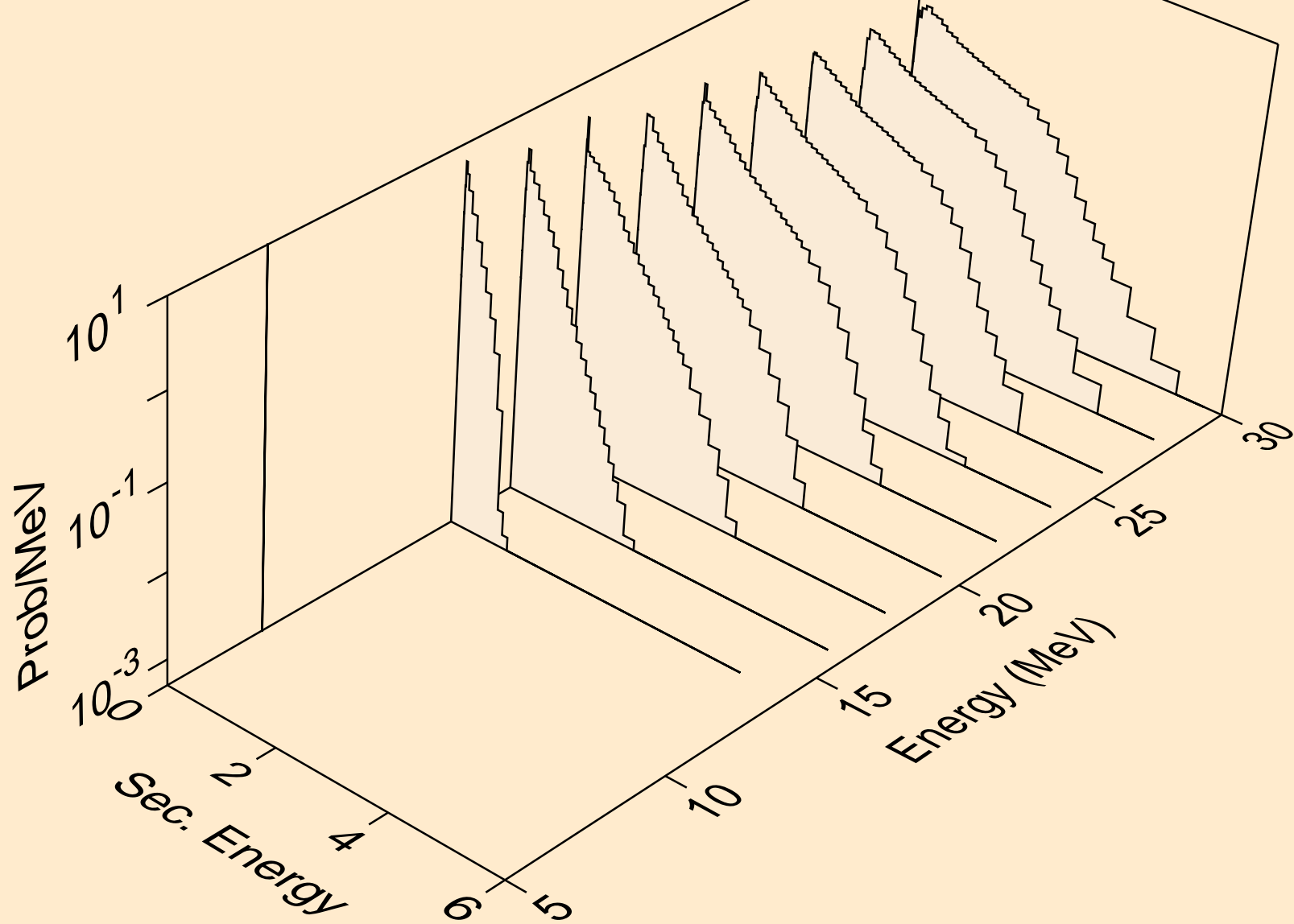

CD123 HELION ACER TENDL-2024 LIBRARY; T=0.K  
neutrons from (s,npa)

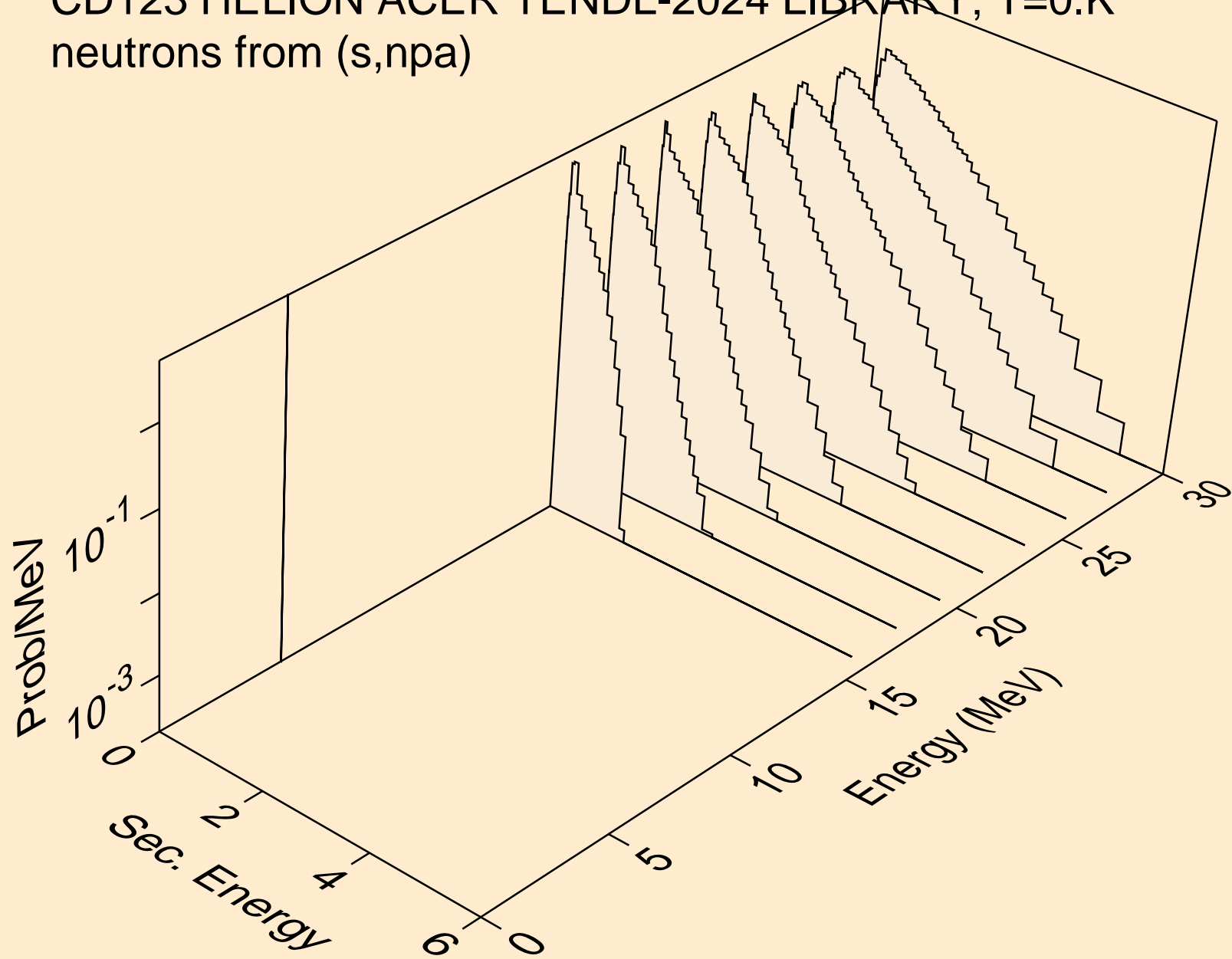

CD123 HELION ACER TENDL-2024 LIBRARY; T=0.K  
protons from (s,x)

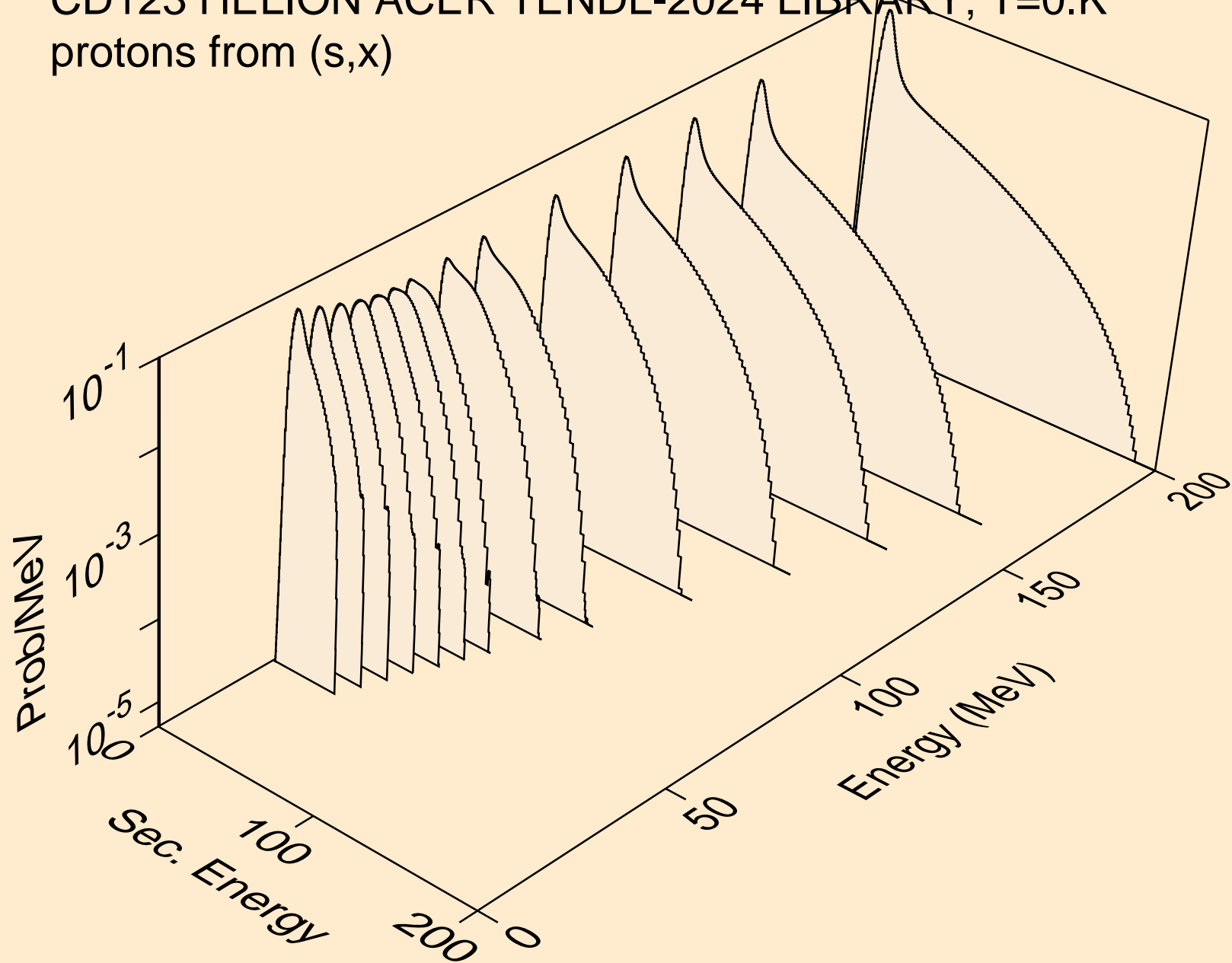

CD123 HELION ACER TENDL-2024 LIBRARY; T=0.K  
protons from (s,n\*)p

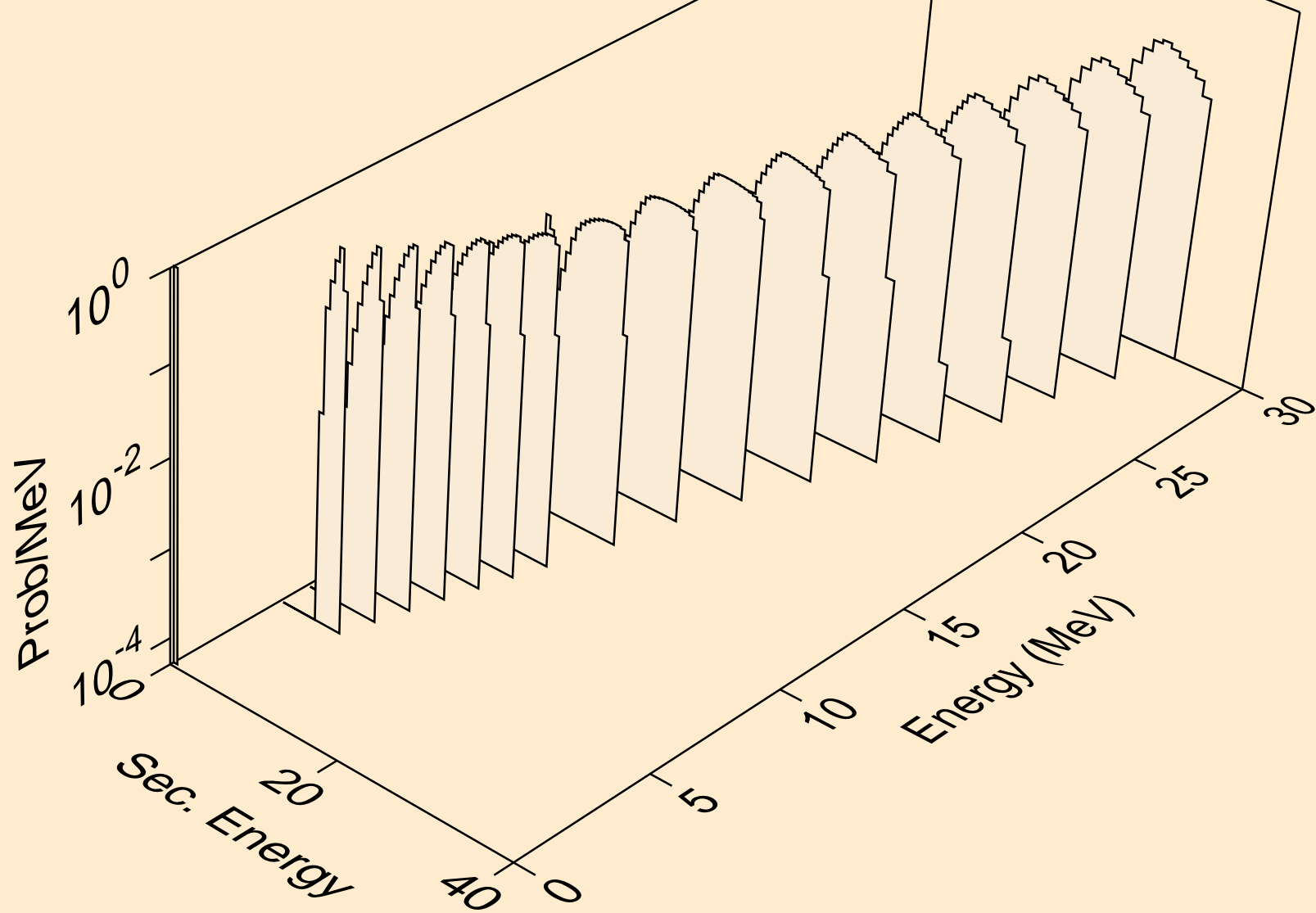

CD123 HELION ACER TENDL-2024 LIBRARY; T=0.K  
protons from (s,2np)

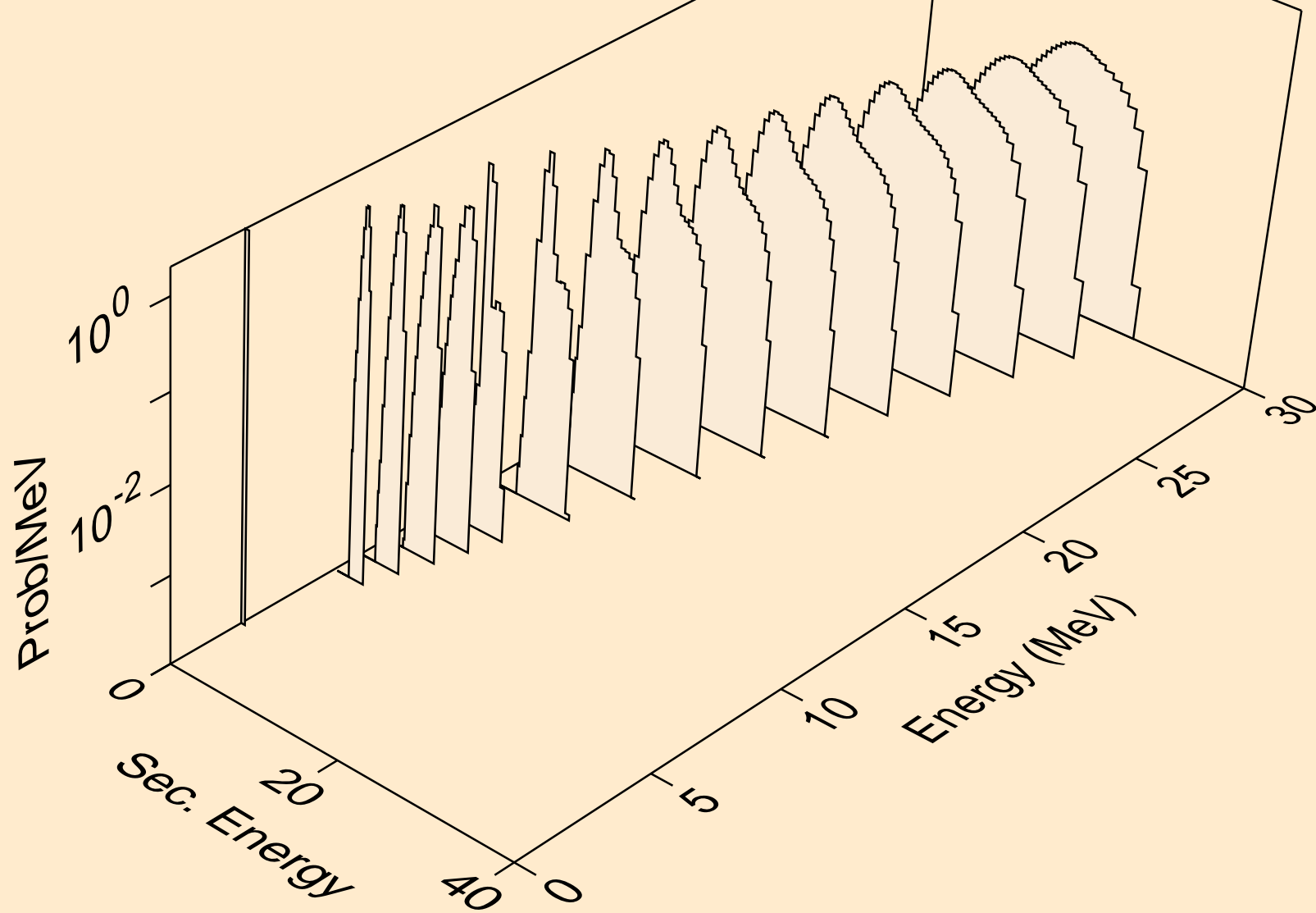

CD123 HELION ACER TENDL-2024 LIBRARY; T=0.K  
protons from (s,3np)

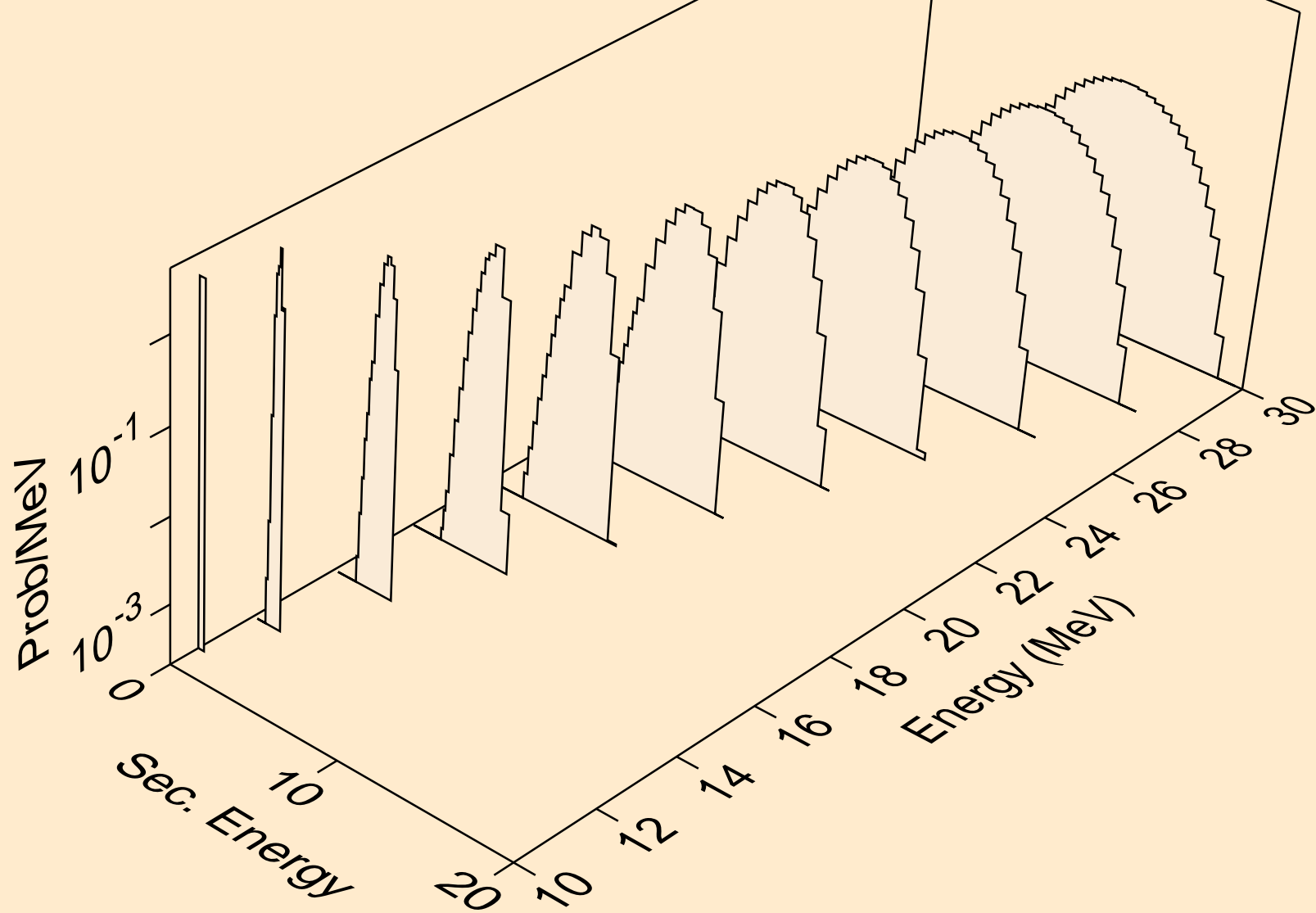

CD123 HELION ACER TENDL-2024 LIBRARY; T=0.K  
protons from (s,n2p)

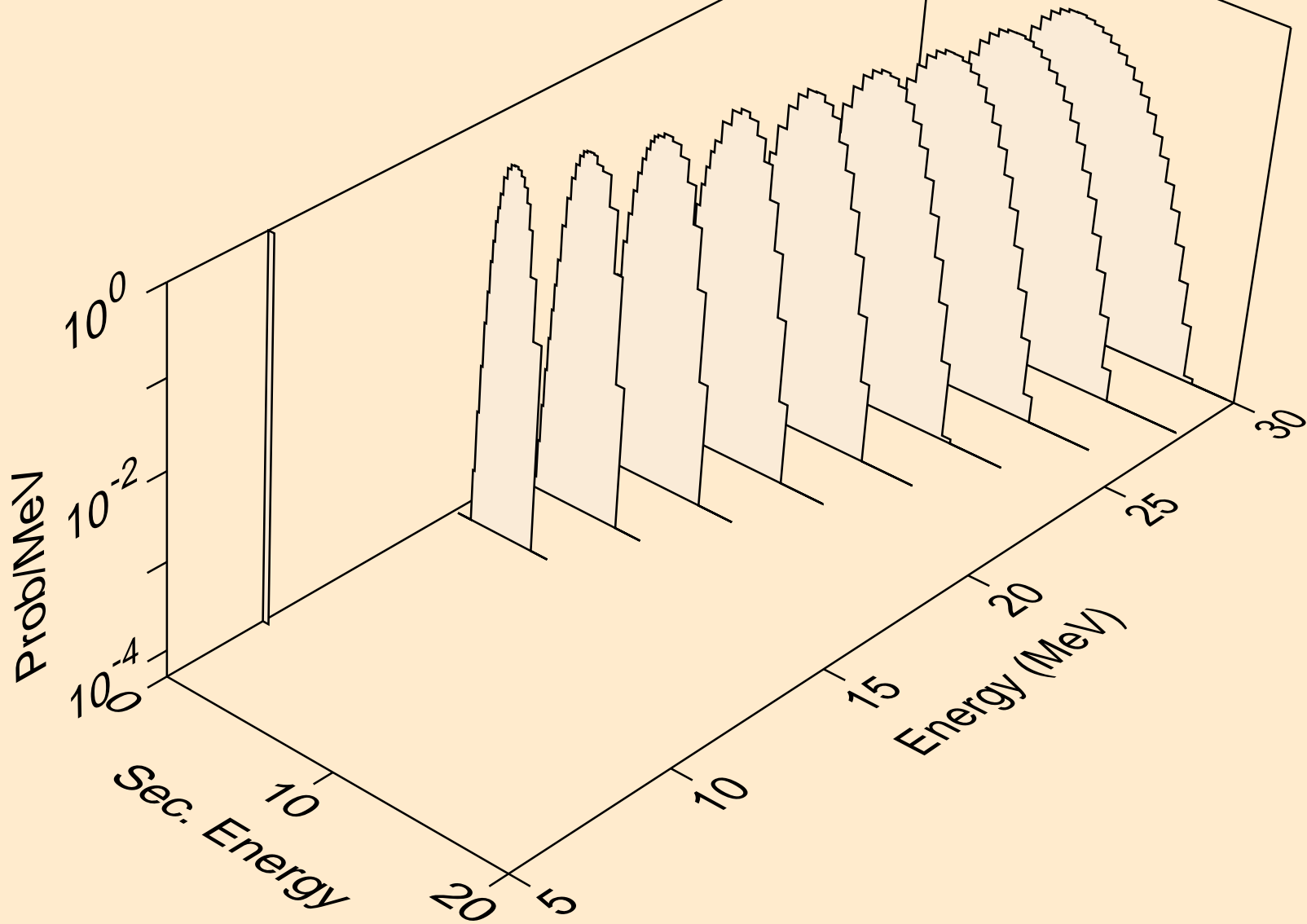

CD123 HELION ACER TENDL-2024 LIBRARY; T=0.K  
protons from (s,npa)

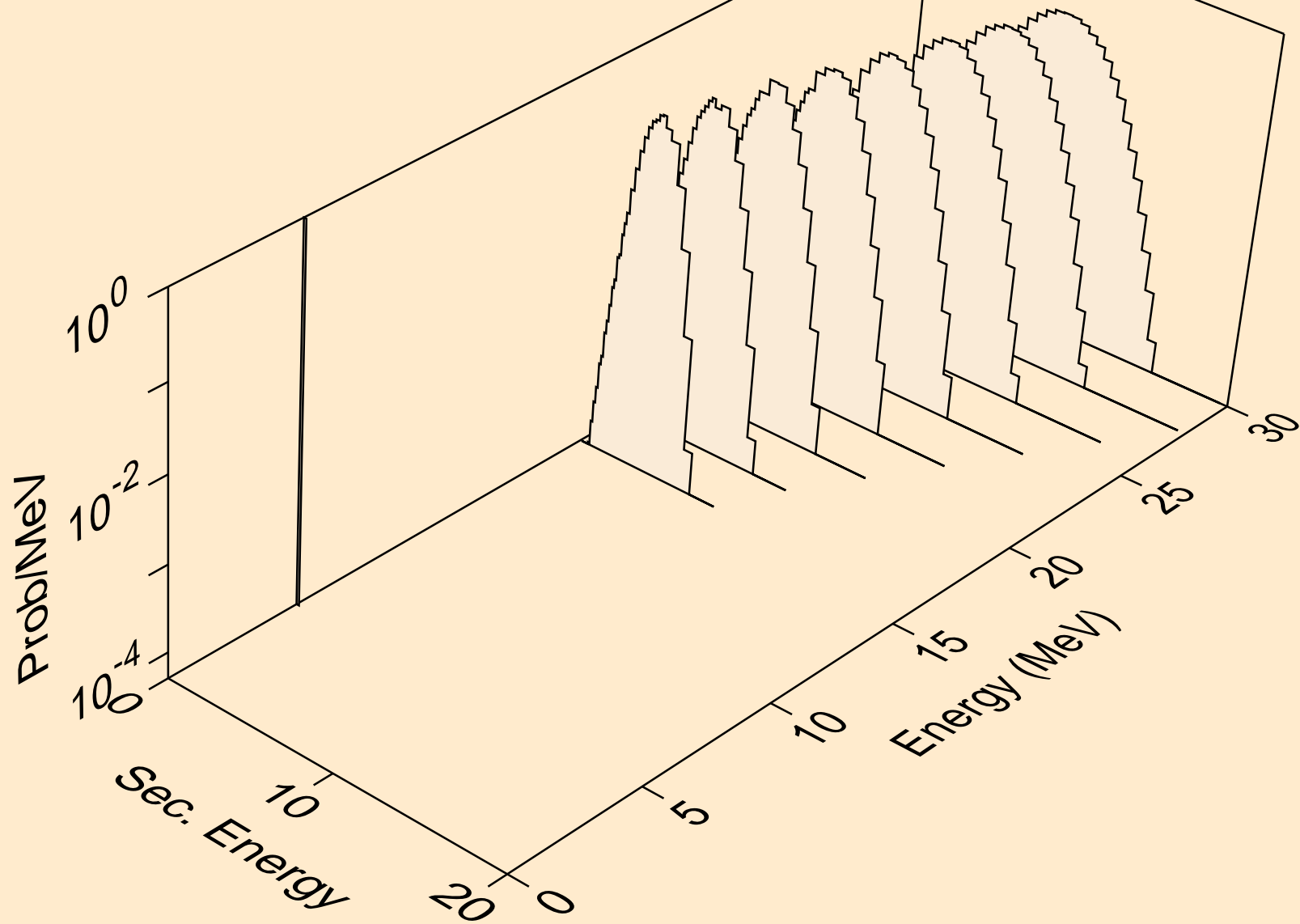

CD123 HELION ACER TENDL-2024 LIBRARY; T=0.K  
protons from (s,p)

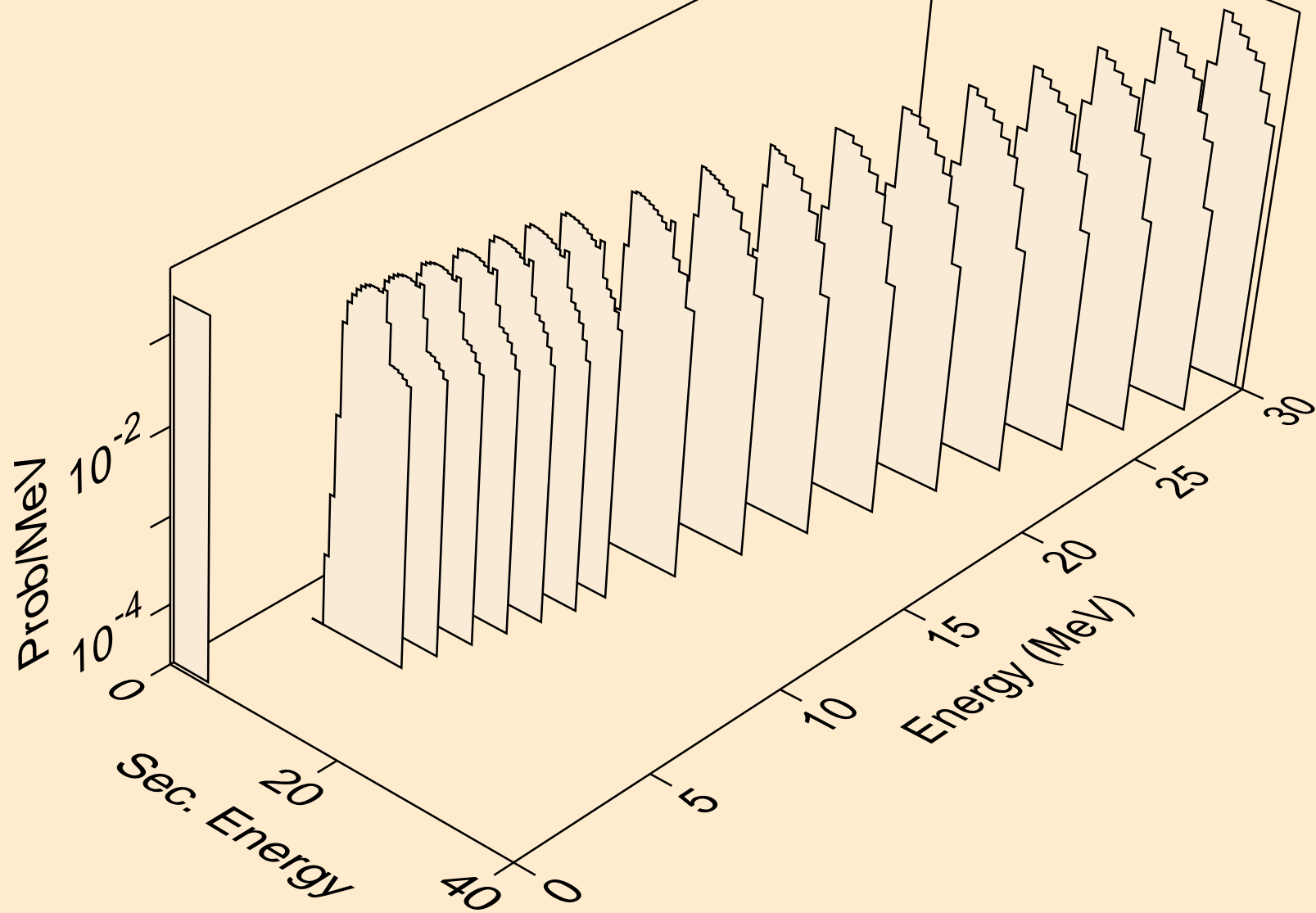

CD123 HELION ACER TENDL-2024 LIBRARY; T=0.K  
protons from (s,2p)

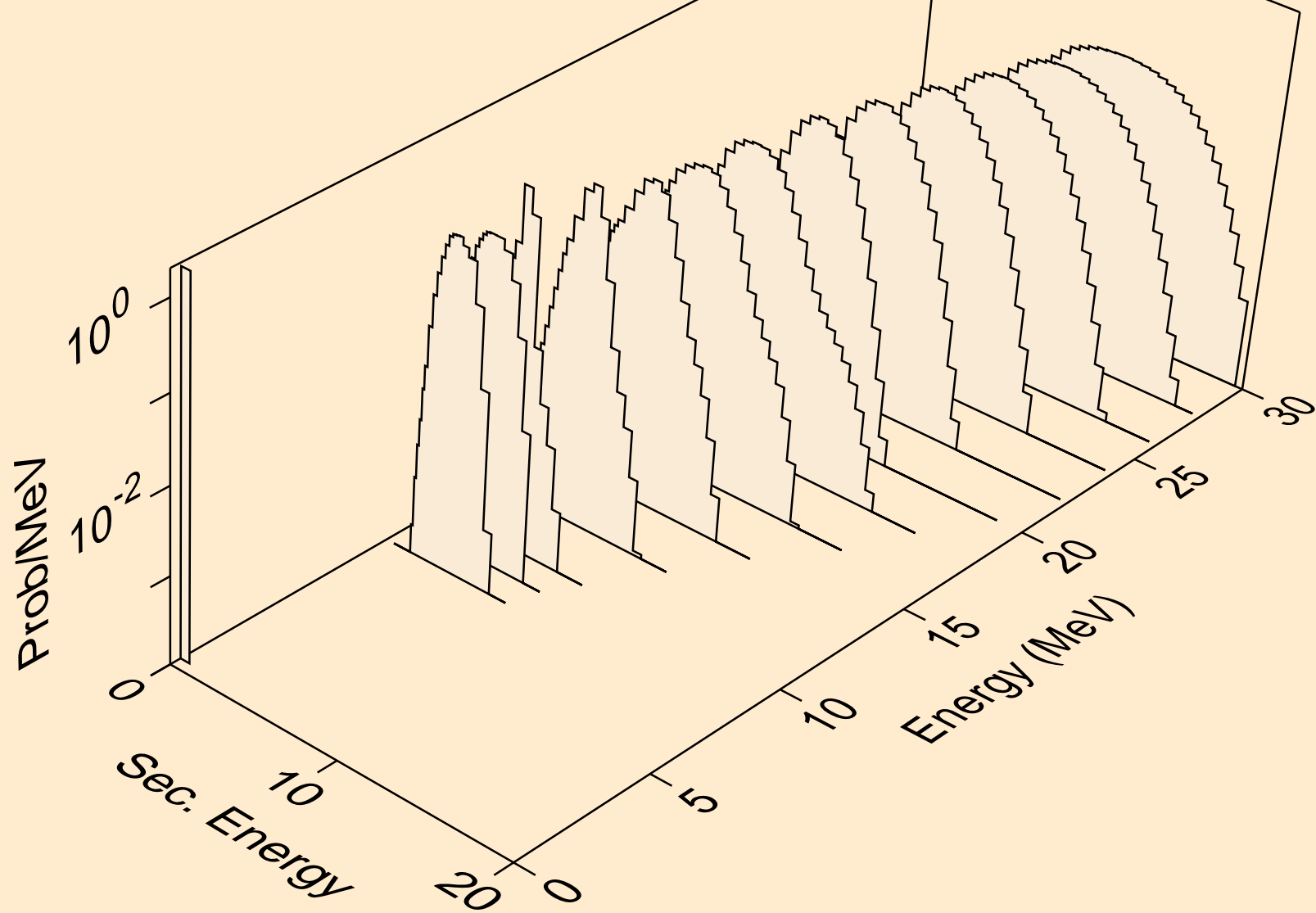

CD123 HELION ACER TENDL-2024 LIBRARY; T=0.K  
protons from (s,pa)

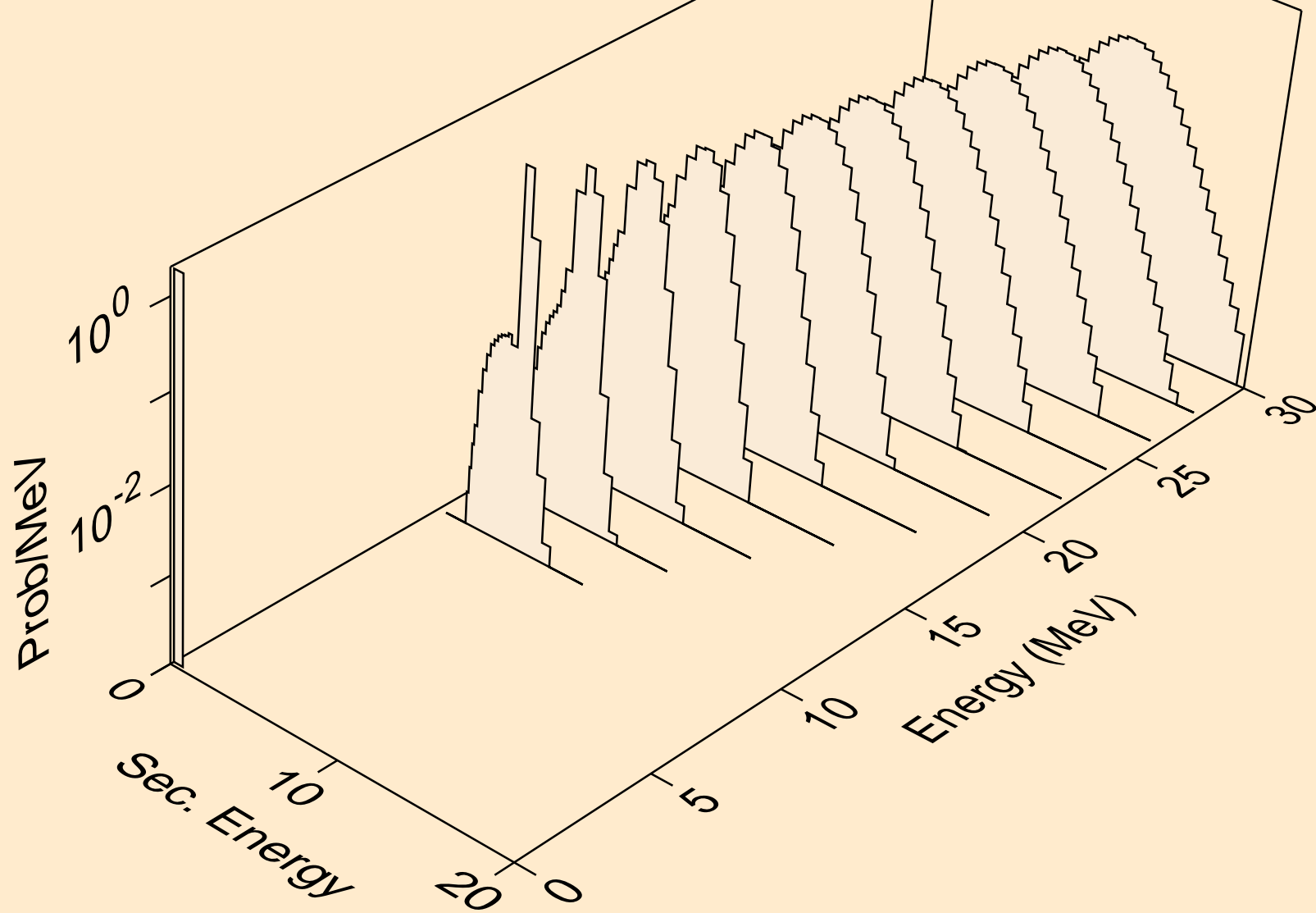

CD123 HELION ACER TENDL-2024 LIBRARY; T=0.K  
protons from (s,pd)

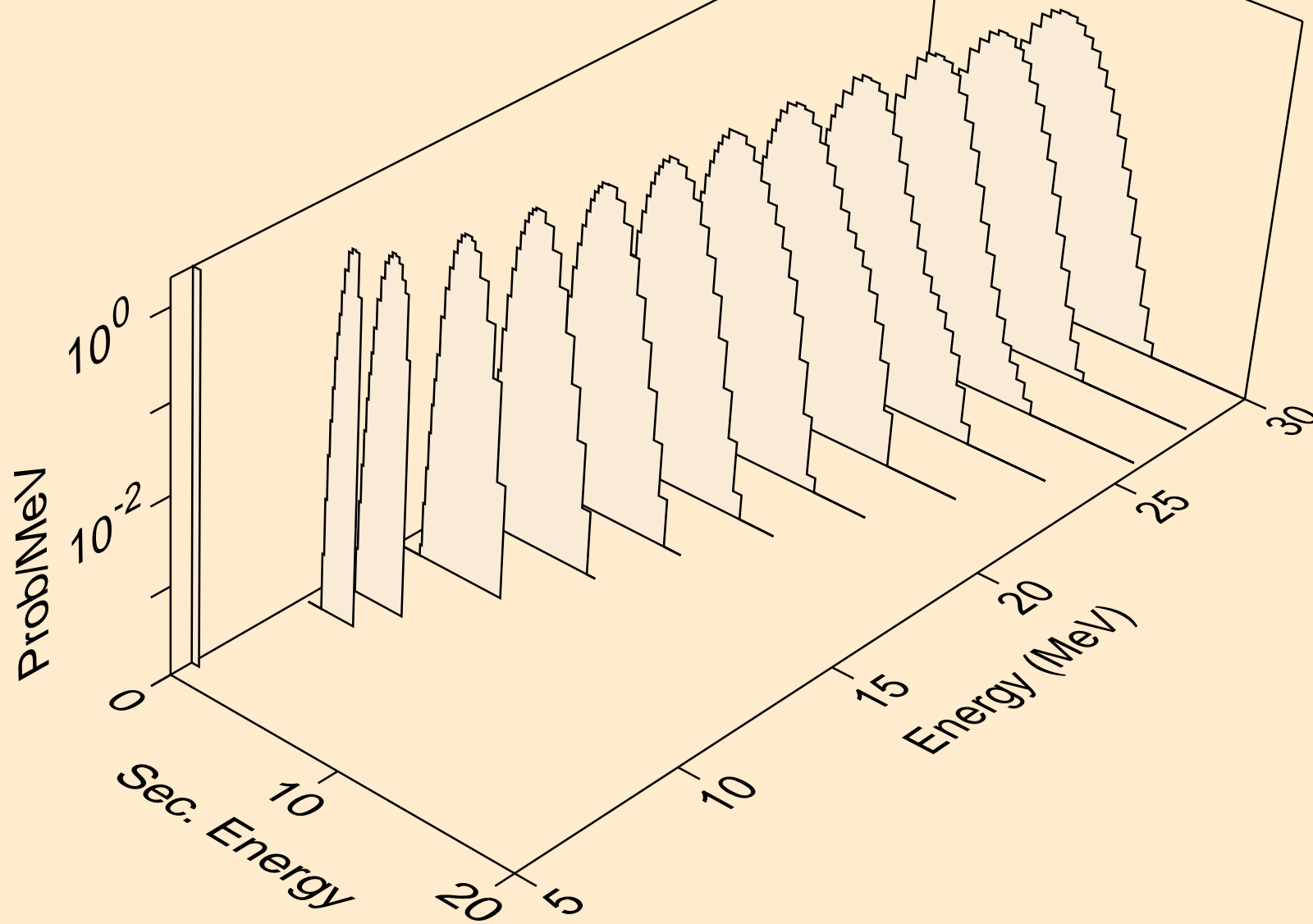

CD123 HELION ACER TENDL-2024 LIBRARY; T=0.K  
protons from (s,pt)

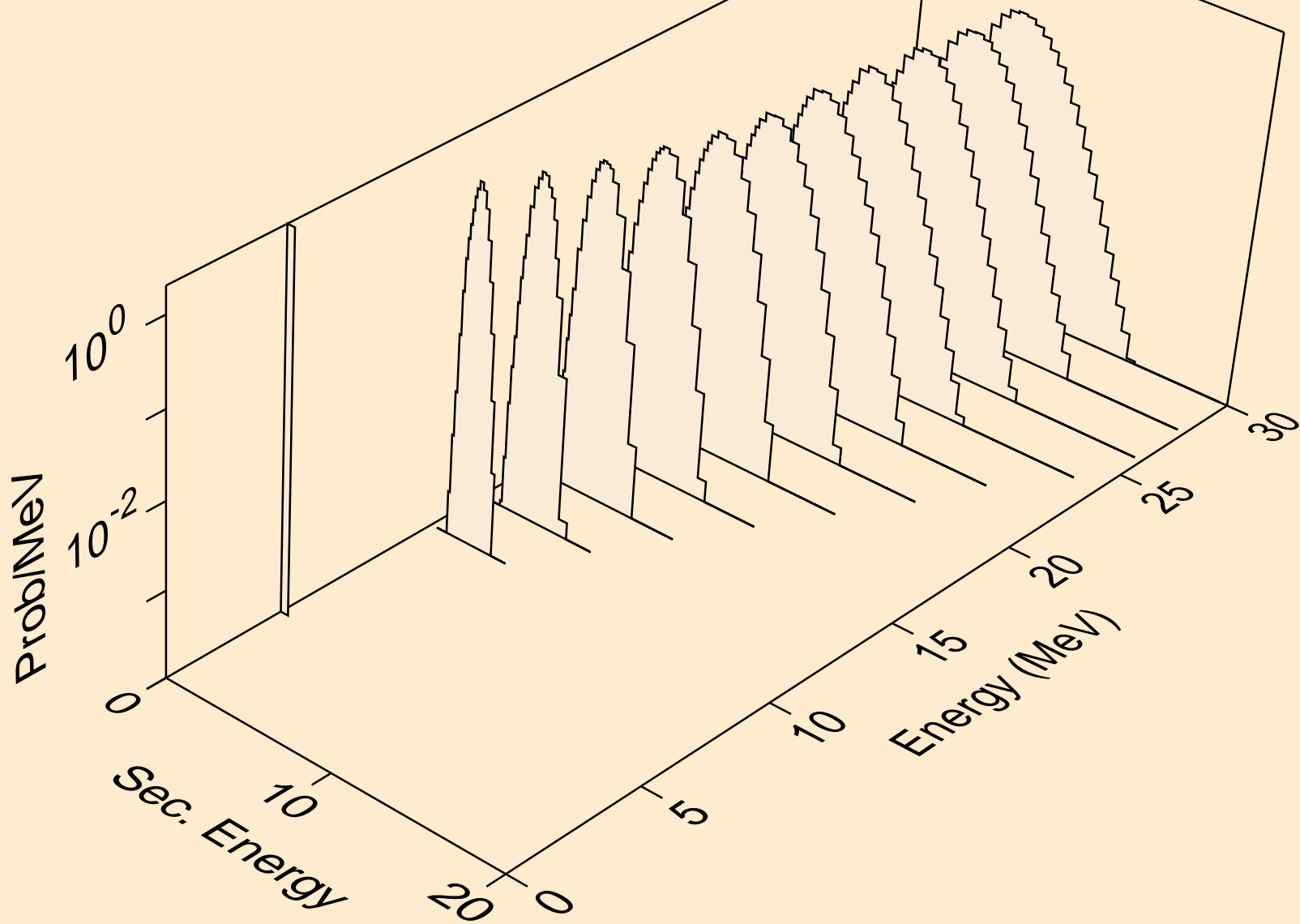

CD123 HELION ACER TENDL-2024 LIBRARY; T=0.K  
deuterons from (s,x)

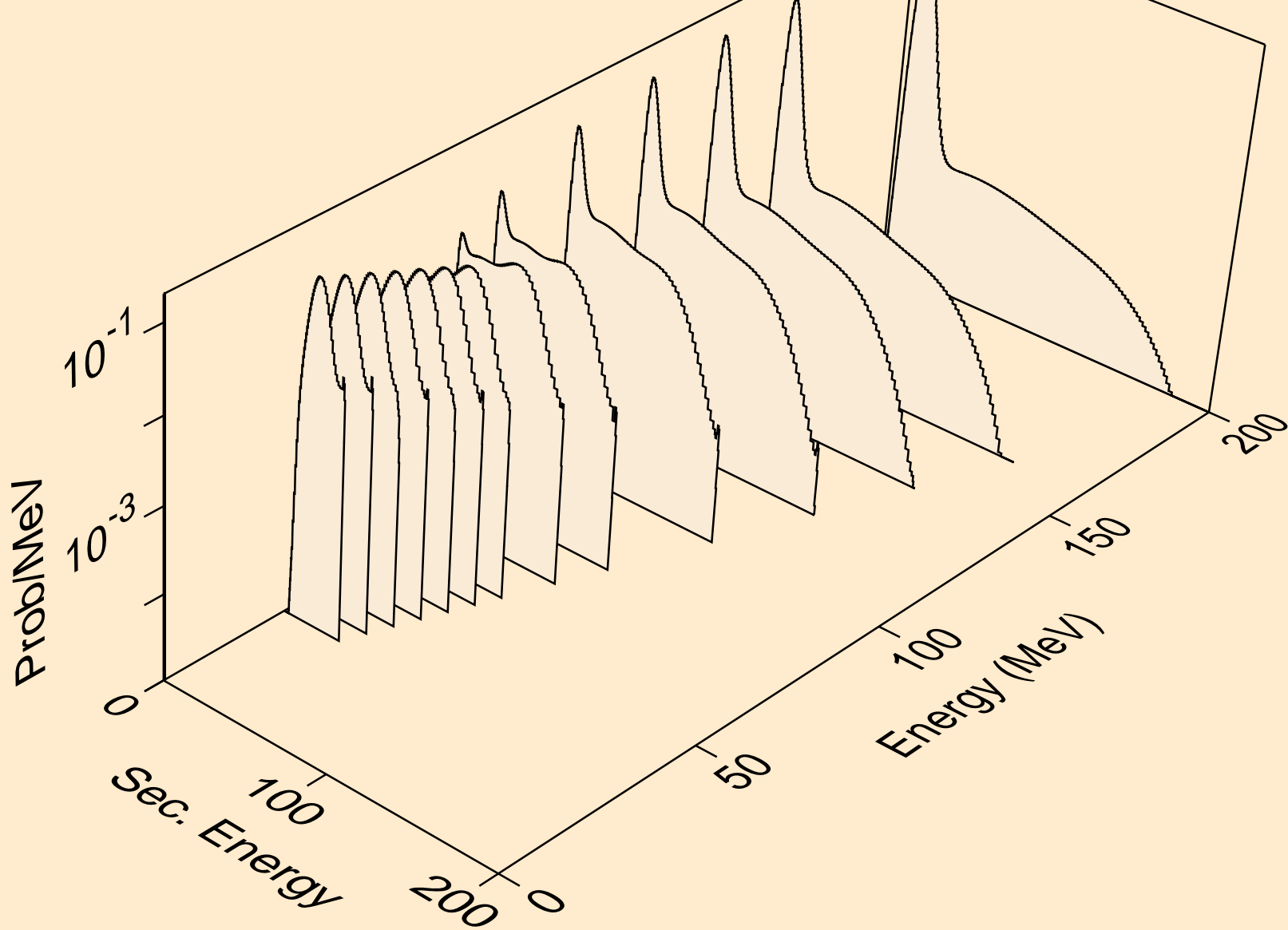

CD123 HELION ACER TENDL-2024 LIBRARY; T=0.K  
deuterons from (s,2nd)

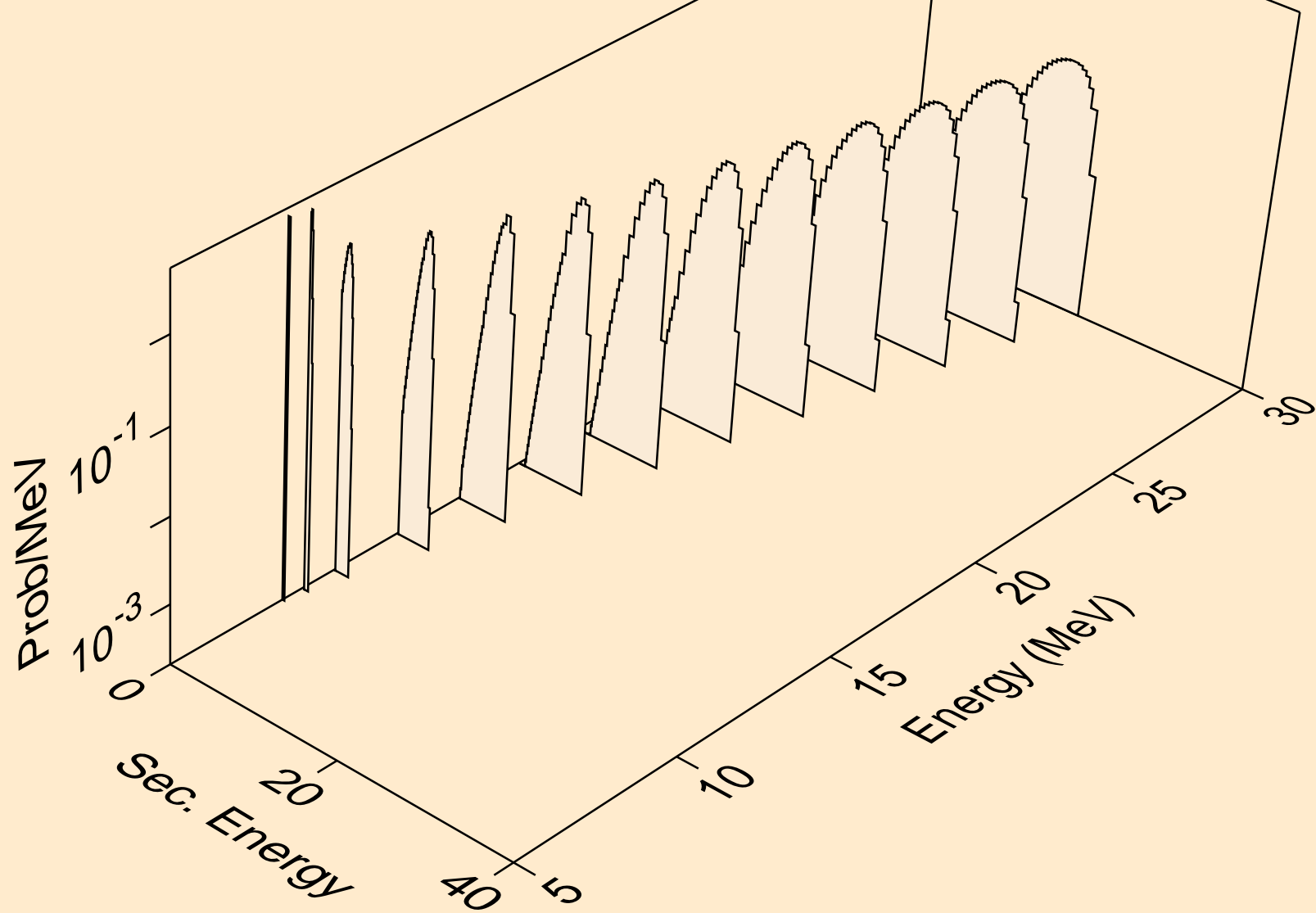

CD123 HELION ACER TENDL-2024 LIBRARY; T=0.K  
deuterons from (s,n\*)d

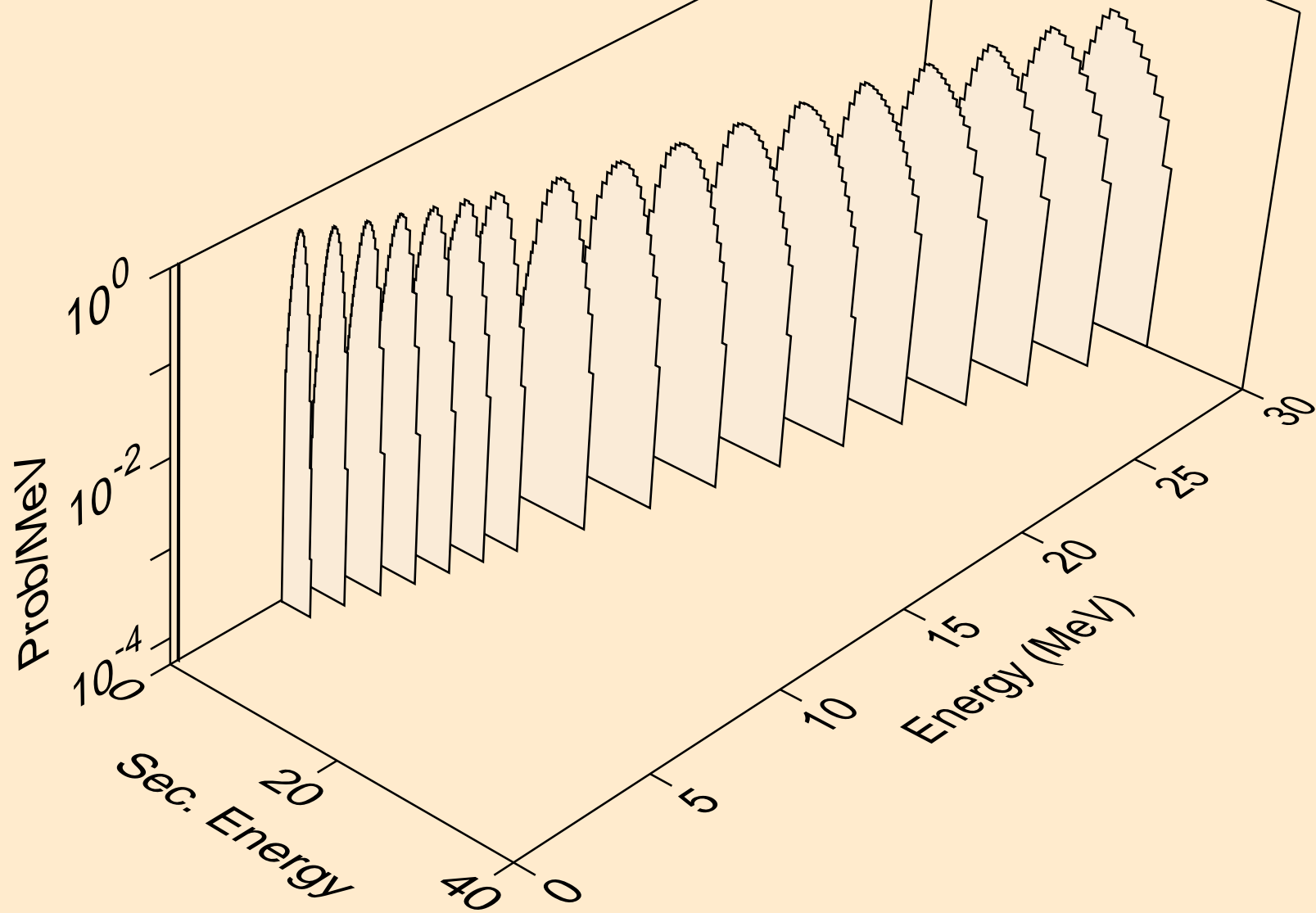

CD123 HELION ACER TENDL-2024 LIBRARY; T=0.K  
deuterons from (s,d)

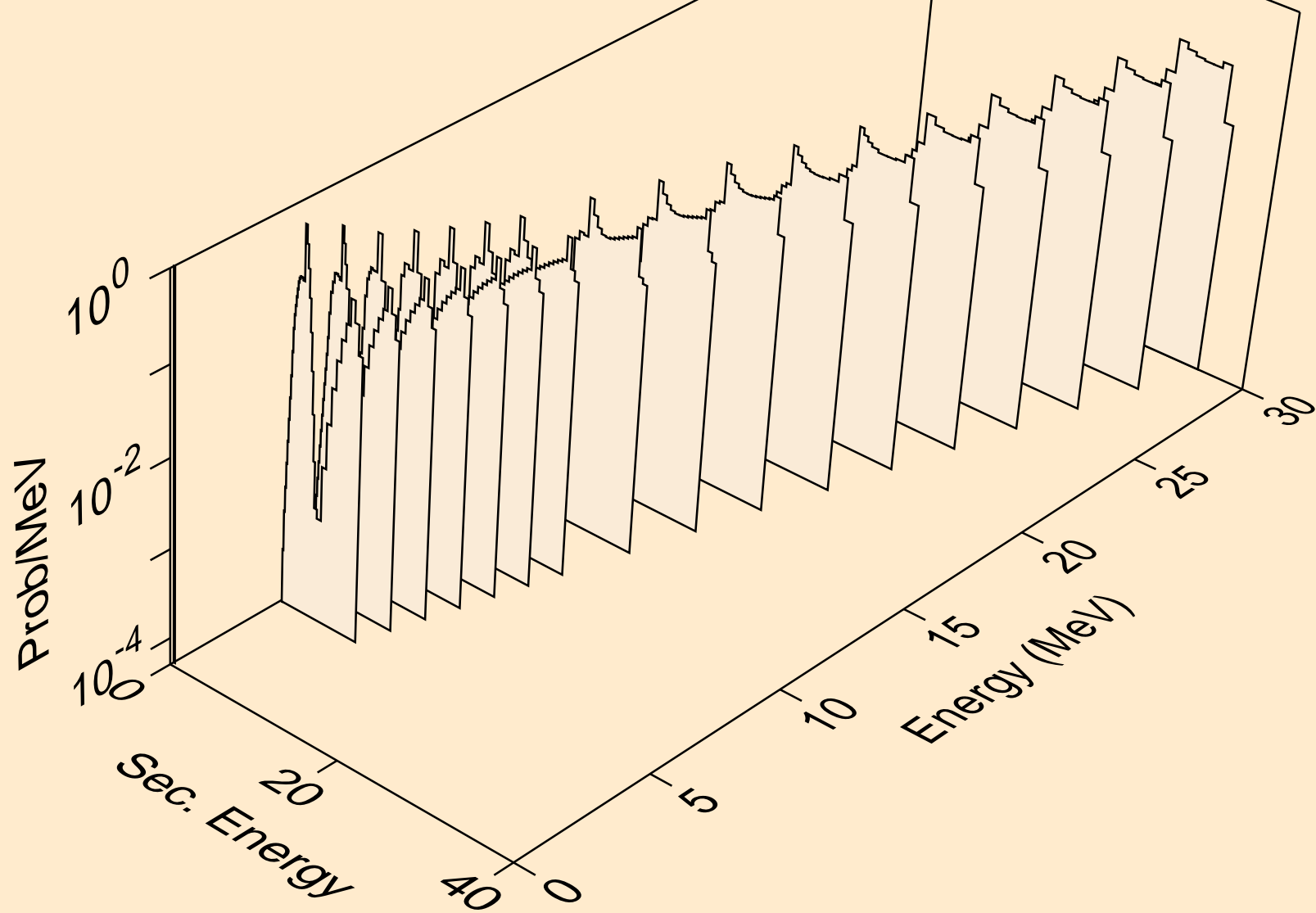

CD123 HELION ACER TENDL-2024 LIBRARY; T=0.K  
deuterons from (s,pd)

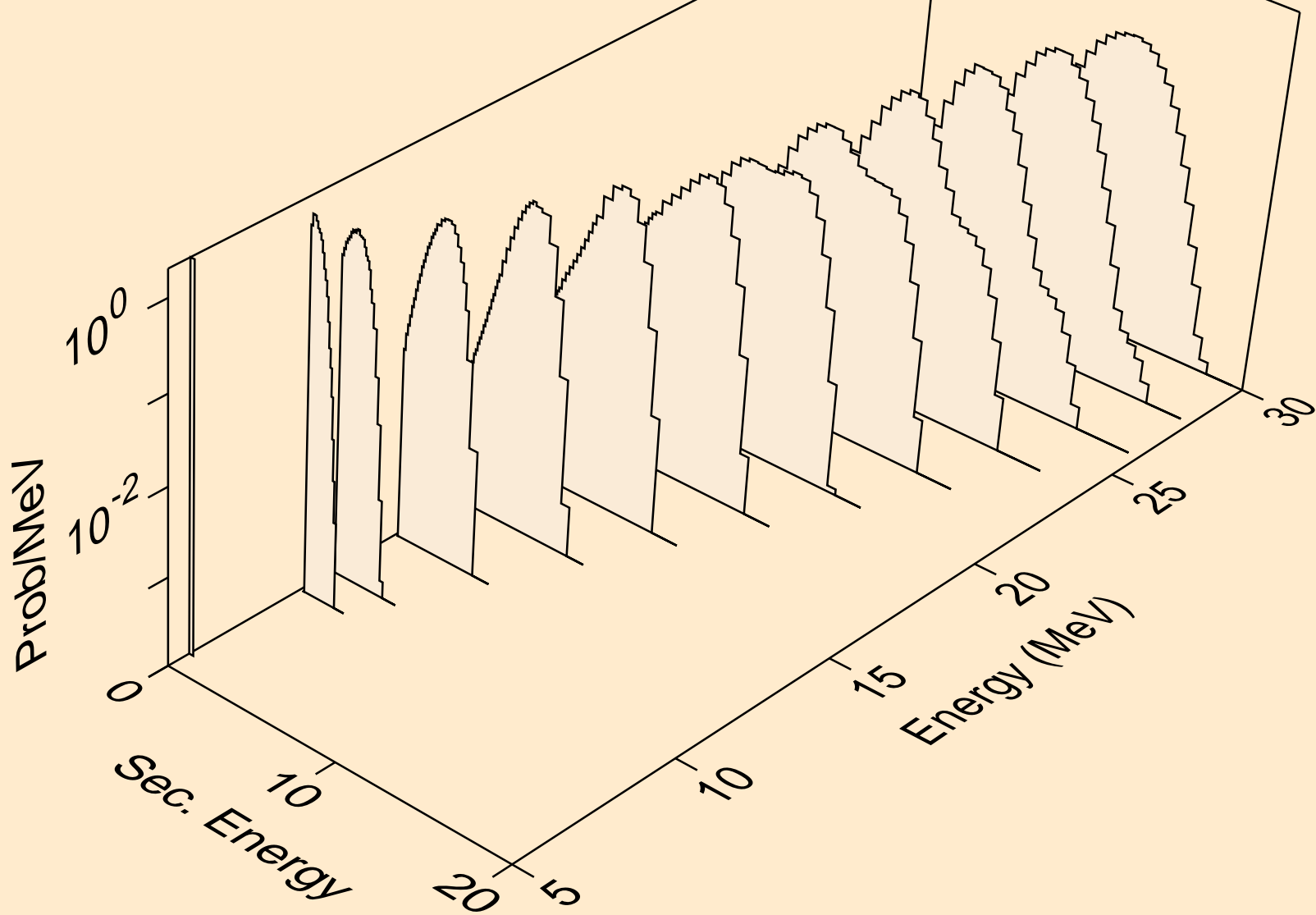

CD123 HELION ACER TENDL-2024 LIBRARY; T=0.K  
tritons from (s,x)

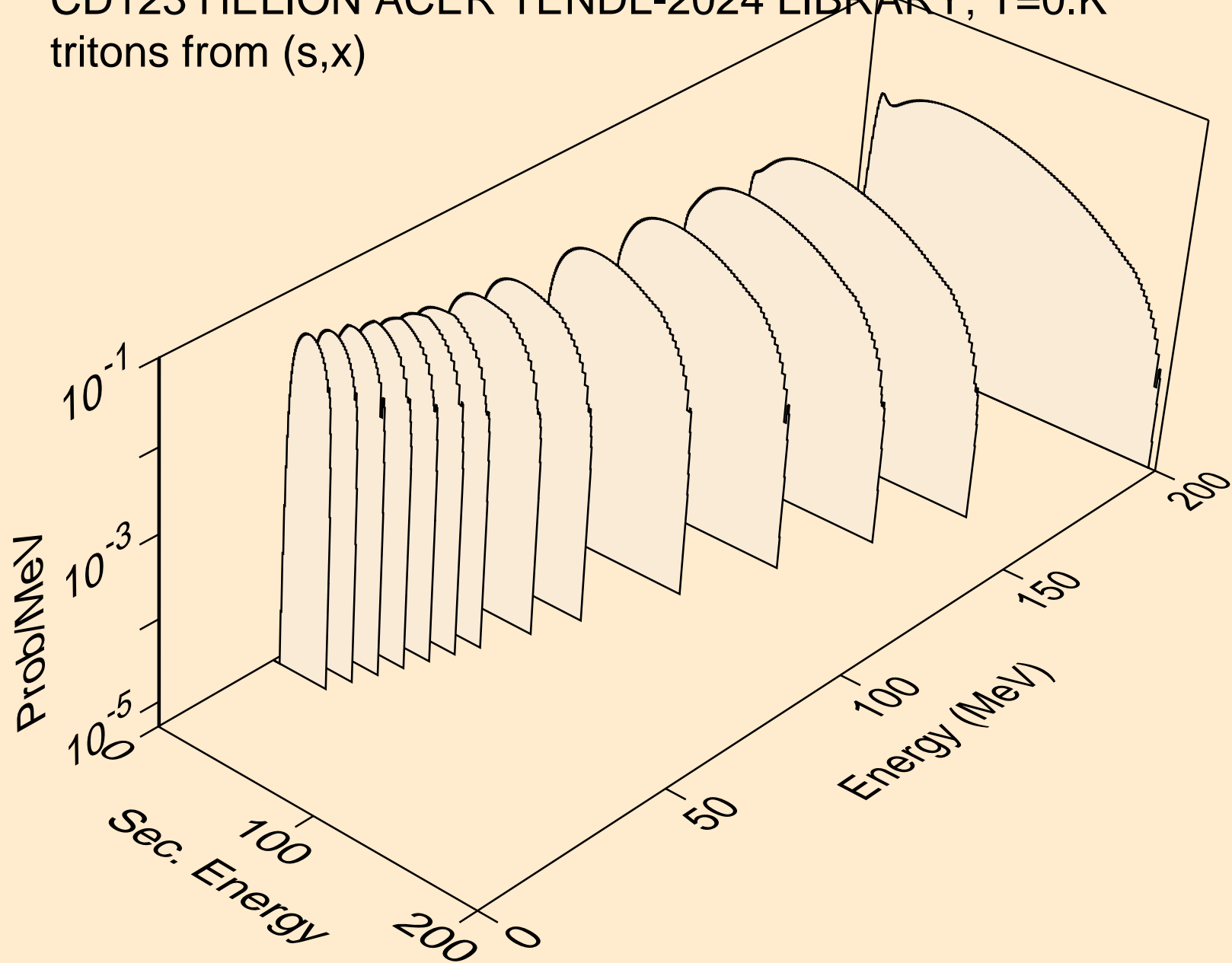

CD123 HELION ACER TENDL-2024 LIBRARY; T=0.K  
tritons from (s,n\*)t

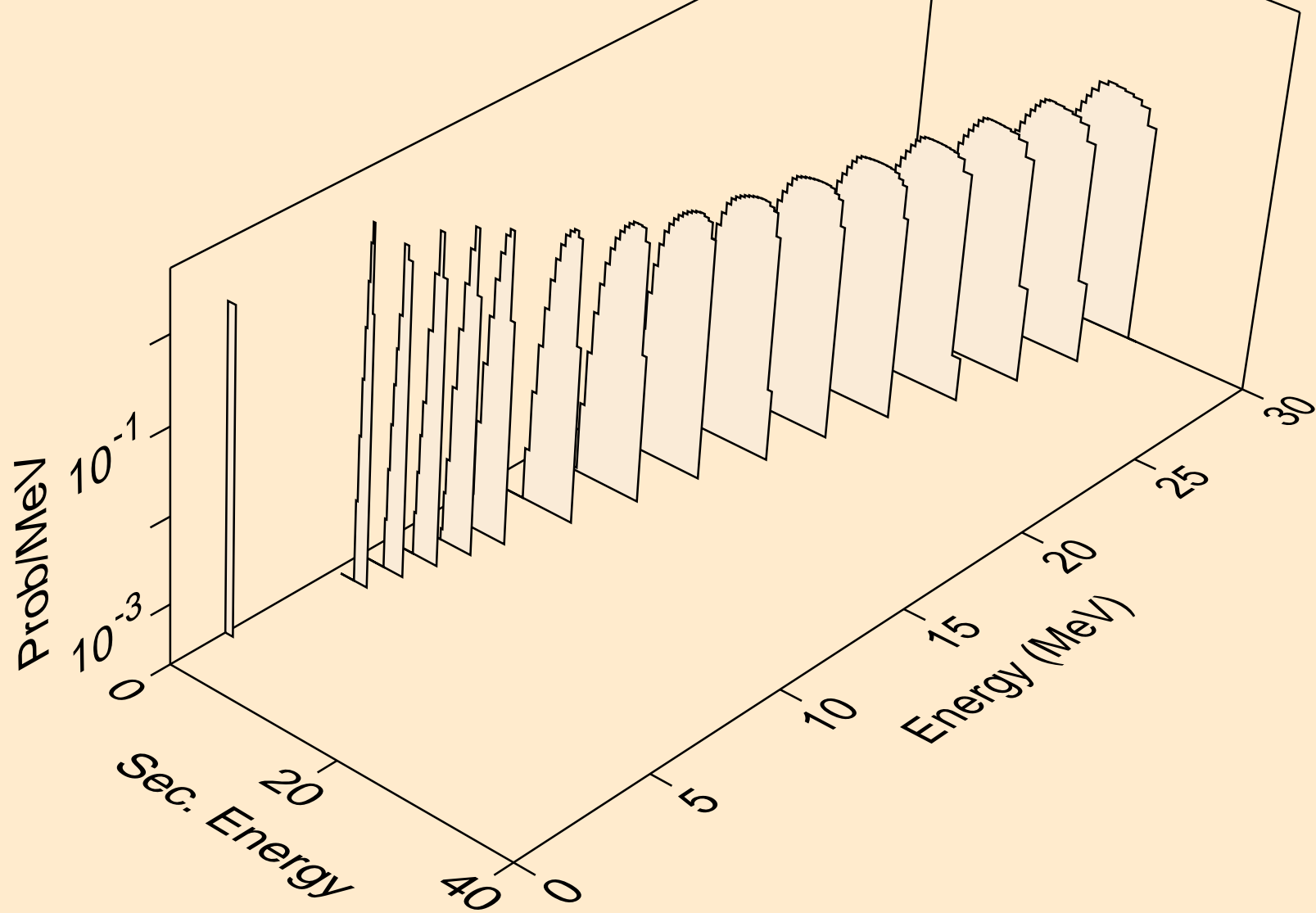

CD123 HELION ACER TENDL-2024 LIBRARY; T=0.K  
tritons from (s,t)

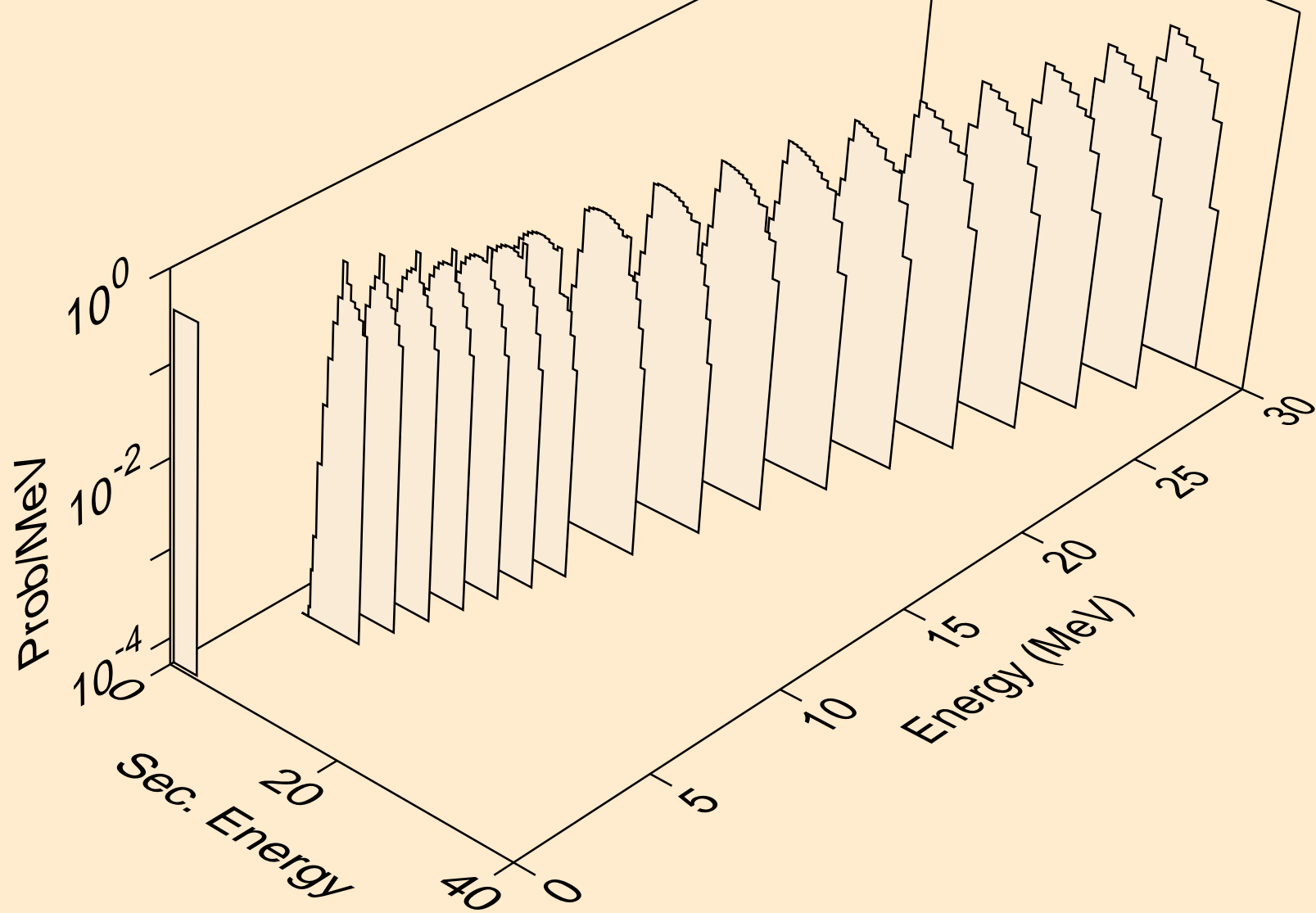

CD123 HELION ACER TENDL-2024 LIBRARY; T=0.K  
tritons from (s,pt)

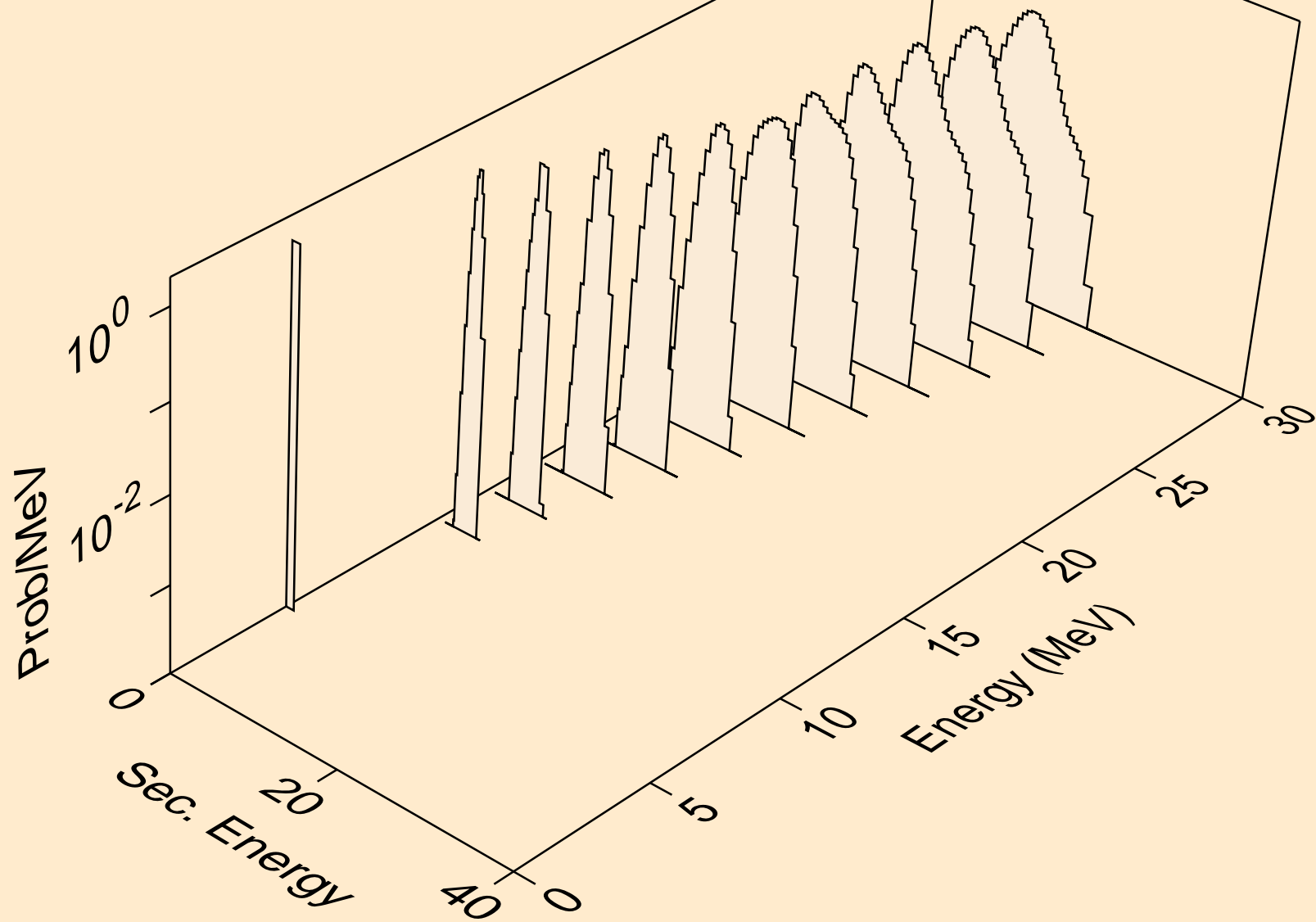

CD123 HELION ACER TENDL-2024 LIBRARY; T=0.K  
alphas from (s,x)

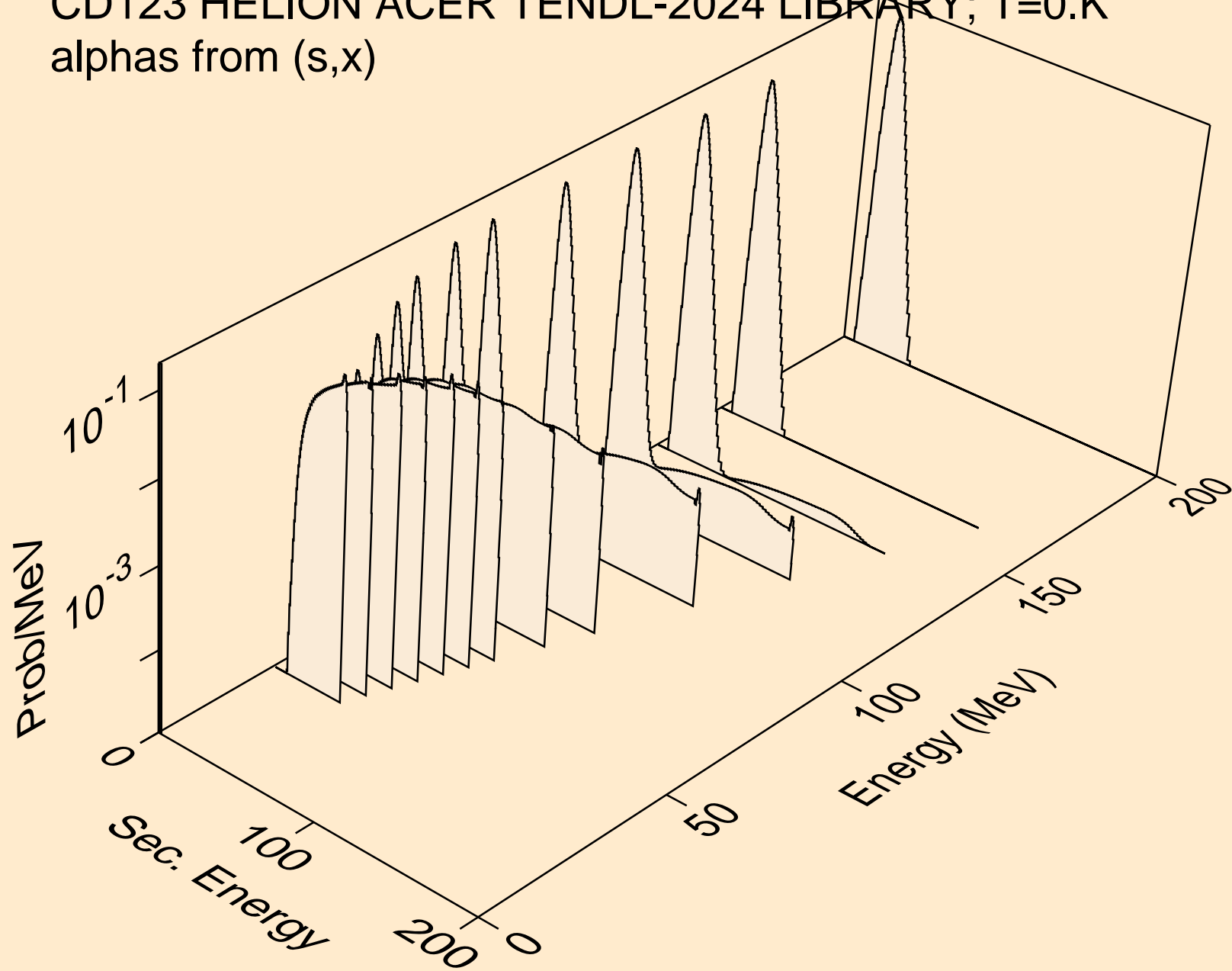

CD123 HELION ACER TENDL-2024 LIBRARY; T=0.K  
alphas from (s,n\*)a

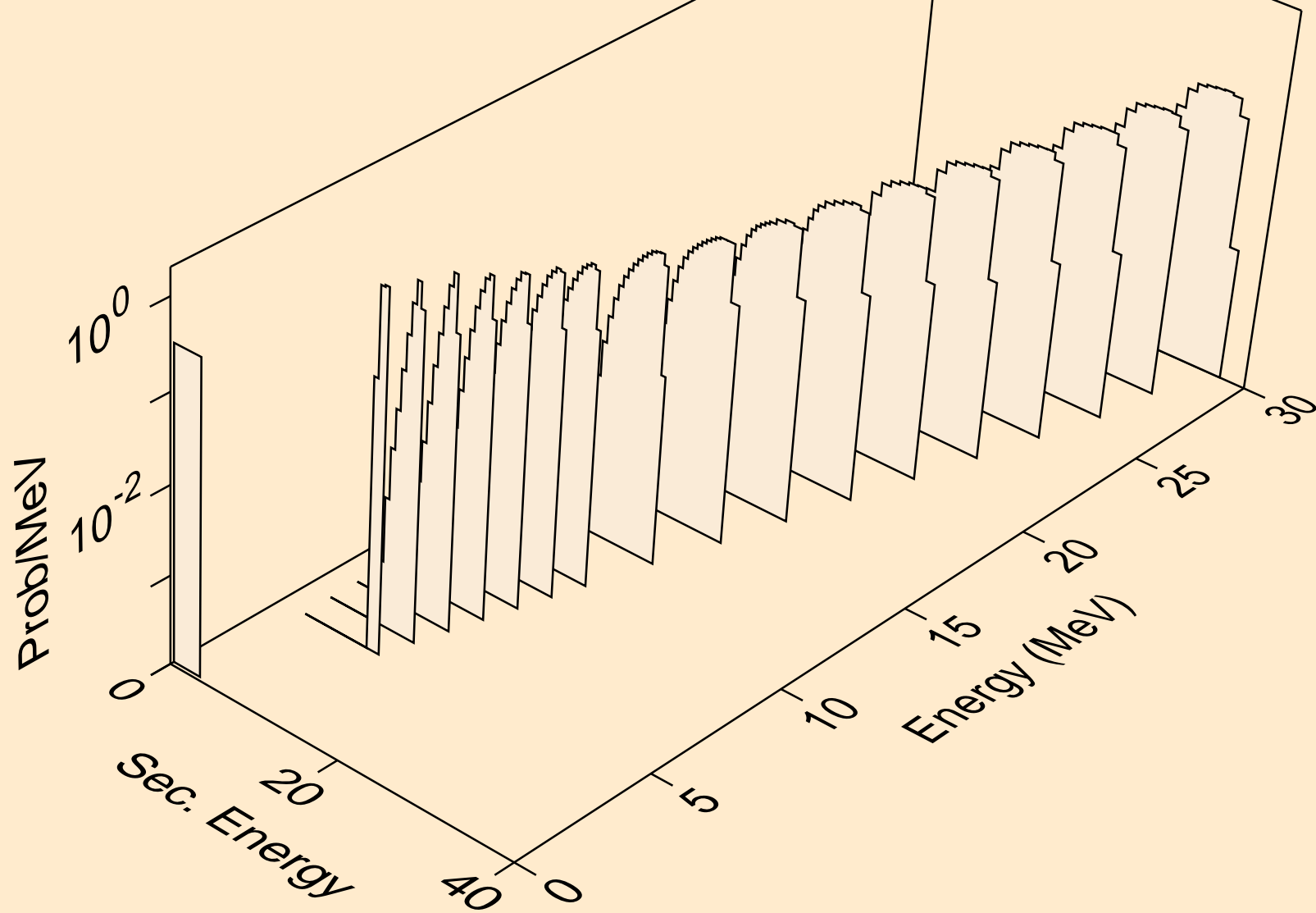

CD123 HELION ACER TENDL-2024 LIBRARY; T=0.K  
alphas from (s,2n)a

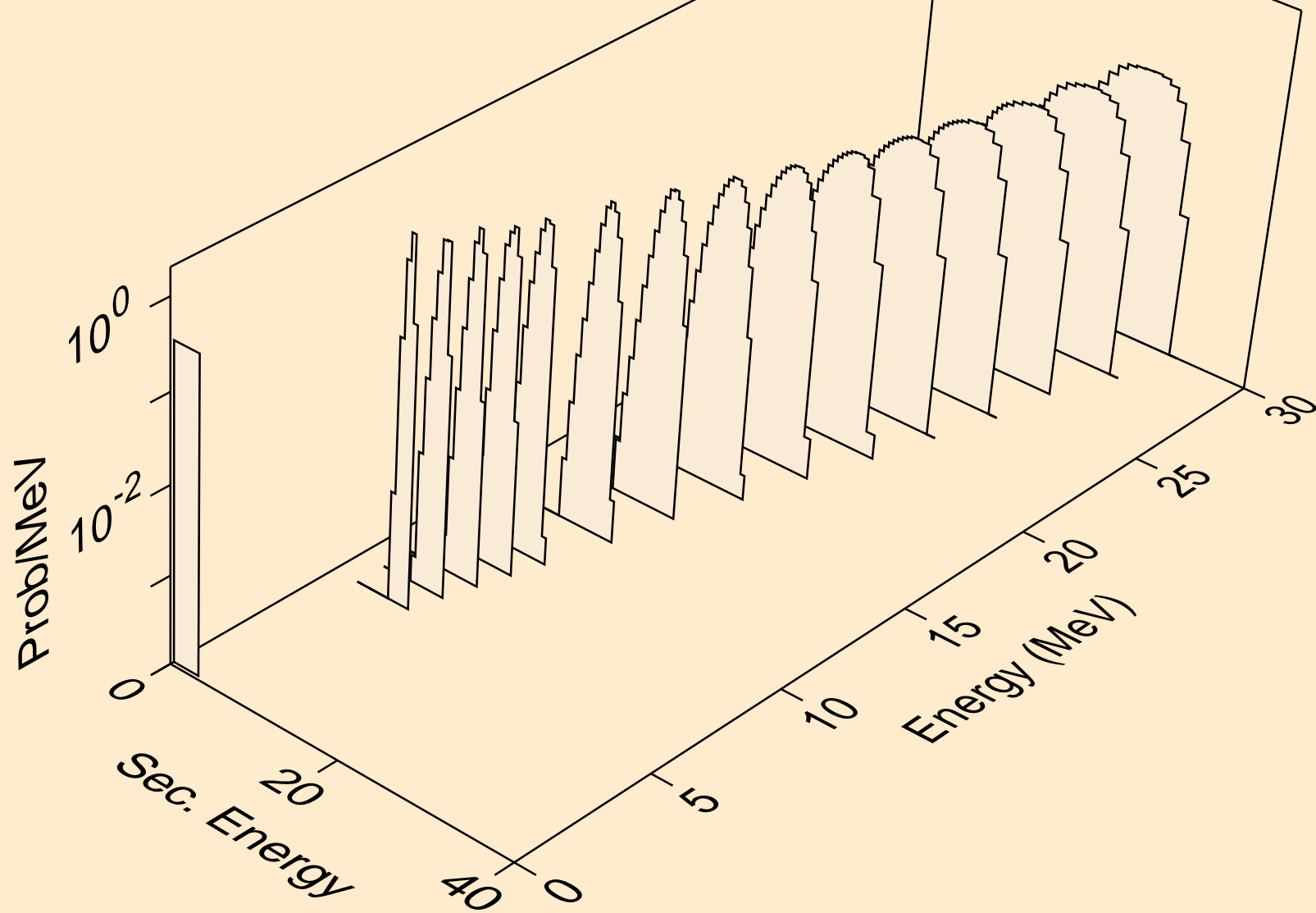

CD123 HELION ACER TENDL-2024 LIBRARY; T=0.K  
alphas from (s,3n)a

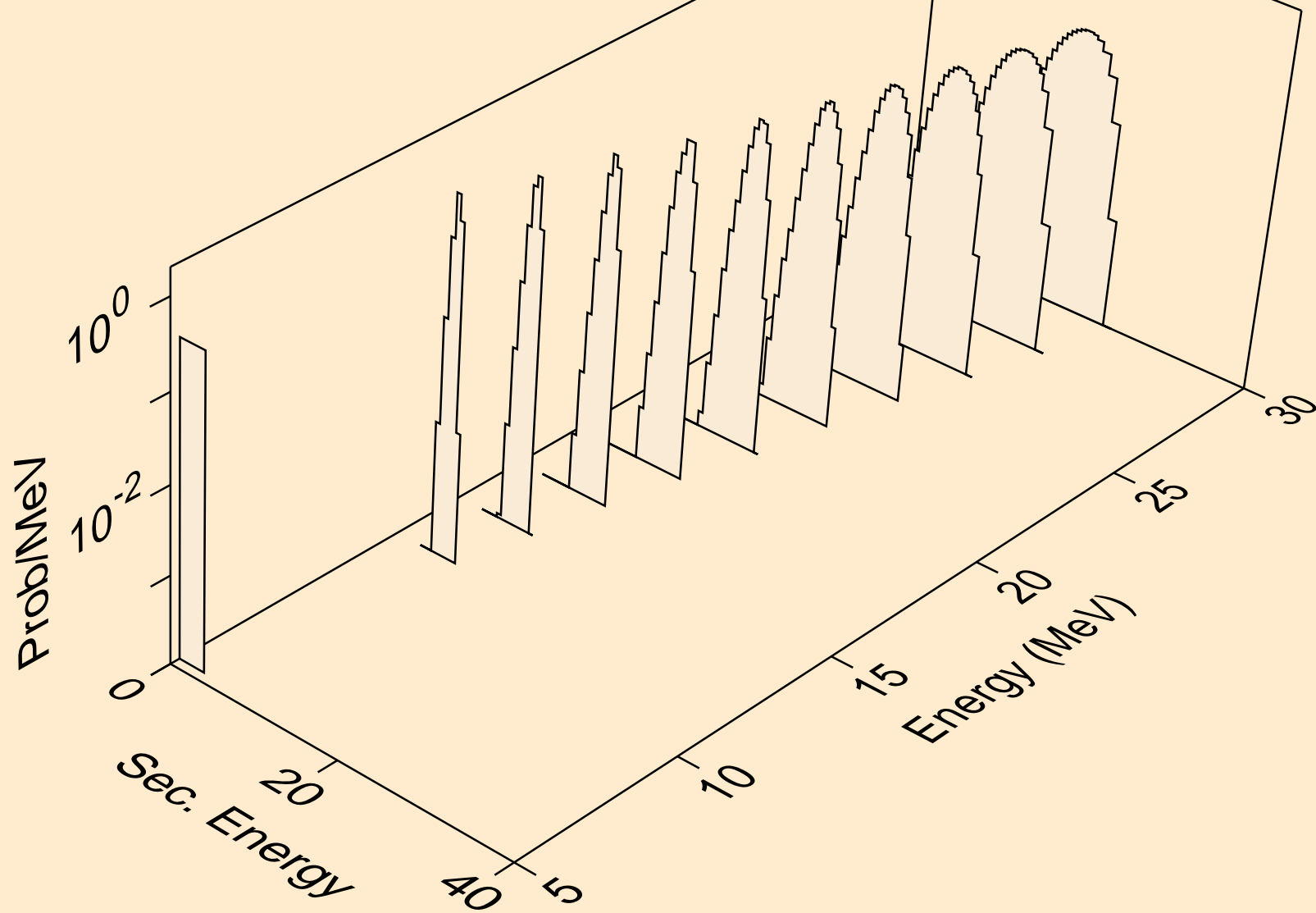

CD123 HELION ACER TENDL-2024 LIBRARY; T=0.K  
alphas from (s,npa)

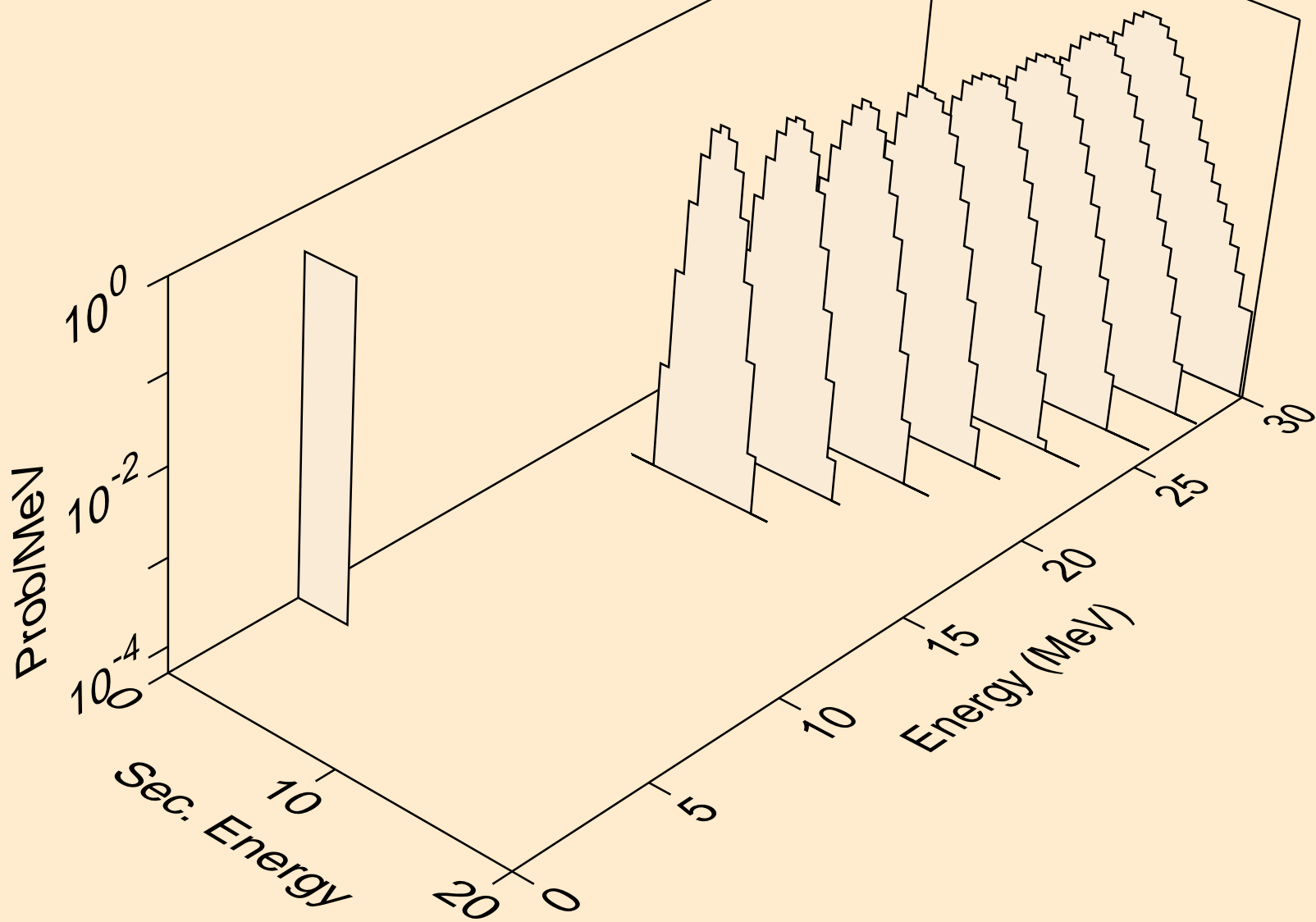

CD123 HELION ACER TENDL-2024 LIBRARY; T=0.K  
alphas from (s,a)

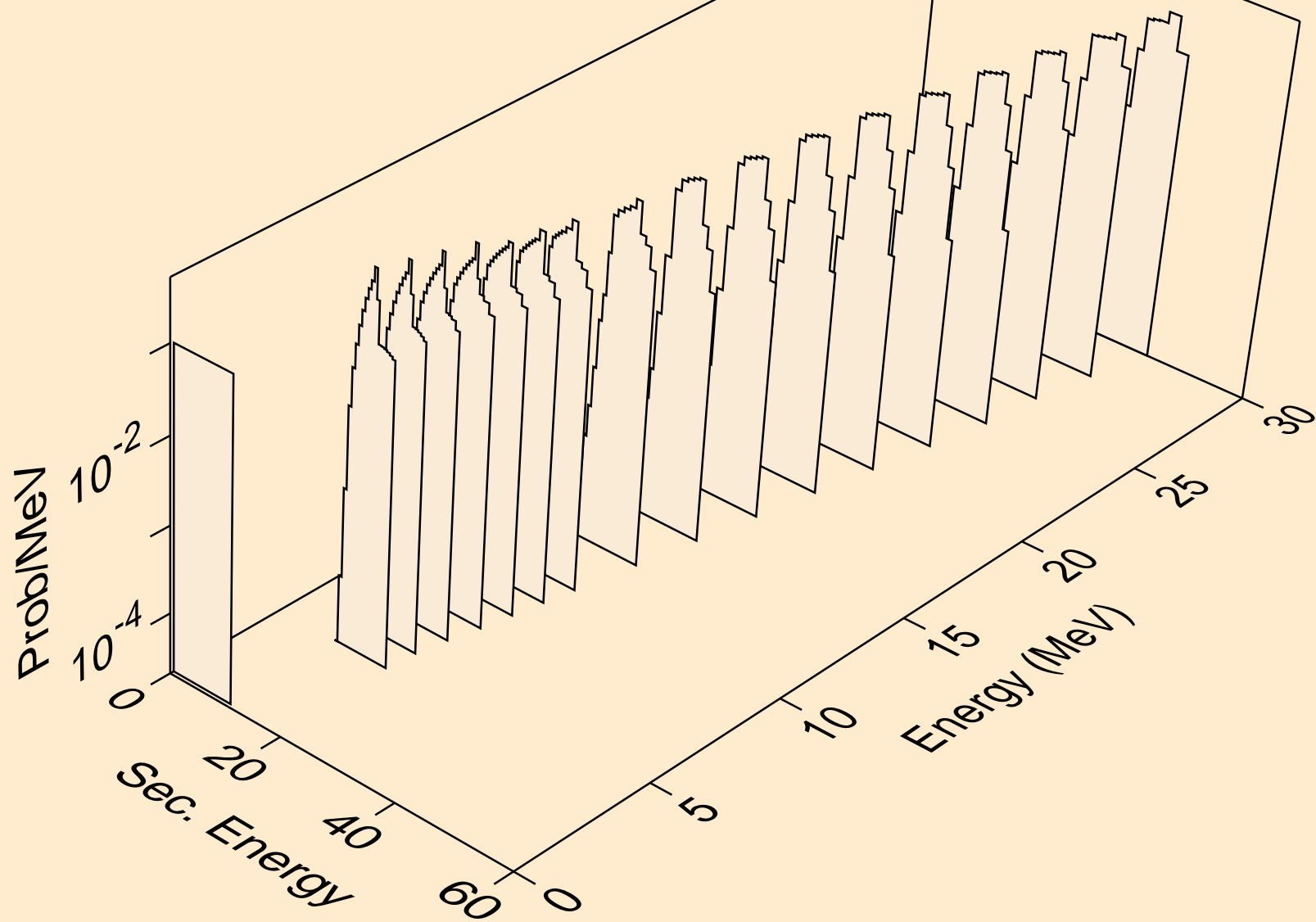

CD123 HELION ACER TENDL-2024 LIBRARY; T=0.K  
alphas from (s,pa)

