

CE123 HELION ACER TENDL-2024 LIBRARY; T=0.K  
Principal cross sections

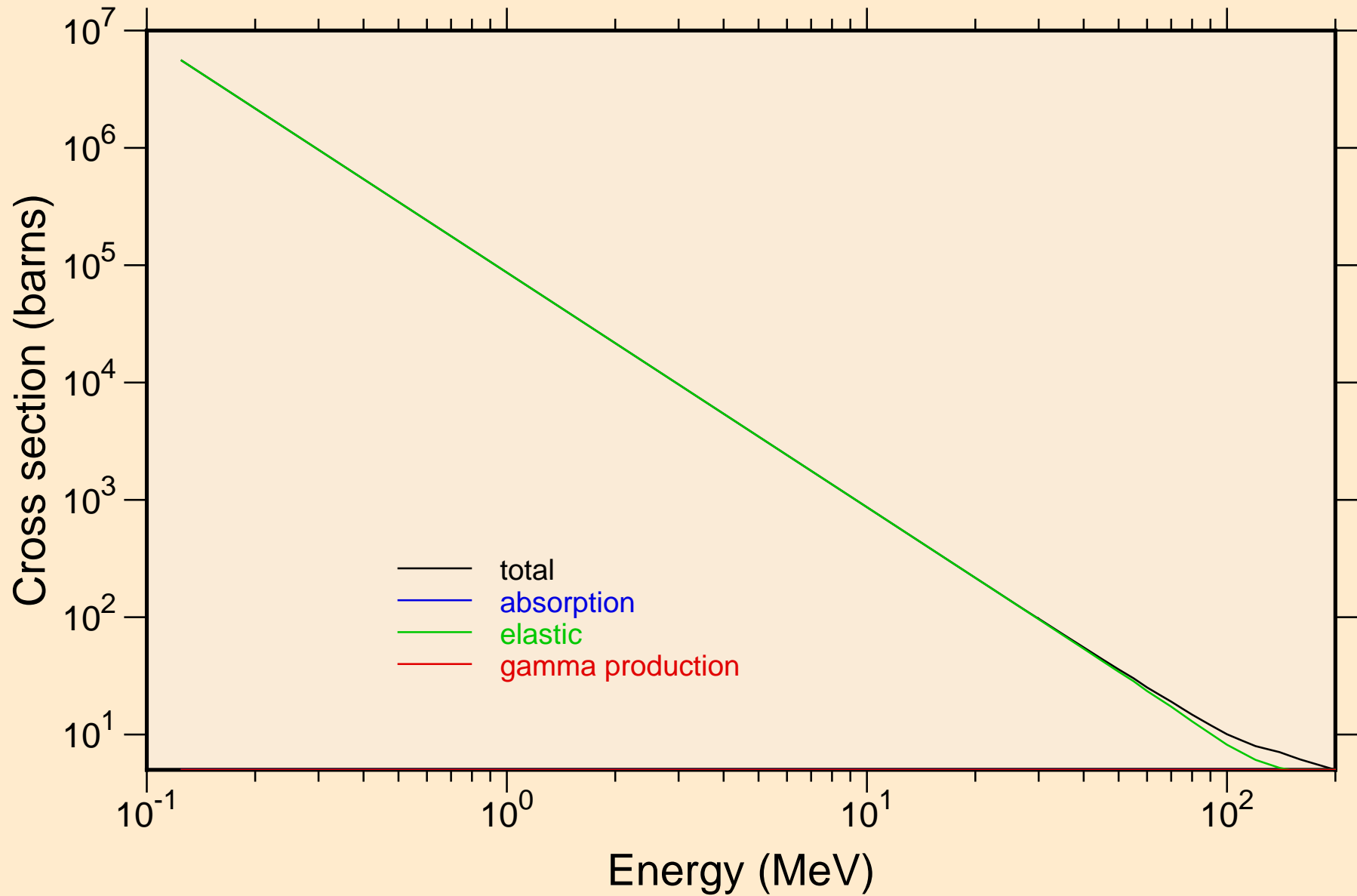

# CE123 HELION ACER TENDL-2024 LIBRARY; T=0.K

## Heating

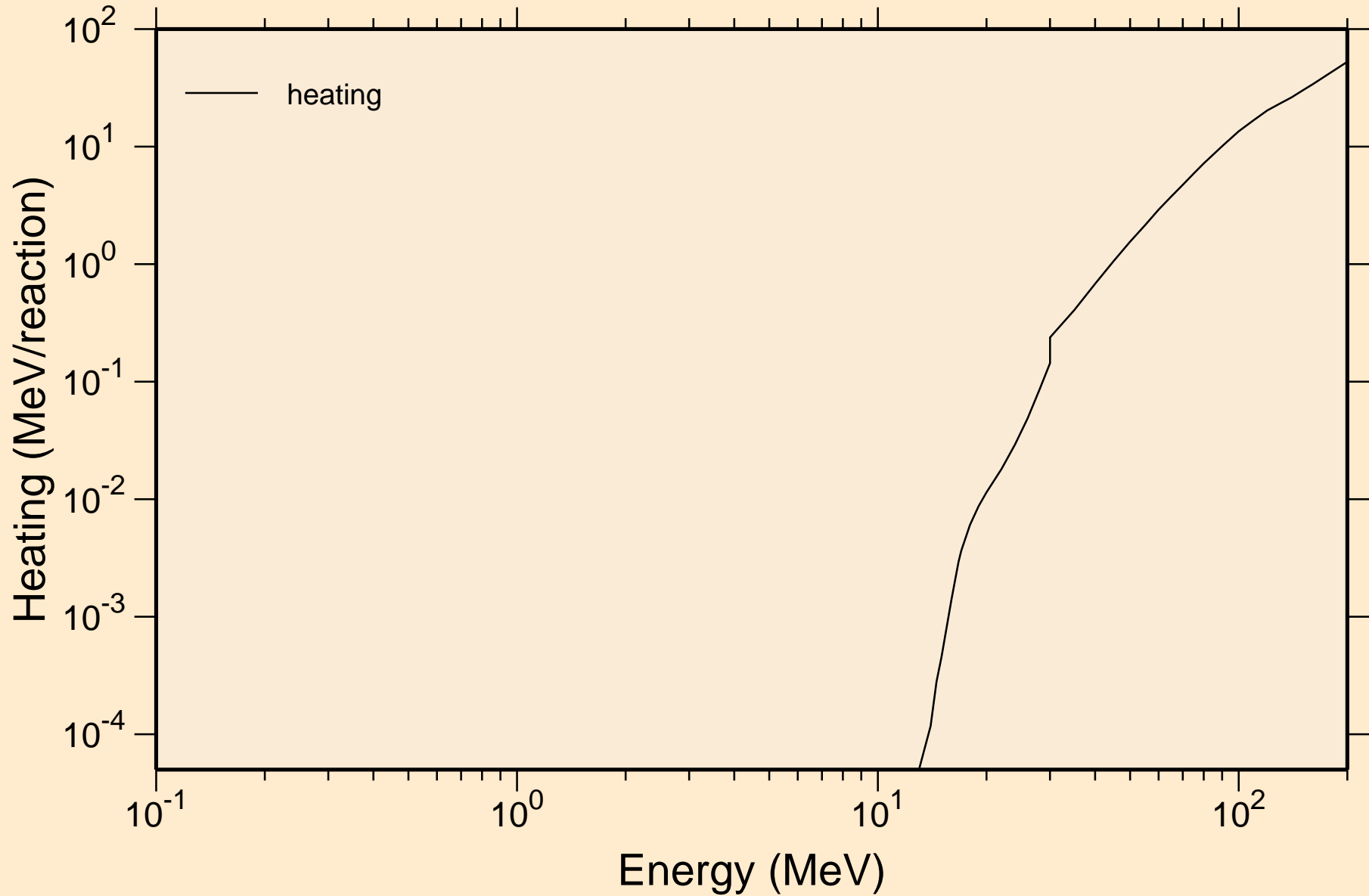

# CE123 HELION ACER TENDL-2024 LIBRARY; T=0.K

## Principal cross sections

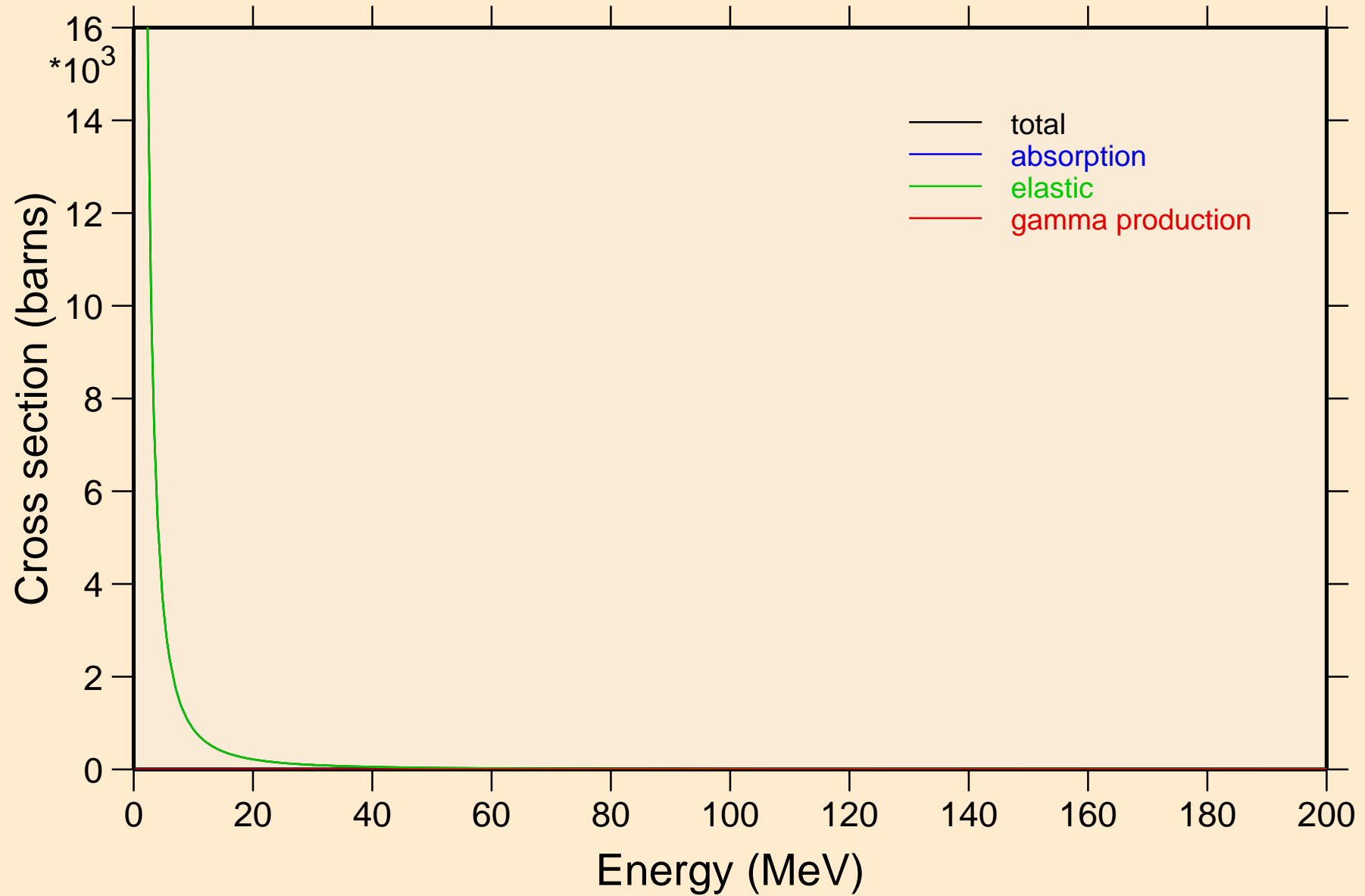

CE123 HELION ACER TENDL-2024 LIBRARY; T=0.K

Heating

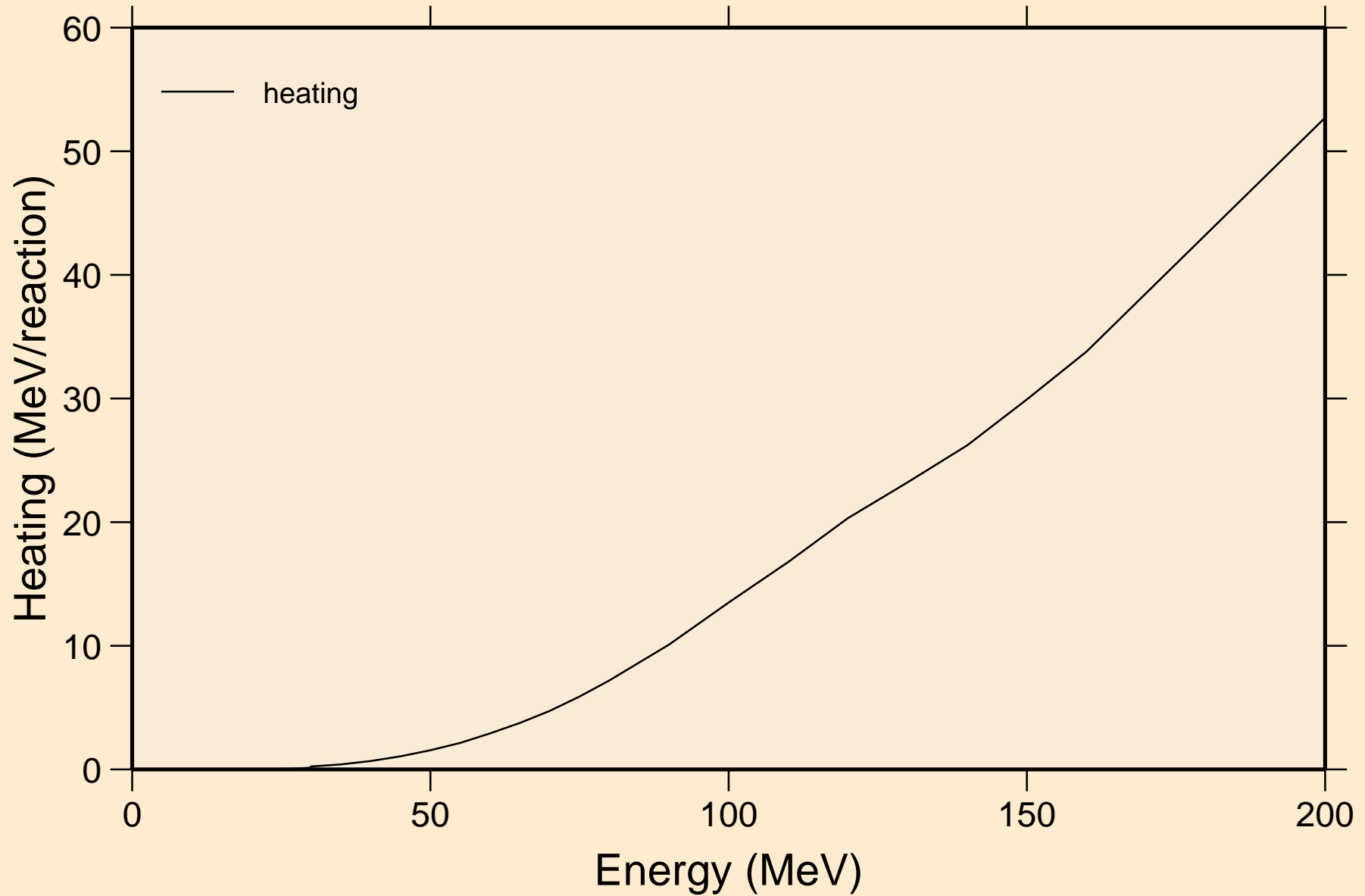

# CE123 HELION ACER TENDL-2024 LIBRARY; T=0.K

## Threshold reactions

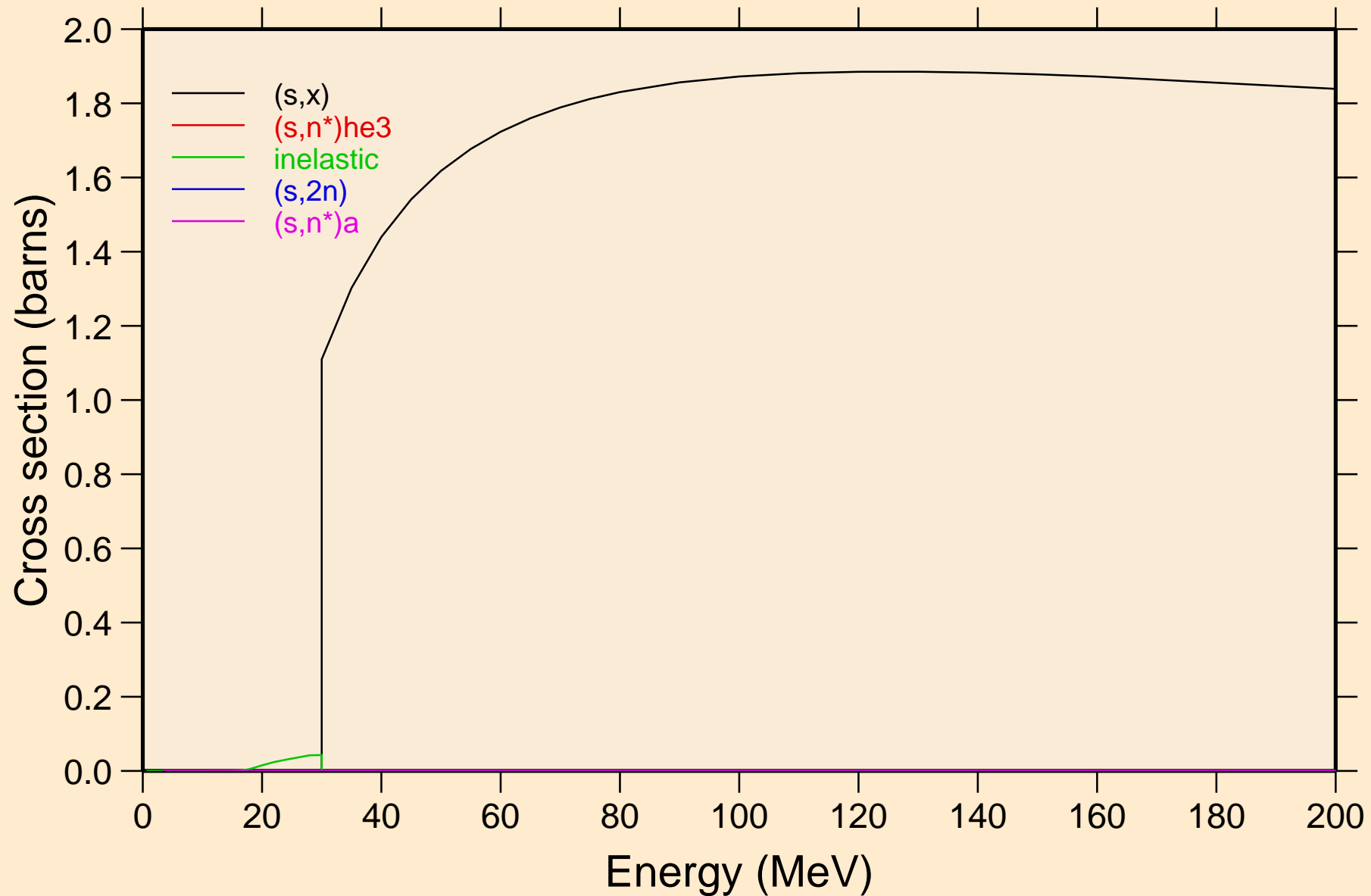

CE123 HELION ACER TENDL-2024 LIBRARY; T=0.K  
Threshold reactions

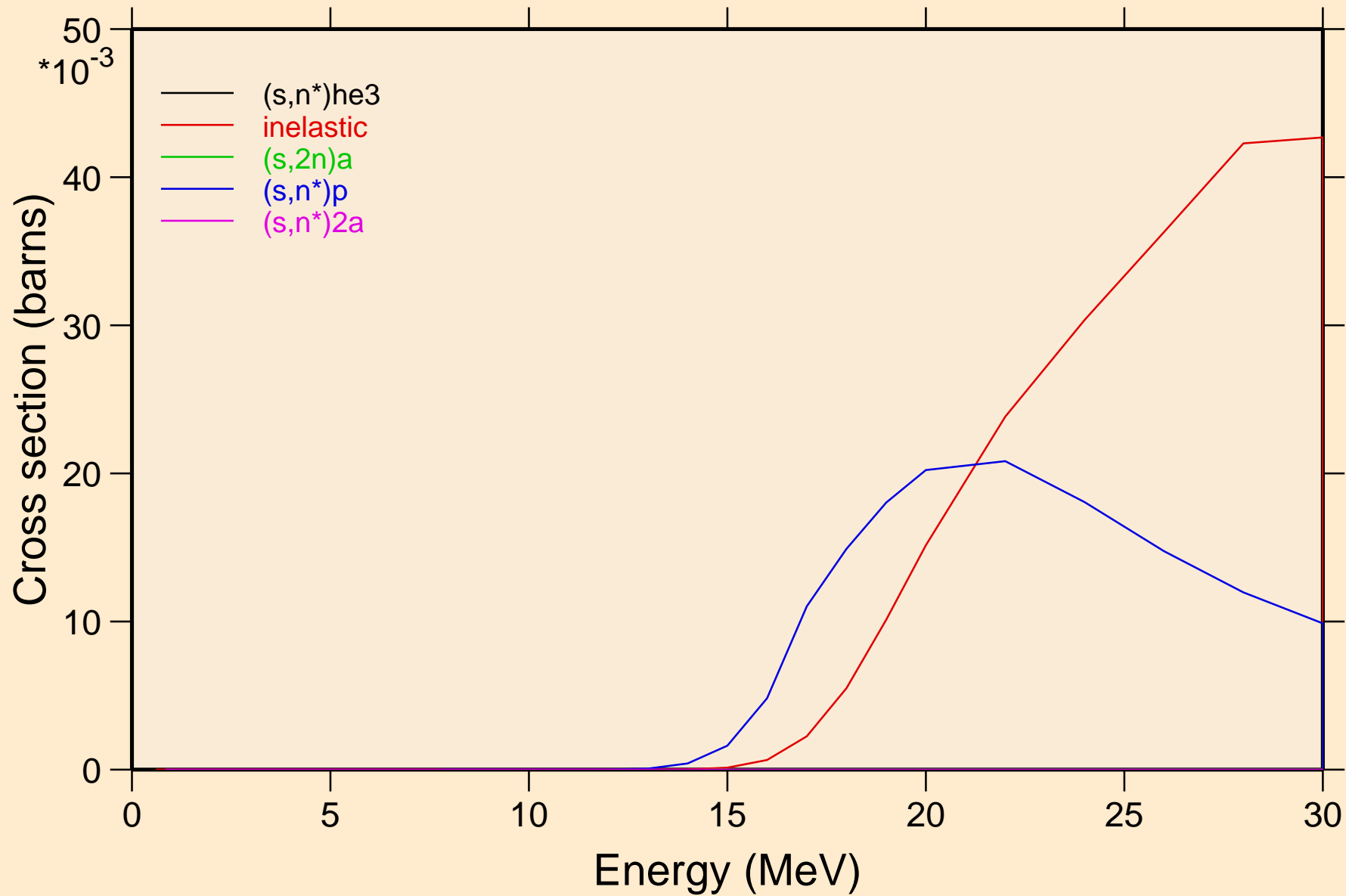

CE123 HELION ACER TENDL-2024 LIBRARY; T=0.K  
Threshold reactions

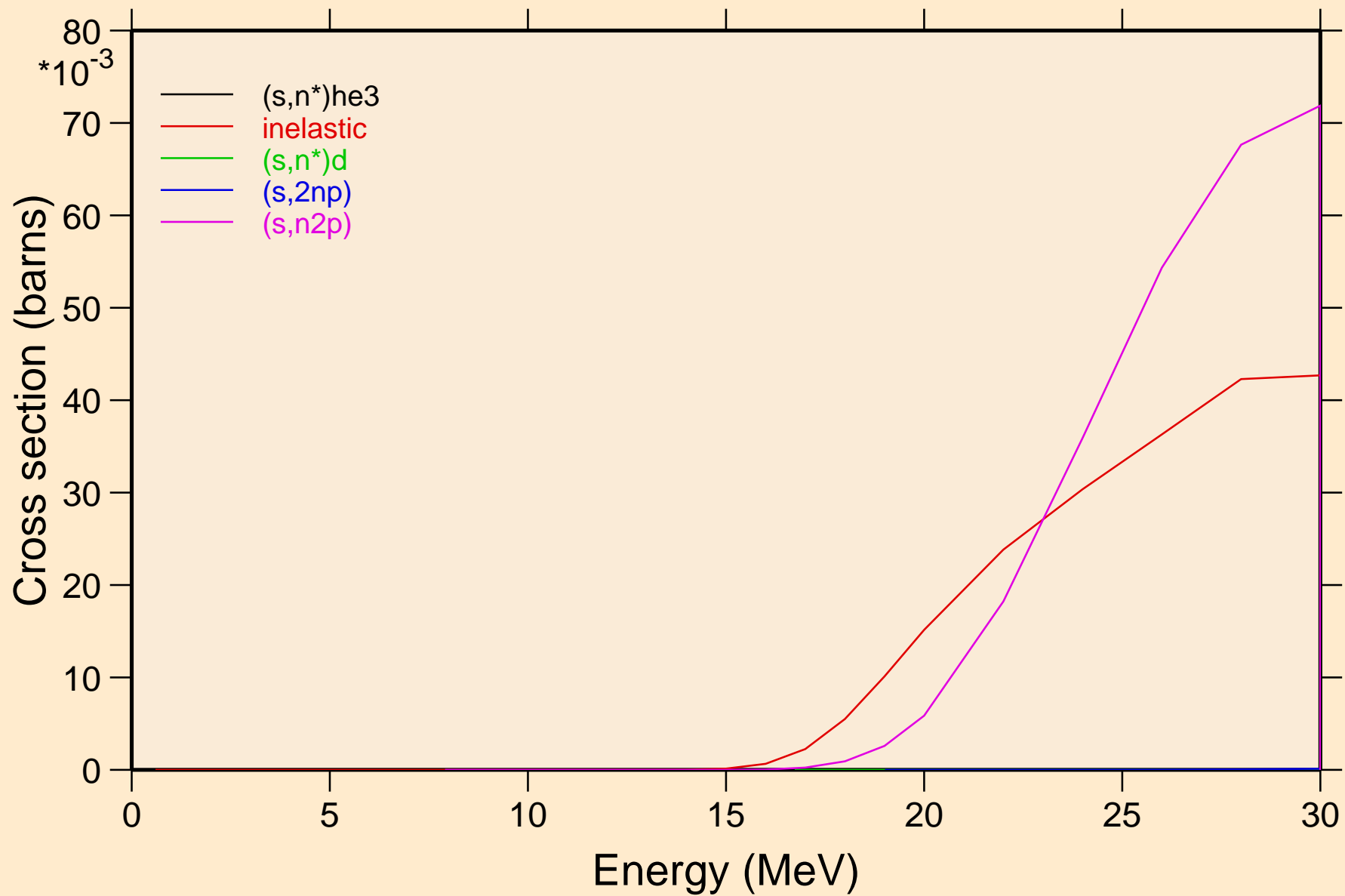

# CE123 HELION ACER TENDL-2024 LIBRARY; T=0.K

## Threshold reactions

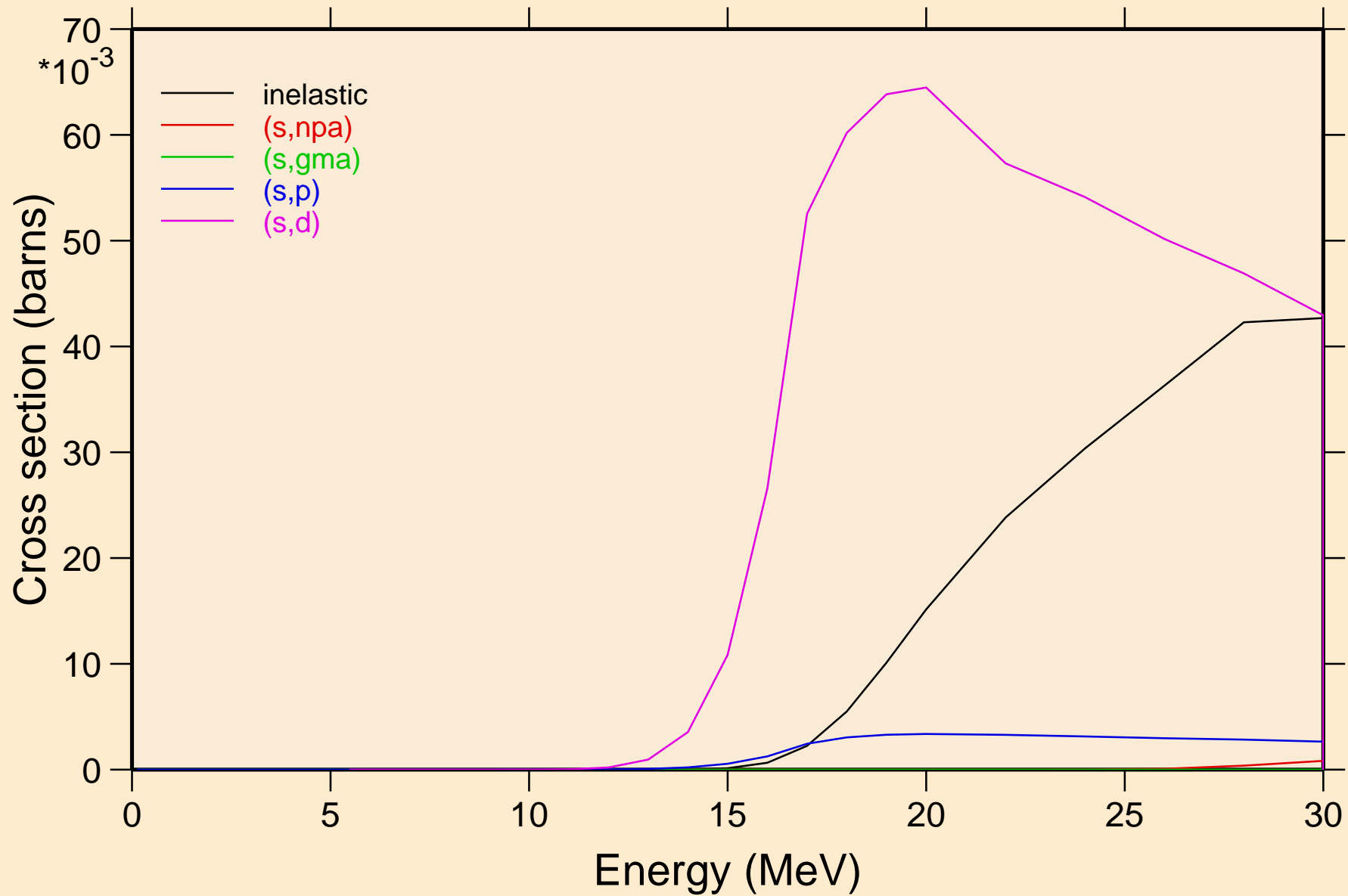

# CE123 HELION ACER TENDL-2024 LIBRARY; T=0.K

## Threshold reactions

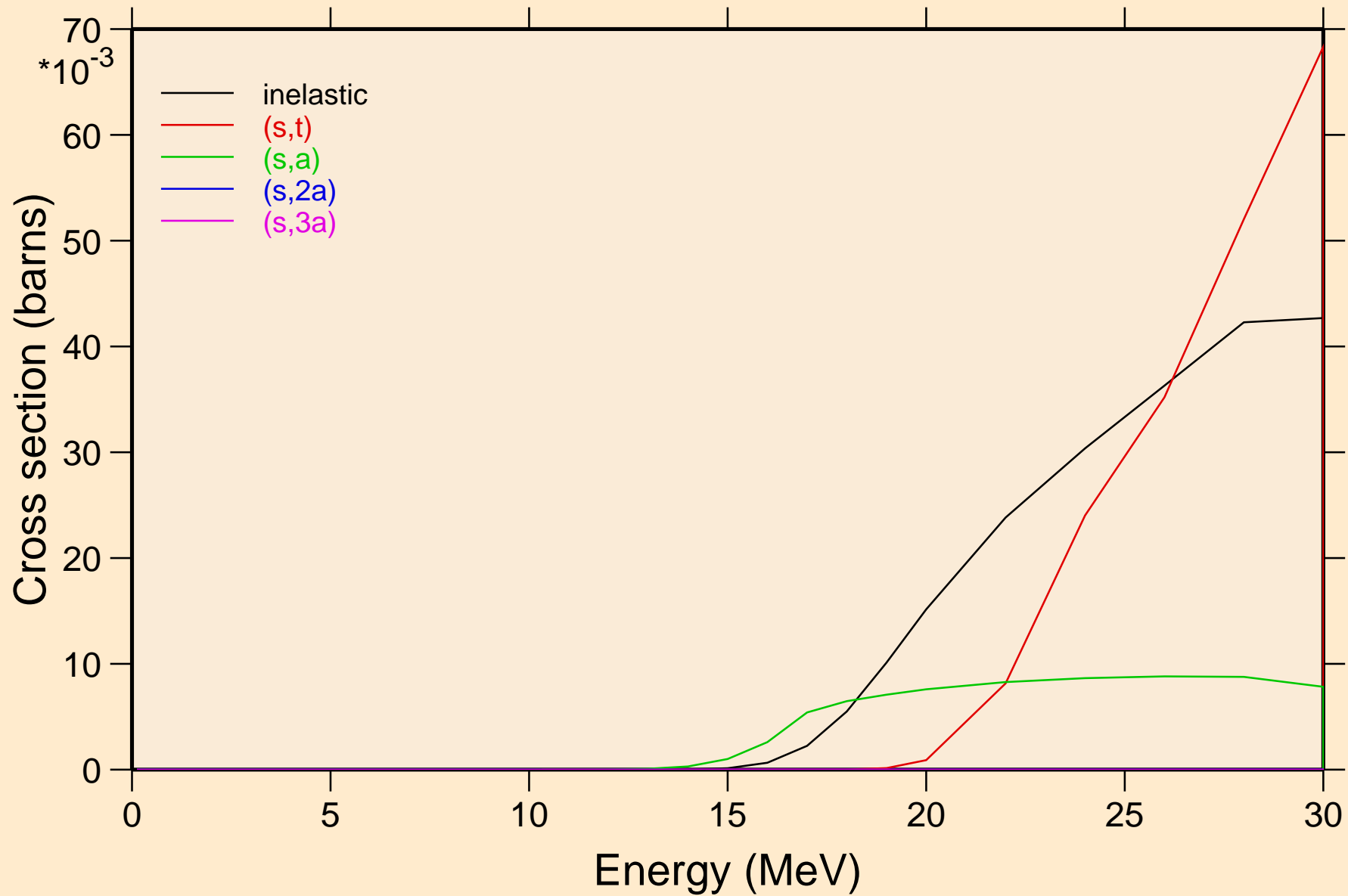

# CE123 HELION ACER TENDL-2024 LIBRARY; T=0.K

## Threshold reactions

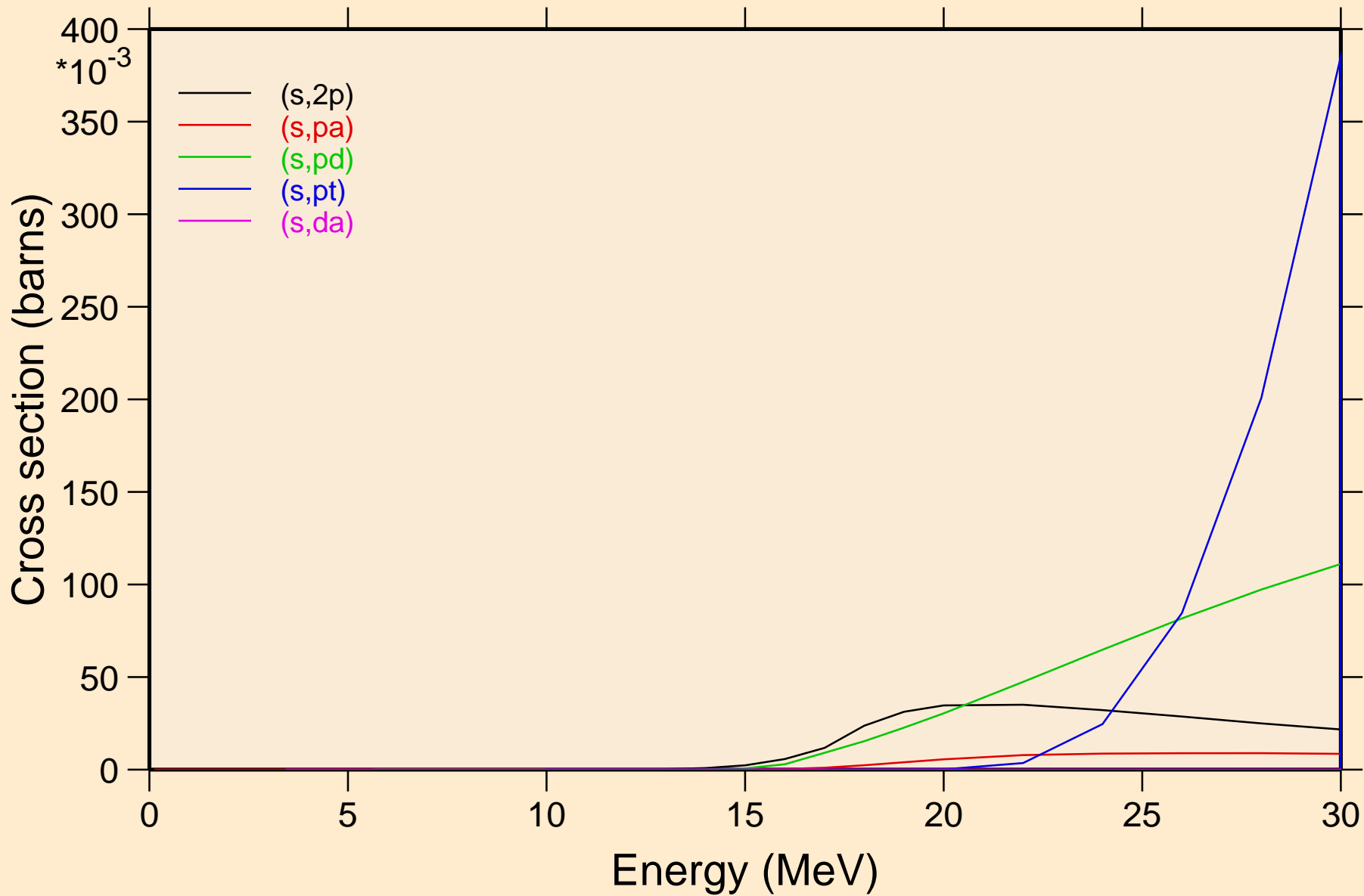

CE123 HELION ACER TENDL-2024 LIBRARY; T=0.K  
angular distribution for elastic

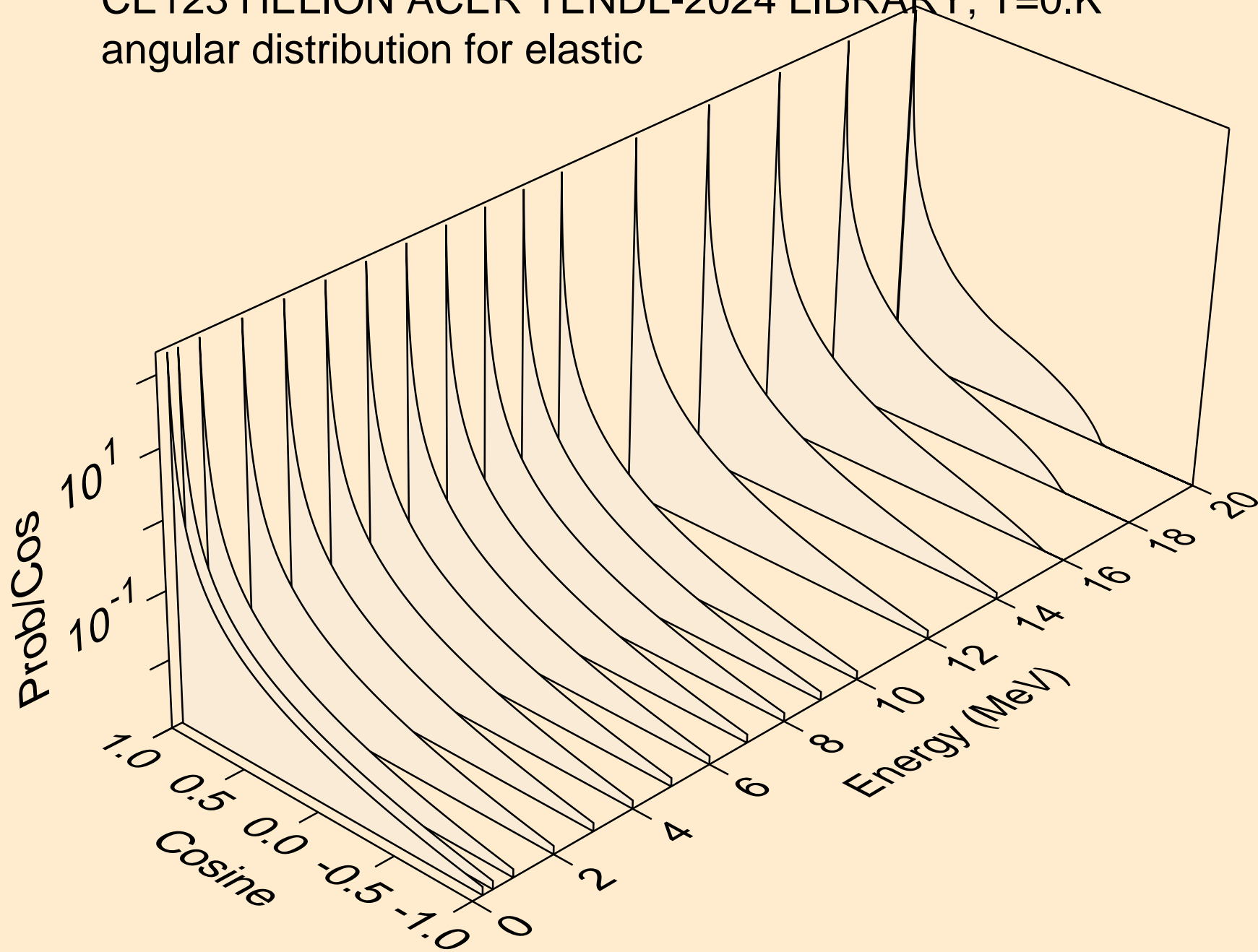

CE123 HELION ACER TENDL-2024 LIBRARY; T=0.K  
angular distribution for elastic

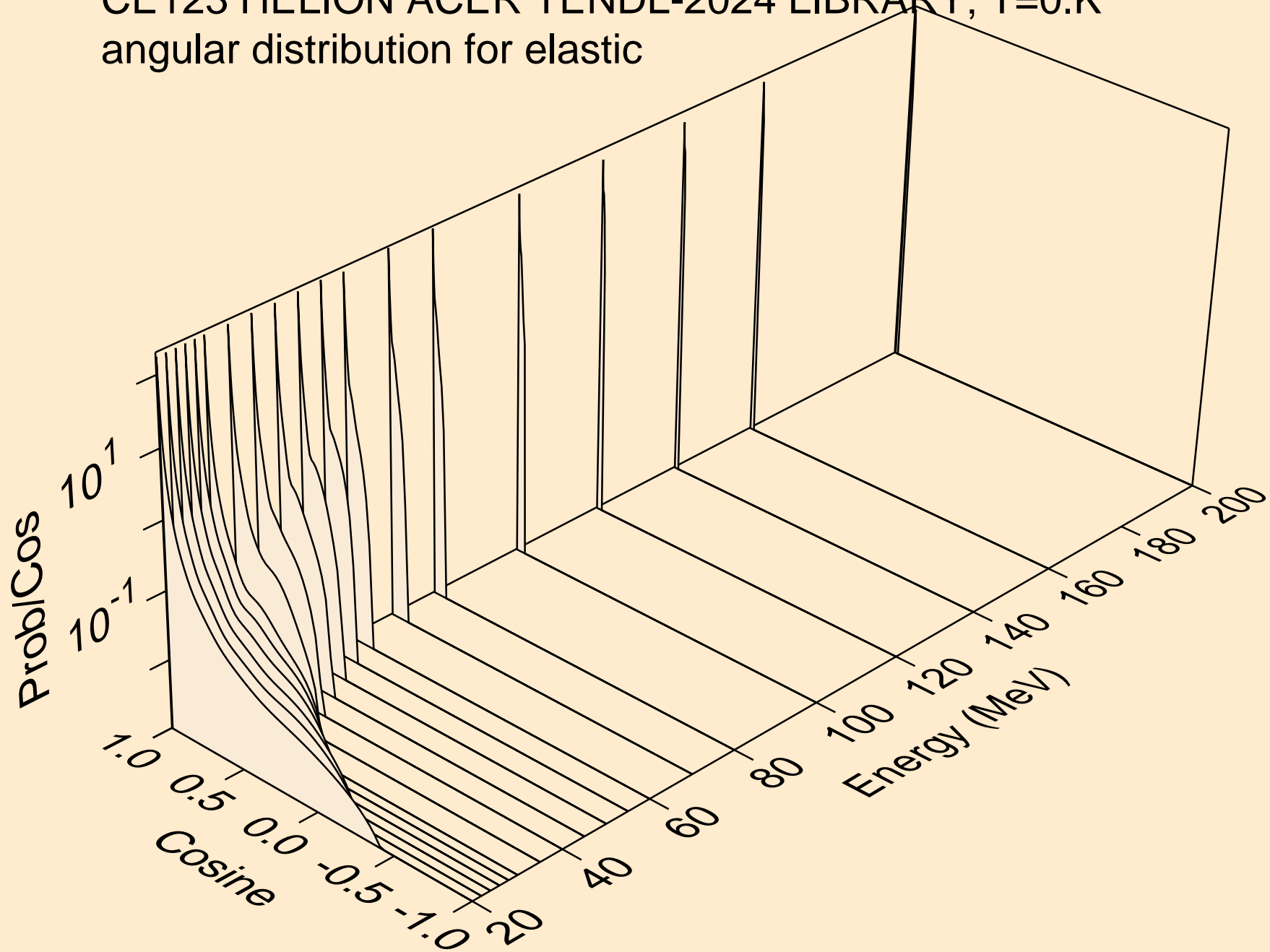

CE123 HELION ACER TENDL-2024 LIBRARY; T=0.K  
He-3 emission for (s,x)

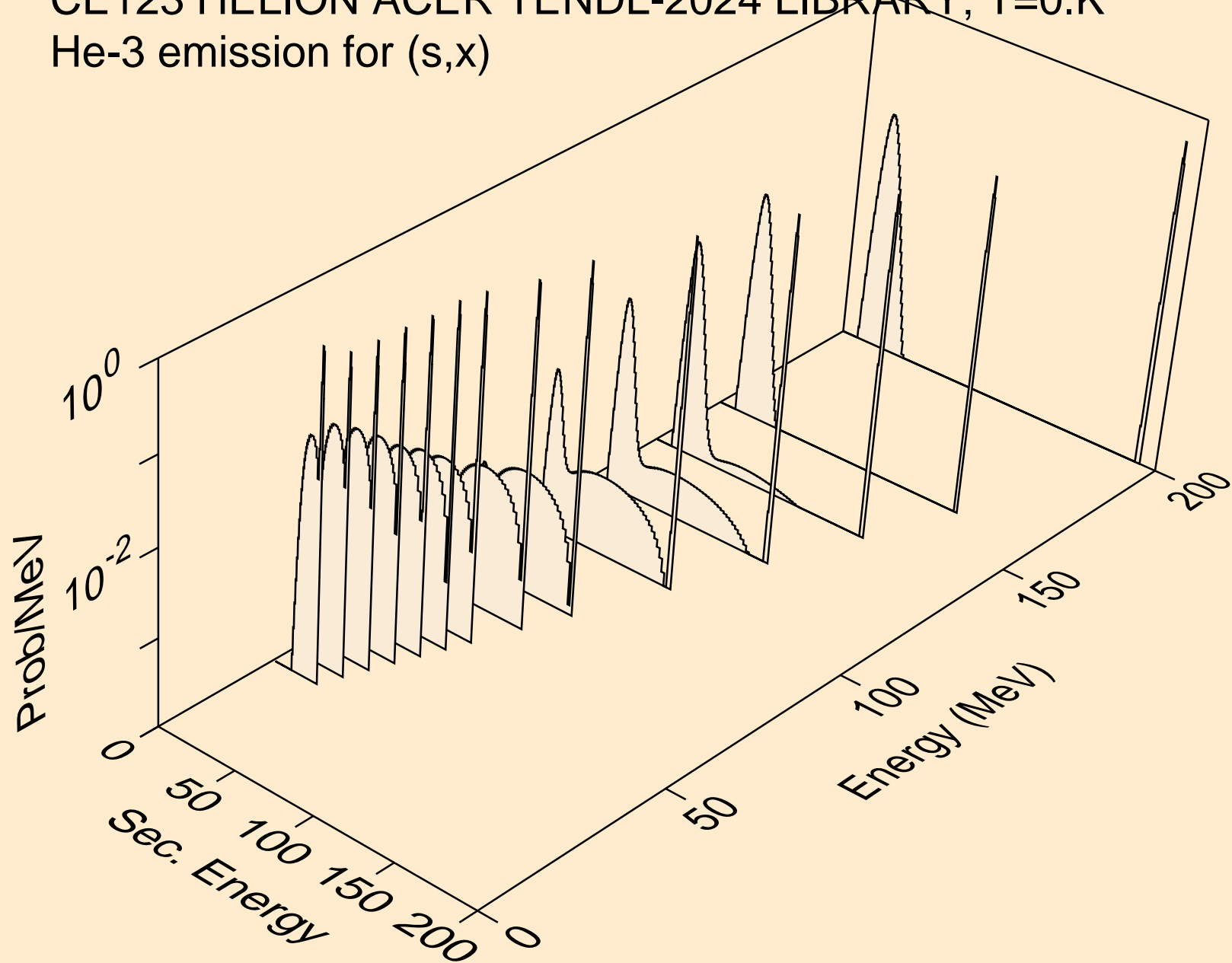

CE123 HELION ACER TENDL-2024 LIBRARY; T=0.K  
He-3 emission for (s,n\*)he3

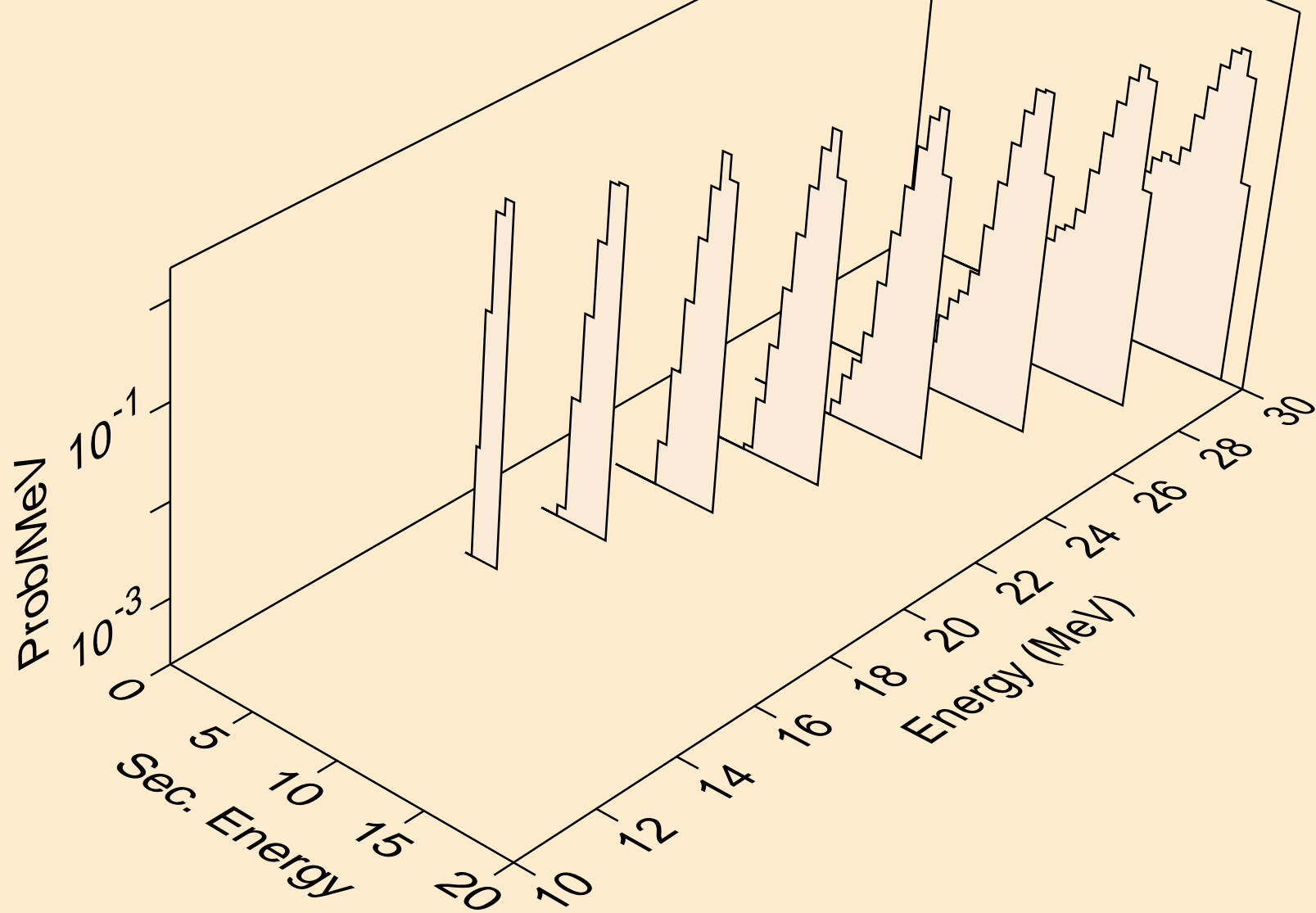

CE123 HELION ACER TENDL-2024 LIBRARY; T=0.K  
He-3 emission for inelastic

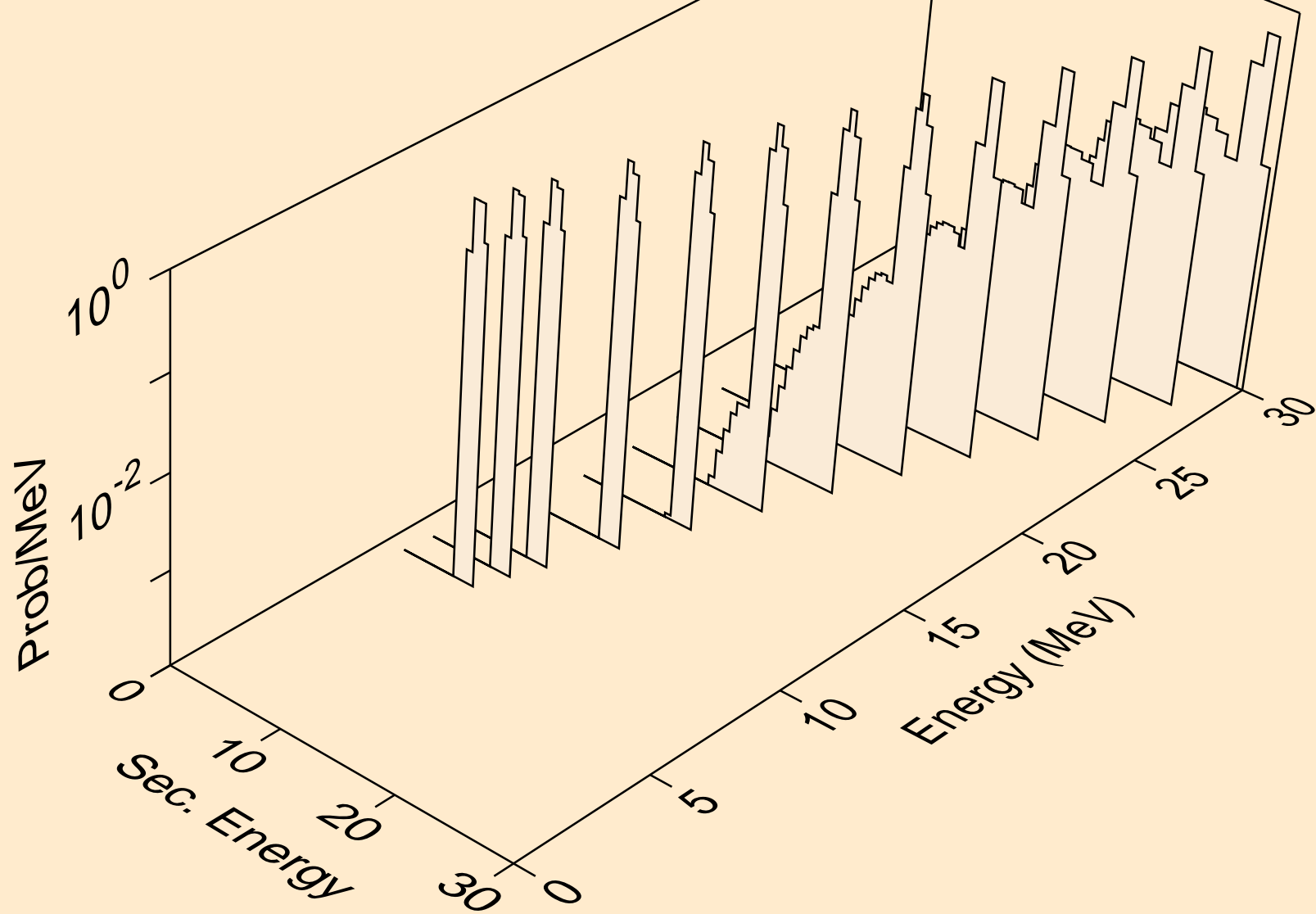

CE123 HELION ACER TENDL-2024 LIBRARY; T=0.K  
Photon emission for (z,n)

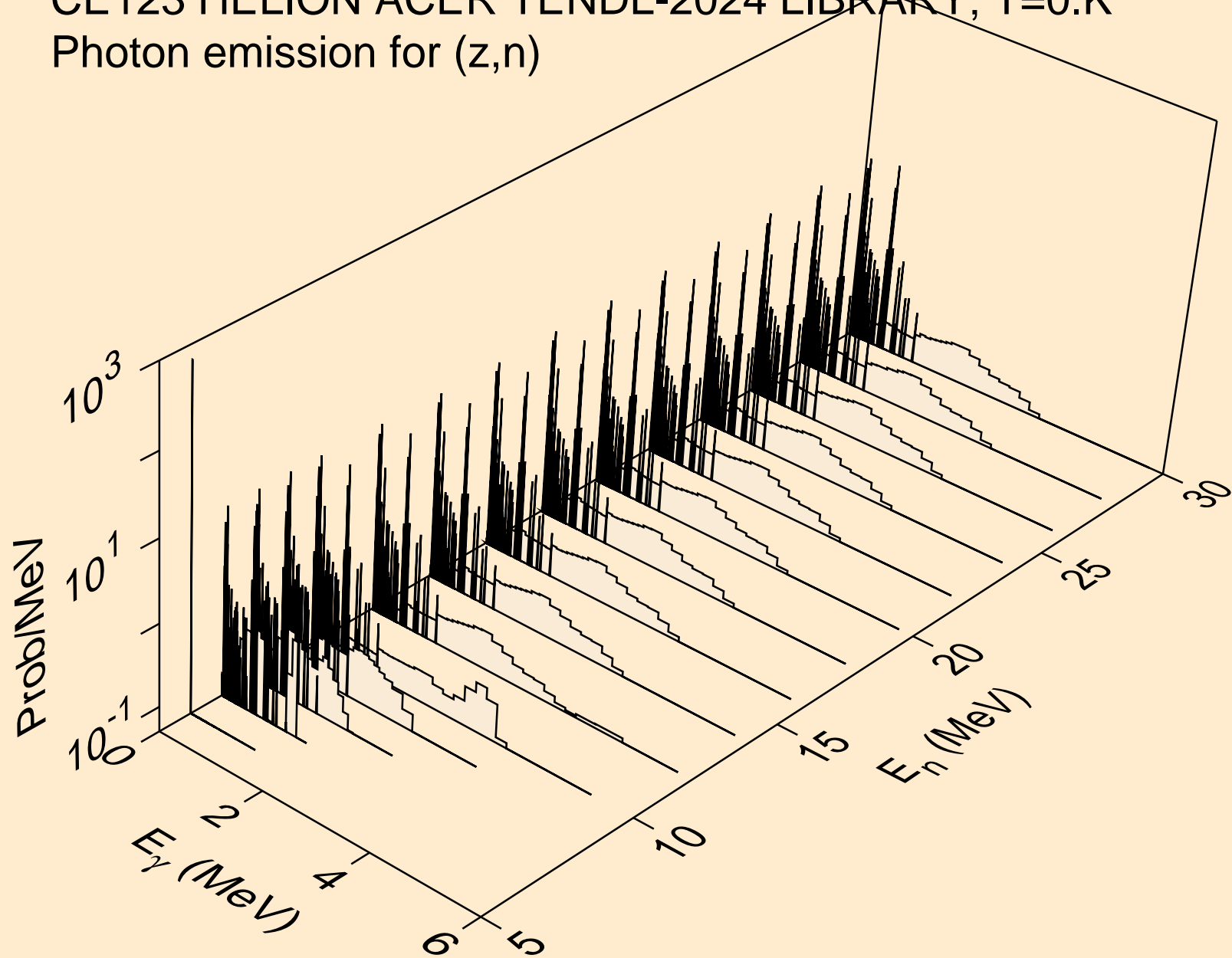

CE123 HELION ACER TENDL-2024 LIBRARY; T=0.K  
Photon emission for (z,x)

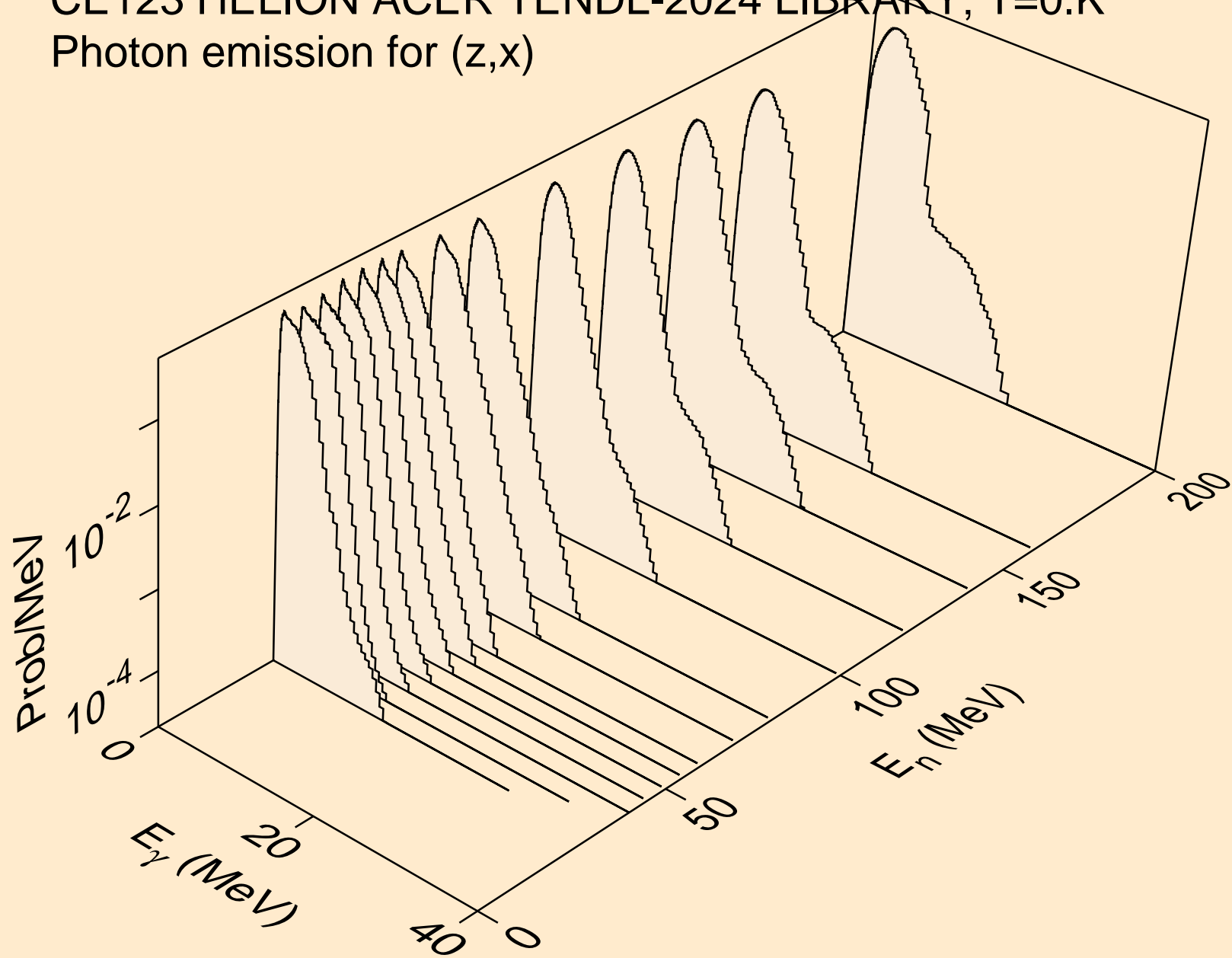

CE123 HELION ACER TENDL-2024 LIBRARY; T=0.K  
Photon emission for (n,2n)

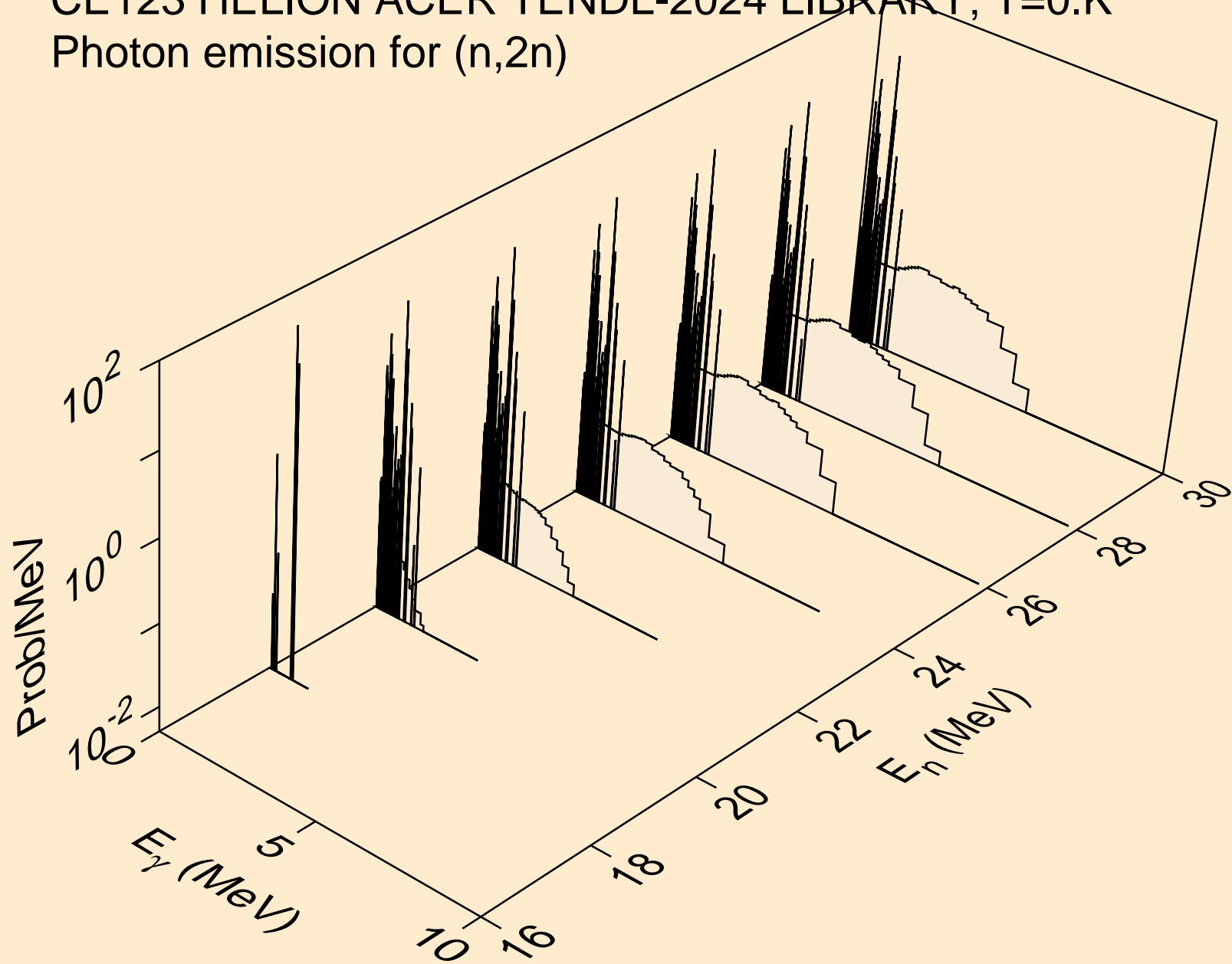

CE123 HELION ACER TENDL-2024 LIBRARY; T=0.K  
Photon emission for (n,n\*)a

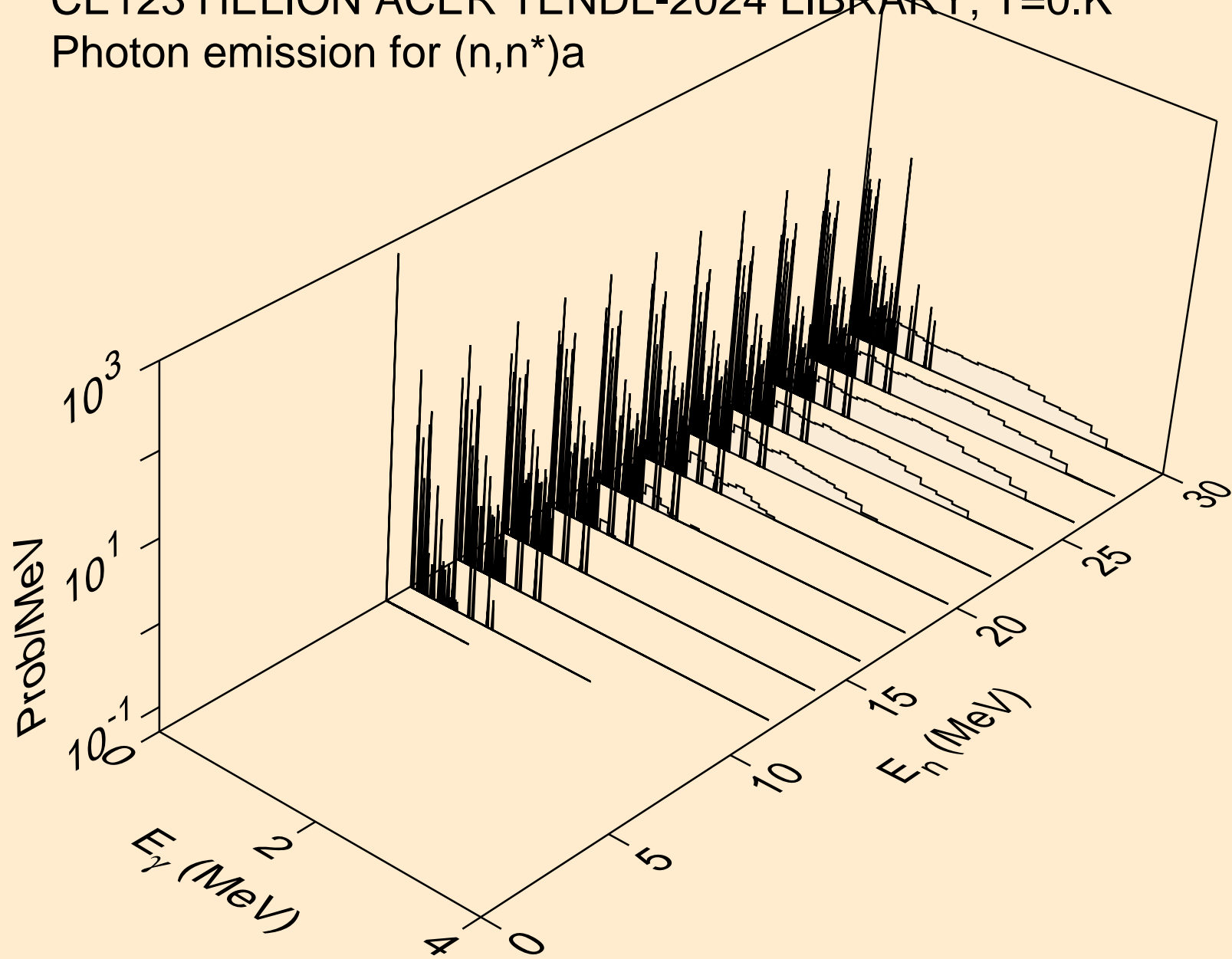

CE123 HELION ACER TENDL-2024 LIBRARY; T=0.K  
Photon emission for (n,2n)a

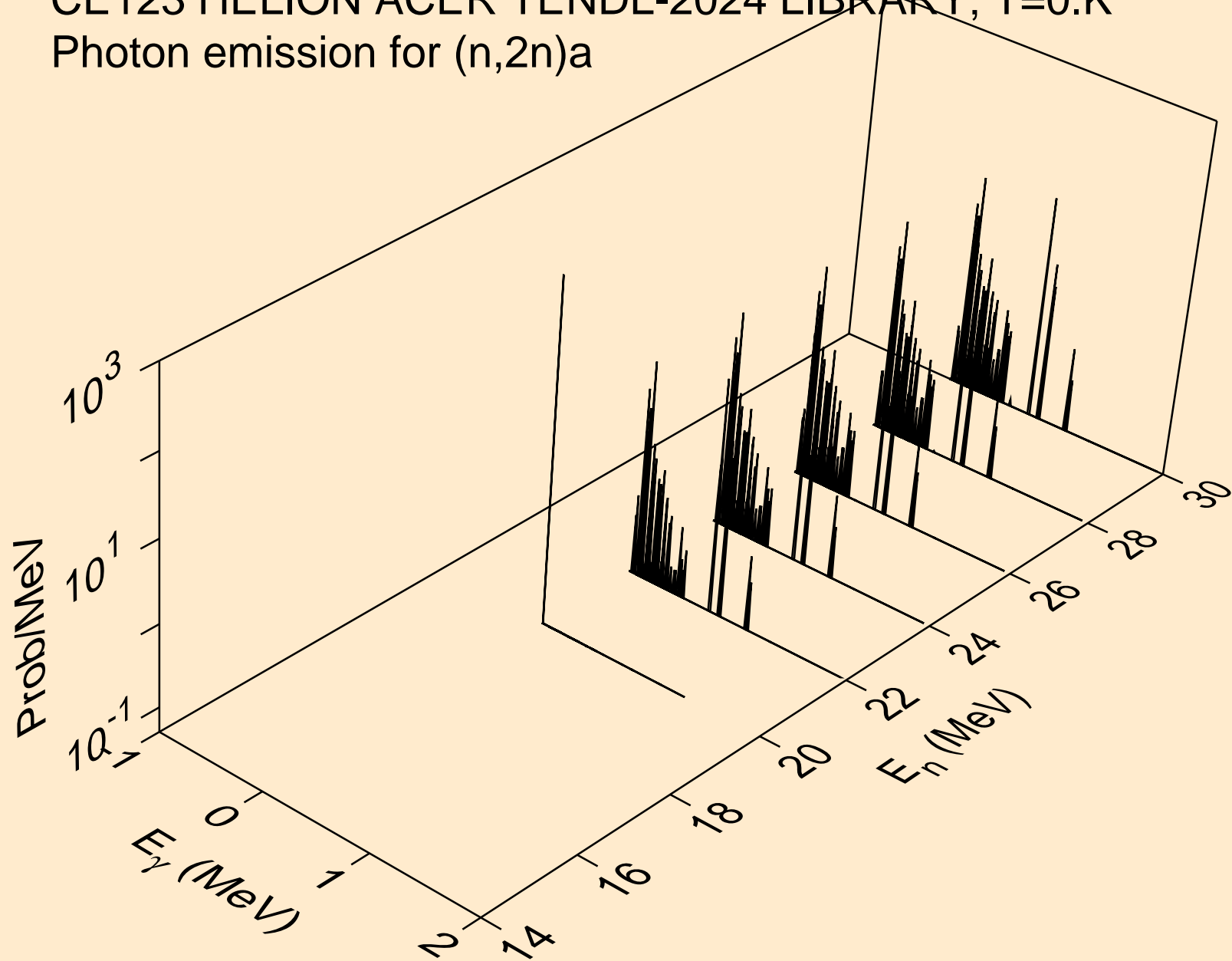

CE123 HELION ACER TENDL-2024 LIBRARY; T=0.K  
Photon emission for (n,n\*)p

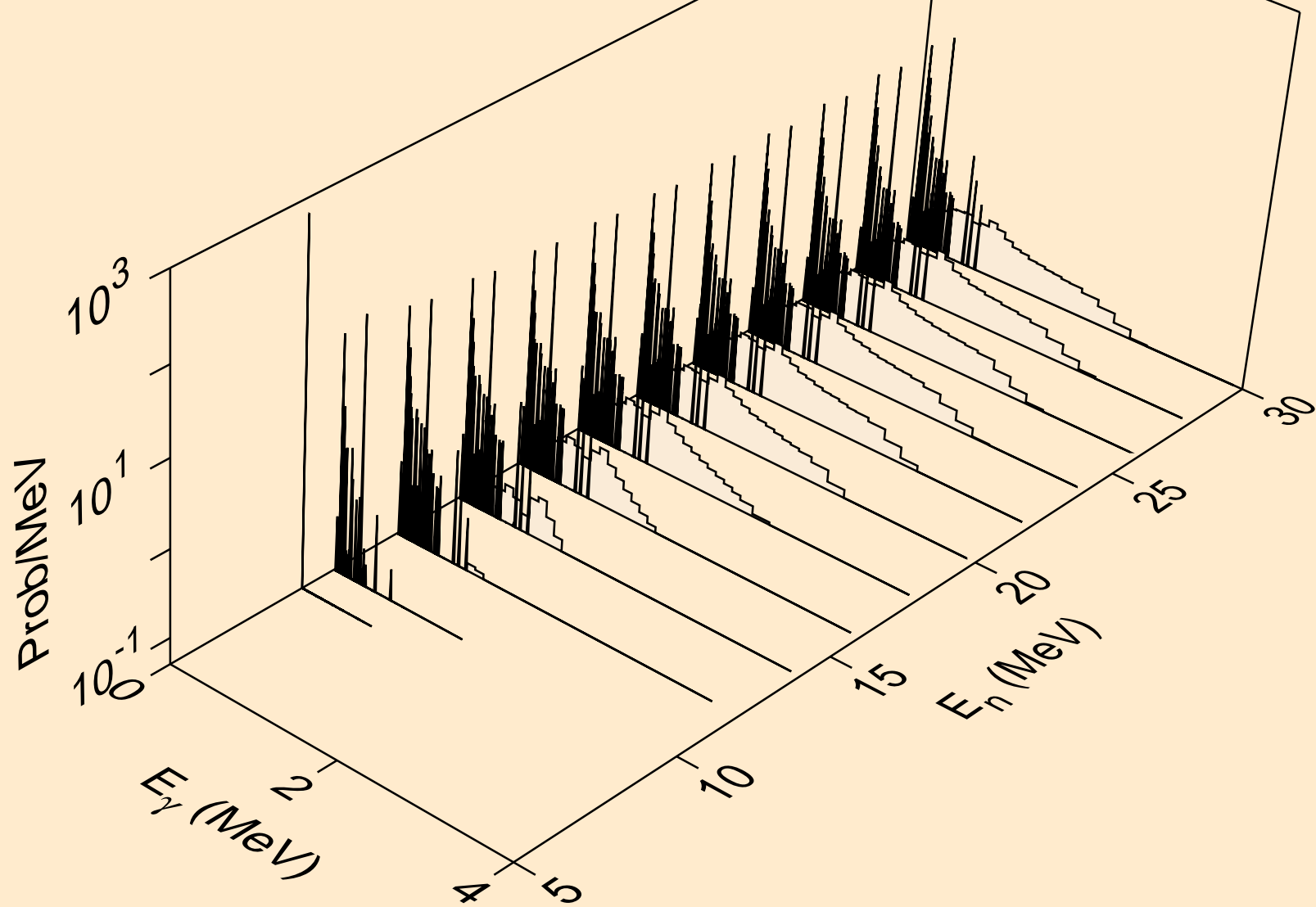

CE123 HELION ACER TENDL-2024 LIBRARY; T=0.K  
Photon emission for (n,n\*)2a

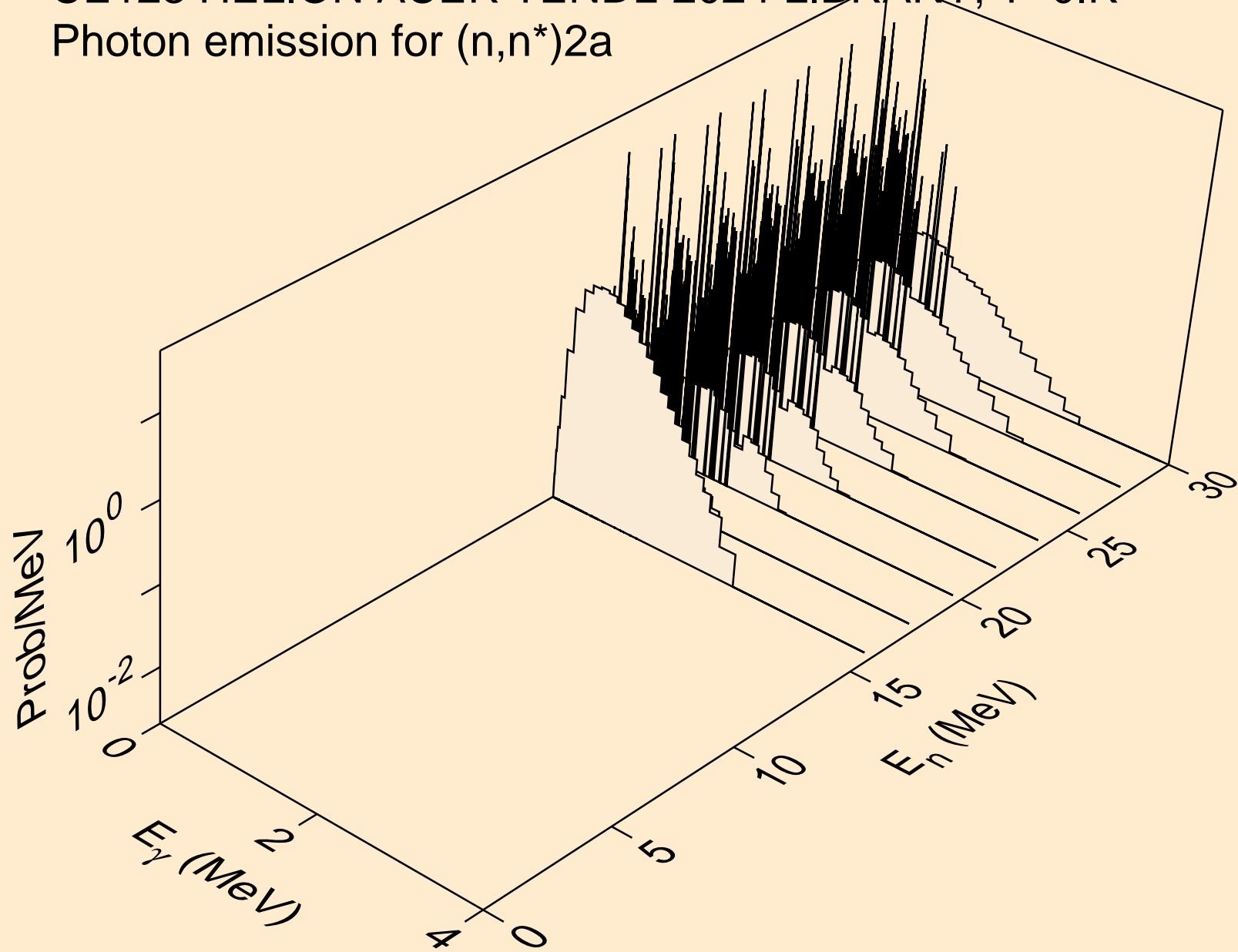

CE123 HELION ACER TENDL-2024 LIBRARY; T=0.K  
Photon emission for (n,n\*)d

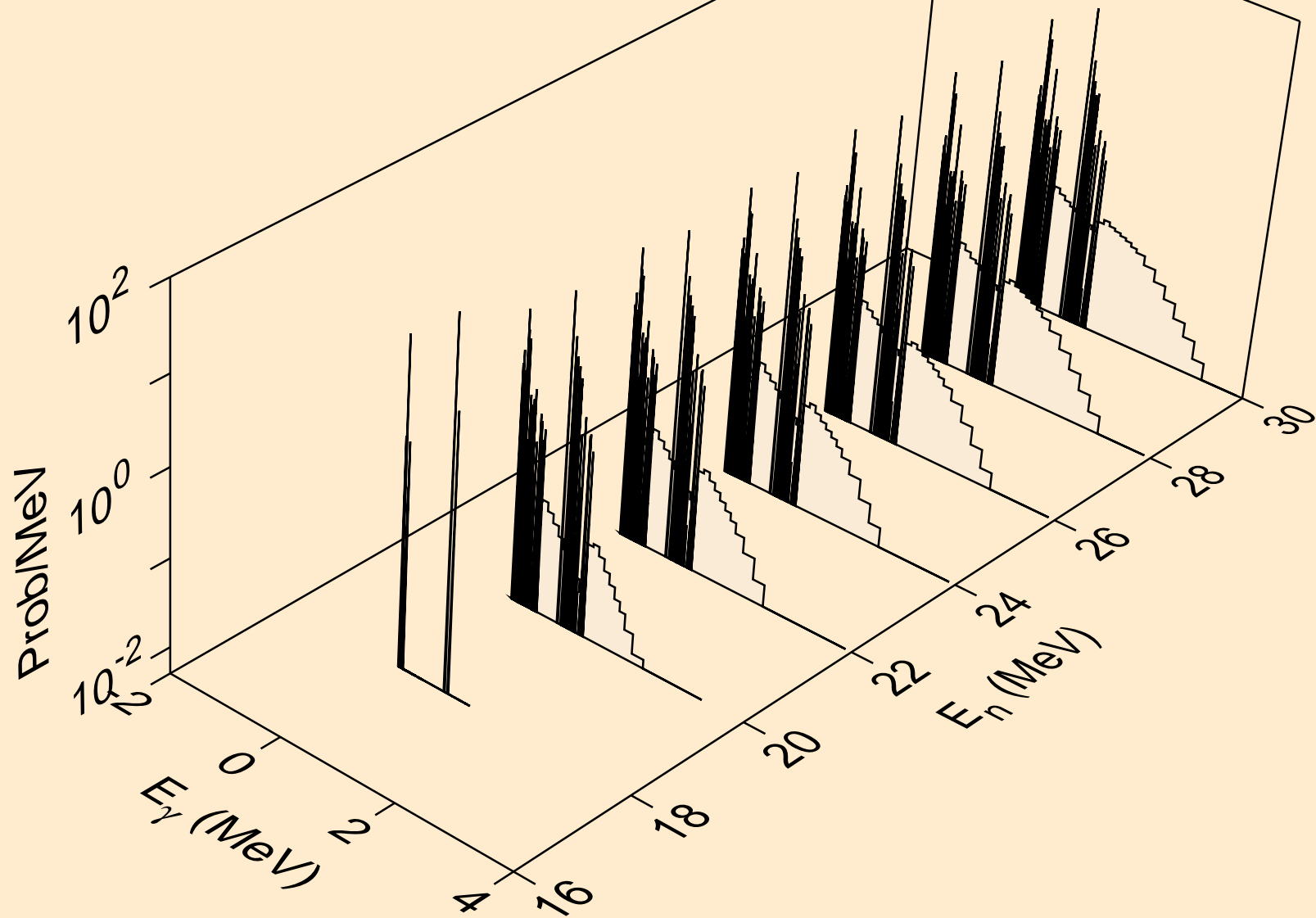

CE123 HELION ACER TENDL-2024 LIBRARY; T=0.K  
Photon emission for (n,n\*)he3

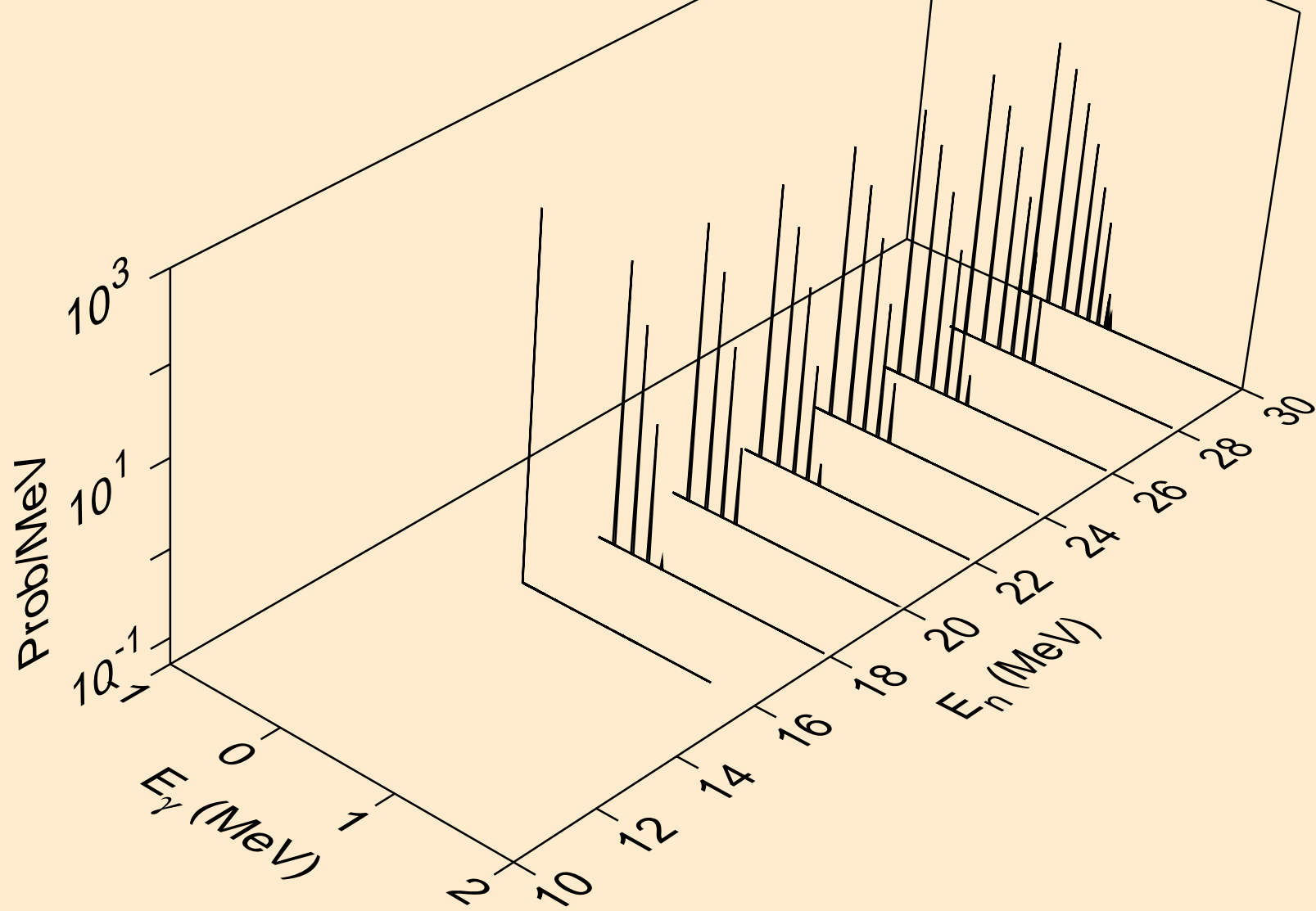

CE123 HELION ACER TENDL-2024 LIBRARY; T=0.K  
Photon emission for (n,2np)

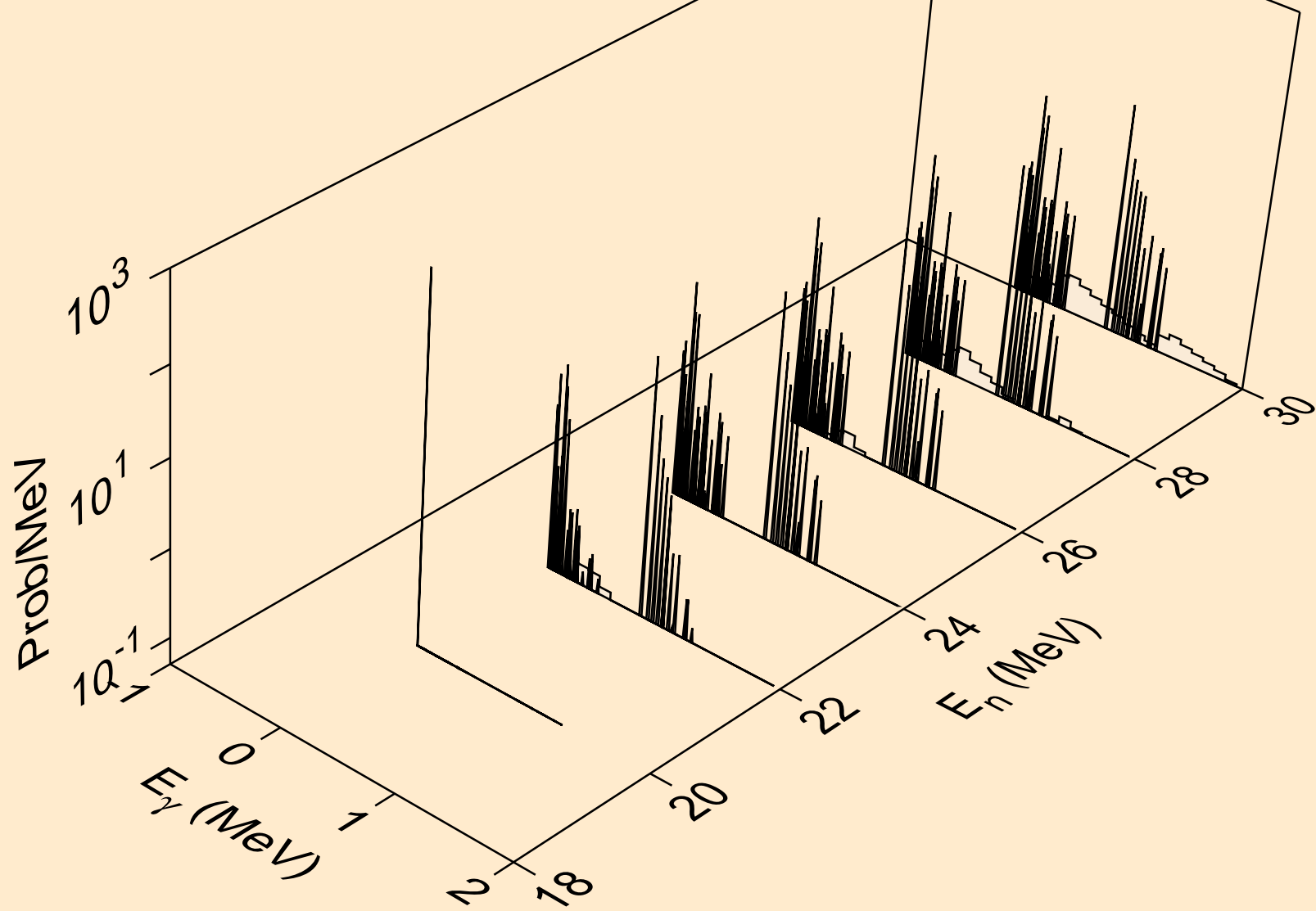

CE123 HELION ACER TENDL-2024 LIBRARY; T=0.K  
Photon emission for (n,n2p)

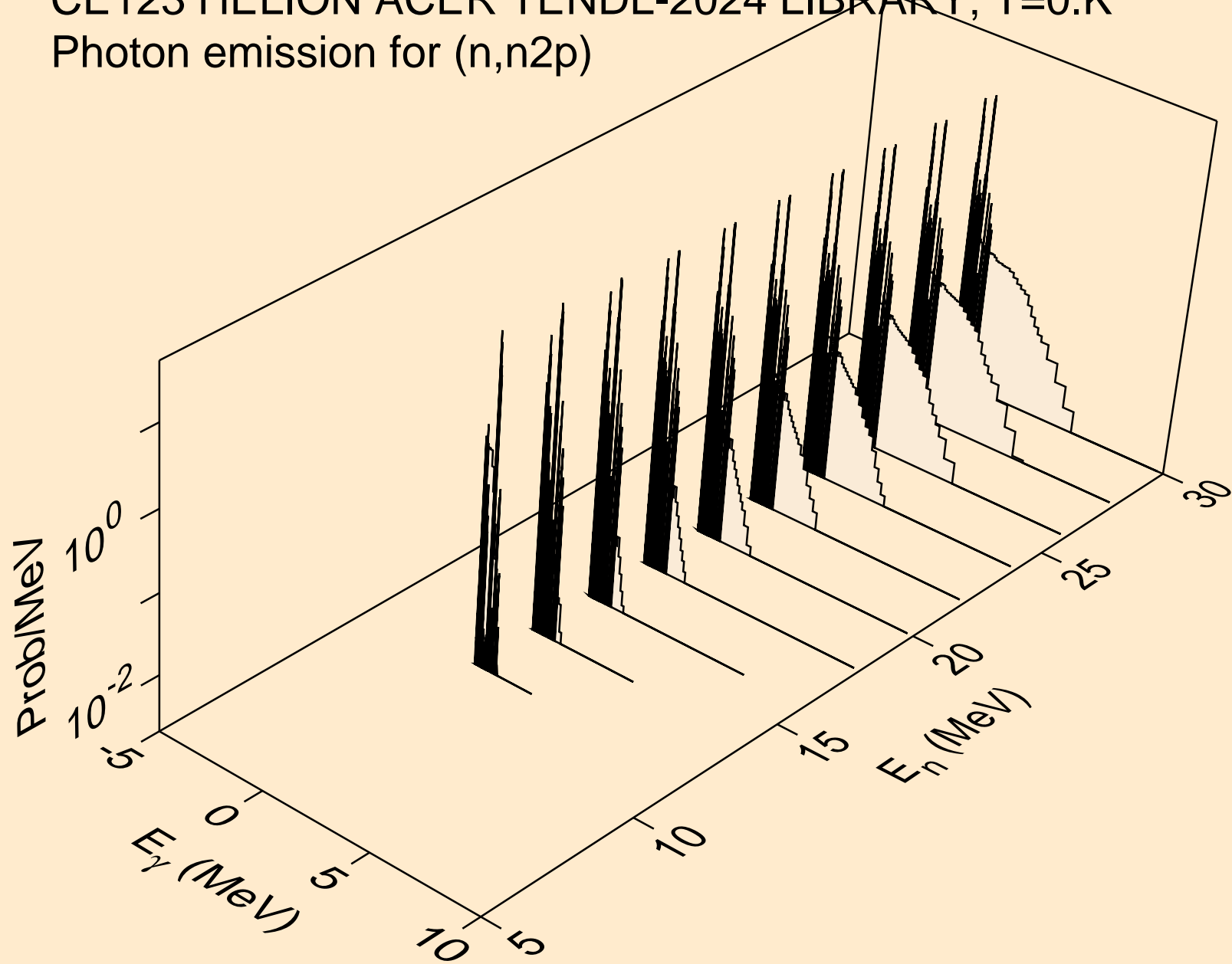

CE123 HELION ACER TENDL-2024 LIBRARY; T=0.K  
Photon emission for (n,npa)

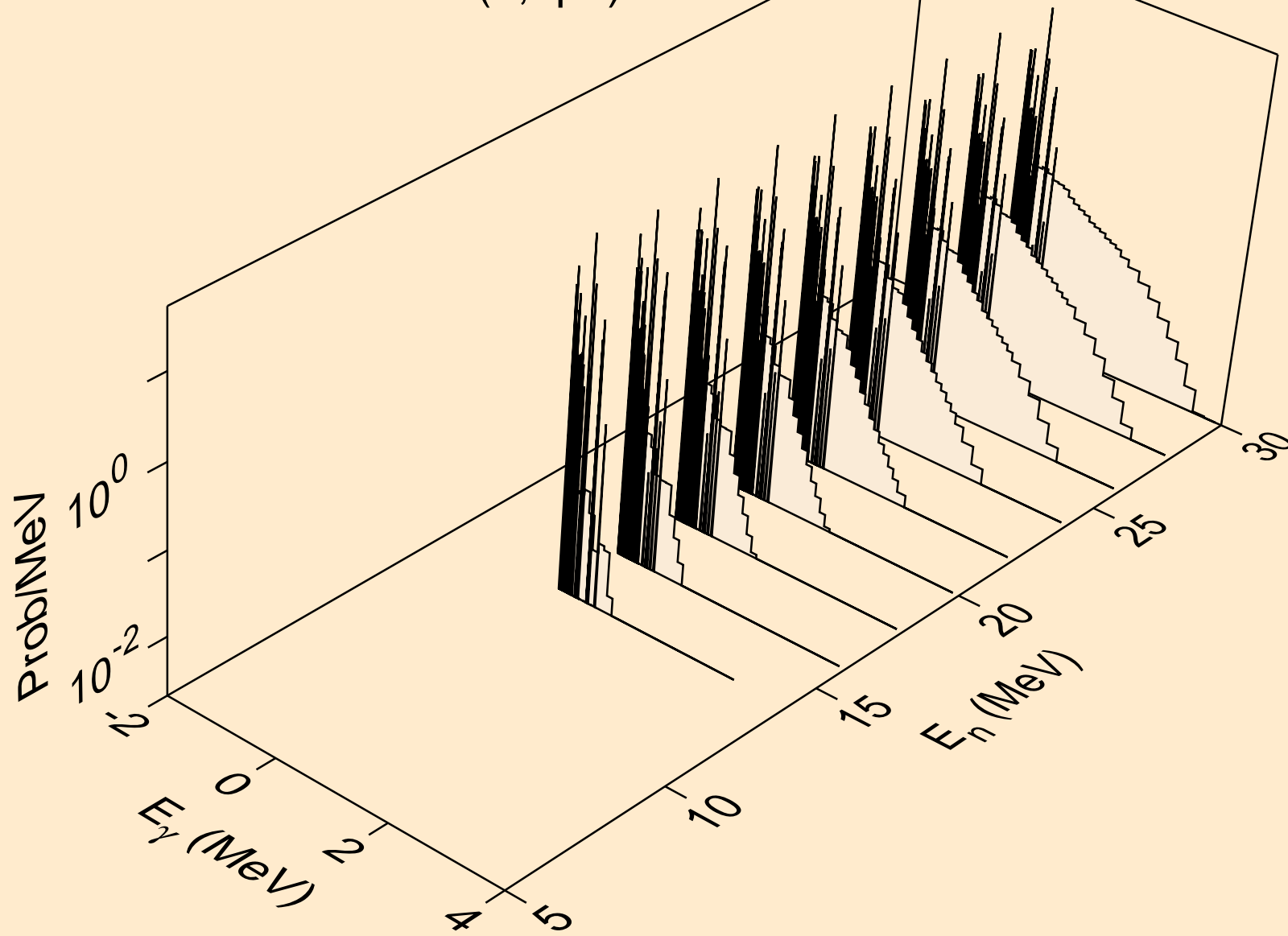

CE123 HELION ACER TENDL-2024 LIBRARY; T=0.K  
Photon emission for (n,gma)

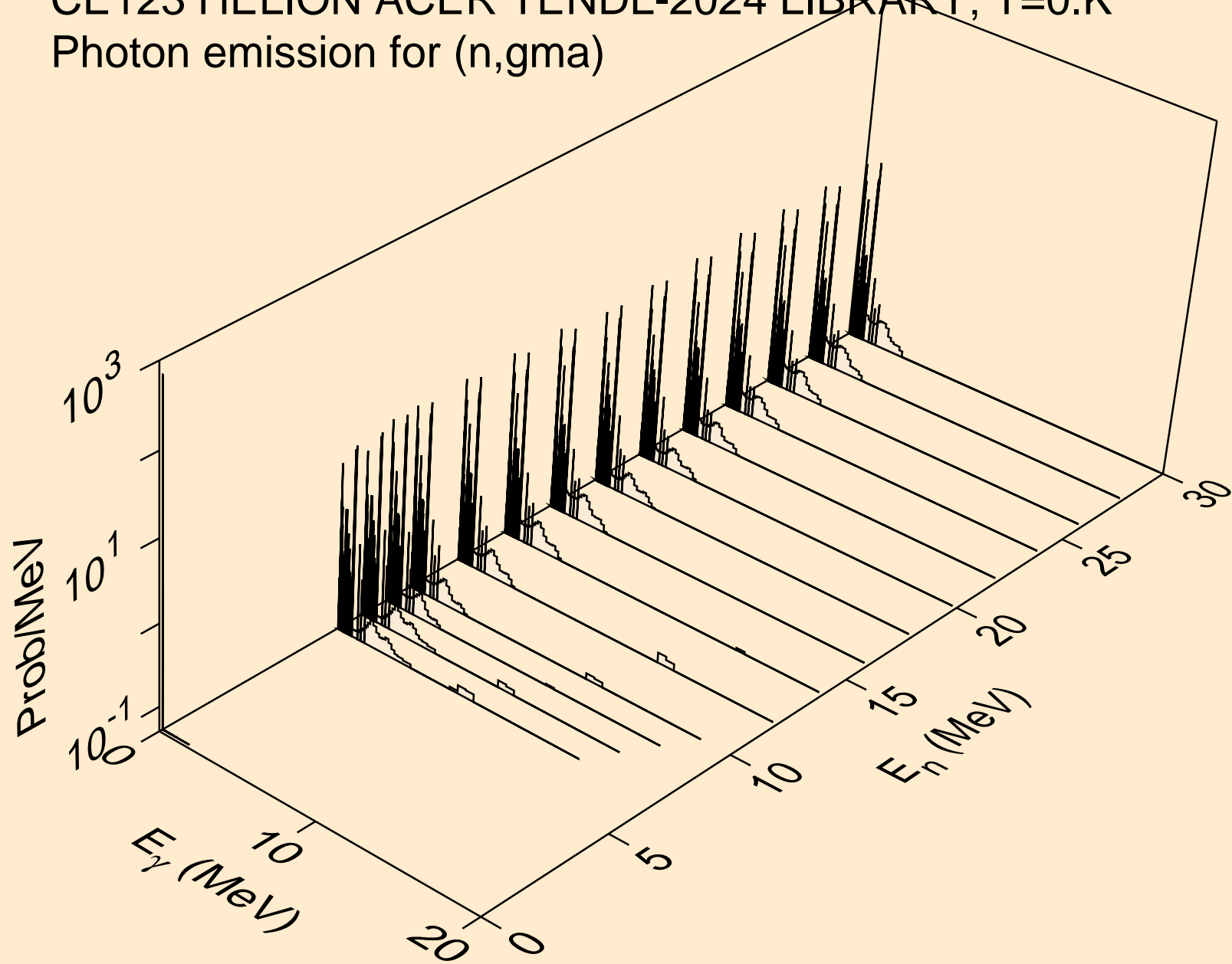

CE123 HELION ACER TENDL-2024 LIBRARY; T=0.K  
Photon emission for (n,p)

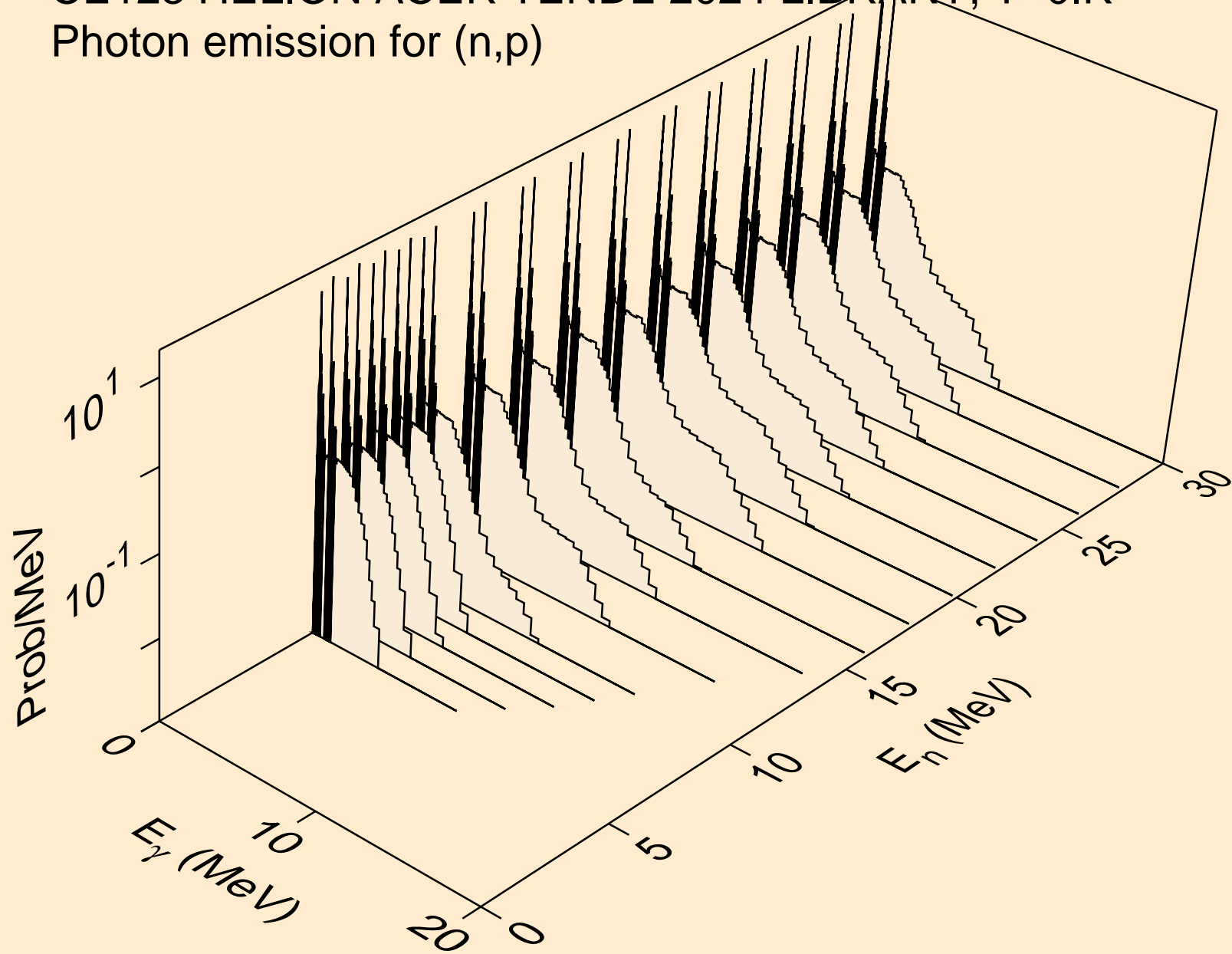

CE123 HELION ACER TENDL-2024 LIBRARY; T=0.K  
Photon emission for (n,d)

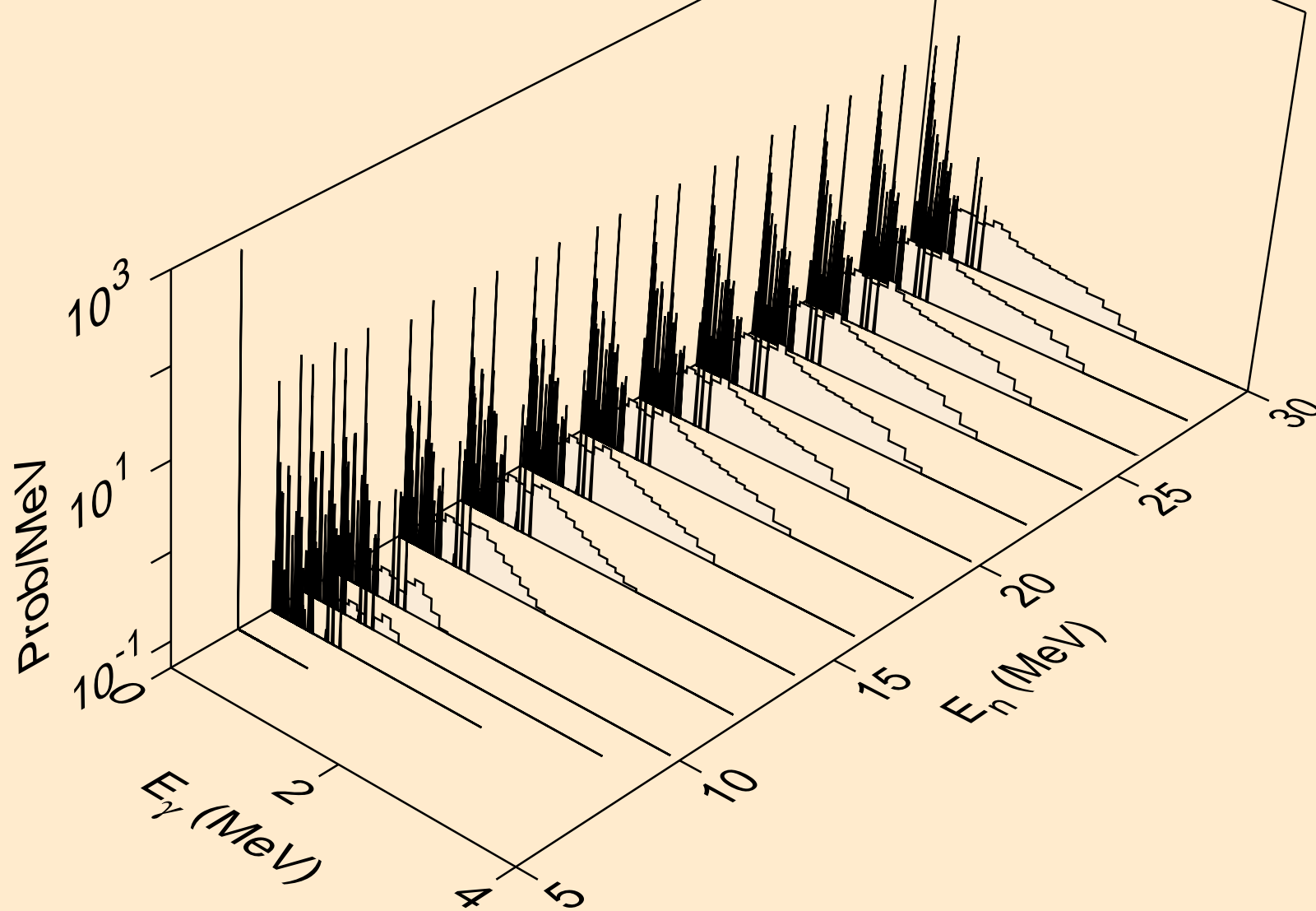

CE123 HELION ACER TENDL-2024 LIBRARY; T=0.K  
Photon emission for (n,t)

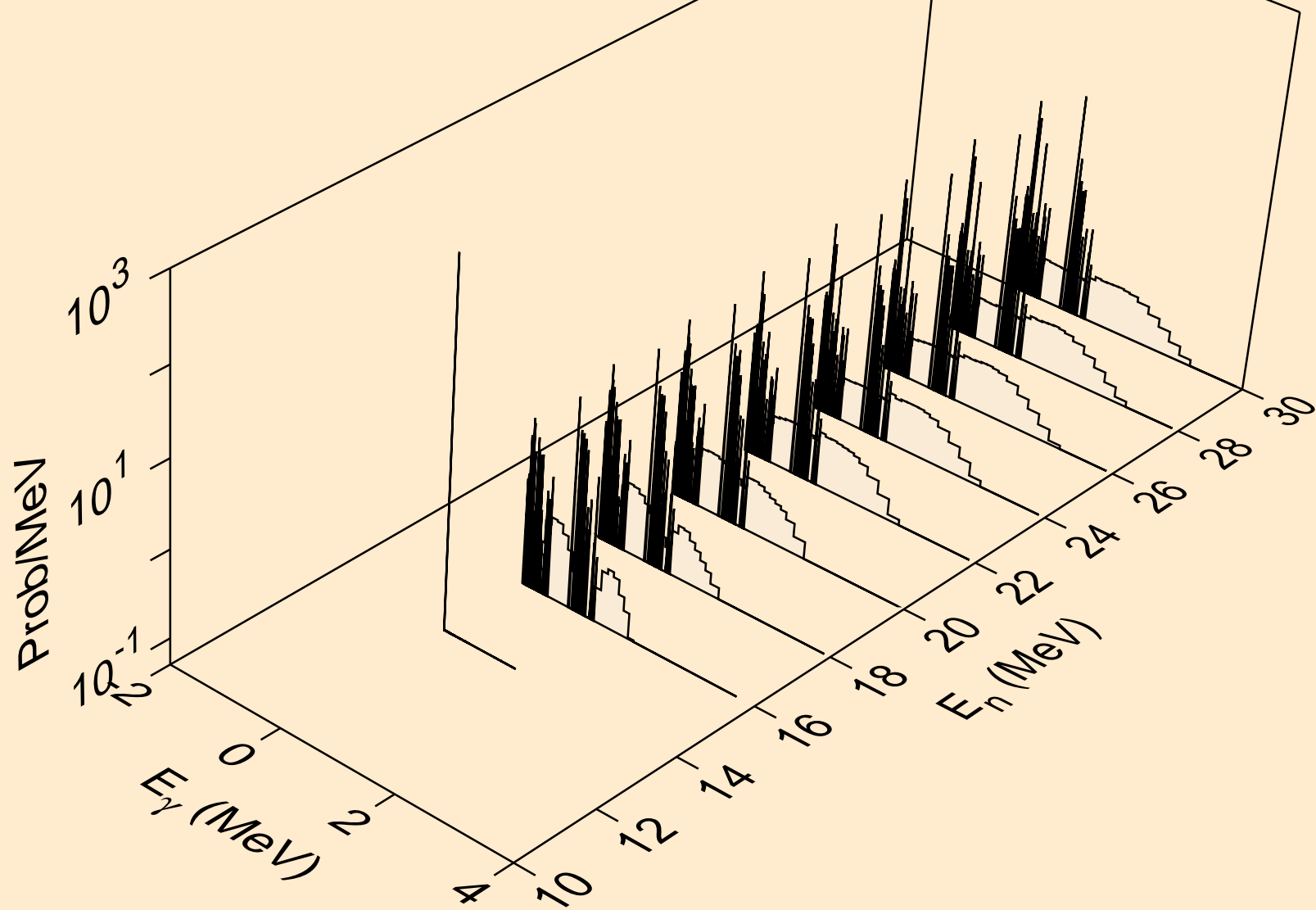

CE123 HELION ACER TENDL-2024 LIBRARY; T=0.K  
Photon emission for inelastic

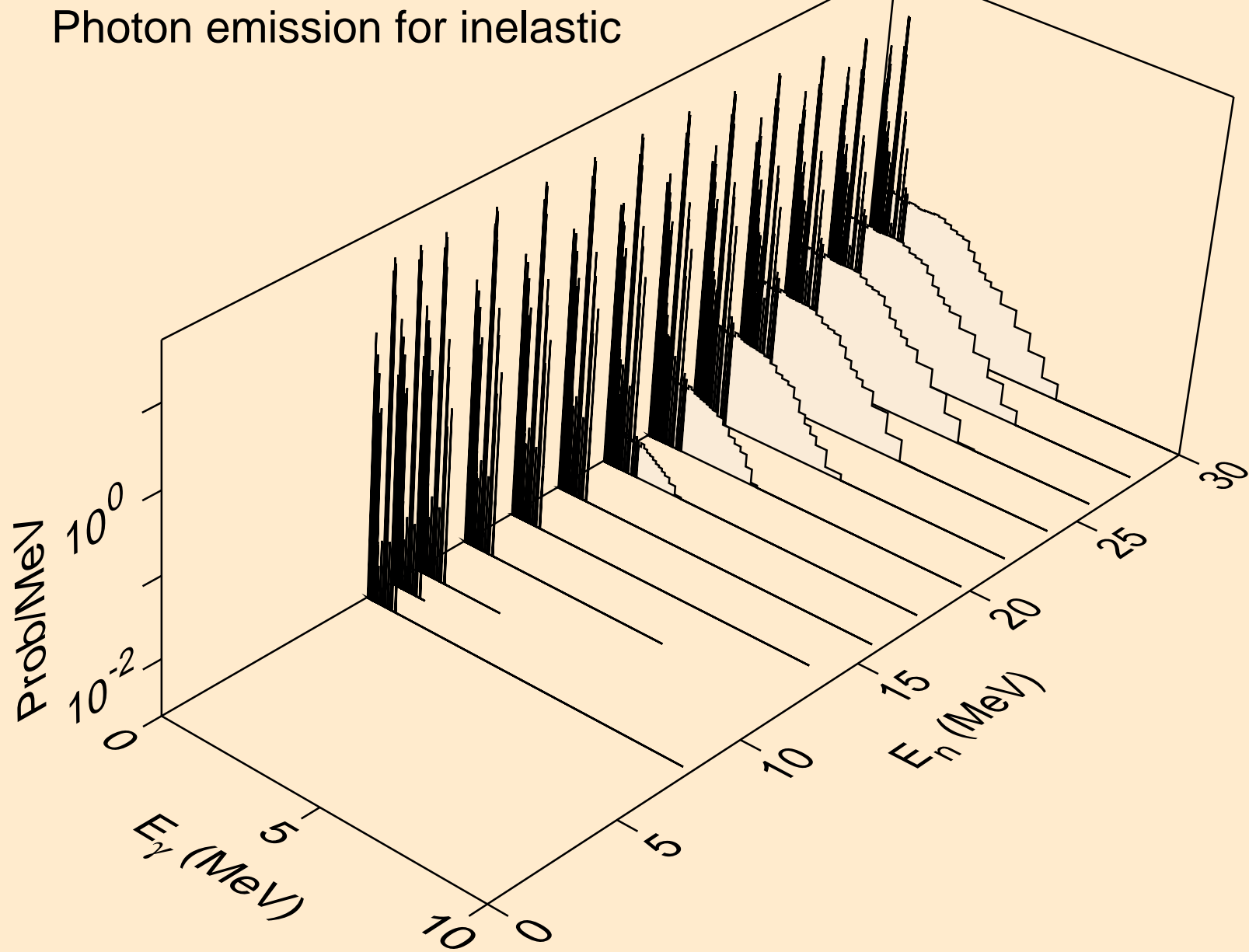

CE123 HELION ACER TENDL-2024 LIBRARY; T=0.K  
Photon emission for (n,a)

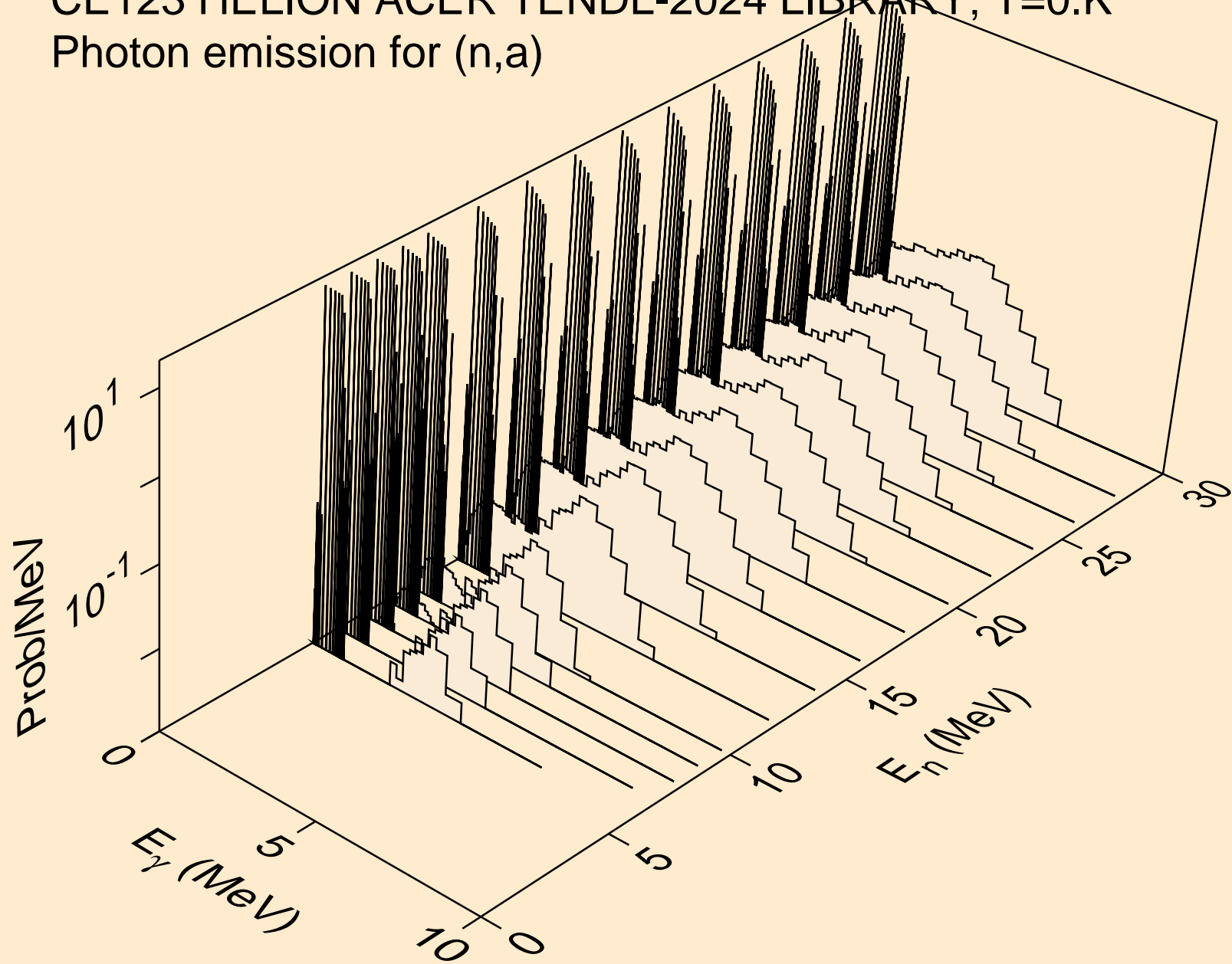

CE123 HELION ACER TENDL-2024 LIBRARY; T=0.K  
Photon emission for (n,2a)

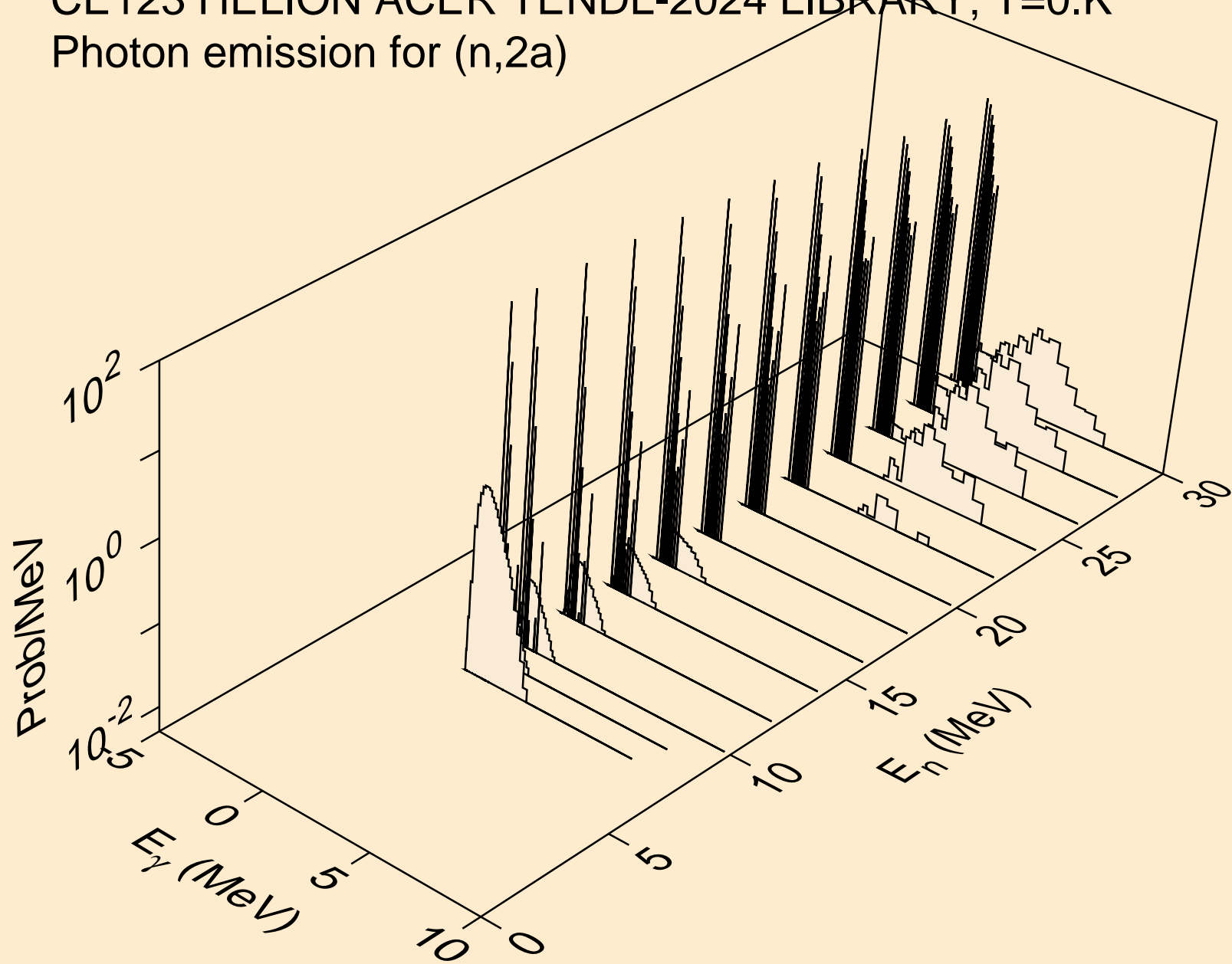

CE123 HELION ACER TENDL-2024 LIBRARY; T=0.K  
Photon emission for (n,3a)

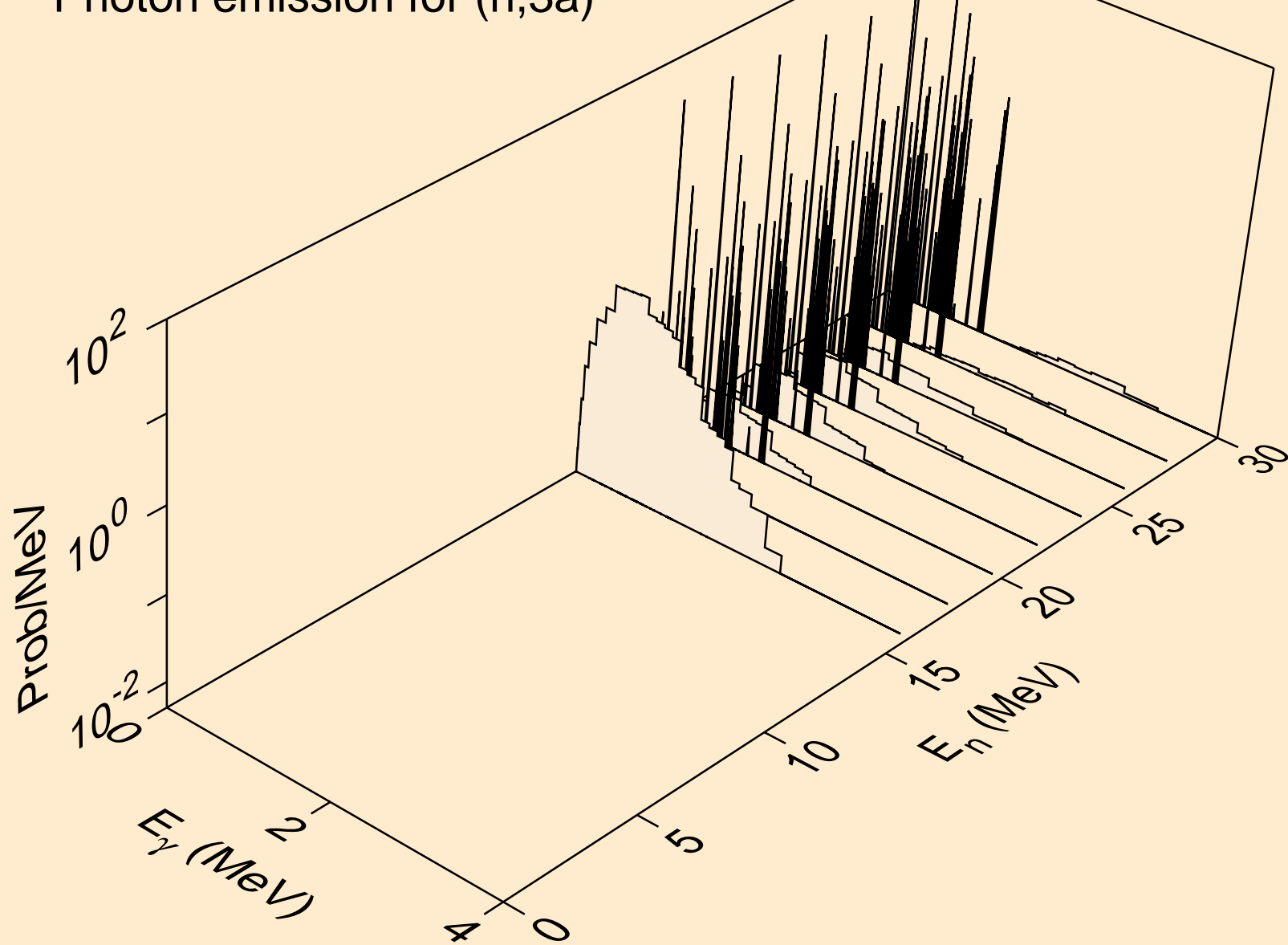

CE123 HELION ACER TENDL-2024 LIBRARY; T=0.K  
Photon emission for (n,2p)

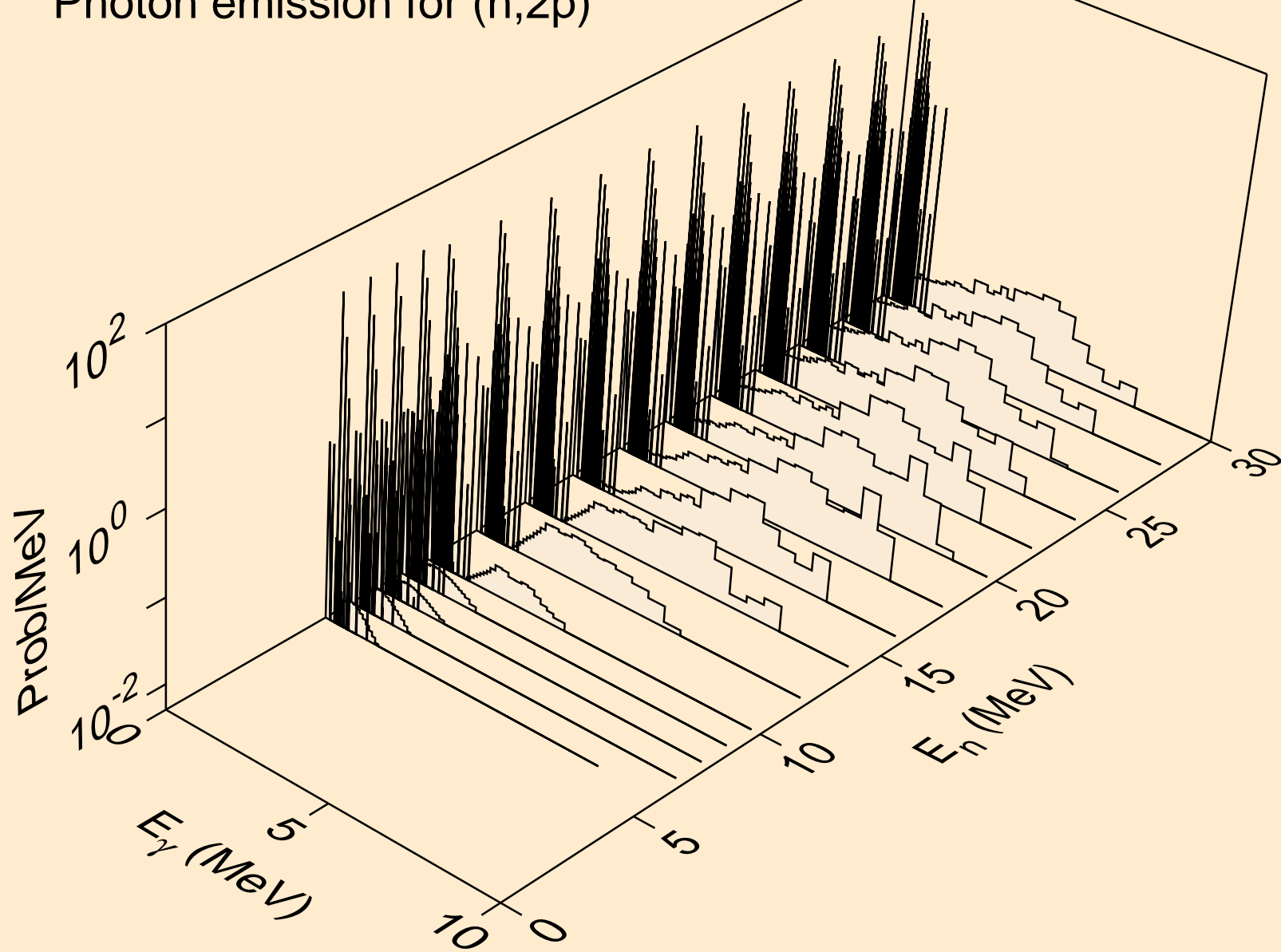

CE123 HELION ACER TENDL-2024 LIBRARY; T=0.K  
Photon emission for (n,pa)

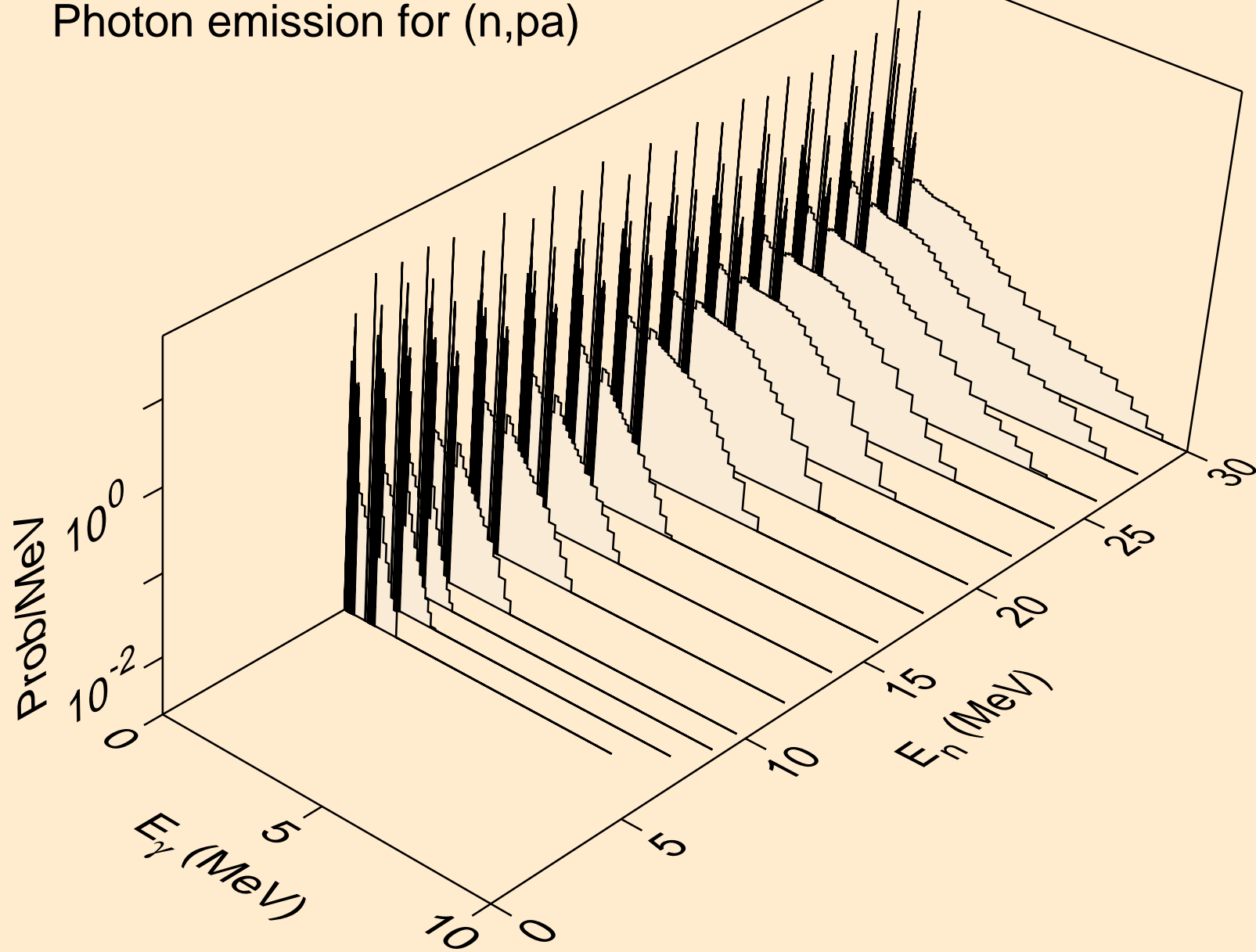

CE123 HELION ACER TENDL-2024 LIBRARY; T=0.K  
Photon emission for (n,pd)

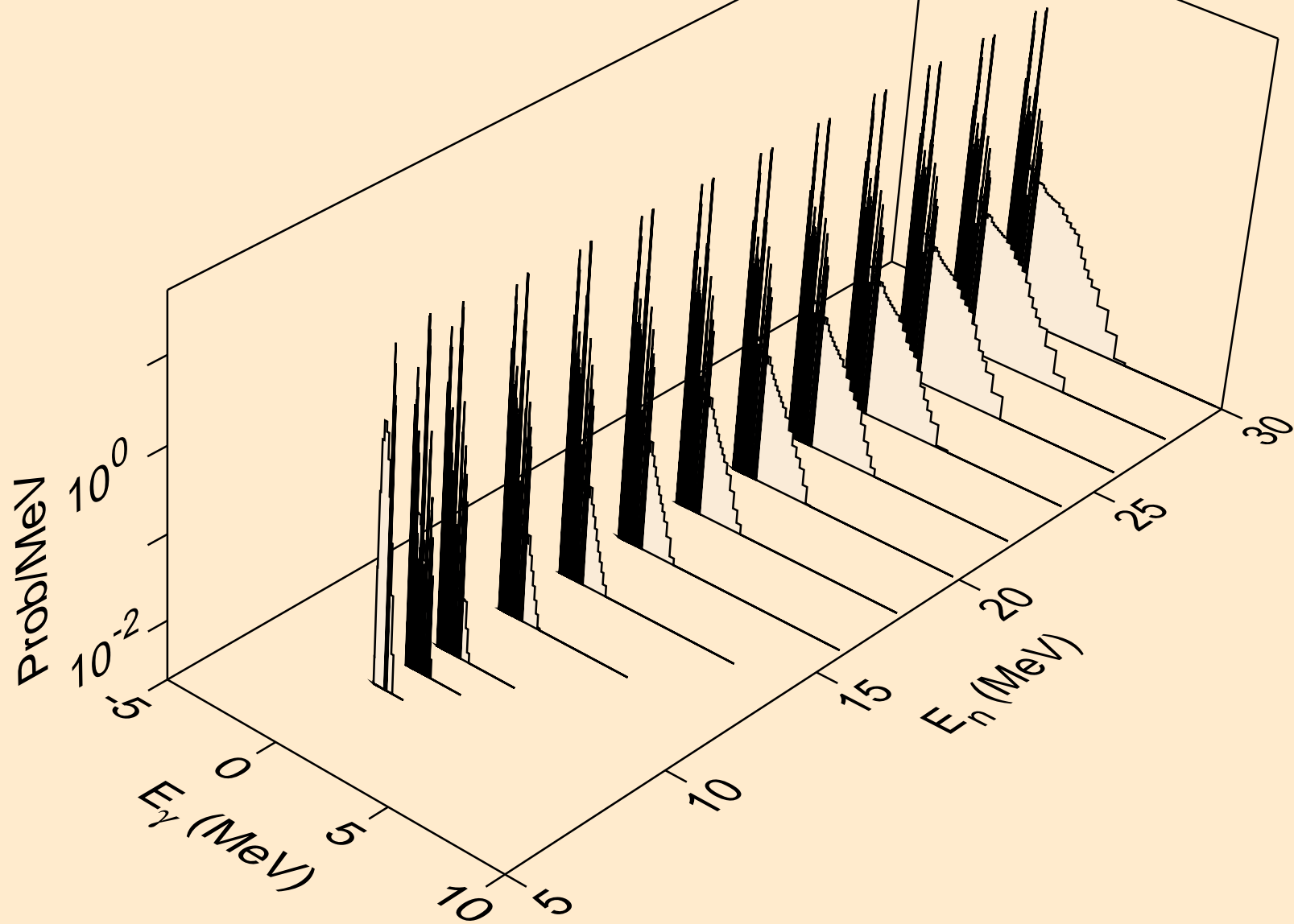

CE123 HELION ACER TENDL-2024 LIBRARY; T=0.K  
Photon emission for (n,pt)

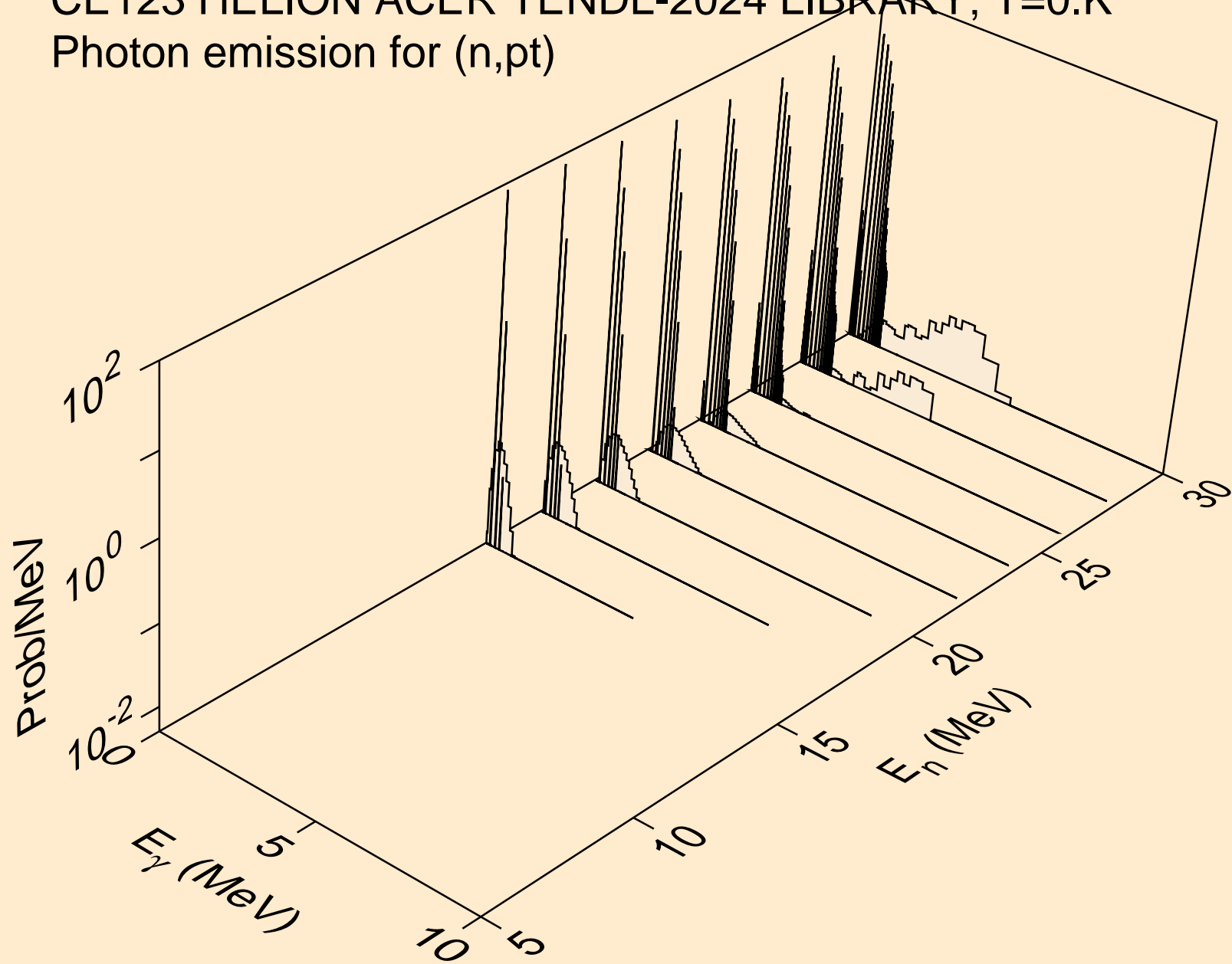

CE123 HELION ACER TENDL-2024 LIBRARY; T=0.K  
Photon emission for (n,da)

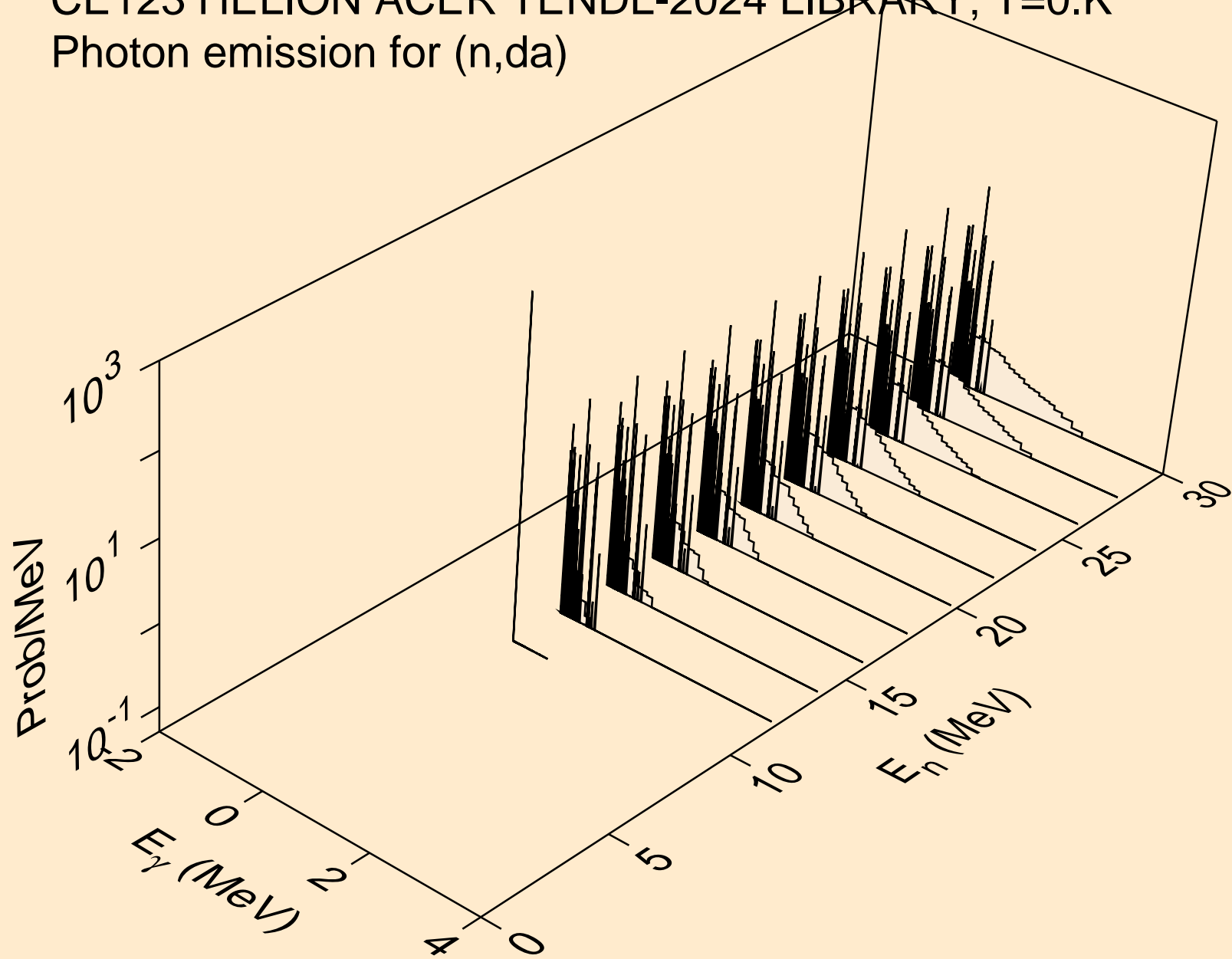

# CE123 HELION ACER TENDL-2024 LIBRARY; T=0.K

## Particle heating contributions

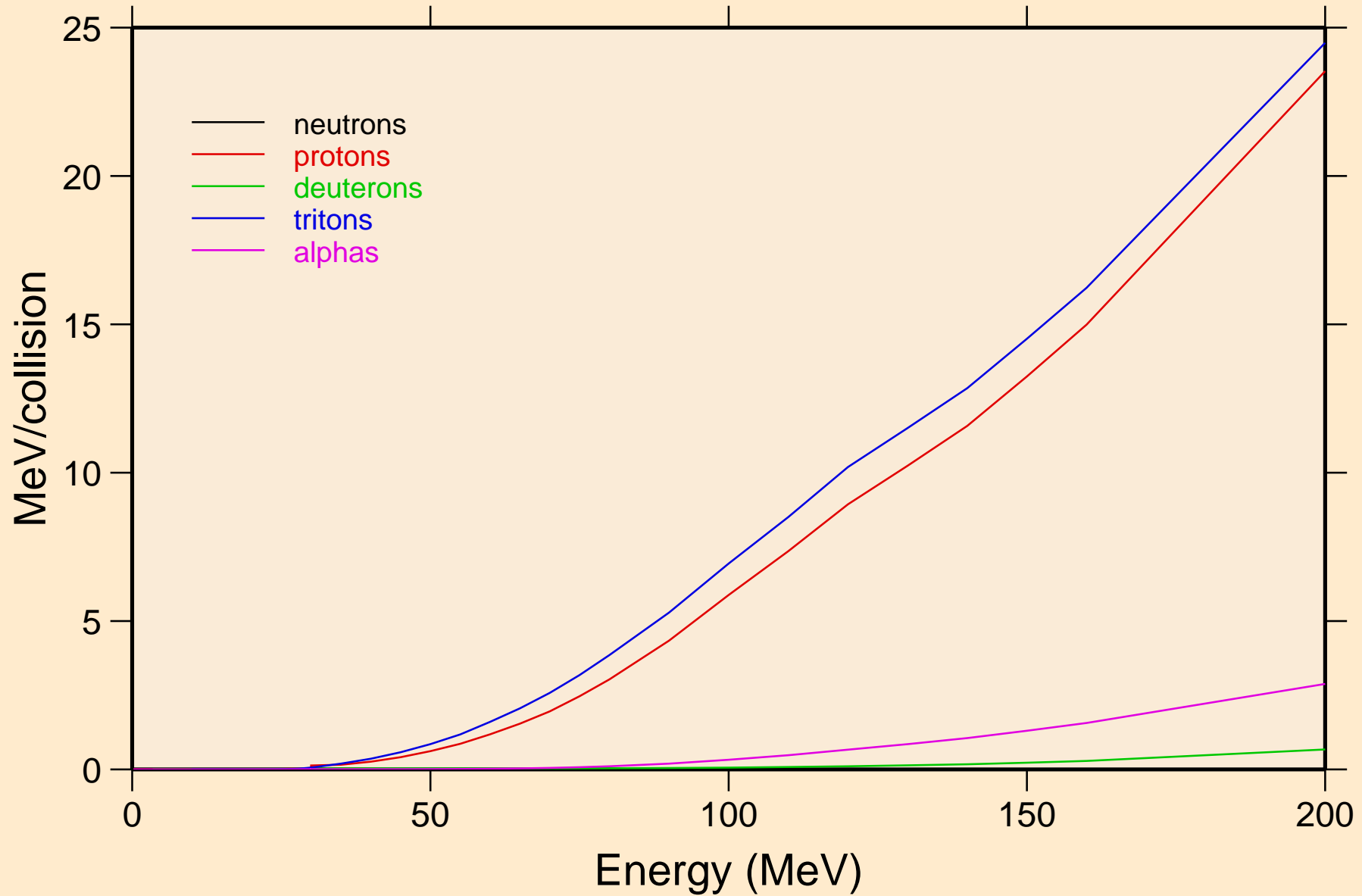

CE123 HELION ACER TENDL-2024 LIBRARY; T=0.K  
Recoil Heating

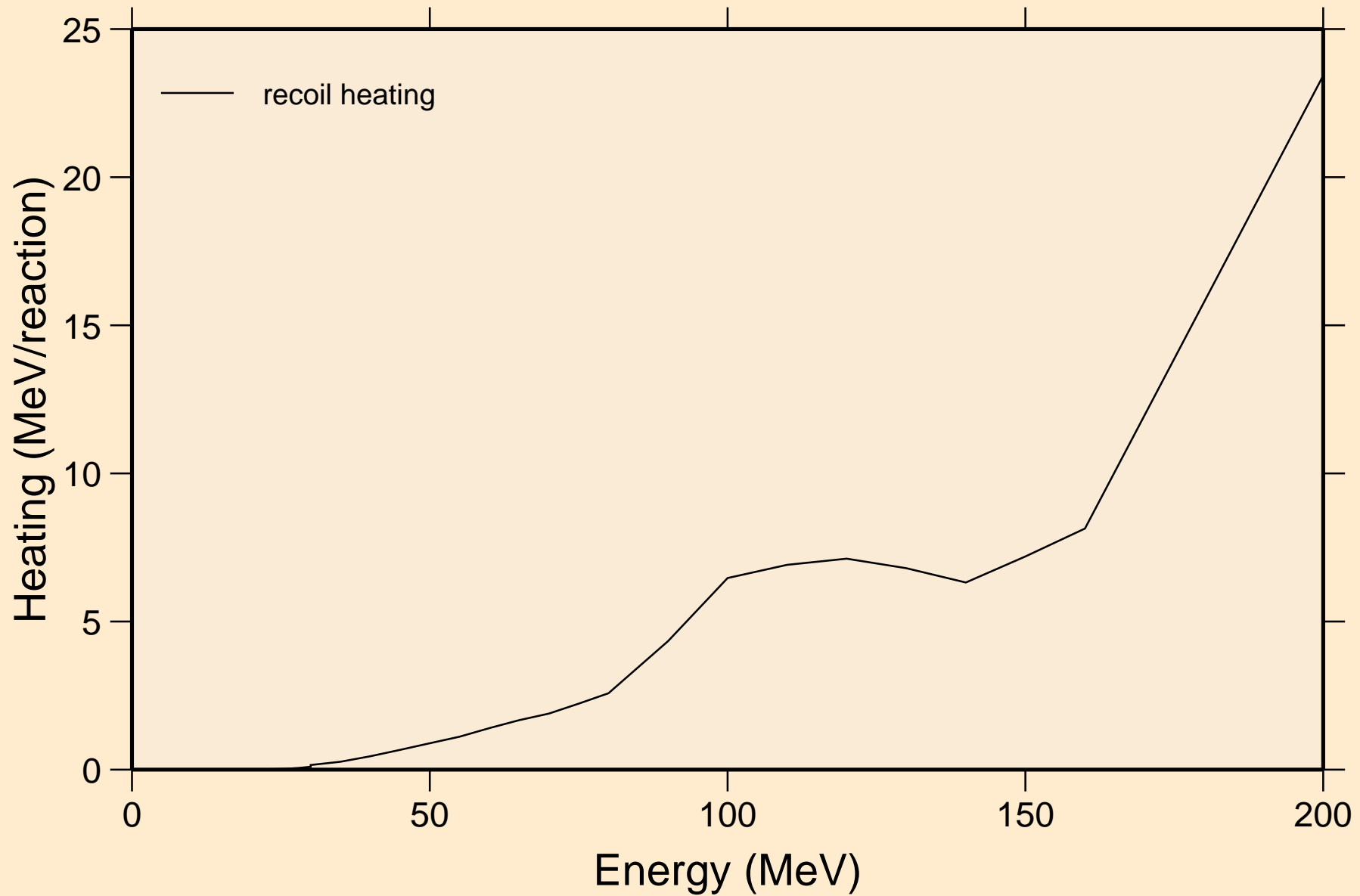

CE123 HELION ACER TENDL-2024 LIBRARY; T=0.K  
Particle production cross sections

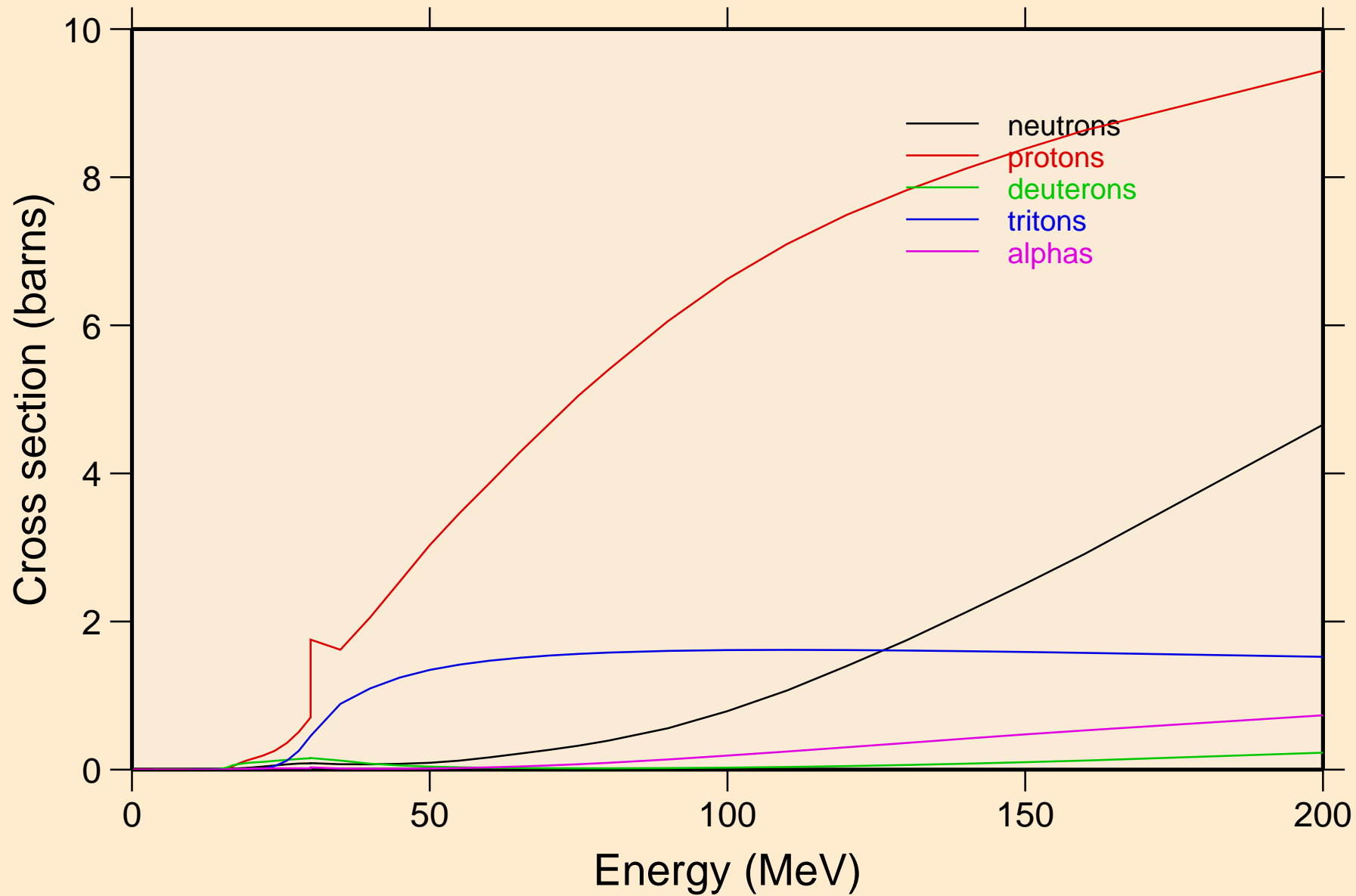

CE123 HELION ACER TENDL-2024 LIBRARY; T=0.K  
neutrons from (s,n)

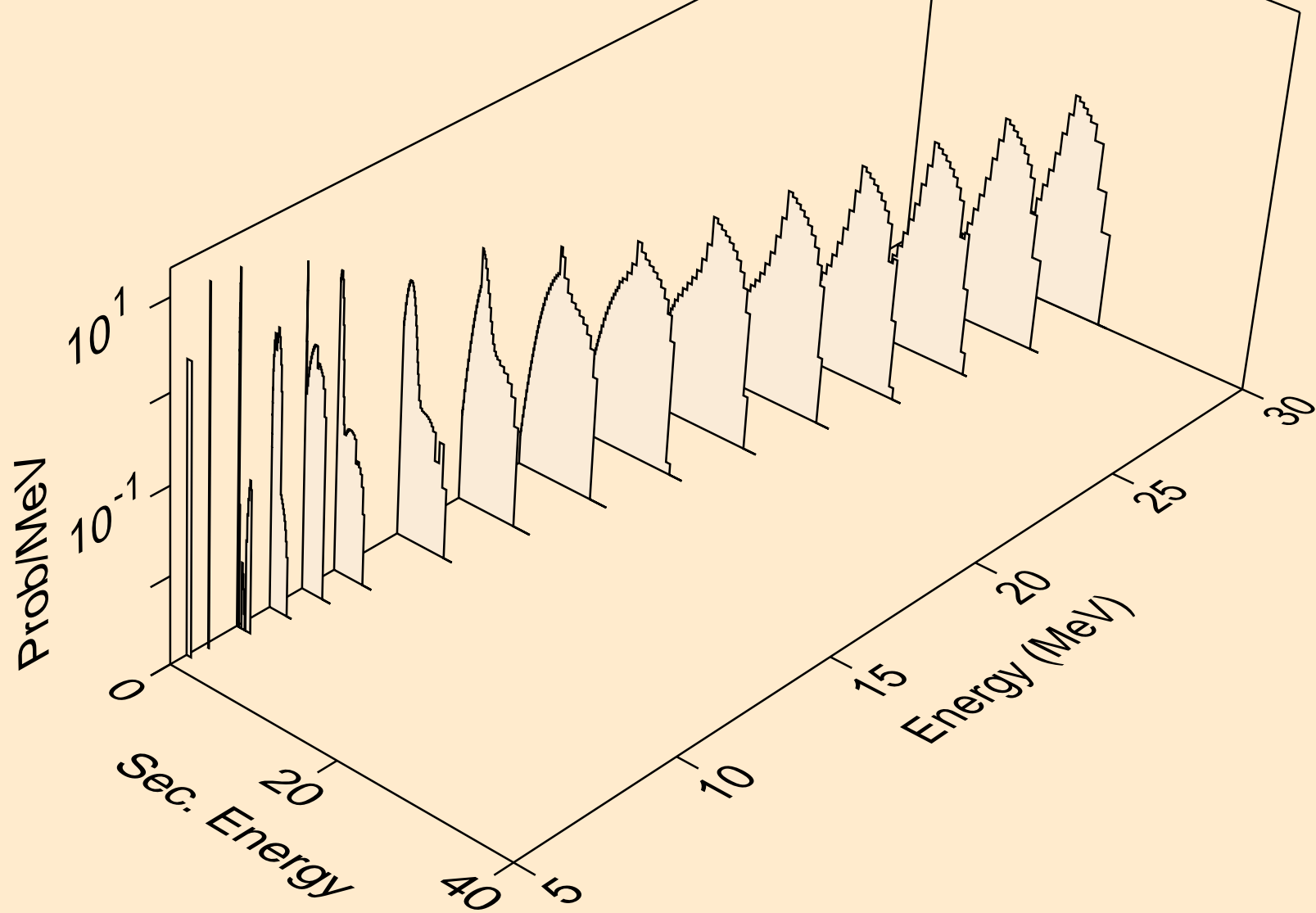

CE123 HELION ACER TENDL-2024 LIBRARY; T=0.K  
neutrons from (s,x)

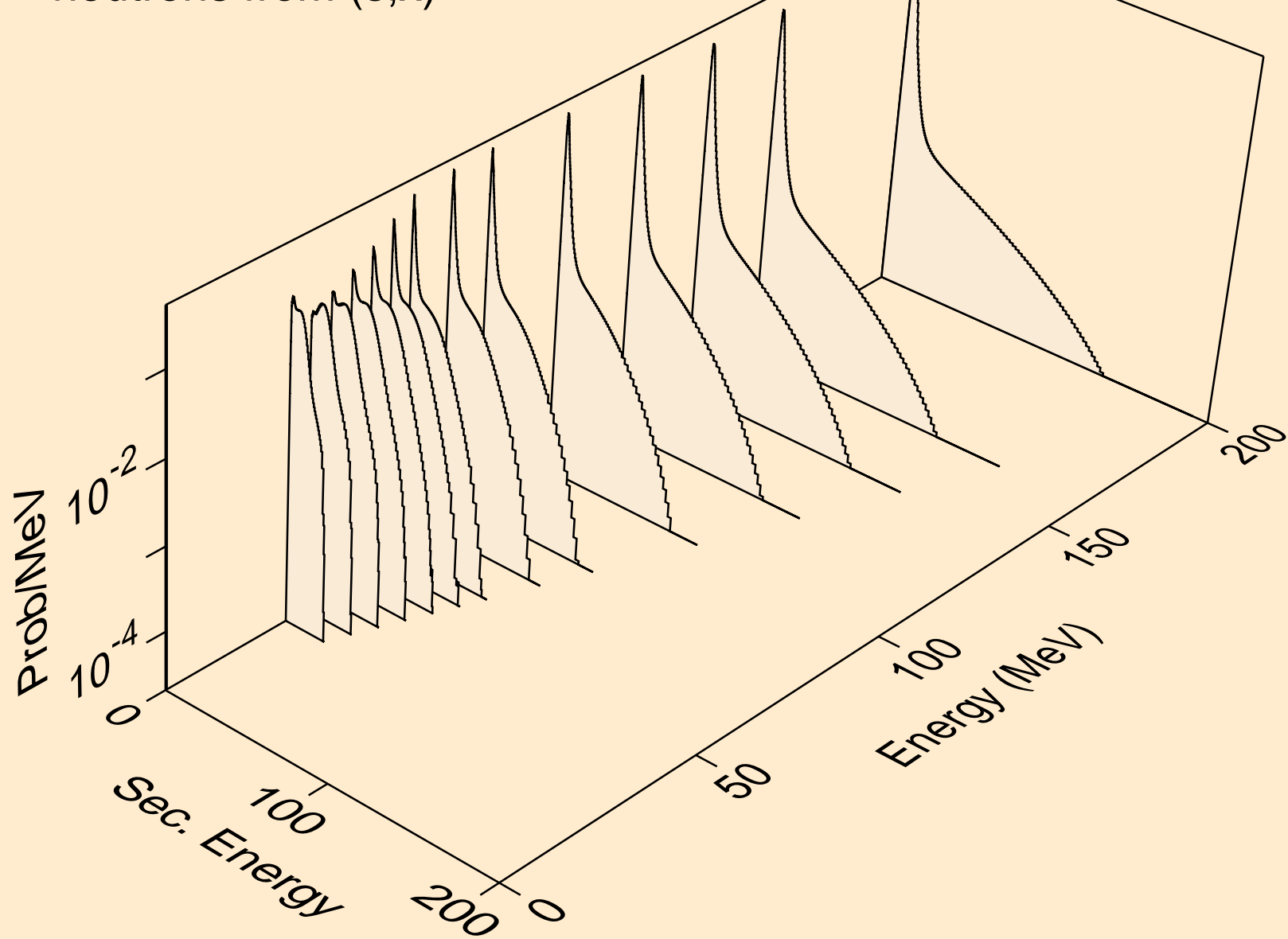

CE123 HELION ACER TENDL-2024 LIBRARY; T=0.K  
neutrons from (s,2n)

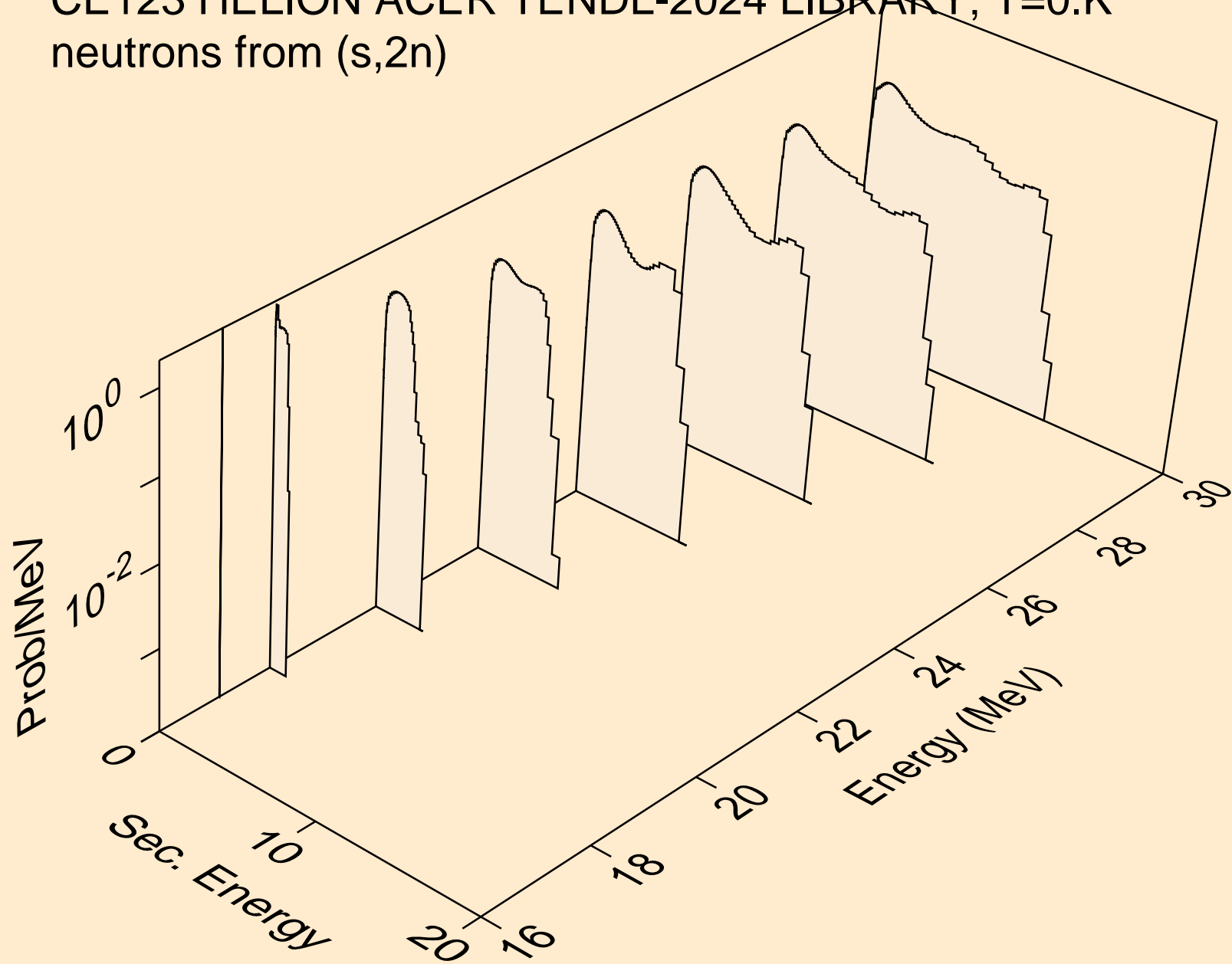

CE123 HELION ACER TENDL-2024 LIBRARY; T=0.K  
neutrons from (s,n\*)a

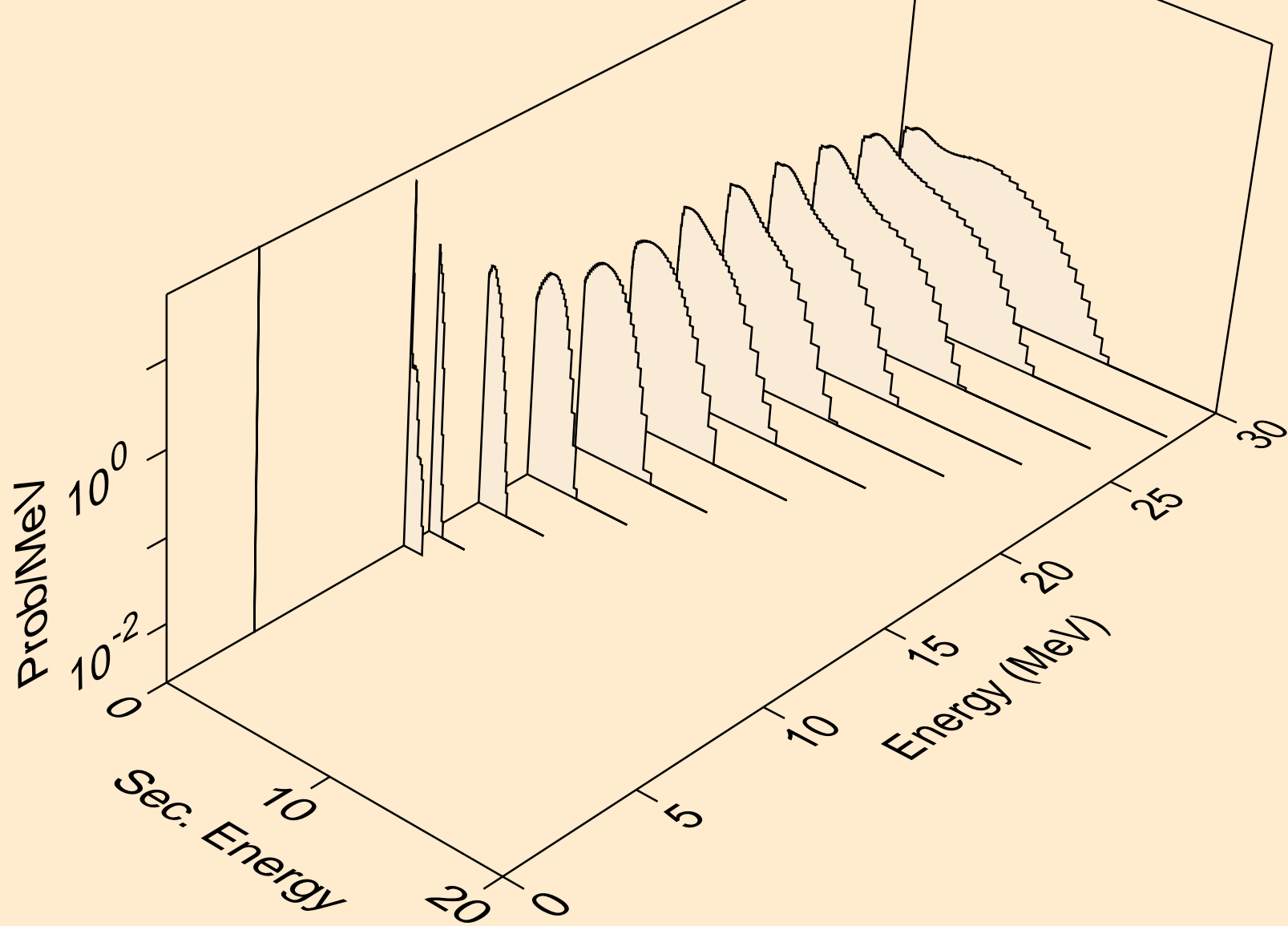

CE123 HELION ACER TENDL-2024 LIBRARY; T=0.K  
neutrons from (s,2n)a

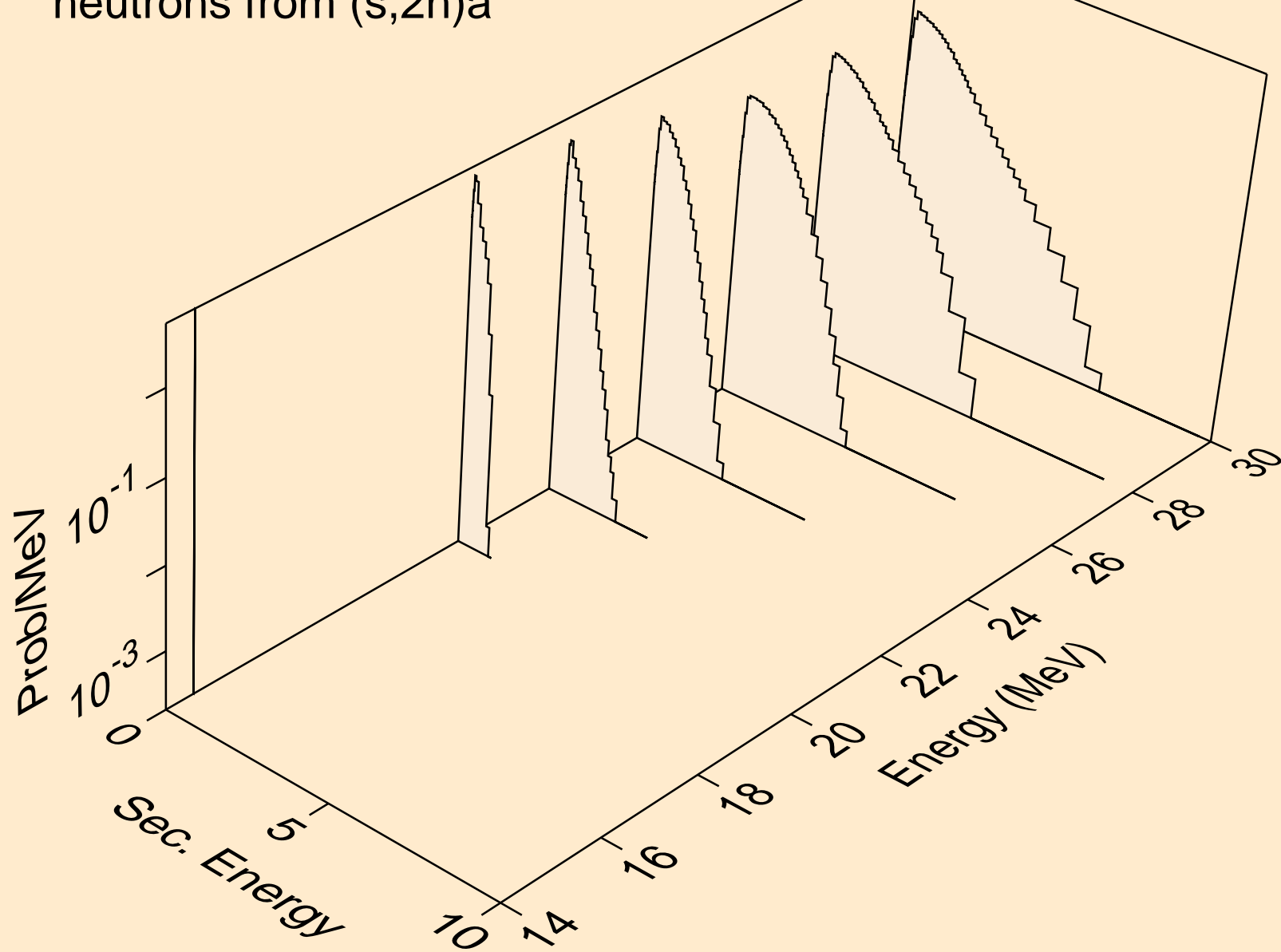

CE123 HELION ACER TENDL-2024 LIBRARY; T=0.K  
neutrons from (s,n\*)p

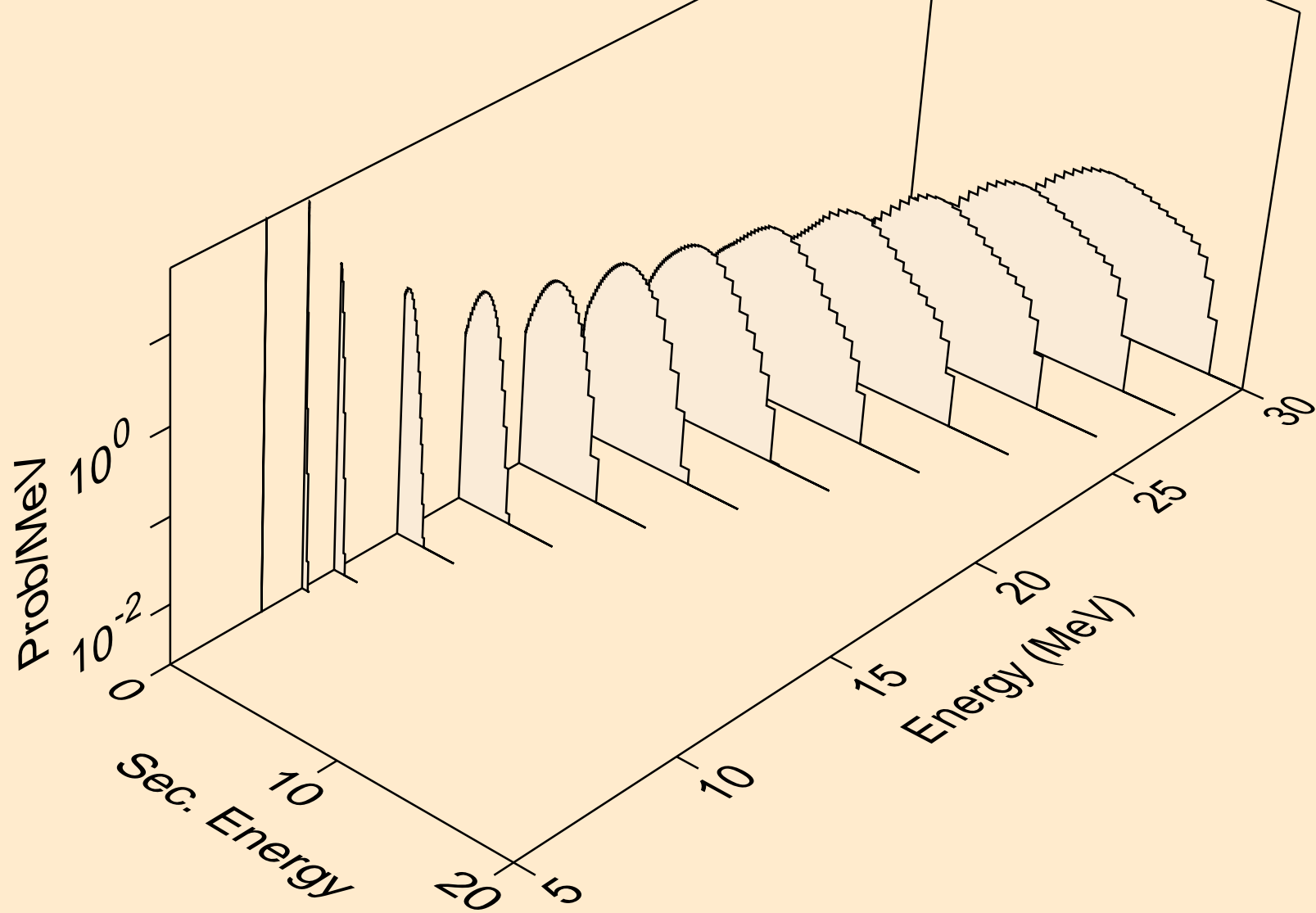

CE123 HELION ACER TENDL-2024 LIBRARY; T=0.K  
neutrons from (s,n\*)2a

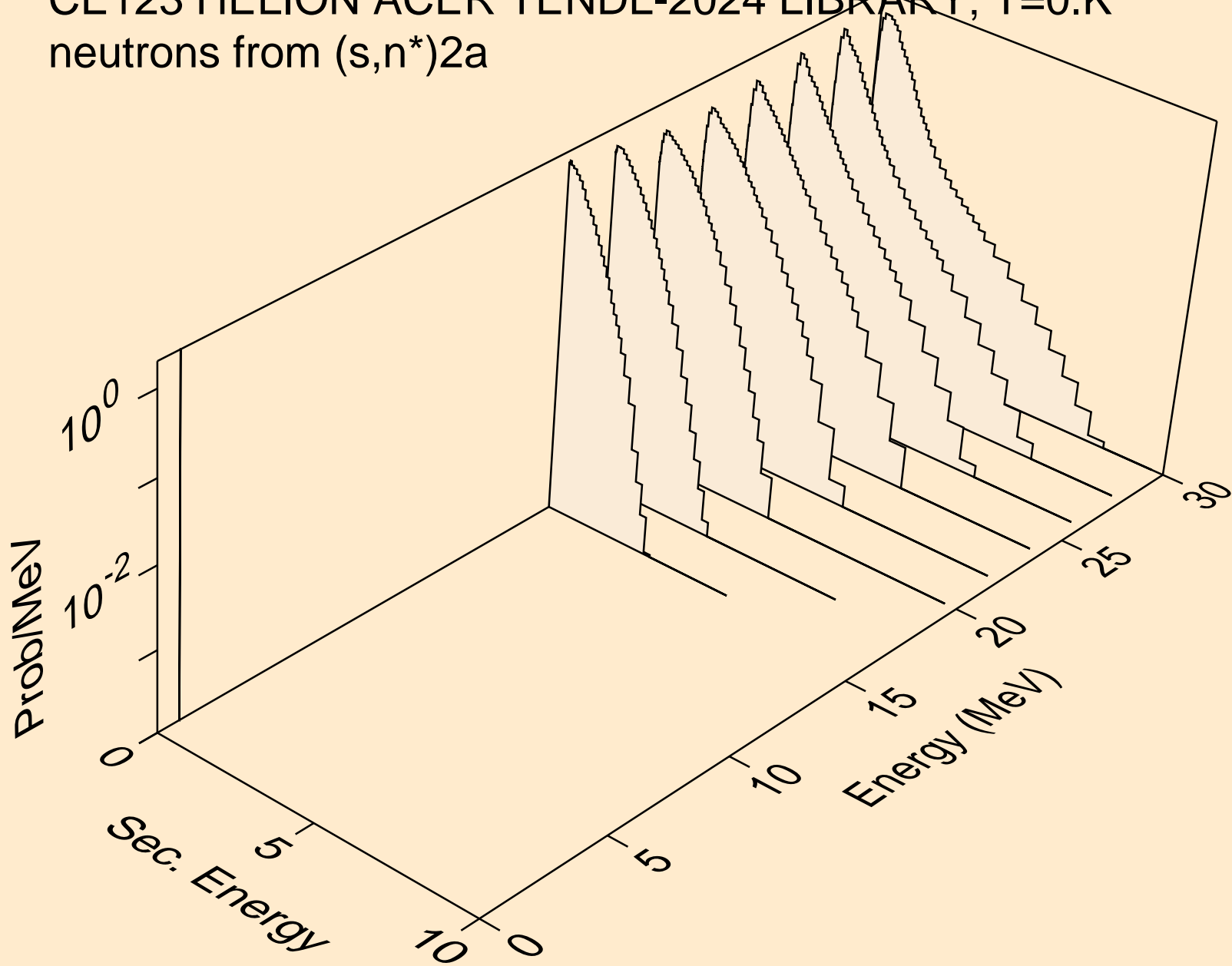

CE123 HELION ACER TENDL-2024 LIBRARY; T=0.K  
neutrons from (s,n\*)d

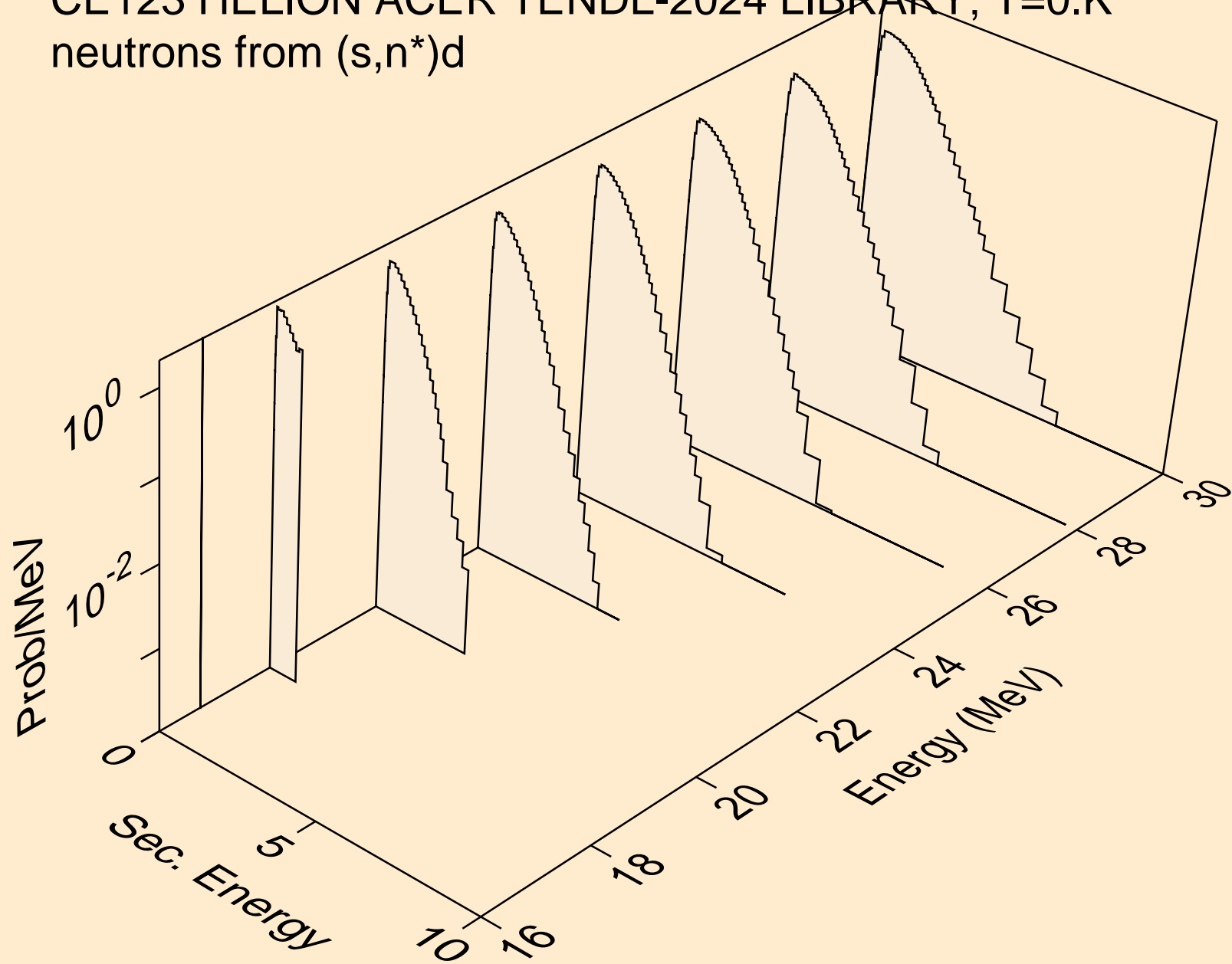

CE123 HELION ACER TENDL-2024 LIBRARY; T=0.K  
neutrons from (s,n\*)he3

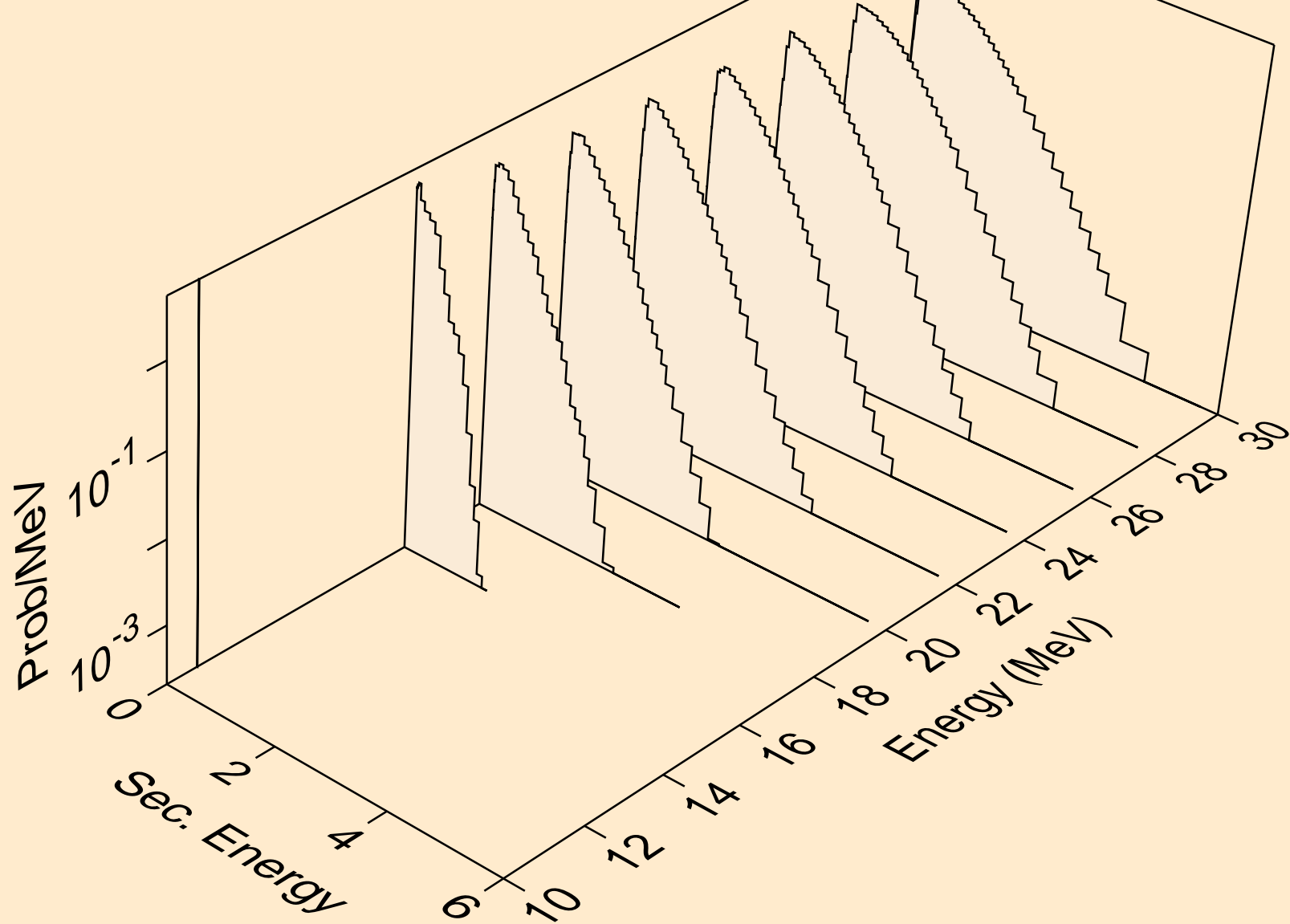

CE123 HELION ACER TENDL-2024 LIBRARY; T=0.K  
neutrons from (s,2np)

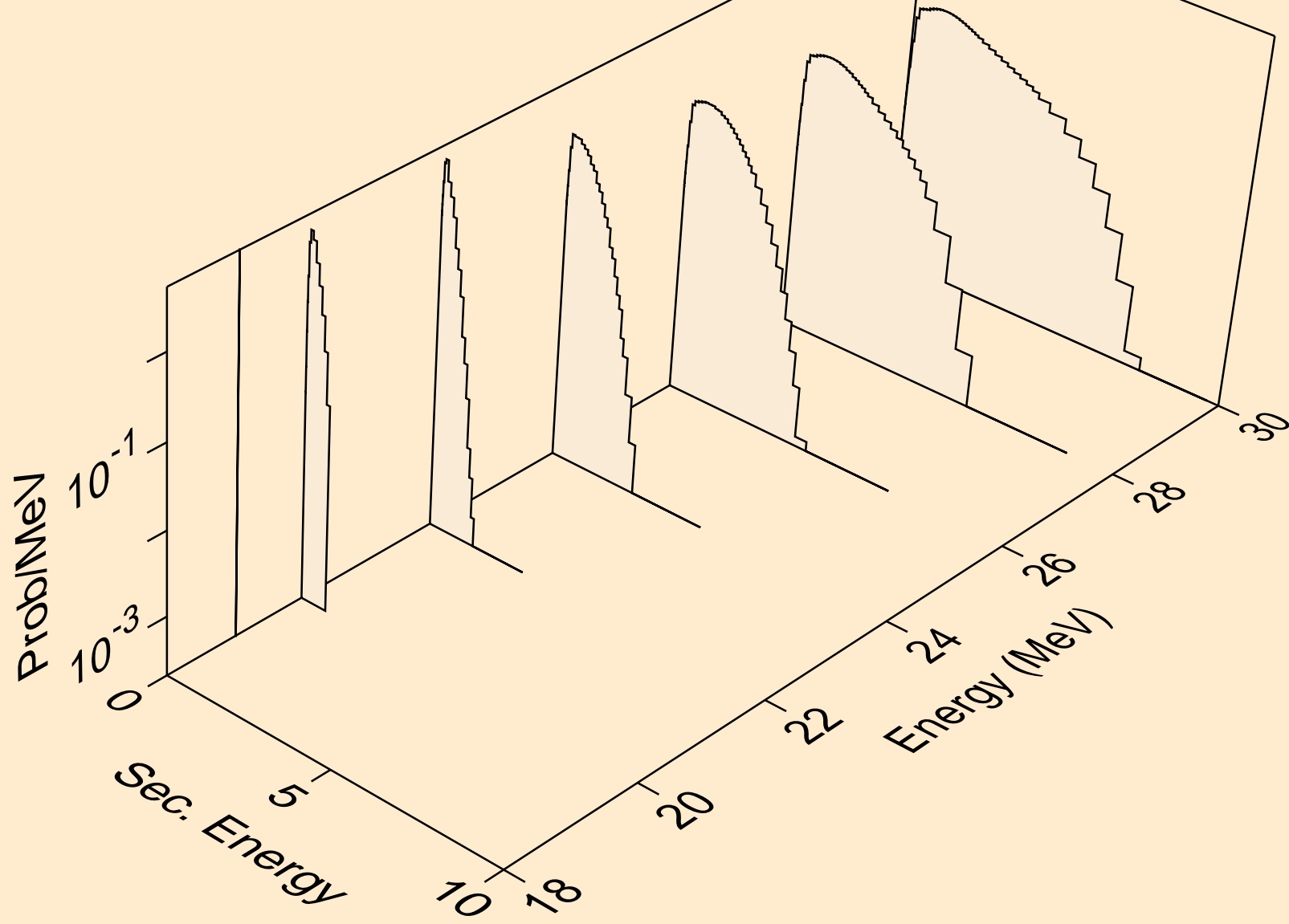

CE123 HELION ACER TENDL-2024 LIBRARY; T=0.K  
neutrons from (s,n2p)

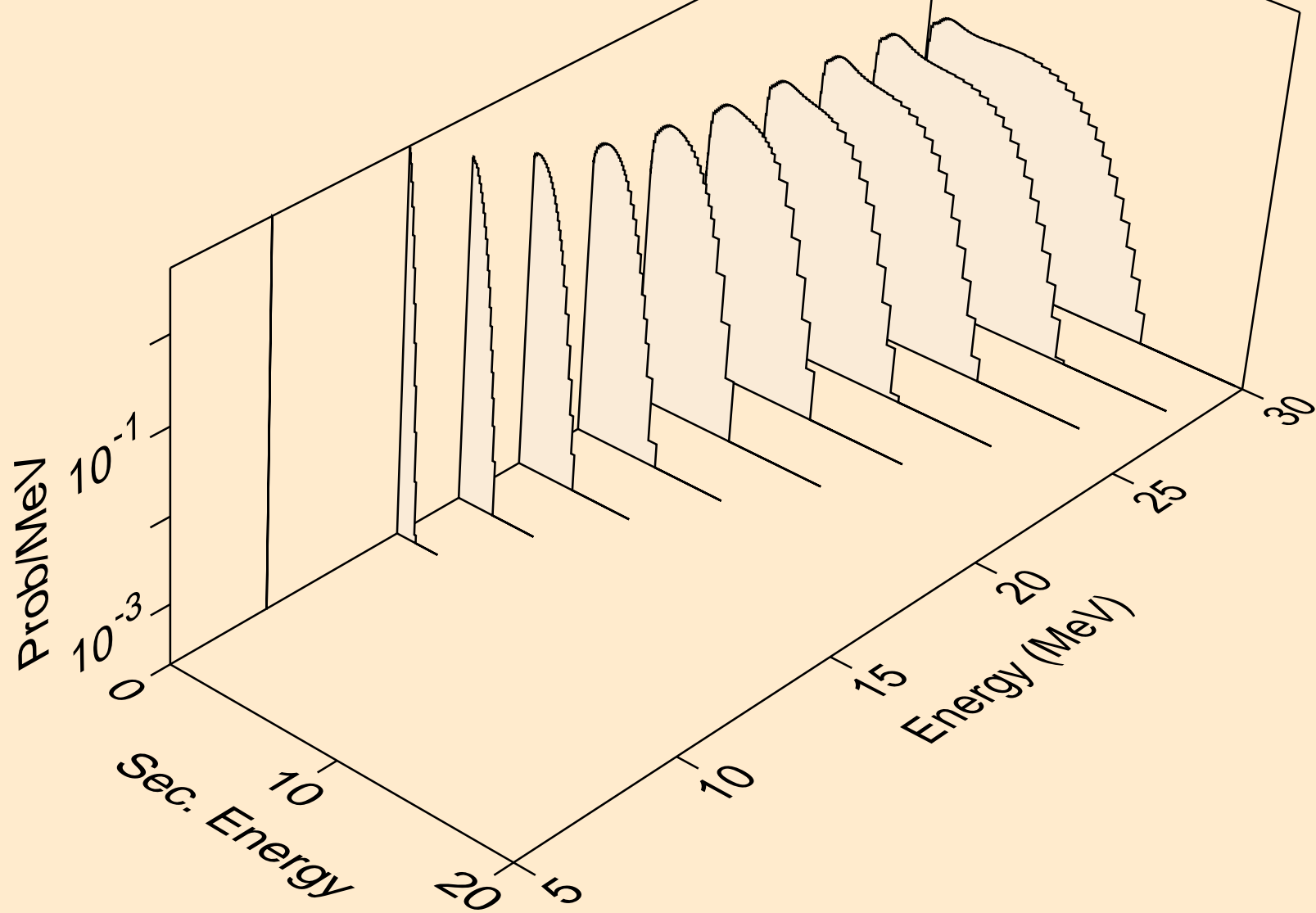

CE123 HELION ACER TENDL-2024 LIBRARY; T=0.K  
neutrons from (s,npa)

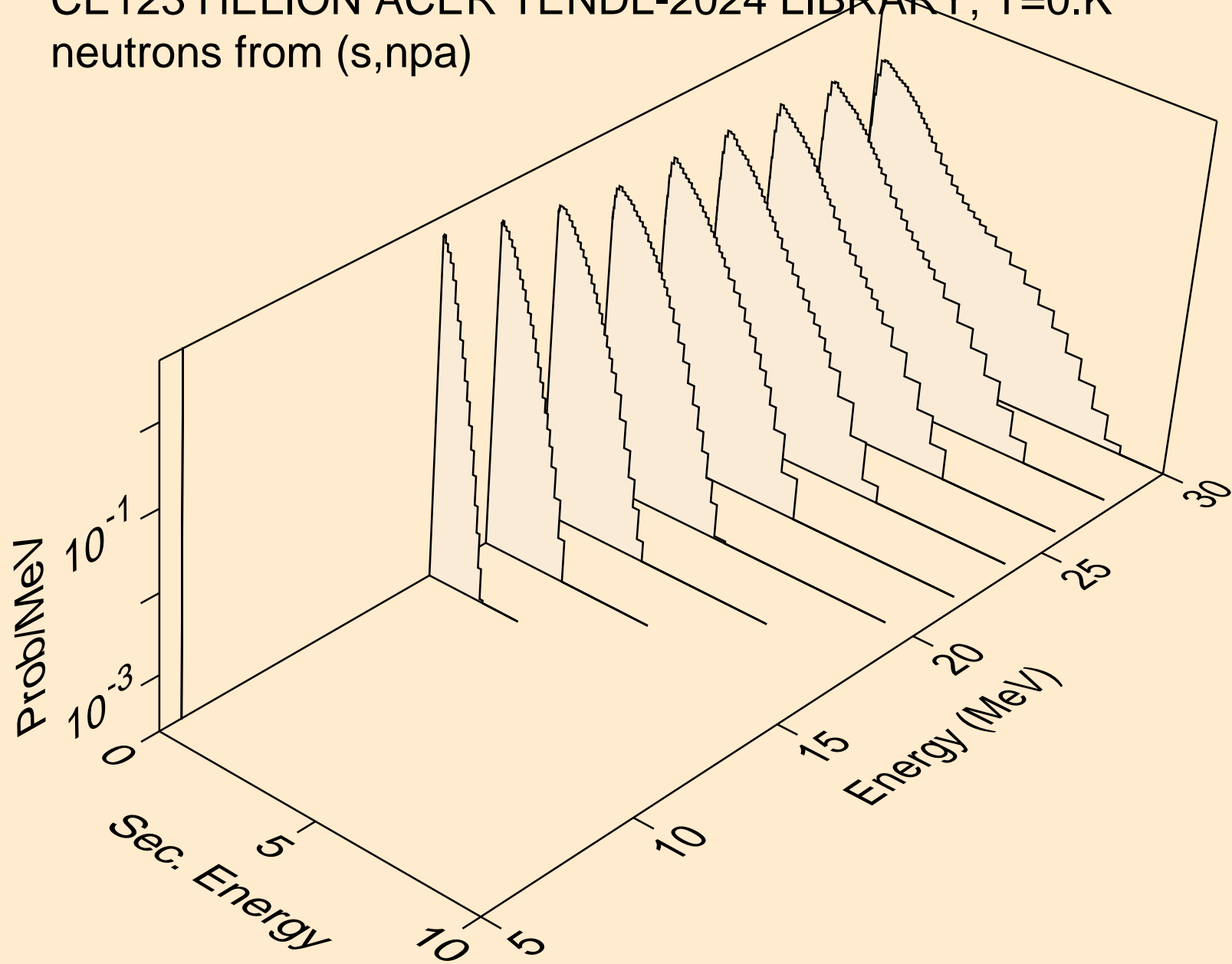

CE123 HELION ACER TENDL-2024 LIBRARY; T=0.K  
protons from (s,x)

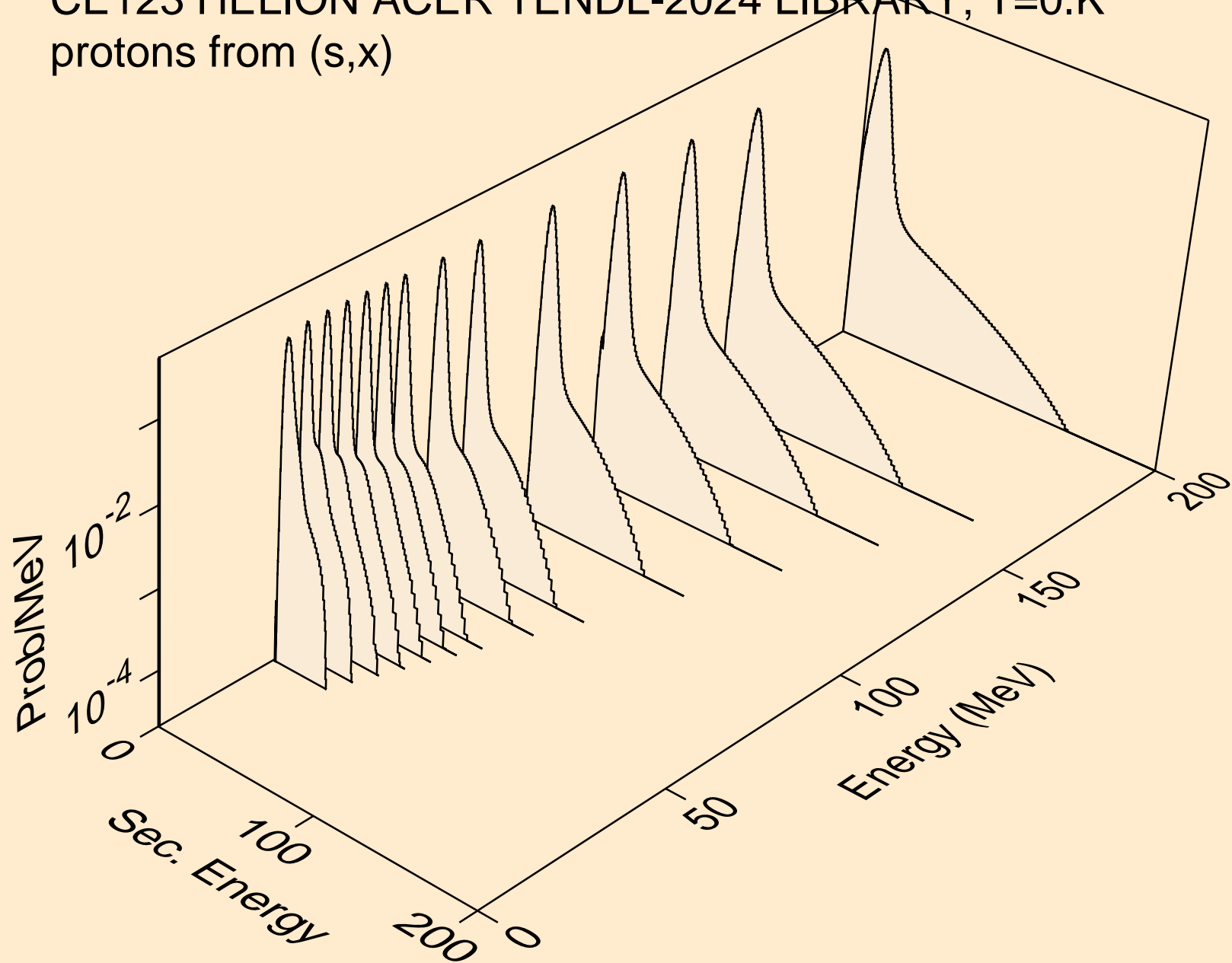

CE123 HELION ACER TENDL-2024 LIBRARY; T=0.K  
protons from (s,n\*)p

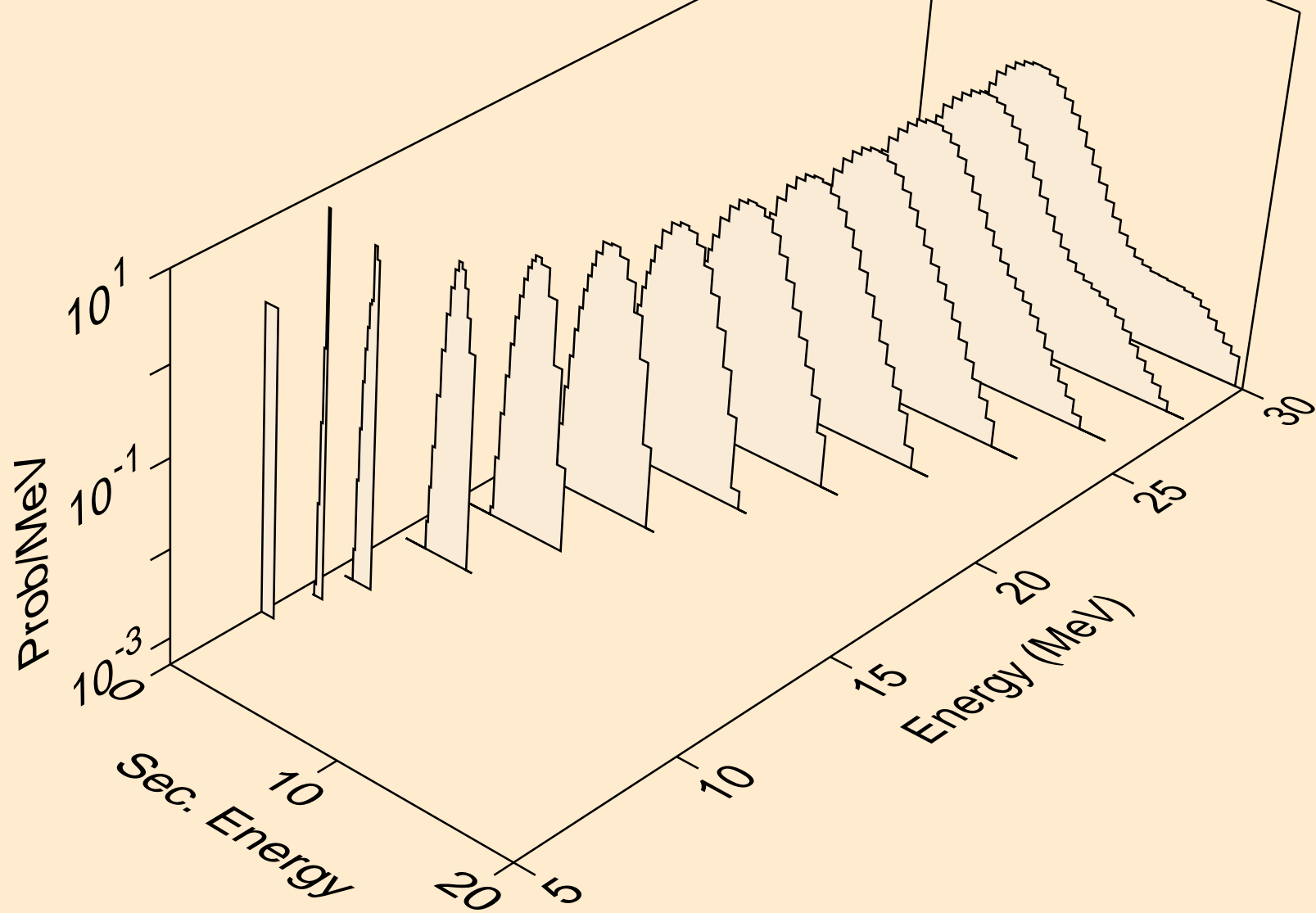

CE123 HELION ACER TENDL-2024 LIBRARY; T=0.K  
protons from (s,2np)

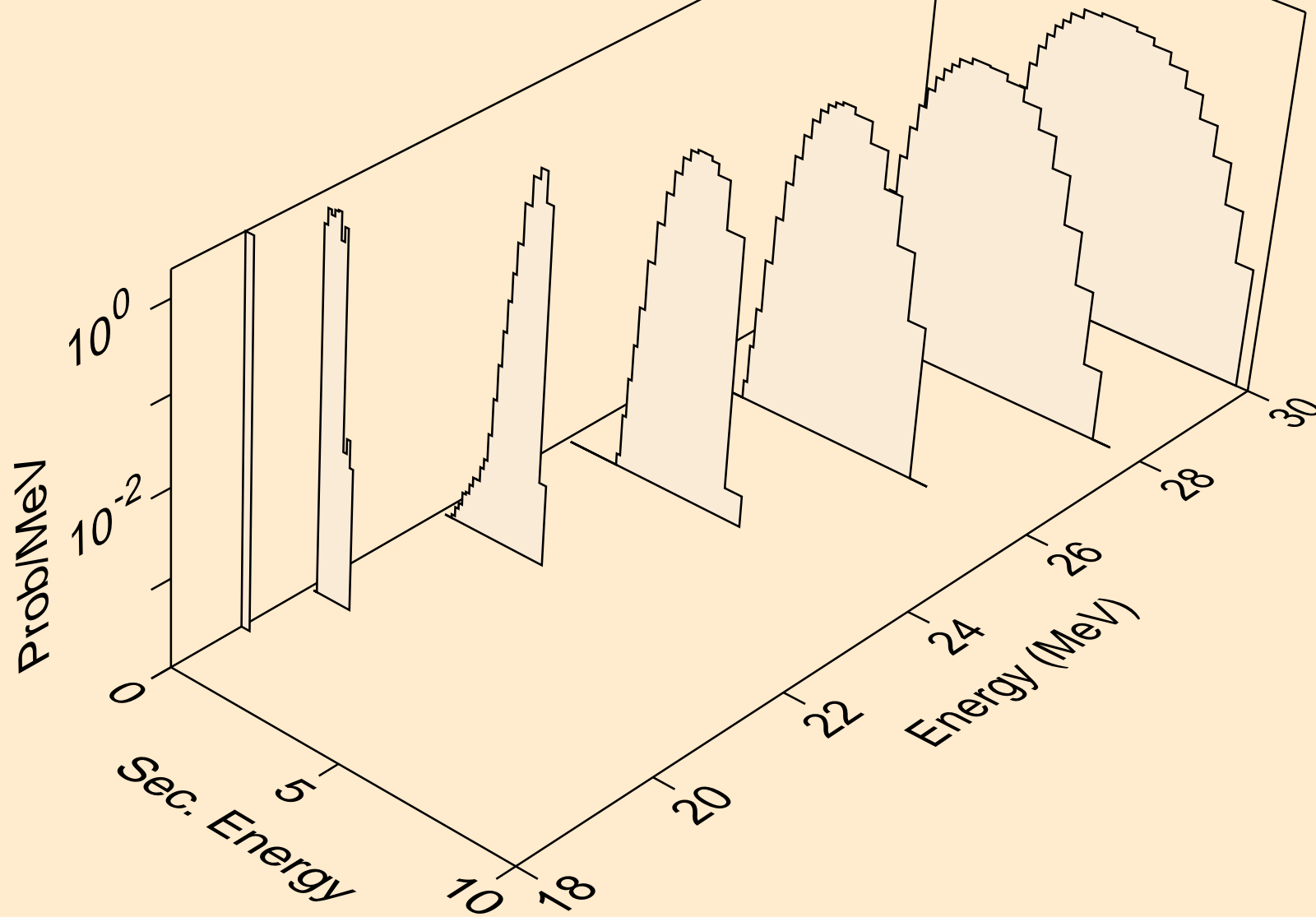

CE123 HELION ACER TENDL-2024 LIBRARY; T=0.K  
protons from (s,n2p)

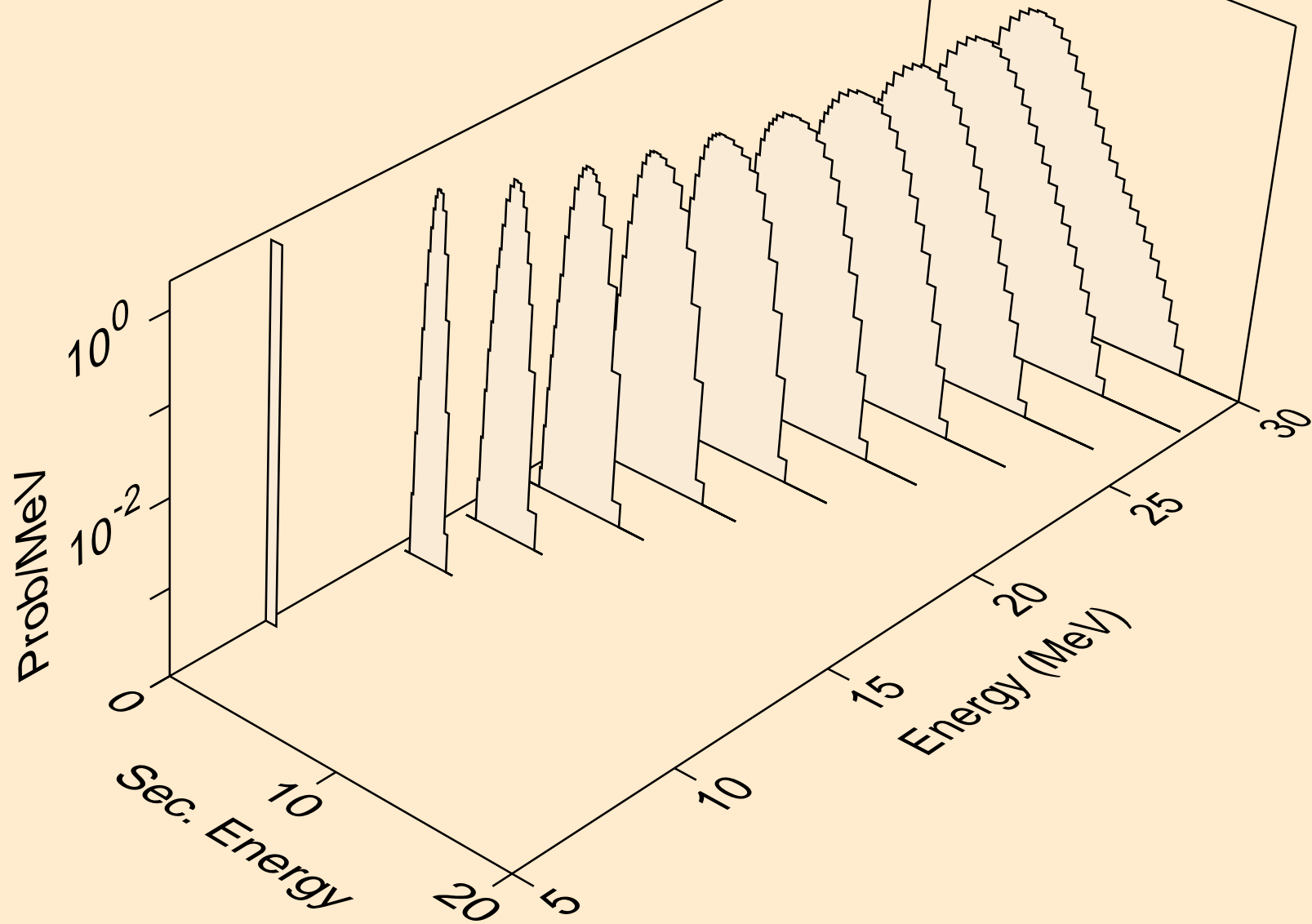

CE123 HELION ACER TENDL-2024 LIBRARY; T=0.K  
protons from (s,npa)

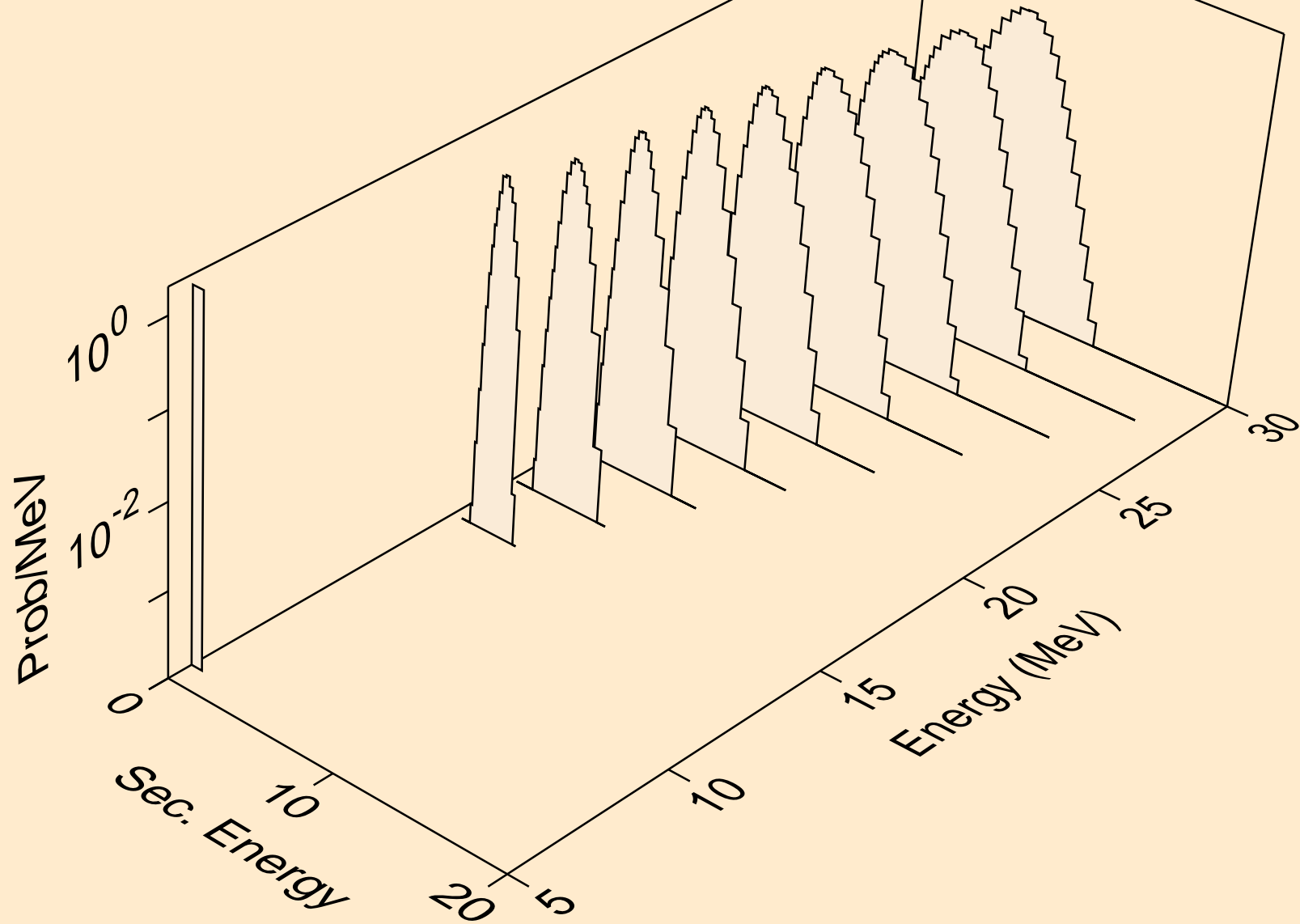

CE123 HELION ACER TENDL-2024 LIBRARY; T=0.K  
protons from (s,p)

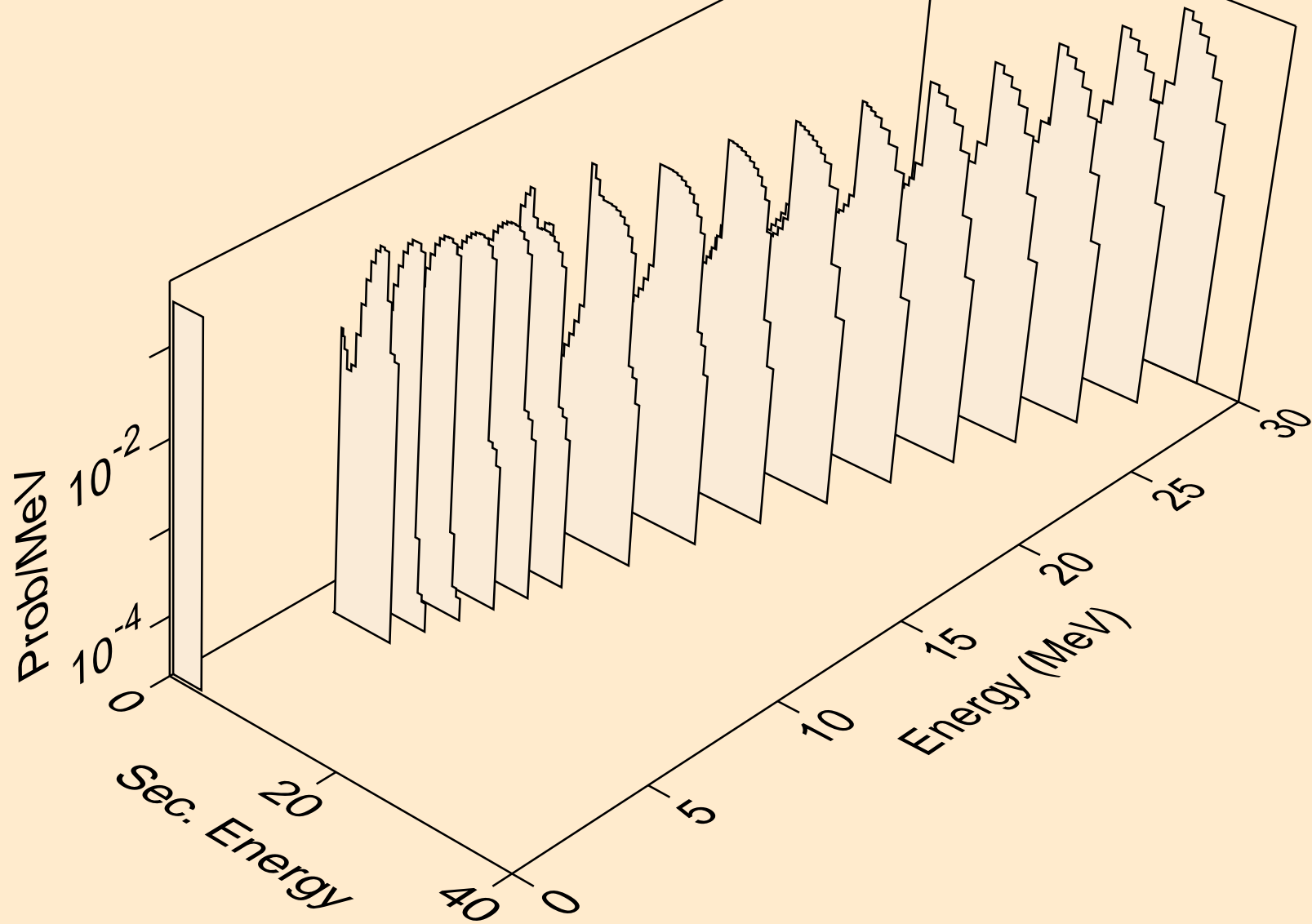

CE123 HELION ACER TENDL-2024 LIBRARY; T=0.K  
protons from (s,2p)

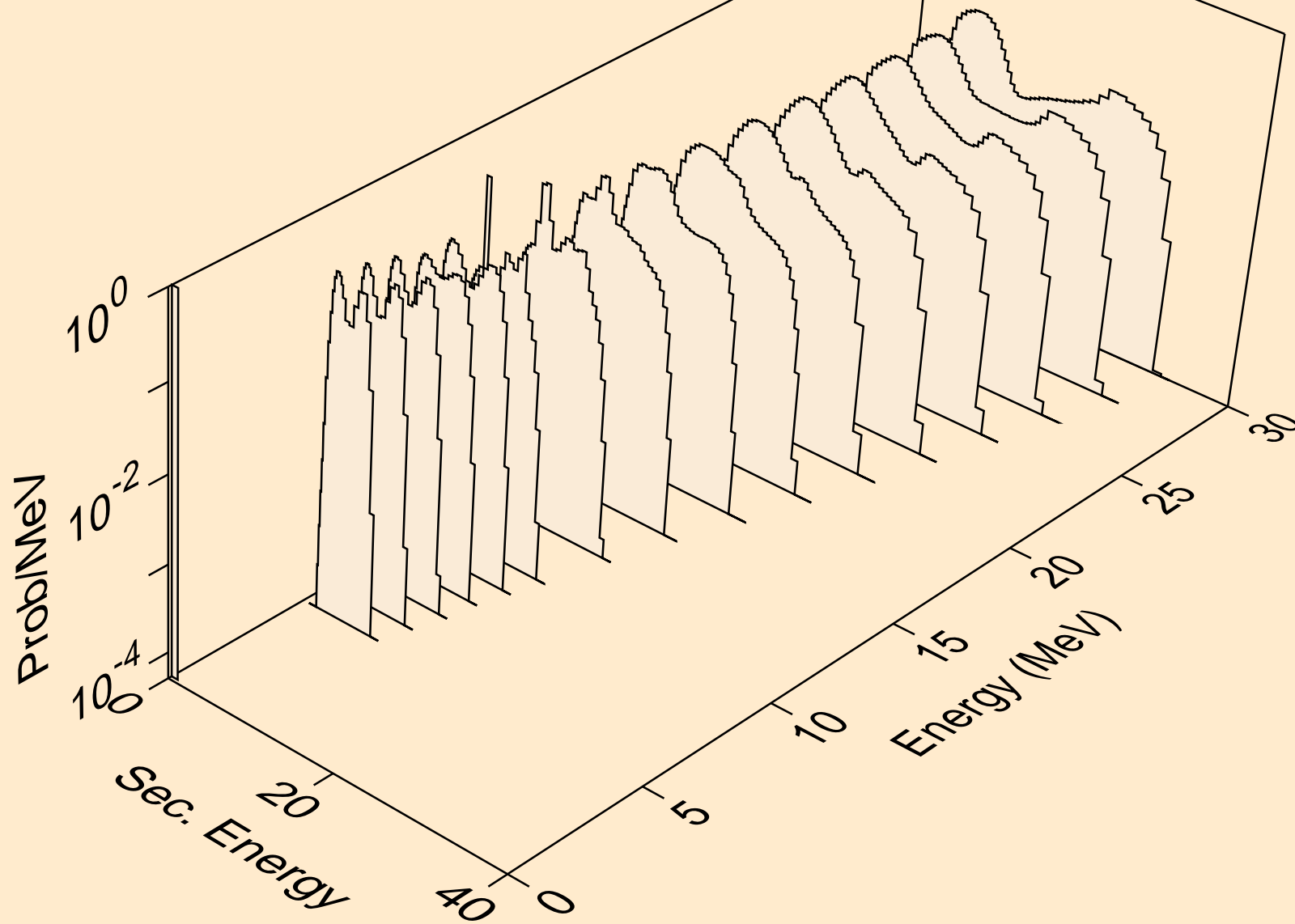

CE123 HELION ACER TENDL-2024 LIBRARY; T=0.K  
protons from (s,pa)

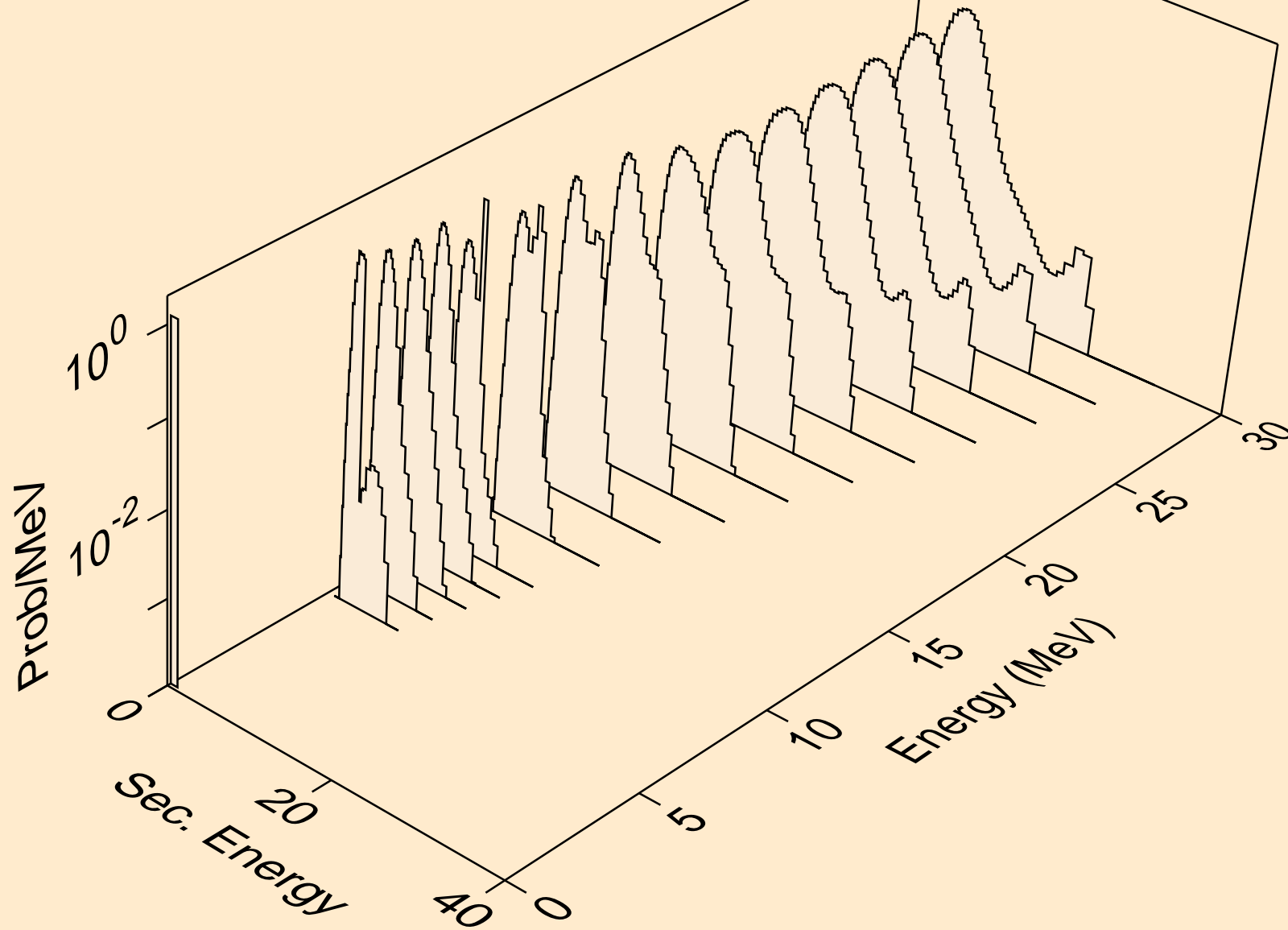

CE123 HELION ACER TENDL-2024 LIBRARY; T=0.K  
protons from (s,pd)

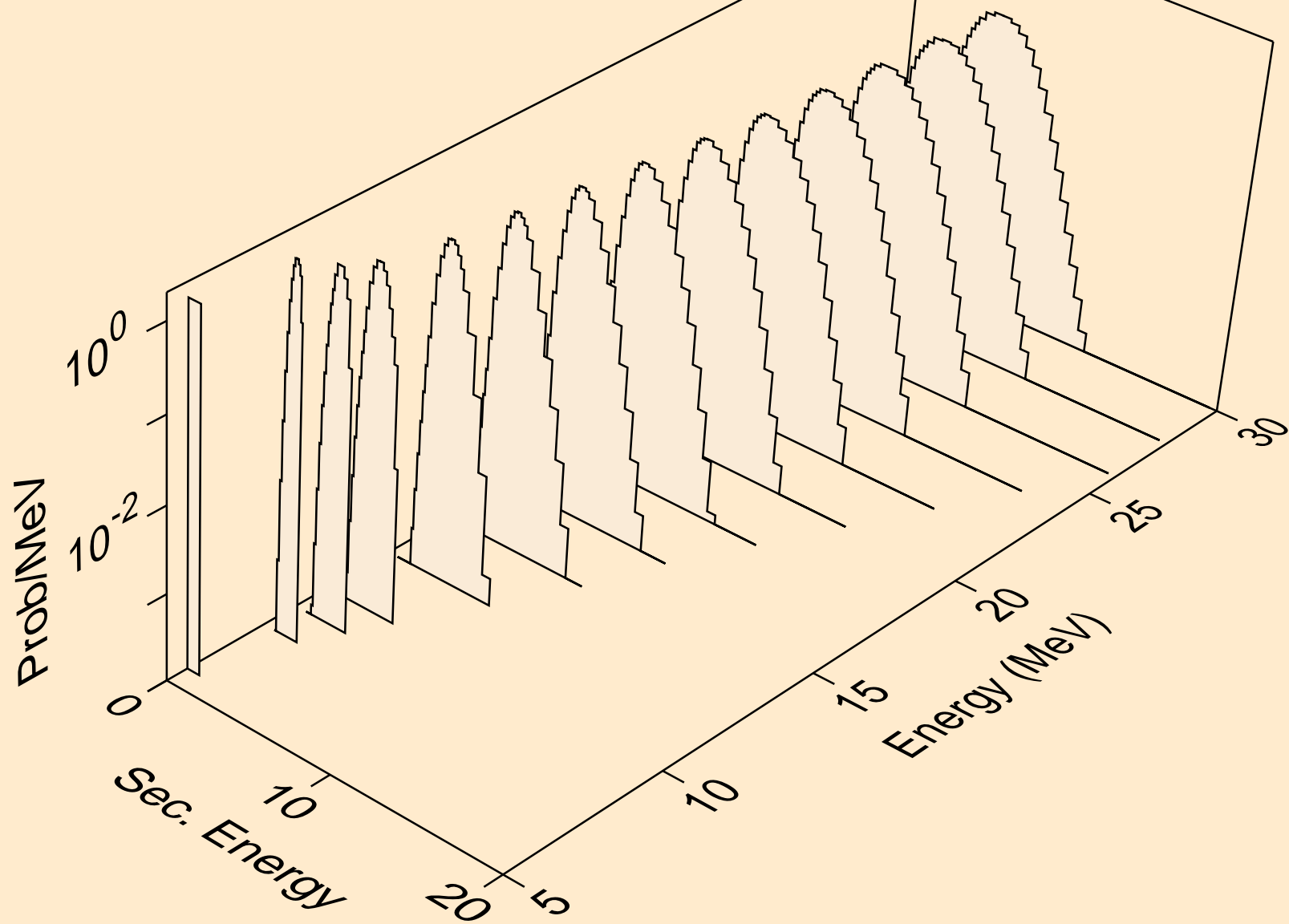

CE123 HELION ACER TENDL-2024 LIBRARY; T=0.K  
protons from (s,pt)

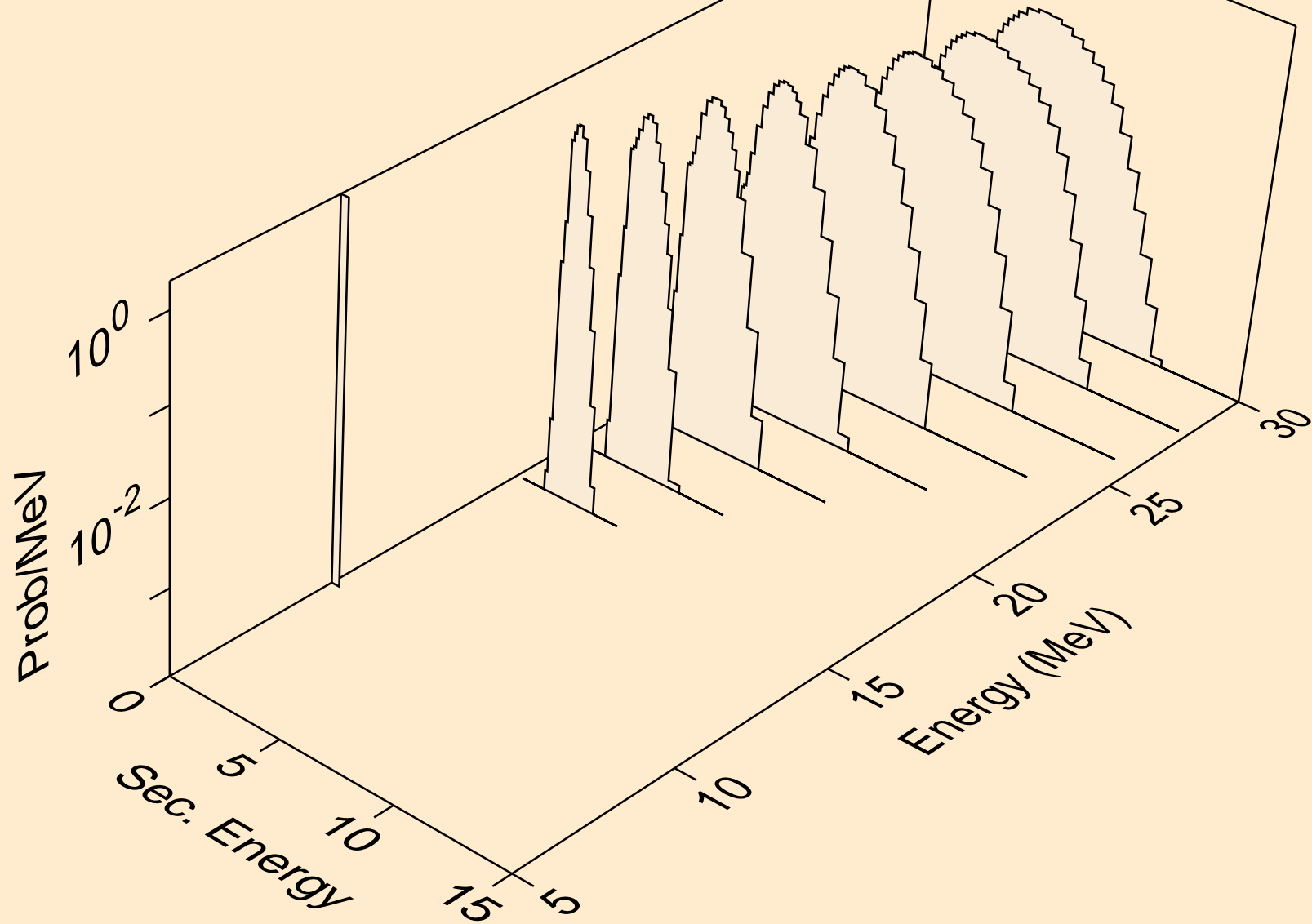

CE123 HELION ACER TENDL-2024 LIBRARY; T=0.K  
deuterons from (s,x)

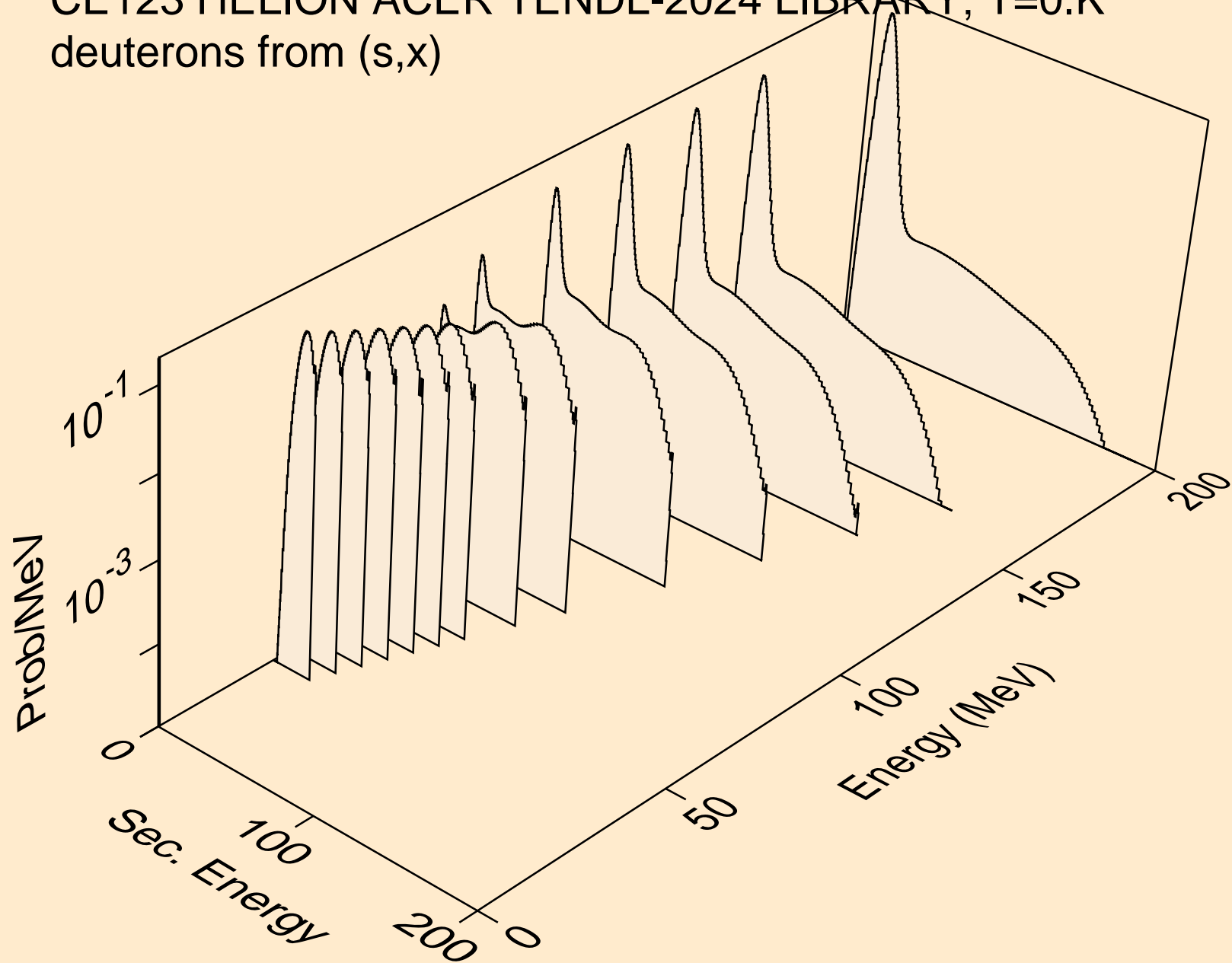

CE123 HELION ACER TENDL-2024 LIBRARY; T=0.K  
deuterons from (s,n\*)d

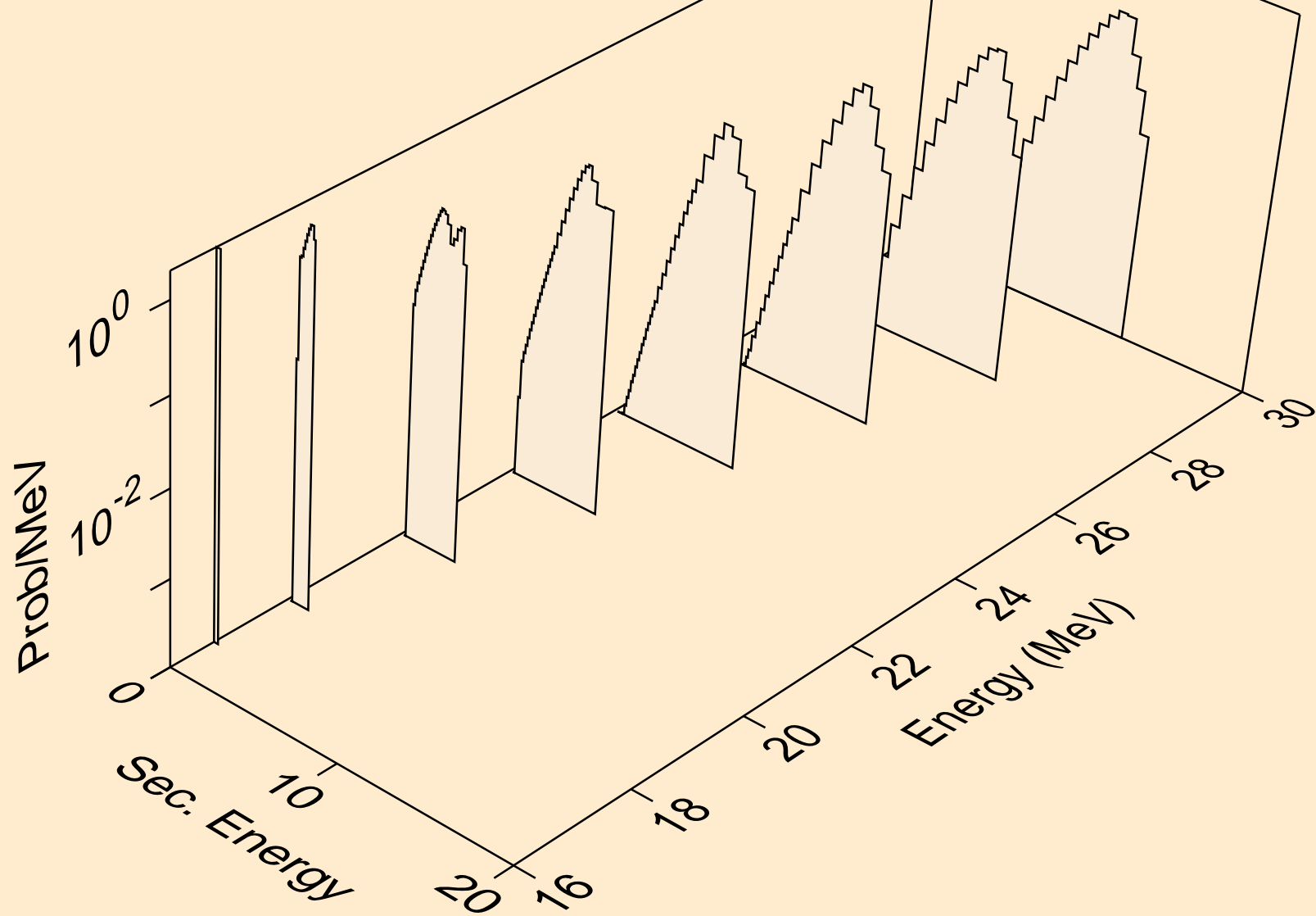

CE123 HELION ACER TENDL-2024 LIBRARY; T=0.K  
deuterons from (s,d)

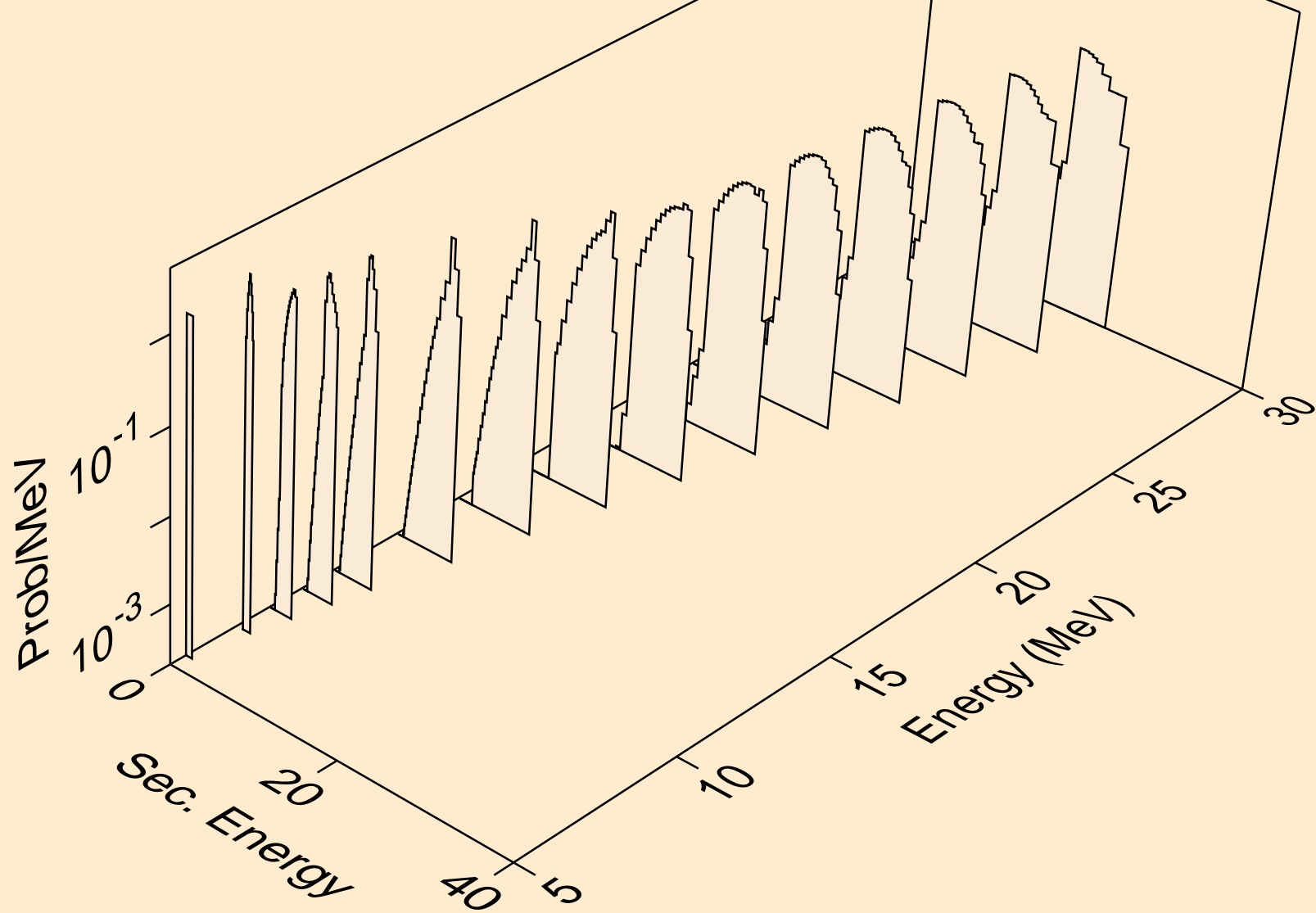

CE123 HELION ACER TENDL-2024 LIBRARY; T=0.K  
deuterons from (s,pd)

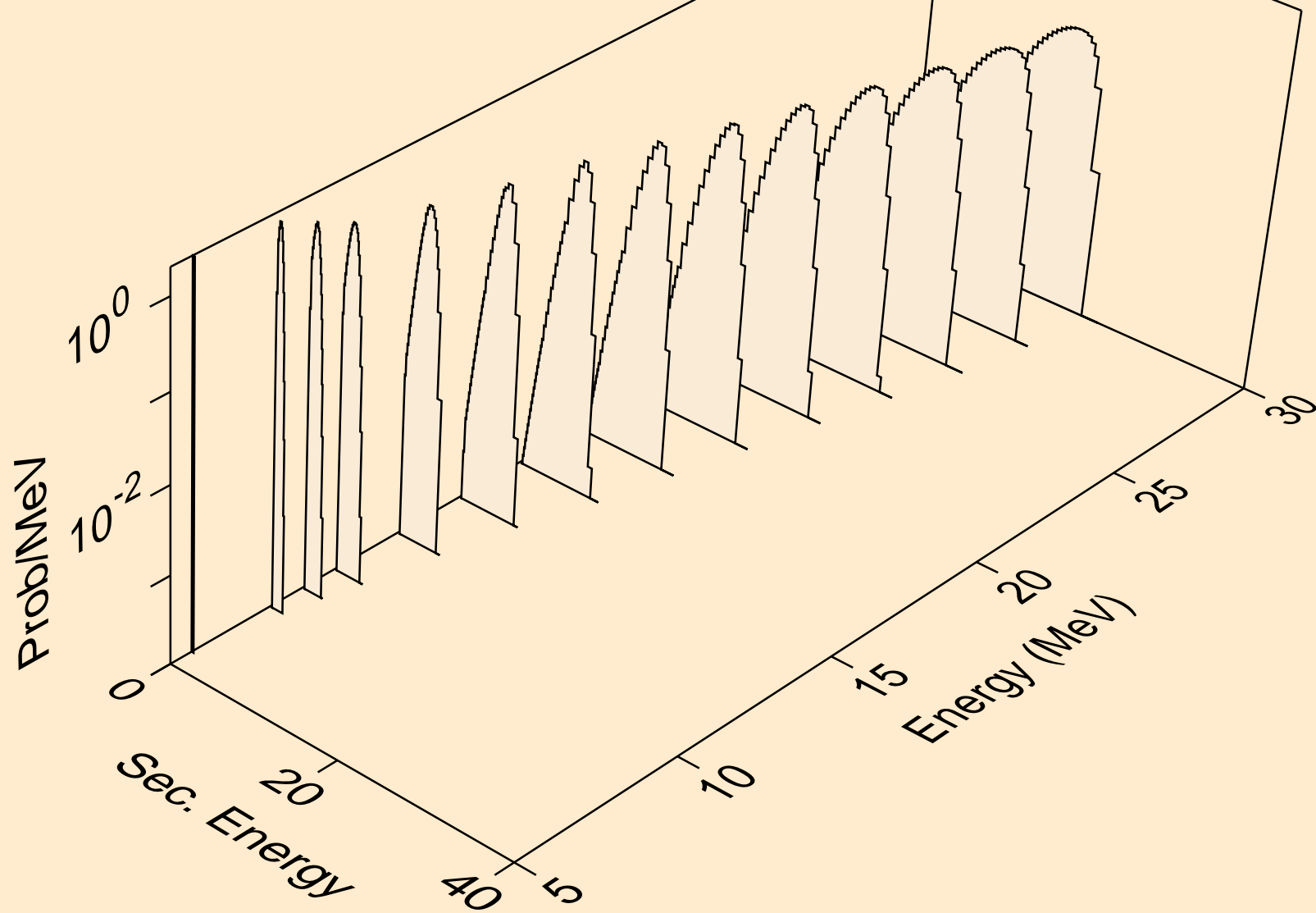

CE123 HELION ACER TENDL-2024 LIBRARY; T=0.K  
deuterons from (s,da)

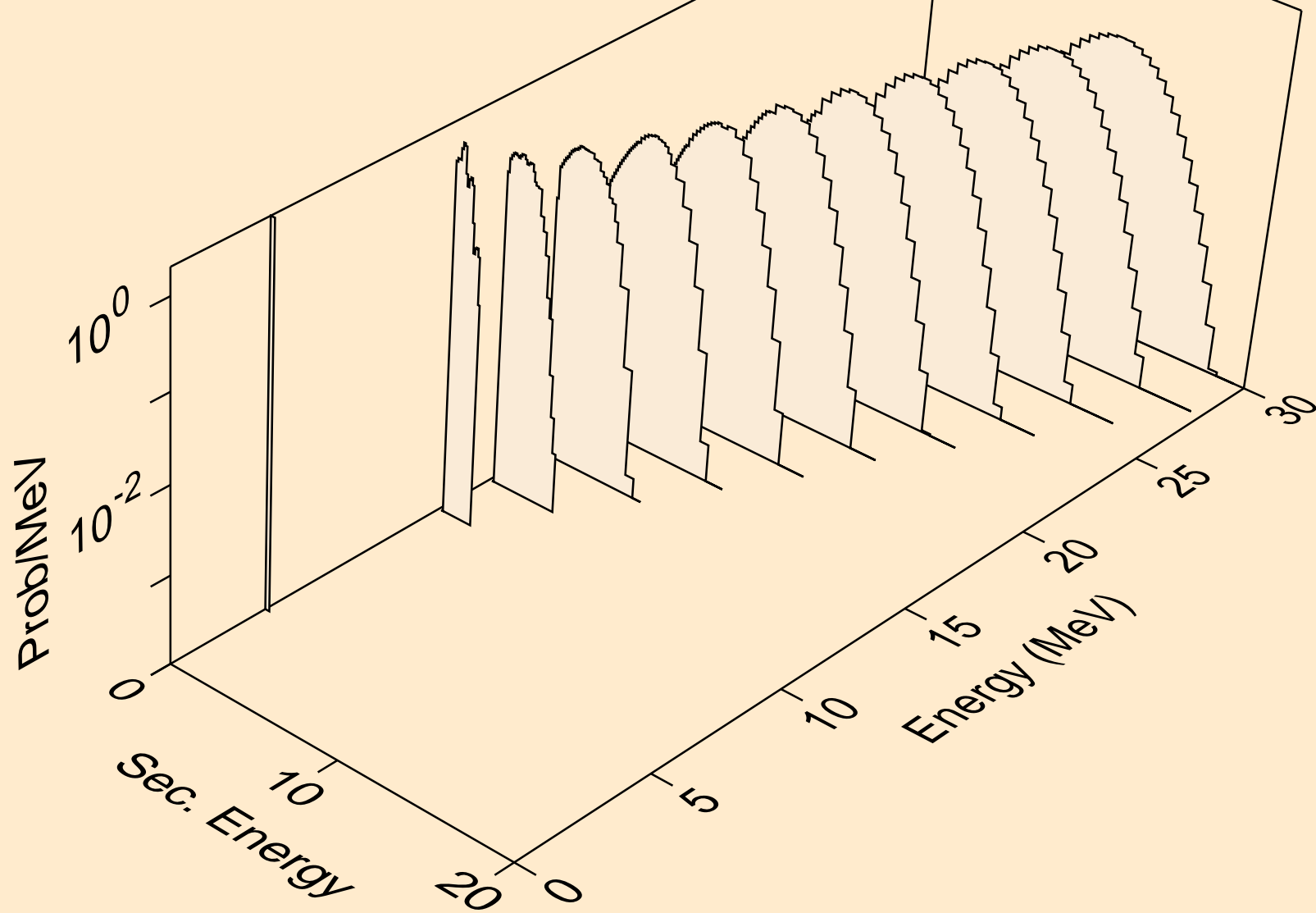

CE123 HELION ACER TENDL-2024 LIBRARY; T=0.K  
tritons from (s,x)

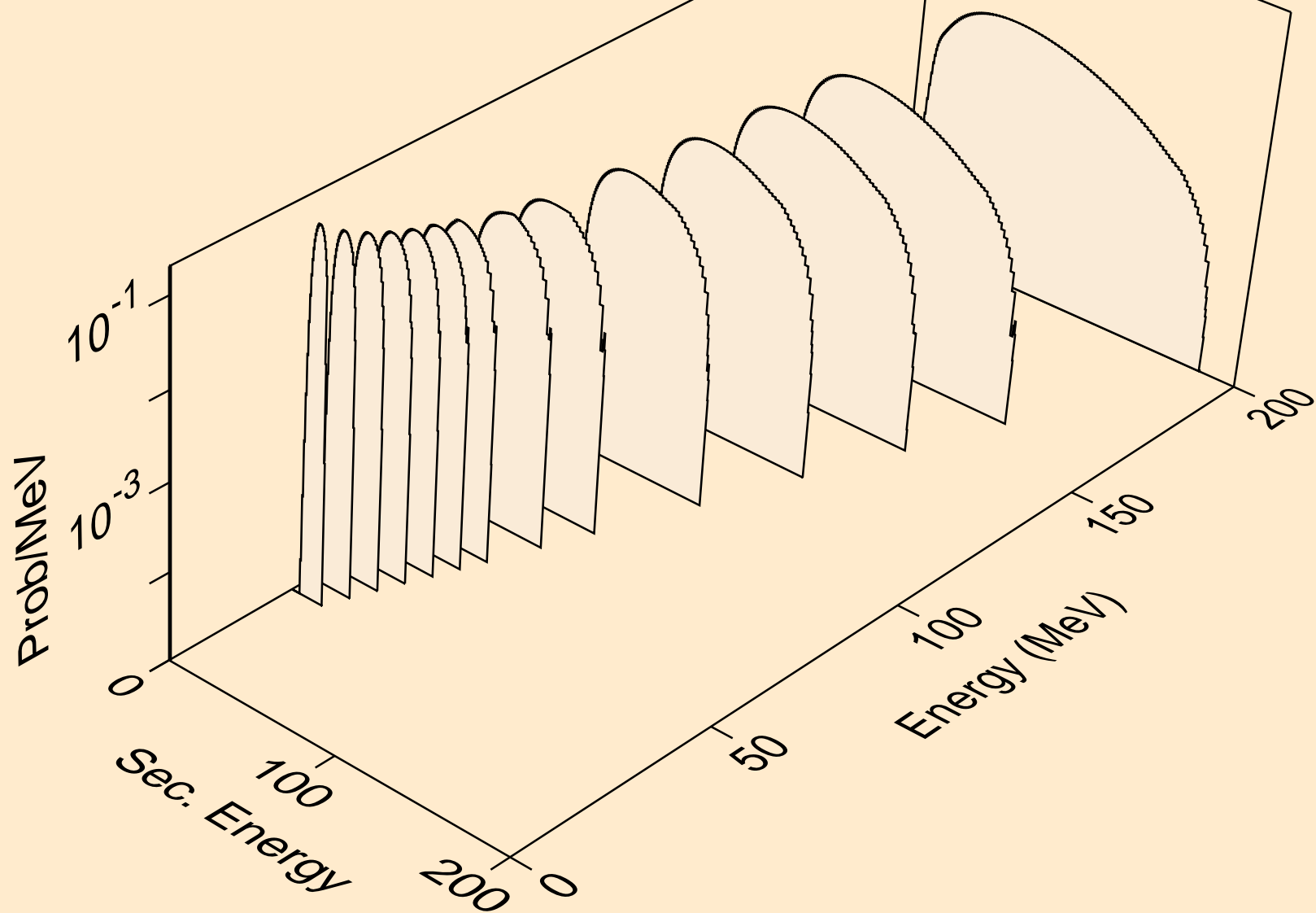

CE123 HELION ACER TENDL-2024 LIBRARY; T=0.K  
tritons from (s,t)

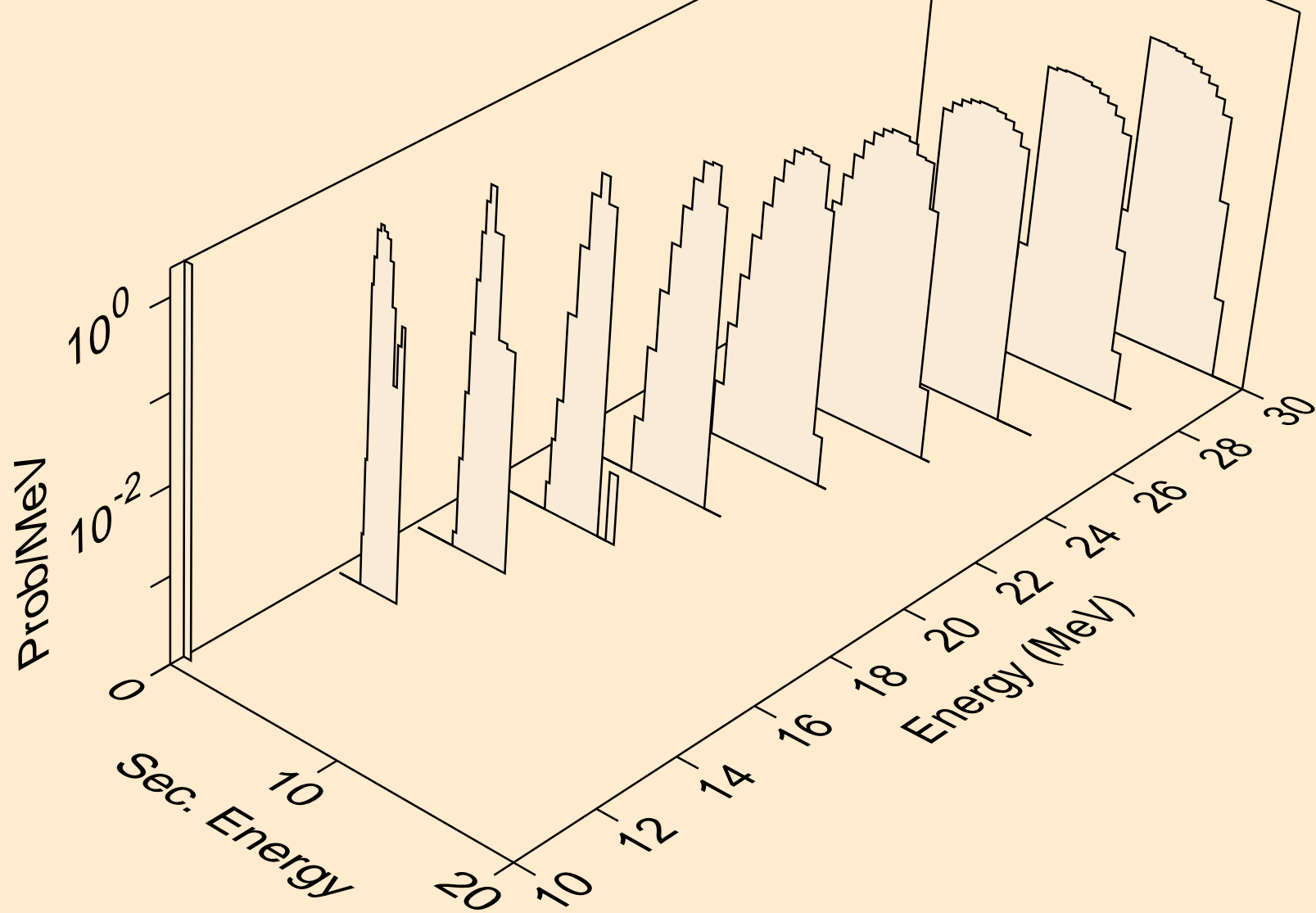

CE123 HELION ACER TENDL-2024 LIBRARY; T=0.K  
tritons from (s,pt)

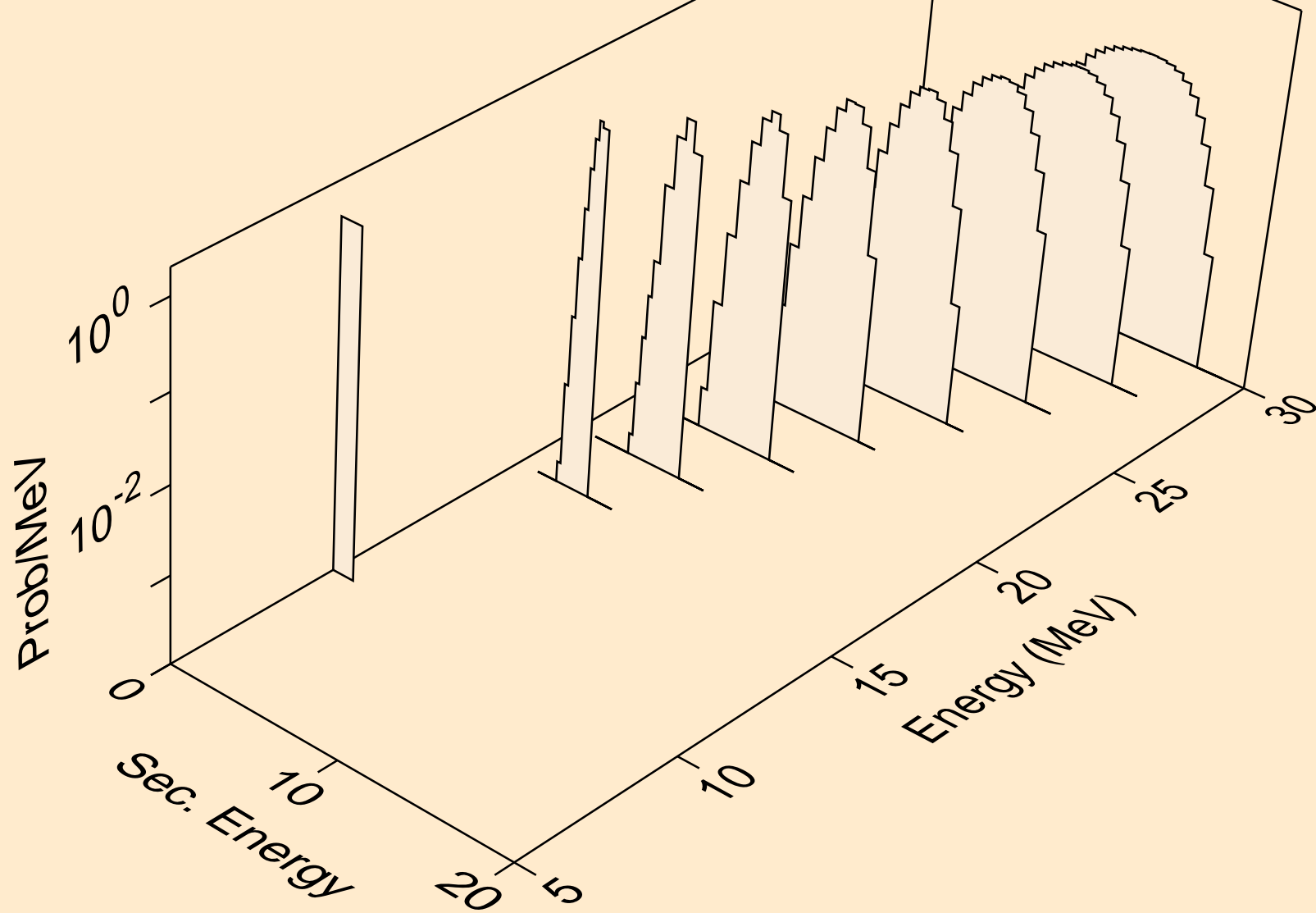

CE123 HELION ACER TENDL-2024 LIBRARY; T=0.K  
alphas from (s,x)

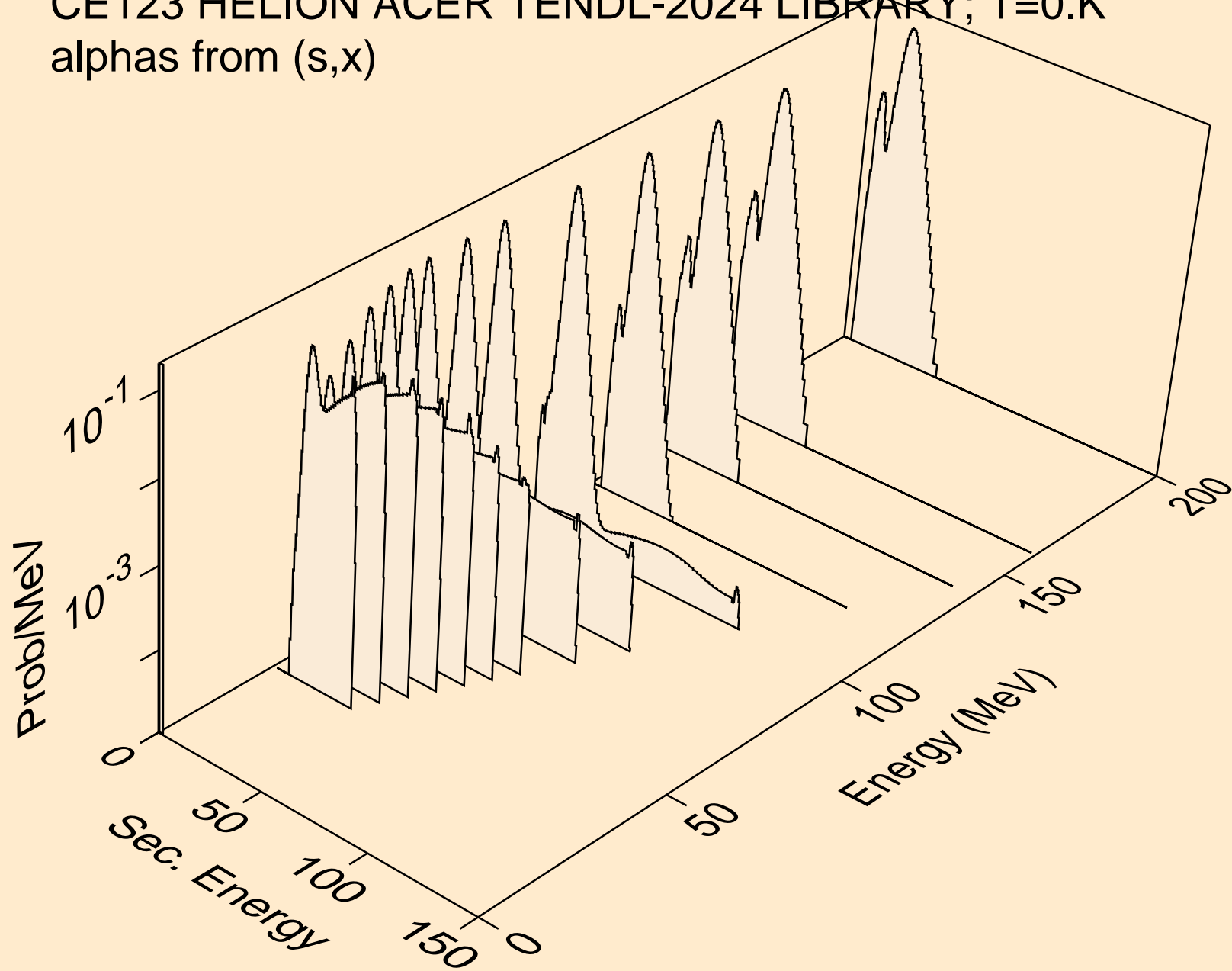

CE123 HELION ACER TENDL-2024 LIBRARY; T=0.K  
alphas from (s,n\*)a

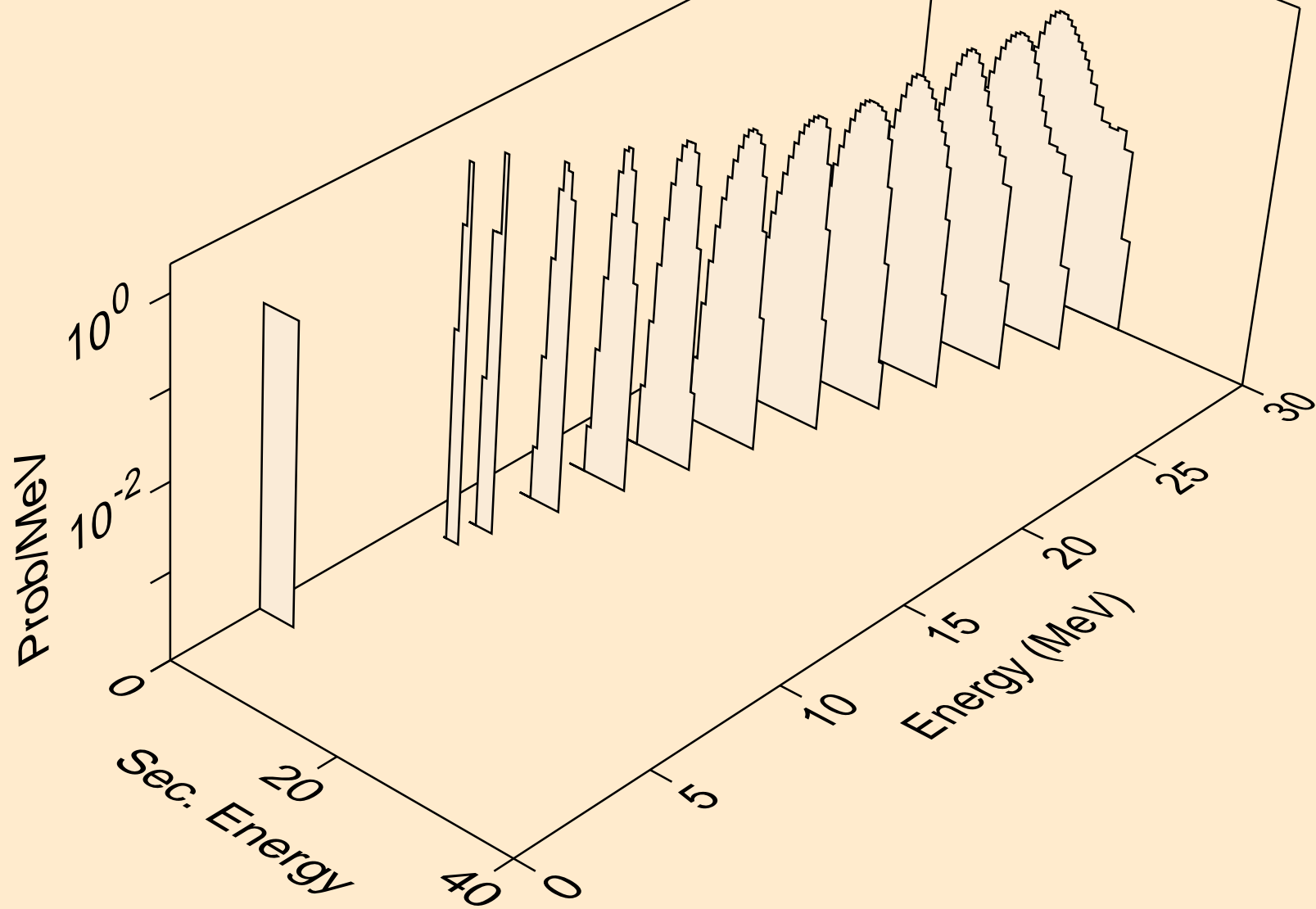

CE123 HELION ACER TENDL-2024 LIBRARY; T=0.K  
alphas from (s,2n)a

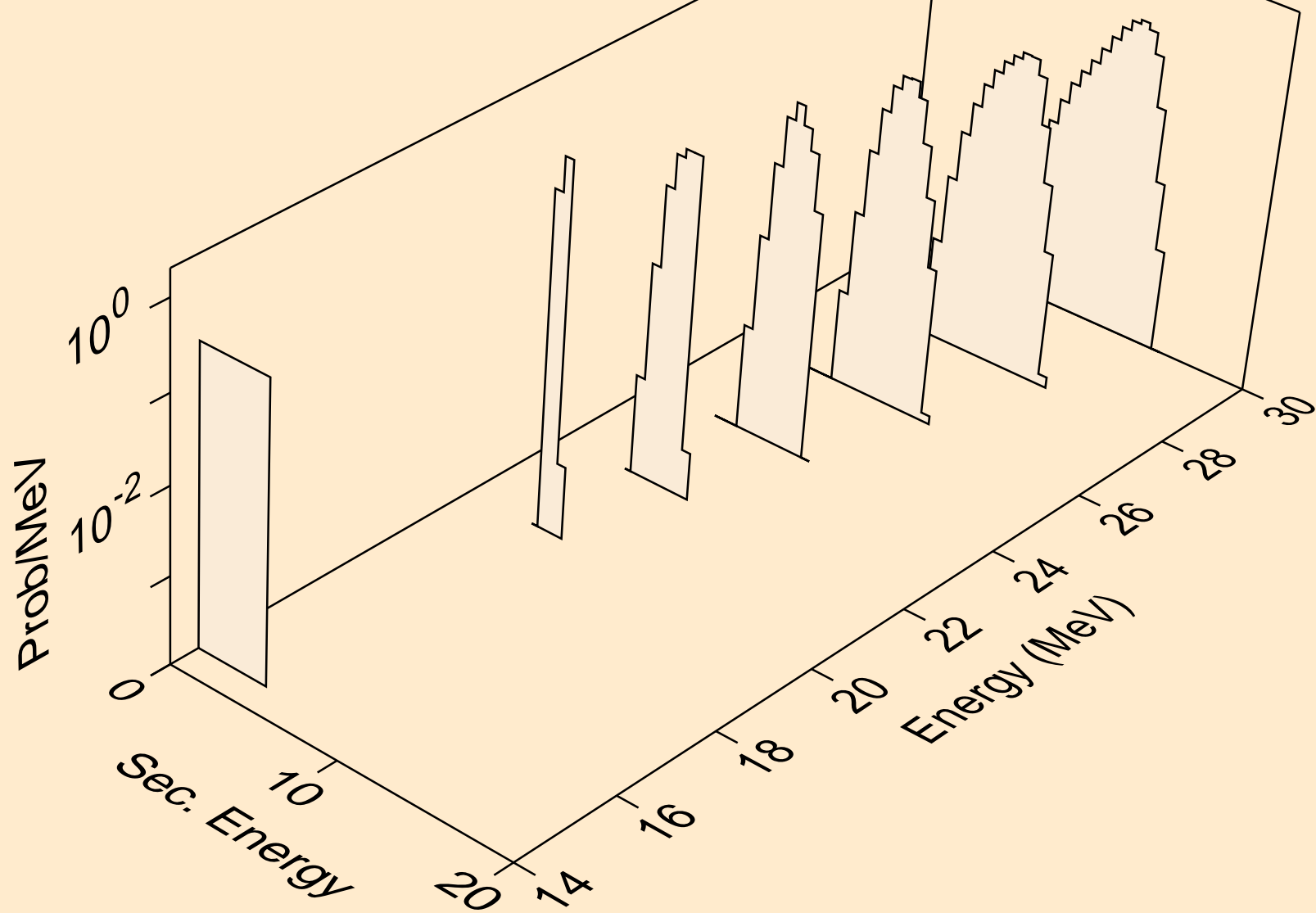

CE123 HELION ACER TENDL-2024 LIBRARY; T=0.K  
alphas from (s,n\*)2a

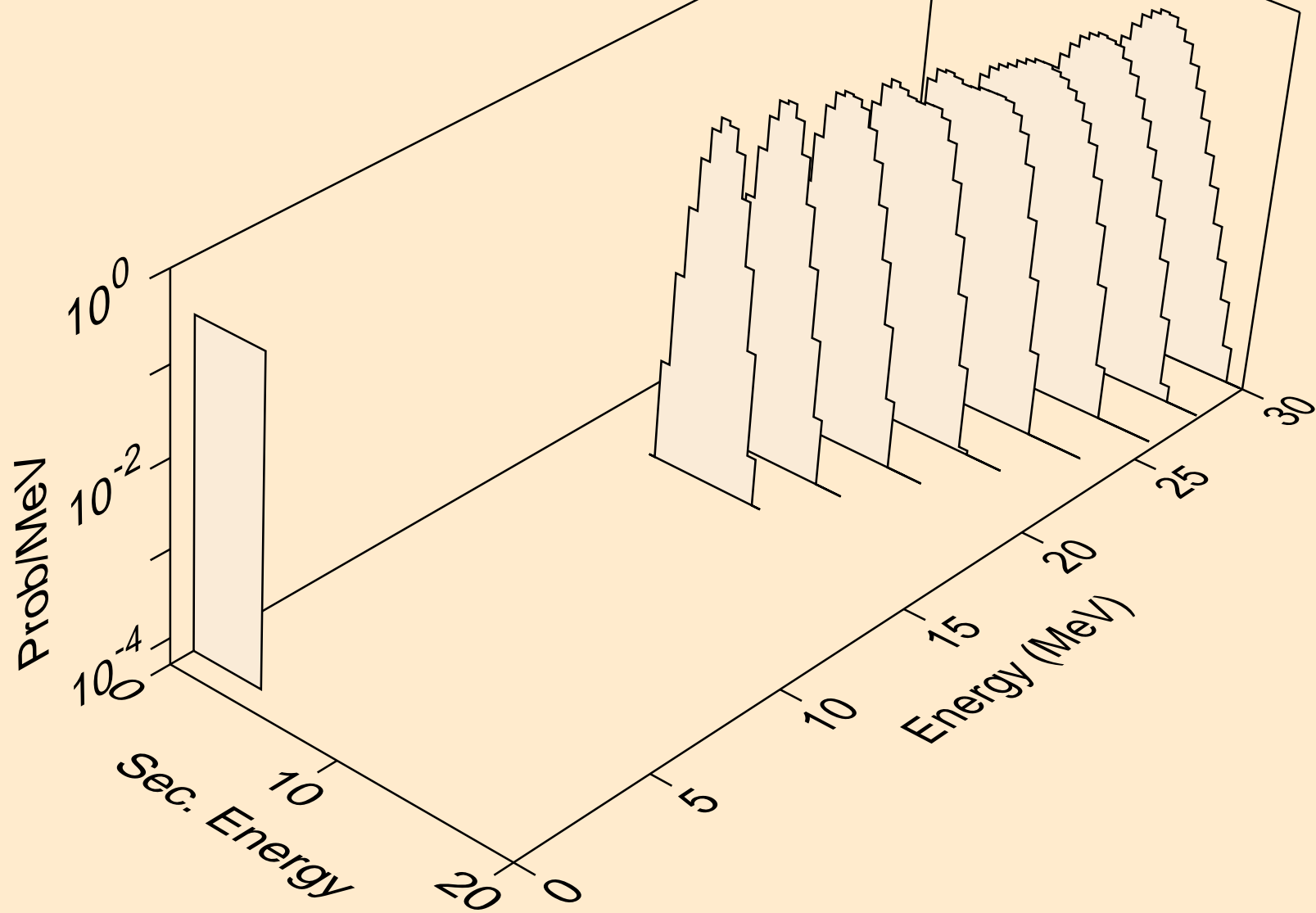

CE123 HELION ACER TENDL-2024 LIBRARY; T=0.K  
alphas from (s,npa)

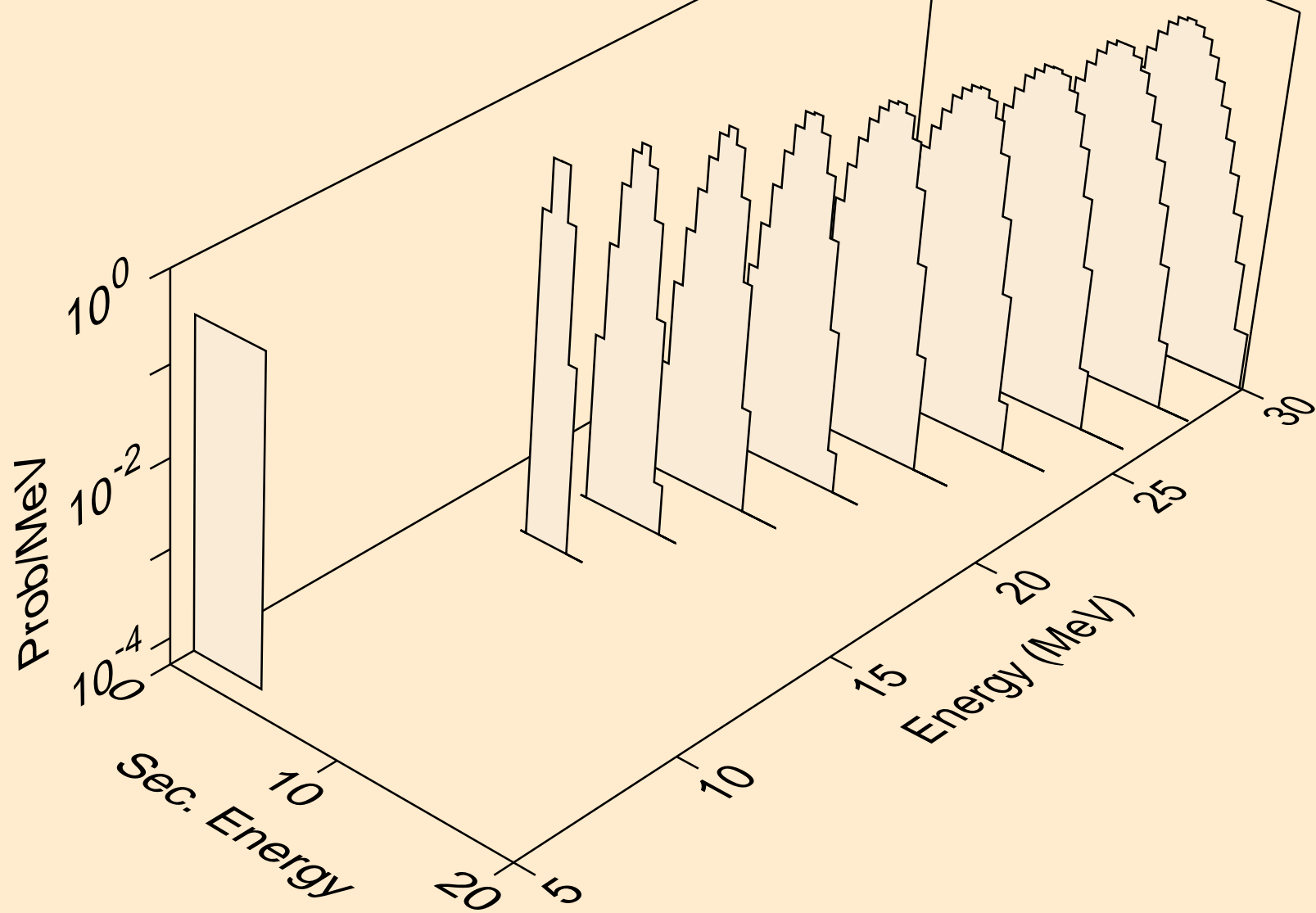

CE123 HELION ACER TENDL-2024 LIBRARY; T=0.K  
alphas from (s,a)

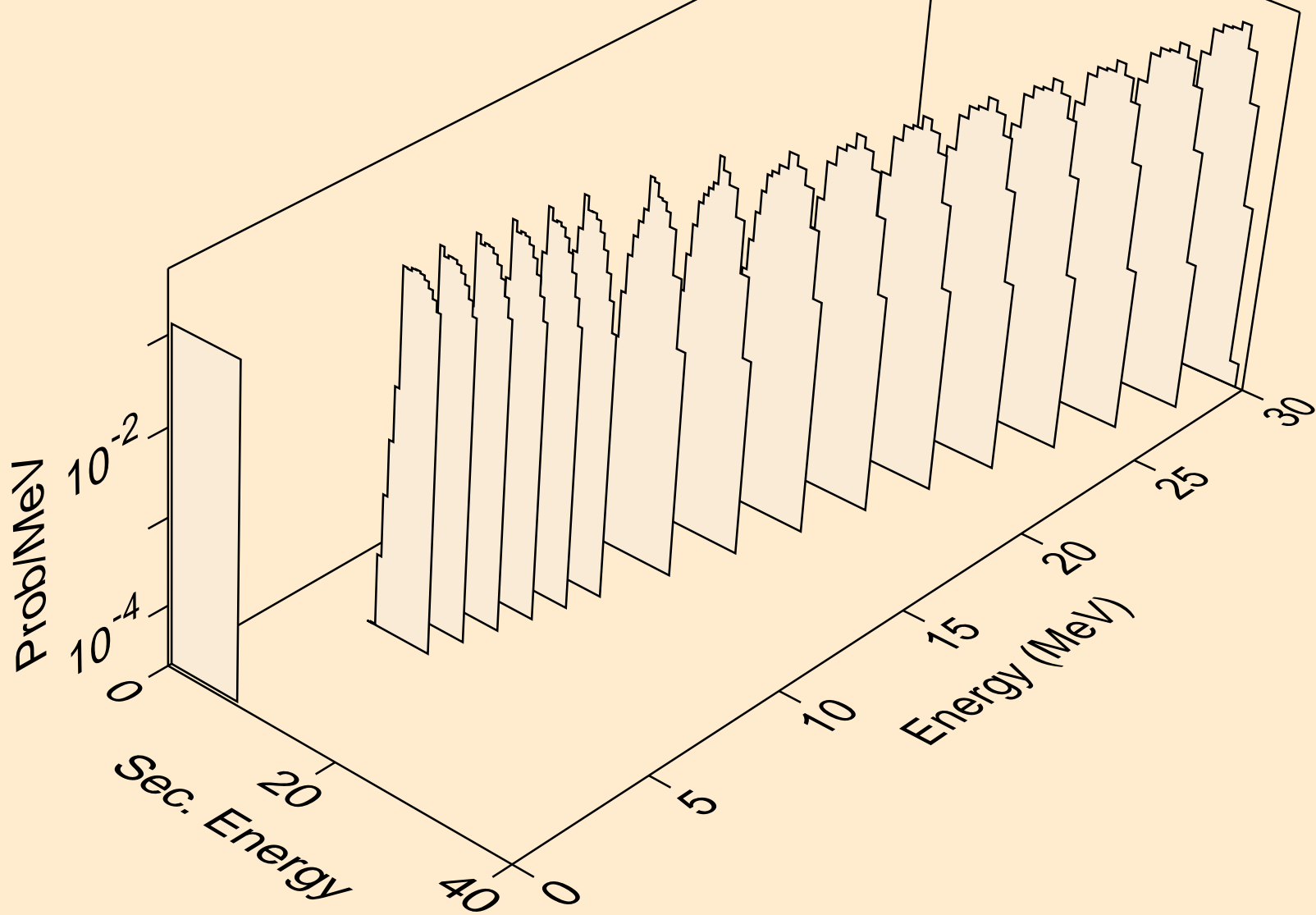

CE123 HELION ACER TENDL-2024 LIBRARY; T=0.K  
alphas from (s,2a)

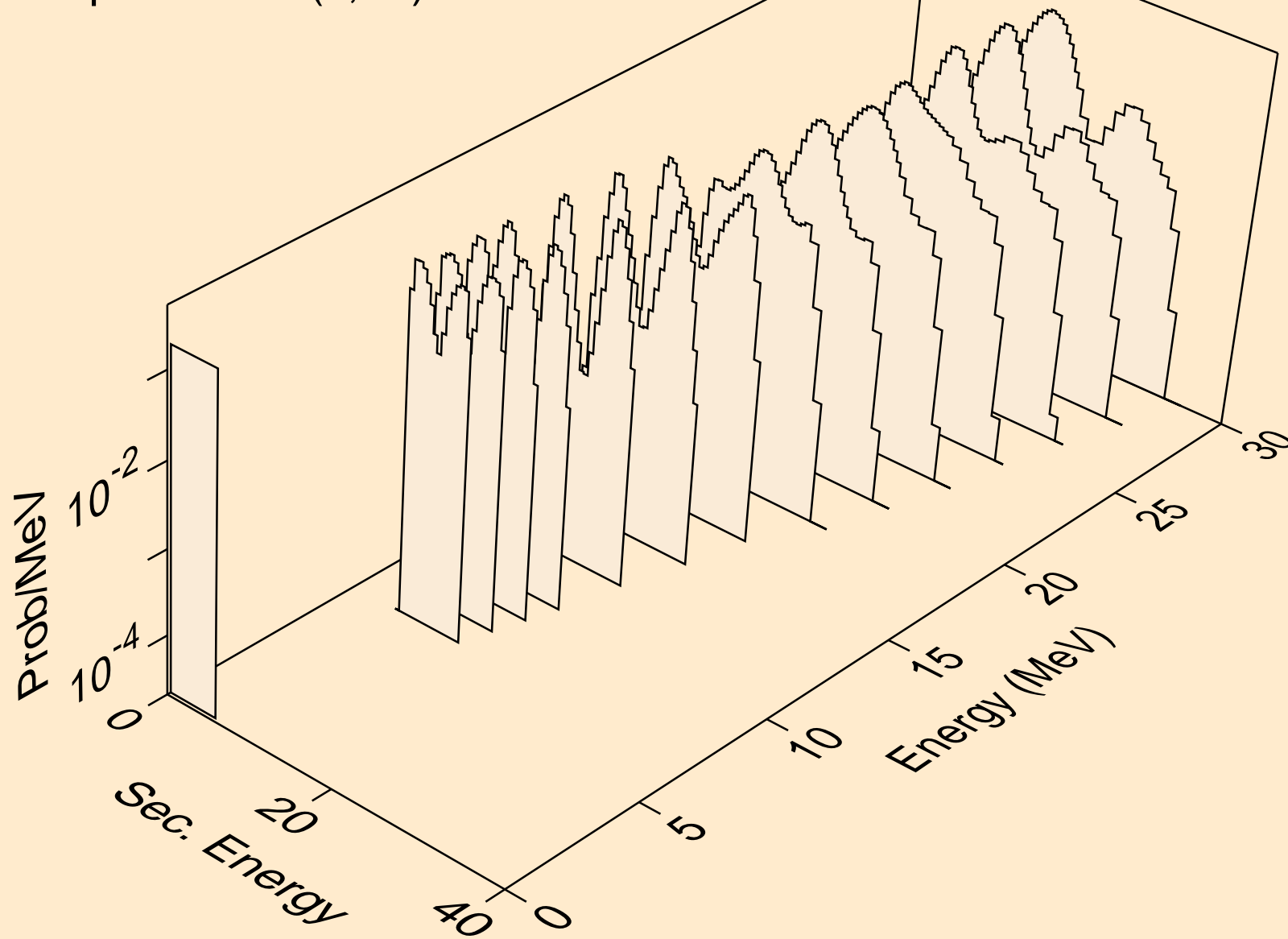

CE123 HELION ACER TENDL-2024 LIBRARY; T=0.K  
alphas from (s,3a)

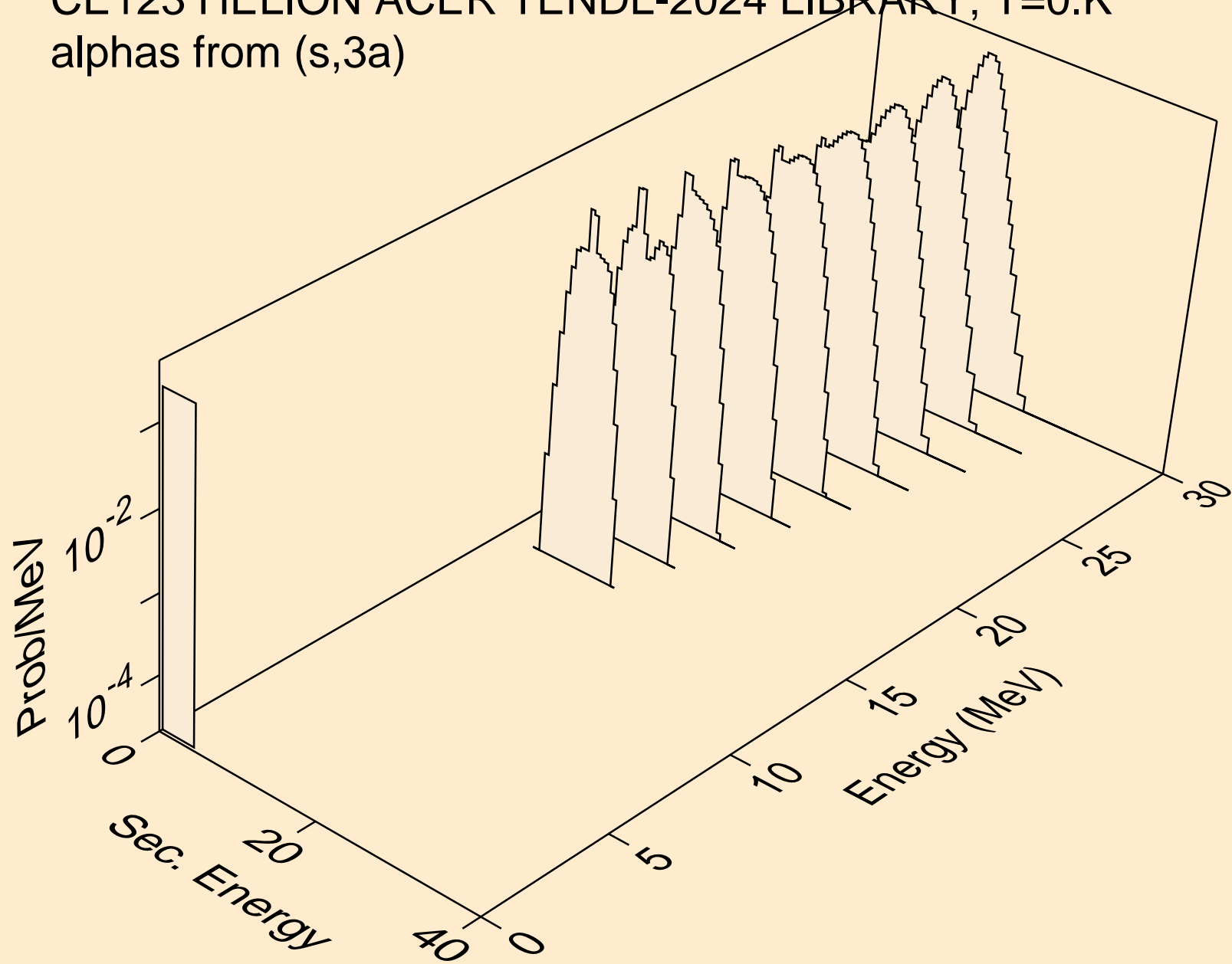

CE123 HELION ACER TENDL-2024 LIBRARY; T=0.K  
alphas from (s,pa)

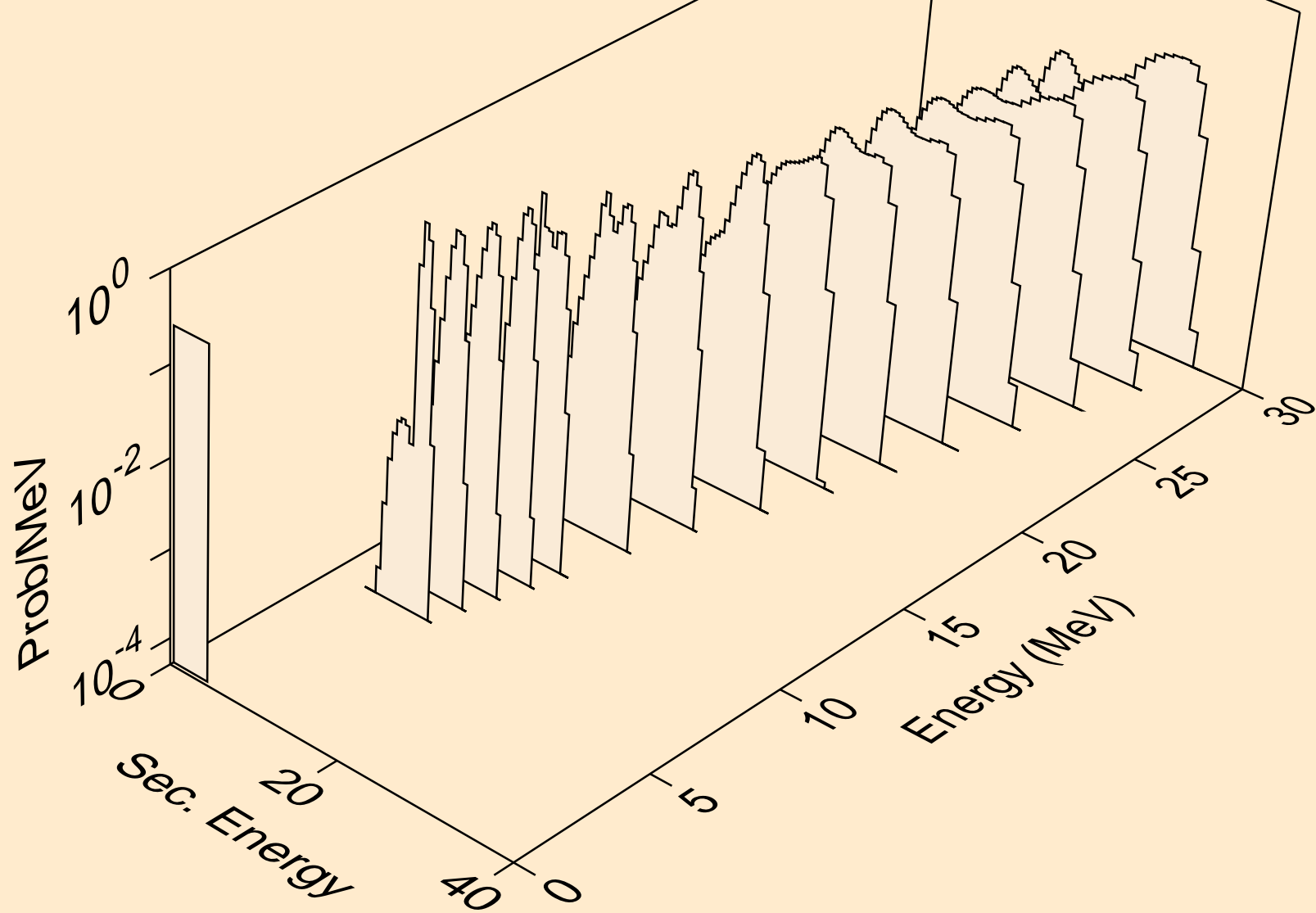

CE123 HELION ACER TENDL-2024 LIBRARY; T=0.K  
alphas from (s,da)

