

DB256 HELION ACER TENDL-2024 LIBRARY; T=0.K
Principal cross sections

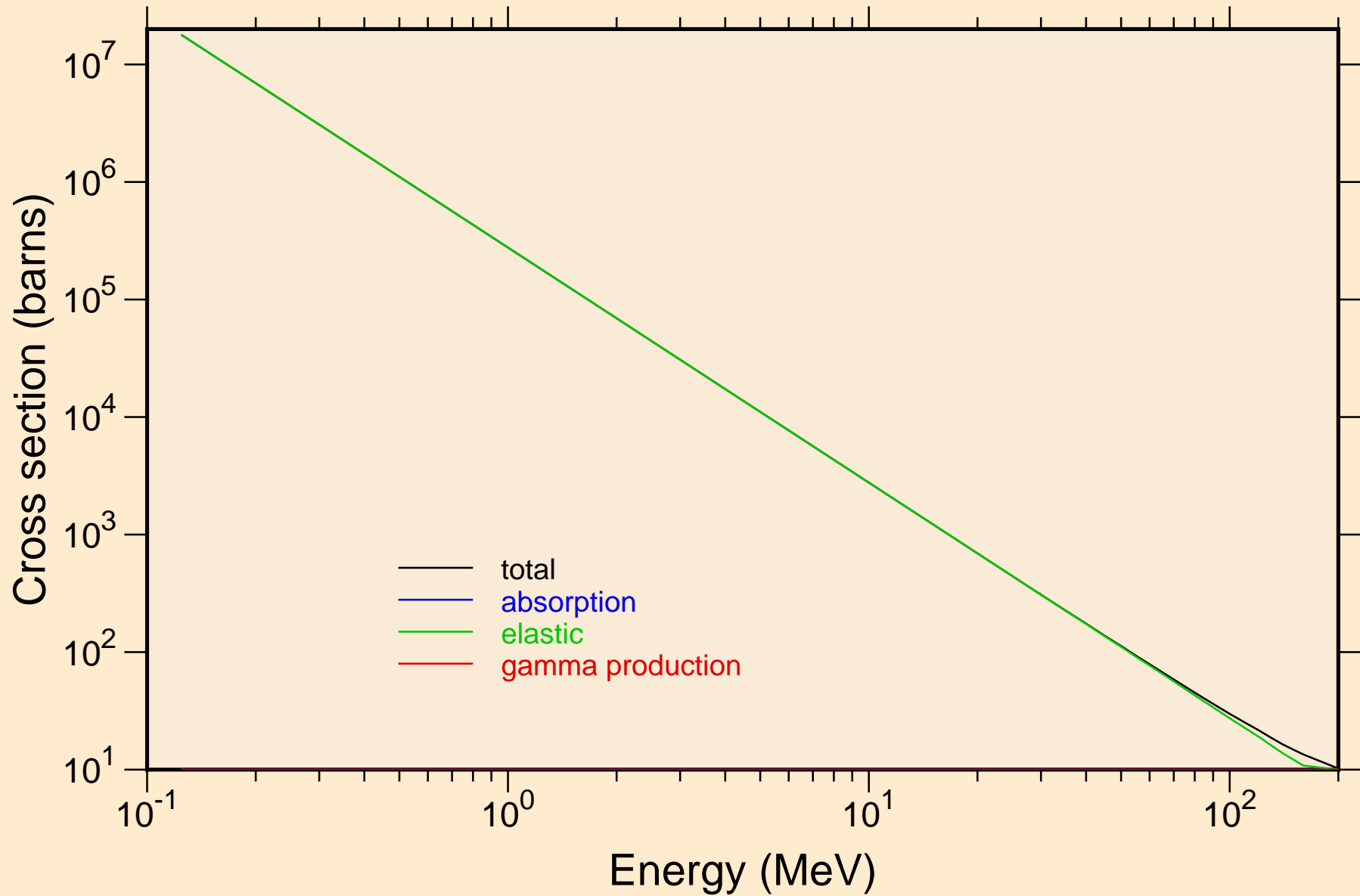

DB256 HELION ACER TENDL-2024 LIBRARY; T=0.K

Heating

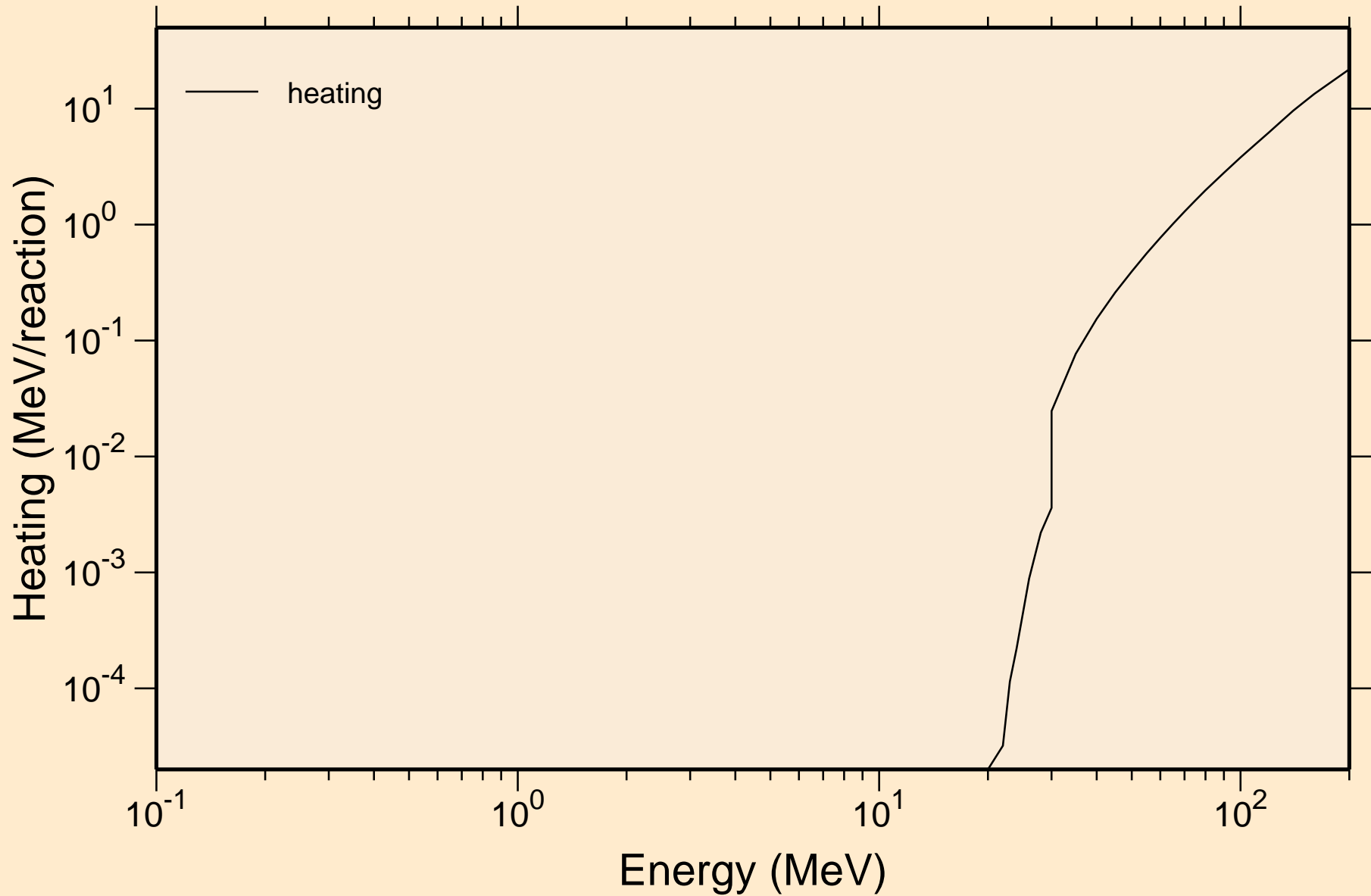

DB256 HELION ACER TENDL-2024 LIBRARY; T=0.K

Principal cross sections

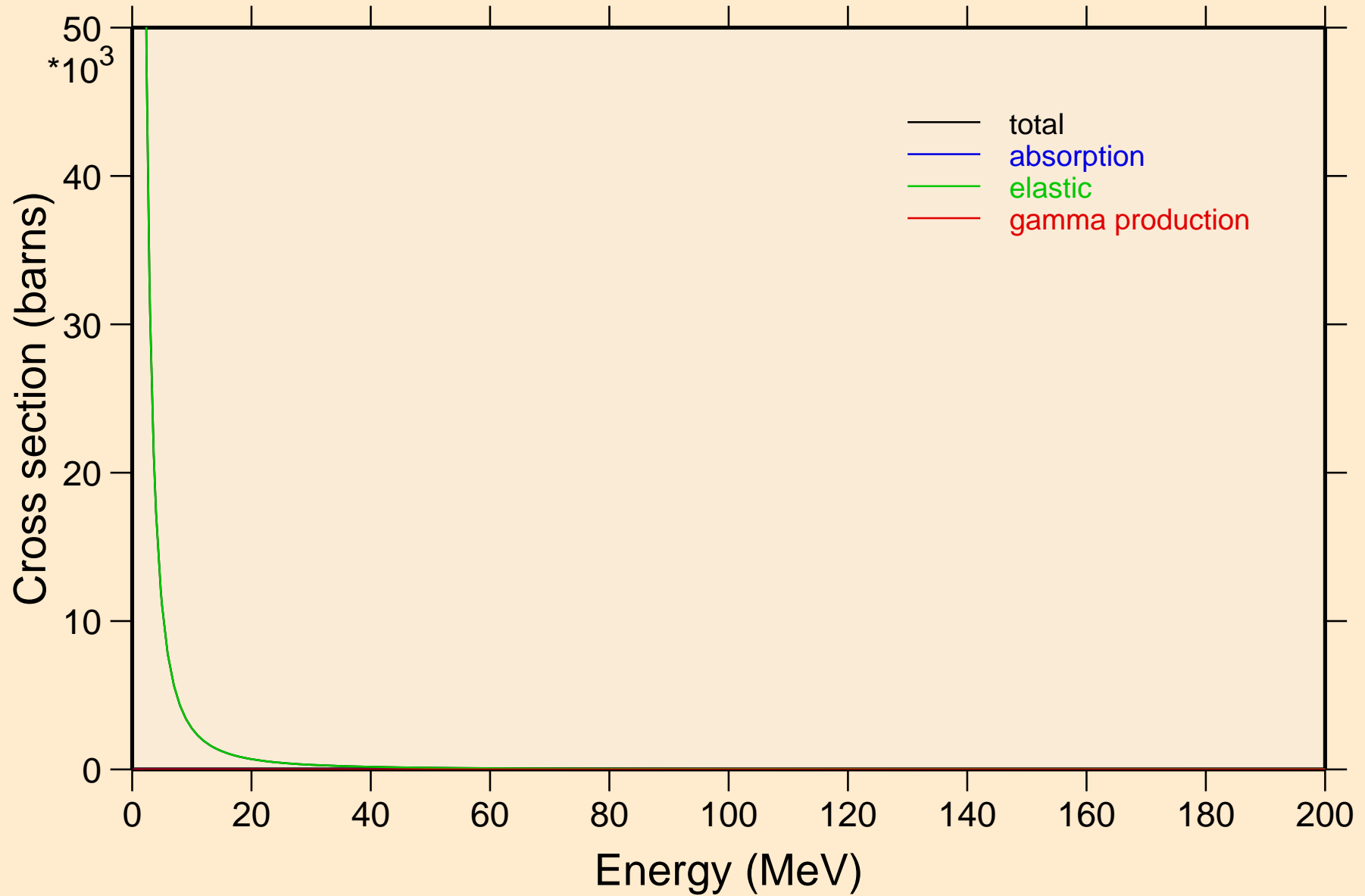

DB256 HELION ACER TENDL-2024 LIBRARY; T=0.K

Heating

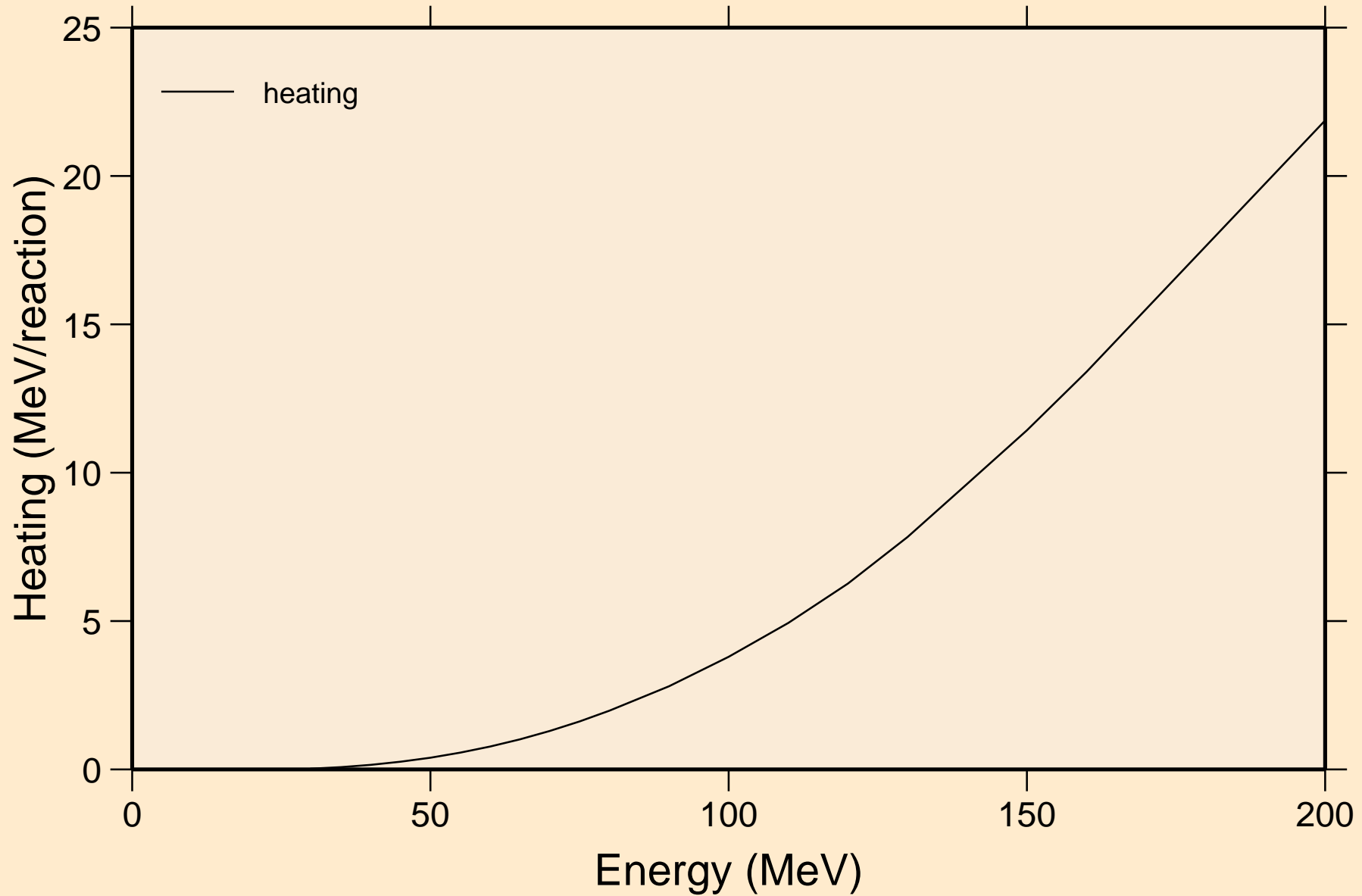

DB256 HELION ACER TENDL-2024 LIBRARY; T=0.K
Threshold reactions

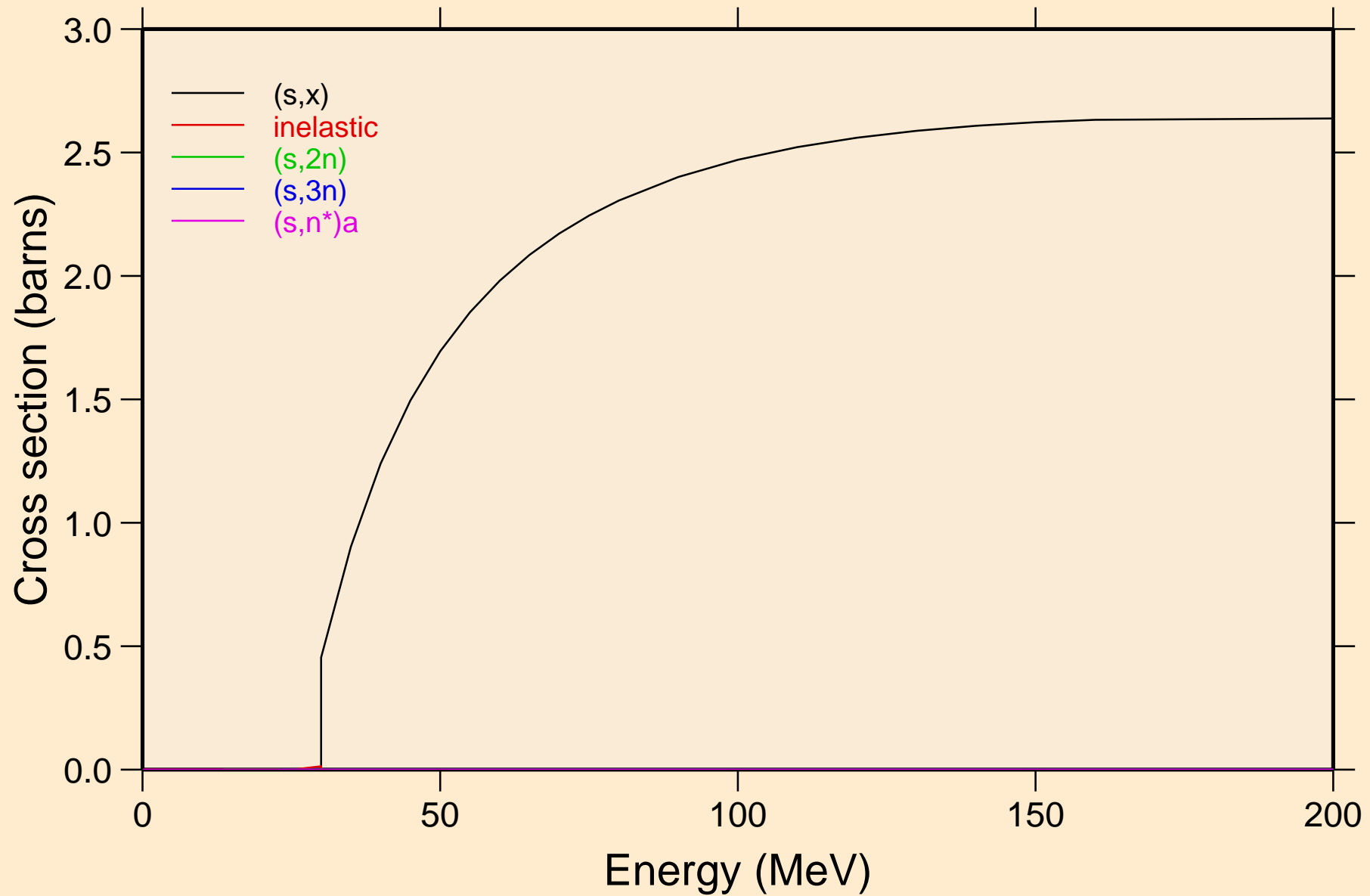

DB256 HELION ACER TENDL-2024 LIBRARY; T=0.K
Threshold reactions

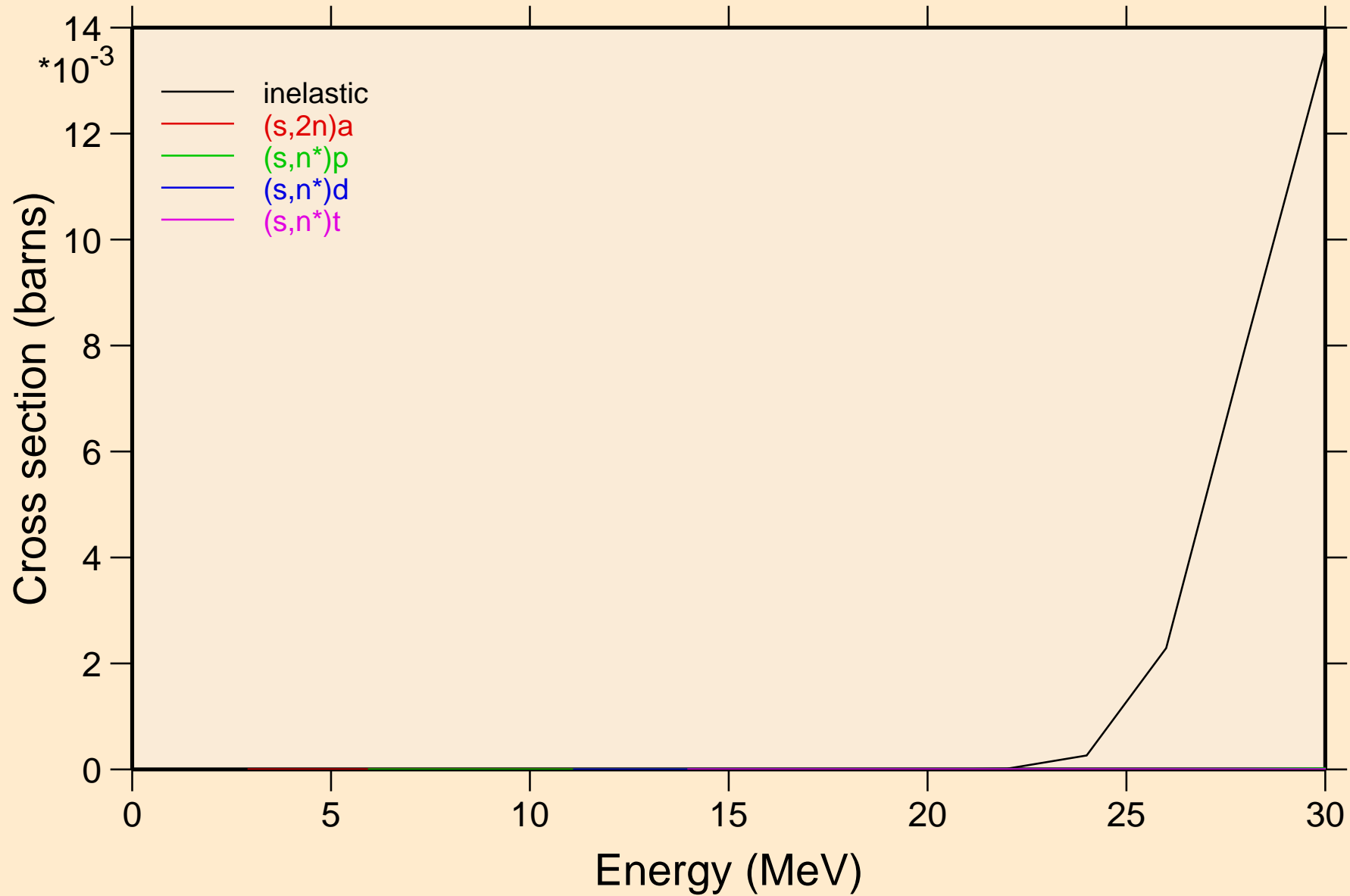

DB256 HELION ACER TENDL-2024 LIBRARY; T=0.K
Threshold reactions

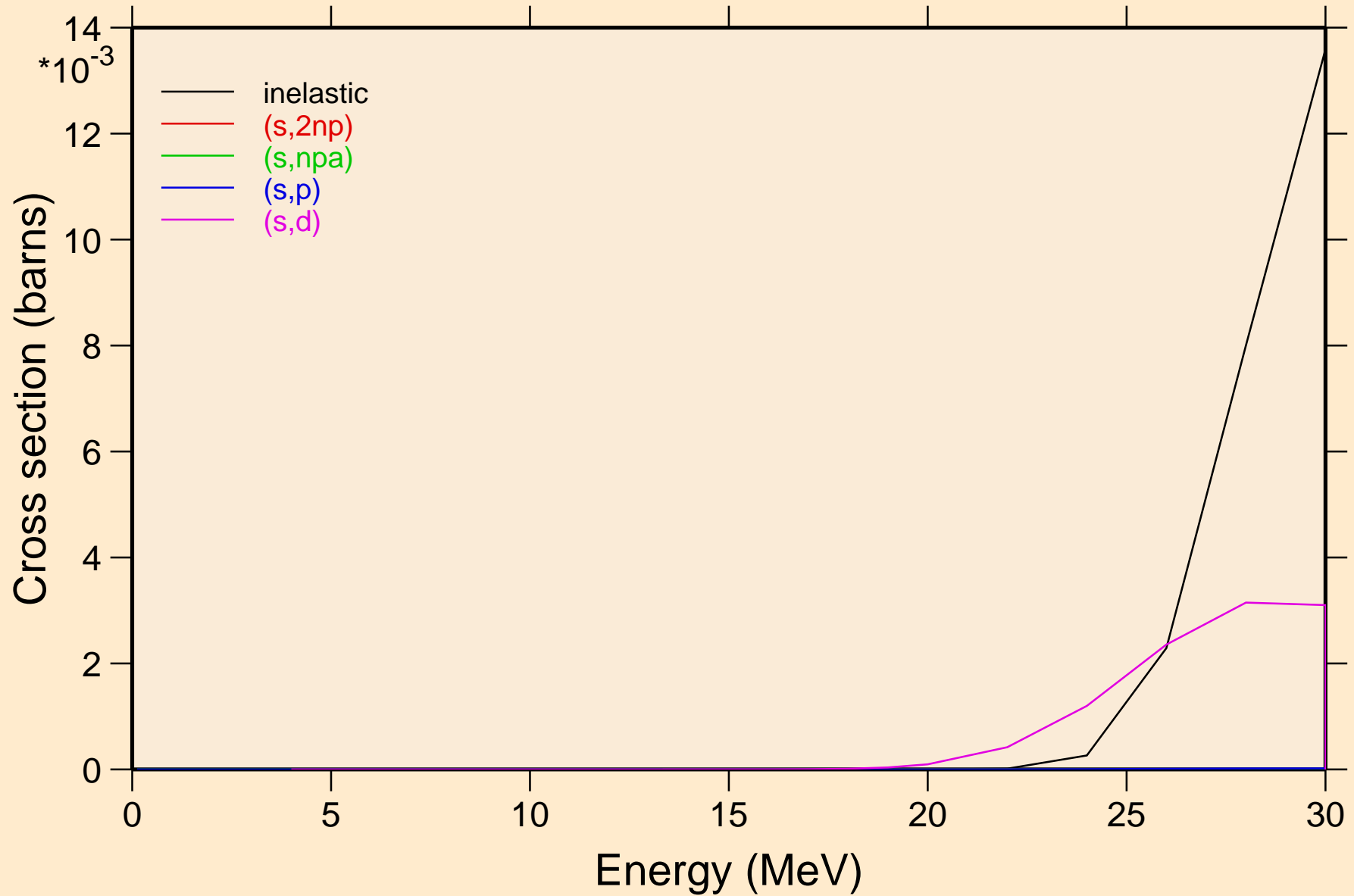

DB256 HELION ACER TENDL-2024 LIBRARY; T=0.K
Threshold reactions

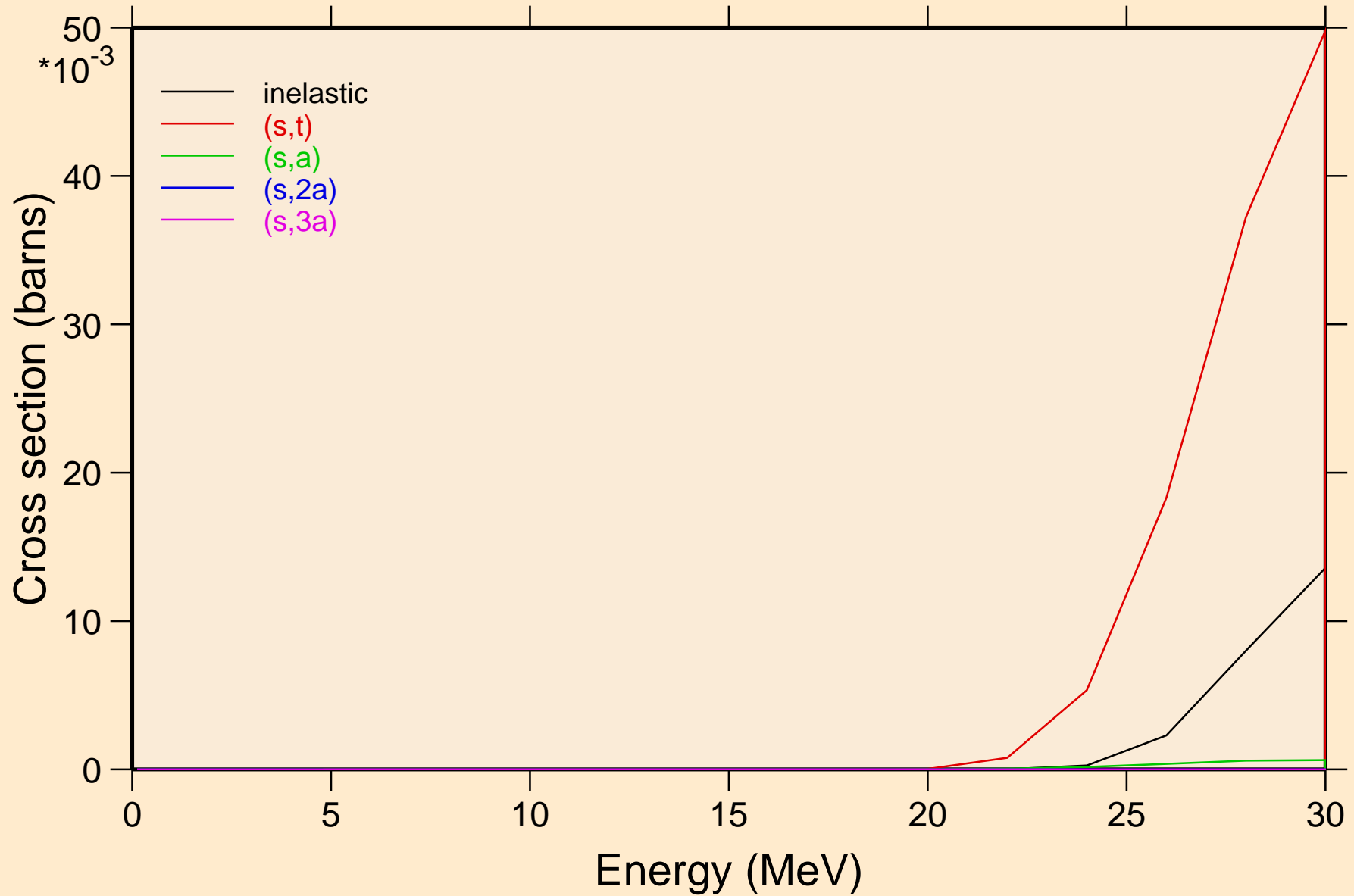

DB256 HELION ACER TENDL-2024 LIBRARY; T=0.K
Threshold reactions

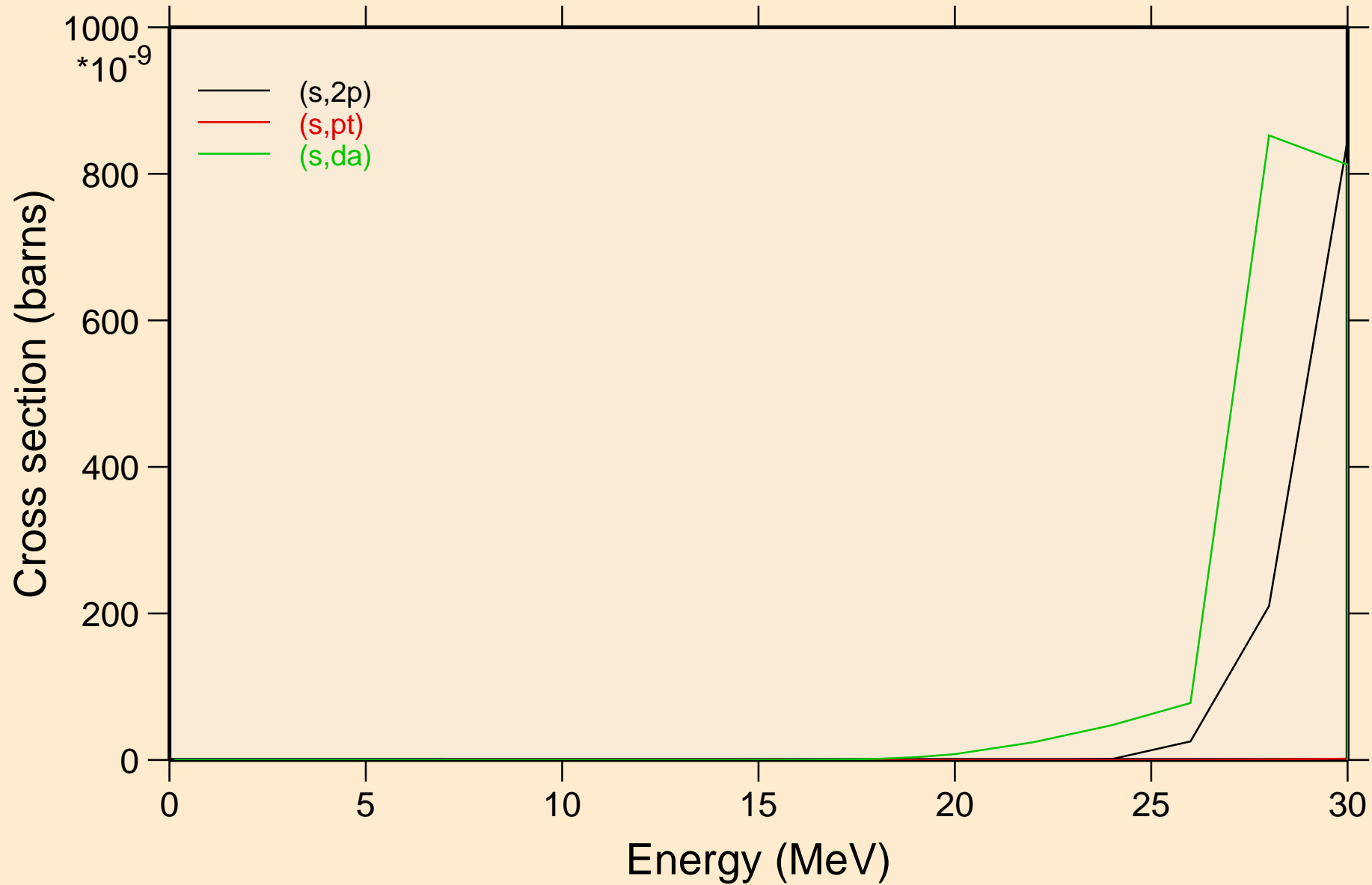

DB256 HELION ACER TENDL-2024 LIBRARY; T=0.K
angular distribution for elastic

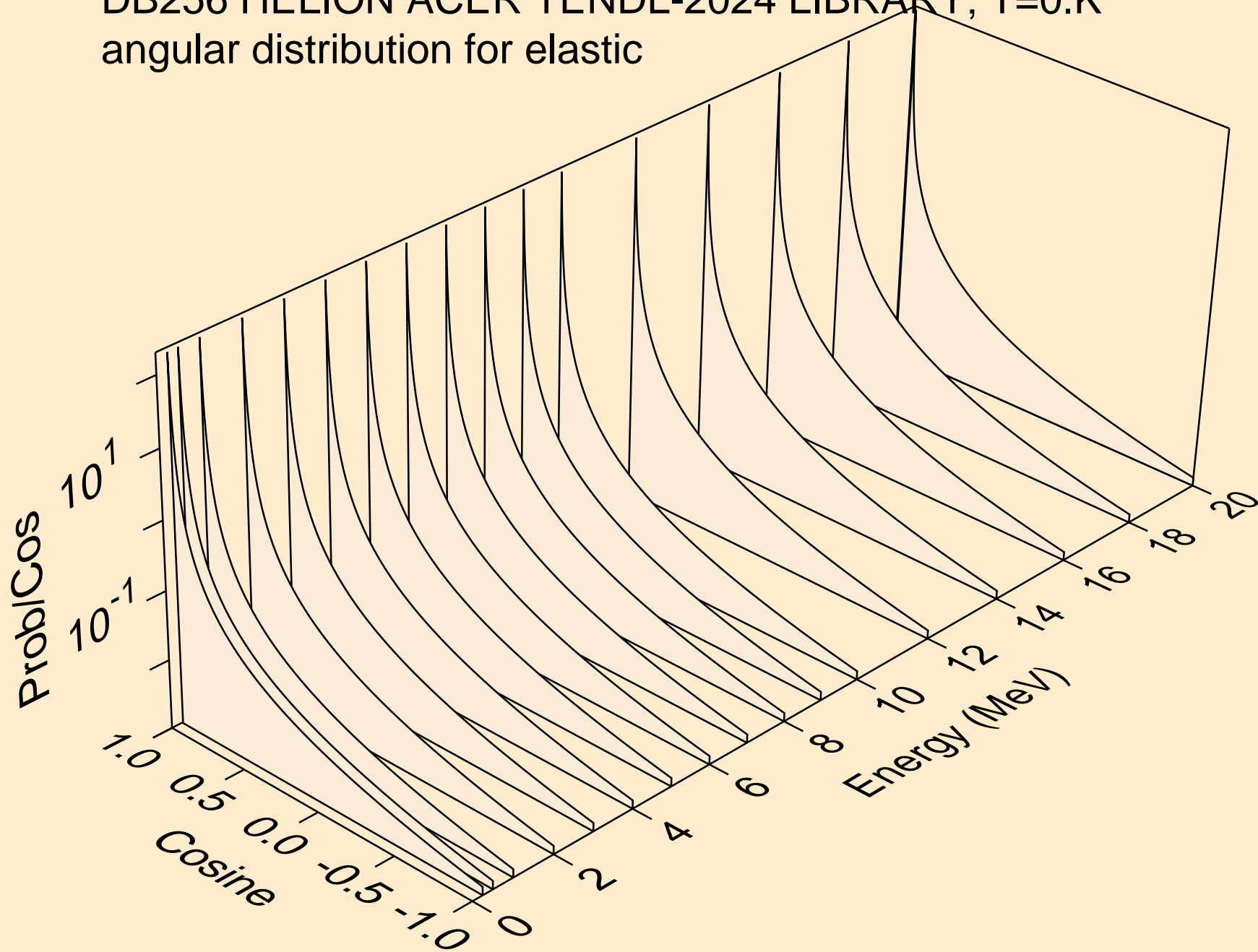

DB256 HELION ACER TENDL-2024 LIBRARY; T=0.K
angular distribution for elastic

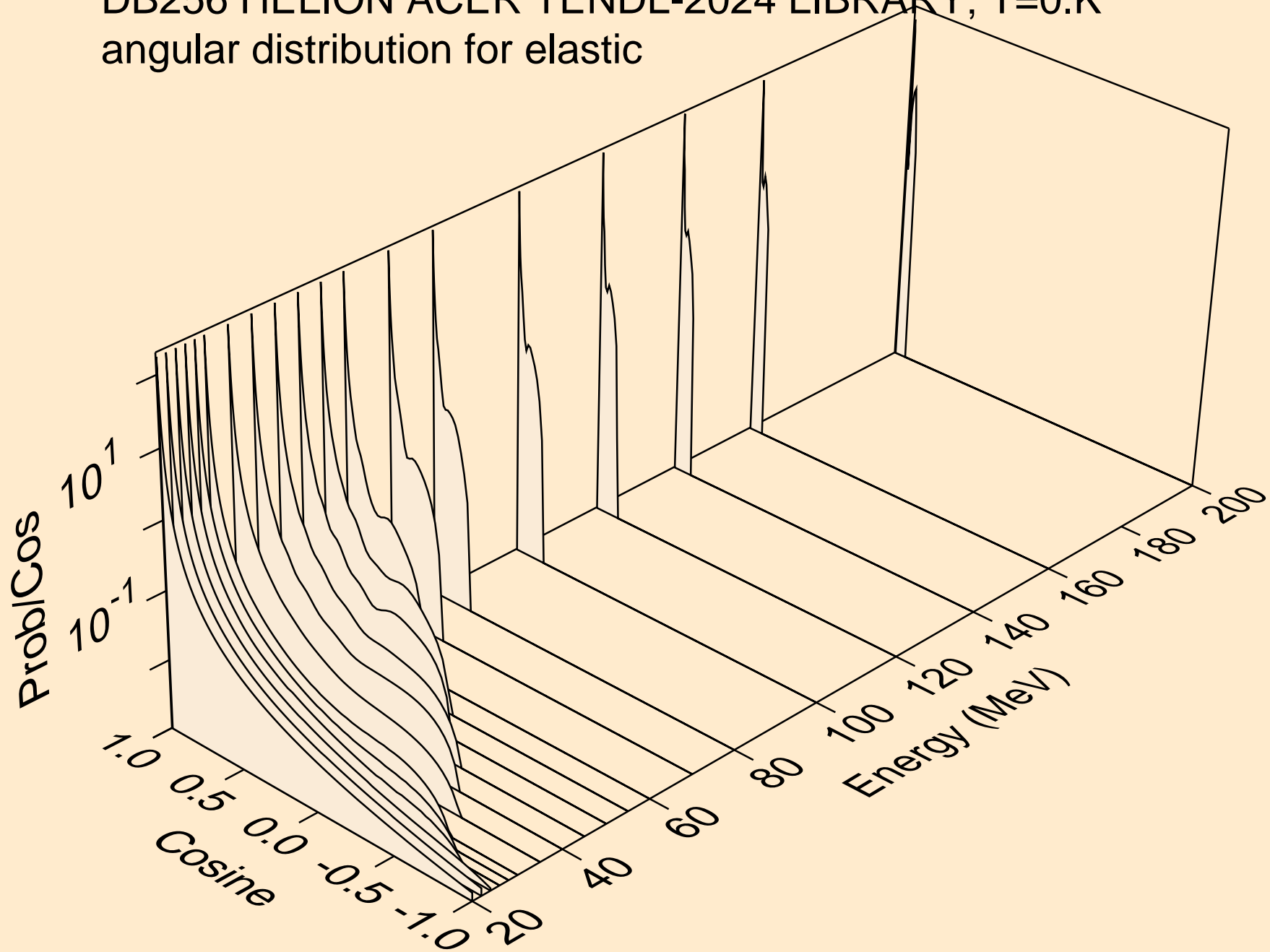

DB256 HELION ACER TENDL-2024 LIBRARY; T=0.K
He-3 emission for (s,x)

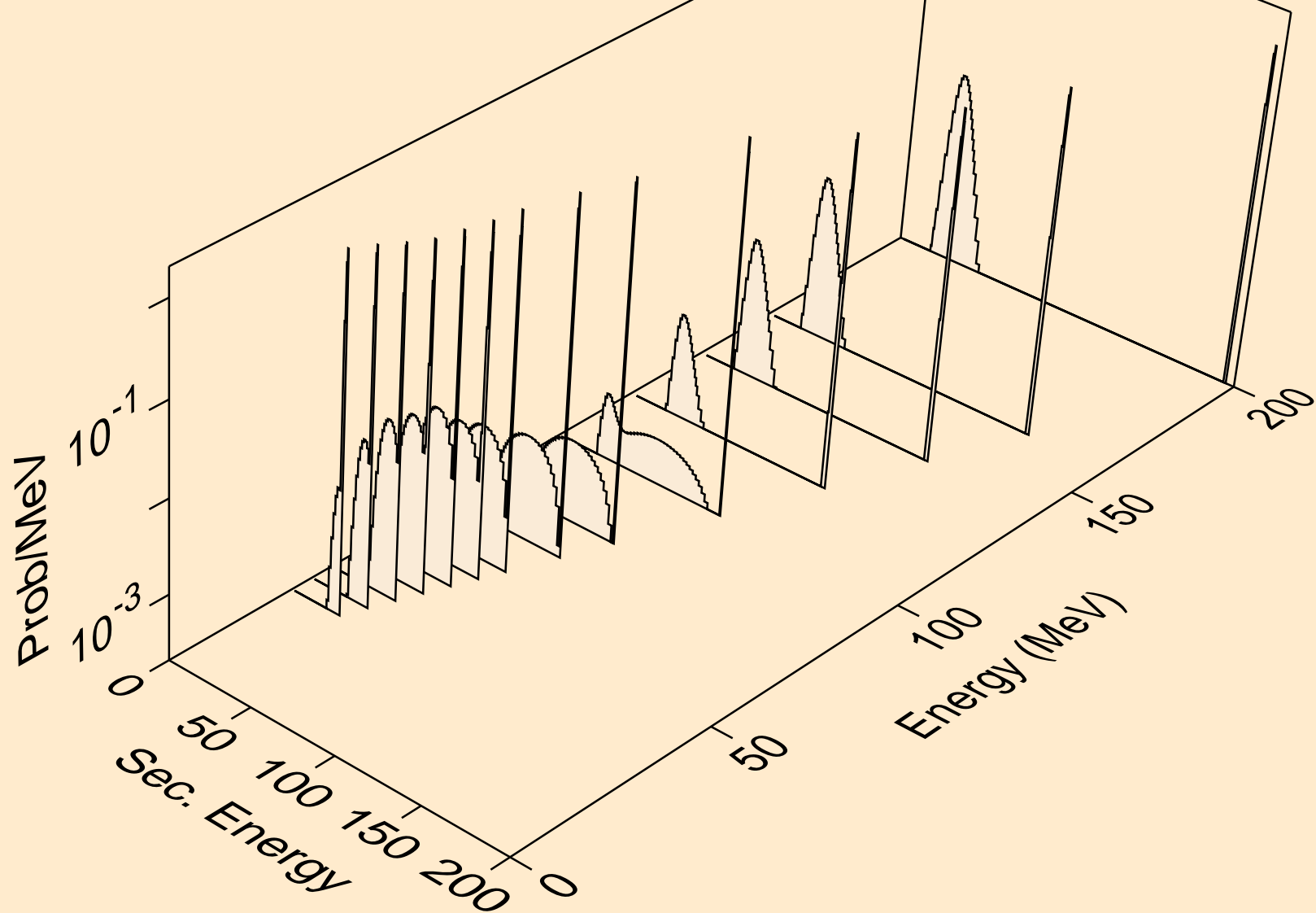

DB256 HELION ACER TENDL-2024 LIBRARY; T=0.K
He-3 emission for inelastic

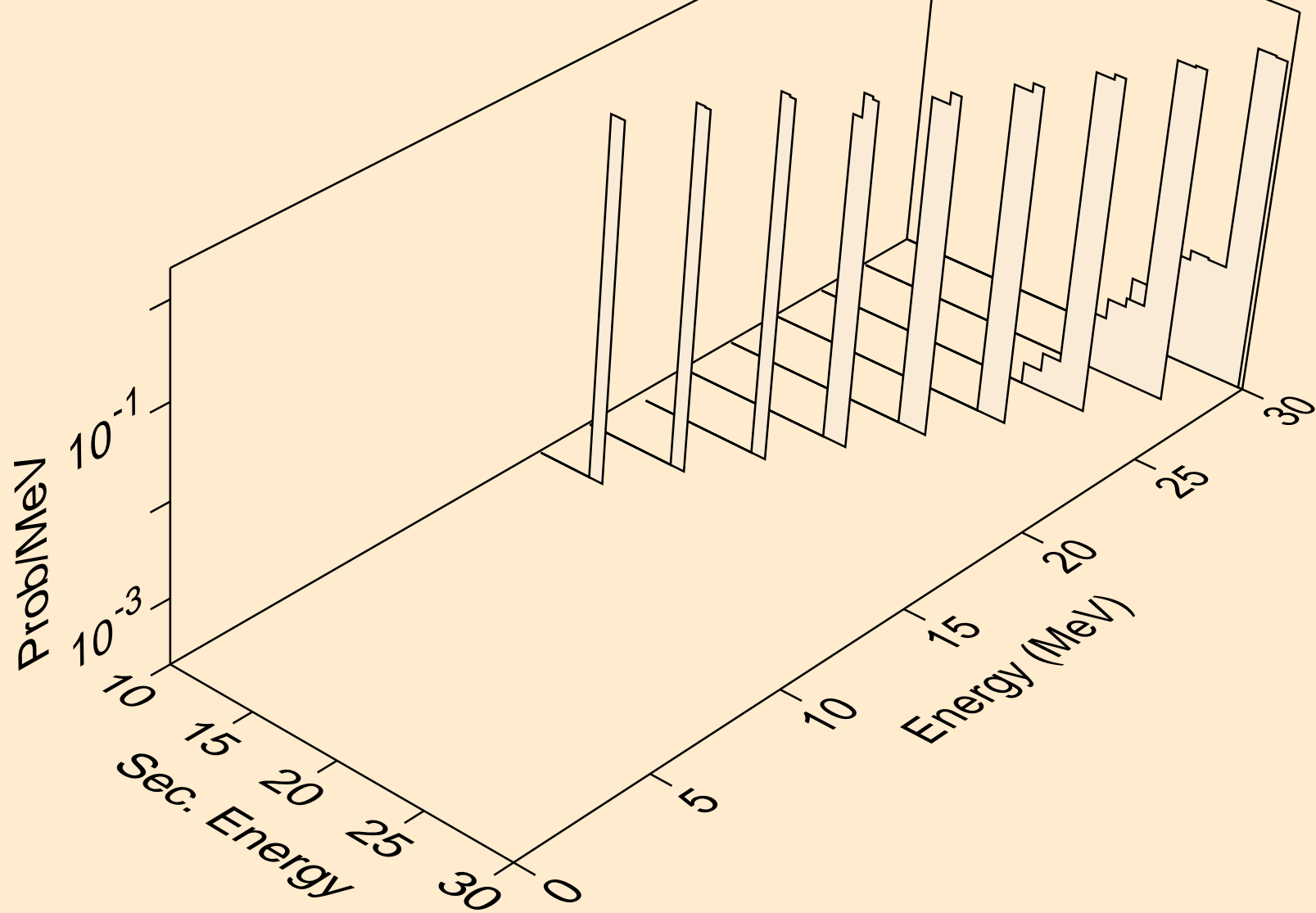

DB256 HELION ACER TENDL-2024 LIBRARY; T=0.K
Photon emission for (z,n)

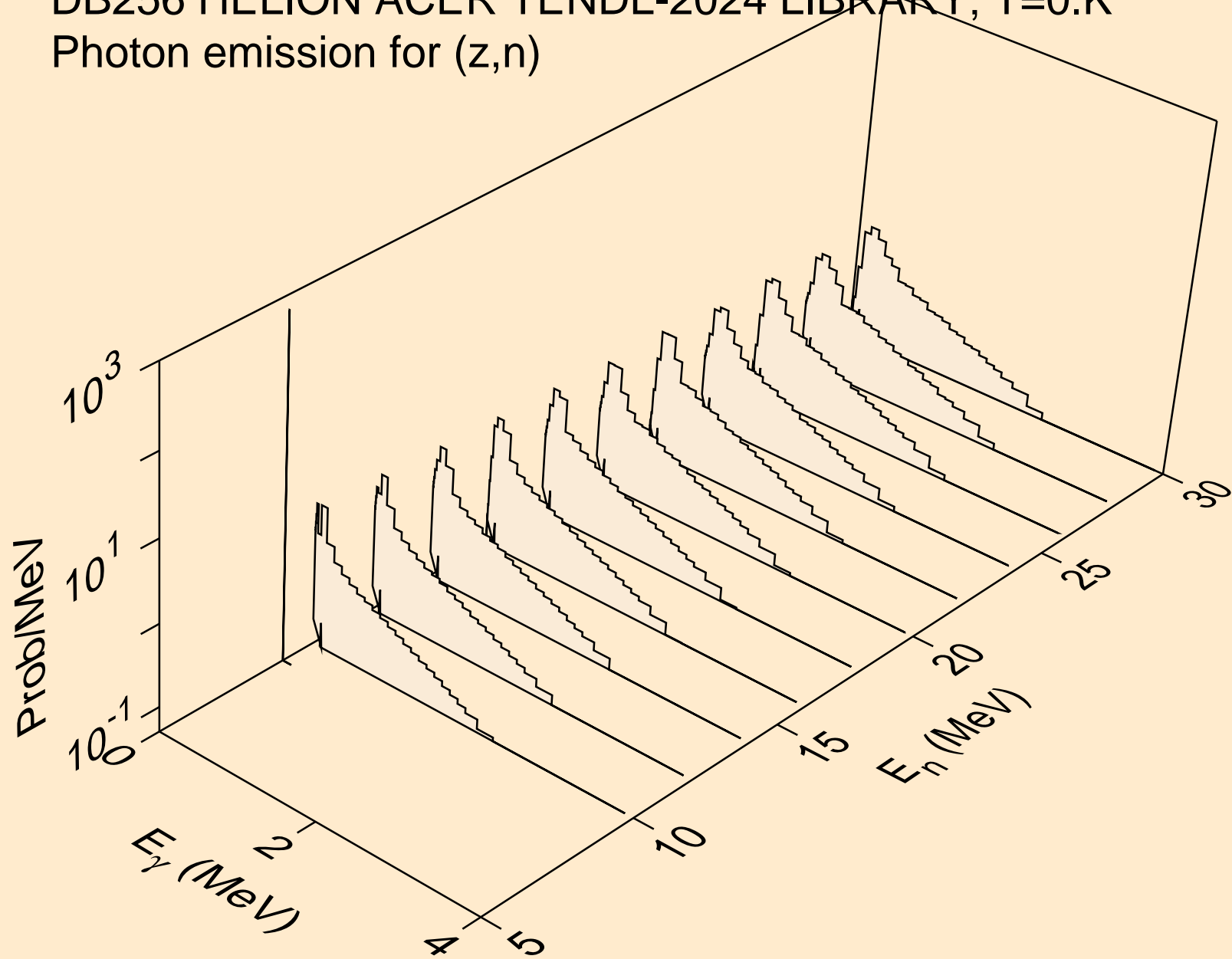

DB256 HELION ACER TENDL-2024 LIBRARY; T=0.K
Photon emission for (z,x)

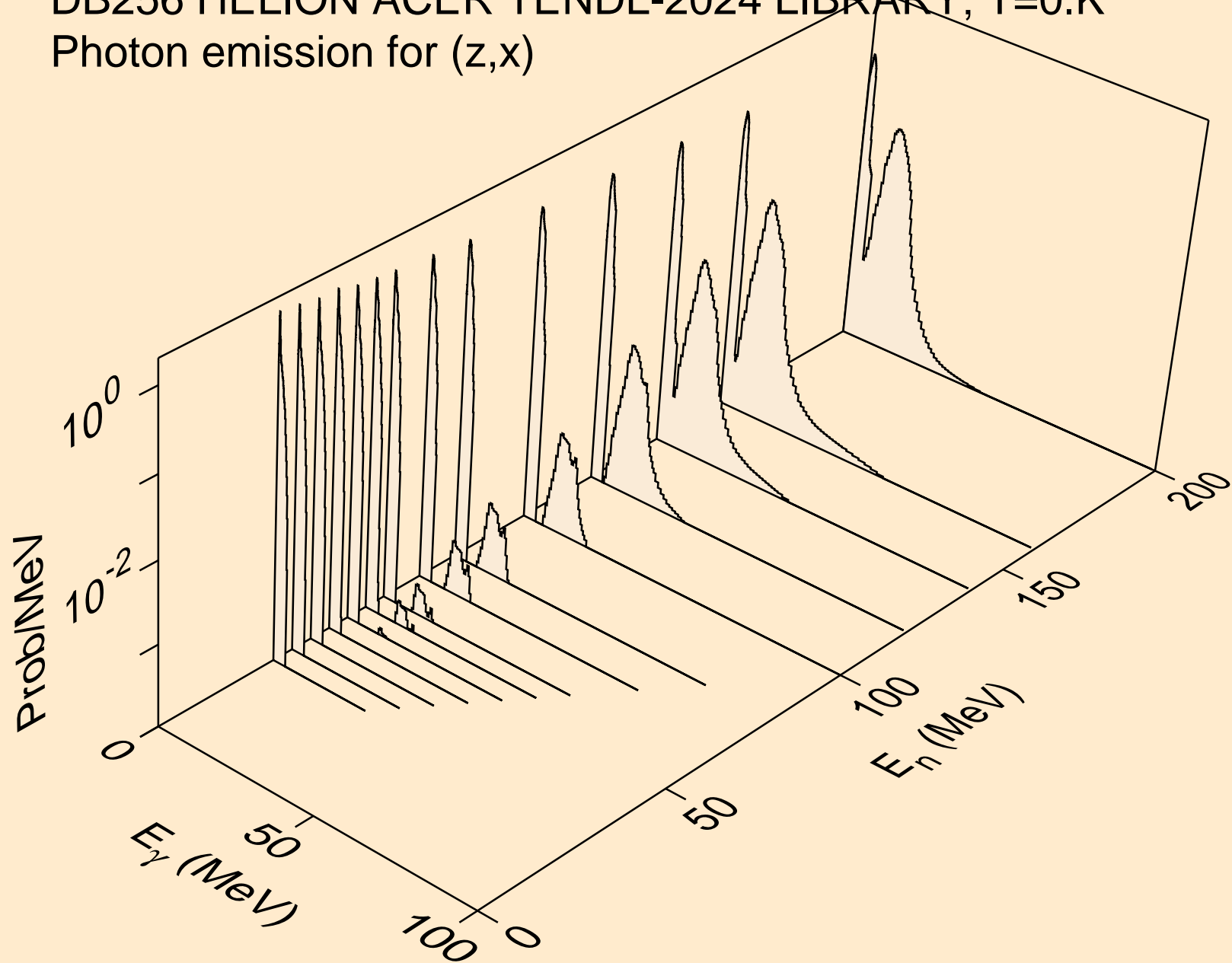

DB256 HELION ACER TENDL-2024 LIBRARY; T=0.K
Photon emission for (n,2n)

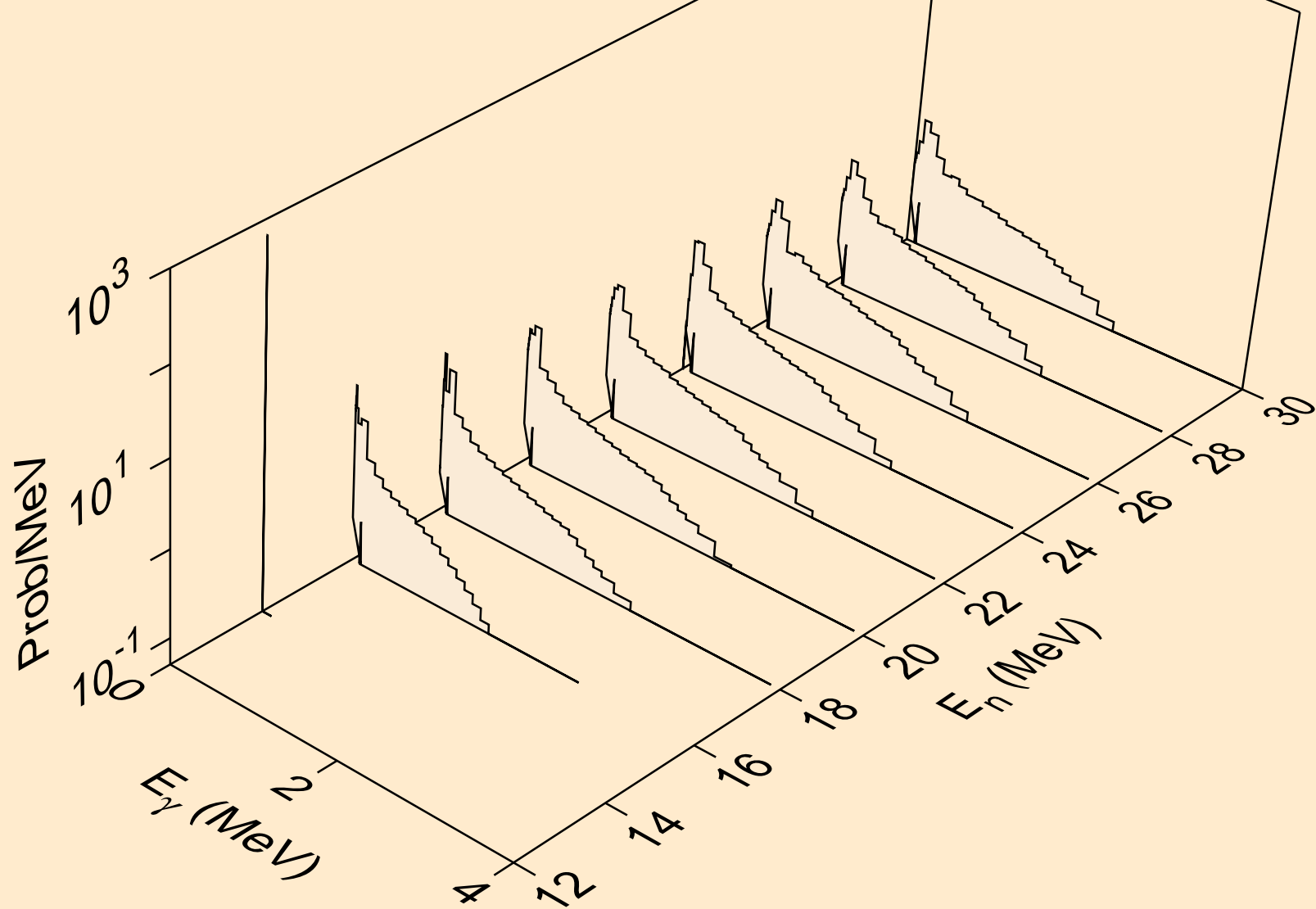

DB256 HELION ACER TENDL-2024 LIBRARY; T=0.K
Photon emission for (n,3n)

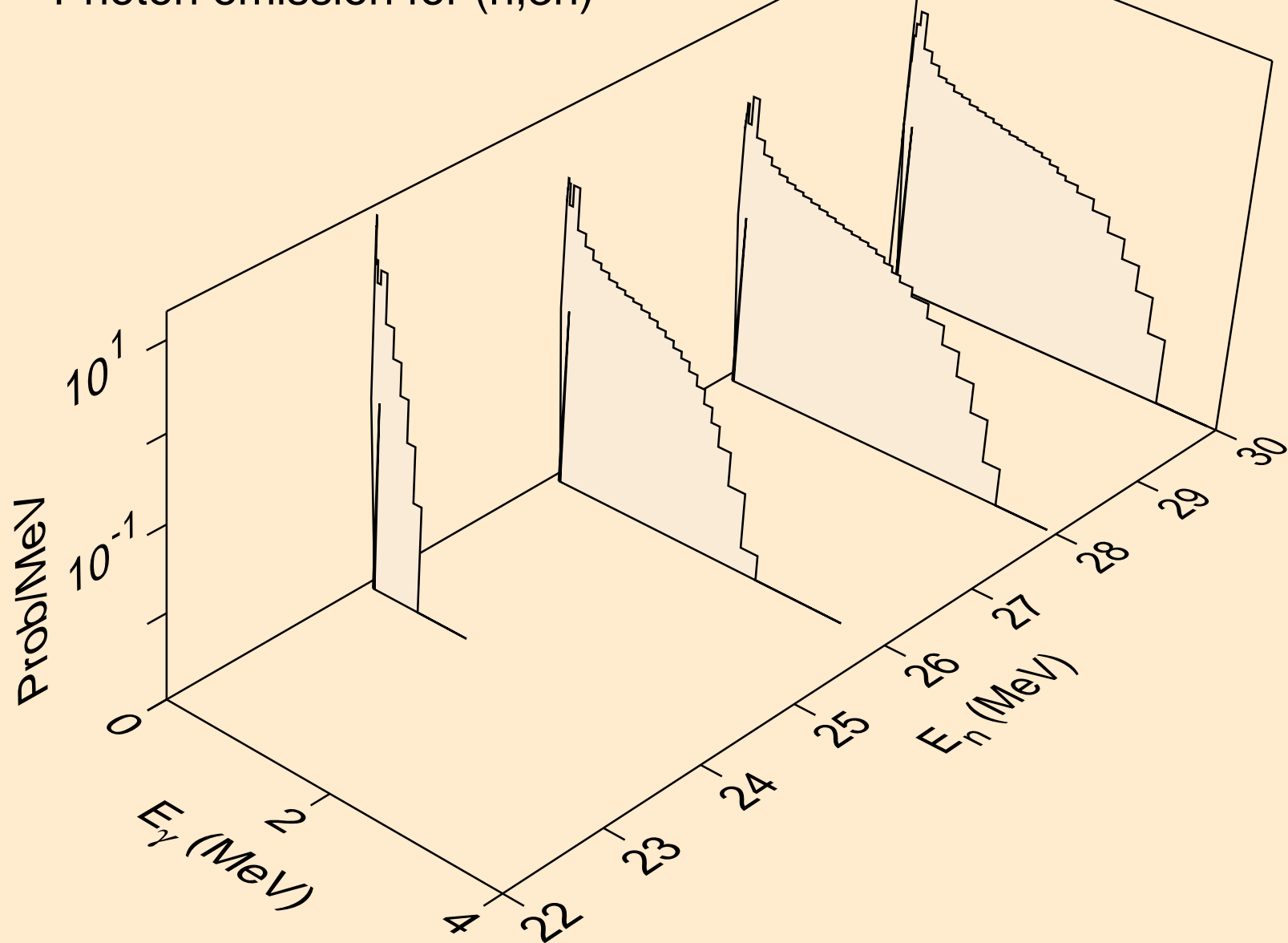

DB256 HELION ACER TENDL-2024 LIBRARY; T=0.K
Photon emission for (n,n*)a

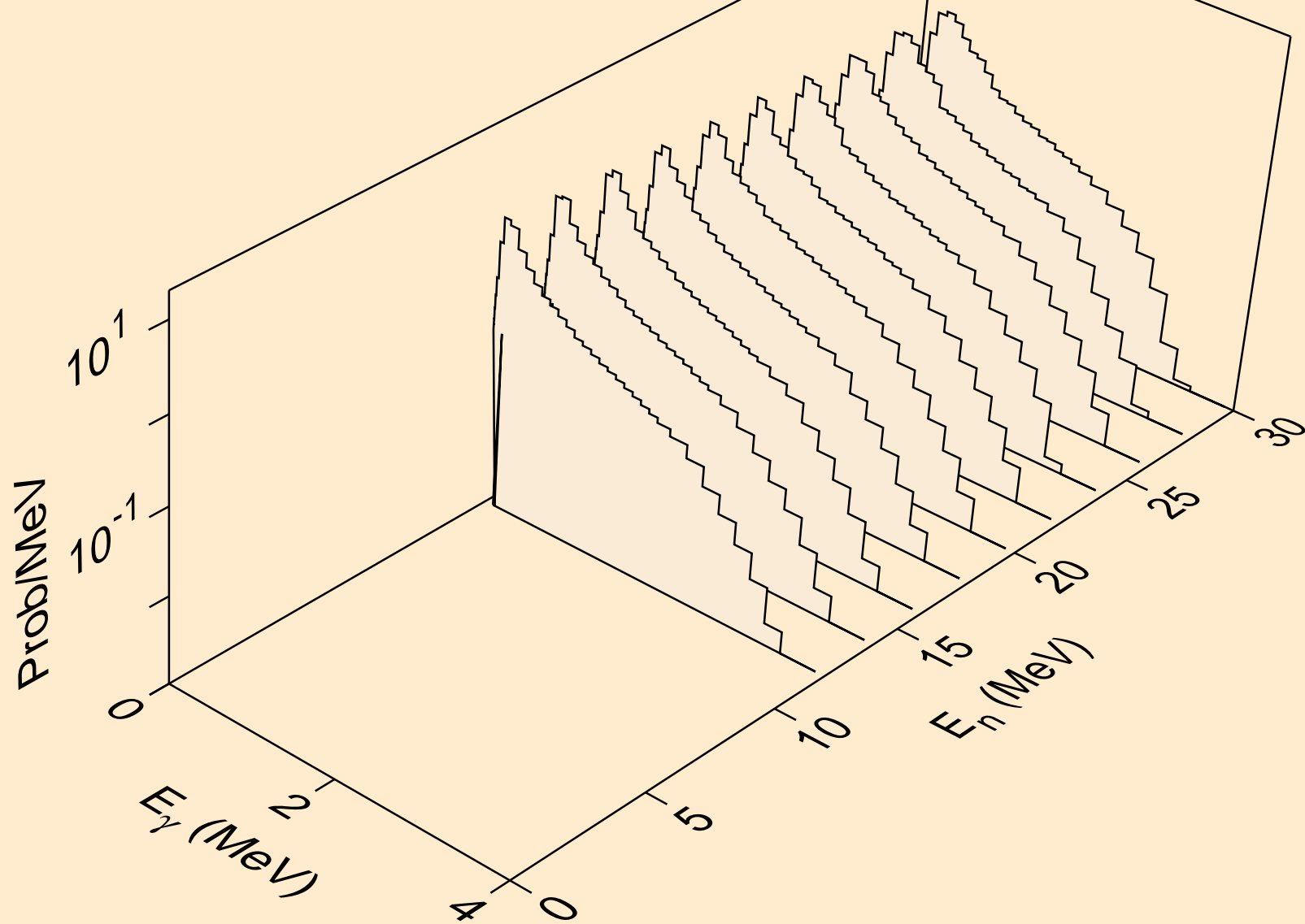

DB256 HELION ACER TENDL-2024 LIBRARY; T=0.K
Photon emission for (n,2n)a

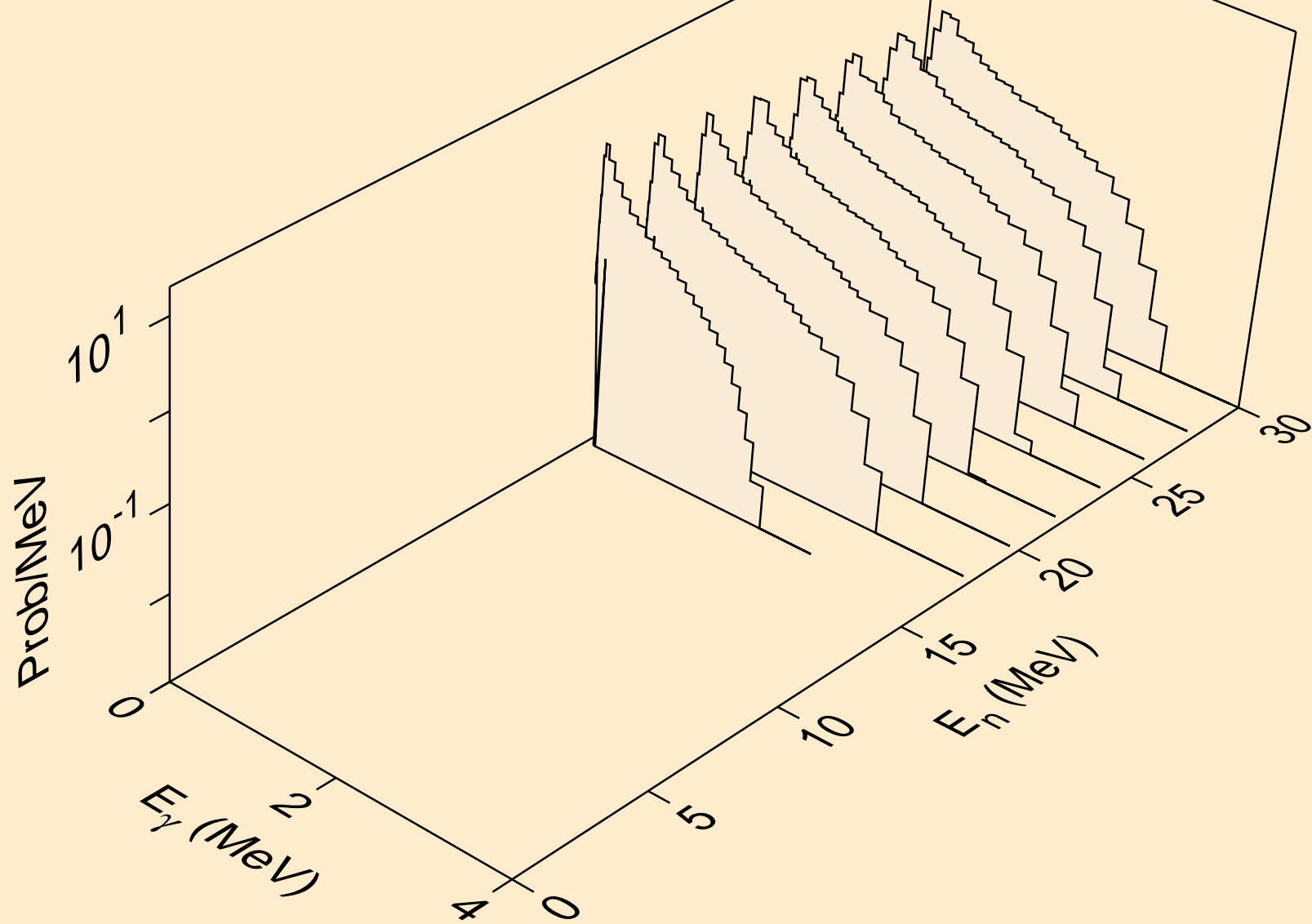

DB256 HELION ACER TENDL-2024 LIBRARY; T=0.K
Photon emission for (n,n*)p

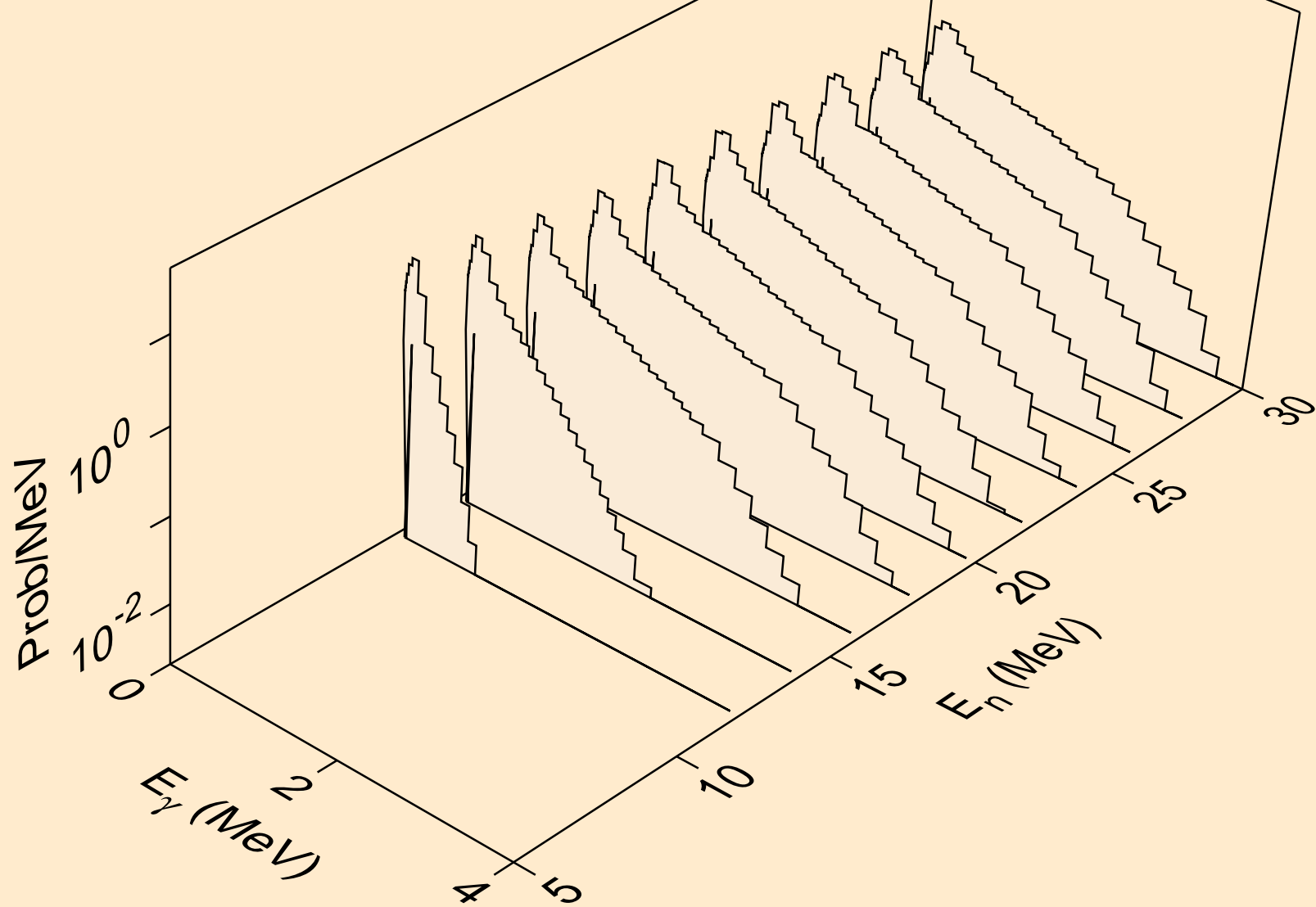

DB256 HELION ACER TENDL-2024 LIBRARY; T=0.K
Photon emission for (n,n*)d

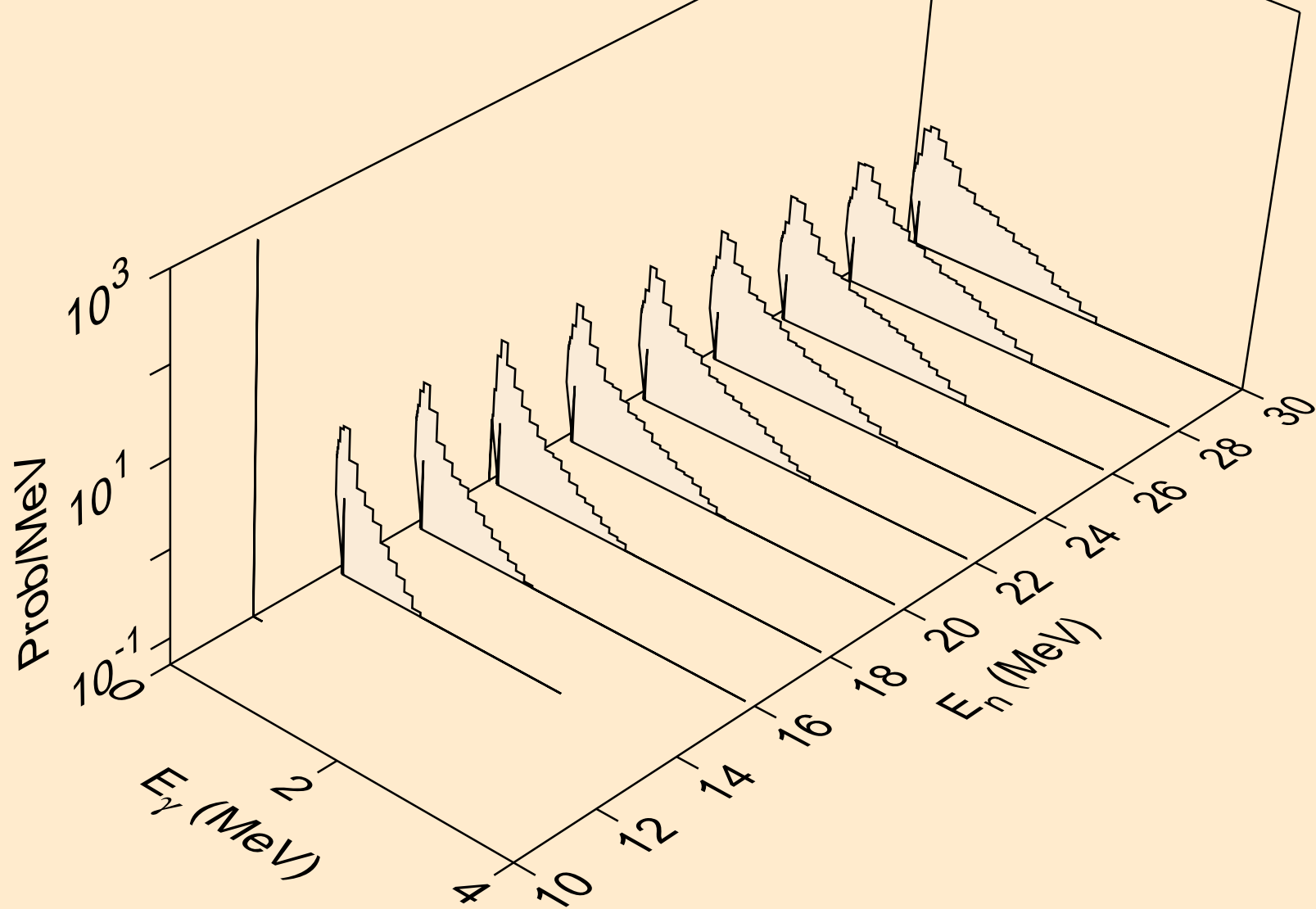

DB256 HELION ACER TENDL-2024 LIBRARY; T=0.K
Photon emission for (n,n*)t

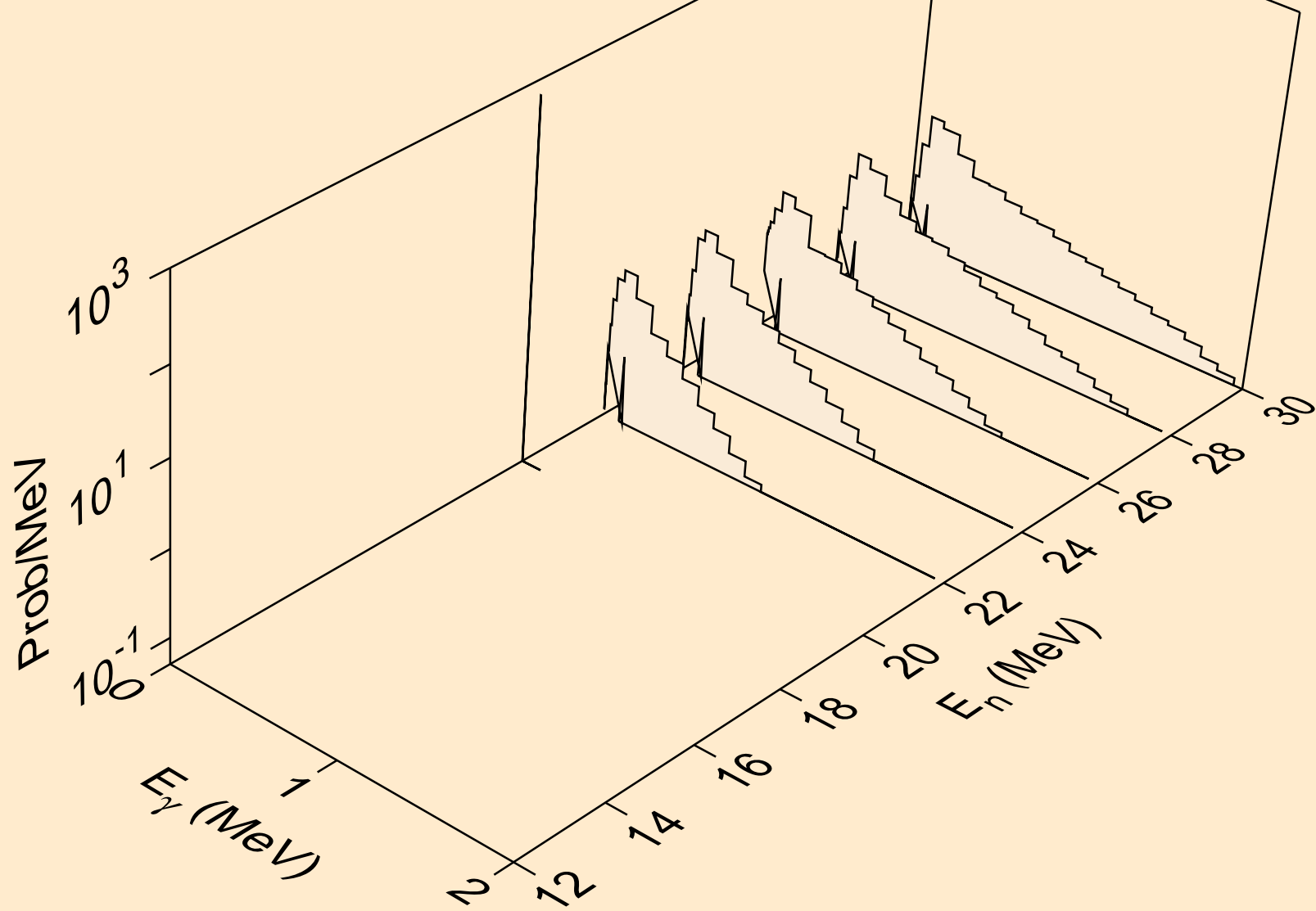

DB256 HELION ACER TENDL-2024 LIBRARY; T=0.K
Photon emission for (n,2np)

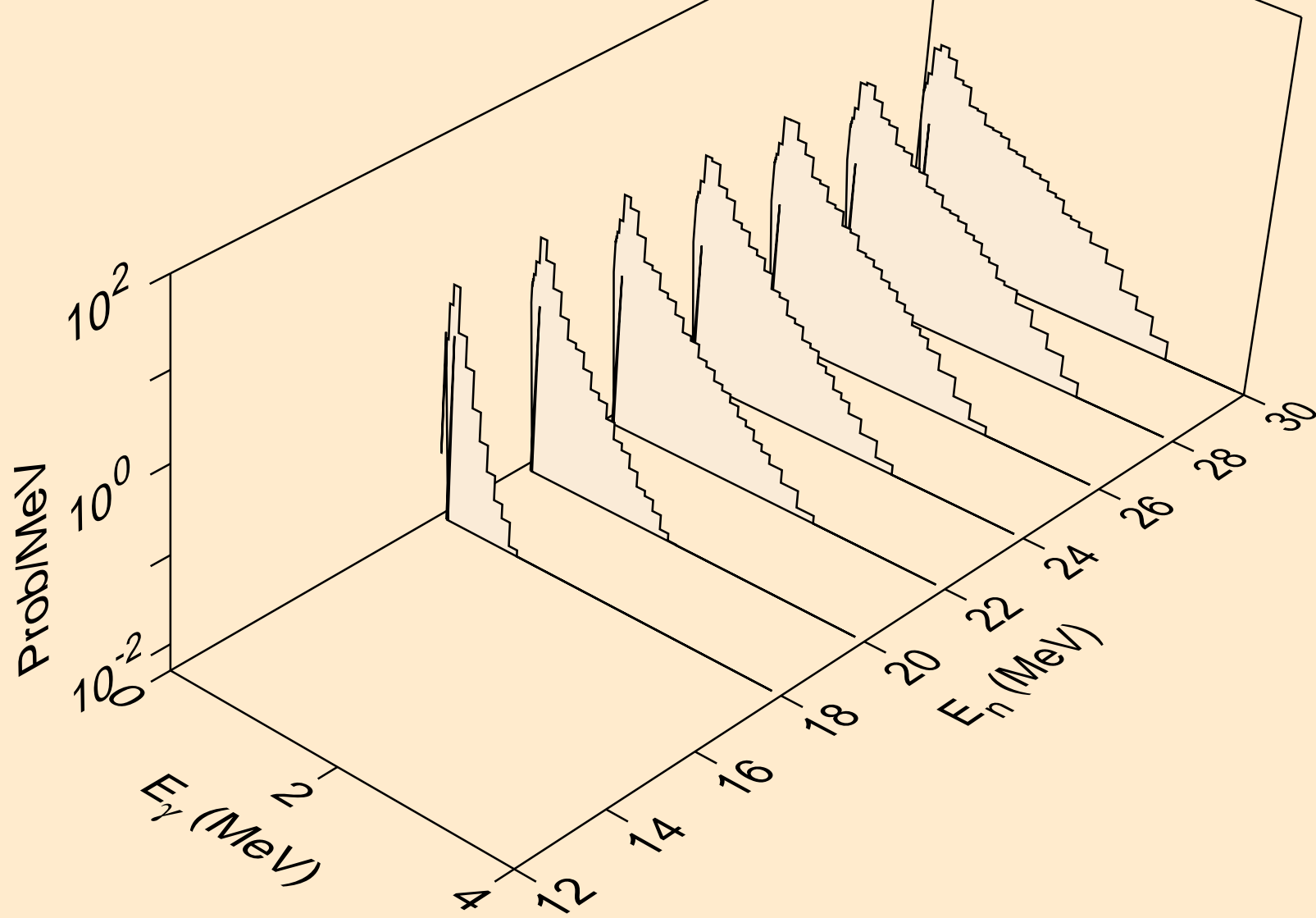

DB256 HELION ACER TENDL-2024 LIBRARY; T=0.K
Photon emission for (n,npa)

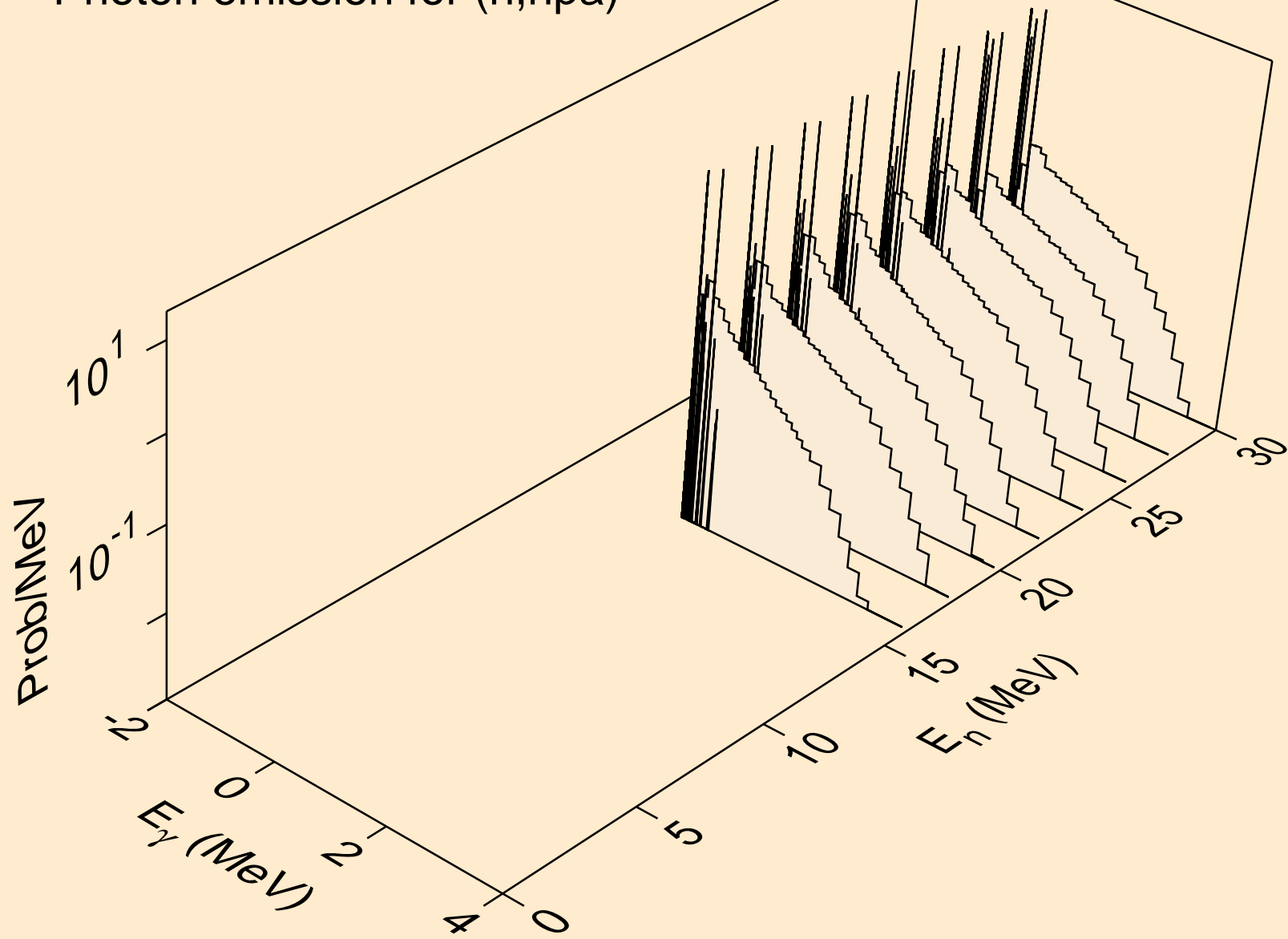

DB256 HELION ACER TENDL-2024 LIBRARY; T=0.K
Photon emission for (n,p)

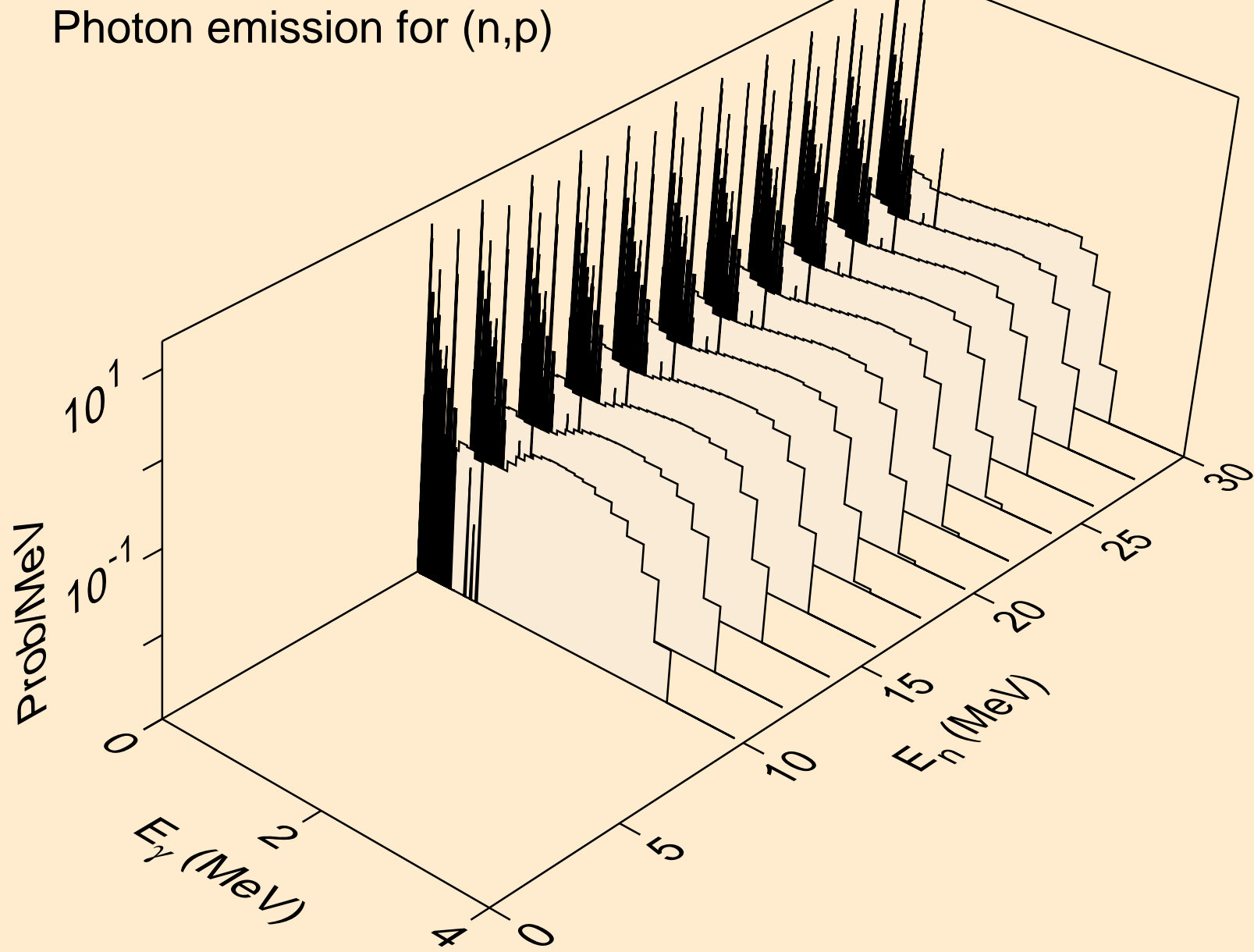

DB256 HELION ACER TENDL-2024 LIBRARY; T=0.K
Photon emission for (n,d)

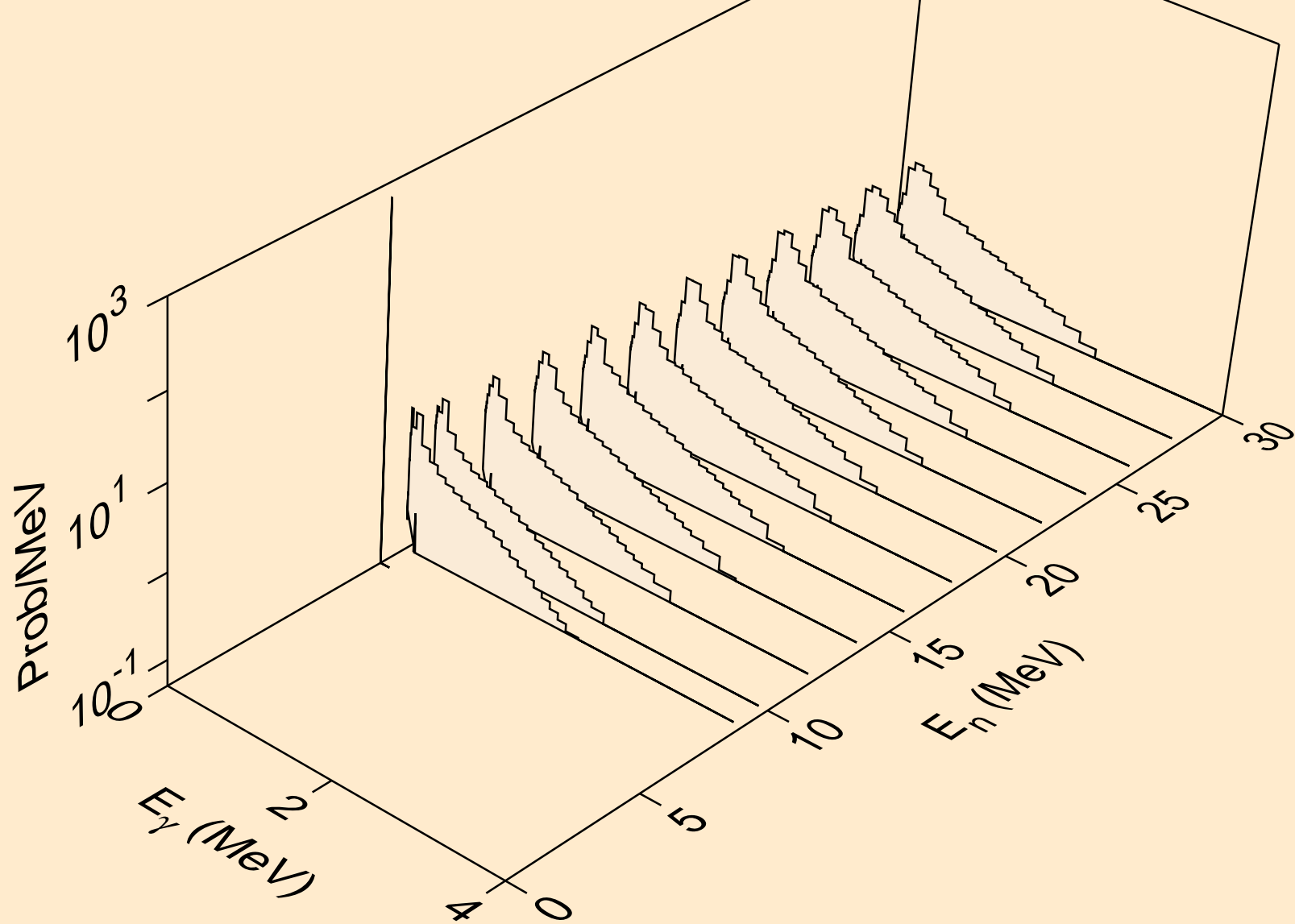

DB256 HELION ACER TENDL-2024 LIBRARY; T=0.K
Photon emission for (n,t)

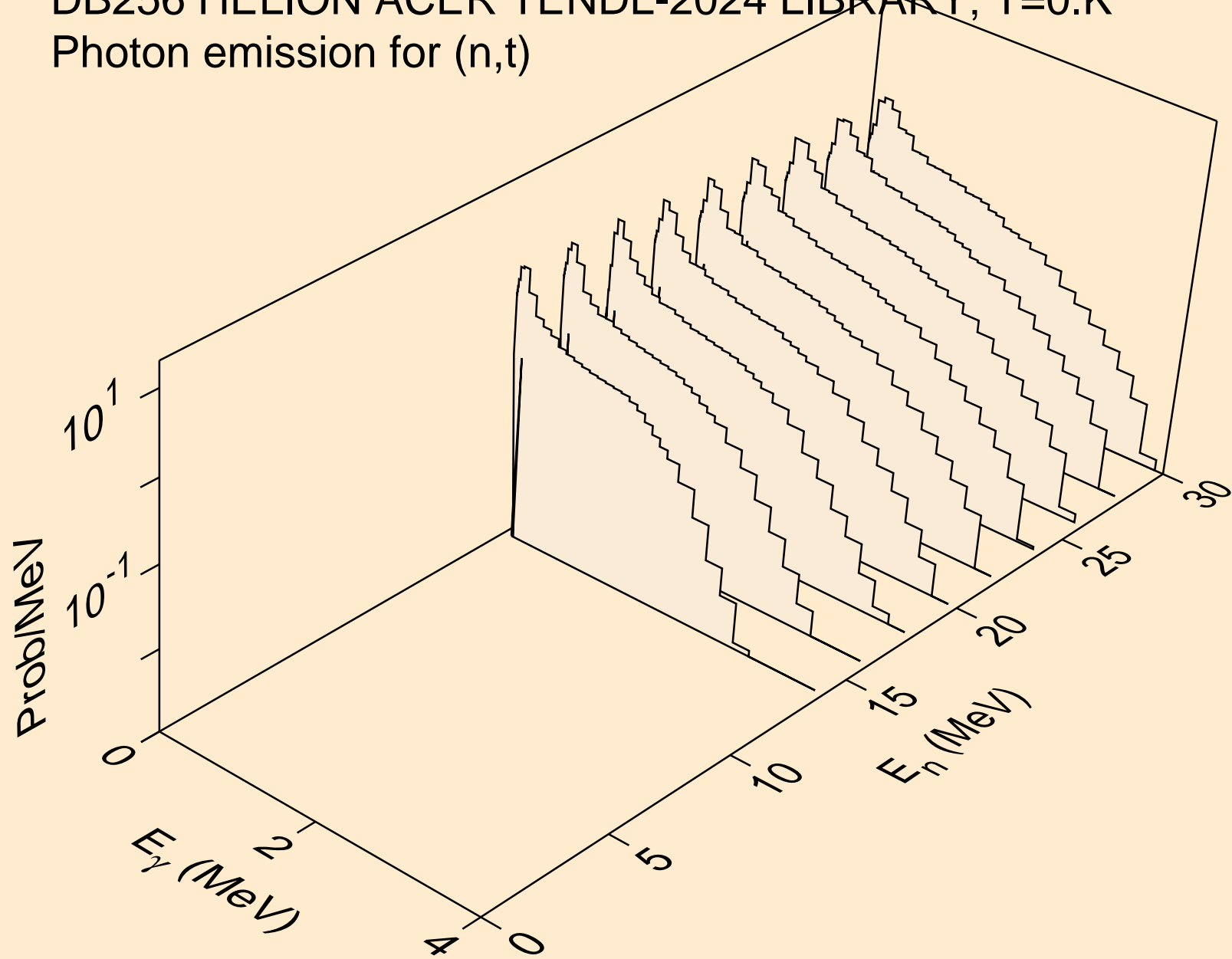

DB256 HELION ACER TENDL-2024 LIBRARY; T=0.K
Photon emission for inelastic

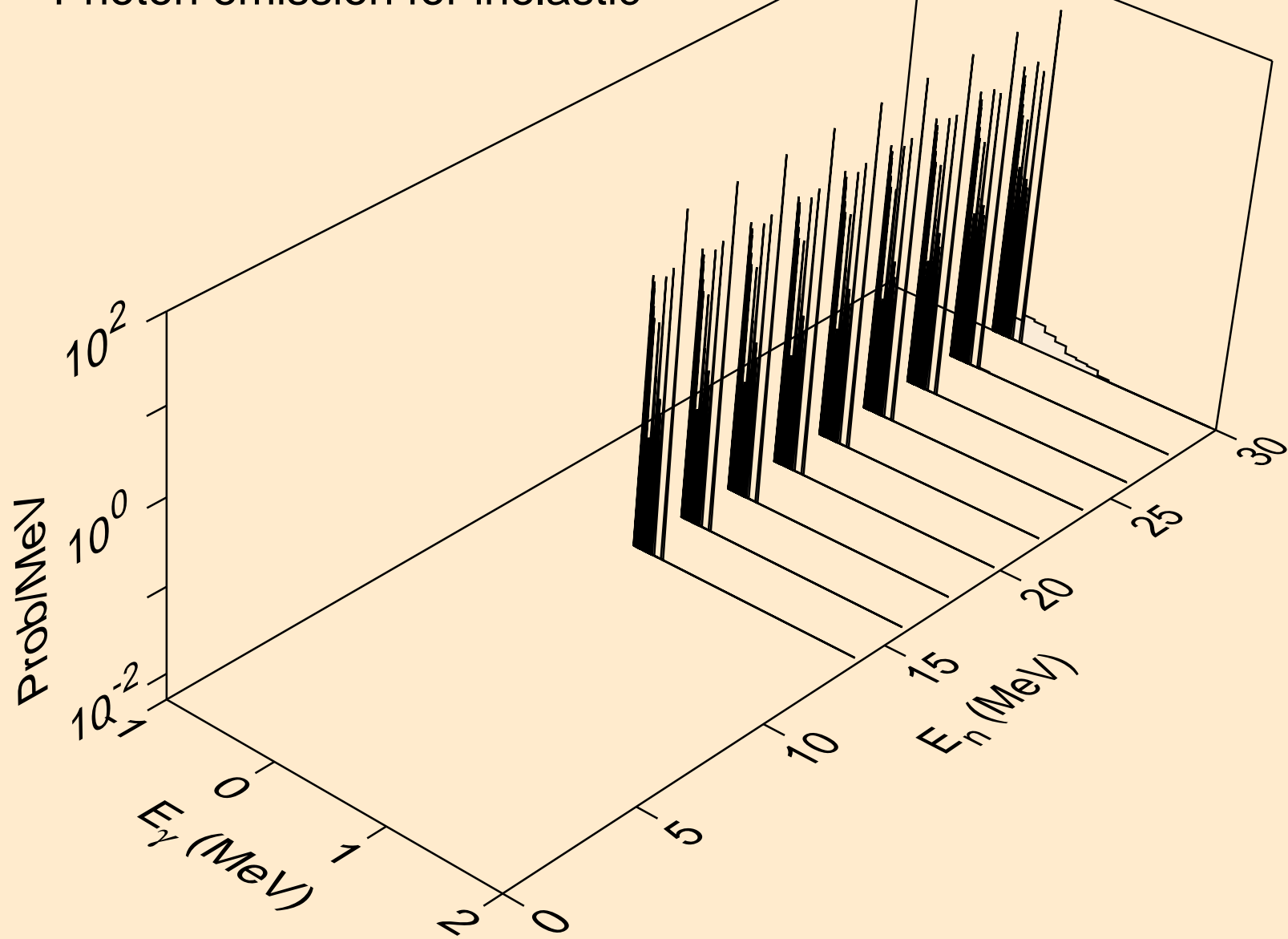

DB256 HELION ACER TENDL-2024 LIBRARY; T=0.K
Photon emission for (n,a)

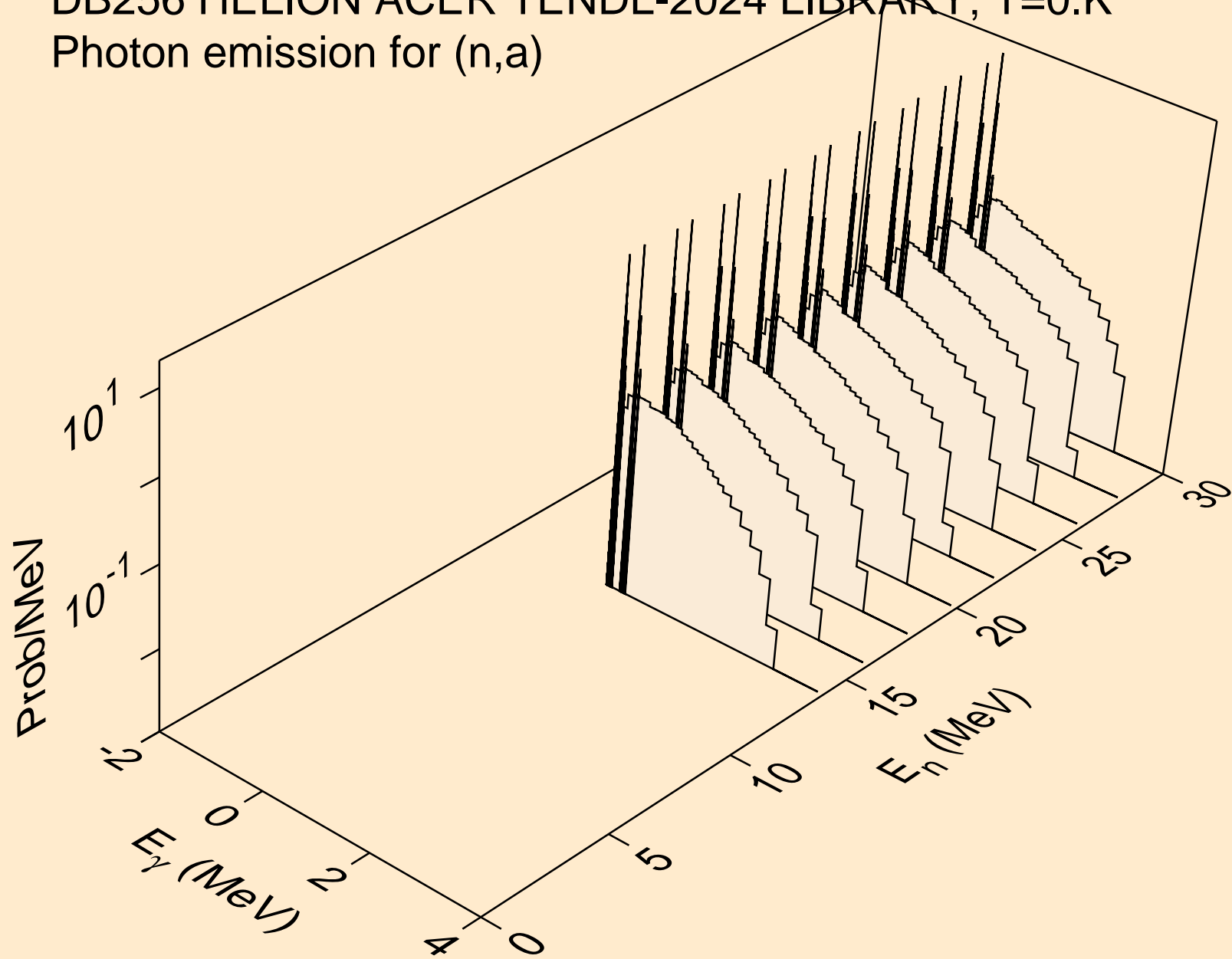

DB256 HELION ACER TENDL-2024 LIBRARY; T=0.K
Photon emission for (n,2a)

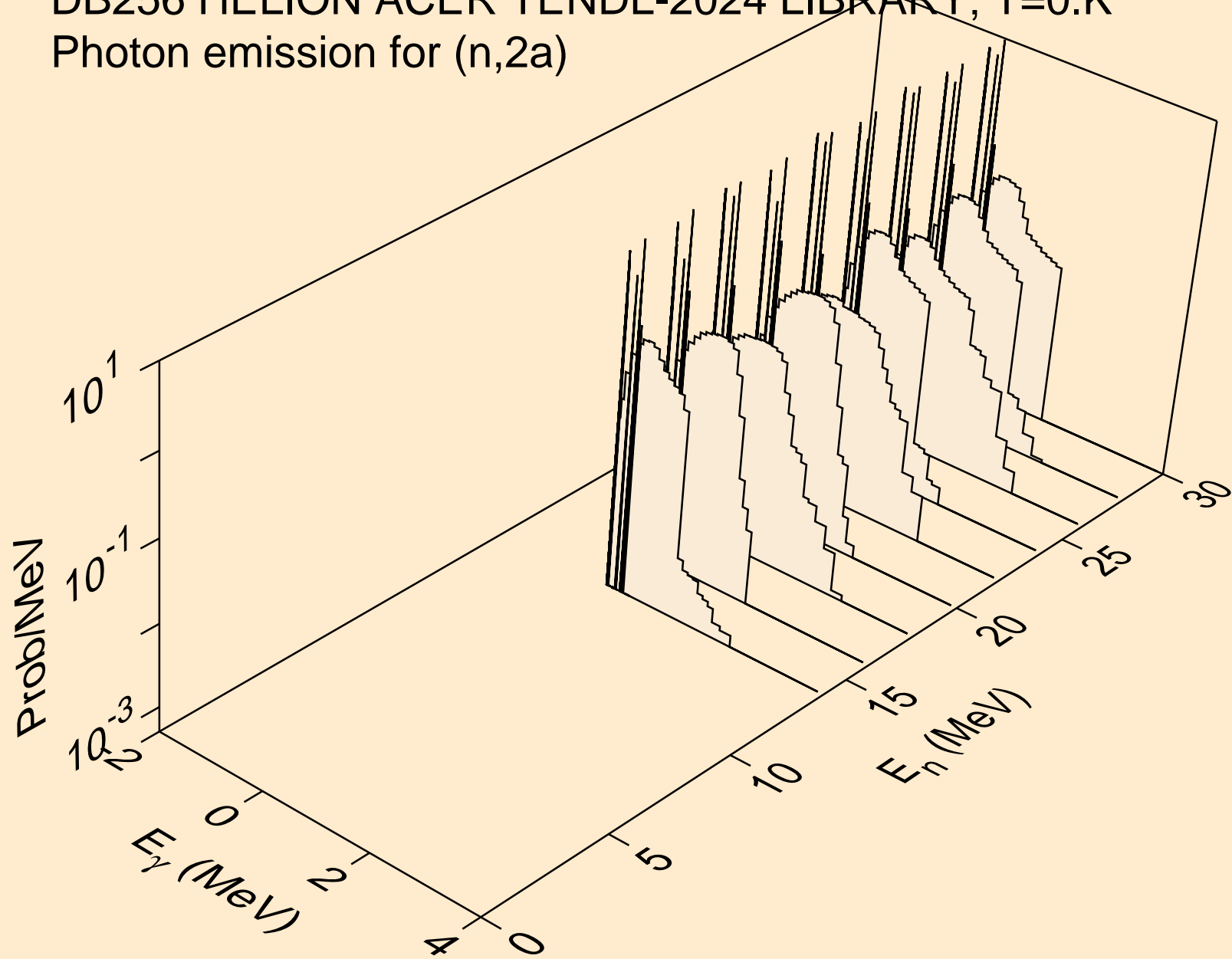

DB256 HELION ACER TENDL-2024 LIBRARY; T=0.K
Photon emission for (n,3a)

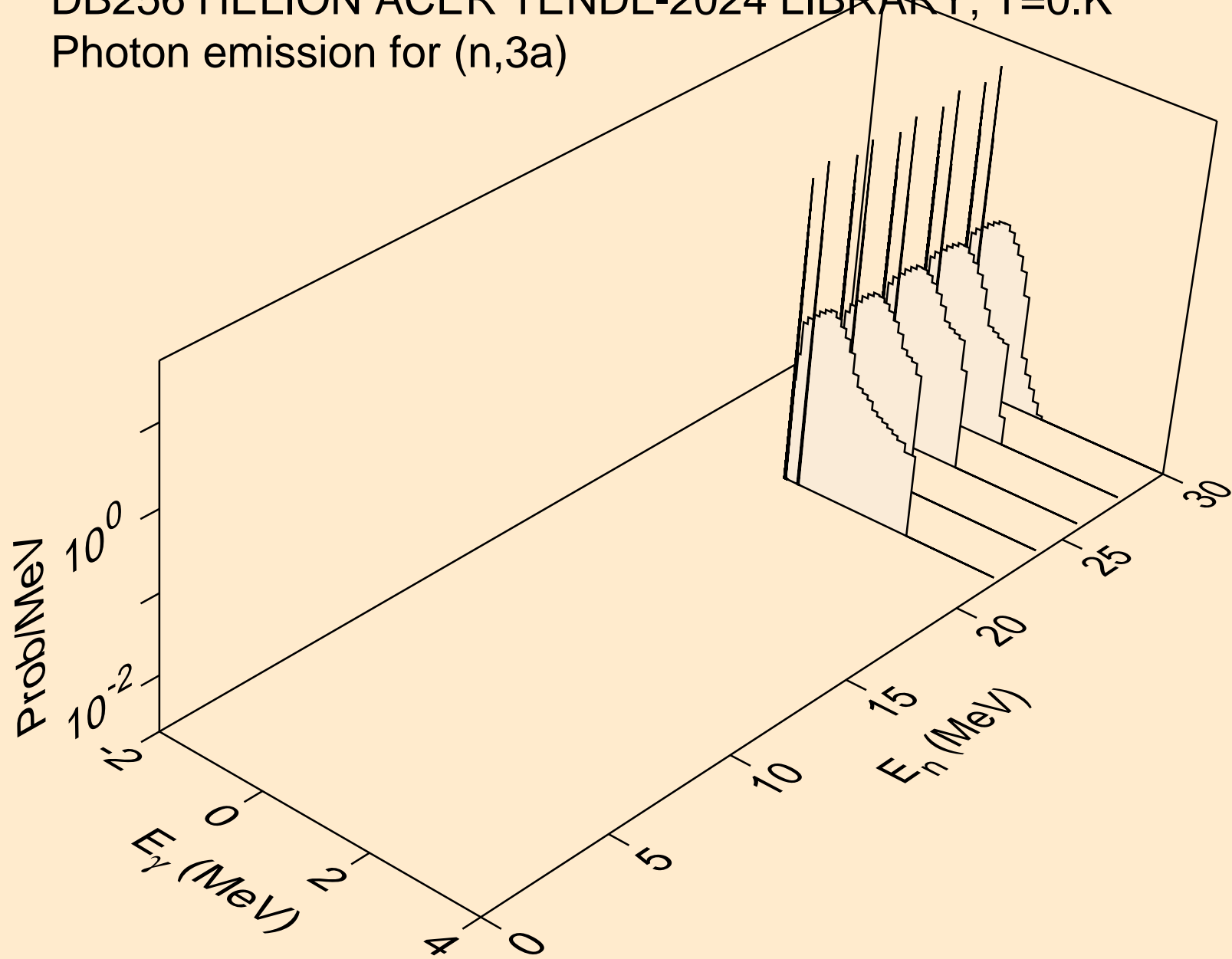

DB256 HELION ACER TENDL-2024 LIBRARY; T=0.K
Photon emission for (n,2p)

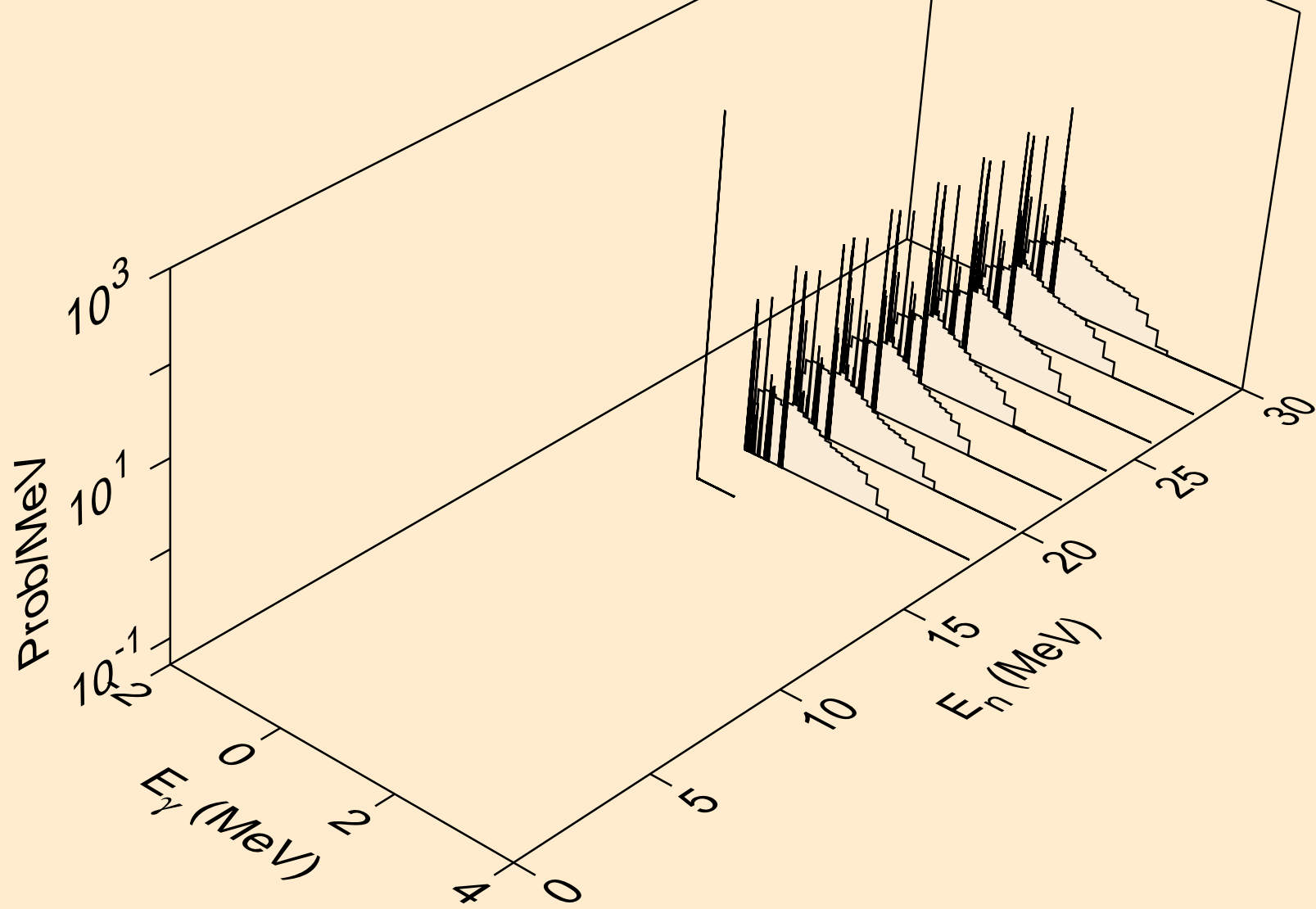

DB256 HELION ACER TENDL-2024 LIBRARY; T=0.K
Photon emission for (n,pt)

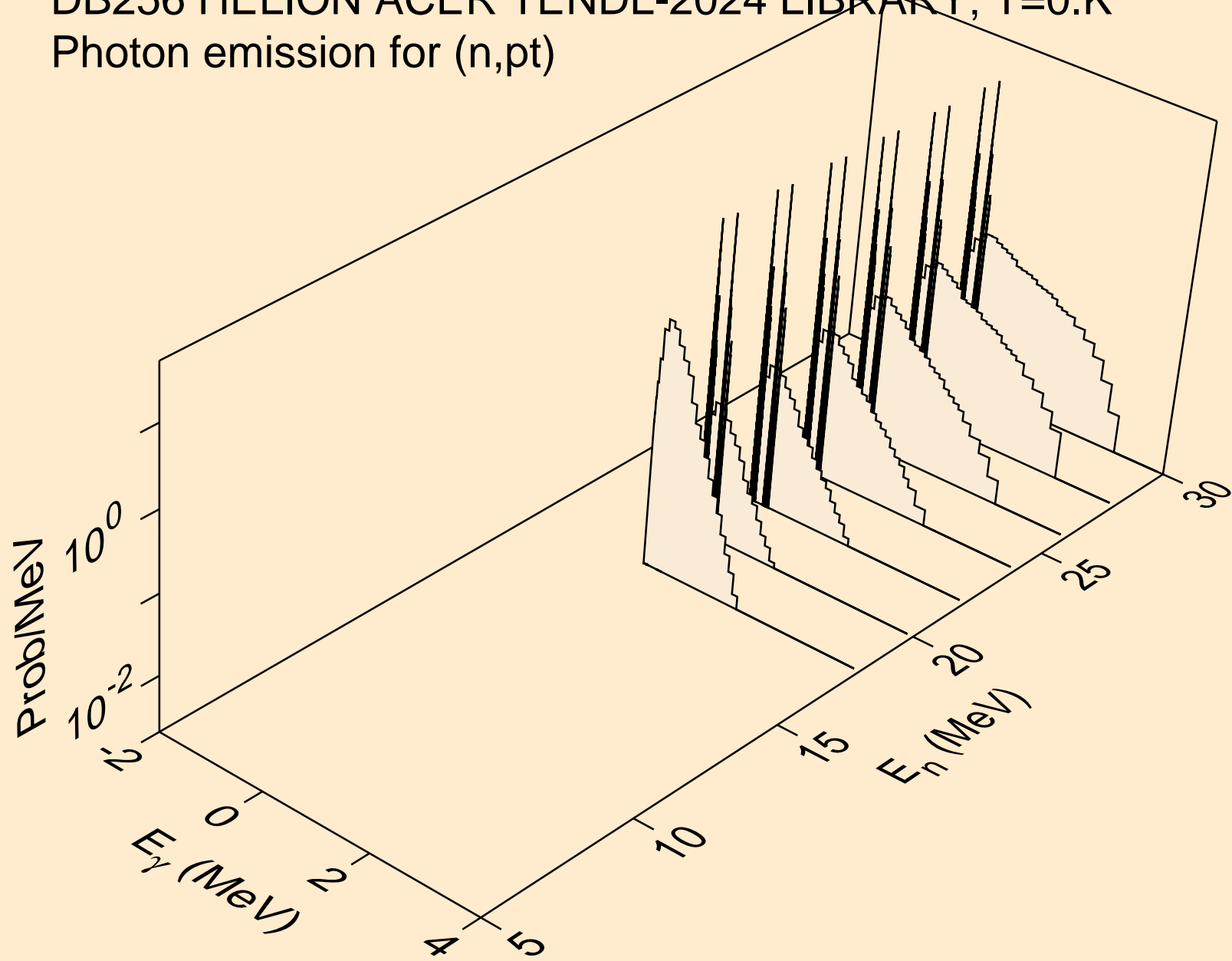

DB256 HELION ACER TENDL-2024 LIBRARY; T=0.K
Photon emission for (n,da)

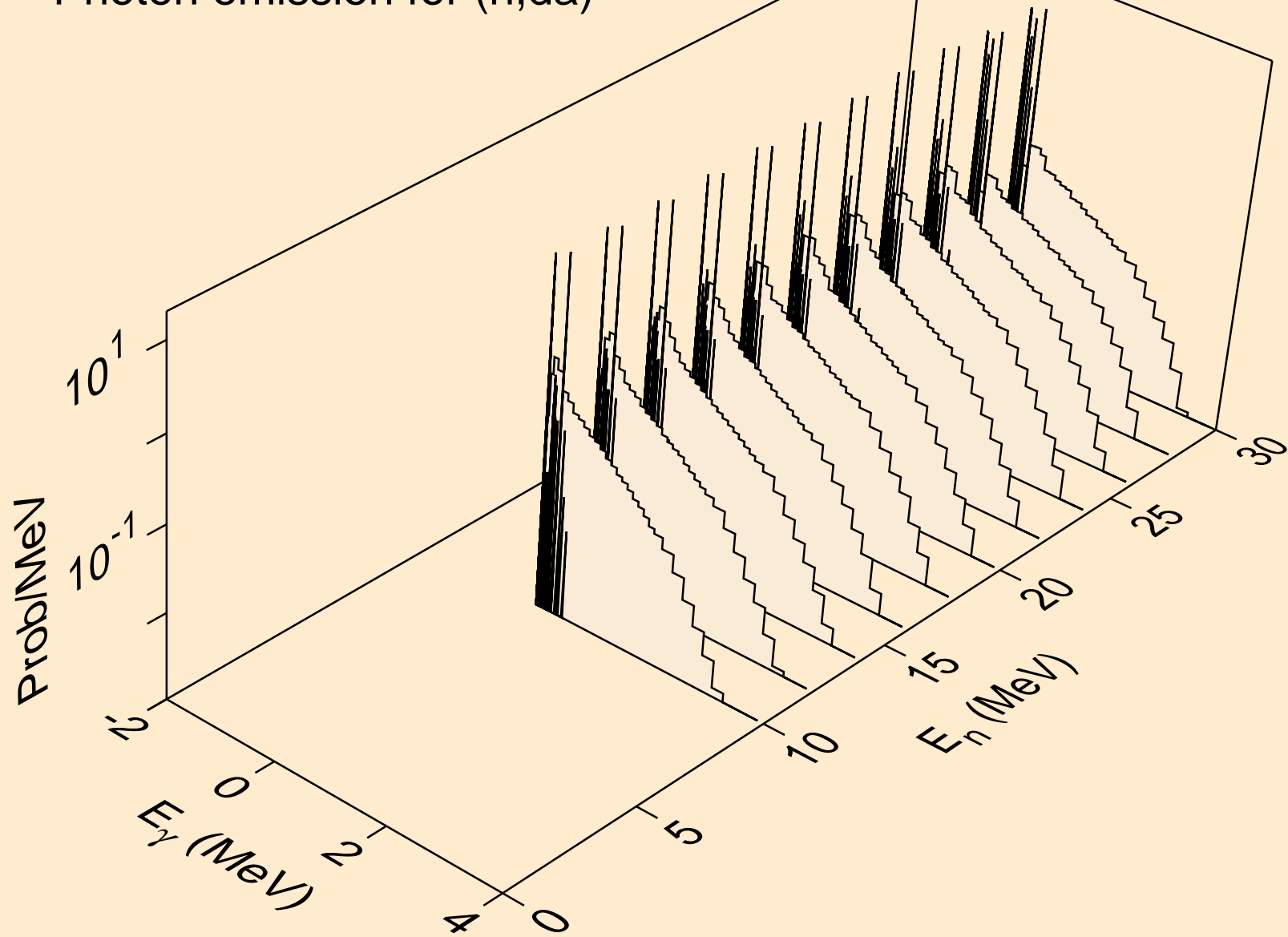

DB256 HELION ACER TENDL-2024 LIBRARY; T=0.K
Particle heating contributions

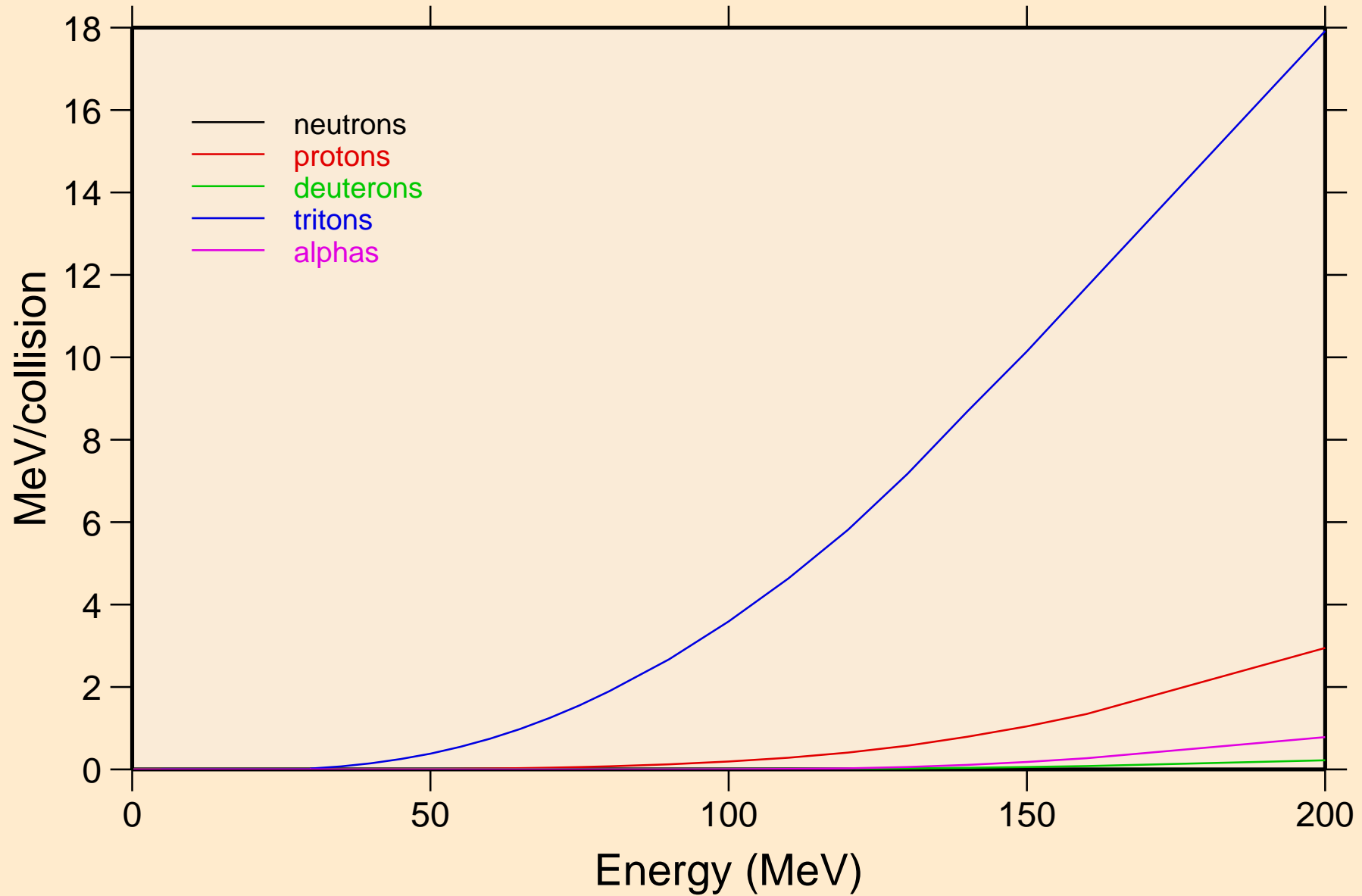

DB256 HELION ACER TENDL-2024 LIBRARY; T=0.K
Recoil Heating

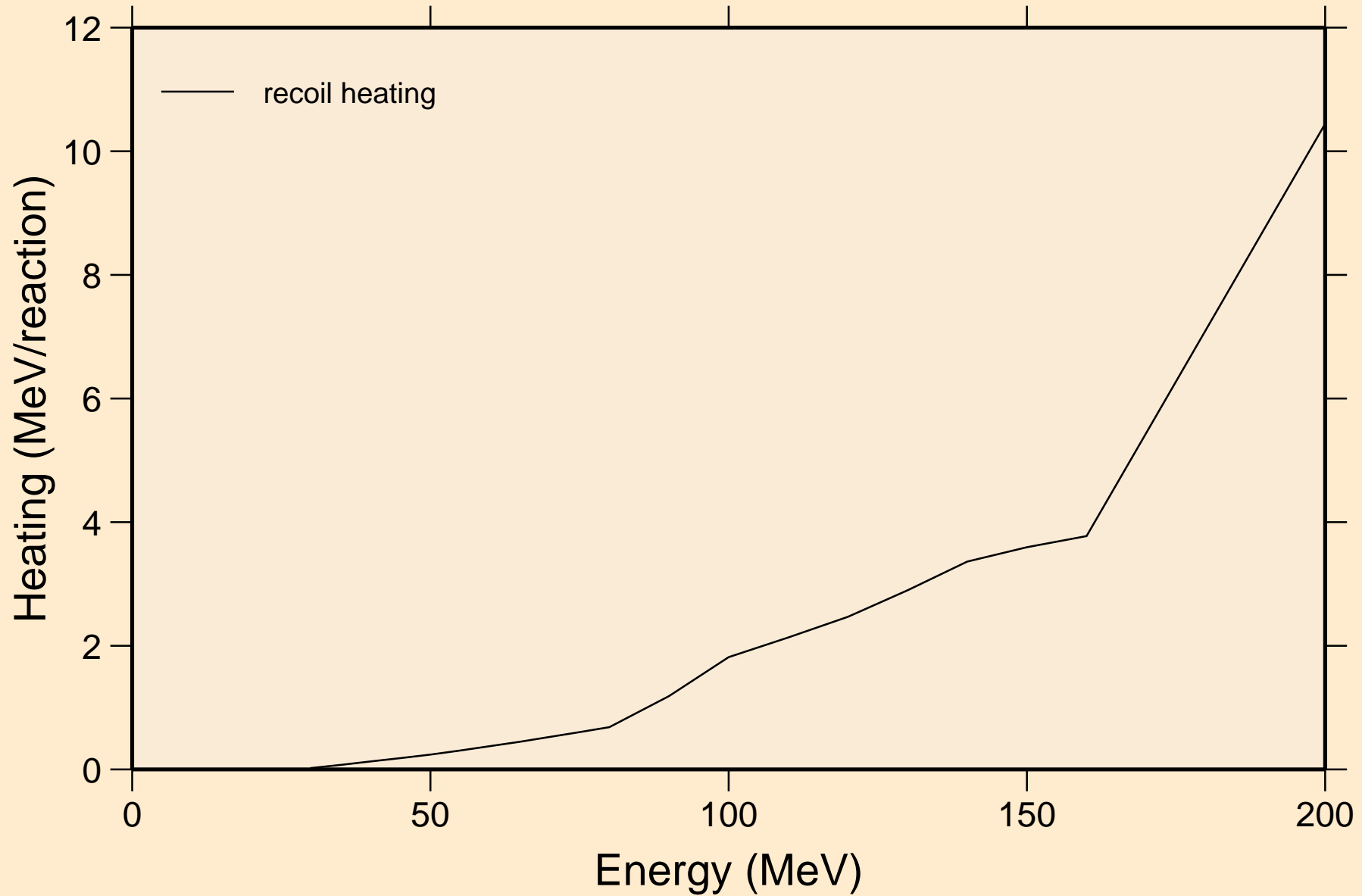

DB256 HELION ACER TENDL-2024 LIBRARY; T=0.K
Particle production cross sections

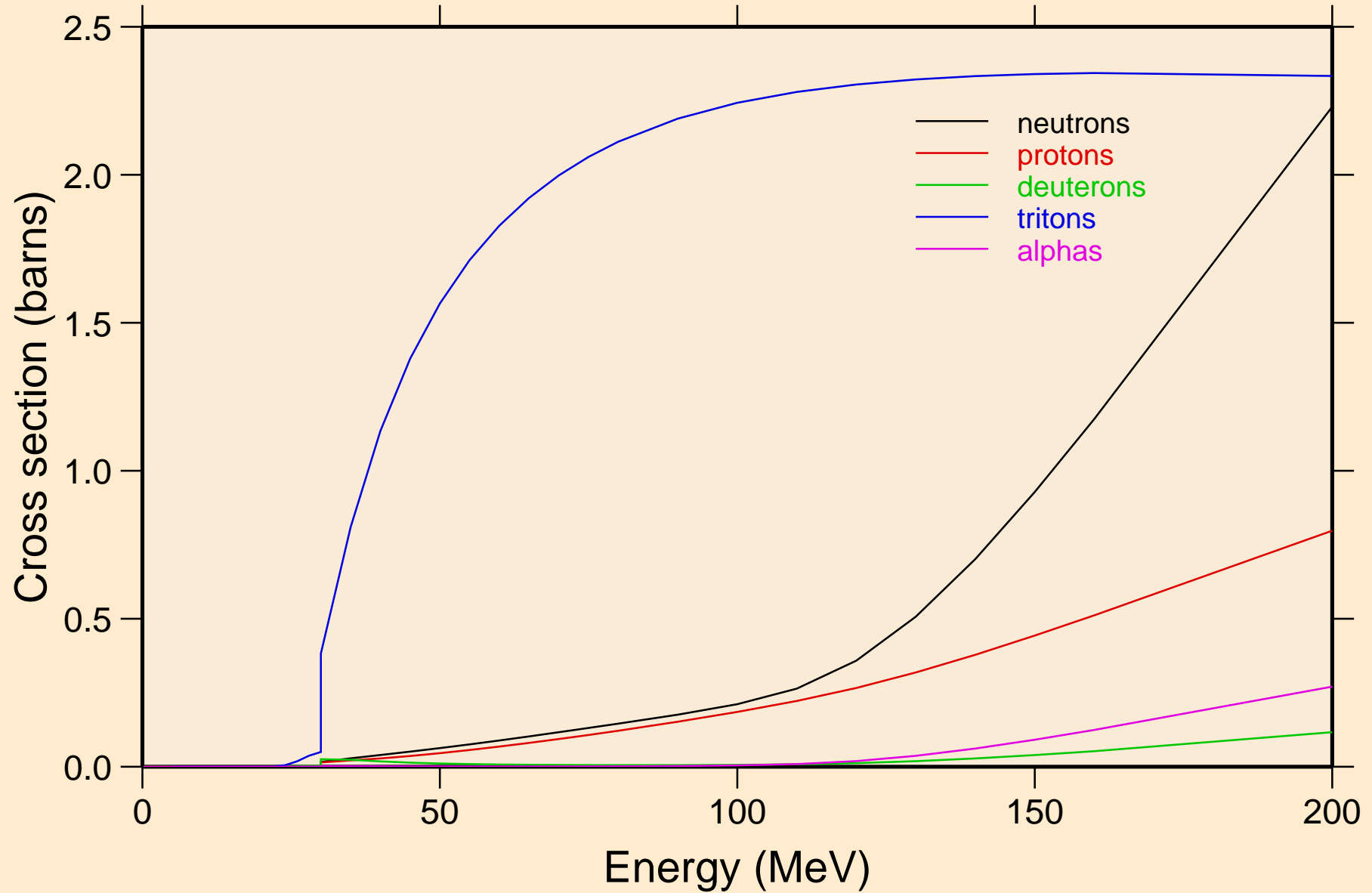

DB256 HELION ACER TENDL-2024 LIBRARY; T=0.K
neutrons from (s,n)

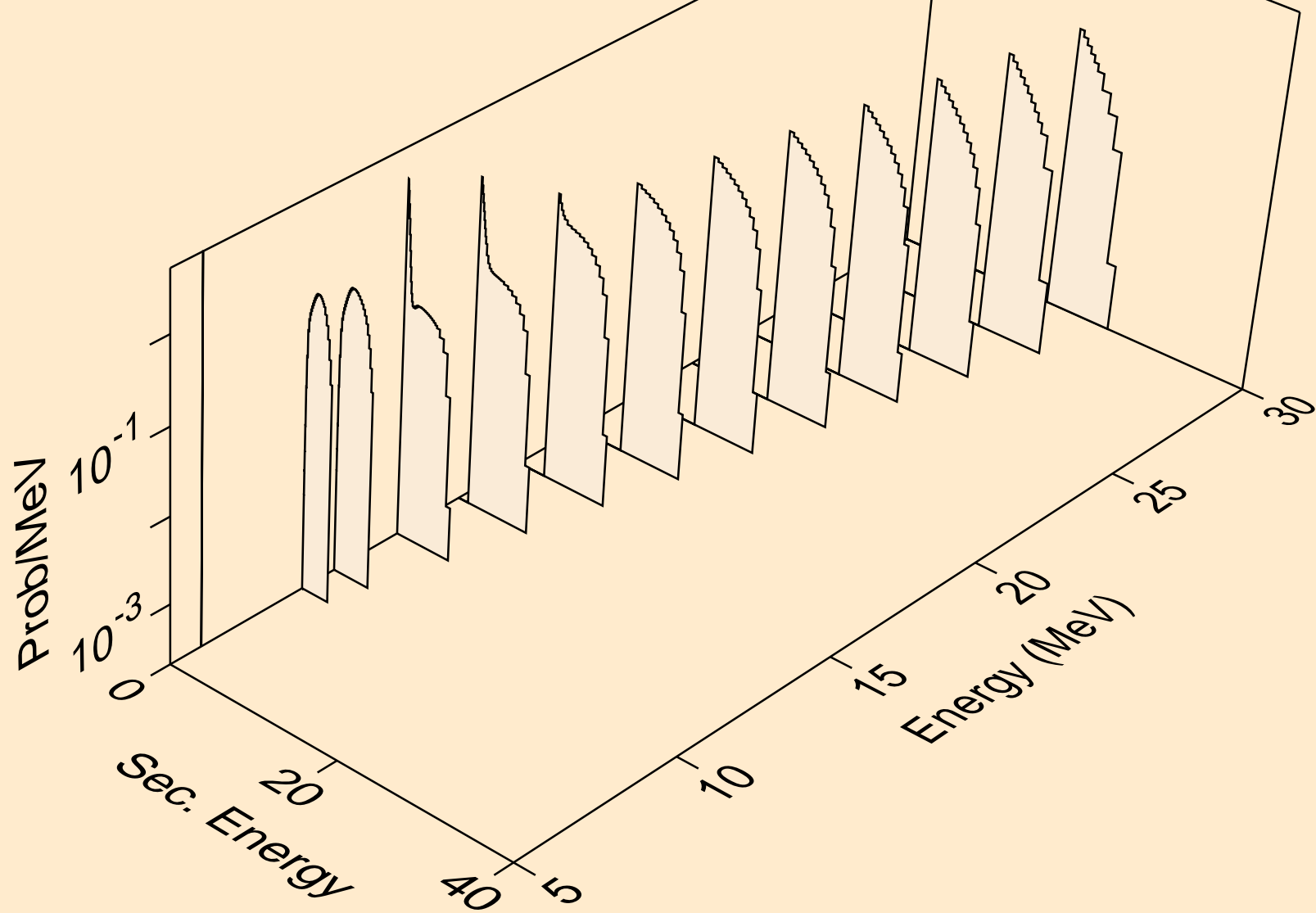

DB256 HELION ACER TENDL-2024 LIBRARY; T=0.K
neutrons from (s,x)

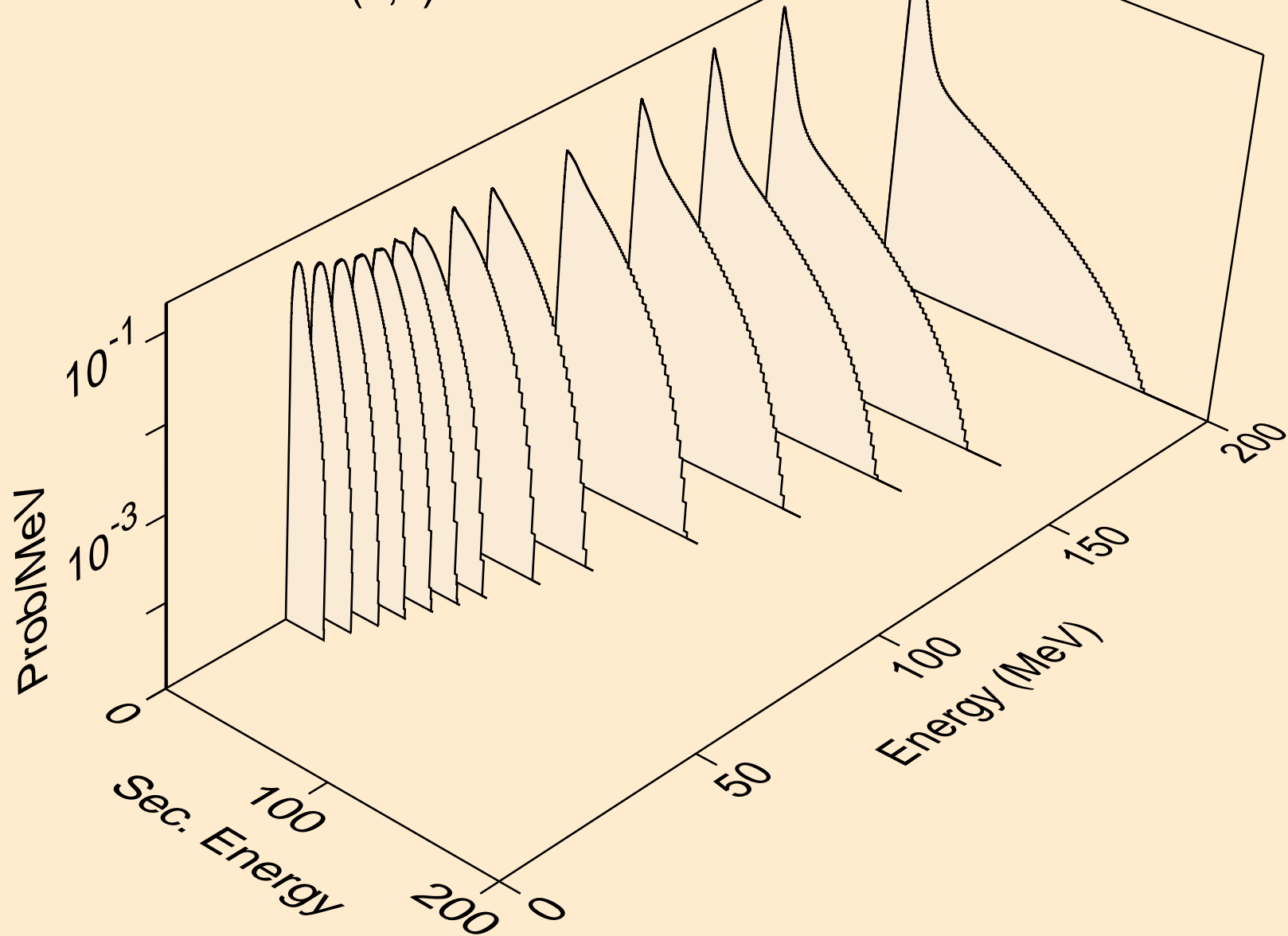

DB256 HELION ACER TENDL-2024 LIBRARY; T=0.K
neutrons from (s,2n)

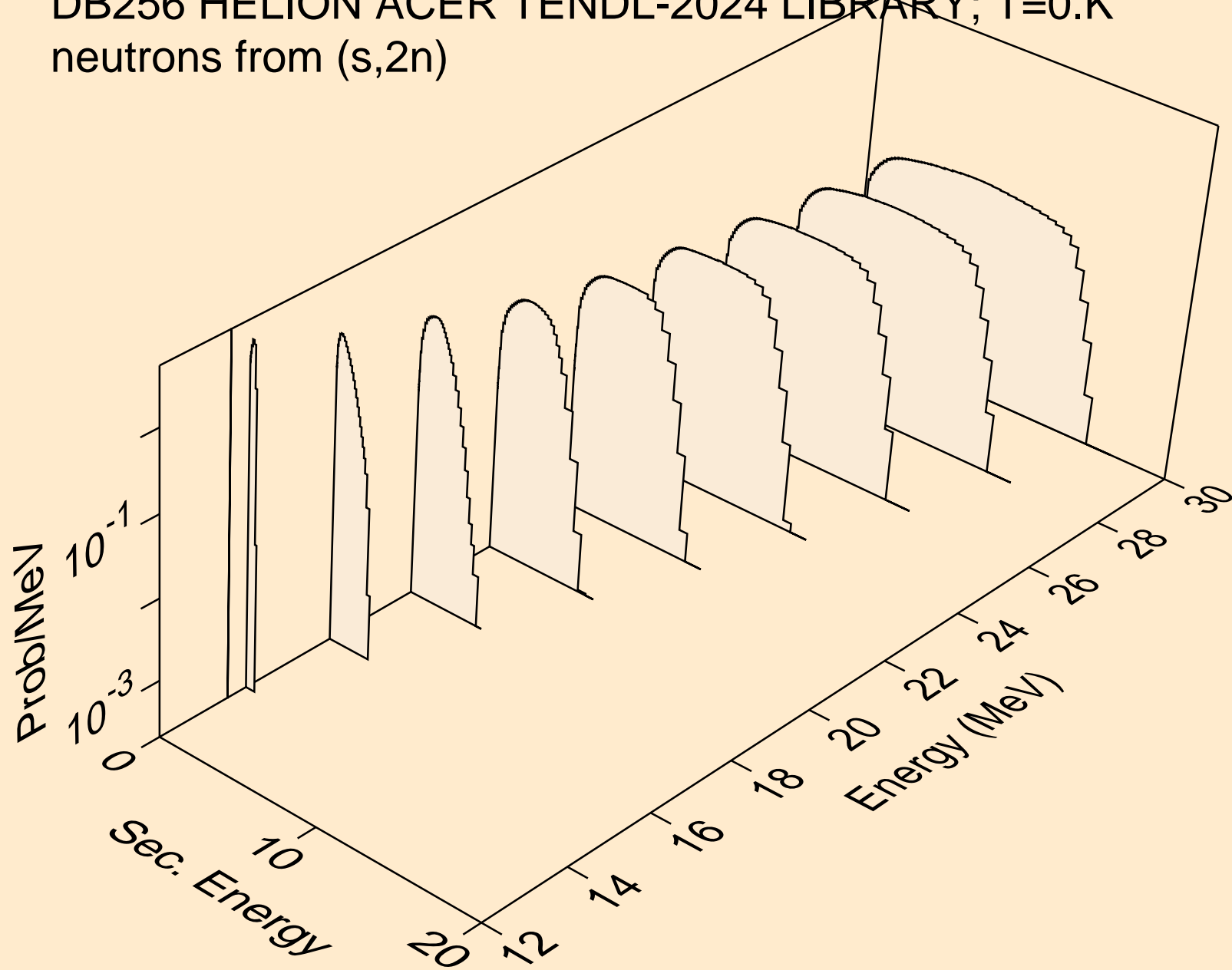

DB256 HELION ACER TENDL-2024 LIBRARY; T=0.K
neutrons from (s,3n)

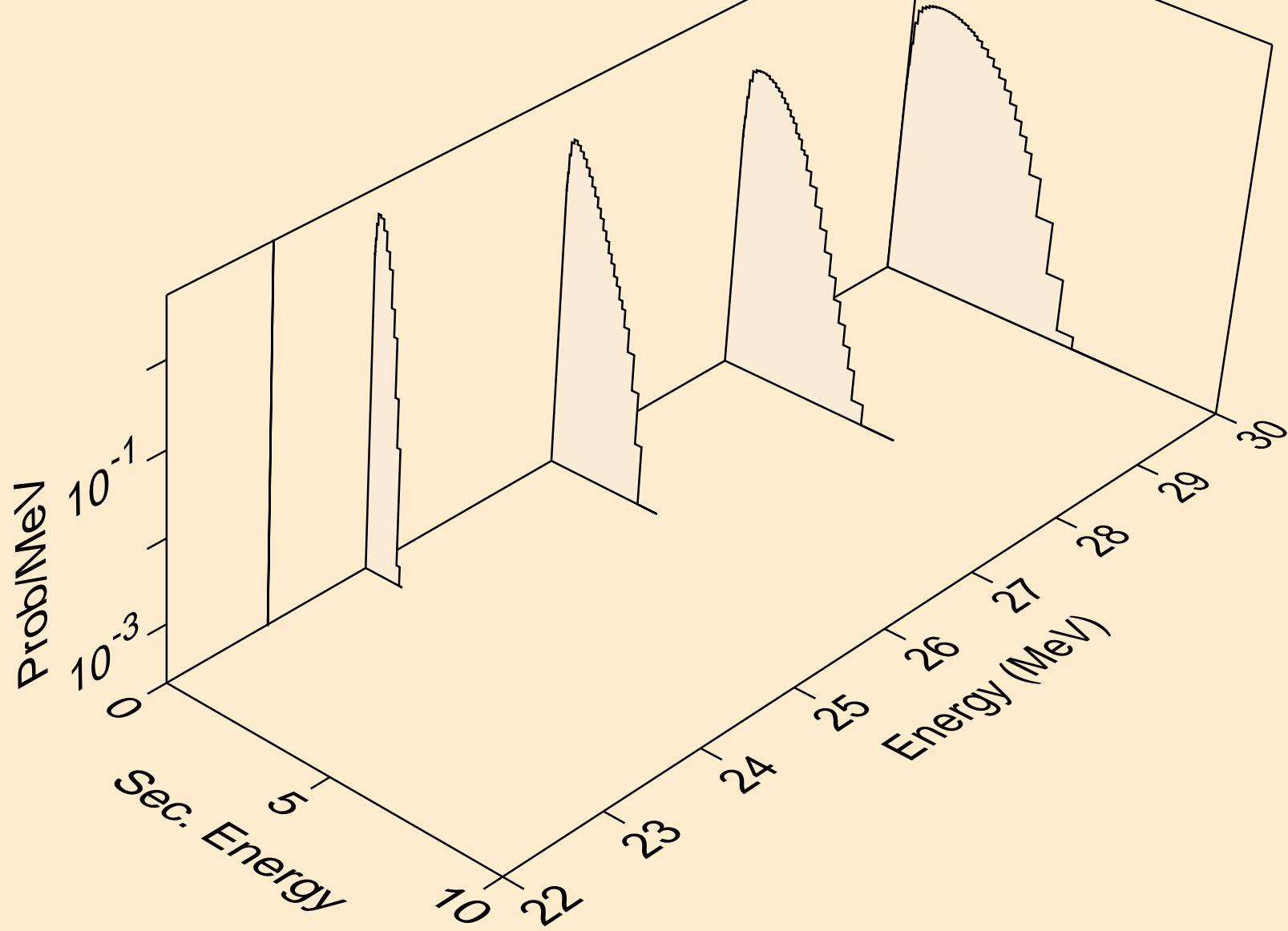

DB256 HELION ACER TENDL-2024 LIBRARY; T=0.K
neutrons from (s,n*)a

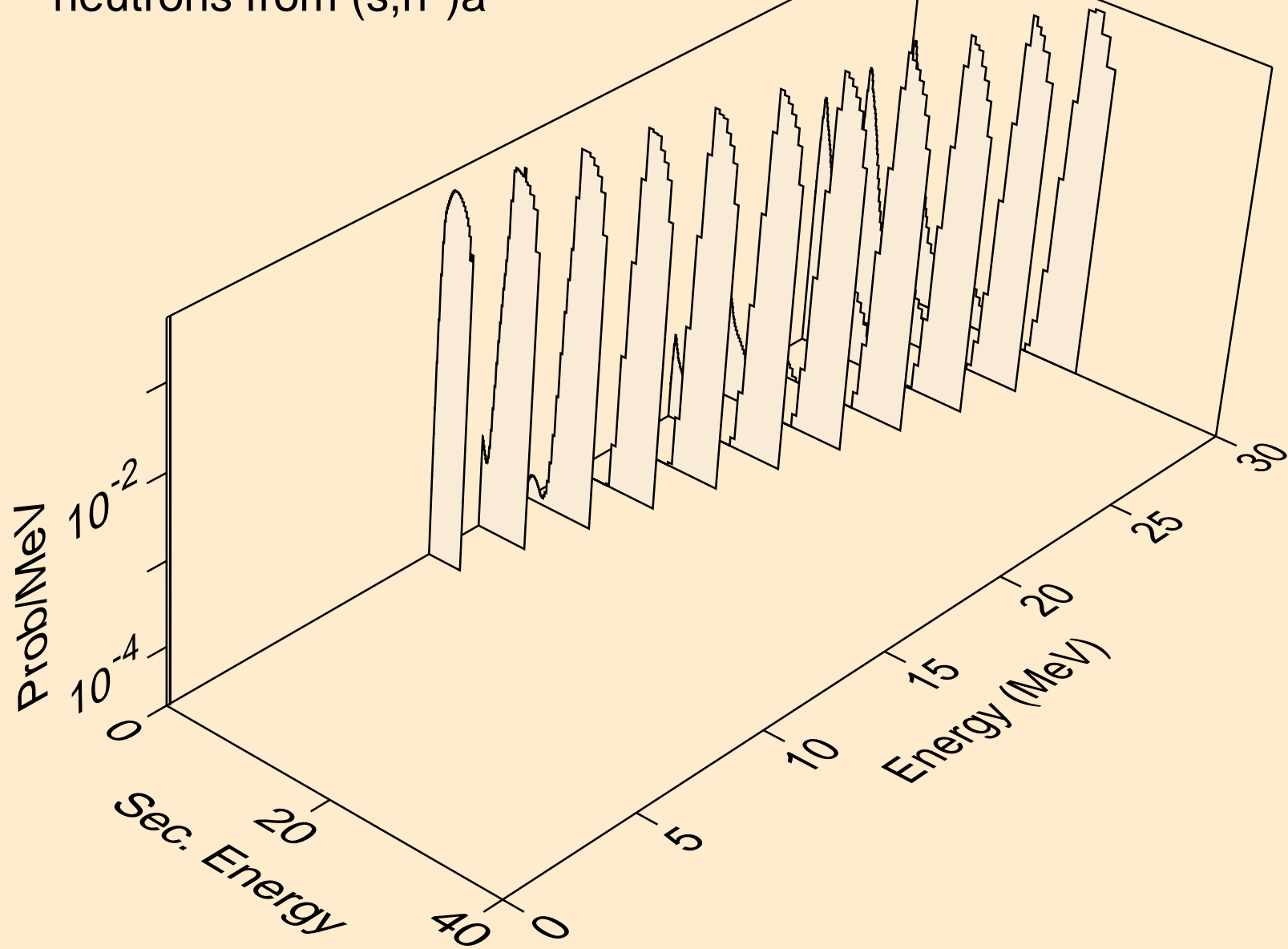

DB256 HELION ACER TENDL-2024 LIBRARY; T=0.K
neutrons from (s,2n)a

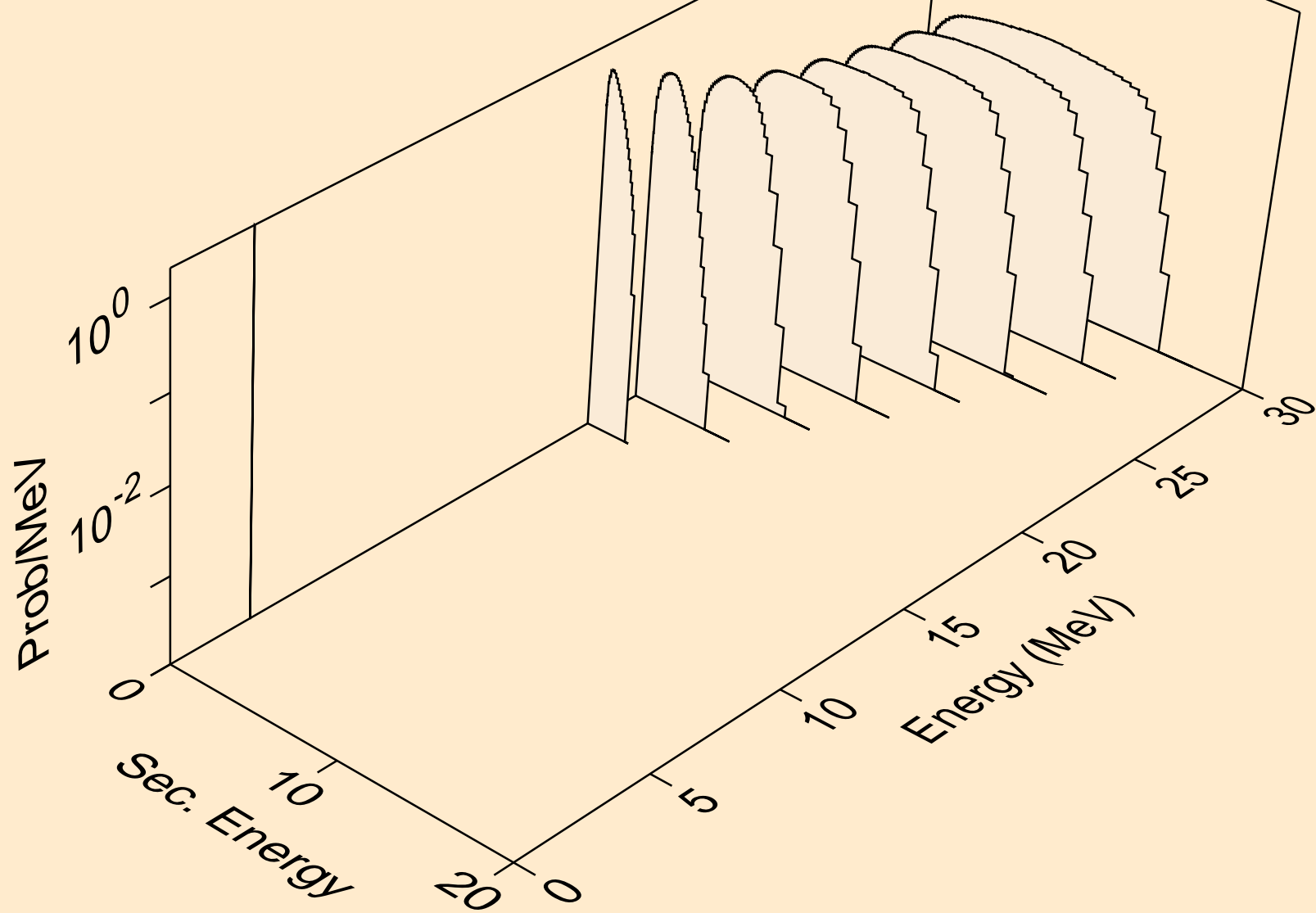

DB256 HELION ACER TENDL-2024 LIBRARY; T=0.K
neutrons from (s,n*)p

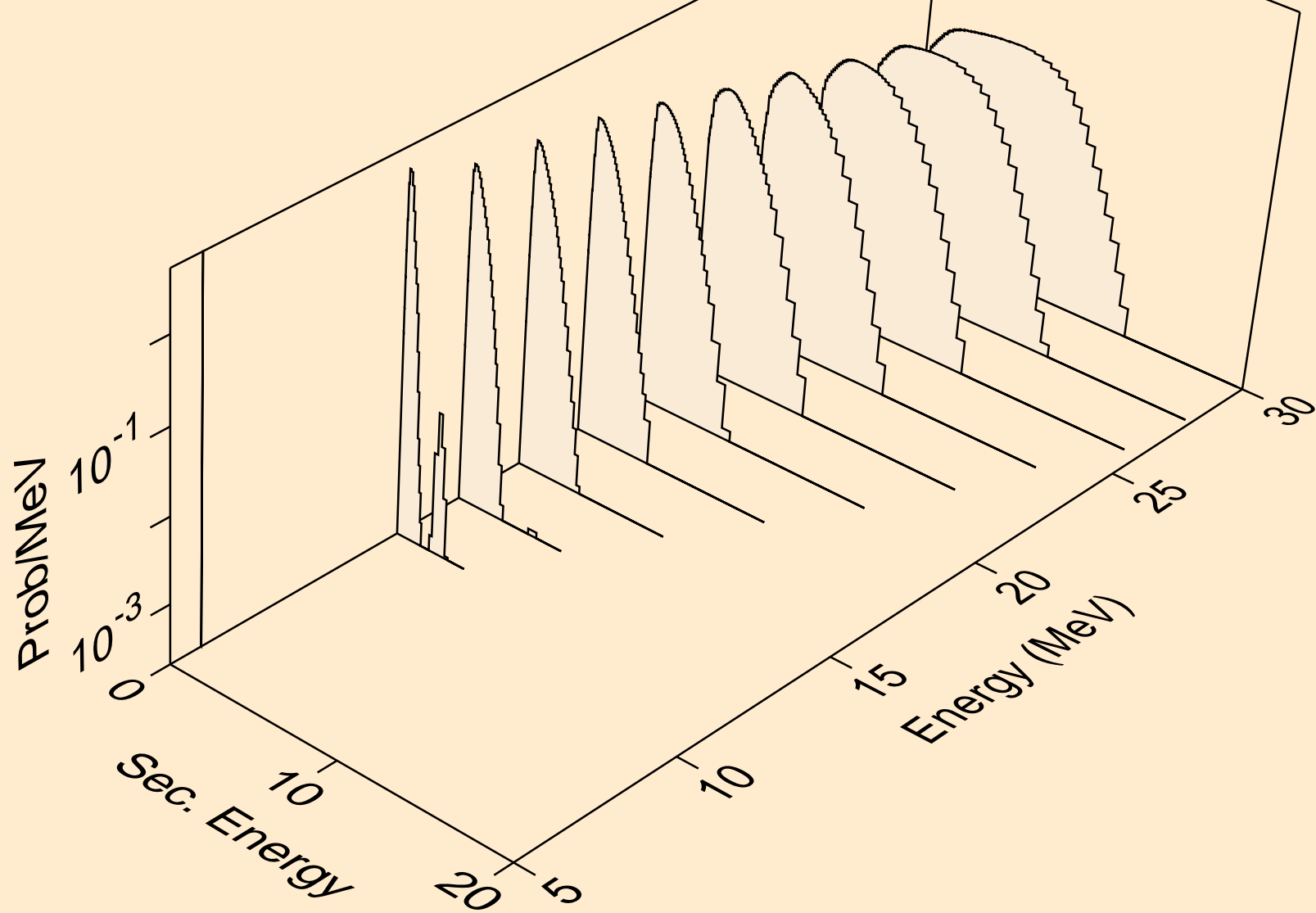

DB256 HELION ACER TENDL-2024 LIBRARY; T=0.K
neutrons from (s,n*)d

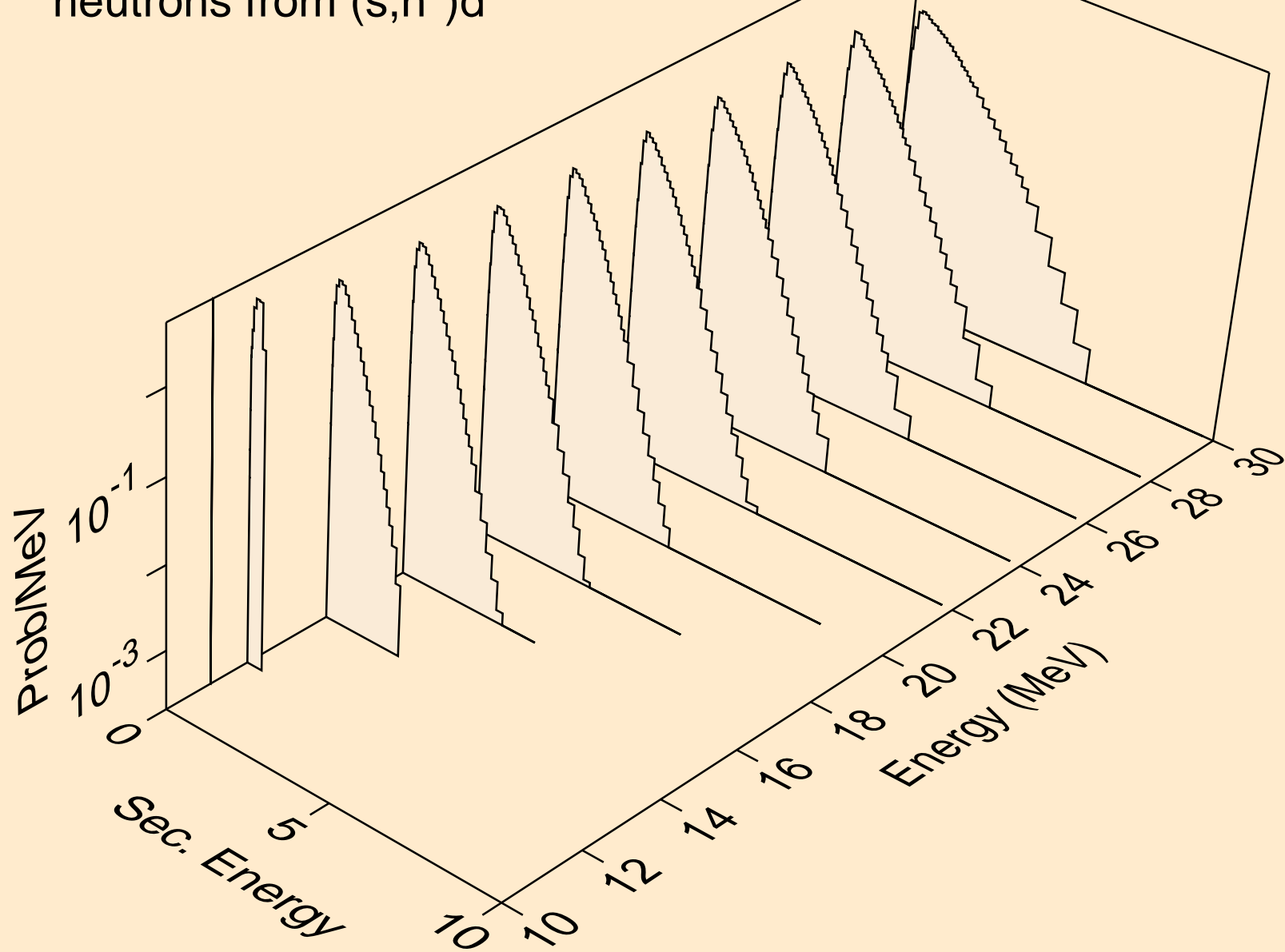

DB256 HELION ACER TENDL-2024 LIBRARY; T=0.K
neutrons from (s,n*)t

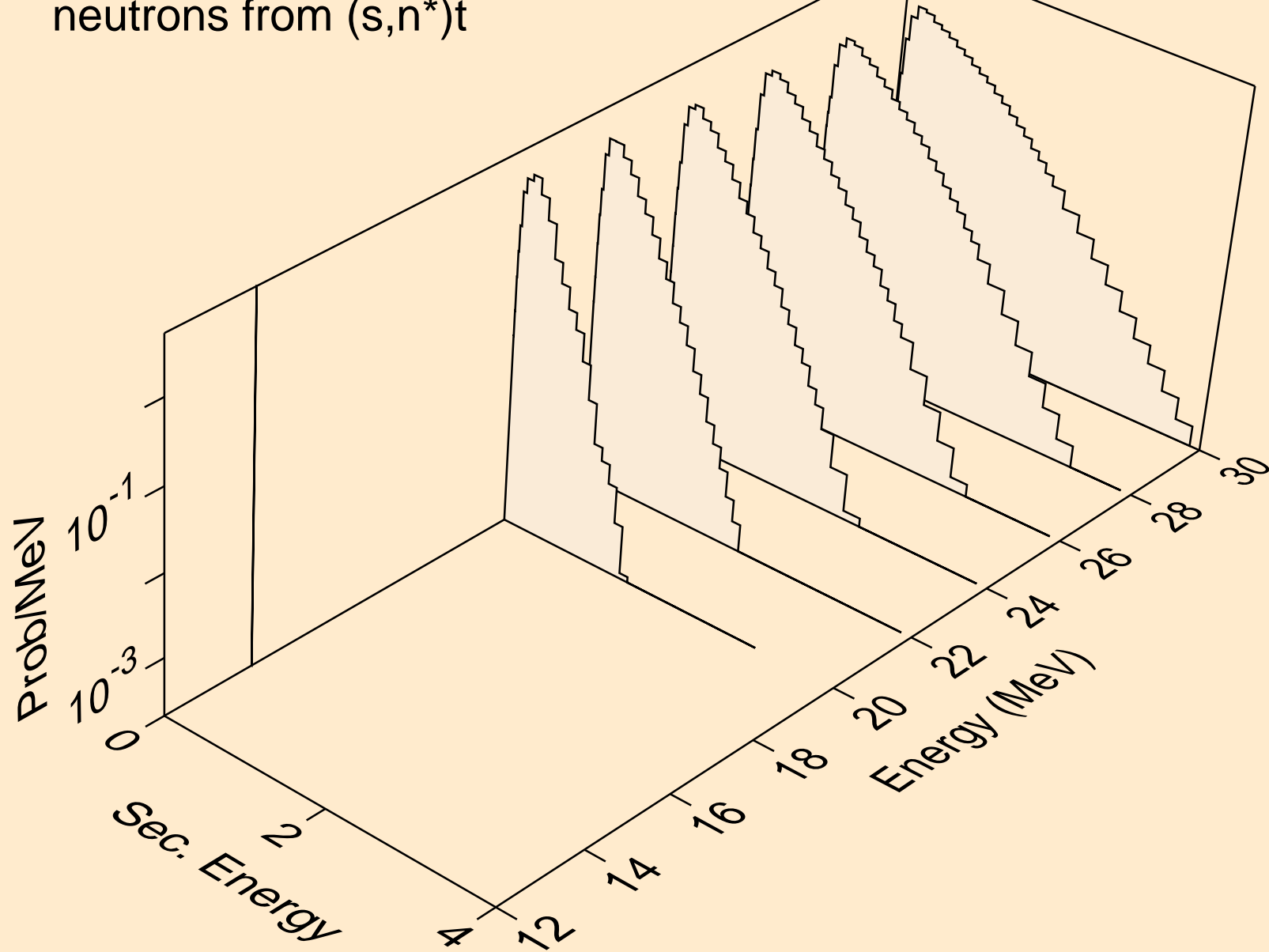

DB256 HELION ACER TENDL-2024 LIBRARY; T=0.K
neutrons from (s,2np)

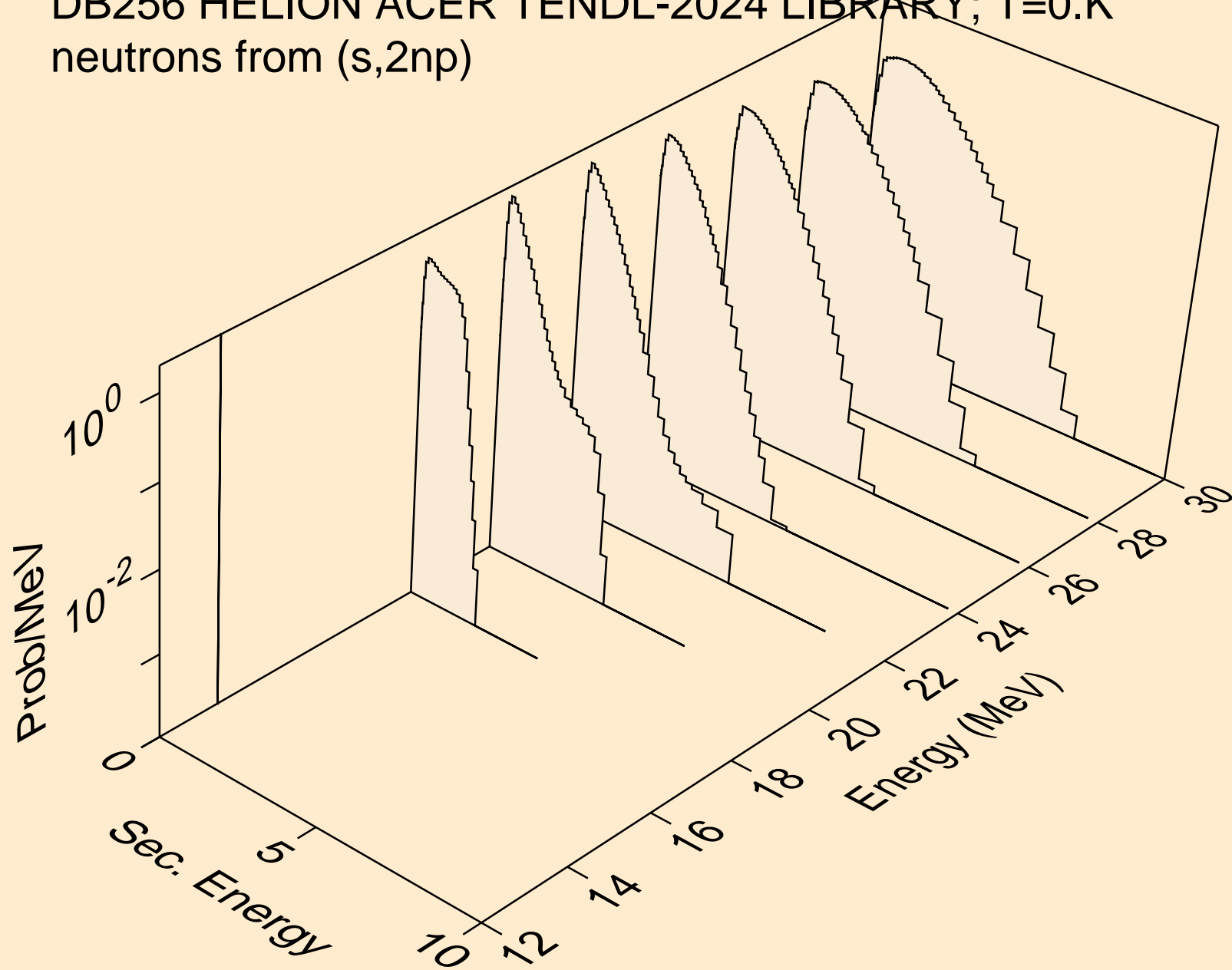

DB256 HELION ACER TENDL-2024 LIBRARY; T=0.K
neutrons from (s,npa)

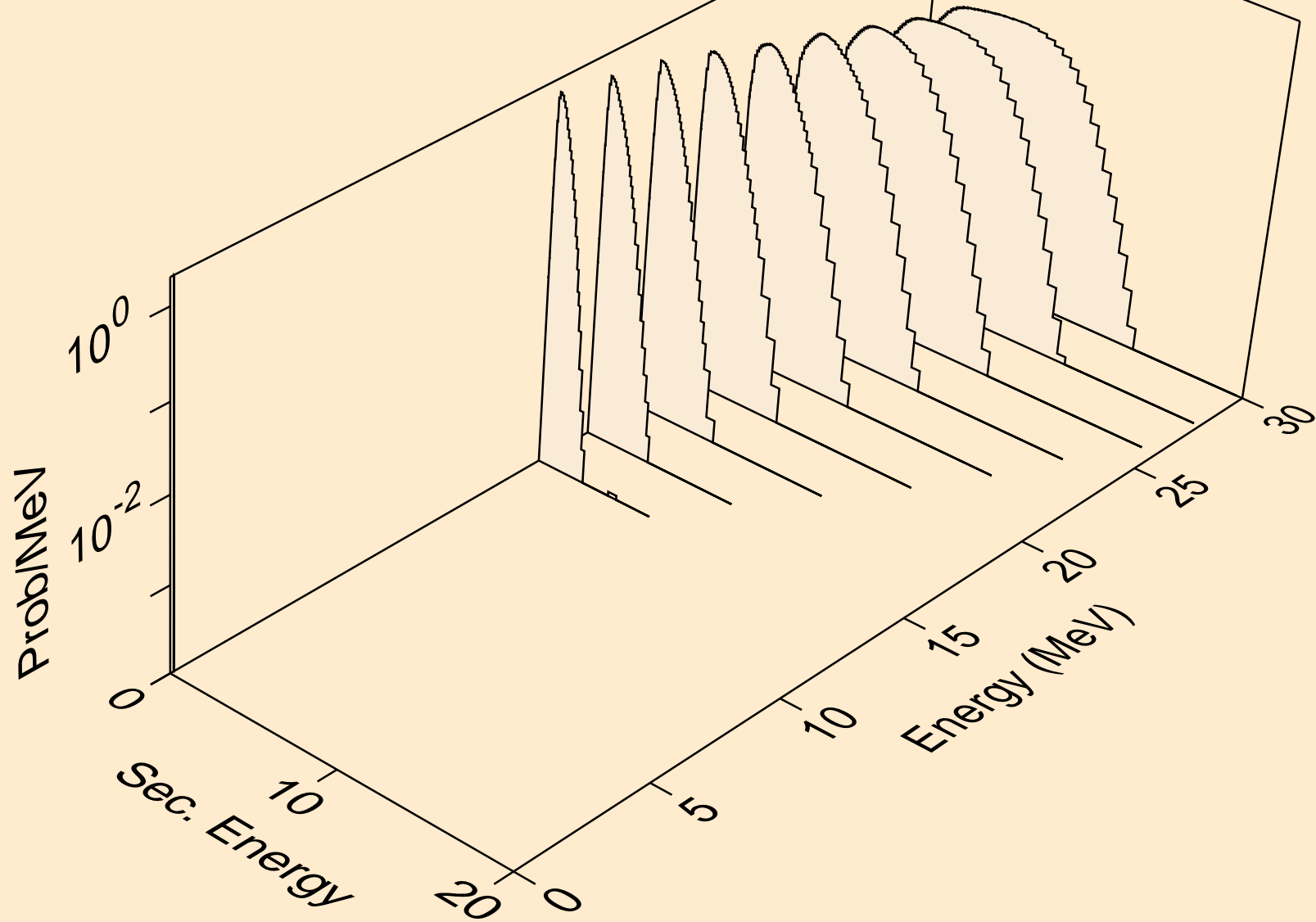

DB256 HELION ACER TENDL-2024 LIBRARY; T=0.K
protons from (s,x)

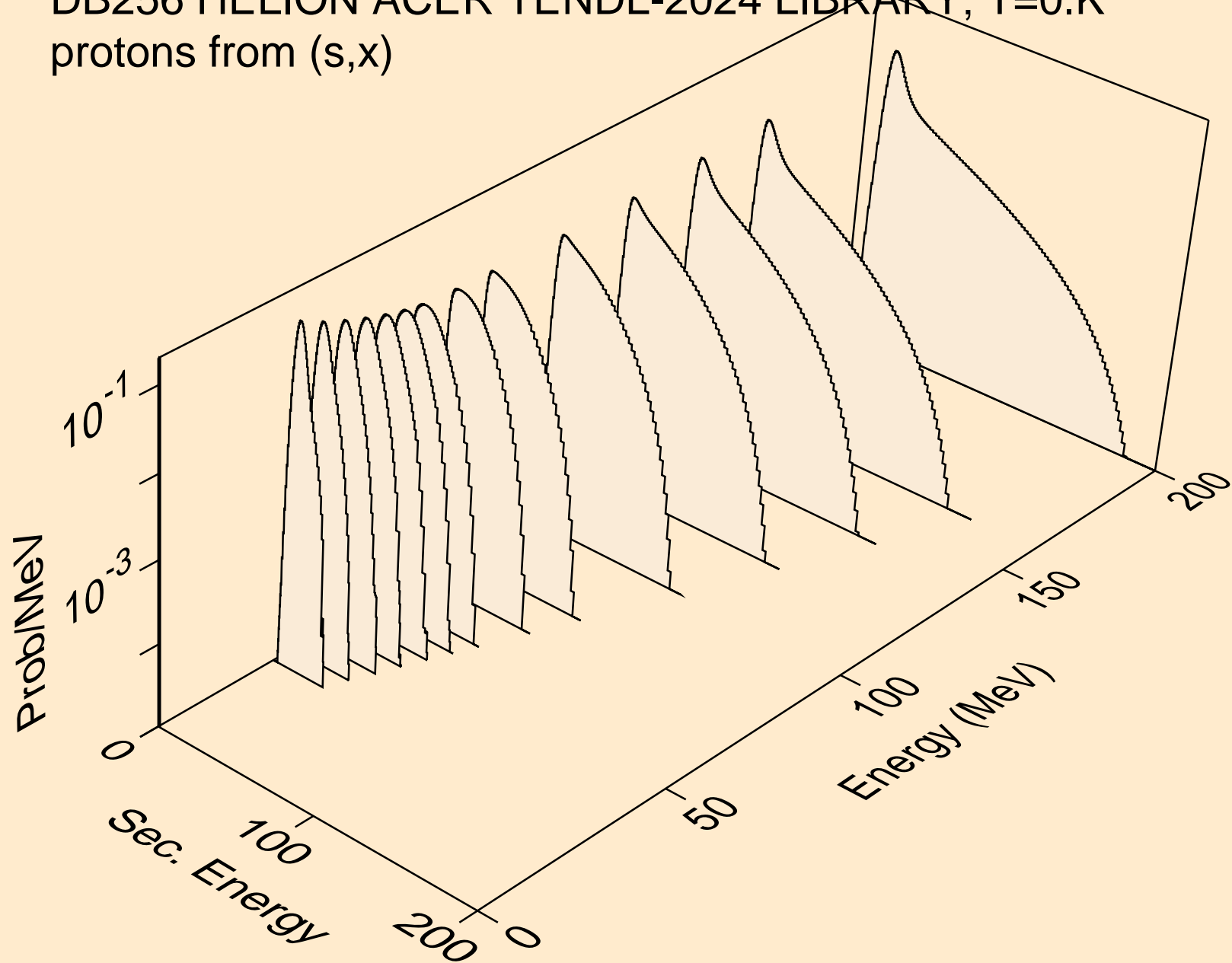

DB256 HELION ACER TENDL-2024 LIBRARY; T=0.K
protons from (s,n*)p

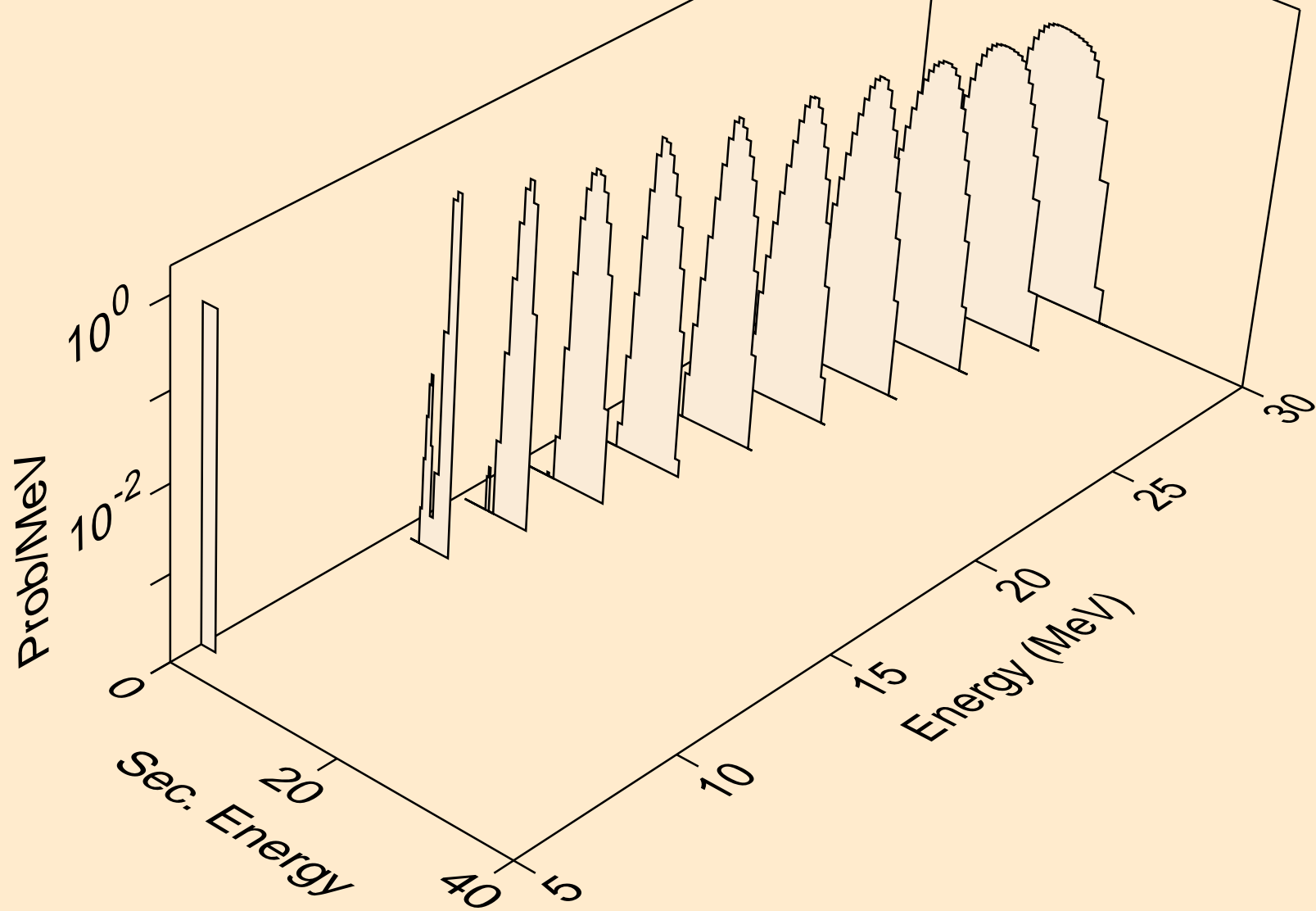

DB256 HELION ACER TENDL-2024 LIBRARY; T=0.K
protons from (s,2np)

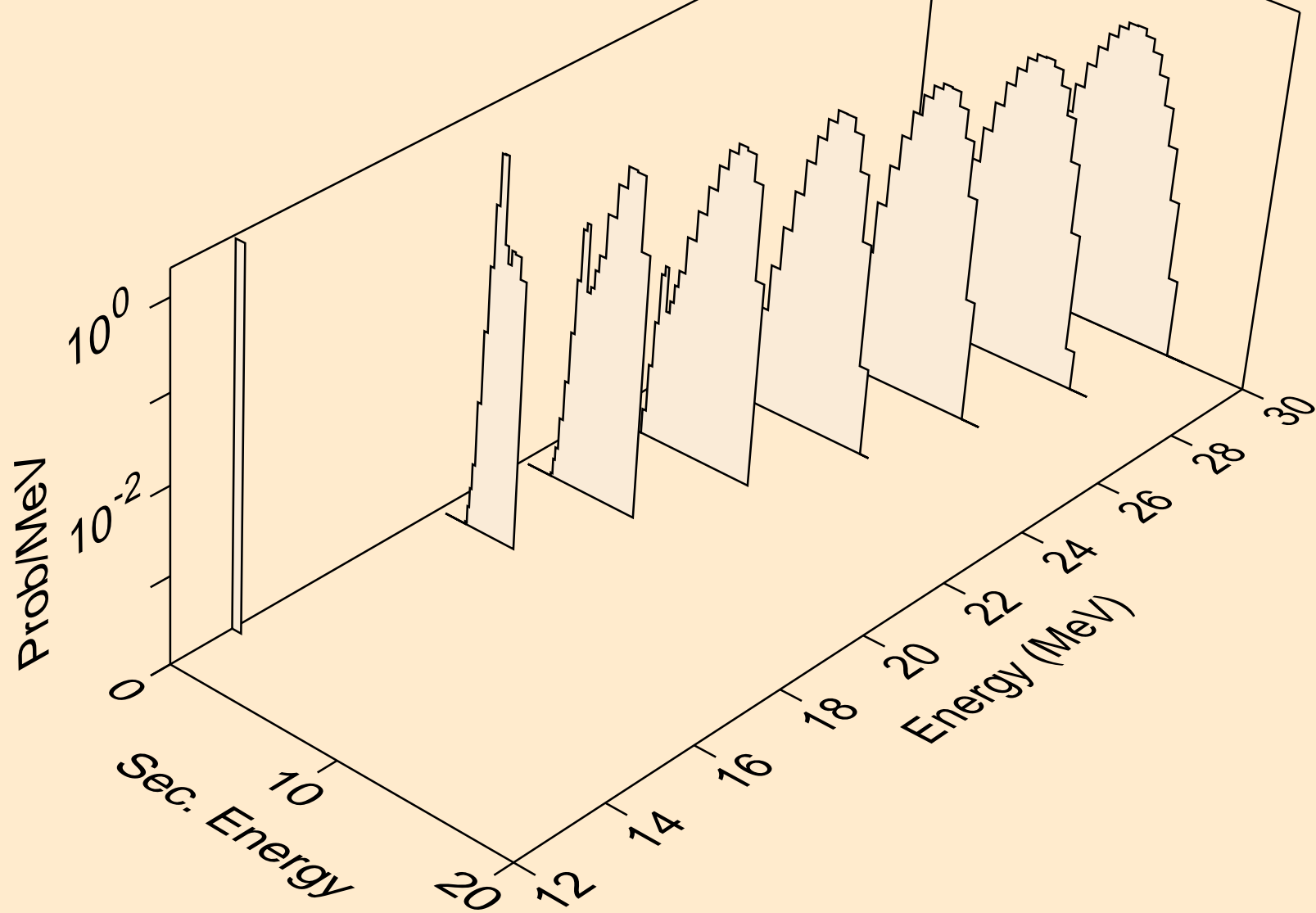

DB256 HELION ACER TENDL-2024 LIBRARY; T=0.K
protons from (s,npa)

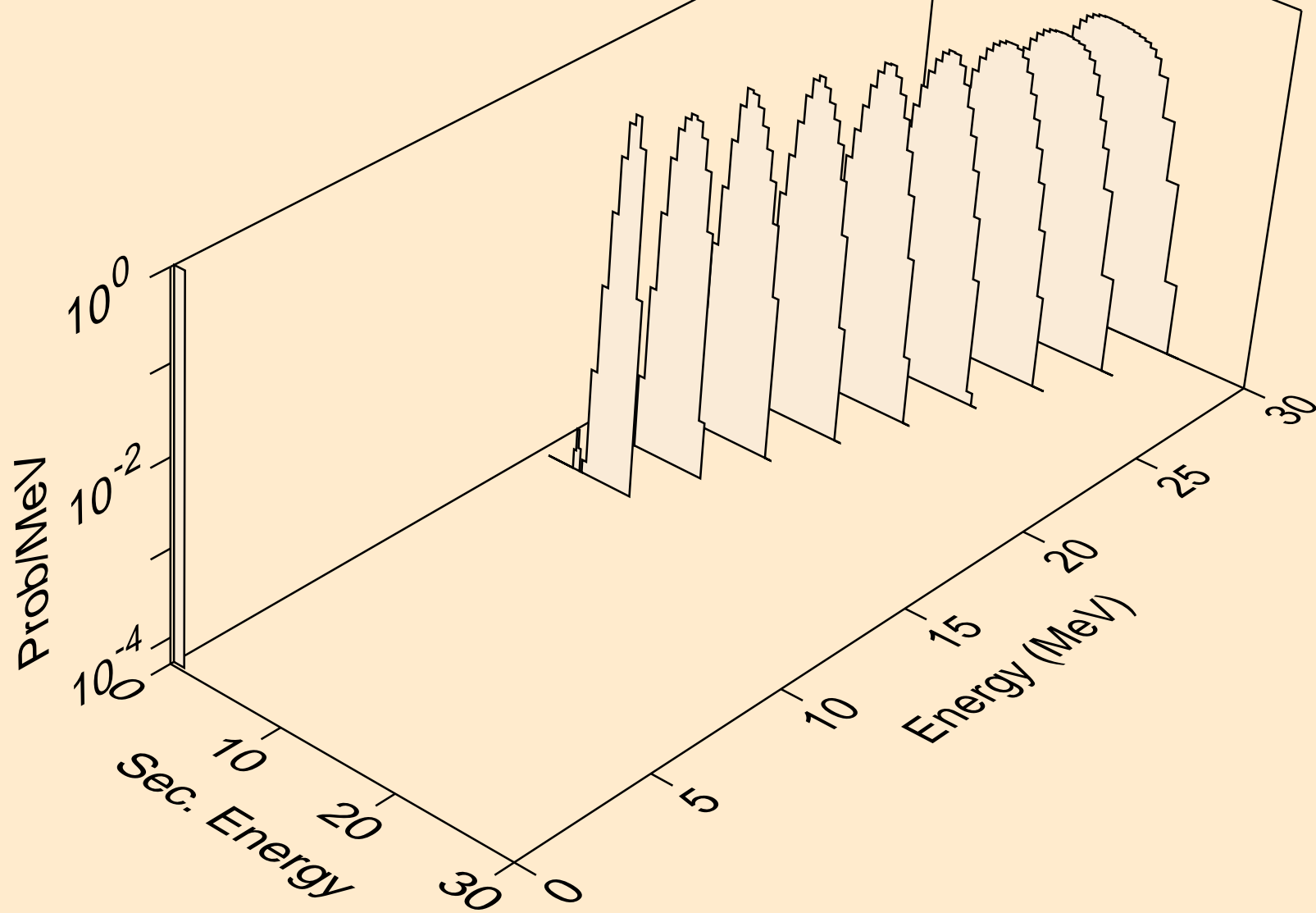

DB256 HELION ACER TENDL-2024 LIBRARY; T=0.K
protons from (s,p)

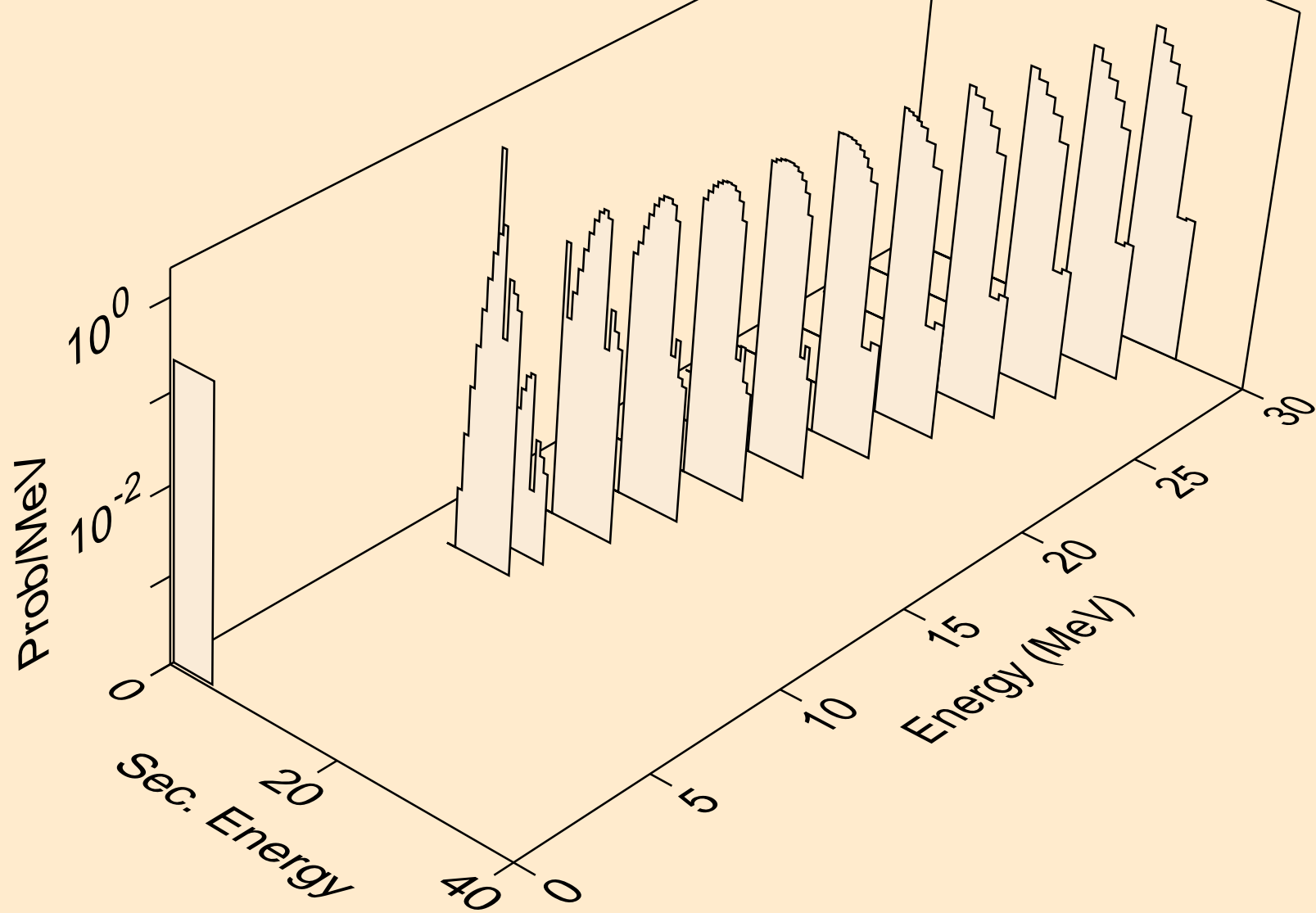

DB256 HELION ACER TENDL-2024 LIBRARY; T=0.K
protons from (s,2p)

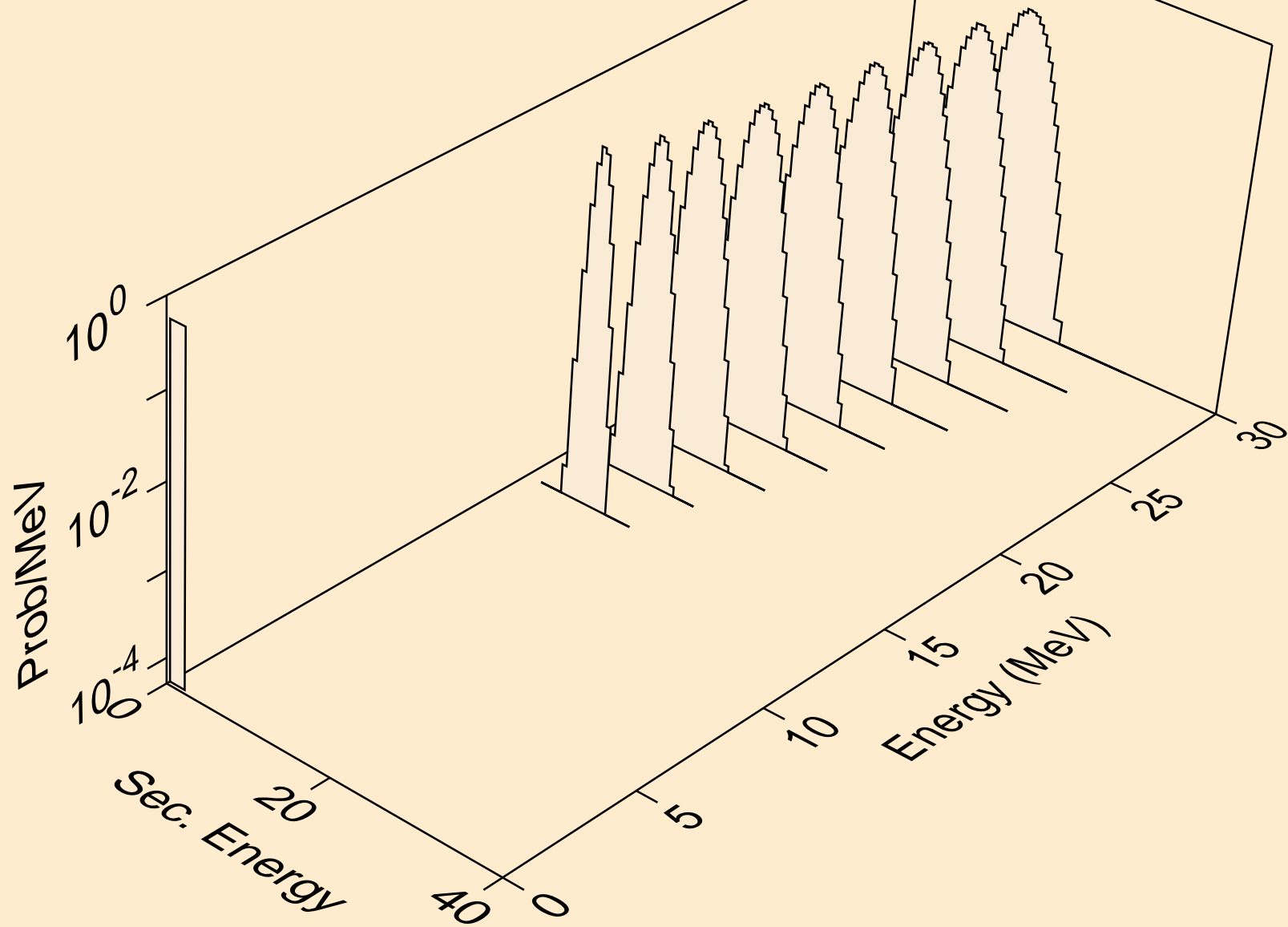

DB256 HELION ACER TENDL-2024 LIBRARY; T=0.K
protons from (s,pt)

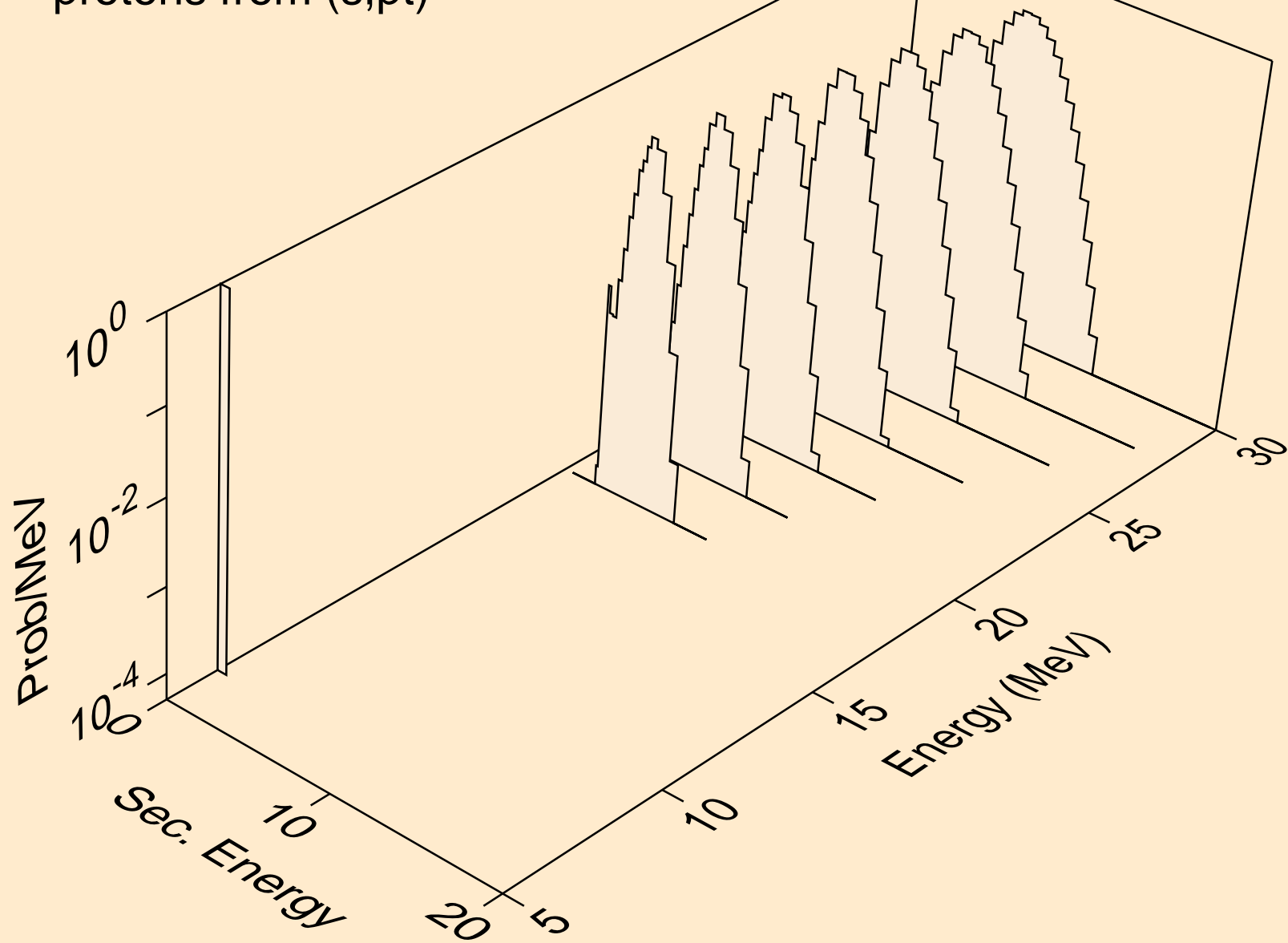

DB256 HELION ACER TENDL-2024 LIBRARY; T=0.K
deuterons from (s,x)

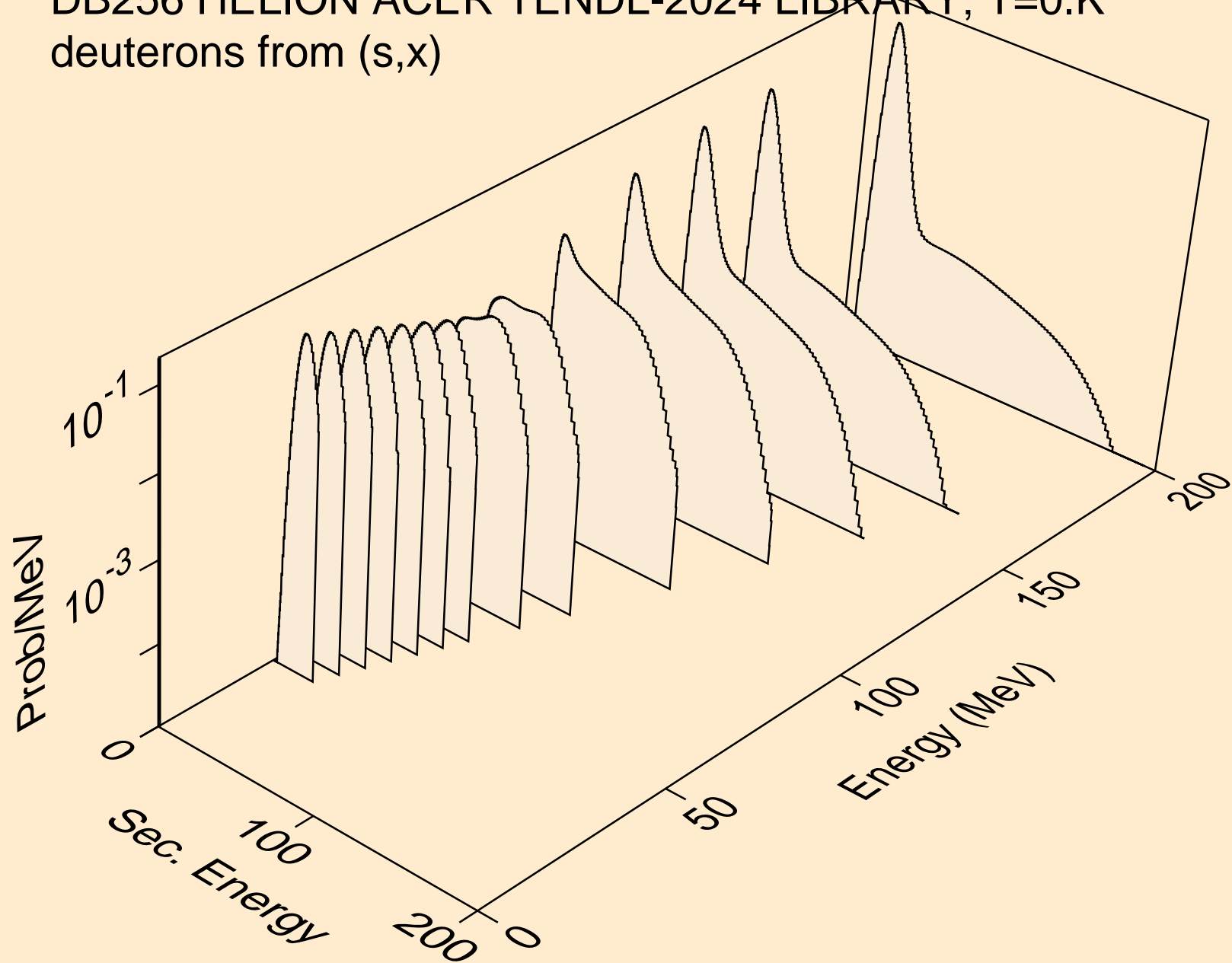

DB256 HELION ACER TENDL-2024 LIBRARY; T=0.K
deuterons from (s,n*)d

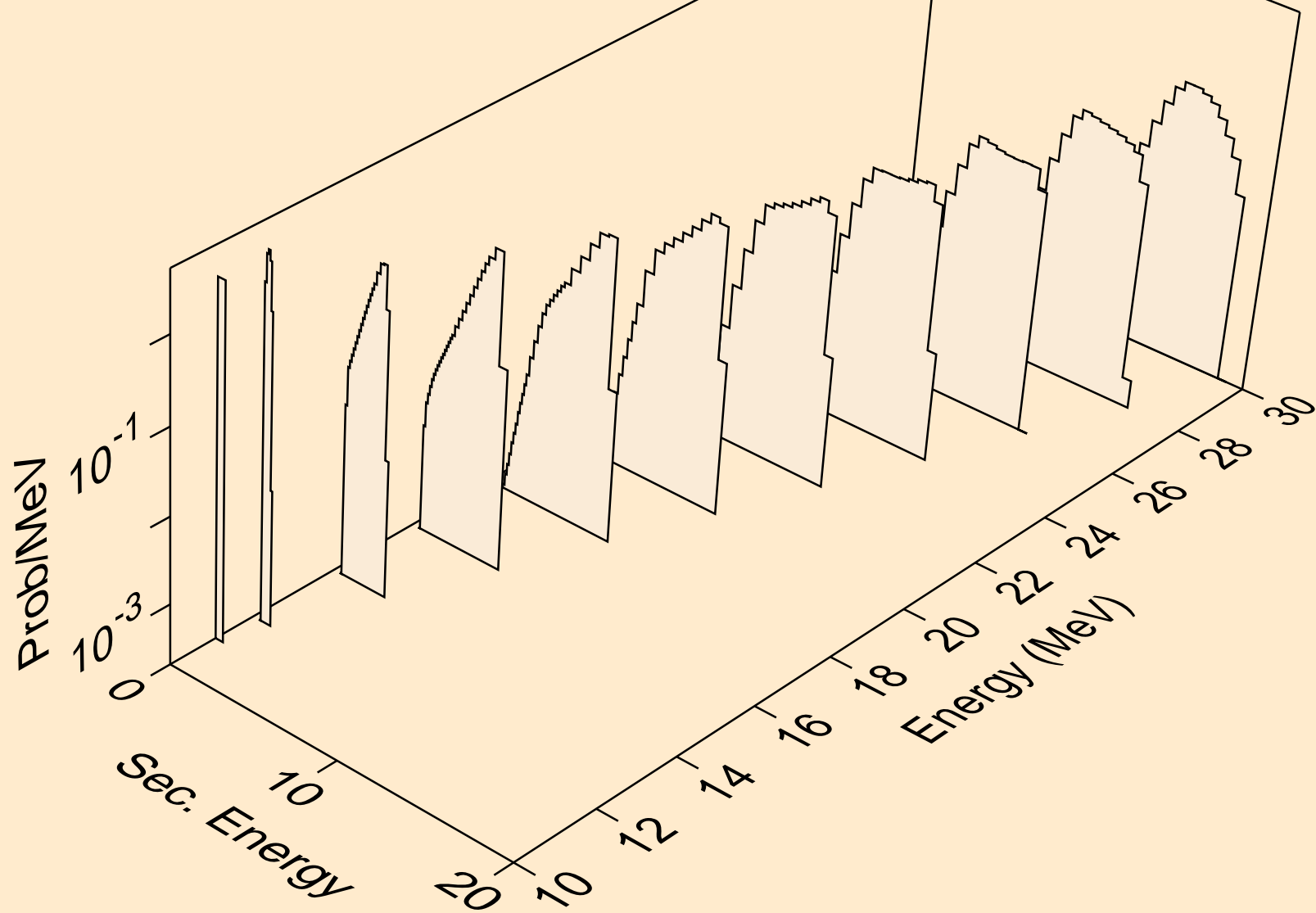

DB256 HELION ACER TENDL-2024 LIBRARY; T=0.K
deuterons from (s,d)

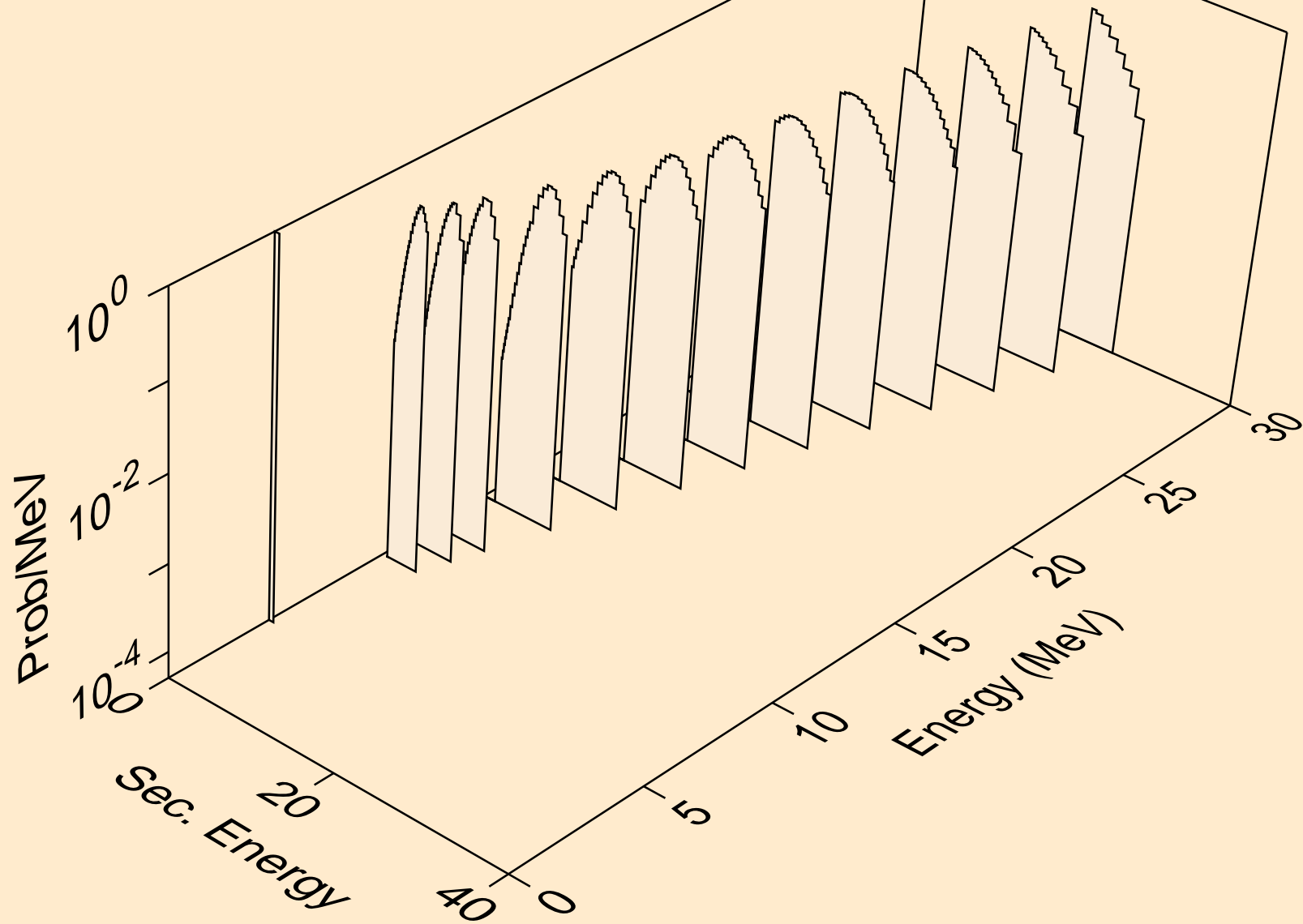

DB256 HELION ACER TENDL-2024 LIBRARY; T=0.K
deuterons from (s,da)

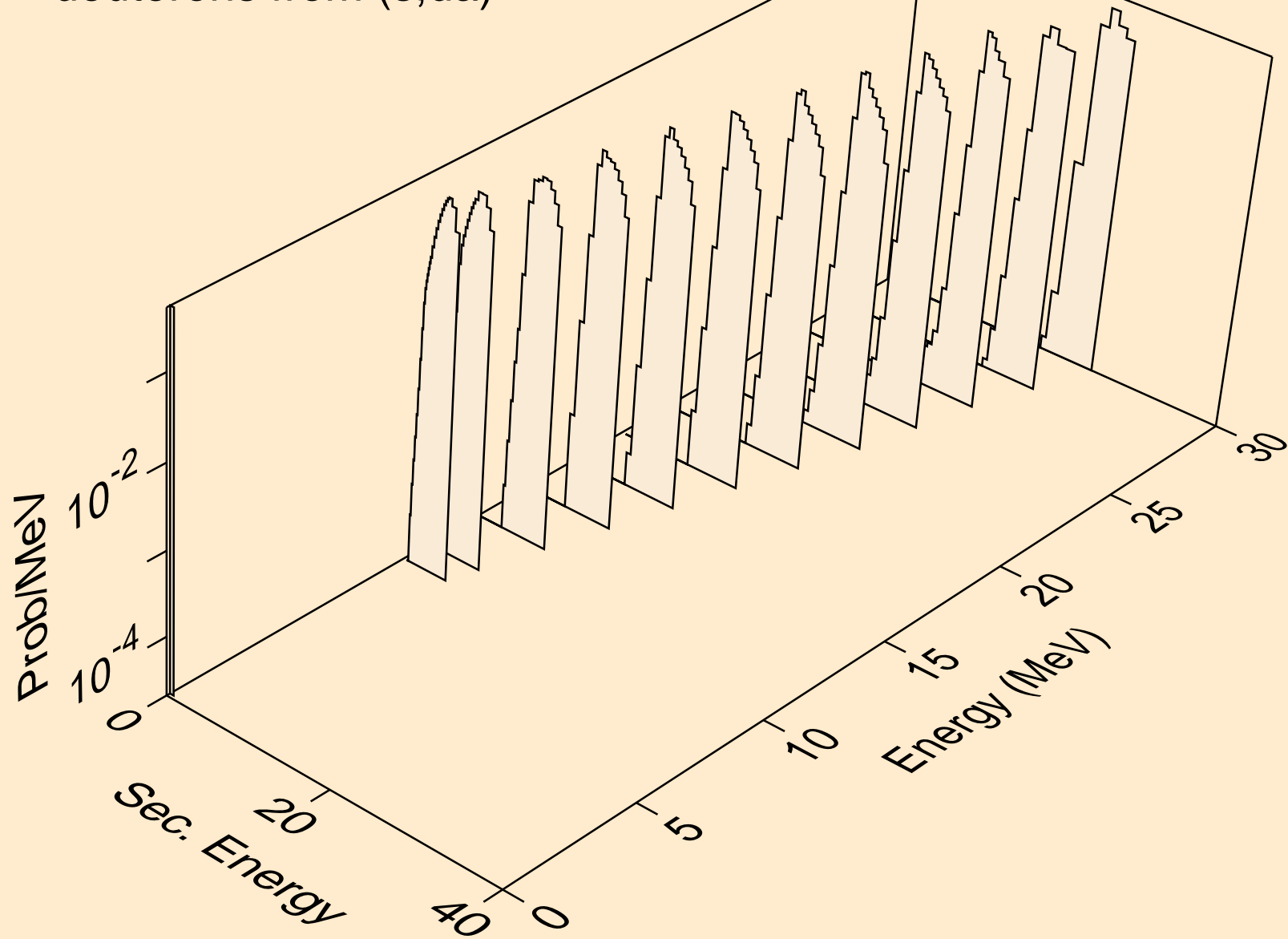

DB256 HELION ACER TENDL-2024 LIBRARY; T=0.K
tritons from (s,x)

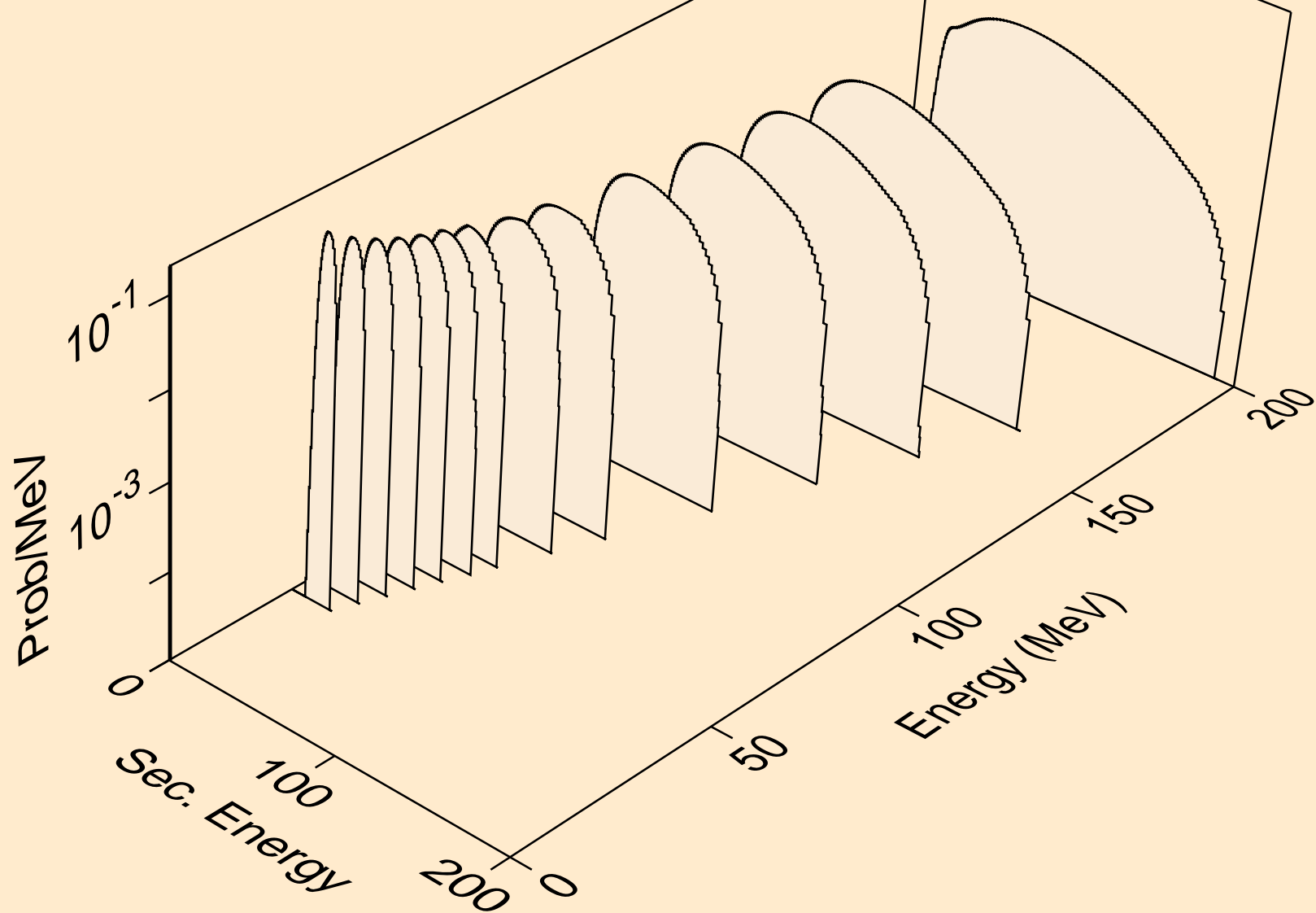

DB256 HELION ACER TENDL-2024 LIBRARY; T=0.K
tritons from (s,n*)t

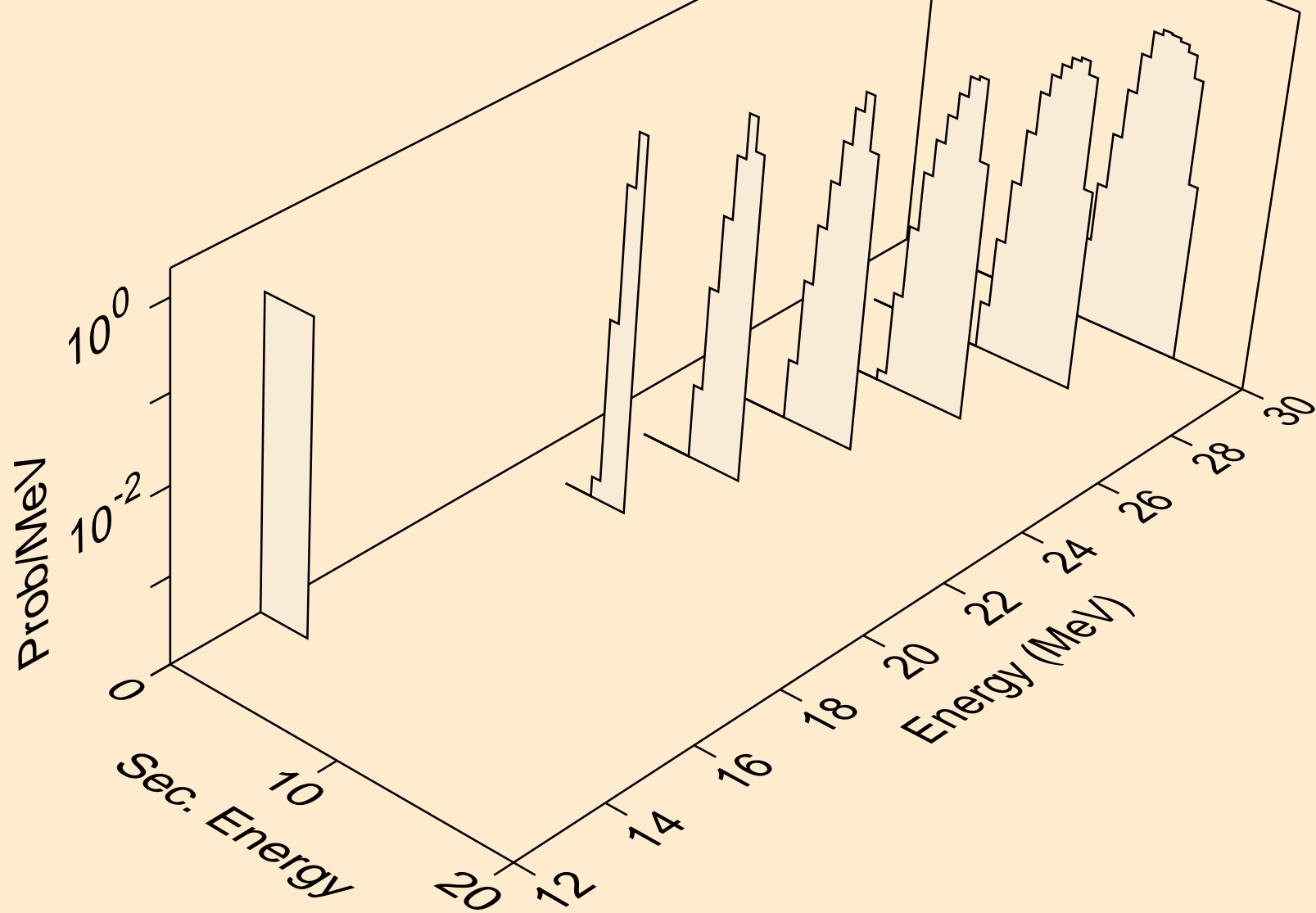

DB256 HELION ACER TENDL-2024 LIBRARY; T=0.K
tritons from (s,t)

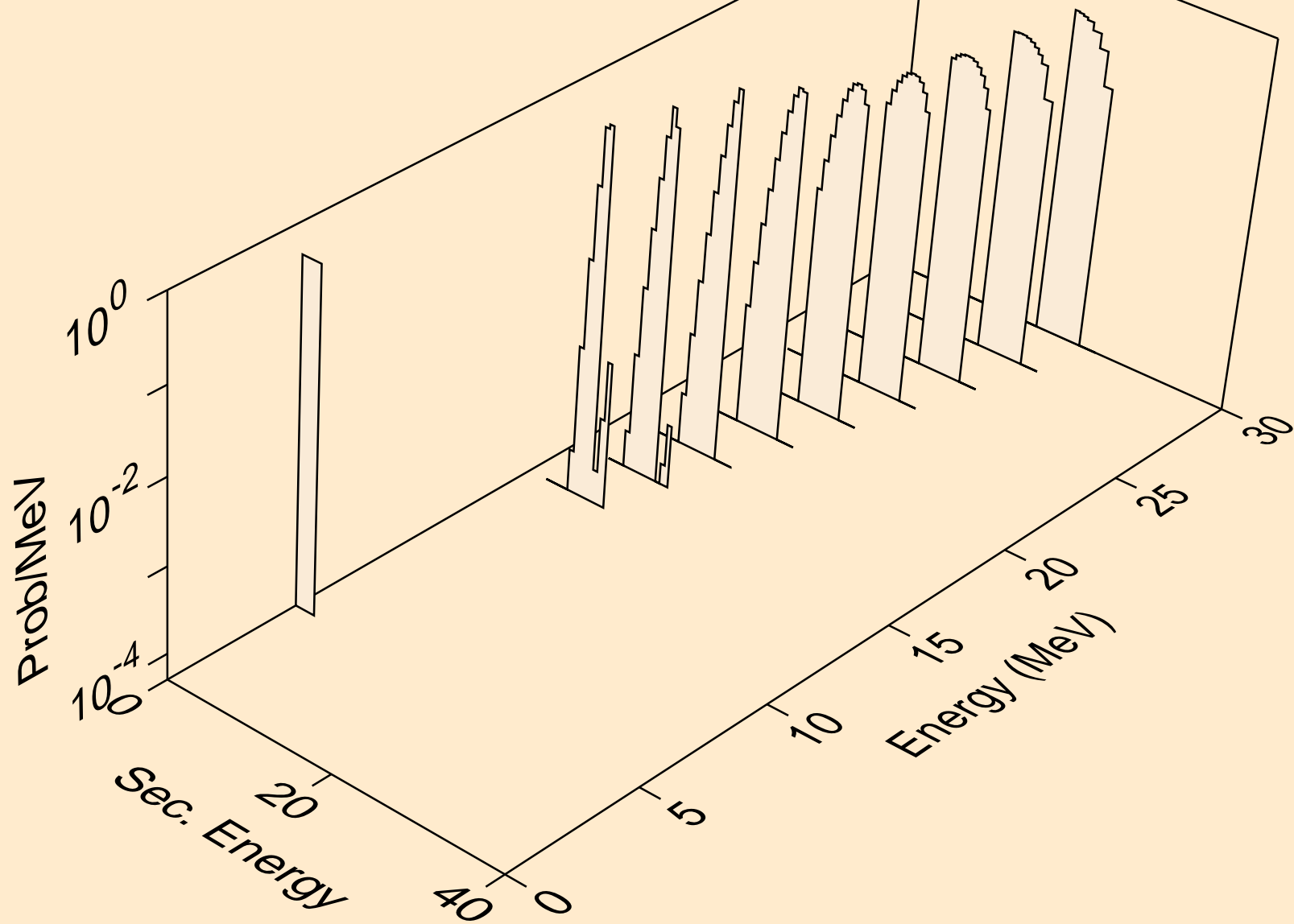

DB256 HELION ACER TENDL-2024 LIBRARY; T=0.K
tritons from (s,pt)

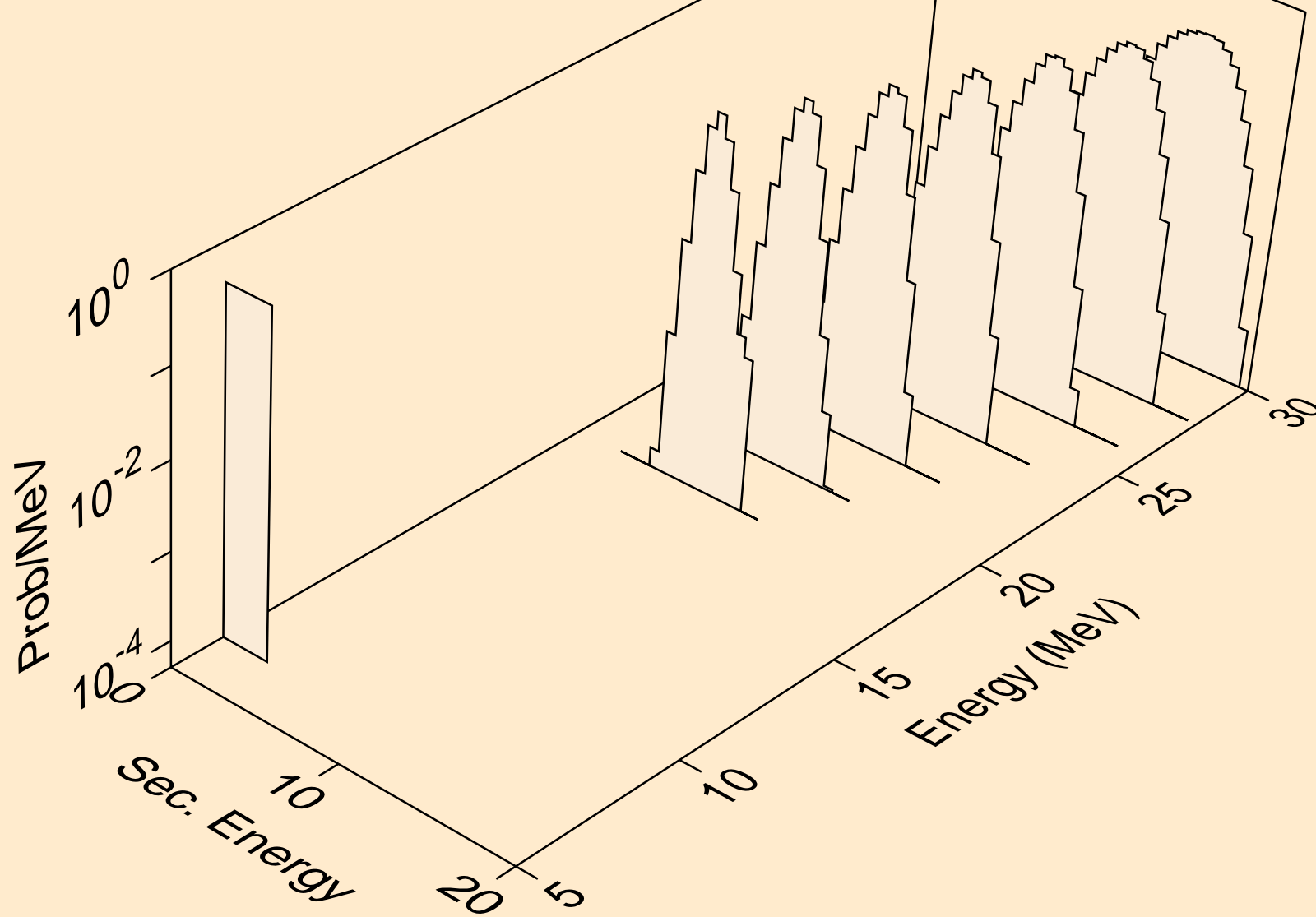

DB256 HELION ACER TENDL-2024 LIBRARY; T=0.K
alphas from (s,x)

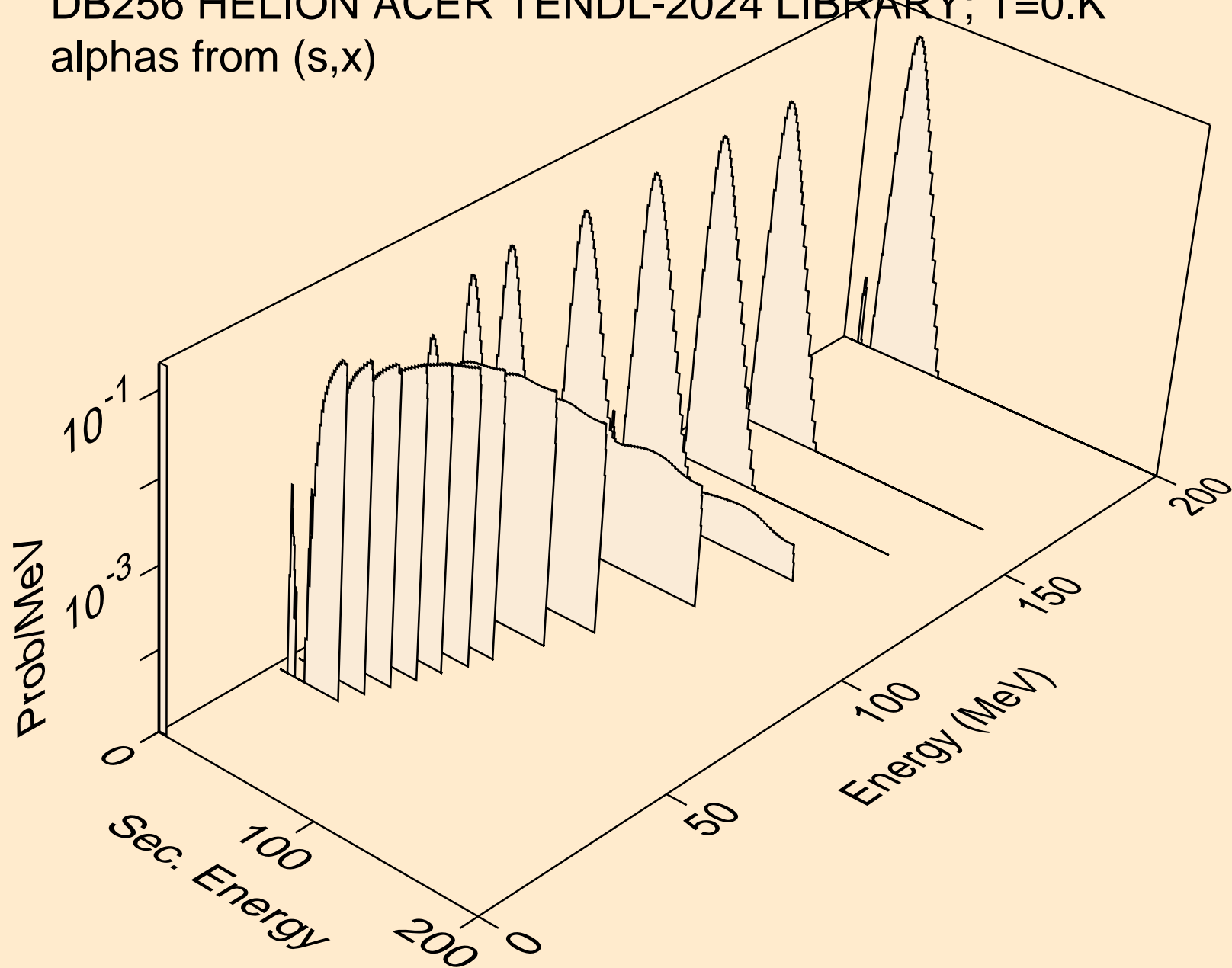

DB256 HELION ACER TENDL-2024 LIBRARY; T=0.K
alphas from (s,n*)a

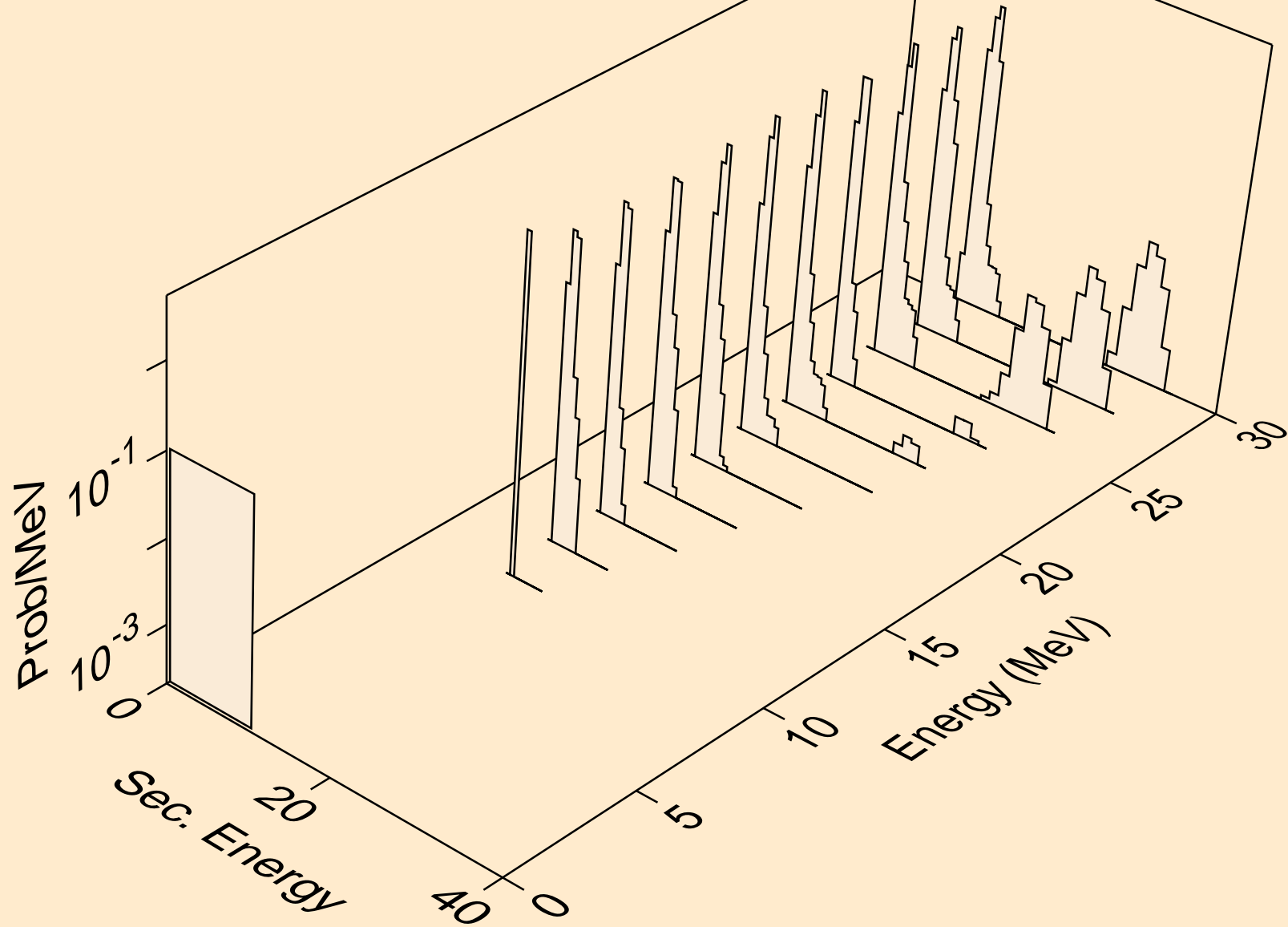

DB256 HELION ACER TENDL-2024 LIBRARY; T=0.K
alphas from (s,2n)a

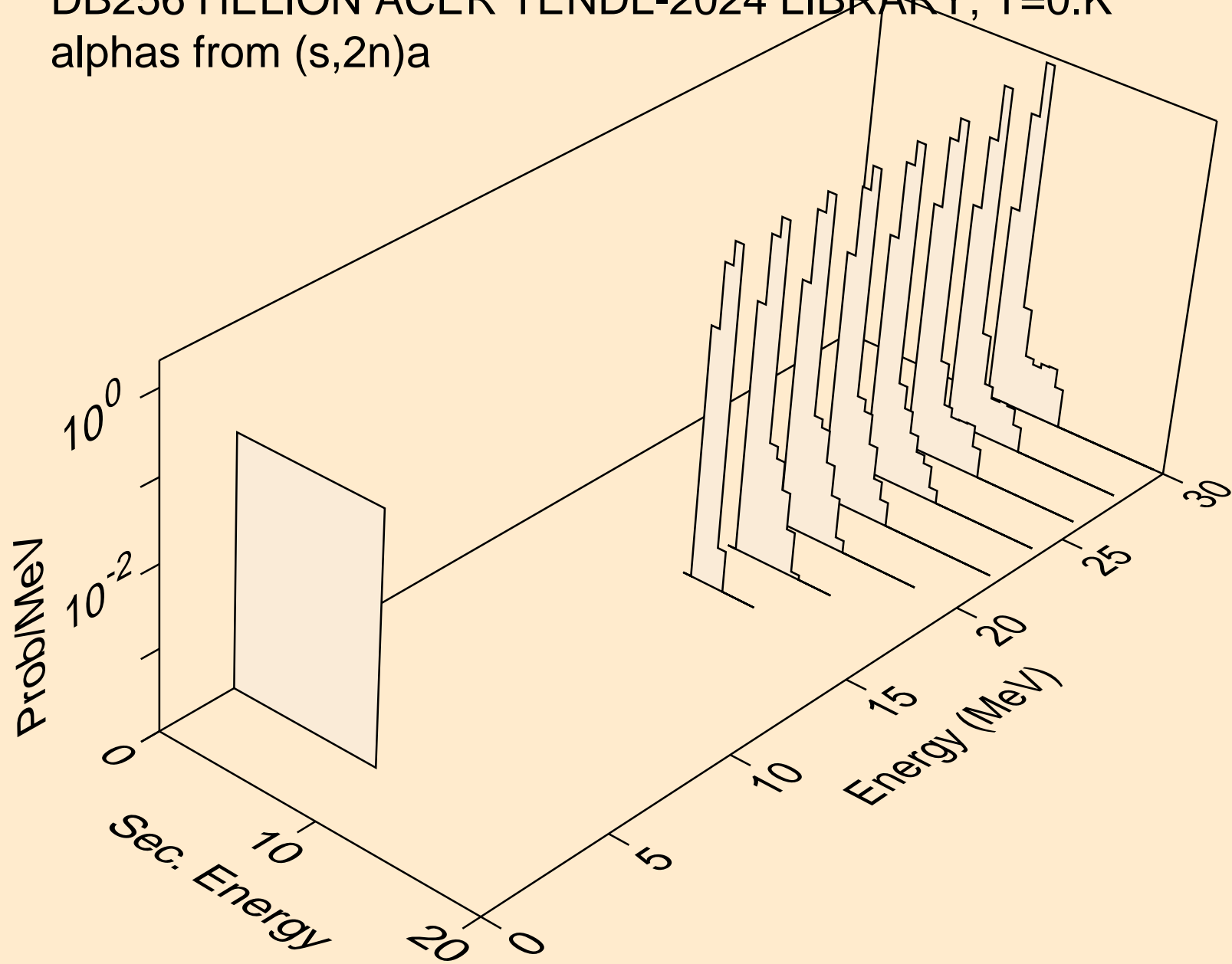

DB256 HELION ACER TENDL-2024 LIBRARY; T=0.K
alphas from (s,npa)

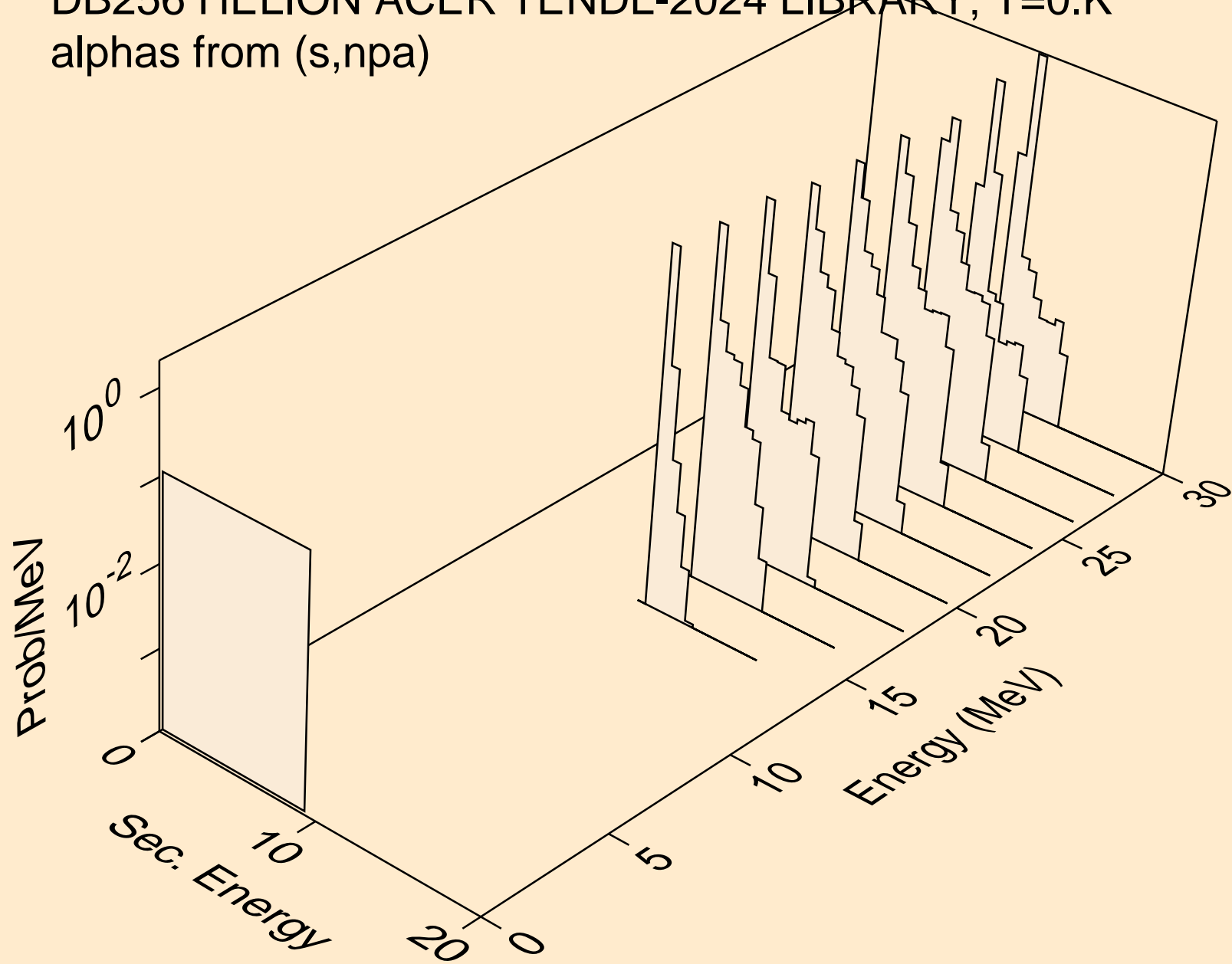

DB256 HELION ACER TENDL-2024 LIBRARY; T=0.K
alphas from (s,a)

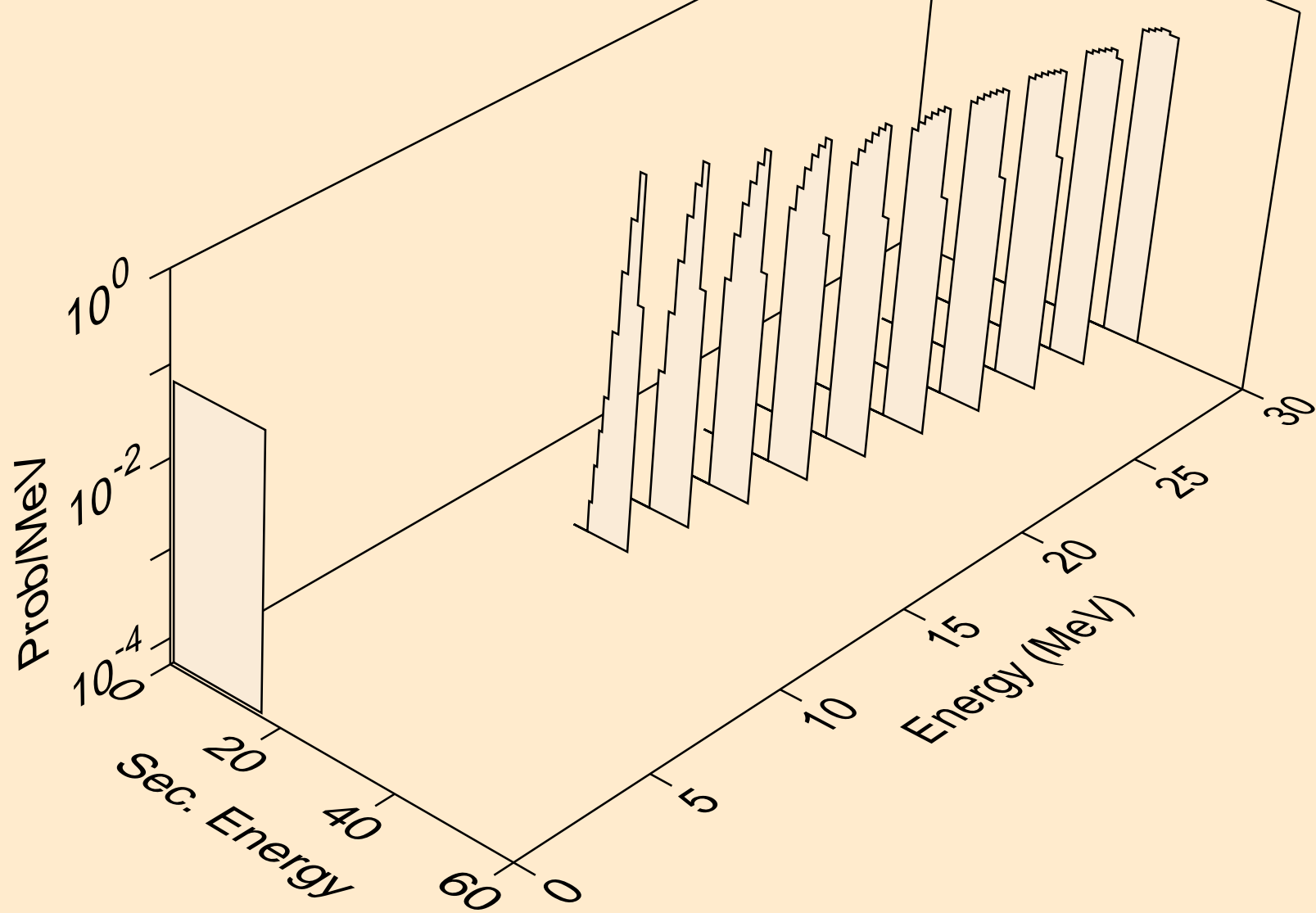

DB256 HELION ACER TENDL-2024 LIBRARY; T=0.K
alphas from (s,2a)

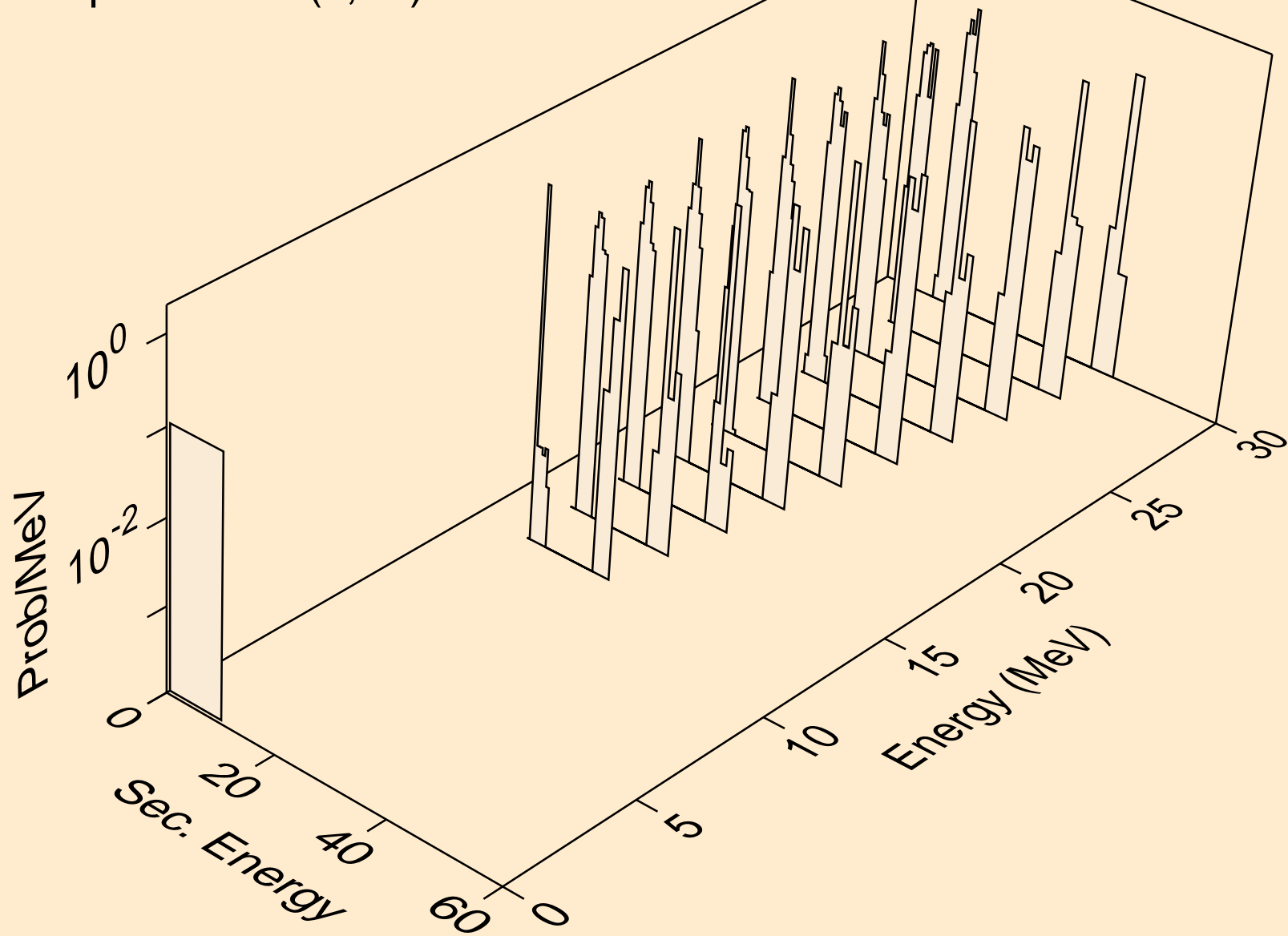

DB256 HELION ACER TENDL-2024 LIBRARY; T=0.K
alphas from (s,3a)

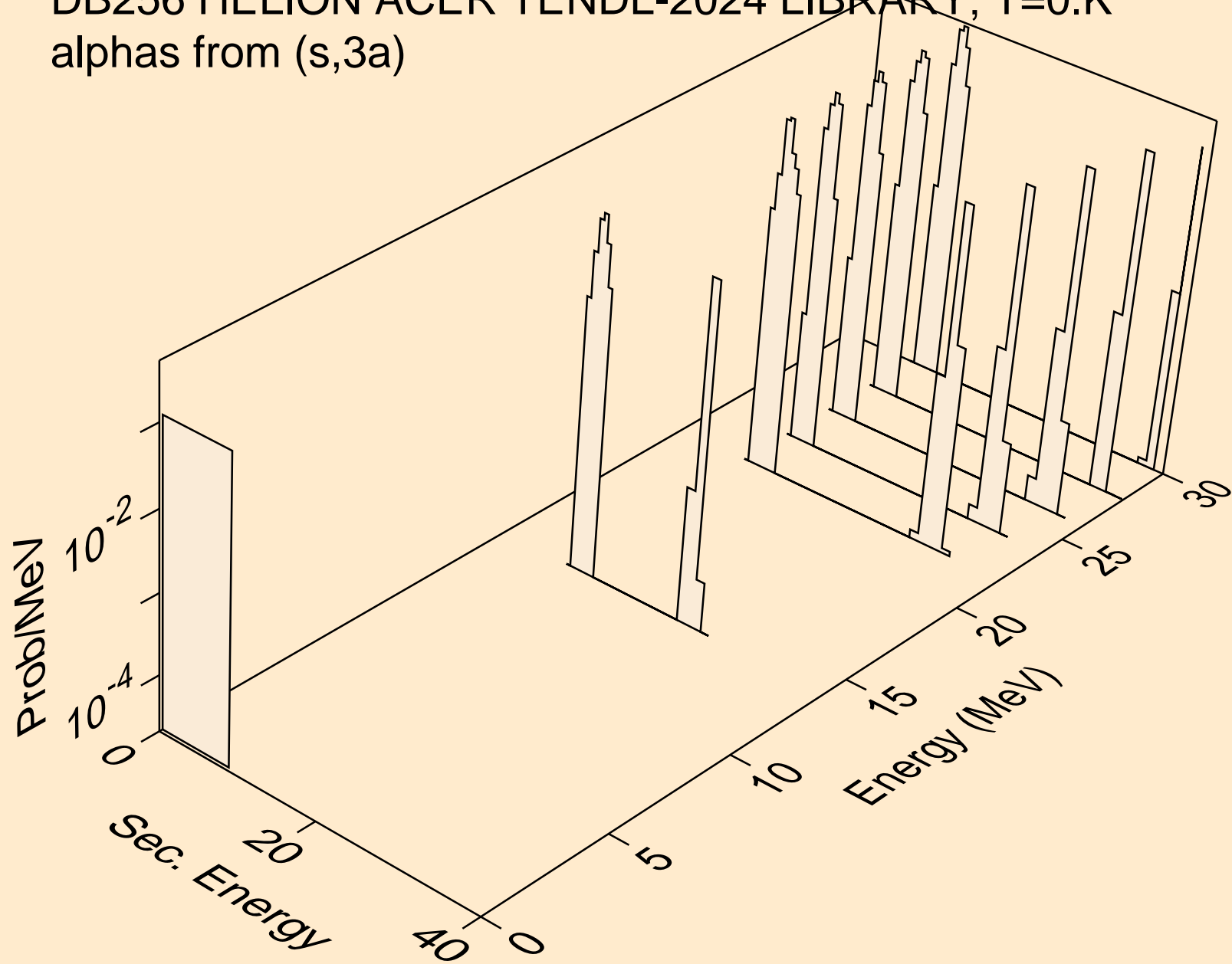

DB256 HELION ACER TENDL-2024 LIBRARY; T=0.K
alphas from (s,da)

