

LR259 HELION ACER TENDL-2024 LIBRARY; T=0.K  
Principal cross sections

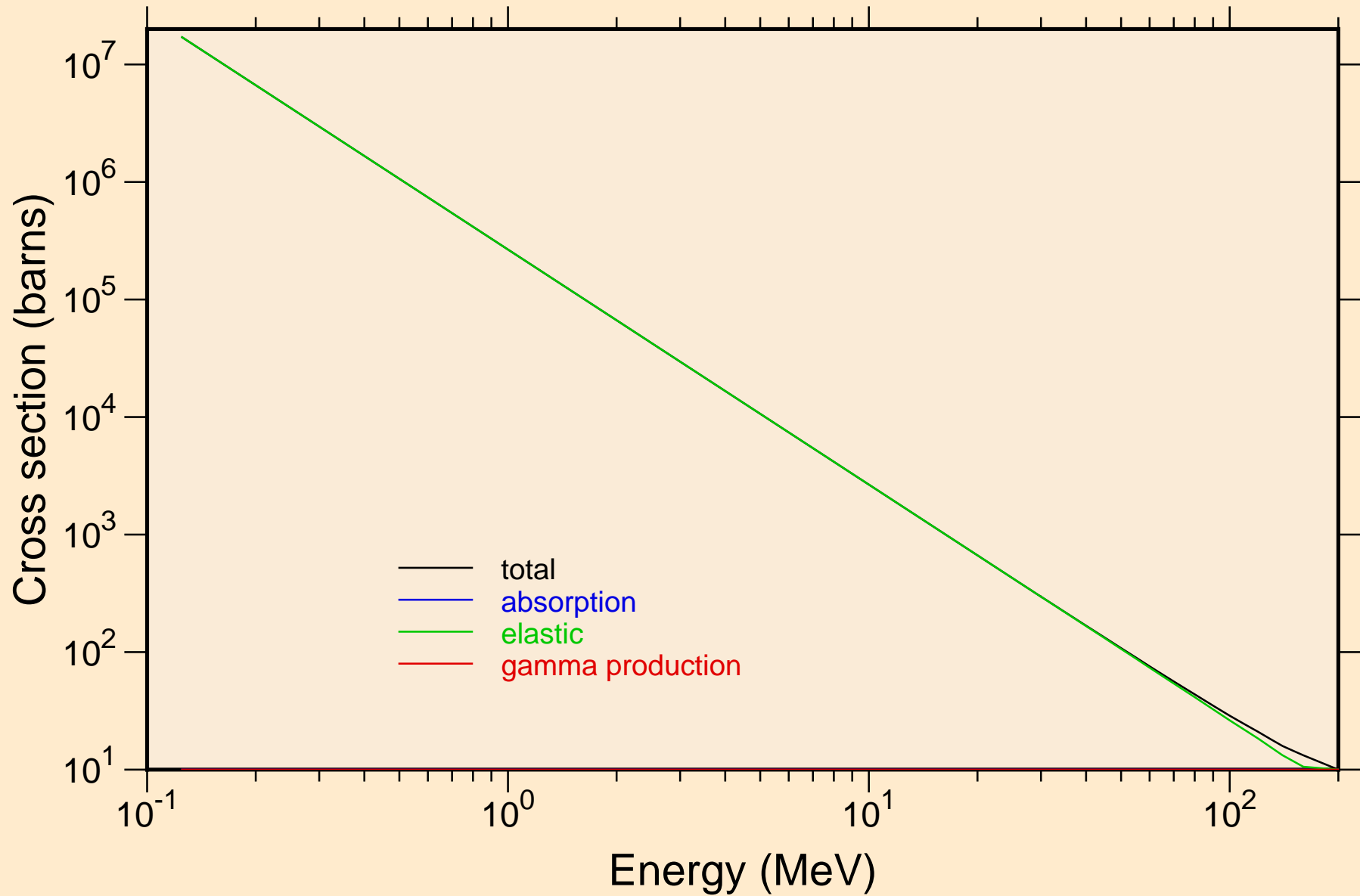

LR259 HELION ACER TENDL-2024 LIBRARY; T=0.K

Heating

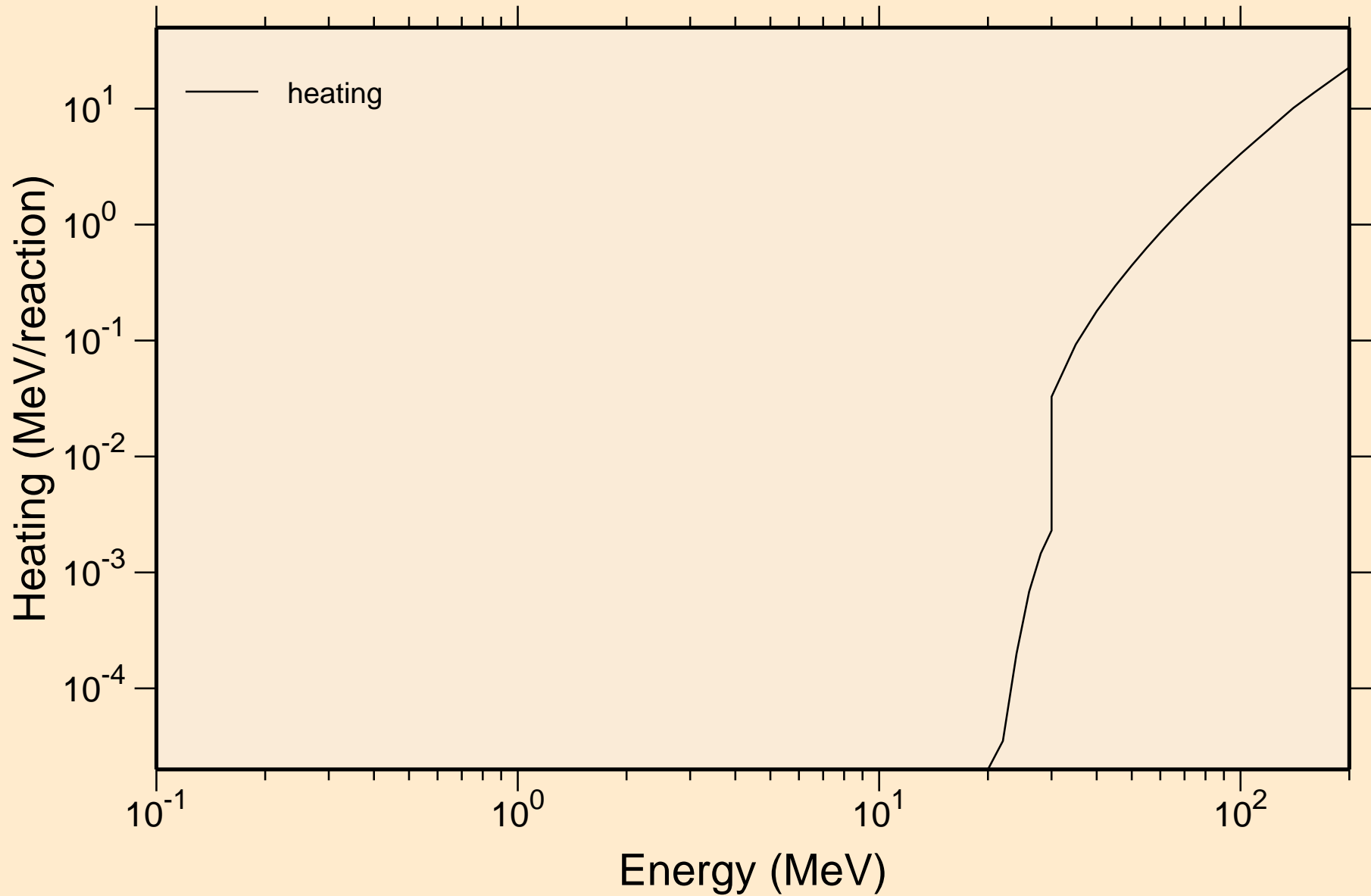

# LR259 HELION ACER TENDL-2024 LIBRARY; T=0.K

## Principal cross sections

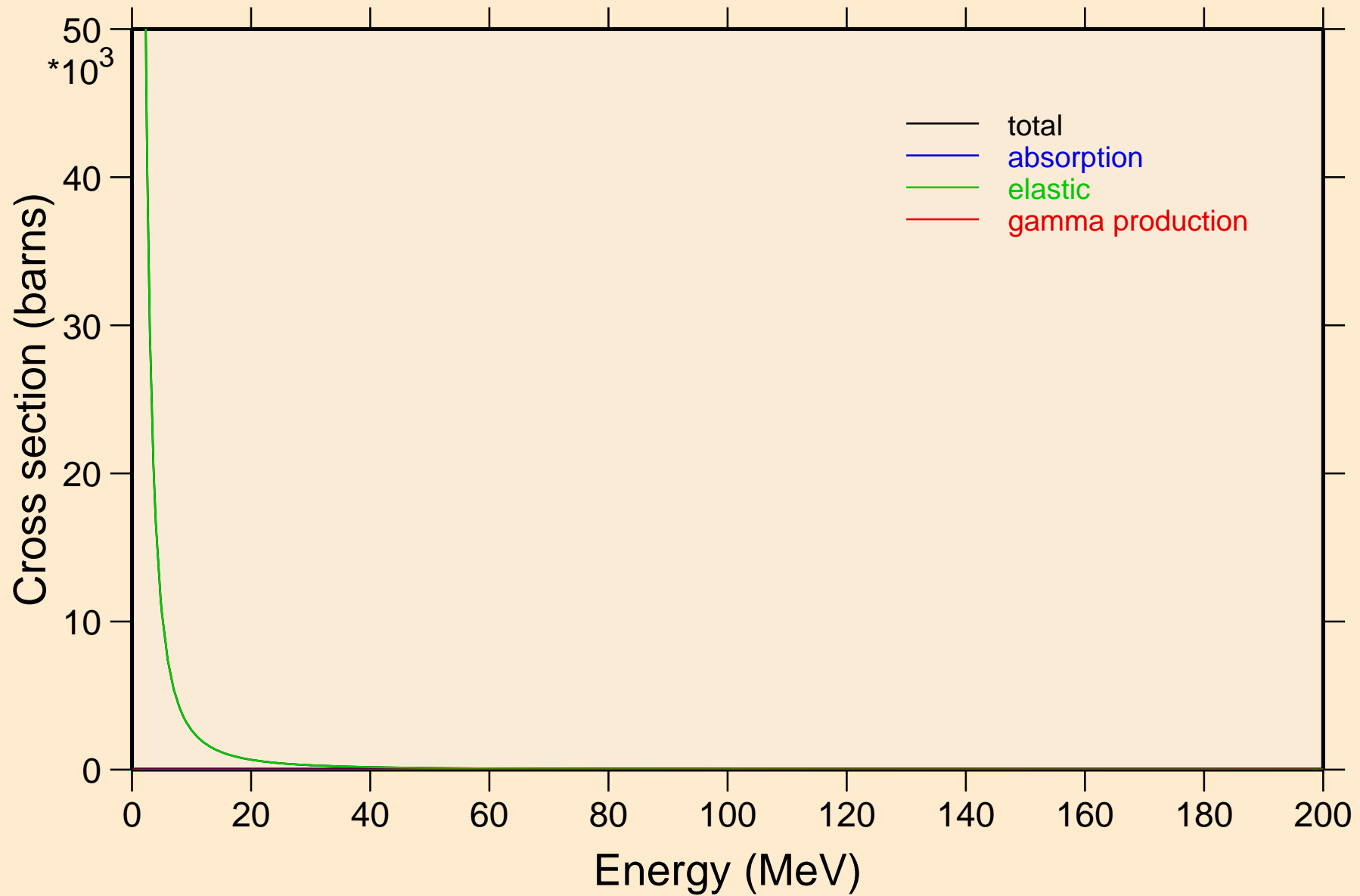

LR259 HELION ACER TENDL-2024 LIBRARY; T=0.K

Heating

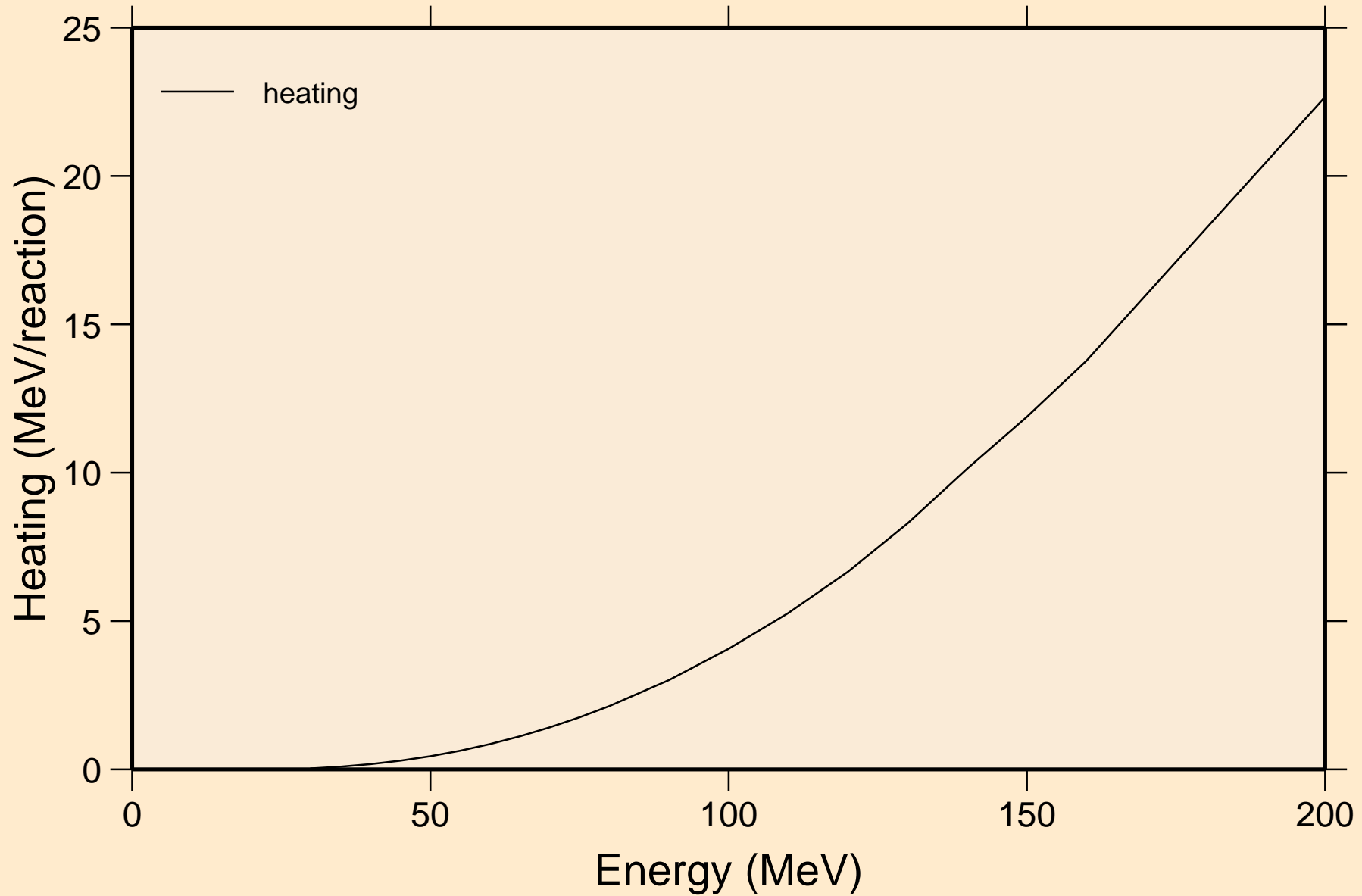

LR259 HELION ACER TENDL-2024 LIBRARY; T=0.K  
Threshold reactions

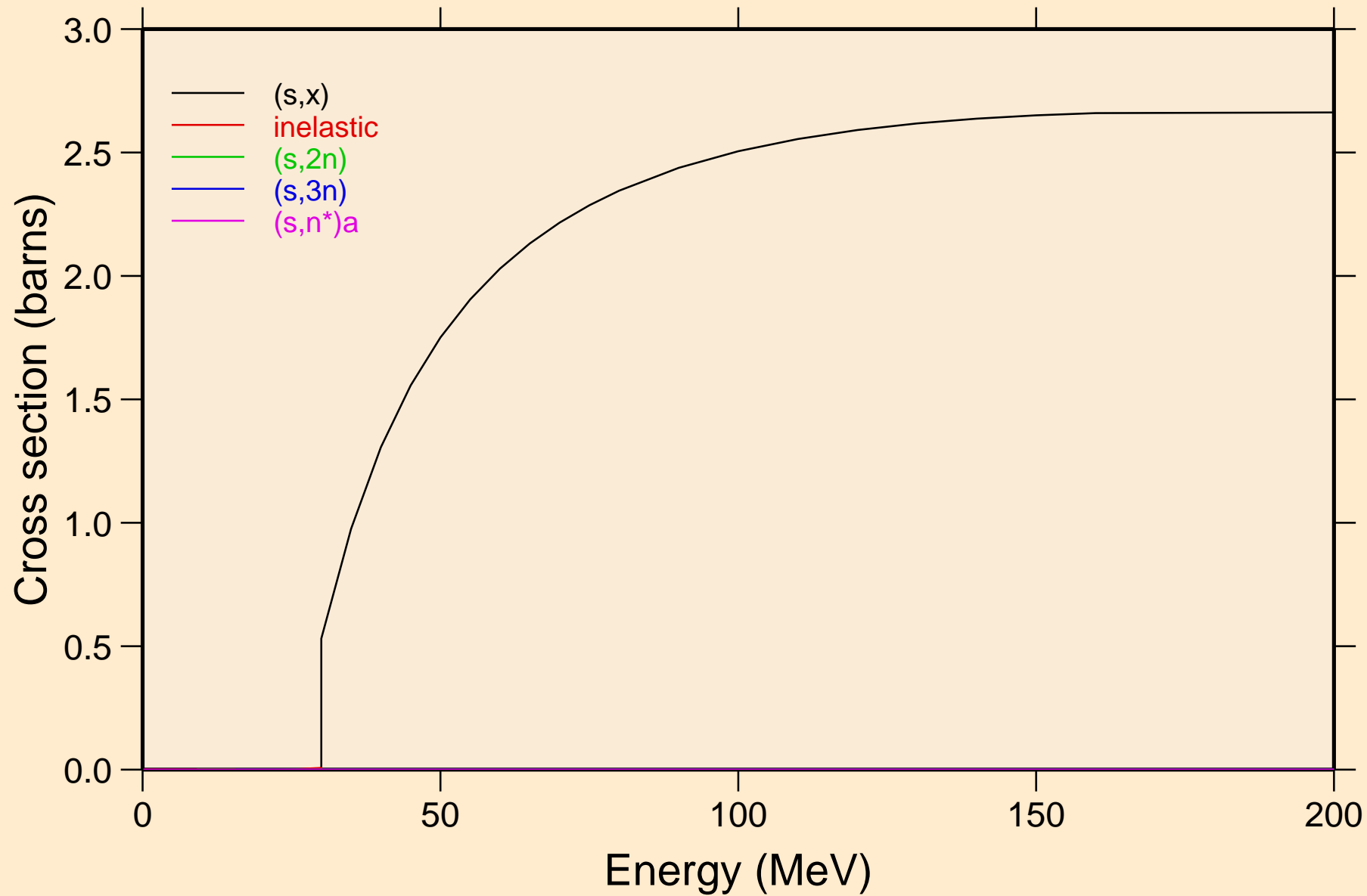

LR259 HELION ACER TENDL-2024 LIBRARY; T=0.K  
Threshold reactions

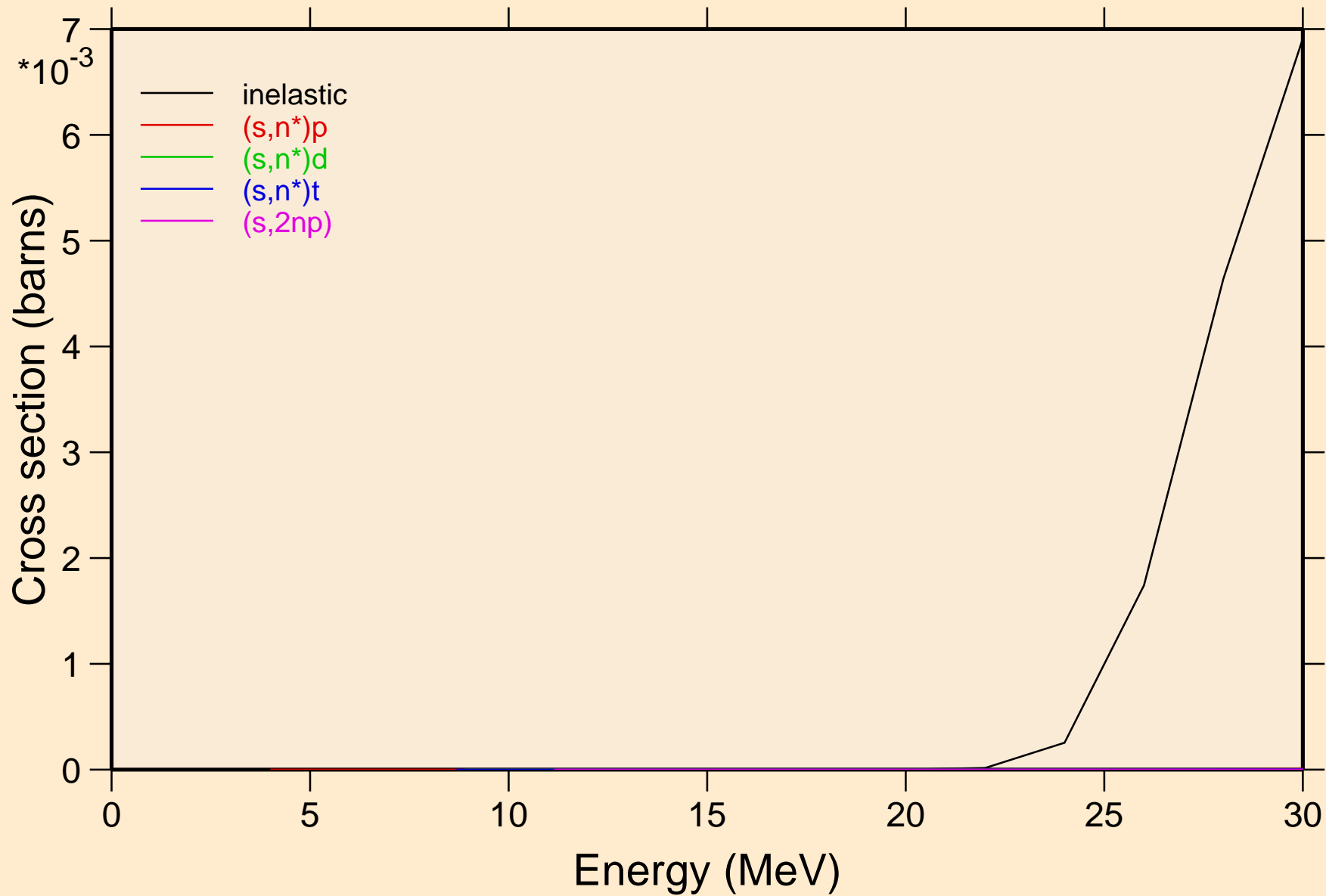

LR259 HELION ACER TENDL-2024 LIBRARY; T=0.K  
Threshold reactions

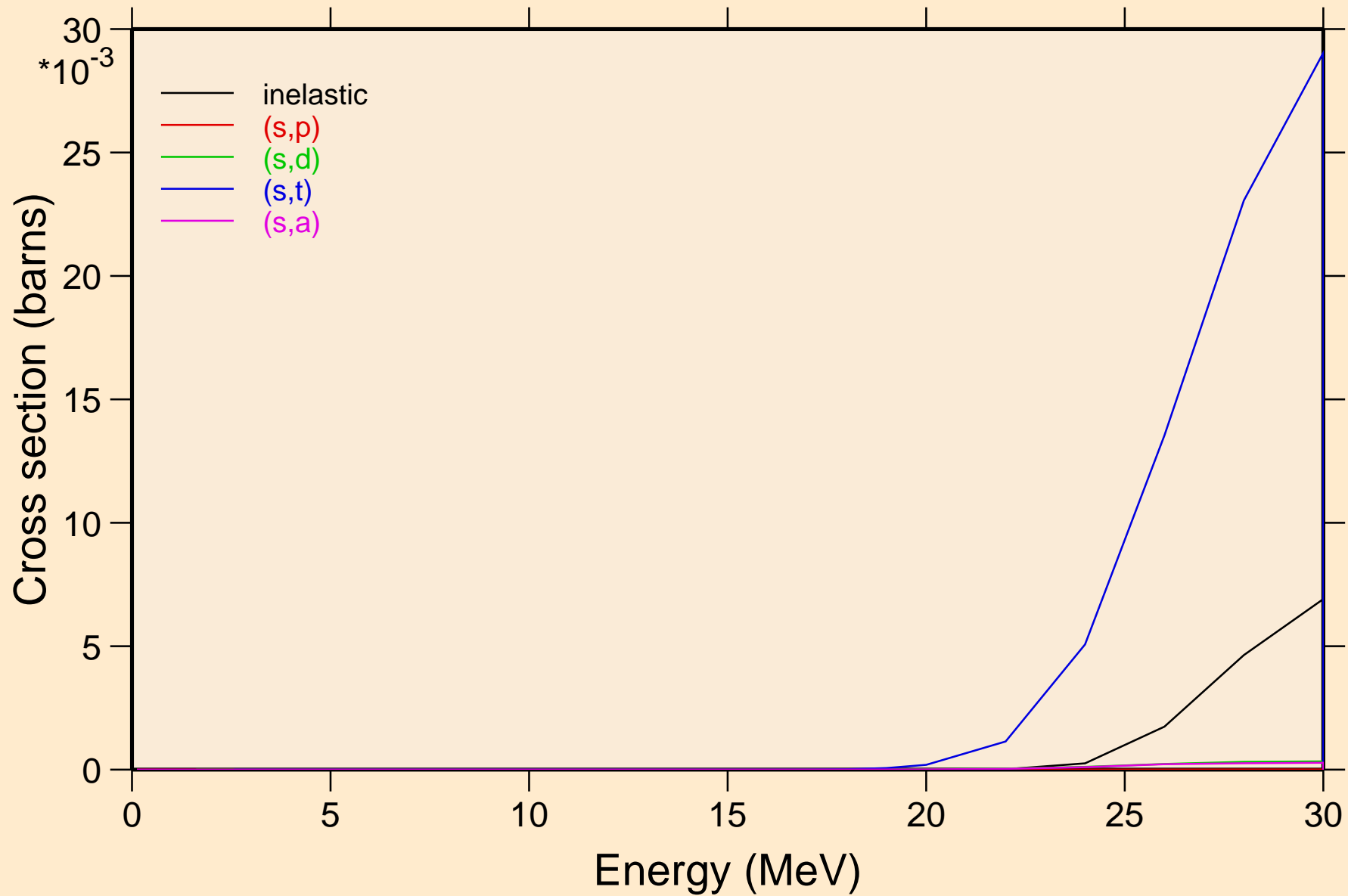

LR259 HELION ACER TENDL-2024 LIBRARY; T=0.K  
Threshold reactions

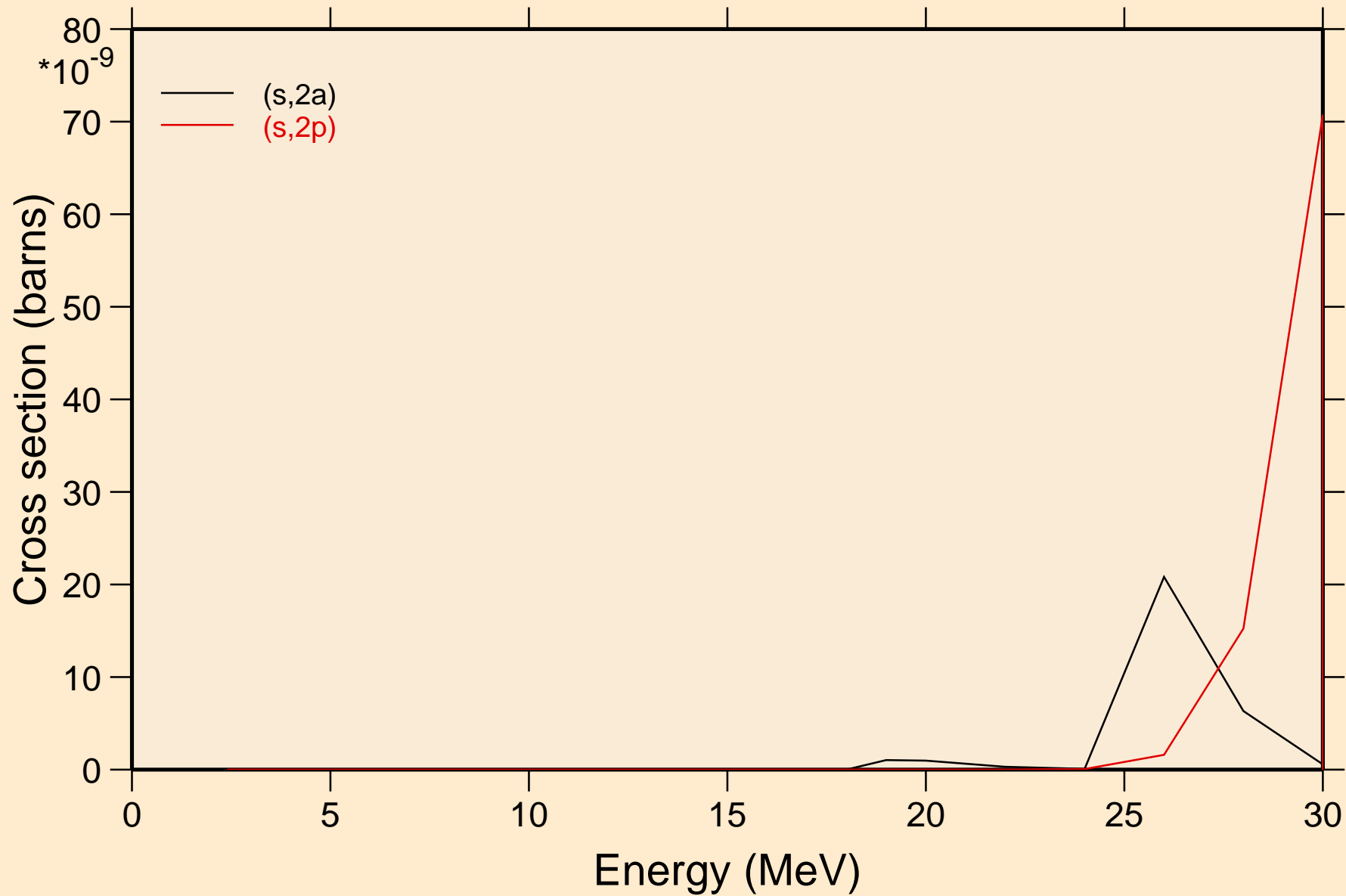

LR259 HELION ACER TENDL-2024 LIBRARY; T=0.K  
angular distribution for elastic

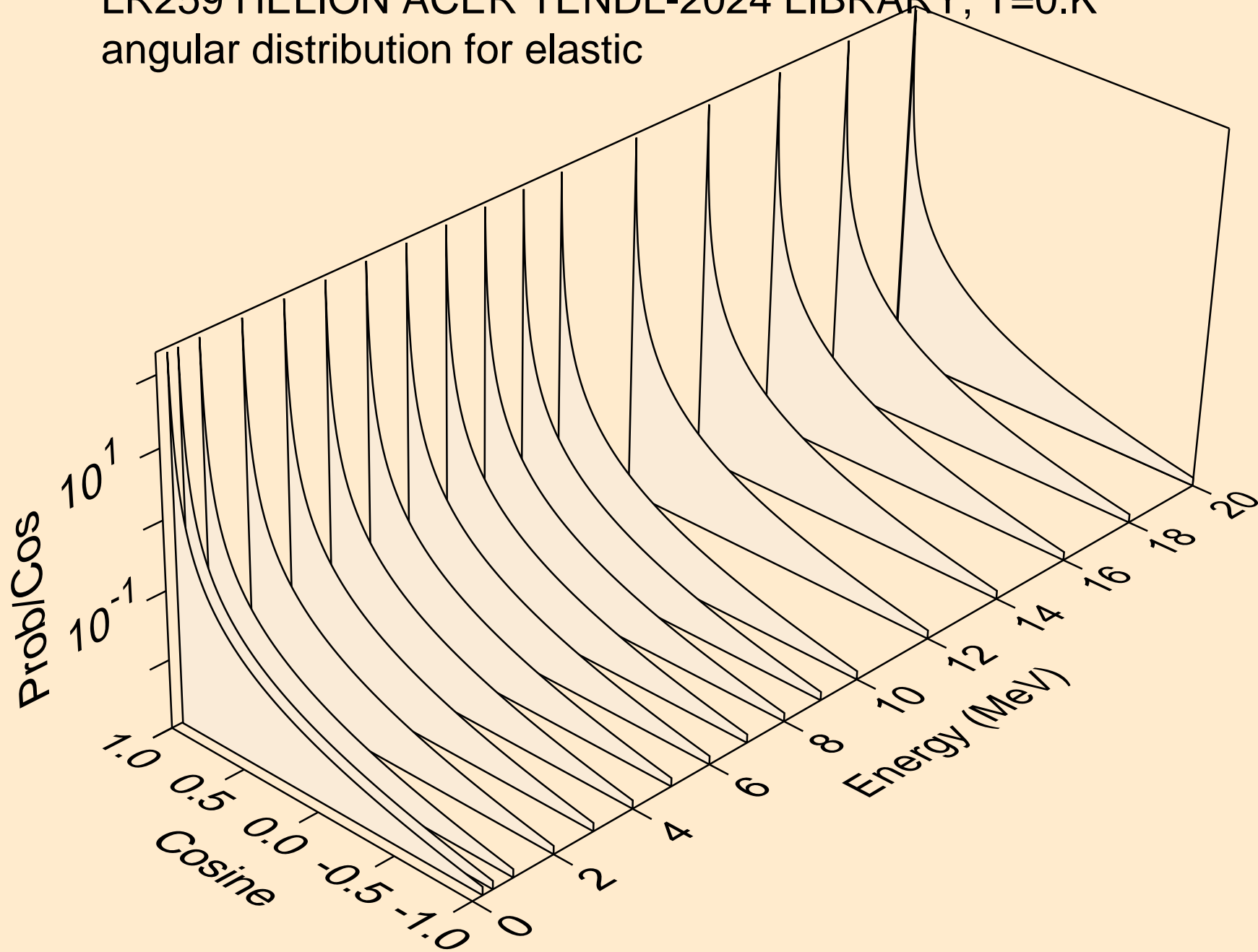

LR259 HELION ACER TENDL-2024 LIBRARY; T=0.K  
angular distribution for elastic

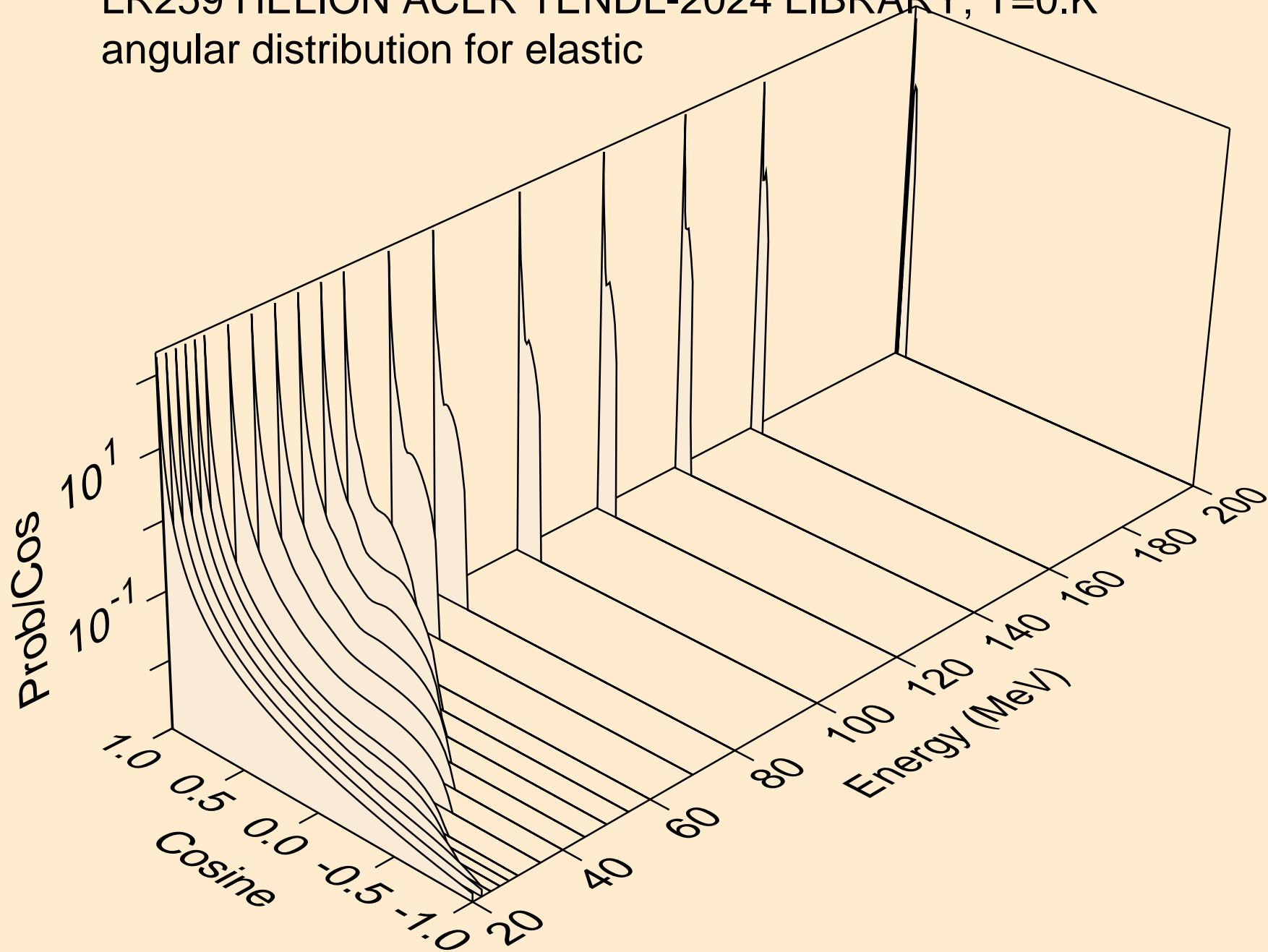

LR259 HELION ACER TENDL-2024 LIBRARY; T=0.K  
He-3 emission for (s,x)

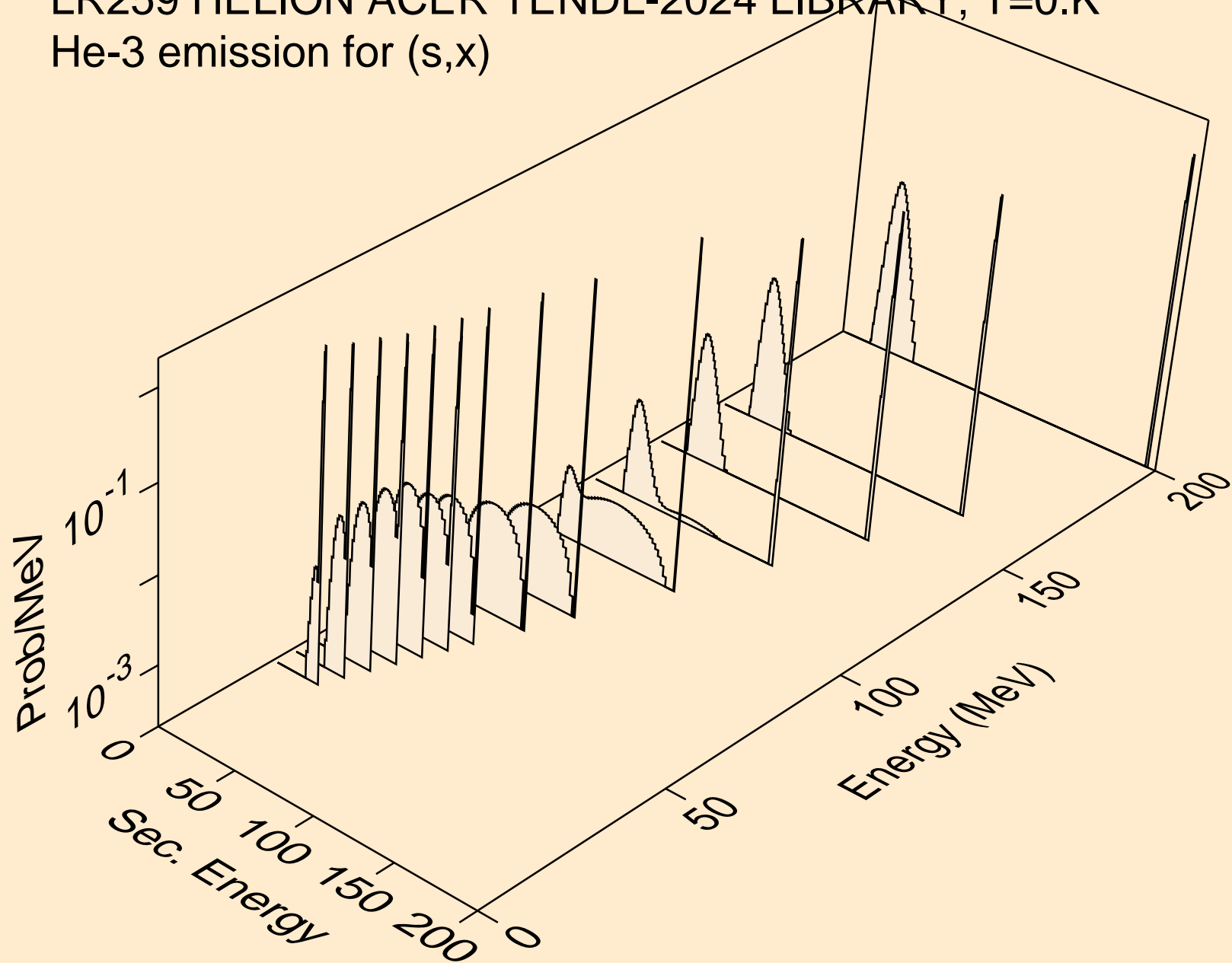

LR259 HELION ACER TENDL-2024 LIBRARY; T=0.K  
He-3 emission for inelastic

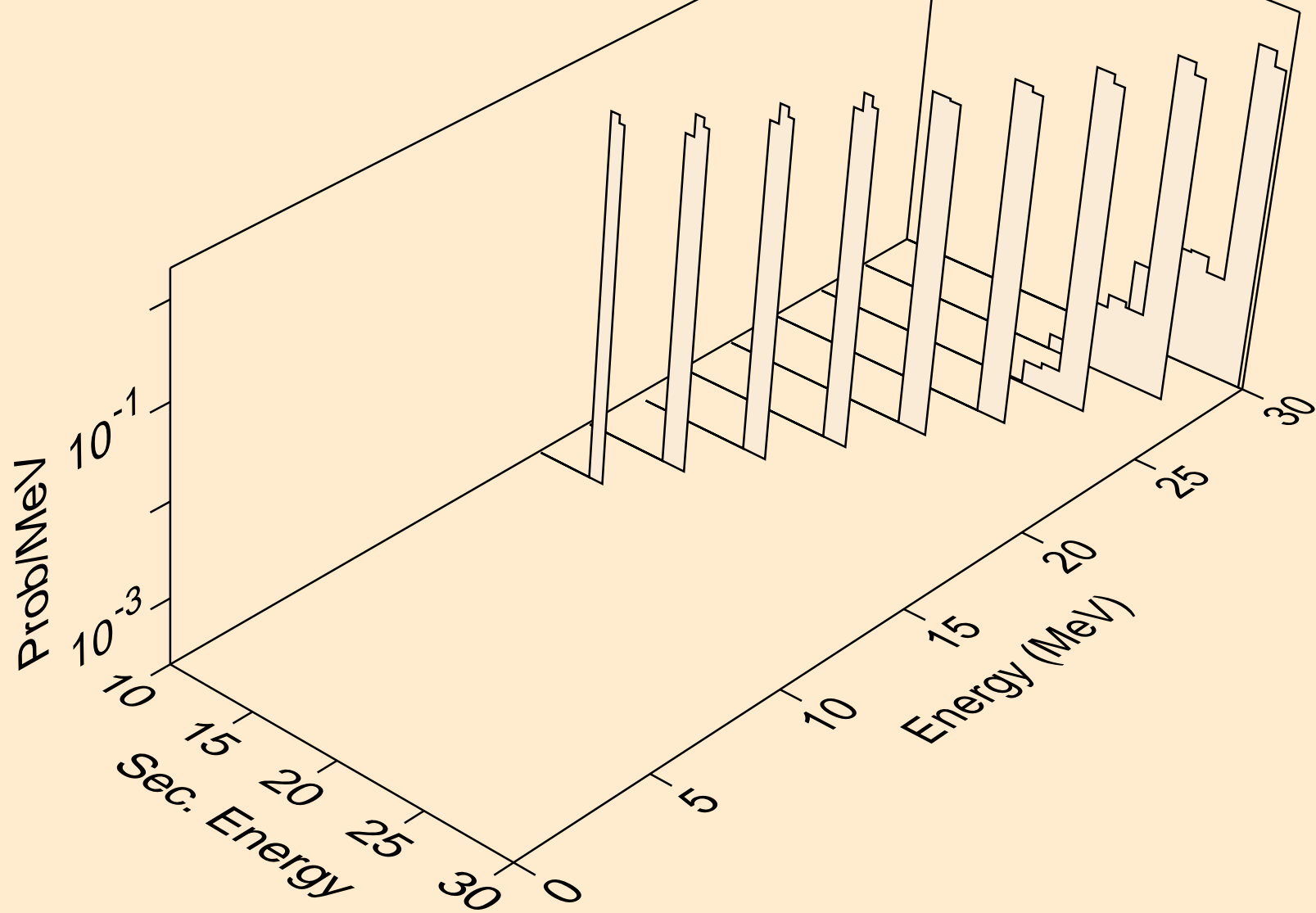

LR259 HELION ACER TENDL-2024 LIBRARY; T=0.K  
Photon emission for (z,n)

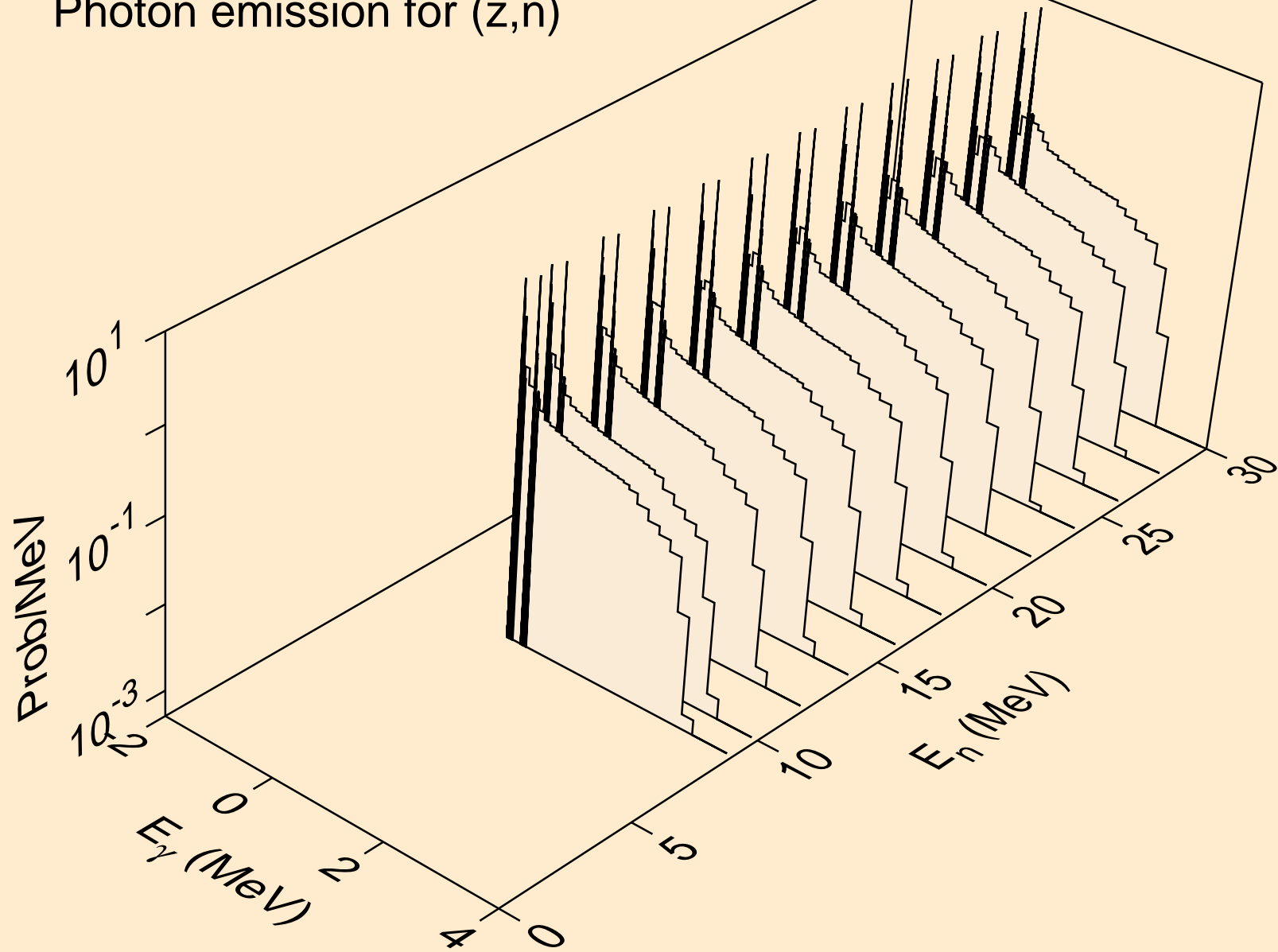

LR259 HELION ACER TENDL-2024 LIBRARY; T=0.K  
Photon emission for (z,x)

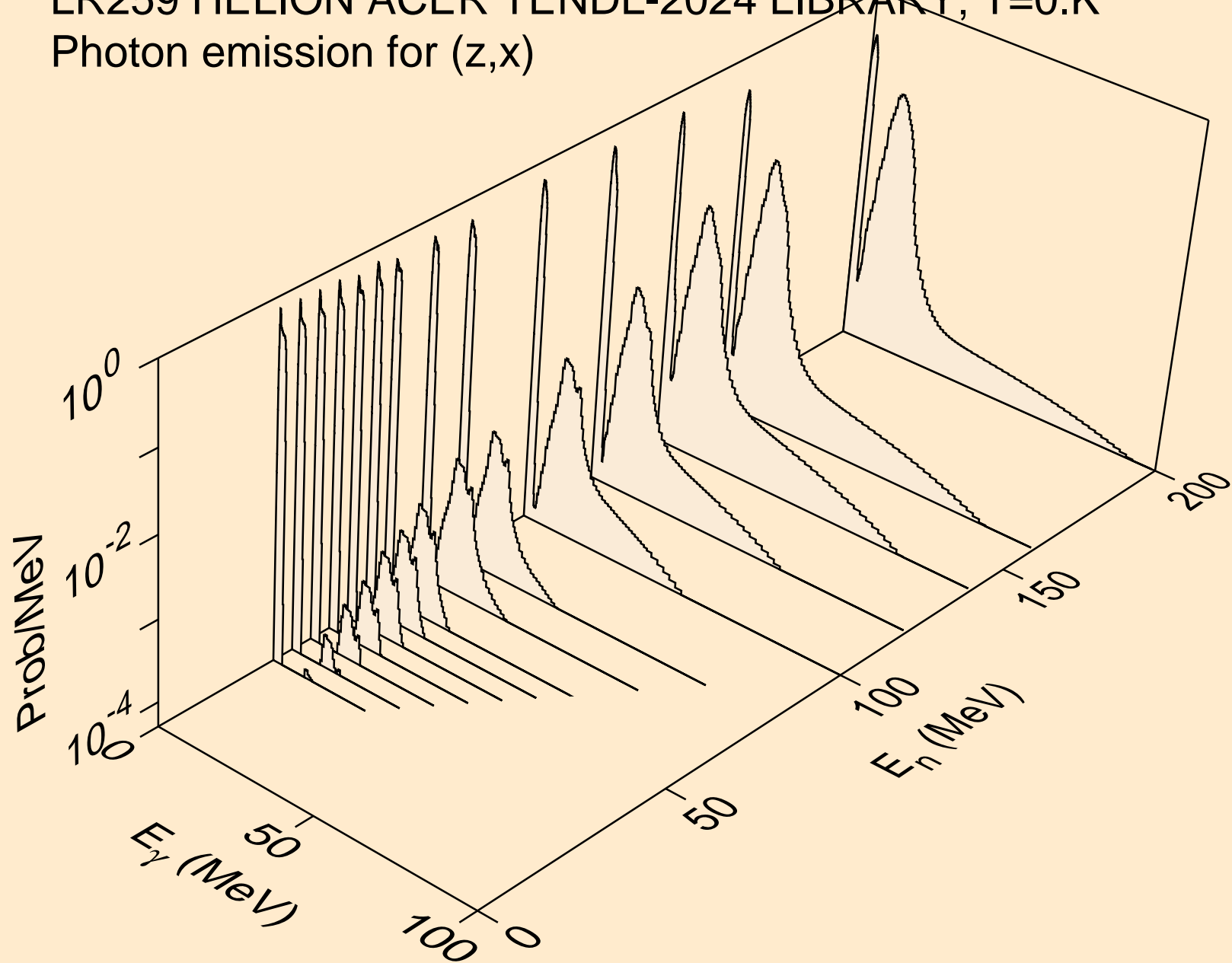

LR259 HELION ACER TENDL-2024 LIBRARY; T=0.K  
Photon emission for (n,2n)

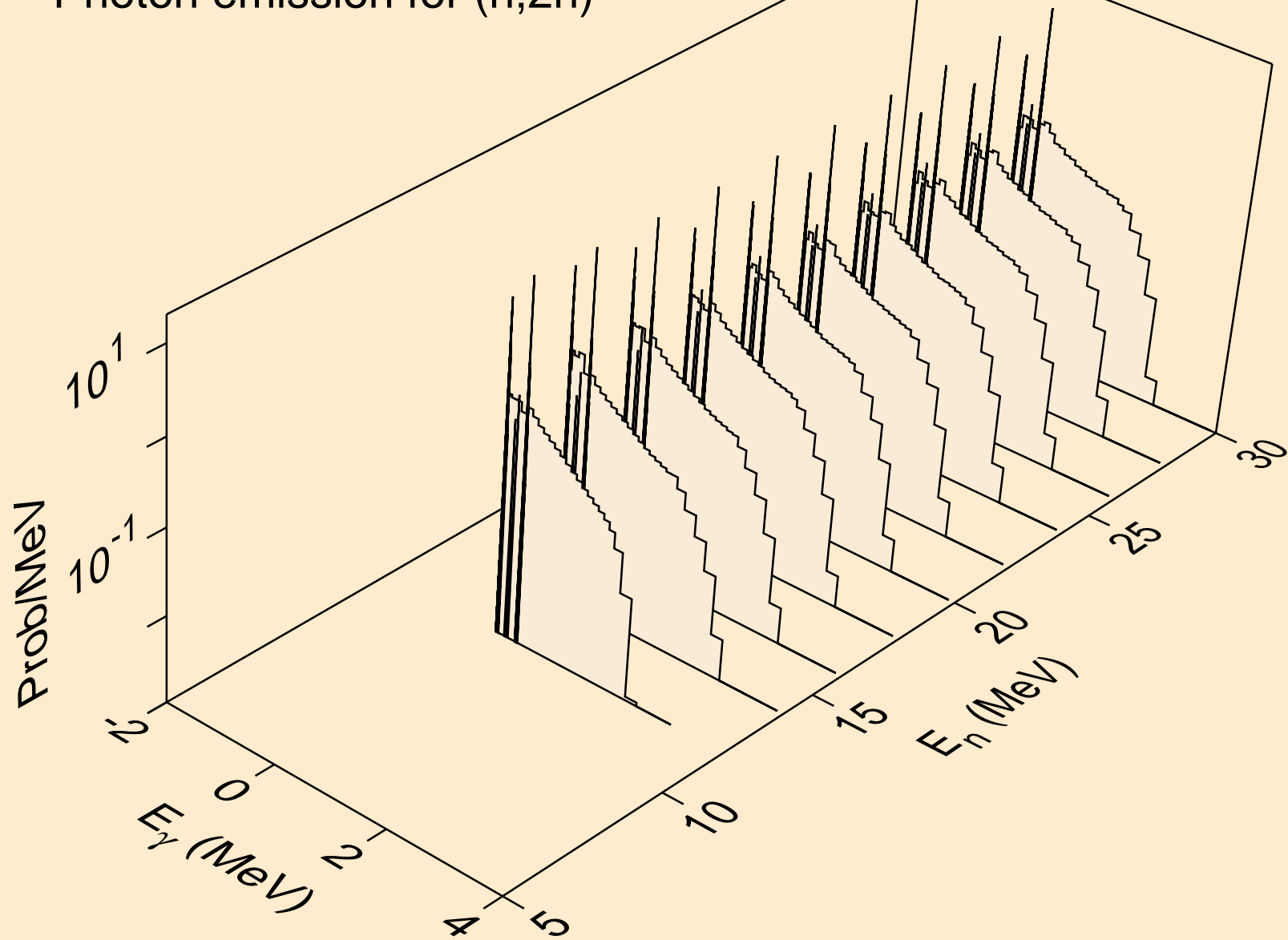

LR259 HELION ACER TENDL-2024 LIBRARY; T=0.K  
Photon emission for (n,3n)

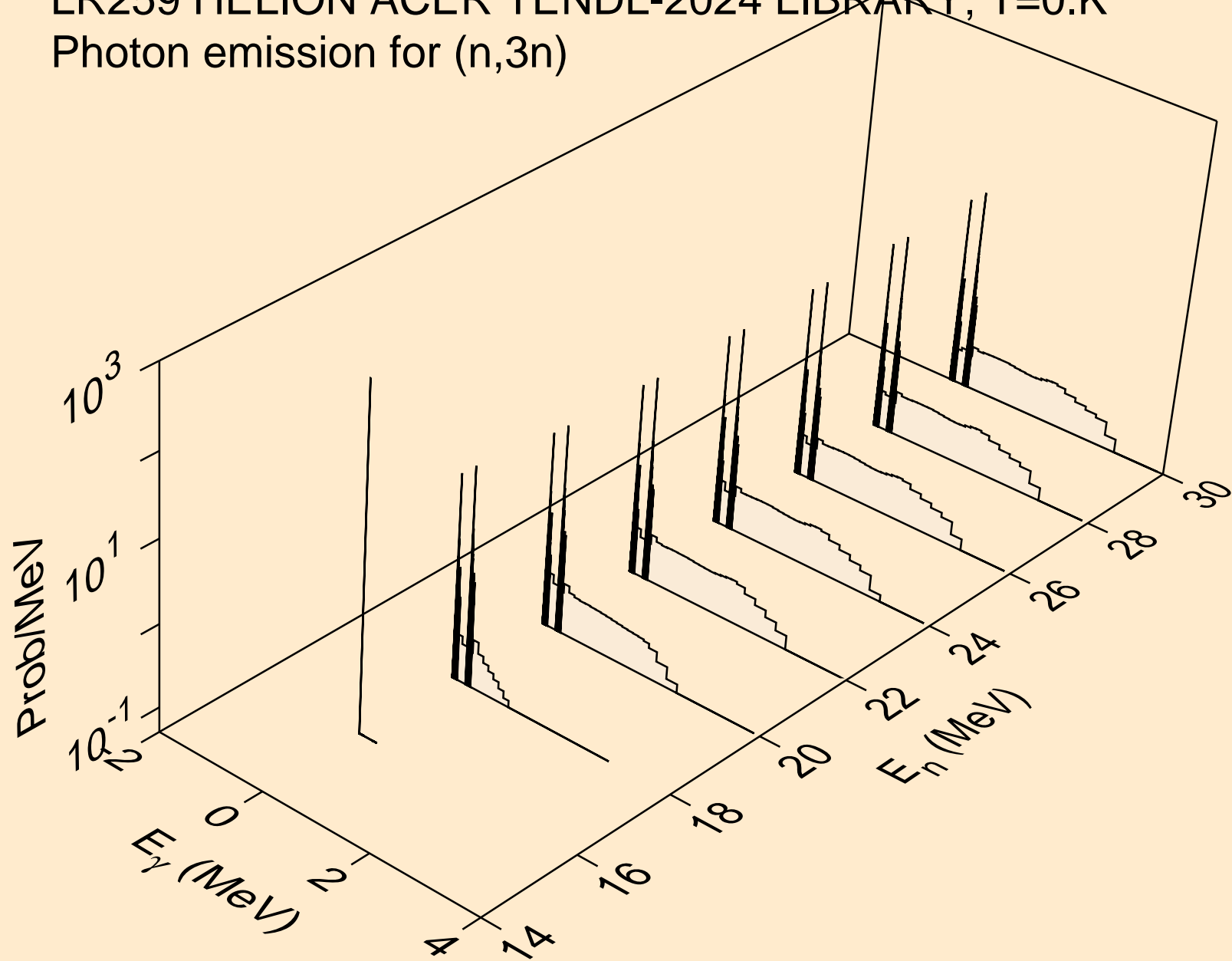

LR259 HELION ACER TENDL-2024 LIBRARY; T=0.K  
Photon emission for (n,n\*)a

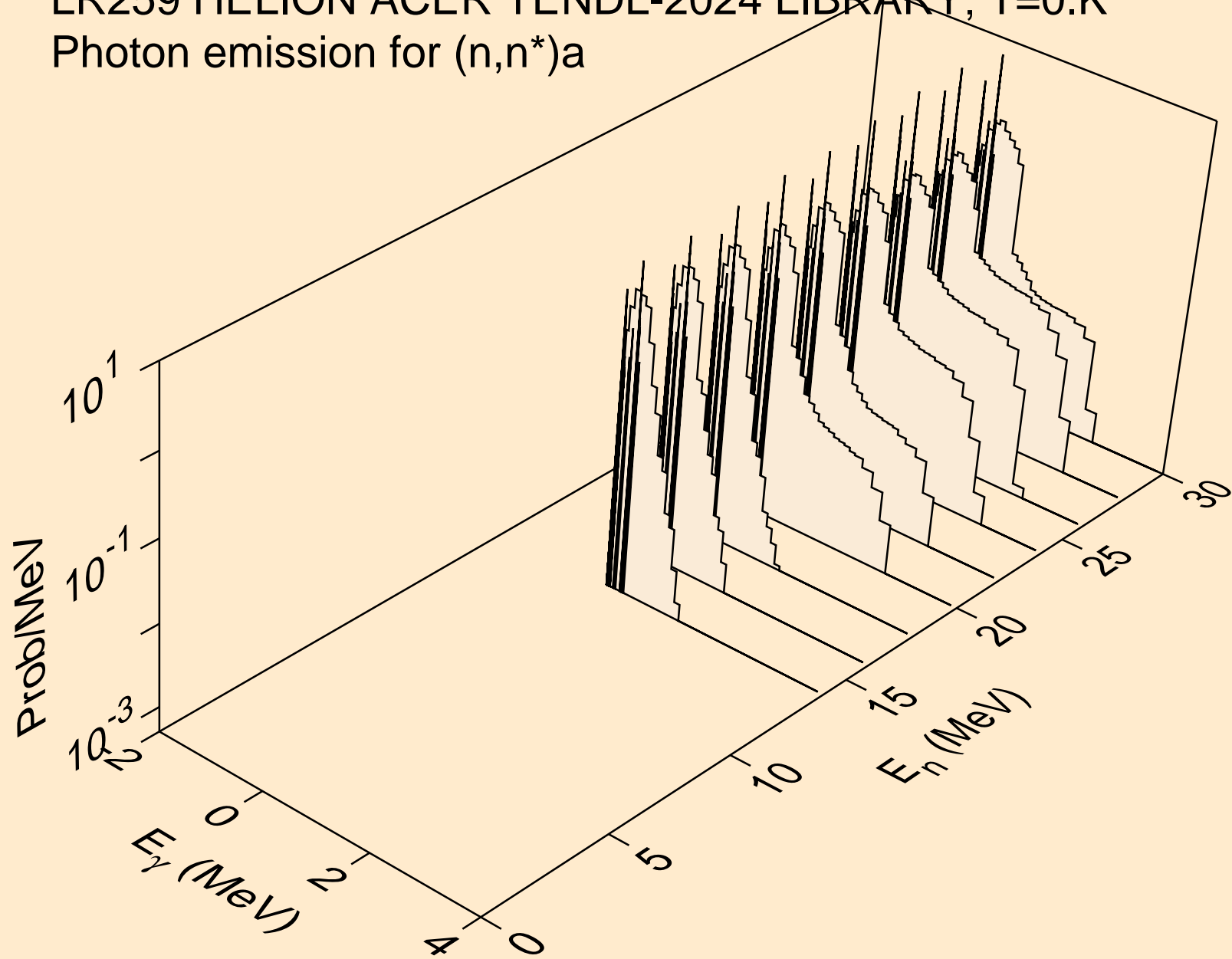

LR259 HELION ACER TENDL-2024 LIBRARY; T=0.K  
Photon emission for (n,n\*)p

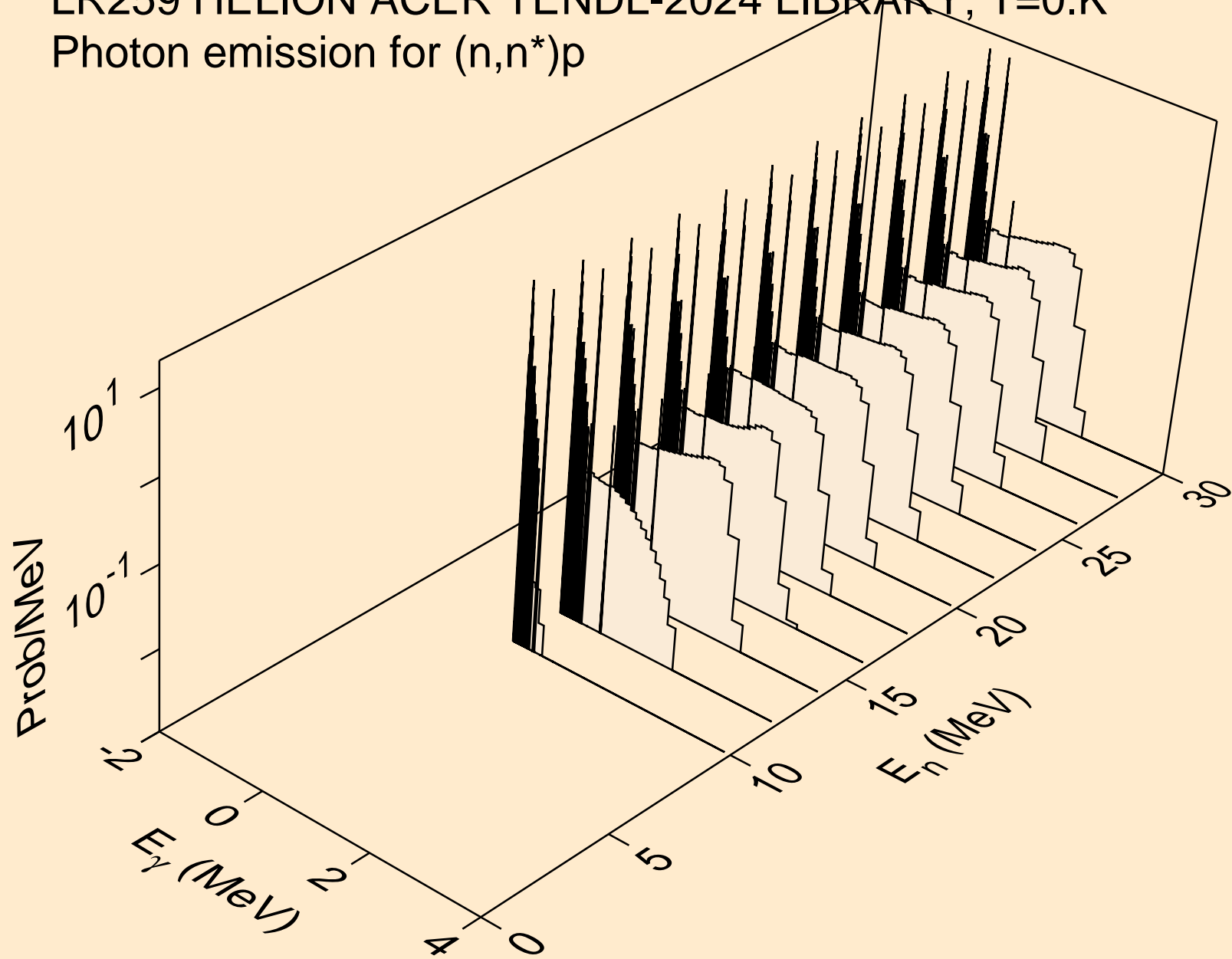

LR259 HELION ACER TENDL-2024 LIBRARY; T=0.K  
Photon emission for (n,n\*)d

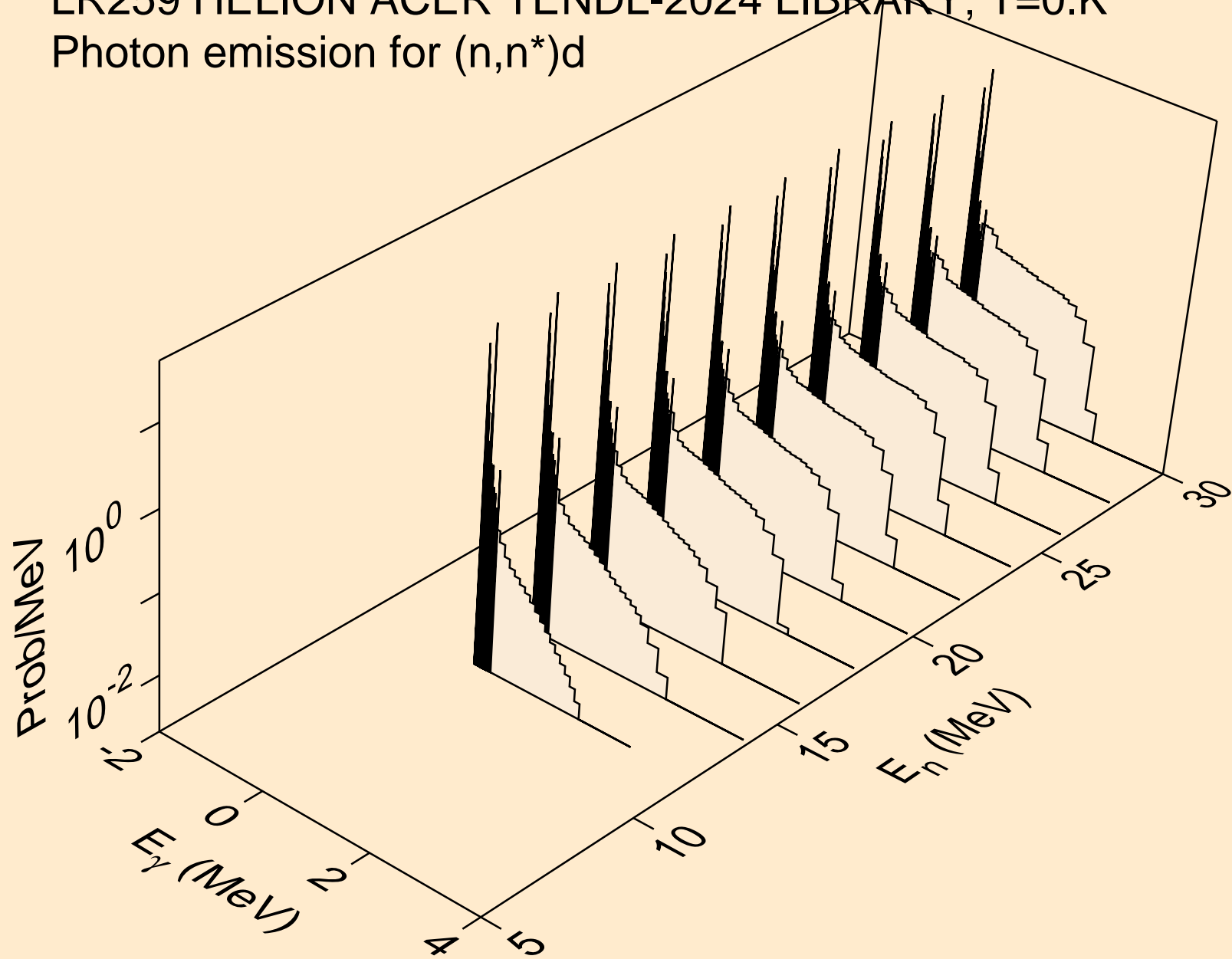

LR259 HELION ACER TENDL-2024 LIBRARY; T=0.K  
Photon emission for (n,n\*)t

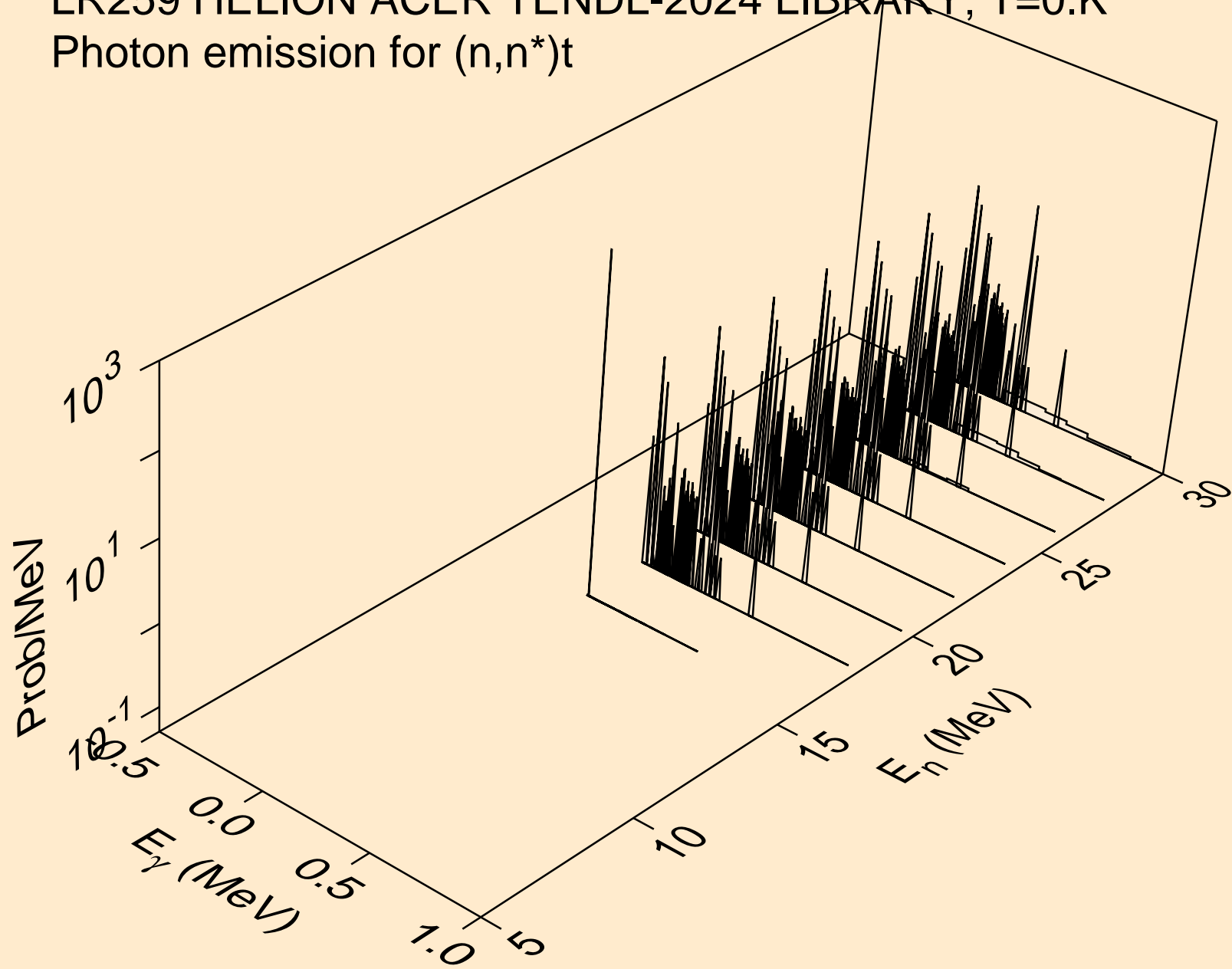

LR259 HELION ACER TENDL-2024 LIBRARY; T=0.K  
Photon emission for (n,2np)

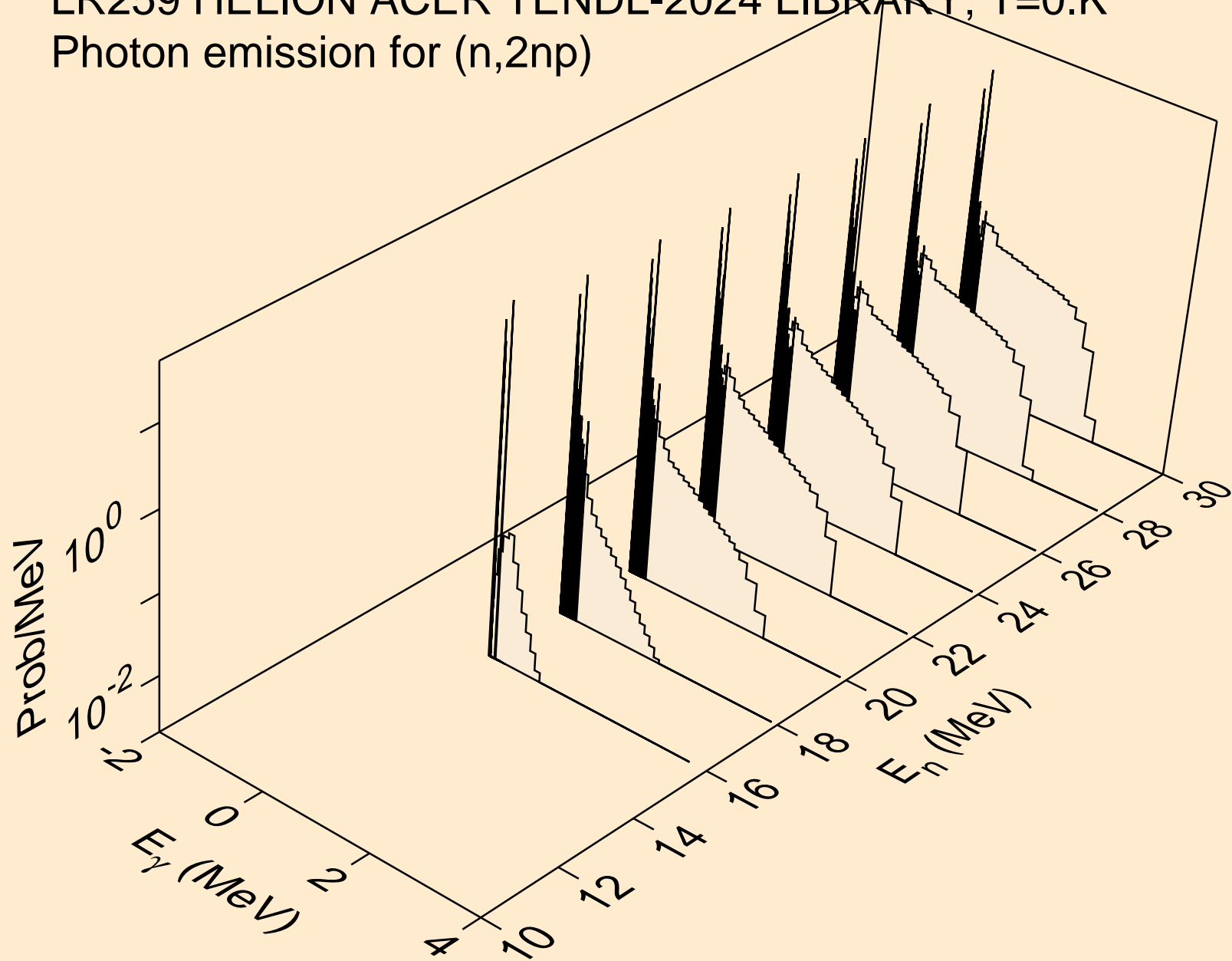

LR259 HELION ACER TENDL-2024 LIBRARY; T=0.K  
Photon emission for (n,p)

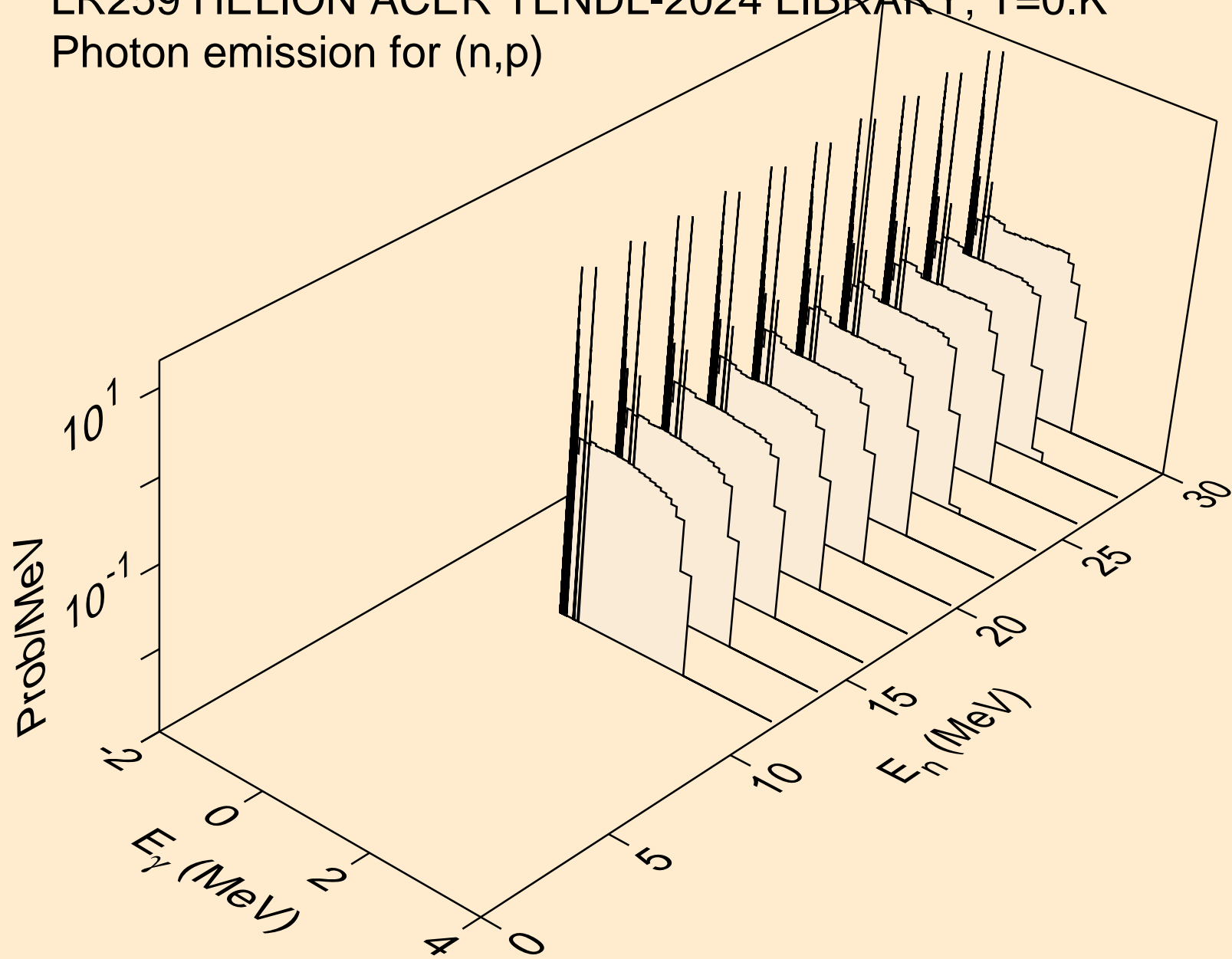

LR259 HELION ACER TENDL-2024 LIBRARY; T=0.K  
Photon emission for (n,d)

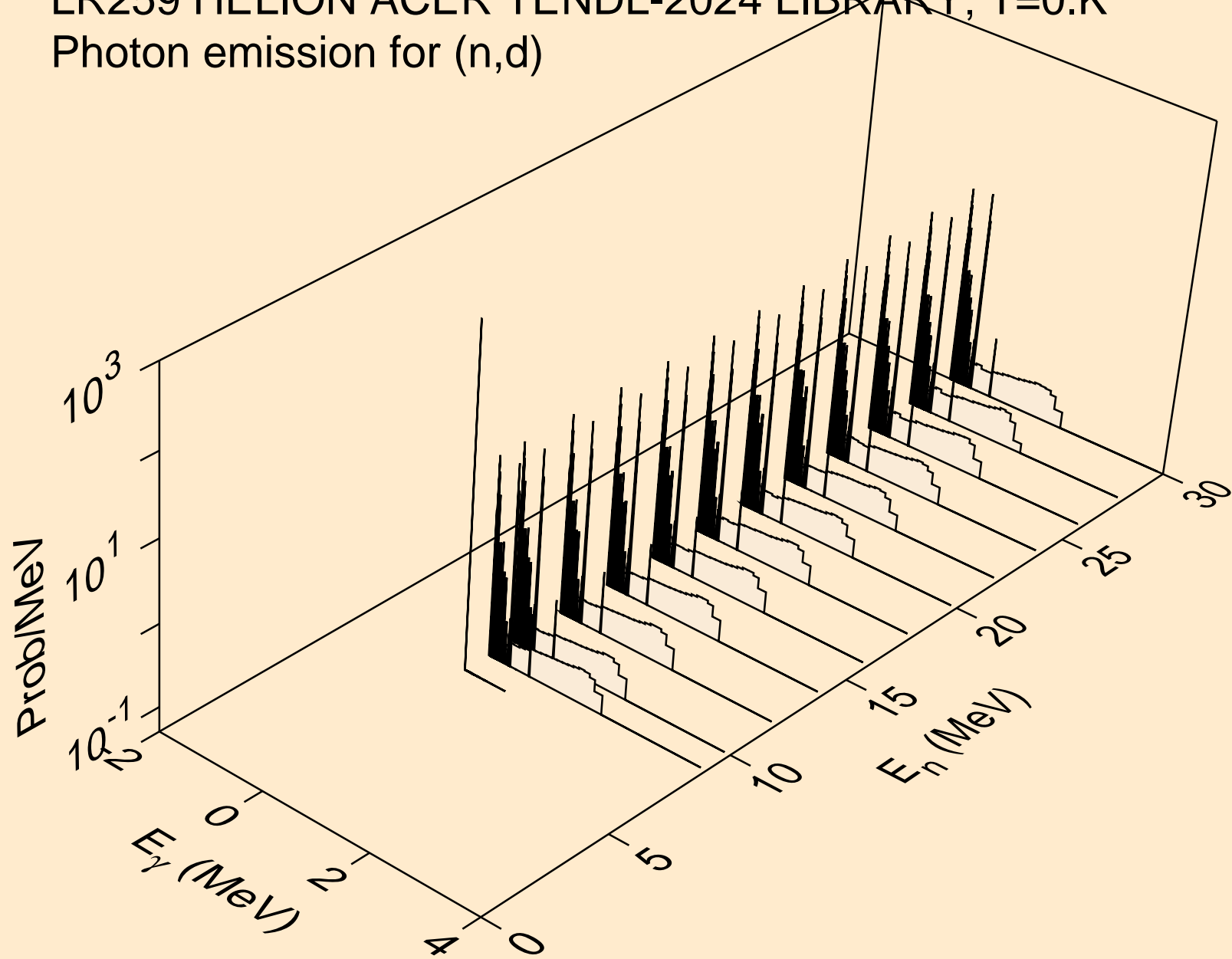

LR259 HELION ACER TENDL-2024 LIBRARY; T=0.K  
Photon emission for (n,t)

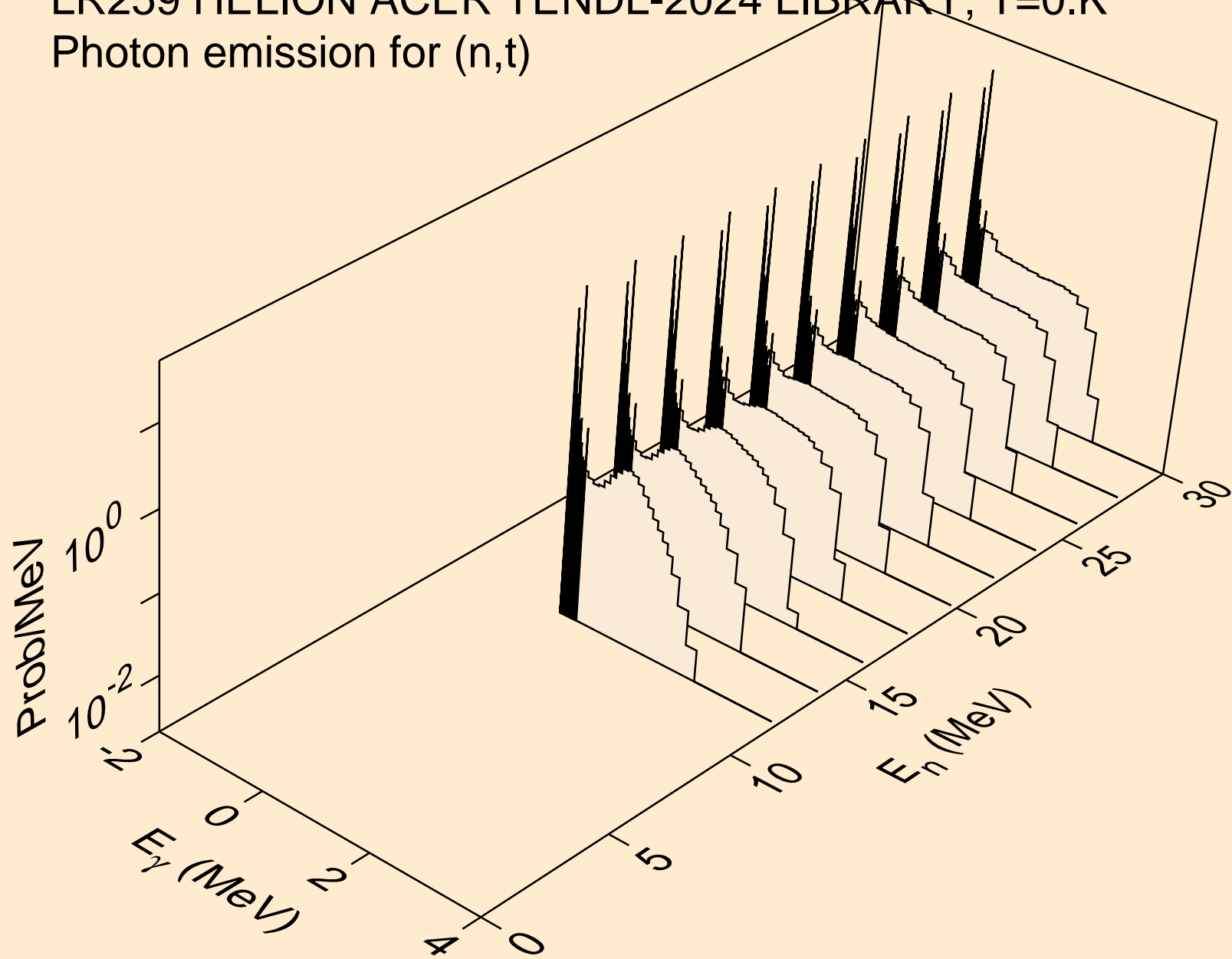

LR259 HELION ACER TENDL-2024 LIBRARY; T=0.K  
Photon emission for inelastic

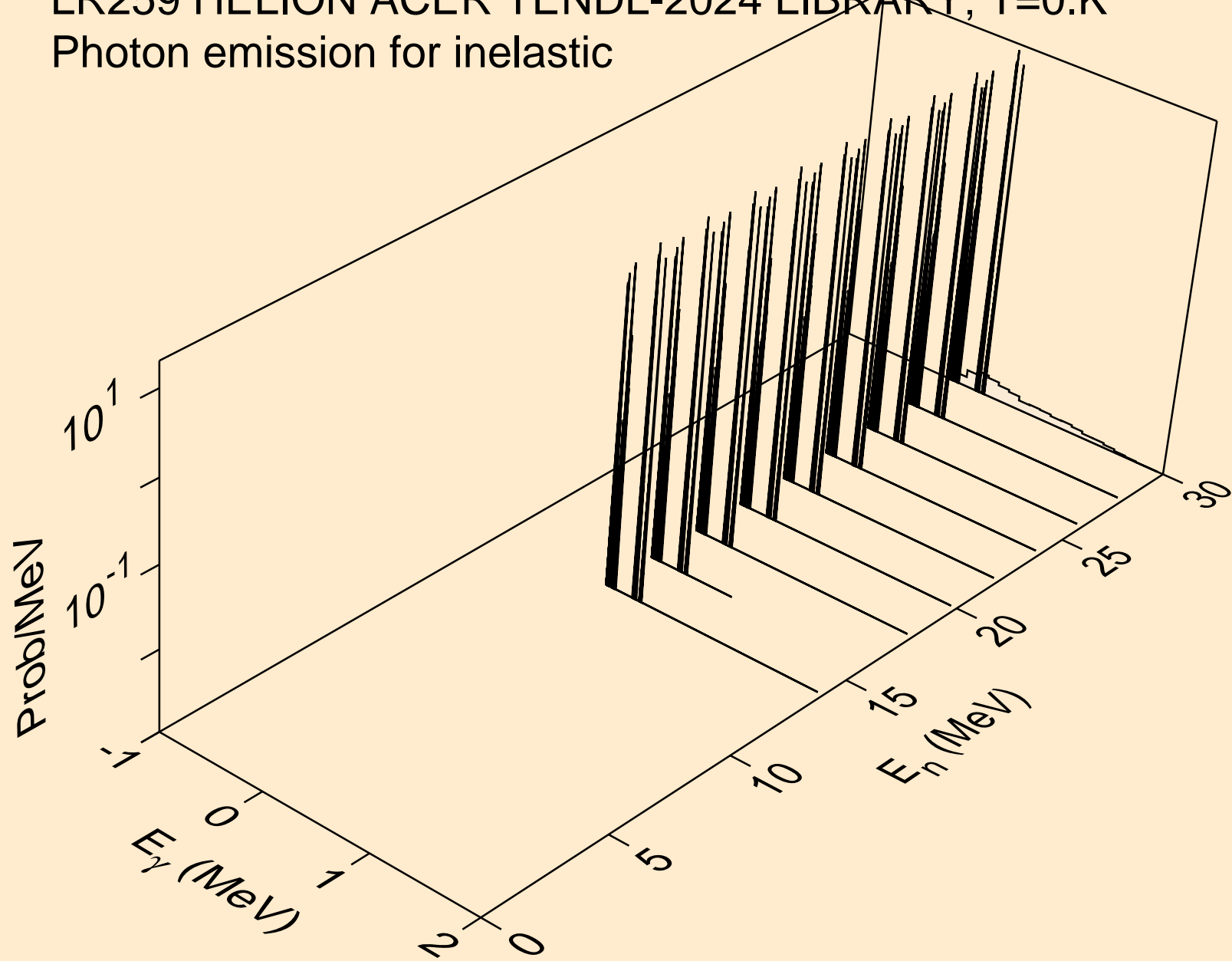

LR259 HELION ACER TENDL-2024 LIBRARY; T=0.K  
Photon emission for (n,a)

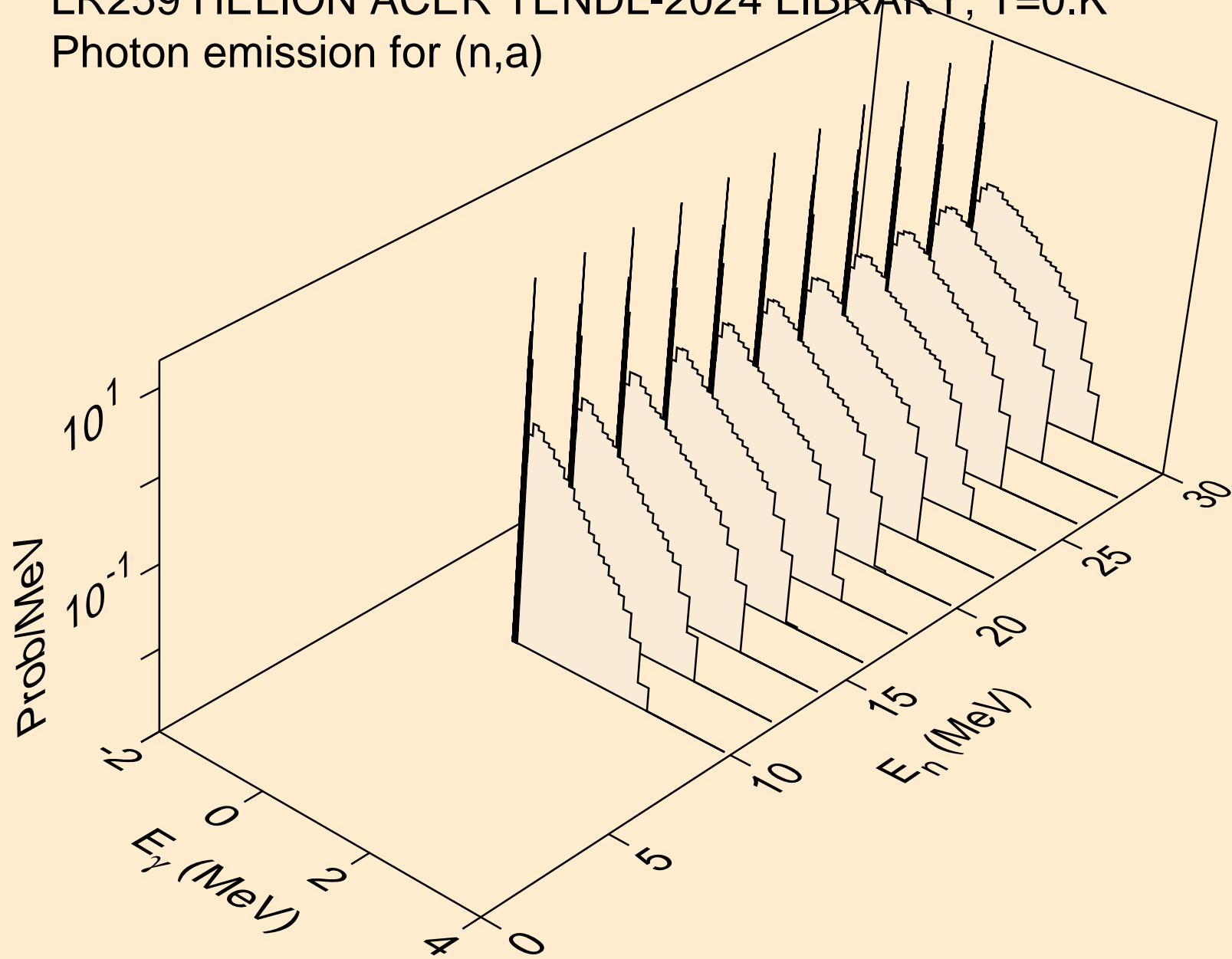

LR259 HELION ACER TENDL-2024 LIBRARY; T=0.K  
Photon emission for (n,2a)

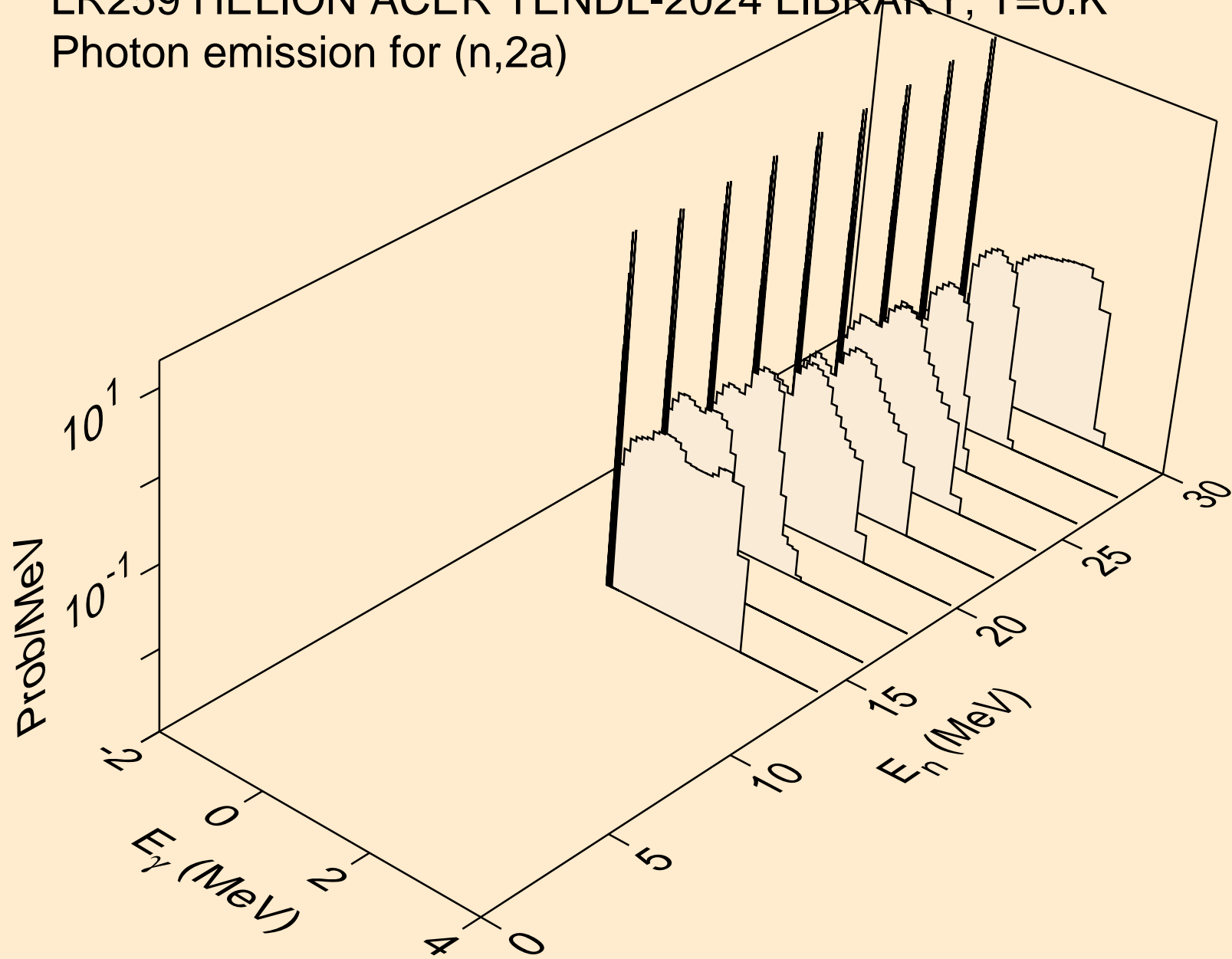

LR259 HELION ACER TENDL-2024 LIBRARY; T=0.K  
Photon emission for (n,2p)

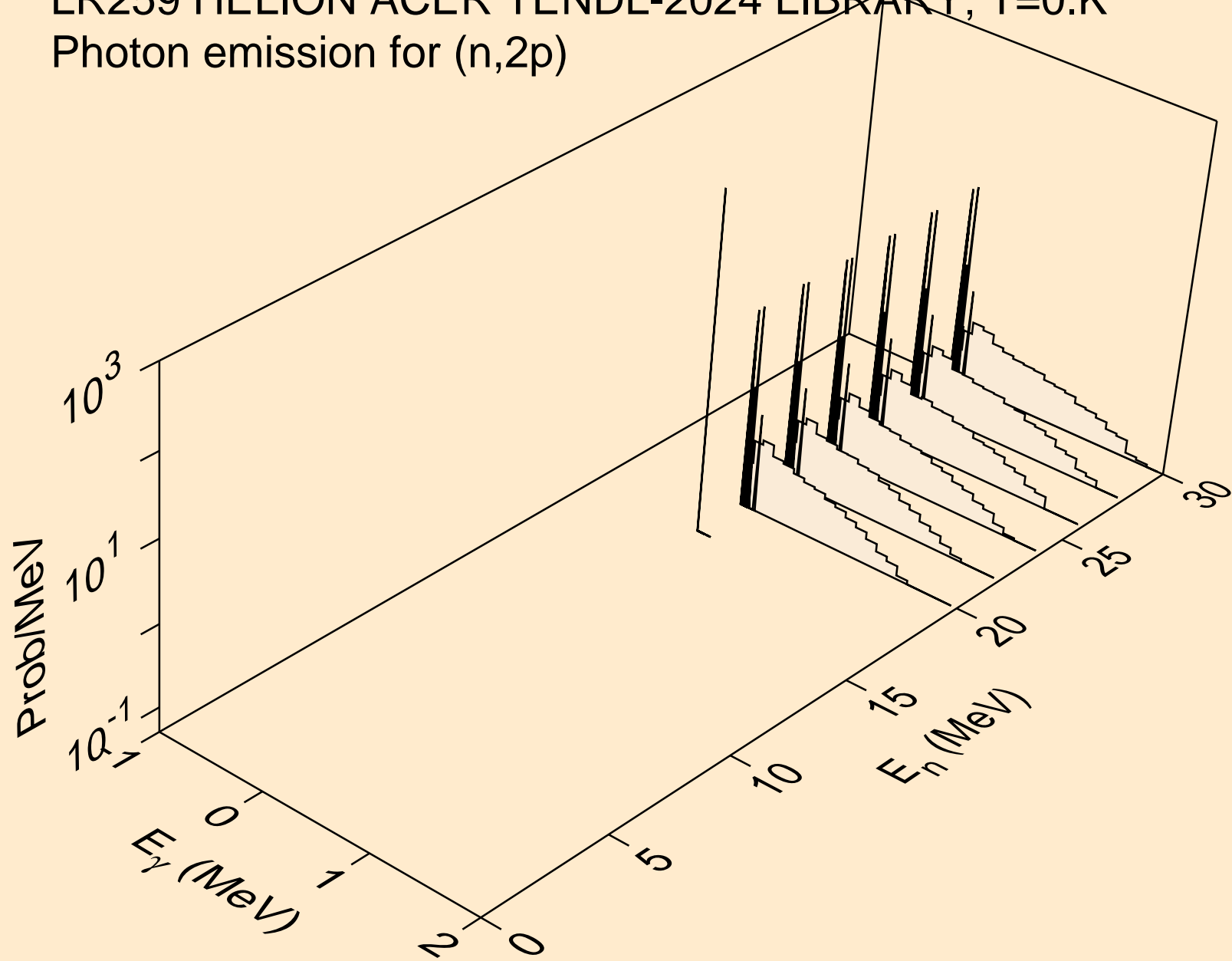

LR259 HELION ACER TENDL-2024 LIBRARY; T=0.K  
Particle heating contributions

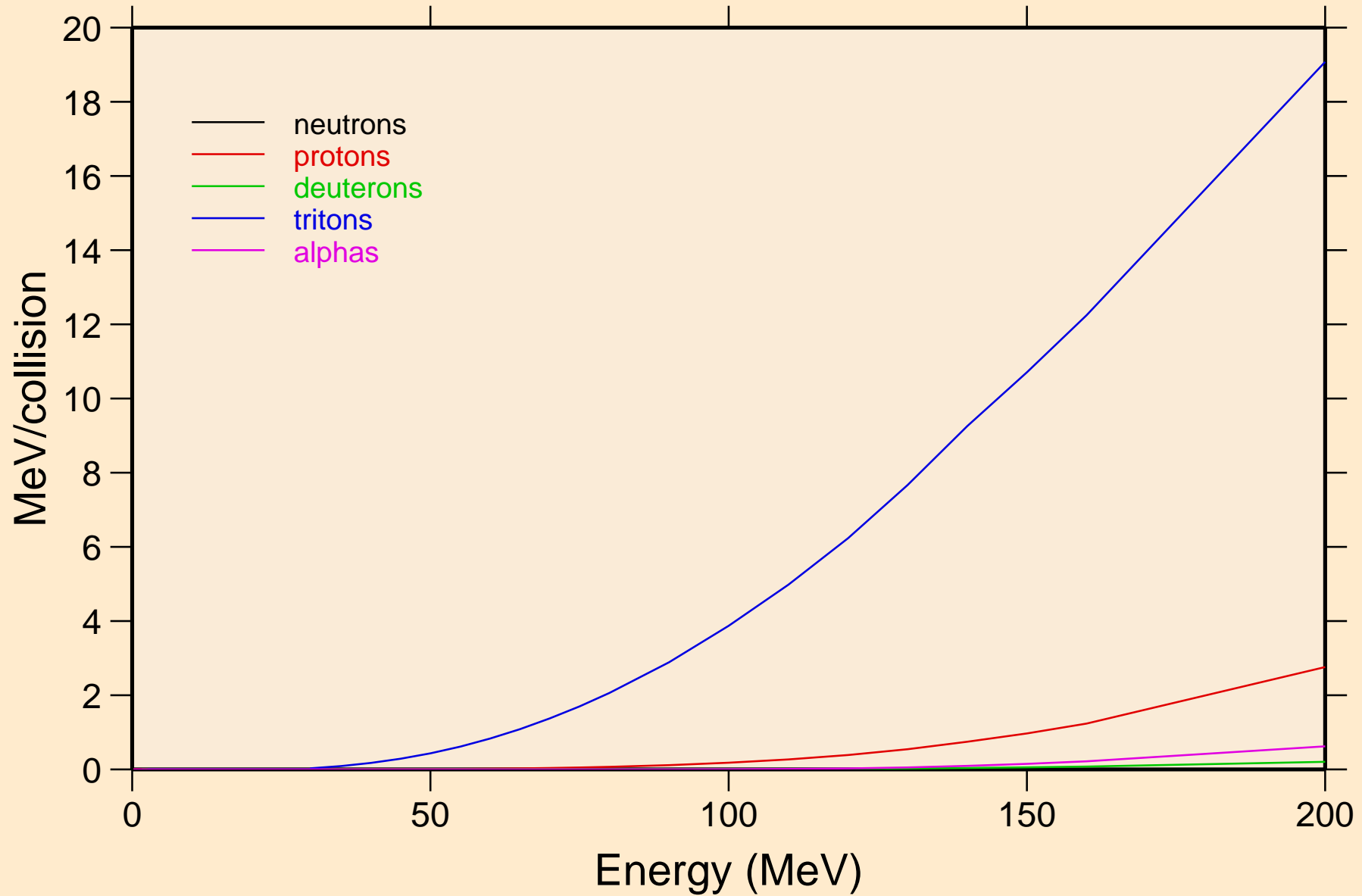

LR259 HELION ACER TENDL-2024 LIBRARY; T=0.K

Recoil Heating

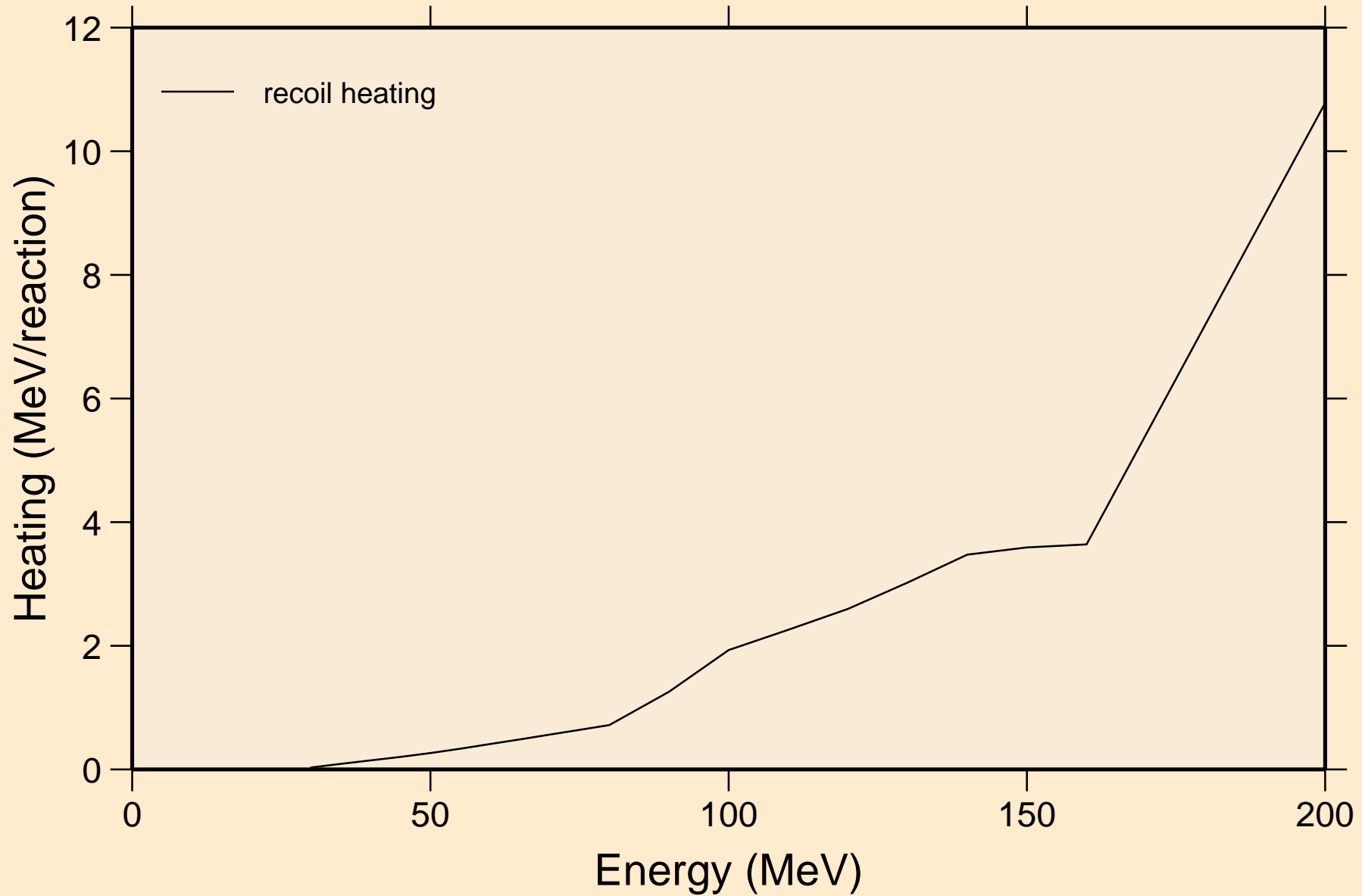

LR259 HELION ACER TENDL-2024 LIBRARY; T=0.K  
Particle production cross sections

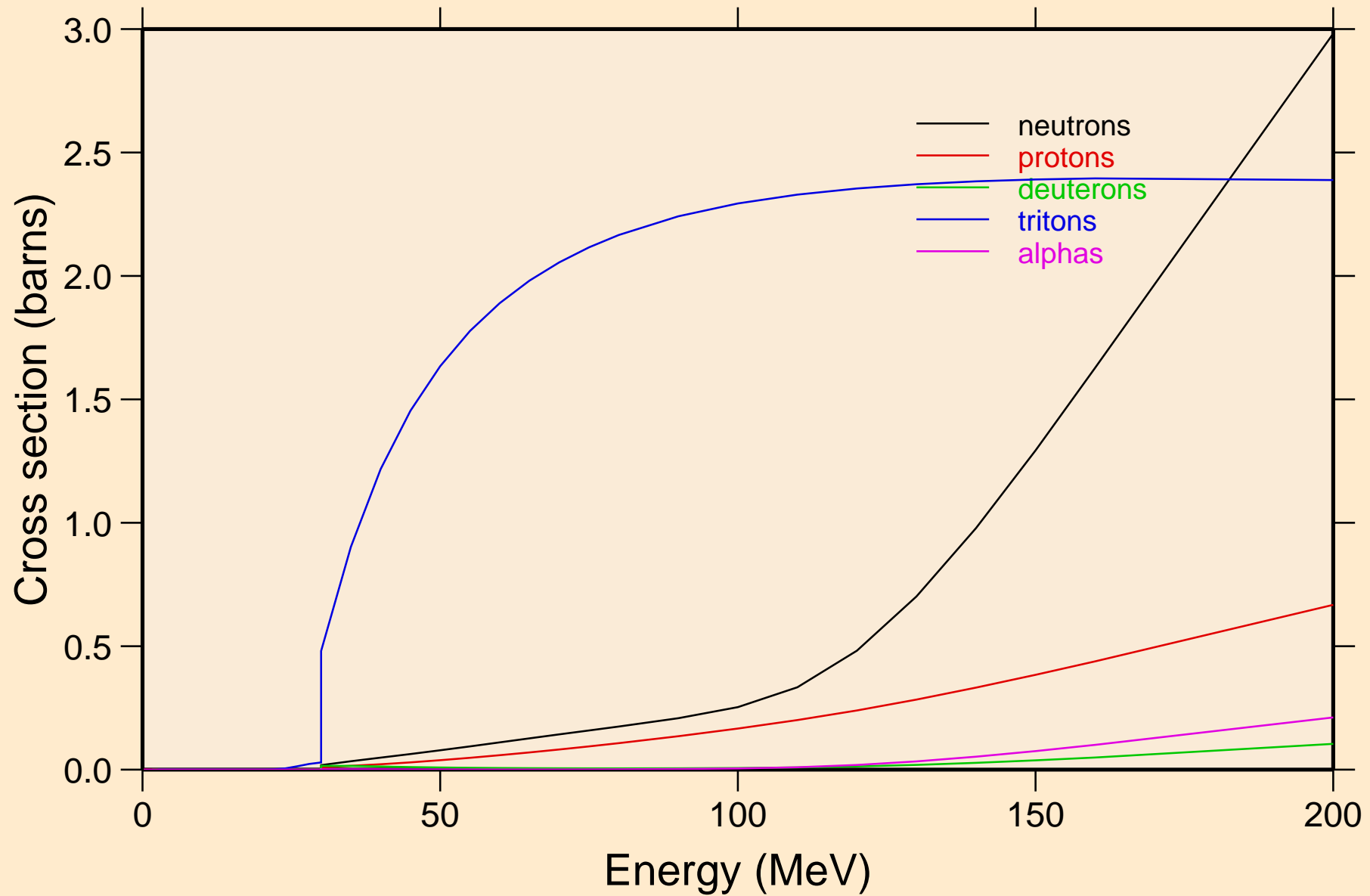

LR259 HELION ACER TENDL-2024 LIBRARY; T=0.K  
neutrons from (s,n)

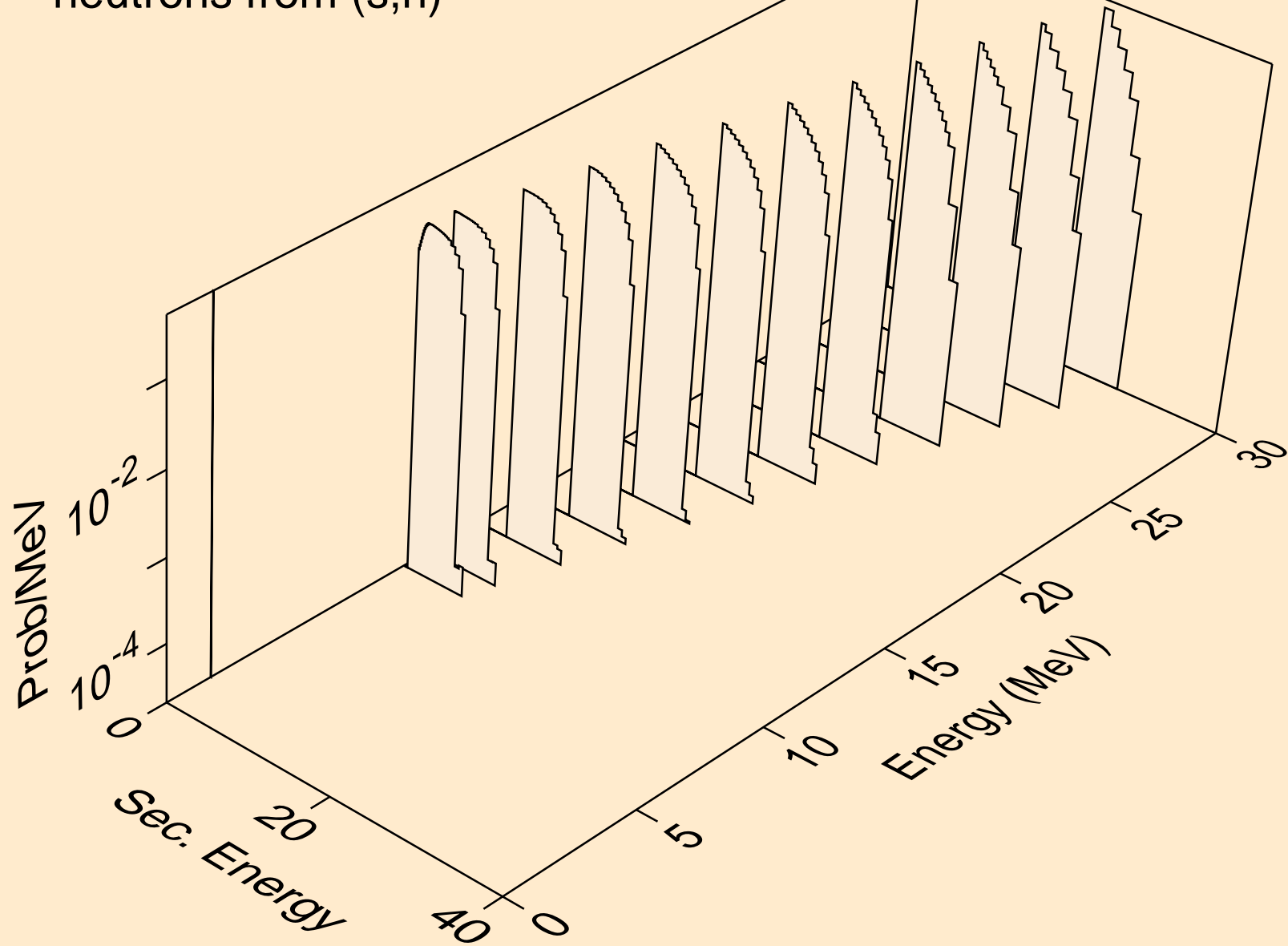

LR259 HELION ACER TENDL-2024 LIBRARY; T=0.K  
neutrons from (s,x)

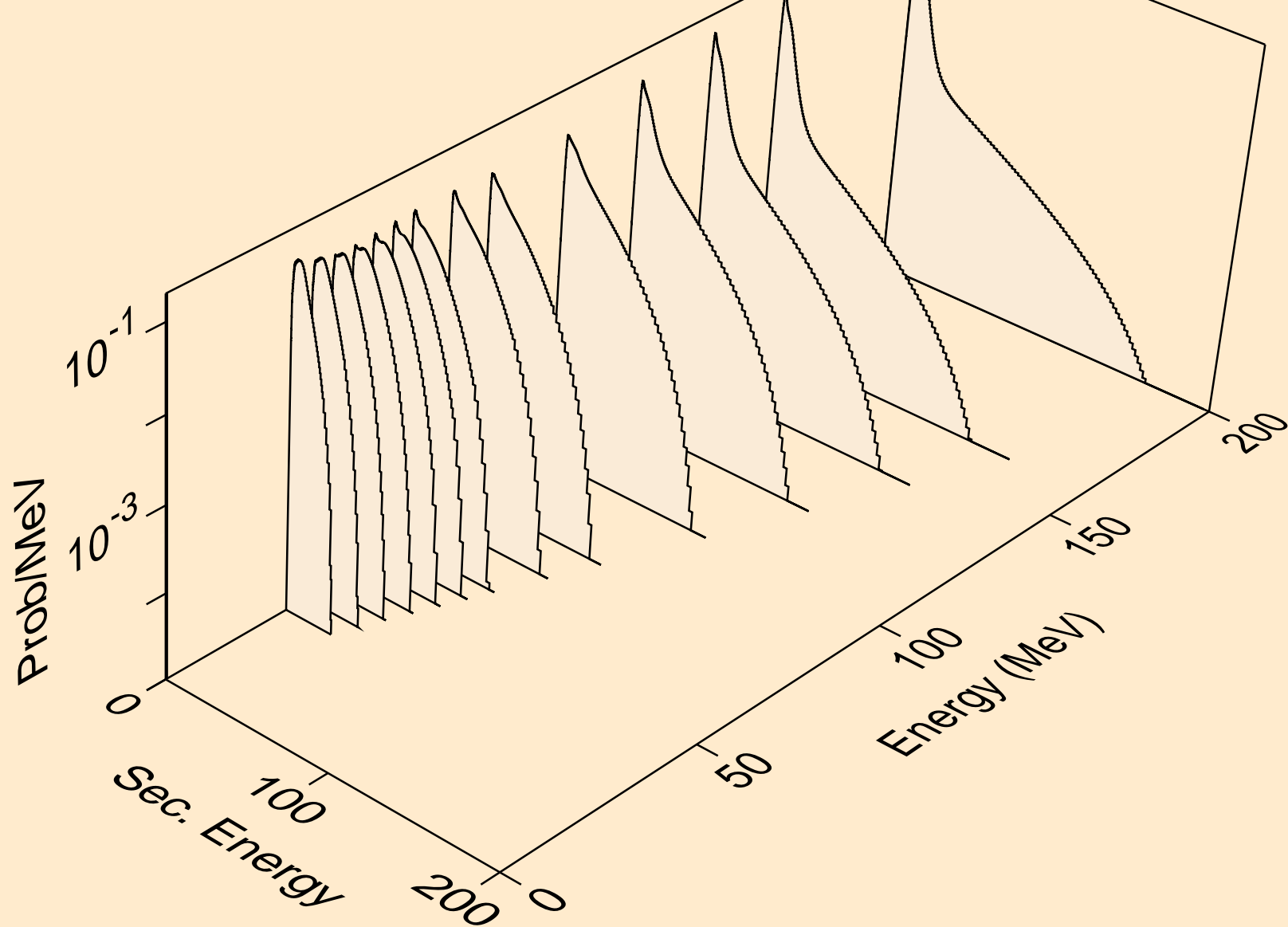

LR259 HELION ACER TENDL-2024 LIBRARY; T=0.K  
neutrons from (s,2n)

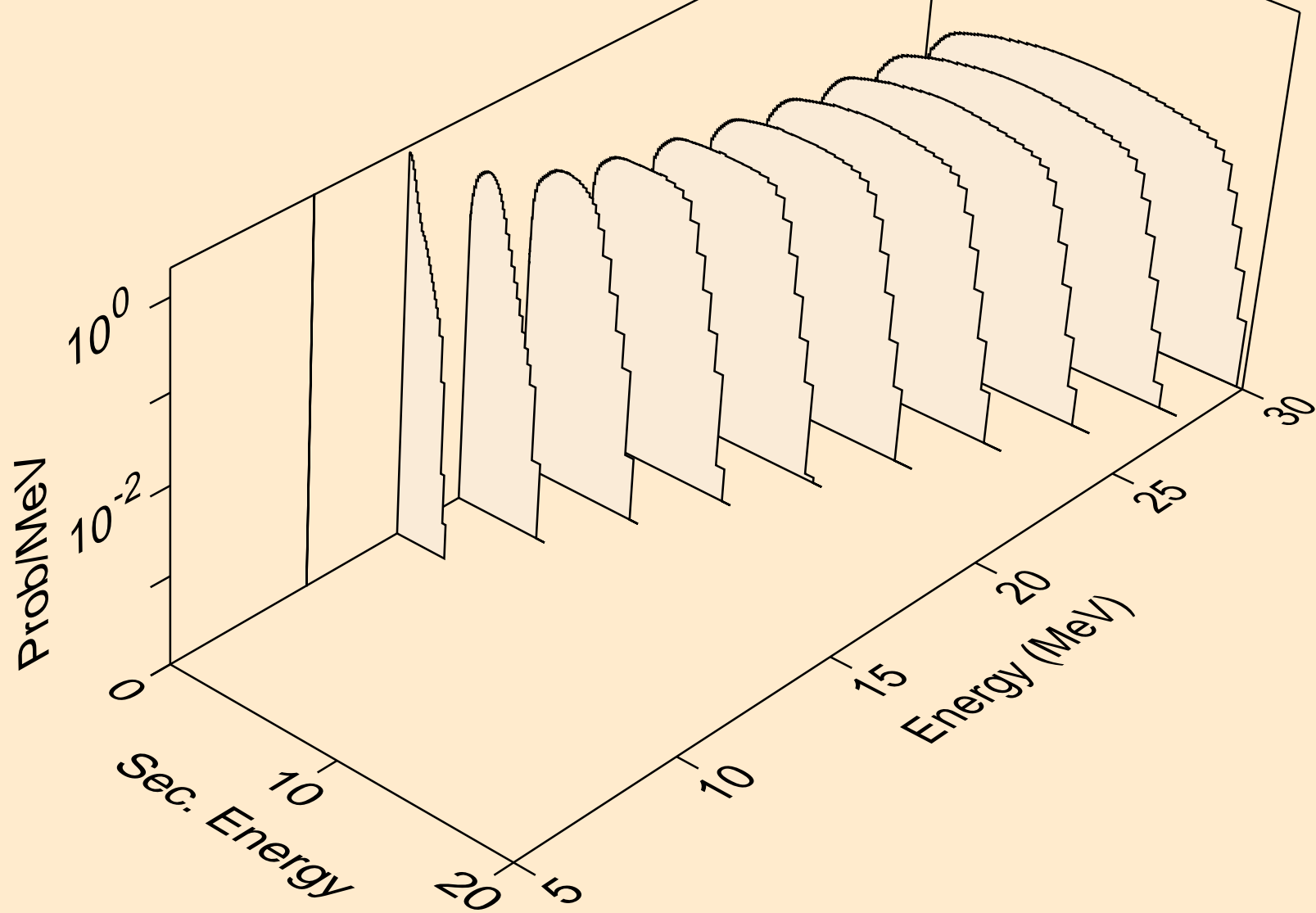

LR259 HELION ACER TENDL-2024 LIBRARY; T=0.K  
neutrons from (s,3n)

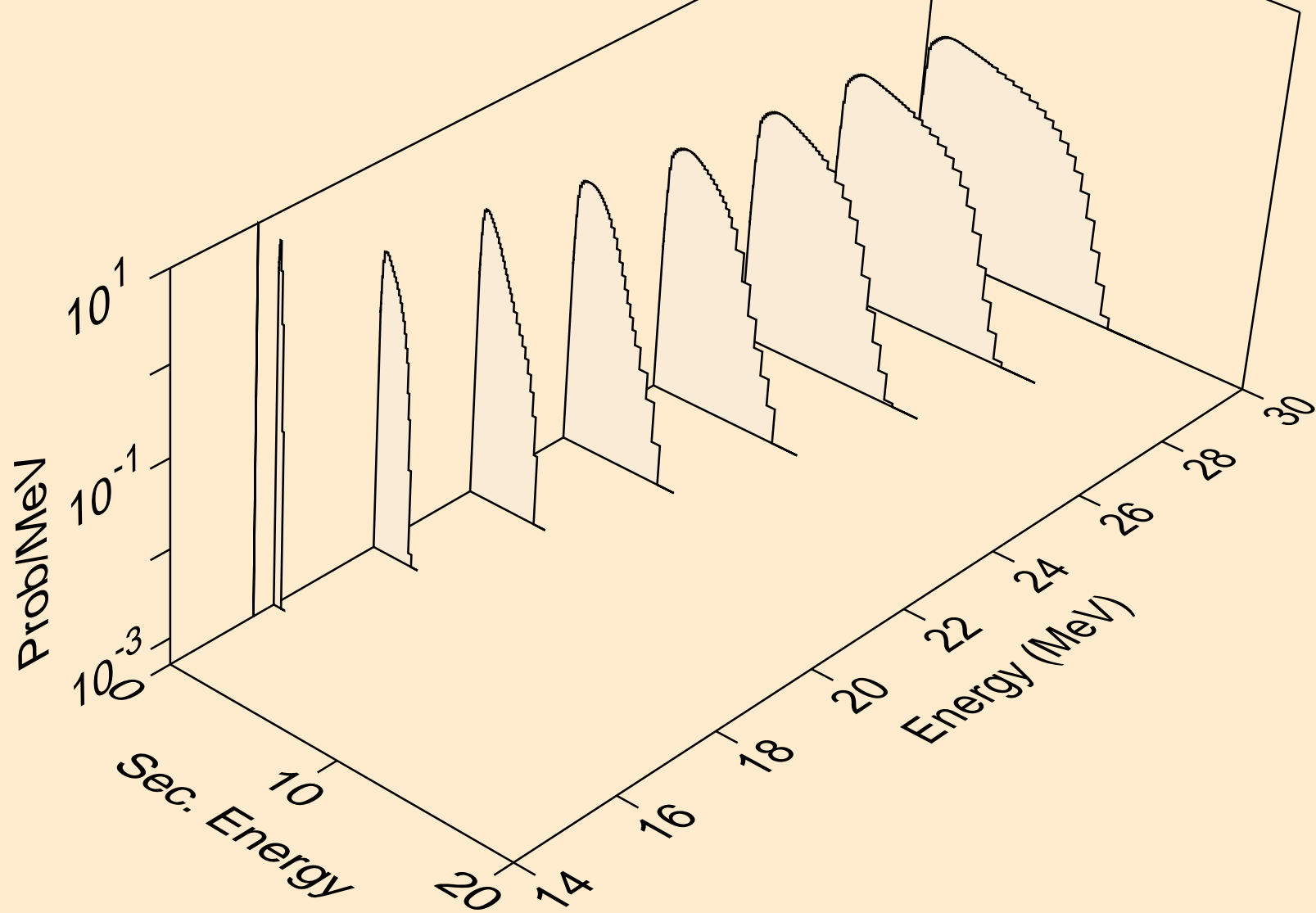

LR259 HELION ACER TENDL-2024 LIBRARY; T=0.K  
neutrons from (s,n\*)a

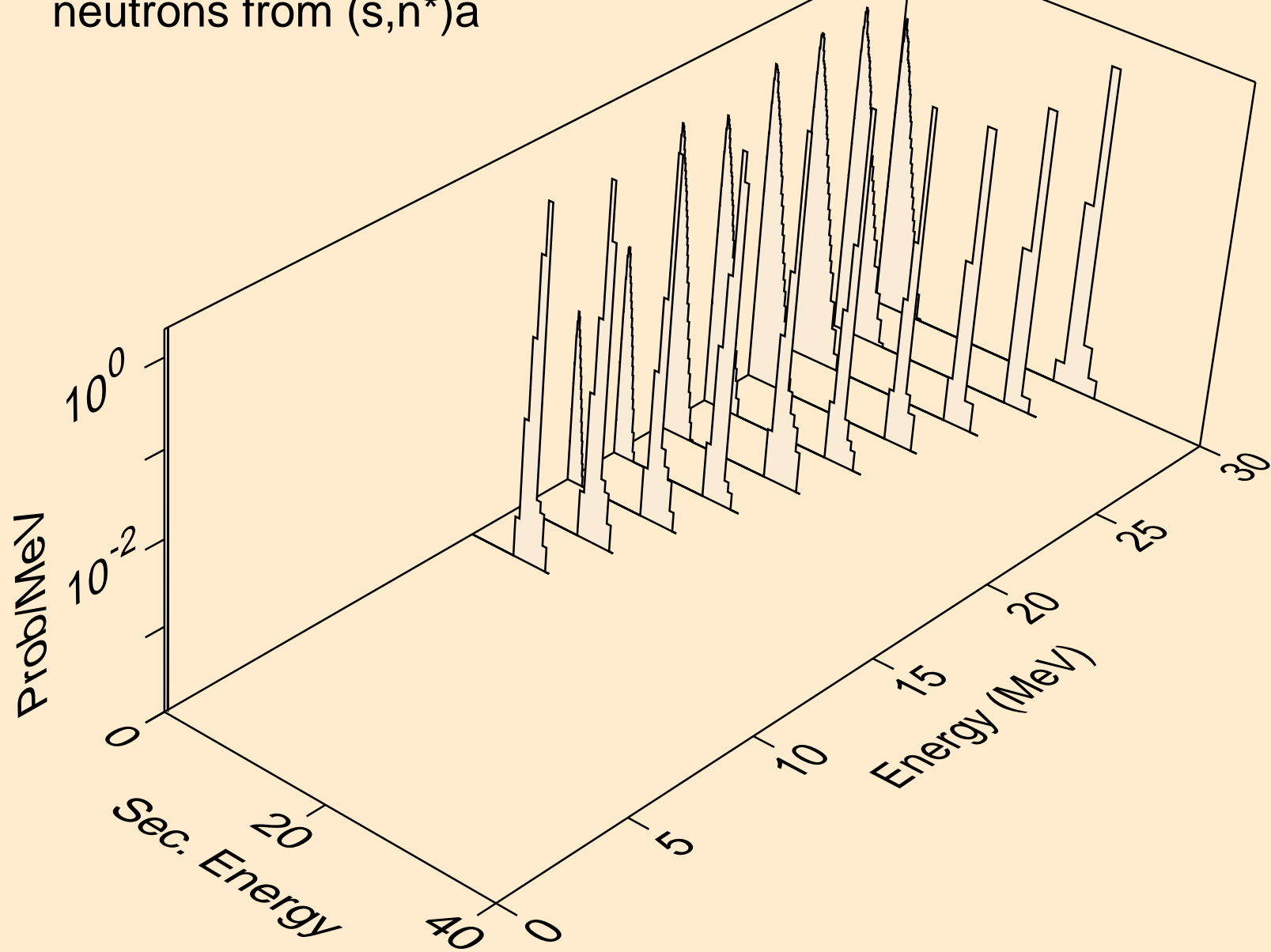

LR259 HELION ACER TENDL-2024 LIBRARY; T=0.K  
neutrons from (s,n\*)p

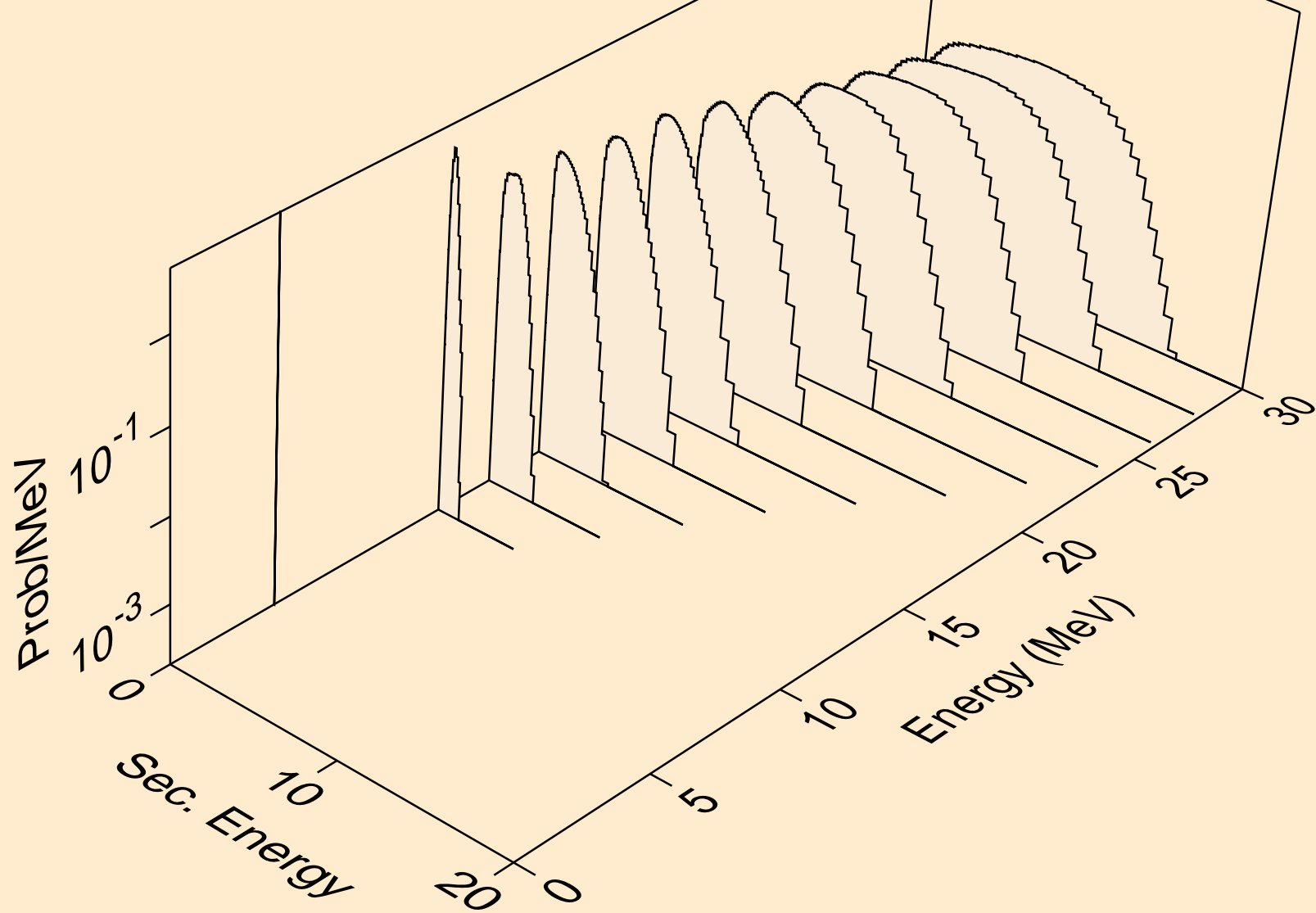

LR259 HELION ACER TENDL-2024 LIBRARY; T=0.K  
neutrons from (s,n\*)d

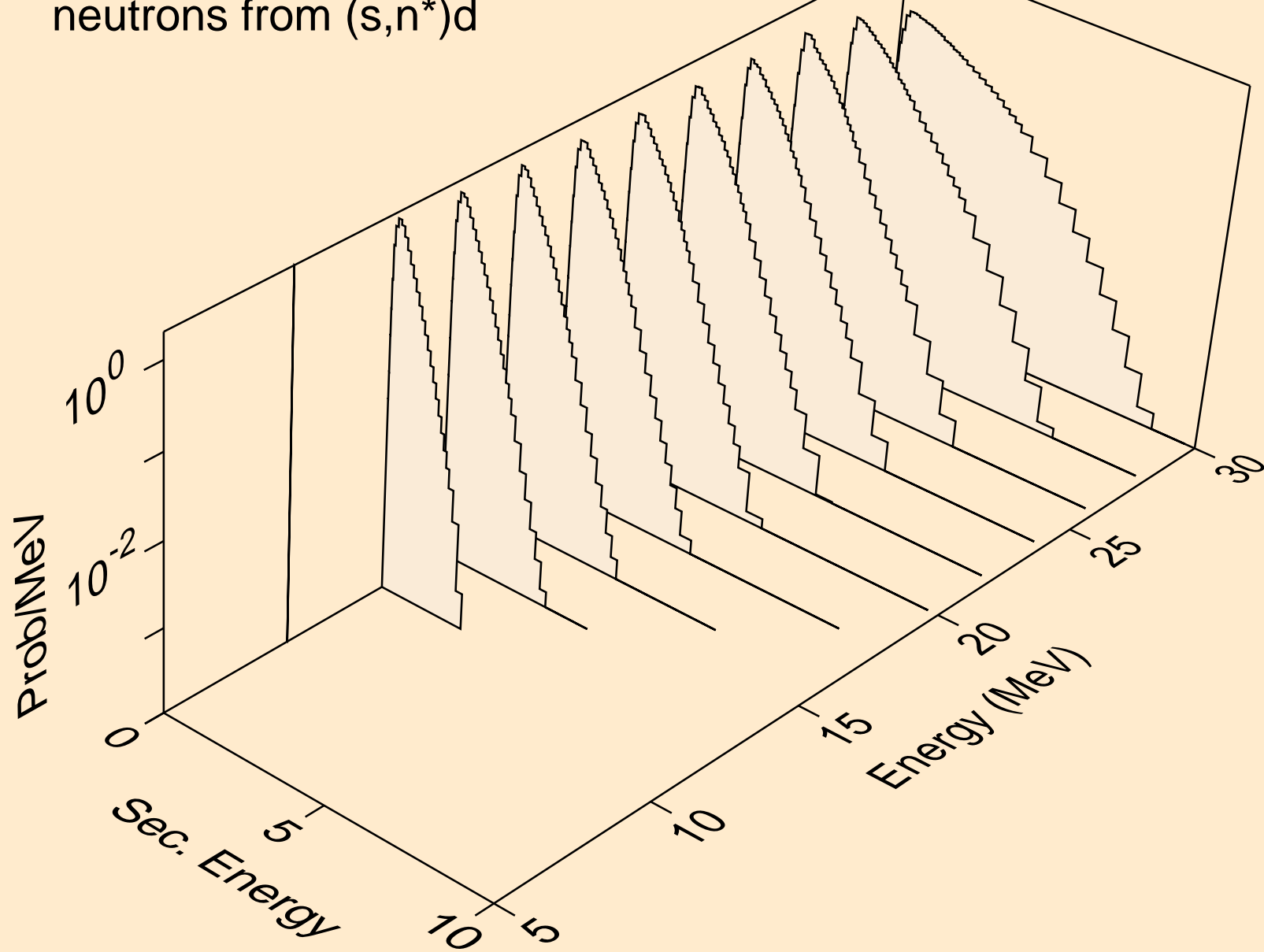

LR259 HELION ACER TENDL-2024 LIBRARY; T=0.K  
neutrons from (s,n\*)t

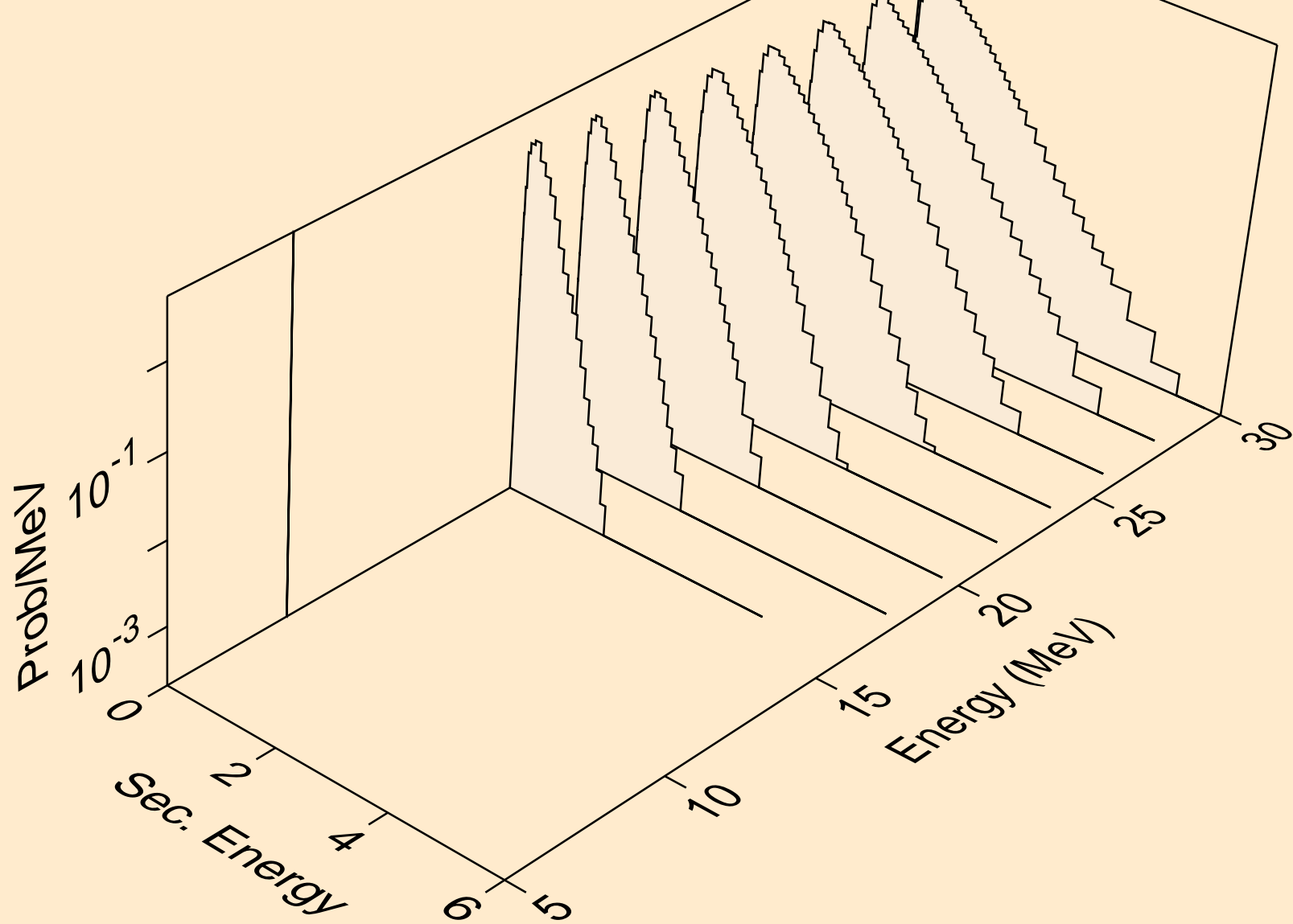

LR259 HELION ACER TENDL-2024 LIBRARY; T=0.K  
neutrons from (s,2np)

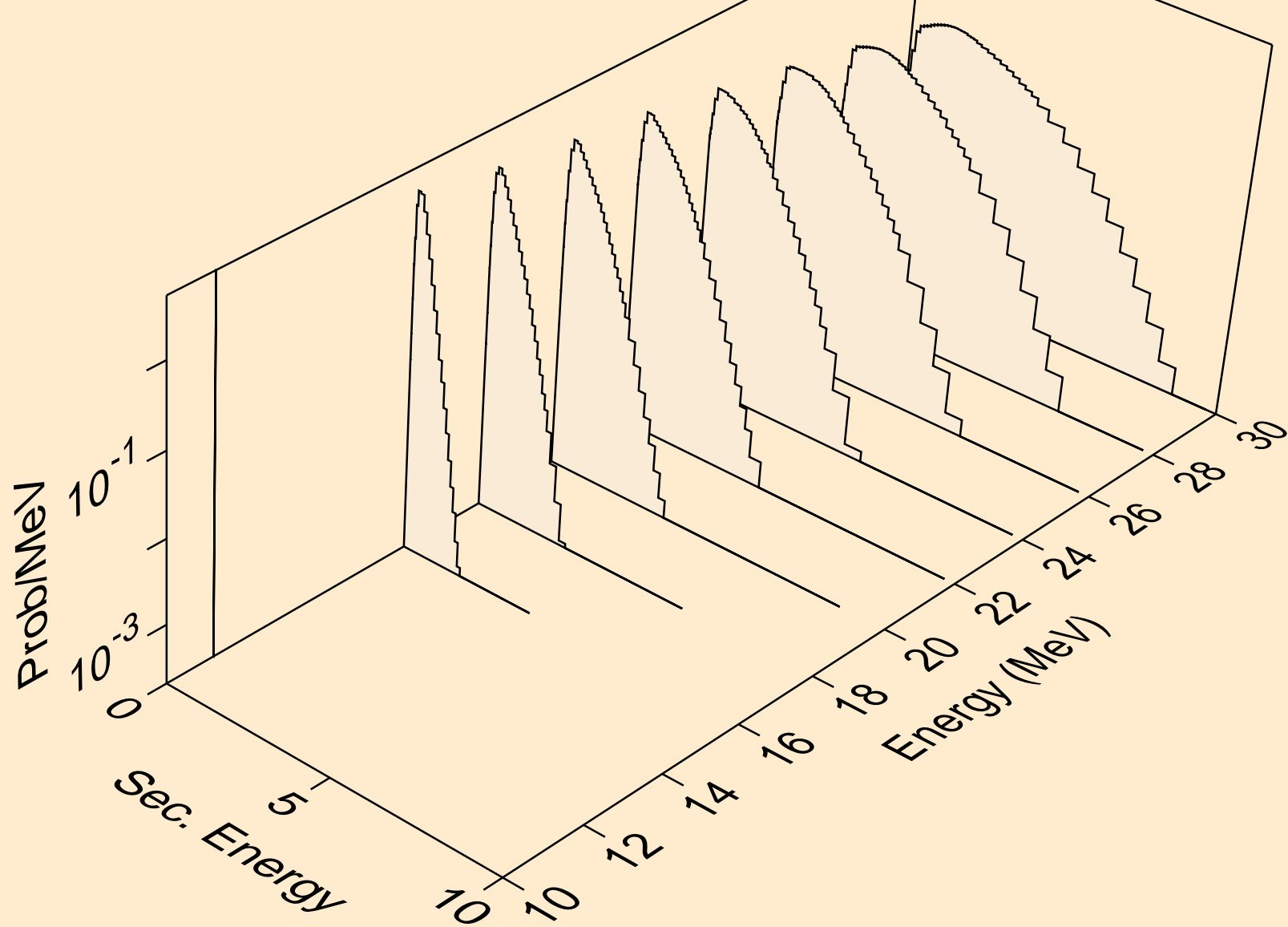

LR259 HELION ACER TENDL-2024 LIBRARY; T=0.K  
protons from (s,x)

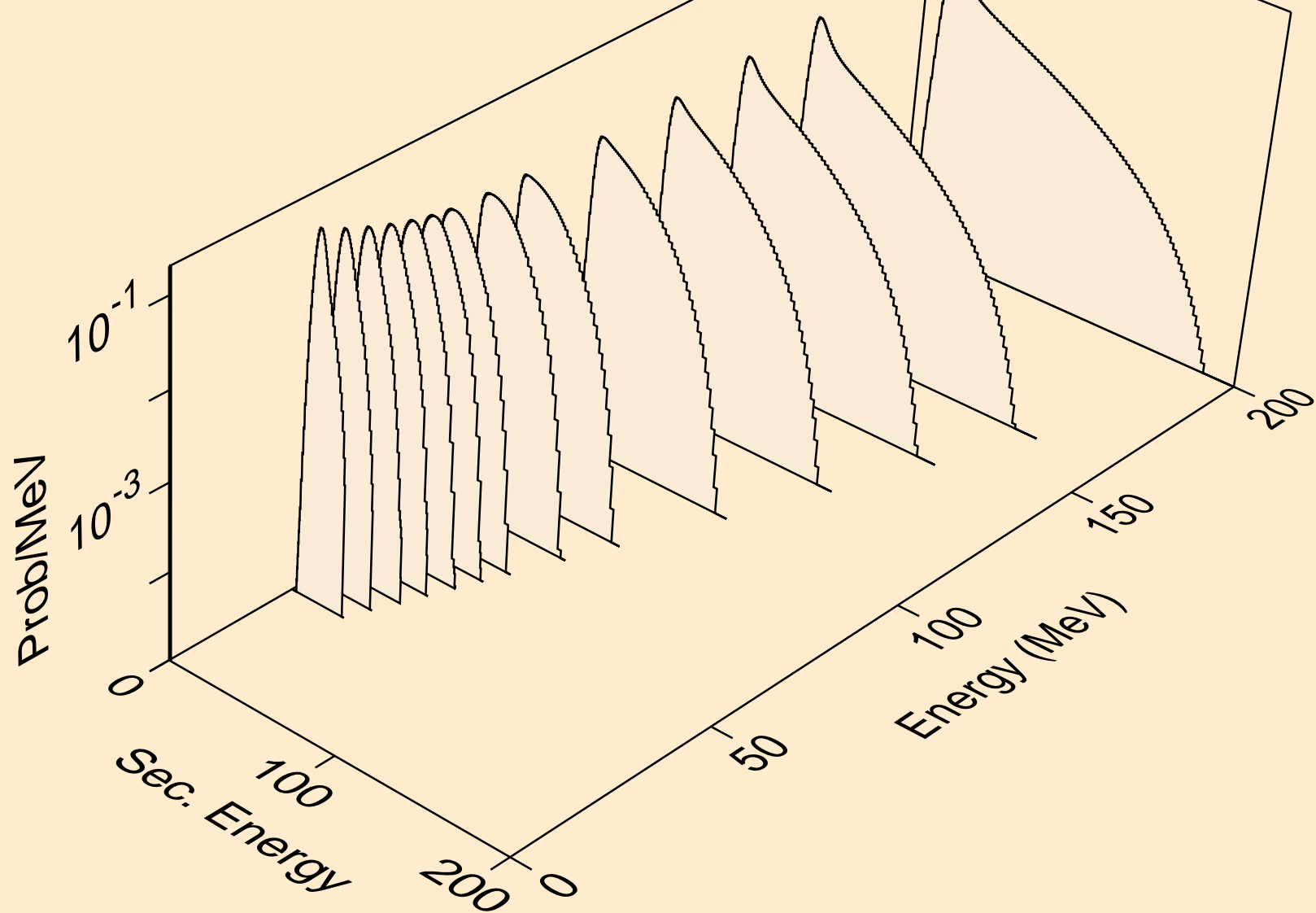

LR259 HELION ACER TENDL-2024 LIBRARY; T=0.K  
protons from (s,n\*)p

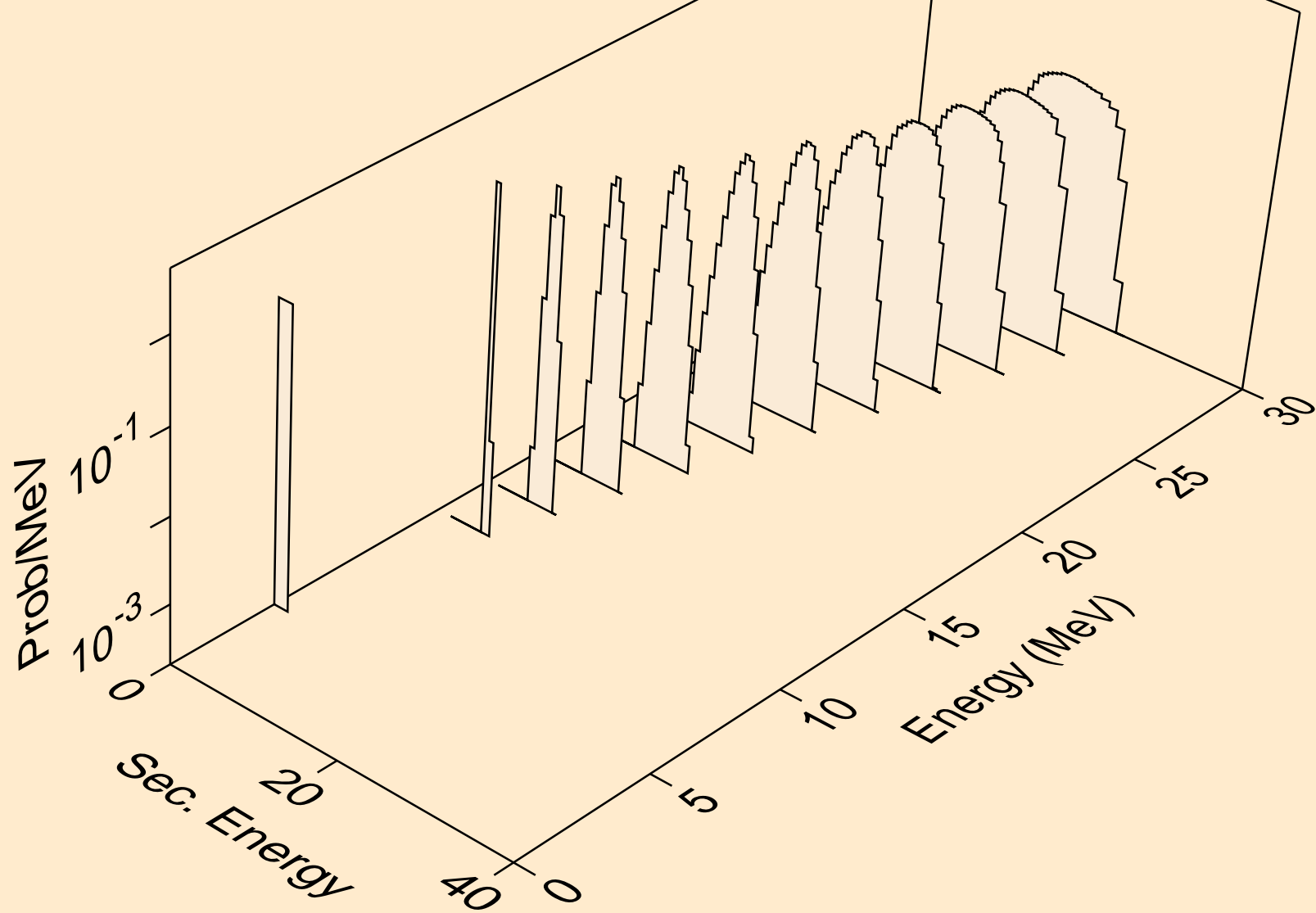

LR259 HELION ACER TENDL-2024 LIBRARY; T=0.K  
protons from (s,2np)

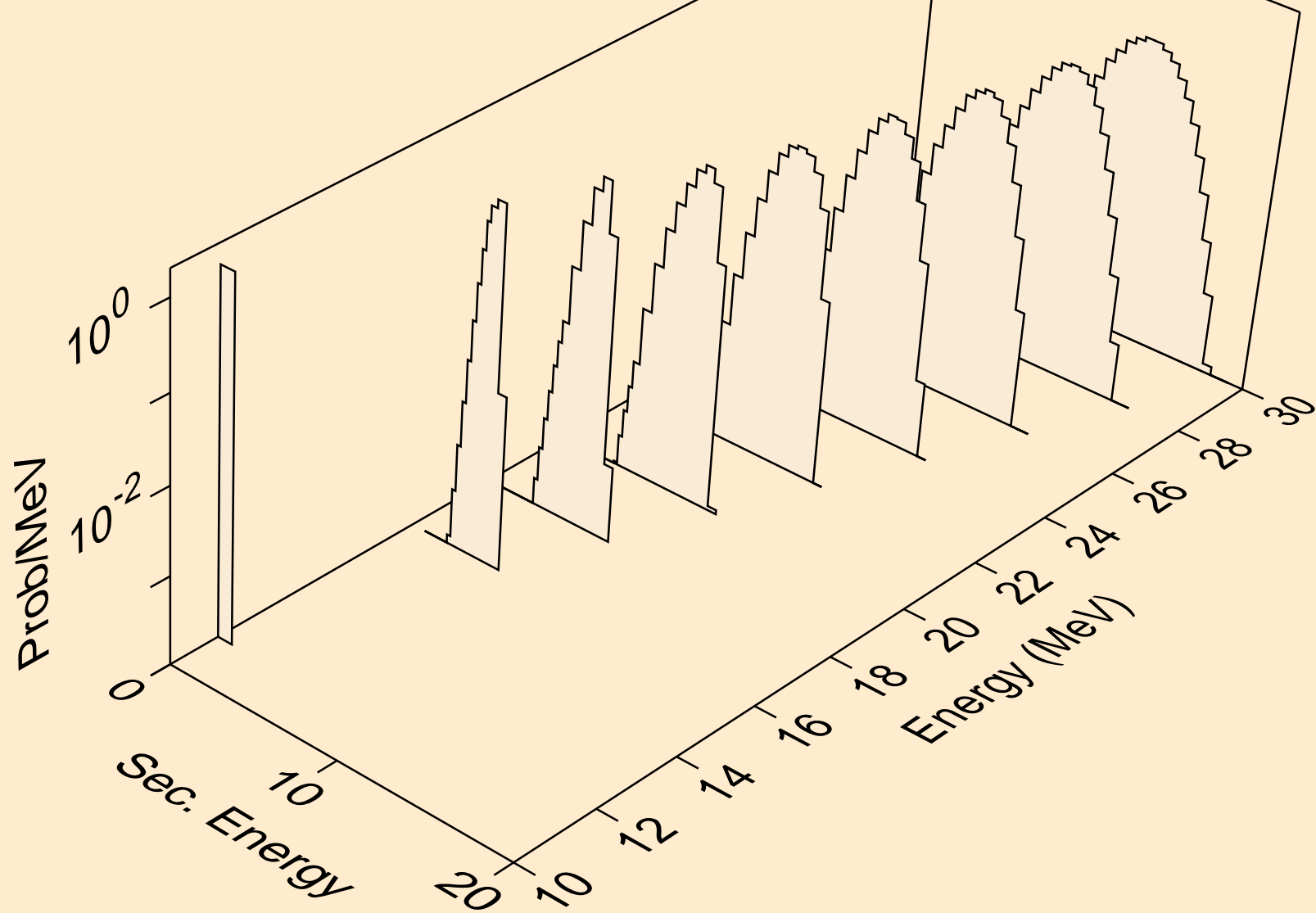

LR259 HELION ACER TENDL-2024 LIBRARY; T=0.K  
protons from (s,p)

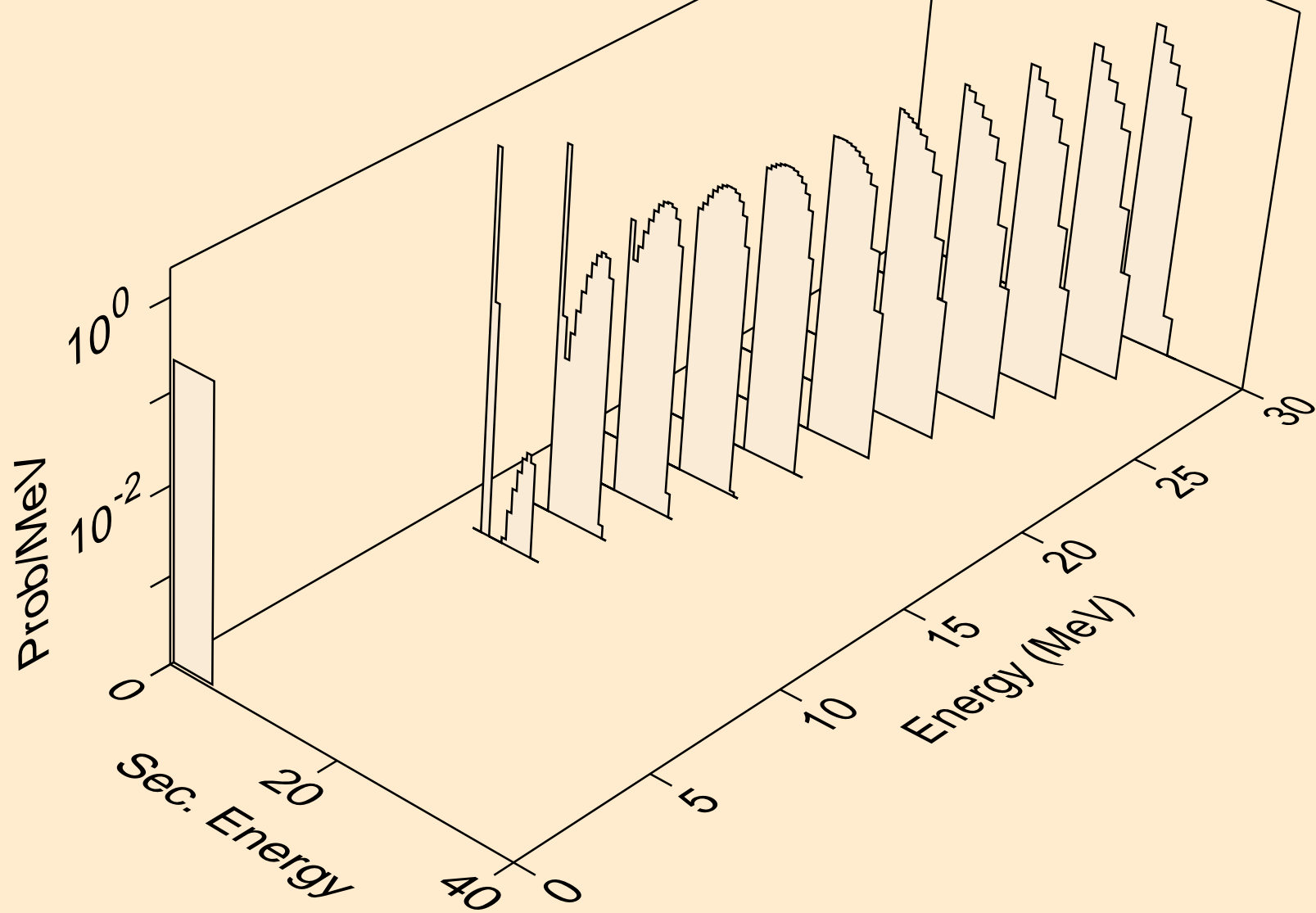

LR259 HELION ACER TENDL-2024 LIBRARY; T=0.K  
protons from (s,2p)

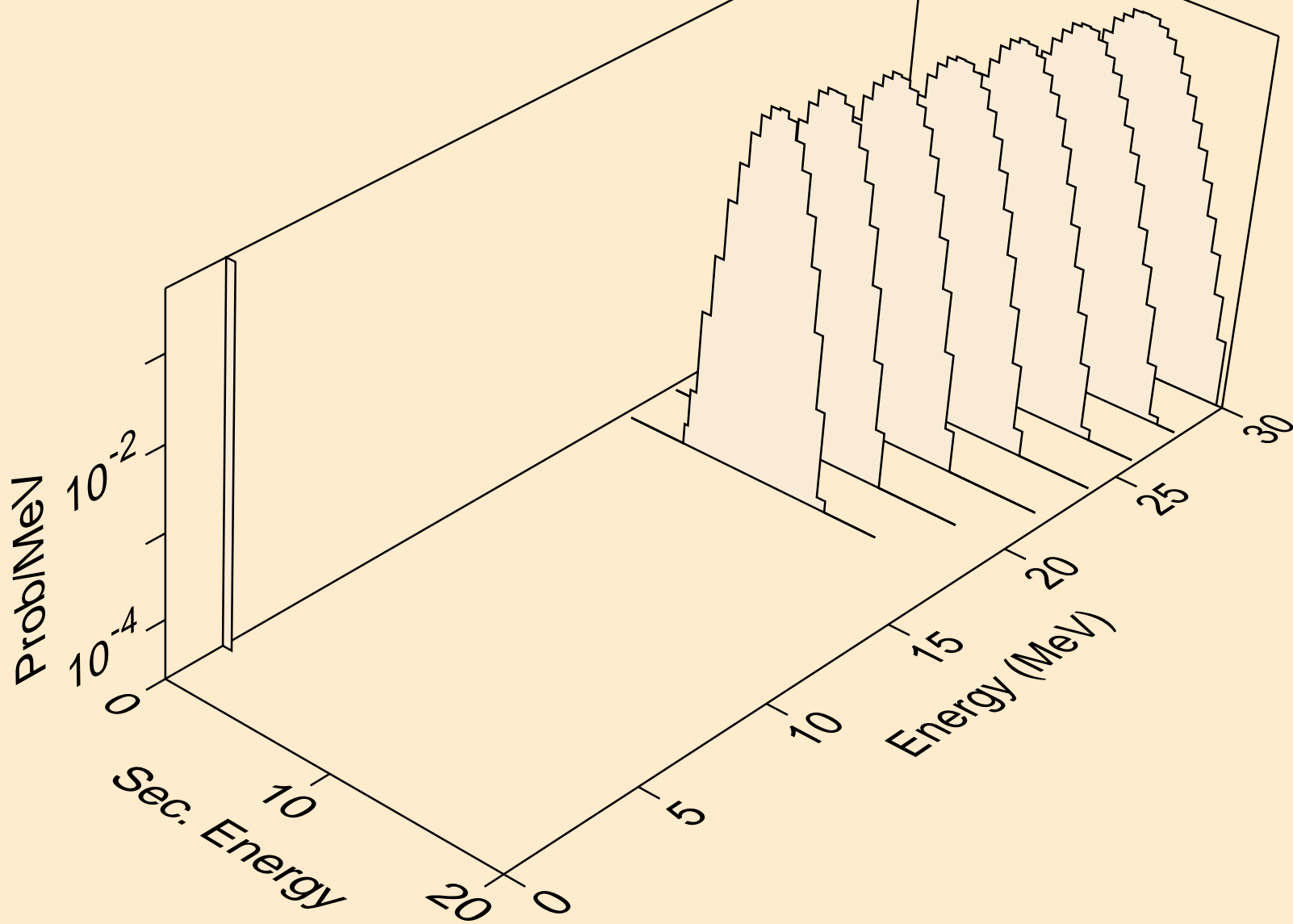

LR259 HELION ACER TENDL-2024 LIBRARY; T=0.K  
deuterons from (s,x)

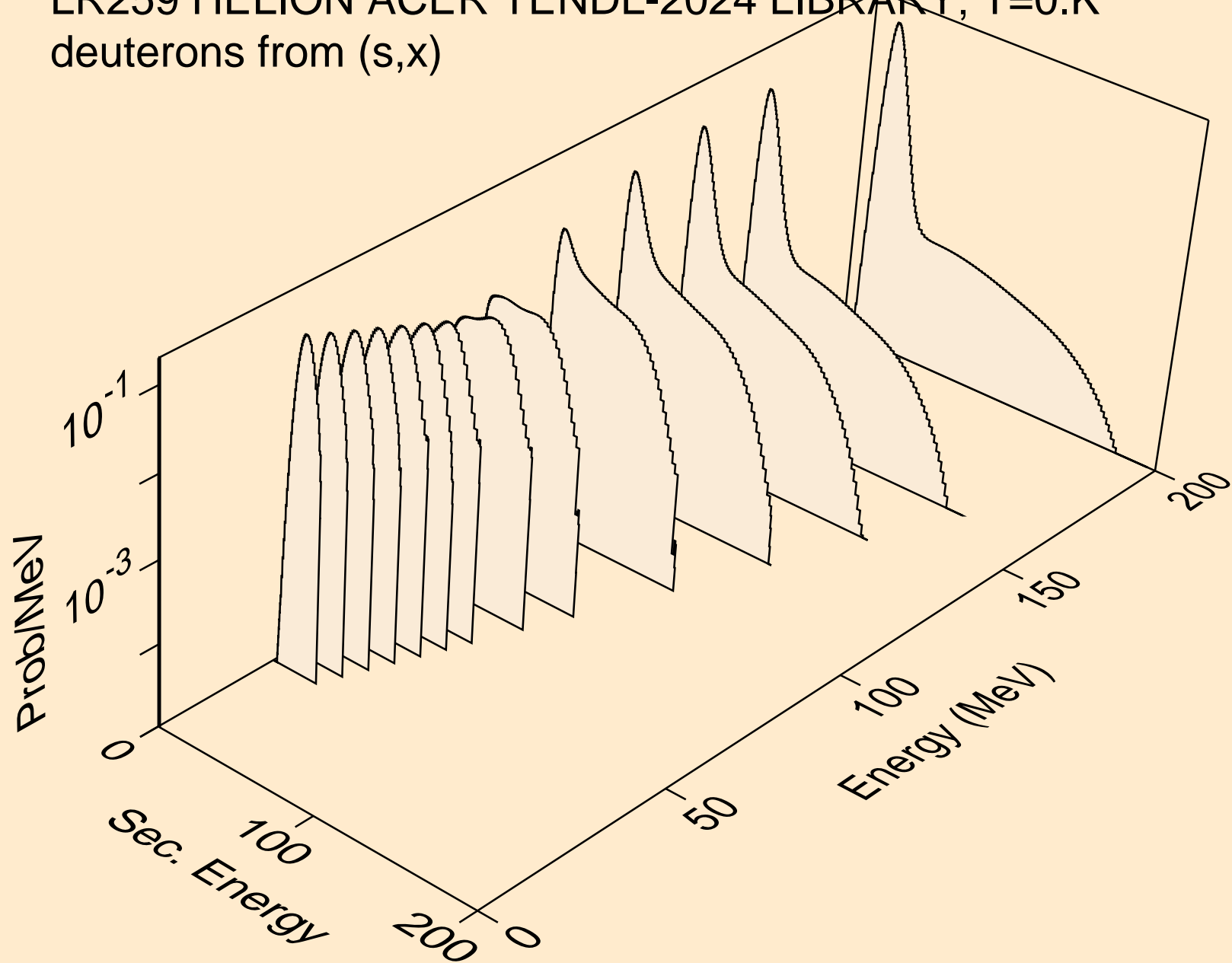

LR259 HELION ACER TENDL-2024 LIBRARY; T=0.K  
deuterons from (s,n\*)d

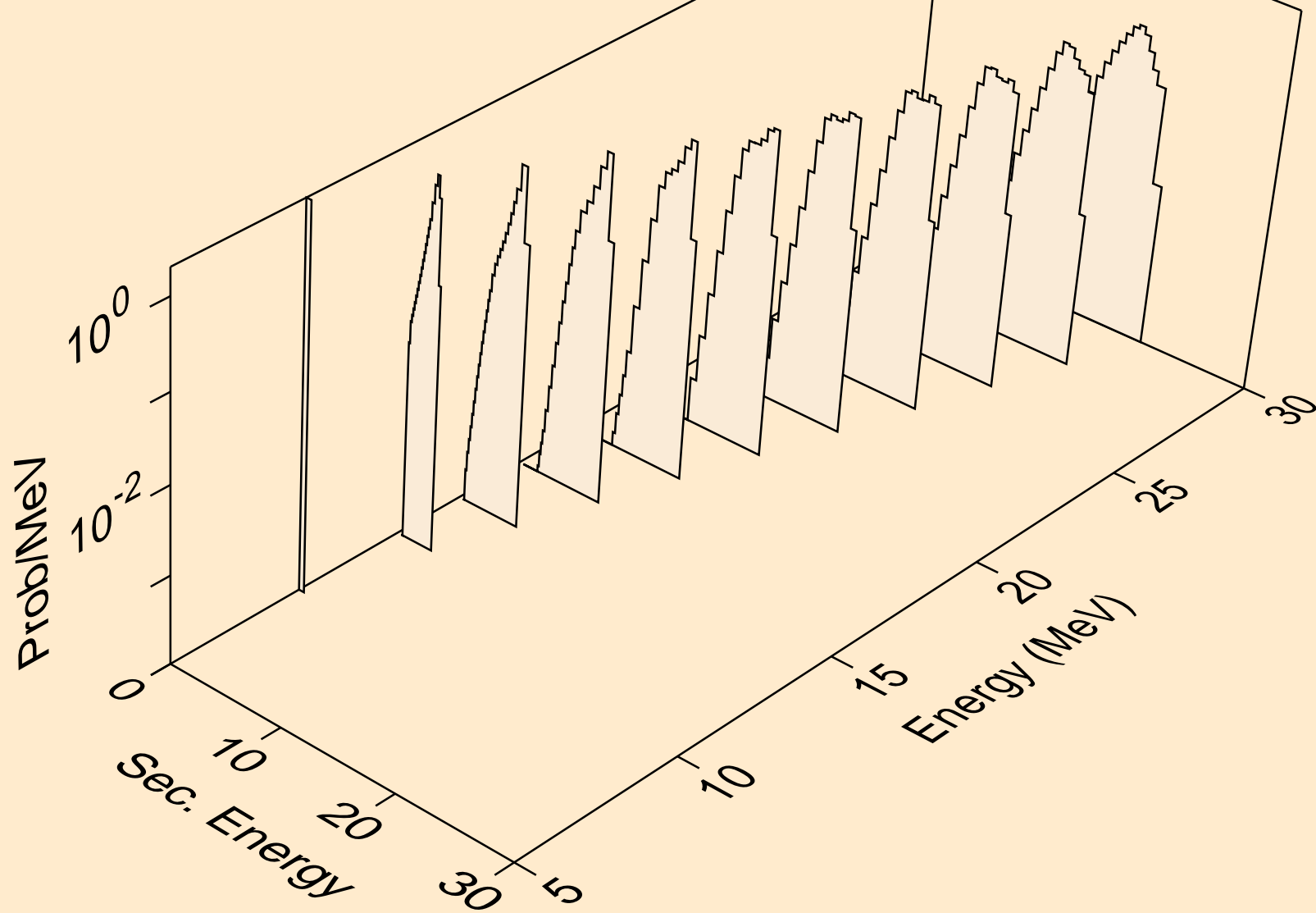

LR259 HELION ACER TENDL-2024 LIBRARY; T=0.K  
deuterons from (s,d)

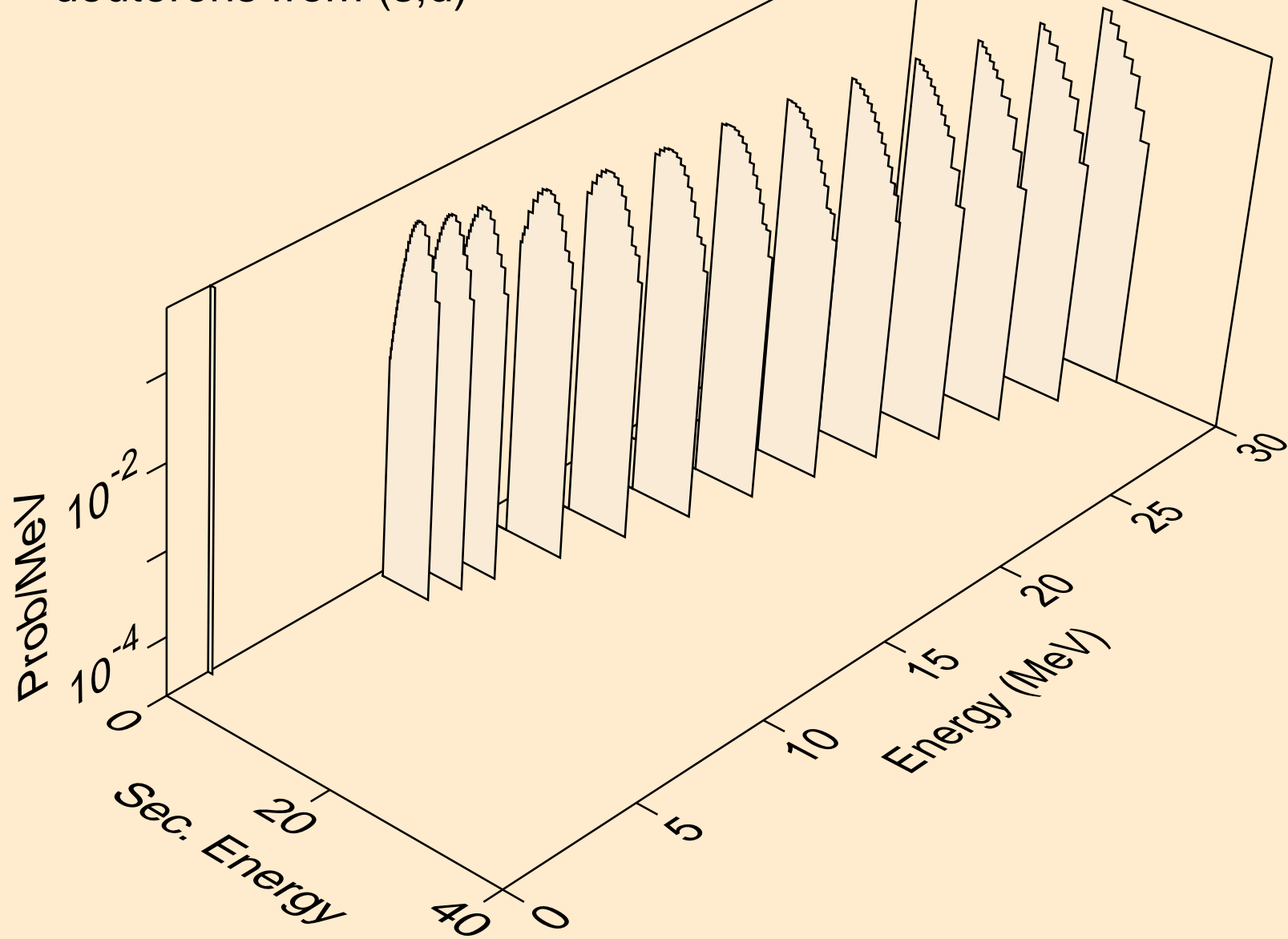

LR259 HELION ACER TENDL-2024 LIBRARY; T=0.K  
tritons from (s,x)

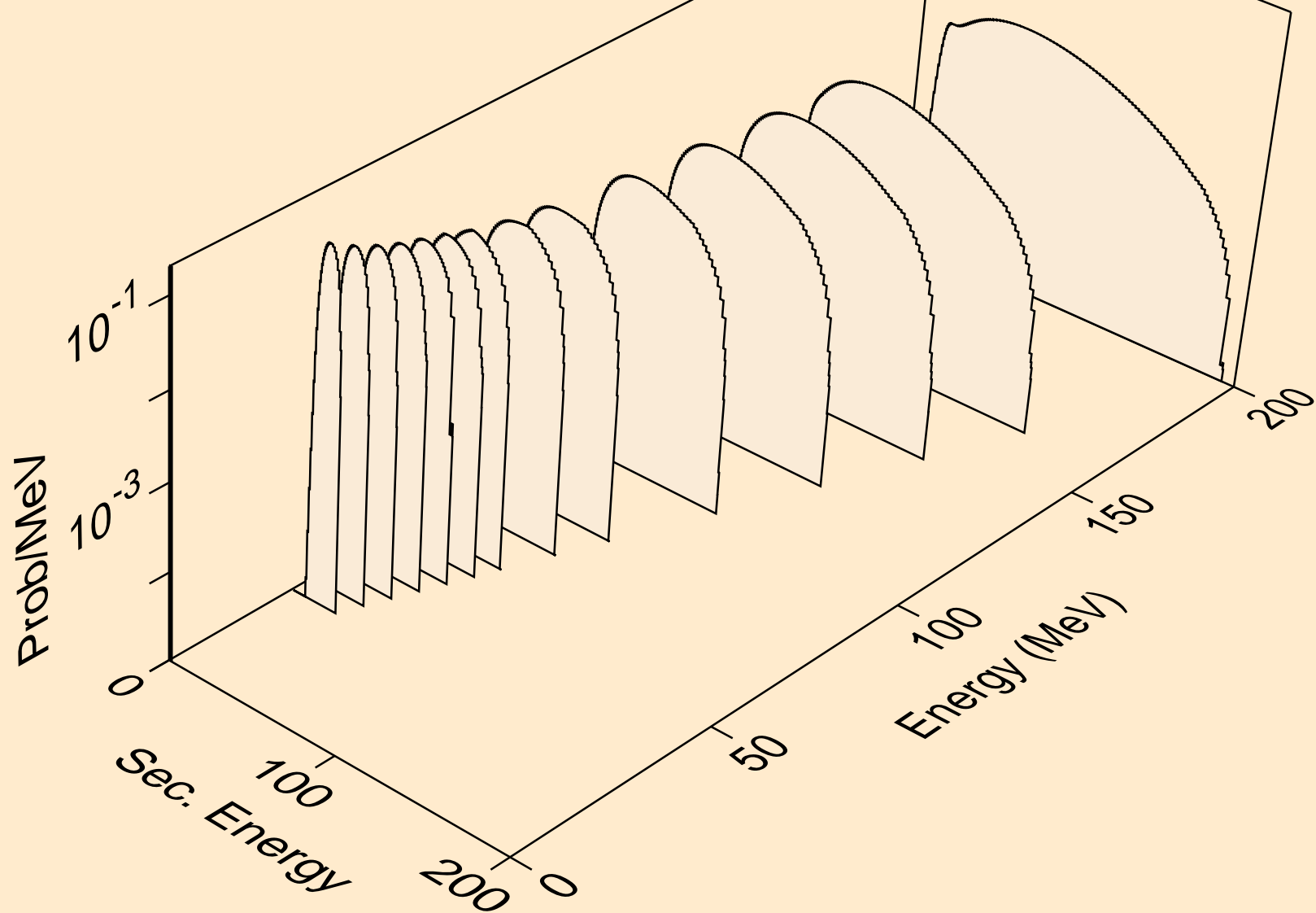

LR259 HELION ACER TENDL-2024 LIBRARY; T=0.K  
tritons from (s,n\*)t

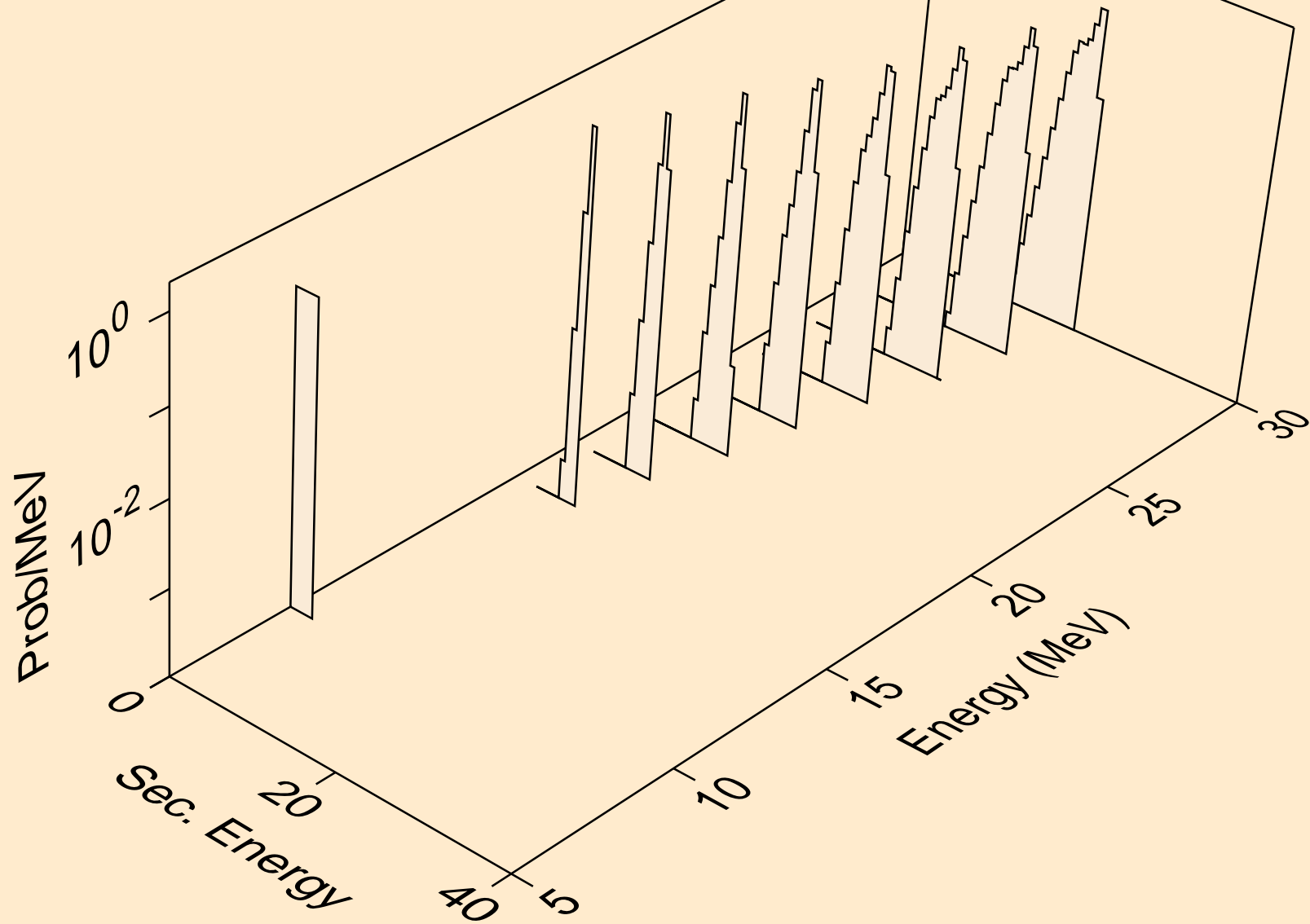

LR259 HELION ACER TENDL-2024 LIBRARY; T=0.K  
tritons from (s,t)

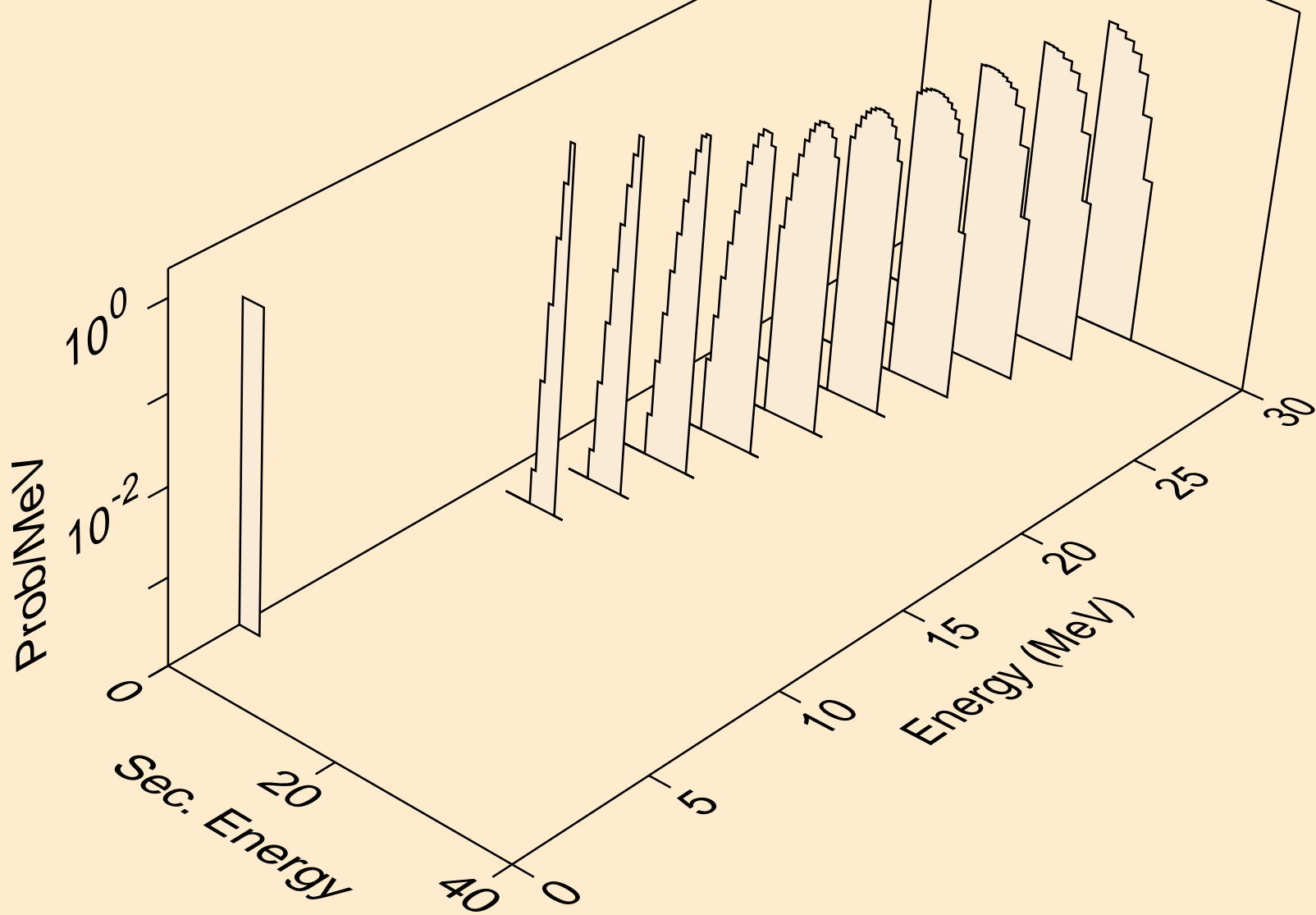

LR259 HELION ACER TENDL-2024 LIBRARY; T=0.K  
alphas from (s,x)

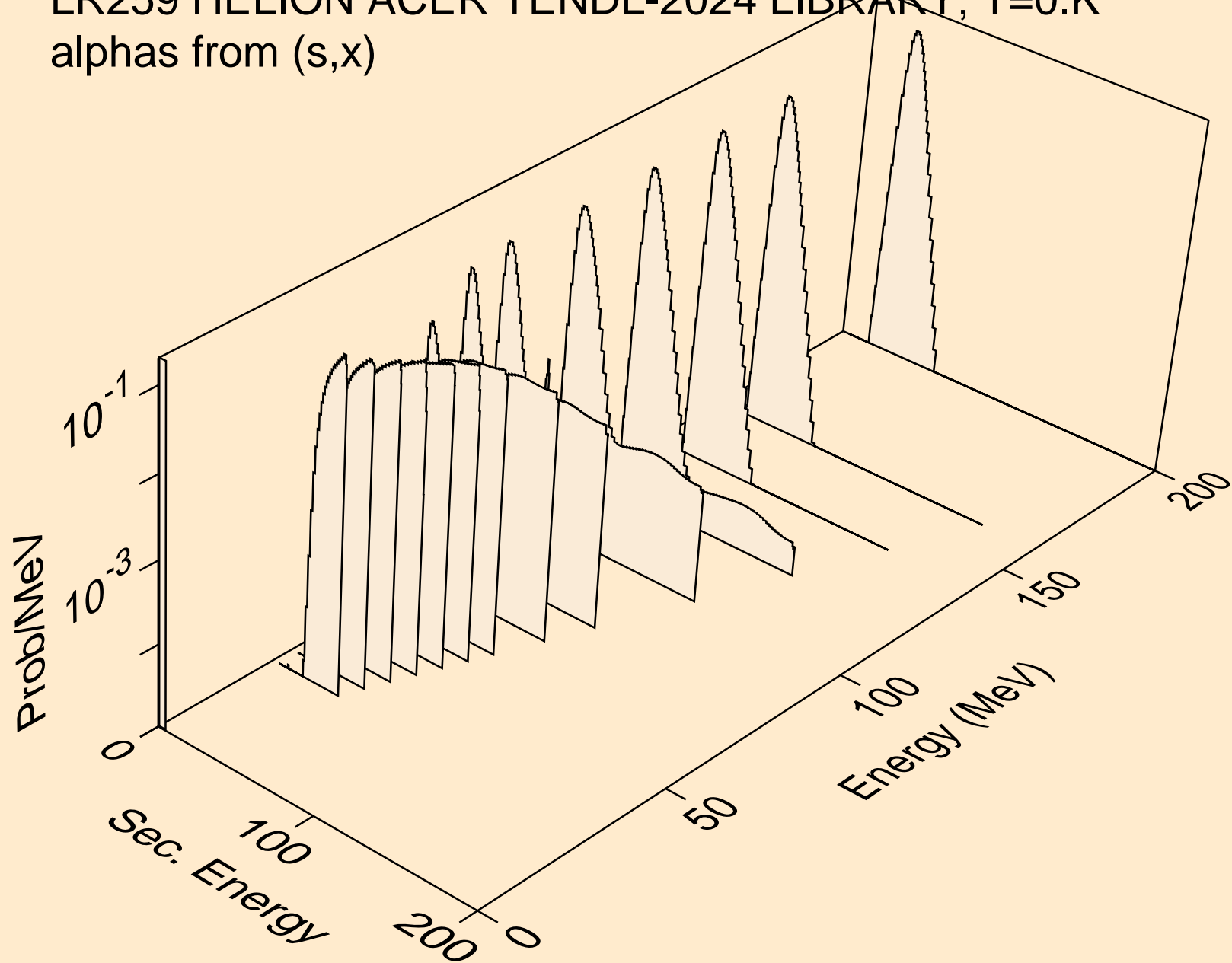

LR259 HELION ACER TENDL-2024 LIBRARY; T=0.K  
alphas from (s,n\*)a

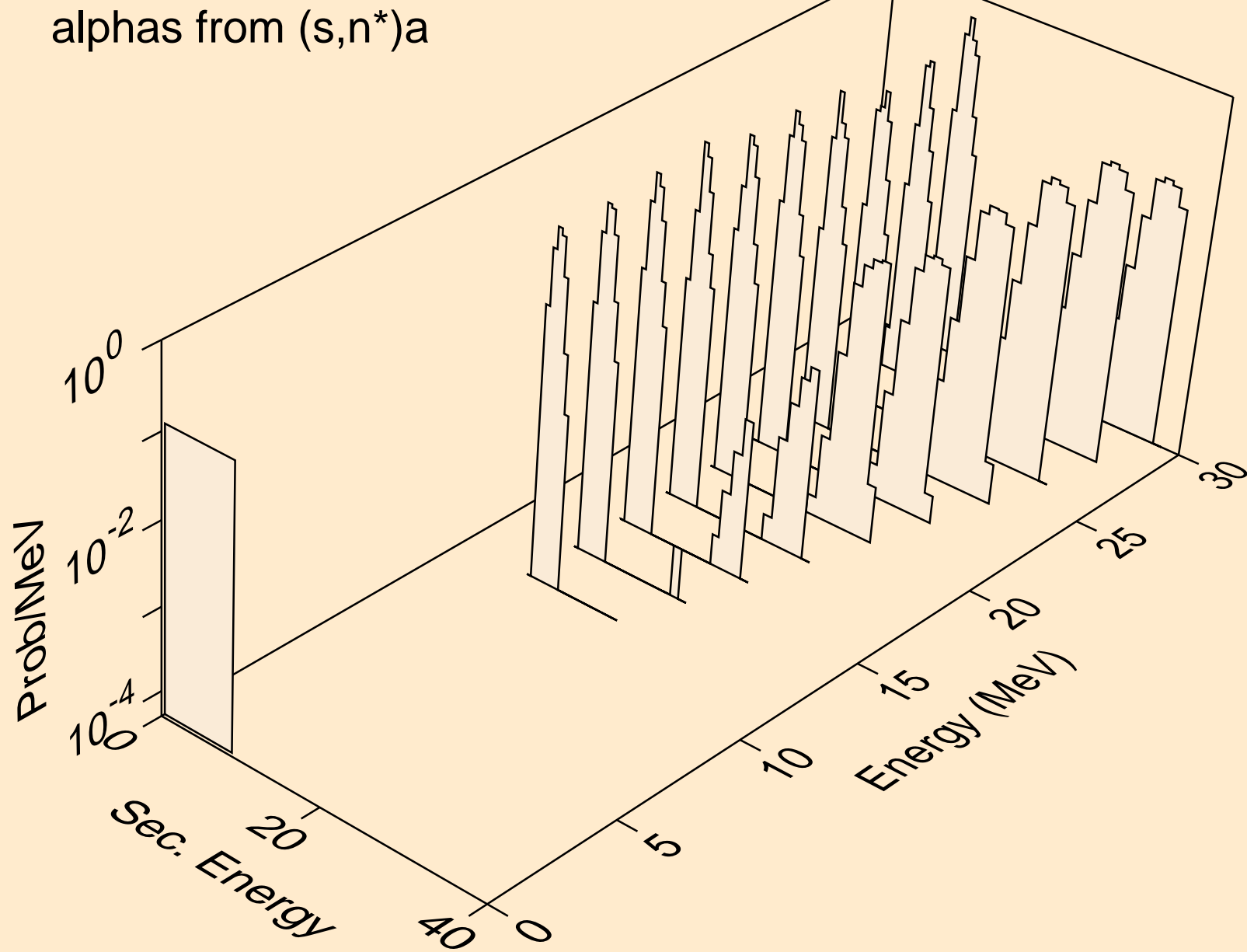

LR259 HELION ACER TENDL-2024 LIBRARY; T=0.K  
alphas from (s,a)

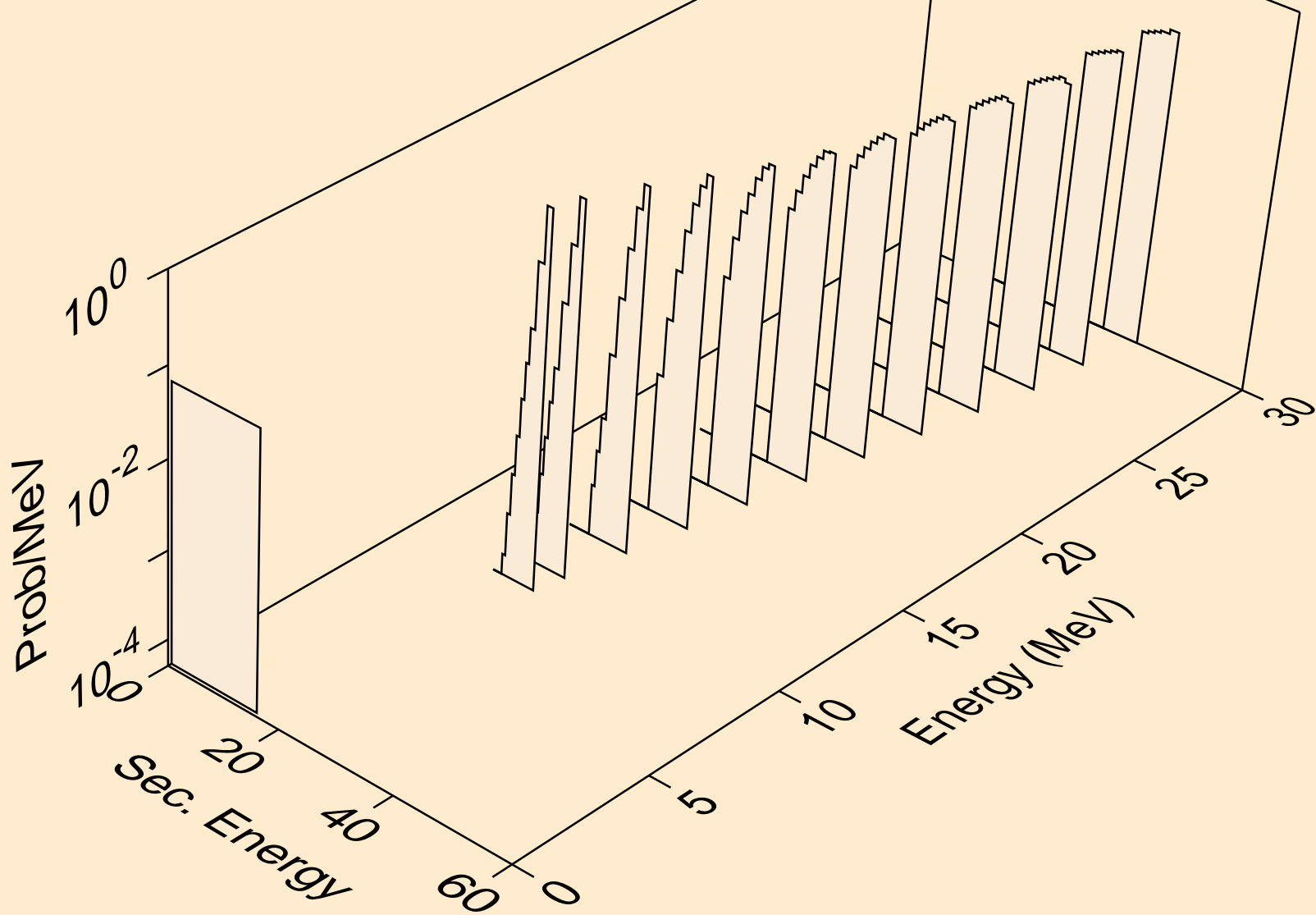

LR259 HELION ACER TENDL-2024 LIBRARY; T=0.K  
alphas from (s,2a)

