

MT277 HELION ACER TENDL-2024 LIBRARY; T=0.K  
Principal cross sections

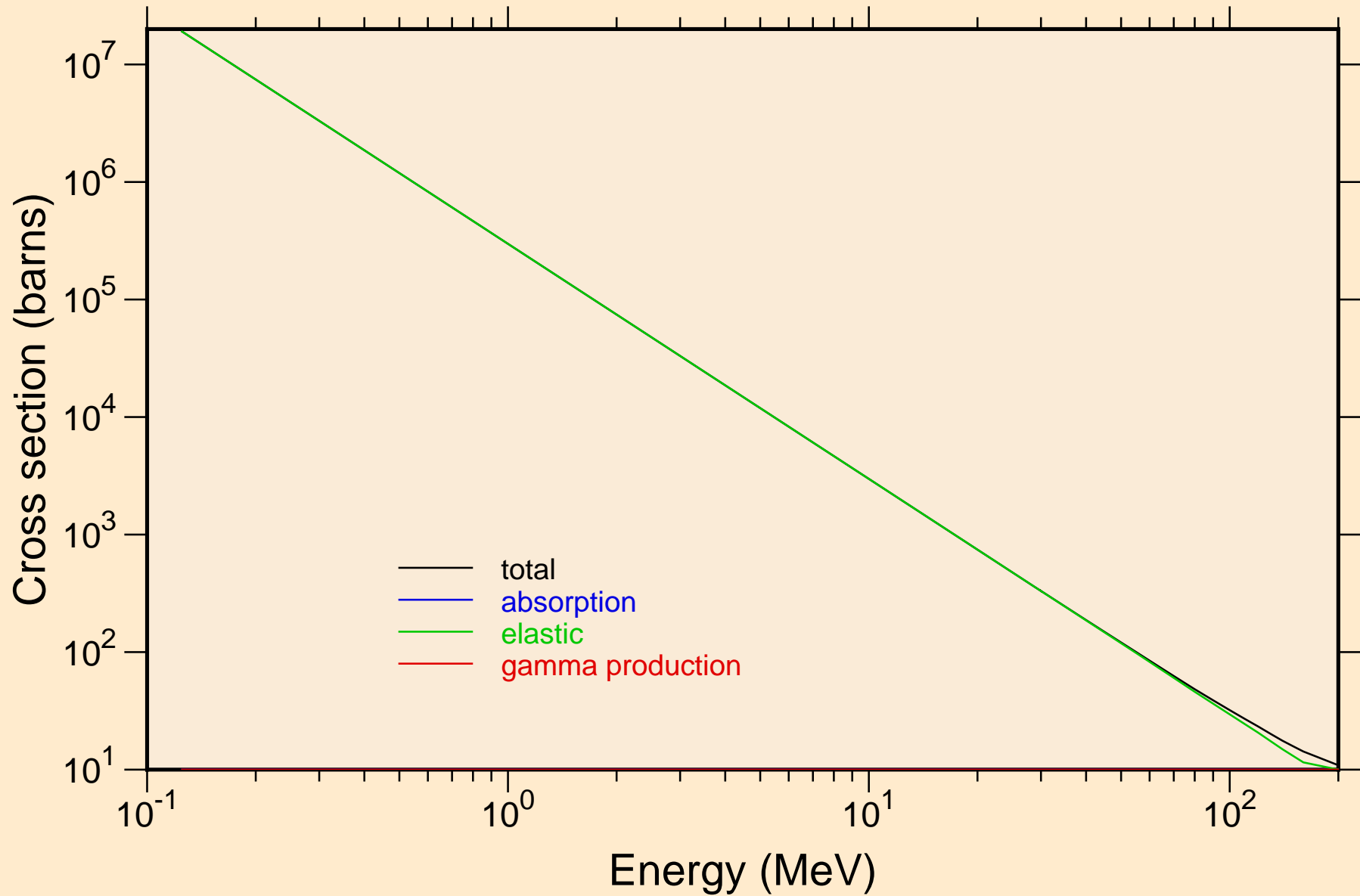

# MT277 HELION ACER TENDL-2024 LIBRARY; T=0.K

## Heating

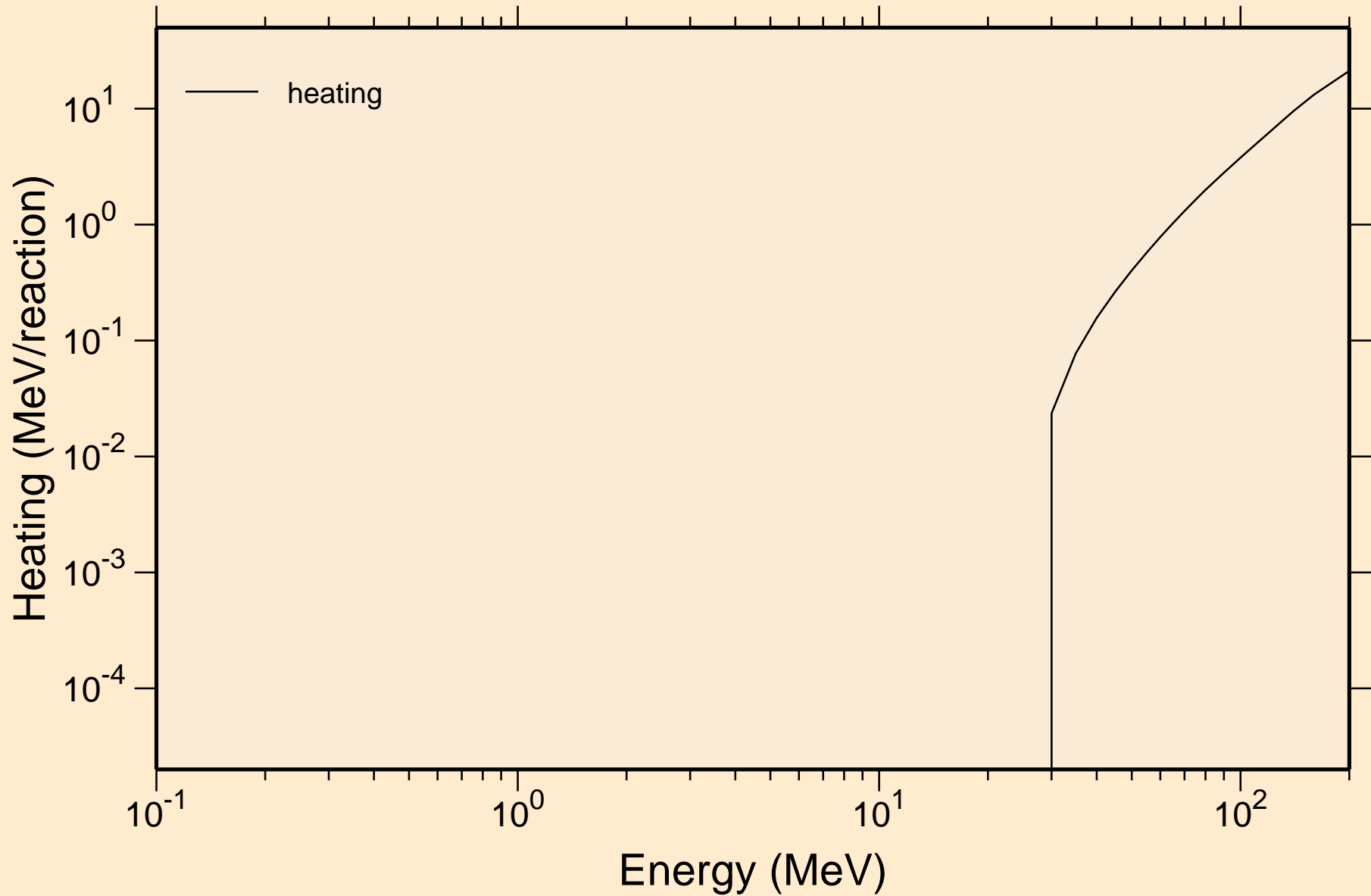

# MT277 HELION ACER TENDL-2024 LIBRARY; T=0.K

## Principal cross sections

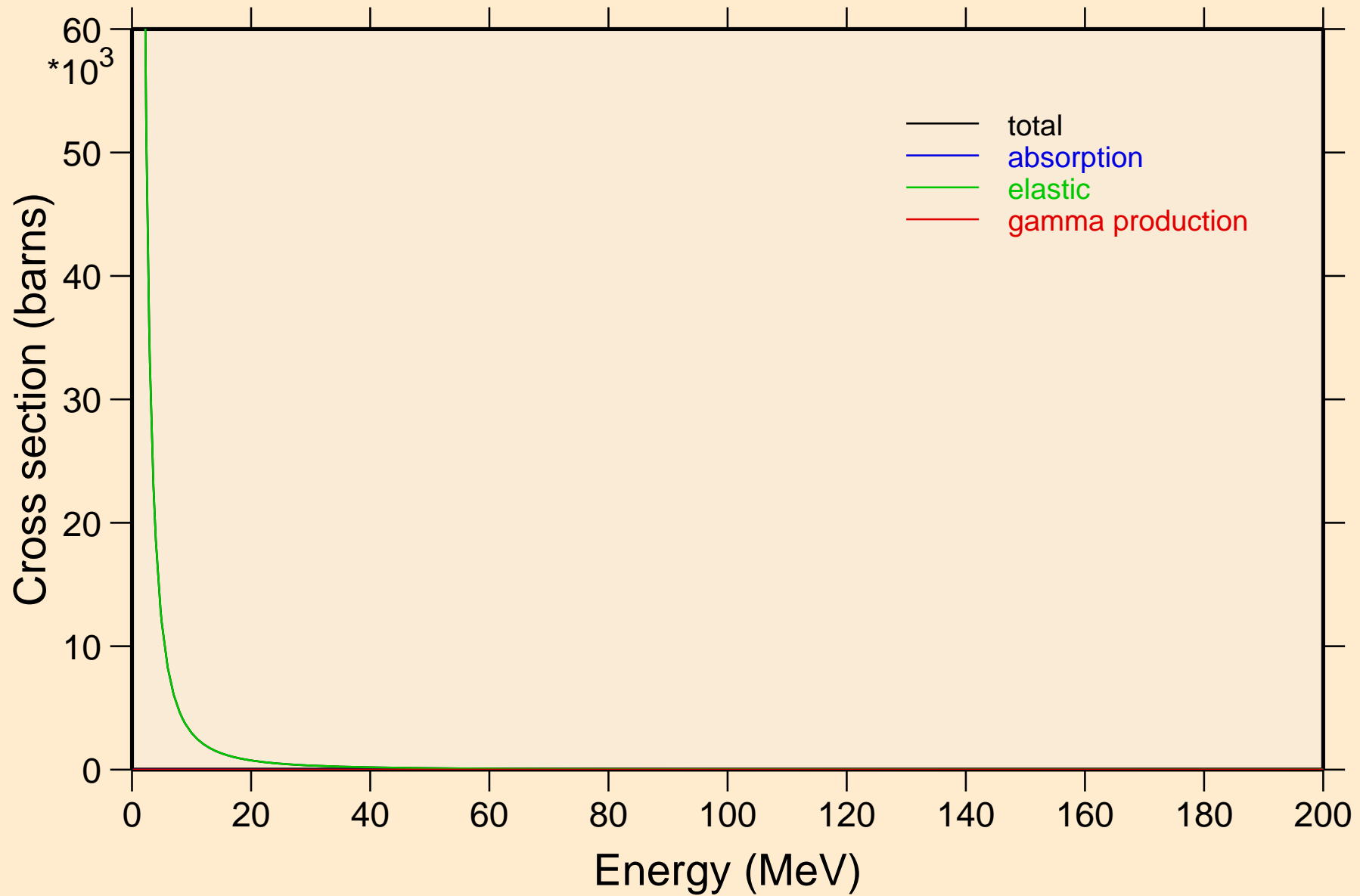

MT277 HELION ACER TENDL-2024 LIBRARY; T=0.K

Heating

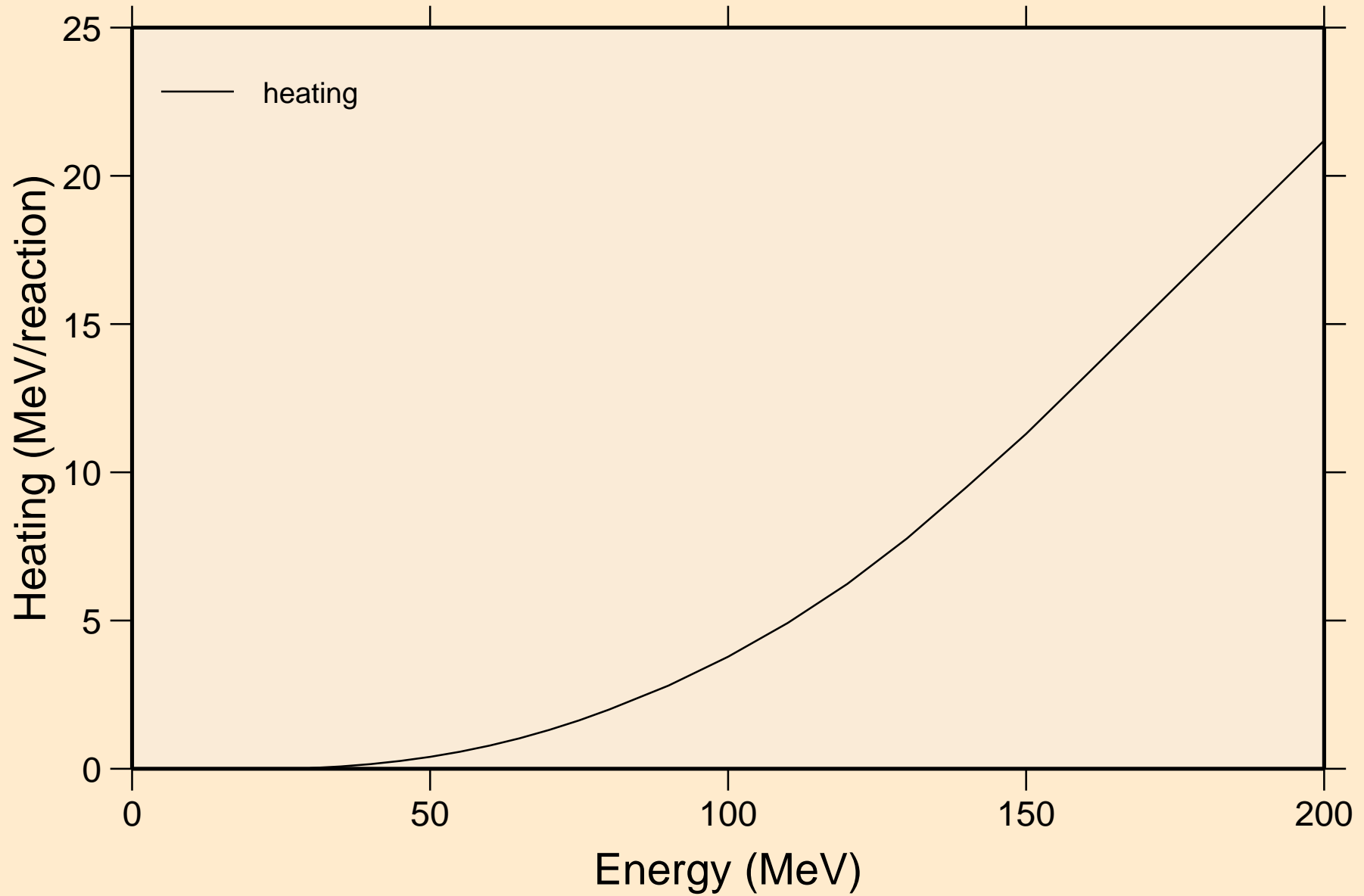

MT277 HELION ACER TENDL-2024 LIBRARY; T=0.K  
Threshold reactions

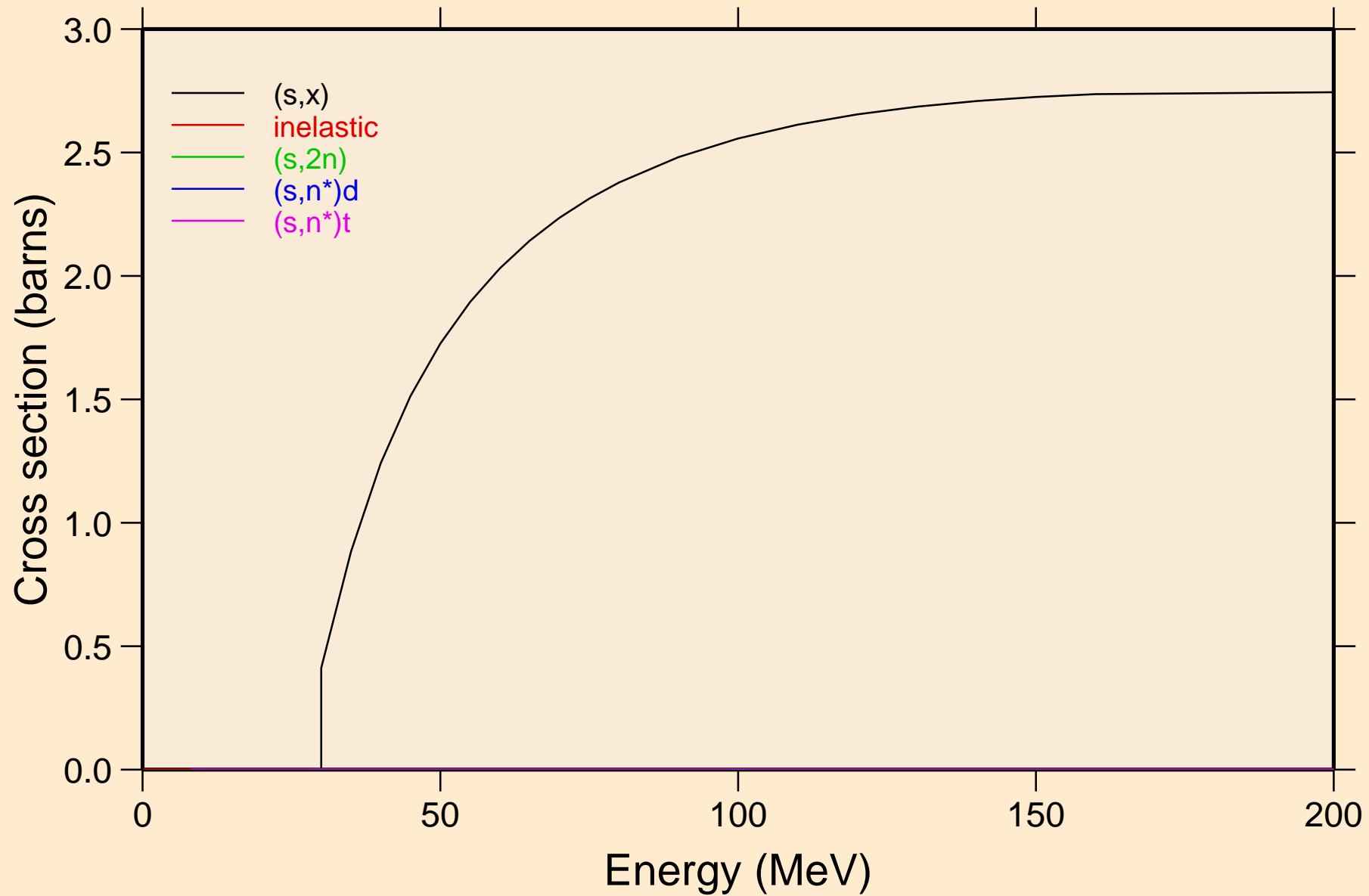

# MT277 HELION ACER TENDL-2024 LIBRARY; T=0.K

## Threshold reactions

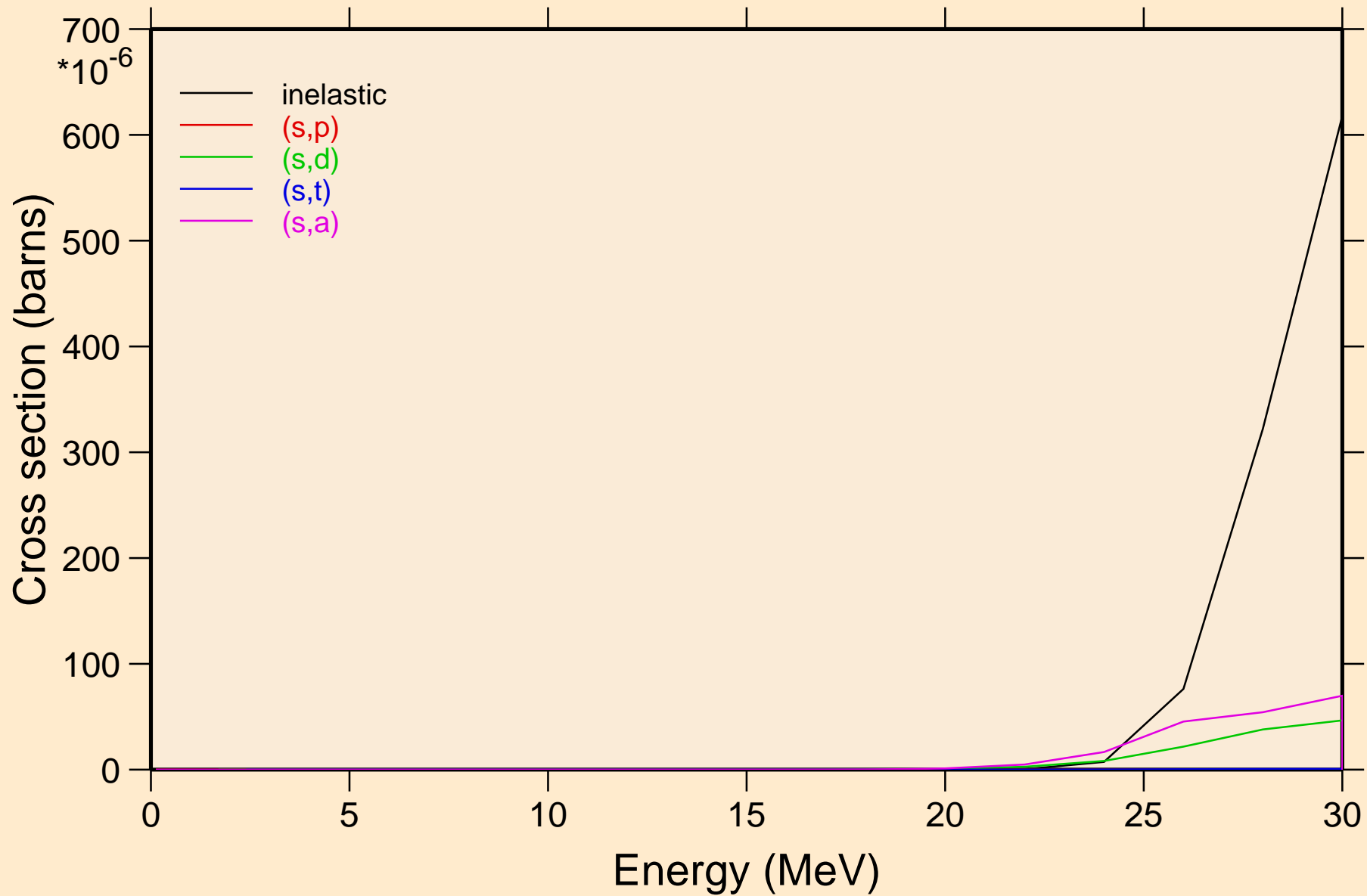

MT277 HELION ACER TENDL-2024 LIBRARY; T=0.K  
angular distribution for elastic

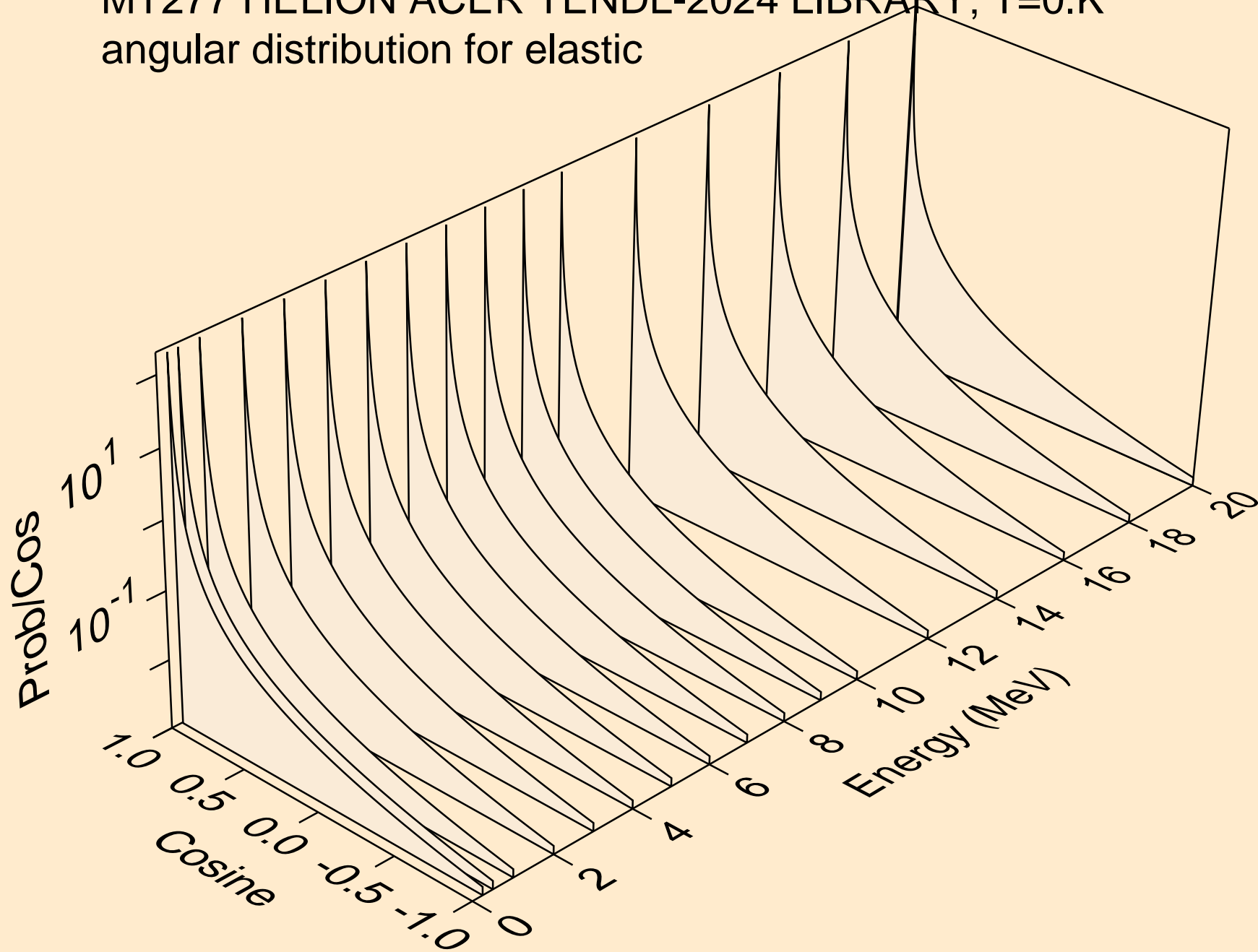

MT277 HELION ACER TENDL-2024 LIBRARY; T=0.K  
angular distribution for elastic

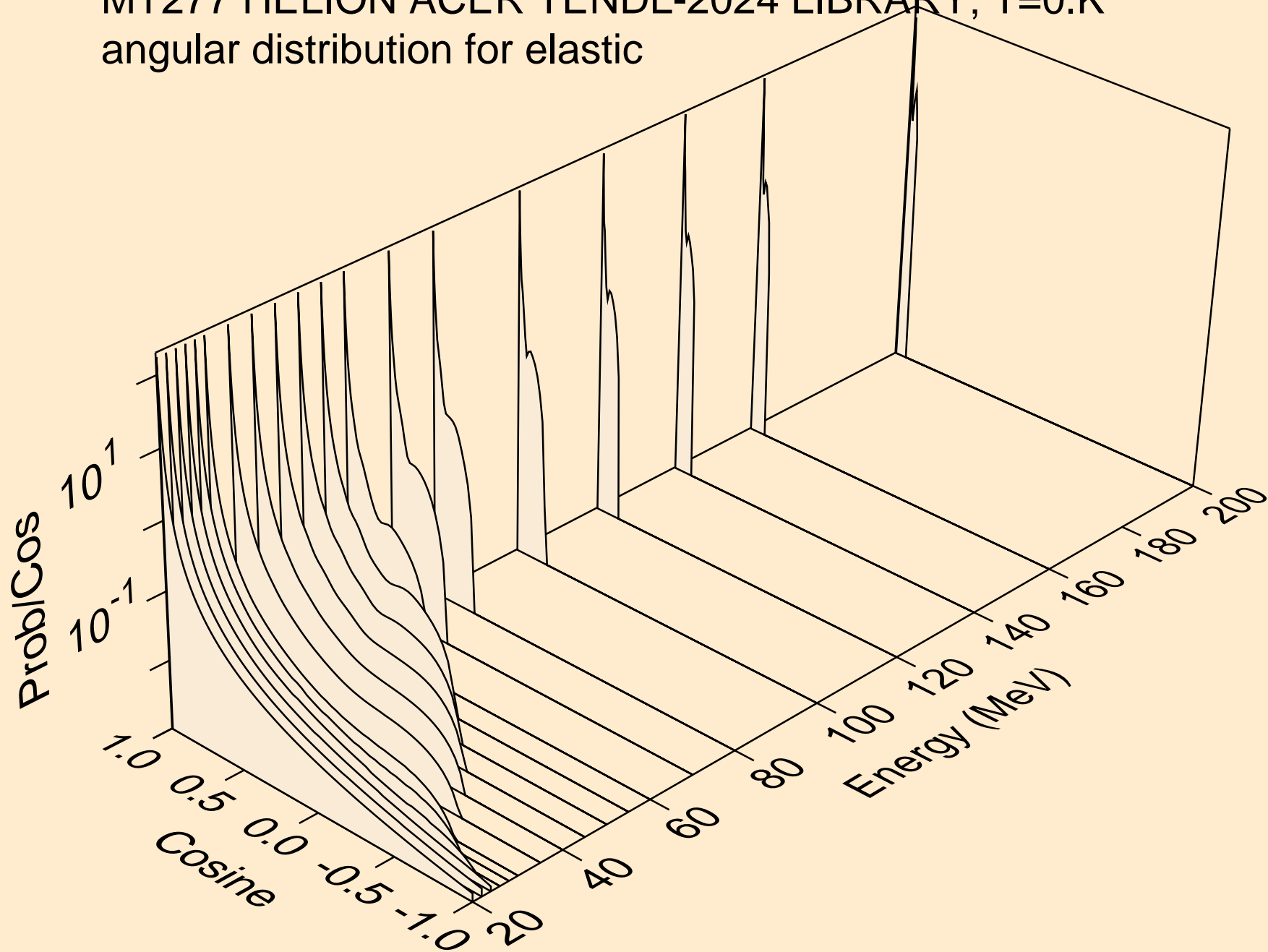

MT277 HELION ACER TENDL-2024 LIBRARY; T=0.K  
He-3 emission for (s,x)

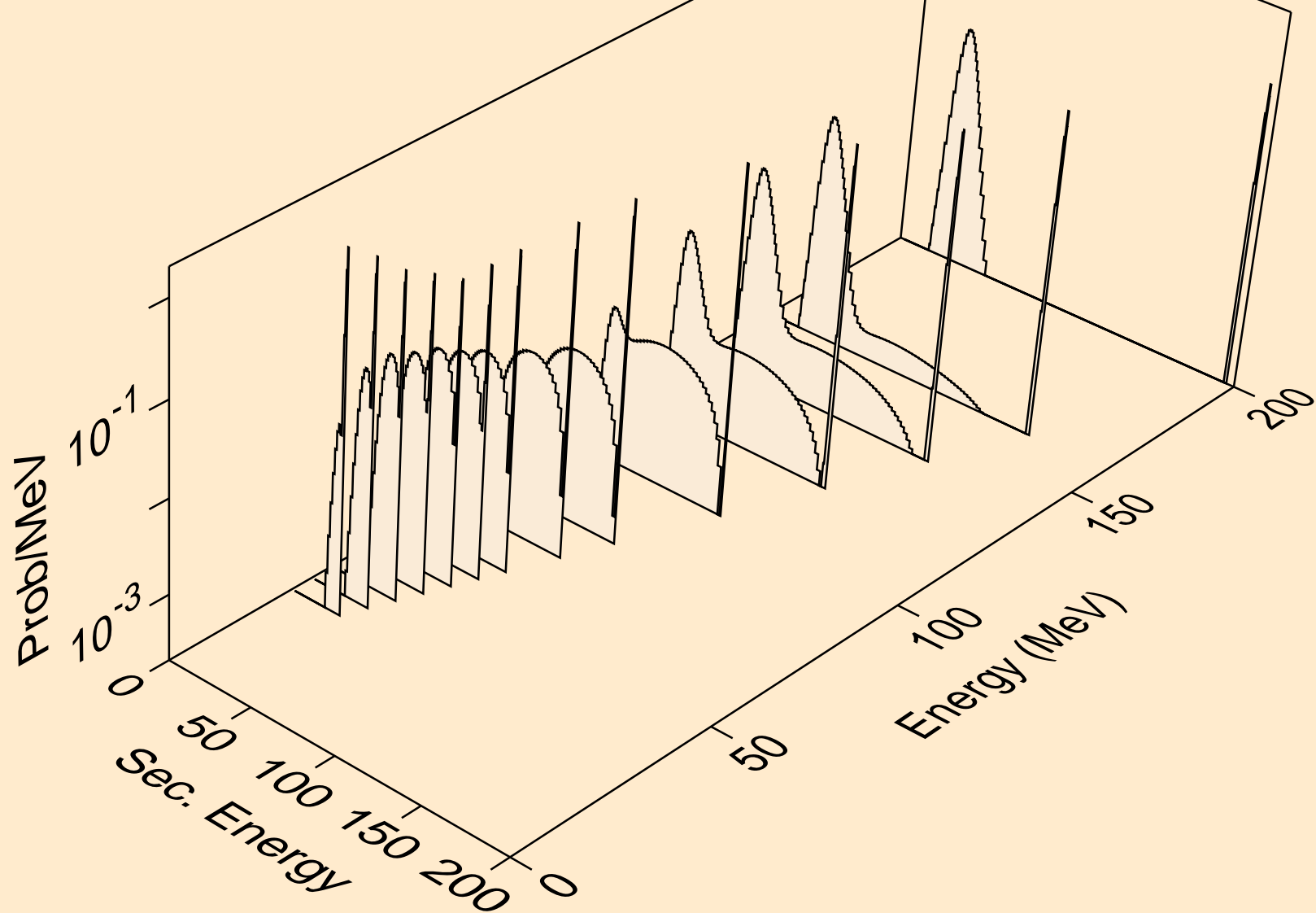

MT277 HELION ACER TENDL-2024 LIBRARY; T=0.K  
He-3 emission for inelastic

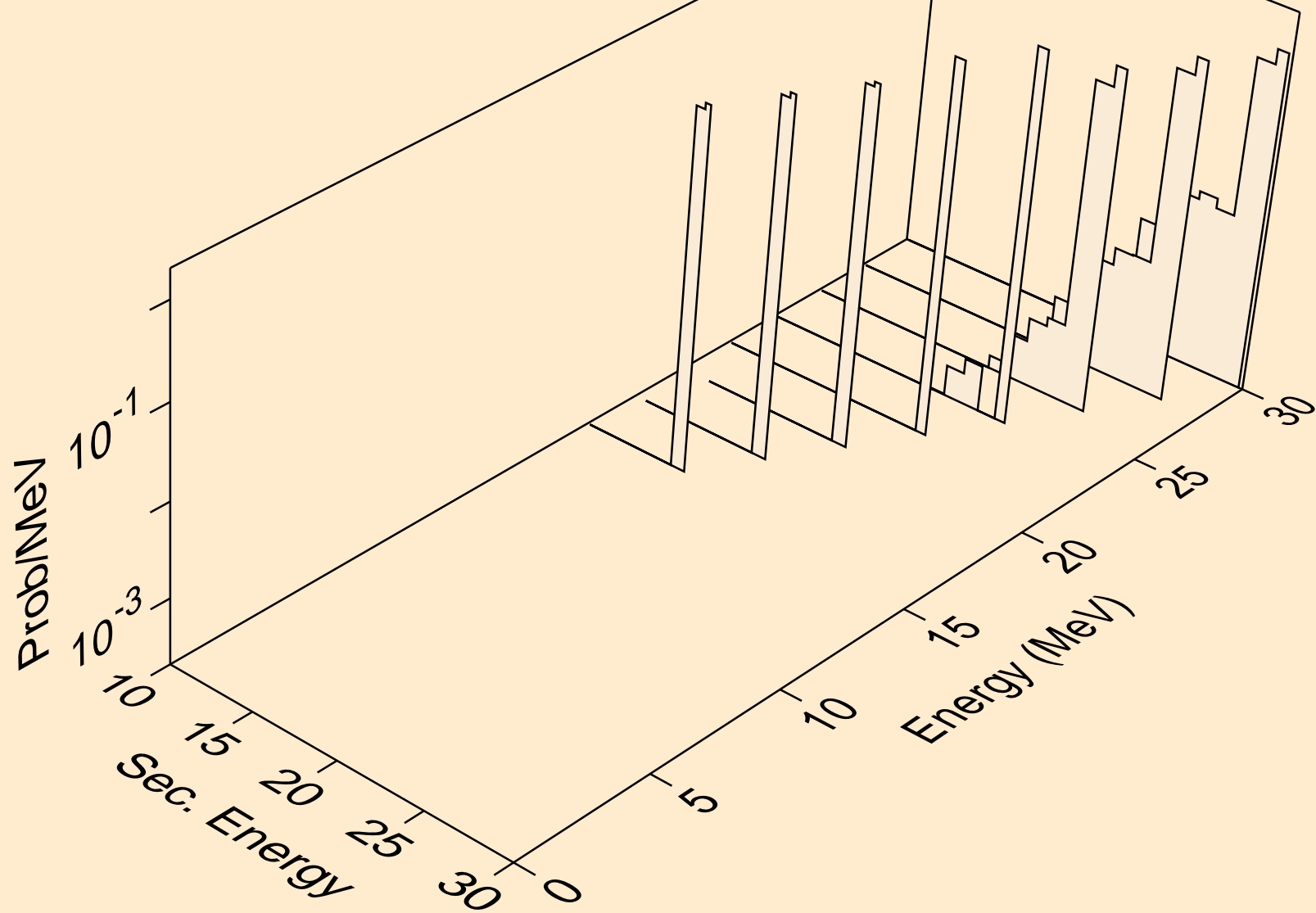

MT277 HELION ACER TENDL-2024 LIBRARY; T=0.K  
Photon emission for (z,n)

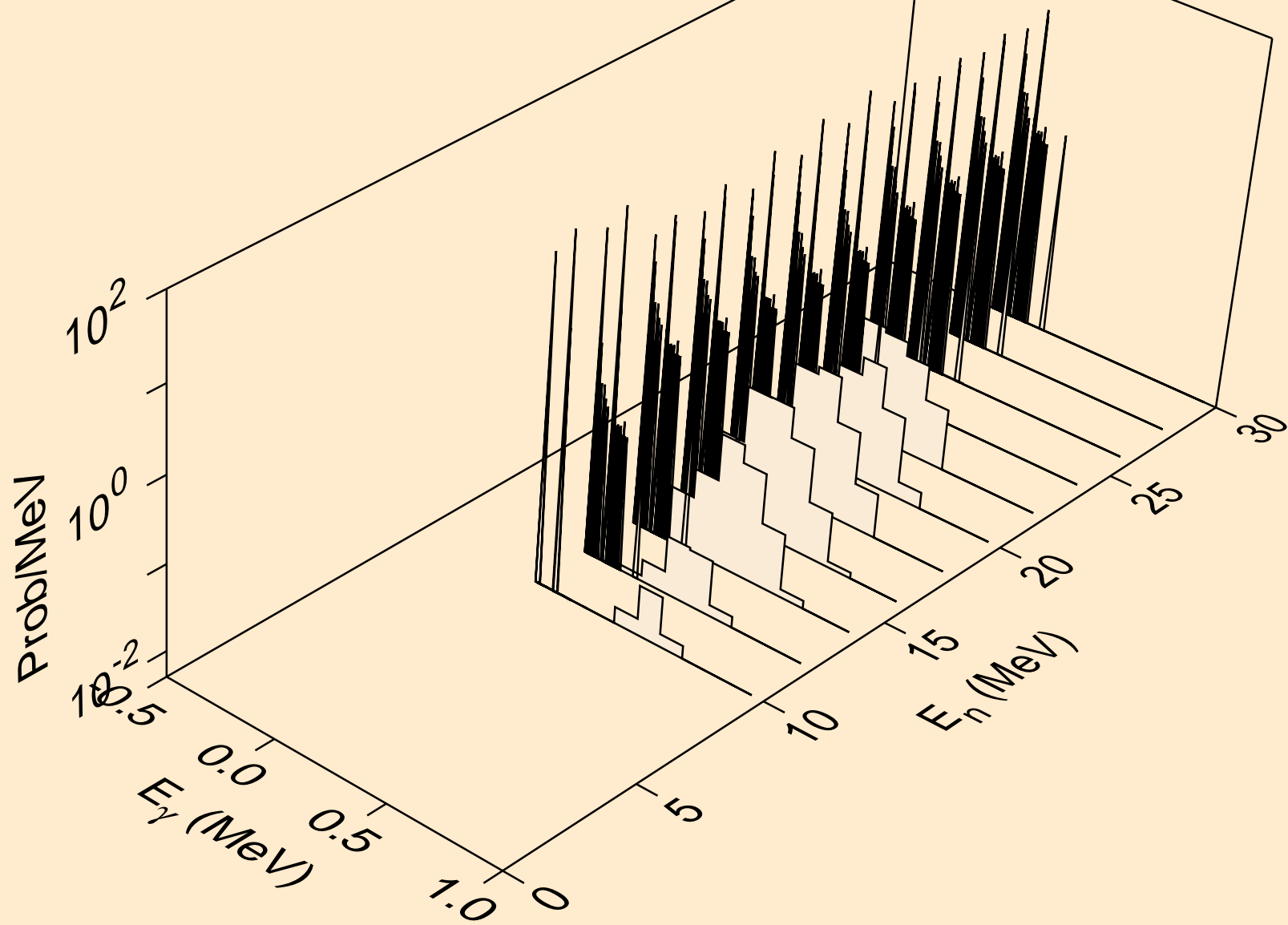

MT277 HELION ACER TENDL-2024 LIBRARY; T=0.K  
Photon emission for (z,x)

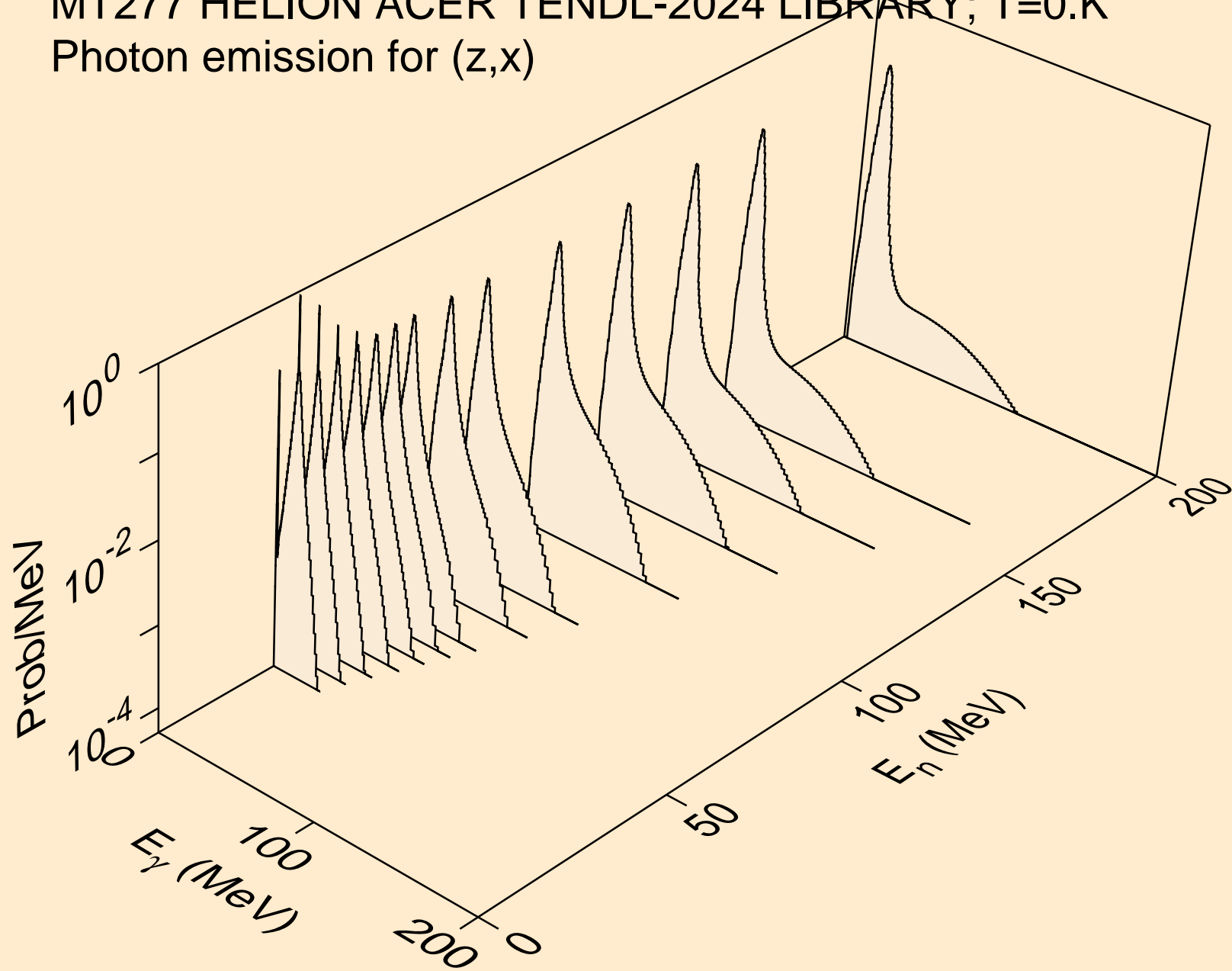

MT277 HELION ACER TENDL-2024 LIBRARY; T=0.K  
Photon emission for (n,2n)

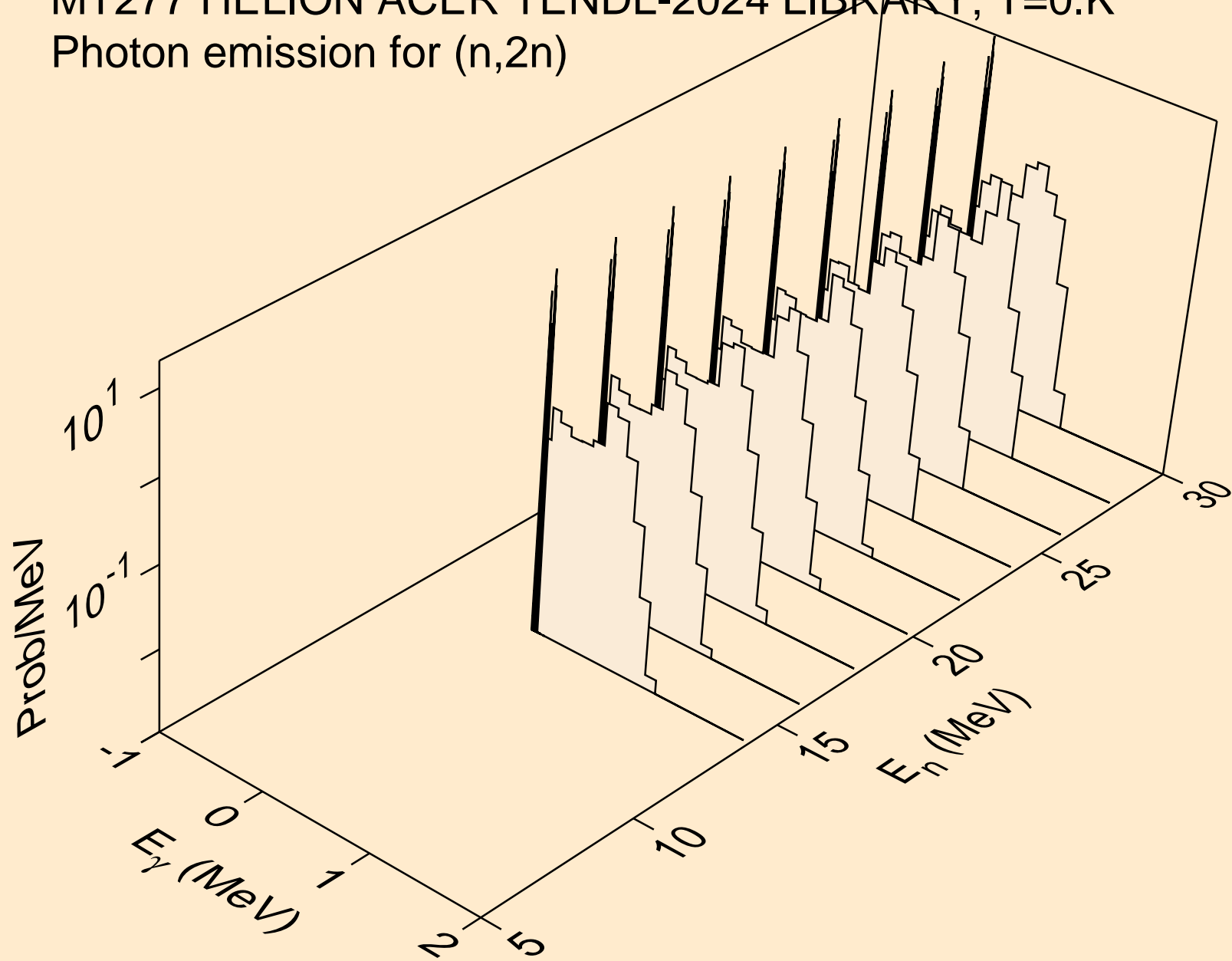

MT277 HELION ACER TENDL-2024 LIBRARY; T=0.K  
Photon emission for (n,n\*)d

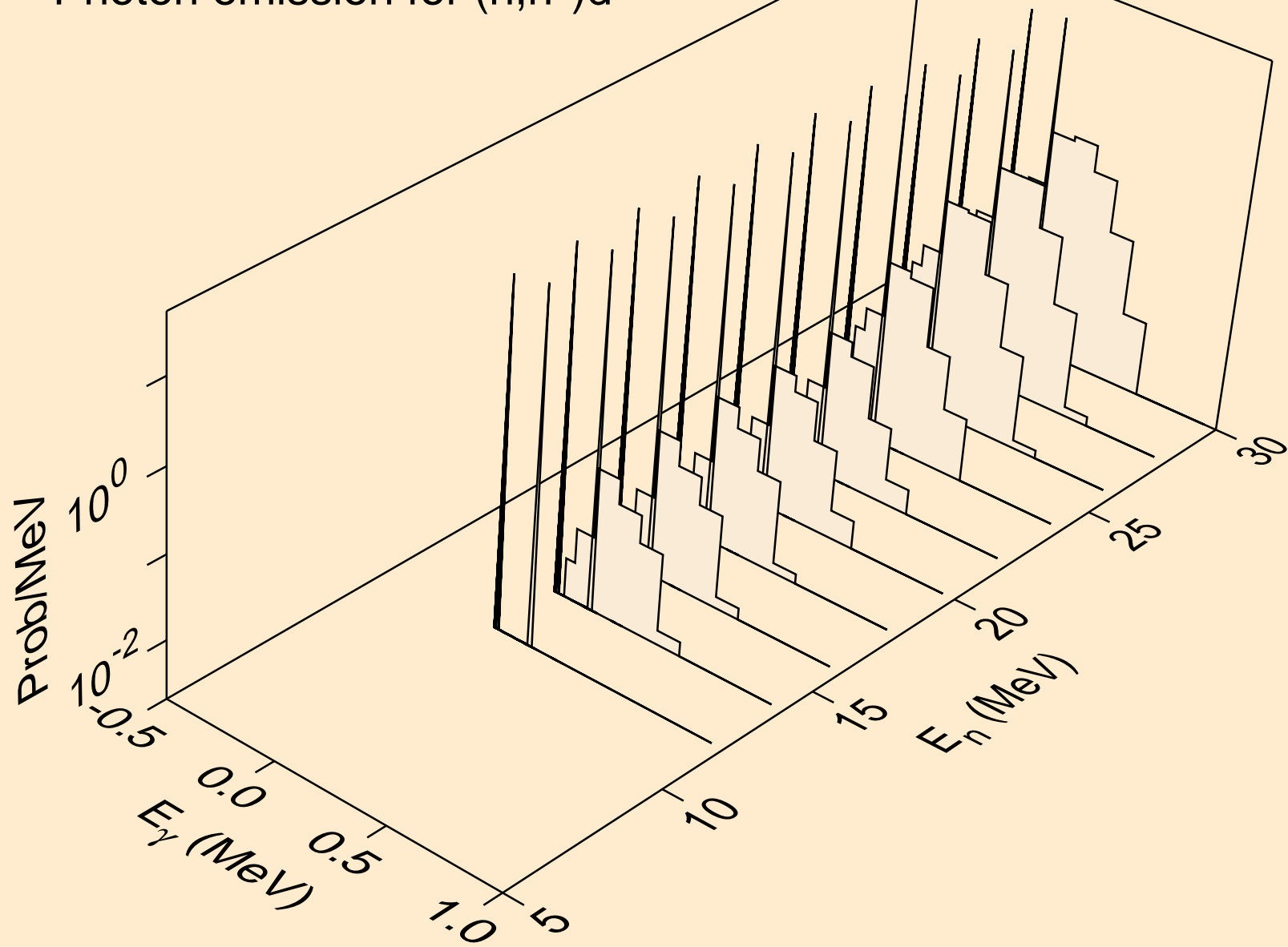

MT277 HELION ACER TENDL-2024 LIBRARY; T=0.K  
Photon emission for (n,n\*)t

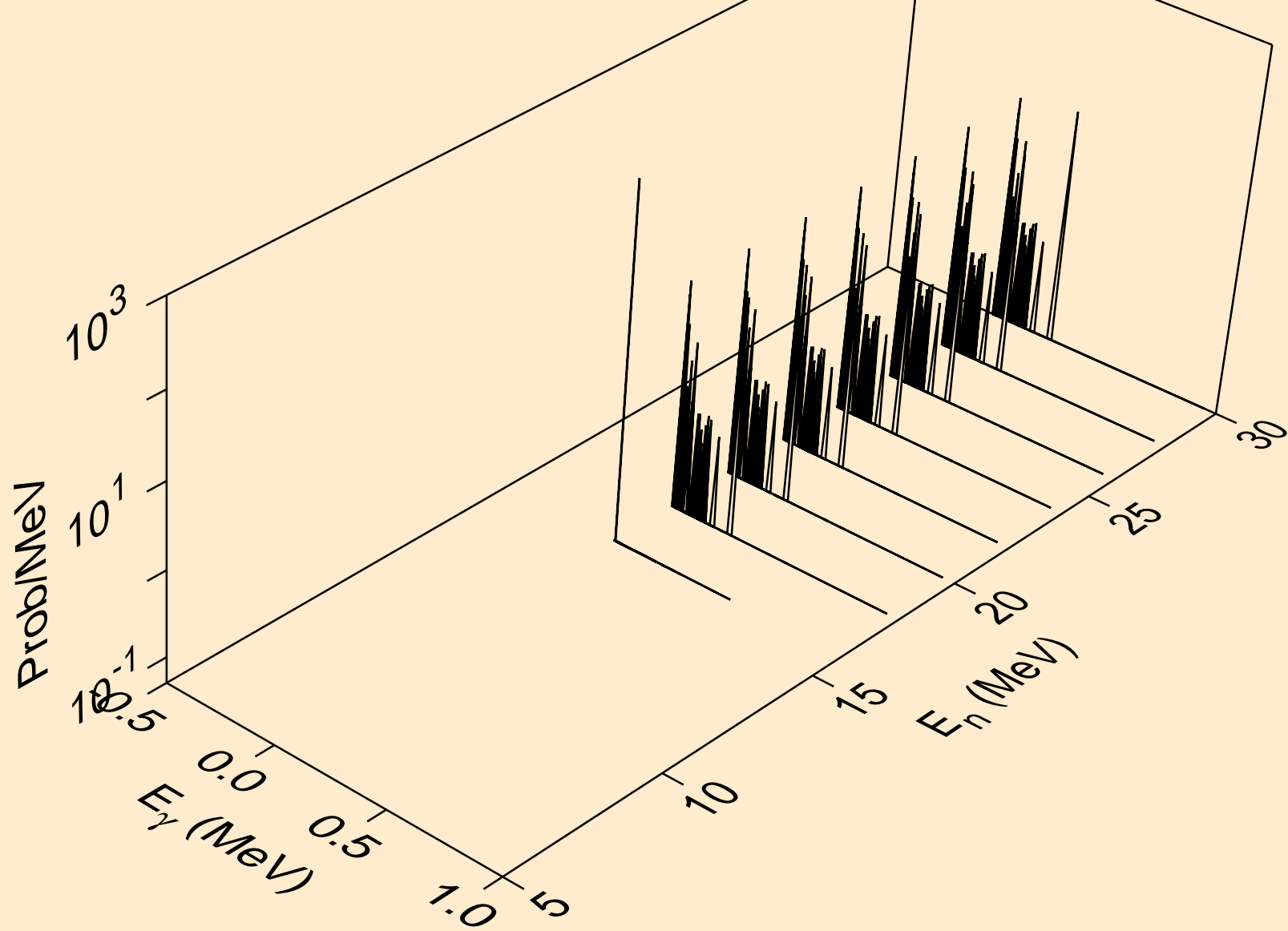

MT277 HELION ACER TENDL-2024 LIBRARY; T=0.K  
Photon emission for (n,p)

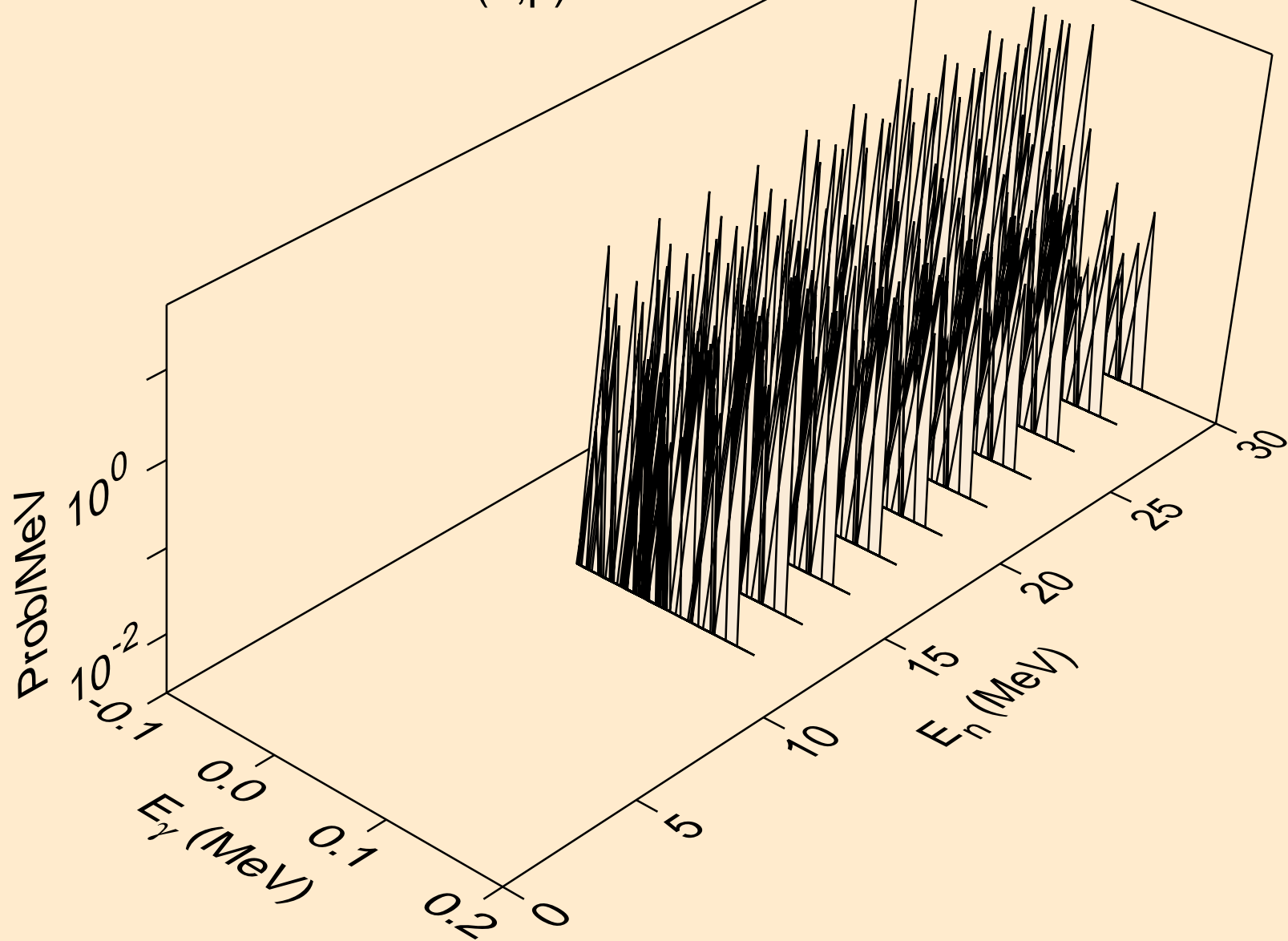

MT277 HELION ACER TENDL-2024 LIBRARY; T=0.K  
Photon emission for (n,d)

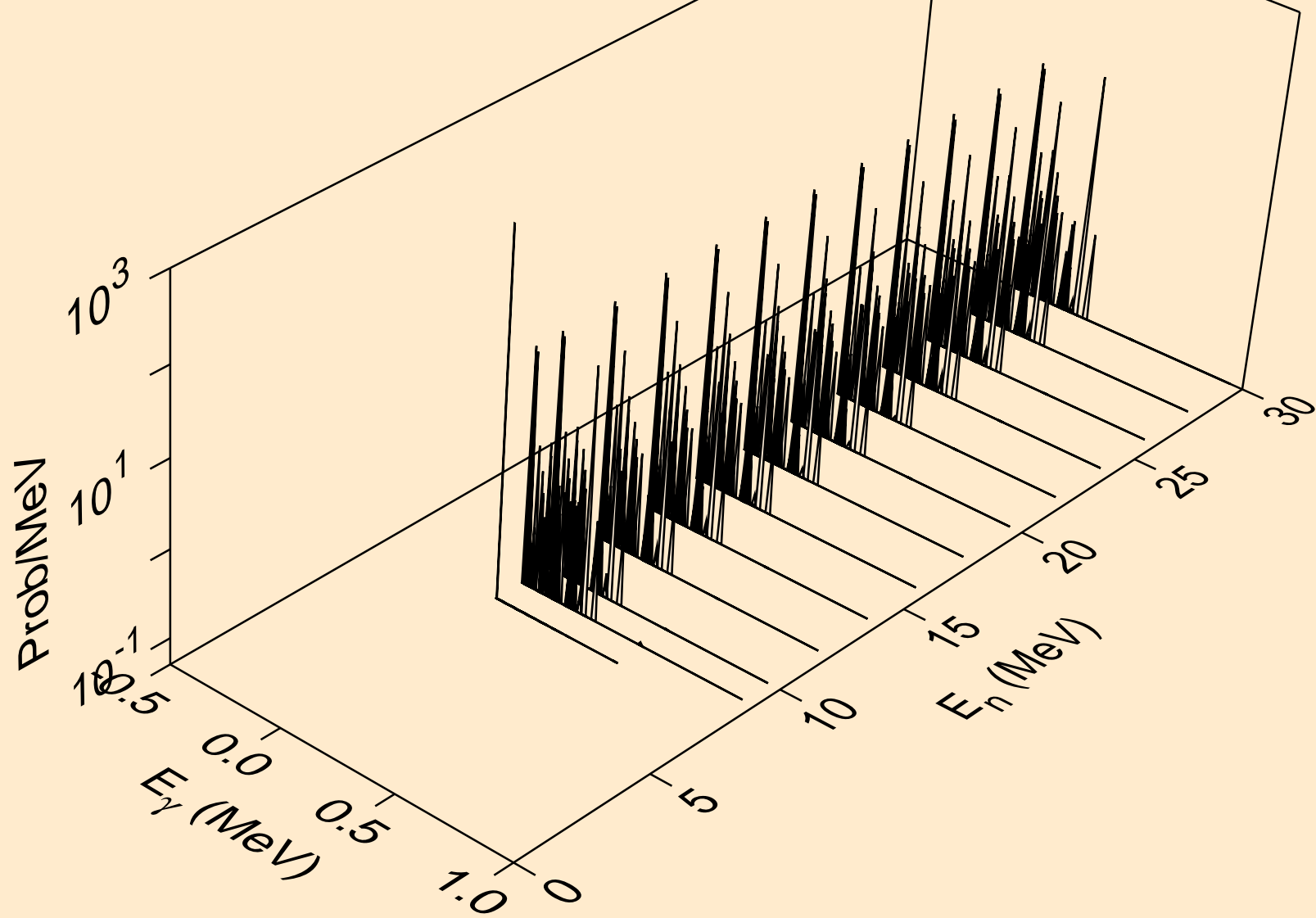

MT277 HELION ACER TENDL-2024 LIBRARY; T=0.K  
Photon emission for (n,t)

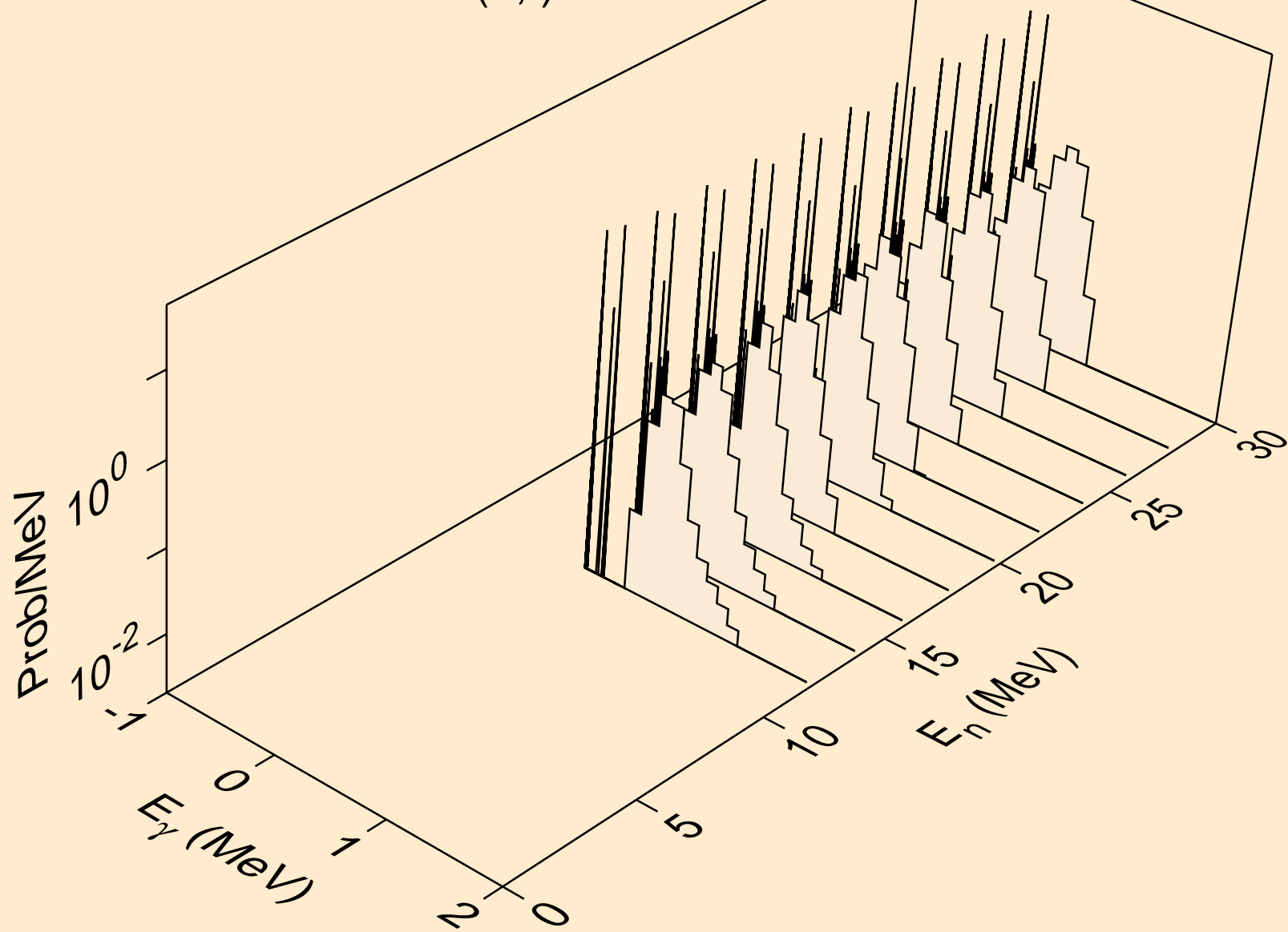

MT277 HELION ACER TENDL-2024 LIBRARY; T=0.K  
Photon emission for inelastic

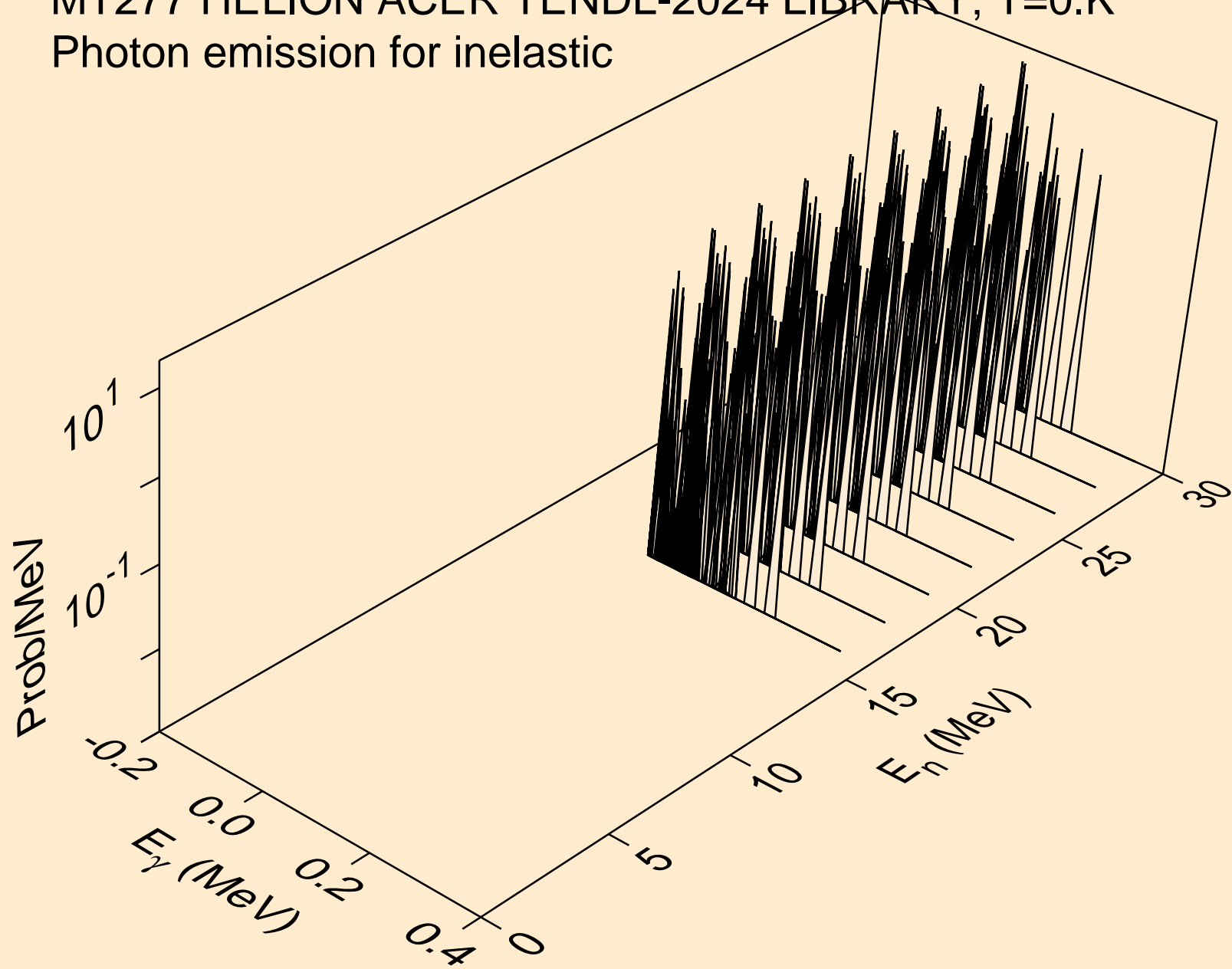

MT277 HELION ACER TENDL-2024 LIBRARY; T=0.K  
Photon emission for (n,a)

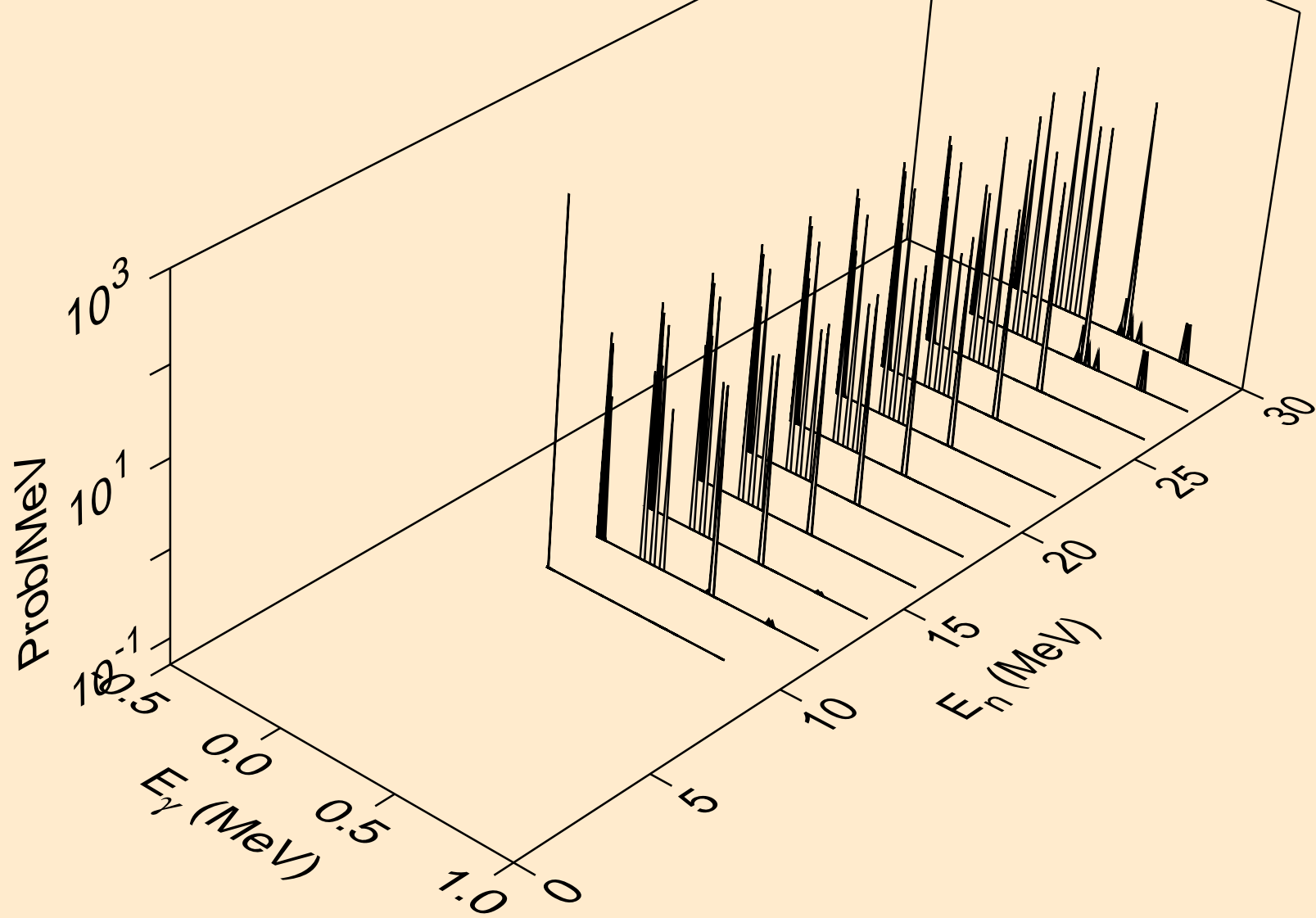

MT277 HELION ACER TENDL-2024 LIBRARY; T=0.K  
Particle heating contributions

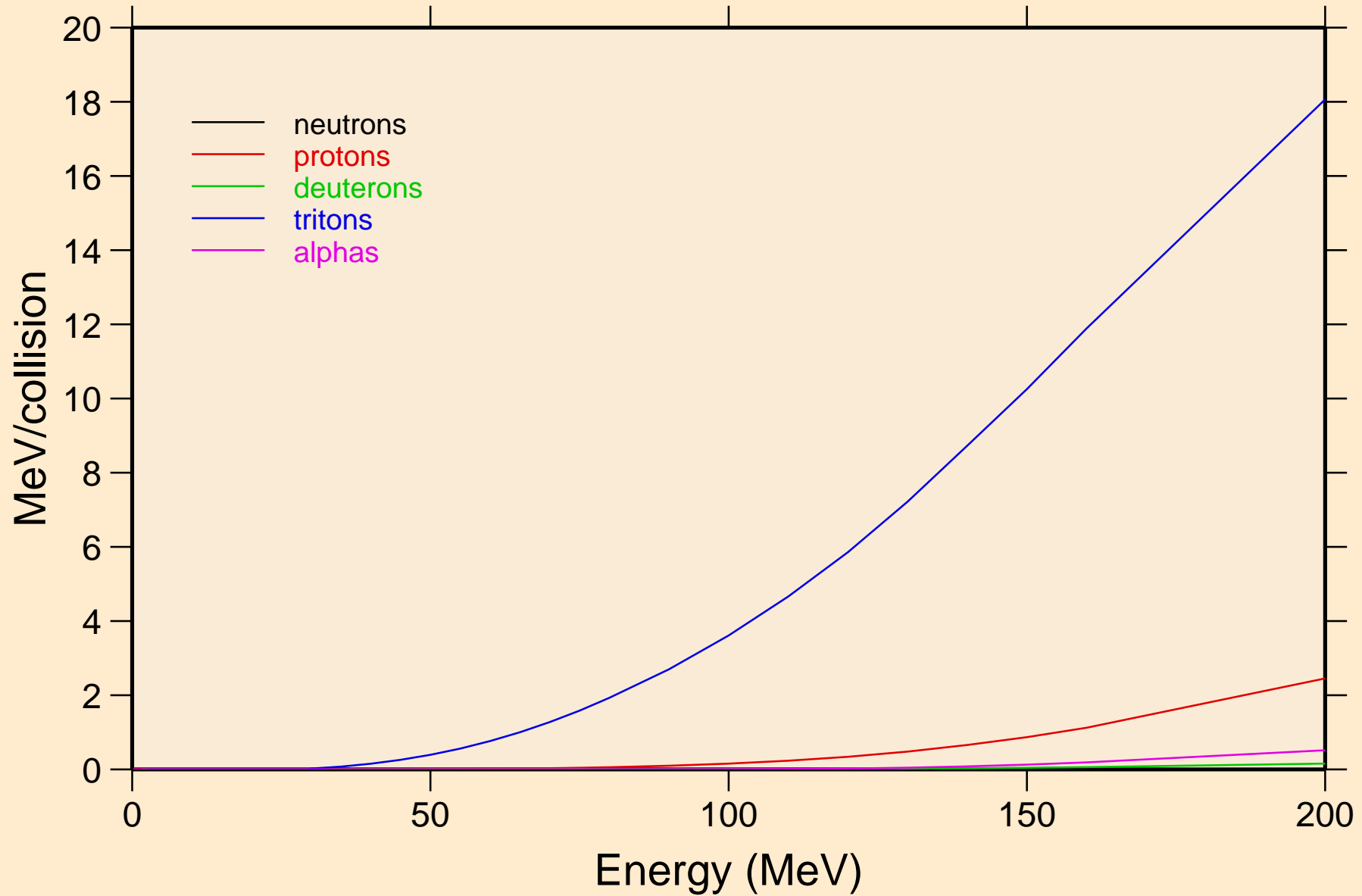

MT277 HELION ACER TENDL-2024 LIBRARY; T=0.K  
Recoil Heating

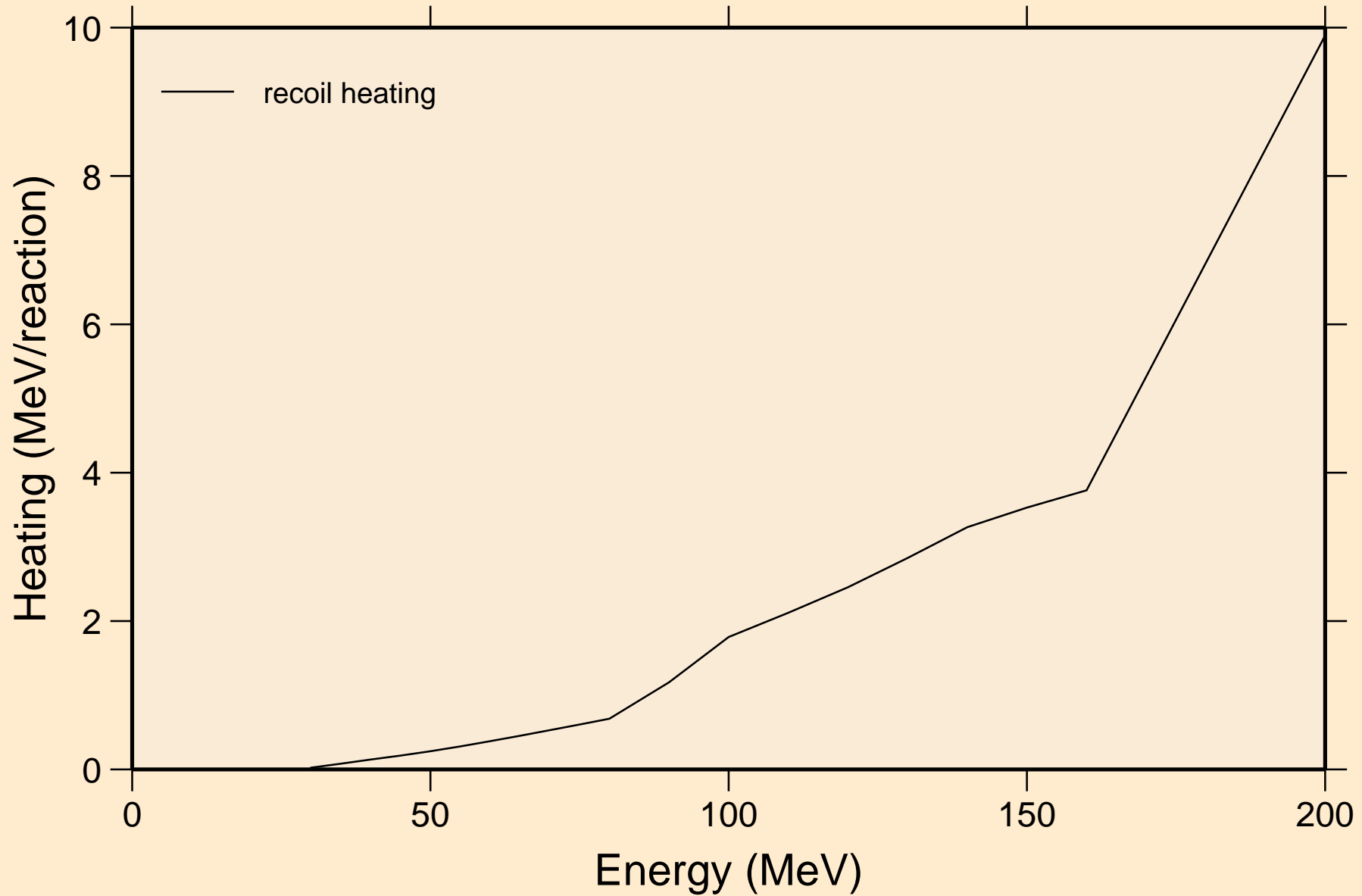

# MT277 HELION ACER TENDL-2024 LIBRARY; T=0.K

## Particle production cross sections

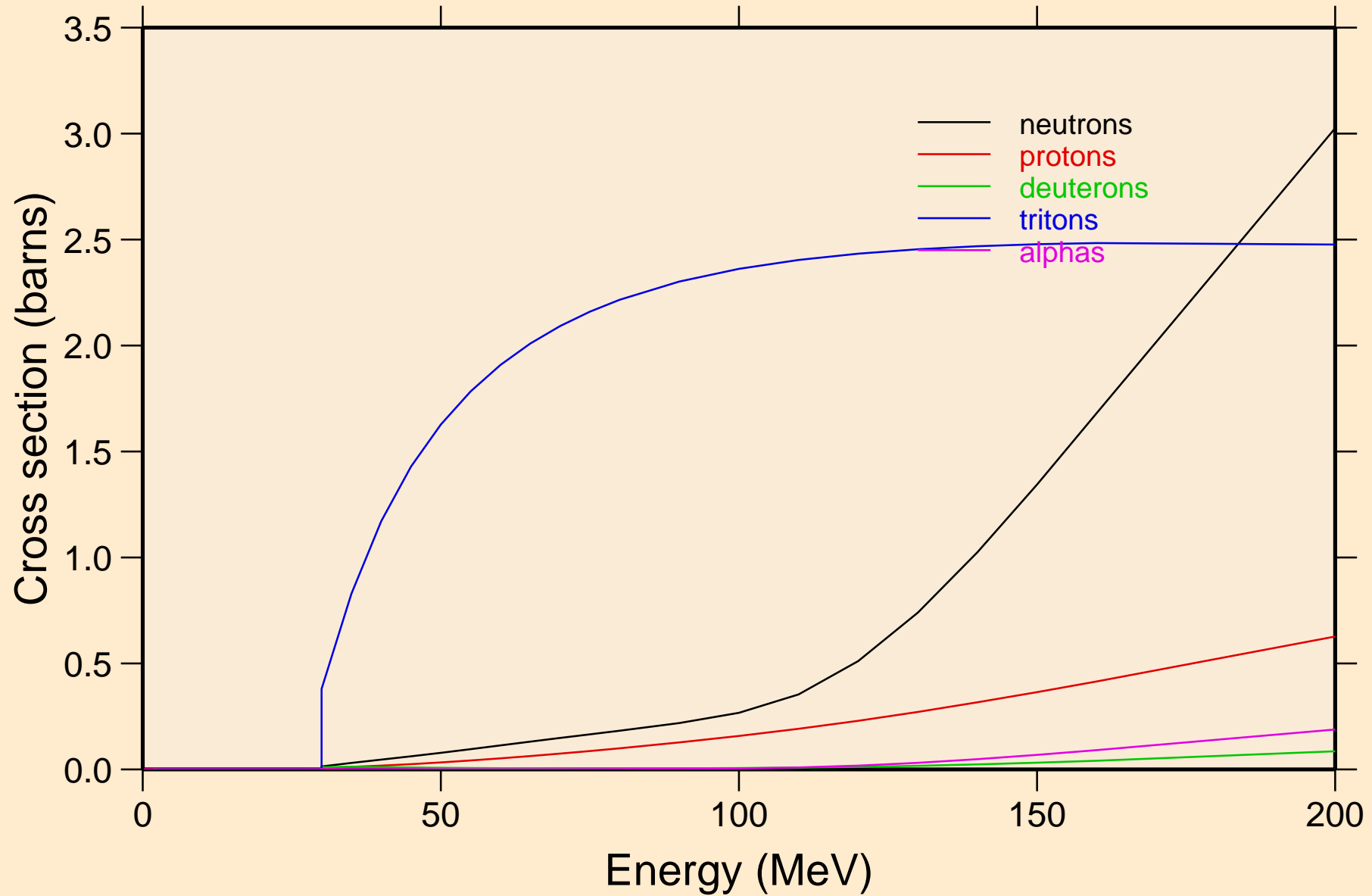

MT277 HELION ACER TENDL-2024 LIBRARY; T=0.K  
neutrons from (s,n)

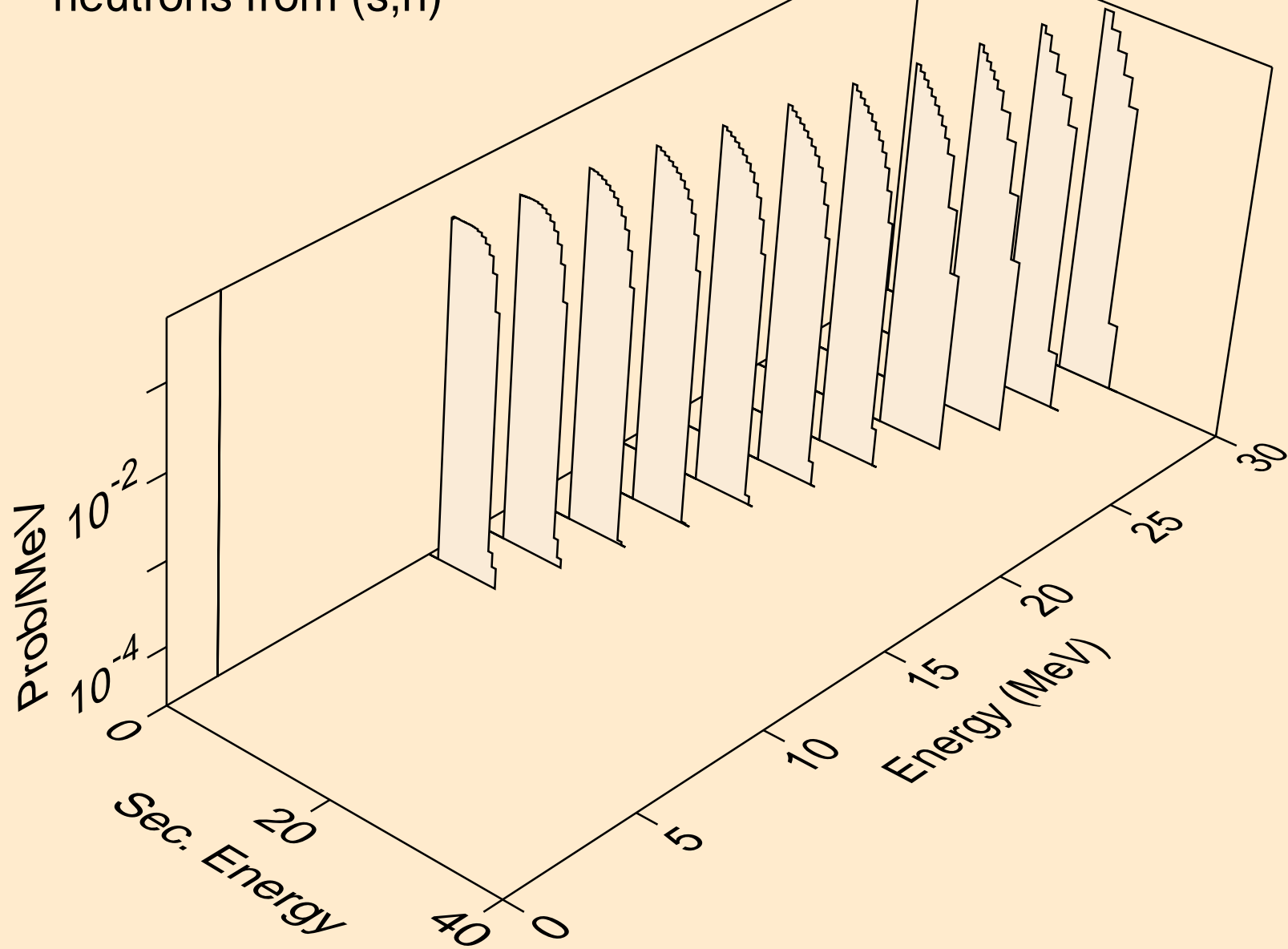

MT277 HELION ACER TENDL-2024 LIBRARY; T=0.K  
neutrons from (s,x)

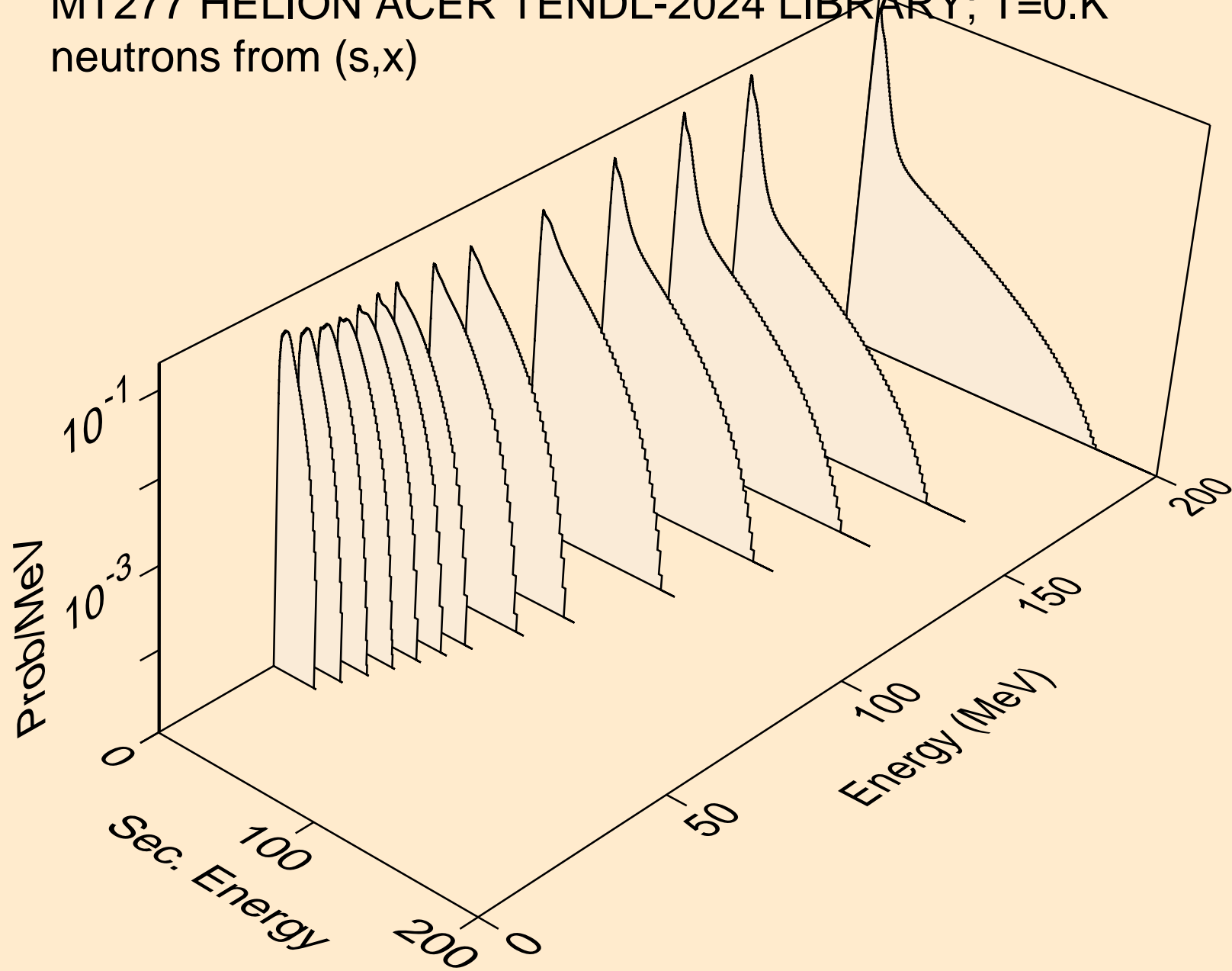

MT277 HELION ACER TENDL-2024 LIBRARY; T=0.K  
neutrons from (s,2n)

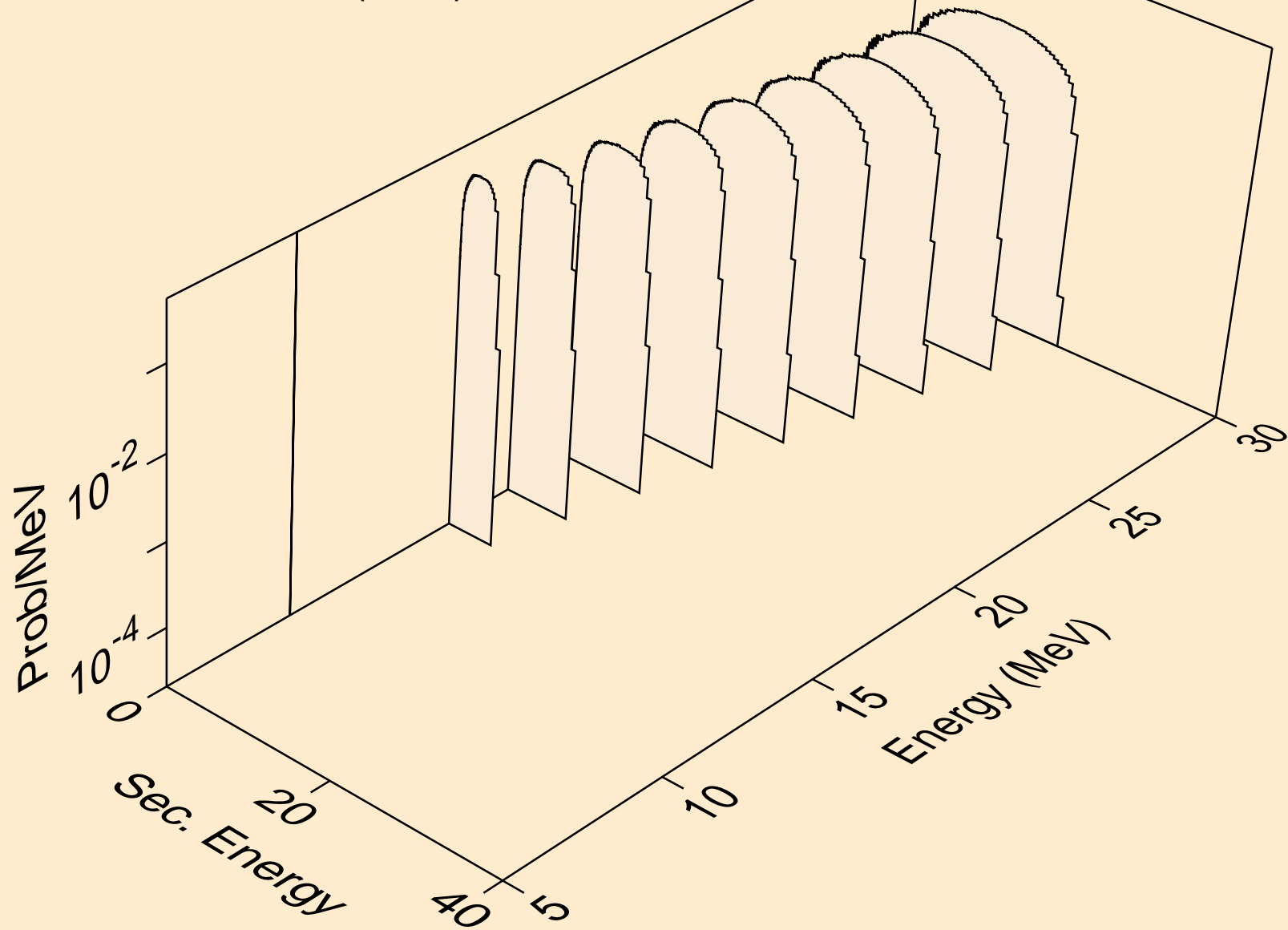

MT277 HELION ACER TENDL-2024 LIBRARY; T=0.K  
neutrons from (s,n\*)d

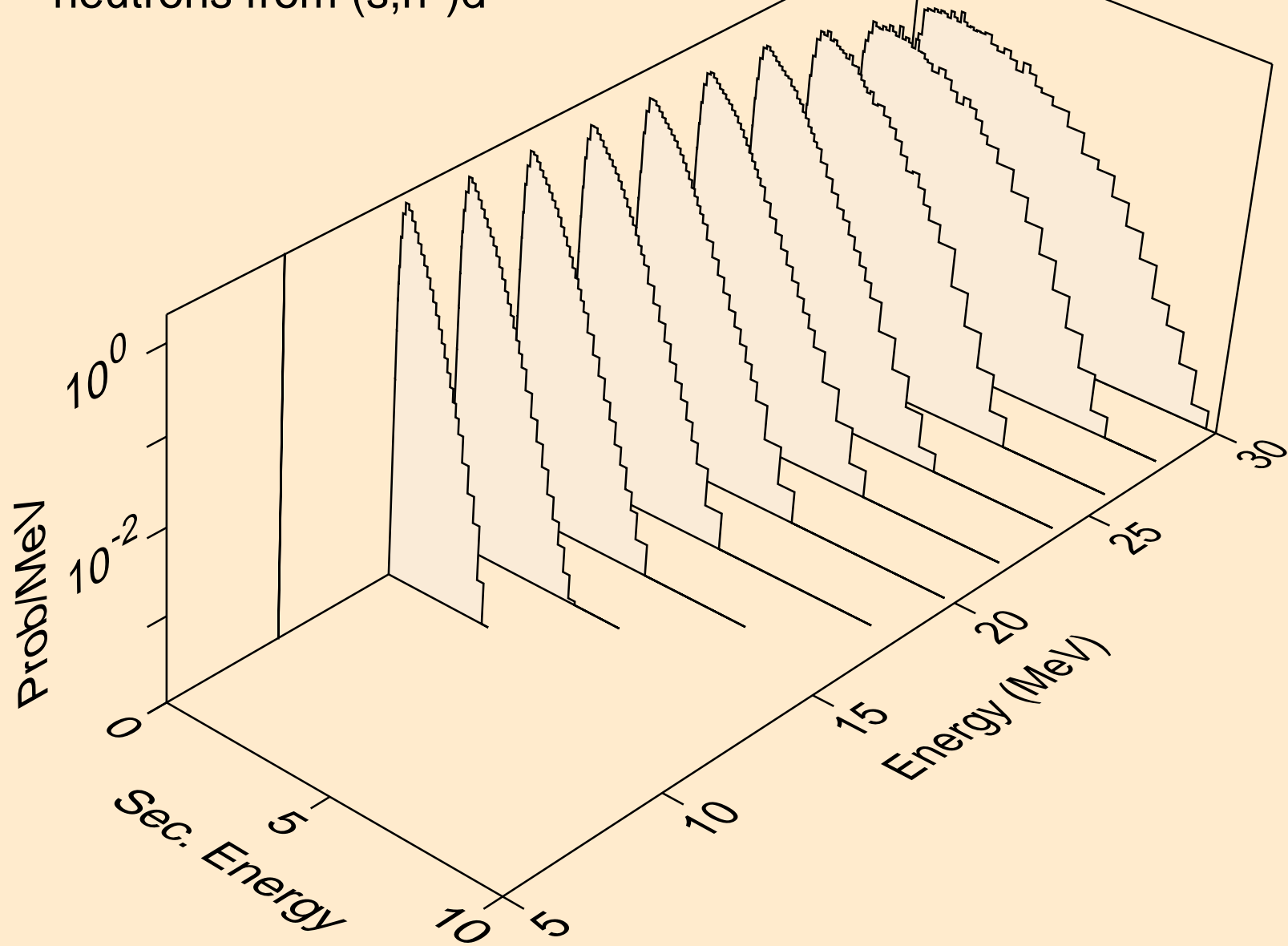

MT277 HELION ACER TENDL-2024 LIBRARY; T=0.K  
neutrons from (s,n\*)t

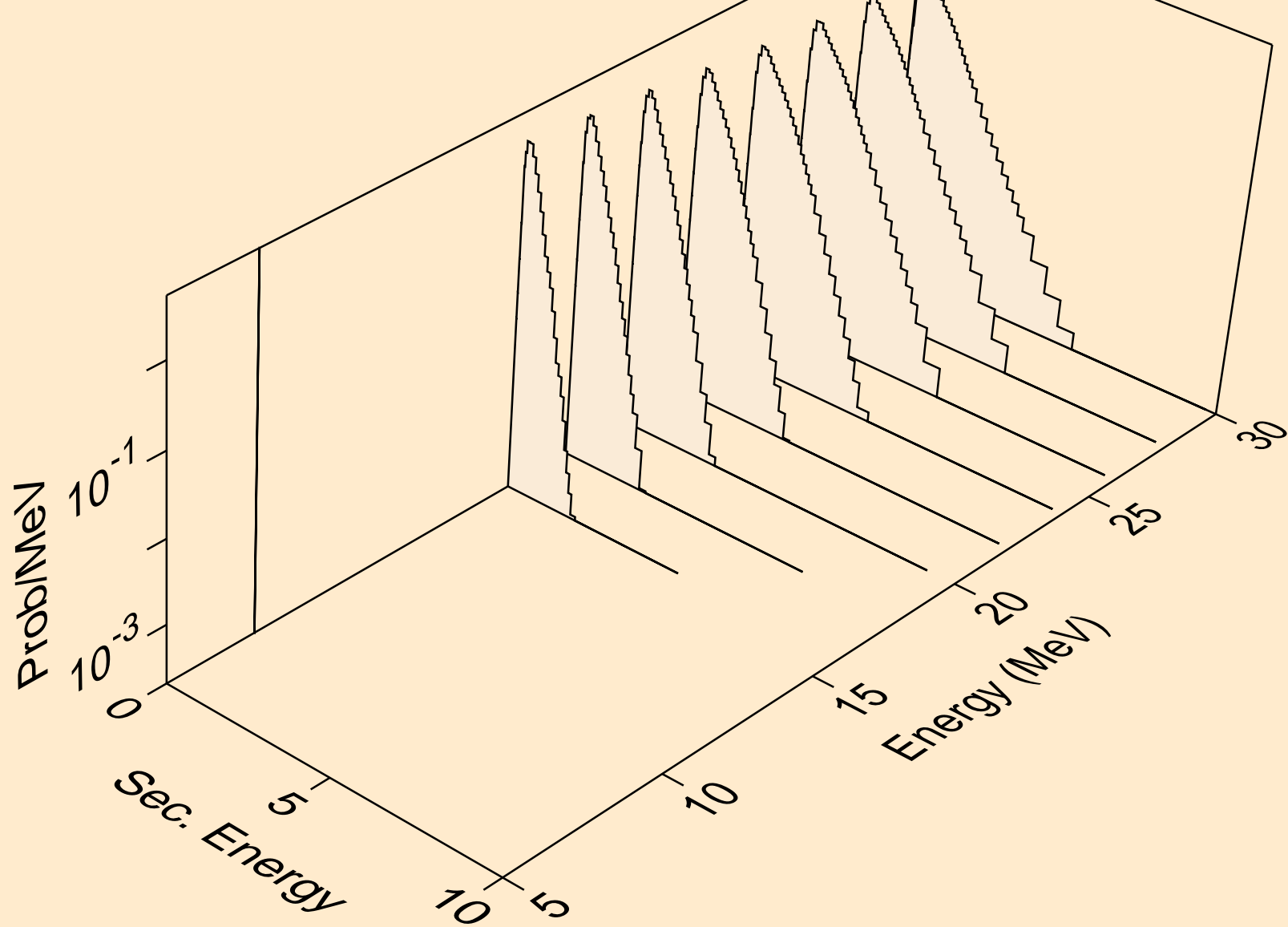

MT277 HELION ACER TENDL-2024 LIBRARY; T=0.K  
protons from (s,x)

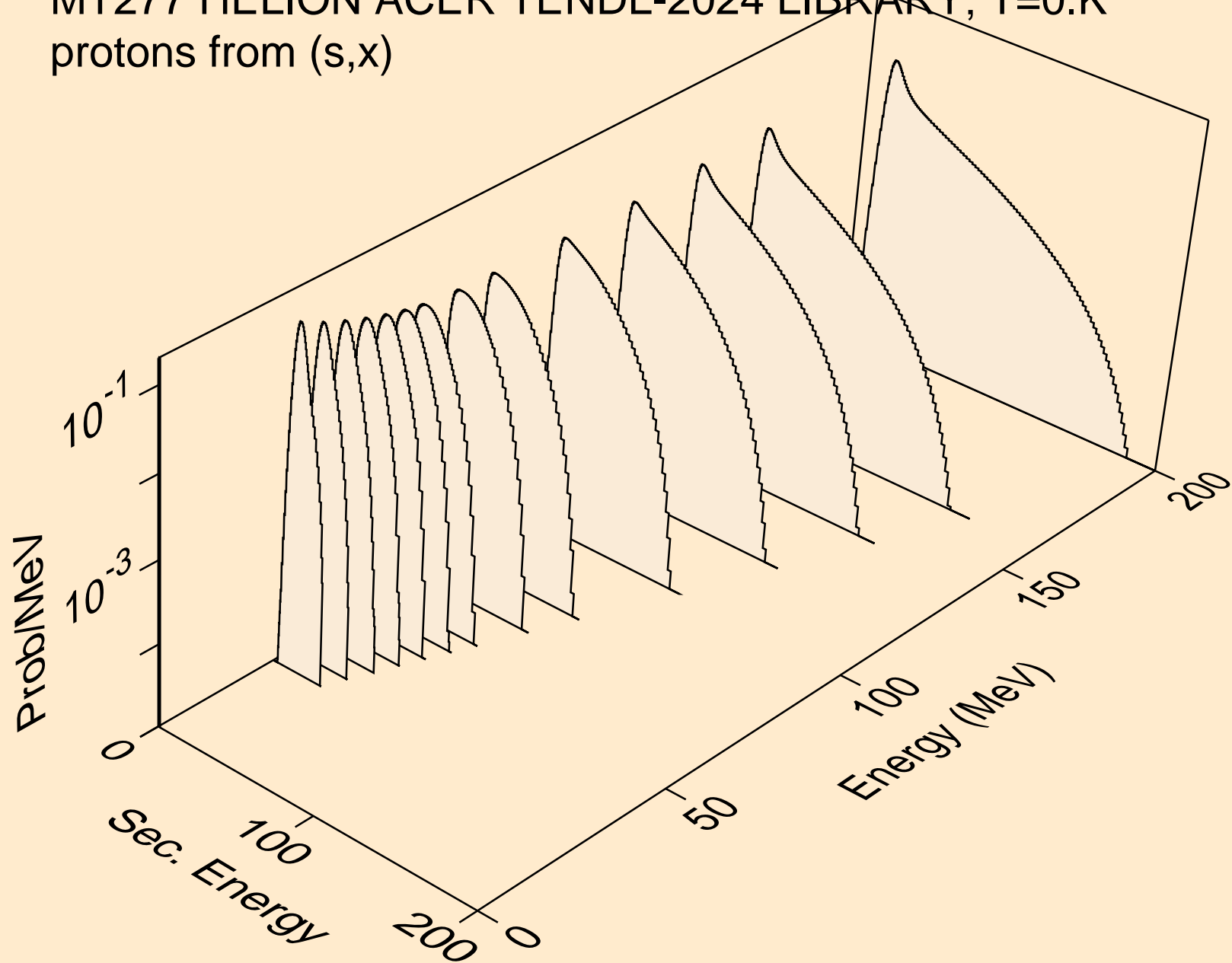

MT277 HELION ACER TENDL-2024 LIBRARY; T=0.K  
protons from (s,p)

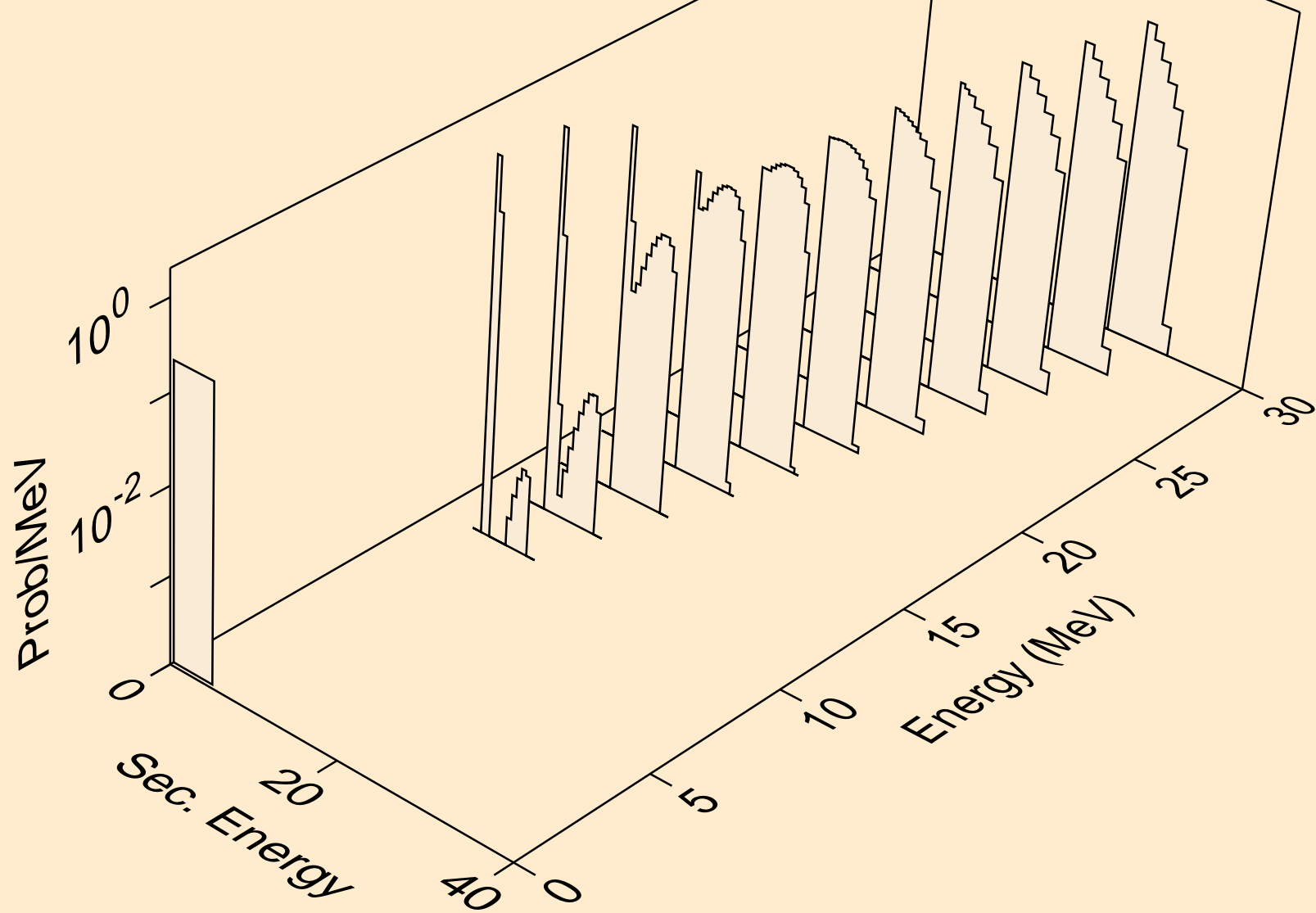

MT277 HELION ACER TENDL-2024 LIBRARY; T=0.K  
deuterons from (s,x)

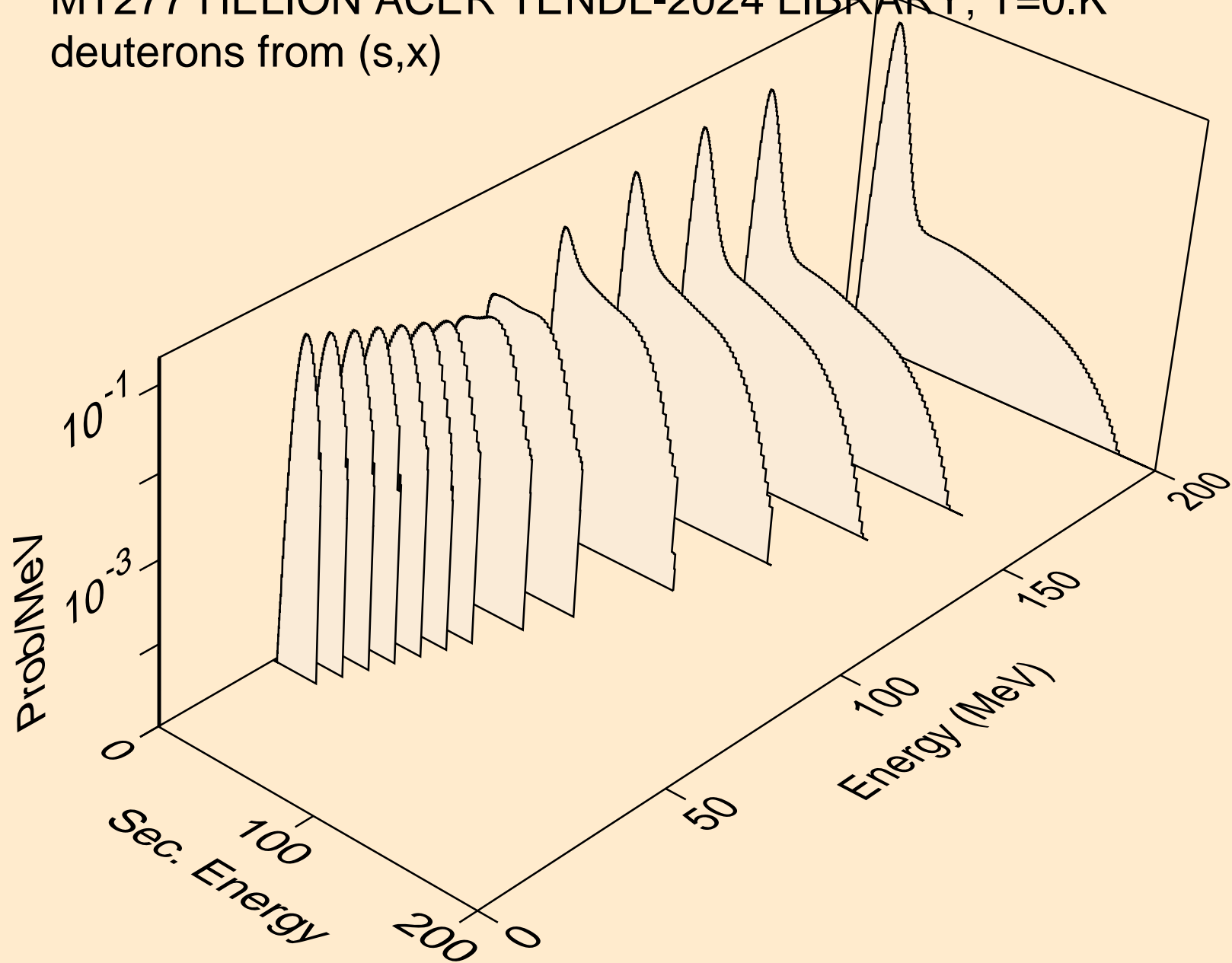

MT277 HELION ACER TENDL-2024 LIBRARY; T=0.K  
deuterons from (s,n\*)d

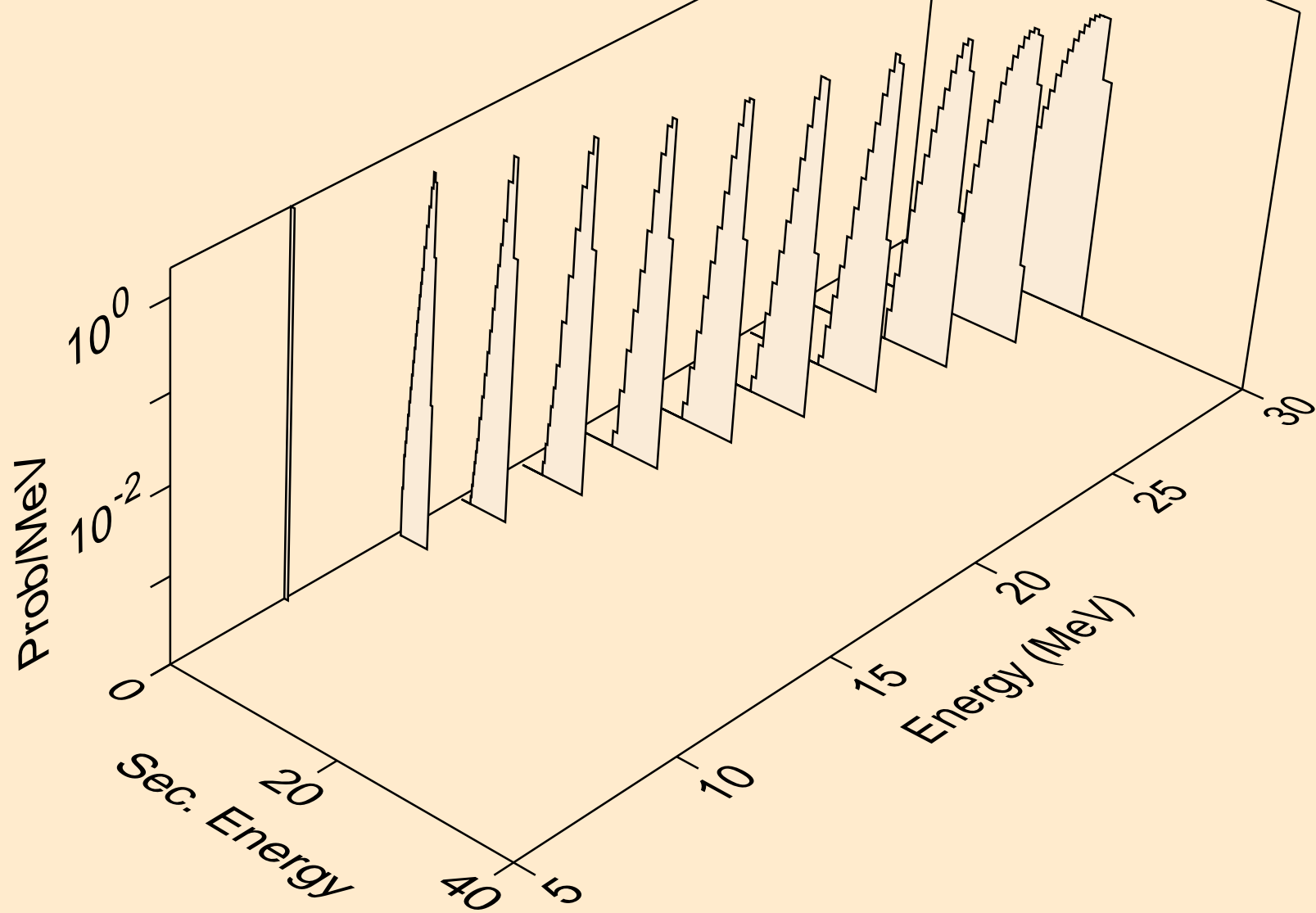

MT277 HELION ACER TENDL-2024 LIBRARY; T=0.K  
deuterons from (s,d)

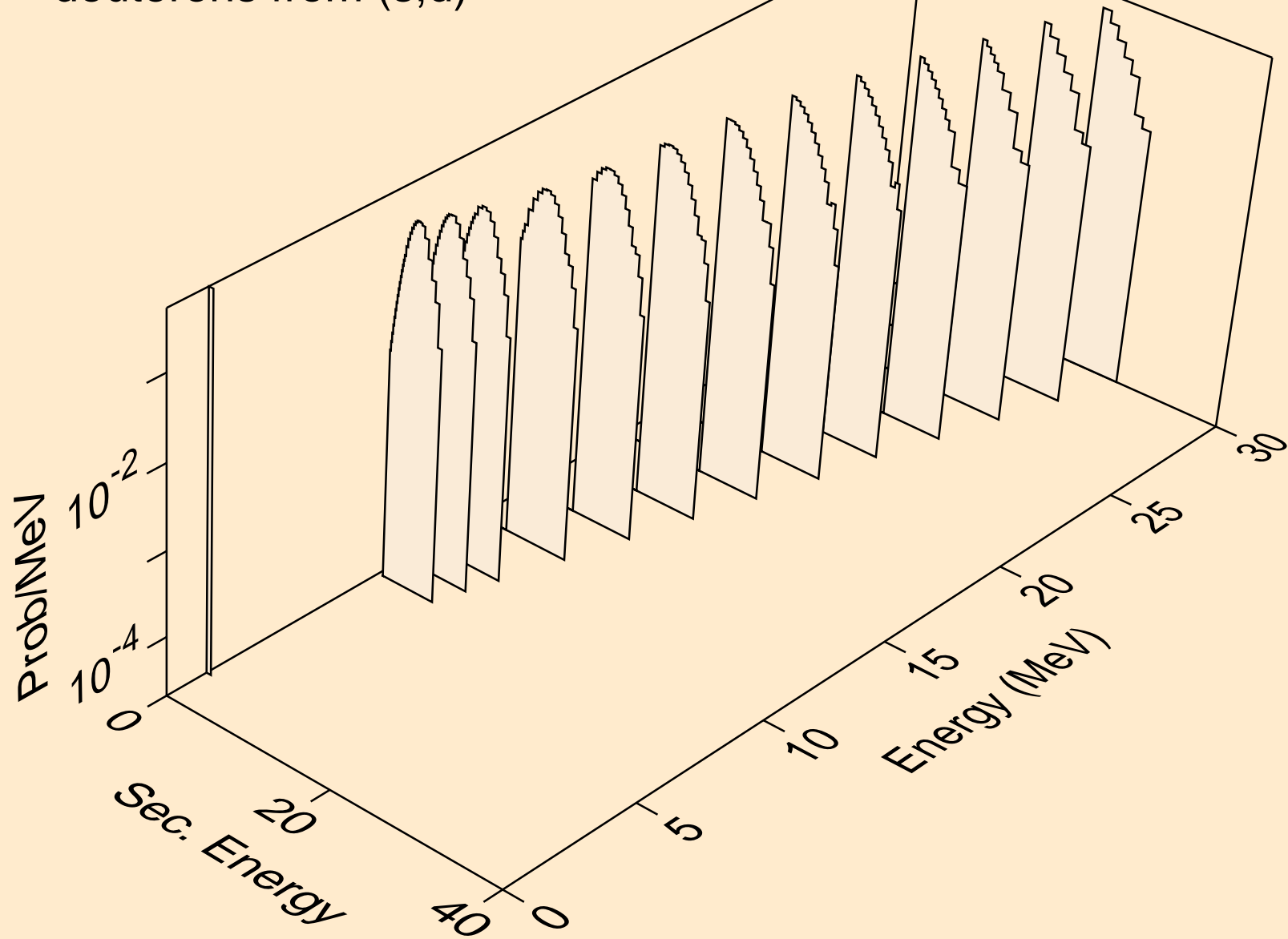

MT277 HELION ACER TENDL-2024 LIBRARY; T=0.K  
tritons from (s,x)

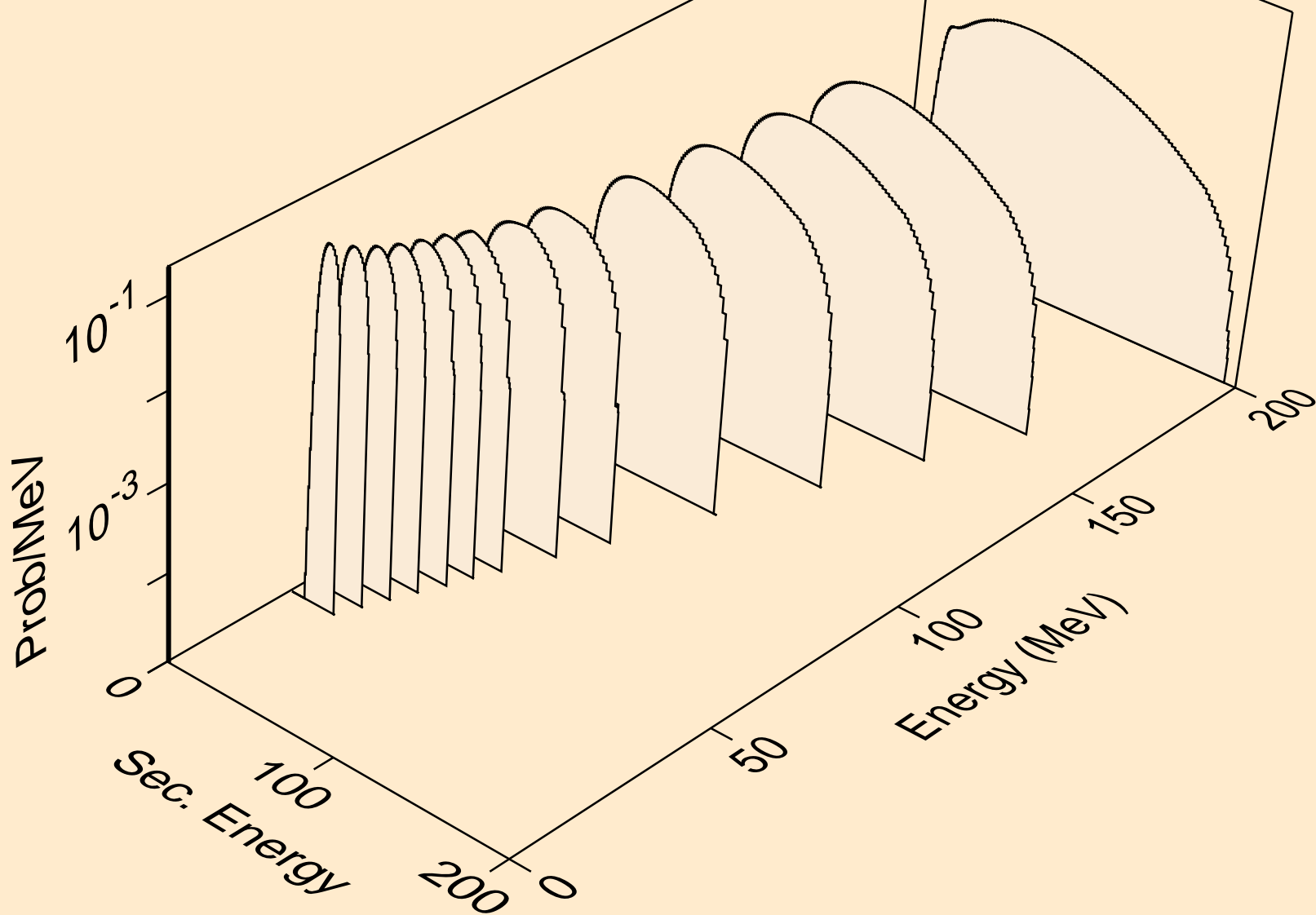

MT277 HELION ACER TENDL-2024 LIBRARY; T=0.K  
tritons from (s,n\*)t

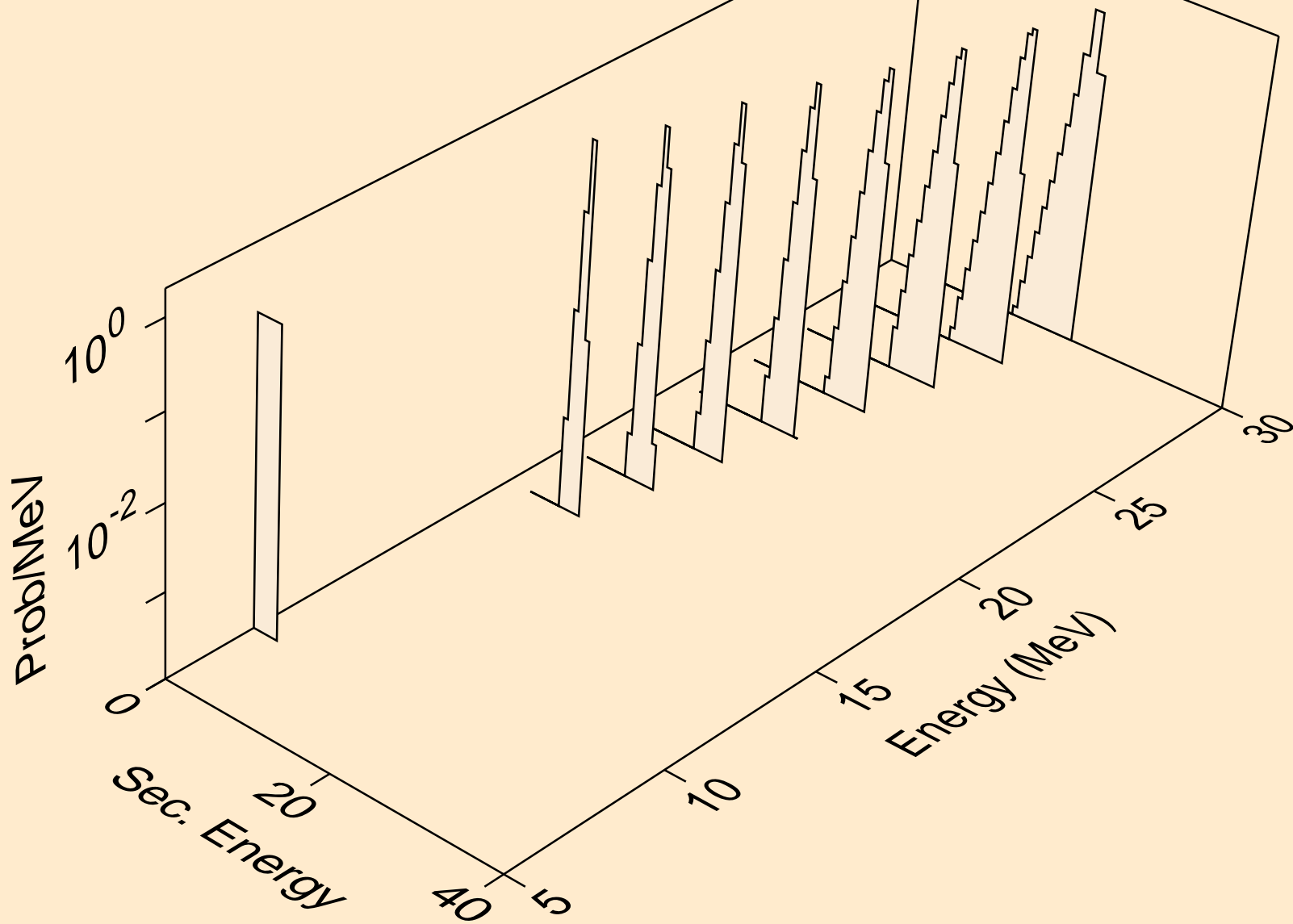

MT277 HELION ACER TENDL-2024 LIBRARY; T=0.K  
tritons from (s,t)

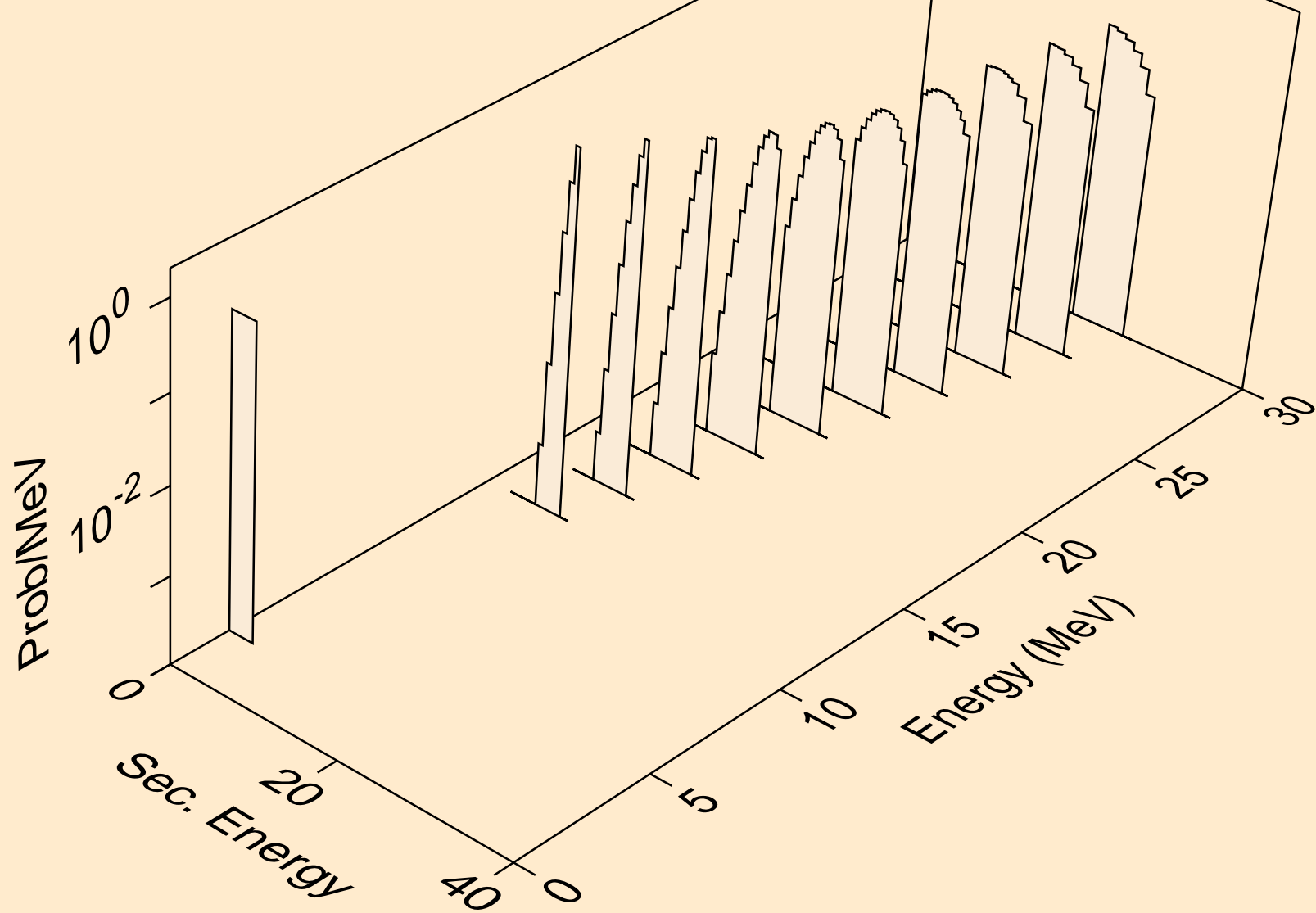

MT277 HELION ACER TENDL-2024 LIBRARY; T=0.K  
alphas from (s,x)

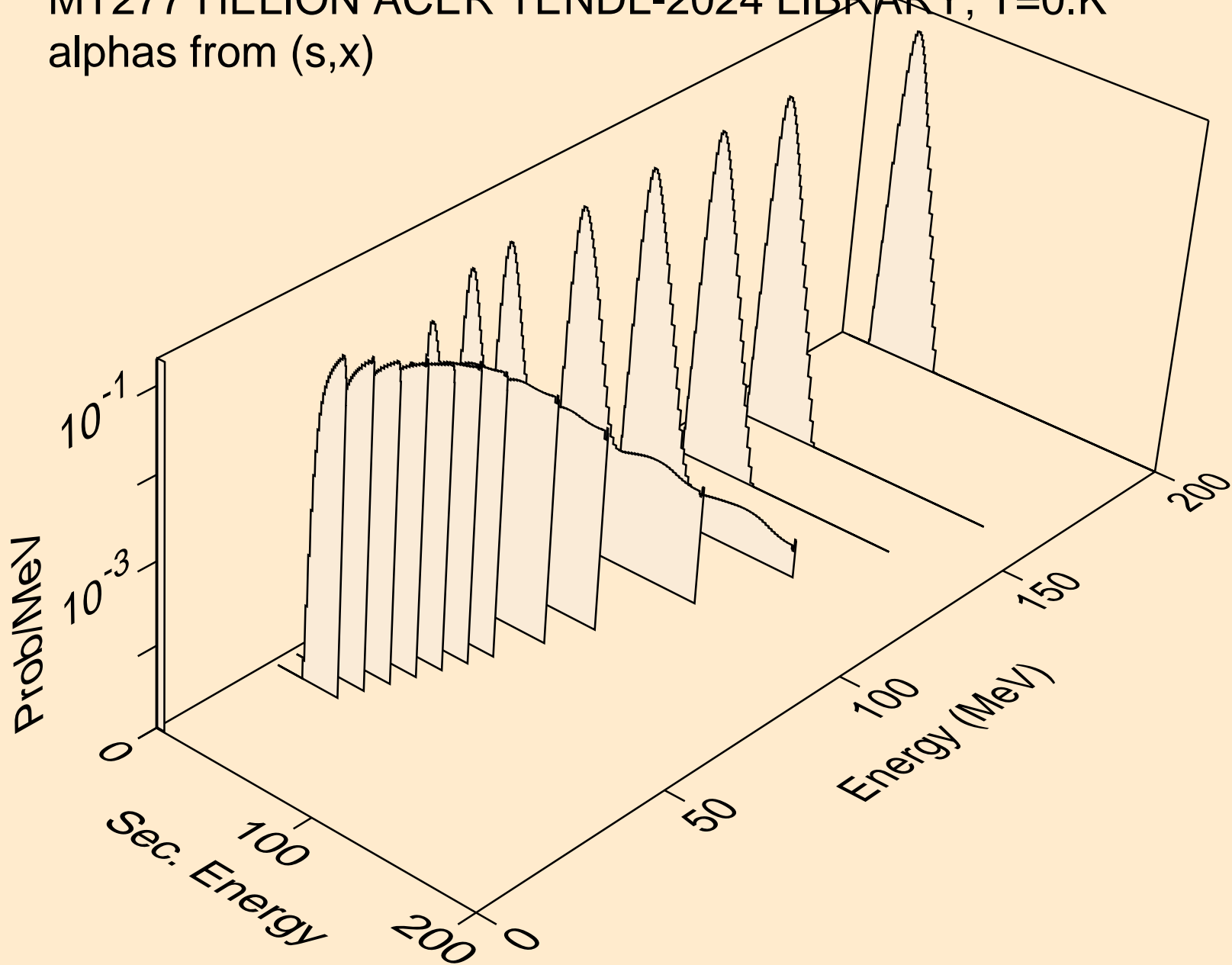

MT277 HELION ACER TENDL-2024 LIBRARY; T=0.K  
alphas from (s,a)

