

# PT204 HELION ACER TENDL-2024 LIBRARY; T=0.K

## Principal cross sections

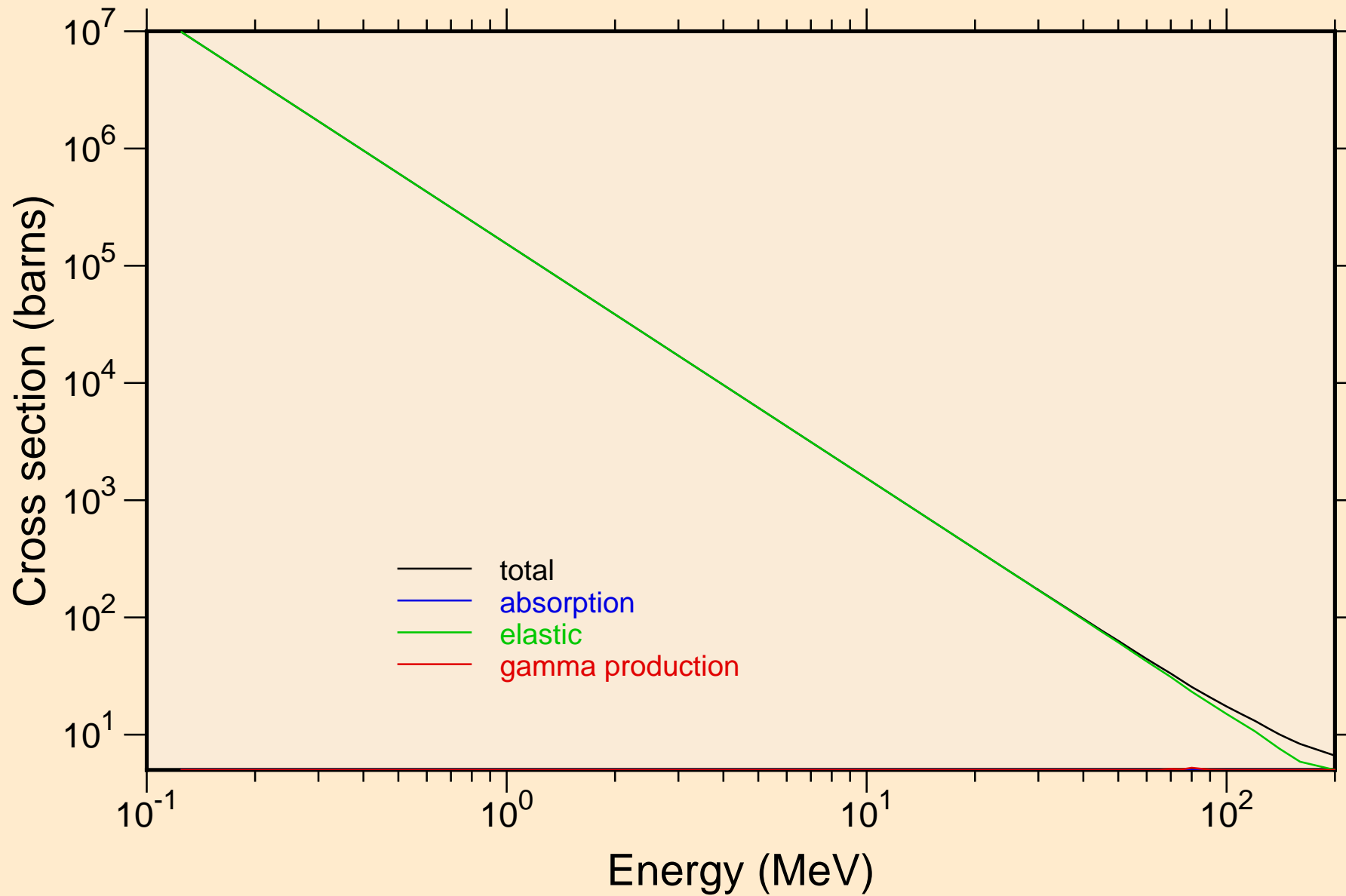

PT204 HELION ACER TENDL-2024 LIBRARY; T=0.K

Heating

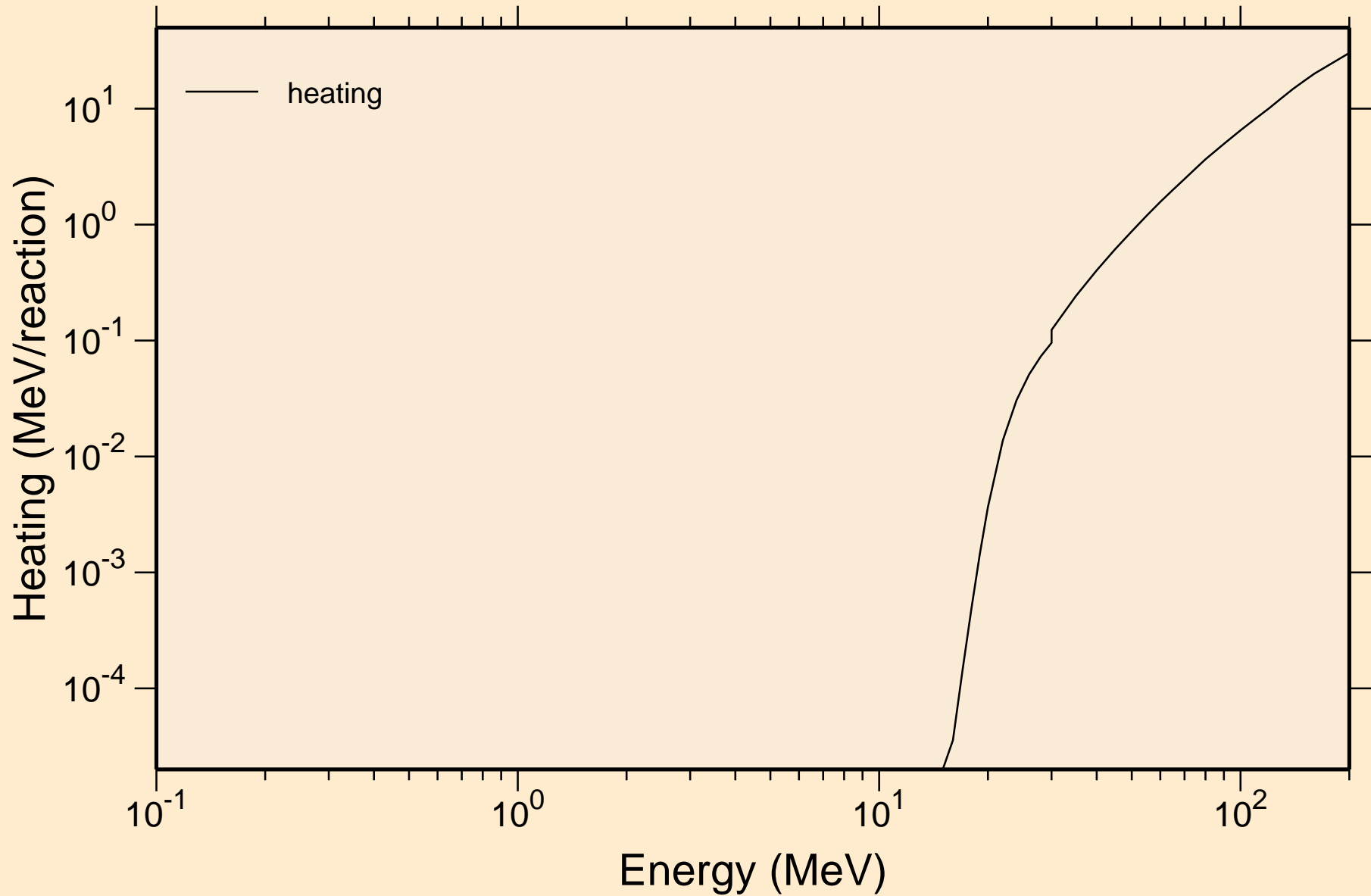

PT204 HELION ACER TENDL-2024 LIBRARY; T=0.K

Principal cross sections

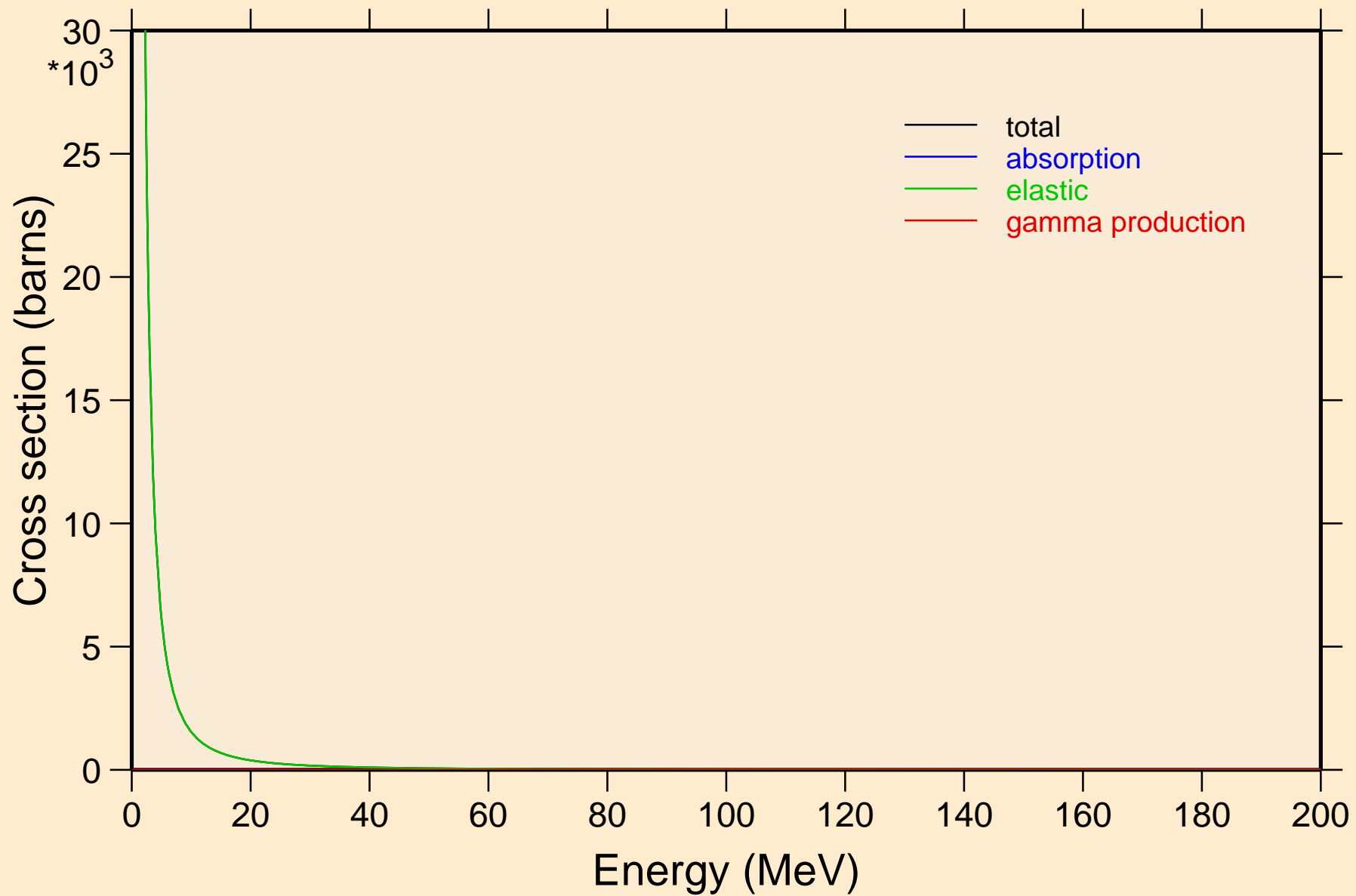

PT204 HELION ACER TENDL-2024 LIBRARY; T=0.K

Heating

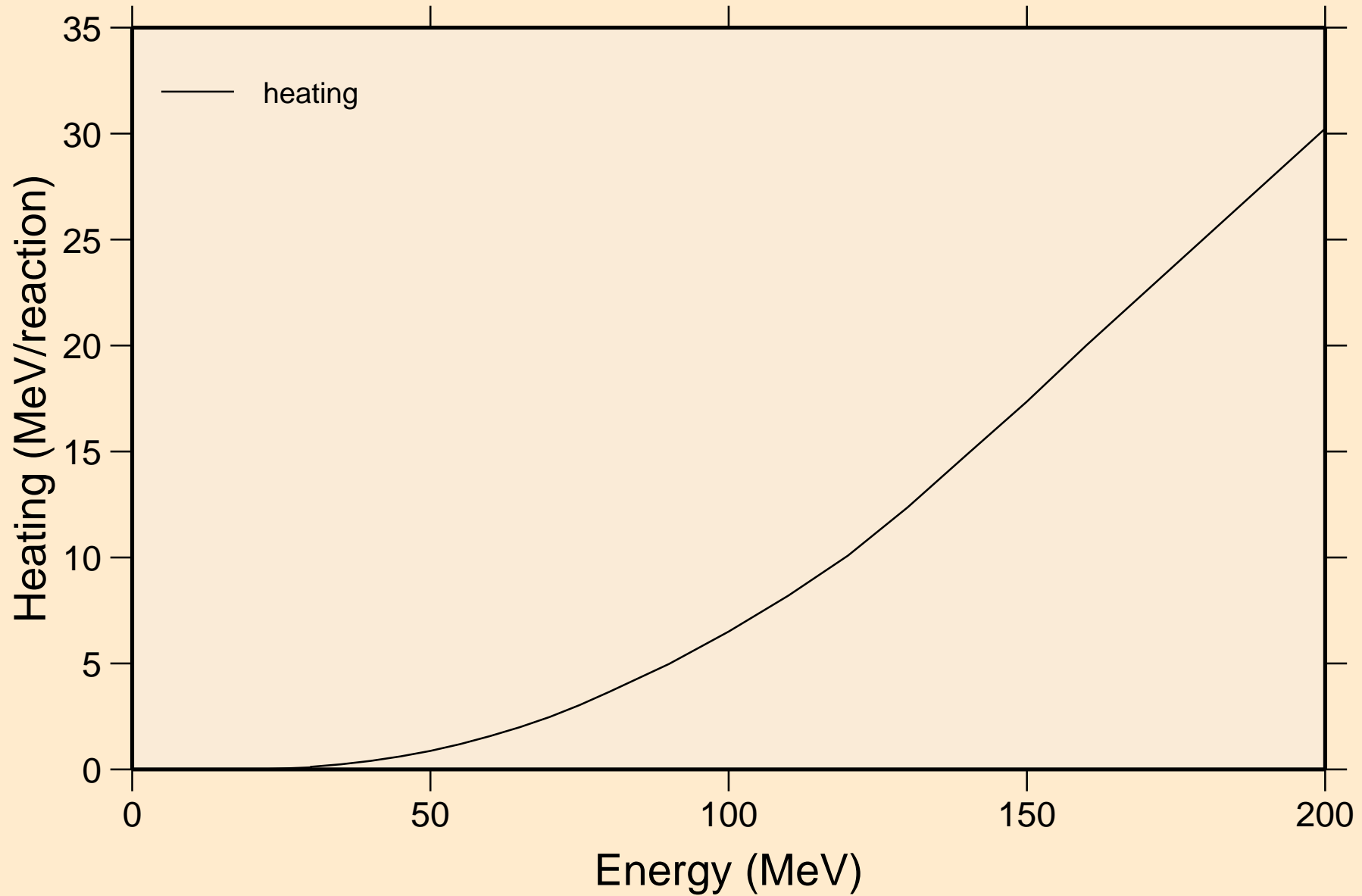

PT204 HELION ACER TENDL-2024 LIBRARY; T=0.K  
Threshold reactions

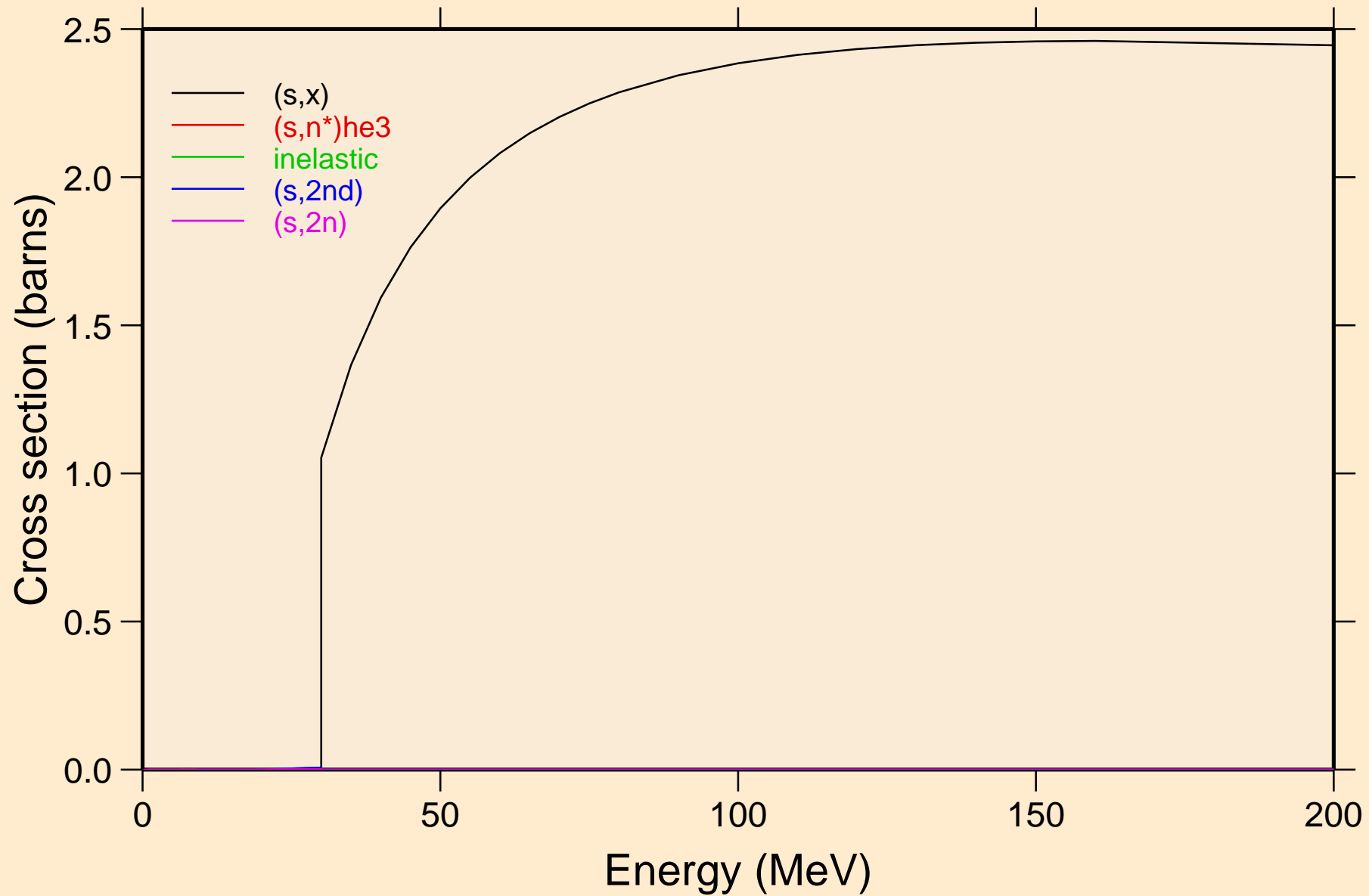

PT204 HELION ACER TENDL-2024 LIBRARY; T=0.K  
Threshold reactions

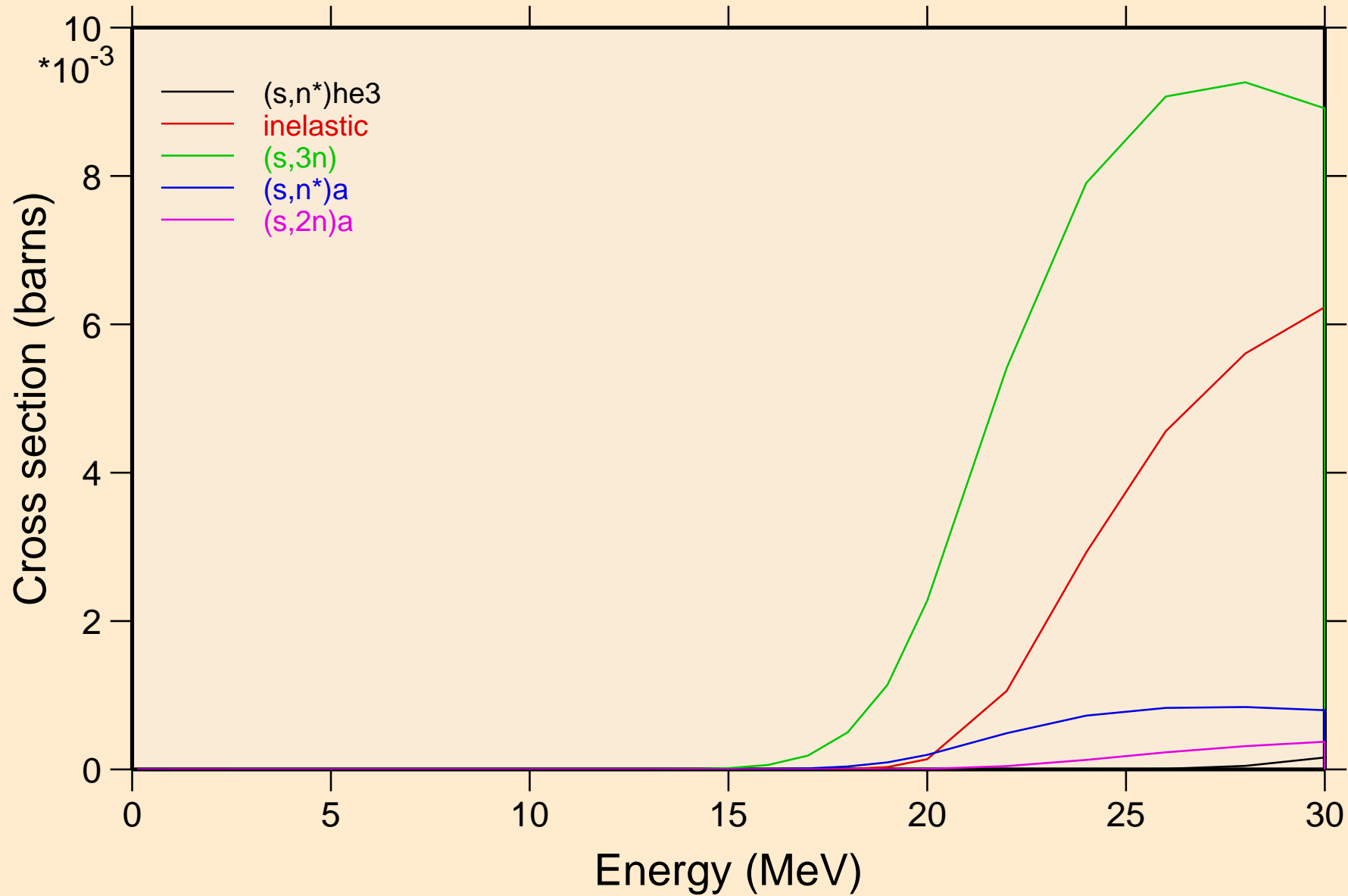

PT204 HELION ACER TENDL-2024 LIBRARY; T=0.K  
Threshold reactions

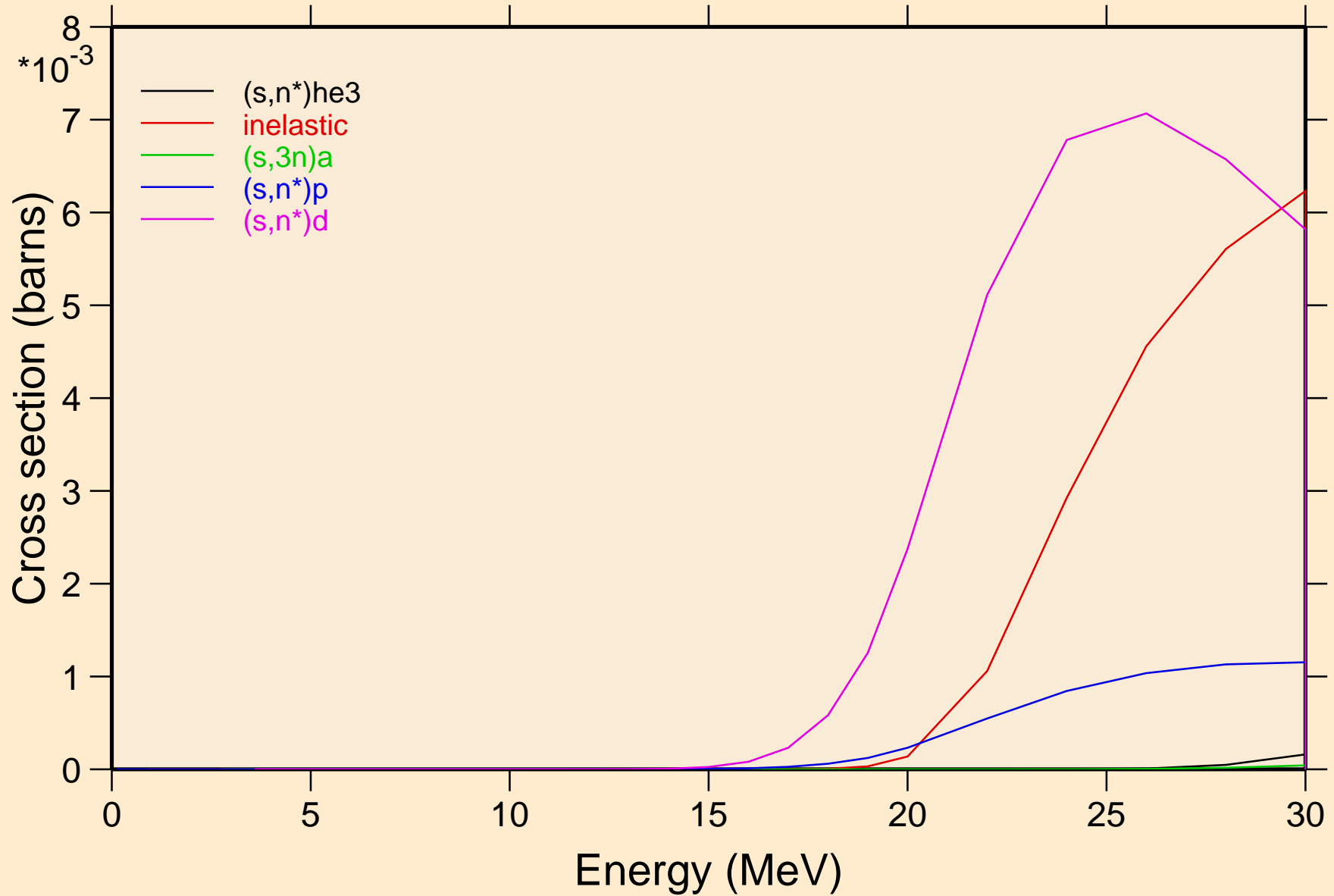

PT204 HELION ACER TENDL-2024 LIBRARY; T=0.K  
Threshold reactions

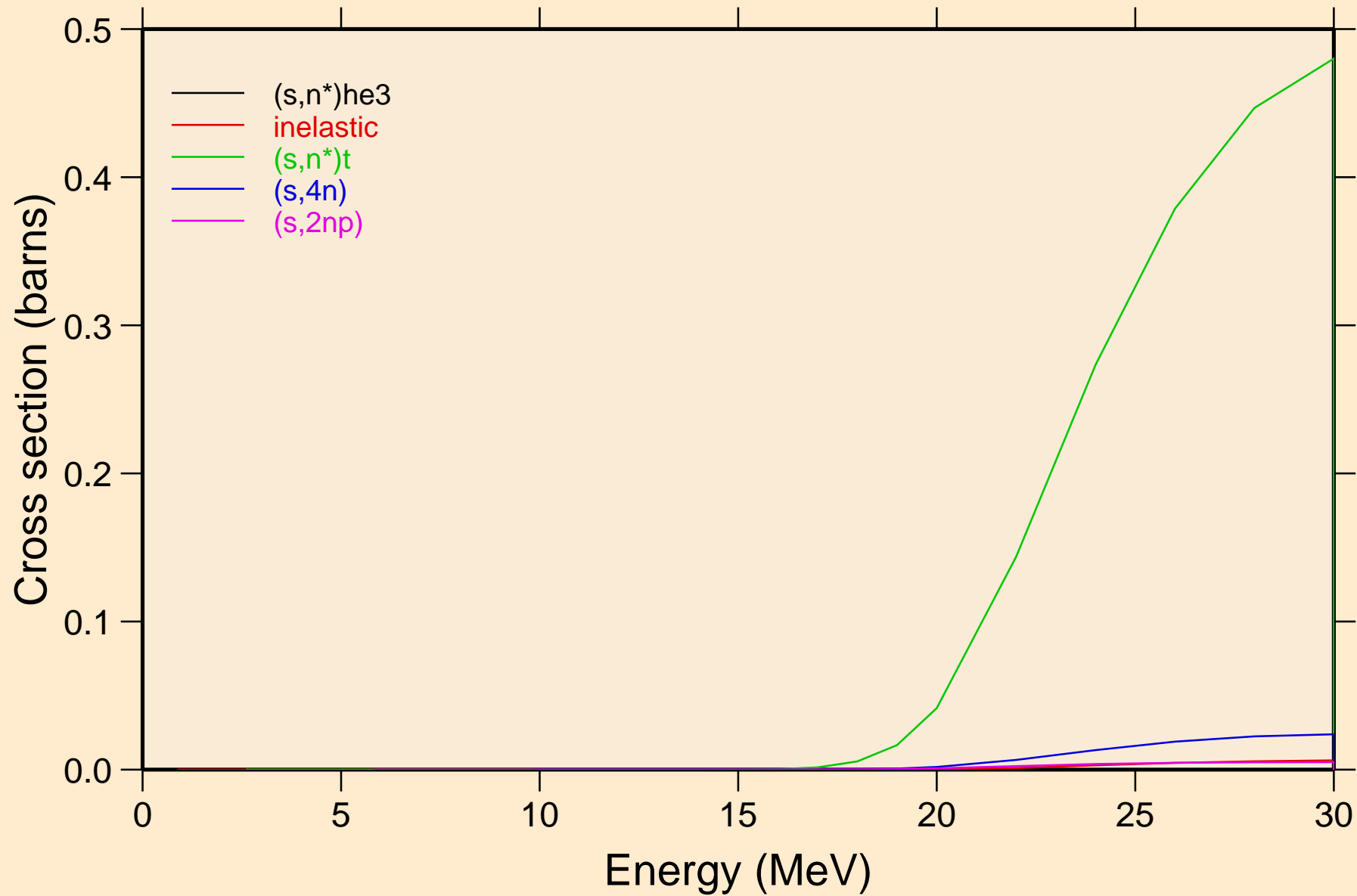

PT204 HELION ACER TENDL-2024 LIBRARY; T=0.K  
Threshold reactions

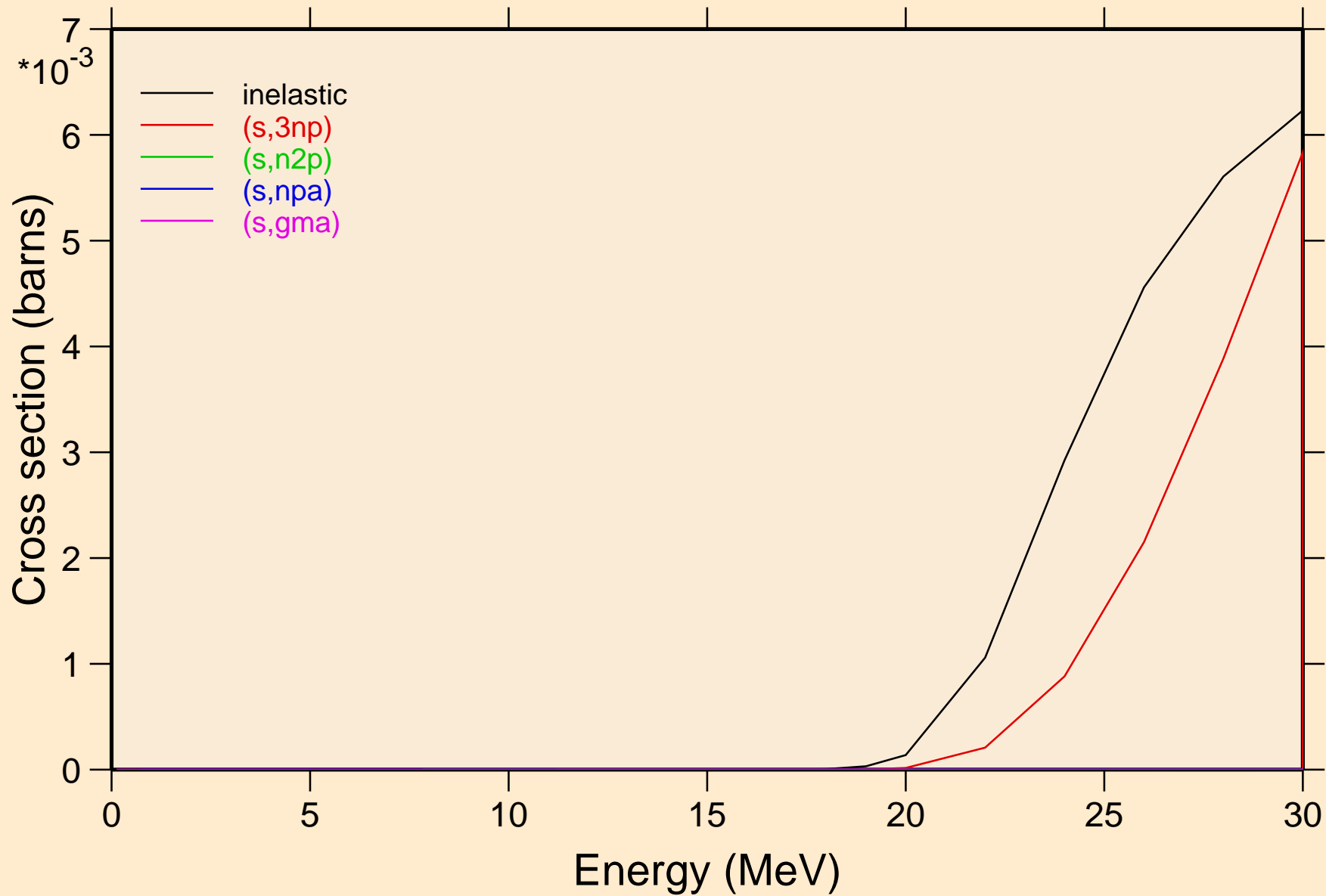

PT204 HELION ACER TENDL-2024 LIBRARY; T=0.K  
Threshold reactions

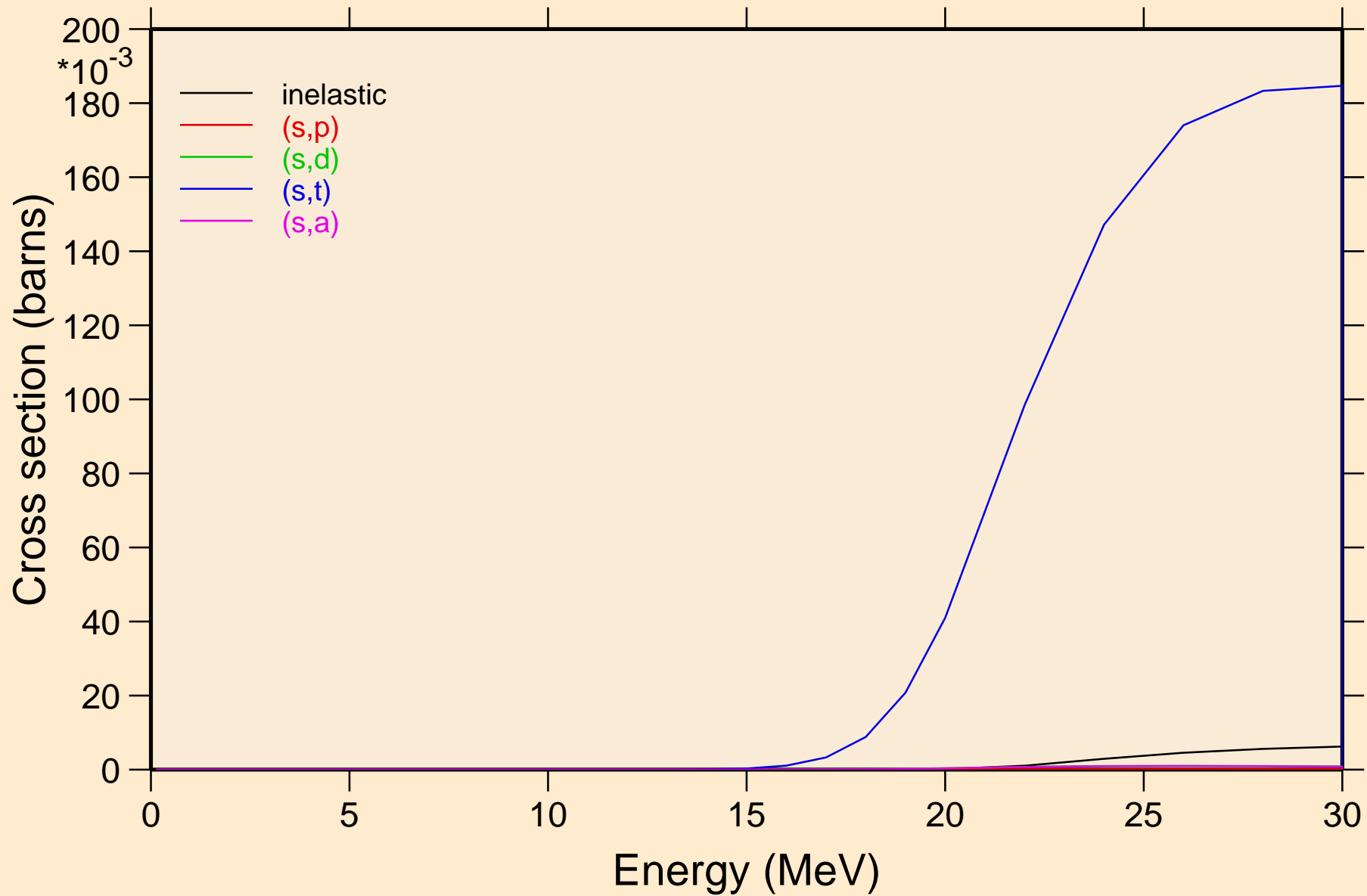

PT204 HELION ACER TENDL-2024 LIBRARY; T=0.K  
Threshold reactions

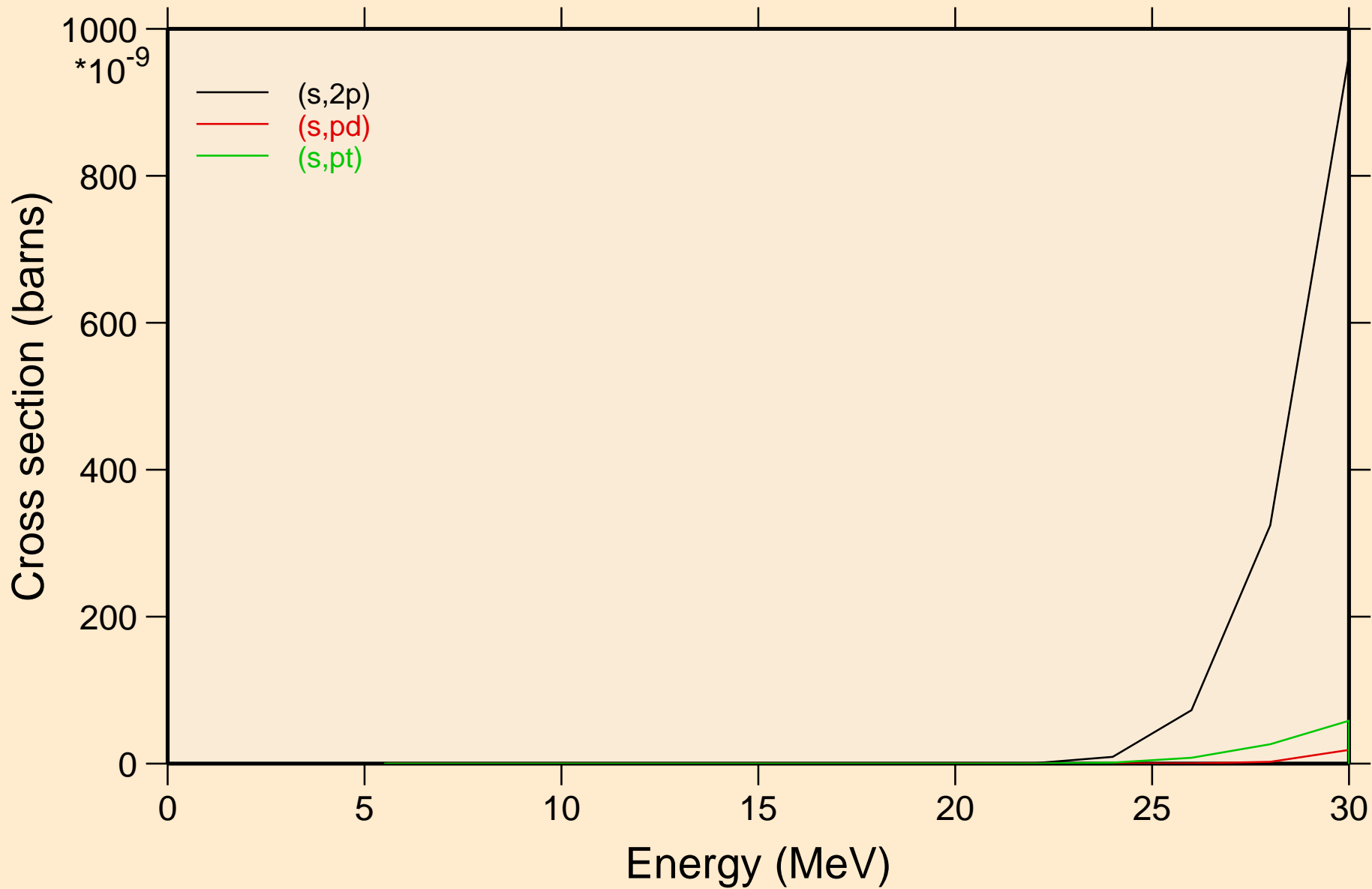

PT204 HELION ACER TENDL-2024 LIBRARY; T=0.K  
angular distribution for elastic

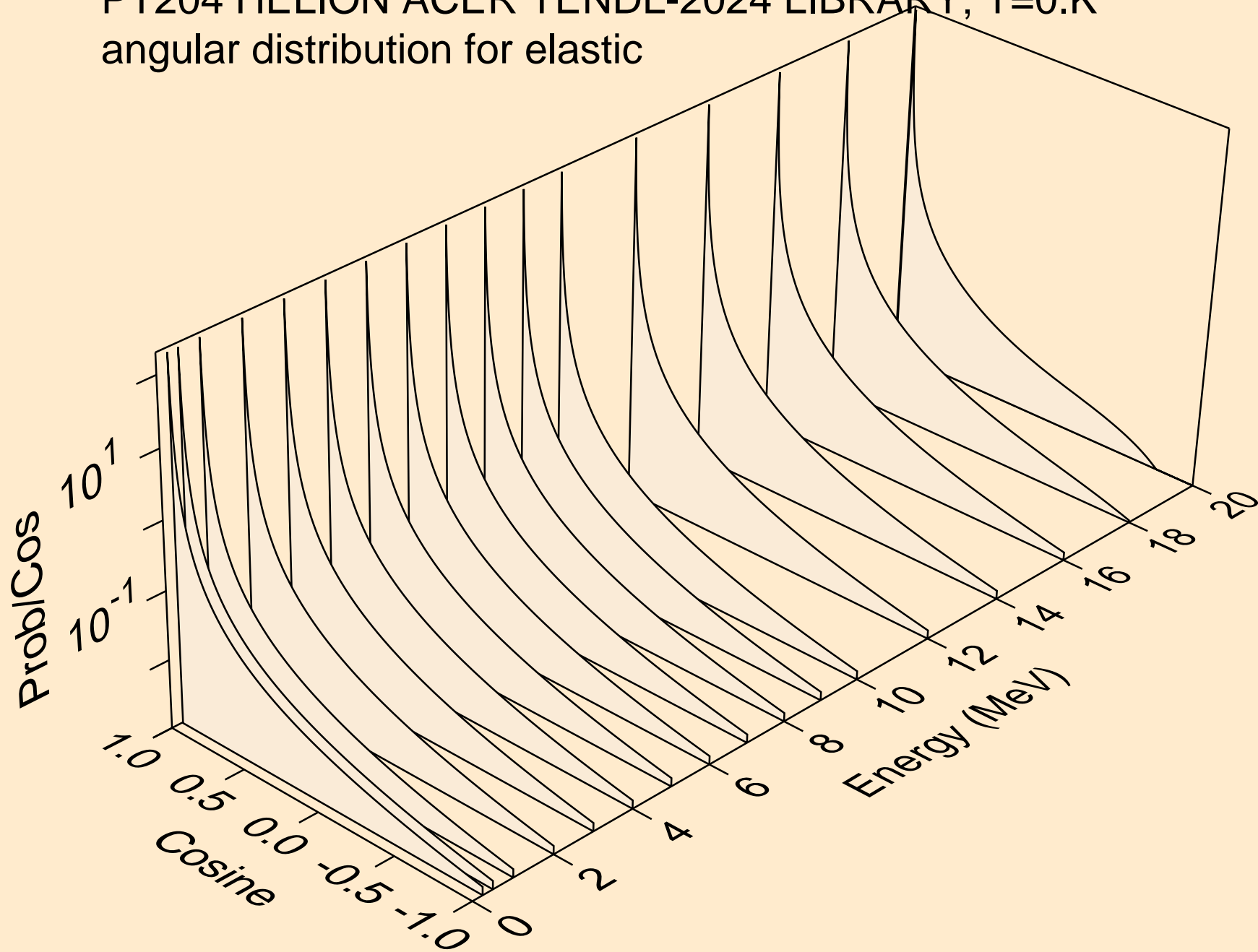

PT204 HELION ACER TENDL-2024 LIBRARY; T=0.K  
angular distribution for elastic

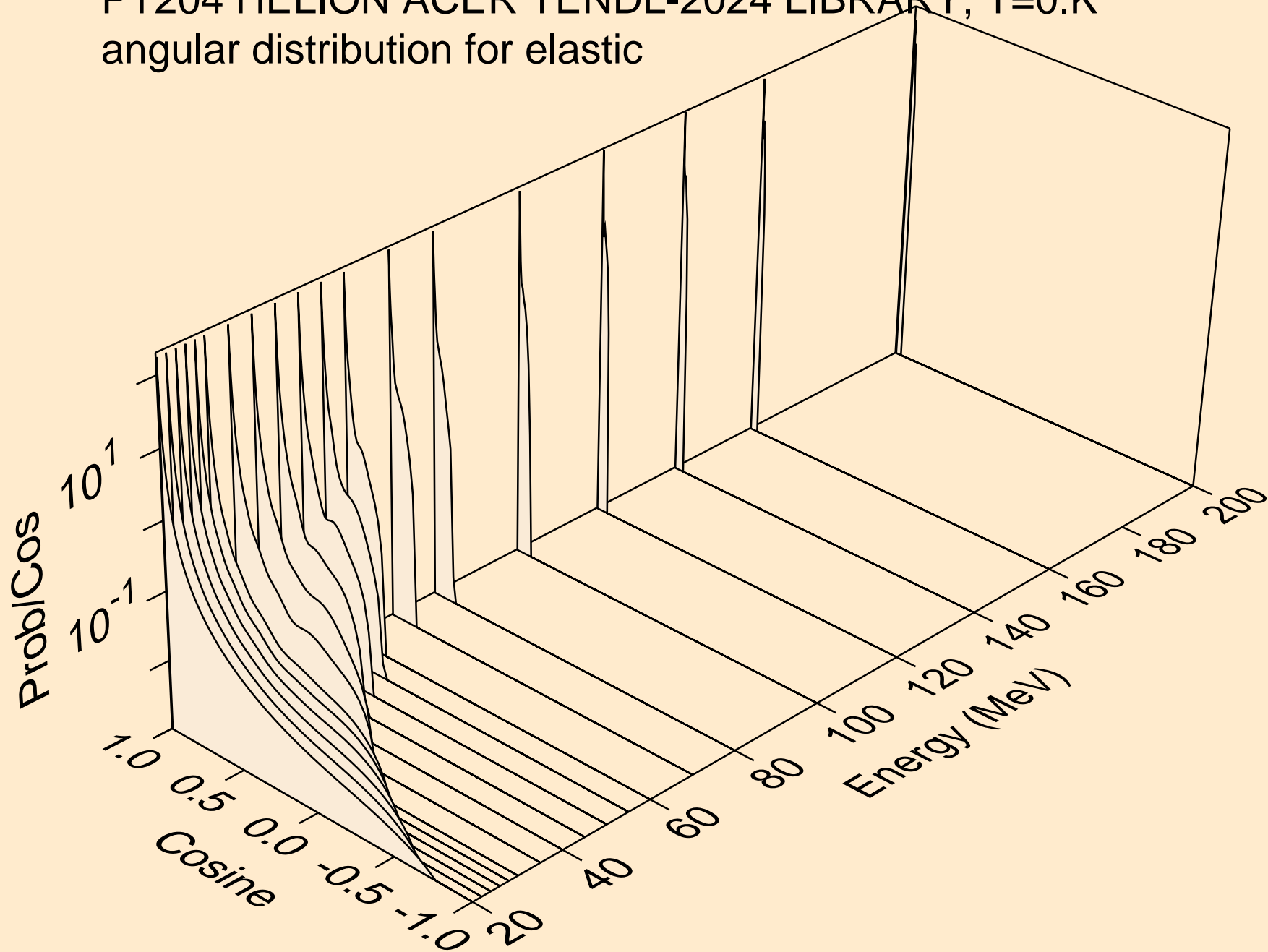

PT204 HELION ACER TENDL-2024 LIBRARY; T=0.K  
He-3 emission for (s,x)

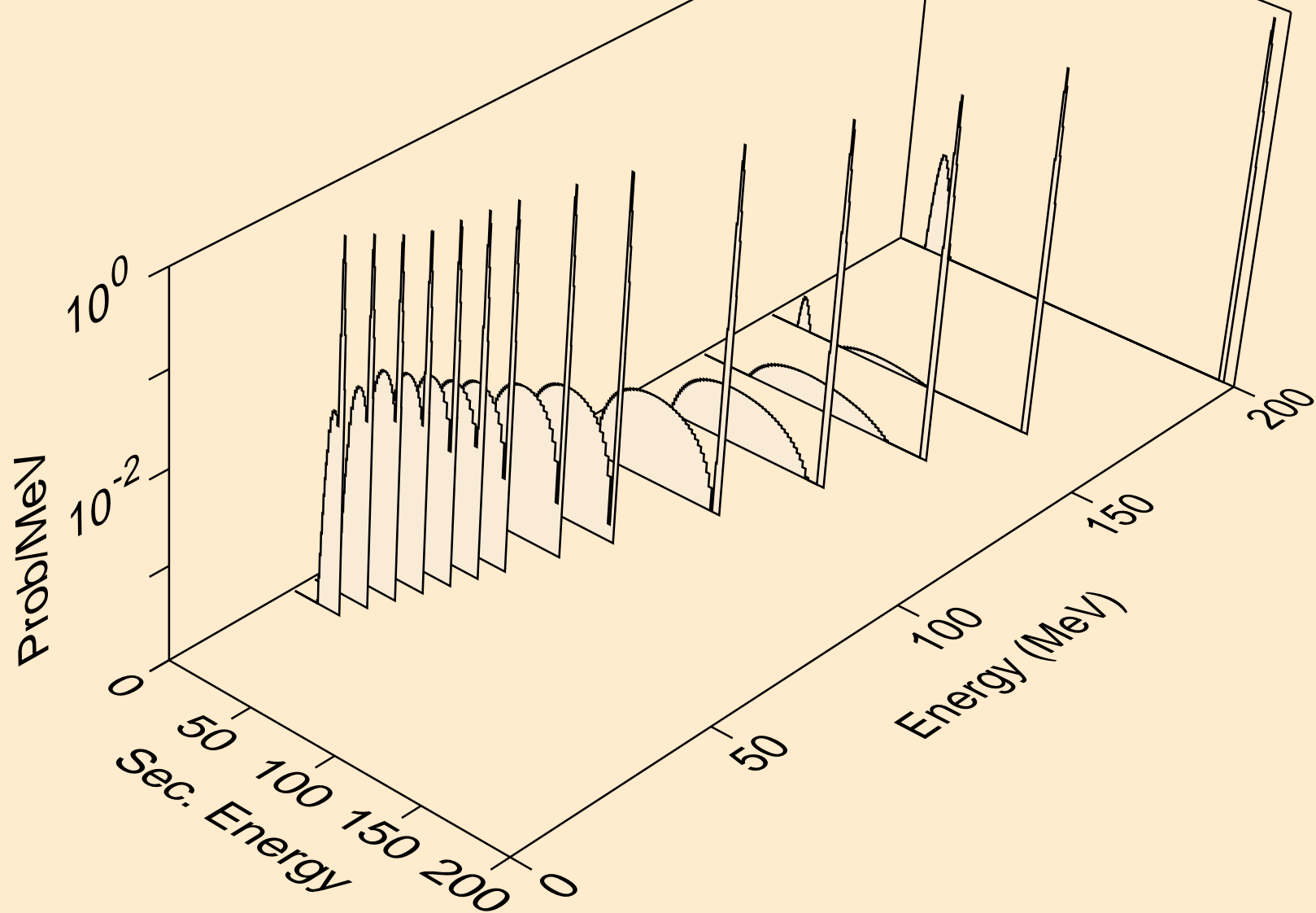

PT204 HELION ACER TENDL-2024 LIBRARY; T=0.K  
He-3 emission for (s,n\*)he3

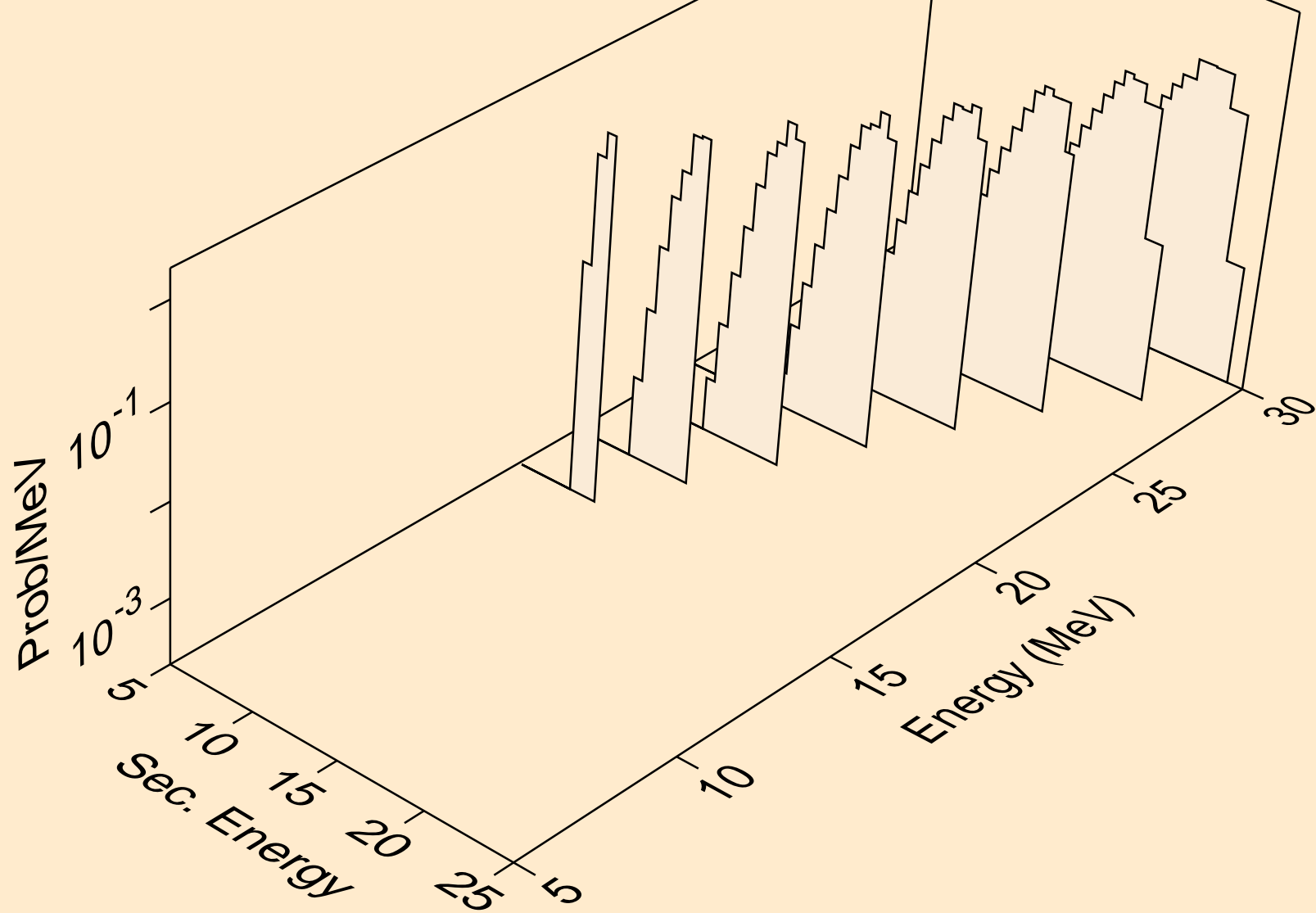

PT204 HELION ACER TENDL-2024 LIBRARY; T=0.K  
He-3 emission for inelastic

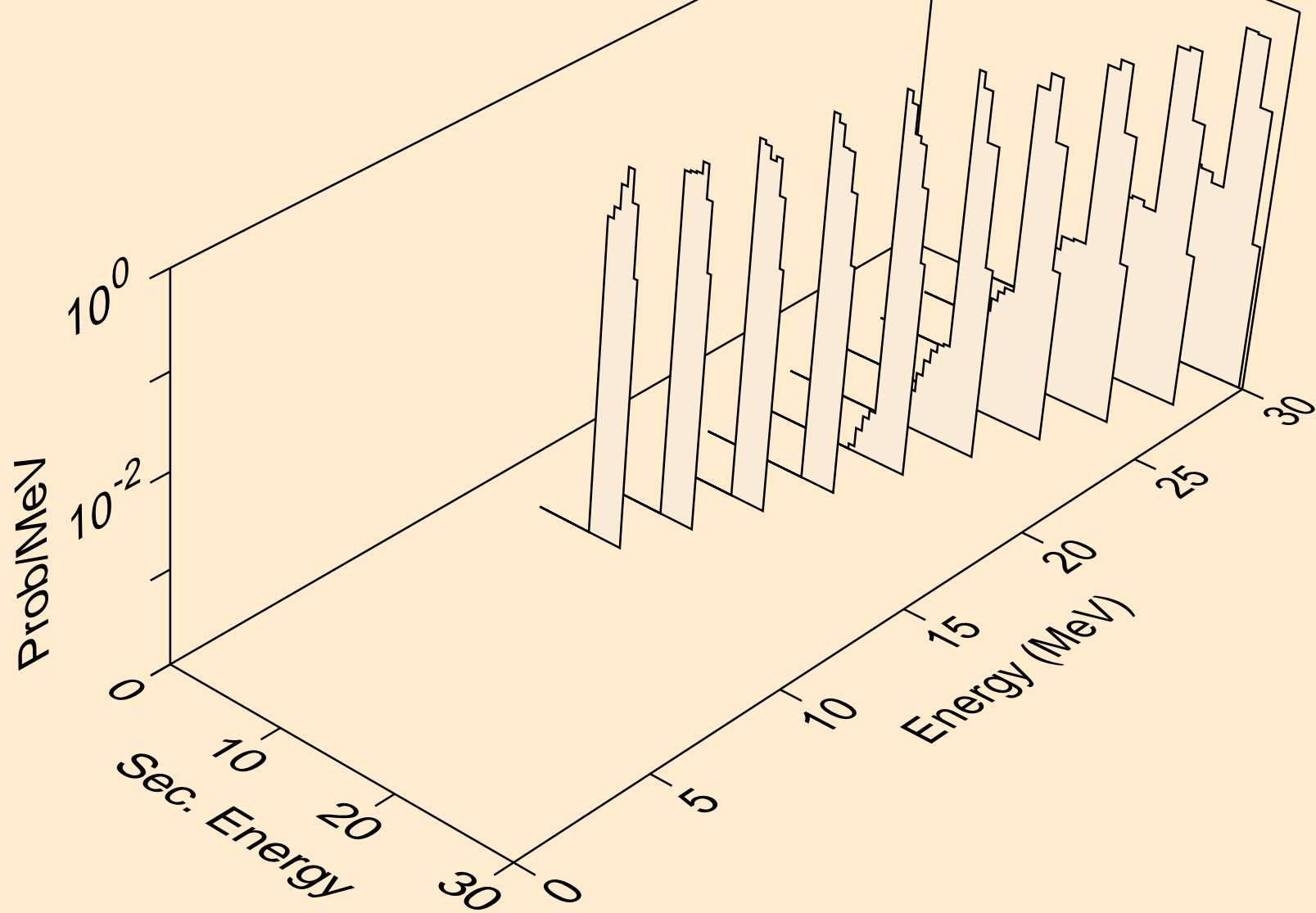

PT204 HELION ACER TENDL-2024 LIBRARY; T=0.K  
Photon emission for (z,n)

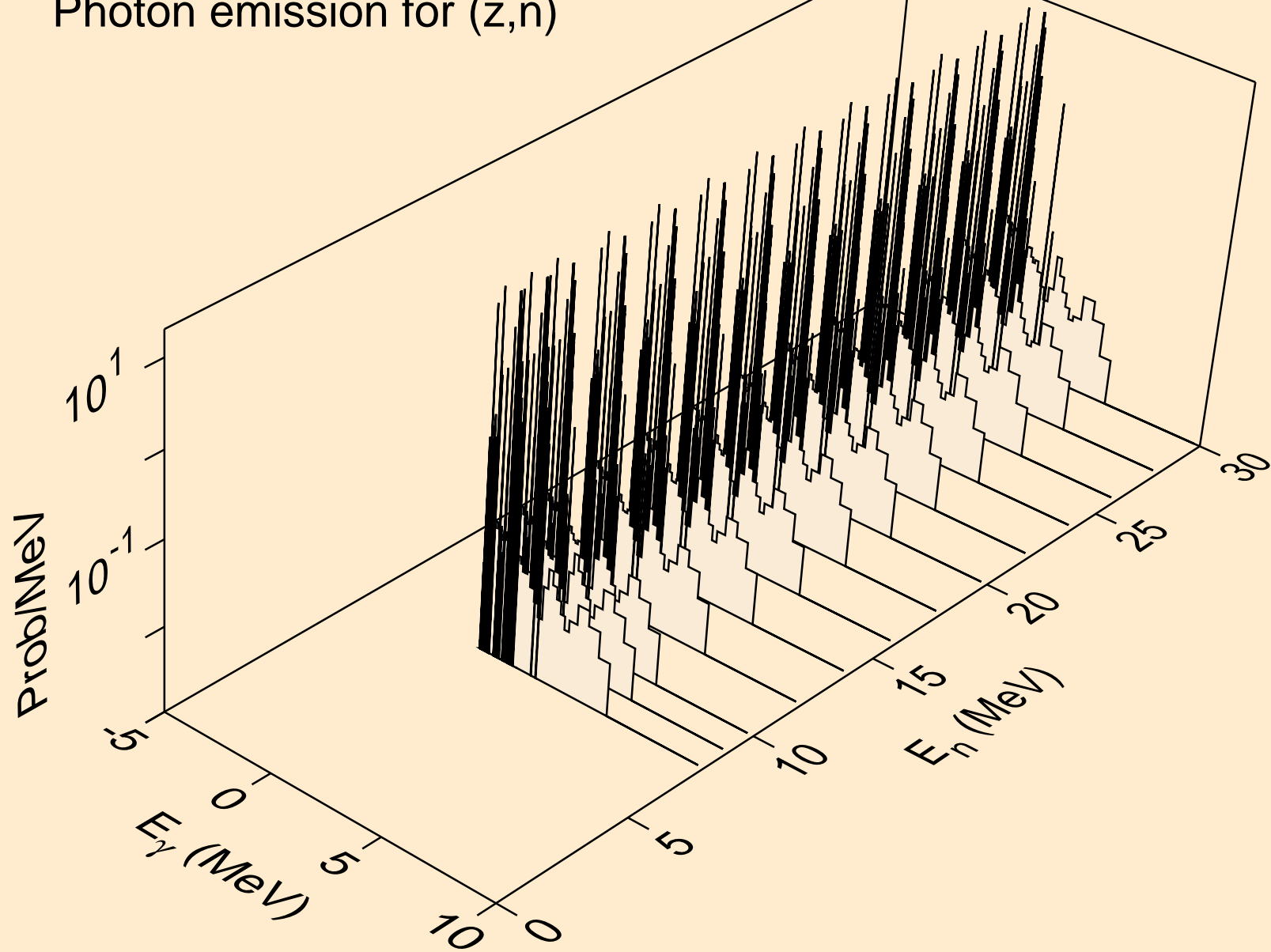

PT204 HELION ACER TENDL-2024 LIBRARY; T=0.K  
Photon emission for (z,x)

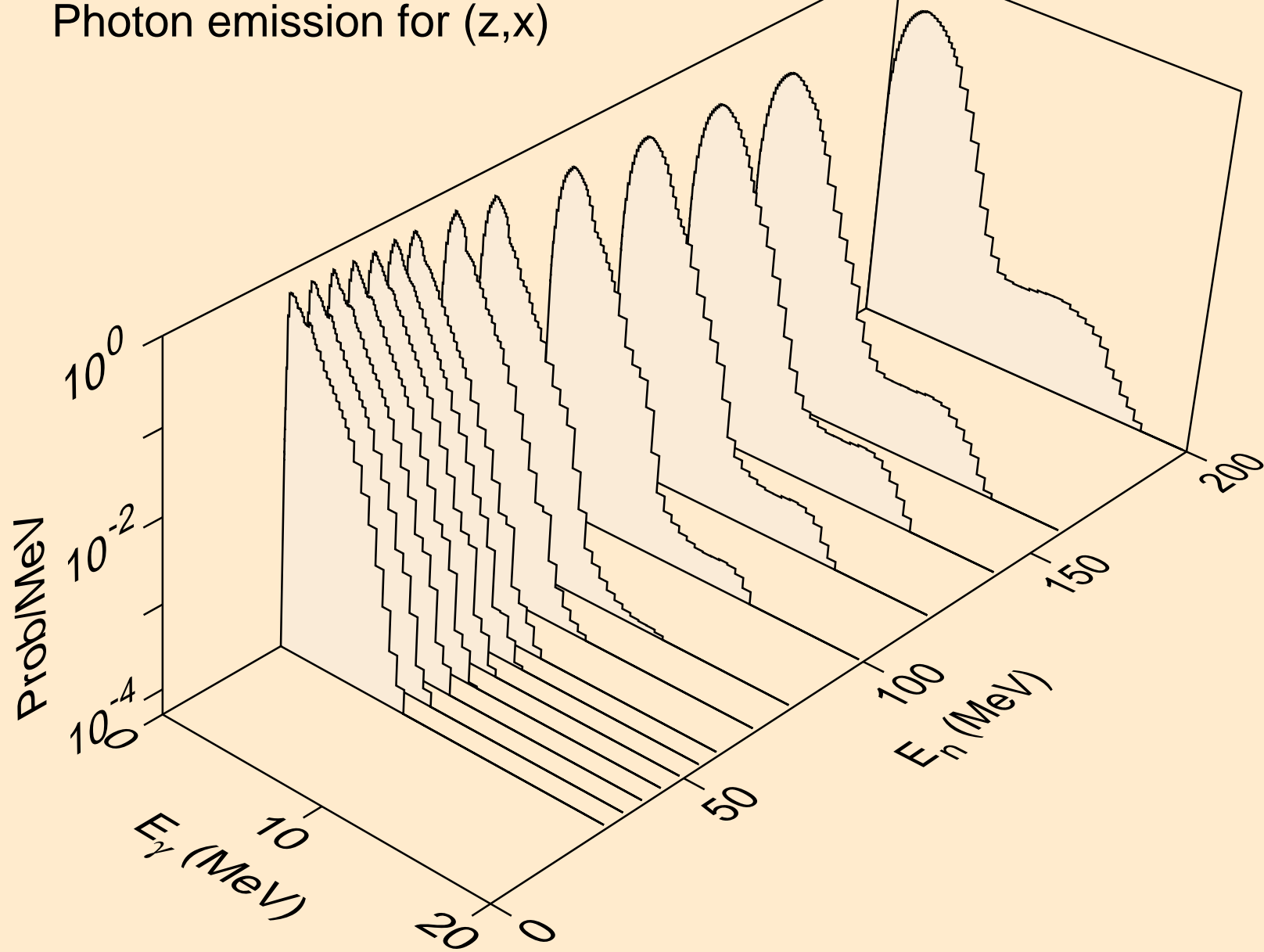

PT204 HELION ACER TENDL-2024 LIBRARY; T=0.K  
Photon emission for (n,2nd)

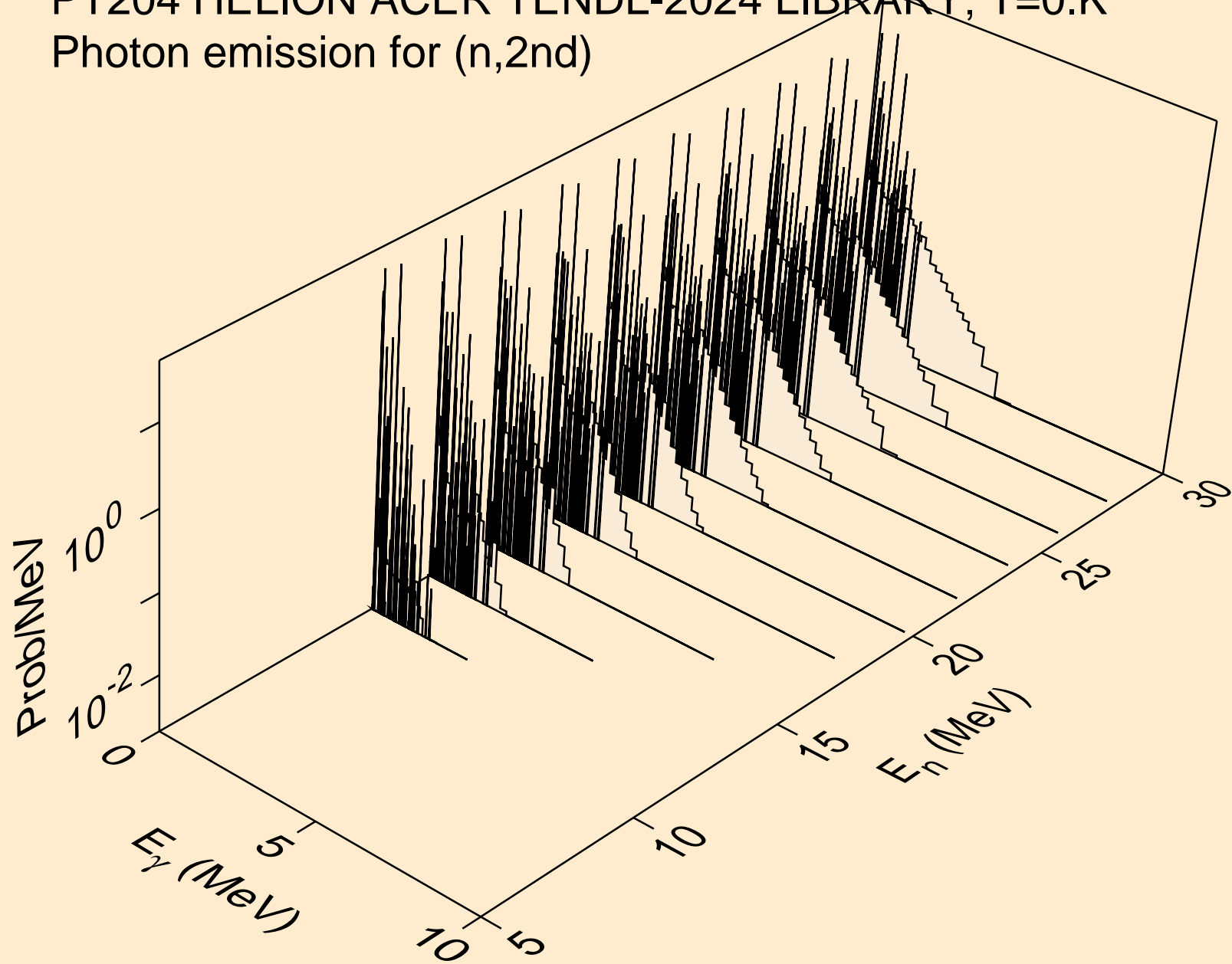

PT204 HELION ACER TENDL-2024 LIBRARY; T=0.K  
Photon emission for (n,2n)

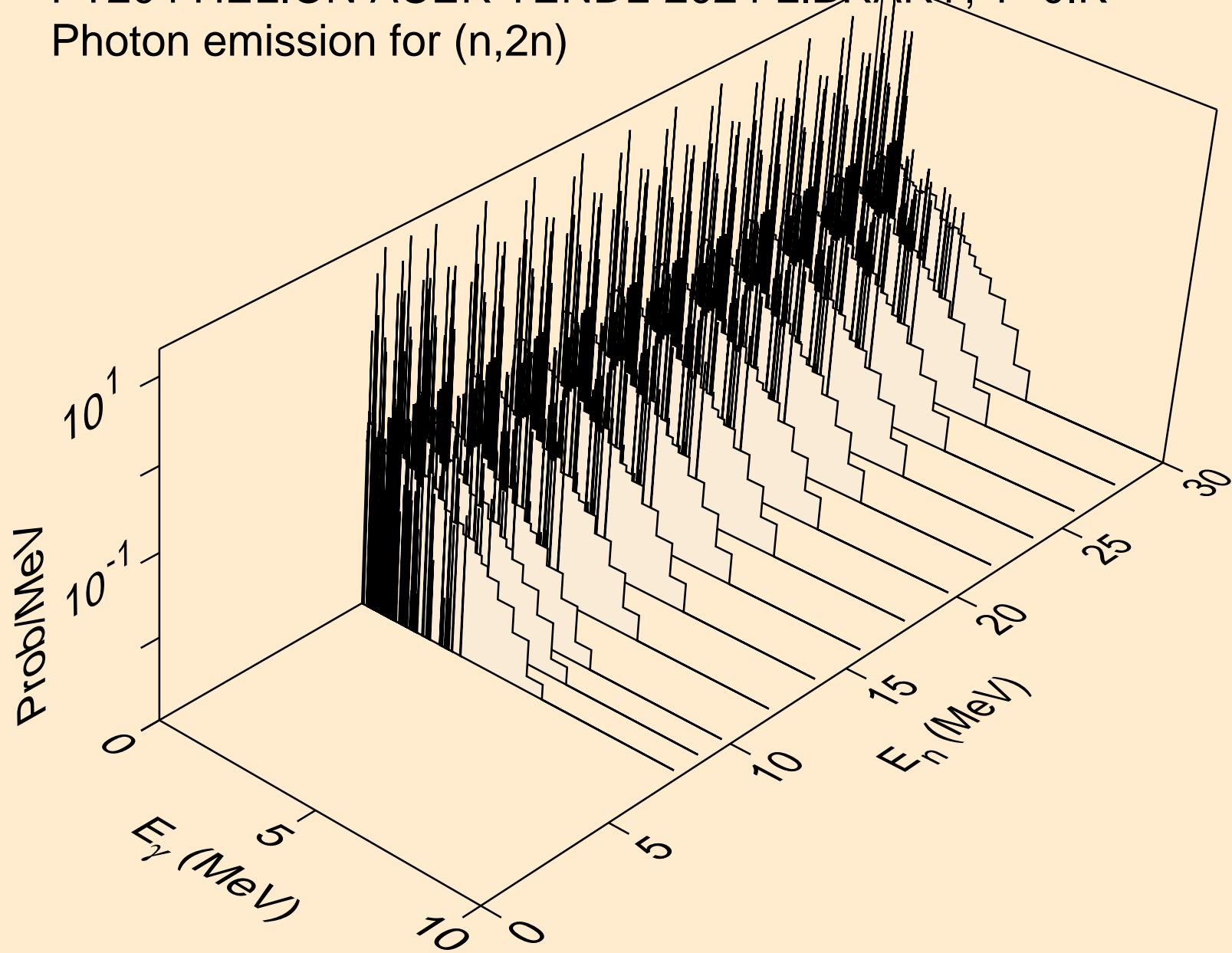

PT204 HELION ACER TENDL-2024 LIBRARY; T=0.K  
Photon emission for (n,3n)

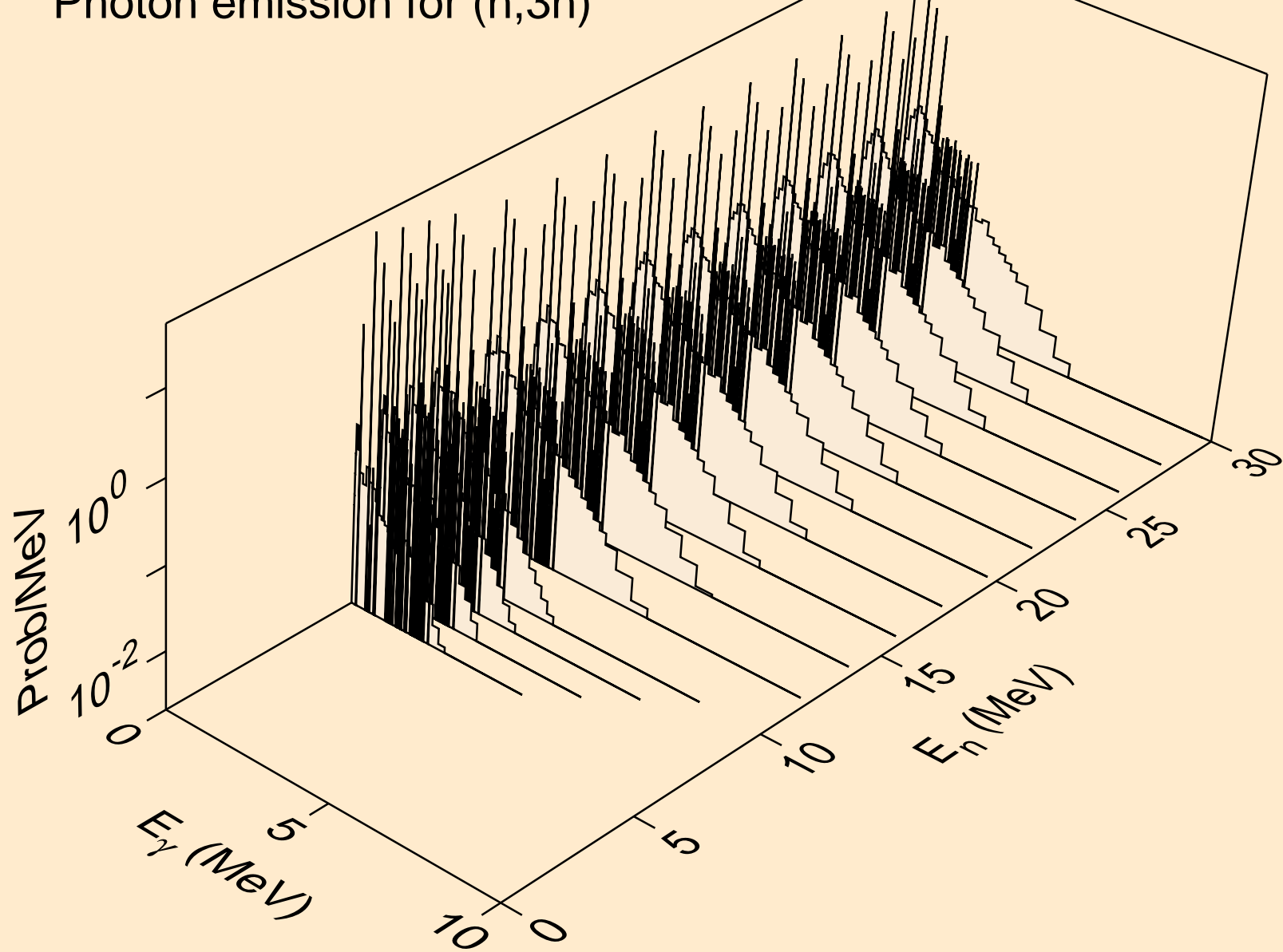

PT204 HELION ACER TENDL-2024 LIBRARY; T=0.K  
Photon emission for (n,n\*)a

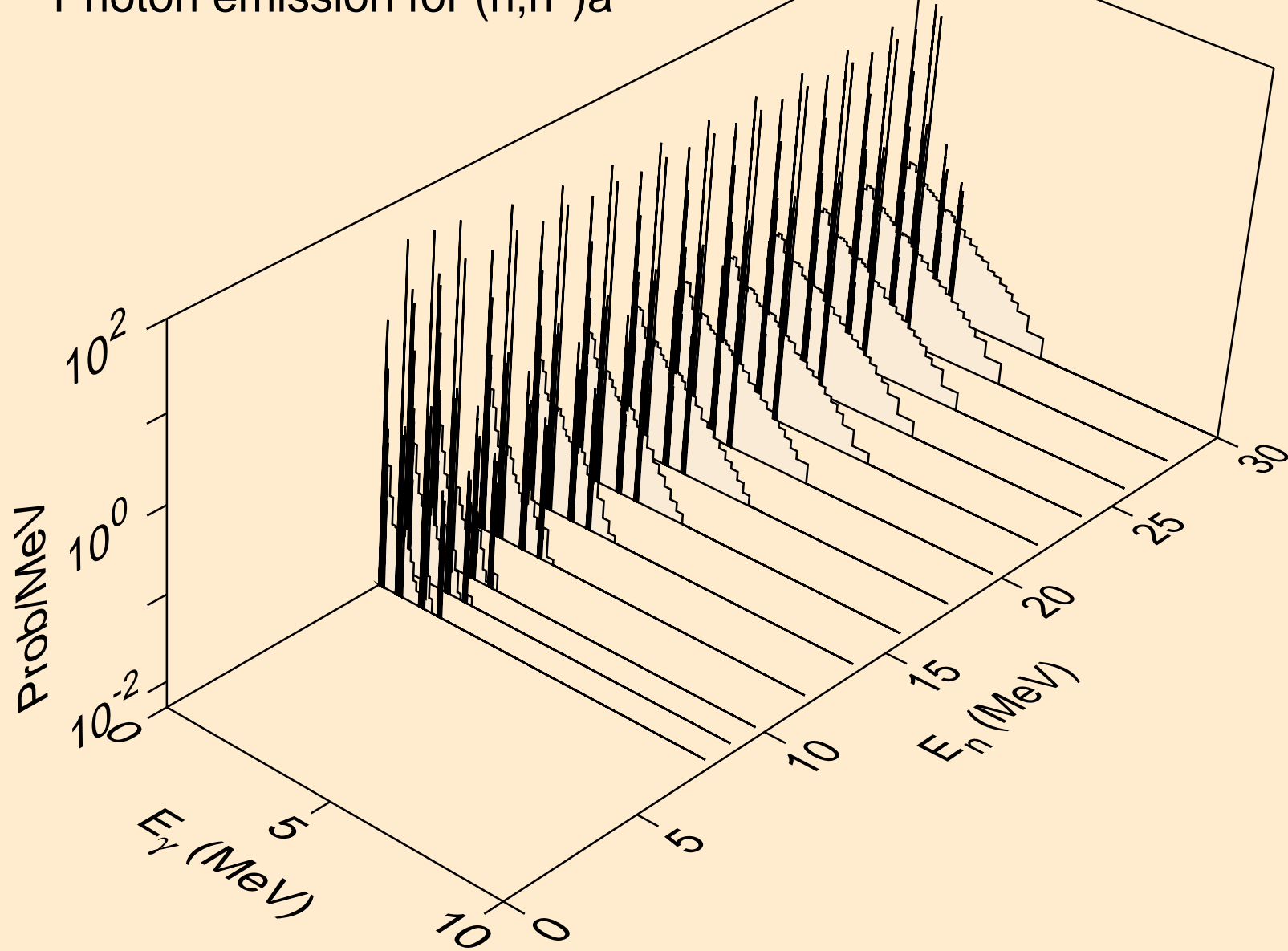

PT204 HELION ACER TENDL-2024 LIBRARY; T=0.K  
Photon emission for (n,2n)a

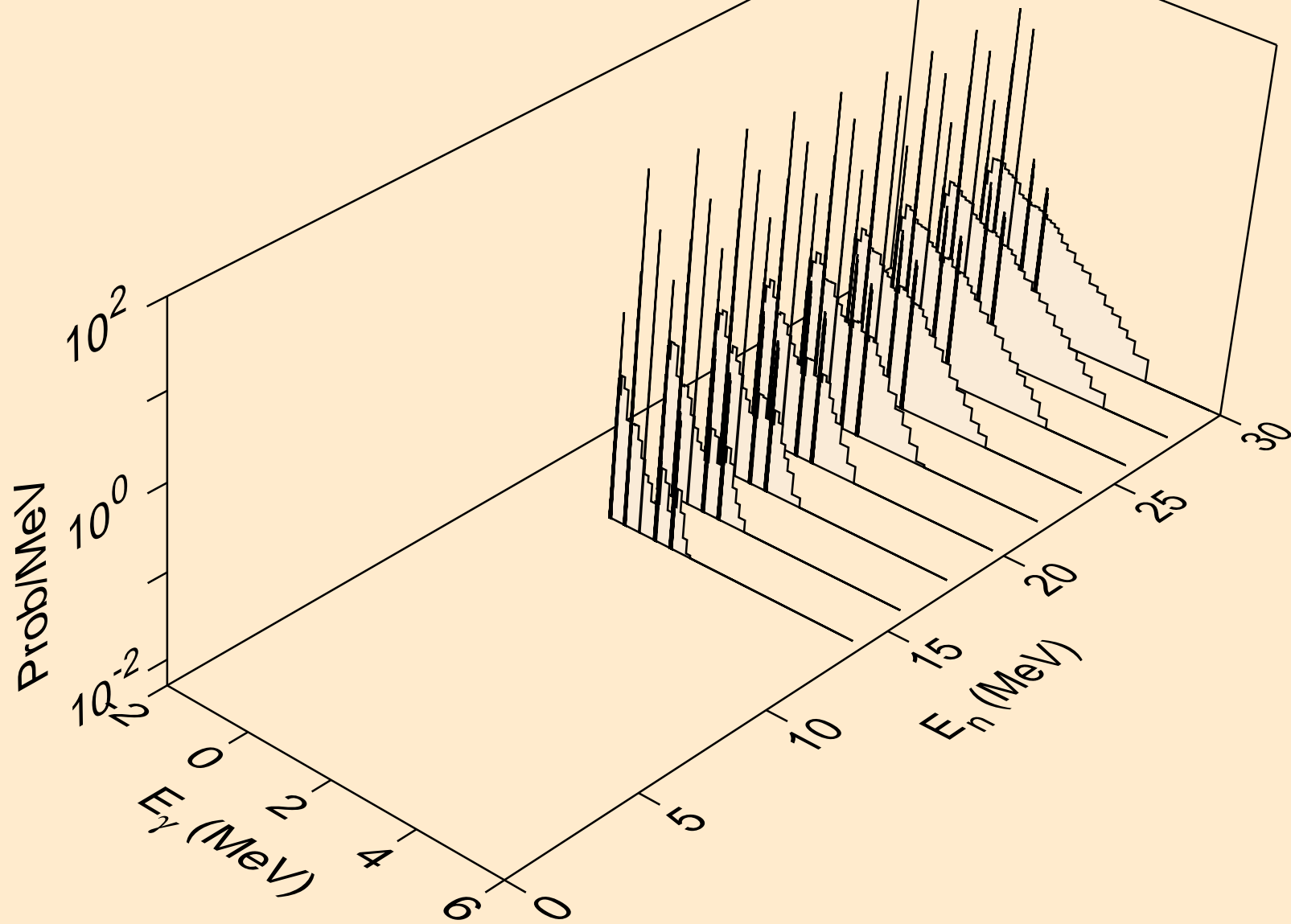

PT204 HELION ACER TENDL-2024 LIBRARY; T=0.K  
Photon emission for (n,3n)a

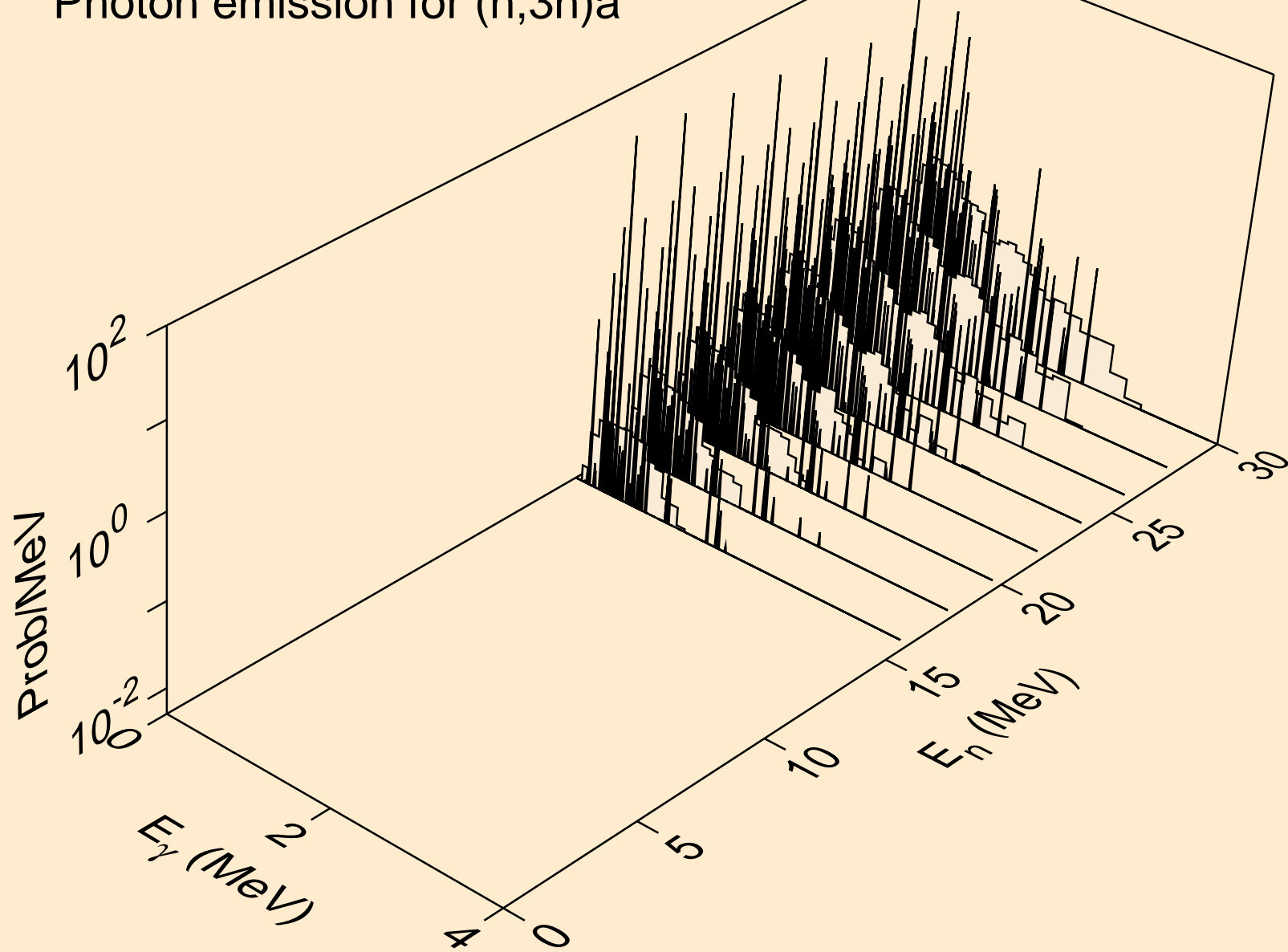

PT204 HELION ACER TENDL-2024 LIBRARY; T=0.K  
Photon emission for (n,n\*)p

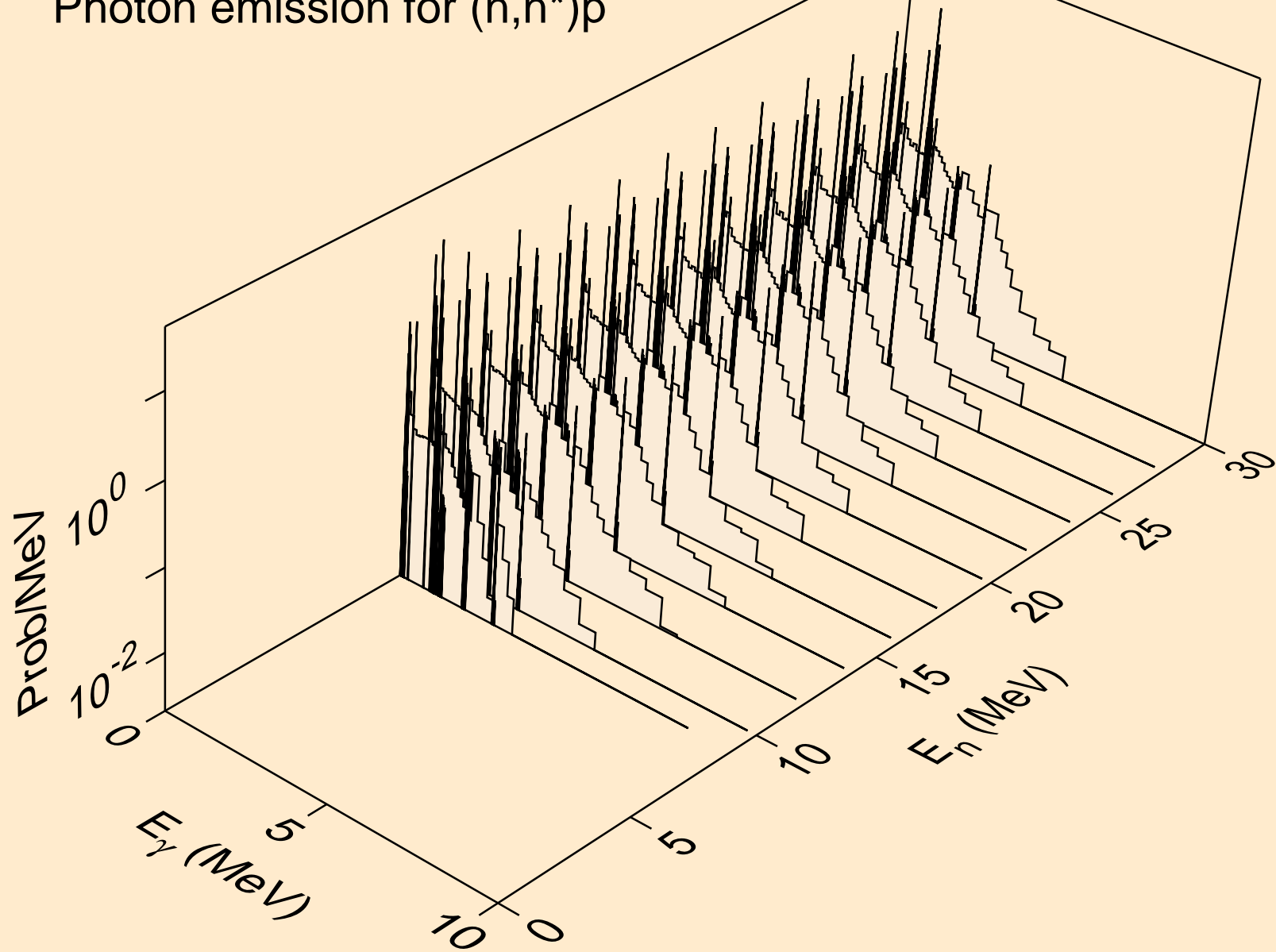

PT204 HELION ACER TENDL-2024 LIBRARY; T=0.K  
Photon emission for (n,n\*)d

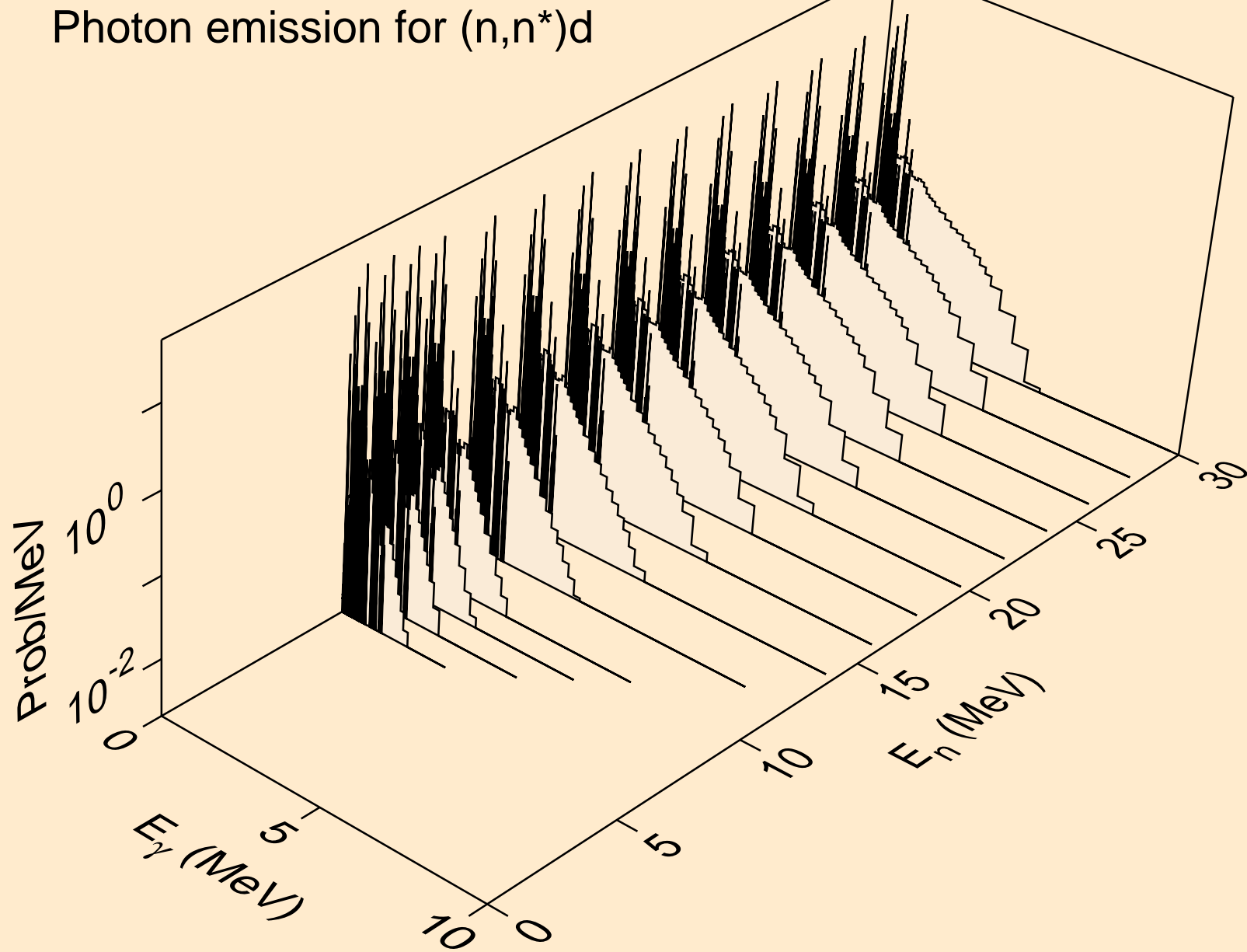

PT204 HELION ACER TENDL-2024 LIBRARY; T=0.K  
Photon emission for (n,n\*)t

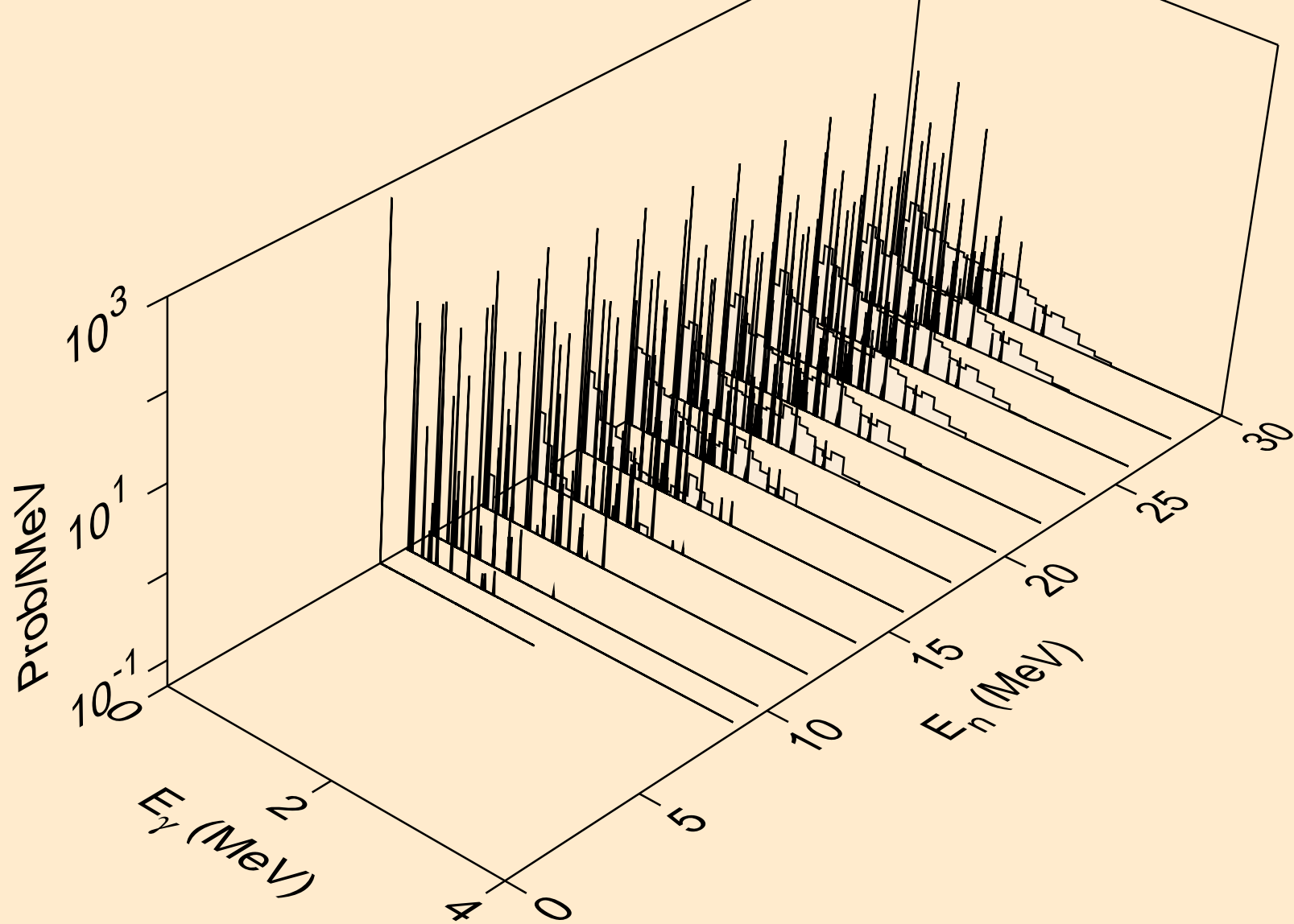

PT204 HELION ACER TENDL-2024 LIBRARY; T=0.K  
Photon emission for (n,n\*)he3

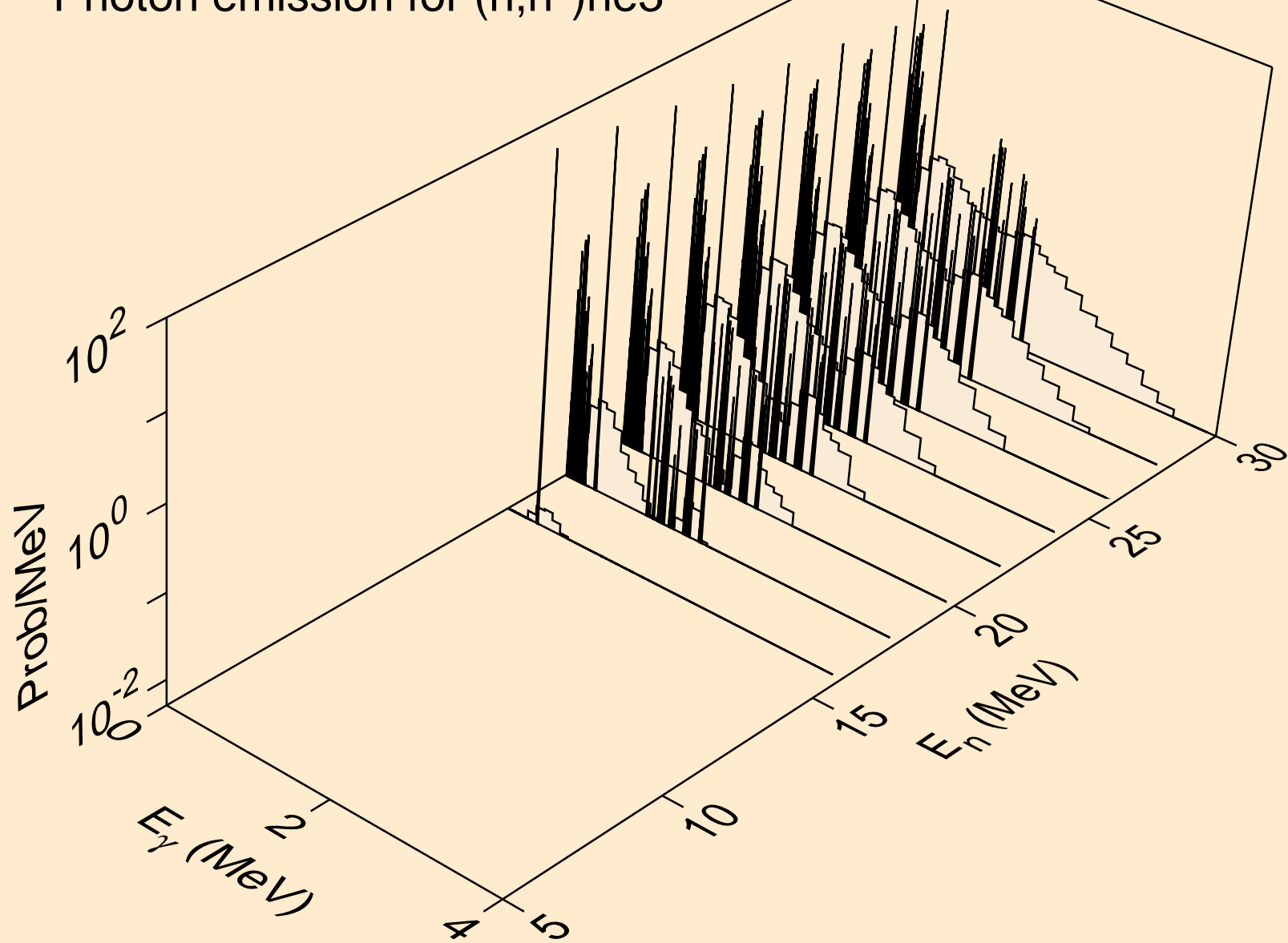

PT204 HELION ACER TENDL-2024 LIBRARY; T=0.K  
Photon emission for (n,4n)

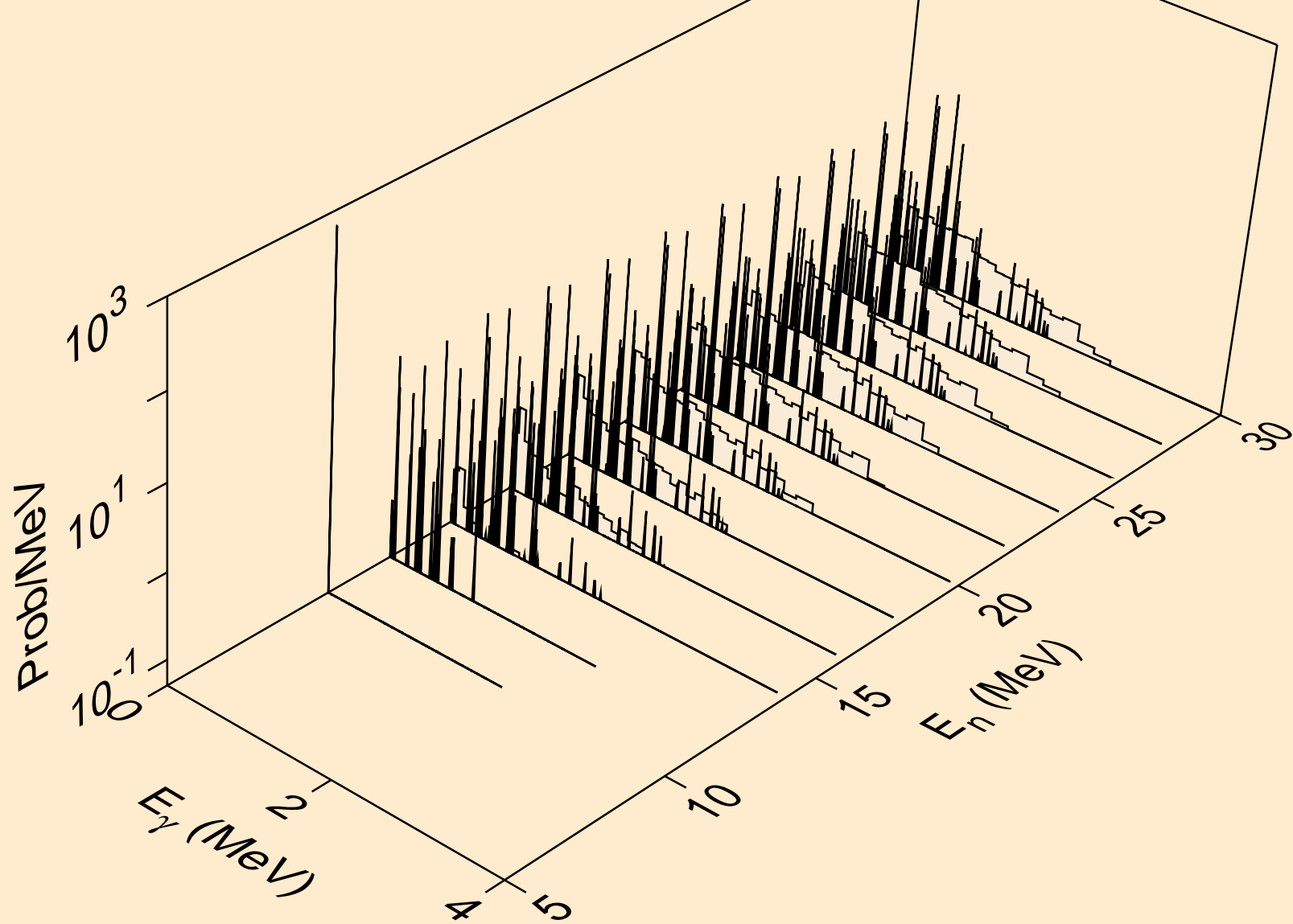

PT204 HELION ACER TENDL-2024 LIBRARY; T=0.K  
Photon emission for (n,2np)

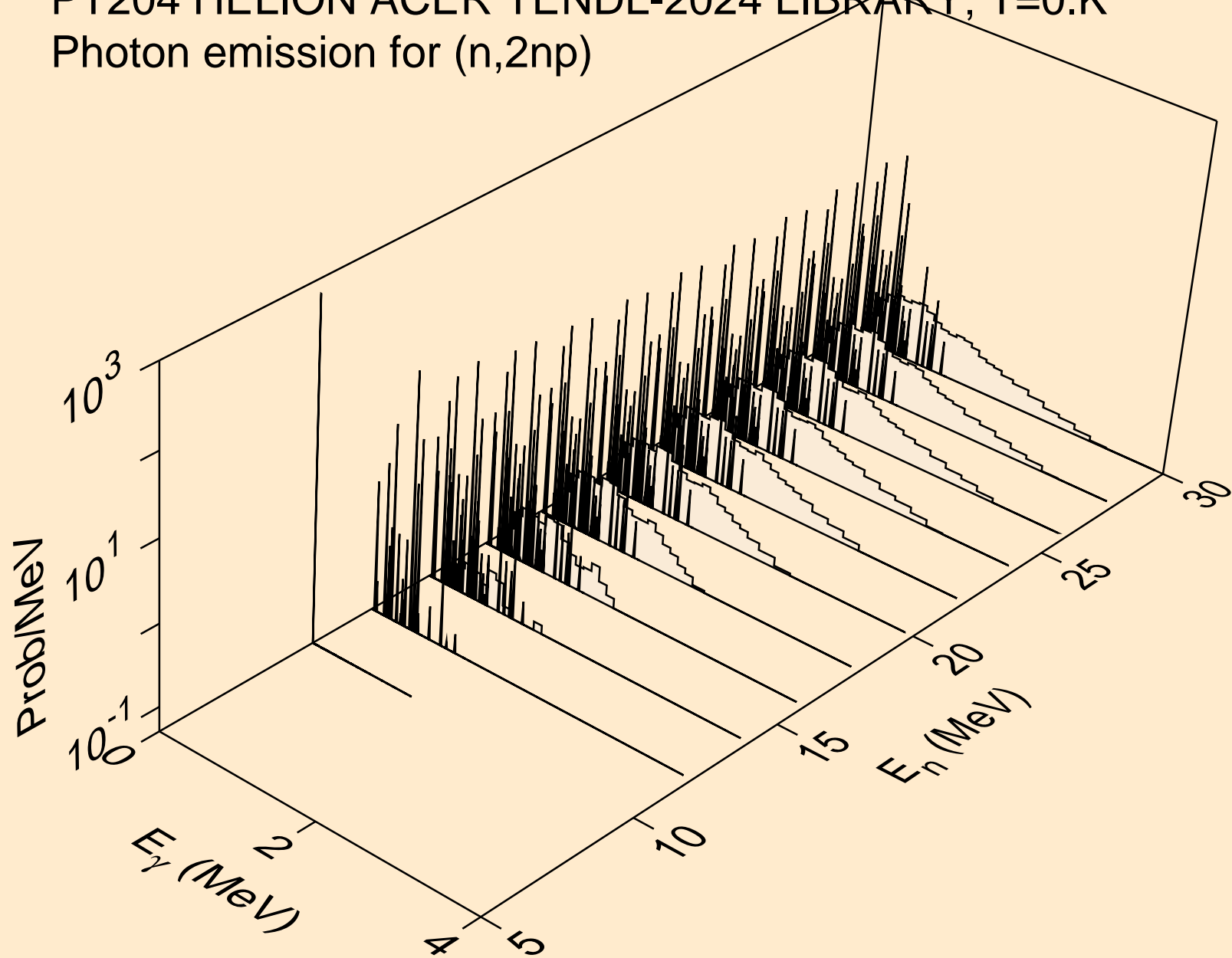

PT204 HELION ACER TENDL-2024 LIBRARY; T=0.K  
Photon emission for (n,3np)

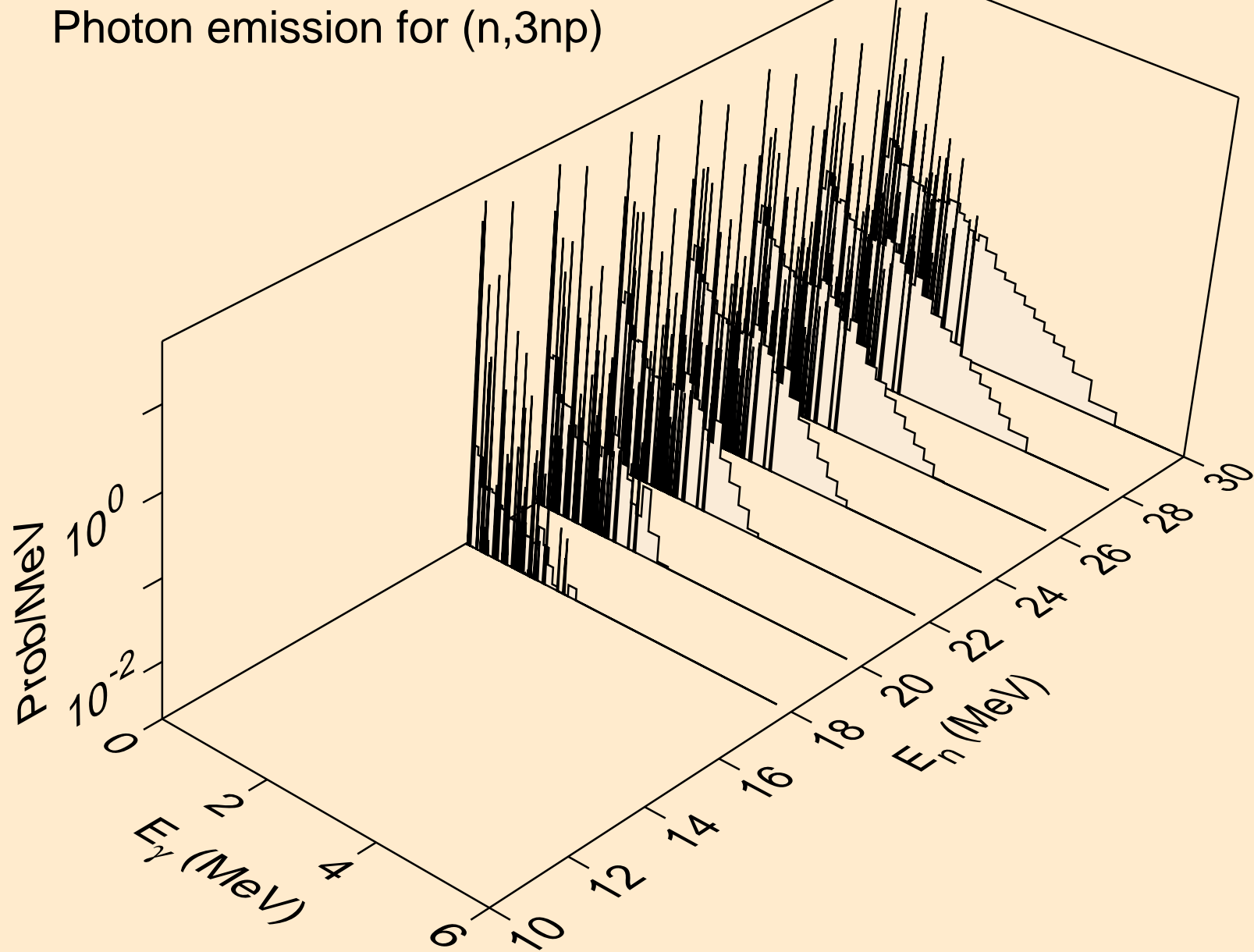

PT204 HELION ACER TENDL-2024 LIBRARY; T=0.K  
Photon emission for (n,n2p)

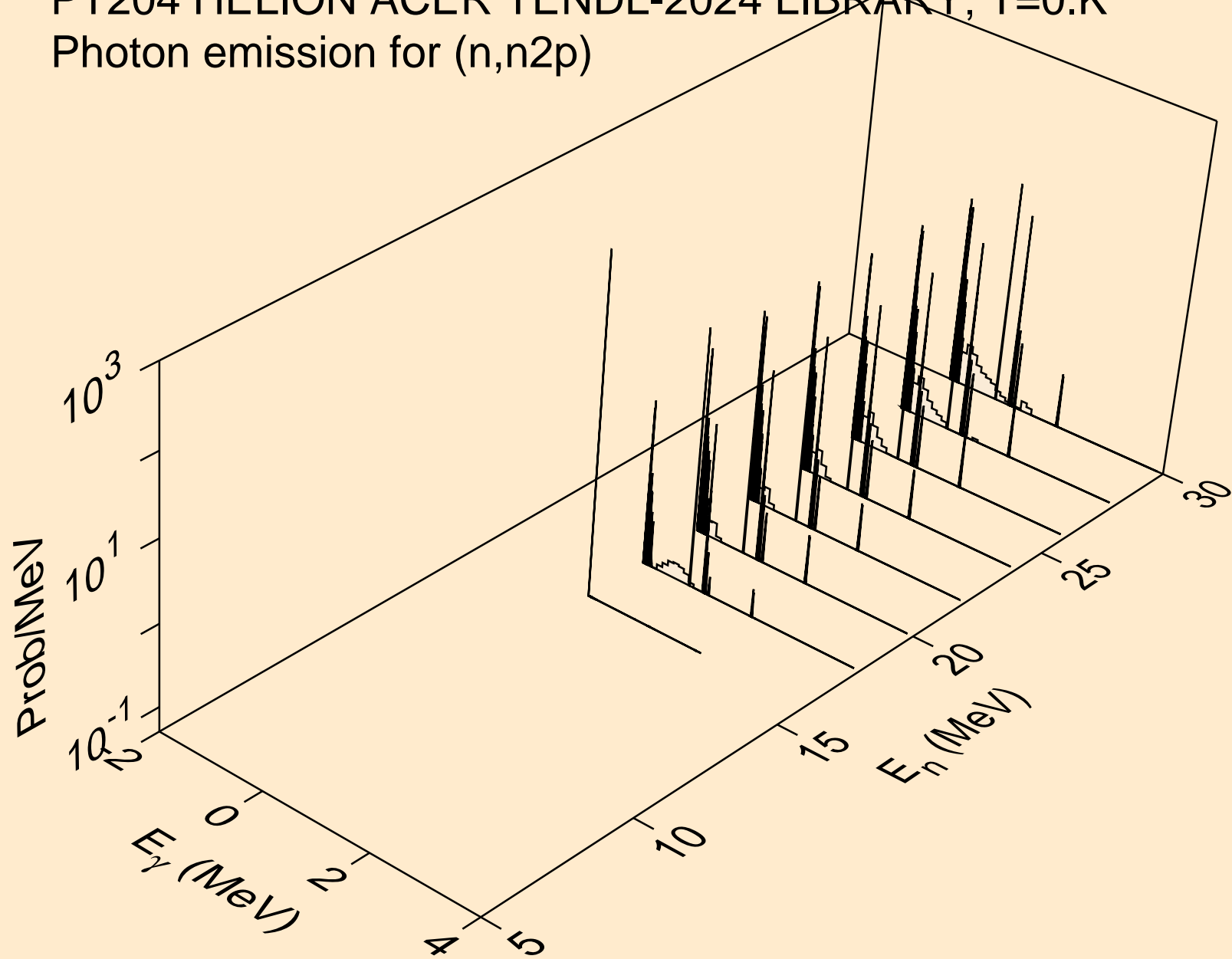

PT204 HELION ACER TENDL-2024 LIBRARY; T=0.K  
Photon emission for (n,npa)

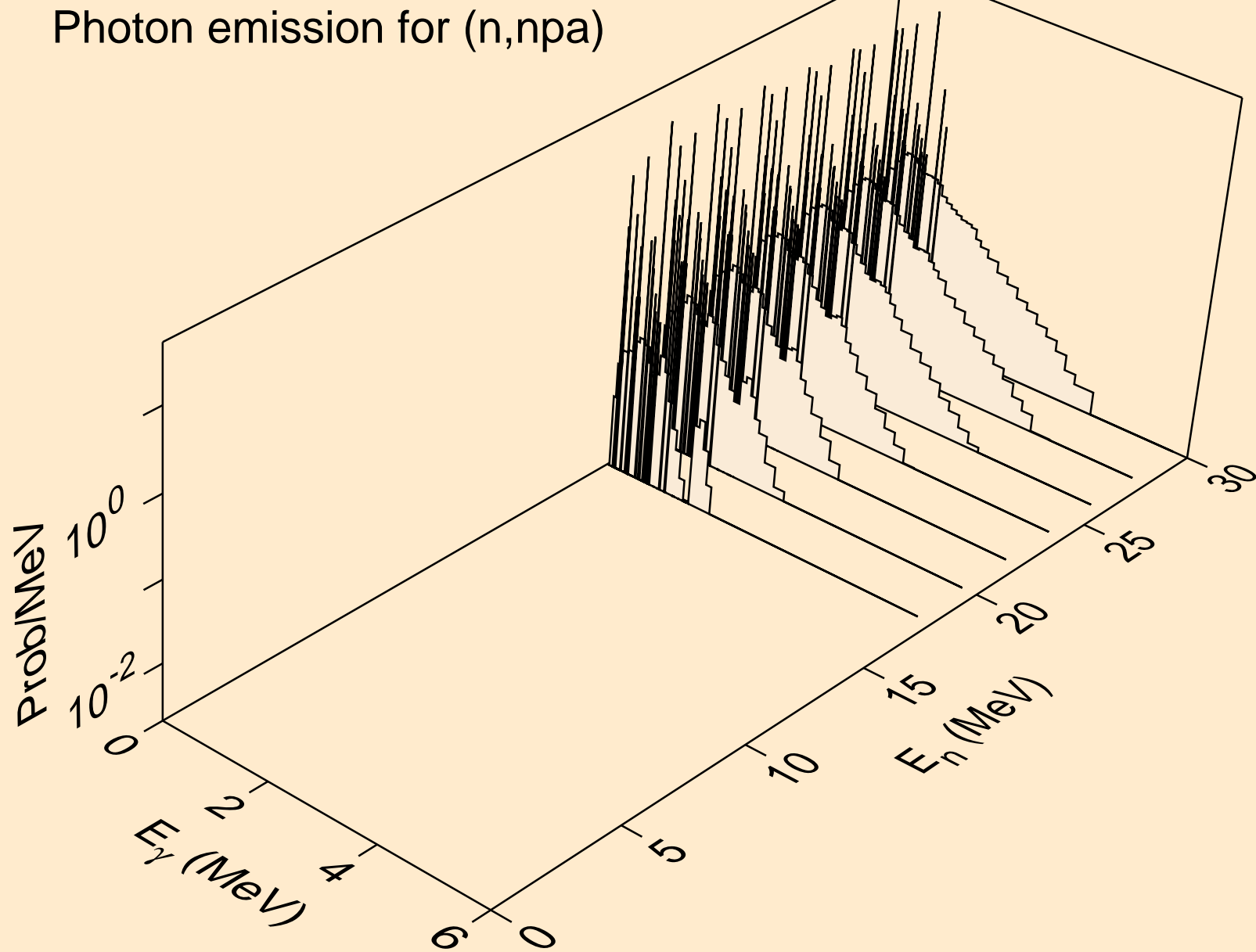

PT204 HELION ACER TENDL-2024 LIBRARY; T=0.K  
Photon emission for (n,gma)

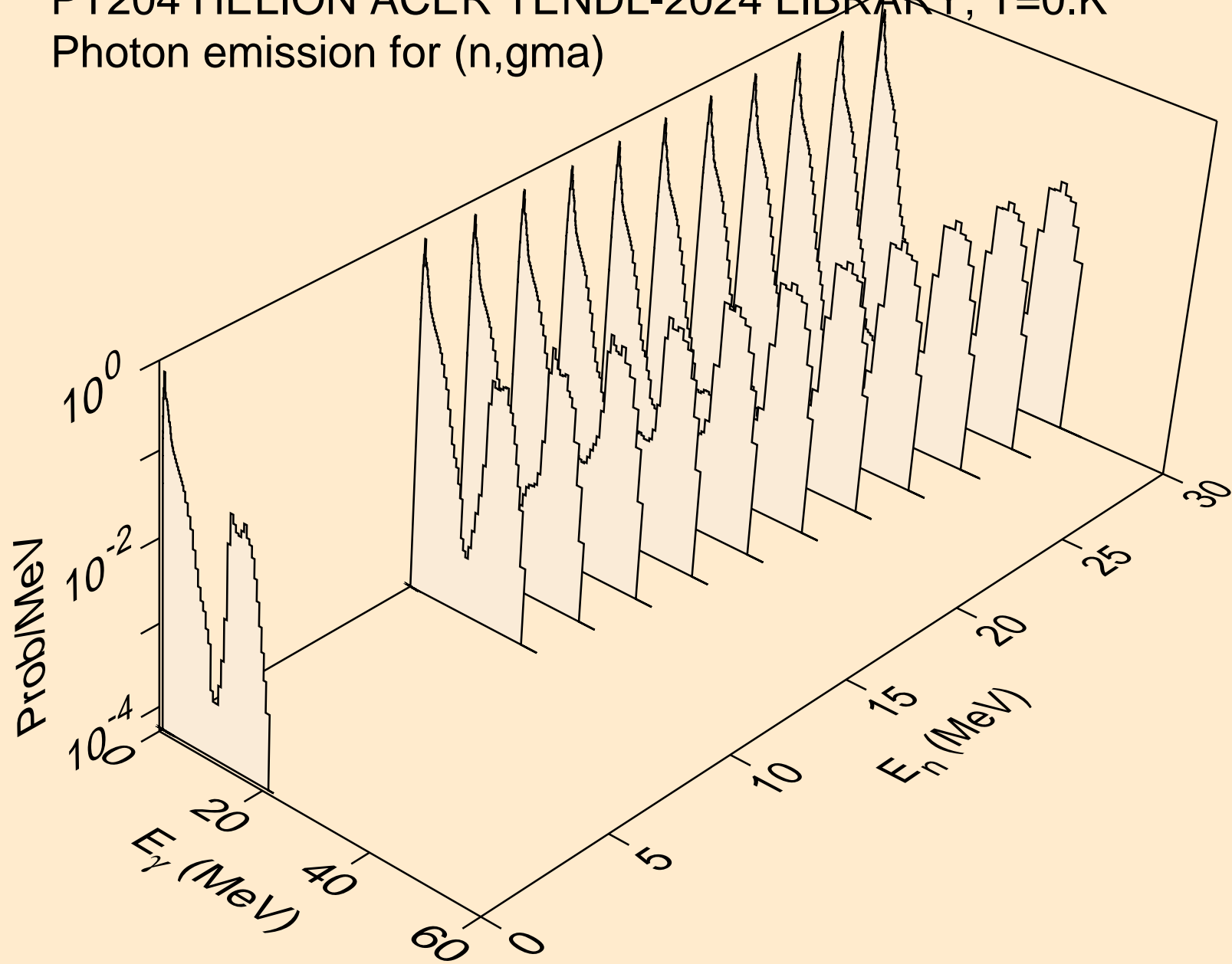

PT204 HELION ACER TENDL-2024 LIBRARY; T=0.K  
Photon emission for (n,p)

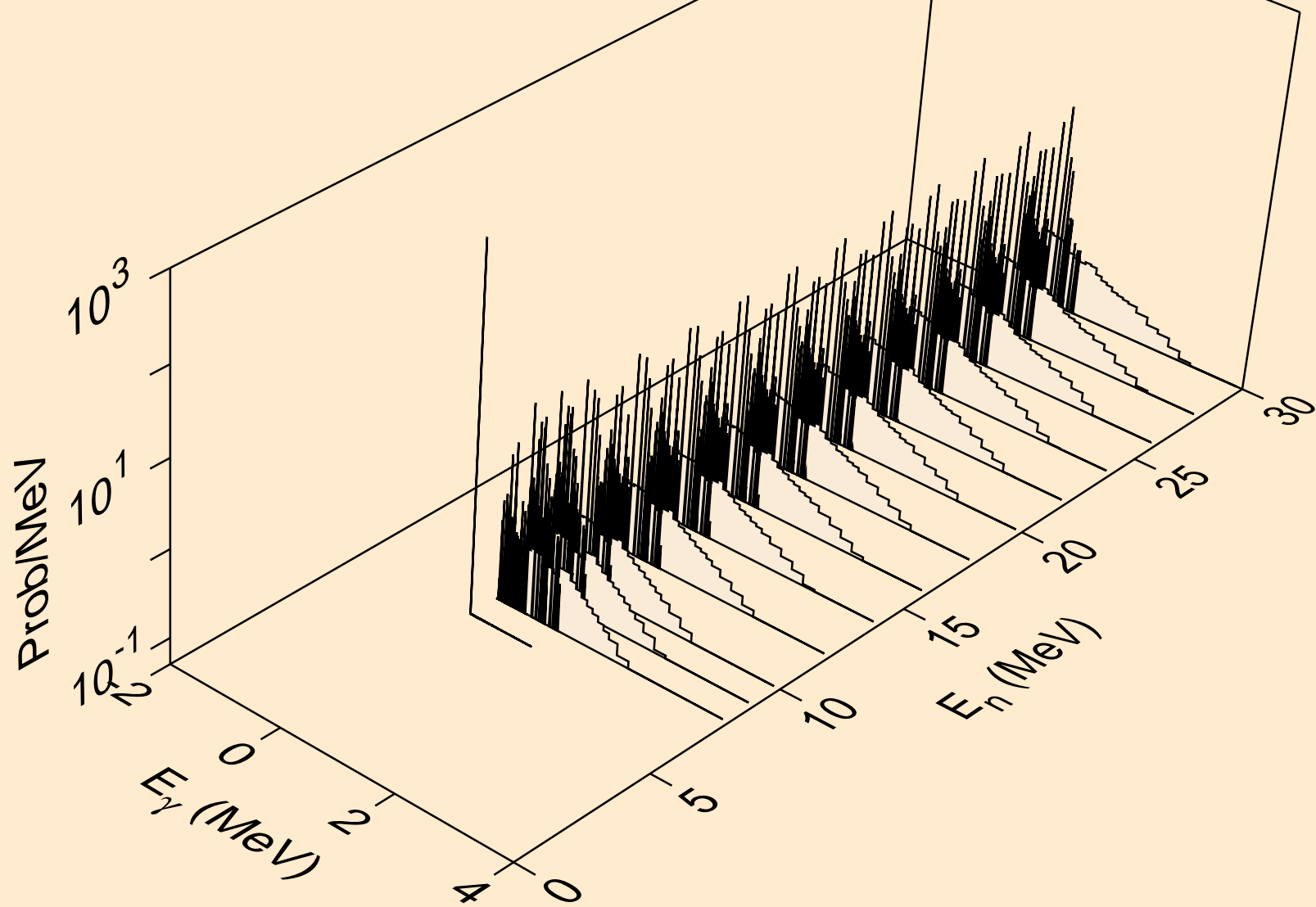

PT204 HELION ACER TENDL-2024 LIBRARY; T=0.K  
Photon emission for (n,d)

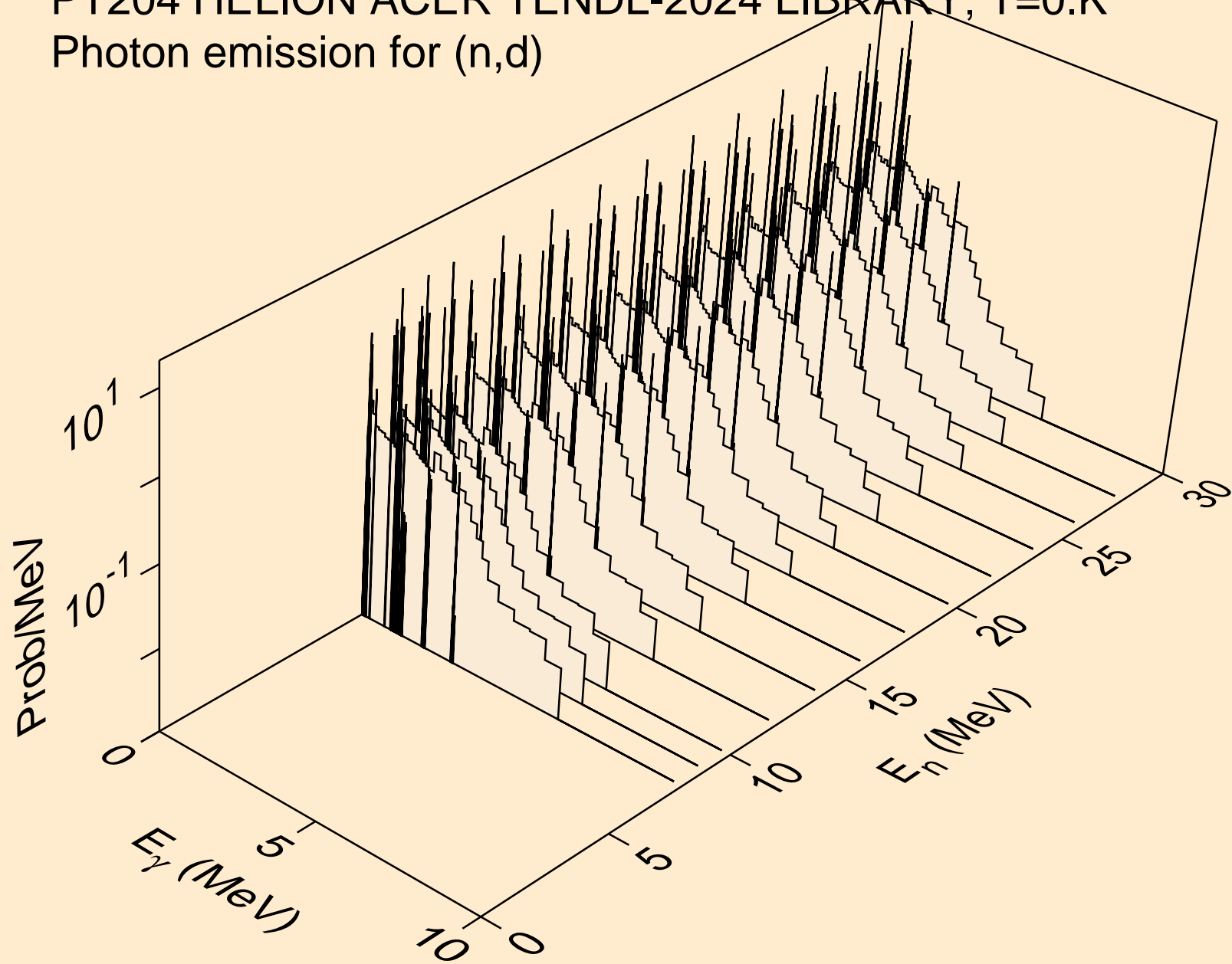

PT204 HELION ACER TENDL-2024 LIBRARY; T=0.K  
Photon emission for (n,t)

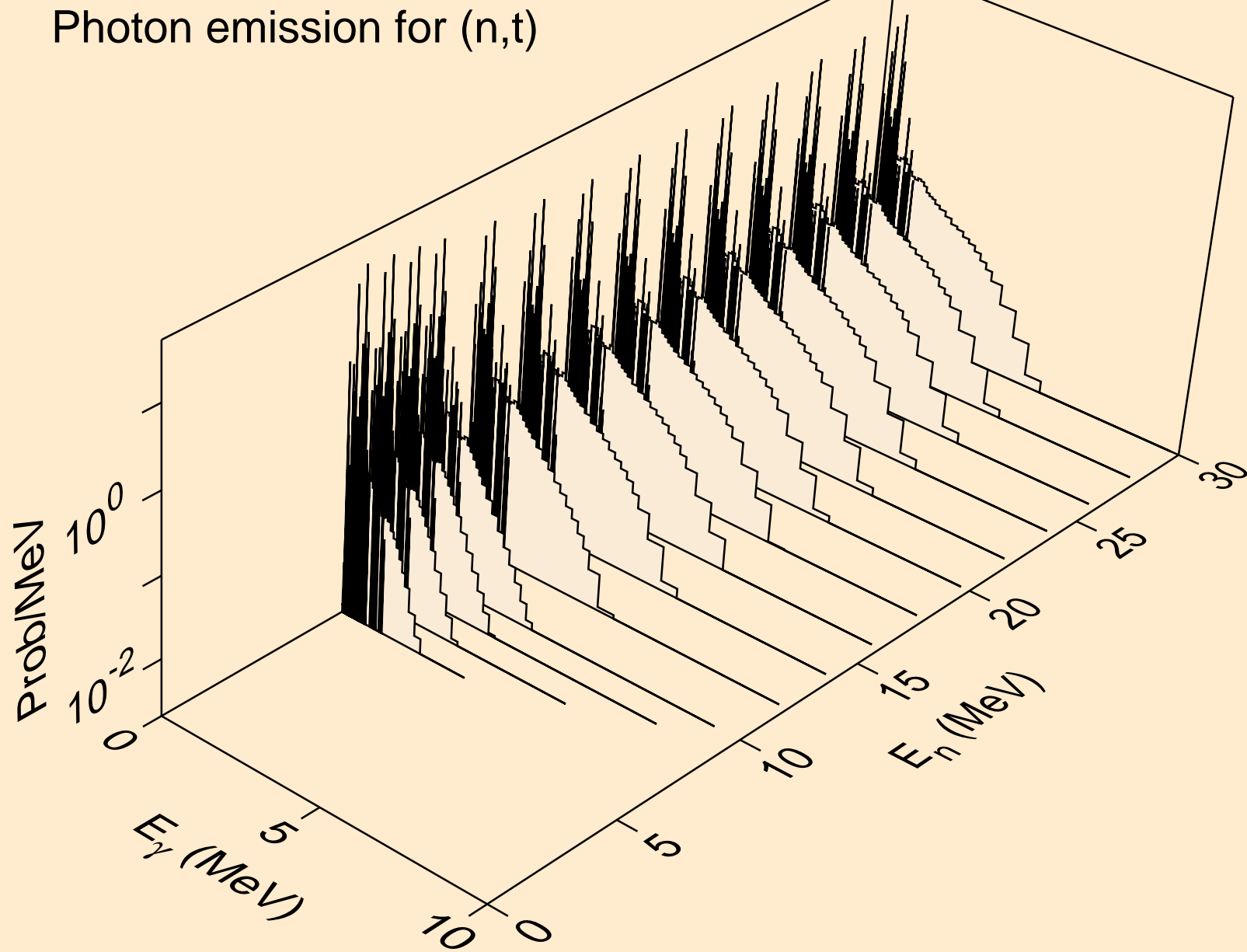

PT204 HELION ACER TENDL-2024 LIBRARY; T=0.K  
Photon emission for inelastic

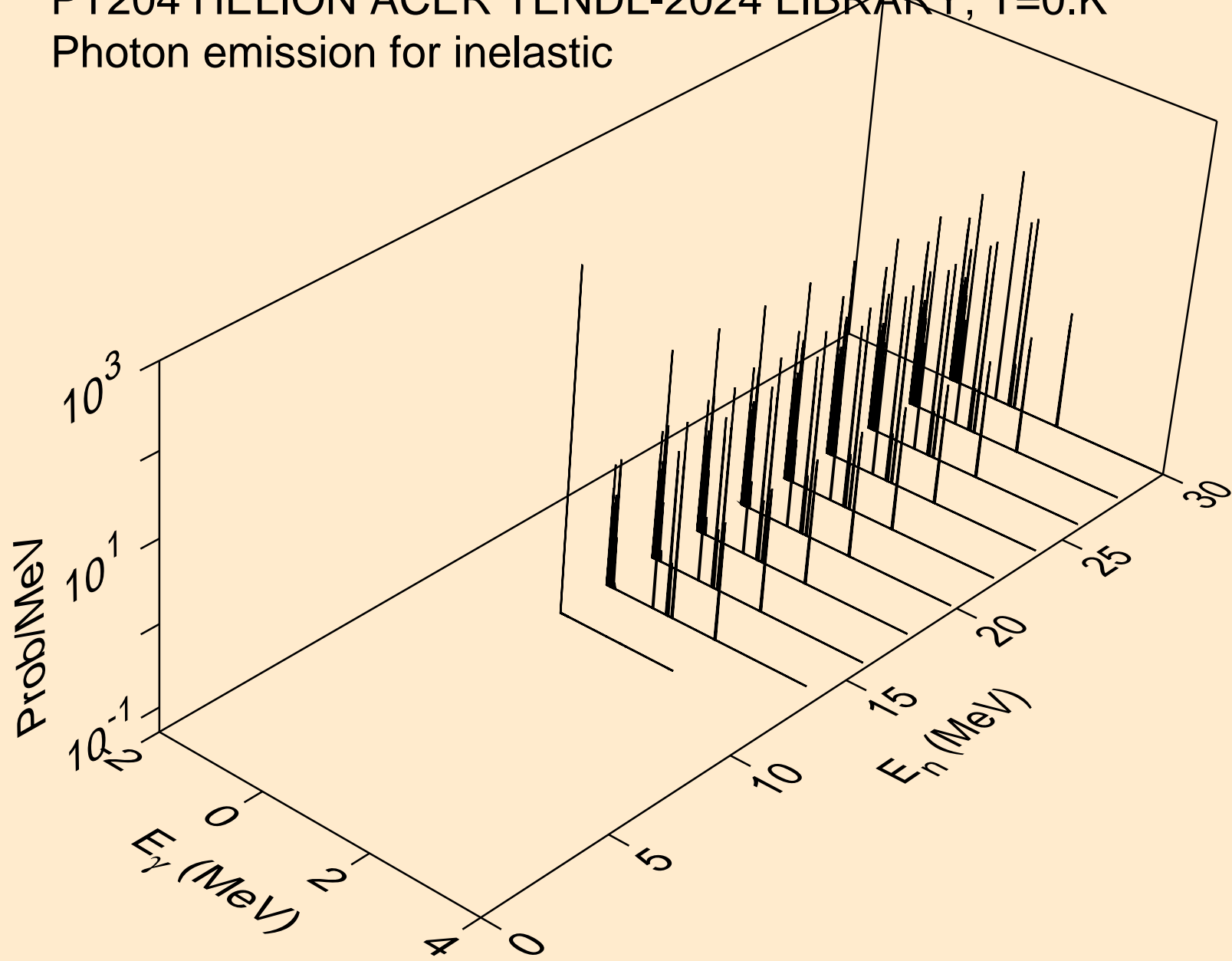

PT204 HELION ACER TENDL-2024 LIBRARY; T=0.K  
Photon emission for (n,a)

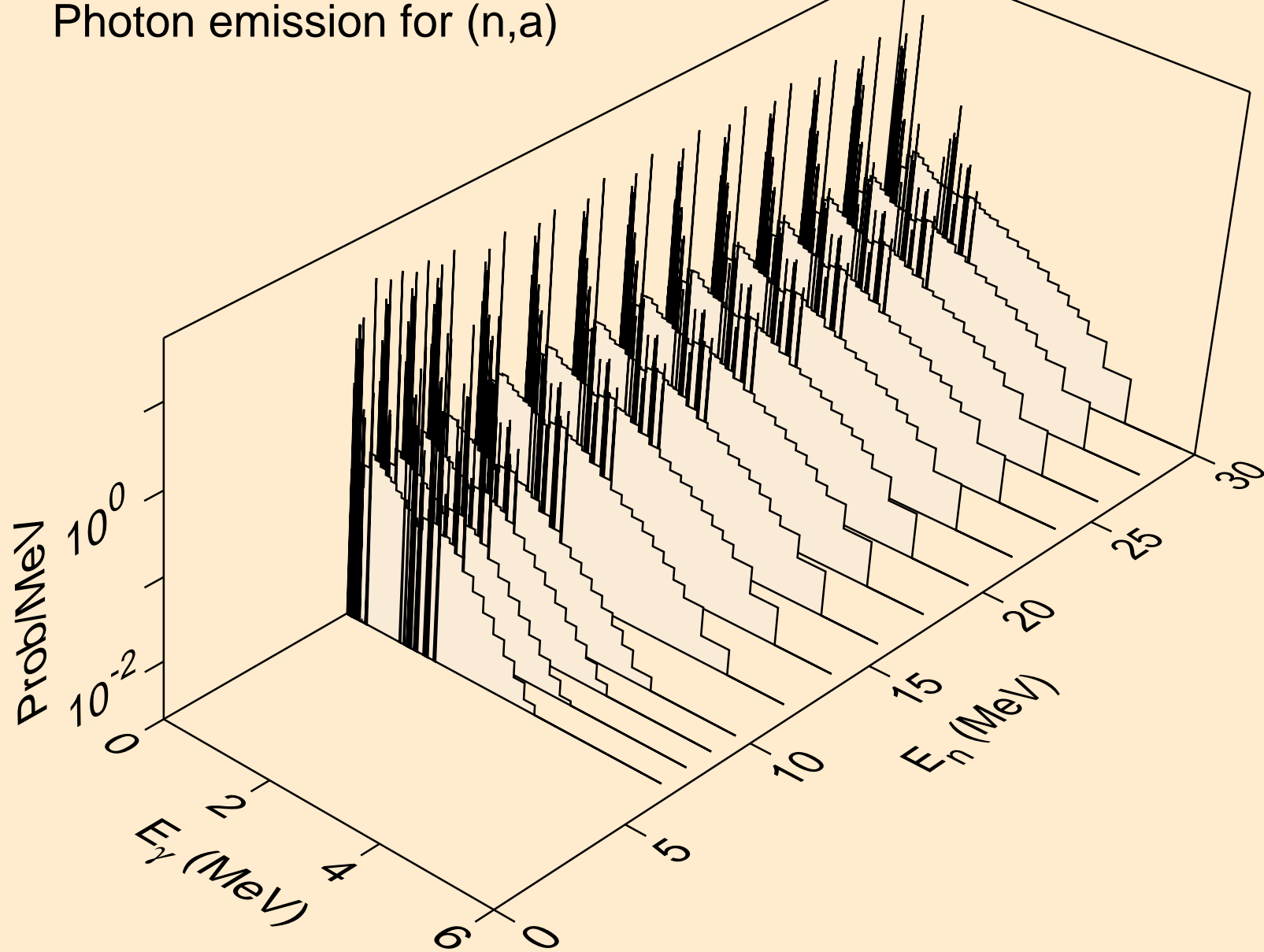

PT204 HELION ACER TENDL-2024 LIBRARY; T=0.K  
Photon emission for (n,2p)

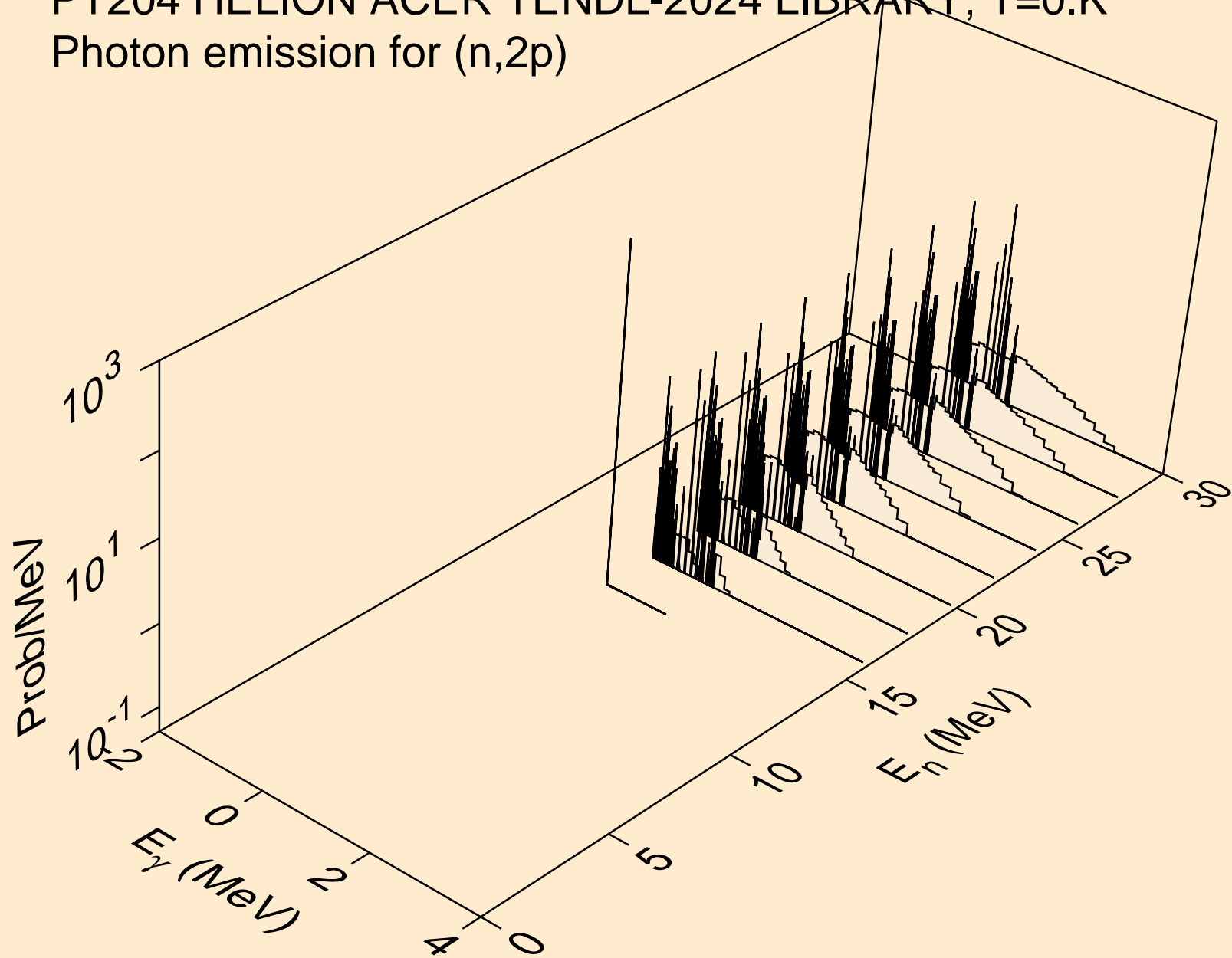

PT204 HELION ACER TENDL-2024 LIBRARY; T=0.K  
Photon emission for (n,pd)

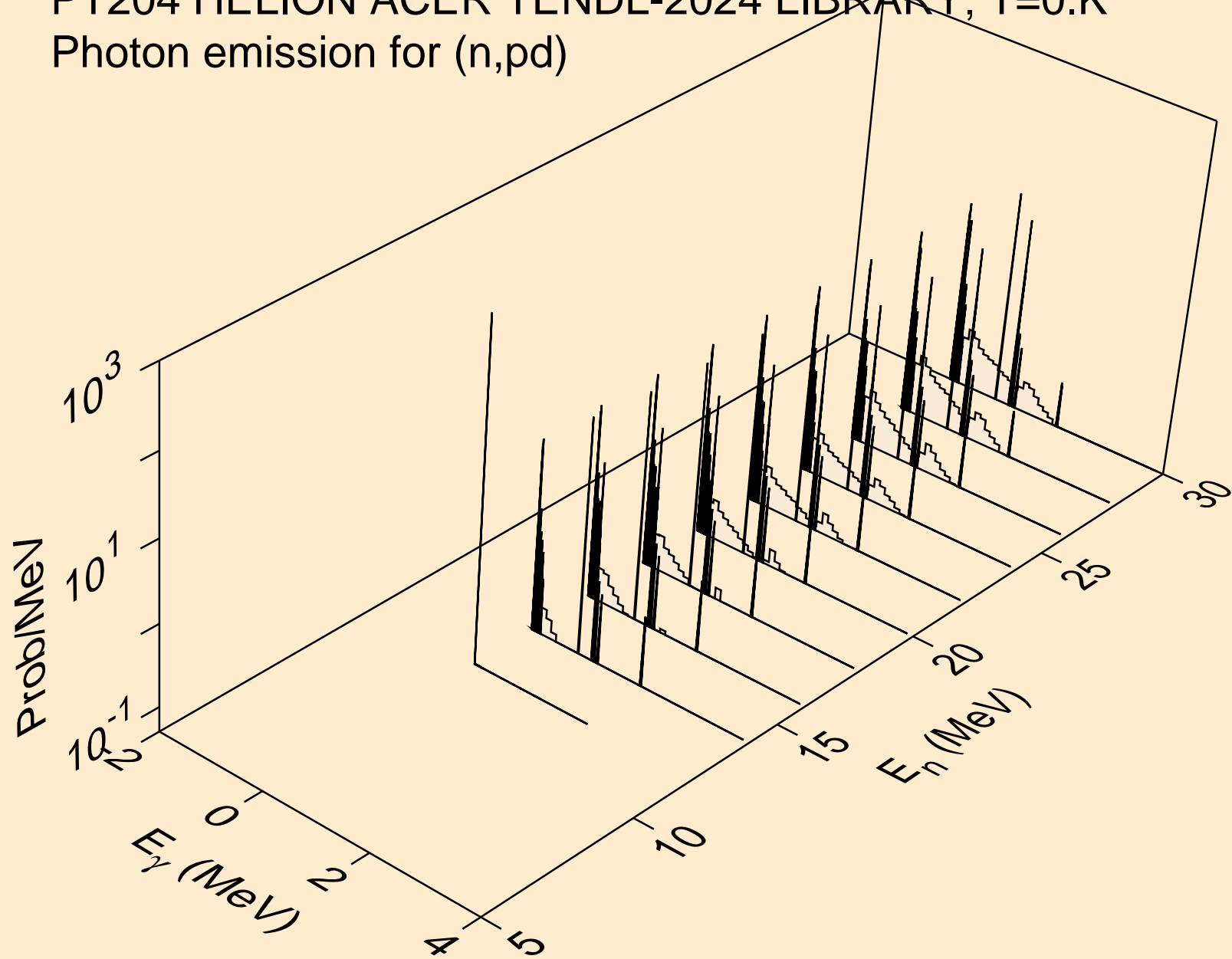

PT204 HELION ACER TENDL-2024 LIBRARY; T=0.K  
Photon emission for (n,pt)

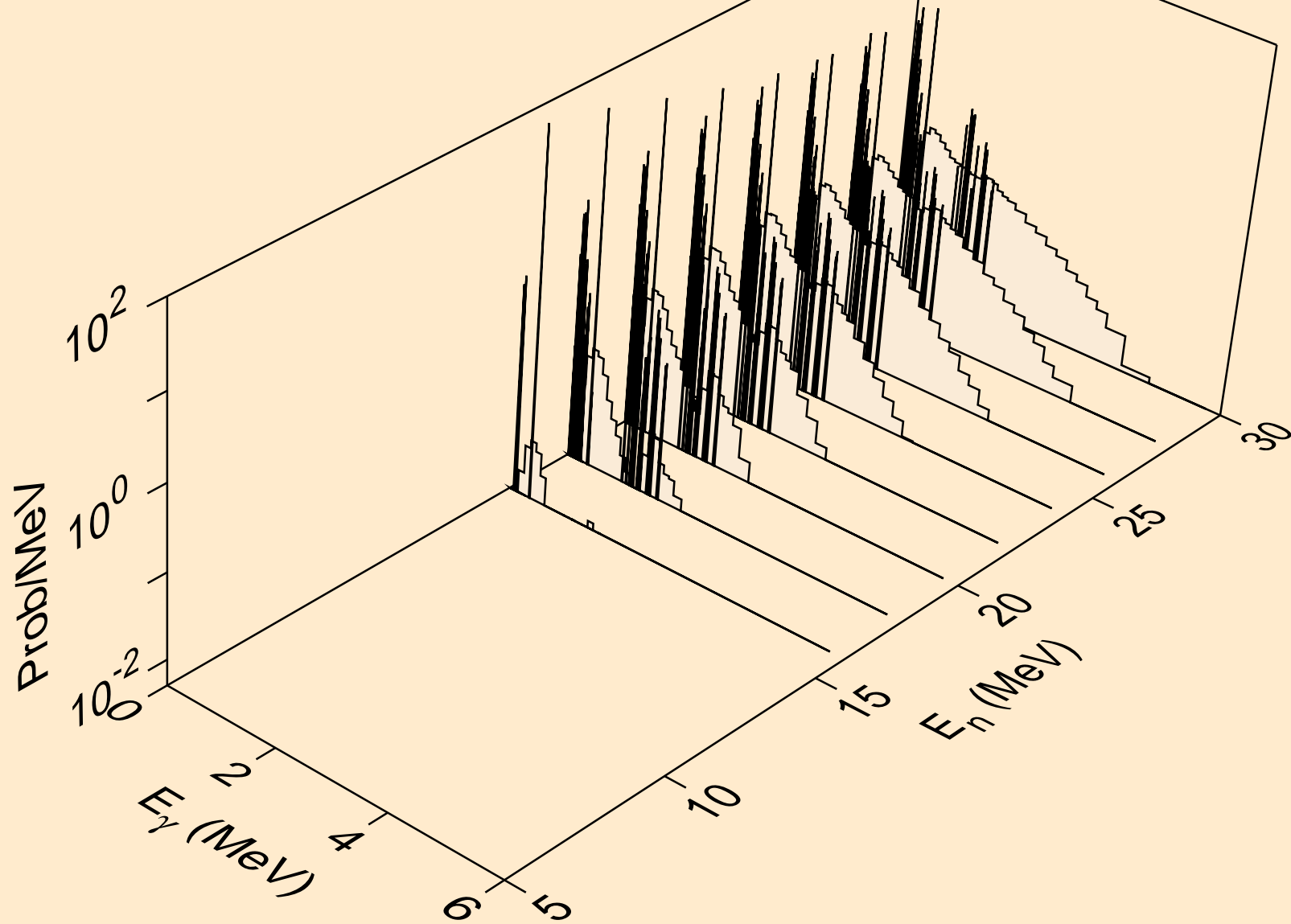

PT204 HELION ACER TENDL-2024 LIBRARY; T=0.K  
Particle heating contributions

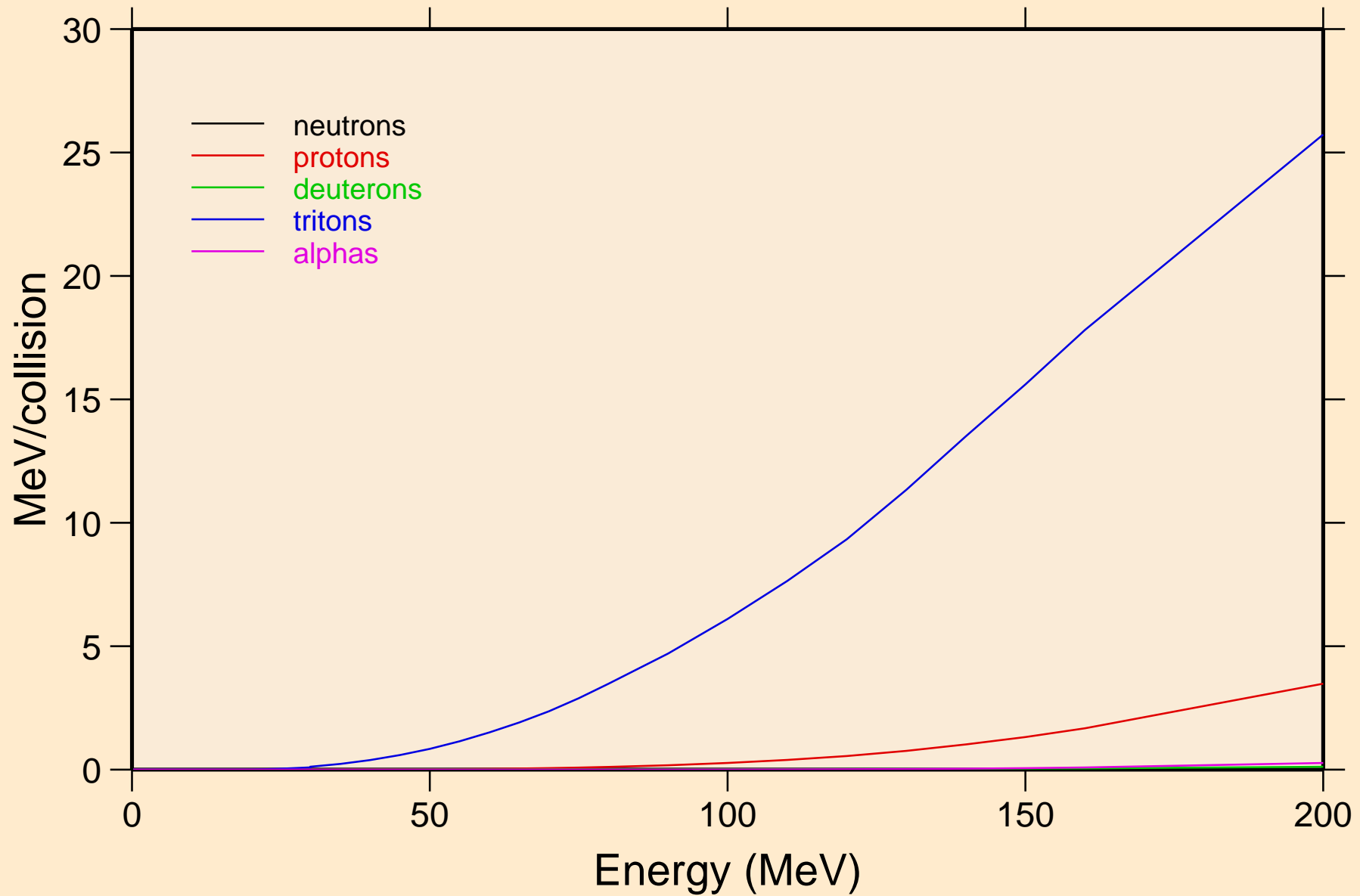

PT204 HELION ACER TENDL-2024 LIBRARY; T=0.K  
Recoil Heating

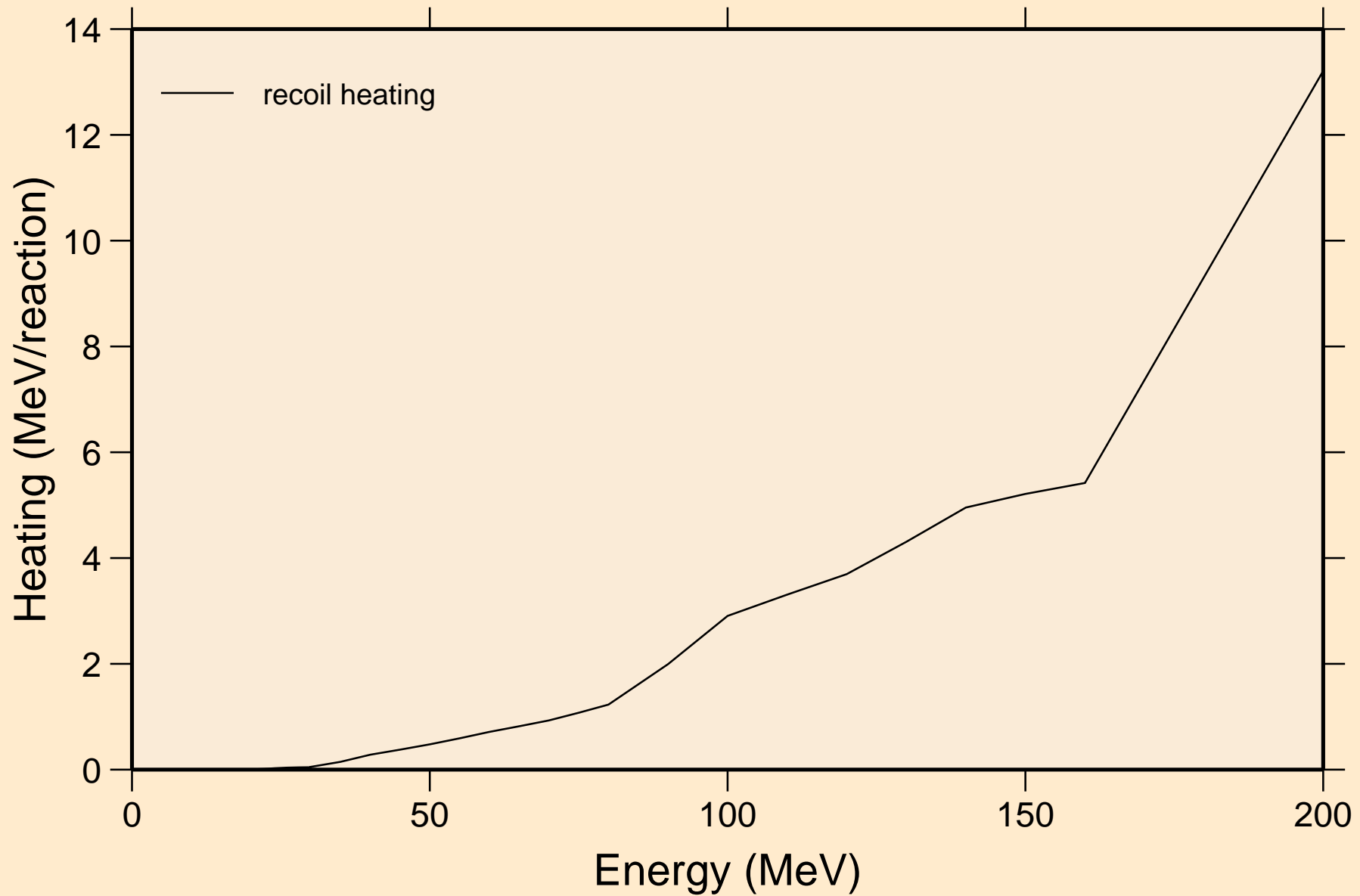

PT204 HELION ACER TENDL-2024 LIBRARY; T=0.K  
Particle production cross sections

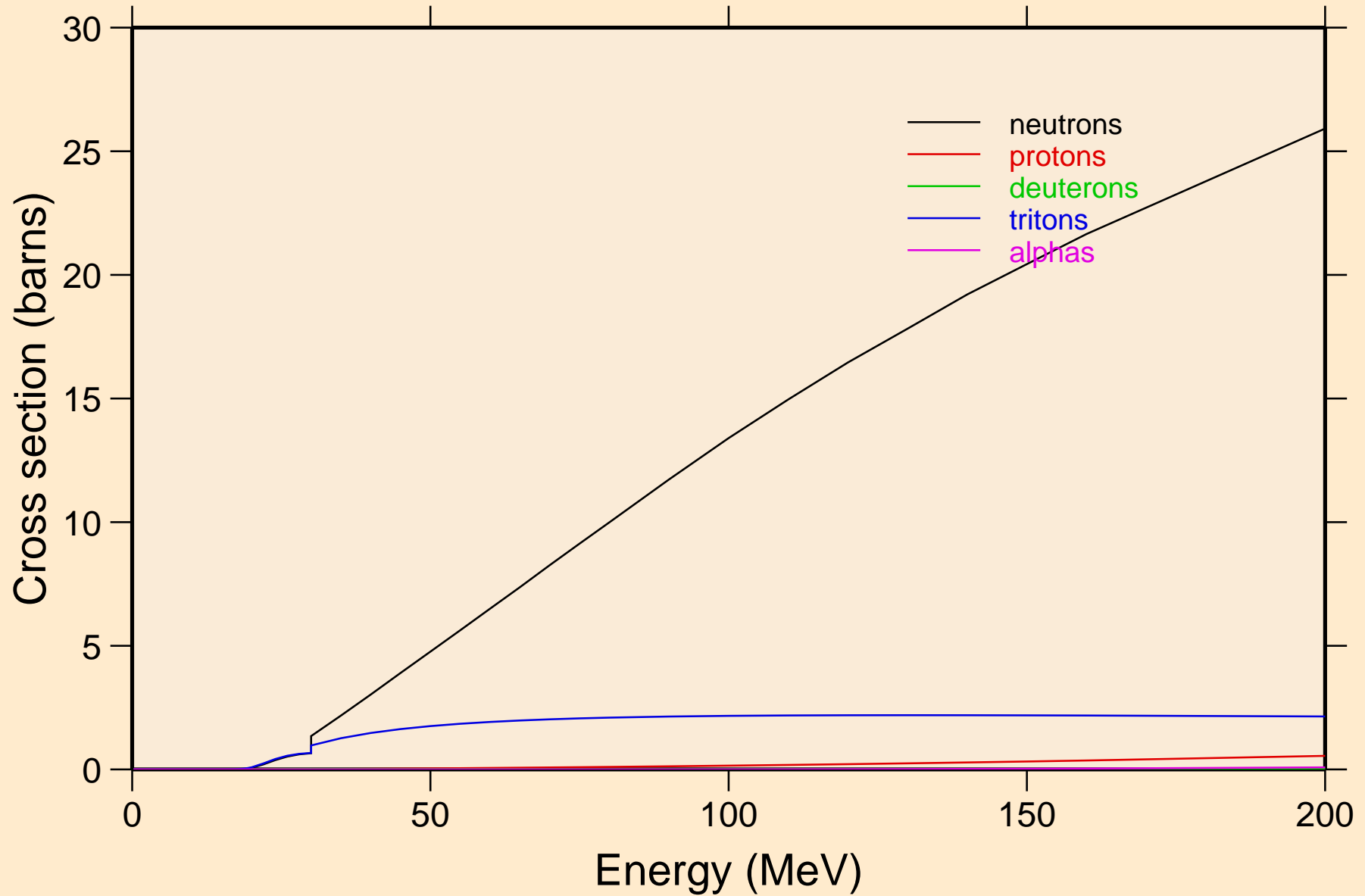

PT204 HELION ACER TENDL-2024 LIBRARY; T=0.K  
neutrons from (s,n)

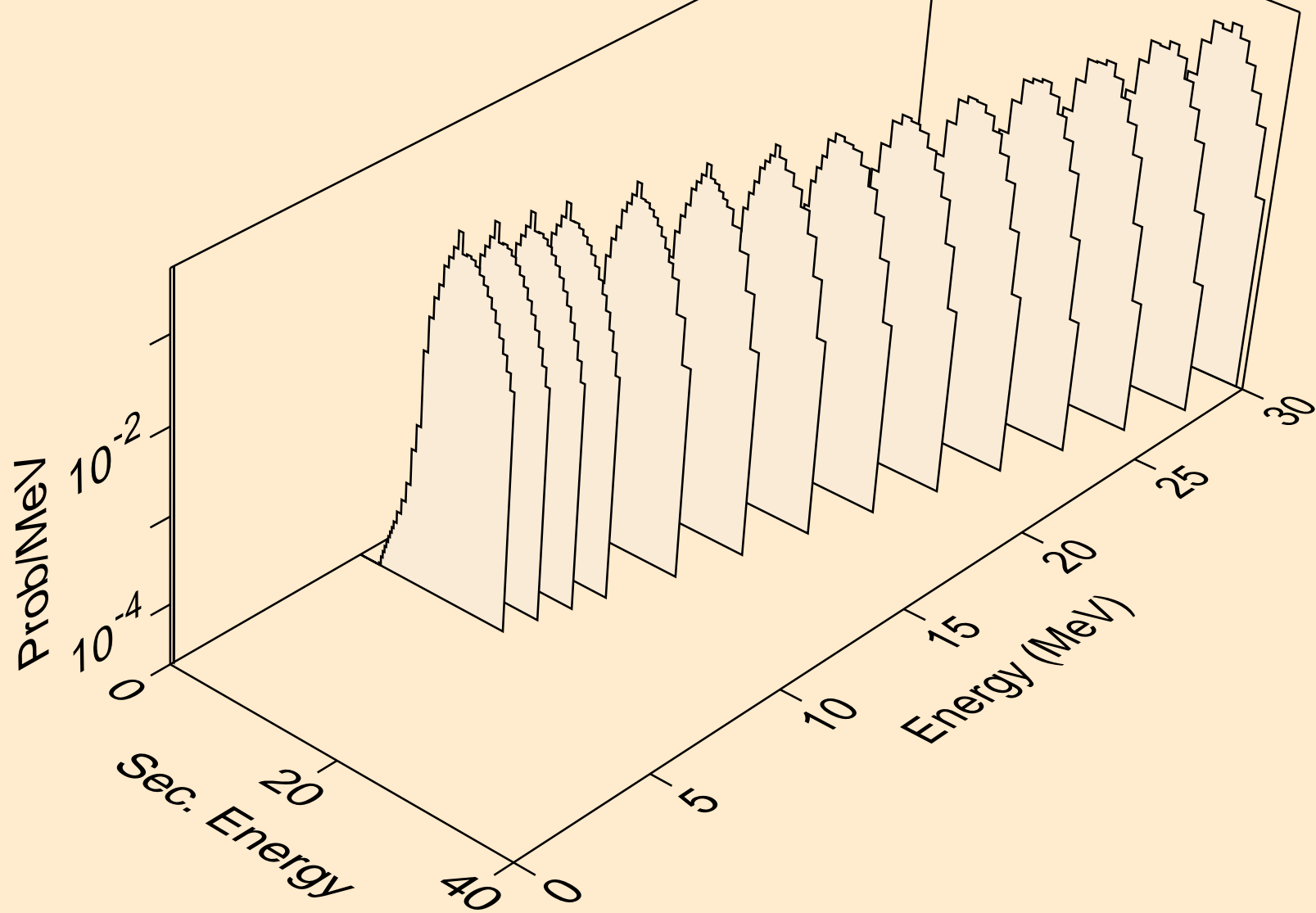

PT204 HELION ACER TENDL-2024 LIBRARY; T=0.K  
neutrons from (s,x)

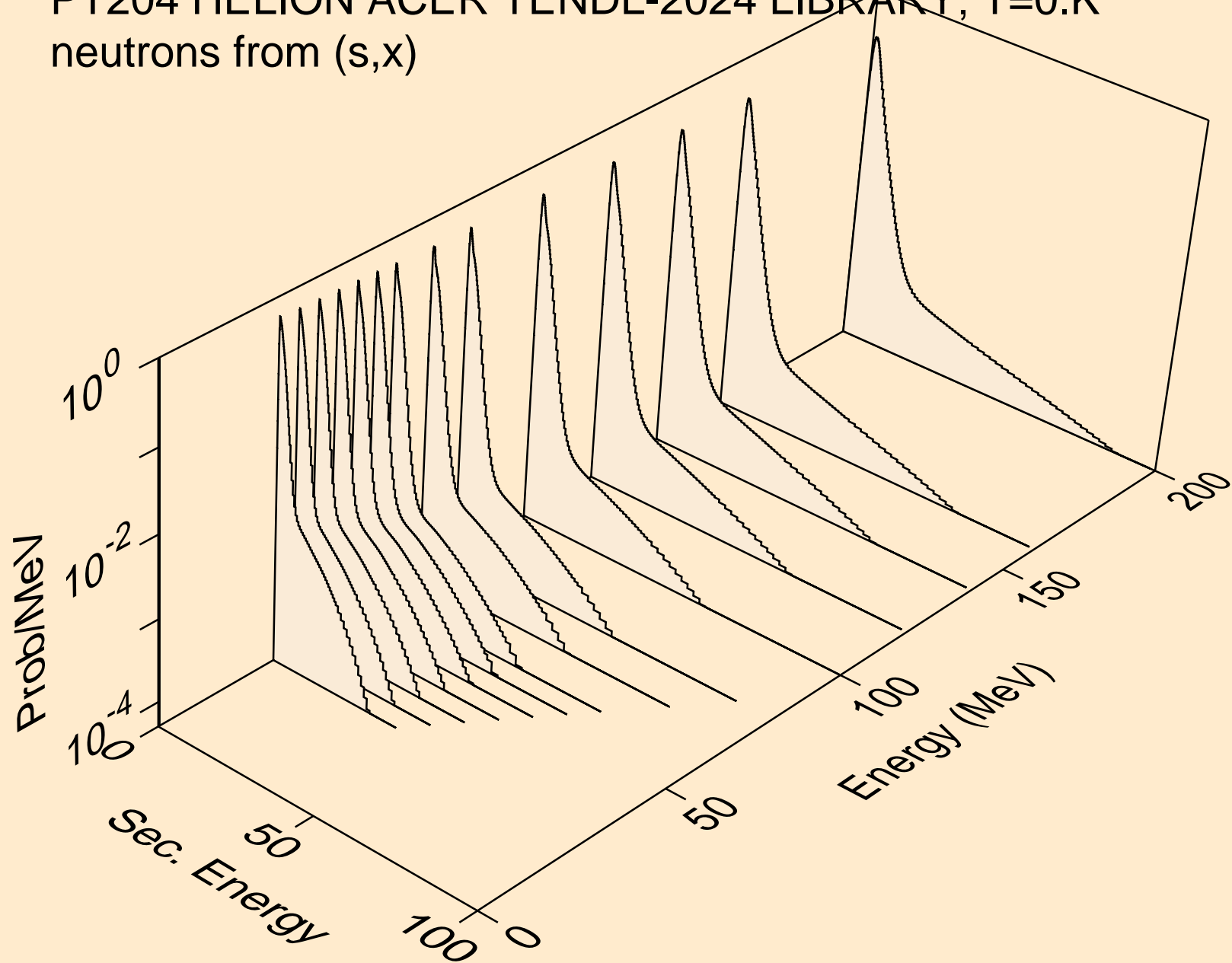

PT204 HELION ACER TENDL-2024 LIBRARY; T=0.K  
neutrons from (s,2nd)

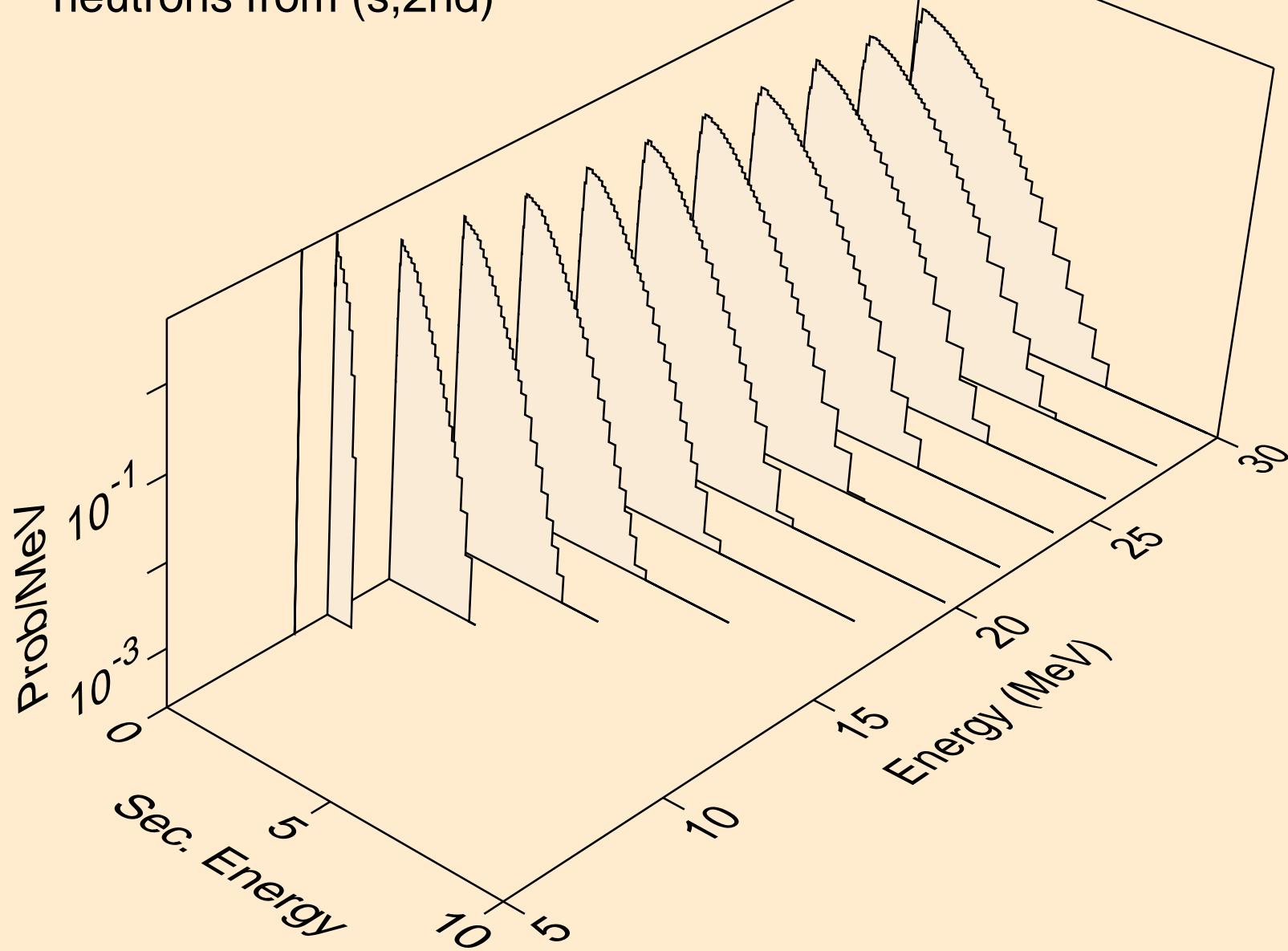

PT204 HELION ACER TENDL-2024 LIBRARY; T=0.K  
neutrons from (s,2n)

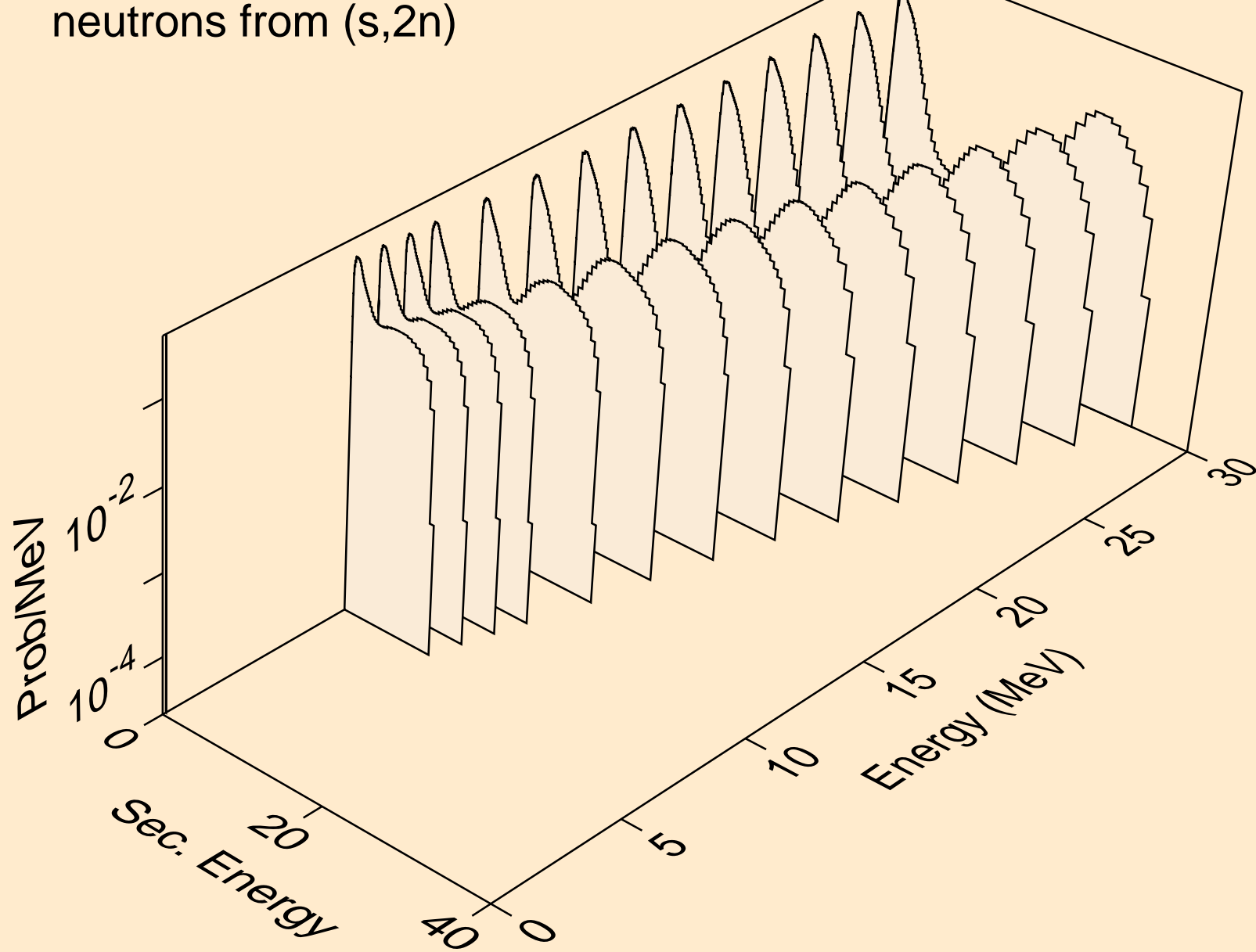

PT204 HELION ACER TENDL-2024 LIBRARY; T=0.K  
neutrons from (s,3n)

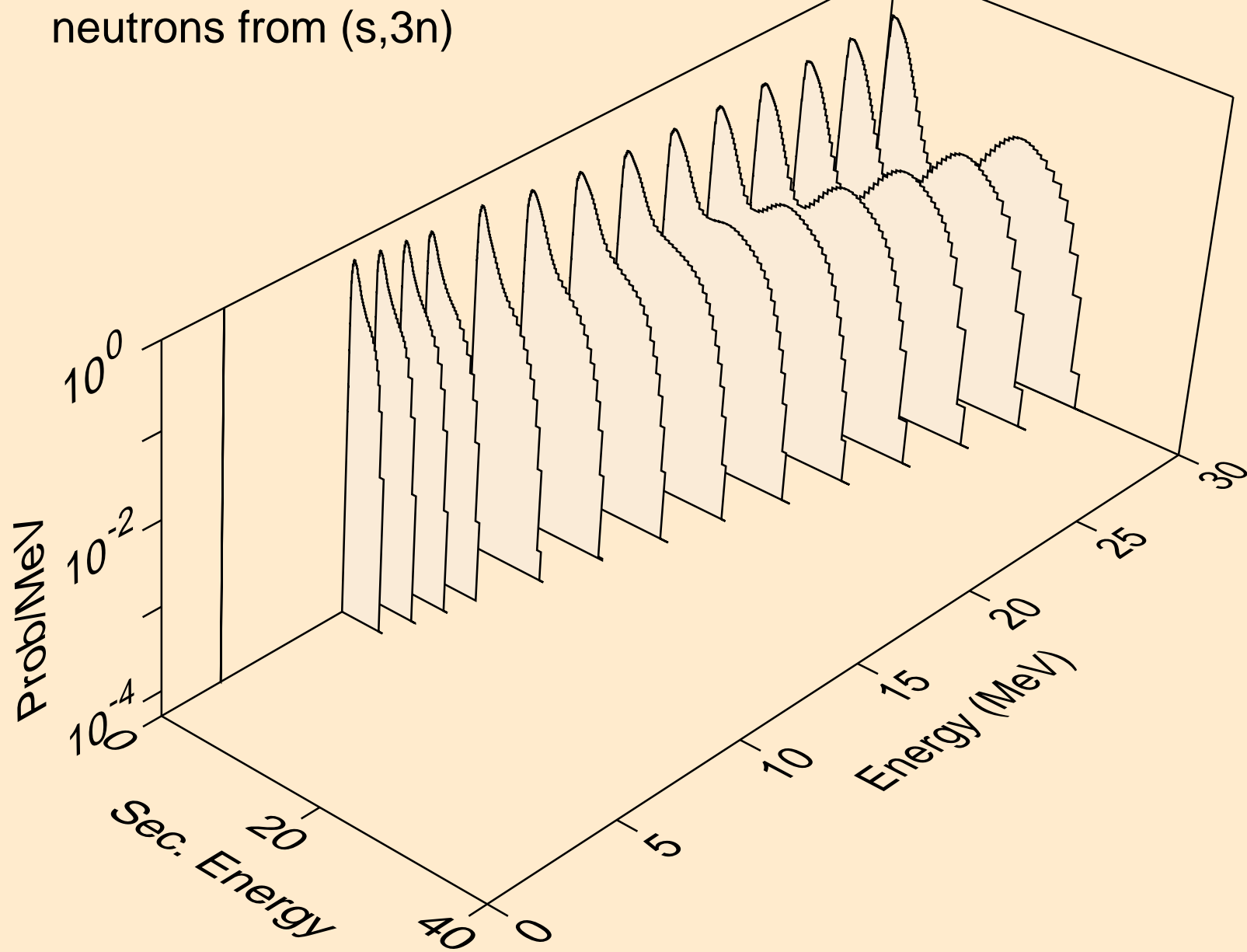

PT204 HELION ACER TENDL-2024 LIBRARY; T=0.K  
neutrons from (s,n\*)a

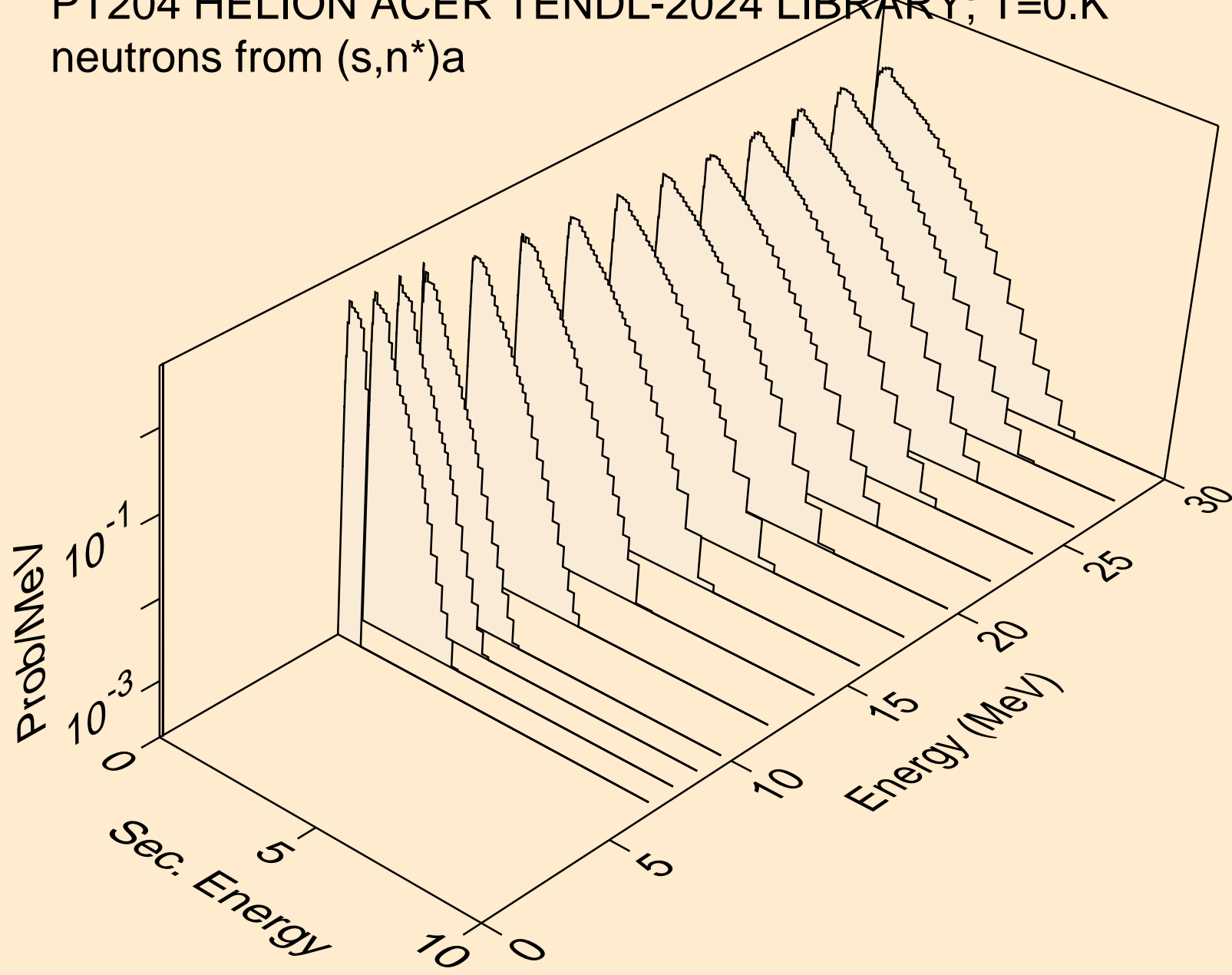

PT204 HELION ACER TENDL-2024 LIBRARY; T=0.K  
neutrons from (s,2n)a

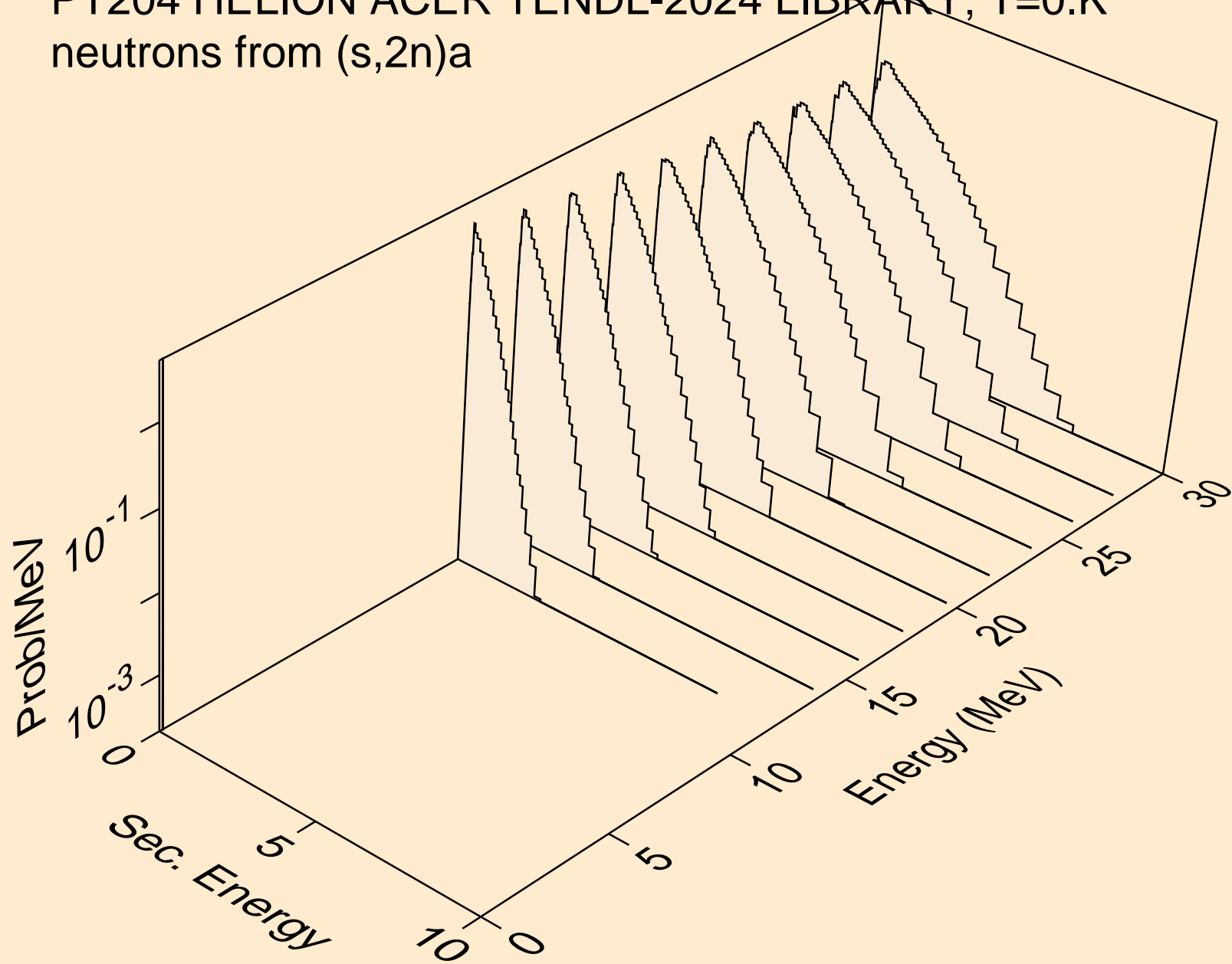

PT204 HELION ACER TENDL-2024 LIBRARY; T=0.K  
neutrons from (s,3n)a

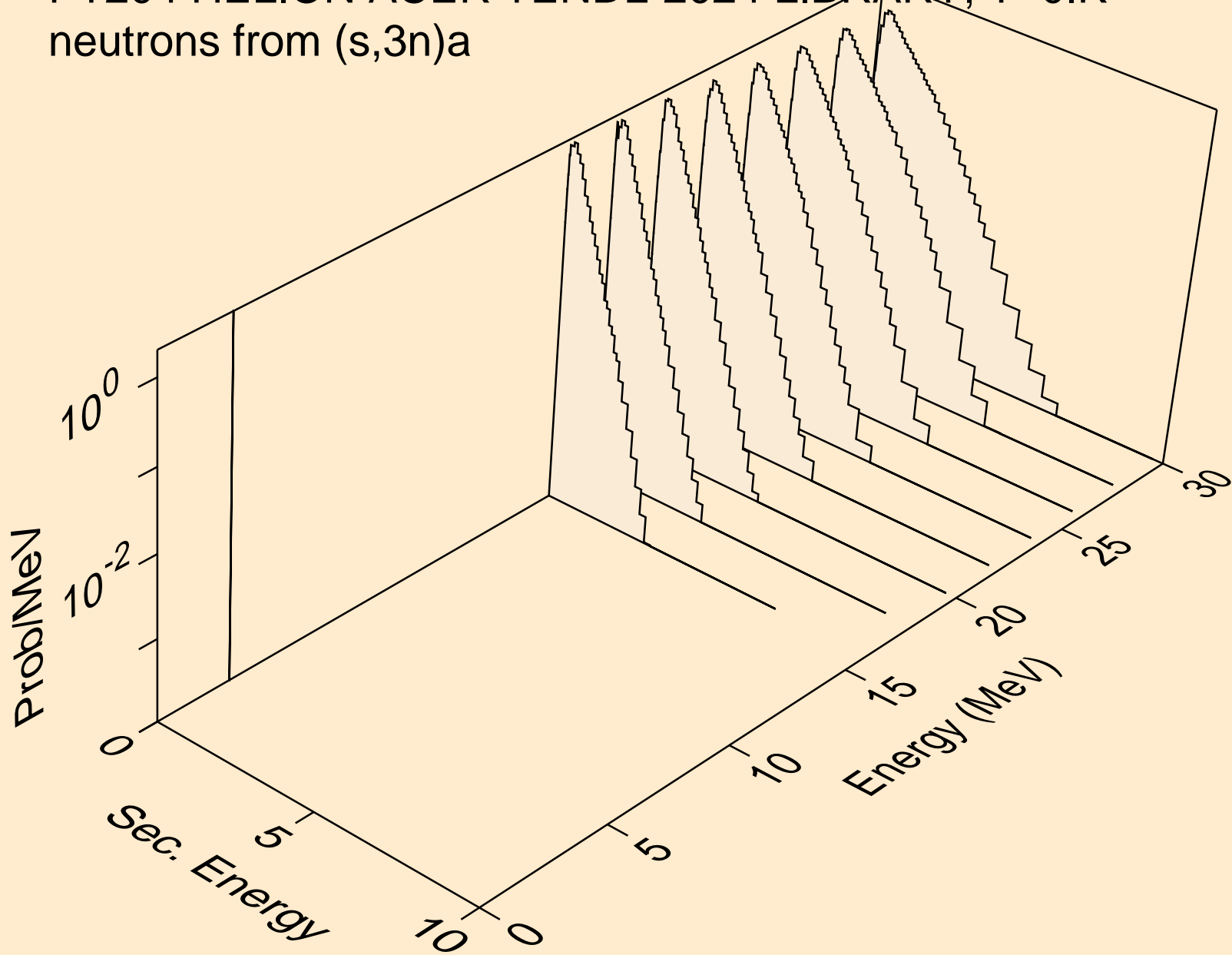

PT204 HELION ACER TENDL-2024 LIBRARY; T=0.K  
neutrons from (s,n\*)p

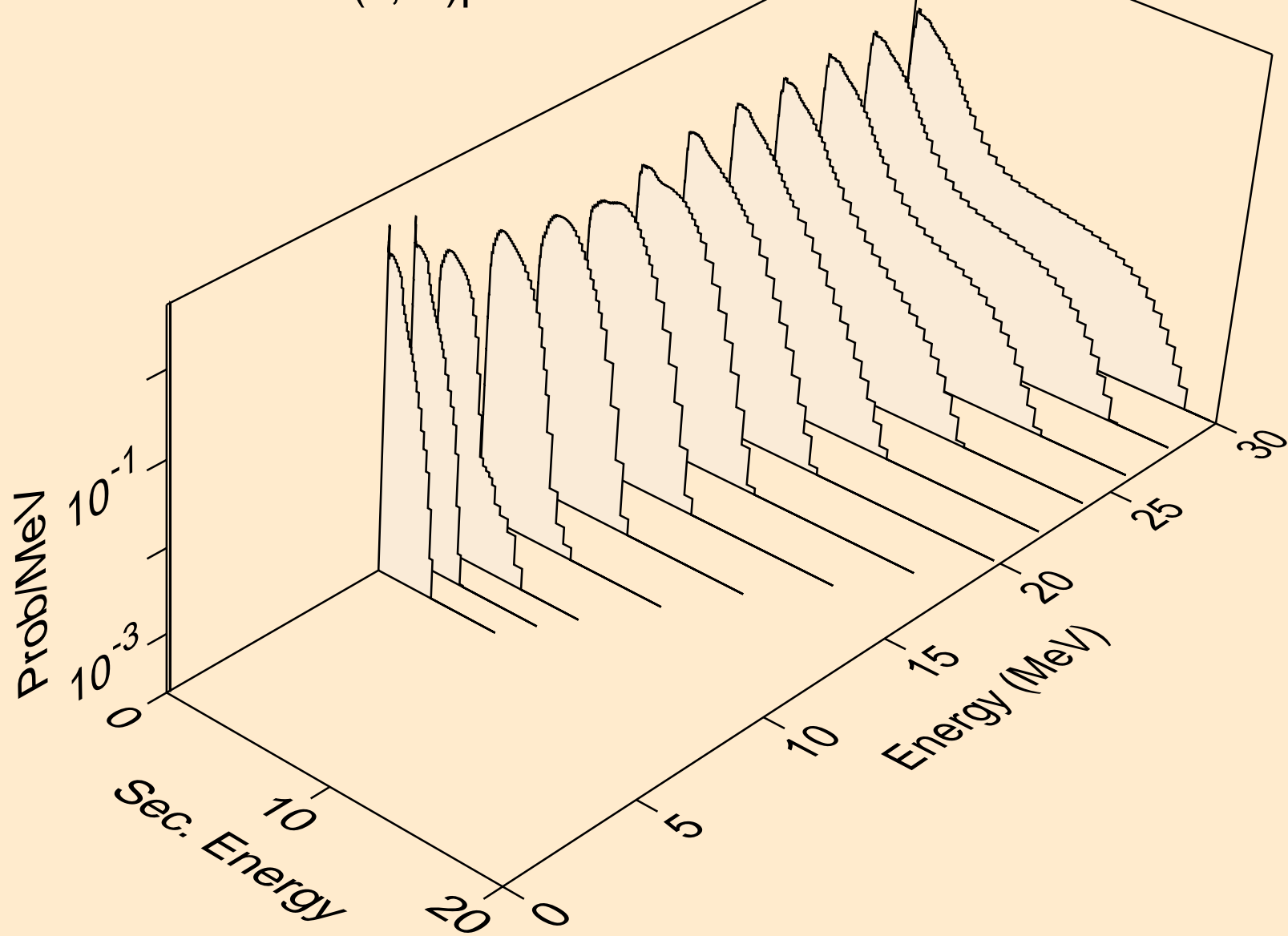

PT204 HELION ACER TENDL-2024 LIBRARY; T=0.K  
neutrons from (s,n\*)d

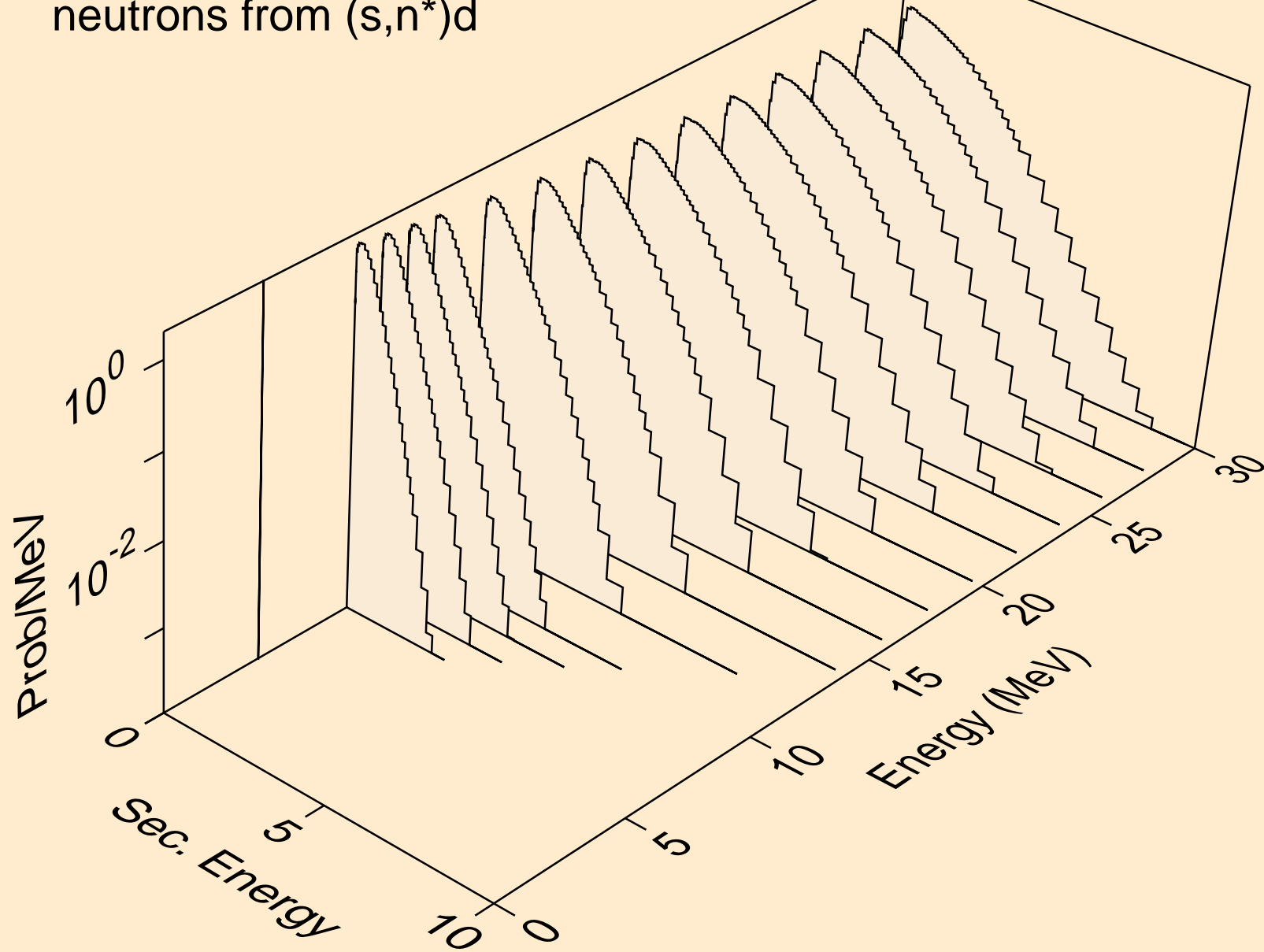

PT204 HELION ACER TENDL-2024 LIBRARY; T=0.K  
neutrons from (s,n\*)t

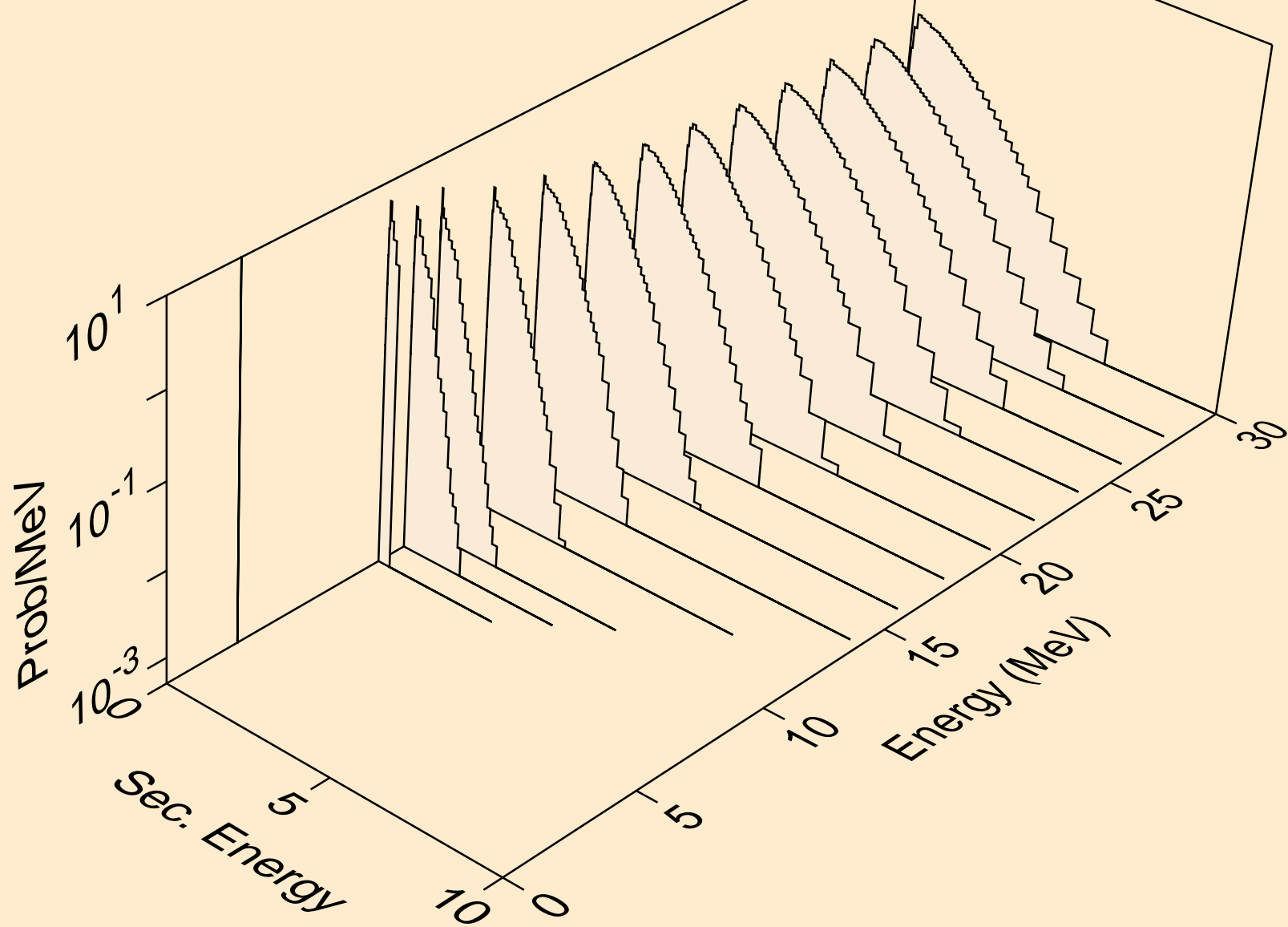

PT204 HELION ACER TENDL-2024 LIBRARY; T=0.K  
neutrons from (s,n\*)he3

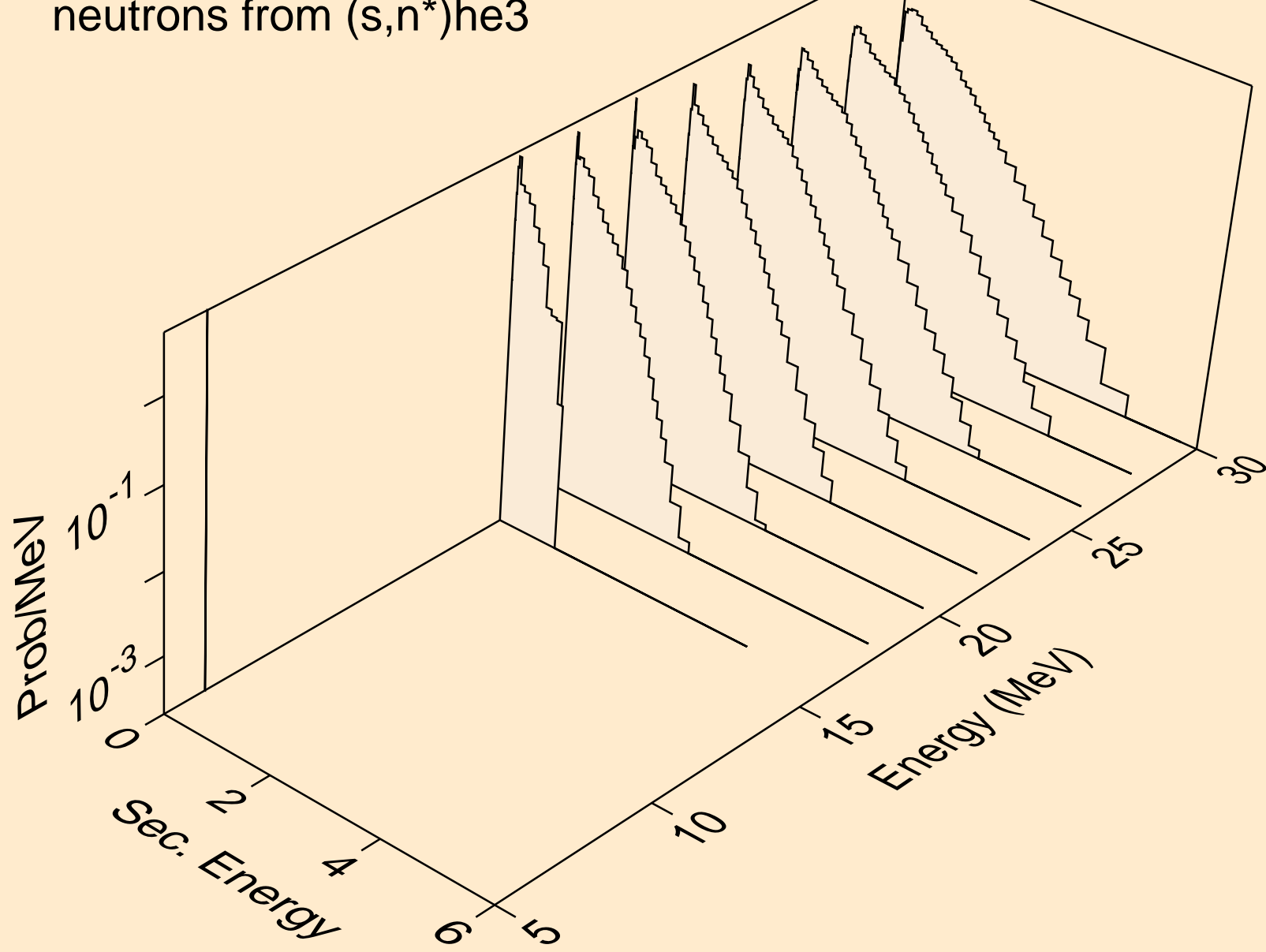

PT204 HELION ACER TENDL-2024 LIBRARY; T=0.K  
neutrons from (s,4n)

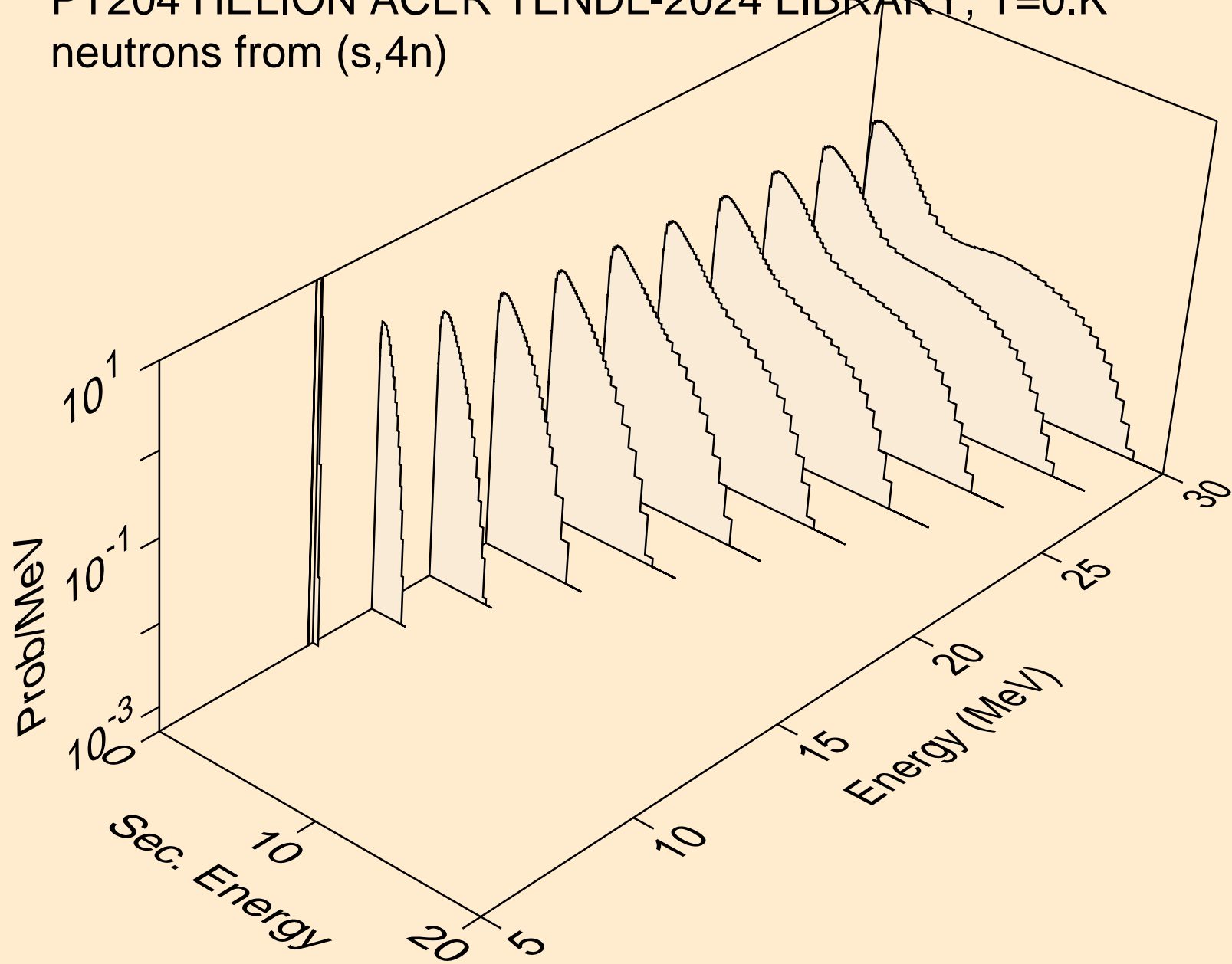

PT204 HELION ACER TENDL-2024 LIBRARY; T=0.K  
neutrons from (s,2np)

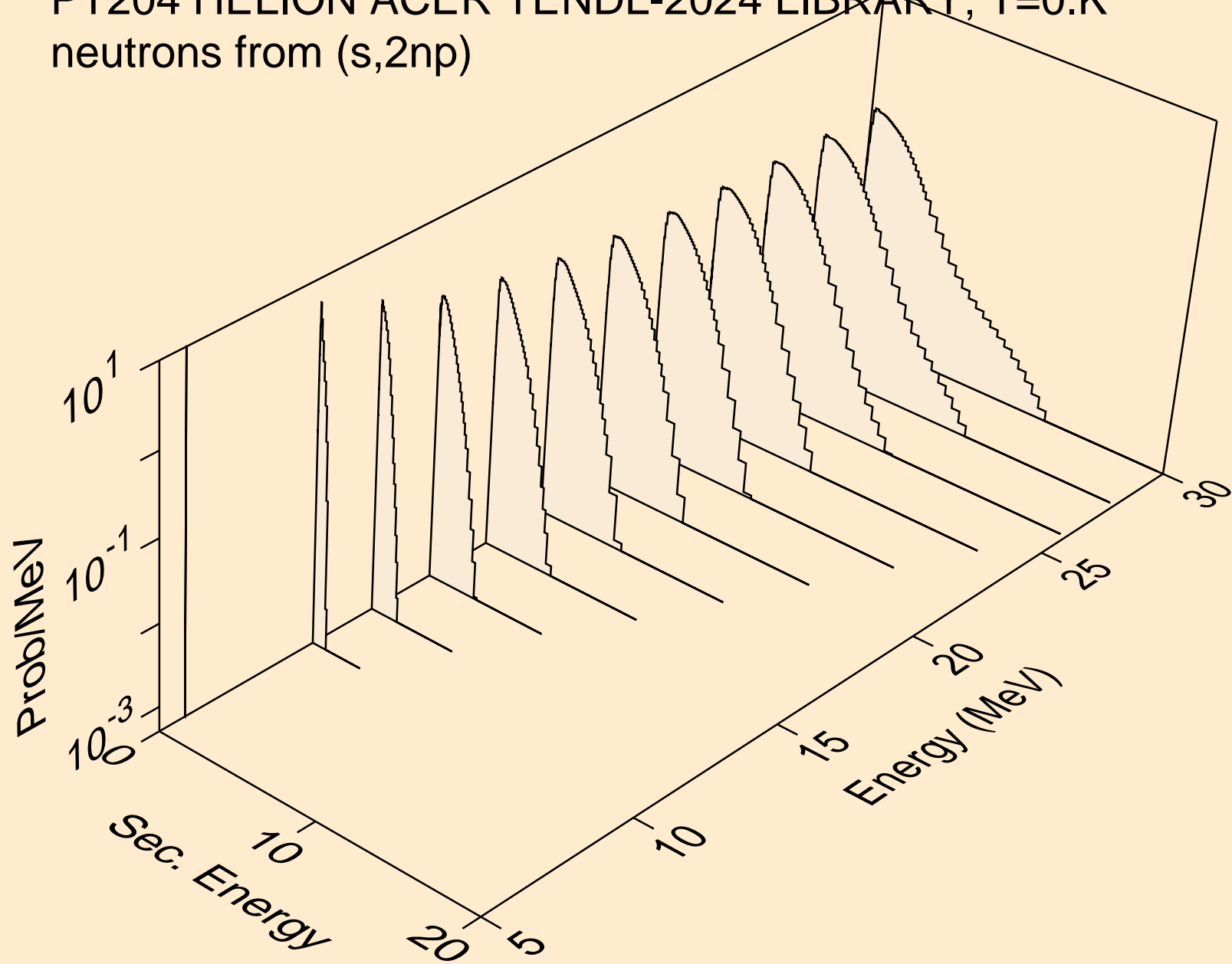

PT204 HELION ACER TENDL-2024 LIBRARY; T=0.K  
neutrons from (s,3np)

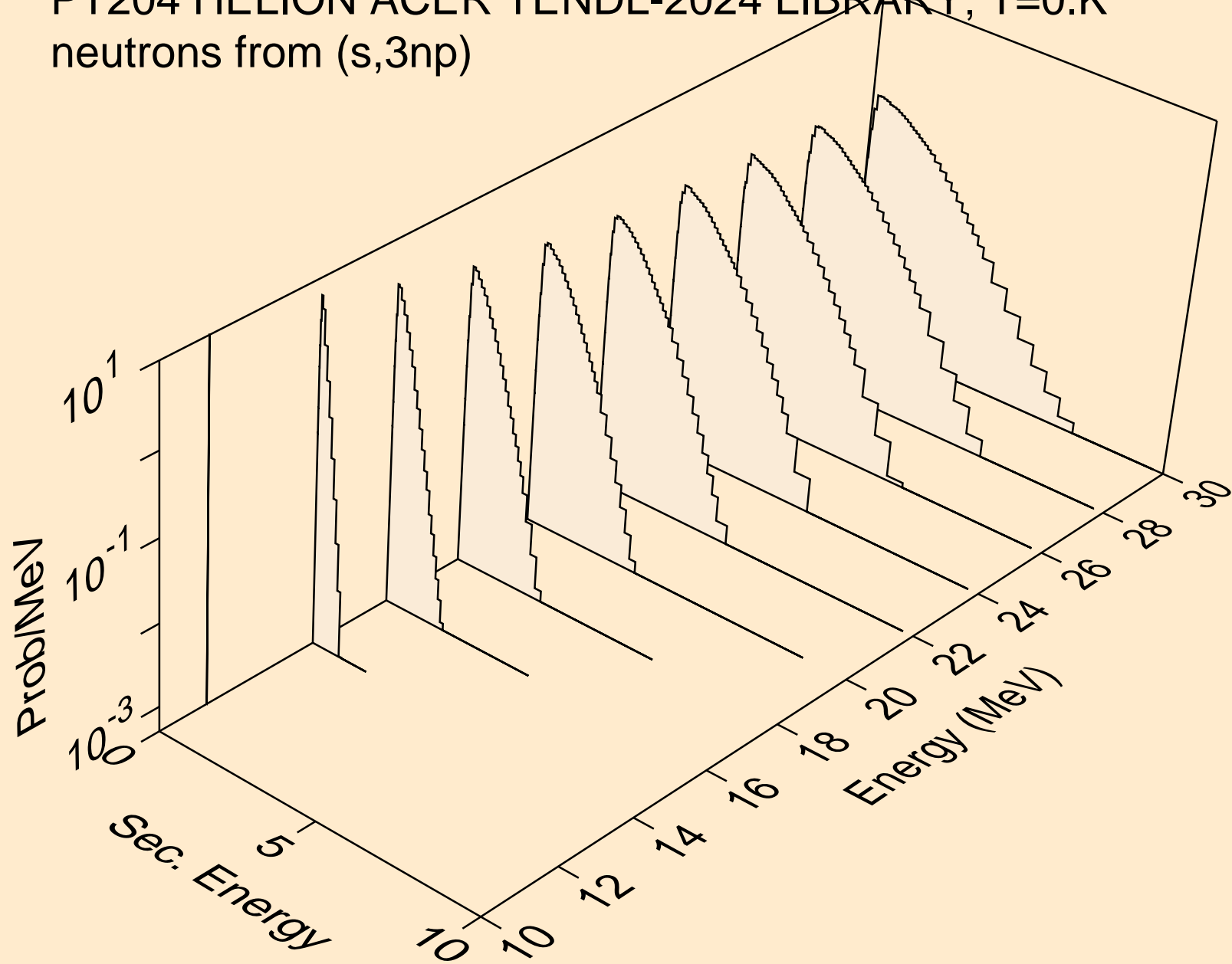

PT204 HELION ACER TENDL-2024 LIBRARY; T=0.K  
neutrons from (s,n2p)

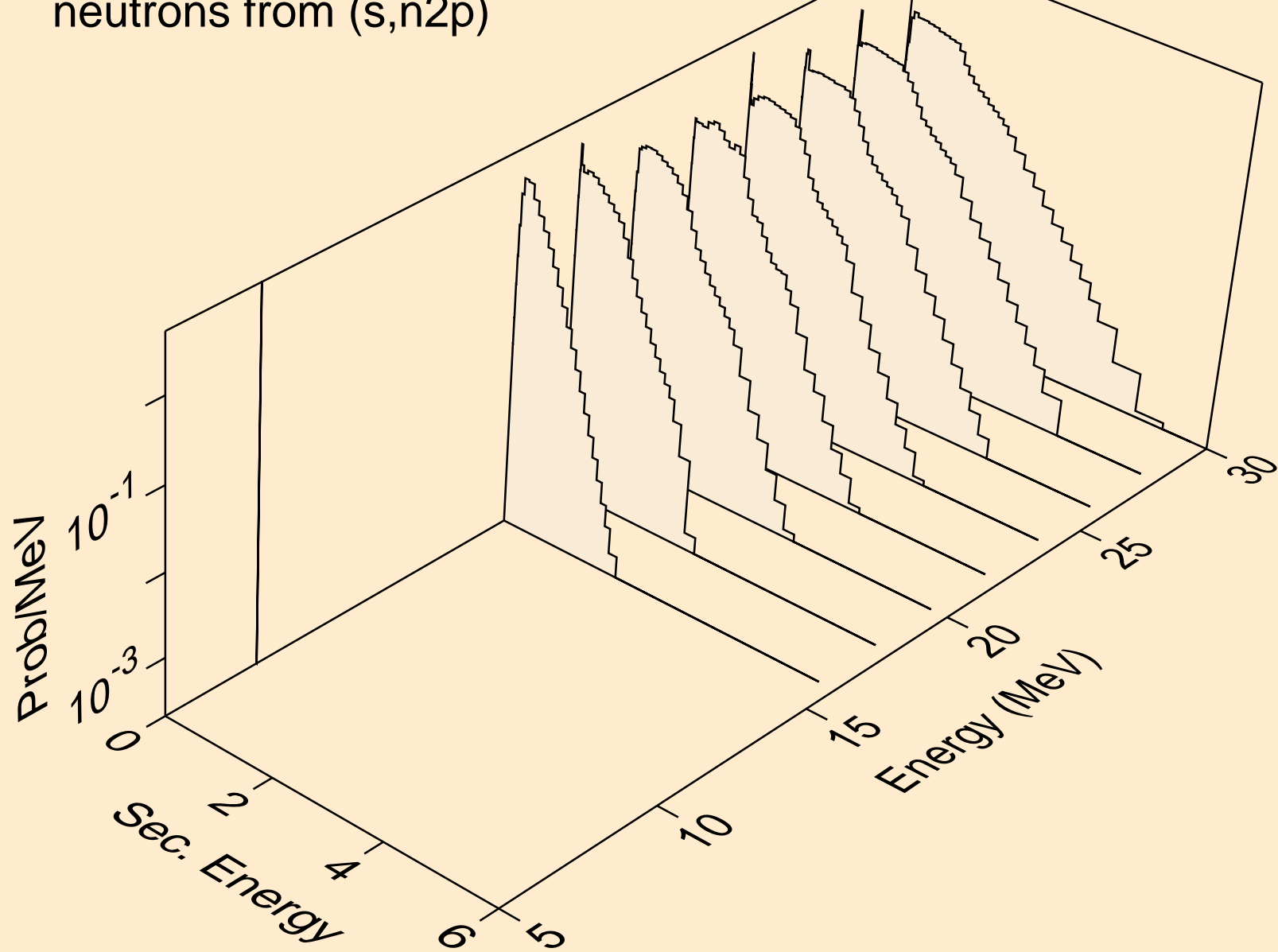

PT204 HELION ACER TENDL-2024 LIBRARY; T=0.K  
neutrons from (s,npa)

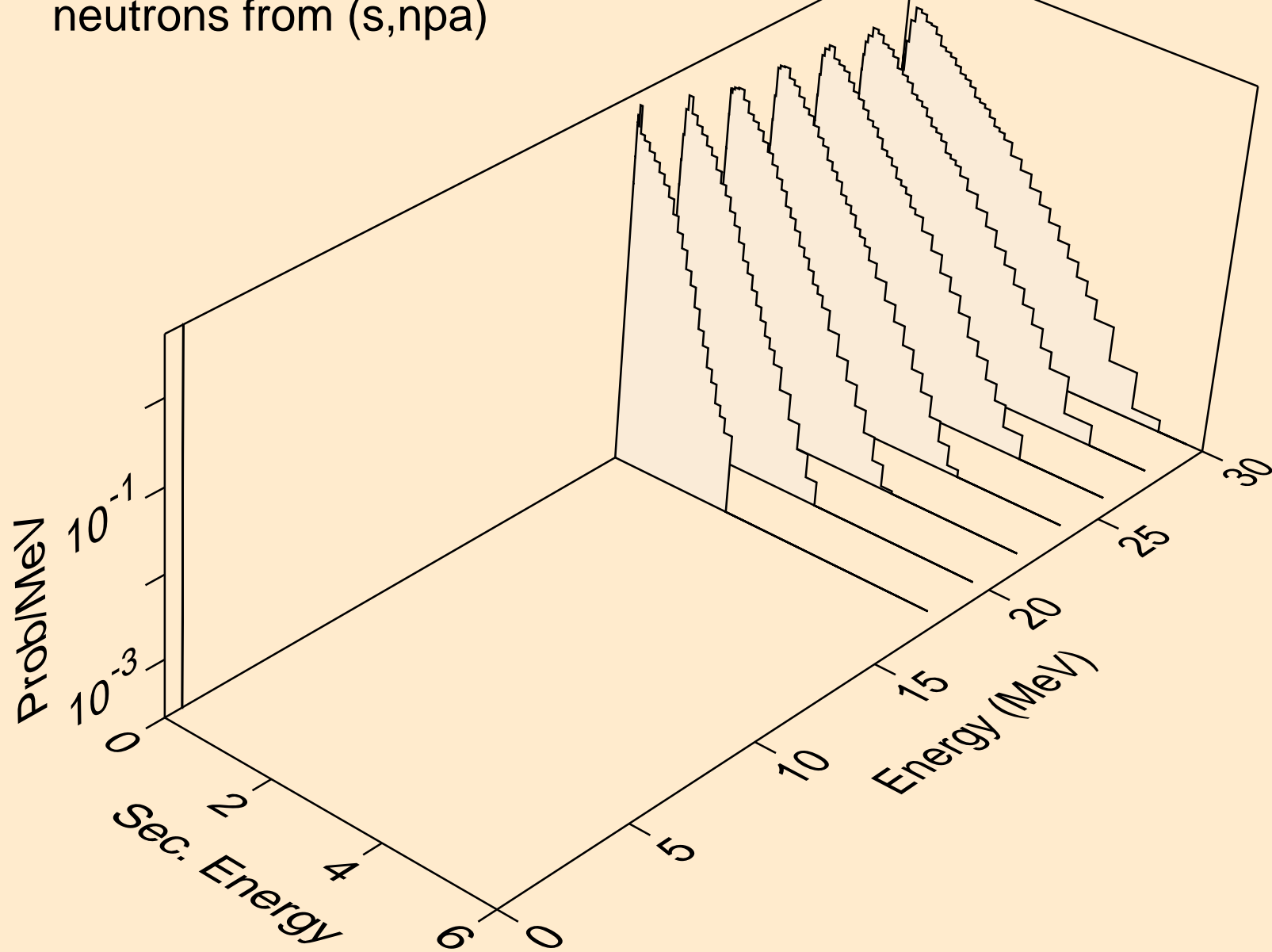

PT204 HELION ACER TENDL-2024 LIBRARY; T=0.K  
protons from (s,x)

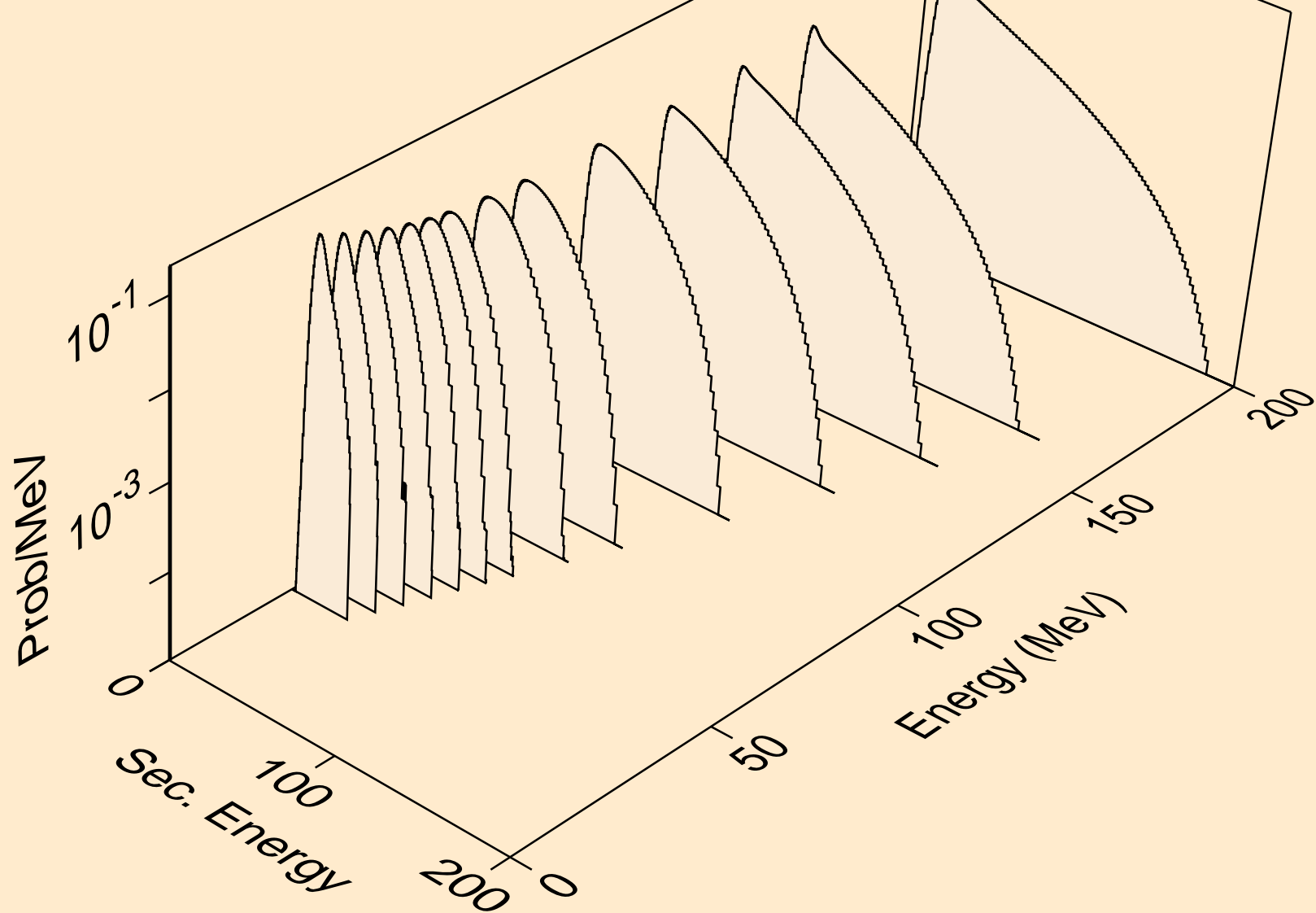

PT204 HELION ACER TENDL-2024 LIBRARY; T=0.K  
protons from (s,n\*)p

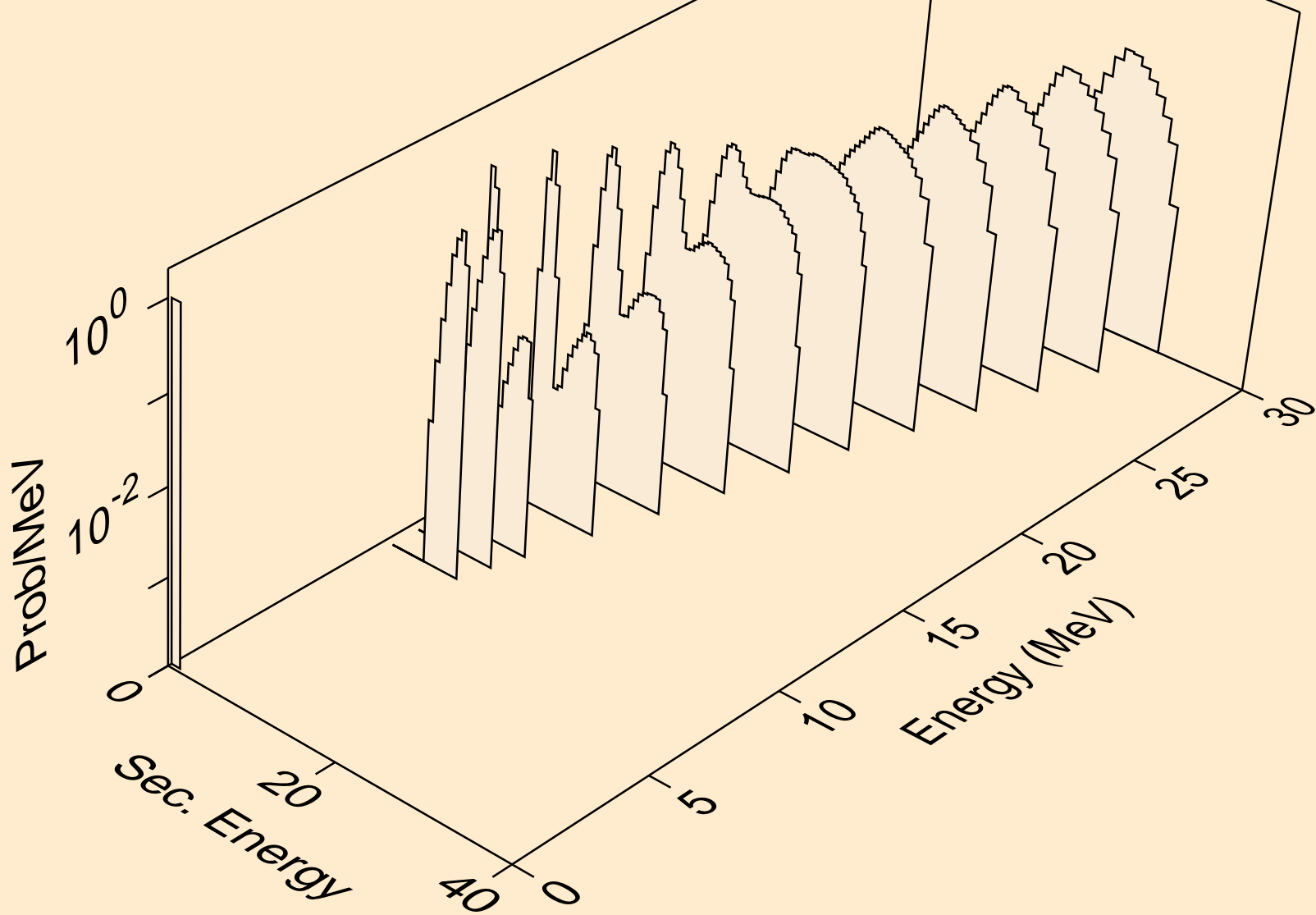

PT204 HELION ACER TENDL-2024 LIBRARY; T=0.K  
protons from (s,2np)

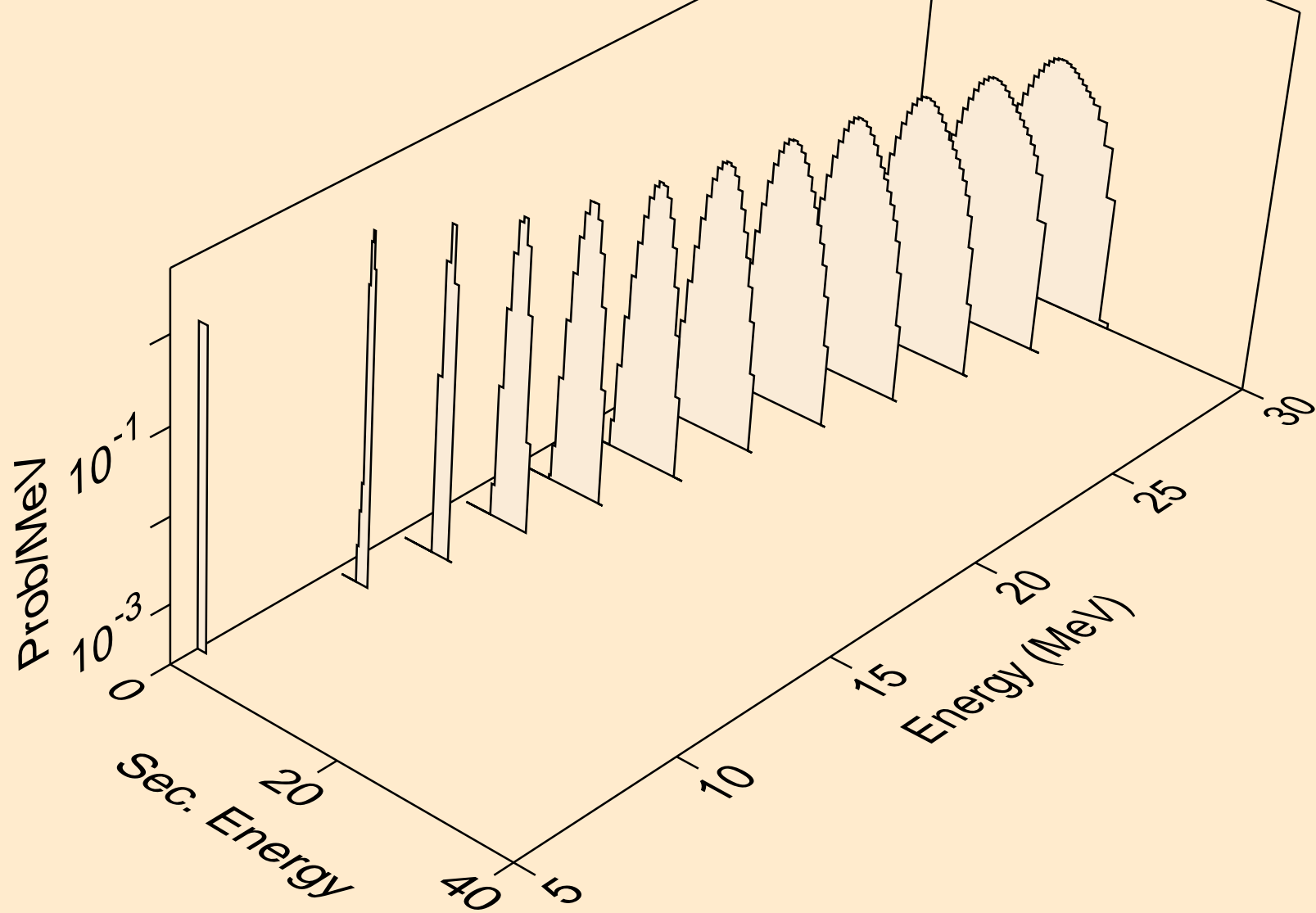

PT204 HELION ACER TENDL-2024 LIBRARY; T=0.K  
protons from (s,3np)

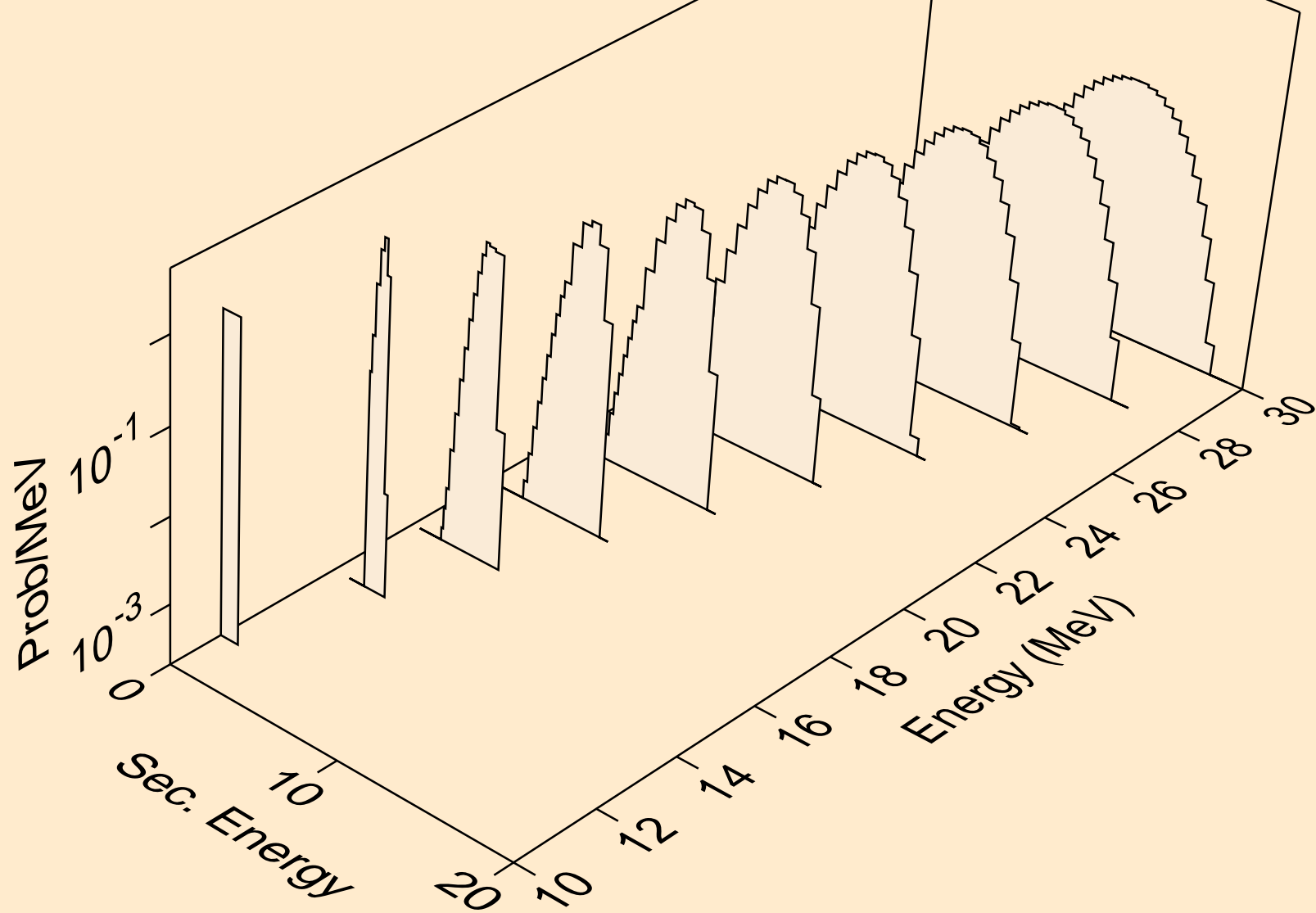

PT204 HELION ACER TENDL-2024 LIBRARY; T=0.K  
protons from (s,n2p)

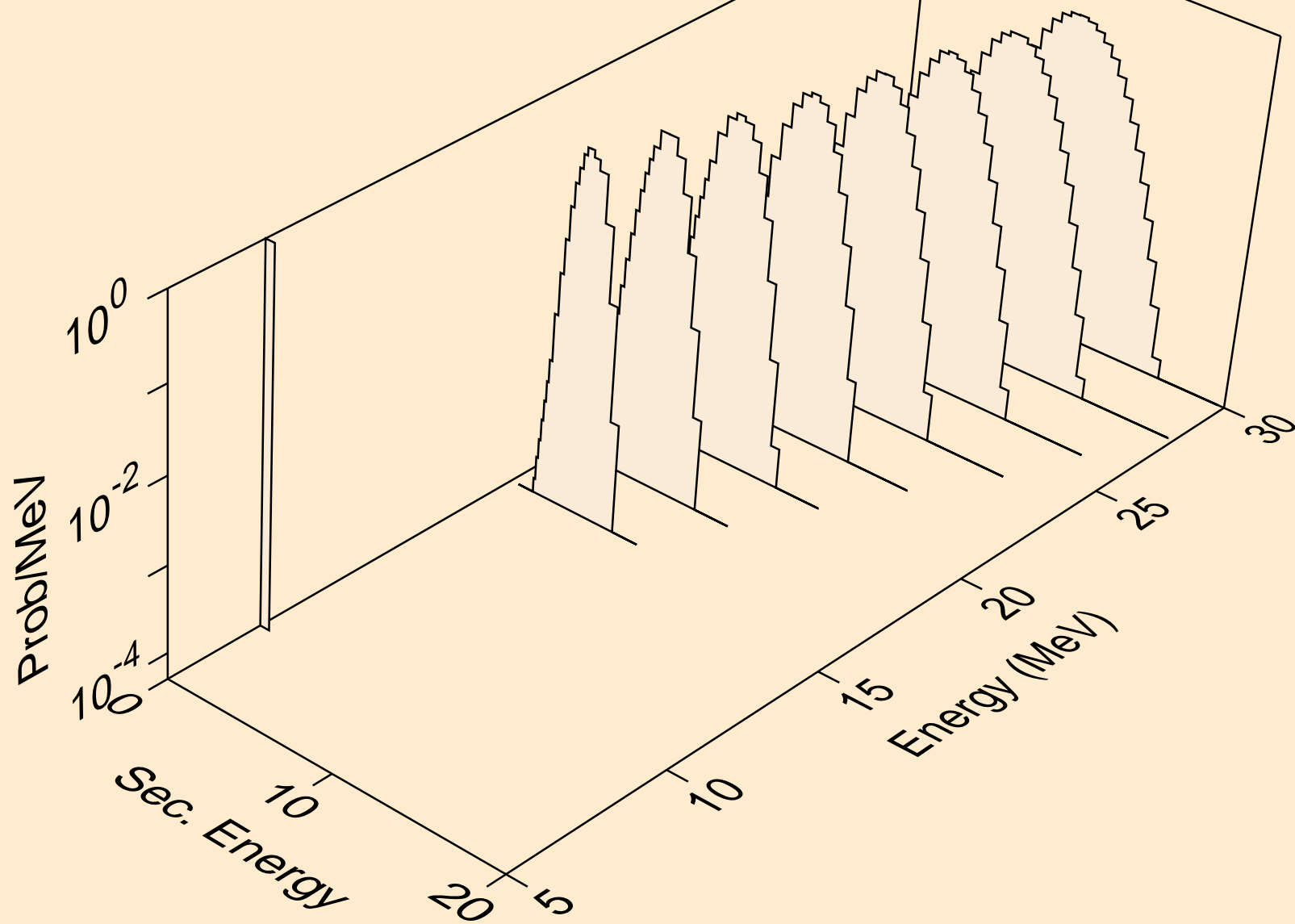

PT204 HELION ACER TENDL-2024 LIBRARY; T=0.K  
protons from (s,npa)

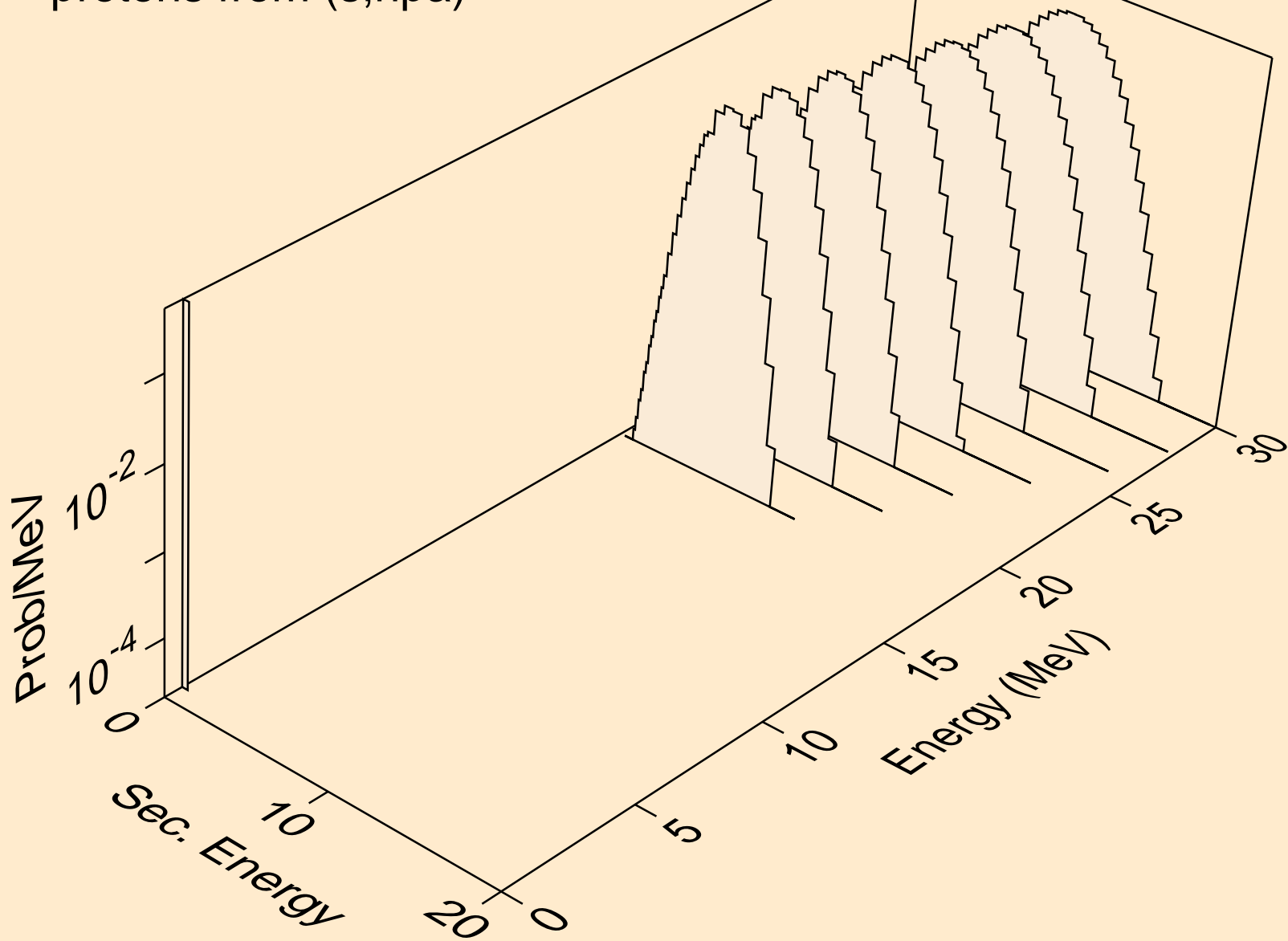

PT204 HELION ACER TENDL-2024 LIBRARY; T=0.K  
protons from (s,p)

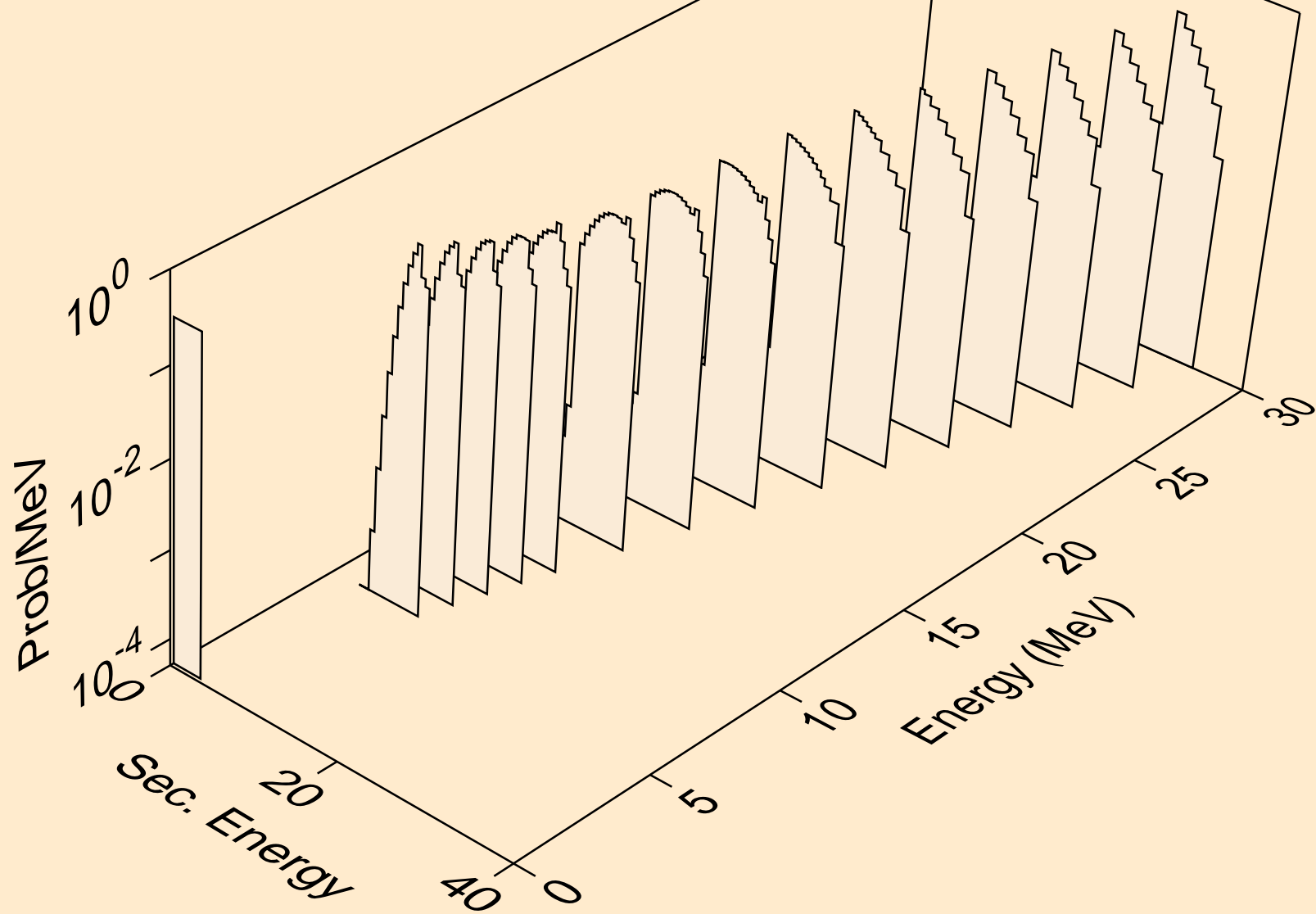

PT204 HELION ACER TENDL-2024 LIBRARY; T=0.K  
protons from (s,2p)

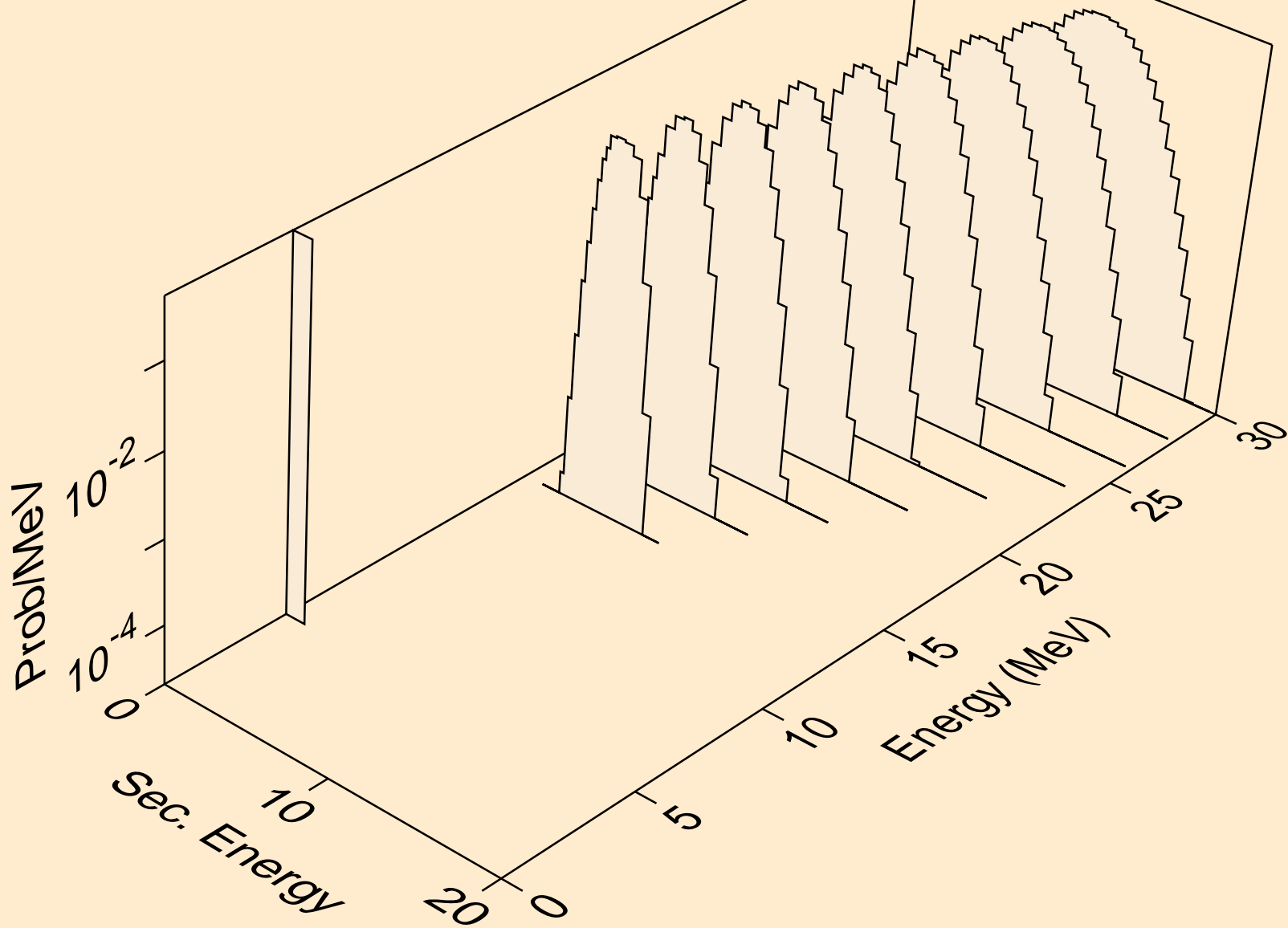

PT204 HELION ACER TENDL-2024 LIBRARY; T=0.K  
protons from (s,pd)

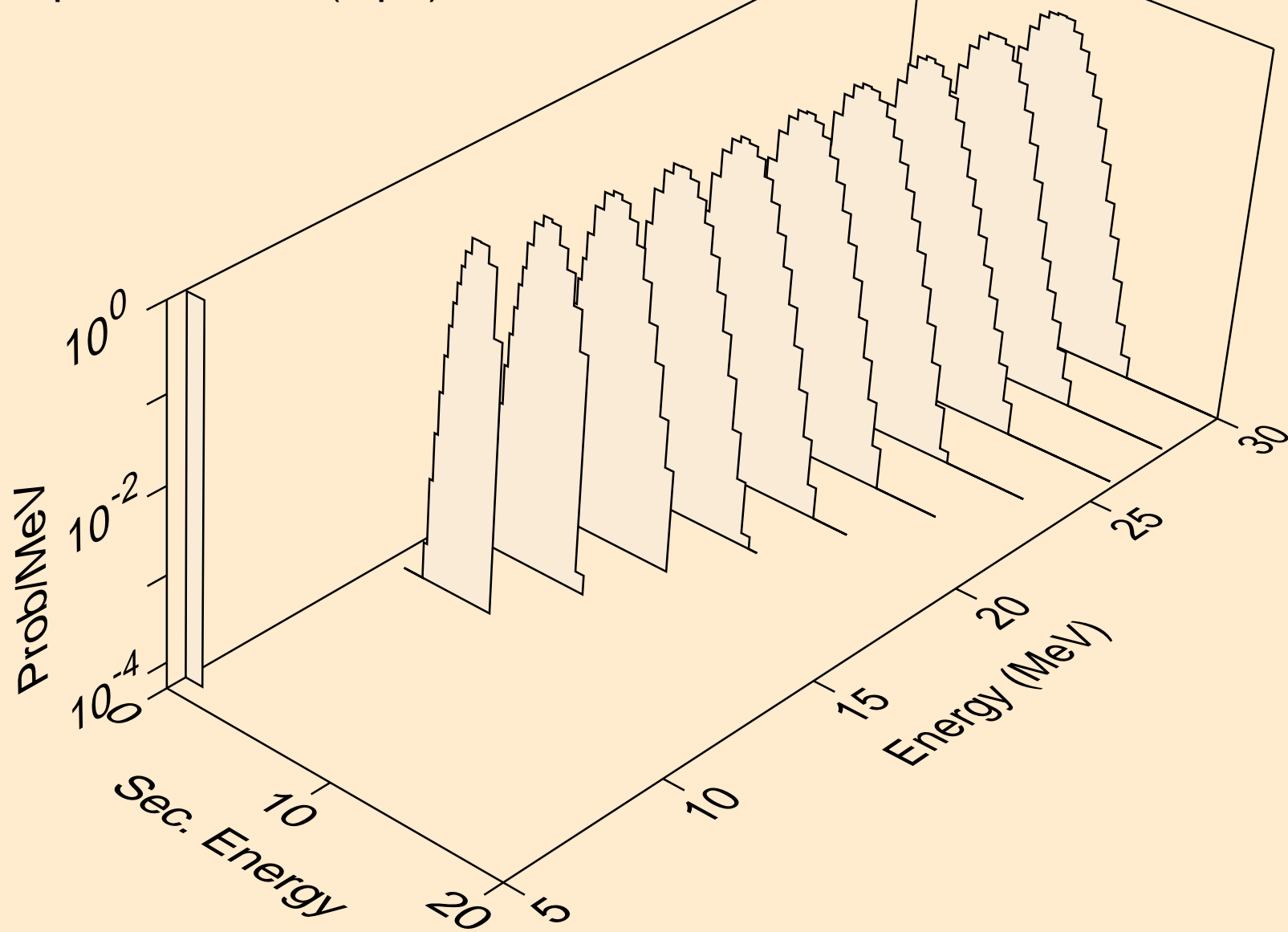

PT204 HELION ACER TENDL-2024 LIBRARY; T=0.K  
protons from (s,pt)

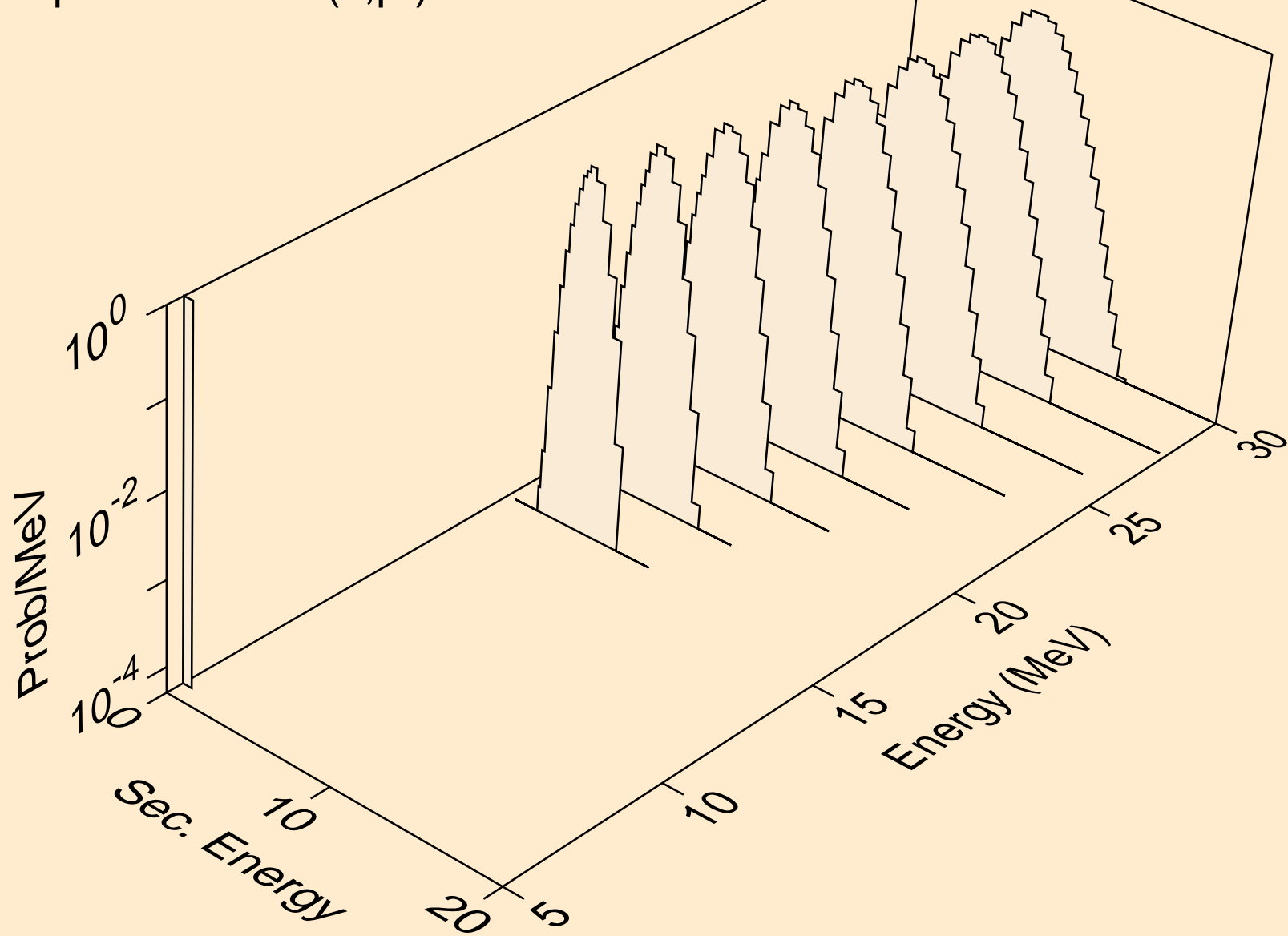

PT204 HELION ACER TENDL-2024 LIBRARY; T=0.K  
deuterons from (s,x)

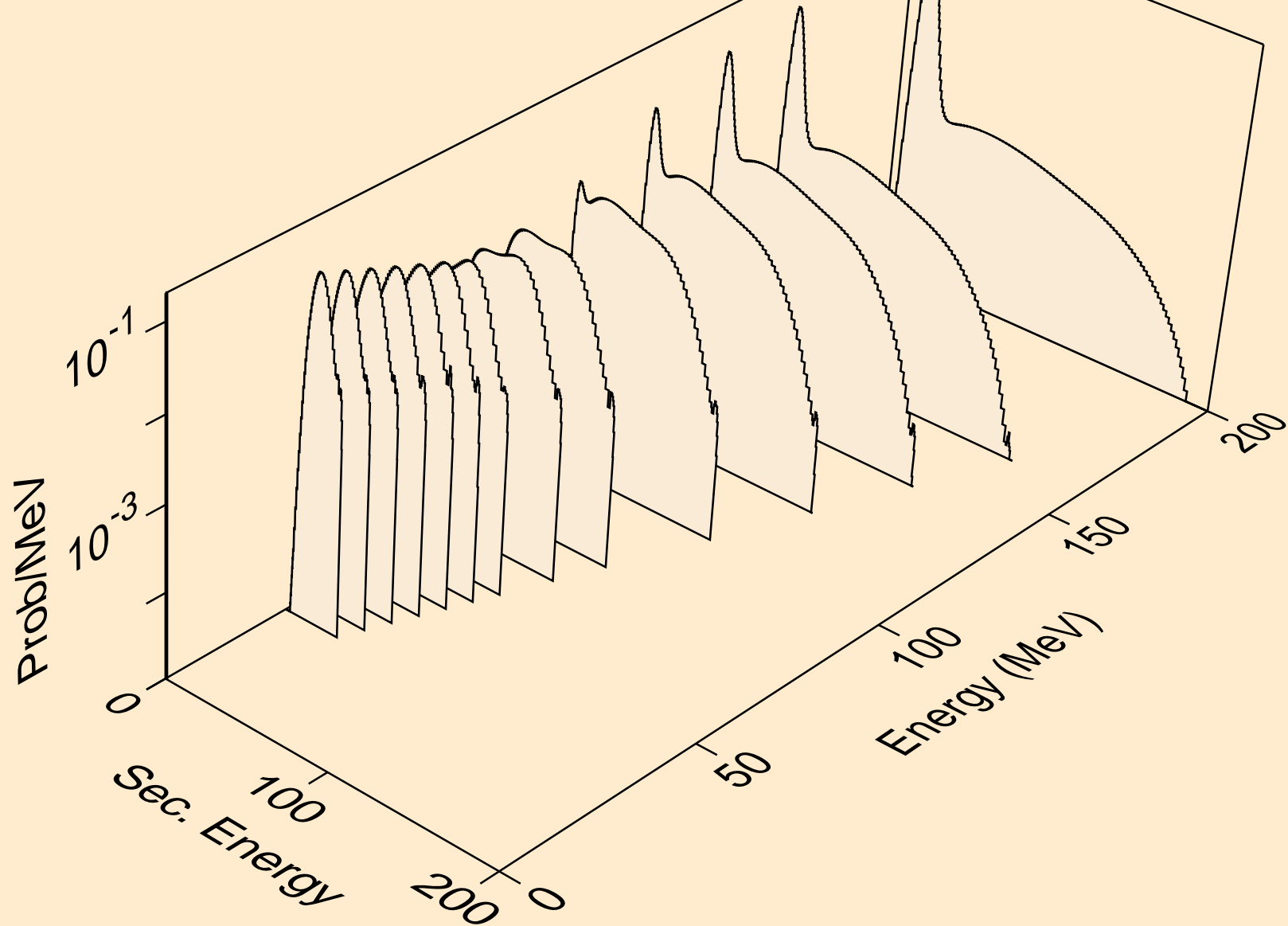

PT204 HELION ACER TENDL-2024 LIBRARY; T=0.K  
deuterons from (s,2nd)

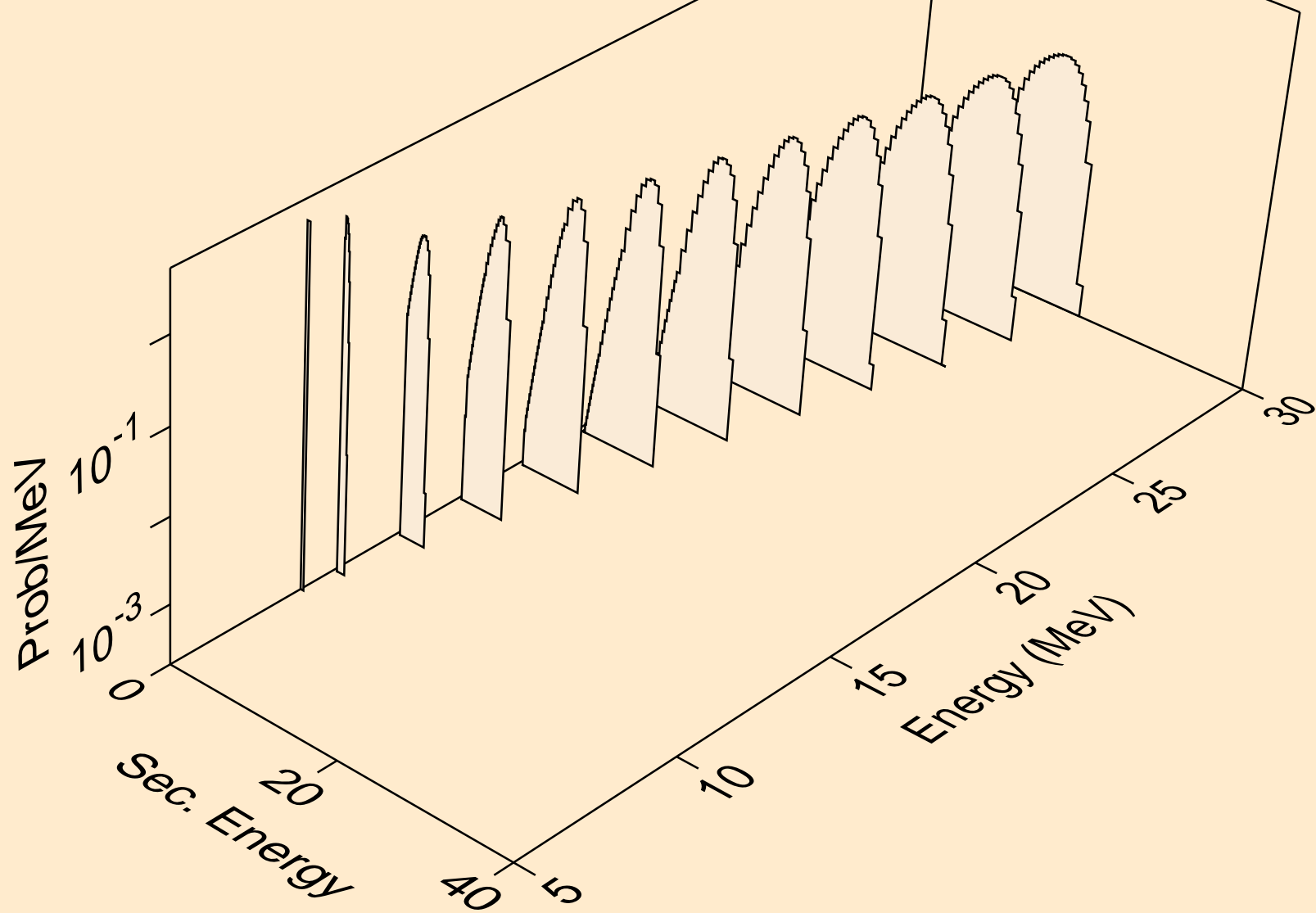

PT204 HELION ACER TENDL-2024 LIBRARY; T=0.K  
deuterons from (s,n\*)d

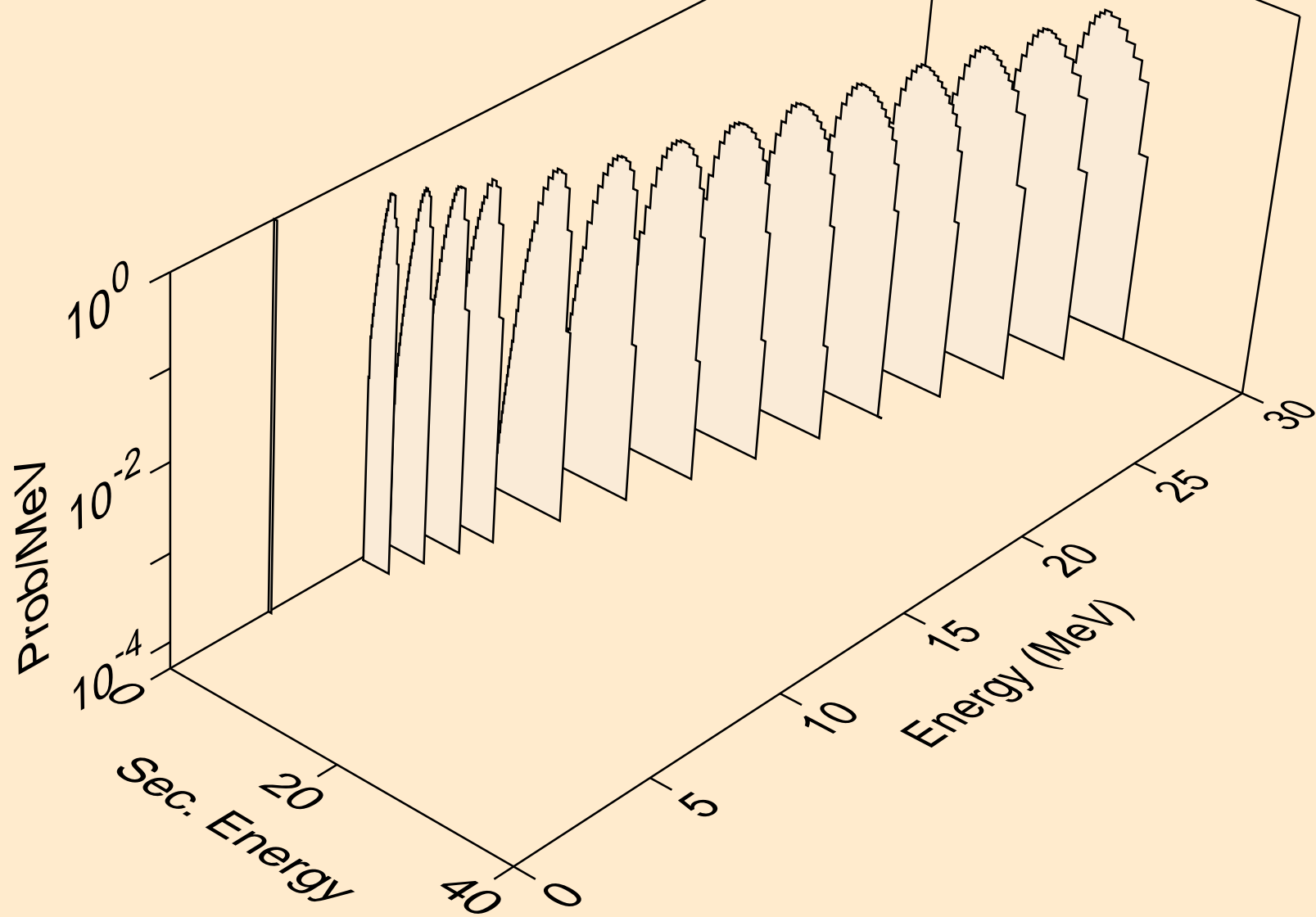

PT204 HELION ACER TENDL-2024 LIBRARY; T=0.K  
deuterons from (s,d)

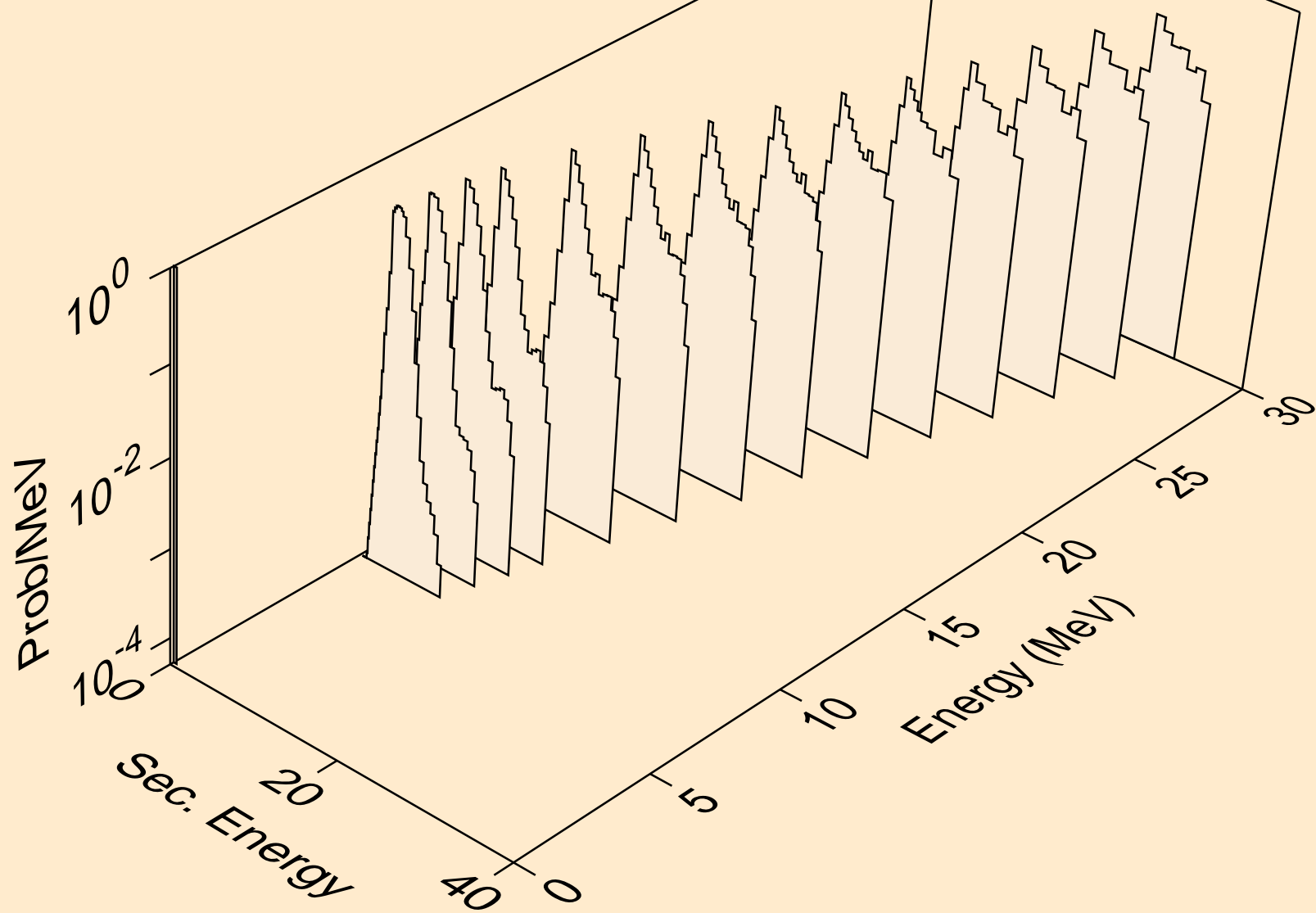

PT204 HELION ACER TENDL-2024 LIBRARY; T=0.K  
deuterons from (s,pd)

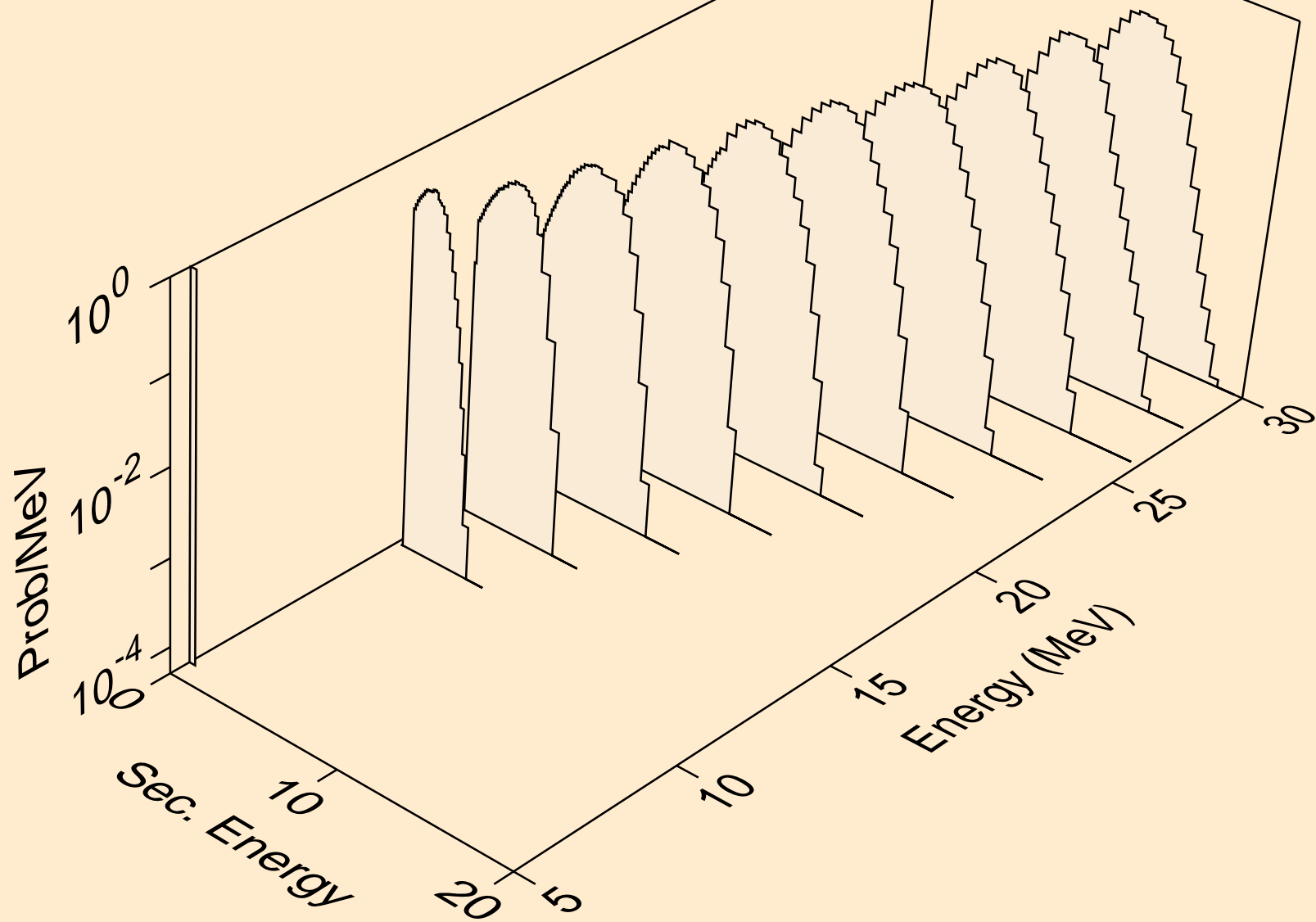

PT204 HELION ACER TENDL-2024 LIBRARY; T=0.K  
tritons from (s,x)

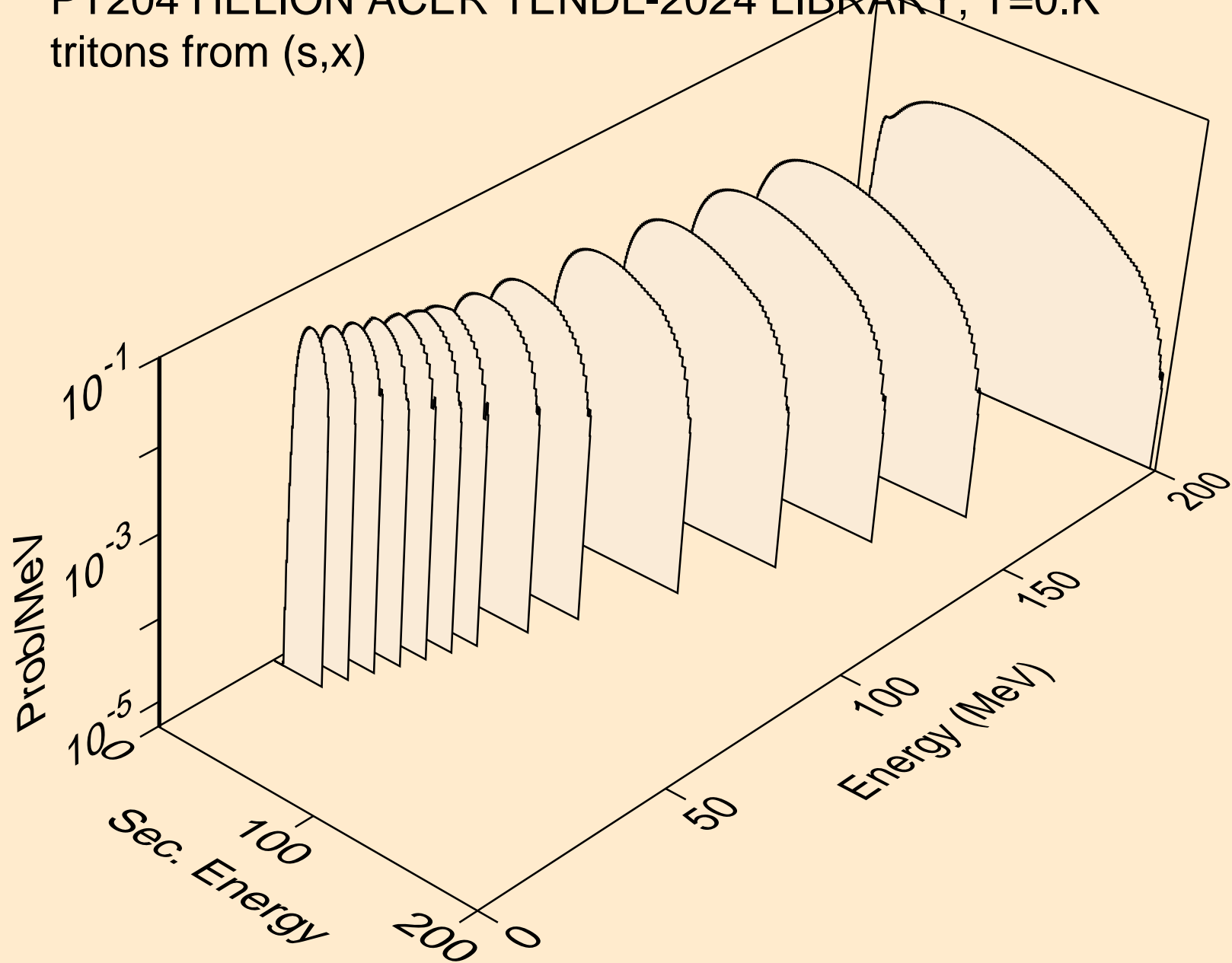

PT204 HELION ACER TENDL-2024 LIBRARY; T=0.K  
tritons from (s,n\*)t

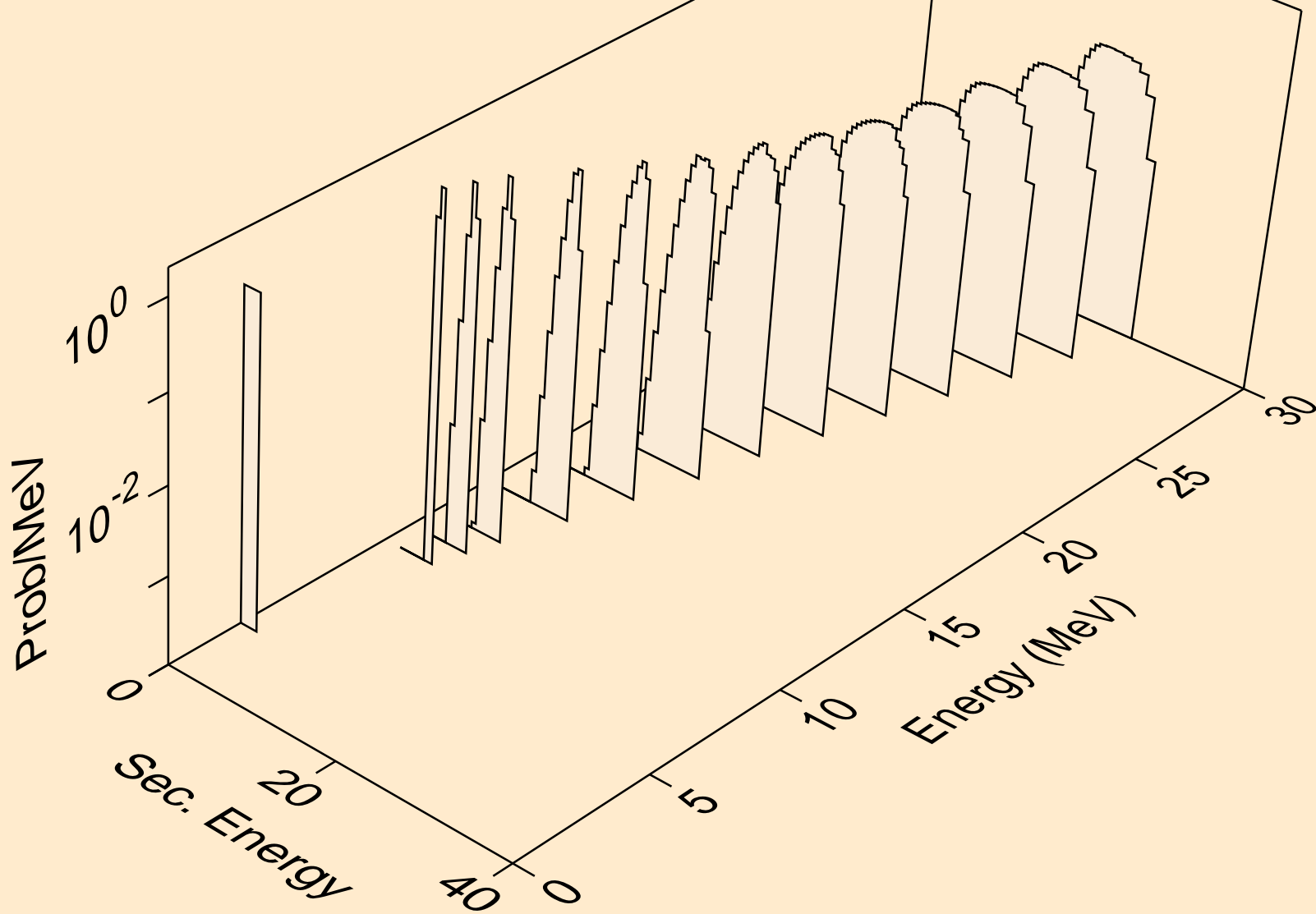

PT204 HELION ACER TENDL-2024 LIBRARY; T=0.K  
tritons from (s,t)

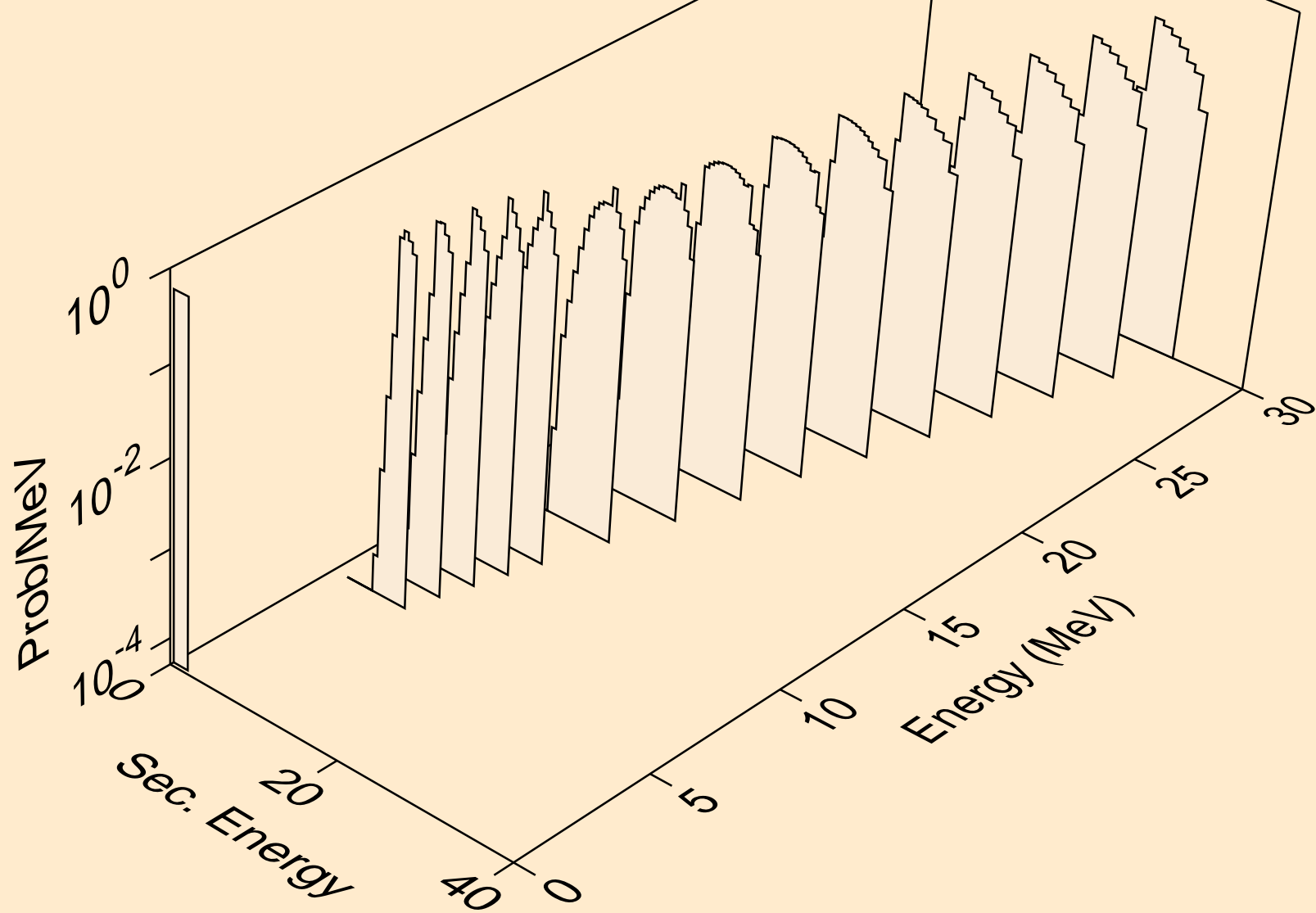

PT204 HELION ACER TENDL-2024 LIBRARY; T=0.K  
tritons from (s,pt)

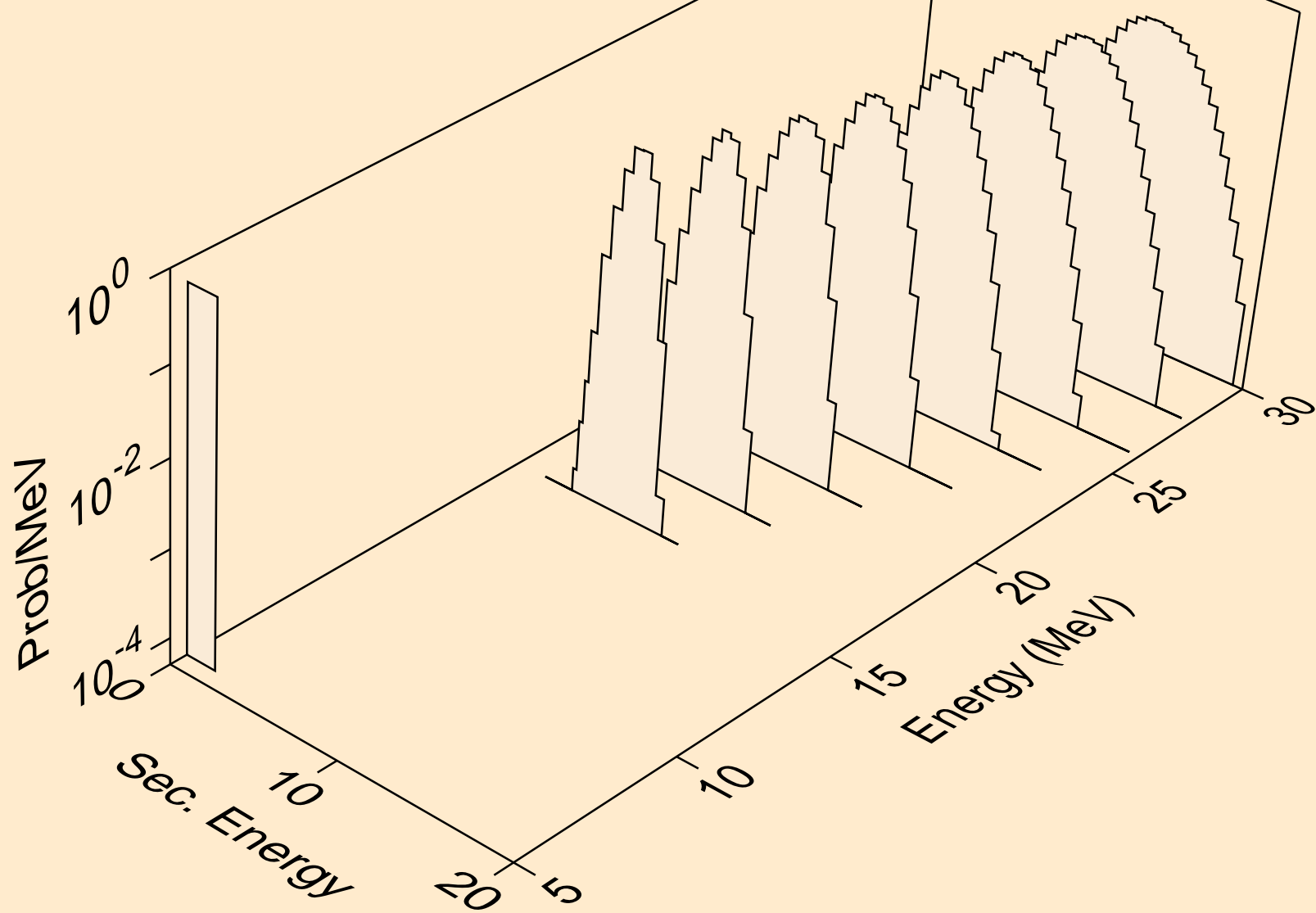

PT204 HELION ACER TENDL-2024 LIBRARY; T=0.K  
alphas from (s,x)

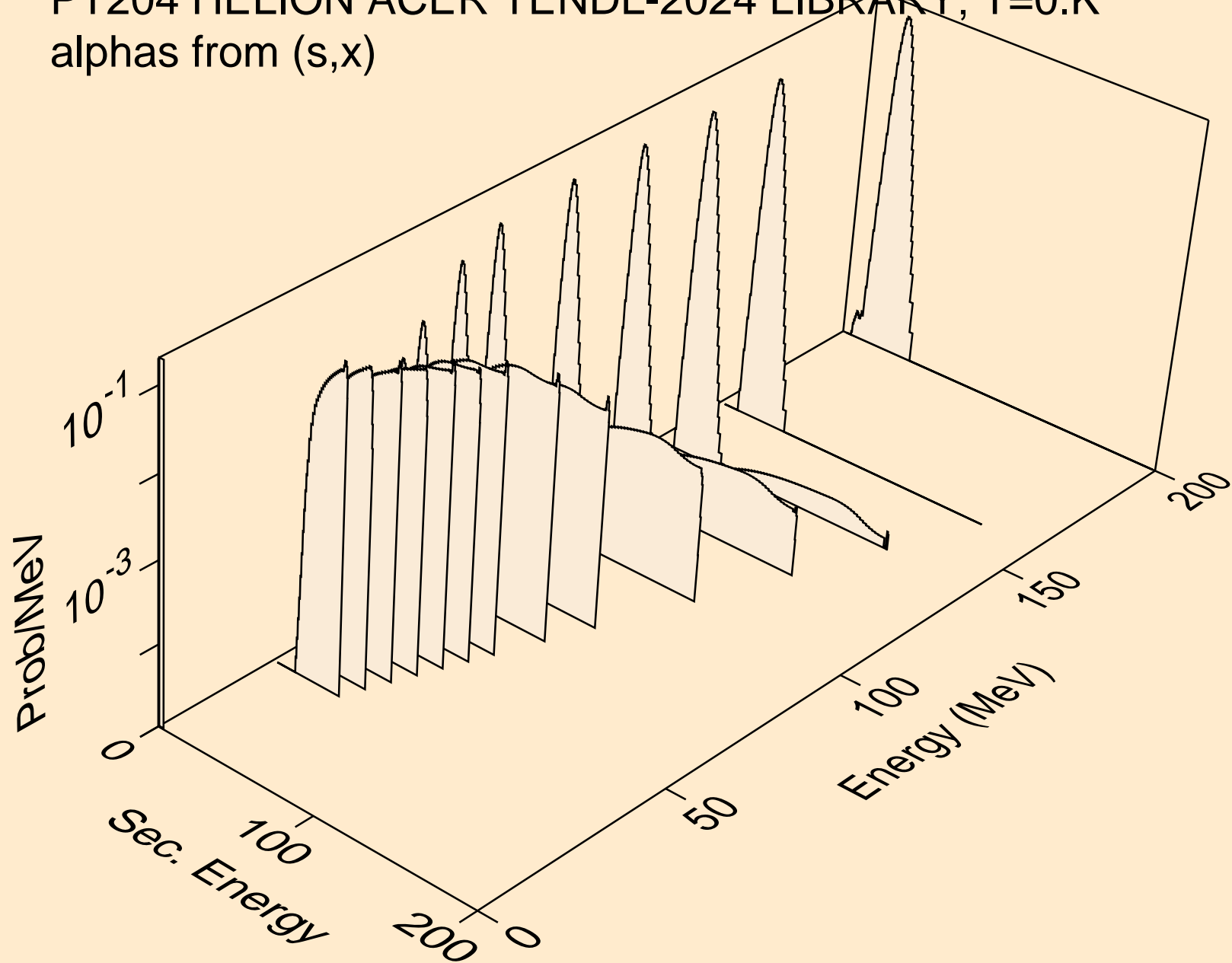

PT204 HELION ACER TENDL-2024 LIBRARY; T=0.K  
alphas from (s,n\*)a

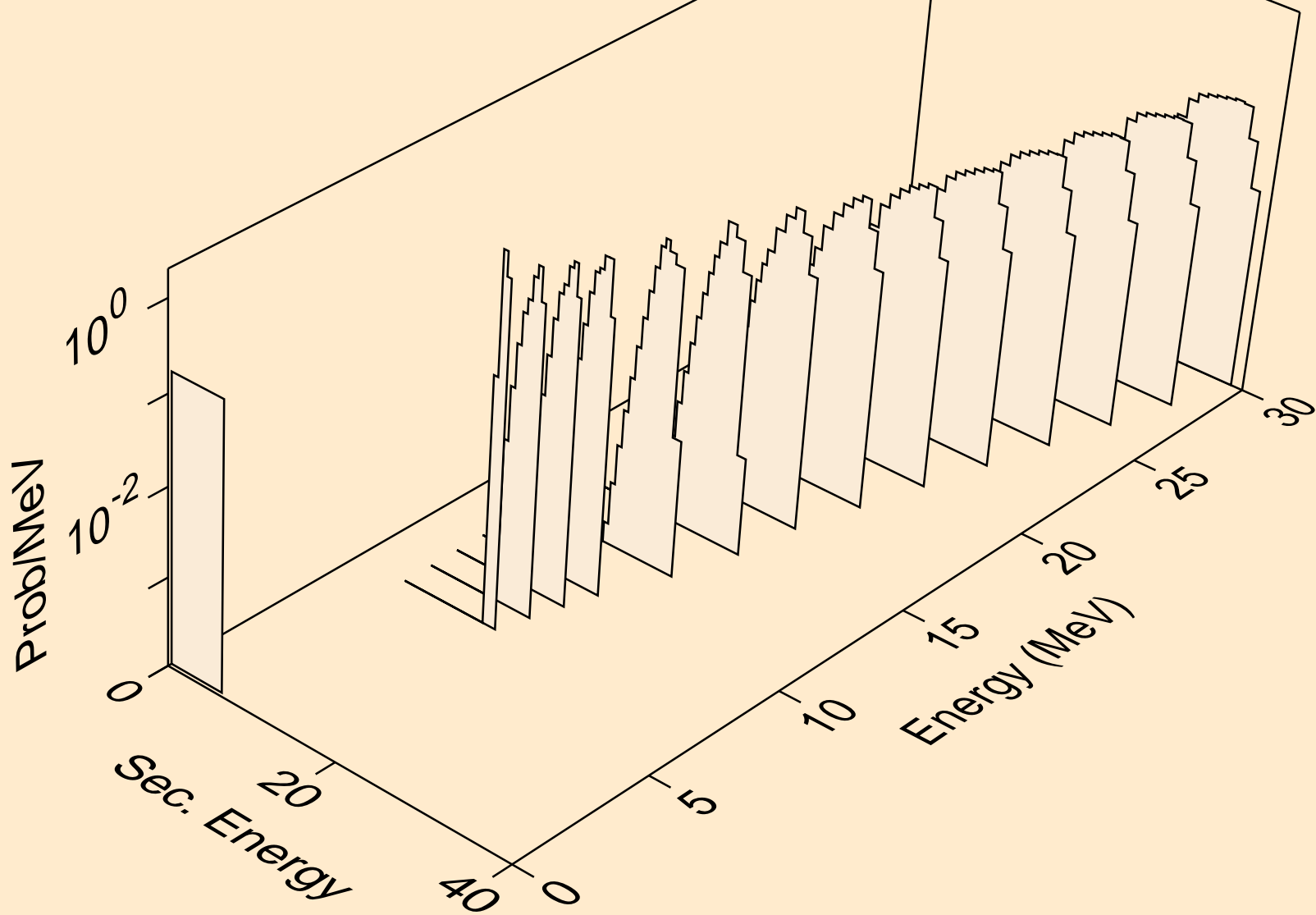

PT204 HELION ACER TENDL-2024 LIBRARY; T=0.K  
alphas from (s,2n)a

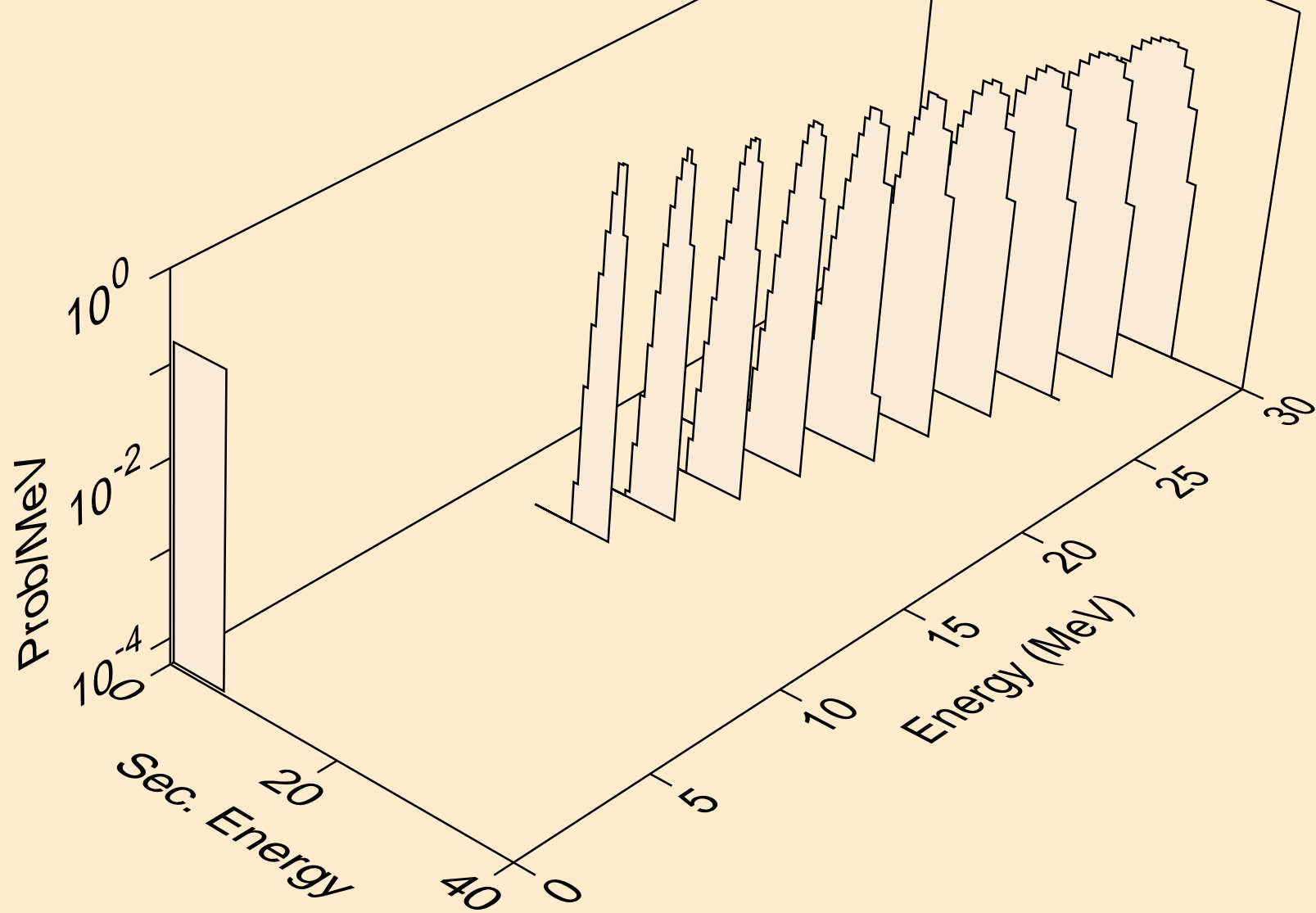

PT204 HELION ACER TENDL-2024 LIBRARY; T=0.K  
alphas from (s,3n)a

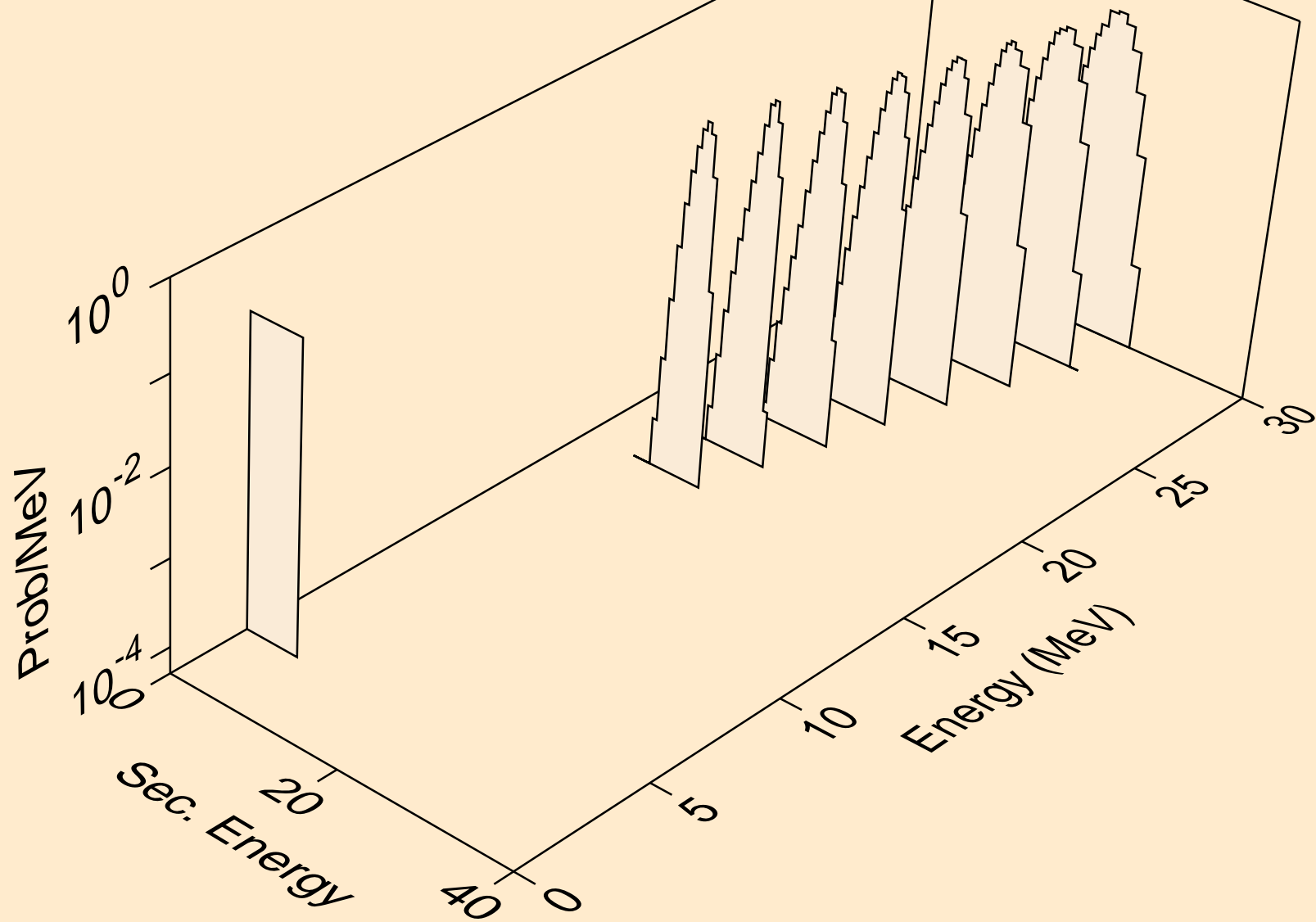

PT204 HELION ACER TENDL-2024 LIBRARY; T=0.K  
alphas from (s,npa)

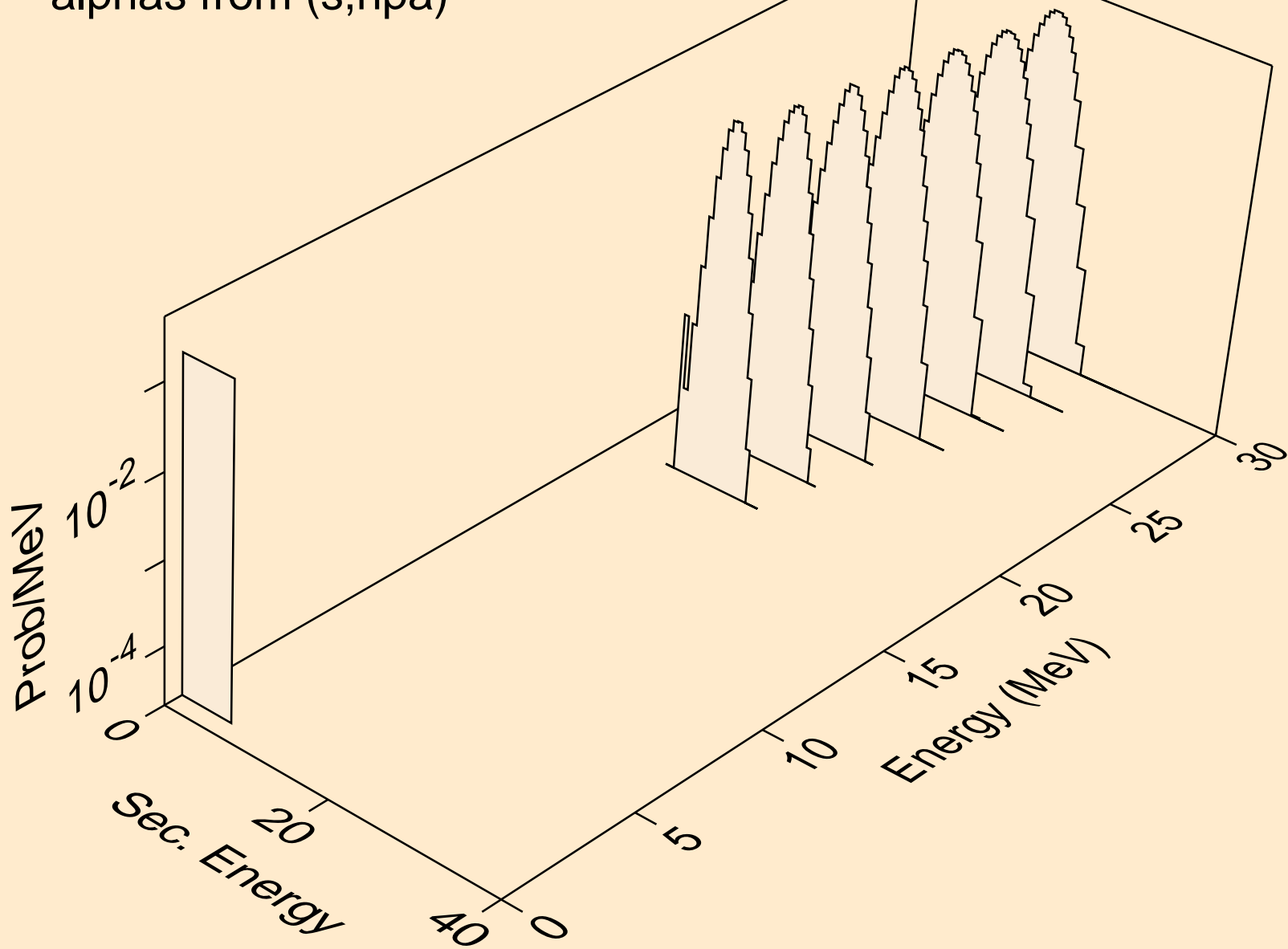

PT204 HELION ACER TENDL-2024 LIBRARY; T=0.K  
alphas from (s,a)

