

# S034 HELION ACER TENDL-2024 LIBRARY; T=0.K

## Principal cross sections

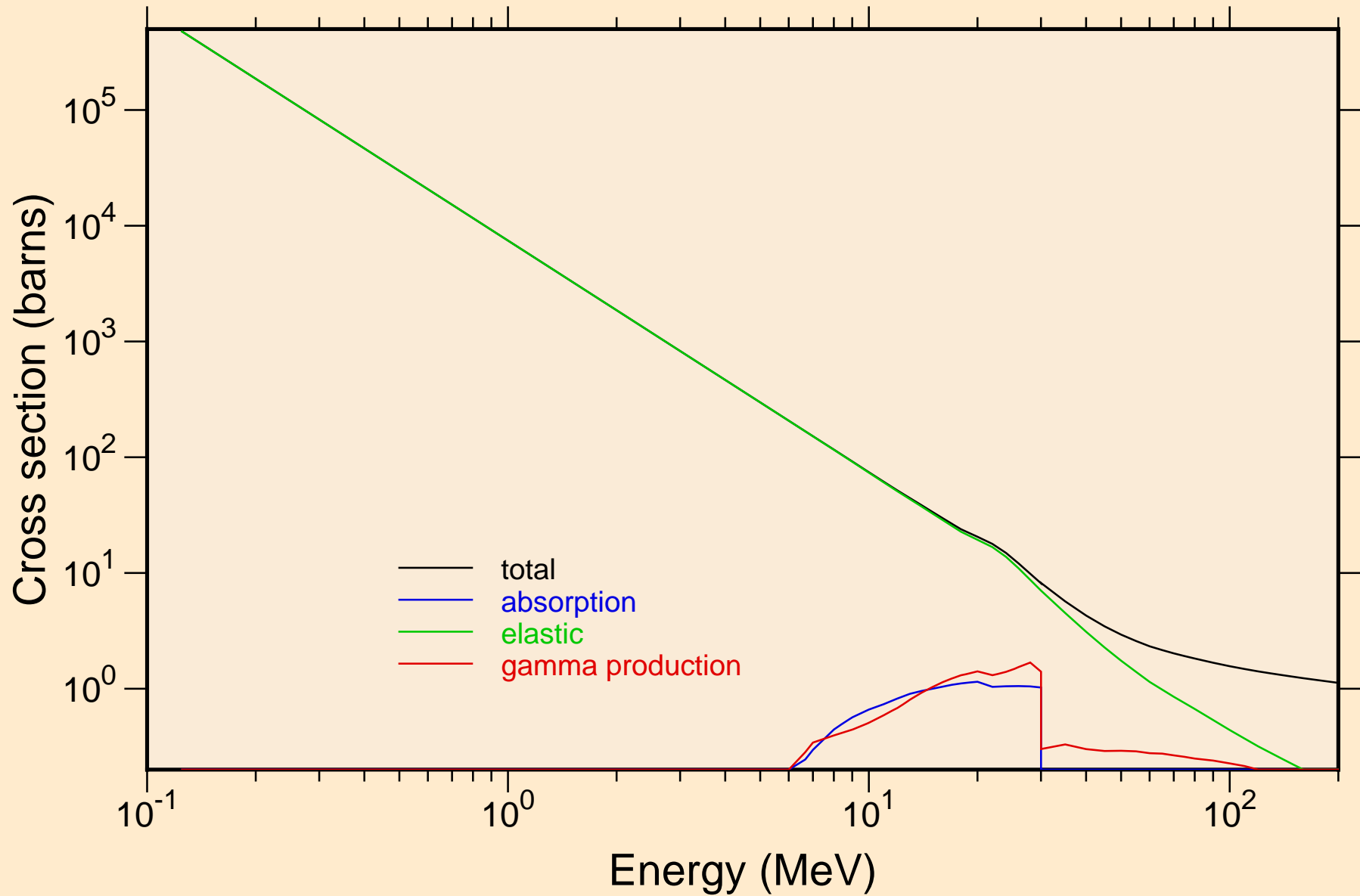

# S034 HELION ACER TENDL-2024 LIBRARY; T=0.K

## Heating

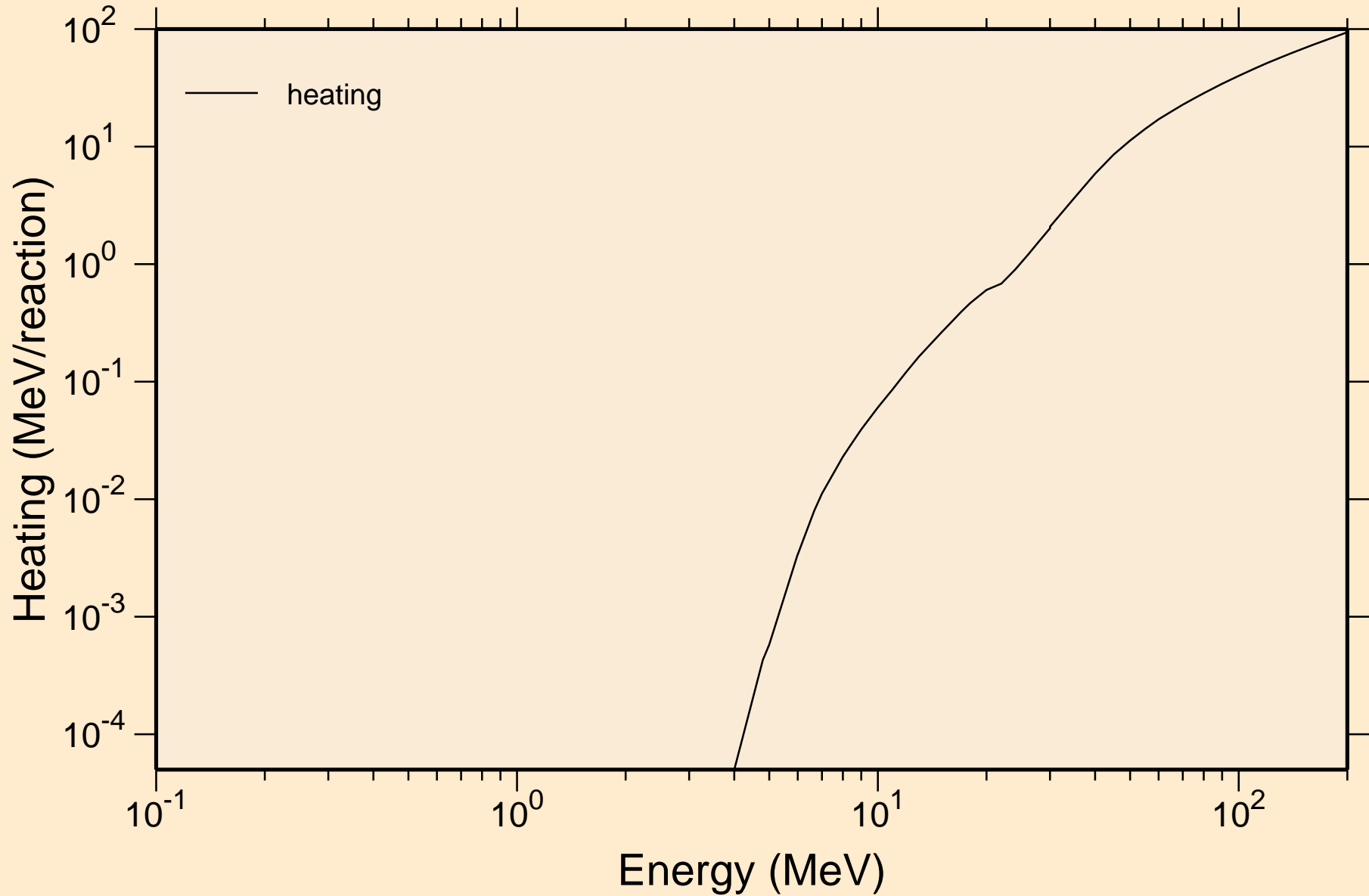

# S034 HELION ACER TENDL-2024 LIBRARY; T=0.K

## Principal cross sections

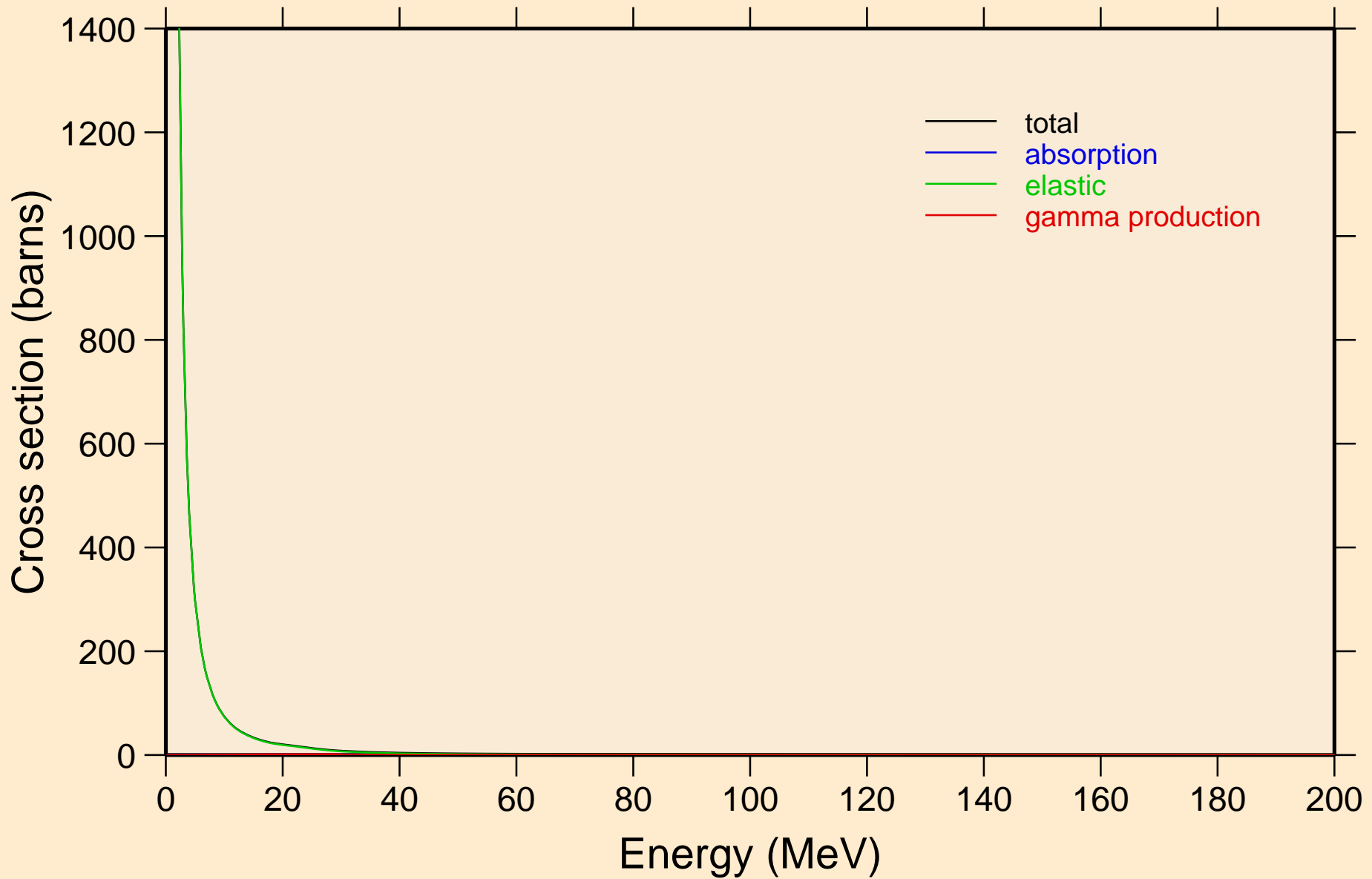

# S034 HELION ACER TENDL-2024 LIBRARY; T=0.K

## Heating

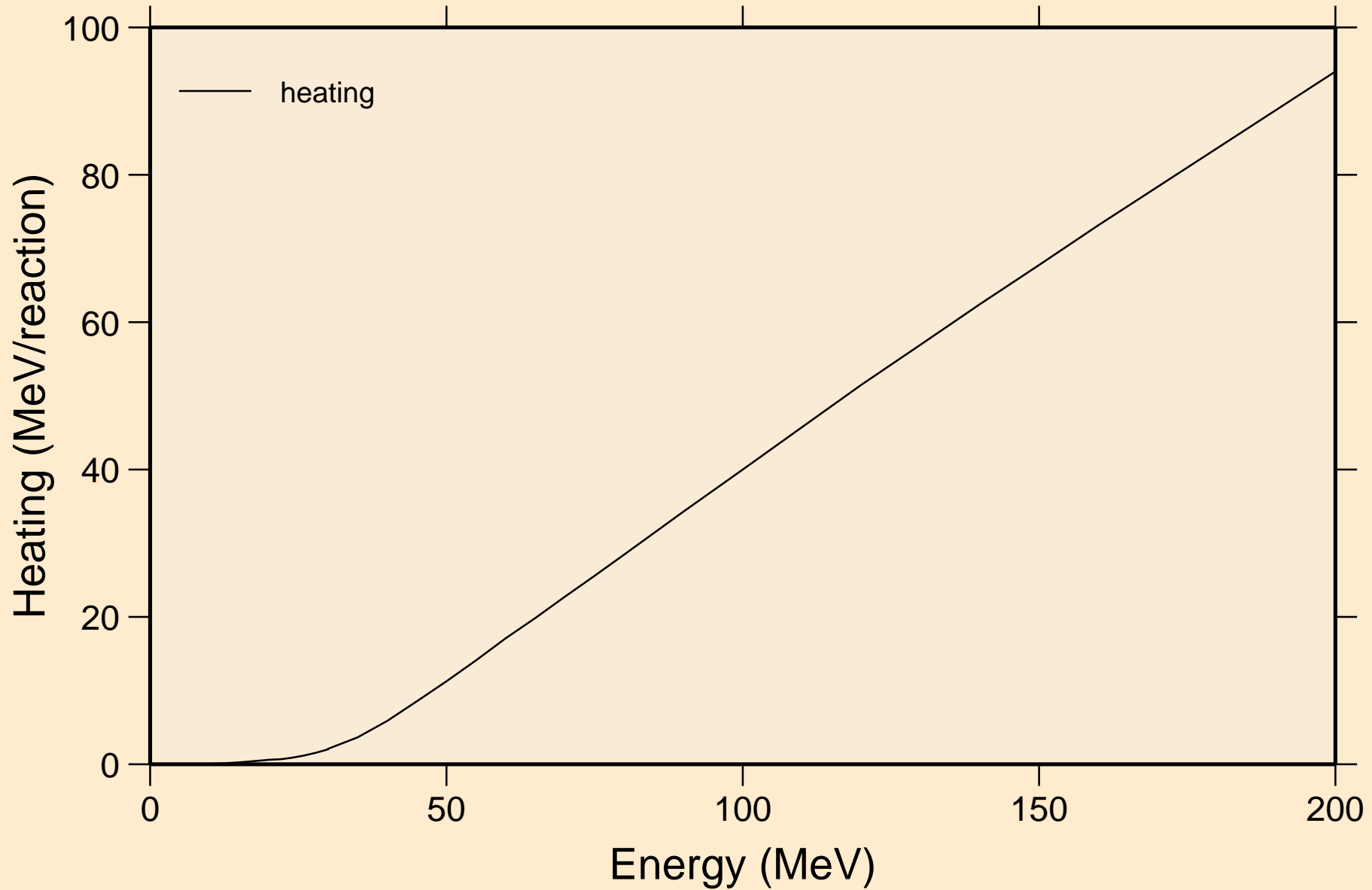

# S034 HELION ACER TENDL-2024 LIBRARY; T=0.K

## Threshold reactions

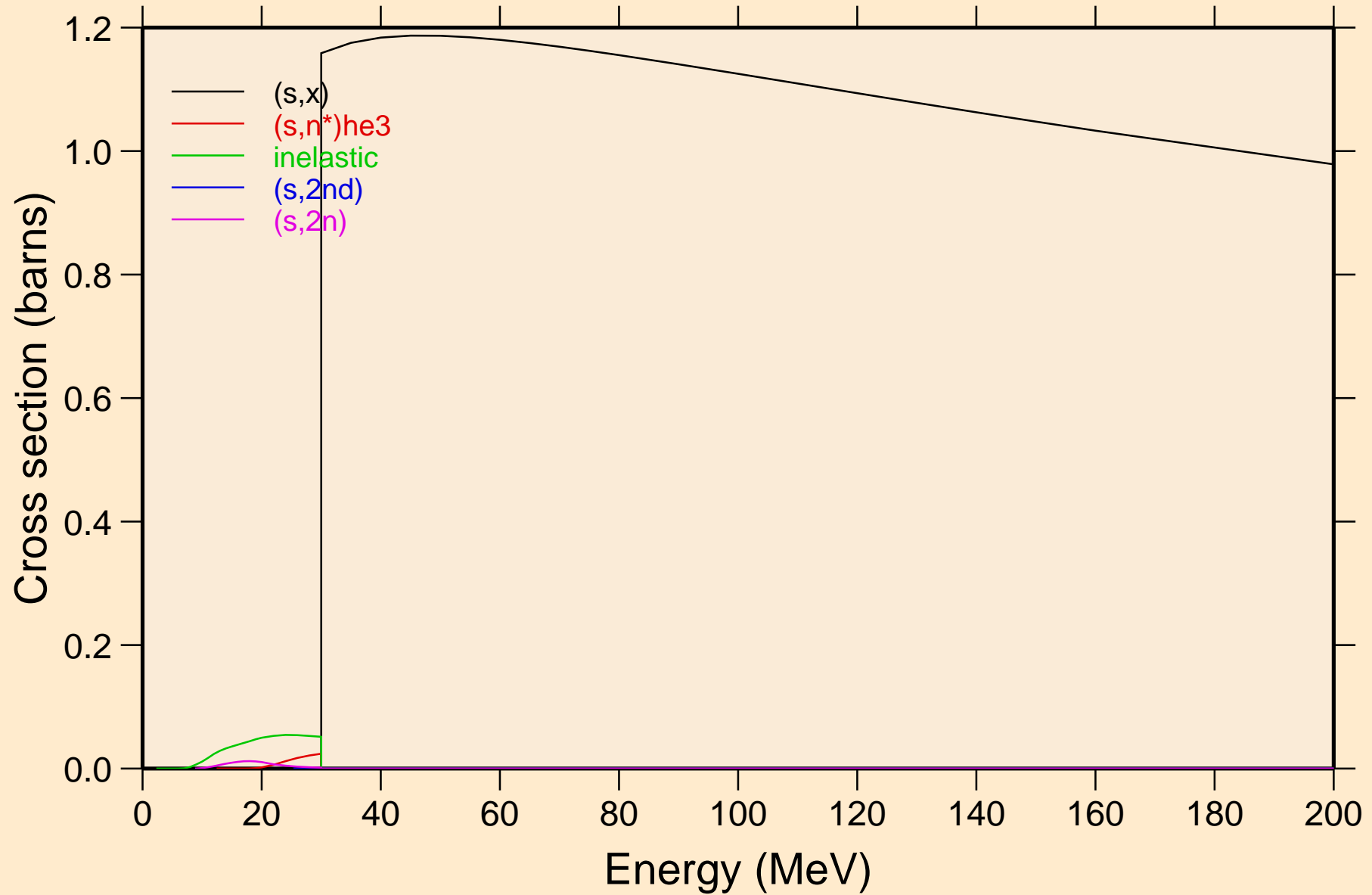

# S034 HELION ACER TENDL-2024 LIBRARY; T=0.K

## Threshold reactions

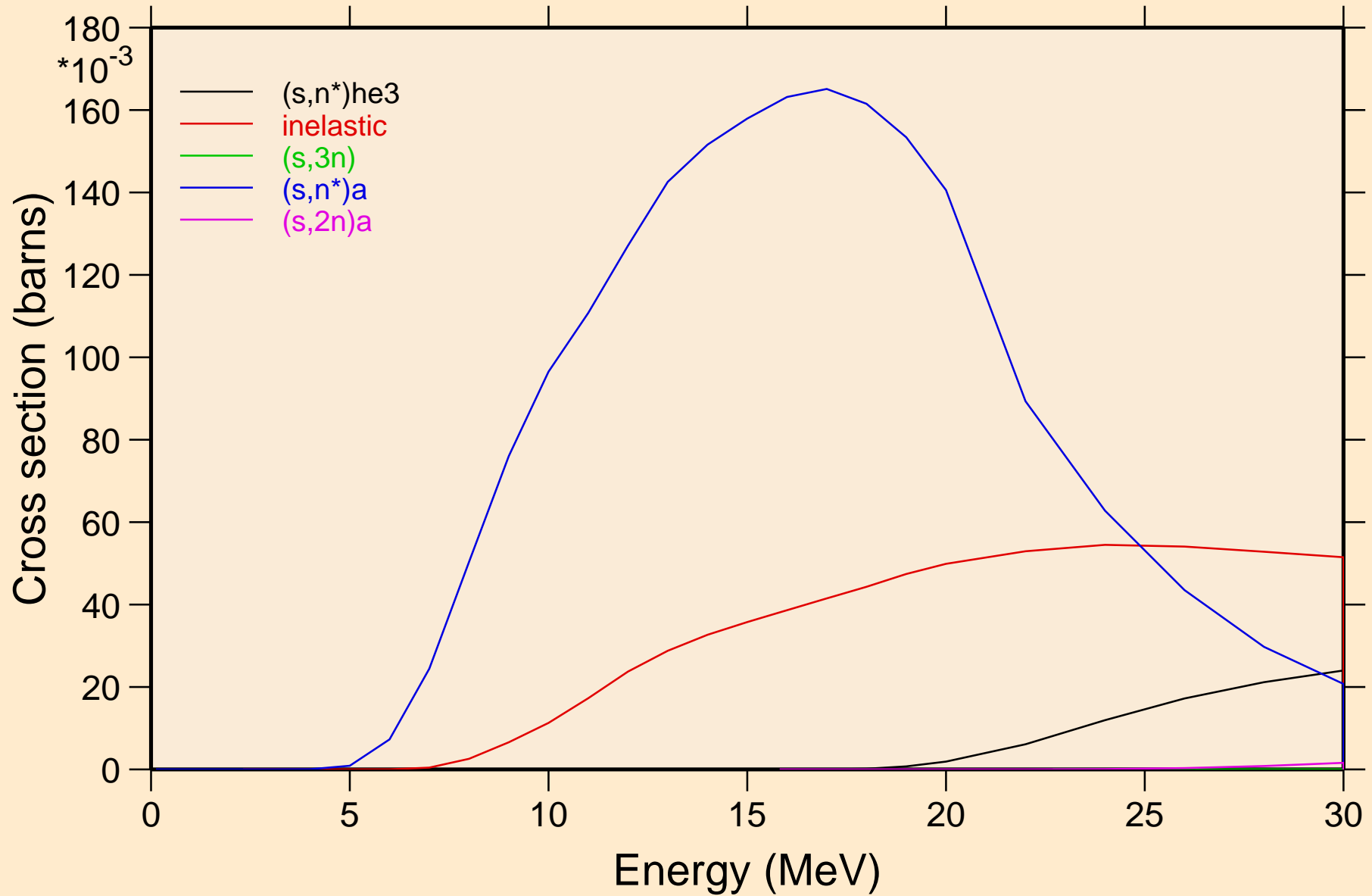

# S034 HELION ACER TENDL-2024 LIBRARY; T=0.K

## Threshold reactions

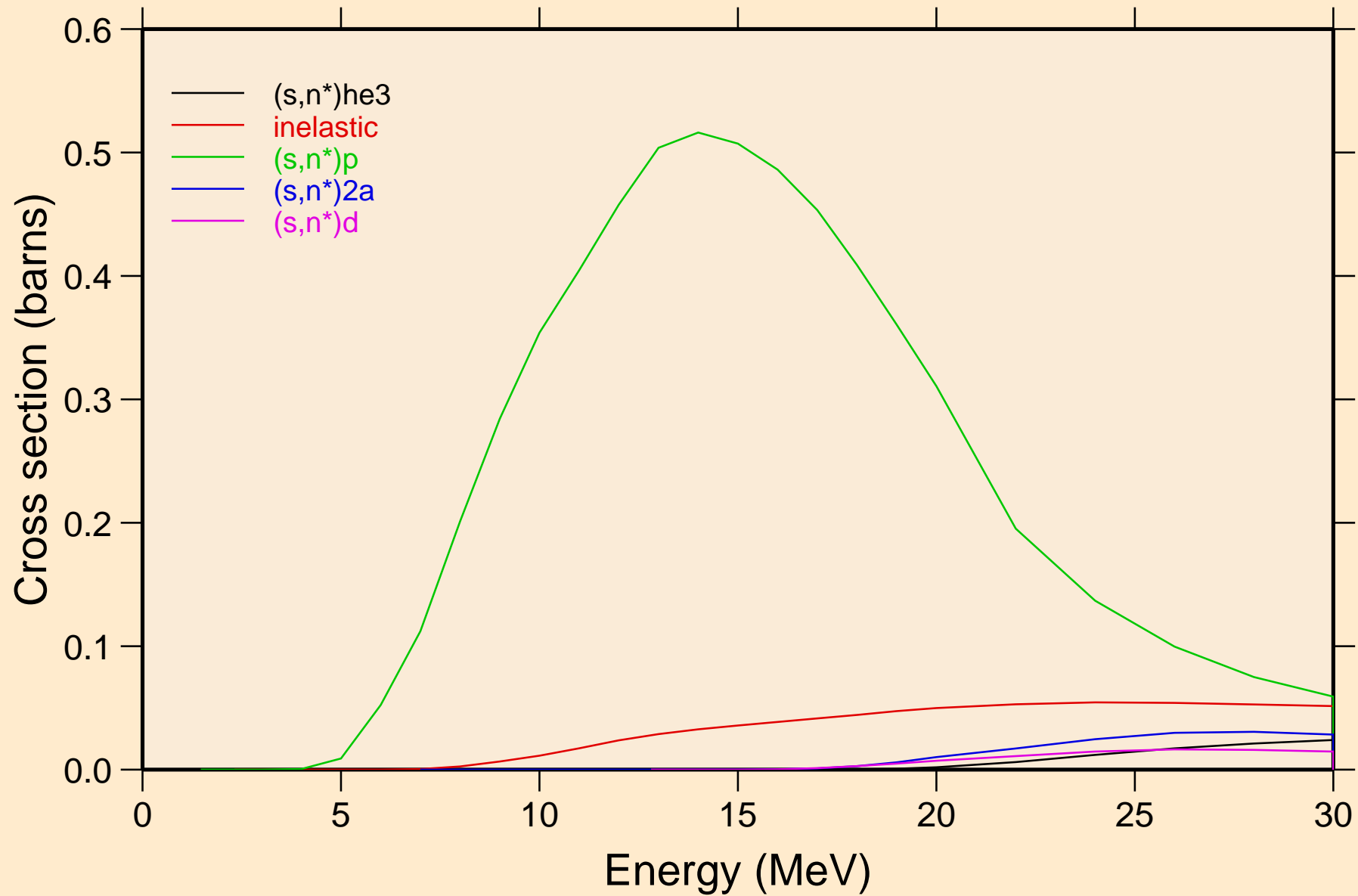

# S034 HELION ACER TENDL-2024 LIBRARY; T=0.K

## Threshold reactions

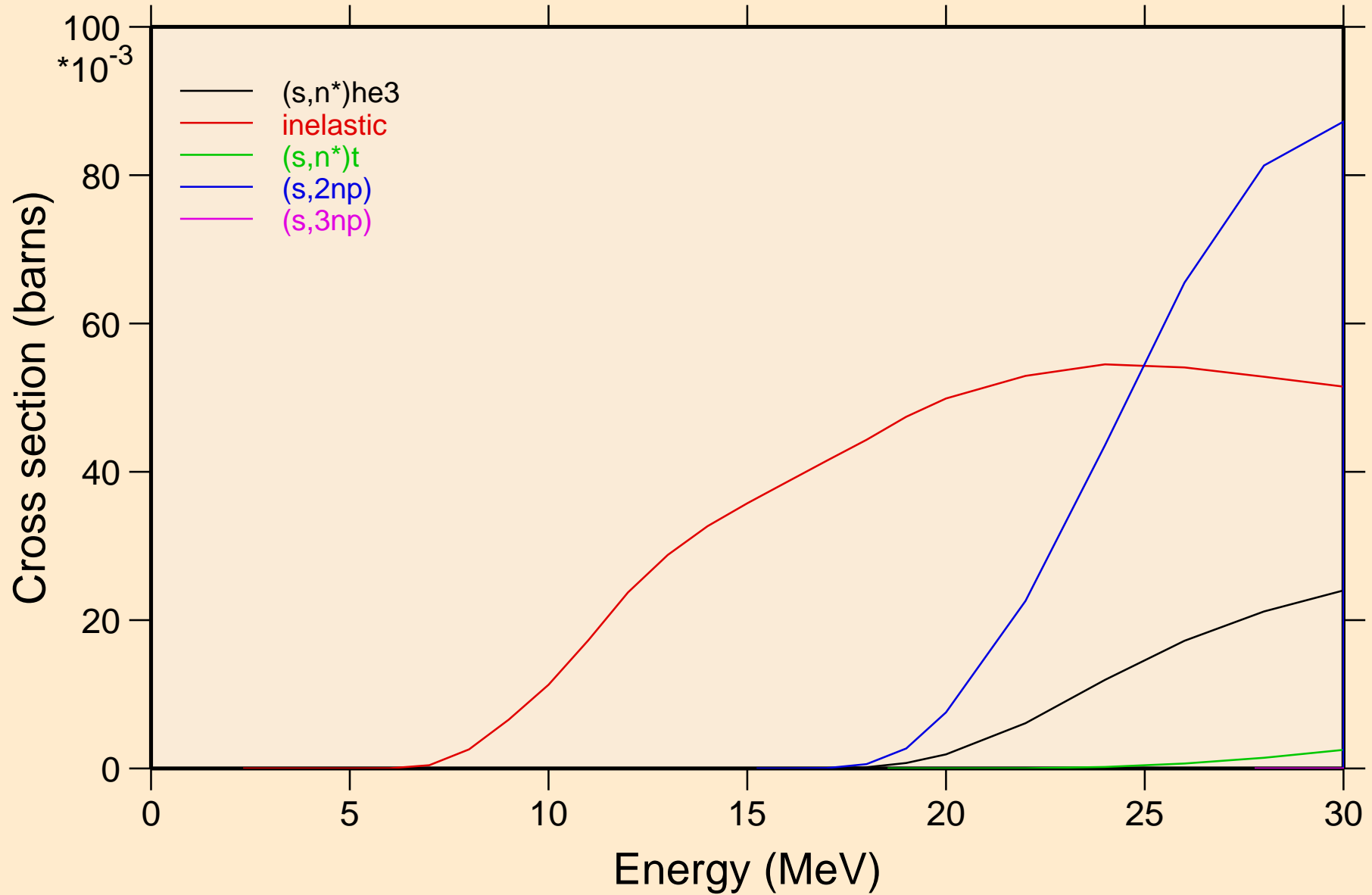

# S034 HELION ACER TENDL-2024 LIBRARY; T=0.K

## Threshold reactions

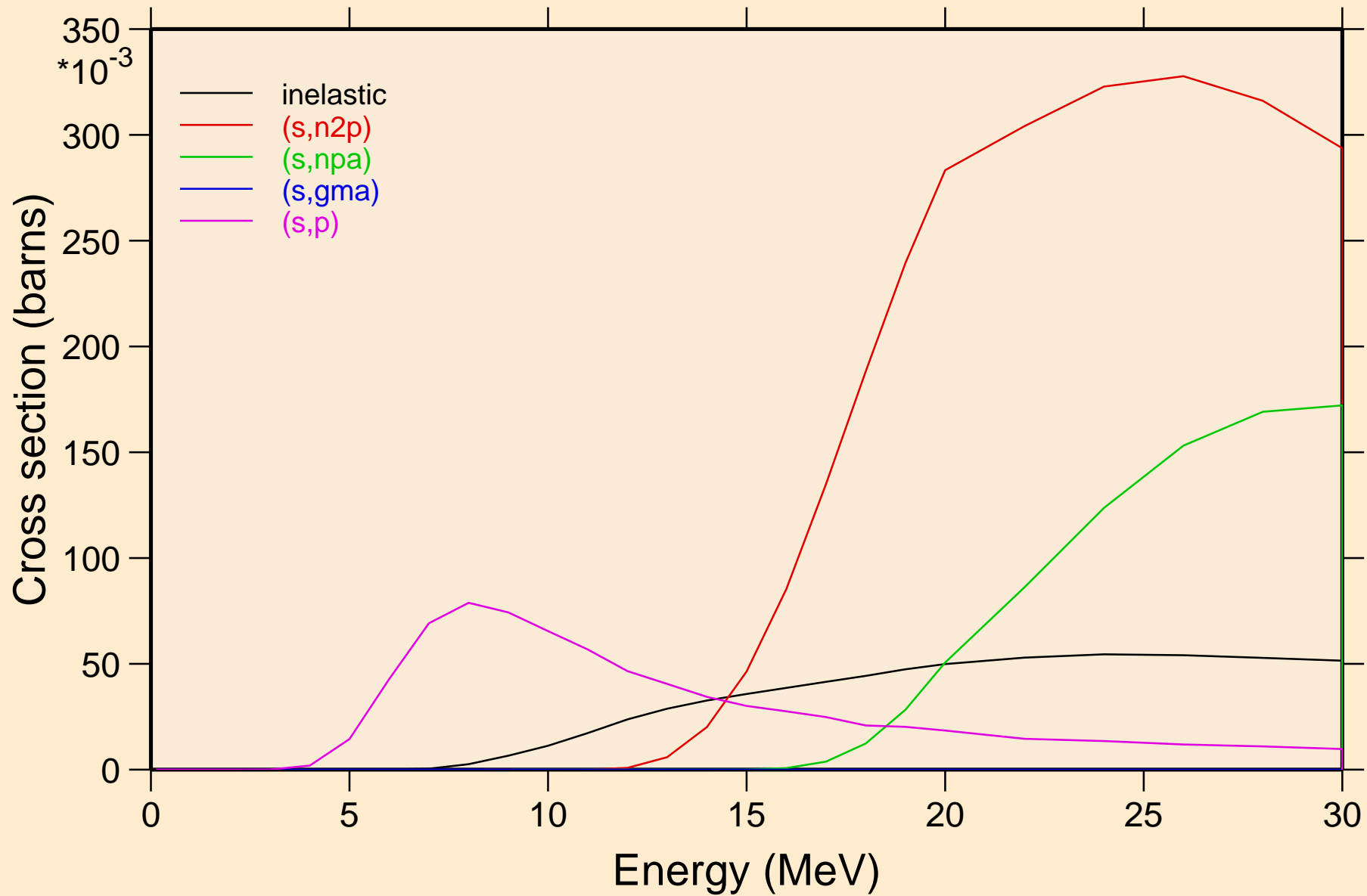

# S034 HELION ACER TENDL-2024 LIBRARY; T=0.K

## Threshold reactions

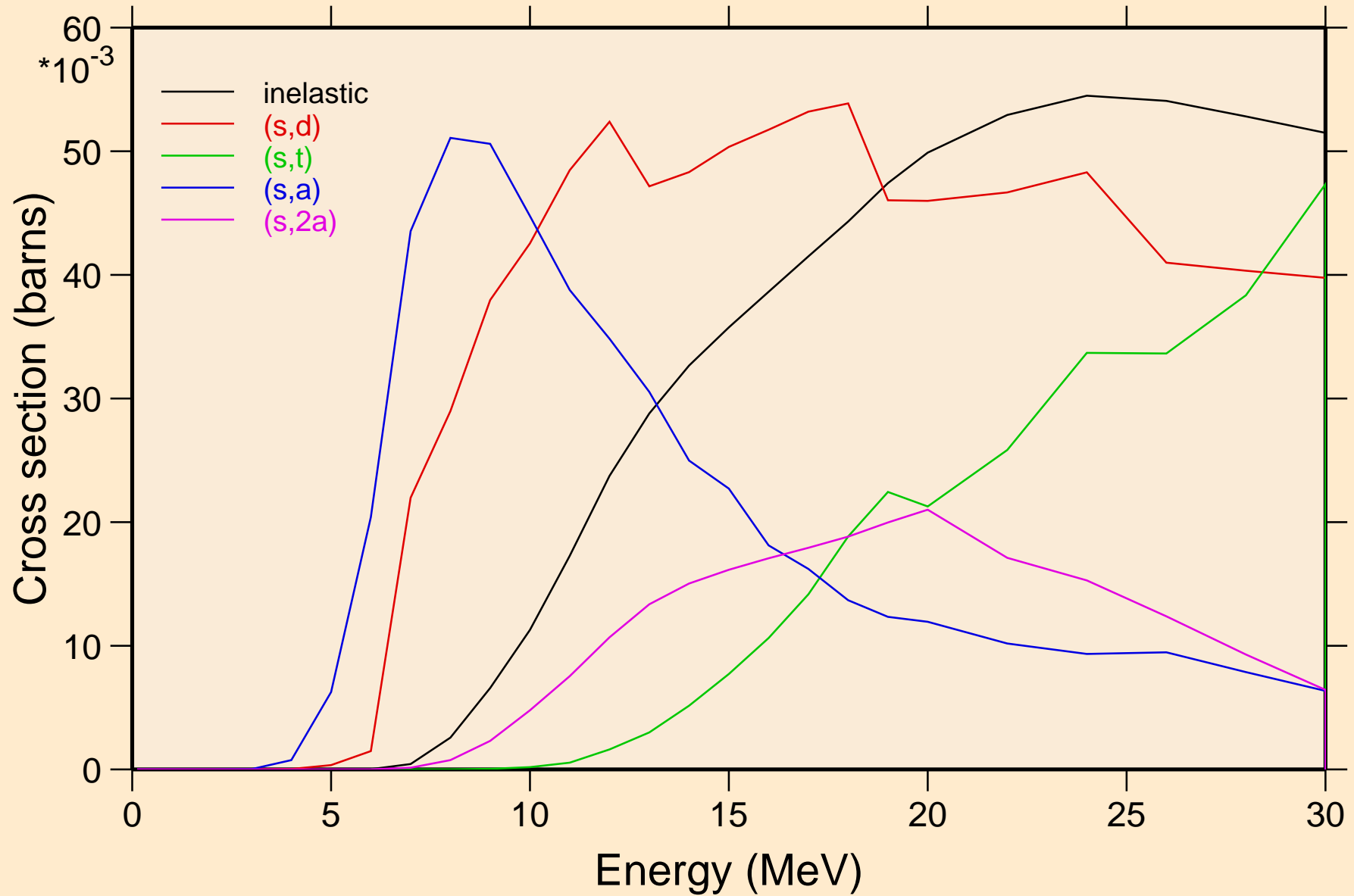

S034 HELION ACER TENDL-2024 LIBRARY; T=0.K  
Threshold reactions

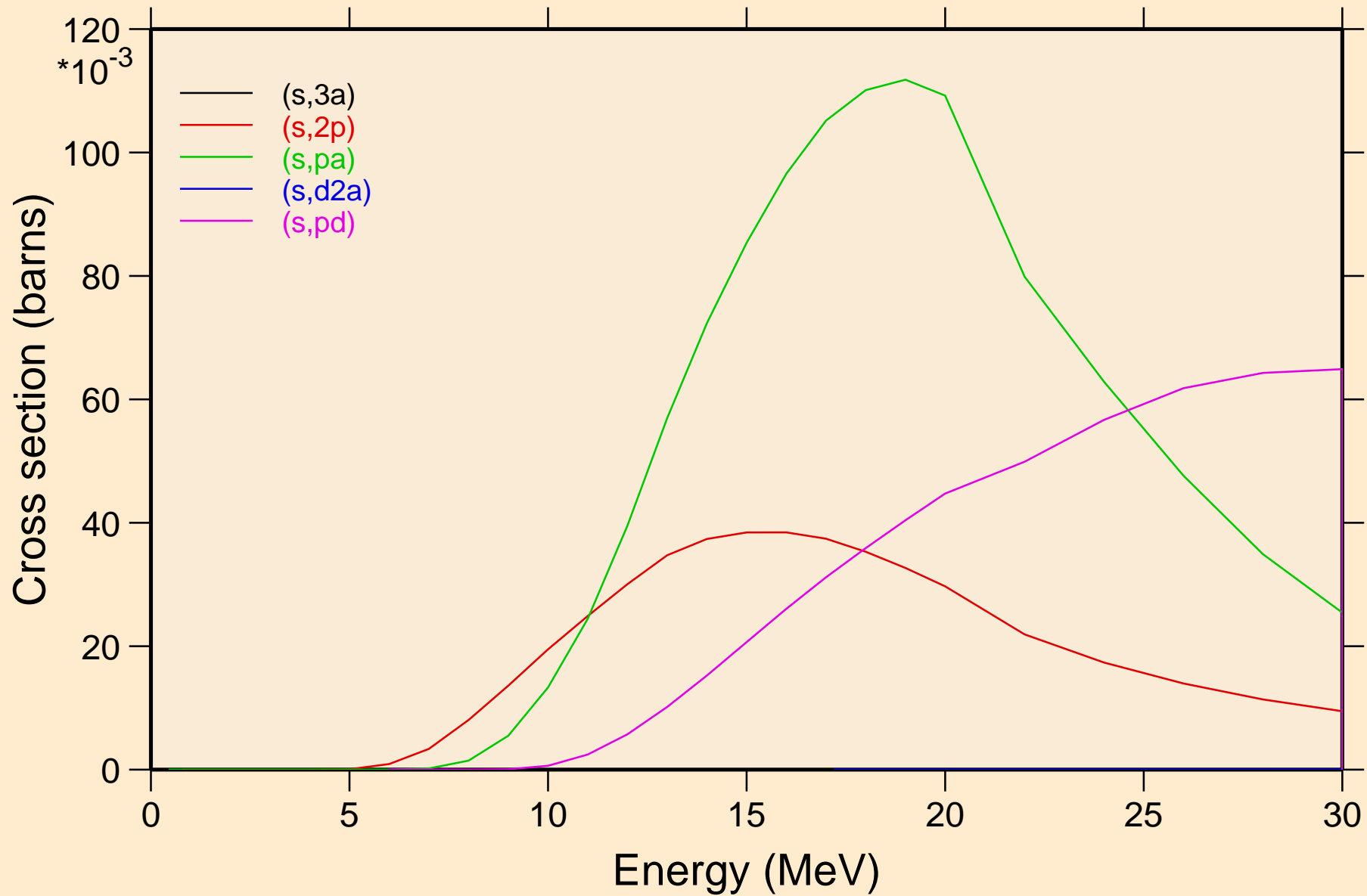

S034 HELION ACER TENDL-2024 LIBRARY; T=0.K  
Threshold reactions

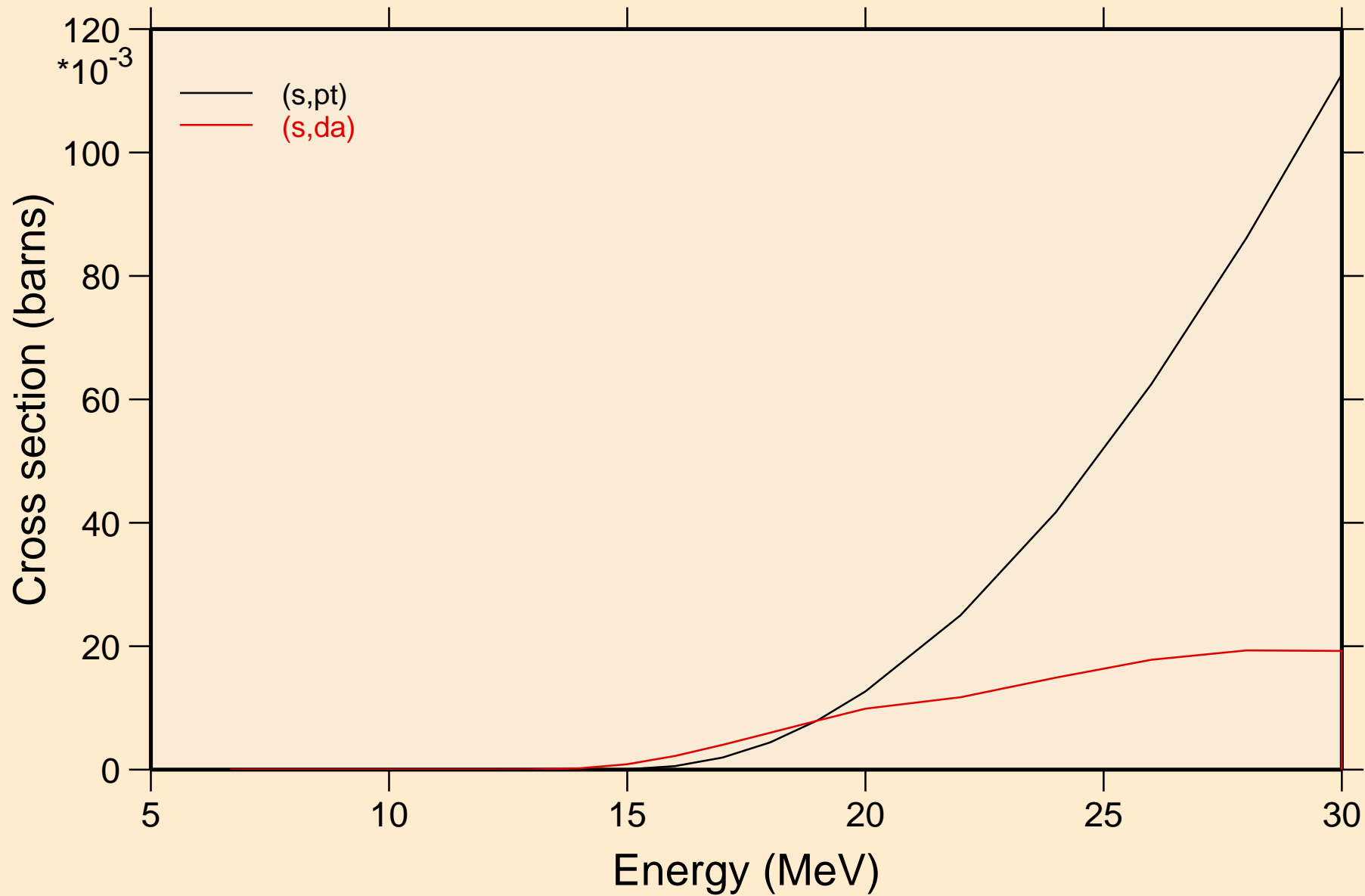

S034 HELION ACER TENDL-2024 LIBRARY; T=0.K  
angular distribution for elastic

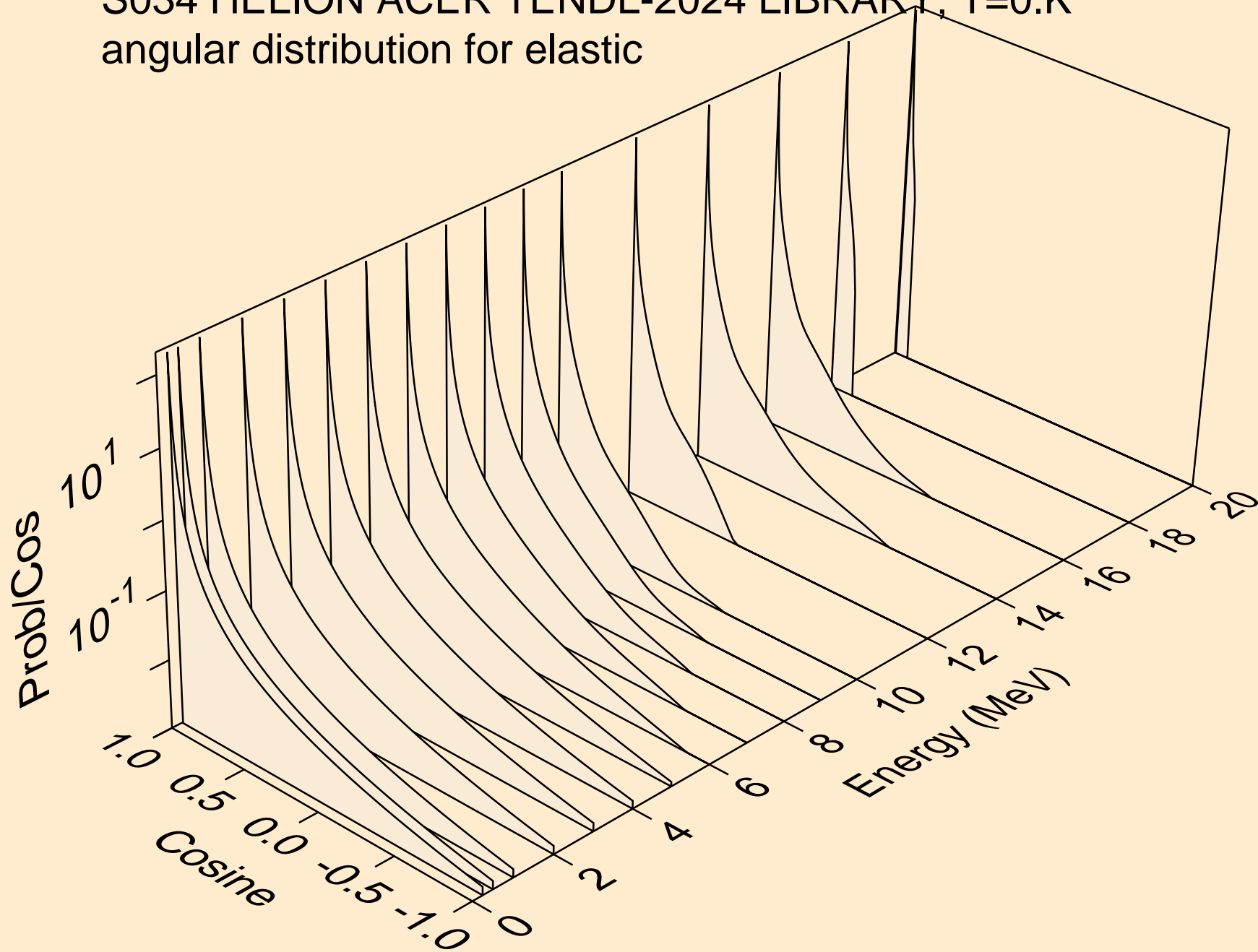

S034 HELION ACER TENDL-2024 LIBRARY; T=0.K  
angular distribution for elastic

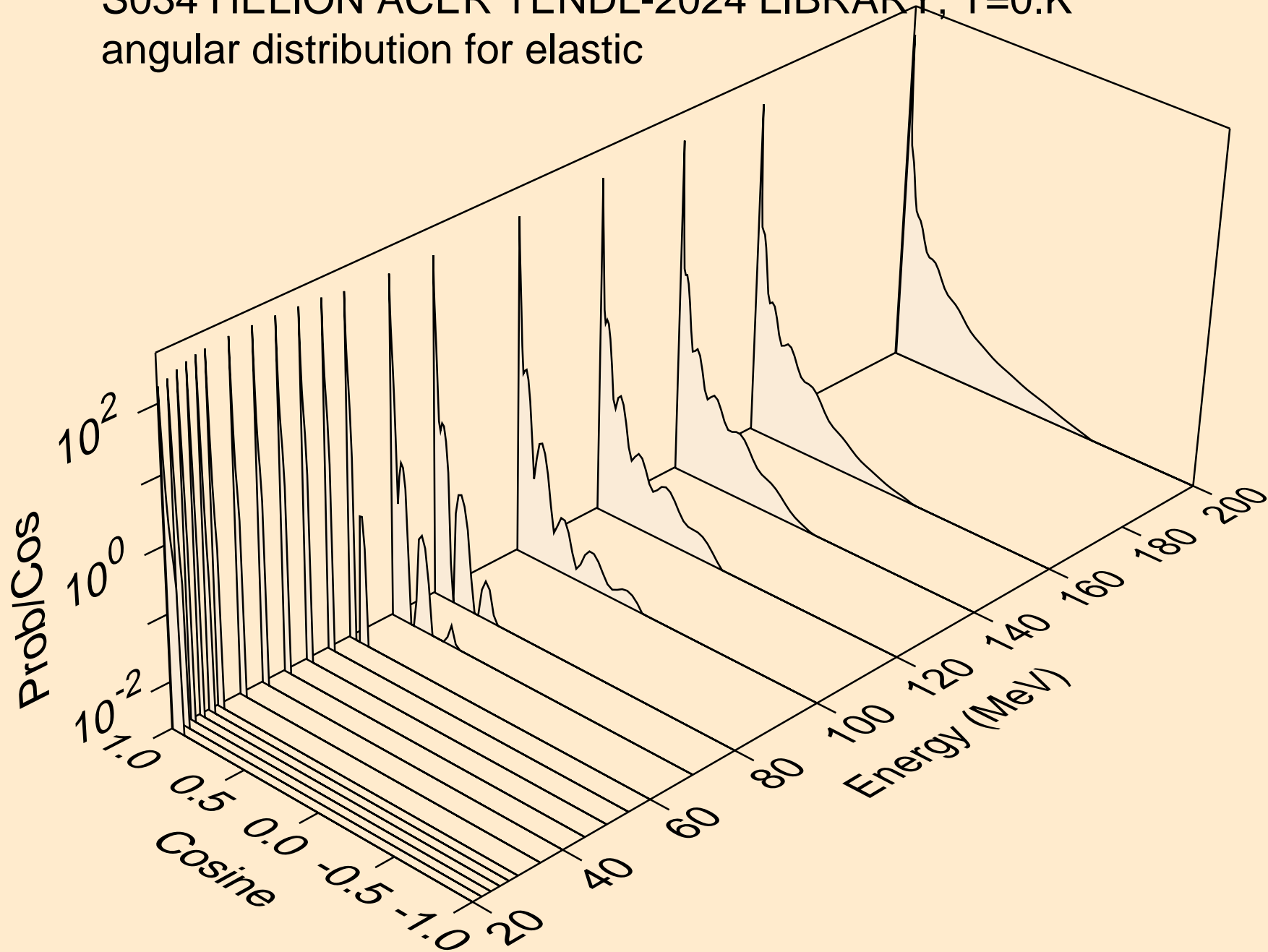

S034 HELION ACER TENDL-2024 LIBRARY; T=0.K  
He-3 emission for (s,x)

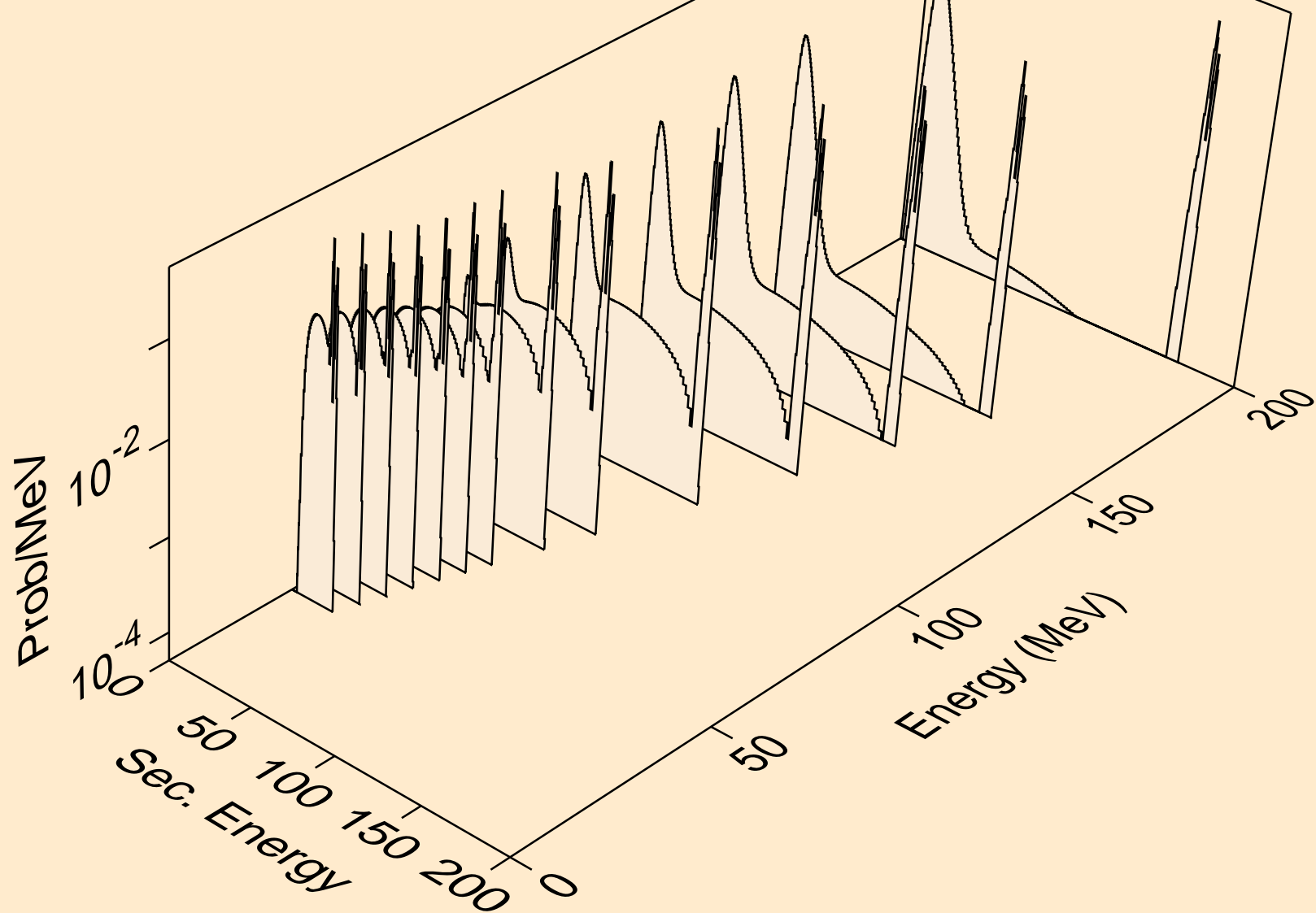

S034 HELION ACER TENDL-2024 LIBRARY; T=0.K  
He-3 emission for (s,n\*)he3

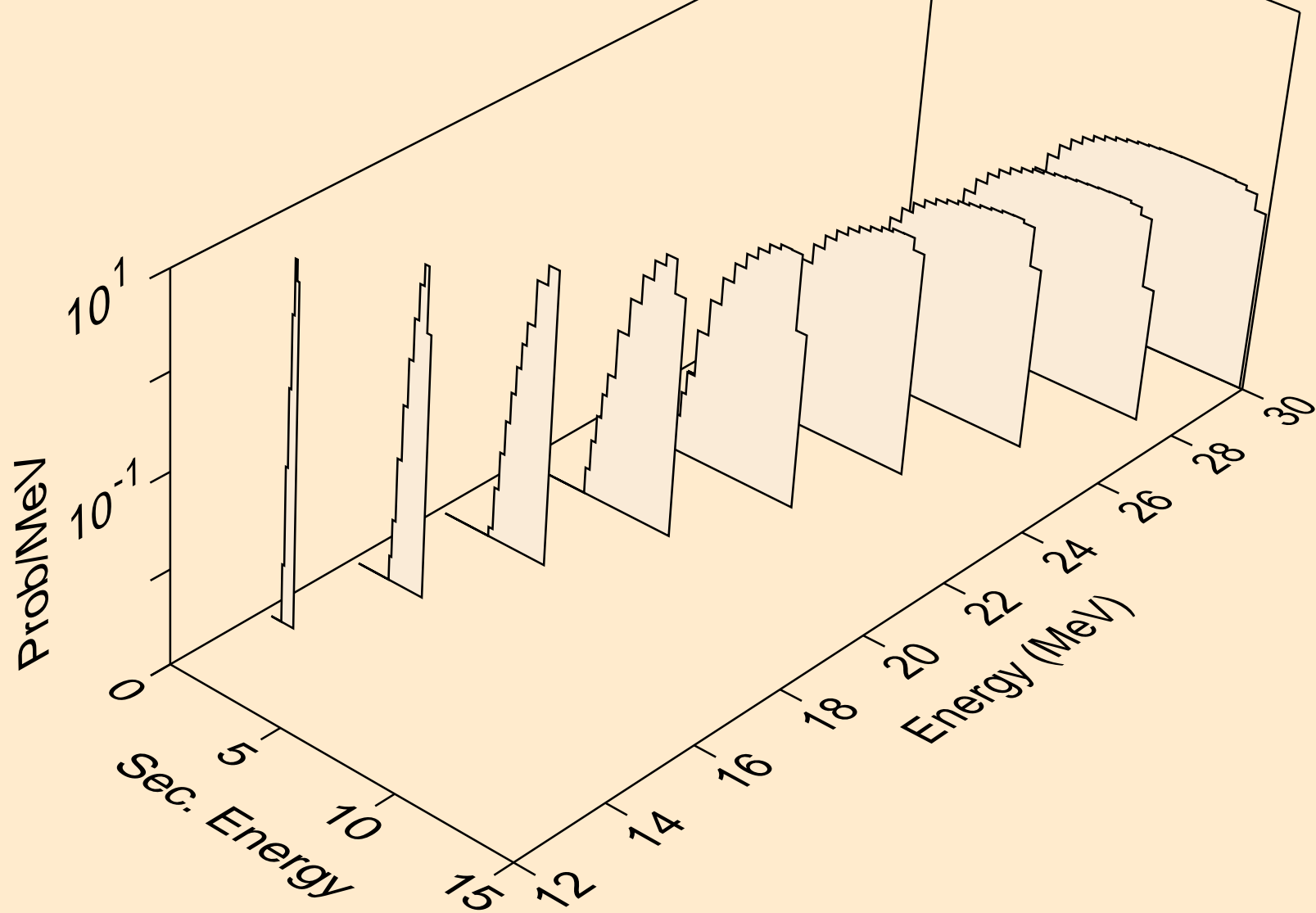

S034 HELION ACER TENDL-2024 LIBRARY; T=0.K  
He-3 emission for inelastic

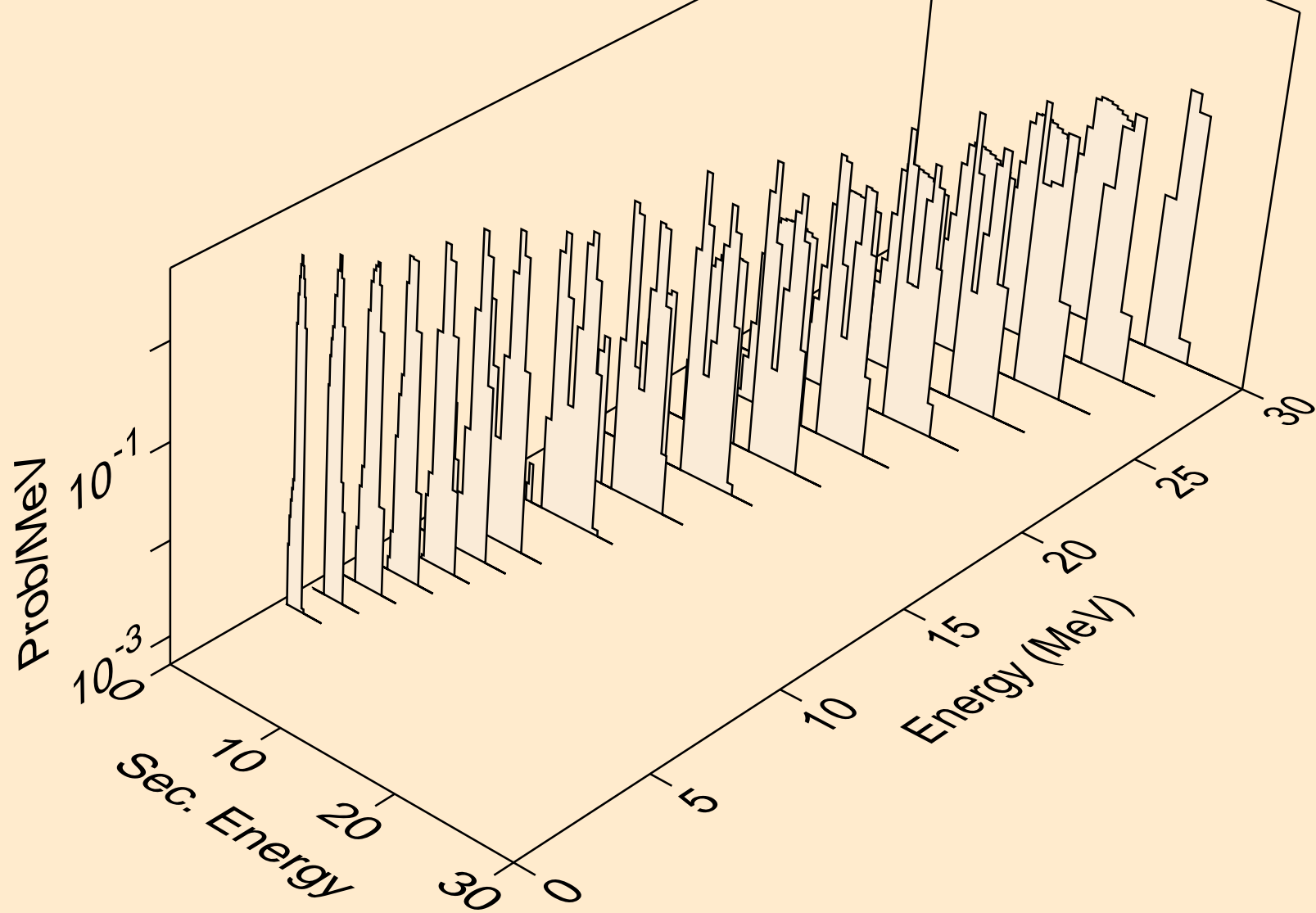

S034 HELION ACER TENDL-2024 LIBRARY; T=0.K  
Photon emission for (z,n)

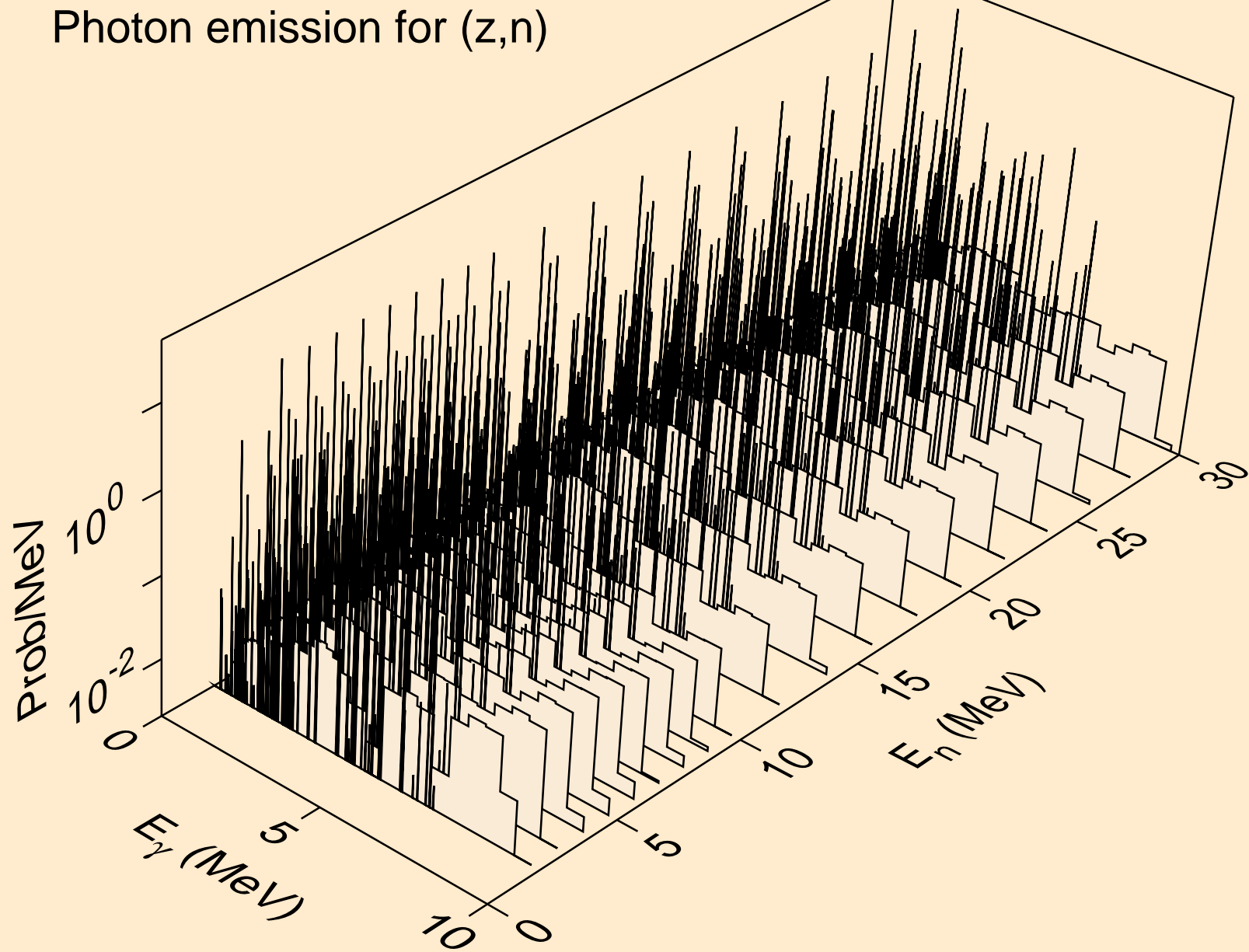

S034 HELION ACER TENDL-2024 LIBRARY; T=0.K

Photon emission for (z,x)

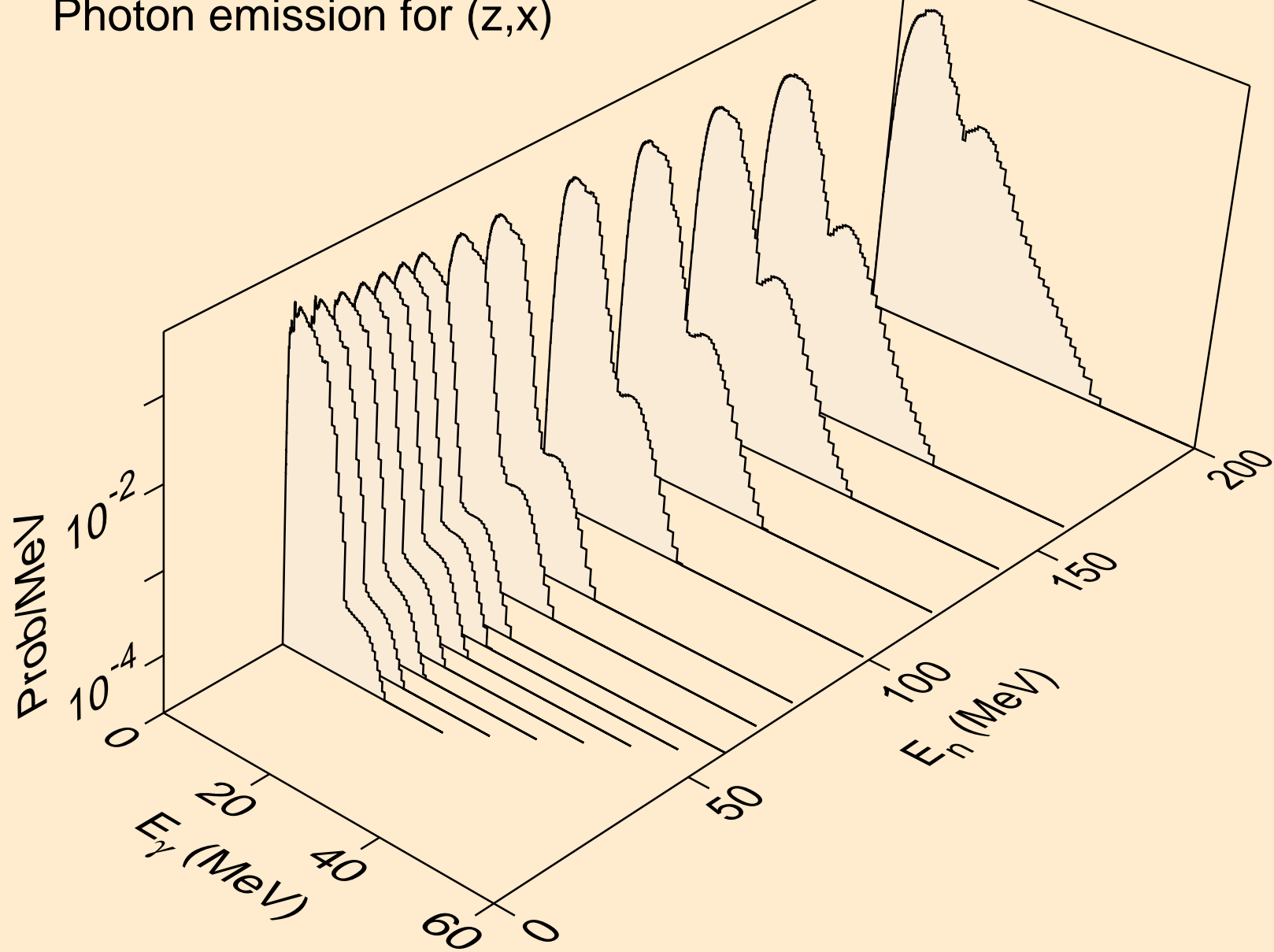

S034 HELION ACER TENDL-2024 LIBRARY; T=0.K  
Photon emission for (n,2nd)

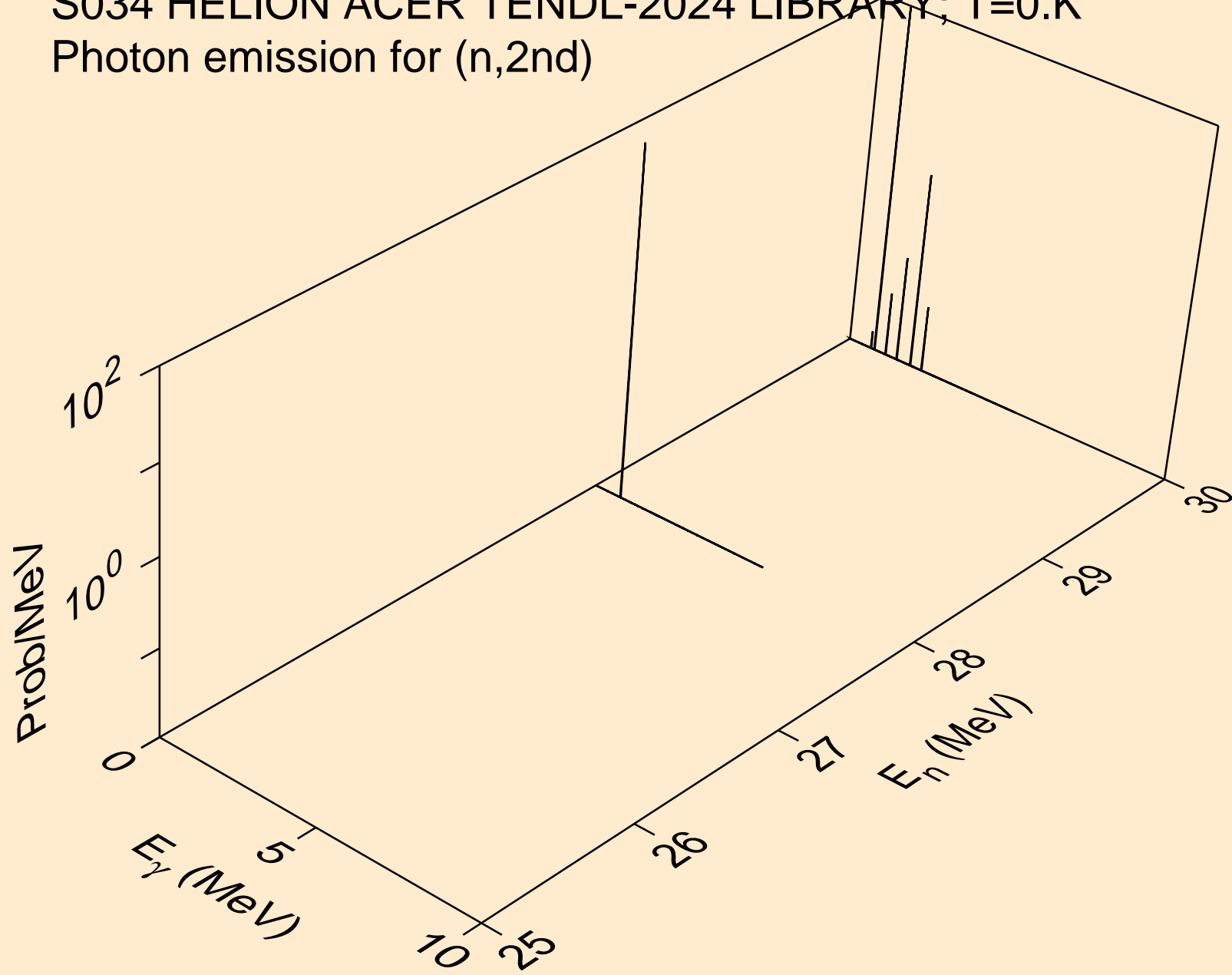

S034 HELION ACER TENDL-2024 LIBRARY; T=0.K  
Photon emission for (n,2n)

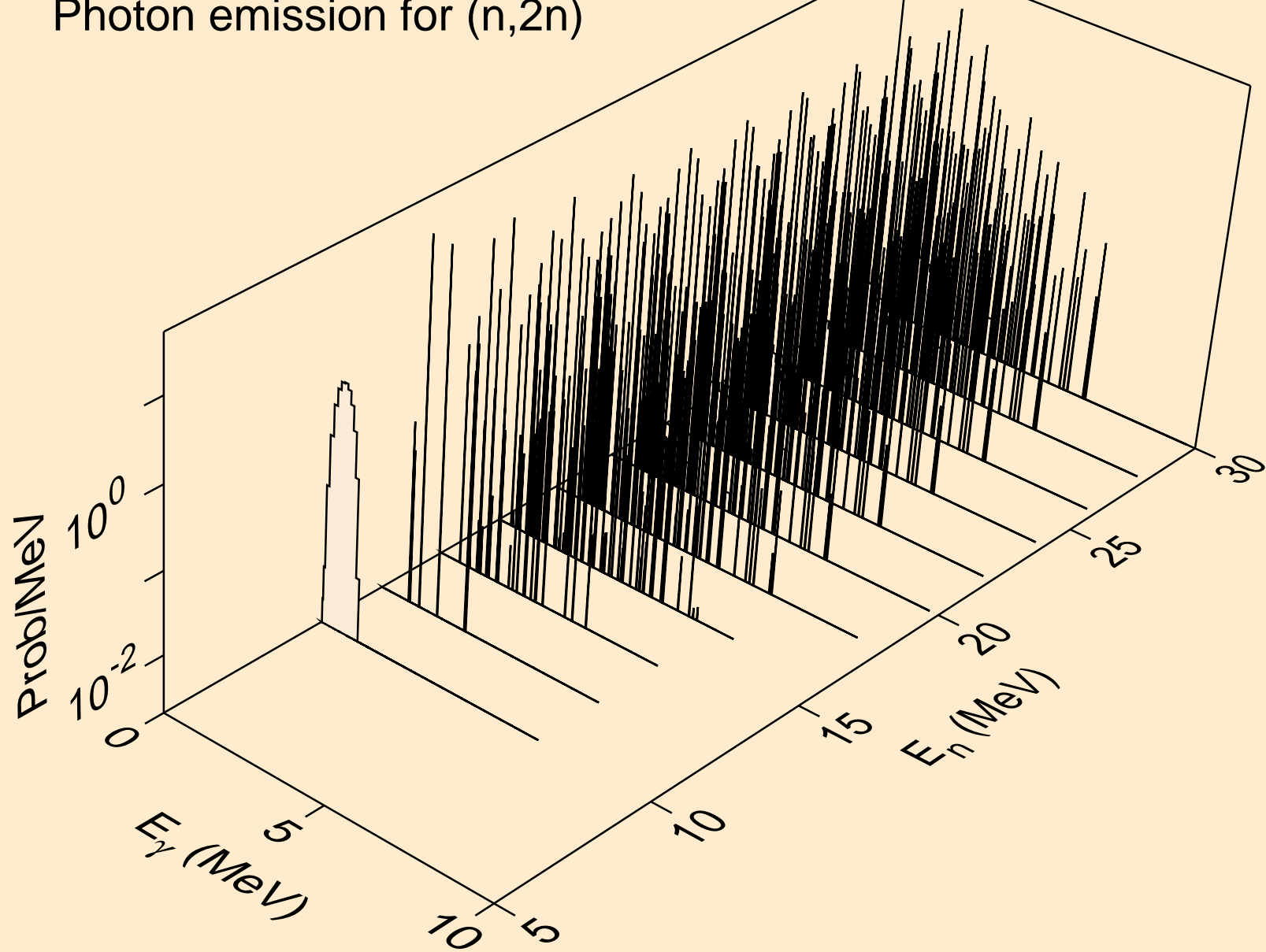

S034 HELION ACER TENDL-2024 LIBRARY; T=0.K  
Photon emission for (n,3n)

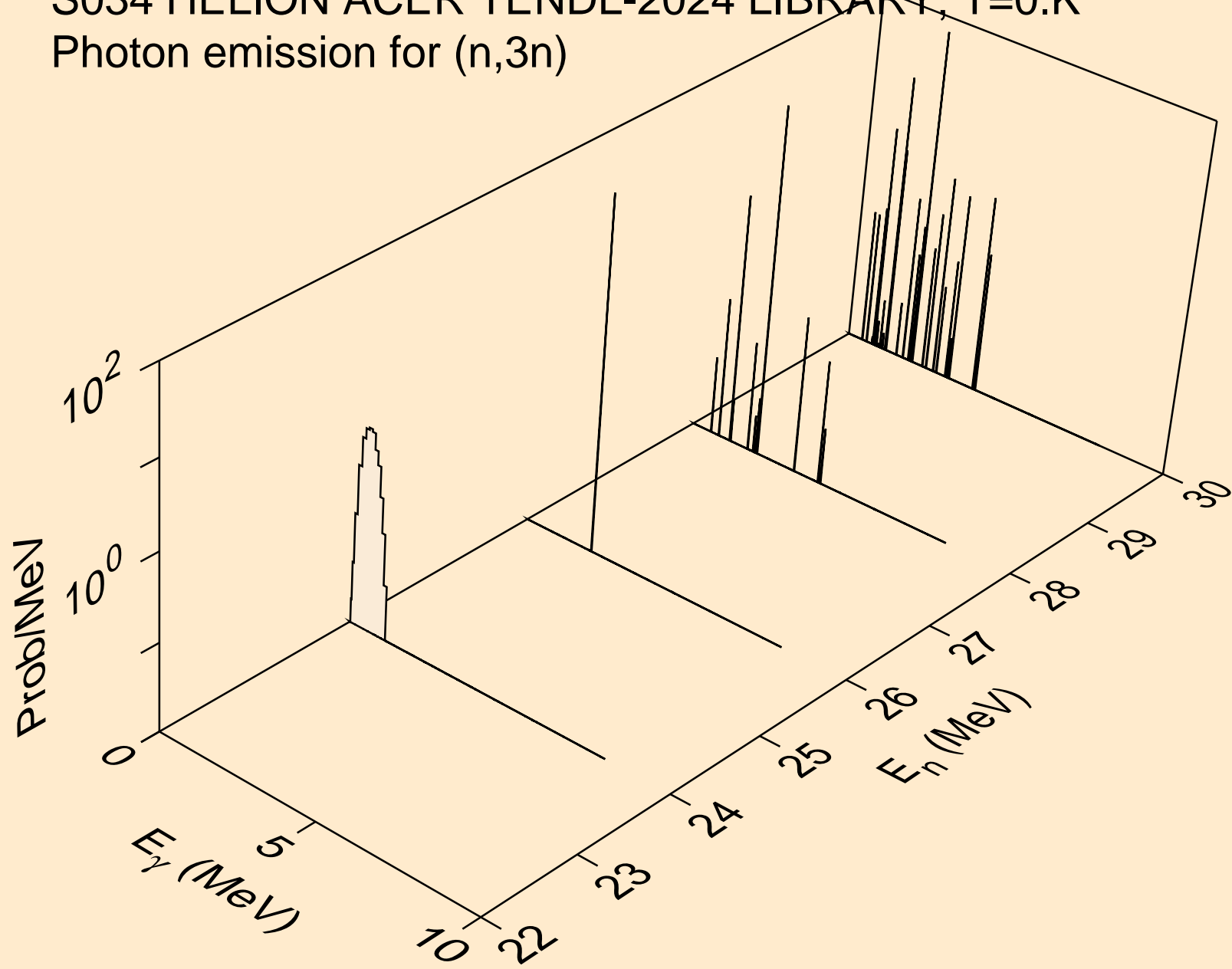

S034 HELION ACER TENDL-2024 LIBRARY; T=0.K  
Photon emission for (n,n\*)a

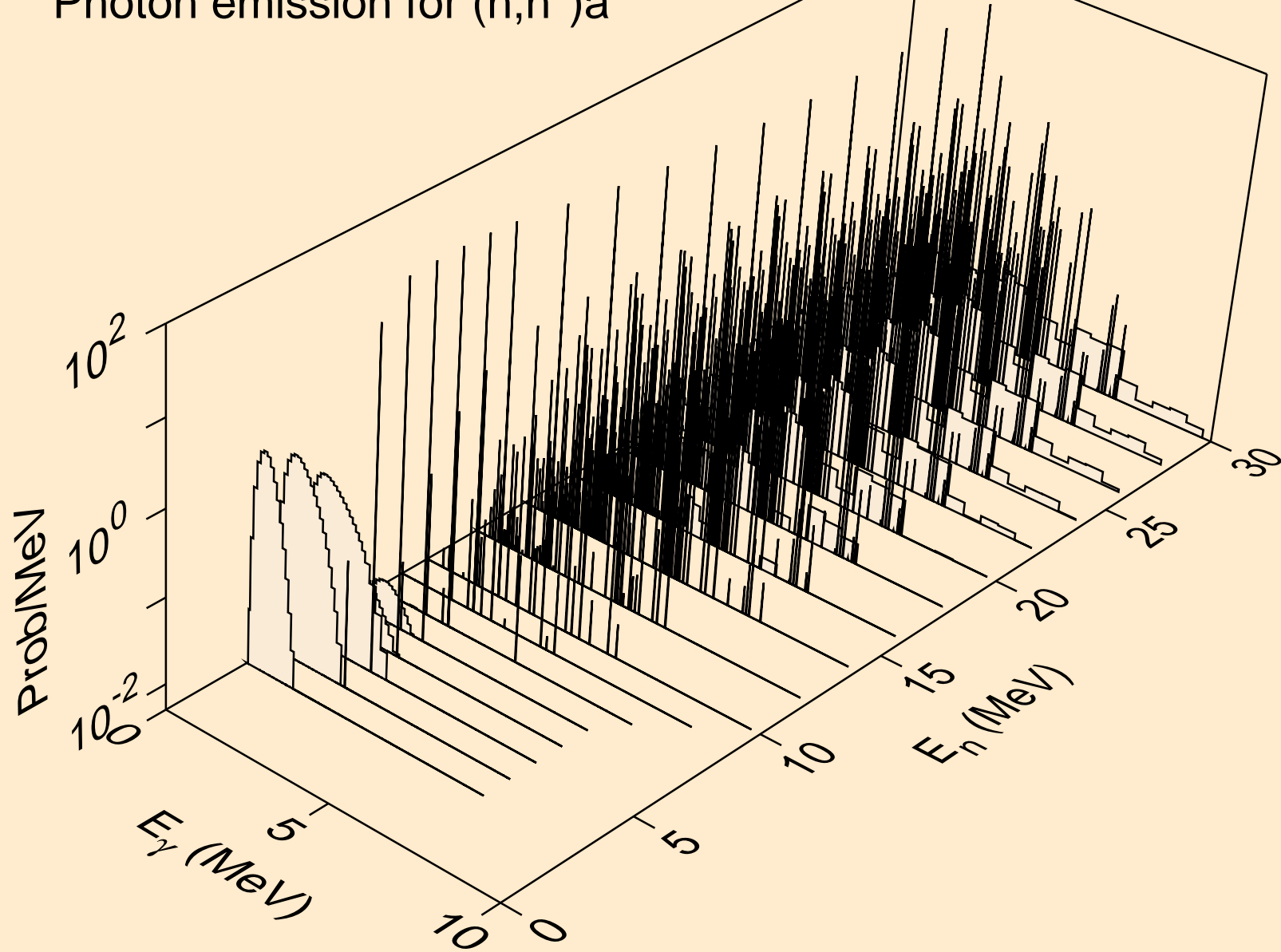

S034 HELION ACER TENDL-2024 LIBRARY; T=0.K  
Photon emission for (n,2n)a

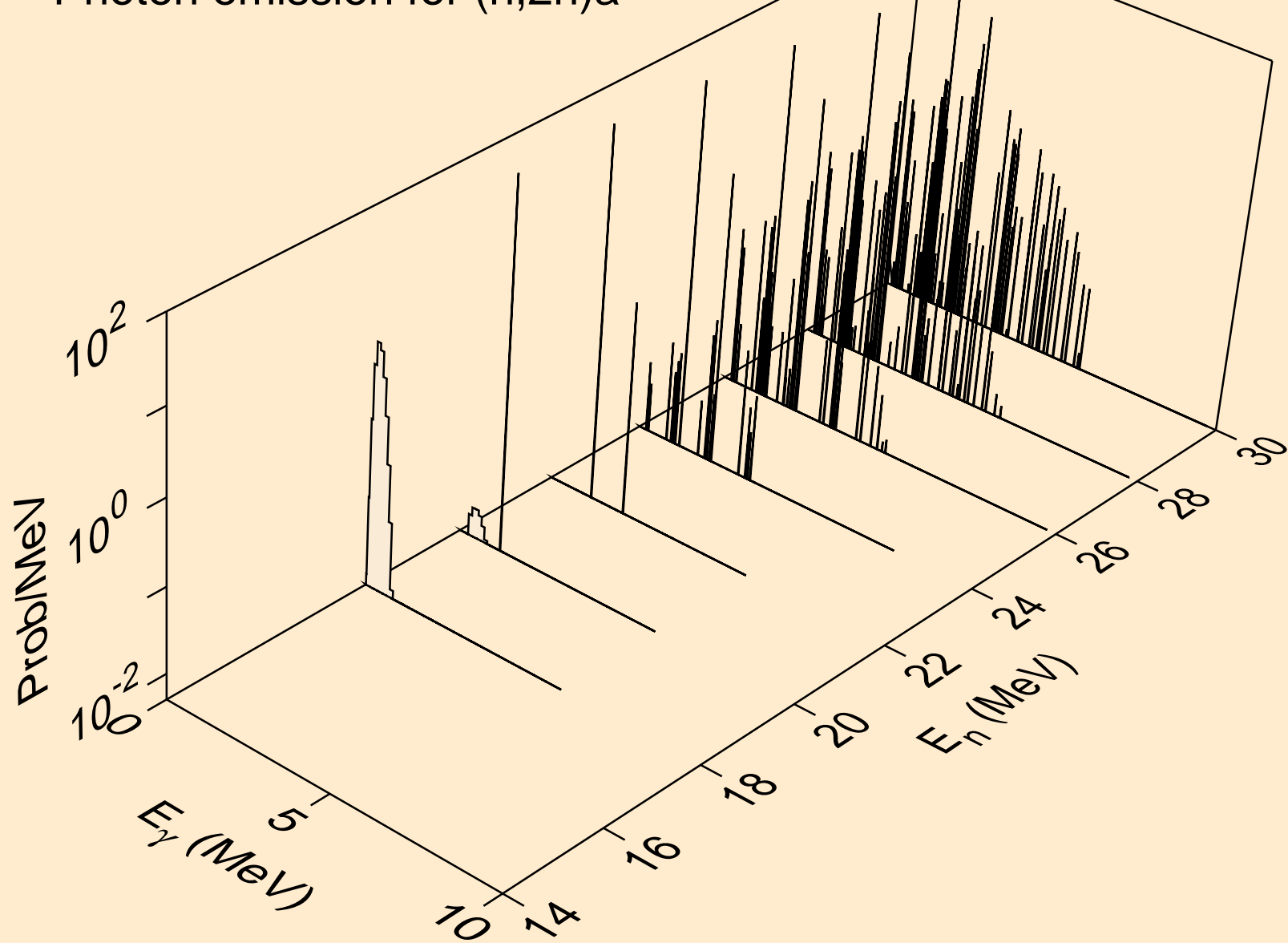

S034 HELION ACER TENDL-2024 LIBRARY; T=0.K  
Photon emission for (n,n\*)p

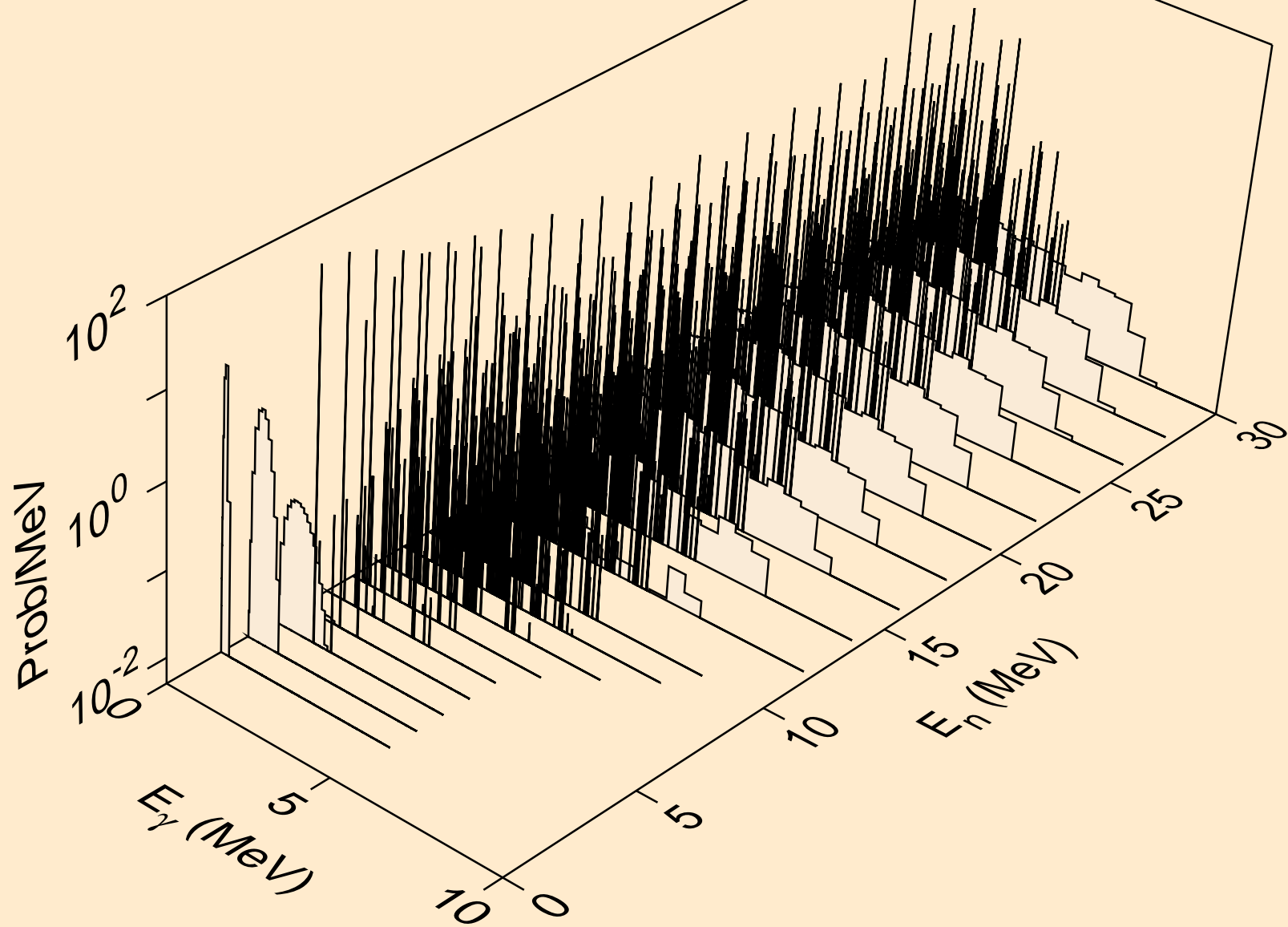

S034 HELION ACER TENDL-2024 LIBRARY; T=0.K  
Photon emission for (n,n\*)2a

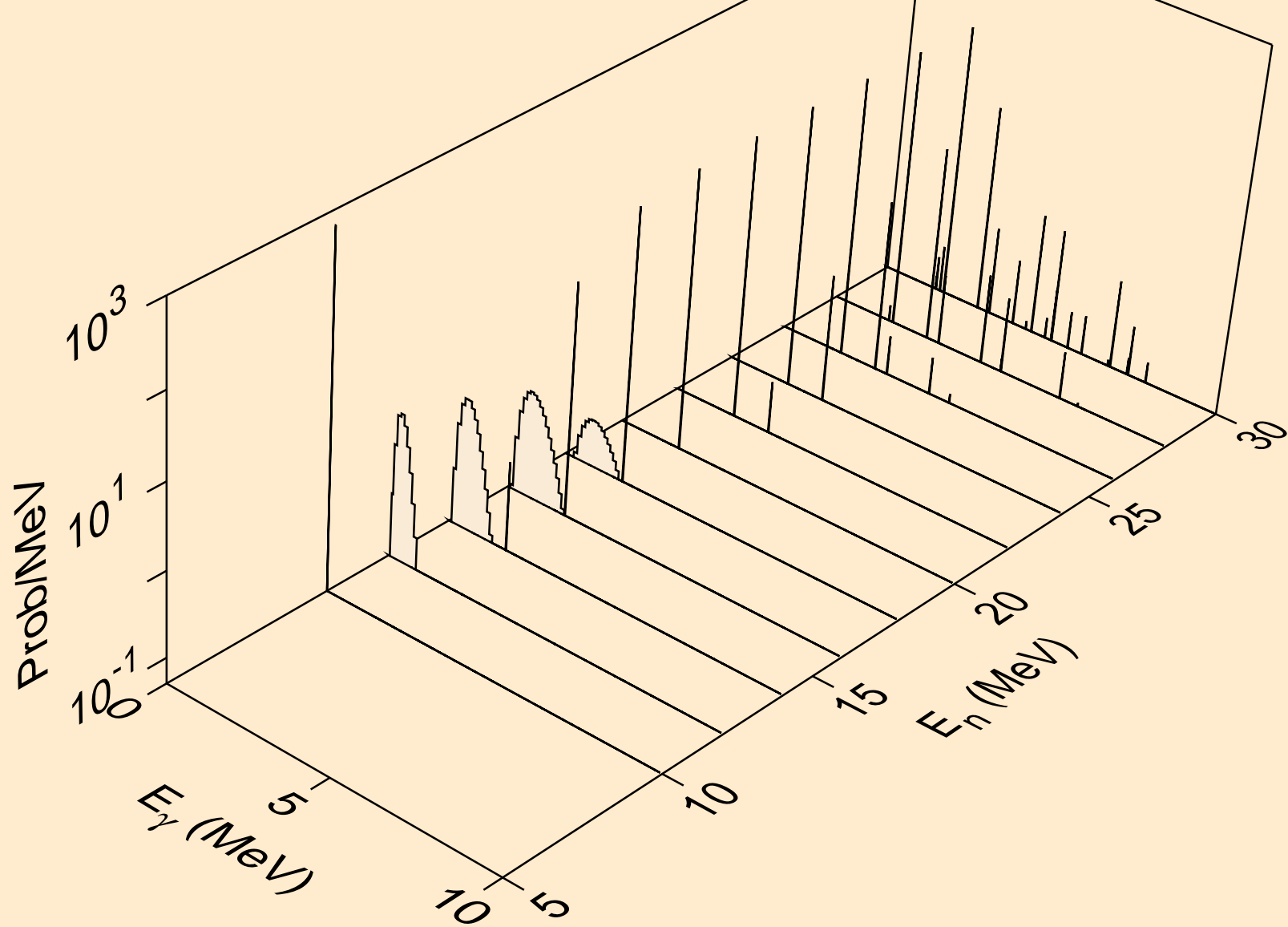

S034 HELION ACER TENDL-2024 LIBRARY; T=0.K  
Photon emission for (n,n\*)d

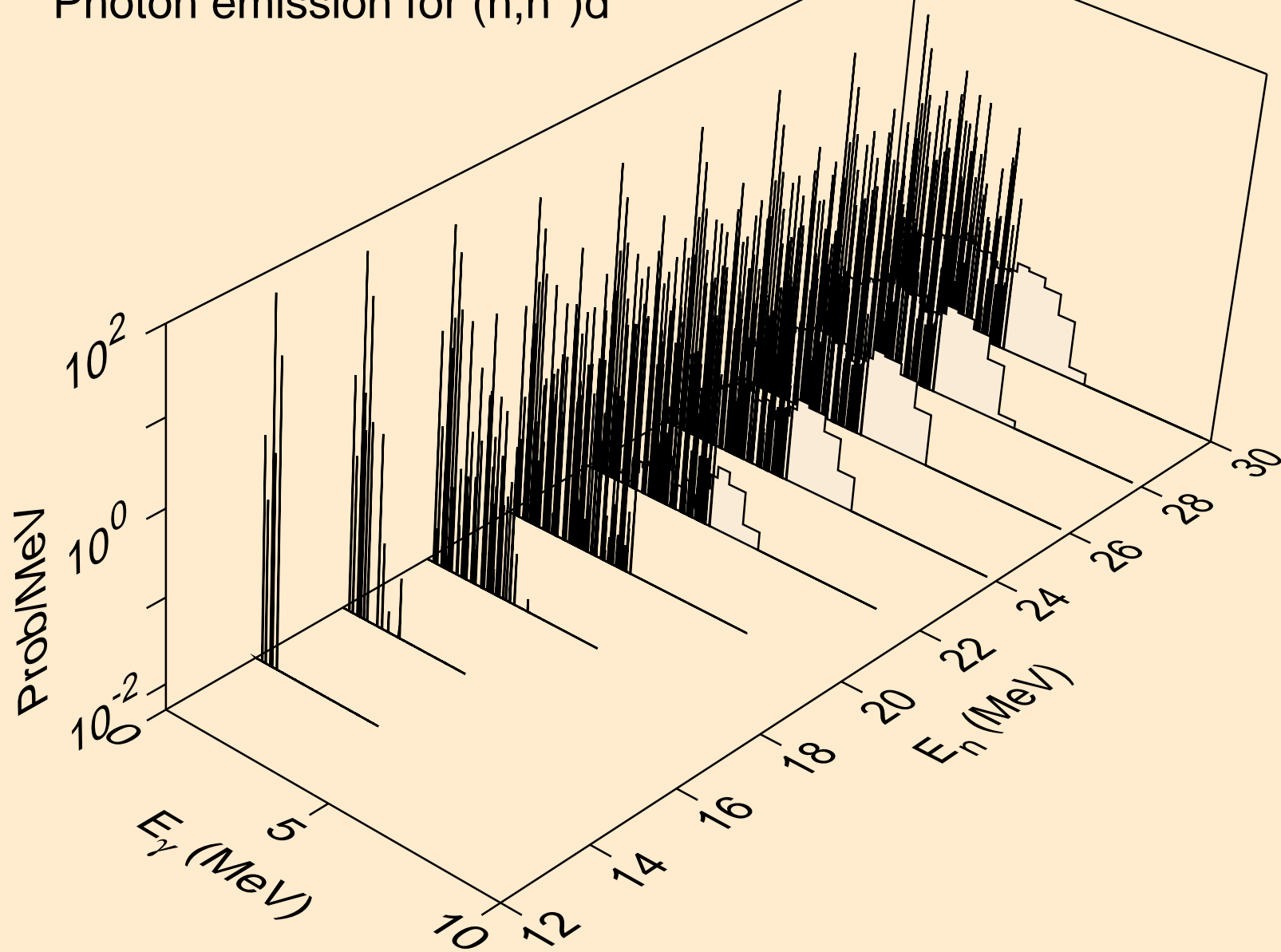

S034 HELION ACER TENDL-2024 LIBRARY; T=0.K  
Photon emission for (n,n\*)t

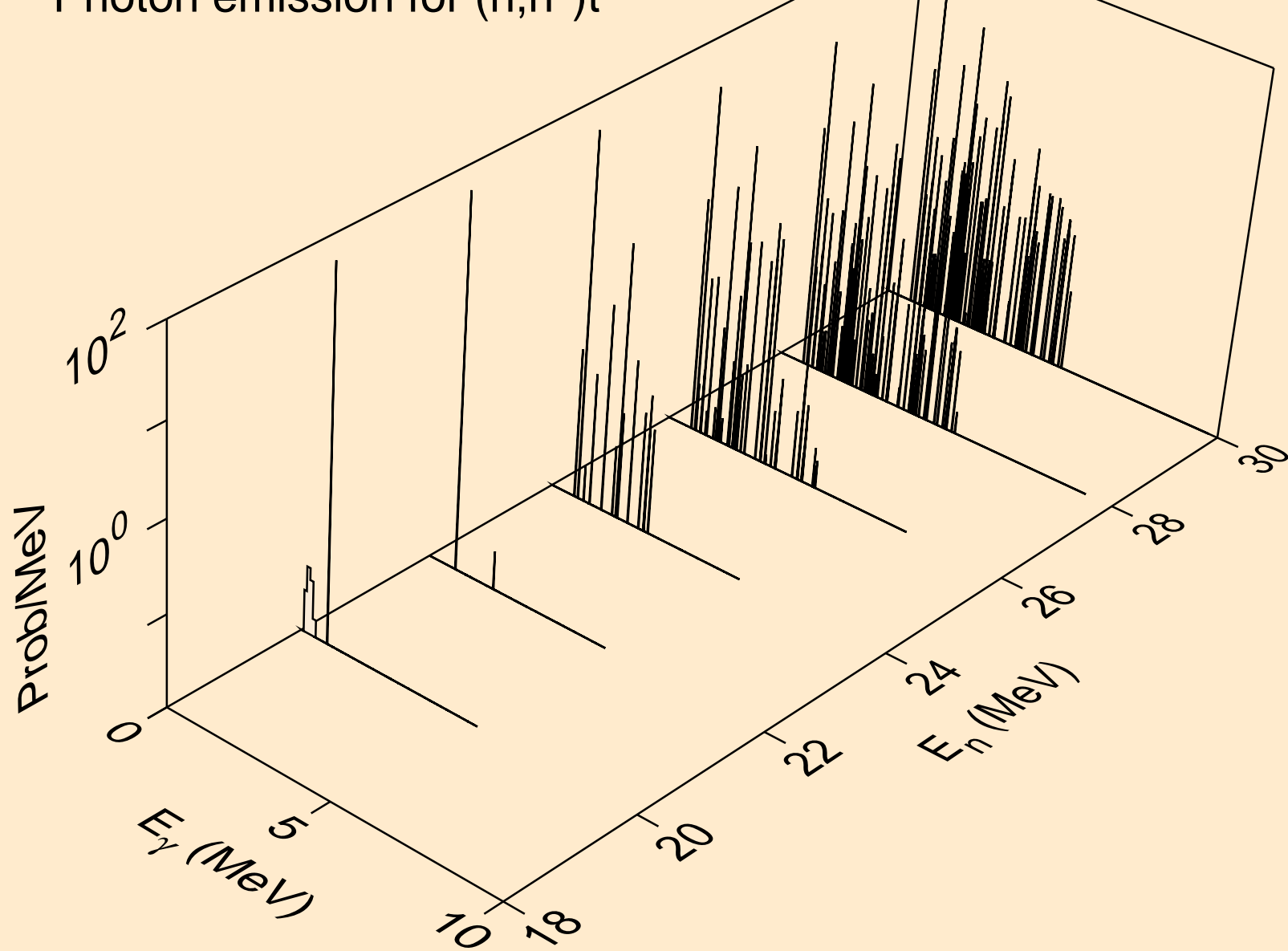

S034 HELION ACER TENDL-2024 LIBRARY; T=0.K  
Photon emission for (n,n\*)he3

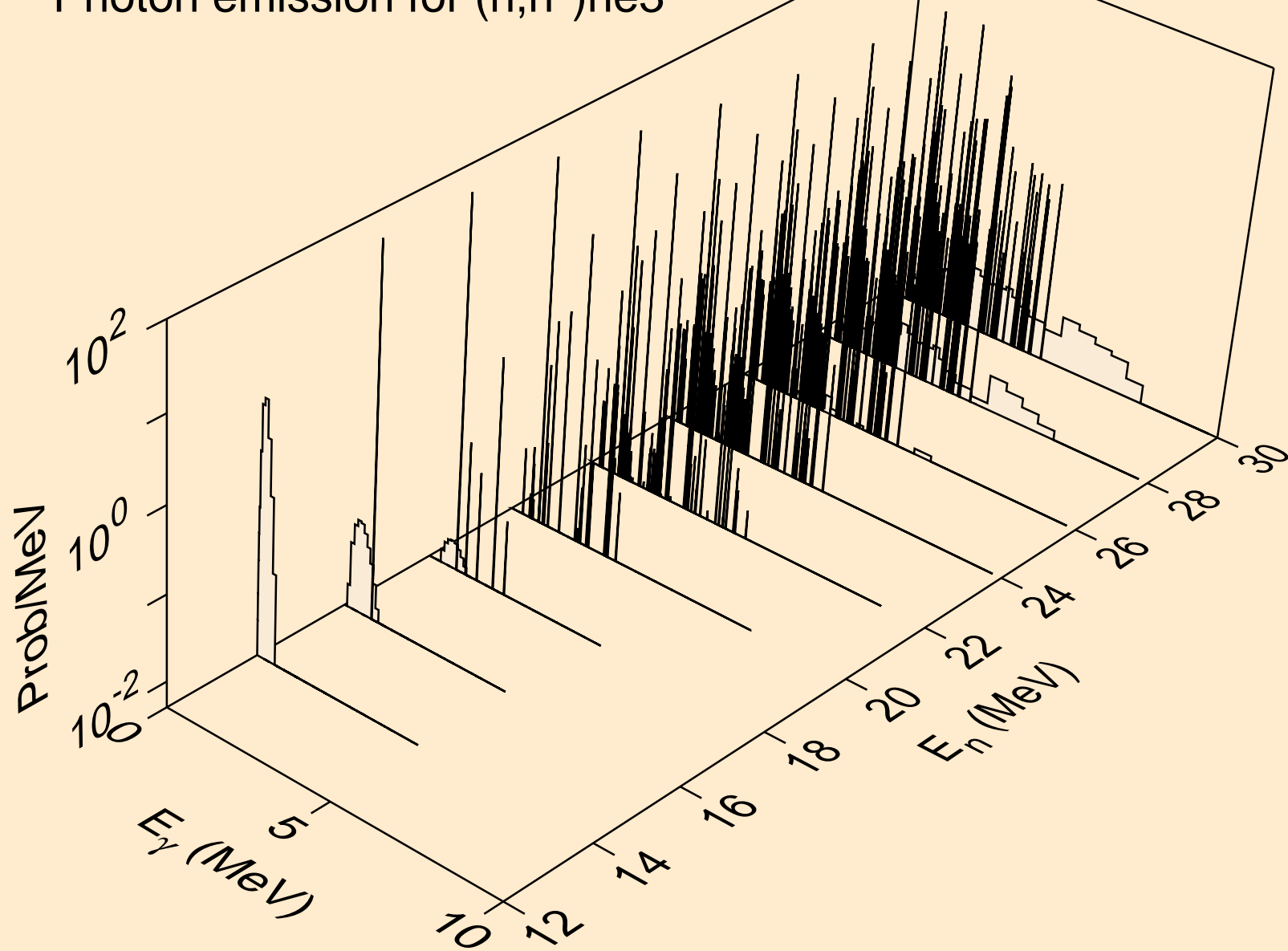

S034 HELION ACER TENDL-2024 LIBRARY; T=0.K  
Photon emission for (n,2np)

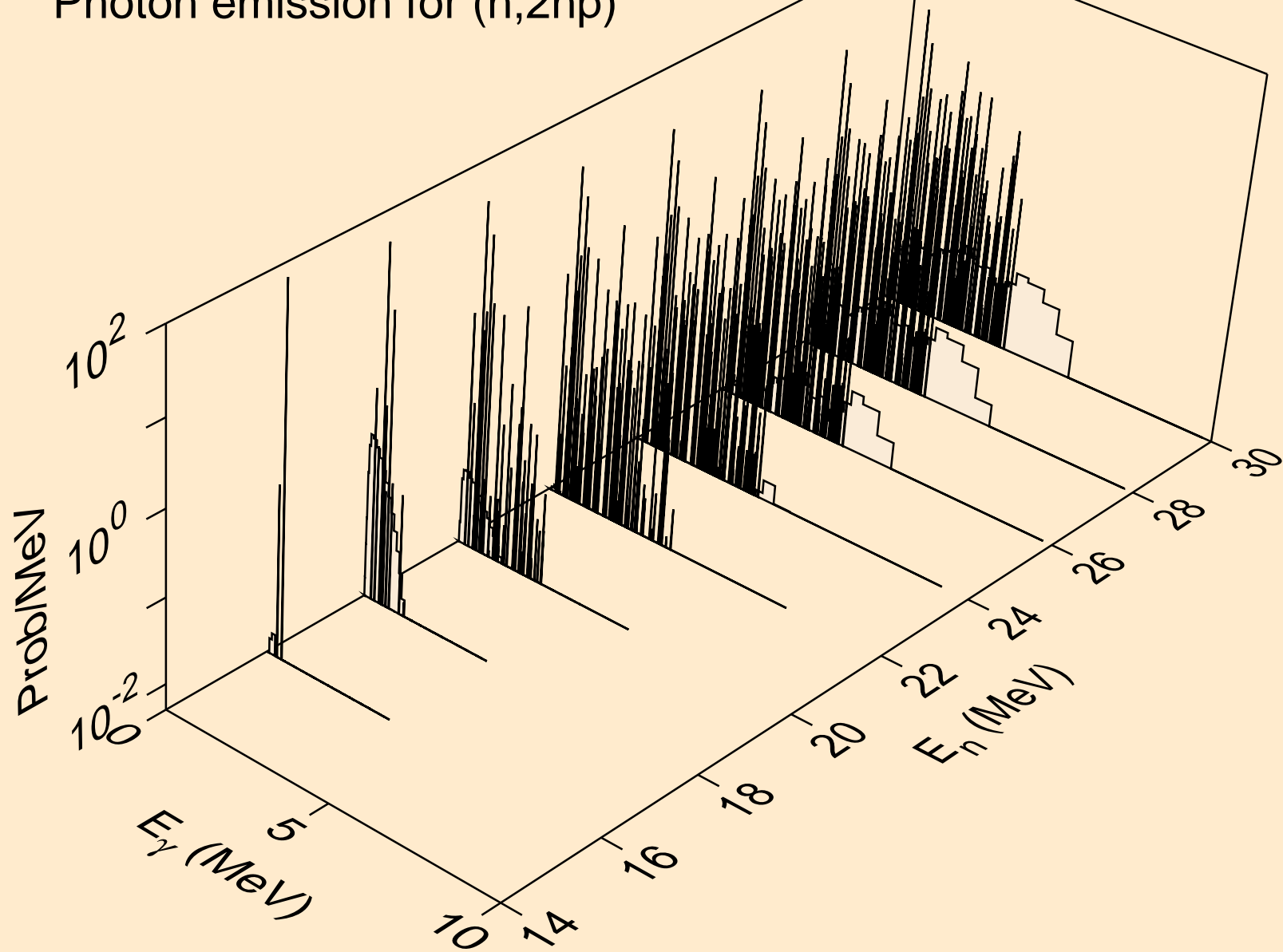

S034 HELION ACER TENDL-2024 LIBRARY; T=0.K  
Photon emission for (n,3np)

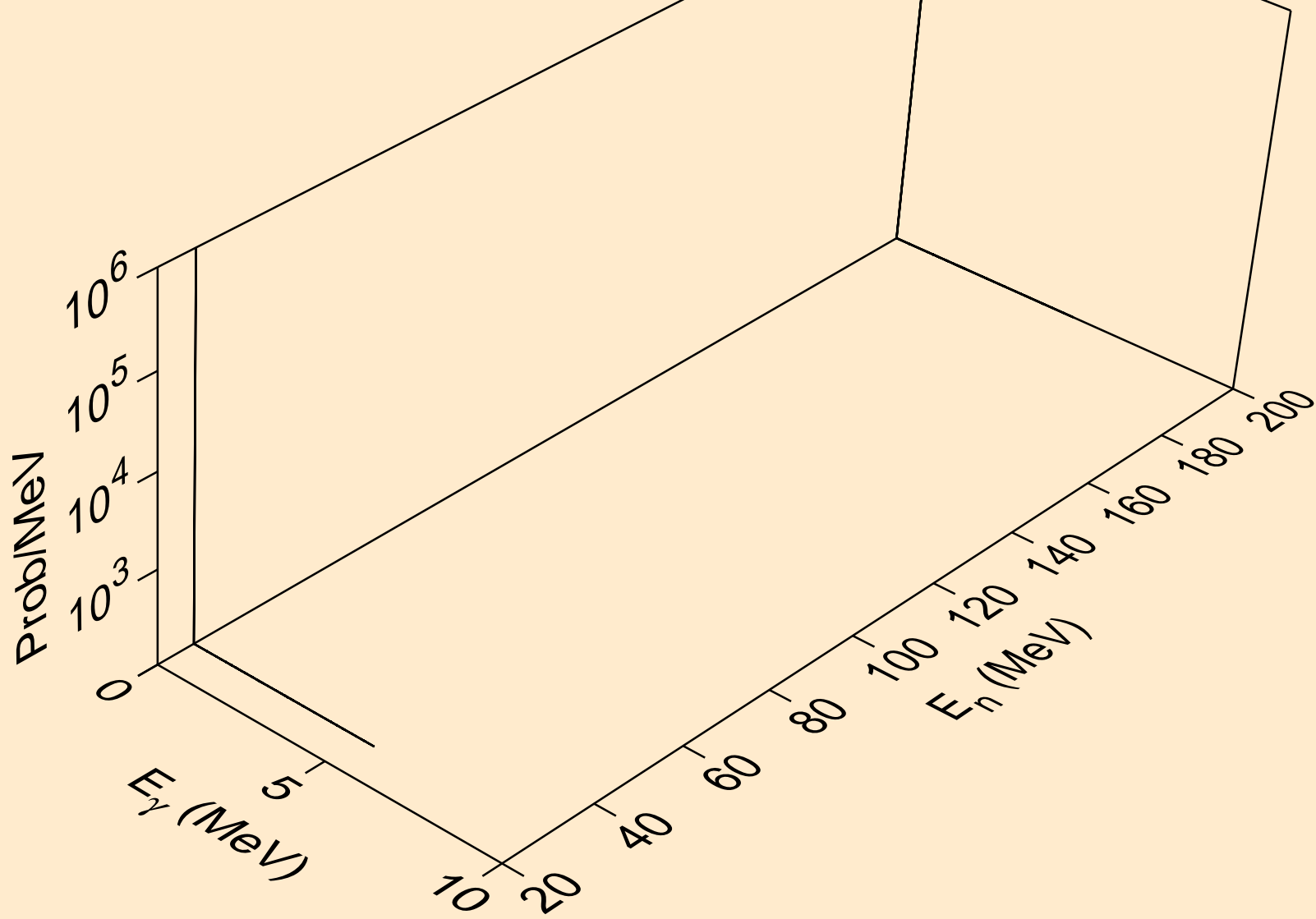

S034 HELION ACER TENDL-2024 LIBRARY; T=0.K  
Photon emission for (n,n2p)

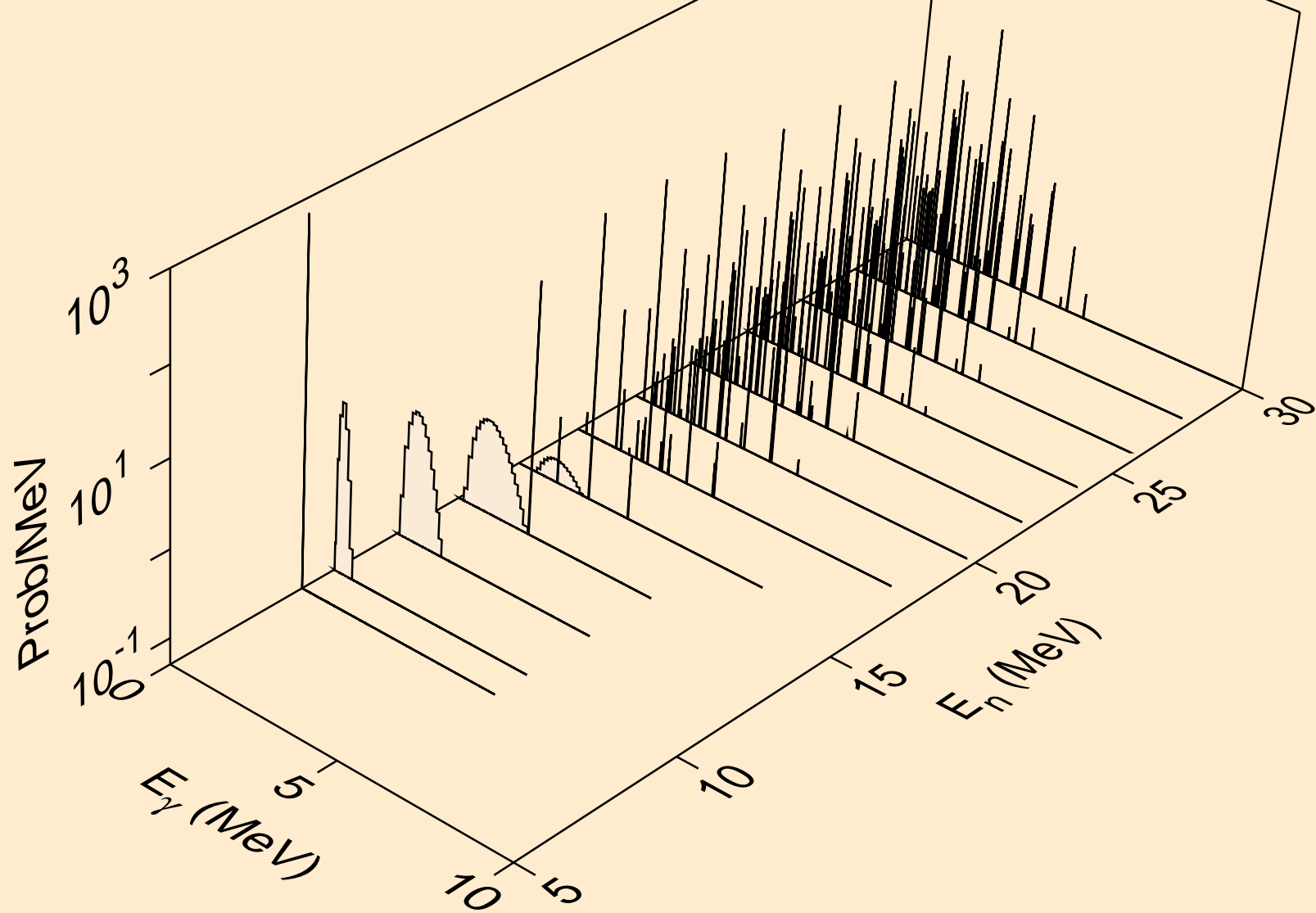

S034 HELION ACER TENDL-2024 LIBRARY; T=0.K  
Photon emission for (n,npa)

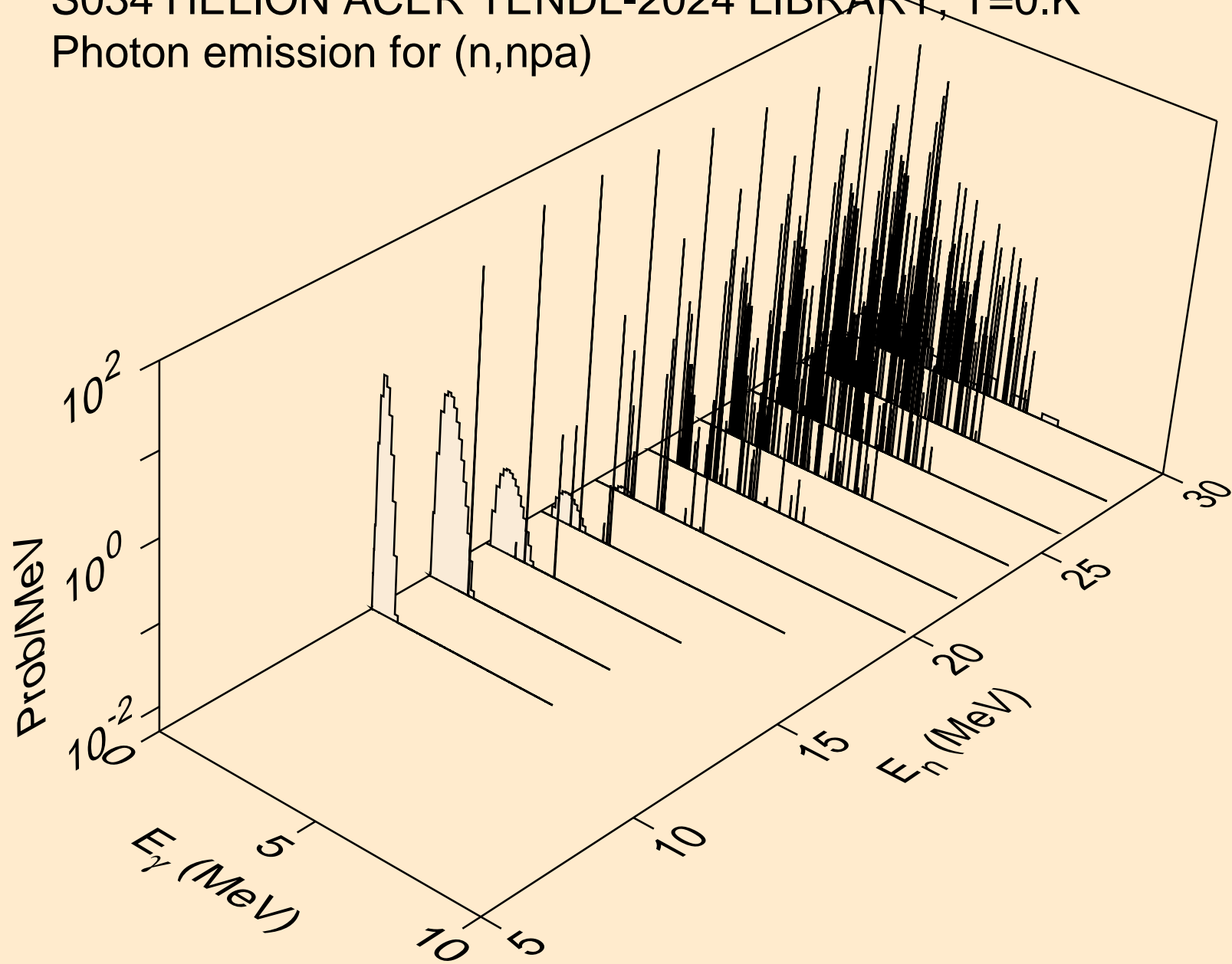

S034 HELION ACER TENDL-2024 LIBRARY; T=0.K  
Photon emission for (n,gma)

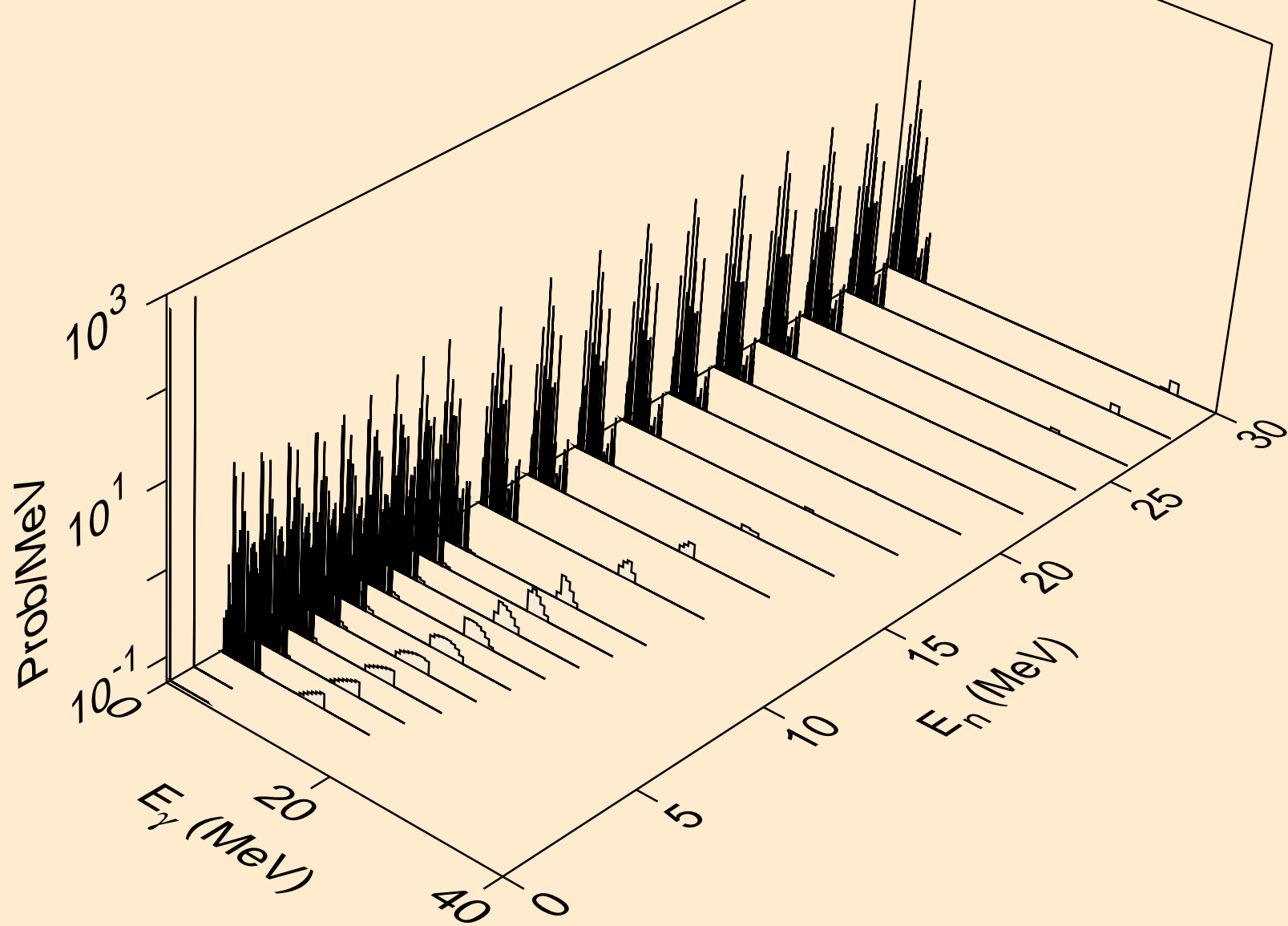

S034 HELION ACER TENDL-2024 LIBRARY; T=0.K  
Photon emission for (n,p)

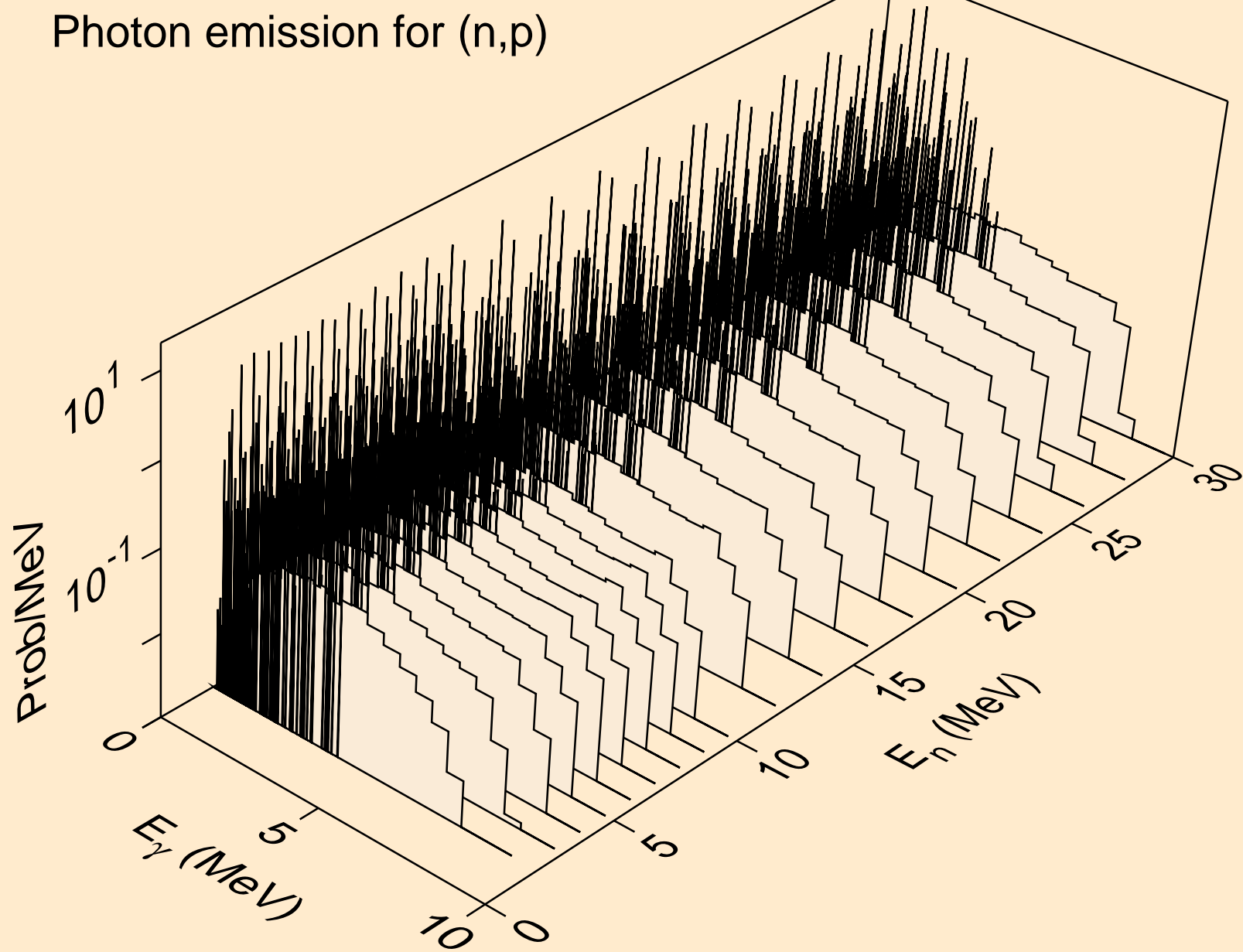

S034 HELION ACER TENDL-2024 LIBRARY; T=0.K  
Photon emission for (n,d)

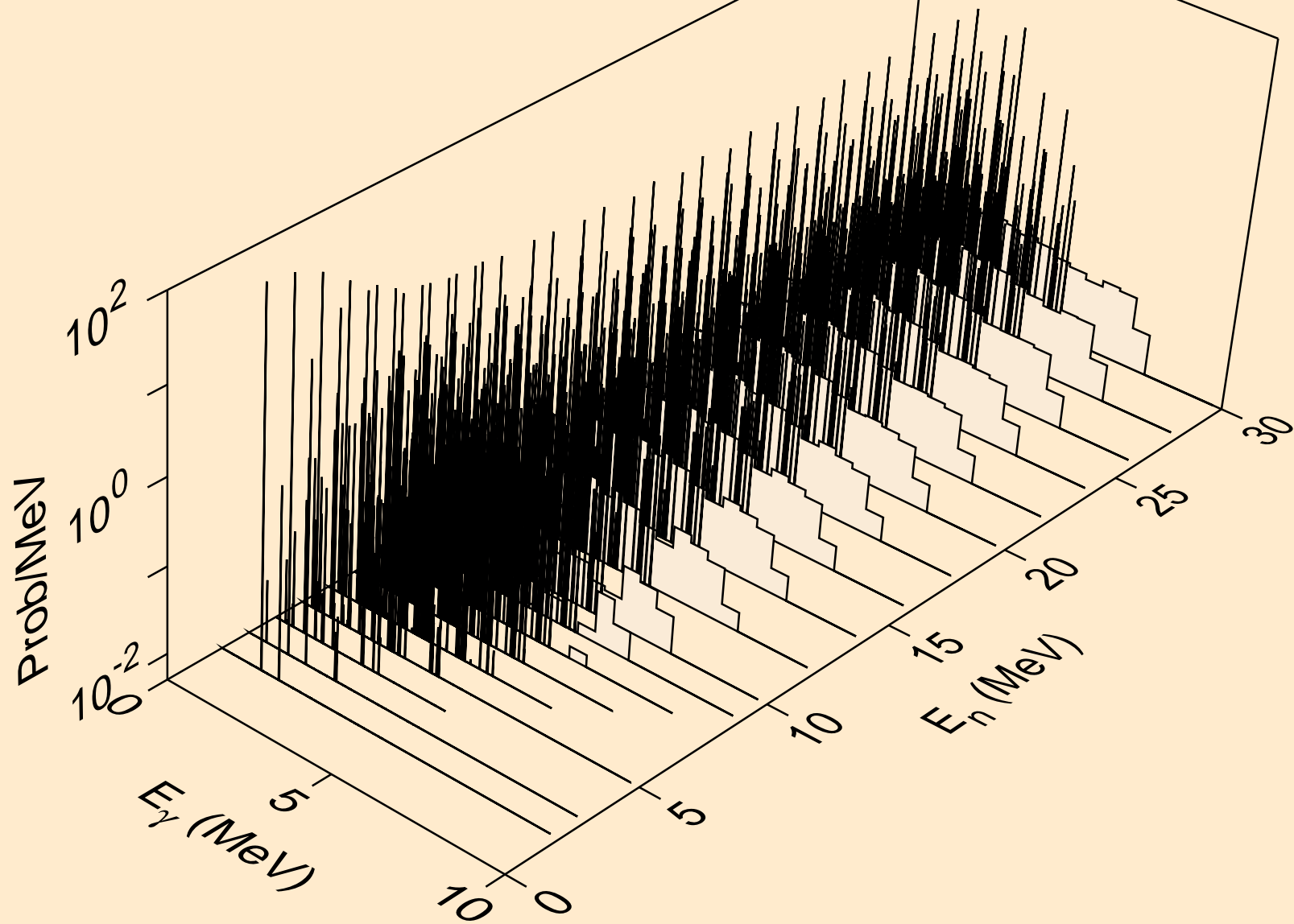

S034 HELION ACER TENDL-2024 LIBRARY; T=0.K  
Photon emission for (n,t)

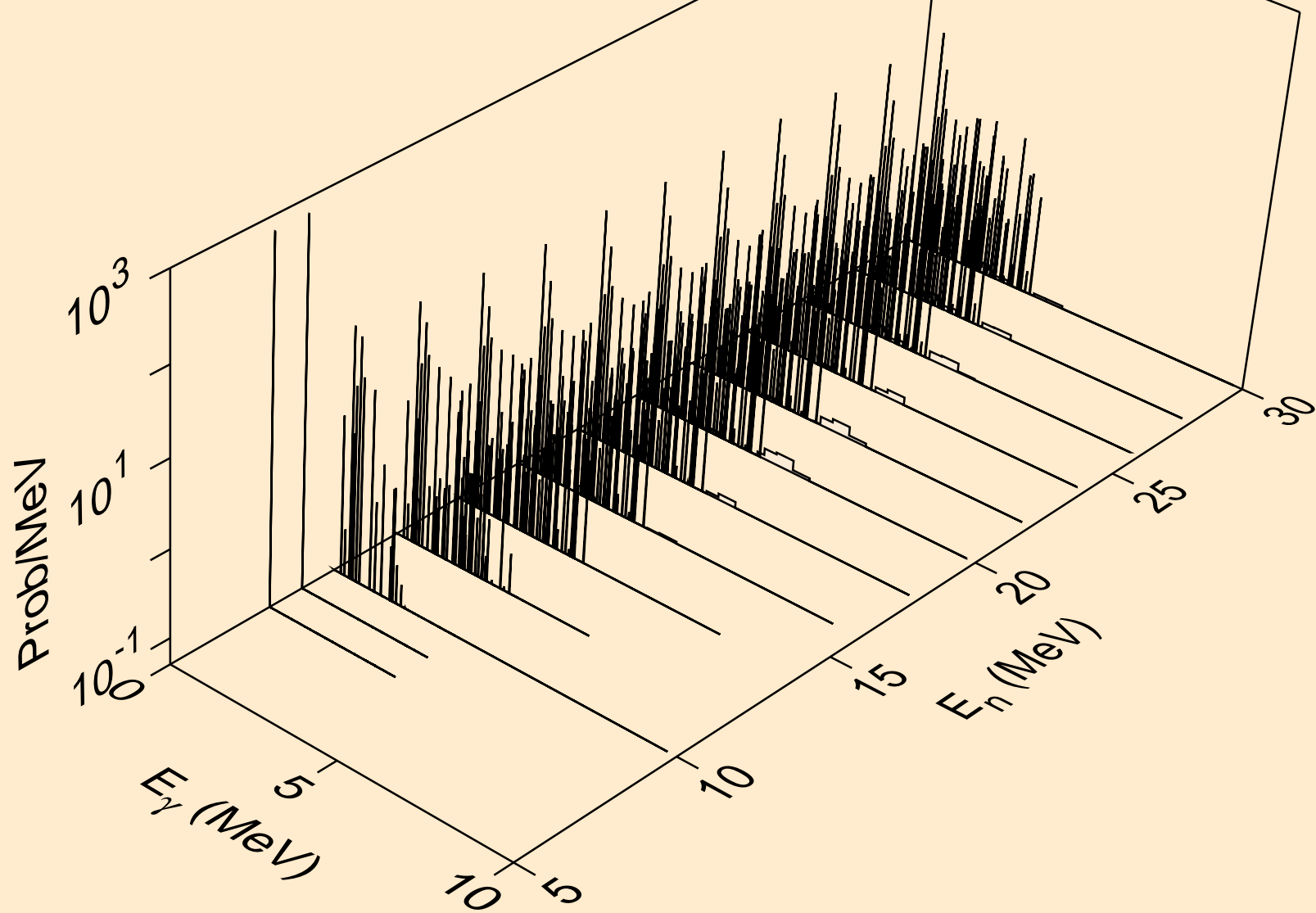

S034 HELION ACER TENDL-2024 LIBRARY; T=0.K  
Photon emission for inelastic

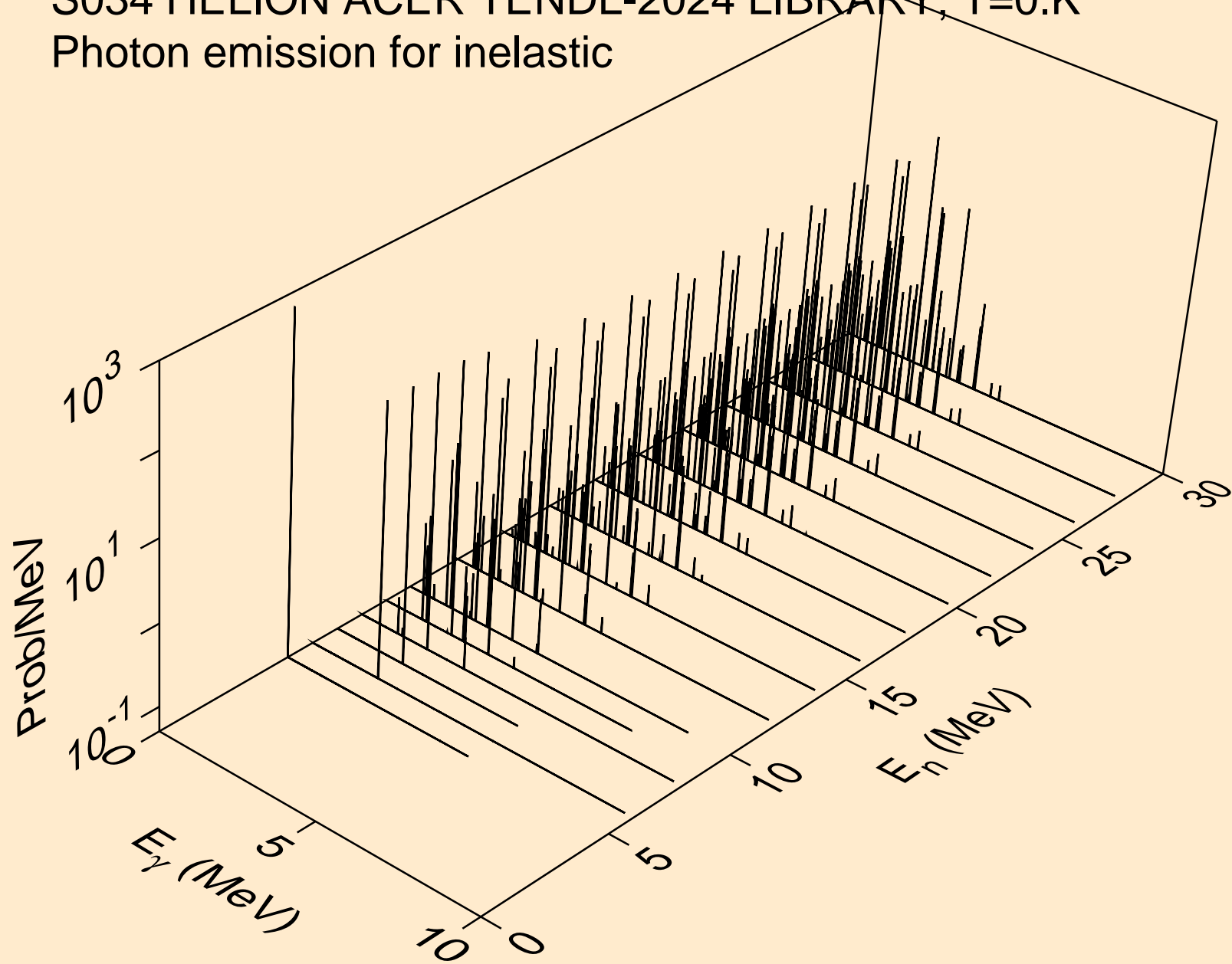

S034 HELION ACER TENDL-2024 LIBRARY; T=0.K  
Photon emission for (n,a)

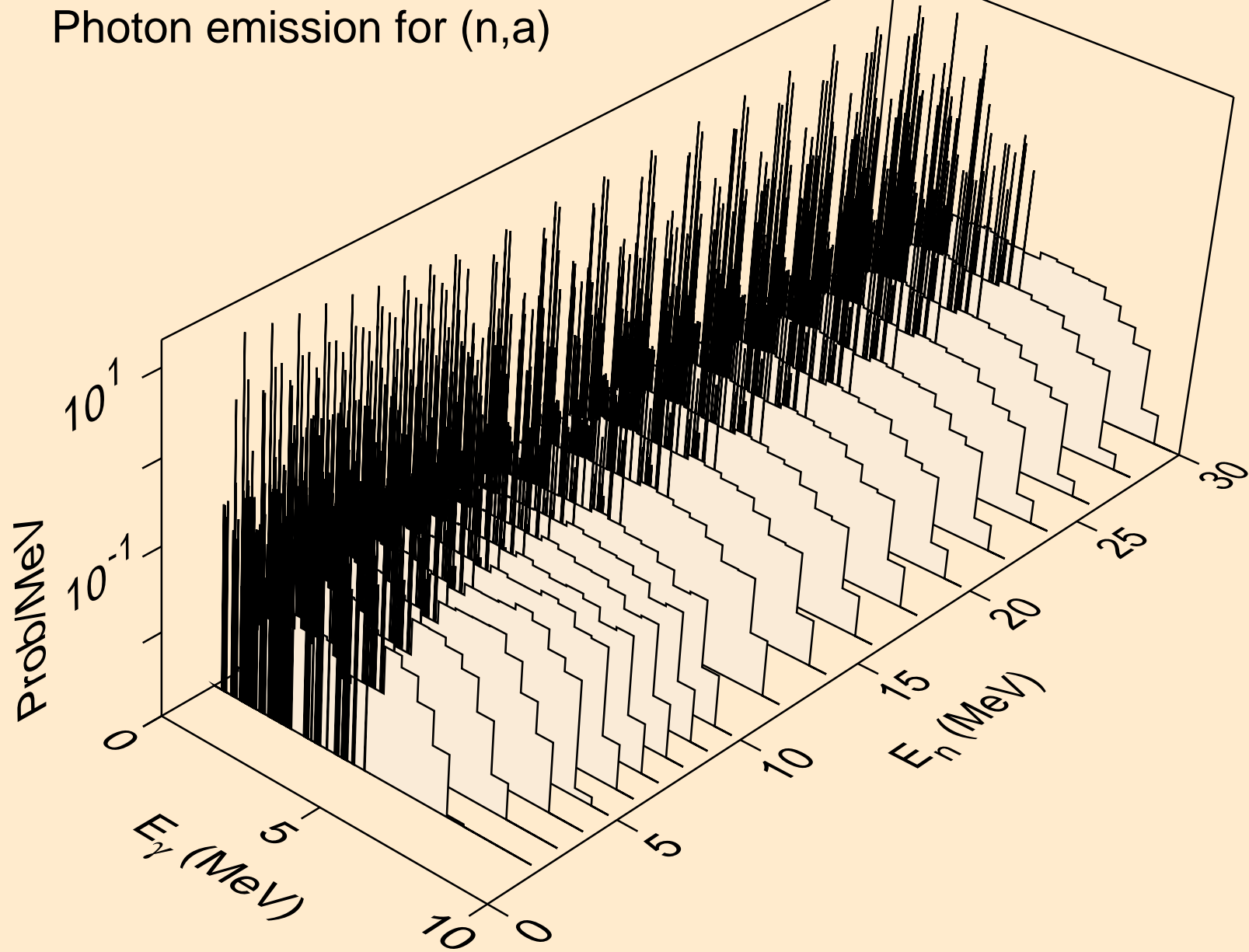

S034 HELION ACER TENDL-2024 LIBRARY; T=0.K  
Photon emission for (n,2a)

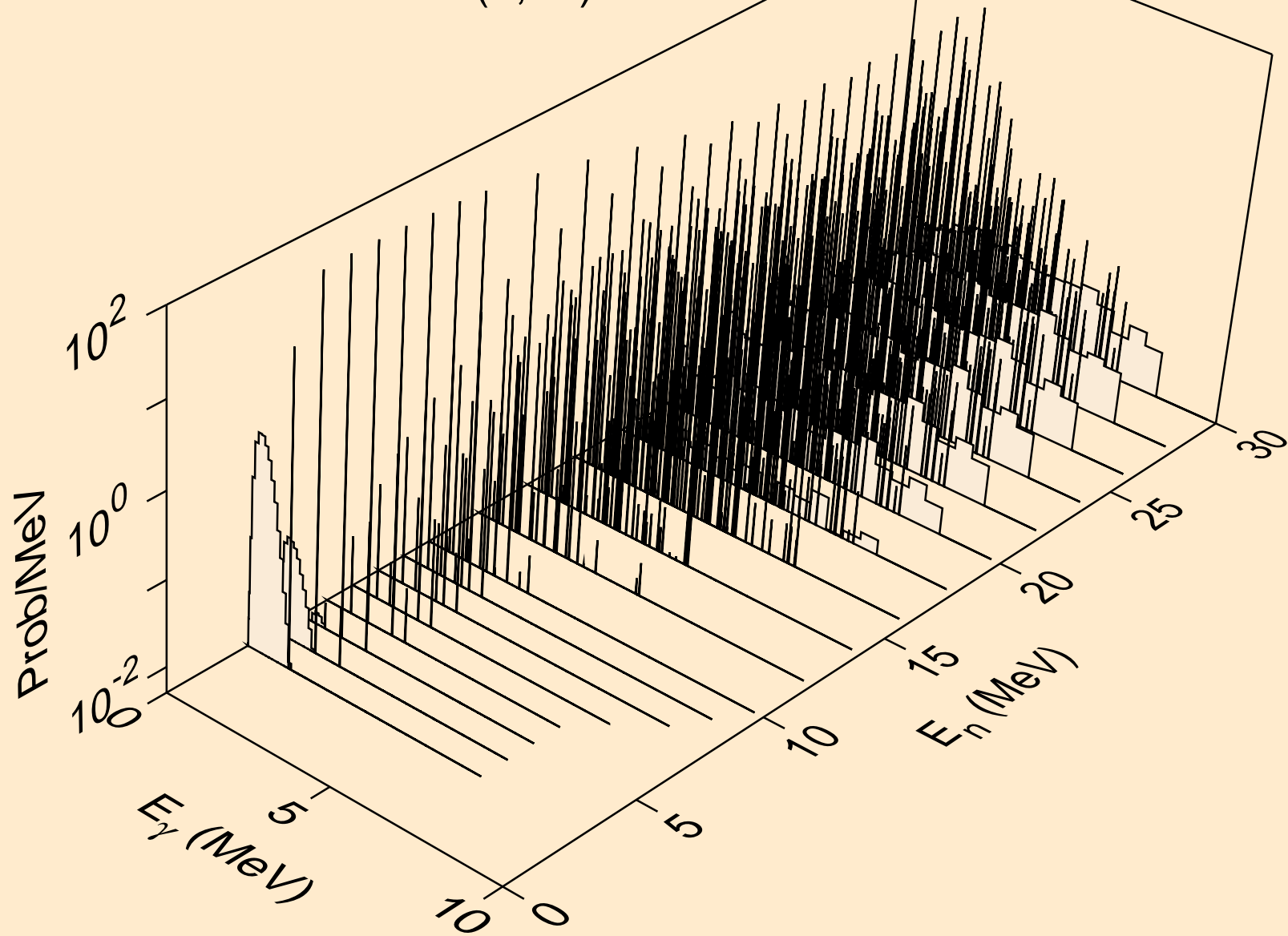

S034 HELION ACER TENDL-2024 LIBRARY; T=0.K  
Photon emission for (n,3a)

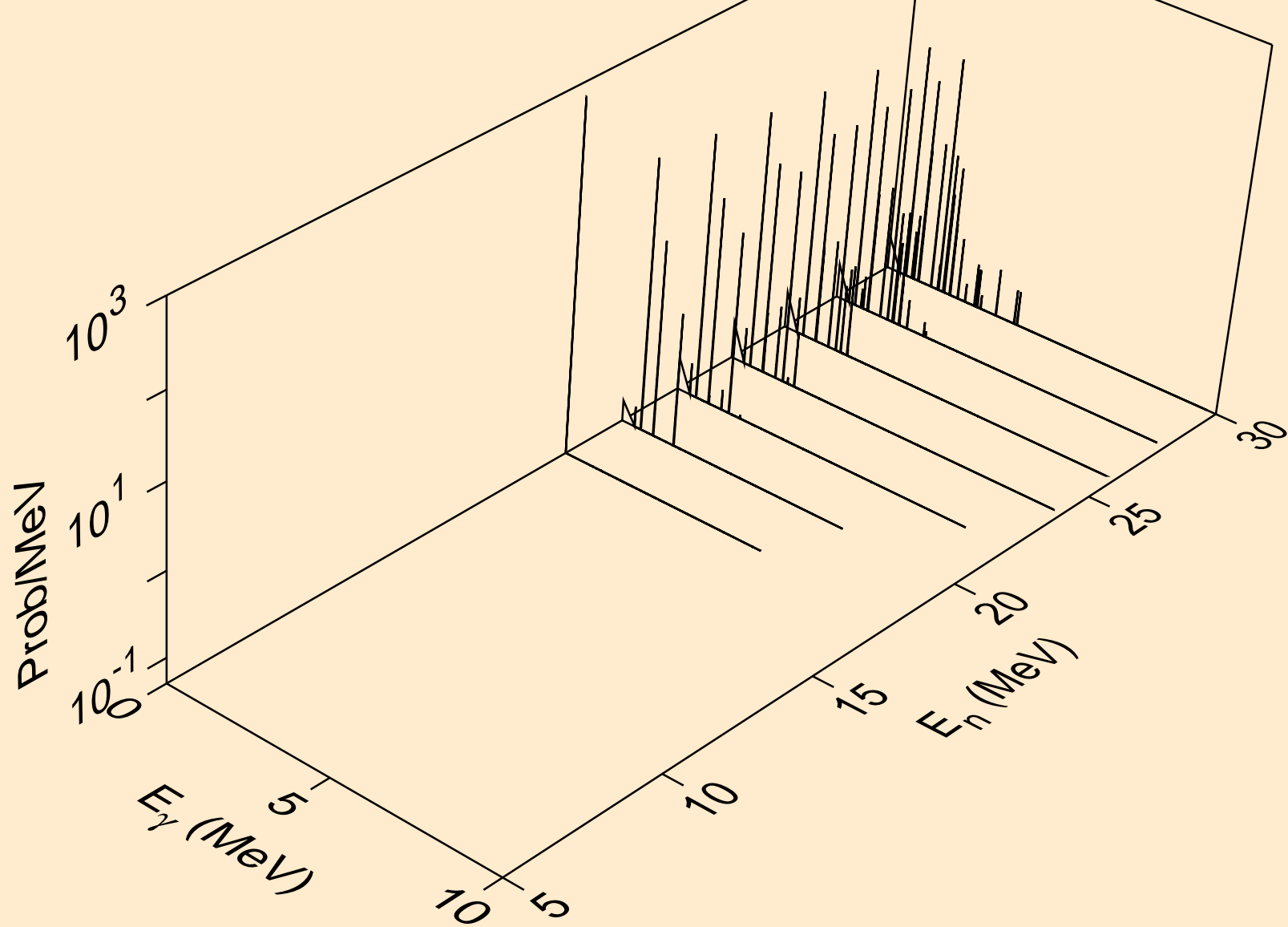

S034 HELION ACER TENDL-2024 LIBRARY; T=0.K  
Photon emission for (n,2p)

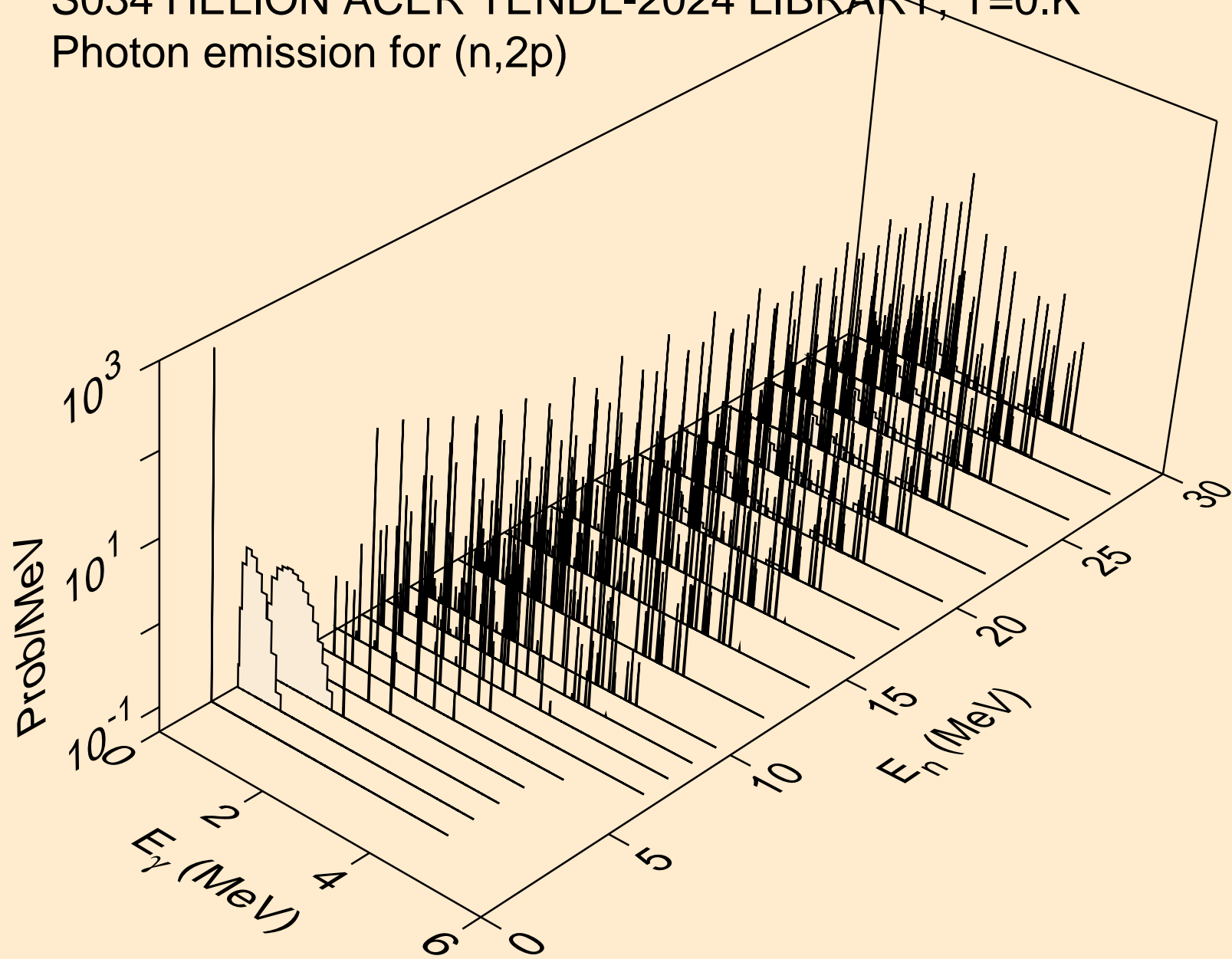

S034 HELION ACER TENDL-2024 LIBRARY; T=0.K  
Photon emission for (n,p $\alpha$ )

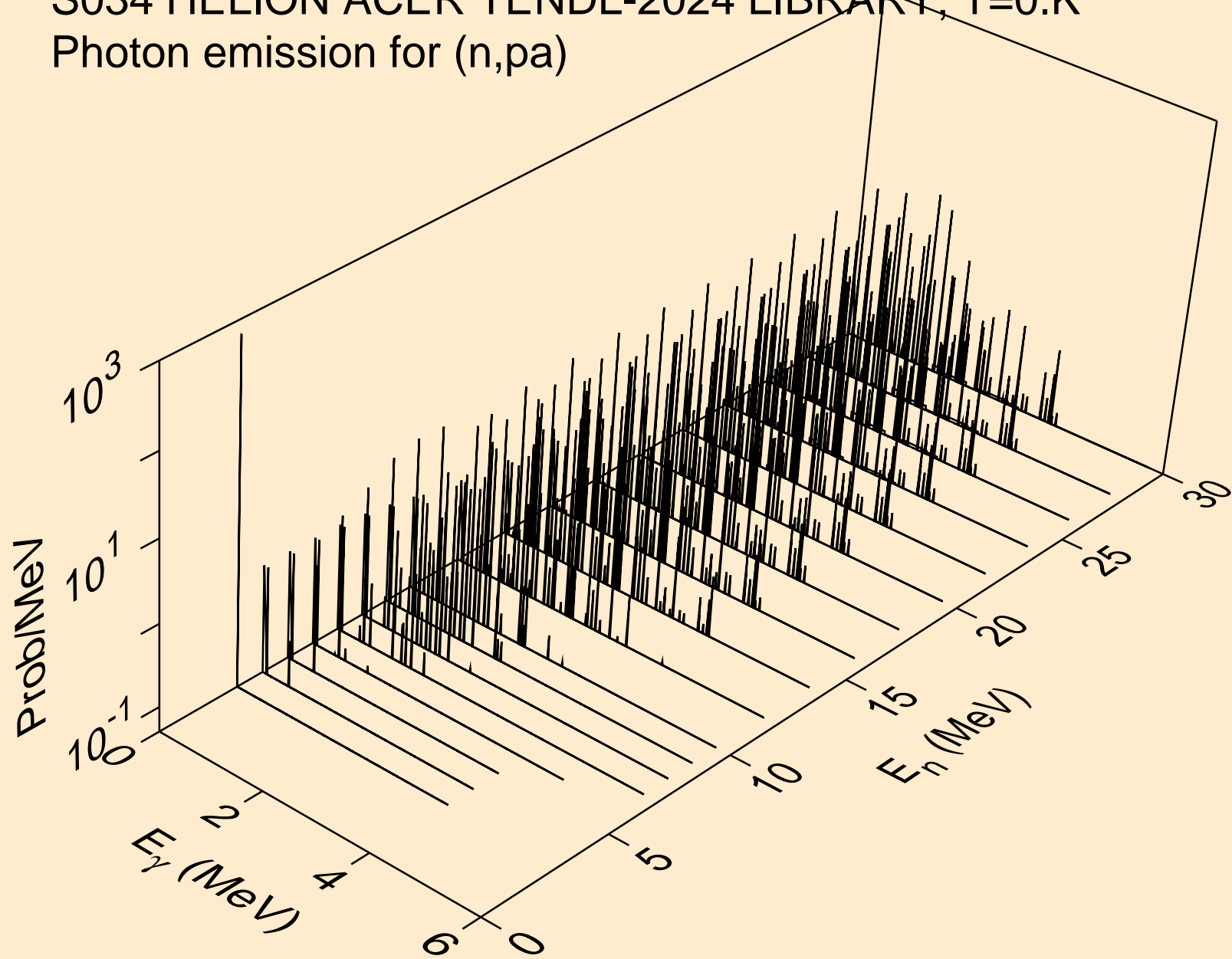

S034 HELION ACER TENDL-2024 LIBRARY; T=0.K  
Photon emission for (n,d2a)

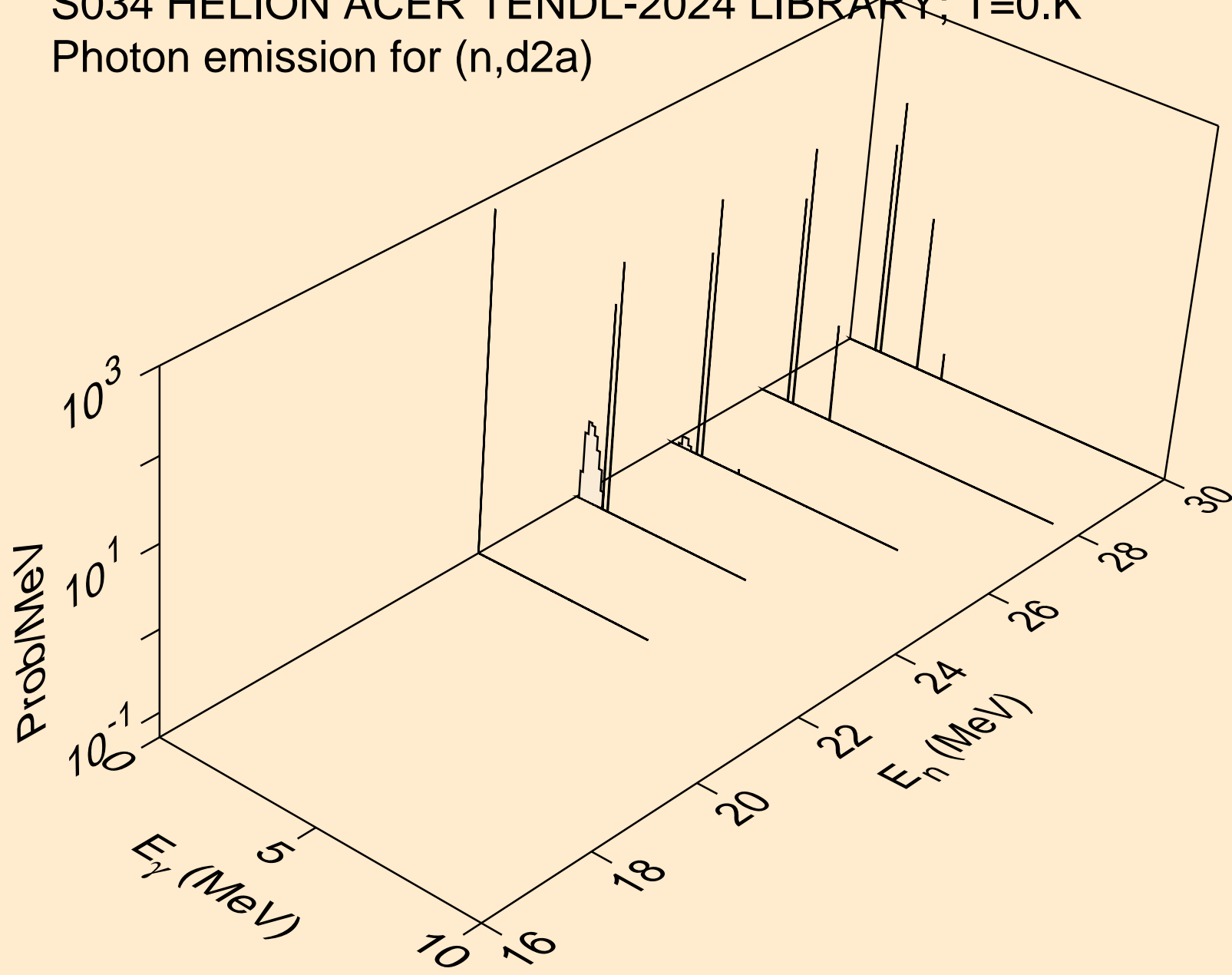

S034 HELION ACER TENDL-2024 LIBRARY; T=0.K  
Photon emission for (n,pd)

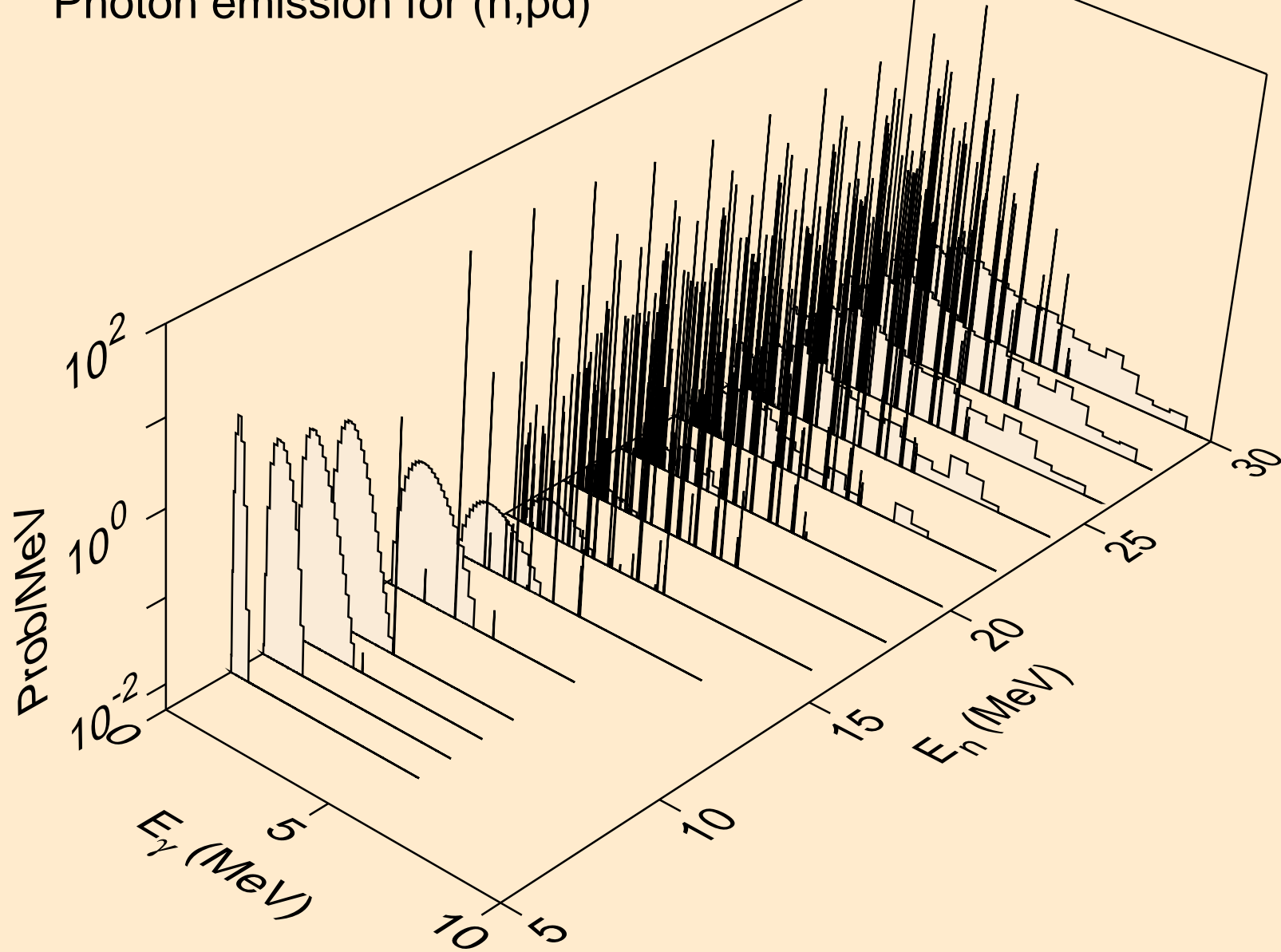

S034 HELION ACER TENDL-2024 LIBRARY; T=0.K  
Photon emission for (n,pt)

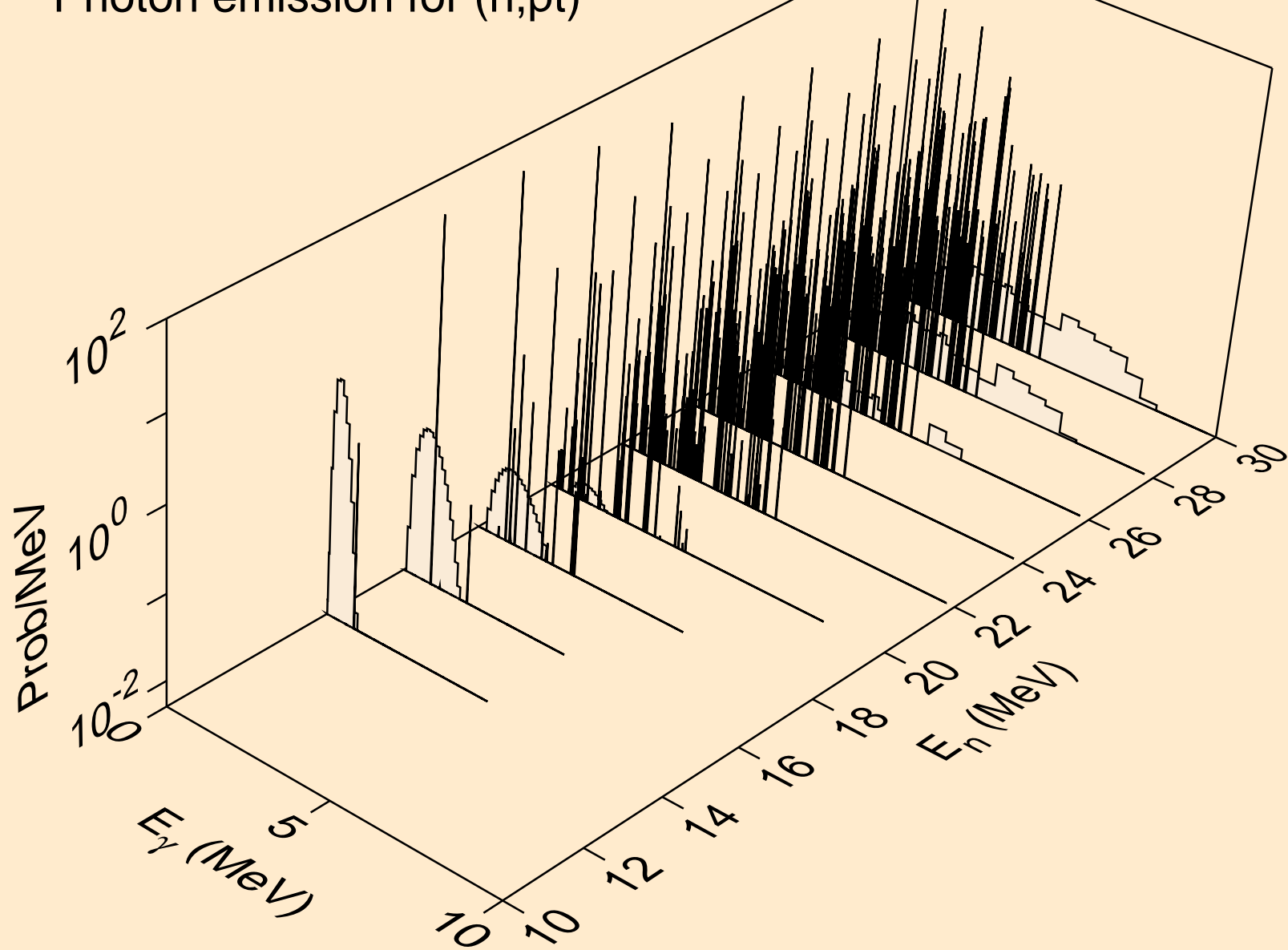

S034 HELION ACER TENDL-2024 LIBRARY; T=0.K  
Photon emission for (n,da)

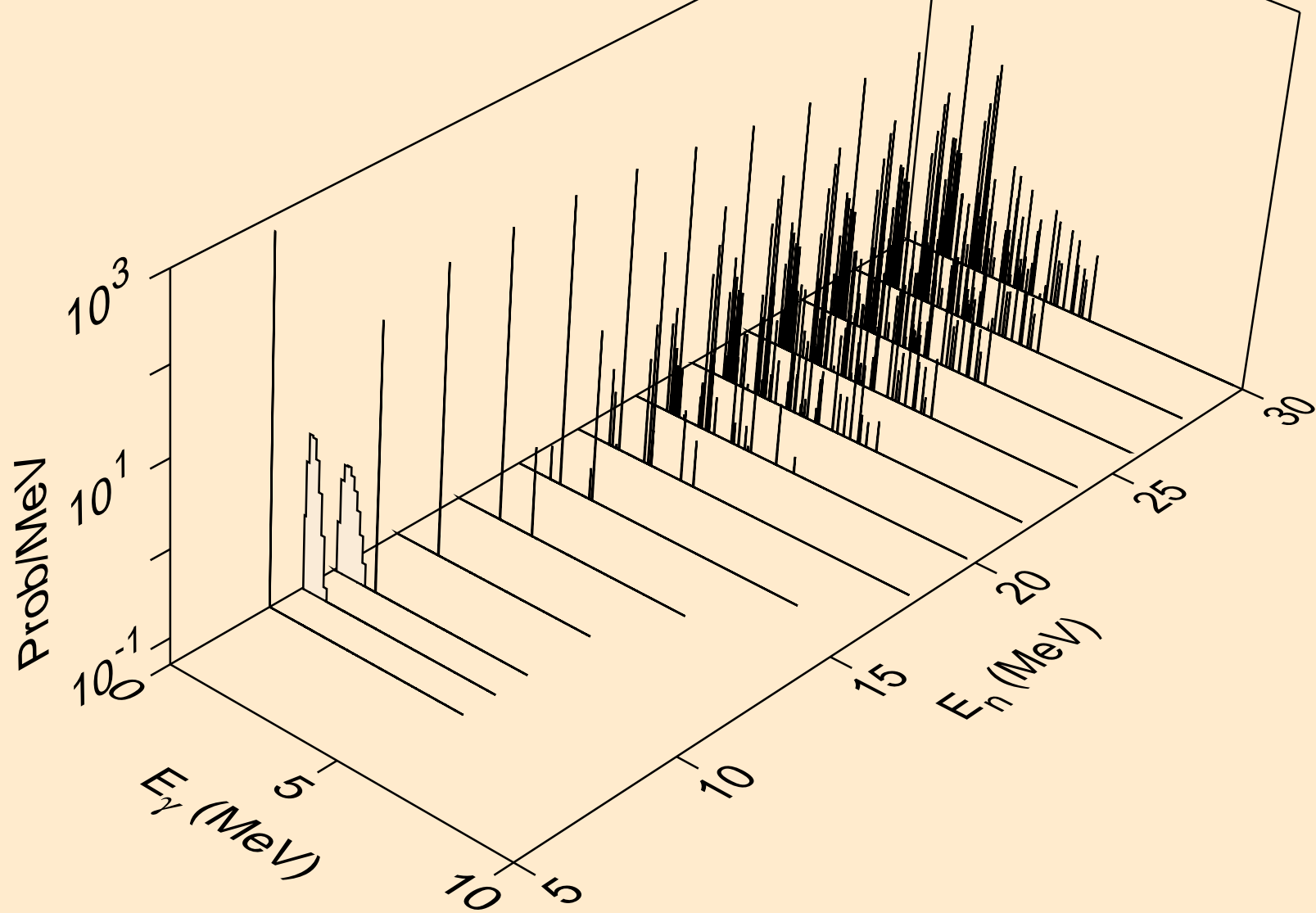

# S034 HELION ACER TENDL-2024 LIBRARY; T=0.K

## Particle heating contributions

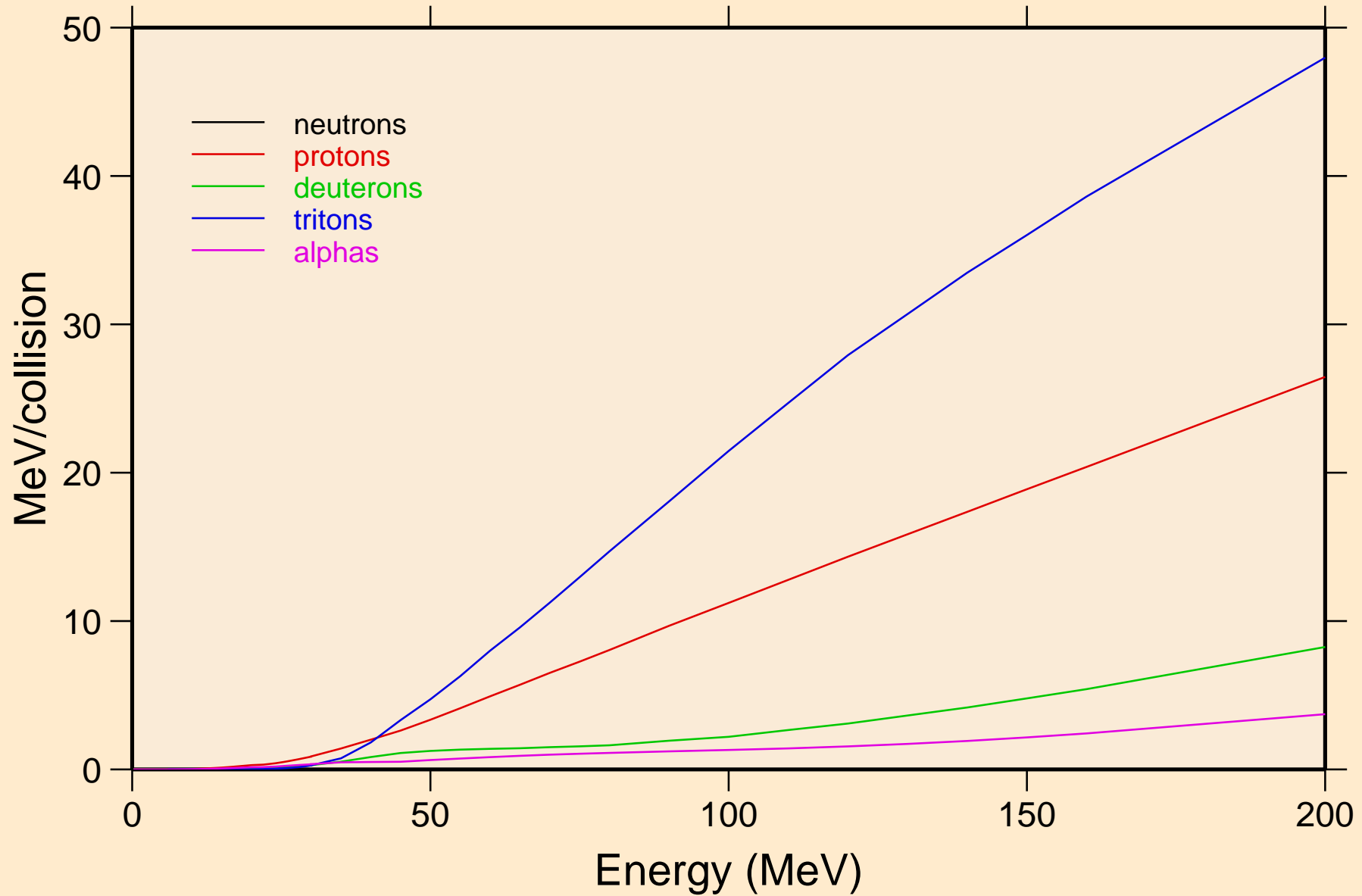

# S034 HELION ACER TENDL-2024 LIBRARY; T=0.K

## Recoil Heating

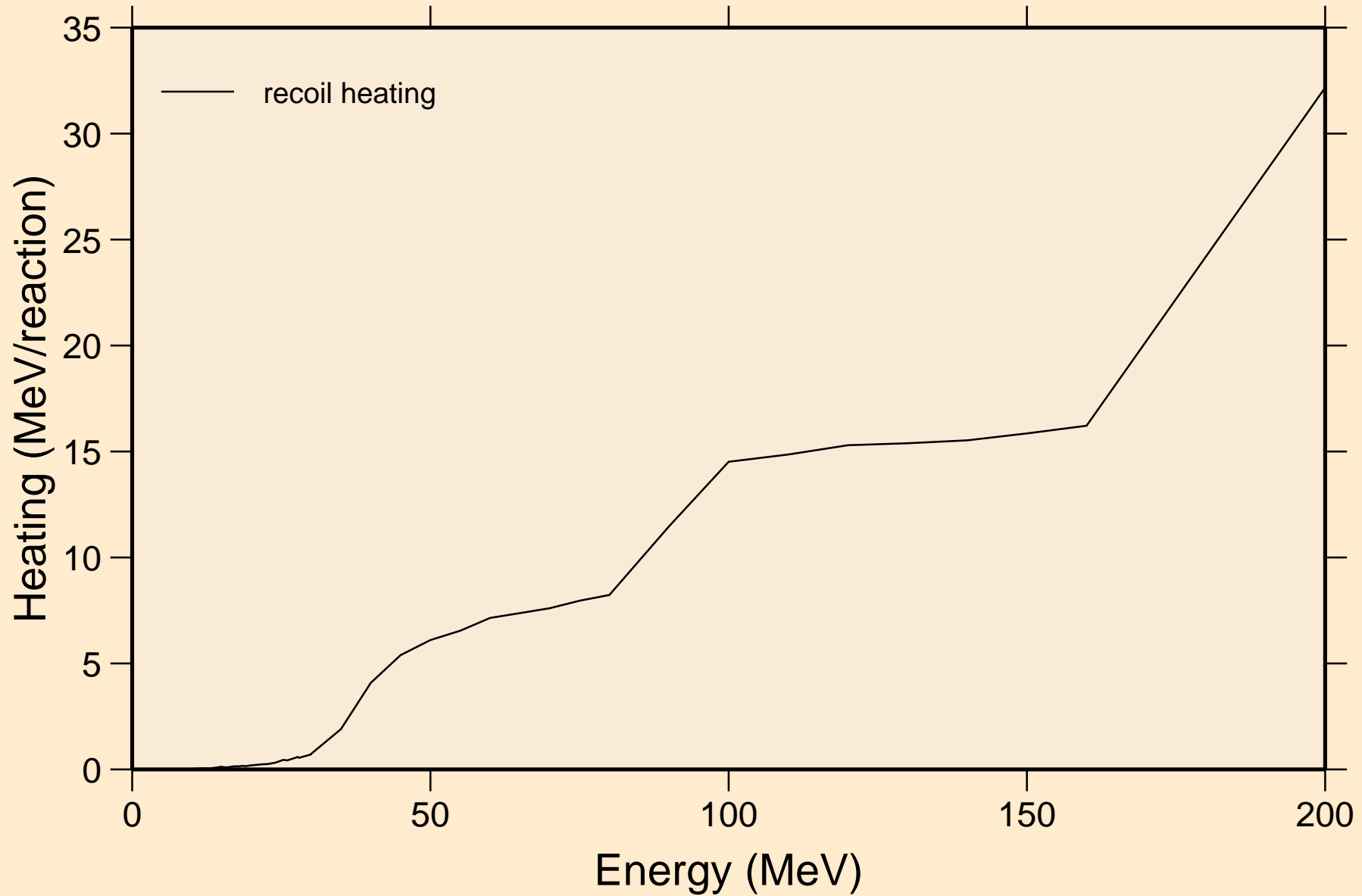

S034 HELION ACER TENDL-2024 LIBRARY; T=0.K  
Particle production cross sections

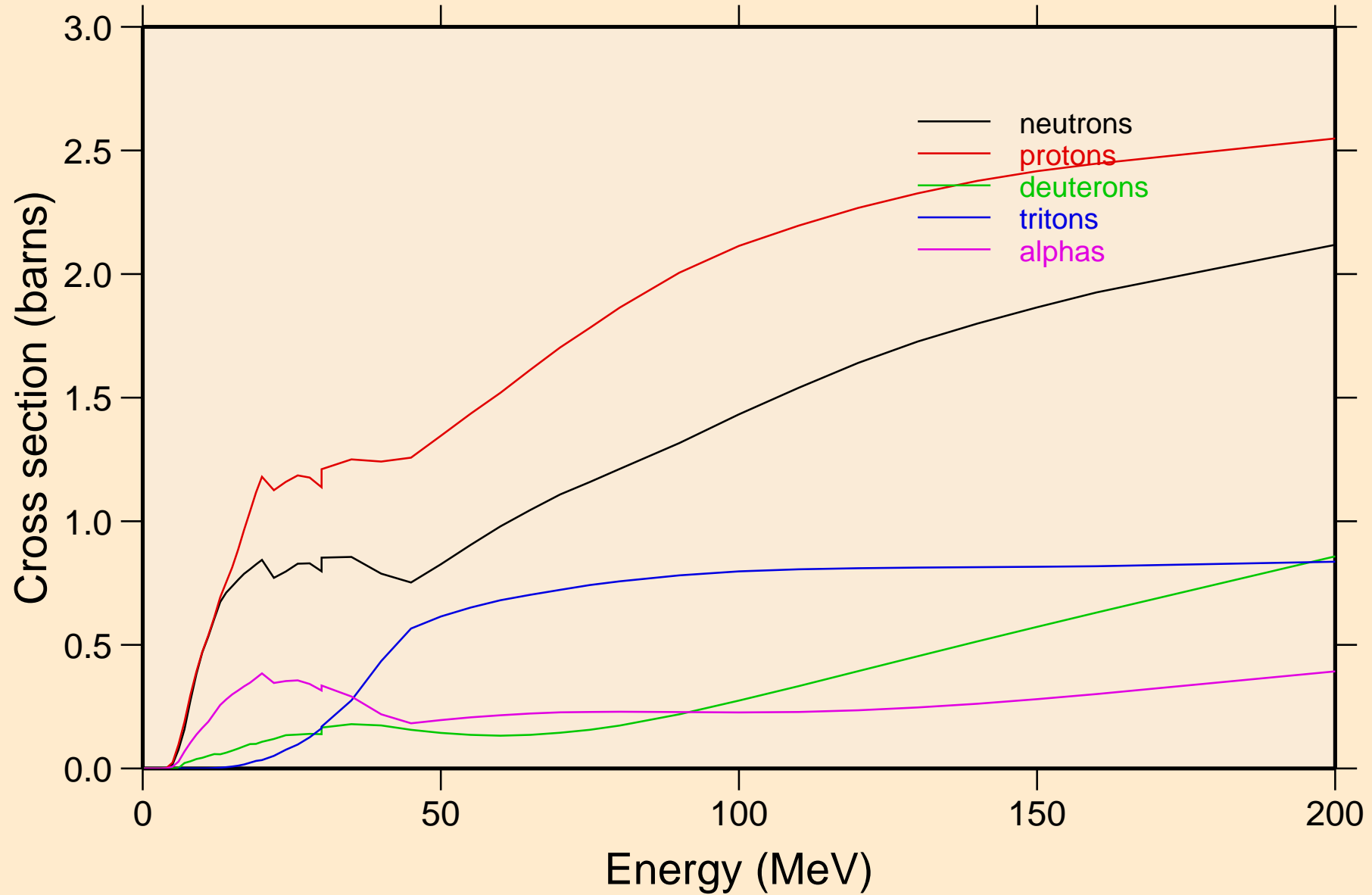

S034 HELION ACER TENDL-2024 LIBRARY; T=0.K  
neutrons from (s,n)

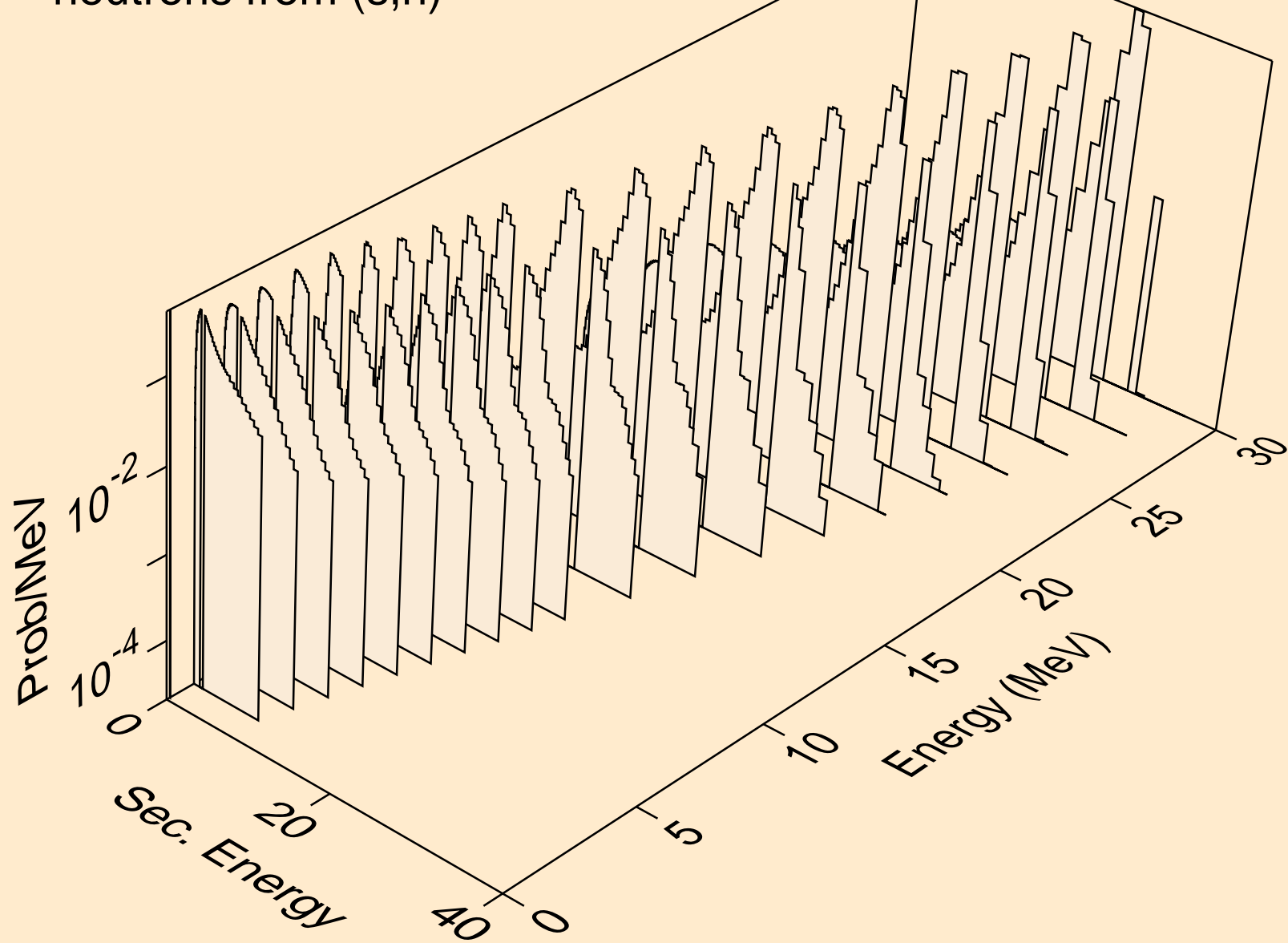

S034 HELION ACER TENDL-2024 LIBRARY; T=0.K  
neutrons from (s,x)

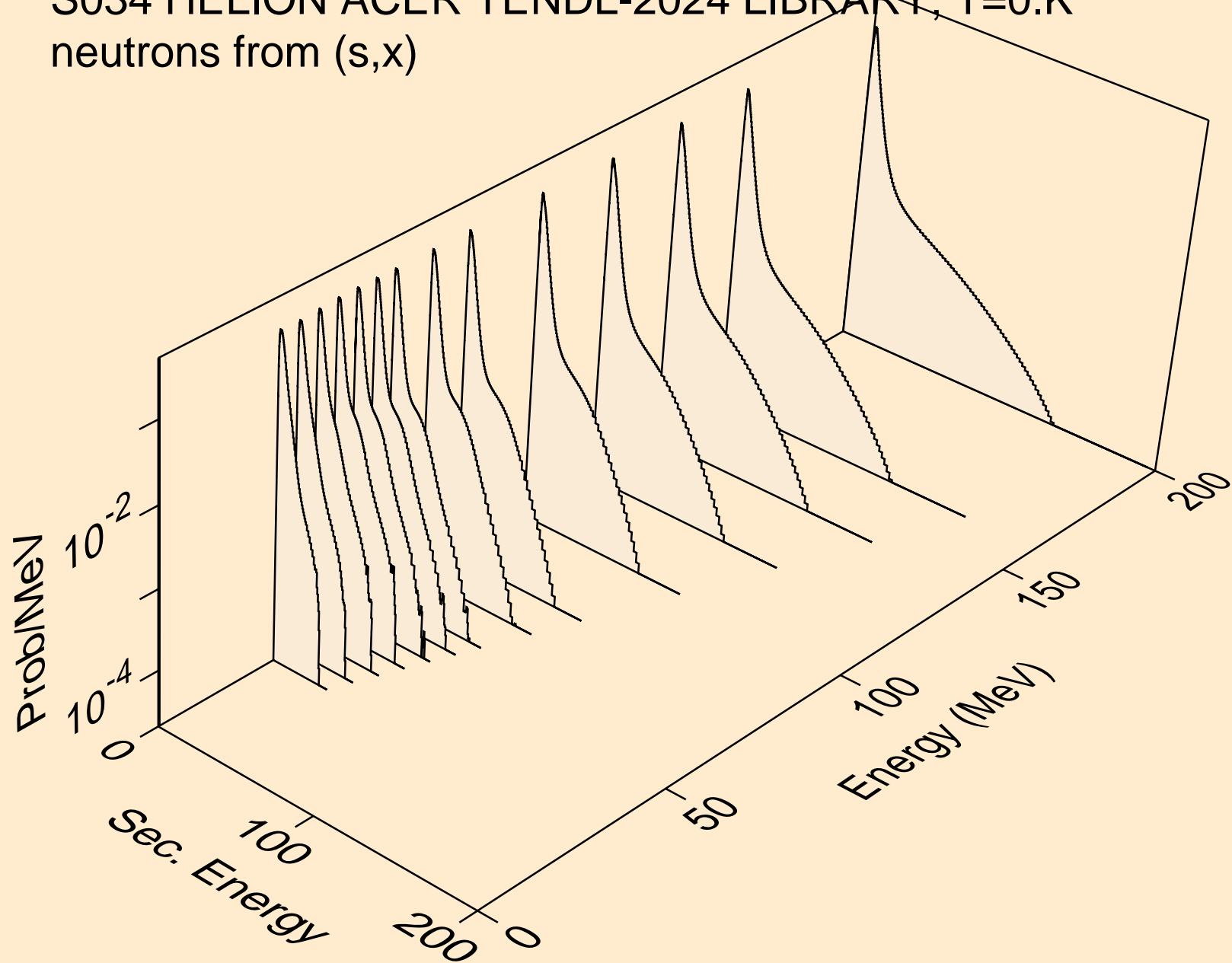

S034 HELION ACER TENDL-2024 LIBRARY; T=0.K  
neutrons from (s,2nd)

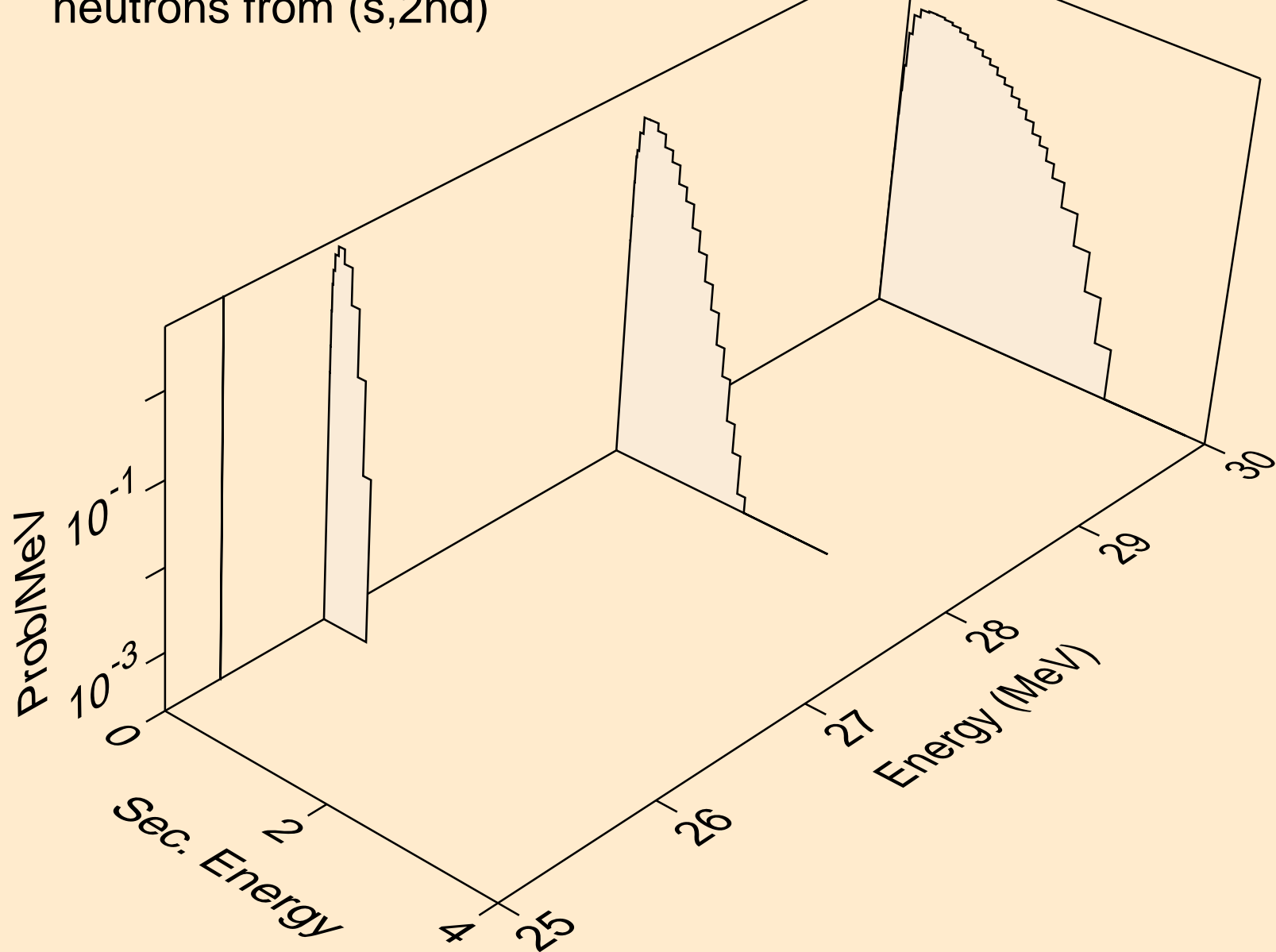

S034 HELION ACER TENDL-2024 LIBRARY; T=0.K  
neutrons from (s,2n)

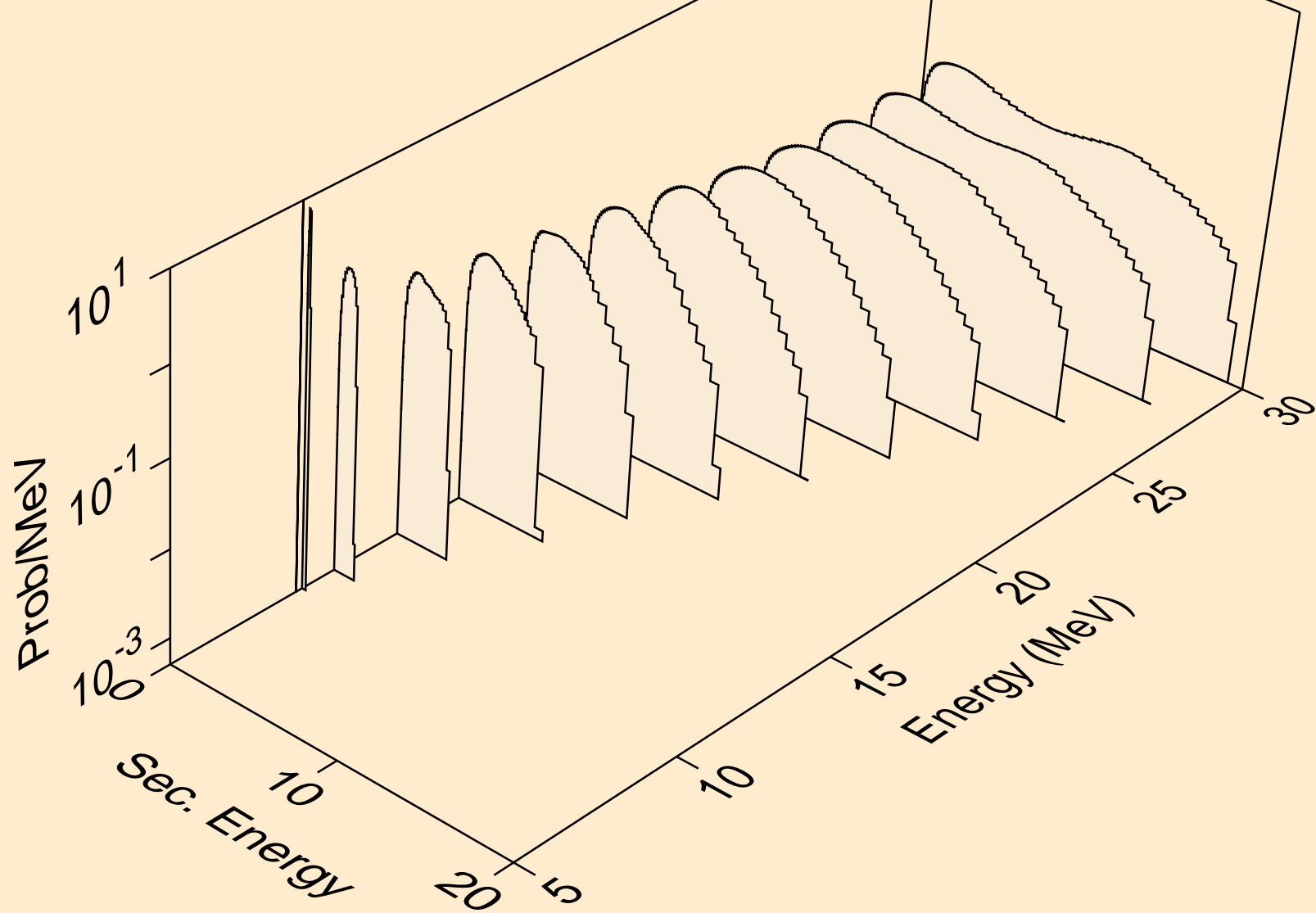

S034 HELION ACER TENDL-2024 LIBRARY; T=0.K  
neutrons from (s,3n)

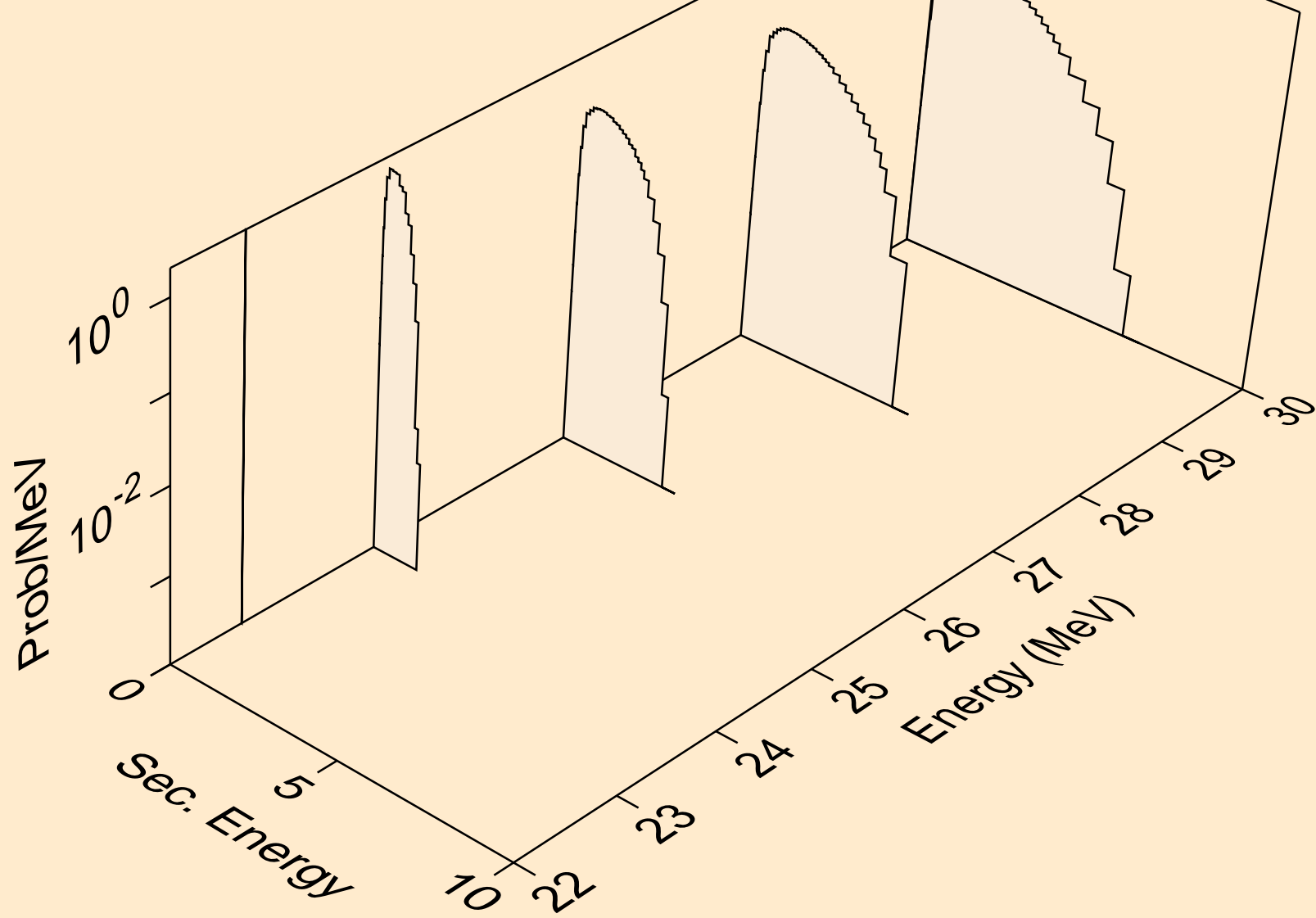

S034 HELION ACER TENDL-2024 LIBRARY; T=0.K  
neutrons from (s,n\*)a

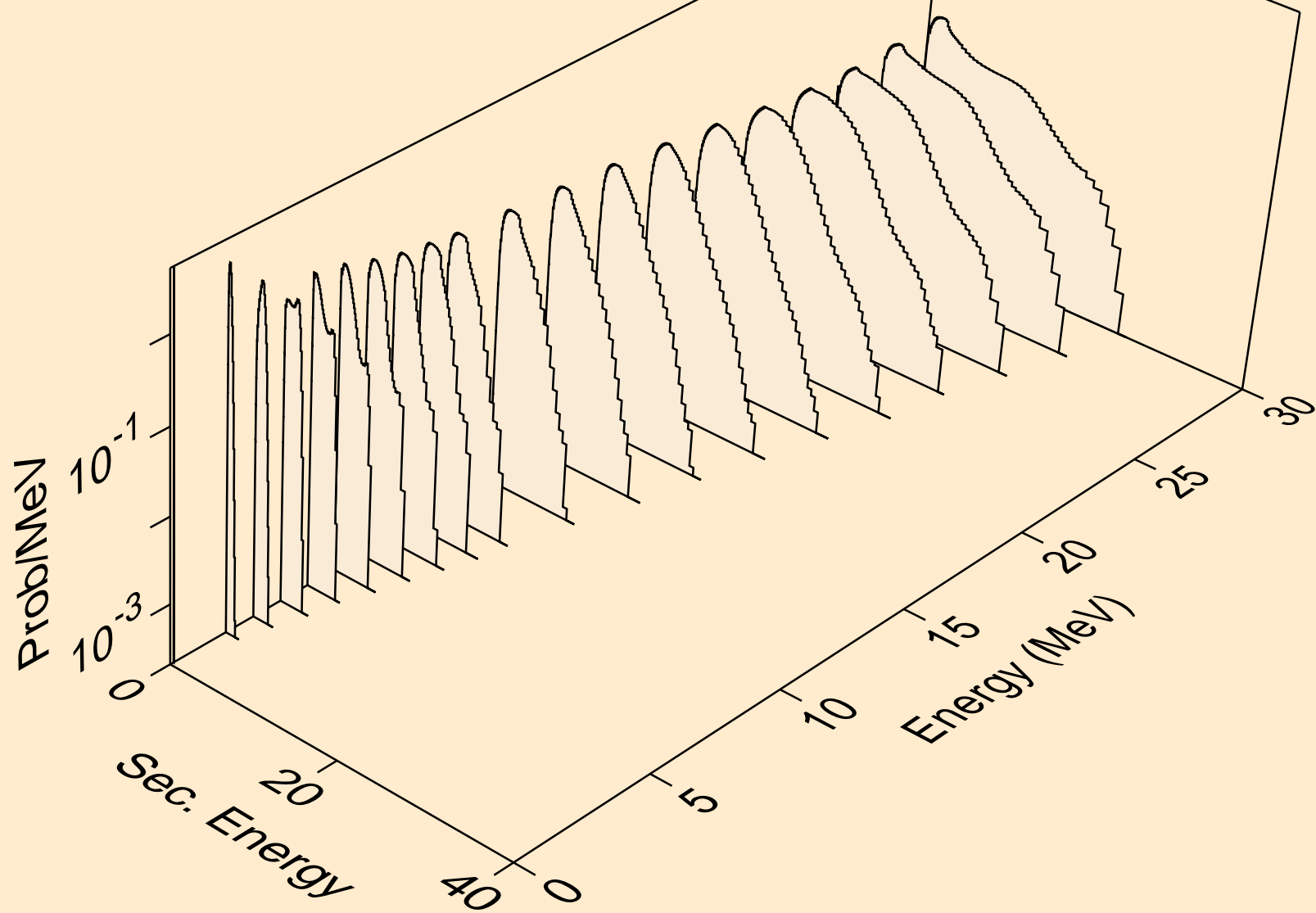

S034 HELION ACER TENDL-2024 LIBRARY; T=0.K  
neutrons from (s,2n)a

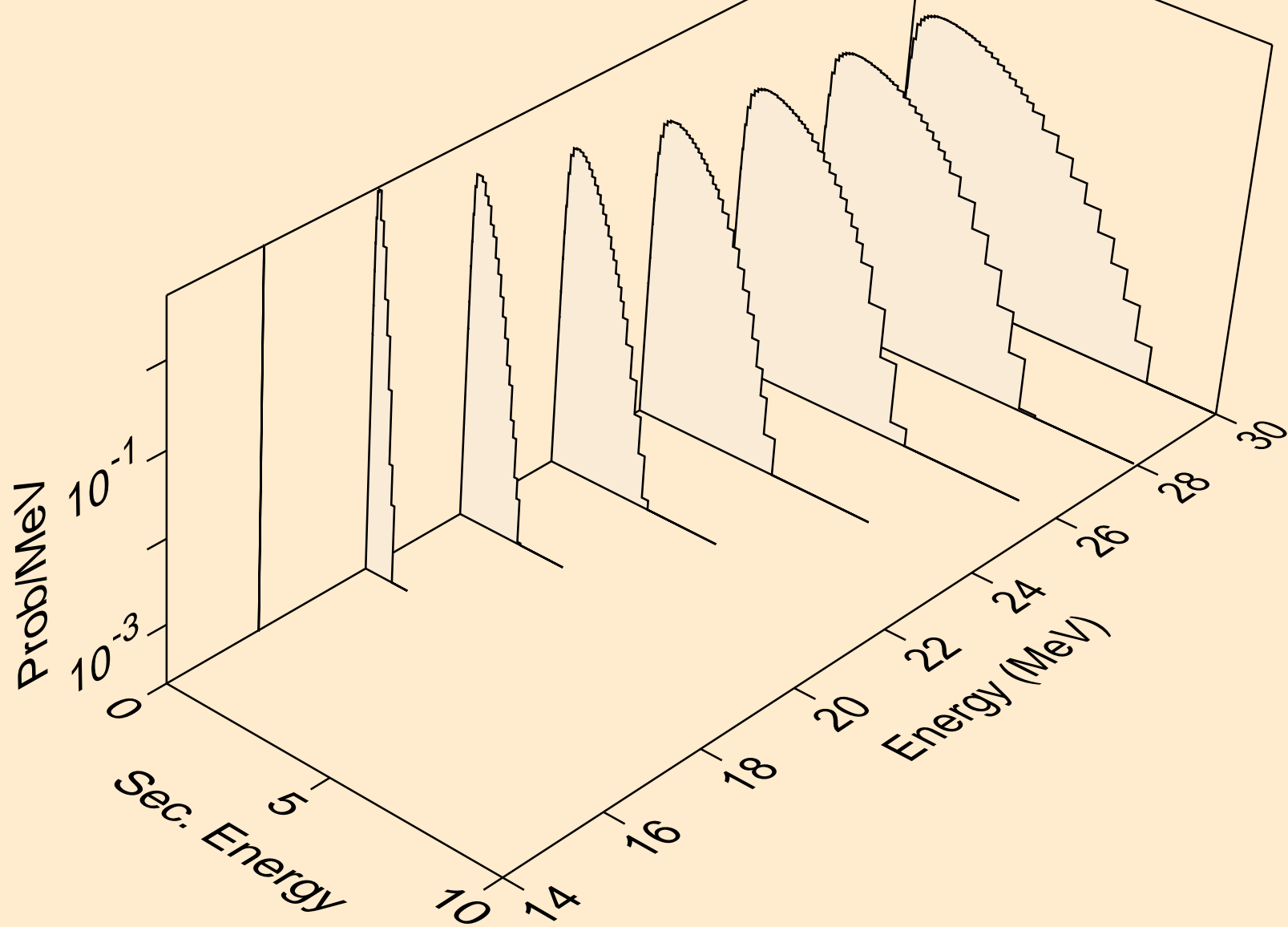

S034 HELION ACER TENDL-2024 LIBRARY; T=0.K  
neutrons from (s,n\*)p

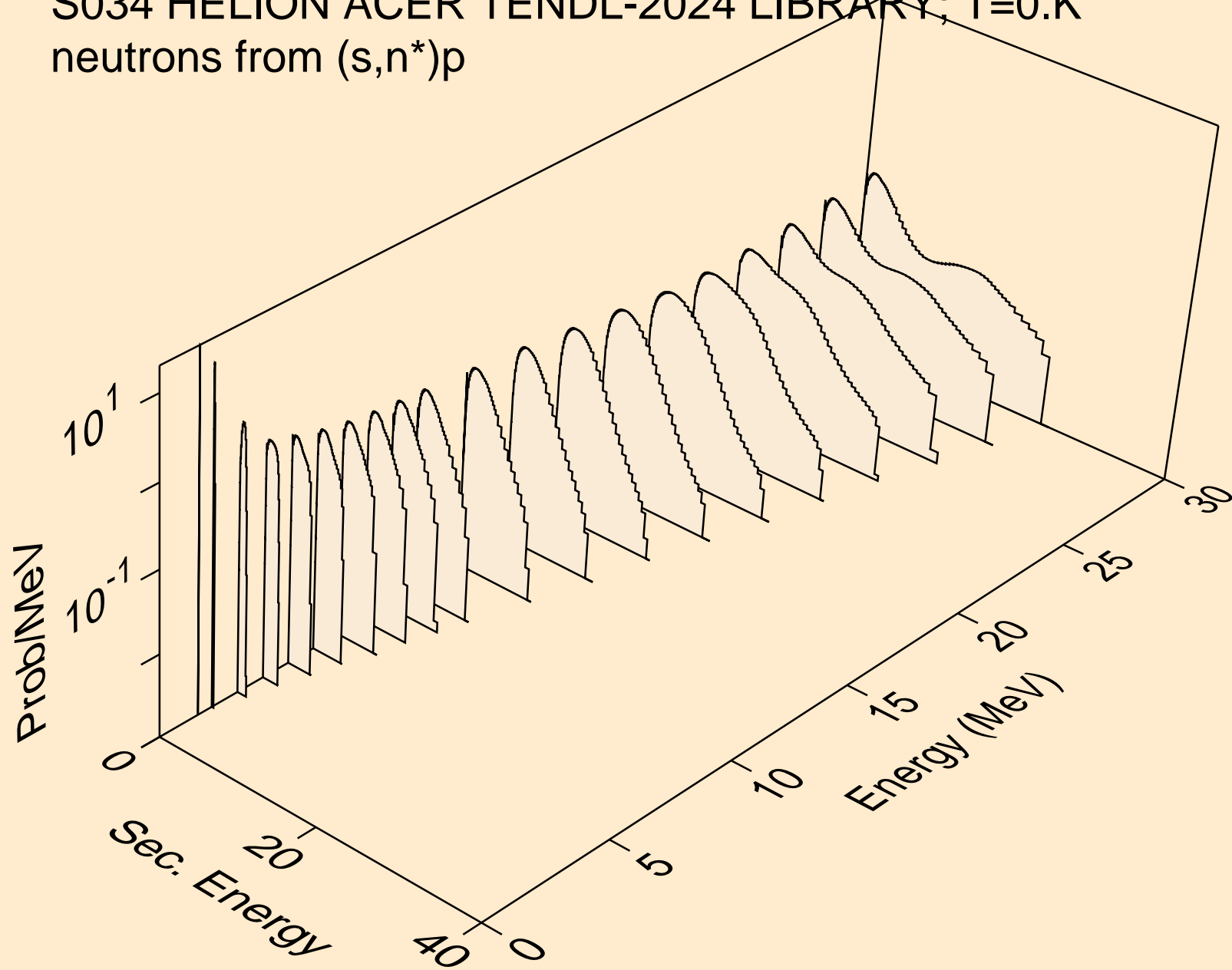

S034 HELION ACER TENDL-2024 LIBRARY; T=0.K  
neutrons from (s,n\*)2a

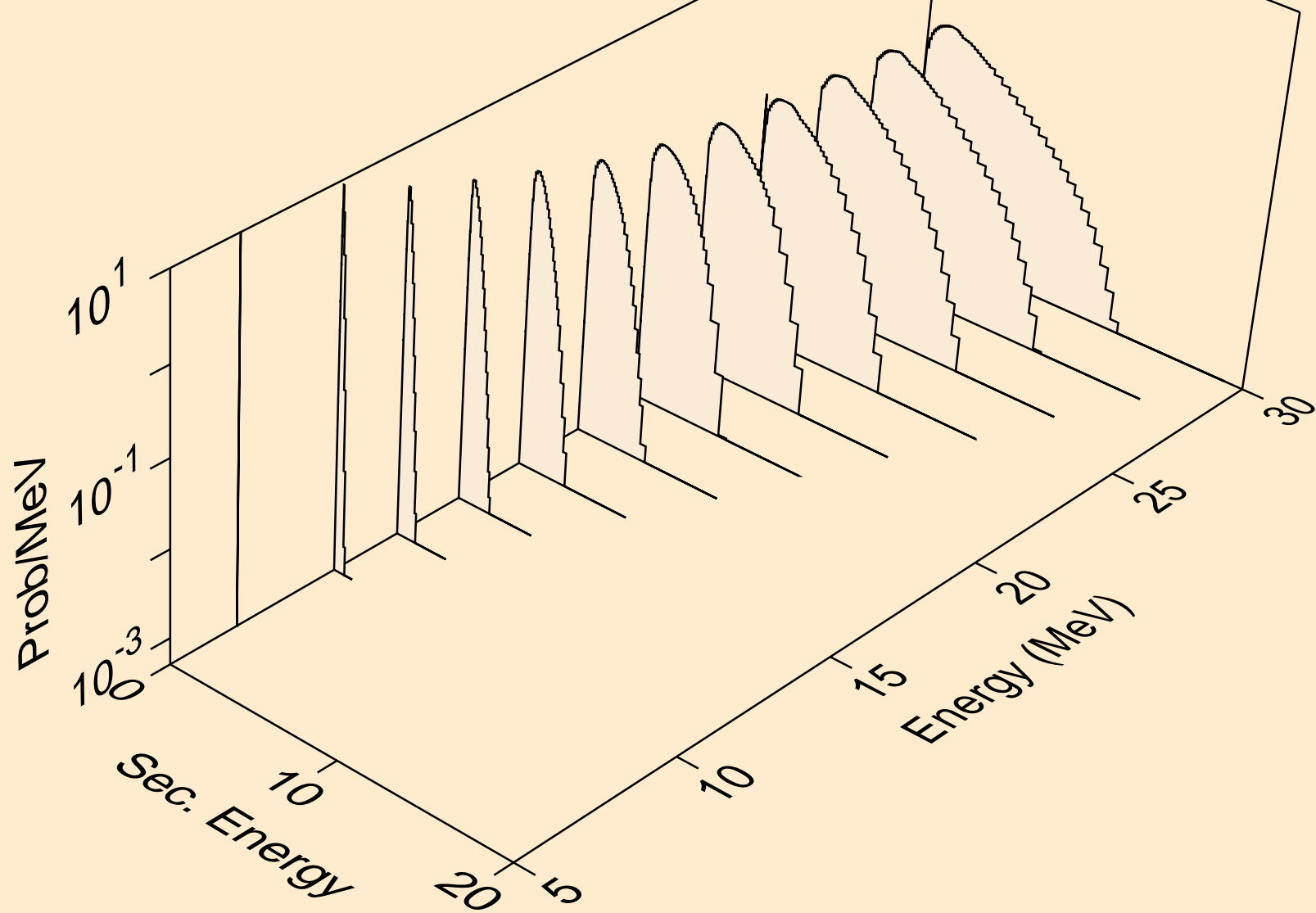

S034 HELION ACER TENDL-2024 LIBRARY; T=0.K  
neutrons from (s,n\*)d

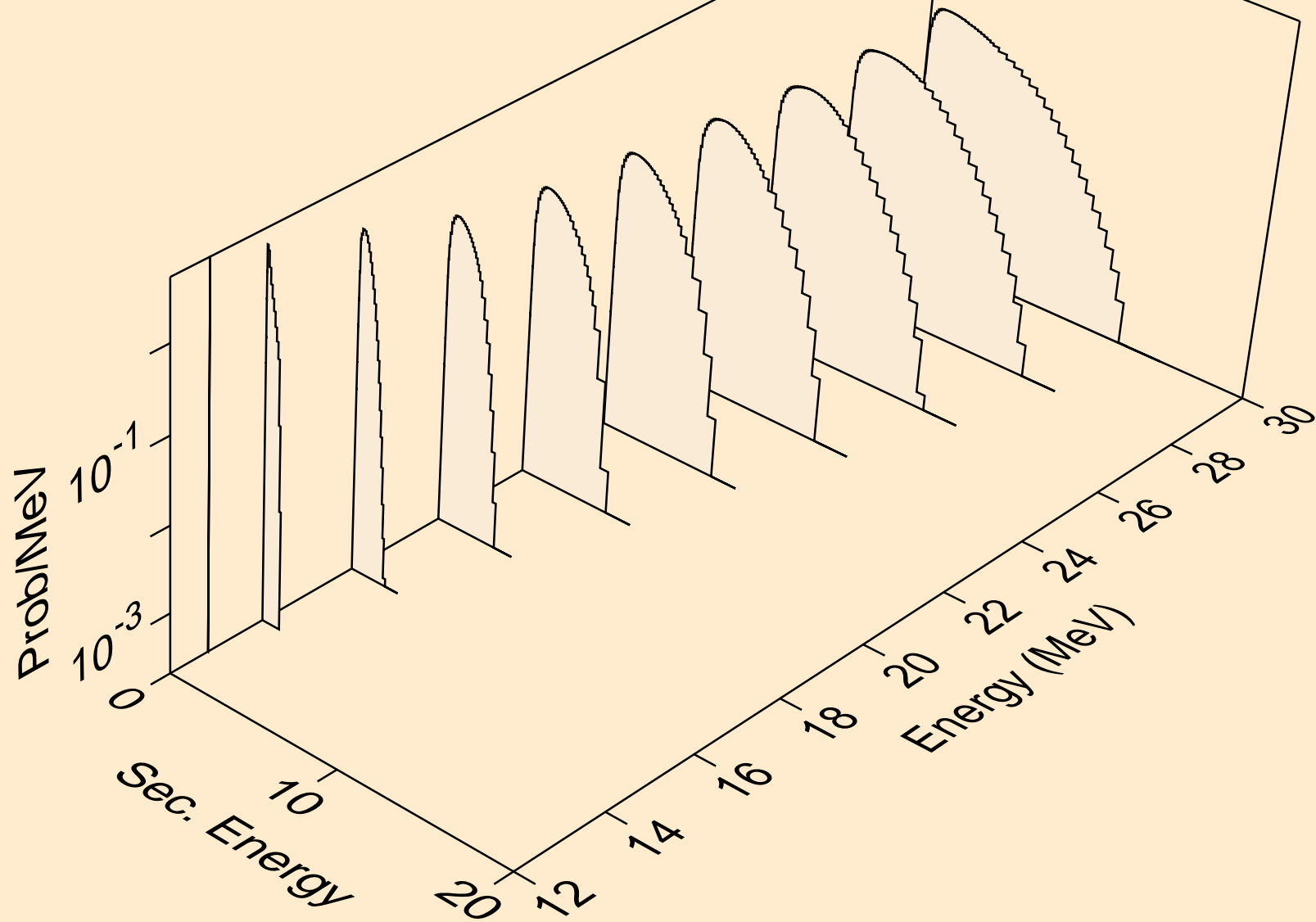

S034 HELION ACER TENDL-2024 LIBRARY; T=0.K  
neutrons from (s,n\*)t

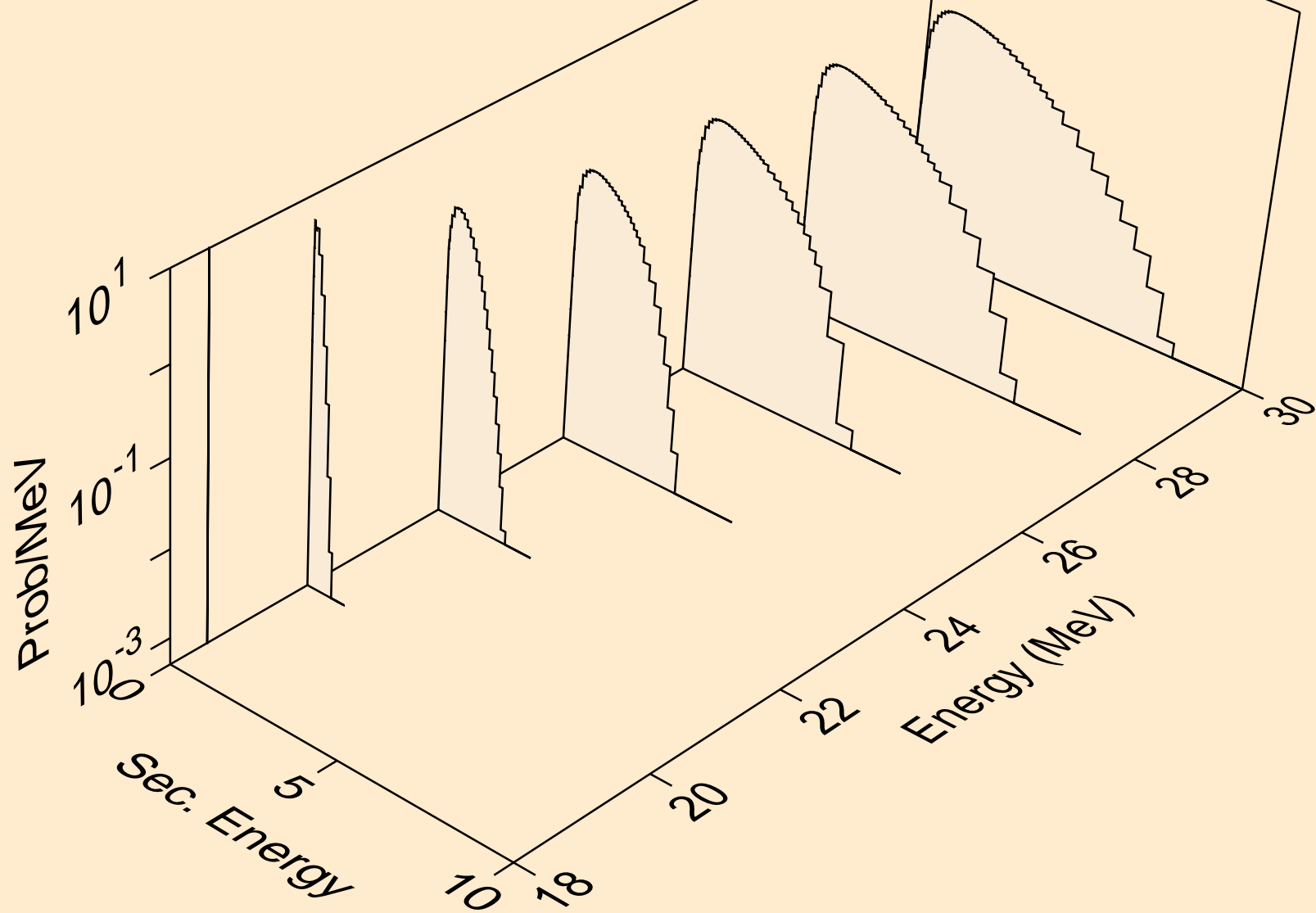

S034 HELION ACER TENDL-2024 LIBRARY; T=0.K  
neutrons from (s,n\*)he3

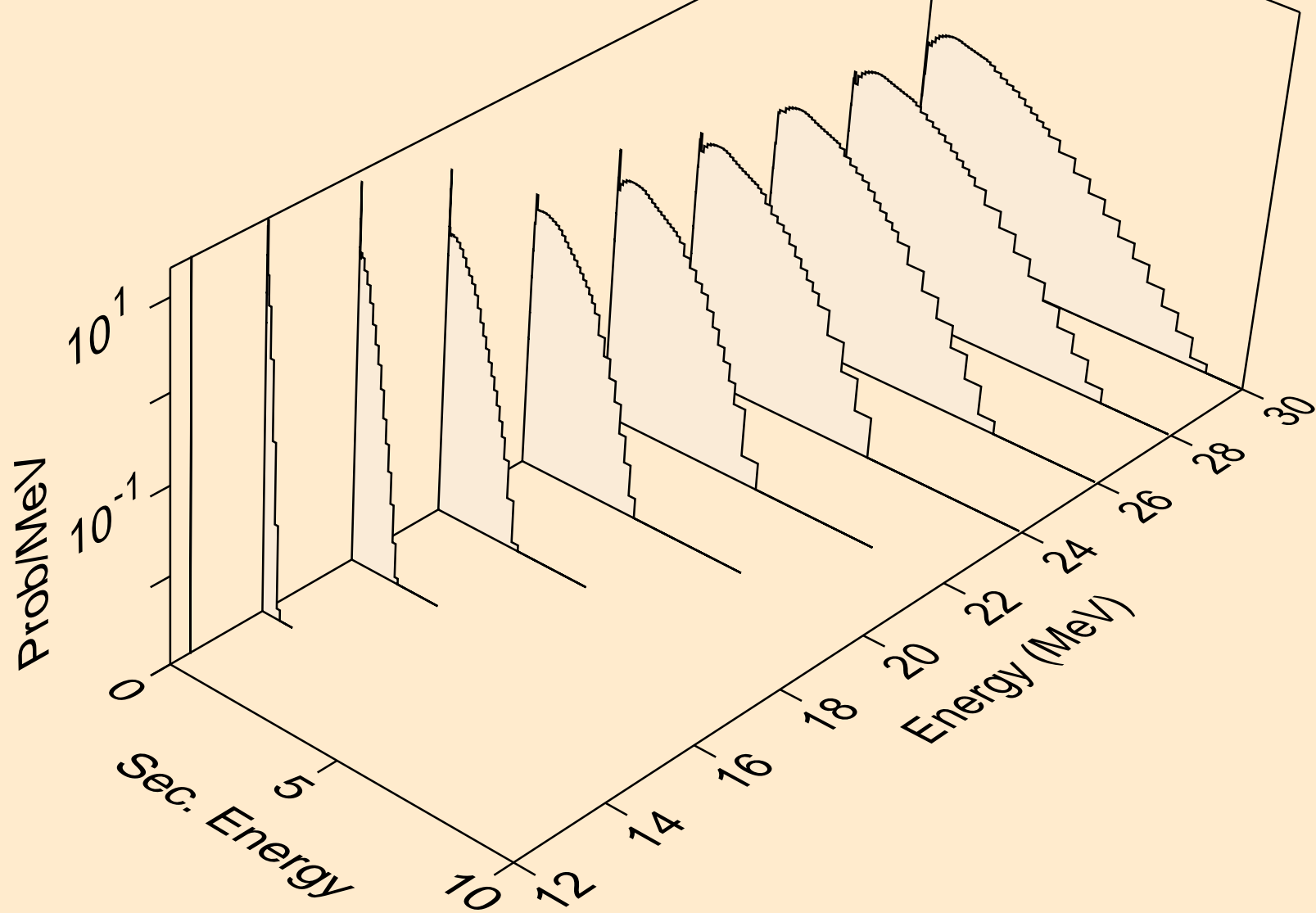

S034 HELION ACER TENDL-2024 LIBRARY; T=0.K  
neutrons from (s,2np)

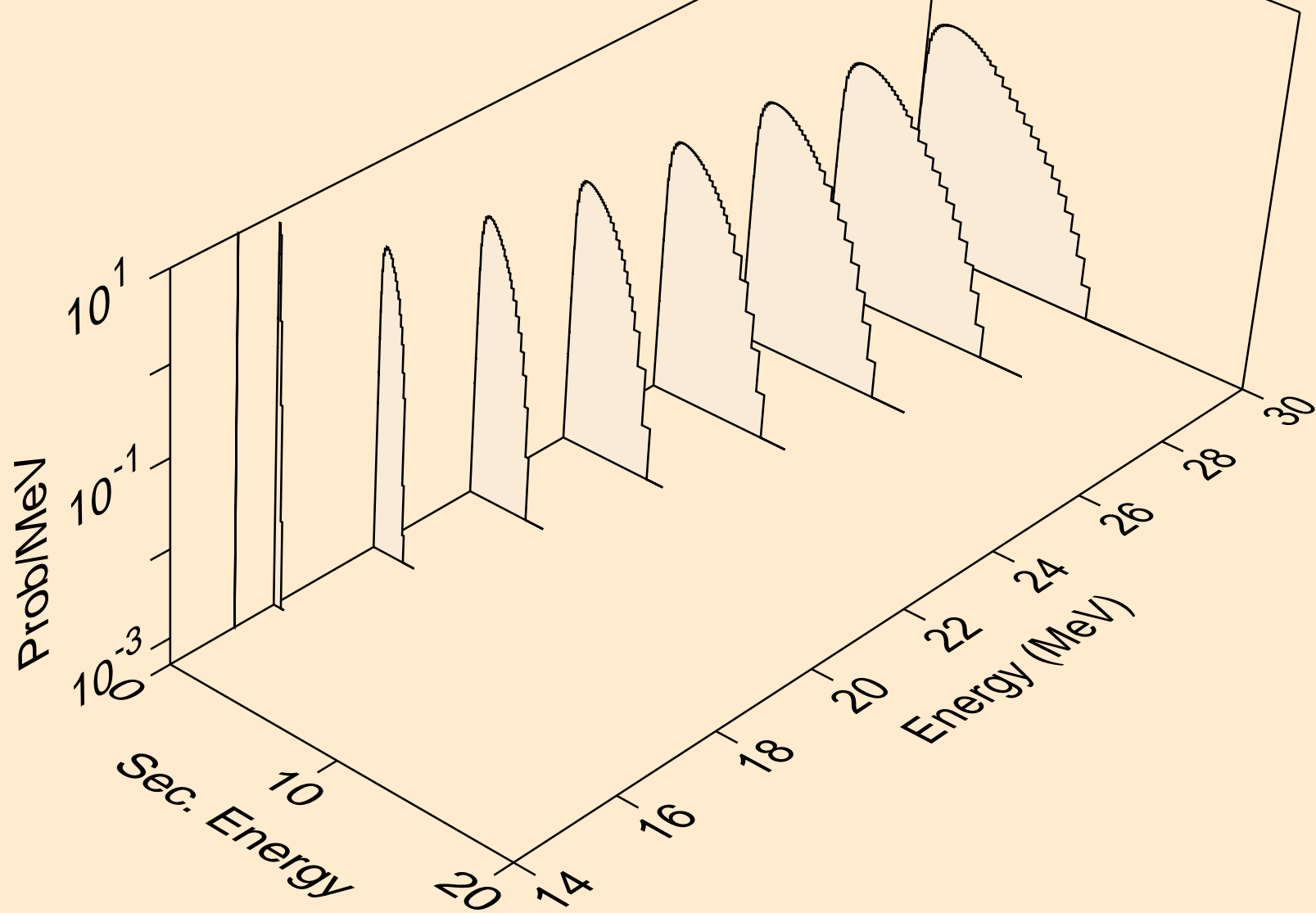

S034 HELION ACER TENDL-2024 LIBRARY; T=0.K  
neutrons from (s,3np)

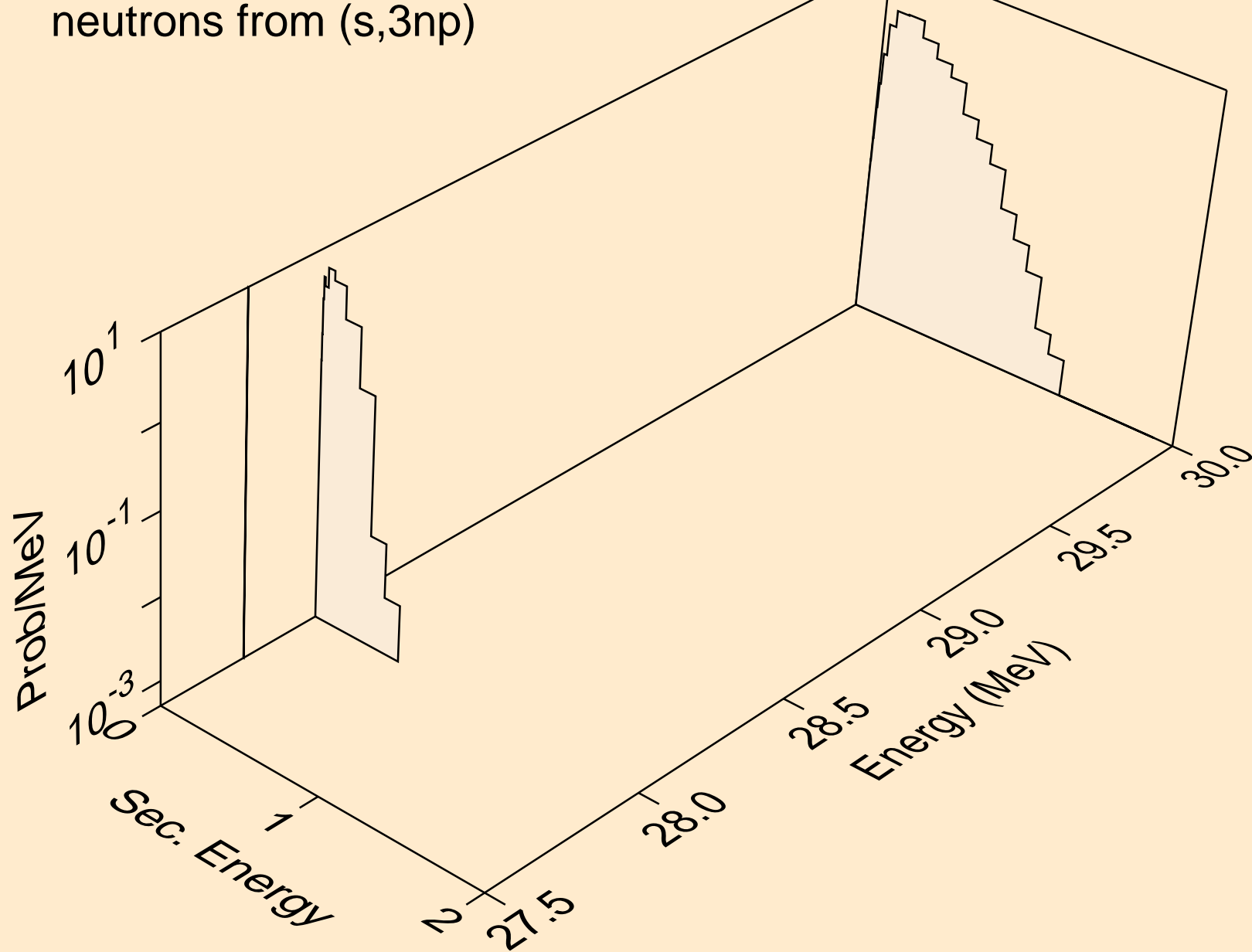

S034 HELION ACER TENDL-2024 LIBRARY; T=0.K  
neutrons from (s,n2p)

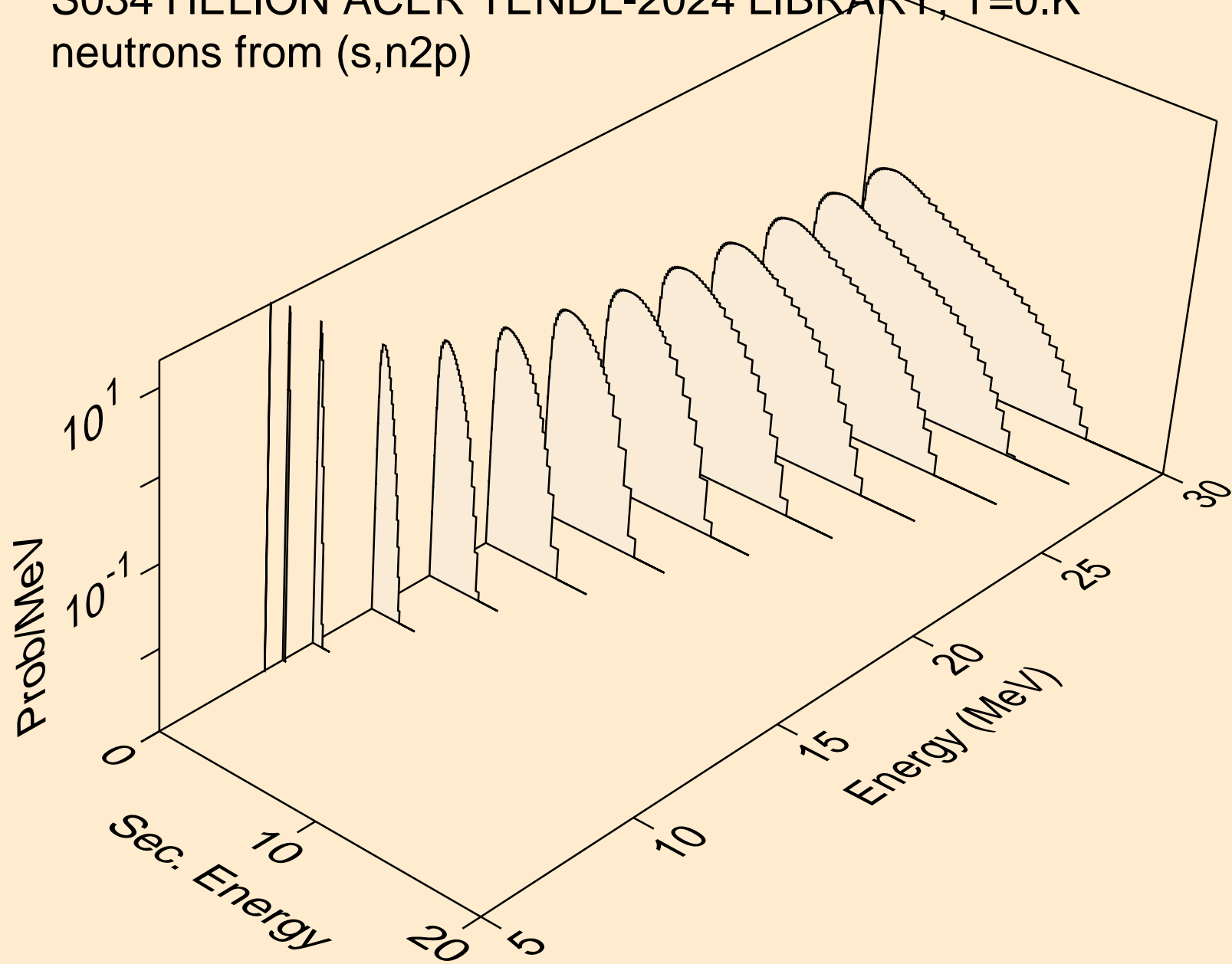

S034 HELION ACER TENDL-2024 LIBRARY; T=0.K  
neutrons from (s,npa)

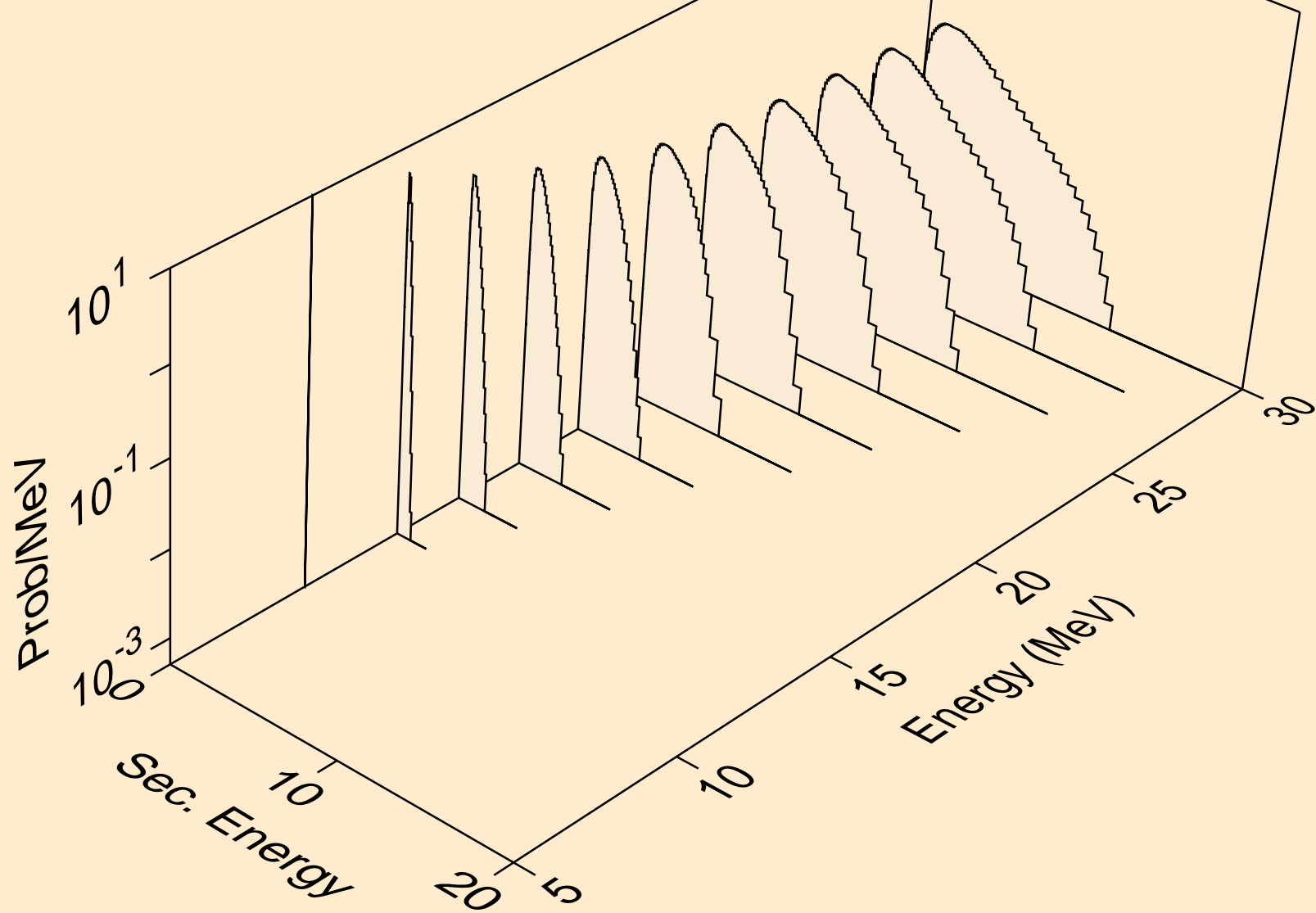

S034 HELION ACER TENDL-2024 LIBRARY; T=0.K  
protons from (s,x)

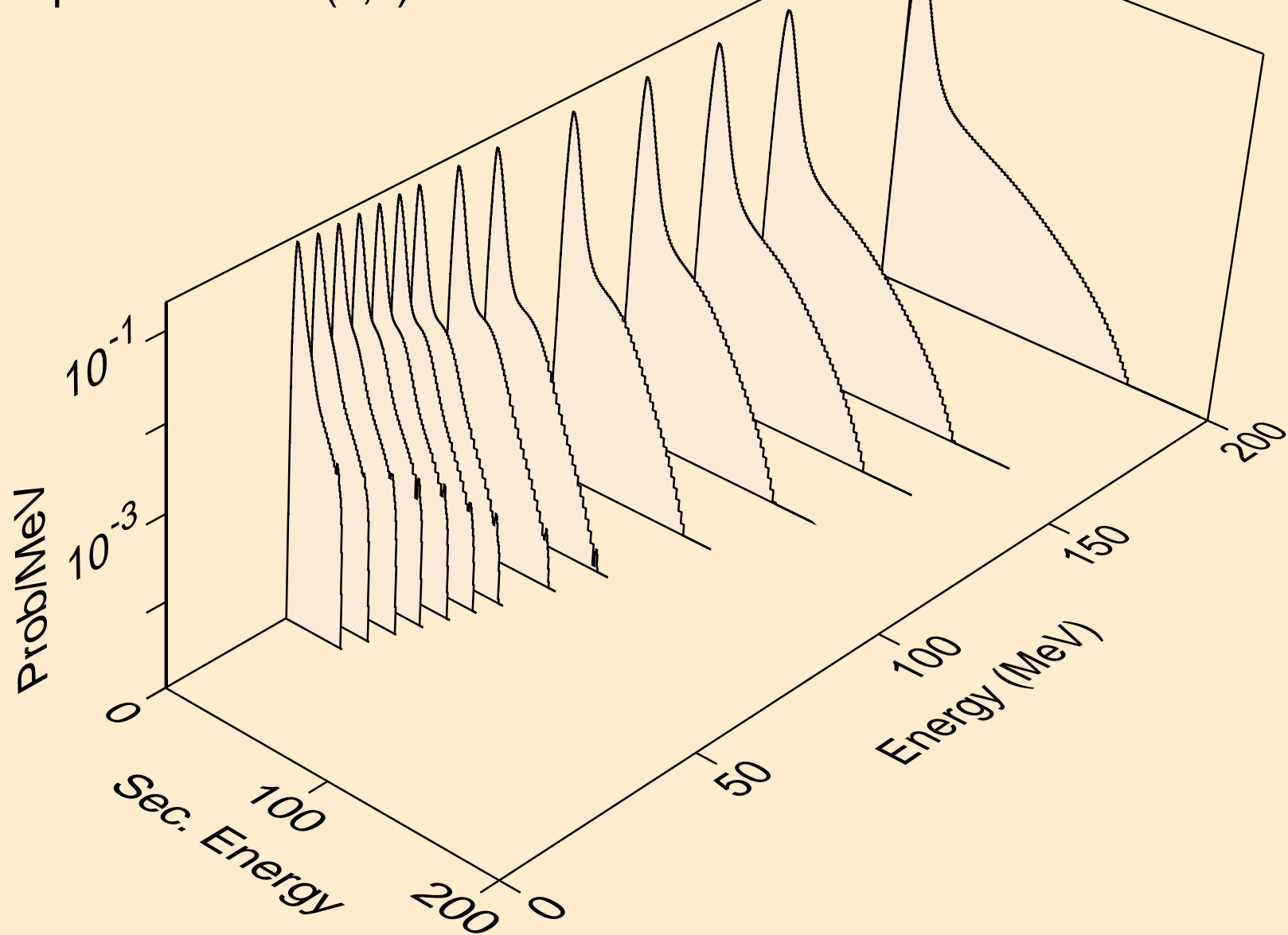

S034 HELION ACER TENDL-2024 LIBRARY; T=0.K  
protons from (s,n\*)p

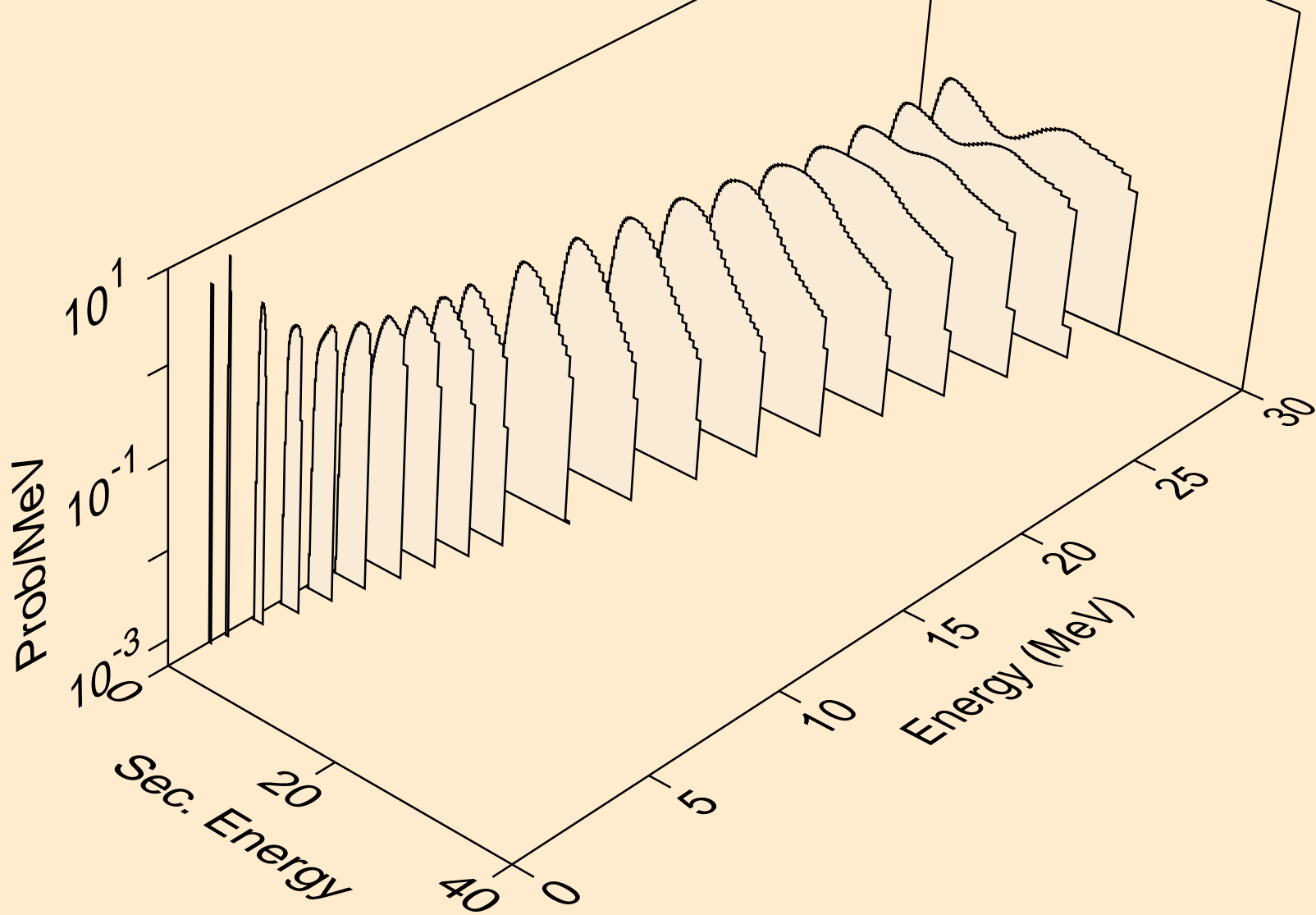

S034 HELION ACER TENDL-2024 LIBRARY; T=0.K  
protons from (s,2np)

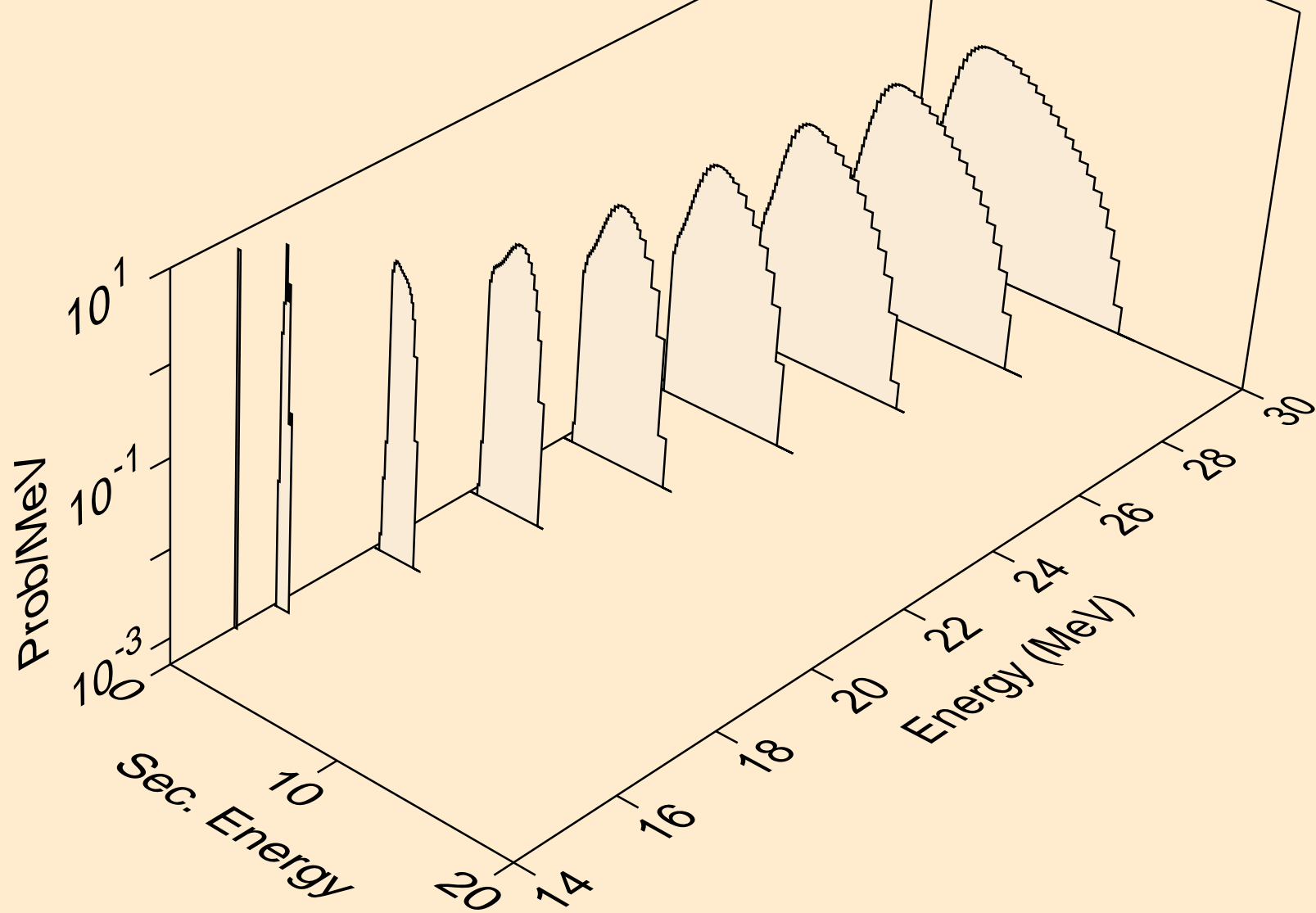

S034 HELION ACER TENDL-2024 LIBRARY; T=0.K  
protons from (s,3np)

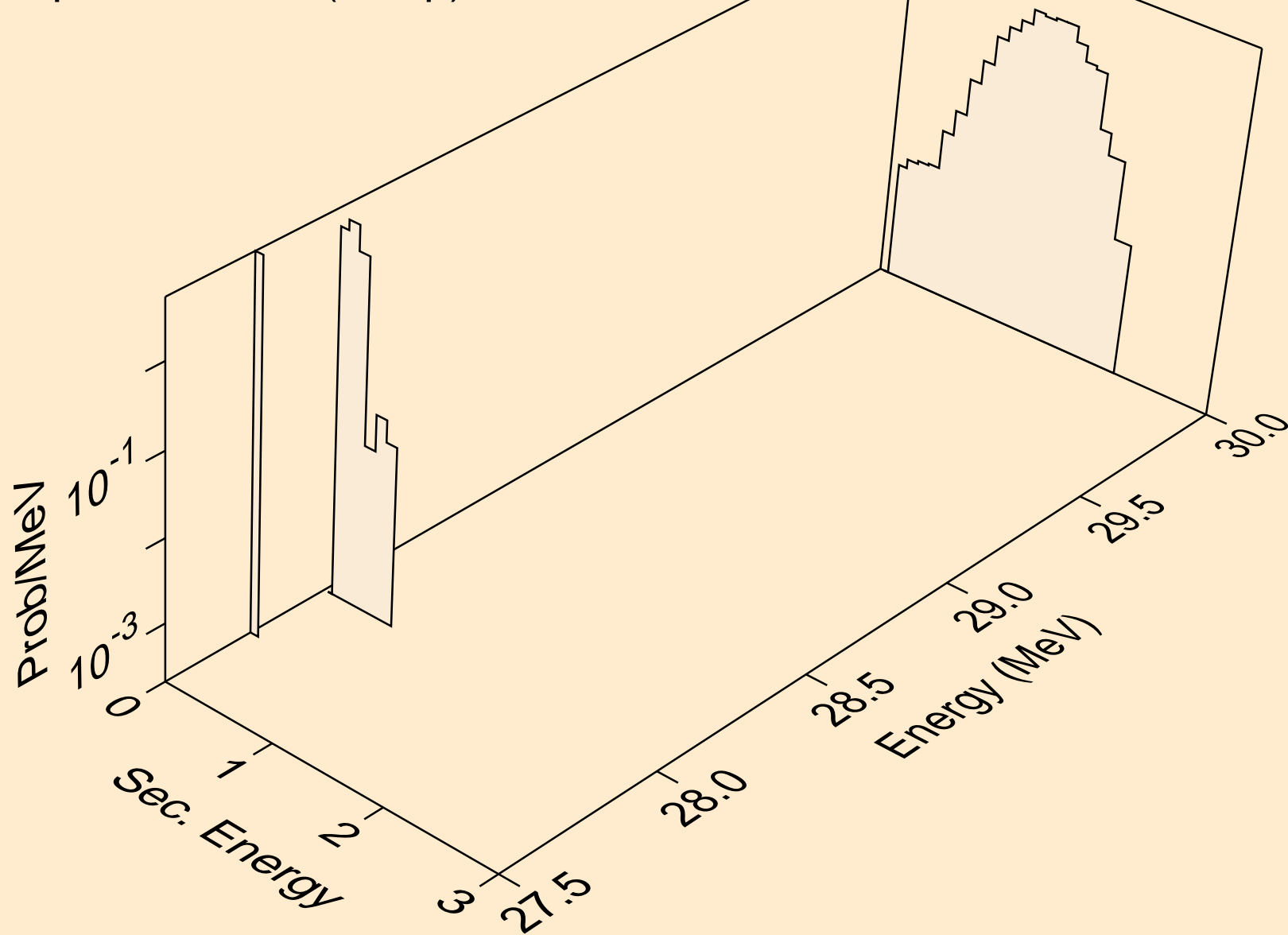

S034 HELION ACER TENDL-2024 LIBRARY; T=0.K  
protons from (s,n2p)

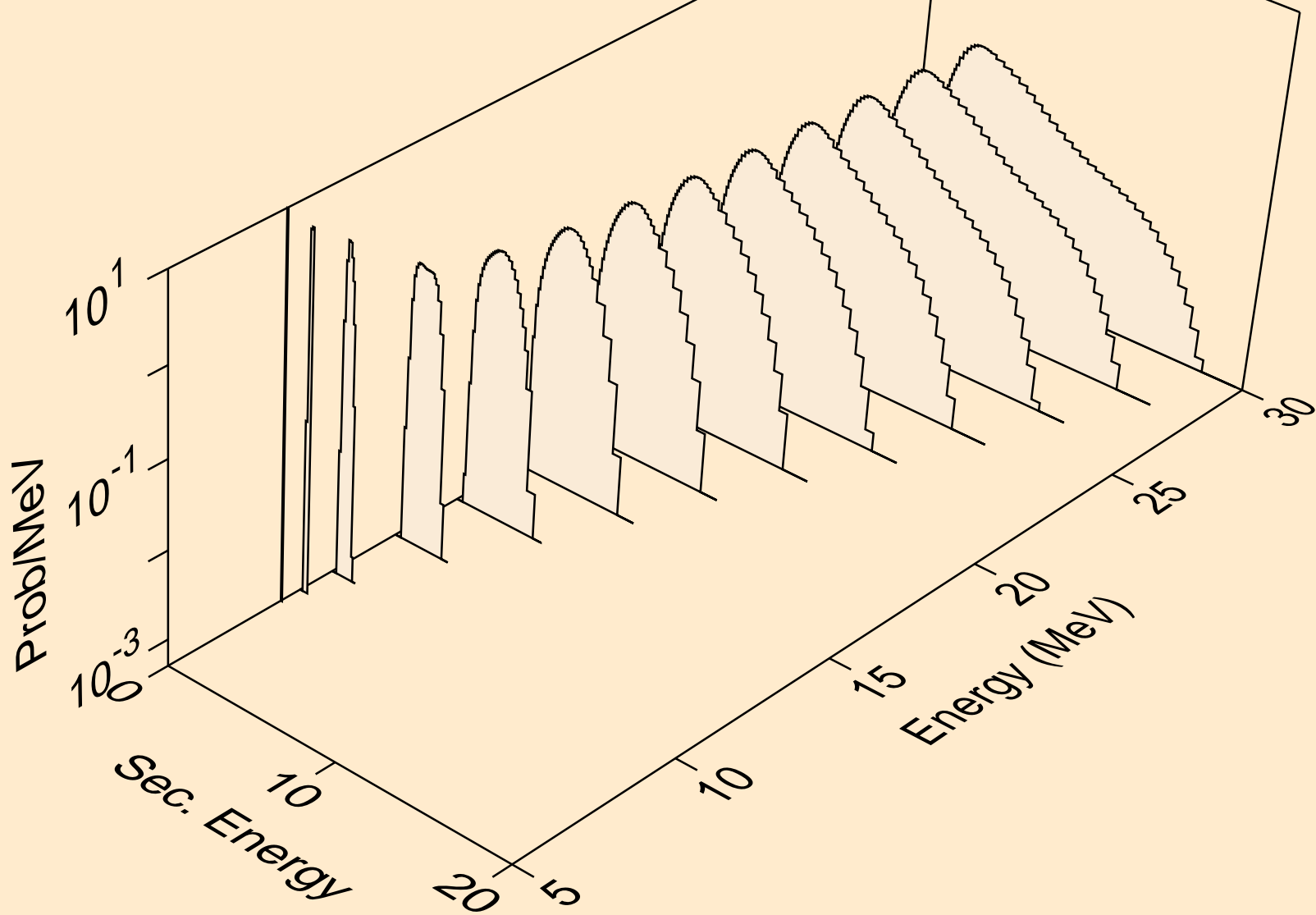

S034 HELION ACER TENDL-2024 LIBRARY; T=0.K  
protons from (s,npa)

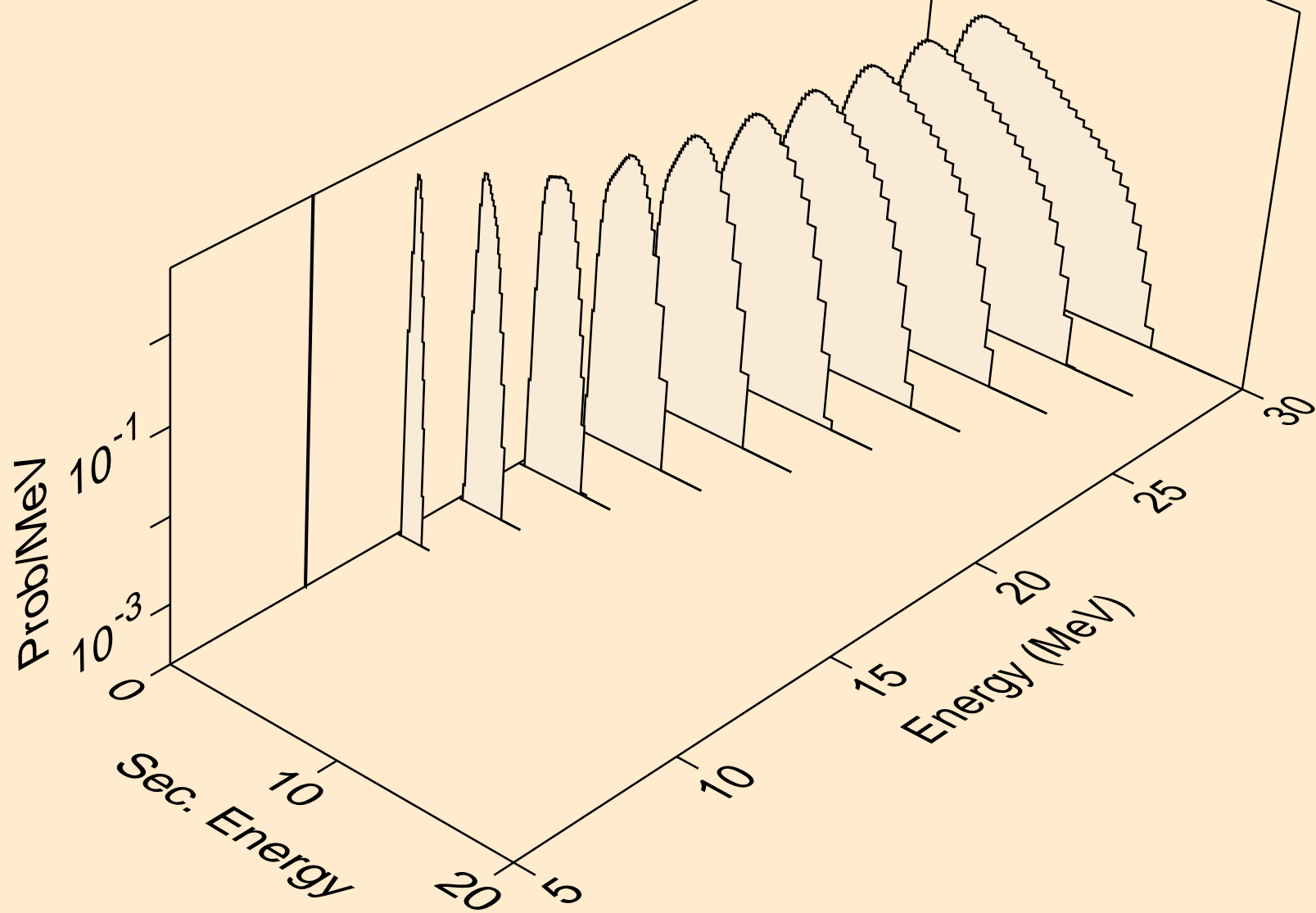

S034 HELION ACER TENDL-2024 LIBRARY; T=0.K  
protons from (s,p)

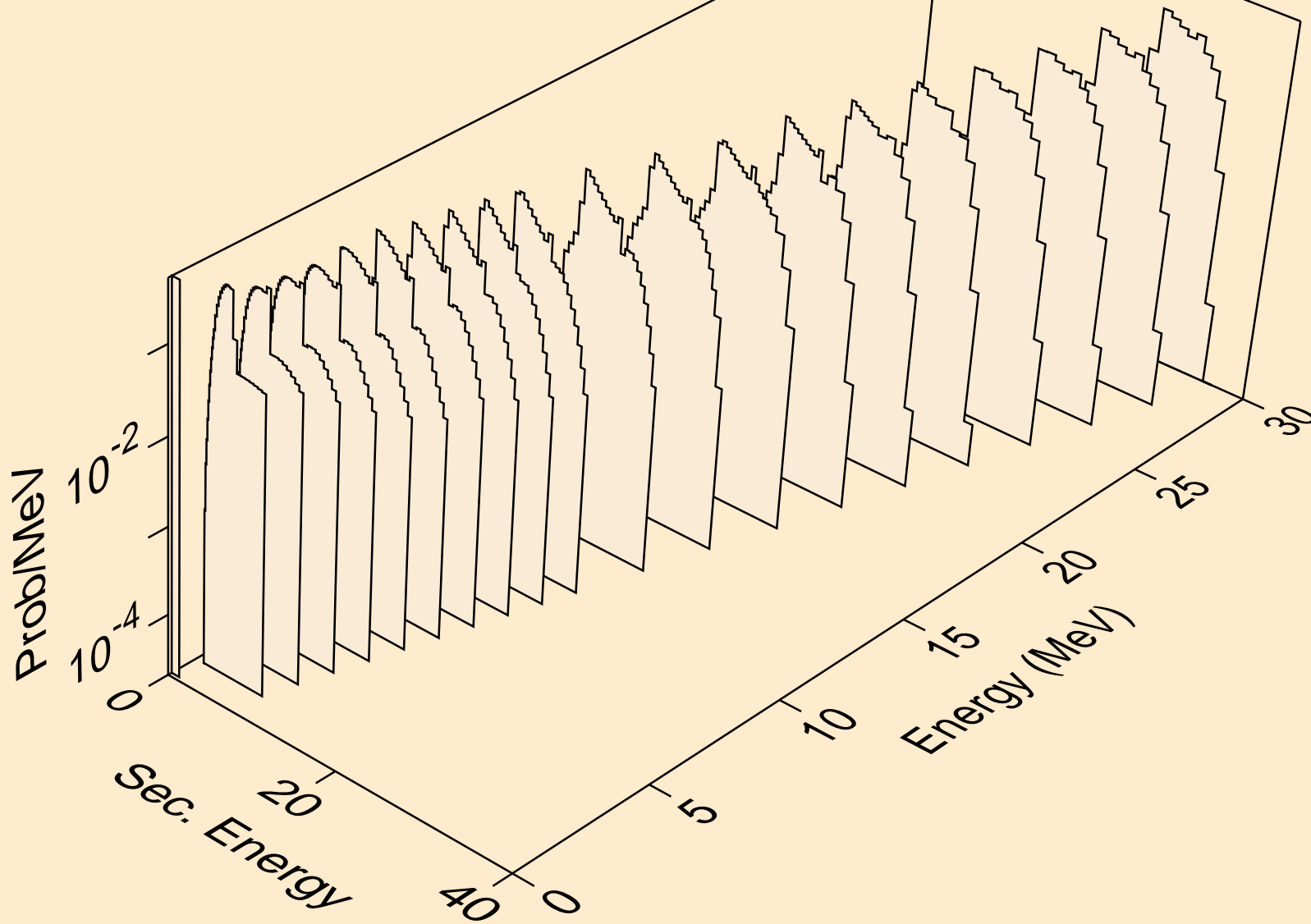

S034 HELION ACER TENDL-2024 LIBRARY; T=0.K  
protons from (s,2p)

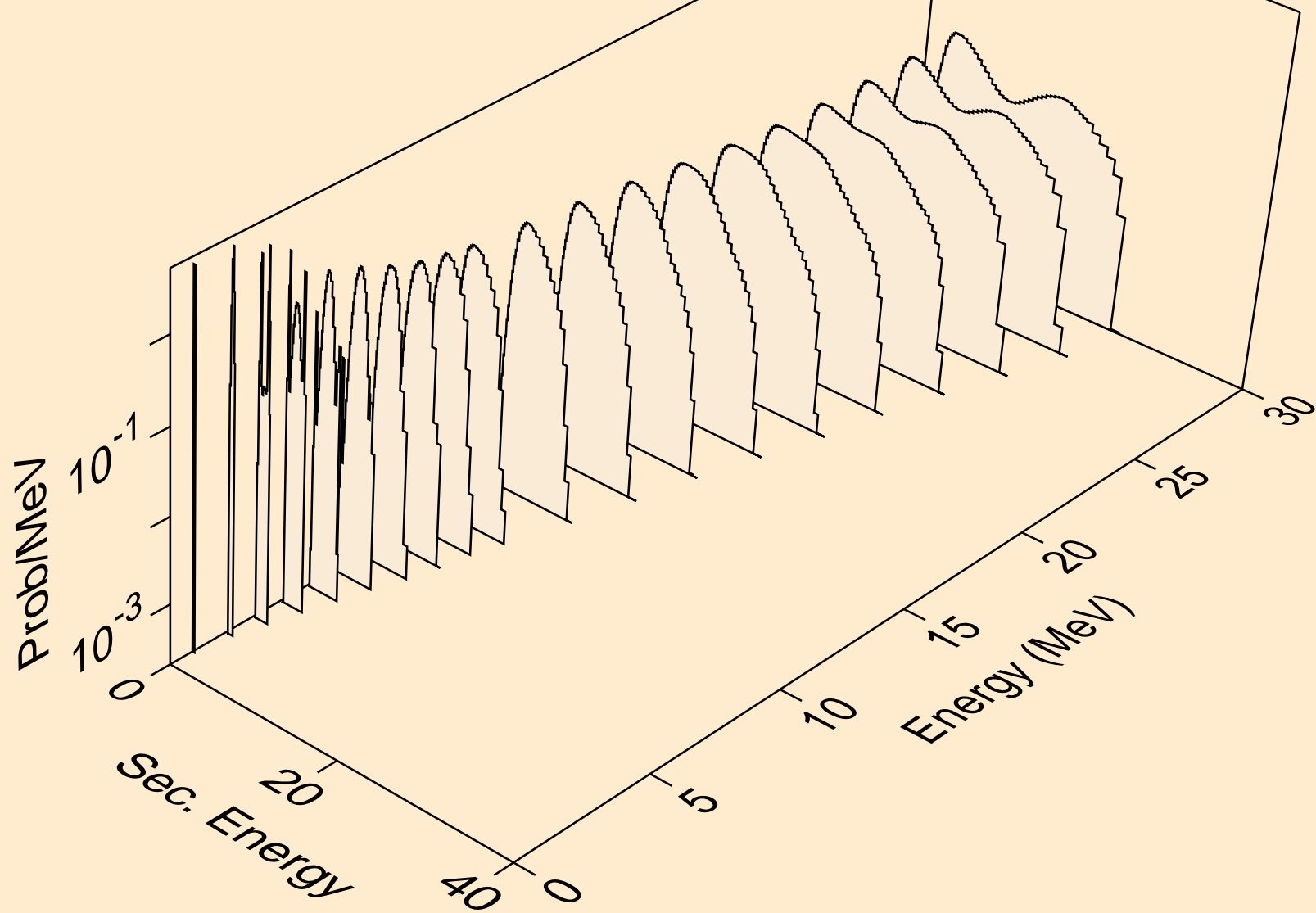

S034 HELION ACER TENDL-2024 LIBRARY; T=0.K  
protons from (s,pa)

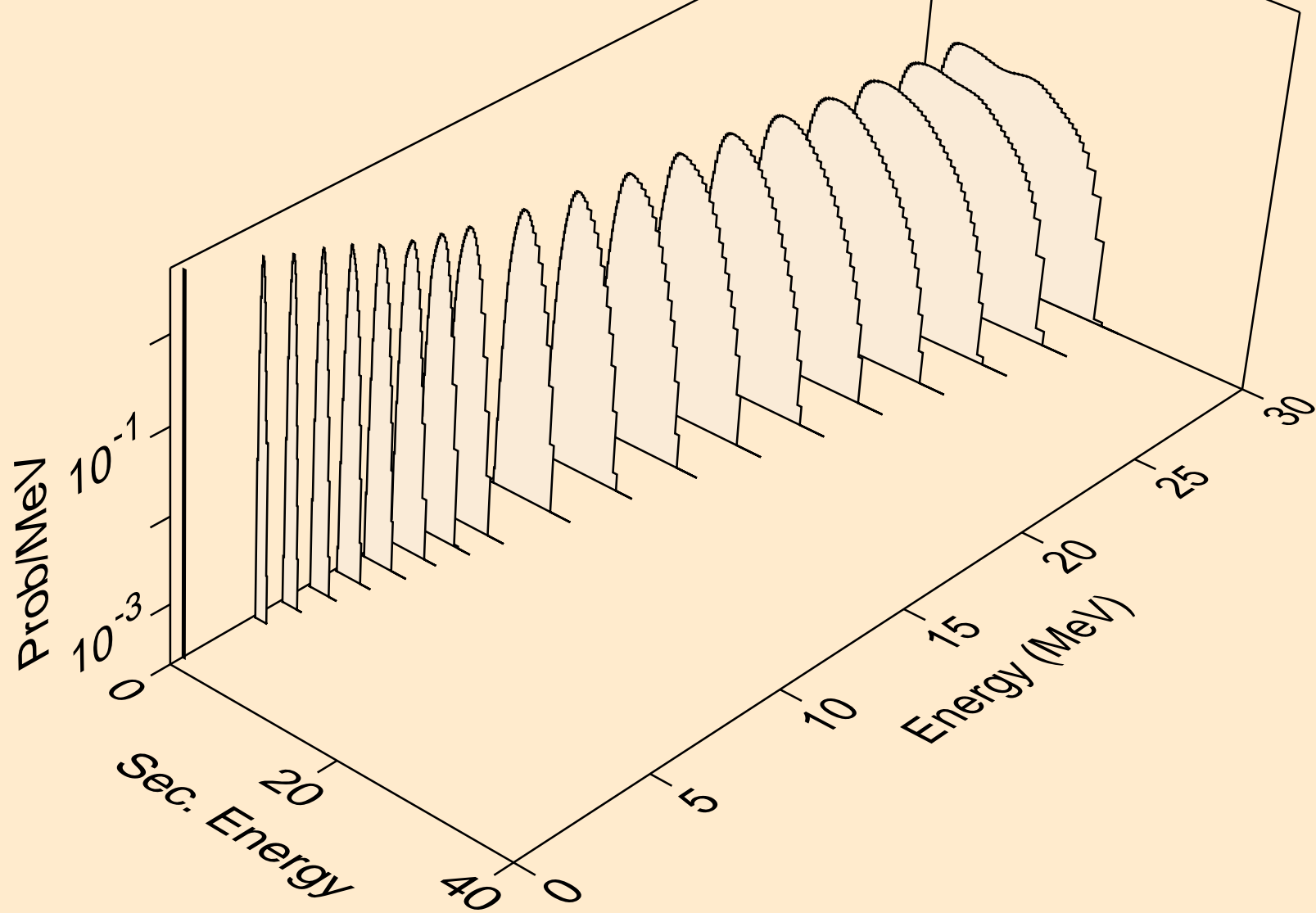

S034 HELION ACER TENDL-2024 LIBRARY; T=0.K  
protons from (s,pd)

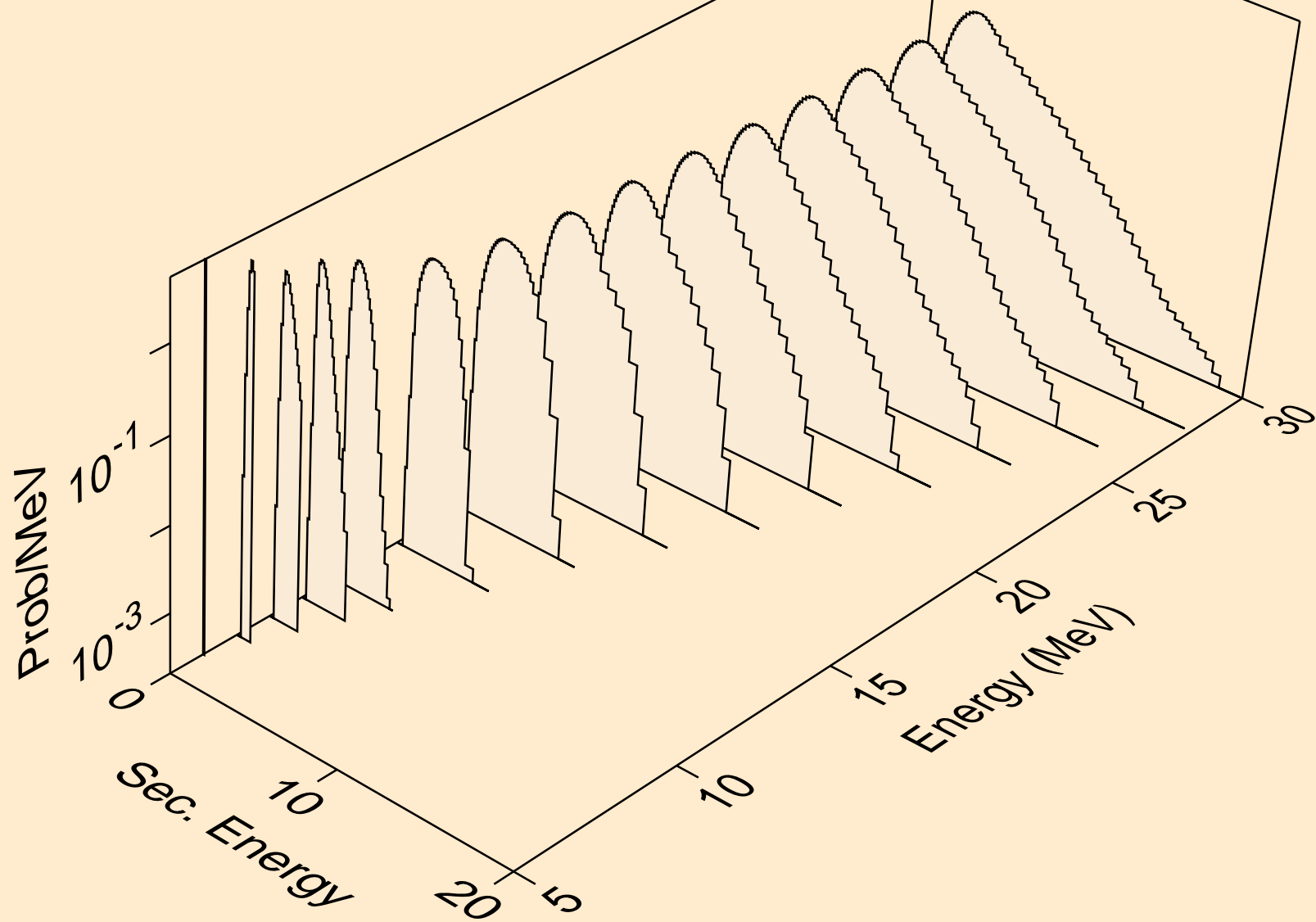

S034 HELION ACER TENDL-2024 LIBRARY; T=0.K  
protons from (s,pt)

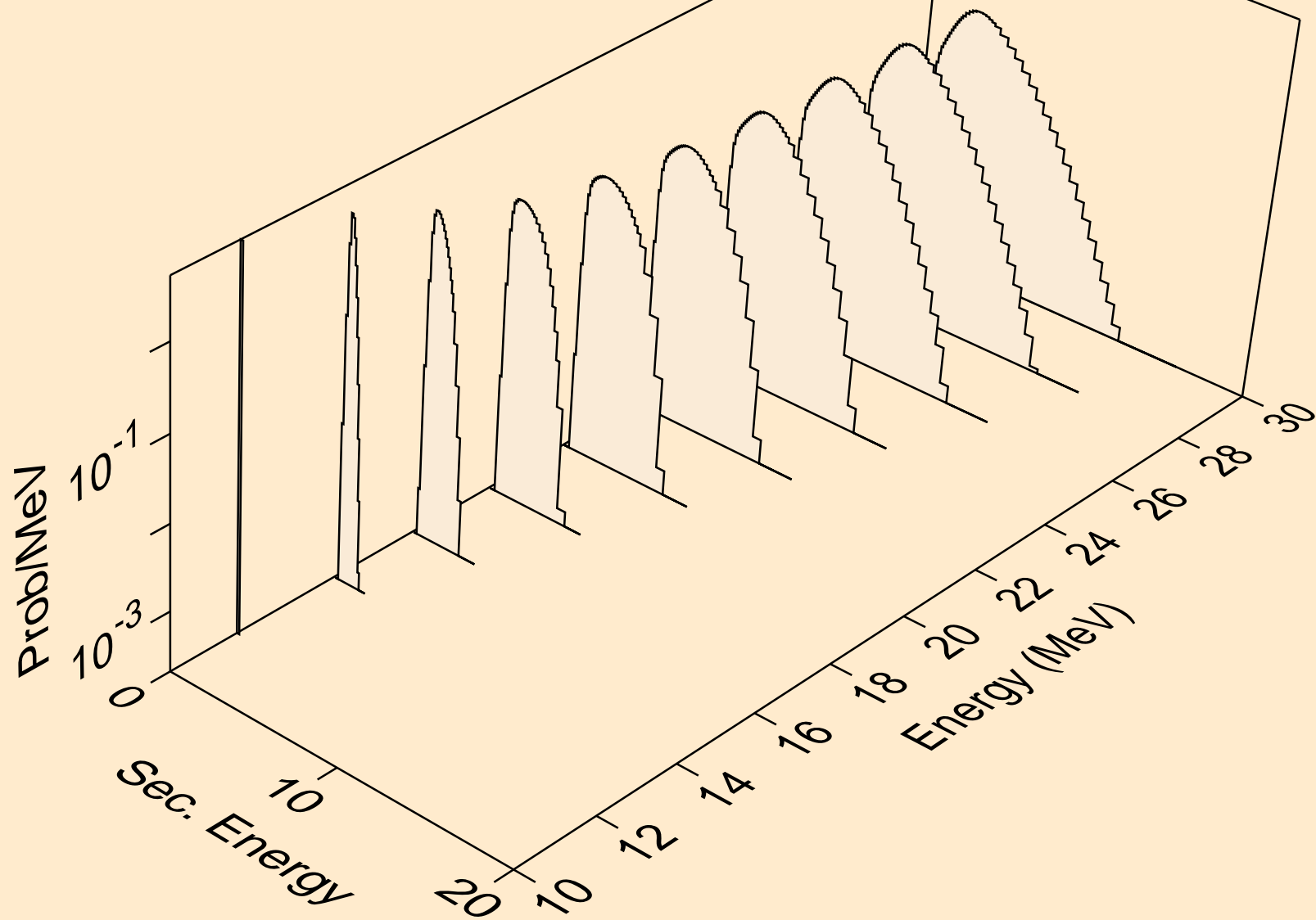

S034 HELION ACER TENDL-2024 LIBRARY; T=0.K  
deuterons from (s,x)

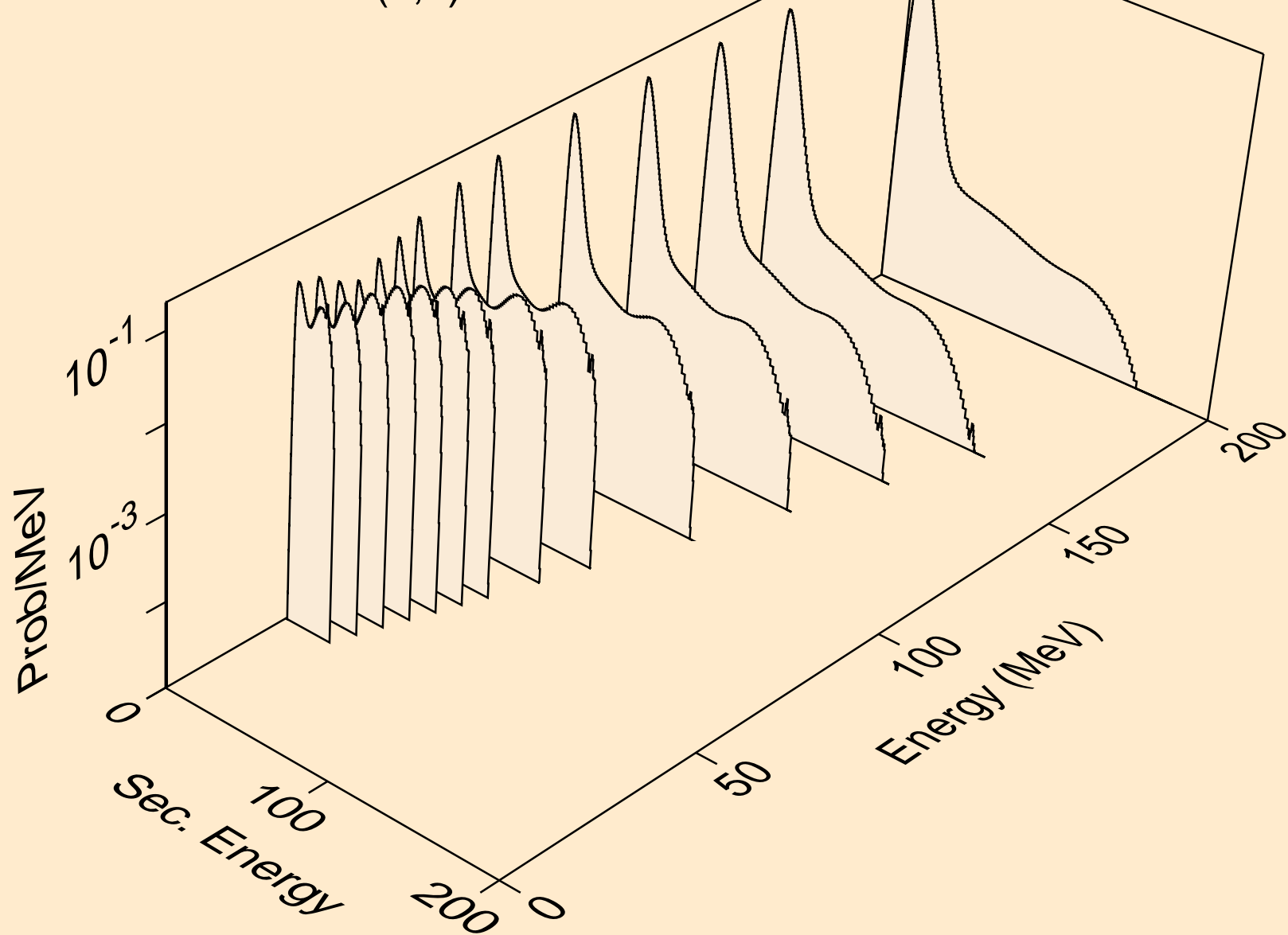

S034 HELION ACER TENDL-2024 LIBRARY; T=0.K  
deuterons from (s,2nd)

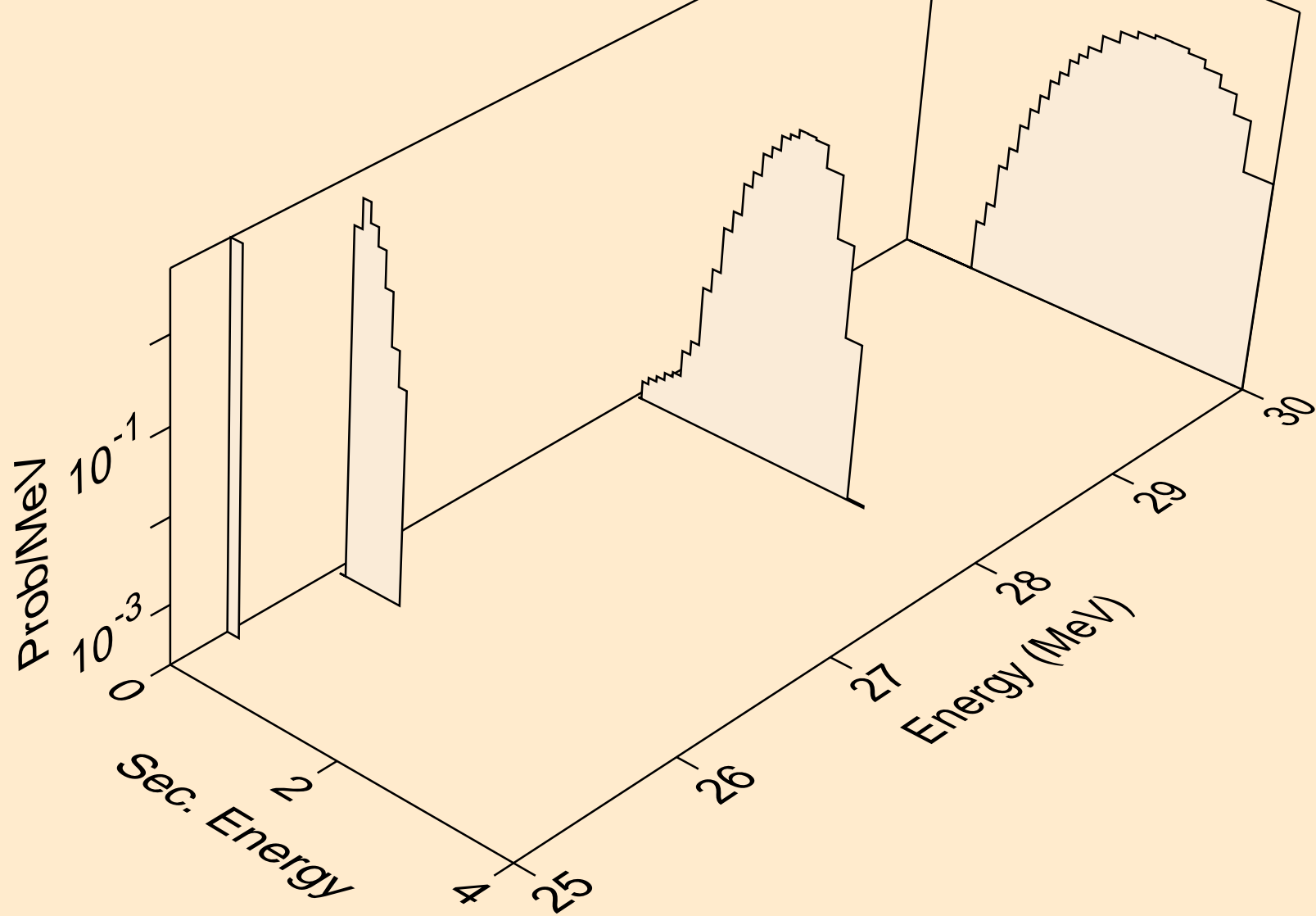

S034 HELION ACER TENDL-2024 LIBRARY; T=0.K  
deuterons from (s,n\*)d

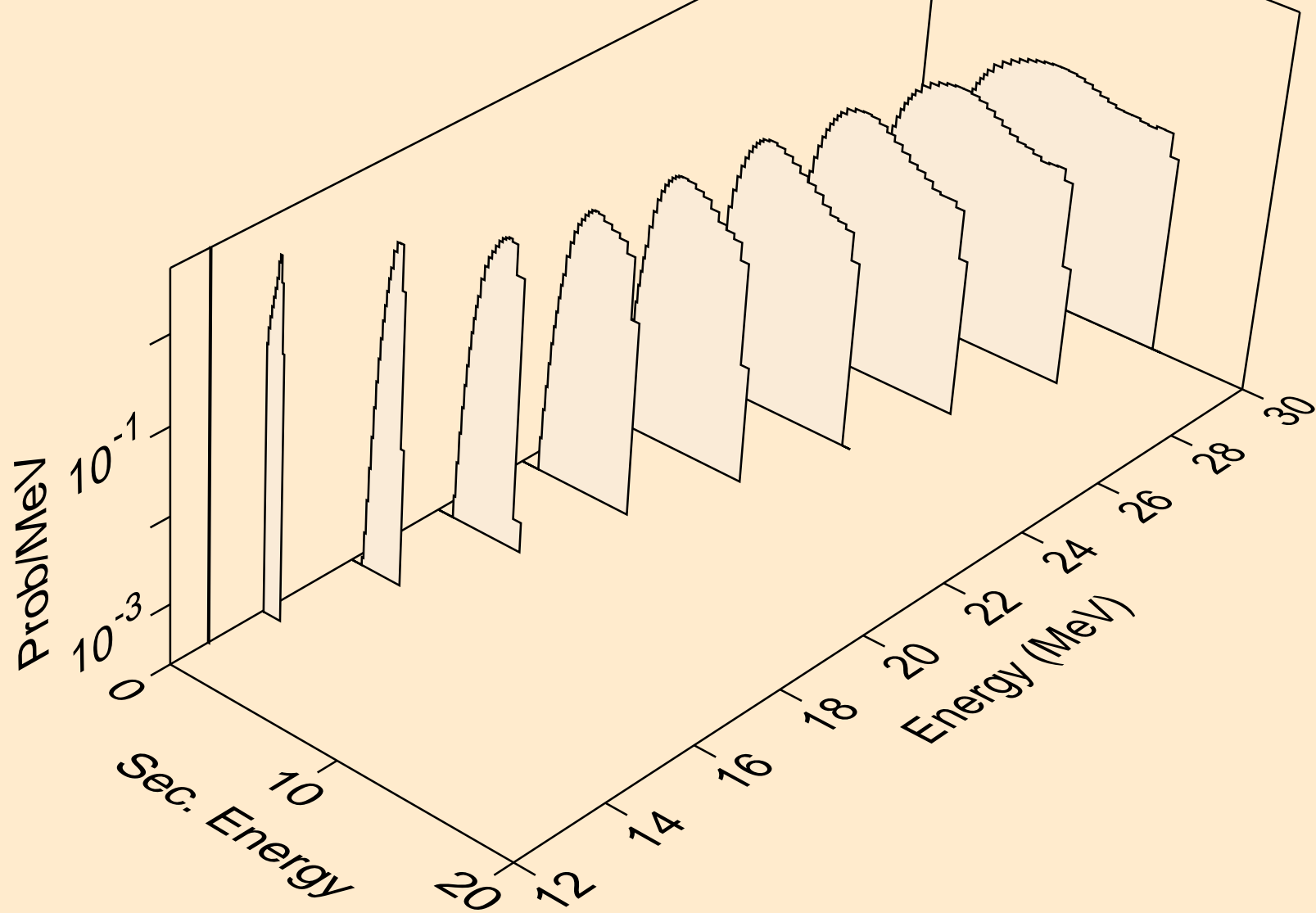

S034 HELION ACER TENDL-2024 LIBRARY; T=0.K  
deuterons from (s,d)

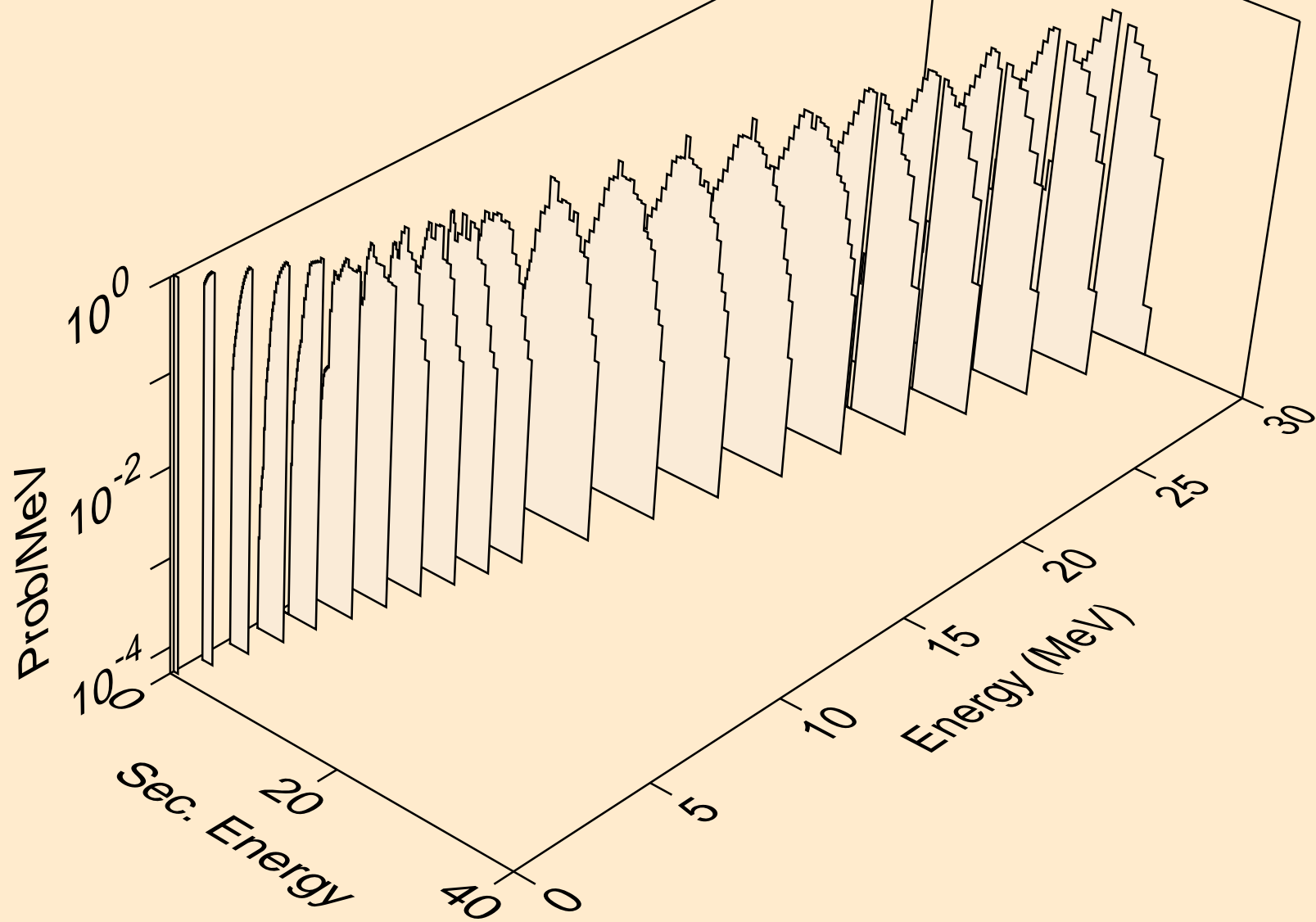

S034 HELION ACER TENDL-2024 LIBRARY; T=0.K  
deuterons from (s,d2a)

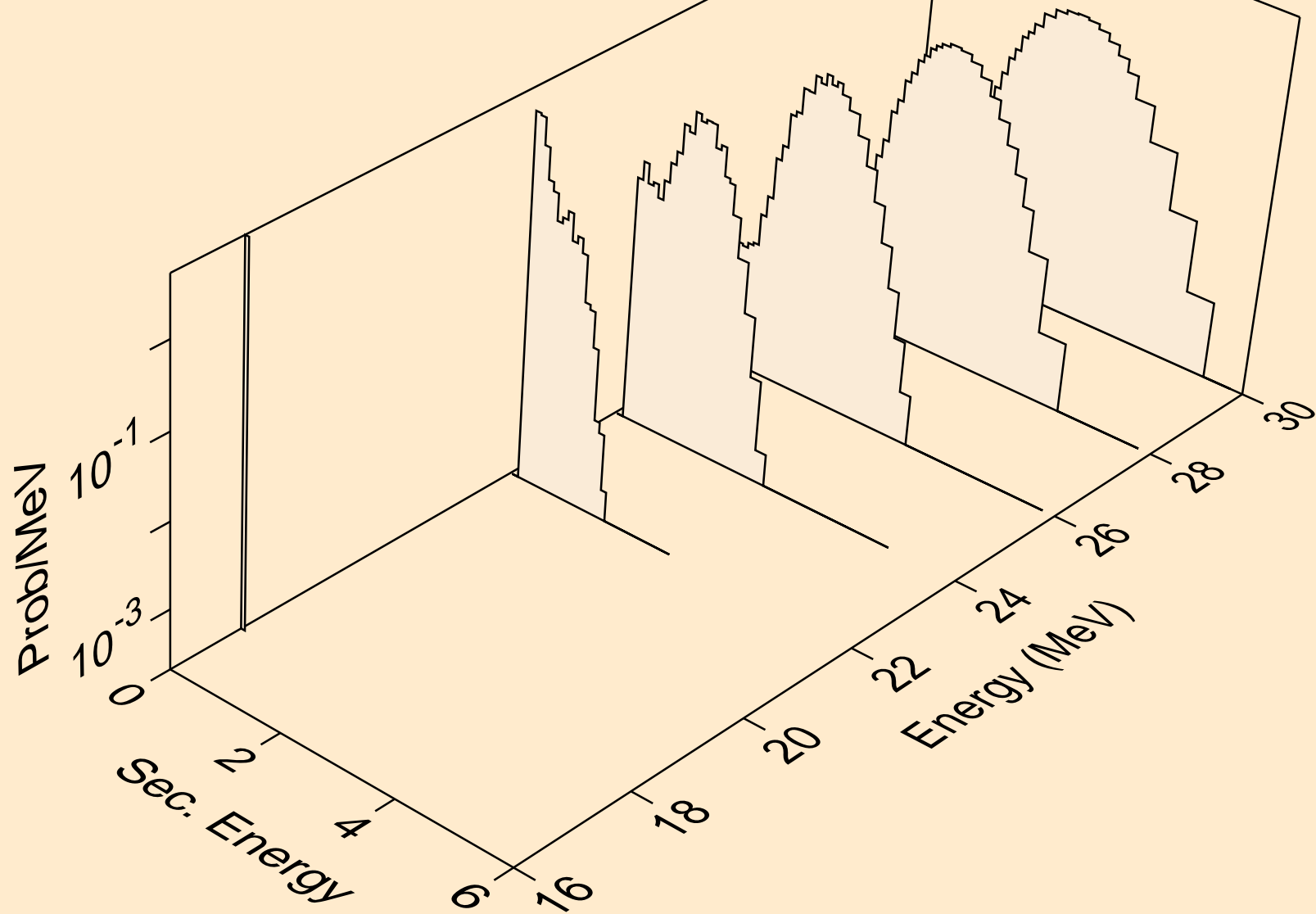

S034 HELION ACER TENDL-2024 LIBRARY; T=0.K  
deuterons from (s,pd)

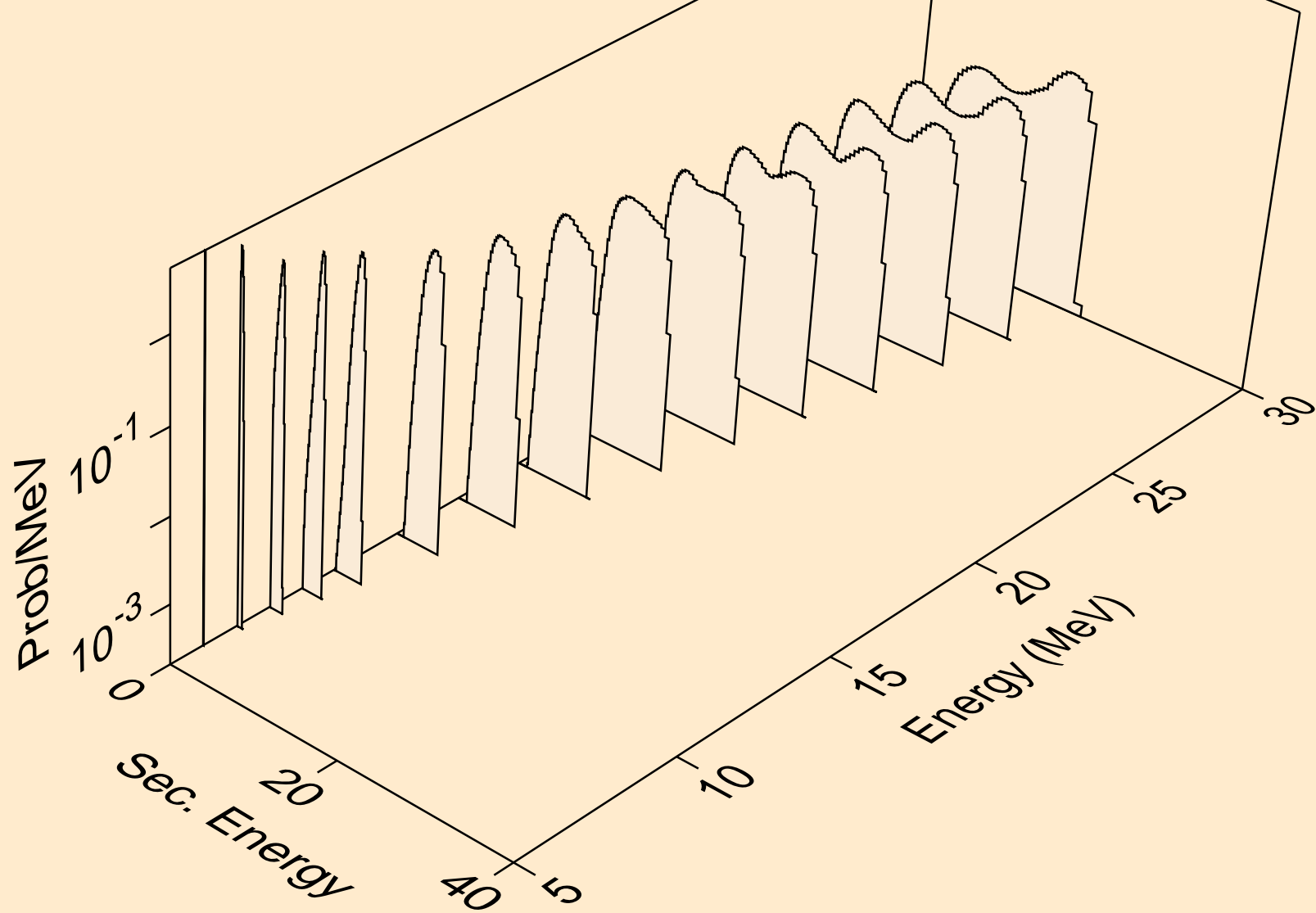

S034 HELION ACER TENDL-2024 LIBRARY; T=0.K  
deuterons from (s,da)

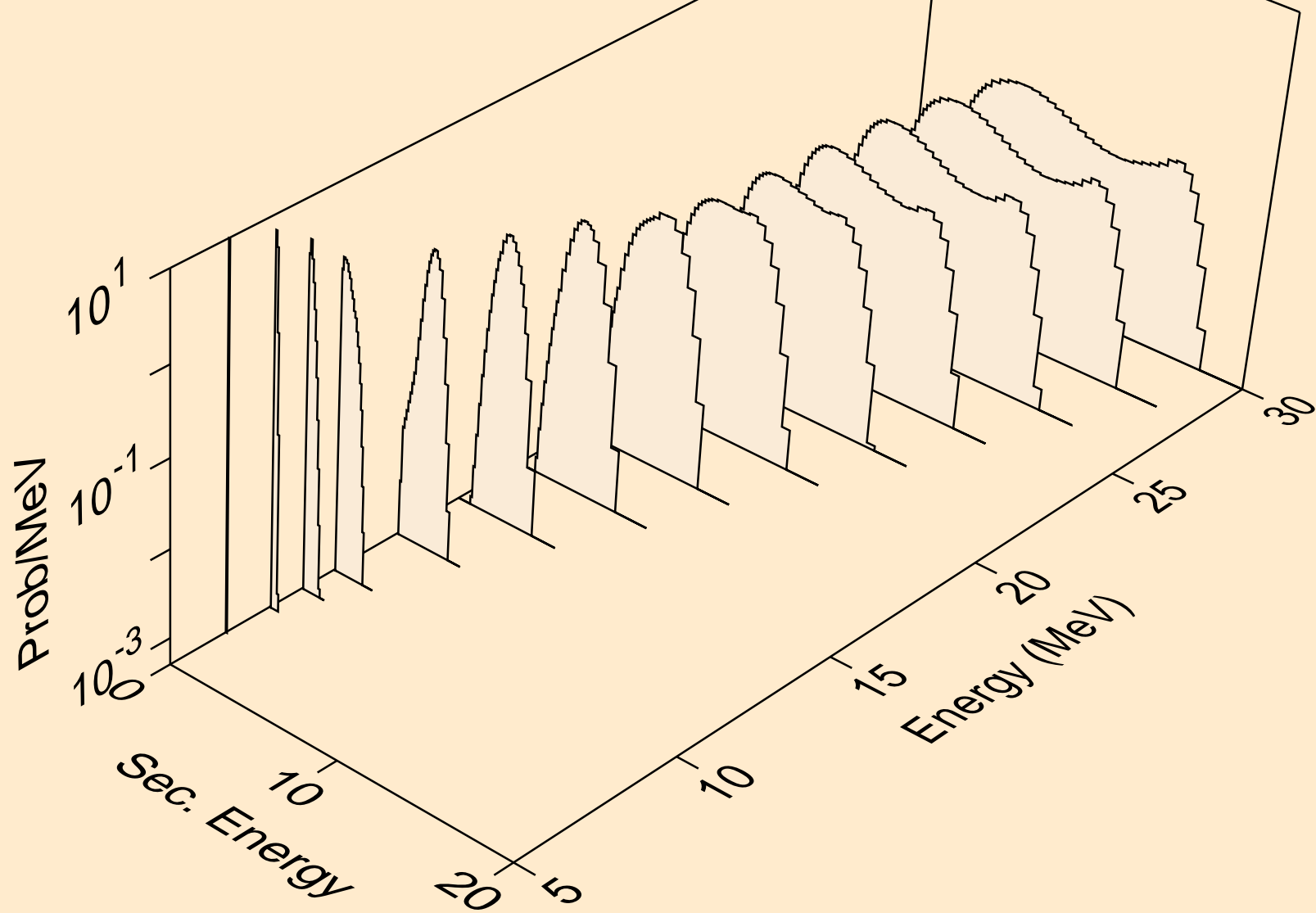

S034 HELION ACER TENDL-2024 LIBRARY; T=0.K  
tritons from (s,x)

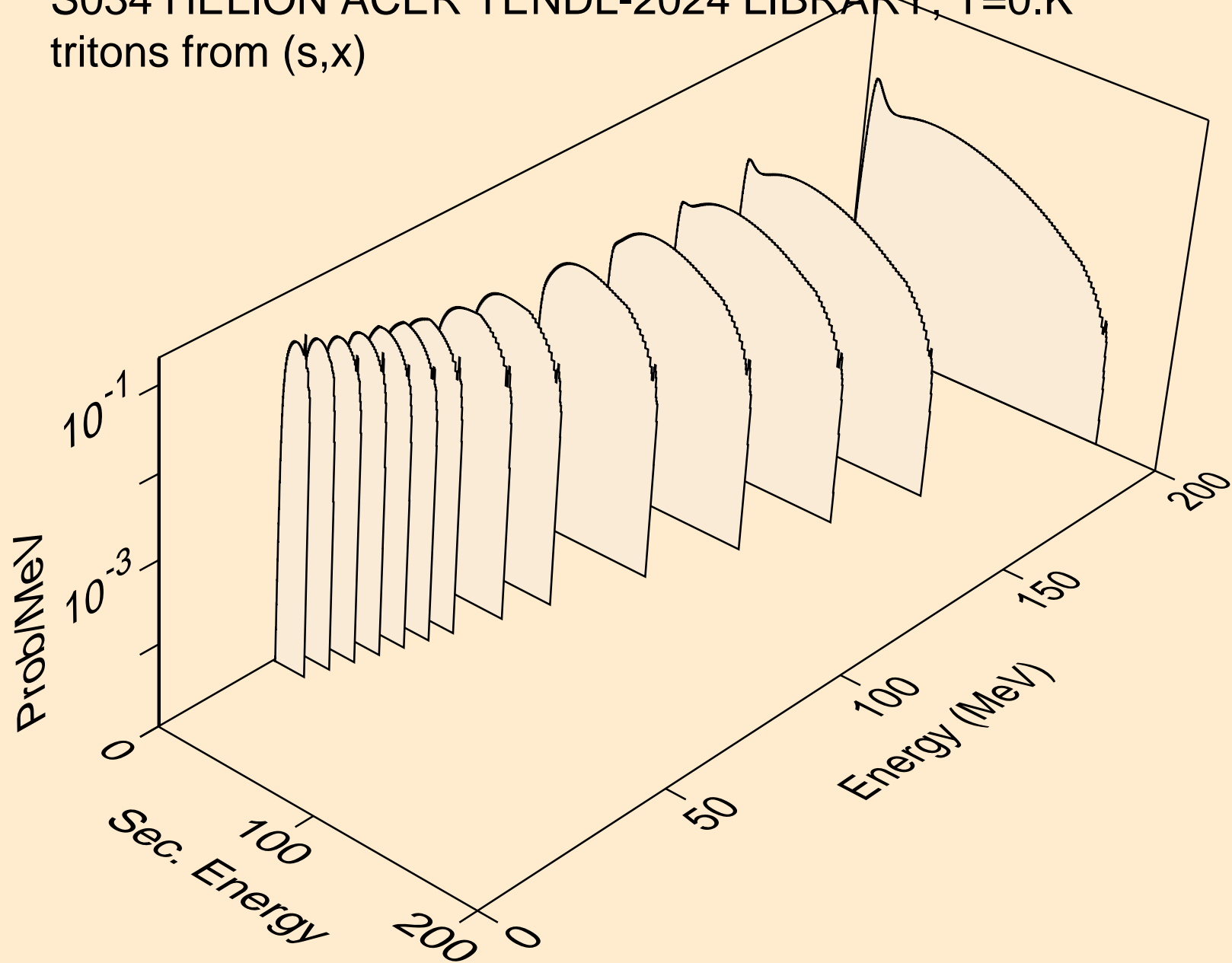

S034 HELION ACER TENDL-2024 LIBRARY; T=0.K  
tritons from (s,n\*)t

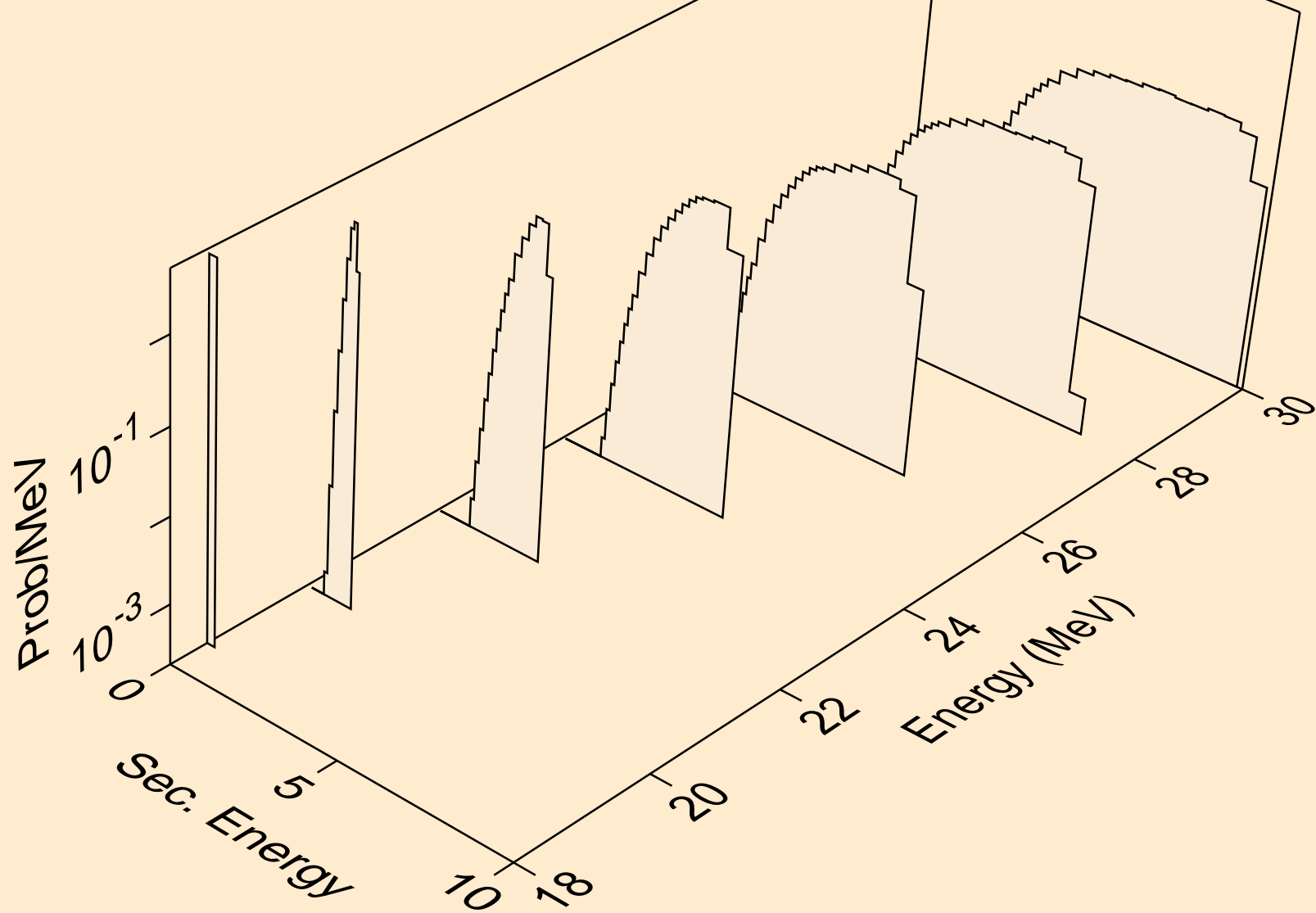

S034 HELION ACER TENDL-2024 LIBRARY; T=0.K  
tritons from (s,t)

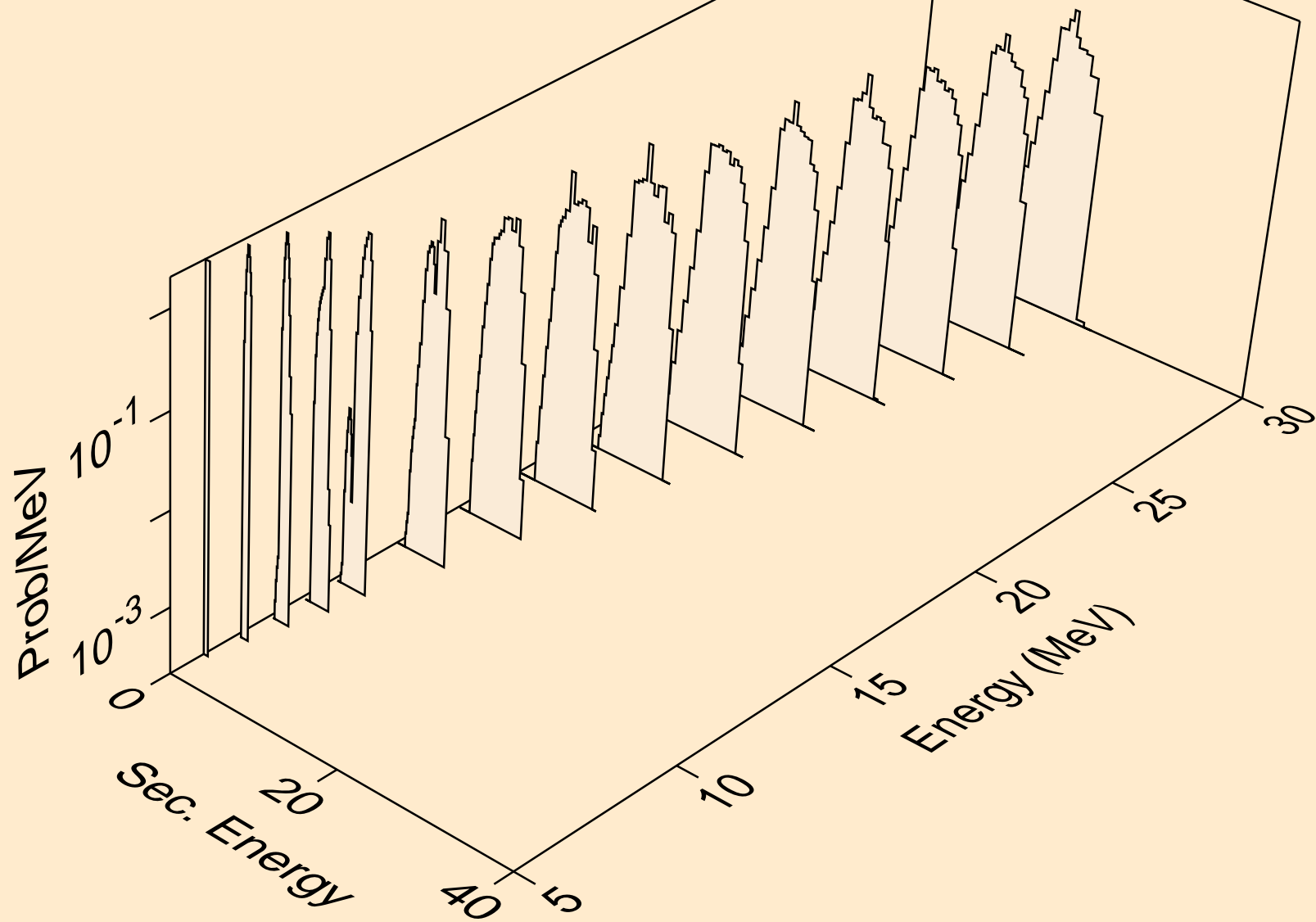

S034 HELION ACER TENDL-2024 LIBRARY; T=0.K  
tritons from (s,pt)

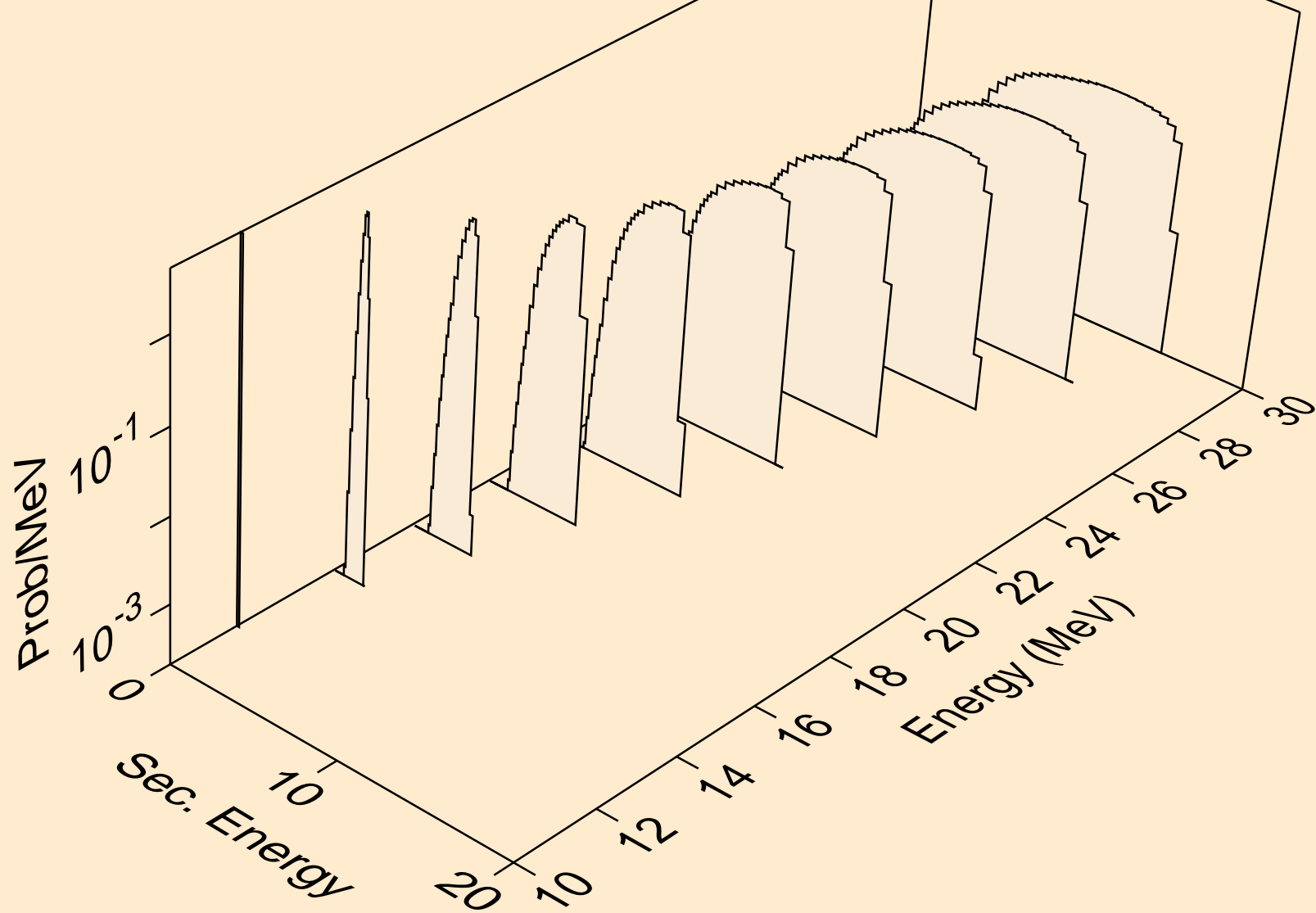

S034 HELION ACER TENDL-2024 LIBRARY; T=0.K  
alphas from (s,x)

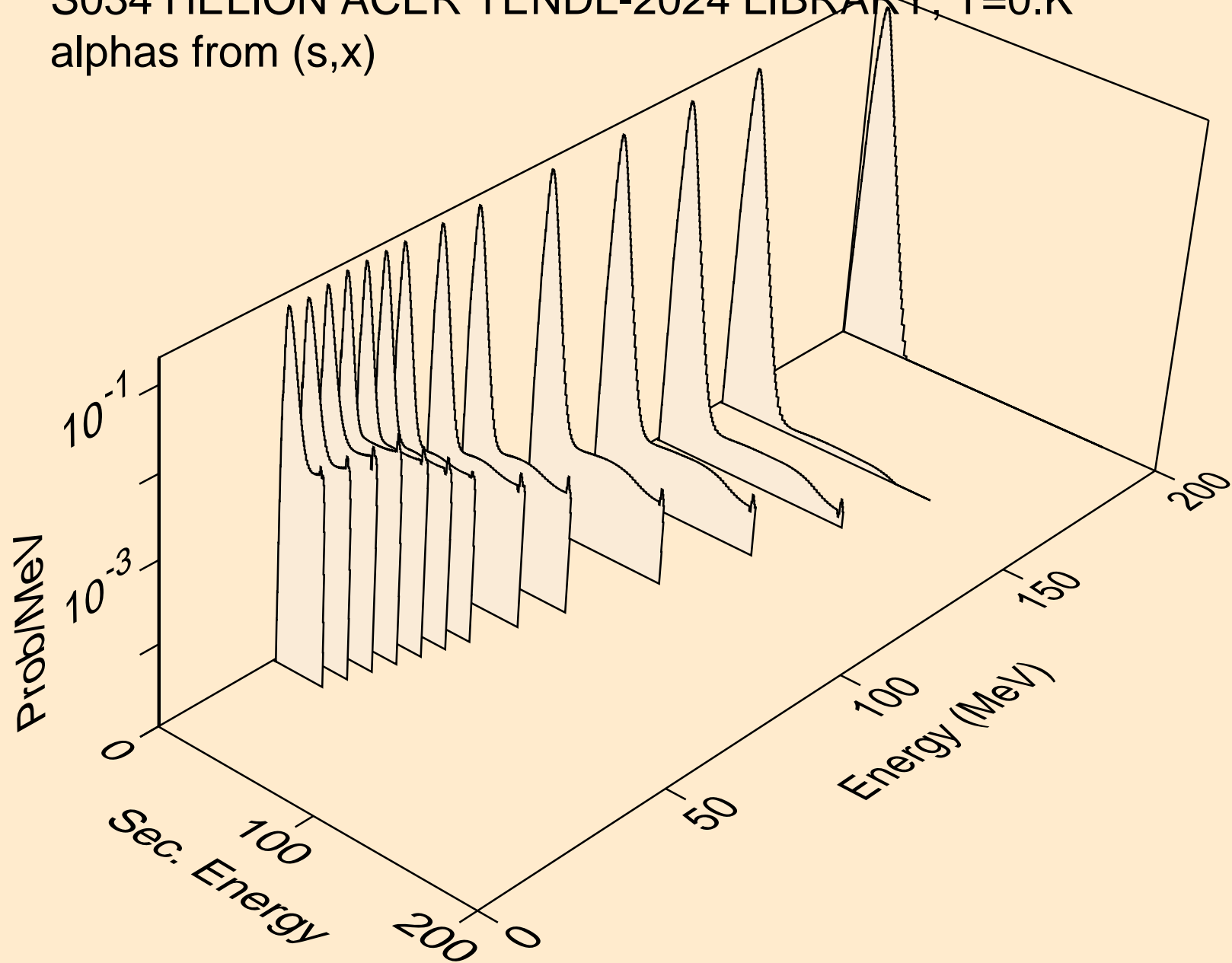

S034 HELION ACER TENDL-2024 LIBRARY; T=0.K  
alphas from (s,n\*)a

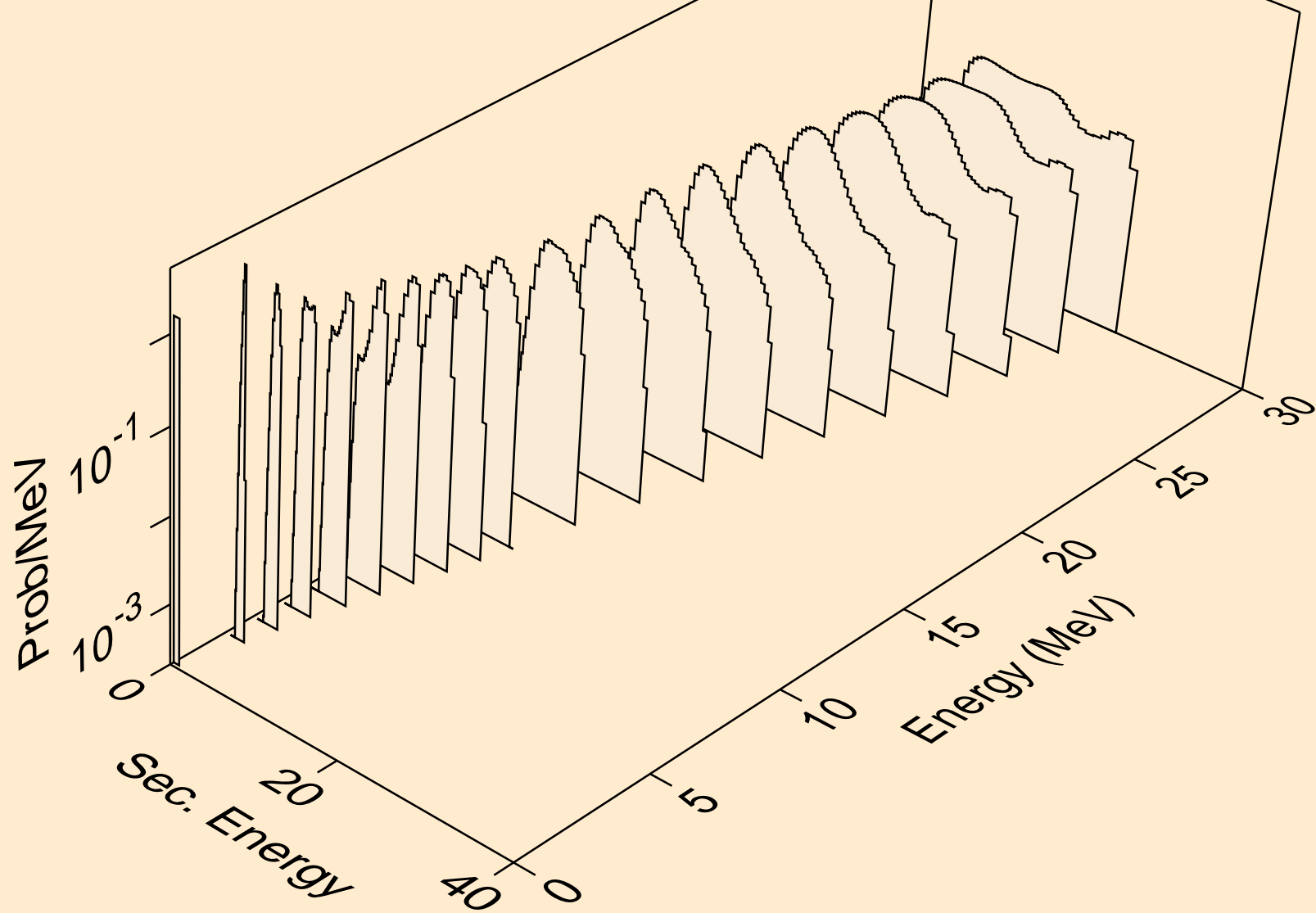

S034 HELION ACER TENDL-2024 LIBRARY; T=0.K  
alphas from (s,2n)a

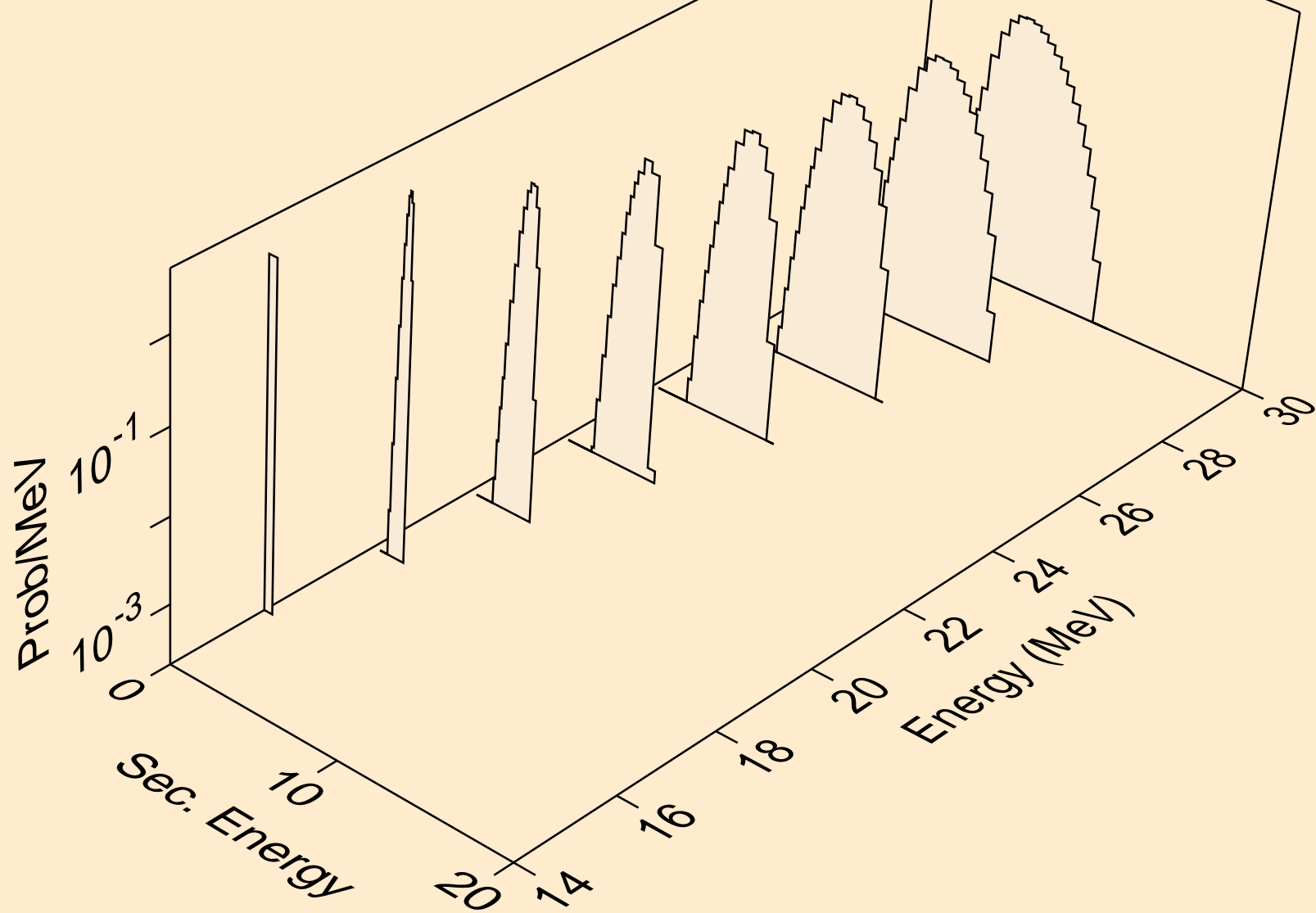

S034 HELION ACER TENDL-2024 LIBRARY; T=0.K  
alphas from (s,n\*)2a

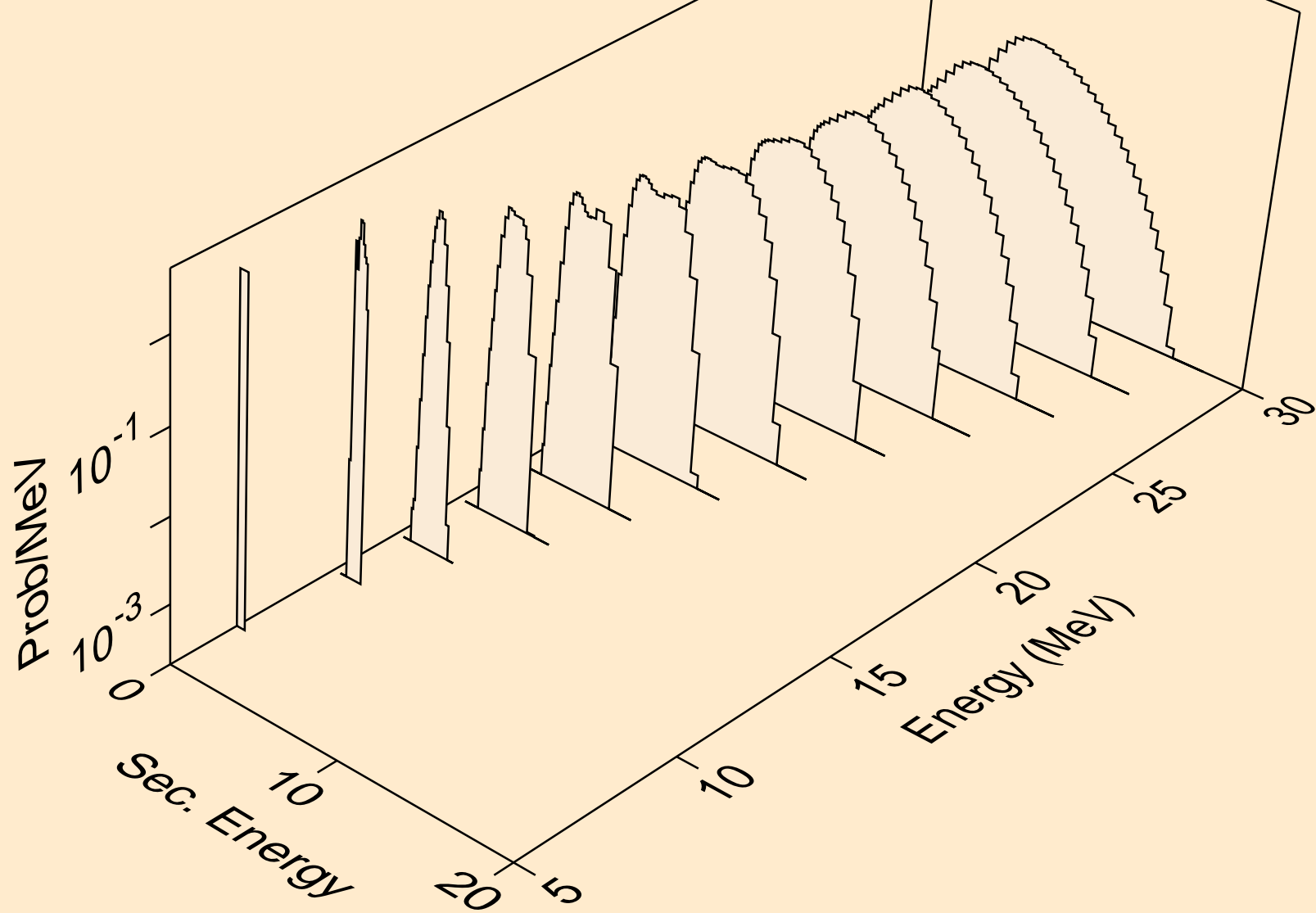

S034 HELION ACER TENDL-2024 LIBRARY; T=0.K  
alphas from (s,npa)

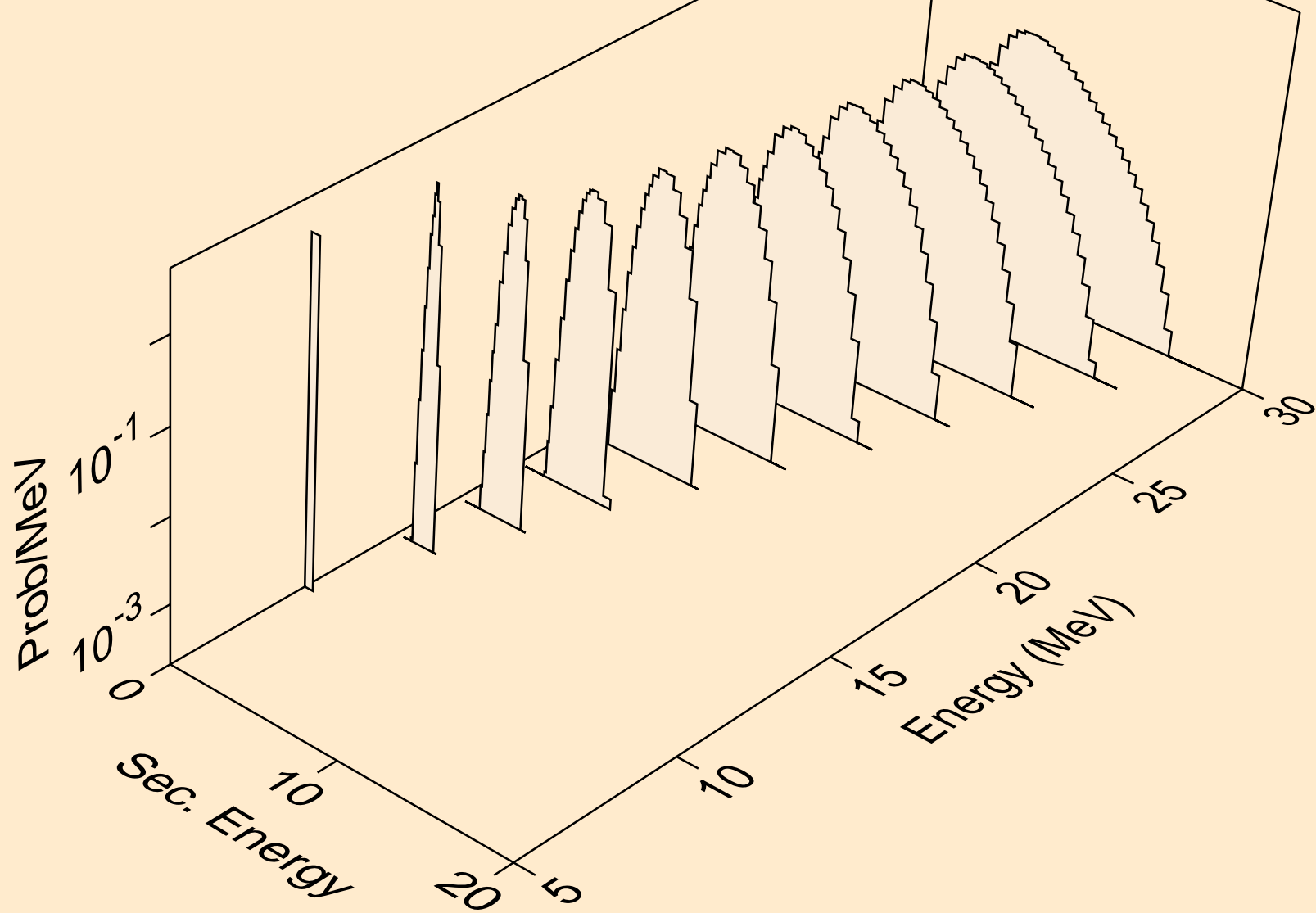

S034 HELION ACER TENDL-2024 LIBRARY; T=0.K  
alphas from (s,a)

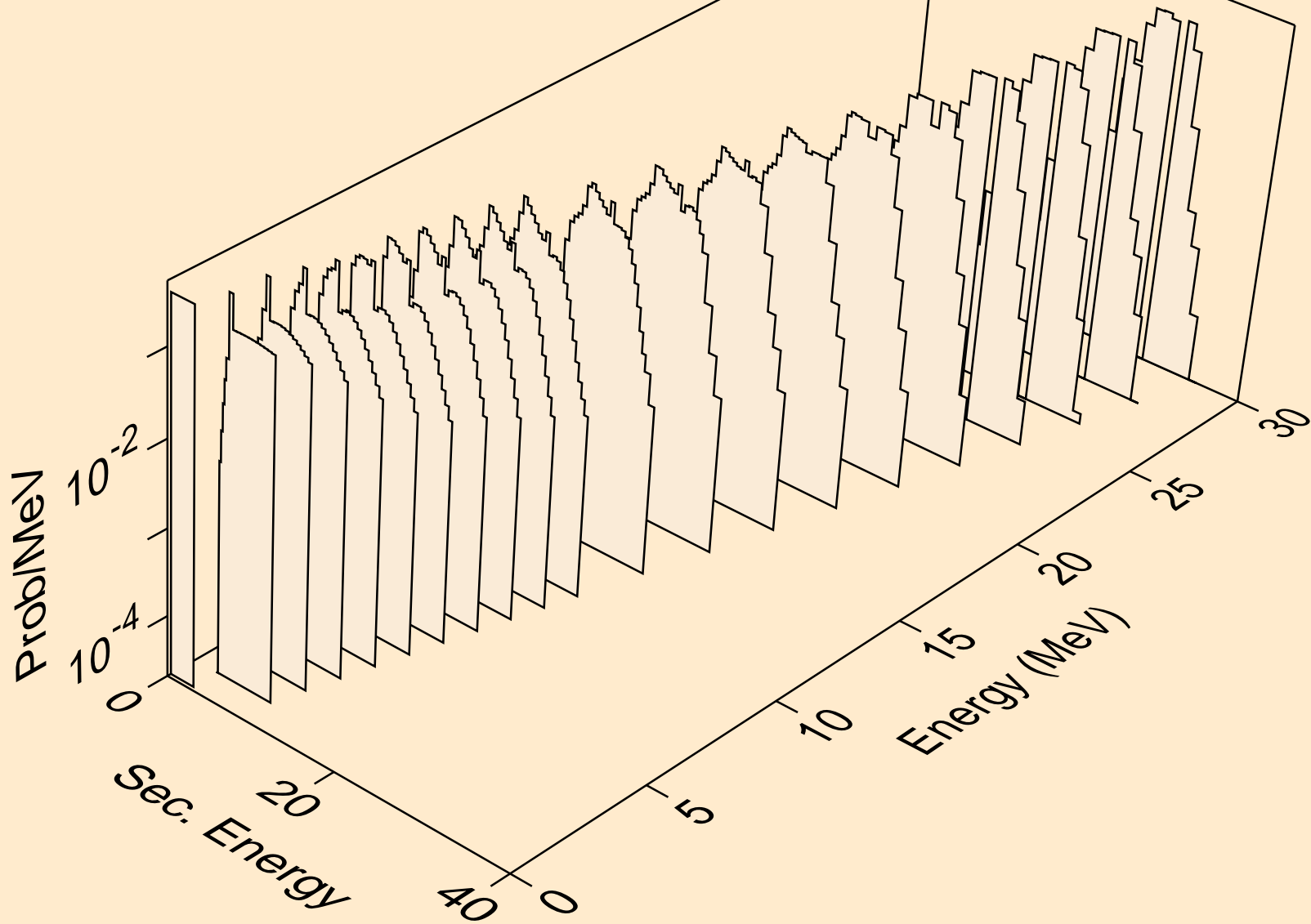

S034 HELION ACER TENDL-2024 LIBRARY; T=0.K  
alphas from (s,2a)

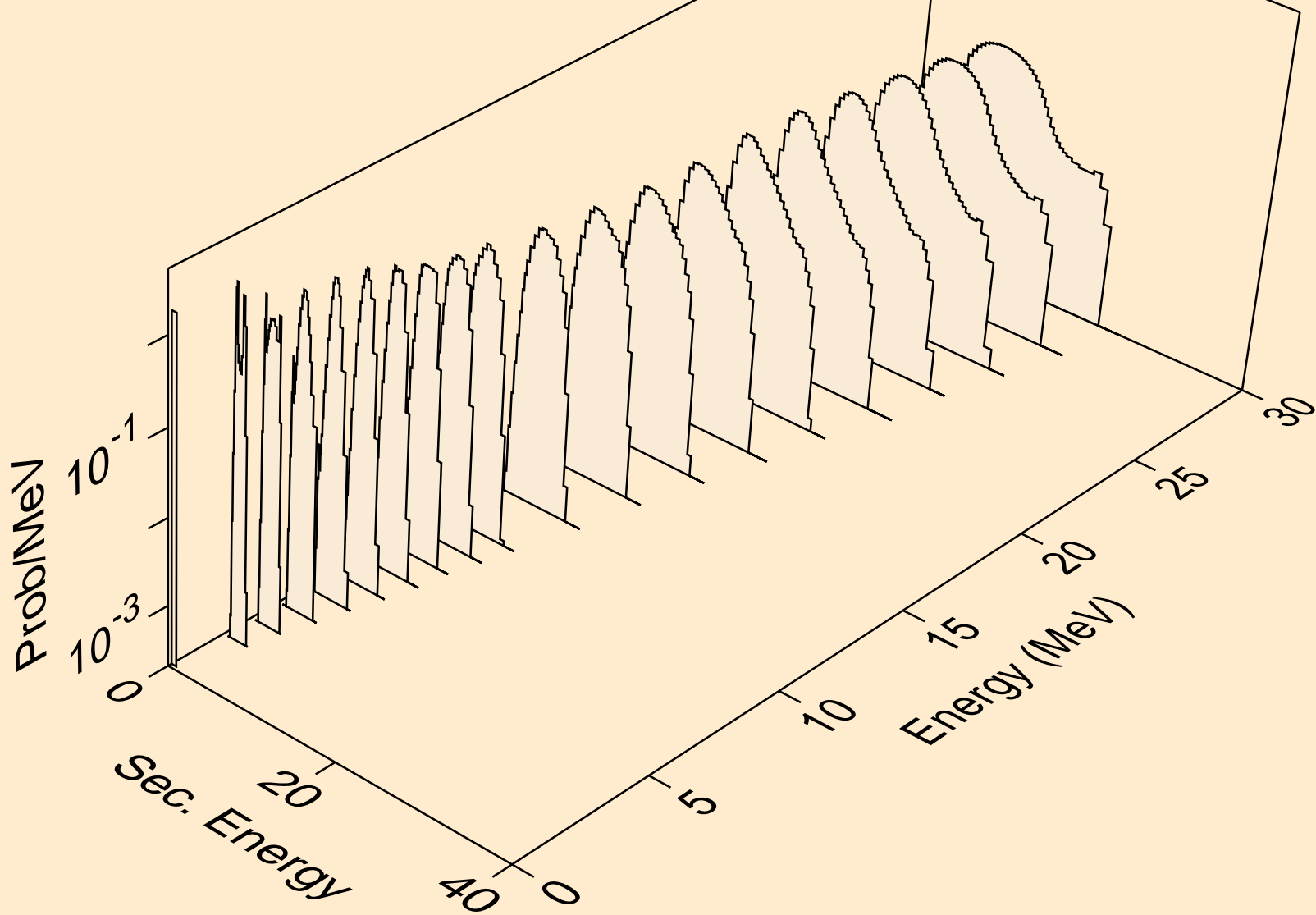

S034 HELION ACER TENDL-2024 LIBRARY; T=0.K  
alphas from (s,3a)

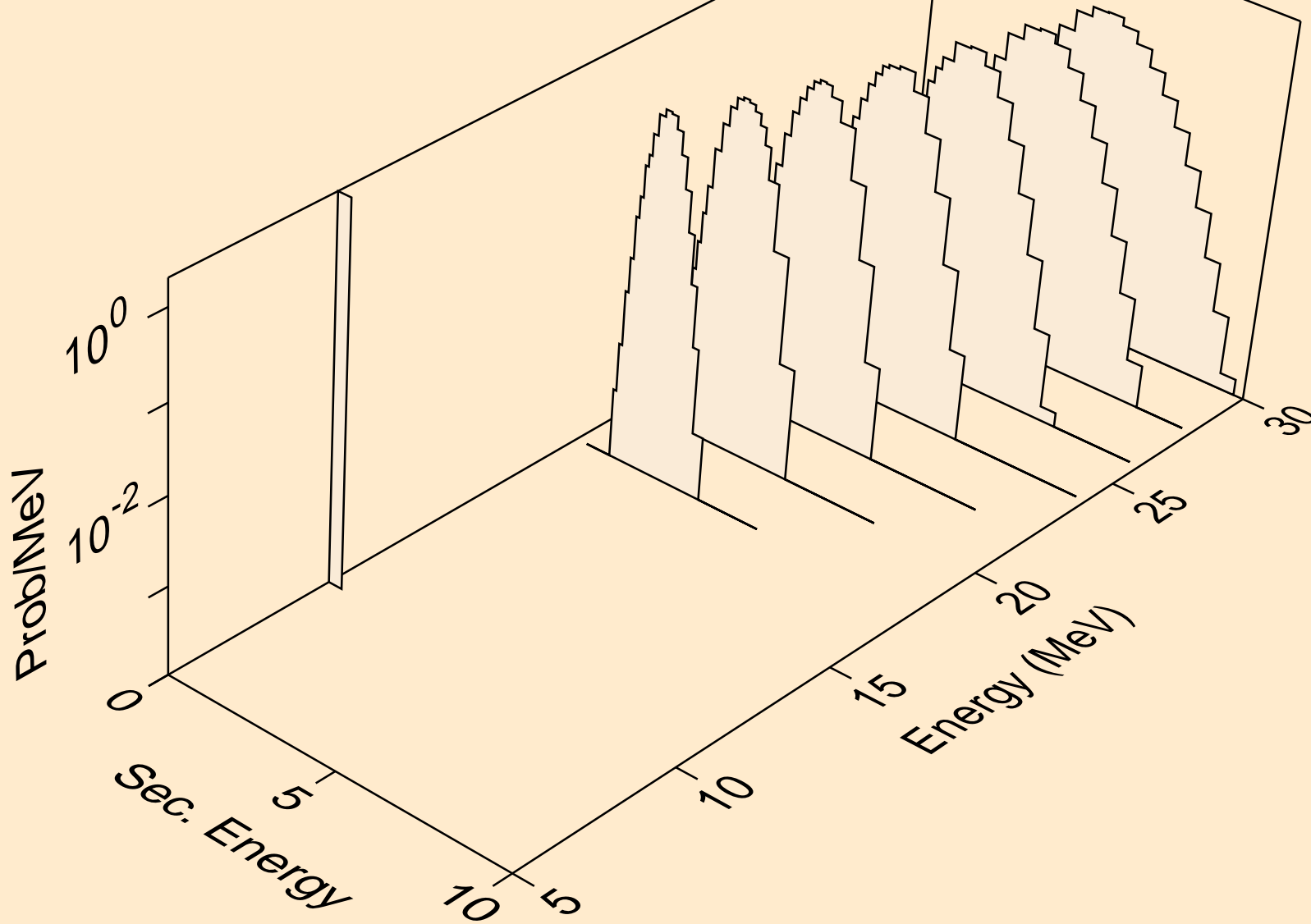

S034 HELION ACER TENDL-2024 LIBRARY; T=0.K  
alphas from (s,pa)

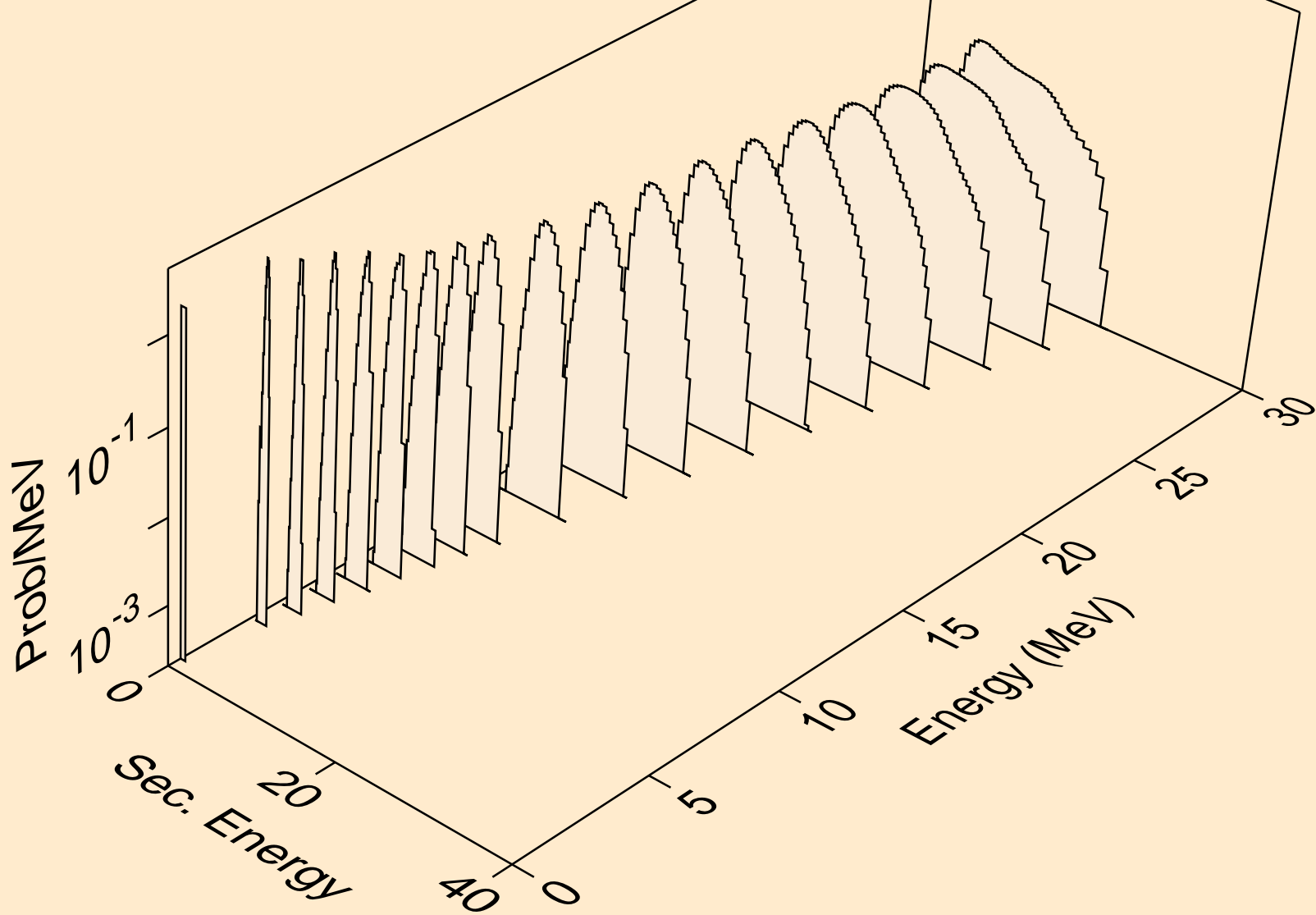

S034 HELION ACER TENDL-2024 LIBRARY; T=0.K  
alphas from (s,d2a)

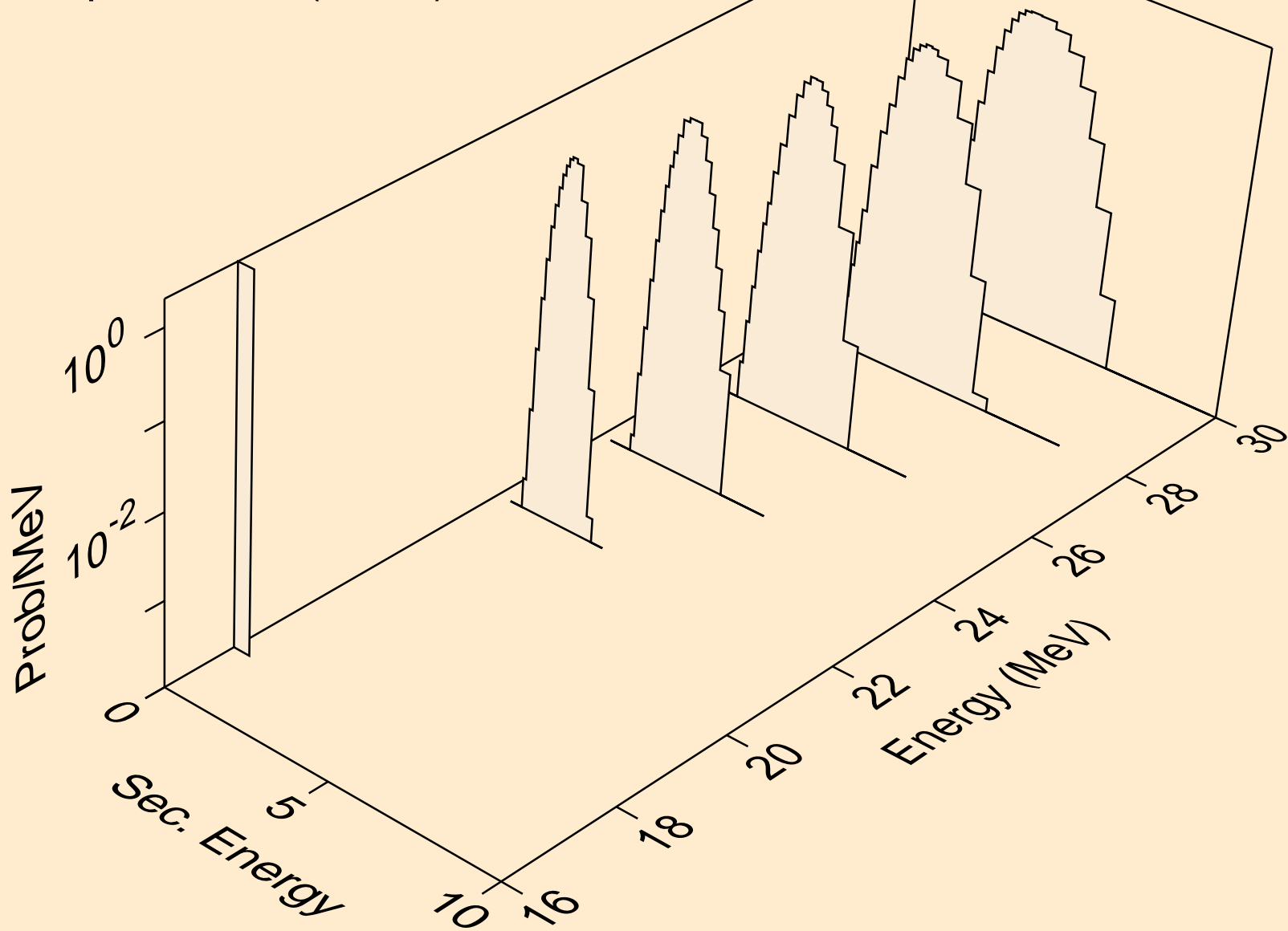

S034 HELION ACER TENDL-2024 LIBRARY; T=0.K  
alphas from (s,da)

