

# SG268 HELION ACER TENDL-2024 LIBRARY; T=0.K

## Principal cross sections

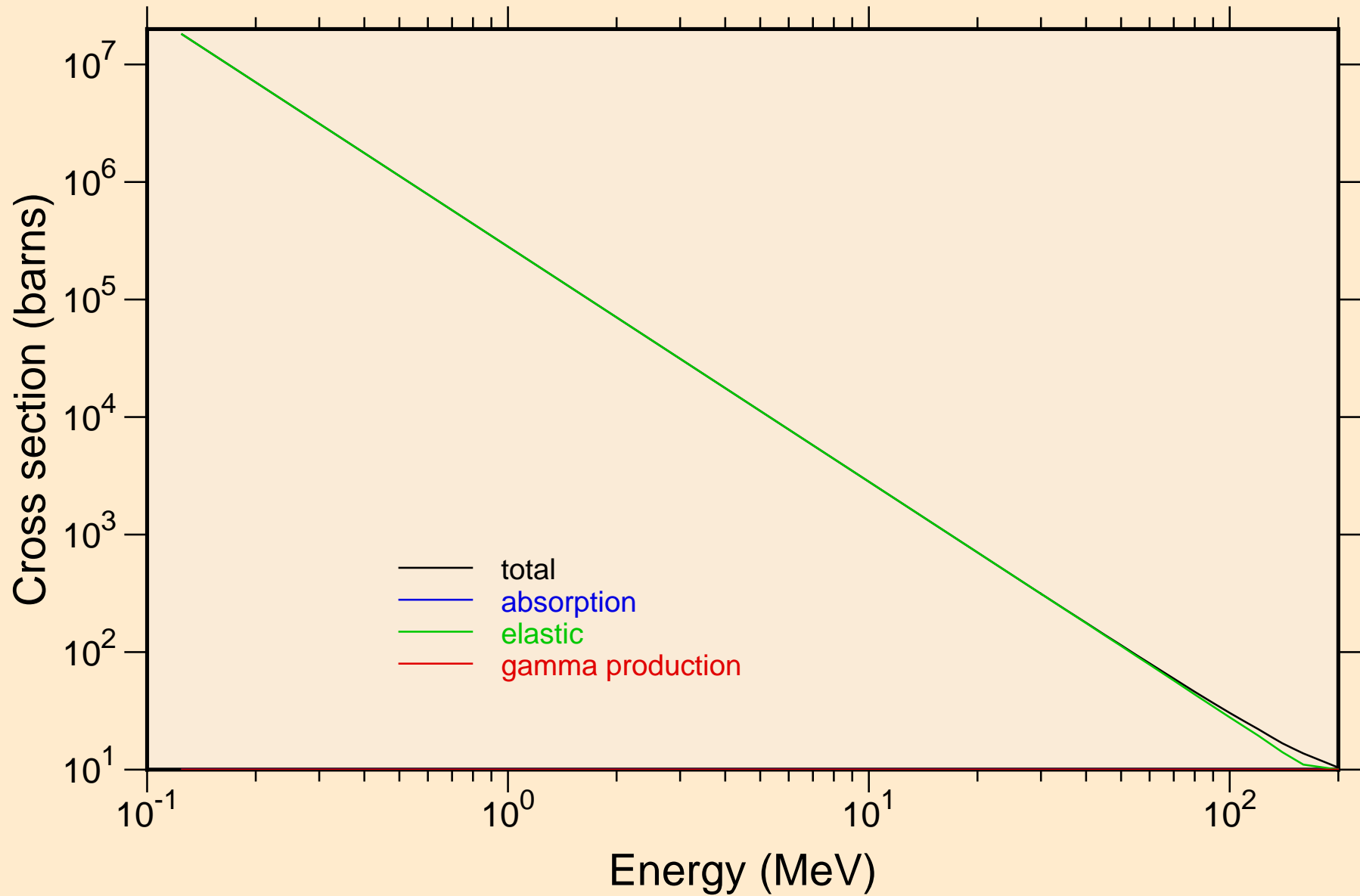

# SG268 HELION ACER TENDL-2024 LIBRARY; T=0.K

## Heating

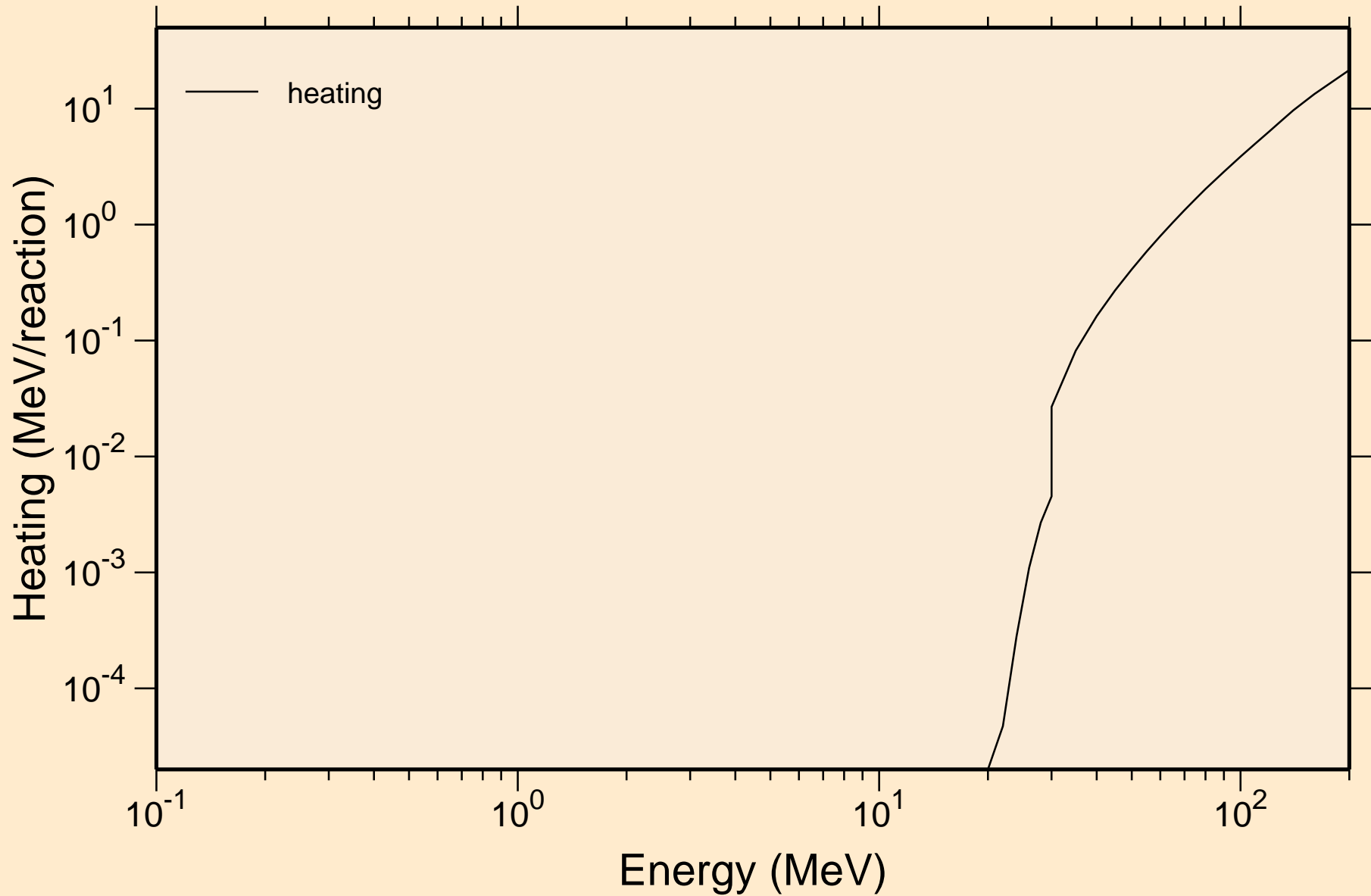

# SG268 HELION ACER TENDL-2024 LIBRARY; T=0.K

## Principal cross sections

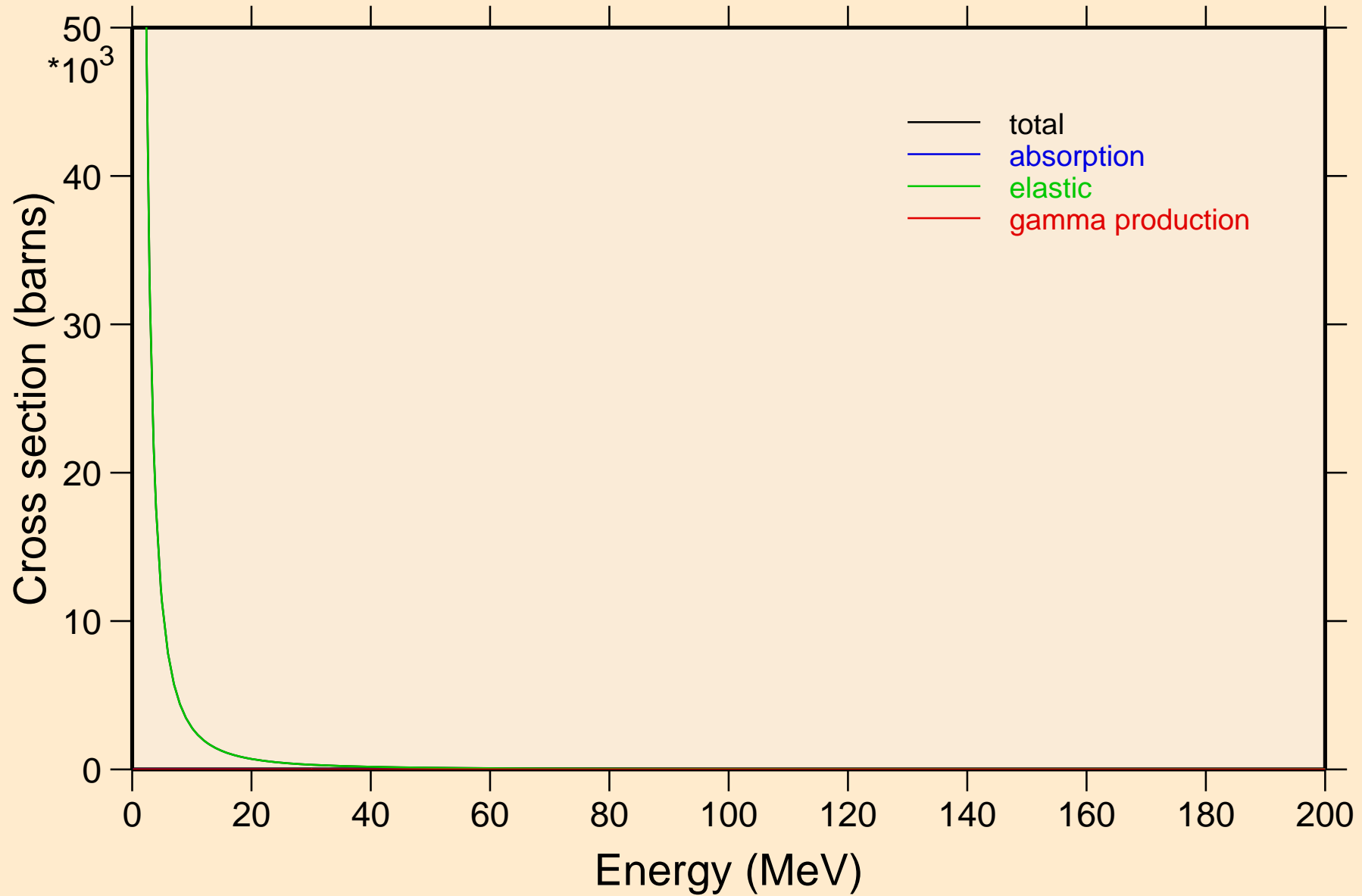

# SG268 HELION ACER TENDL-2024 LIBRARY; T=0.K

## Heating

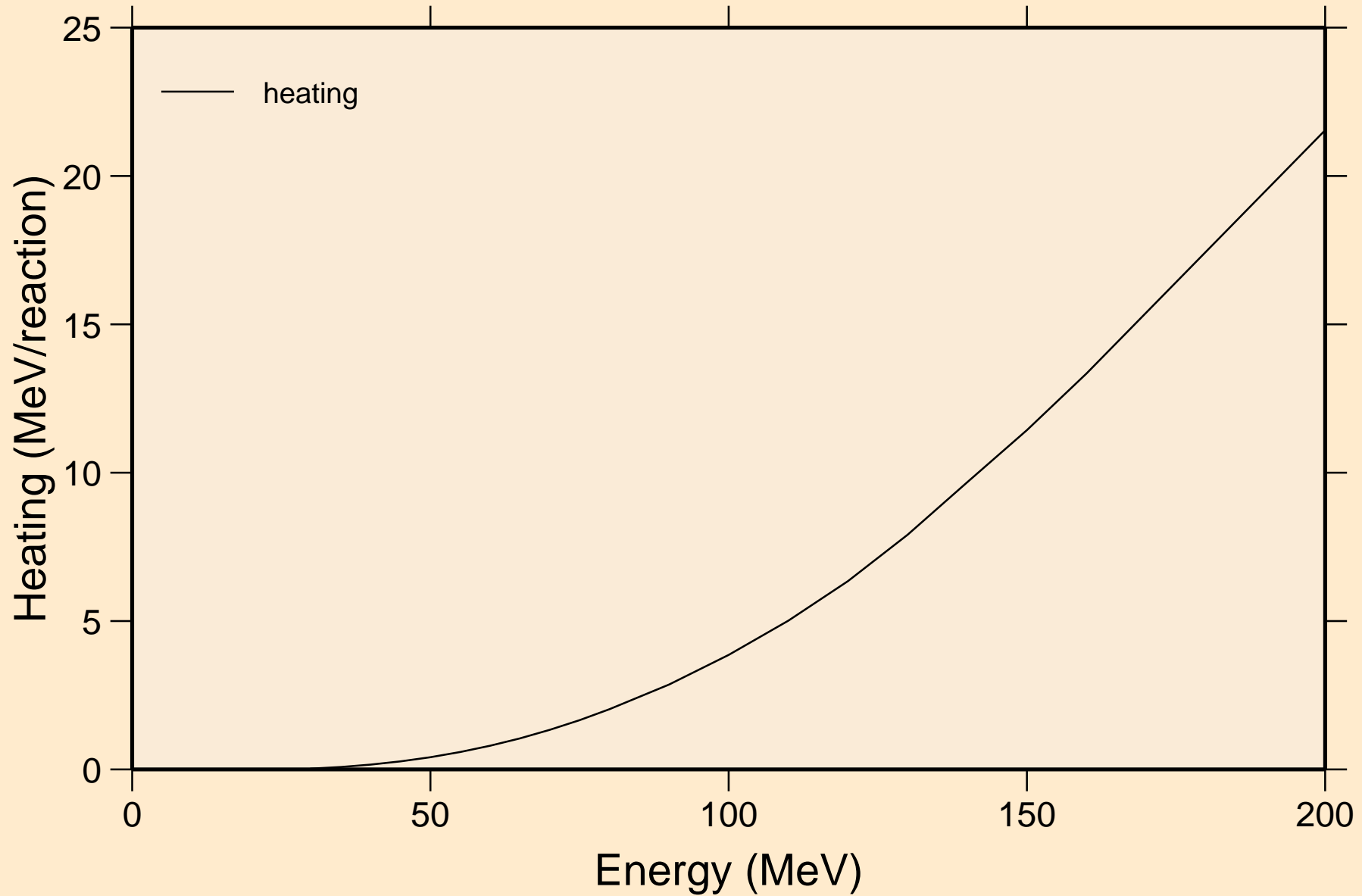

SG268 HELION ACER TENDL-2024 LIBRARY; T=0.K  
Threshold reactions

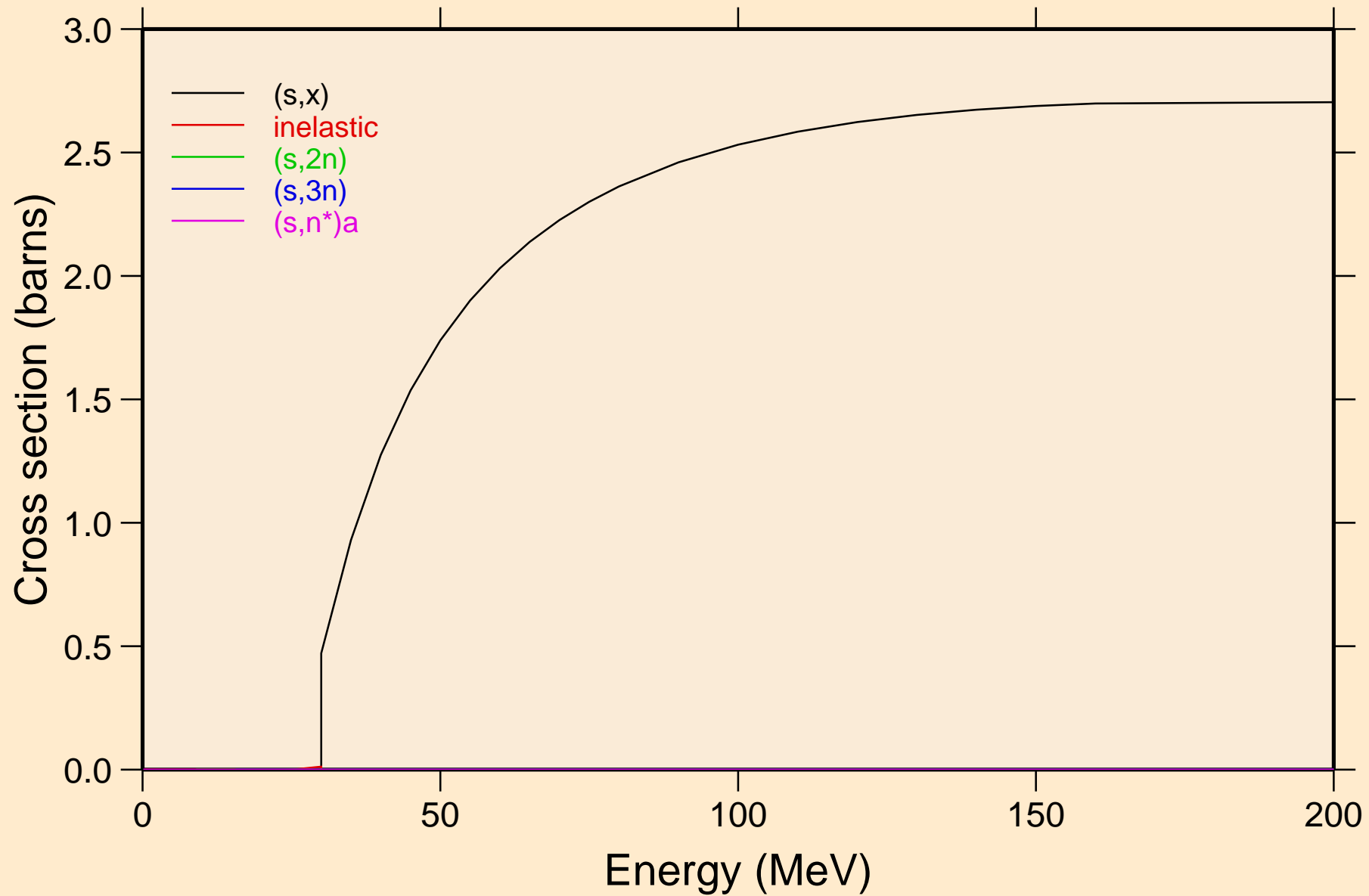

SG268 HELION ACER TENDL-2024 LIBRARY; T=0.K  
Threshold reactions

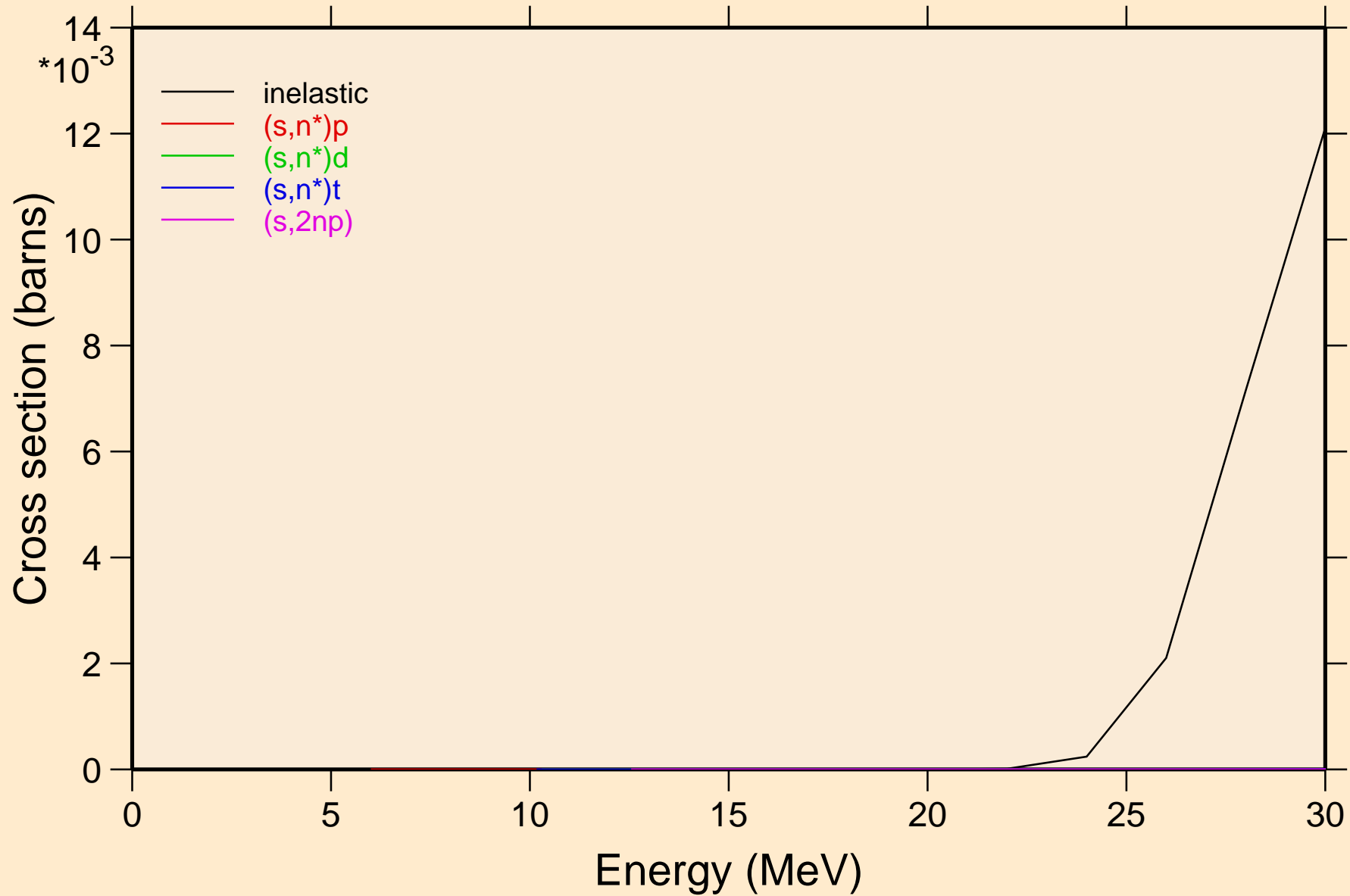

# SG268 HELION ACER TENDL-2024 LIBRARY; T=0.K

## Threshold reactions

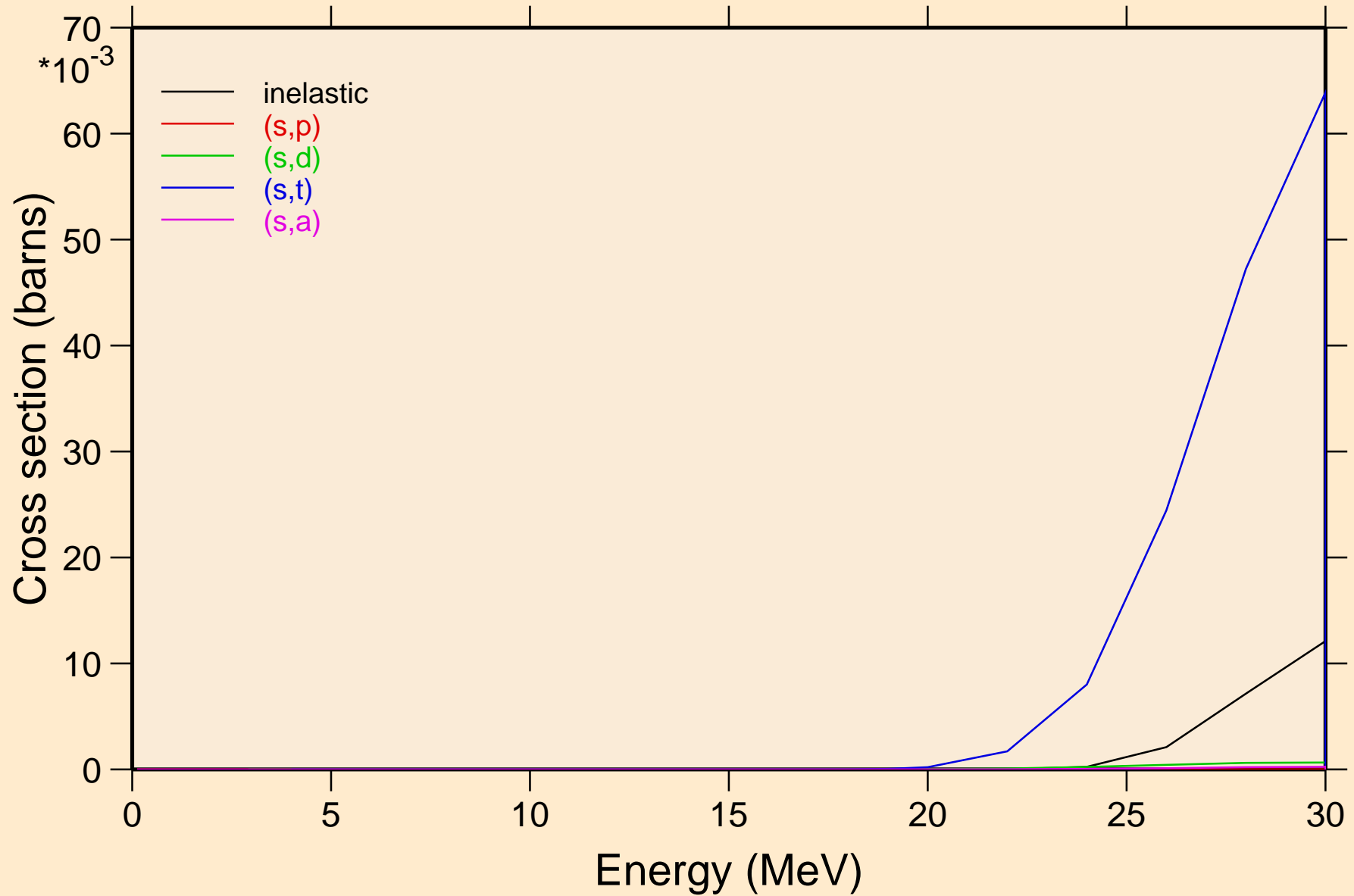

SG268 HELION ACER TENDL-2024 LIBRARY; T=0.K  
Threshold reactions

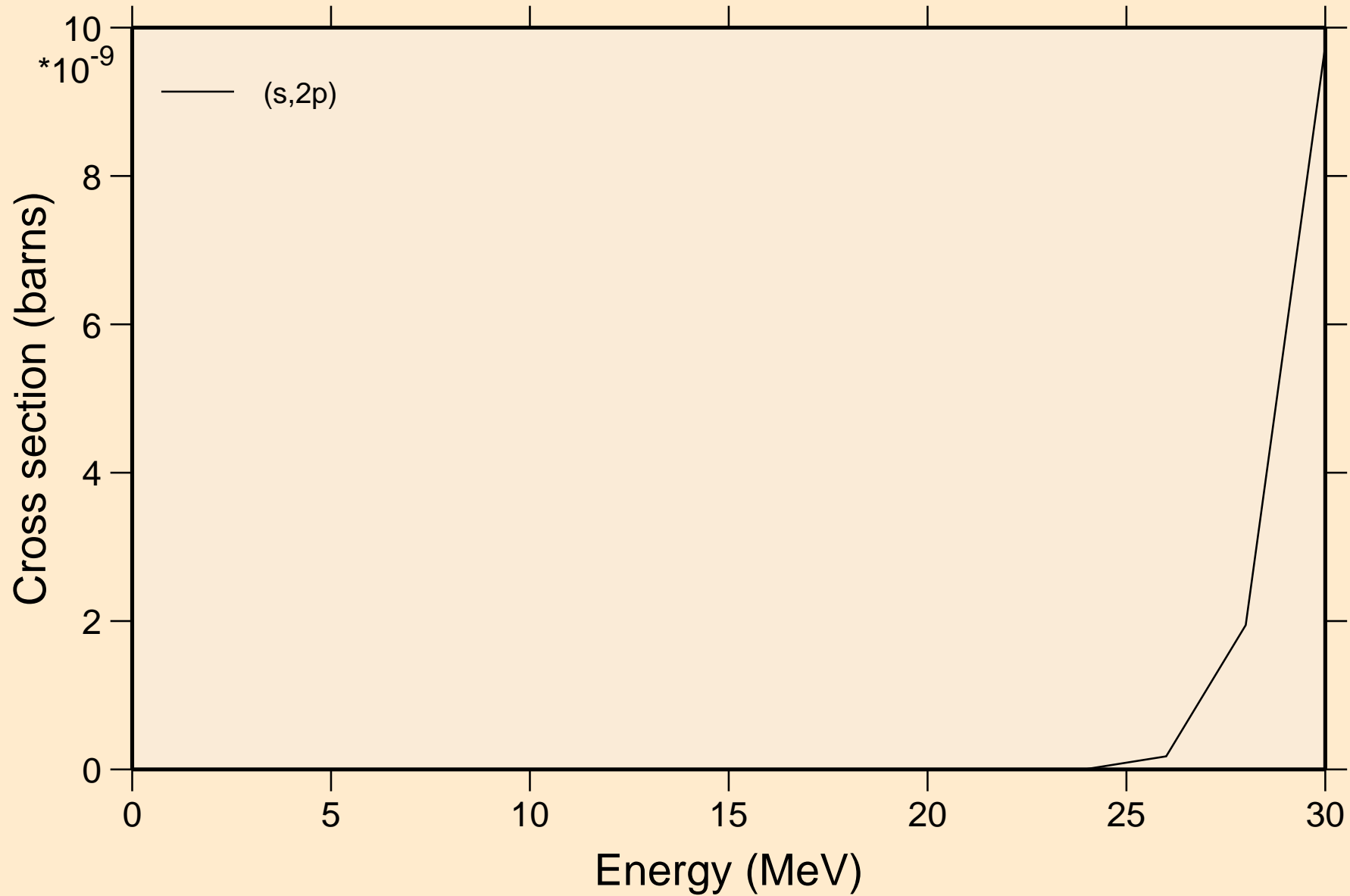

SG268 HELION ACER TENDL-2024 LIBRARY; T=0.K  
angular distribution for elastic

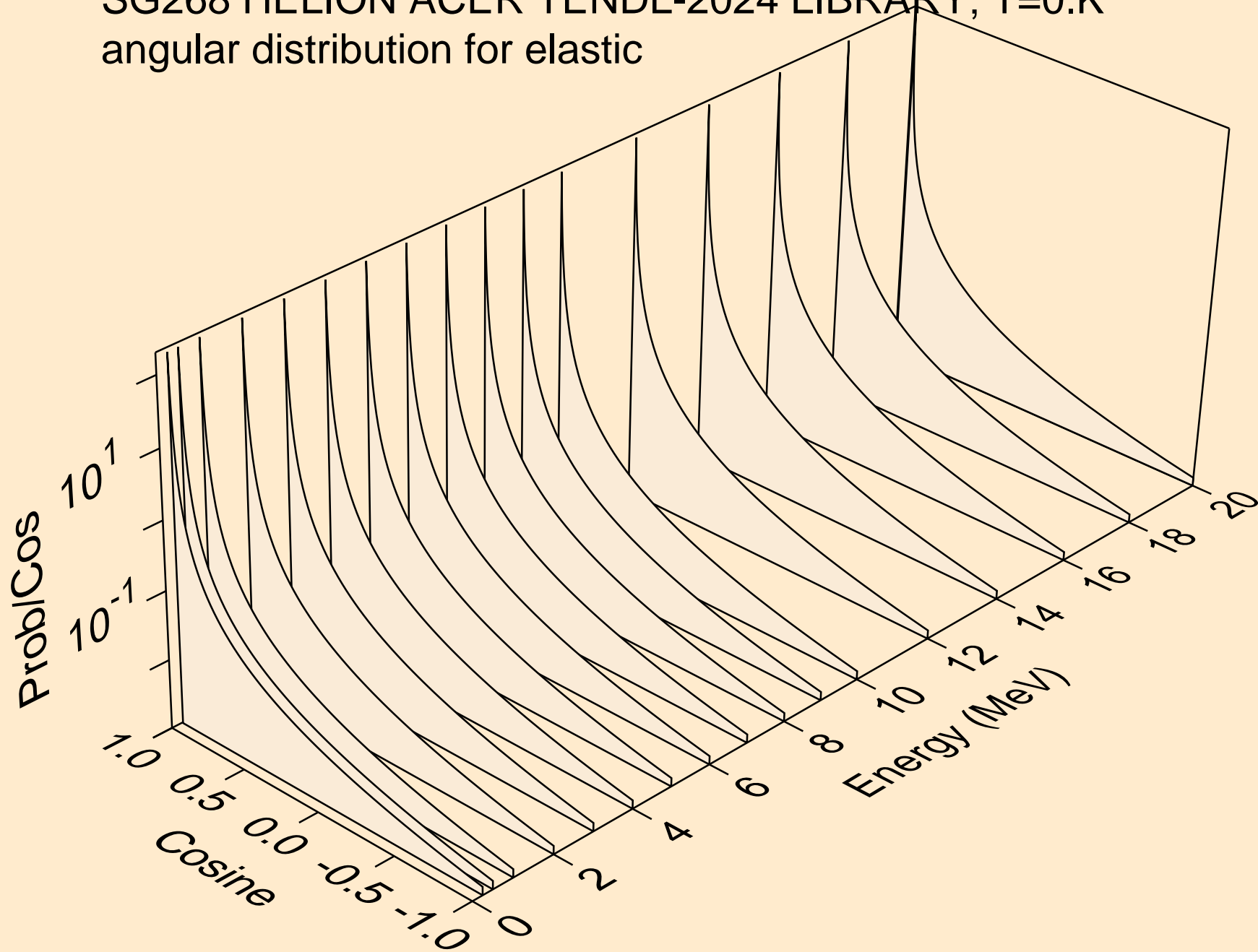

SG268 HELION ACER TENDL-2024 LIBRARY; T=0.K  
angular distribution for elastic

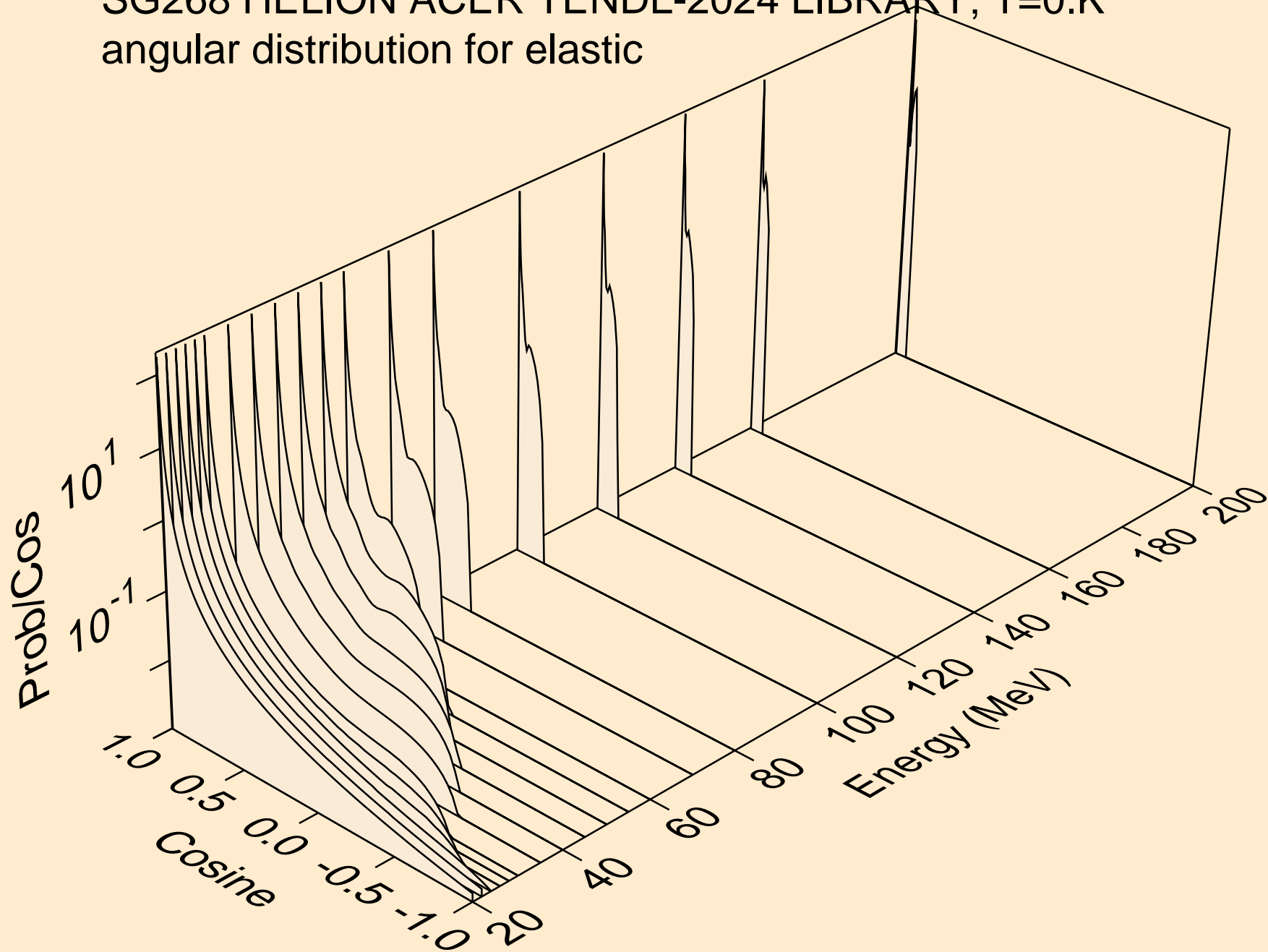

SG268 HELION ACER TENDL-2024 LIBRARY; T=0.K  
He-3 emission for (s,x)

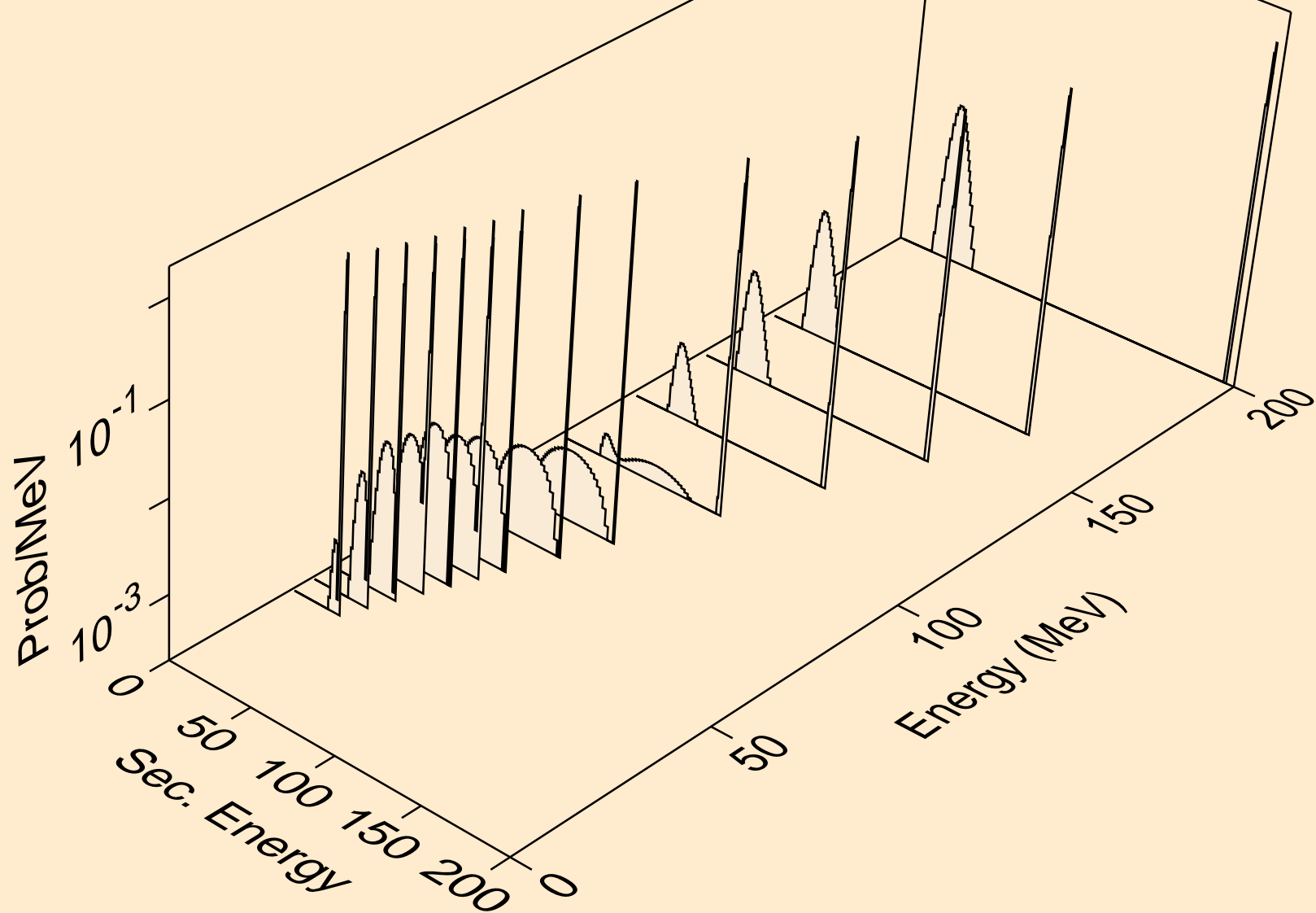

SG268 HELION ACER TENDL-2024 LIBRARY; T=0.K  
He-3 emission for inelastic

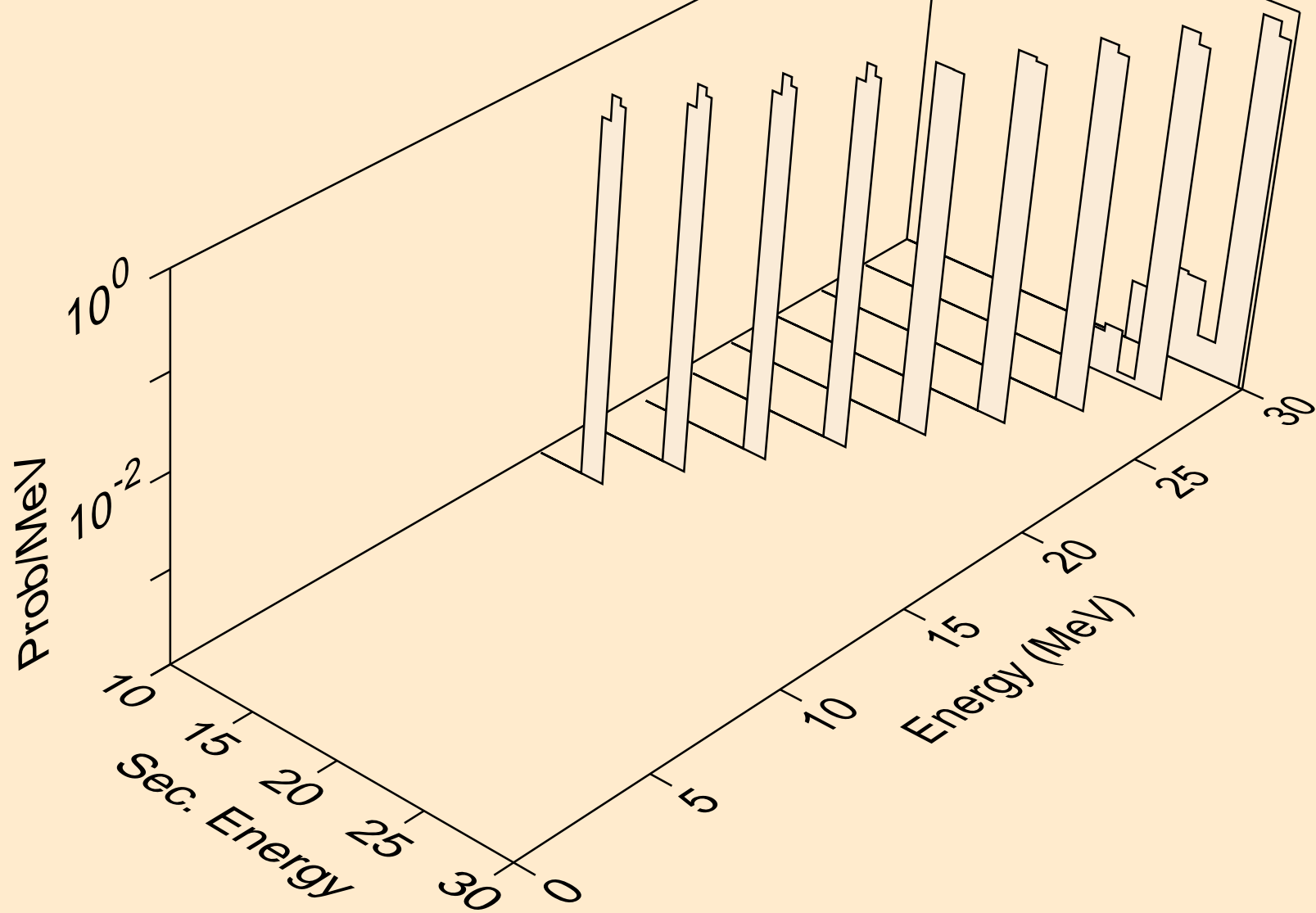

SG268 HELION ACER TENDL-2024 LIBRARY; T=0.K  
Photon emission for (z,n)

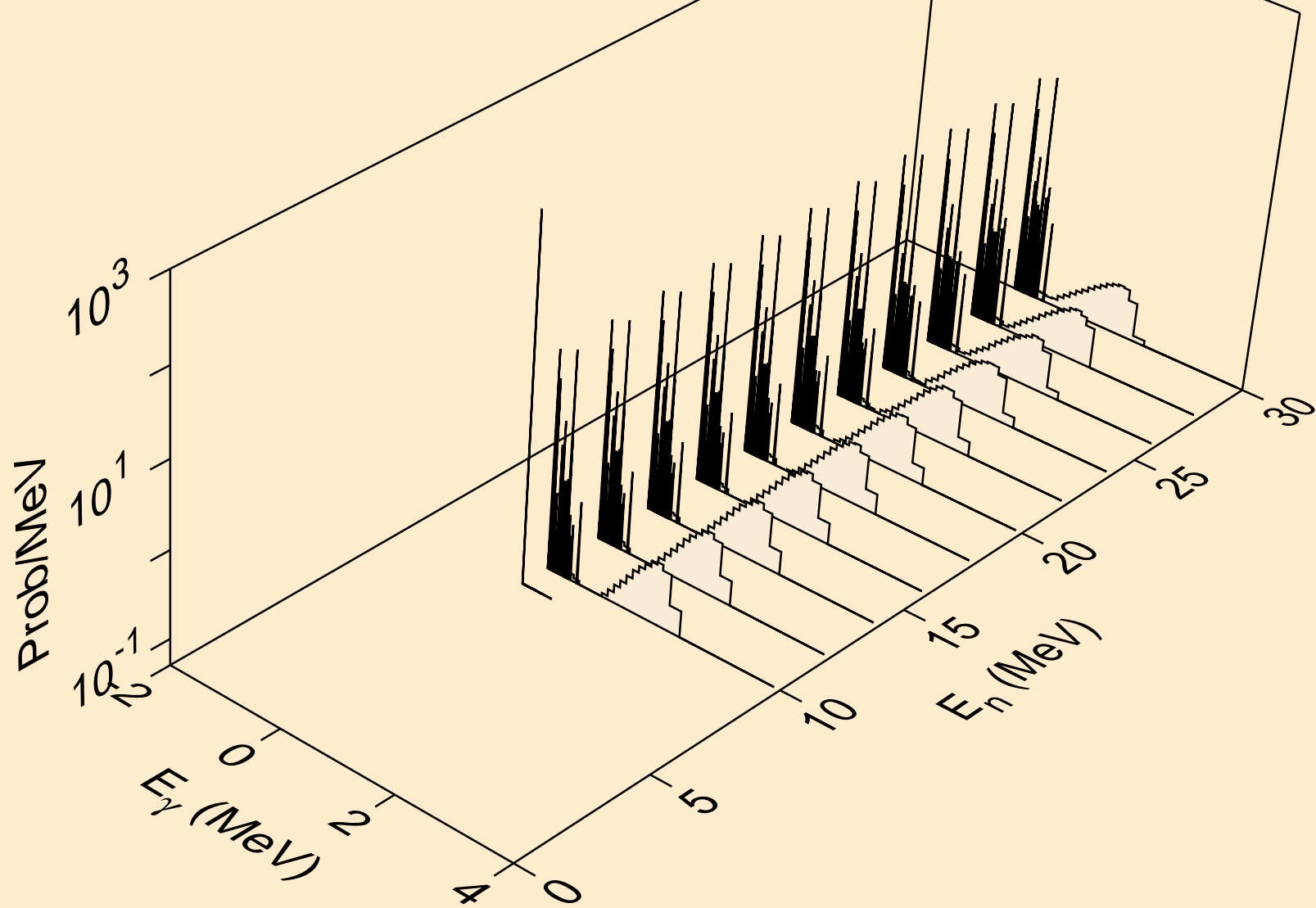

SG268 HELION ACER TENDL-2024 LIBRARY; T=0.K  
Photon emission for (z,x)

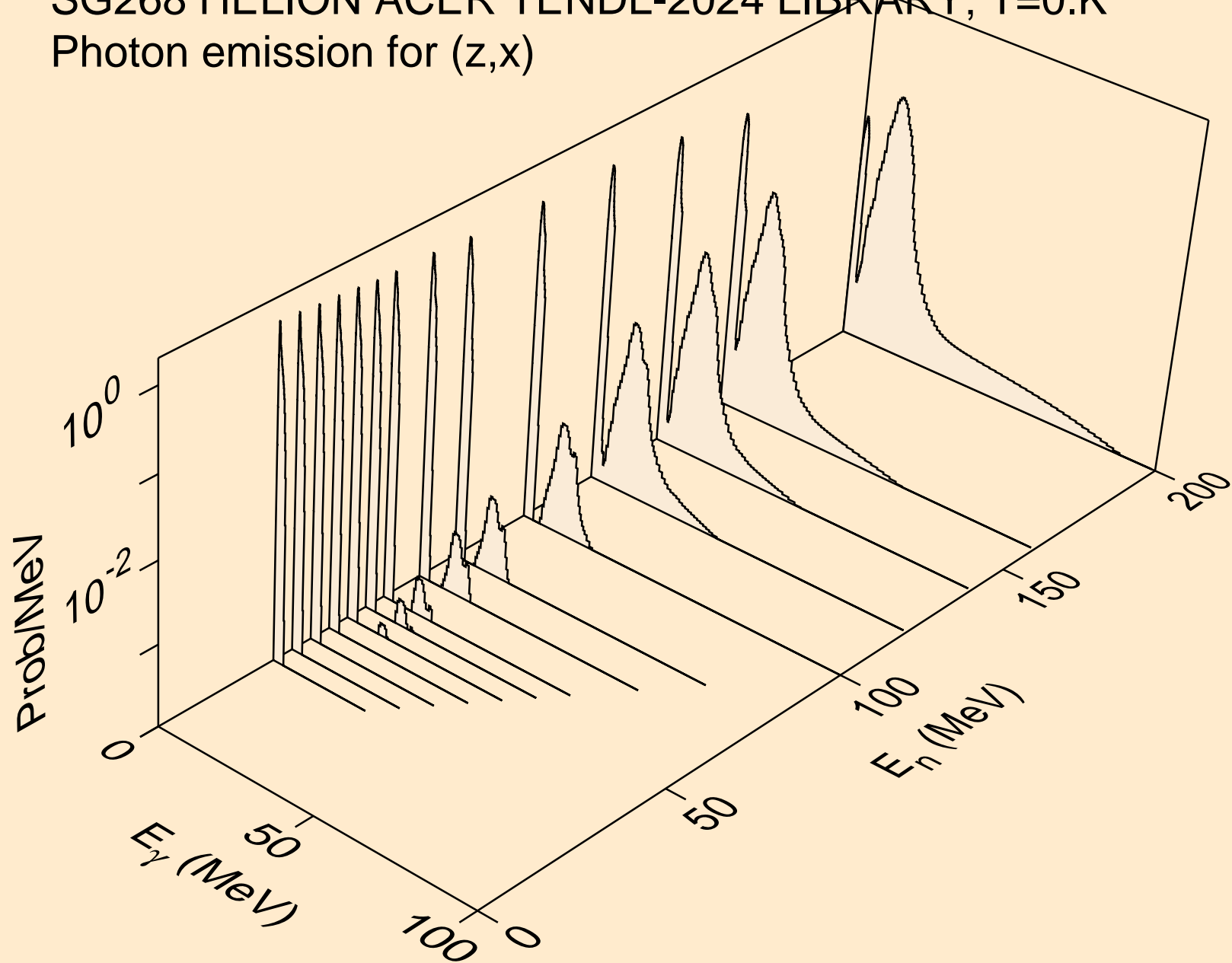

SG268 HELION ACER TENDL-2024 LIBRARY; T=0.K  
Photon emission for (n,2n)

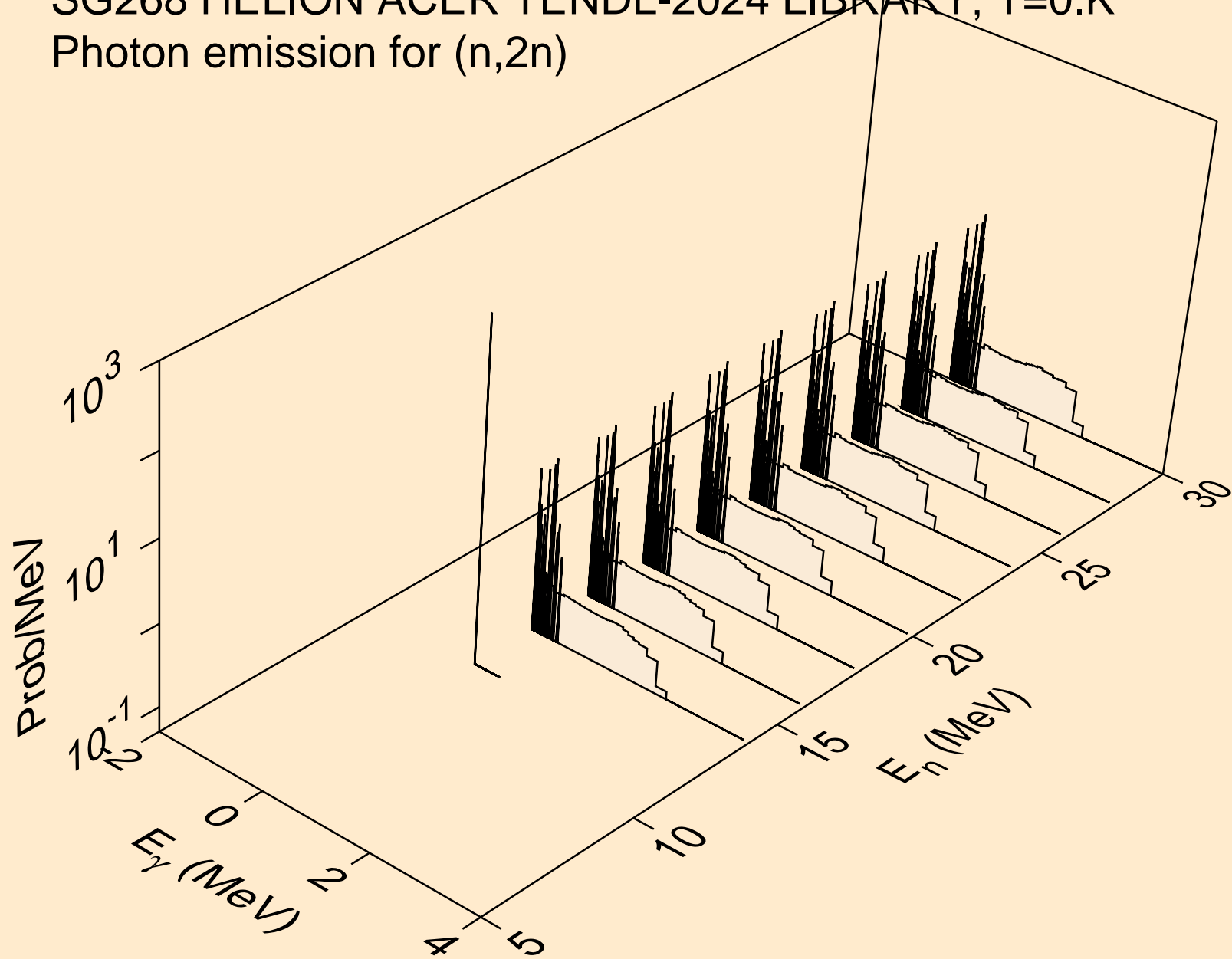

SG268 HELION ACER TENDL-2024 LIBRARY; T=0.K  
Photon emission for (n,3n)

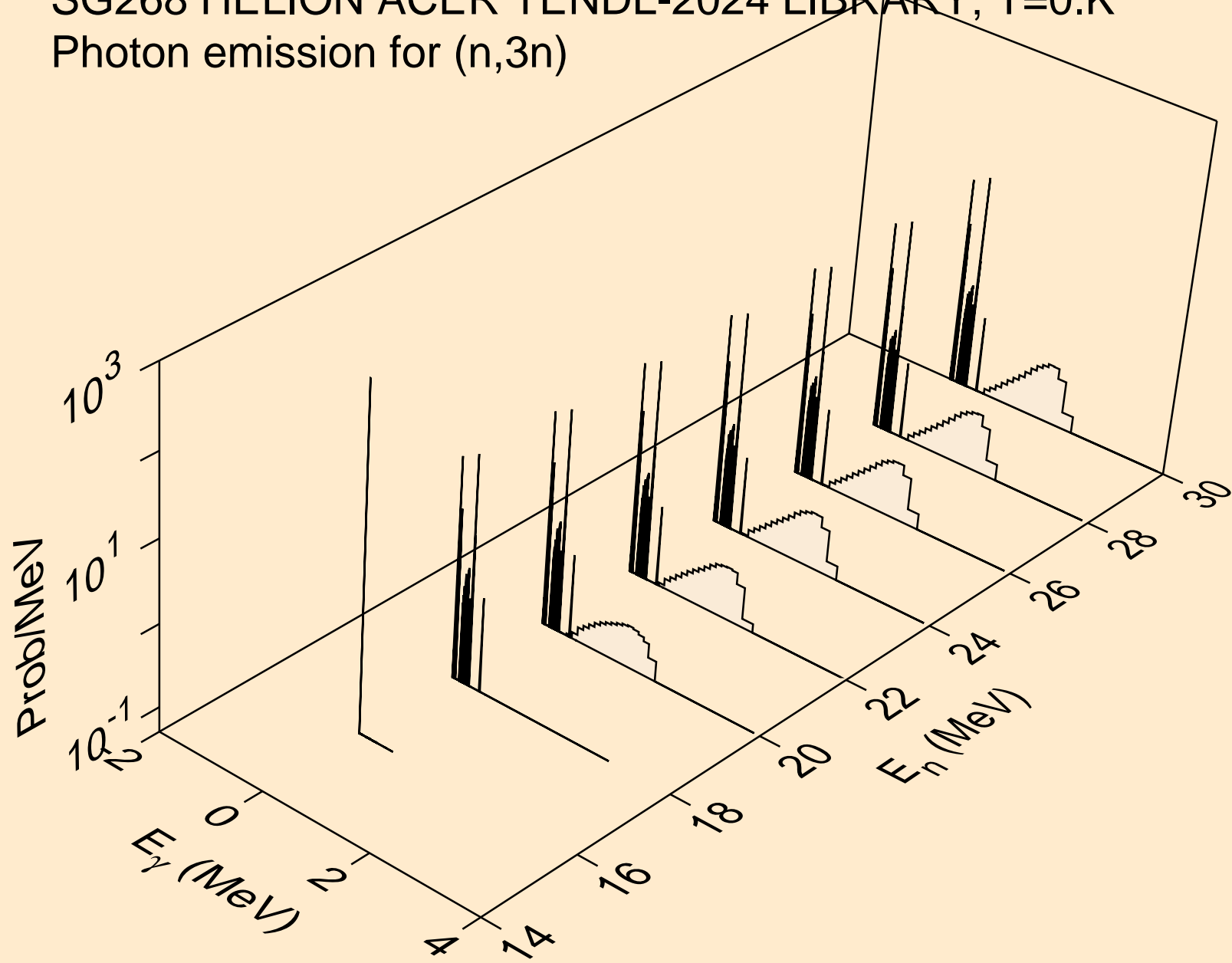

SG268 HELION ACER TENDL-2024 LIBRARY; T=0.K  
Photon emission for (n,n\*)a

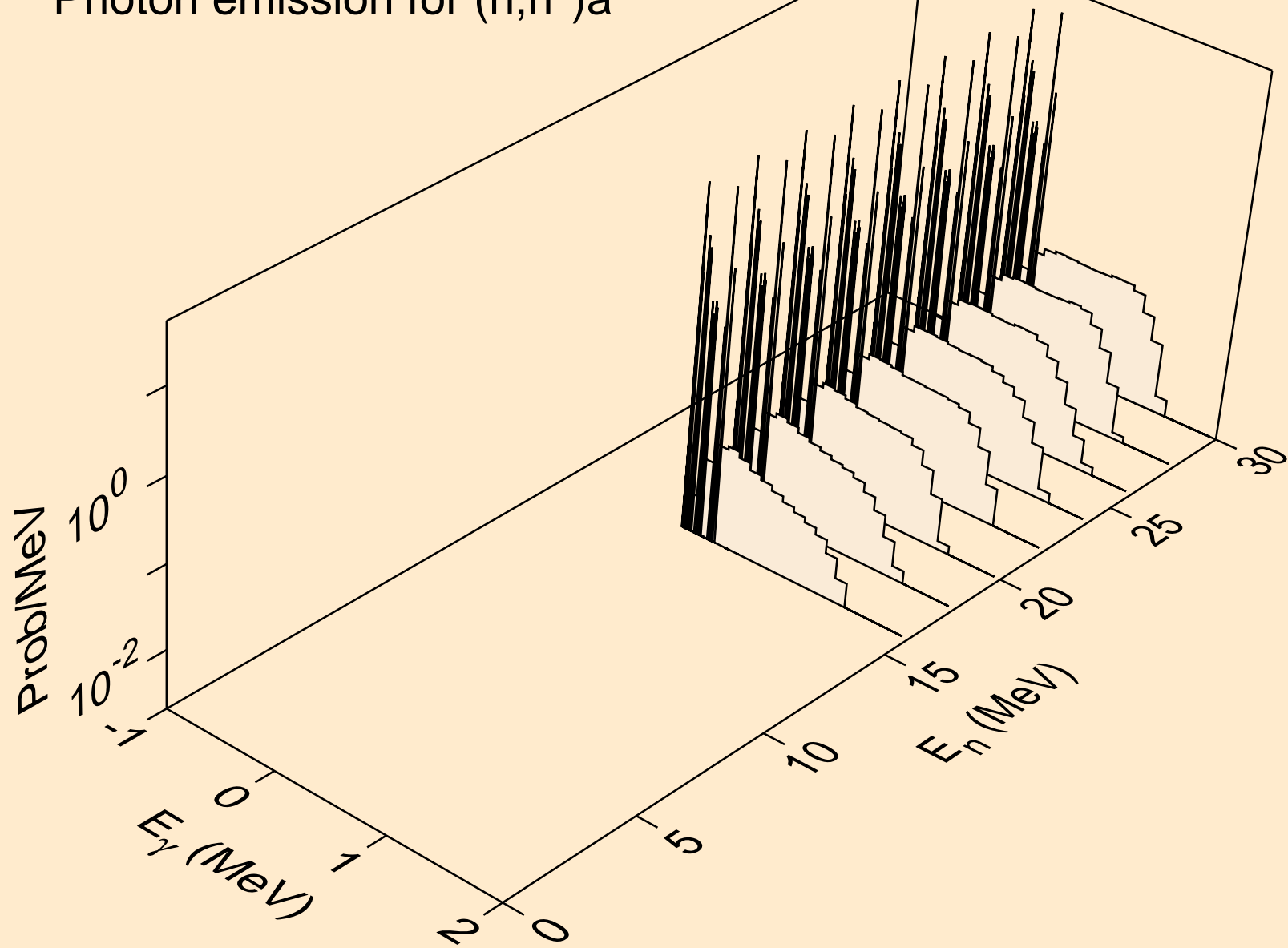

SG268 HELION ACER TENDL-2024 LIBRARY; T=0.K  
Photon emission for (n,n\*)p

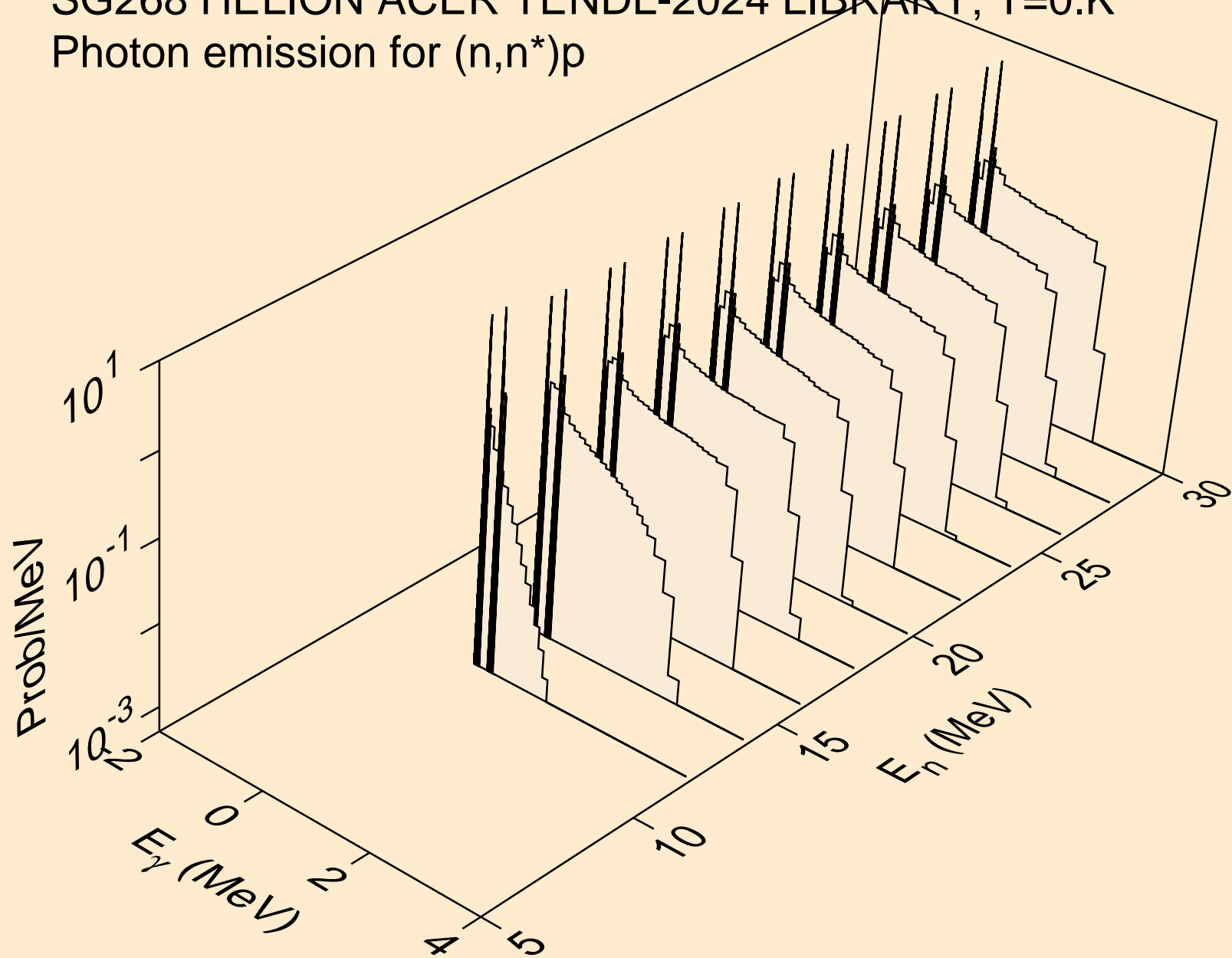

SG268 HELION ACER TENDL-2024 LIBRARY; T=0.K  
Photon emission for (n,n\*)d

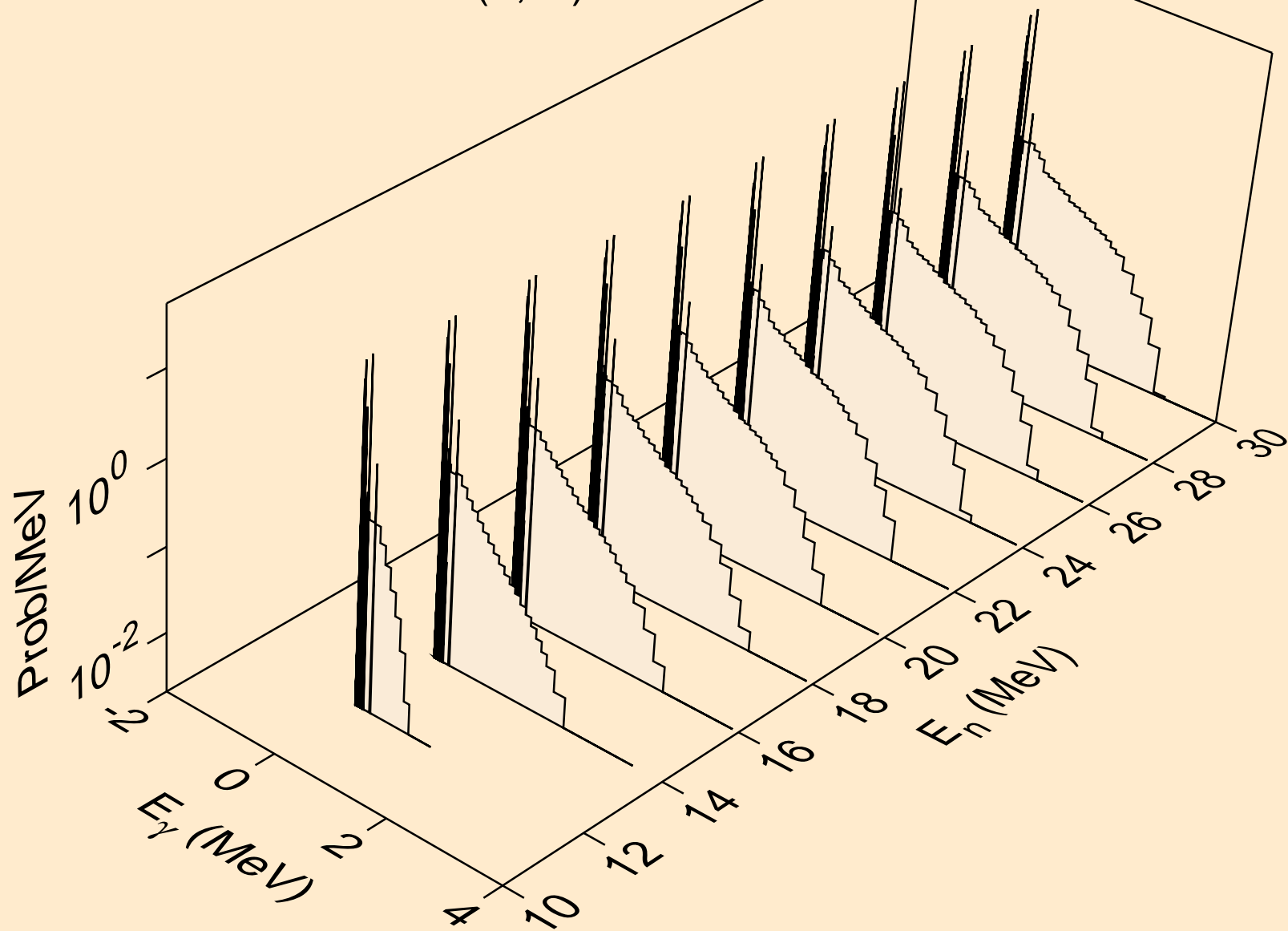

SG268 HELION ACER TENDL-2024 LIBRARY; T=0.K  
Photon emission for (n,n\*)t

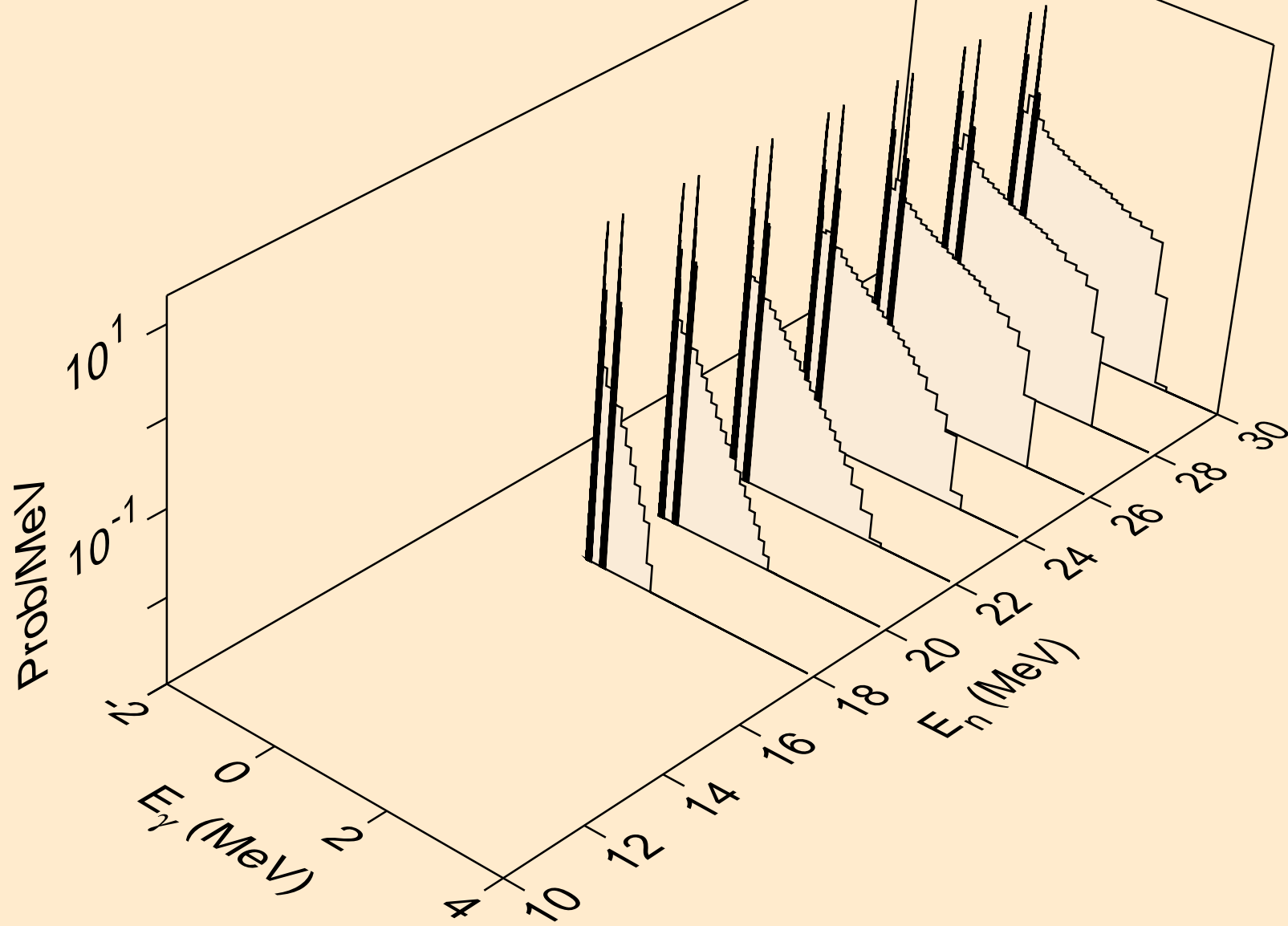

SG268 HELION ACER TENDL-2024 LIBRARY; T=0.K  
Photon emission for (n,2np)

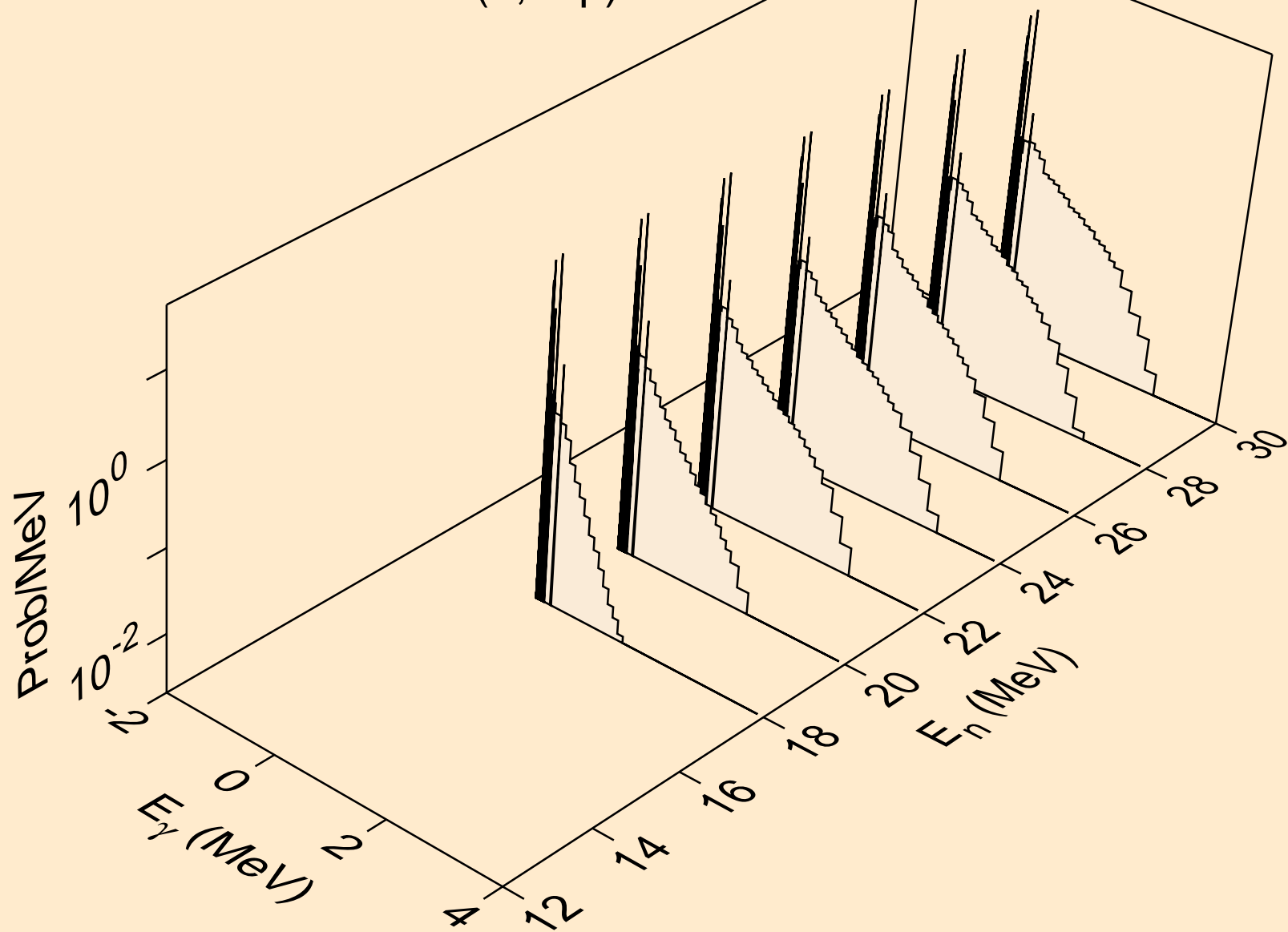

SG268 HELION ACER TENDL-2024 LIBRARY; T=0.K  
Photon emission for (n,p)

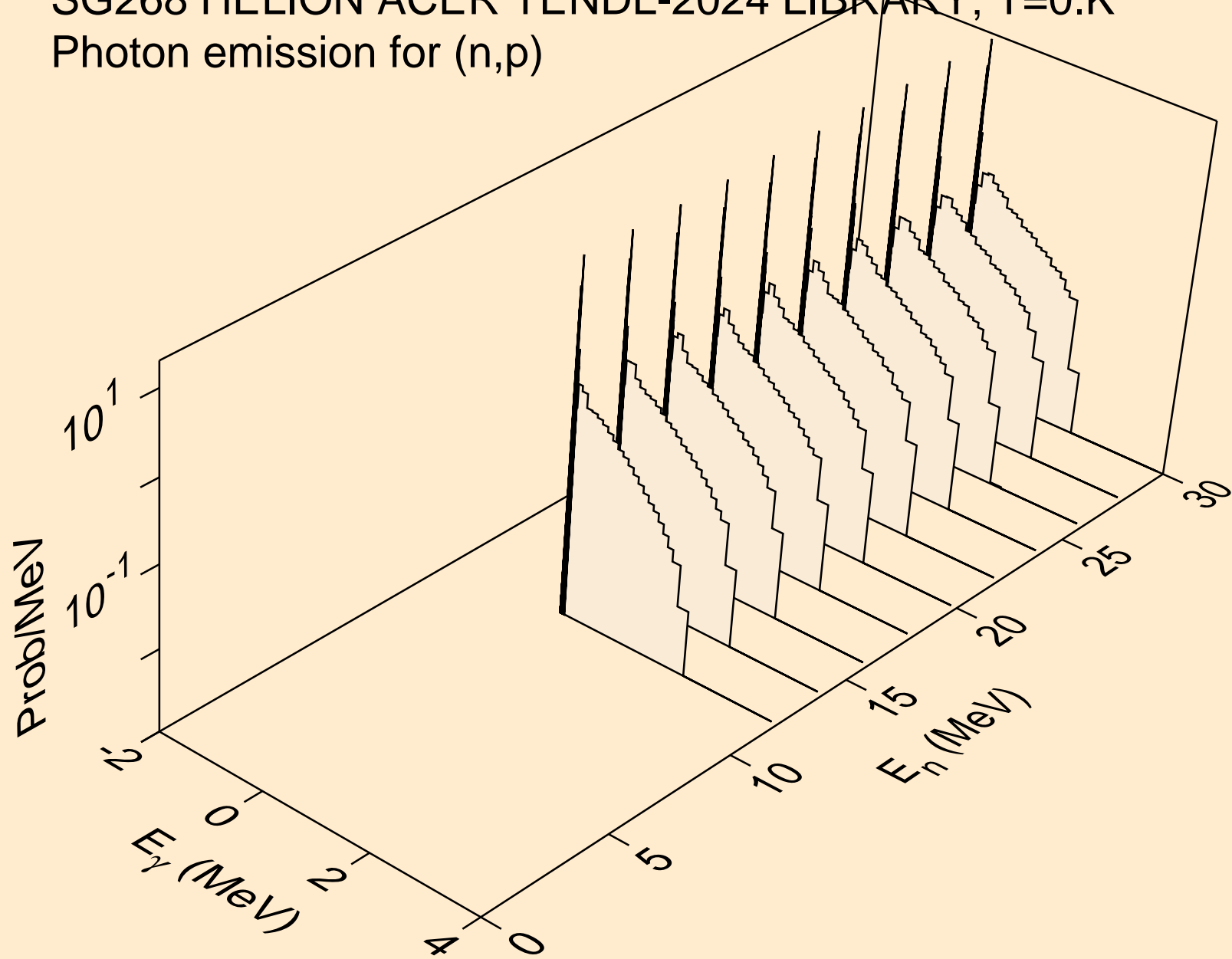

SG268 HELION ACER TENDL-2024 LIBRARY; T=0.K  
Photon emission for (n,d)

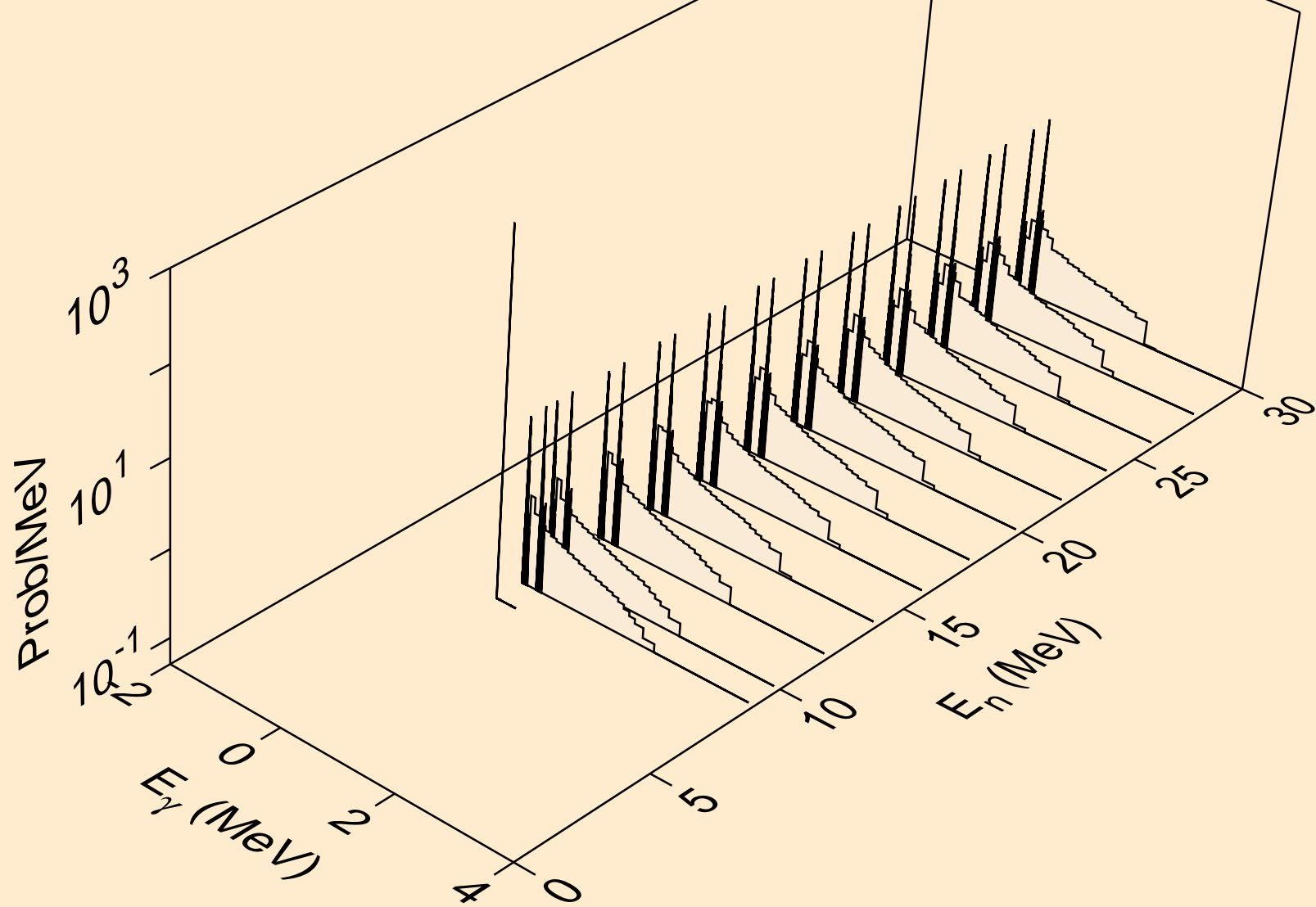

SG268 HELION ACER TENDL-2024 LIBRARY; T=0.K  
Photon emission for (n,t)

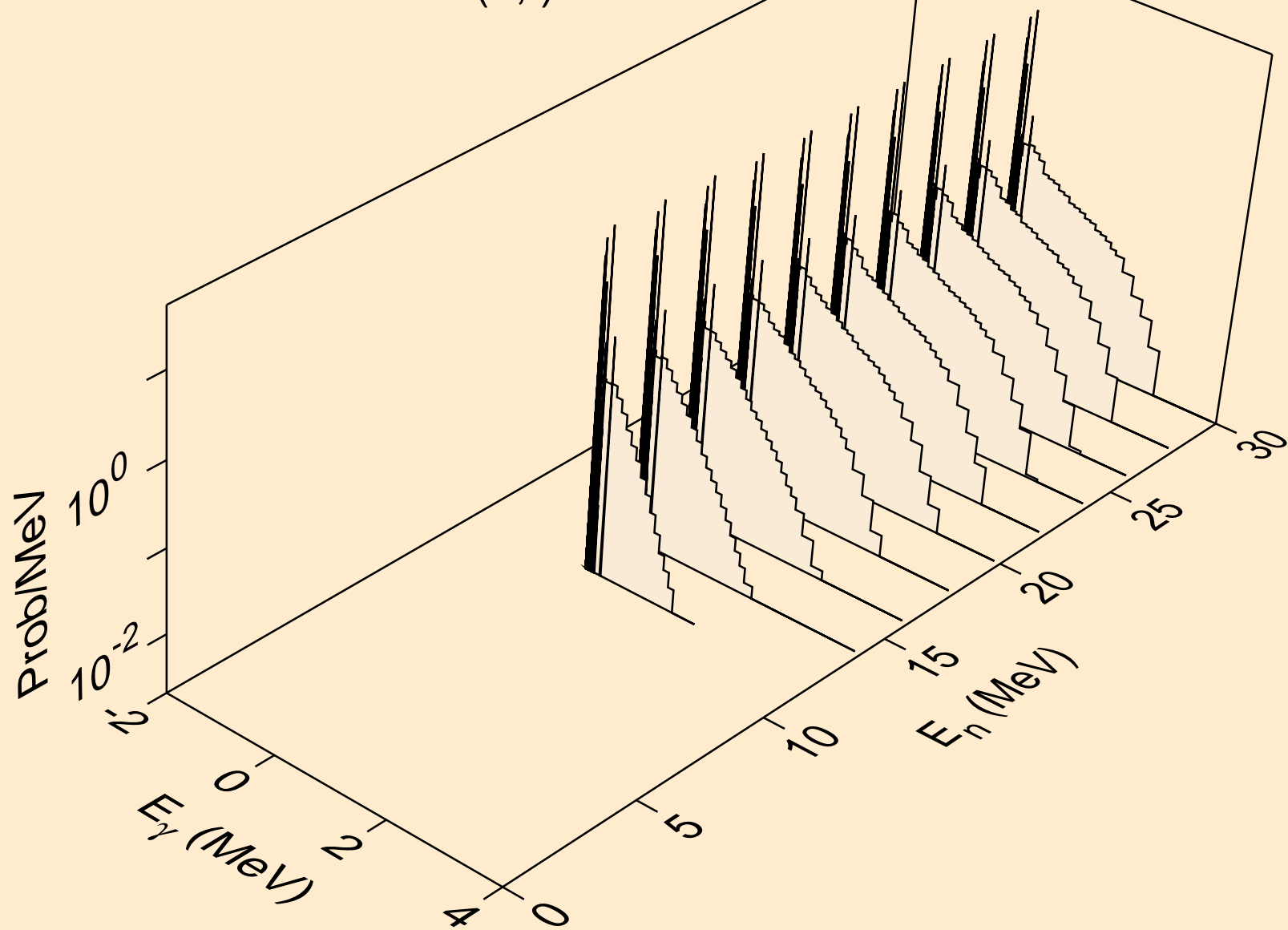

SG268 HELION ACER TENDL-2024 LIBRARY; T=0.K  
Photon emission for inelastic

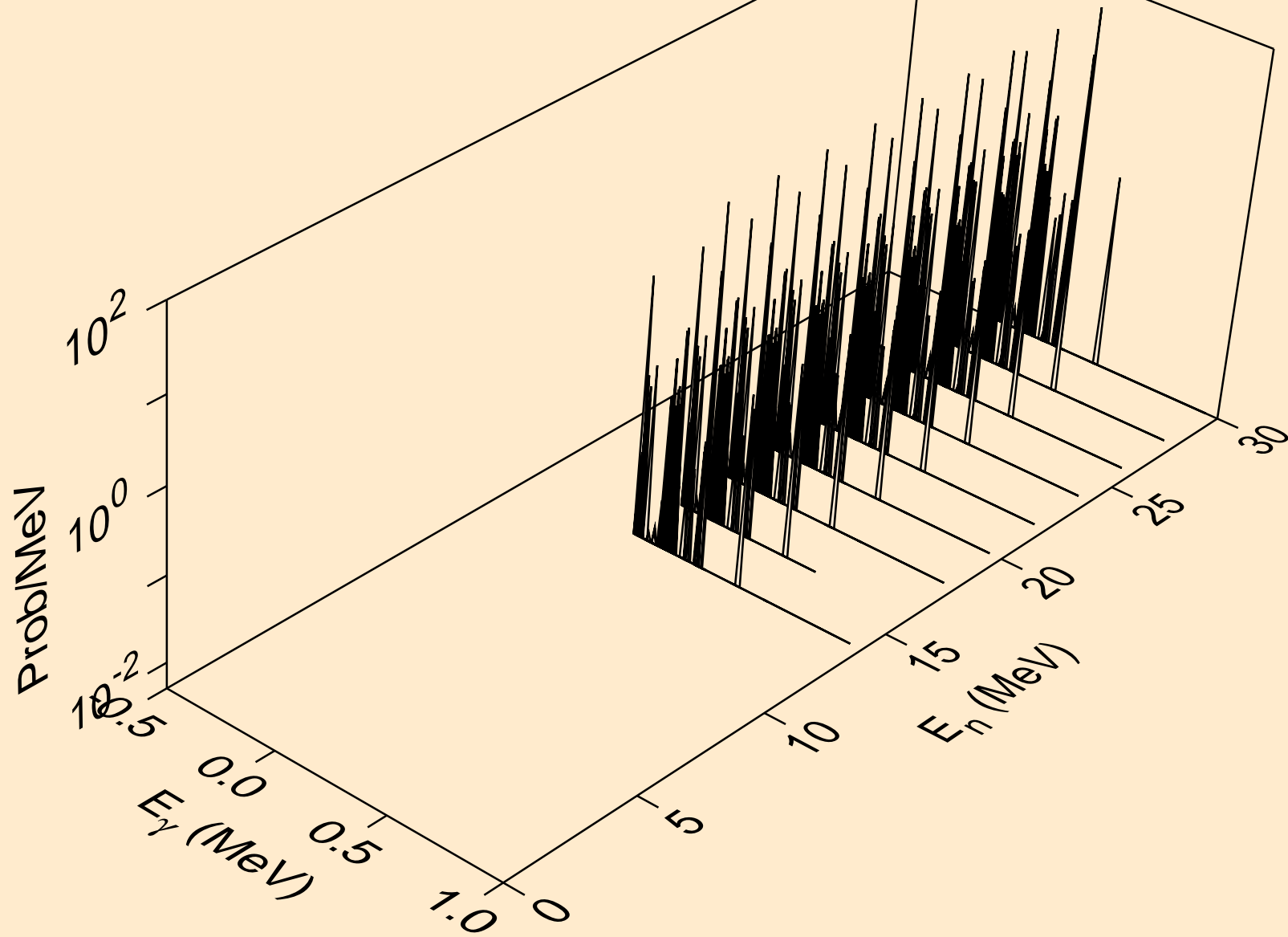

SG268 HELION ACER TENDL-2024 LIBRARY; T=0.K  
Photon emission for (n,a)

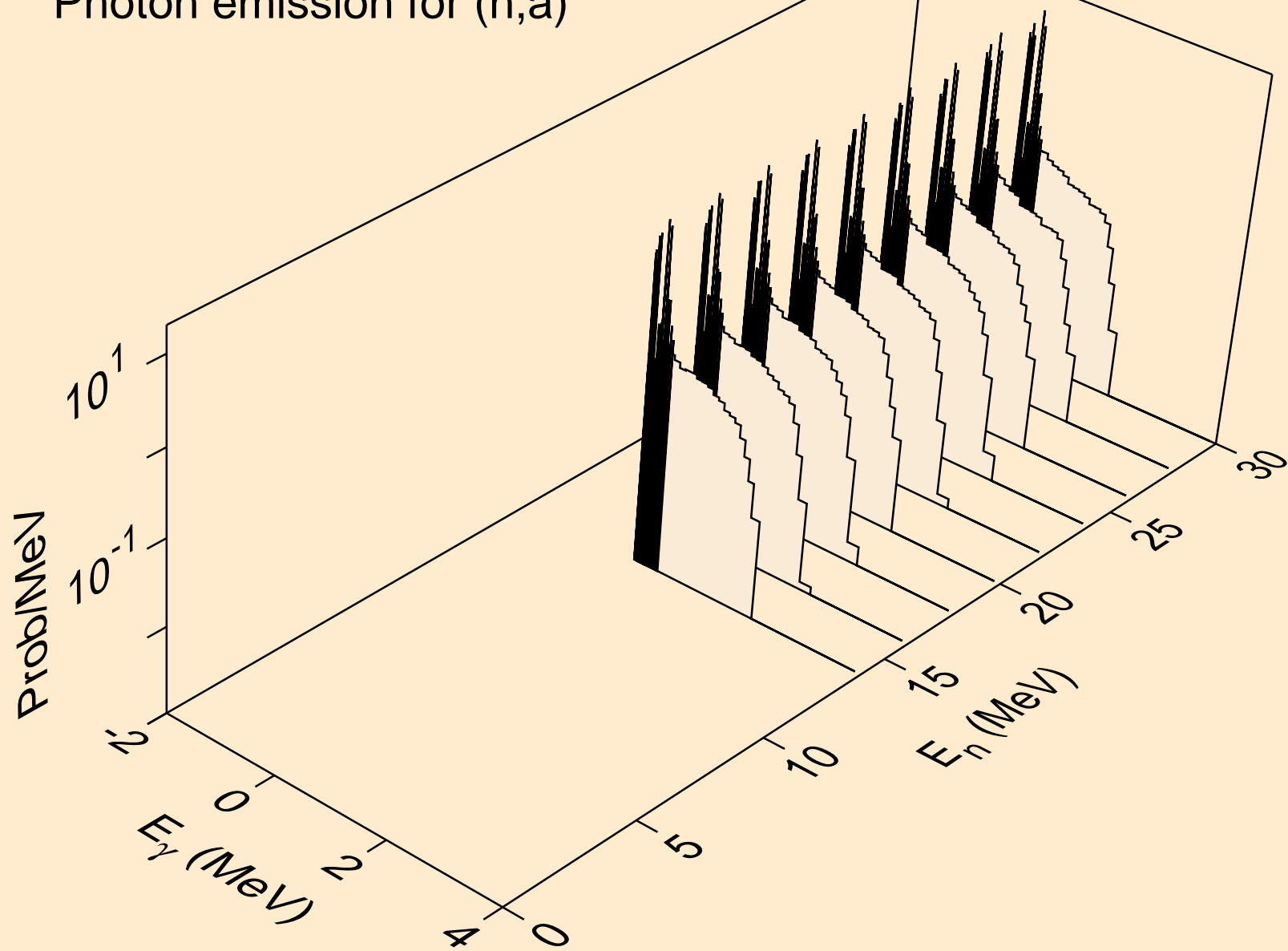

SG268 HELION ACER TENDL-2024 LIBRARY; T=0.K  
Photon emission for (n,2p)

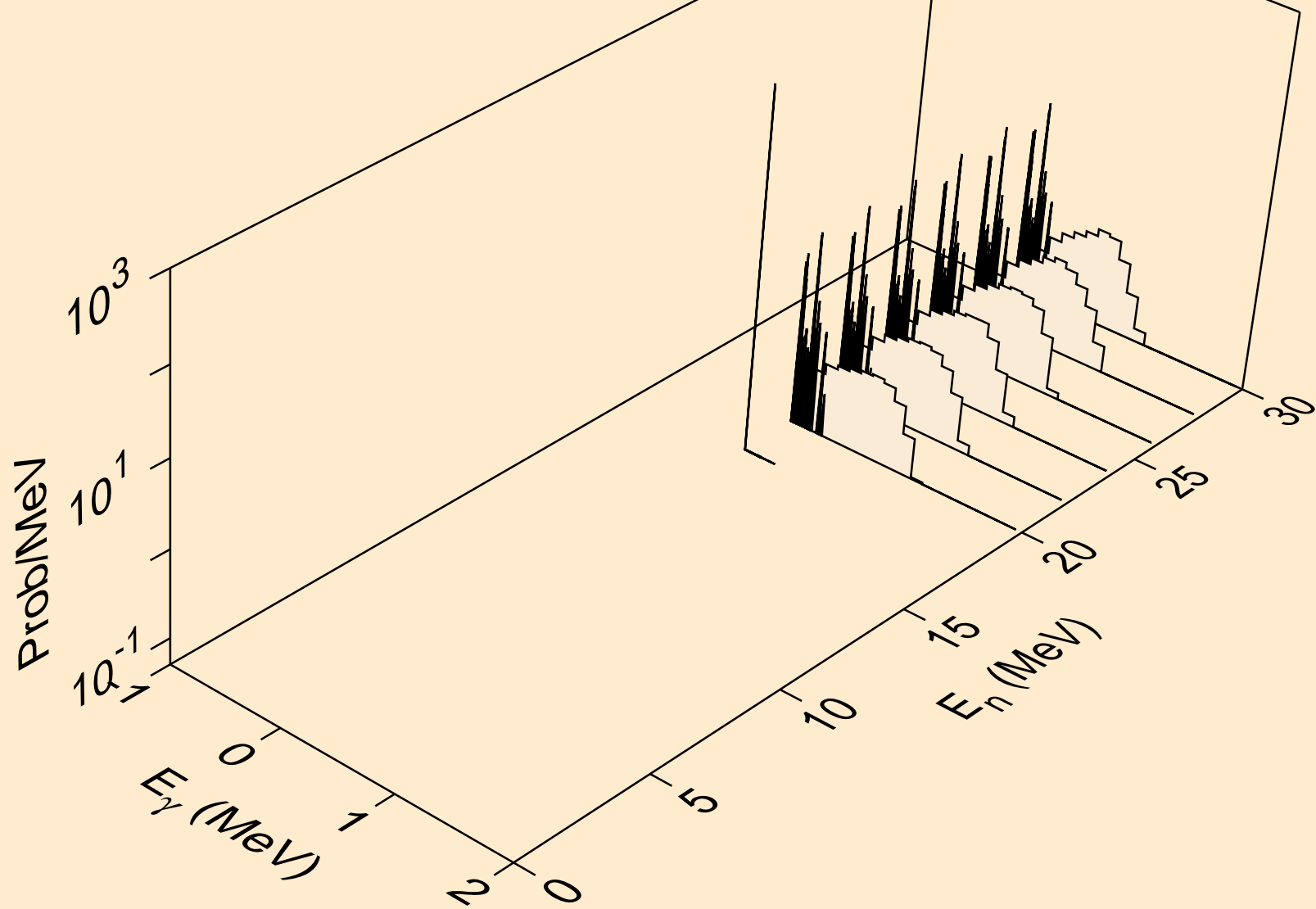

# SG268 HELION ACER TENDL-2024 LIBRARY; T=0.K

## Particle heating contributions

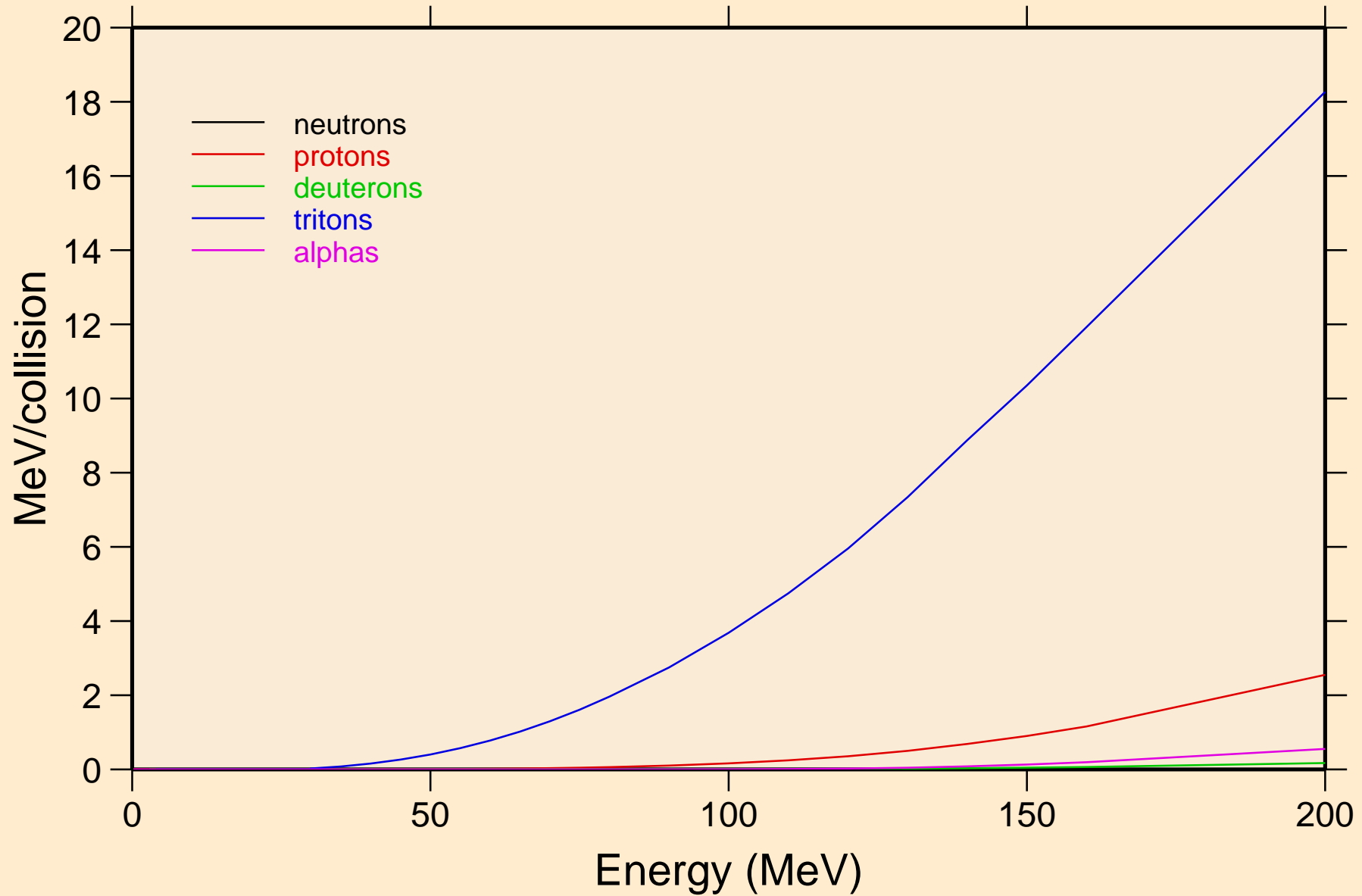

# SG268 HELION ACER TENDL-2024 LIBRARY; T=0.K

## Recoil Heating

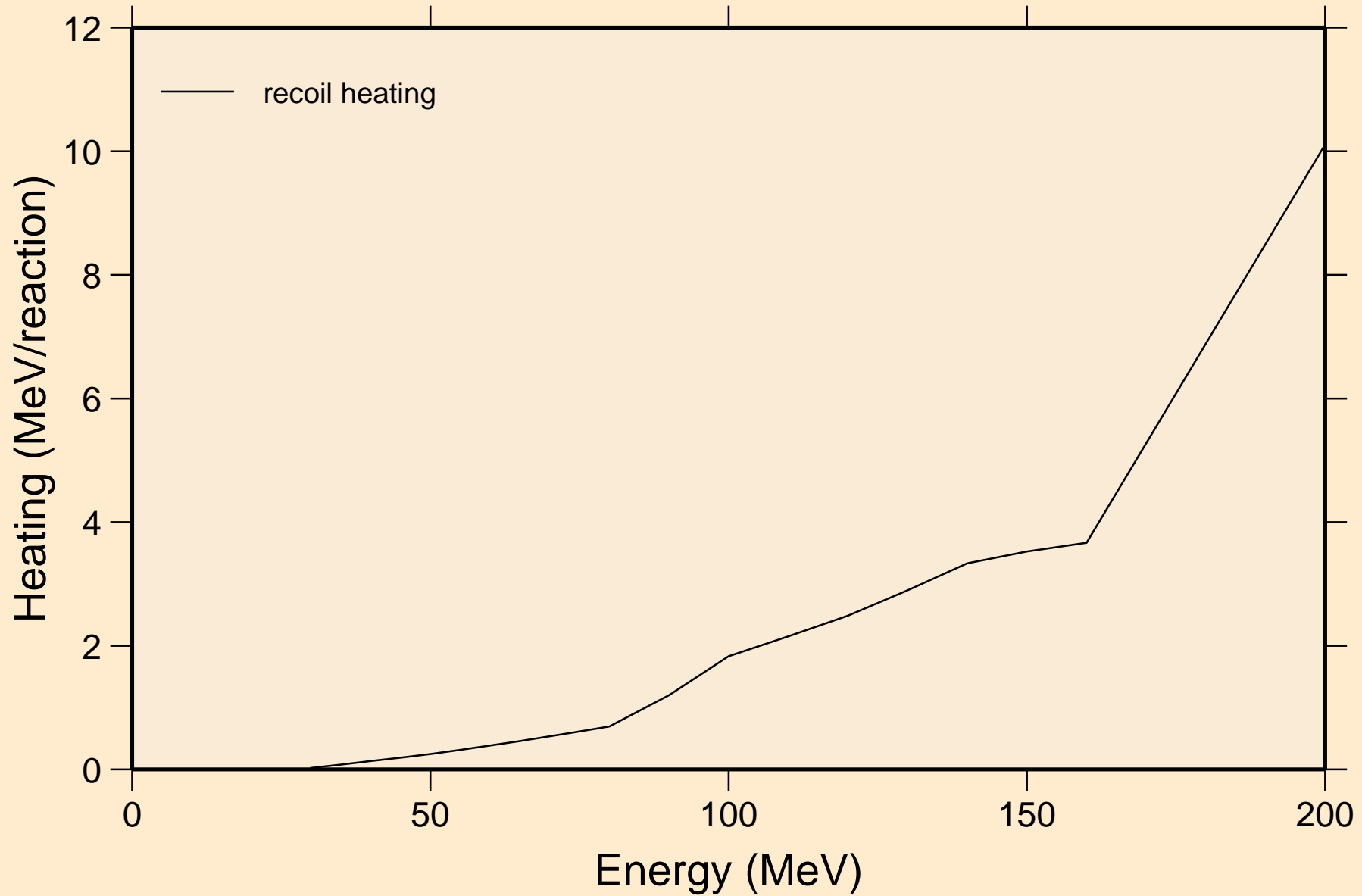

SG268 HELION ACER TENDL-2024 LIBRARY; T=0.K  
Particle production cross sections

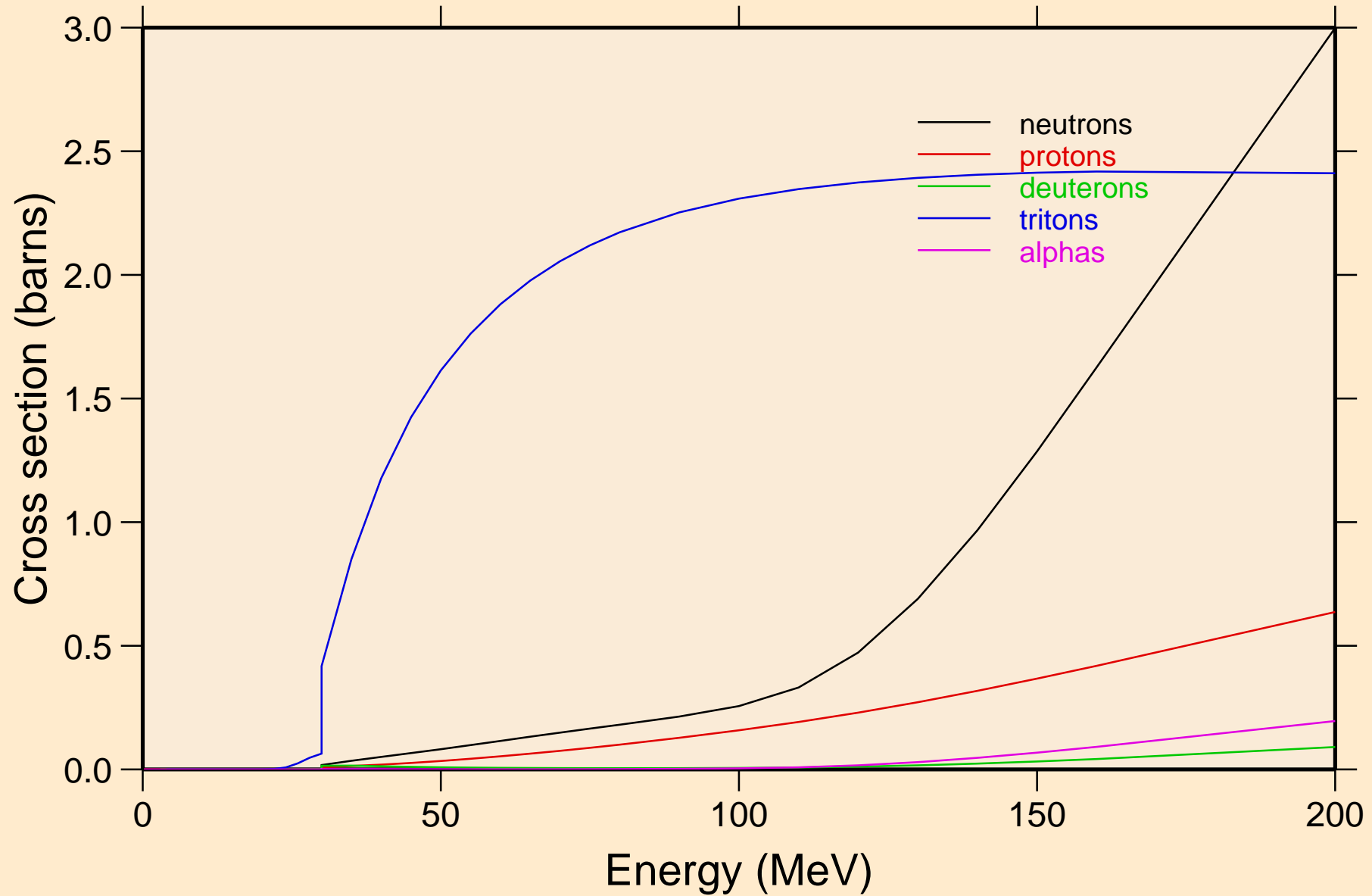

SG268 HELION ACER TENDL-2024 LIBRARY; T=0.K  
neutrons from (s,n)

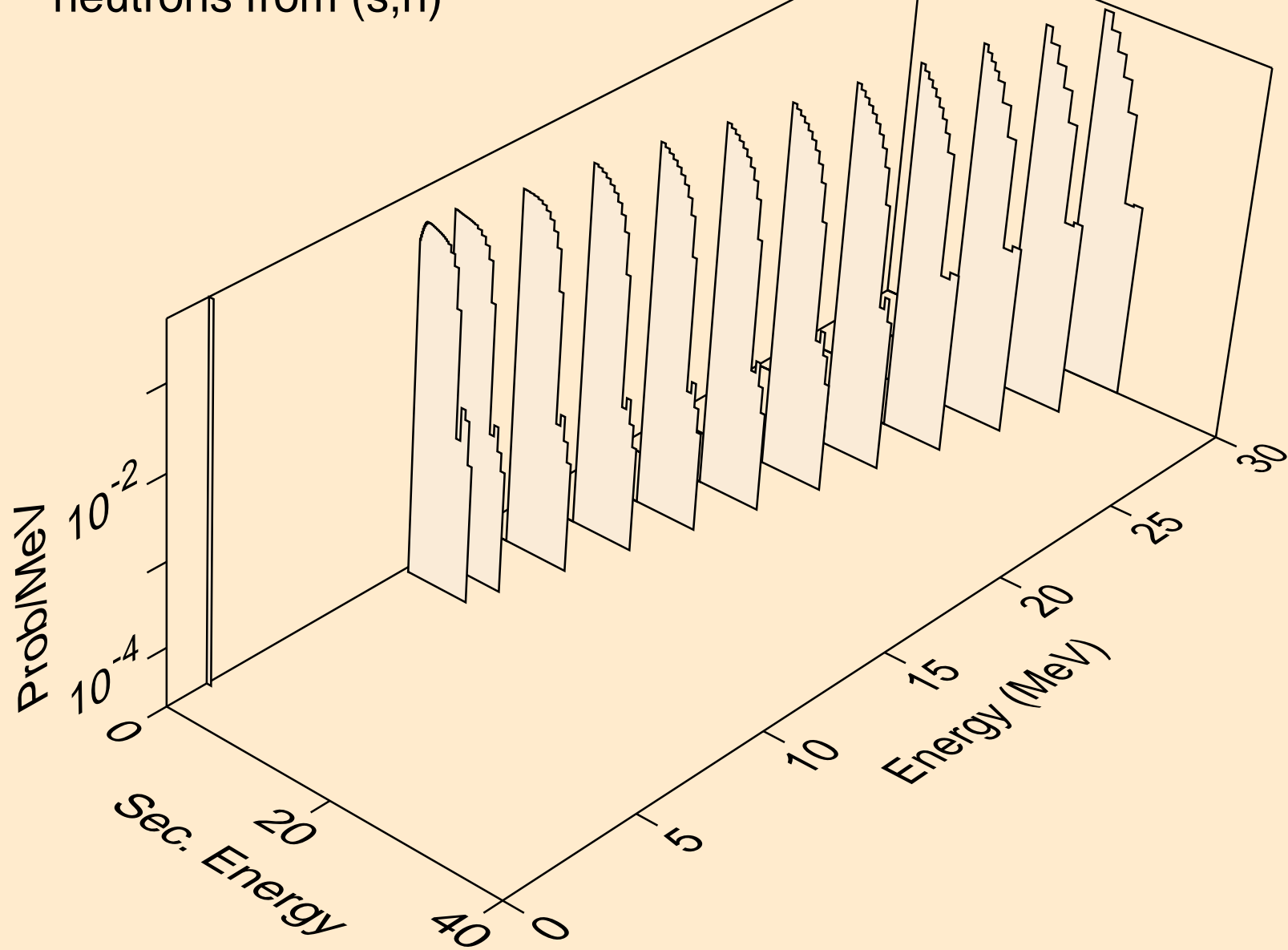

SG268 HELION ACER TENDL-2024 LIBRARY; T=0.K  
neutrons from (s,x)

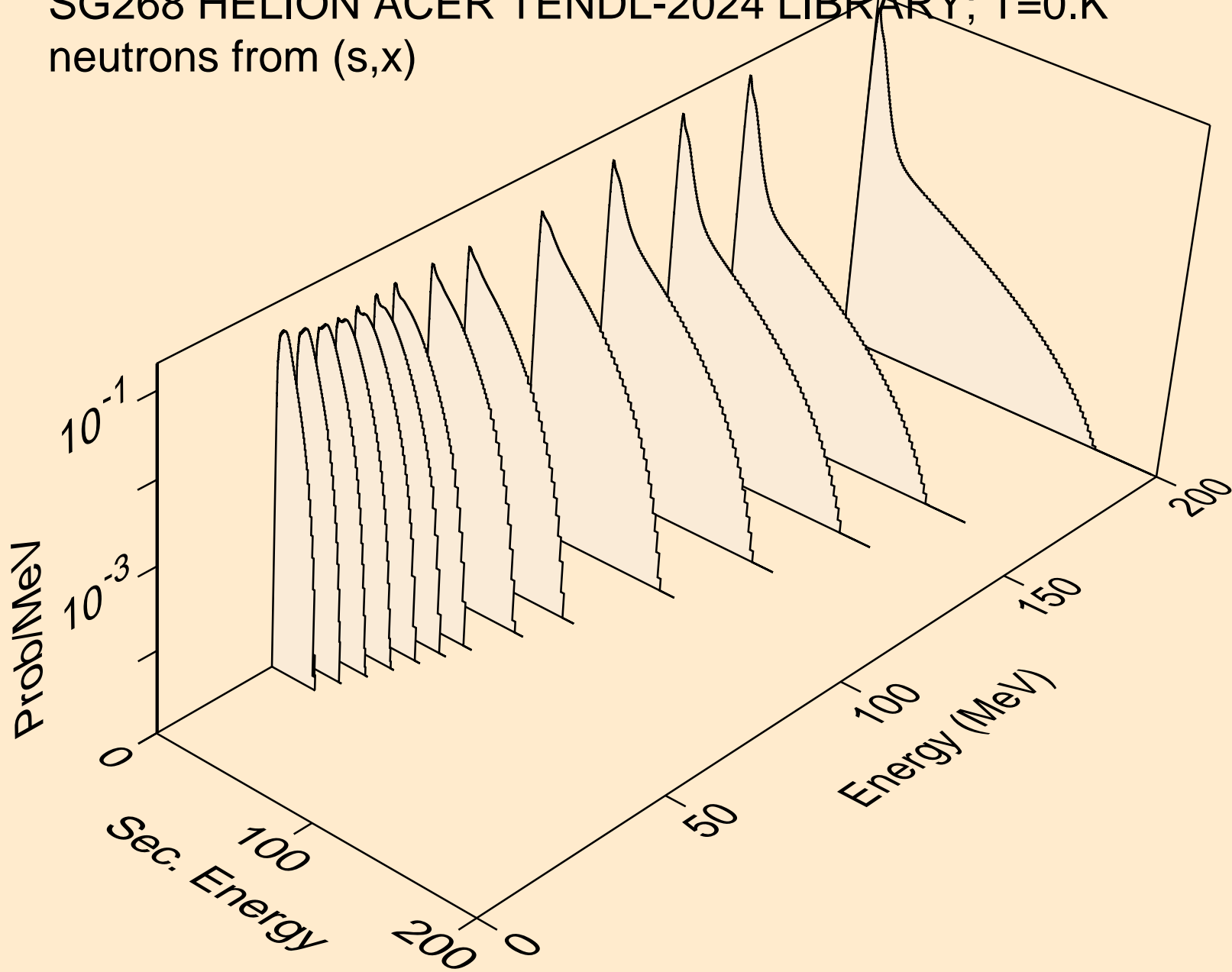

SG268 HELION ACER TENDL-2024 LIBRARY; T=0.K  
neutrons from (s,2n)

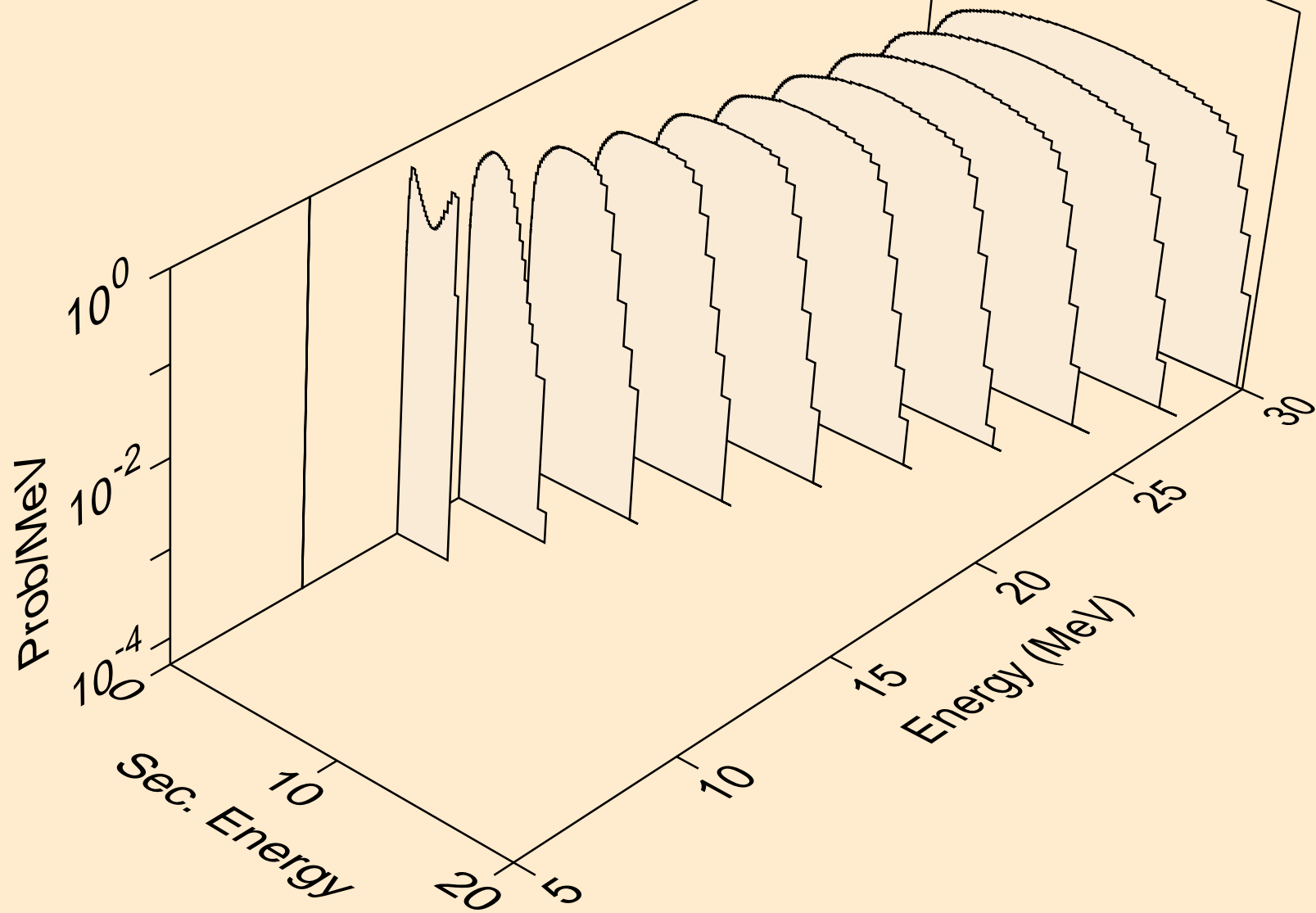

SG268 HELION ACER TENDL-2024 LIBRARY; T=0.K  
neutrons from (s,3n)

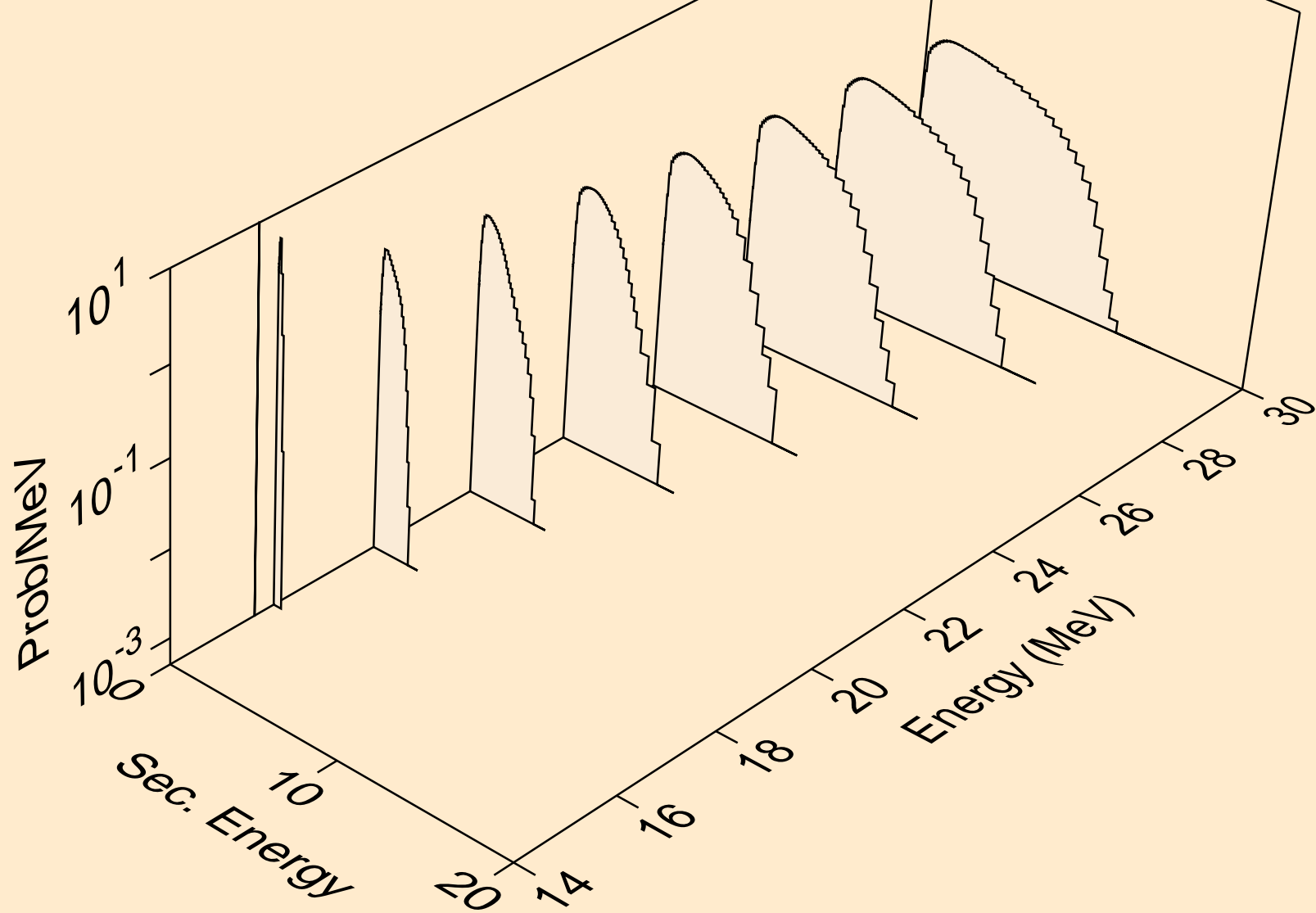

SG268 HELION ACER TENDL-2024 LIBRARY; T=0.K  
neutrons from (s,n\*)a

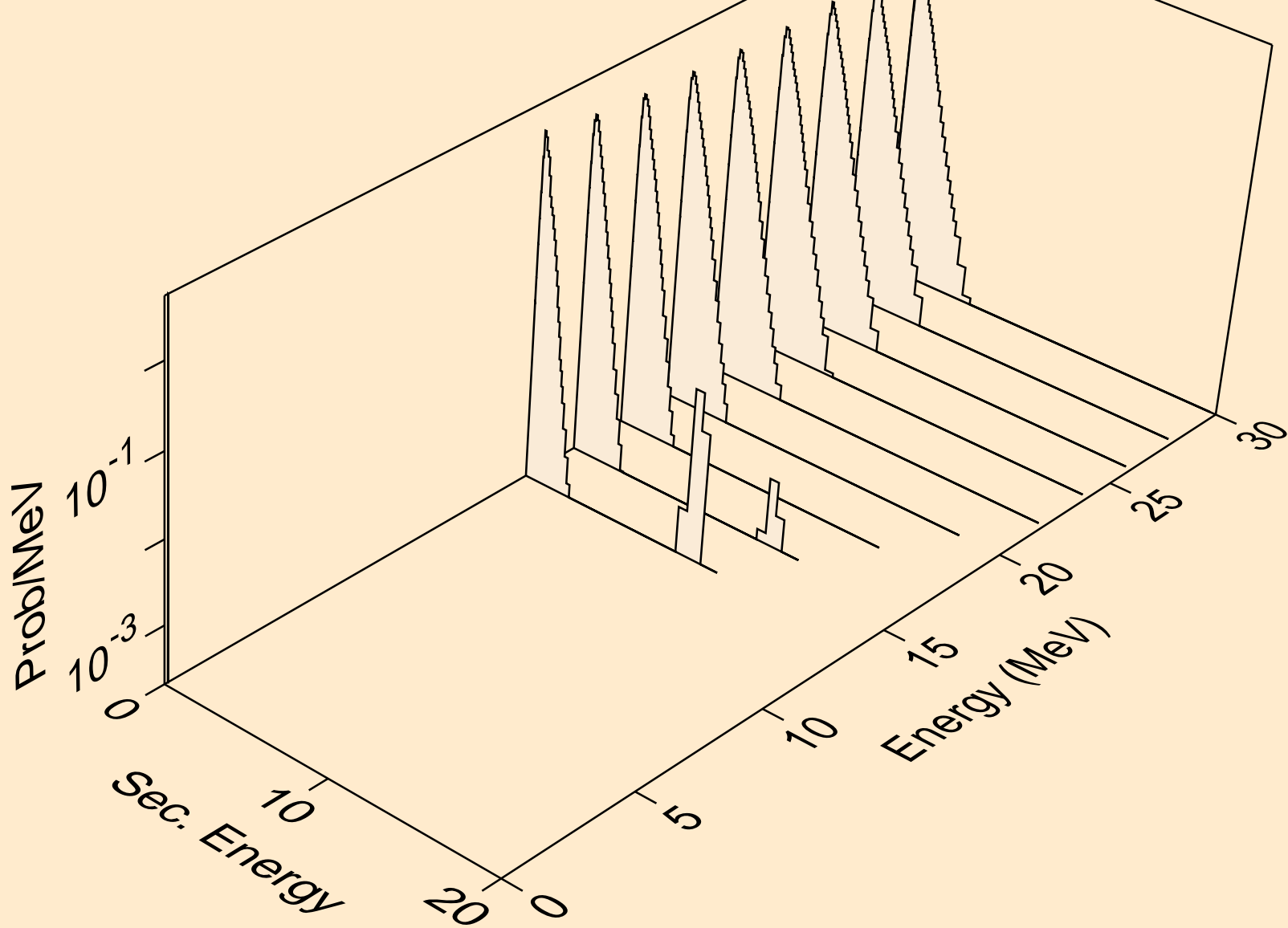

SG268 HELION ACER TENDL-2024 LIBRARY; T=0.K  
neutrons from (s,n\*)p

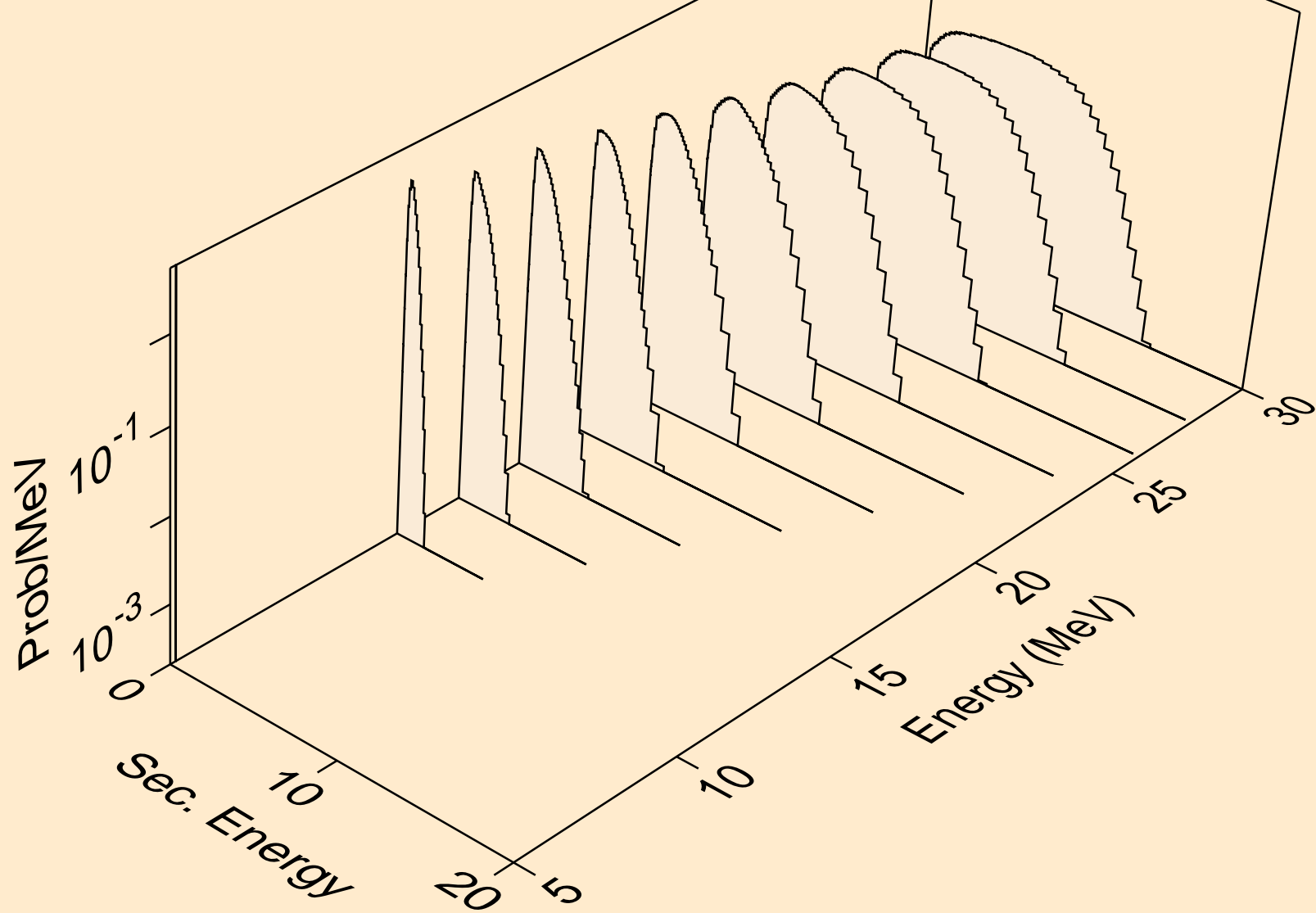

SG268 HELION ACER TENDL-2024 LIBRARY; T=0.K  
neutrons from (s,n\*)d

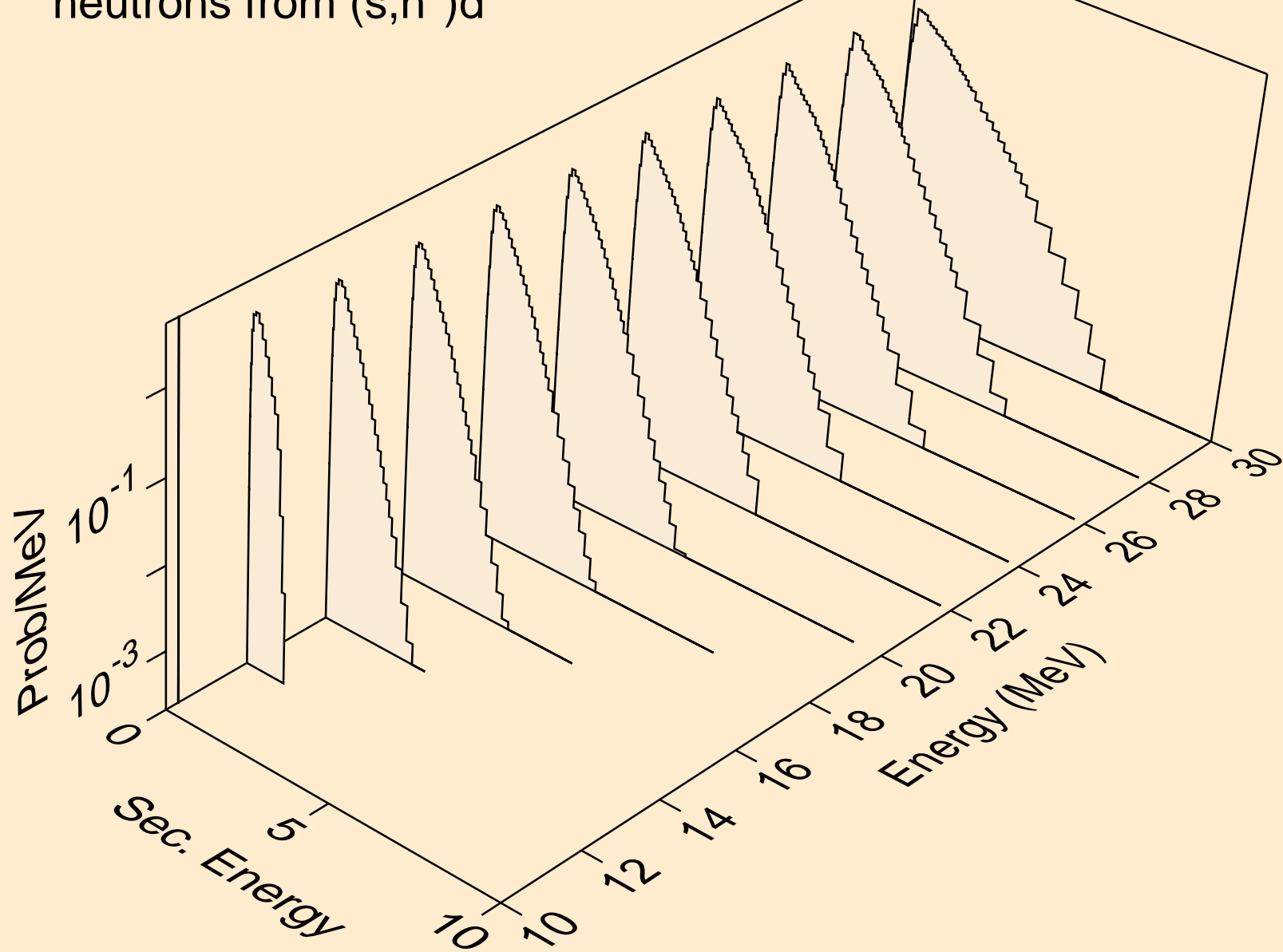

SG268 HELION ACER TENDL-2024 LIBRARY; T=0.K  
neutrons from (s,n\*)t

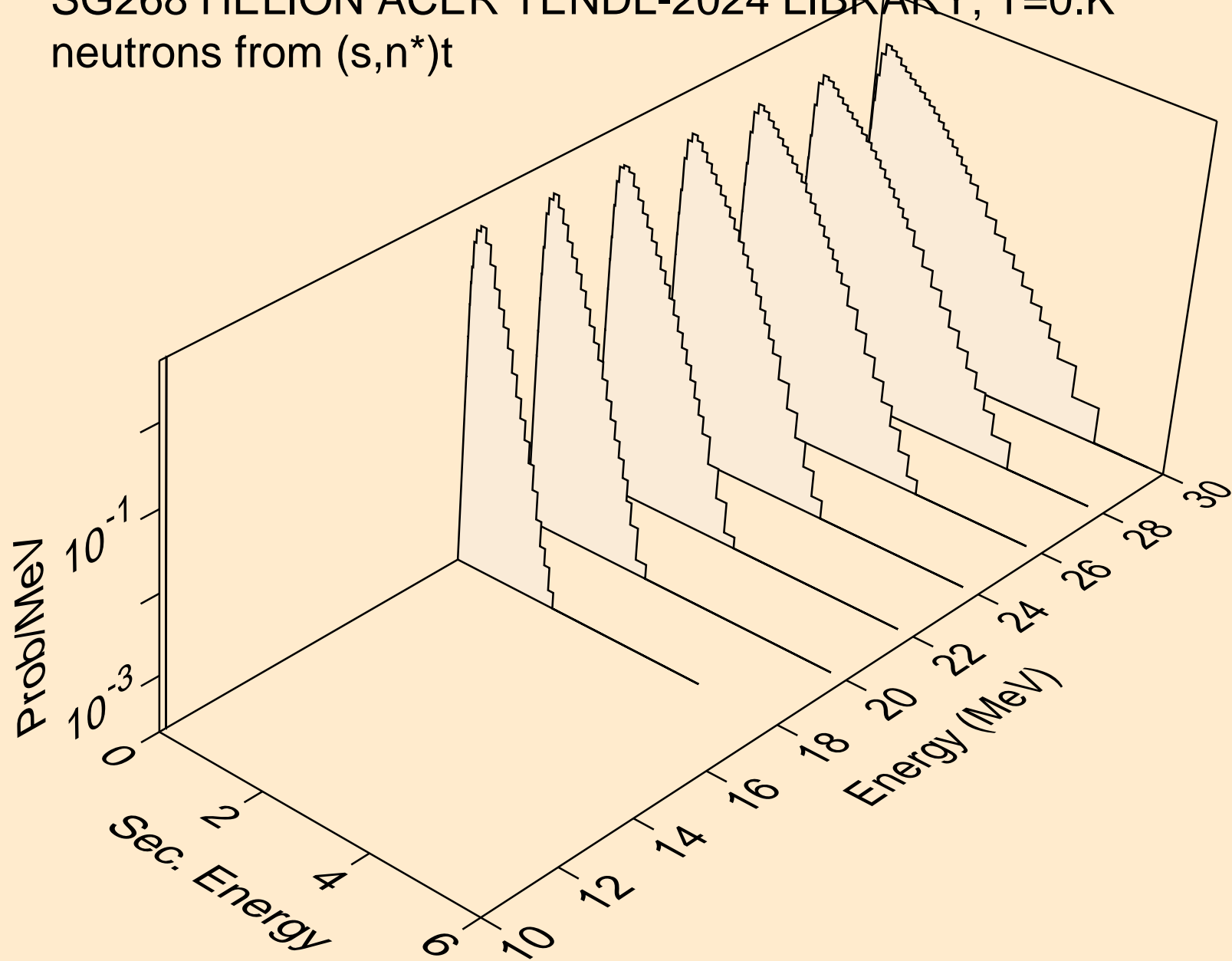

SG268 HELION ACER TENDL-2024 LIBRARY; T=0.K  
neutrons from (s,2np)

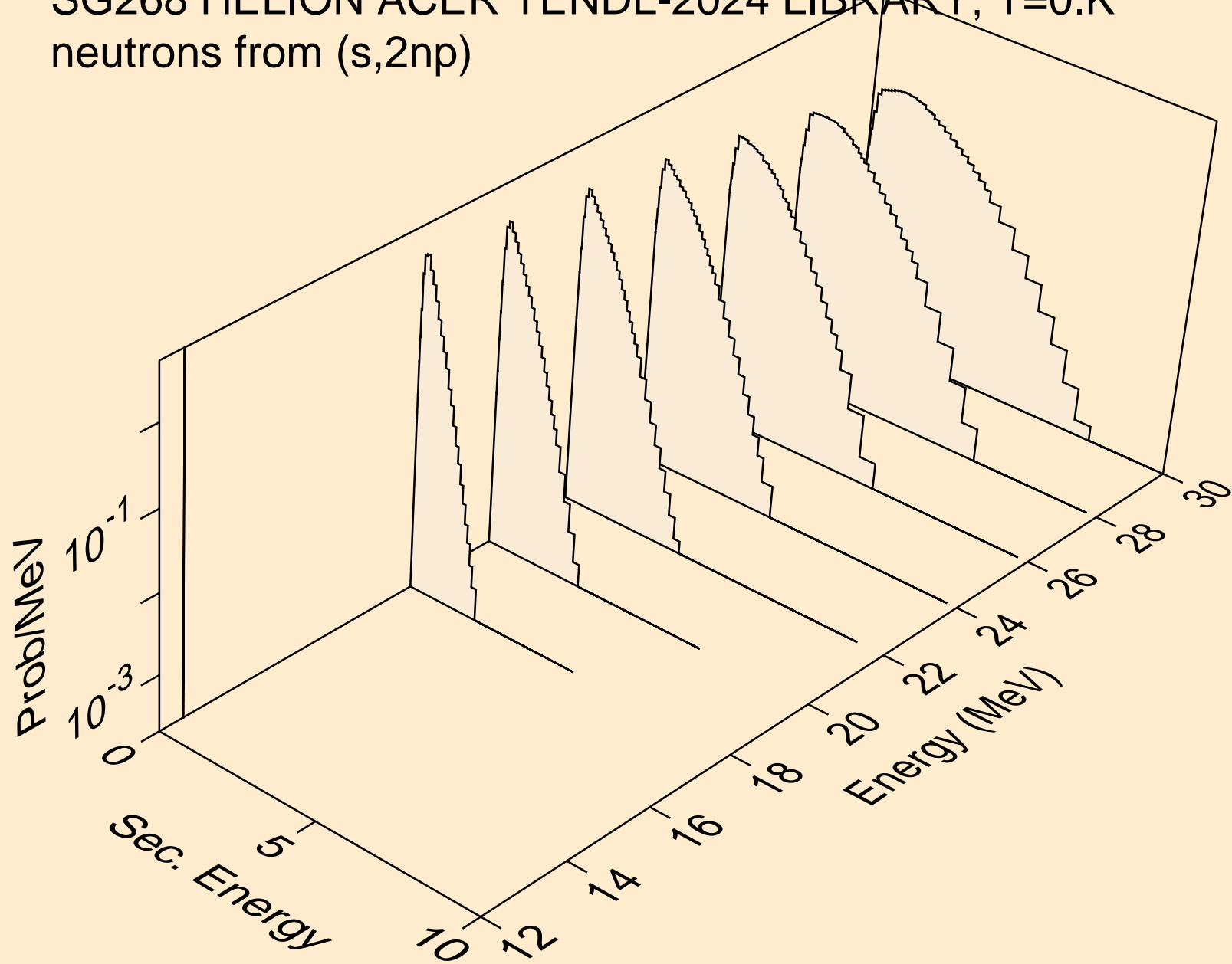

SG268 HELION ACER TENDL-2024 LIBRARY; T=0.K  
protons from (s,x)

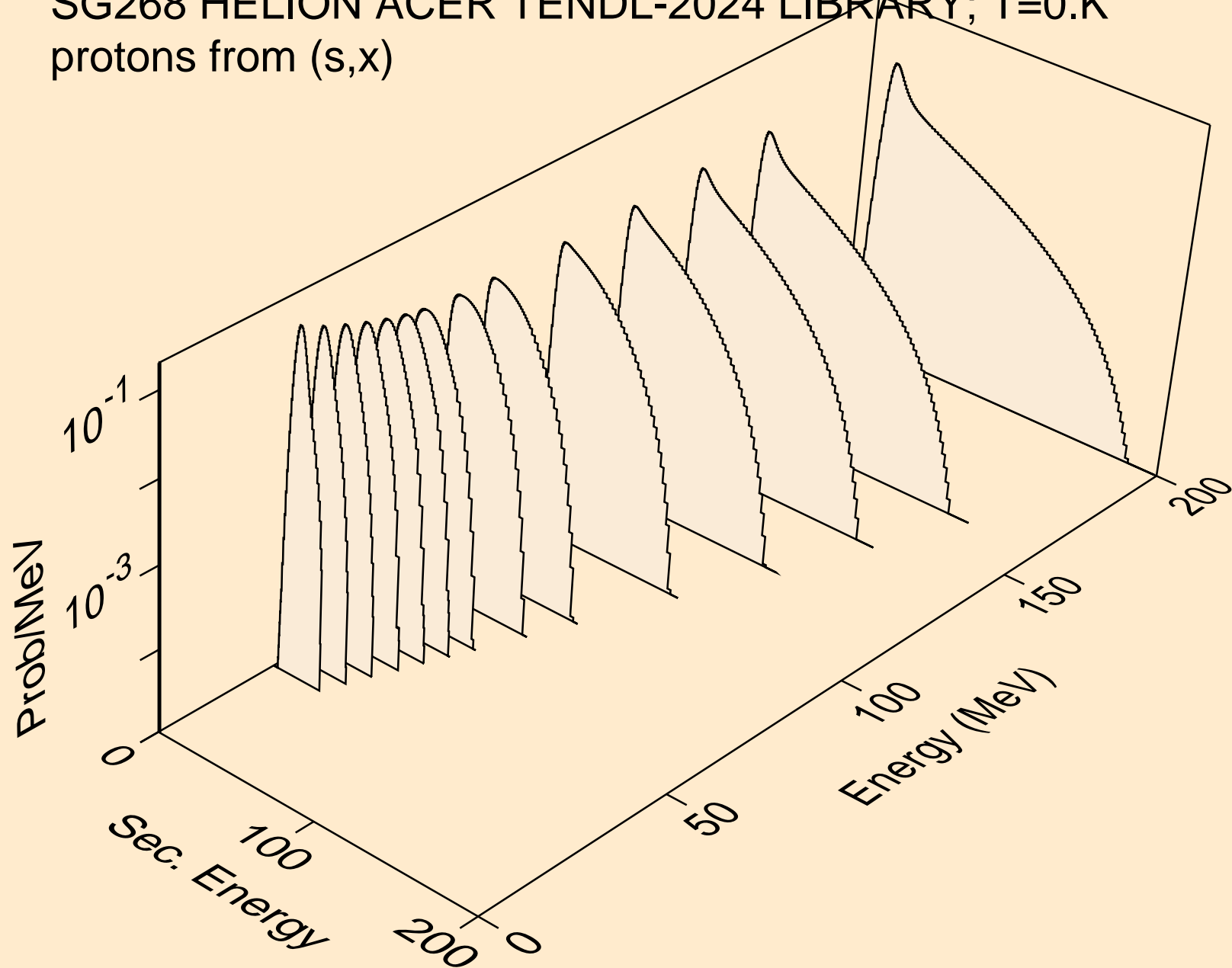

SG268 HELION ACER TENDL-2024 LIBRARY; T=0.K  
protons from (s,n\*)p

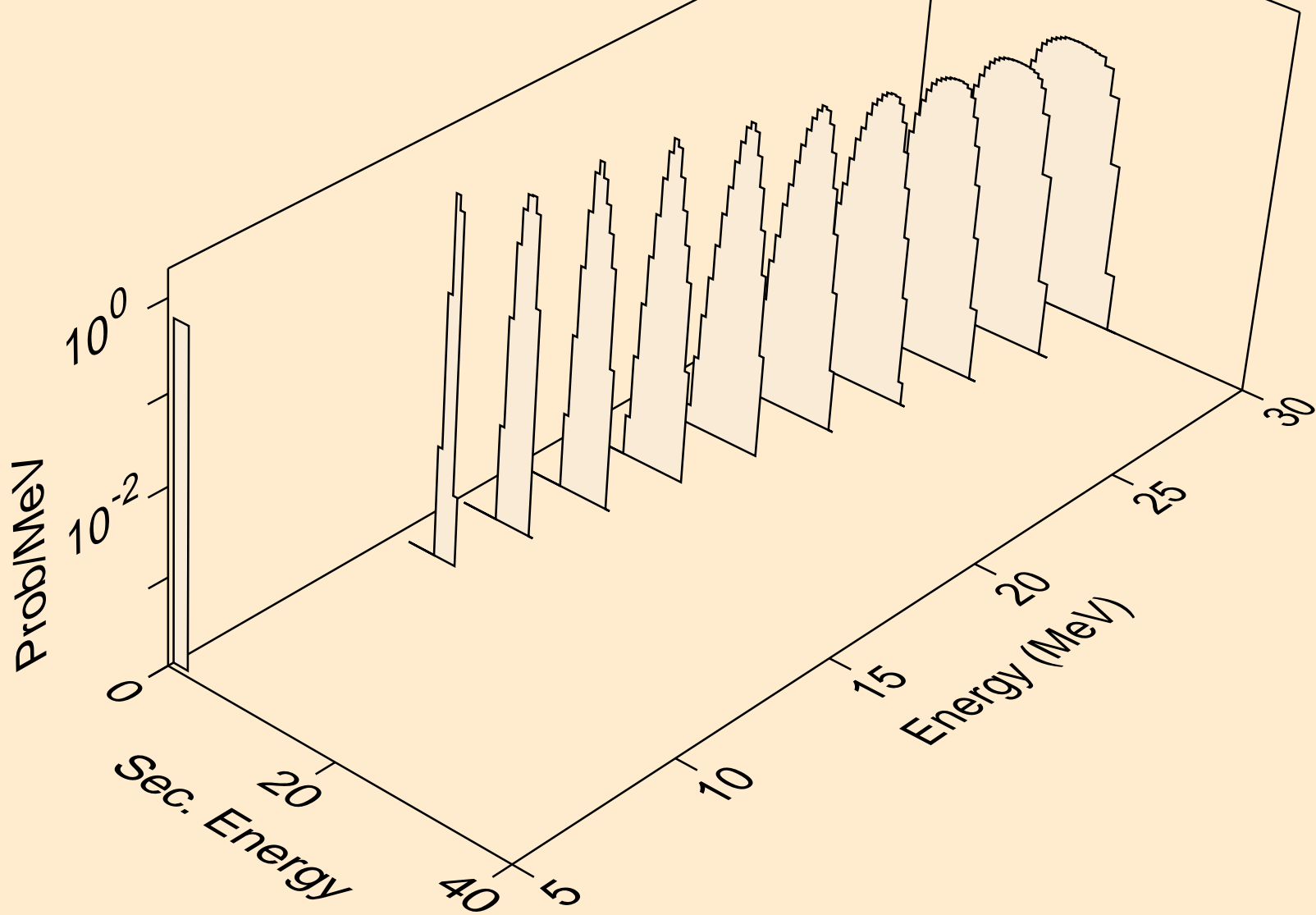

SG268 HELION ACER TENDL-2024 LIBRARY; T=0.K  
protons from (s,2np)

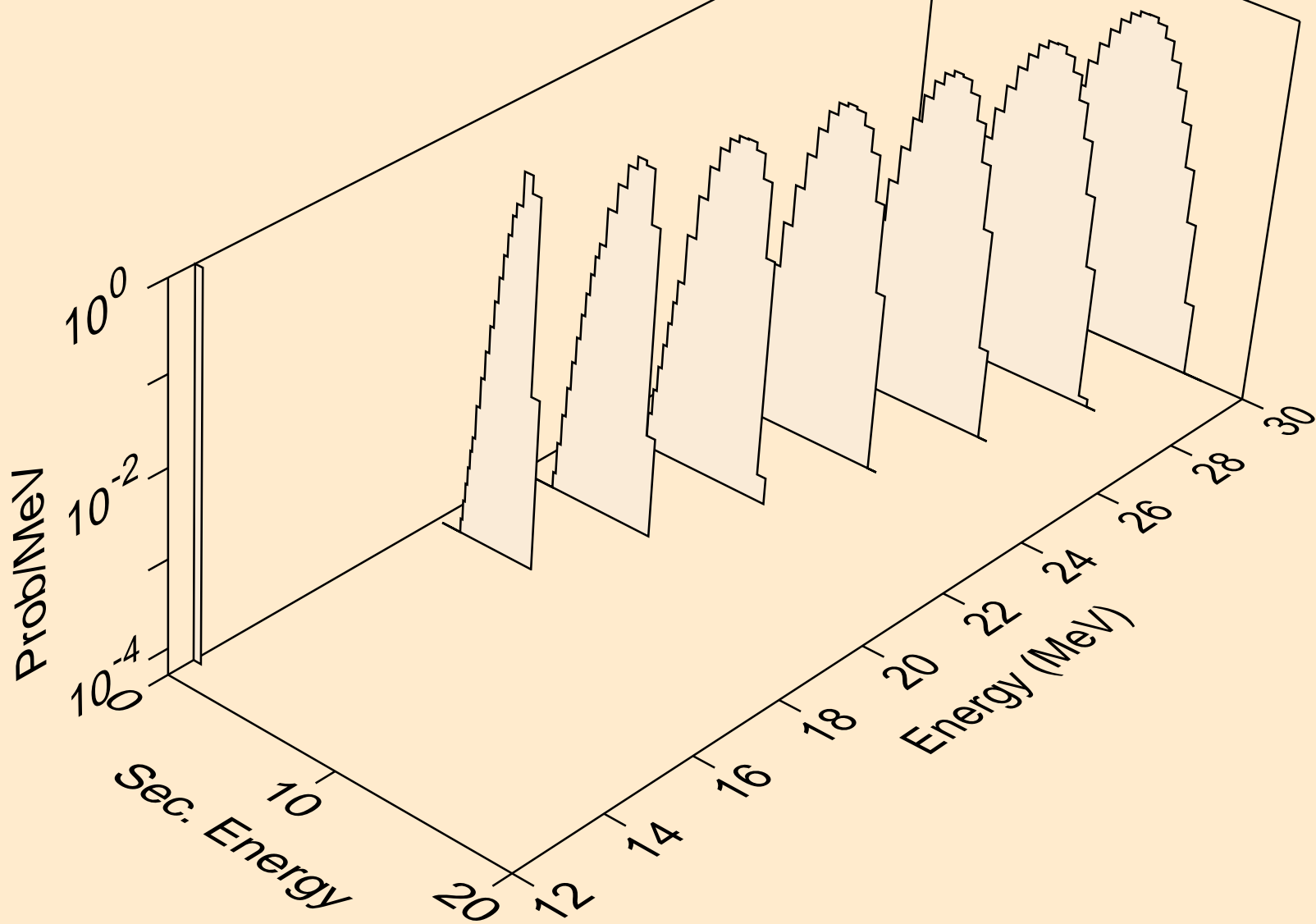

SG268 HELION ACER TENDL-2024 LIBRARY; T=0.K  
protons from (s,p)

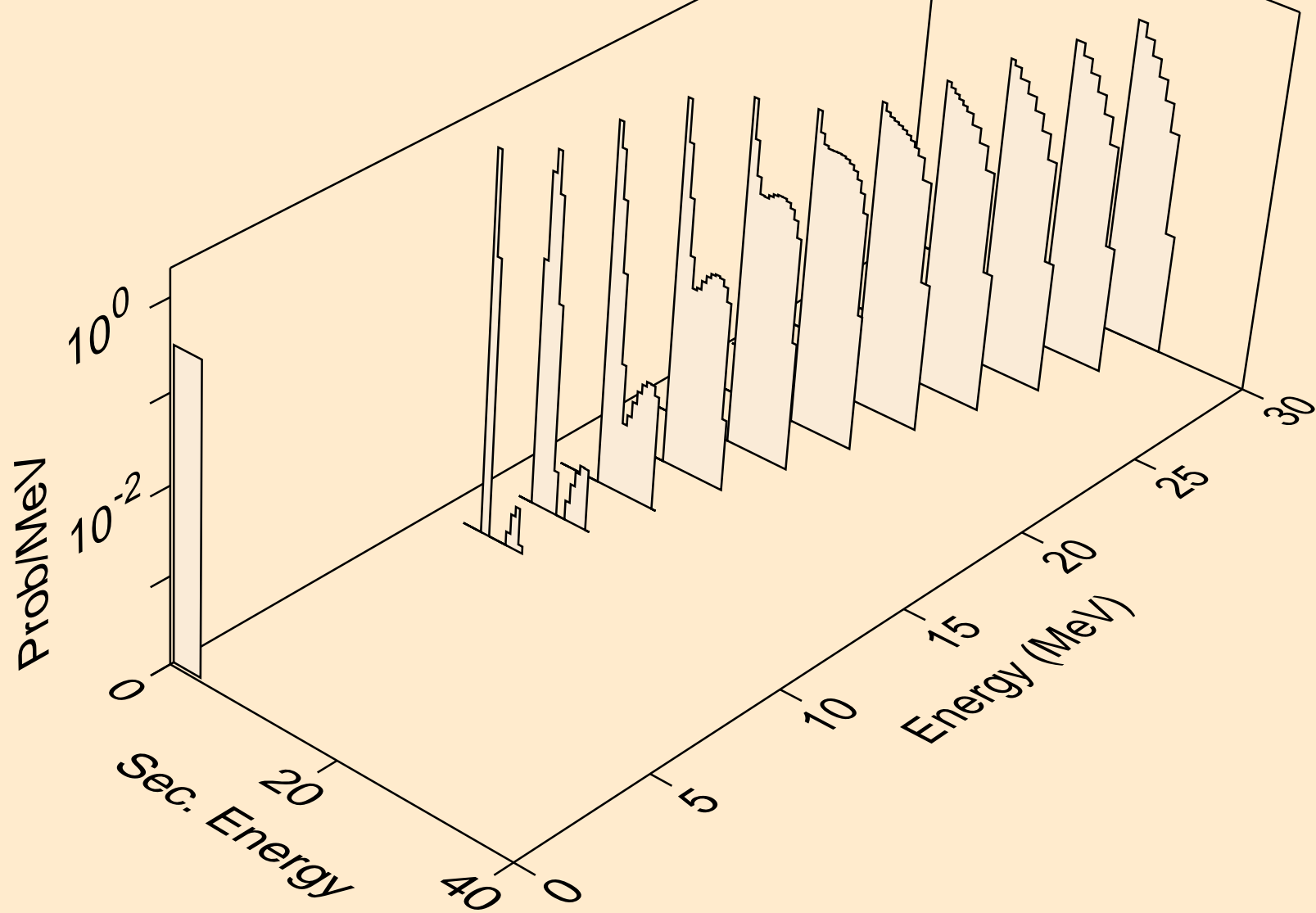

SG268 HELION ACER TENDL-2024 LIBRARY; T=0.K  
protons from (s,2p)

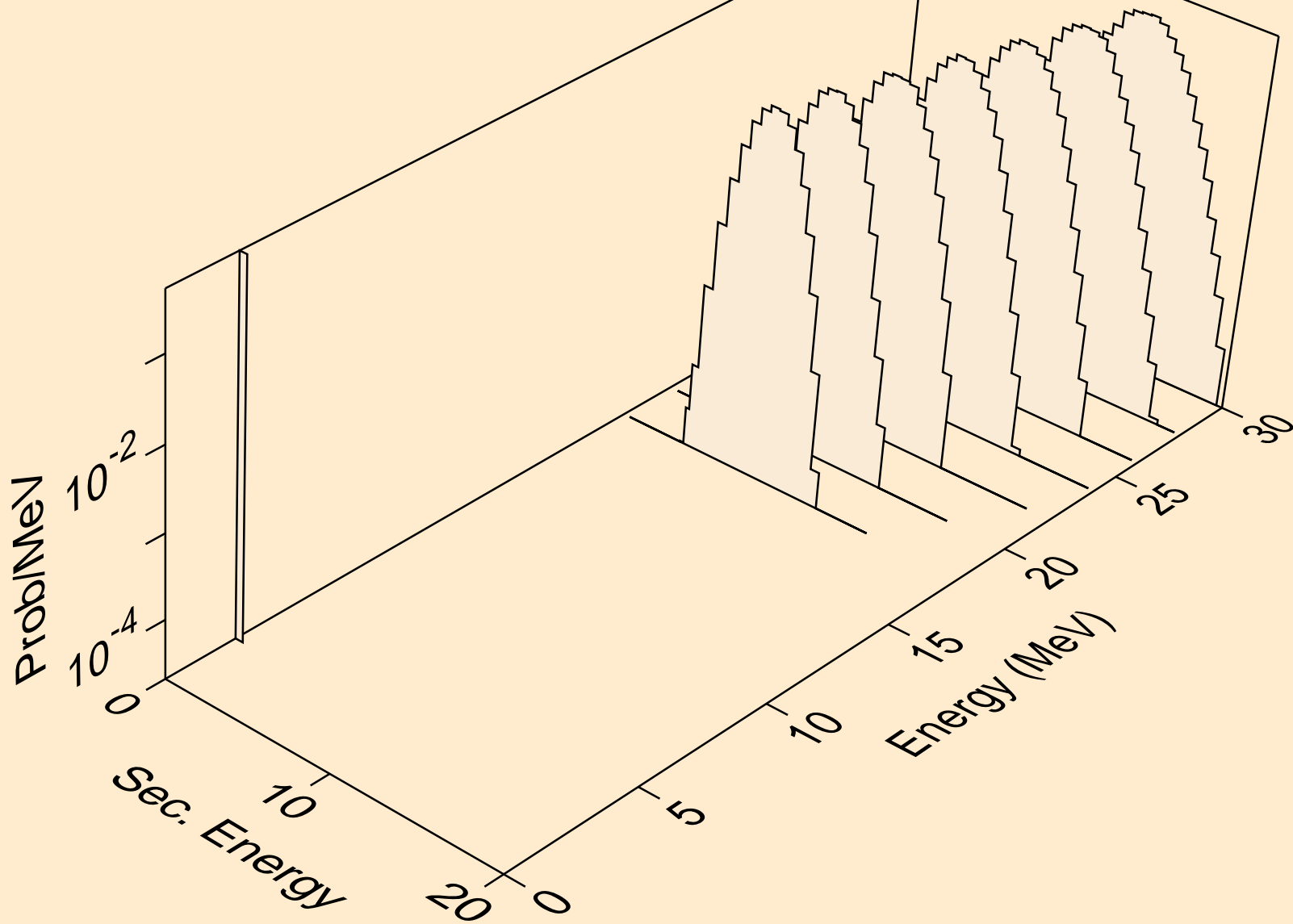

SG268 HELION ACER TENDL-2024 LIBRARY; T=0.K  
deuterons from (s,x)

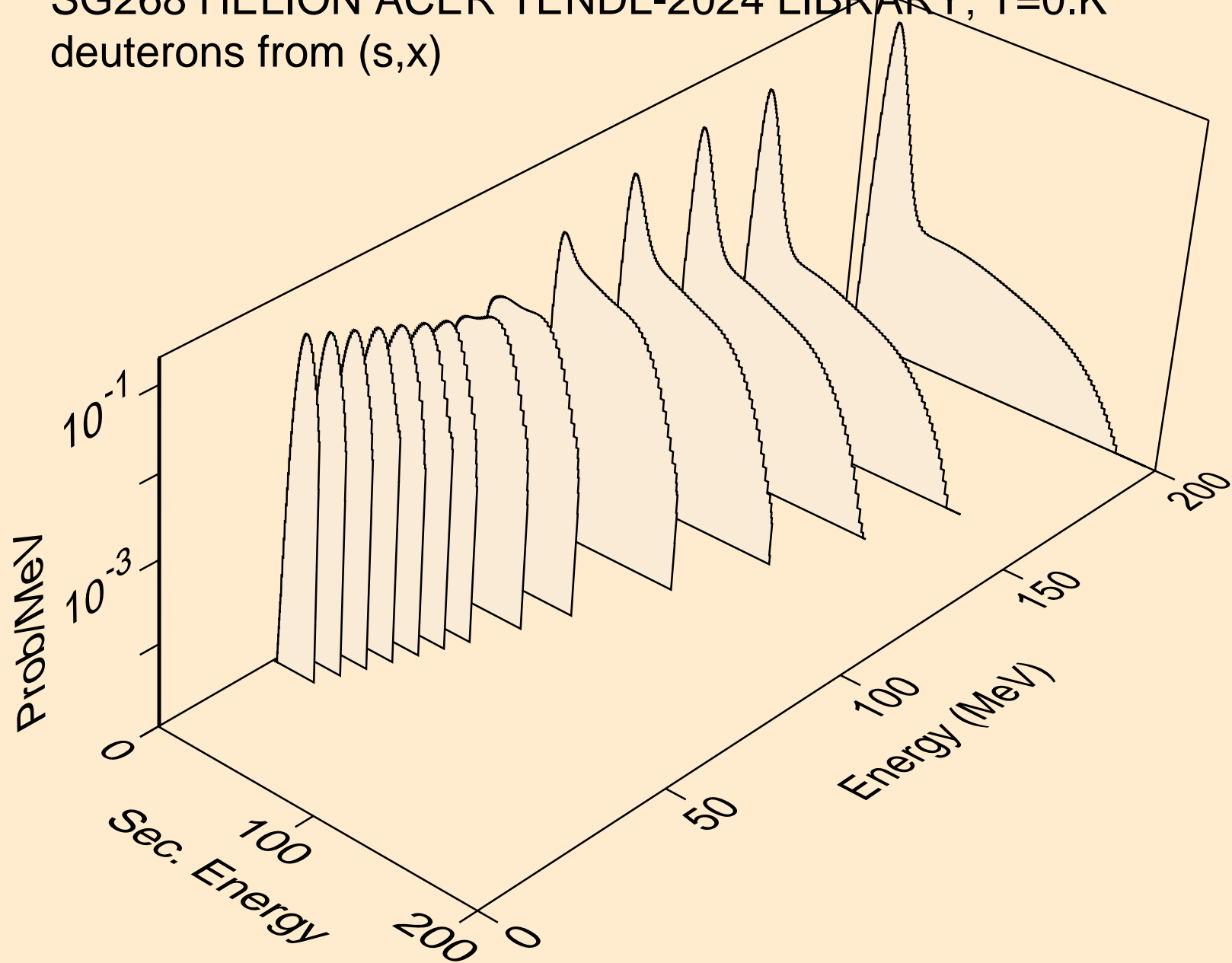

SG268 HELION ACER TENDL-2024 LIBRARY; T=0.K  
deuterons from (s,n\*)d

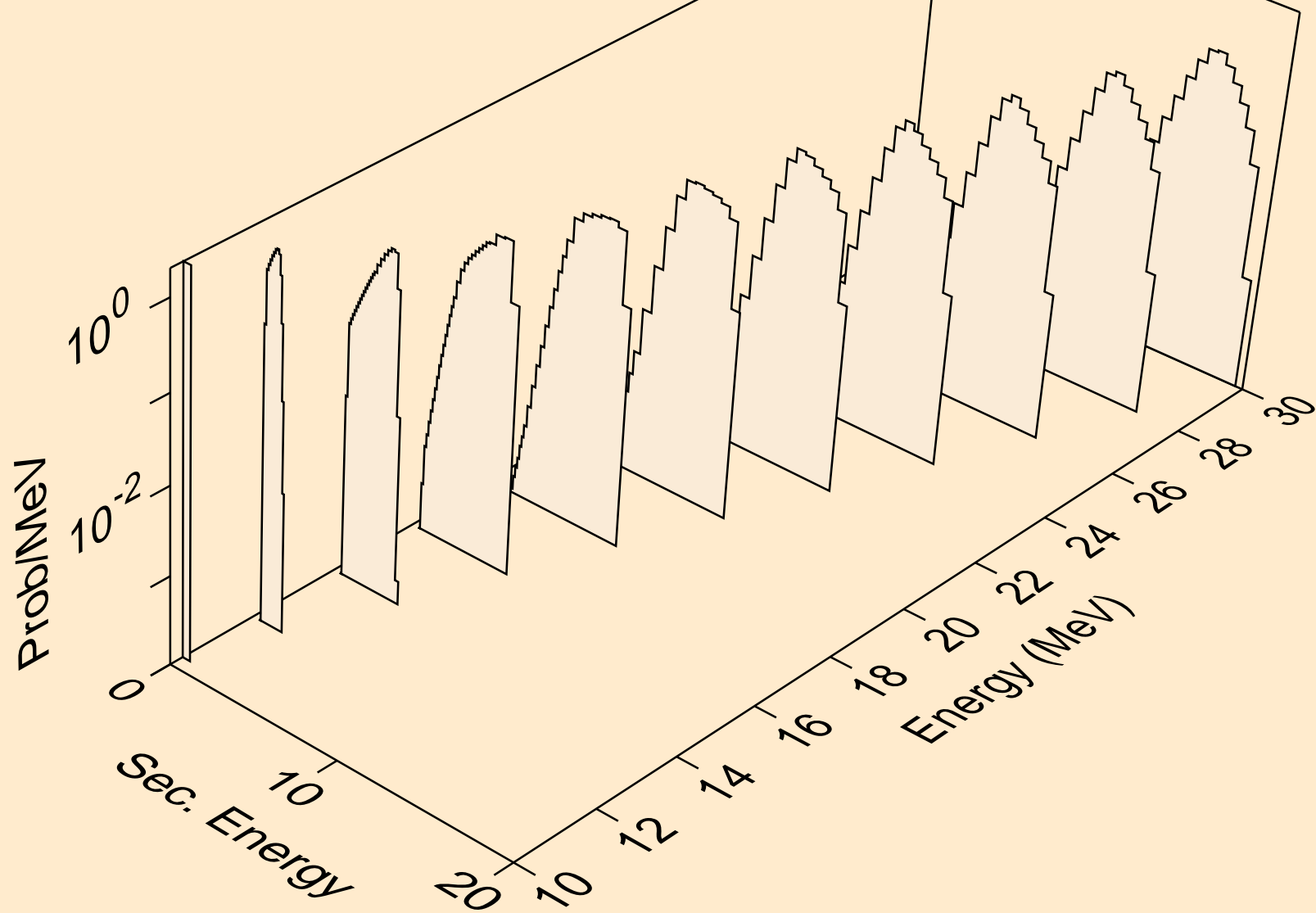

SG268 HELION ACER TENDL-2024 LIBRARY; T=0.K  
deuterons from (s,d)

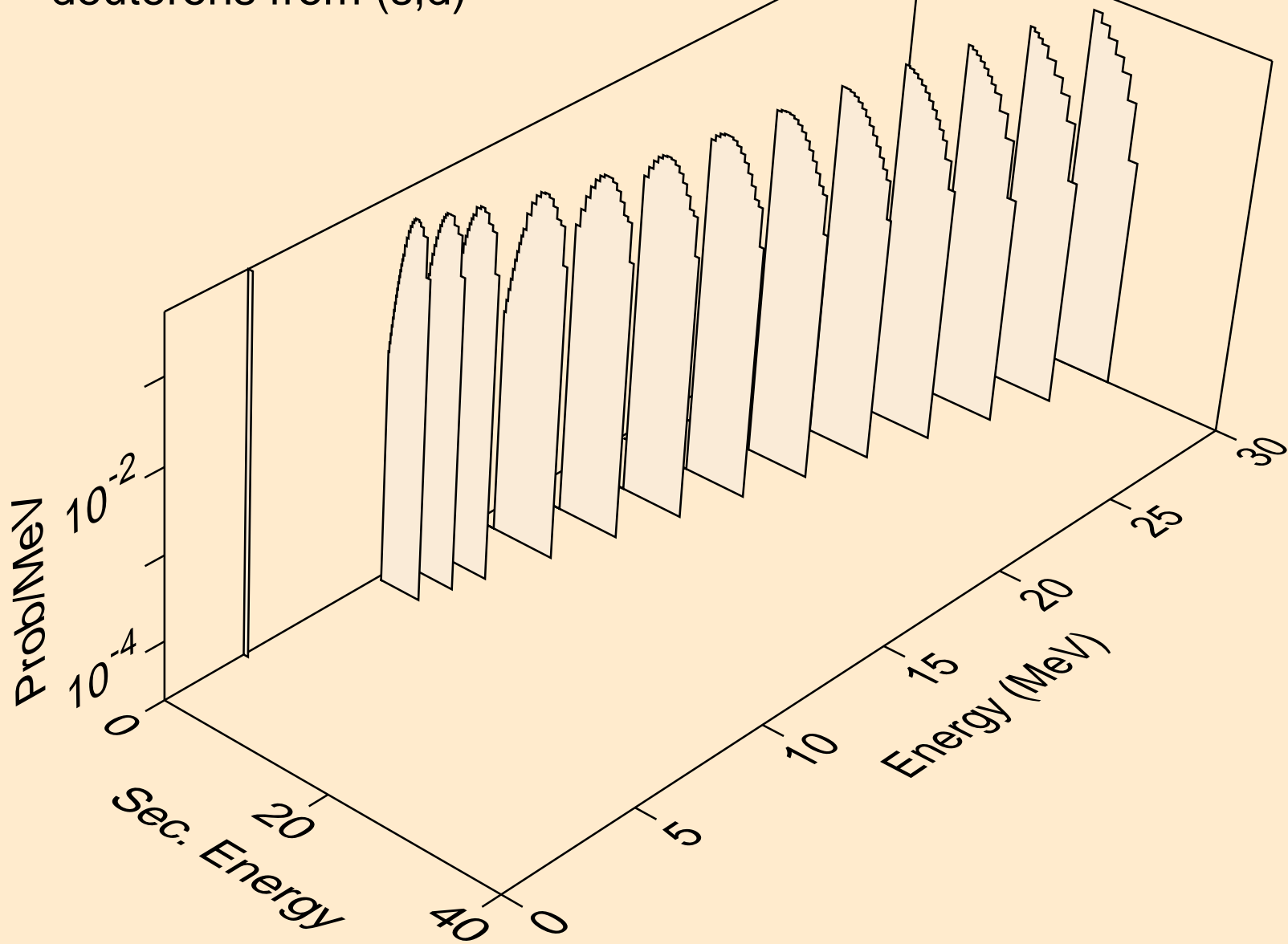

SG268 HELION ACER TENDL-2024 LIBRARY; T=0.K  
tritons from (s,x)

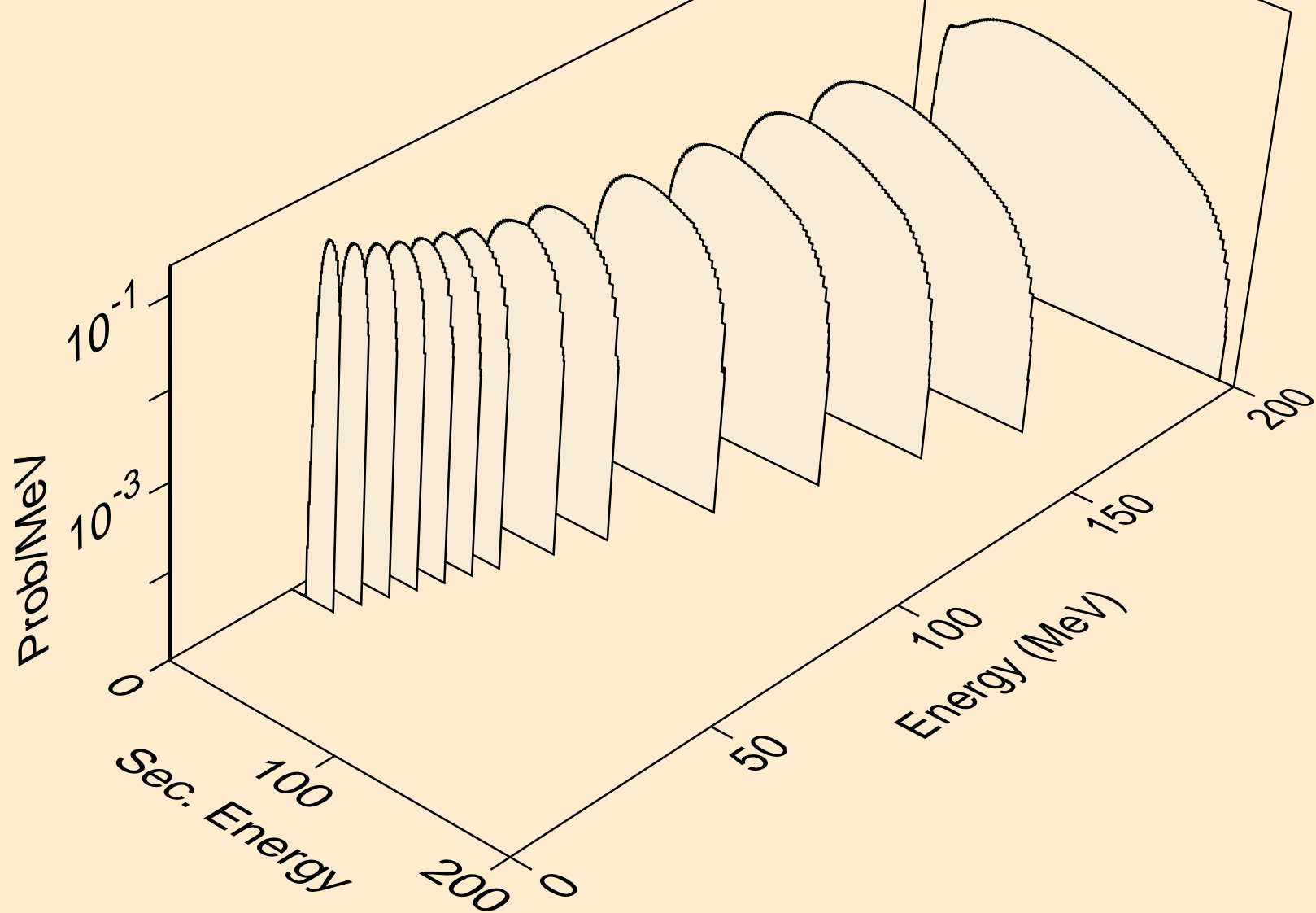

SG268 HELION ACER TENDL-2024 LIBRARY; T=0.K  
tritons from (s,n\*)t

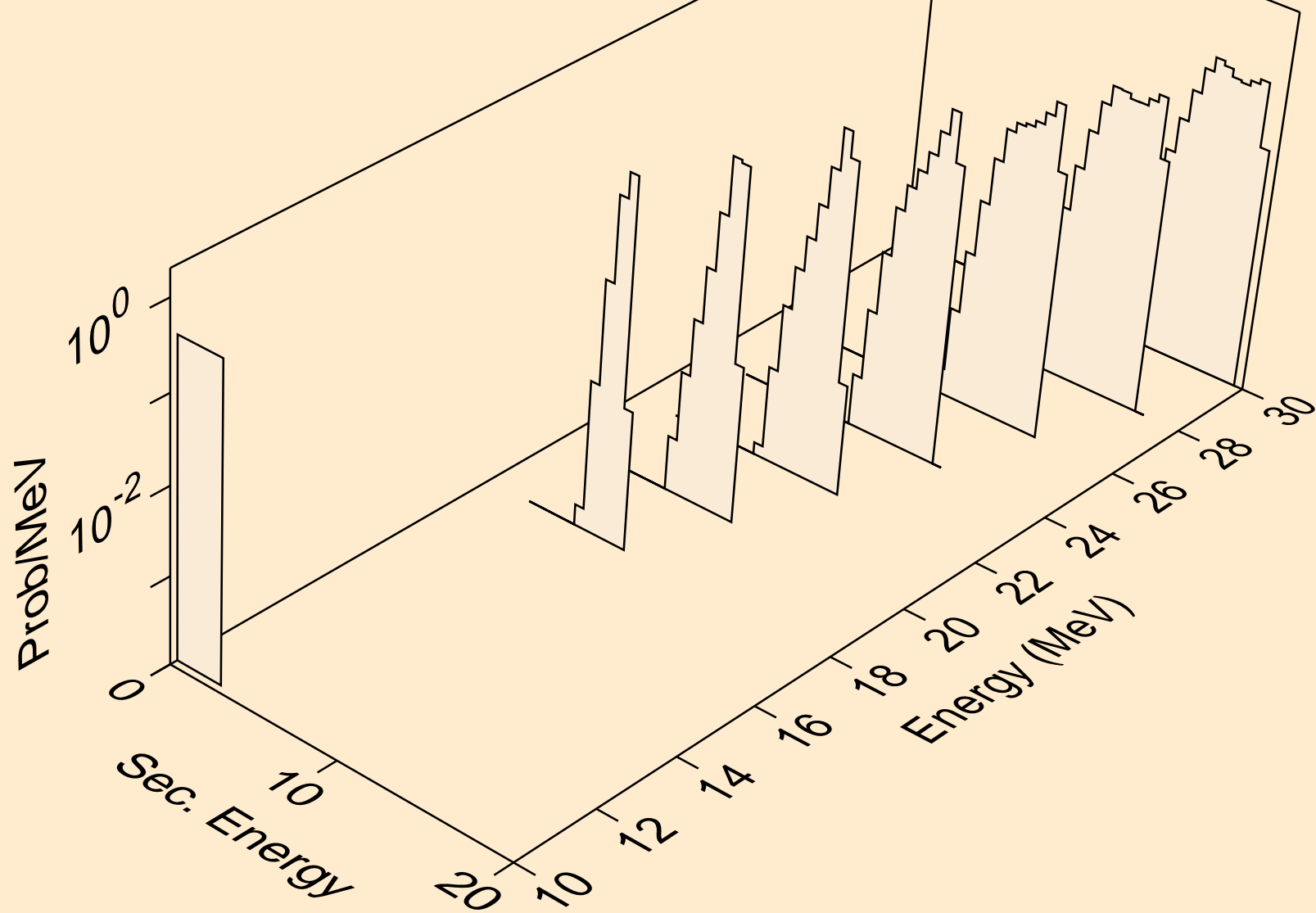

SG268 HELION ACER TENDL-2024 LIBRARY; T=0.K  
tritons from (s,t)

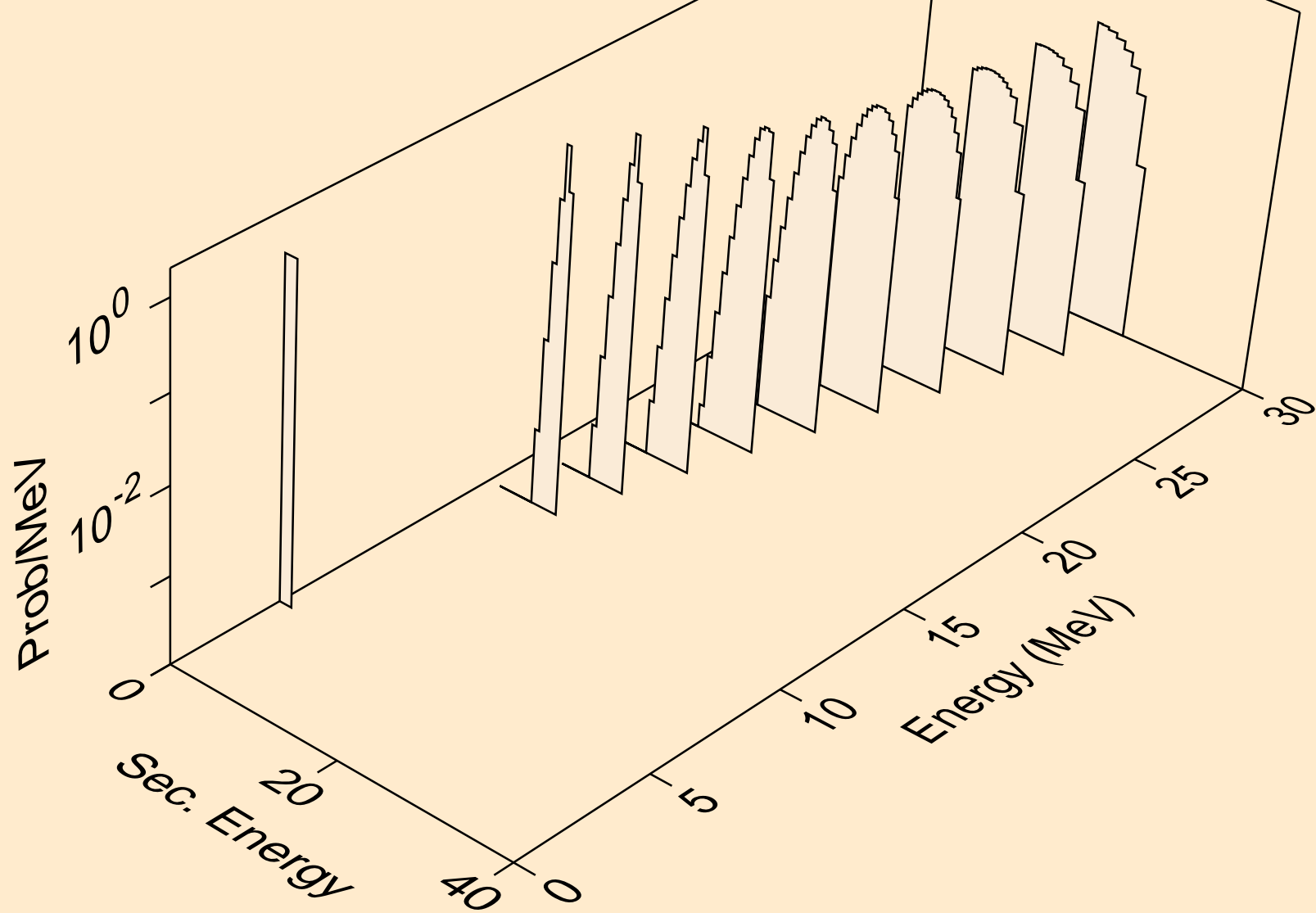

SG268 HELION ACER TENDL-2024 LIBRARY; T=0.K  
alphas from (s,x)

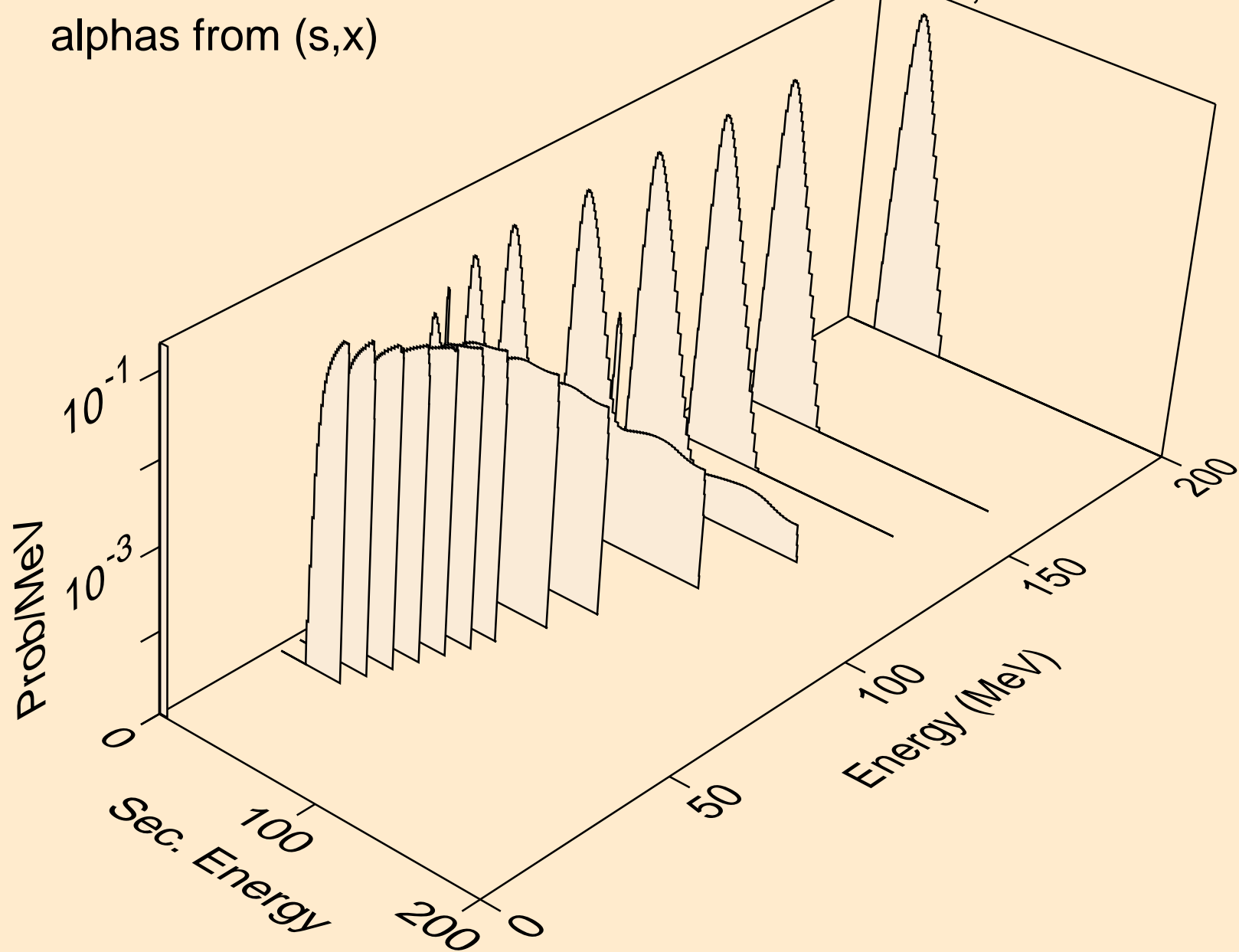

SG268 HELION ACER TENDL-2024 LIBRARY; T=0.K  
alphas from (s,n\*)a

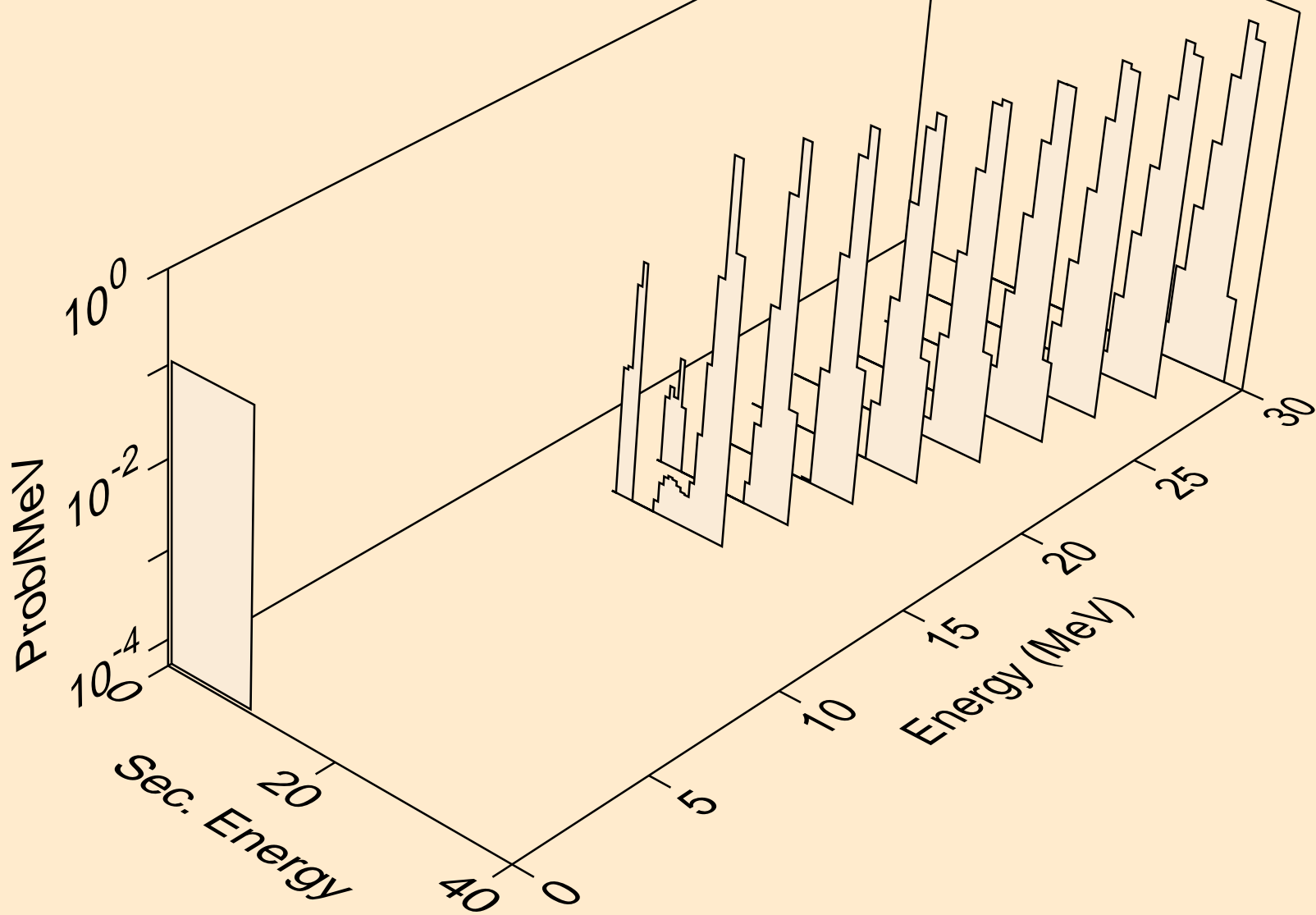

SG268 HELION ACER TENDL-2024 LIBRARY; T=0.K  
alphas from (s,a)

