

AG098 NEUTRON ACER TENDL-2024 LIBRARY; T=293.6K
Principal cross sections

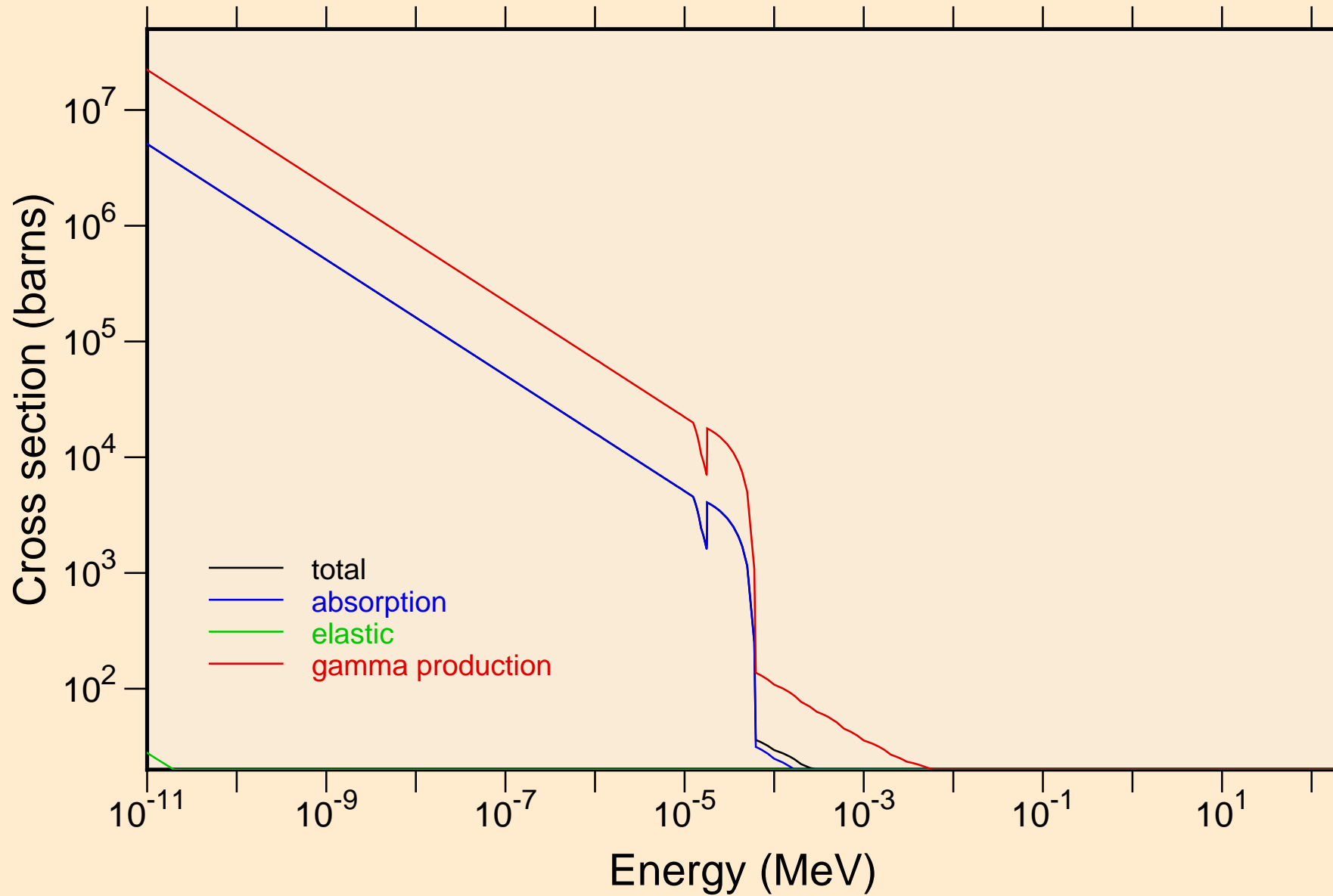

AG098 NEUTRON ACER TENDL-2024 LIBRARY; T=293.6K
Heating

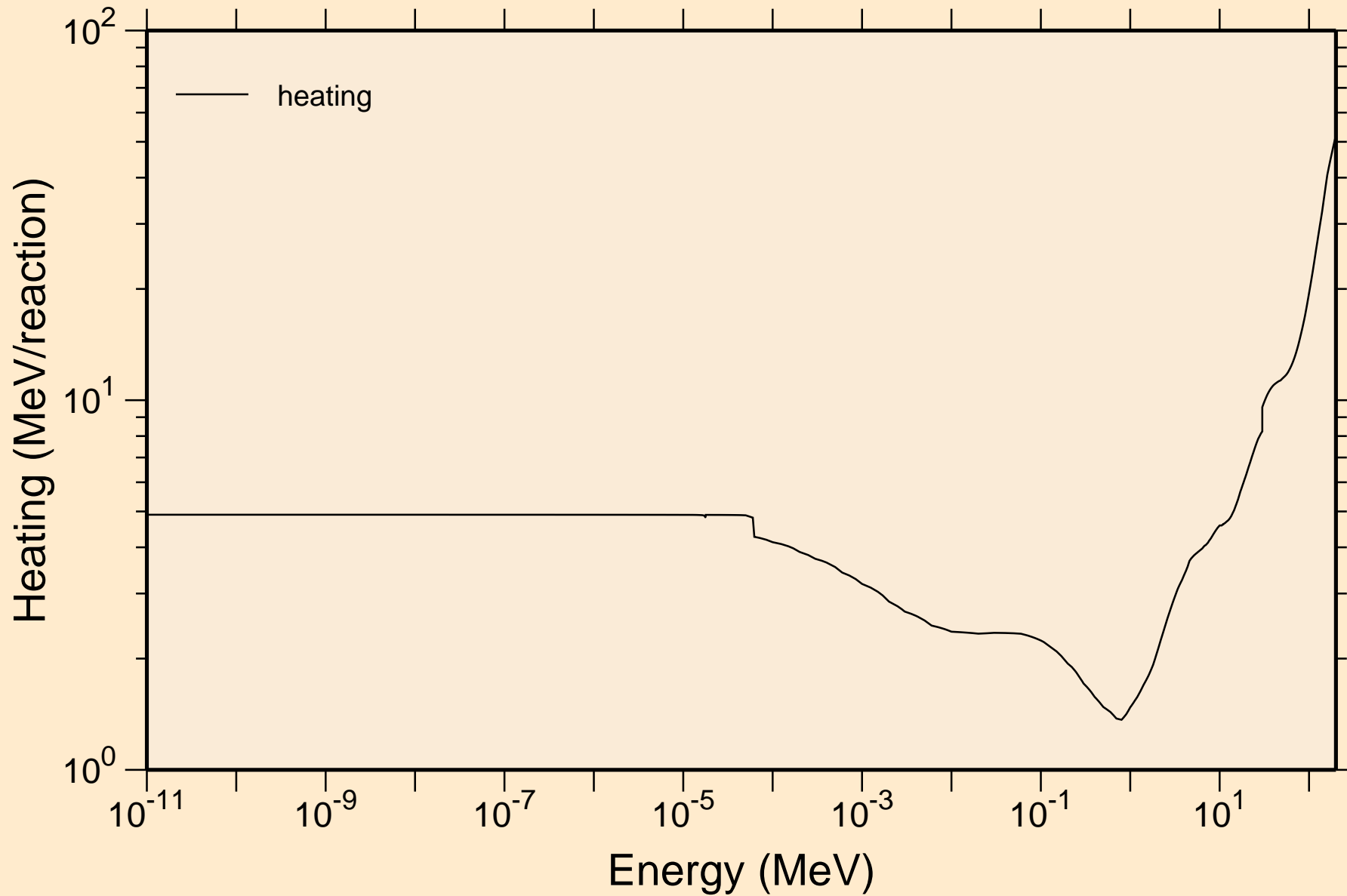

AG098 NEUTRON ACER TENDL-2024 LIBRARY; T=293.6K
Damage

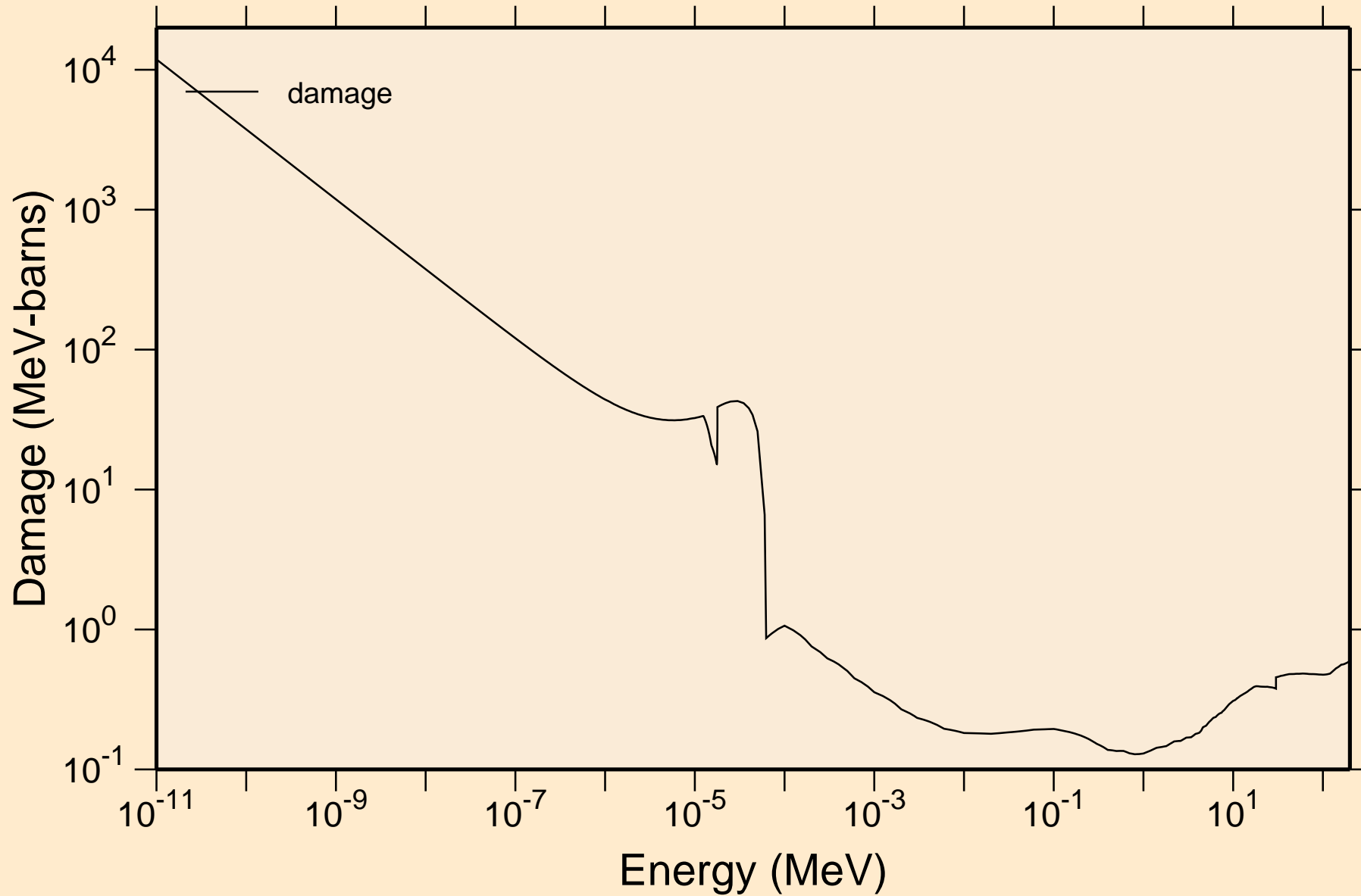

AG098 NEUTRON ACER TENDL-2024 LIBRARY; T=293.6K
Non-threshold reactions

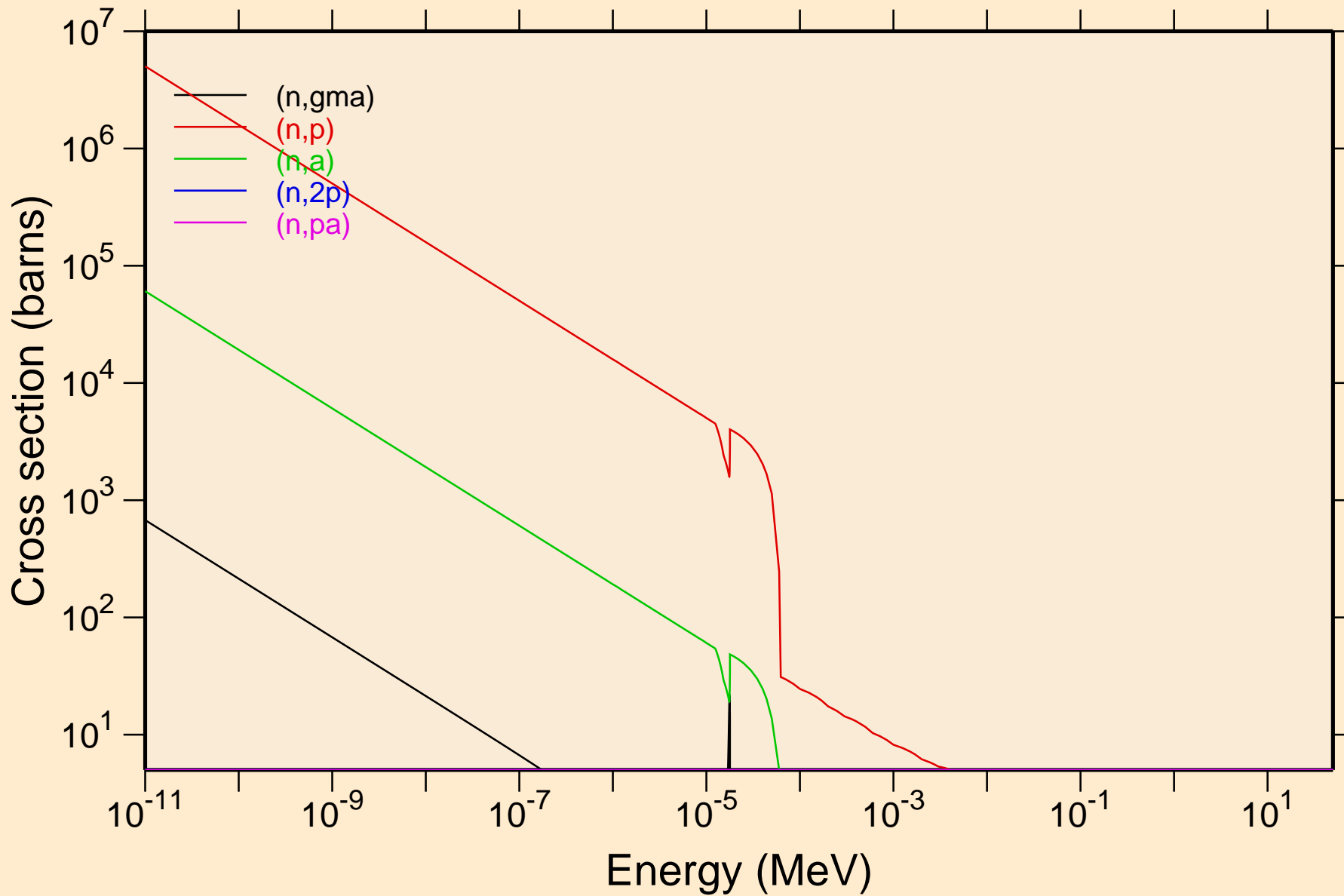

AG098 NEUTRON ACER TENDL-2024 LIBRARY; T=293.6K
Non-threshold reactions

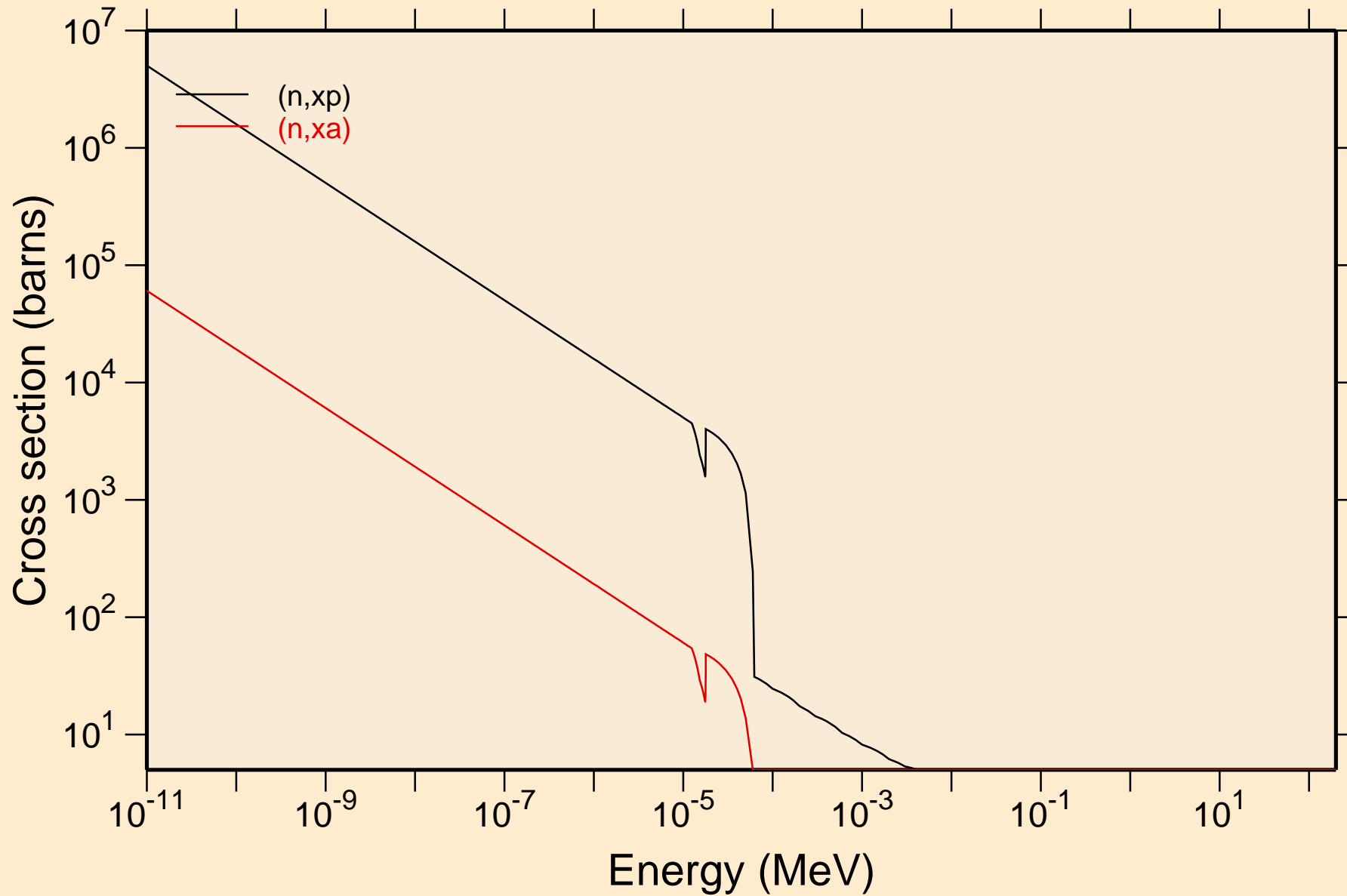

AG098 NEUTRON ACER TENDL-2024 LIBRARY; T=293.6K
Principal cross sections

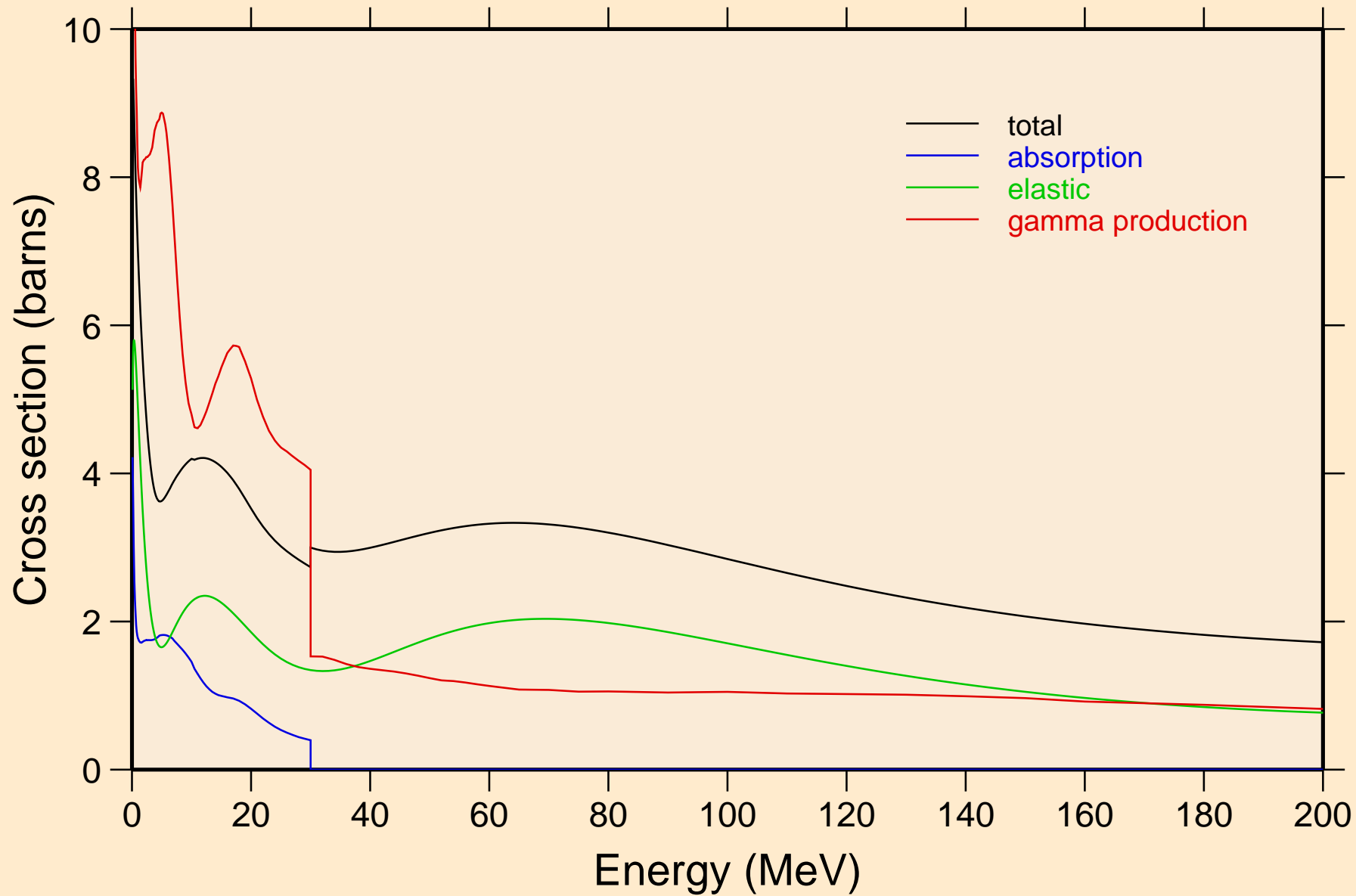

AG098 NEUTRON ACER TENDL-2024 LIBRARY; T=293.6K
Heating

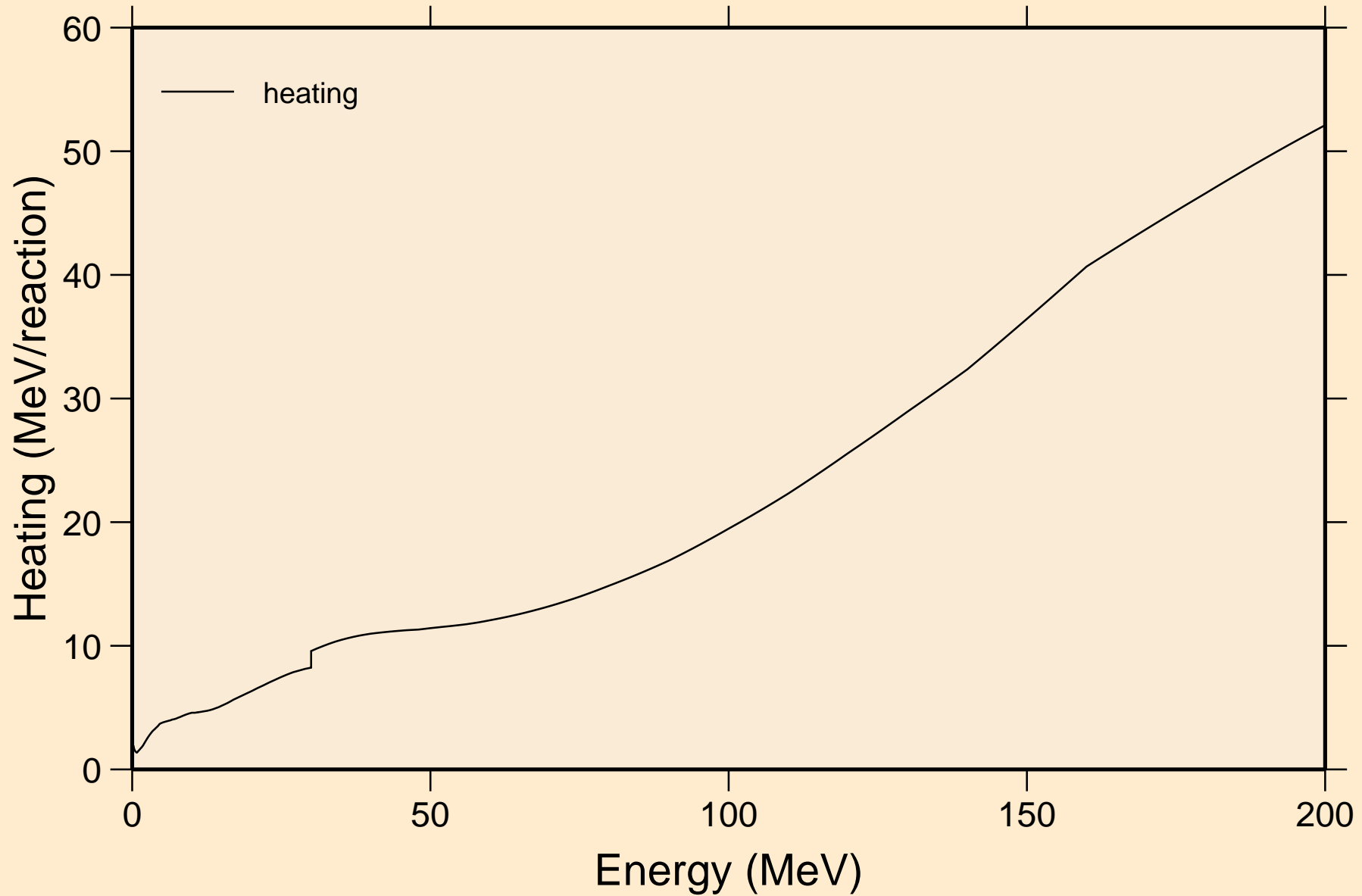

AG098 NEUTRON ACER TENDL-2024 LIBRARY; T=293.6K
Damage

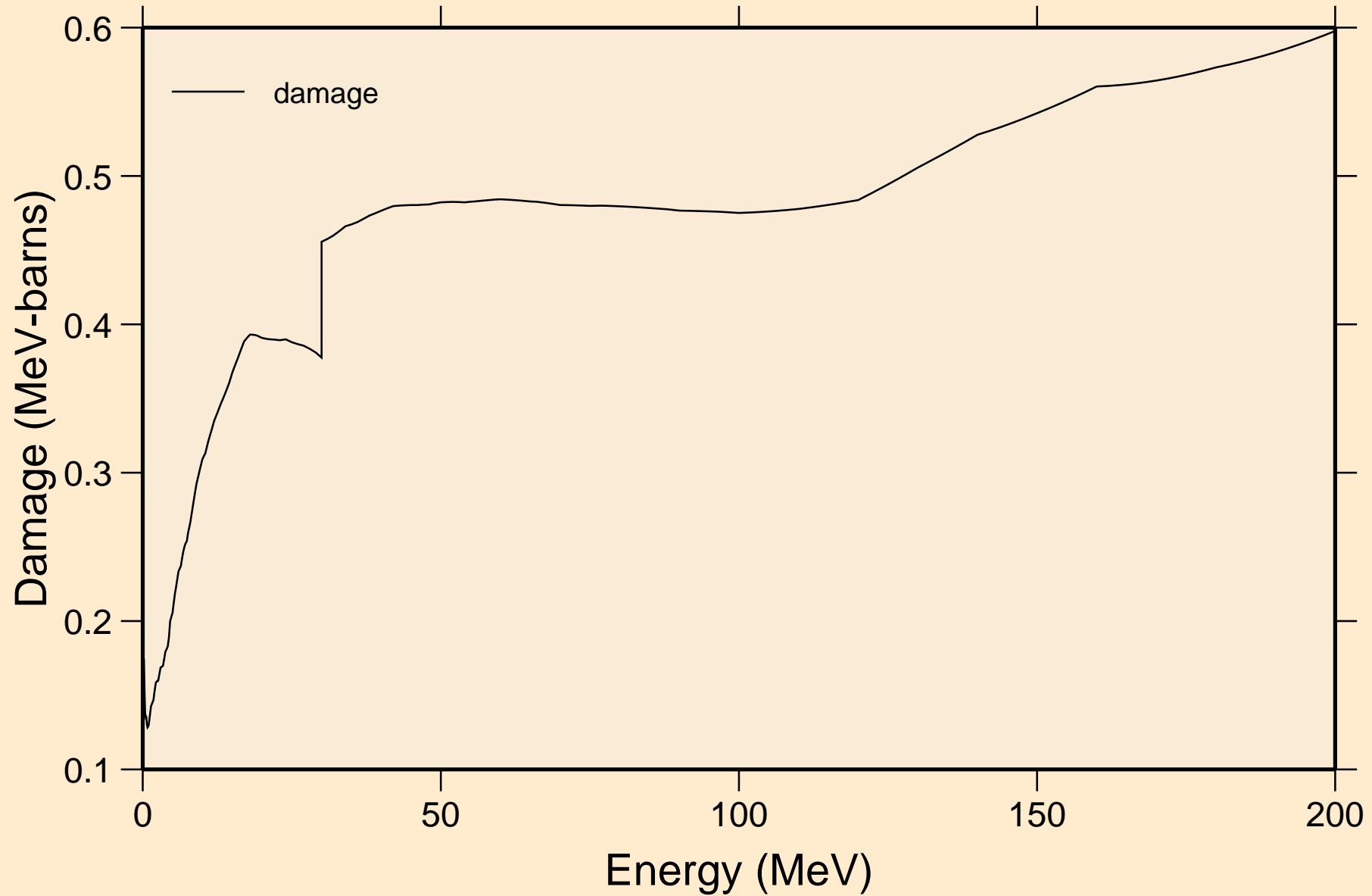

AG098 NEUTRON ACER TENDL-2024 LIBRARY; T=293.6K
Non-threshold reactions

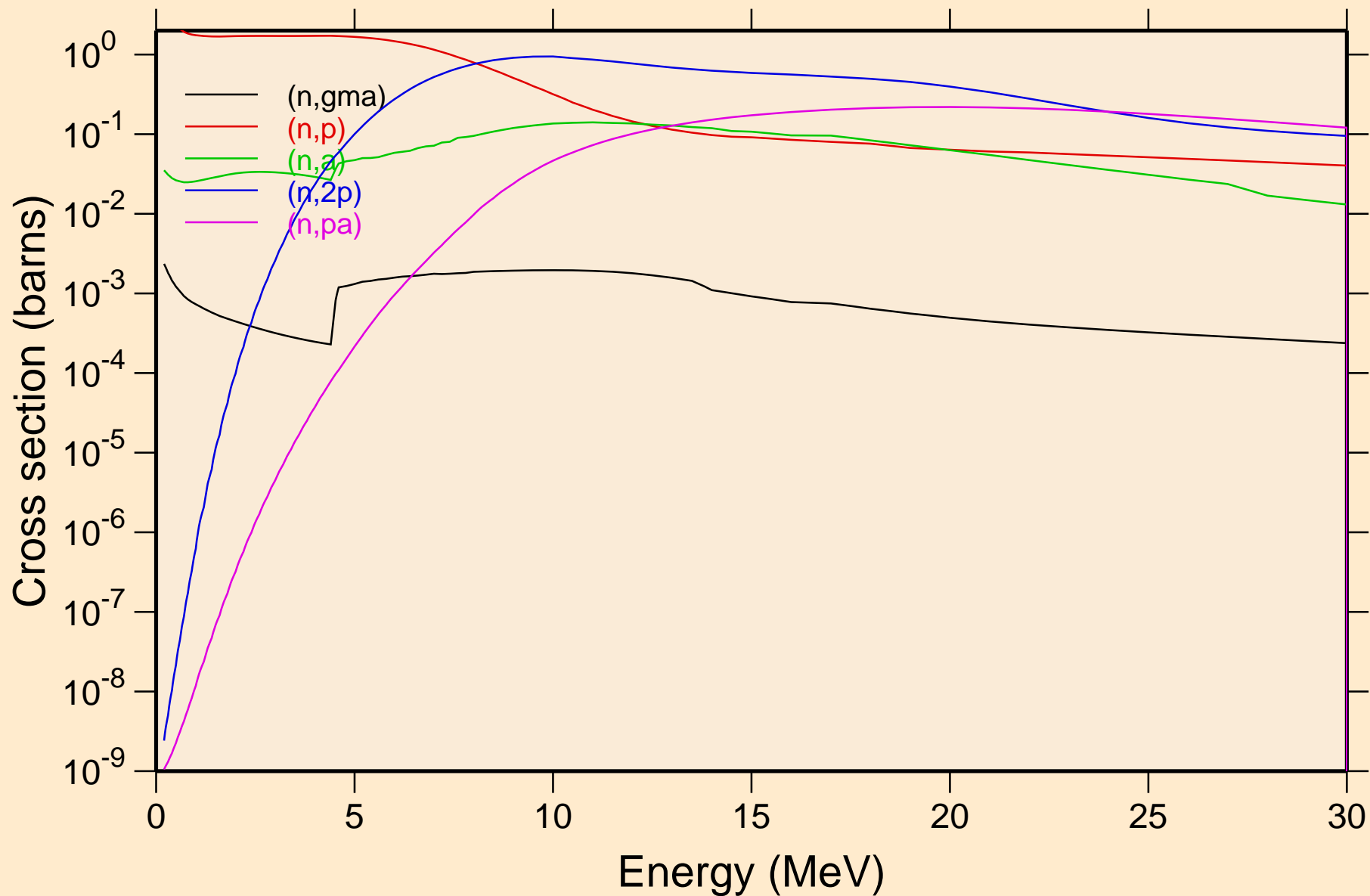

AG098 NEUTRON ACER TENDL-2024 LIBRARY; T=293.6K
Non-threshold reactions

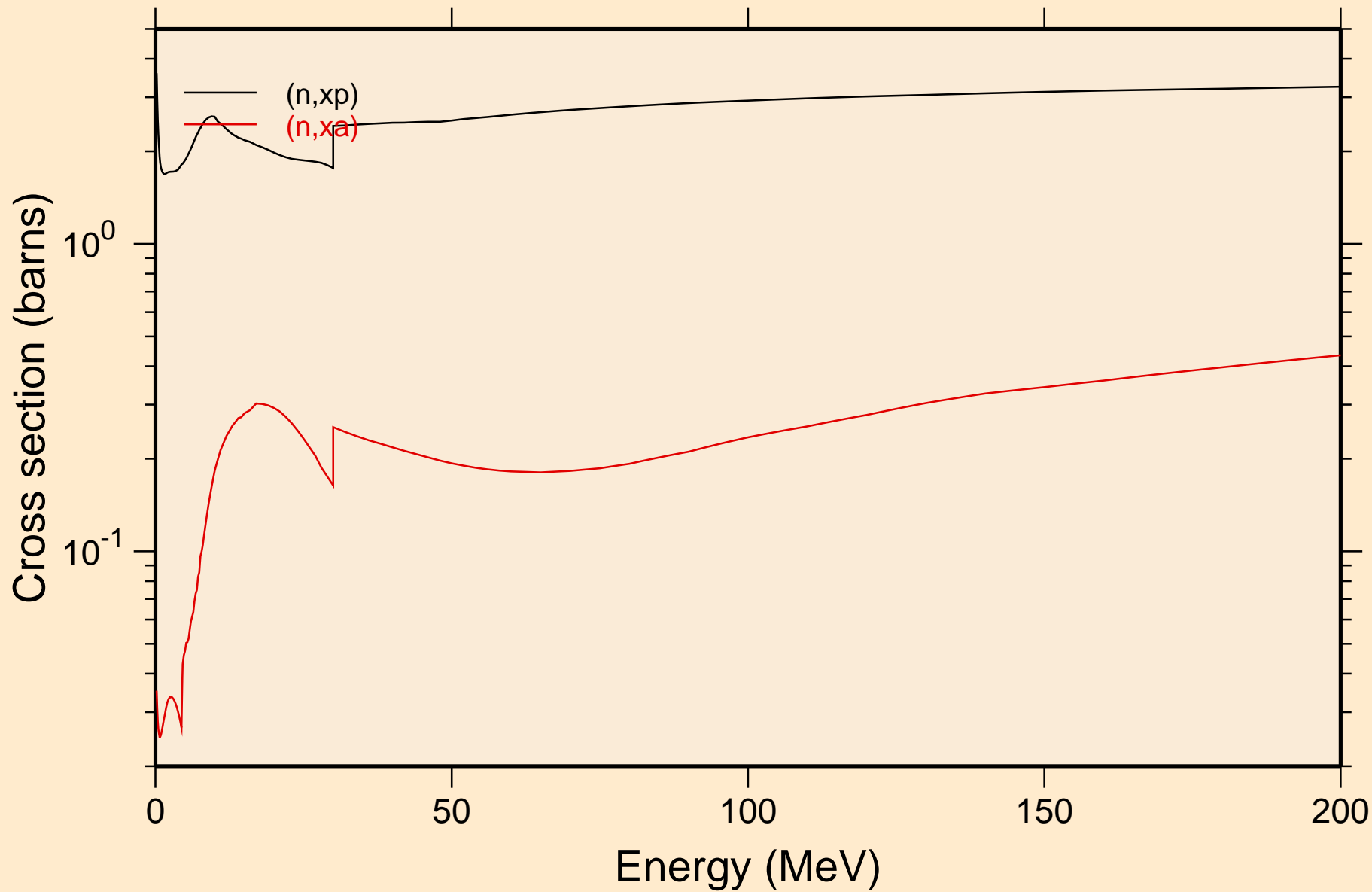

AG098 NEUTRON ACER TENDL-2024 LIBRARY; T=293.6K
Inelastic levels

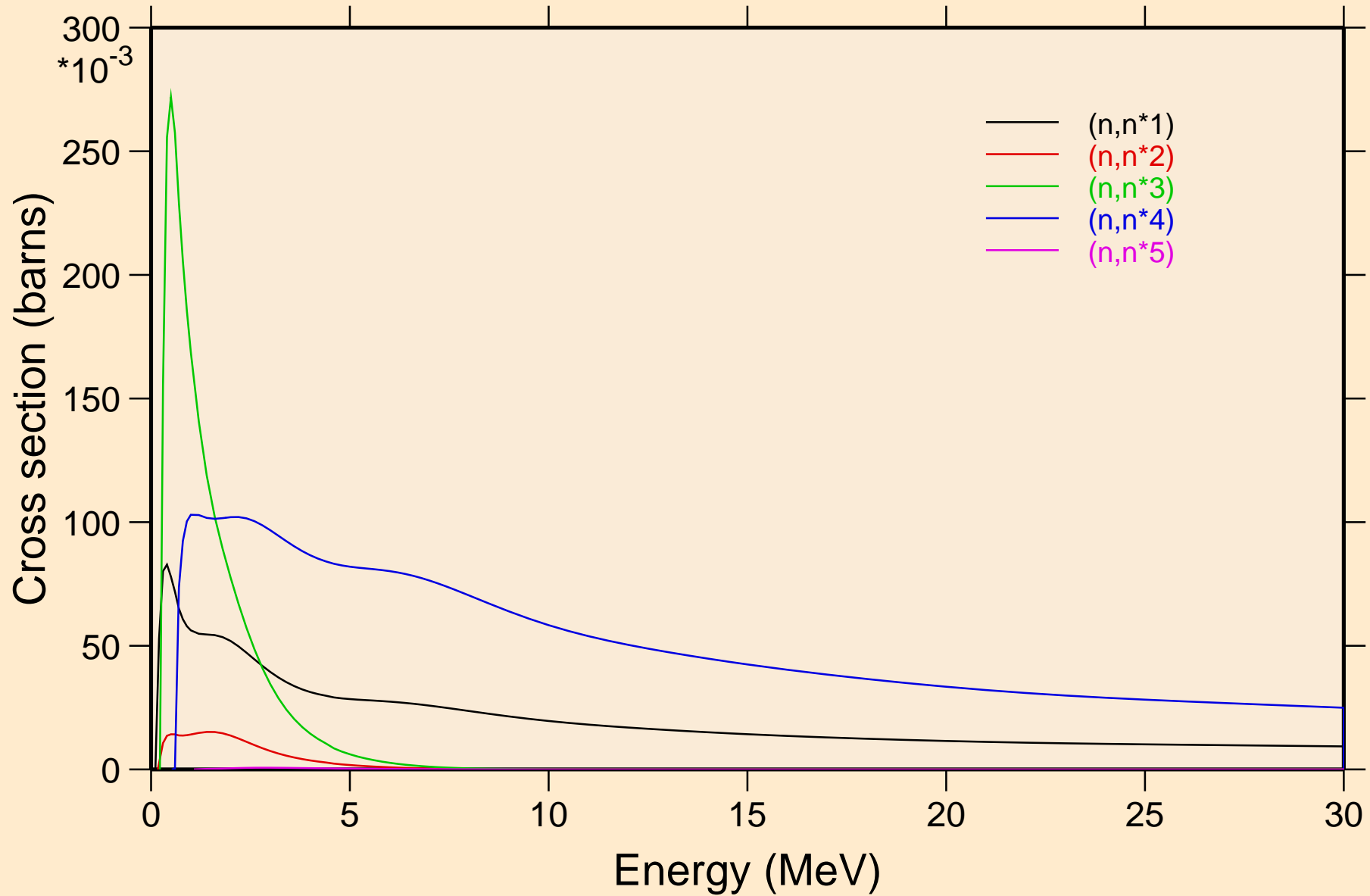

AG098 NEUTRON ACER TENDL-2024 LIBRARY; T=293.6K
Inelastic levels

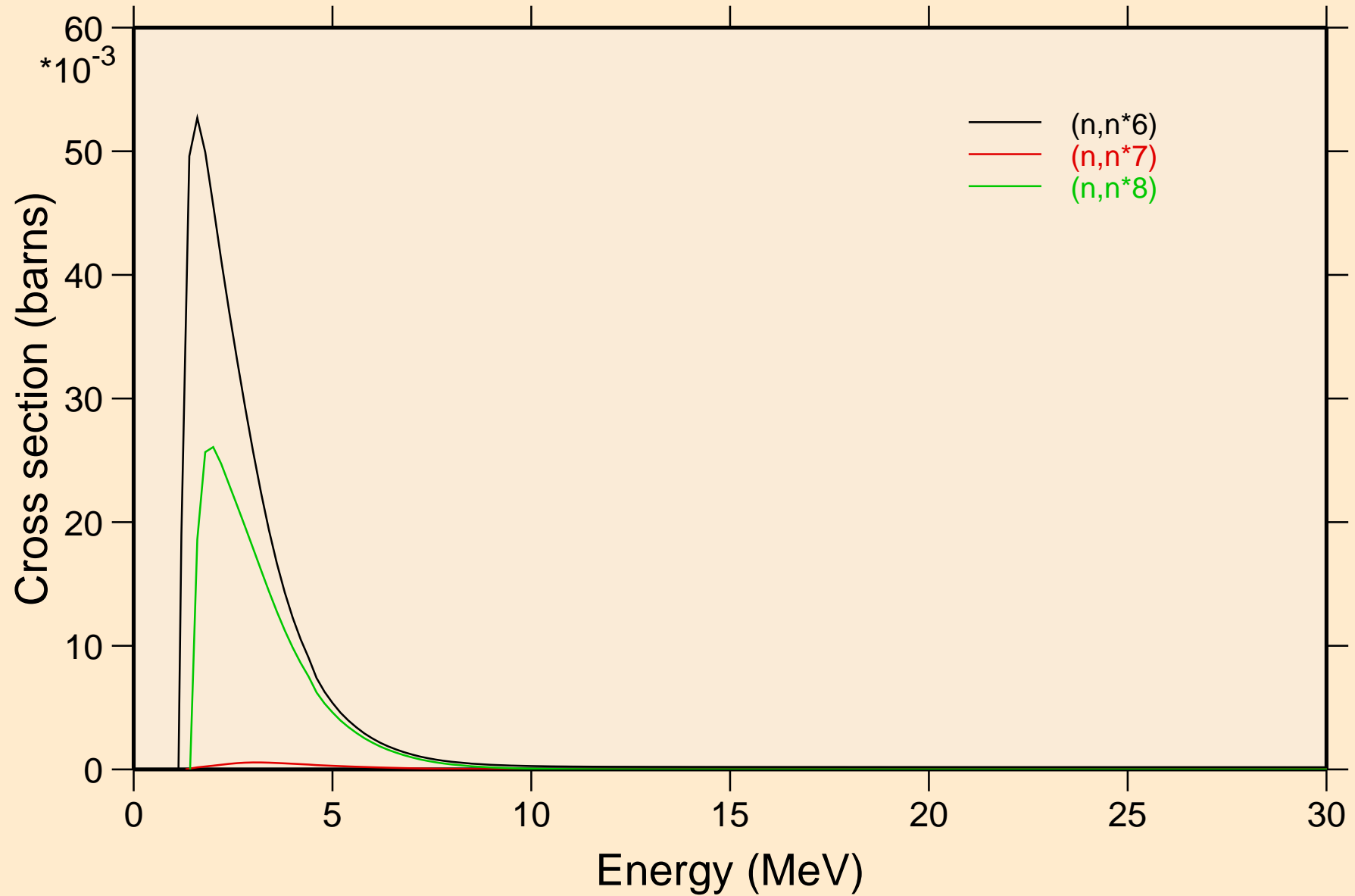

AG098 NEUTRON ACER TENDL-2024 LIBRARY; T=293.6K
Threshold reactions

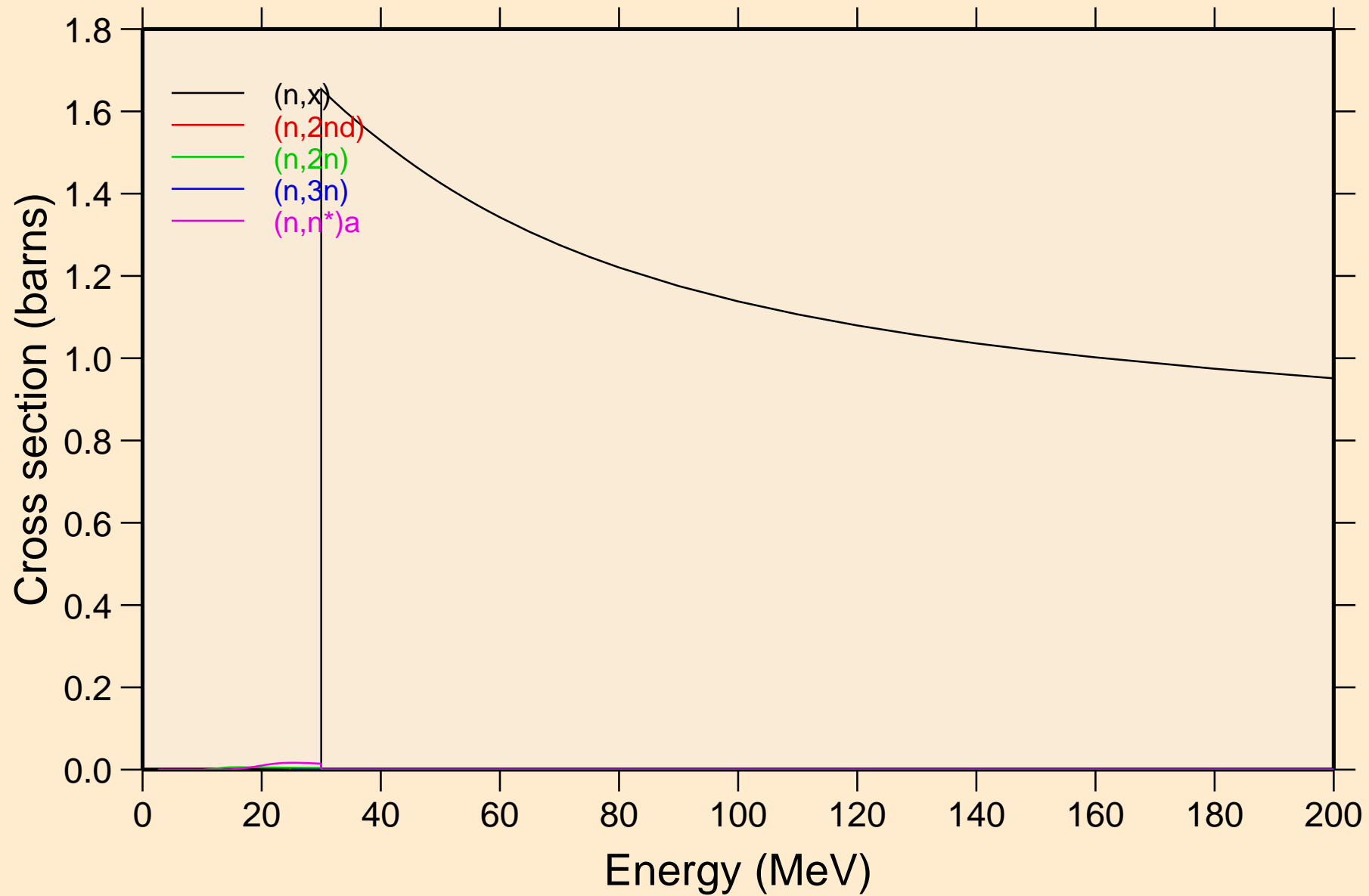

AG098 NEUTRON ACER TENDL-2024 LIBRARY; T=293.6K
Threshold reactions

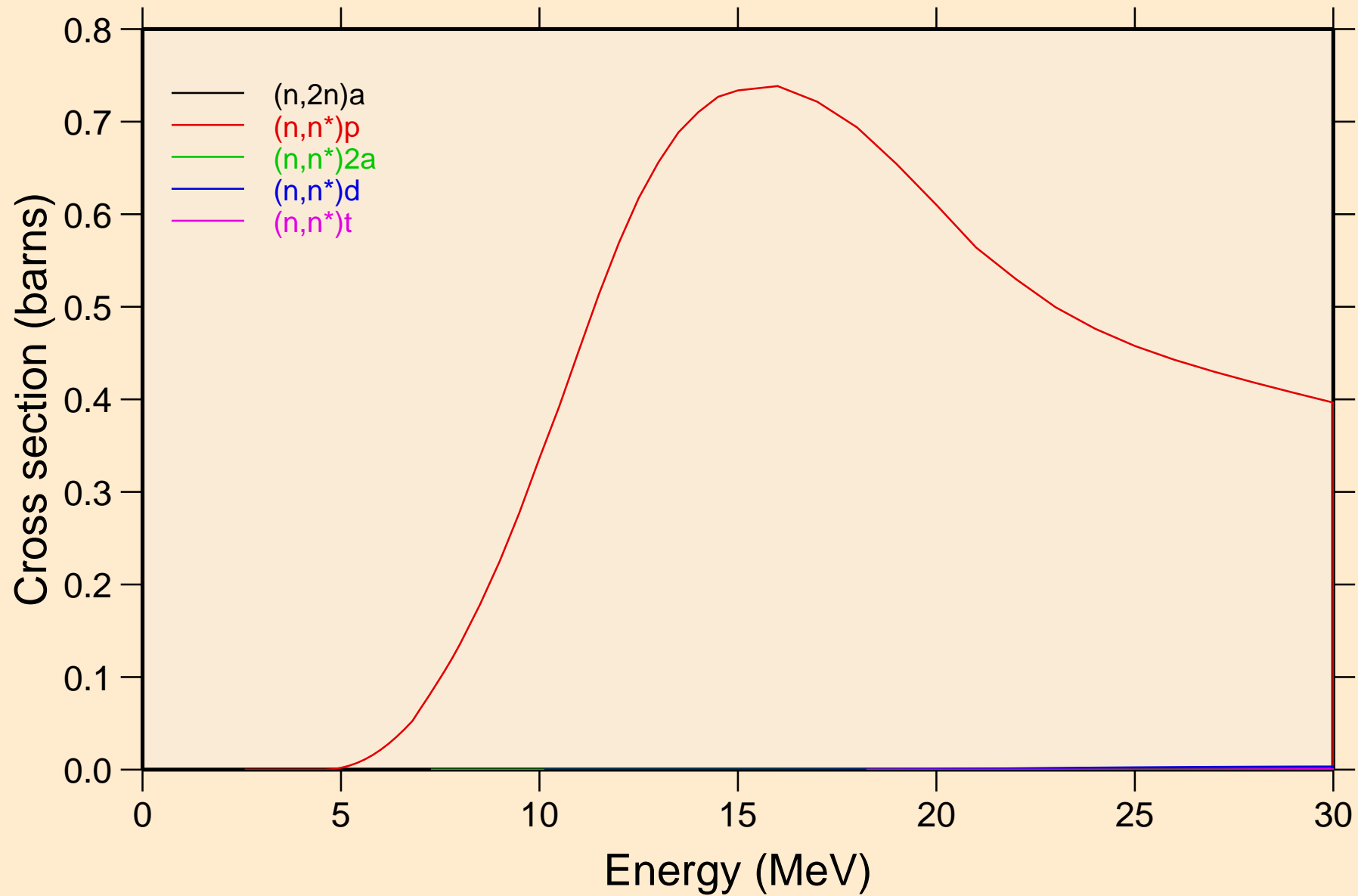

AG098 NEUTRON ACER TENDL-2024 LIBRARY; T=293.6K
Threshold reactions

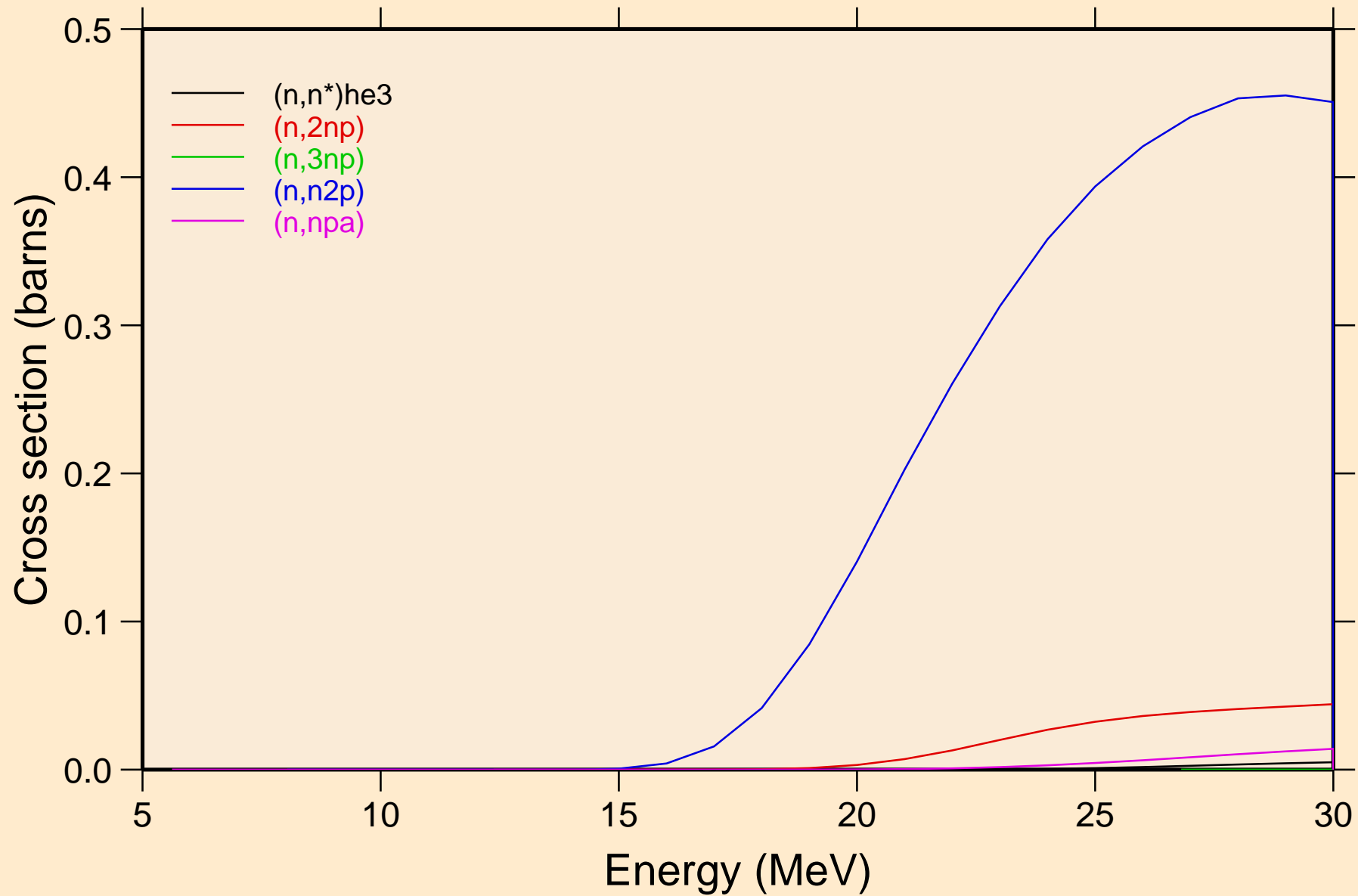

AG098 NEUTRON ACER TENDL-2024 LIBRARY; T=293.6K

Threshold reactions

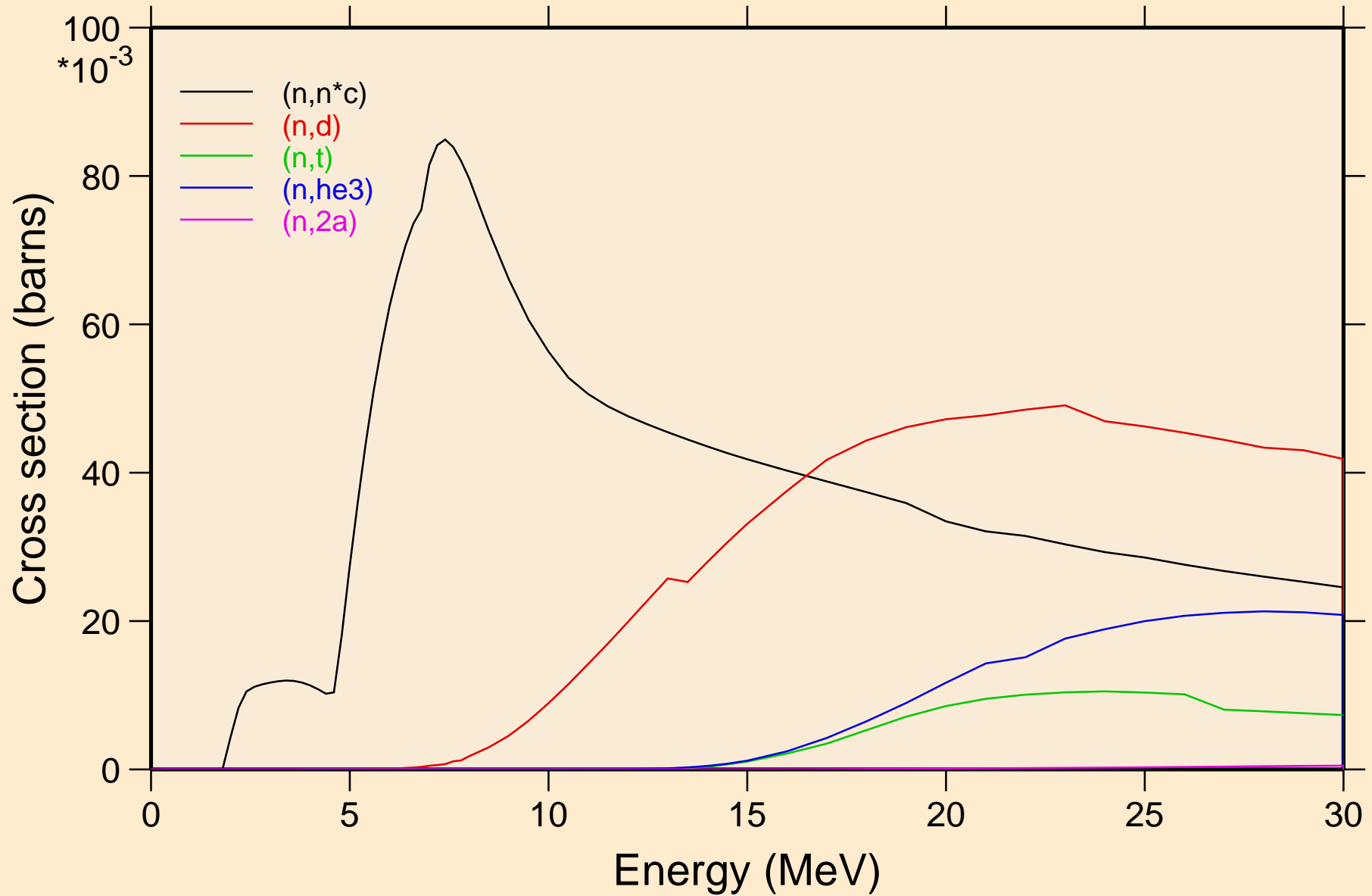

AG098 NEUTRON ACER TENDL-2024 LIBRARY; T=293.6K
Threshold reactions

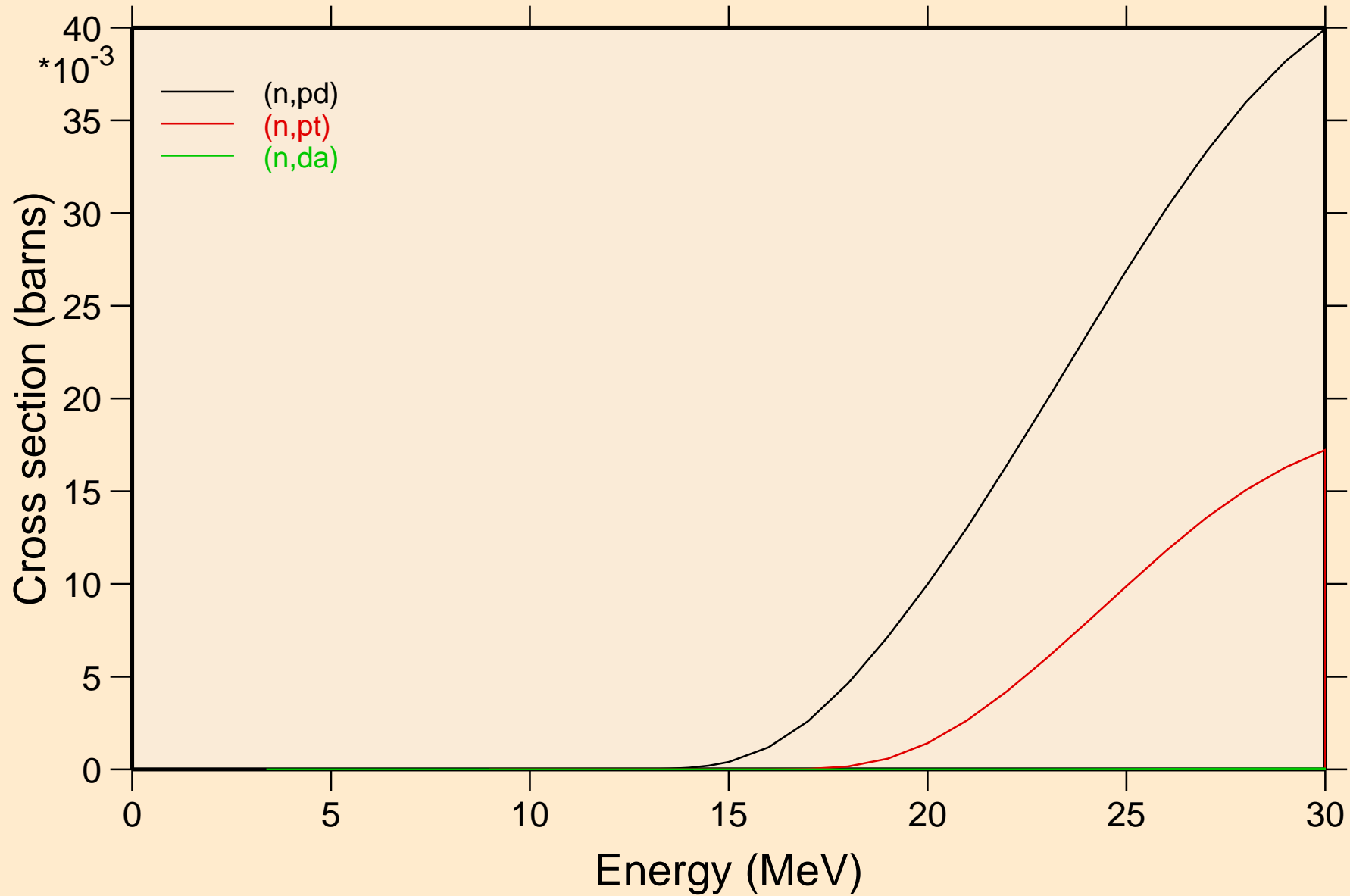

AG098 NEUTRON ACER TENDL-2024 LIBRARY; T=293.6K
Threshold reactions

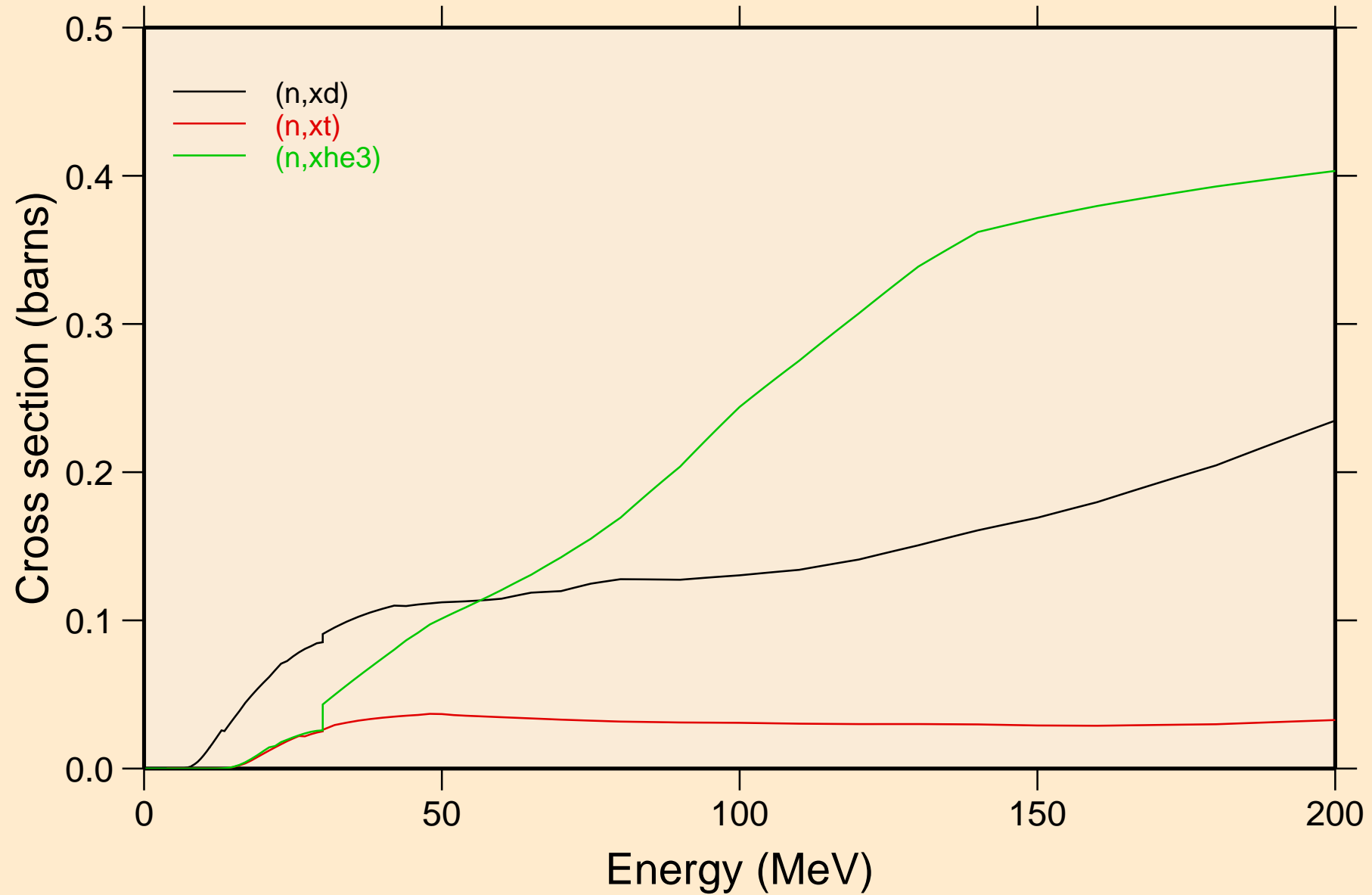

AG098 NEUTRON ACER TENDL-2024 LIBRARY; T=293.6K
angular distribution for elastic

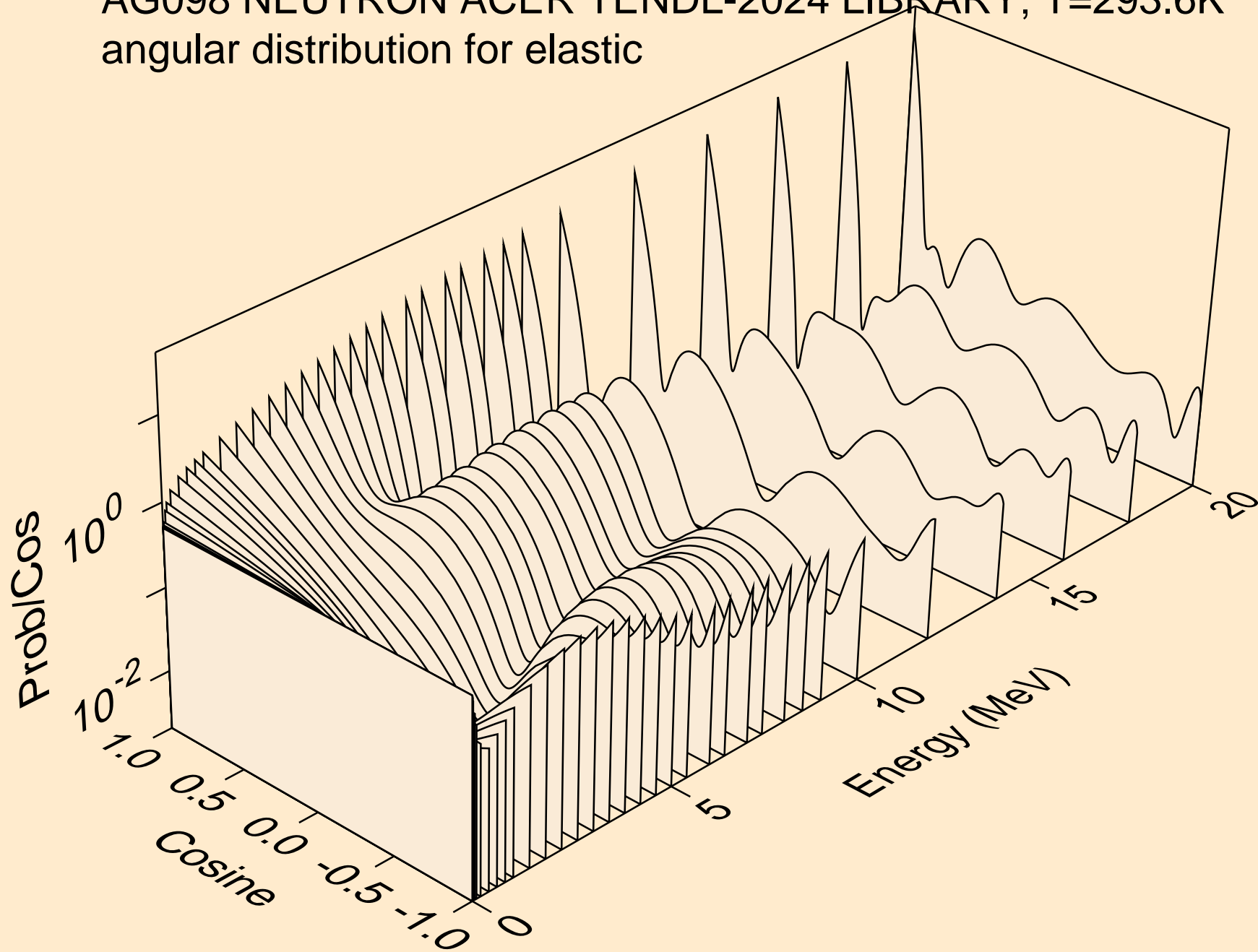

AG098 NEUTRON ACER TENDL-2024 LIBRARY; T=293.6K
angular distribution for elastic

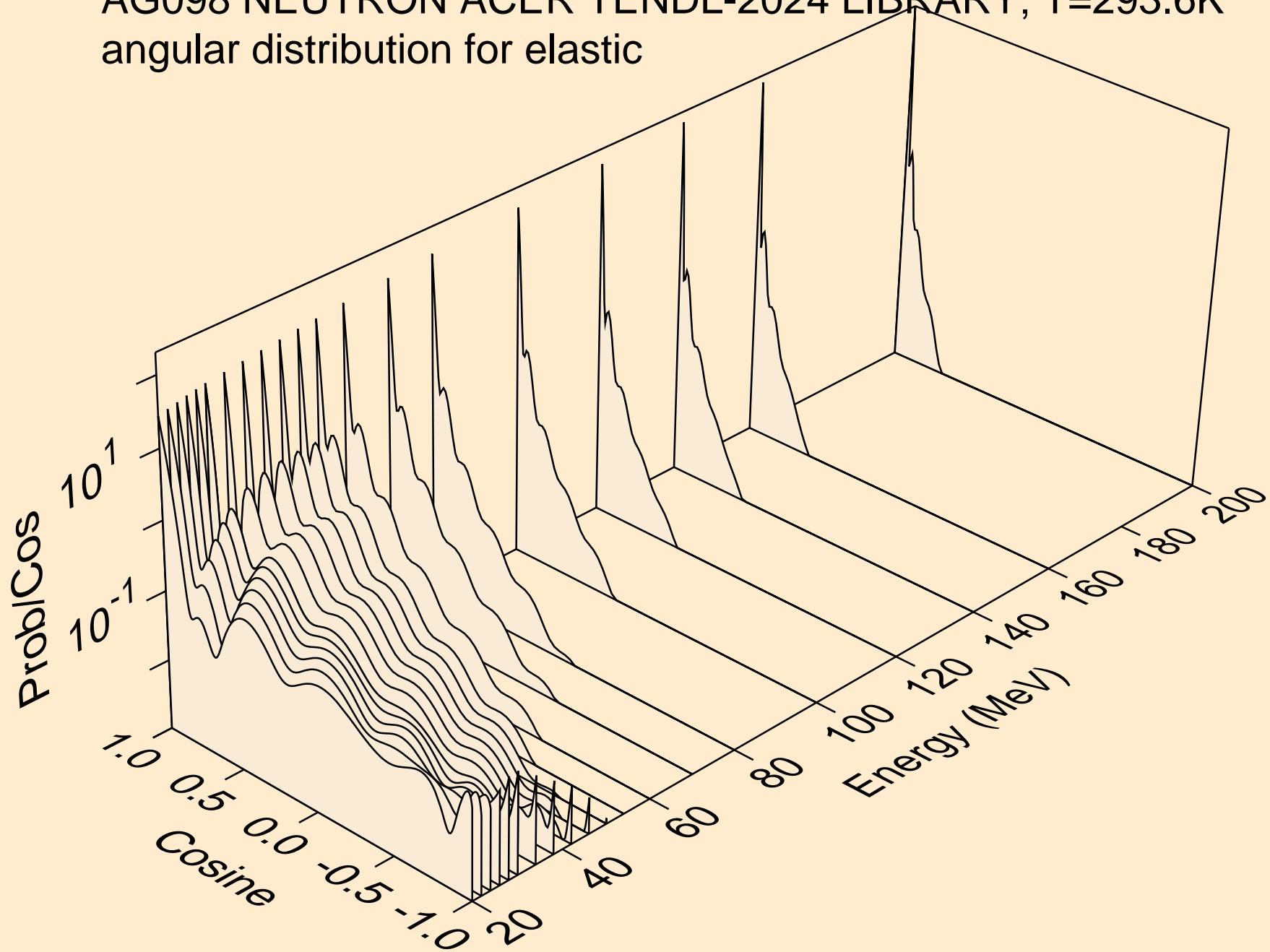

AG098 NEUTRON ACER TENDL-2024 LIBRARY; T=293.6K
angular distribution for (n,n*1)

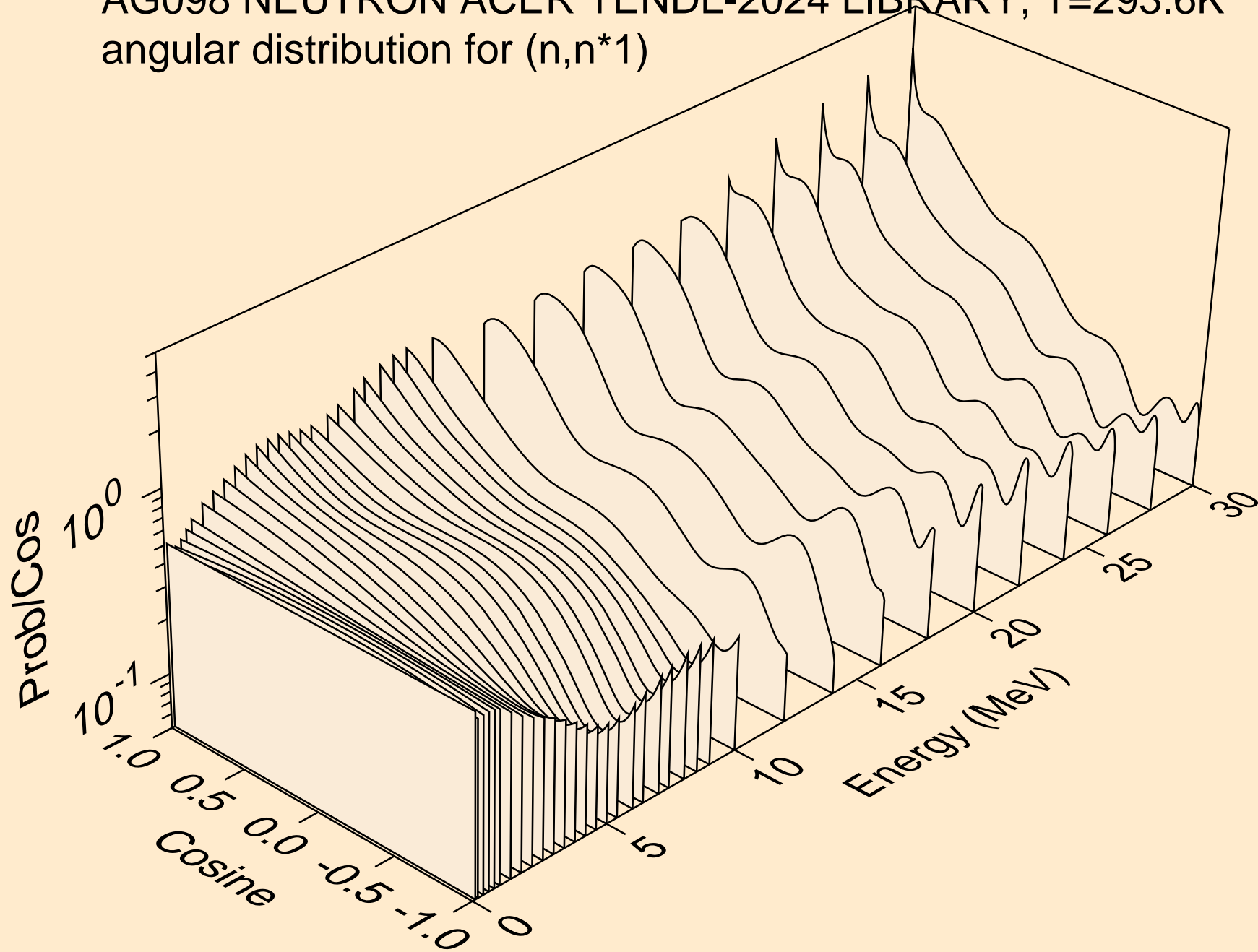

AG098 NEUTRON ACER TENDL-2024 LIBRARY; T=293.6K
angular distribution for (n,n*2)

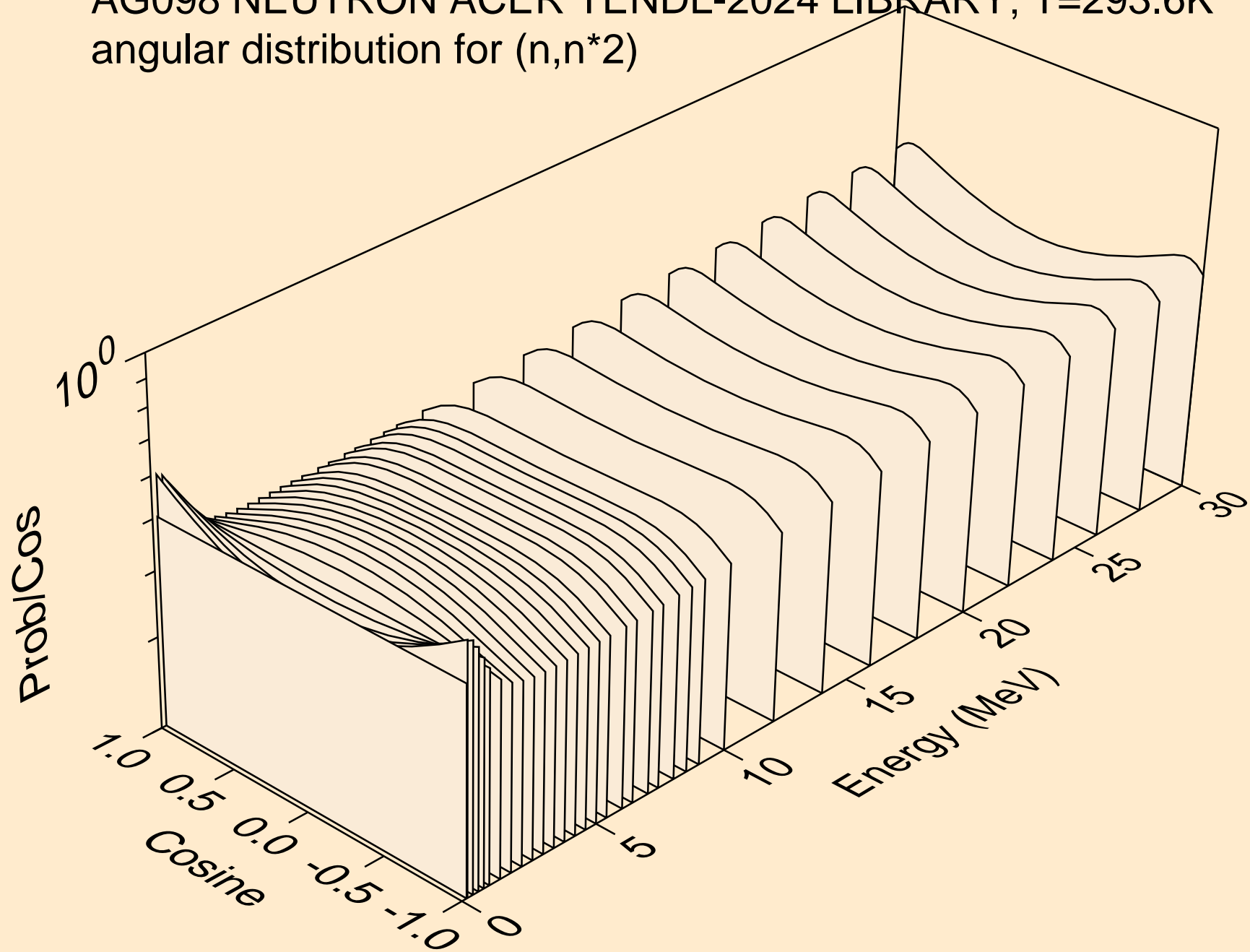

AG098 NEUTRON ACER TENDL-2024 LIBRARY; T=293.6K
angular distribution for (n,n*3)

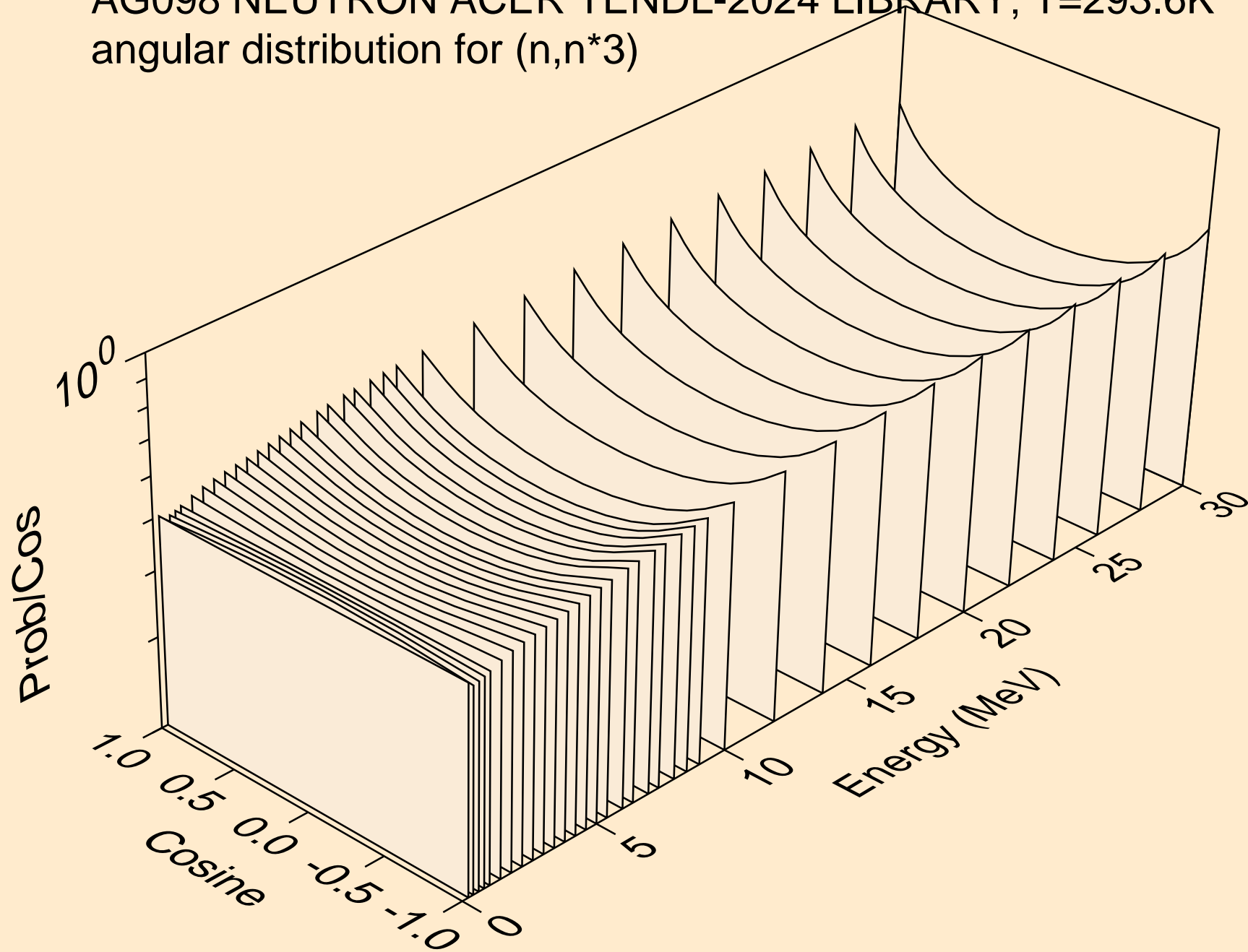

AG098 NEUTRON ACER TENDL-2024 LIBRARY; T=293.6K
angular distribution for (n,n*4)

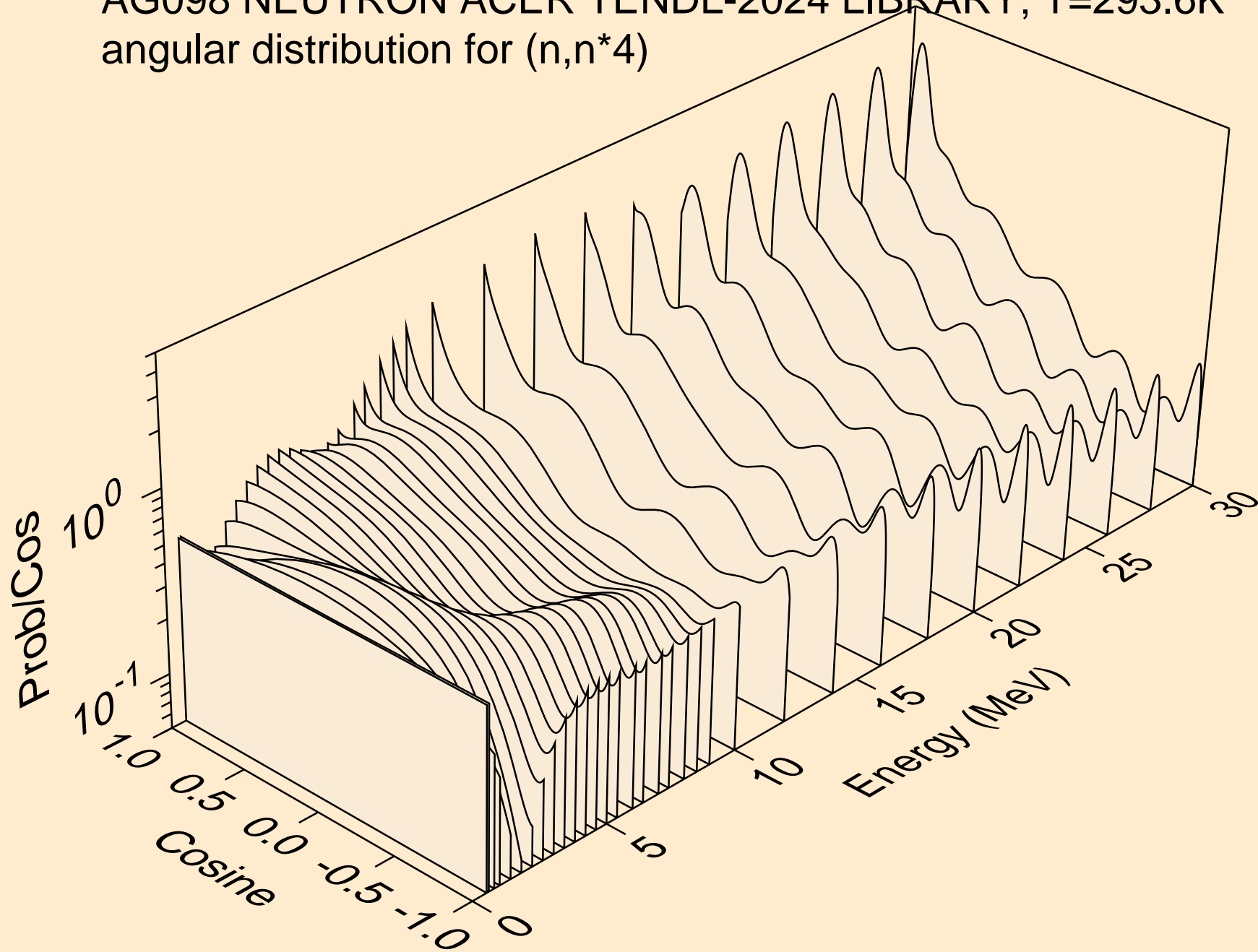

AG098 NEUTRON ACER TENDL-2024 LIBRARY; T=293.6K
angular distribution for (n,n*5)

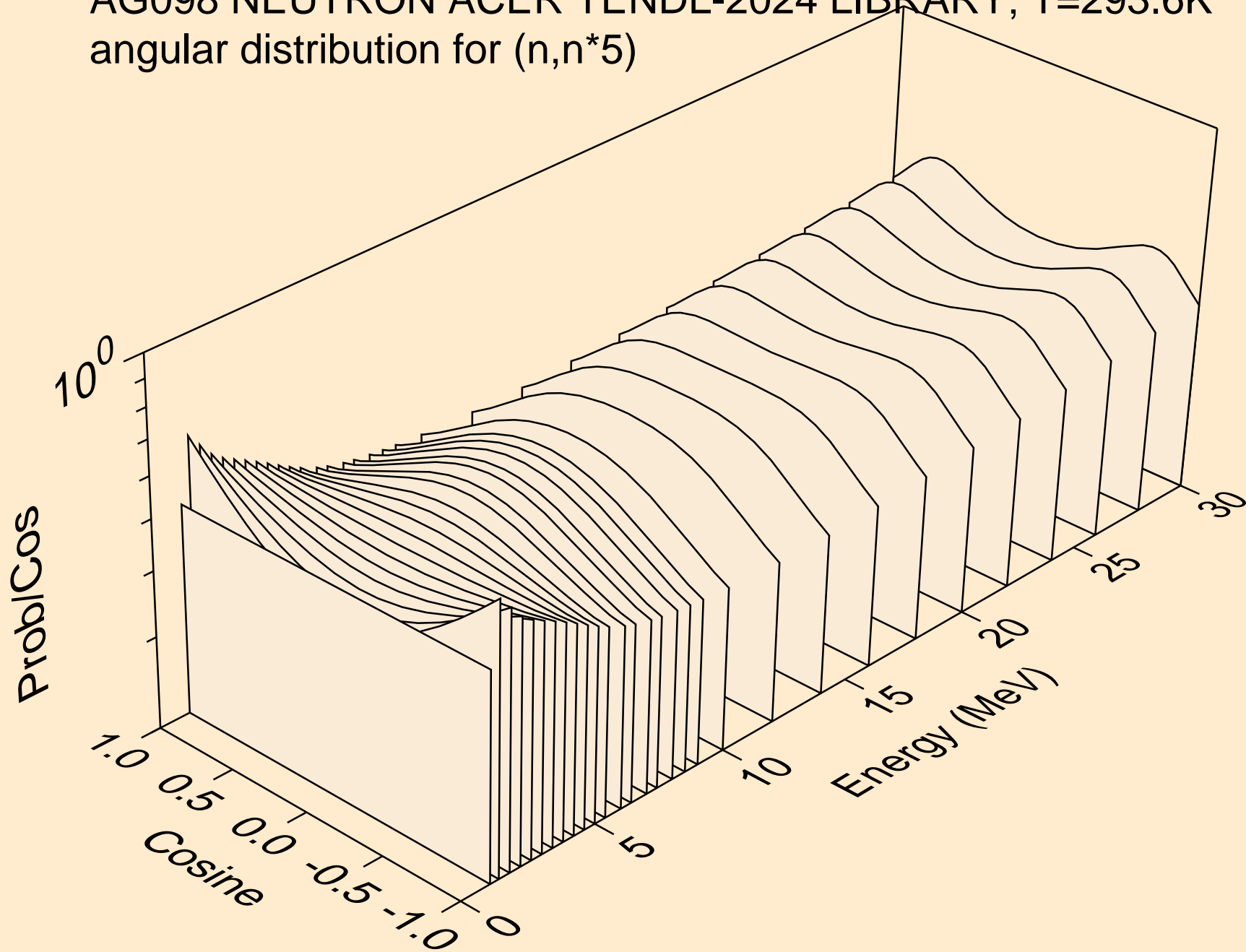

AG098 NEUTRON ACER TENDL-2024 LIBRARY; T=293.6K
angular distribution for (n,n*6)

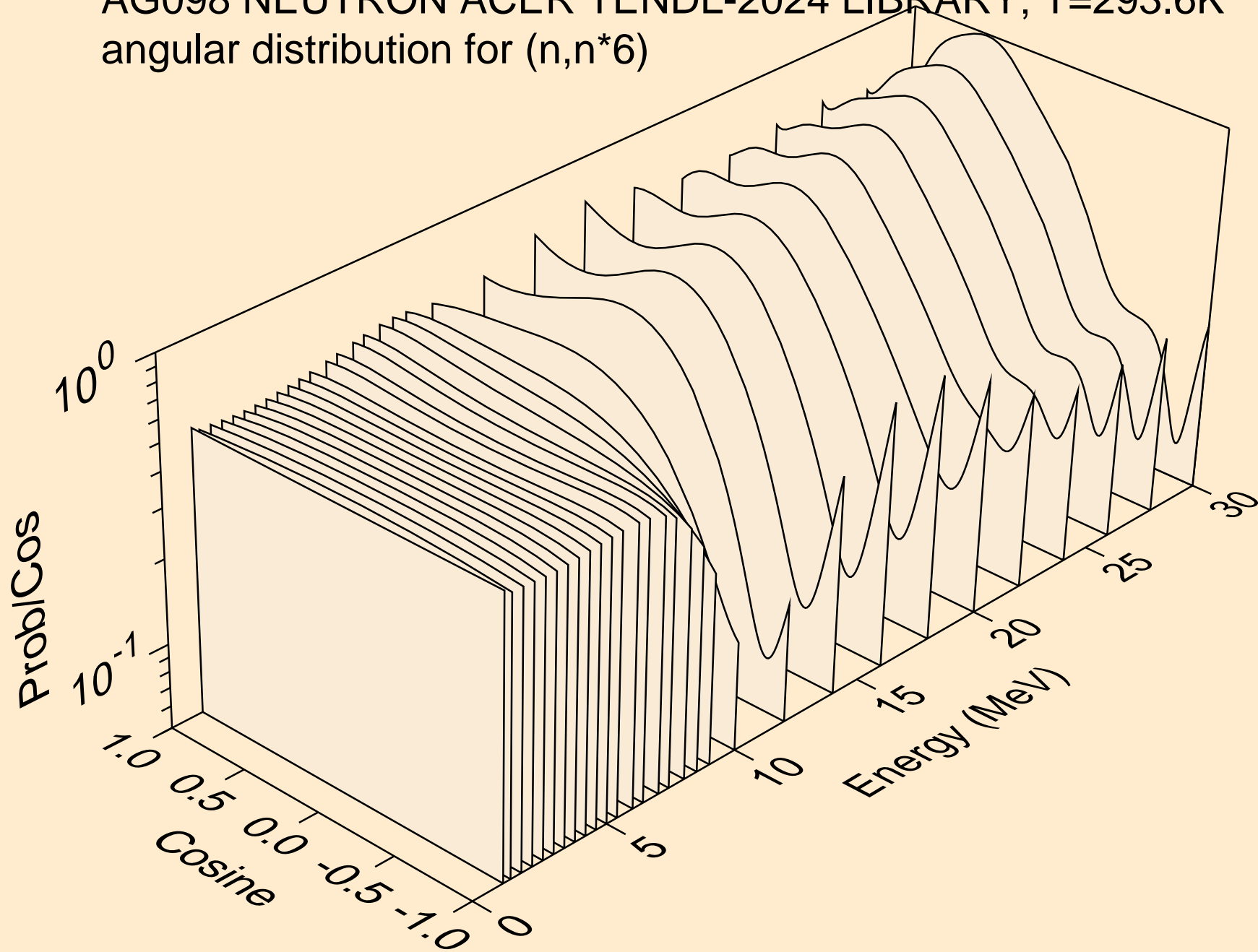

AG098 NEUTRON ACER TENDL-2024 LIBRARY; T=293.6K
angular distribution for (n,n*7)

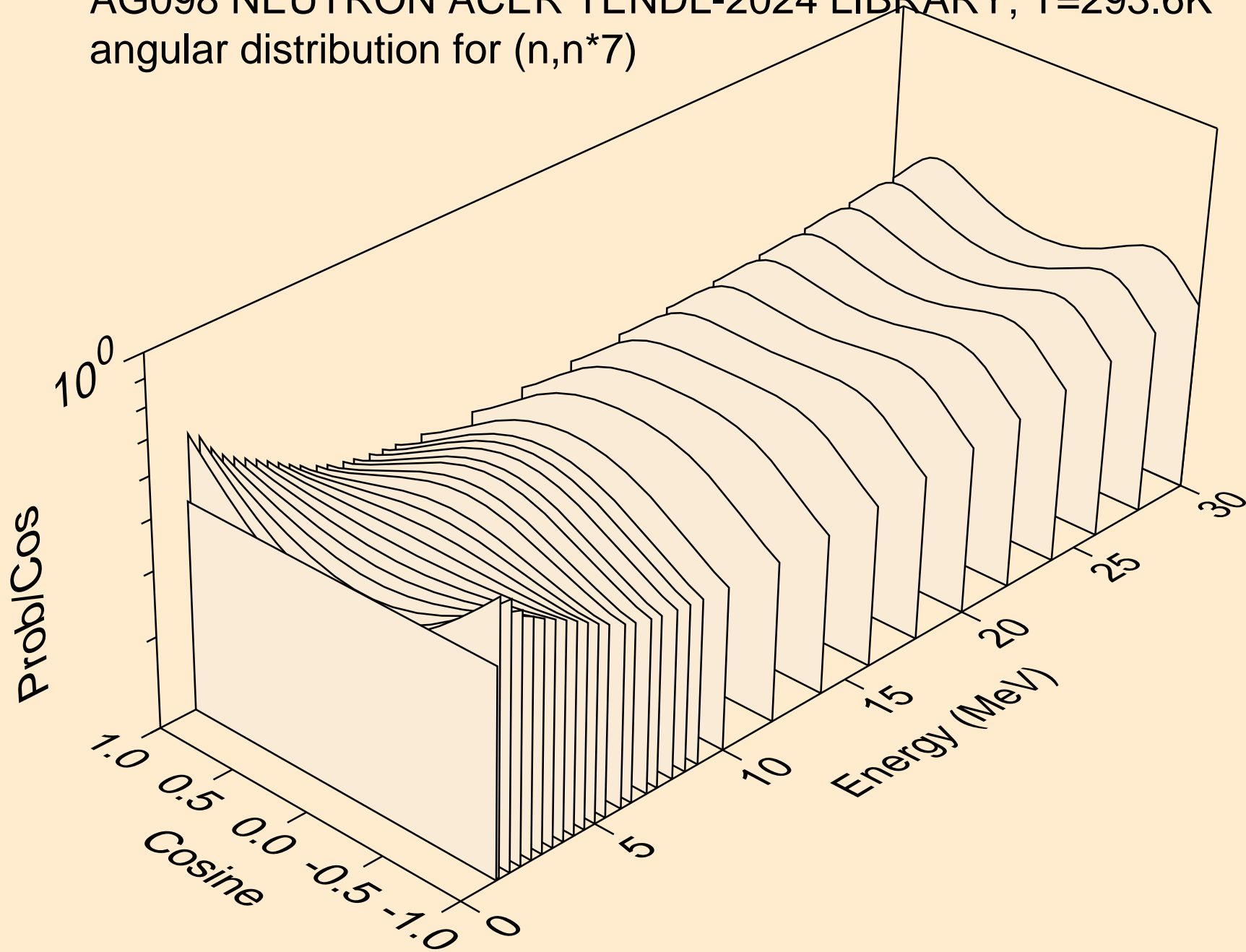

AG098 NEUTRON ACER TENDL-2024 LIBRARY; T=293.6K
angular distribution for (n,n*8)

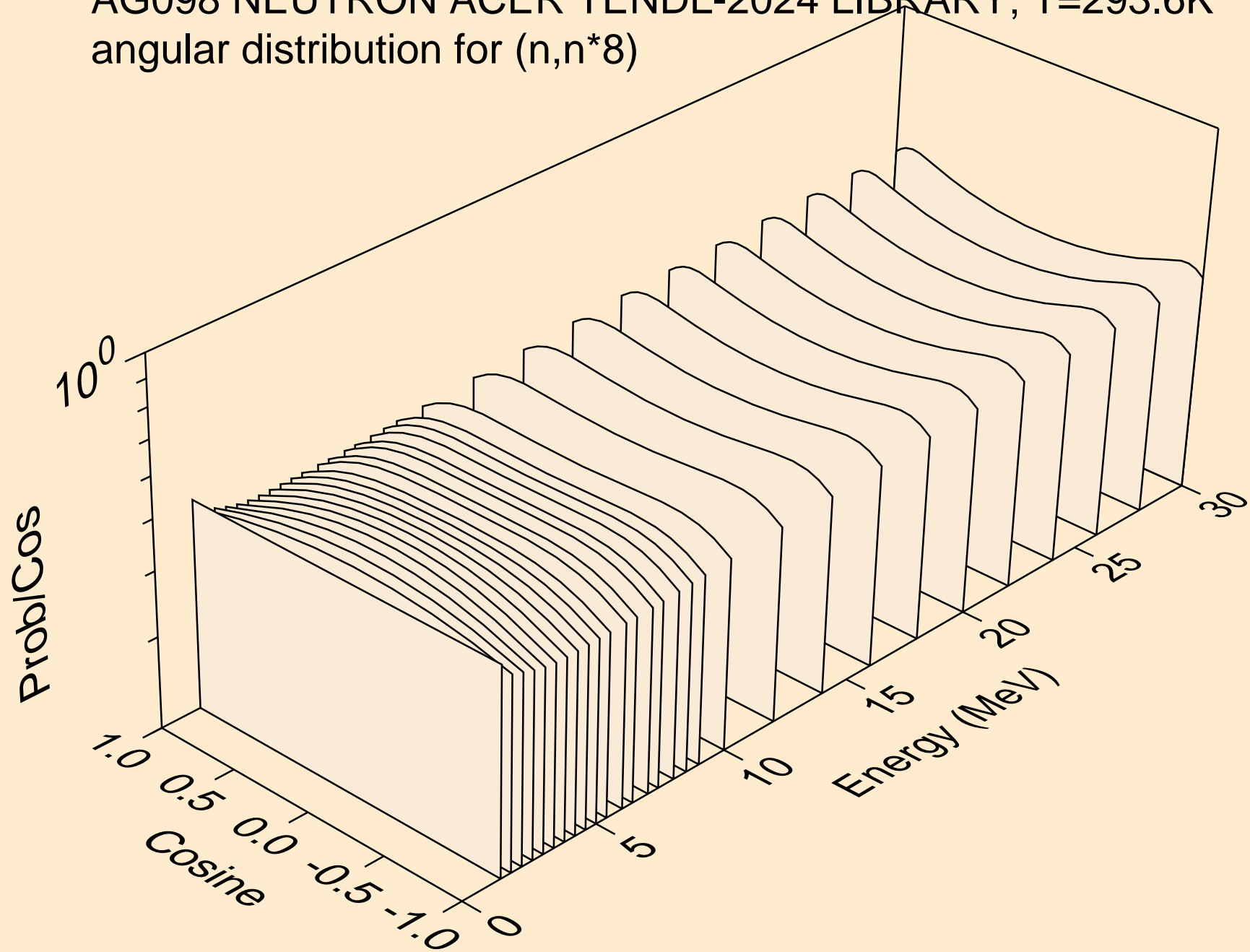

AG098 NEUTRON ACER TENDL-2024 LIBRARY; T=293.6K
Neutron emission for (n,x)

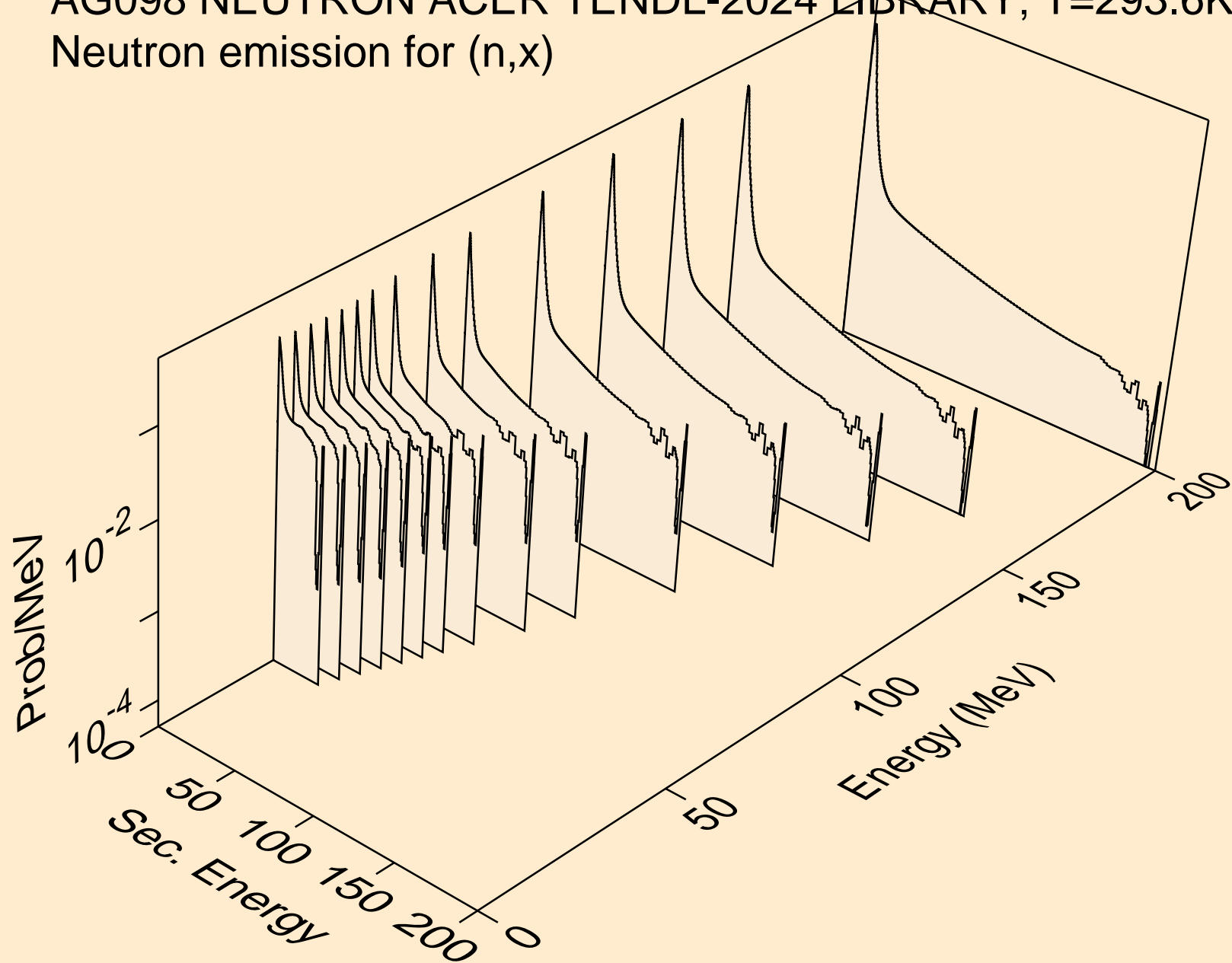

AG098 NEUTRON ACER TENDL-2024 LIBRARY; T=293.6K
Neutron emission for (n,2nd)

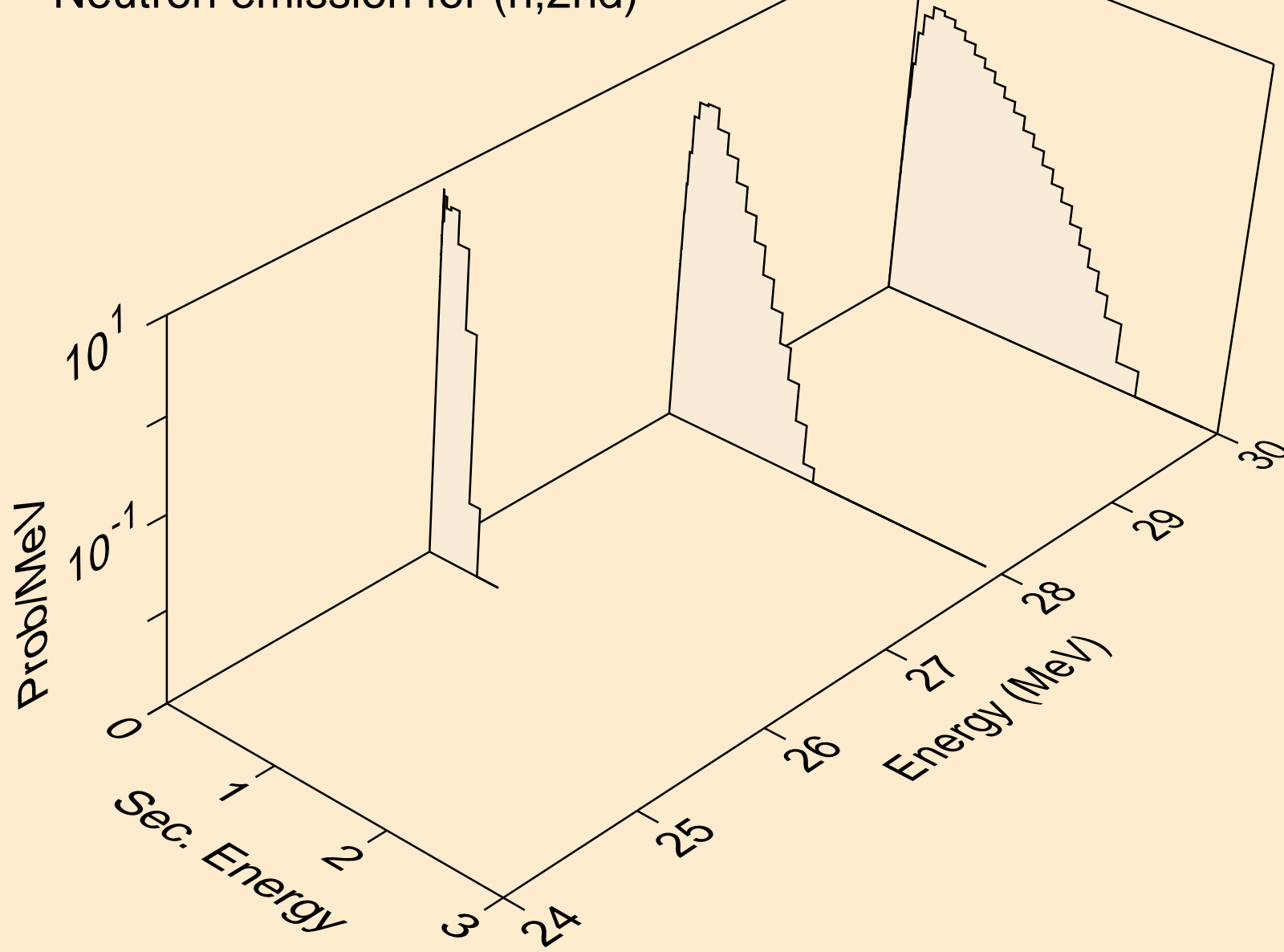

AG098 NEUTRON ACER TENDL-2024 LIBRARY; T=293.6K
Neutron emission for (n,2n)

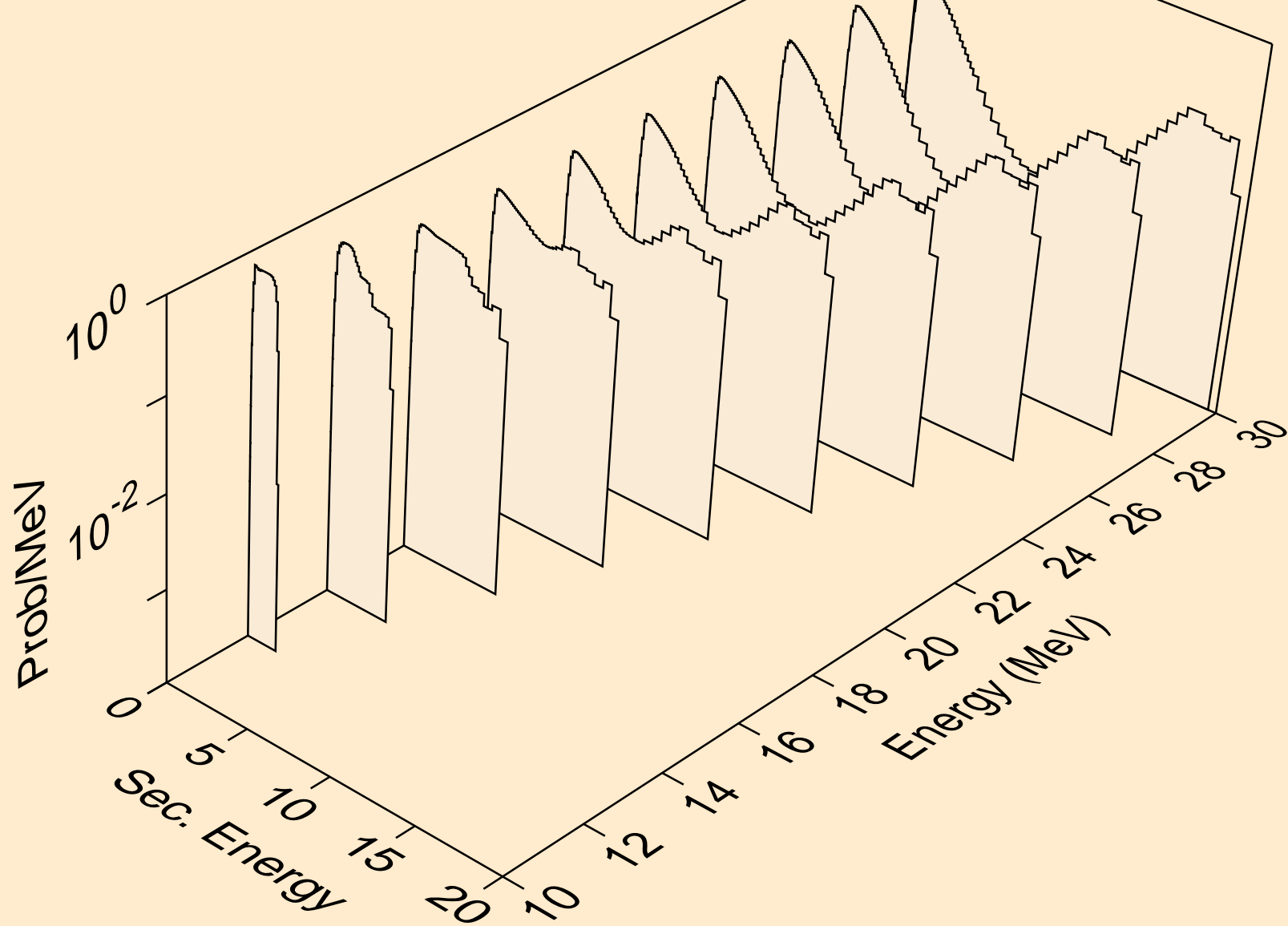

AG098 NEUTRON ACER TENDL-2024 LIBRARY; T=293.6K
Neutron emission for (n,3n)

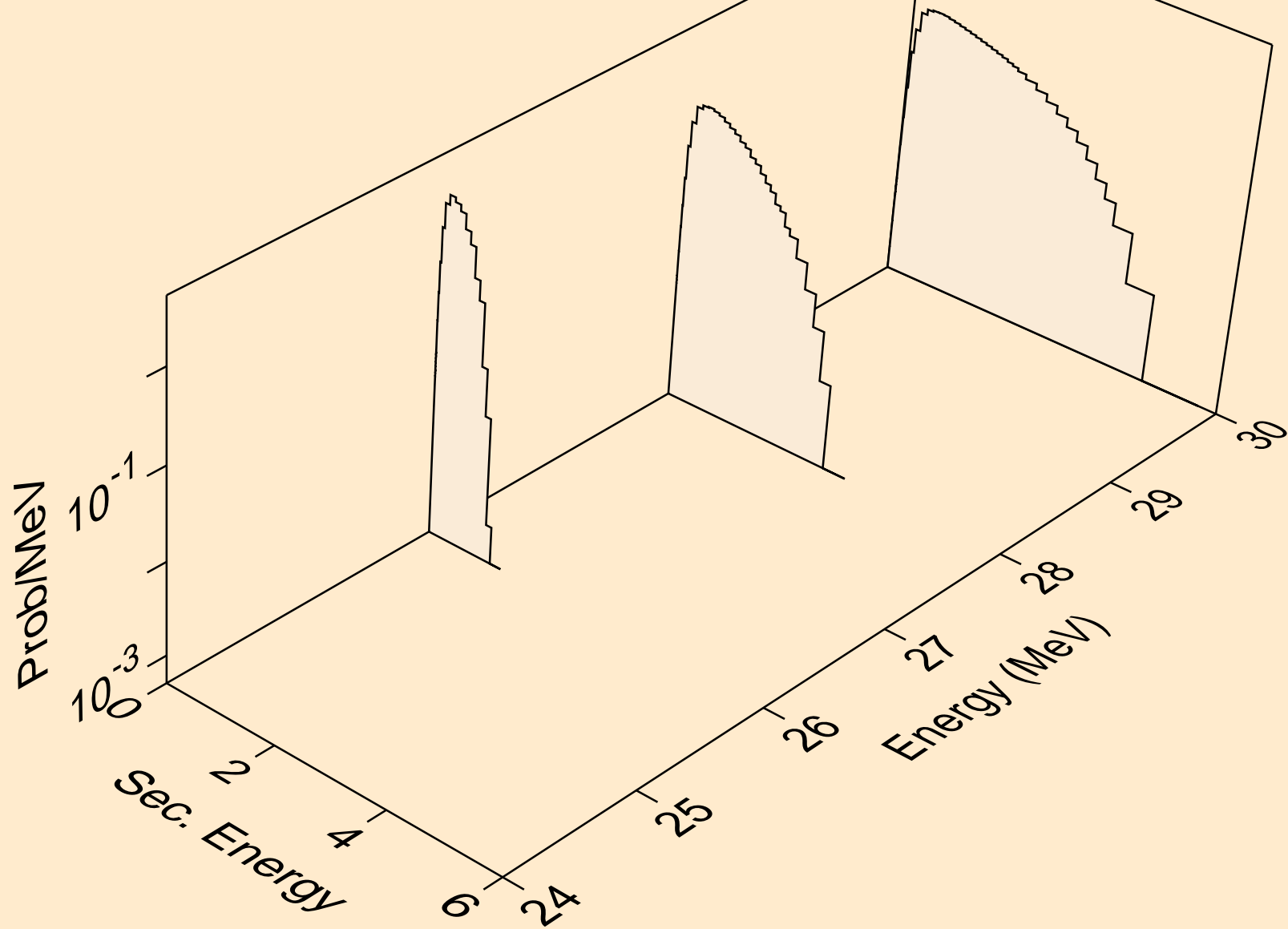

AG098 NEUTRON ACER TENDL-2024 LIBRARY; T=293.6K
Neutron emission for (n,n*)a

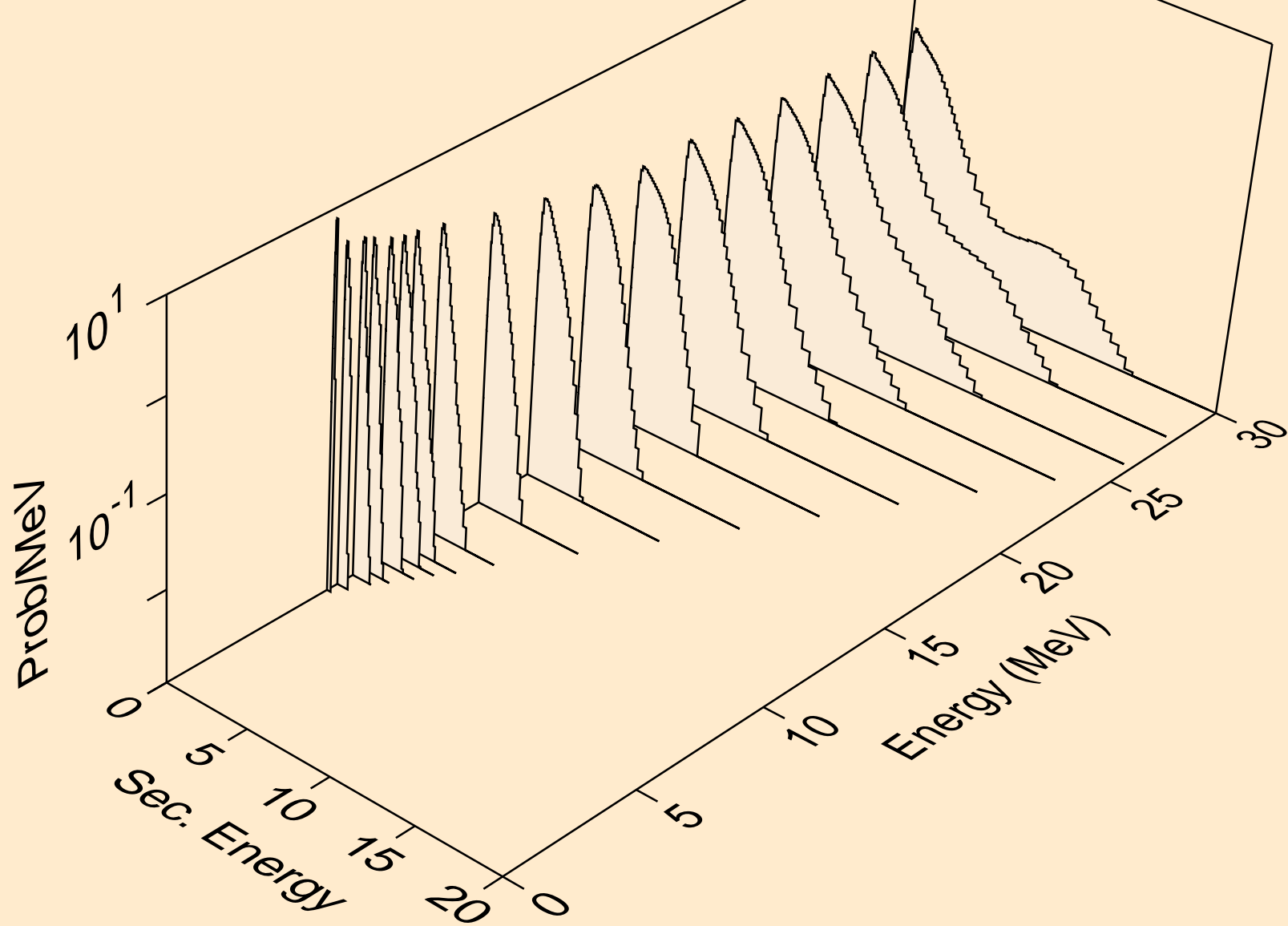

AG098 NEUTRON ACER TENDL-2024 LIBRARY; T=293.6K
Neutron emission for (n,2n)_a

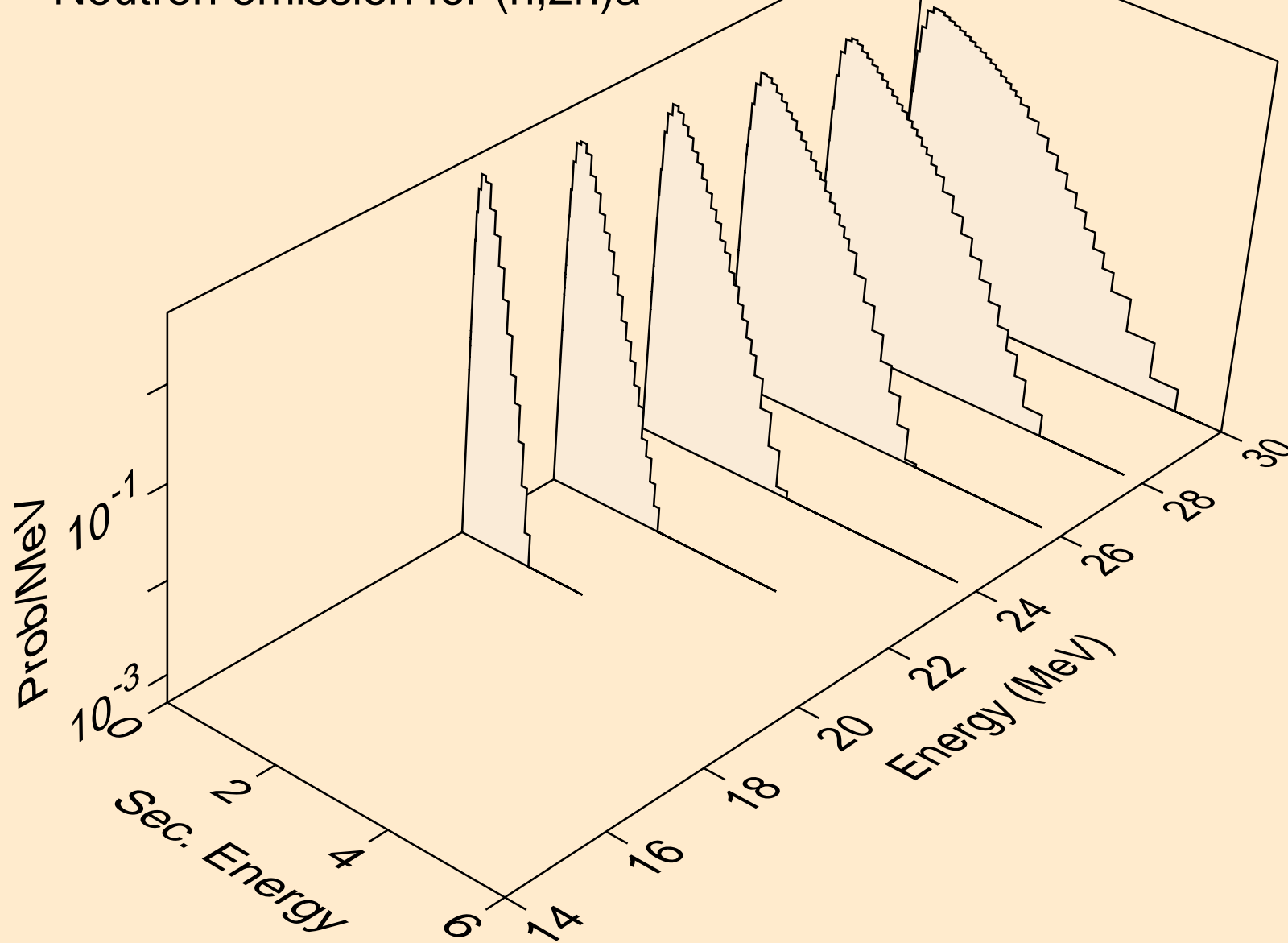

AG098 NEUTRON ACER TENDL-2024 LIBRARY; T=293.6K
Neutron emission for (n,n*)p

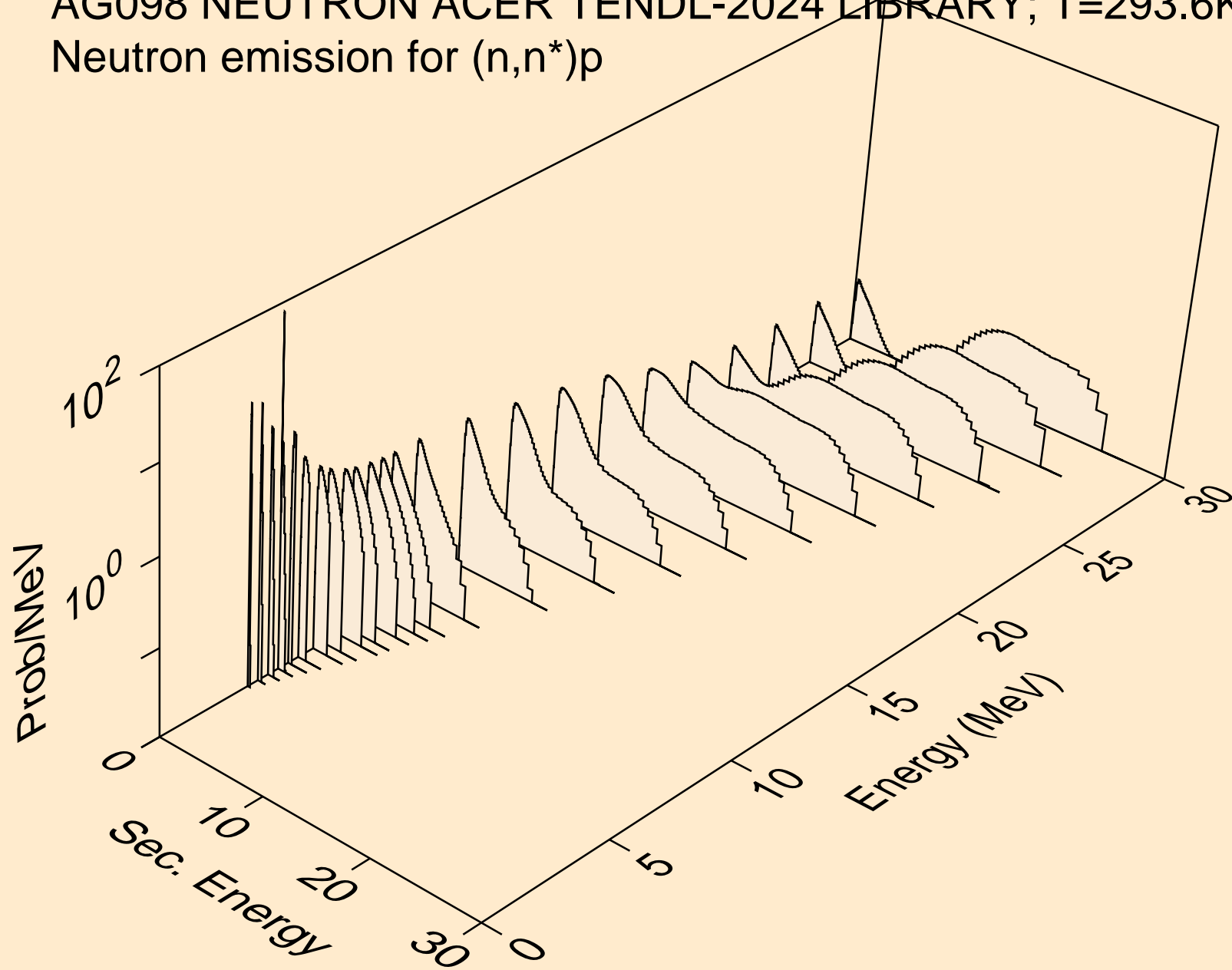

AG098 NEUTRON ACER TENDL-2024 LIBRARY; T=293.6K
Neutron emission for (n,n*)2a

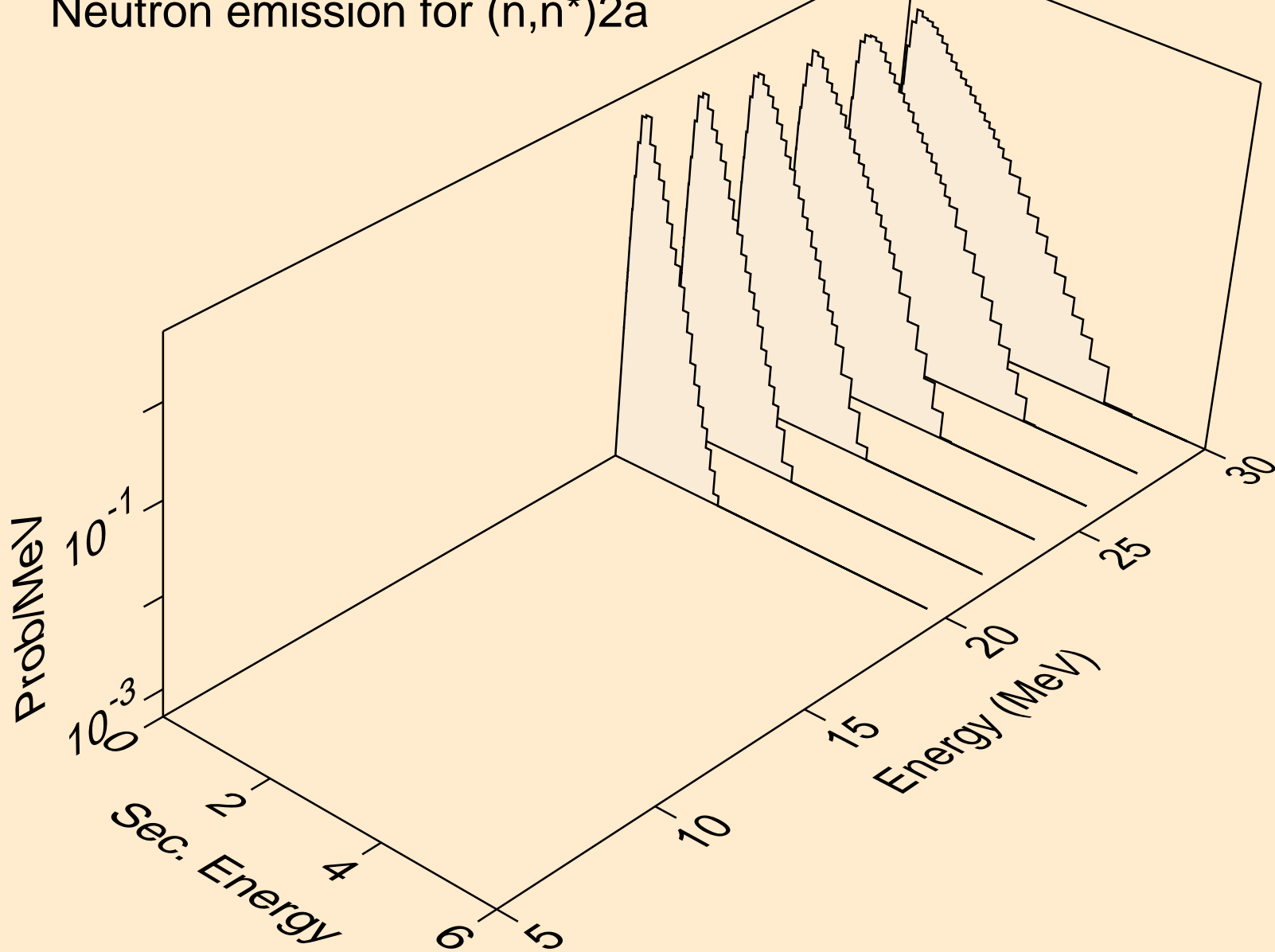

AG098 NEUTRON ACER TENDL-2024 LIBRARY; T=293.6K
Neutron emission for (n,n*)d

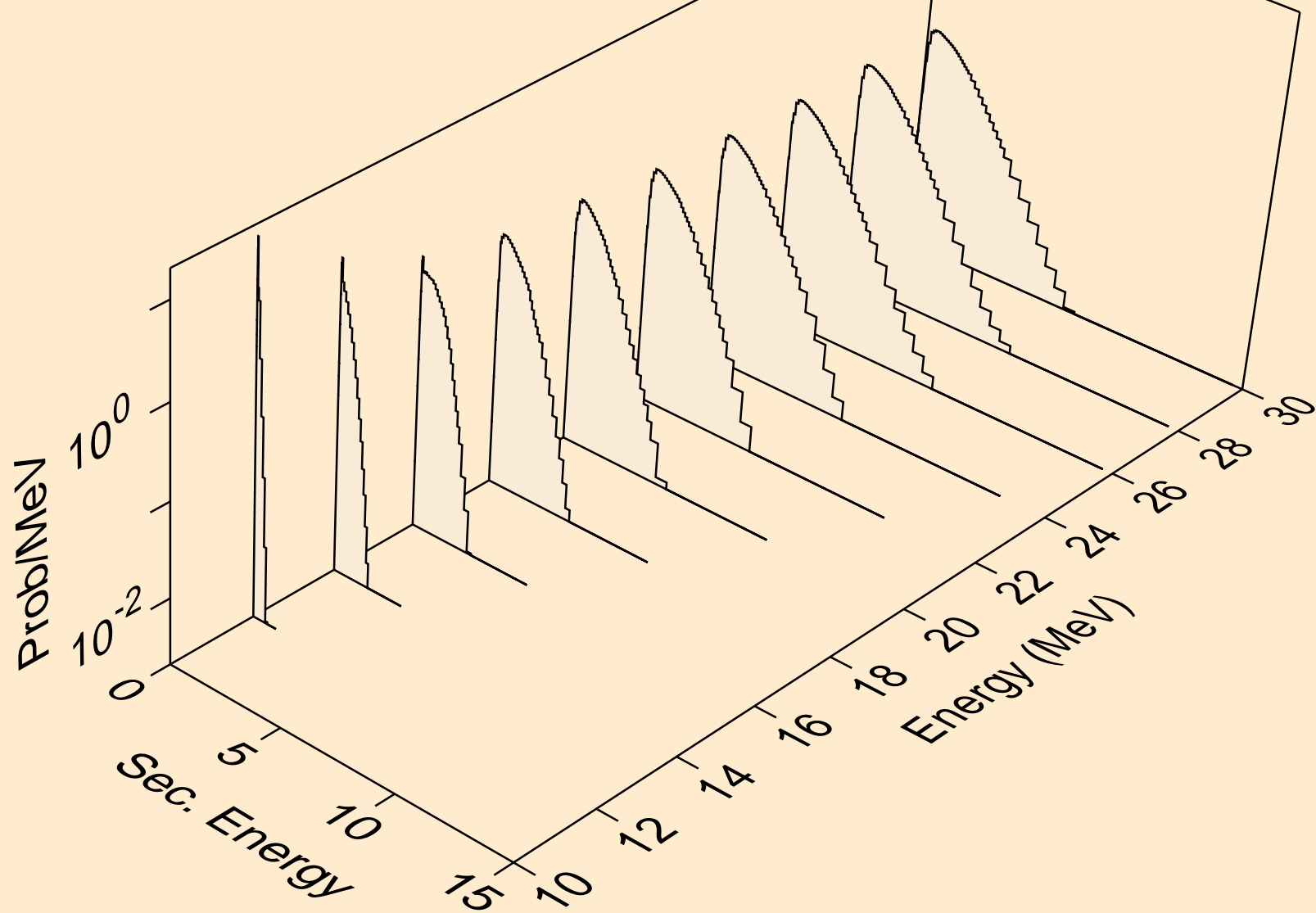

AG098 NEUTRON ACER TENDL-2024 LIBRARY; T=293.6K
Neutron emission for (n,n*)t

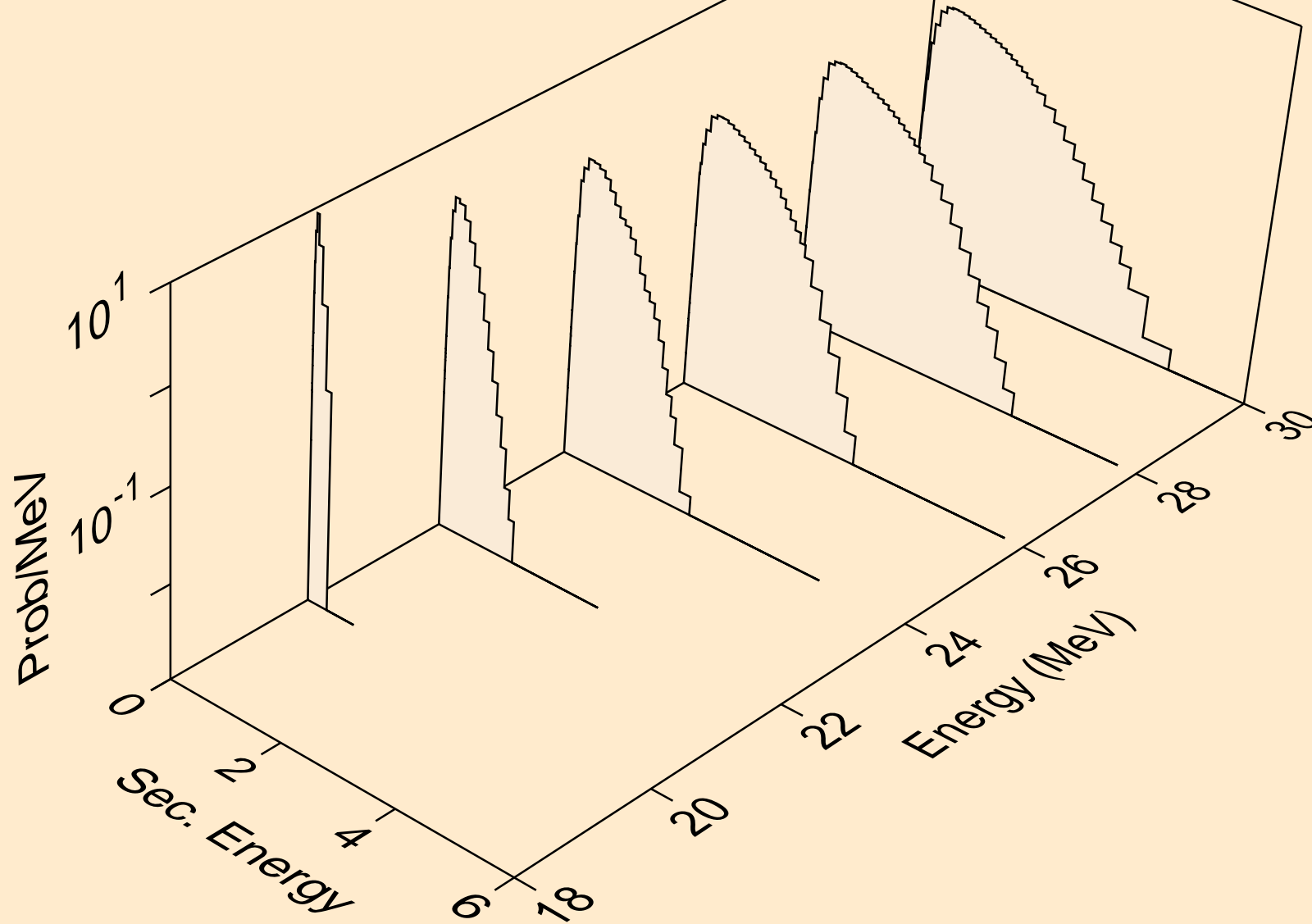

AG098 NEUTRON ACER TENDL-2024 LIBRARY; T=293.6K
Neutron emission for (n,n*)he3

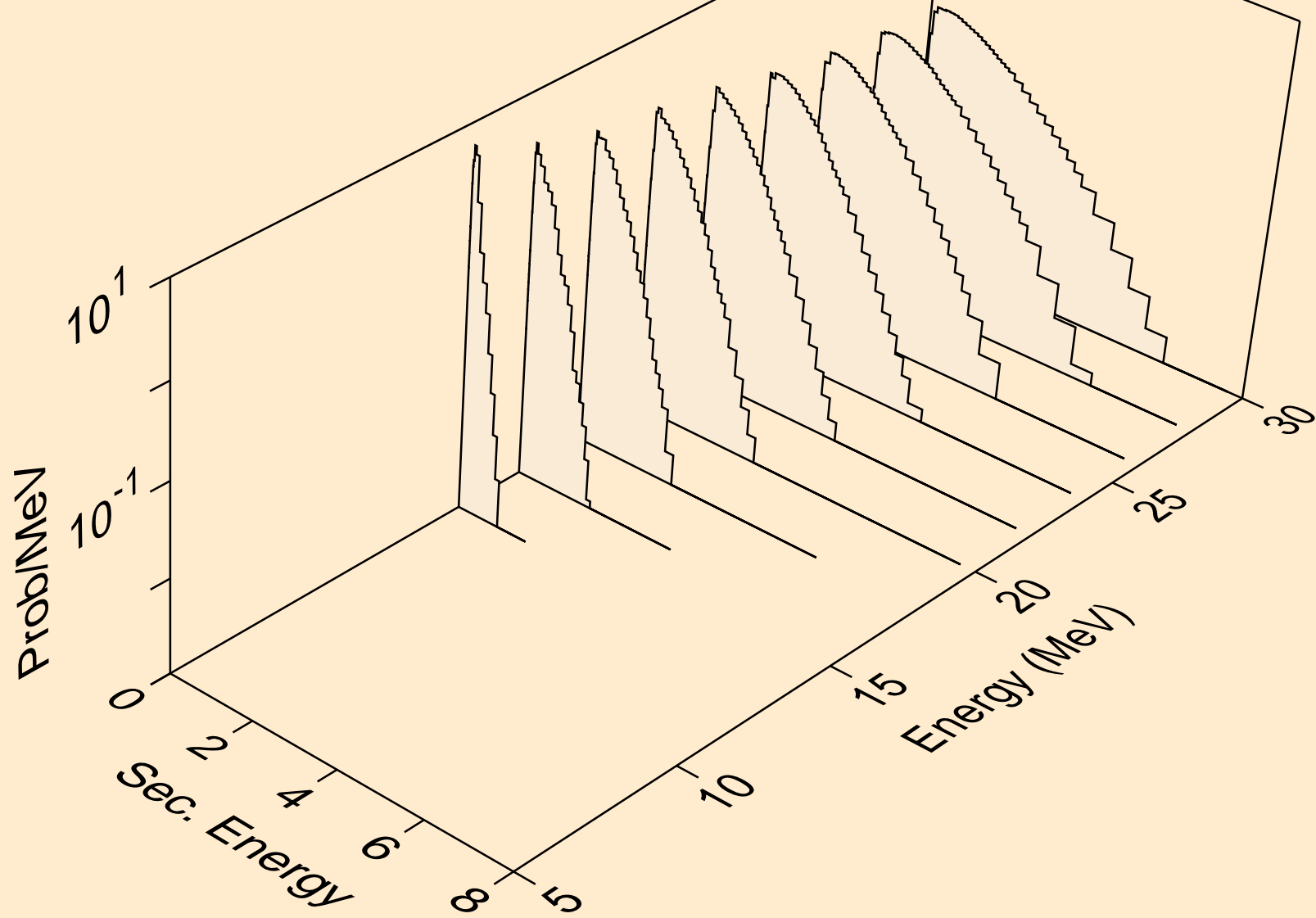

AG098 NEUTRON ACER TENDL-2024 LIBRARY; T=293.6K
Neutron emission for (n,2np)

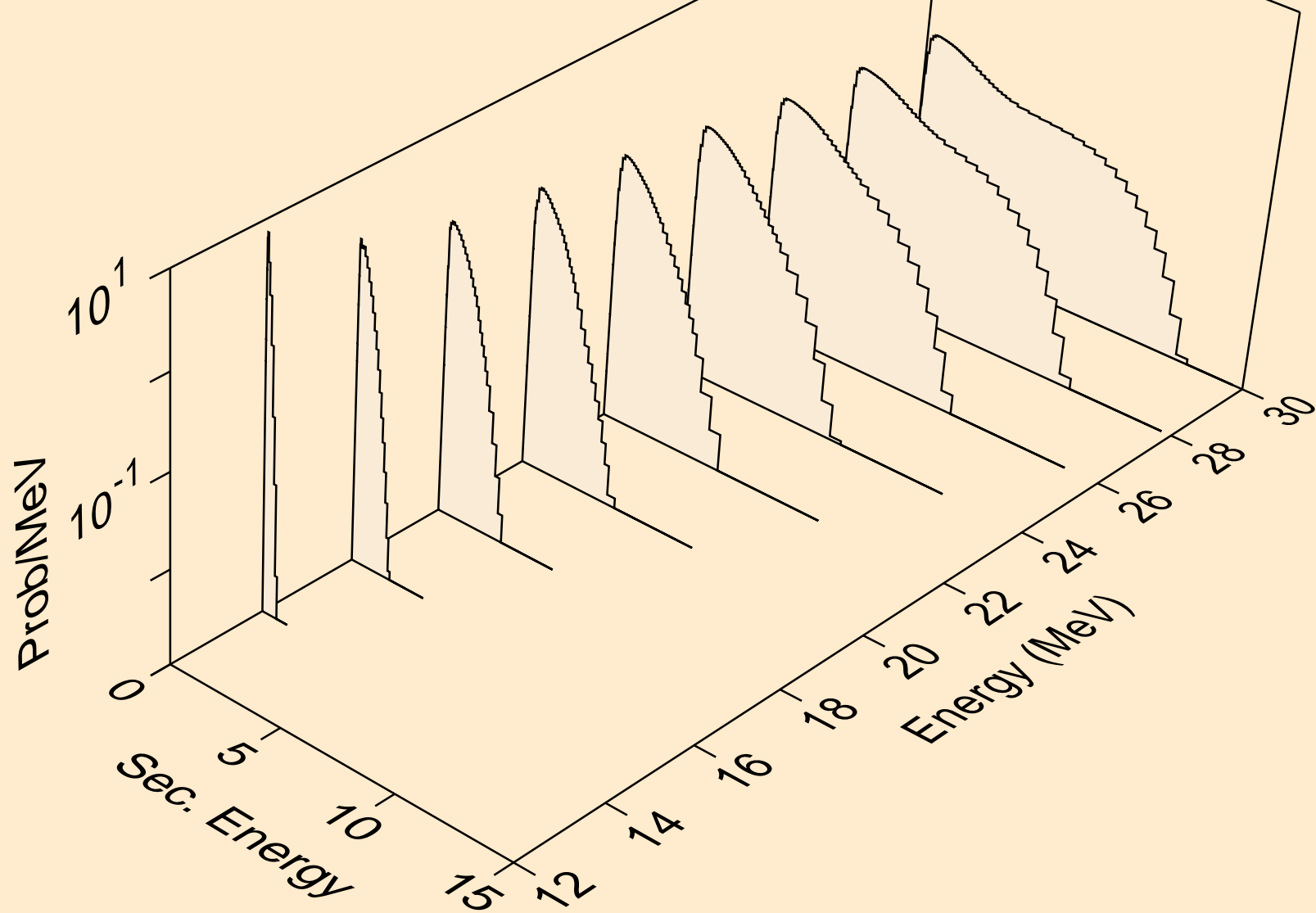

AG098 NEUTRON ACER TENDL-2024 LIBRARY; T=293.6K
Neutron emission for (n,3np)

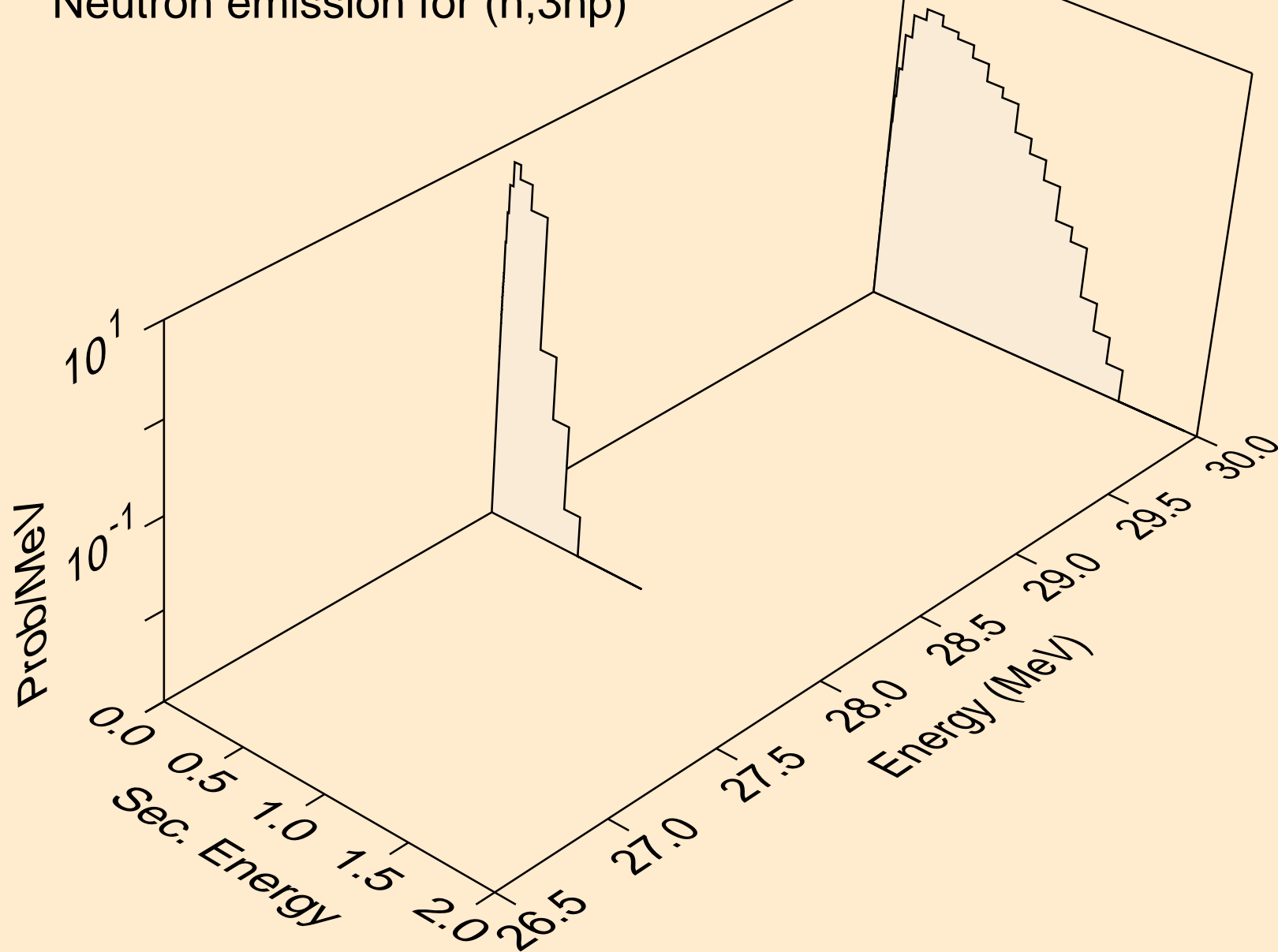

AG098 NEUTRON ACER TENDL-2024 LIBRARY; T=293.6K
Neutron emission for (n,n2p)

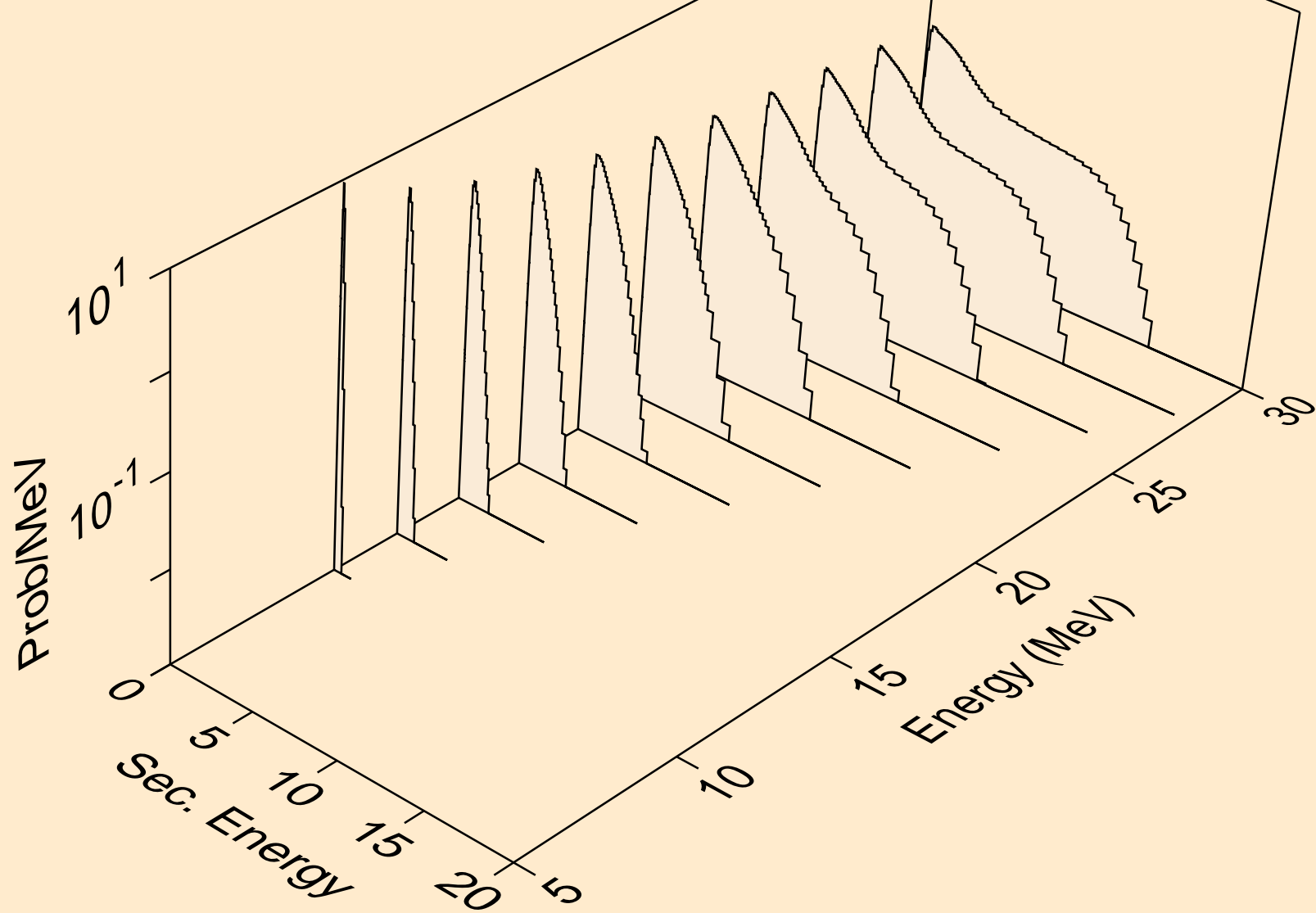

AG098 NEUTRON ACER TENDL-2024 LIBRARY; T=293.6K
Neutron emission for (n,npa)

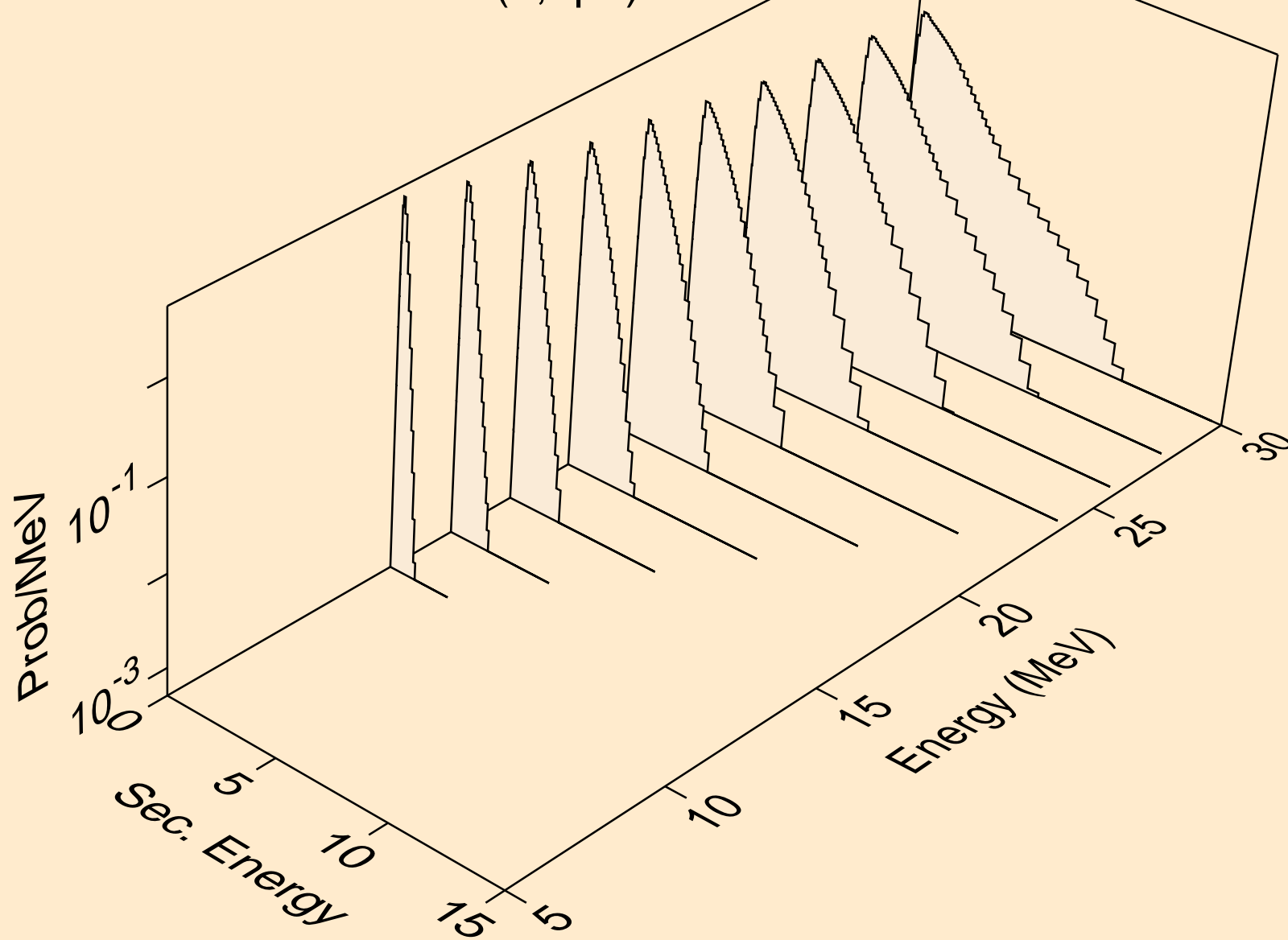

AG098 NEUTRON ACER TENDL-2024 LIBRARY; T=293.6K
Neutron emission for (n,n*c)

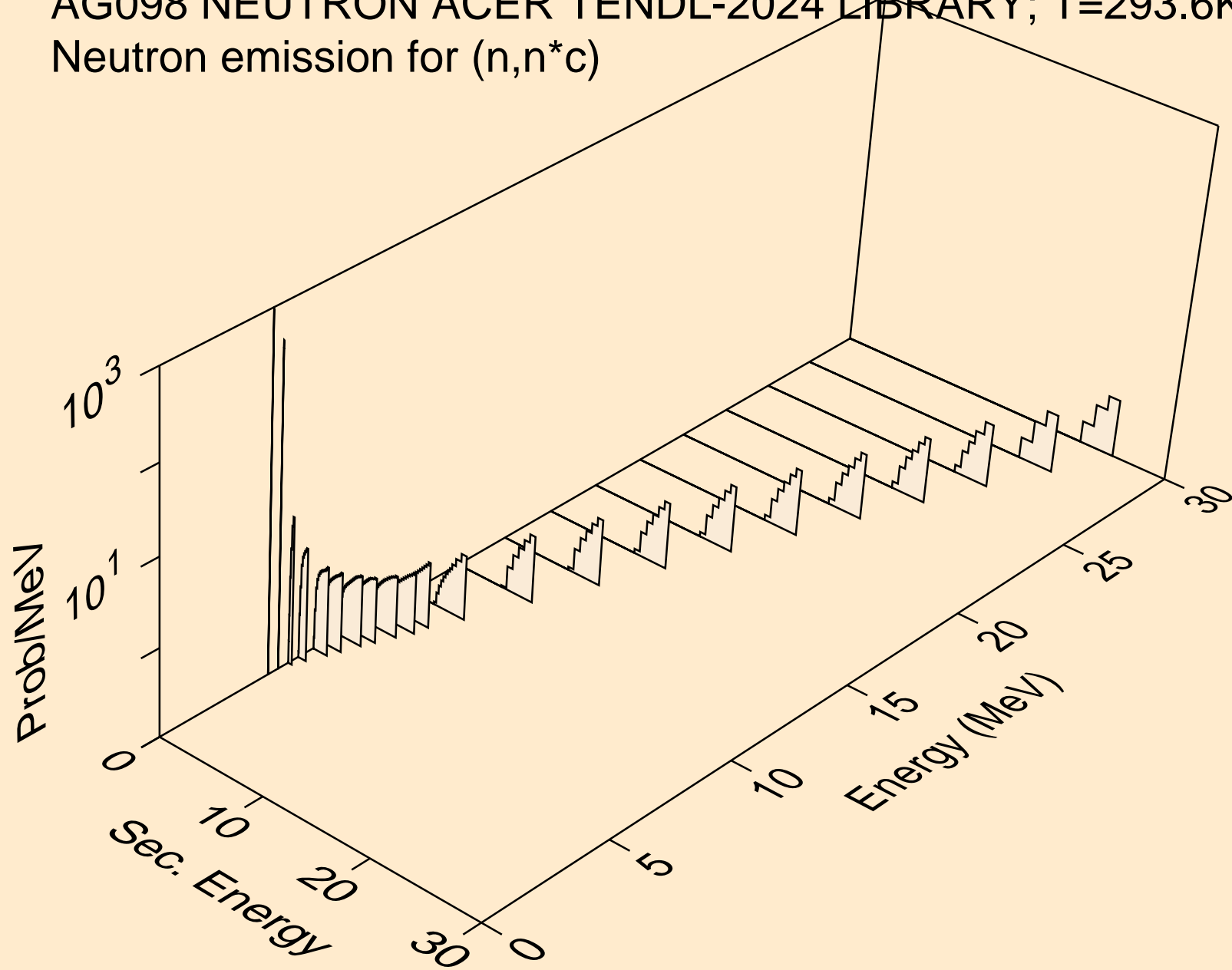

AG098 NEUTRON ACER TENDL-2024 LIBRARY; T=293.6K
Photon emission for (n,x)

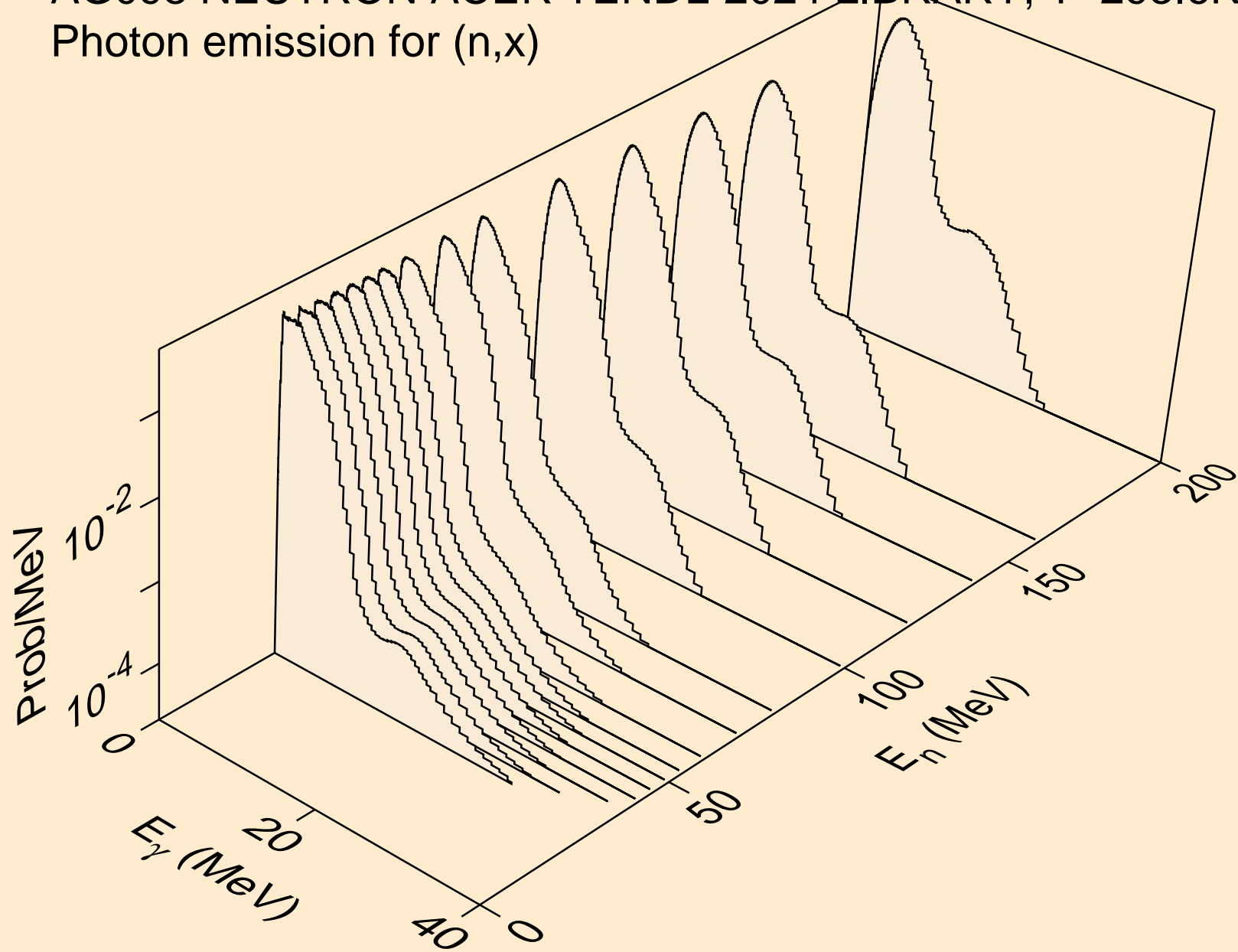

AG098 NEUTRON ACER TENDL-2024 LIBRARY; T=293.6K
Photon emission for (n,2nd)

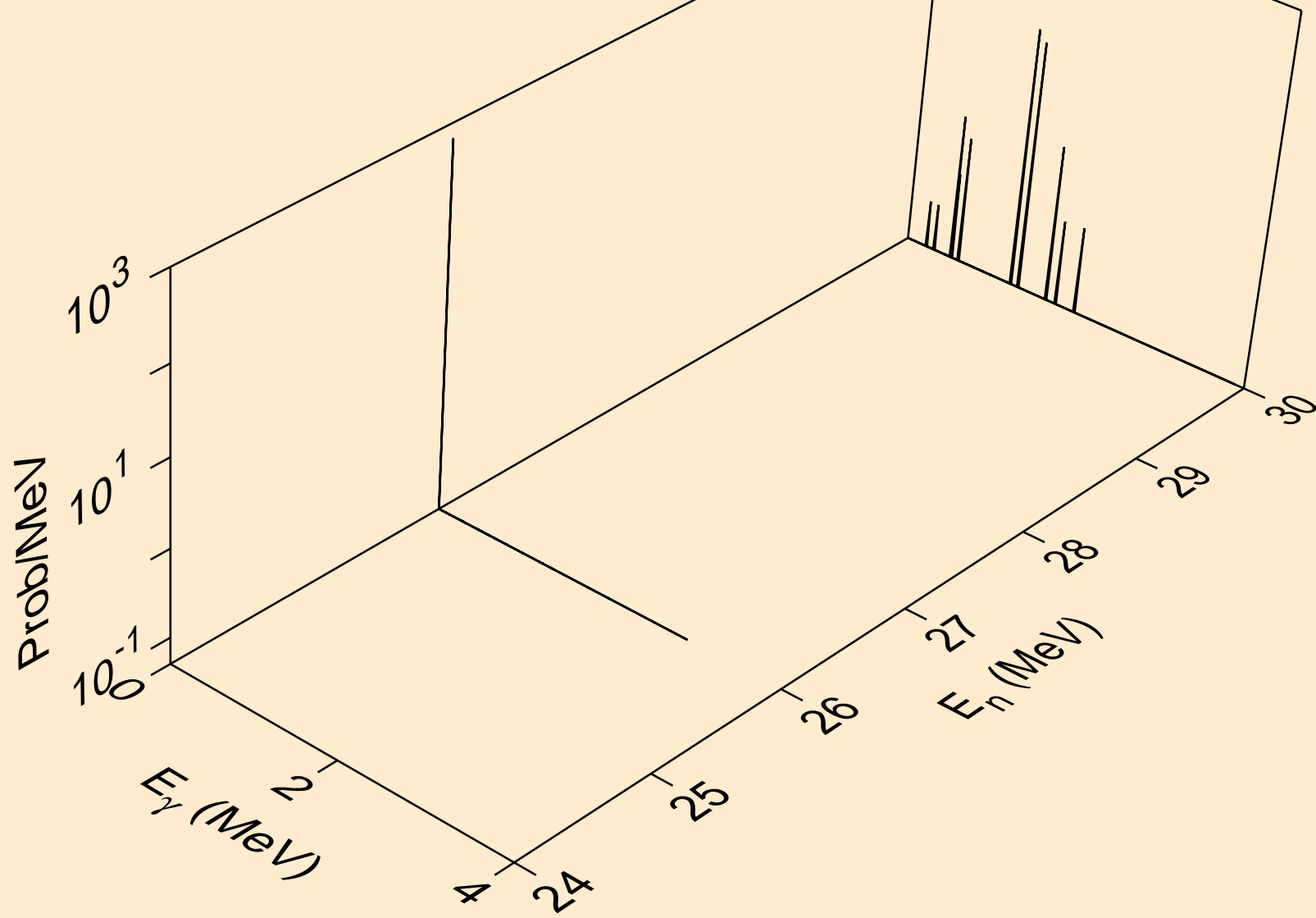

AG098 NEUTRON ACER TENDL-2024 LIBRARY; T=293.6K
Photon emission for (n,2n)

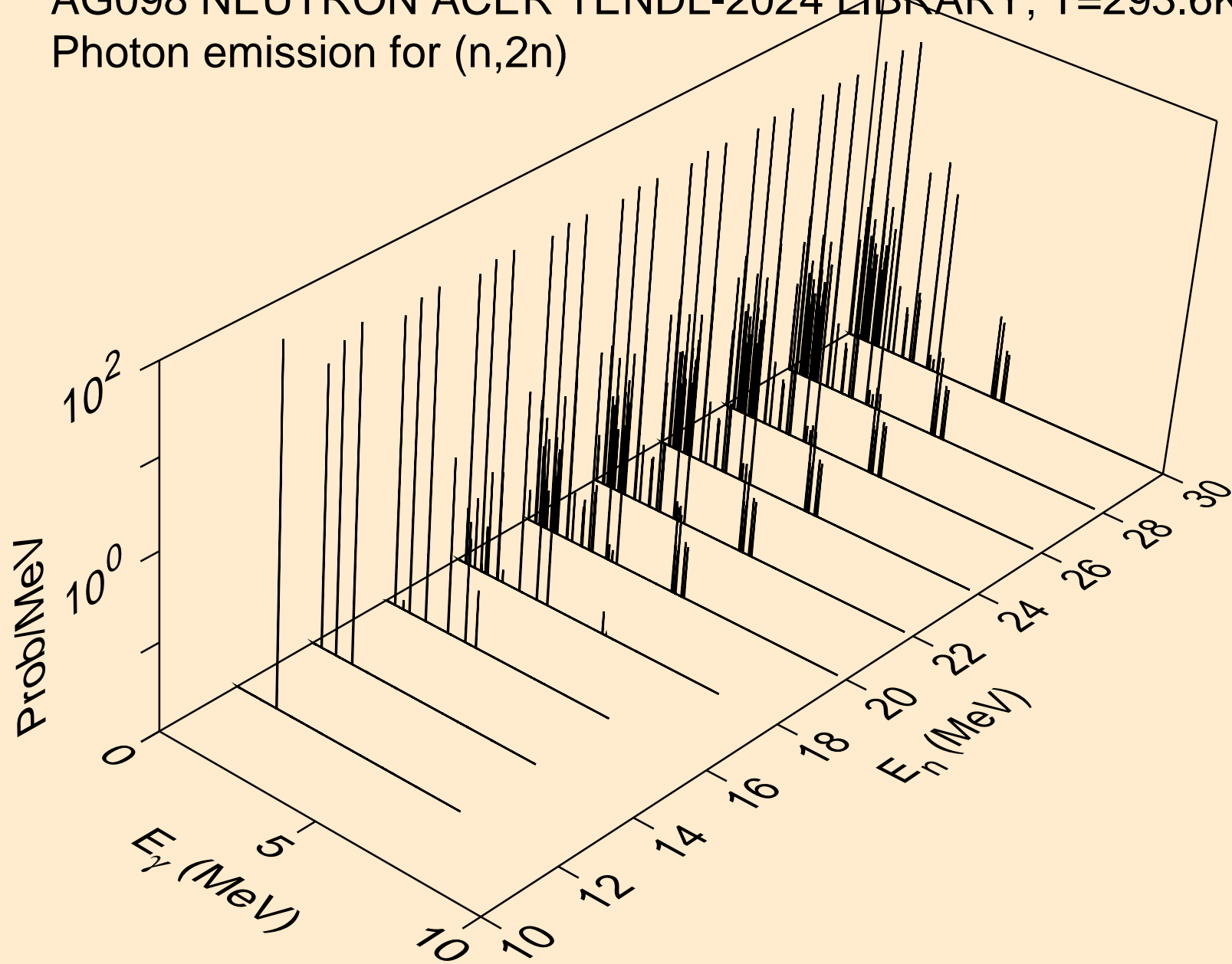

AG098 NEUTRON ACER TENDL-2024 LIBRARY; T=293.6K
Photon emission for (n,3n)

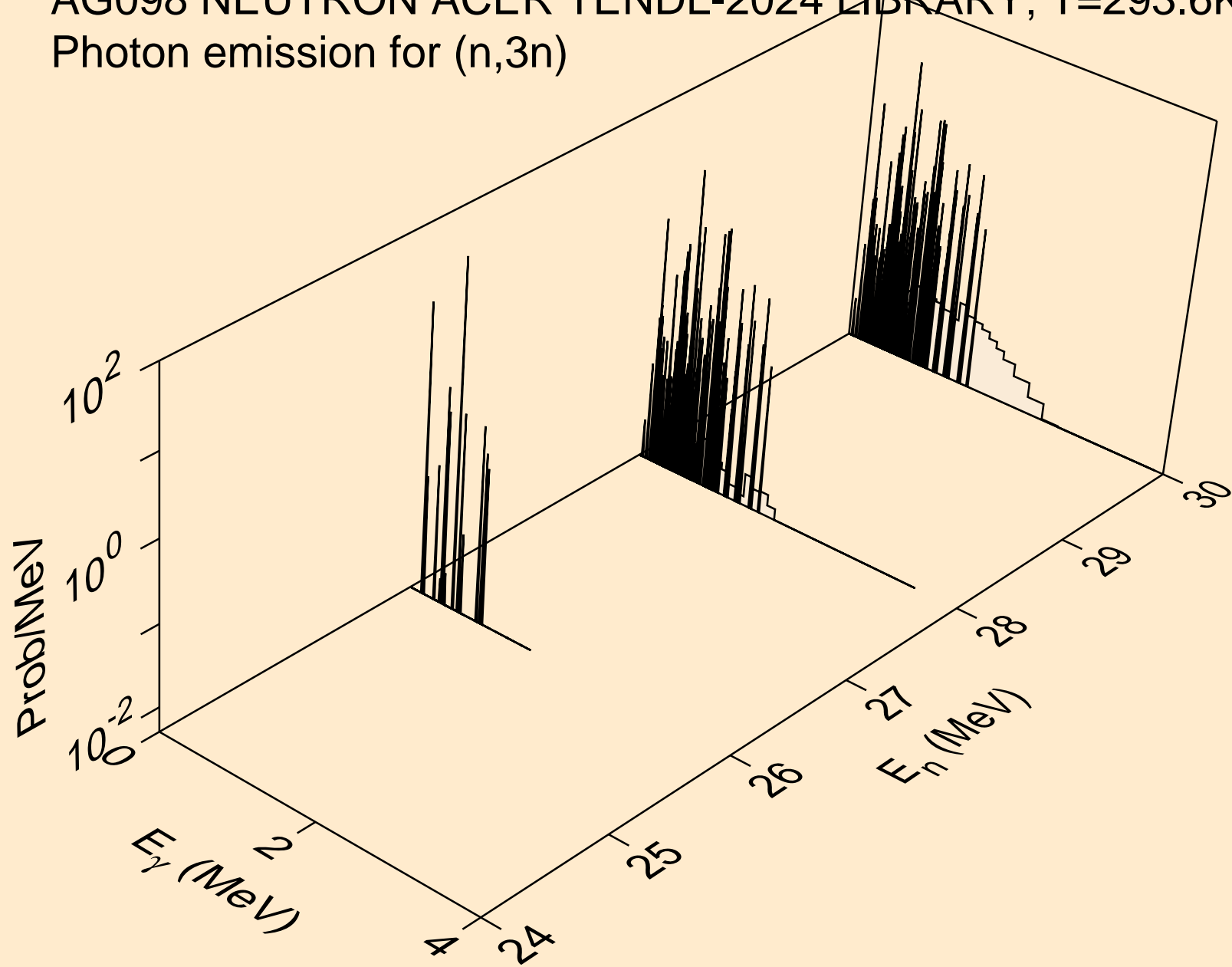

AG098 NEUTRON ACER TENDL-2024 LIBRARY; T=293.6K
Photon emission for (n,n*)a

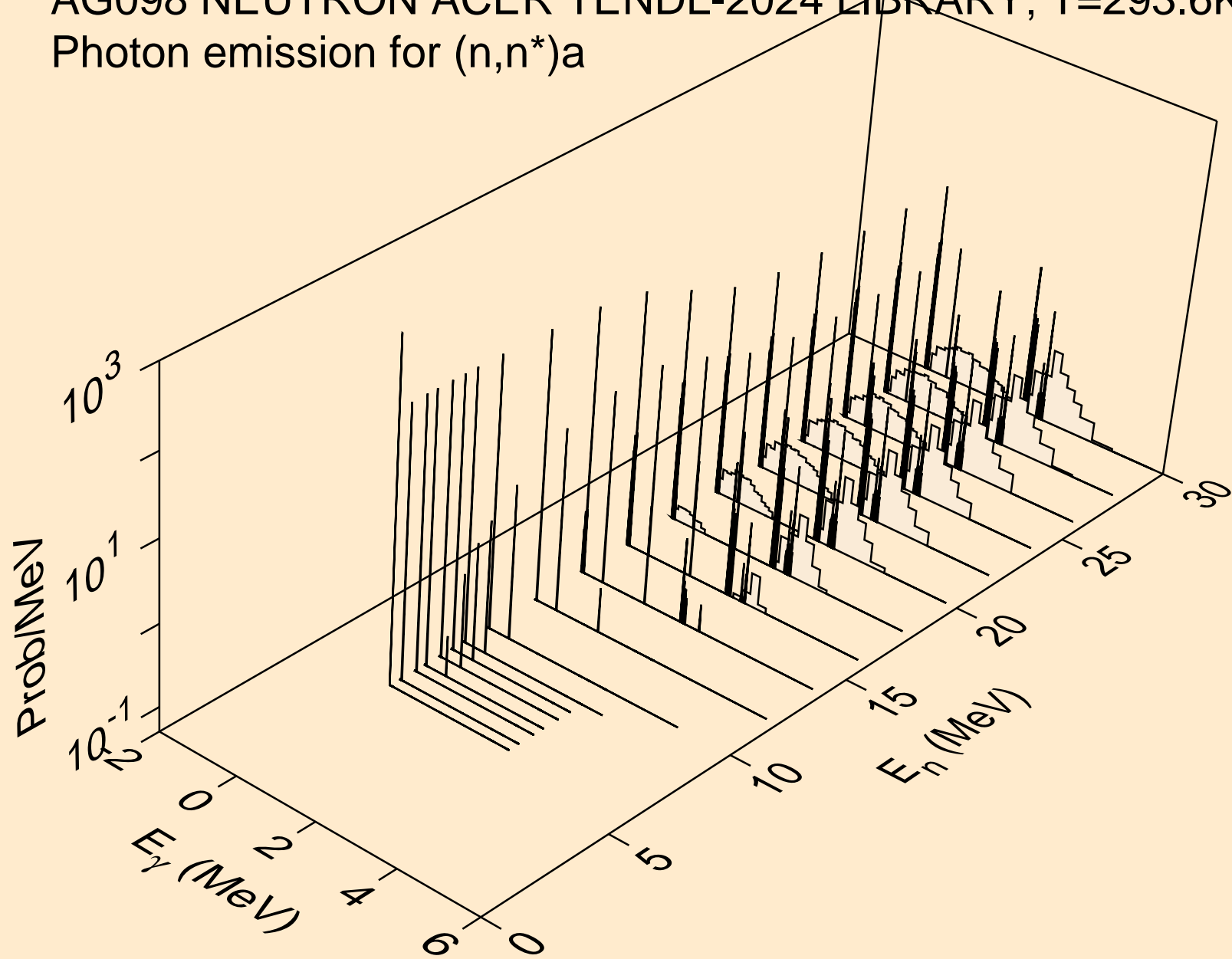

AG098 NEUTRON ACER TENDL-2024 LIBRARY; T=293.6K
Photon emission for (n,2n)a

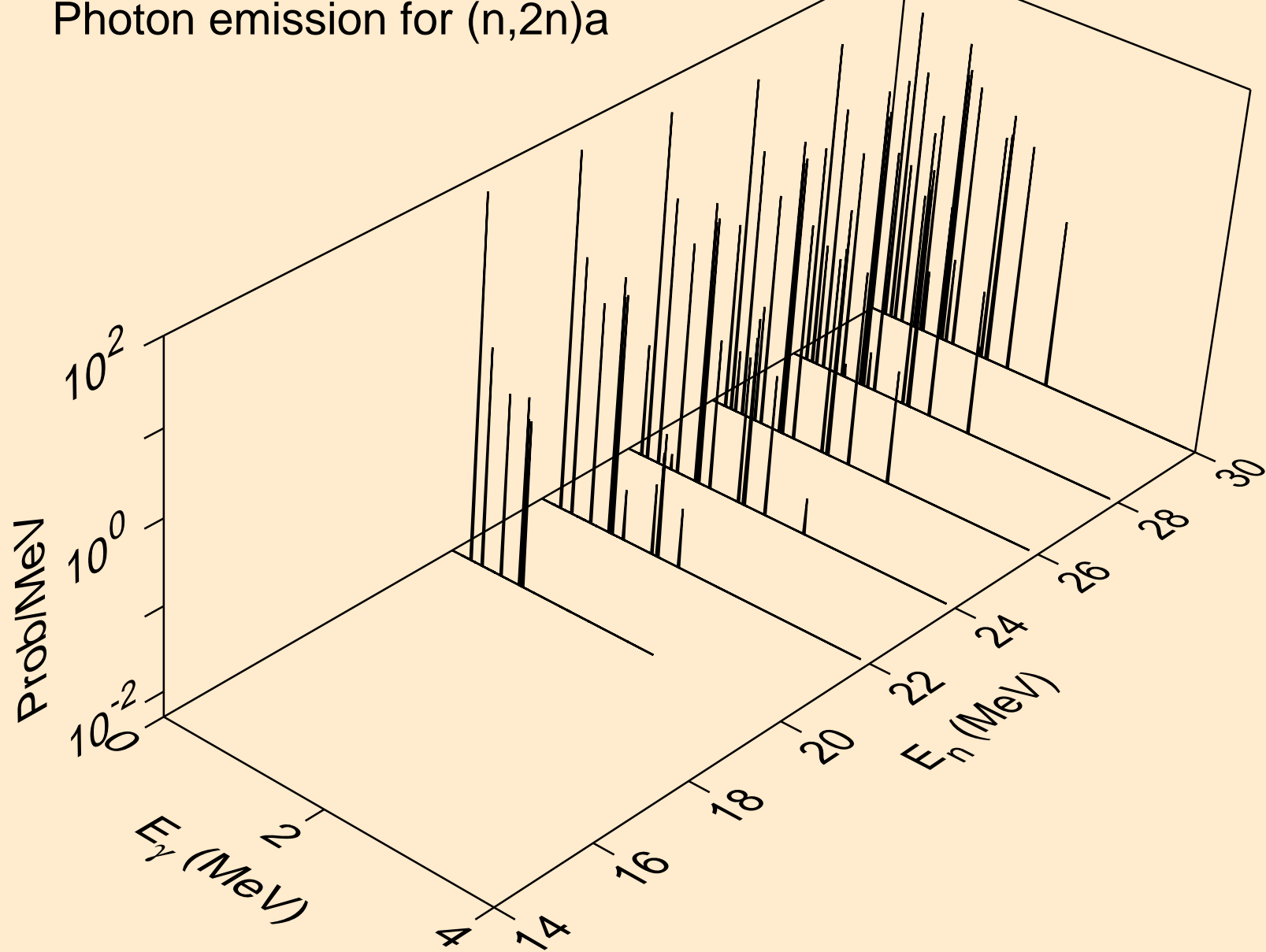

AG098 NEUTRON ACER TENDL-2024 LIBRARY; T=293.6K
Photon emission for (n,n*)p

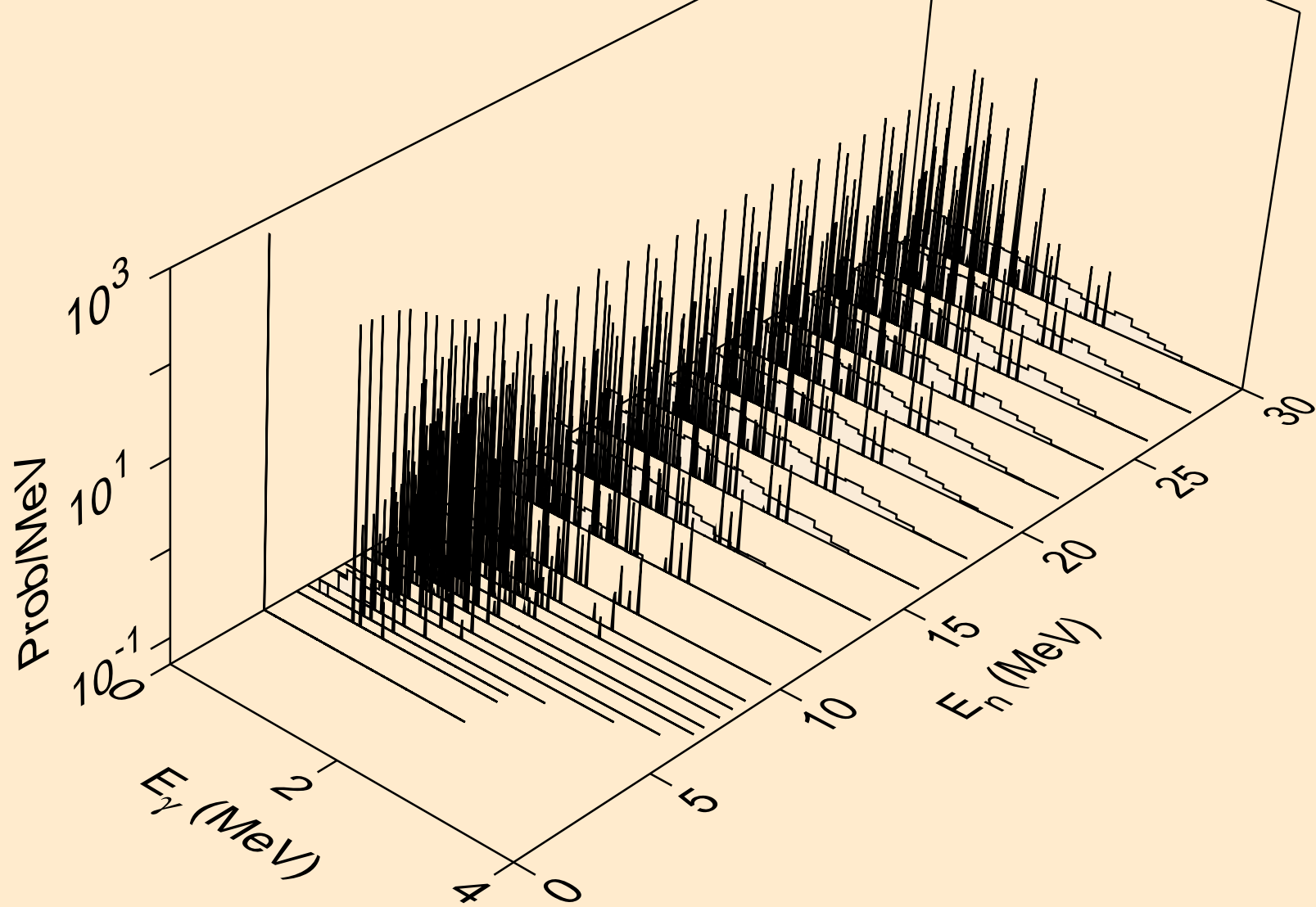

AG098 NEUTRON ACER TENDL-2024 LIBRARY; T=293.6K
Photon emission for (n,n*)2a

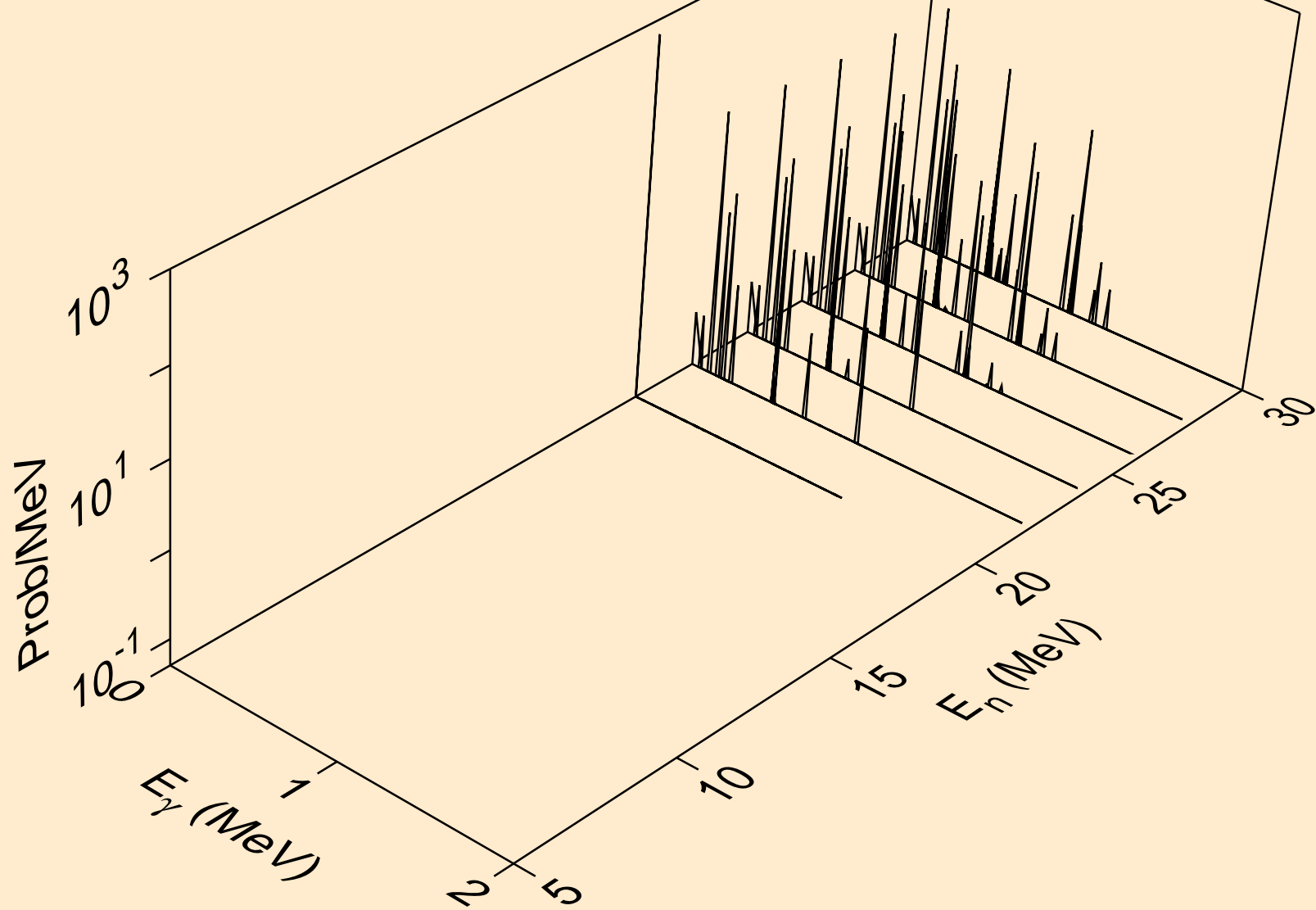

AG098 NEUTRON ACER TENDL-2024 LIBRARY; T=293.6K
Photon emission for (n,n*)d

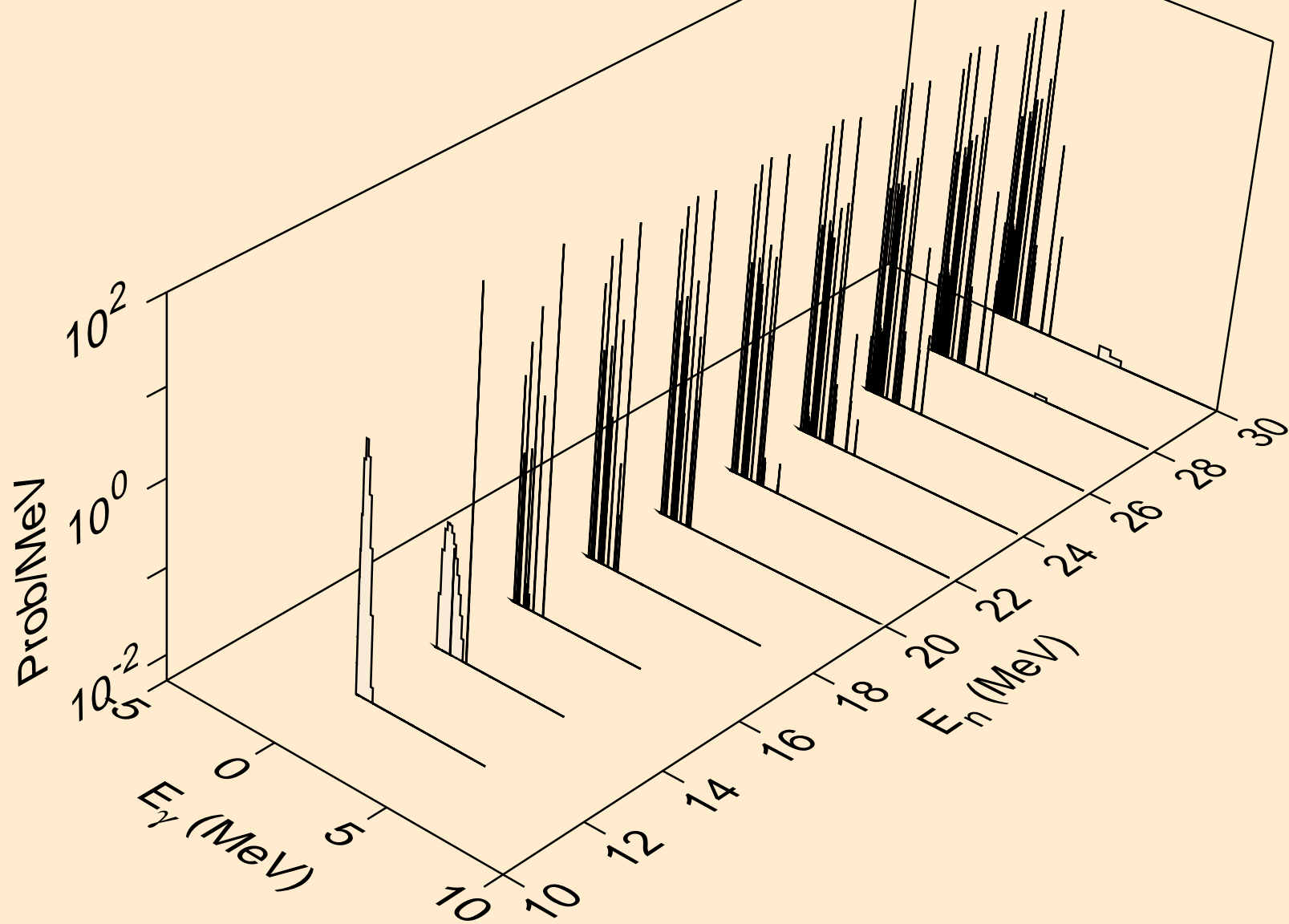

AG098 NEUTRON ACER TENDL-2024 LIBRARY; T=293.6K
Photon emission for (n,n*)t

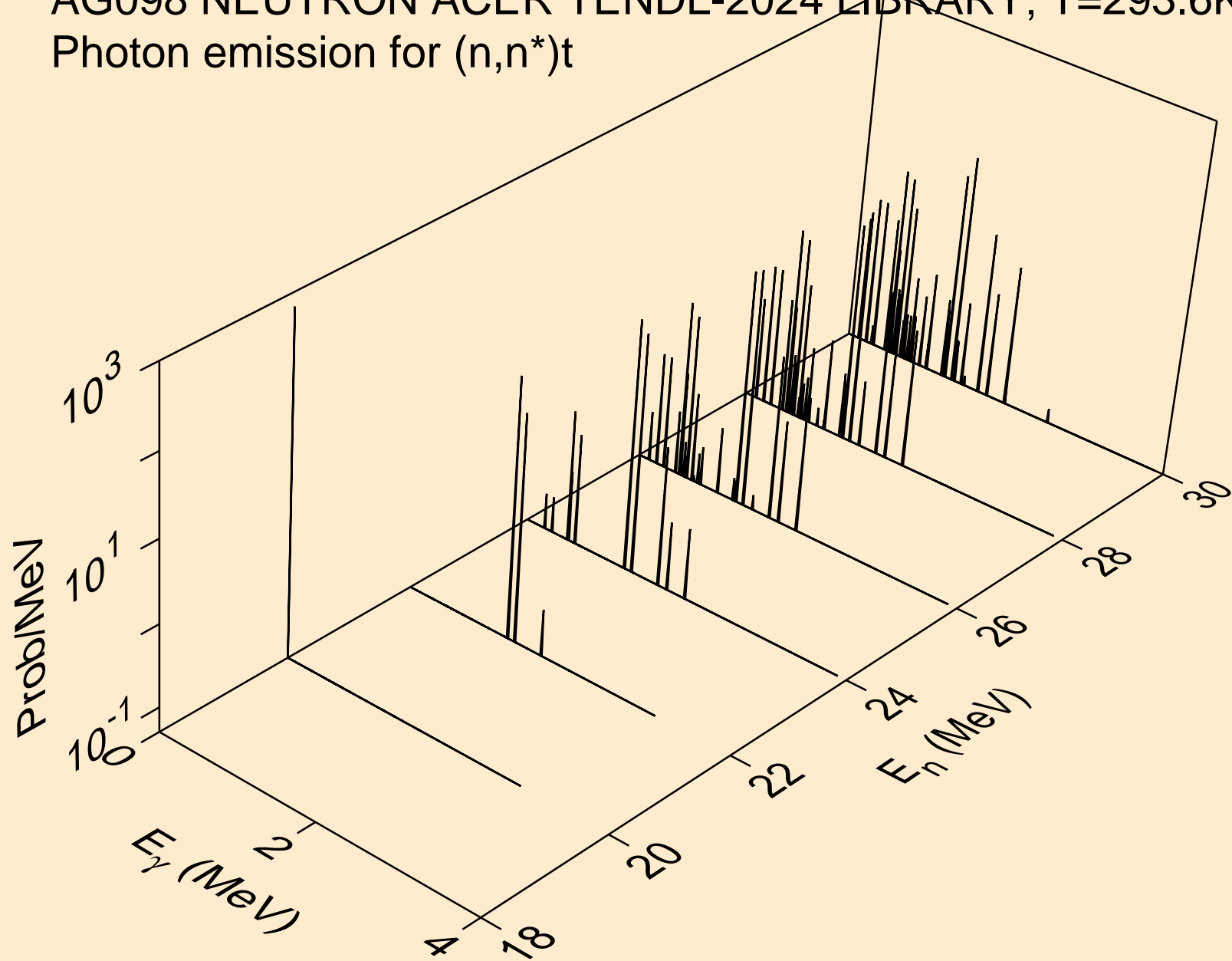

AG098 NEUTRON ACER TENDL-2024 LIBRARY; T=293.6K
Photon emission for (n,n*)he3

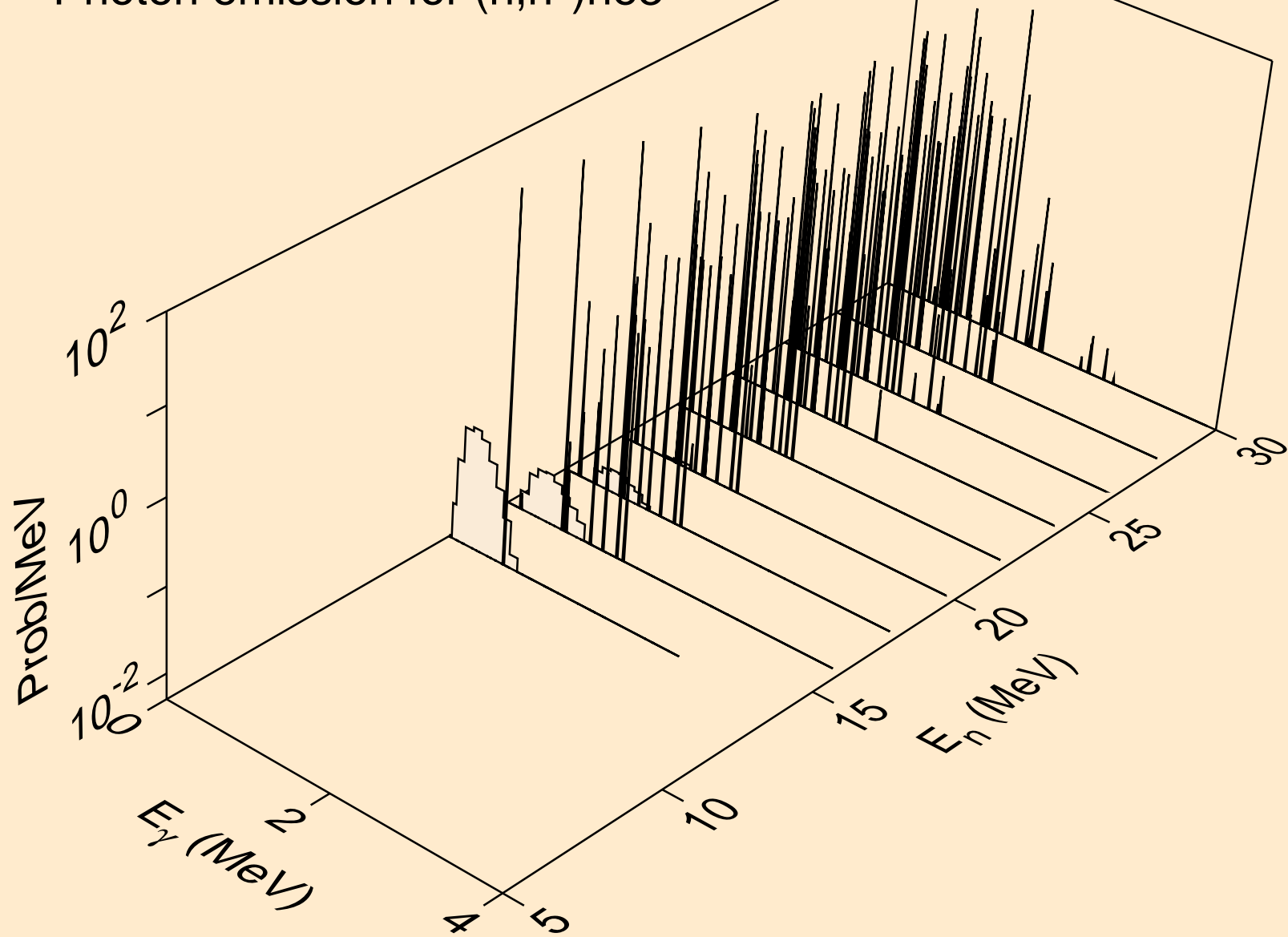

AG098 NEUTRON ACER TENDL-2024 LIBRARY; T=293.6K
Photon emission for (n,2np)

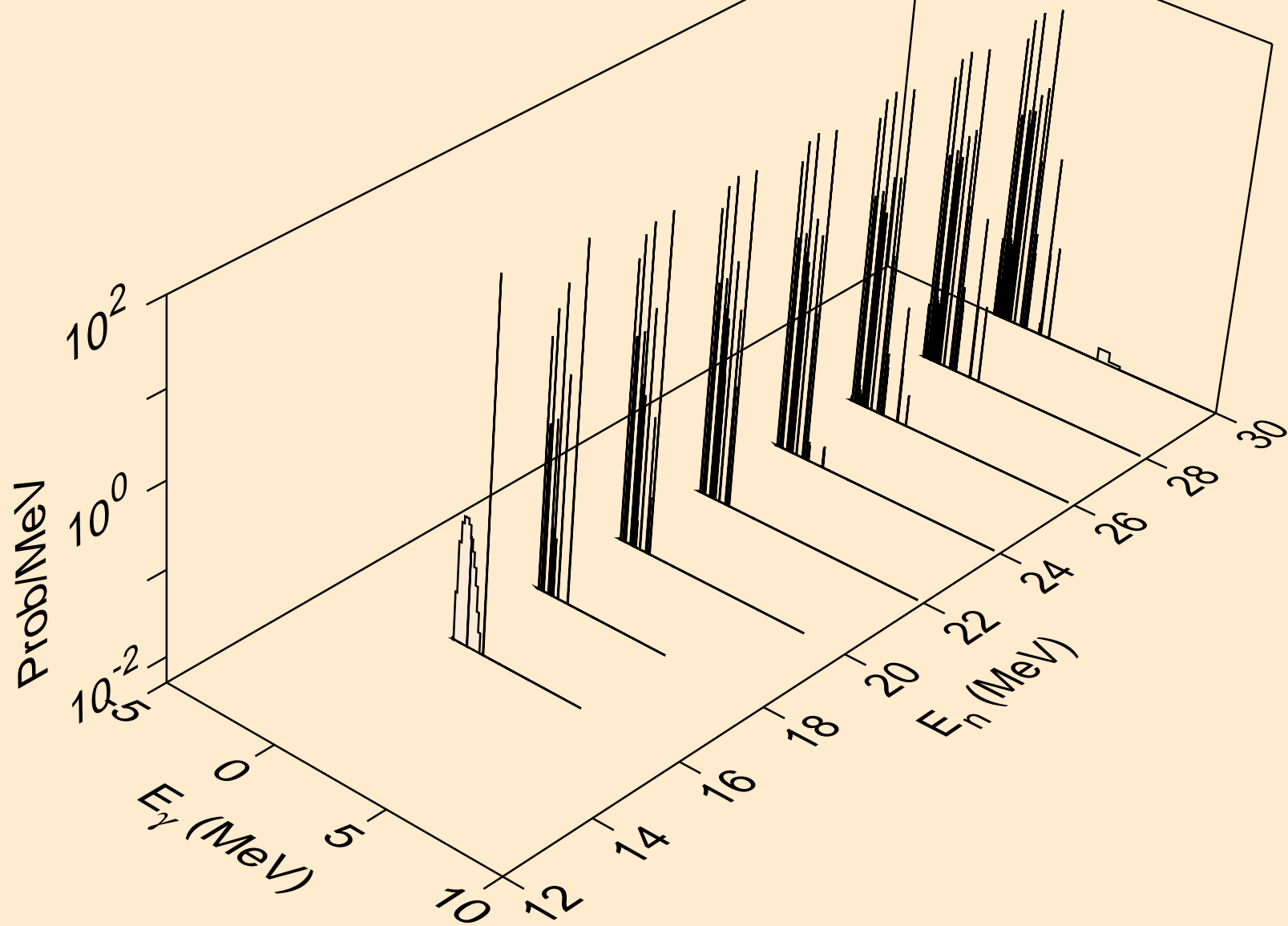

AG098 NEUTRON ACER TENDL-2024 LIBRARY; T=293.6K
Photon emission for (n,3np)

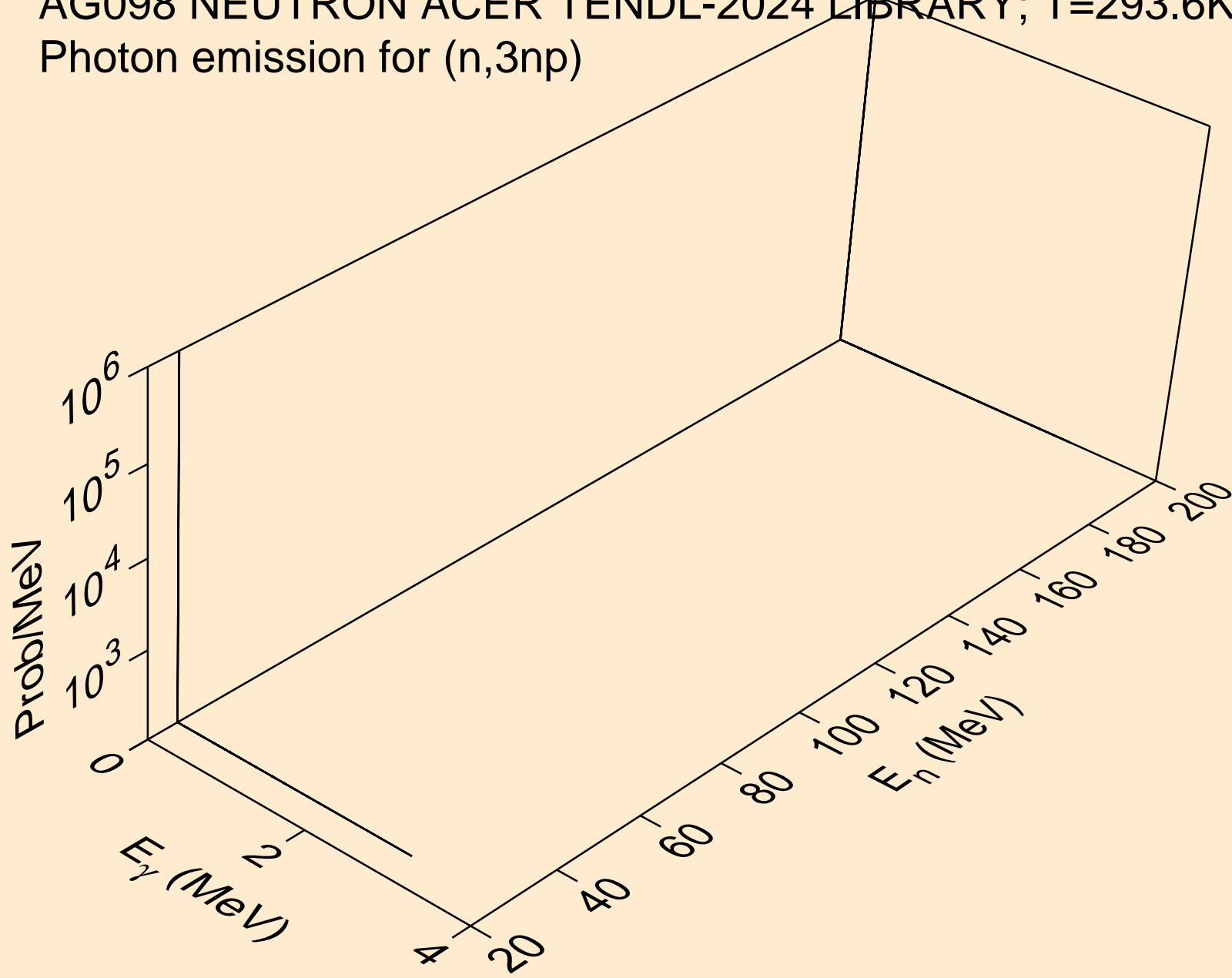

AG098 NEUTRON ACER TENDL-2024 LIBRARY; T=293.6K
Photon emission for (n,n2p)

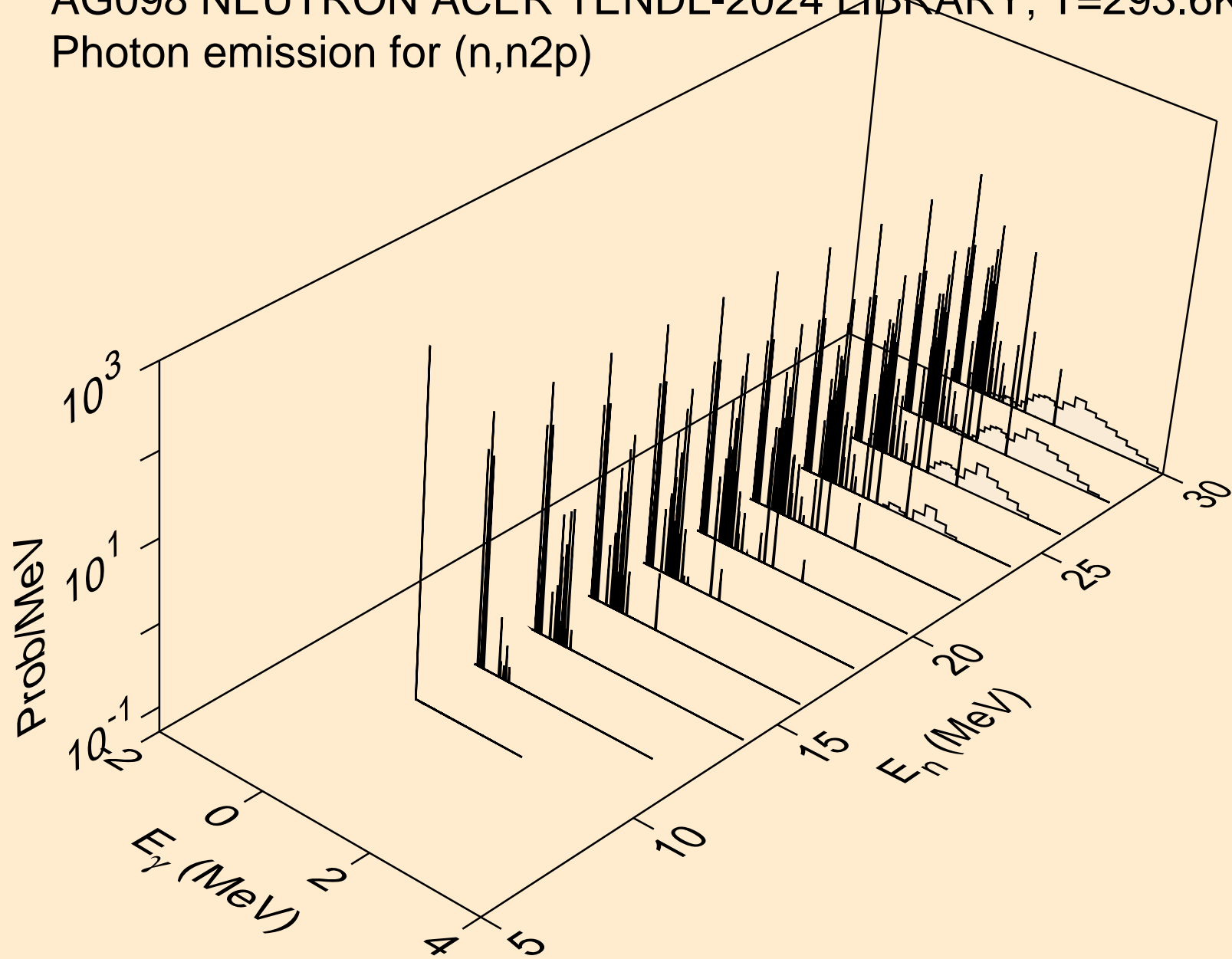

AG098 NEUTRON ACER TENDL-2024 LIBRARY; T=293.6K
Photon emission for (n,npa)

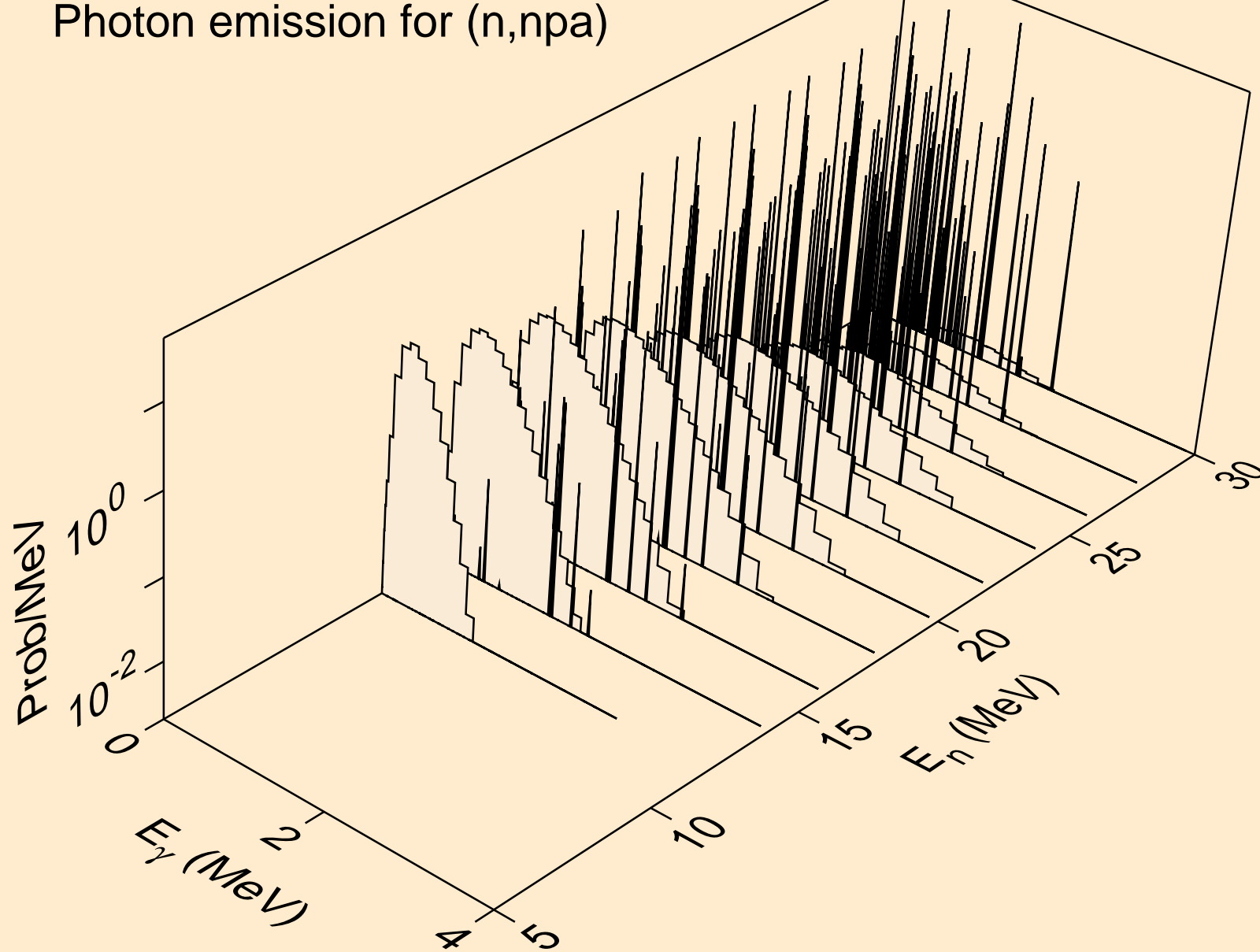

AG098 NEUTRON ACER TENDL-2024 LIBRARY; T=293.6K
Photon emission for (n,n*c)

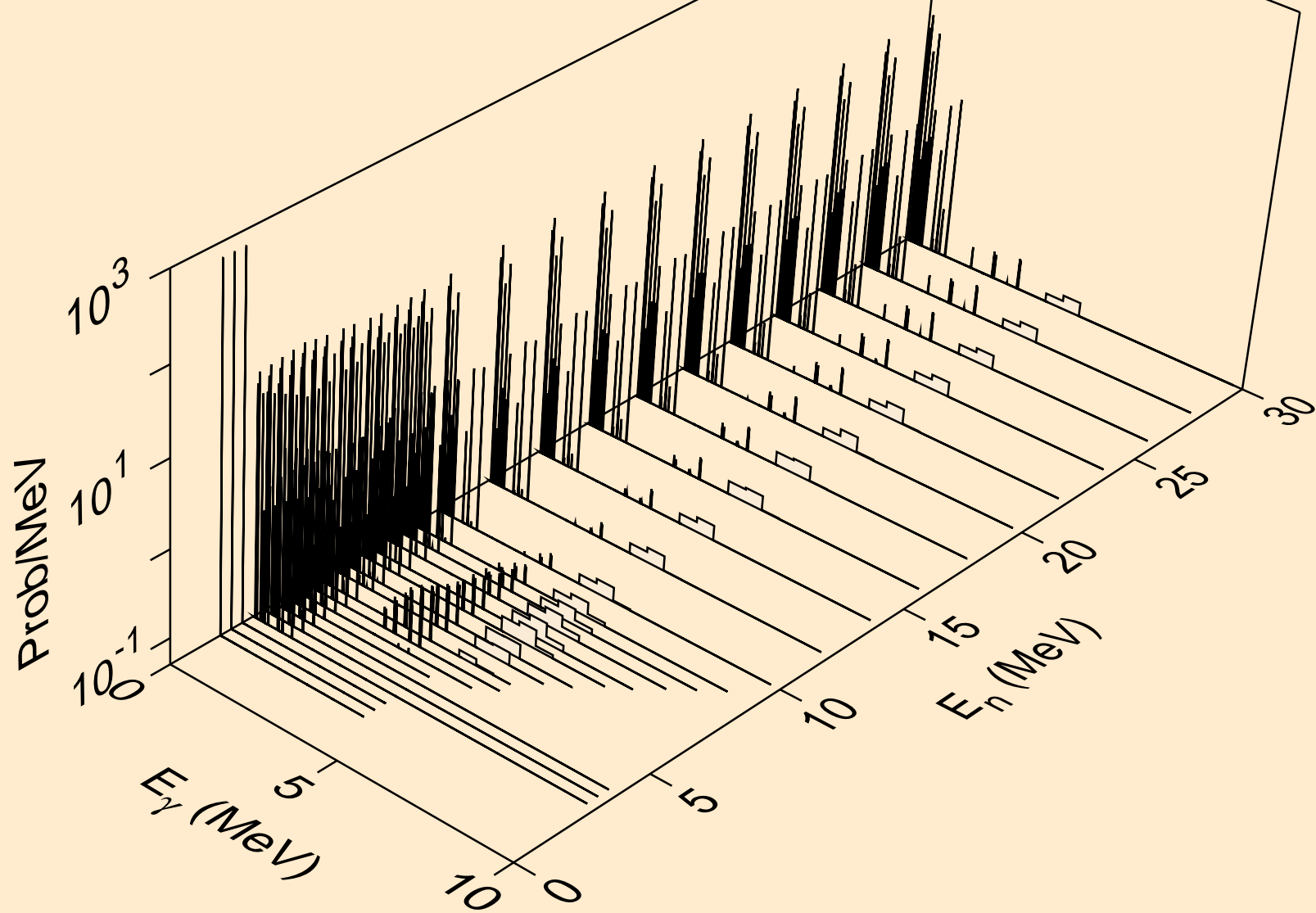

AG098 NEUTRON ACER TENDL-2024 LIBRARY; T=293.6K
Photon emission for (n,gma)

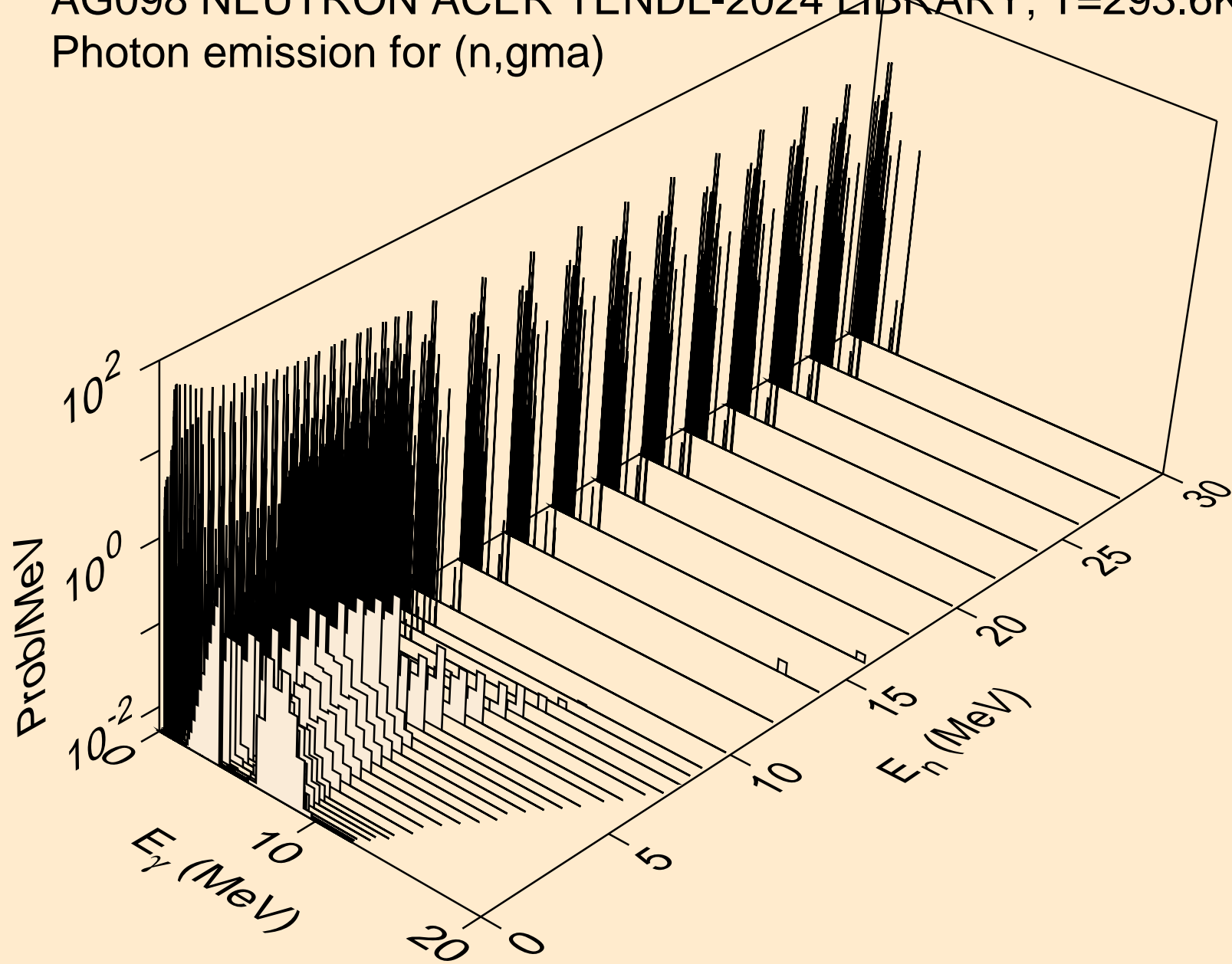

AG098 NEUTRON ACER TENDL-2024 LIBRARY; T=293.6K
Photon emission for (n,p)

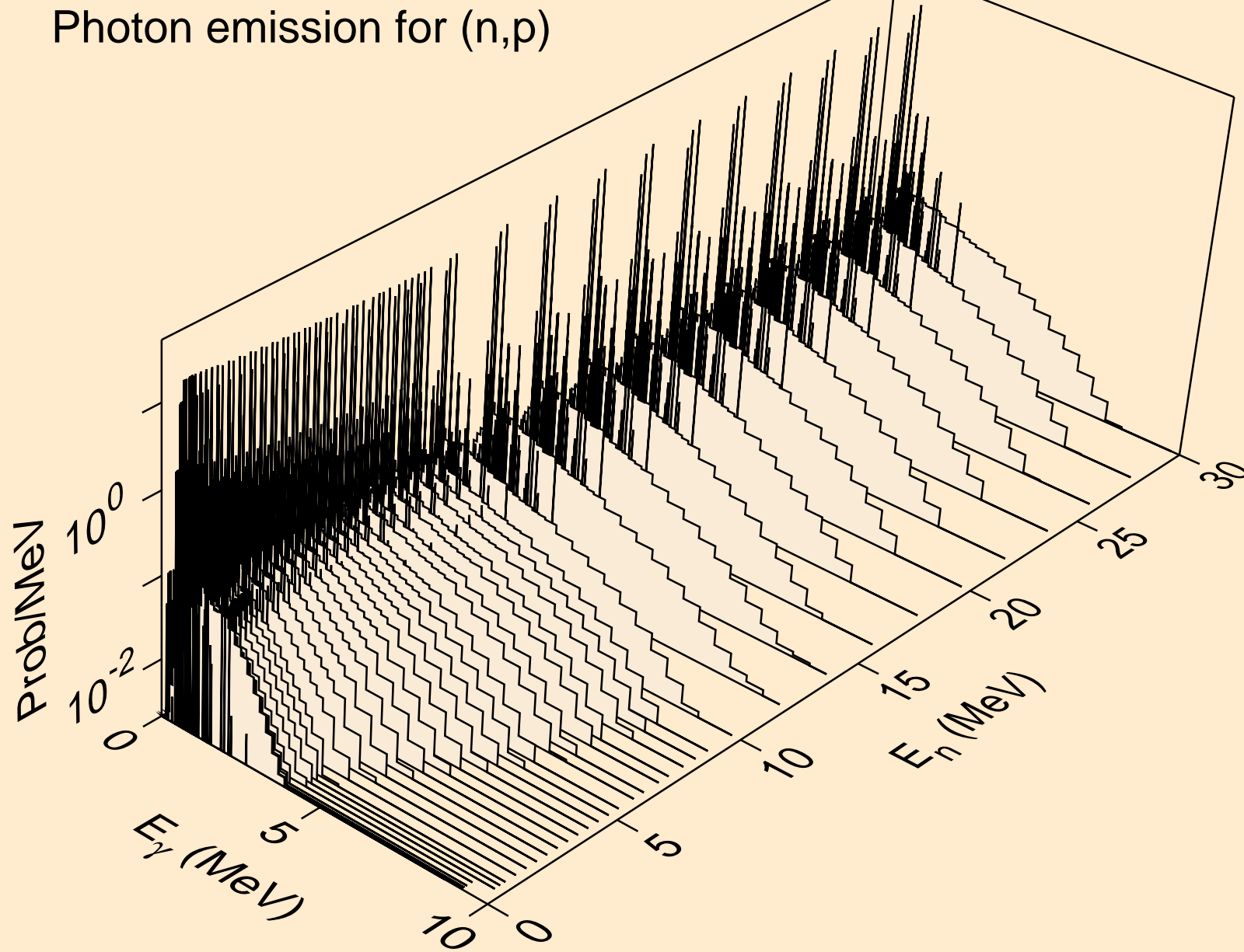

AG098 NEUTRON ACER TENDL-2024 LIBRARY; T=293.6K
Photon emission for (n,d)

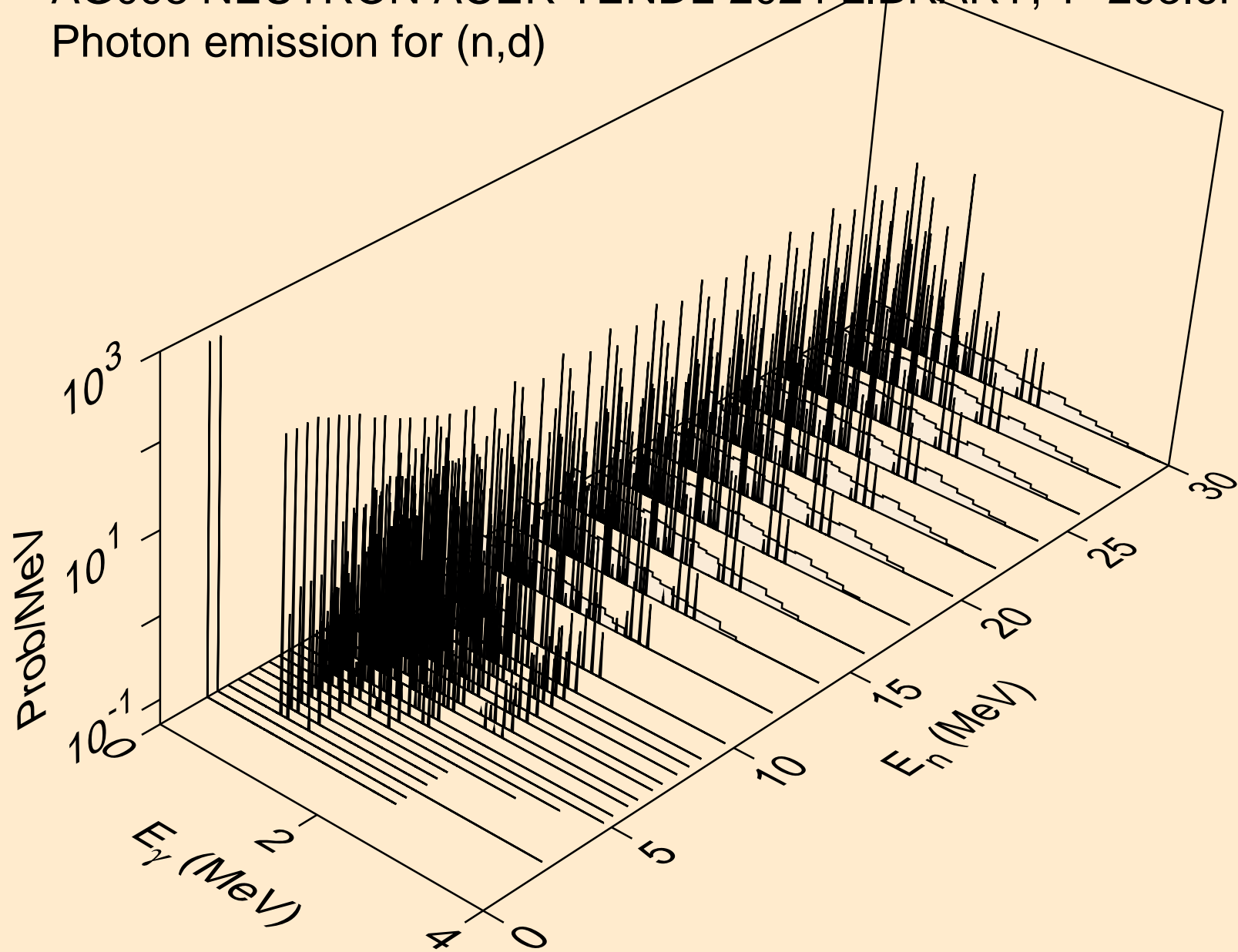

AG098 NEUTRON ACER TENDL-2024 LIBRARY; T=293.6K
Photon emission for (n,t)

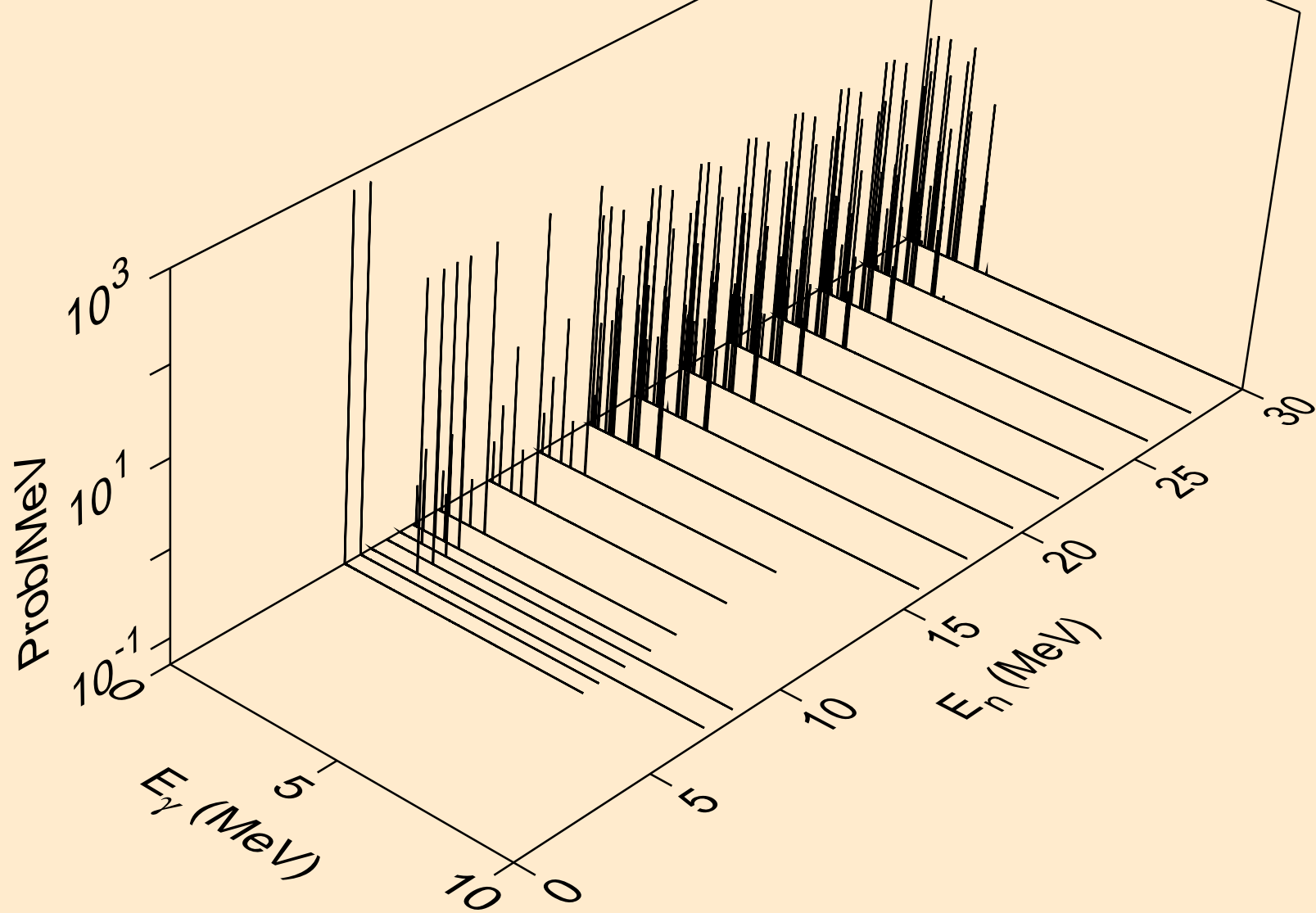

AG098 NEUTRON ACER TENDL-2024 LIBRARY; T=293.6K
Photon emission for (n,he3)

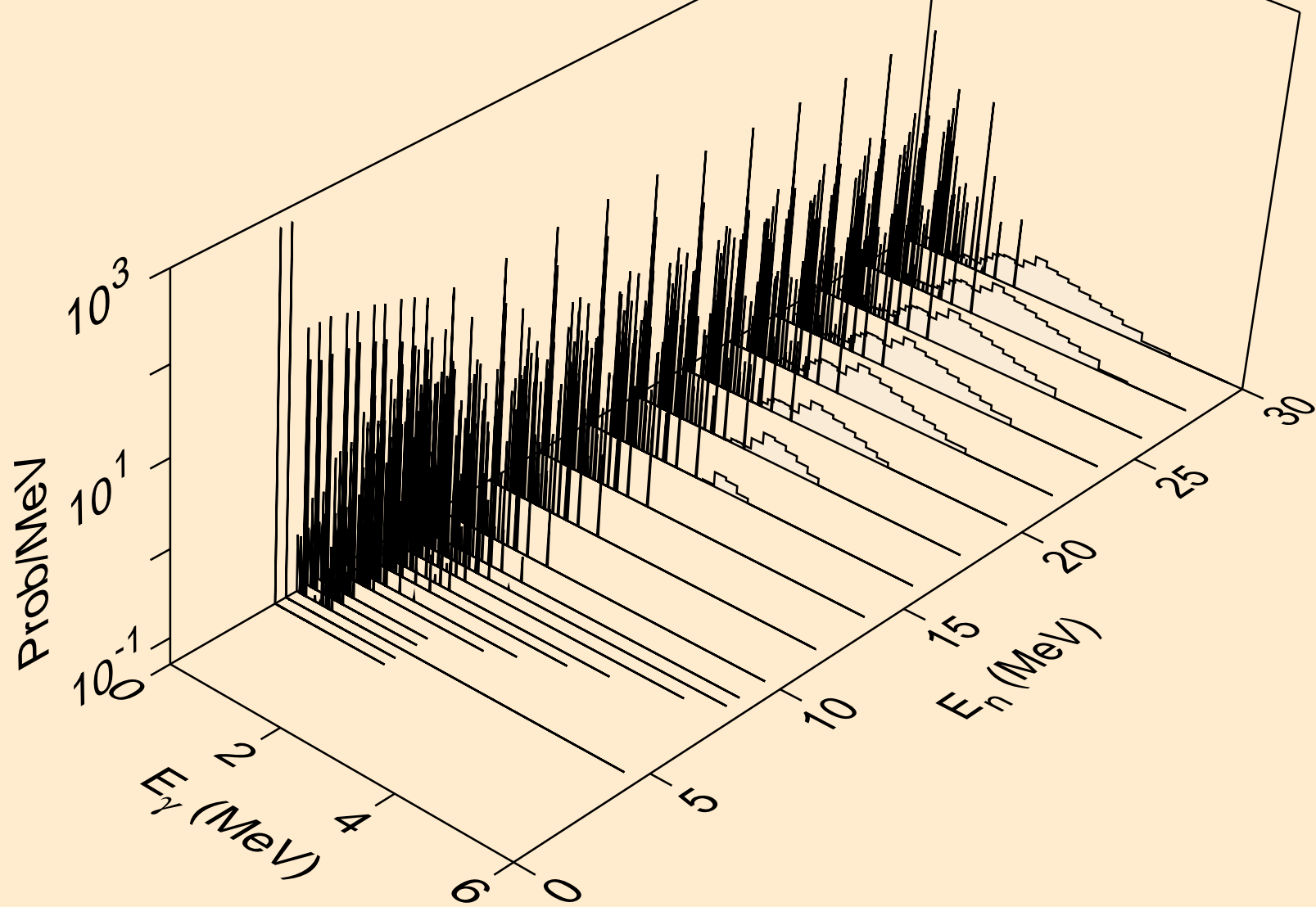

AG098 NEUTRON ACER TENDL-2024 LIBRARY; T=293.6K
Photon emission for (n,a)

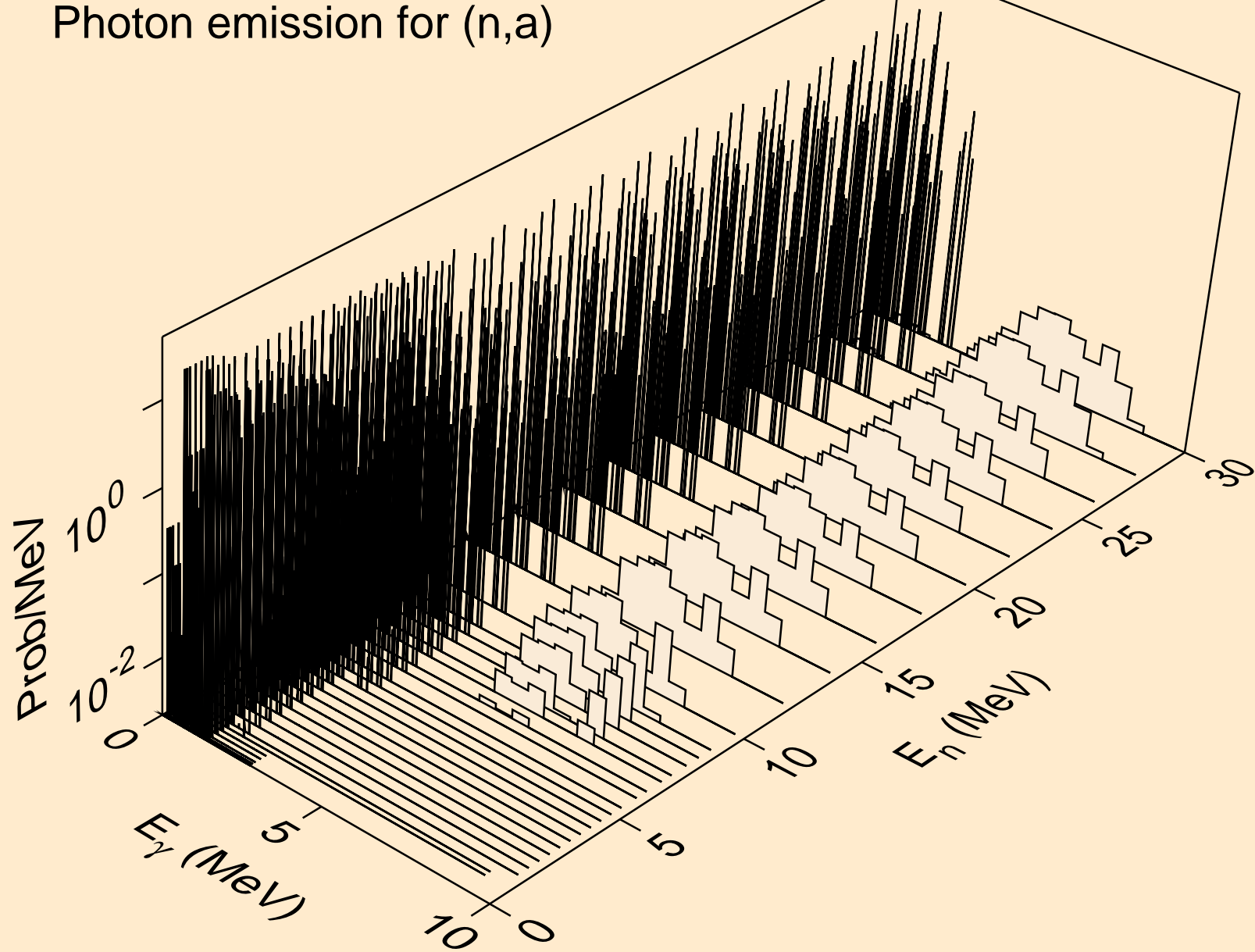

AG098 NEUTRON ACER TENDL-2024 LIBRARY; T=293.6K
Photon emission for (n,2a)

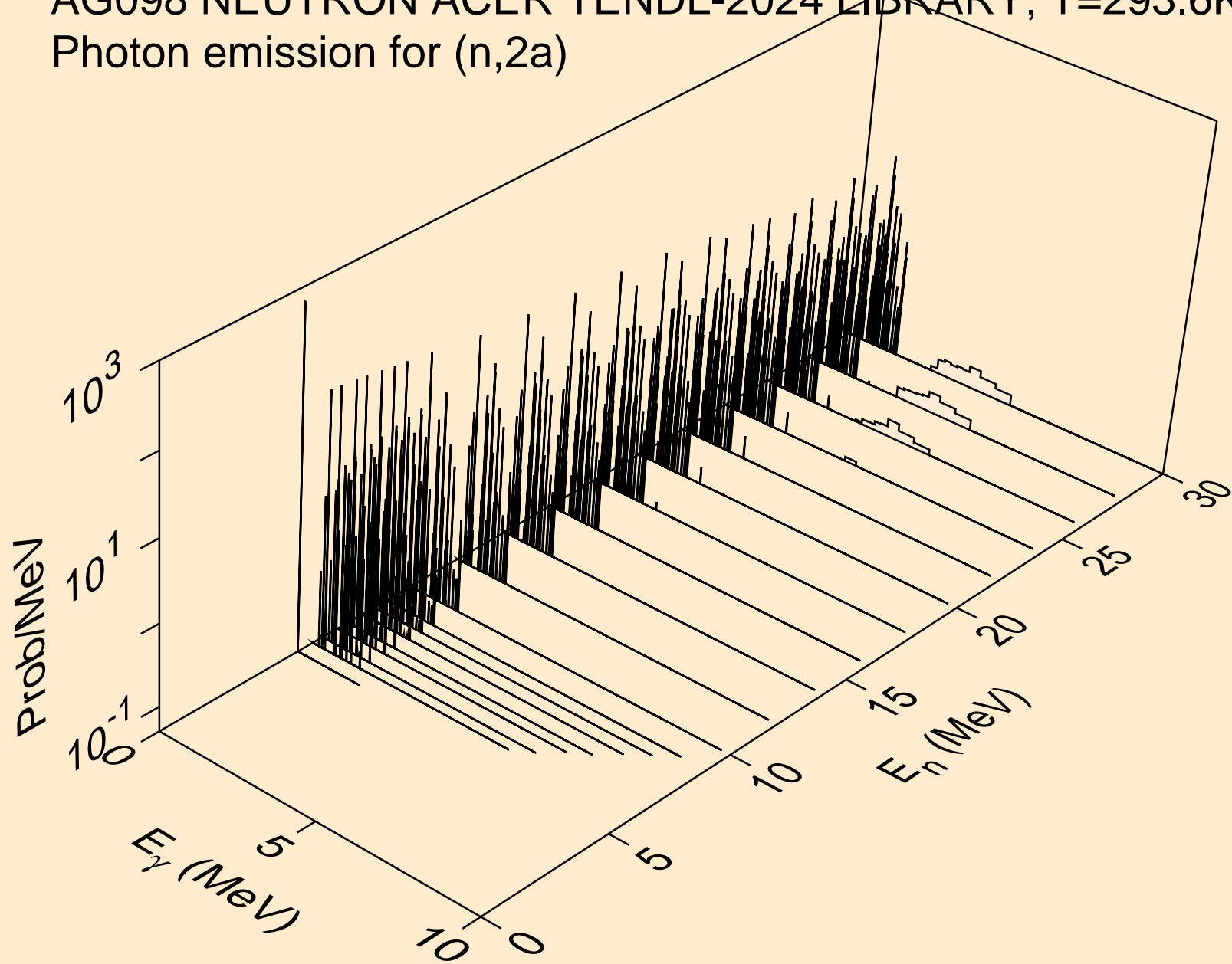

AG098 NEUTRON ACER TENDL-2024 LIBRARY; T=293.6K
Photon emission for (n,2p)

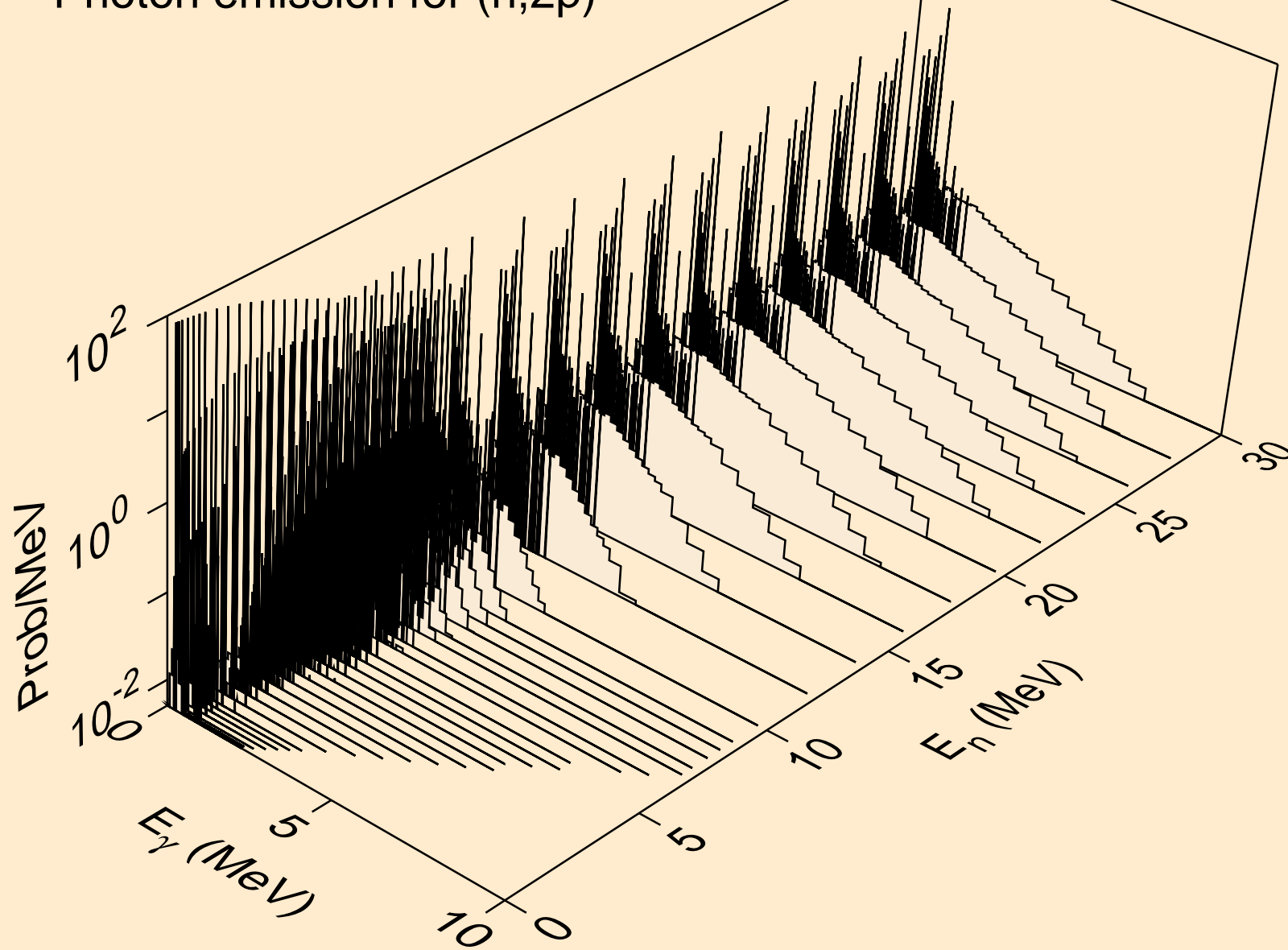

AG098 NEUTRON ACER TENDL-2024 LIBRARY; T=293.6K
Photon emission for (n,p α)

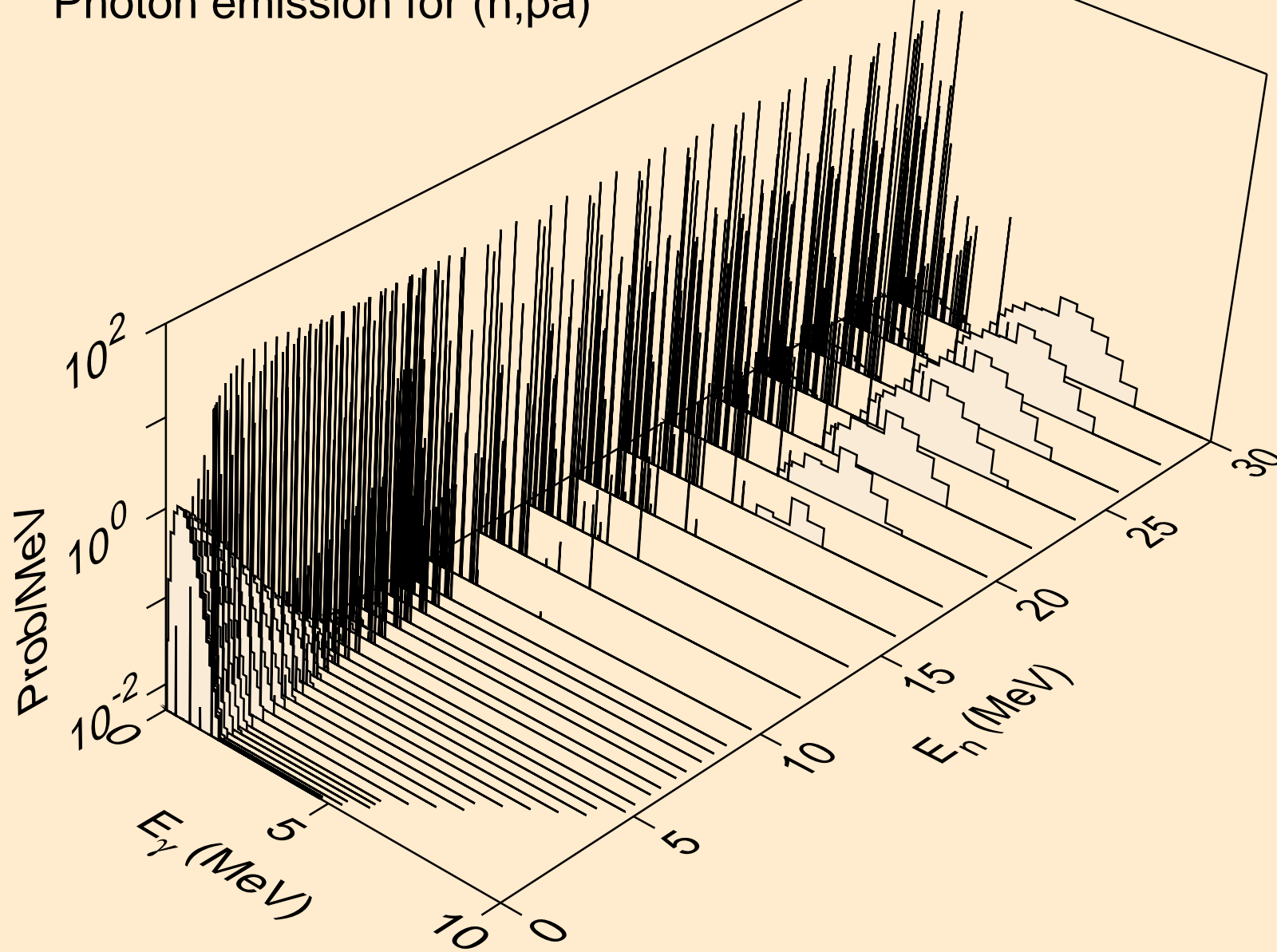

AG098 NEUTRON ACER TENDL-2024 LIBRARY; T=293.6K
Photon emission for (n,pd)

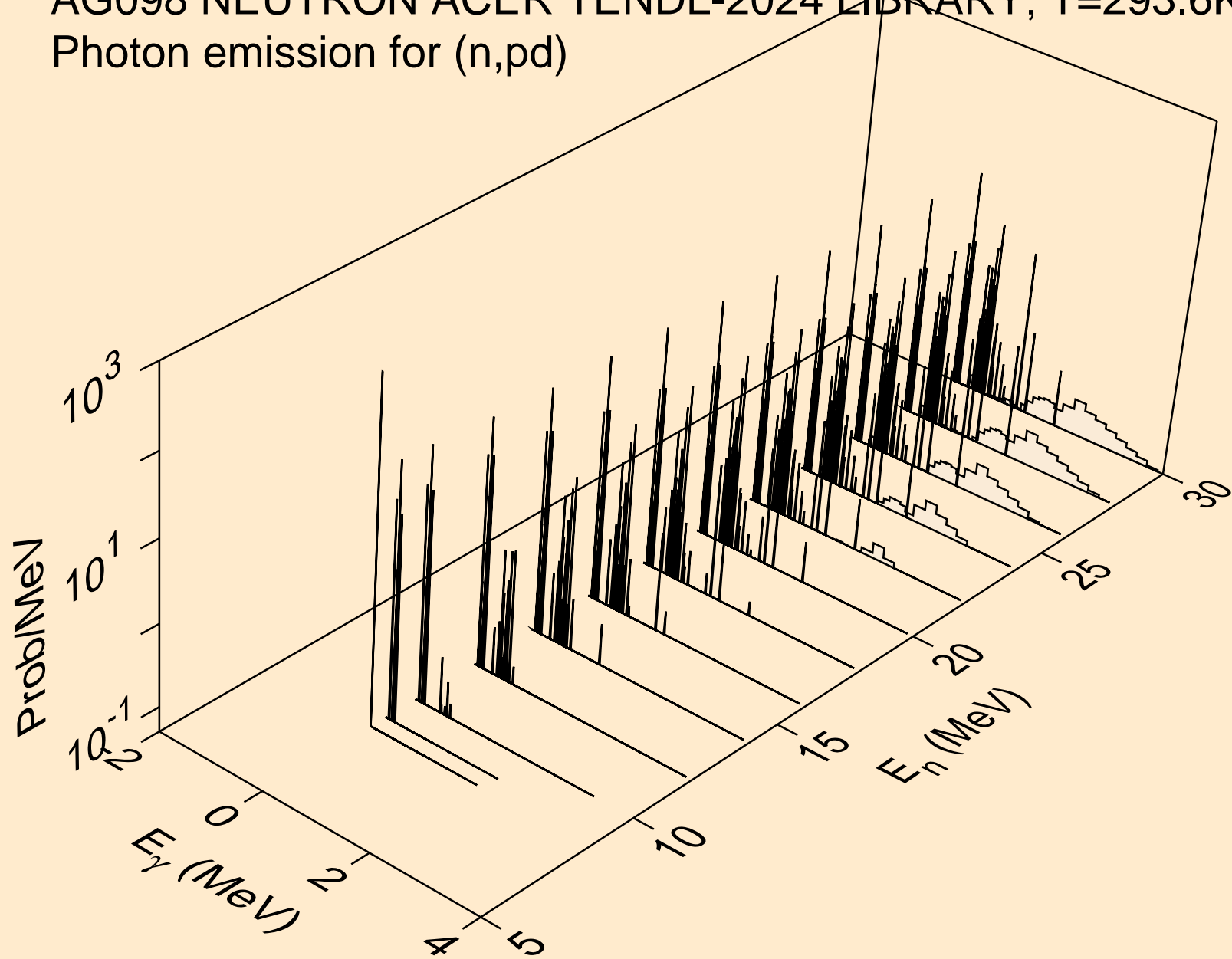

AG098 NEUTRON ACER TENDL-2024 LIBRARY; T=293.6K
Photon emission for (n,pt)

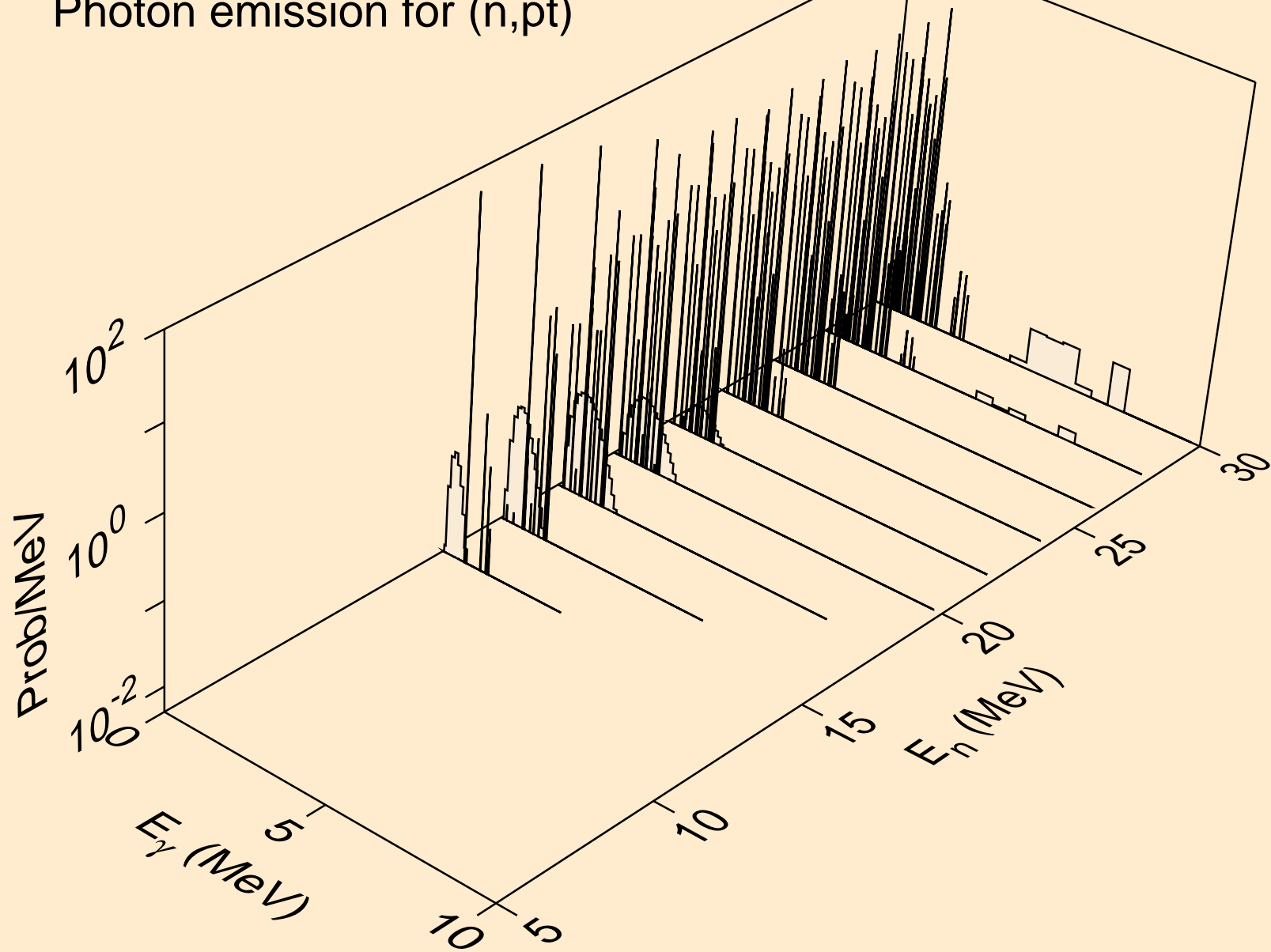

AG098 NEUTRON ACER TENDL-2024 LIBRARY; T=293.6K
Photon emission for (n,da)

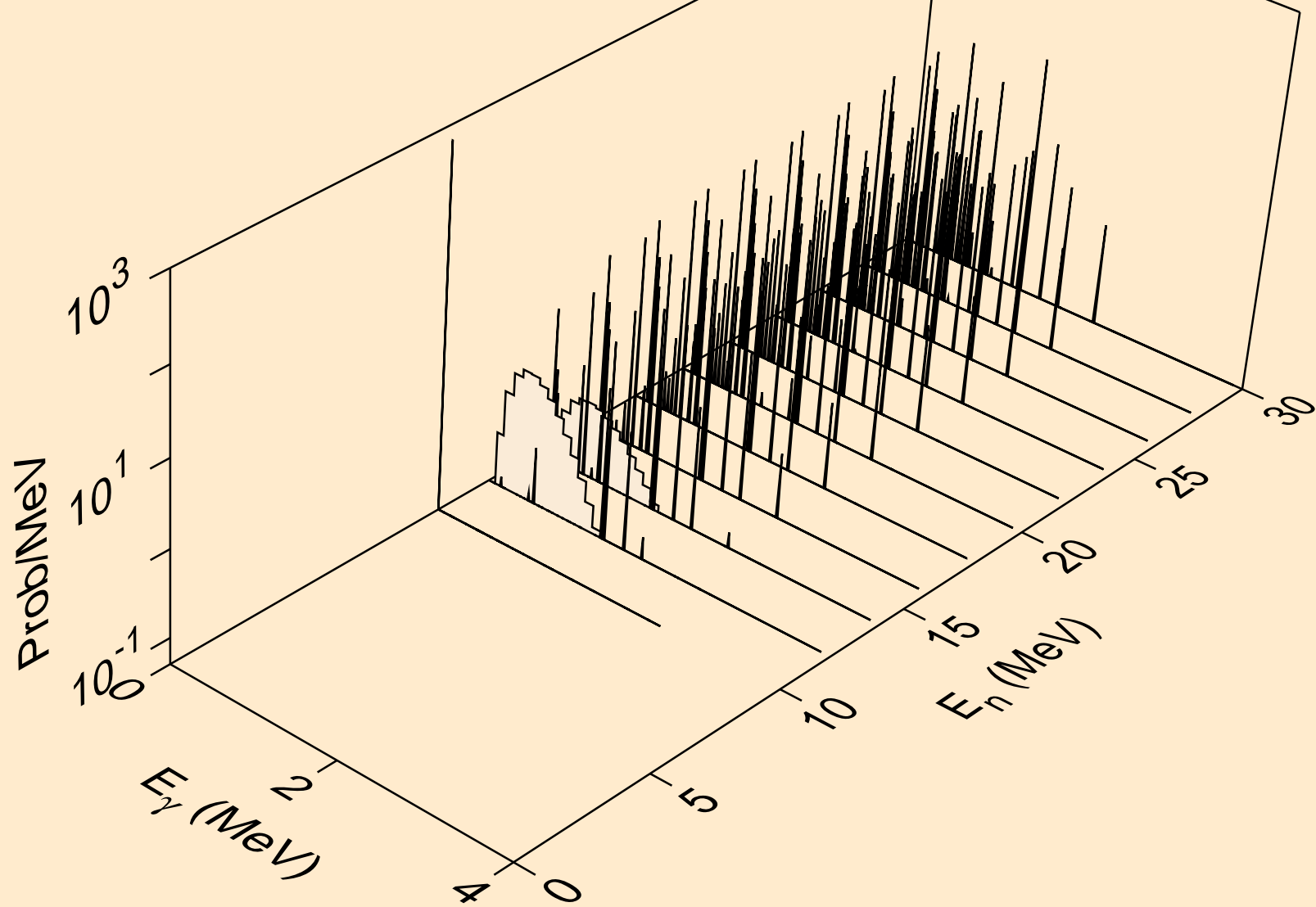

AG098 NEUTRON ACER TENDL-2024 LIBRARY; T=293.6K
thermal capture photon spectrum

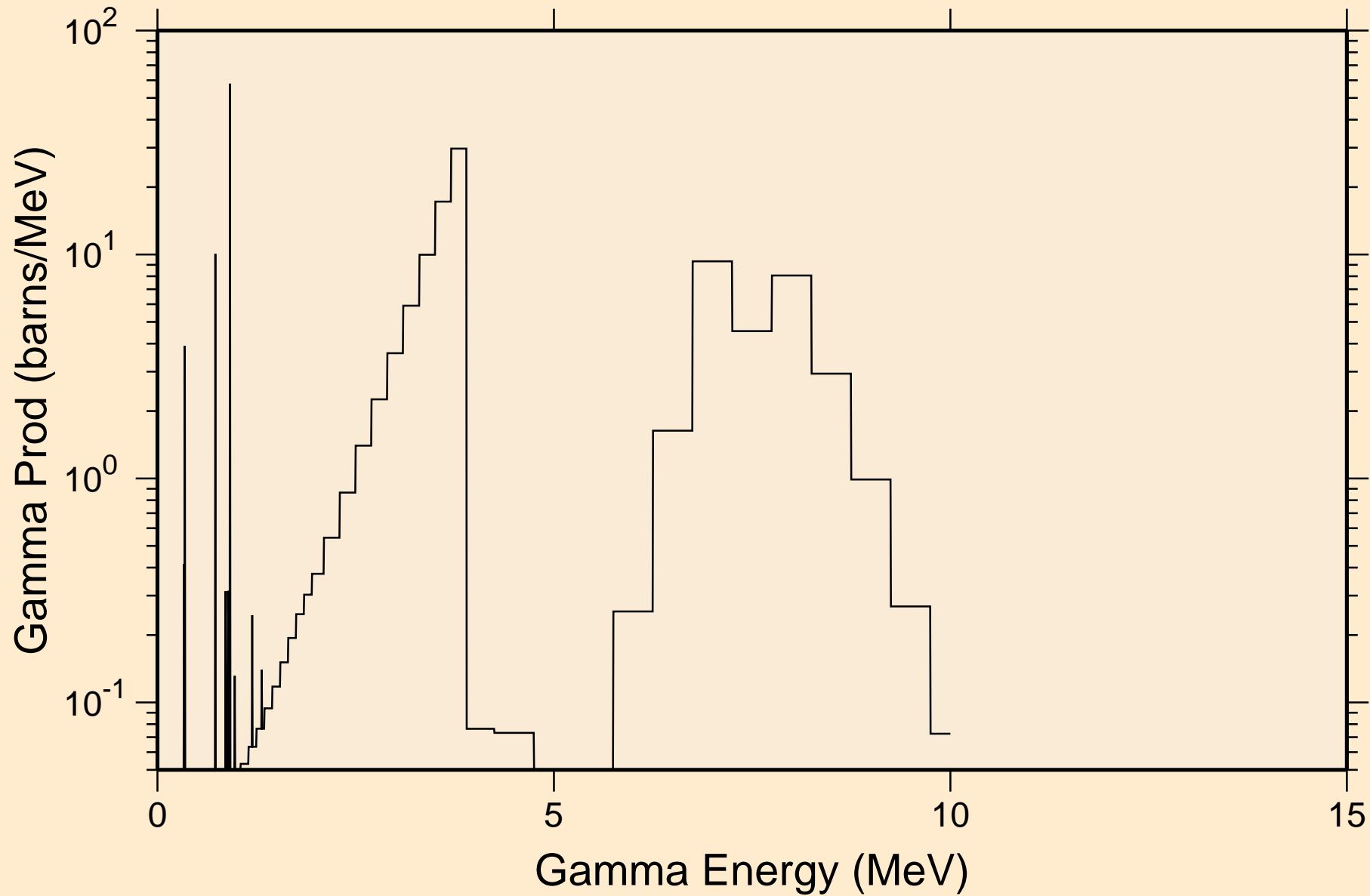

AG098 NEUTRON ACER TENDL-2024 LIBRARY; T=293.6K
14 MeV photon spectrum

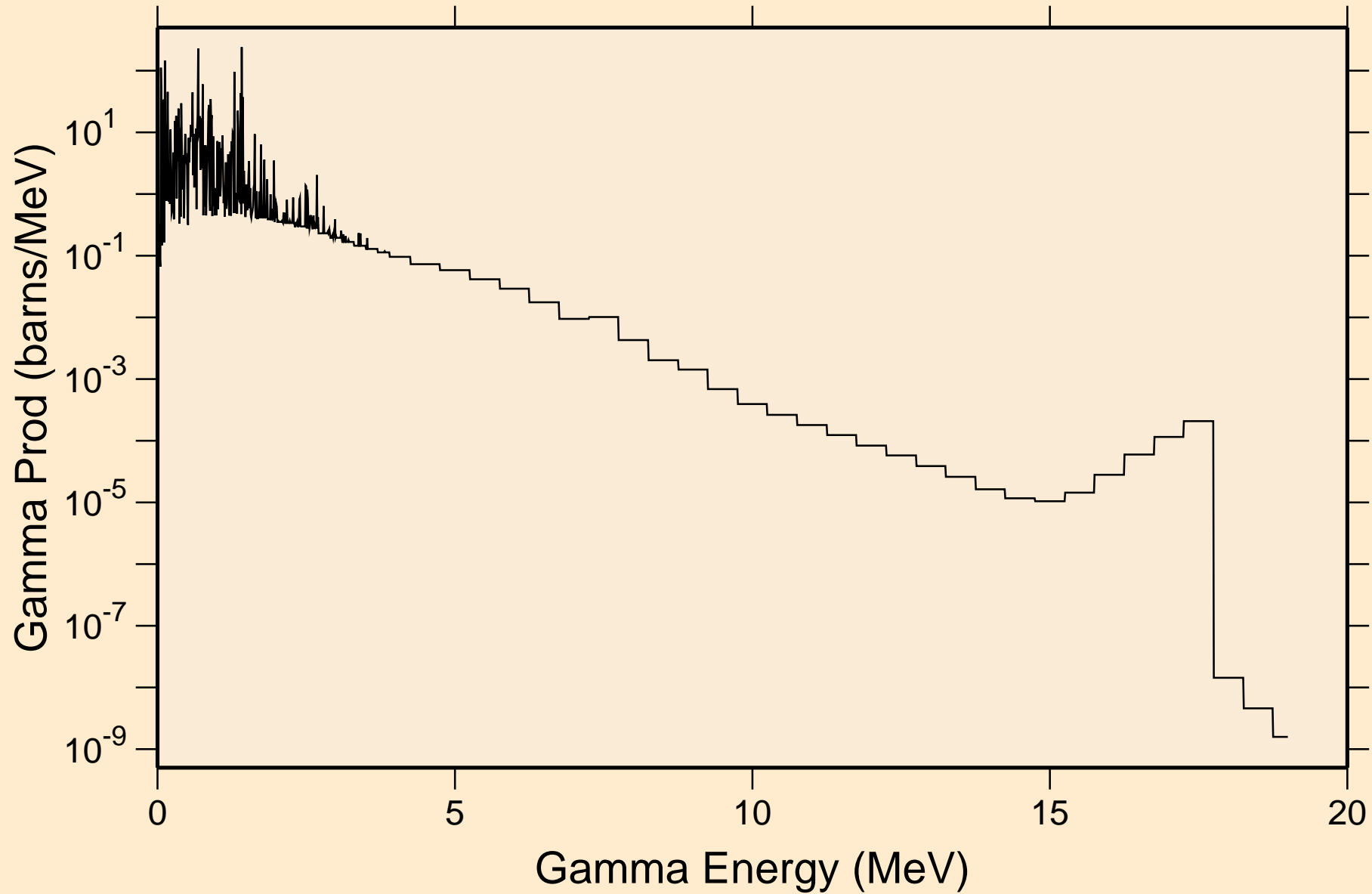

AG098 NEUTRON ACER TENDL-2024 LIBRARY; T=293.6K
Particle heating contributions

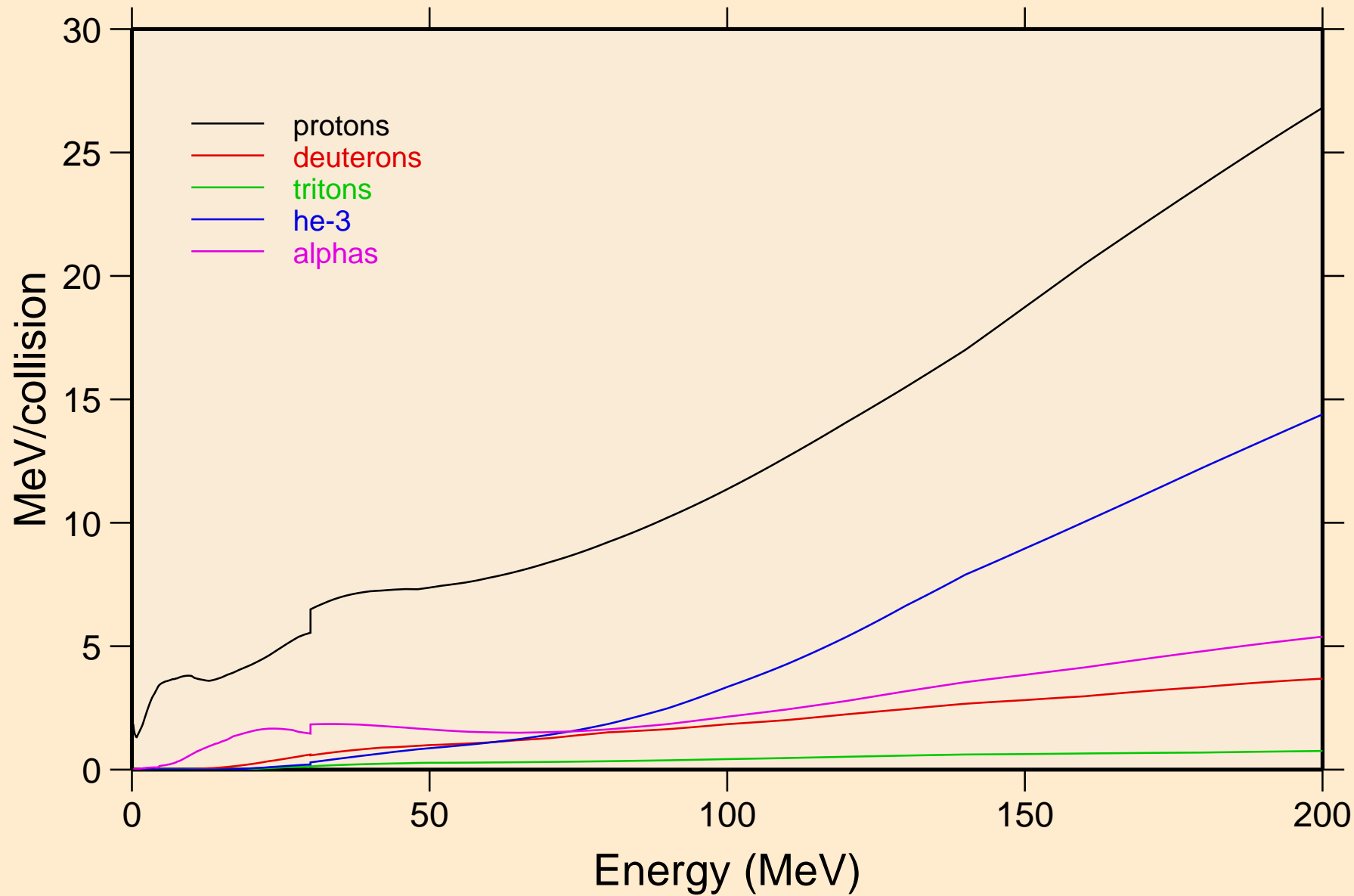

AG098 NEUTRON ACER TENDL-2024 LIBRARY; T=293.6K
Recoil Heating

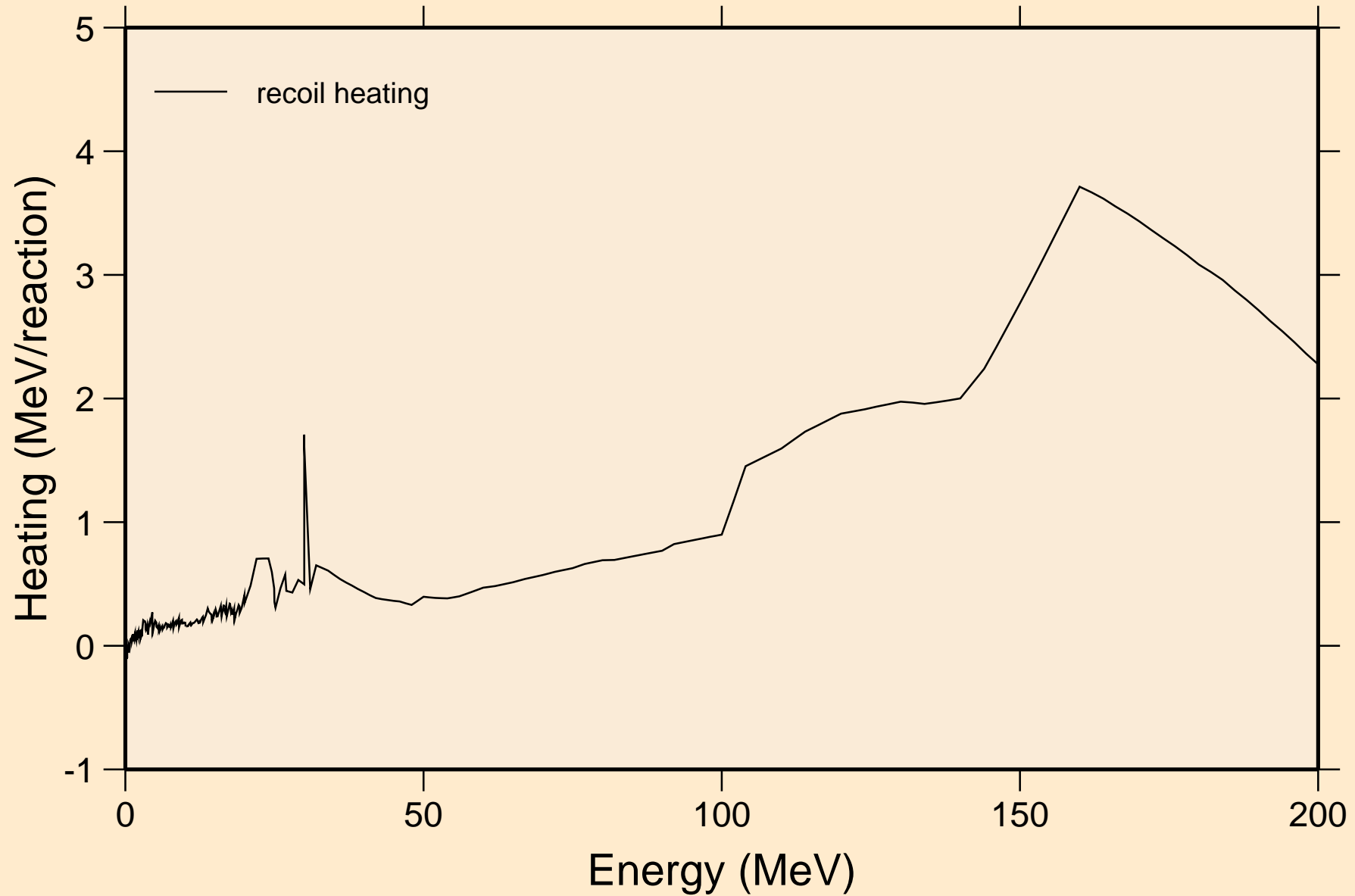

AG098 NEUTRON ACER TENDL-2024 LIBRARY; T=293.6K
Particle production cross sections

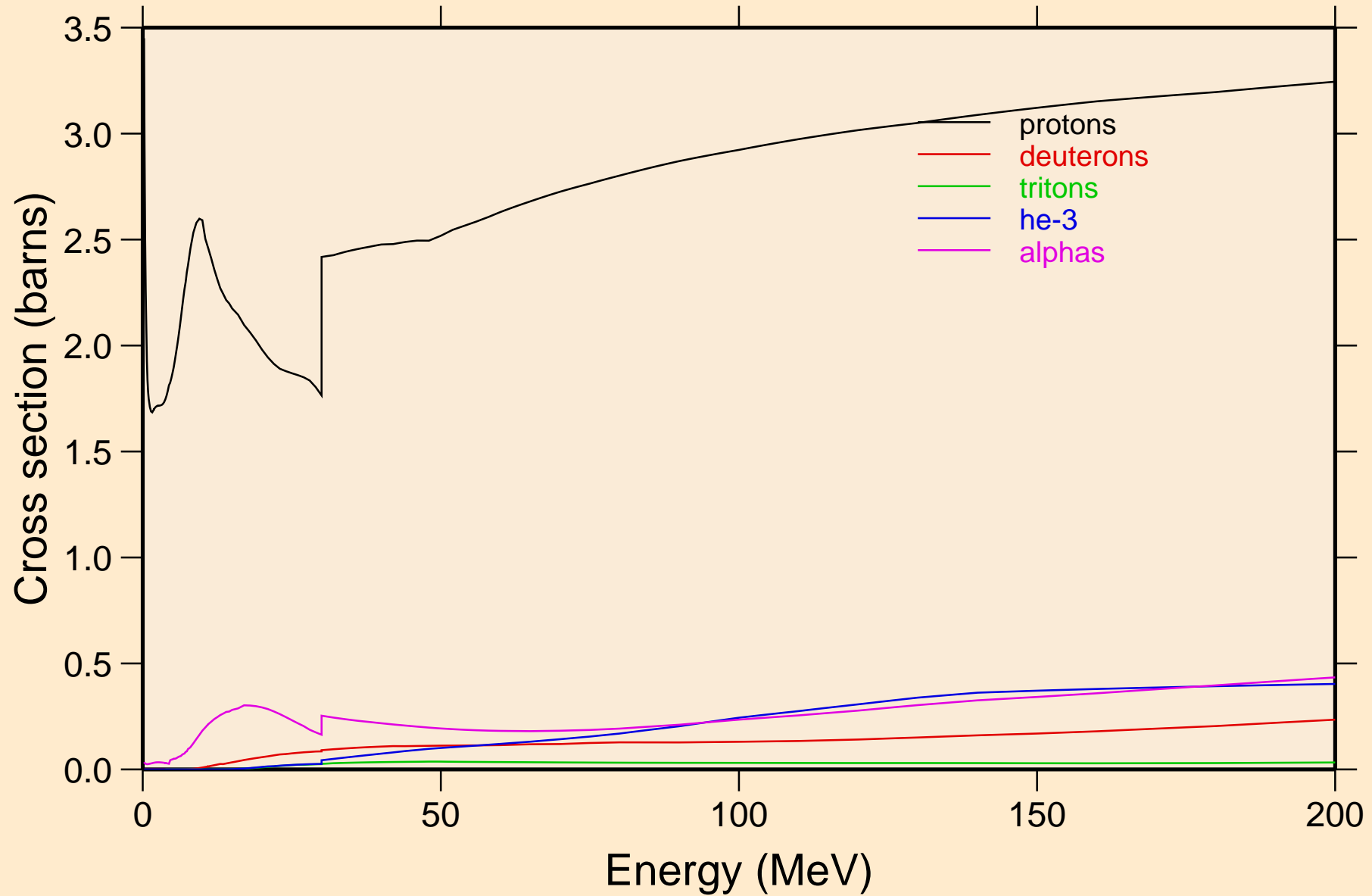

AG098 NEUTRON ACER TENDL-2024 LIBRARY; T=293.6K
protons from (n,x)

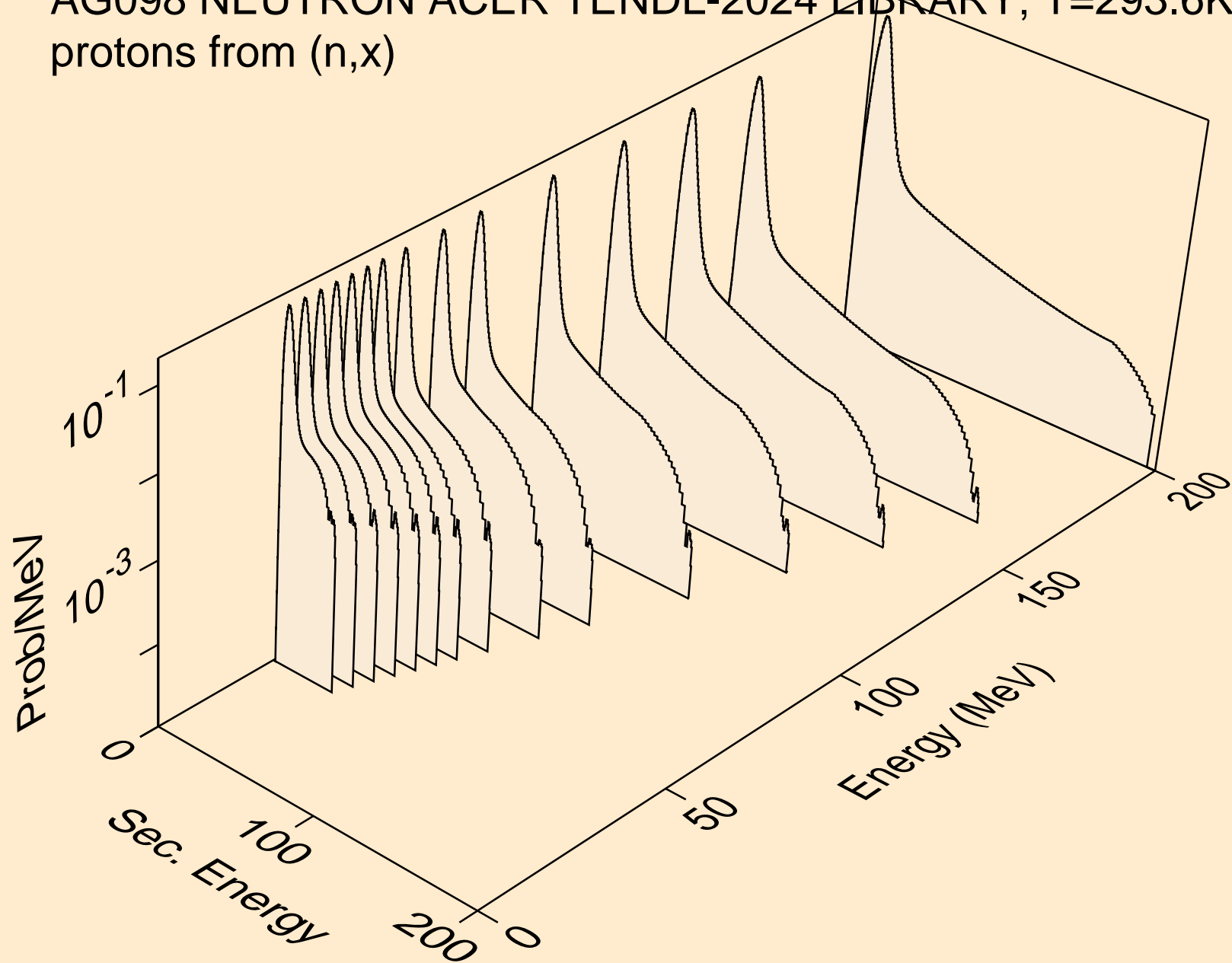

AG098 NEUTRON ACER TENDL-2024 LIBRARY; T=293.6K
protons from (n,n*)p

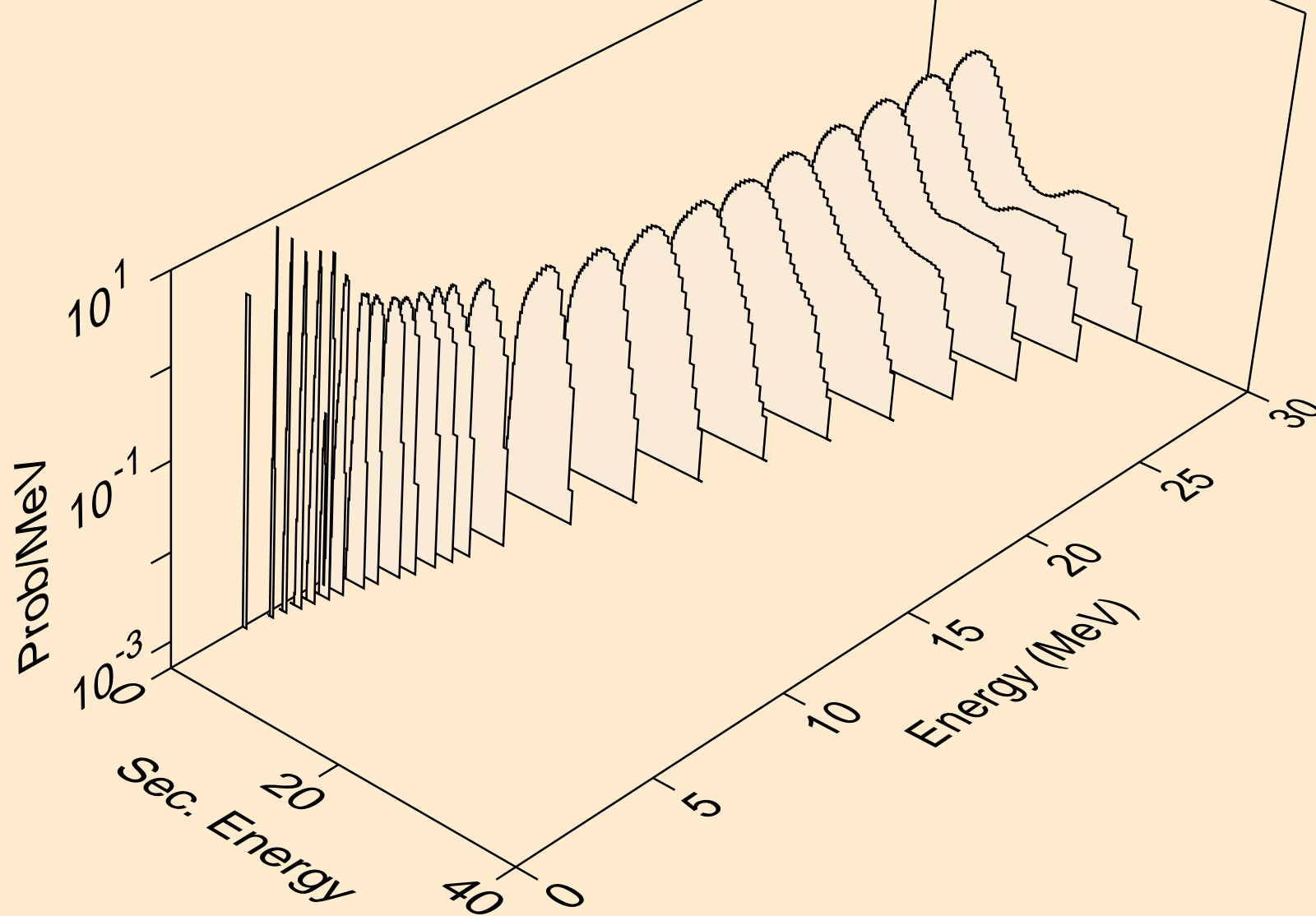

AG098 NEUTRON ACER TENDL-2024 LIBRARY; T=293.6K
protons from (n,2np)

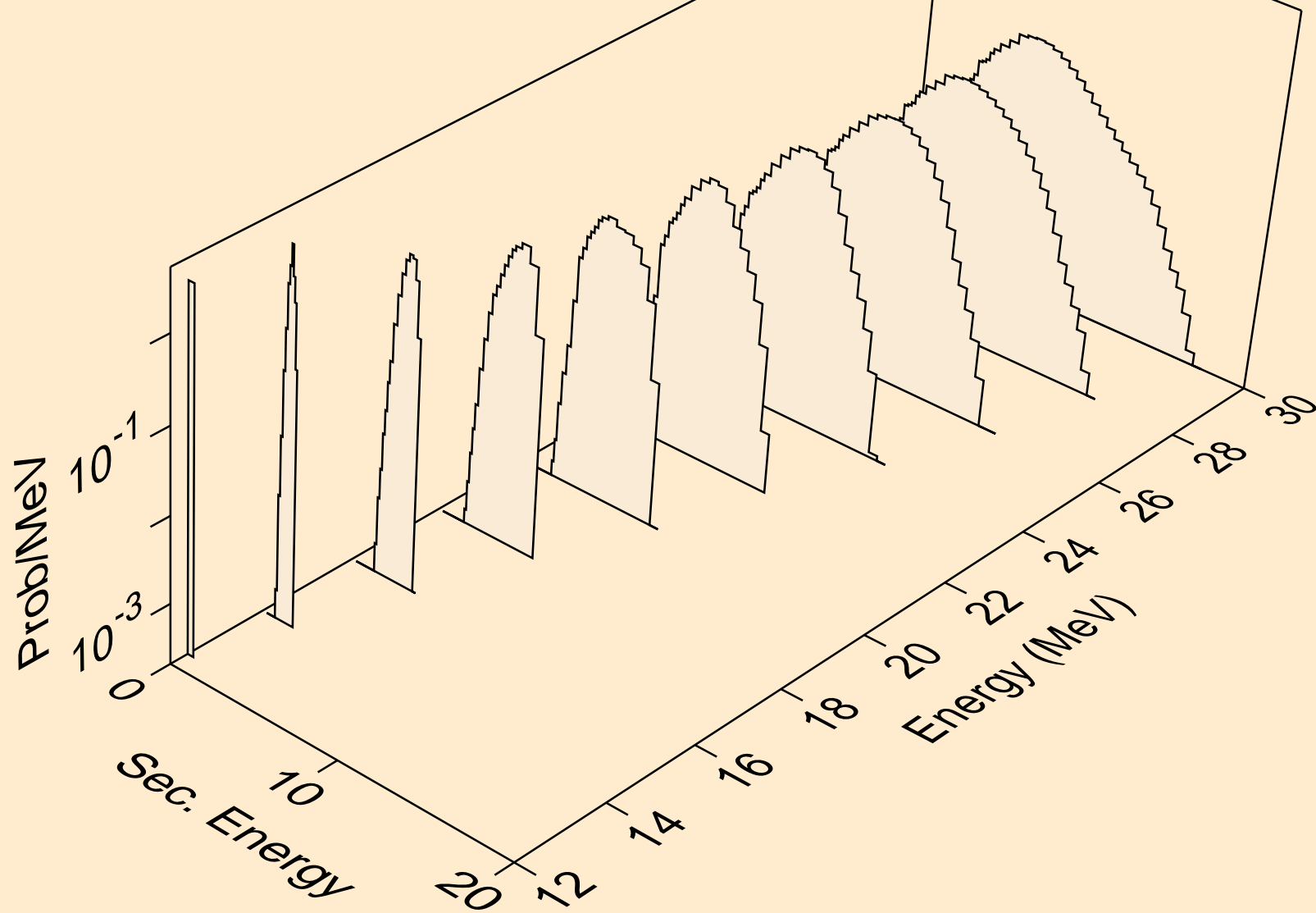

AG098 NEUTRON ACER TENDL-2024 LIBRARY; T=293.6K
protons from (n,3np)

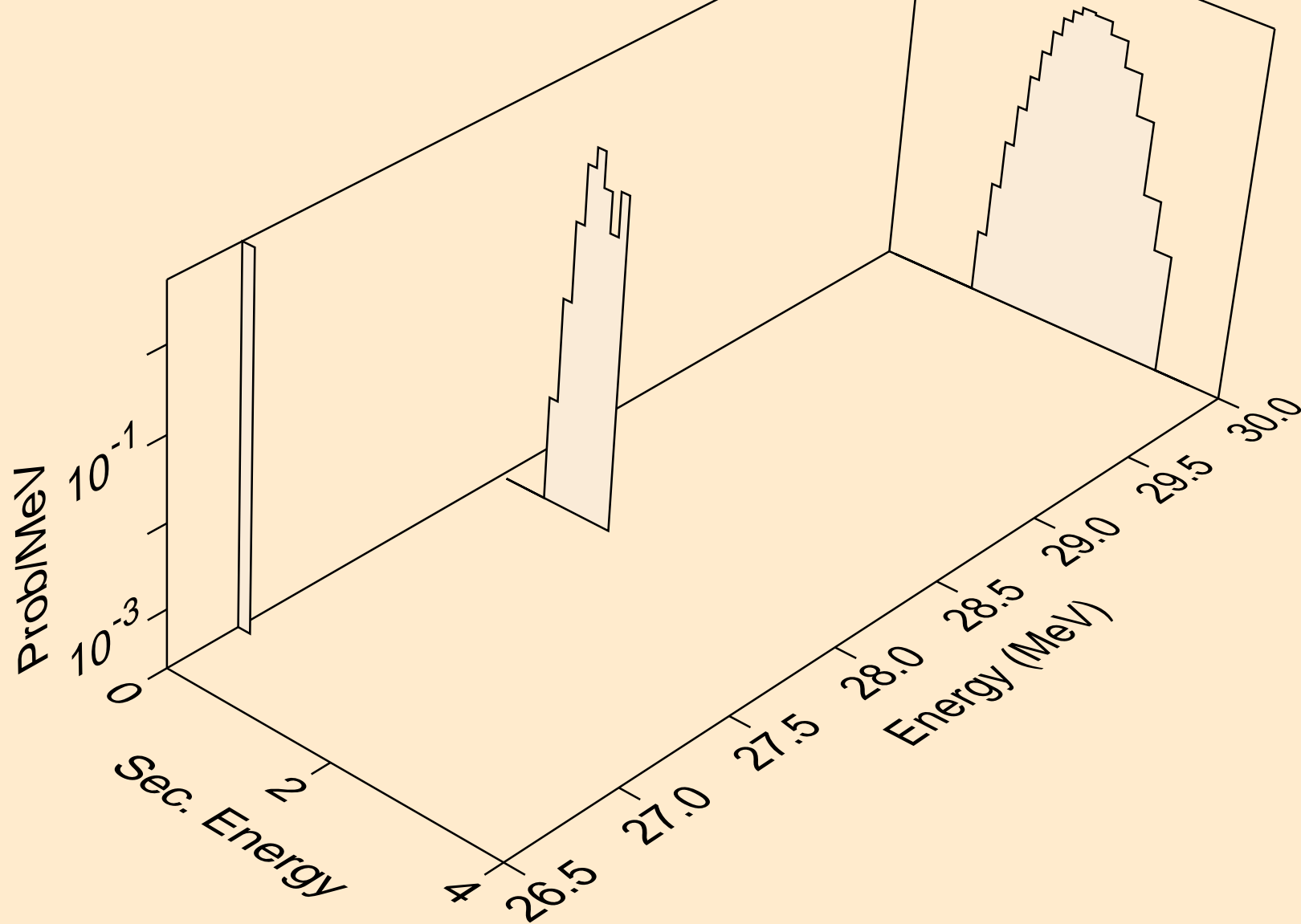

AG098 NEUTRON ACER TENDL-2024 LIBRARY; T=293.6K
protons from (n,n2p)

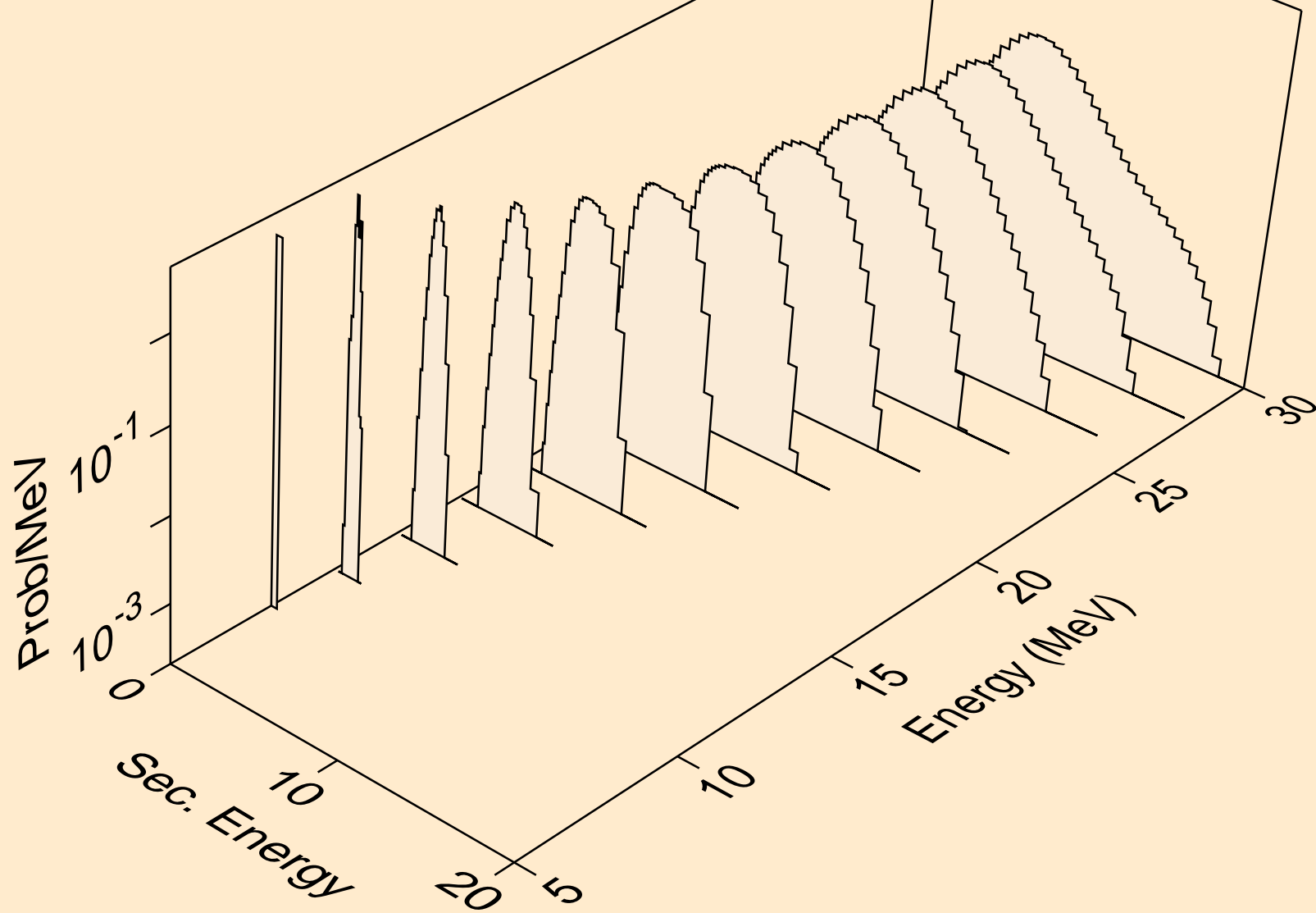

AG098 NEUTRON ACER TENDL-2024 LIBRARY; T=293.6K
protons from (n,npa)

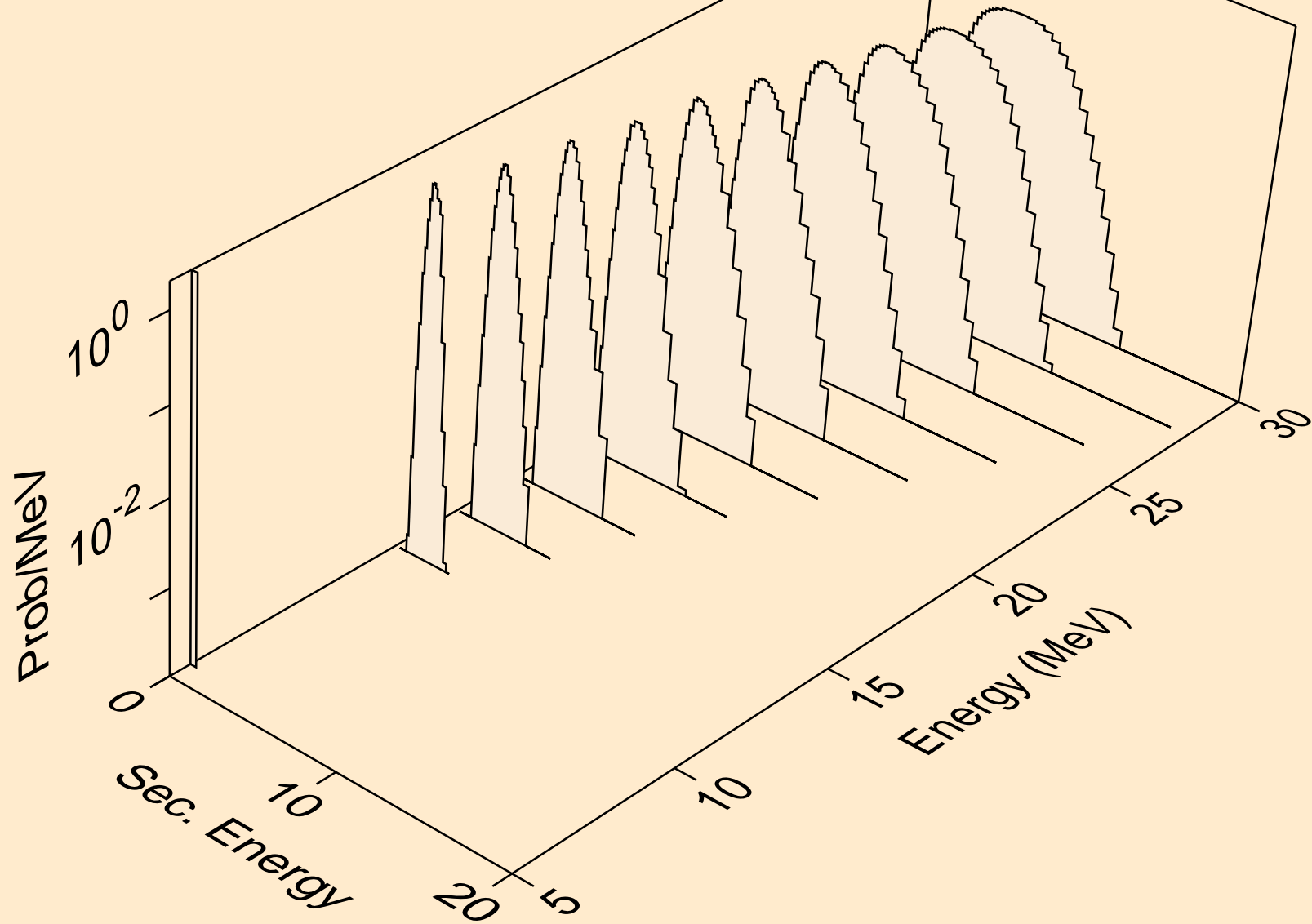

AG098 NEUTRON ACER TENDL-2024 LIBRARY; T=293.6K
protons from (n,p)

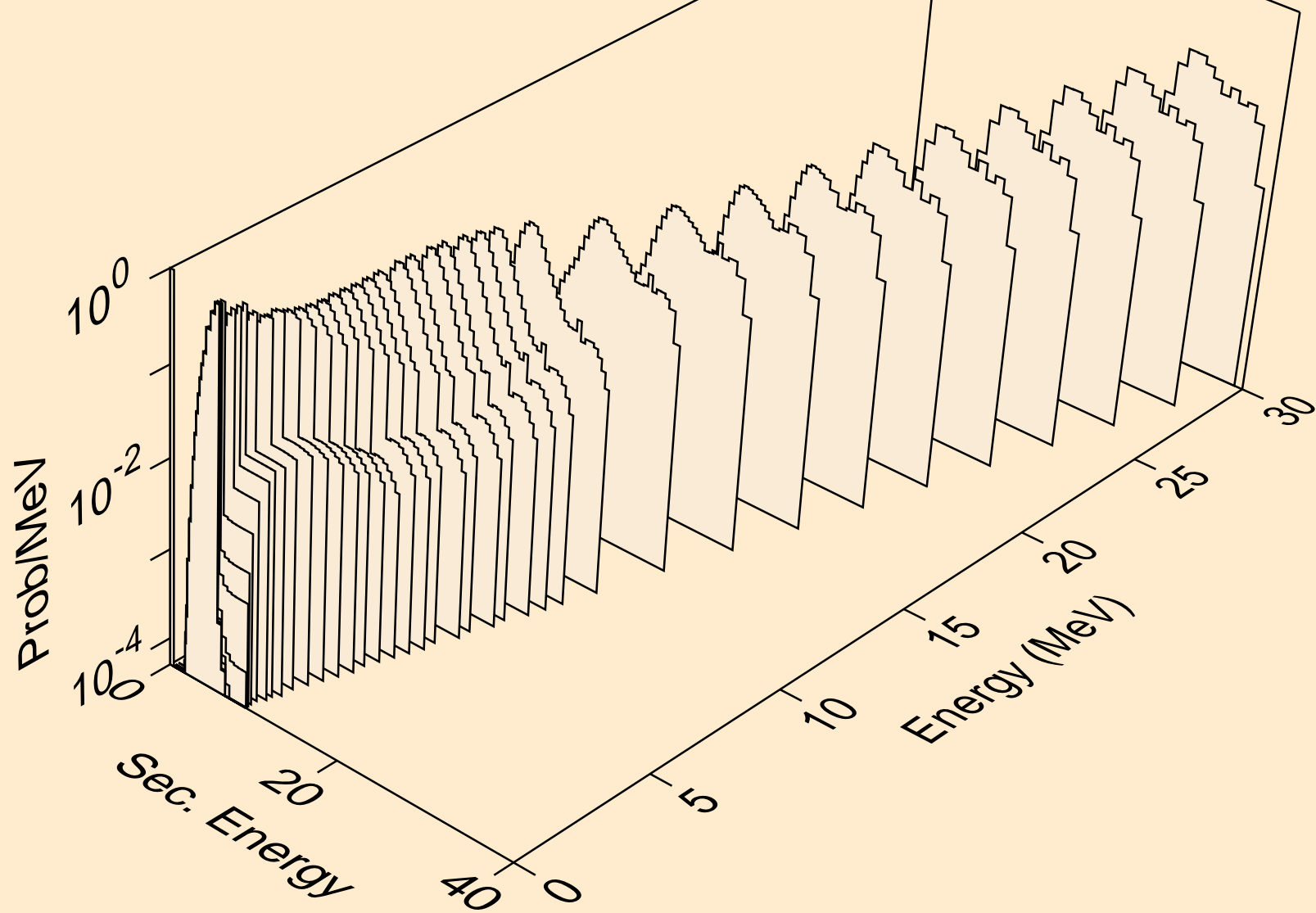

AG098 NEUTRON ACER TENDL-2024 LIBRARY; T=293.6K
protons from (n,2p)

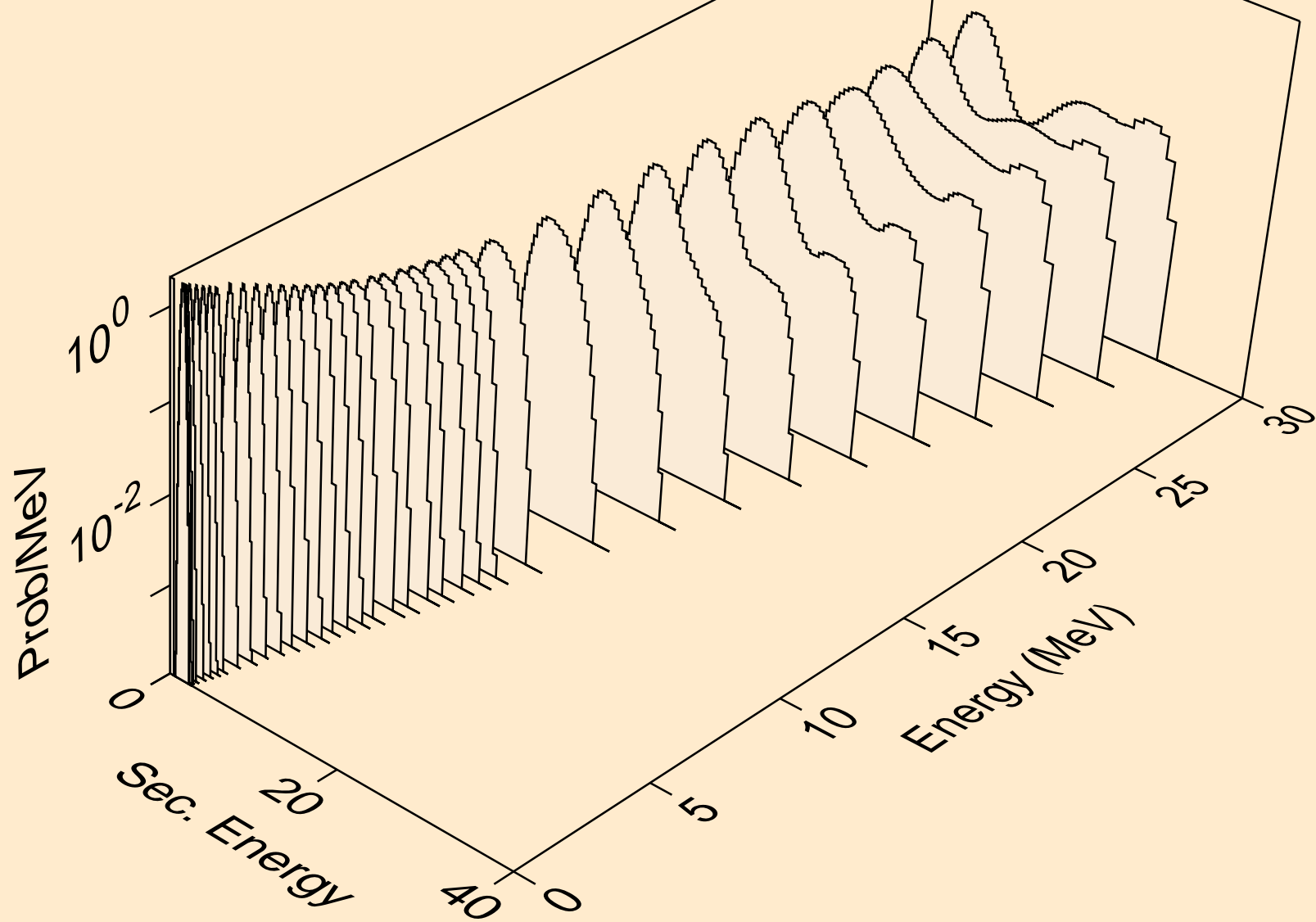

AG098 NEUTRON ACER TENDL-2024 LIBRARY; T=293.6K
protons from (n,p)

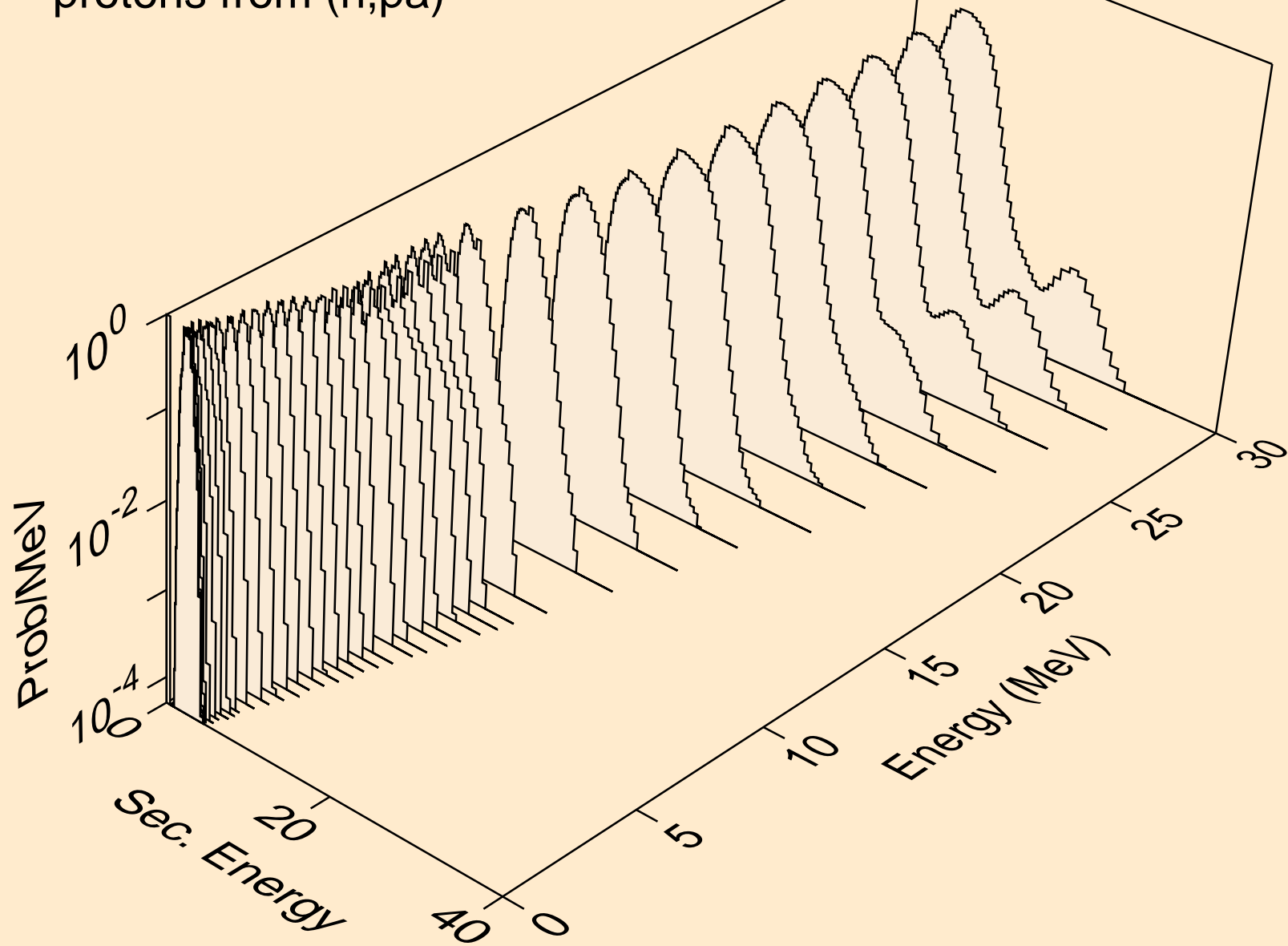

AG098 NEUTRON ACER TENDL-2024 LIBRARY; T=293.6K
protons from (n,pd)

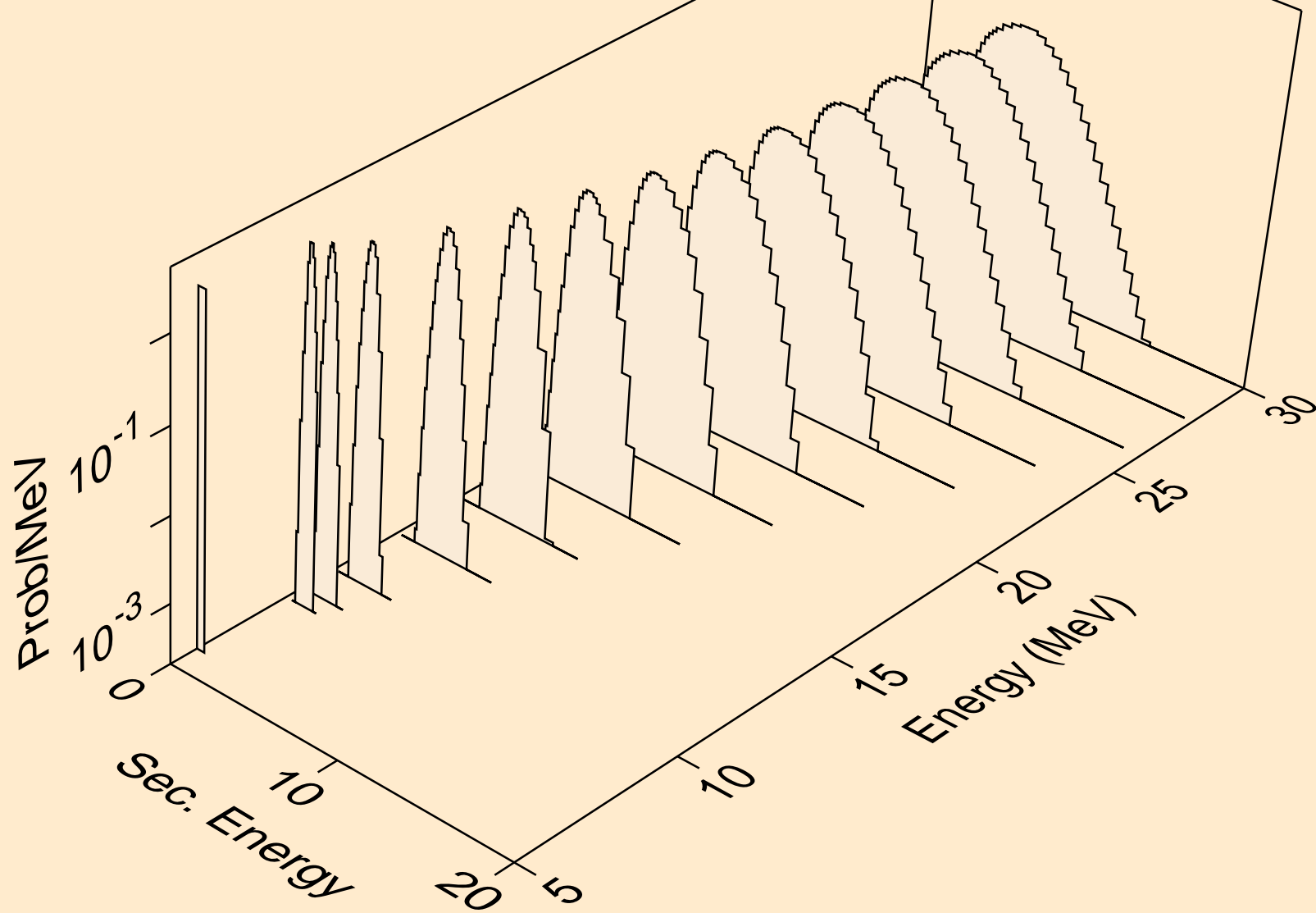

AG098 NEUTRON ACER TENDL-2024 LIBRARY; T=293.6K
protons from (n,pt)

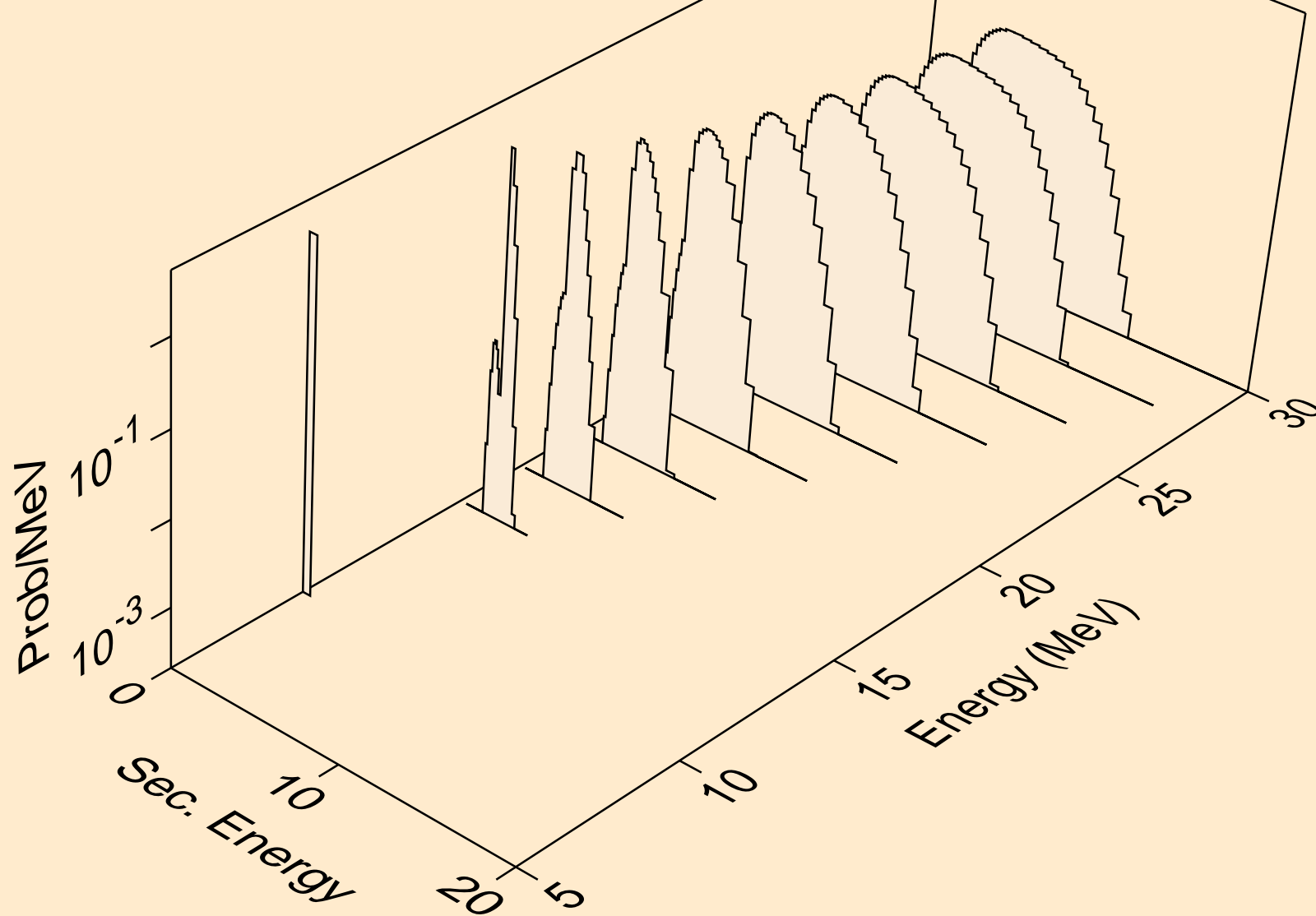

AG098 NEUTRON ACER TENDL-2024 LIBRARY; T=293.6K
deuterons from (n,x)

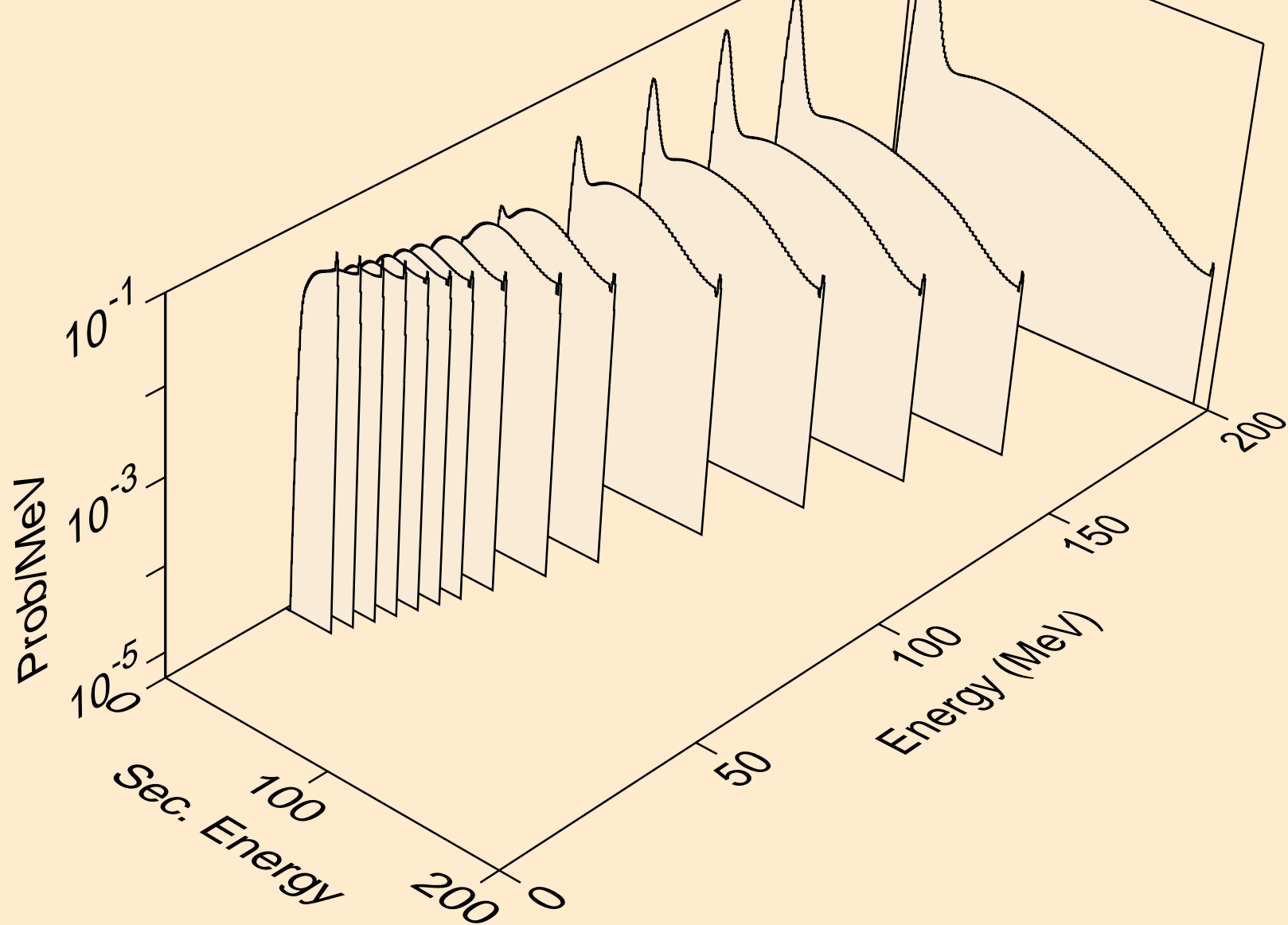

AG098 NEUTRON ACER TENDL-2024 LIBRARY; T=293.6K
deuterons from (n,2nd)

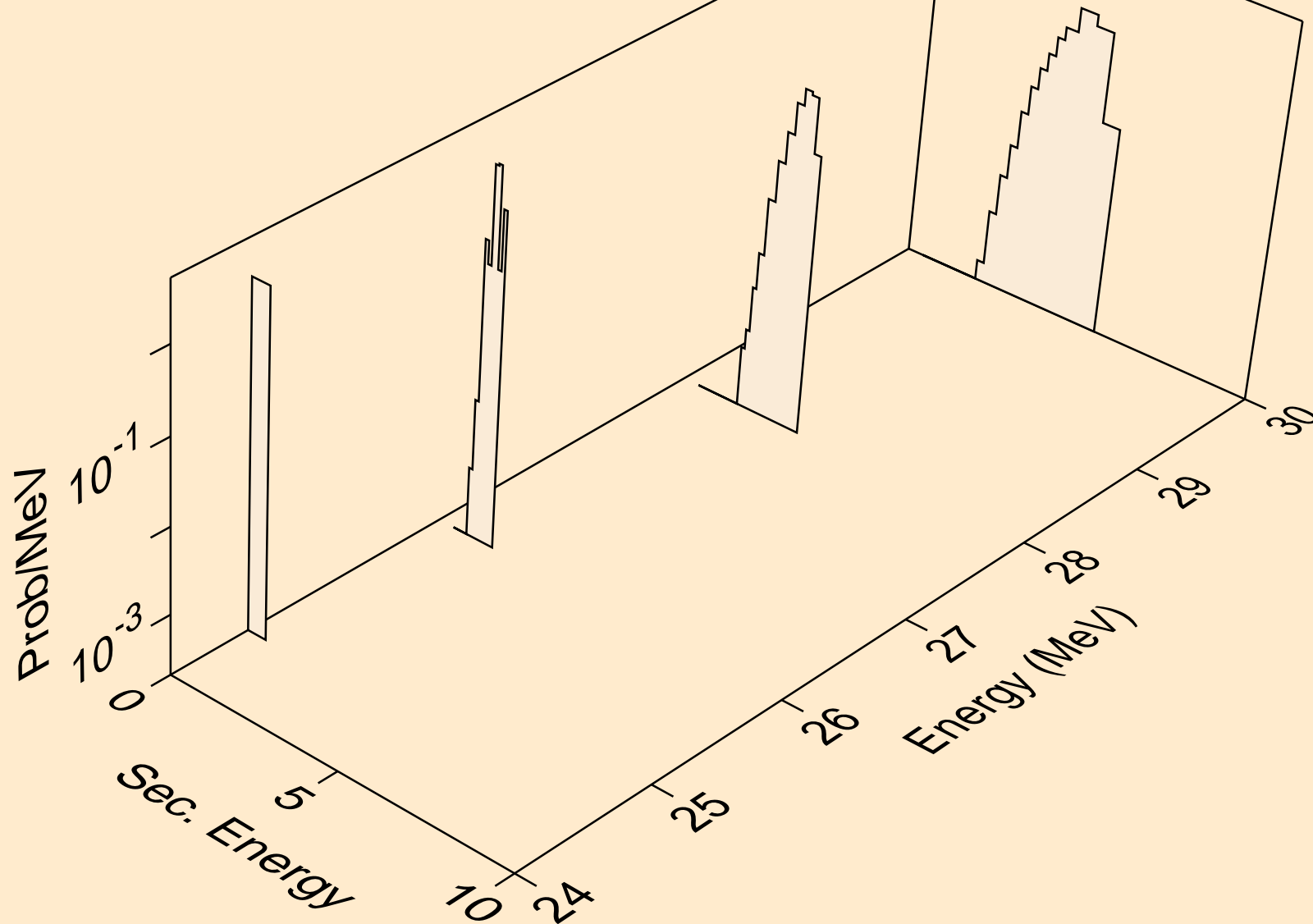

AG098 NEUTRON ACER TENDL-2024 LIBRARY; T=293.6K
deuterons from (n,n*)d

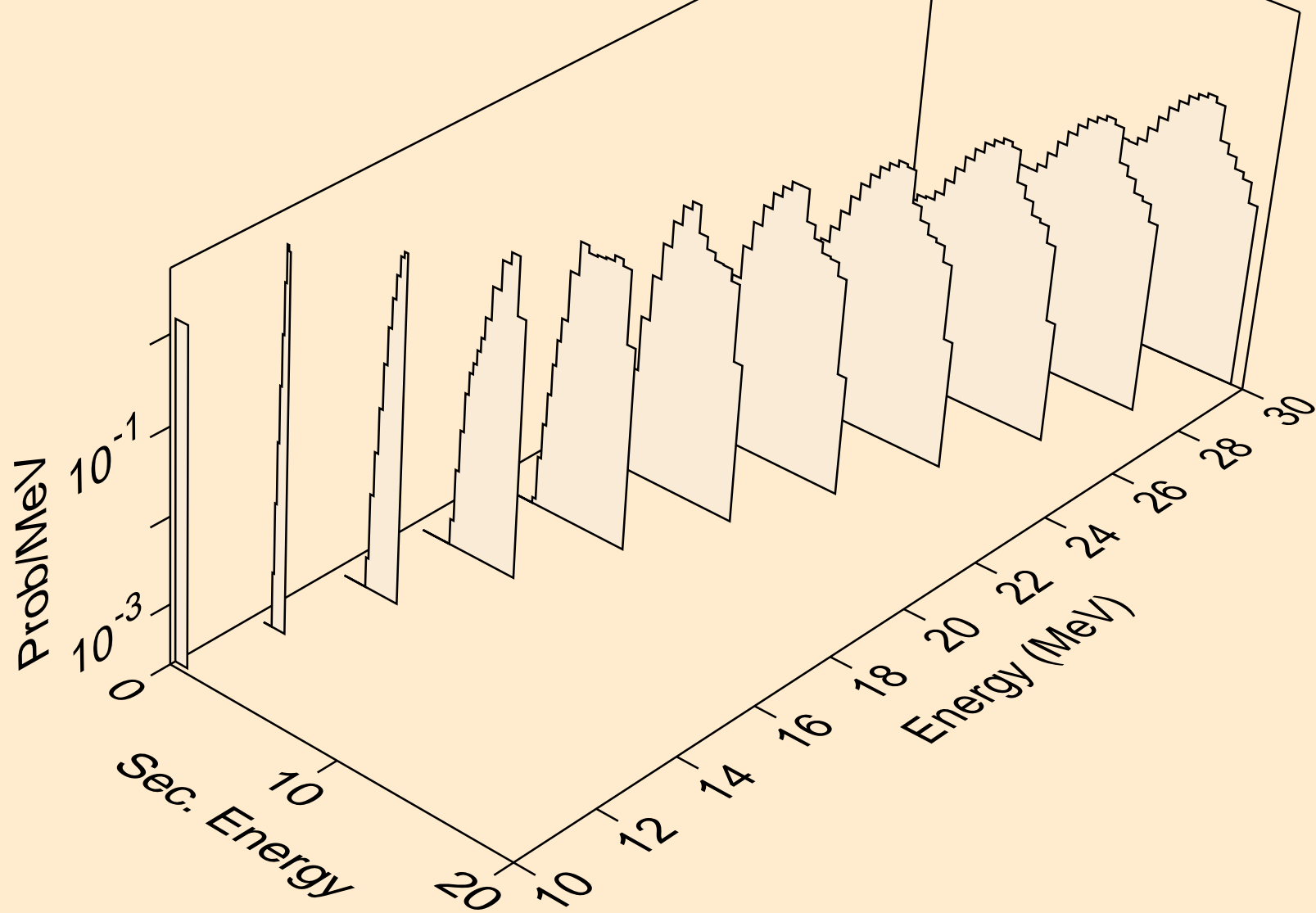

AG098 NEUTRON ACER TENDL-2024 LIBRARY; T=293.6K
deuterons from (n,d)

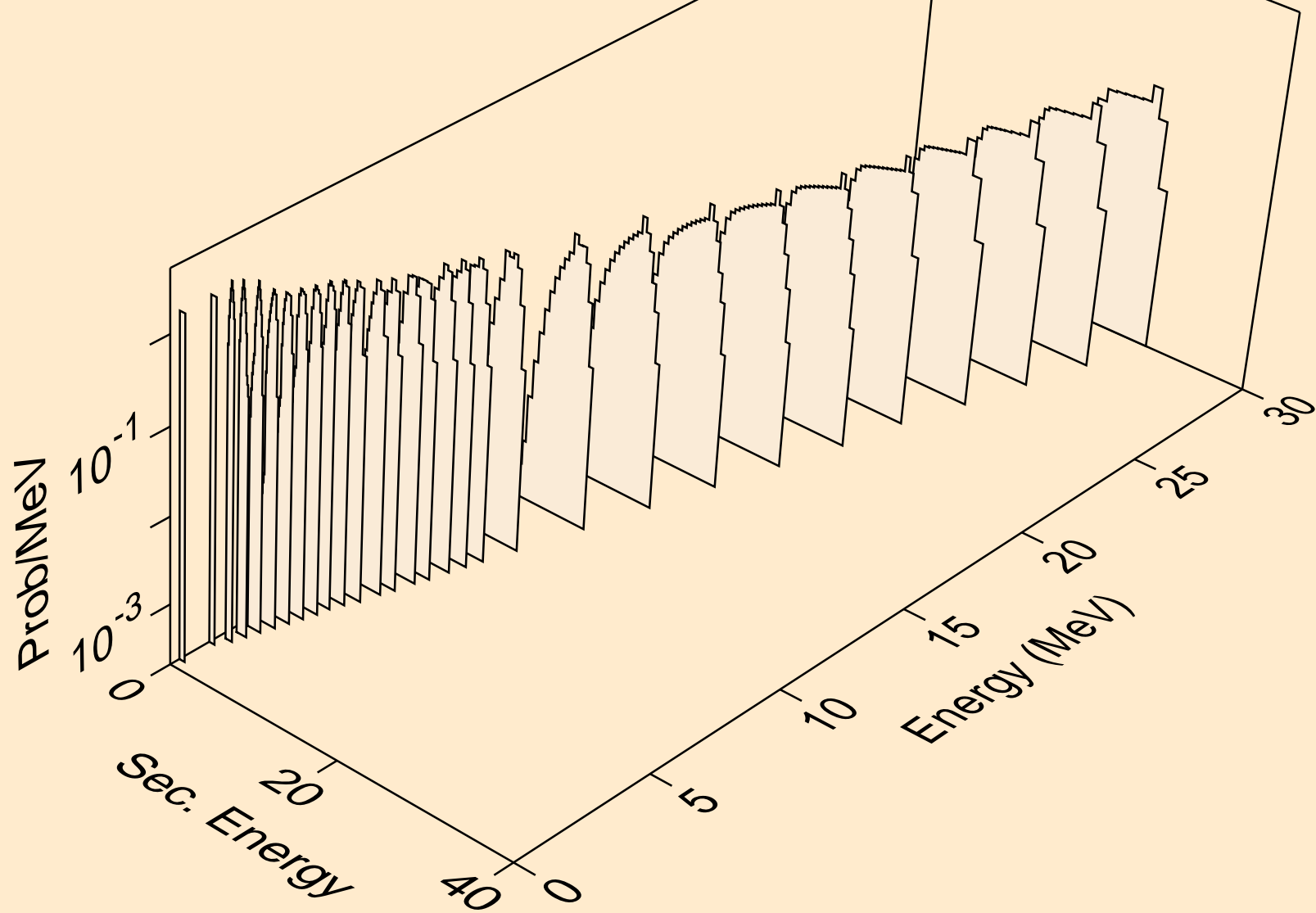

AG098 NEUTRON ACER TENDL-2024 LIBRARY; T=293.6K
deuterons from (n,pd)

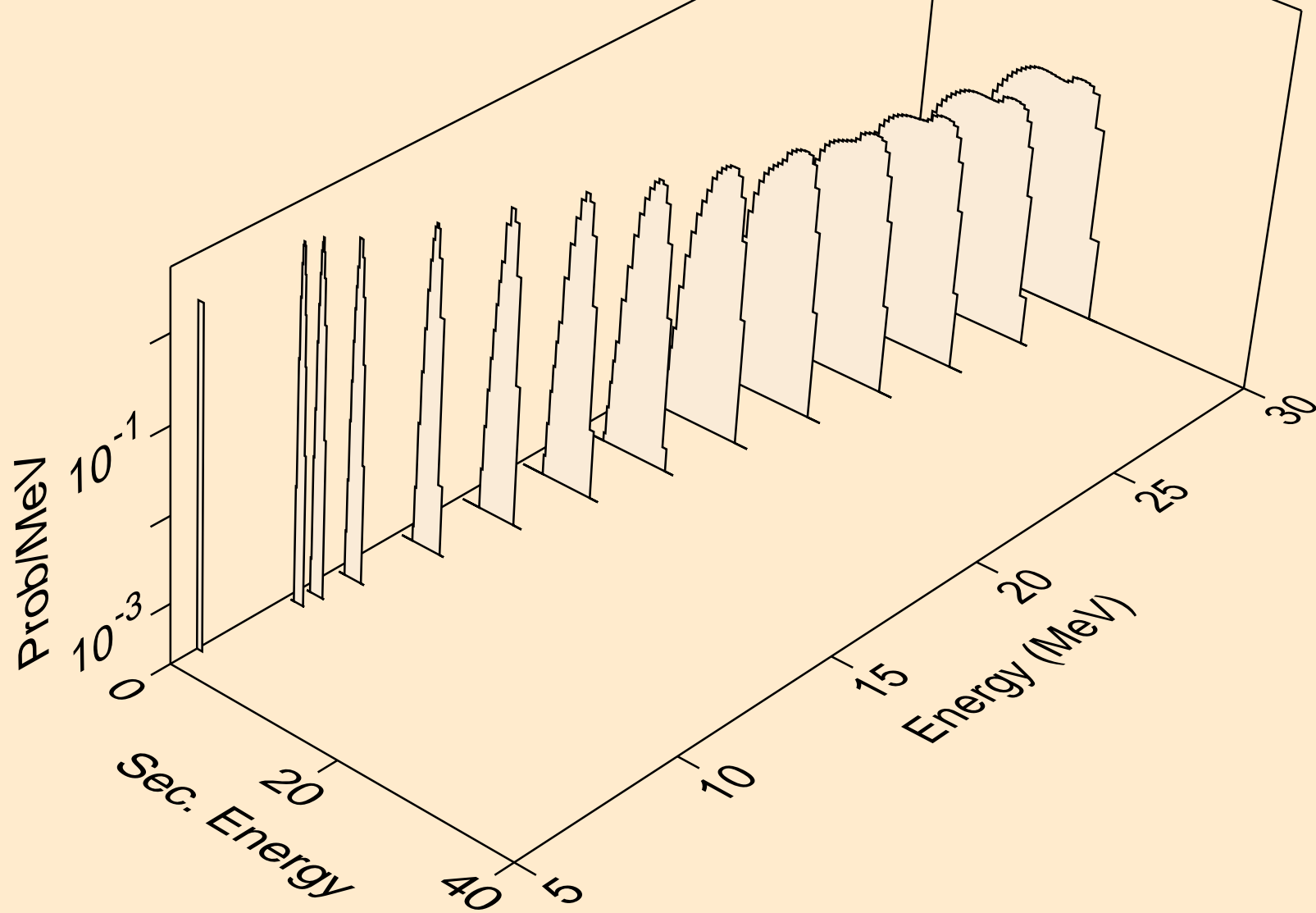

AG098 NEUTRON ACER TENDL-2024 LIBRARY; T=293.6K
deuterons from (n,da)

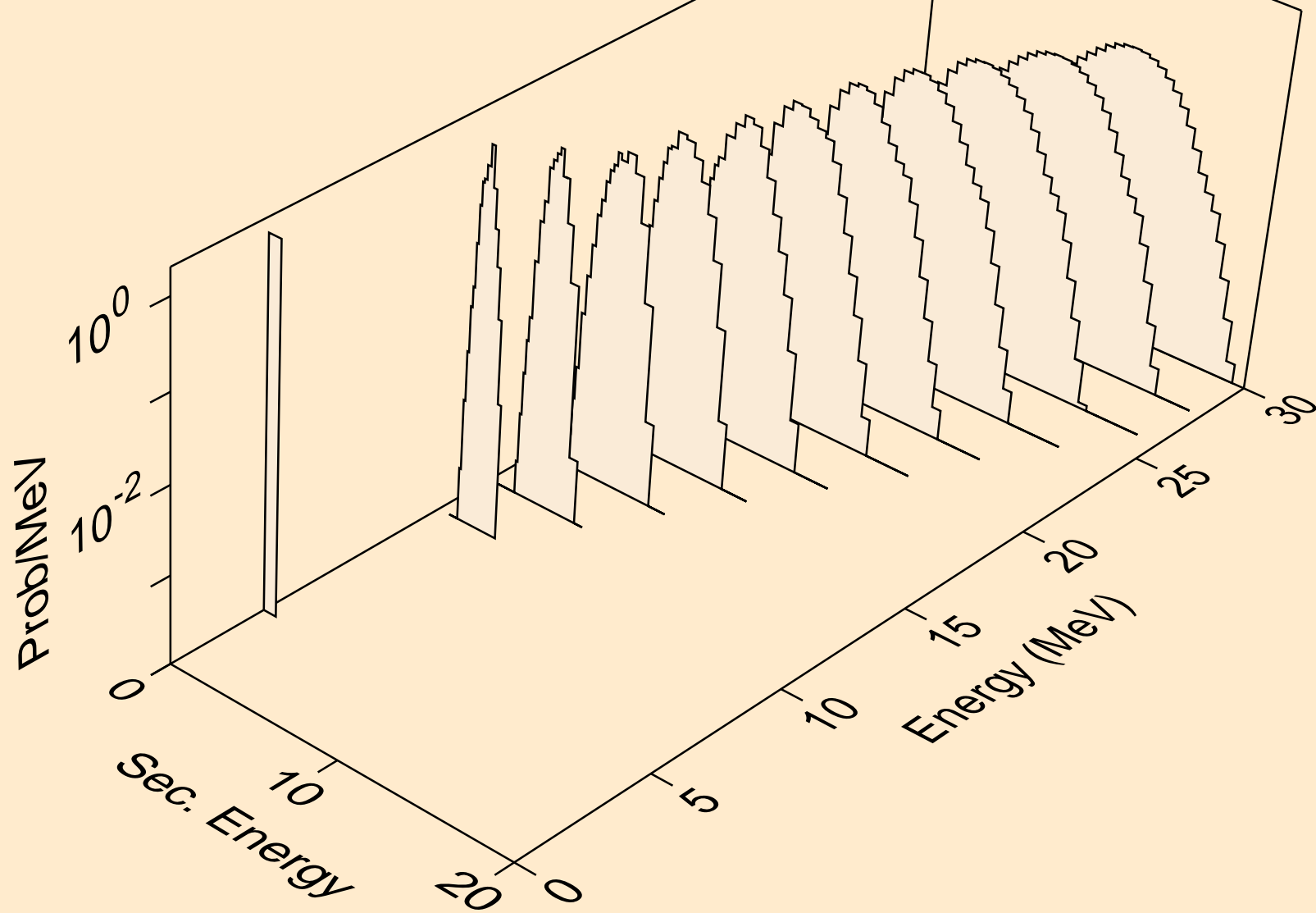

AG098 NEUTRON ACER TENDL-2024 LIBRARY; T=293.6K
tritons from (n,x)

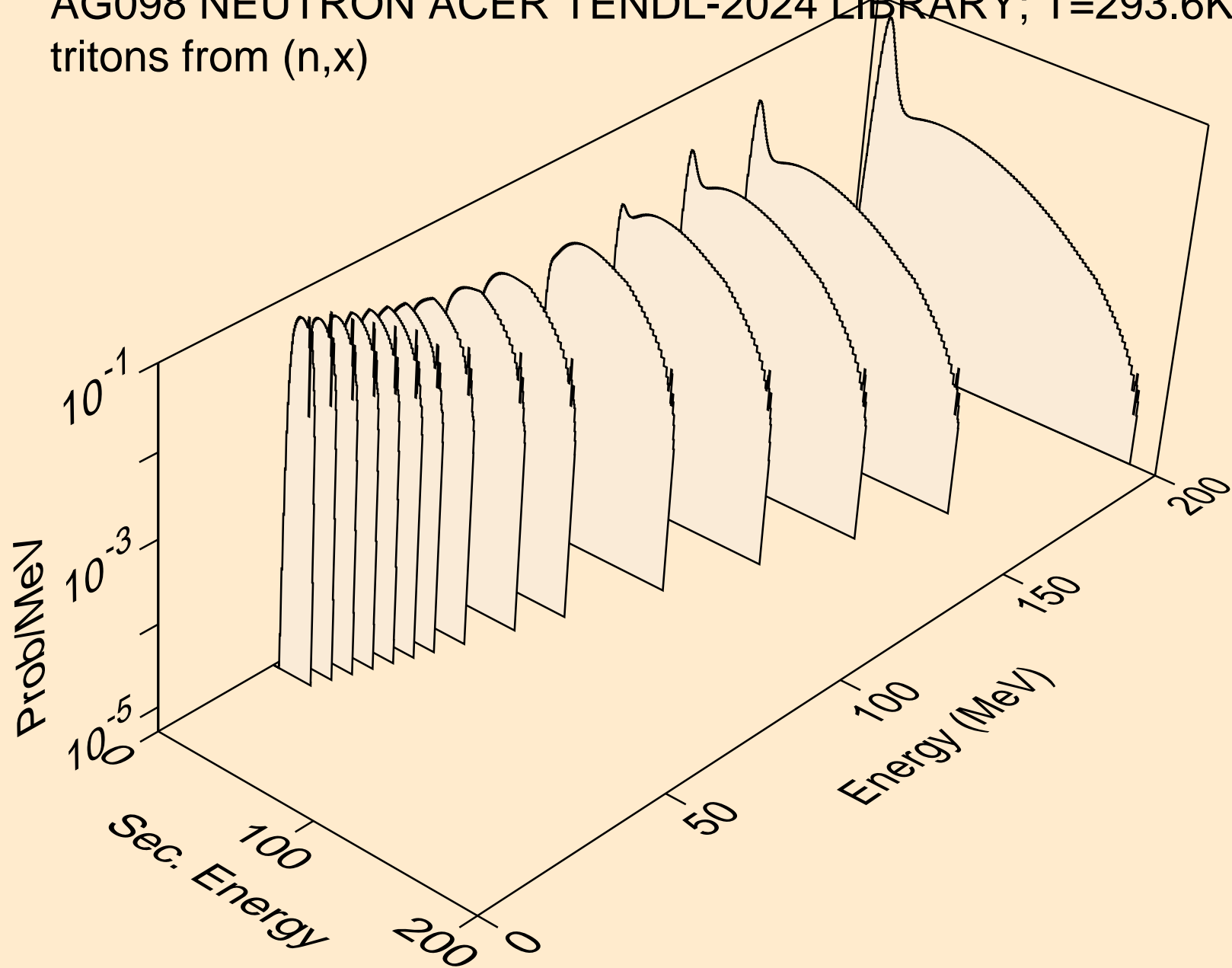

AG098 NEUTRON ACER TENDL-2024 LIBRARY; T=293.6K
tritons from (n,n*)t

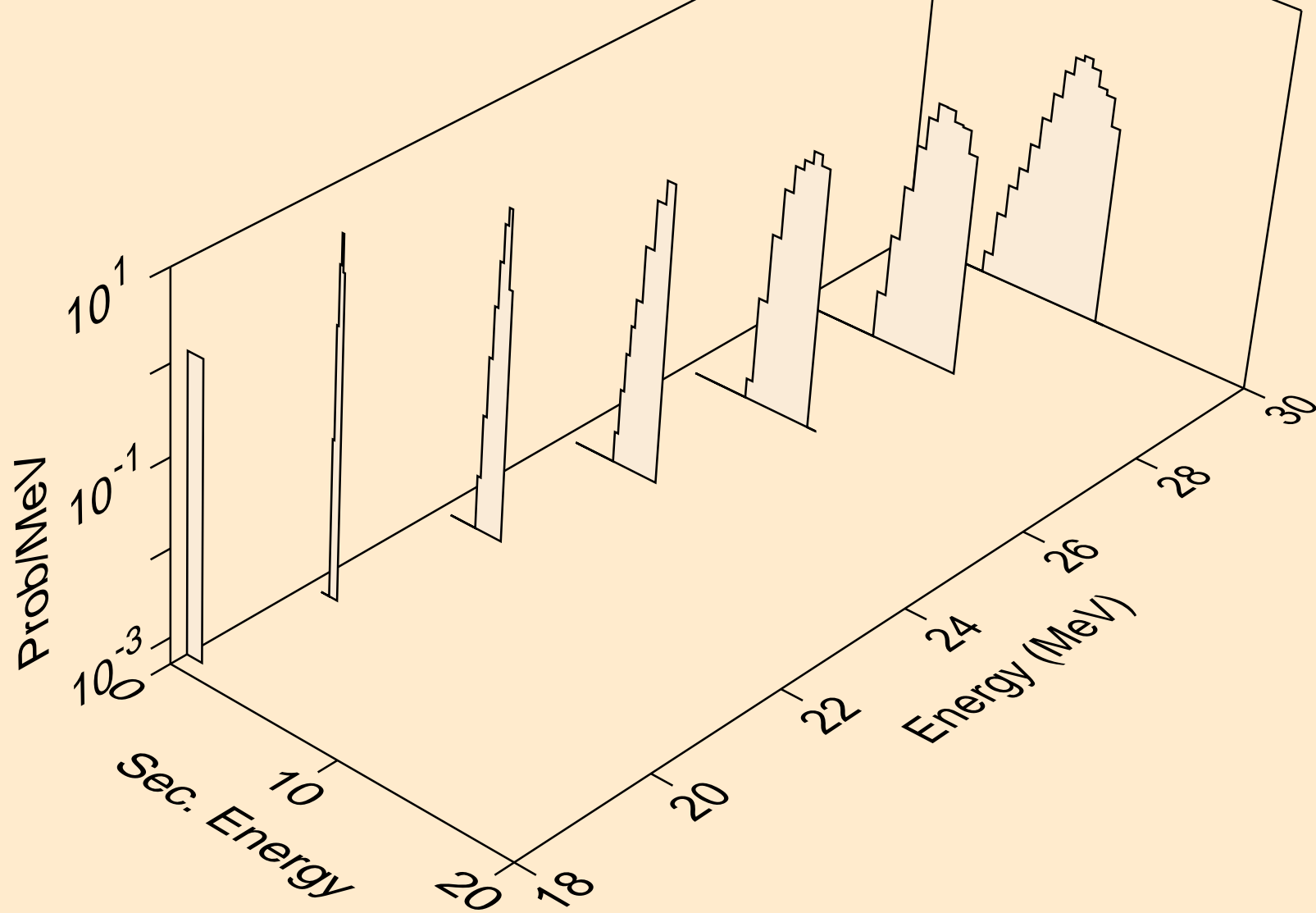

AG098 NEUTRON ACER TENDL-2024 LIBRARY; T=293.6K
tritons from (n,t)

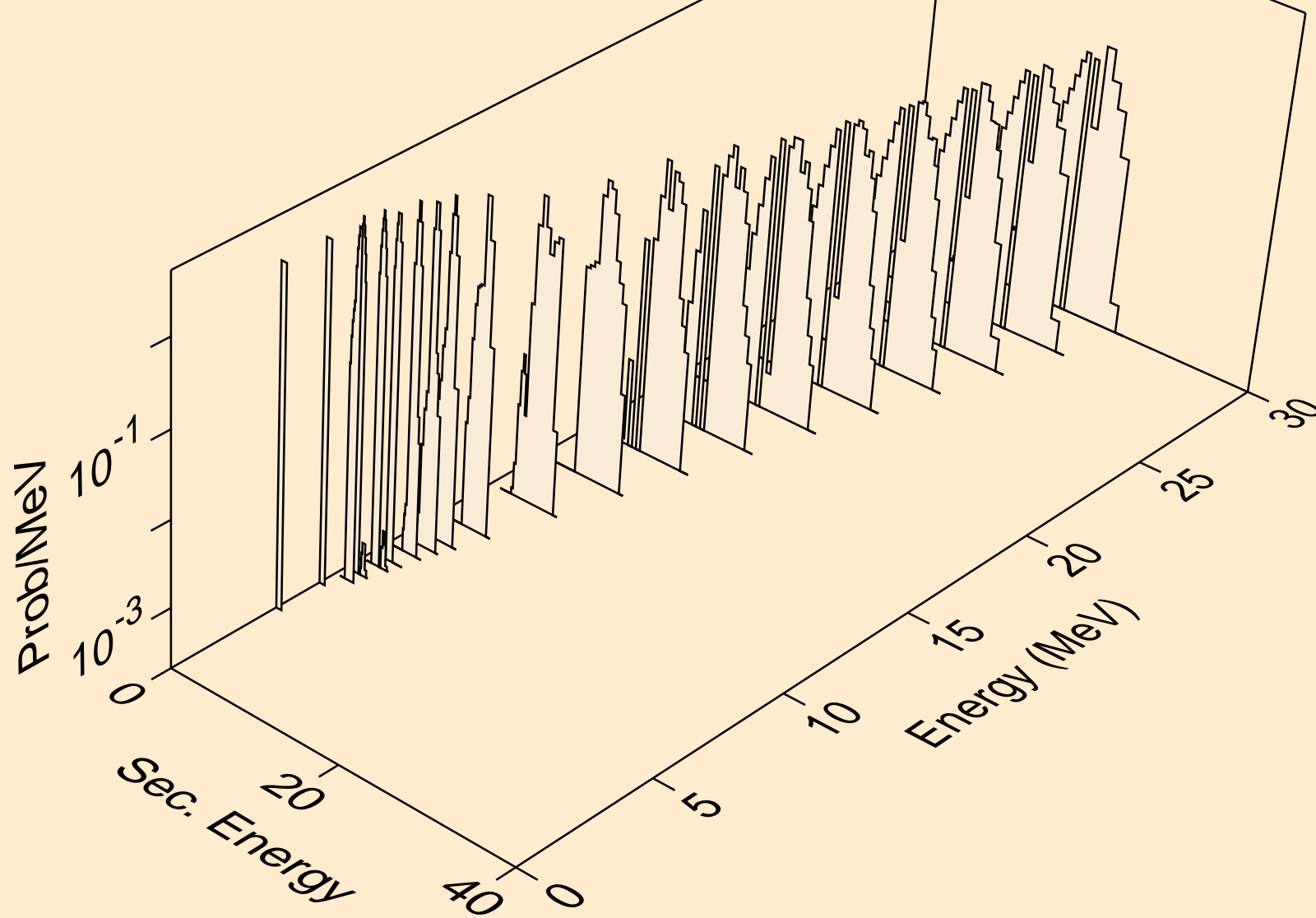

AG098 NEUTRON ACER TENDL-2024 LIBRARY; T=293.6K
tritons from (n,pt)

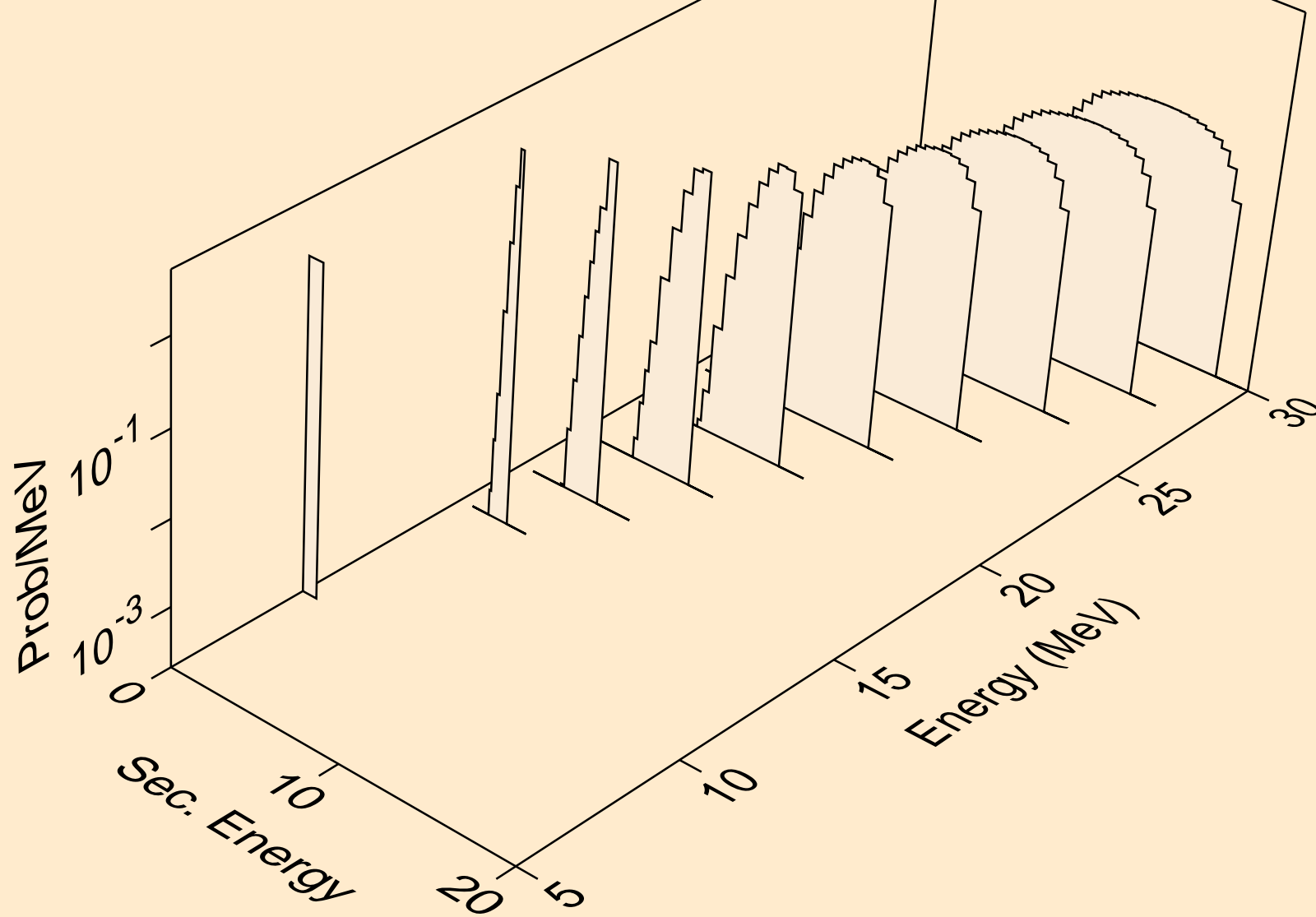

AG098 NEUTRON ACER TENDL-2024 LIBRARY; T=293.6K
he3s from (n,x)

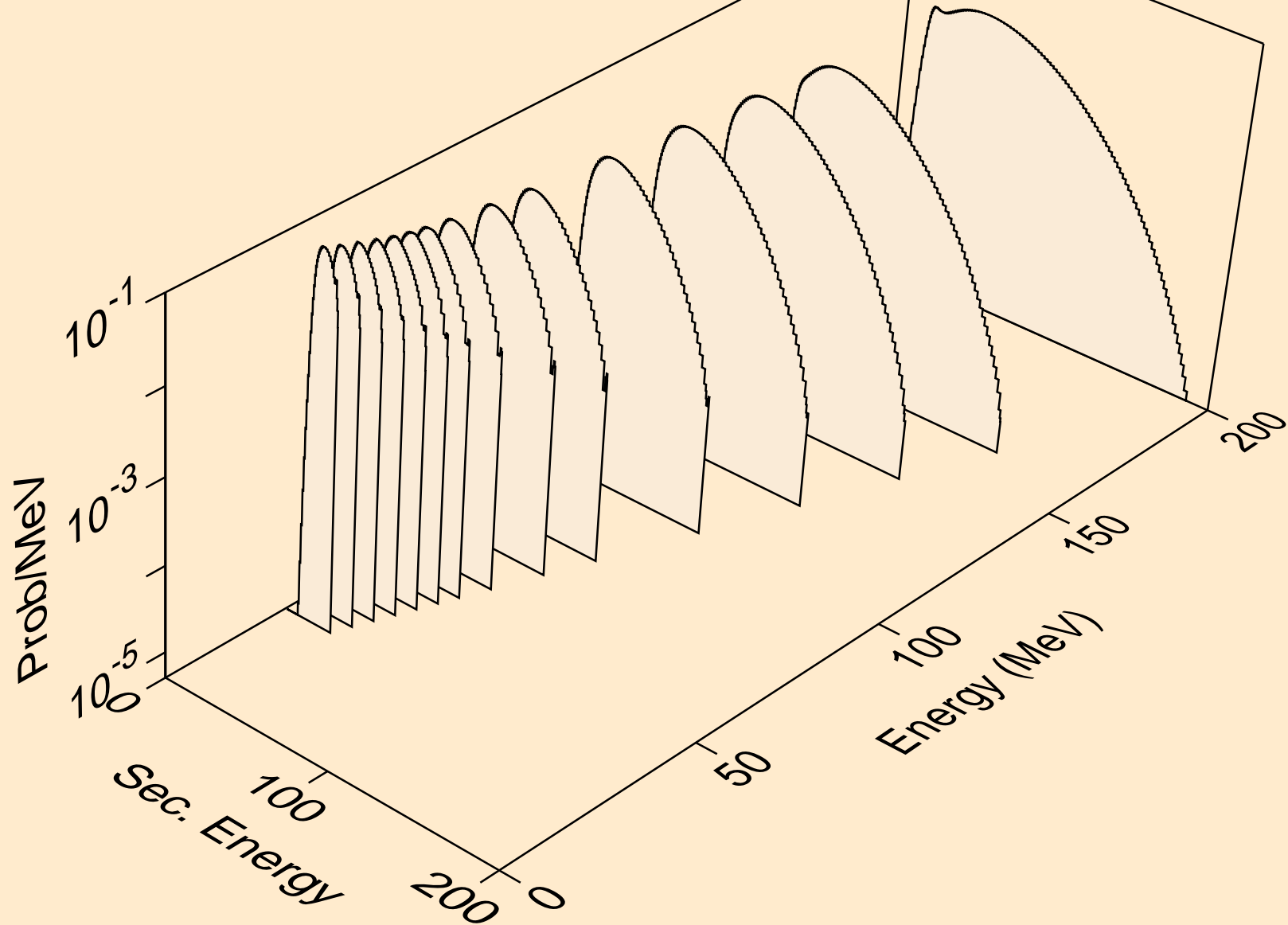

AG098 NEUTRON ACER TENDL-2024 LIBRARY; T=293.6K
he3s from (n,n*)he3

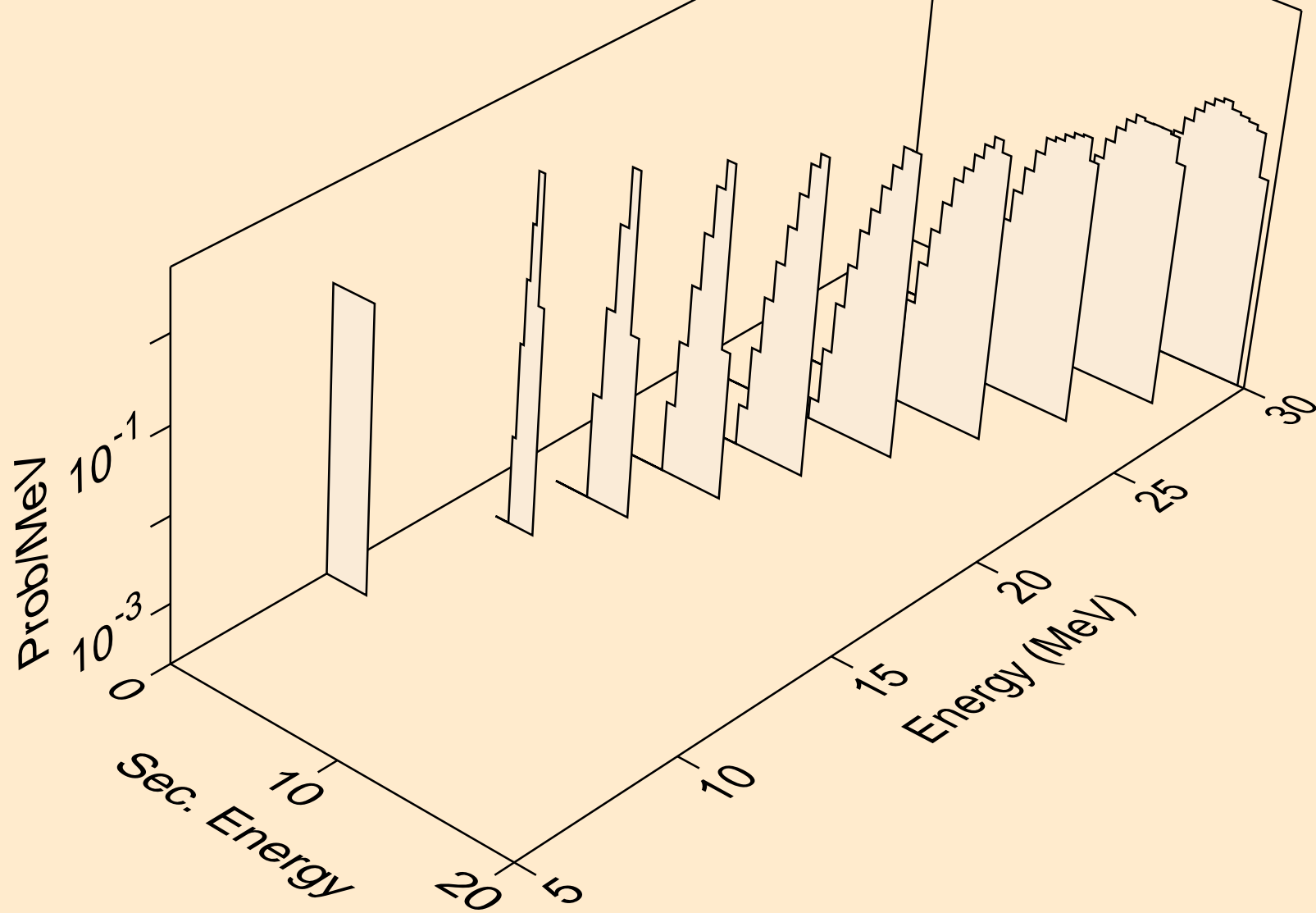

AG098 NEUTRON ACER TENDL-2024 LIBRARY; T=293.6K
he3s from (n,he3)

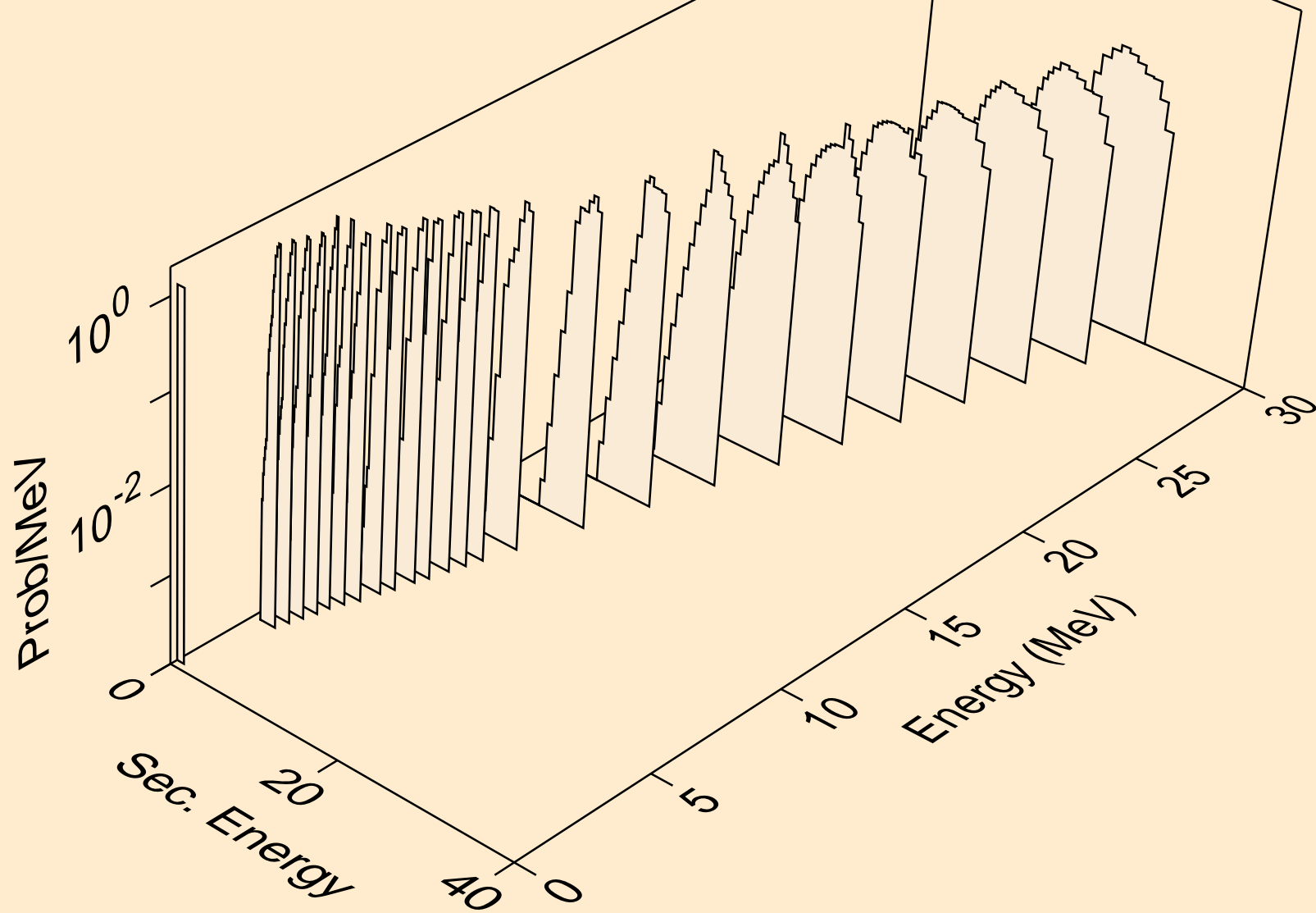

AG098 NEUTRON ACER TENDL-2024 LIBRARY; T=293.6K
alphas from (n,x)

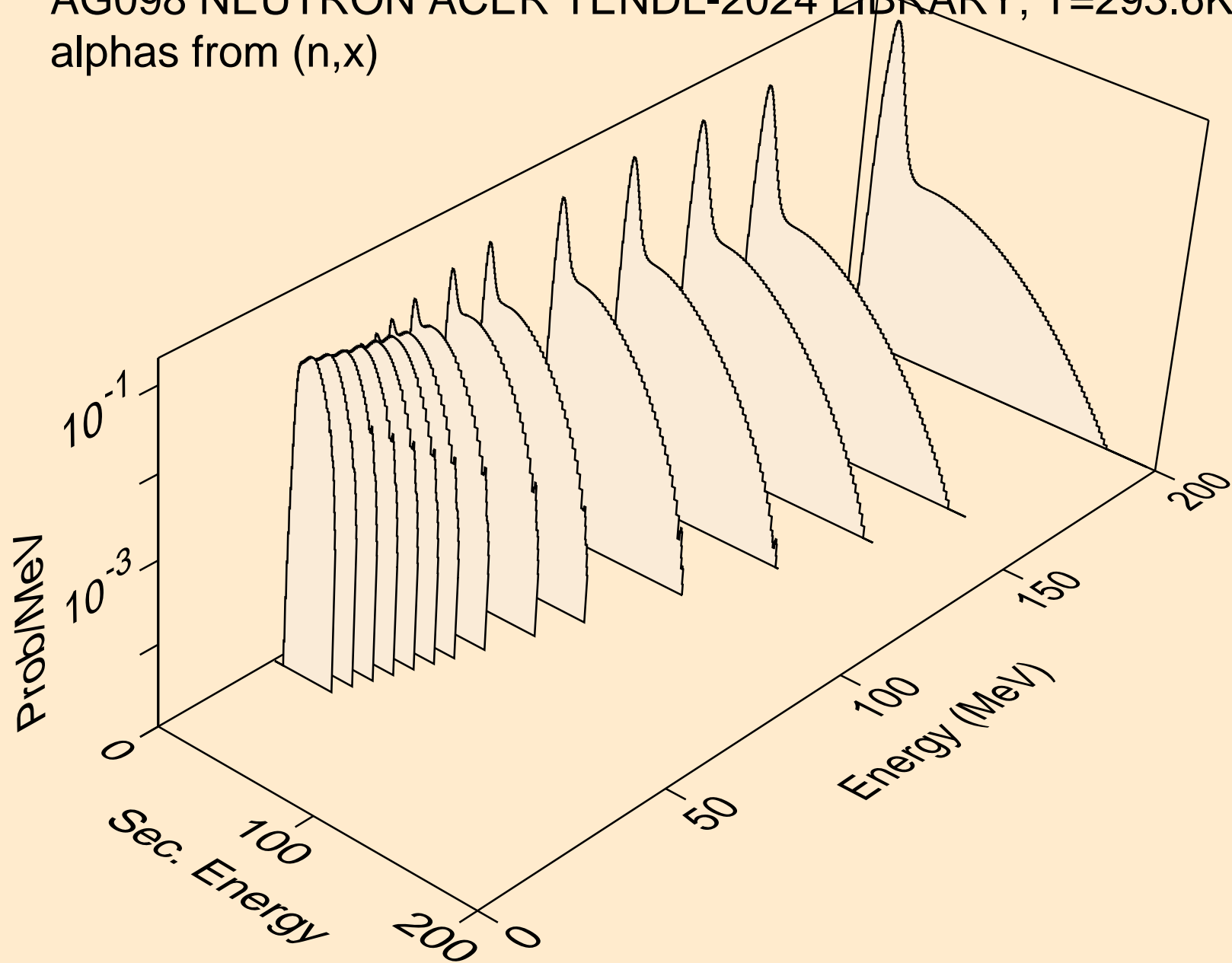

AG098 NEUTRON ACER TENDL-2024 LIBRARY; T=293.6K
alphas from (n,n*)a

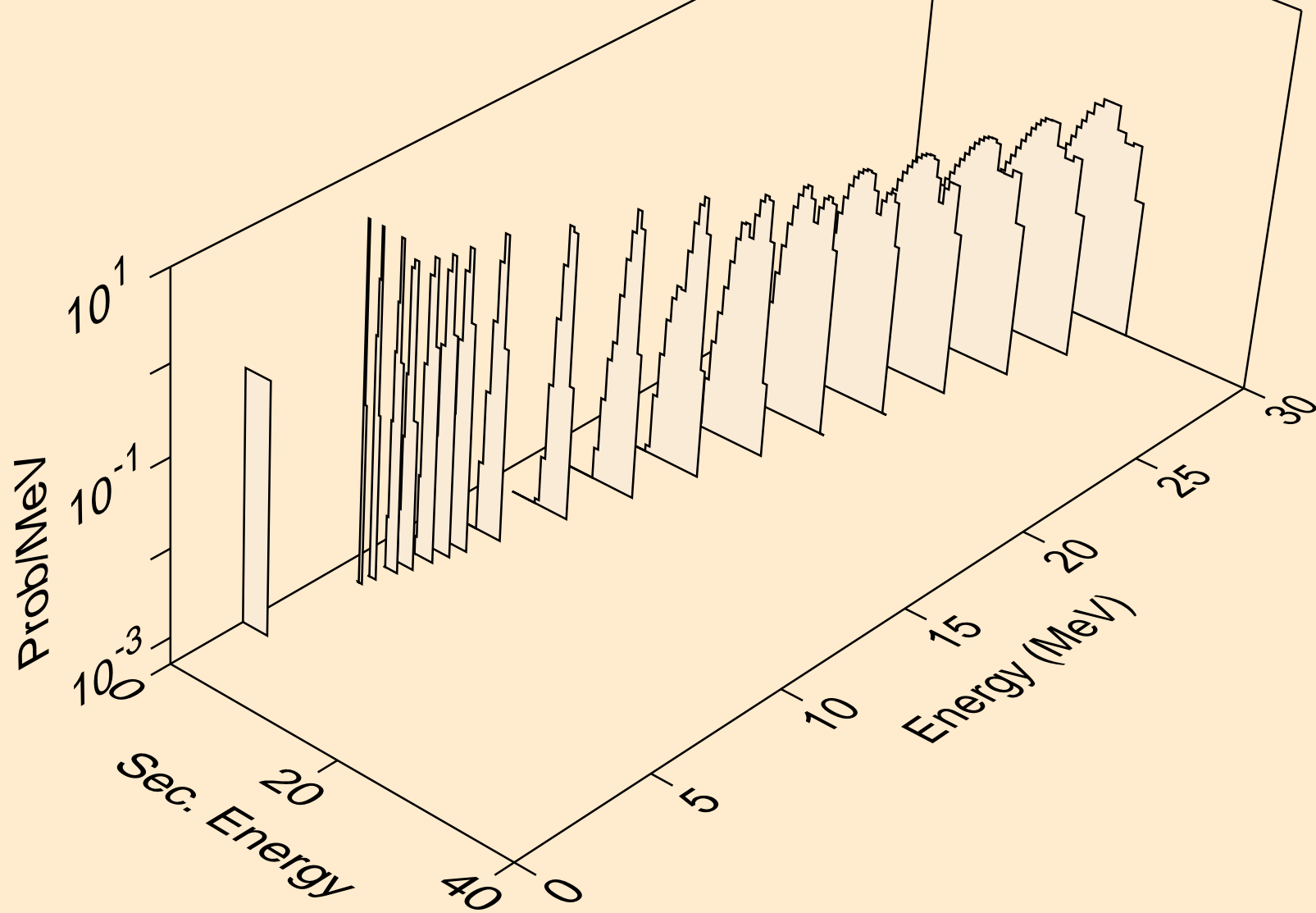

AG098 NEUTRON ACER TENDL-2024 LIBRARY; T=293.6K
alphas from (n,2n)a

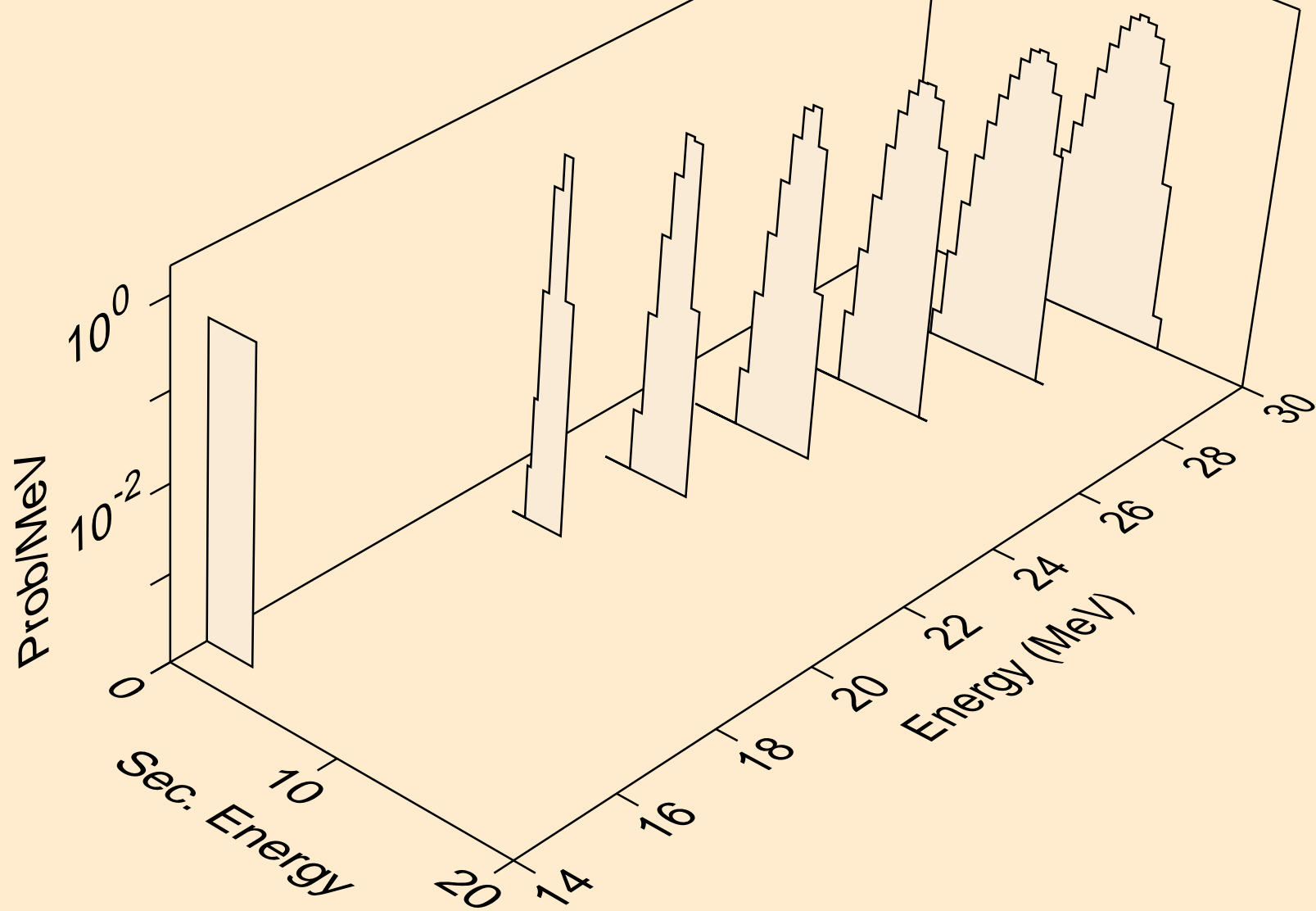

AG098 NEUTRON ACER TENDL-2024 LIBRARY; T=293.6K
alphas from (n,n*)2a

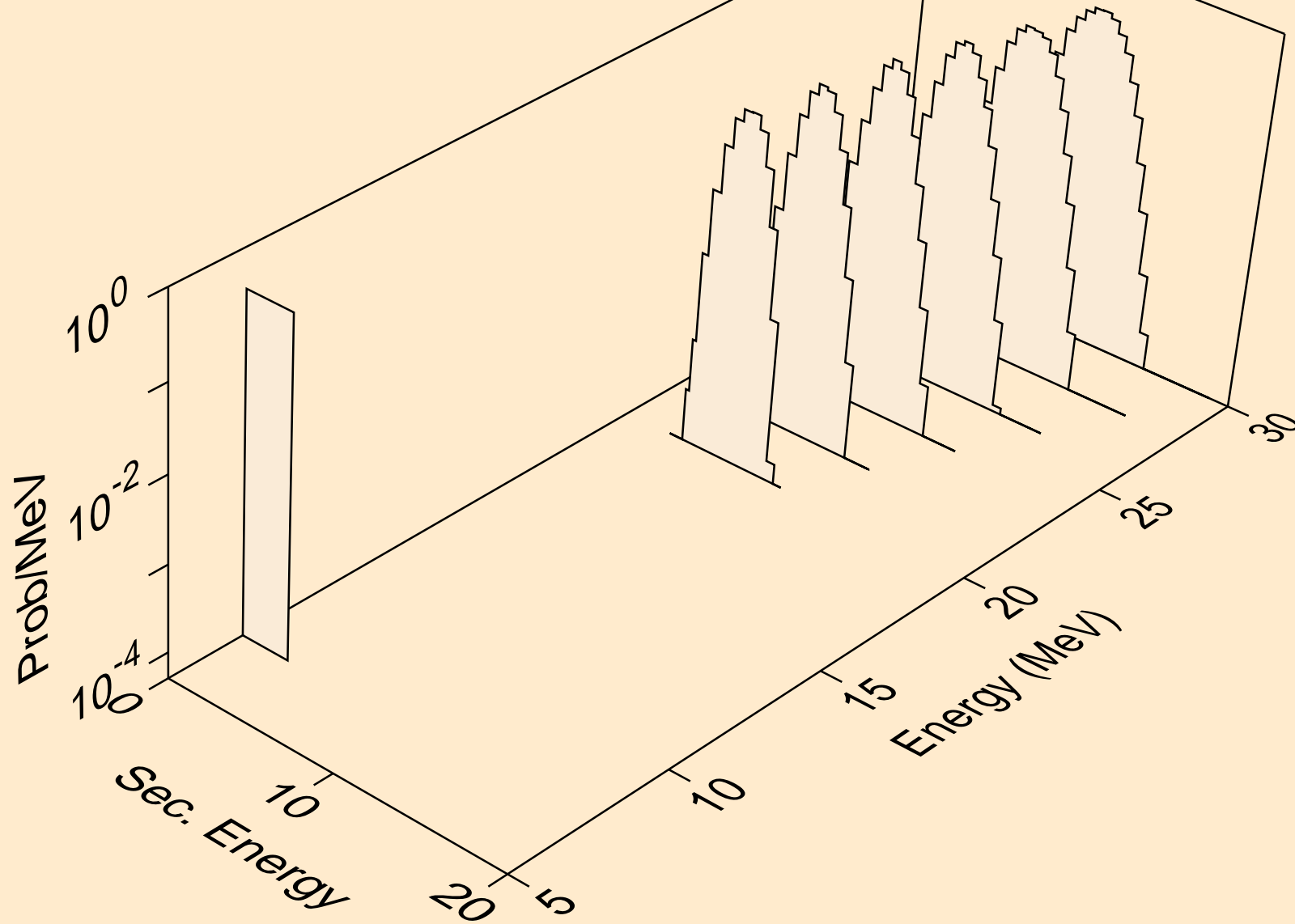

AG098 NEUTRON ACER TENDL-2024 LIBRARY; T=293.6K
alphas from (n,npa)

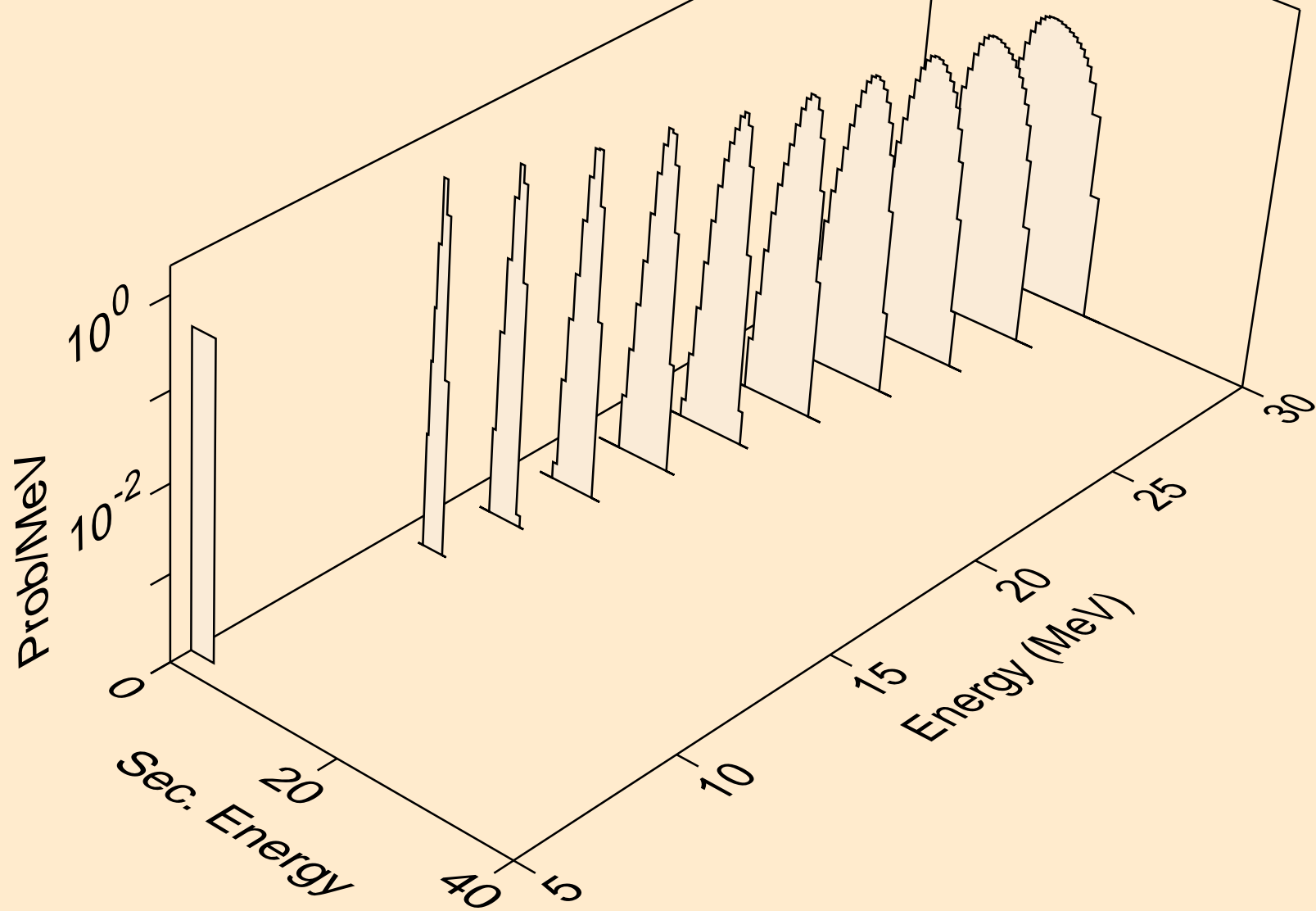

AG098 NEUTRON ACER TENDL-2024 LIBRARY; T=293.6K
alphas from (n,a)

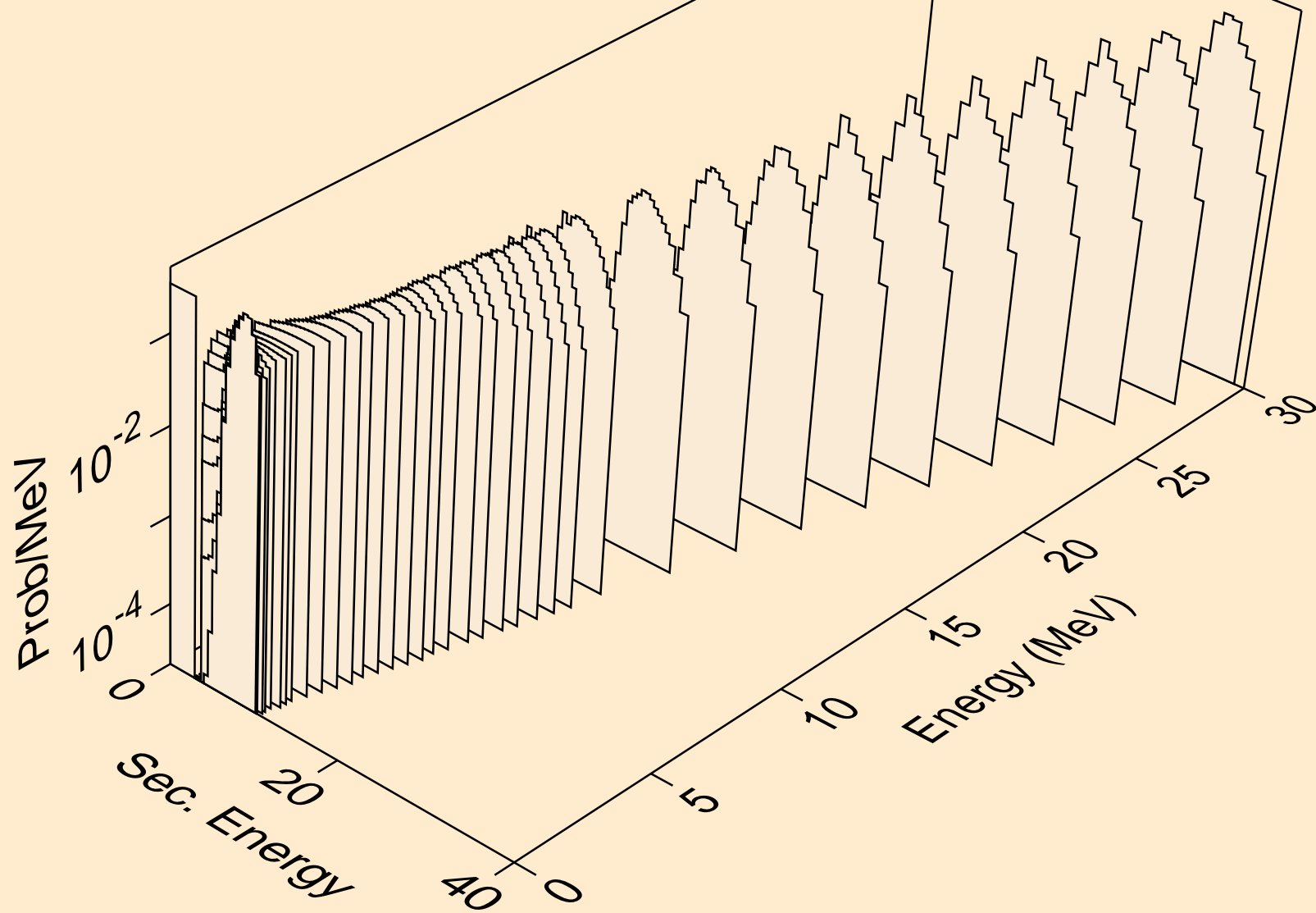

AG098 NEUTRON ACER TENDL-2024 LIBRARY; T=293.6K
alphas from (n,2a)

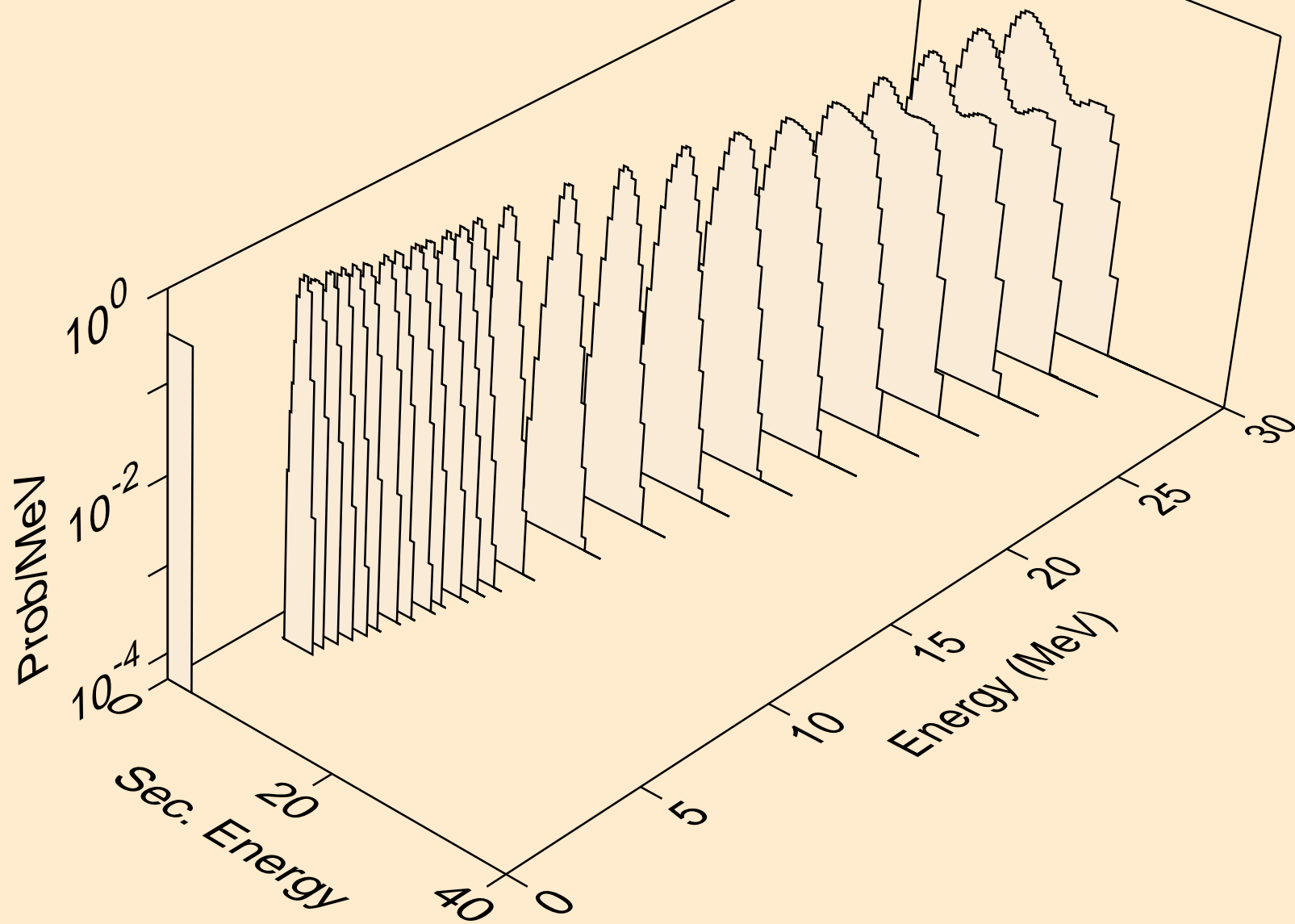

AG098 NEUTRON ACER TENDL-2024 LIBRARY; T=293.6K
alphas from (n,pa)

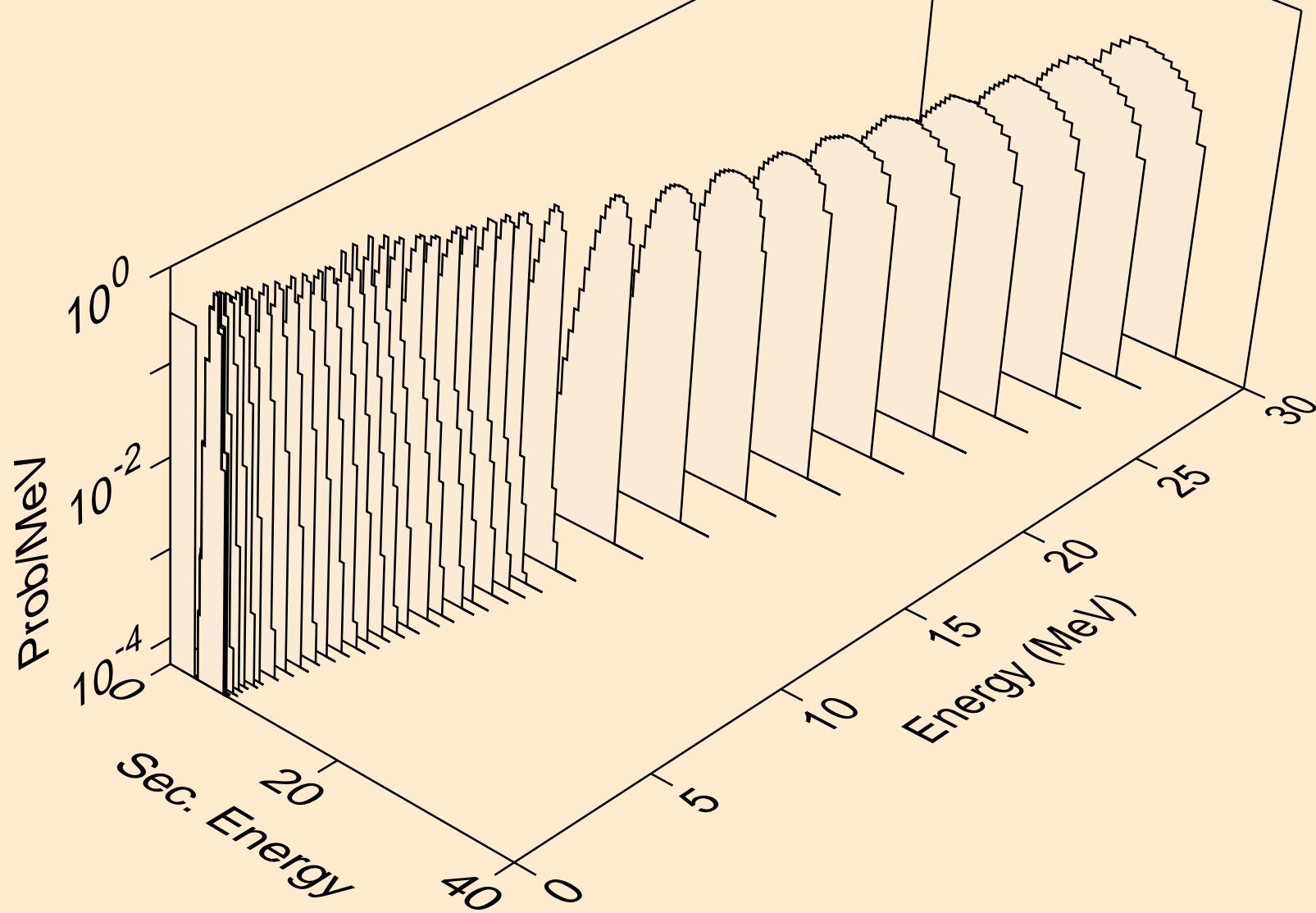

AG098 NEUTRON ACER TENDL-2024 LIBRARY; T=293.6K
alphas from (n,da)

