

AL028 NEUTRON ACER TENDL-2024 LIBRARY; T=293.6K
Principal cross sections

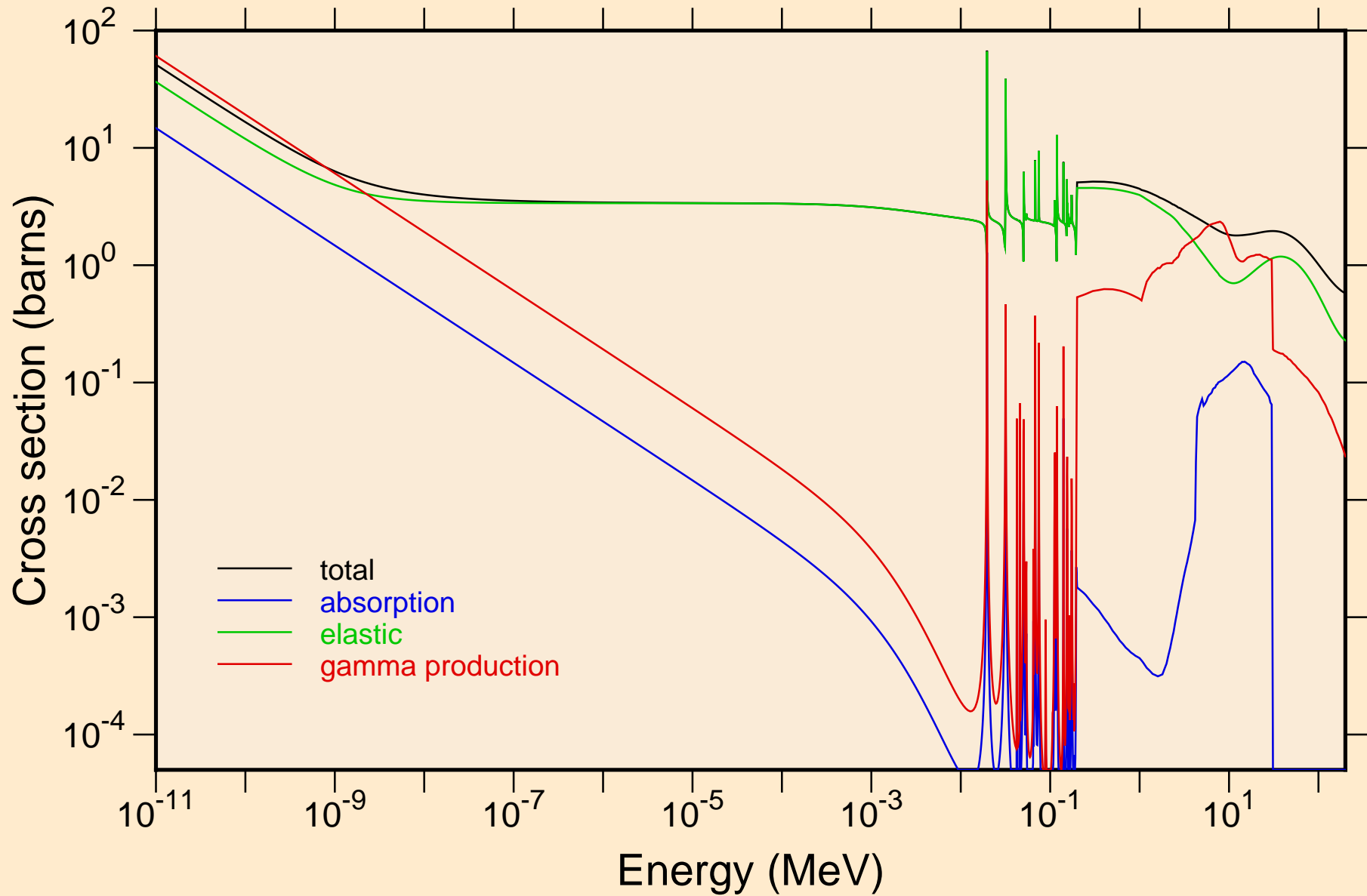

AL028 NEUTRON ACER TENDL-2024 LIBRARY; T=293.6K
resonance total cross section

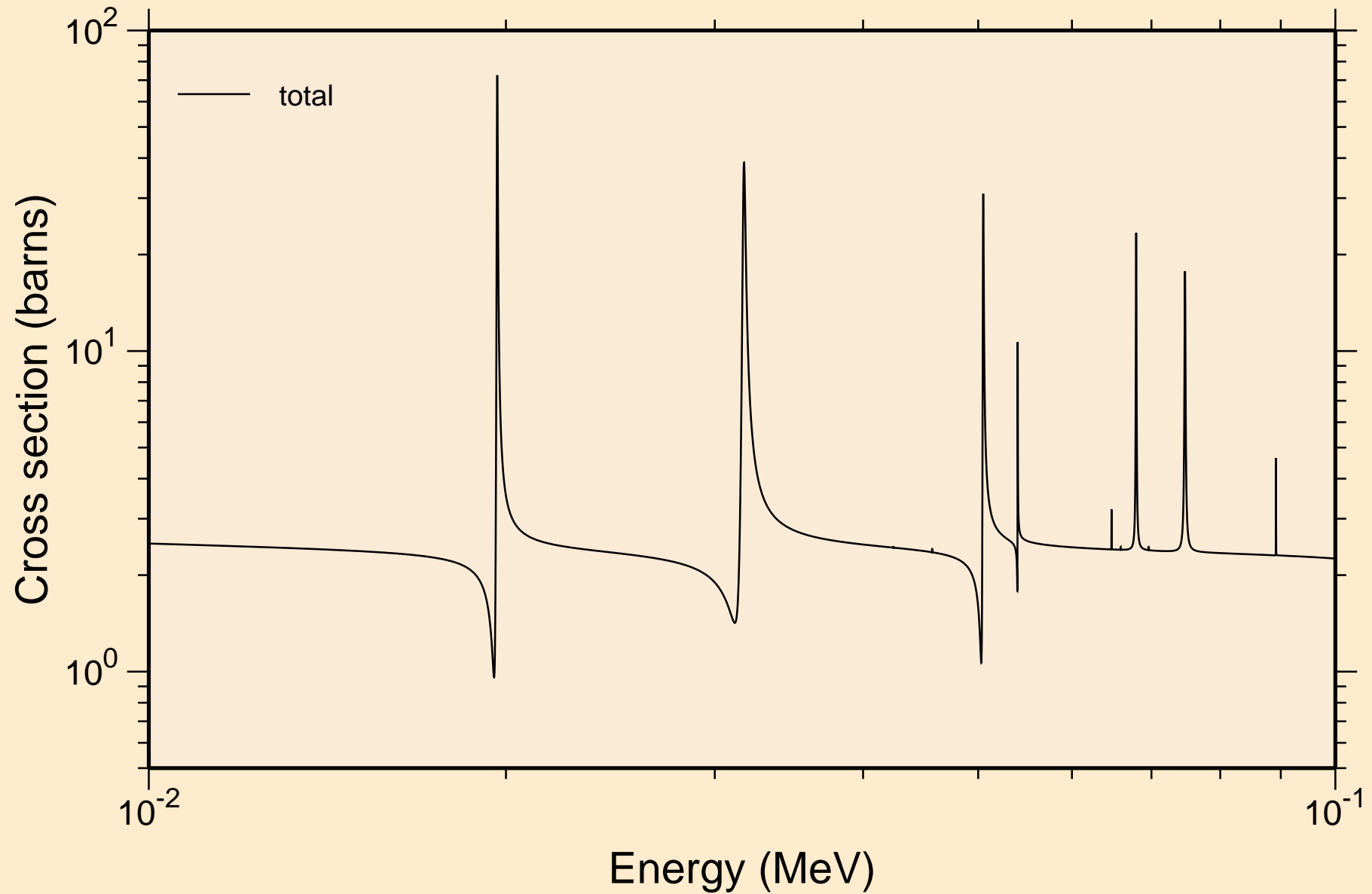

AL028 NEUTRON ACER TENDL-2024 LIBRARY; T=293.6K
resonance total cross section

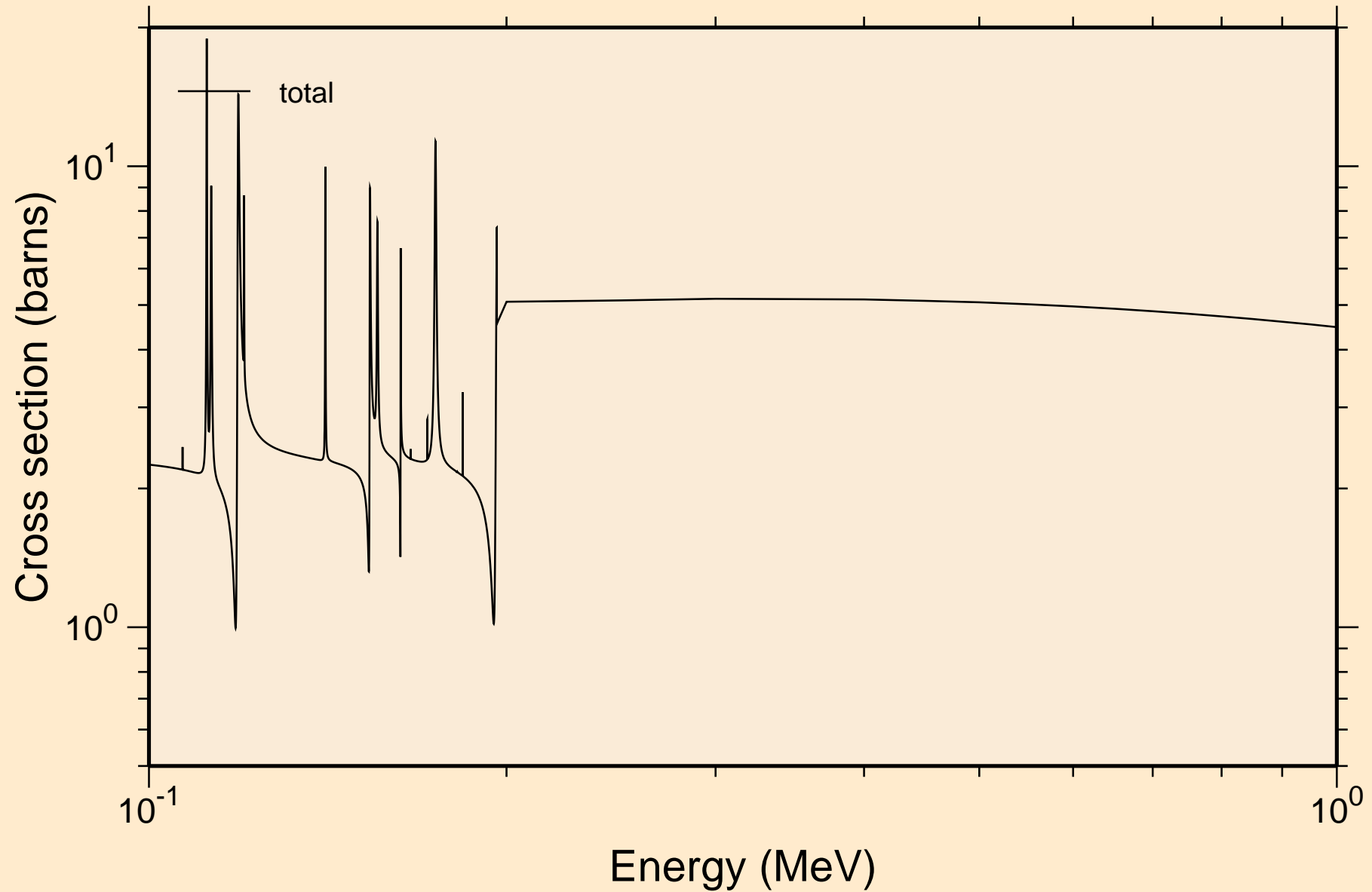

AL028 NEUTRON ACER TENDL-2024 LIBRARY; T=293.6K
resonance total cross section

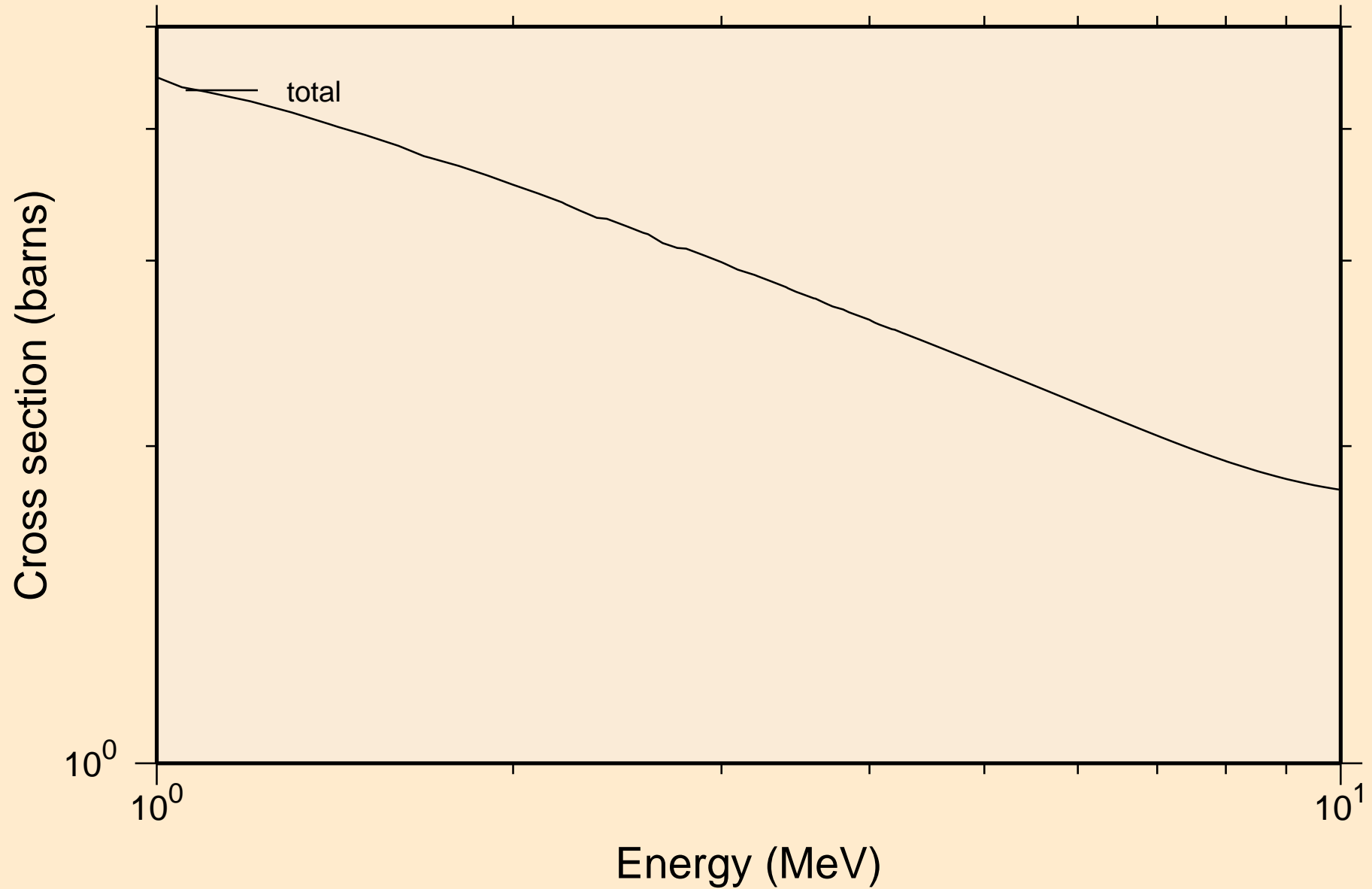

AL028 NEUTRON ACER TENDL-2024 LIBRARY; T=293.6K
resonance absorption cross sections

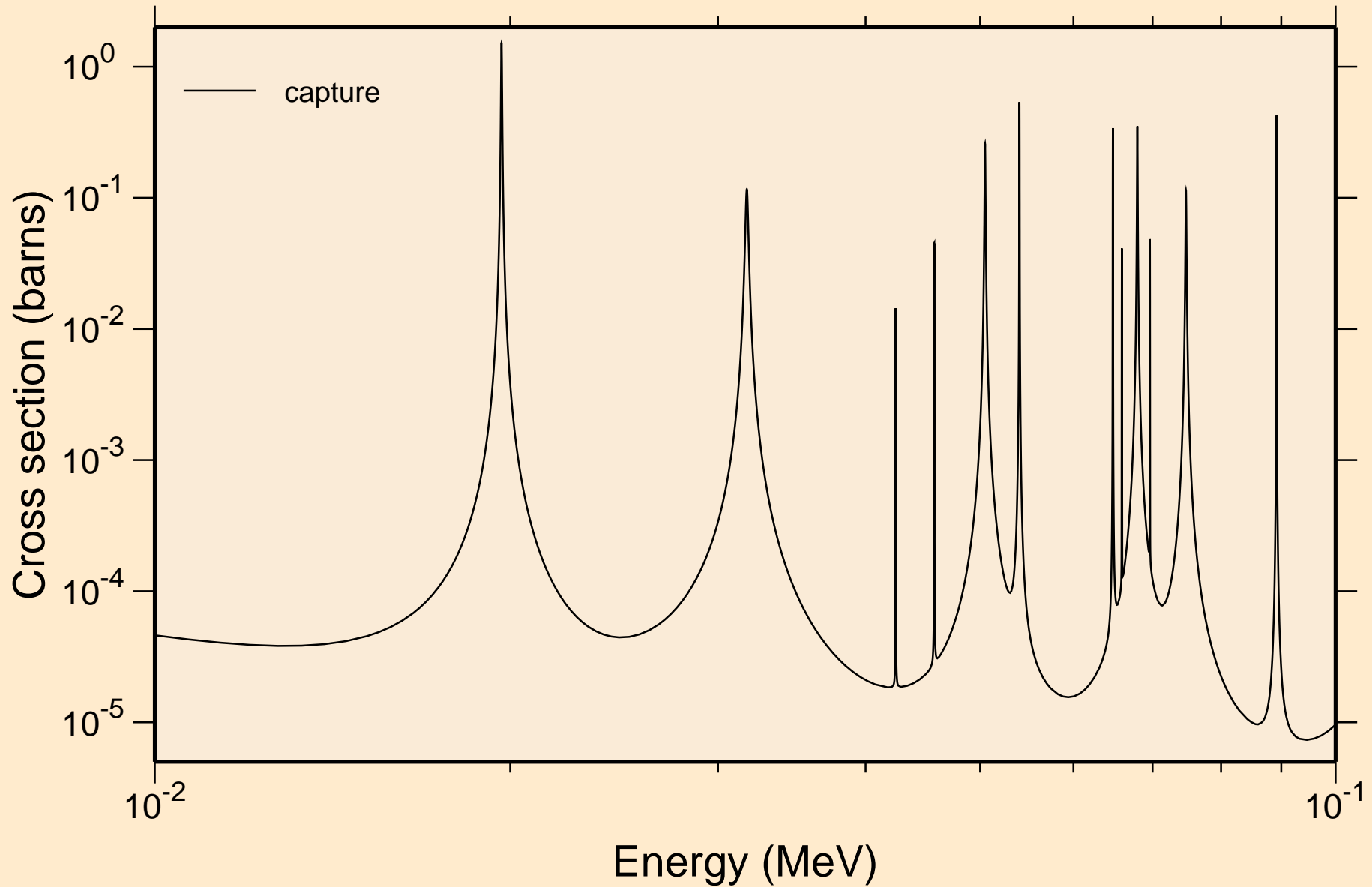

AL028 NEUTRON ACER TENDL-2024 LIBRARY; T=293.6K
resonance absorption cross sections

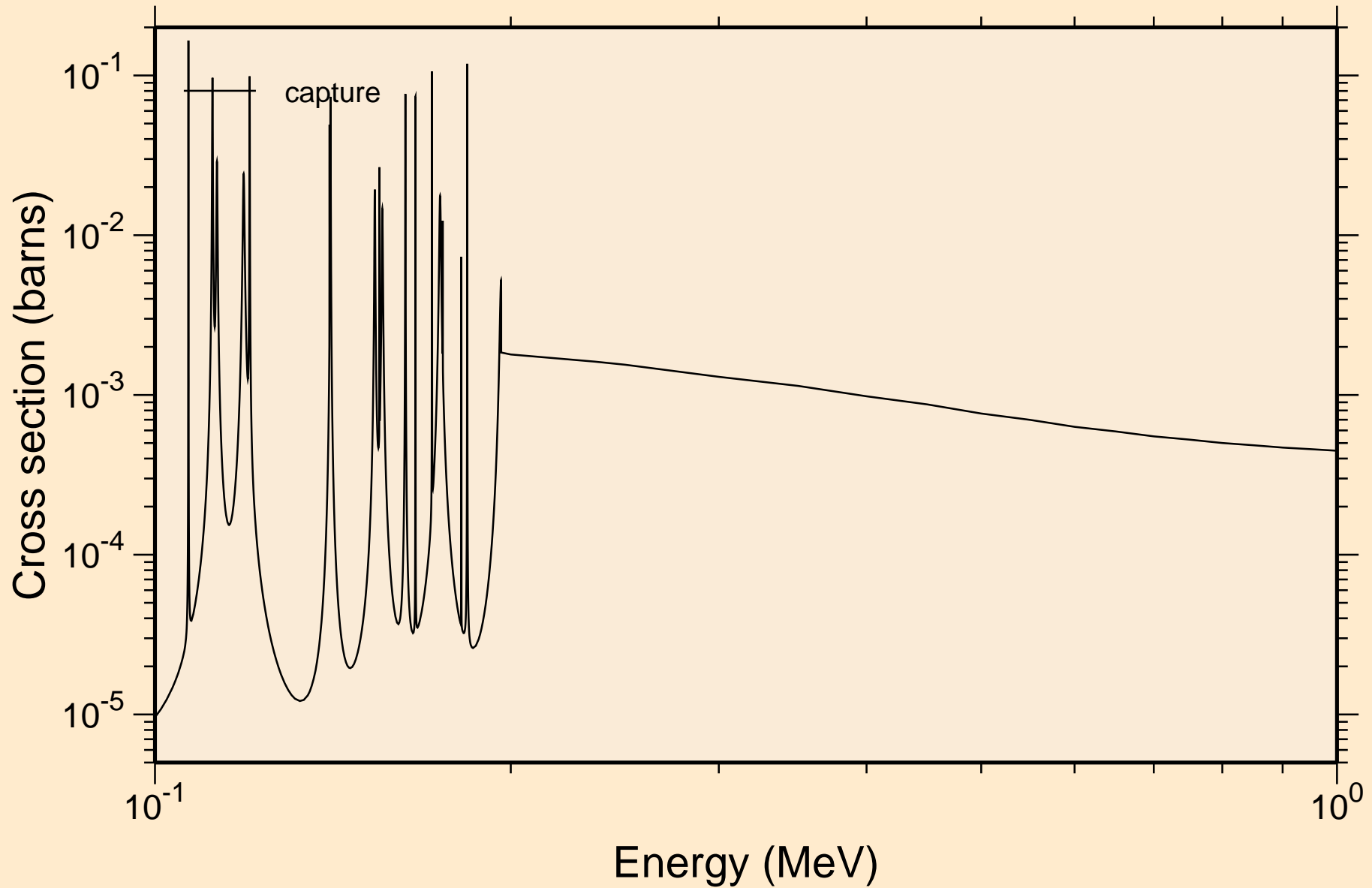

AL028 NEUTRON ACER TENDL-2024 LIBRARY; T=293.6K
resonance absorption cross sections

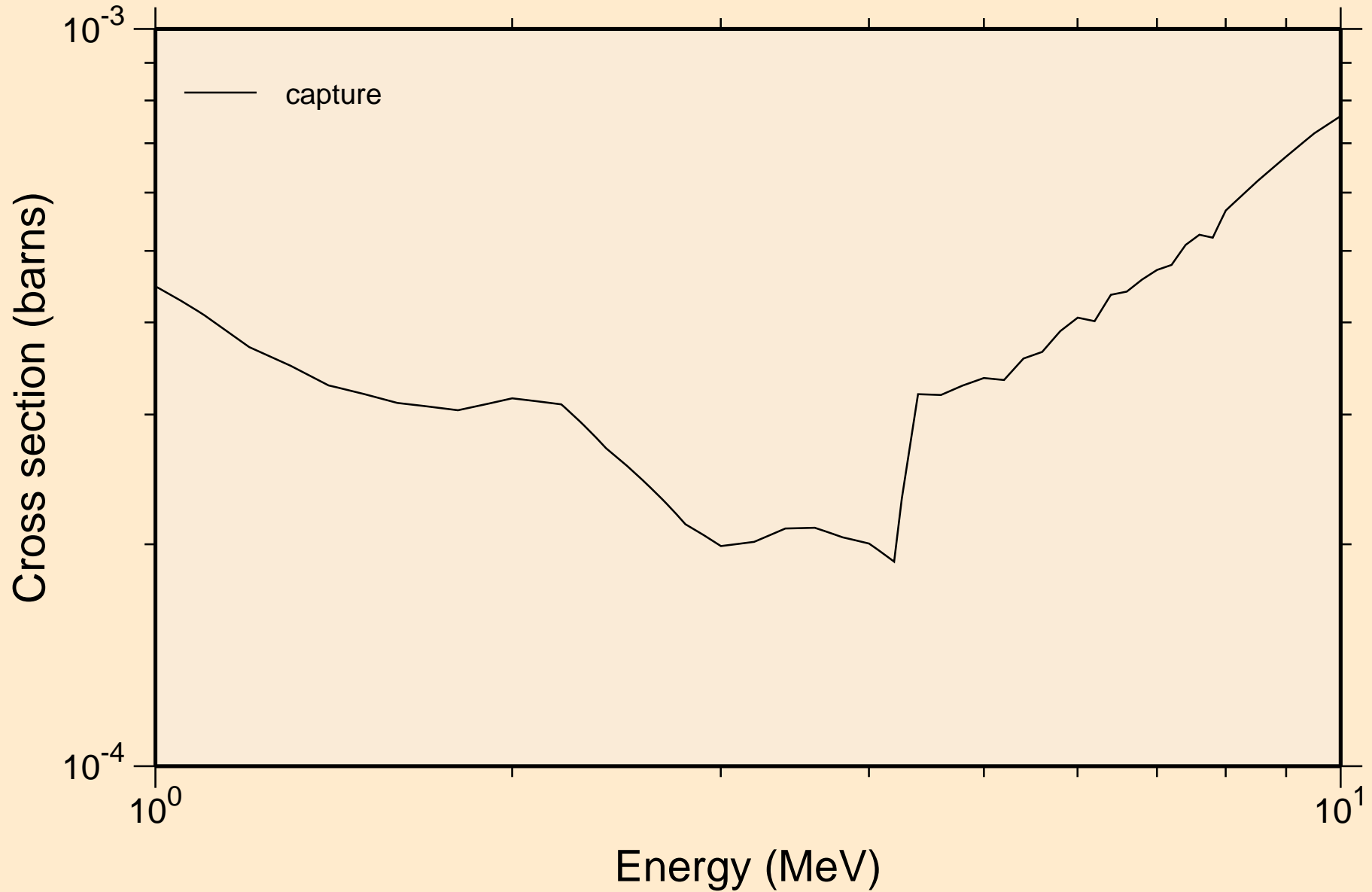

AL028 NEUTRON ACER TENDL-2024 LIBRARY; T=293.6K
Heating

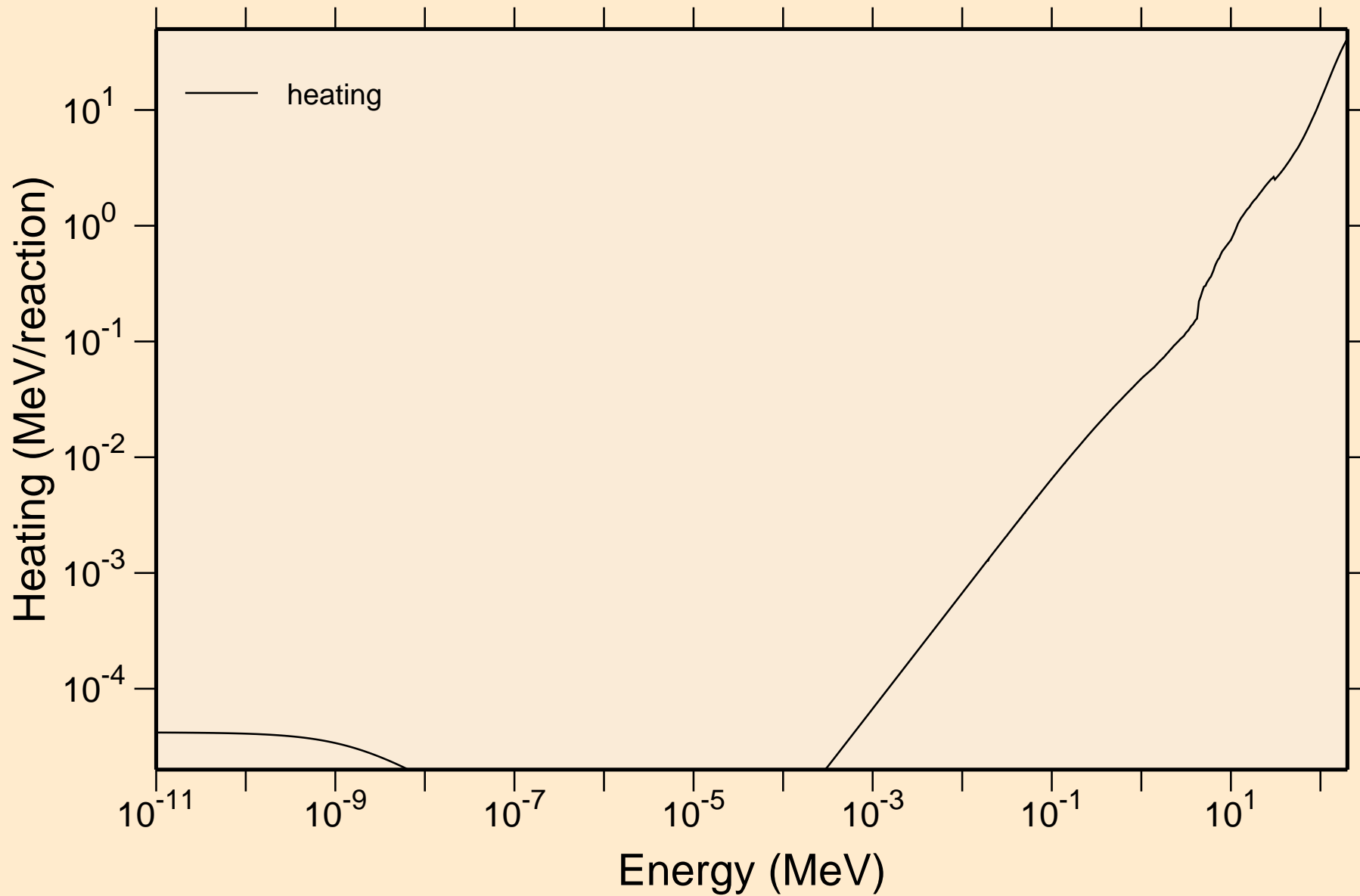

AL028 NEUTRON ACER TENDL-2024 LIBRARY; T=293.6K
Damage

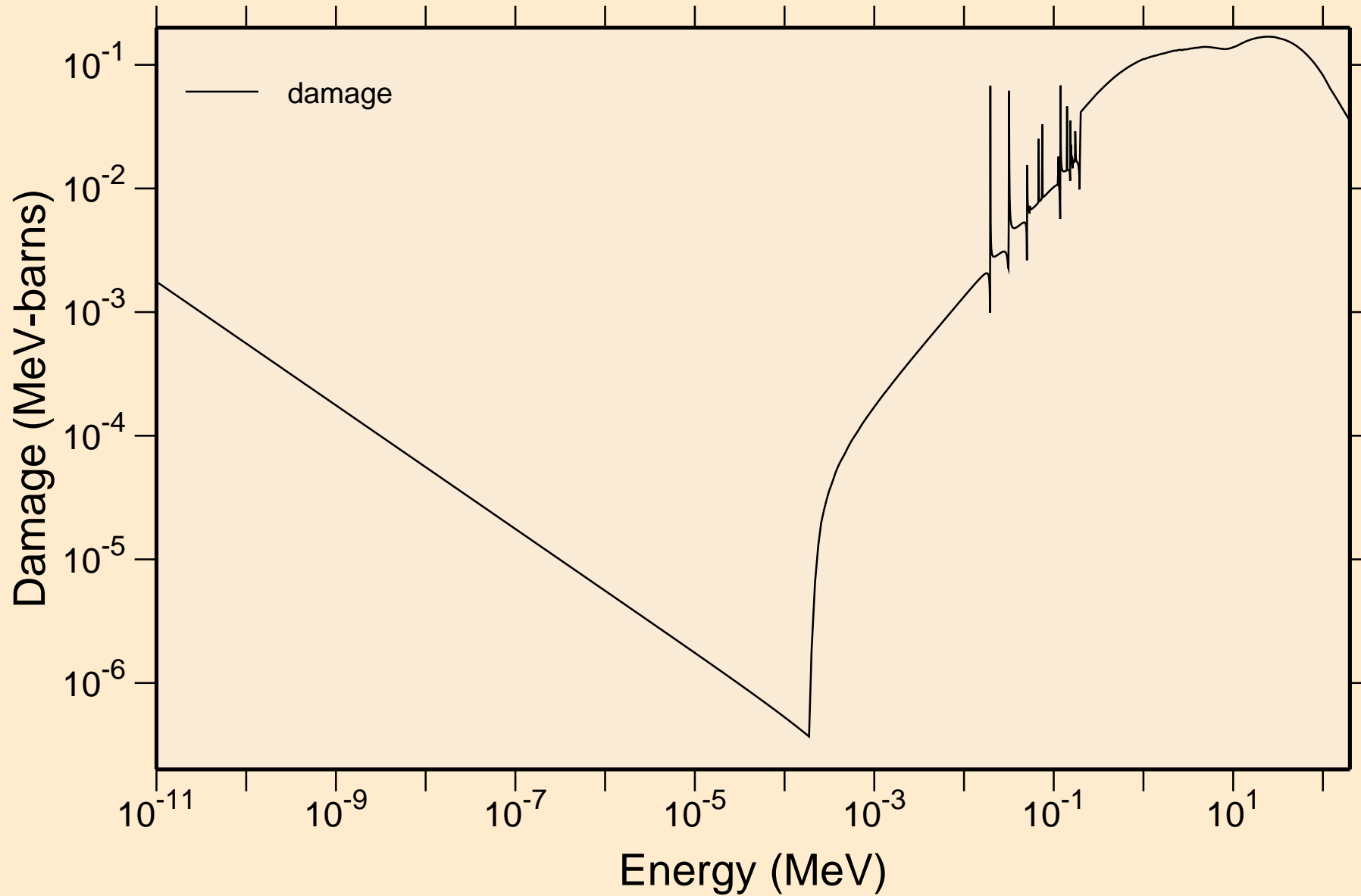

AL028 NEUTRON ACER TENDL-2024 LIBRARY; T=293.6K
Non-threshold reactions

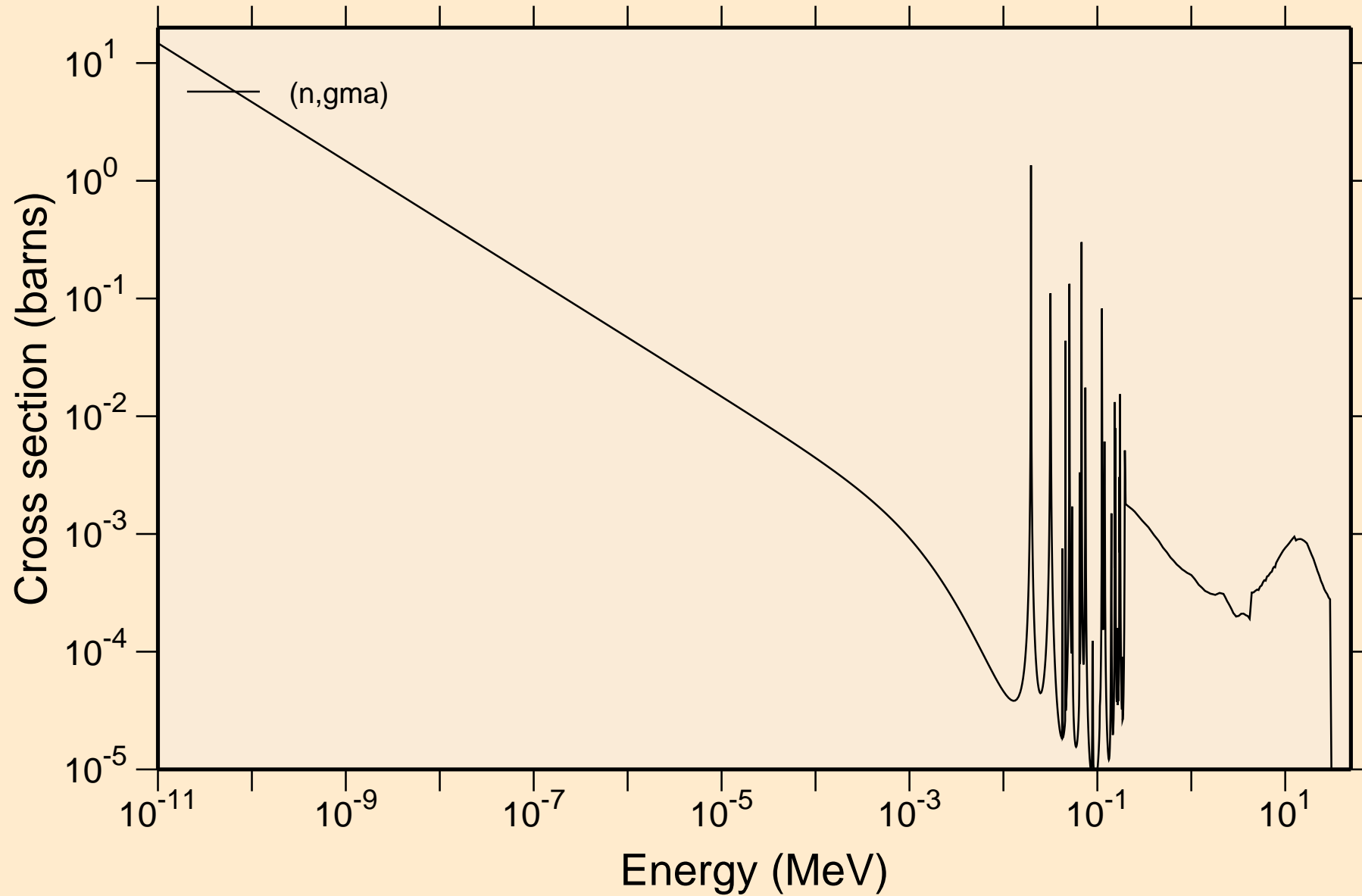

AL028 NEUTRON ACER TENDL-2024 LIBRARY; T=293.6K

Principal cross sections

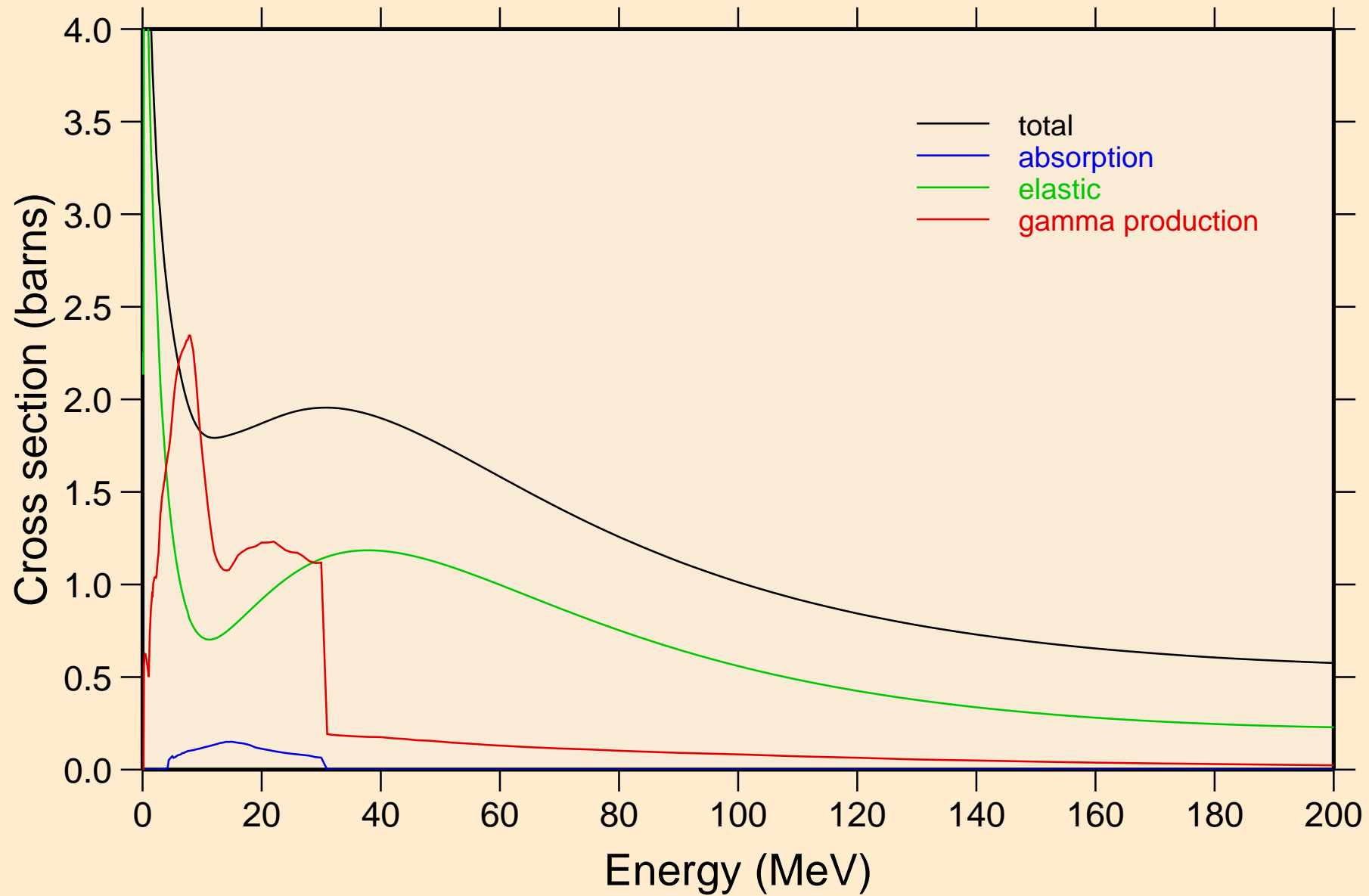

AL028 NEUTRON ACER TENDL-2024 LIBRARY; T=293.6K

Heating

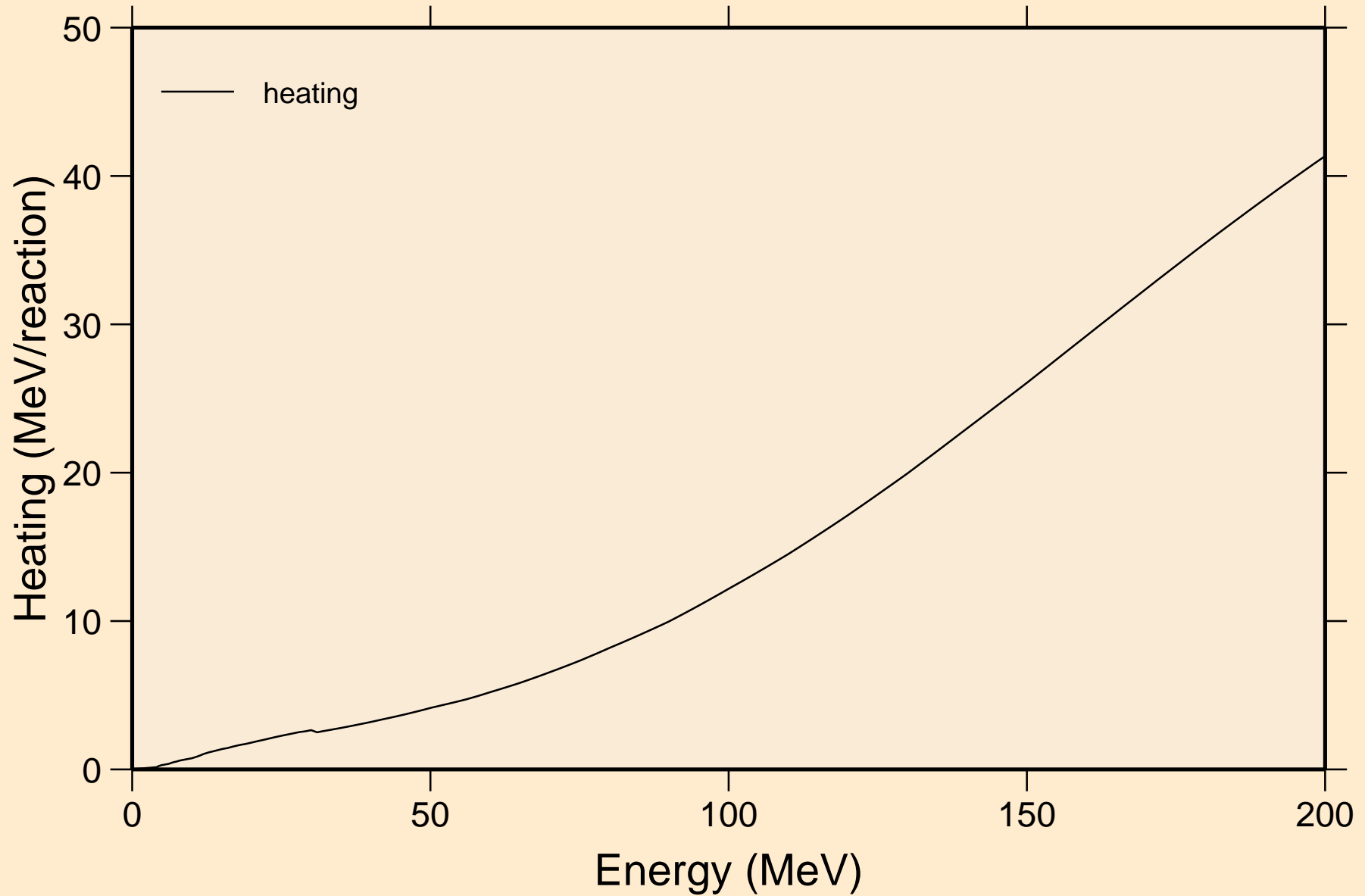

AL028 NEUTRON ACER TENDL-2024 LIBRARY; T=293.6K
Damage

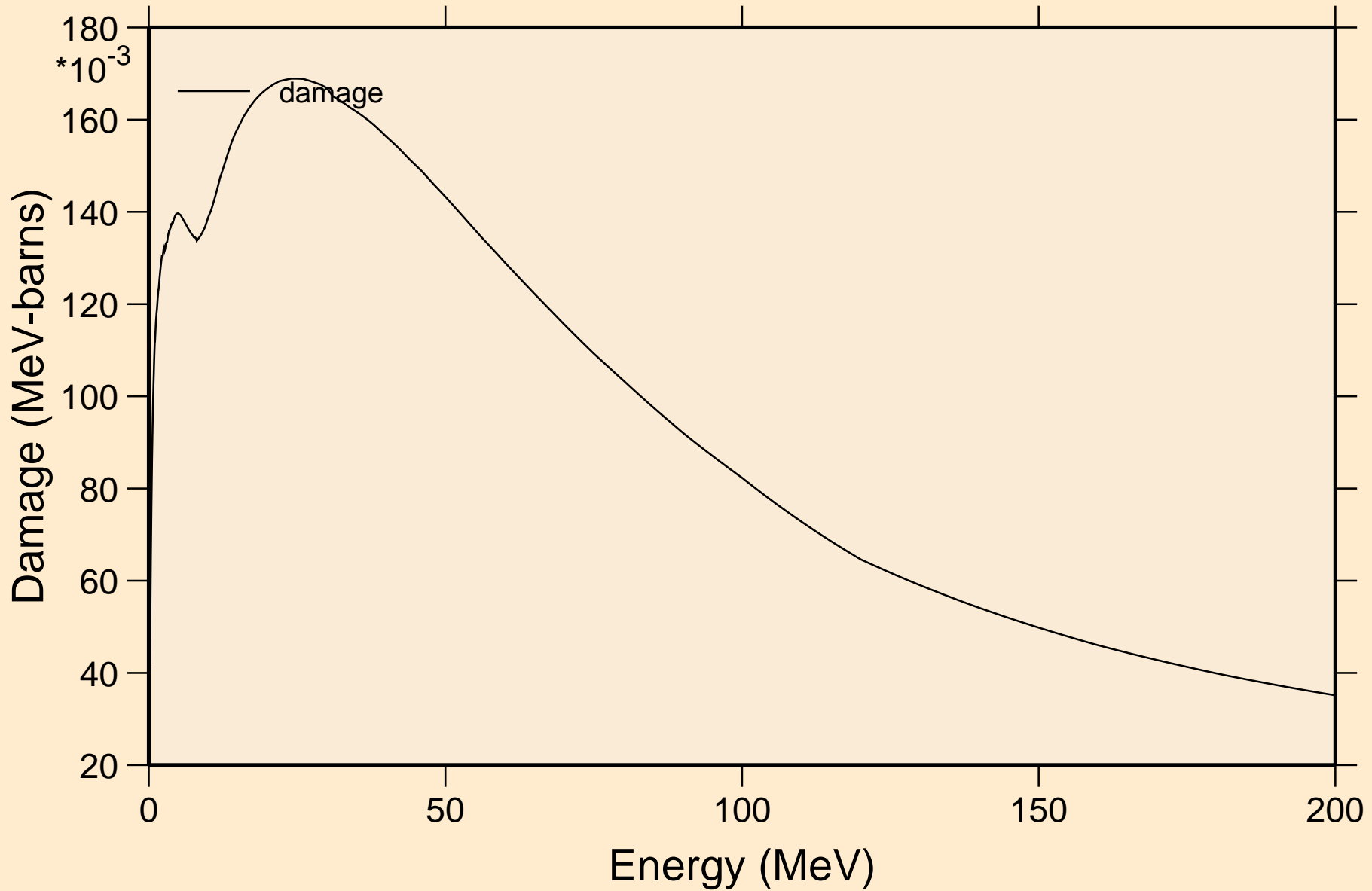

AL028 NEUTRON ACER TENDL-2024 LIBRARY; T=293.6K
Non-threshold reactions

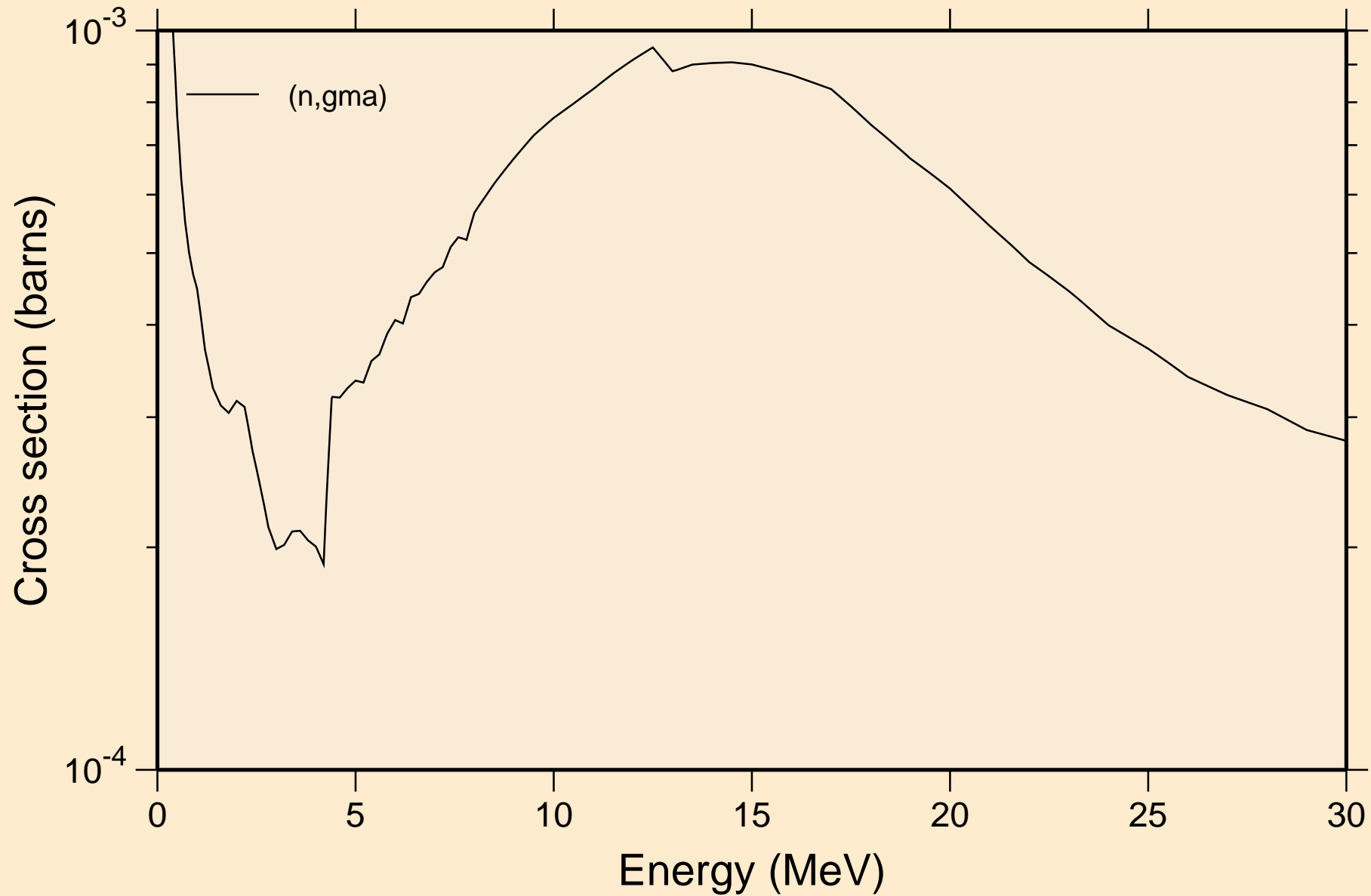

AL028 NEUTRON ACER TENDL-2024 LIBRARY; T=293.6K
Inelastic levels

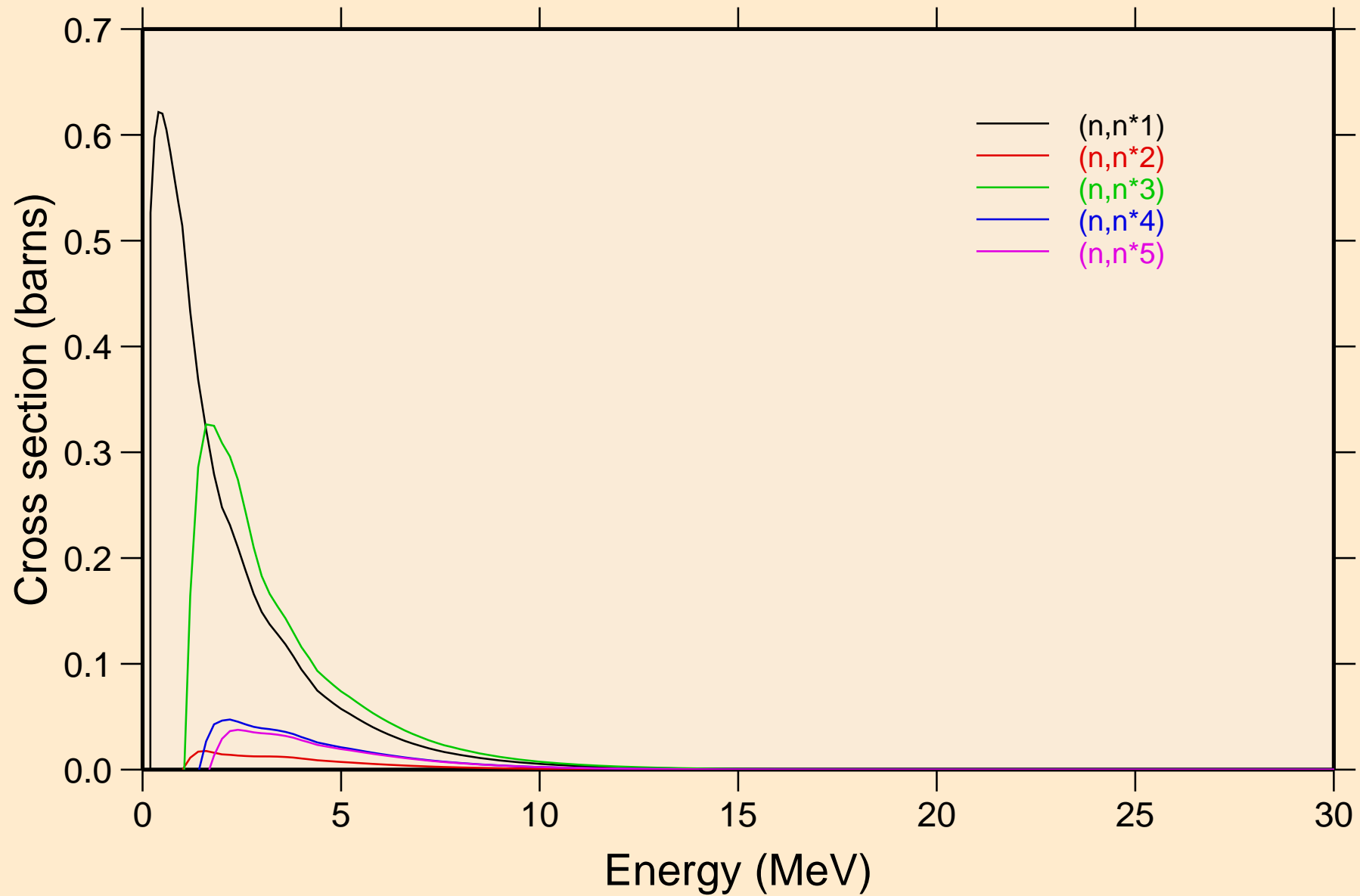

AL028 NEUTRON ACER TENDL-2024 LIBRARY; T=293.6K
Inelastic levels

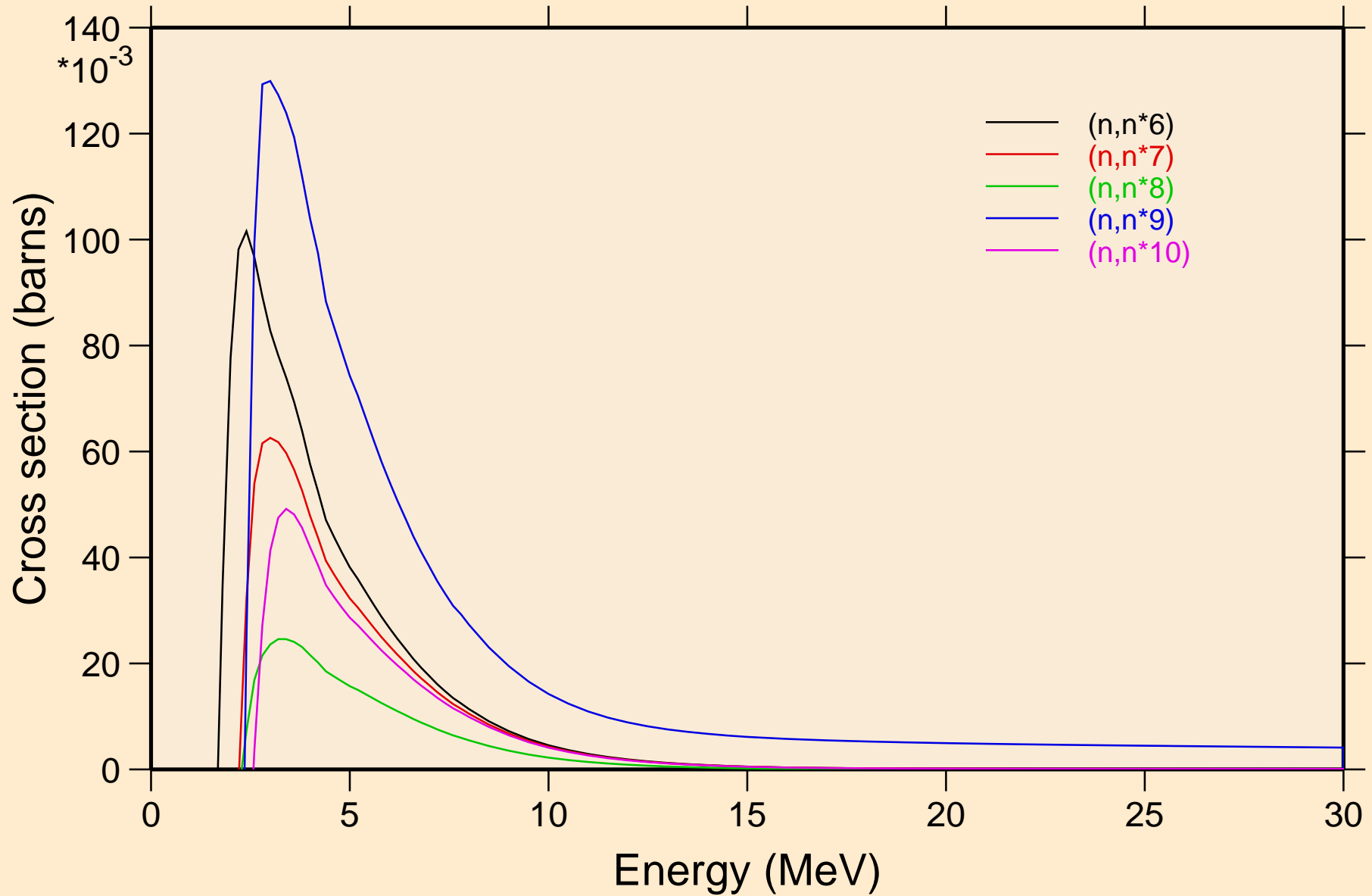

AL028 NEUTRON ACER TENDL-2024 LIBRARY; T=293.6K
Inelastic levels

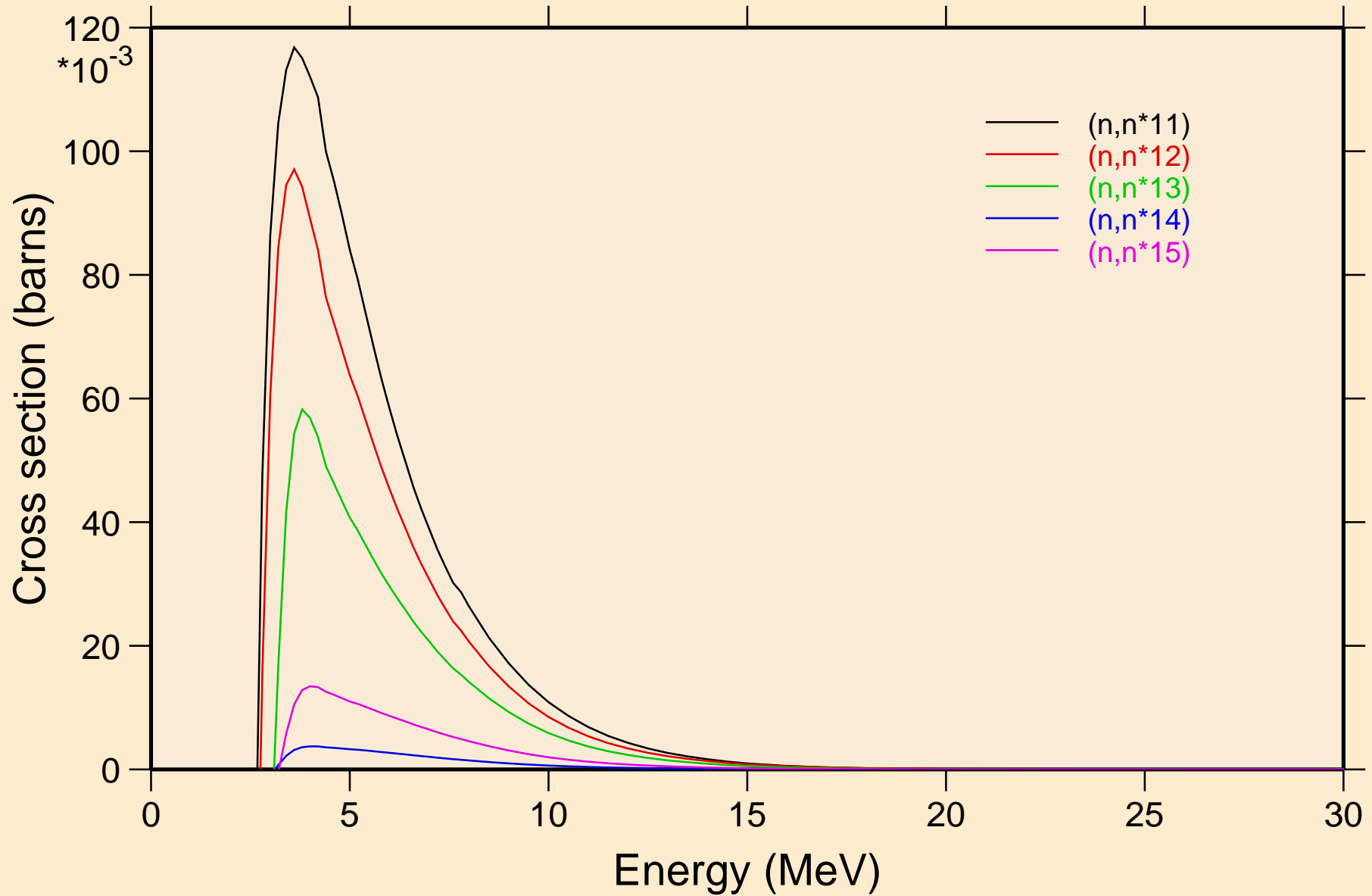

AL028 NEUTRON ACER TENDL-2024 LIBRARY; T=293.6K
Inelastic levels

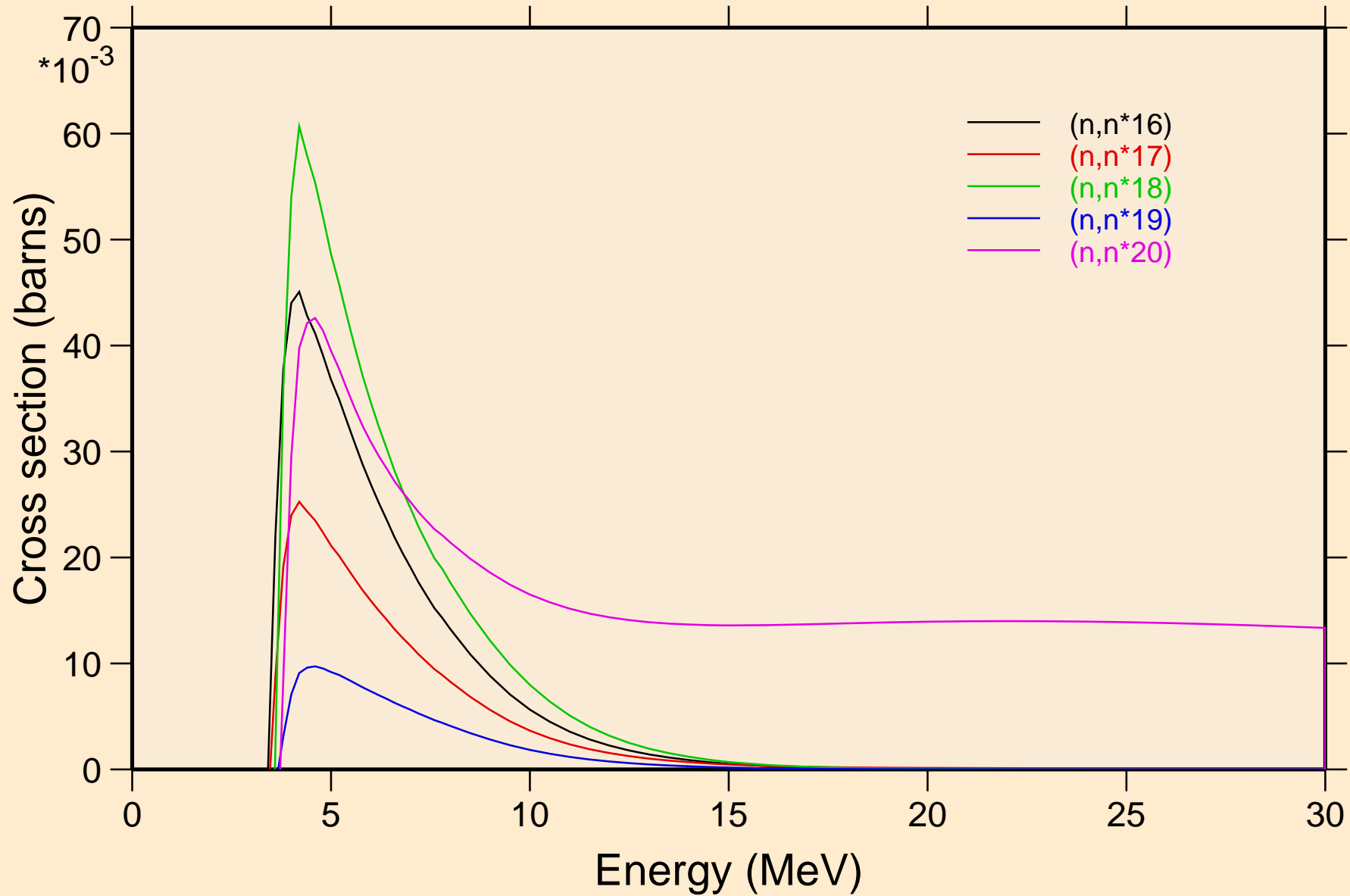

AL028 NEUTRON ACER TENDL-2024 LIBRARY; T=293.6K
Inelastic levels

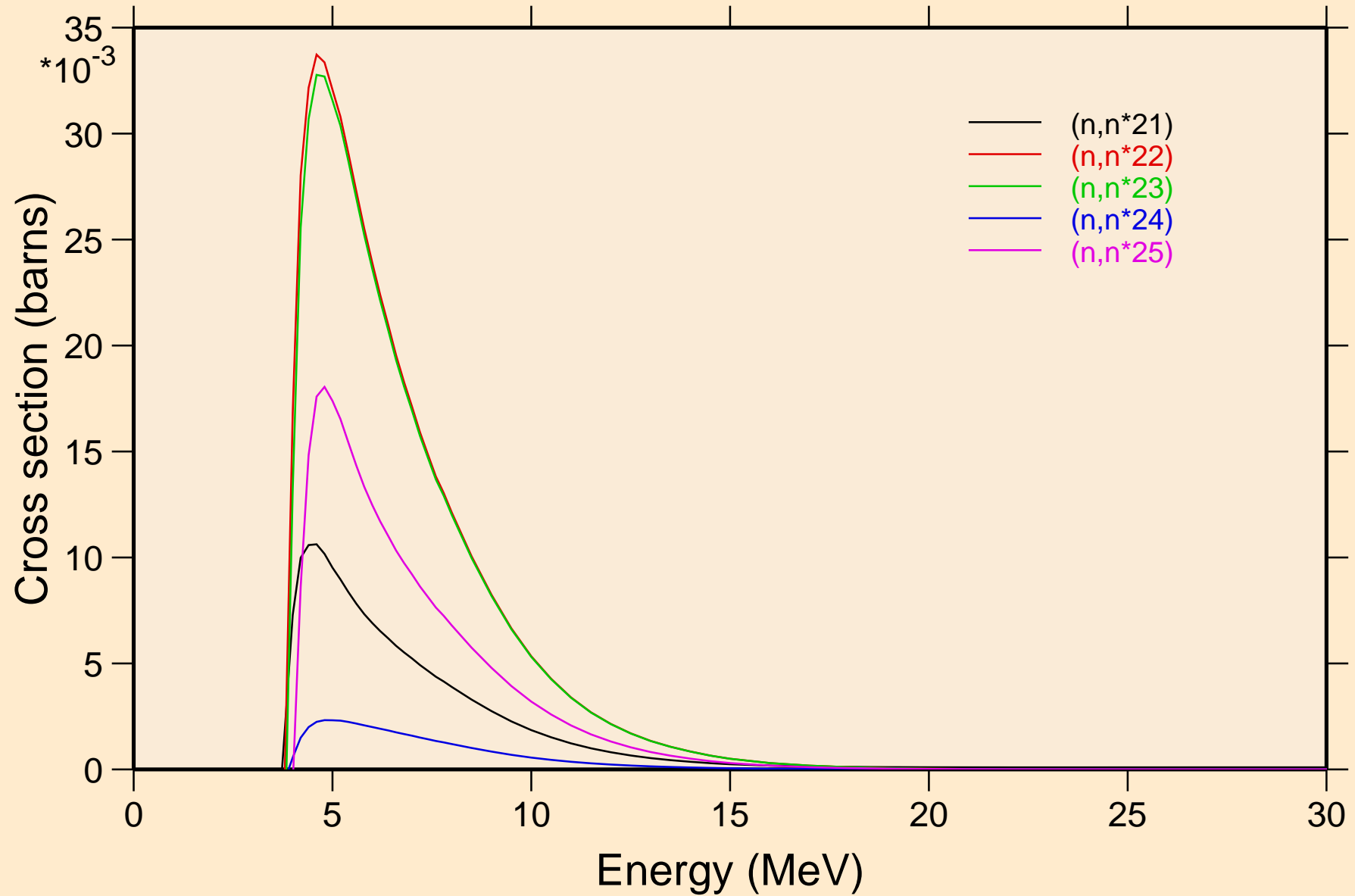

AL028 NEUTRON ACER TENDL-2024 LIBRARY; T=293.6K
Inelastic levels

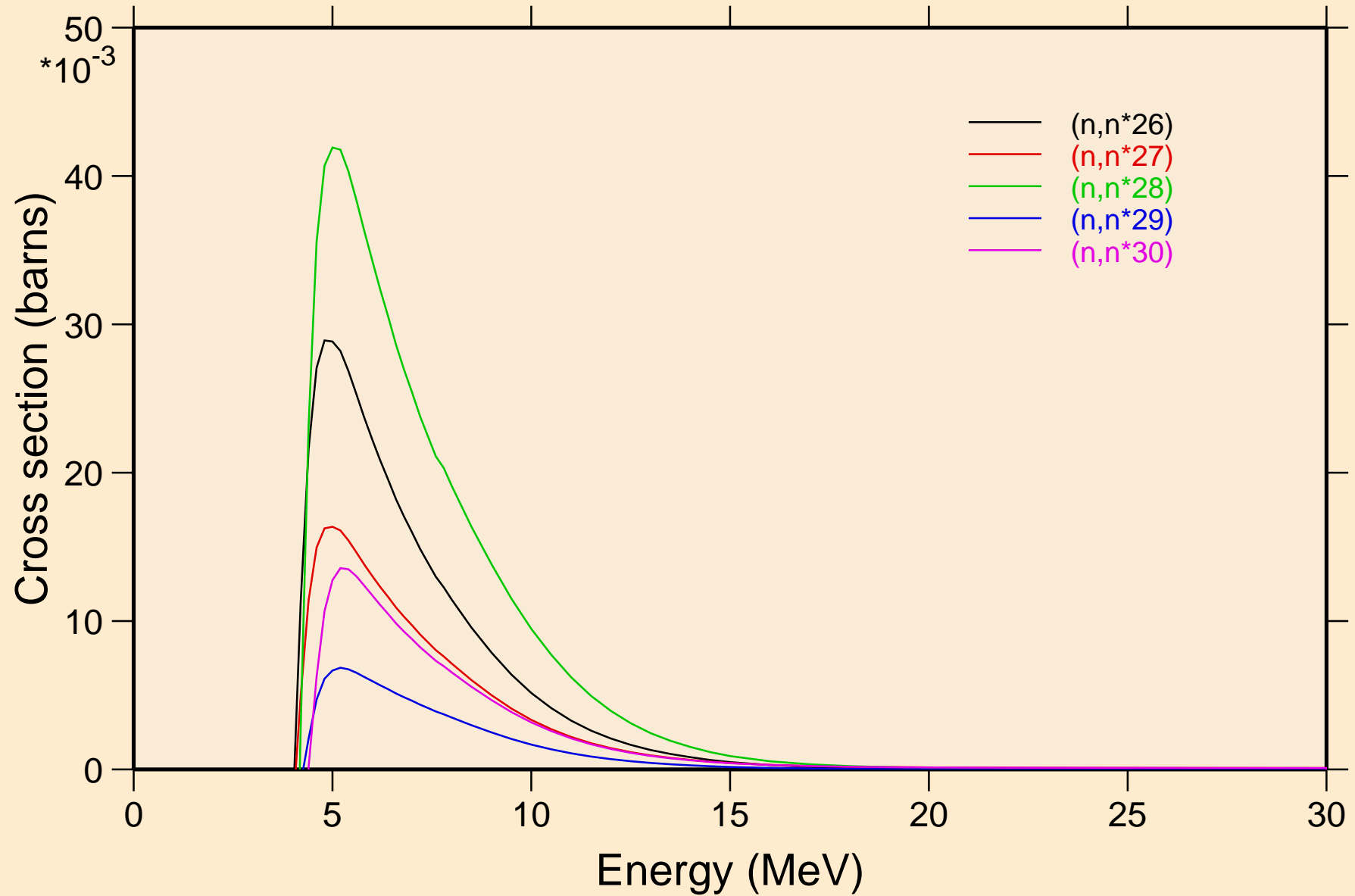

AL028 NEUTRON ACER TENDL-2024 LIBRARY; T=293.6K
Threshold reactions

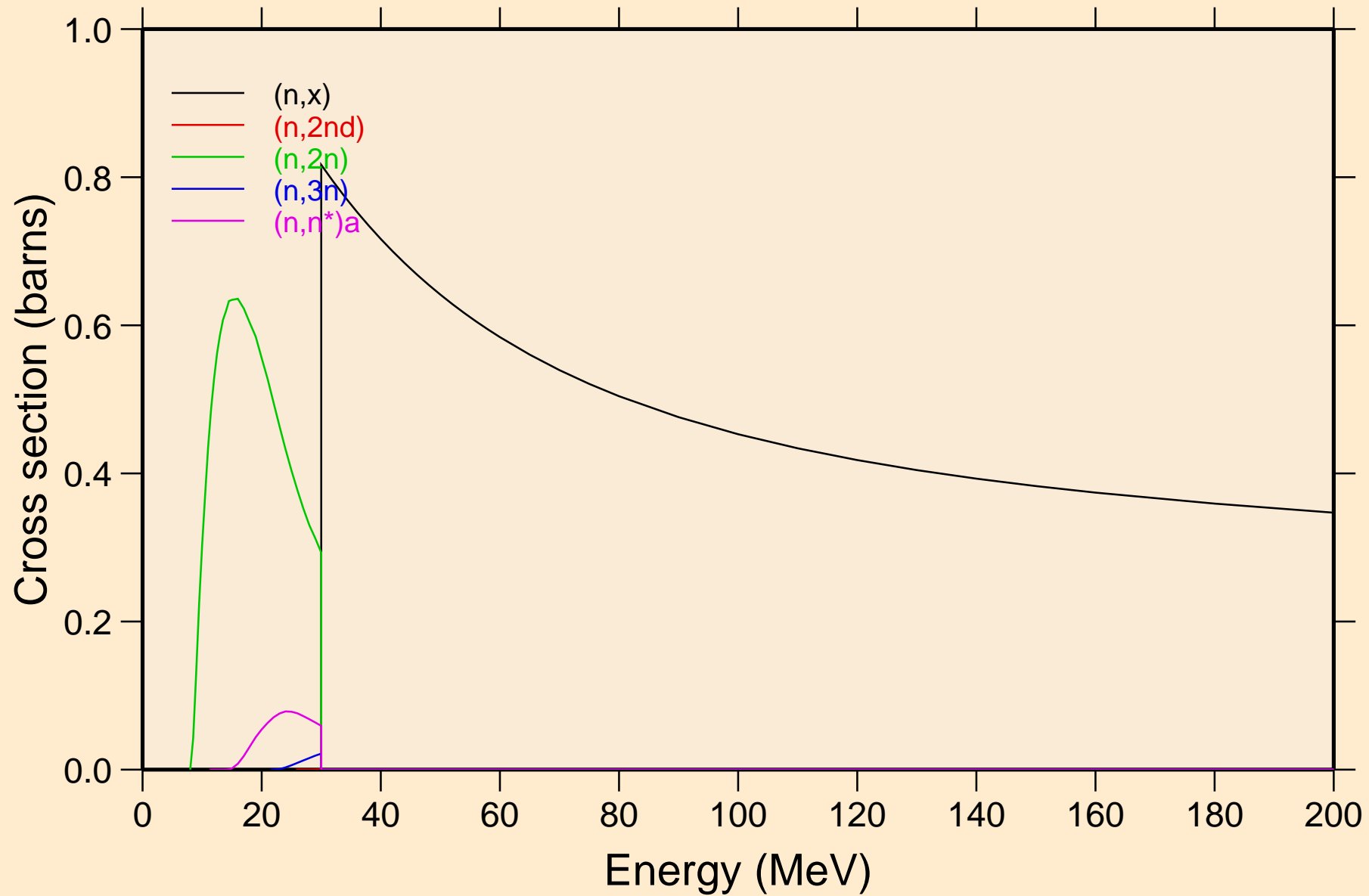

AL028 NEUTRON ACER TENDL-2024 LIBRARY; T=293.6K
Threshold reactions

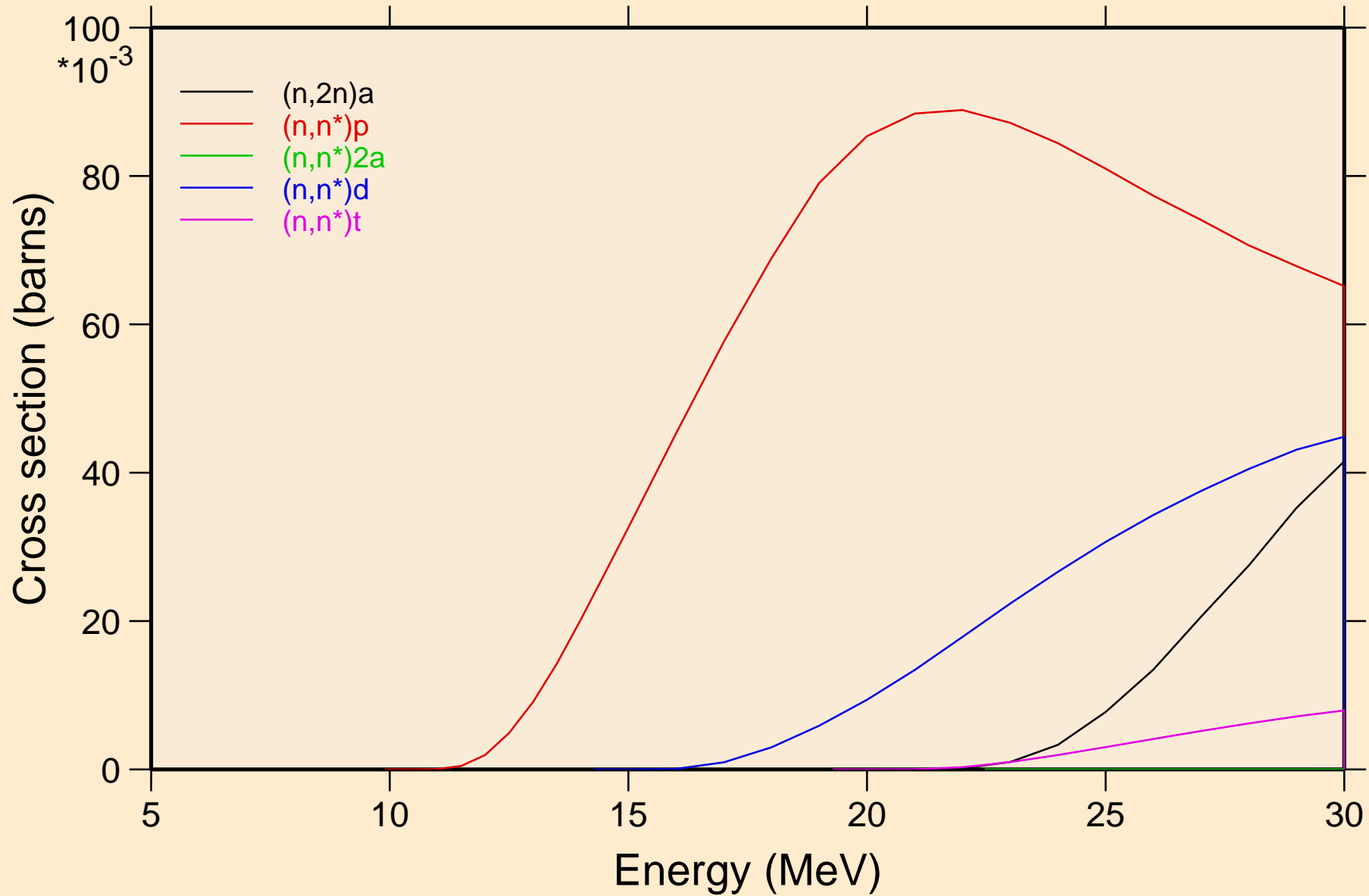

AL028 NEUTRON ACER TENDL-2024 LIBRARY; T=293.6K
Threshold reactions

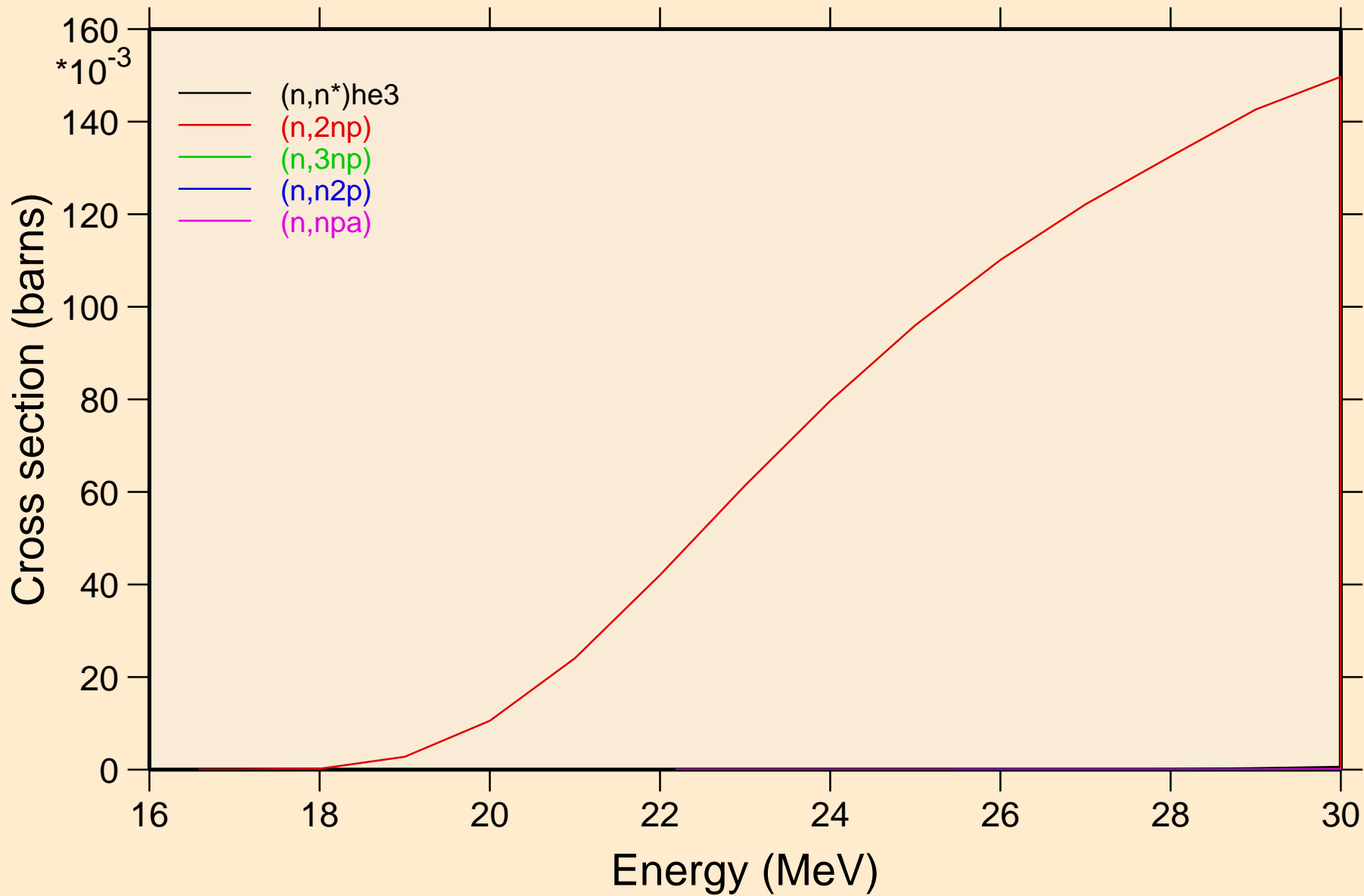

AL028 NEUTRON ACER TENDL-2024 LIBRARY; T=293.6K
Threshold reactions

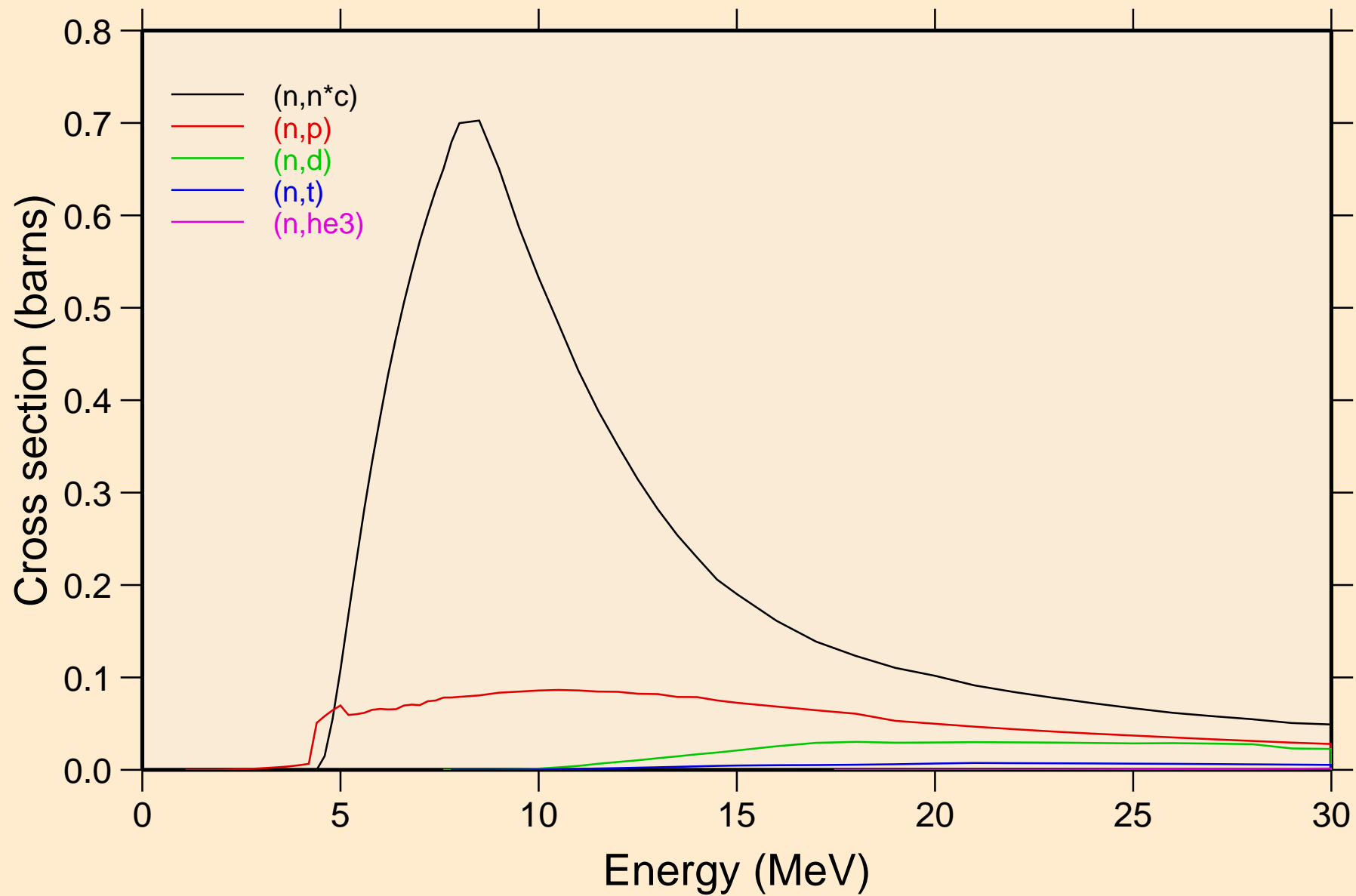

AL028 NEUTRON ACER TENDL-2024 LIBRARY; T=293.6K
Threshold reactions

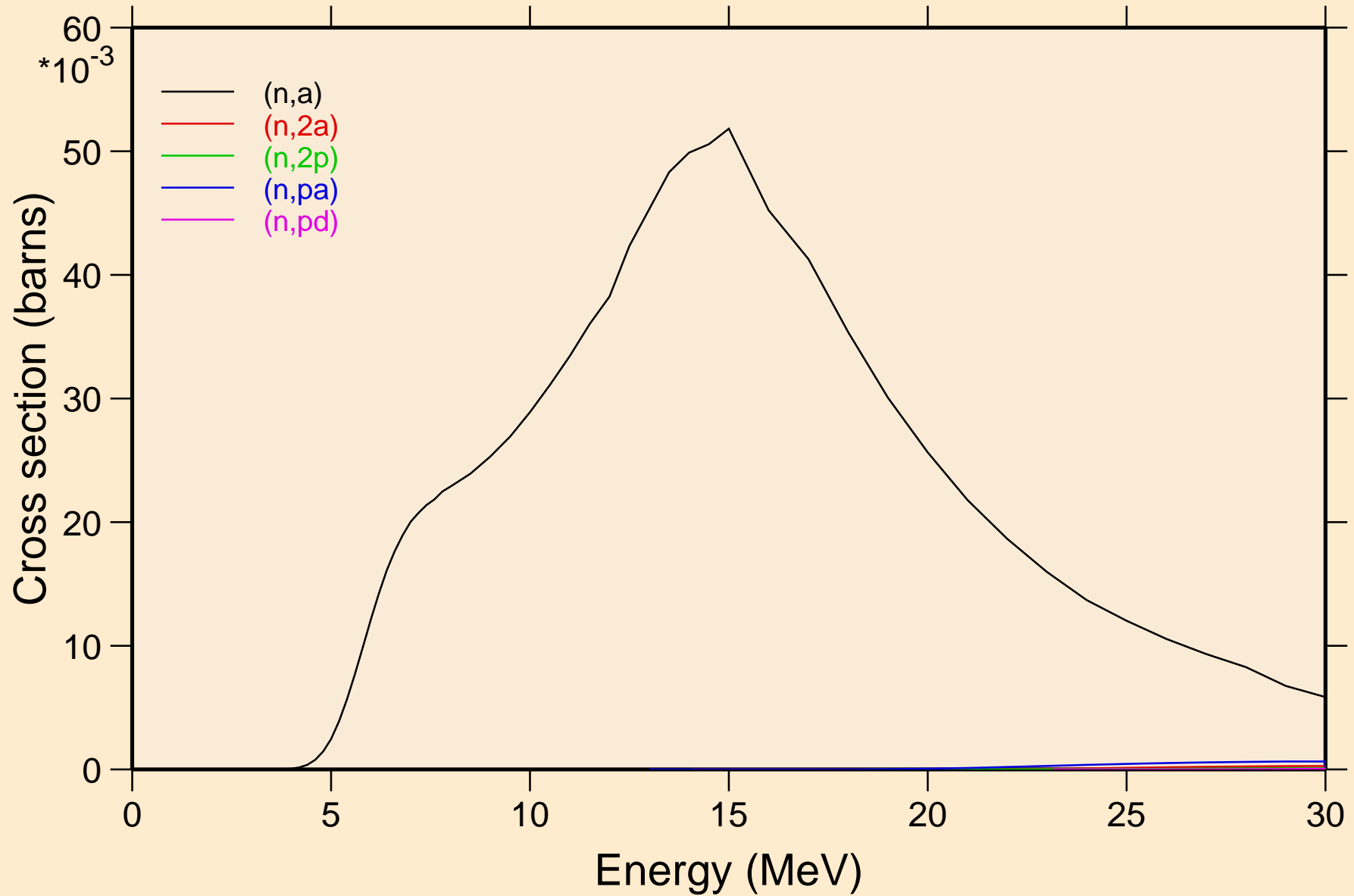

AL028 NEUTRON ACER TENDL-2024 LIBRARY; T=293.6K
Threshold reactions

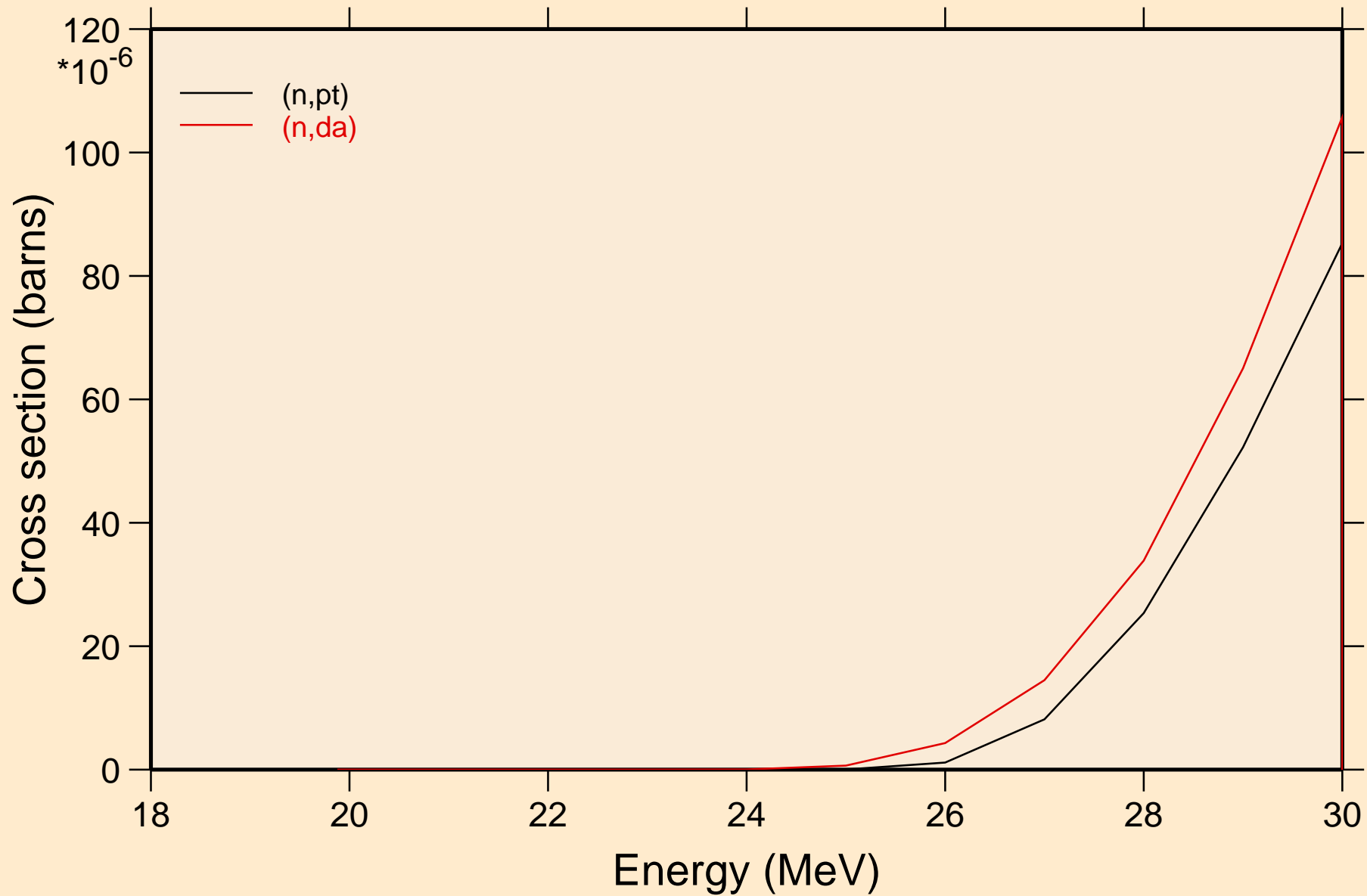

AL028 NEUTRON ACER TENDL-2024 LIBRARY; T=293.6K
Threshold reactions

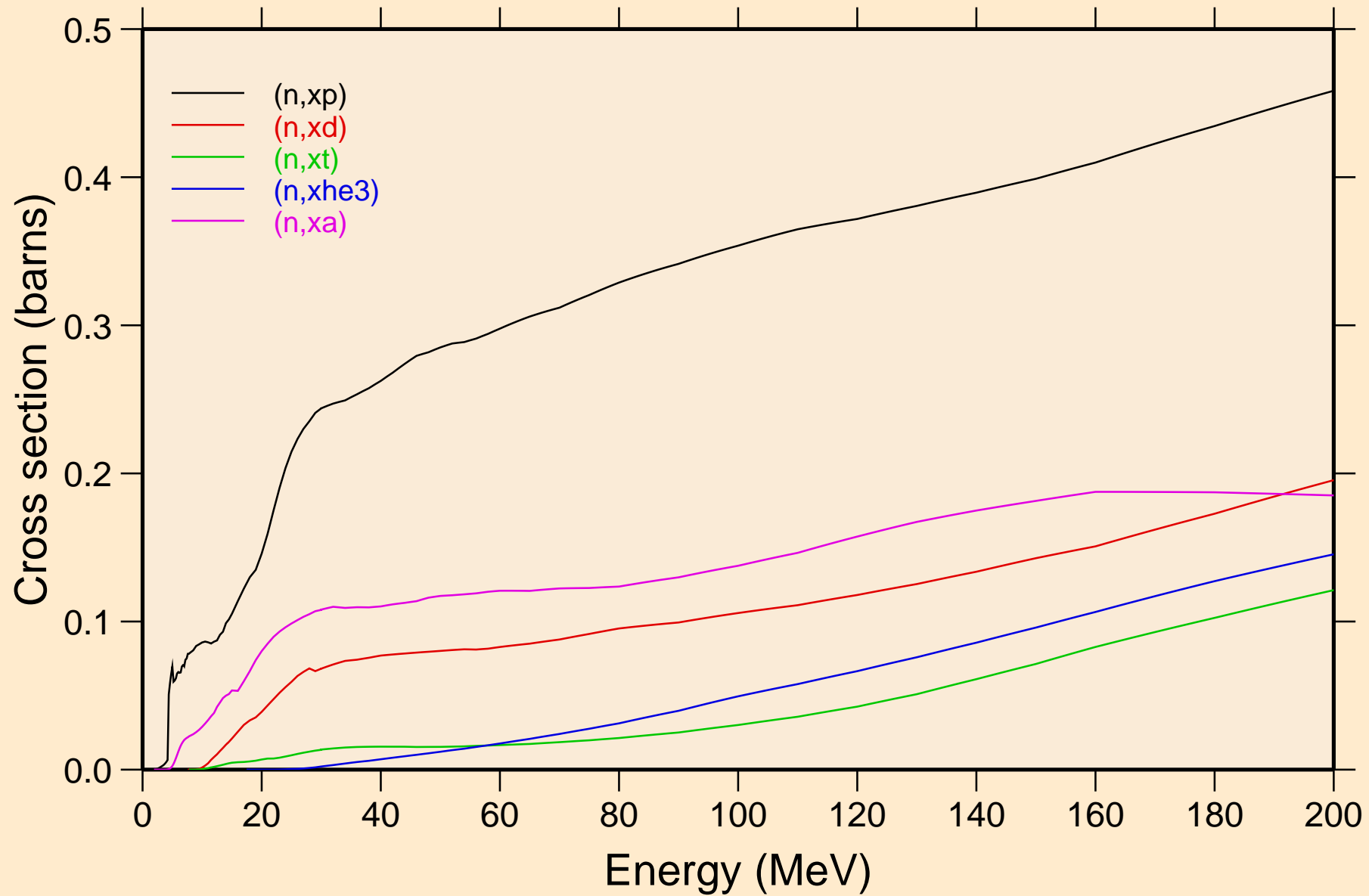

AL028 NEUTRON ACER TENDL-2024 LIBRARY; T=293.6K
angular distribution for elastic

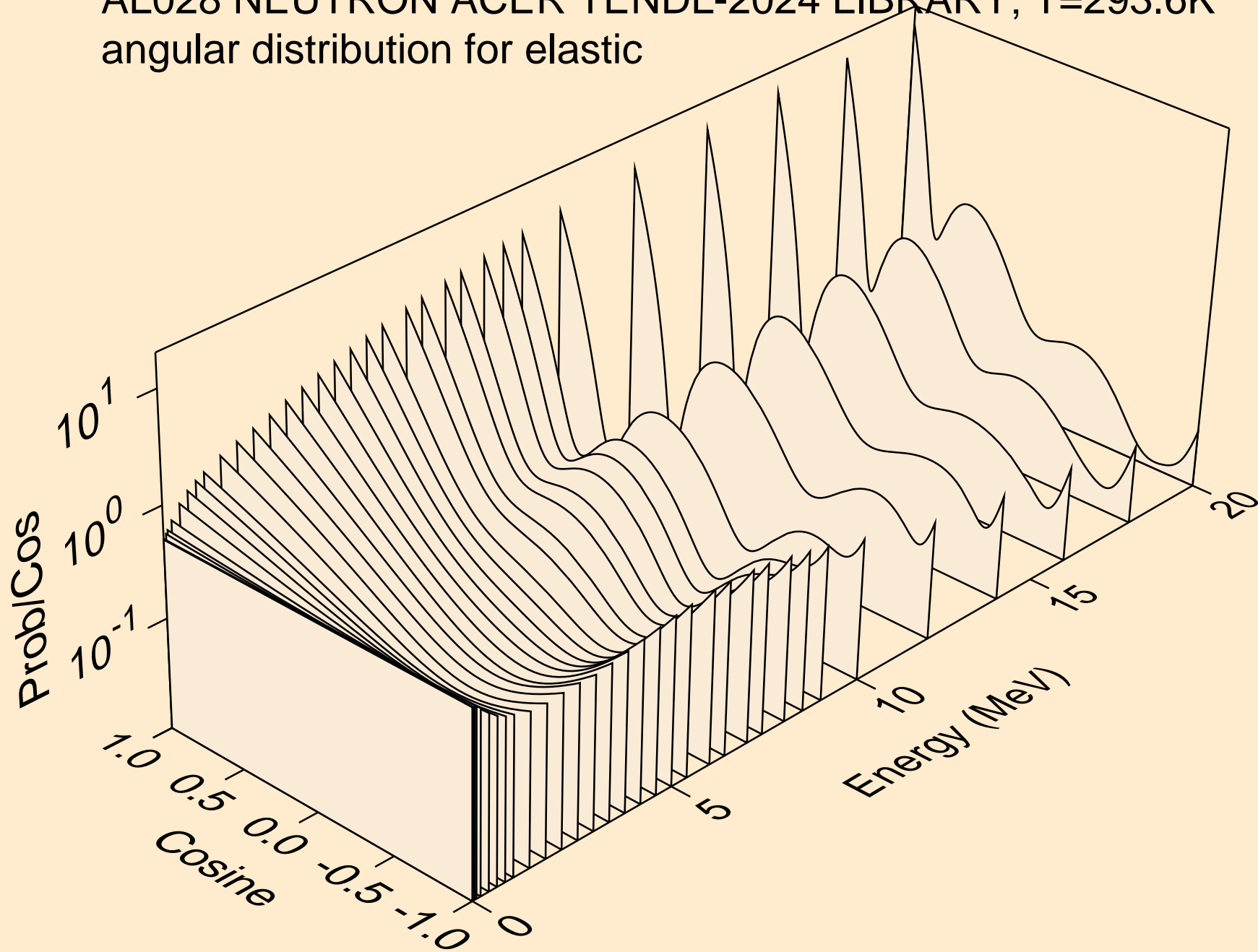

AL028 NEUTRON ACER TENDL-2024 LIBRARY; T=293.6K
angular distribution for elastic

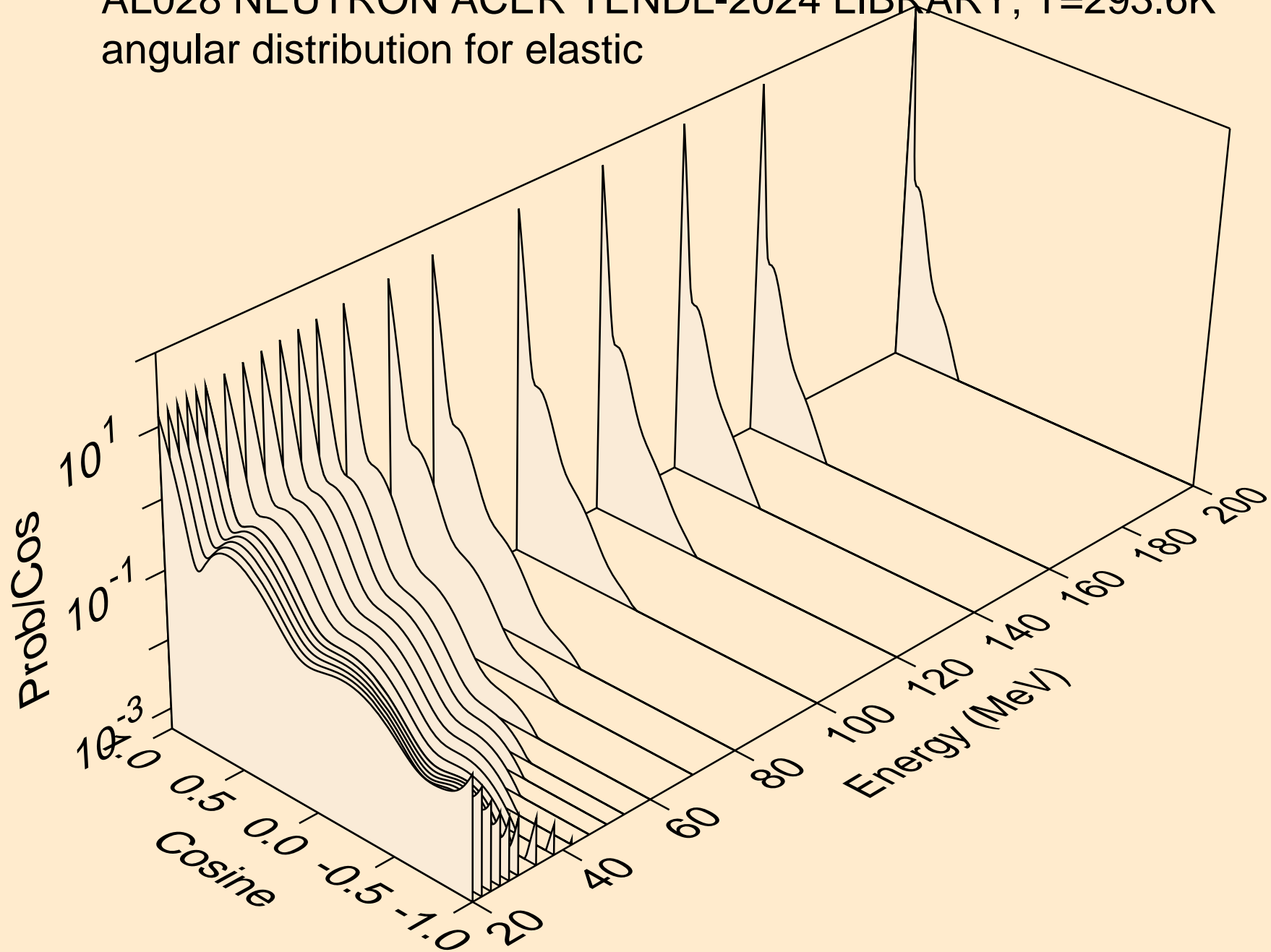

AL028 NEUTRON ACER TENDL-2024 LIBRARY; T=293.6K
angular distribution for (n,n*1)

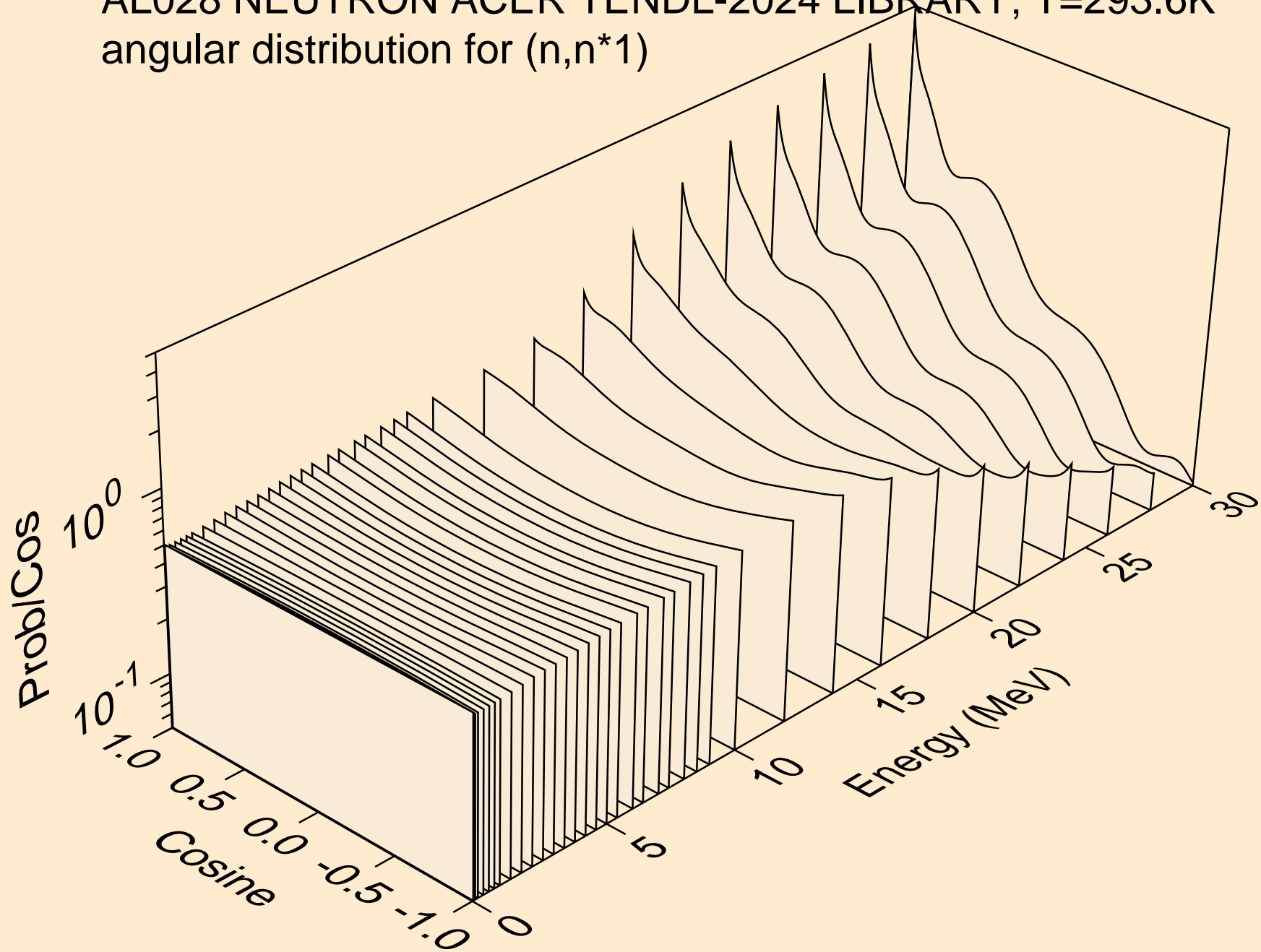

AL028 NEUTRON ACER TENDL-2024 LIBRARY; T=293.6K
angular distribution for (n,n*2)

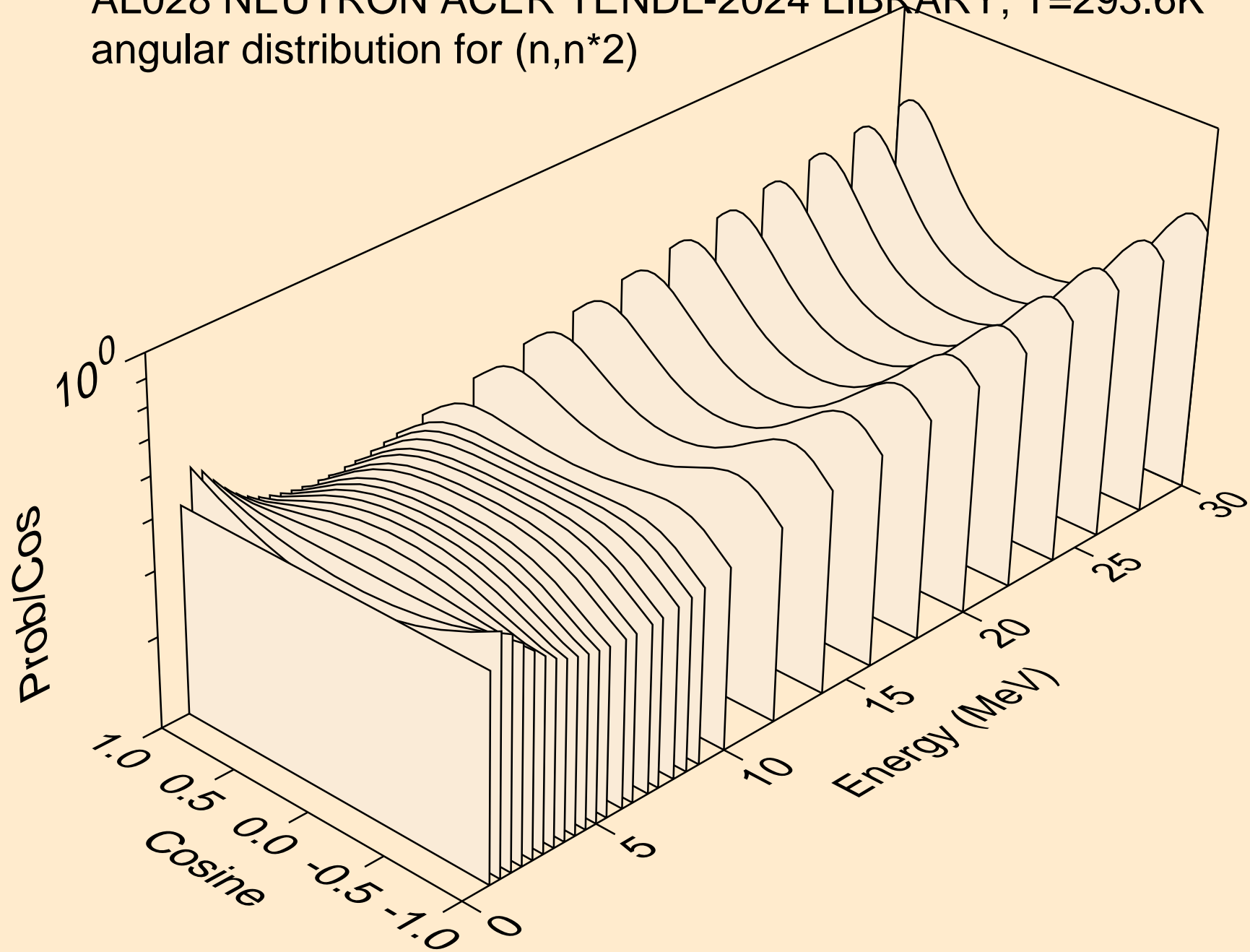

AL028 NEUTRON ACER TENDL-2024 LIBRARY; T=293.6K
angular distribution for (n,n*3)

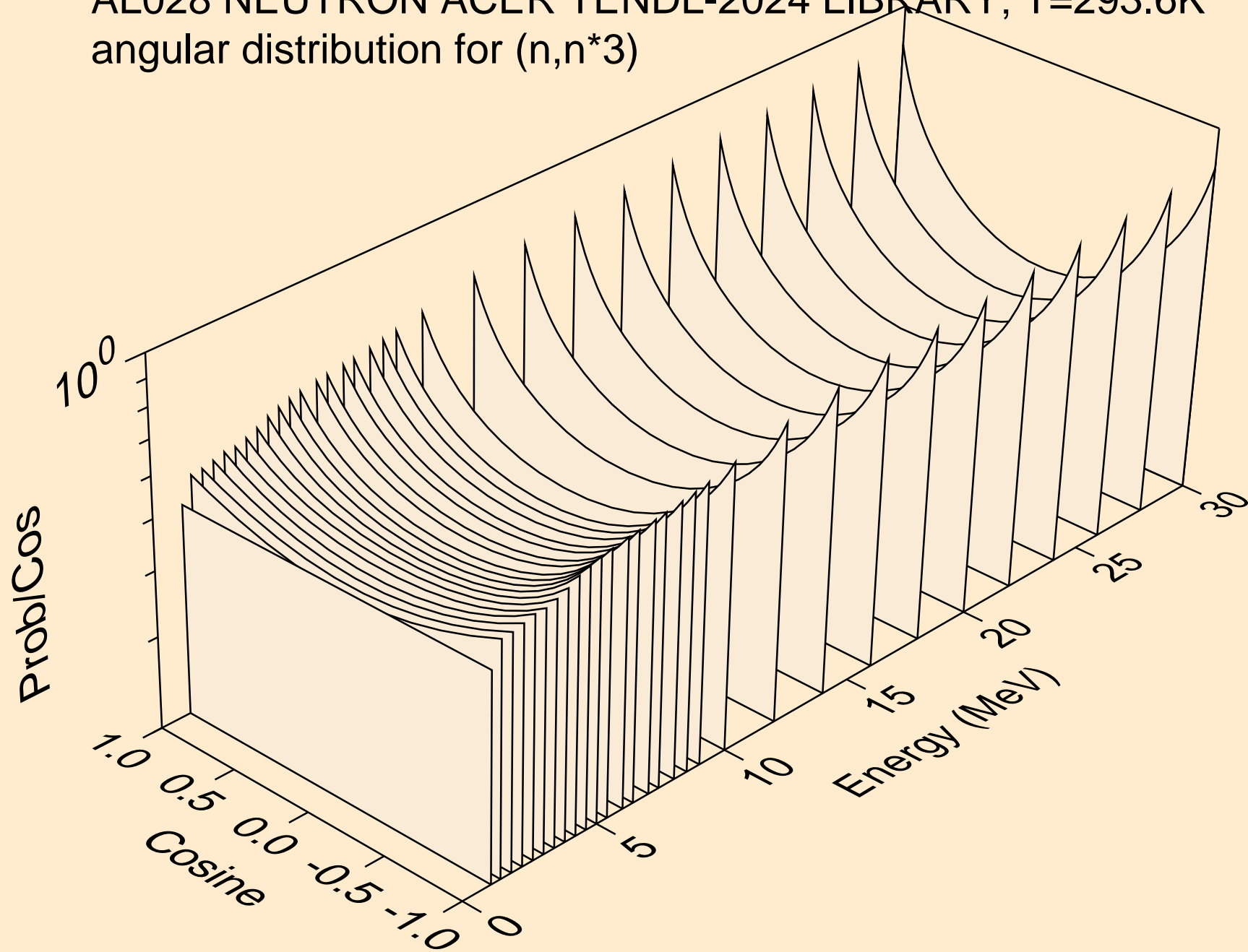

AL028 NEUTRON ACER TENDL-2024 LIBRARY; T=293.6K
angular distribution for (n,n*4)

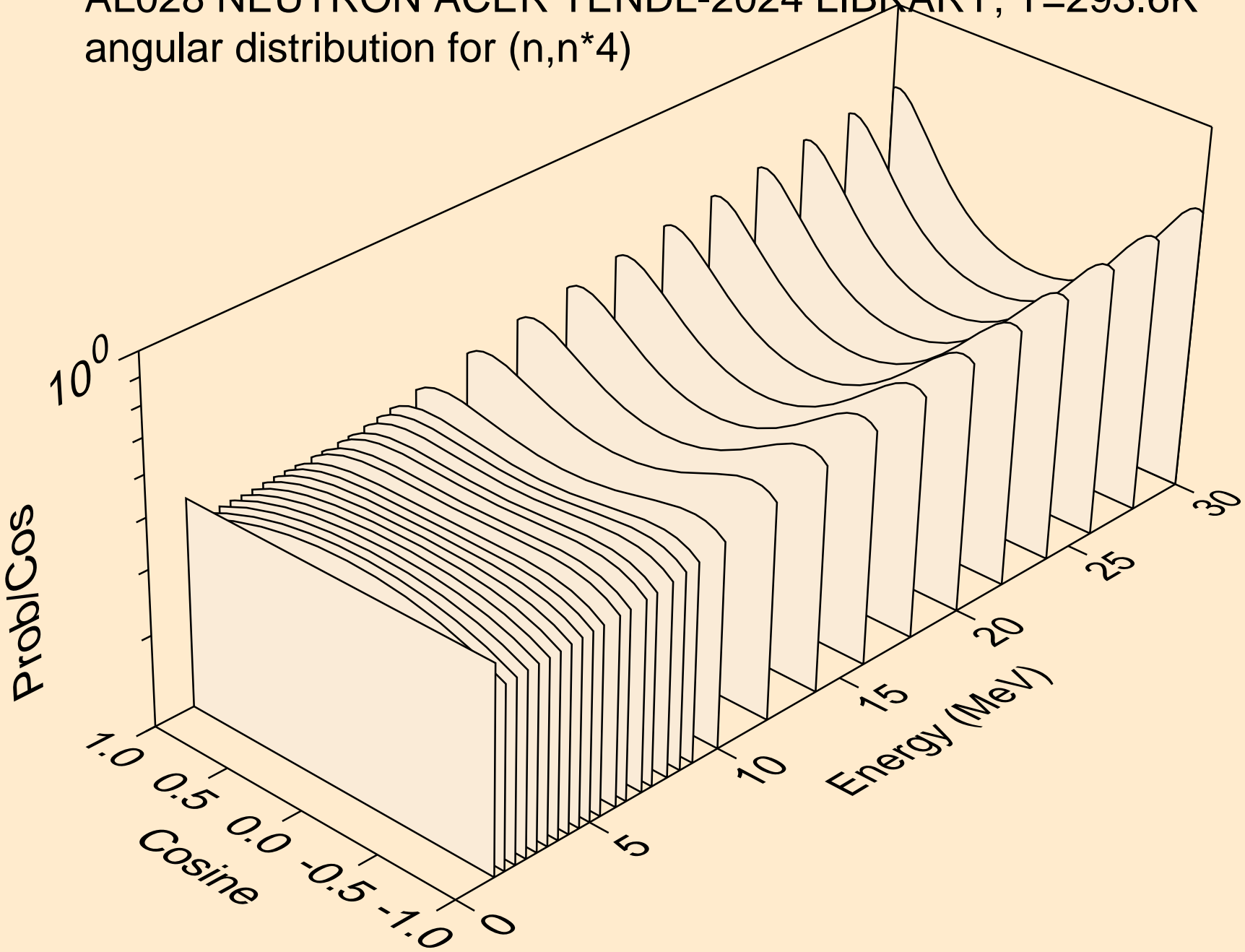

AL028 NEUTRON ACER TENDL-2024 LIBRARY; T=293.6K
angular distribution for (n,n*5)

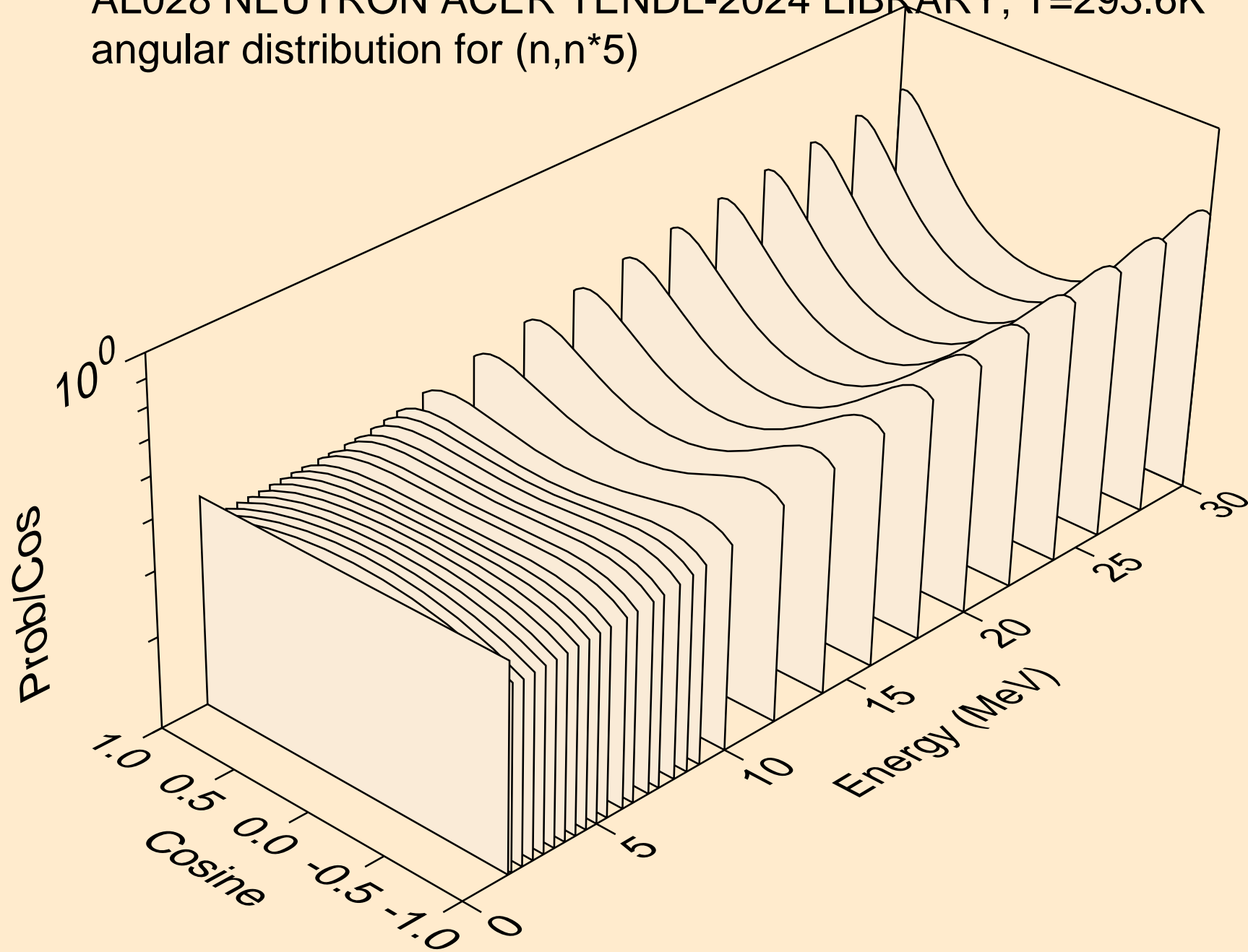

AL028 NEUTRON ACER TENDL-2024 LIBRARY; T=293.6K
angular distribution for (n,n*6)

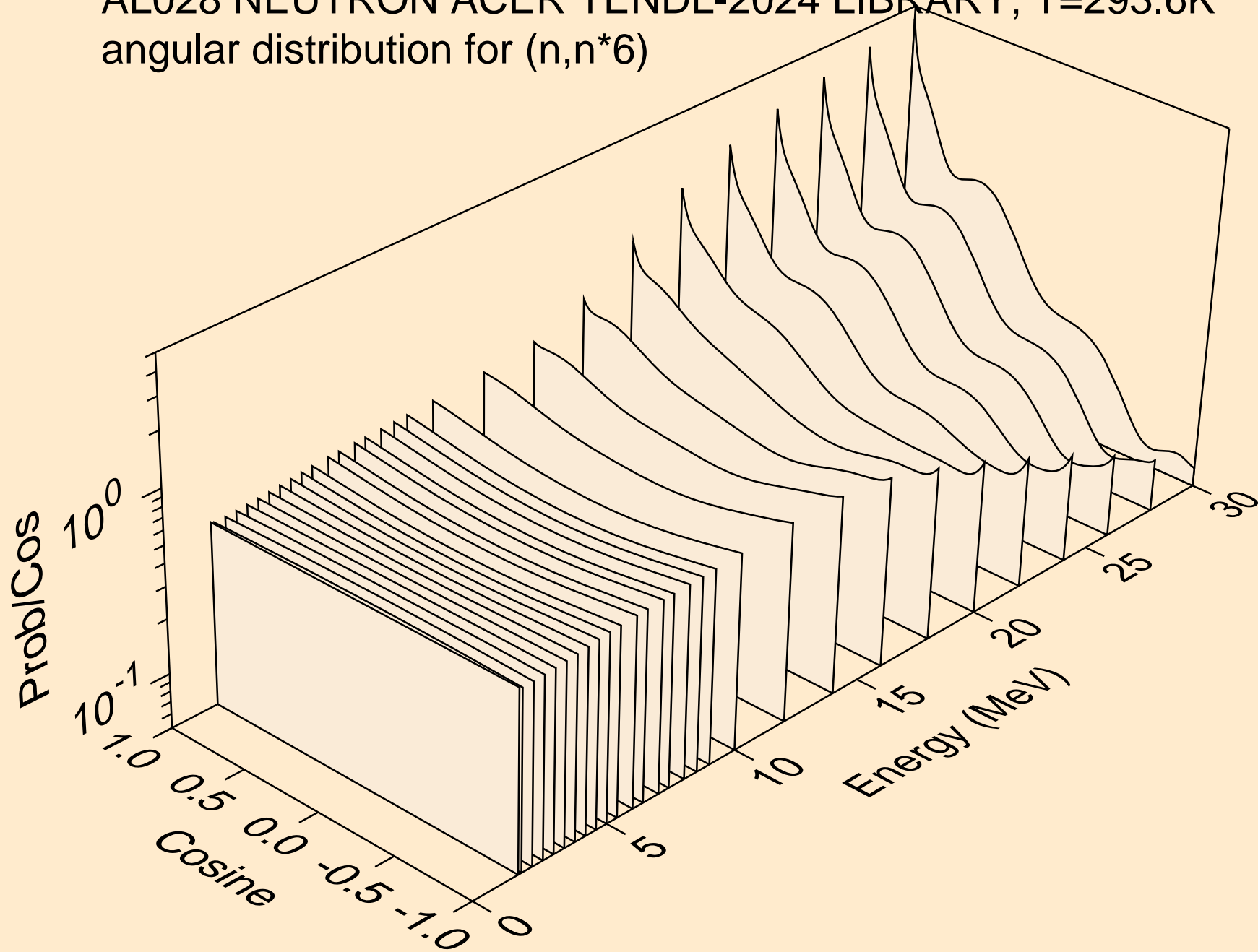

AL028 NEUTRON ACER TENDL-2024 LIBRARY; T=293.6K
angular distribution for (n,n*7)

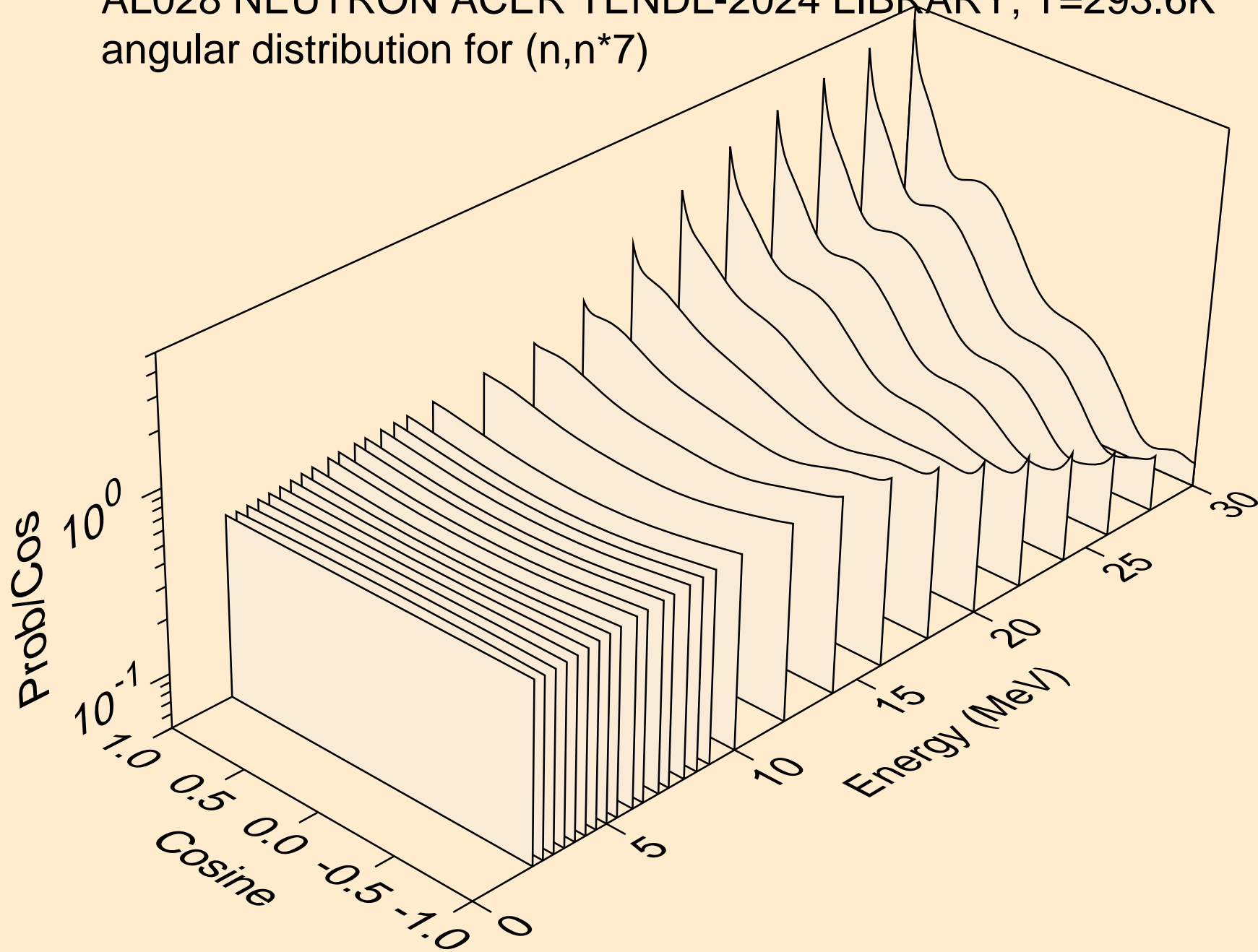

AL028 NEUTRON ACER TENDL-2024 LIBRARY; T=293.6K
angular distribution for (n,n*8)

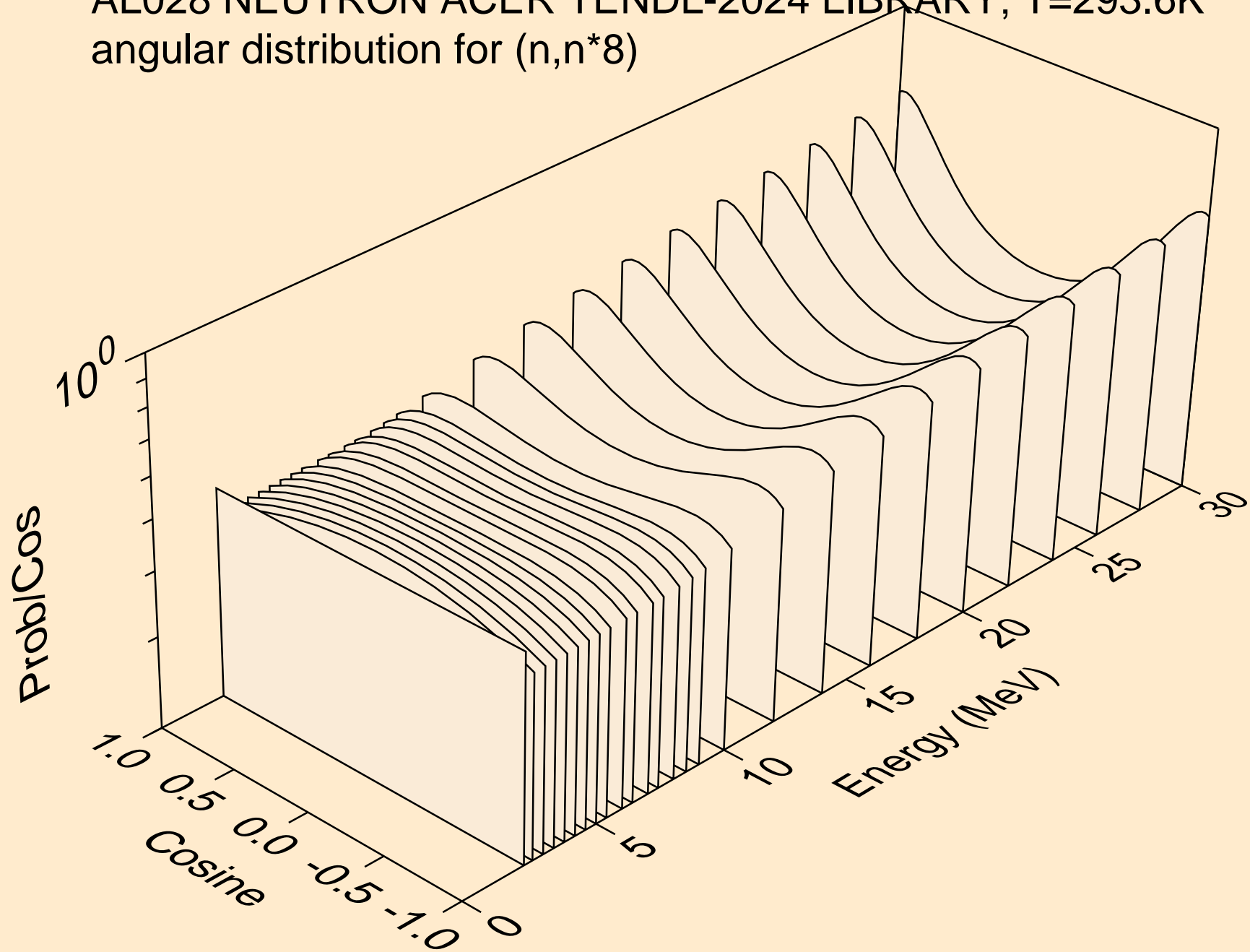

AL028 NEUTRON ACER TENDL-2024 LIBRARY; T=293.6K
angular distribution for (n,n*9)

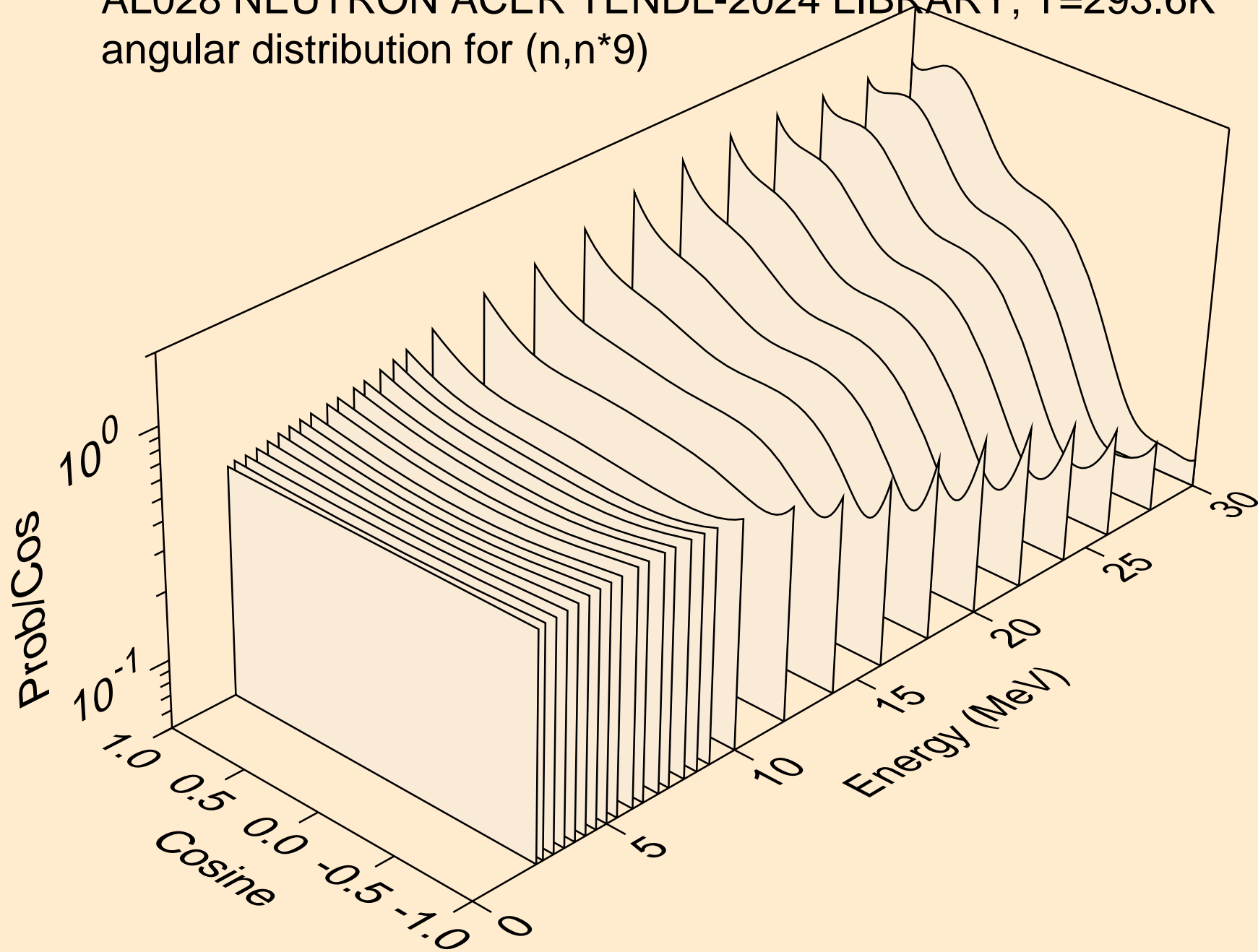

AL028 NEUTRON ACER TENDL-2024 LIBRARY; T=293.6K
angular distribution for (n,n*10)

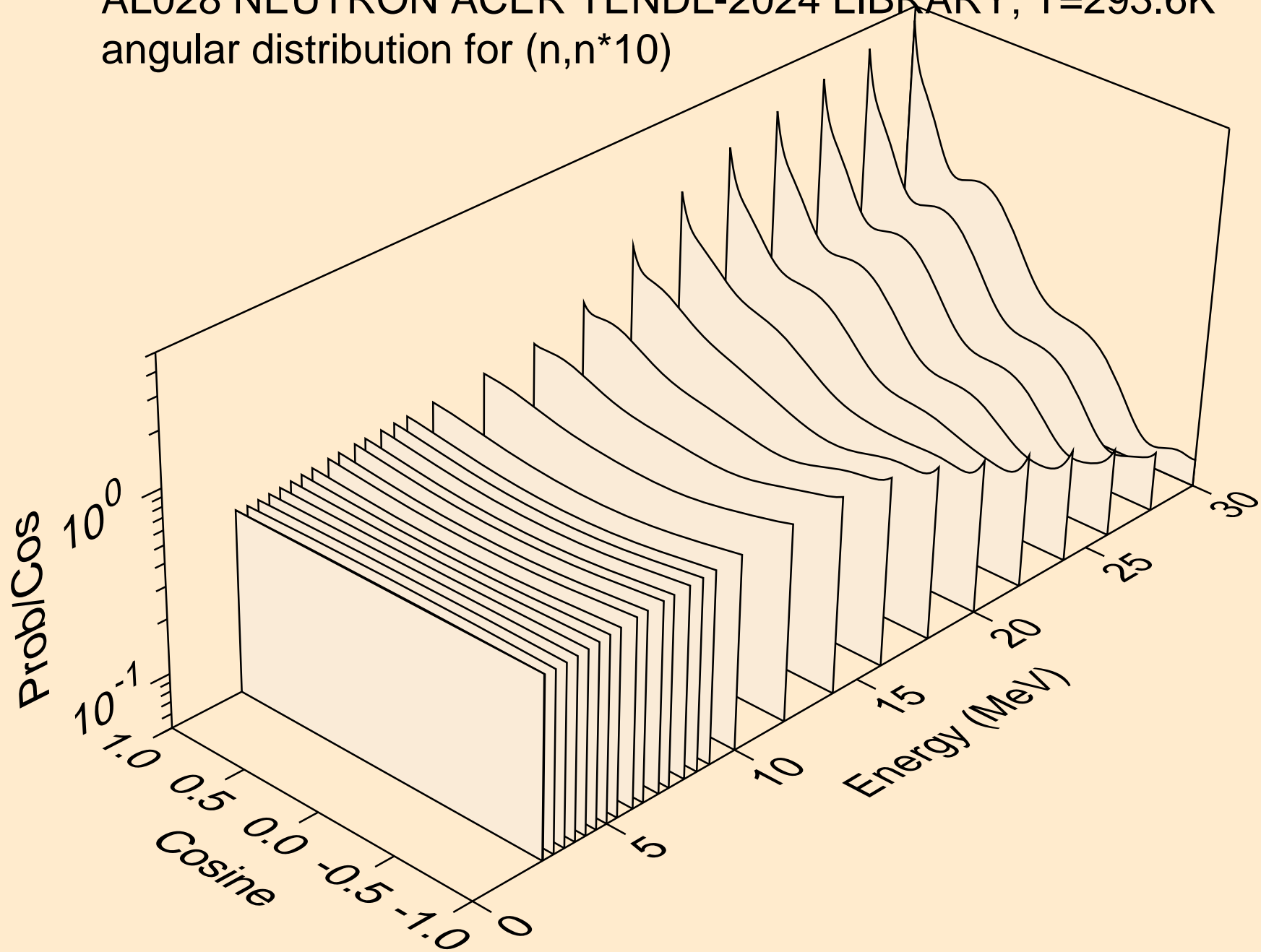

AL028 NEUTRON ACER TENDL-2024 LIBRARY; T=293.6K
angular distribution for (n,n*11)

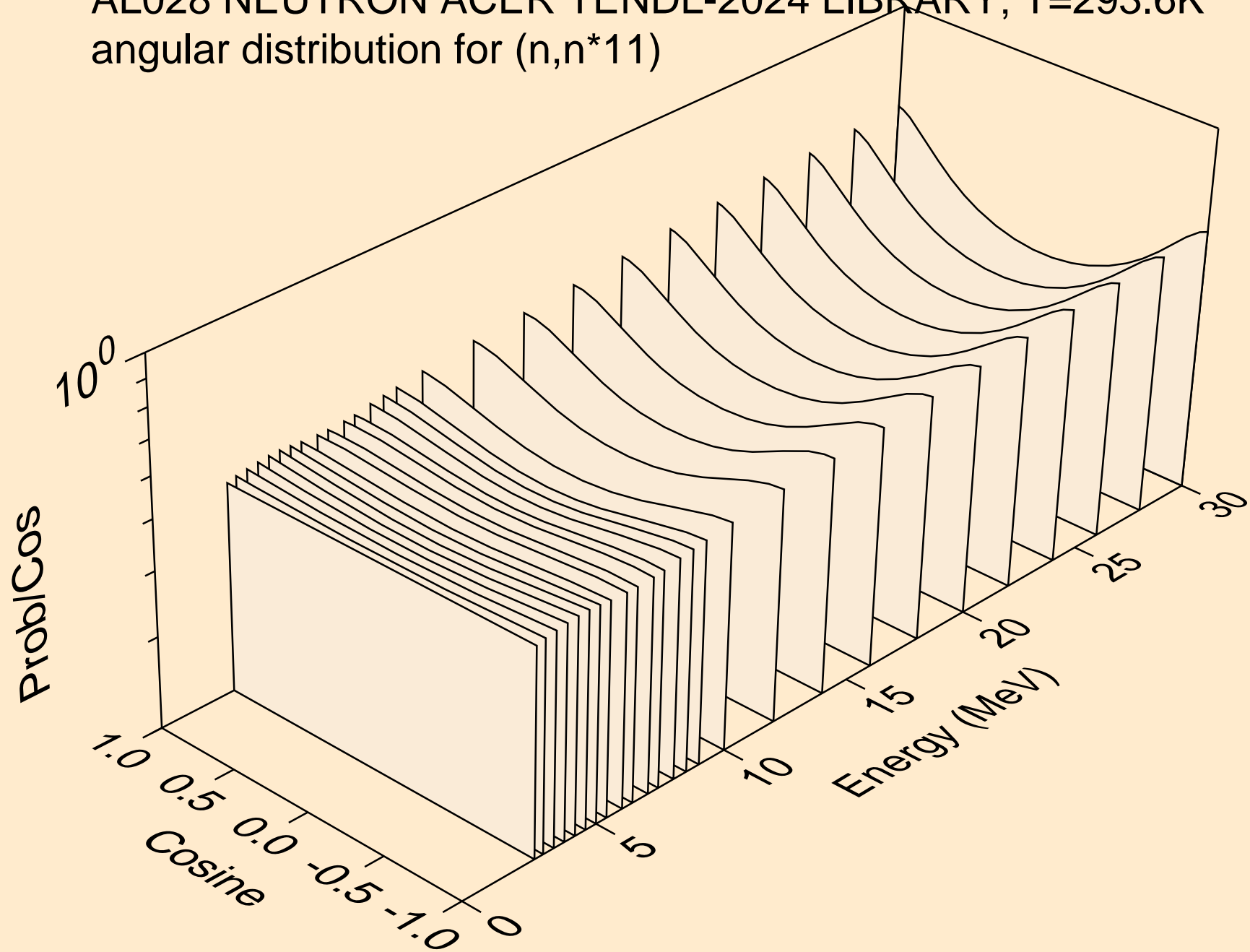

AL028 NEUTRON ACER TENDL-2024 LIBRARY; T=293.6K
angular distribution for (n,n*12)

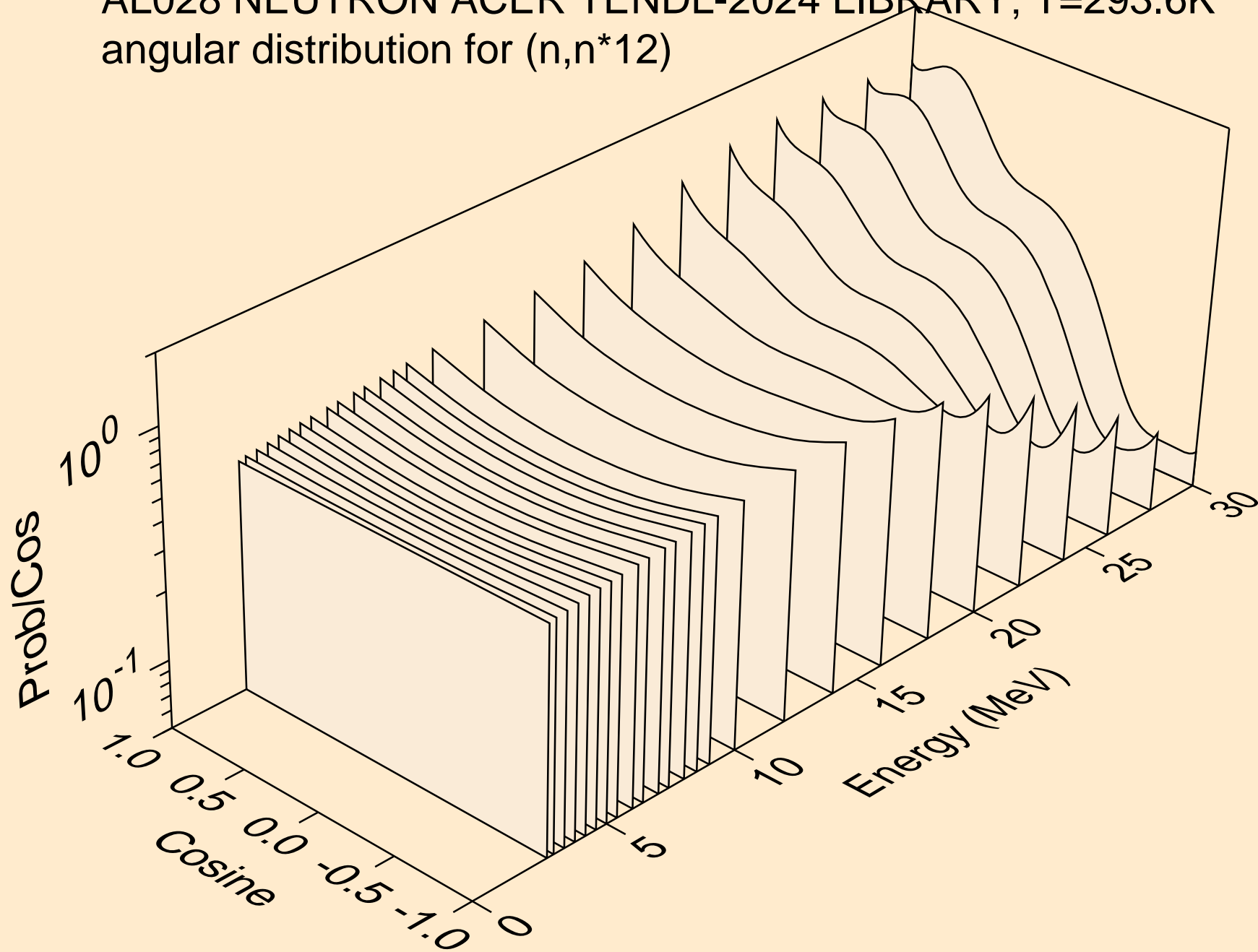

AL028 NEUTRON ACER TENDL-2024 LIBRARY; T=293.6K
angular distribution for (n,n*13)

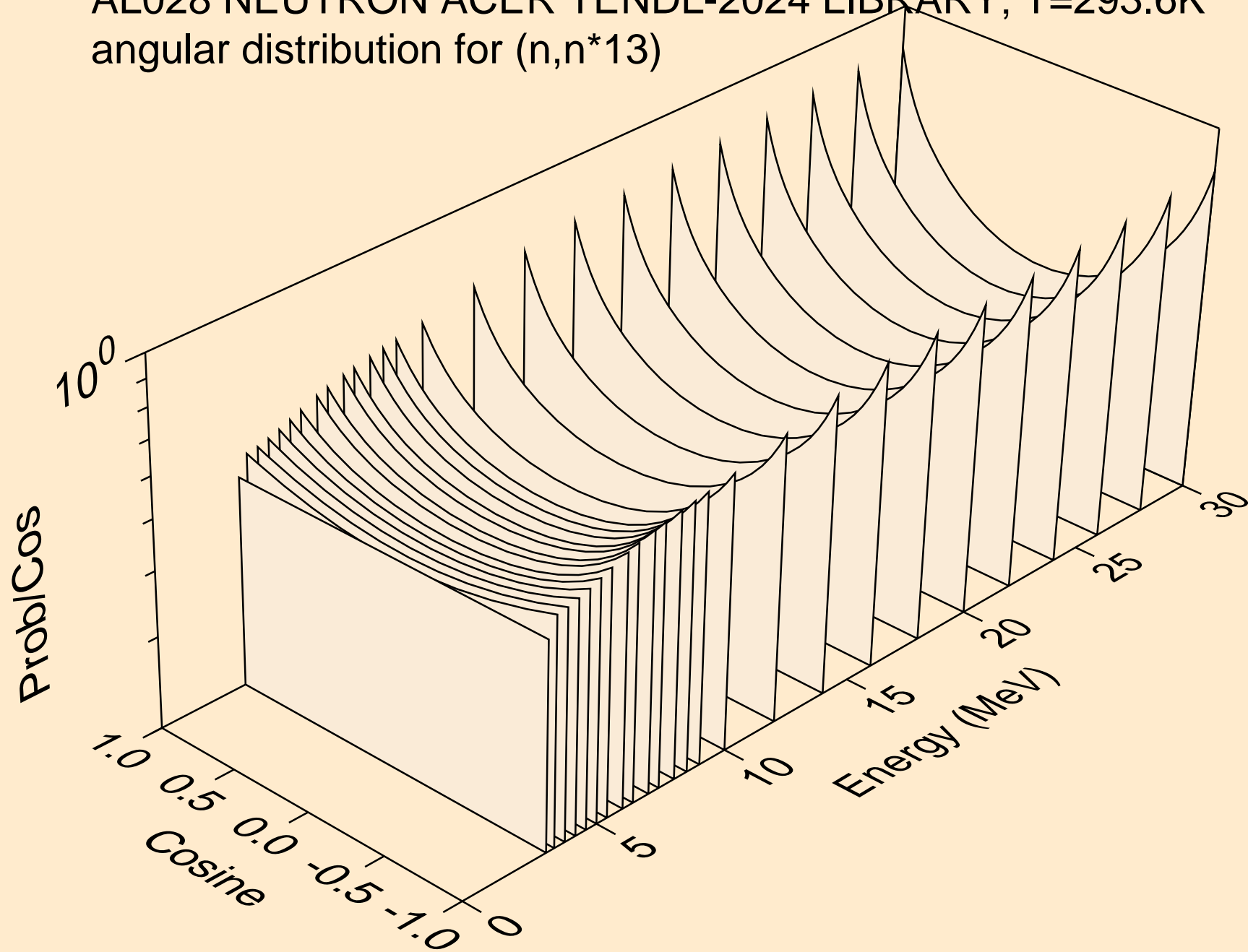

AL028 NEUTRON ACER TENDL-2024 LIBRARY; T=293.6K
angular distribution for (n,n*14)

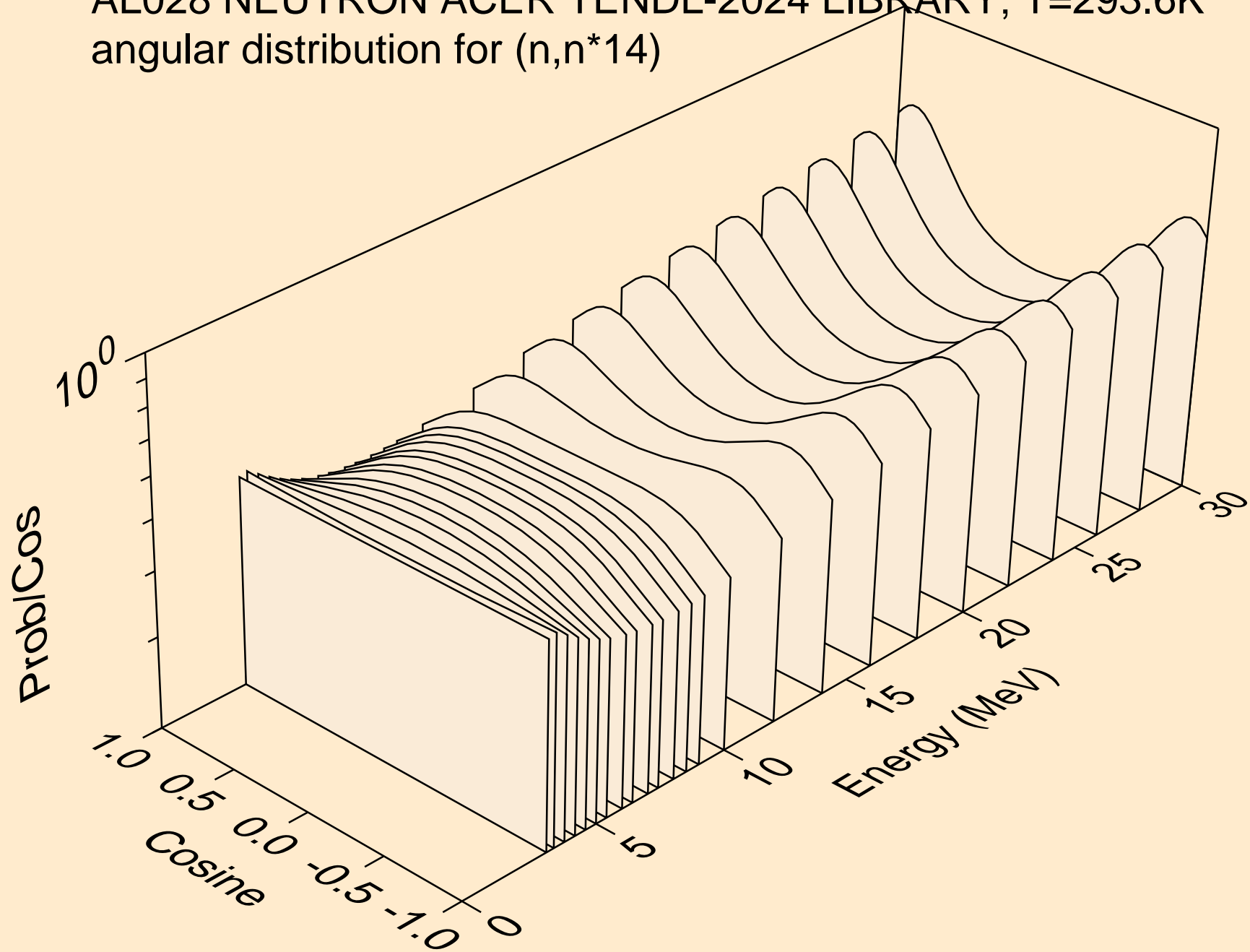

AL028 NEUTRON ACER TENDL-2024 LIBRARY; T=293.6K
angular distribution for (n,n*15)

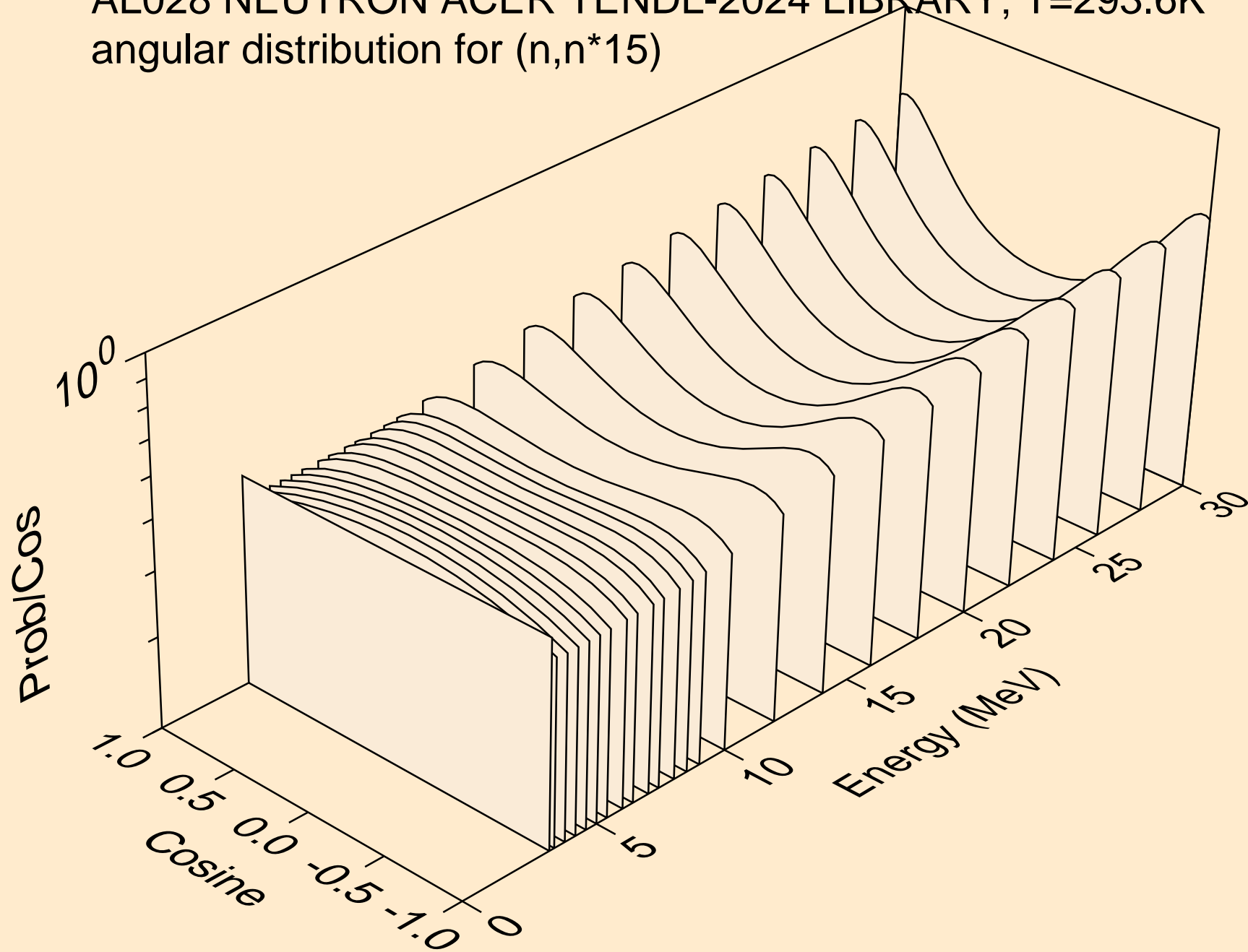

AL028 NEUTRON ACER TENDL-2024 LIBRARY; T=293.6K
angular distribution for (n,n*16)

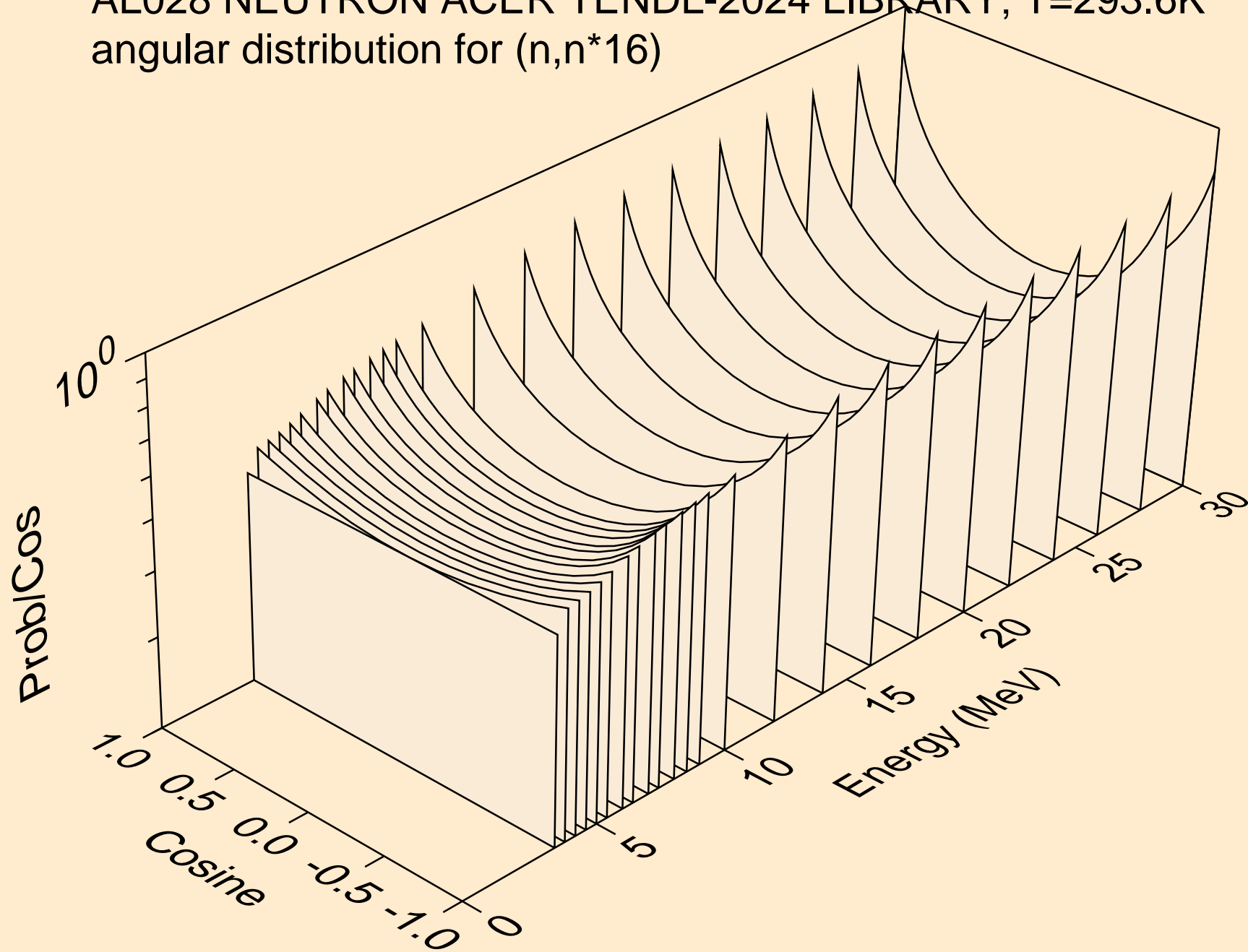

AL028 NEUTRON ACER TENDL-2024 LIBRARY; T=293.6K
angular distribution for (n,n*17)

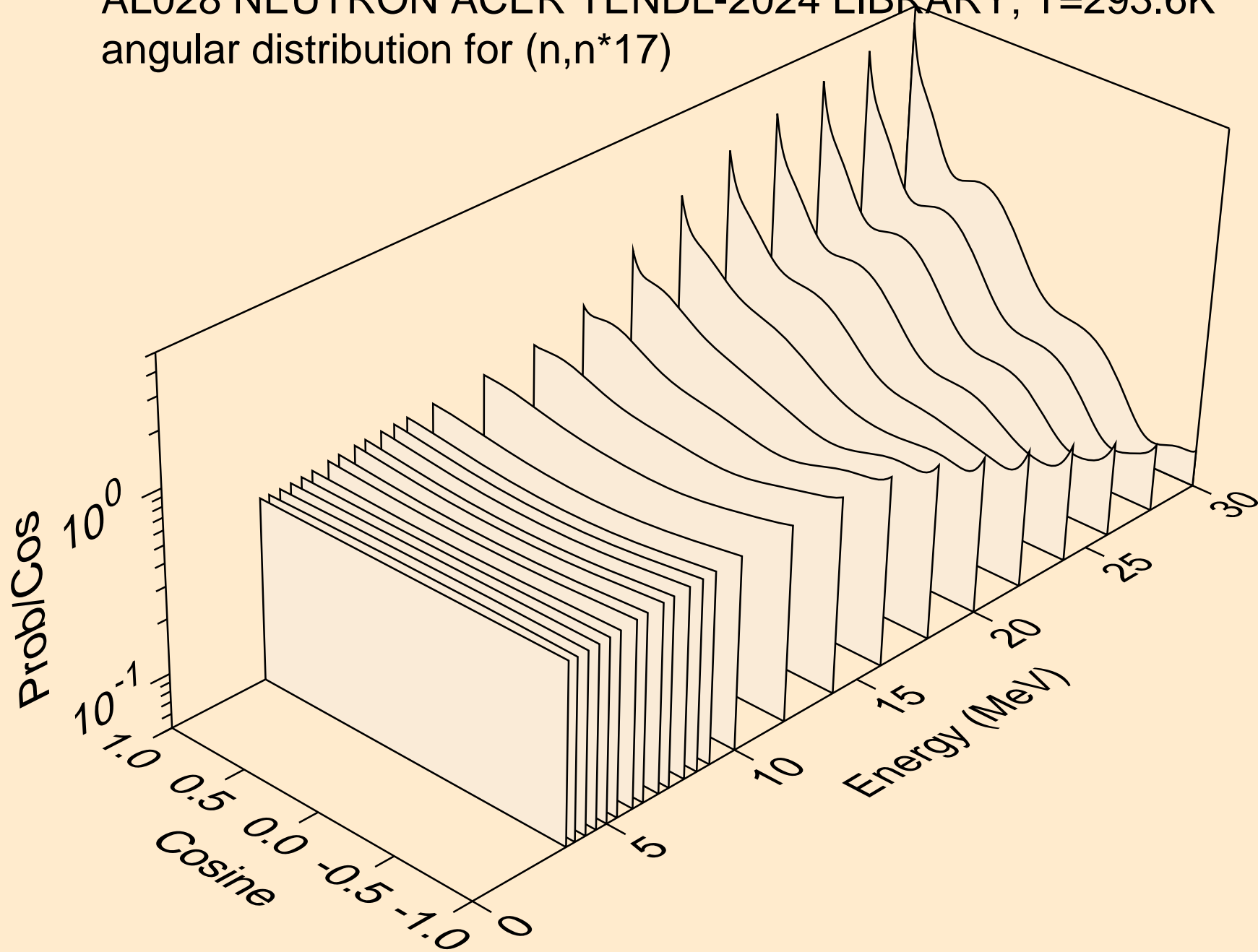

AL028 NEUTRON ACER TENDL-2024 LIBRARY; T=293.6K
angular distribution for (n,n*18)

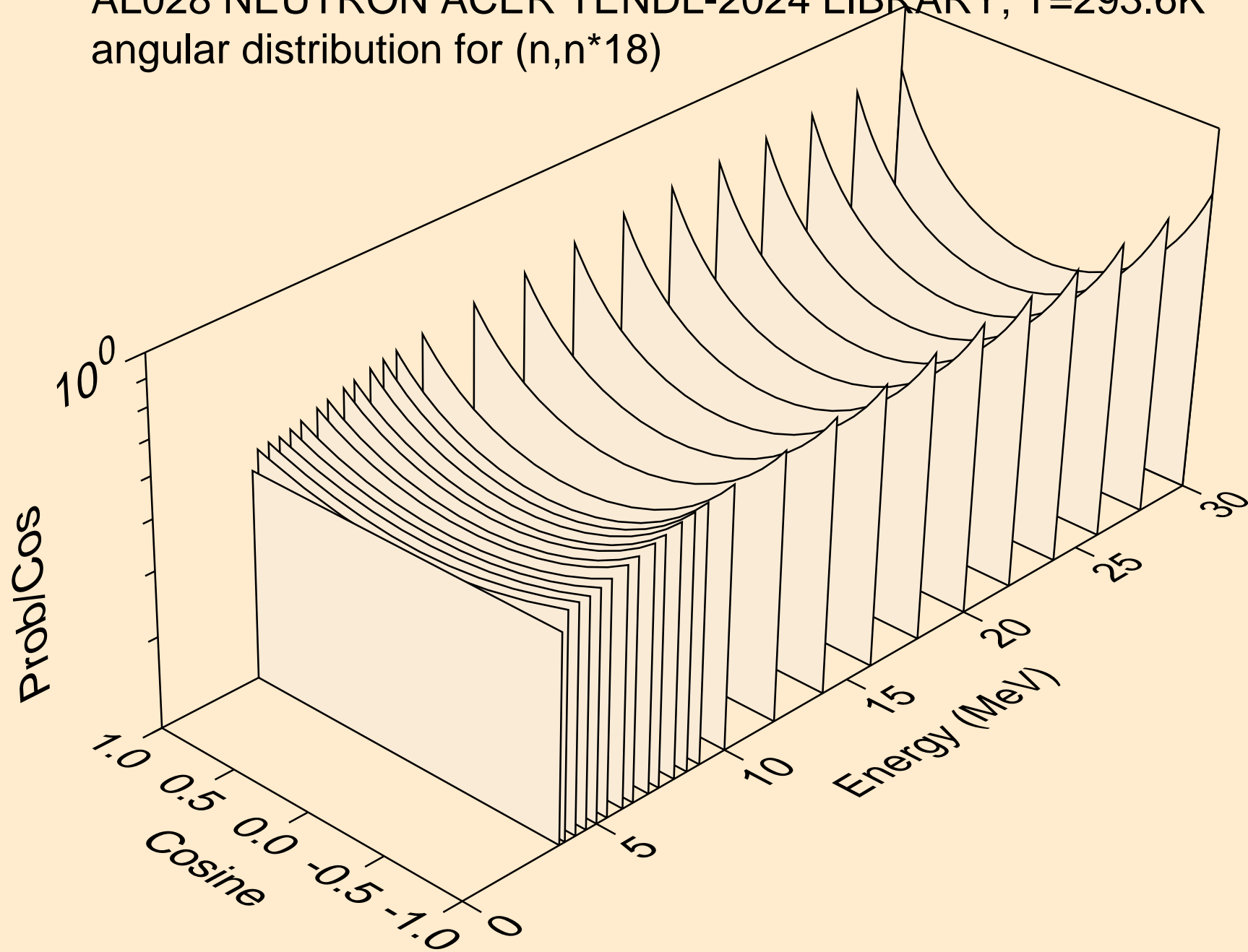

AL028 NEUTRON ACER TENDL-2024 LIBRARY; T=293.6K
angular distribution for (n,n*19)

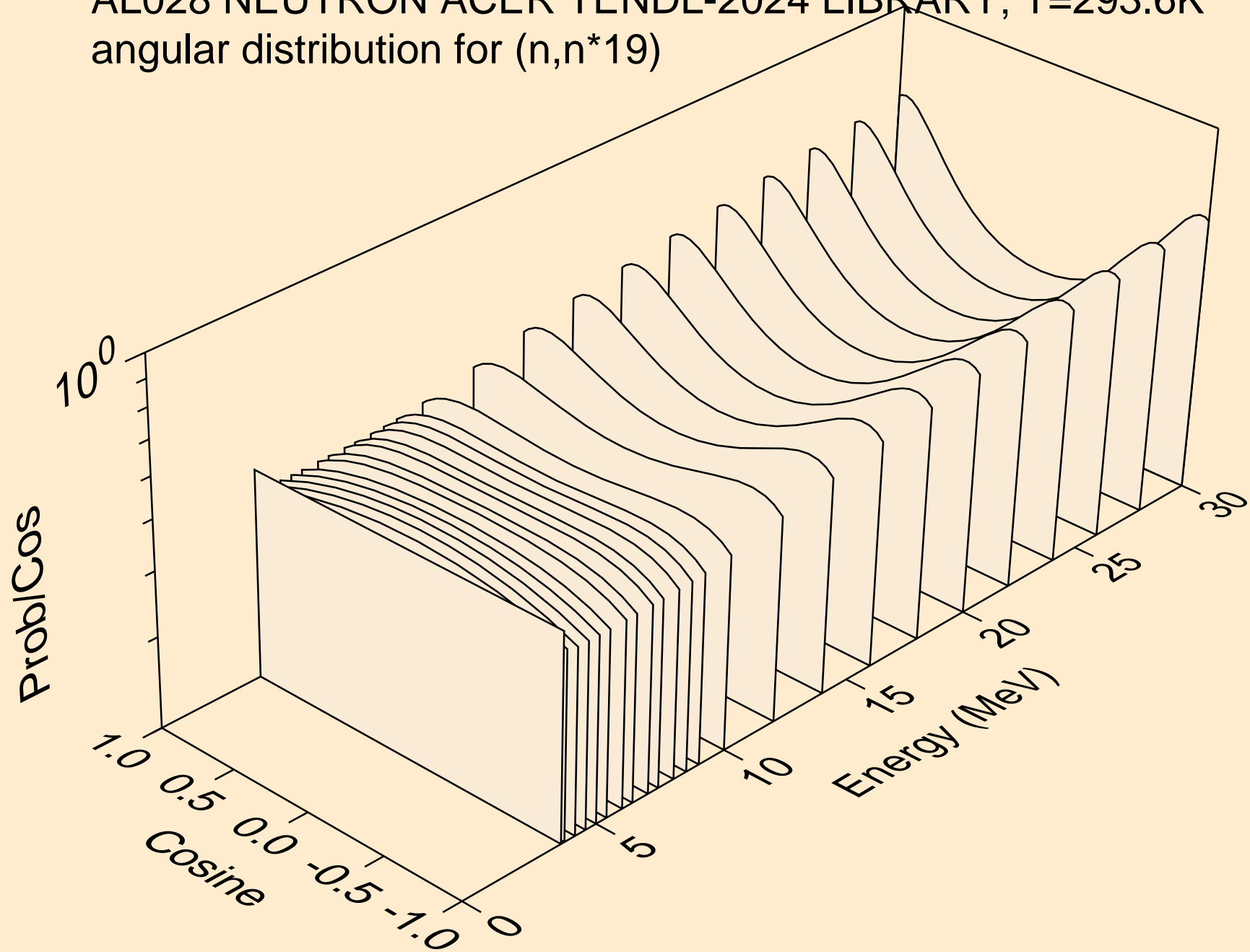

AL028 NEUTRON ACER TENDL-2024 LIBRARY; T=293.6K
angular distribution for (n,n*20)

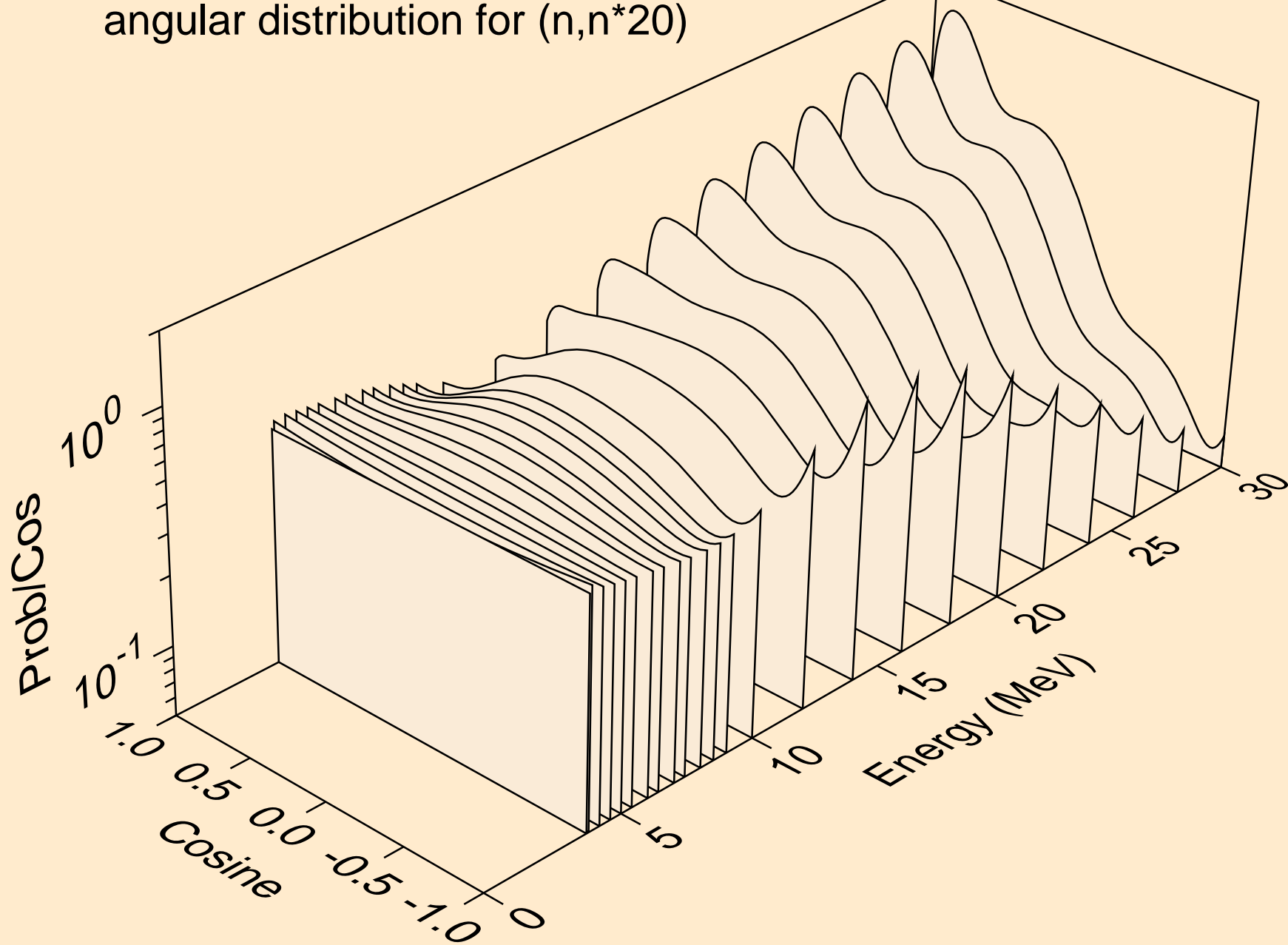

AL028 NEUTRON ACER TENDL-2024 LIBRARY; T=293.6K
angular distribution for (n,n*21)

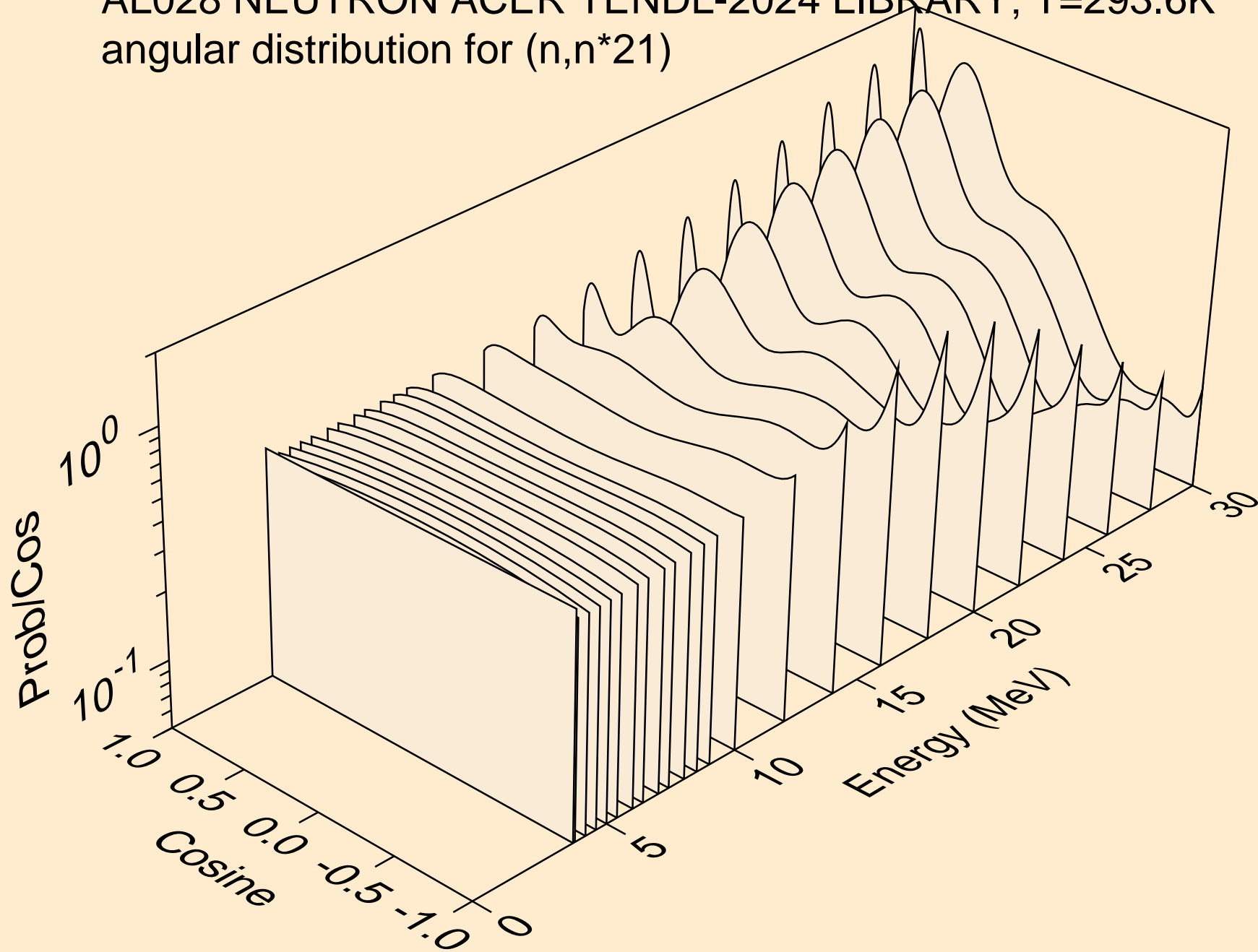

AL028 NEUTRON ACER TENDL-2024 LIBRARY; T=293.6K
angular distribution for (n,n*22)

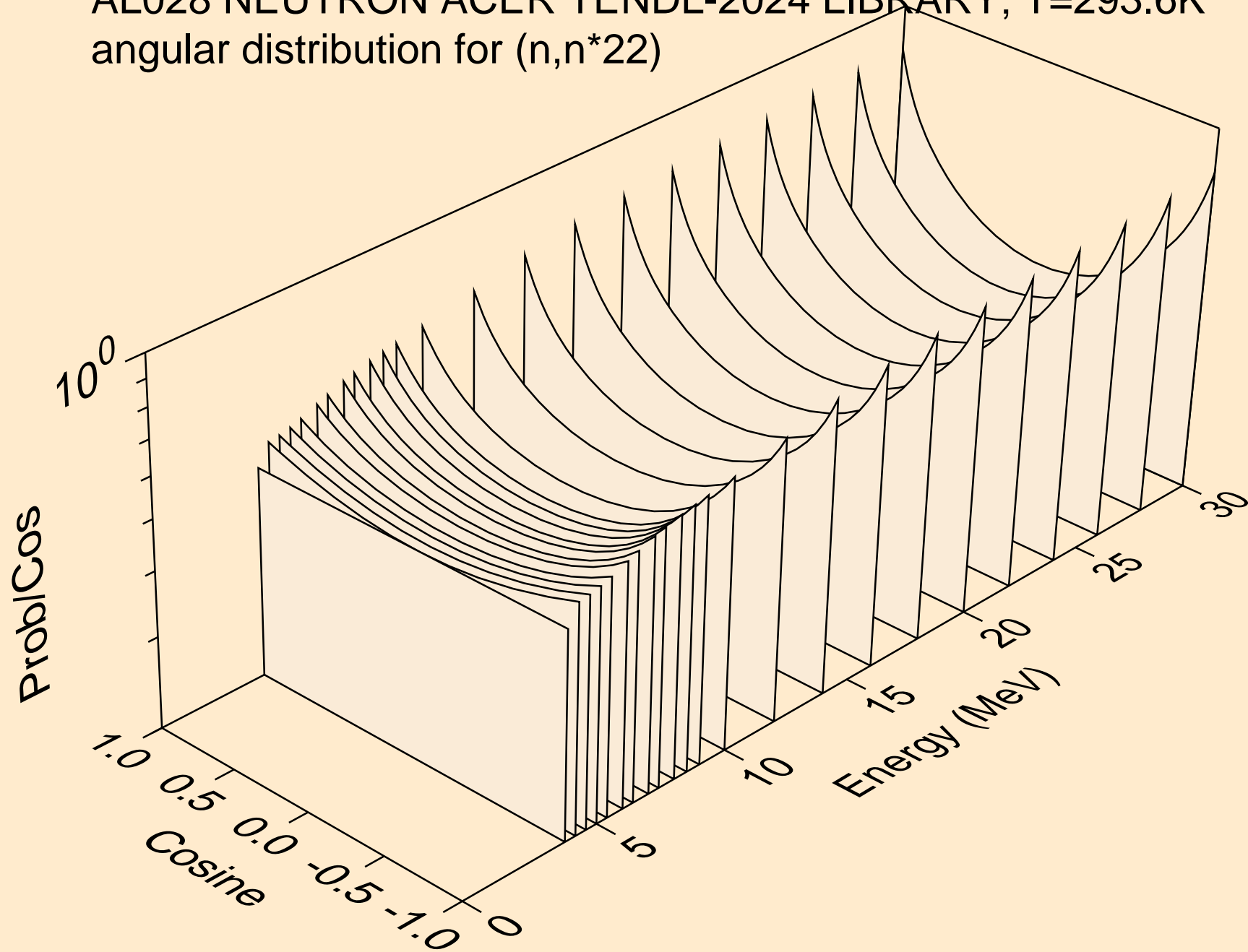

AL028 NEUTRON ACER TENDL-2024 LIBRARY; T=293.6K
angular distribution for (n,n*23)

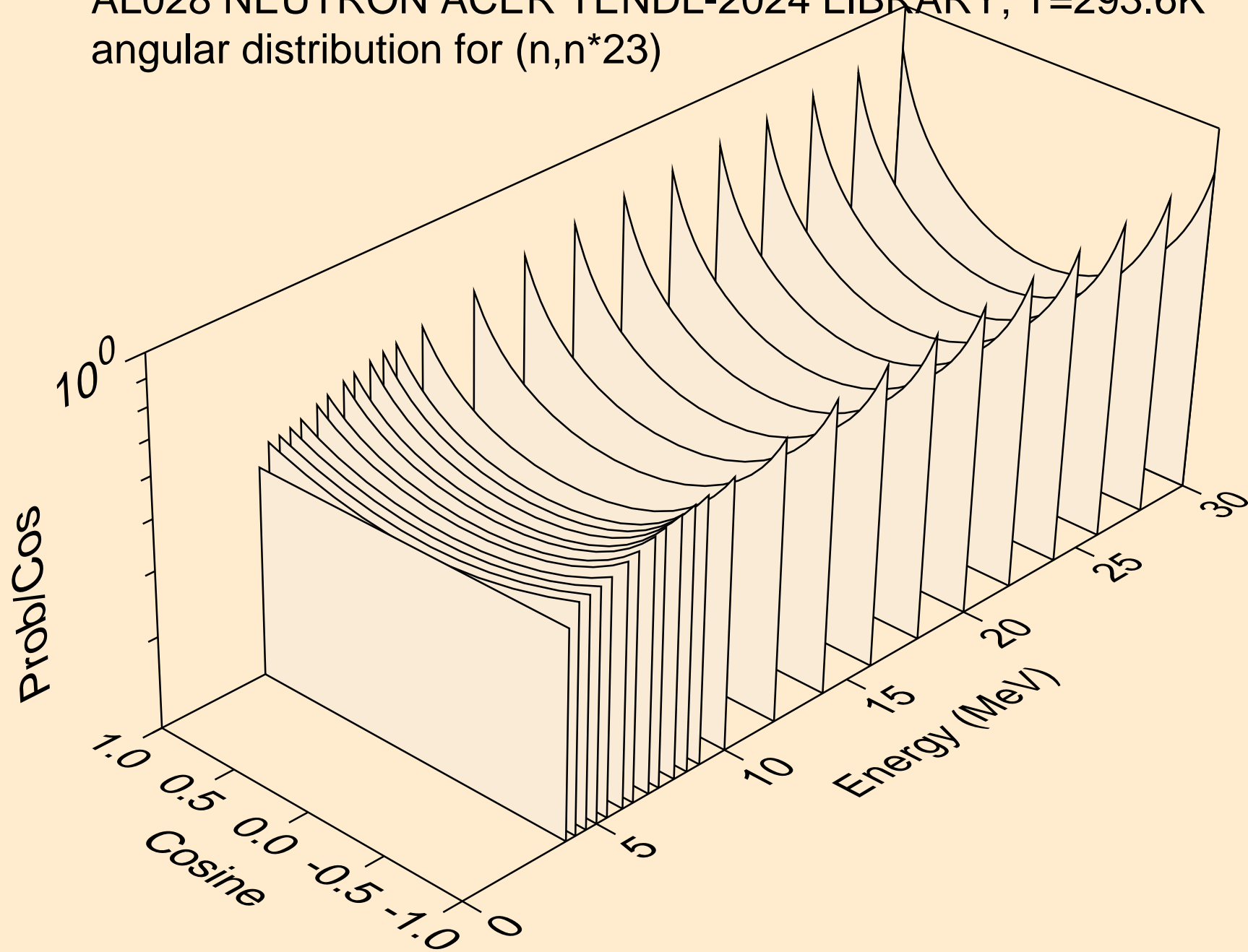

AL028 NEUTRON ACER TENDL-2024 LIBRARY; T=293.6K
angular distribution for (n,n*24)

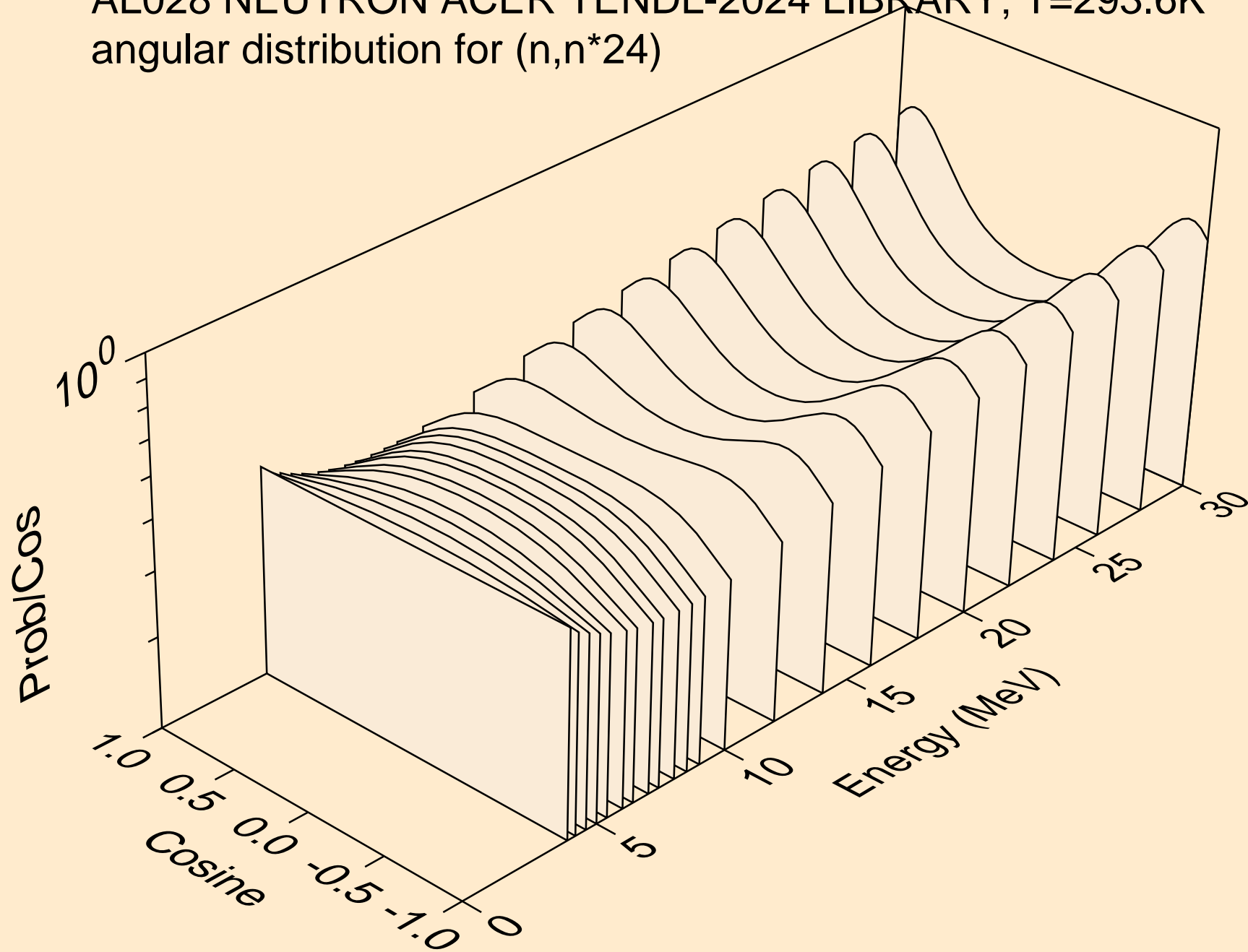

AL028 NEUTRON ACER TENDL-2024 LIBRARY; T=293.6K
angular distribution for (n,n*25)

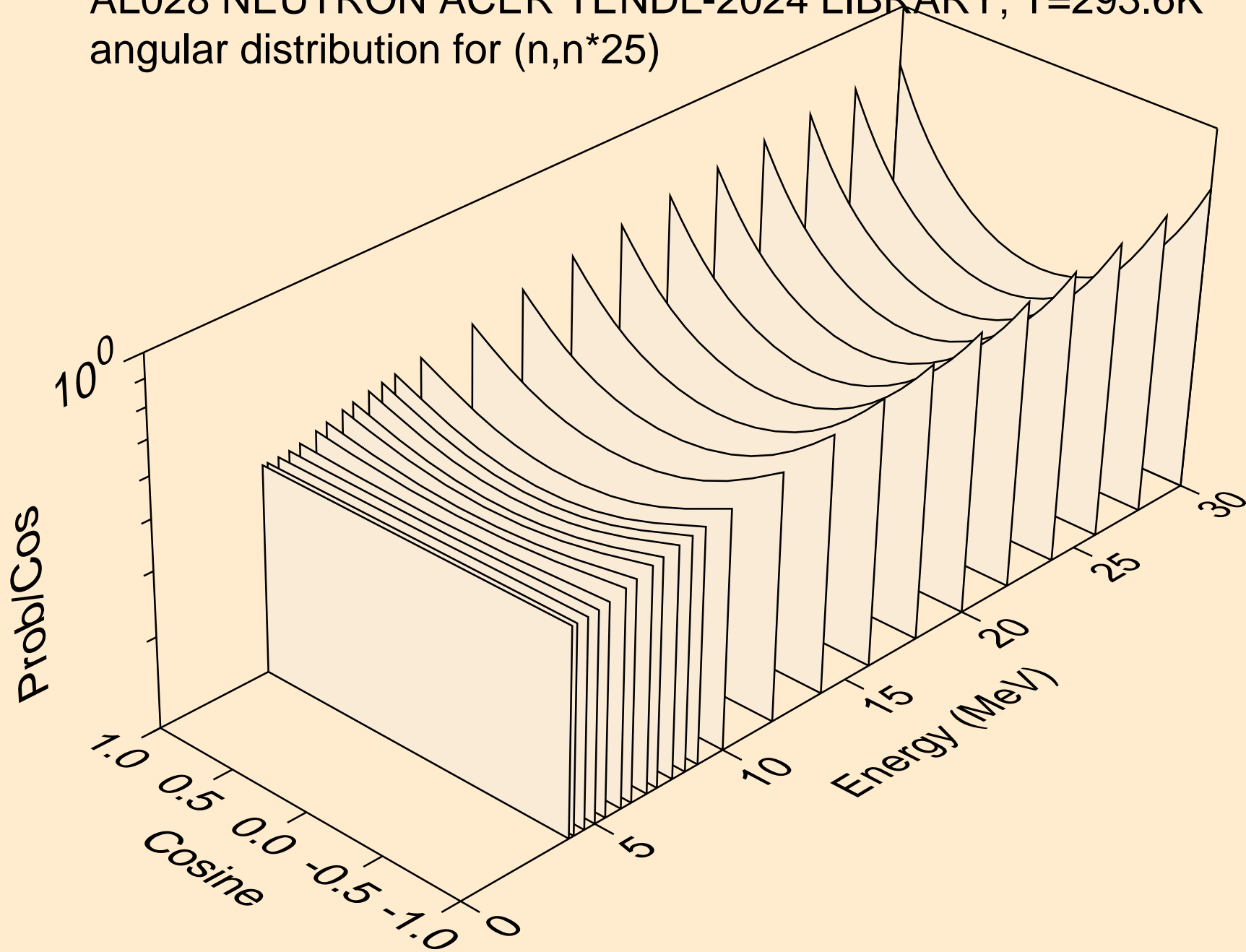

AL028 NEUTRON ACER TENDL-2024 LIBRARY; T=293.6K
angular distribution for (n,n*26)

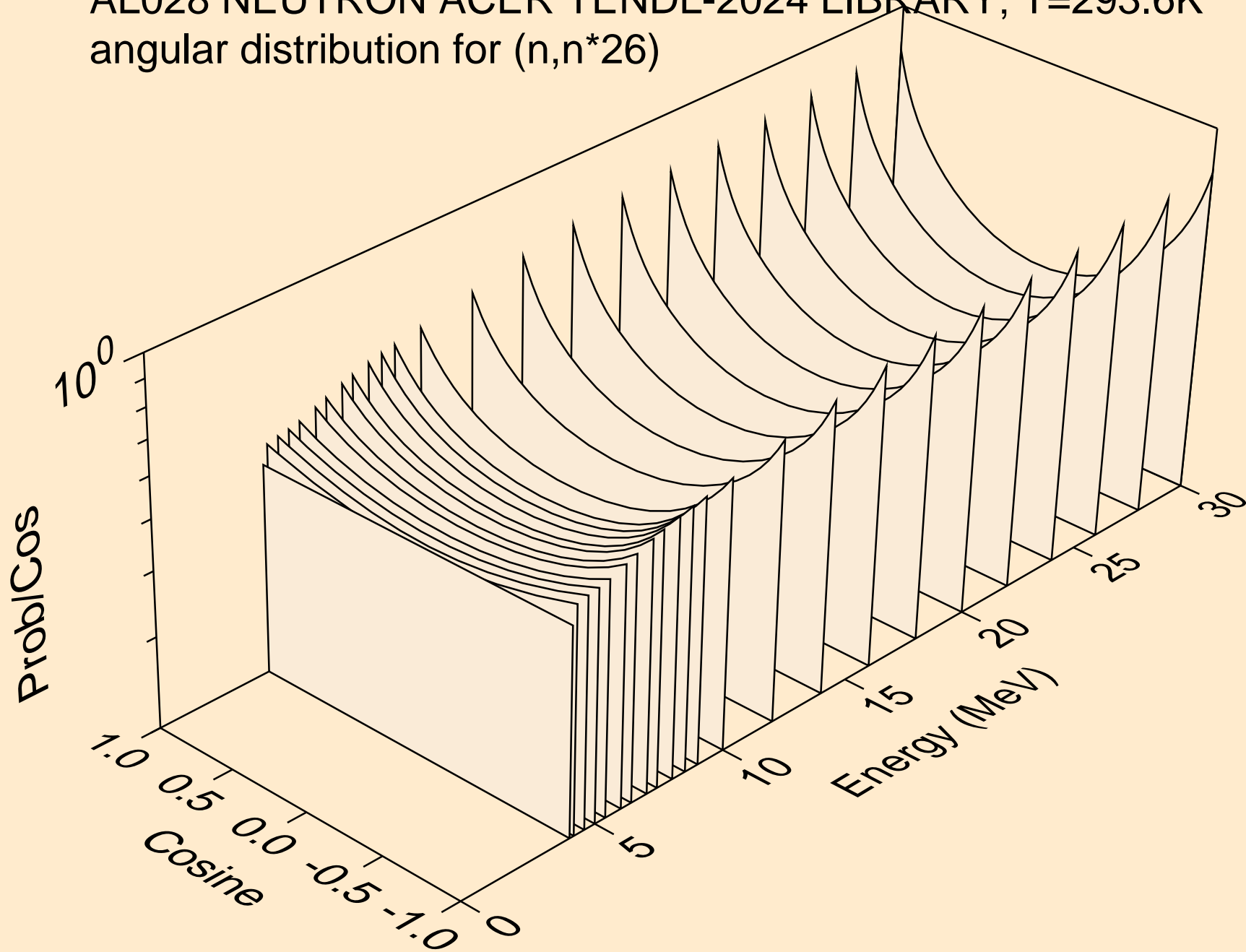

AL028 NEUTRON ACER TENDL-2024 LIBRARY; T=293.6K
angular distribution for (n,n*27)

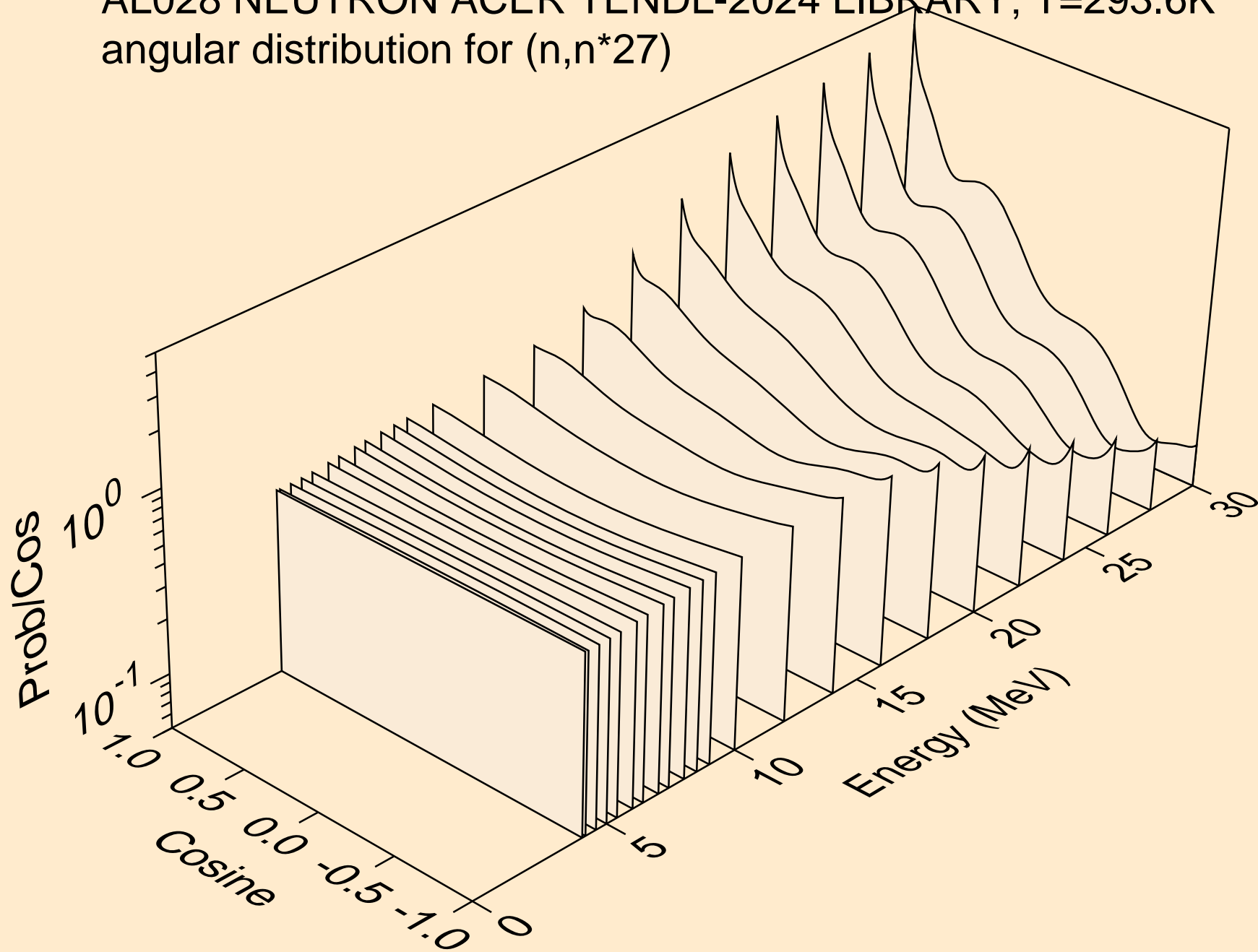

AL028 NEUTRON ACER TENDL-2024 LIBRARY; T=293.6K
angular distribution for (n,n*28)

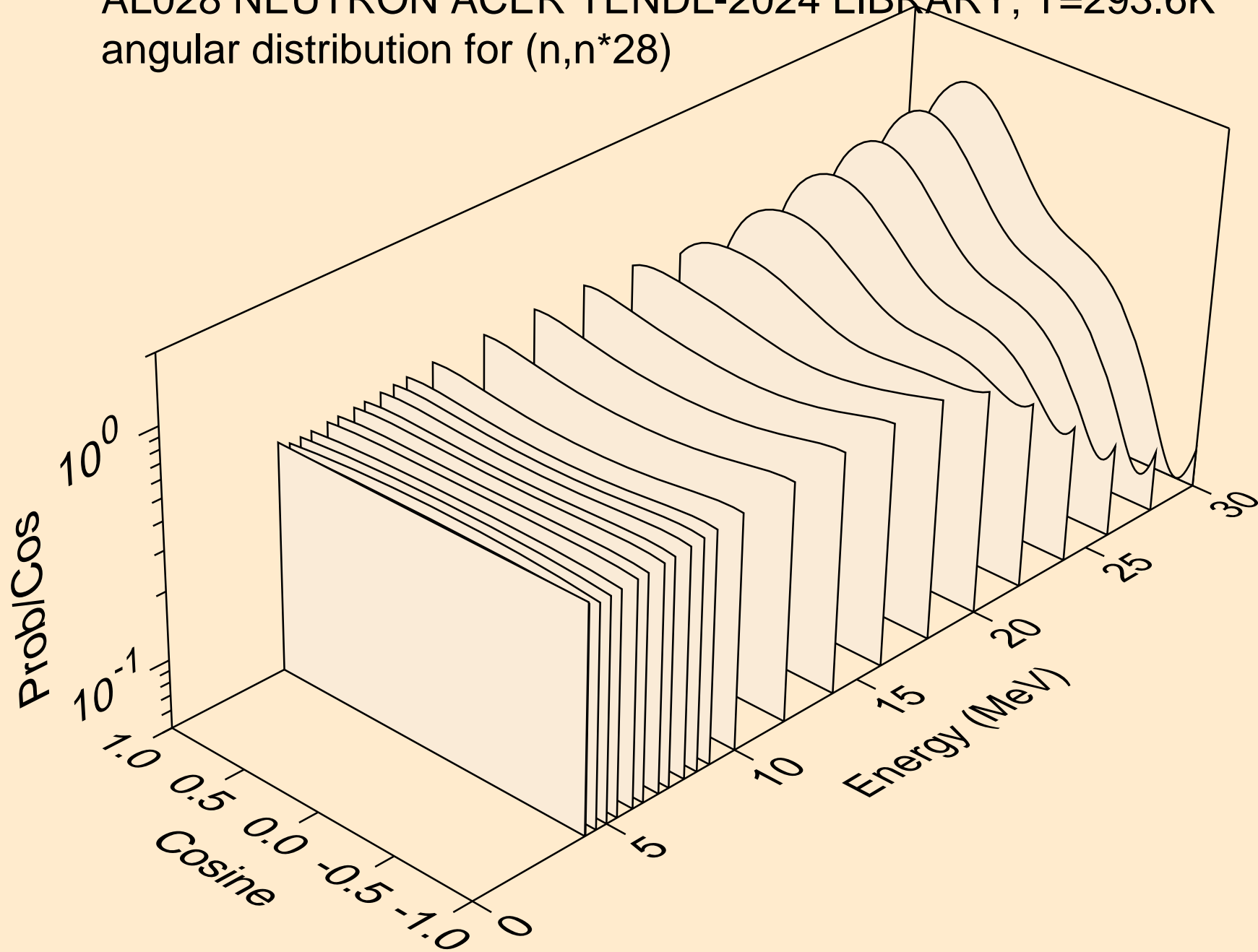

AL028 NEUTRON ACER TENDL-2024 LIBRARY; T=293.6K
angular distribution for (n,n*29)

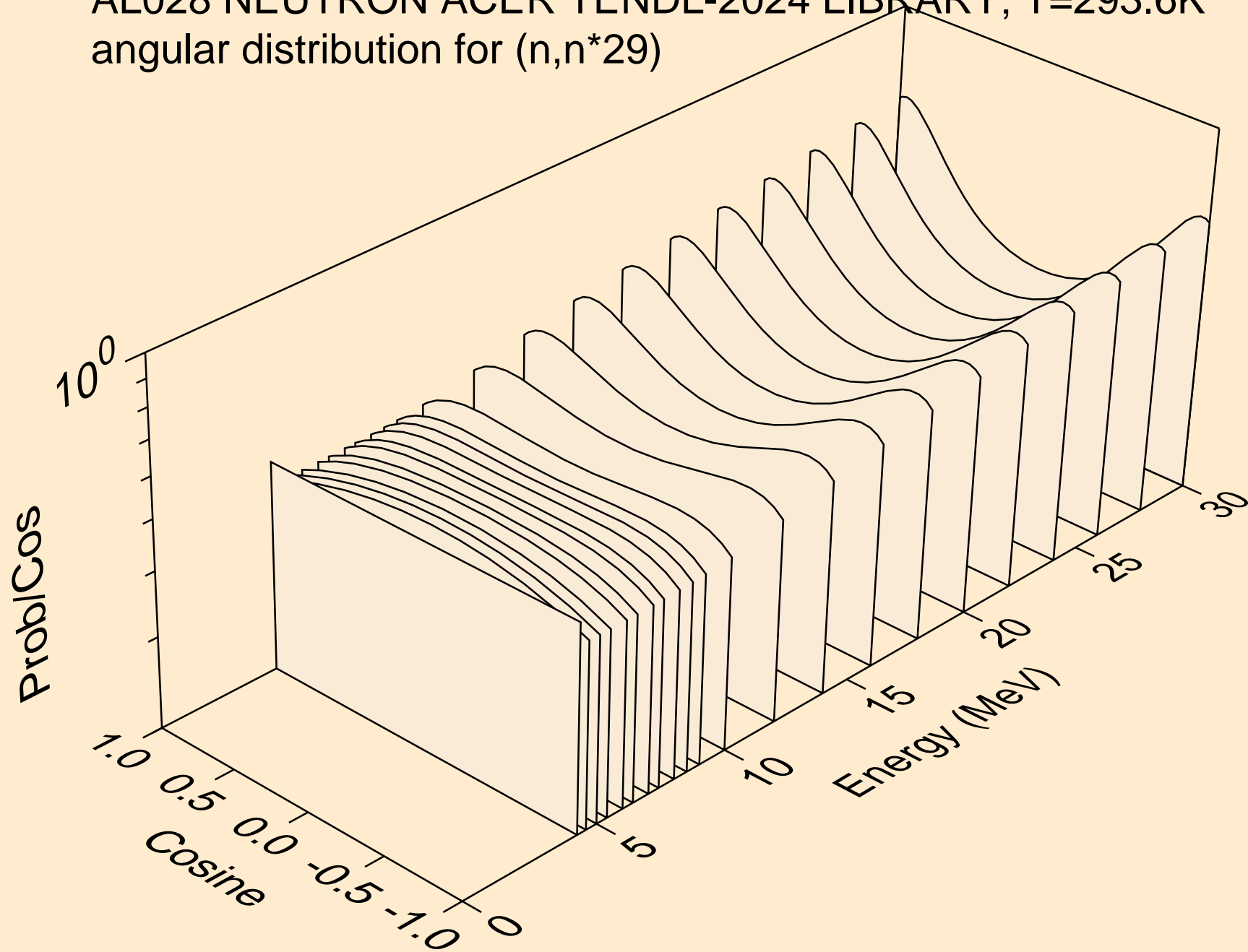

AL028 NEUTRON ACER TENDL-2024 LIBRARY; T=293.6K
angular distribution for (n,n*30)

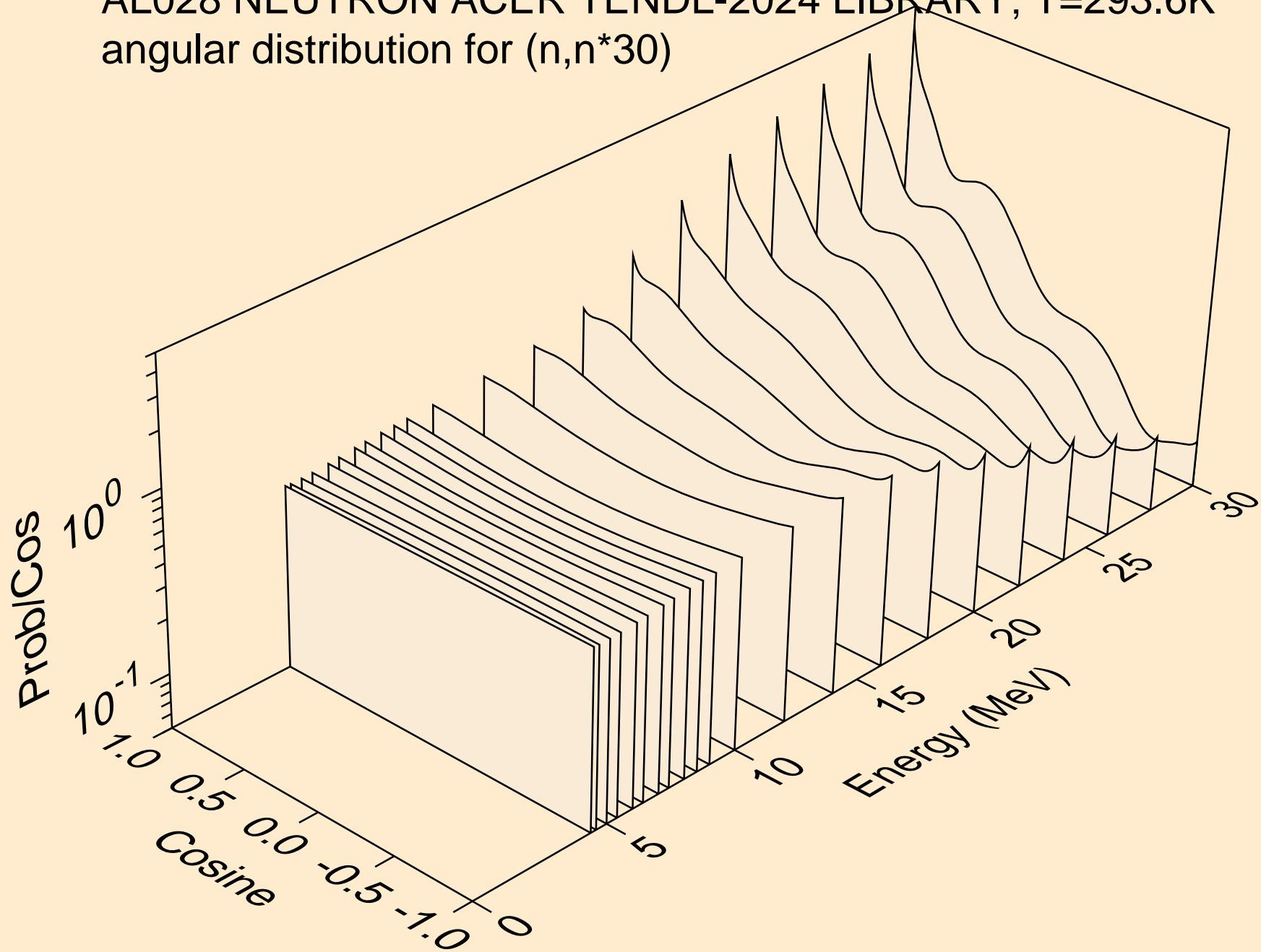

AL028 NEUTRON ACER TENDL-2024 LIBRARY; T=293.6K
Neutron emission for (n,x)

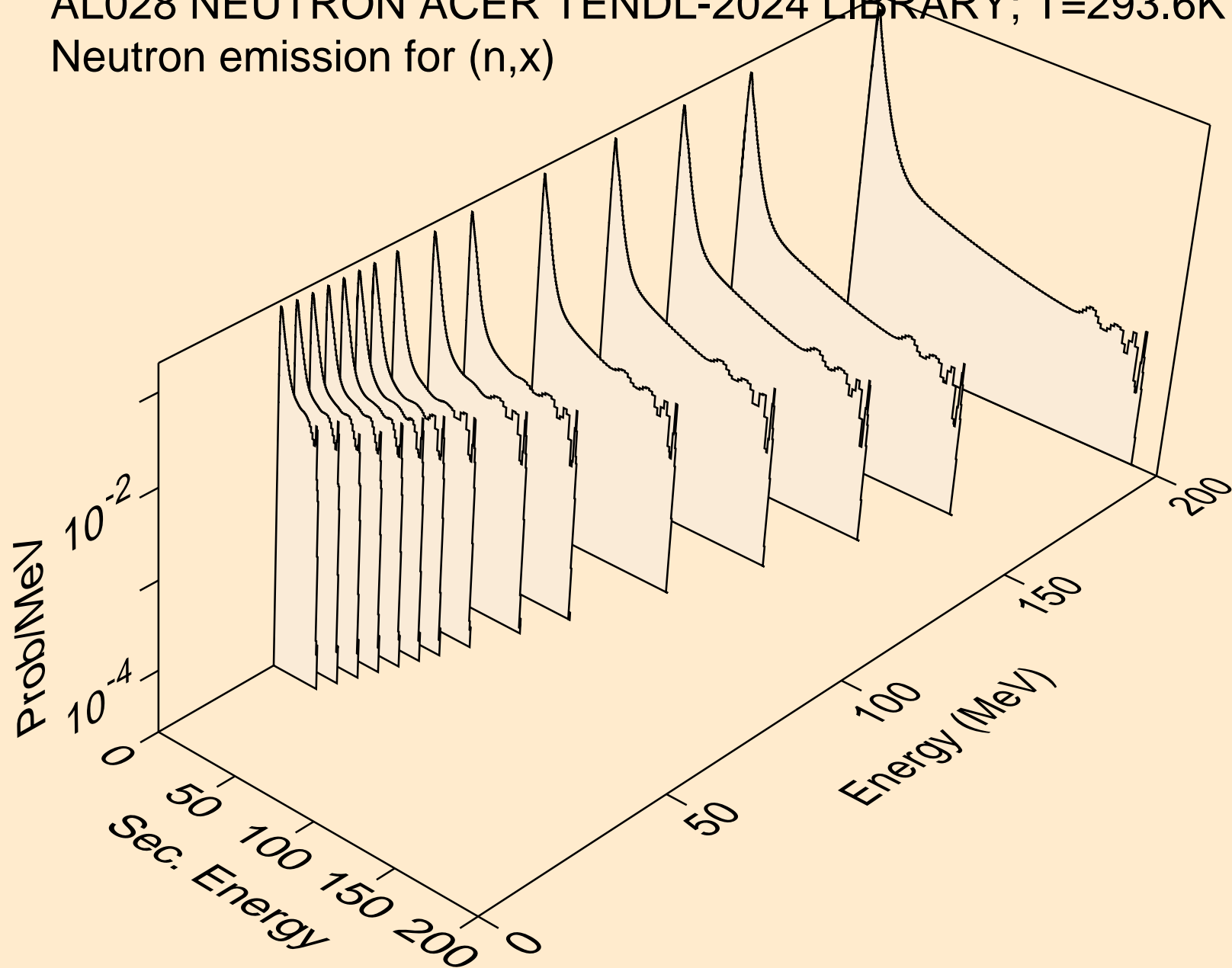

AL028 NEUTRON ACER TENDL-2024 LIBRARY; T=293.6K
Neutron emission for (n,2nd)

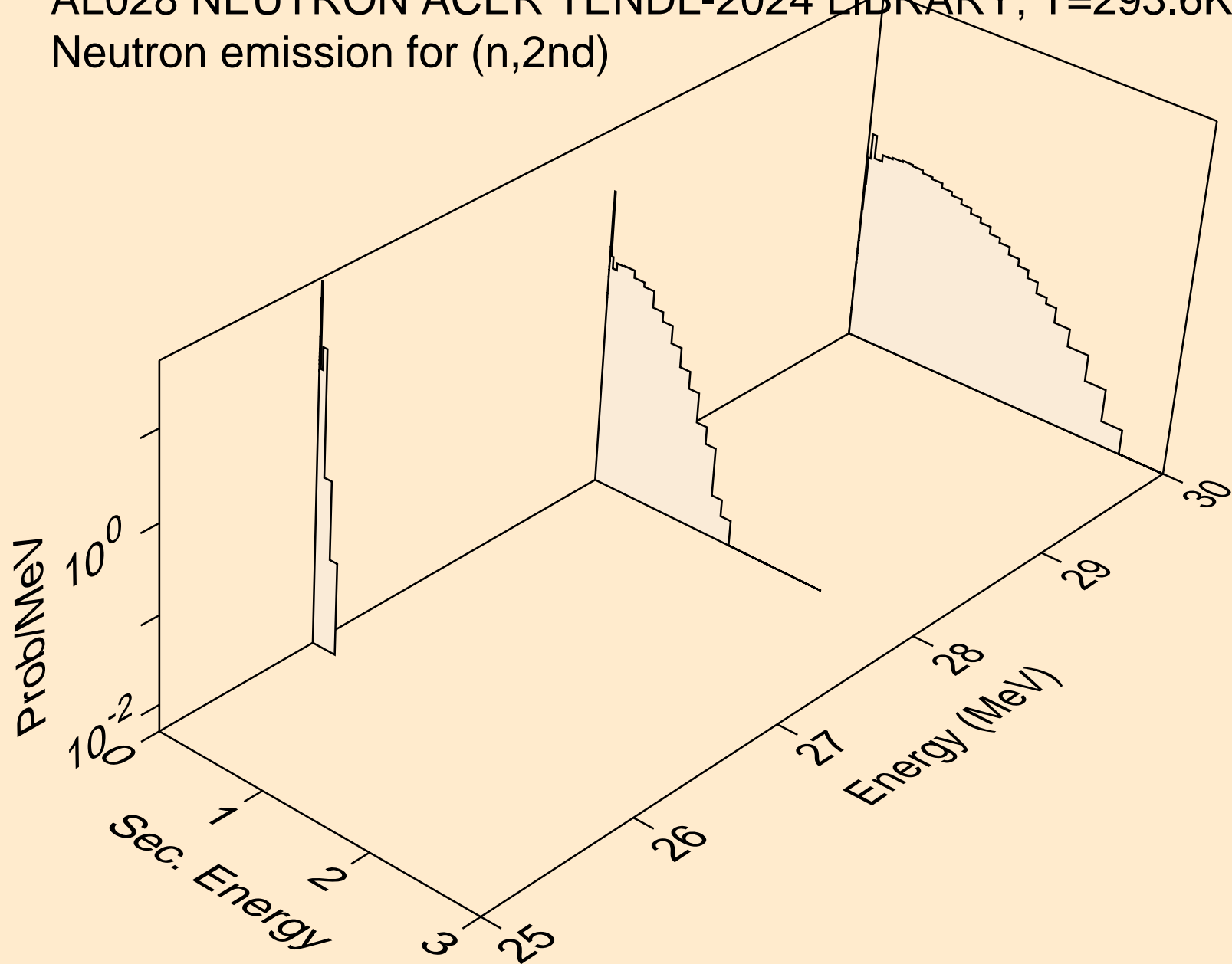

AL028 NEUTRON ACER TENDL-2024 LIBRARY; T=293.6K
Neutron emission for (n,2n)

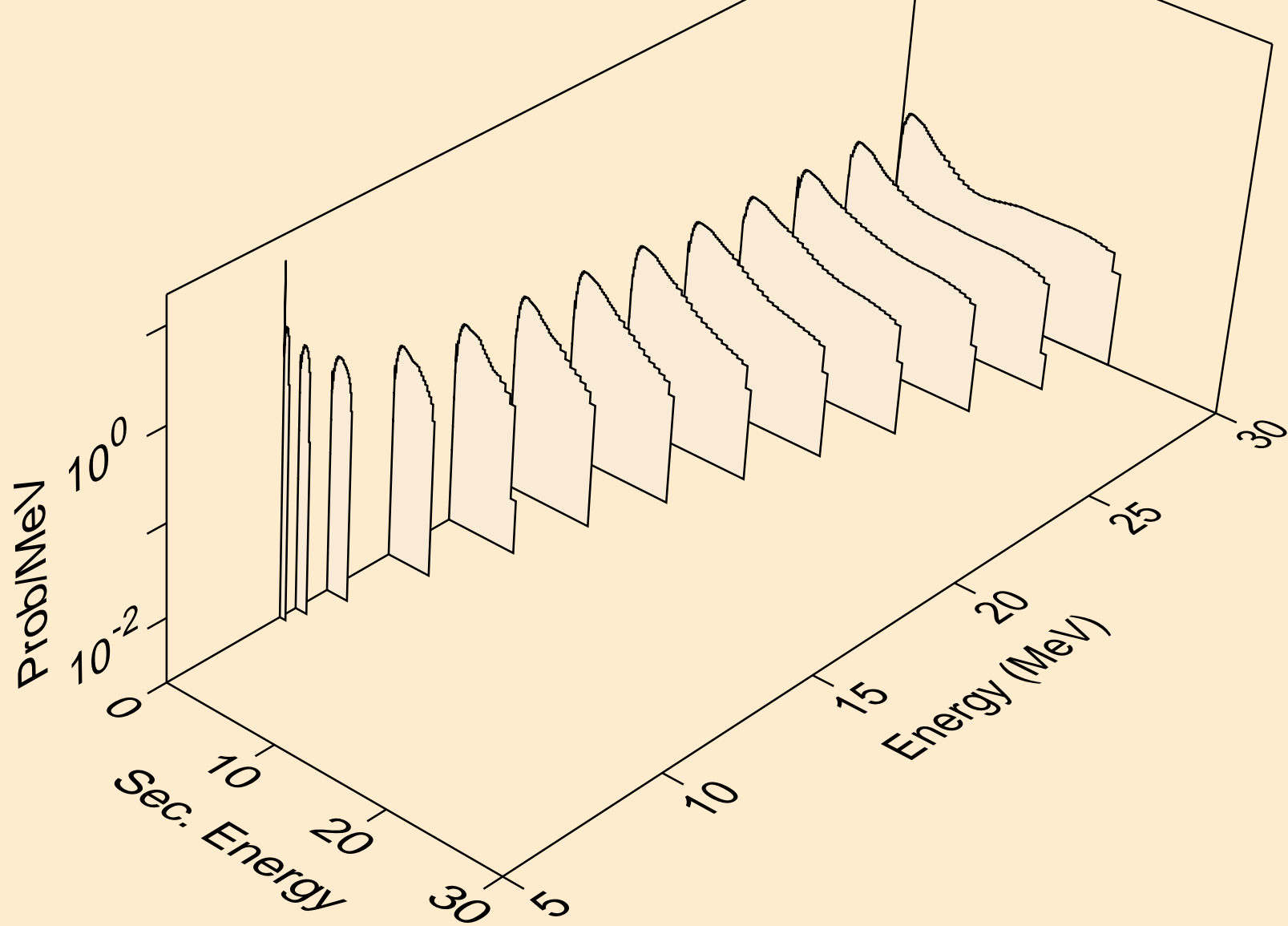

AL028 NEUTRON ACER TENDL-2024 LIBRARY; T=293.6K
Neutron emission for (n,3n)

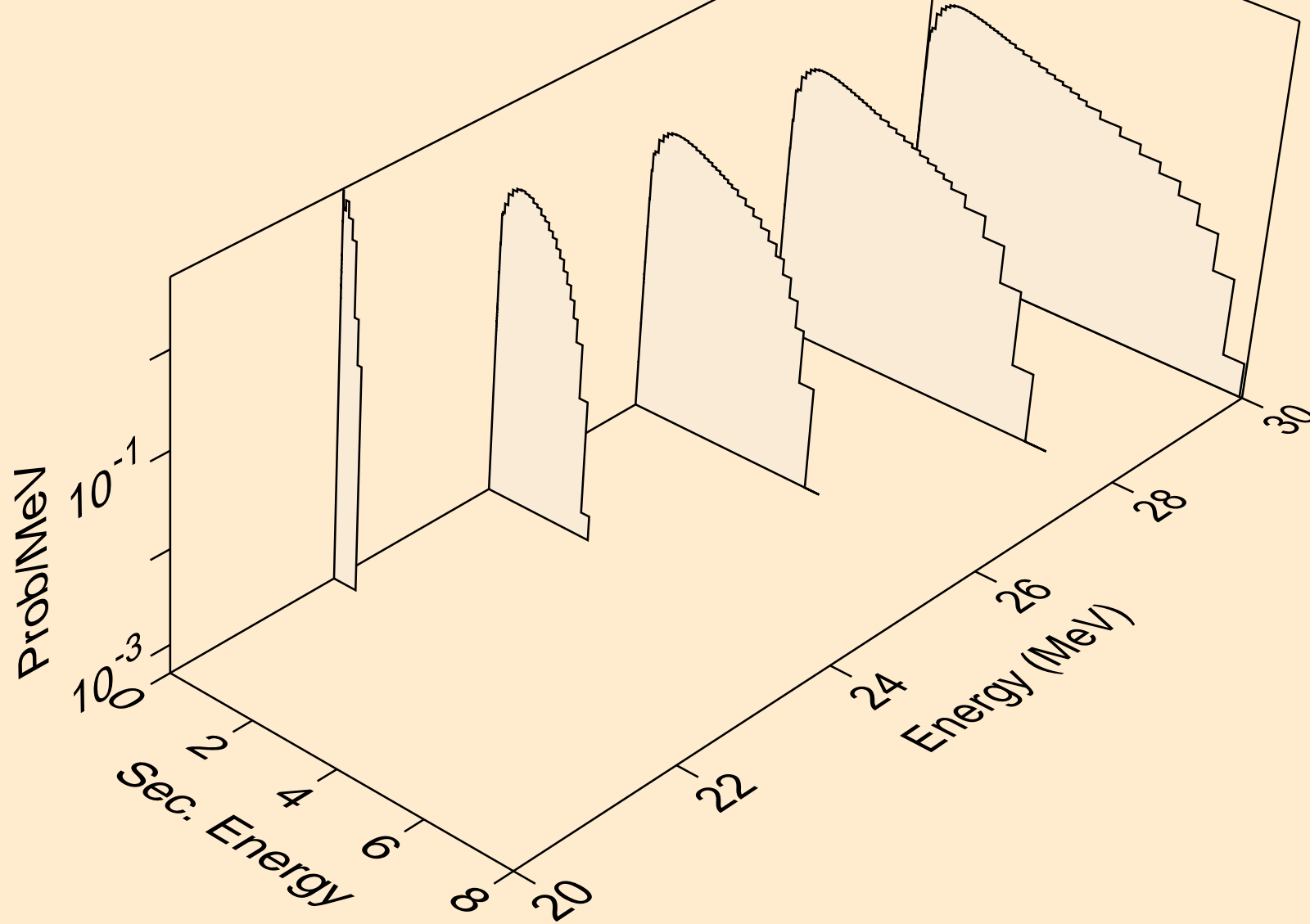

AL028 NEUTRON ACER TENDL-2024 LIBRARY; T=293.6K
Neutron emission for (n,n*)a

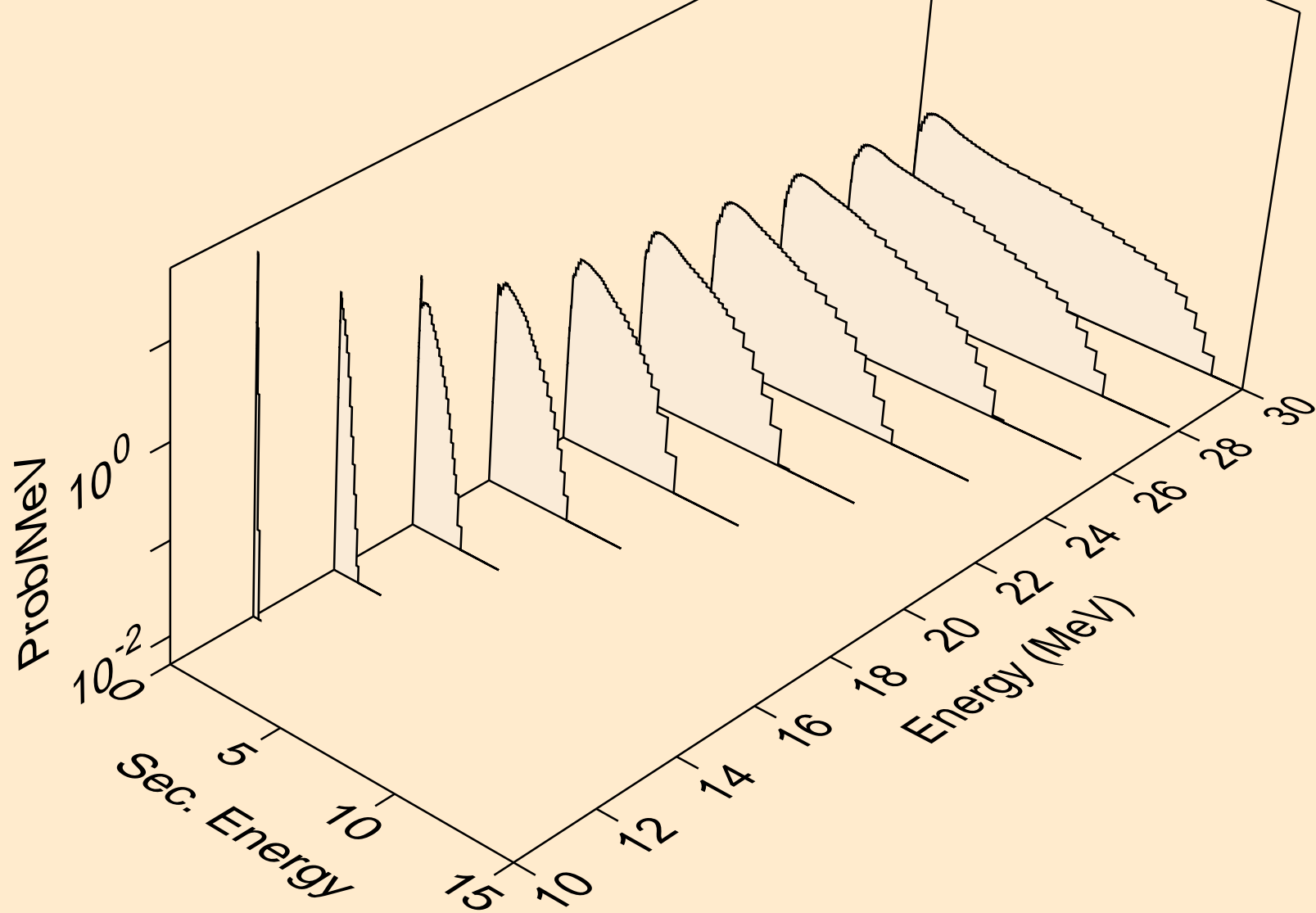

AL028 NEUTRON ACER TENDL-2024 LIBRARY; T=293.6K
Neutron emission for (n,2n)a

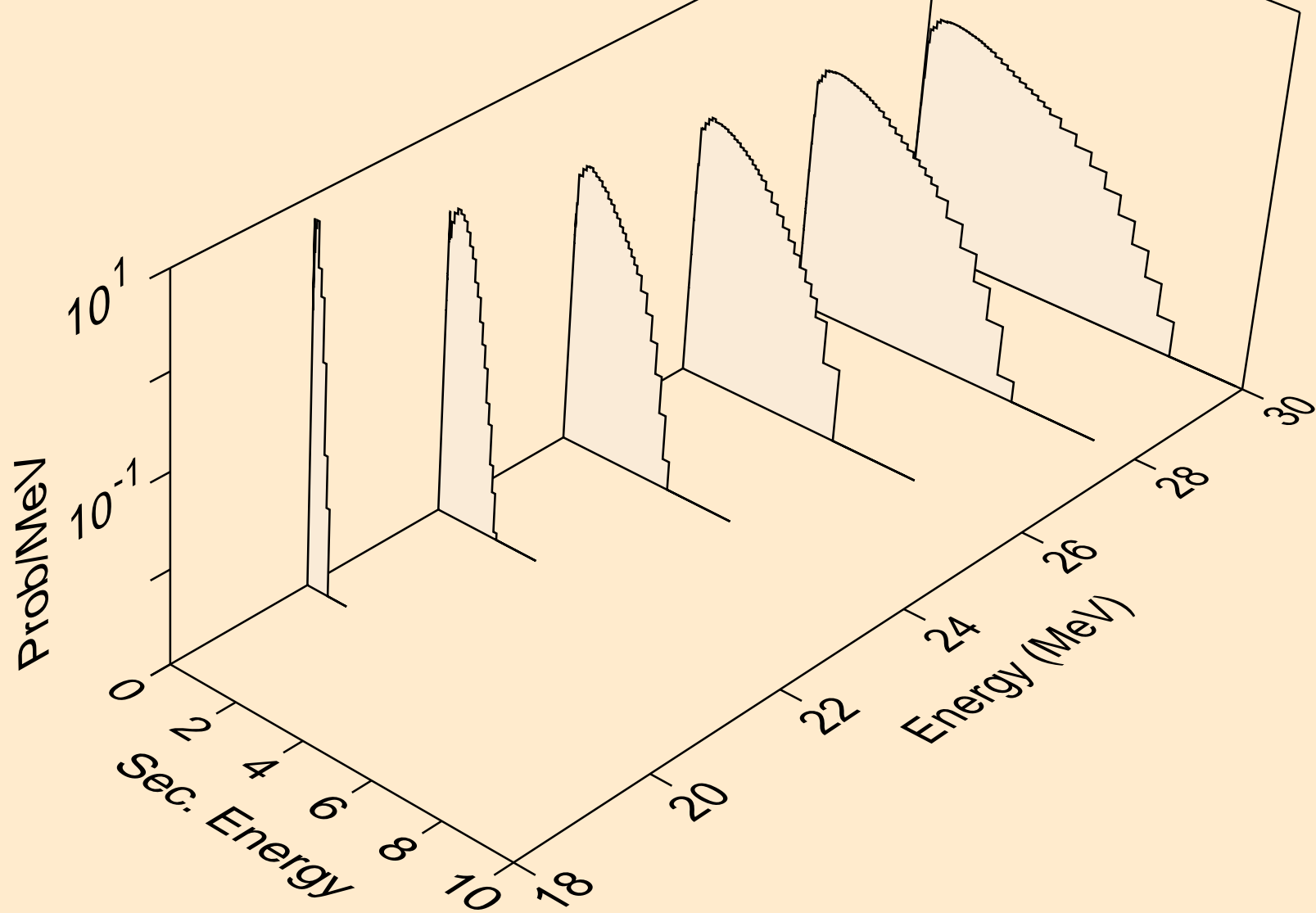

AL028 NEUTRON ACER TENDL-2024 LIBRARY; T=293.6K
Neutron emission for (n,n*)p

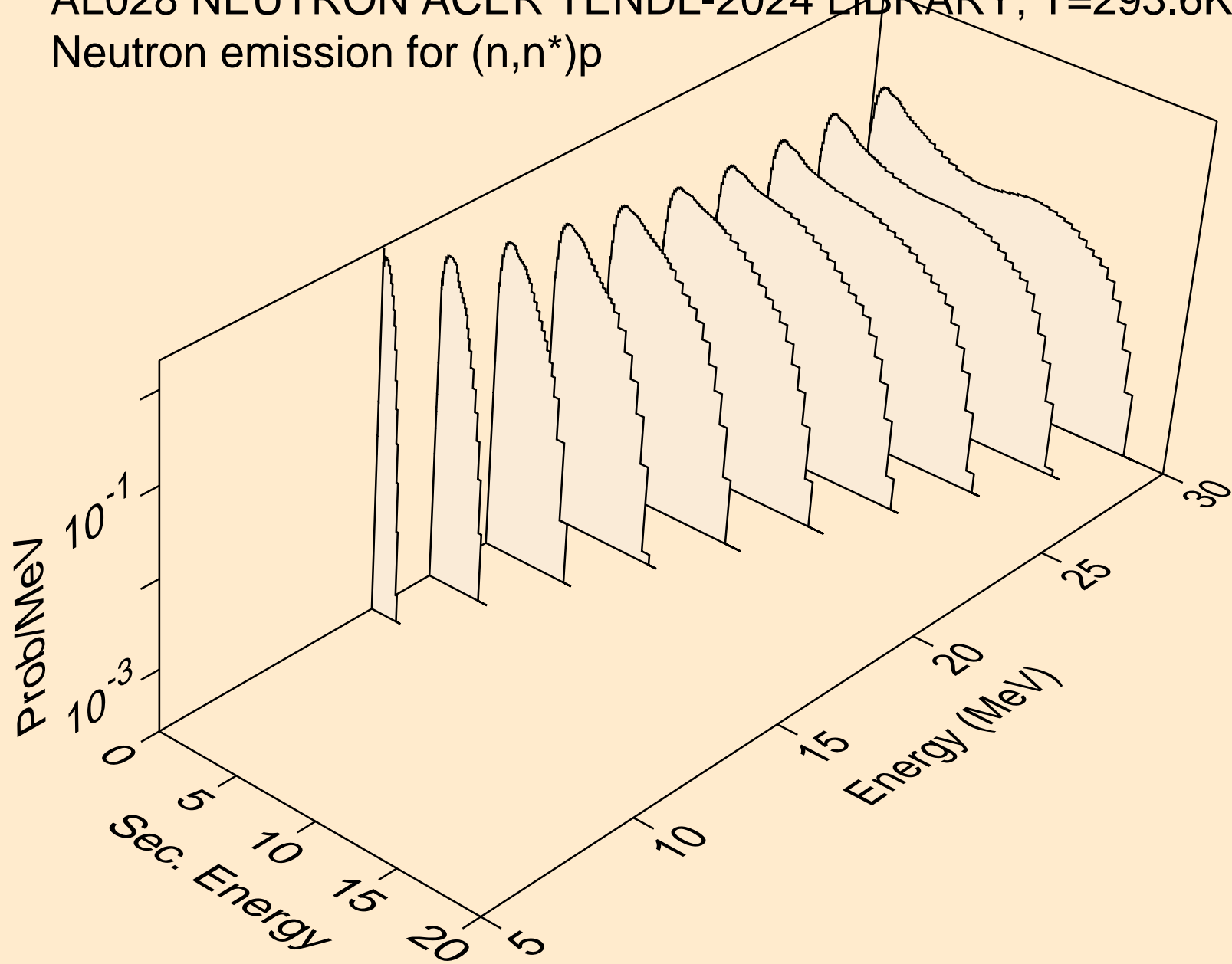

AL028 NEUTRON ACER TENDL-2024 LIBRARY; T=293.6K
Neutron emission for (n,n*)2a

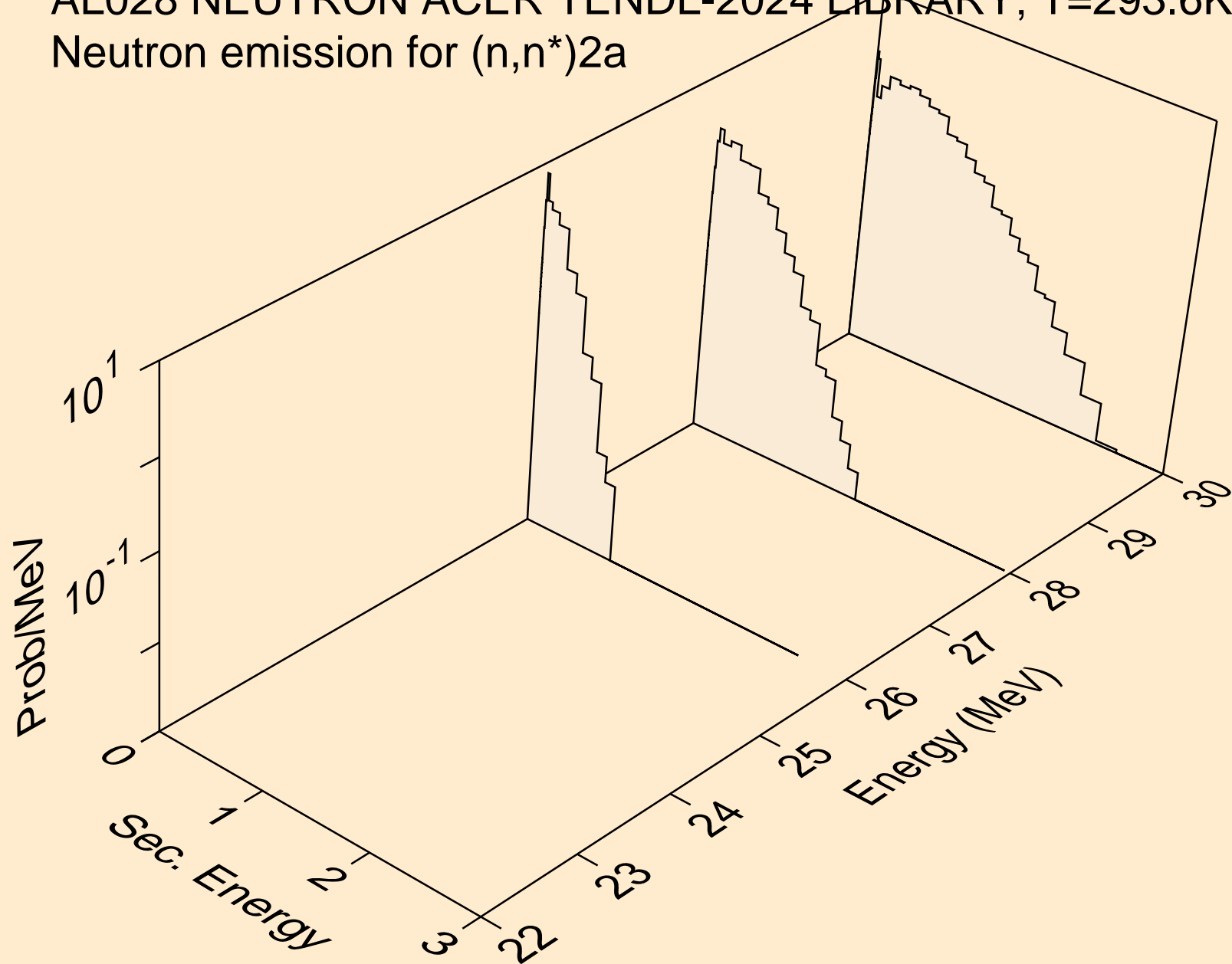

AL028 NEUTRON ACER TENDL-2024 LIBRARY; T=293.6K
Neutron emission for (n,n*)d

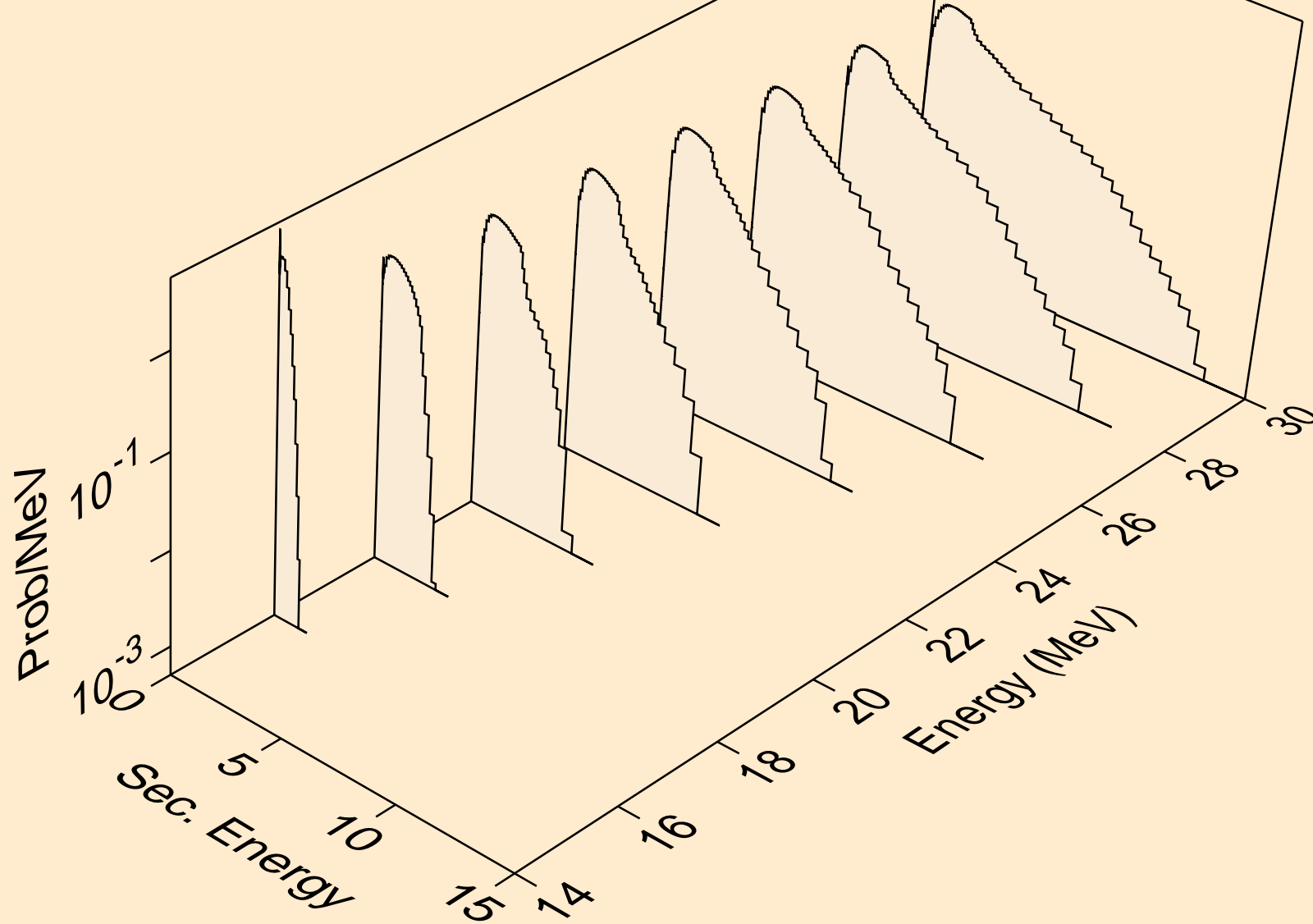

AL028 NEUTRON ACER TENDL-2024 LIBRARY; T=293.6K
Neutron emission for (n,n*)t

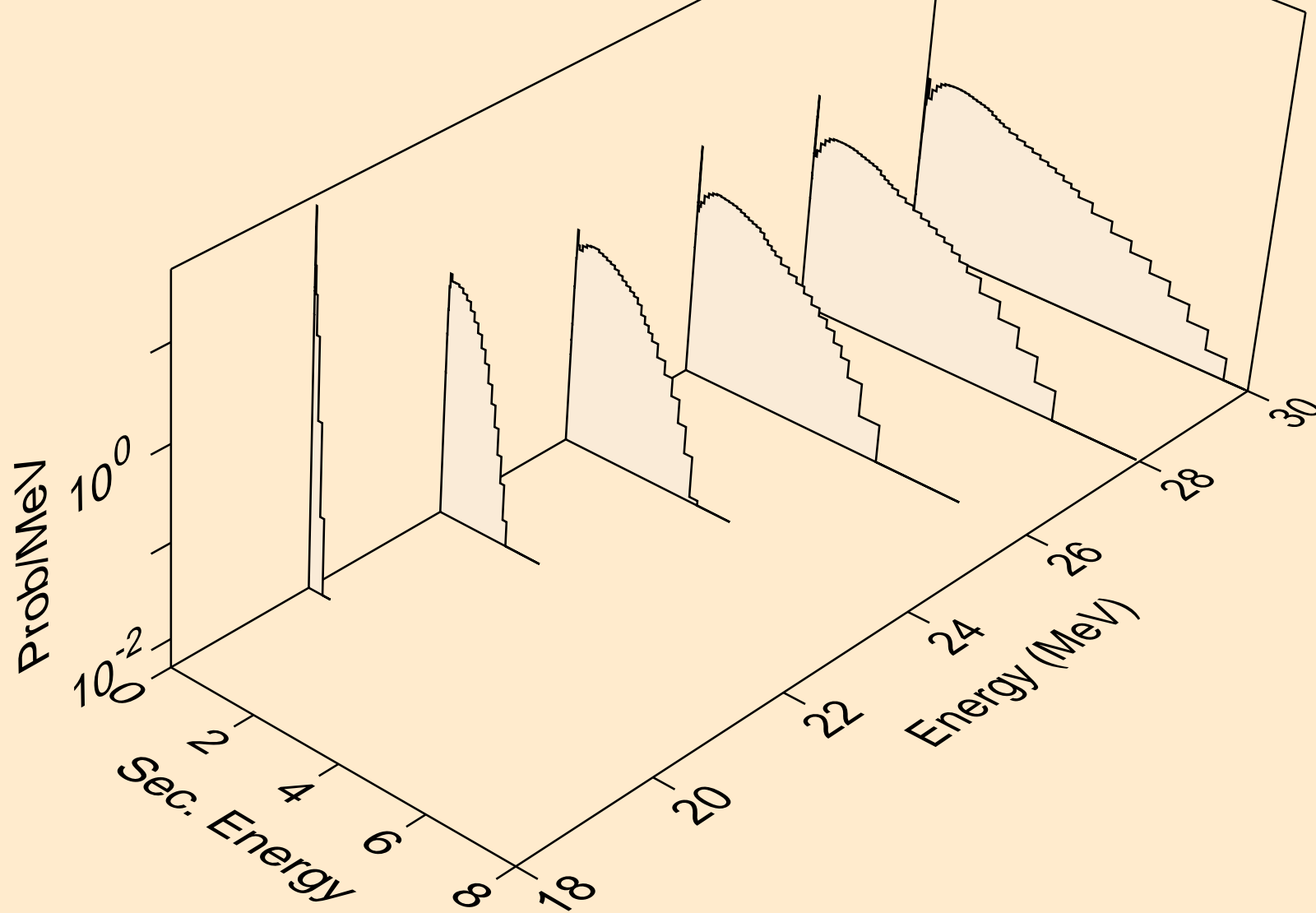

AL028 NEUTRON ACER TENDL-2024 LIBRARY; T=293.6K
Neutron emission for (n,n*)he3

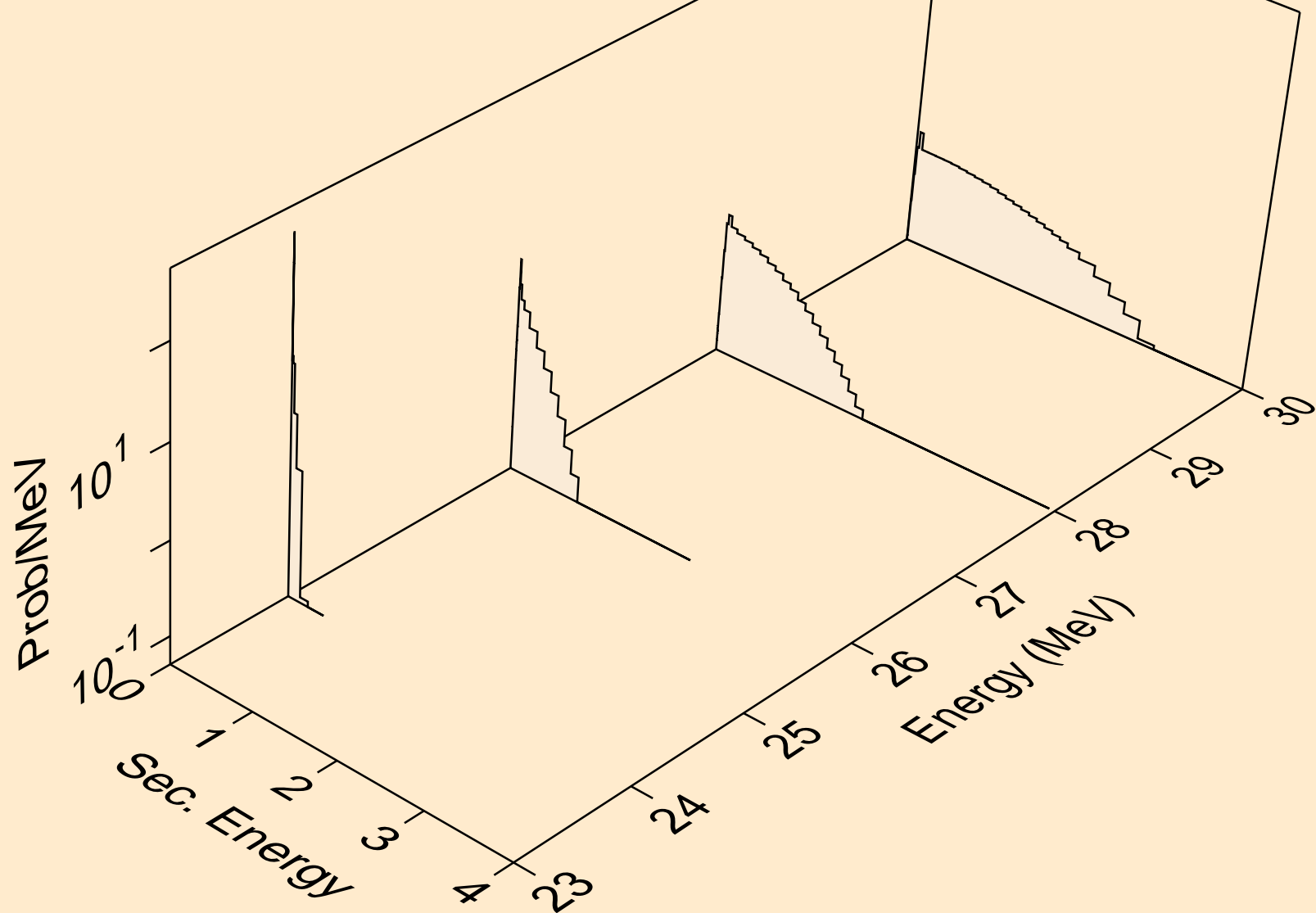

AL028 NEUTRON ACER TENDL-2024 LIBRARY; T=293.6K
Neutron emission for (n,2np)

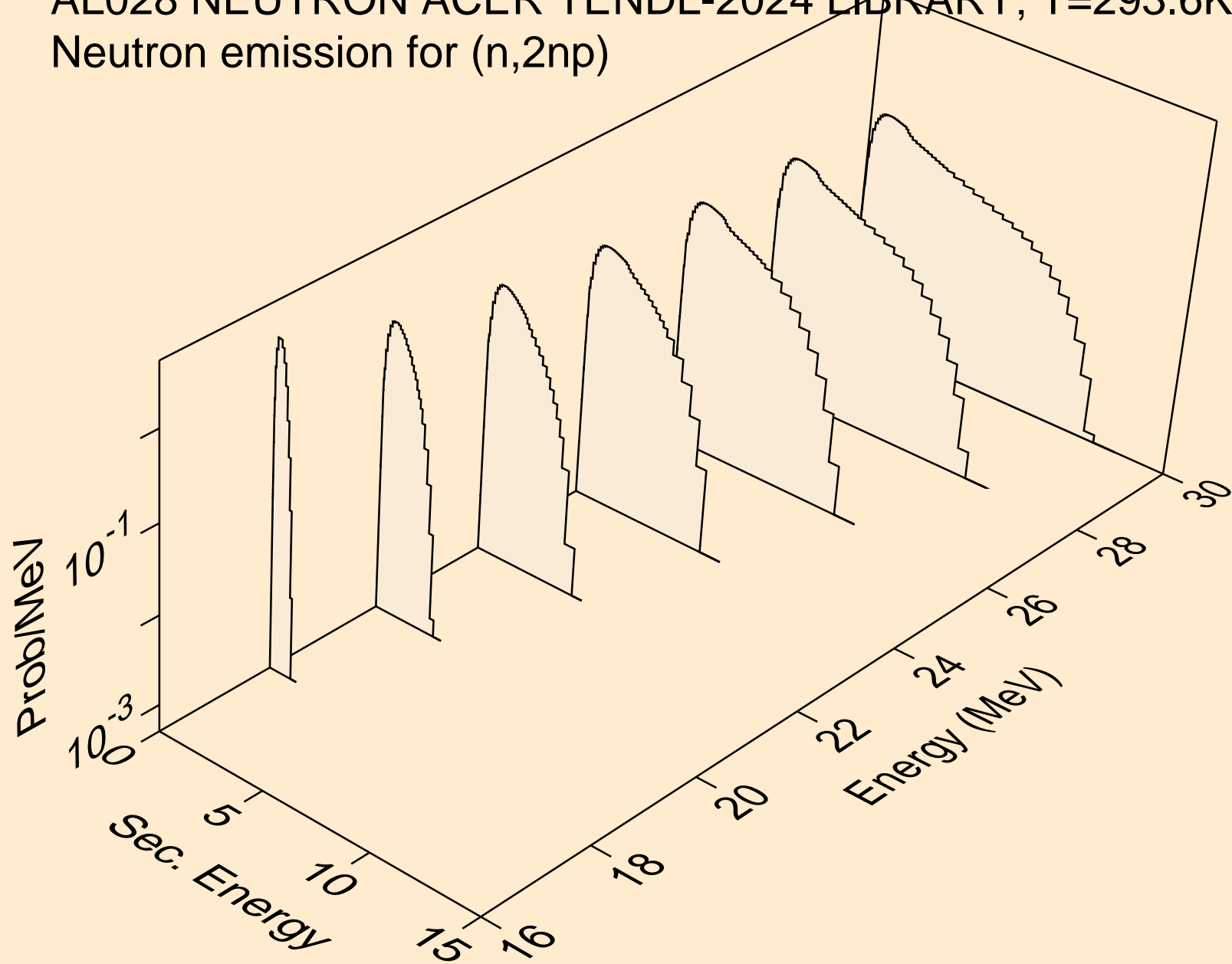

AL028 NEUTRON ACER TENDL-2024 LIBRARY; T=293.6K
Neutron emission for (n,3np)

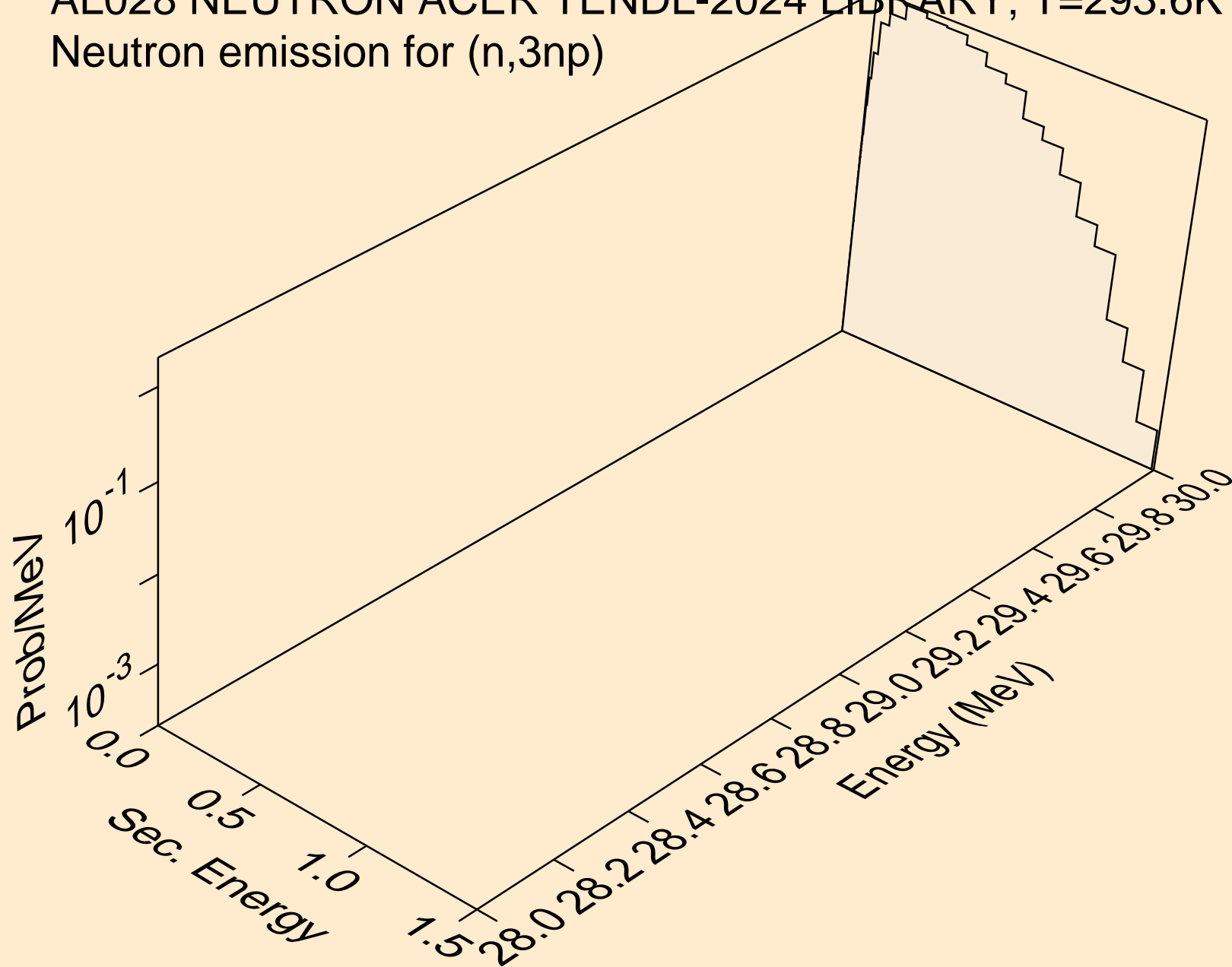

AL028 NEUTRON ACER TENDL-2024 LIBRARY; T=293.6K
Neutron emission for (n,n2p)

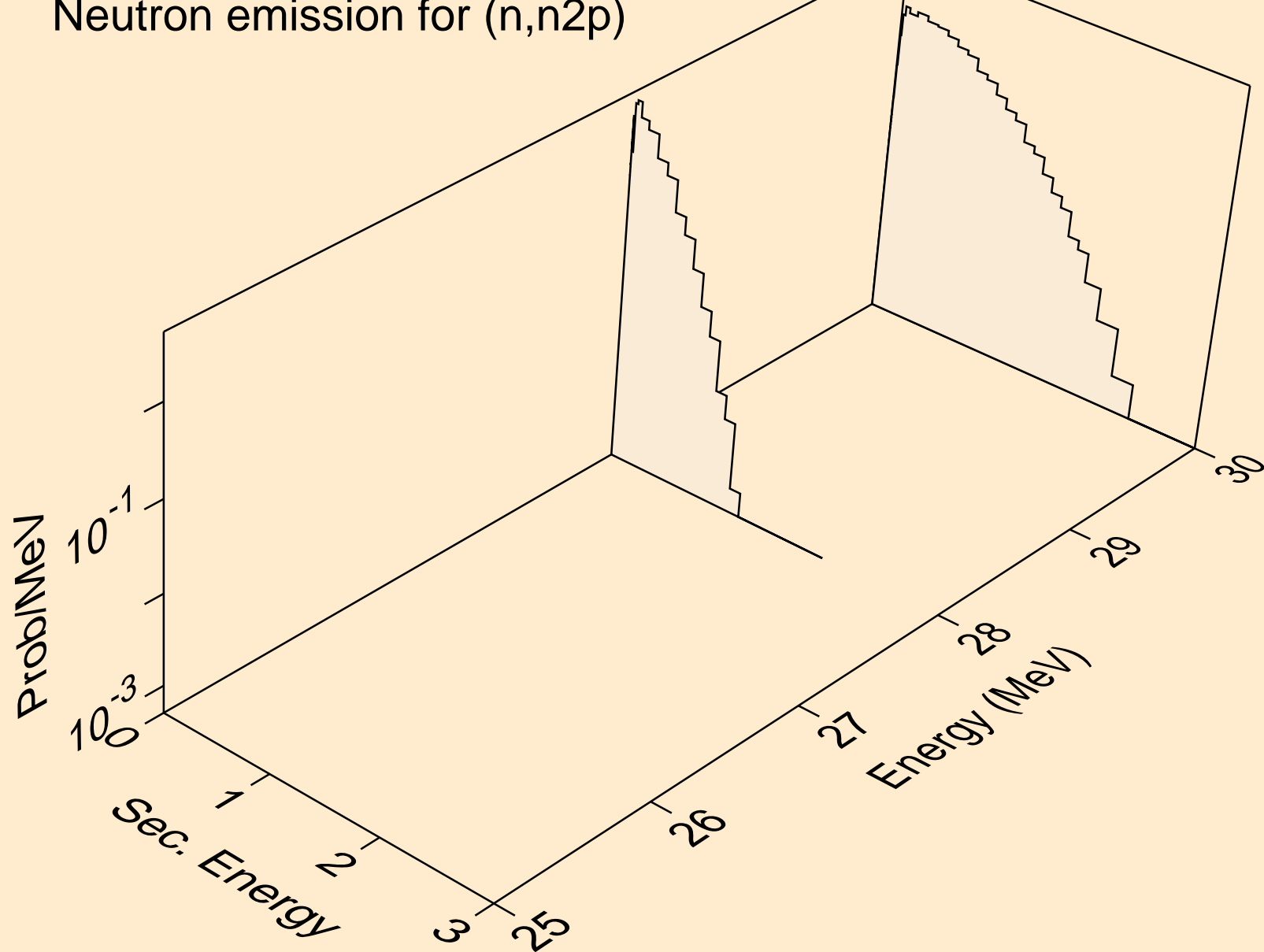

AL028 NEUTRON ACER TENDL-2024 LIBRARY; T=293.6K
Neutron emission for (n,npa)

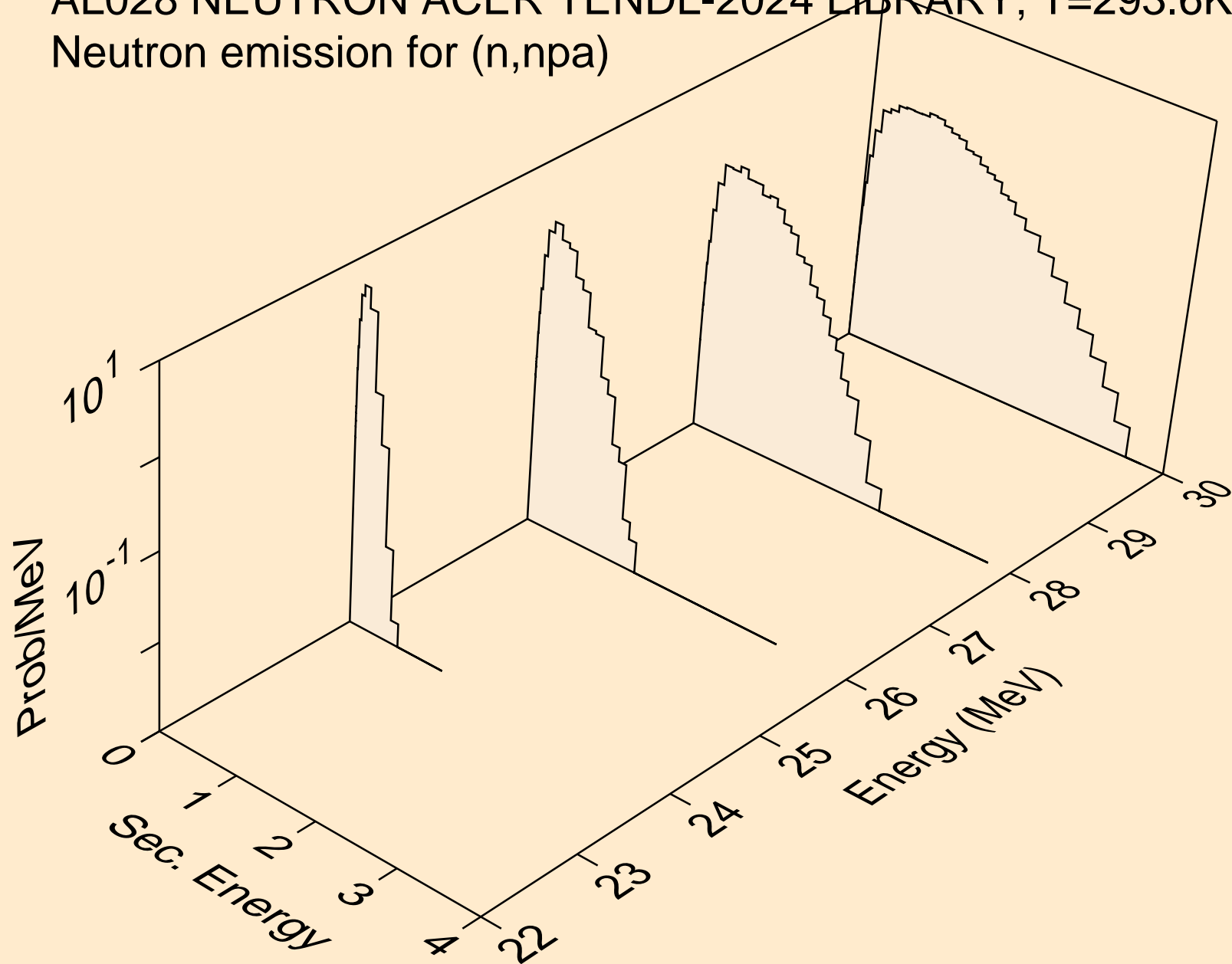

AL028 NEUTRON ACER TENDL-2024 LIBRARY; T=293.6K
Neutron emission for (n,n*c)

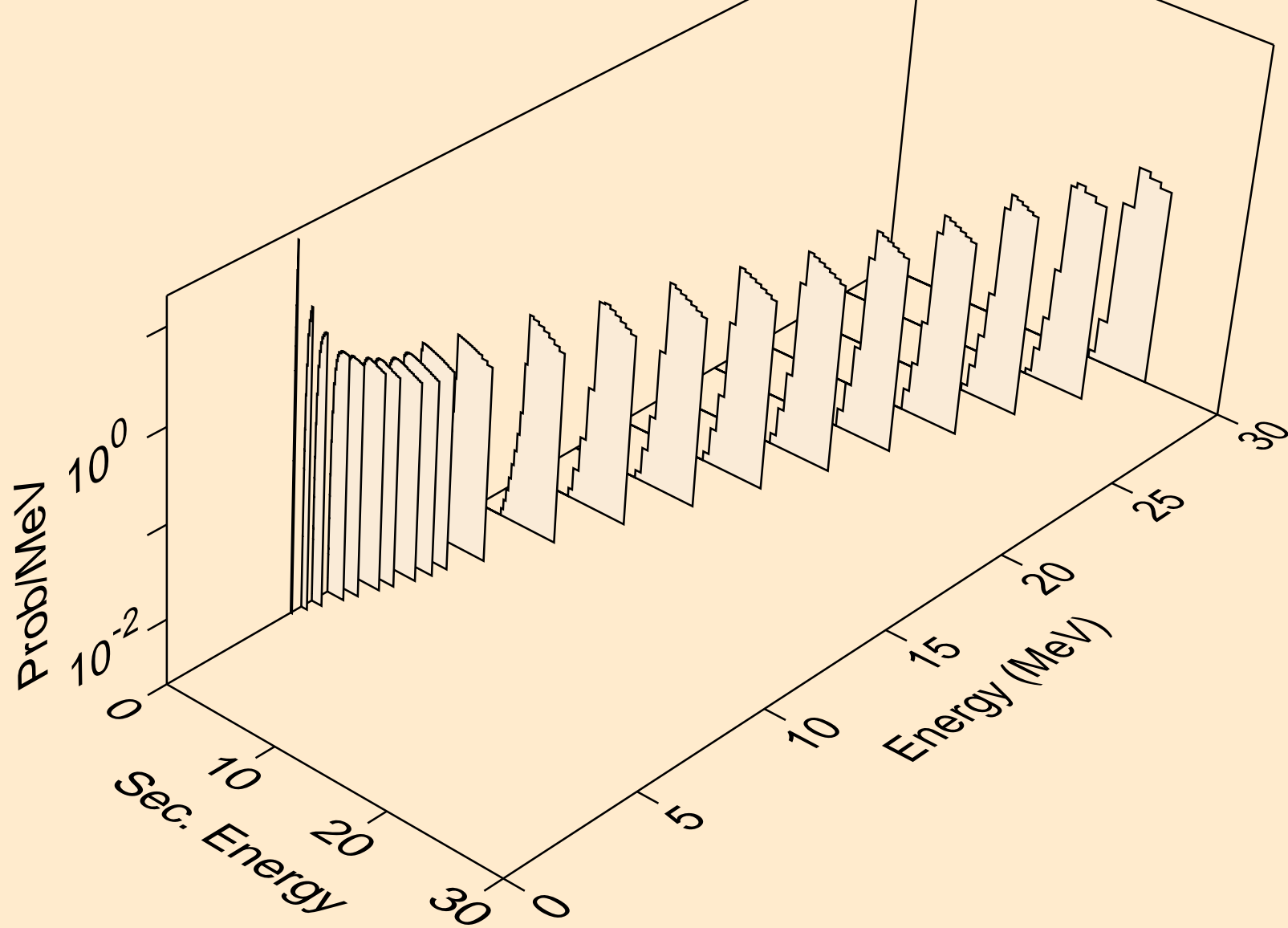

AL028 NEUTRON ACER TENDL-2024 LIBRARY; T=293.6K
Photon emission for (n,x)

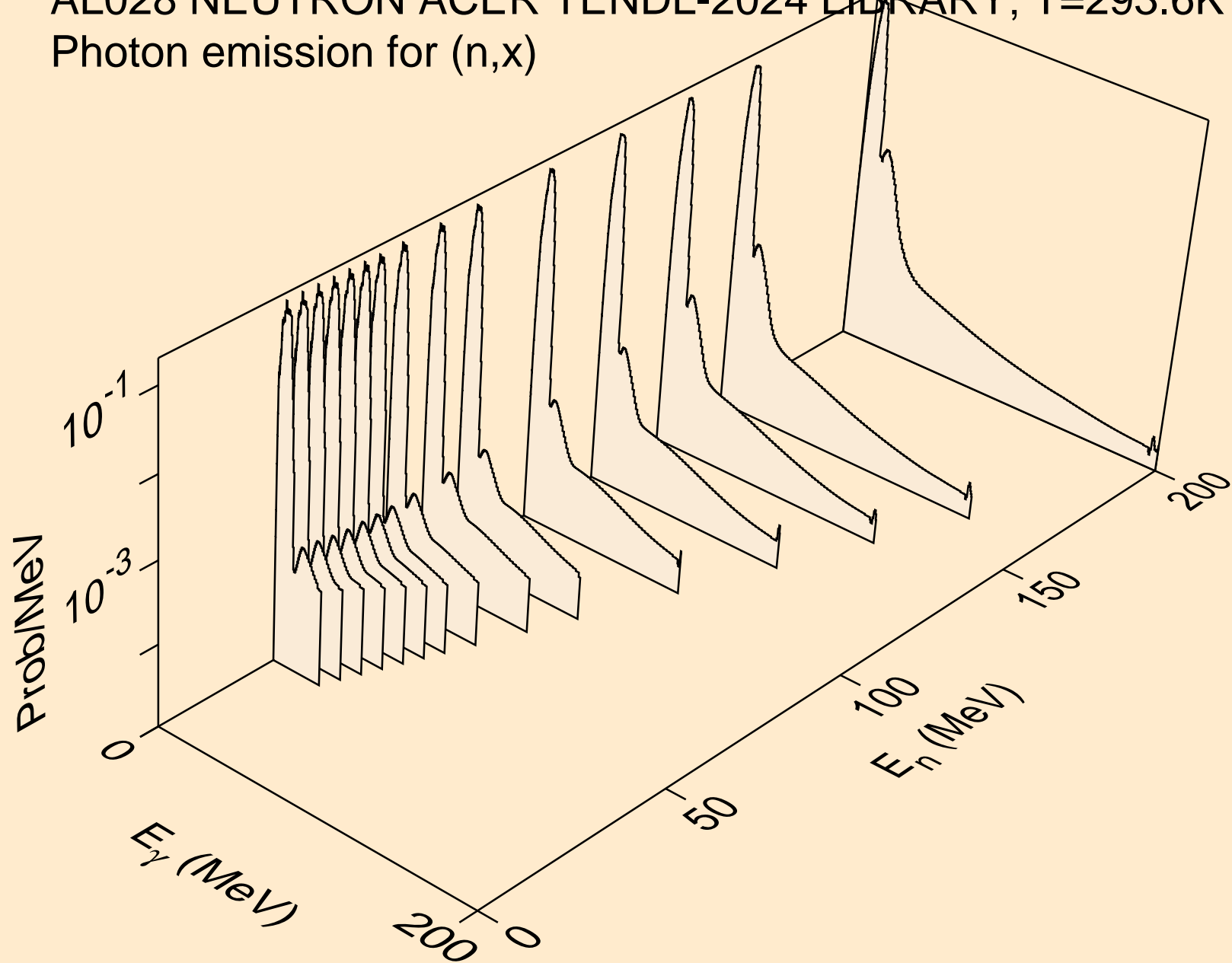

AL028 NEUTRON ACER TENDL-2024 LIBRARY; T=293.6K
Photon emission for (n,2nd)

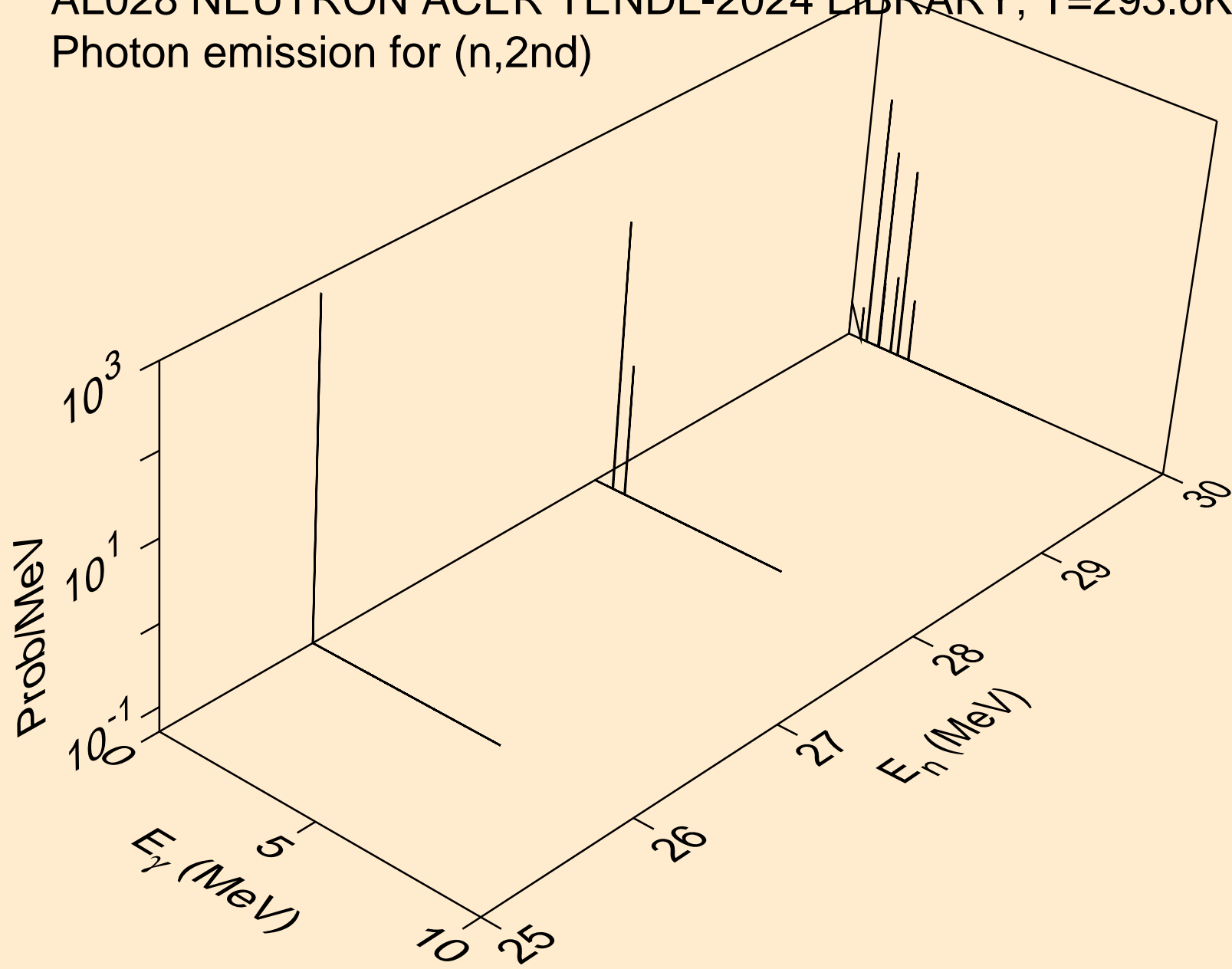

AL028 NEUTRON ACER TENDL-2024 LIBRARY; T=293.6K
Photon emission for (n,2n)

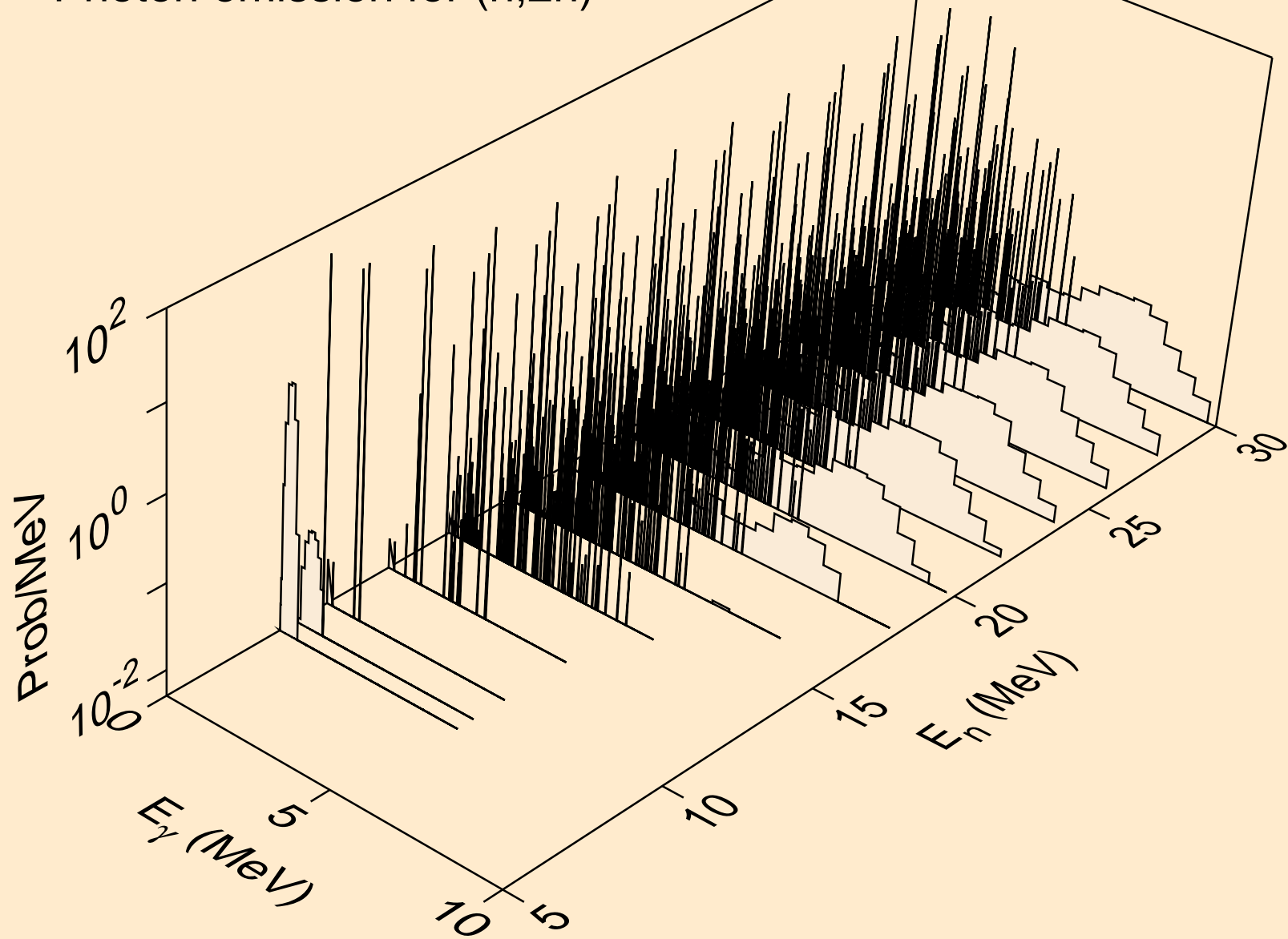

AL028 NEUTRON ACER TENDL-2024 LIBRARY; T=293.6K
Photon emission for (n,3n)

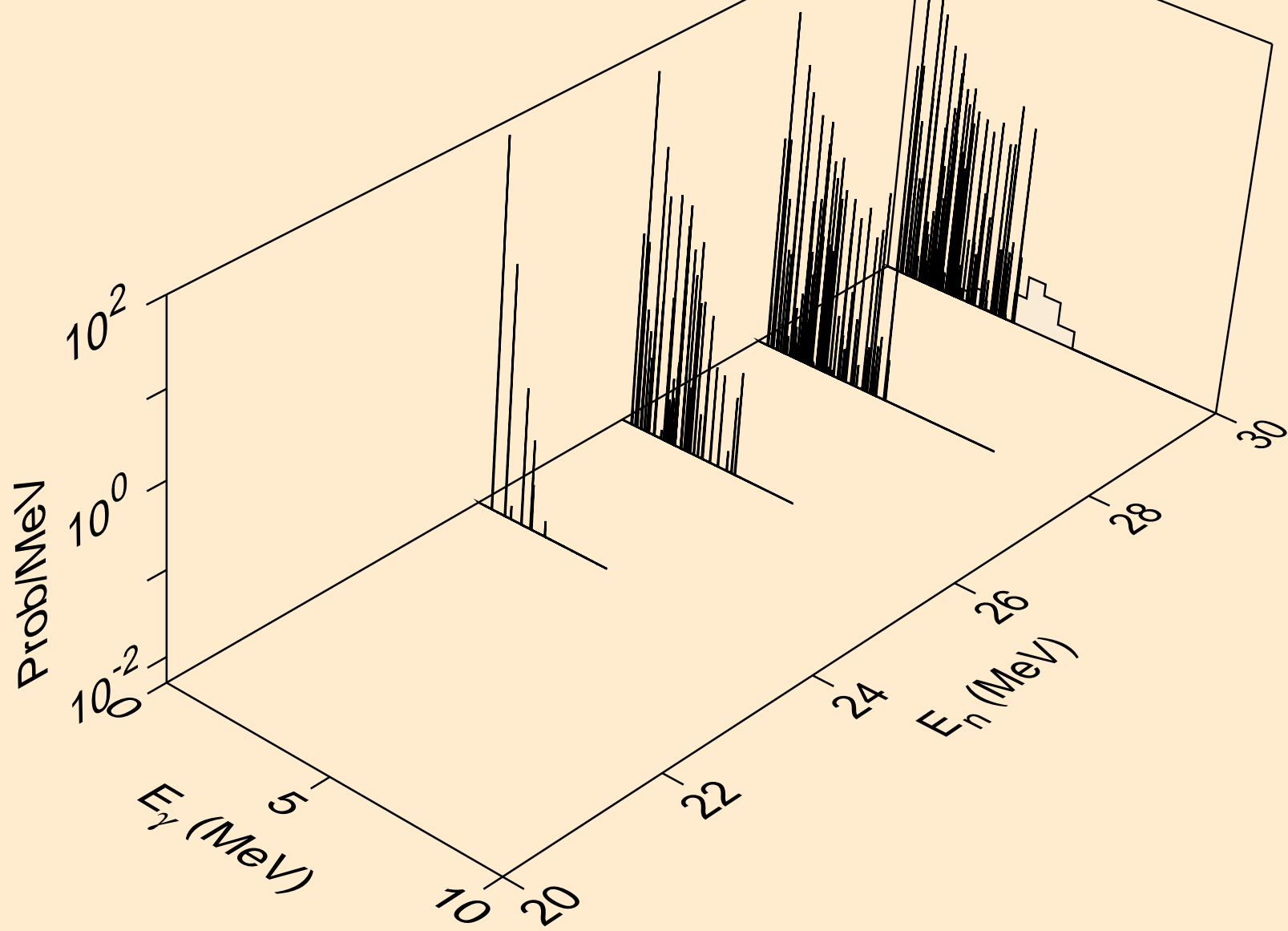

AL028 NEUTRON ACER TENDL-2024 LIBRARY; T=293.6K
Photon emission for (n,n*)a

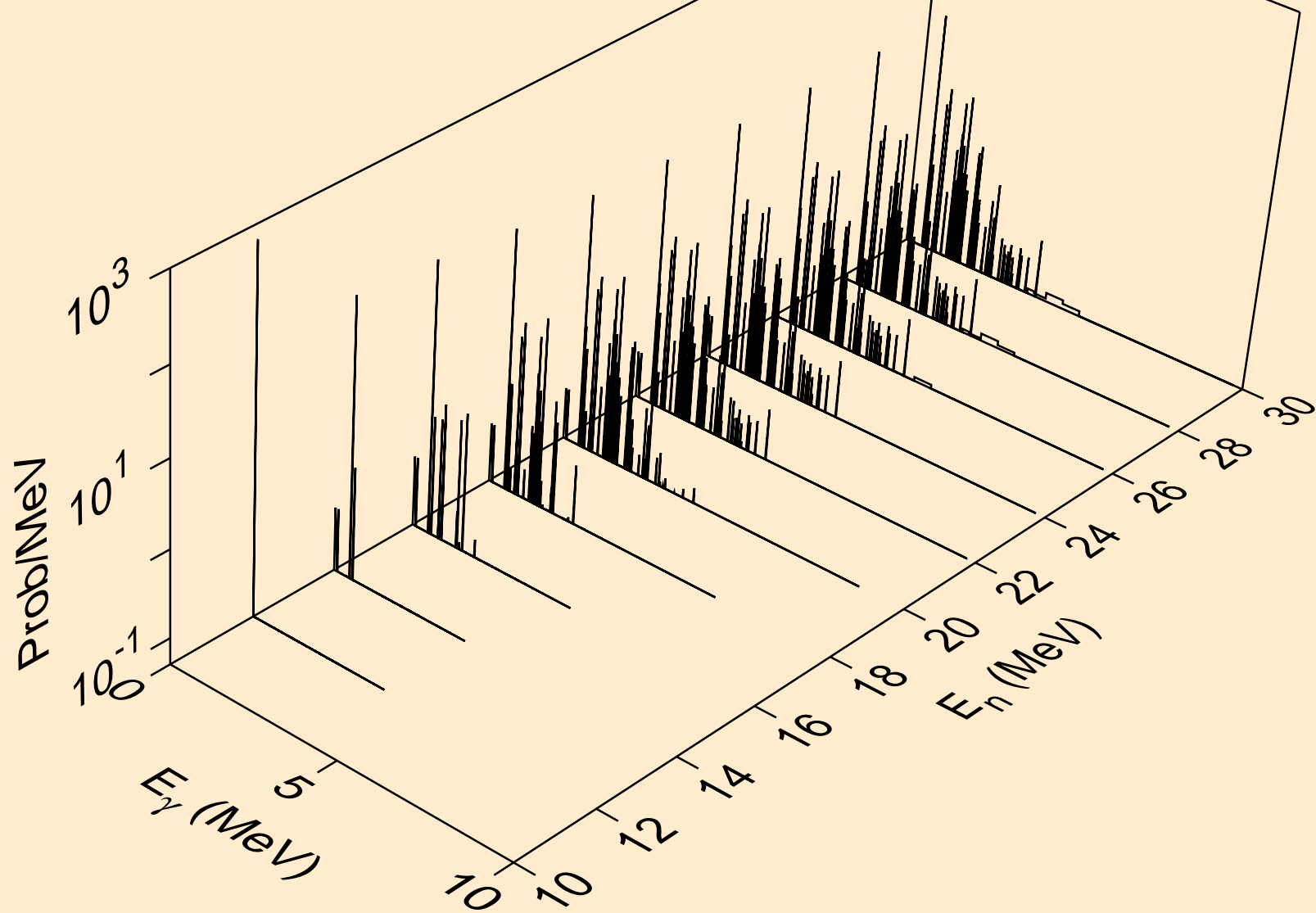

AL028 NEUTRON ACER TENDL-2024 LIBRARY; T=293.6K
Photon emission for (n,2n)a

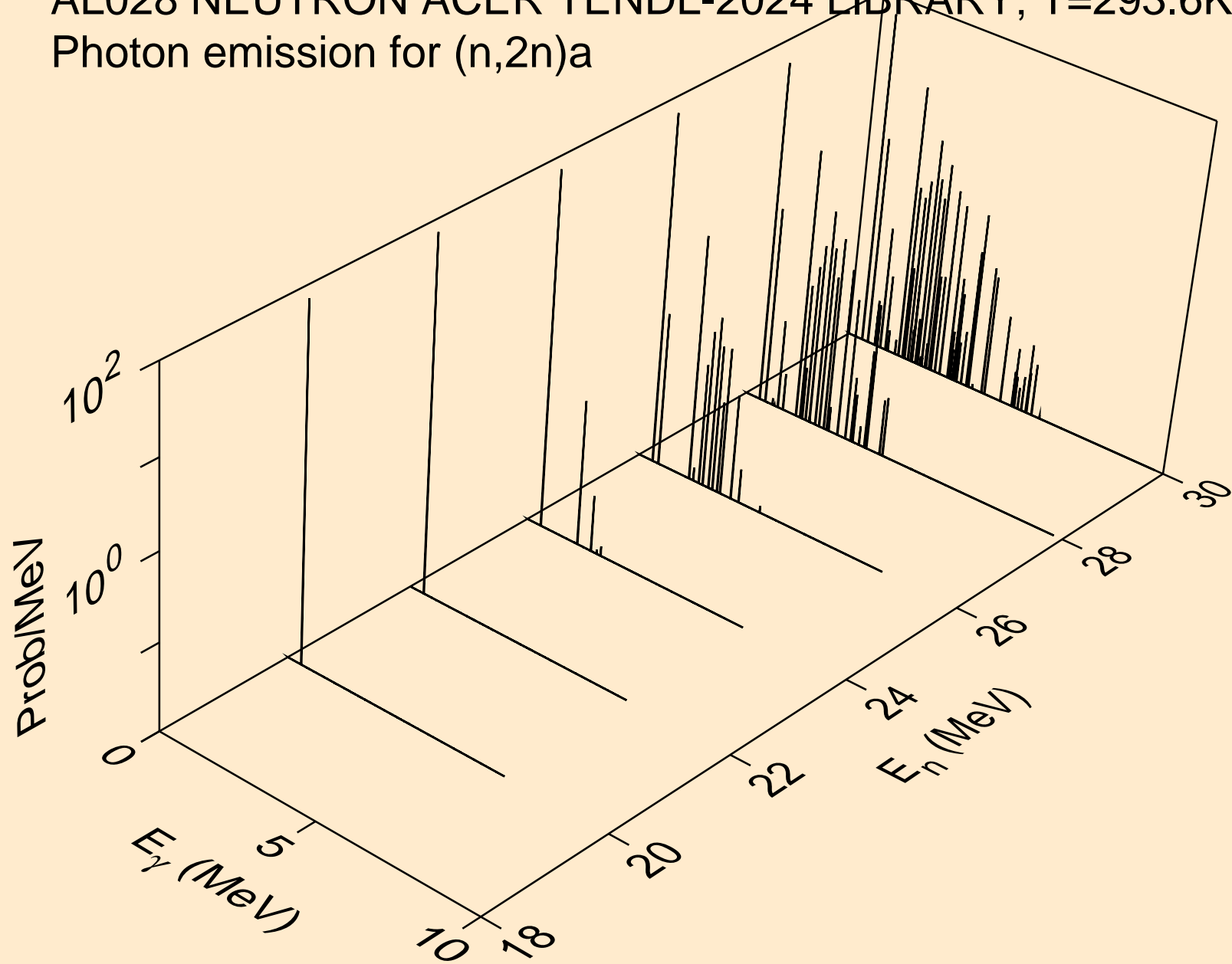

AL028 NEUTRON ACER TENDL-2024 LIBRARY; T=293.6K
Photon emission for (n,n*)p

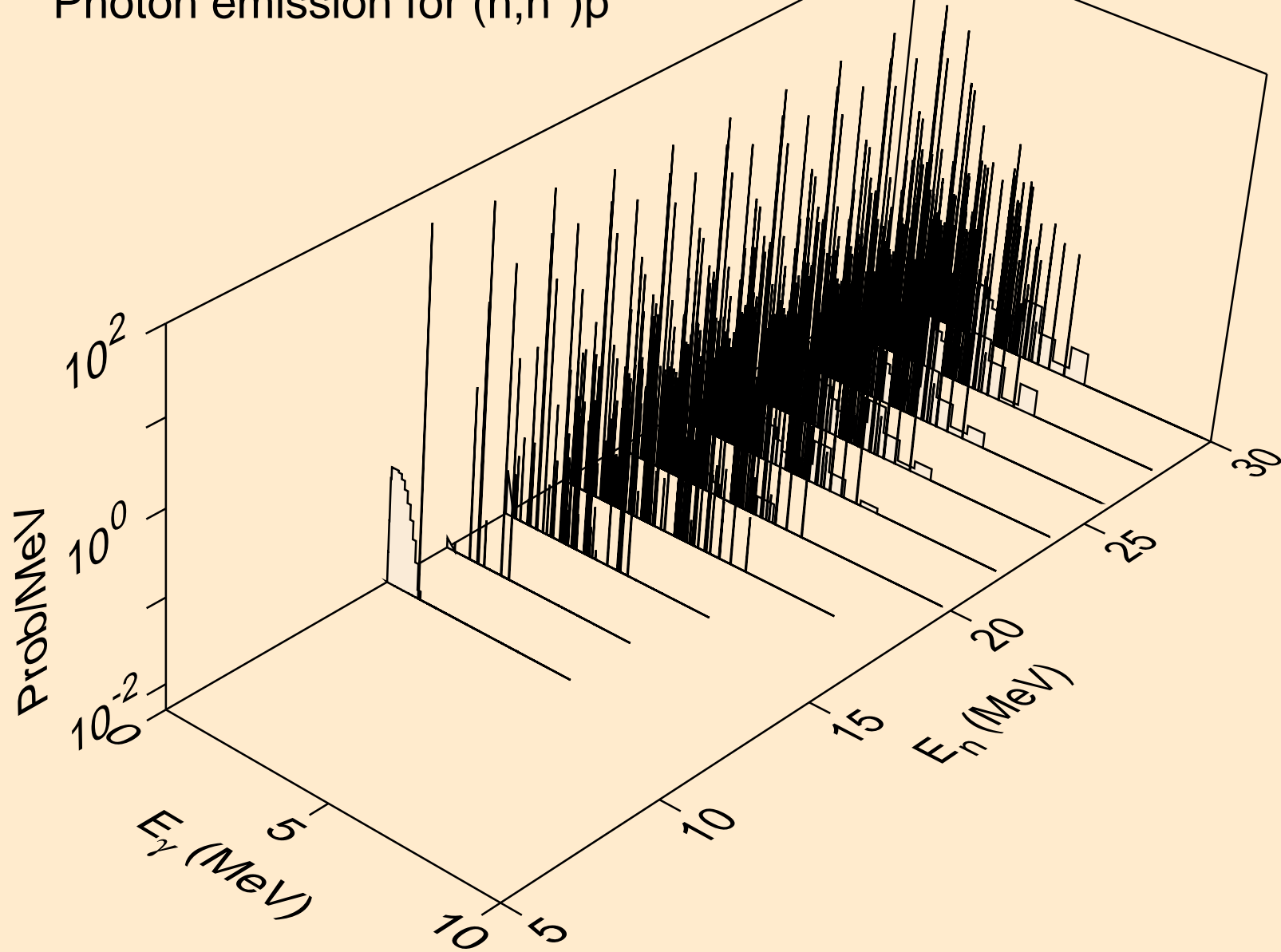

AL028 NEUTRON ACER TENDL-2024 LIBRARY; T=293.6K
Photon emission for (n,n*)2a

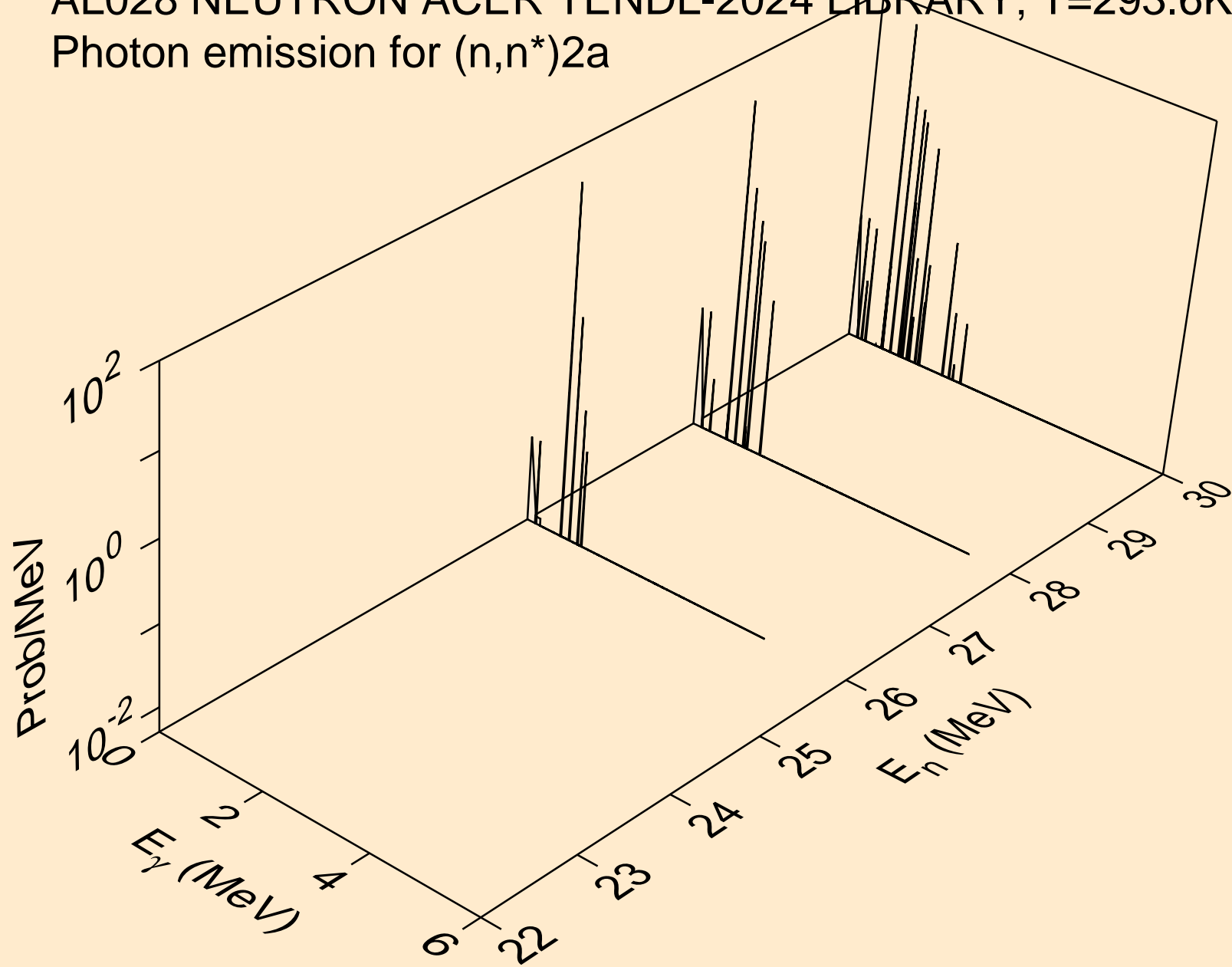

AL028 NEUTRON ACER TENDL-2024 LIBRARY; T=293.6K
Photon emission for (n,n*)d

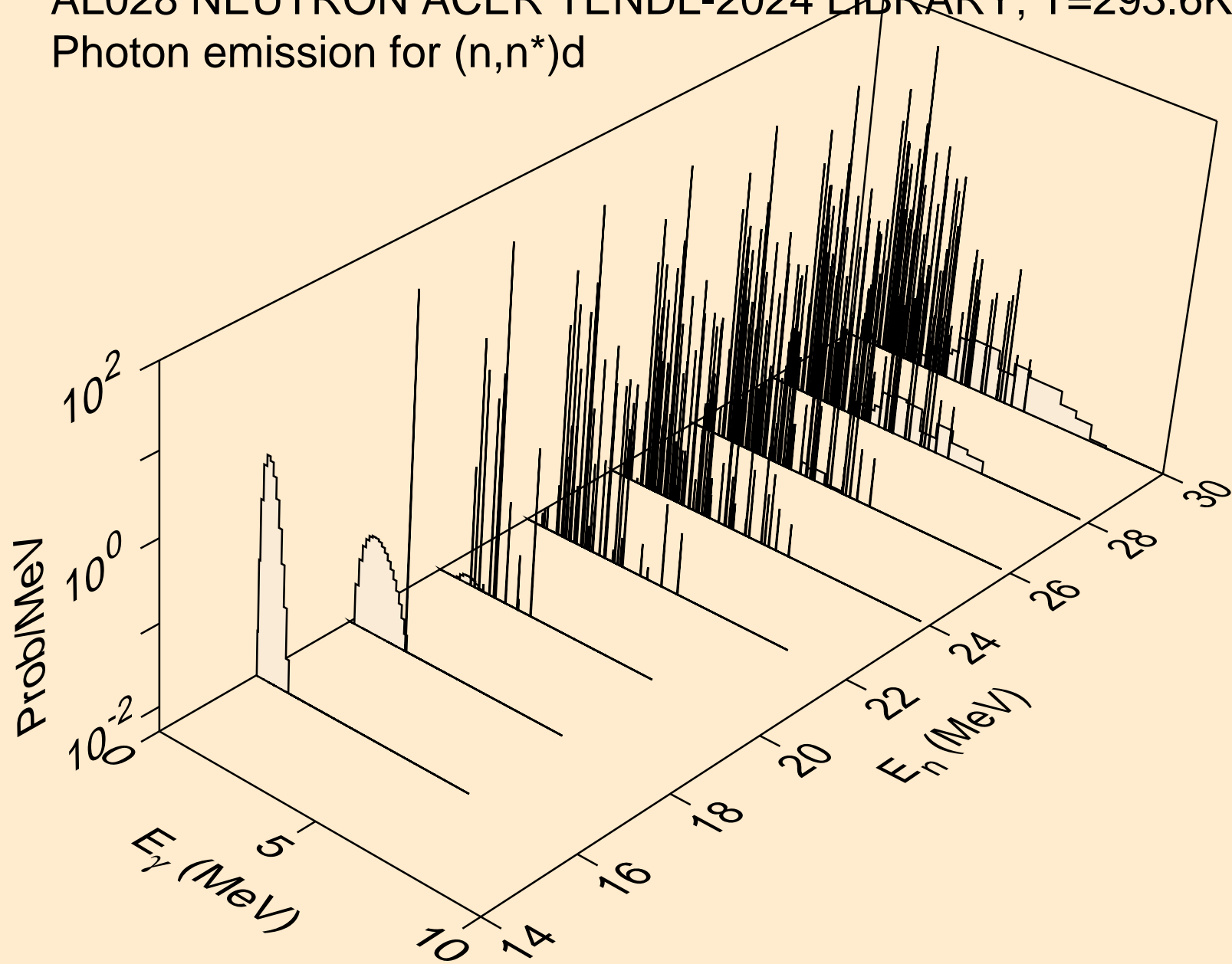

AL028 NEUTRON ACER TENDL-2024 LIBRARY; T=293.6K
Photon emission for (n,n*)t

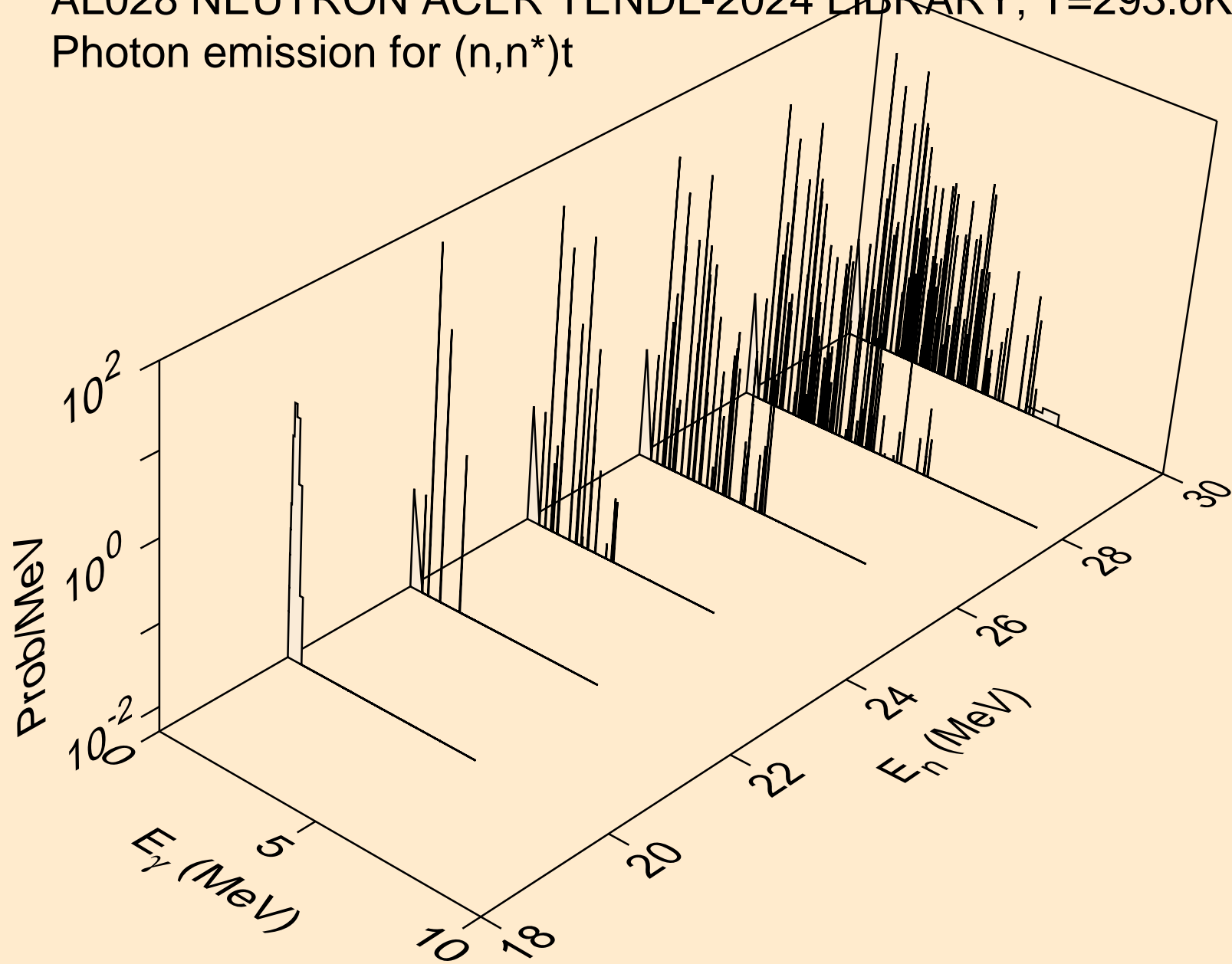

AL028 NEUTRON ACER TENDL-2024 LIBRARY; T=293.6K
Photon emission for (n,n*)he3

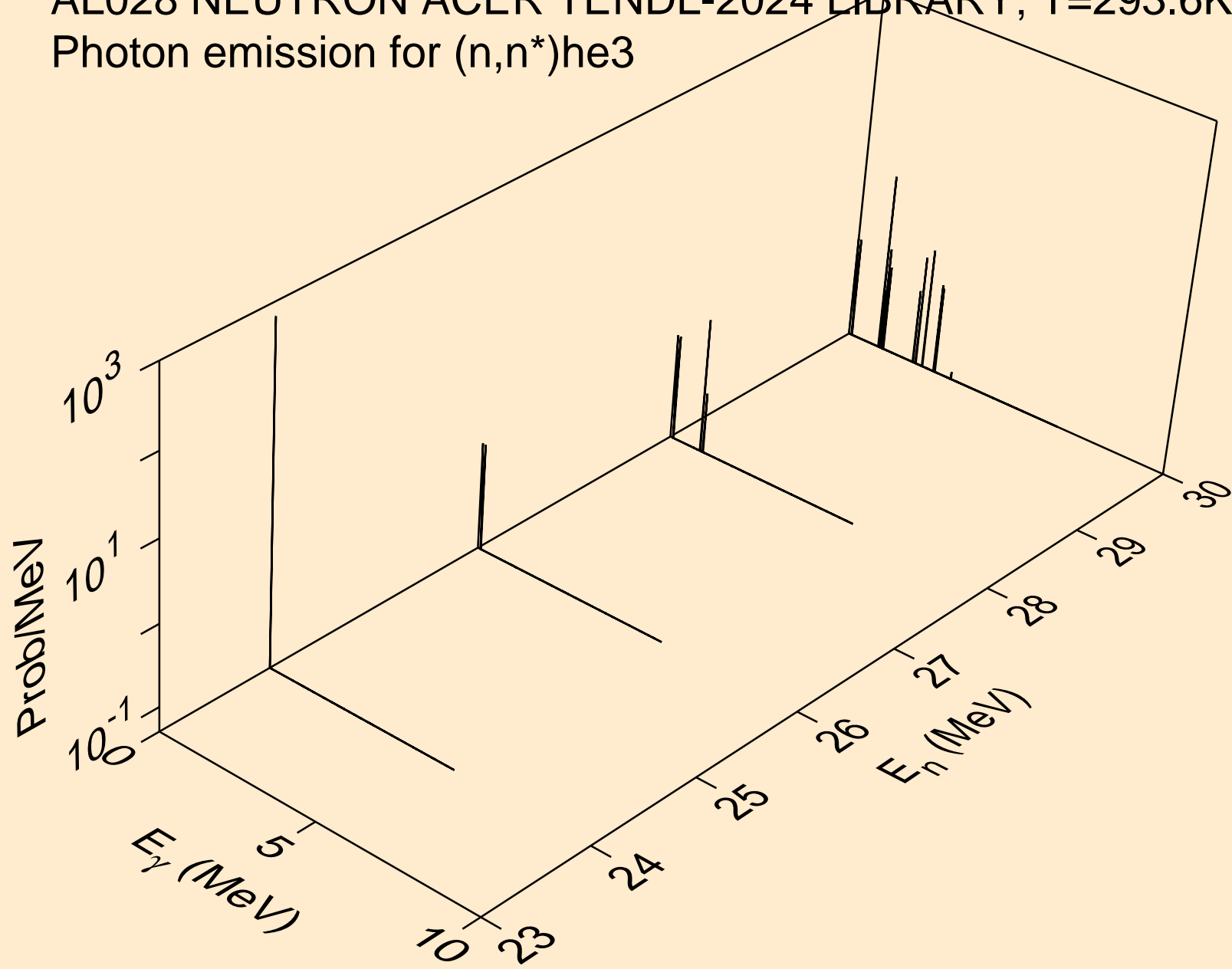

AL028 NEUTRON ACER TENDL-2024 LIBRARY; T=293.6K
Photon emission for (n,2np)

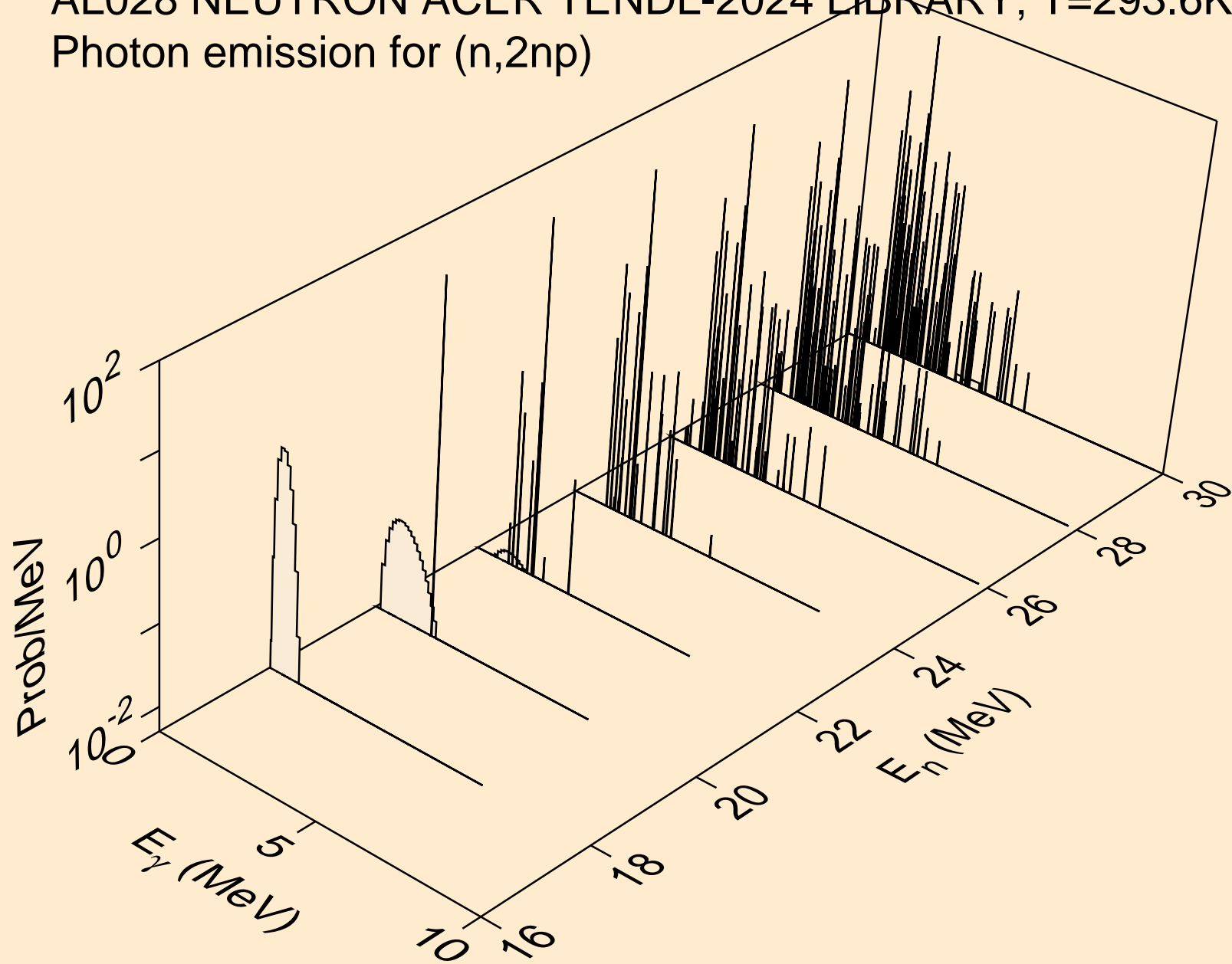

AL028 NEUTRON ACER TENDL-2024 LIBRARY; T=293.6K
Photon emission for (n,3np)

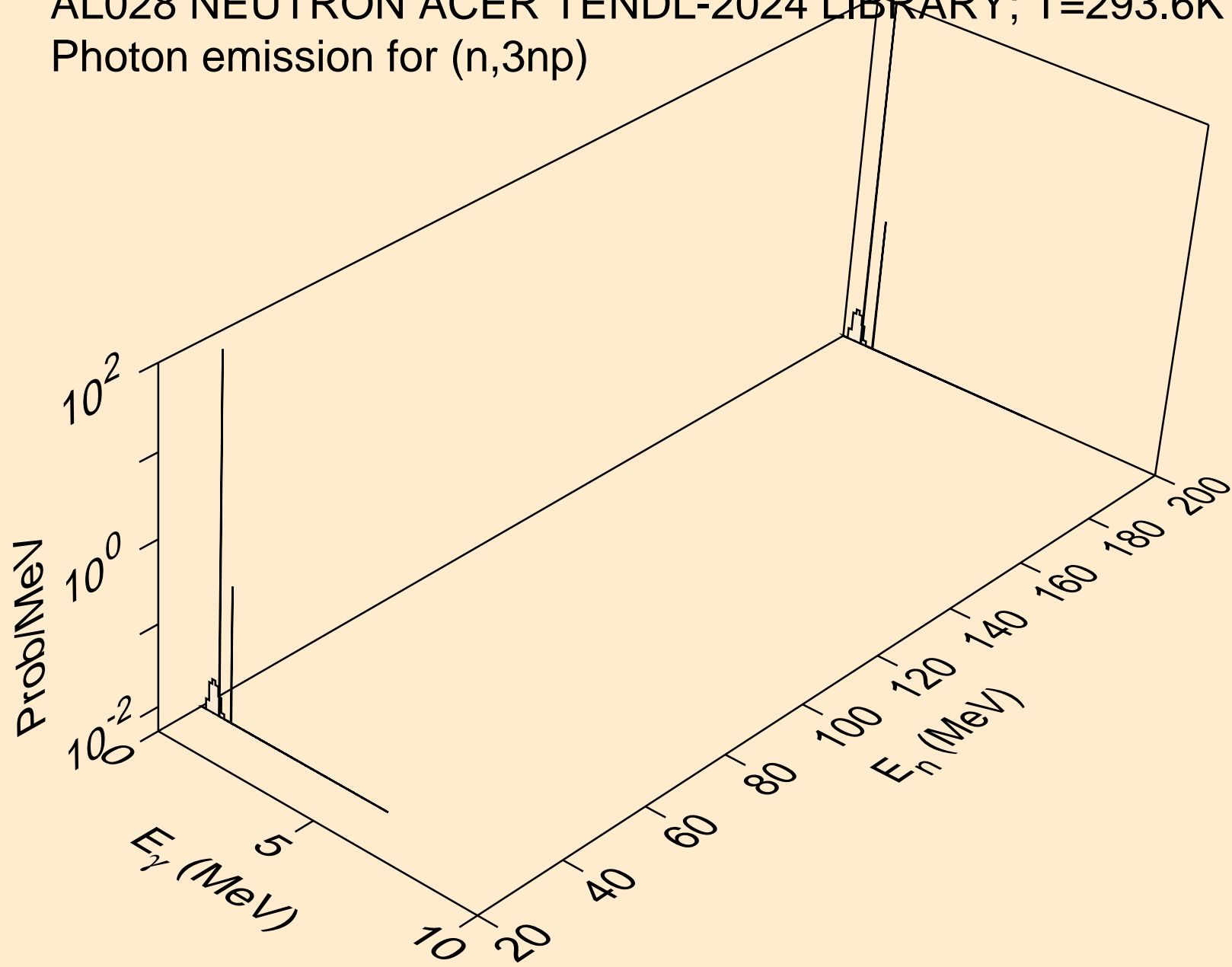

AL028 NEUTRON ACER TENDL-2024 LIBRARY; T=293.6K
Photon emission for (n,n2p)

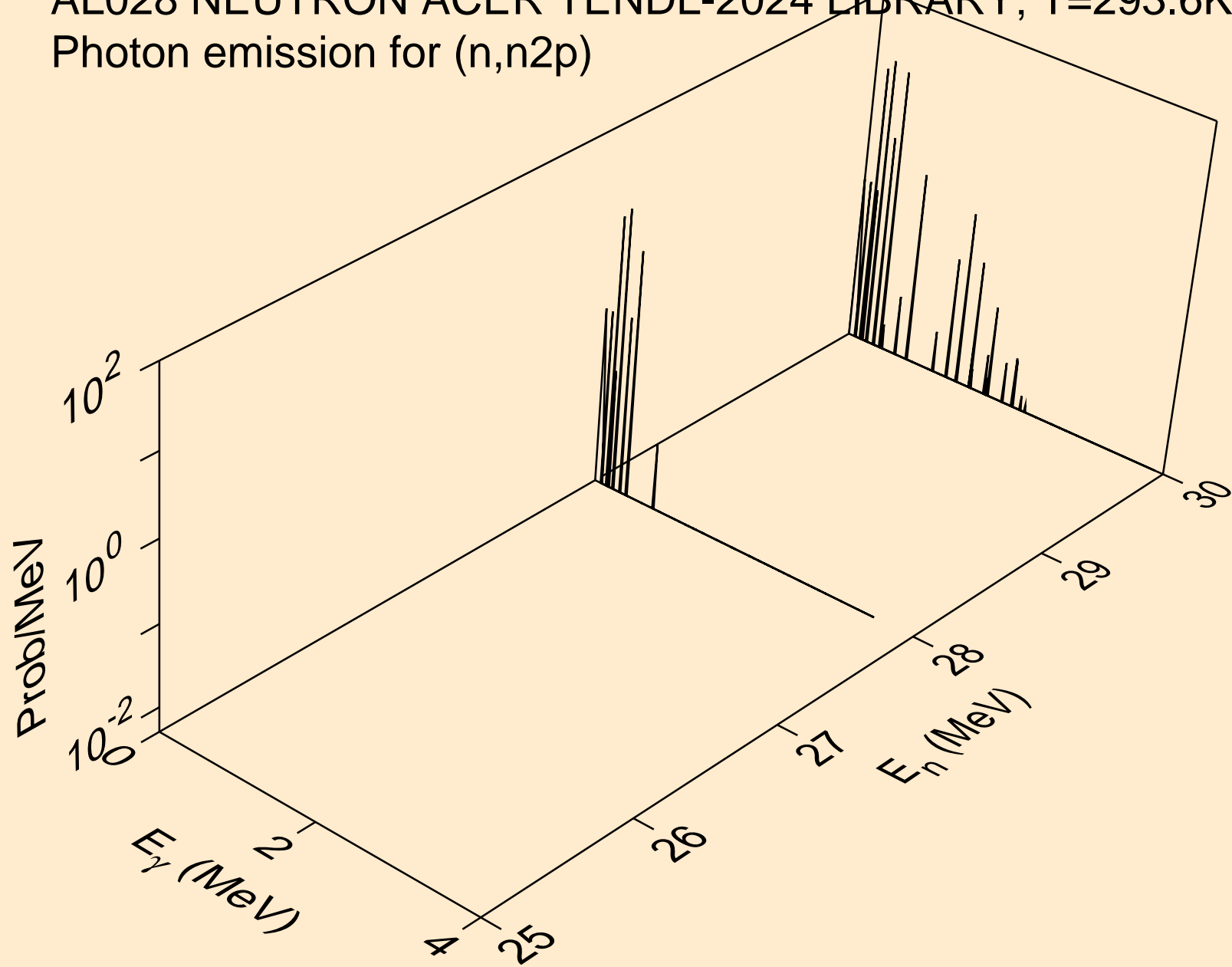

AL028 NEUTRON ACER TENDL-2024 LIBRARY; T=293.6K
Photon emission for (n,npa)

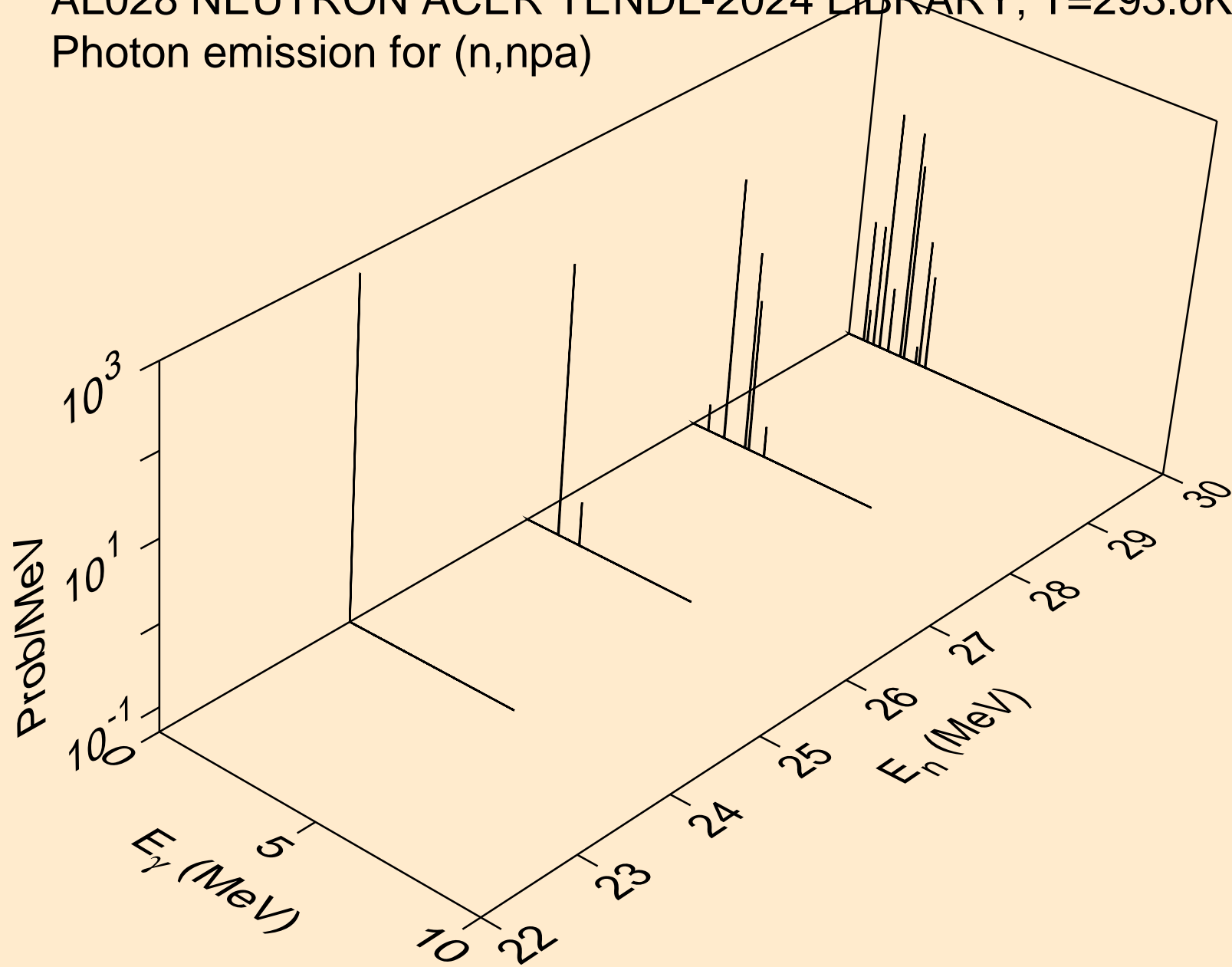

AL028 NEUTRON ACER TENDL-2024 LIBRARY; T=293.6K
Photon emission for (n,n*c)

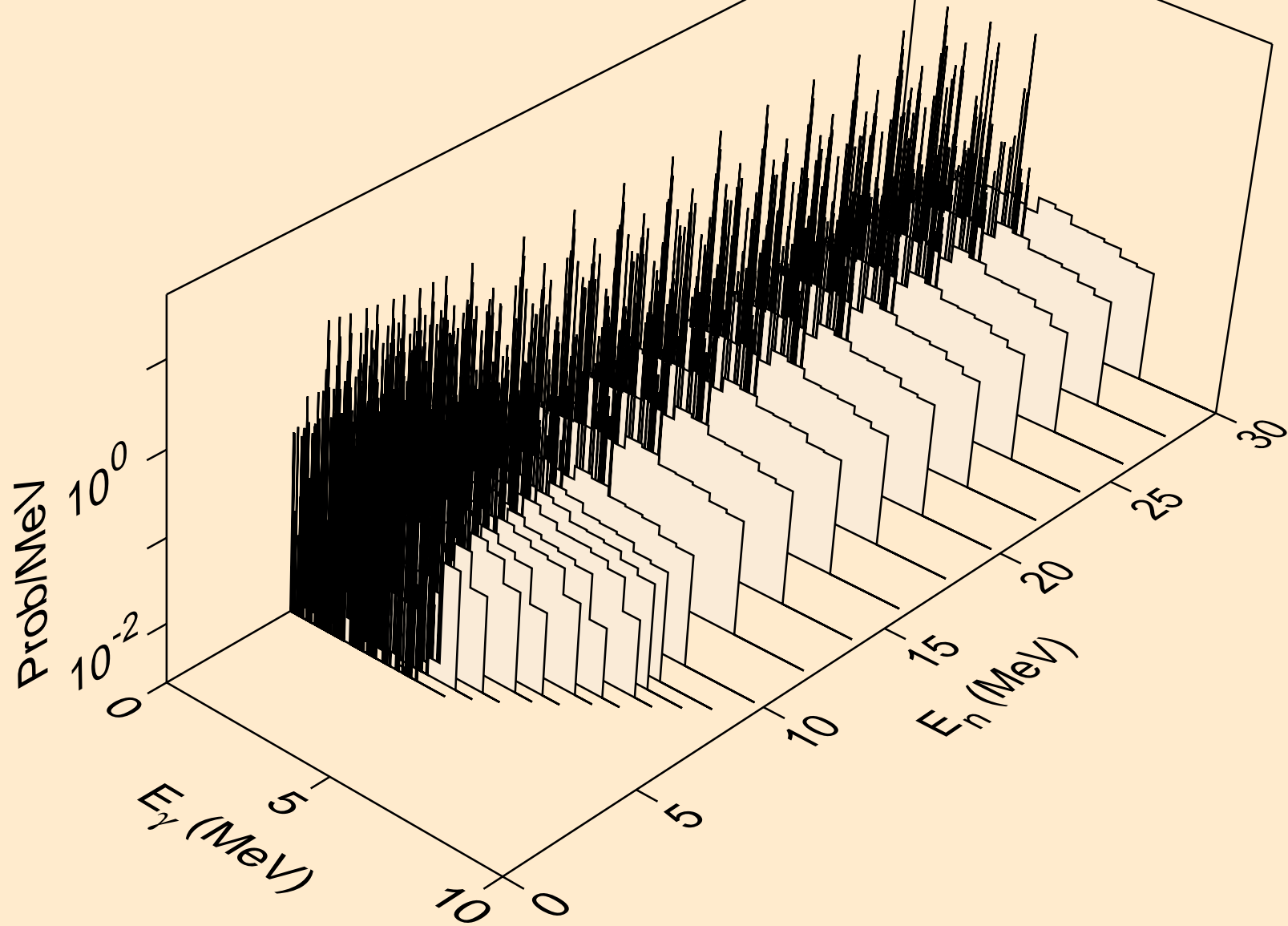

AL028 NEUTRON ACER TENDL-2024 LIBRARY; T=293.6K
Photon emission for (n,gma)

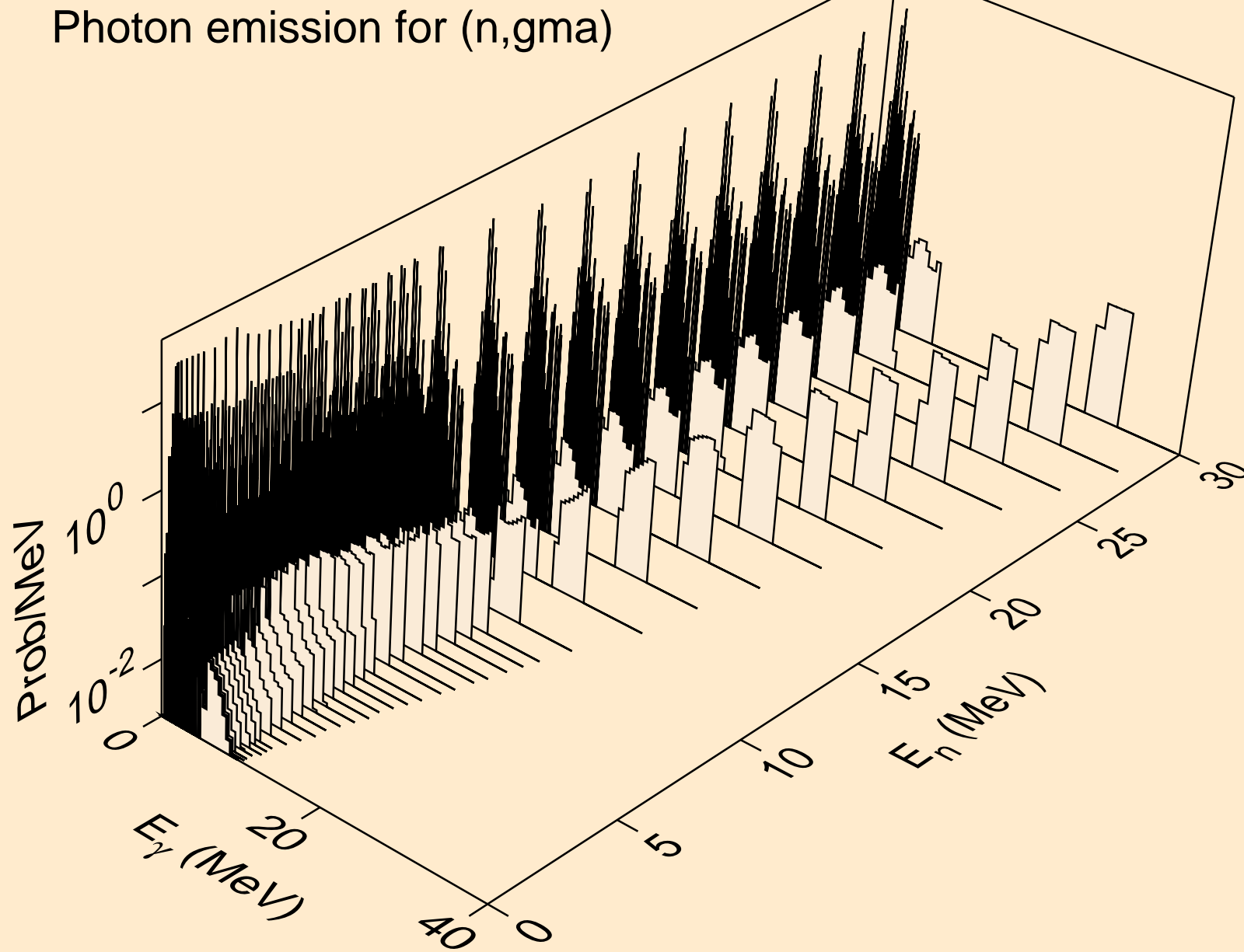

AL028 NEUTRON ACER TENDL-2024 LIBRARY; T=293.6K
Photon emission for (n,p)

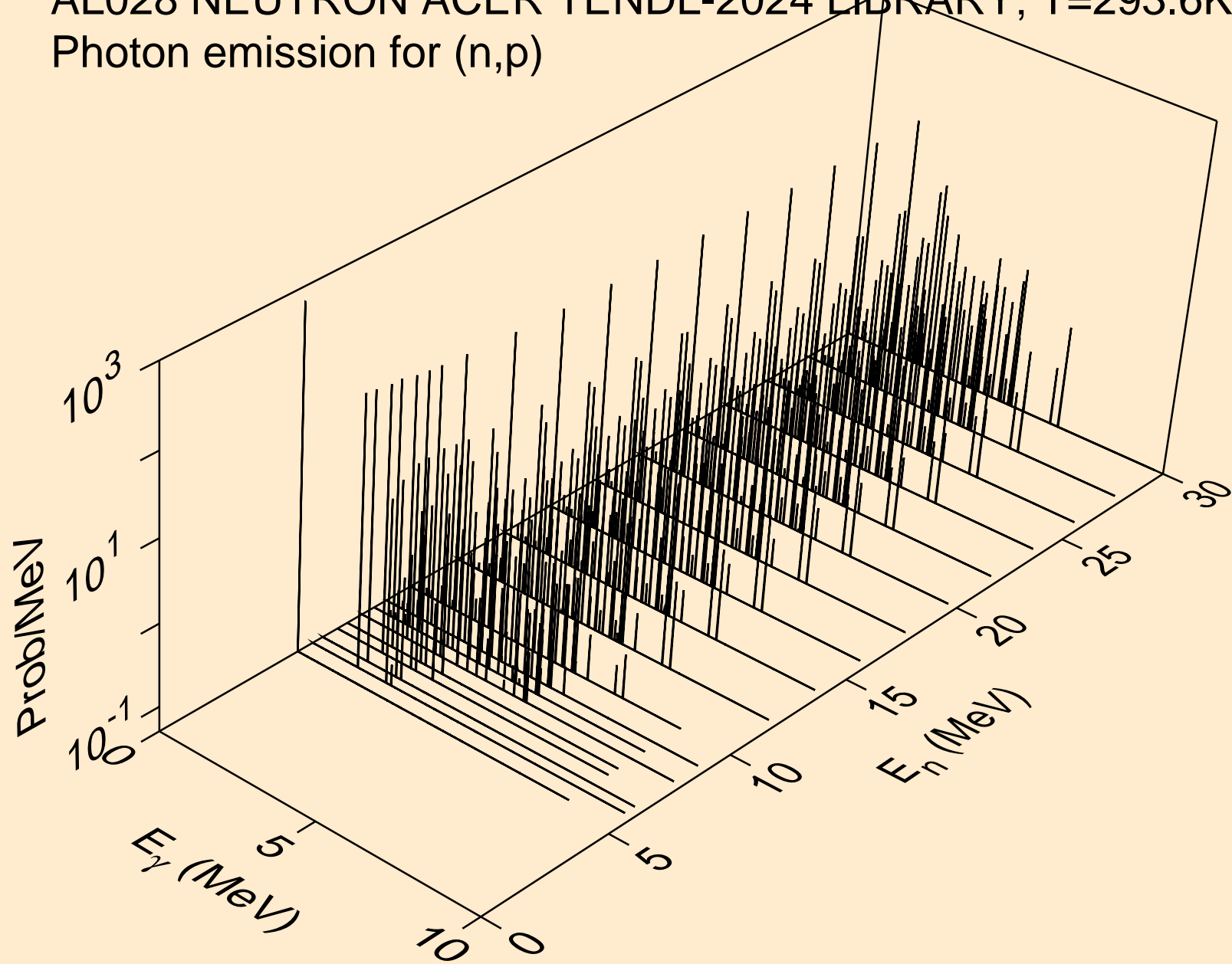

AL028 NEUTRON ACER TENDL-2024 LIBRARY; T=293.6K
Photon emission for (n,d)

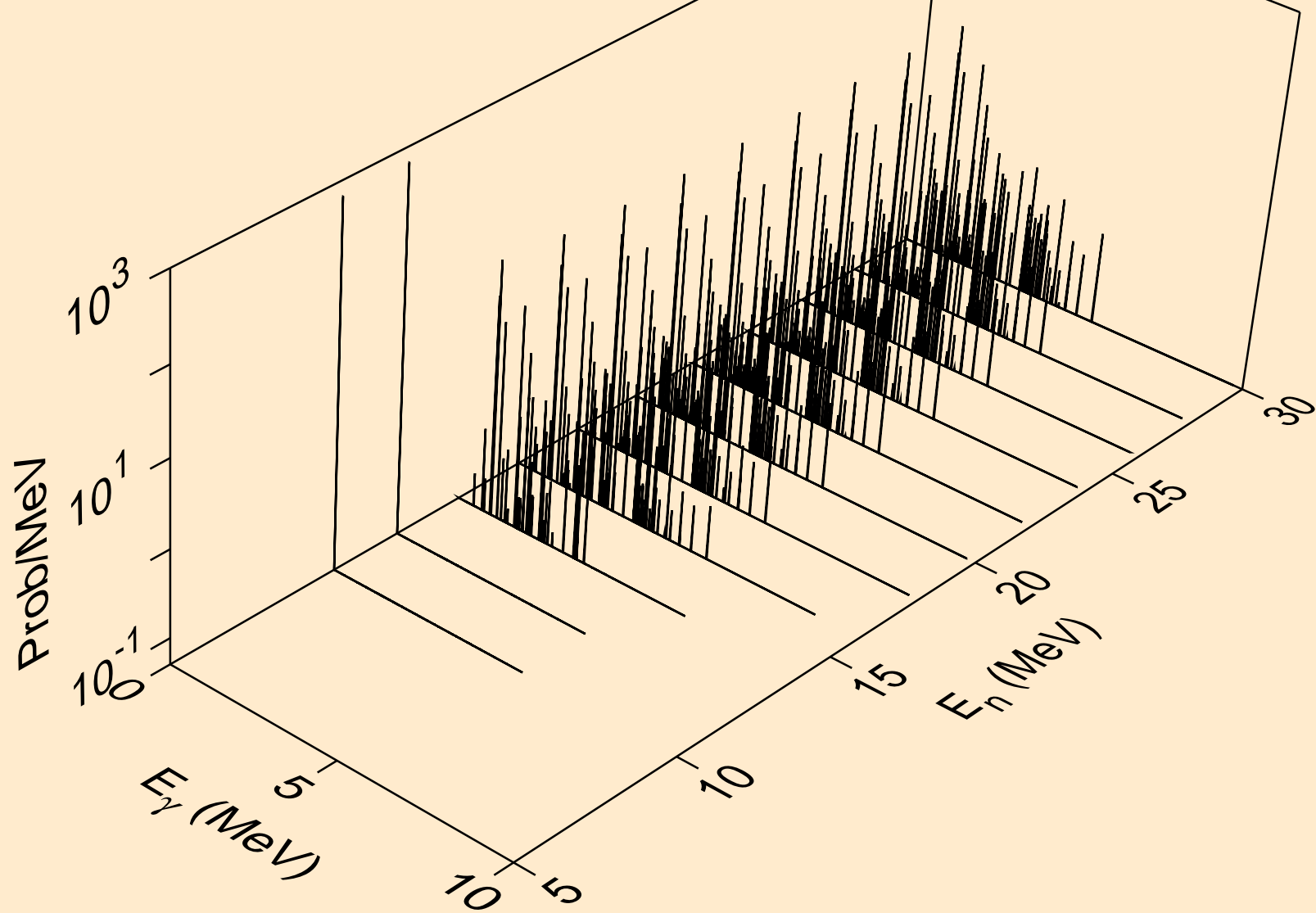

AL028 NEUTRON ACER TENDL-2024 LIBRARY; T=293.6K
Photon emission for (n,t)

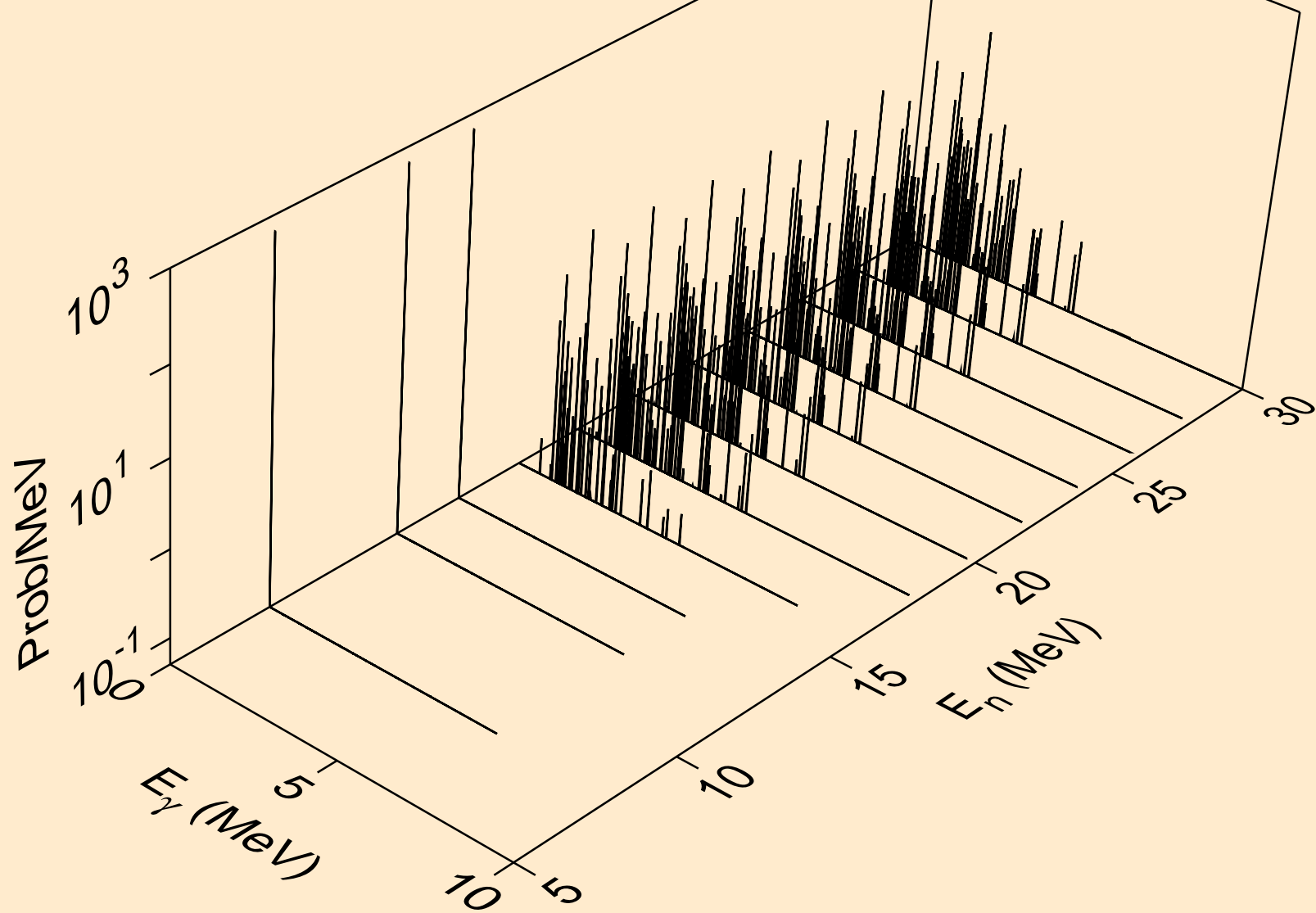

AL028 NEUTRON ACER TENDL-2024 LIBRARY; T=293.6K
Photon emission for (n,he3)

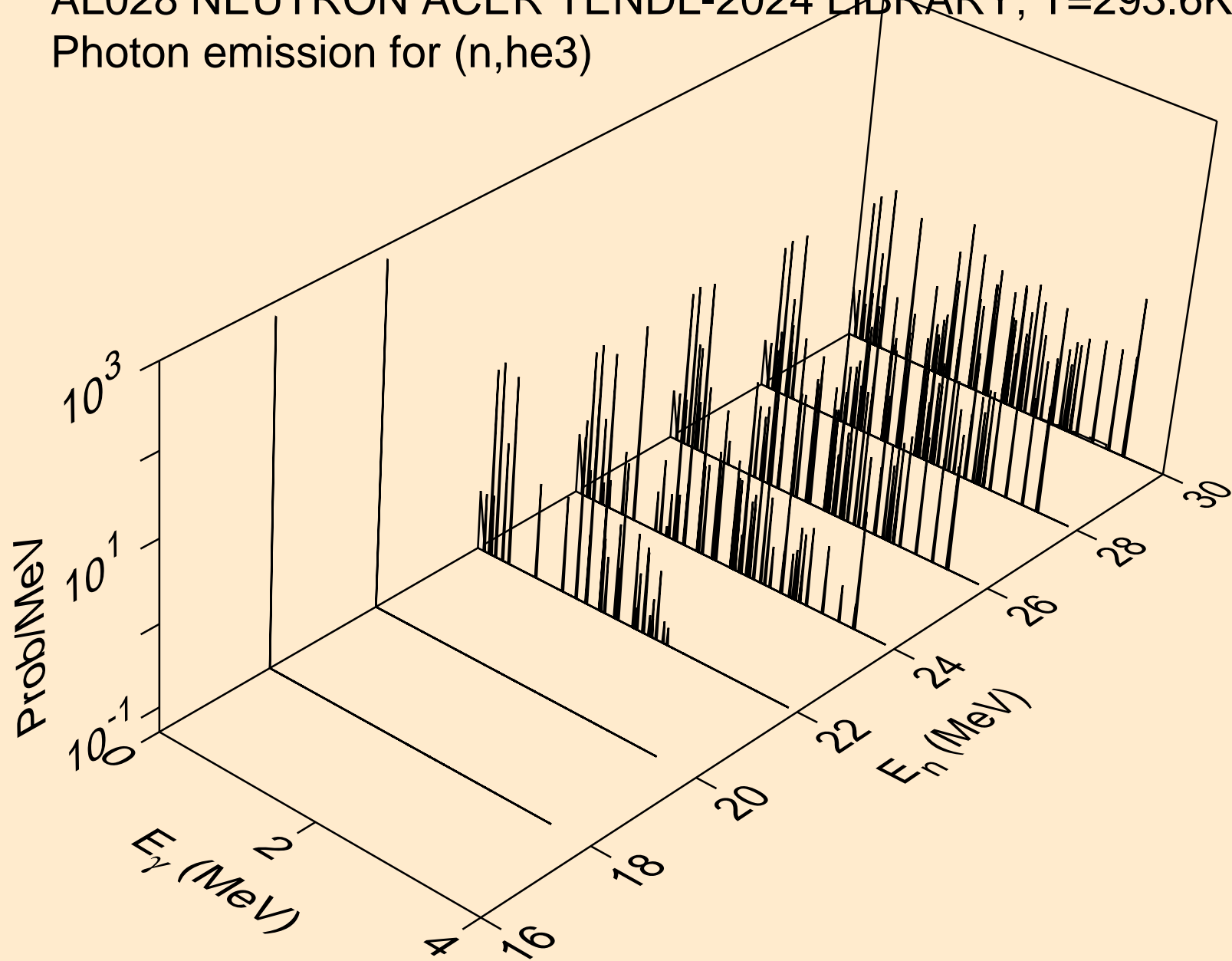

AL028 NEUTRON ACER TENDL-2024 LIBRARY; T=293.6K
Photon emission for (n,a)

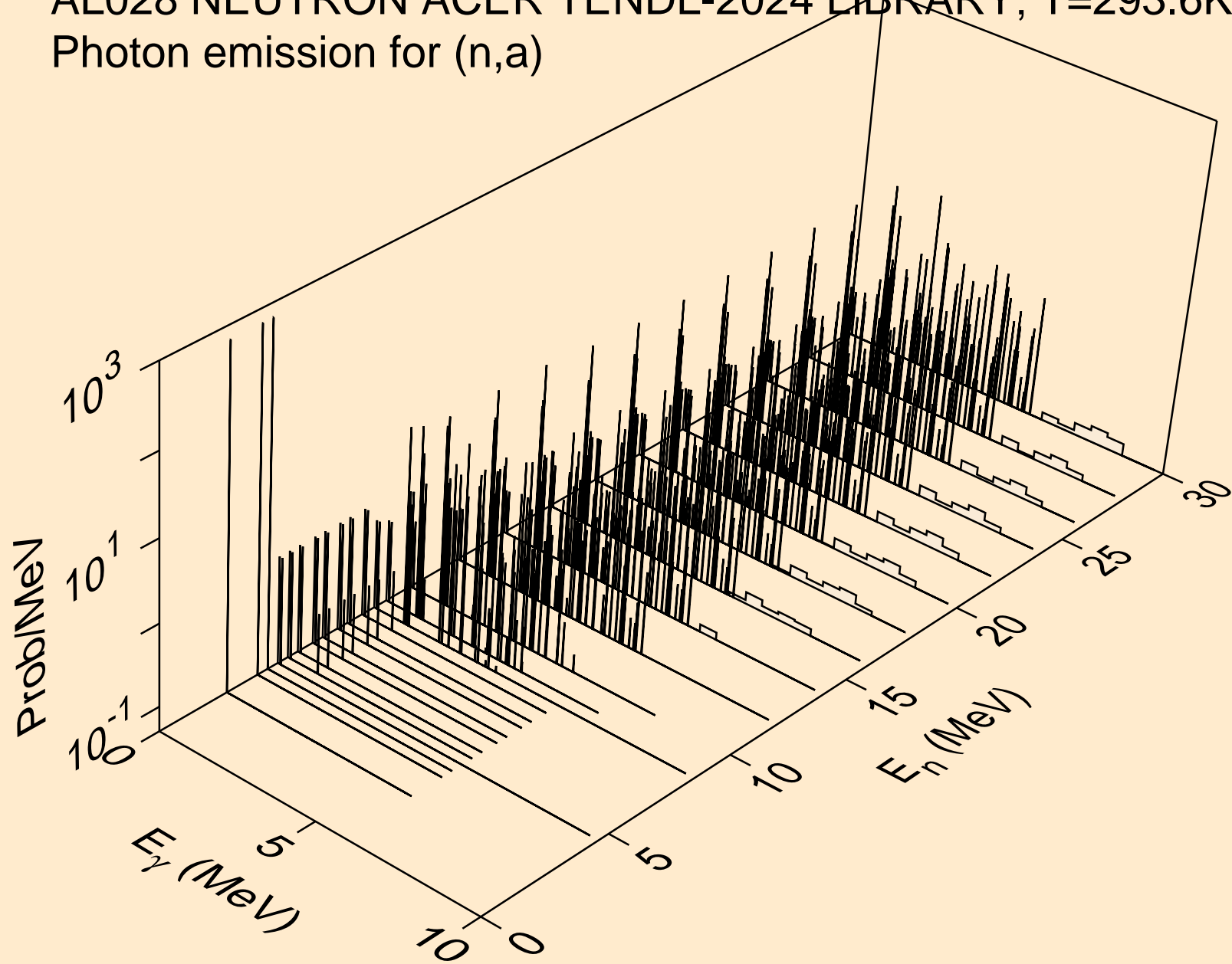

AL028 NEUTRON ACER TENDL-2024 LIBRARY; T=293.6K
Photon emission for (n,2a)

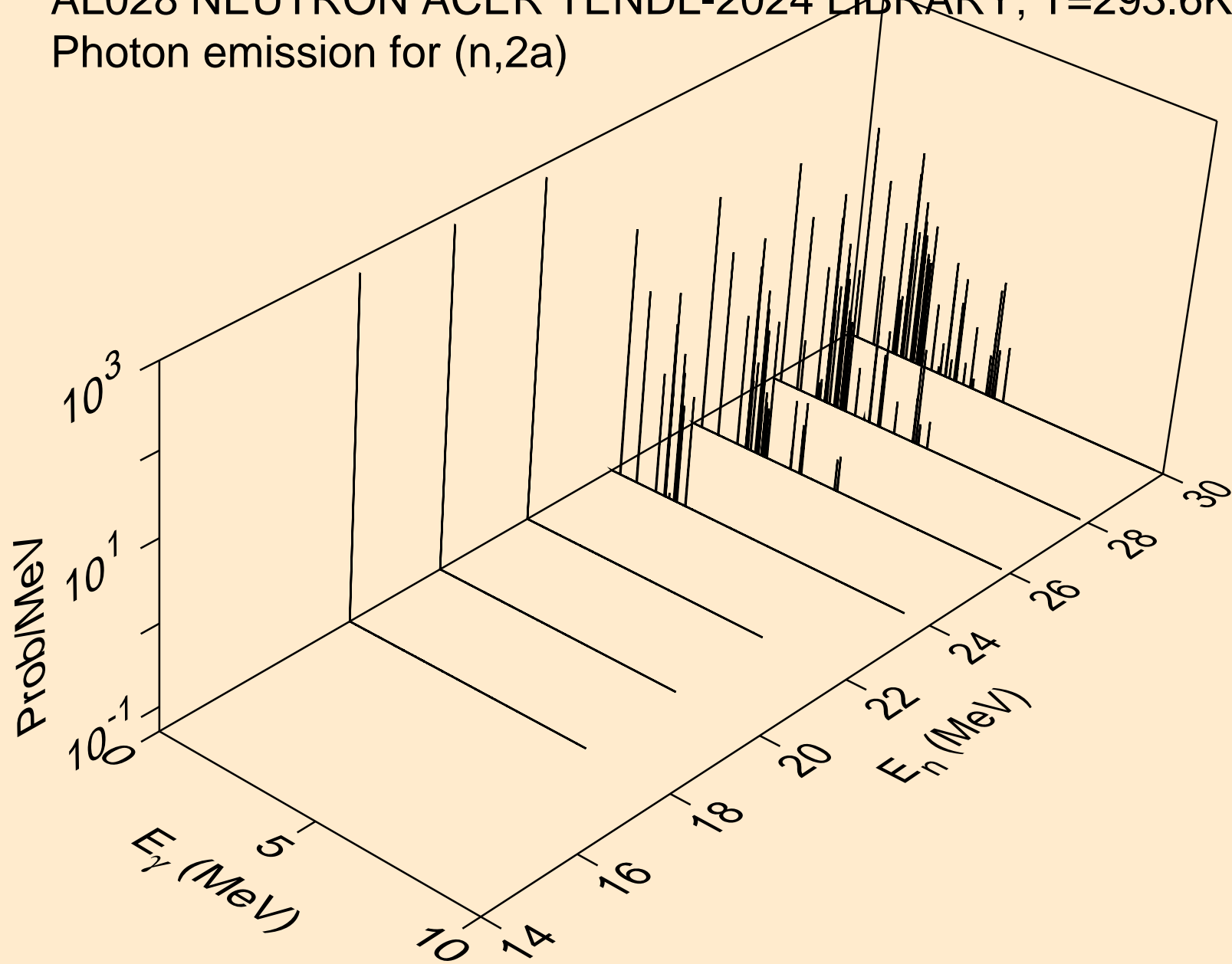

AL028 NEUTRON ACER TENDL-2024 LIBRARY; T=293.6K
Photon emission for (n,2p)

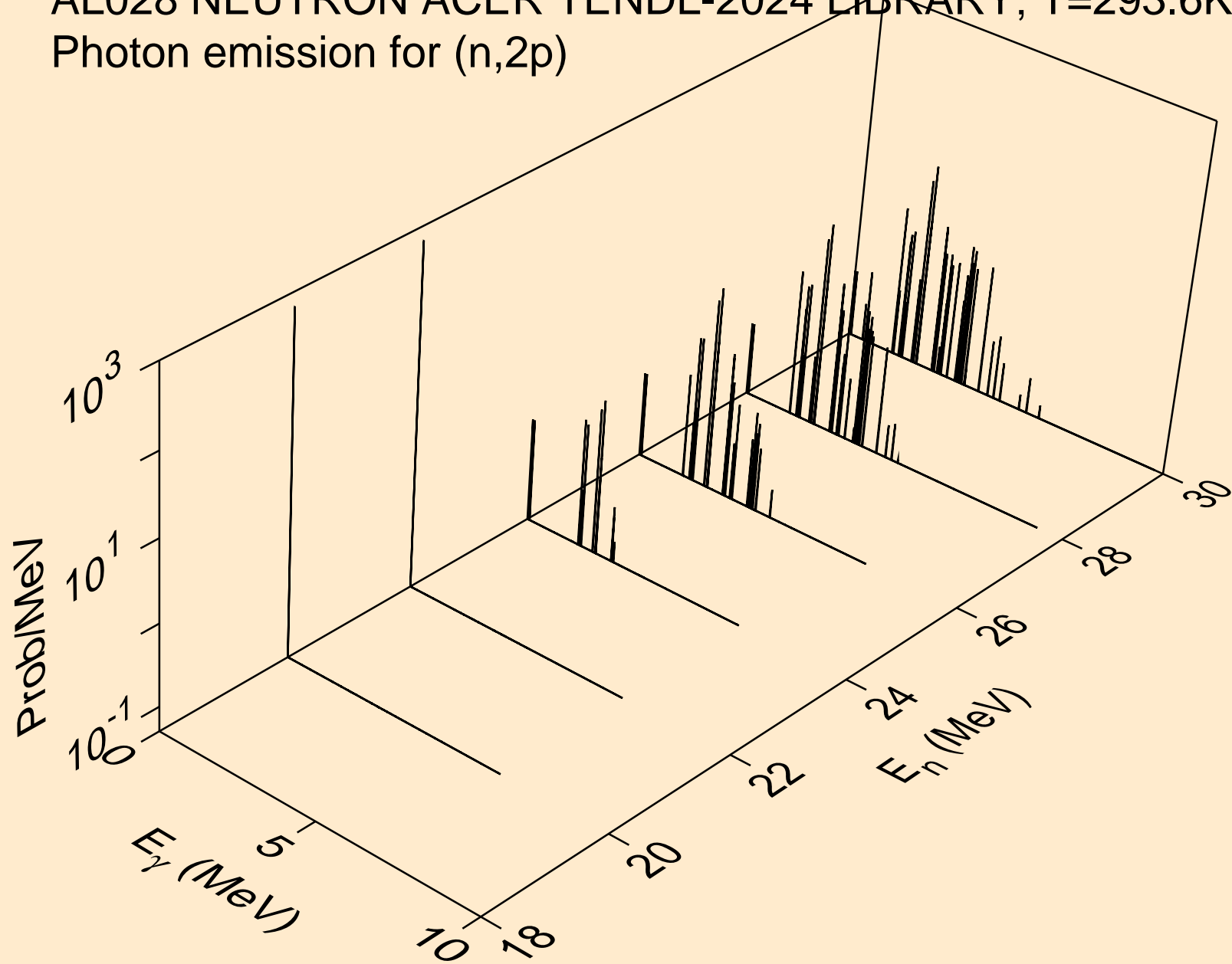

AL028 NEUTRON ACER TENDL-2024 LIBRARY; T=293.6K
Photon emission for (n,p α)

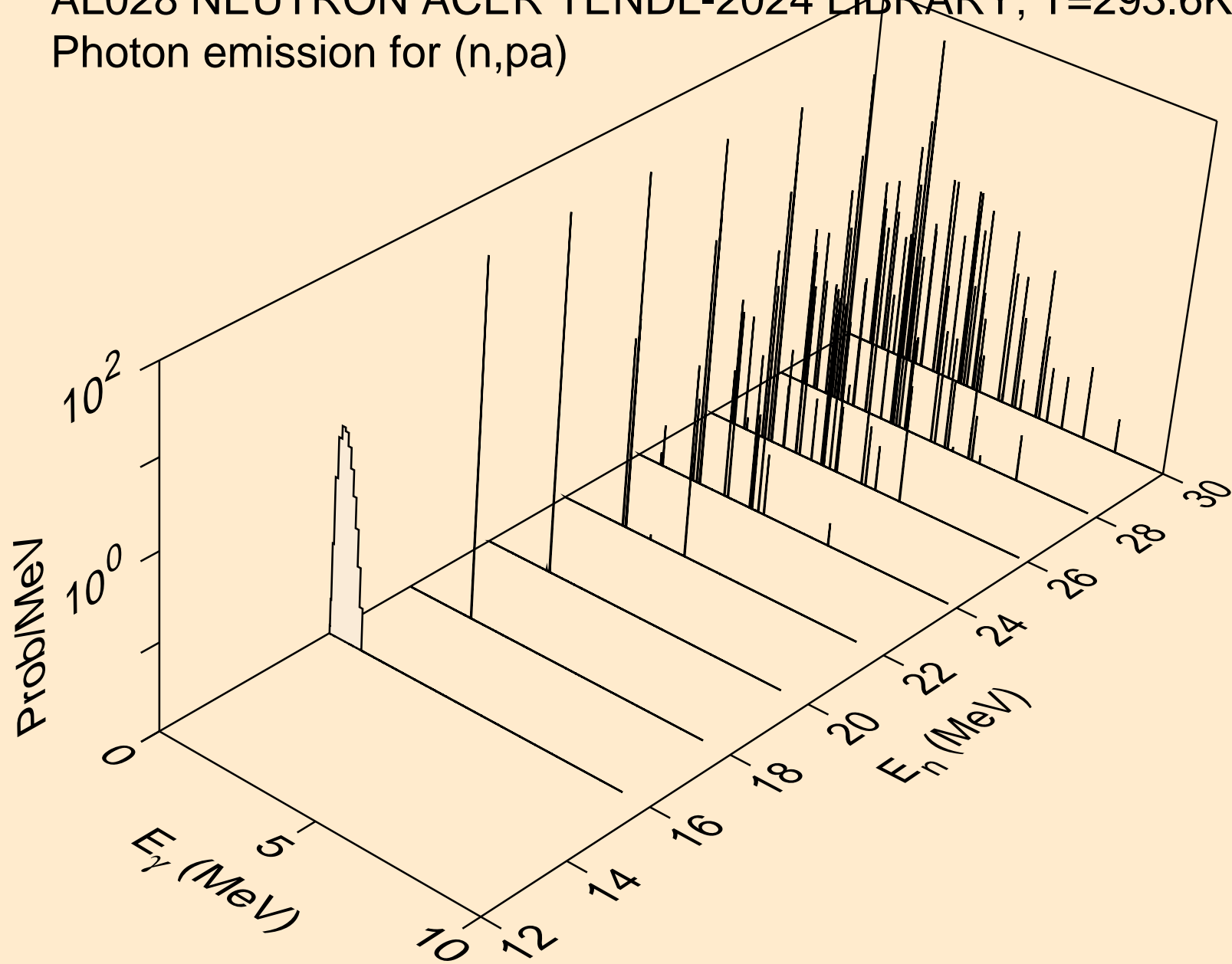

AL028 NEUTRON ACER TENDL-2024 LIBRARY; T=293.6K
Photon emission for (n,pd)

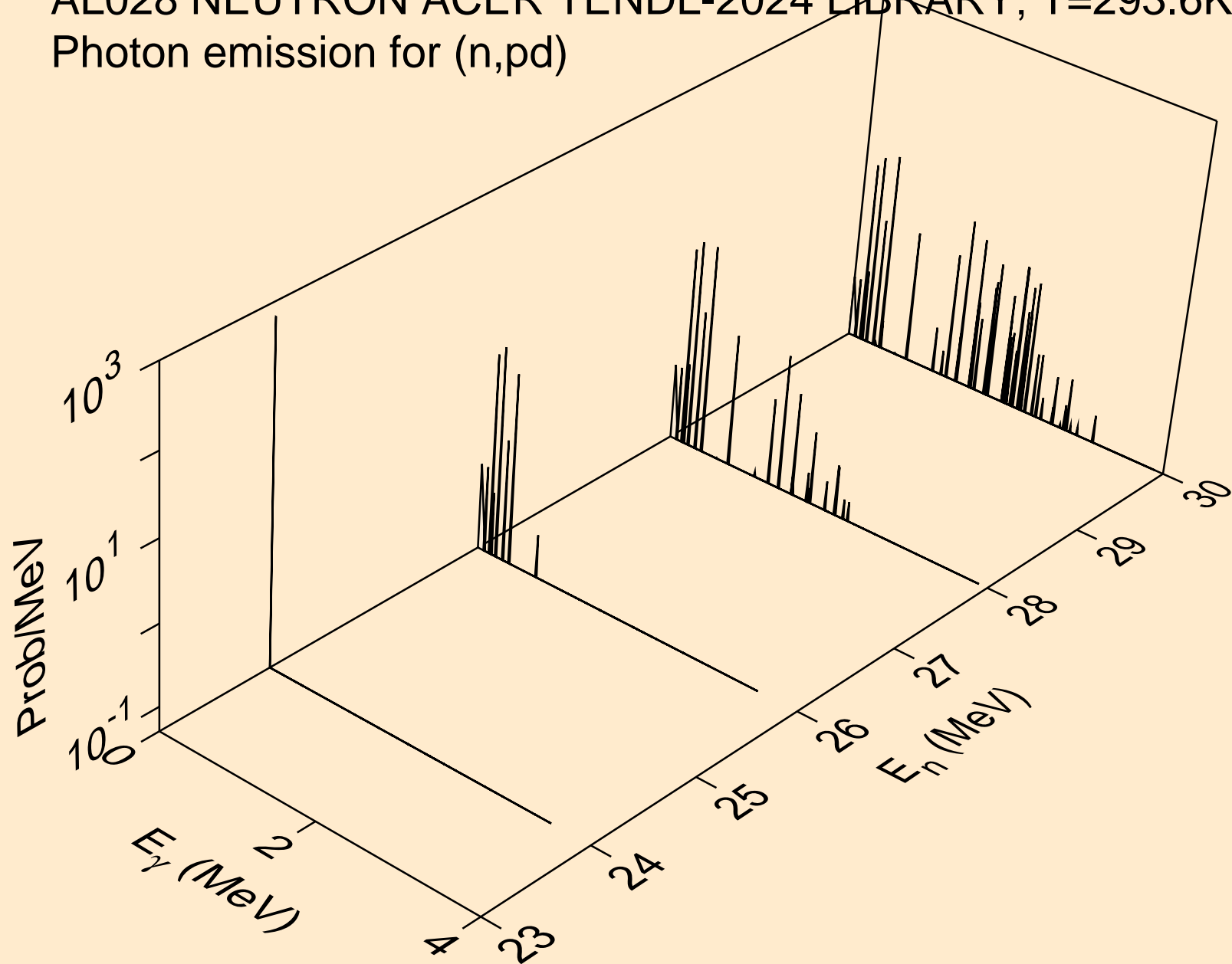

AL028 NEUTRON ACER TENDL-2024 LIBRARY; T=293.6K
Photon emission for (n,pt)

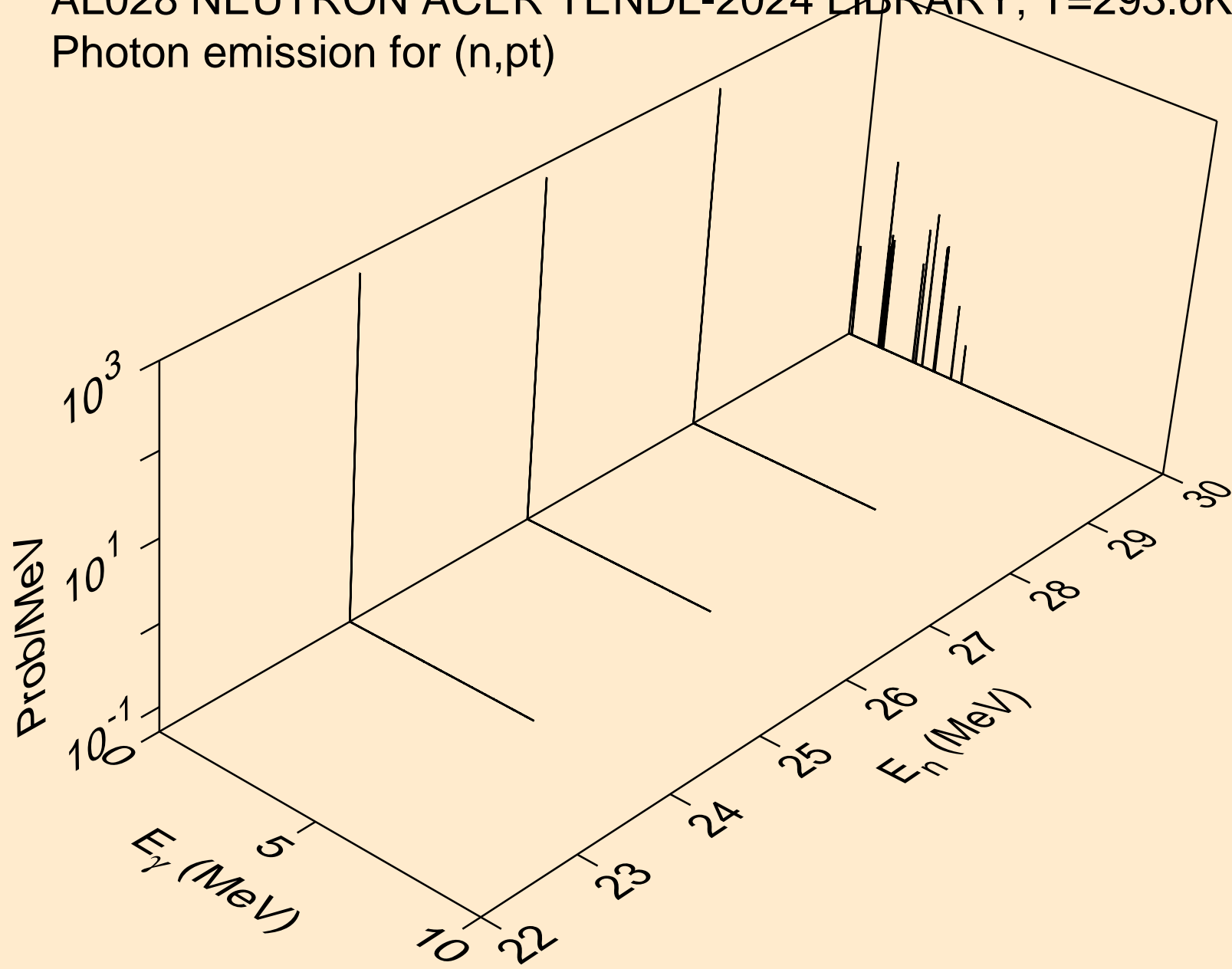

AL028 NEUTRON ACER TENDL-2024 LIBRARY; T=293.6K
Photon emission for (n,da)

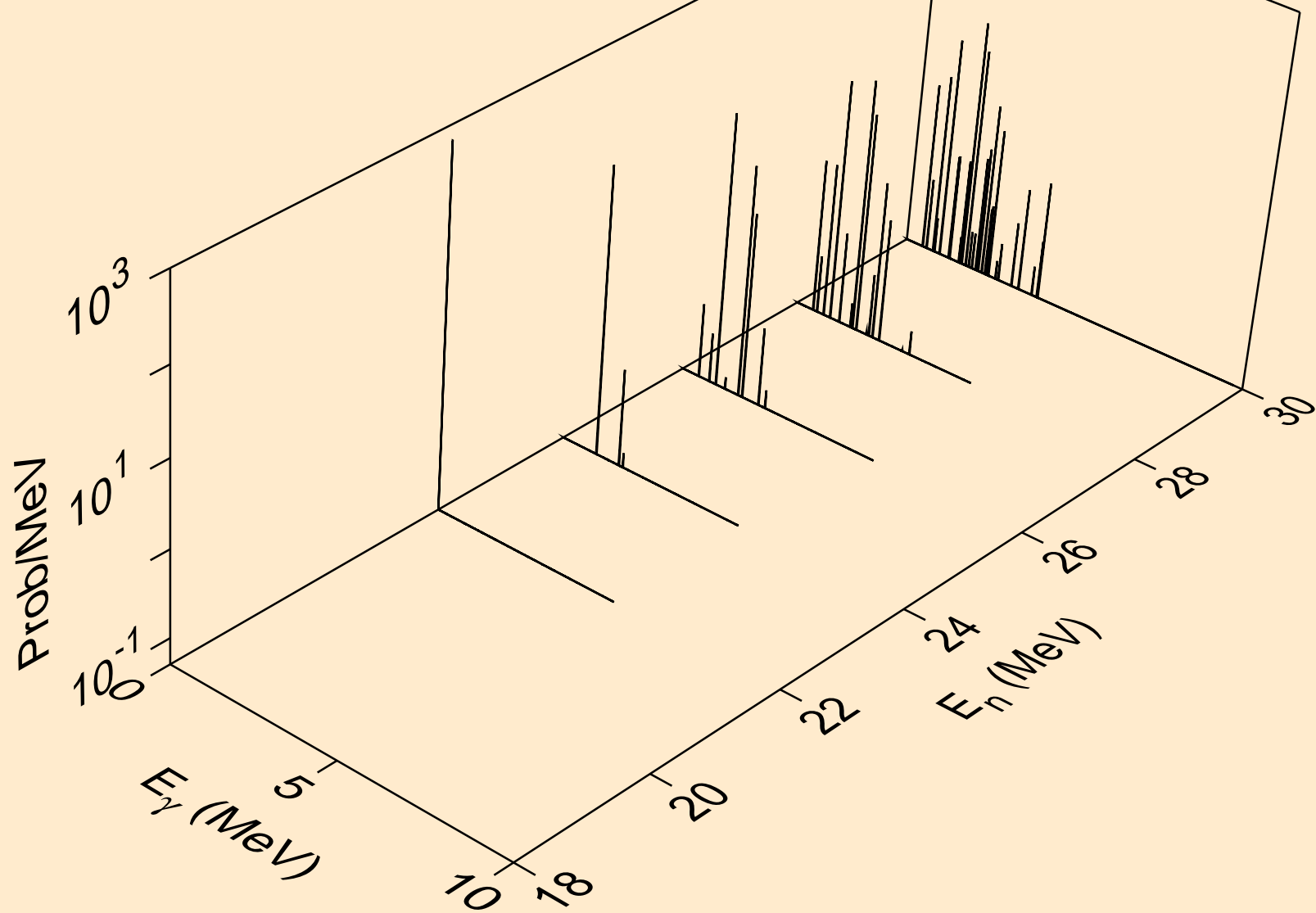

AL028 NEUTRON ACER TENDL-2024 LIBRARY; T=293.6K
thermal capture photon spectrum

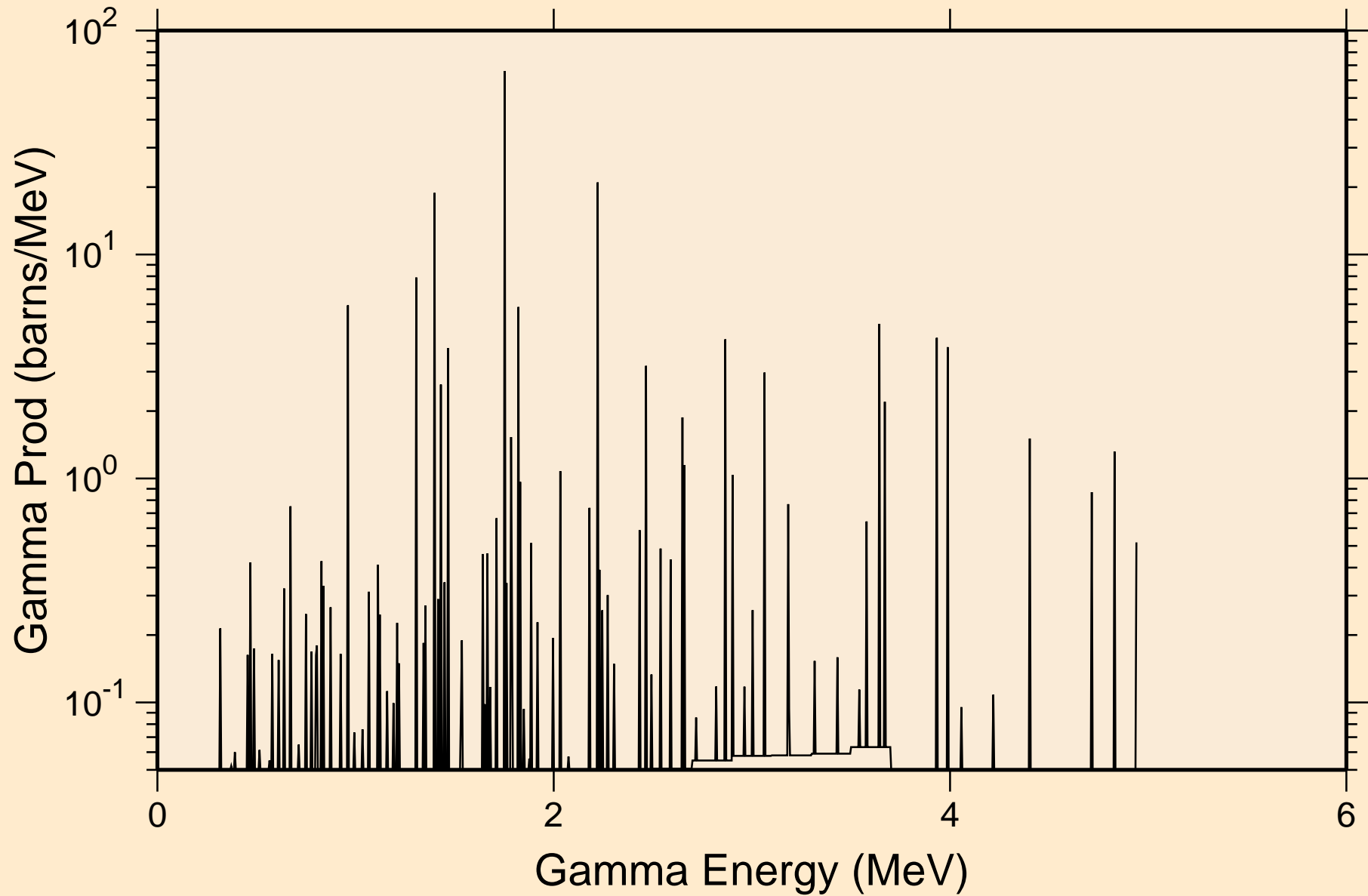

AL028 NEUTRON ACER TENDL-2024 LIBRARY; T=293.6K
14 MeV photon spectrum

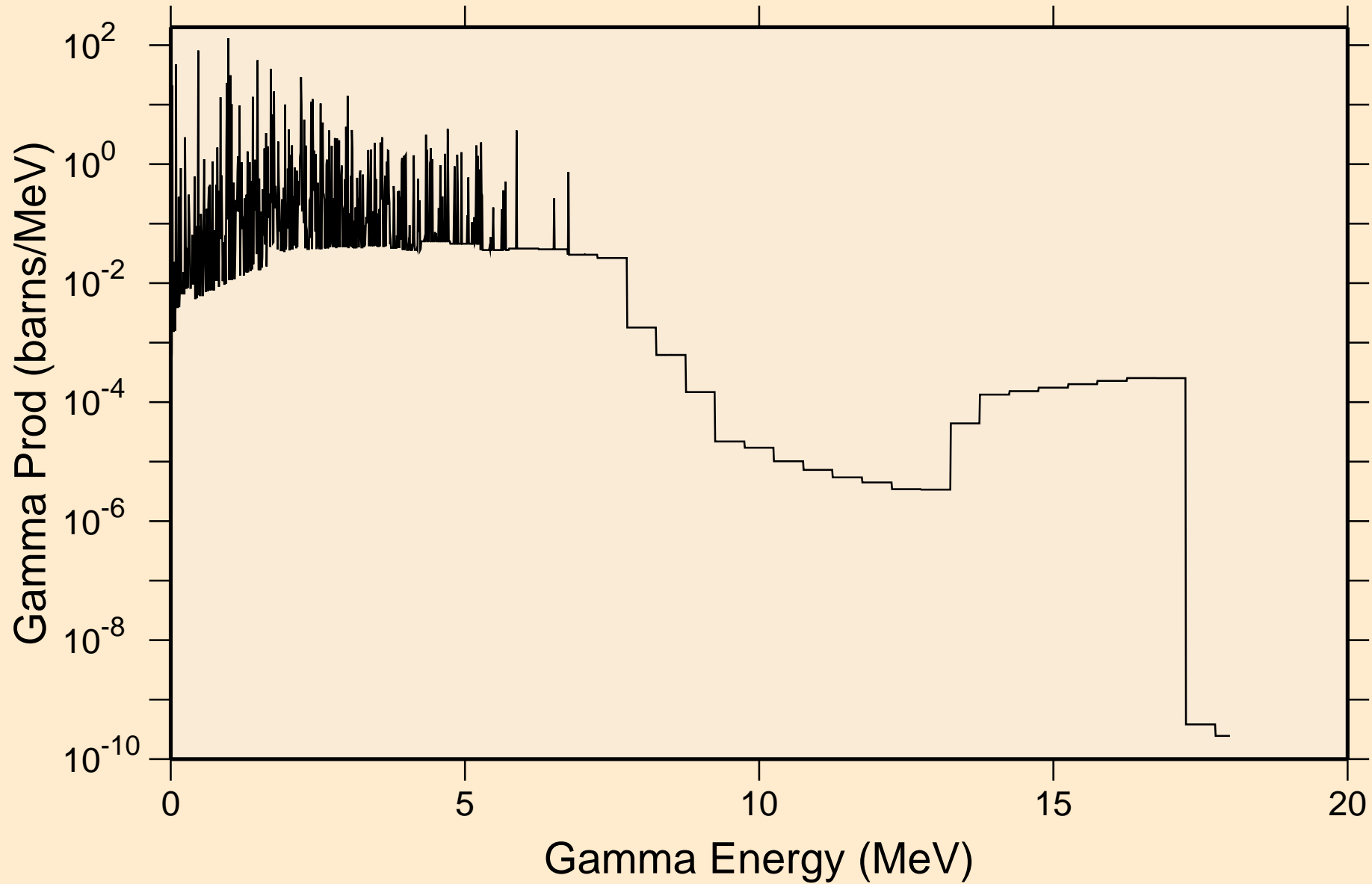

AL028 NEUTRON ACER TENDL-2024 LIBRARY; T=293.6K
Particle heating contributions

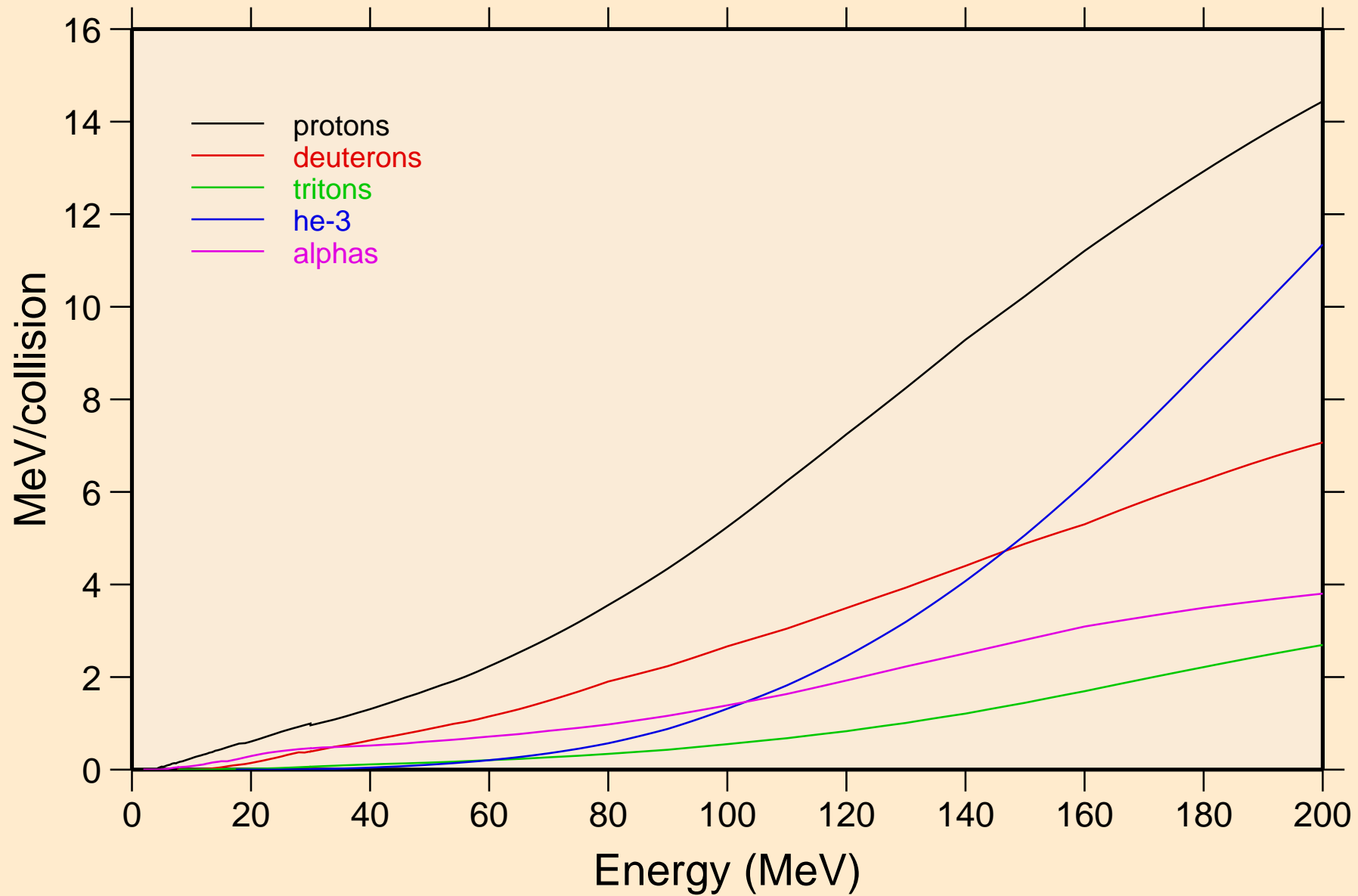

AL028 NEUTRON ACER TENDL-2024 LIBRARY; T=293.6K
Recoil Heating

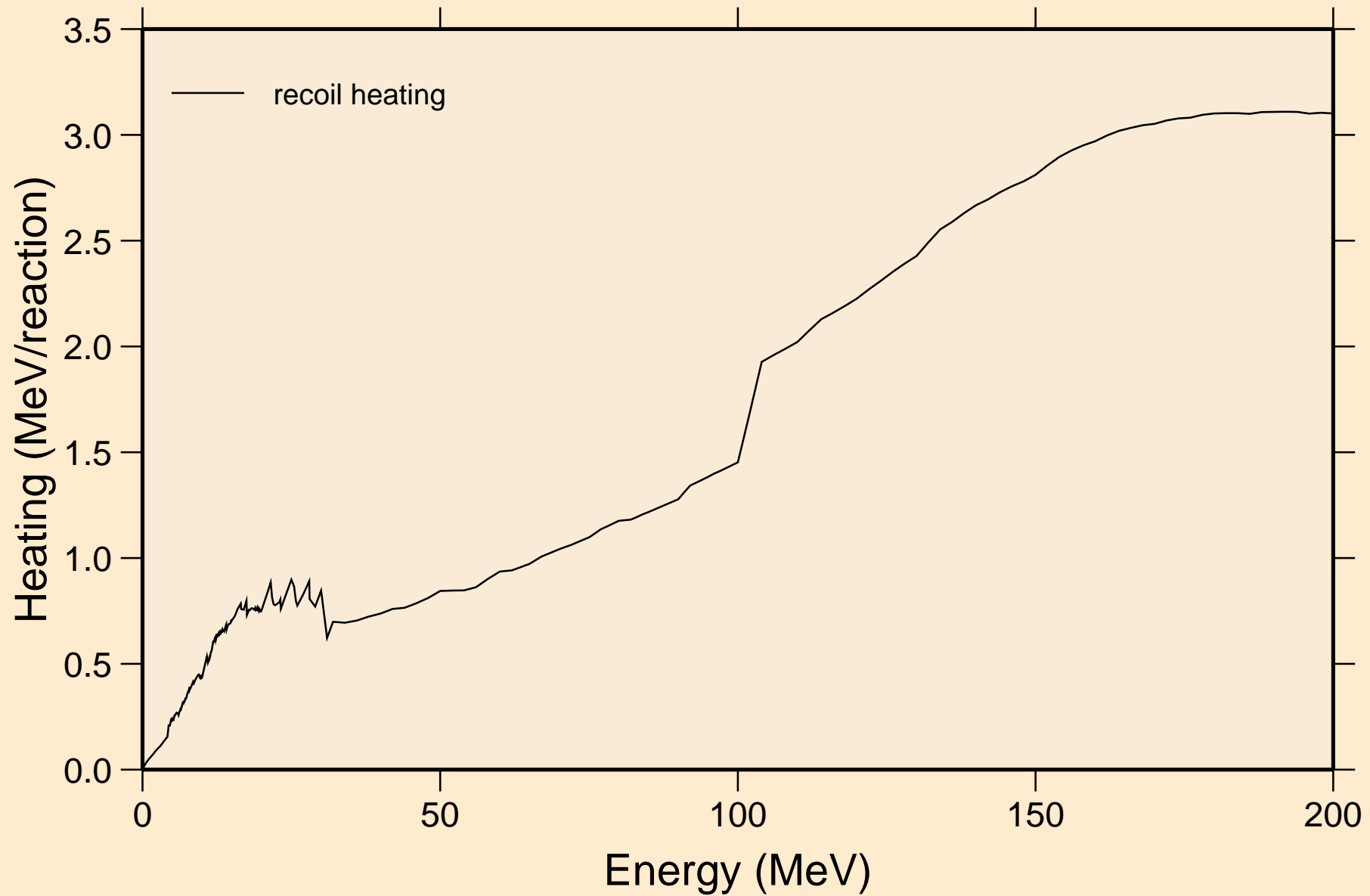

AL028 NEUTRON ACER TENDL-2024 LIBRARY; T=293.6K
Particle production cross sections

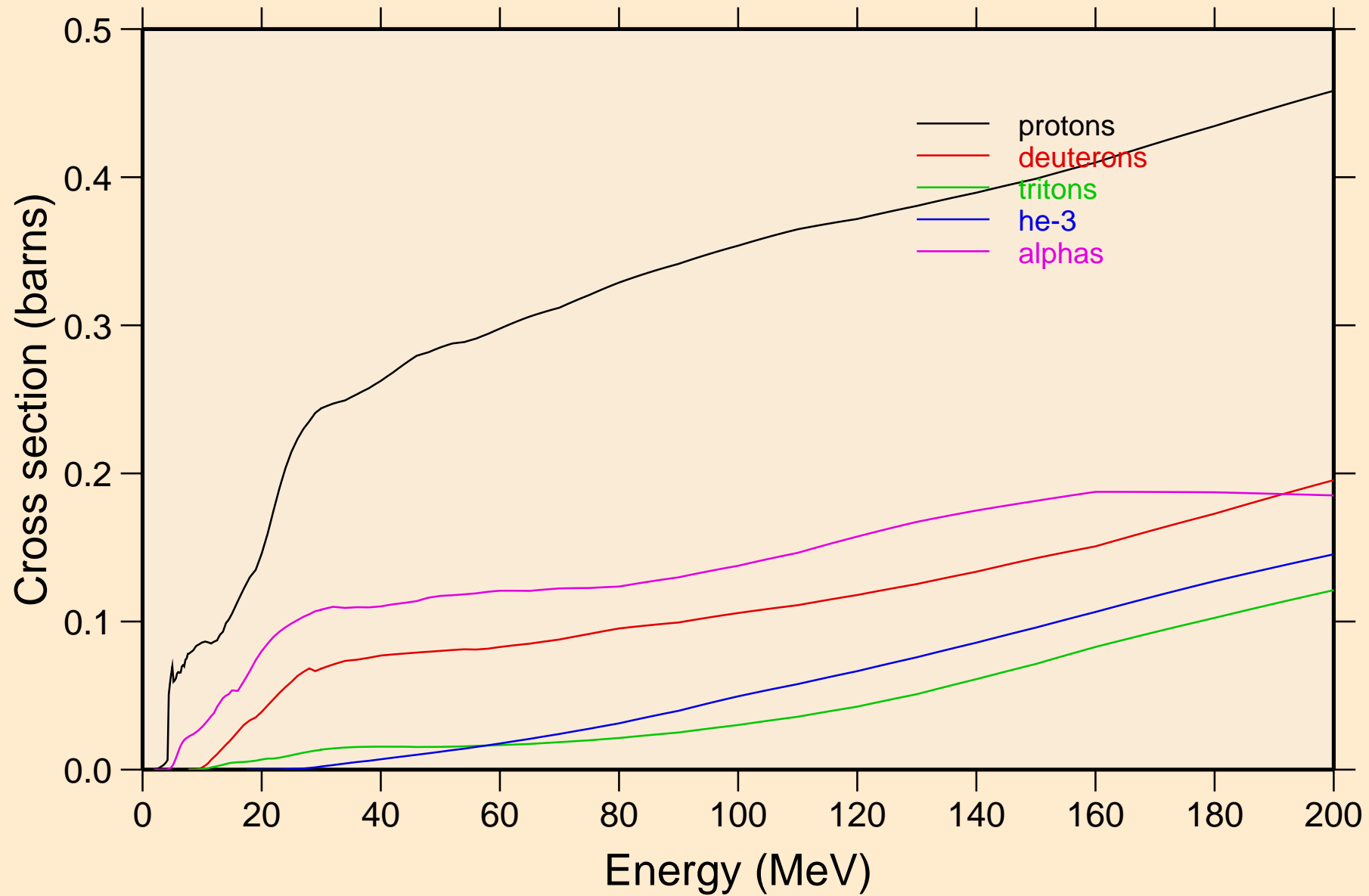

AL028 NEUTRON ACER TENDL-2024 LIBRARY; T=293.6K
protons from (n,x)

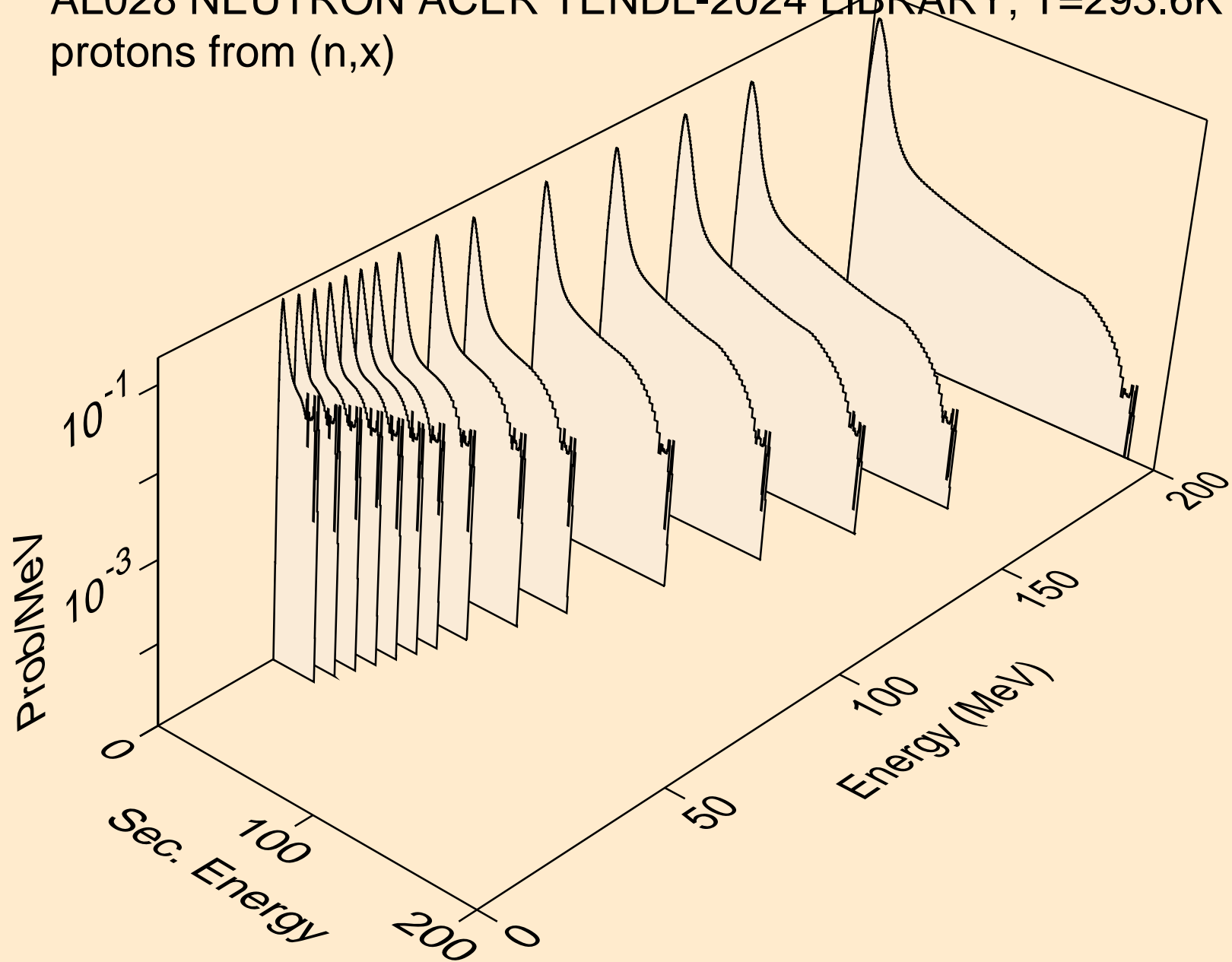

AL028 NEUTRON ACER TENDL-2024 LIBRARY; T=293.6K
protons from (n,n*)p

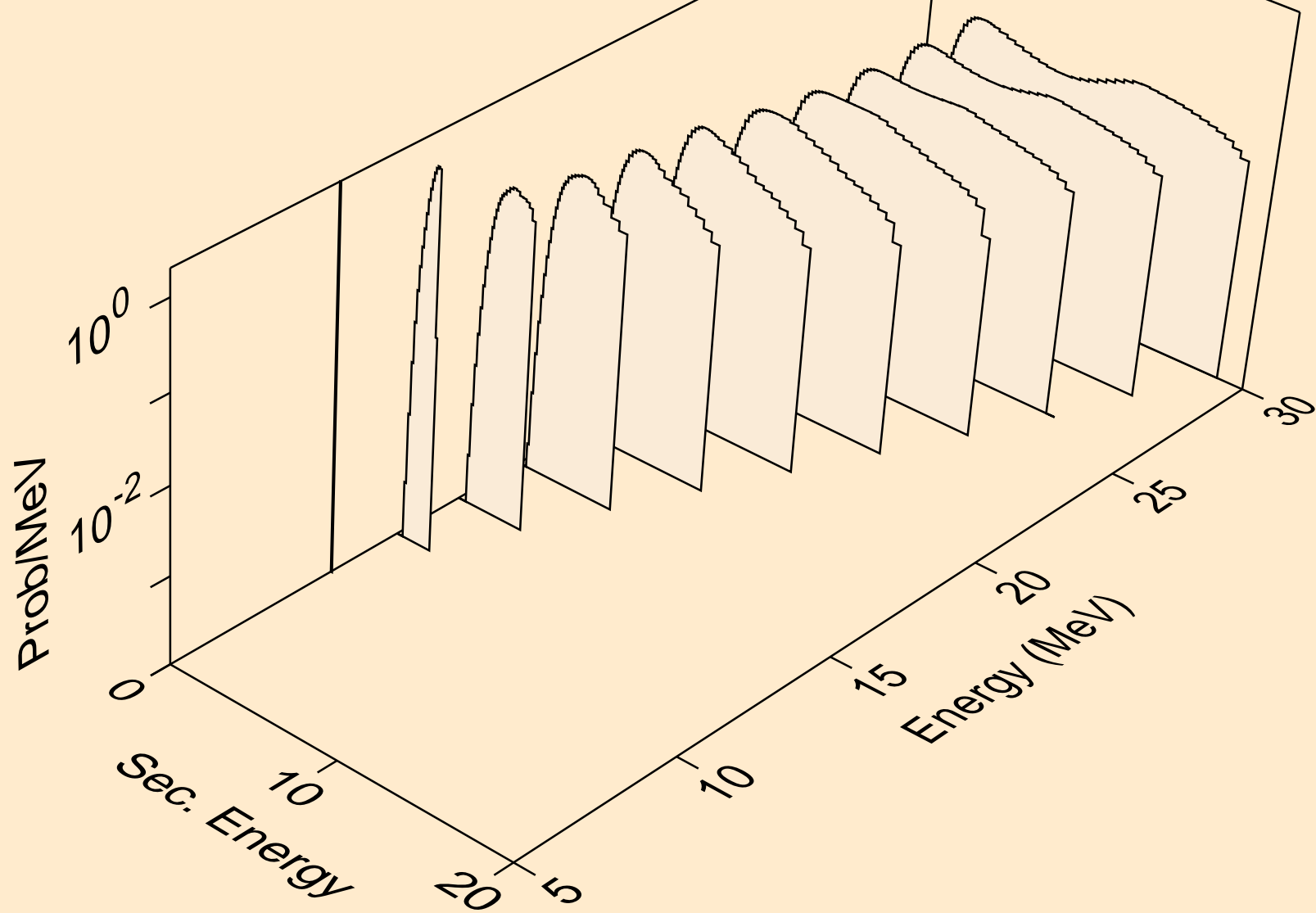

AL028 NEUTRON ACER TENDL-2024 LIBRARY; T=293.6K
protons from (n,2np)

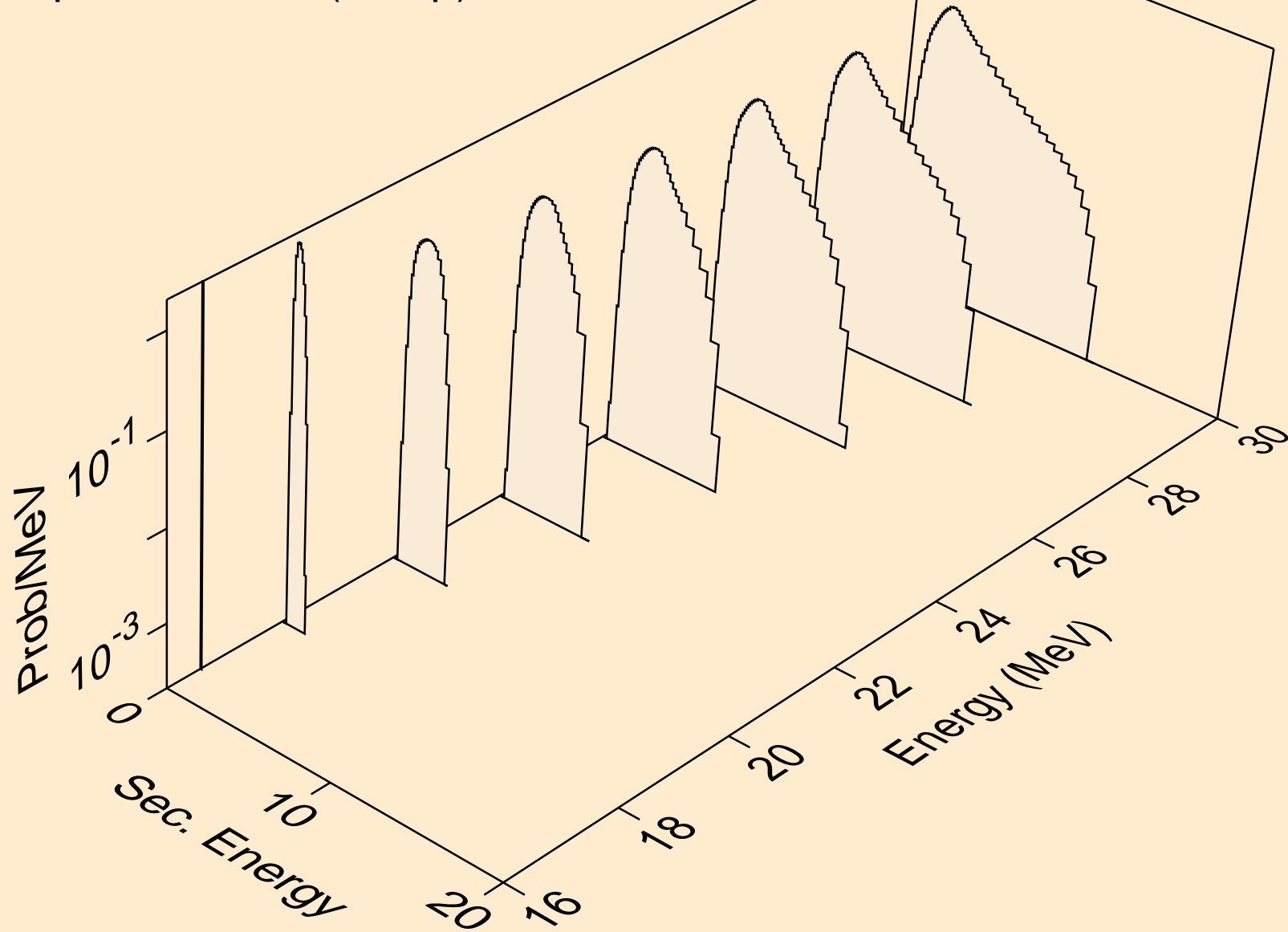

AL028 NEUTRON ACER TENDL-2024 LIBRARY; T=293.6K
protons from (n,3np)

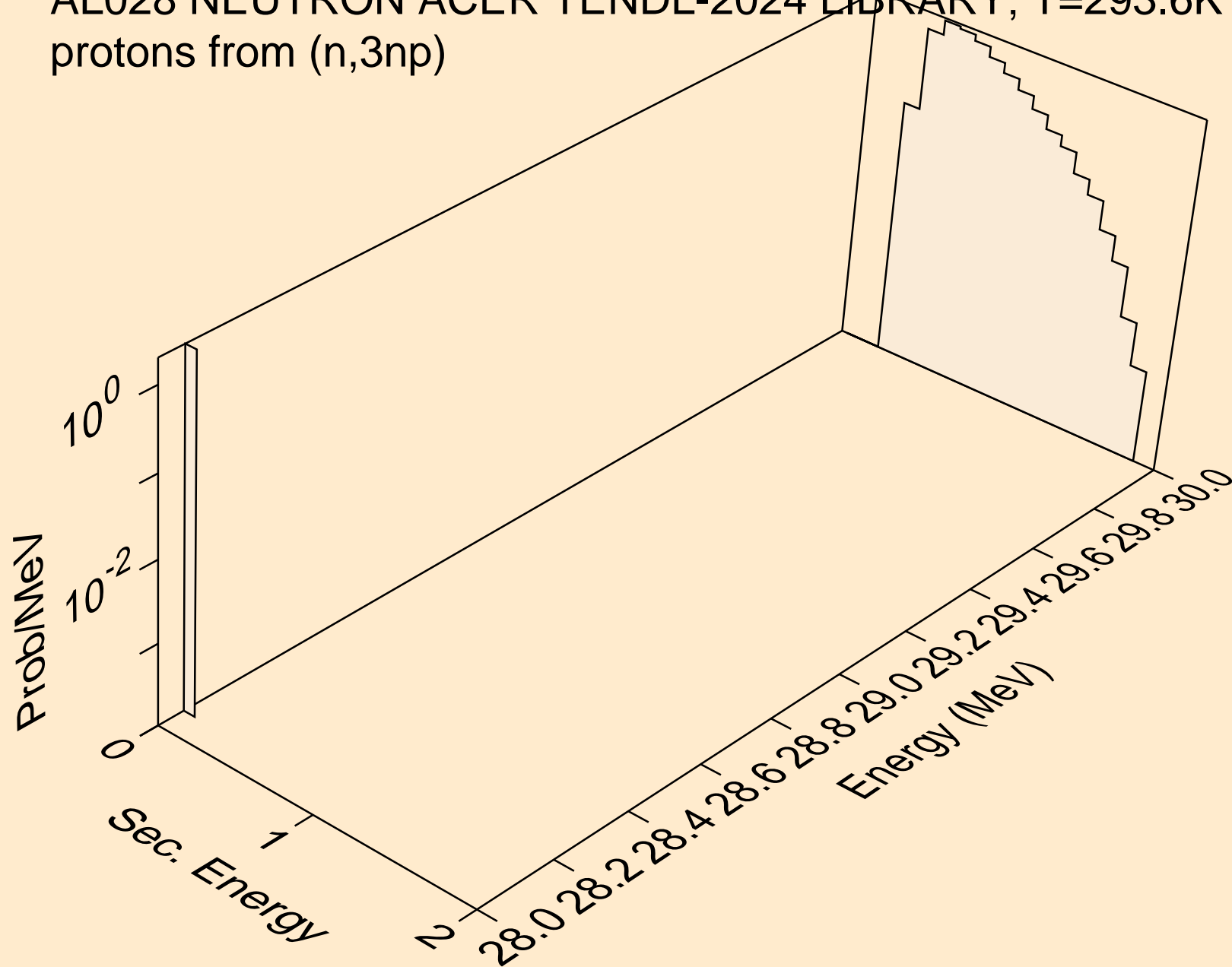

AL028 NEUTRON ACER TENDL-2024 LIBRARY; T=293.6K
protons from (n,n2p)

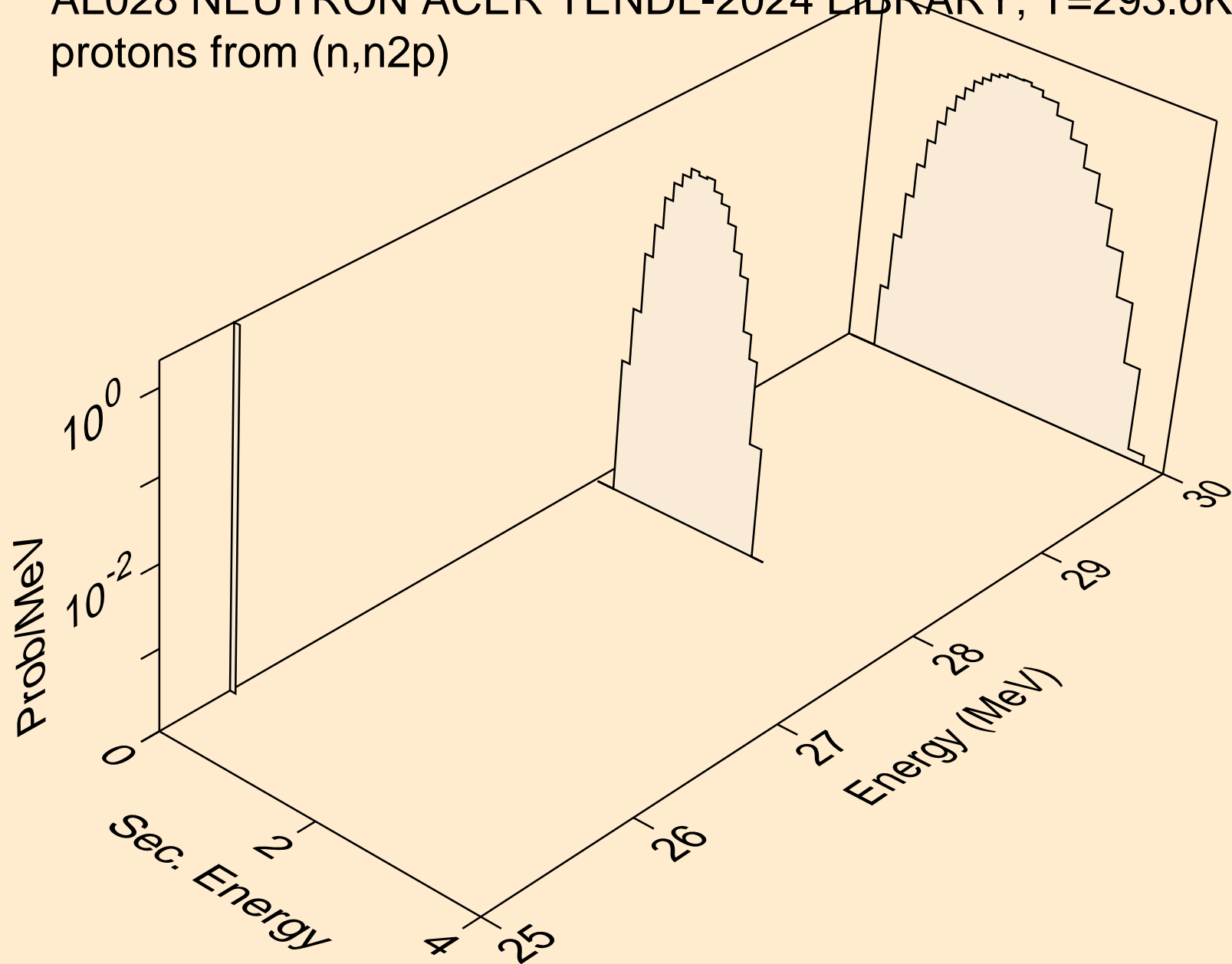

AL028 NEUTRON ACER TENDL-2024 LIBRARY; T=293.6K
protons from (n,npa)

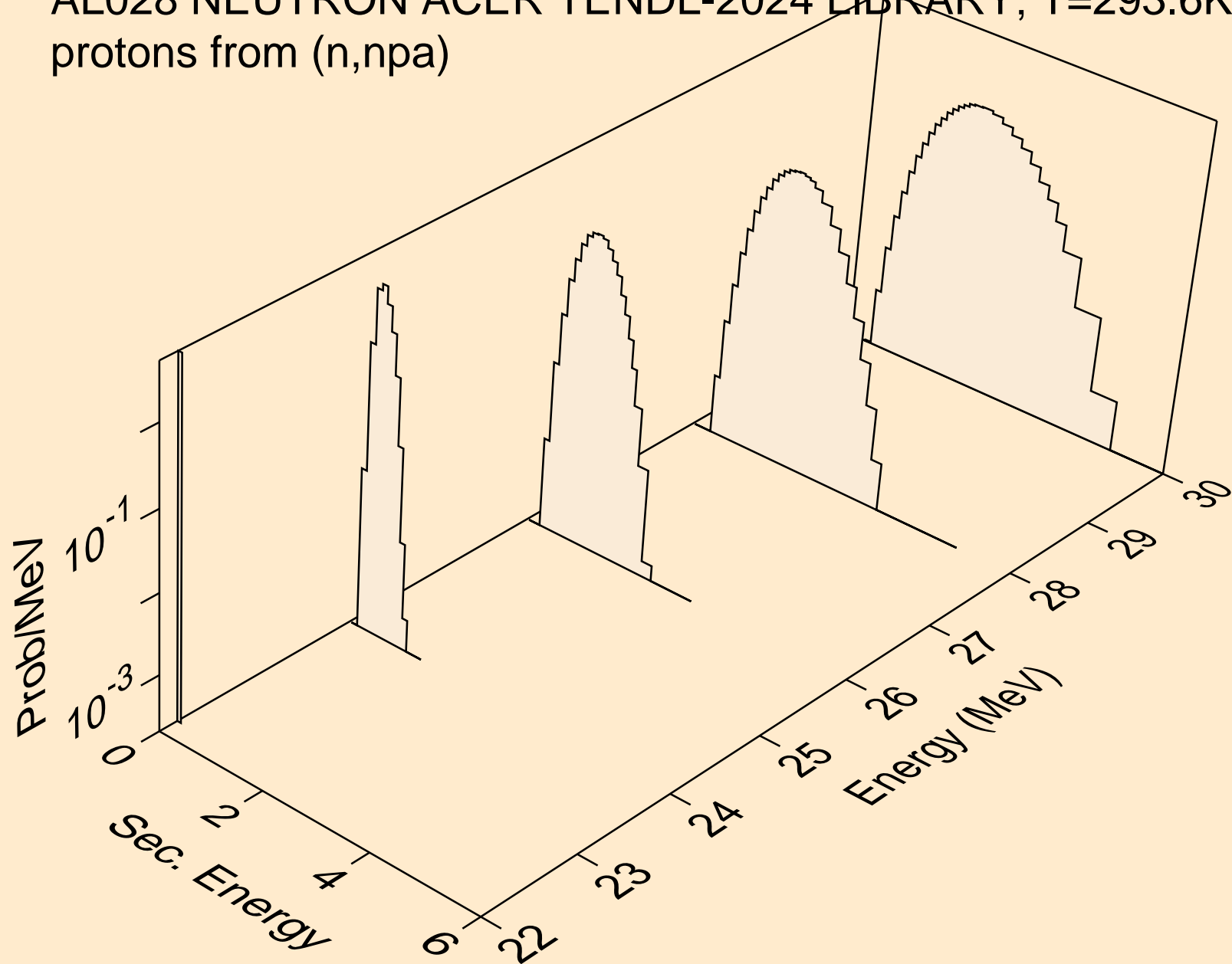

AL028 NEUTRON ACER TENDL-2024 LIBRARY; T=293.6K
protons from (n,p)

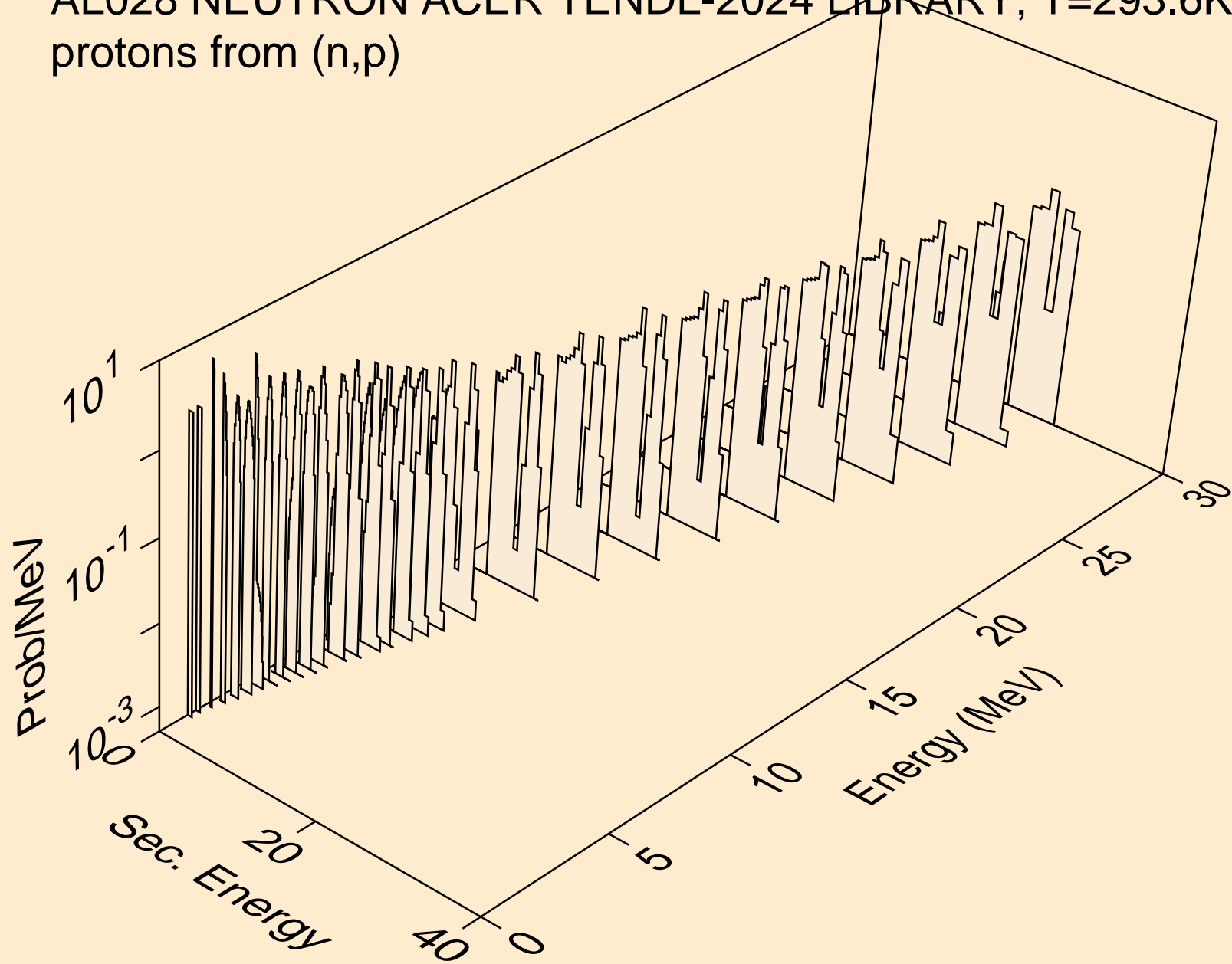

AL028 NEUTRON ACER TENDL-2024 LIBRARY; T=293.6K
protons from (n,2p)

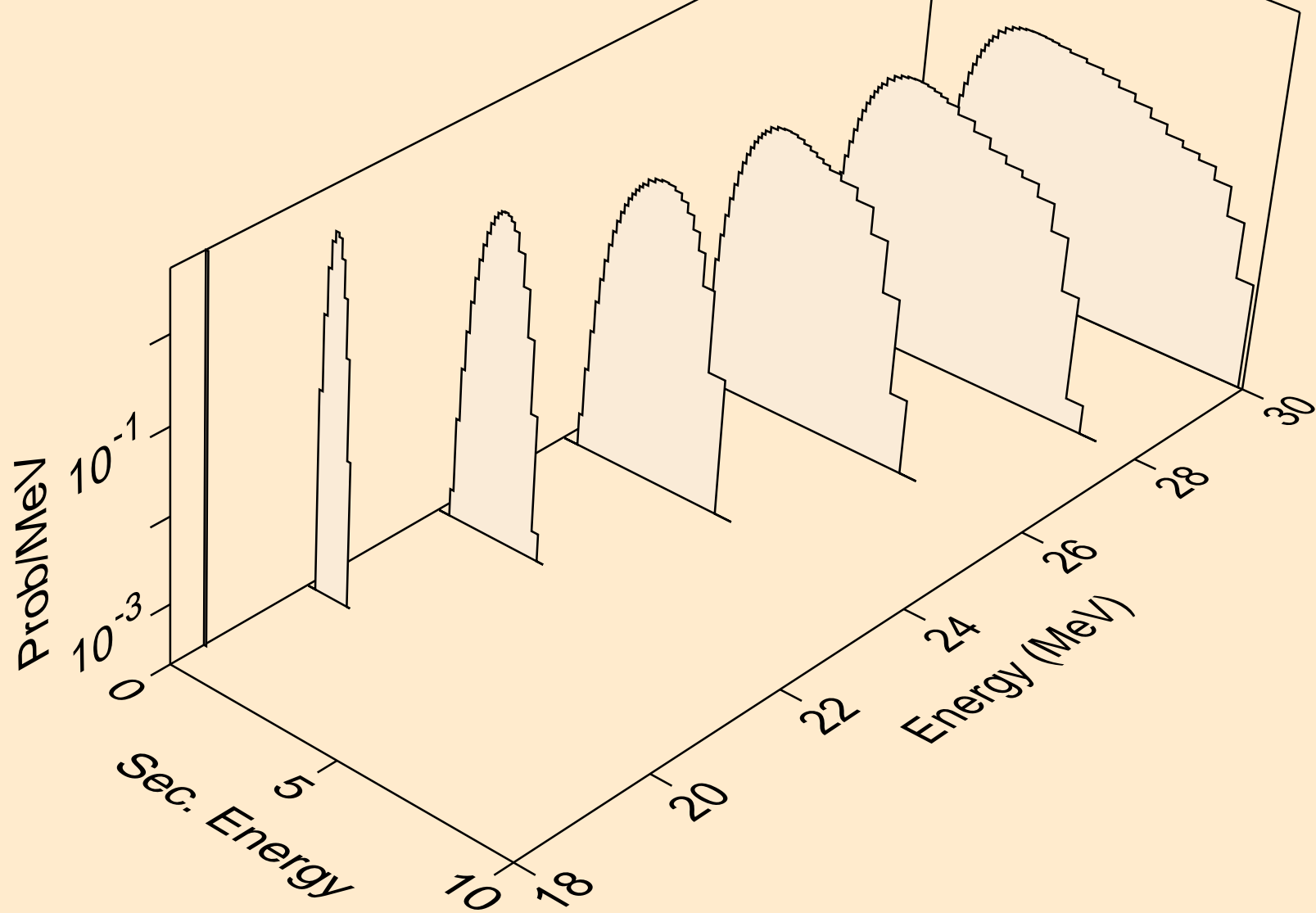

AL028 NEUTRON ACER TENDL-2024 LIBRARY; T=293.6K
protons from (n,p)

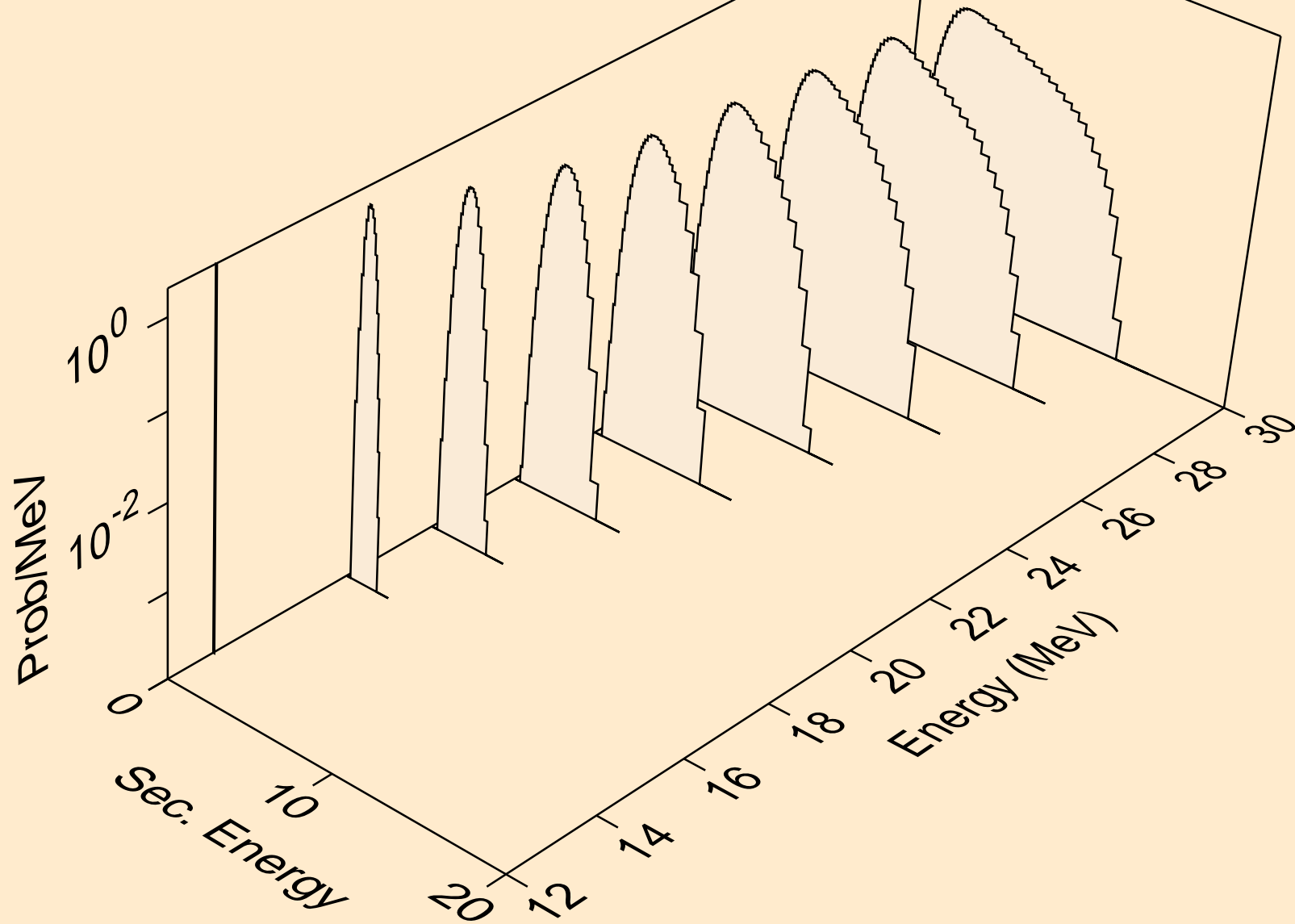

AL028 NEUTRON ACER TENDL-2024 LIBRARY; T=293.6K
protons from (n,pd)

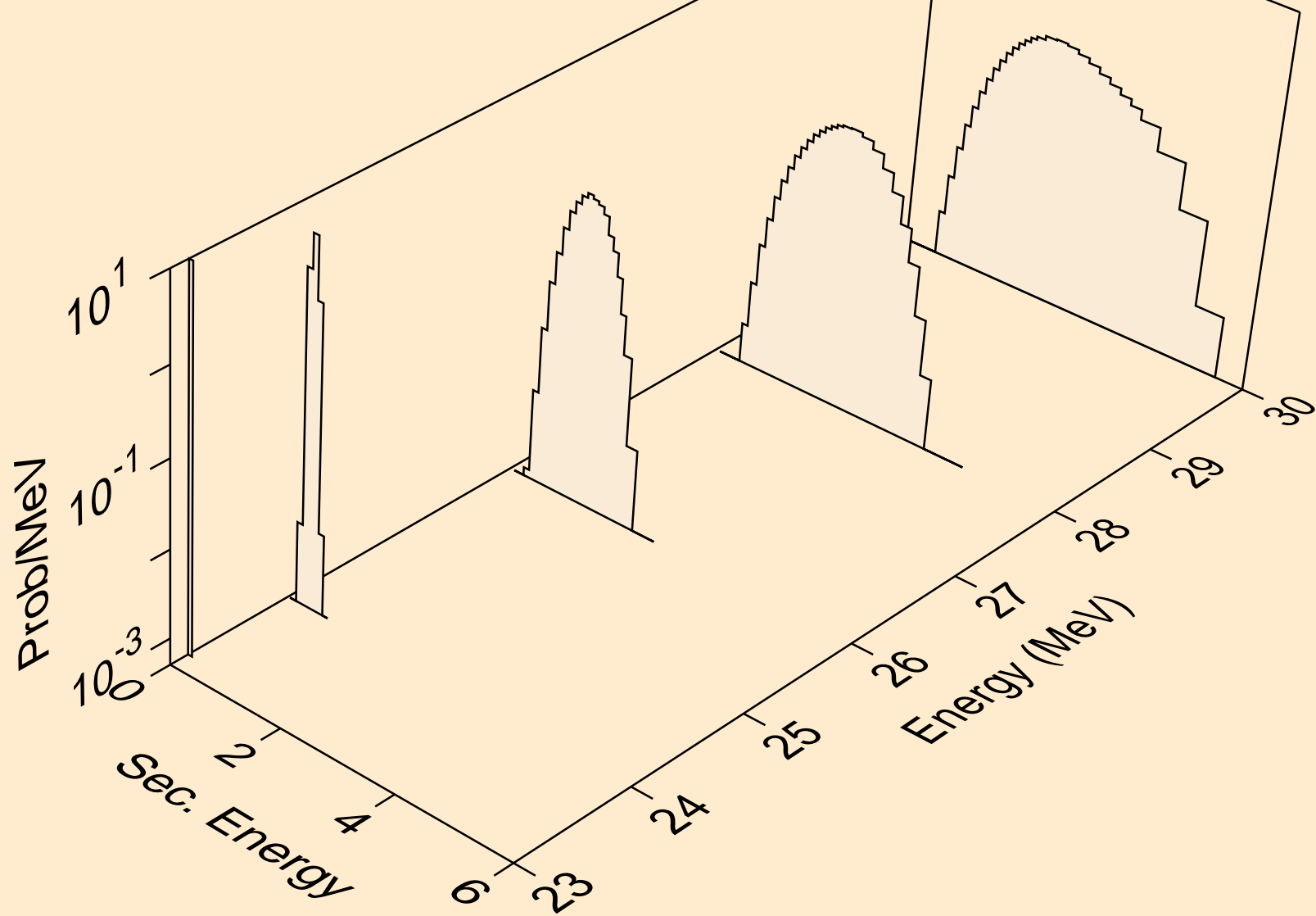

AL028 NEUTRON ACER TENDL-2024 LIBRARY; T=293.6K
protons from (n,pt)

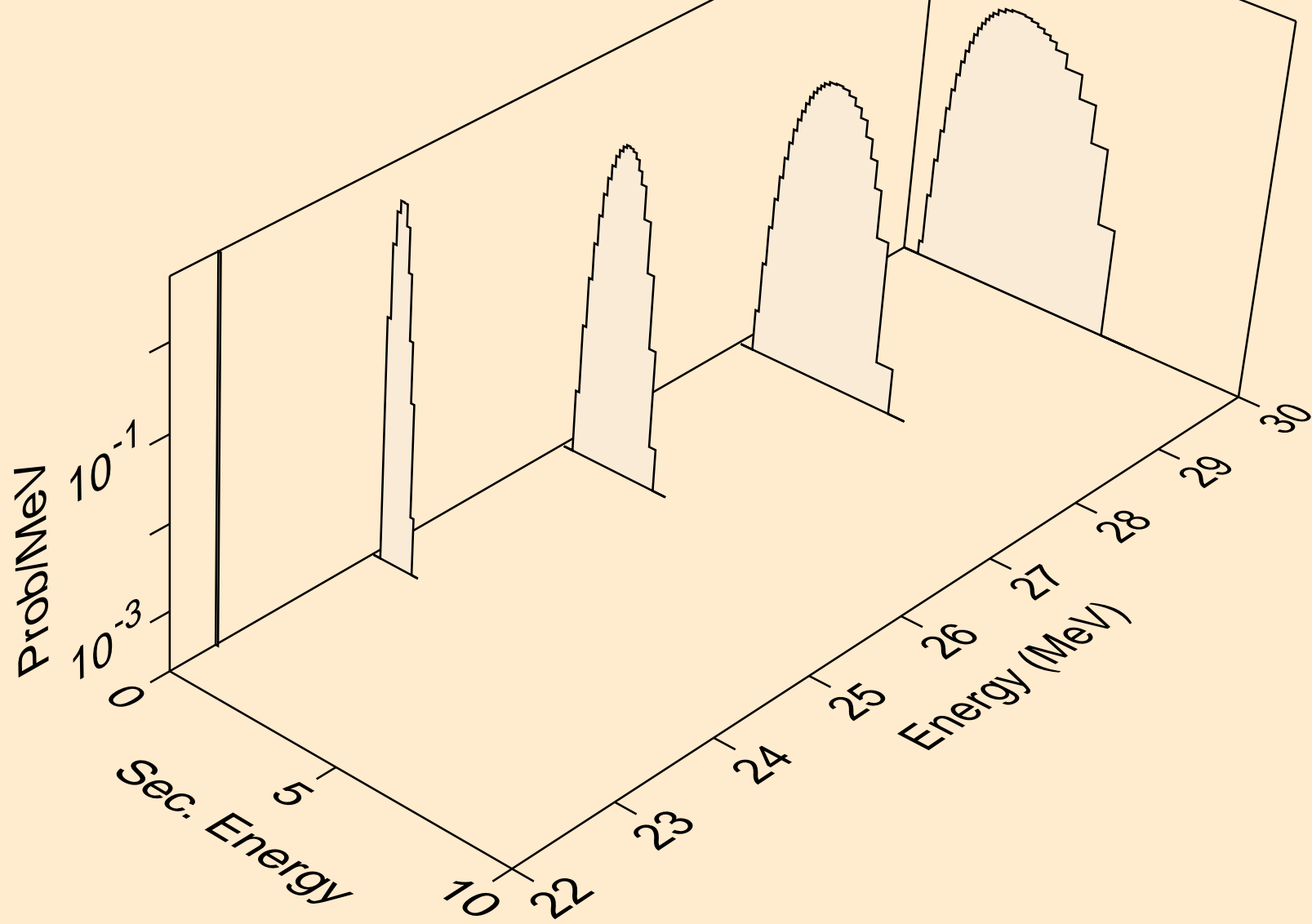

AL028 NEUTRON ACER TENDL-2024 LIBRARY; T=293.6K
deuterons from (n,x)

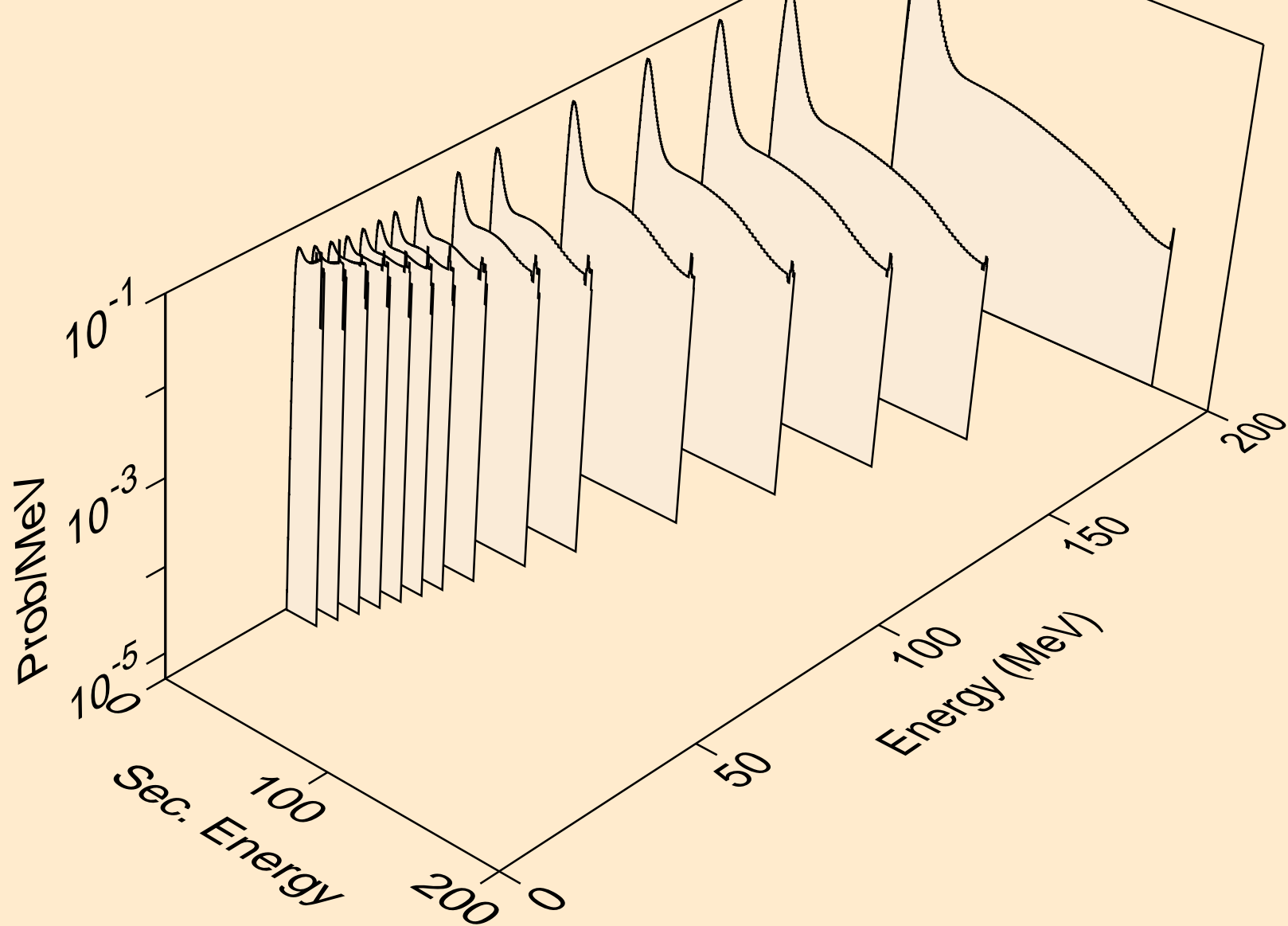

AL028 NEUTRON ACER TENDL-2024 LIBRARY; T=293.6K
deuterons from (n,2nd)

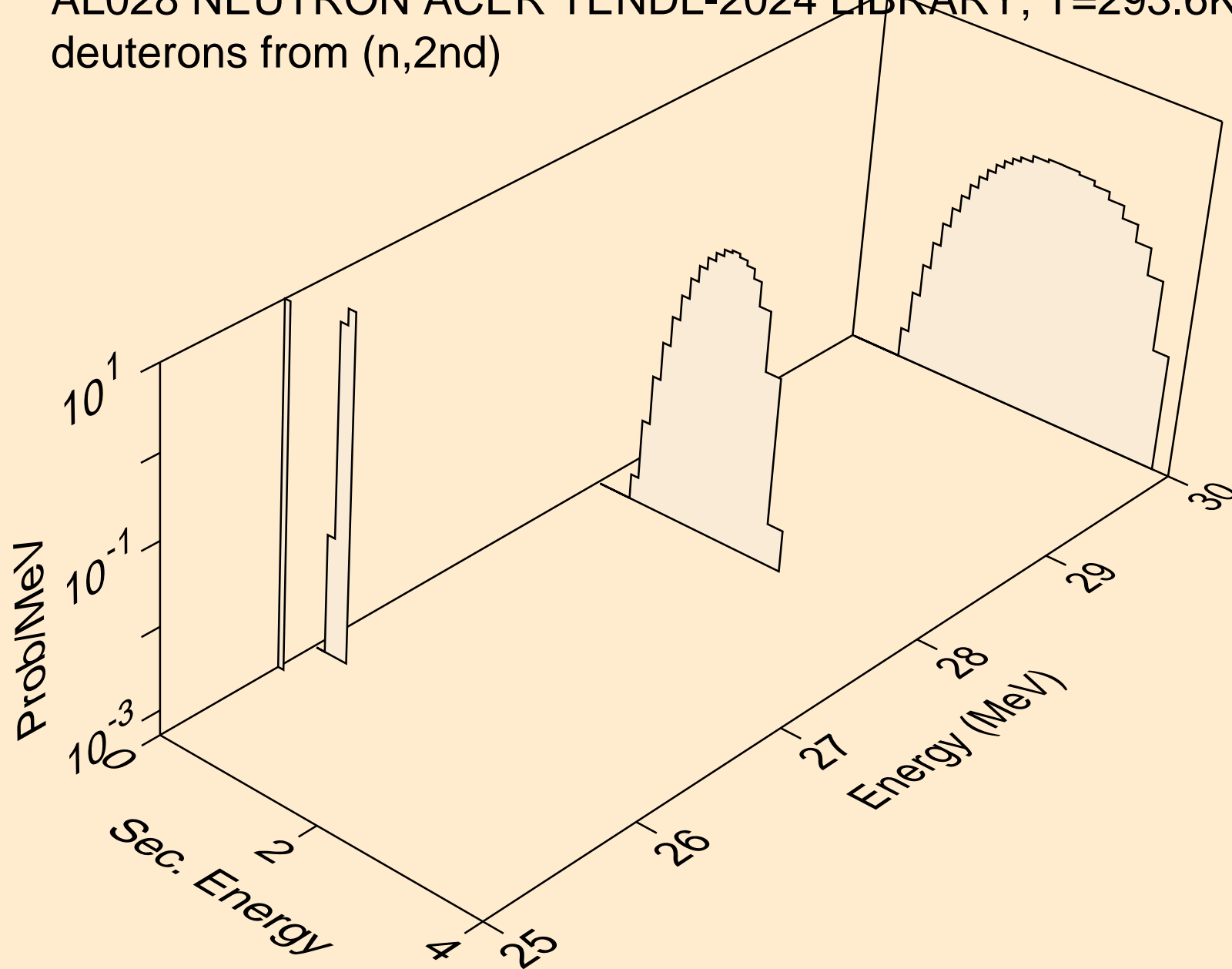

AL028 NEUTRON ACER TENDL-2024 LIBRARY; T=293.6K
deuterons from (n,n*)d

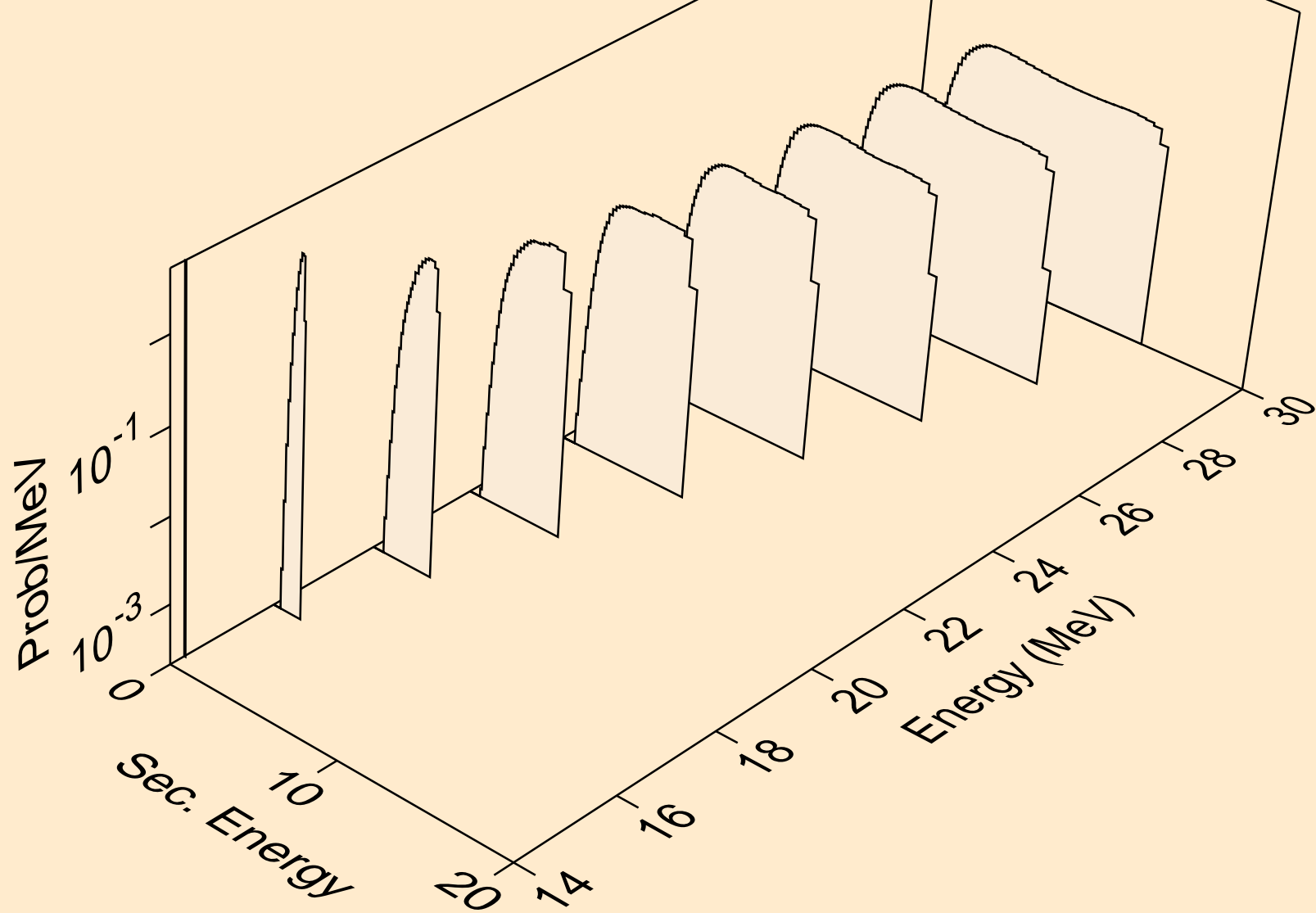

AL028 NEUTRON ACER TENDL-2024 LIBRARY; T=293.6K
deuterons from (n,d)

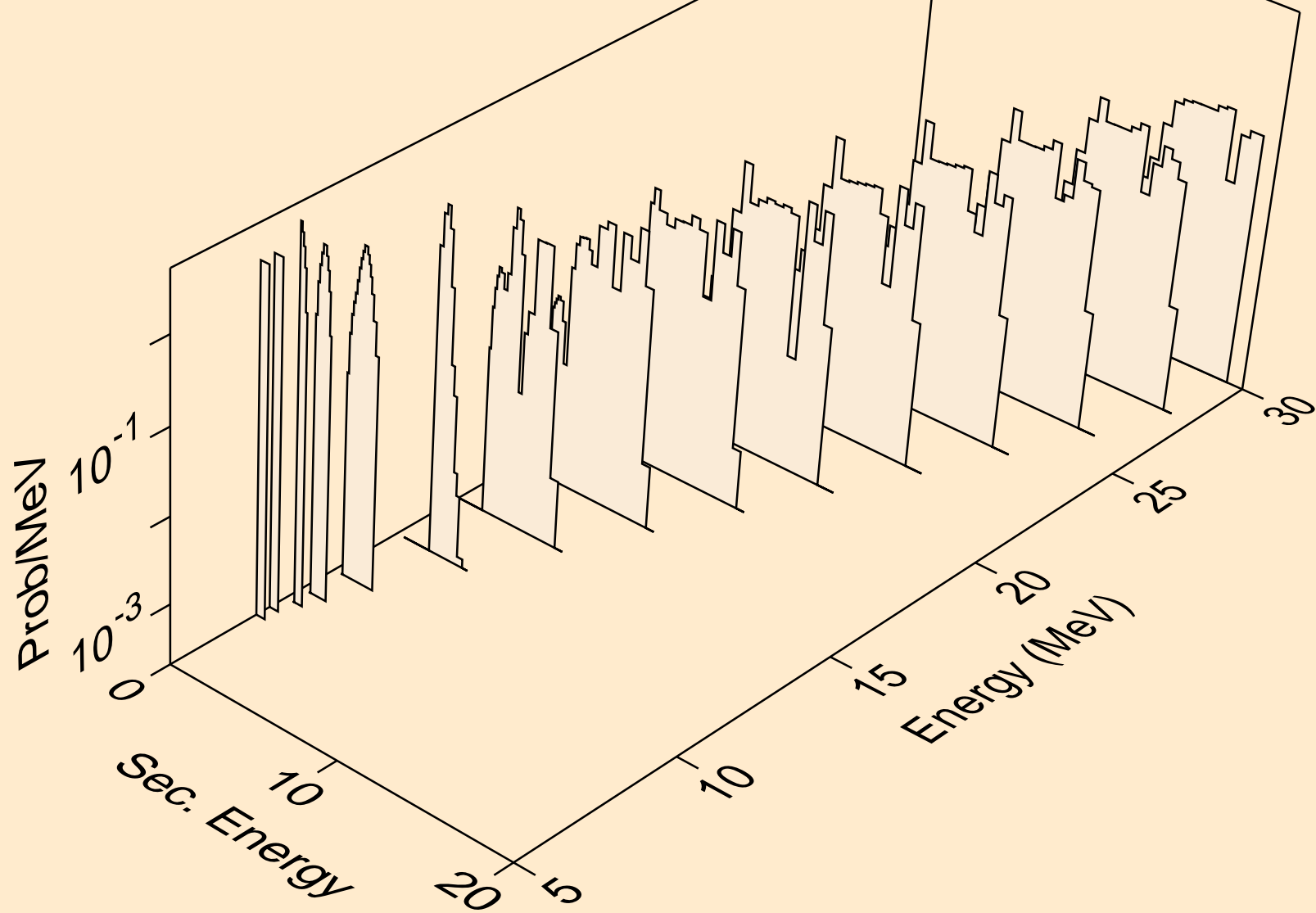

AL028 NEUTRON ACER TENDL-2024 LIBRARY; T=293.6K
deuterons from (n,pd)

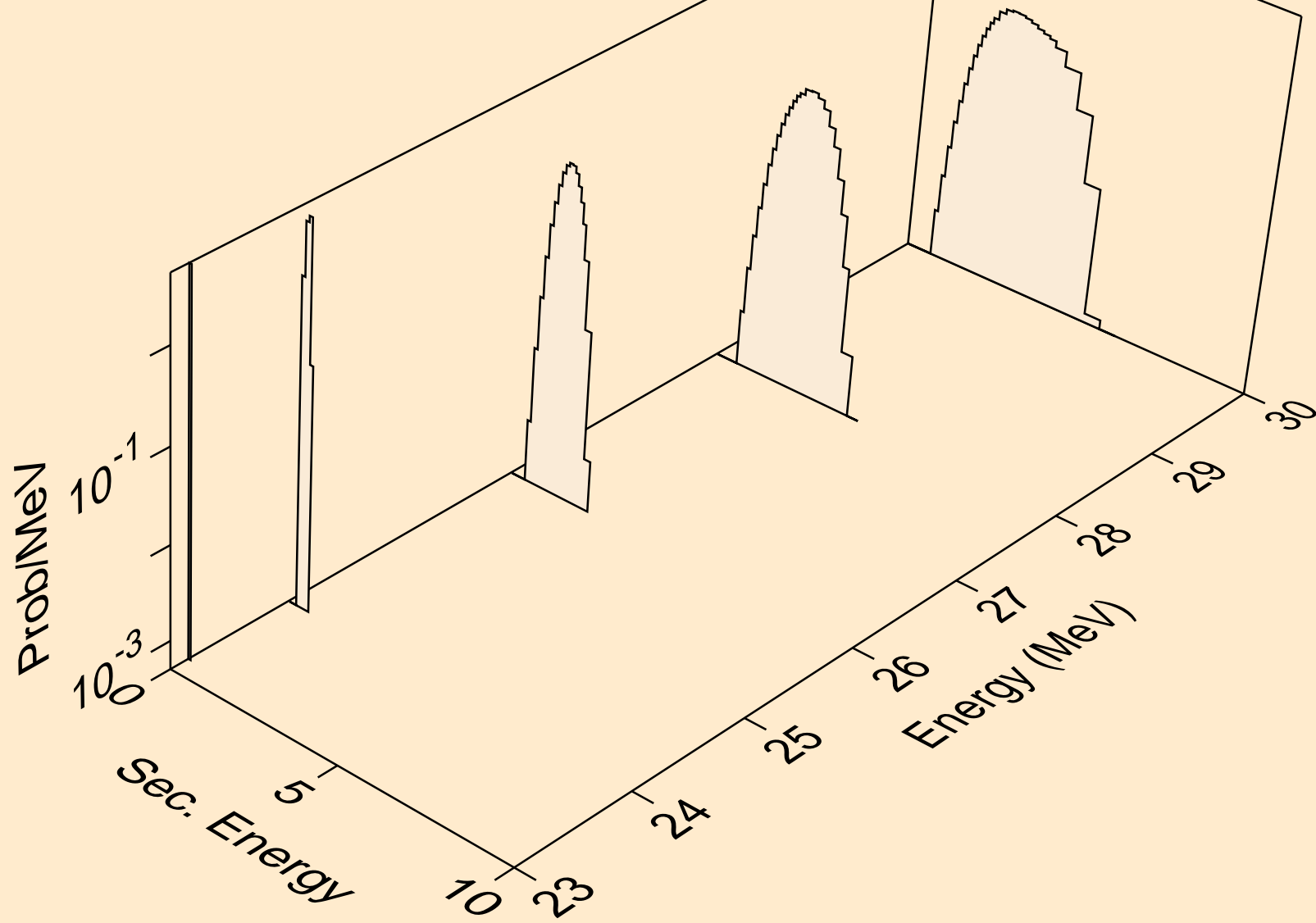

AL028 NEUTRON ACER TENDL-2024 LIBRARY; T=293.6K
deuterons from (n,da)

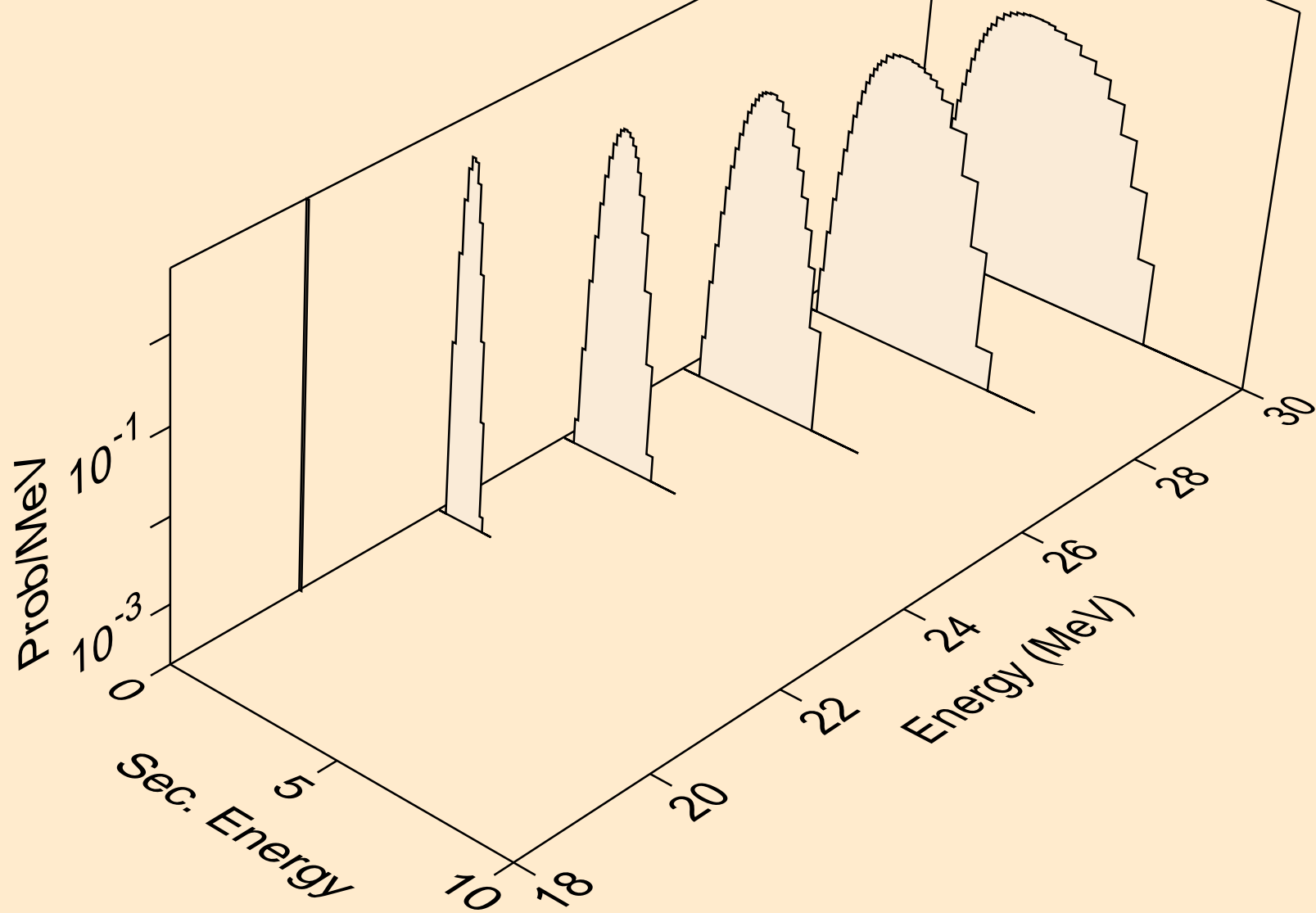

AL028 NEUTRON ACER TENDL-2024 LIBRARY; T=293.6K
tritons from (n,x)

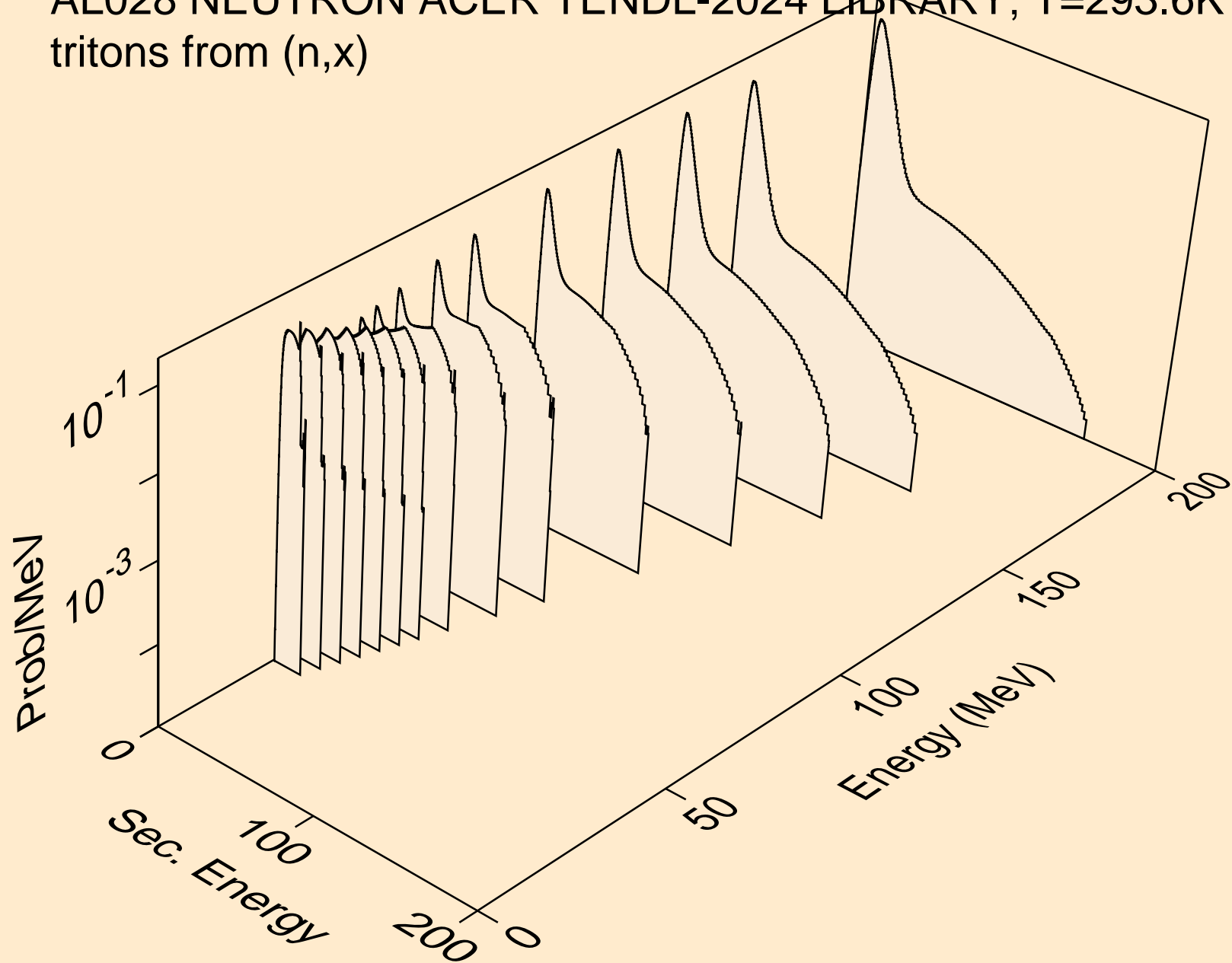

AL028 NEUTRON ACER TENDL-2024 LIBRARY; T=293.6K
tritons from (n,n*)t

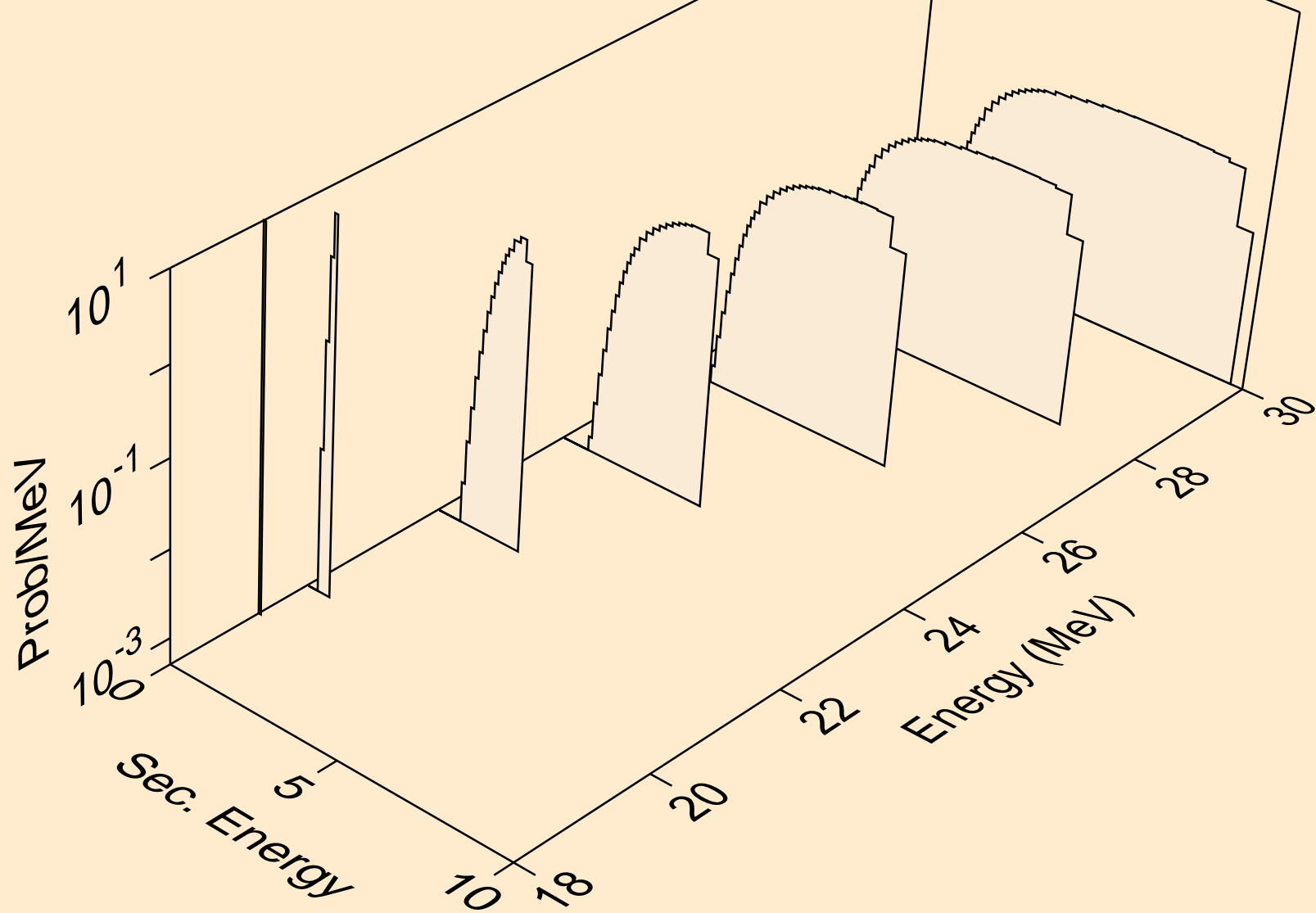

AL028 NEUTRON ACER TENDL-2024 LIBRARY; T=293.6K
tritons from (n,t)

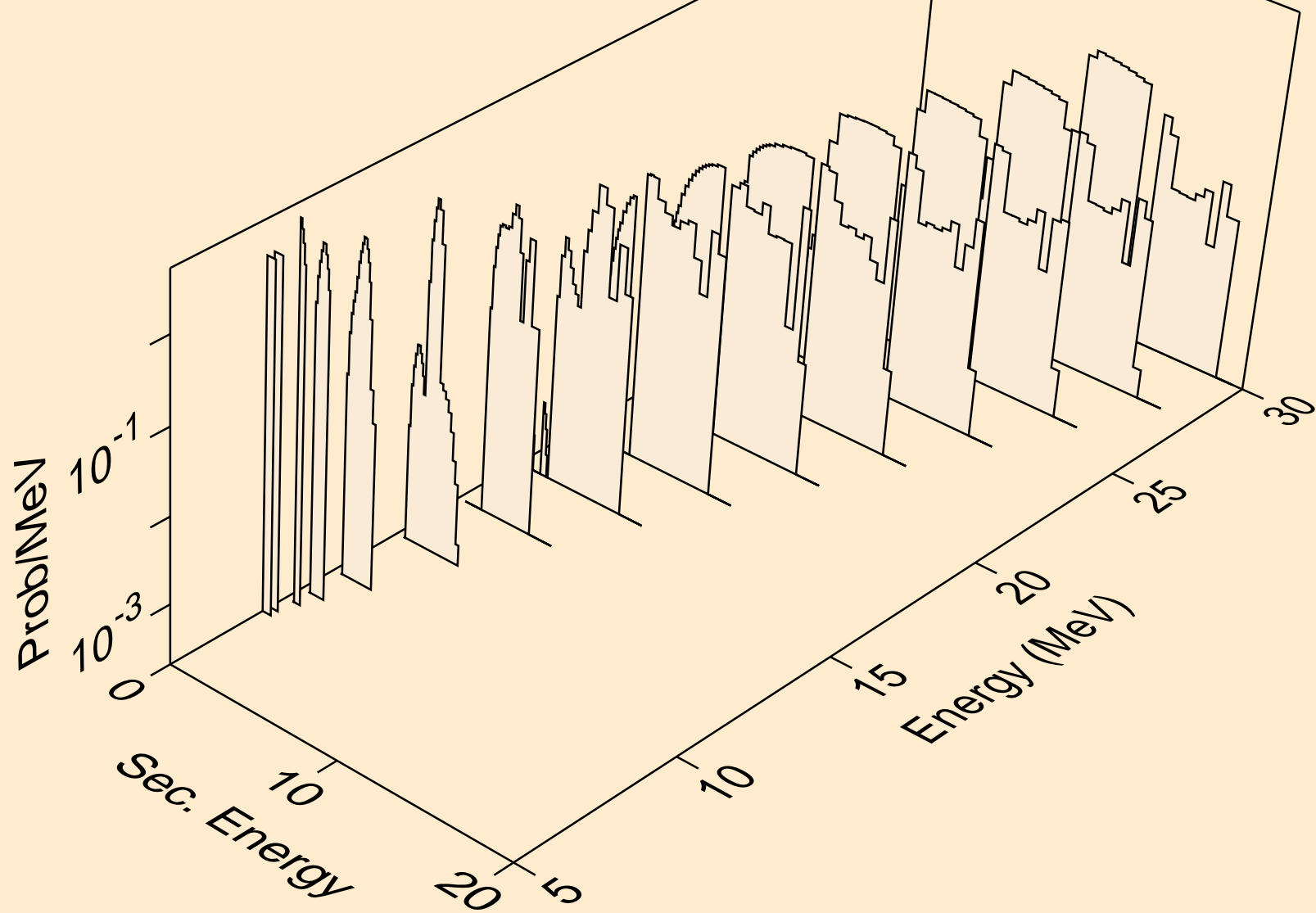

AL028 NEUTRON ACER TENDL-2024 LIBRARY; T=293.6K
tritons from (n,pt)

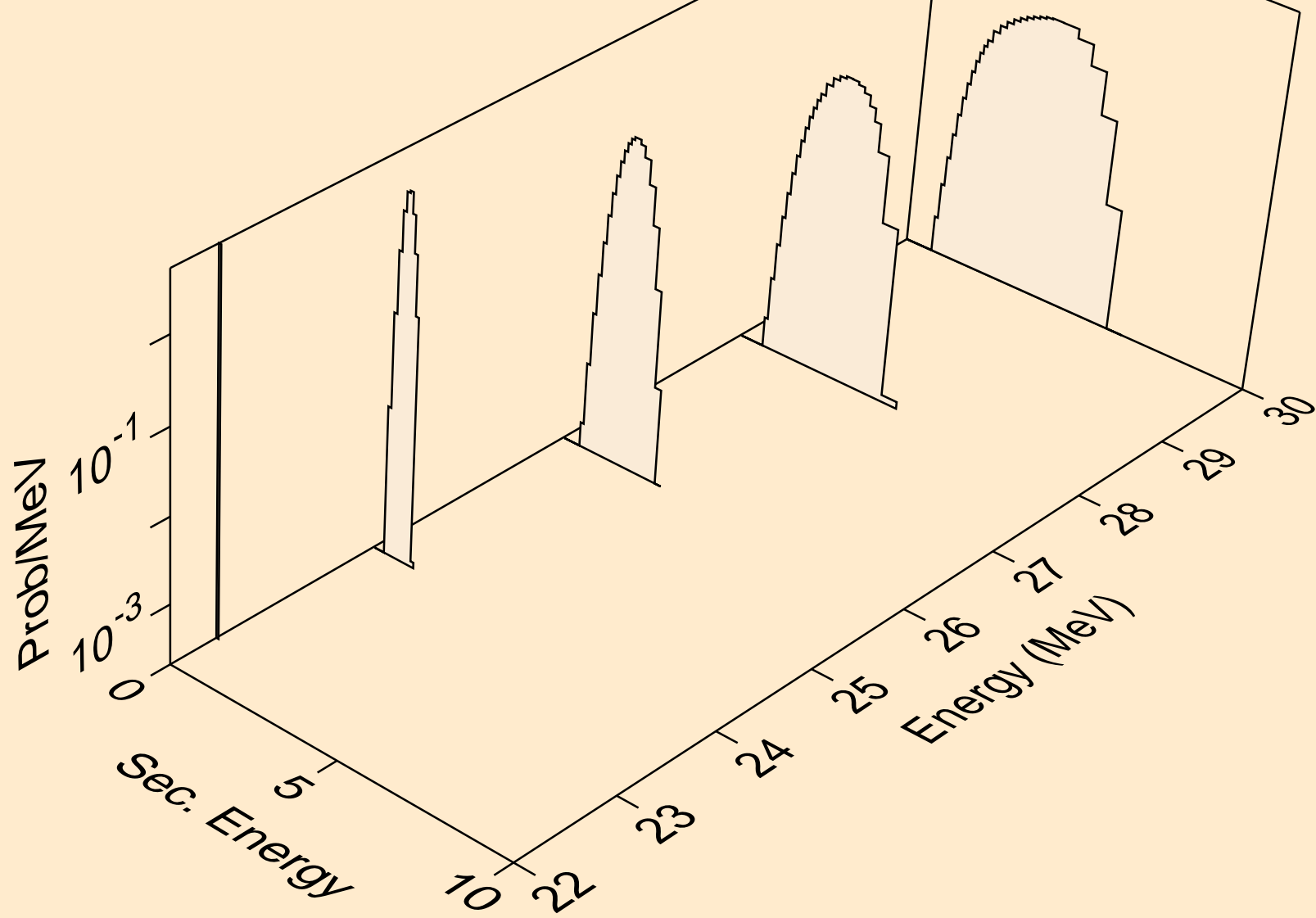

AL028 NEUTRON ACER TENDL-2024 LIBRARY; T=293.6K
he3s from (n,x)

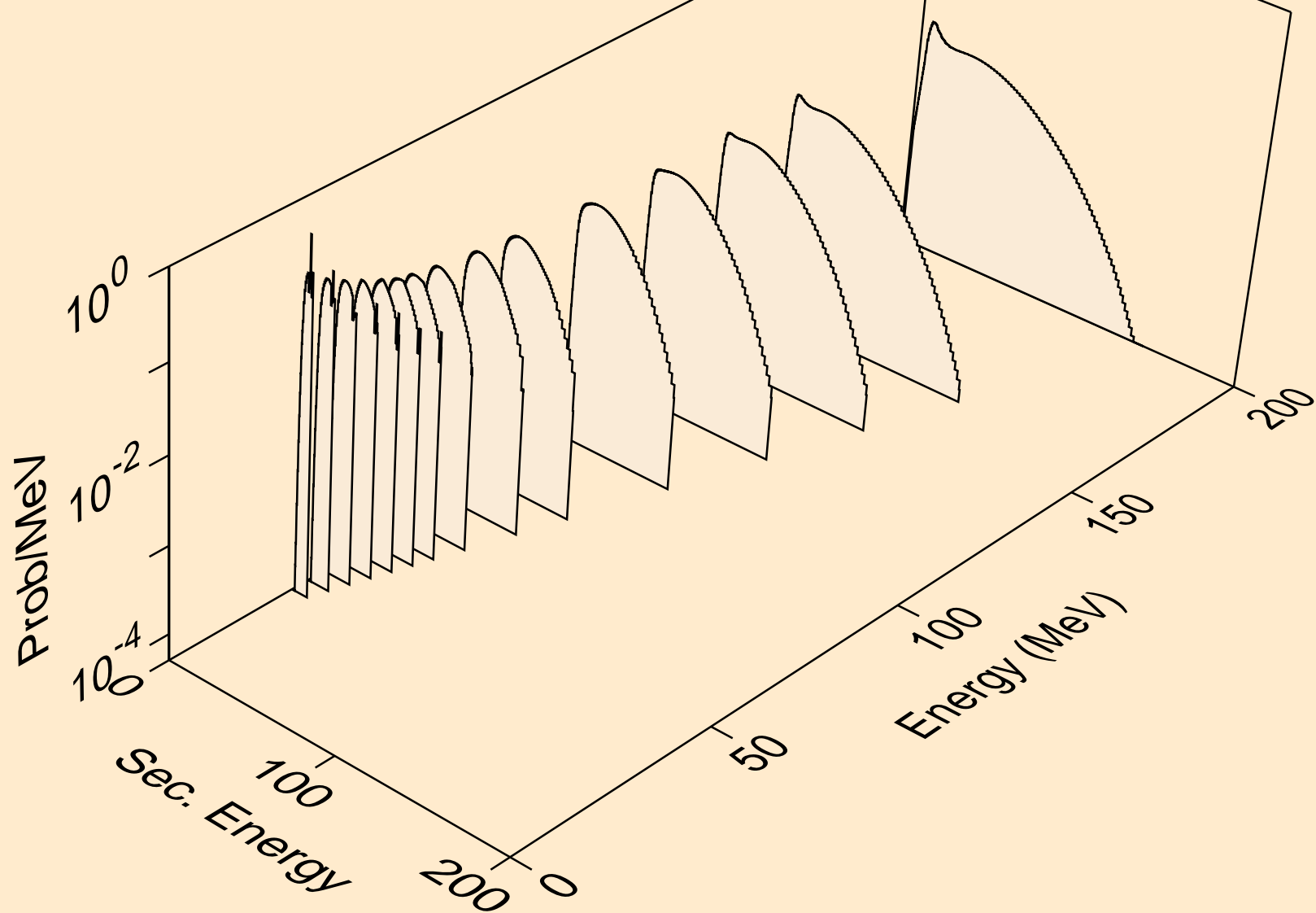

AL028 NEUTRON ACER TENDL-2024 LIBRARY; T=293.6K
he3s from (n,n*)he3

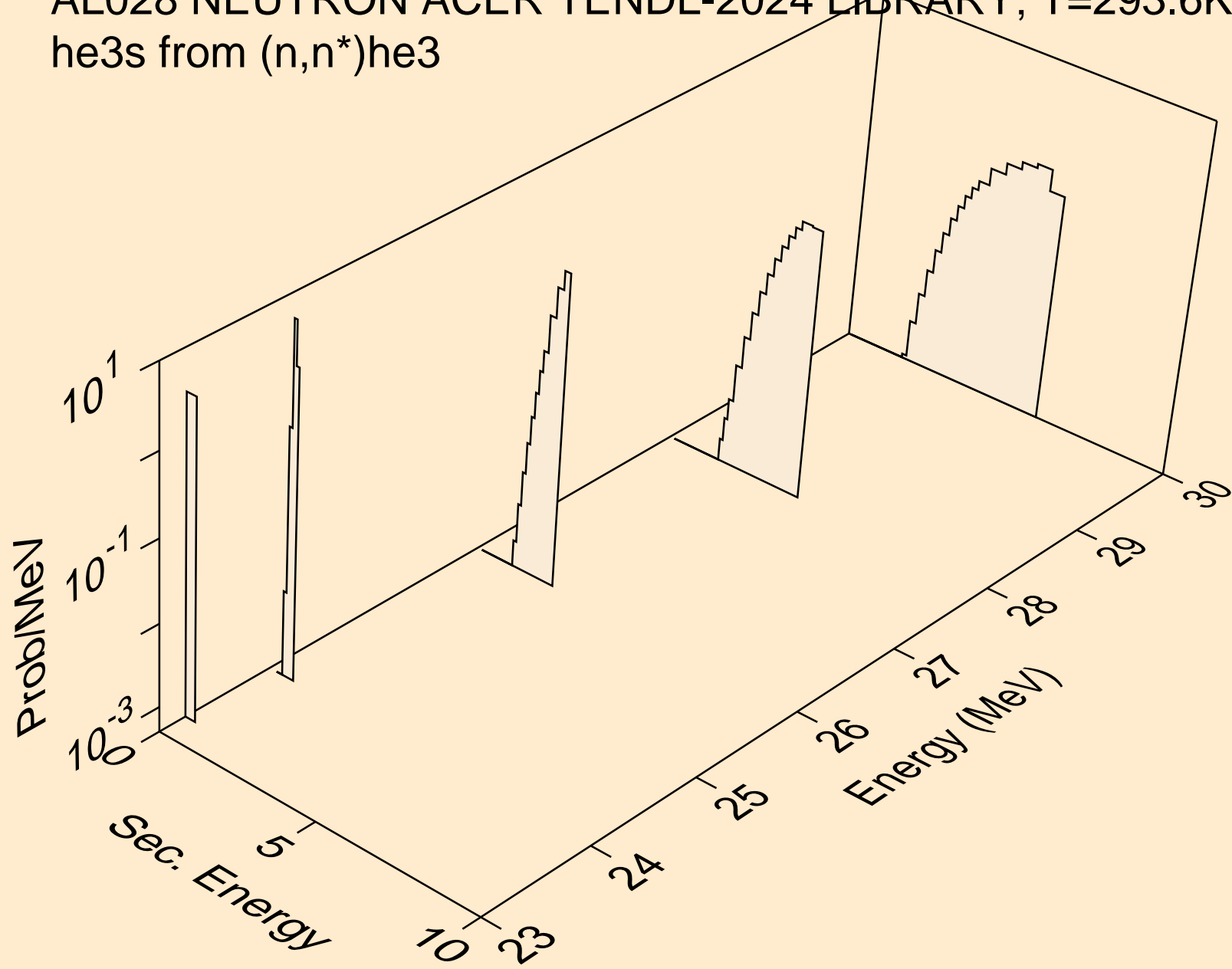

AL028 NEUTRON ACER TENDL-2024 LIBRARY; T=293.6K
he3s from (n,he3)

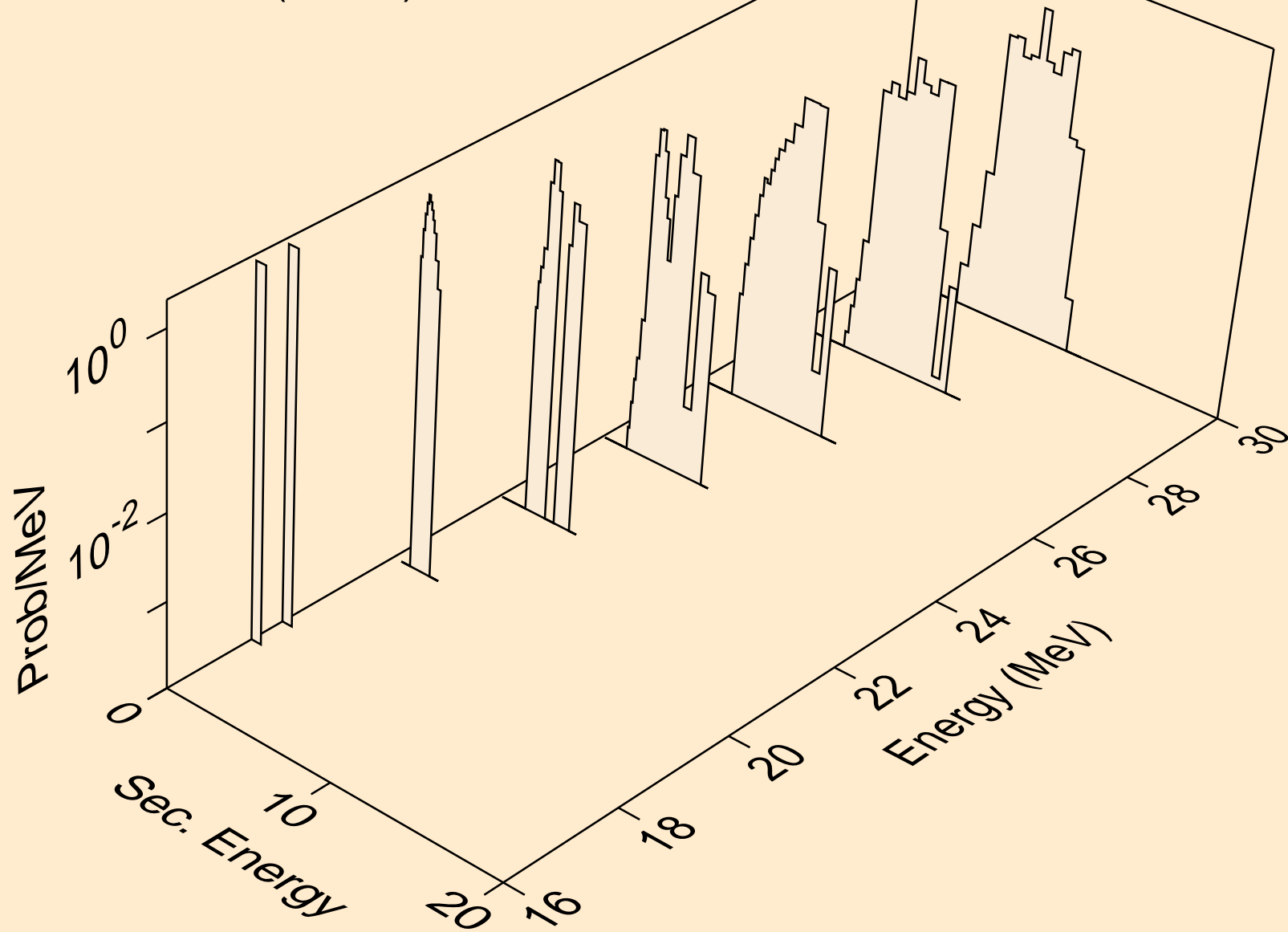

AL028 NEUTRON ACER TENDL-2024 LIBRARY; T=293.6K
alphas from (n,x)

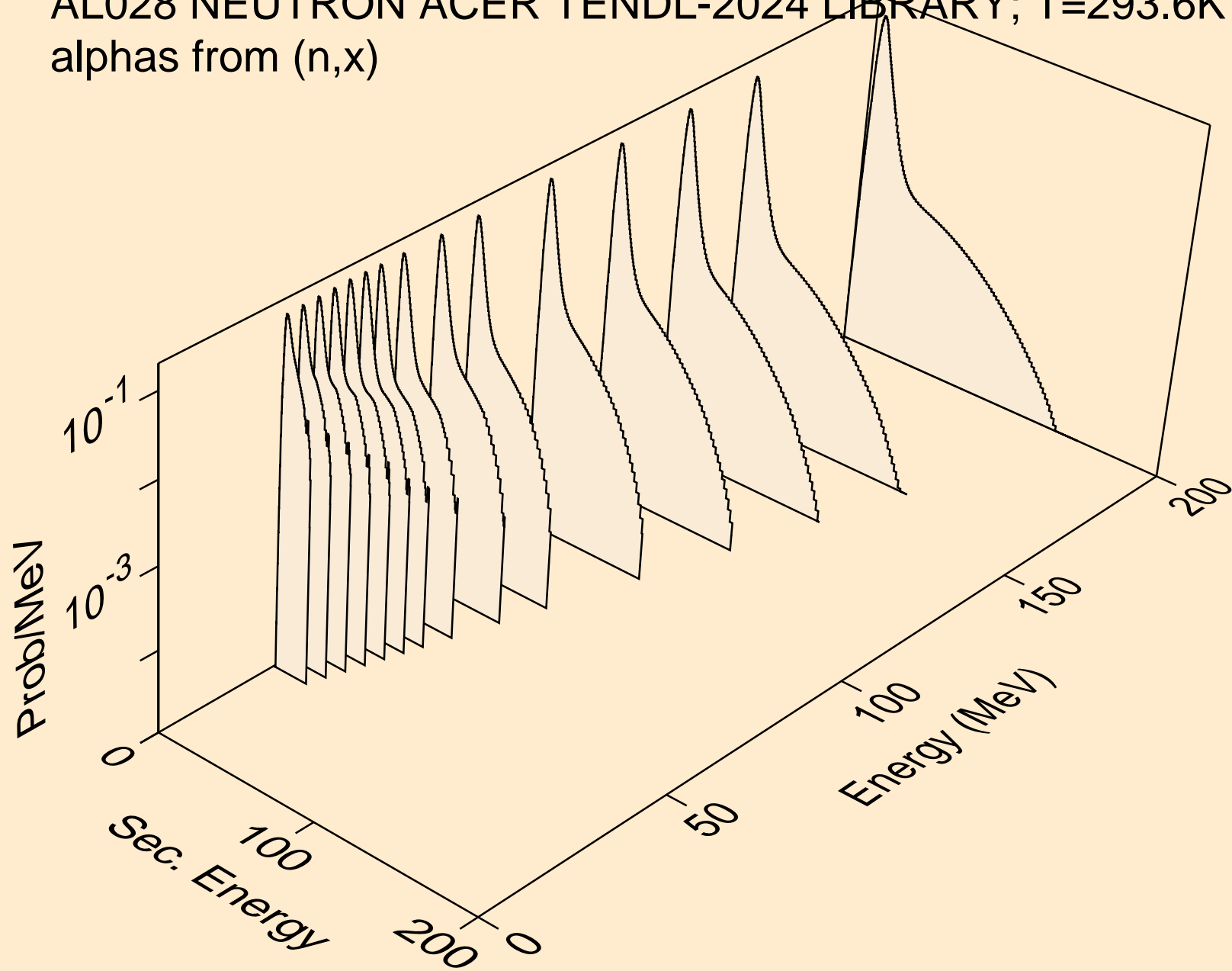

AL028 NEUTRON ACER TENDL-2024 LIBRARY; T=293.6K
alphas from (n,n*)a

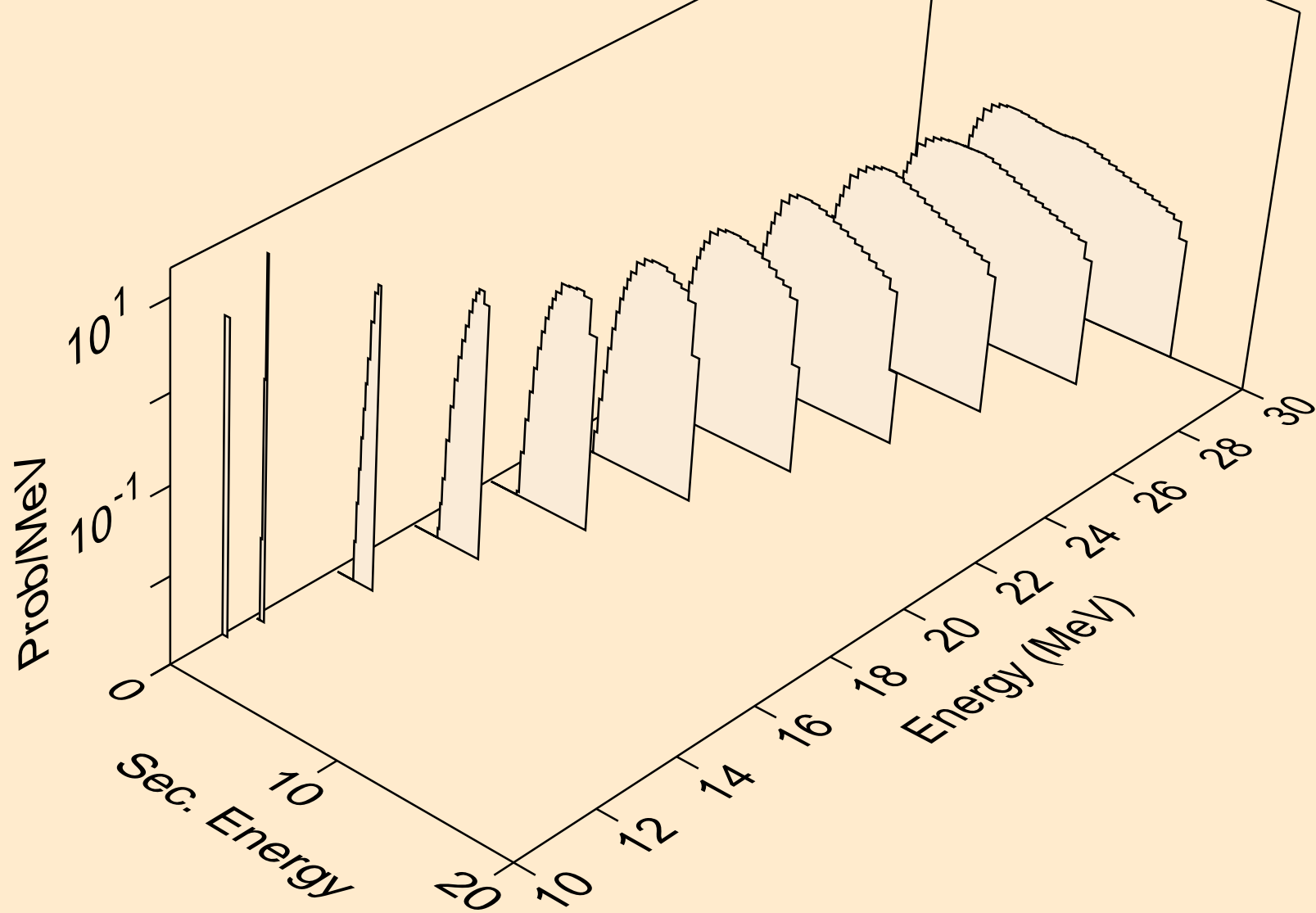

AL028 NEUTRON ACER TENDL-2024 LIBRARY; T=293.6K
alphas from (n,2n)a

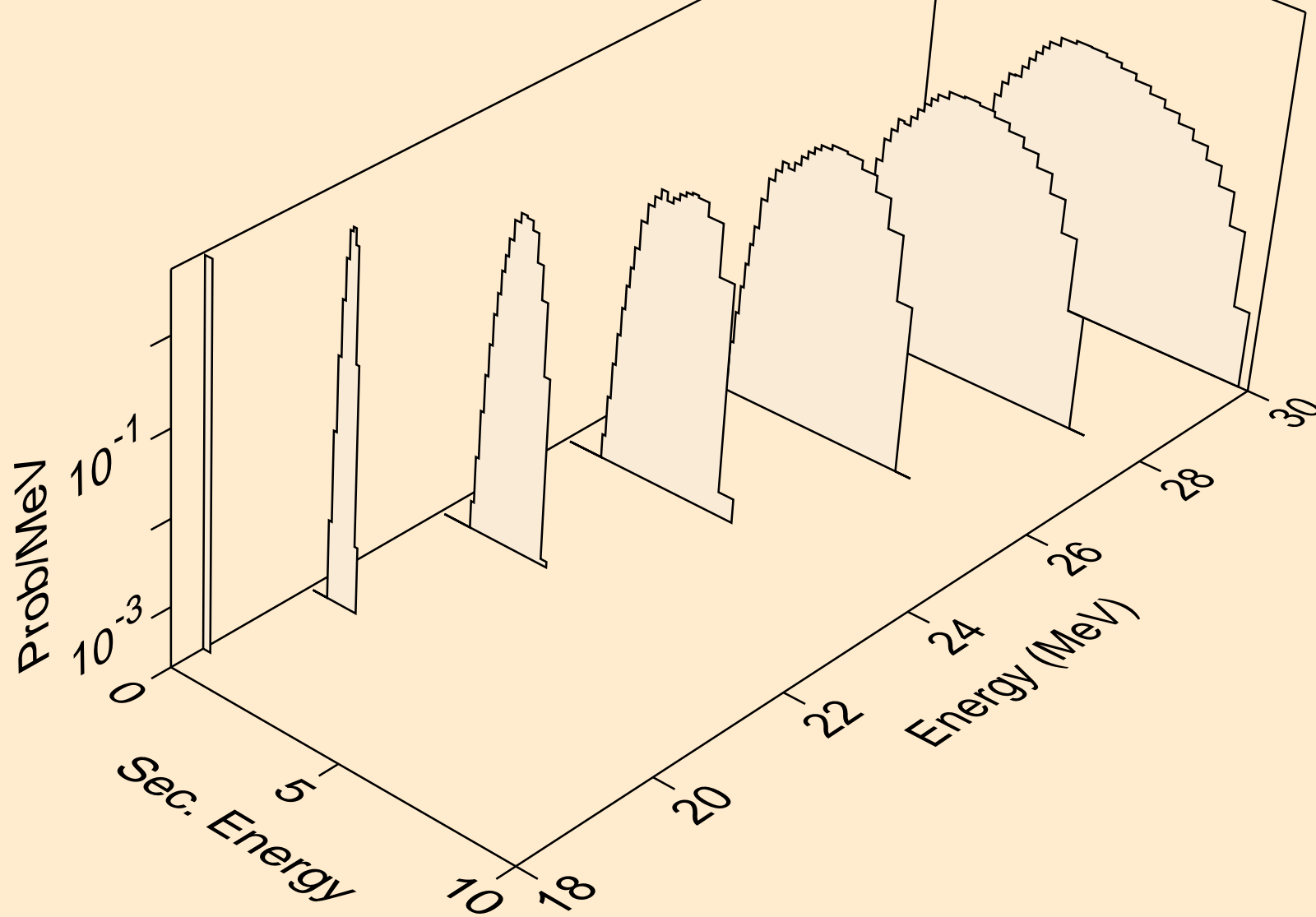

AL028 NEUTRON ACER TENDL-2024 LIBRARY; T=293.6K
alphas from (n,n*)2a

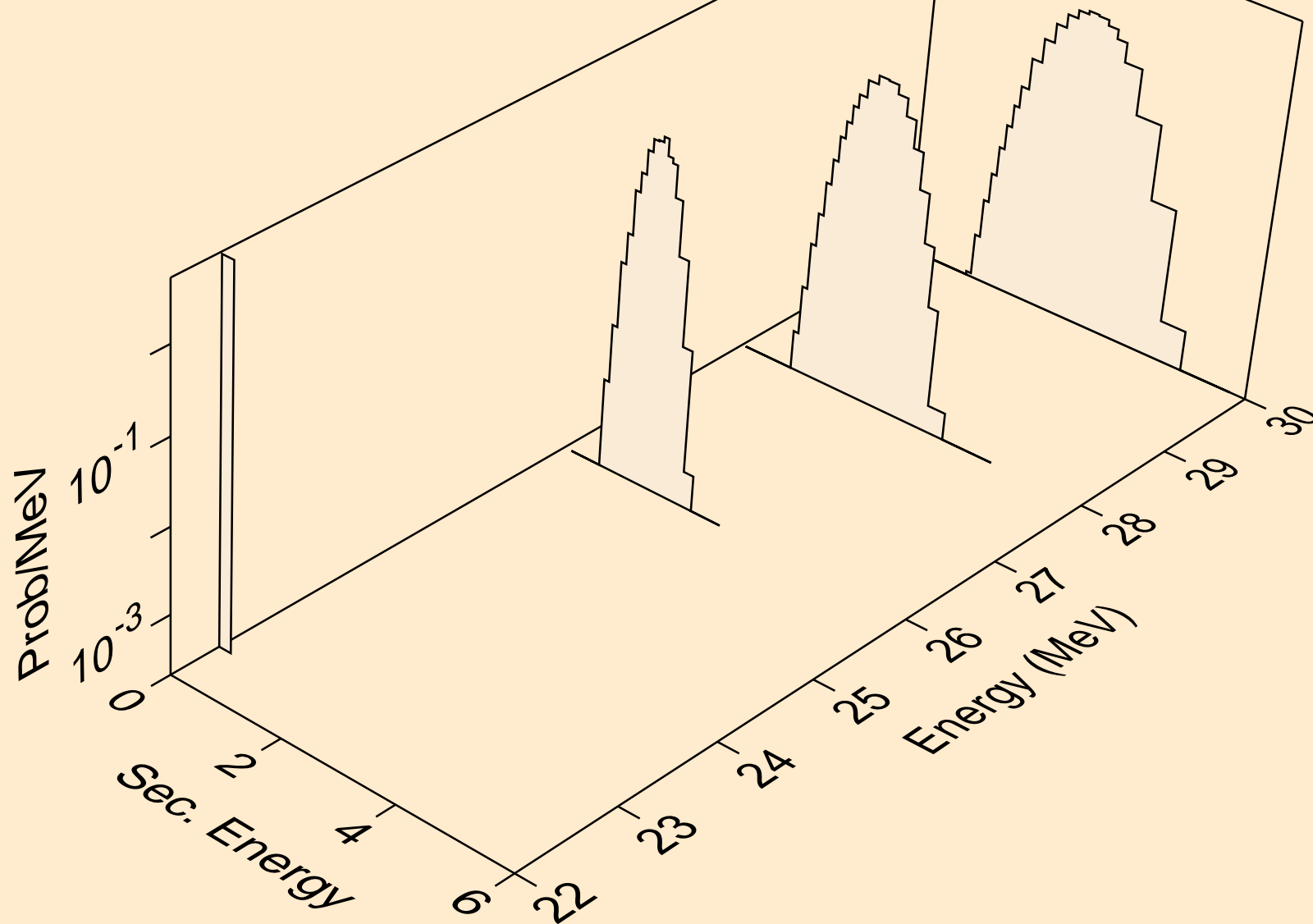

AL028 NEUTRON ACER TENDL-2024 LIBRARY; T=293.6K
alphas from (n,npa)

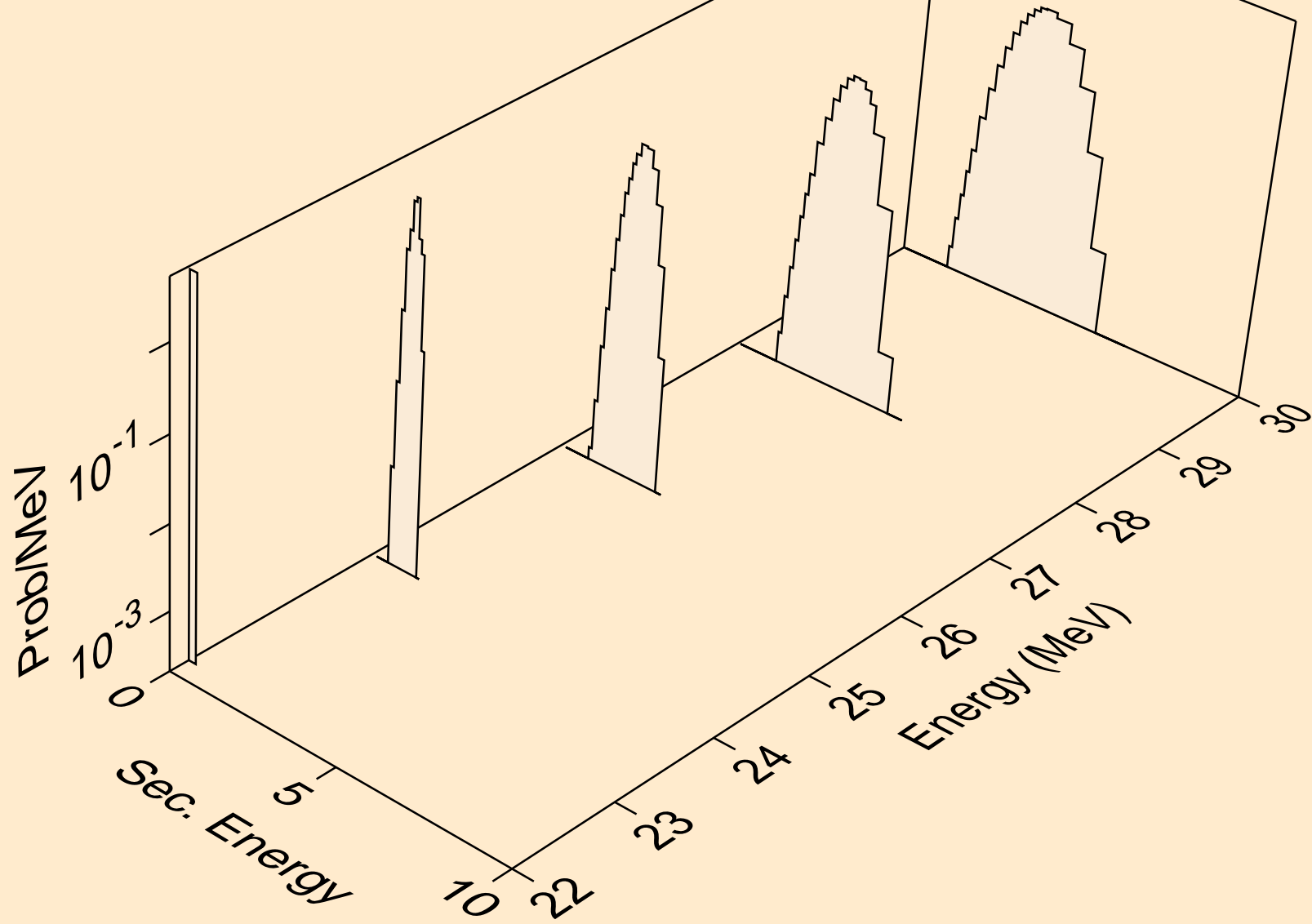

AL028 NEUTRON ACER TENDL-2024 LIBRARY; T=293.6K
alphas from (n,a)

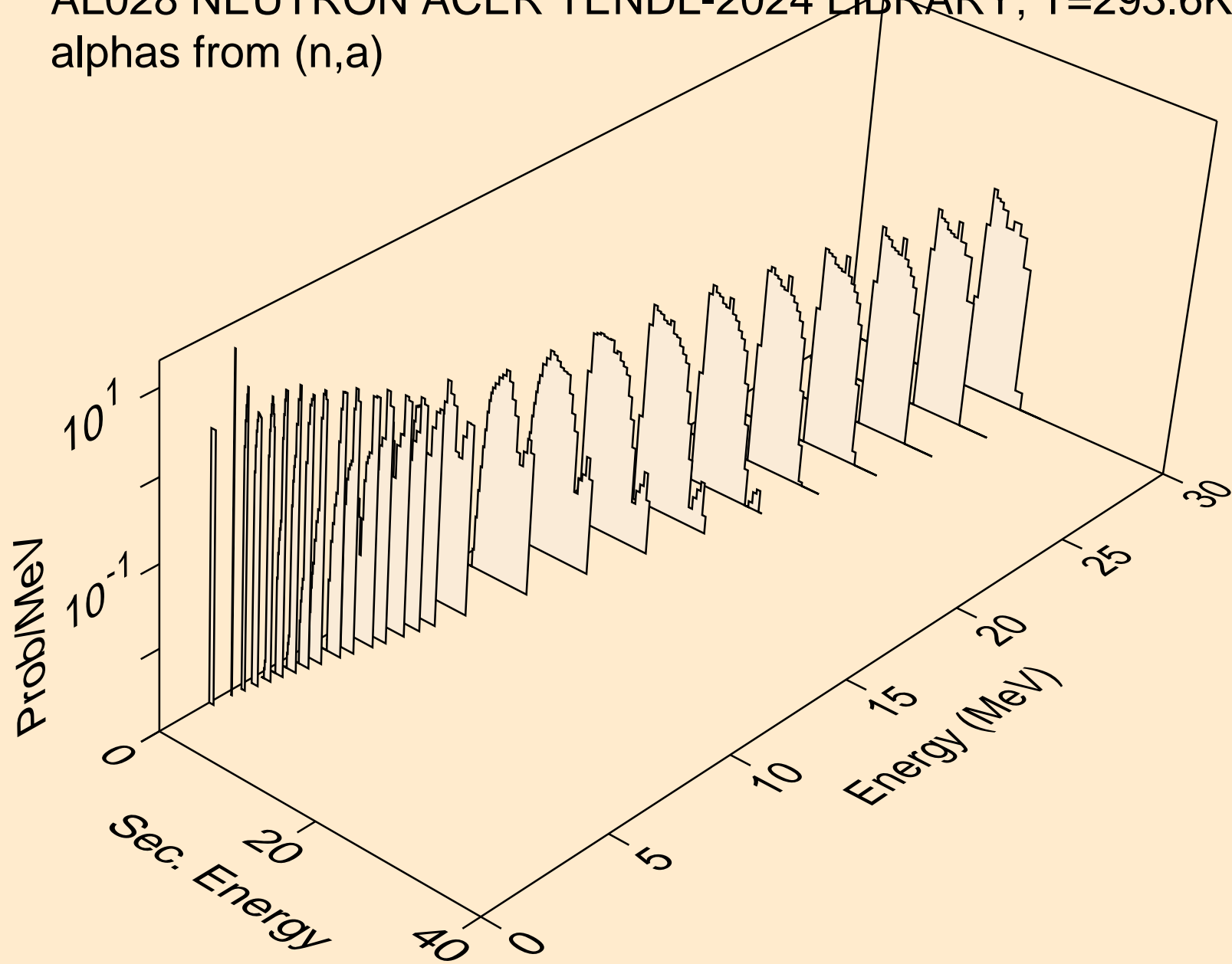

AL028 NEUTRON ACER TENDL-2024 LIBRARY; T=293.6K
alphas from (n,2a)

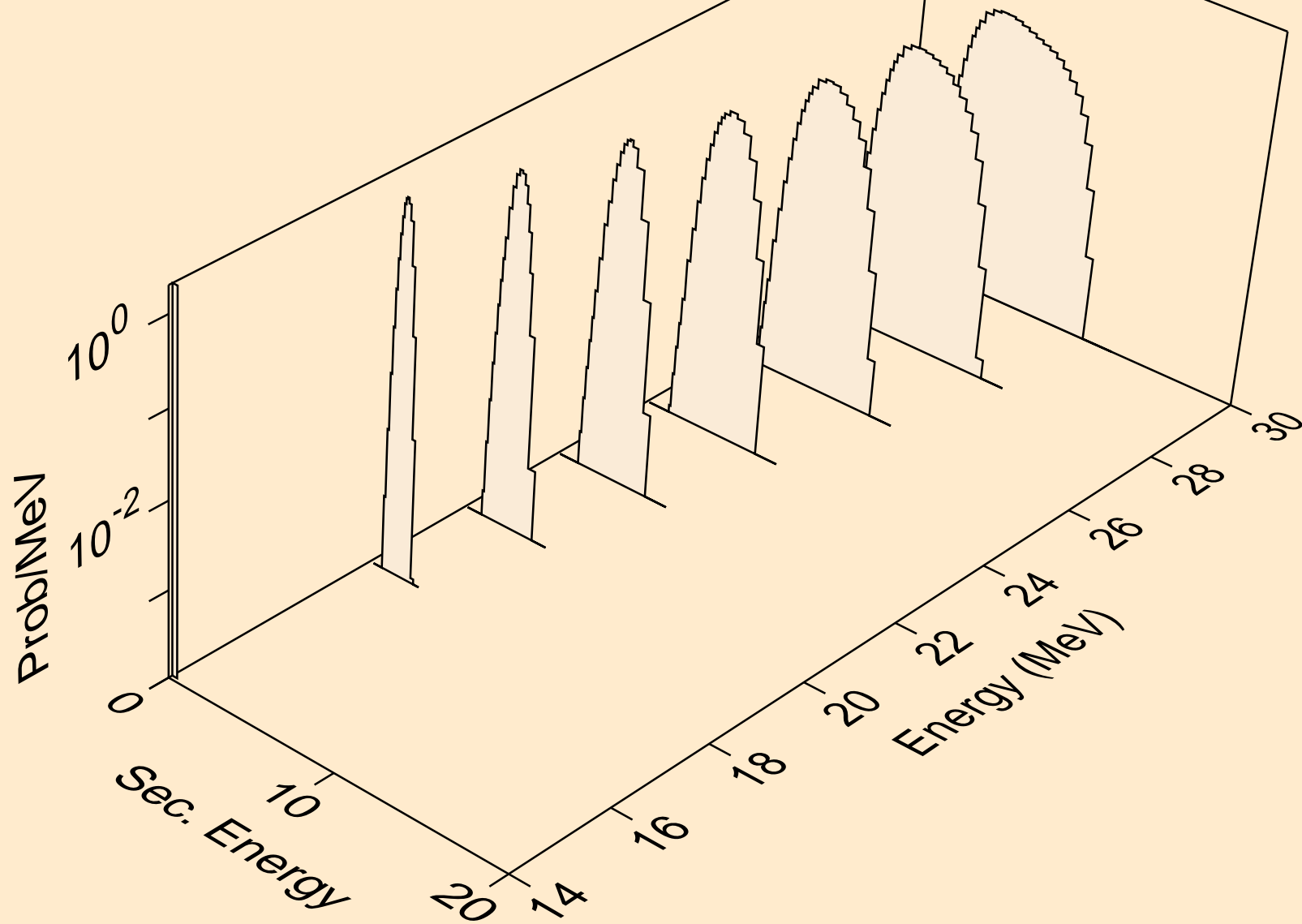

AL028 NEUTRON ACER TENDL-2024 LIBRARY; T=293.6K
alphas from (n,pa)

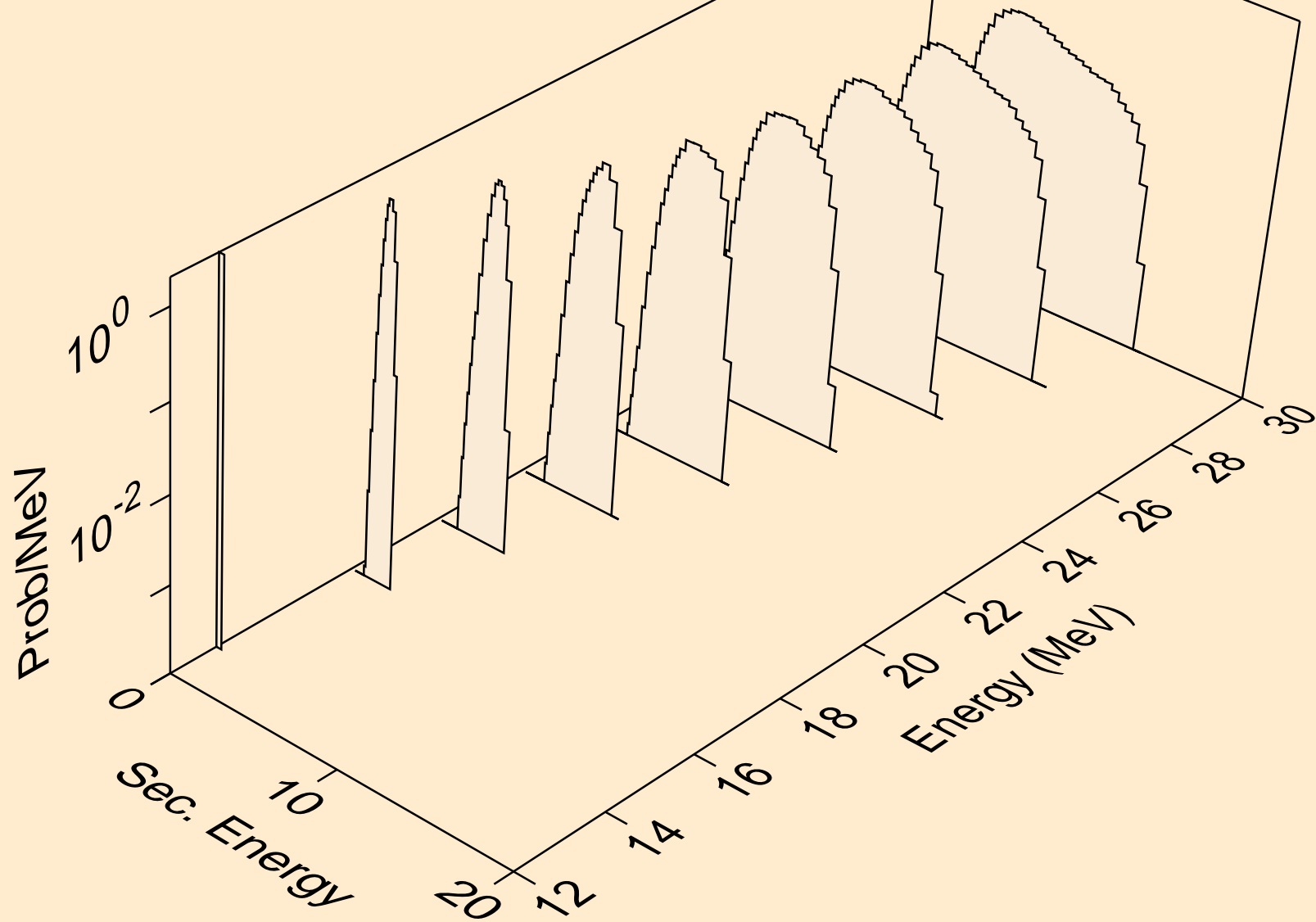

AL028 NEUTRON ACER TENDL-2024 LIBRARY; T=293.6K
alphas from (n,da)

