

# AL030 NEUTRON ACER TENDL-2024 LIBRARY; T=293.6K

## Principal cross sections

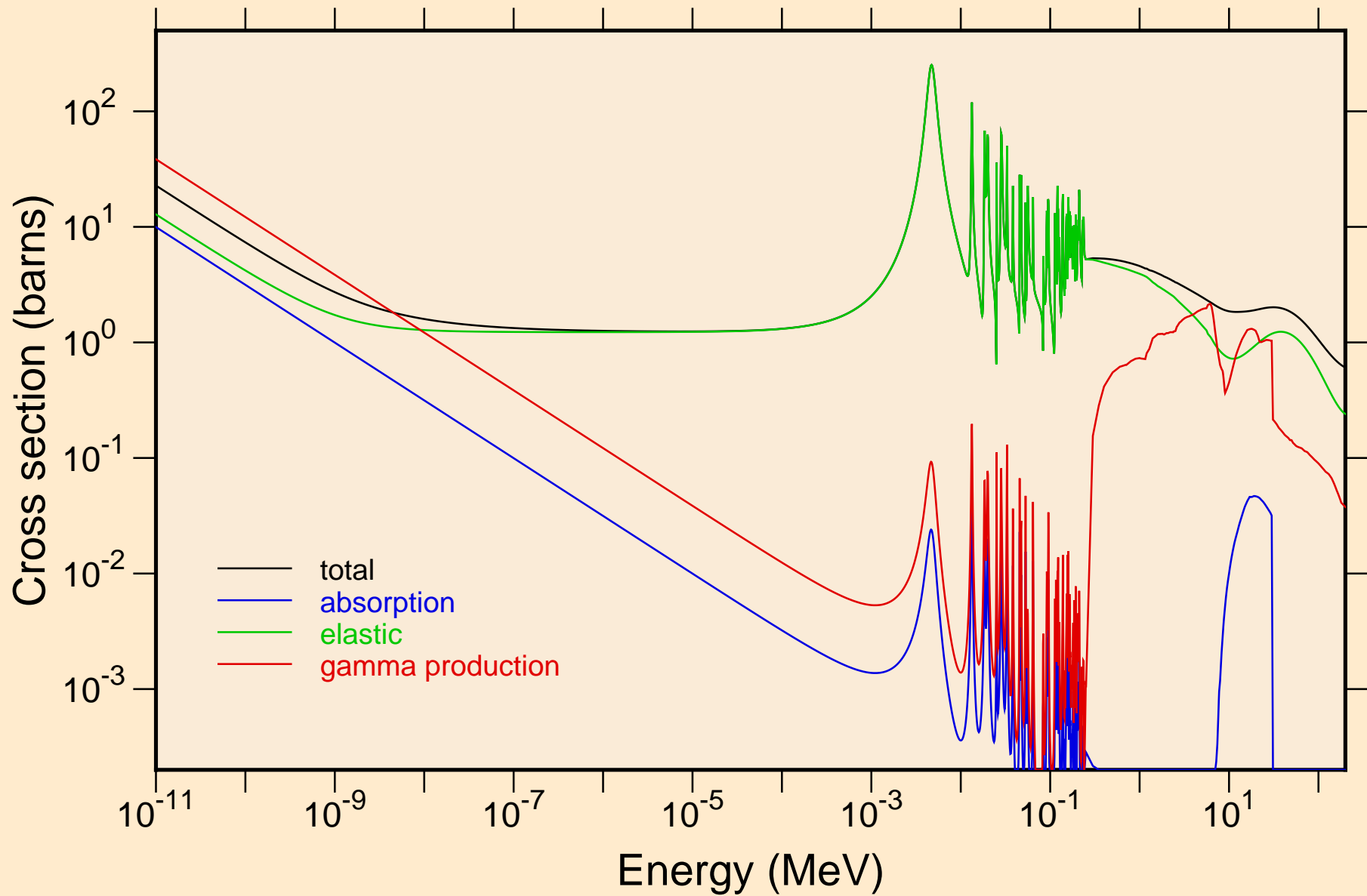

AL030 NEUTRON ACER TENDL-2024 LIBRARY; T=293.6K  
resonance total cross section

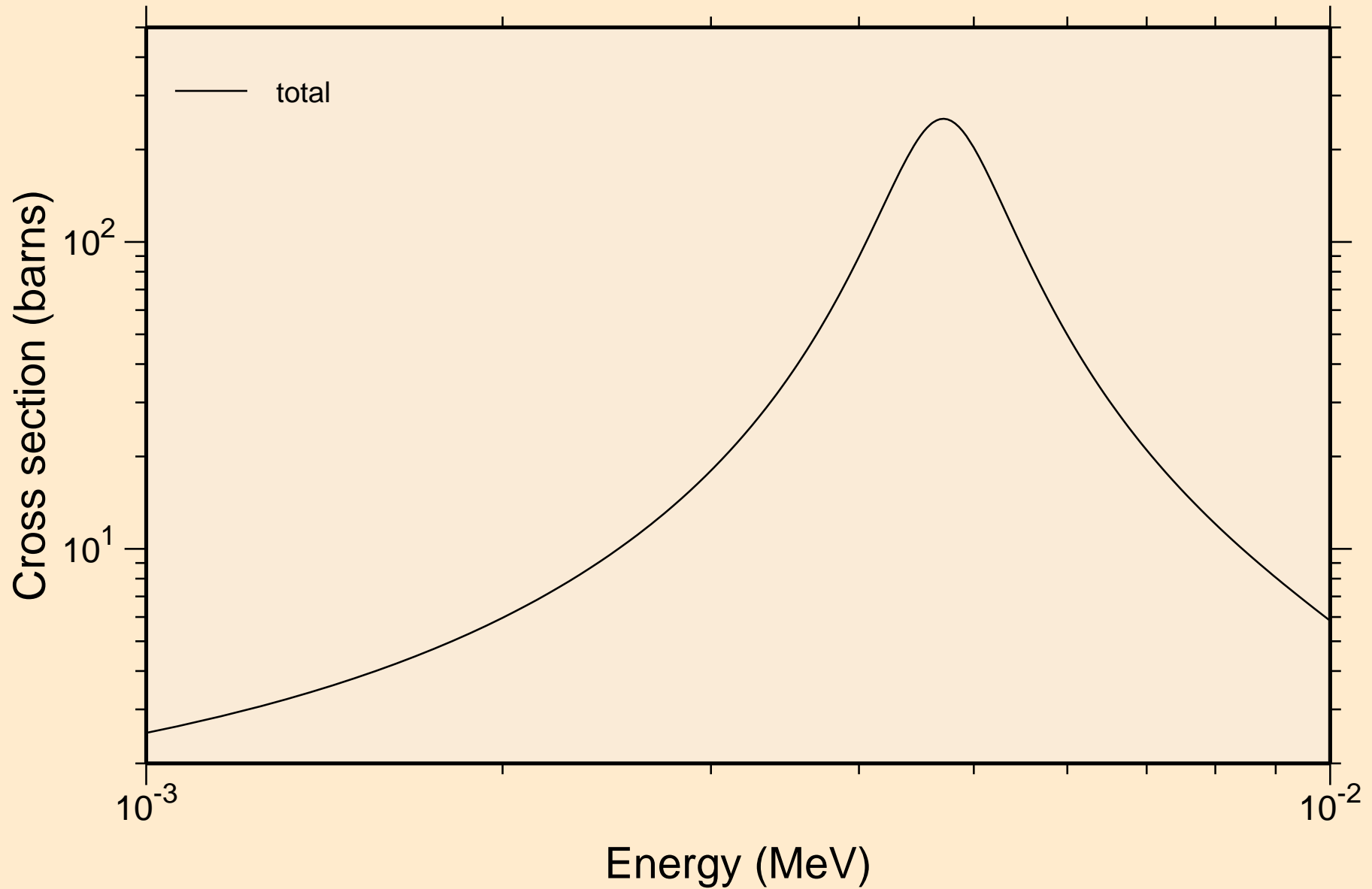

AL030 NEUTRON ACER TENDL-2024 LIBRARY; T=293.6K  
resonance total cross section

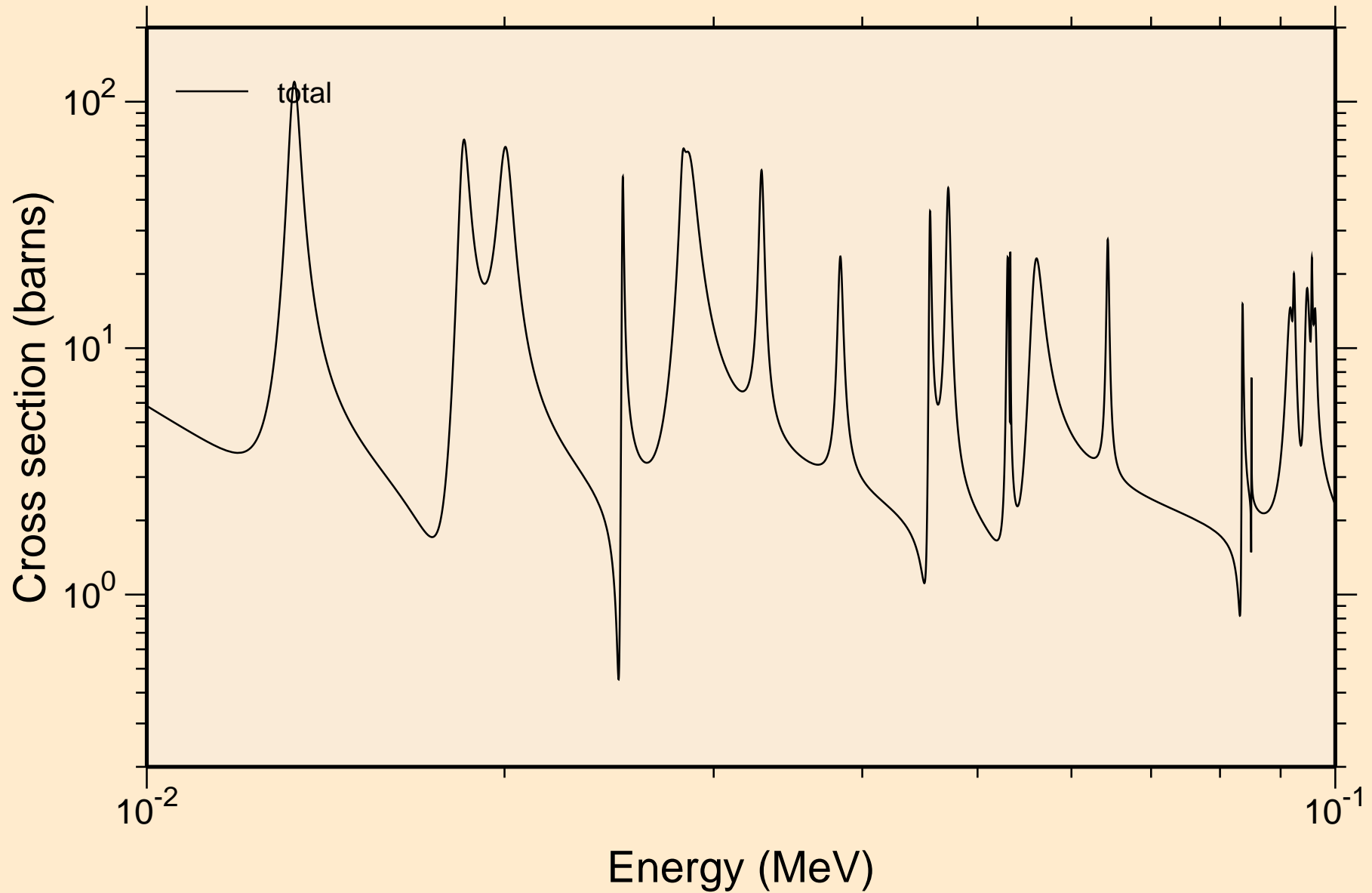

AL030 NEUTRON ACER TENDL-2024 LIBRARY; T=293.6K  
resonance total cross section

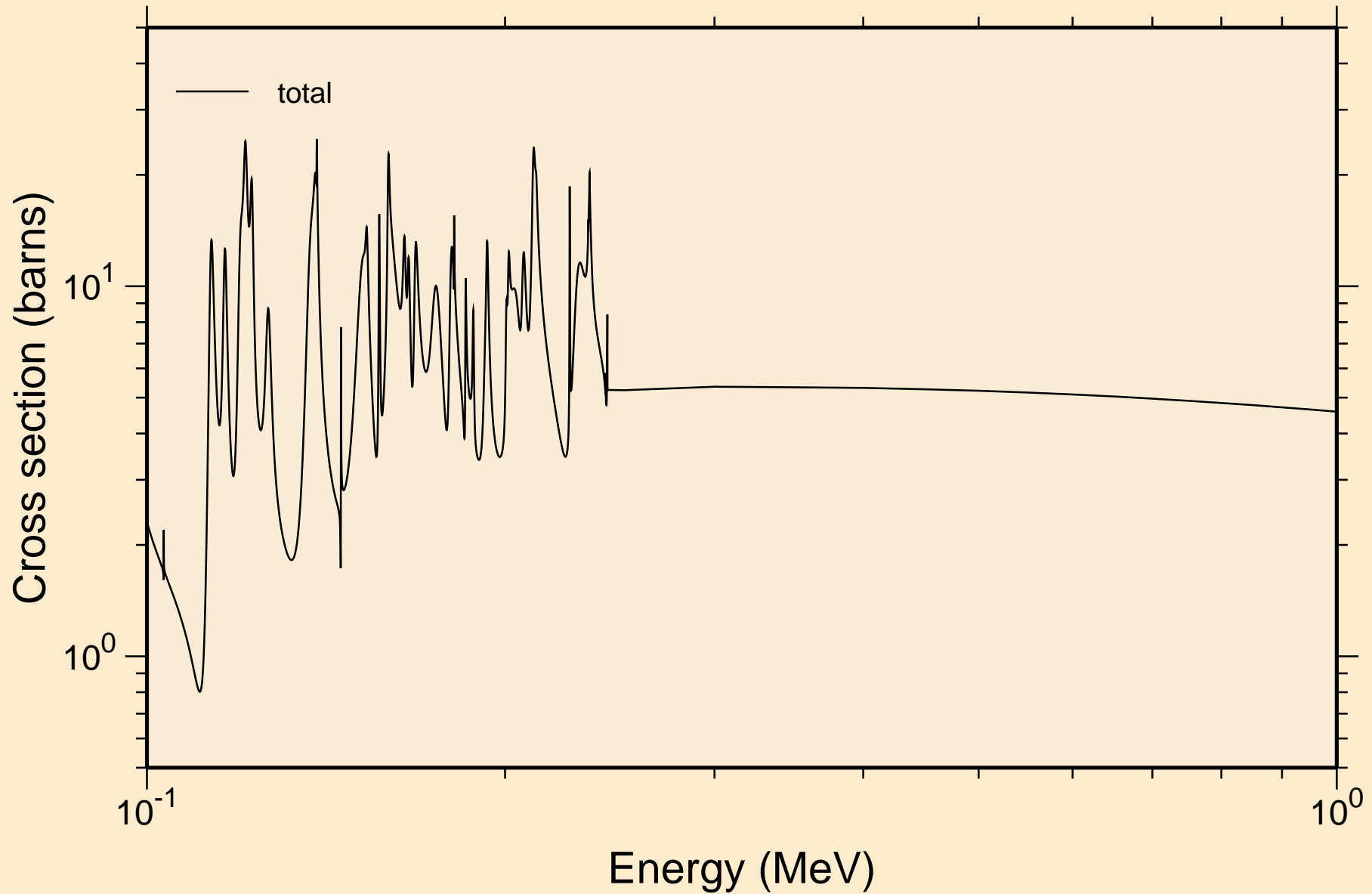

AL030 NEUTRON ACER TENDL-2024 LIBRARY; T=293.6K  
resonance total cross section

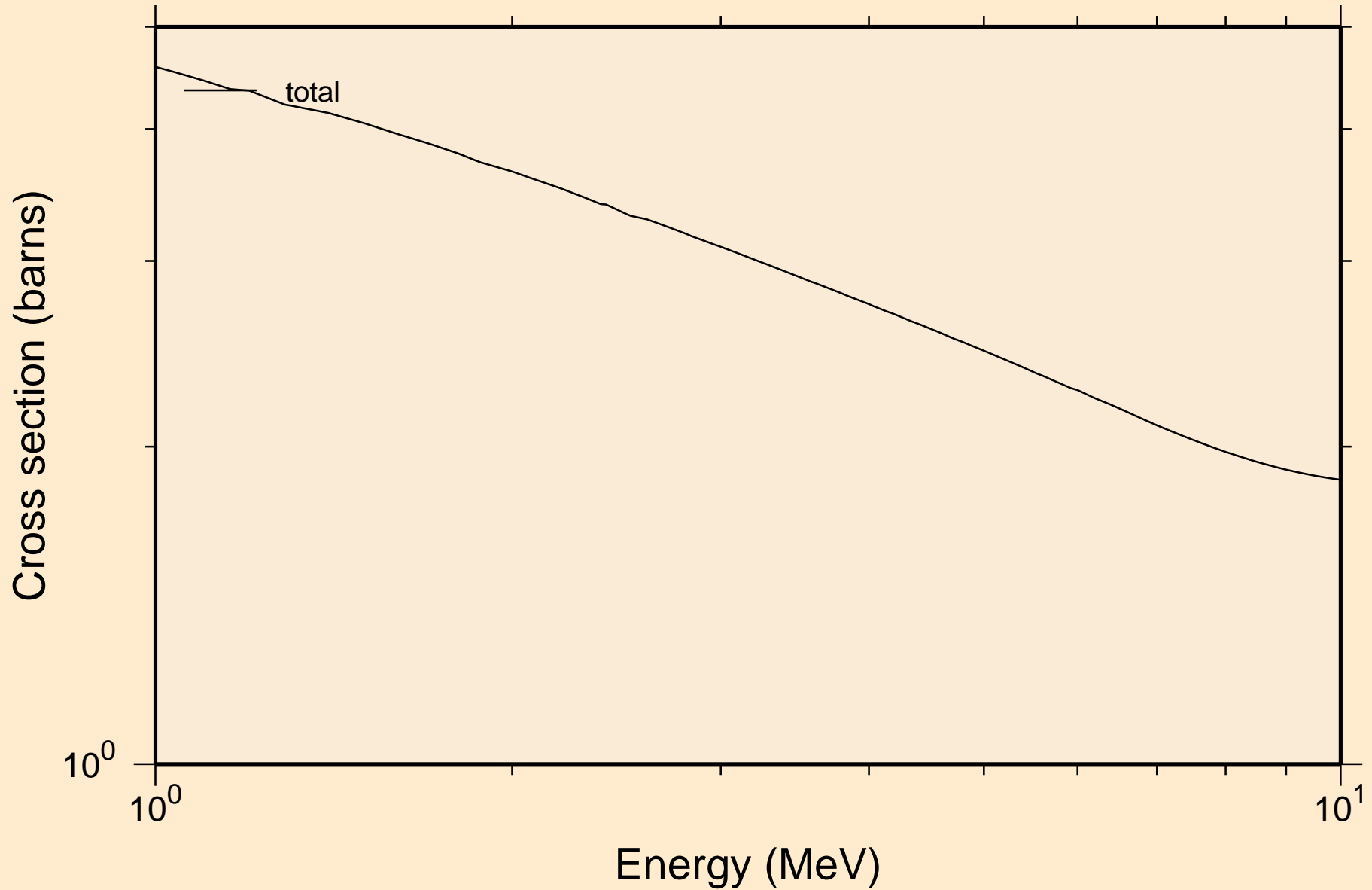

AL030 NEUTRON ACER TENDL-2024 LIBRARY; T=293.6K  
resonance absorption cross sections

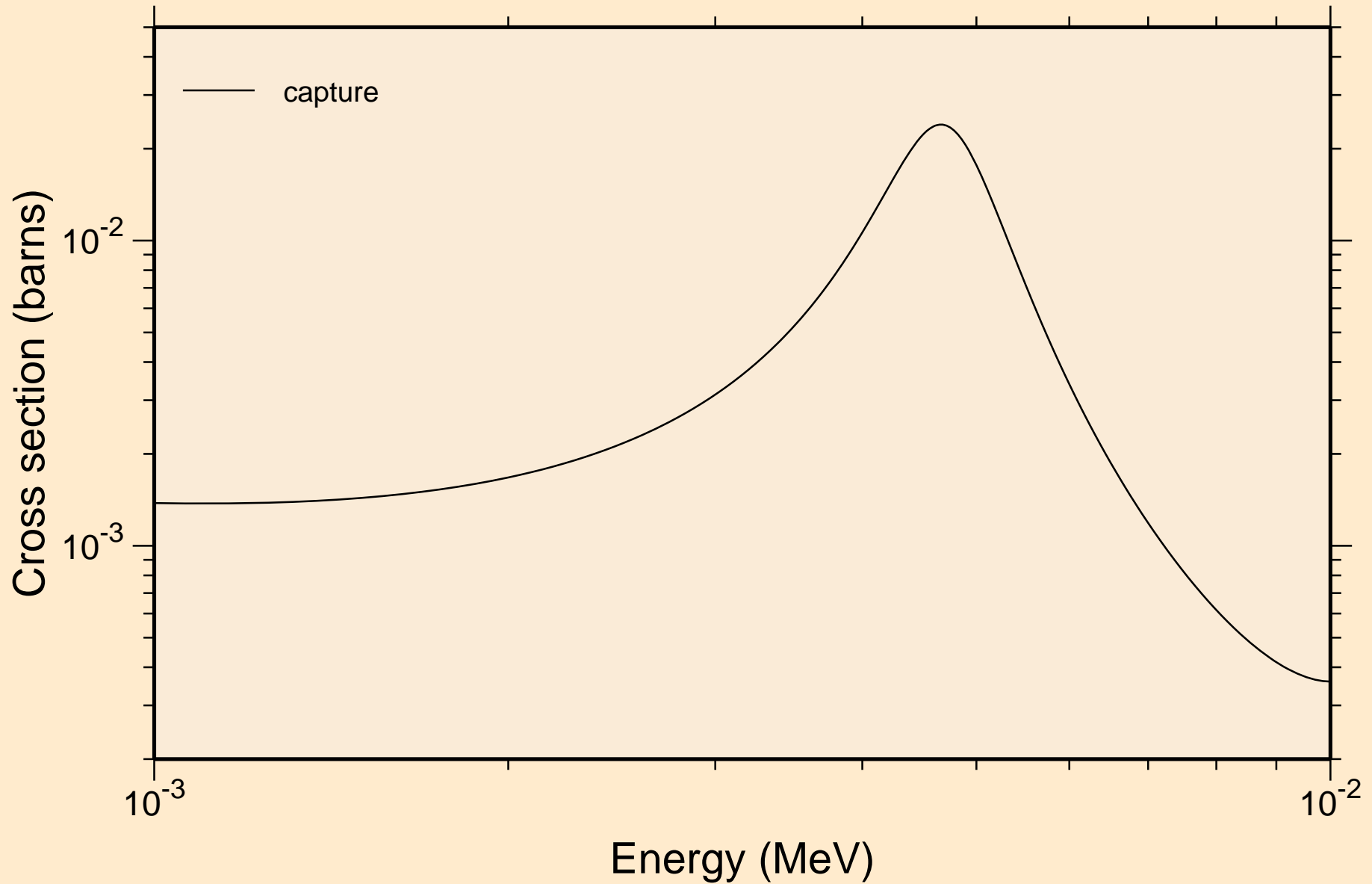

AL030 NEUTRON ACER TENDL-2024 LIBRARY; T=293.6K  
resonance absorption cross sections

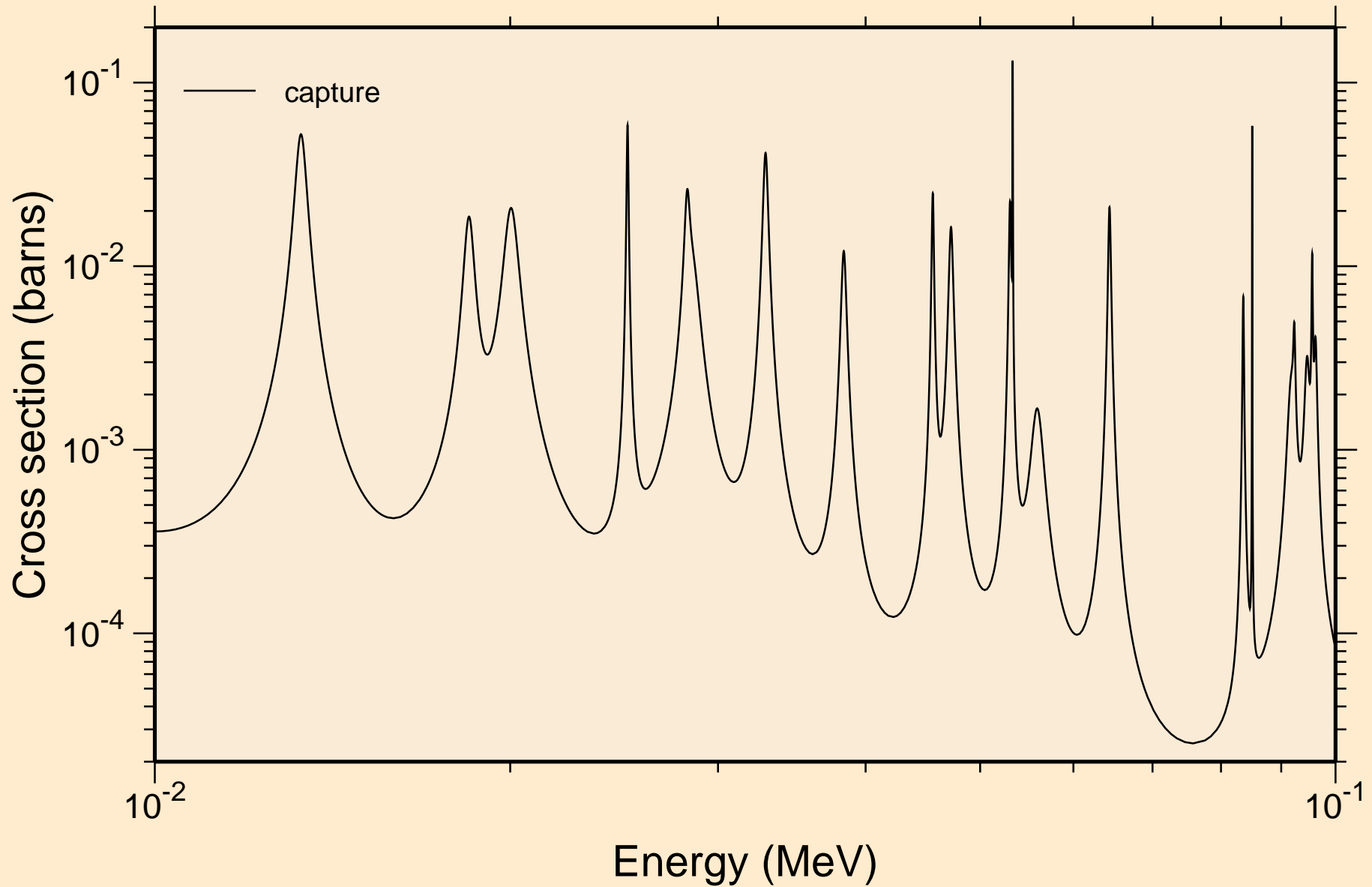

AL030 NEUTRON ACER TENDL-2024 LIBRARY; T=293.6K  
resonance absorption cross sections

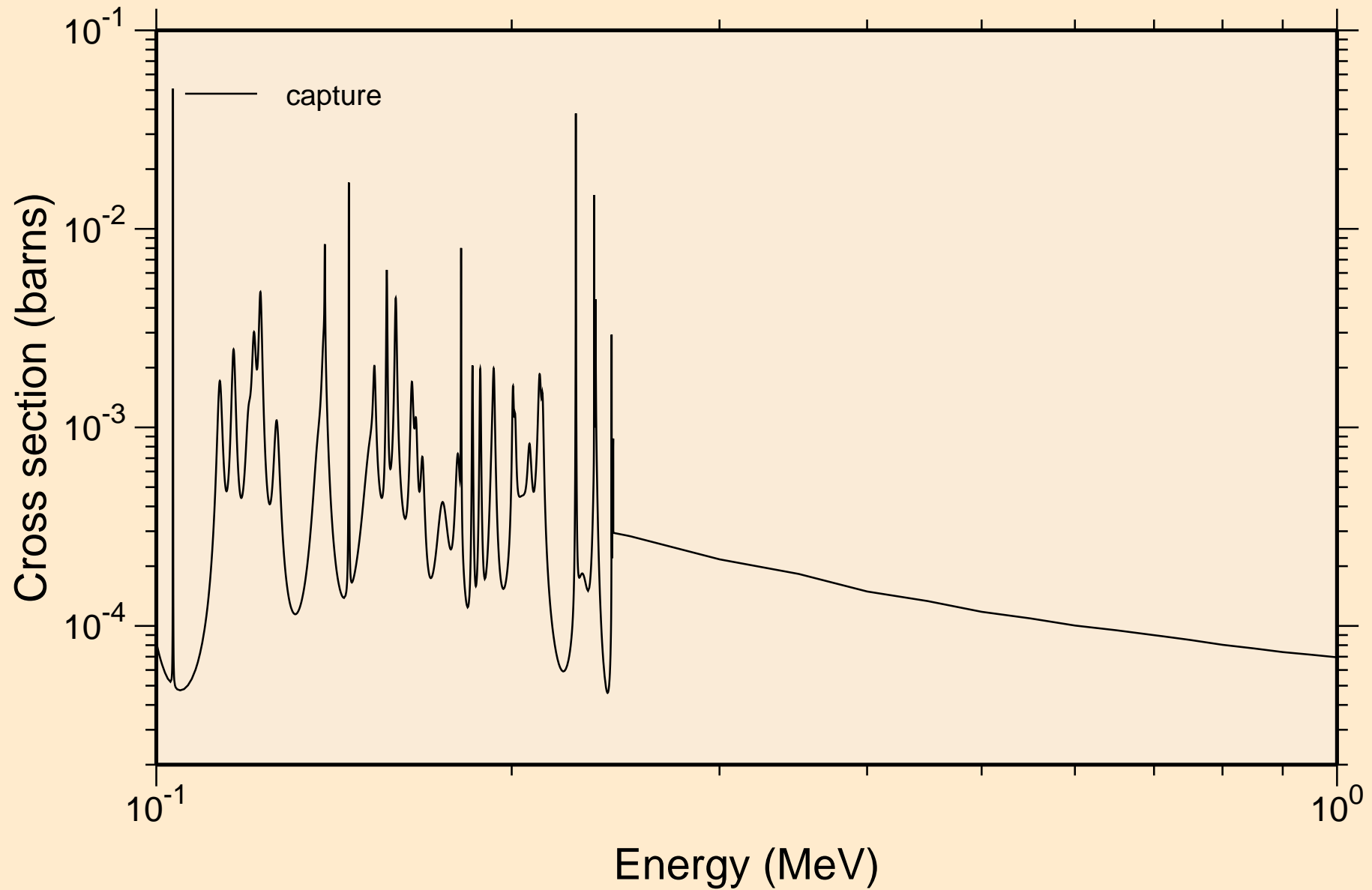

AL030 NEUTRON ACER TENDL-2024 LIBRARY; T=293.6K  
resonance absorption cross sections

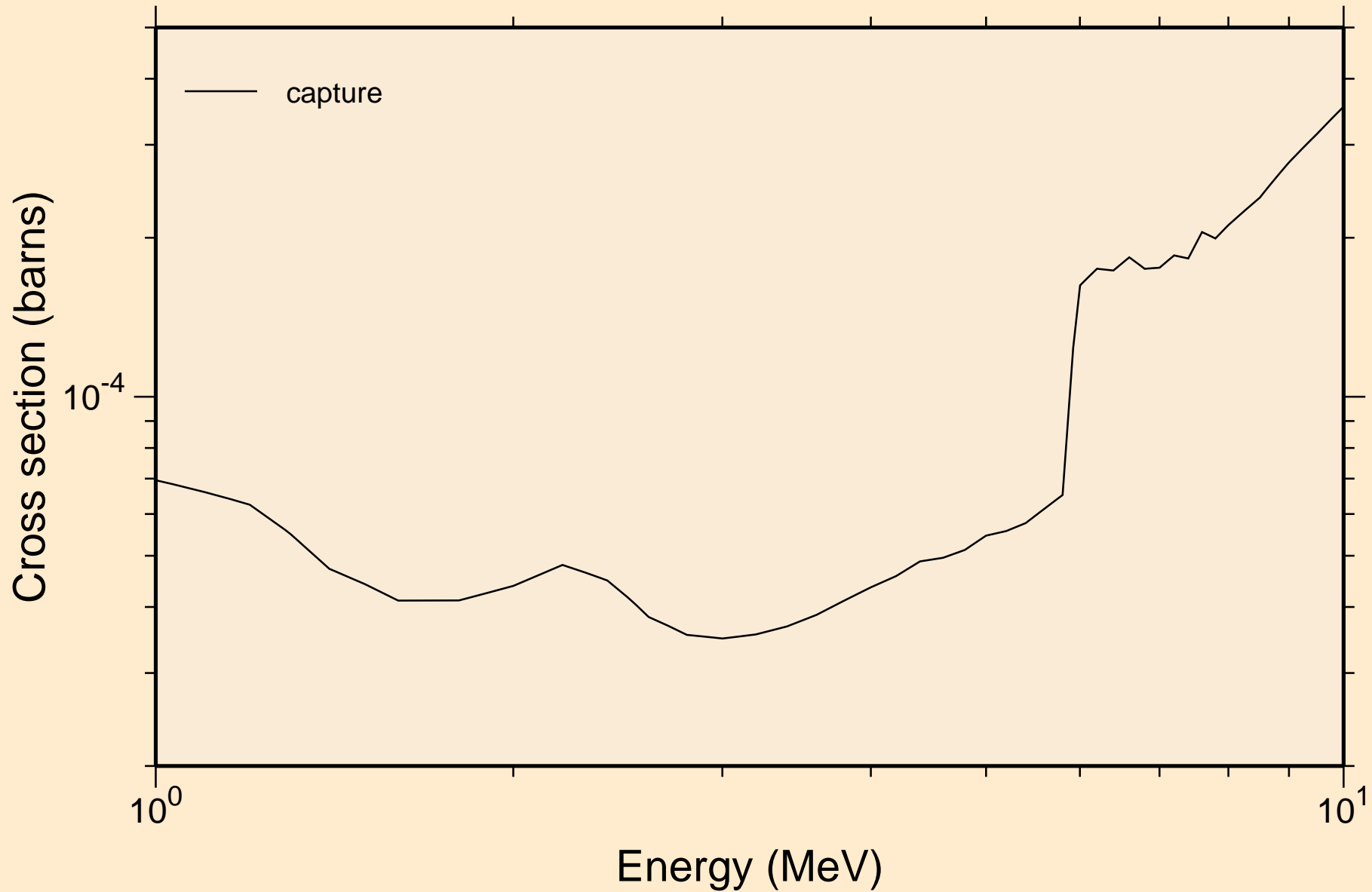

AL030 NEUTRON ACER TENDL-2024 LIBRARY; T=293.6K  
Heating

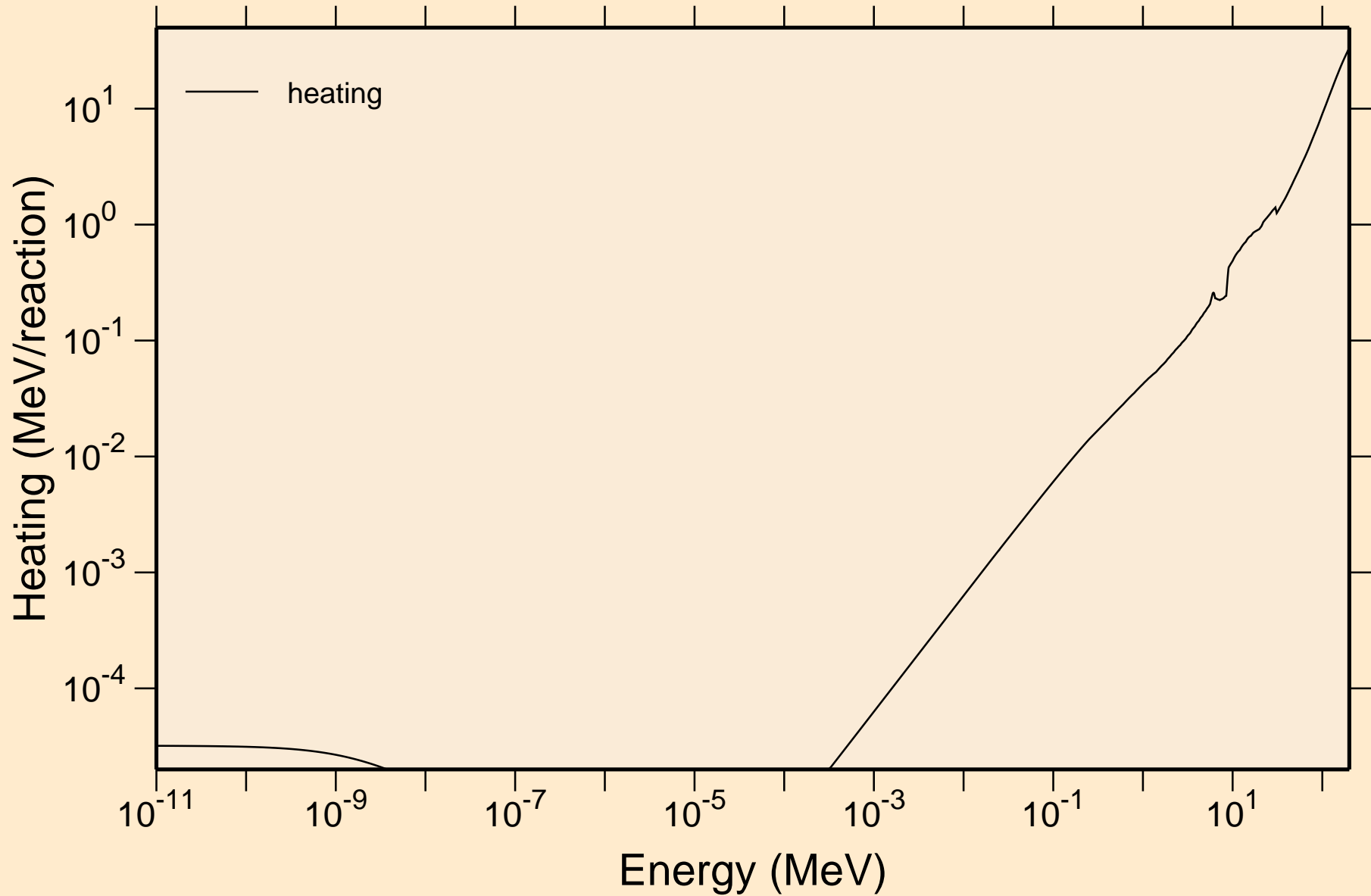

AL030 NEUTRON ACER TENDL-2024 LIBRARY; T=293.6K  
Damage

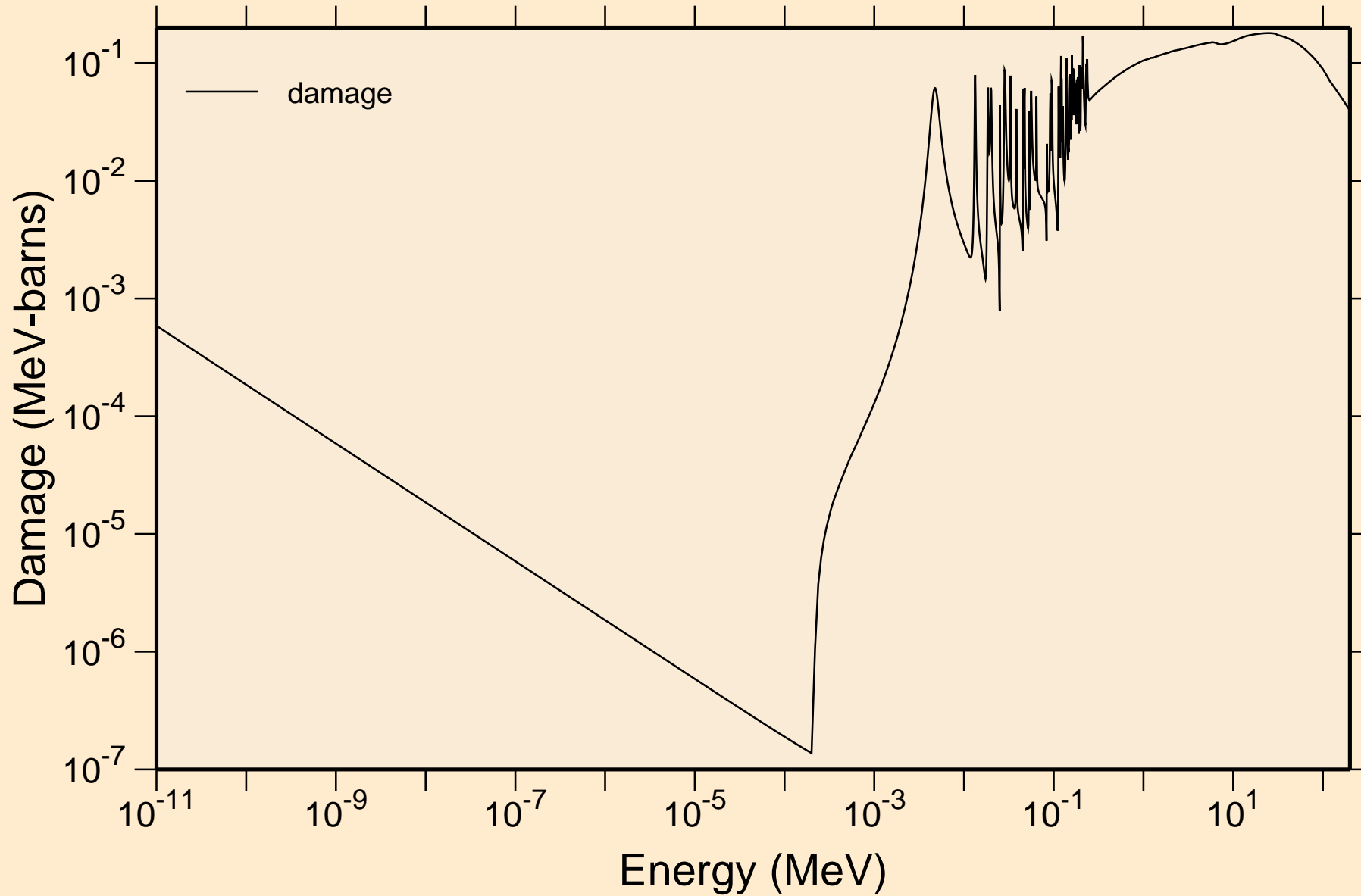

AL030 NEUTRON ACER TENDL-2024 LIBRARY; T=293.6K  
Non-threshold reactions

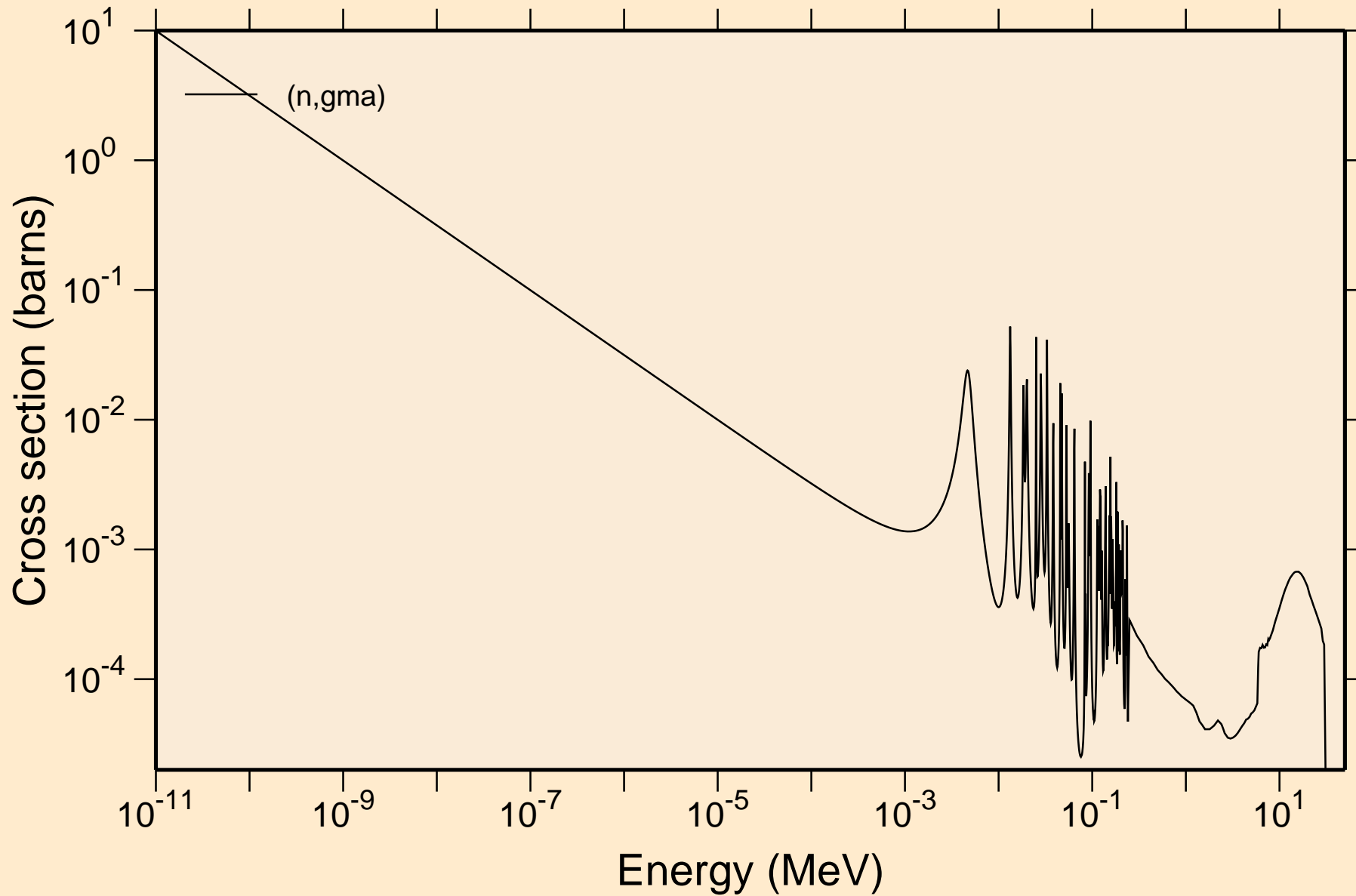

# AL030 NEUTRON ACER TENDL-2024 LIBRARY; T=293.6K

## Principal cross sections

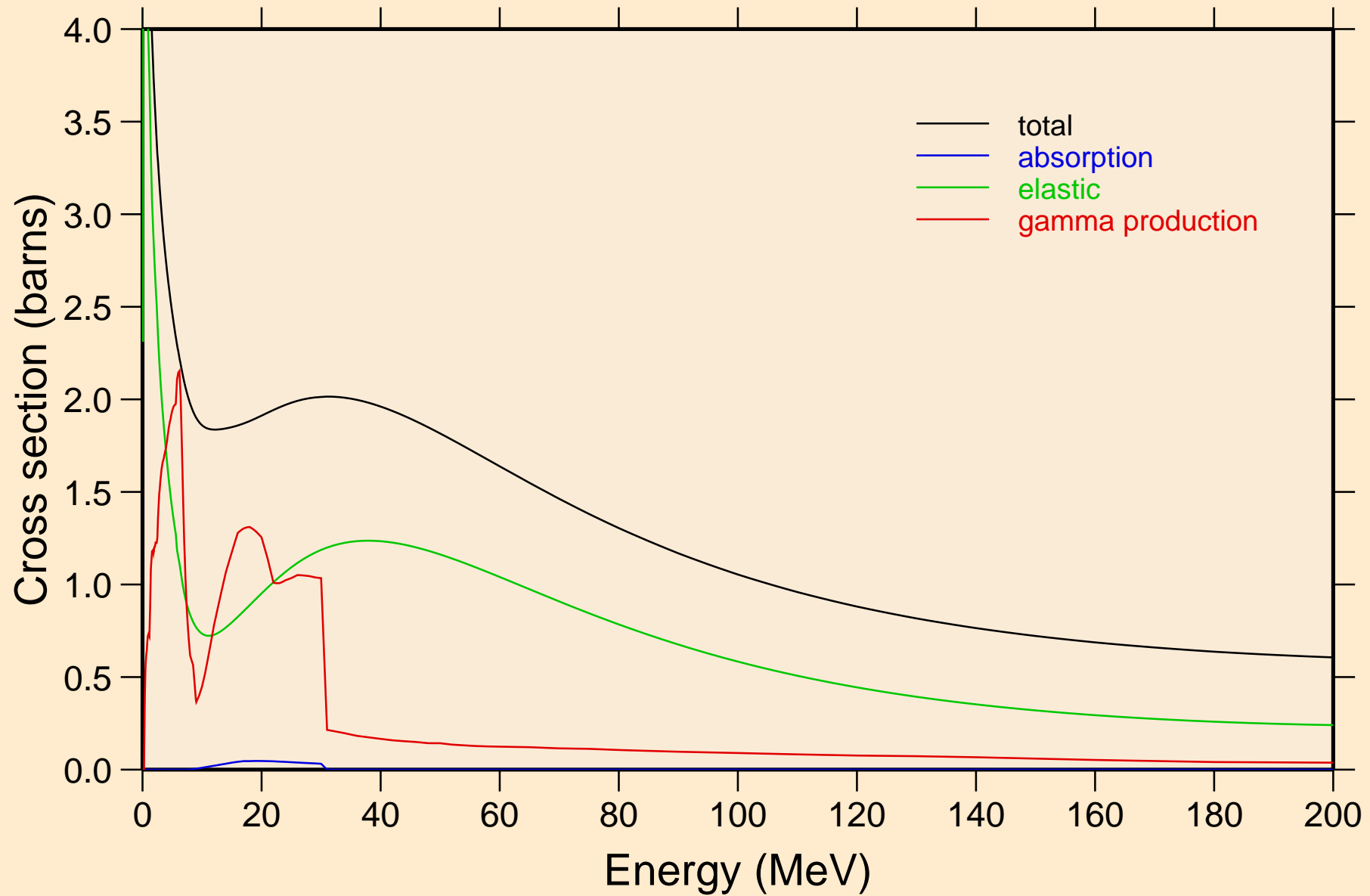

AL030 NEUTRON ACER TENDL-2024 LIBRARY; T=293.6K

Heating

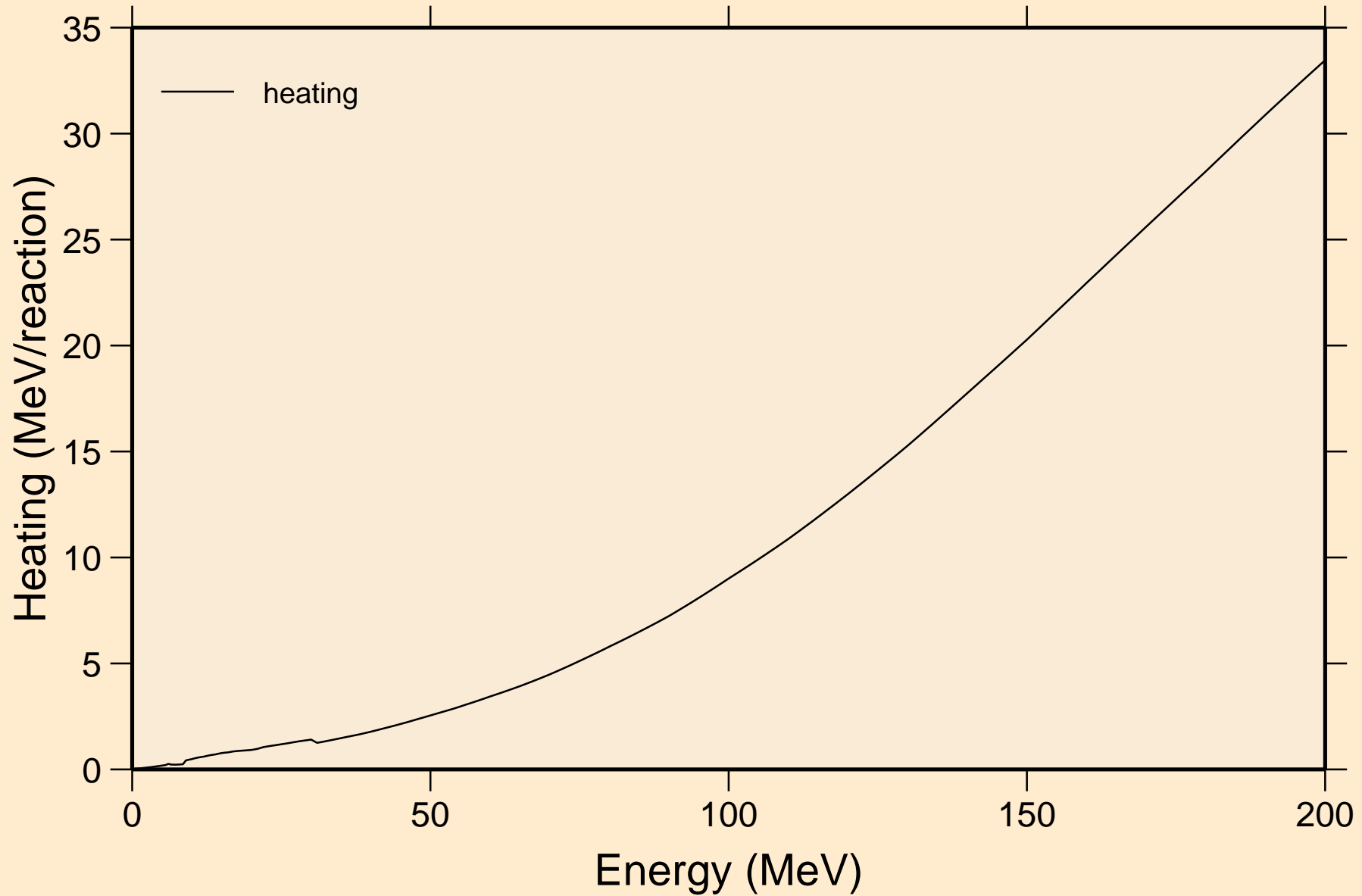

AL030 NEUTRON ACER TENDL-2024 LIBRARY; T=293.6K  
Damage

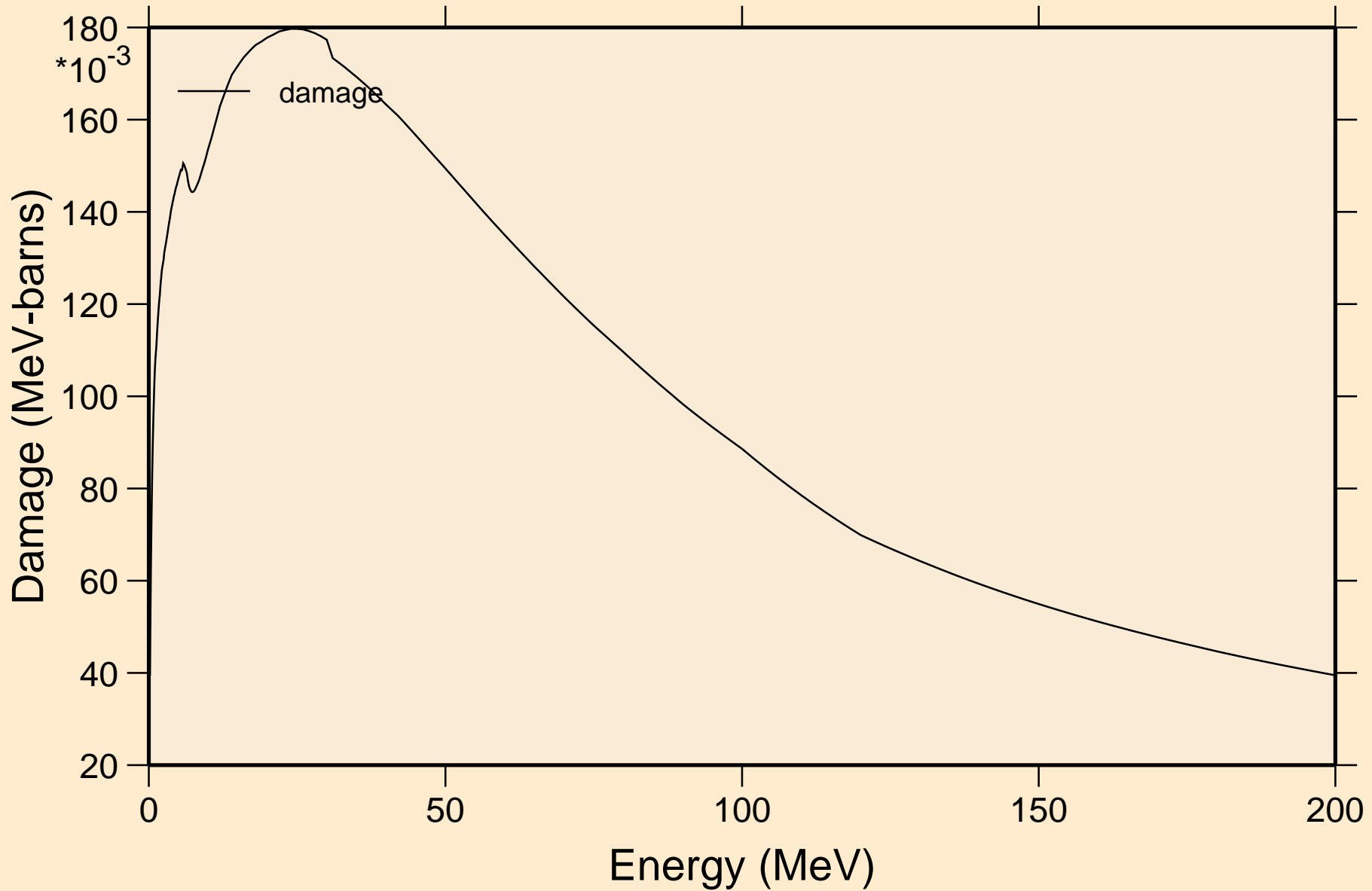

AL030 NEUTRON ACER TENDL-2024 LIBRARY; T=293.6K  
Non-threshold reactions

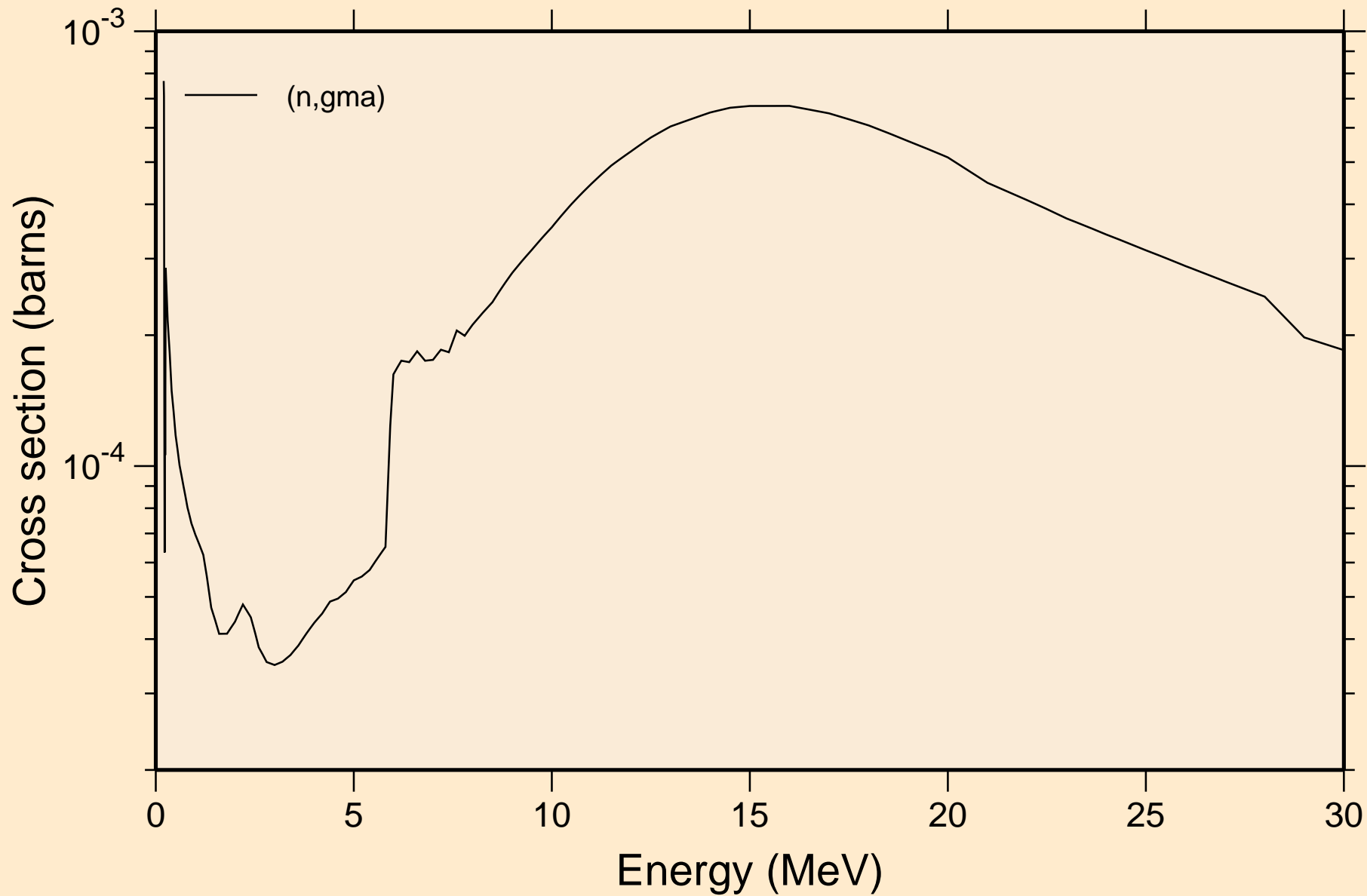

AL030 NEUTRON ACER TENDL-2024 LIBRARY; T=293.6K  
Inelastic levels

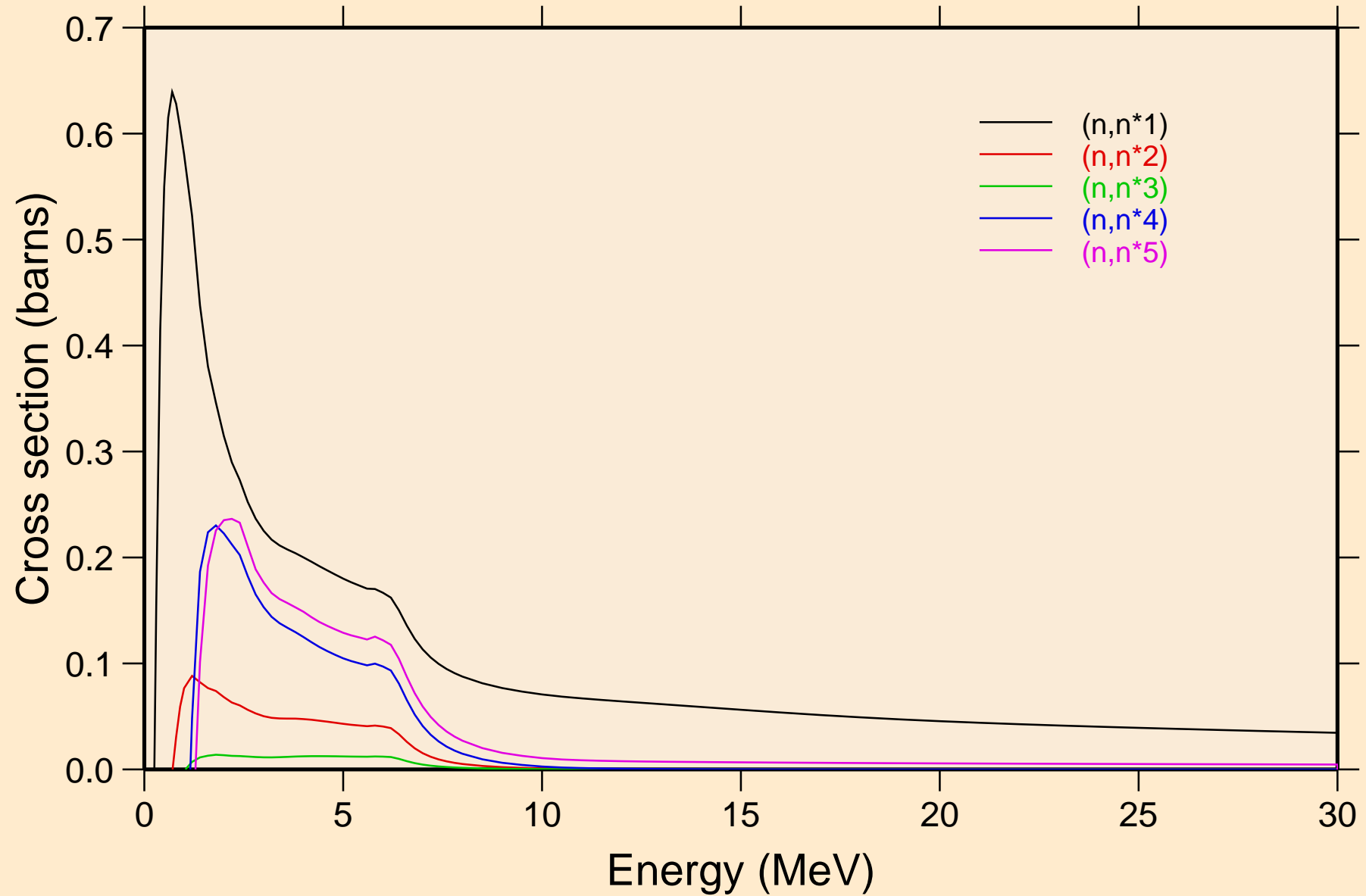

AL030 NEUTRON ACER TENDL-2024 LIBRARY; T=293.6K  
Inelastic levels

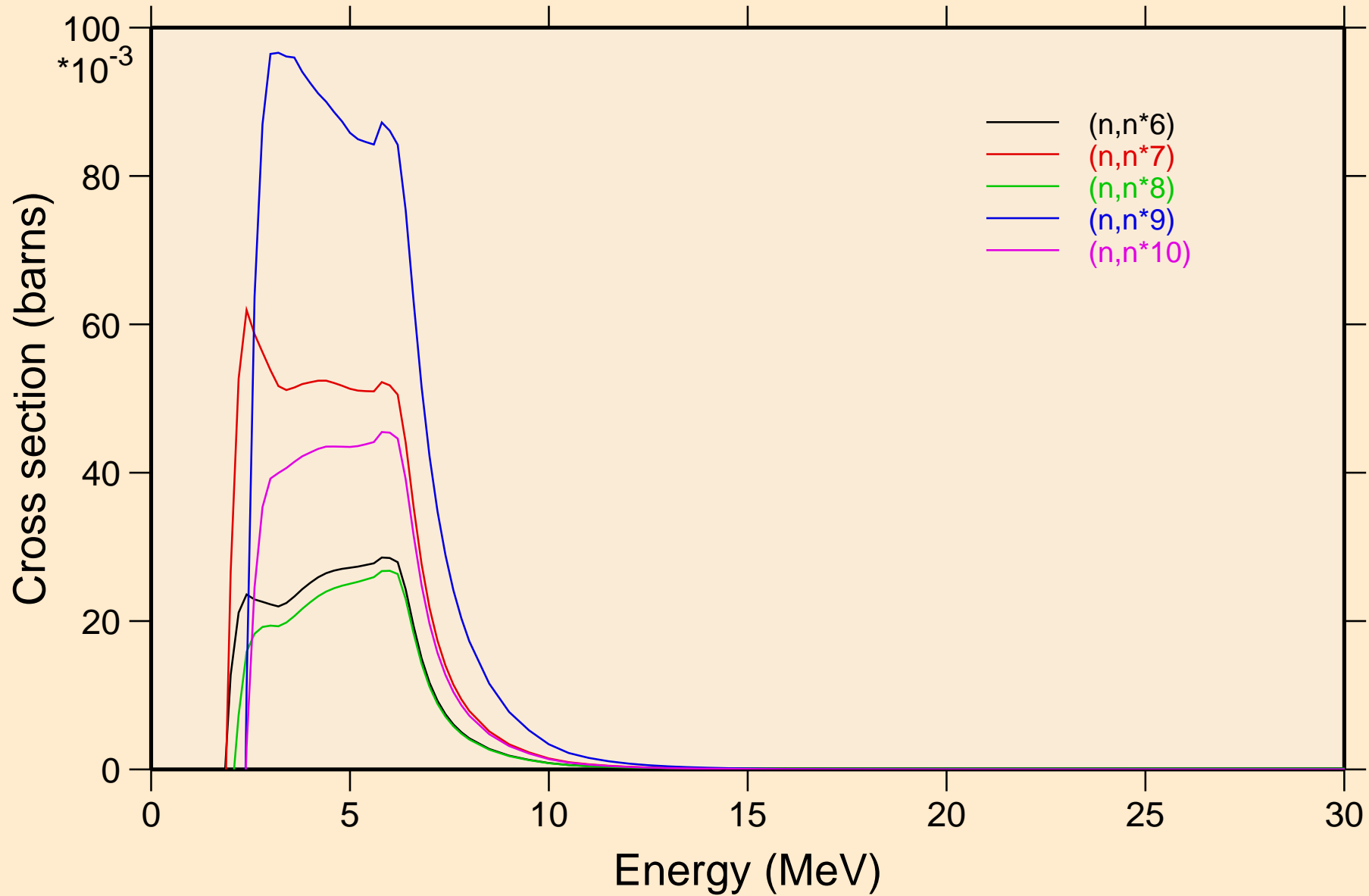

AL030 NEUTRON ACER TENDL-2024 LIBRARY; T=293.6K  
Inelastic levels

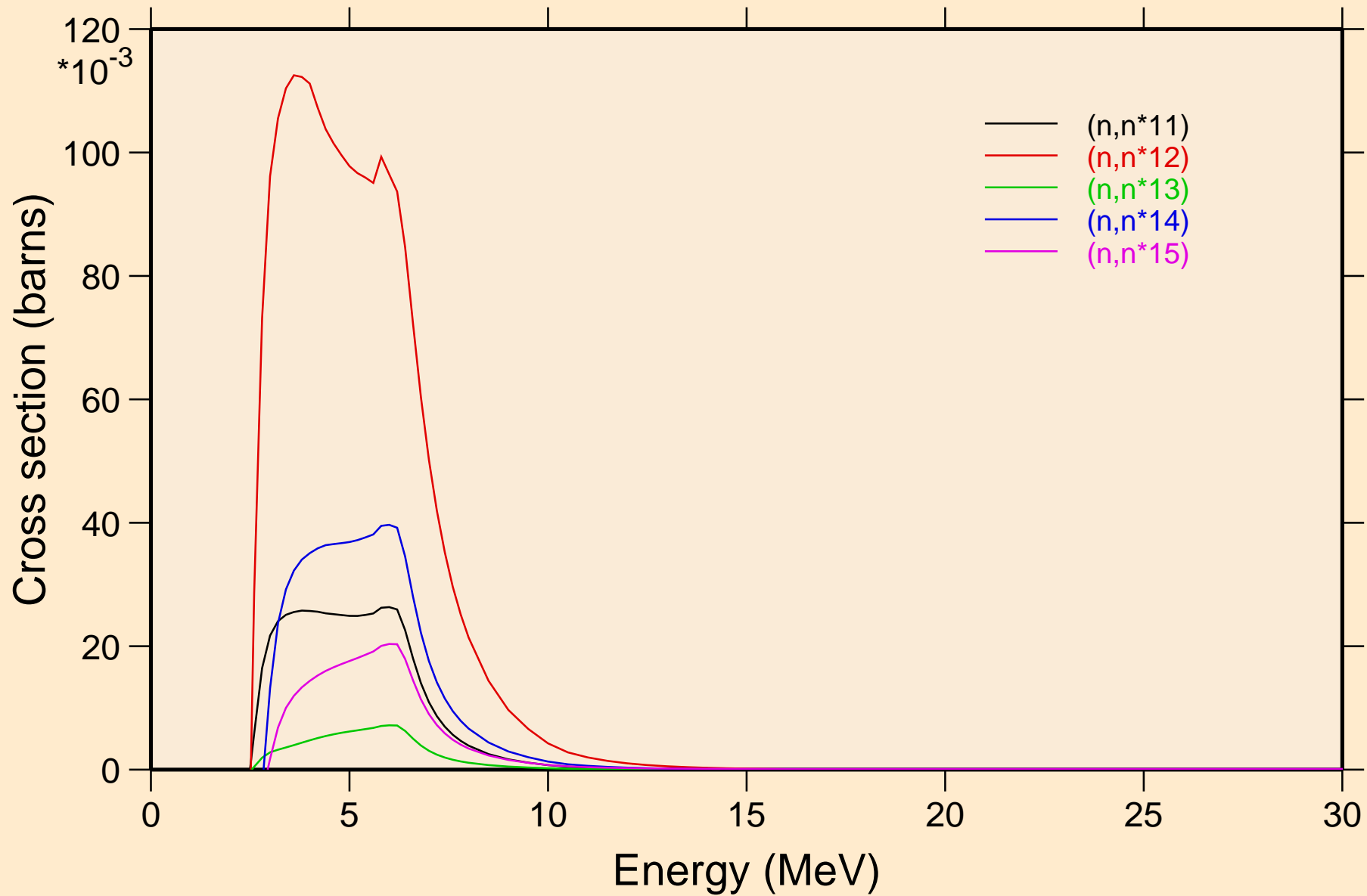

AL030 NEUTRON ACER TENDL-2024 LIBRARY; T=293.6K  
Inelastic levels

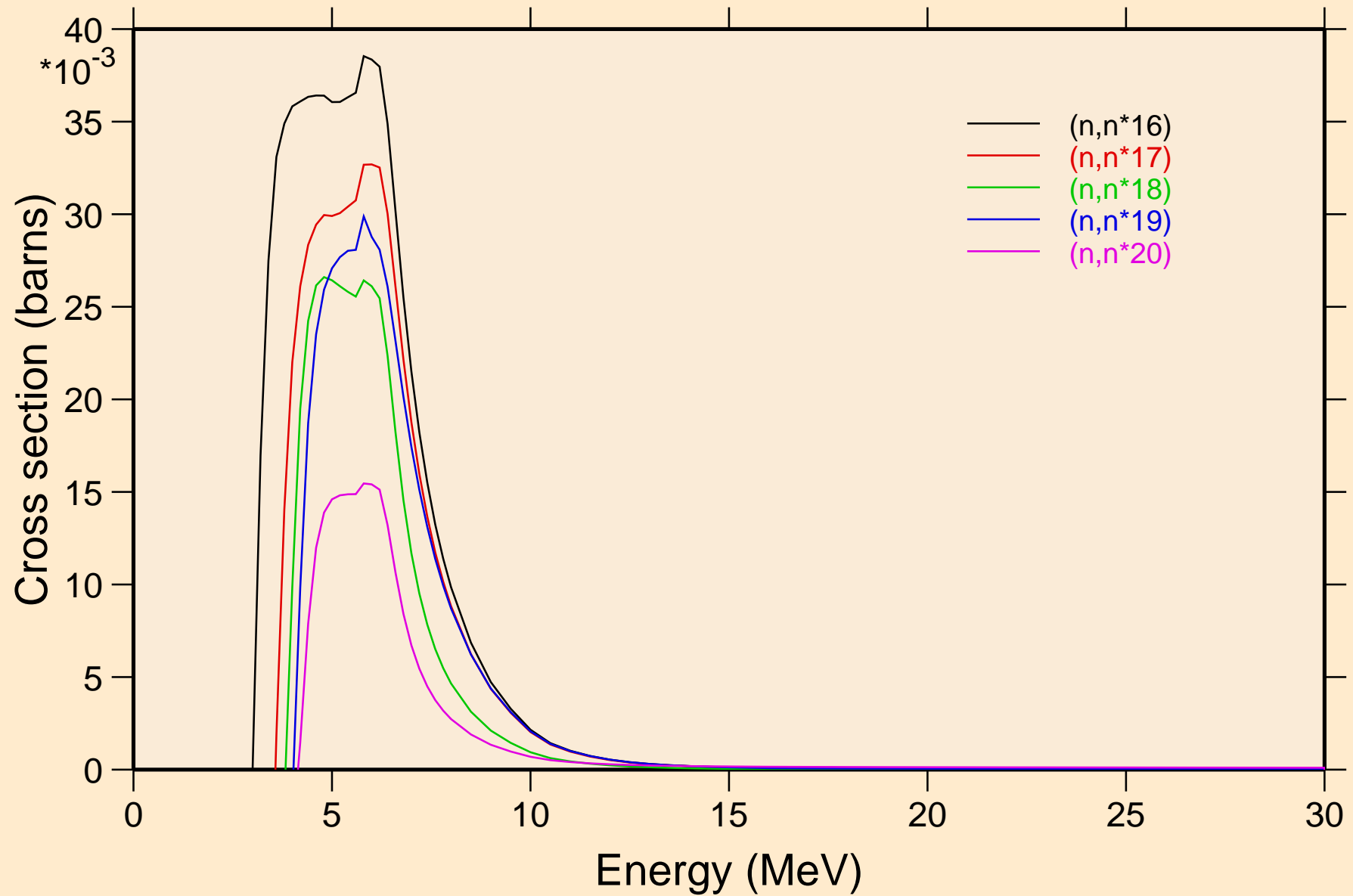

AL030 NEUTRON ACER TENDL-2024 LIBRARY; T=293.6K  
Inelastic levels

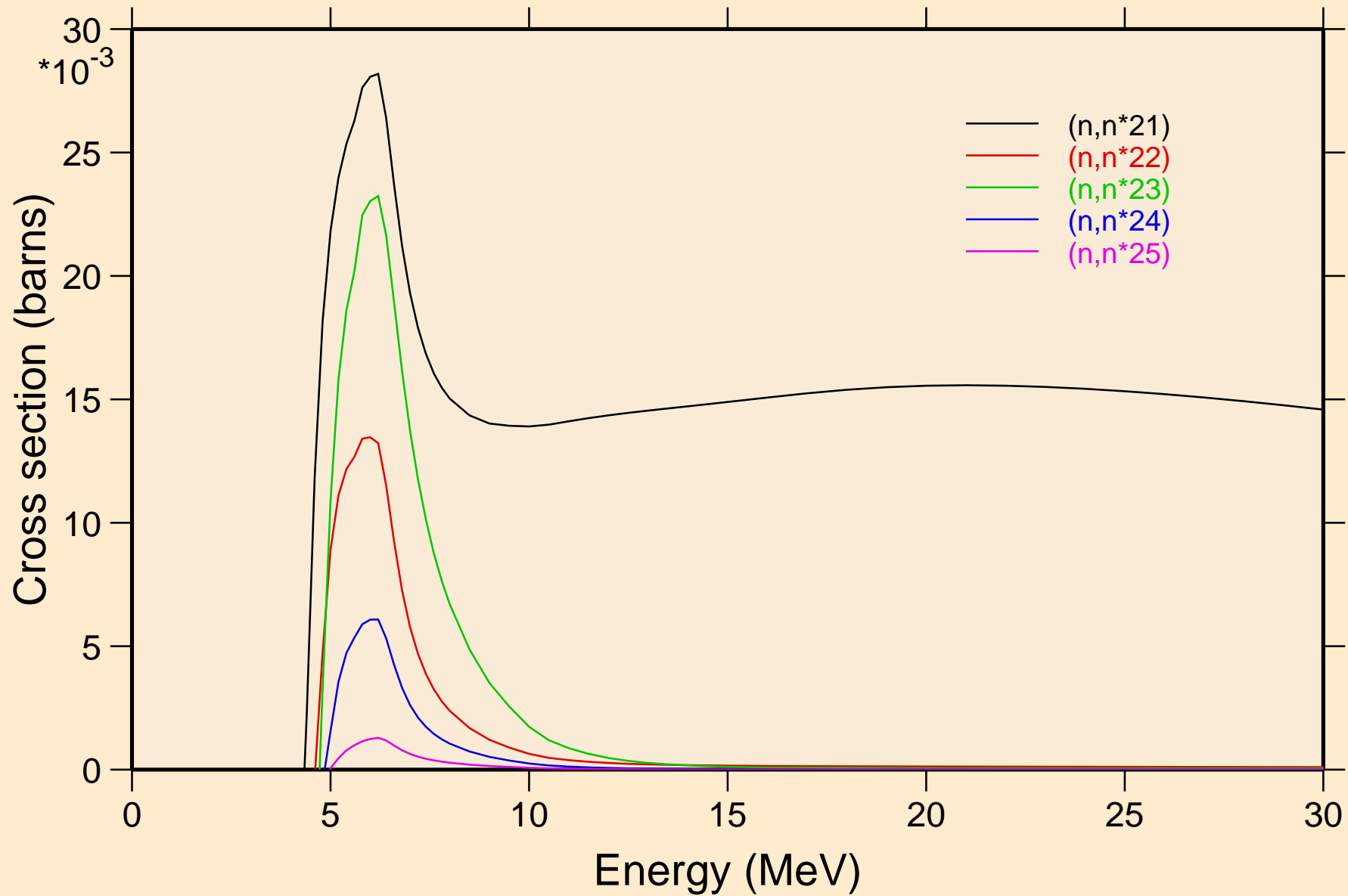

AL030 NEUTRON ACER TENDL-2024 LIBRARY; T=293.6K  
Inelastic levels

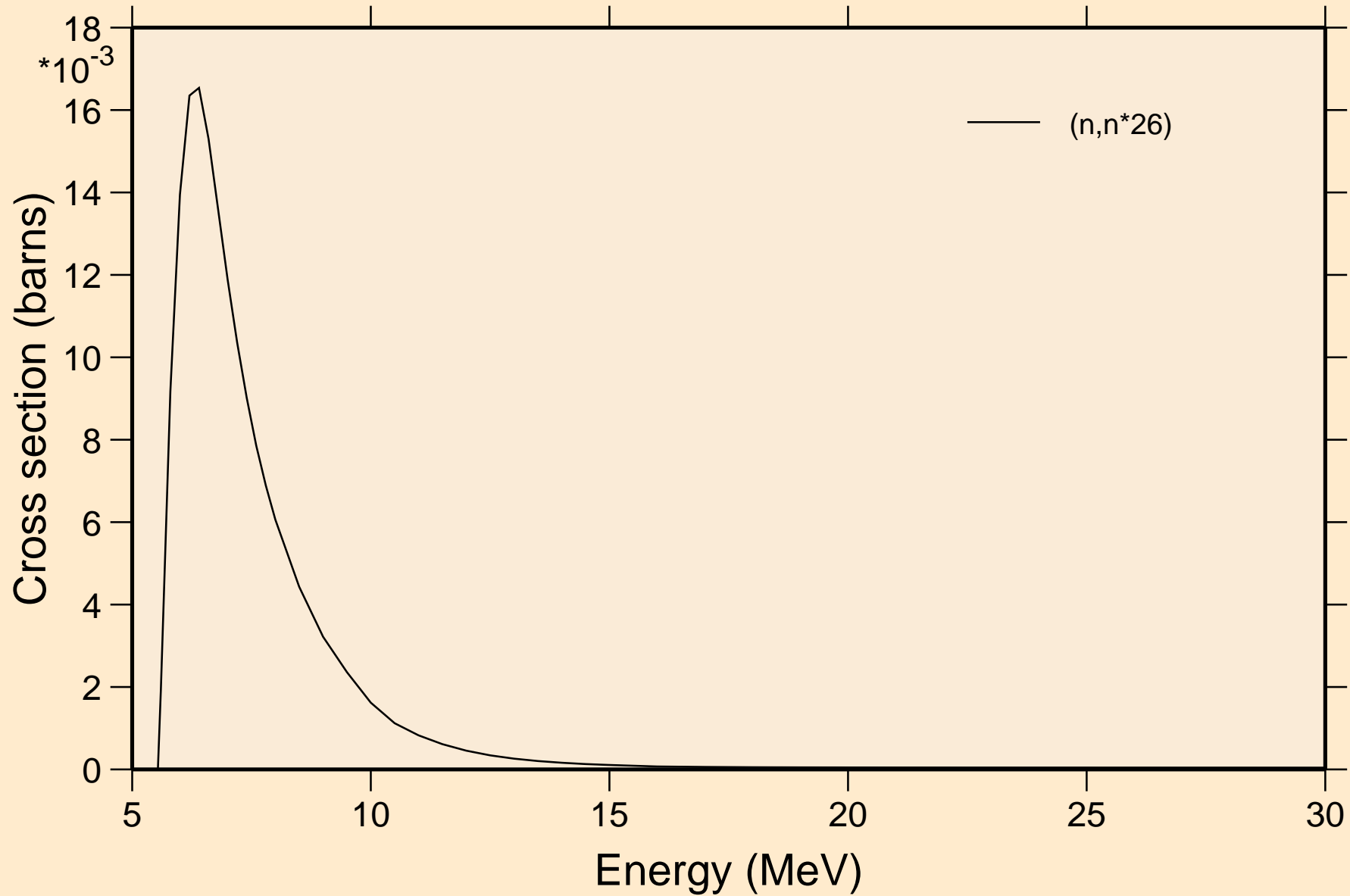

AL030 NEUTRON ACER TENDL-2024 LIBRARY; T=293.6K  
Threshold reactions

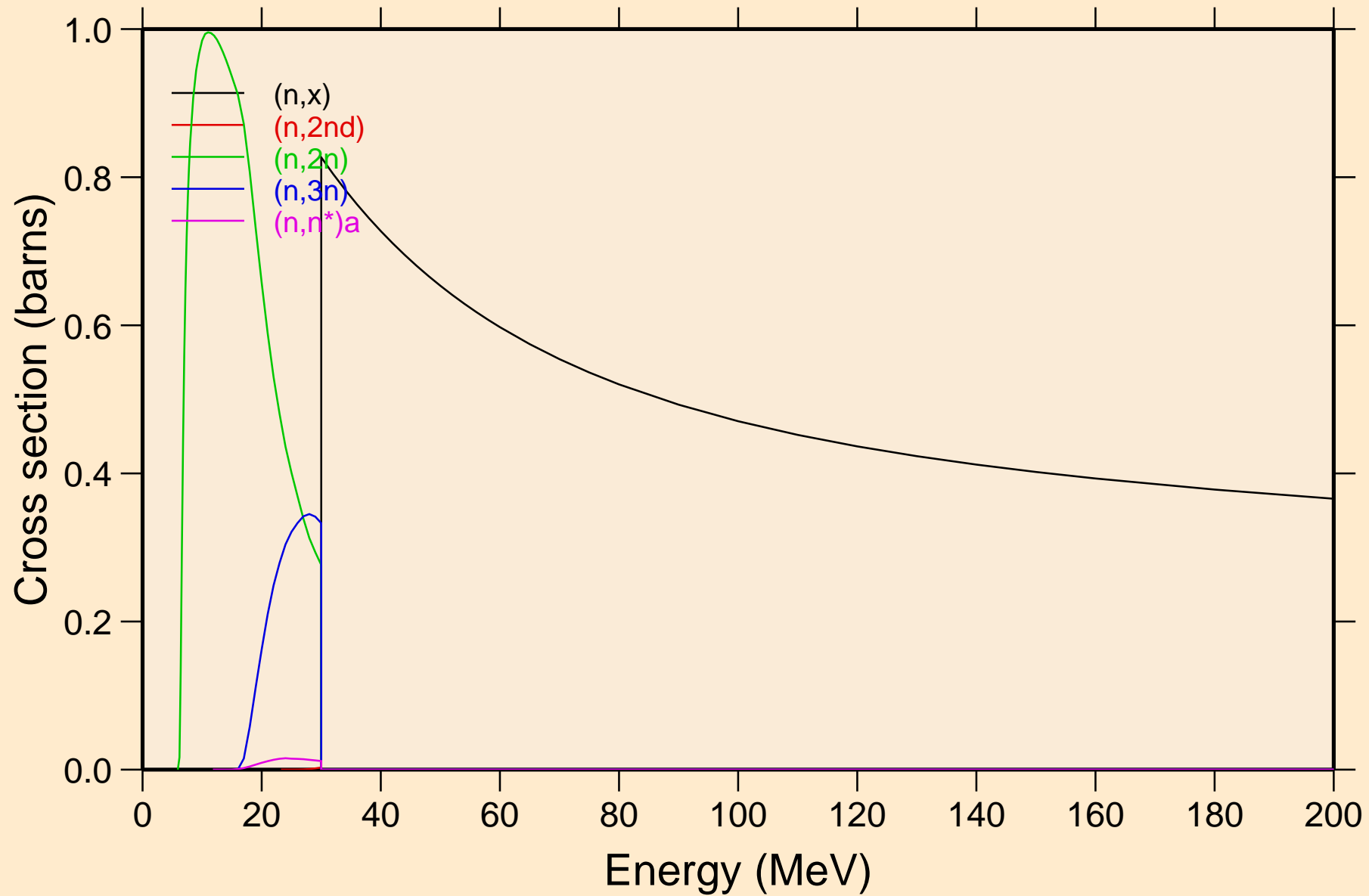

AL030 NEUTRON ACER TENDL-2024 LIBRARY; T=293.6K  
Threshold reactions

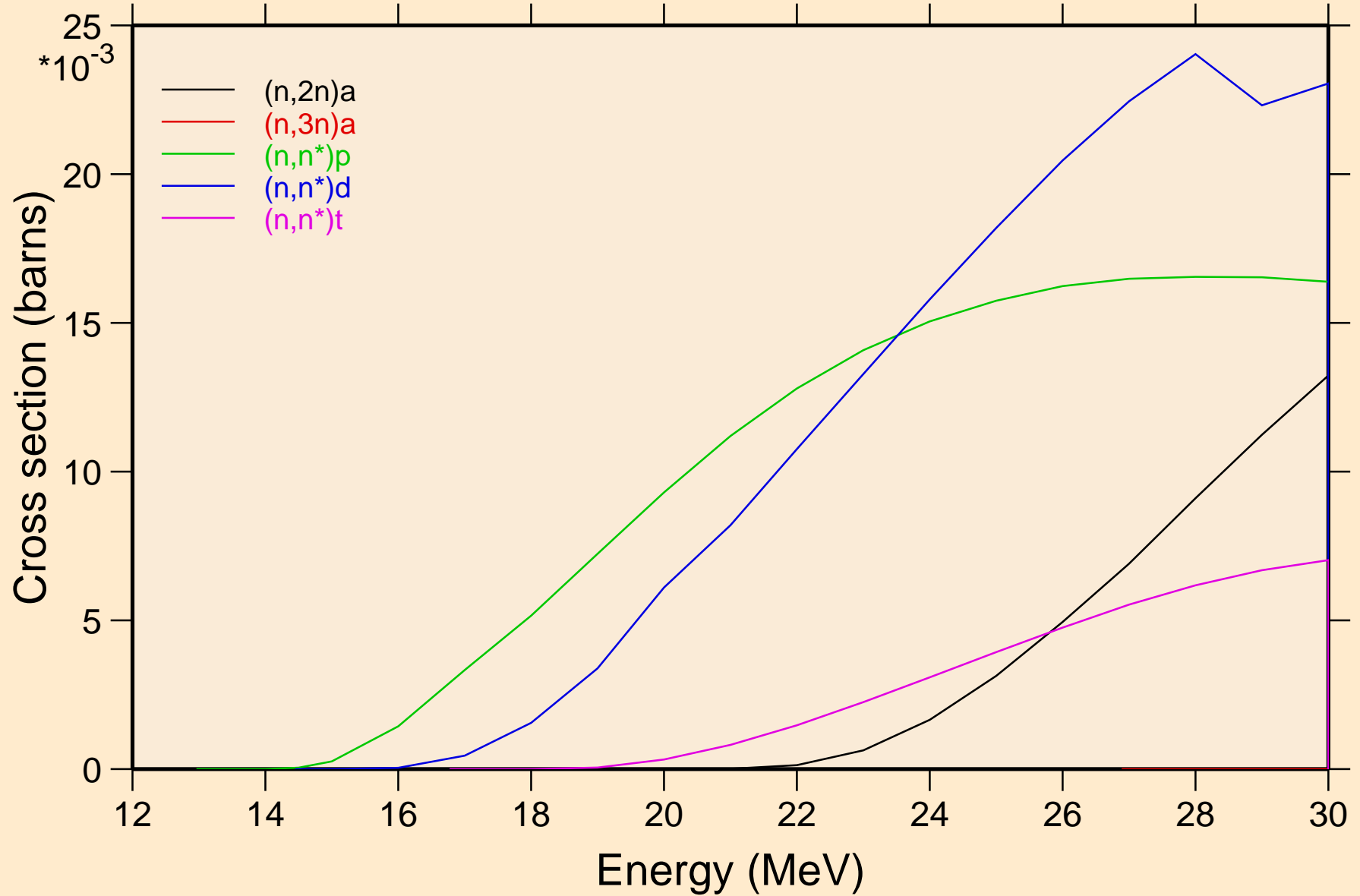

AL030 NEUTRON ACER TENDL-2024 LIBRARY; T=293.6K  
Threshold reactions

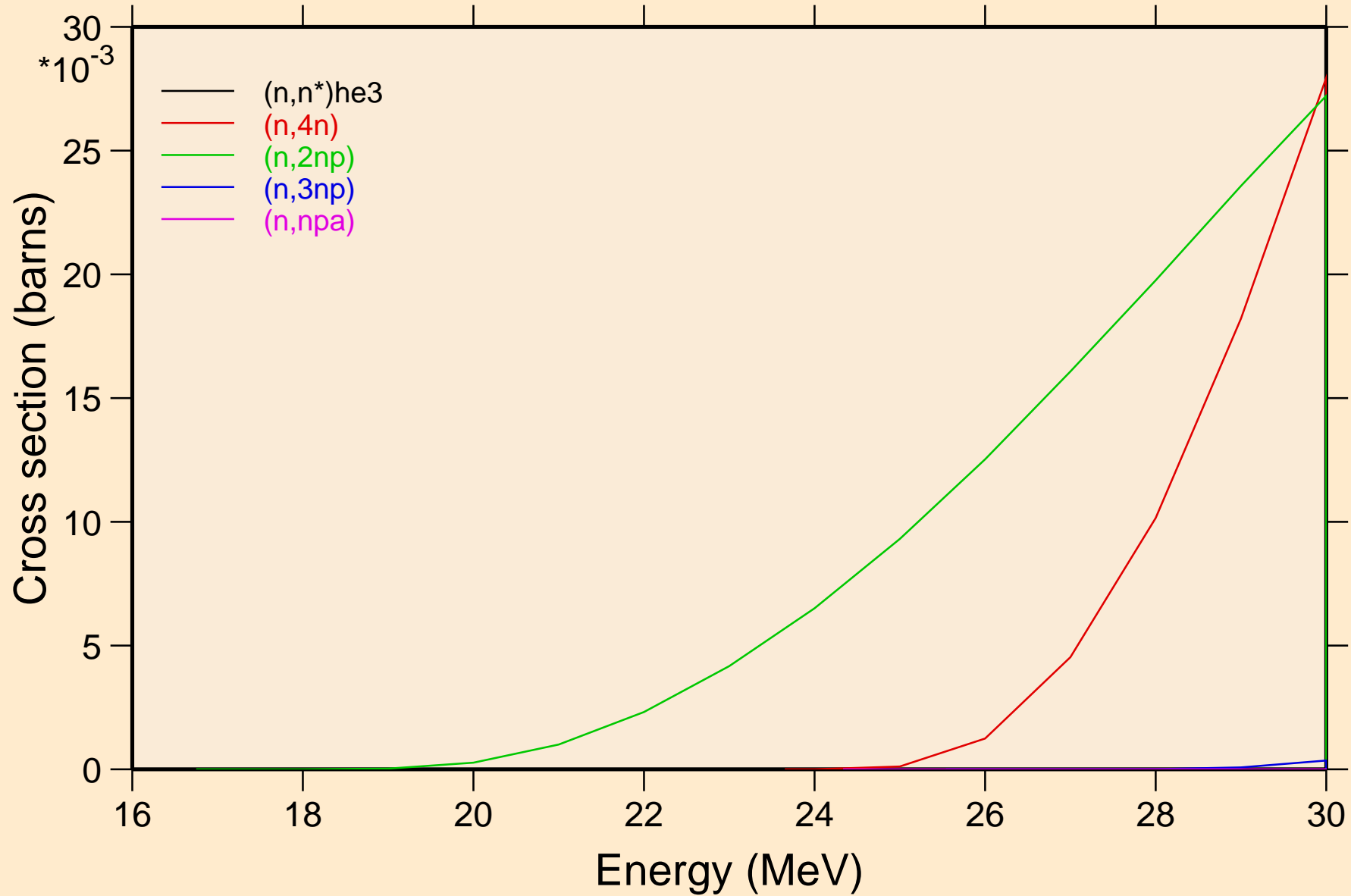

AL030 NEUTRON ACER TENDL-2024 LIBRARY; T=293.6K  
Threshold reactions

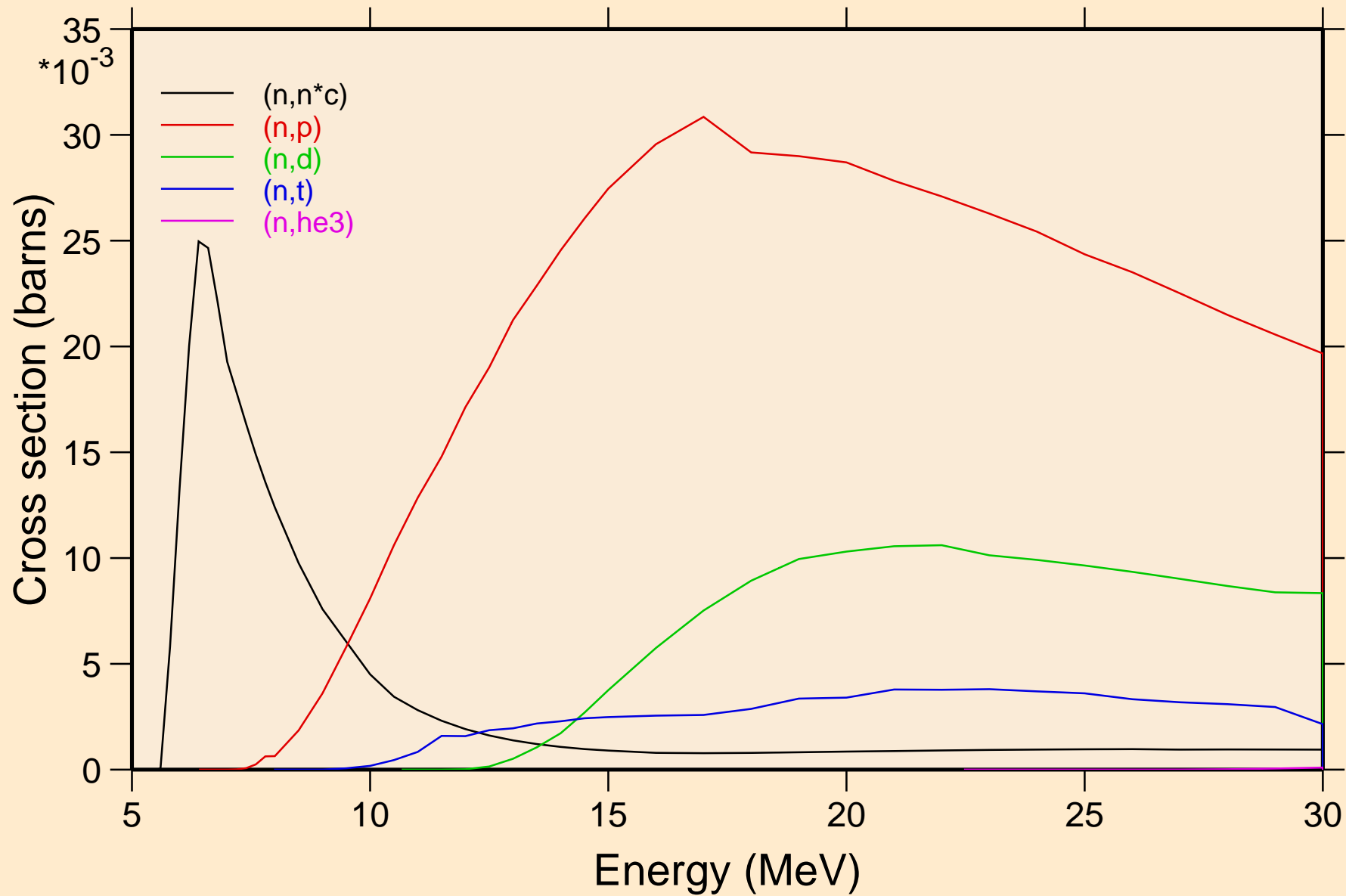

AL030 NEUTRON ACER TENDL-2024 LIBRARY; T=293.6K  
Threshold reactions

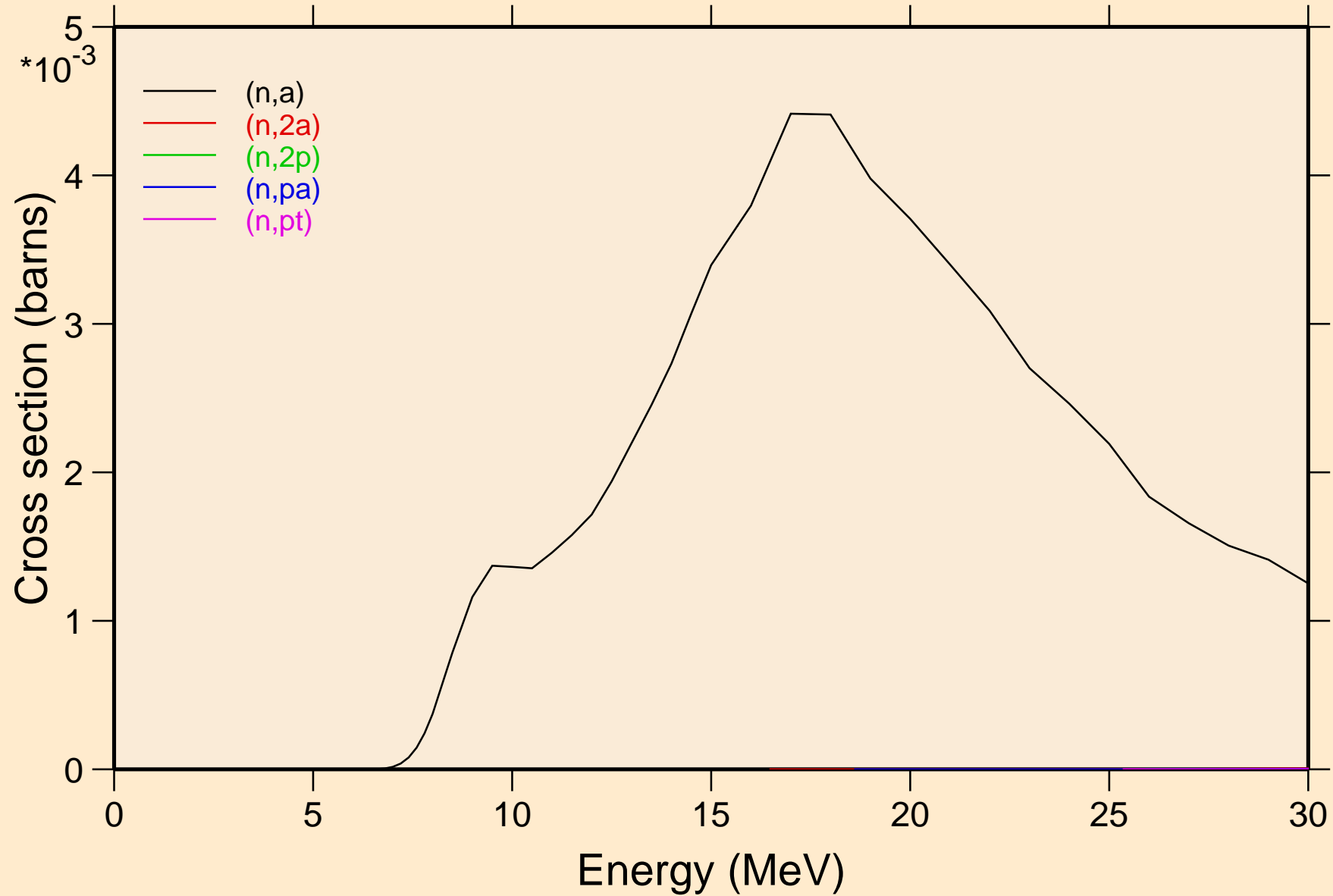

AL030 NEUTRON ACER TENDL-2024 LIBRARY; T=293.6K  
Threshold reactions

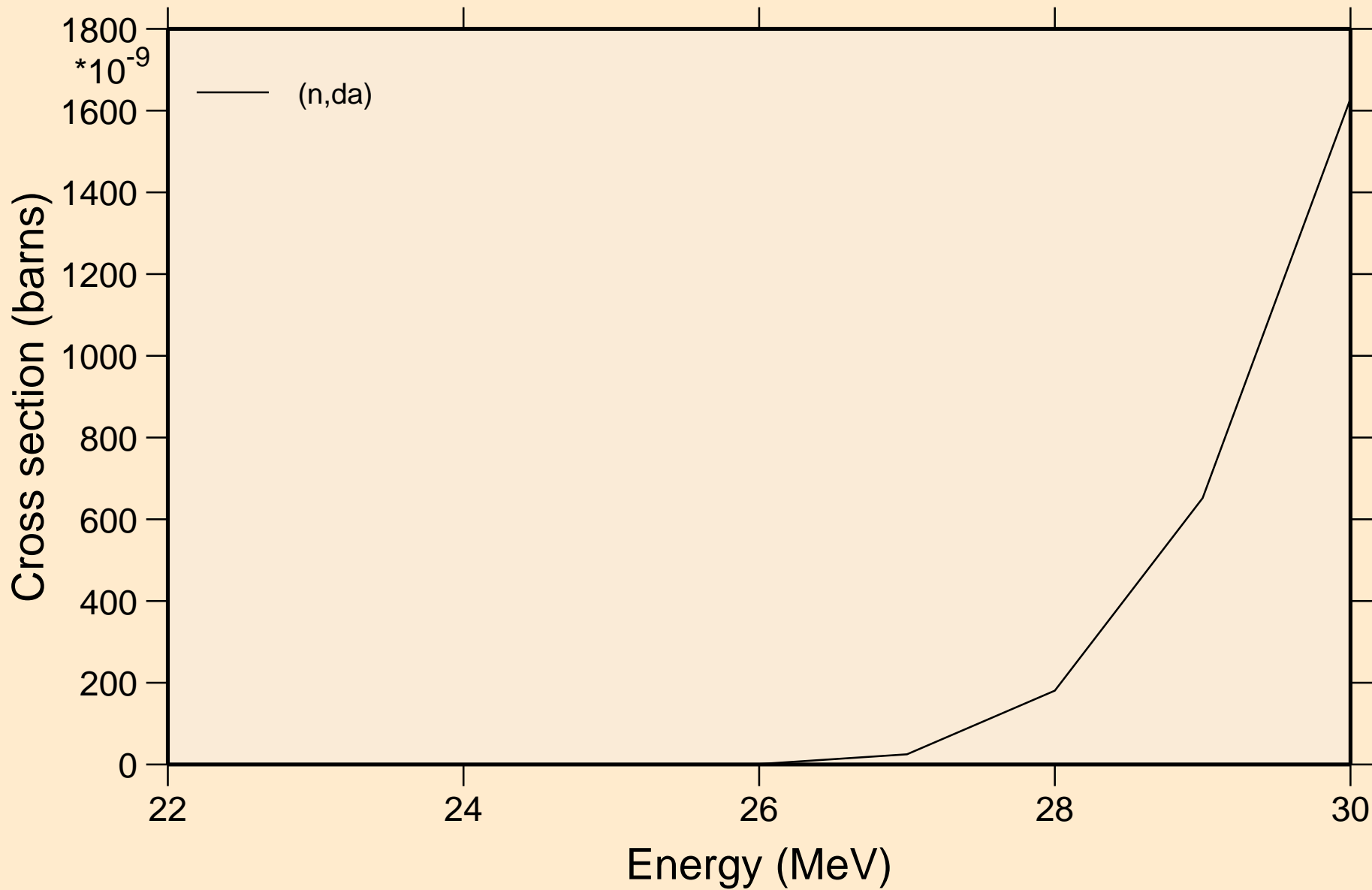

# AL030 NEUTRON ACER TENDL-2024 LIBRARY; T=293.6K

## Threshold reactions

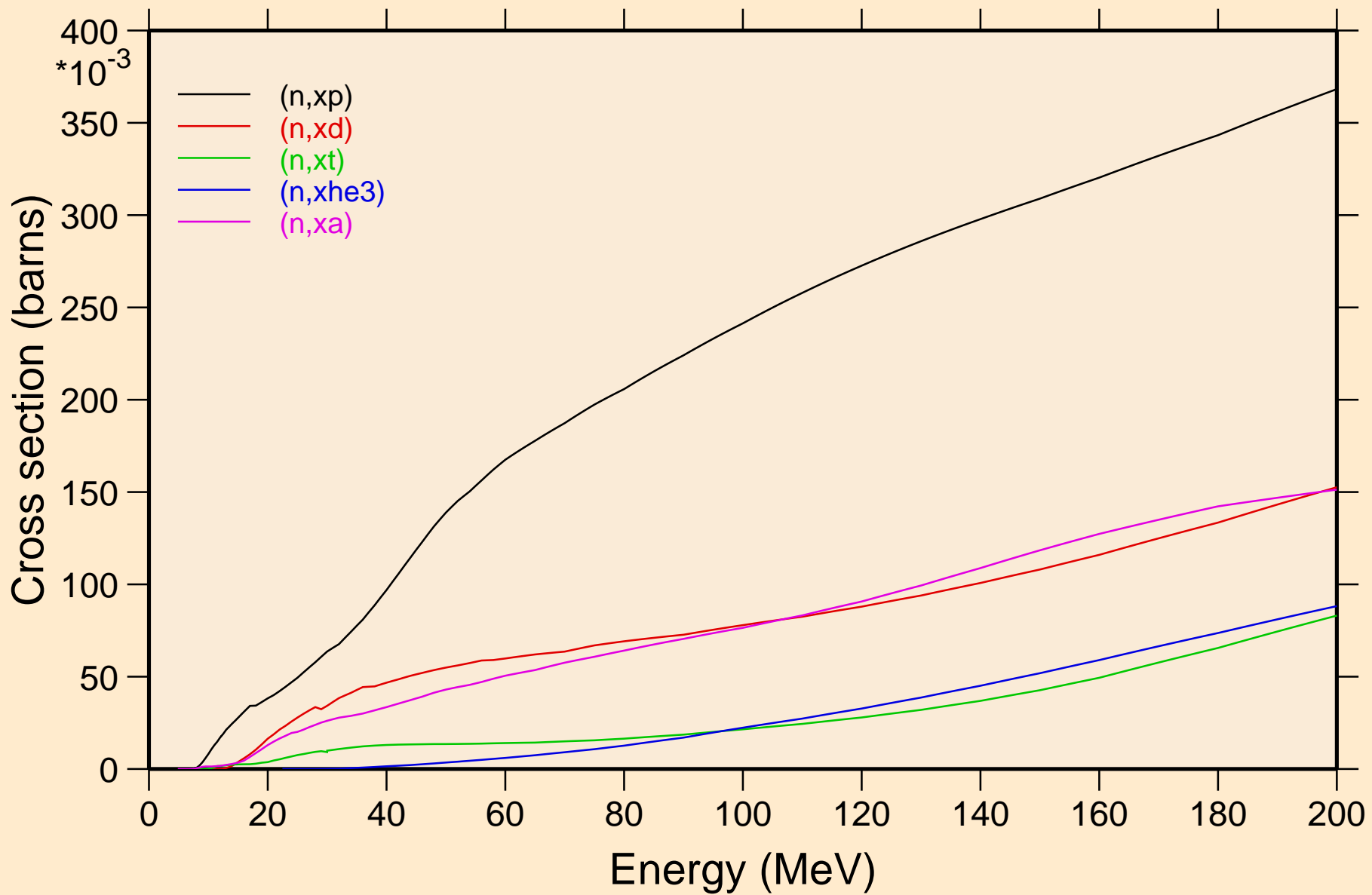

AL030 NEUTRON ACER TENDL-2024 LIBRARY; T=293.6K  
angular distribution for elastic

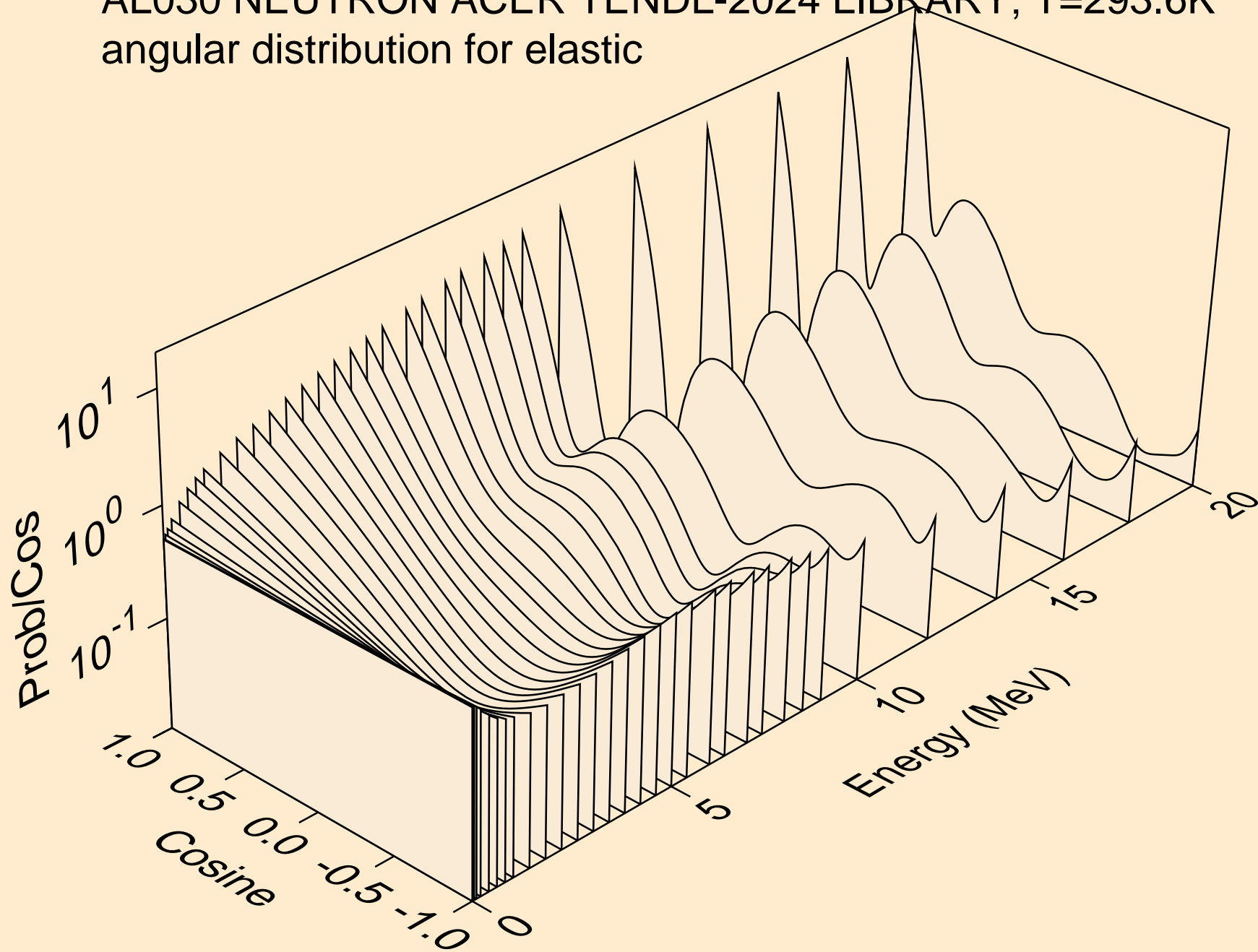

AL030 NEUTRON ACER TENDL-2024 LIBRARY; T=293.6K  
angular distribution for elastic

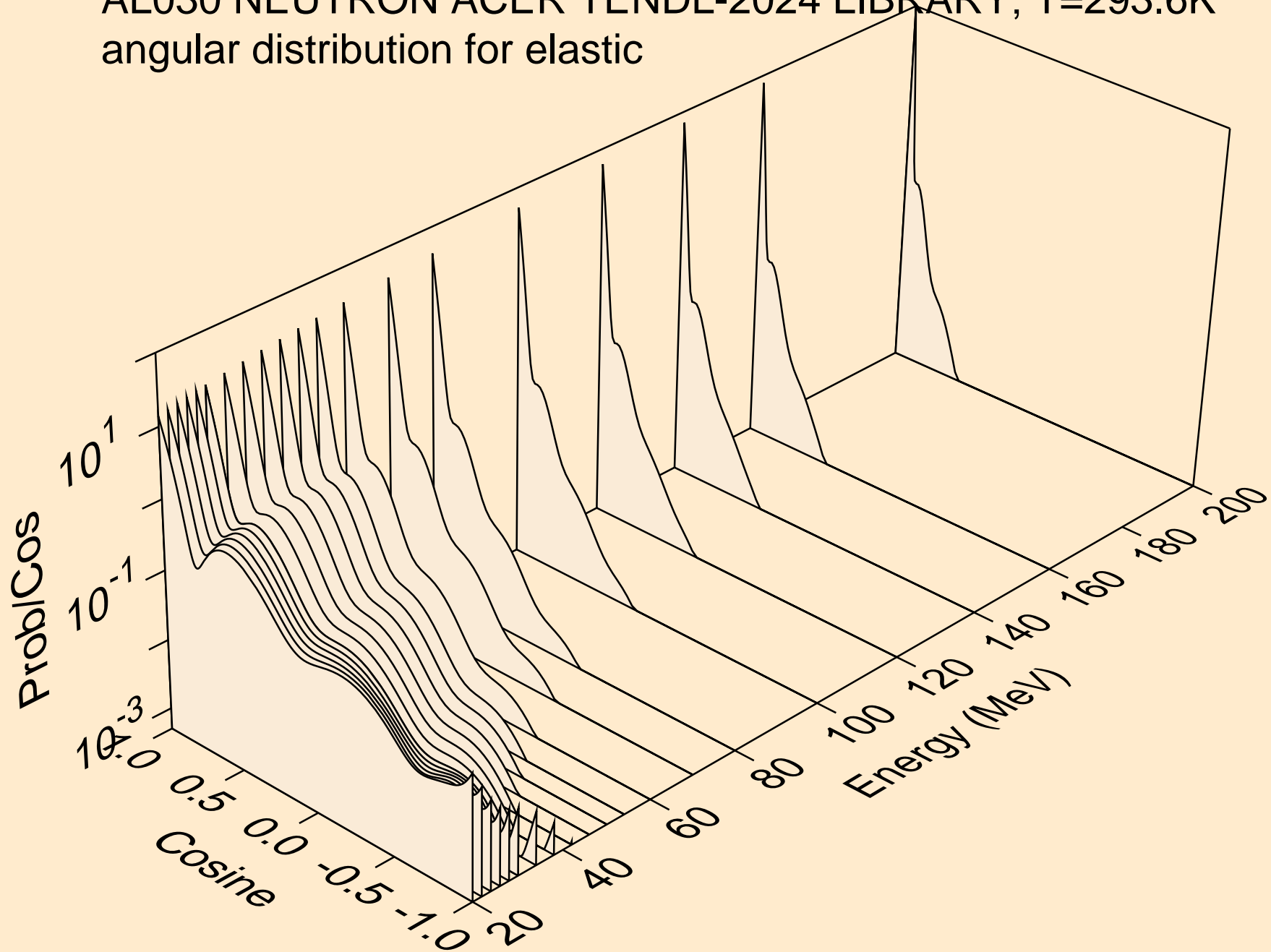

AL030 NEUTRON ACER TENDL-2024 LIBRARY; T=293.6K  
angular distribution for (n,n\*1)

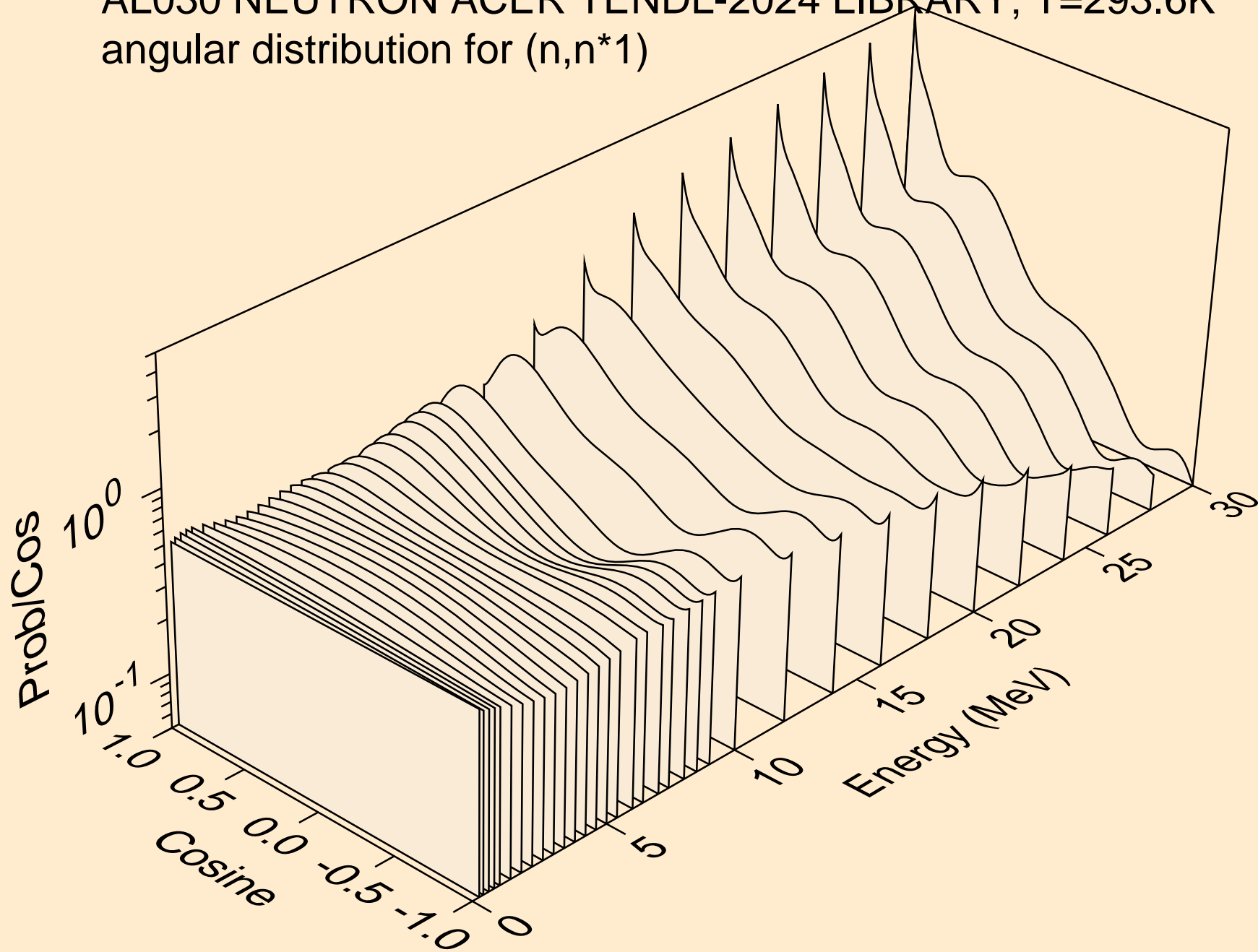

AL030 NEUTRON ACER TENDL-2024 LIBRARY; T=293.6K  
angular distribution for (n,n\*2)

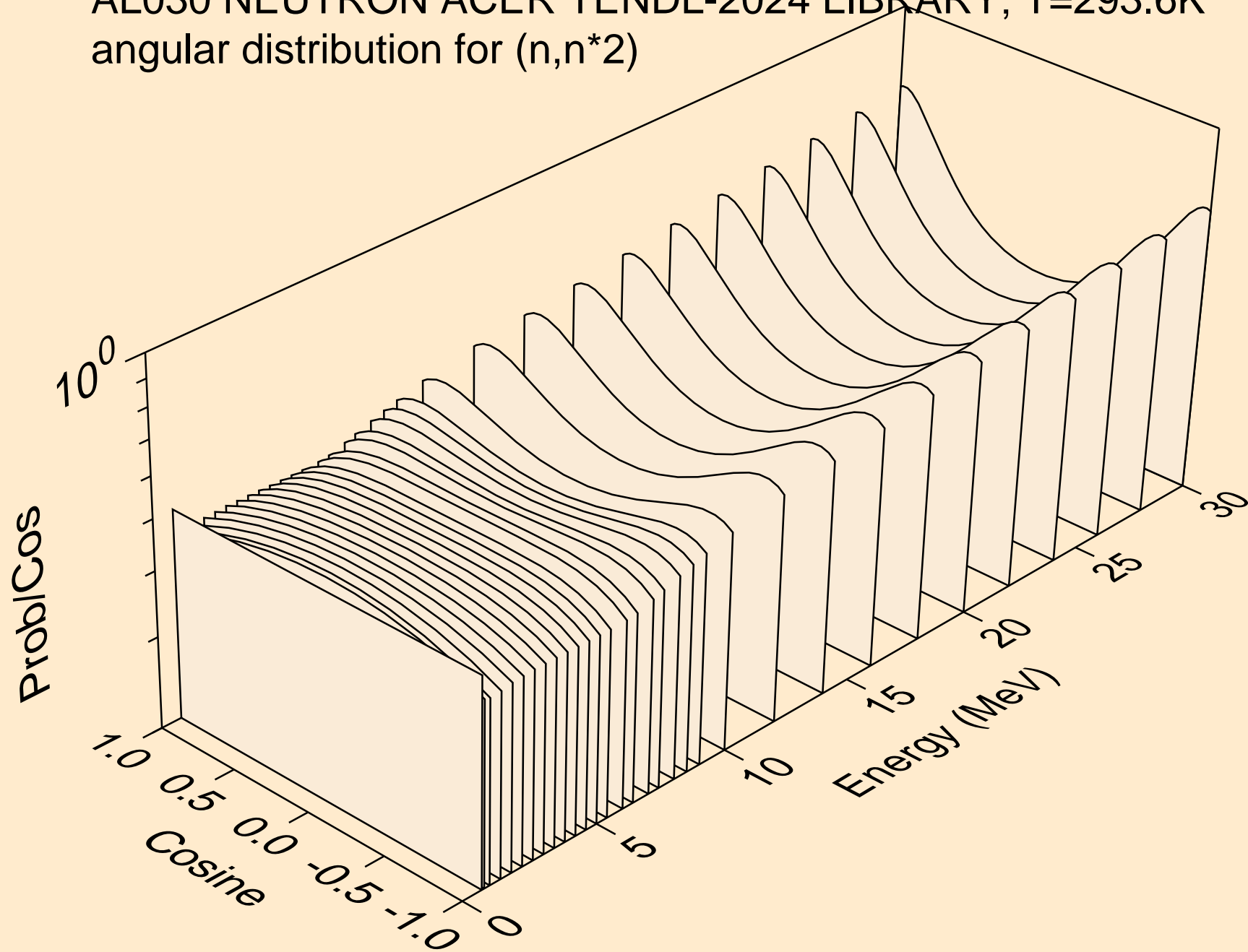

AL030 NEUTRON ACER TENDL-2024 LIBRARY; T=293.6K  
angular distribution for (n,n\*3)

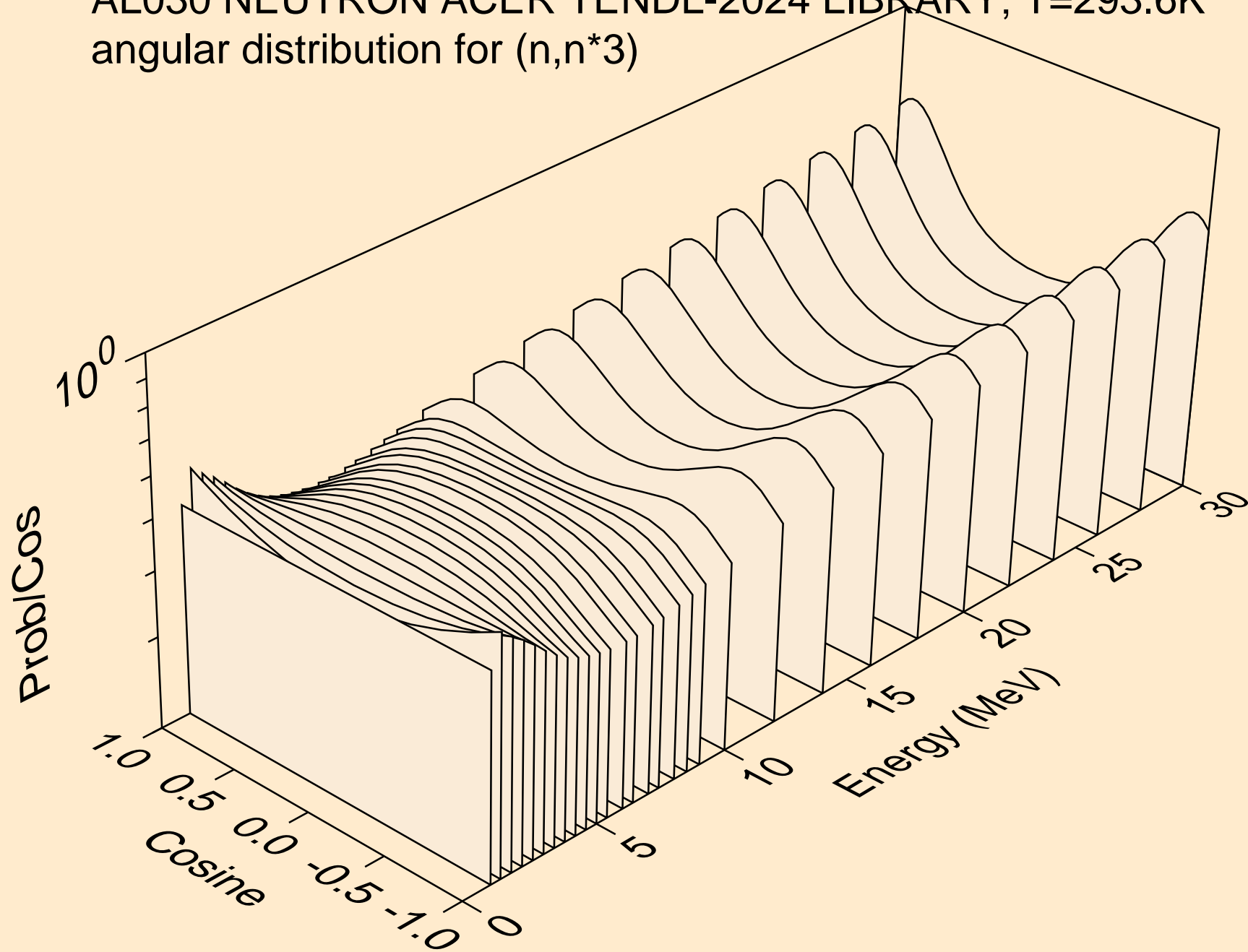

AL030 NEUTRON ACER TENDL-2024 LIBRARY; T=293.6K  
angular distribution for (n,n\*4)

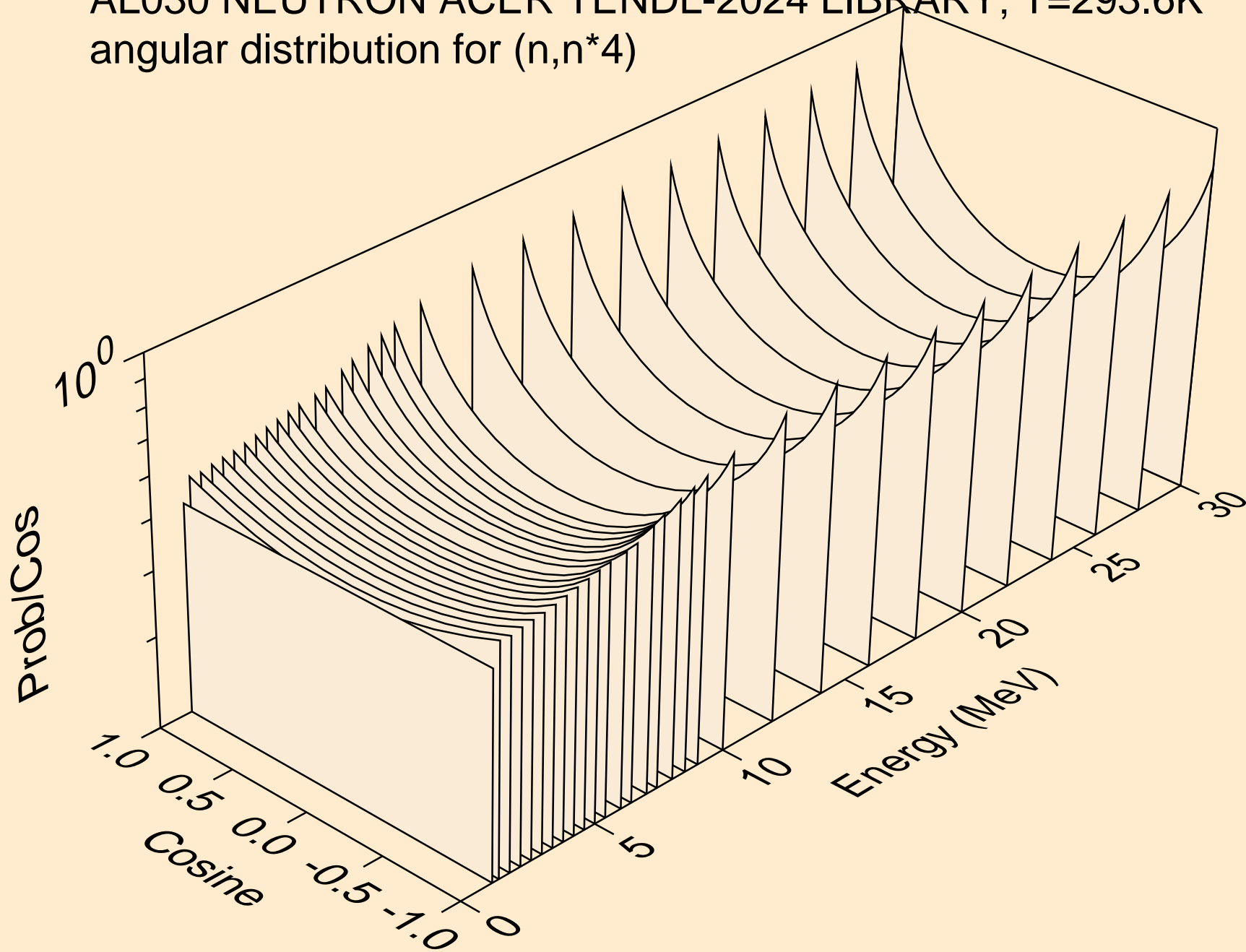

AL030 NEUTRON ACER TENDL-2024 LIBRARY; T=293.6K  
angular distribution for (n,n\*5)

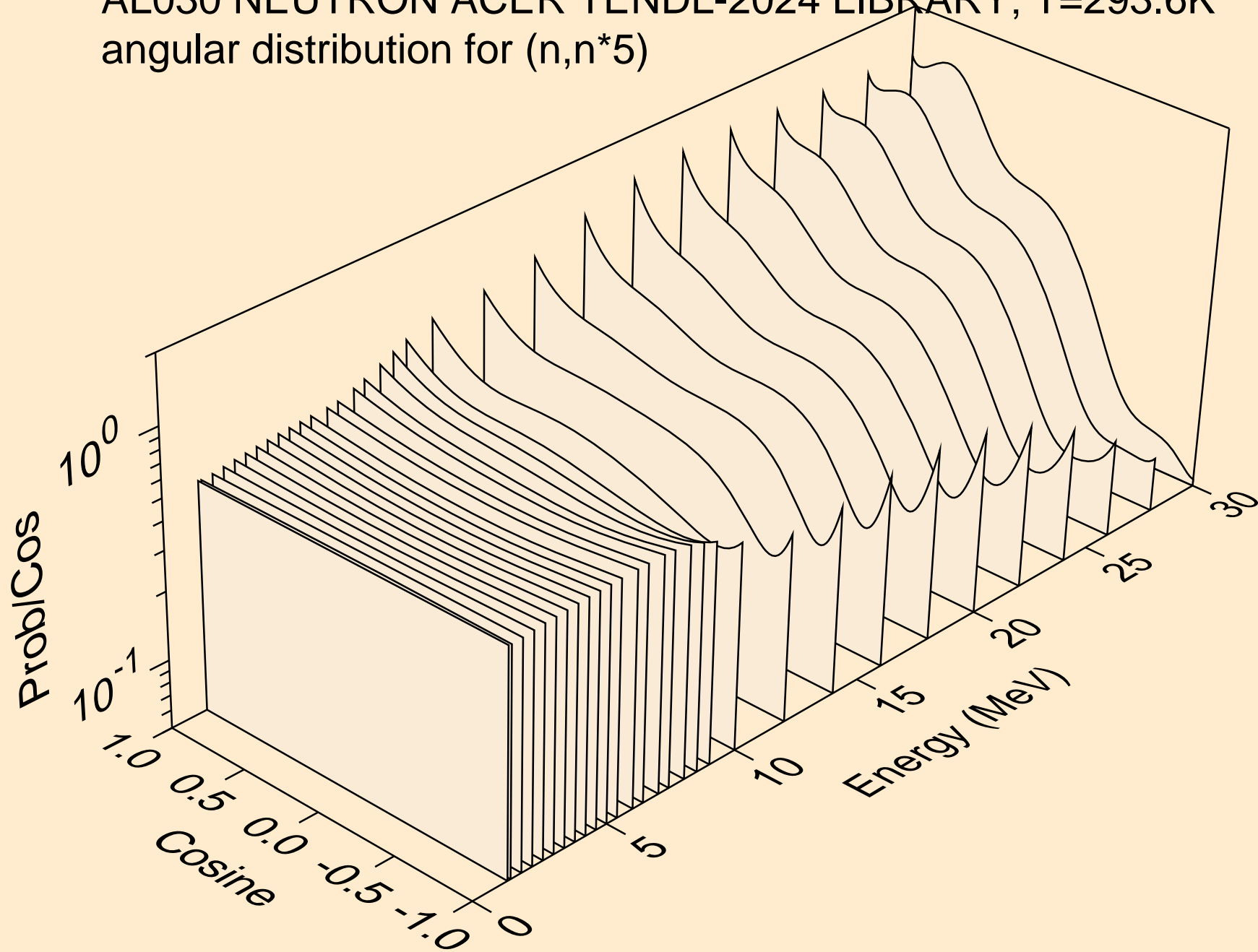

AL030 NEUTRON ACER TENDL-2024 LIBRARY; T=293.6K  
angular distribution for (n,n\*6)

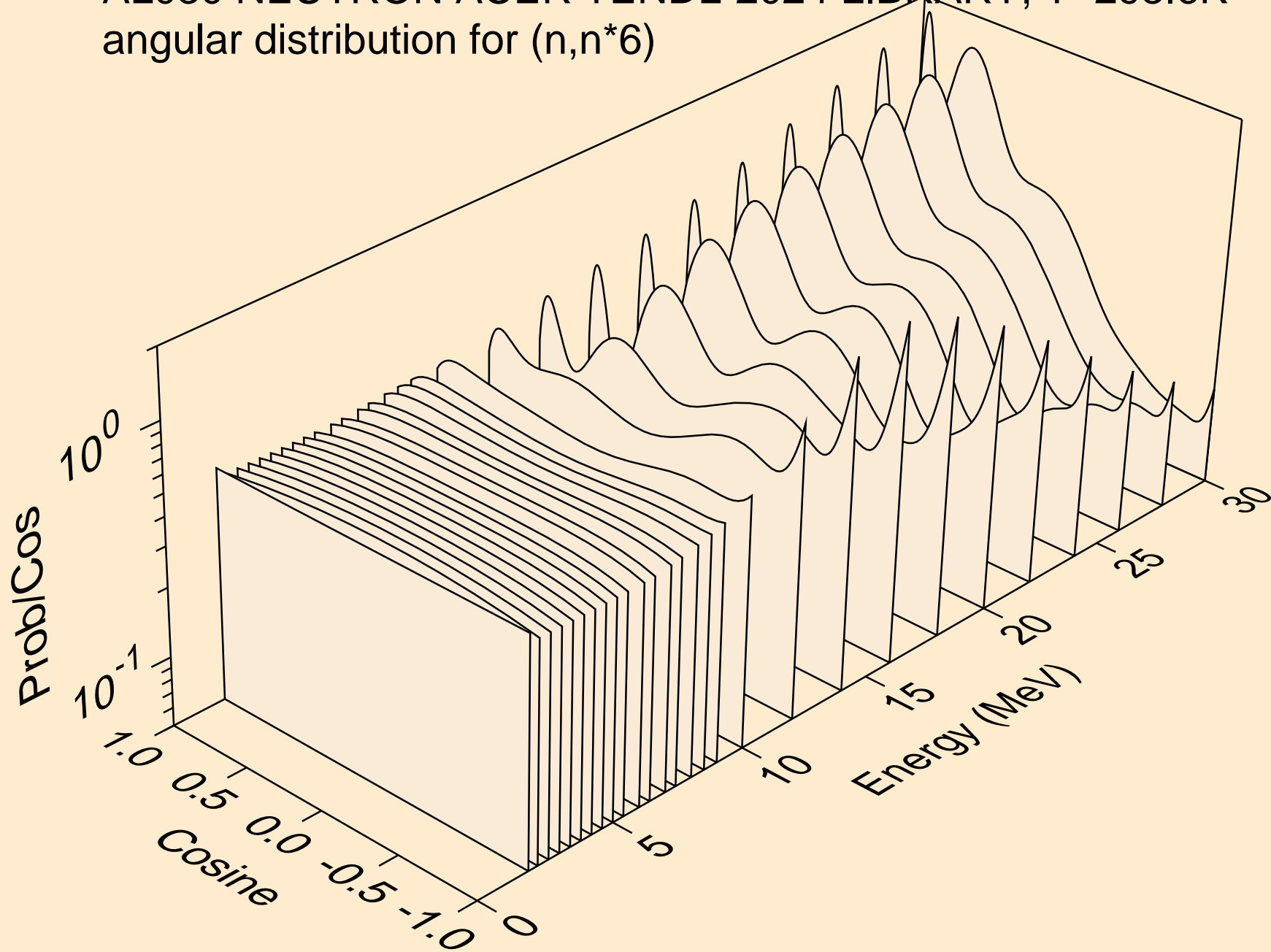

AL030 NEUTRON ACER TENDL-2024 LIBRARY; T=293.6K  
angular distribution for (n,n\*7)

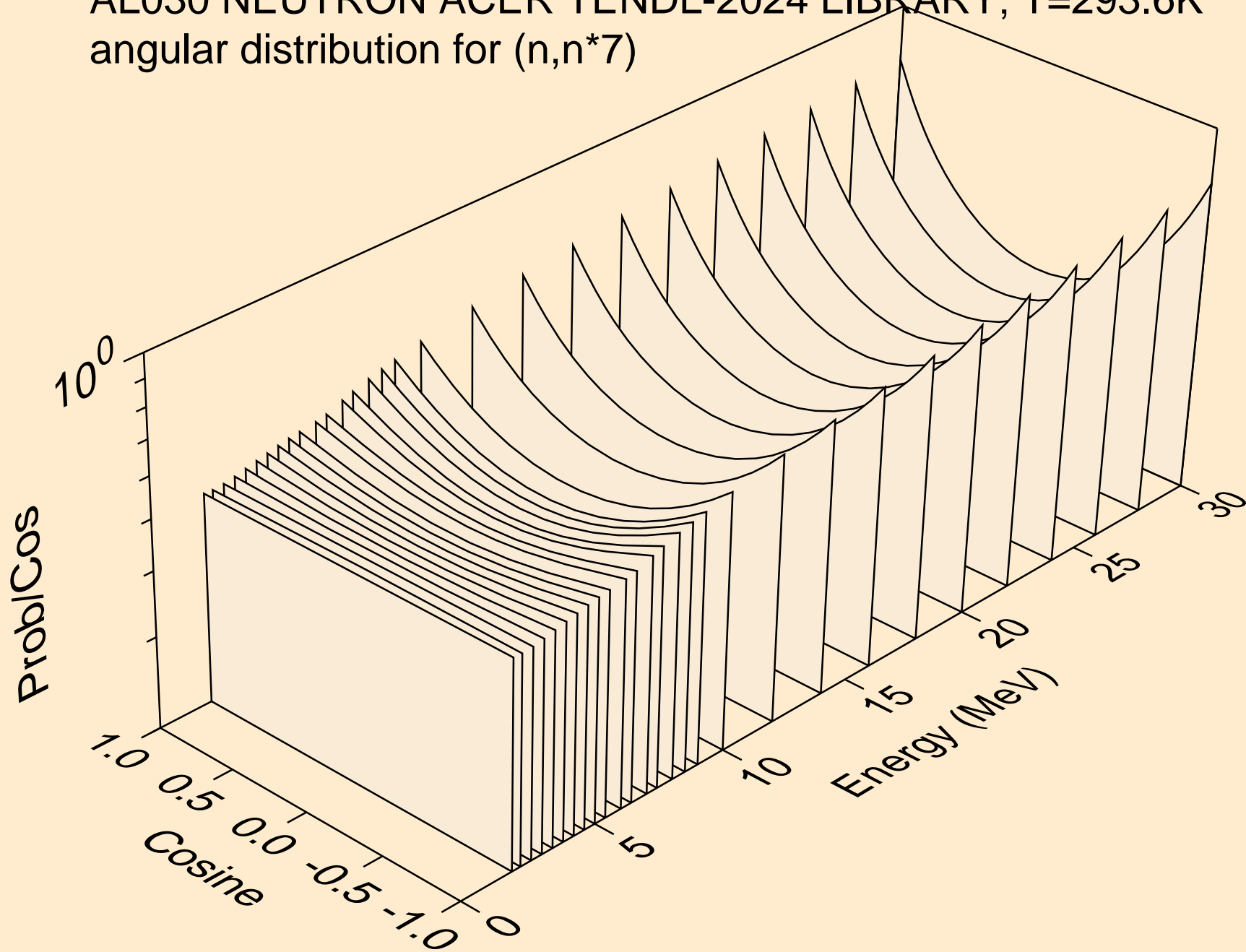

AL030 NEUTRON ACER TENDL-2024 LIBRARY; T=293.6K  
angular distribution for (n,n\*8)

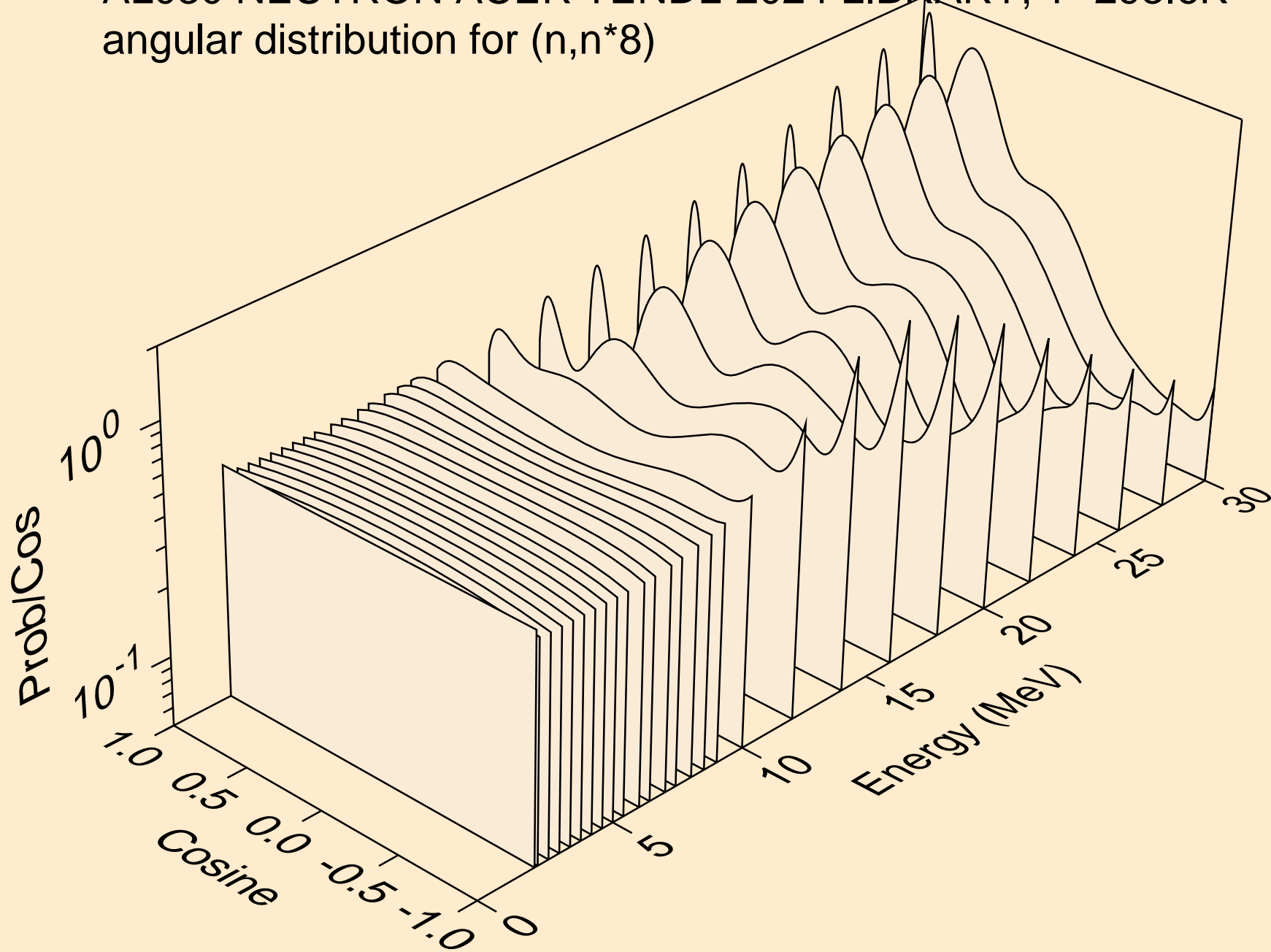

AL030 NEUTRON ACER TENDL-2024 LIBRARY; T=293.6K  
angular distribution for (n,n\*9)

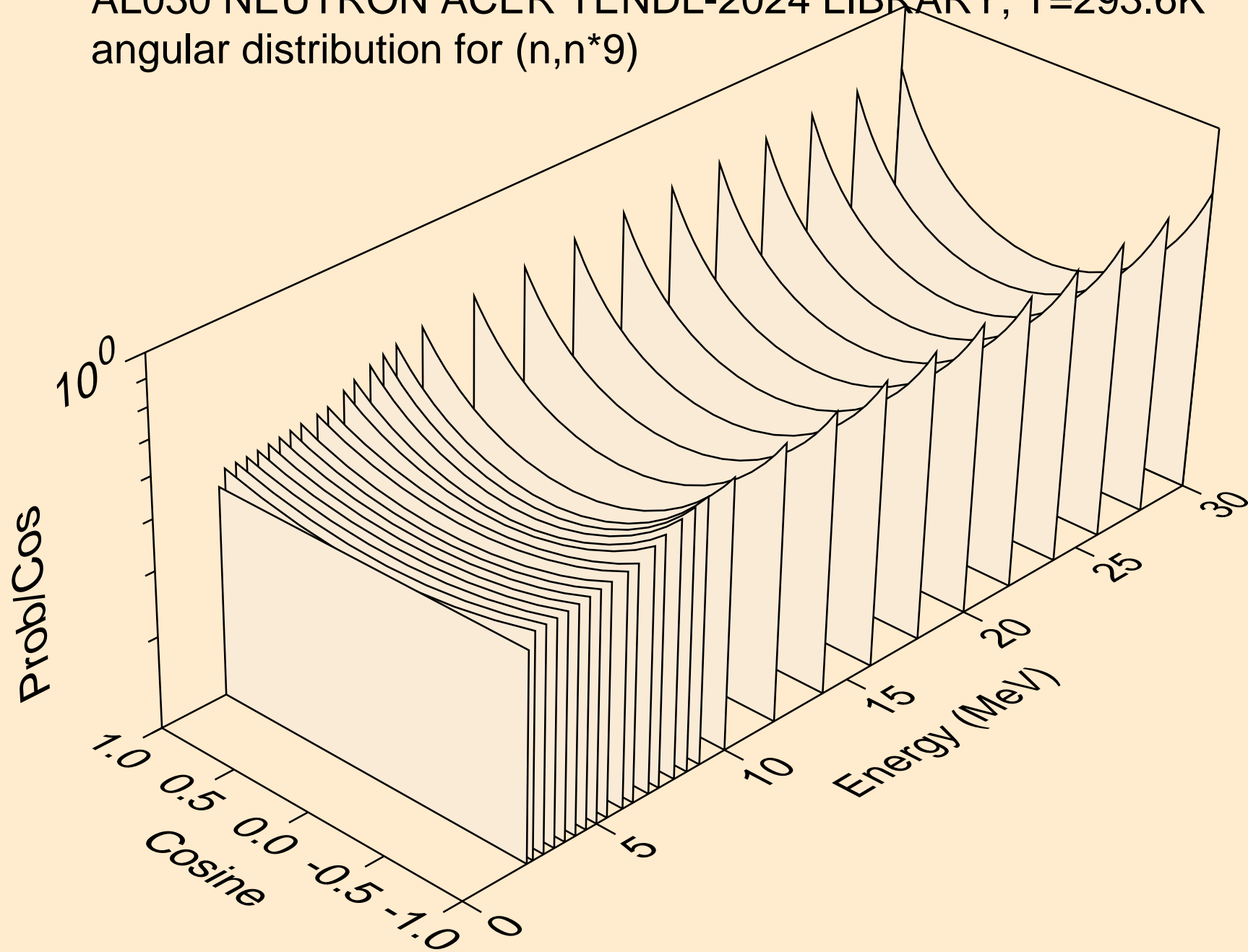

AL030 NEUTRON ACER TENDL-2024 LIBRARY; T=293.6K  
angular distribution for (n,n\*10)

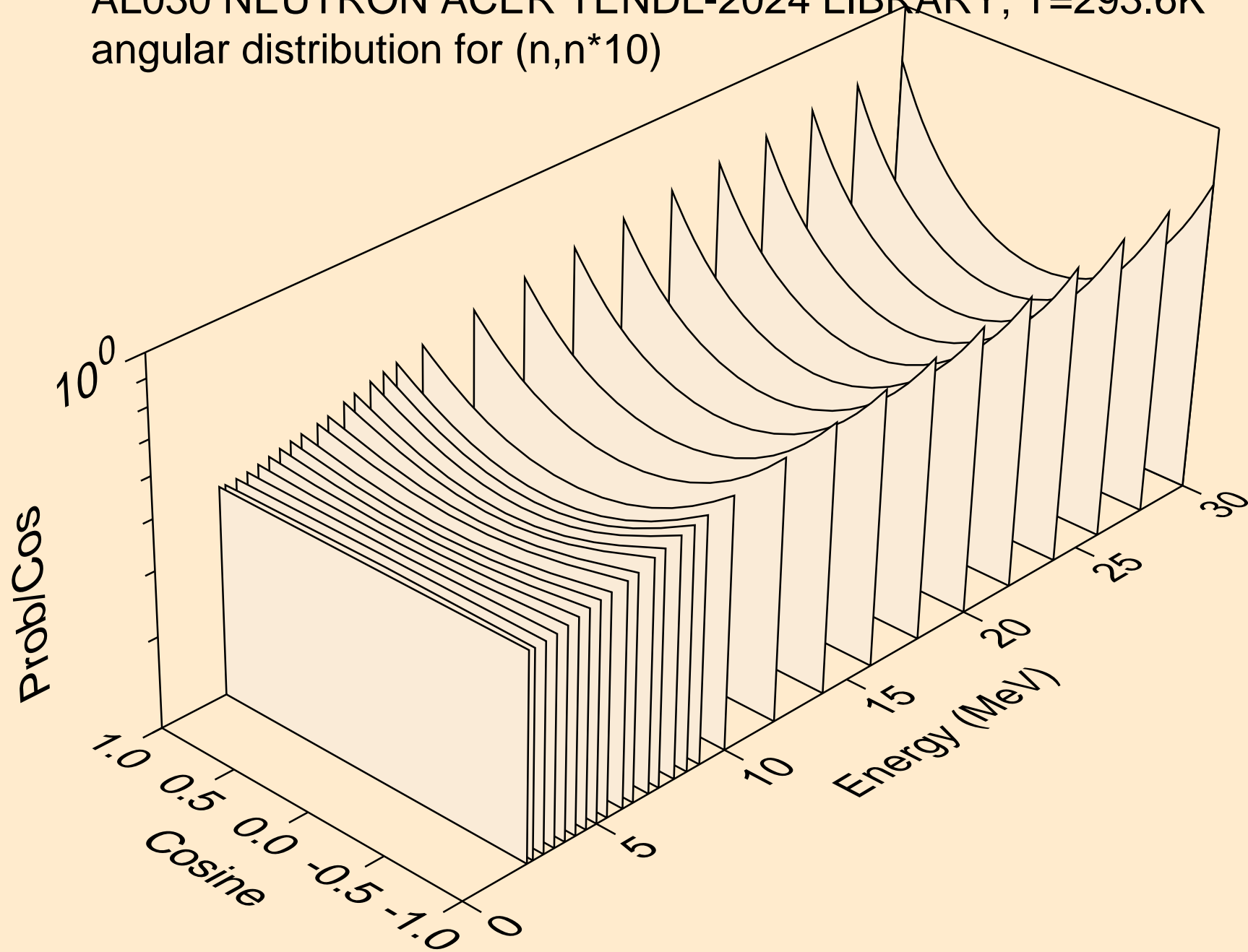

AL030 NEUTRON ACER TENDL-2024 LIBRARY; T=293.6K  
angular distribution for (n,n\*11)

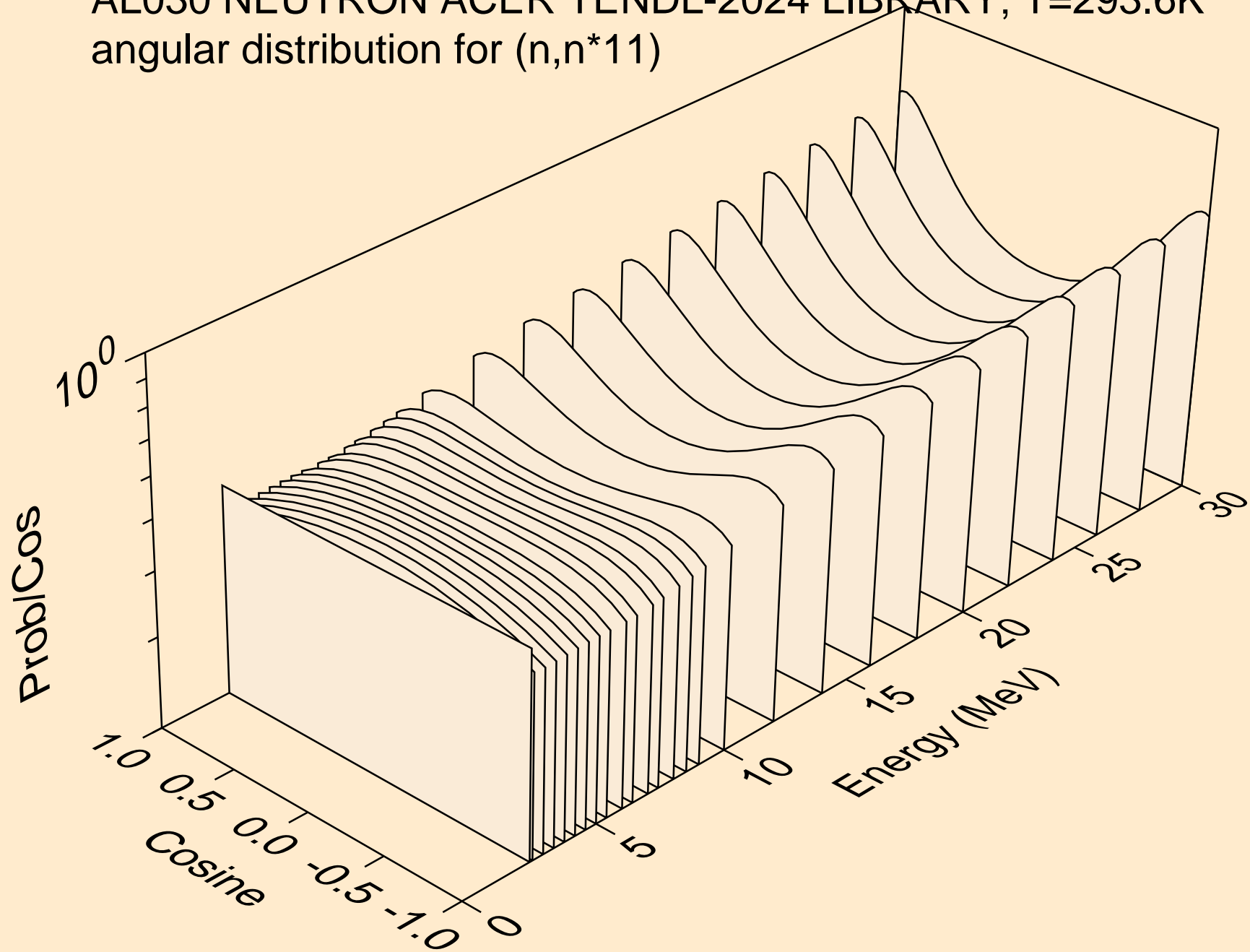

AL030 NEUTRON ACER TENDL-2024 LIBRARY; T=293.6K  
angular distribution for (n,n\*12)

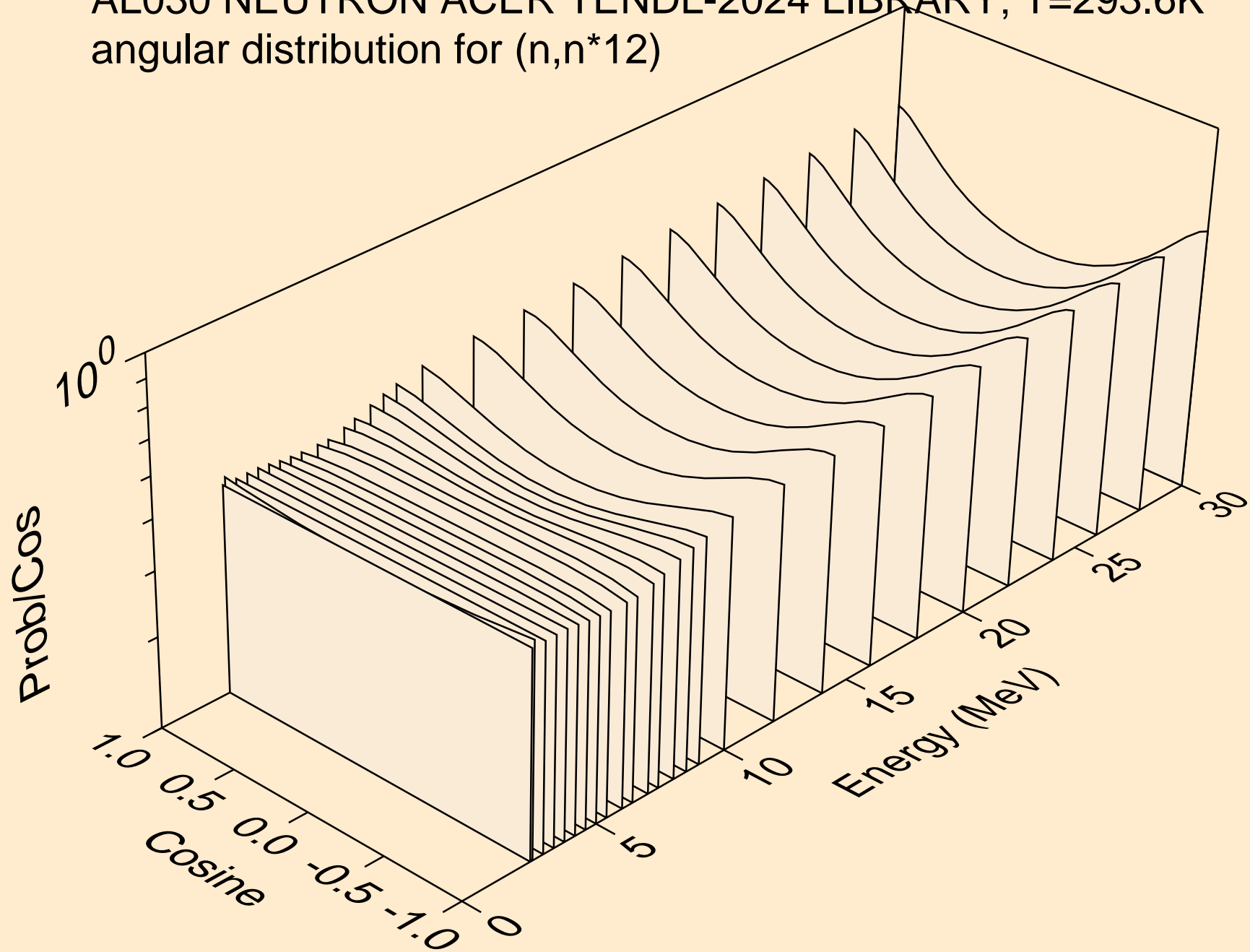

AL030 NEUTRON ACER TENDL-2024 LIBRARY; T=293.6K  
angular distribution for (n,n\*13)

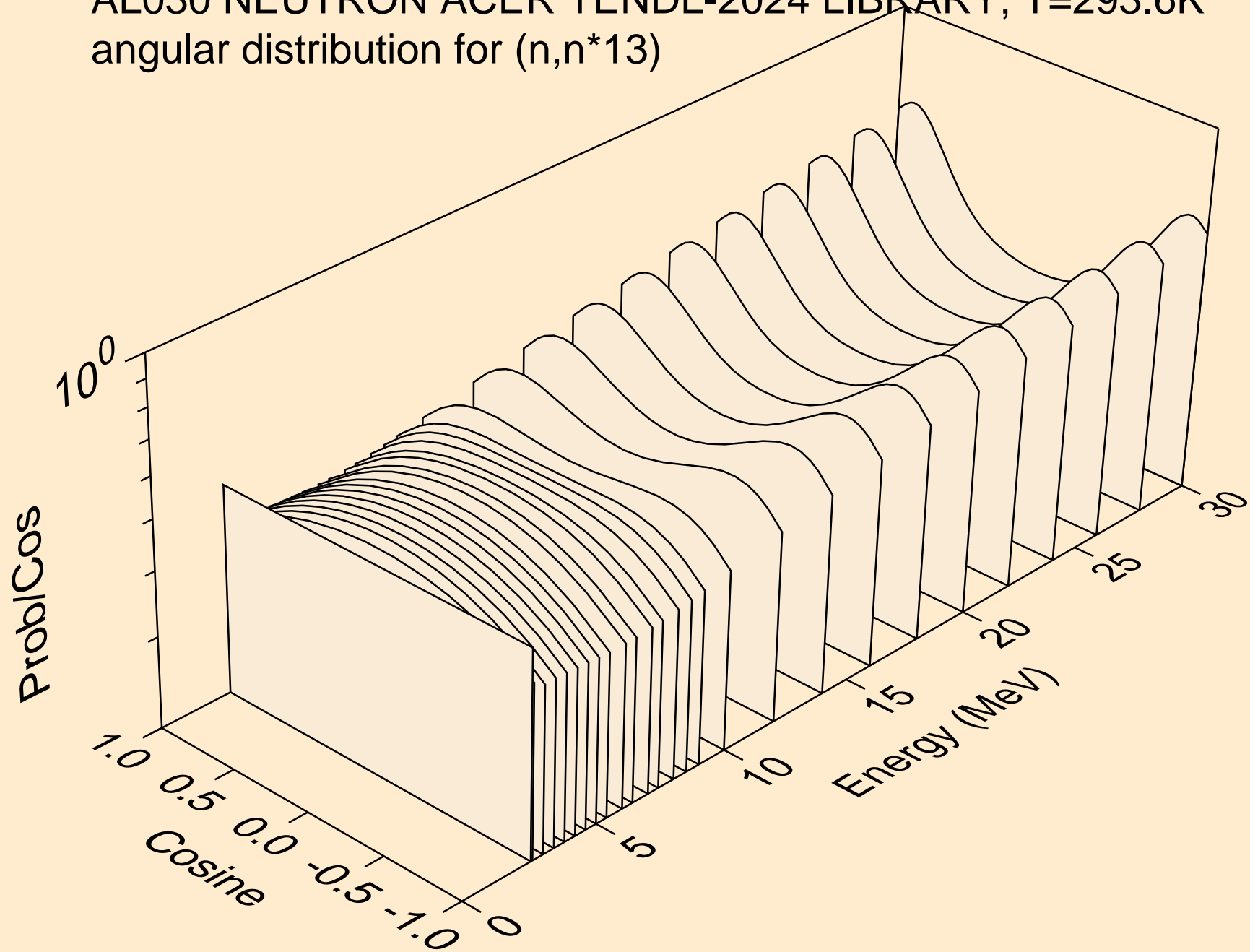

AL030 NEUTRON ACER TENDL-2024 LIBRARY; T=293.6K  
angular distribution for (n,n\*14)

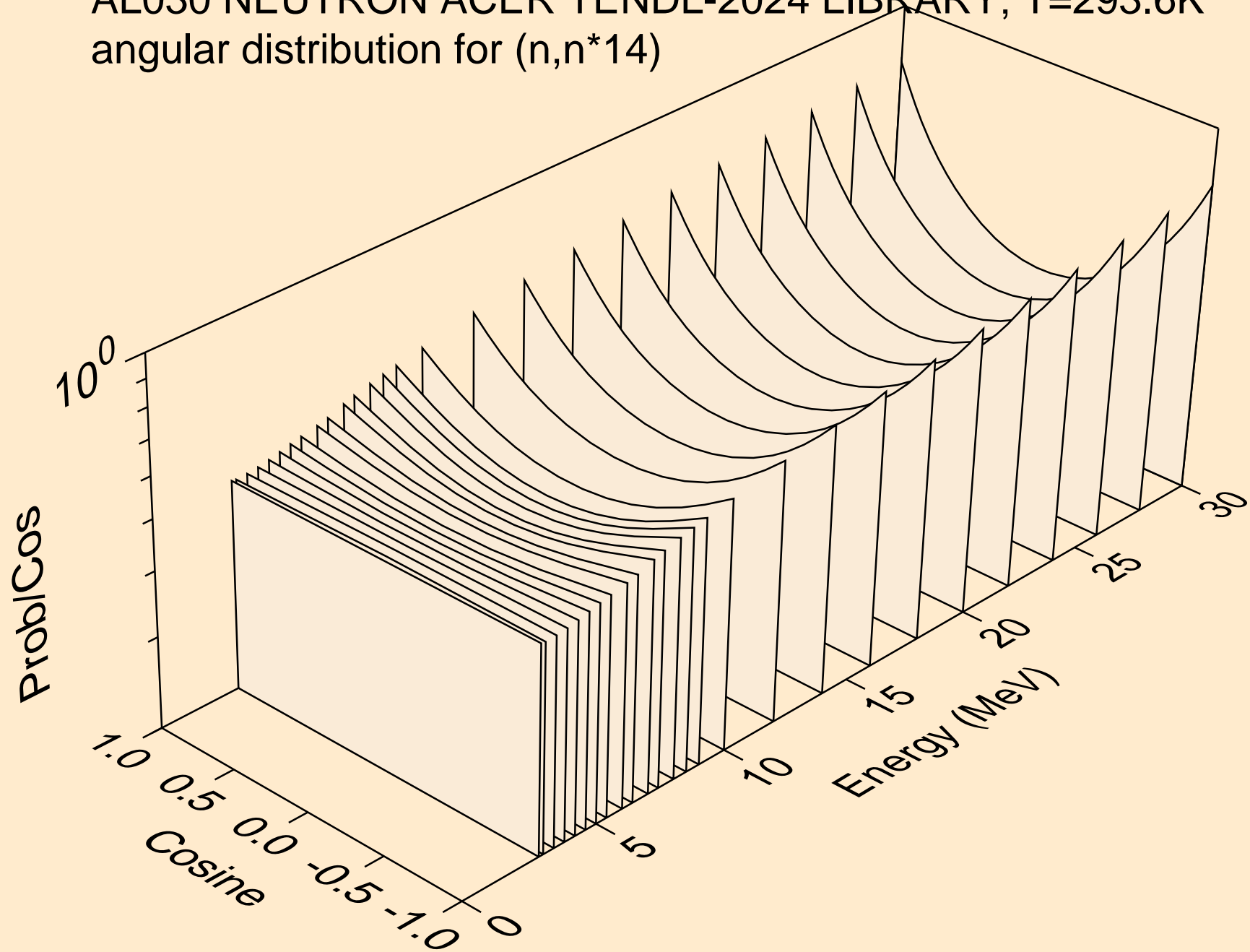

AL030 NEUTRON ACER TENDL-2024 LIBRARY; T=293.6K  
angular distribution for (n,n\*15)

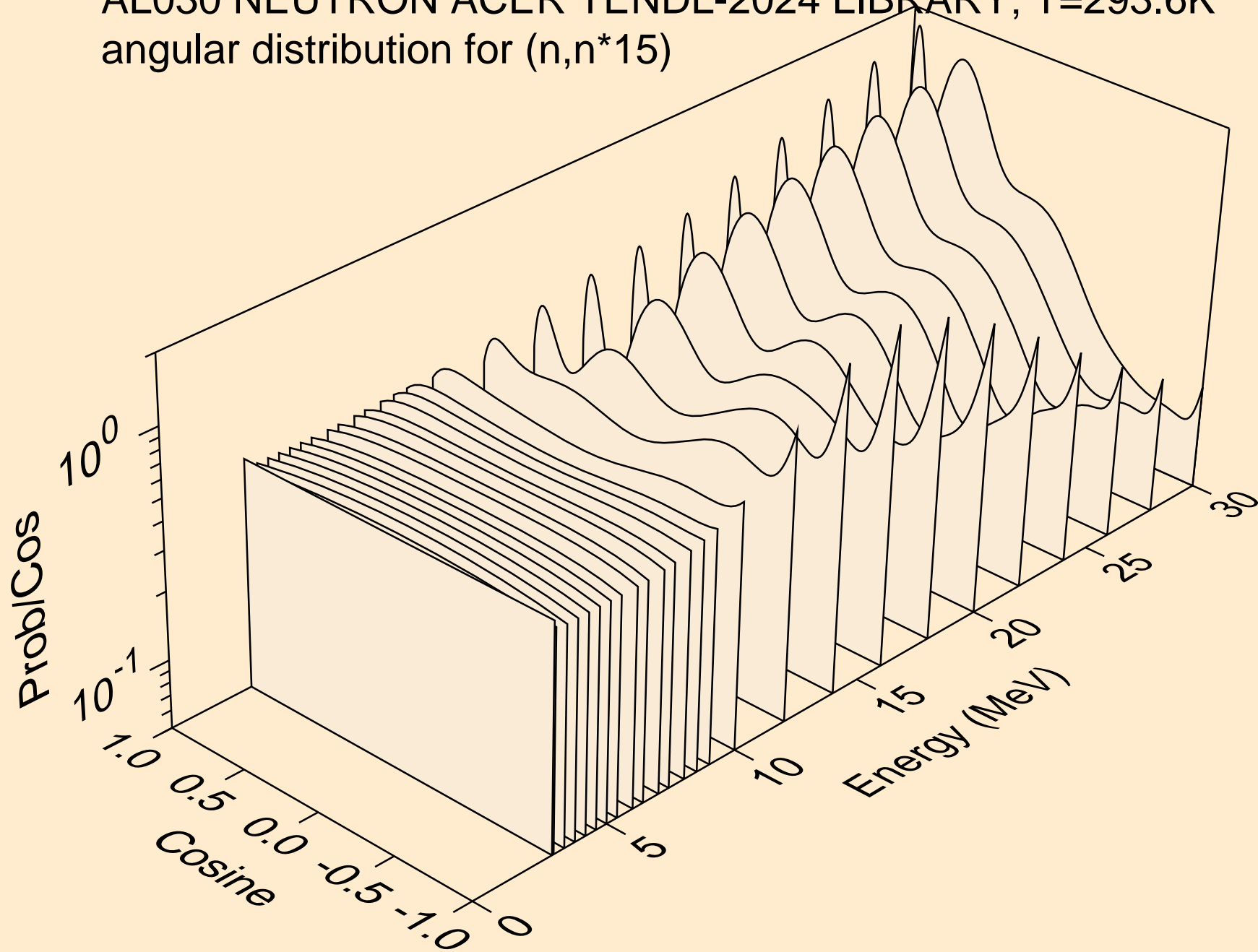

AL030 NEUTRON ACER TENDL-2024 LIBRARY; T=293.6K  
angular distribution for (n,n\*16)

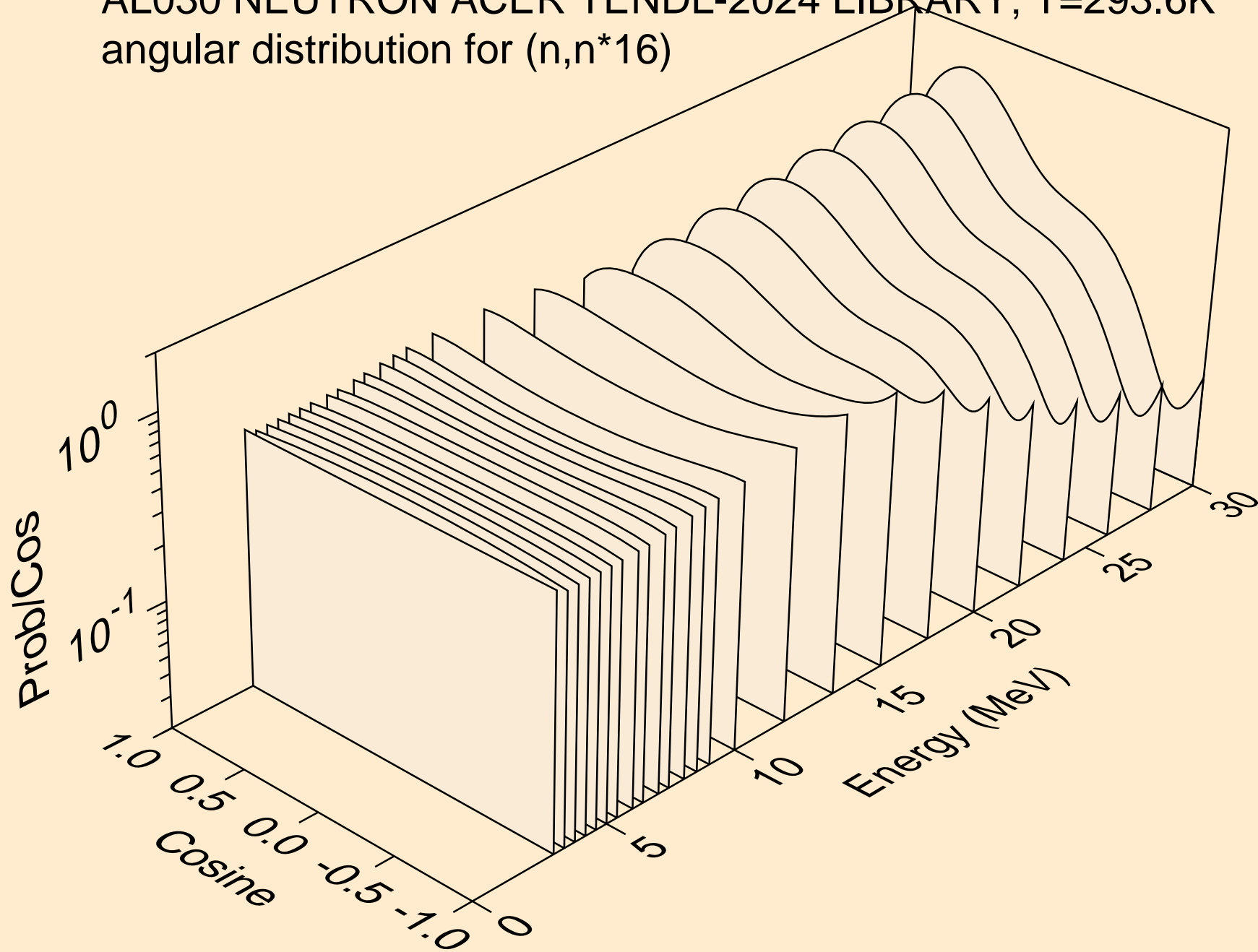

AL030 NEUTRON ACER TENDL-2024 LIBRARY; T=293.6K  
angular distribution for (n,n\*17)

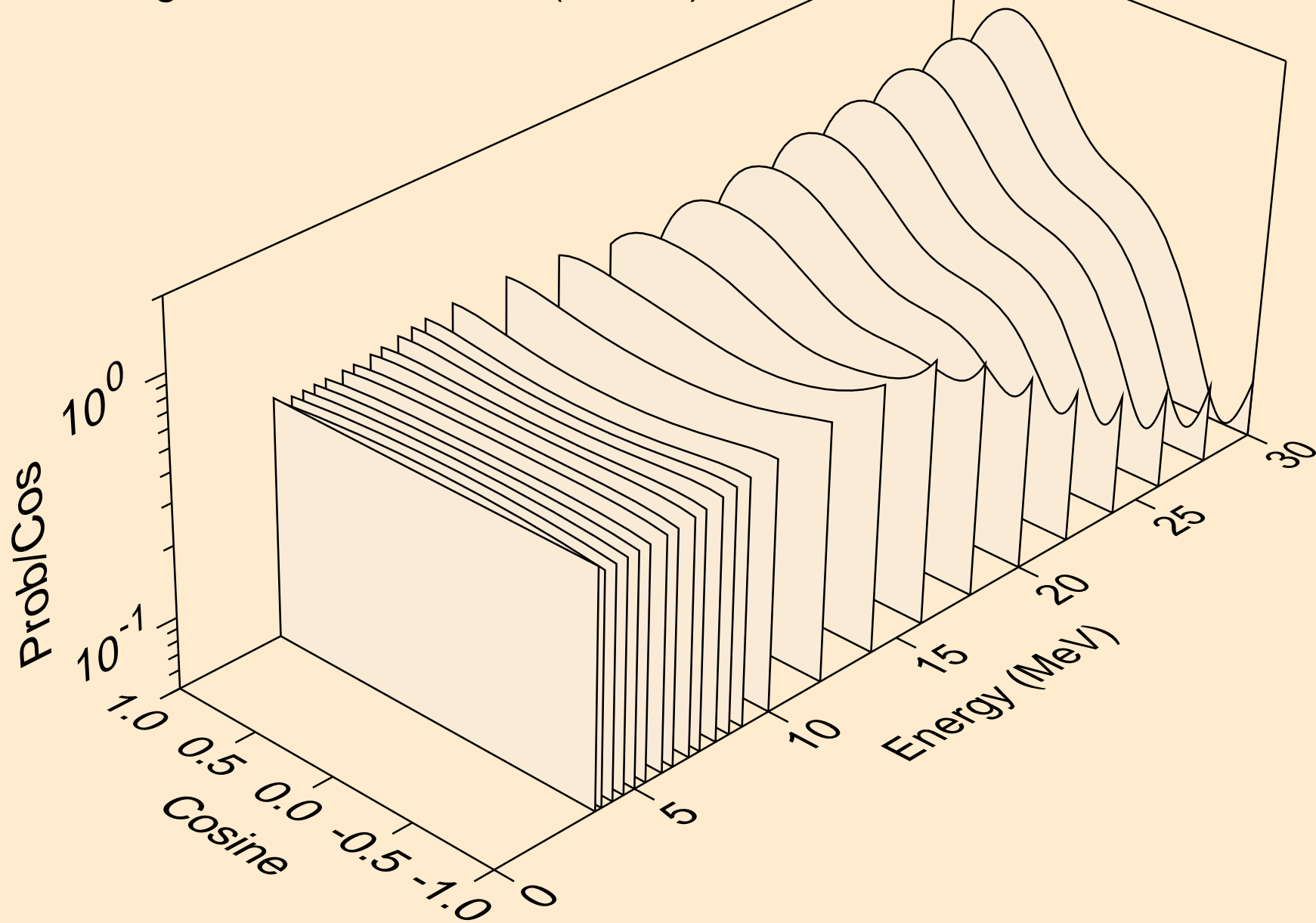

AL030 NEUTRON ACER TENDL-2024 LIBRARY; T=293.6K  
angular distribution for (n,n\*18)

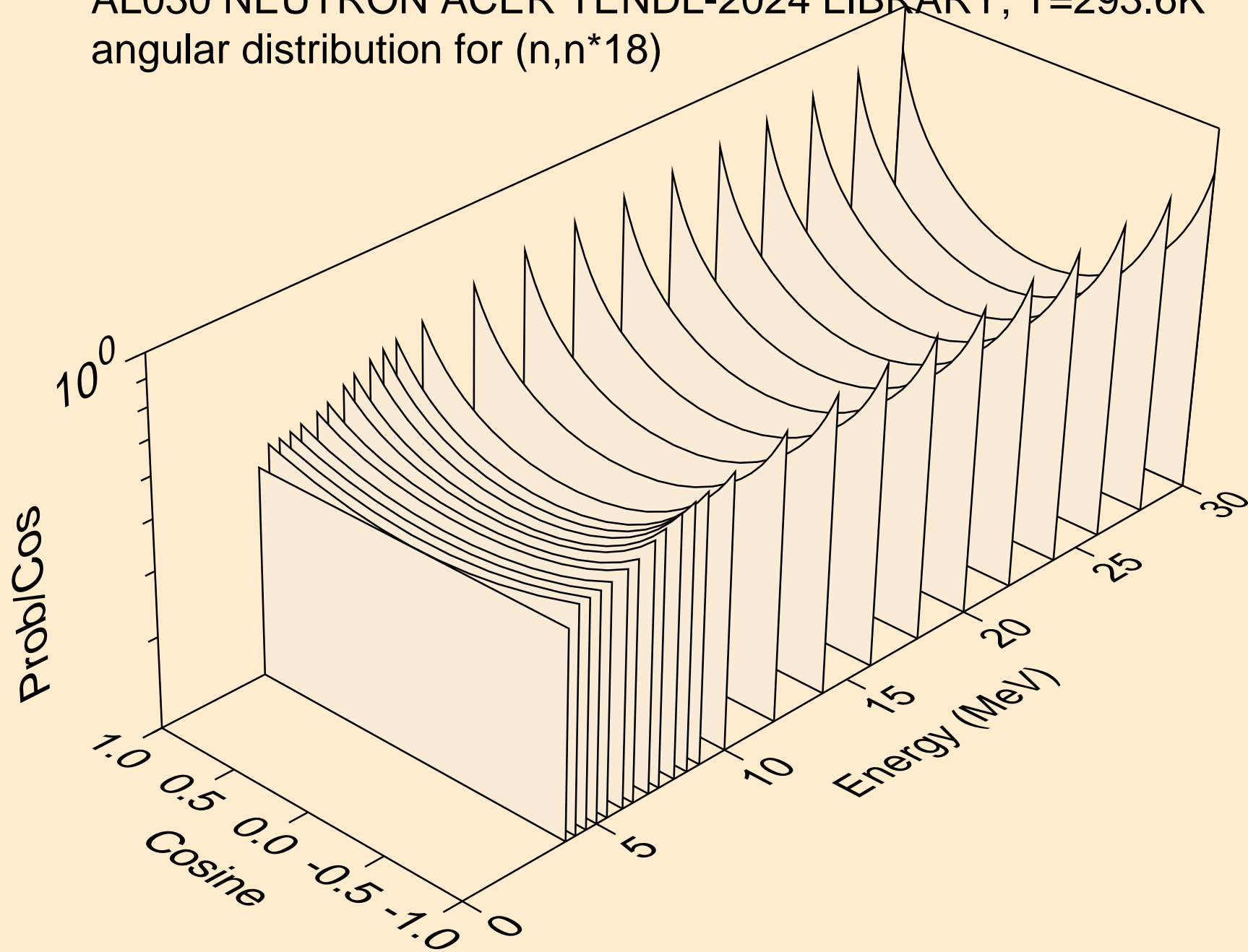

AL030 NEUTRON ACER TENDL-2024 LIBRARY; T=293.6K  
angular distribution for (n,n\*19)

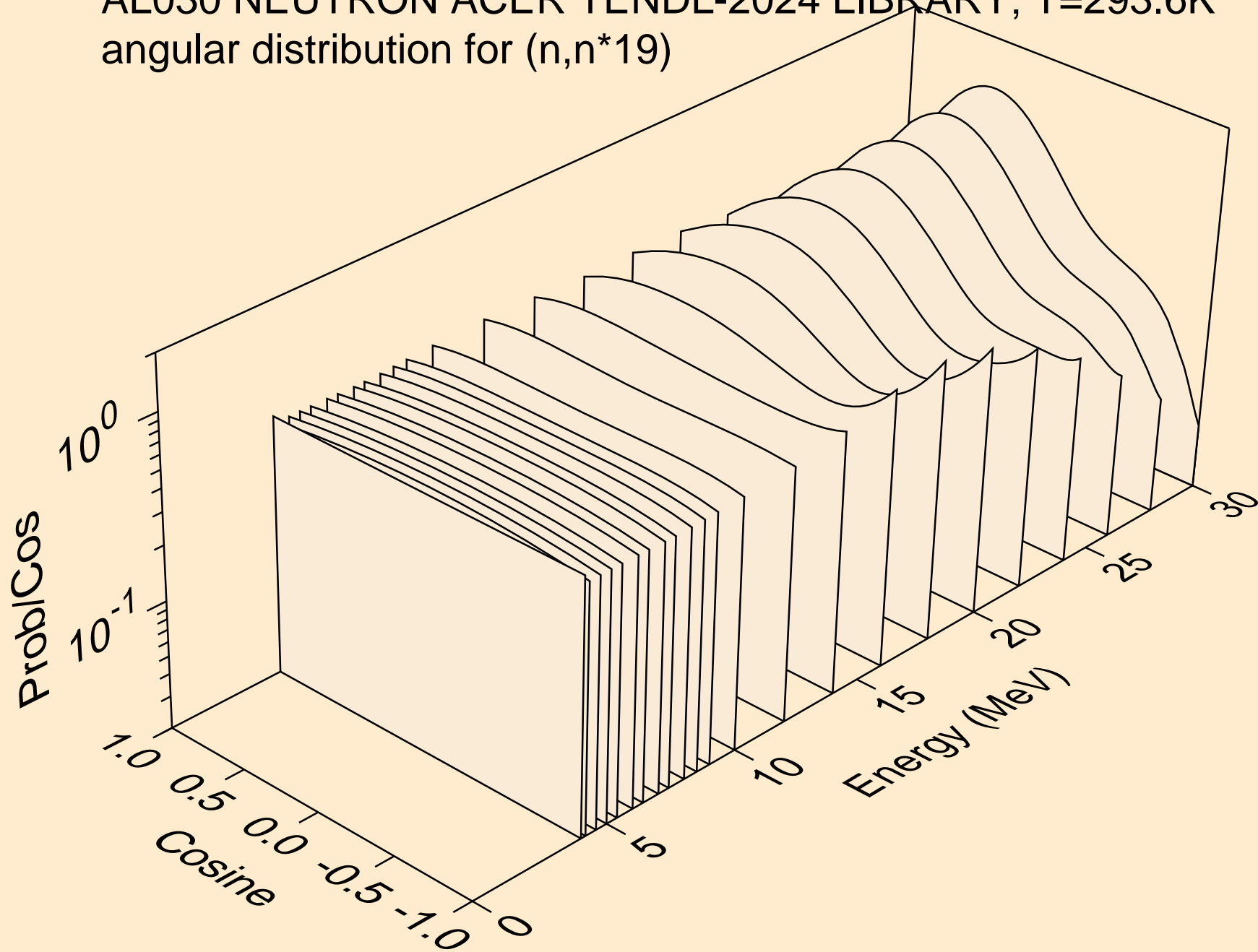

AL030 NEUTRON ACER TENDL-2024 LIBRARY; T=293.6K  
angular distribution for (n,n\*20)

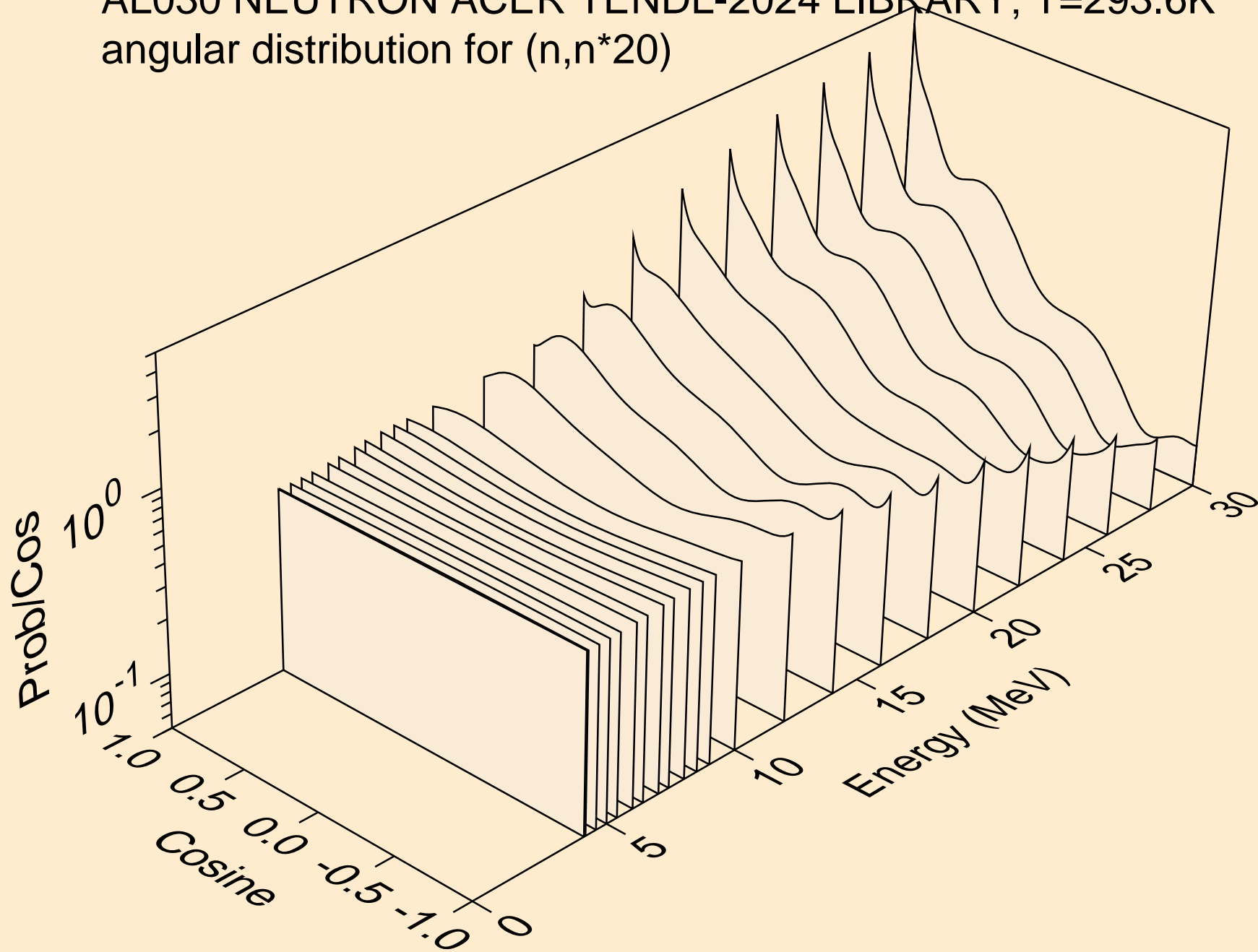

AL030 NEUTRON ACER TENDL-2024 LIBRARY; T=293.6K  
angular distribution for (n,n\*21)

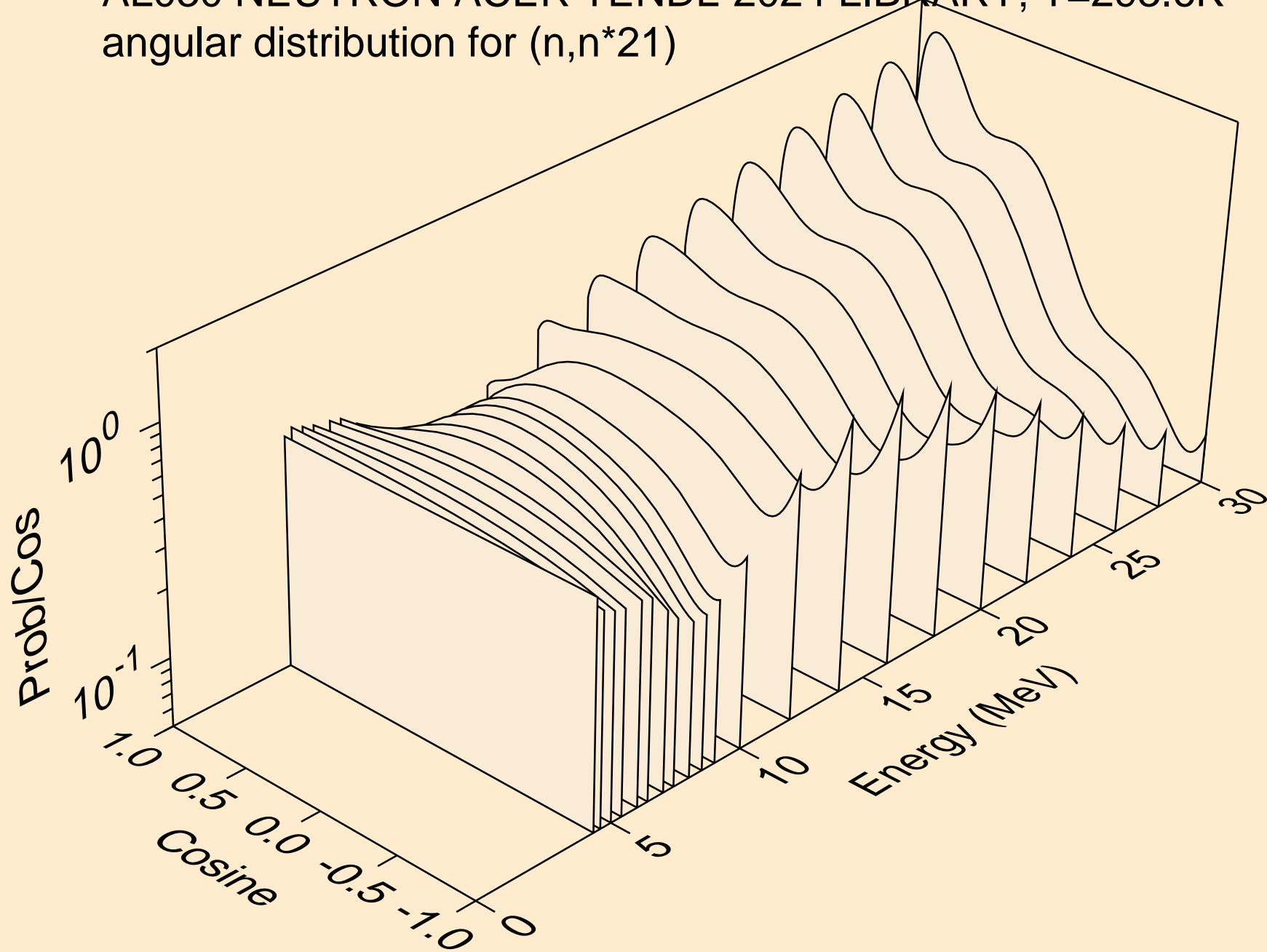

AL030 NEUTRON ACER TENDL-2024 LIBRARY; T=293.6K  
angular distribution for (n,n\*22)

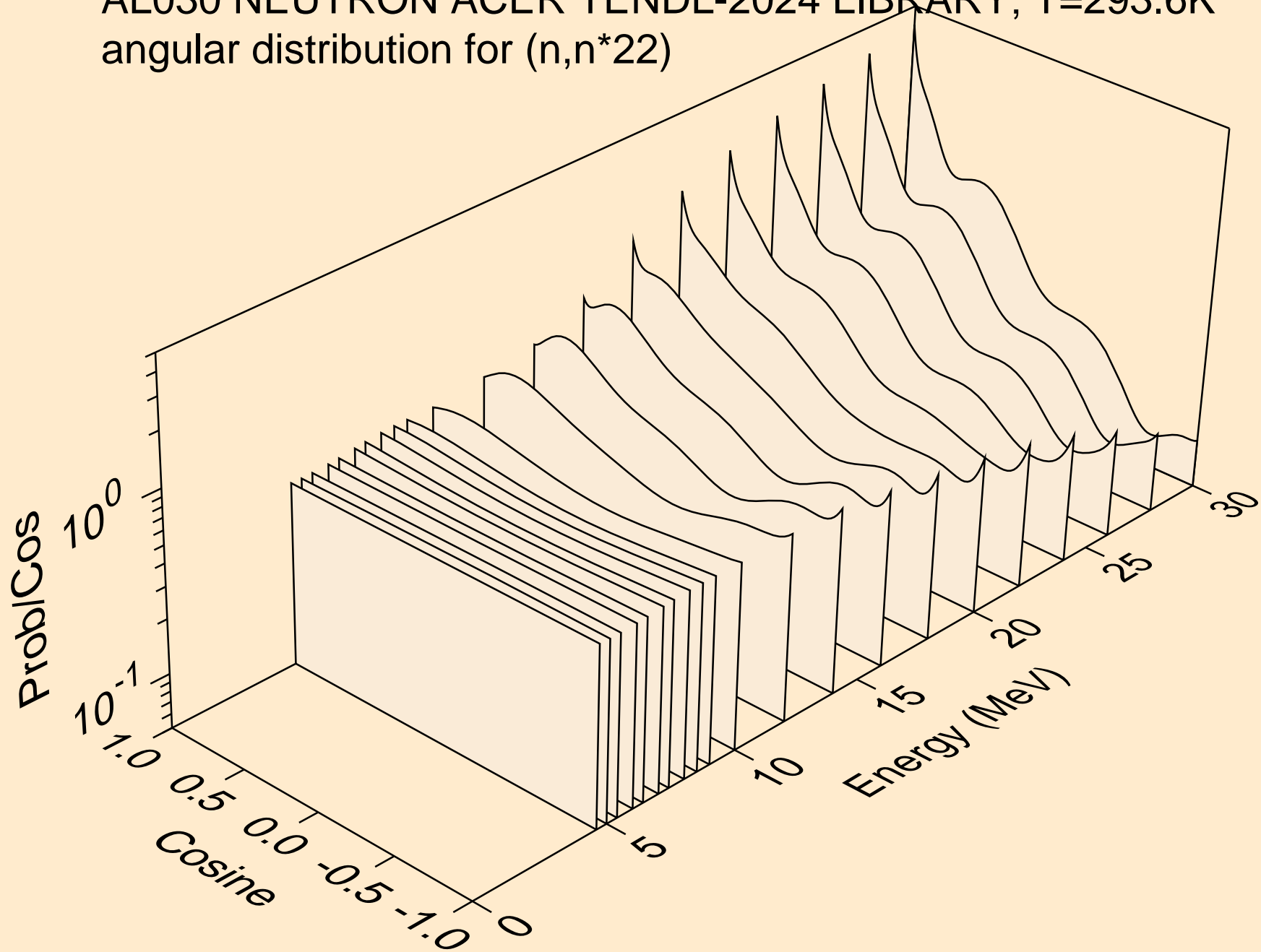

AL030 NEUTRON ACER TENDL-2024 LIBRARY; T=293.6K  
angular distribution for (n,n\*23)

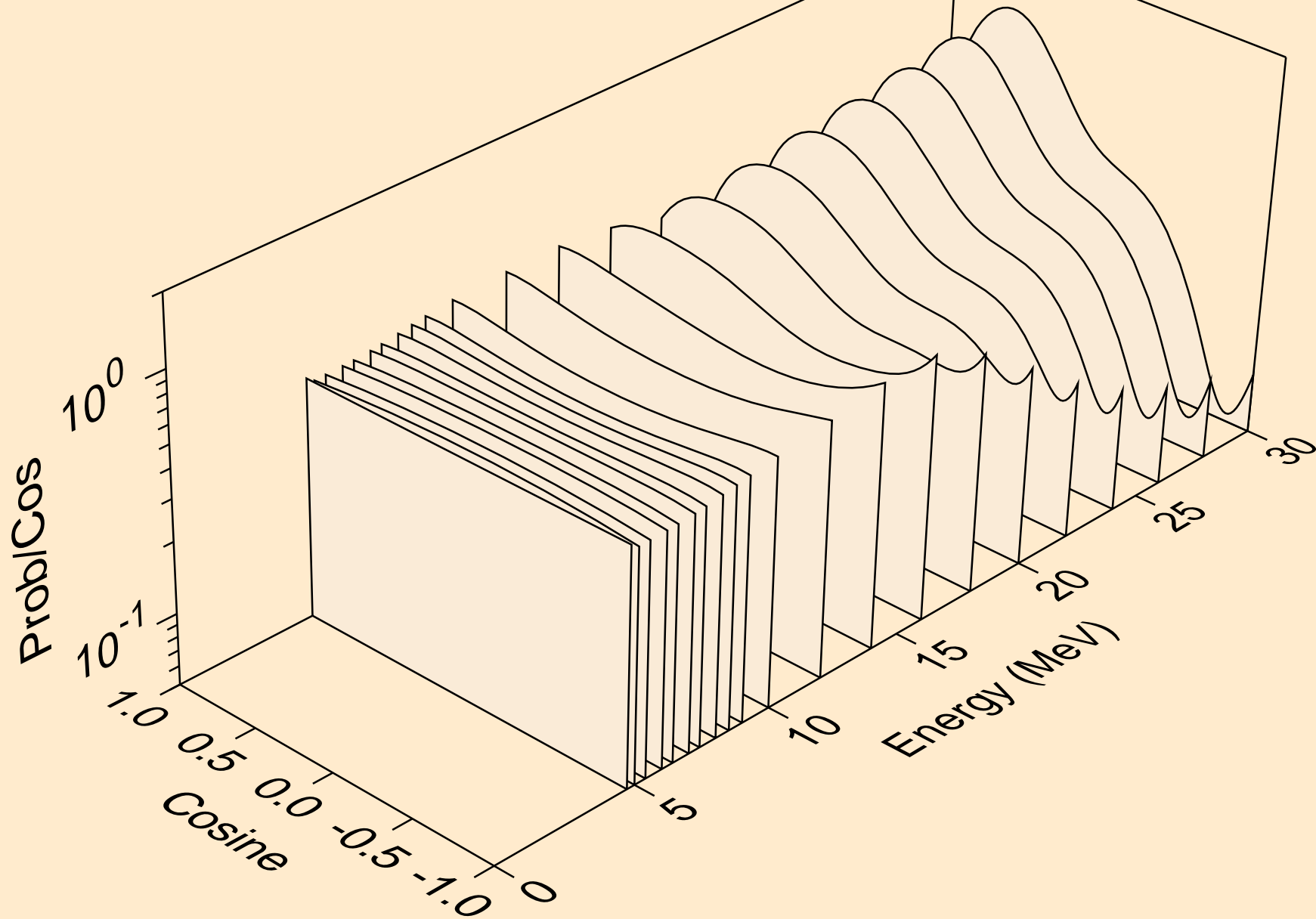

AL030 NEUTRON ACER TENDL-2024 LIBRARY; T=293.6K  
angular distribution for (n,n\*24)

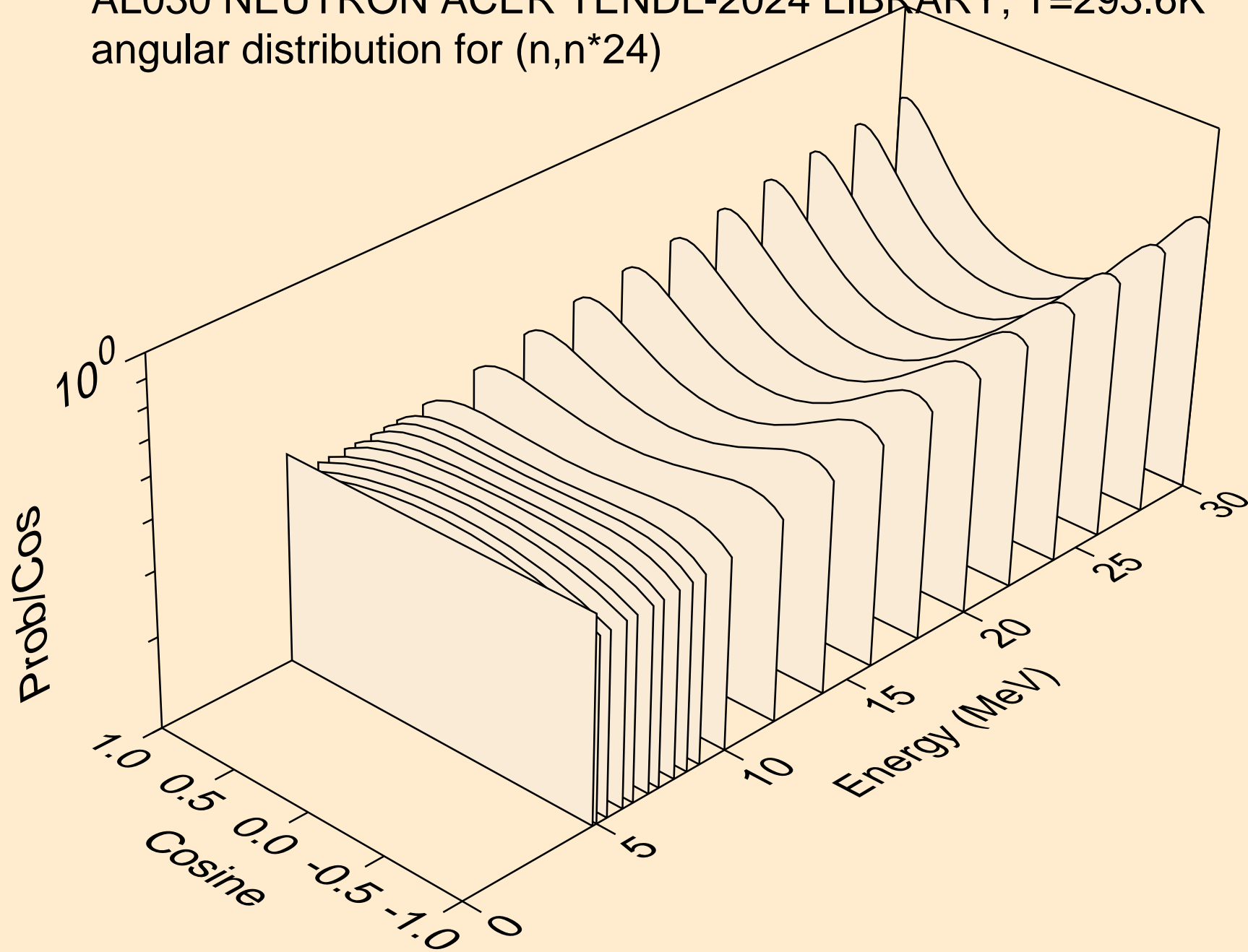

AL030 NEUTRON ACER TENDL-2024 LIBRARY; T=293.6K  
angular distribution for (n,n\*25)

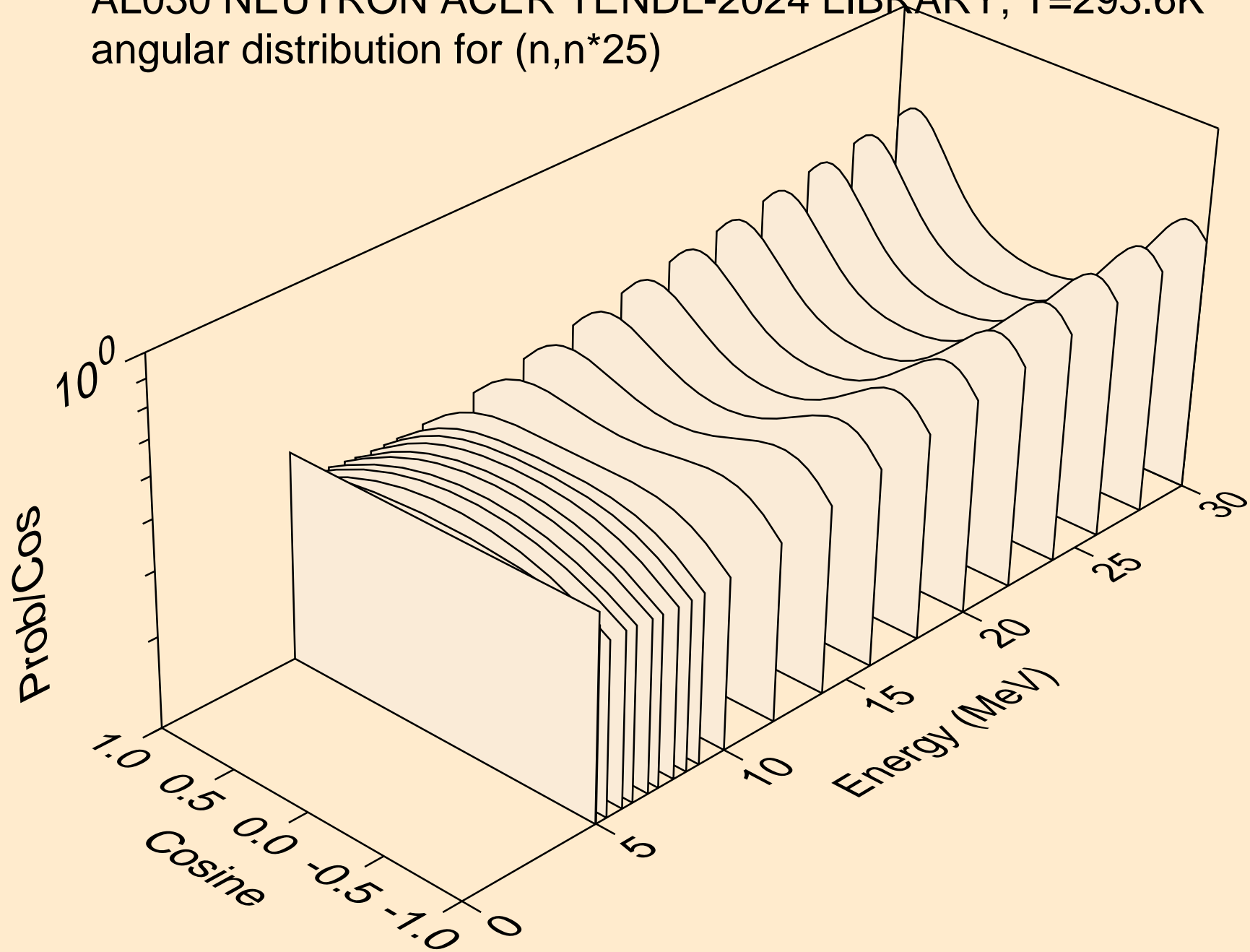

AL030 NEUTRON ACER TENDL-2024 LIBRARY; T=293.6K  
angular distribution for (n,n\*26)

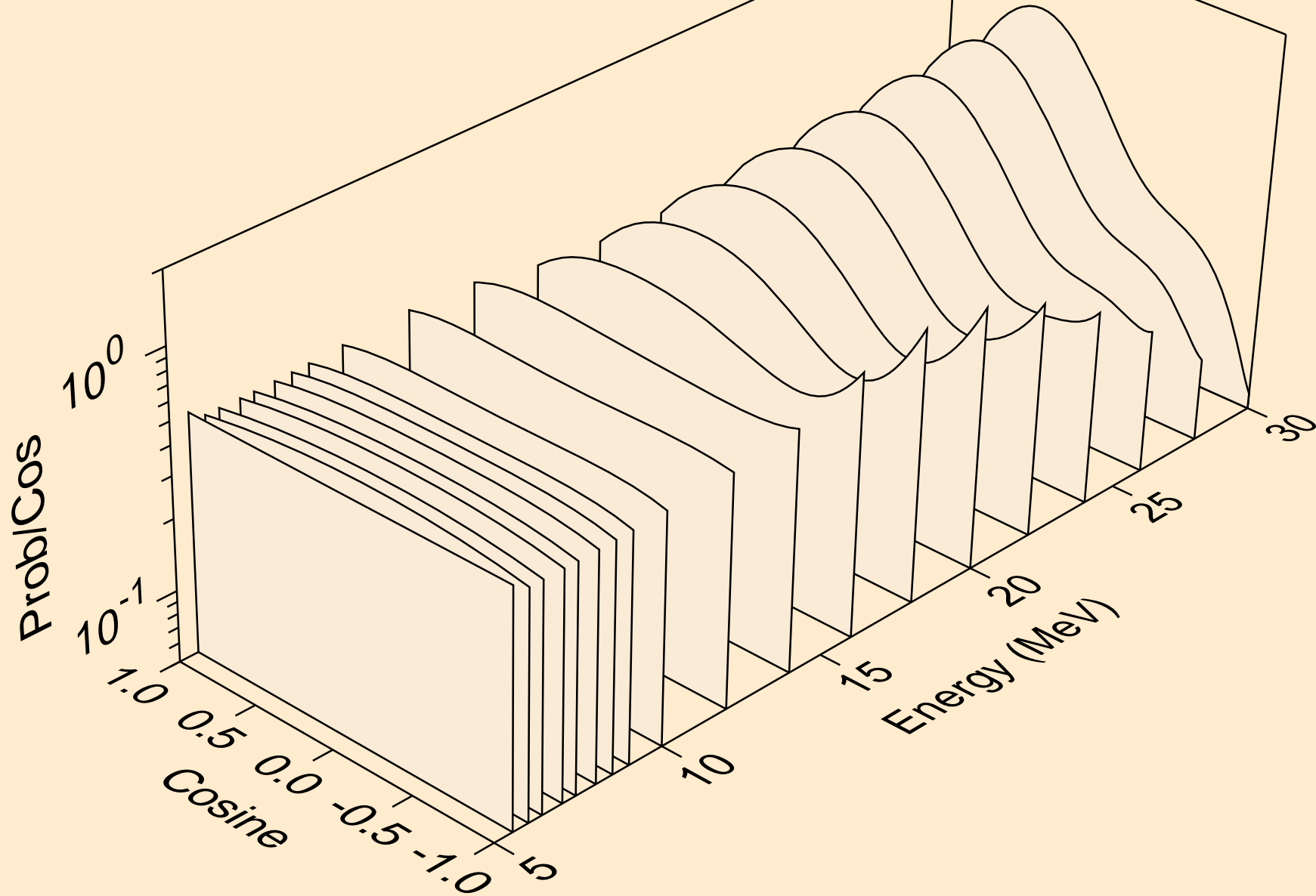

AL030 NEUTRON ACER TENDL-2024 LIBRARY; T=293.6K  
Neutron emission for (n,x)

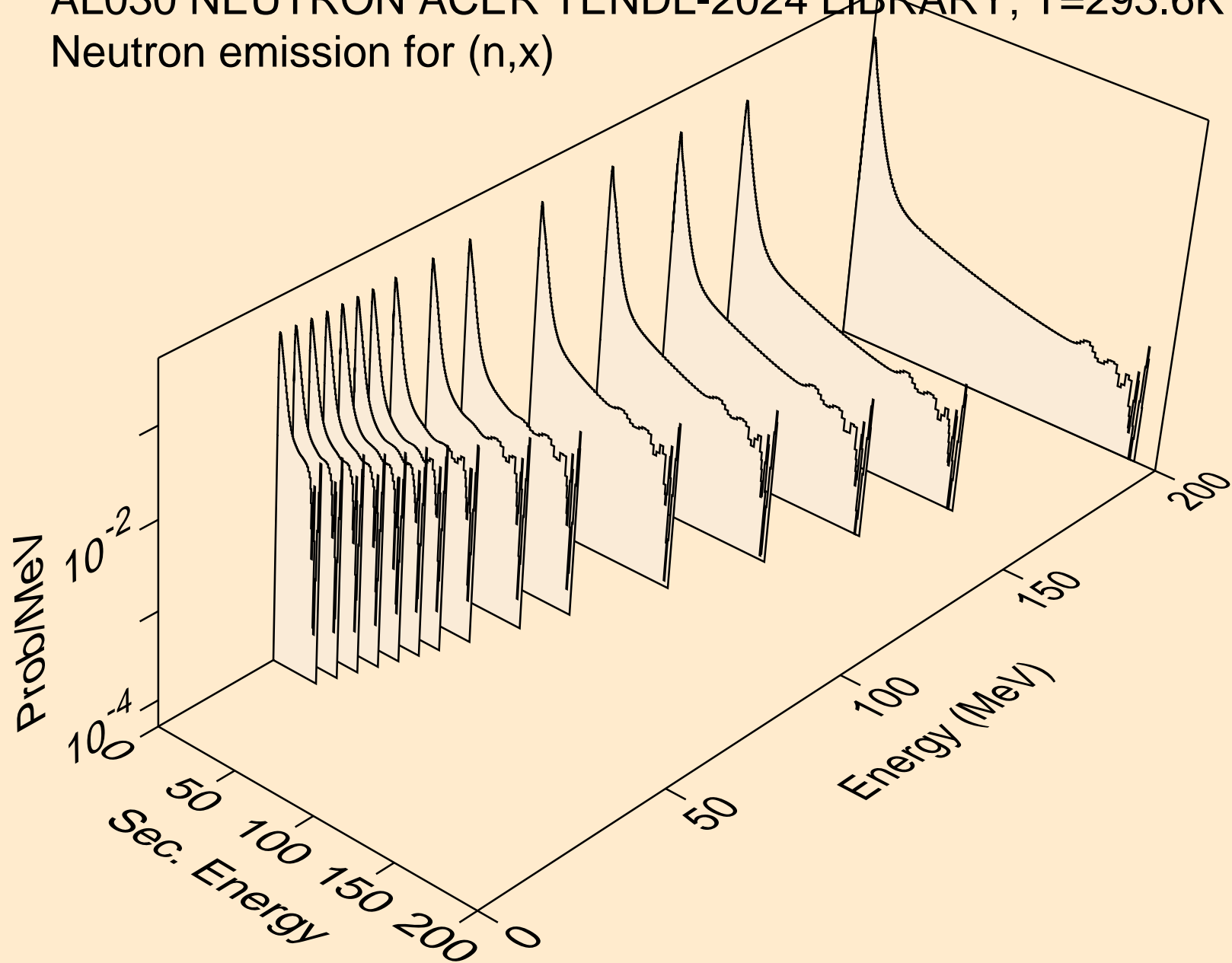

AL030 NEUTRON ACER TENDL-2024 LIBRARY; T=293.6K  
Neutron emission for (n,2nd)

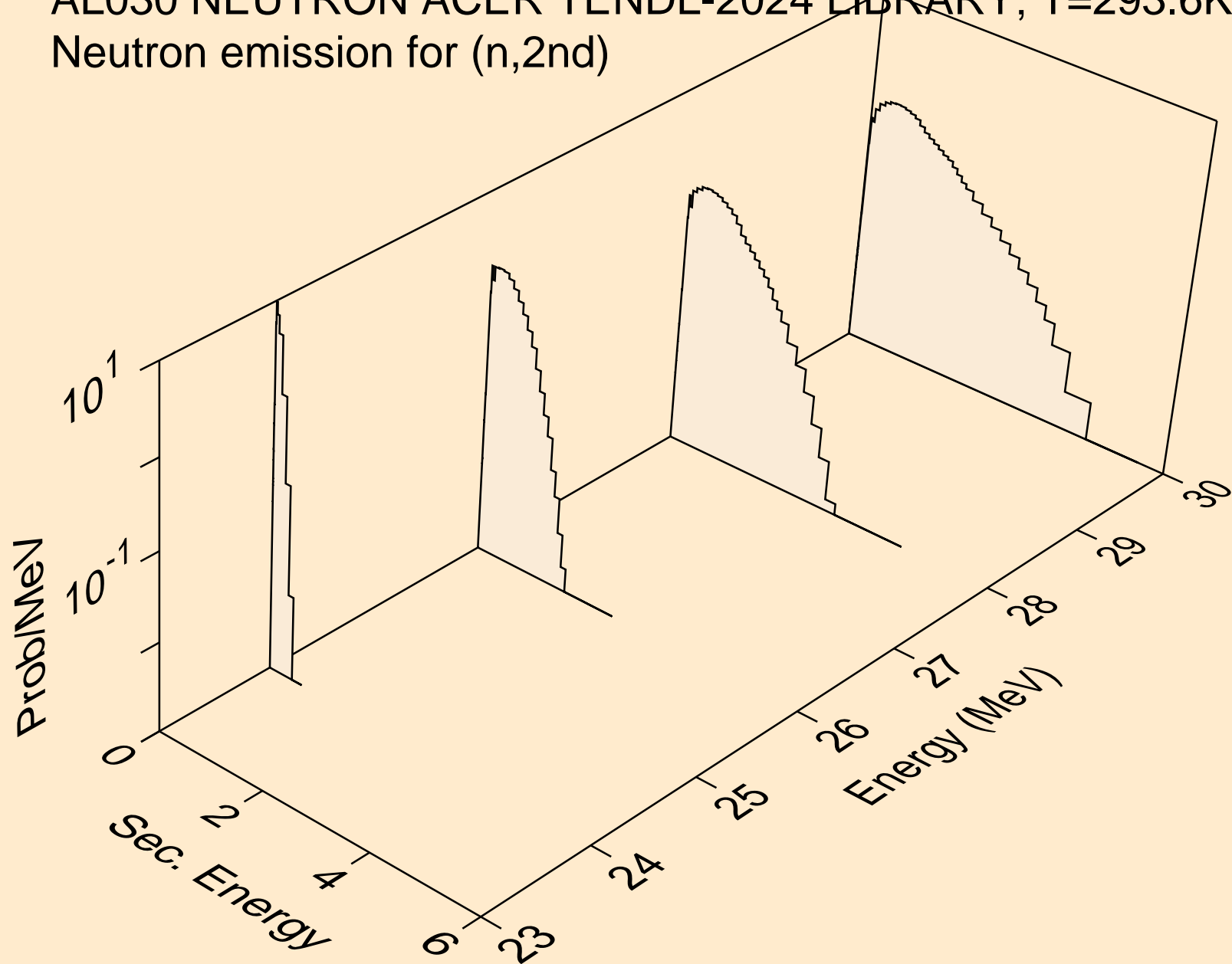

AL030 NEUTRON ACER TENDL-2024 LIBRARY; T=293.6K  
Neutron emission for (n,2n)

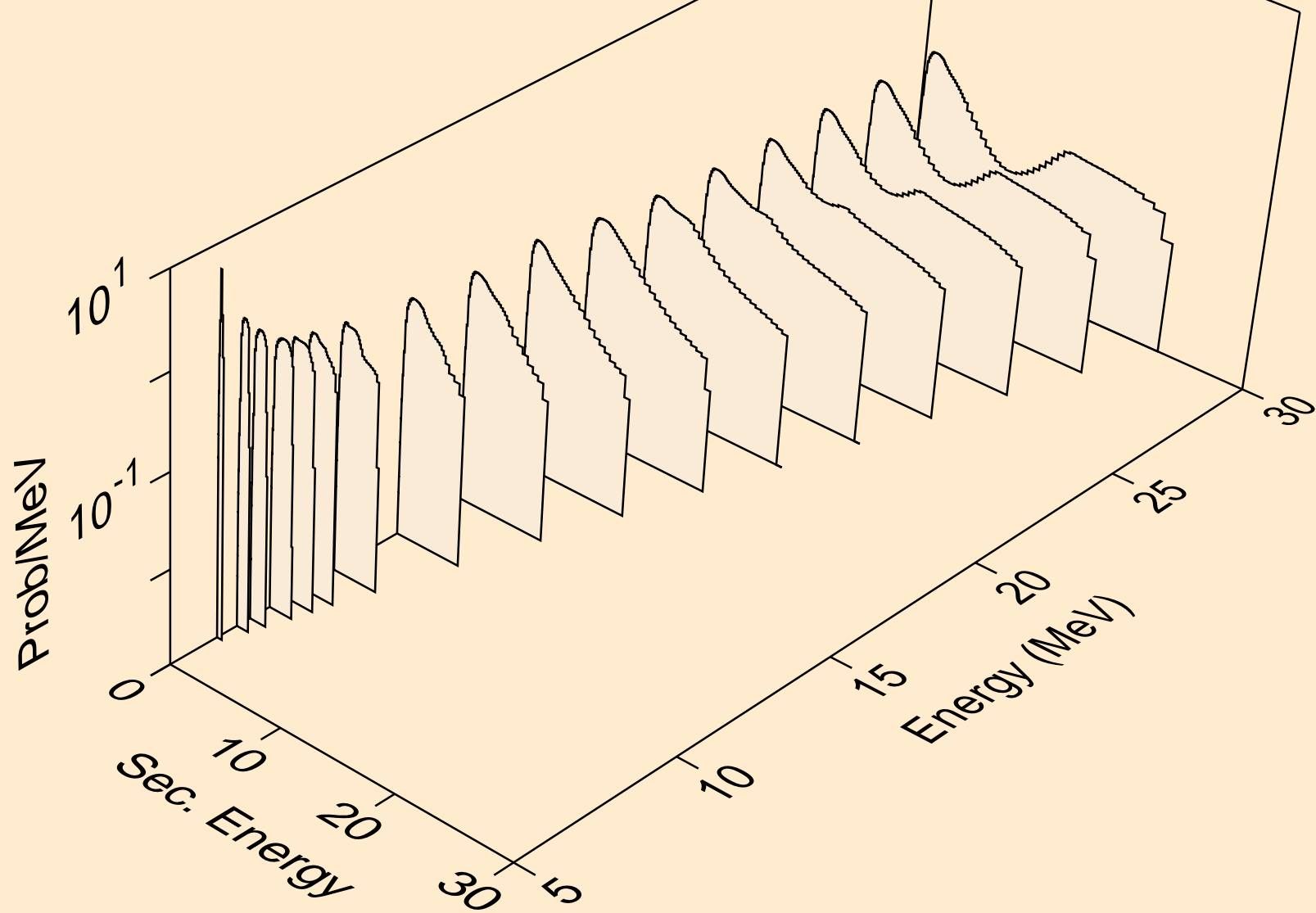

AL030 NEUTRON ACER TENDL-2024 LIBRARY; T=293.6K  
Neutron emission for (n,3n)

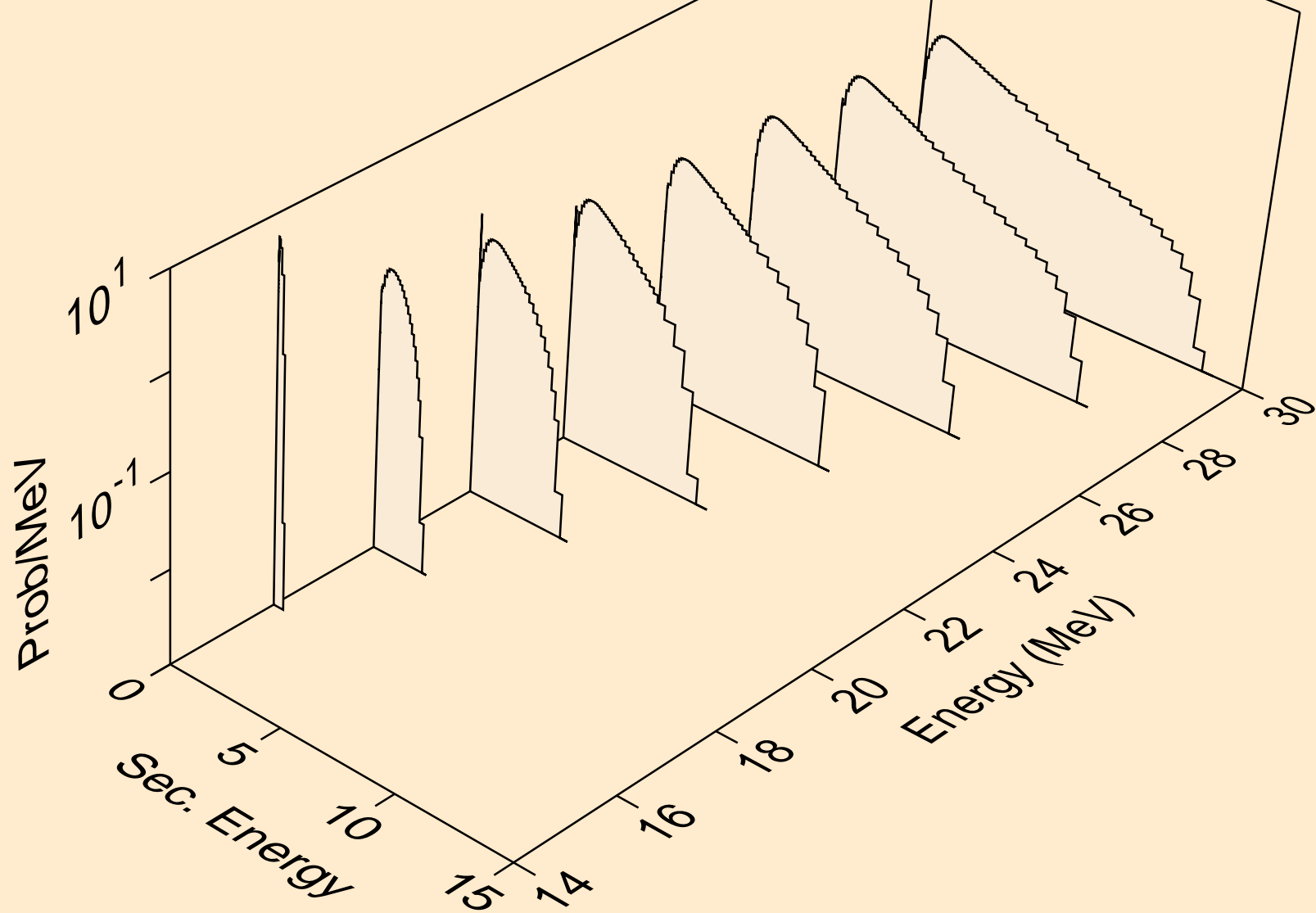

AL030 NEUTRON ACER TENDL-2024 LIBRARY; T=293.6K  
Neutron emission for (n,n\*)a

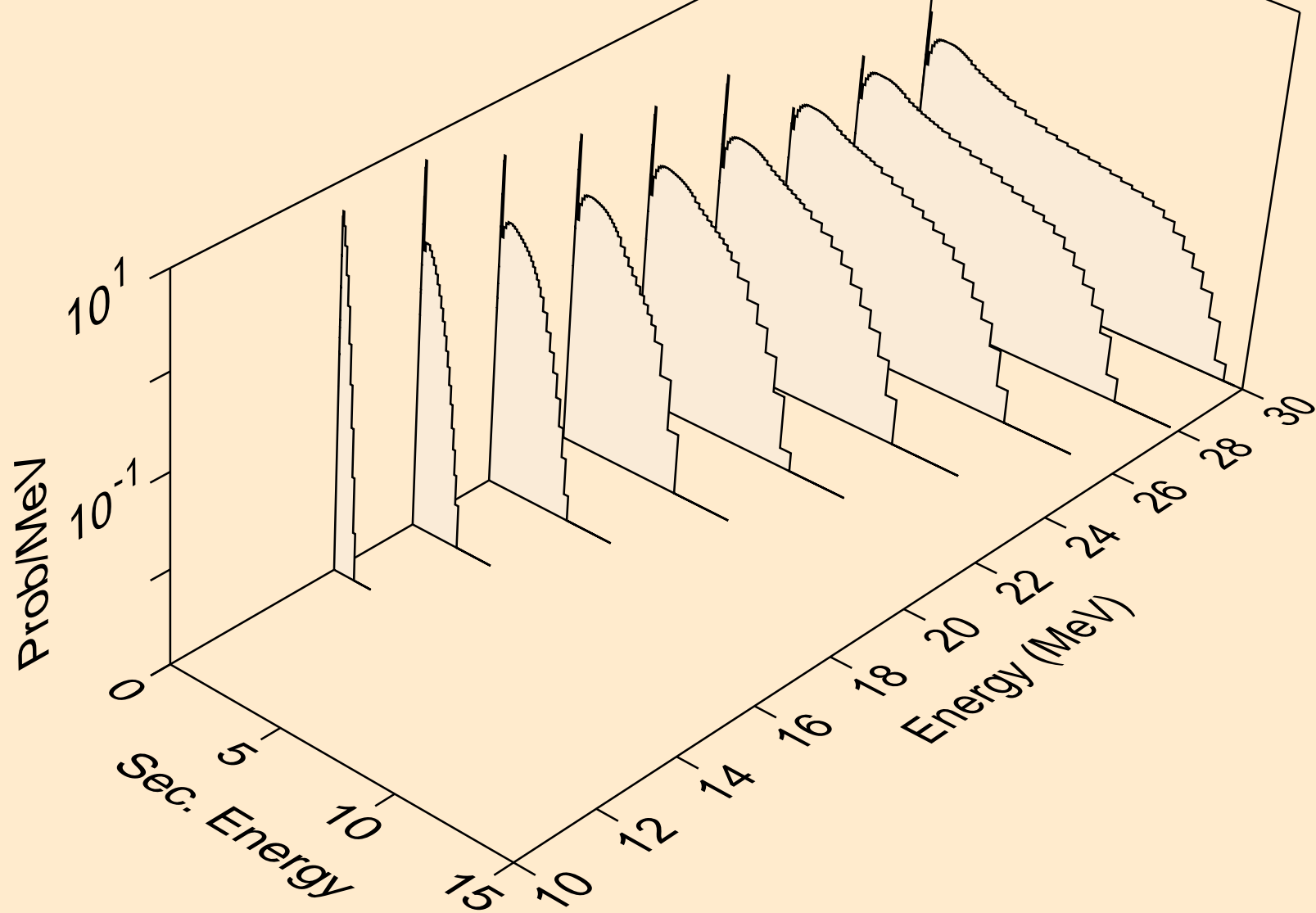

AL030 NEUTRON ACER TENDL-2024 LIBRARY; T=293.6K  
Neutron emission for (n,2n)<sub>a</sub>

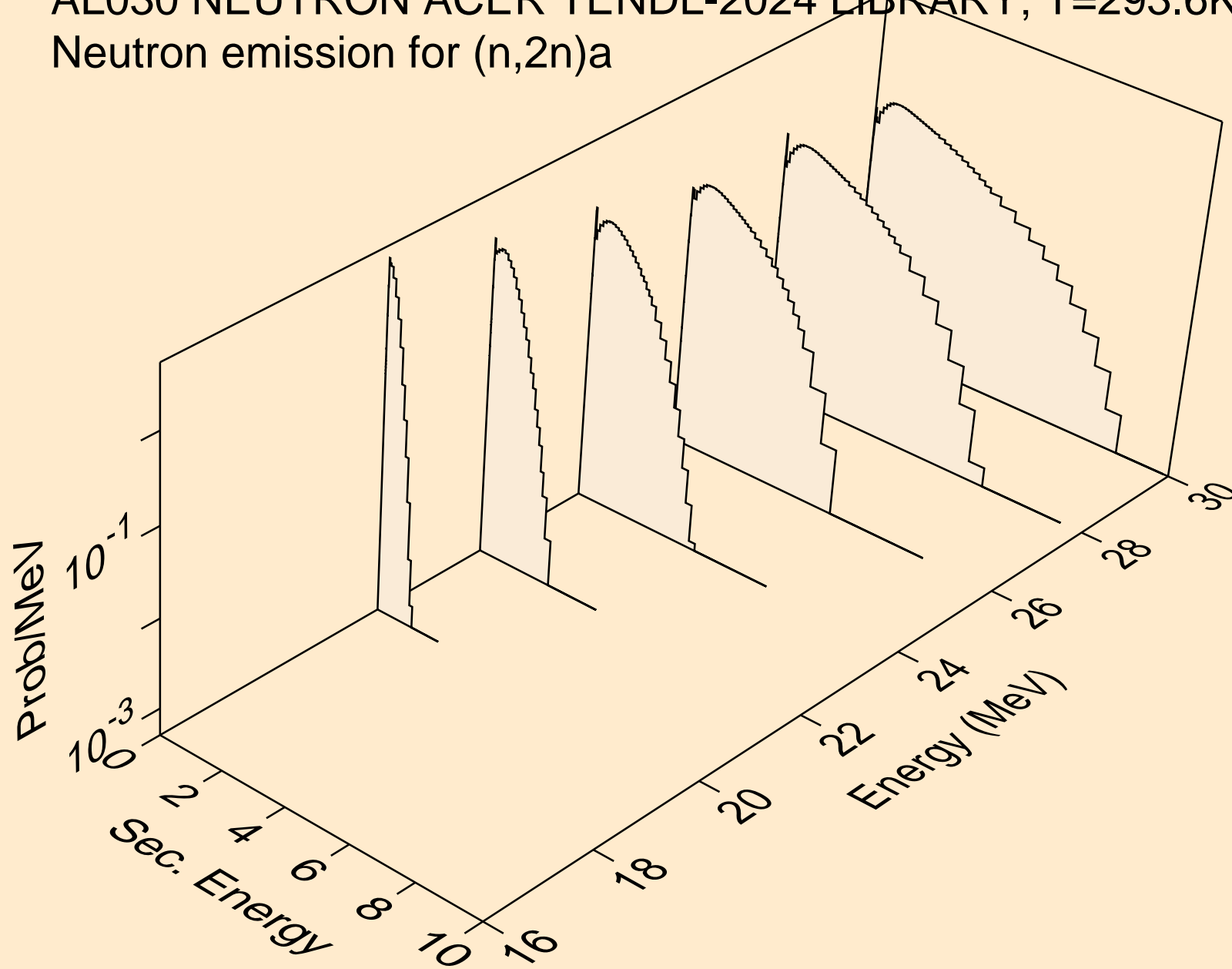

AL030 NEUTRON ACER TENDL-2024 LIBRARY; T=293.6K  
Neutron emission for (n,3n)a

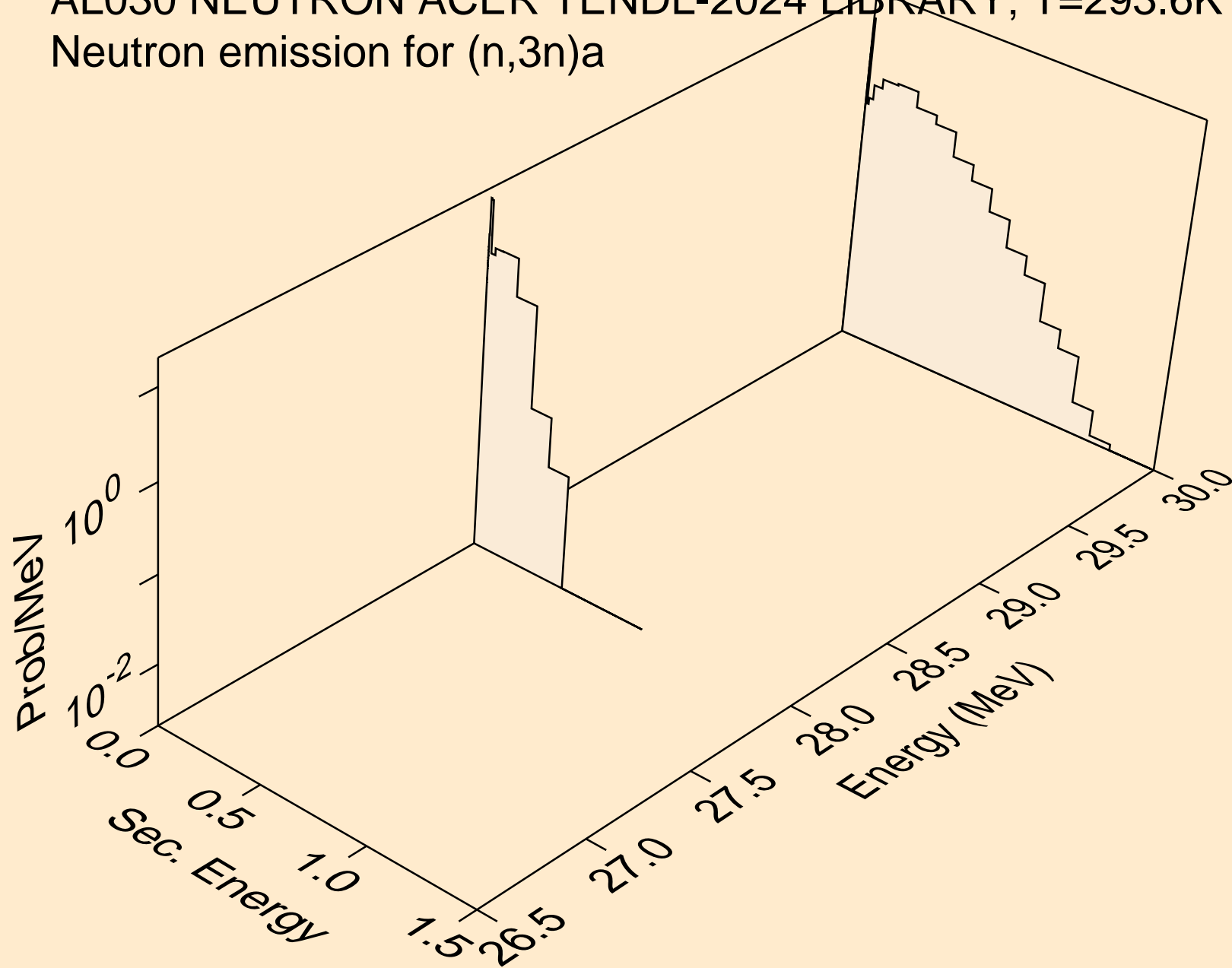

AL030 NEUTRON ACER TENDL-2024 LIBRARY; T=293.6K  
Neutron emission for (n,n\*)p

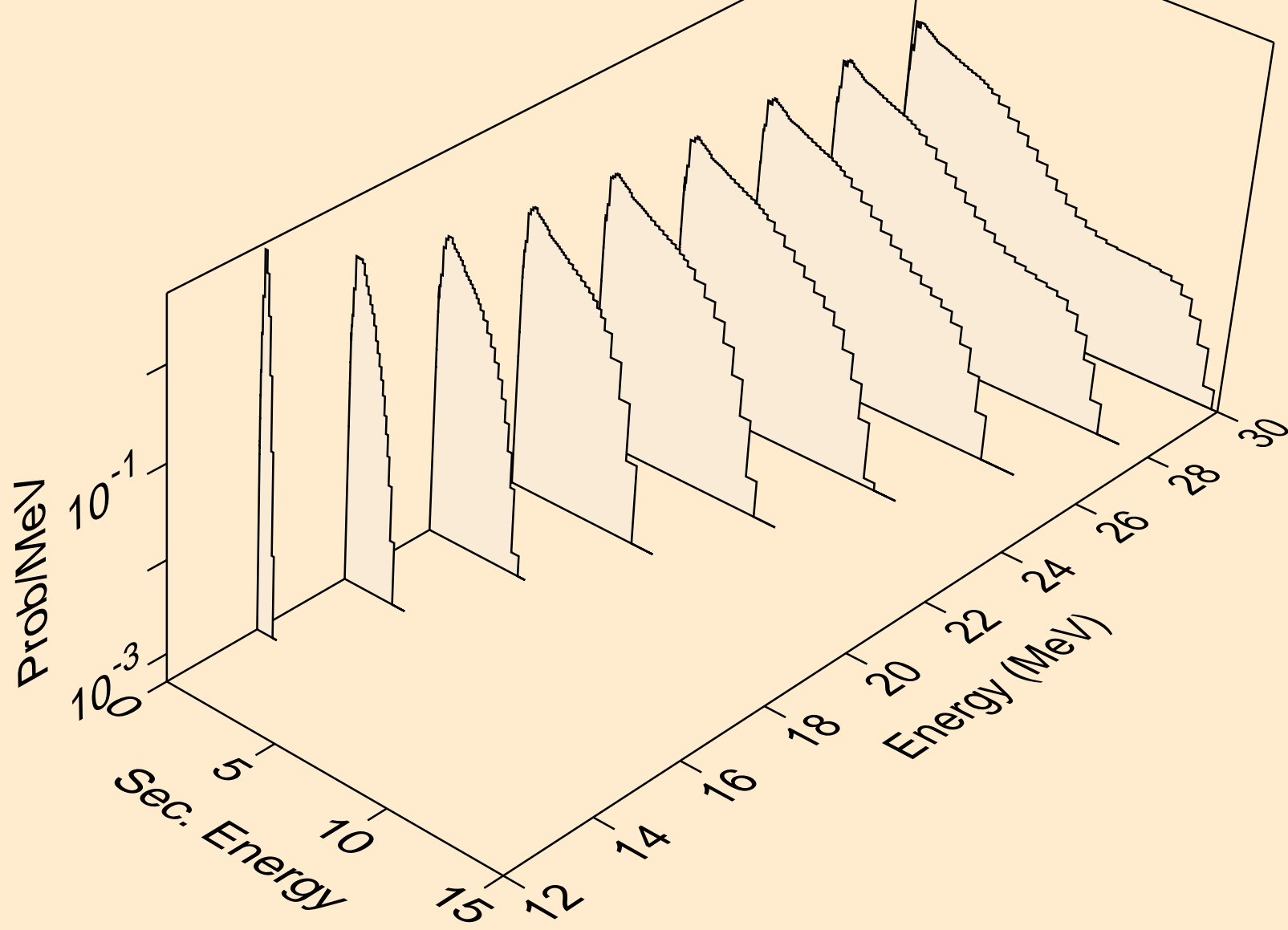

AL030 NEUTRON ACER TENDL-2024 LIBRARY; T=293.6K  
Neutron emission for (n,n\*)d

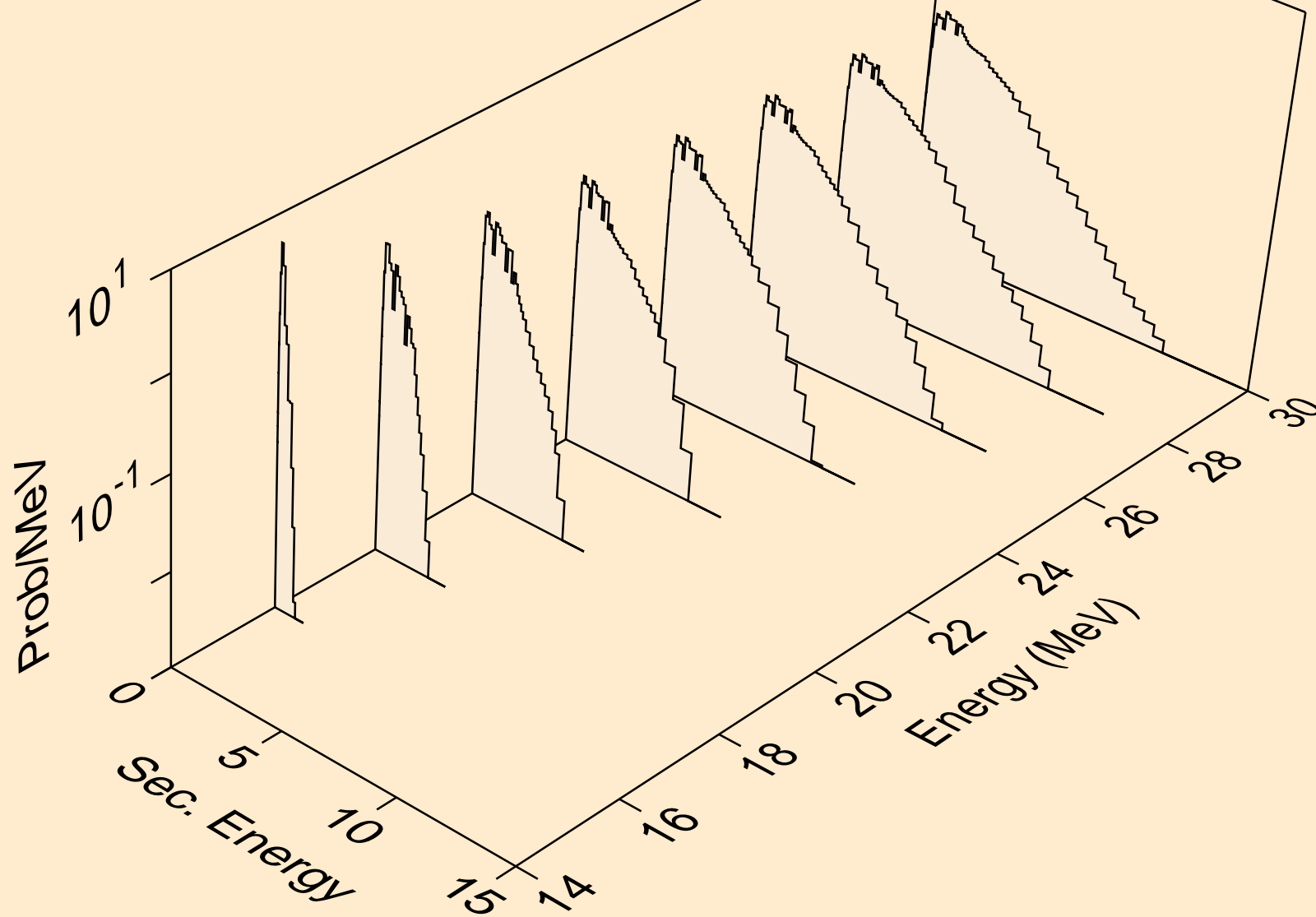

AL030 NEUTRON ACER TENDL-2024 LIBRARY; T=293.6K  
Neutron emission for (n,n\*)t

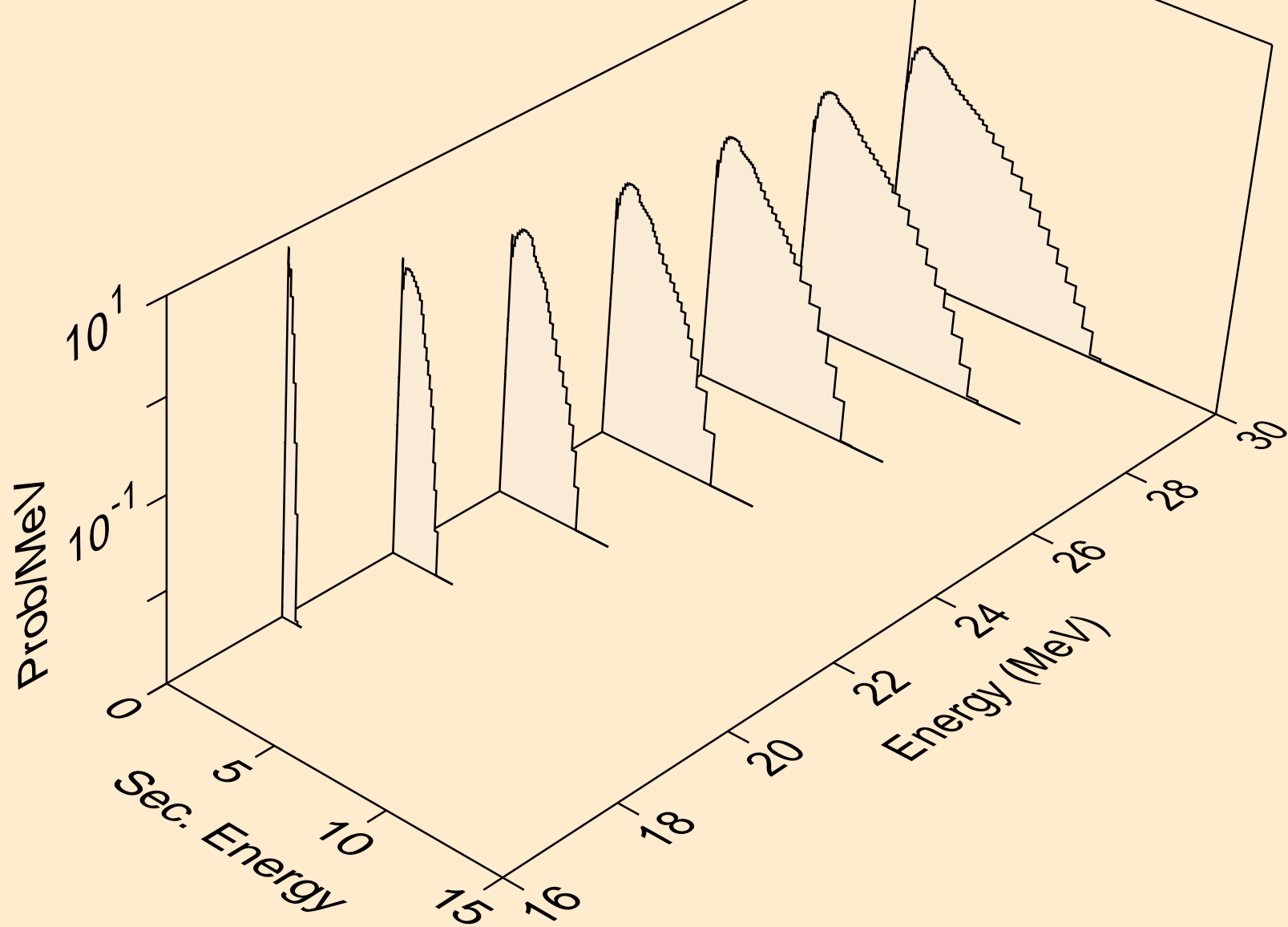

AL030 NEUTRON ACER TENDL-2024 LIBRARY; T=293.6K  
Neutron emission for (n,n\*)he3

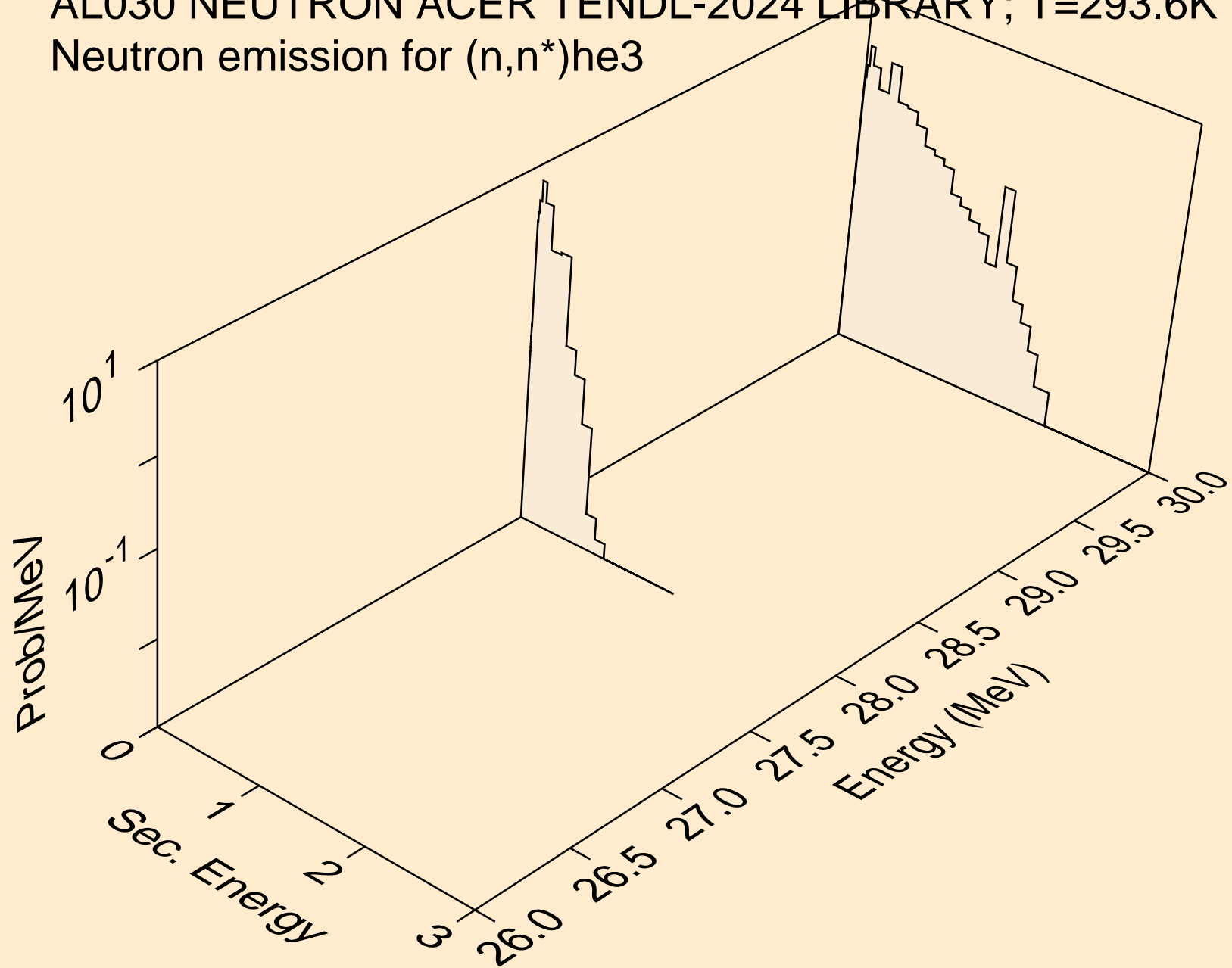

AL030 NEUTRON ACER TENDL-2024 LIBRARY; T=293.6K  
Neutron emission for (n,4n)

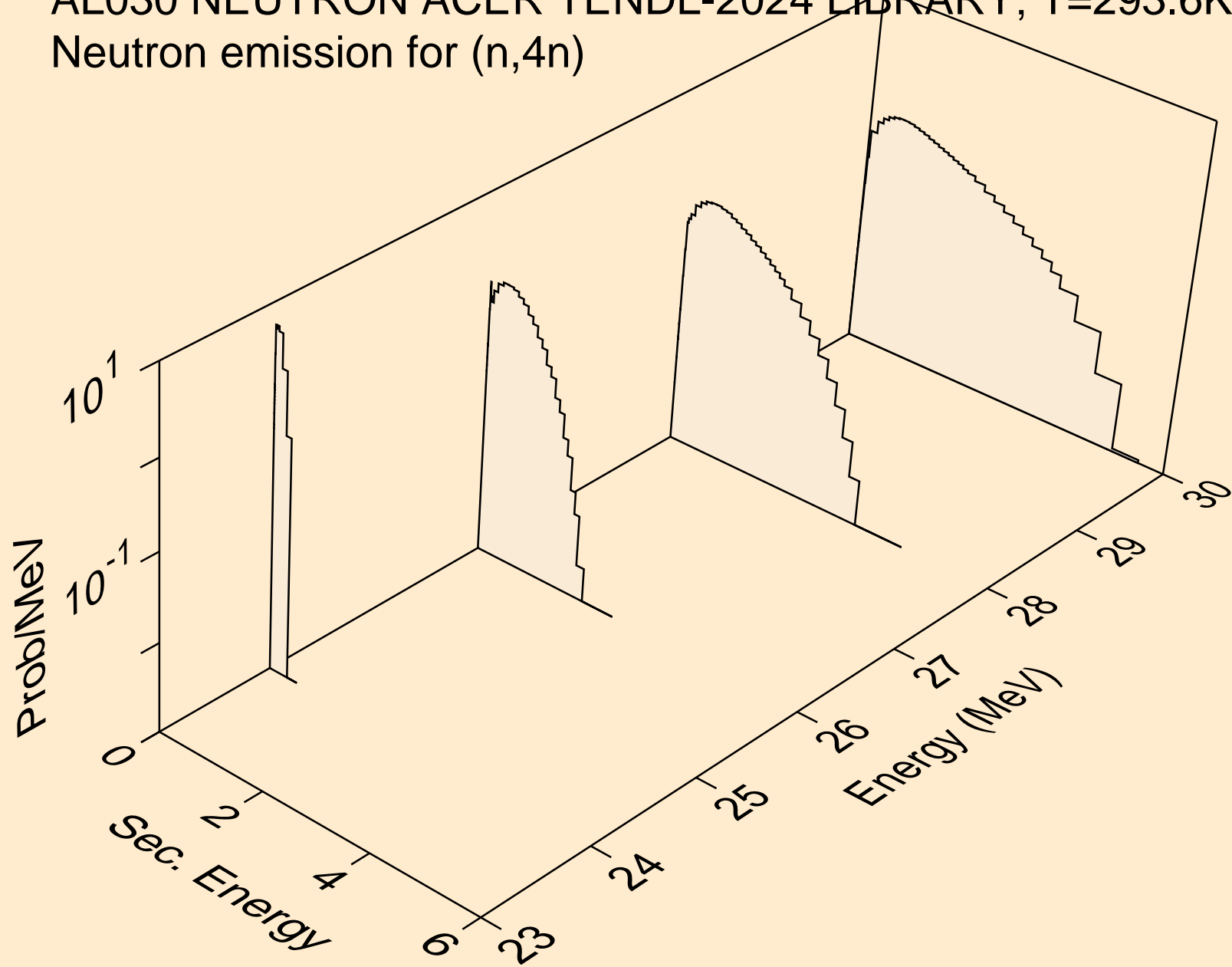

AL030 NEUTRON ACER TENDL-2024 LIBRARY; T=293.6K  
Neutron emission for (n,2np)

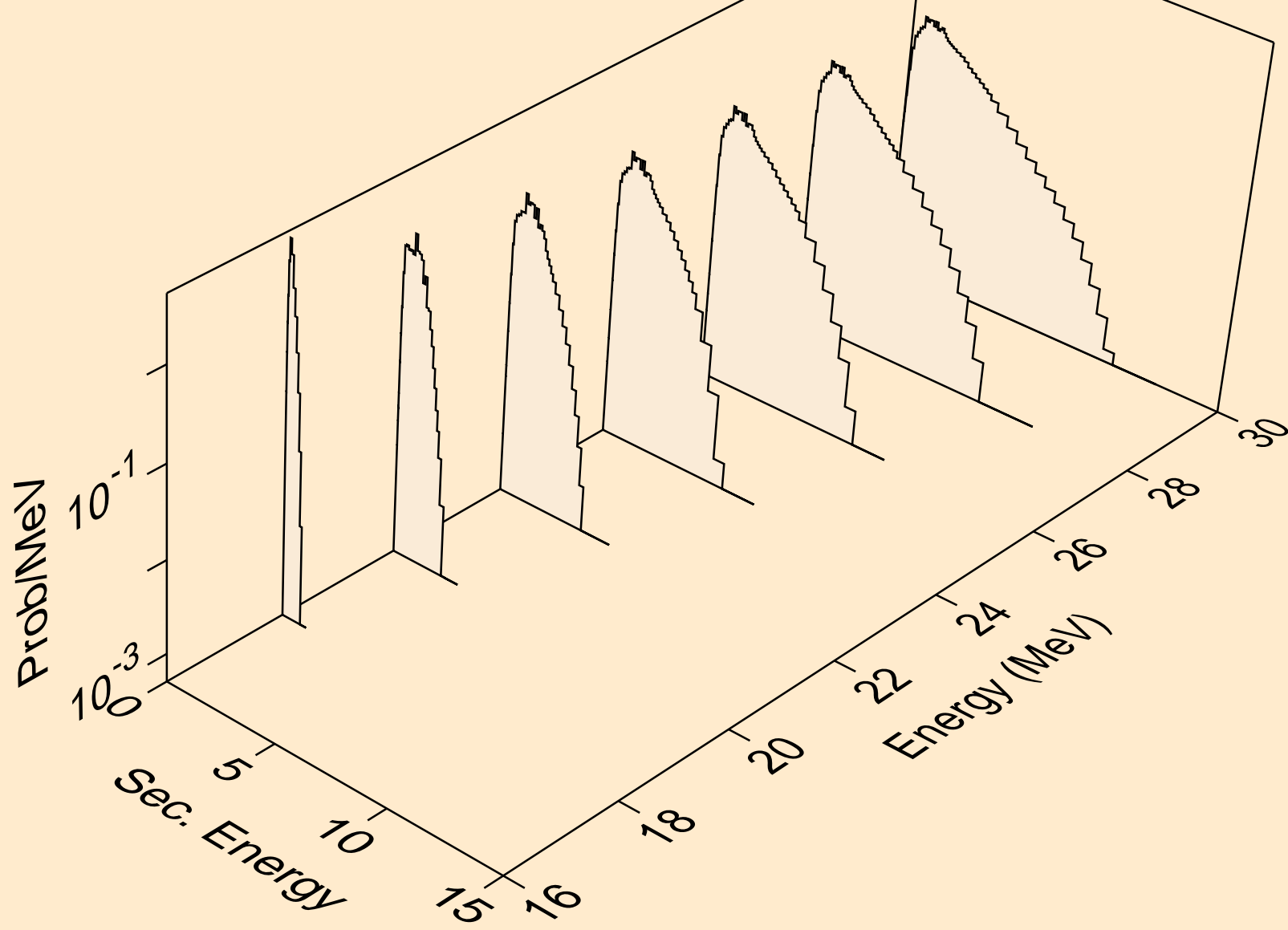

AL030 NEUTRON ACER TENDL-2024 LIBRARY; T=293.6K  
Neutron emission for (n,3np)

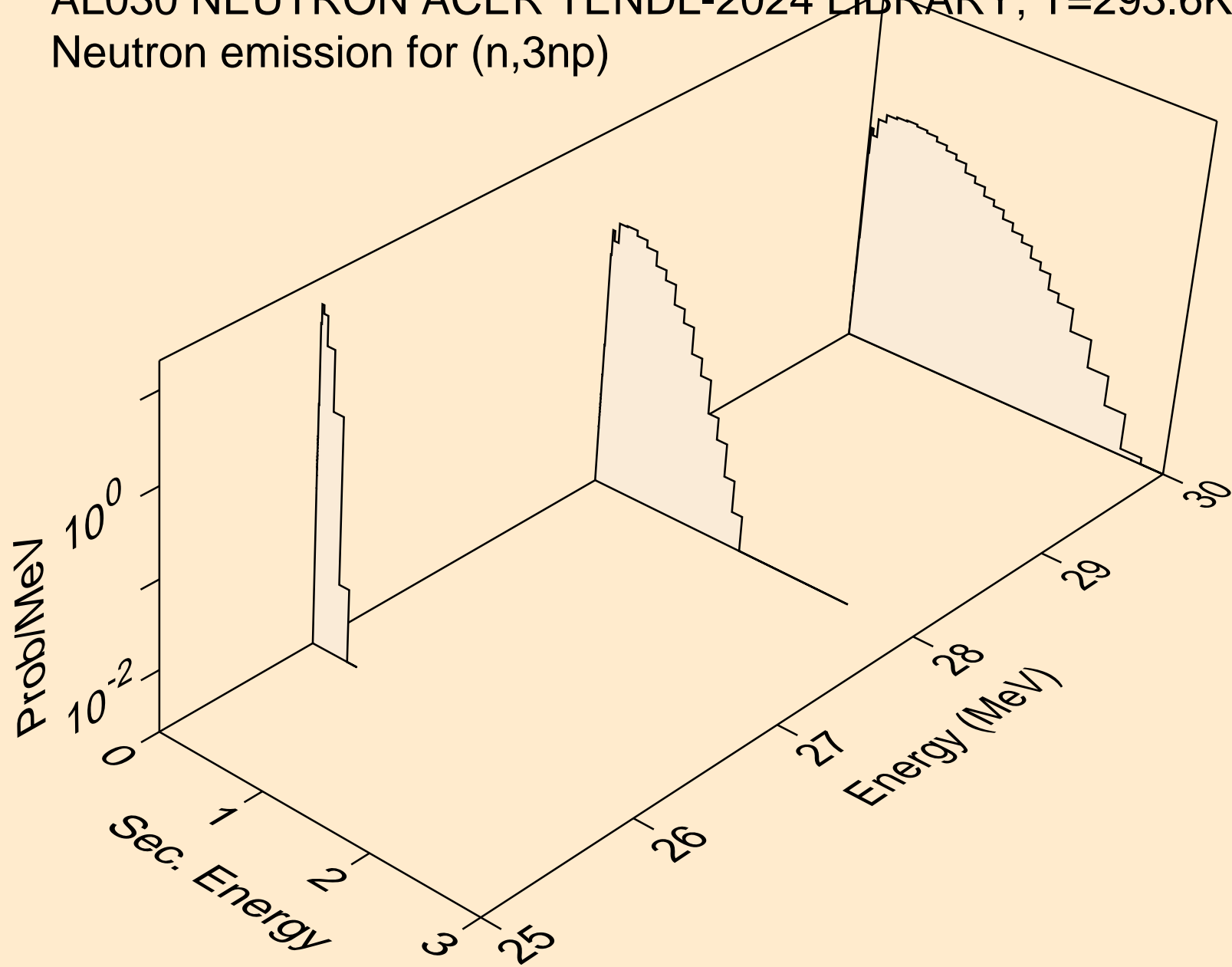

AL030 NEUTRON ACER TENDL-2024 LIBRARY; T=293.6K  
Neutron emission for (n,npa)

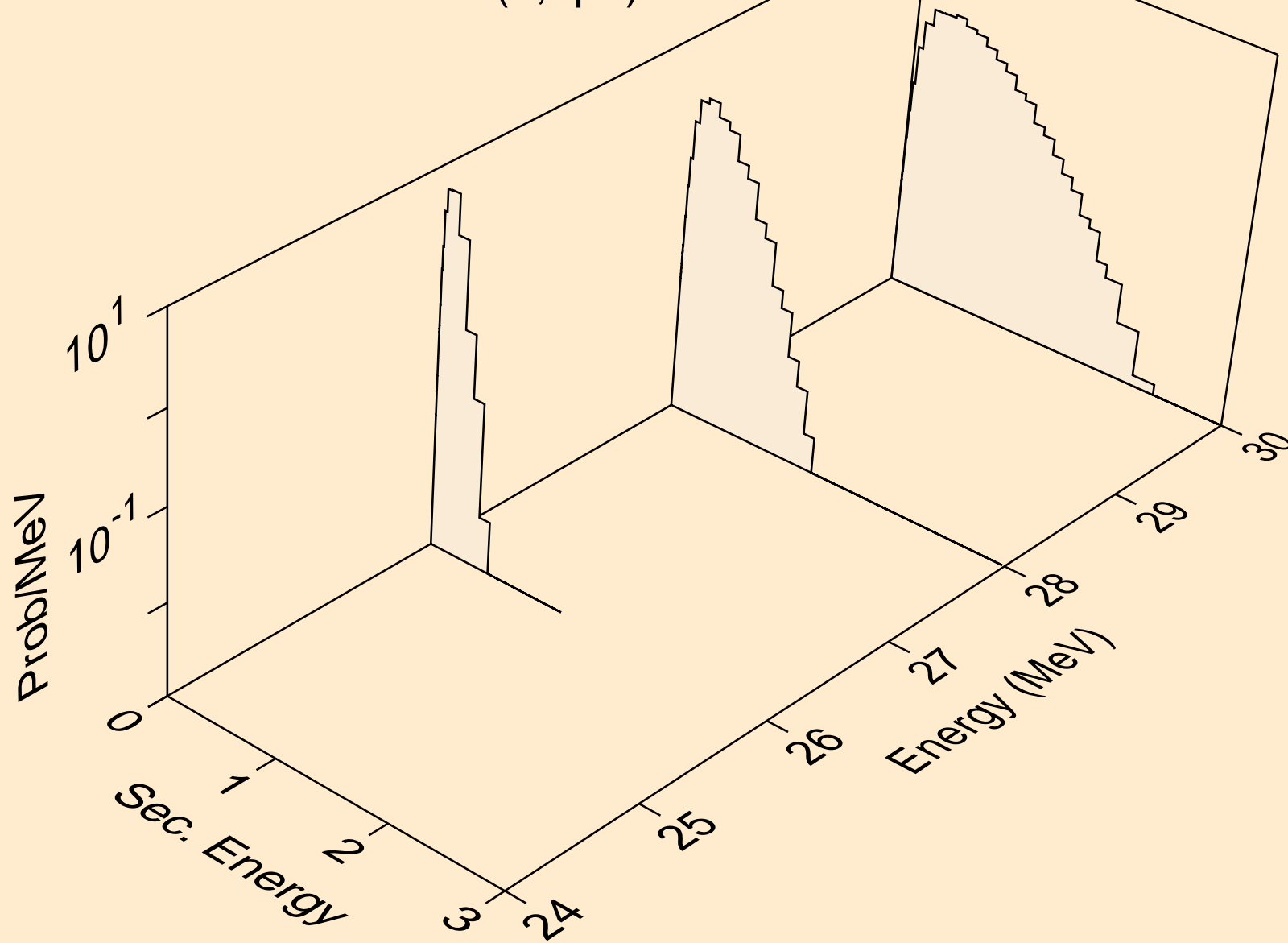

AL030 NEUTRON ACER TENDL-2024 LIBRARY; T=293.6K  
Neutron emission for (n,n\*c)

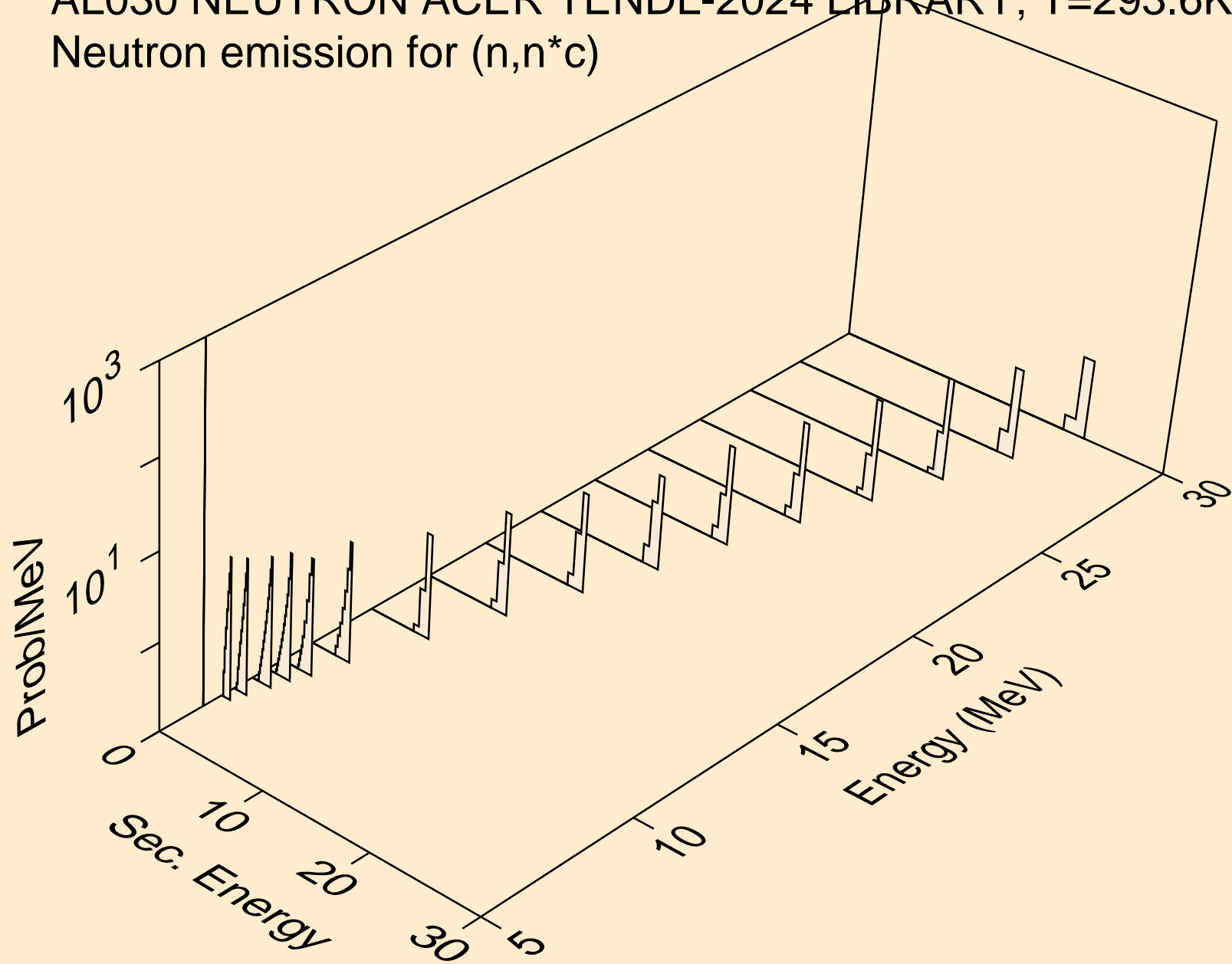

AL030 NEUTRON ACER TENDL-2024 LIBRARY; T=293.6K  
Photon emission for (n,x)

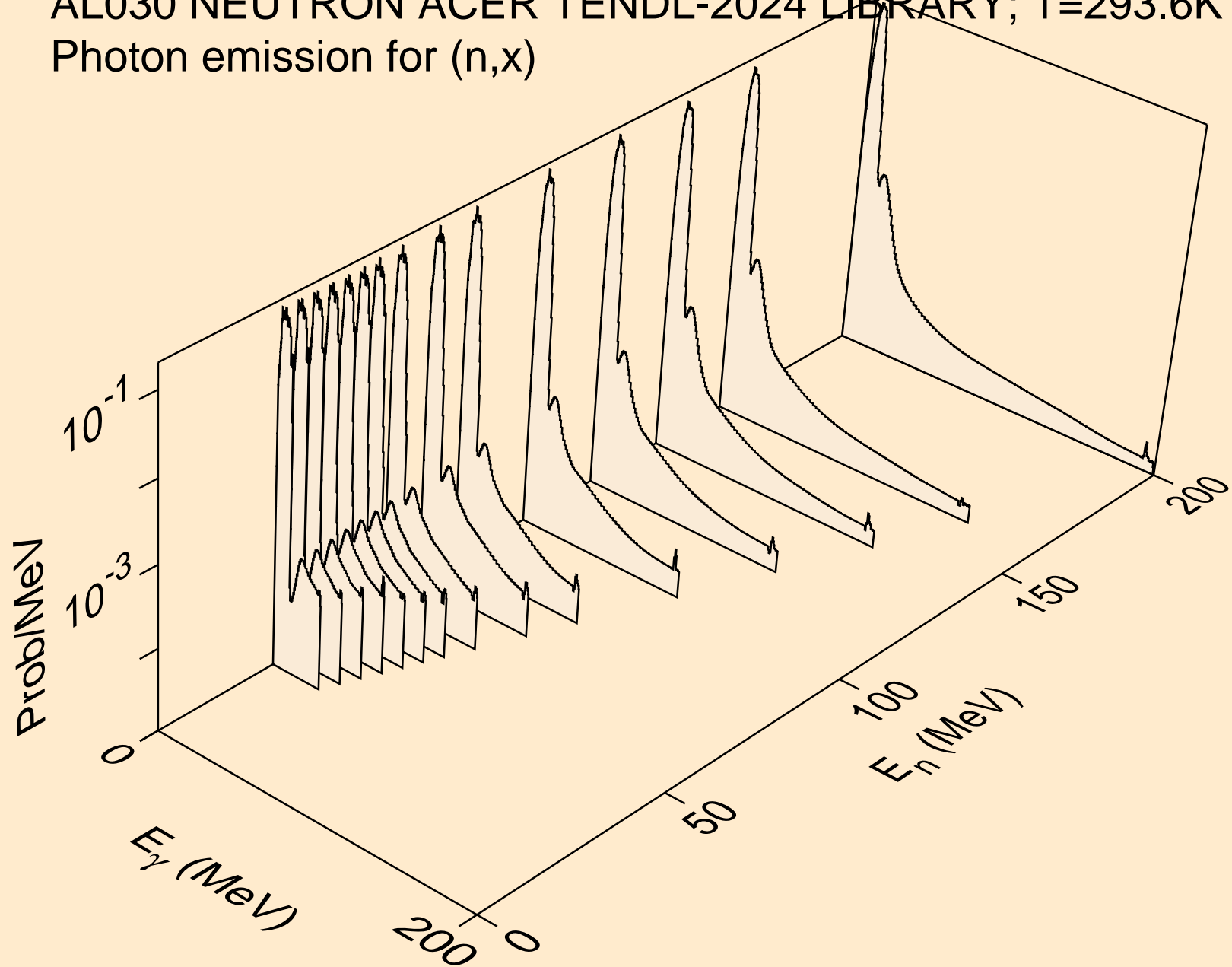

AL030 NEUTRON ACER TENDL-2024 LIBRARY; T=293.6K  
Photon emission for (n,2nd)

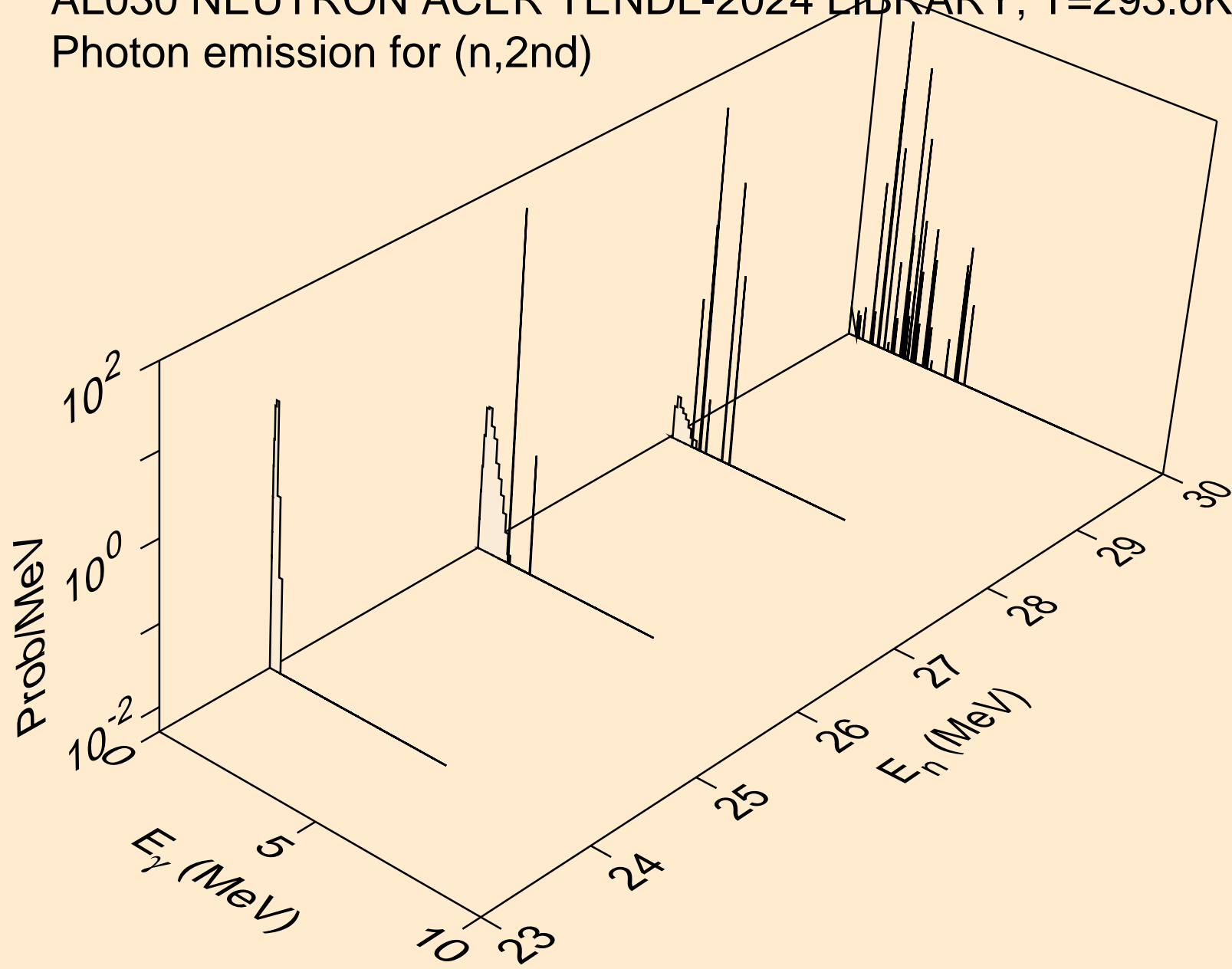

AL030 NEUTRON ACER TENDL-2024 LIBRARY; T=293.6K  
Photon emission for (n,2n)

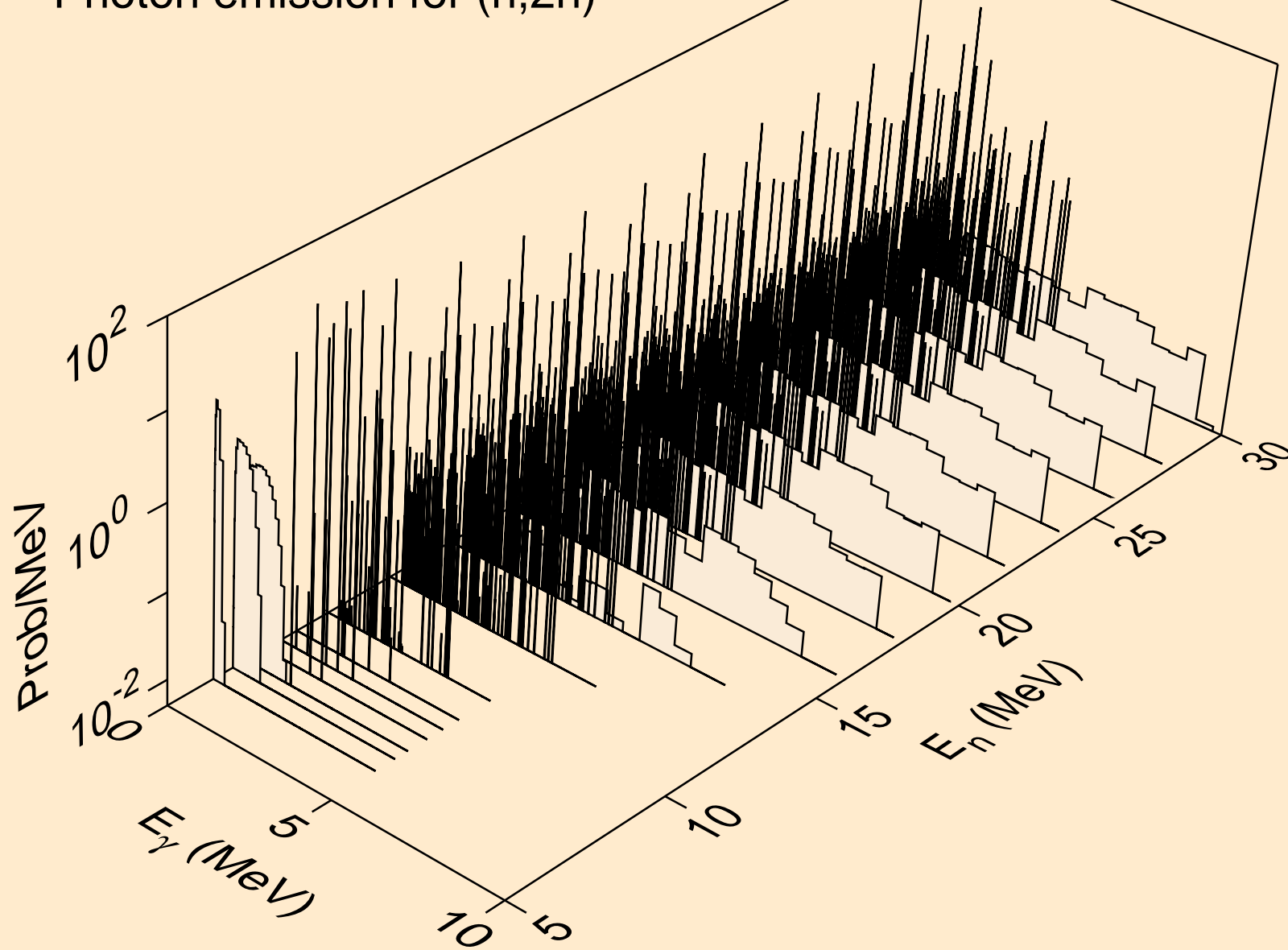

AL030 NEUTRON ACER TENDL-2024 LIBRARY; T=293.6K  
Photon emission for (n,3n)

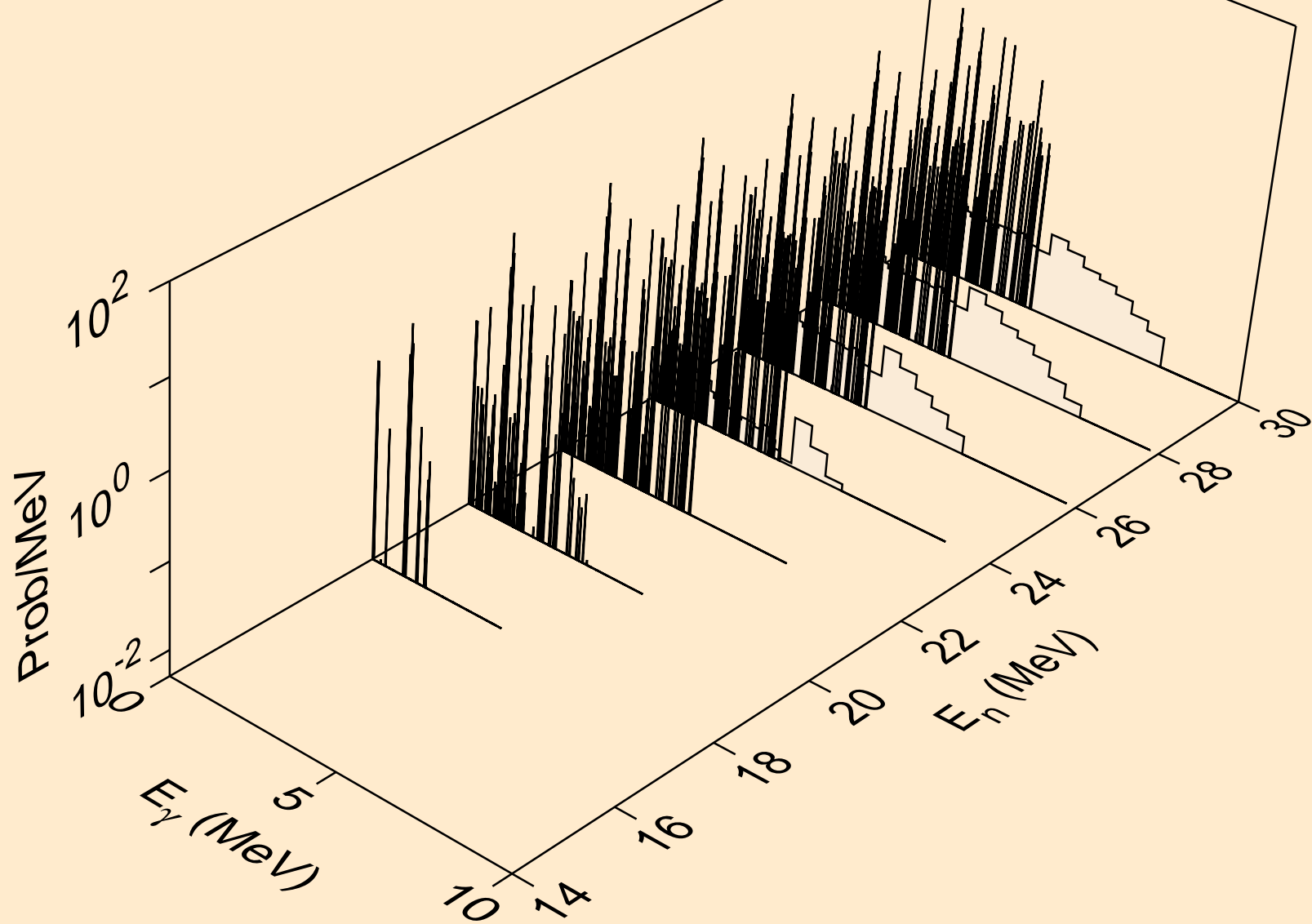

AL030 NEUTRON ACER TENDL-2024 LIBRARY; T=293.6K  
Photon emission for (n,n\*)a

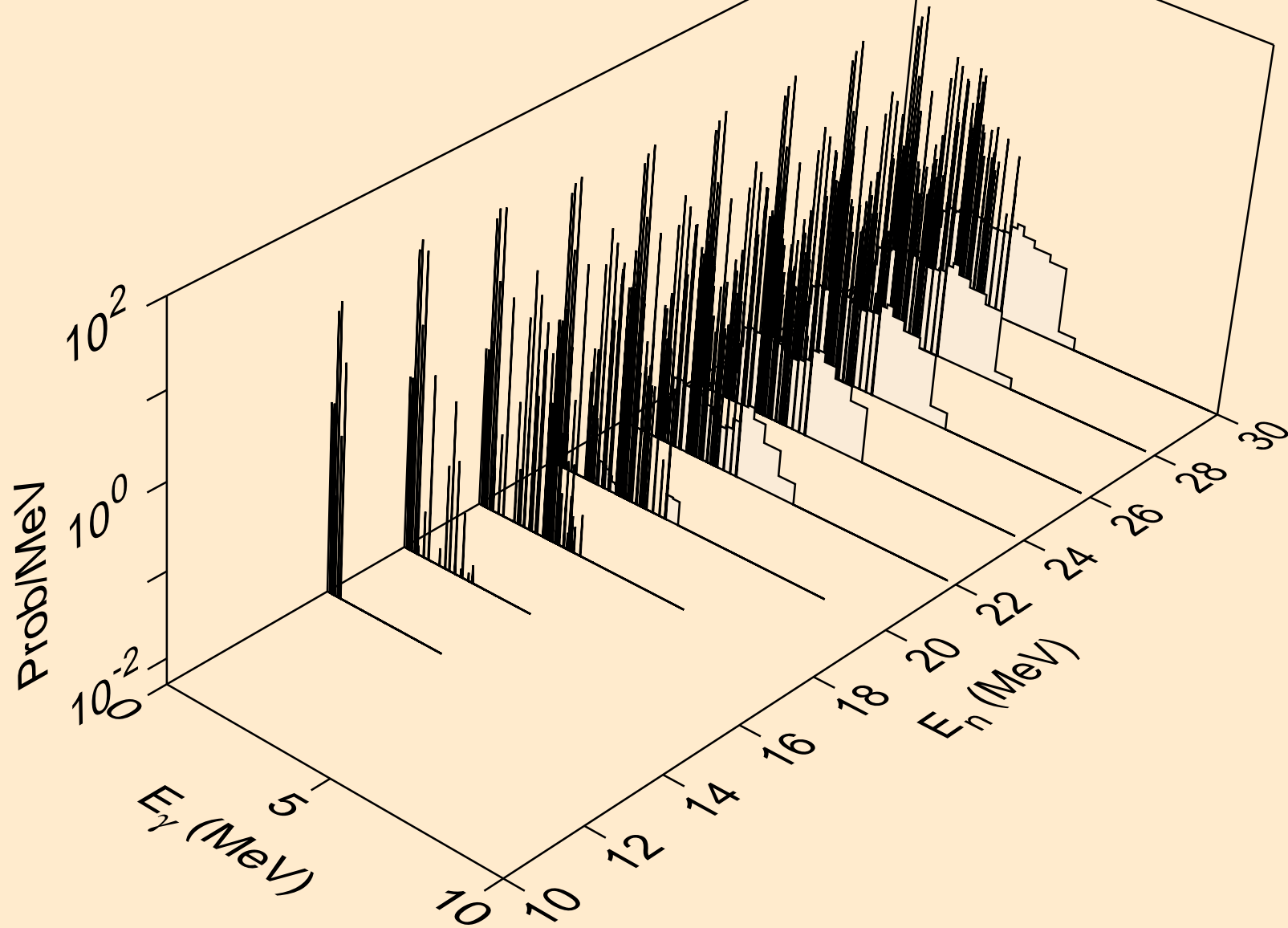

AL030 NEUTRON ACER TENDL-2024 LIBRARY; T=293.6K  
Photon emission for (n,2n)a

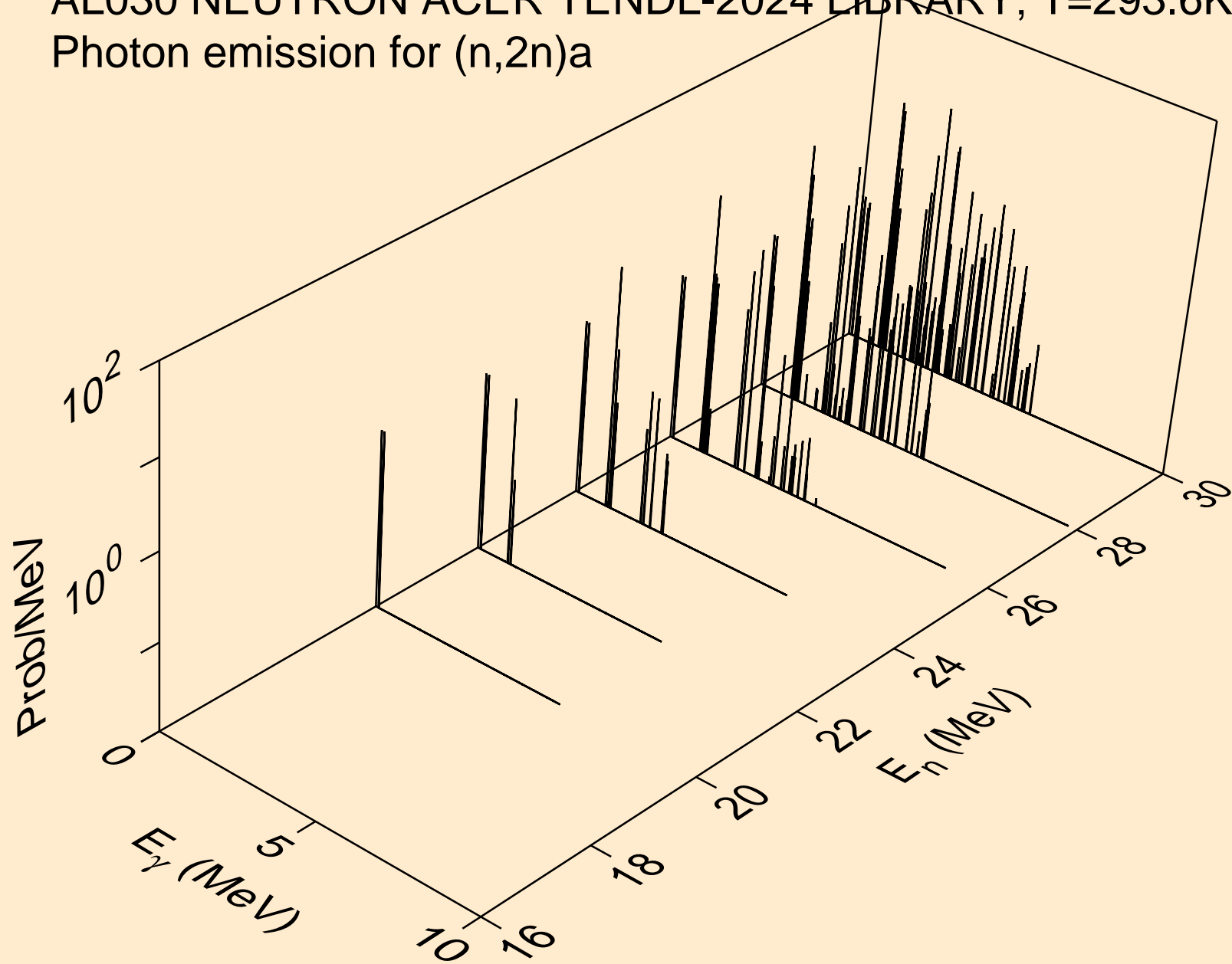

AL030 NEUTRON ACER TENDL-2024 LIBRARY; T=293.6K  
Photon emission for (n,3n)a

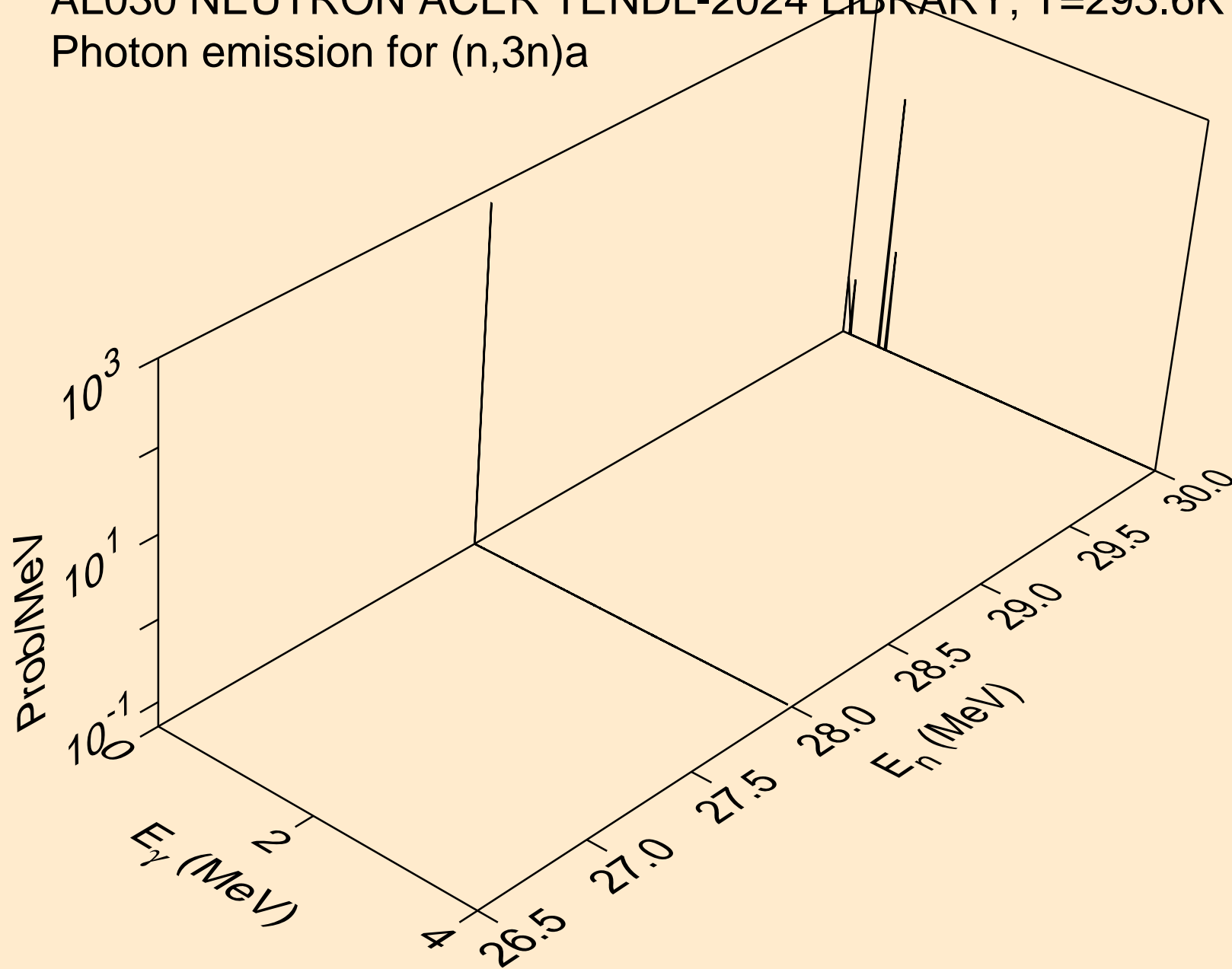

AL030 NEUTRON ACER TENDL-2024 LIBRARY; T=293.6K  
Photon emission for (n,n\*)p

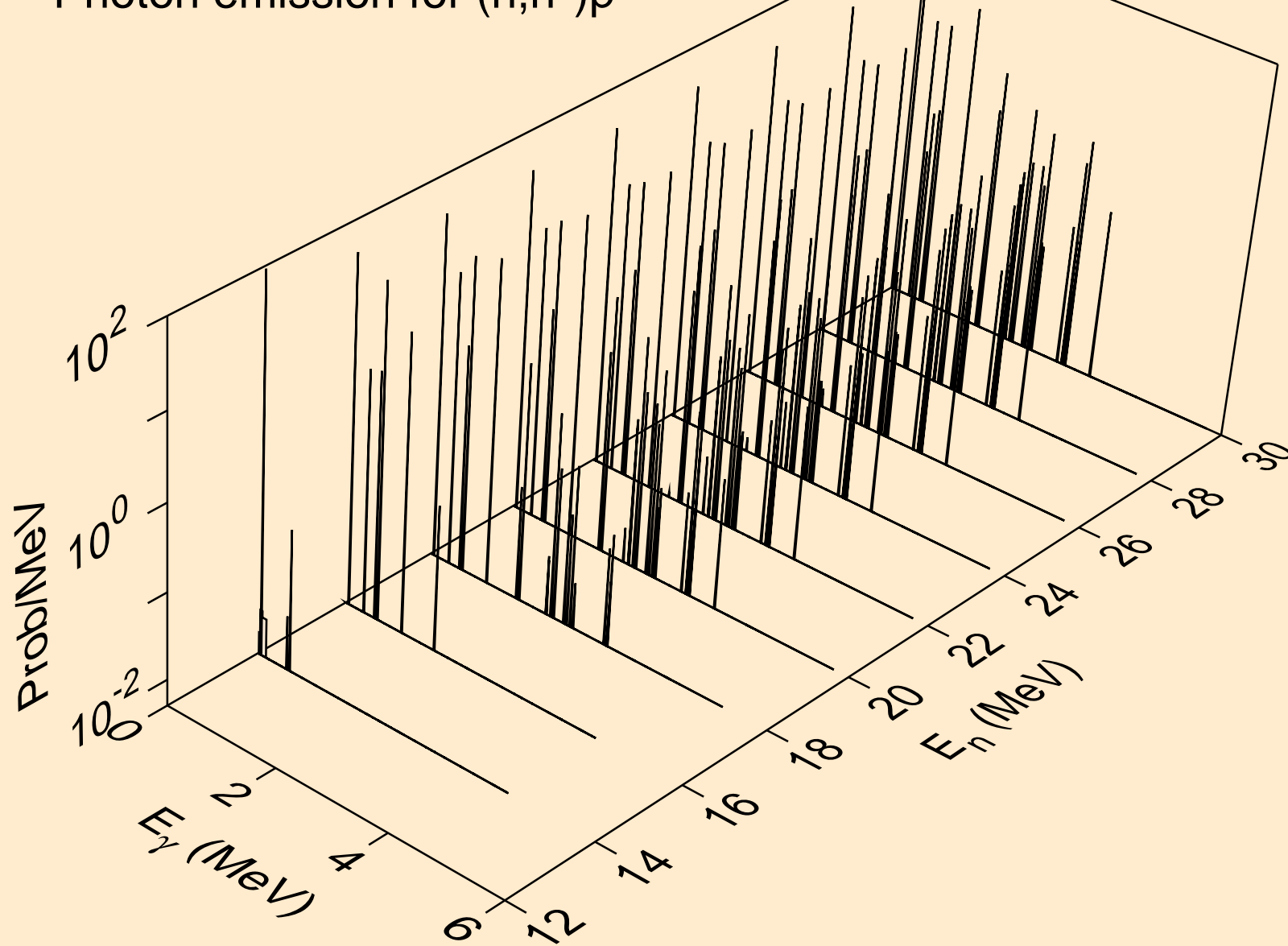

AL030 NEUTRON ACER TENDL-2024 LIBRARY; T=293.6K  
Photon emission for (n,n\*)d

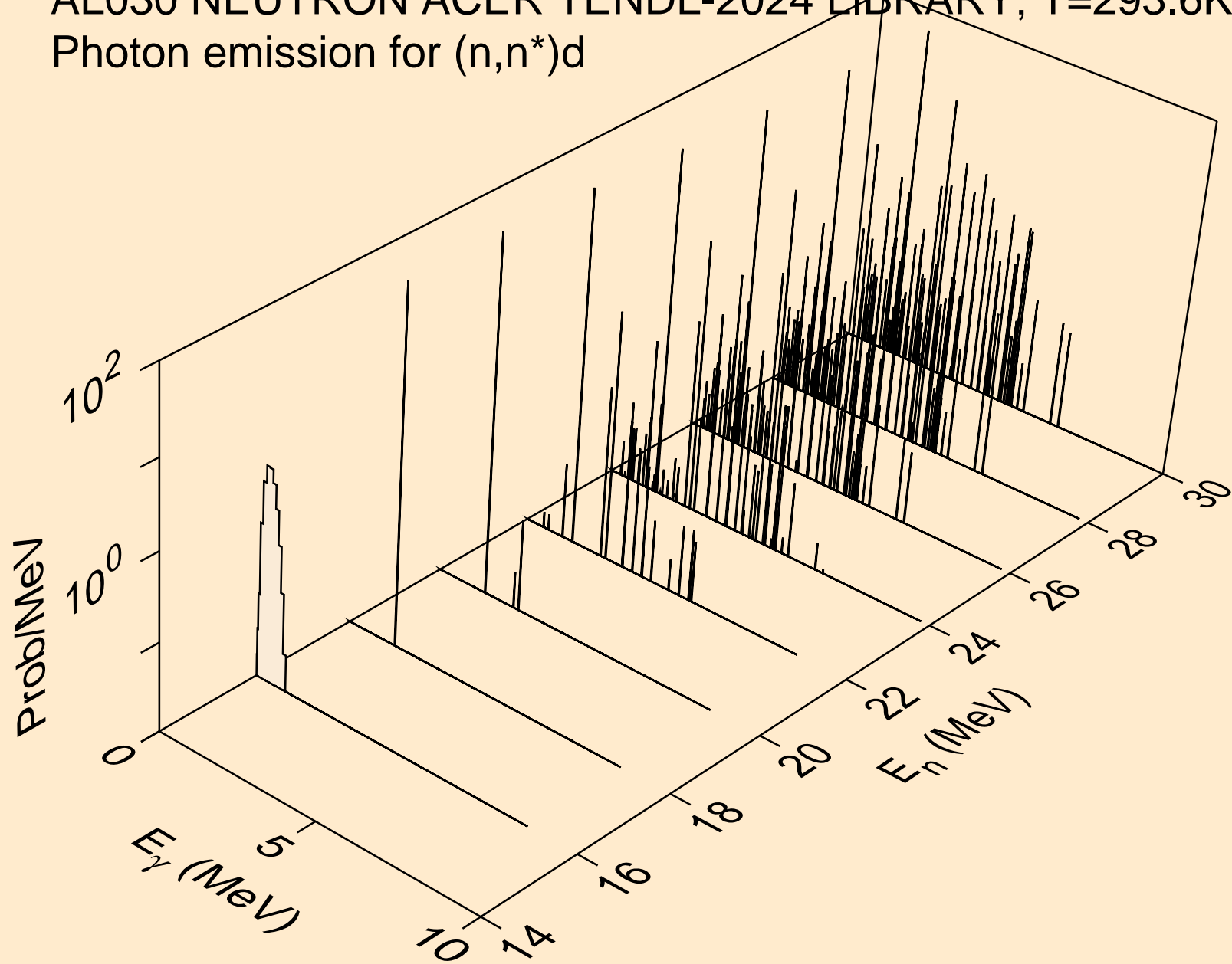

AL030 NEUTRON ACER TENDL-2024 LIBRARY; T=293.6K  
Photon emission for (n,n\*)t

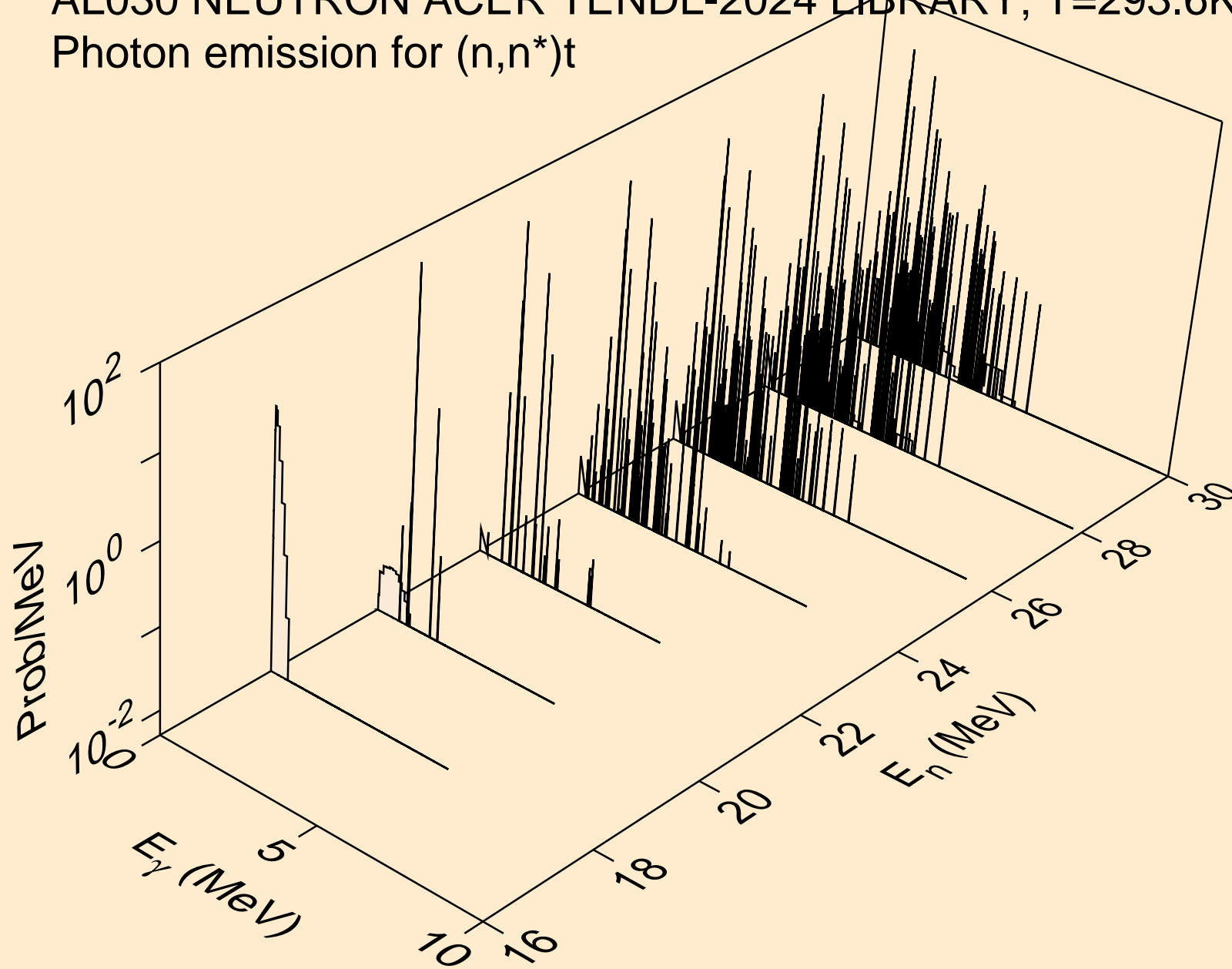

AL030 NEUTRON ACER TENDL-2024 LIBRARY; T=293.6K  
Photon emission for (n,n\*)he3

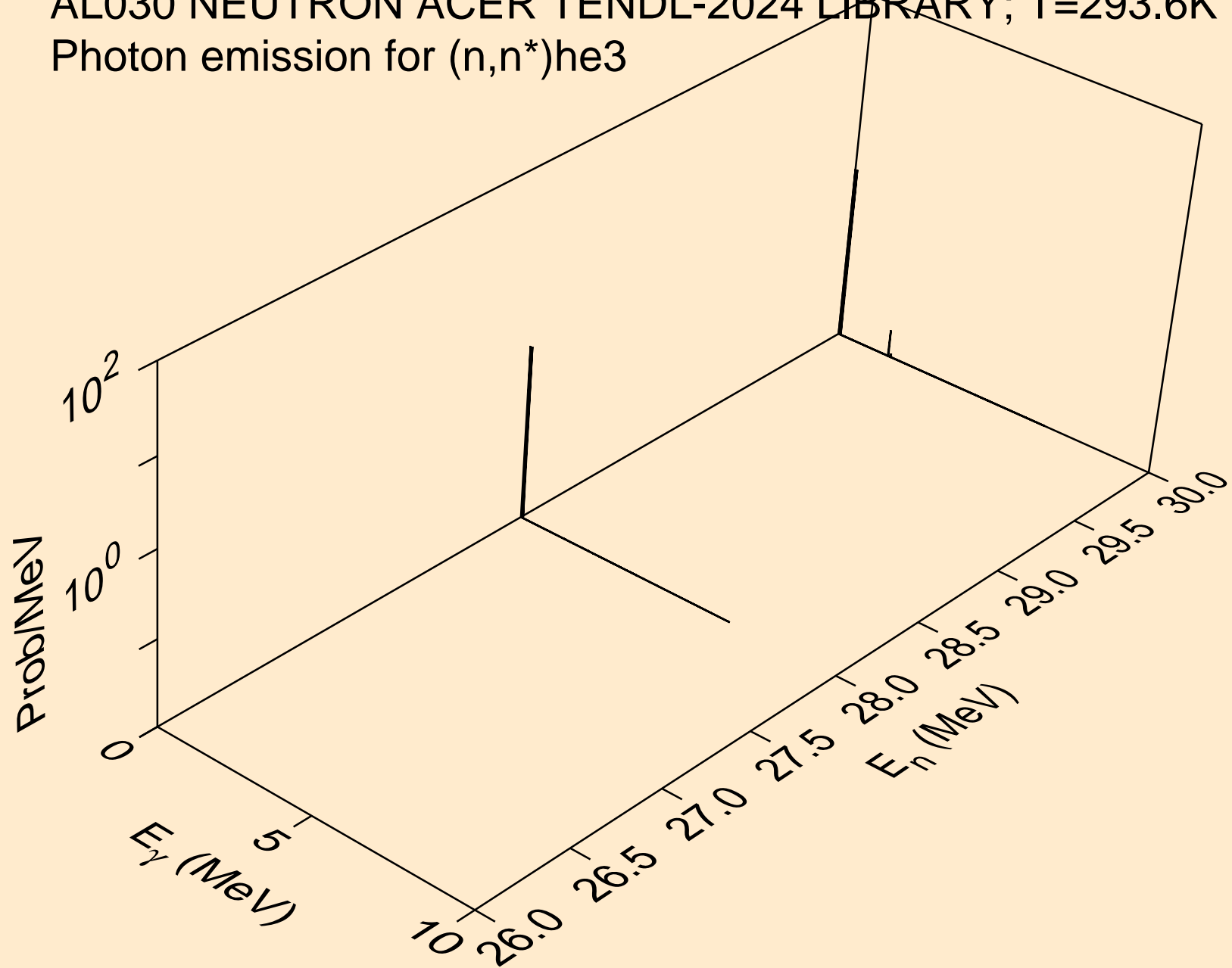

AL030 NEUTRON ACER TENDL-2024 LIBRARY; T=293.6K  
Photon emission for (n,4n)

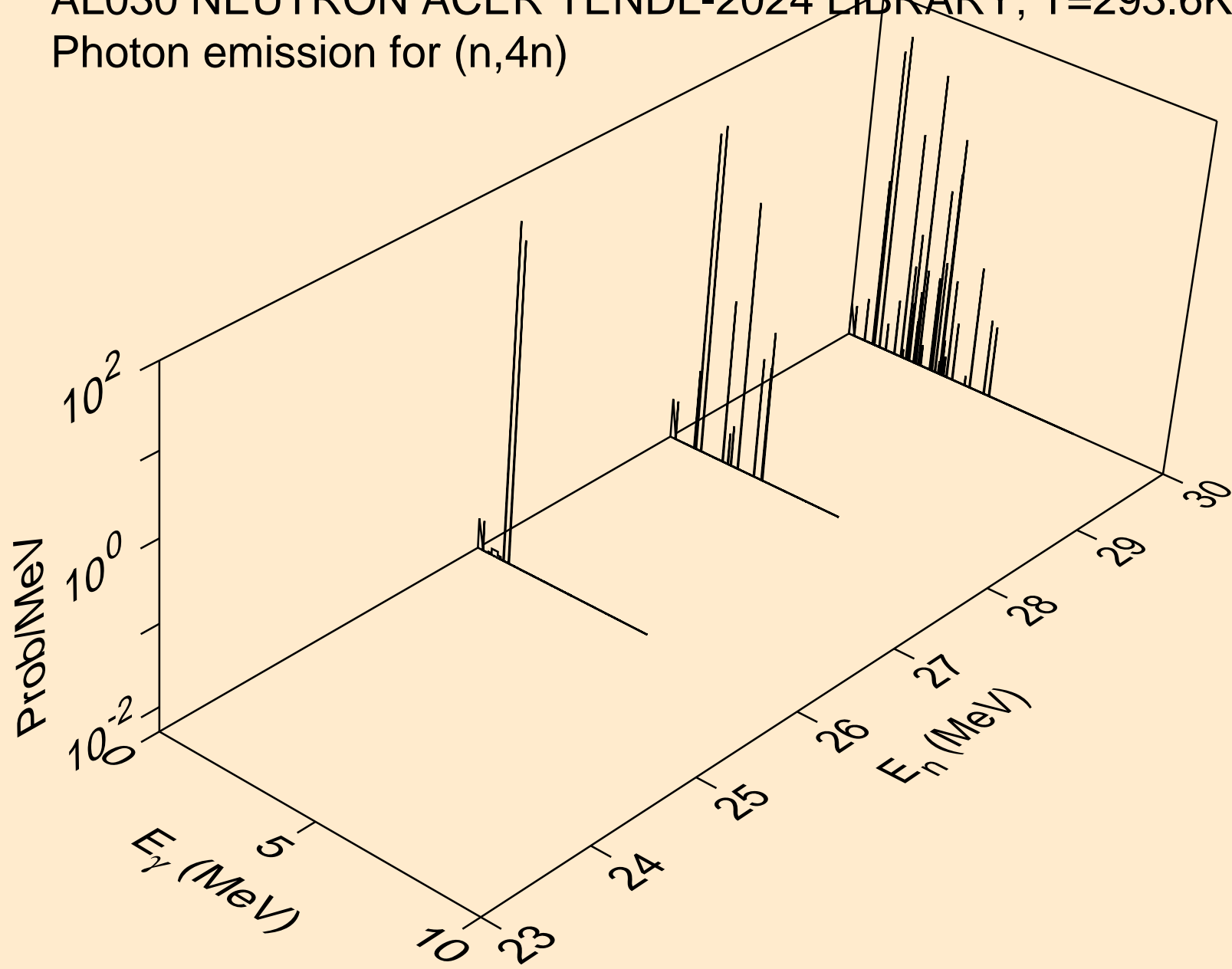

AL030 NEUTRON ACER TENDL-2024 LIBRARY; T=293.6K  
Photon emission for (n,2np)

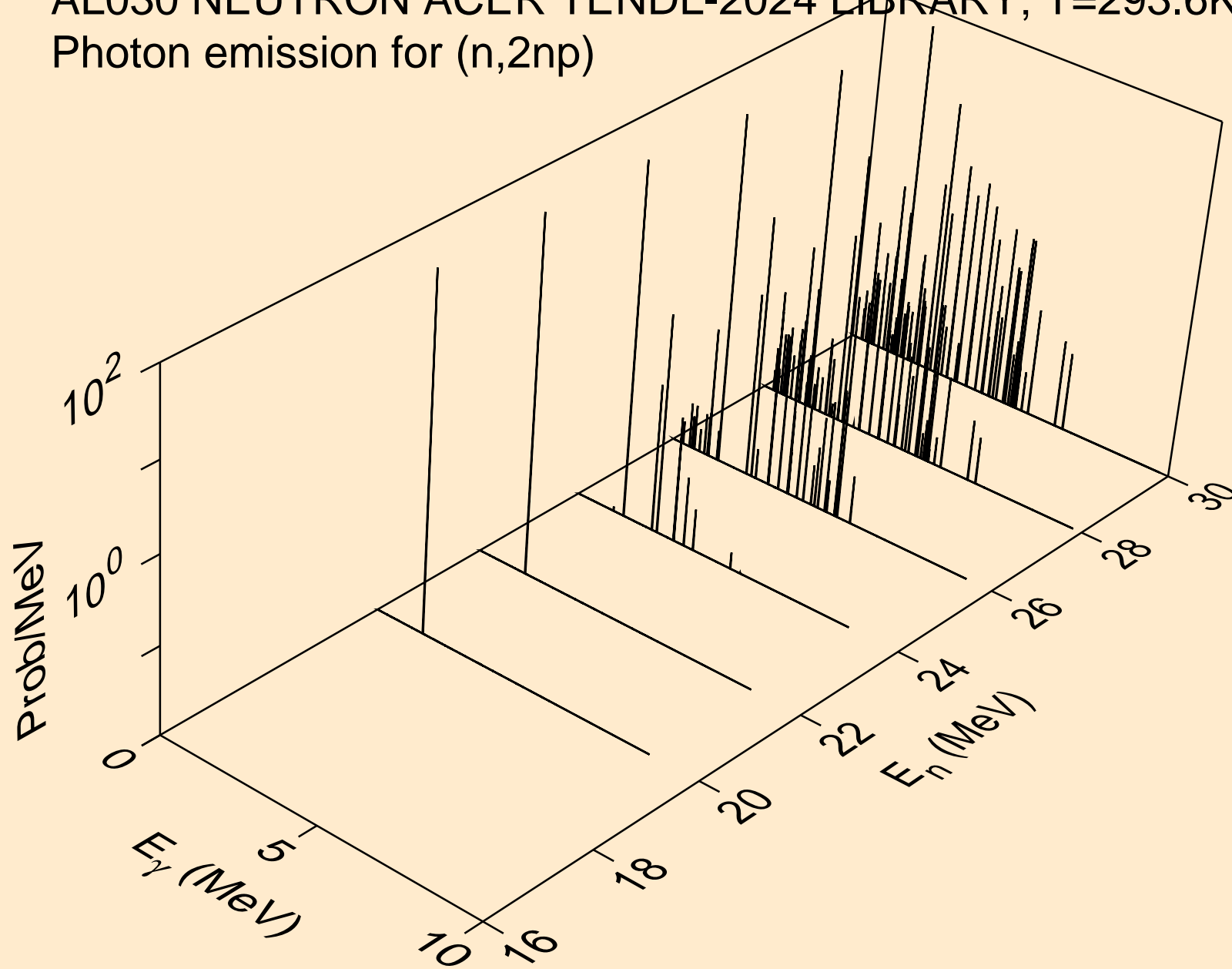

AL030 NEUTRON ACER TENDL-2024 LIBRARY; T=293.6K  
Photon emission for (n,3np)

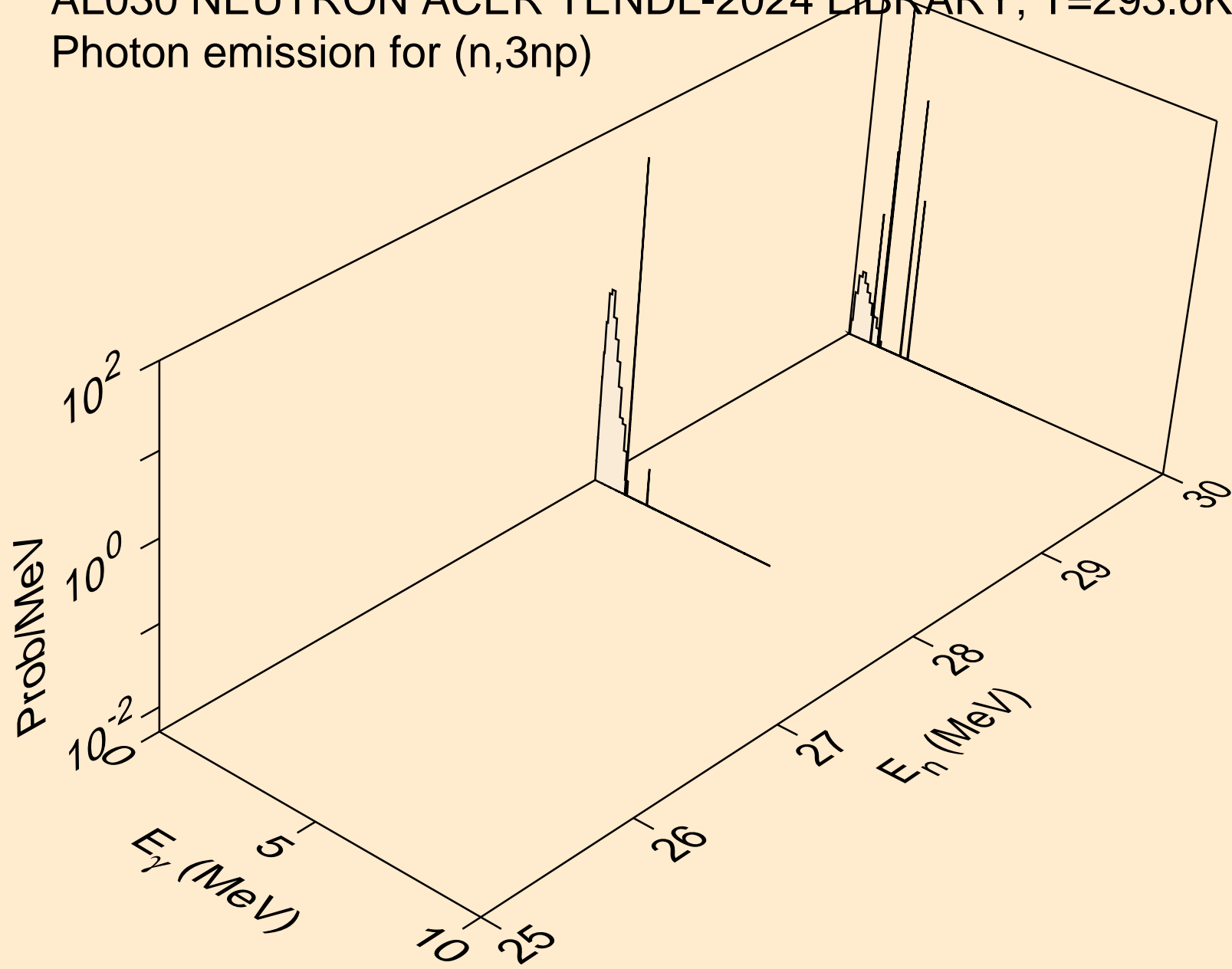

AL030 NEUTRON ACER TENDL-2024 LIBRARY; T=293.6K  
Photon emission for (n,npa)

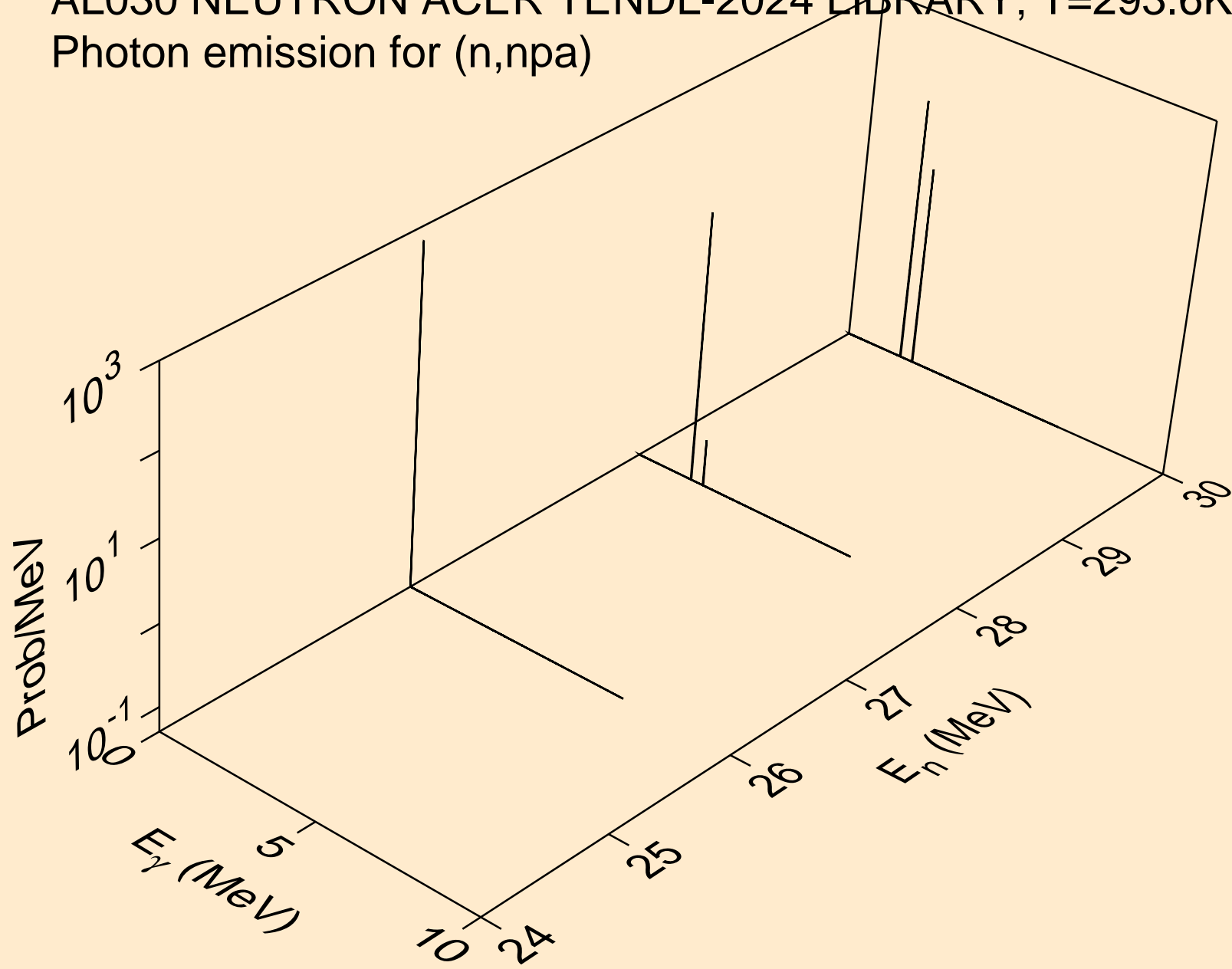

AL030 NEUTRON ACER TENDL-2024 LIBRARY; T=293.6K  
Photon emission for (n,n\*c)

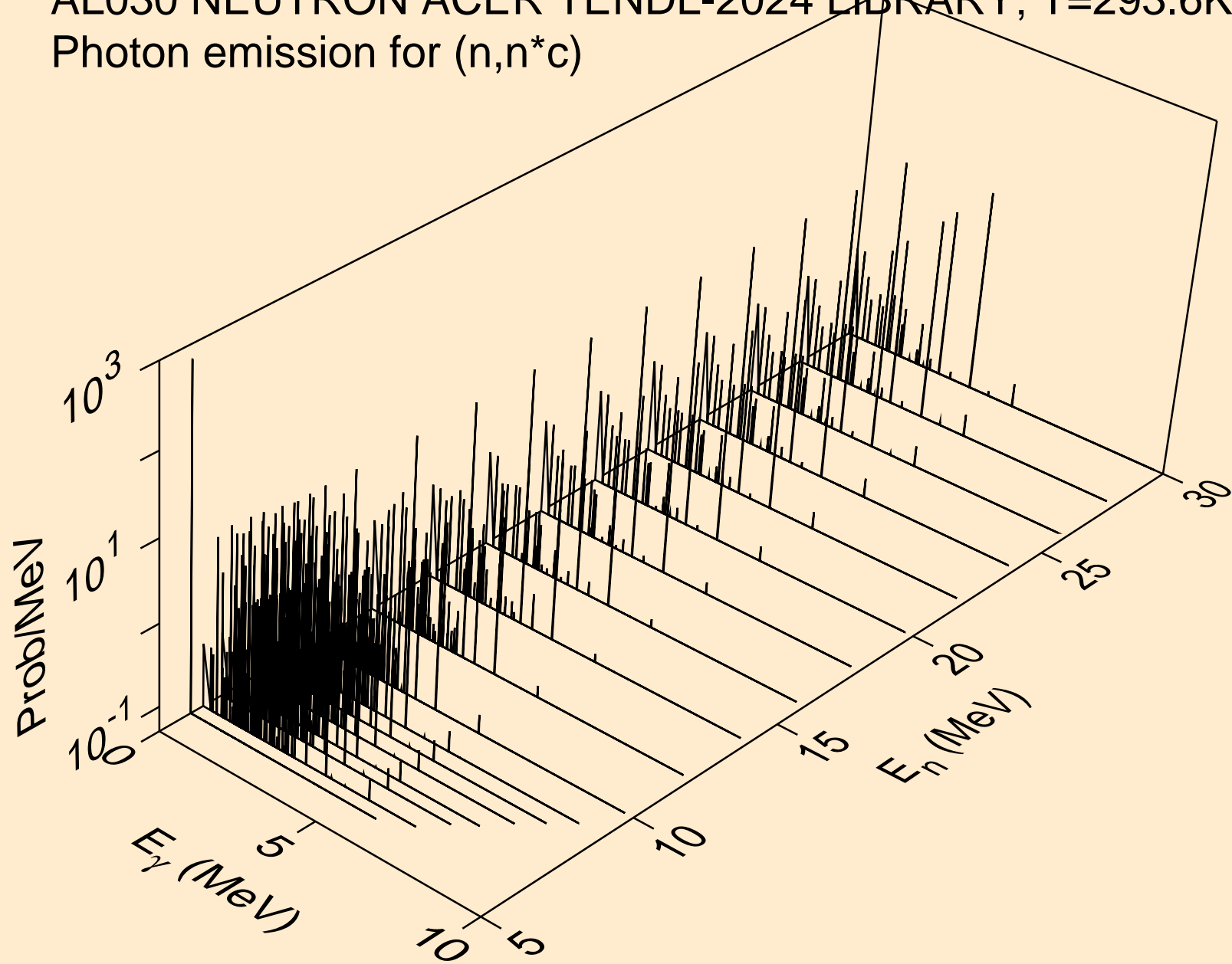

AL030 NEUTRON ACER TENDL-2024 LIBRARY; T=293.6K  
Photon emission for (n,gma)

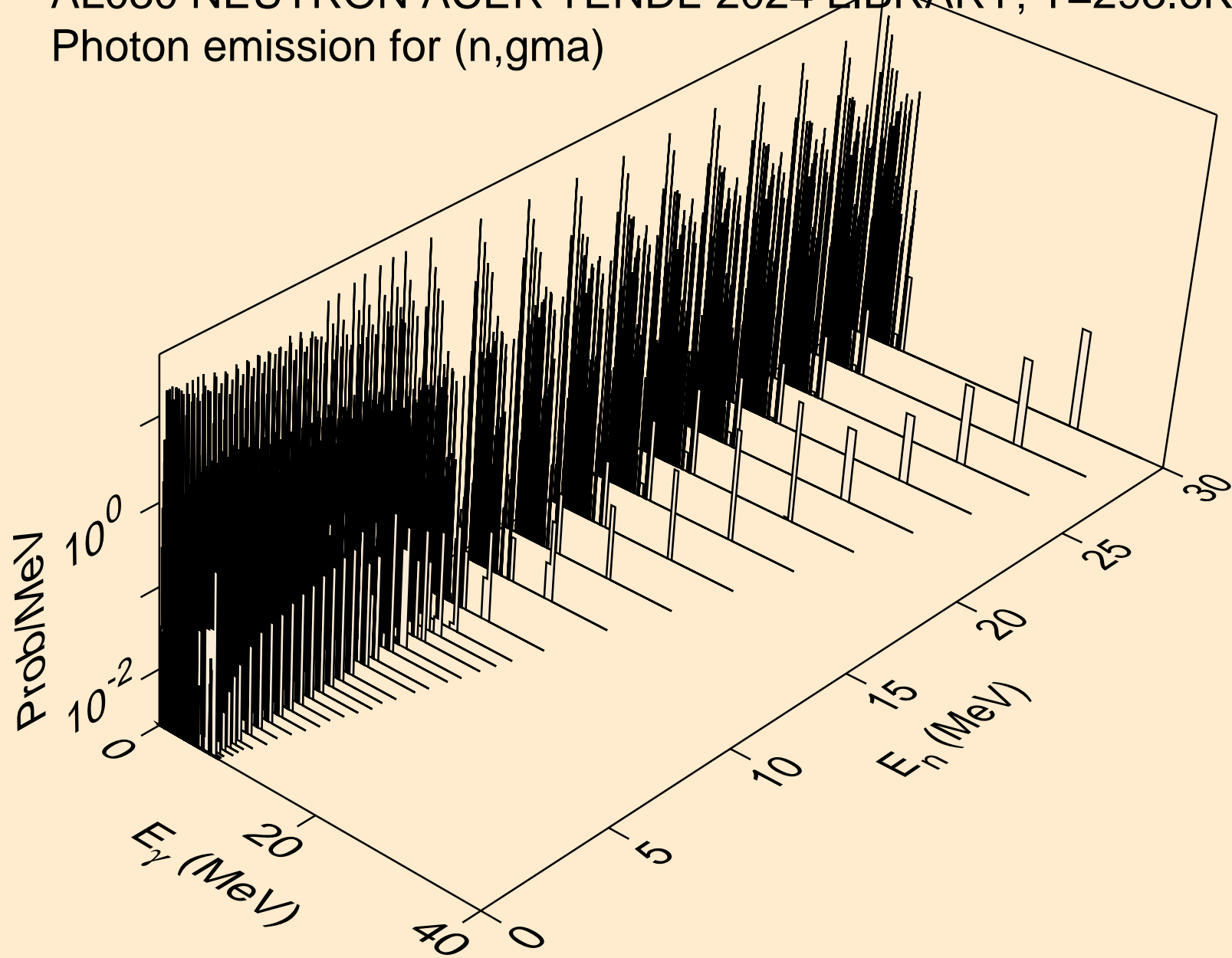

AL030 NEUTRON ACER TENDL-2024 LIBRARY; T=293.6K  
Photon emission for (n,p)

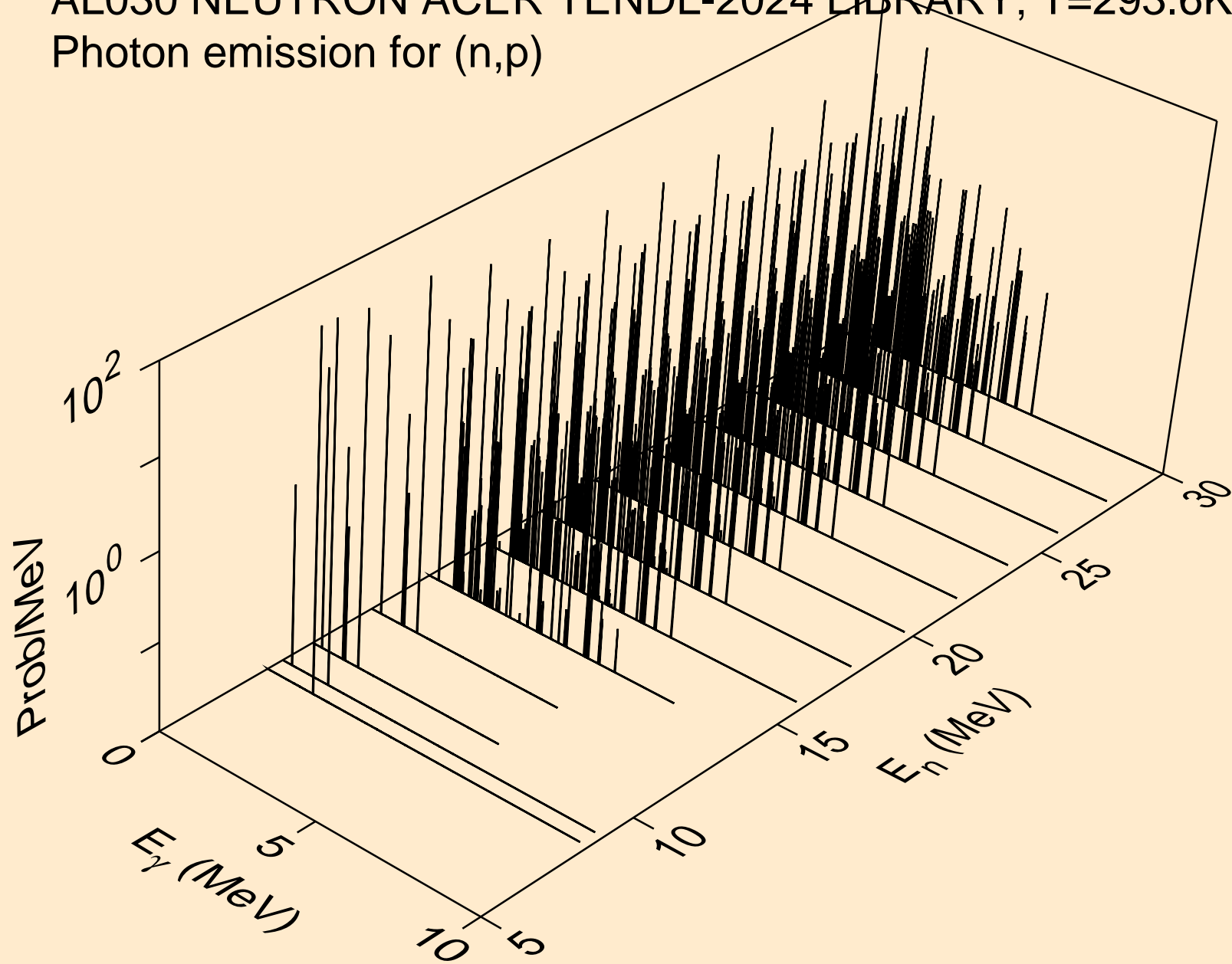

AL030 NEUTRON ACER TENDL-2024 LIBRARY; T=293.6K  
Photon emission for (n,d)

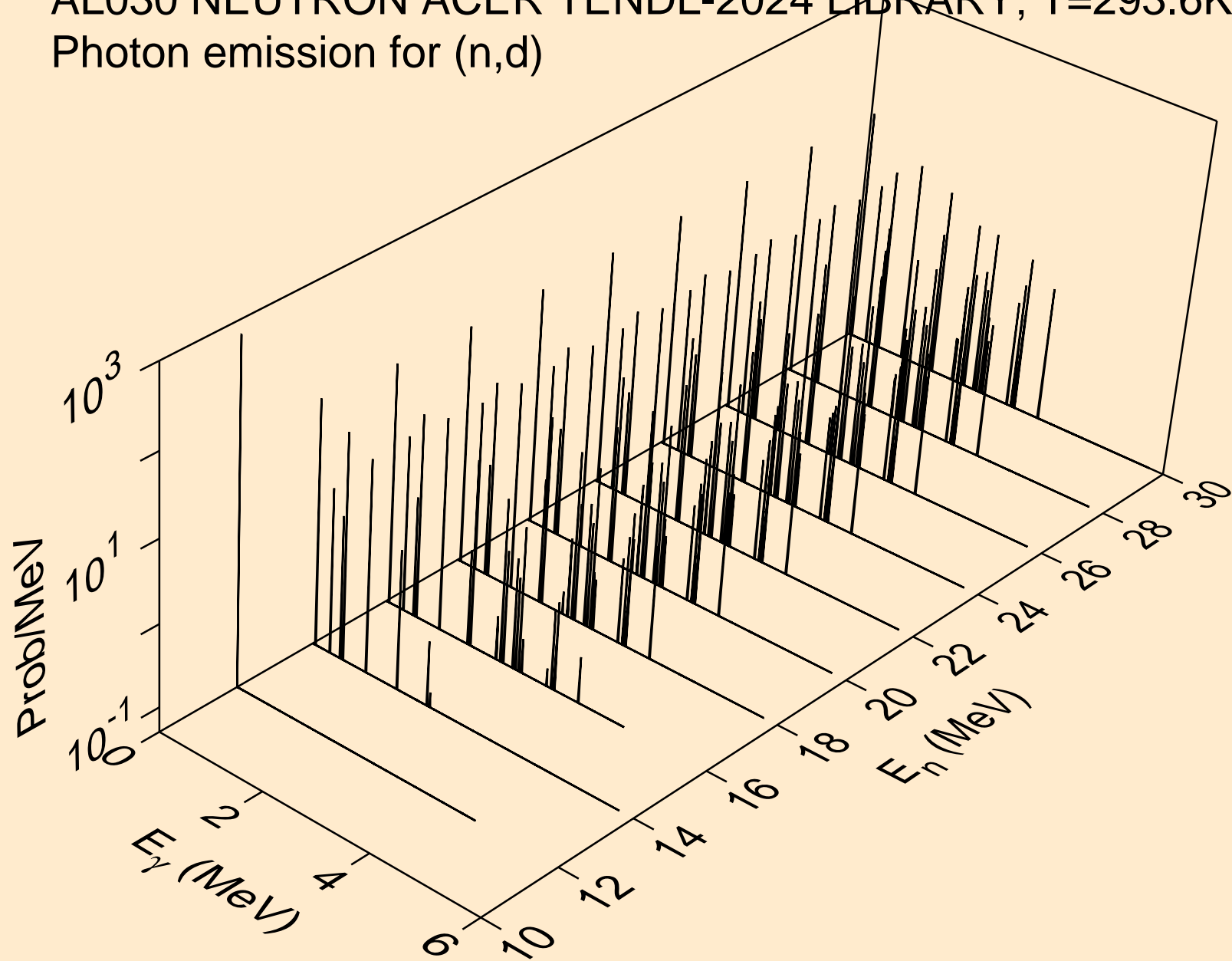

AL030 NEUTRON ACER TENDL-2024 LIBRARY; T=293.6K  
Photon emission for (n,t)

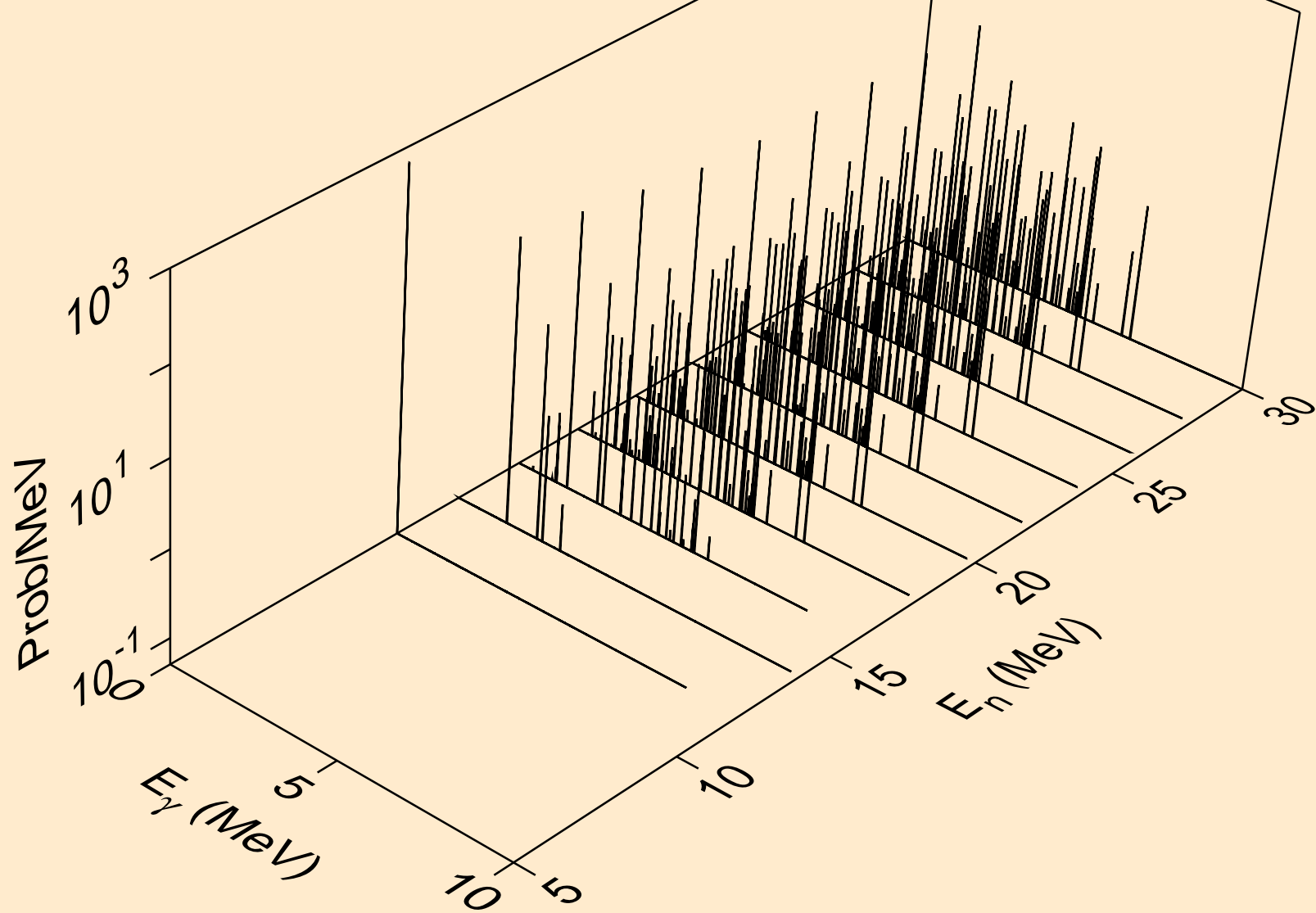

AL030 NEUTRON ACER TENDL-2024 LIBRARY; T=293.6K  
Photon emission for (n,he3)

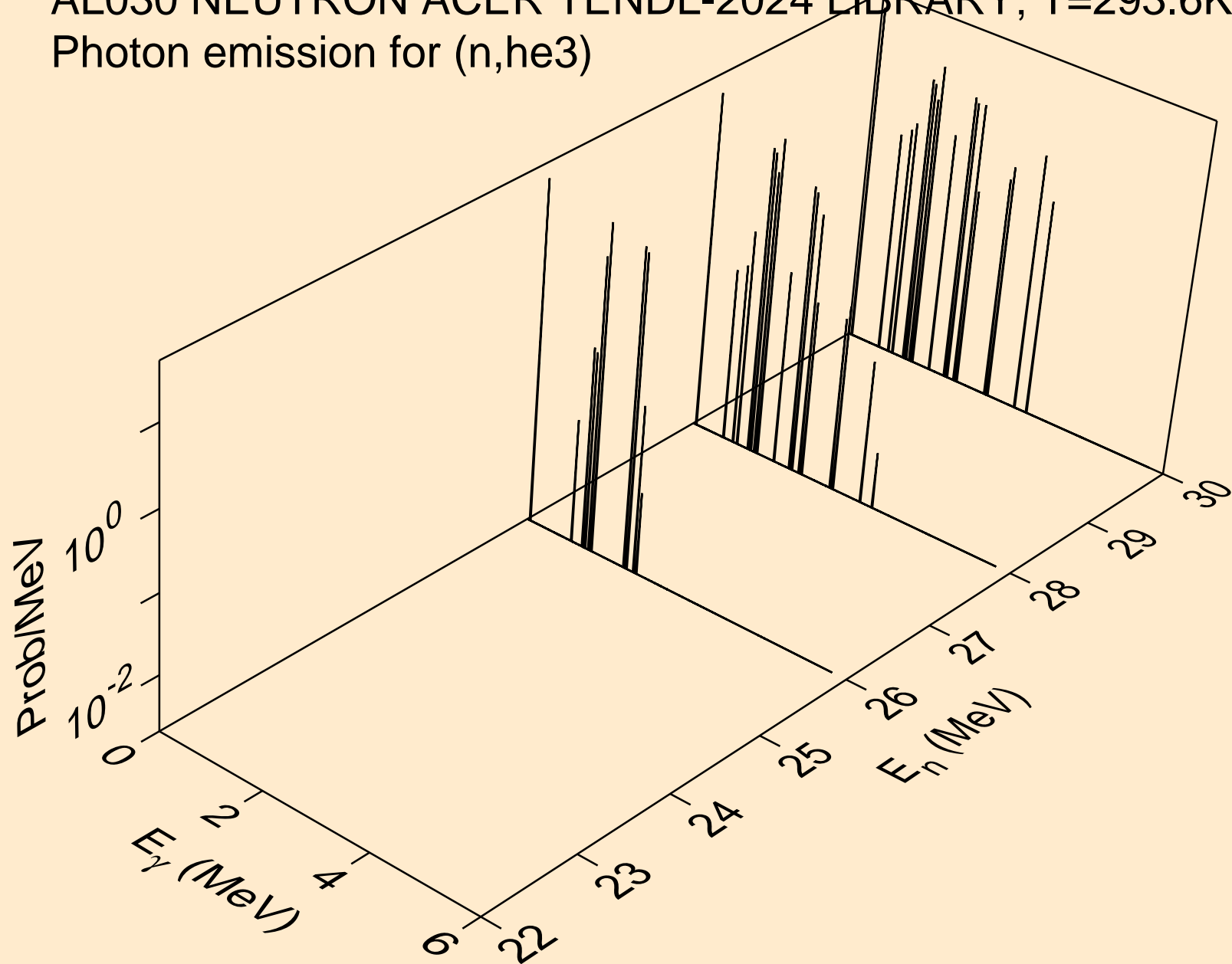

AL030 NEUTRON ACER TENDL-2024 LIBRARY; T=293.6K  
Photon emission for (n,a)

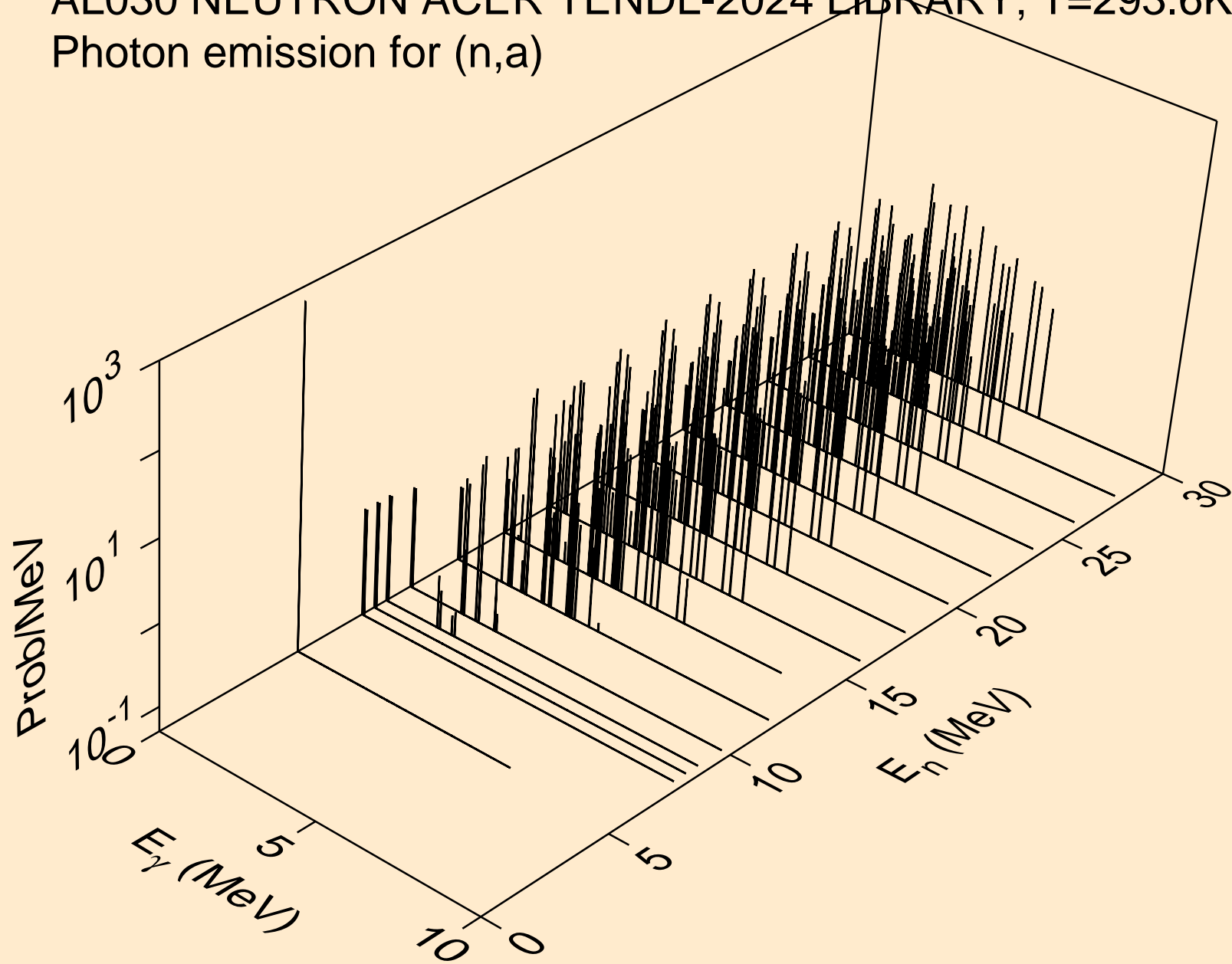

AL030 NEUTRON ACER TENDL-2024 LIBRARY; T=293.6K  
Photon emission for (n,2a)

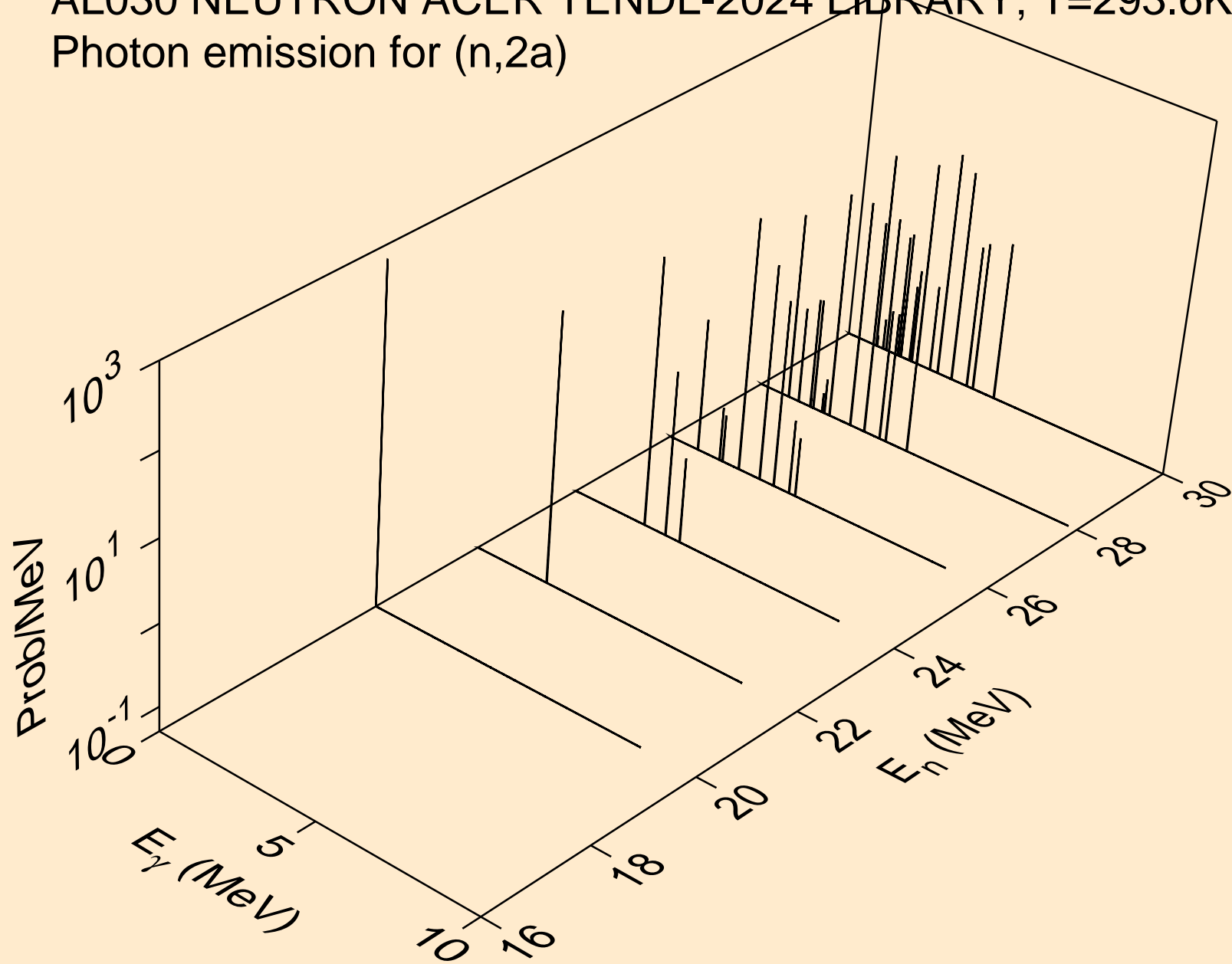

AL030 NEUTRON ACER TENDL-2024 LIBRARY; T=293.6K  
Photon emission for (n,2p)

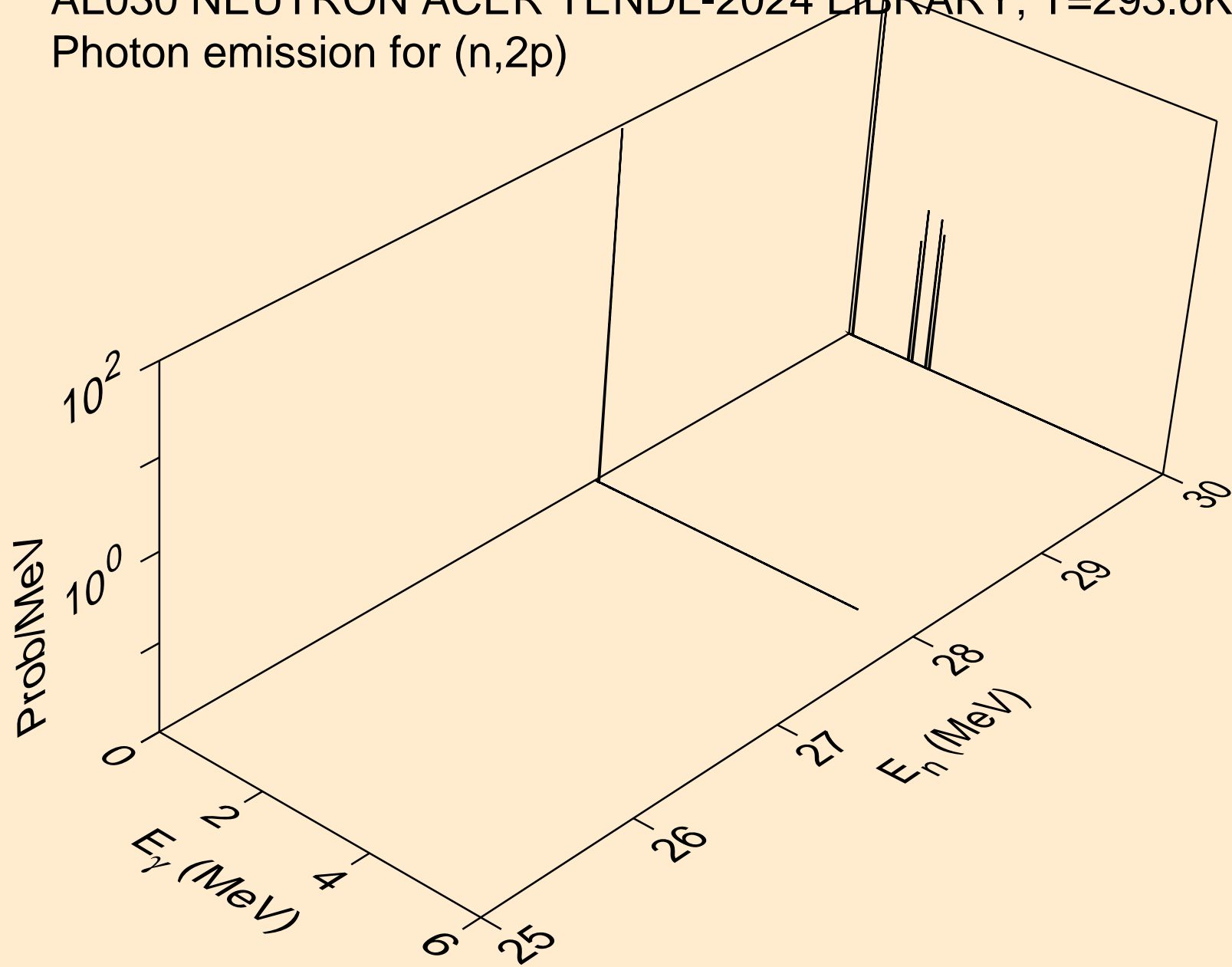

AL030 NEUTRON ACER TENDL-2024 LIBRARY; T=293.6K  
Photon emission for (n,p $\alpha$ )

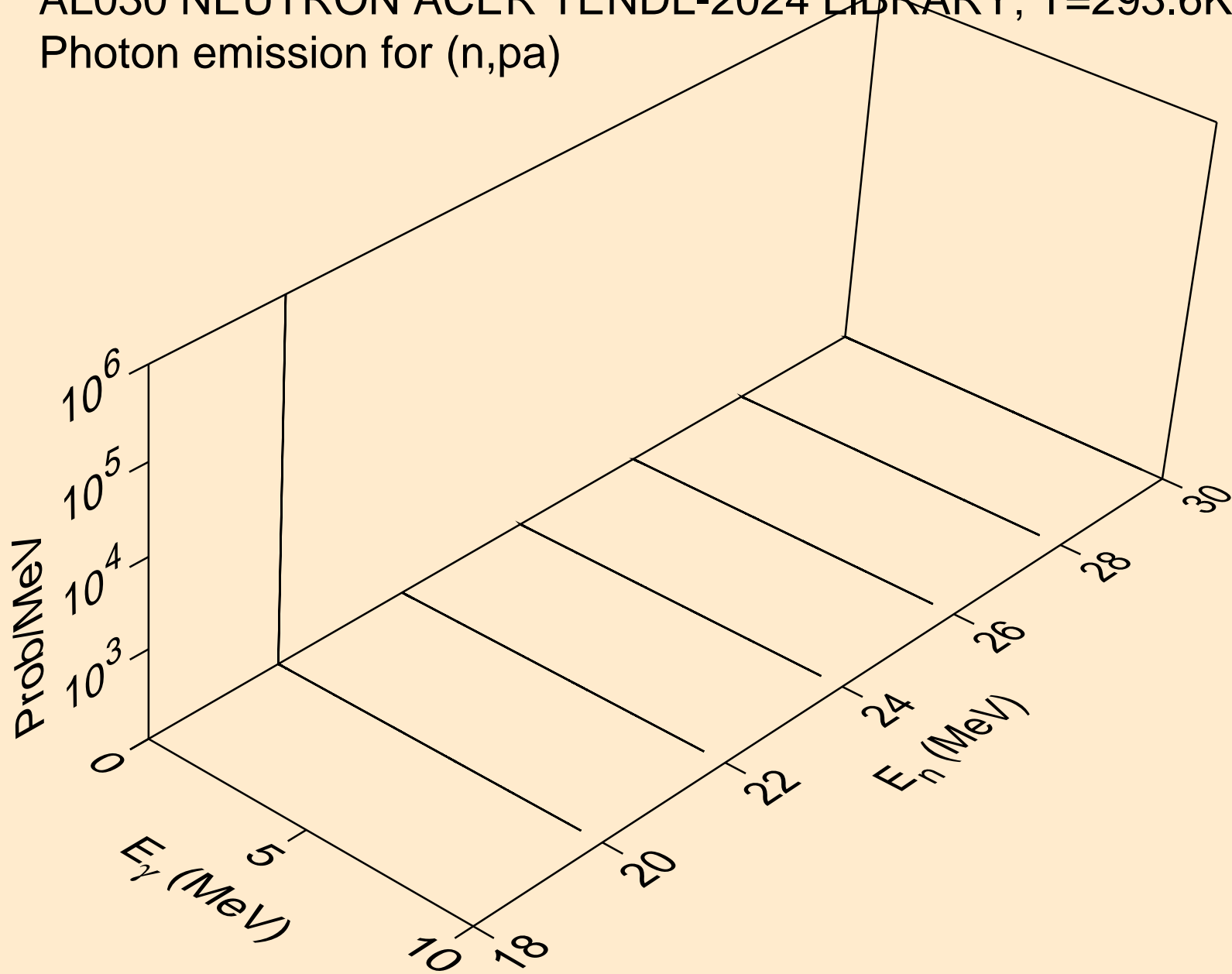

AL030 NEUTRON ACER TENDL-2024 LIBRARY; T=293.6K  
Photon emission for (n,pt)

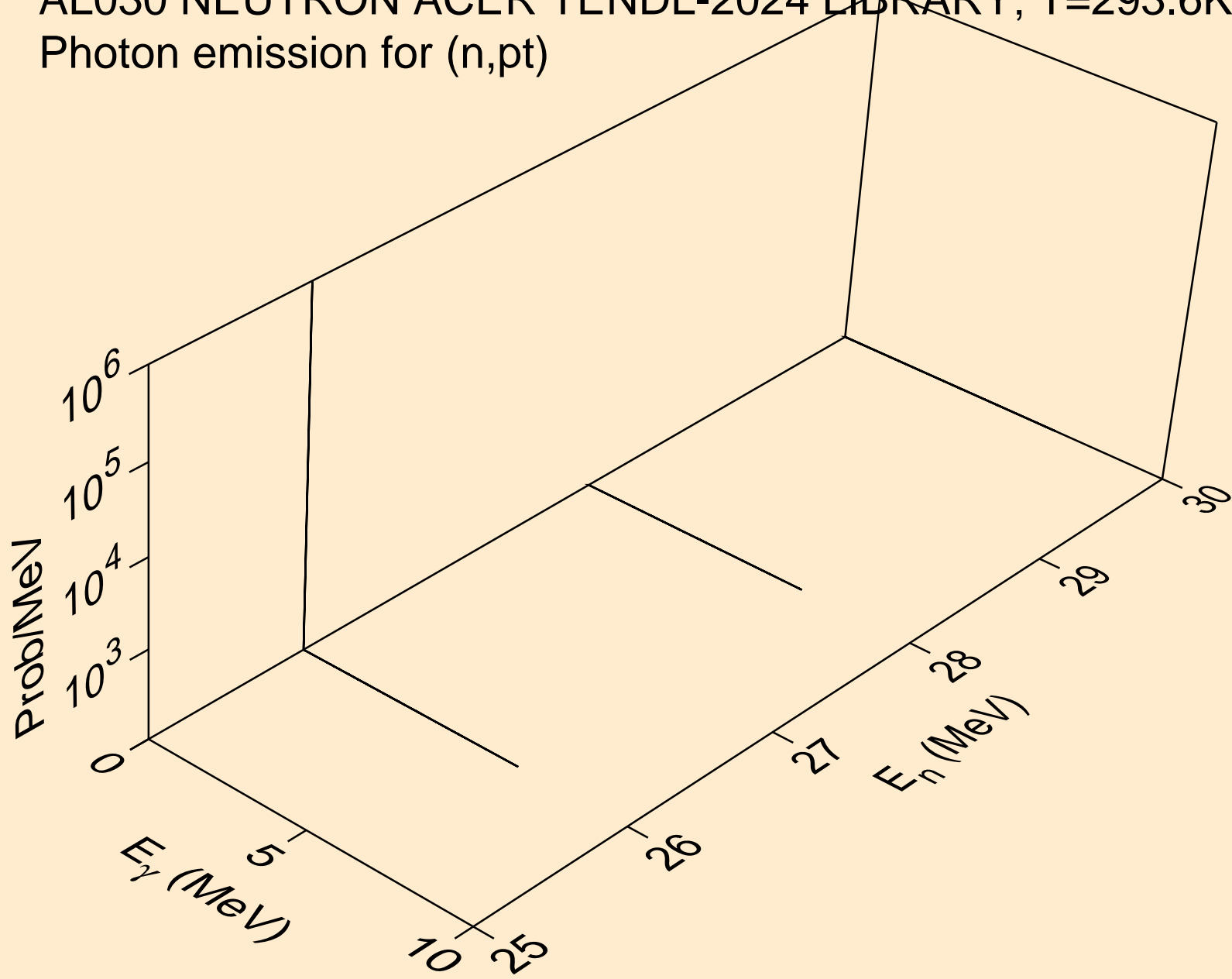

AL030 NEUTRON ACER TENDL-2024 LIBRARY; T=293.6K  
Photon emission for (n,da)

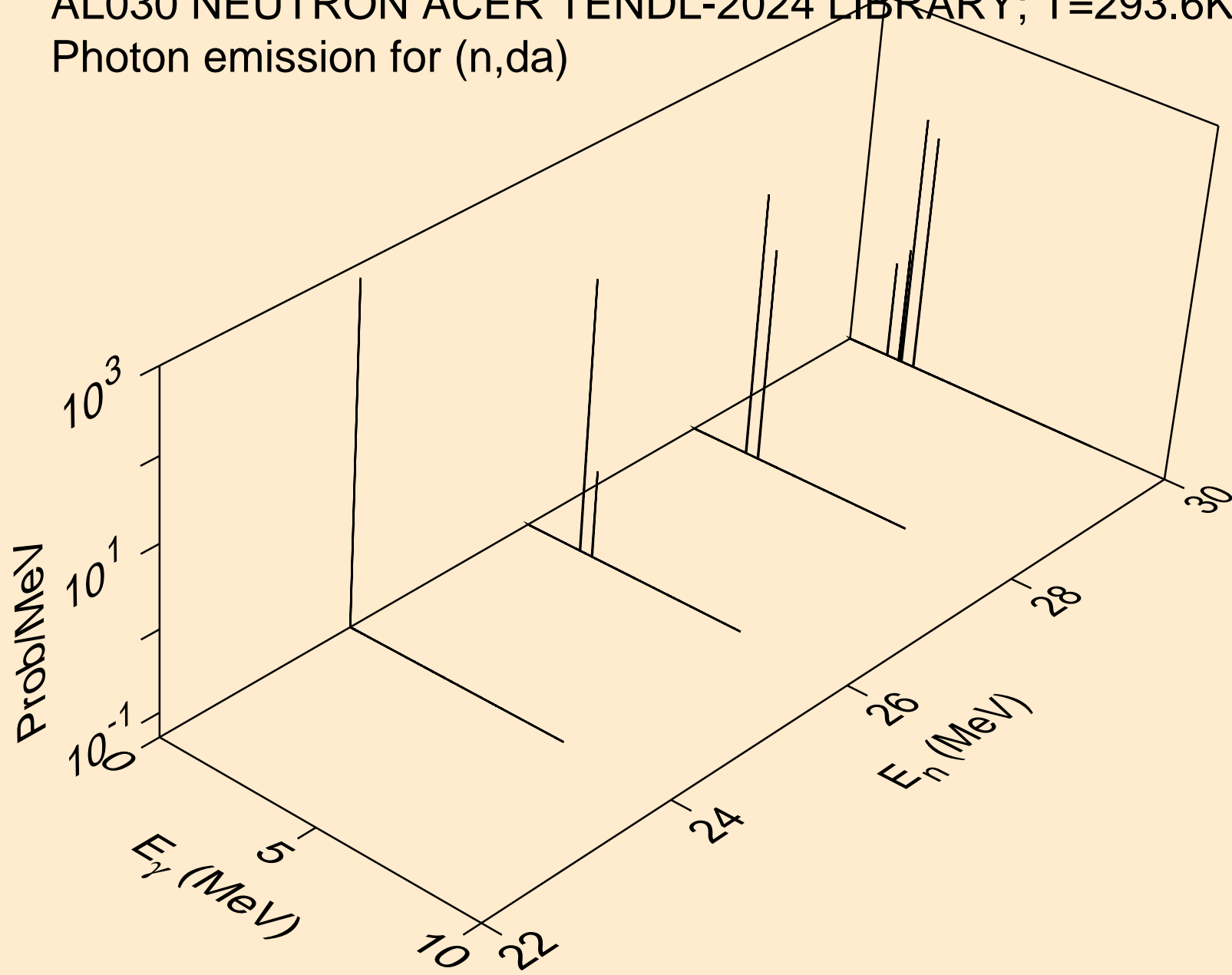

AL030 NEUTRON ACER TENDL-2024 LIBRARY; T=293.6K  
thermal capture photon spectrum

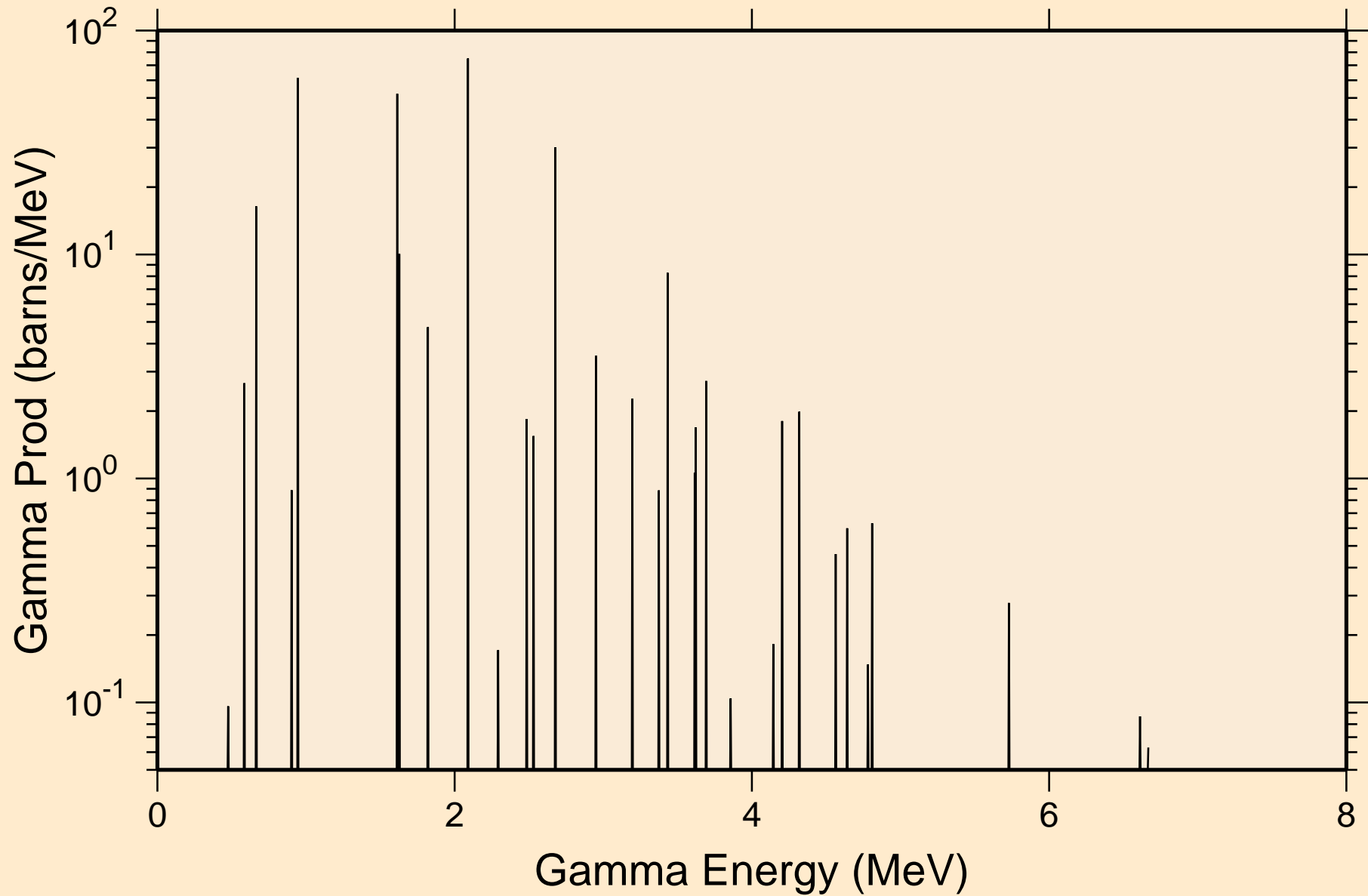

AL030 NEUTRON ACER TENDL-2024 LIBRARY; T=293.6K  
14 MeV photon spectrum

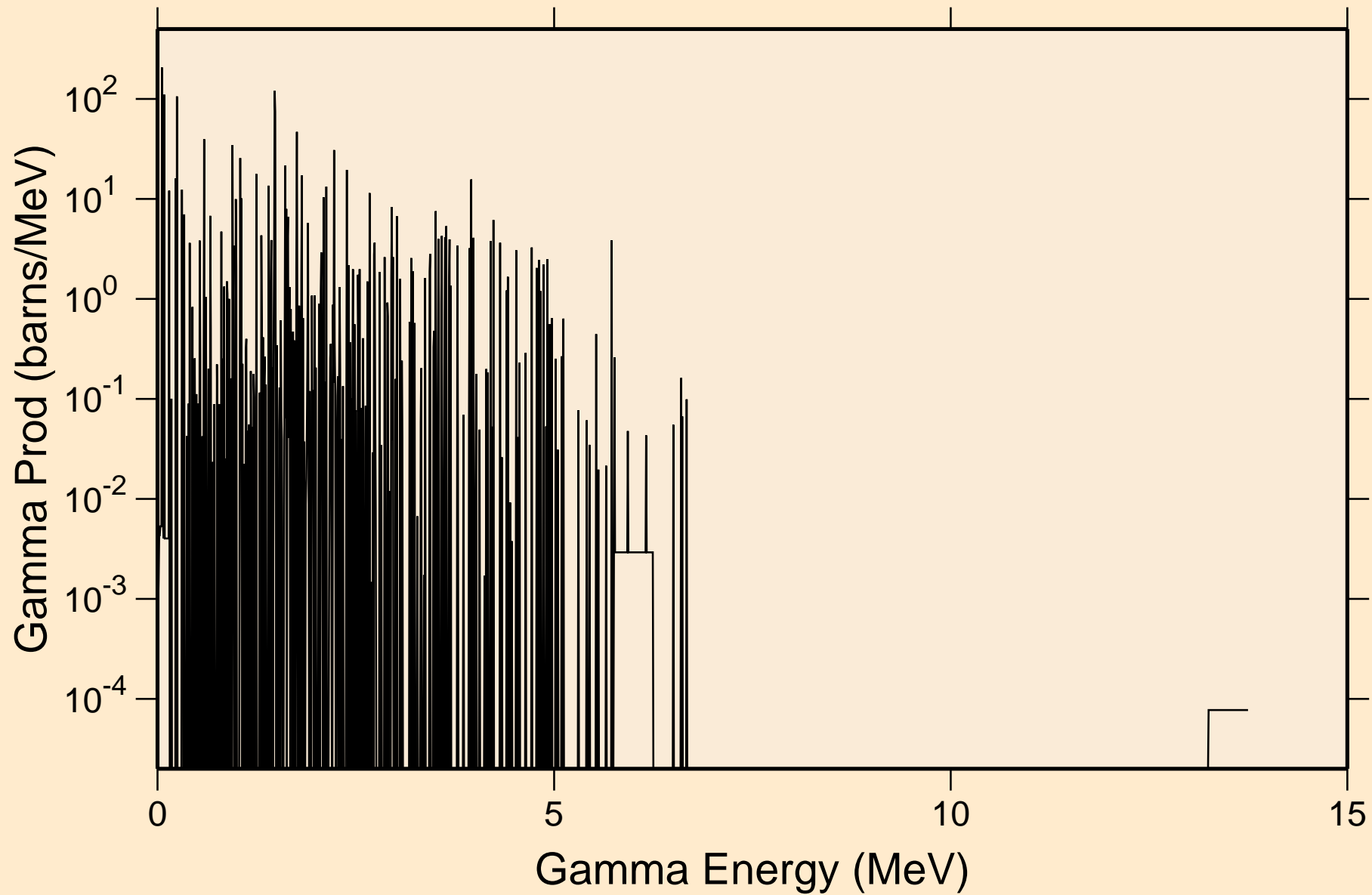

AL030 NEUTRON ACER TENDL-2024 LIBRARY; T=293.6K  
Particle heating contributions

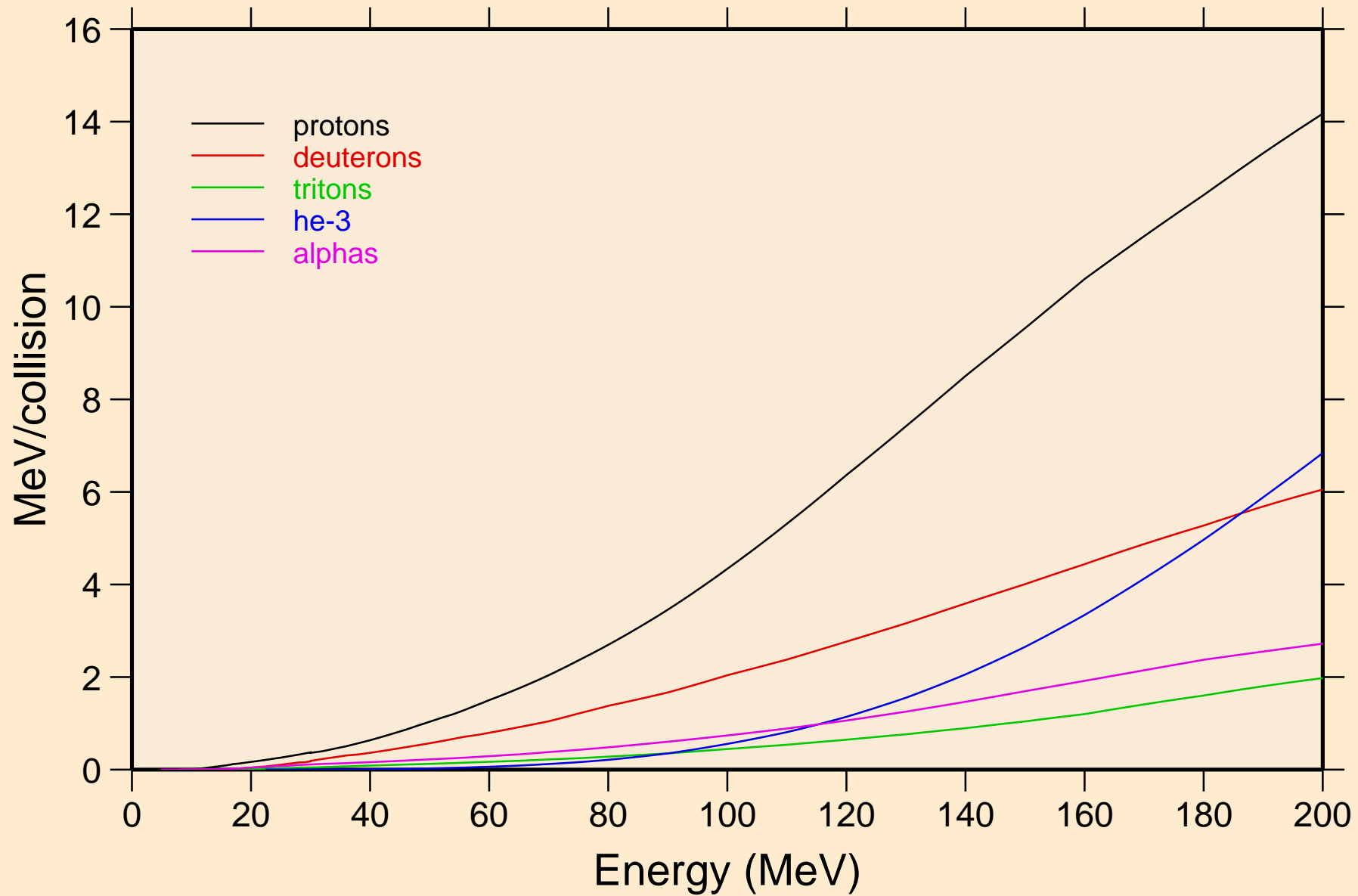

AL030 NEUTRON ACER TENDL-2024 LIBRARY; T=293.6K  
Recoil Heating

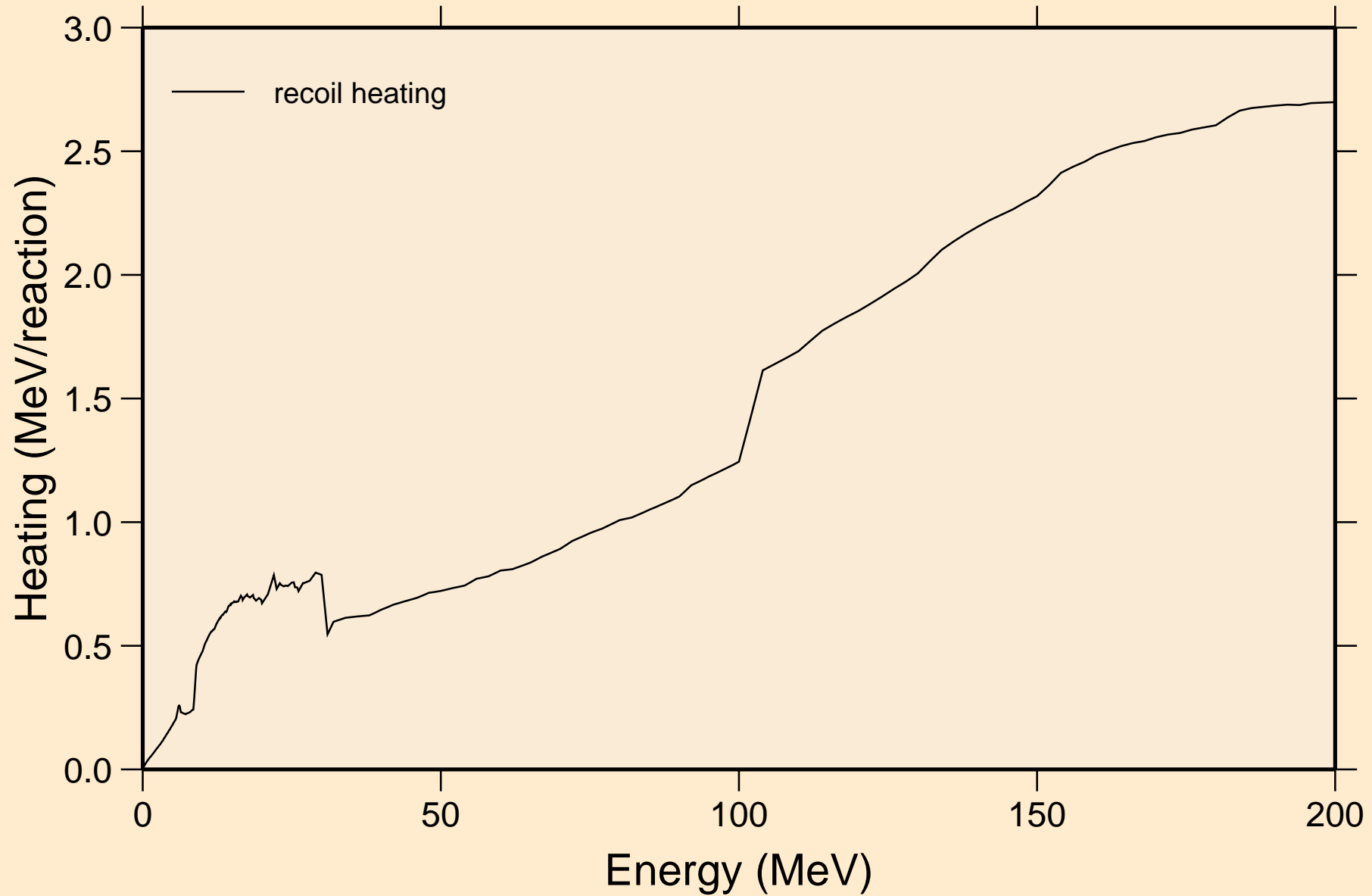

AL030 NEUTRON ACER TENDL-2024 LIBRARY; T=293.6K  
Particle production cross sections

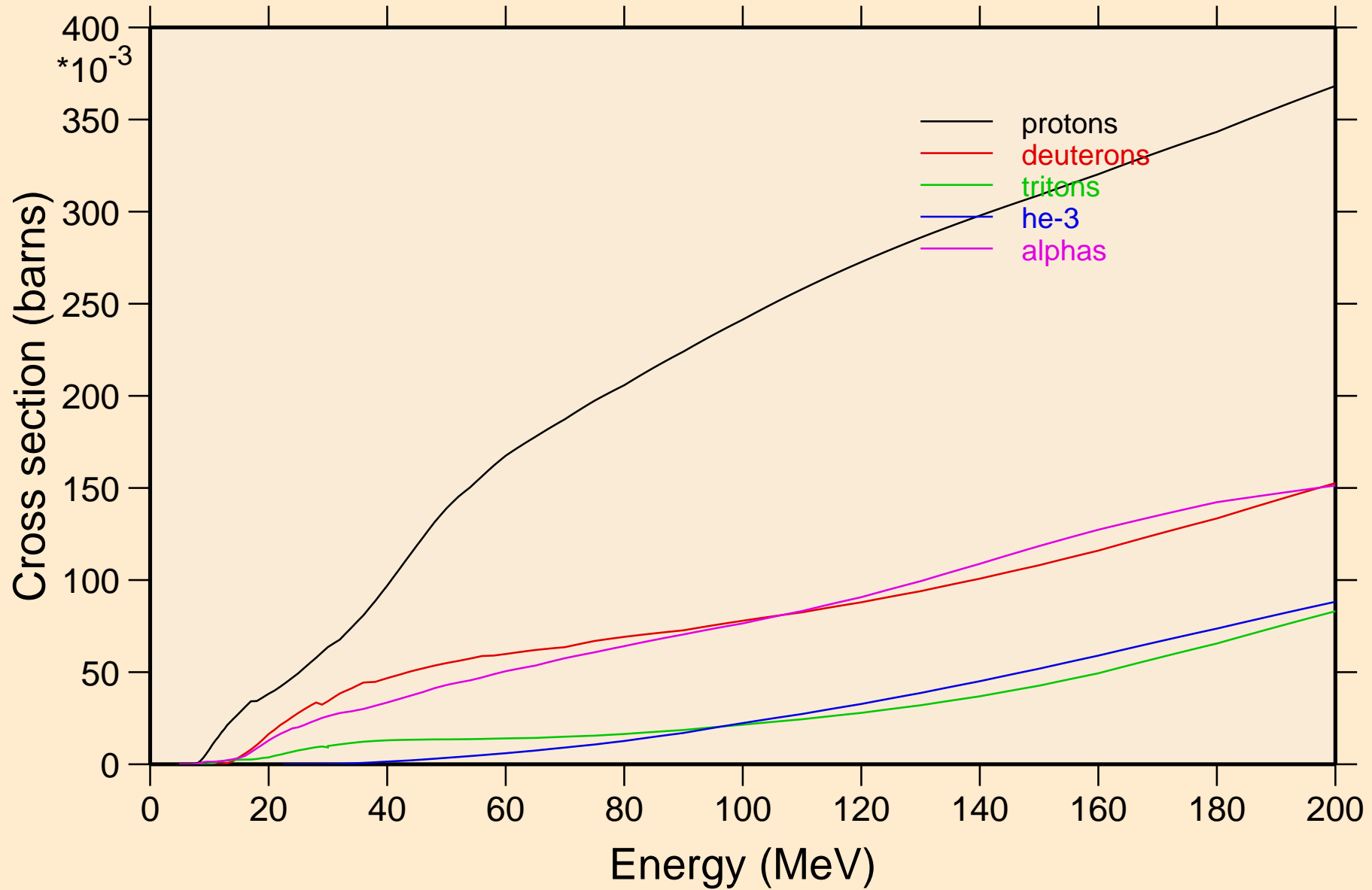

AL030 NEUTRON ACER TENDL-2024 LIBRARY; T=293.6K  
protons from (n,x)

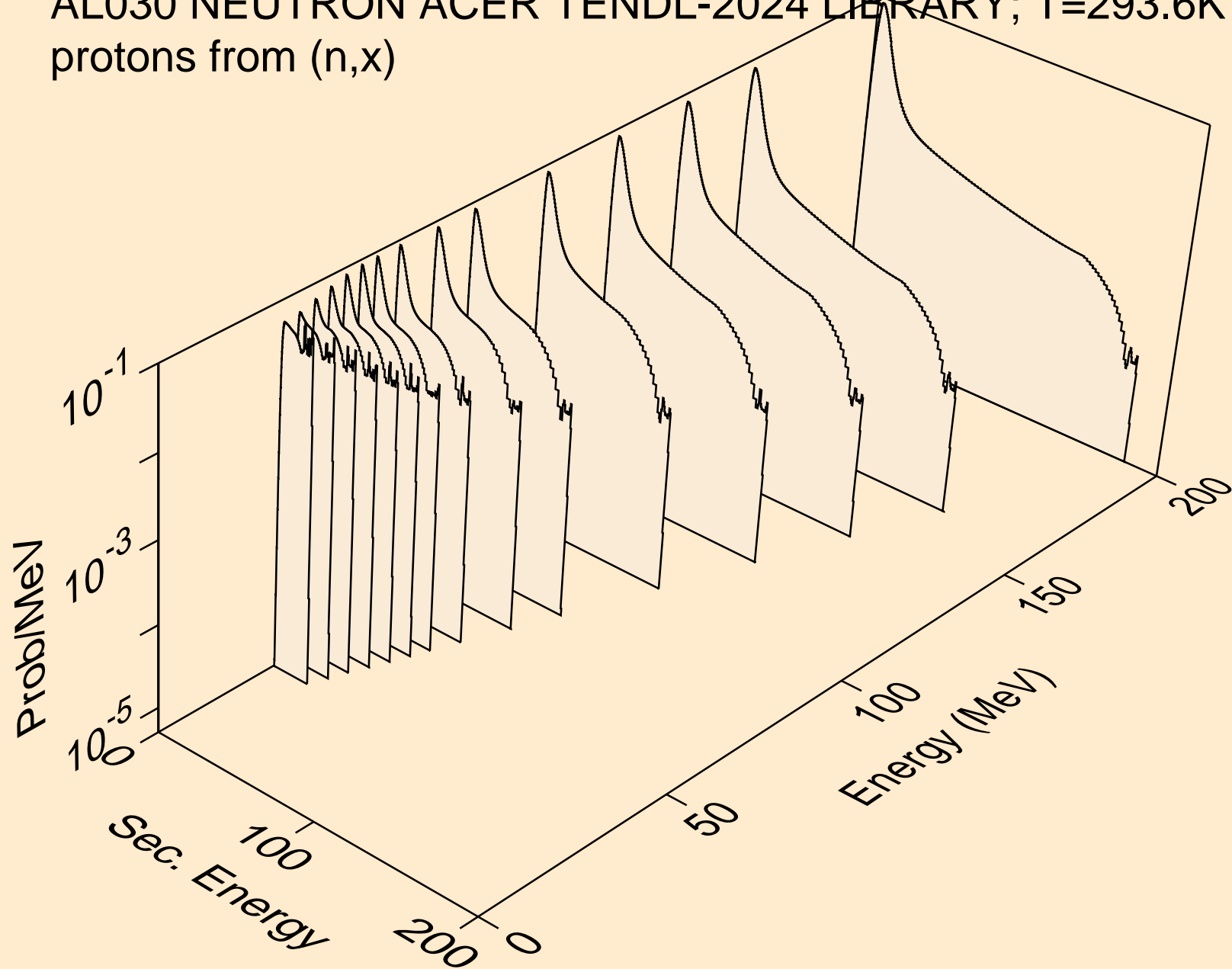

AL030 NEUTRON ACER TENDL-2024 LIBRARY; T=293.6K  
protons from (n,n\*)p

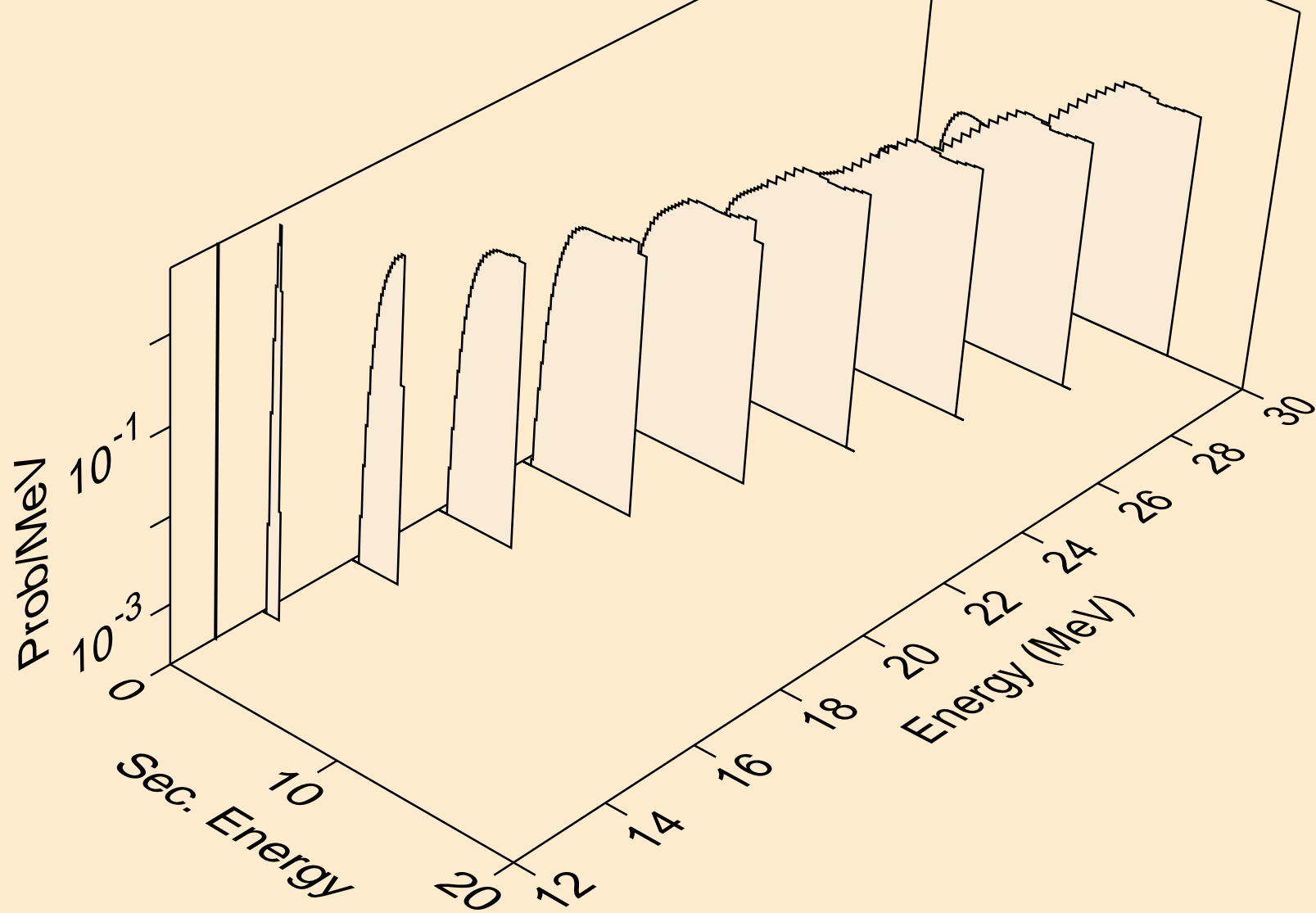

AL030 NEUTRON ACER TENDL-2024 LIBRARY; T=293.6K  
protons from (n,2np)

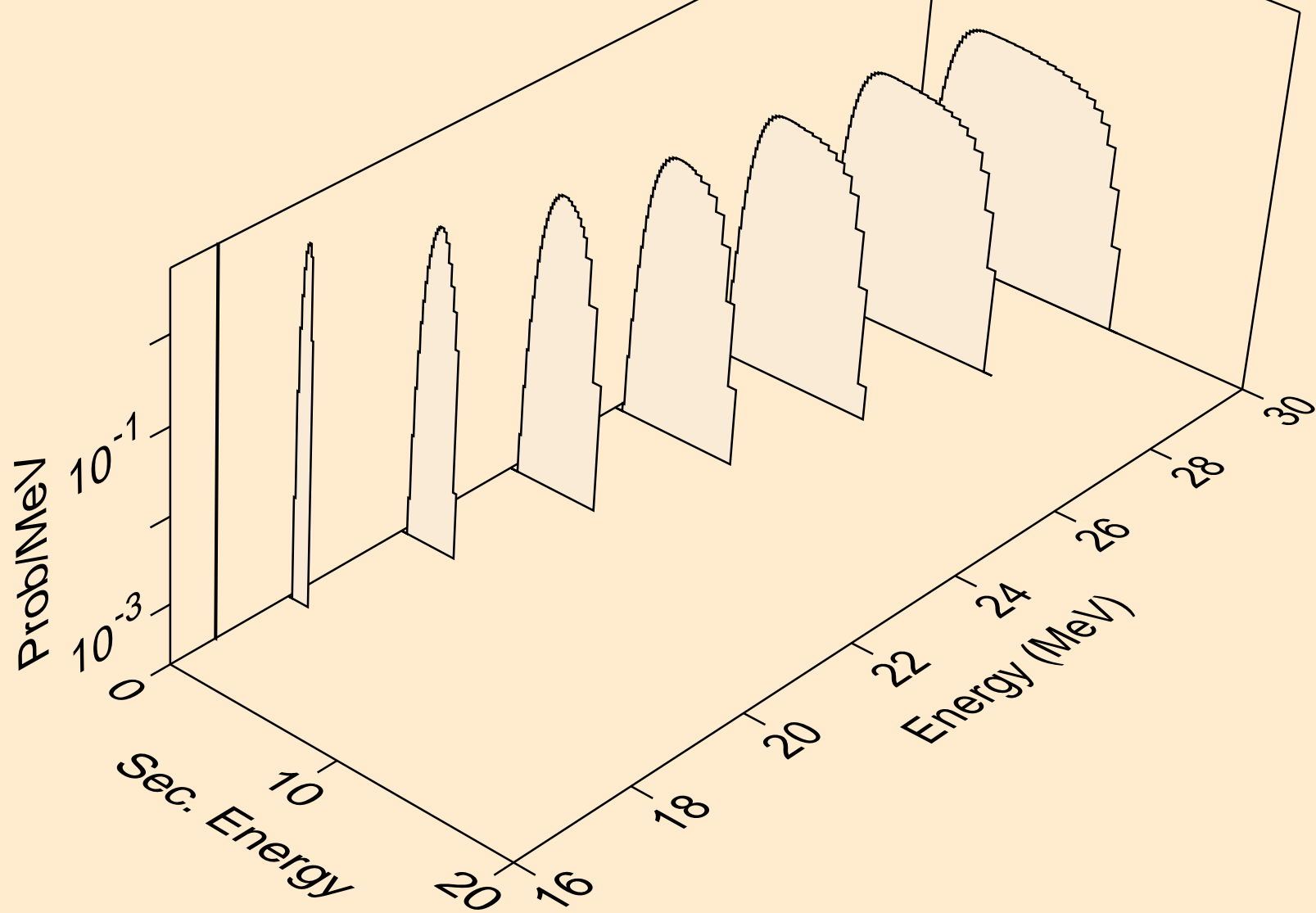

AL030 NEUTRON ACER TENDL-2024 LIBRARY; T=293.6K  
protons from (n,3np)

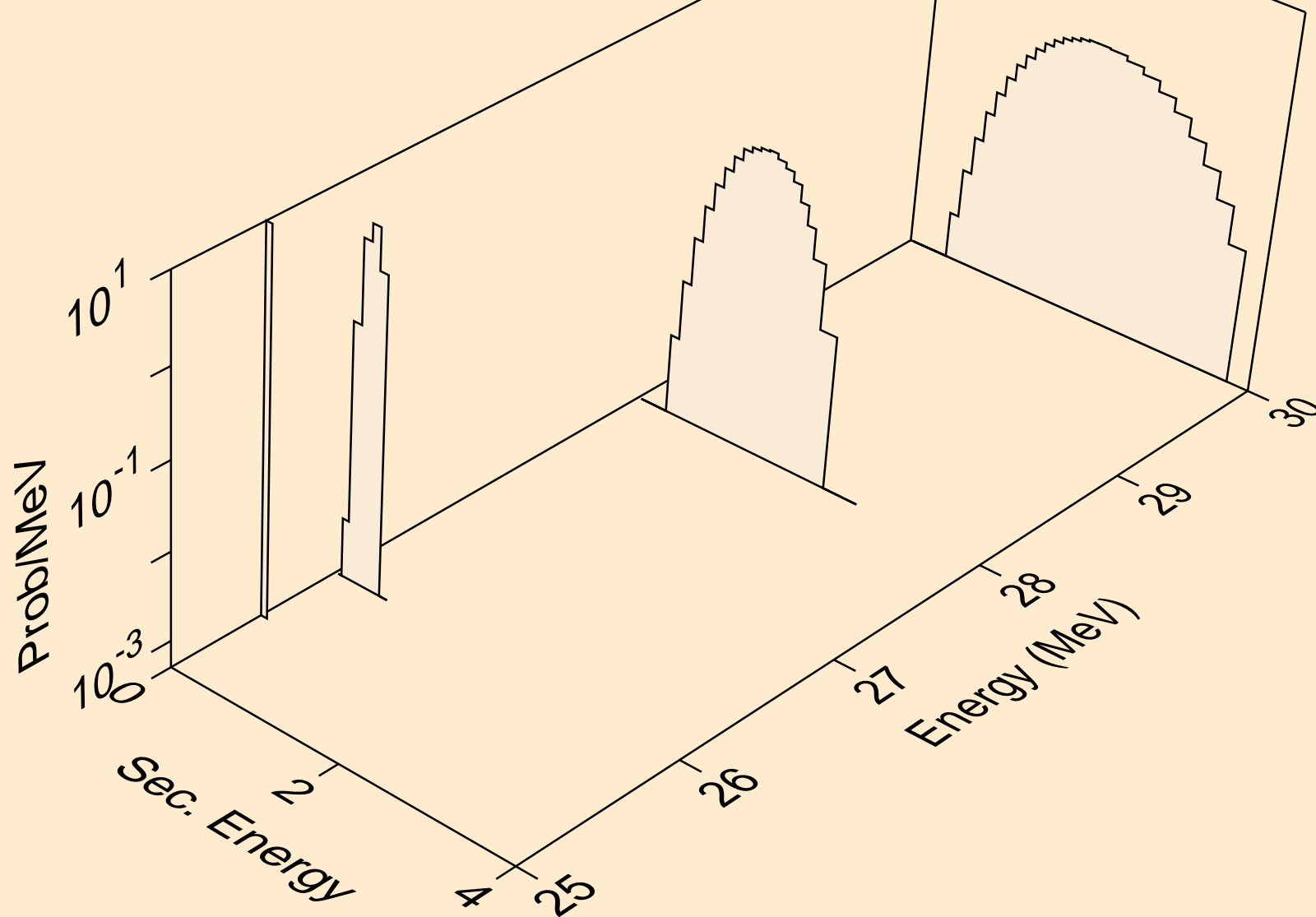

AL030 NEUTRON ACER TENDL-2024 LIBRARY; T=293.6K  
protons from (n,npa)

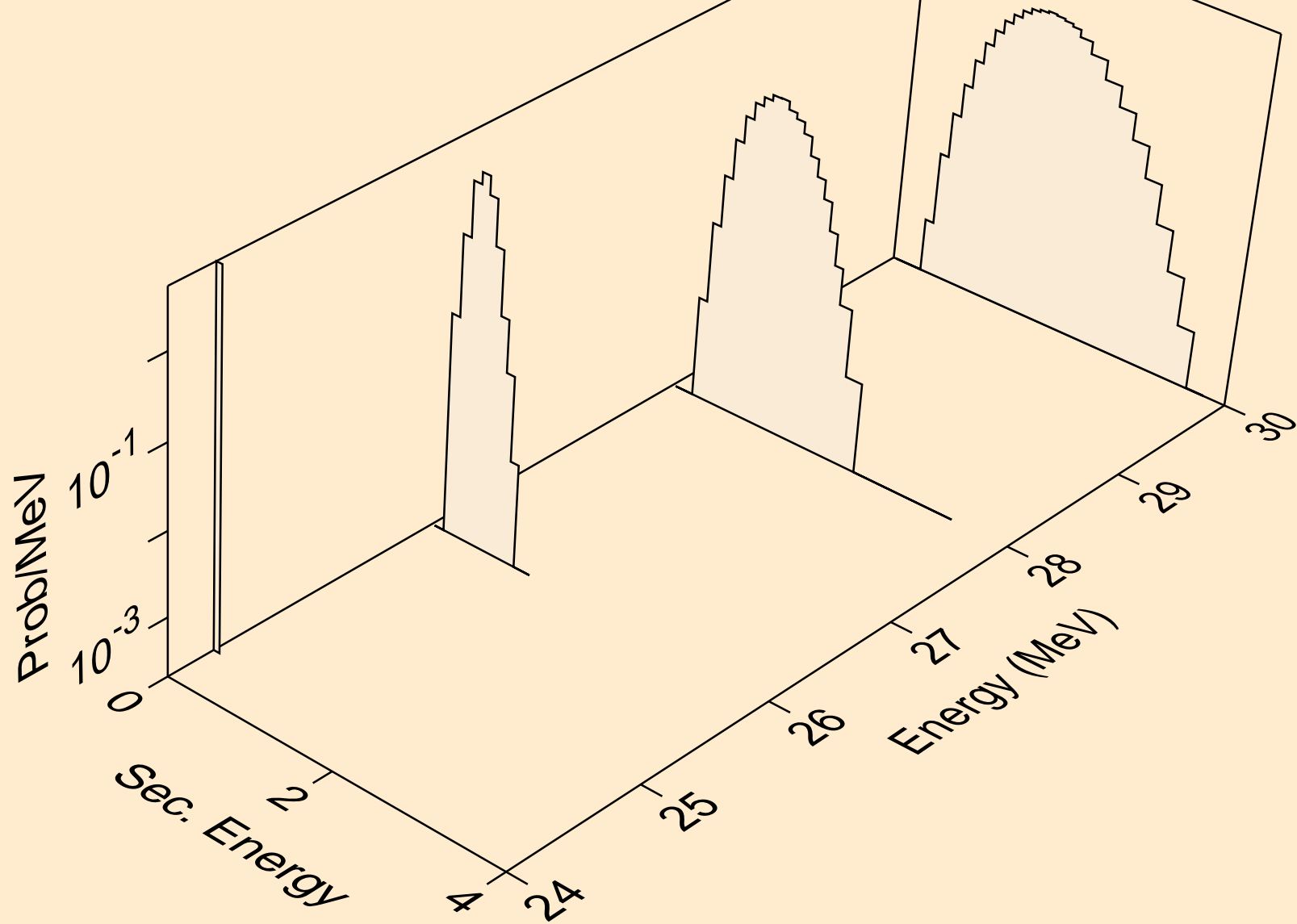

AL030 NEUTRON ACER TENDL-2024 LIBRARY; T=293.6K  
protons from (n,p)

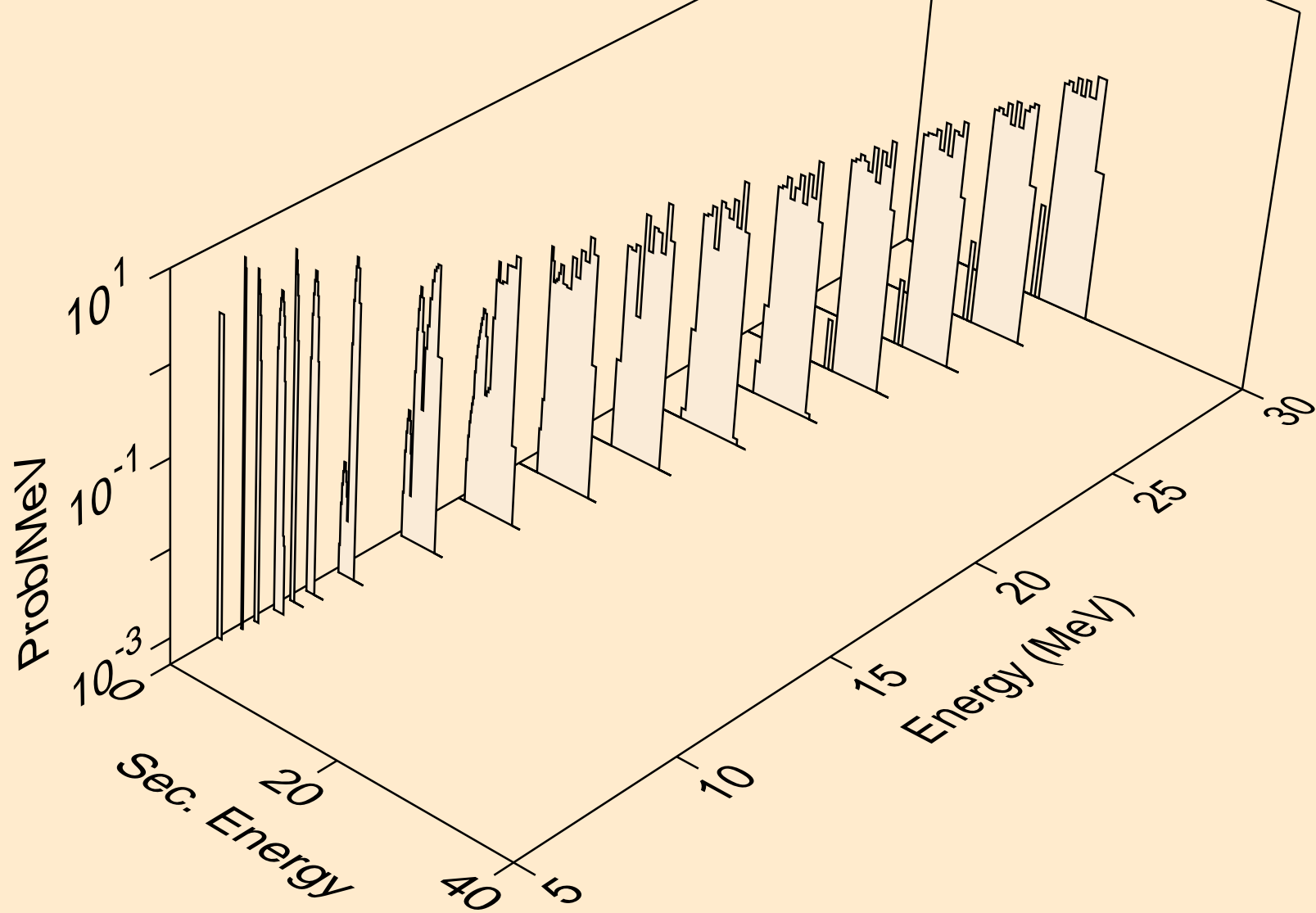

AL030 NEUTRON ACER TENDL-2024 LIBRARY; T=293.6K  
protons from (n,2p)

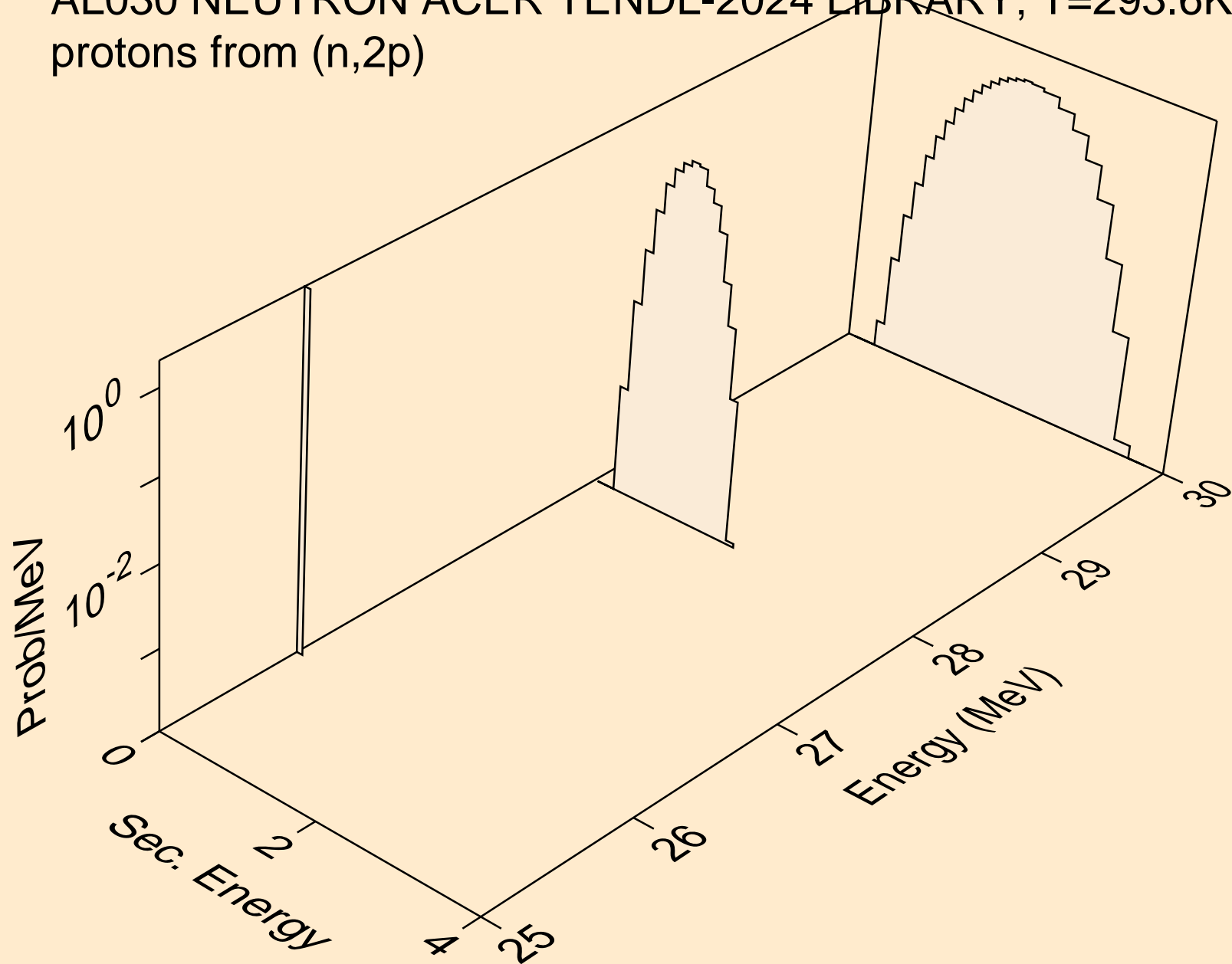

AL030 NEUTRON ACER TENDL-2024 LIBRARY; T=293.6K  
protons from (n,p)

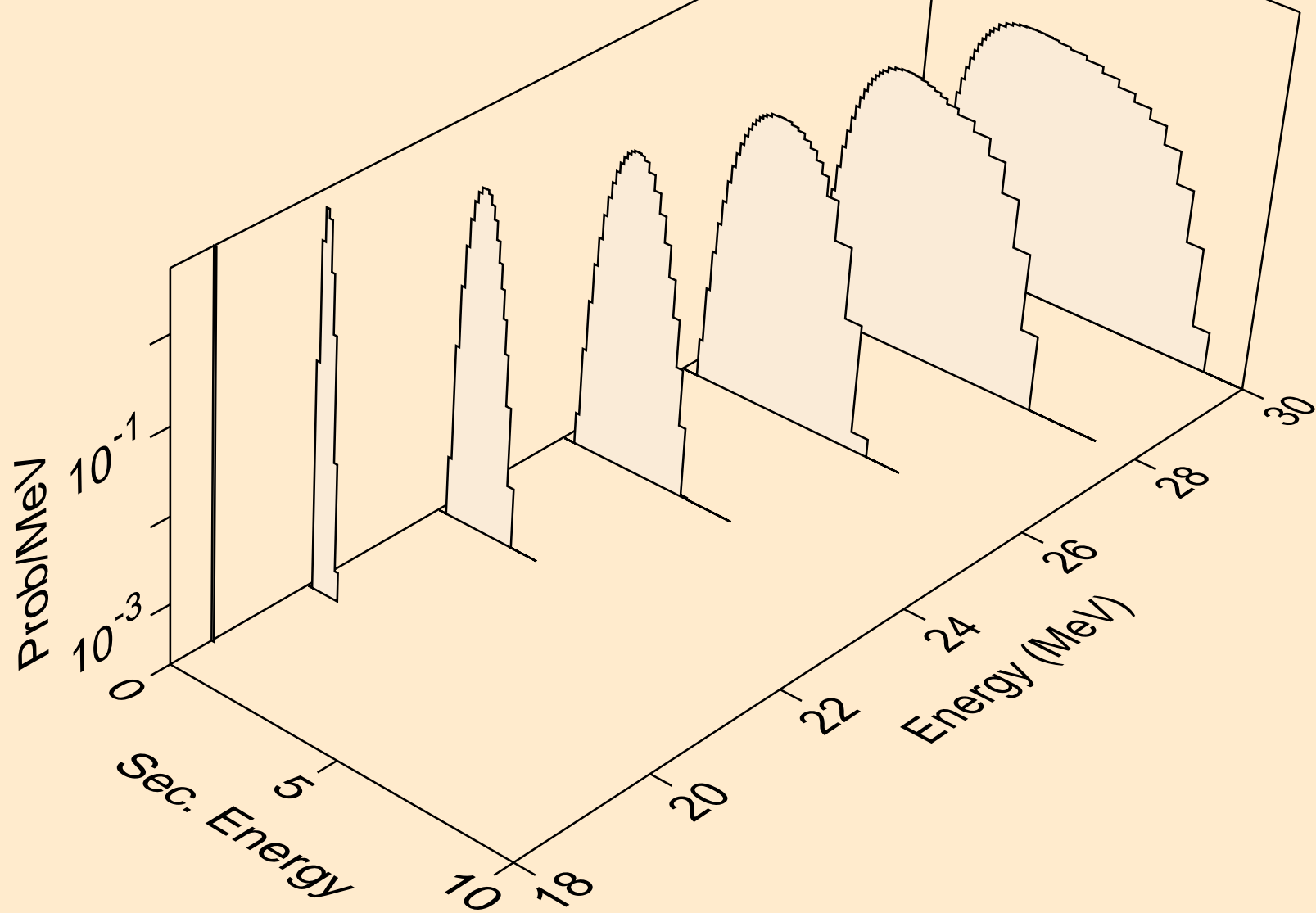

AL030 NEUTRON ACER TENDL-2024 LIBRARY; T=293.6K  
protons from (n,pt)

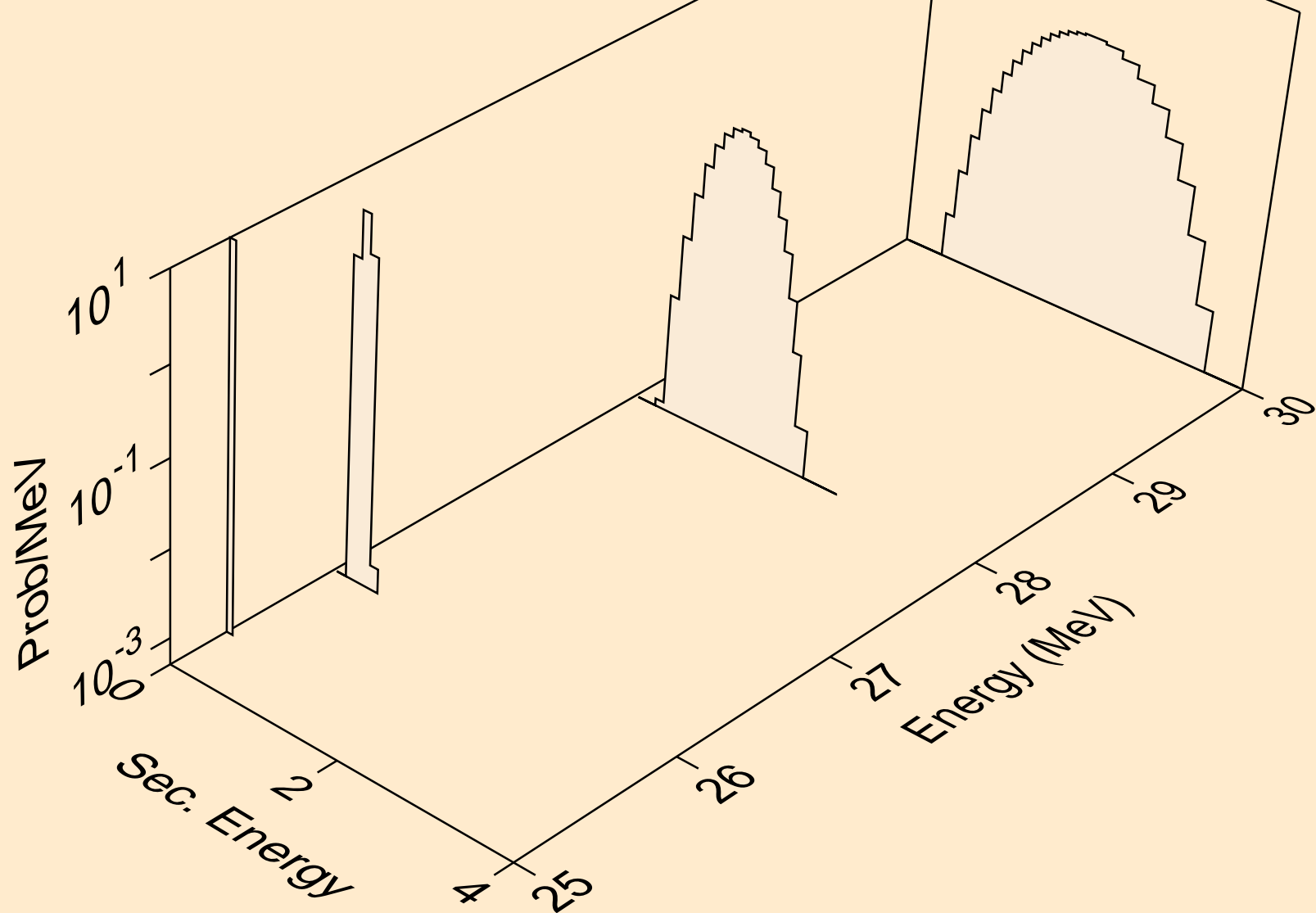

AL030 NEUTRON ACER TENDL-2024 LIBRARY; T=293.6K  
deuterons from (n,x)

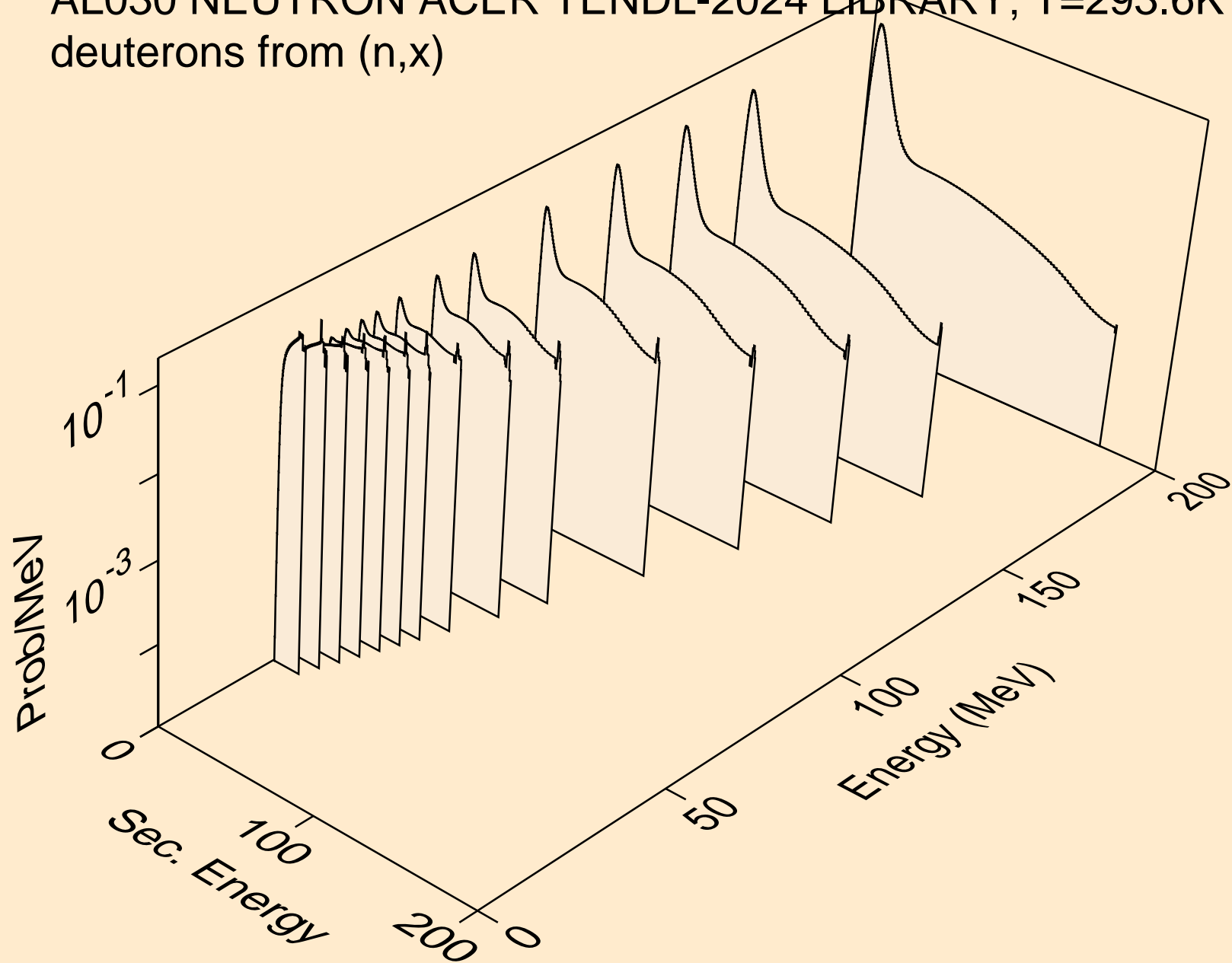

AL030 NEUTRON ACER TENDL-2024 LIBRARY; T=293.6K  
deuterons from (n,2nd)

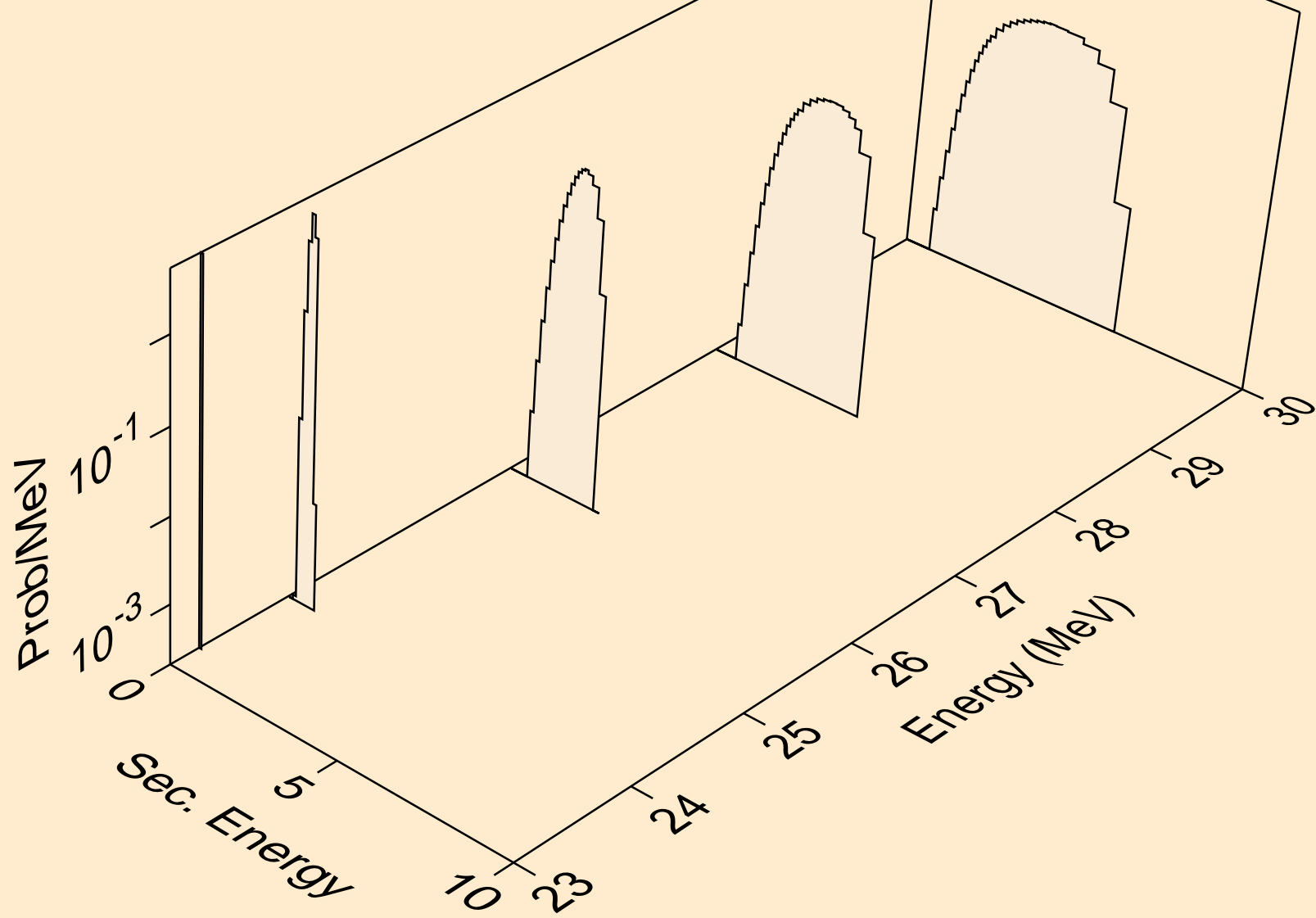

AL030 NEUTRON ACER TENDL-2024 LIBRARY; T=293.6K  
deuterons from (n,n\*)d

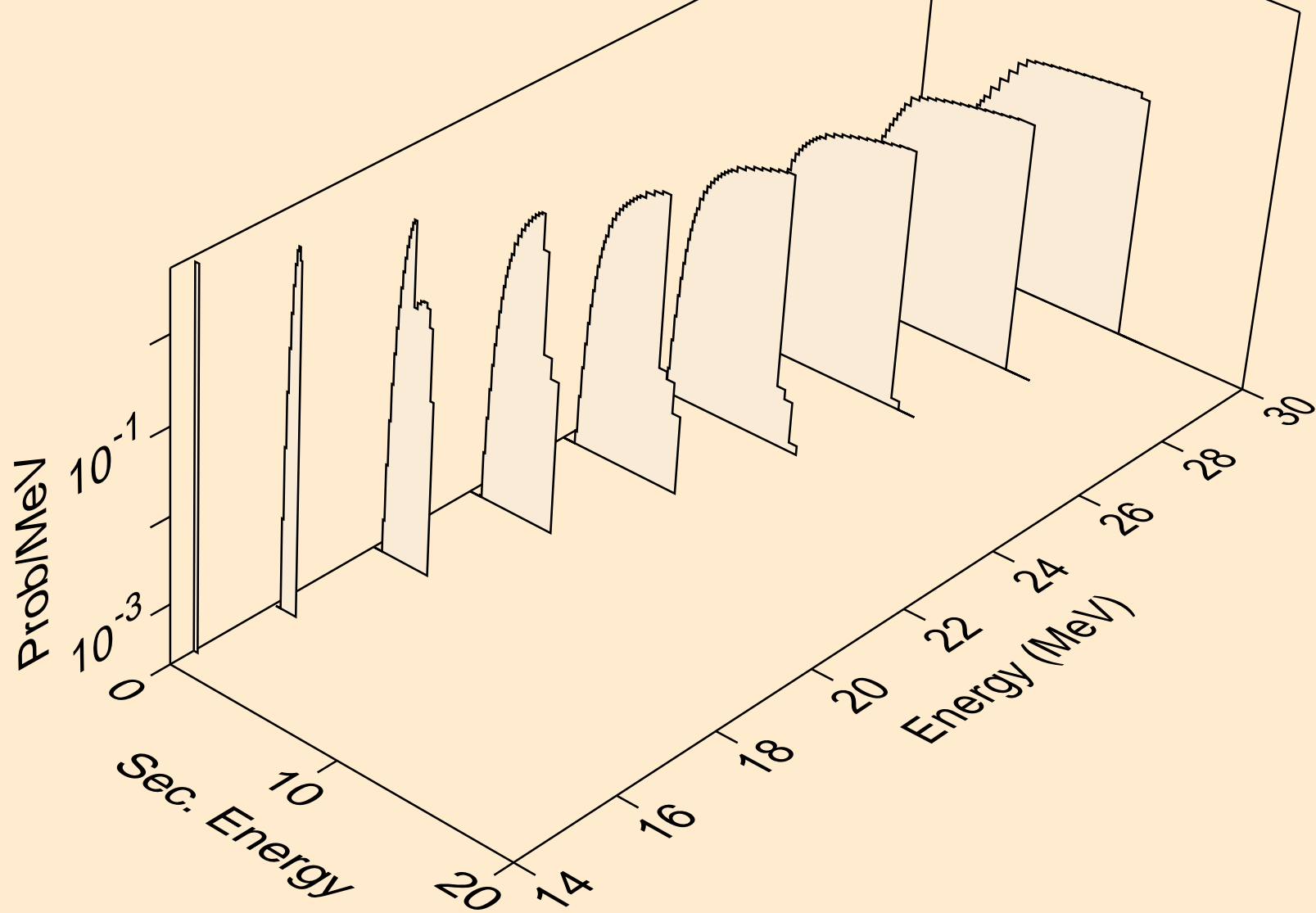

AL030 NEUTRON ACER TENDL-2024 LIBRARY; T=293.6K  
deuterons from (n,d)

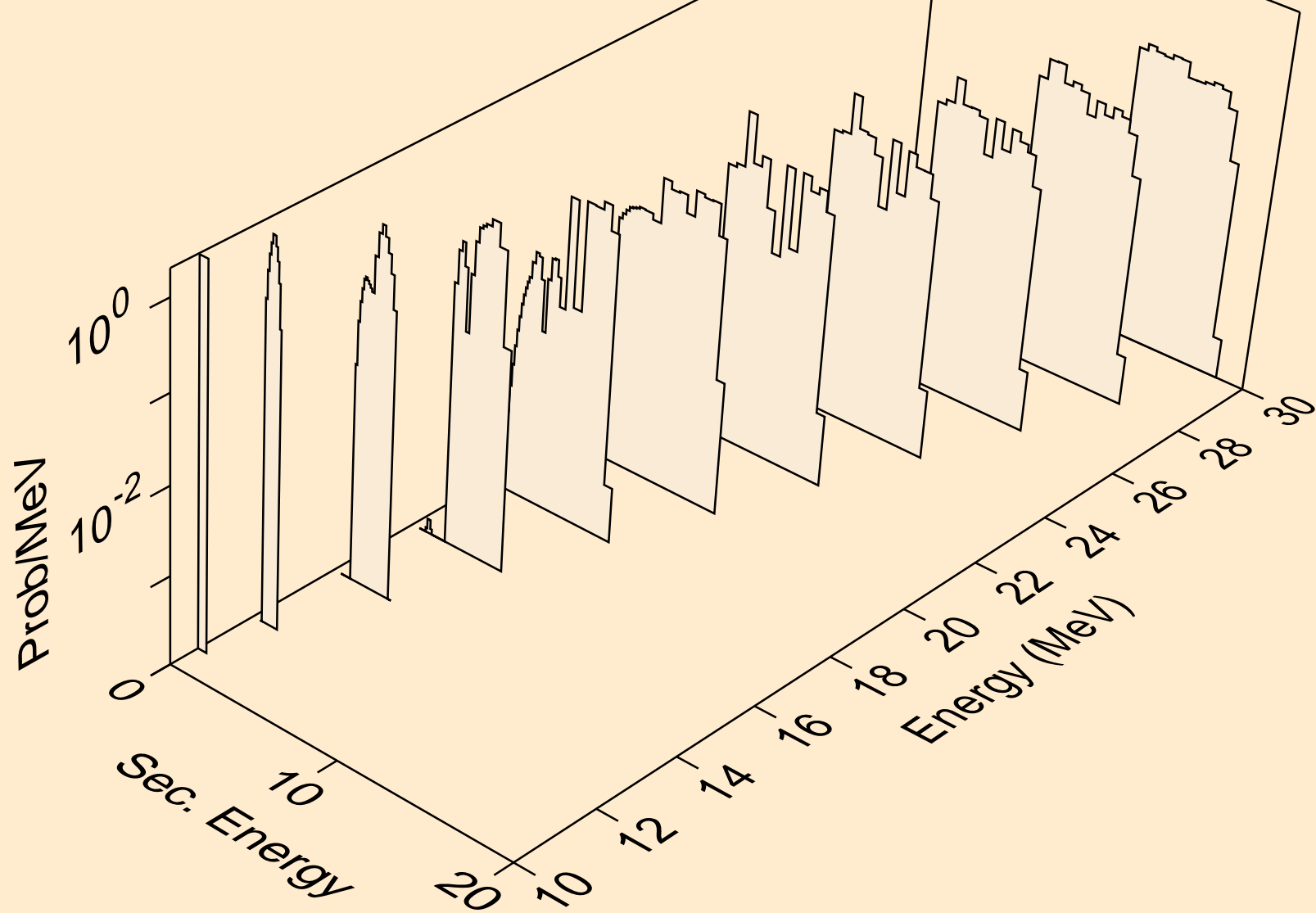

AL030 NEUTRON ACER TENDL-2024 LIBRARY; T=293.6K  
deuterons from (n,da)

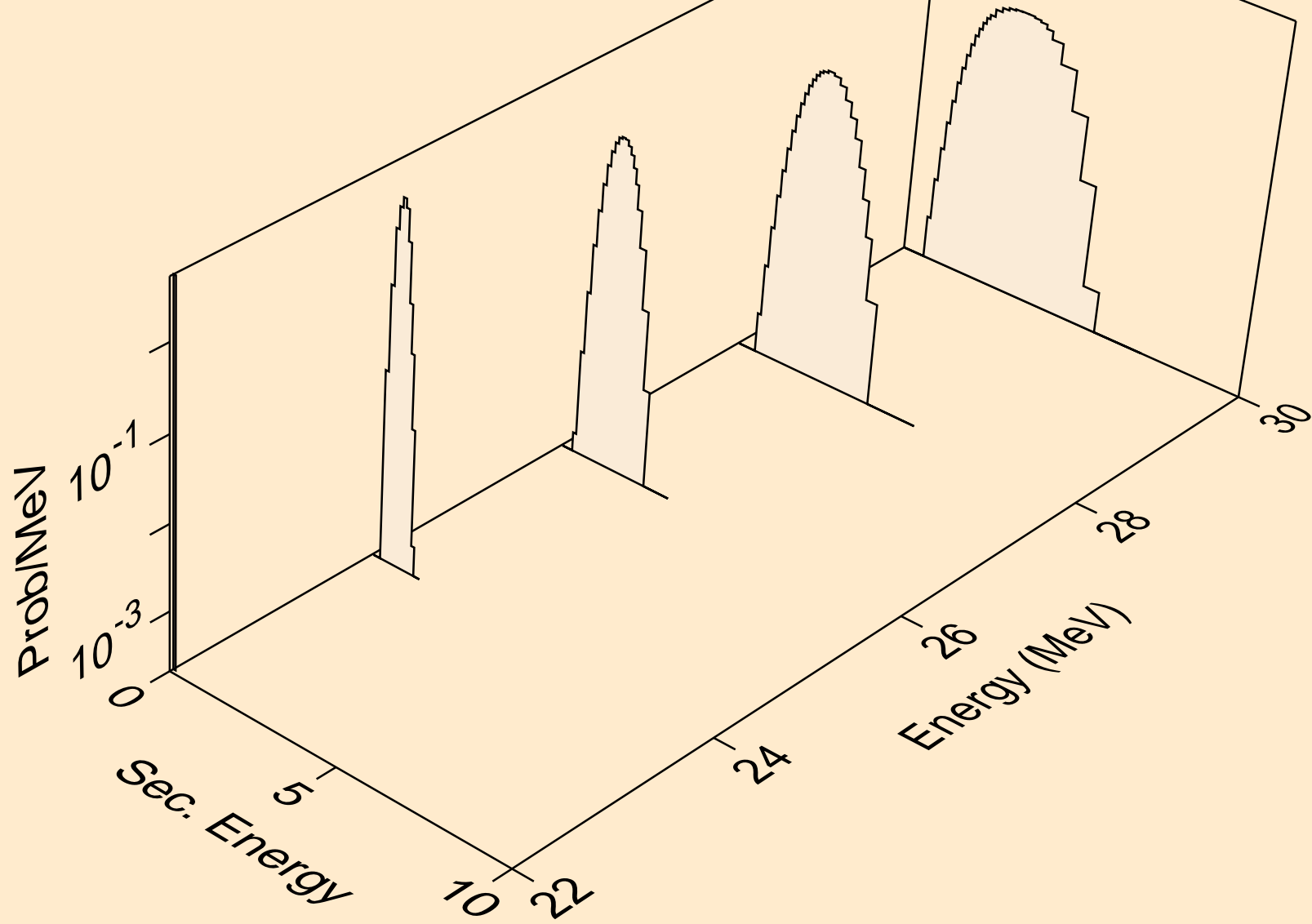

AL030 NEUTRON ACER TENDL-2024 LIBRARY; T=293.6K  
tritons from (n,x)

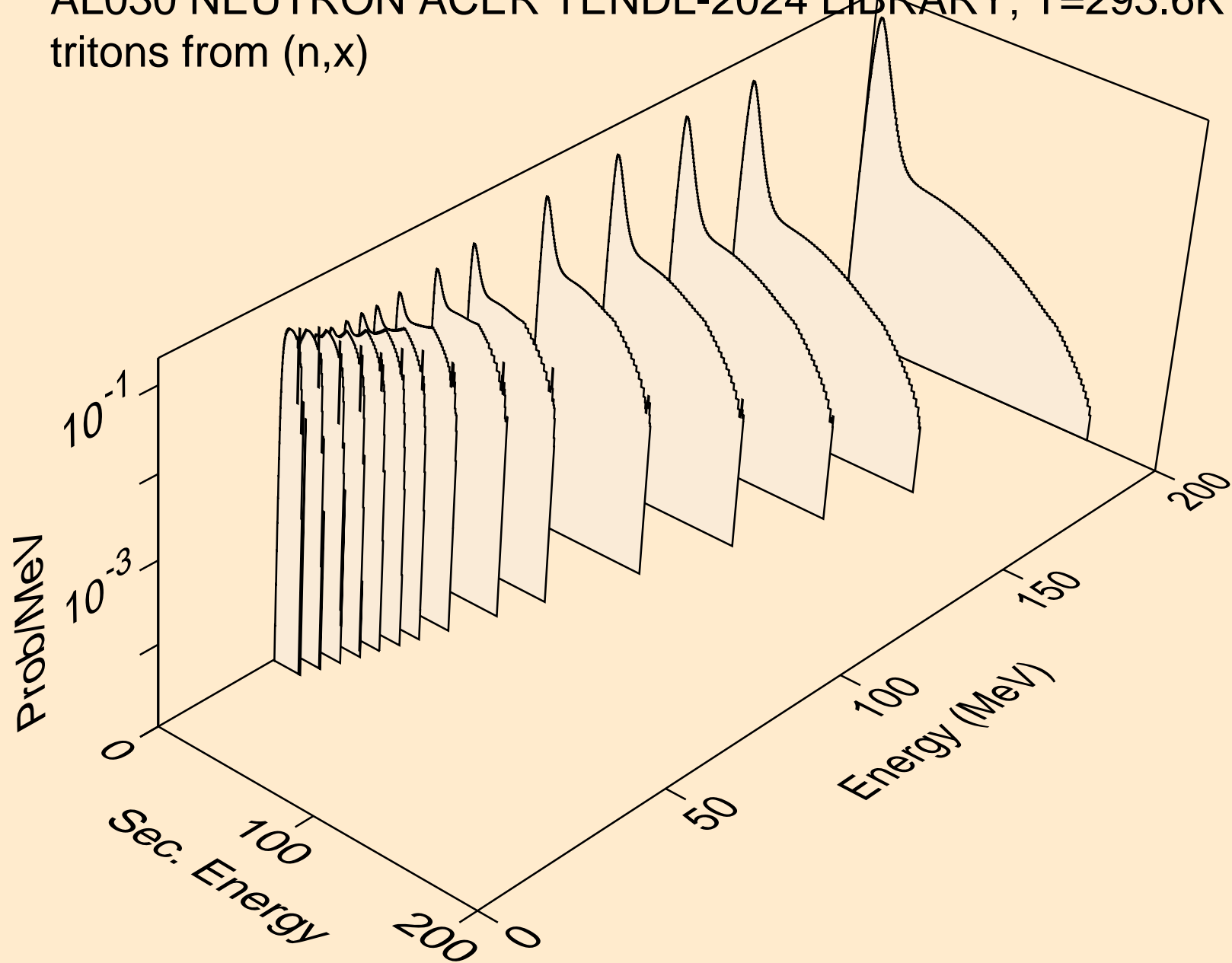

AL030 NEUTRON ACER TENDL-2024 LIBRARY; T=293.6K  
tritons from (n,n\*)t

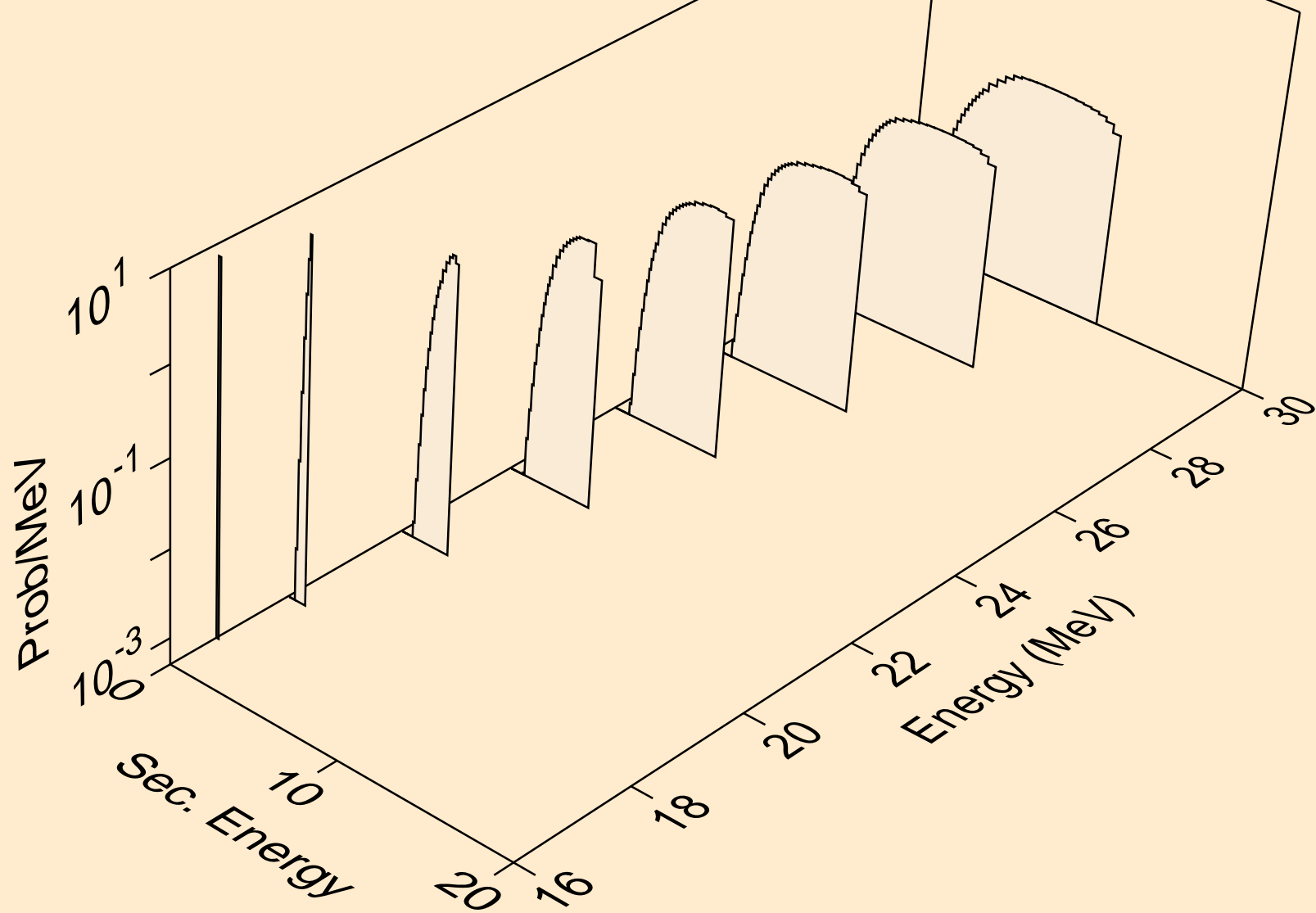

AL030 NEUTRON ACER TENDL-2024 LIBRARY; T=293.6K  
tritons from (n,t)

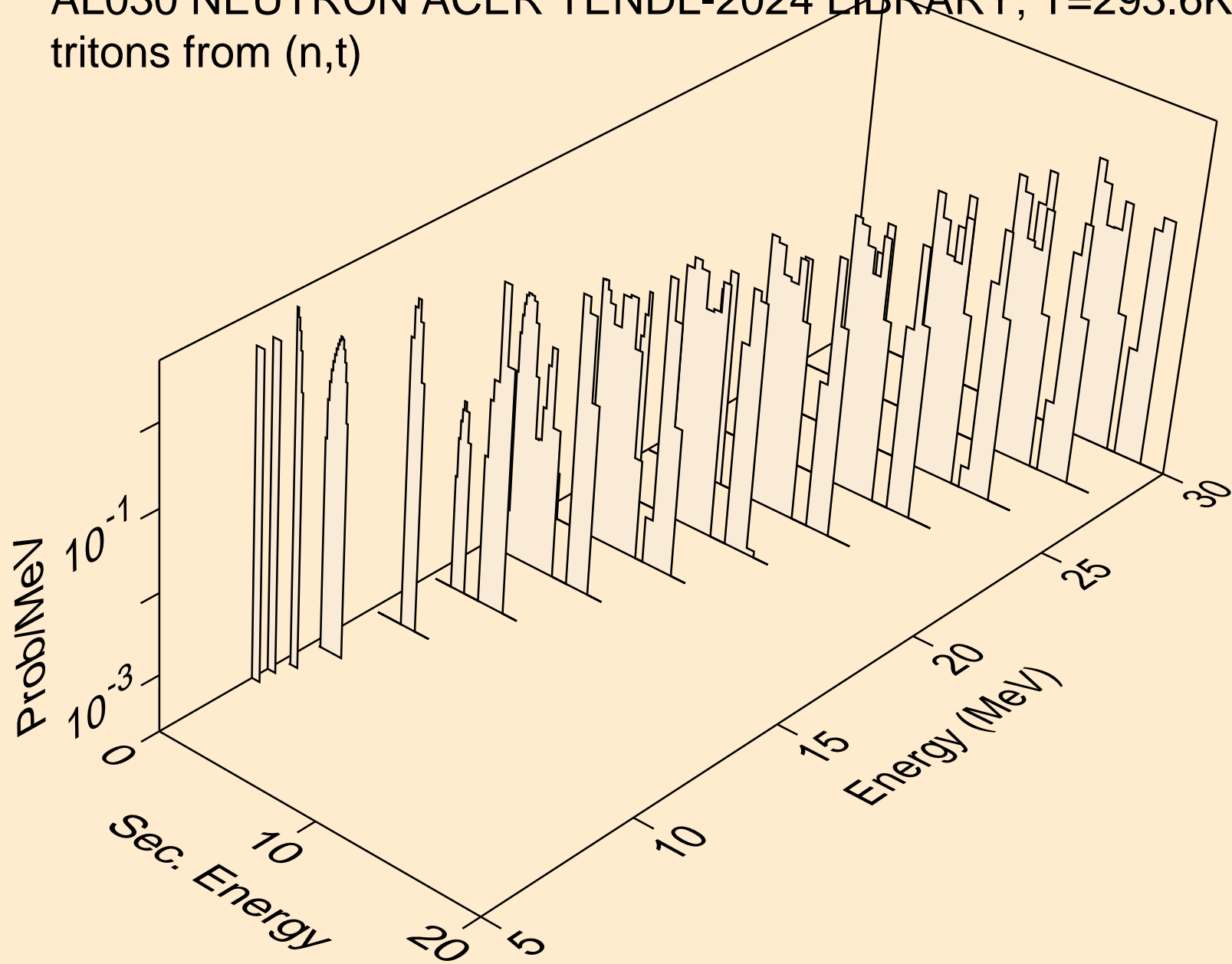

AL030 NEUTRON ACER TENDL-2024 LIBRARY; T=293.6K  
tritons from (n,pt)

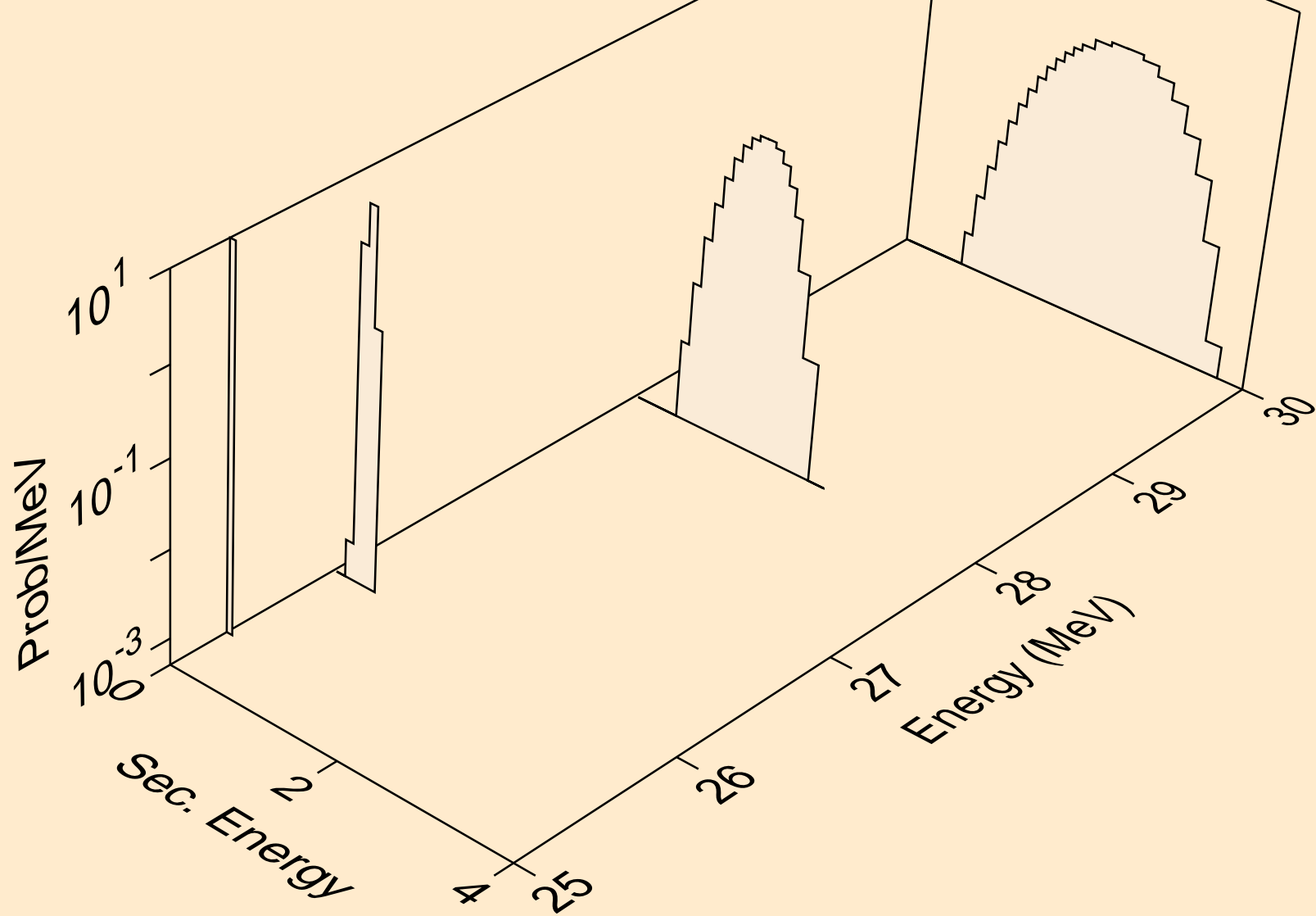

AL030 NEUTRON ACER TENDL-2024 LIBRARY; T=293.6K  
he3s from (n,x)

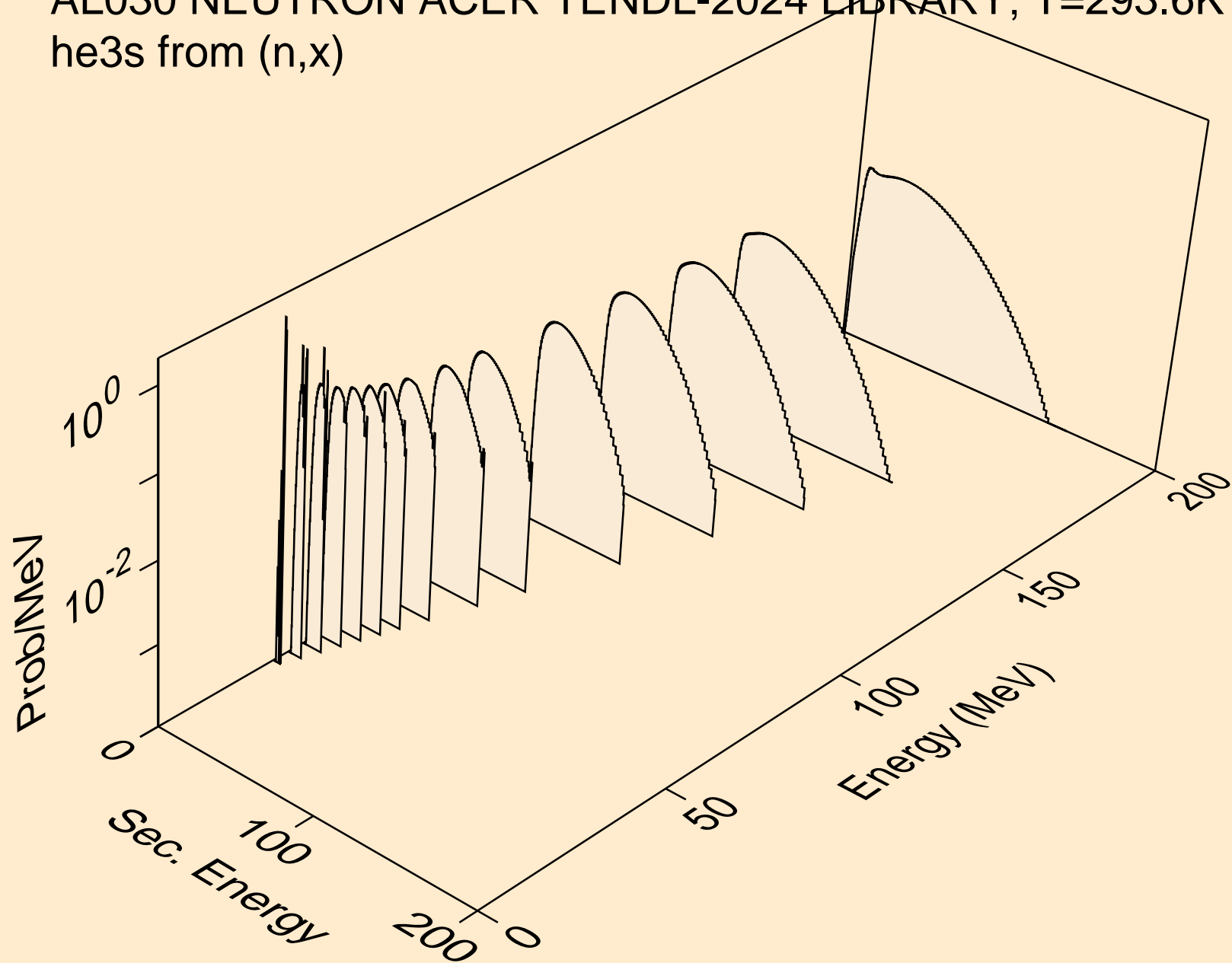

AL030 NEUTRON ACER TENDL-2024 LIBRARY; T=293.6K  
he3s from (n,n\*)he3

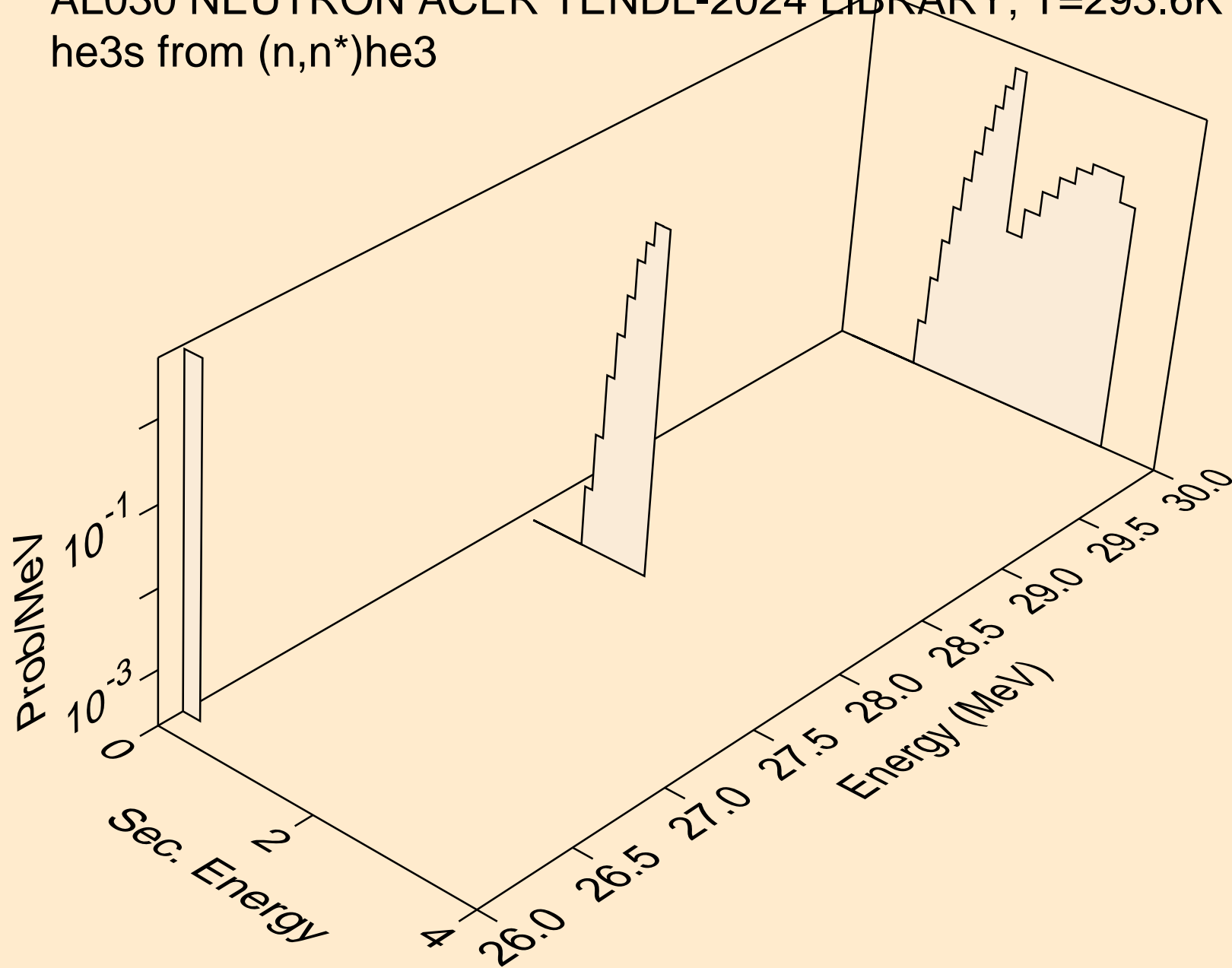

AL030 NEUTRON ACER TENDL-2024 LIBRARY; T=293.6K  
he3s from (n,he3)

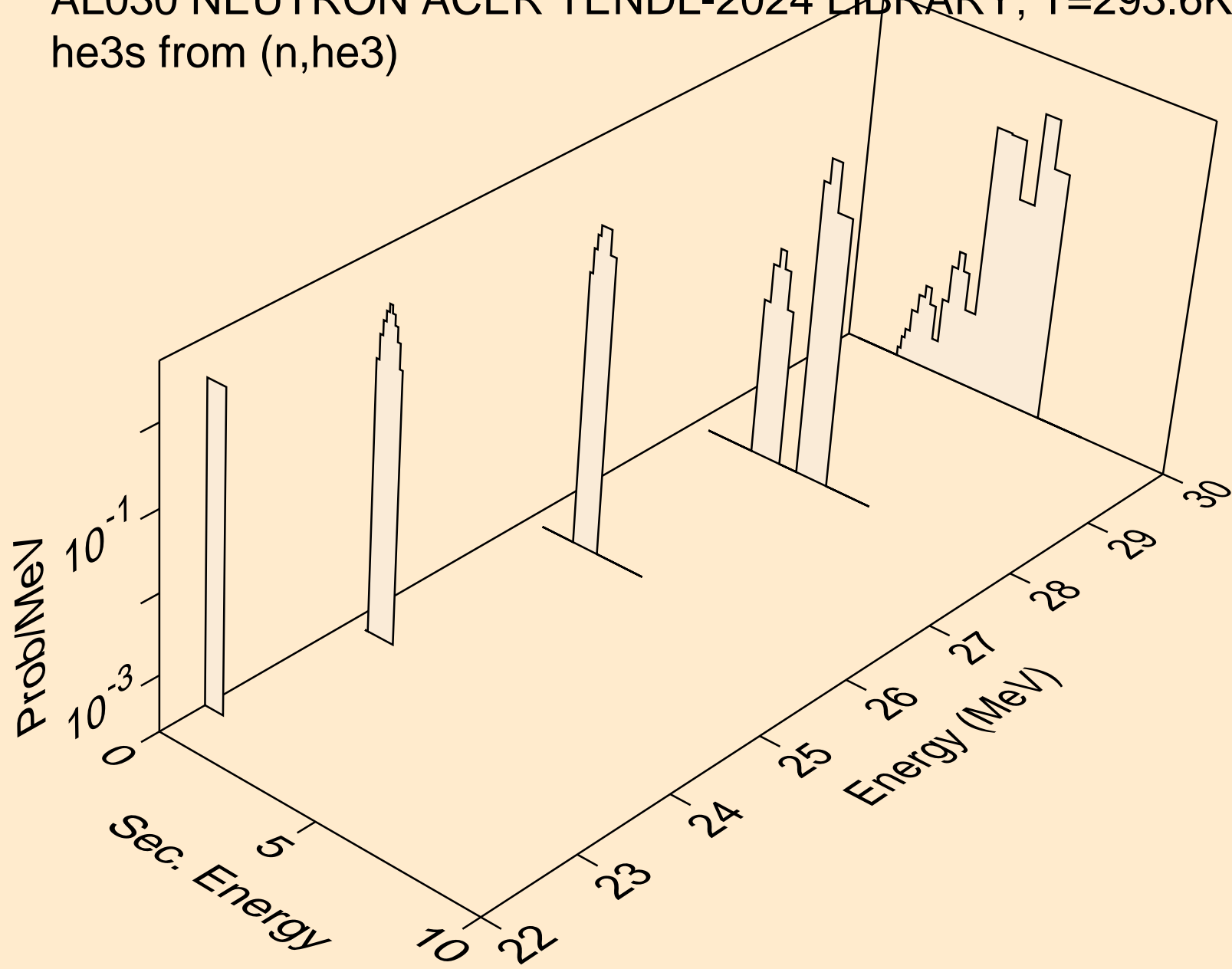

AL030 NEUTRON ACER TENDL-2024 LIBRARY; T=293.6K  
alphas from (n,x)

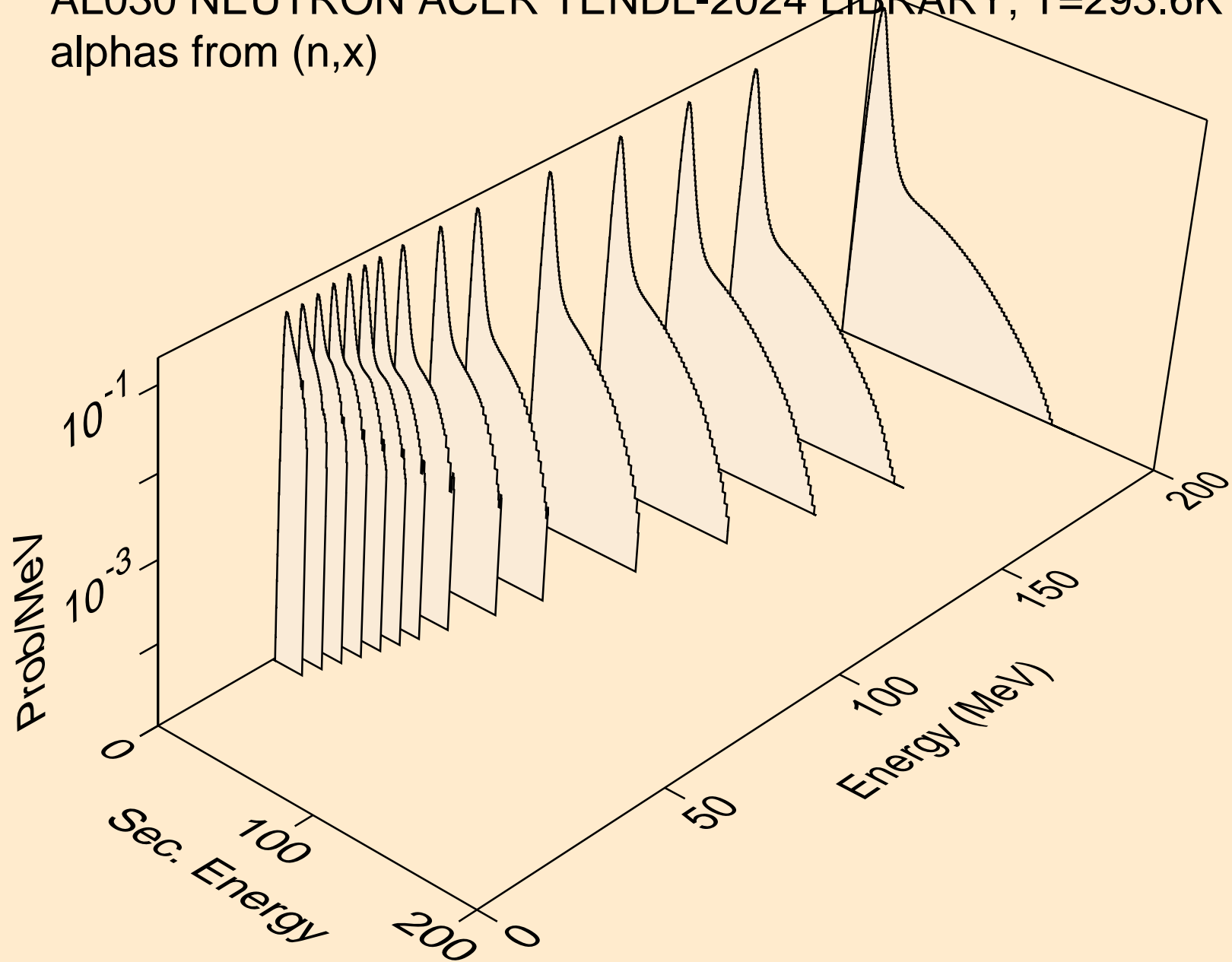

AL030 NEUTRON ACER TENDL-2024 LIBRARY; T=293.6K  
alphas from (n,n\*)a

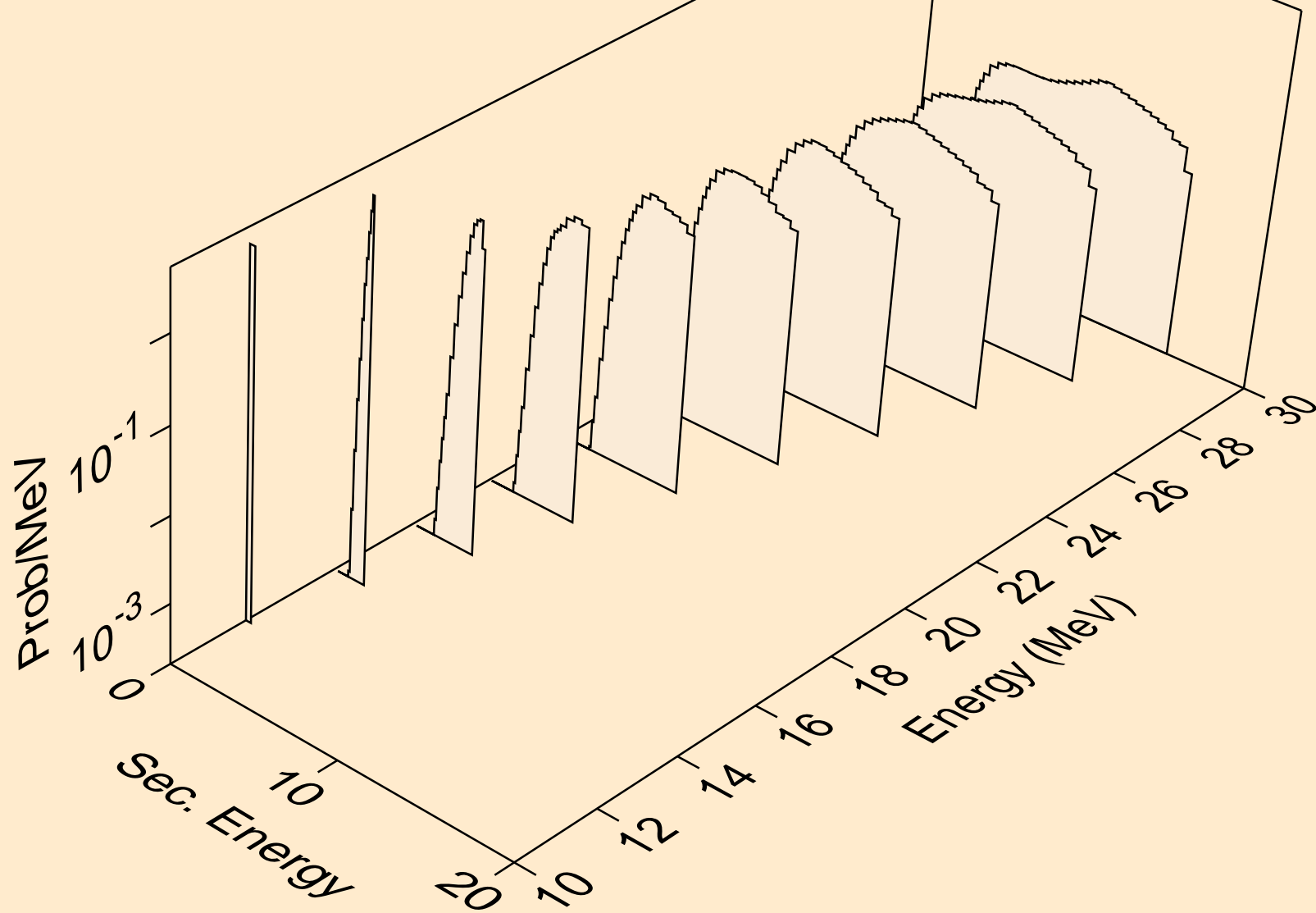

AL030 NEUTRON ACER TENDL-2024 LIBRARY; T=293.6K  
alphas from (n,2n)a

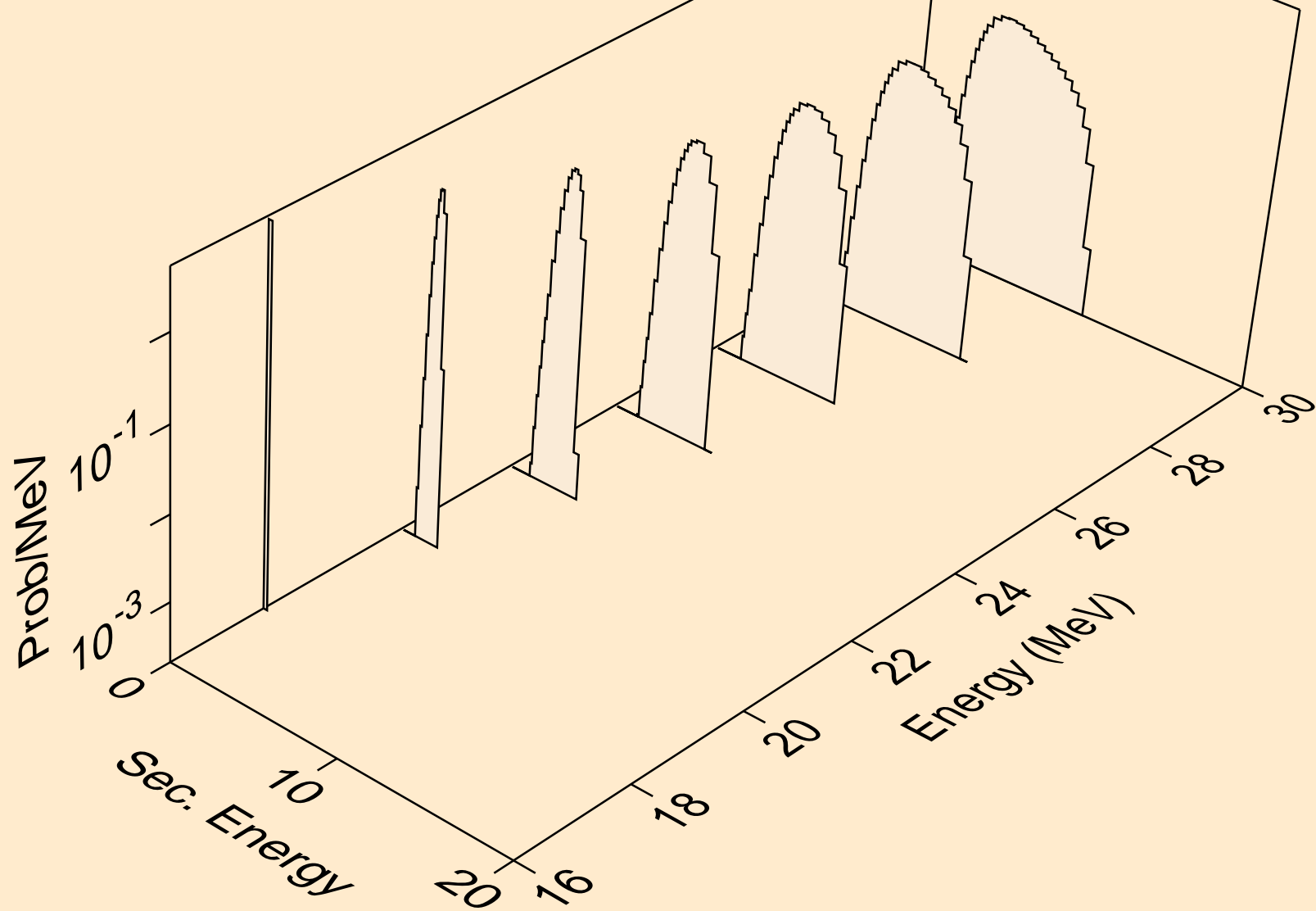

AL030 NEUTRON ACER TENDL-2024 LIBRARY; T=293.6K  
alphas from (n,3n)a

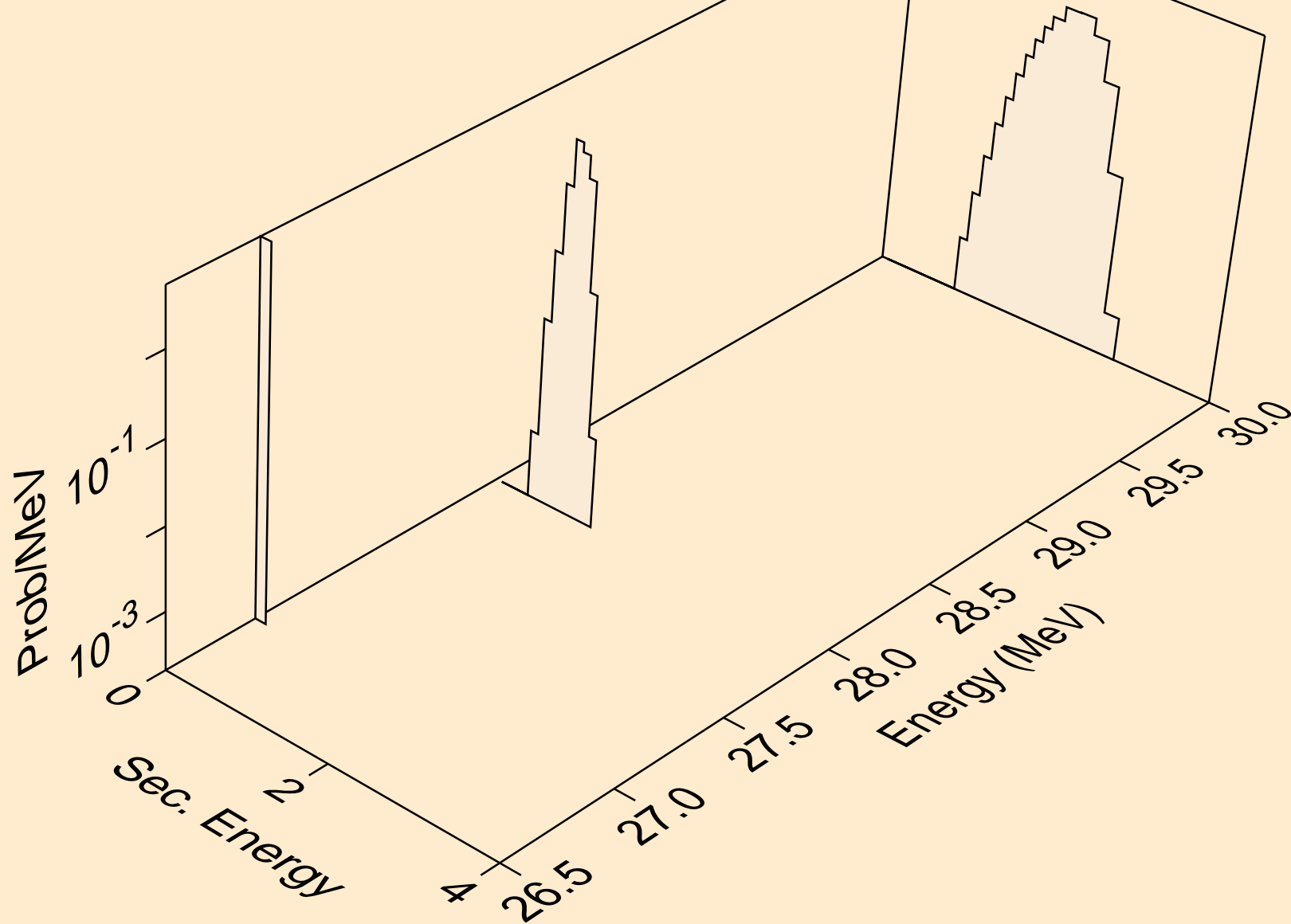

AL030 NEUTRON ACER TENDL-2024 LIBRARY; T=293.6K  
alphas from (n,npa)

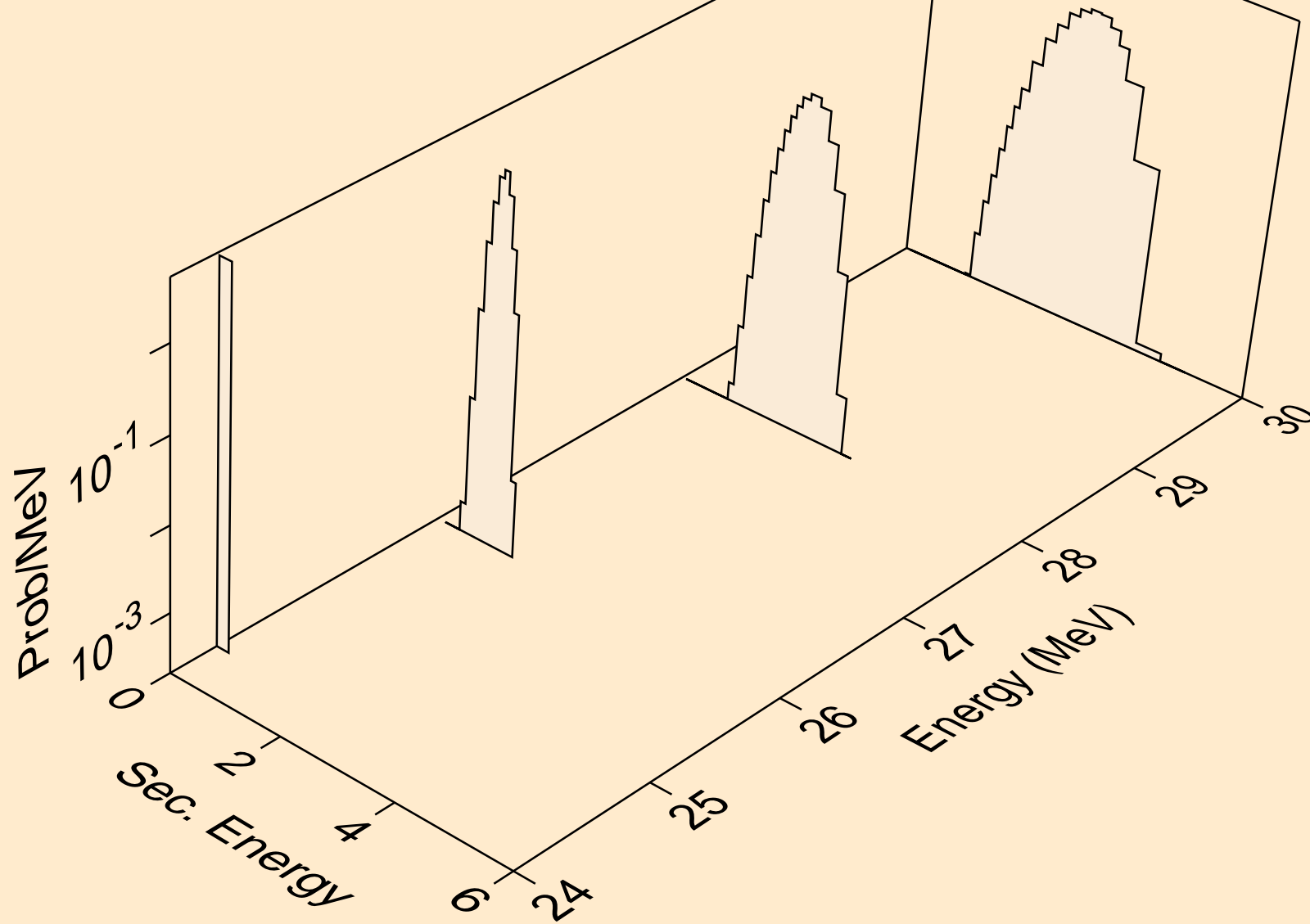

AL030 NEUTRON ACER TENDL-2024 LIBRARY; T=293.6K  
alphas from (n,a)

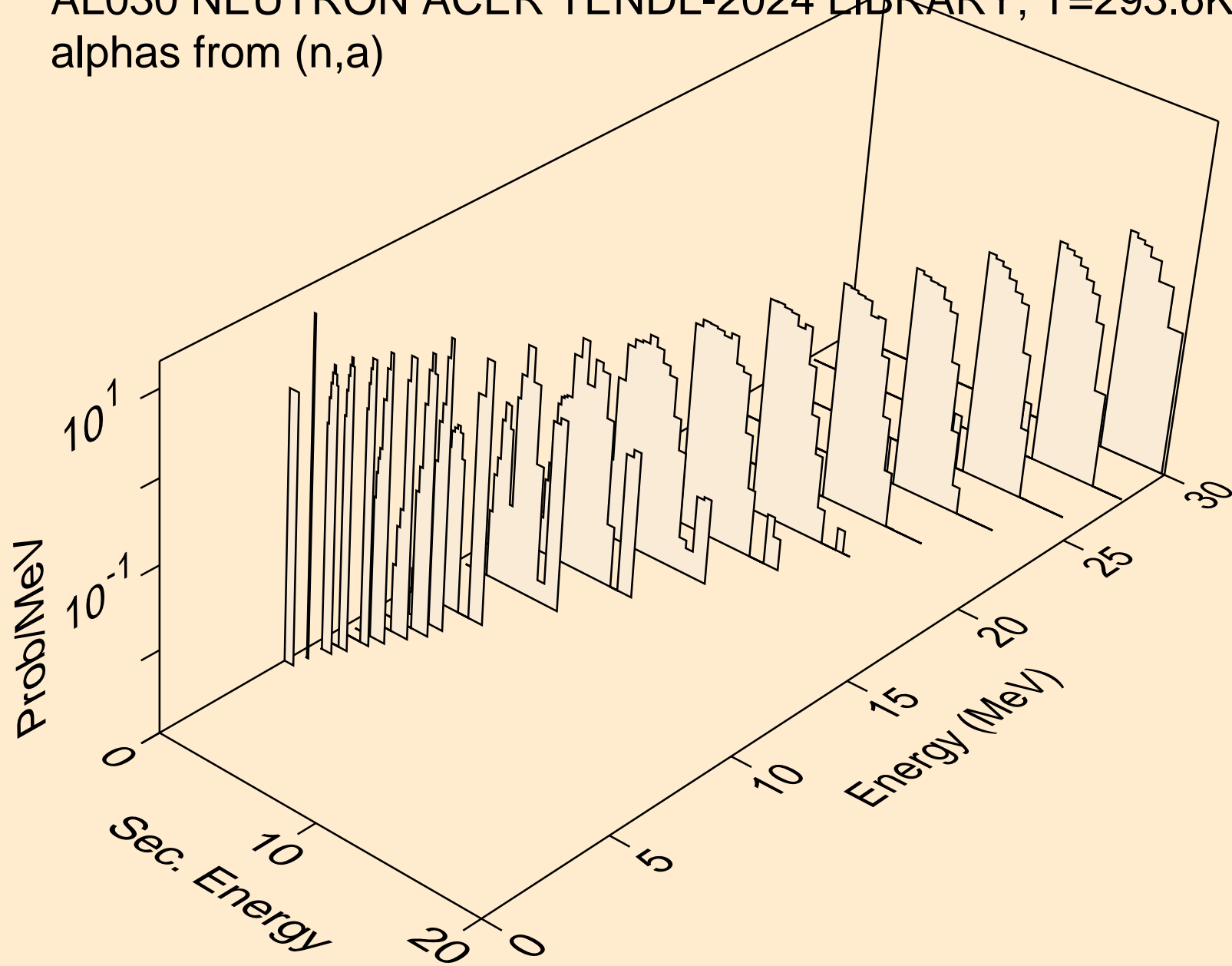

AL030 NEUTRON ACER TENDL-2024 LIBRARY; T=293.6K  
alphas from (n,2a)

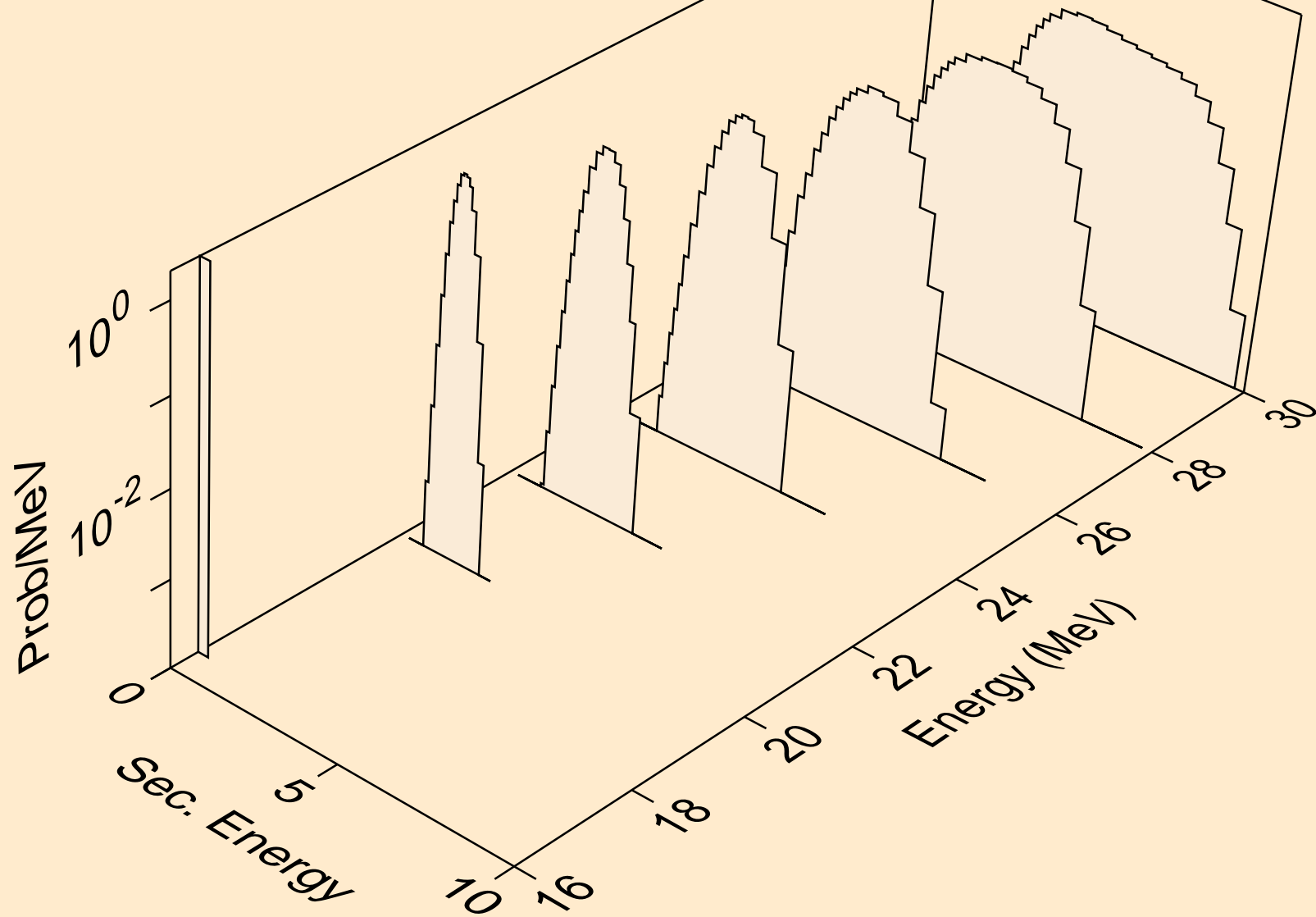

AL030 NEUTRON ACER TENDL-2024 LIBRARY; T=293.6K  
alphas from (n,pa)

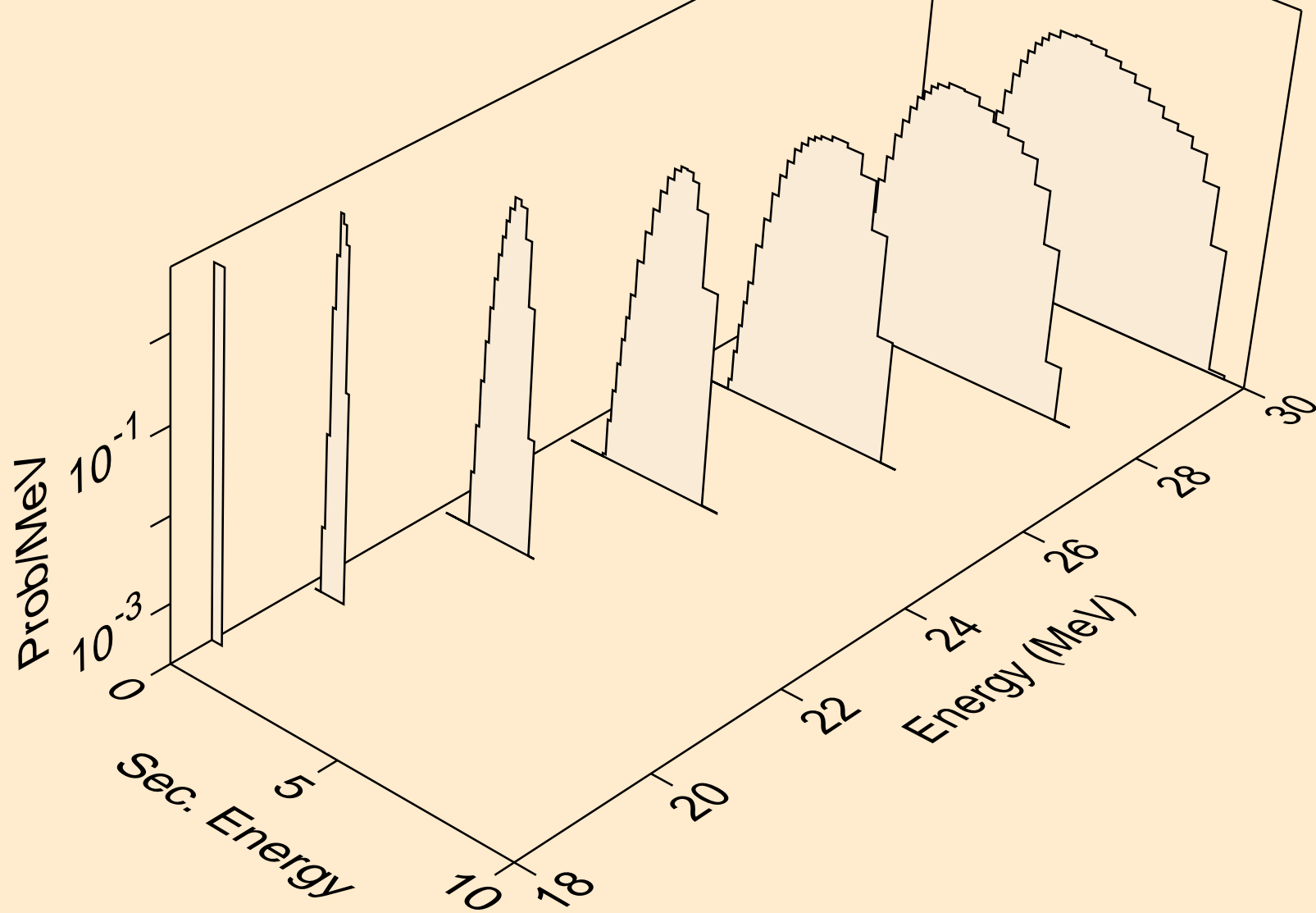

AL030 NEUTRON ACER TENDL-2024 LIBRARY; T=293.6K  
alphas from (n,da)

