

AM235 NEUTRON ACER TENDL-2024 LIBRARY; T=293.6K  
Principal cross sections

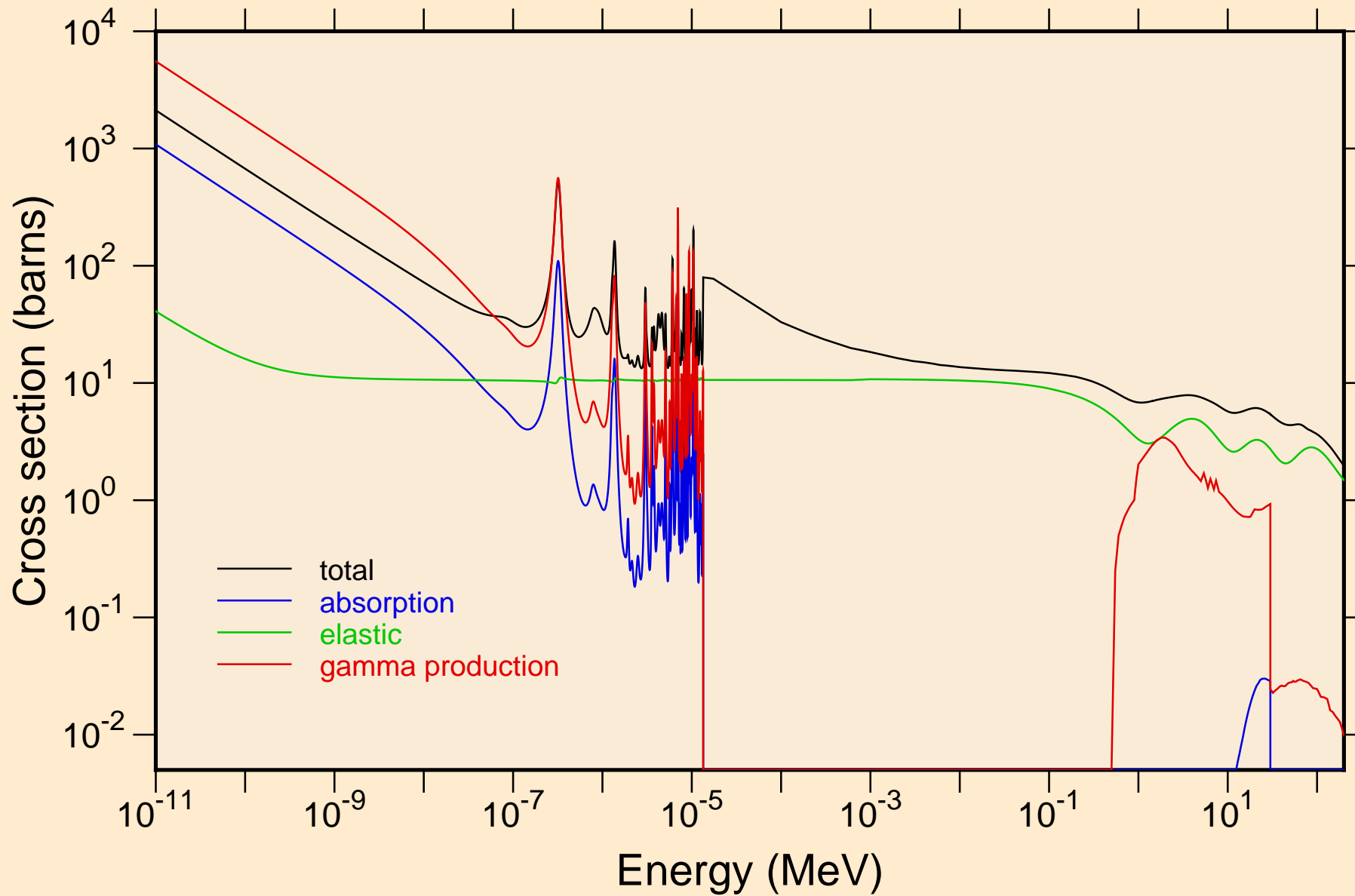

AM235 NEUTRON ACER TENDL-2024 LIBRARY; T=293.6K  
resonance total cross section

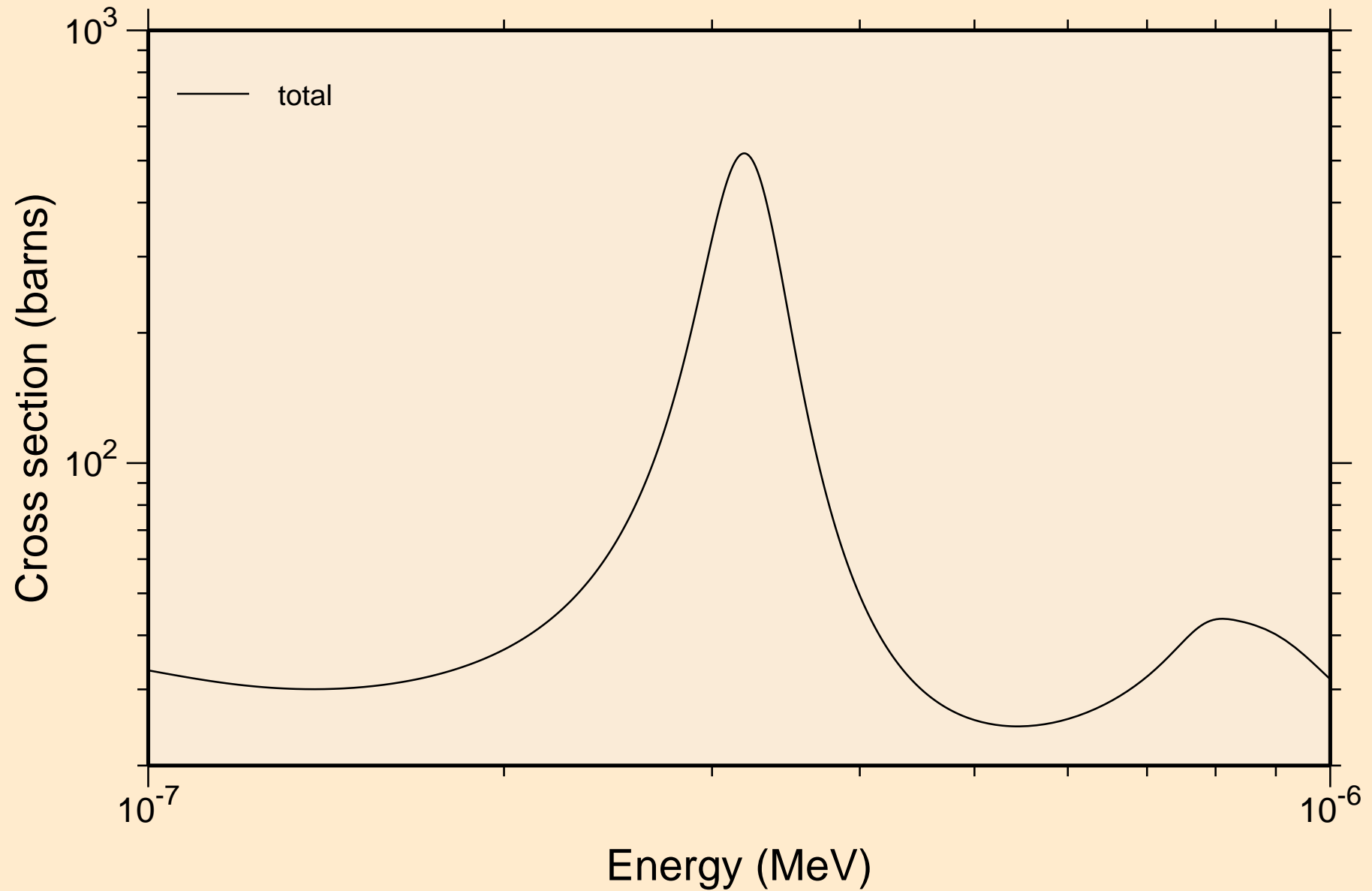

AM235 NEUTRON ACER TENDL-2024 LIBRARY; T=293.6K  
resonance total cross section

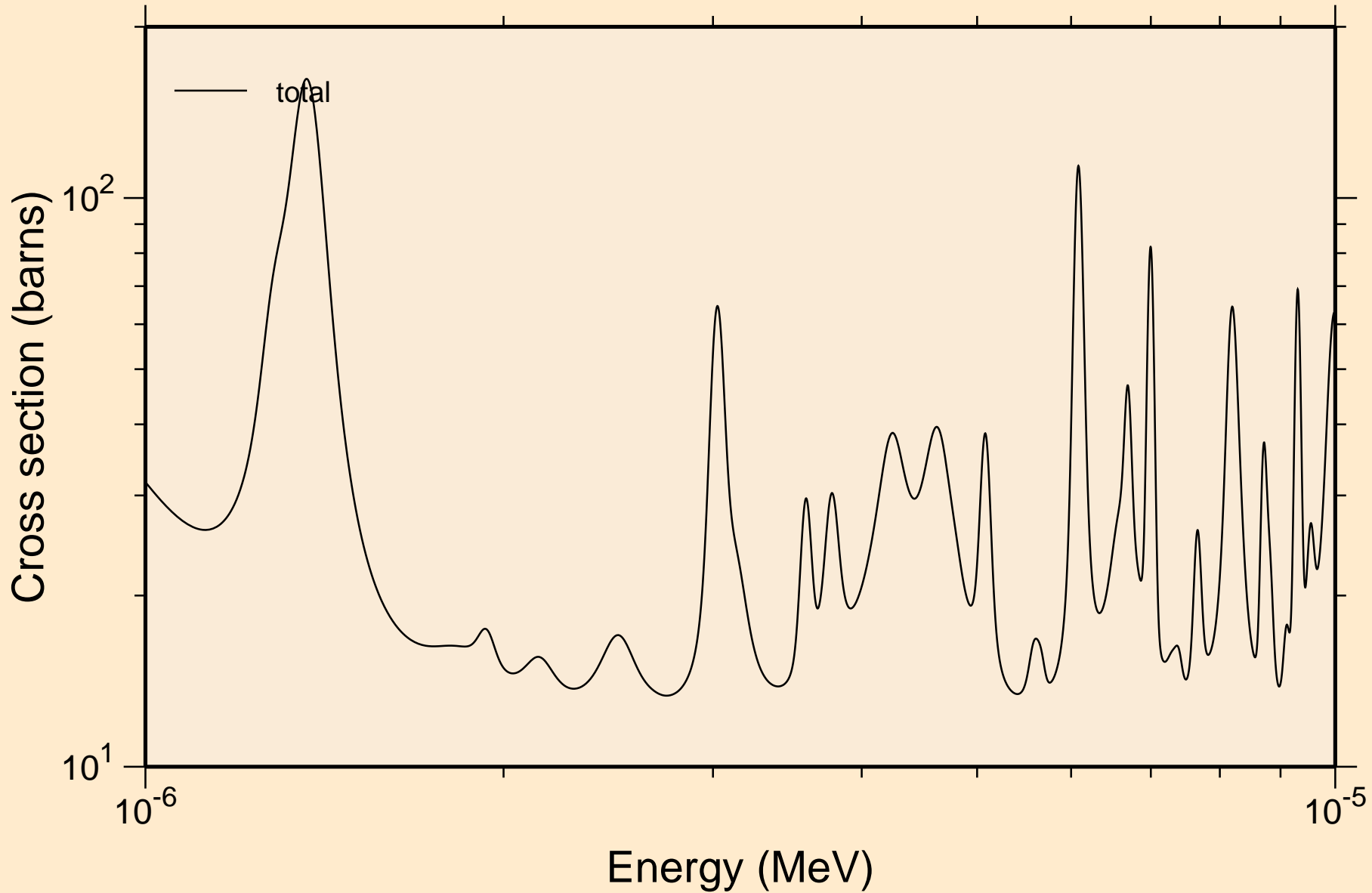

AM235 NEUTRON ACER TENDL-2024 LIBRARY; T=293.6K  
resonance total cross section

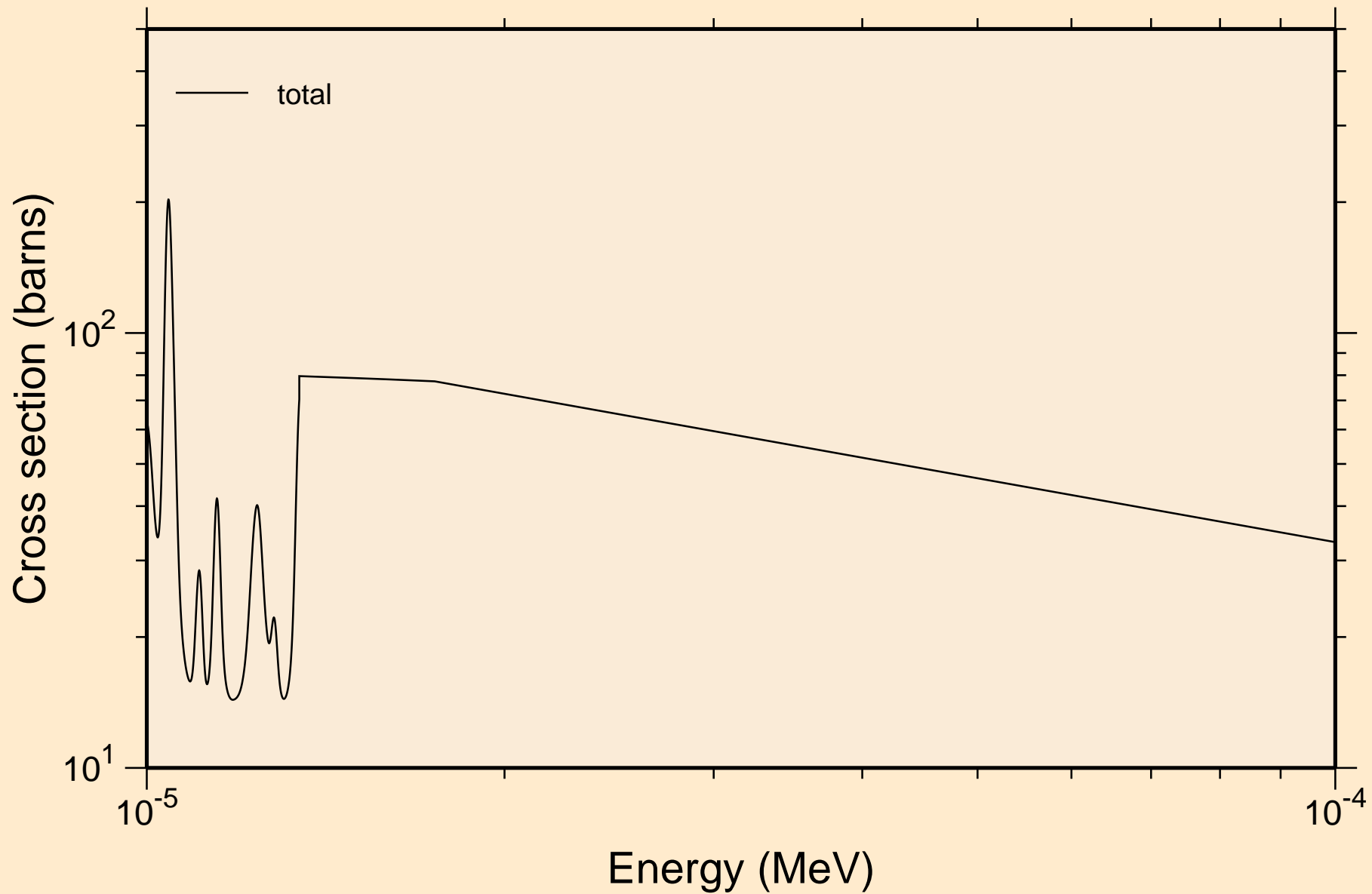

AM235 NEUTRON ACER TENDL-2024 LIBRARY; T=293.6K  
resonance total cross section

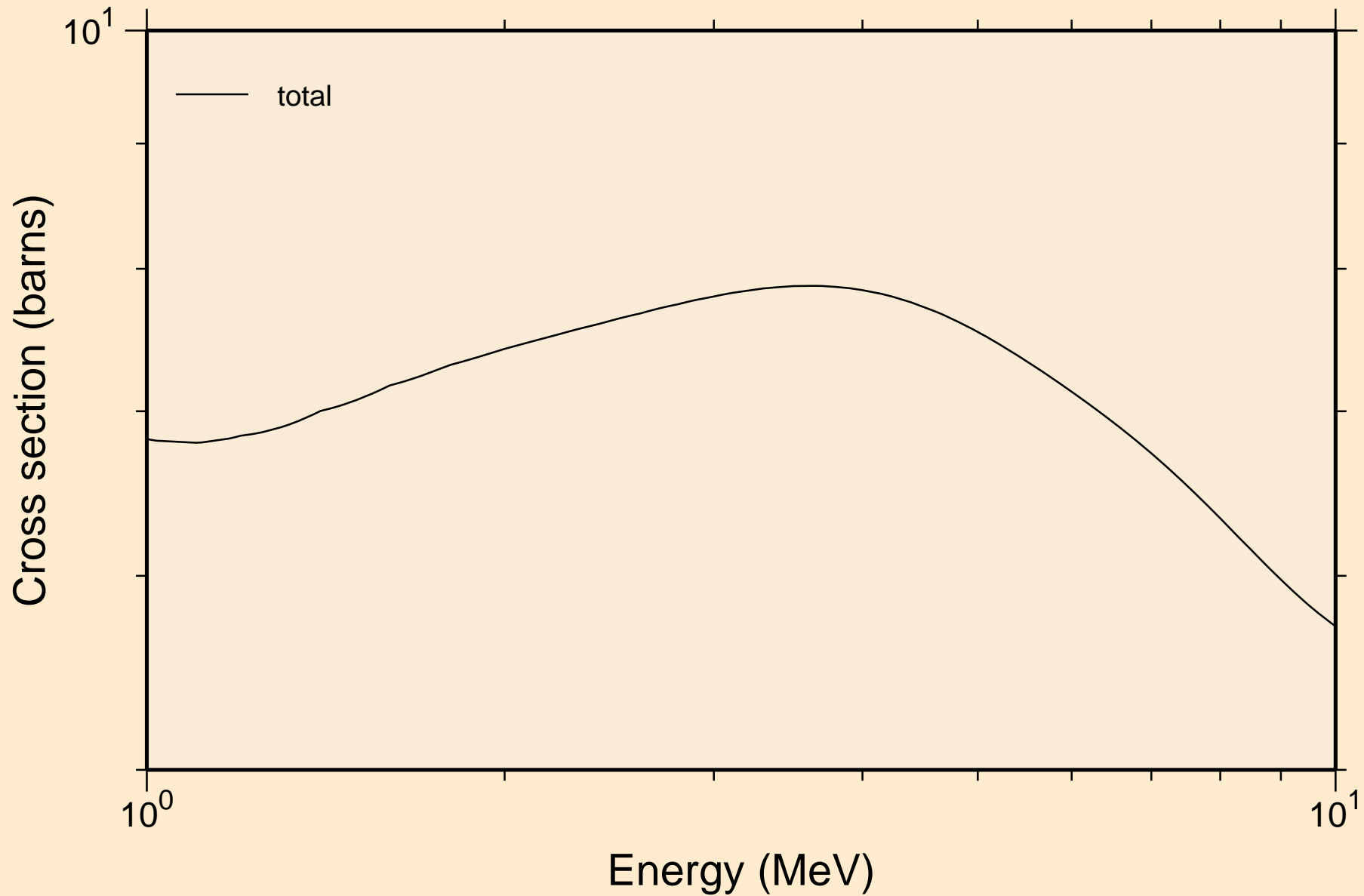

AM235 NEUTRON ACER TENDL-2024 LIBRARY; T=293.6K  
resonance absorption cross sections

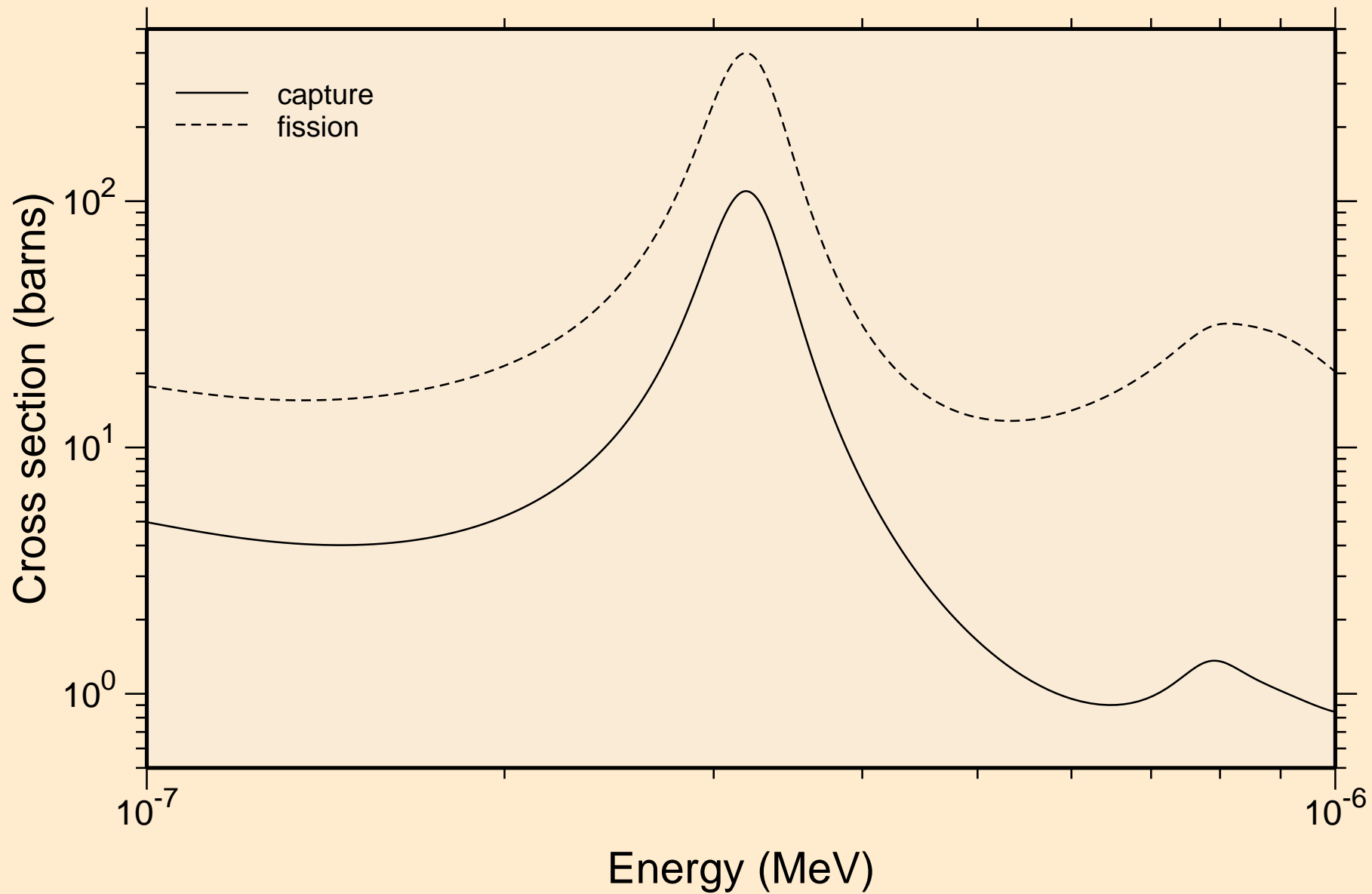

AM235 NEUTRON ACER TENDL-2024 LIBRARY; T=293.6K  
resonance absorption cross sections

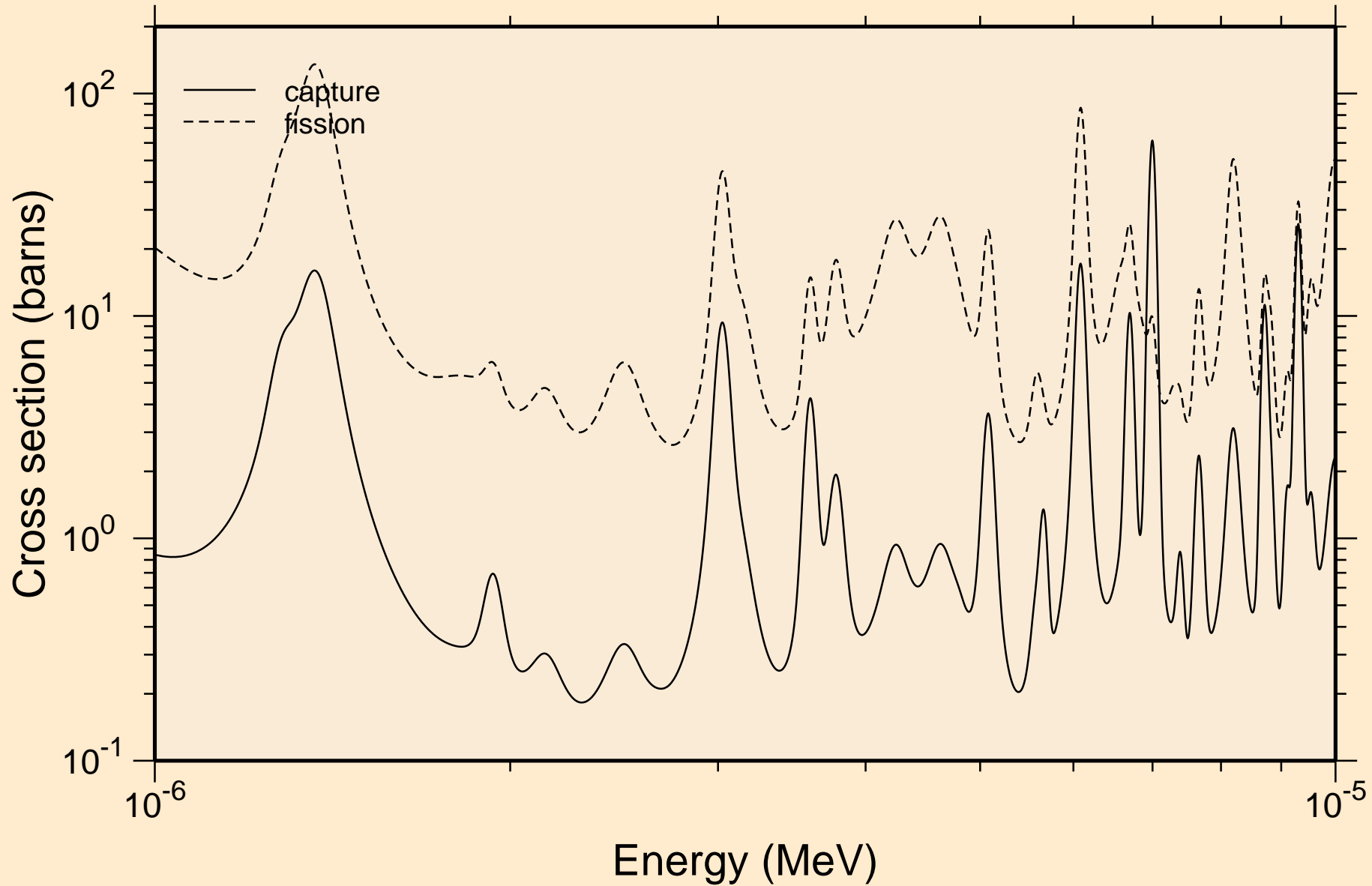

AM235 NEUTRON ACER TENDL-2024 LIBRARY; T=293.6K  
resonance absorption cross sections

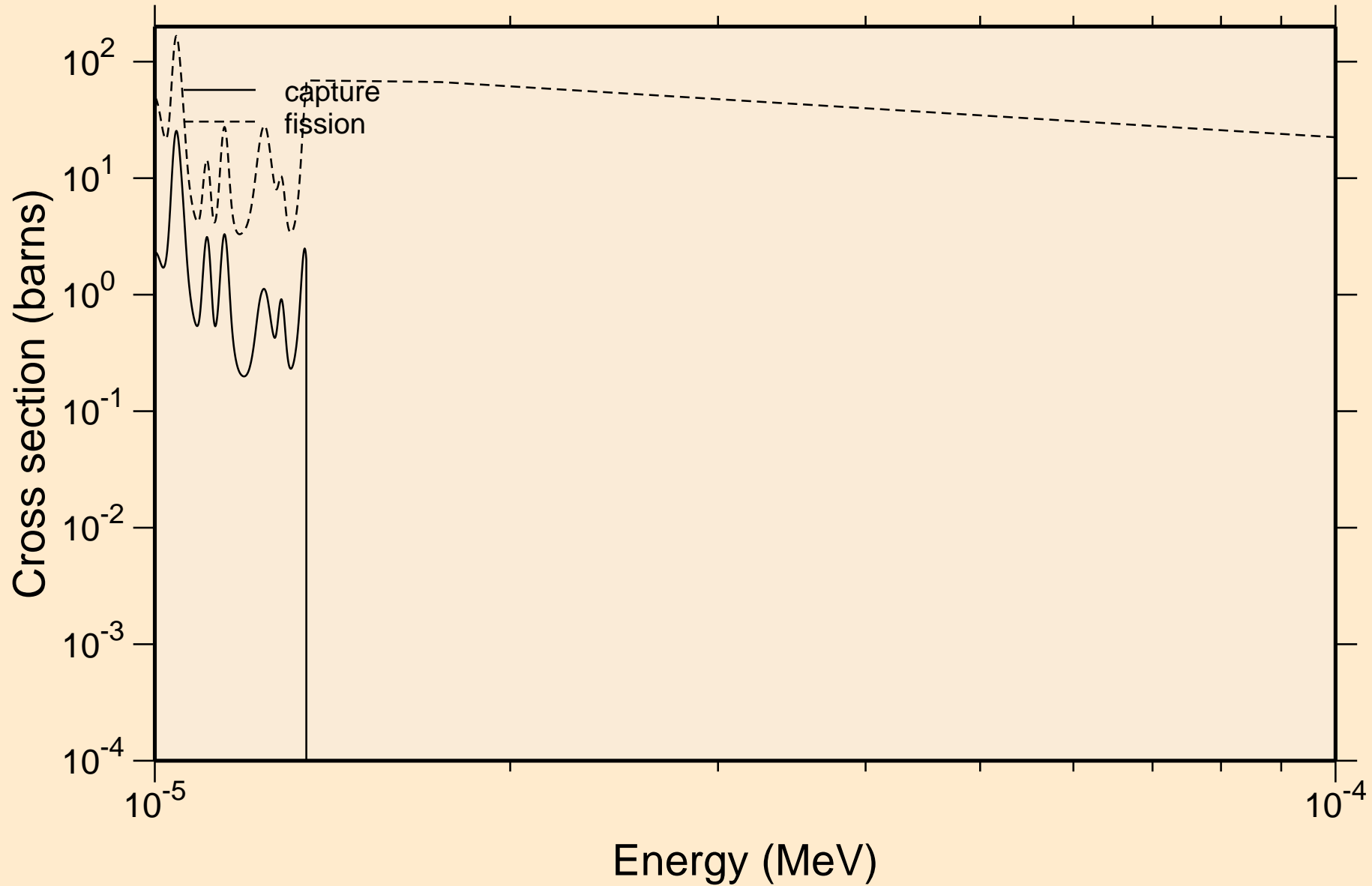

AM235 NEUTRON ACER TENDL-2024 LIBRARY; T=293.6K  
resonance absorption cross sections

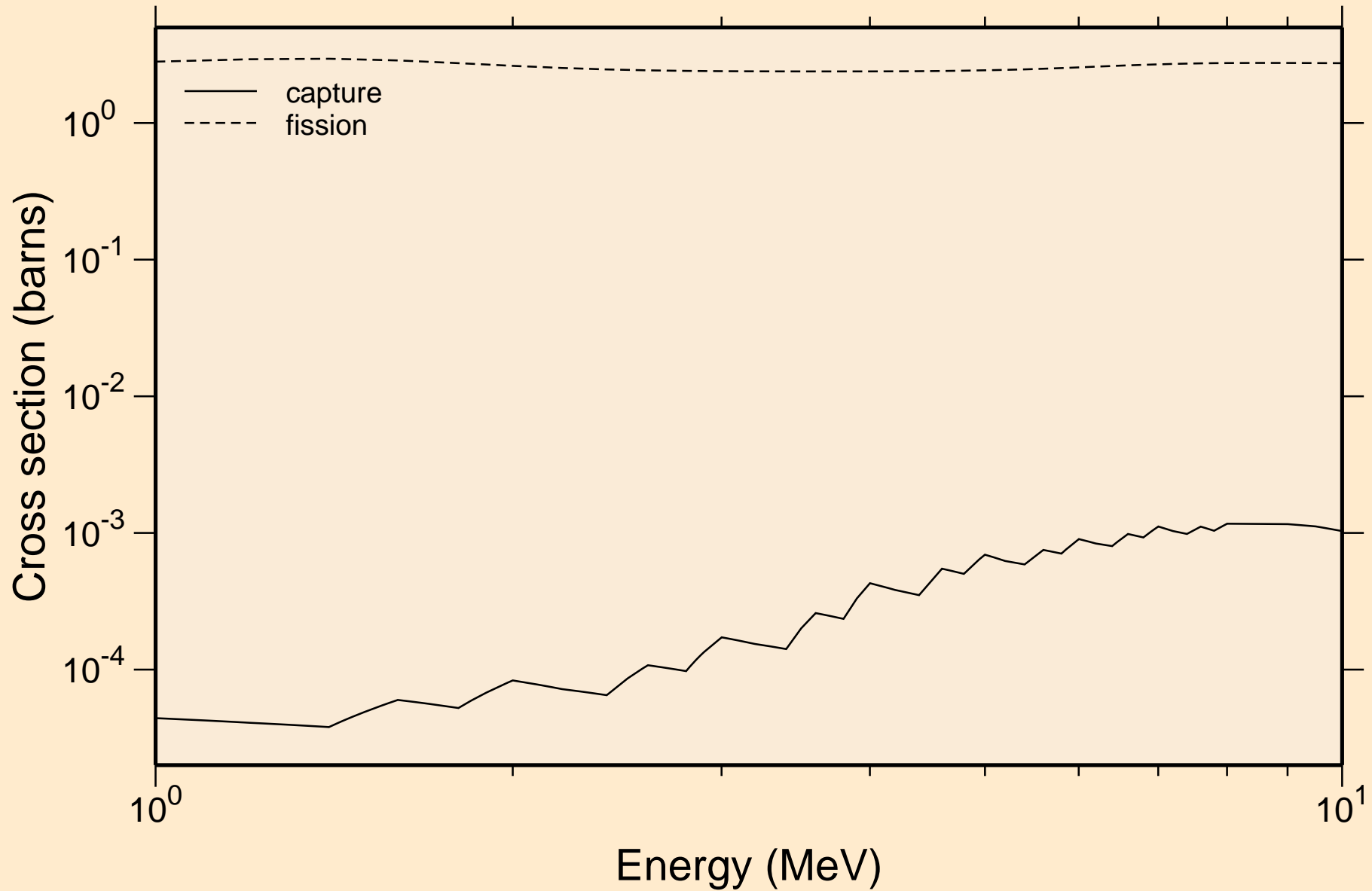

AM235 NEUTRON ACER TENDL-2024 LIBRARY; T=293.6K  
Heating

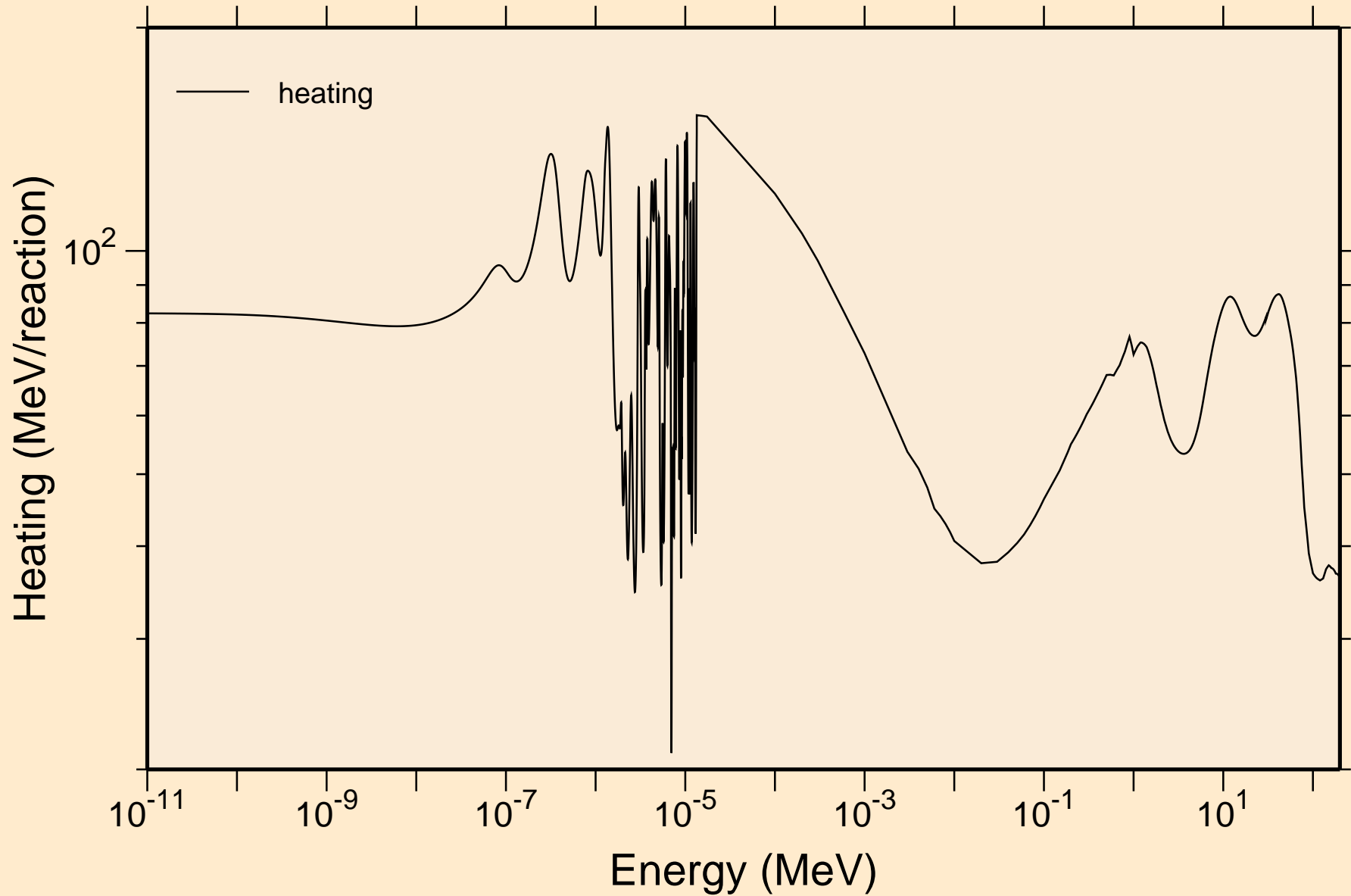

AM235 NEUTRON ACER TENDL-2024 LIBRARY; T=293.6K  
Damage

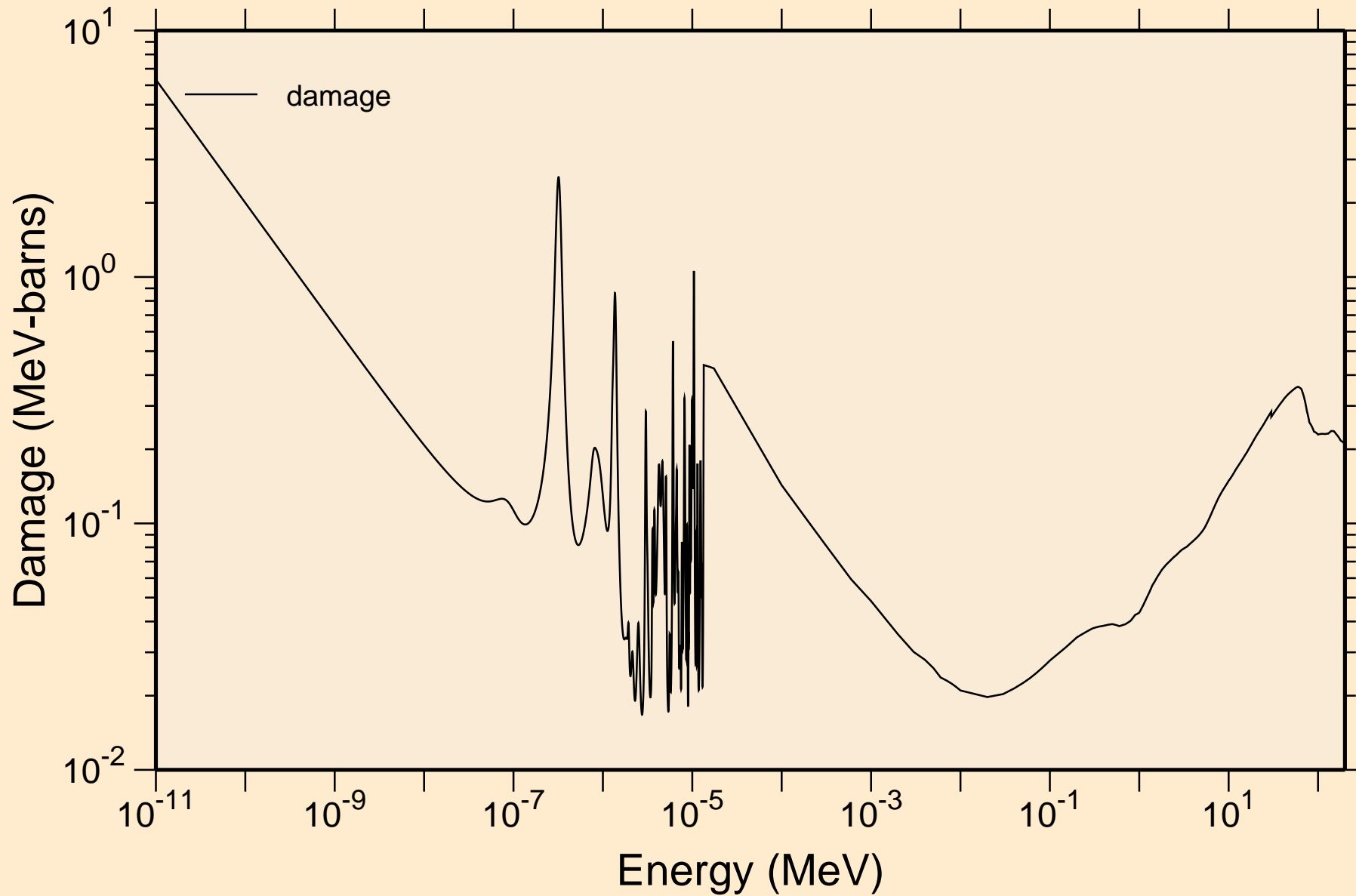

# AM235 NEUTRON ACER TENDL-2024 LIBRARY; T=293.6K

## Non-threshold reactions

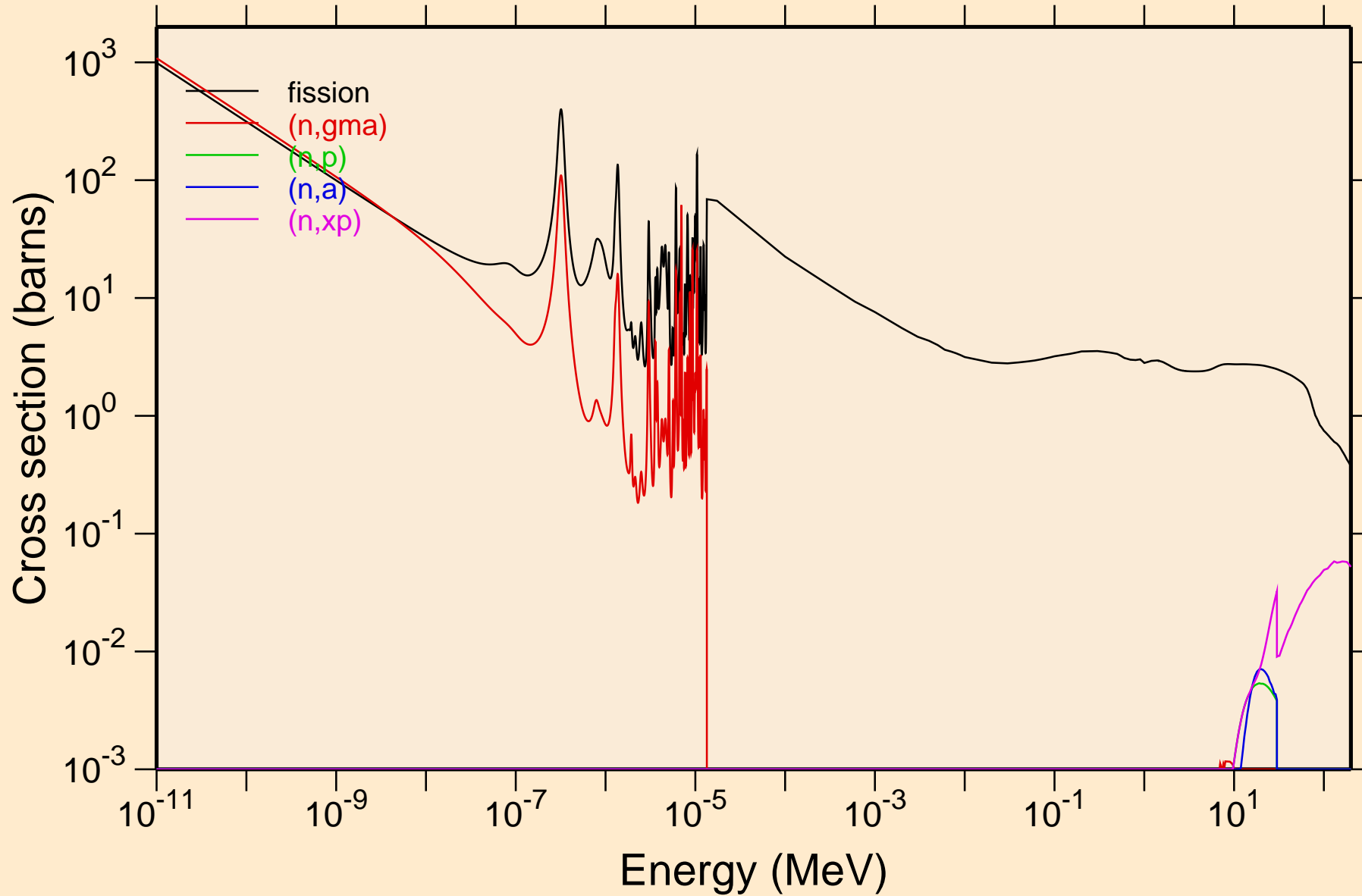

AM235 NEUTRON ACER TENDL-2024 LIBRARY; T=293.6K  
Non-threshold reactions

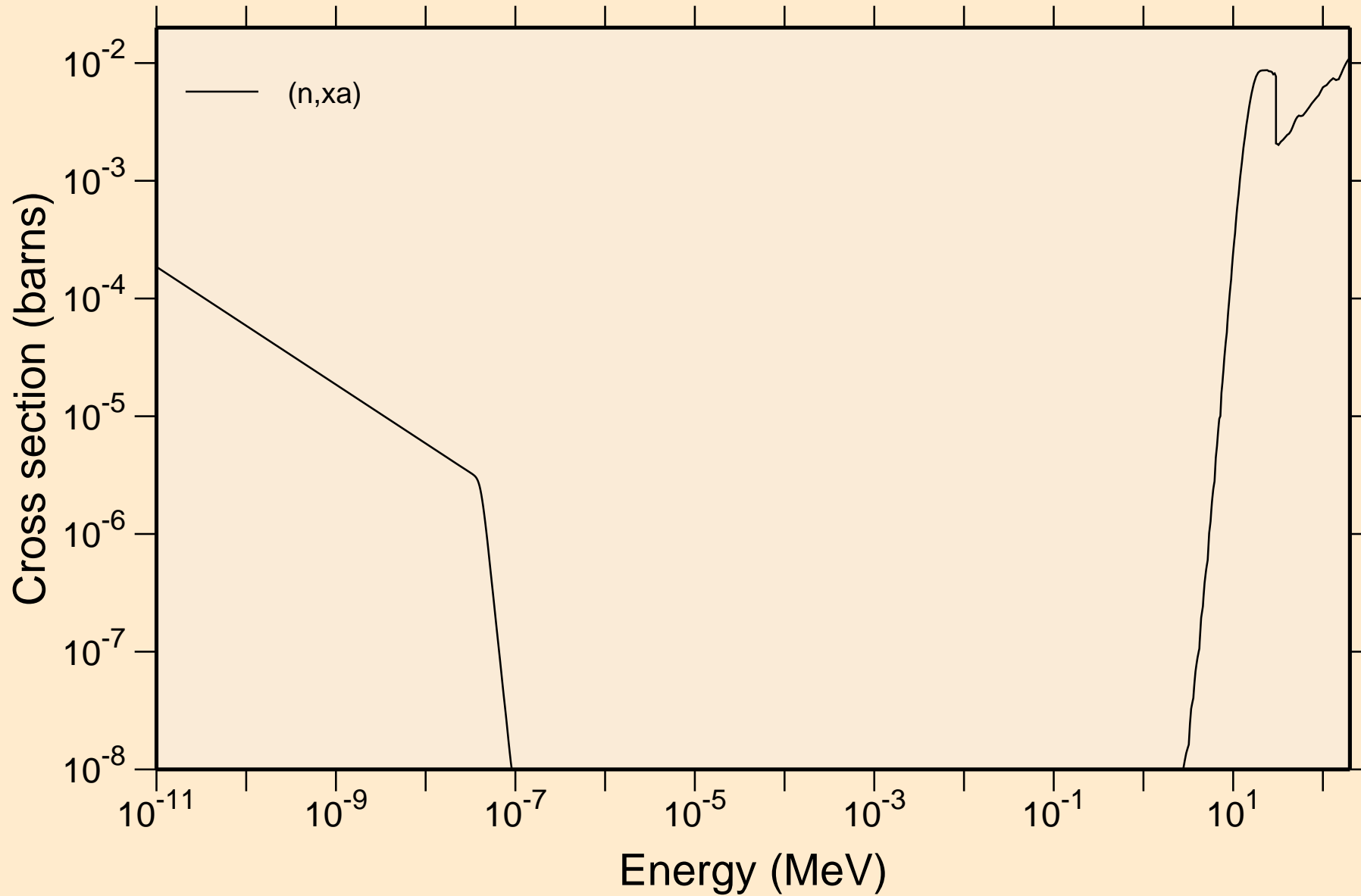

# AM235 NEUTRON ACER TENDL-2024 LIBRARY; T=293.6K

## Principal cross sections

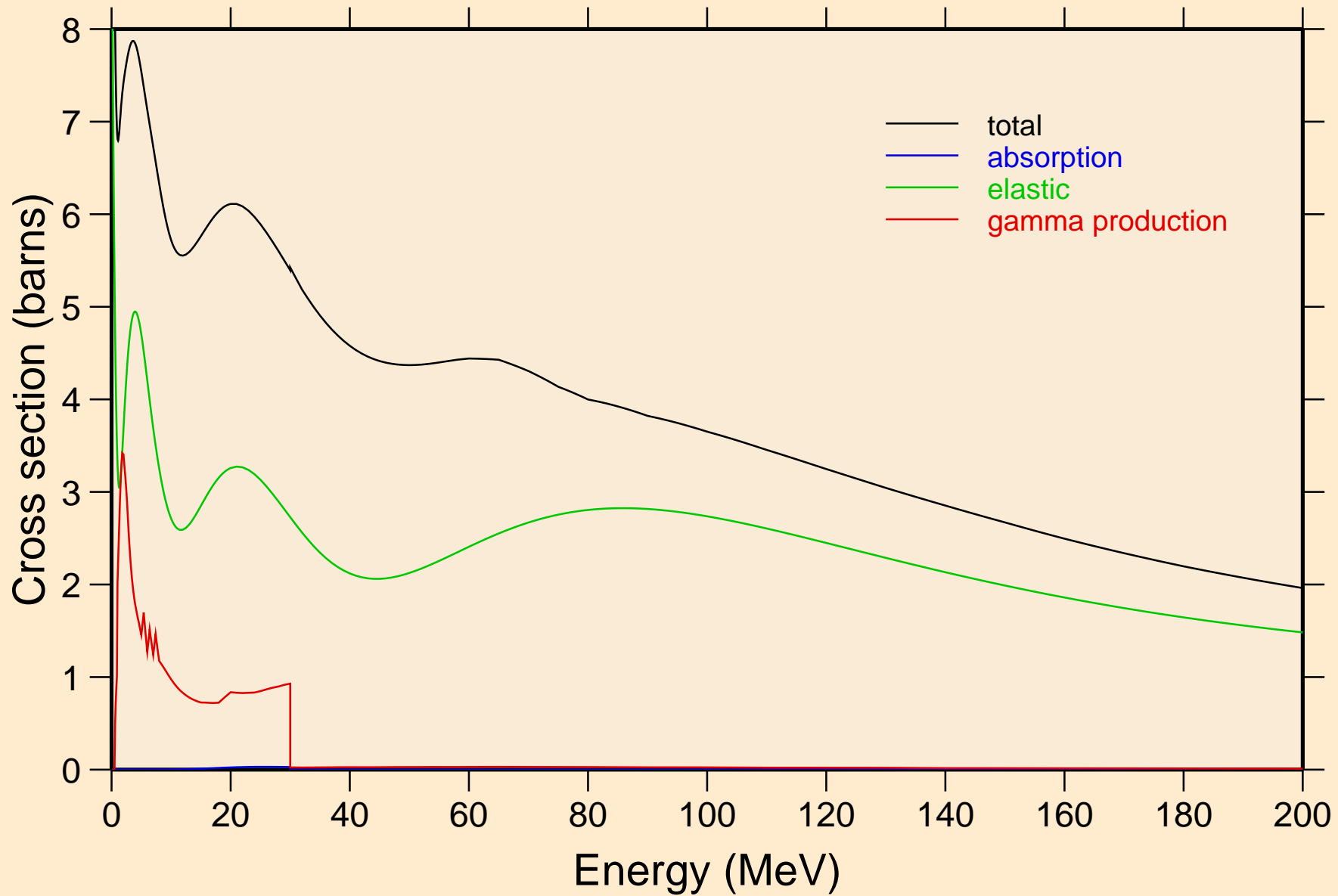

AM235 NEUTRON ACER TENDL-2024 LIBRARY; T=293.6K

Heating

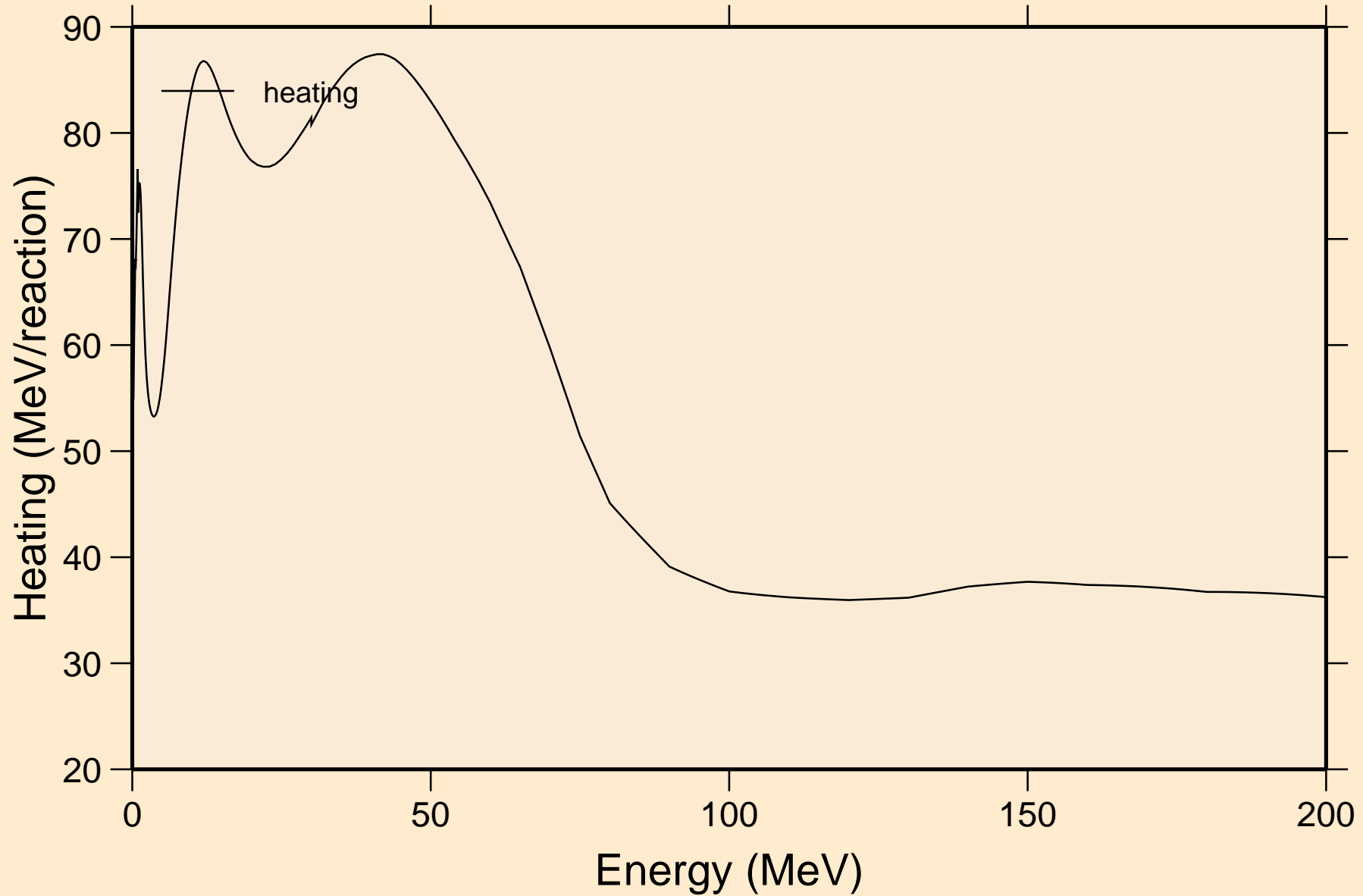

AM235 NEUTRON ACER TENDL-2024 LIBRARY; T=293.6K  
Damage

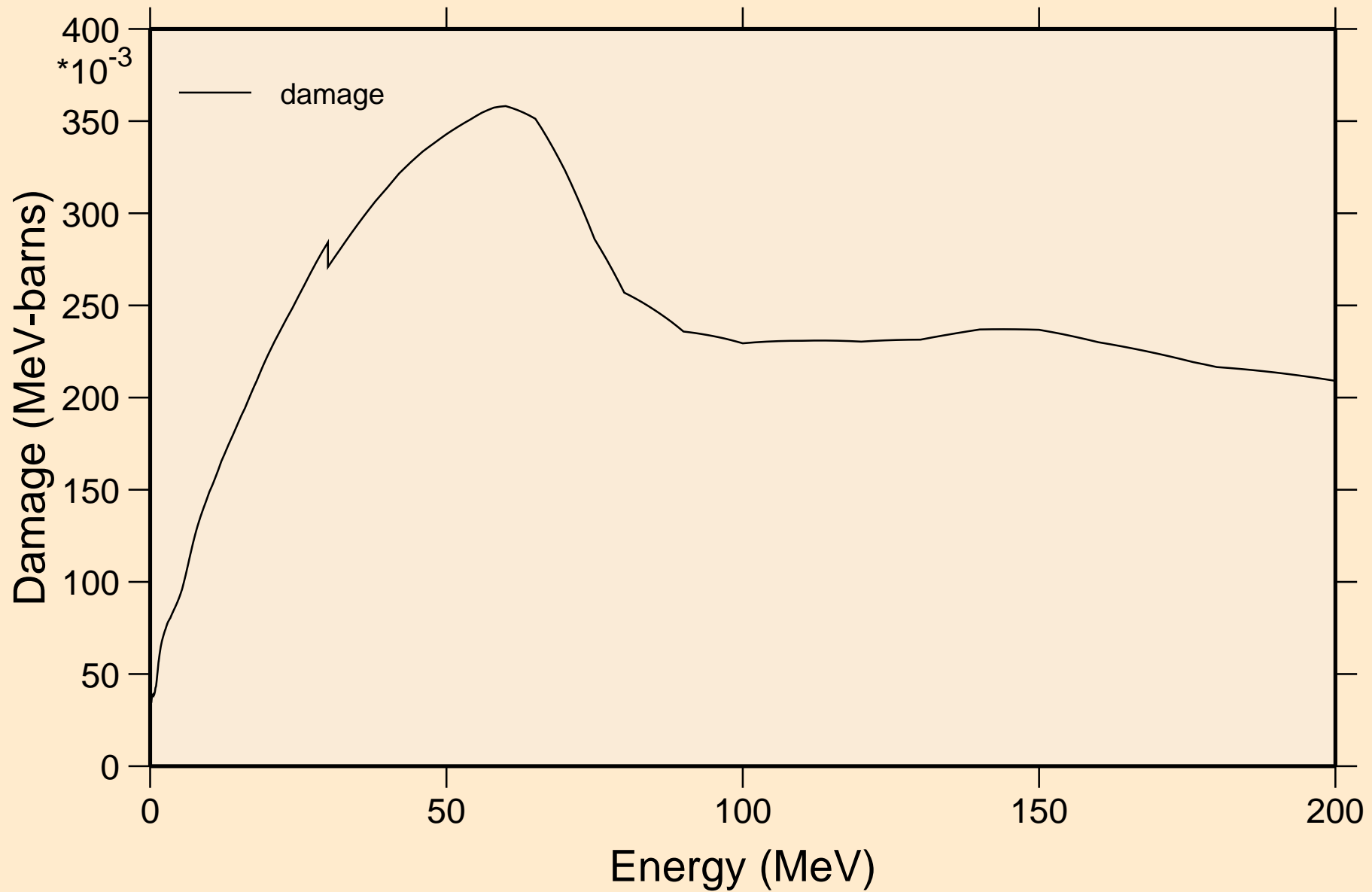

AM235 NEUTRON ACER TENDL-2024 LIBRARY; T=293.6K  
Non-threshold reactions

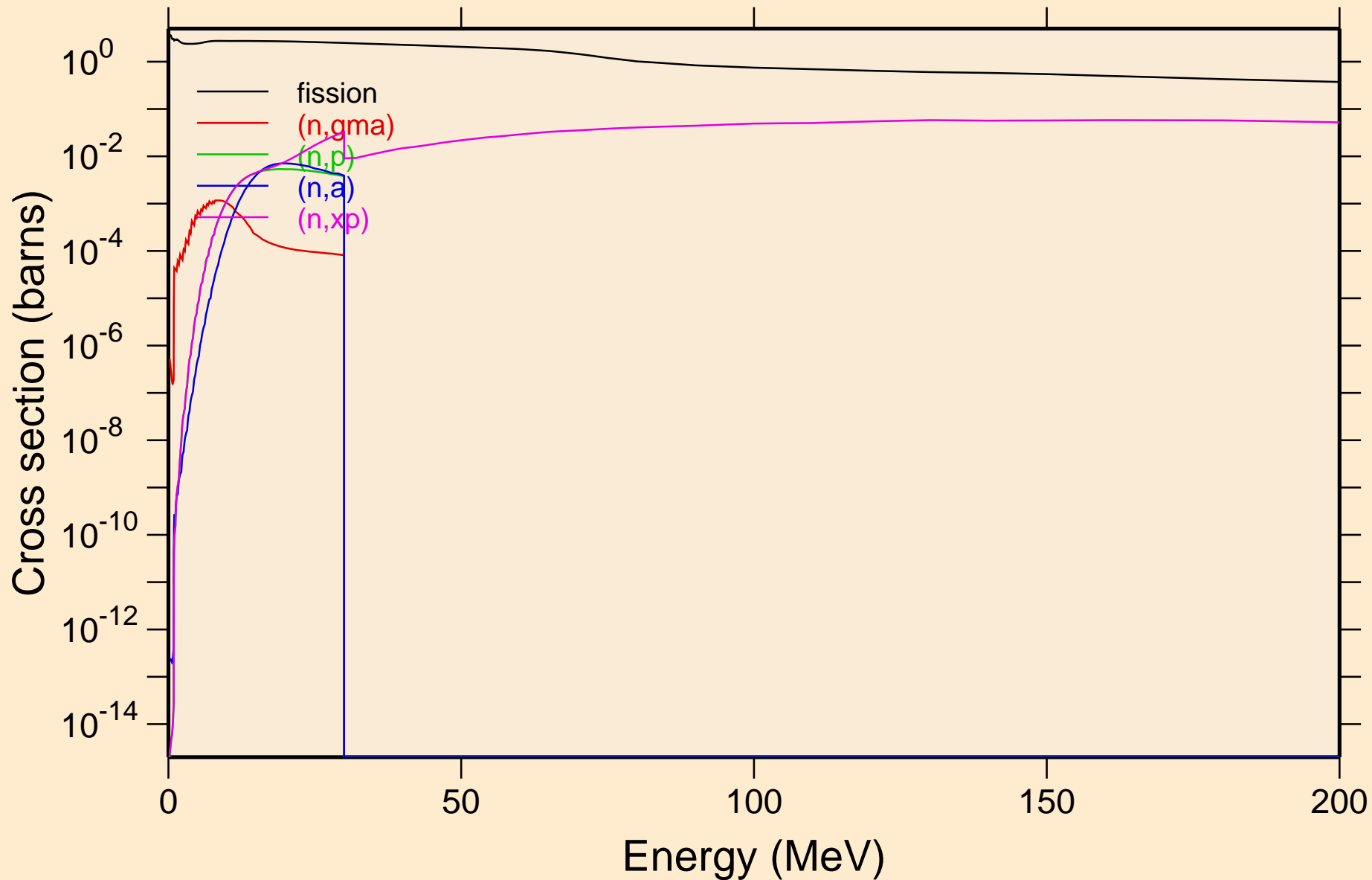

AM235 NEUTRON ACER TENDL-2024 LIBRARY; T=293.6K  
Non-threshold reactions

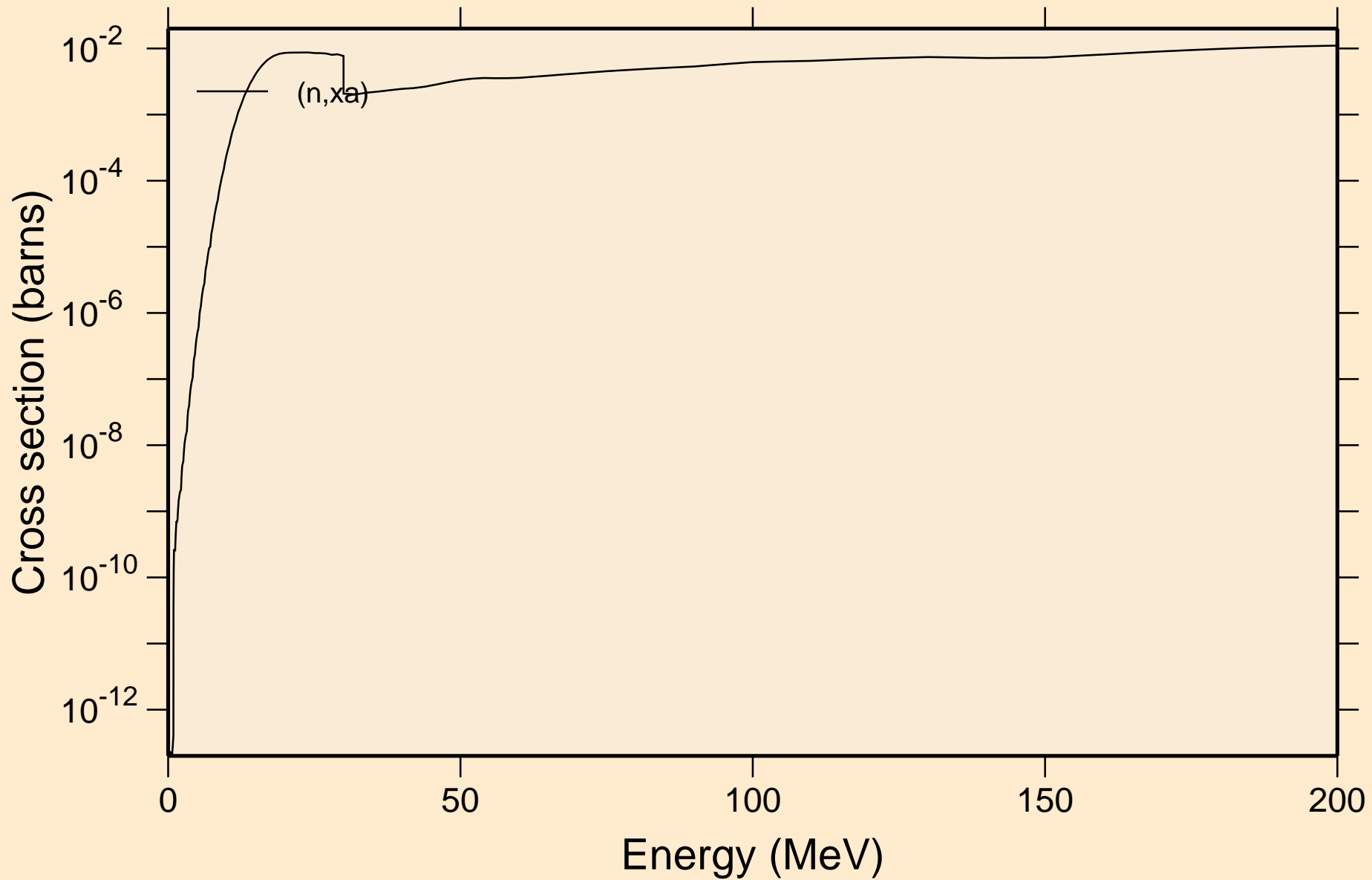

AM235 NEUTRON ACER TENDL-2024 LIBRARY; T=293.6K  
Inelastic levels

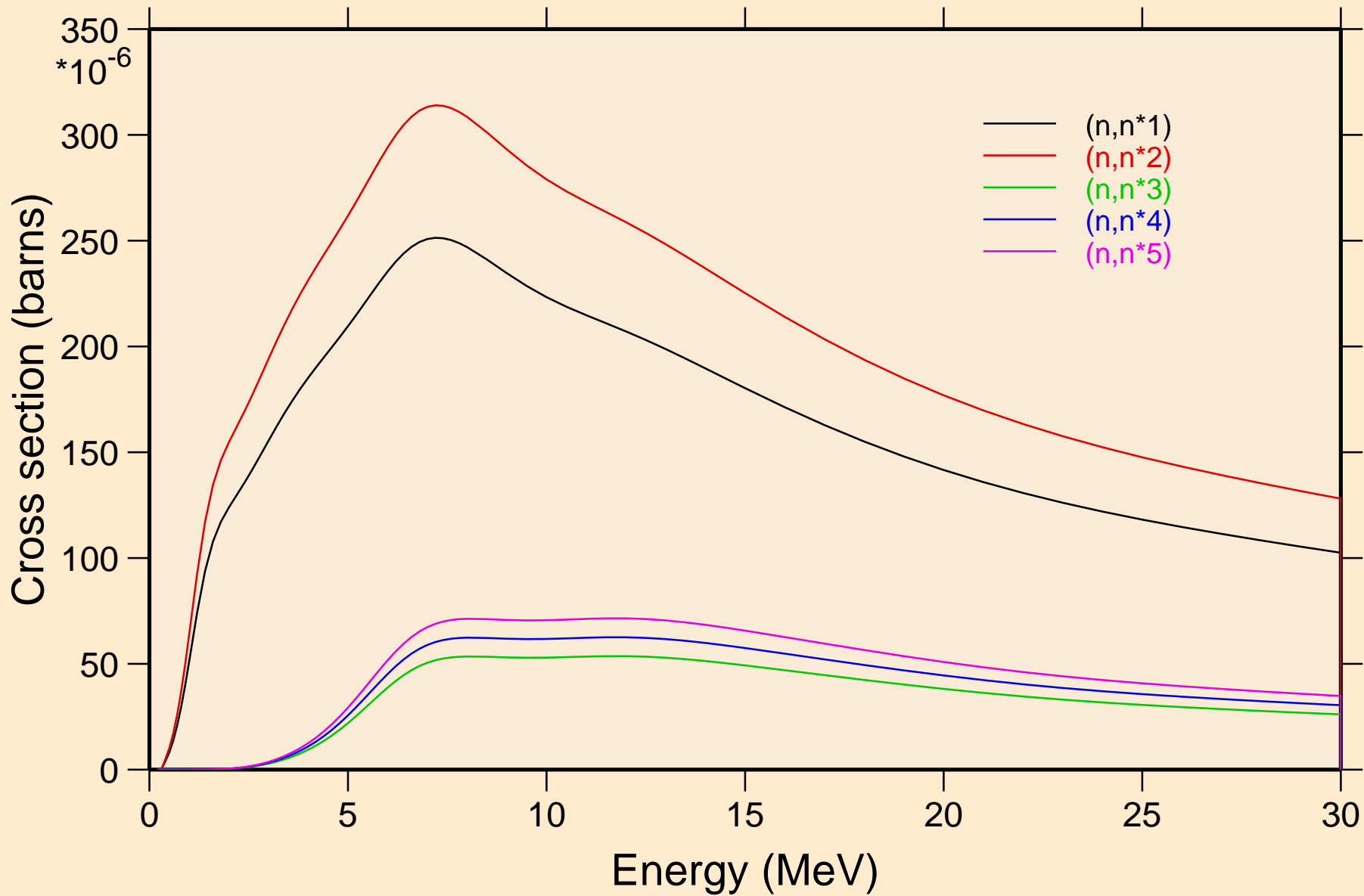

AM235 NEUTRON ACER TENDL-2024 LIBRARY; T=293.6K  
Inelastic levels

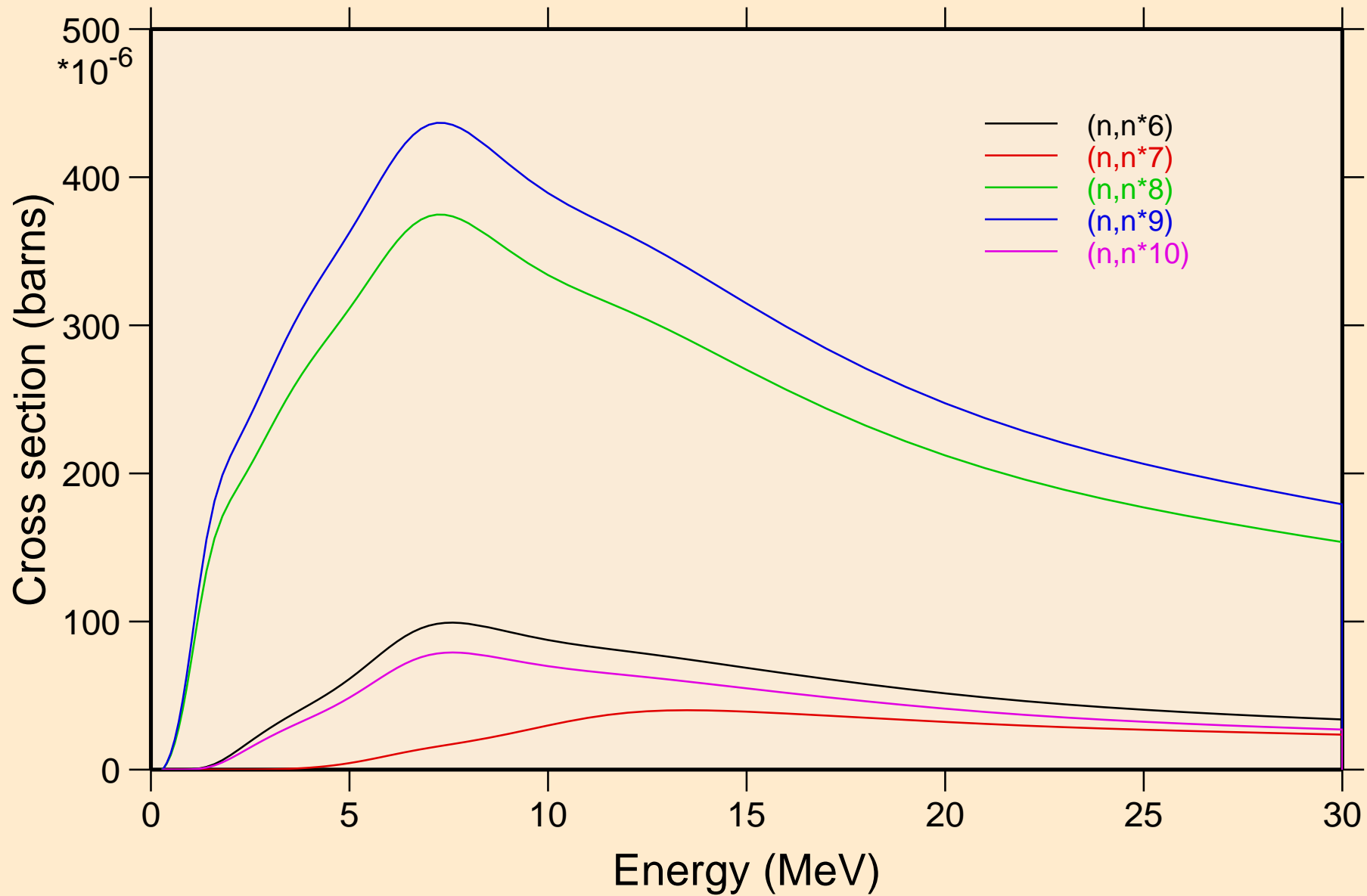

AM235 NEUTRON ACER TENDL-2024 LIBRARY; T=293.6K  
Inelastic levels

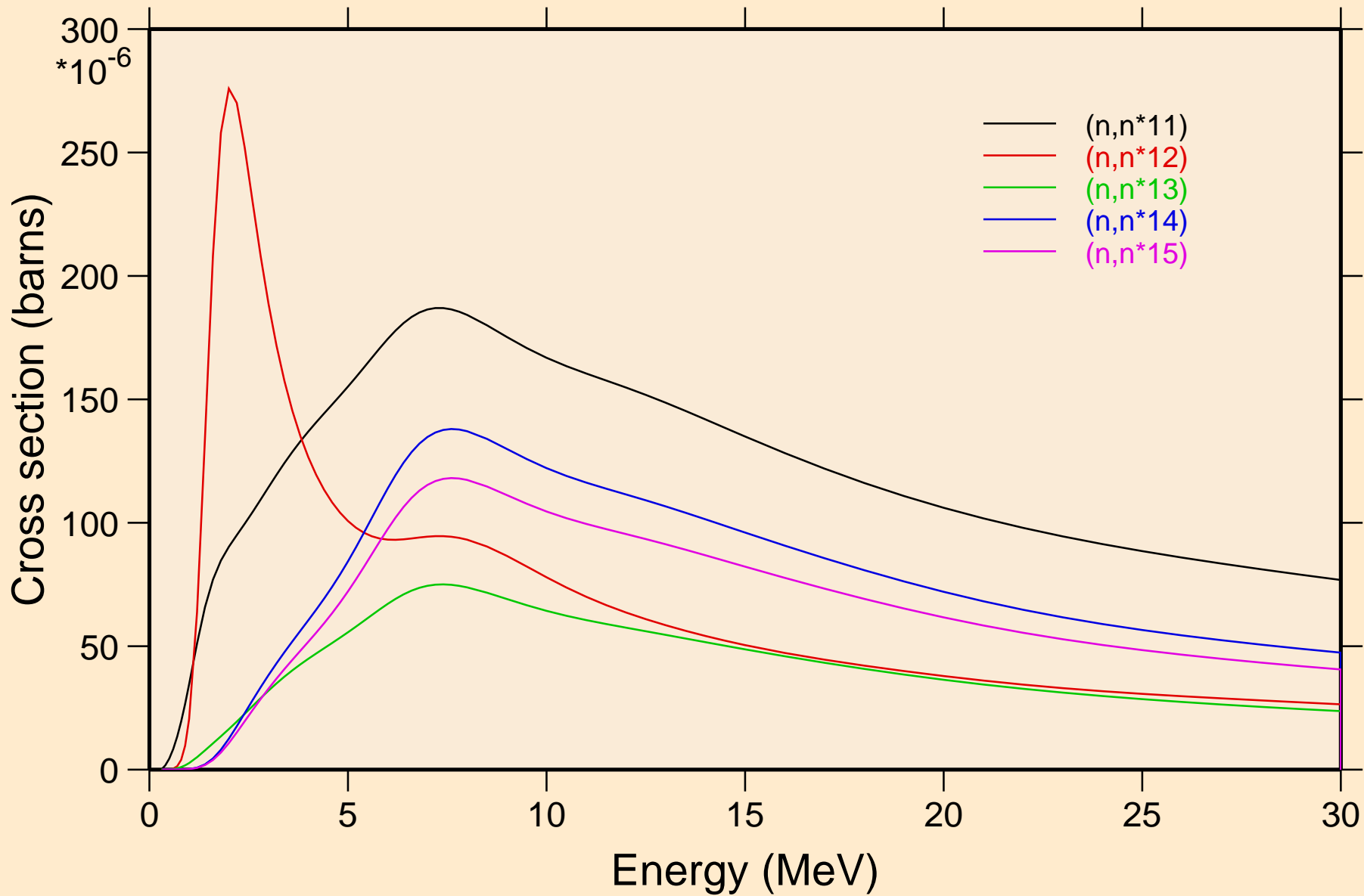

AM235 NEUTRON ACER TENDL-2024 LIBRARY; T=293.6K  
Inelastic levels

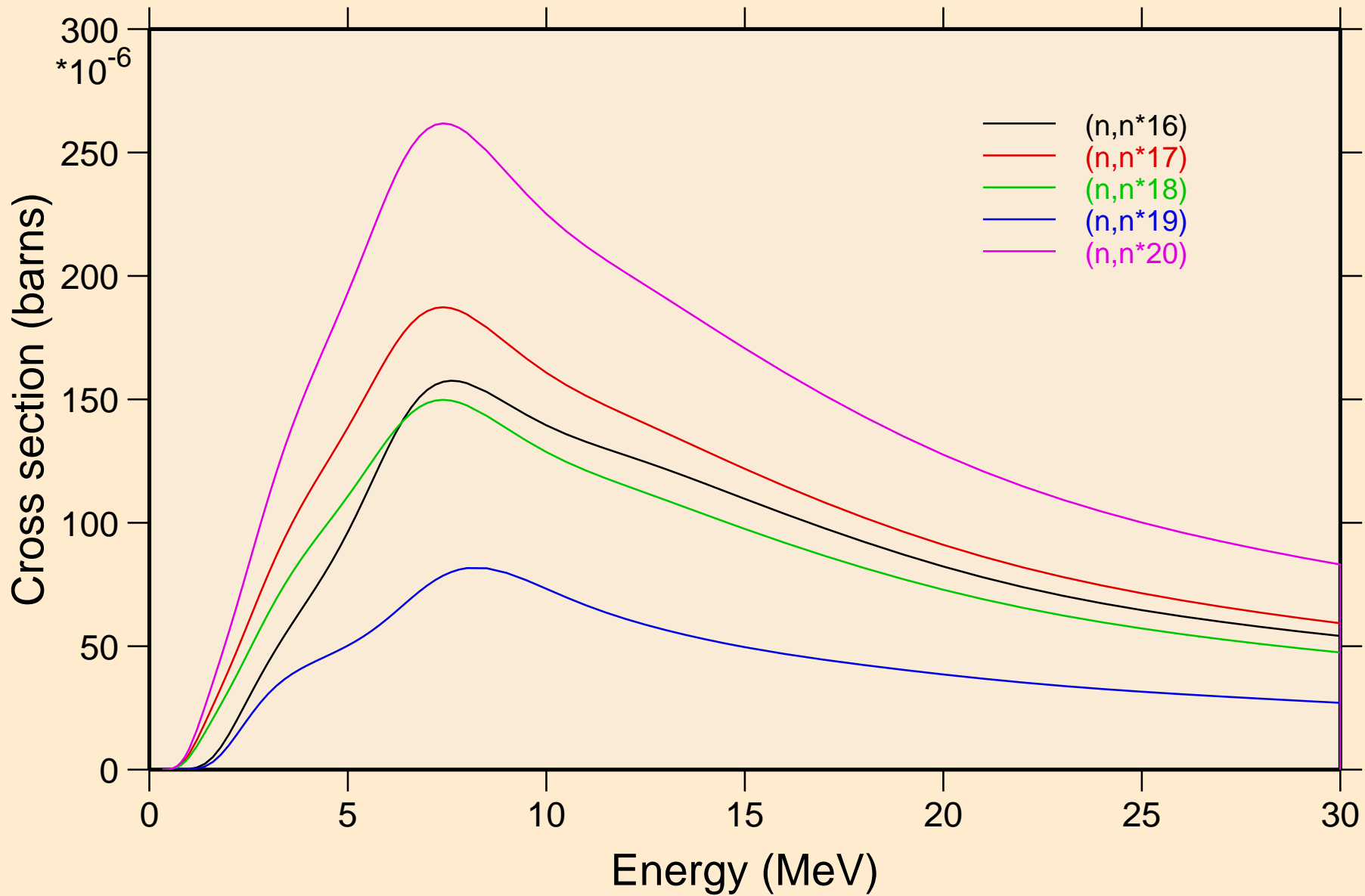

AM235 NEUTRON ACER TENDL-2024 LIBRARY; T=293.6K  
Inelastic levels

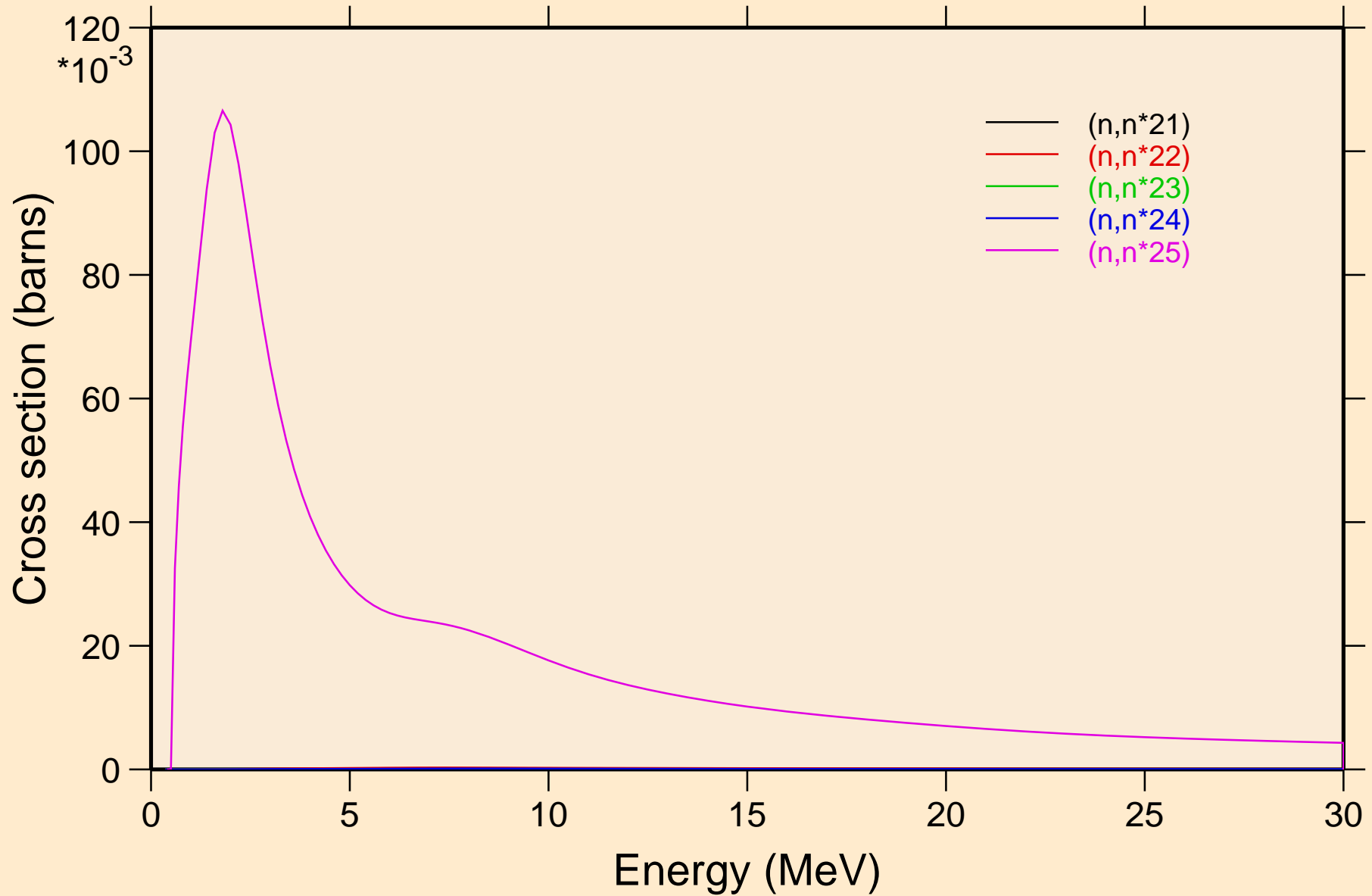

AM235 NEUTRON ACER TENDL-2024 LIBRARY; T=293.6K  
Inelastic levels

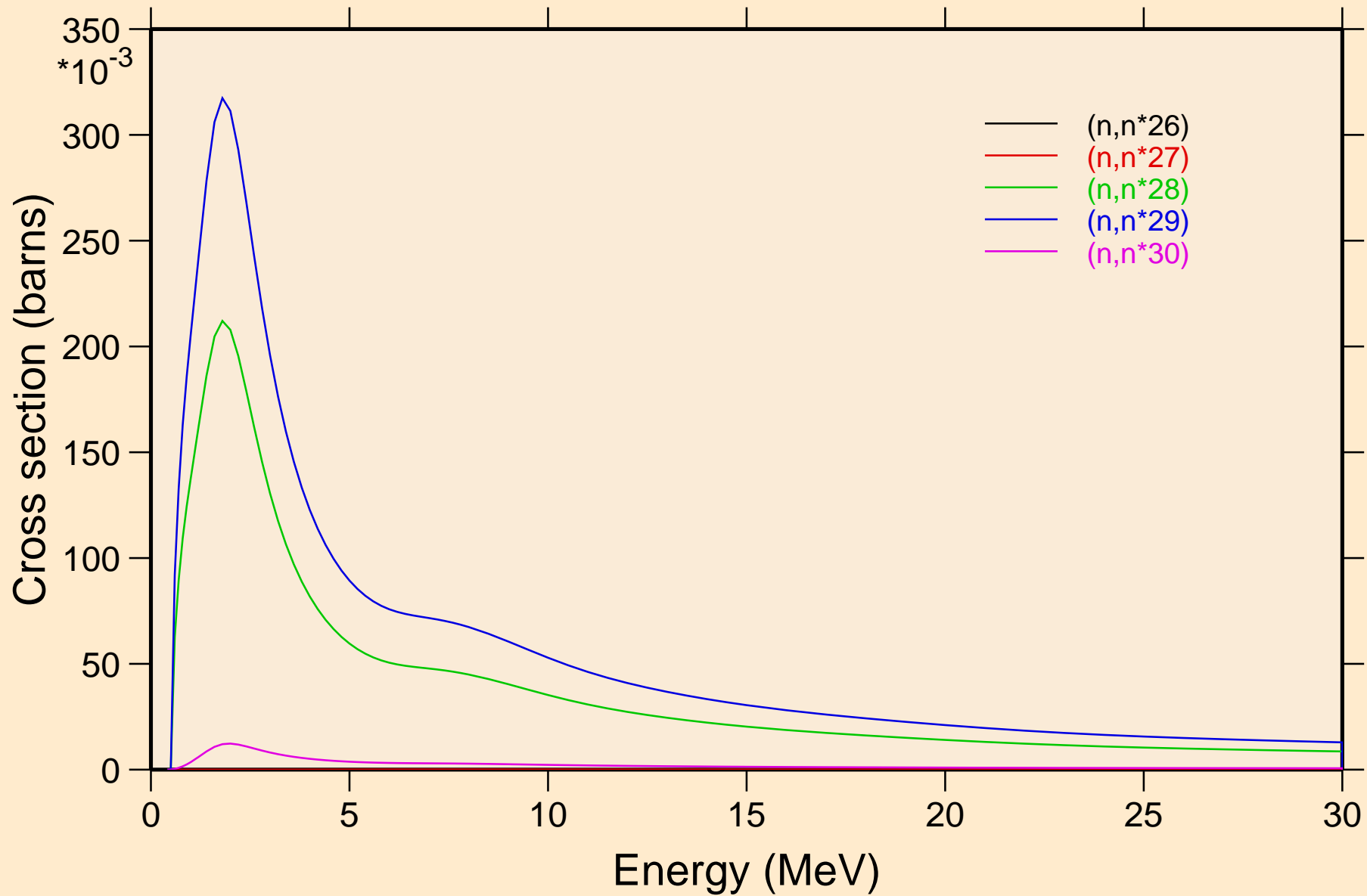

# AM235 NEUTRON ACER TENDL-2024 LIBRARY; T=293.6K

## Threshold reactions

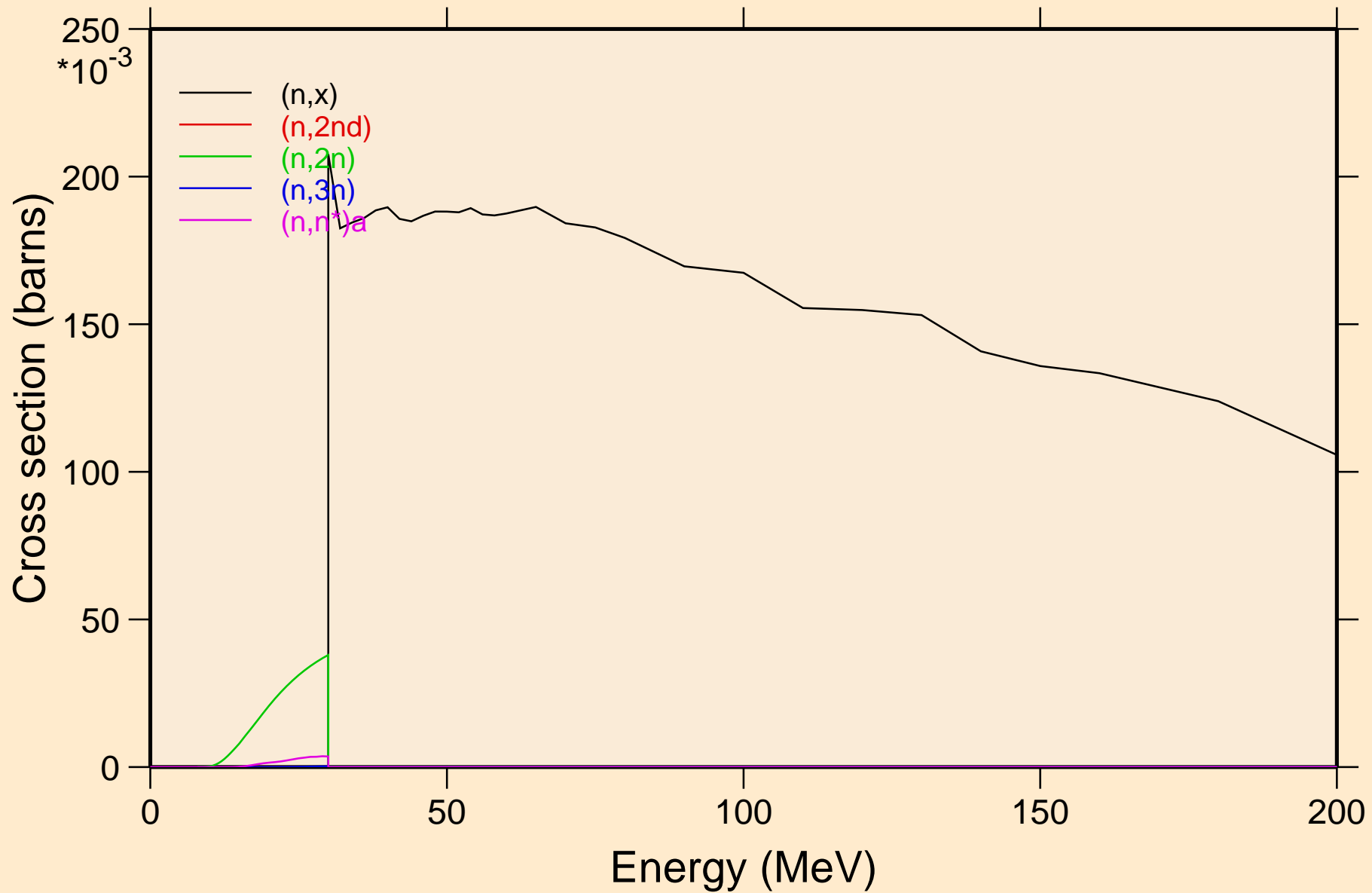

AM235 NEUTRON ACER TENDL-2024 LIBRARY; T=293.6K  
Threshold reactions

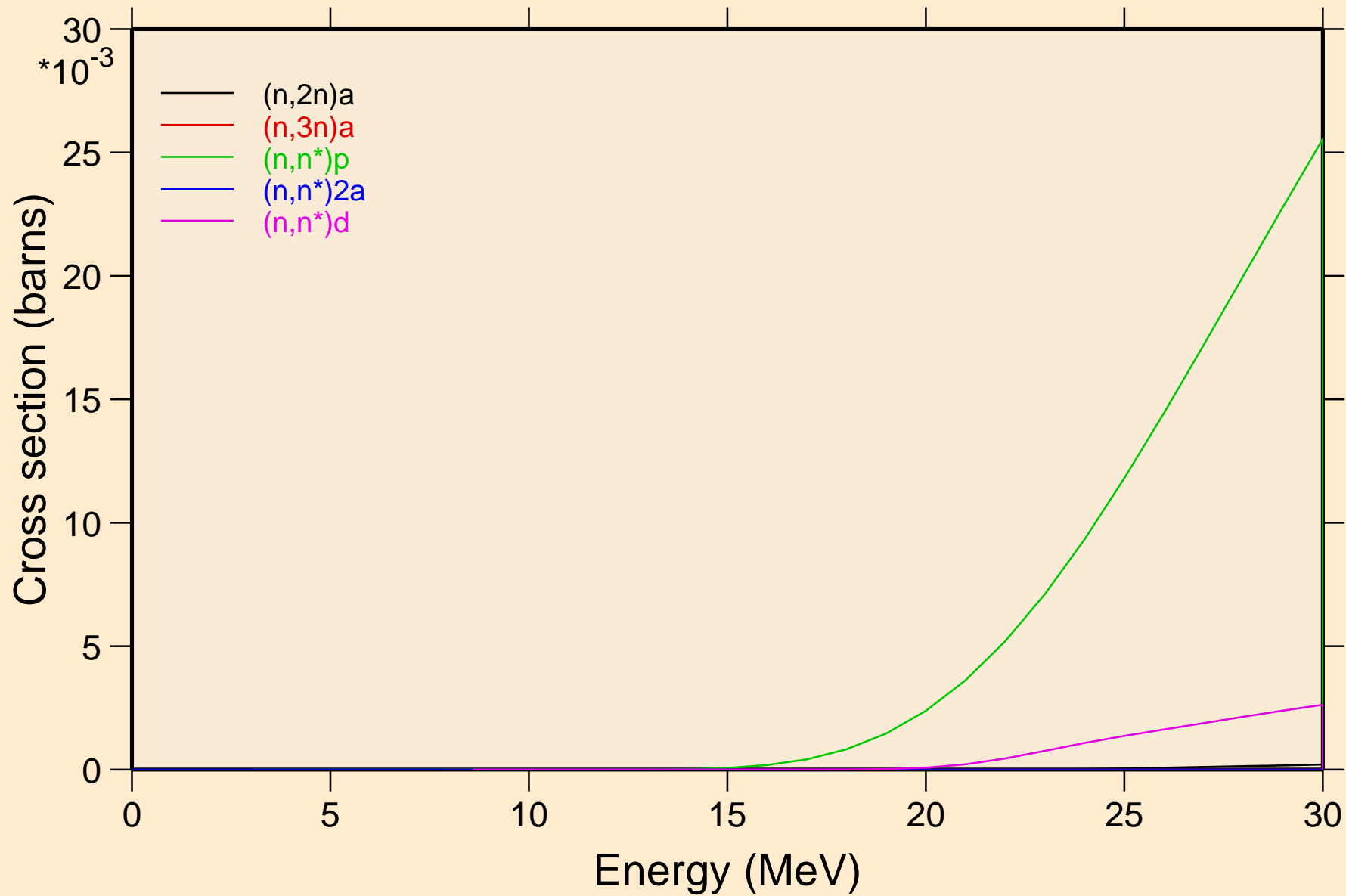

AM235 NEUTRON ACER TENDL-2024 LIBRARY; T=293.6K  
Threshold reactions

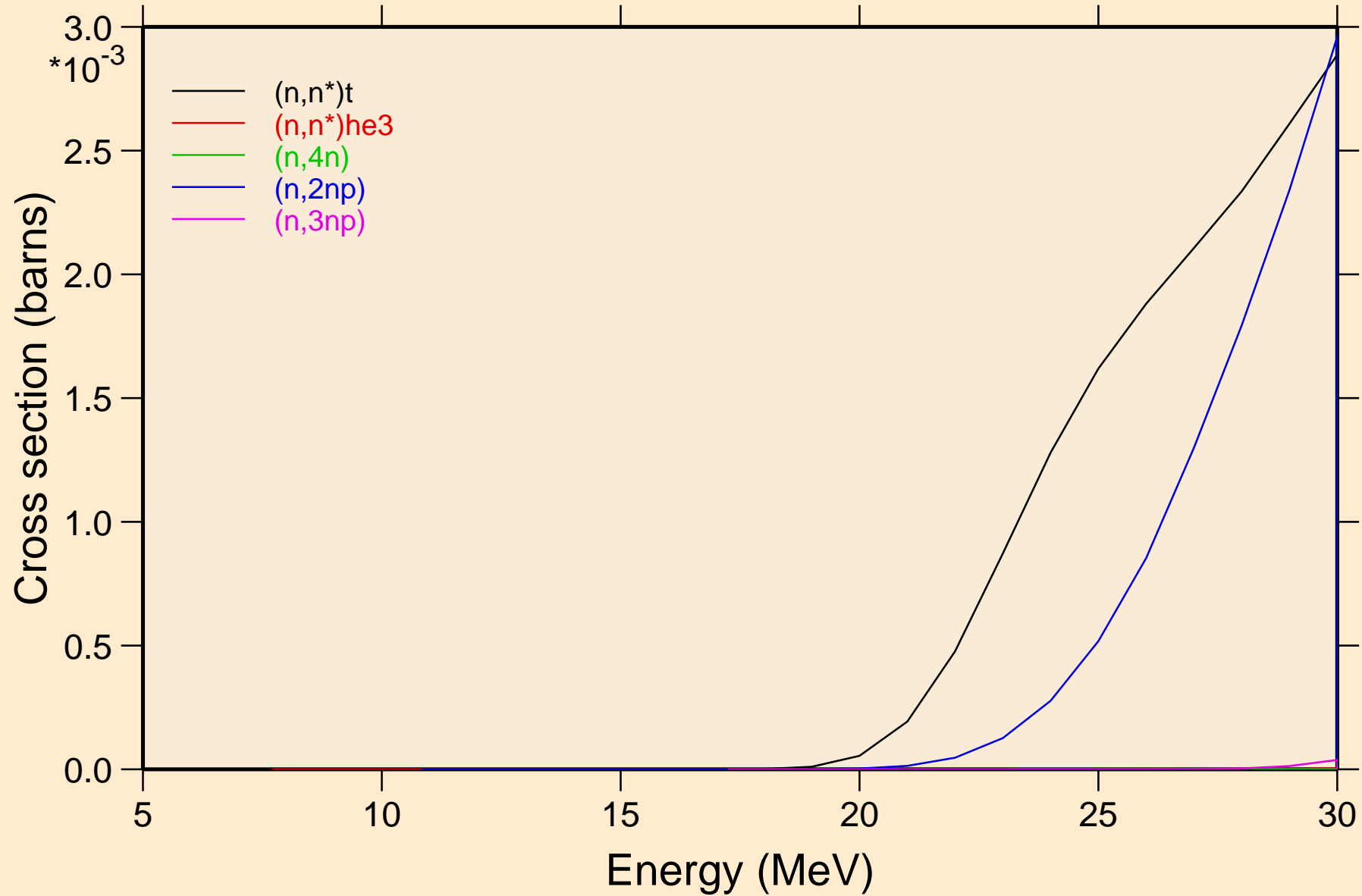

# AM235 NEUTRON ACER TENDL-2024 LIBRARY; T=293.6K

## Threshold reactions

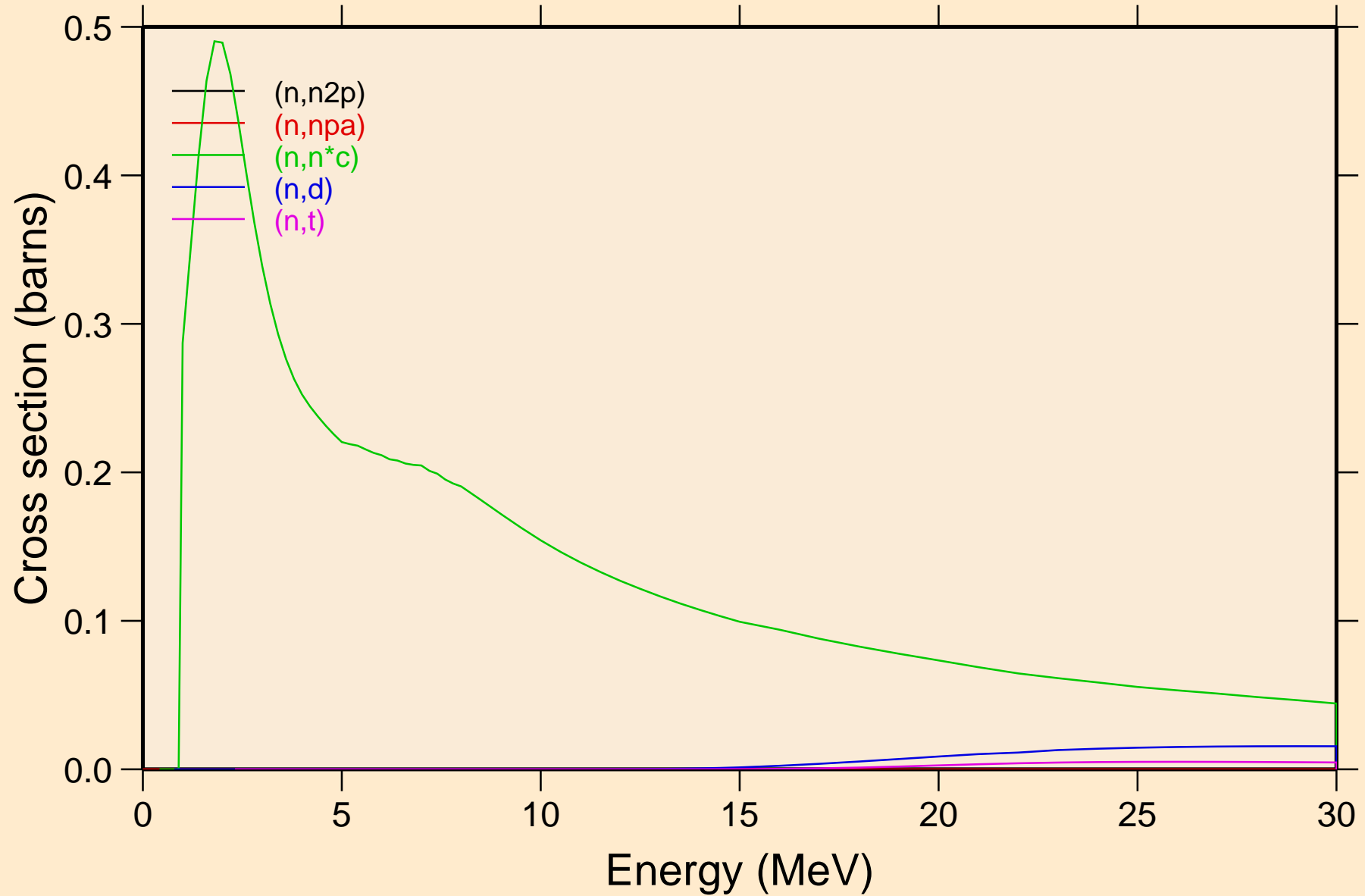

AM235 NEUTRON ACER TENDL-2024 LIBRARY; T=293.6K  
Threshold reactions

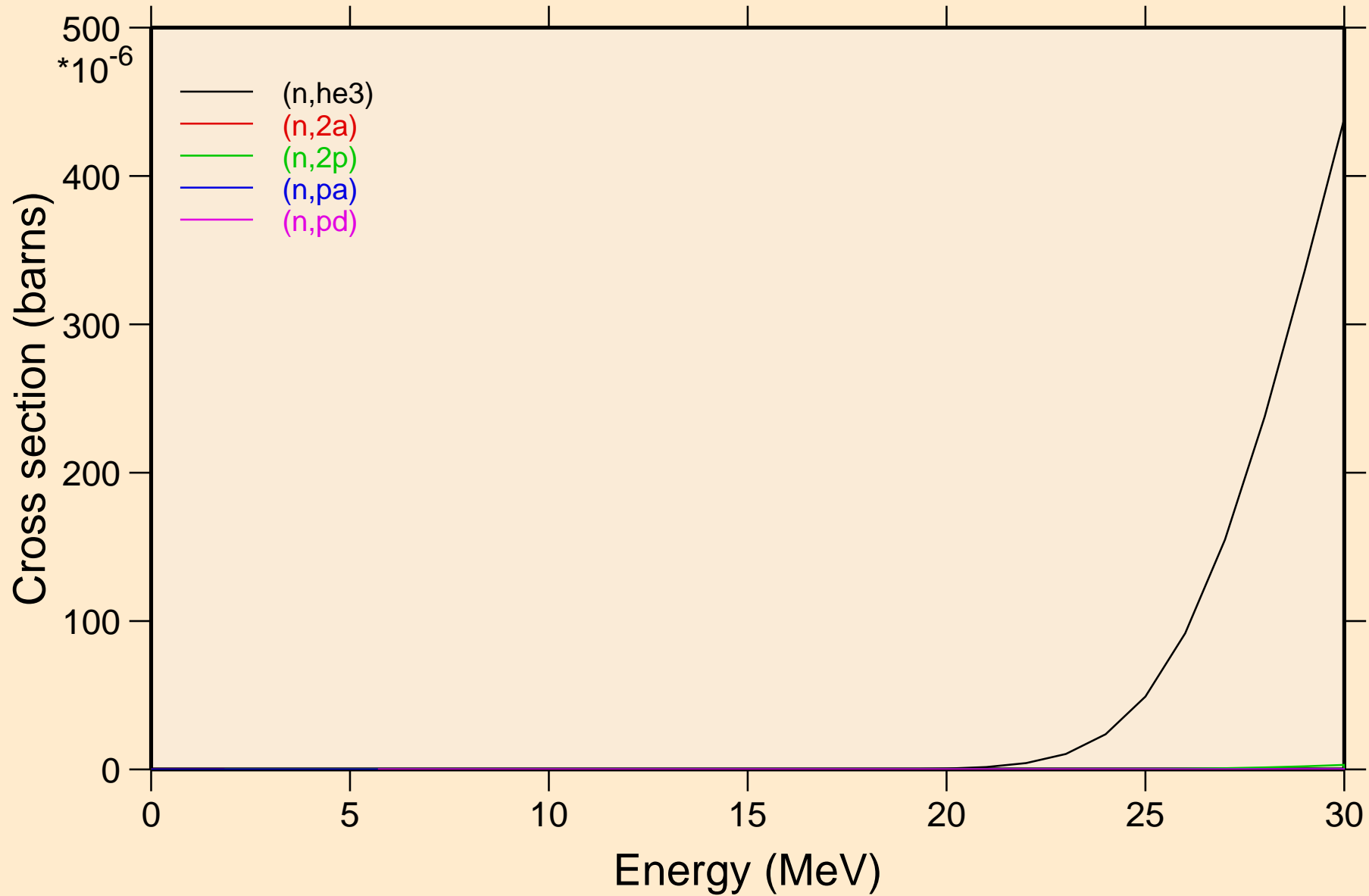

AM235 NEUTRON ACER TENDL-2024 LIBRARY; T=293.6K  
Threshold reactions

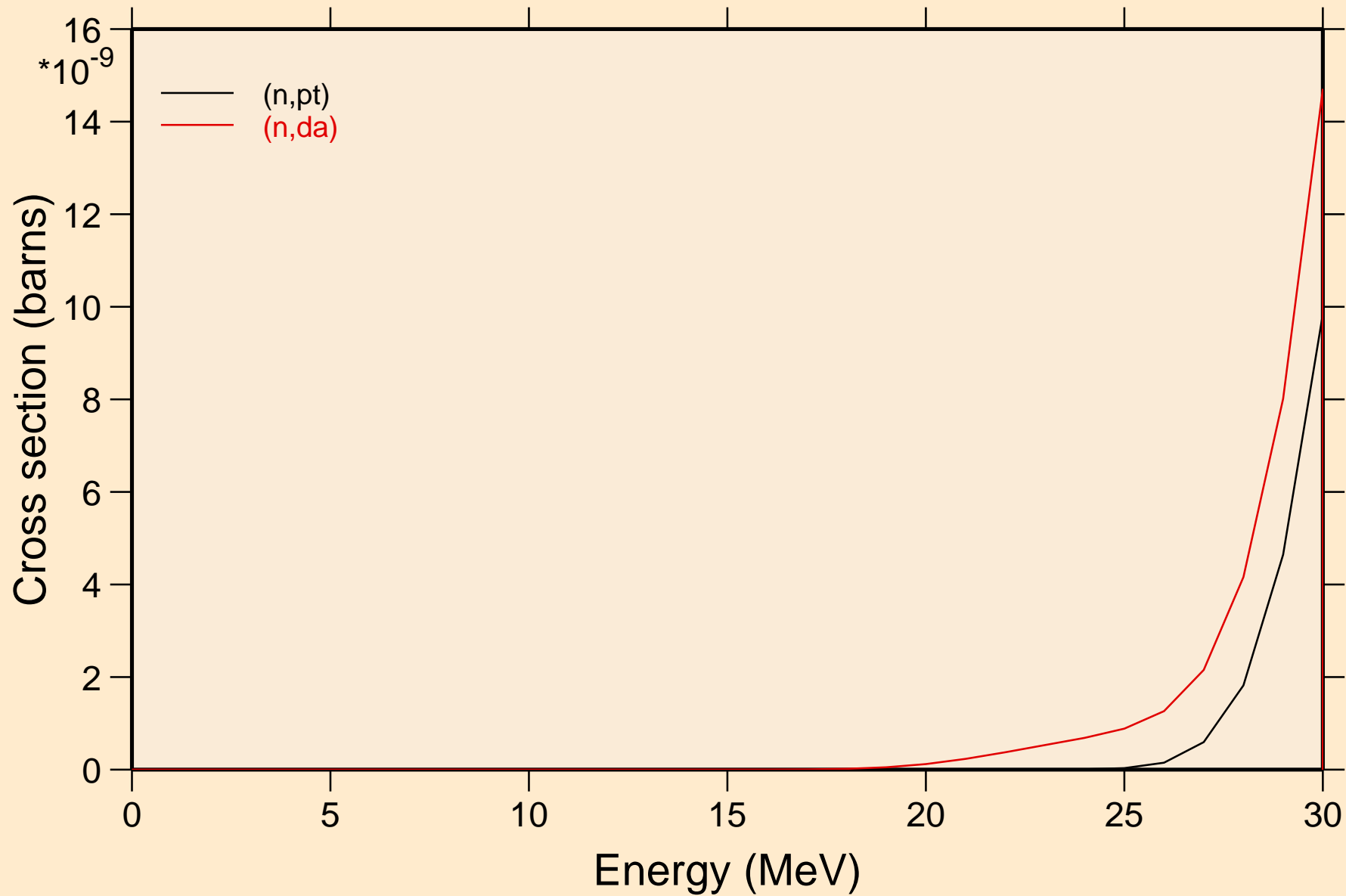

AM235 NEUTRON ACER TENDL-2024 LIBRARY; T=293.6K  
Threshold reactions

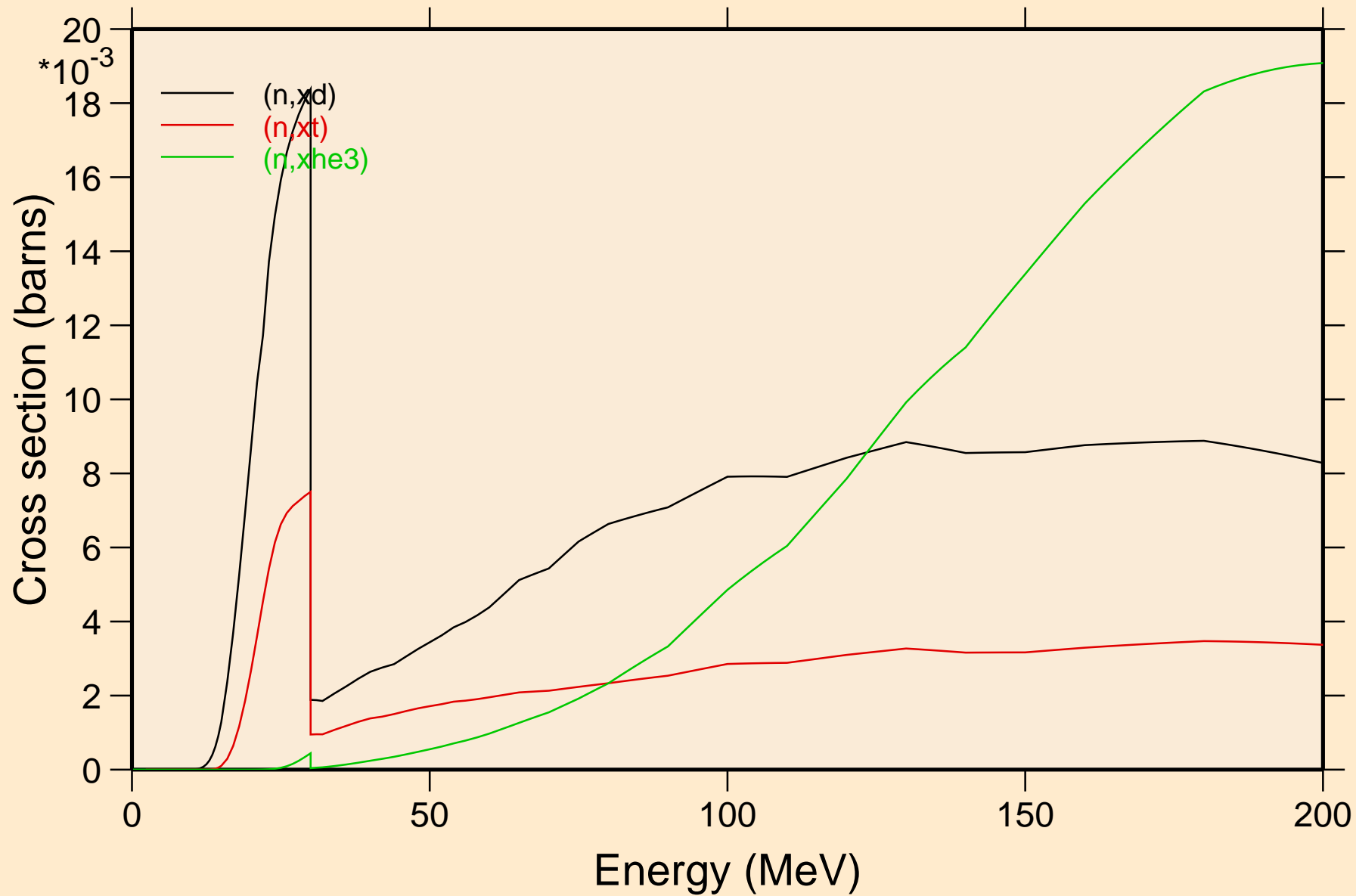

AM235 NEUTRON ACER TENDL-2024 LIBRARY; T=293.6K  
angular distribution for elastic

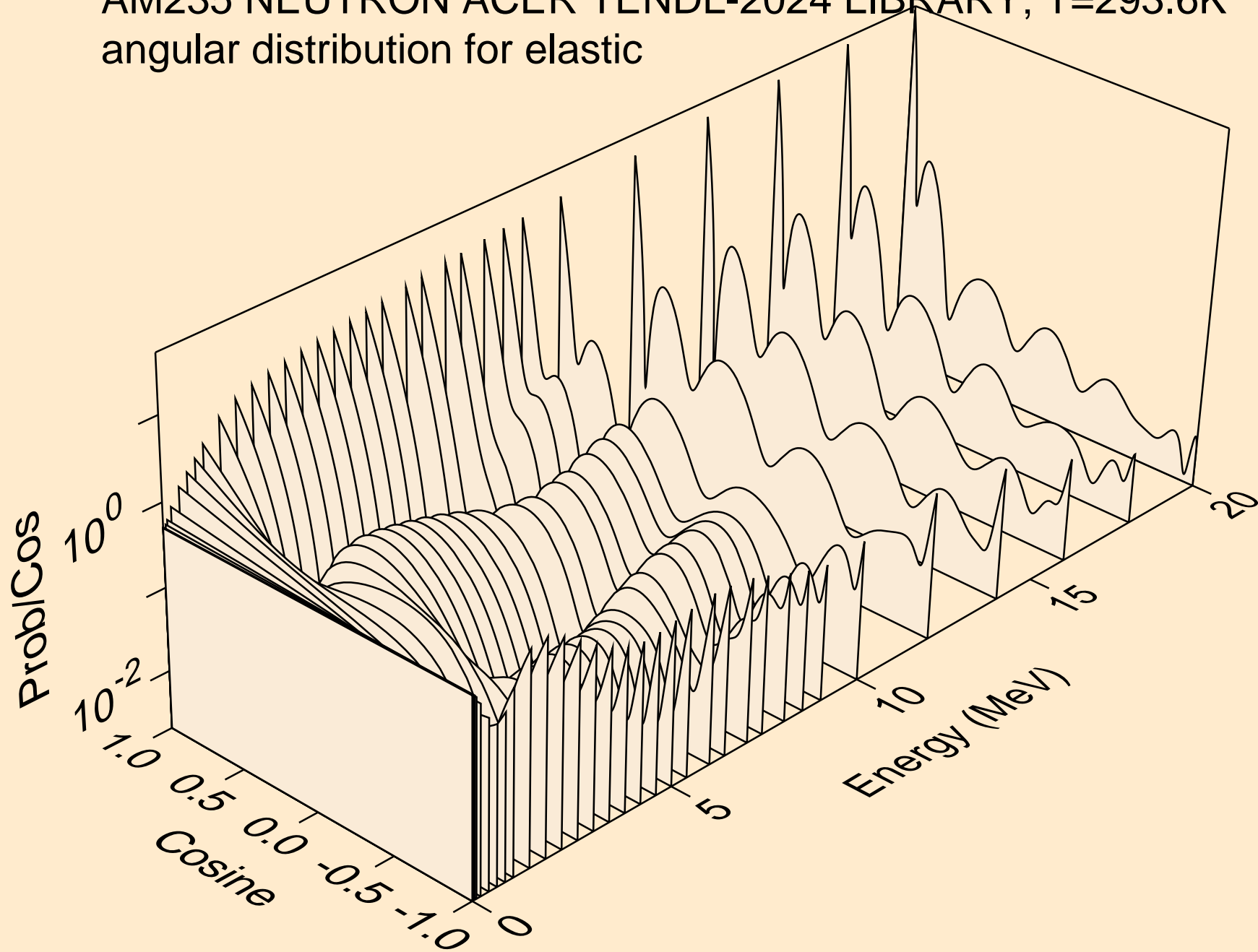

AM235 NEUTRON ACER TENDL-2024 LIBRARY; T=293.6K  
angular distribution for elastic

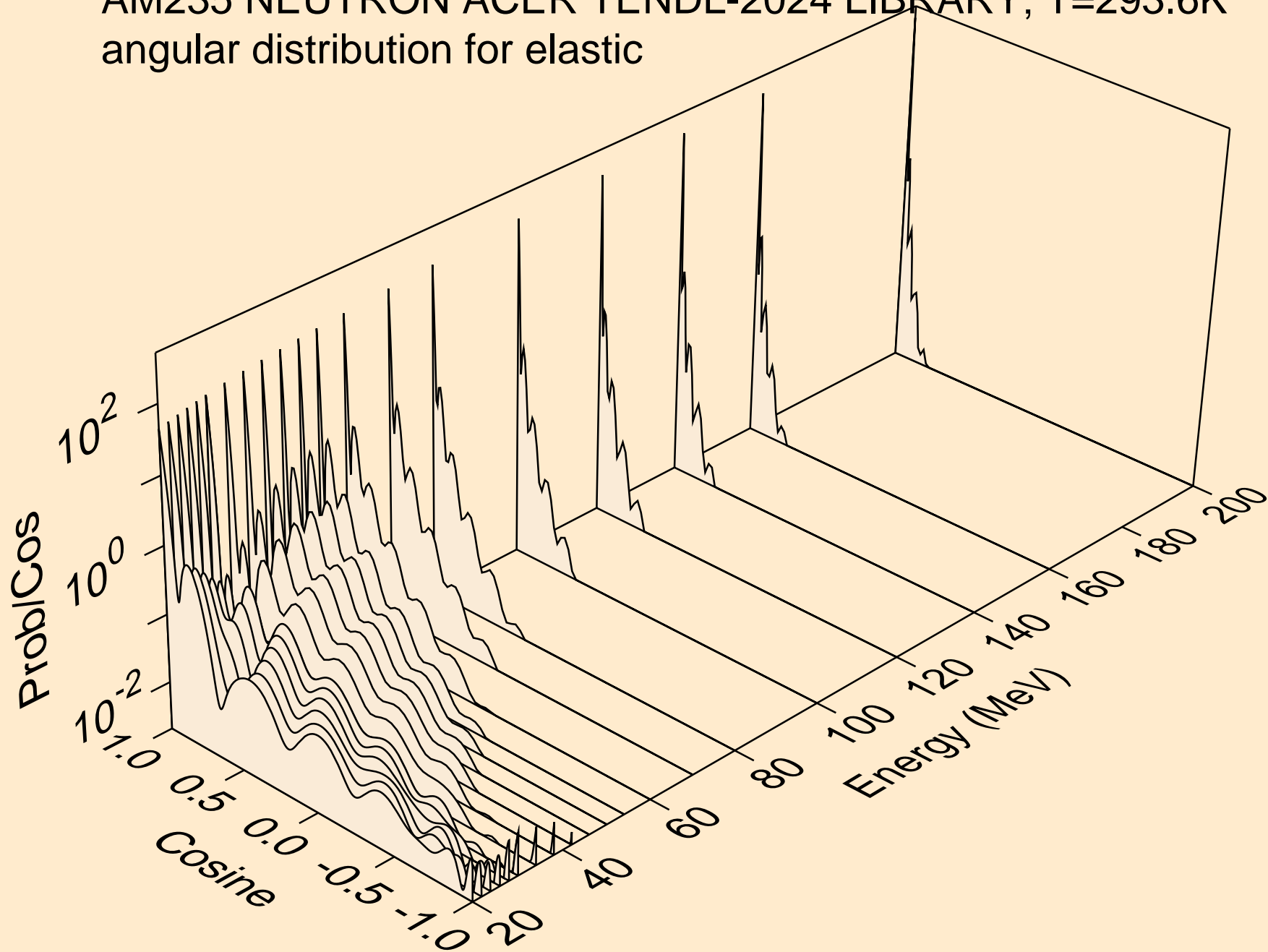

AM235 NEUTRON ACER TENDL-2024 LIBRARY; T=293.6K  
angular distribution for (n,n\*1)

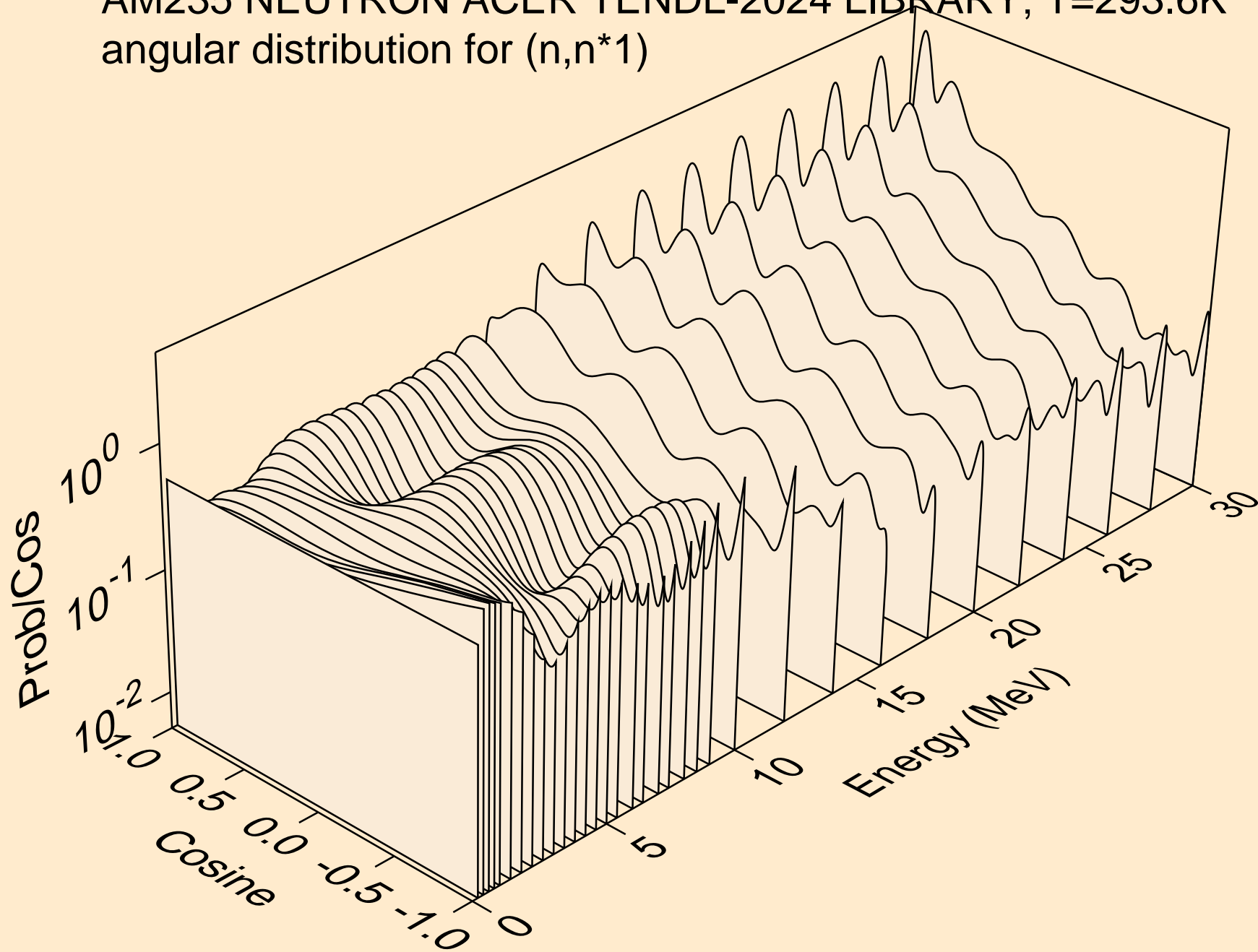

AM235 NEUTRON ACER TENDL-2024 LIBRARY; T=293.6K  
angular distribution for (n,n\*2)

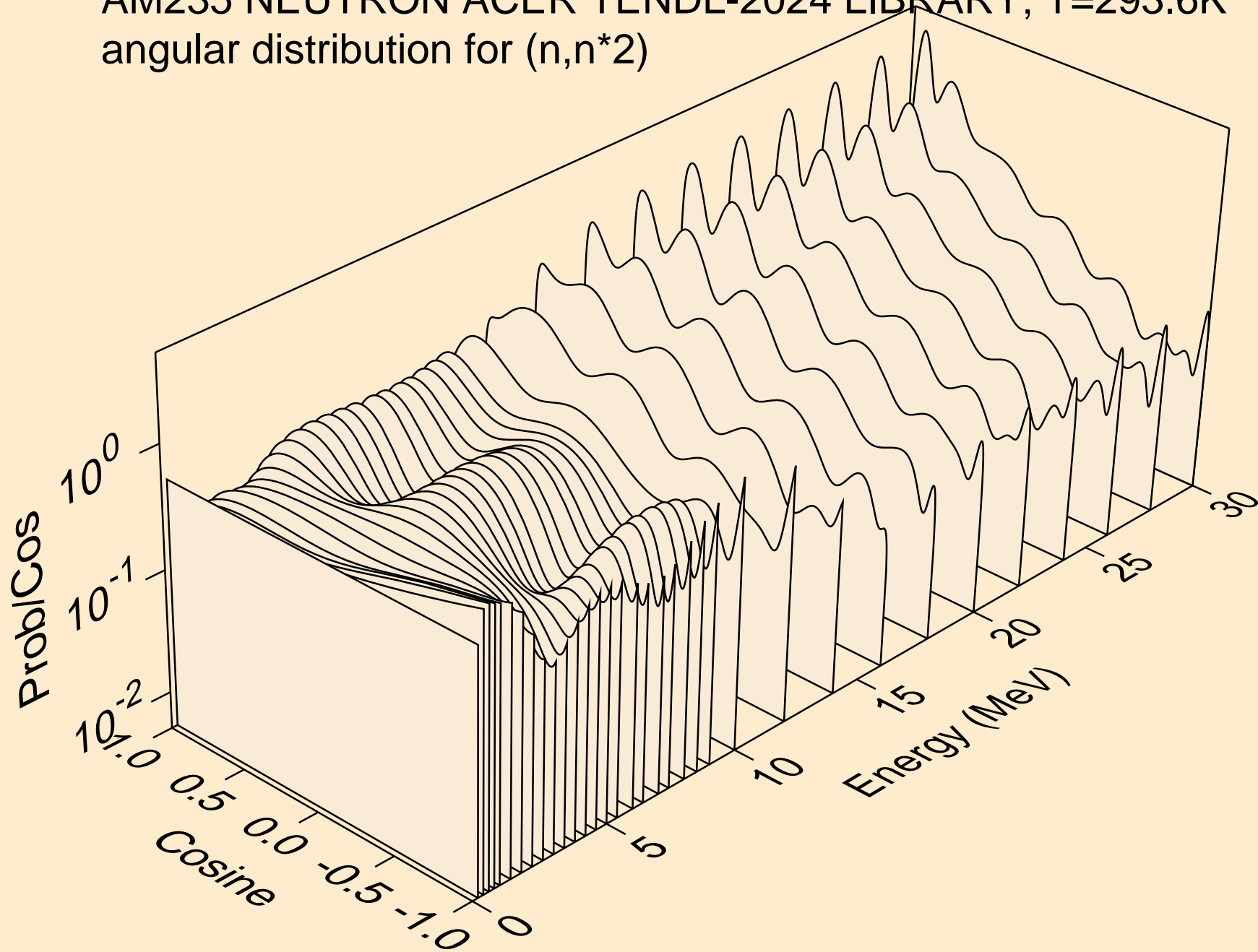

AM235 NEUTRON ACER TENDL-2024 LIBRARY; T=293.6K  
angular distribution for (n,n\*3)

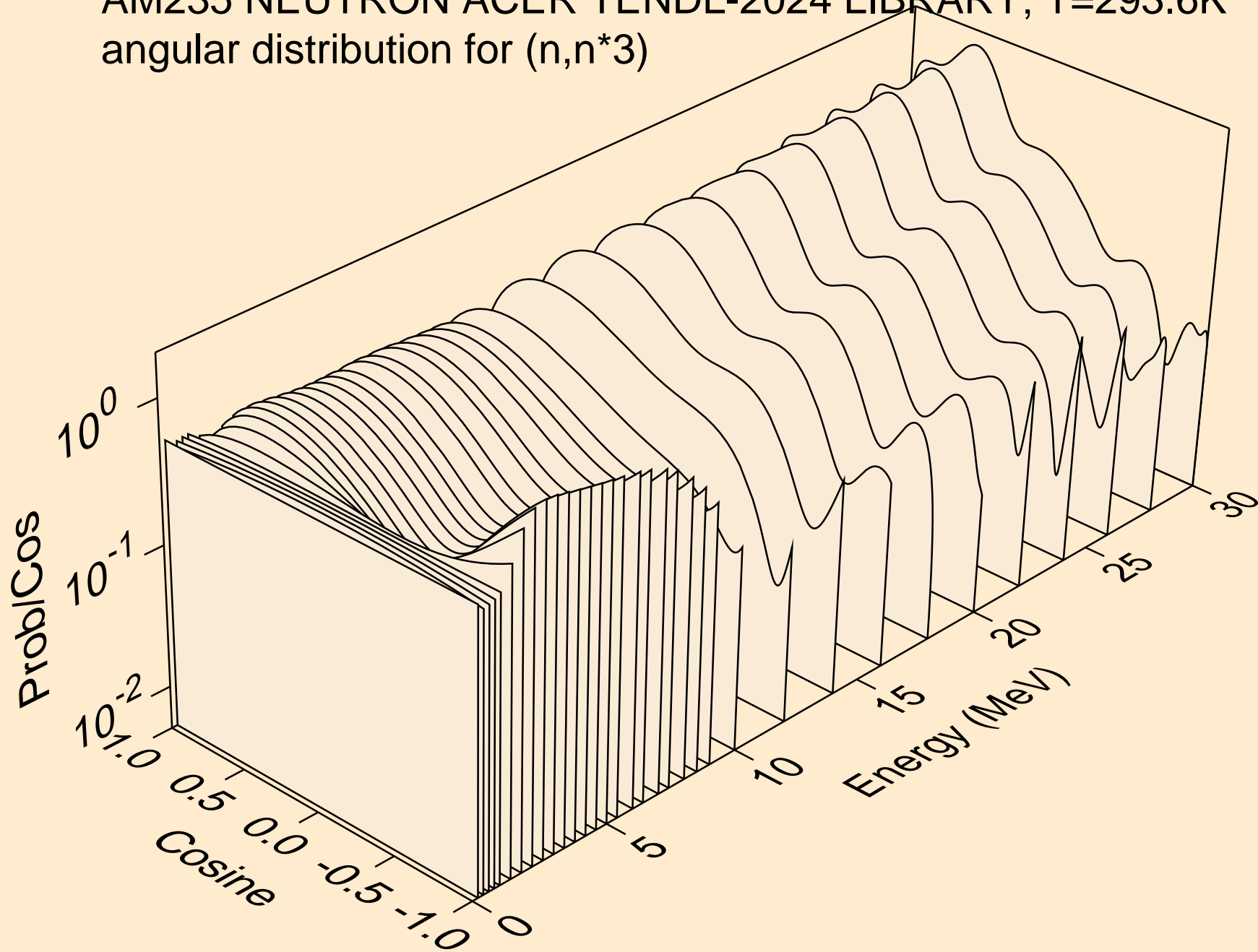

AM235 NEUTRON ACER TENDL-2024 LIBRARY; T=293.6K  
angular distribution for (n,n\*4)

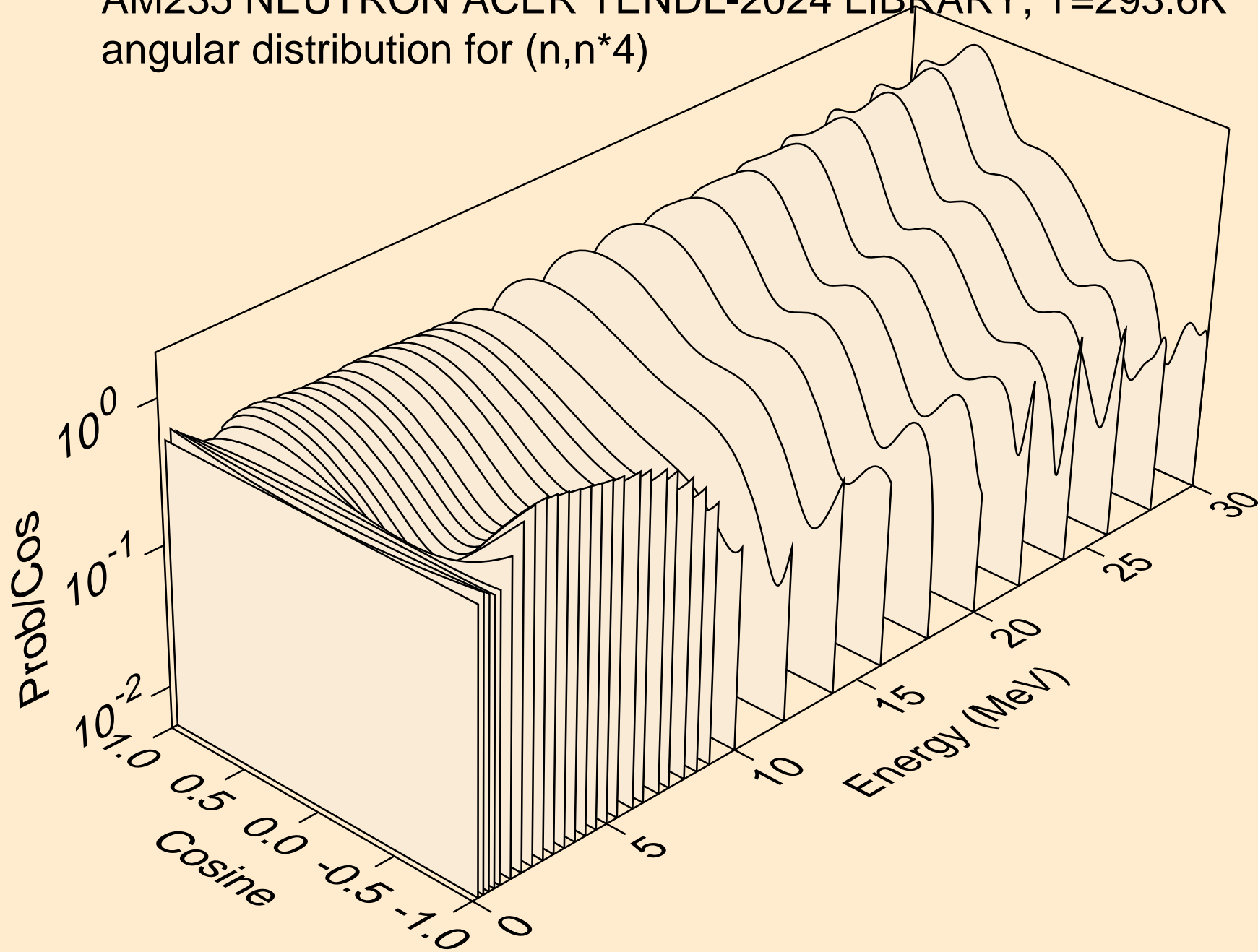

AM235 NEUTRON ACER TENDL-2024 LIBRARY; T=293.6K  
angular distribution for (n,n\*5)

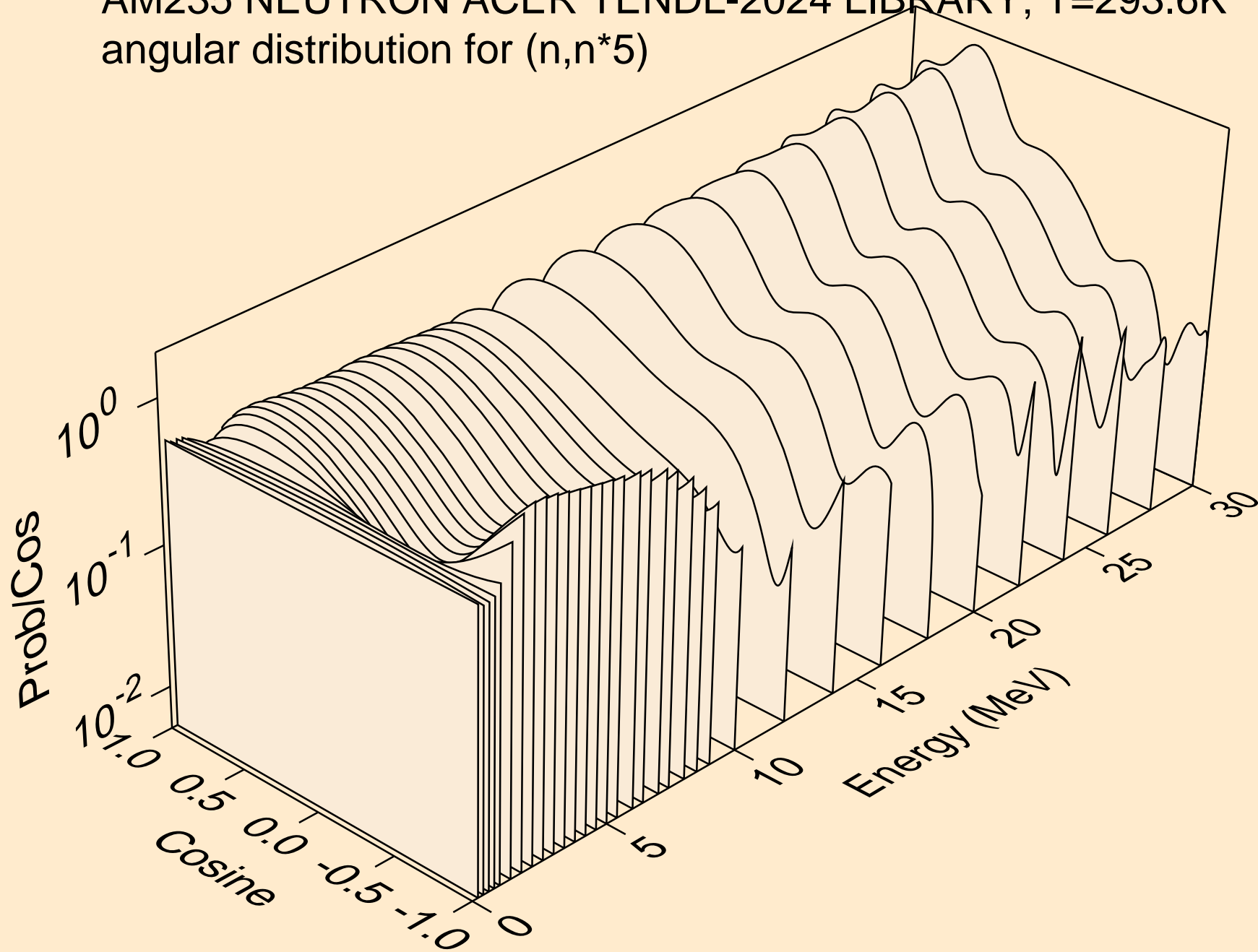

AM235 NEUTRON ACER TENDL-2024 LIBRARY; T=293.6K  
angular distribution for (n,n\*6)

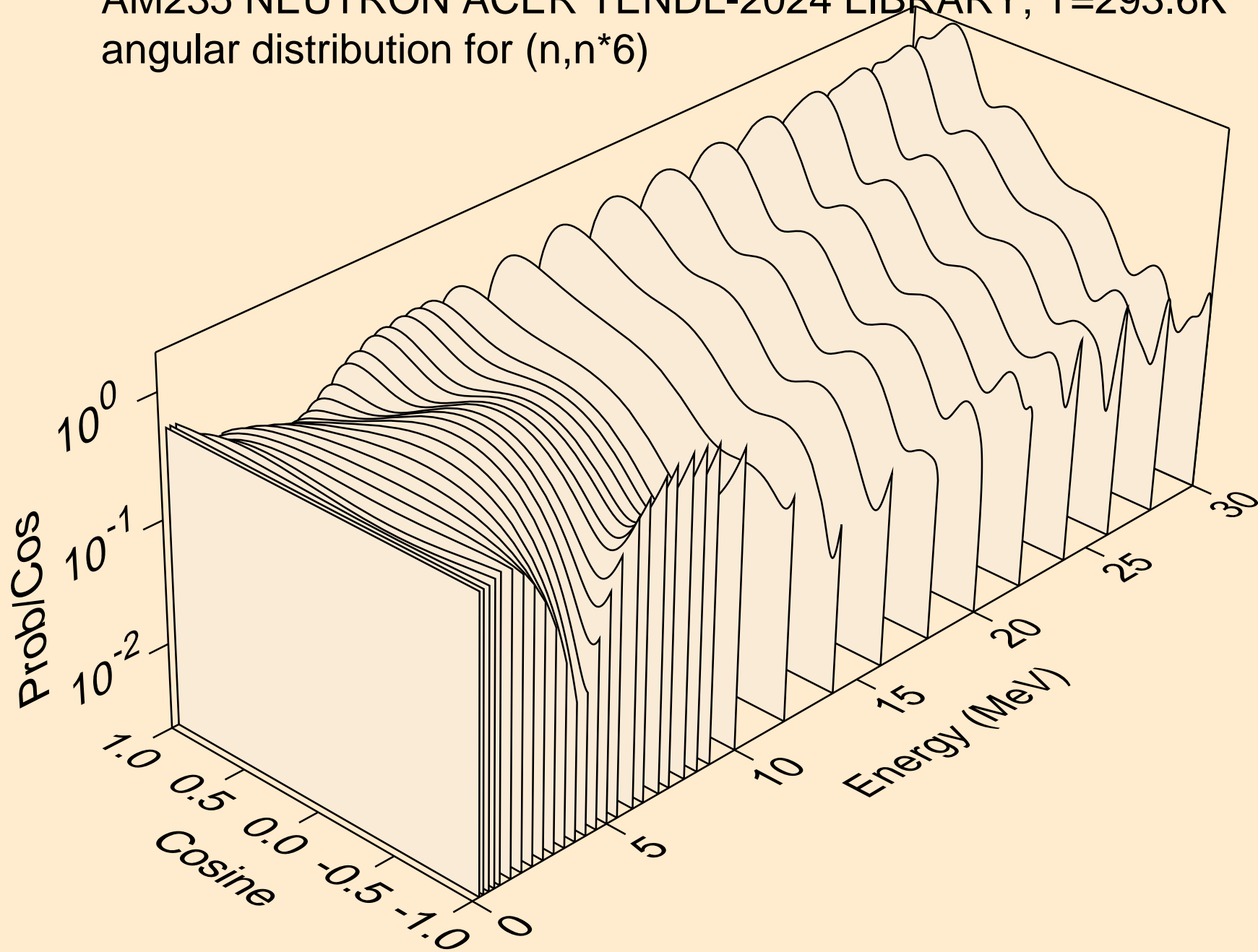

AM235 NEUTRON ACER TENDL-2024 LIBRARY; T=293.6K  
angular distribution for (n,n\*7)

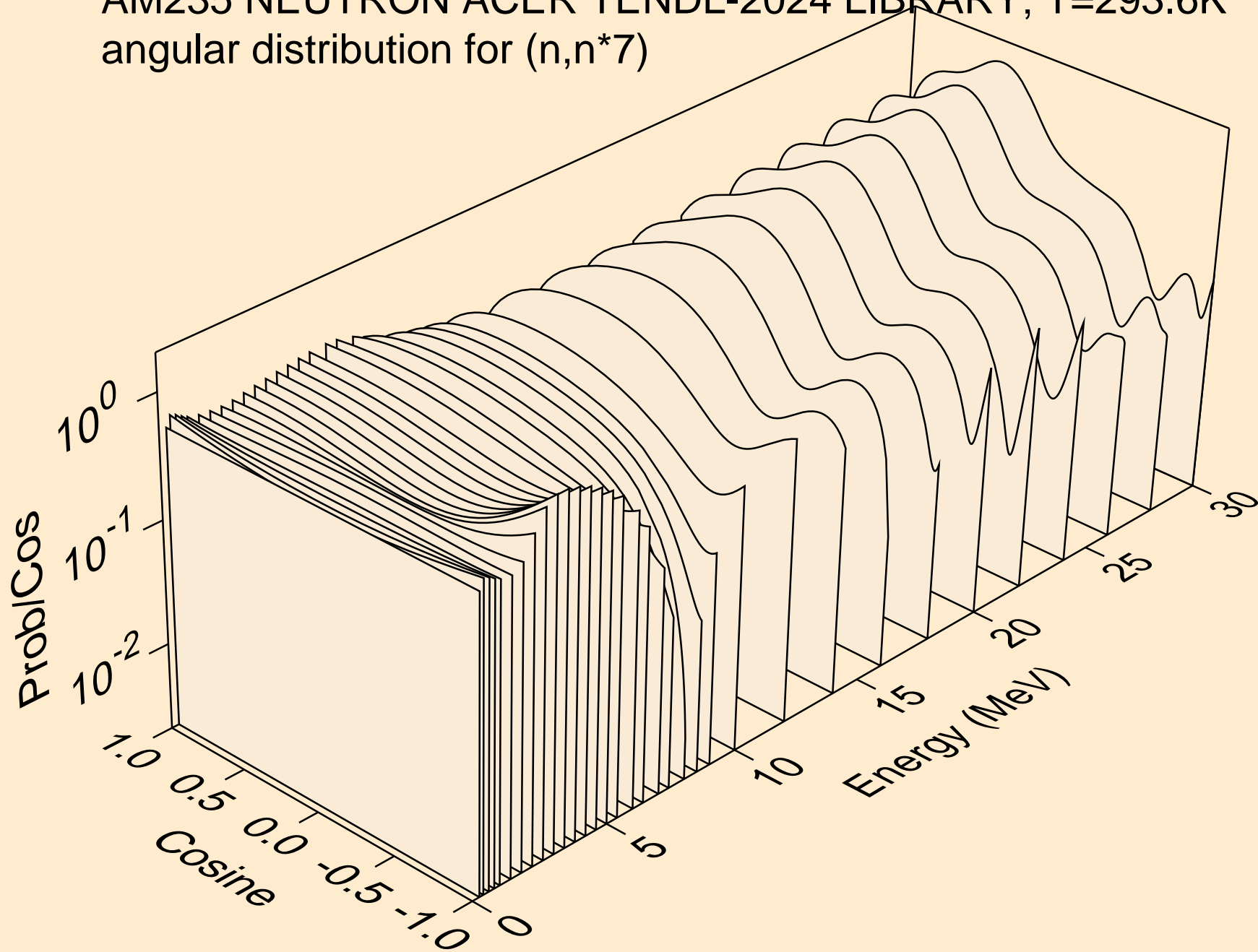

AM235 NEUTRON ACER TENDL-2024 LIBRARY; T=293.6K  
angular distribution for (n,n\*8)

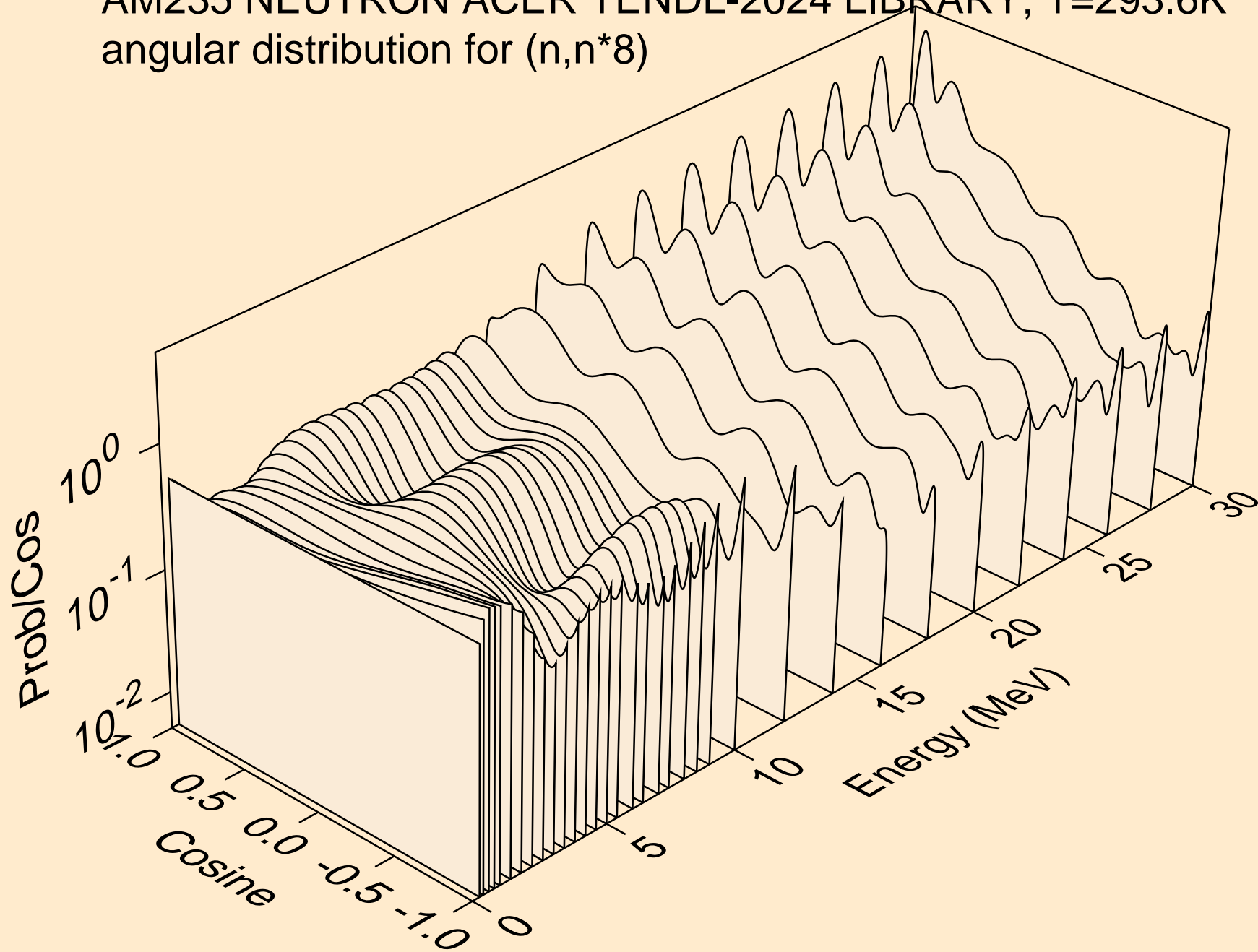

AM235 NEUTRON ACER TENDL-2024 LIBRARY; T=293.6K  
angular distribution for (n,n\*9)

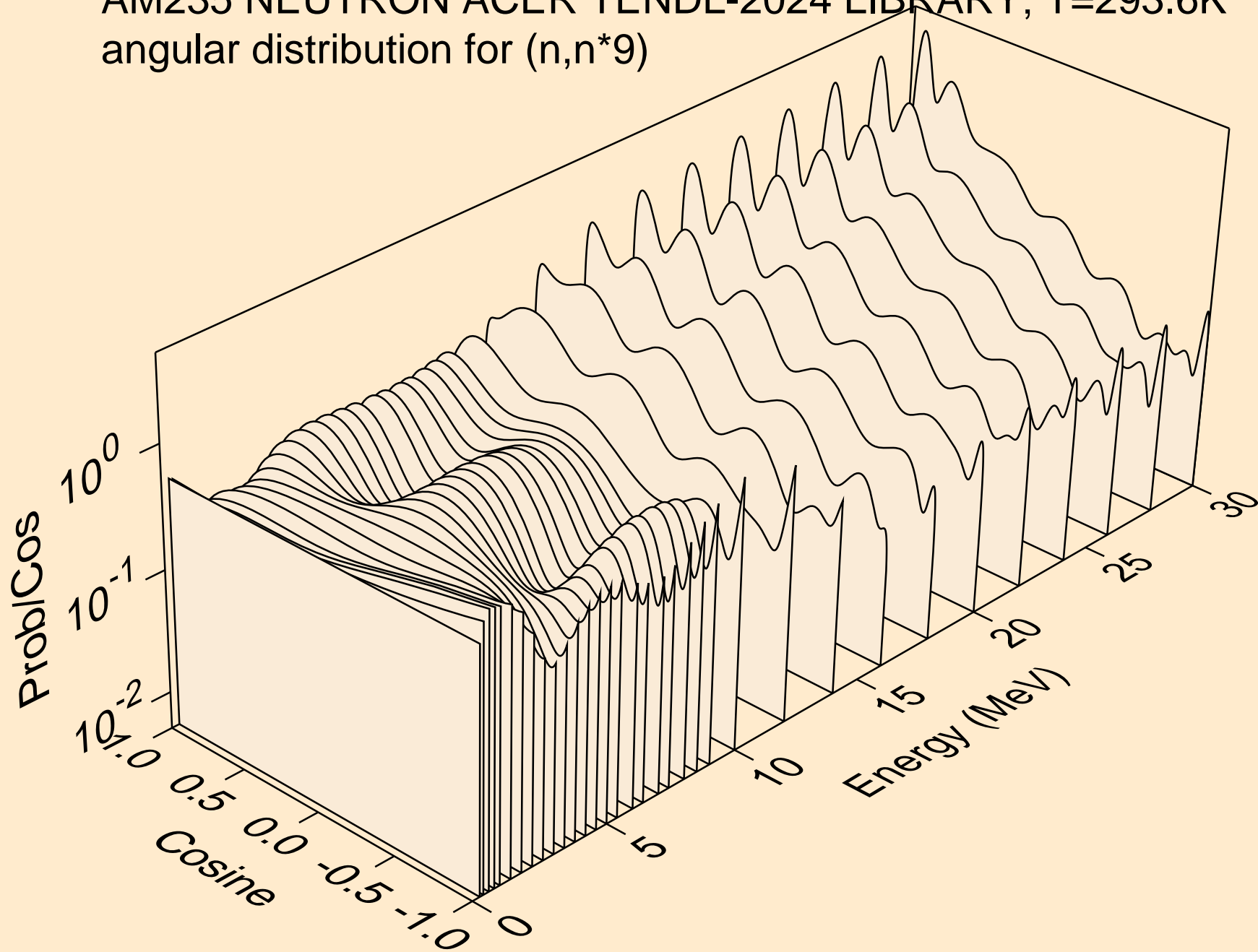

AM235 NEUTRON ACER TENDL-2024 LIBRARY; T=293.6K  
angular distribution for (n,n\*10)

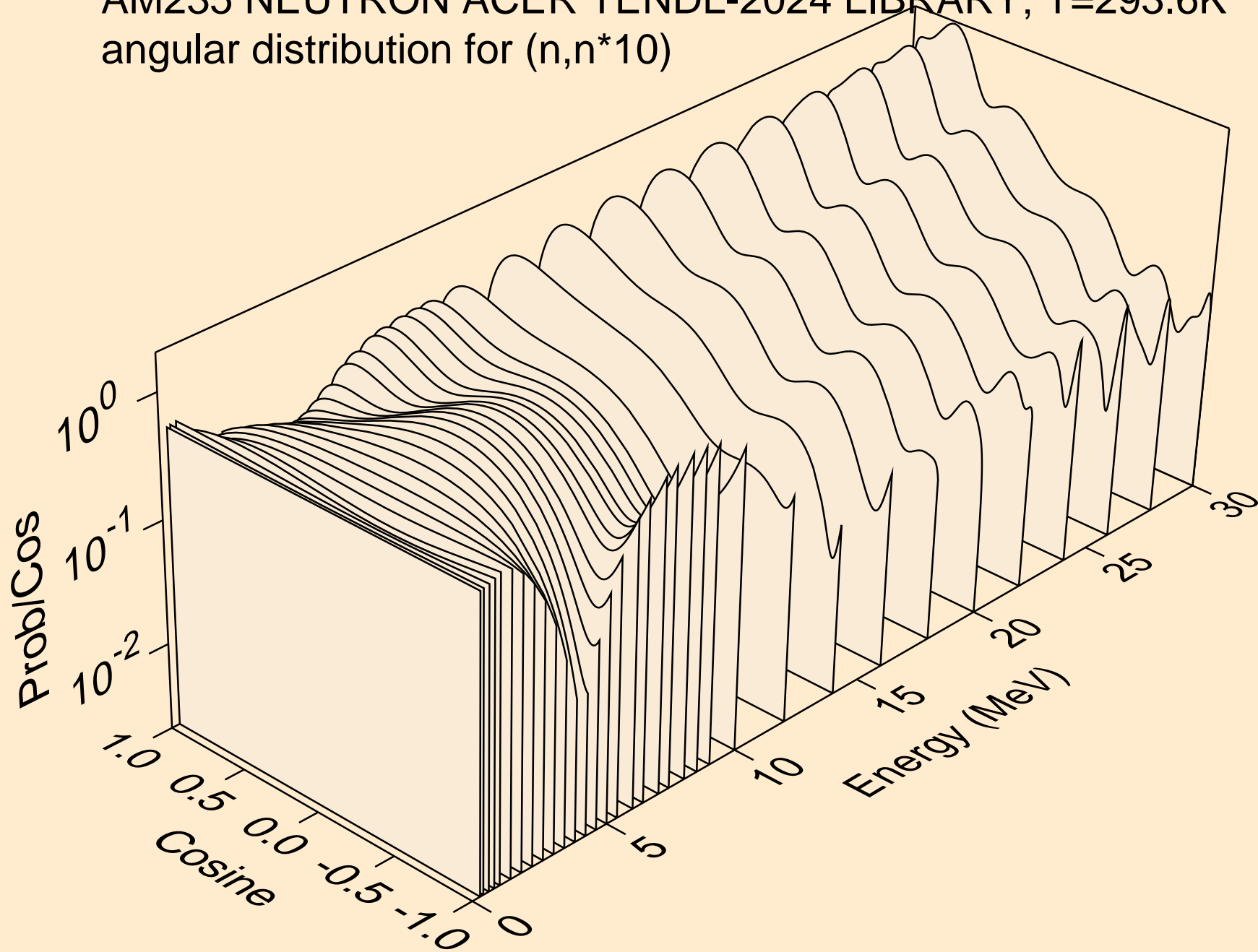

AM235 NEUTRON ACER TENDL-2024 LIBRARY; T=293.6K  
angular distribution for (n,n\*11)

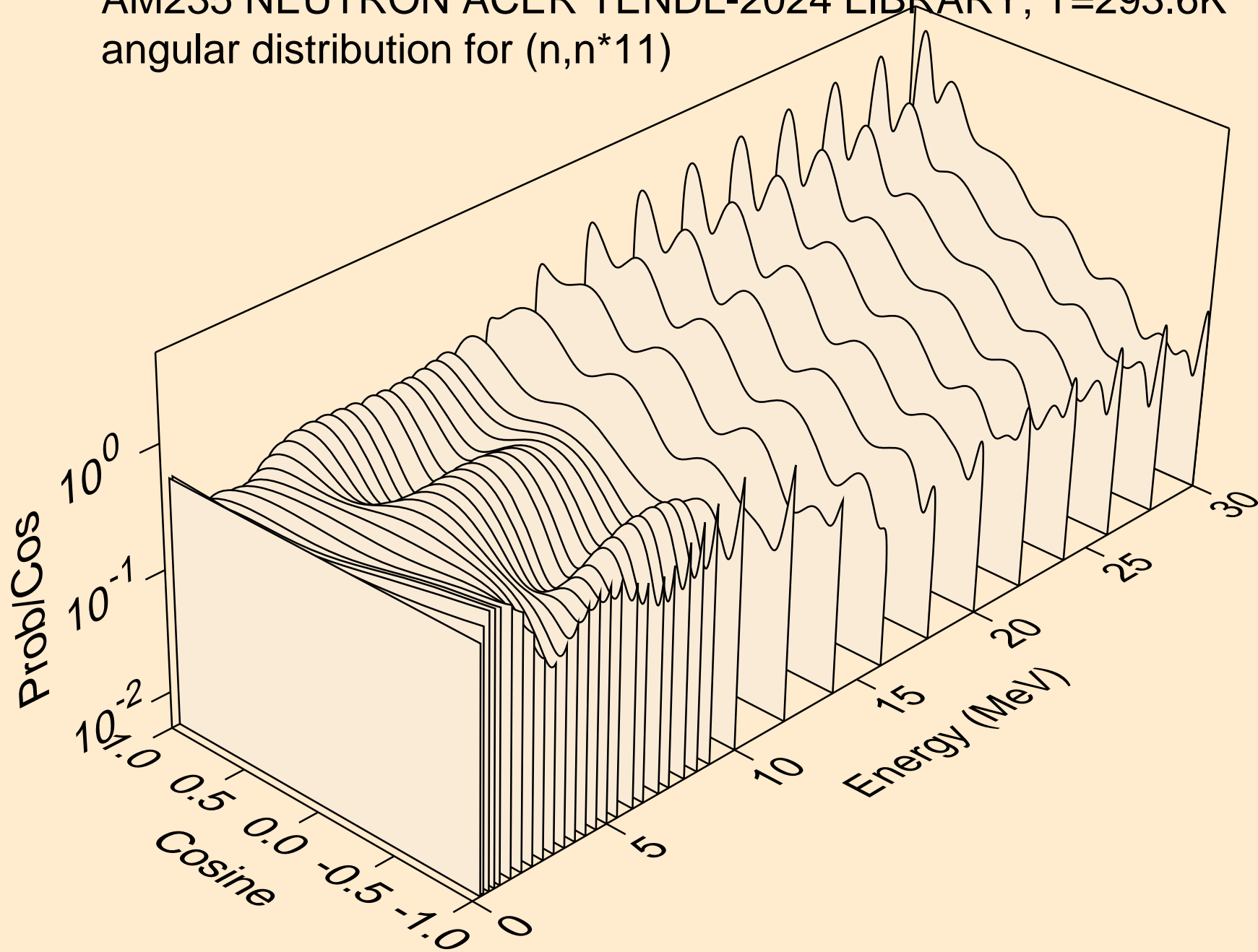

AM235 NEUTRON ACER TENDL-2024 LIBRARY; T=293.6K  
angular distribution for (n,n\*12)

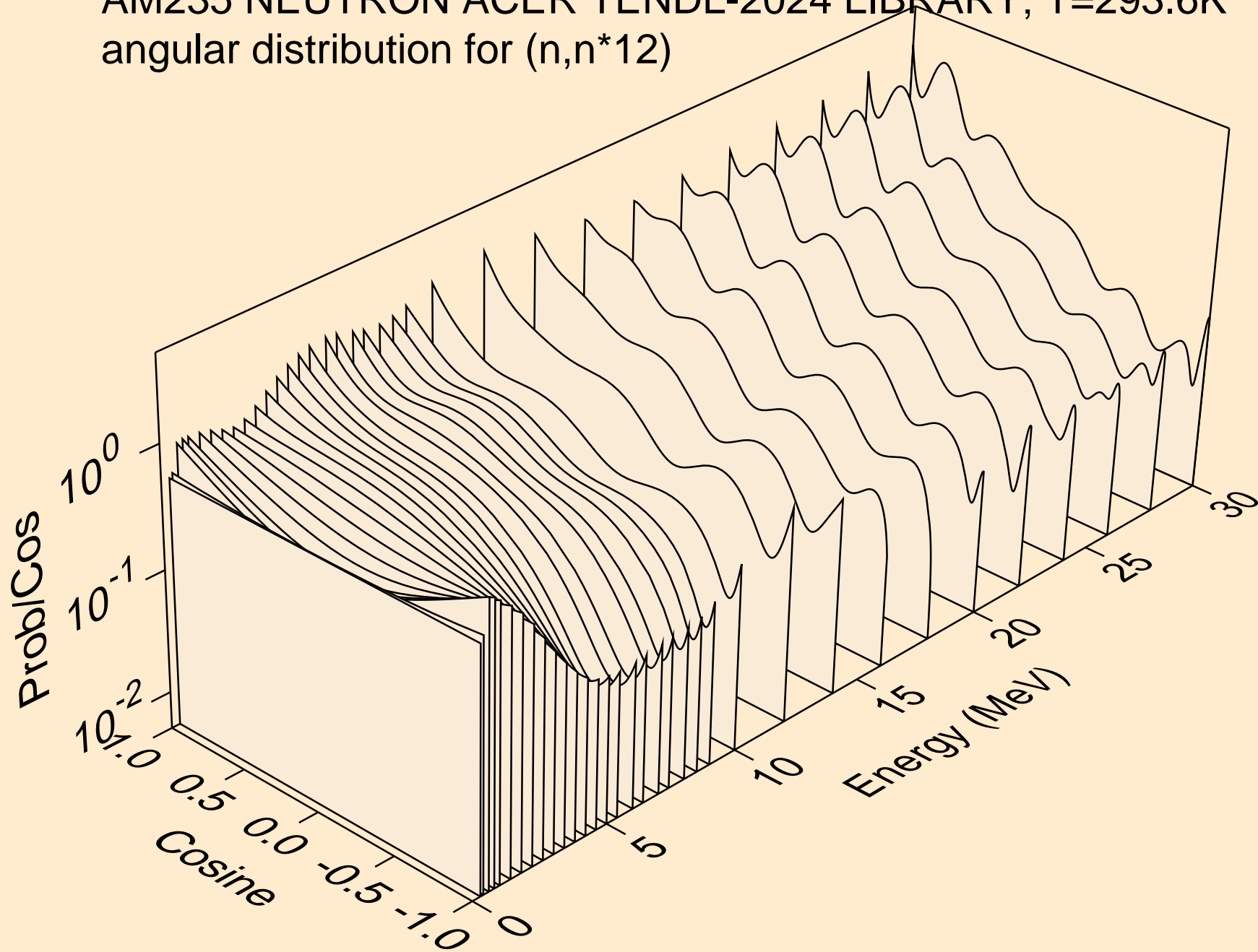

AM235 NEUTRON ACER TENDL-2024 LIBRARY; T=293.6K  
angular distribution for (n,n\*13)

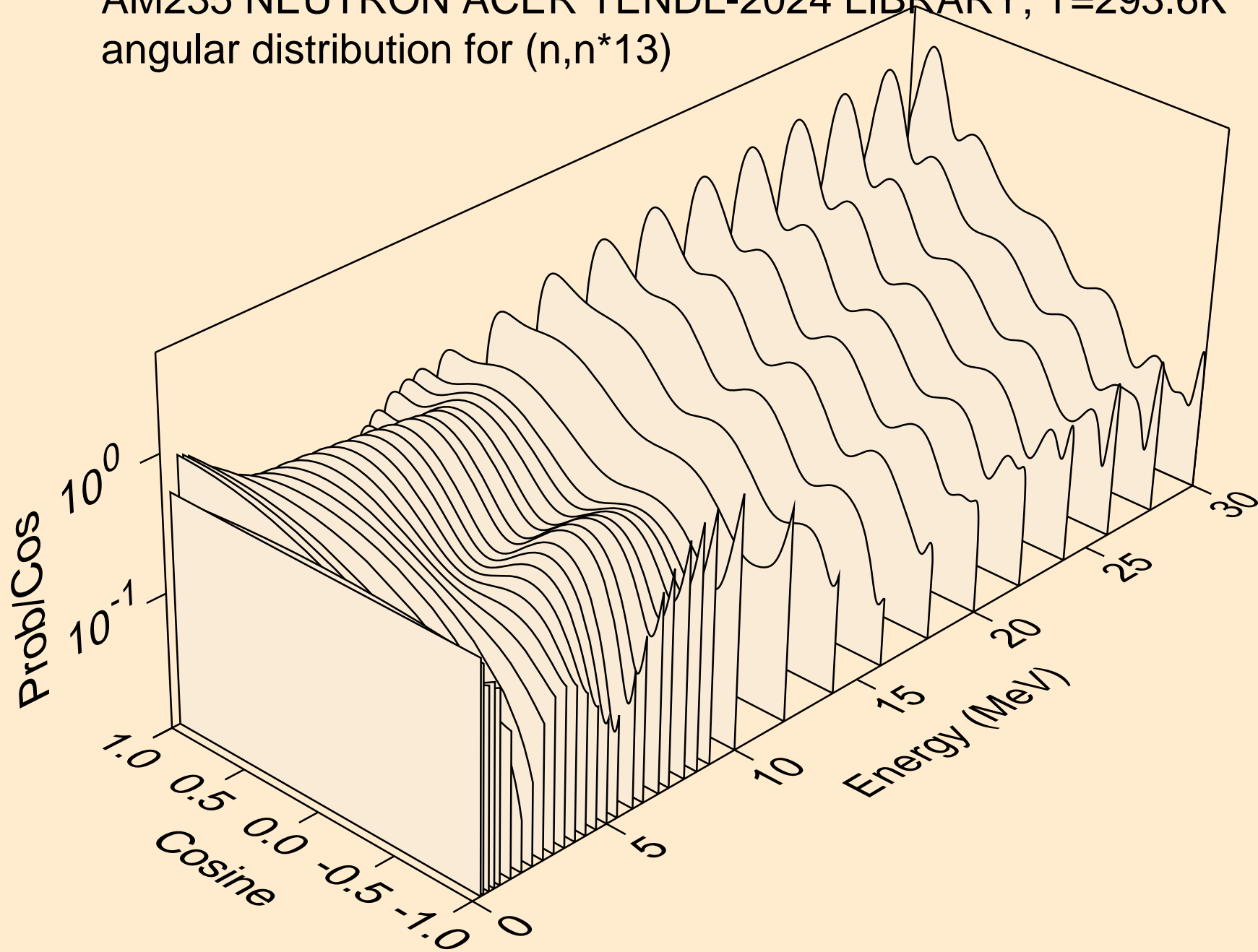

AM235 NEUTRON ACER TENDL-2024 LIBRARY; T=293.6K  
angular distribution for (n,n\*14)

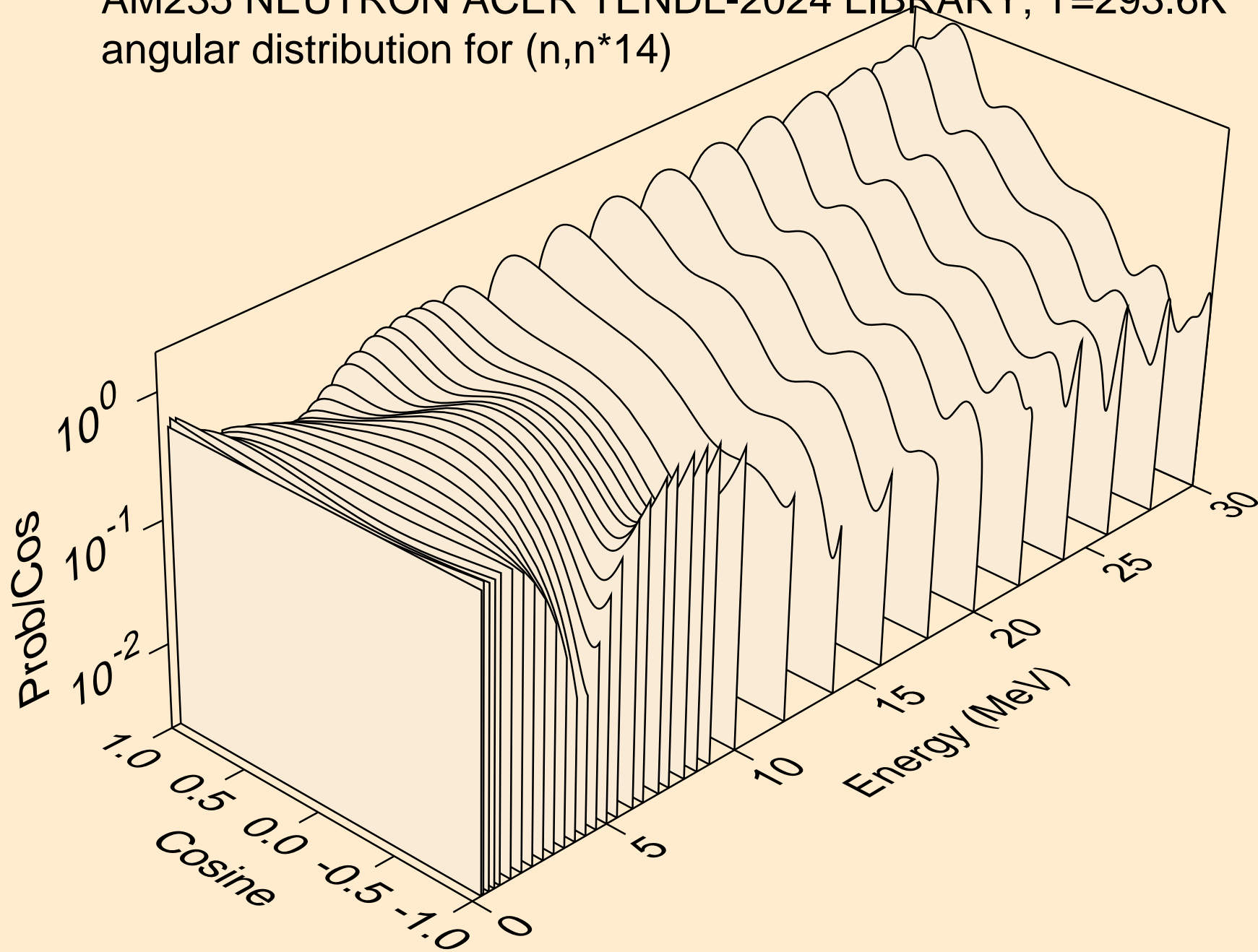

AM235 NEUTRON ACER TENDL-2024 LIBRARY; T=293.6K  
angular distribution for (n,n\*15)

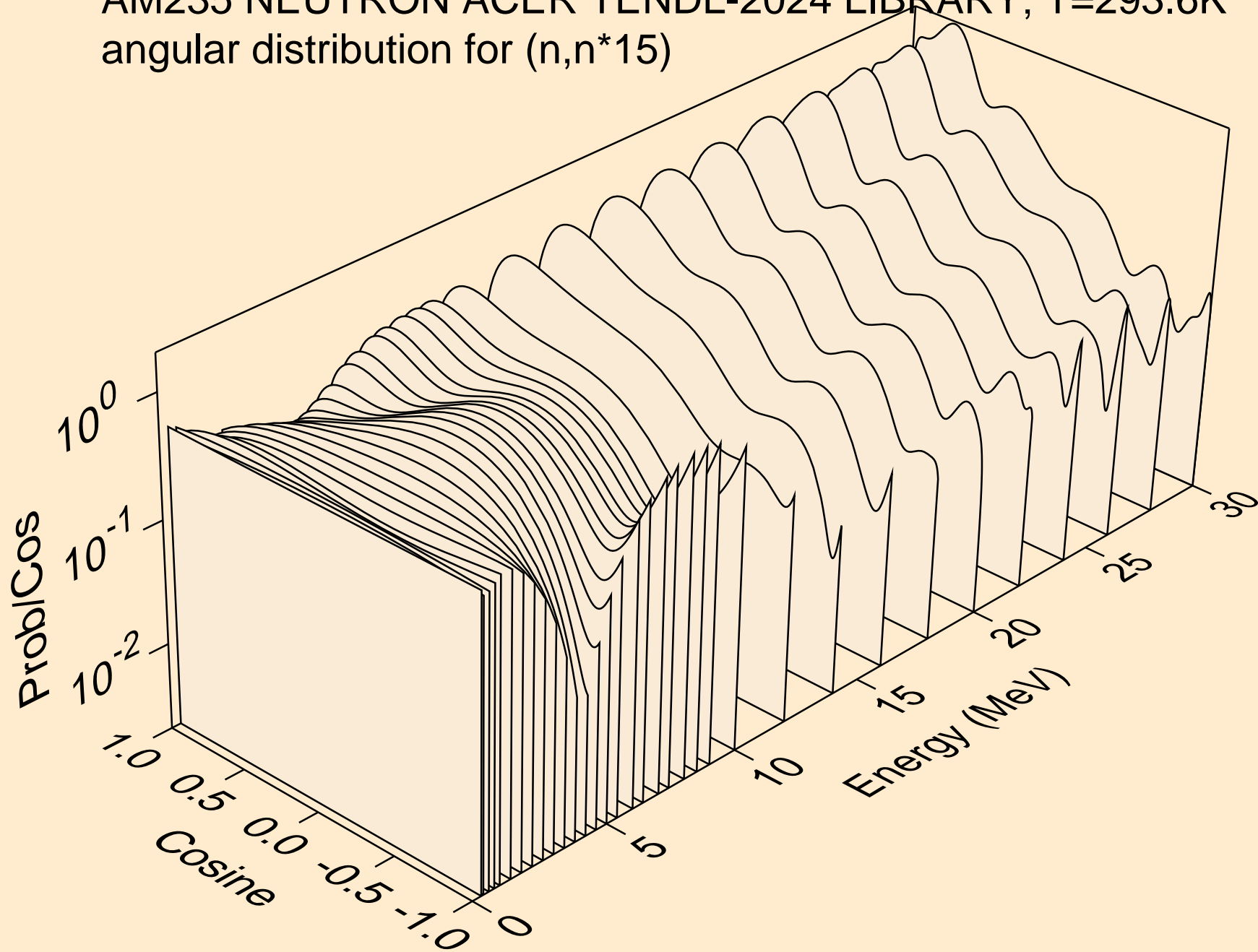

AM235 NEUTRON ACER TENDL-2024 LIBRARY; T=293.6K  
angular distribution for (n,n\*16)

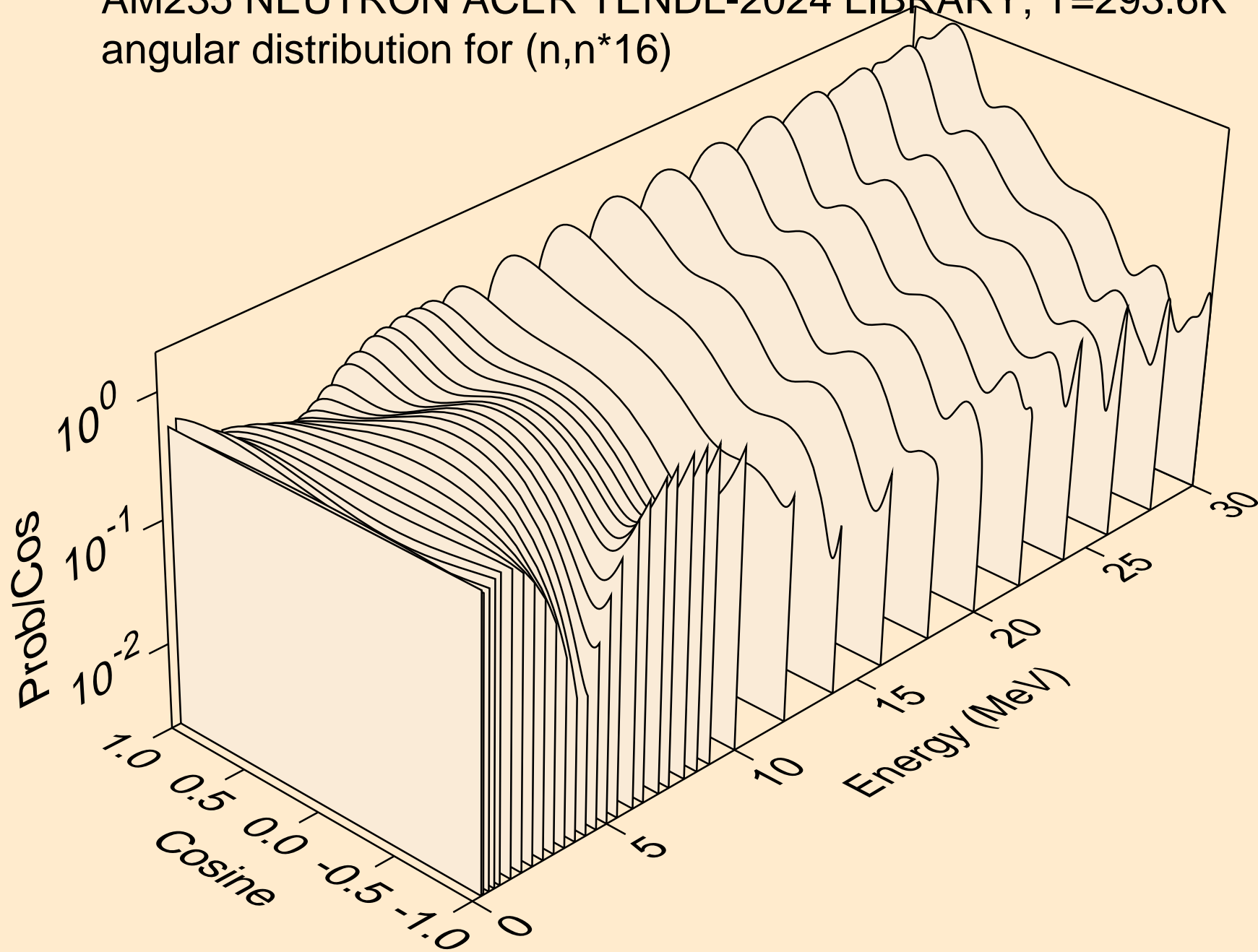

AM235 NEUTRON ACER TENDL-2024 LIBRARY; T=293.6K  
angular distribution for (n,n\*17)

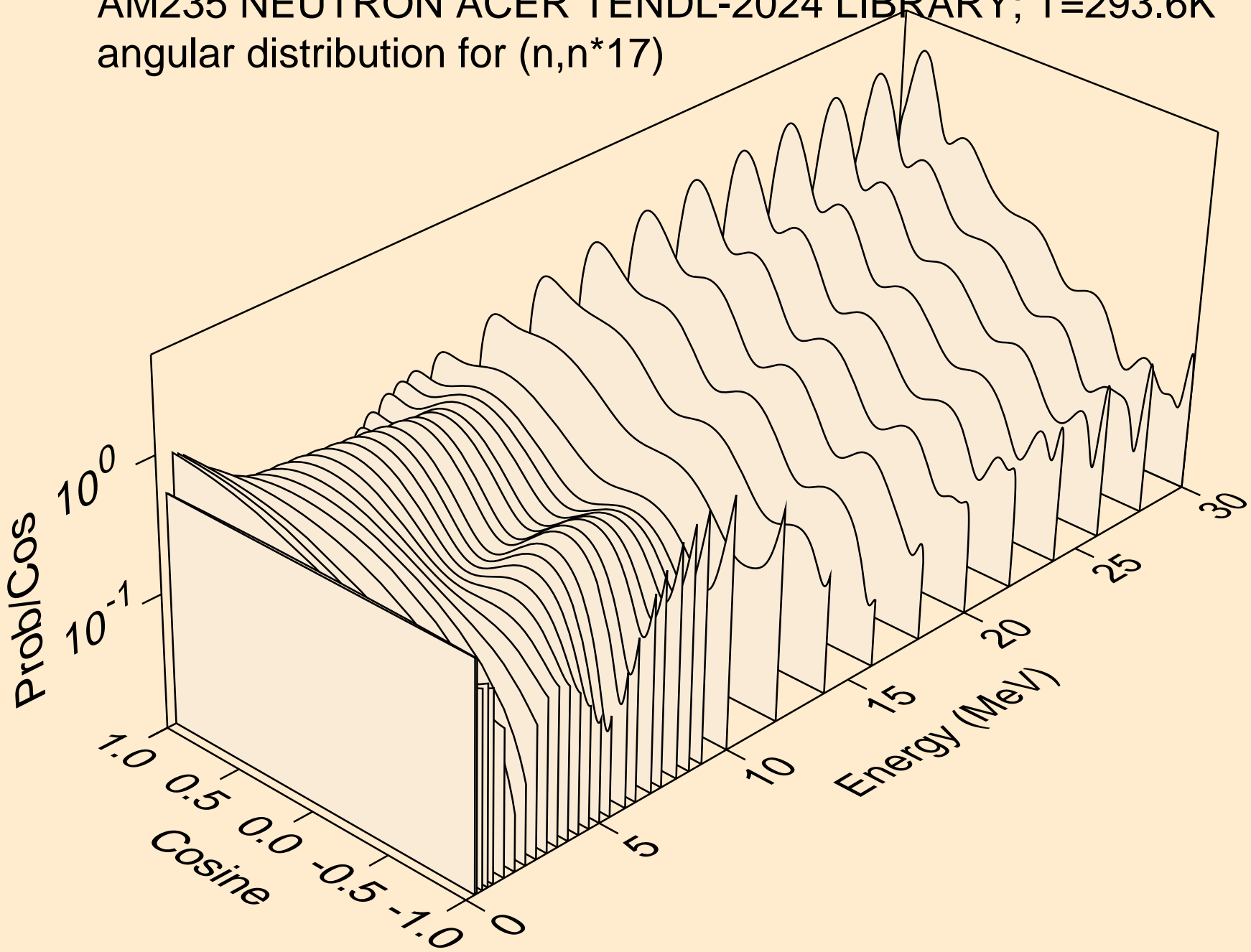

AM235 NEUTRON ACER TENDL-2024 LIBRARY; T=293.6K  
angular distribution for (n,n\*18)

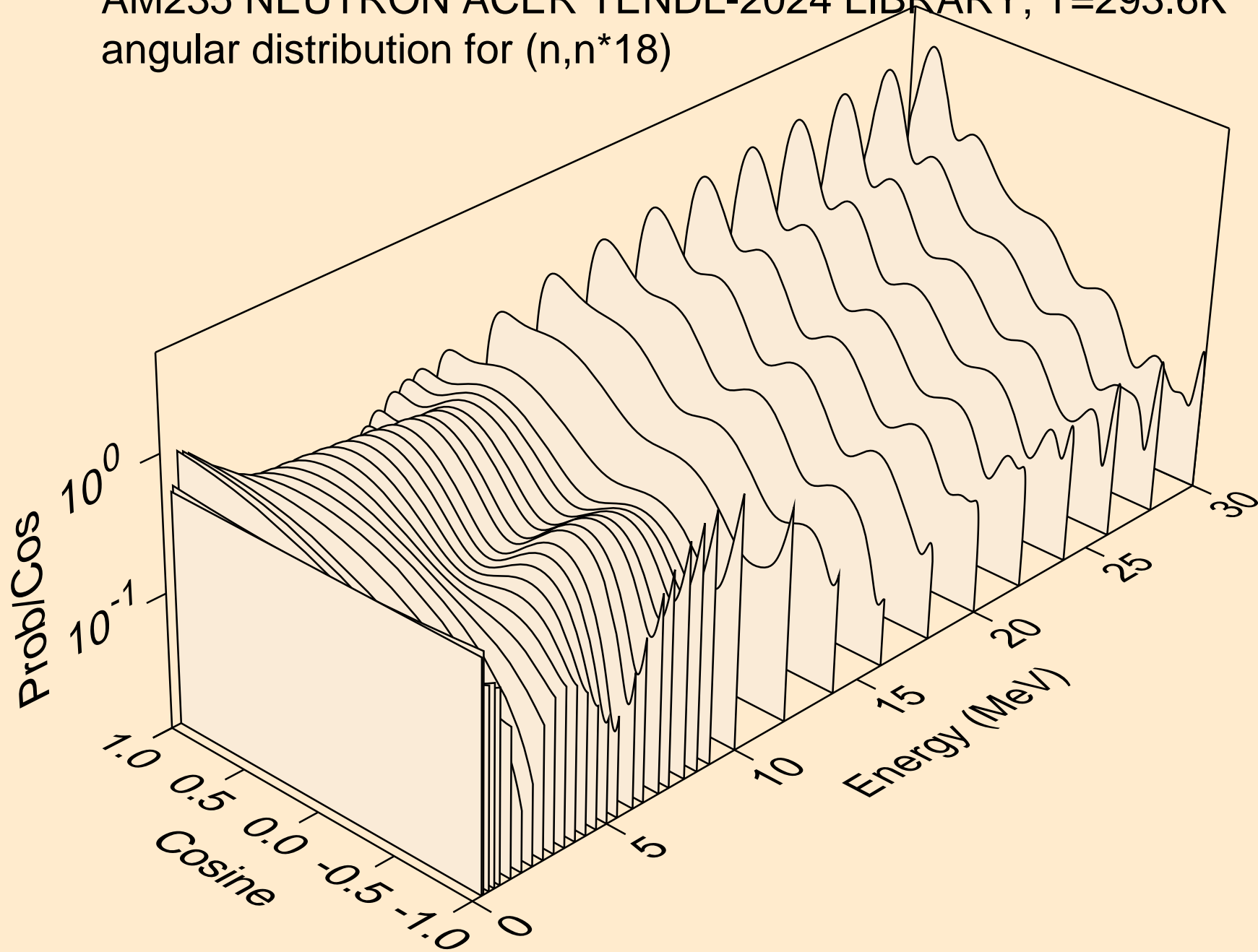

AM235 NEUTRON ACER TENDL-2024 LIBRARY; T=293.6K  
angular distribution for (n,n\*19)

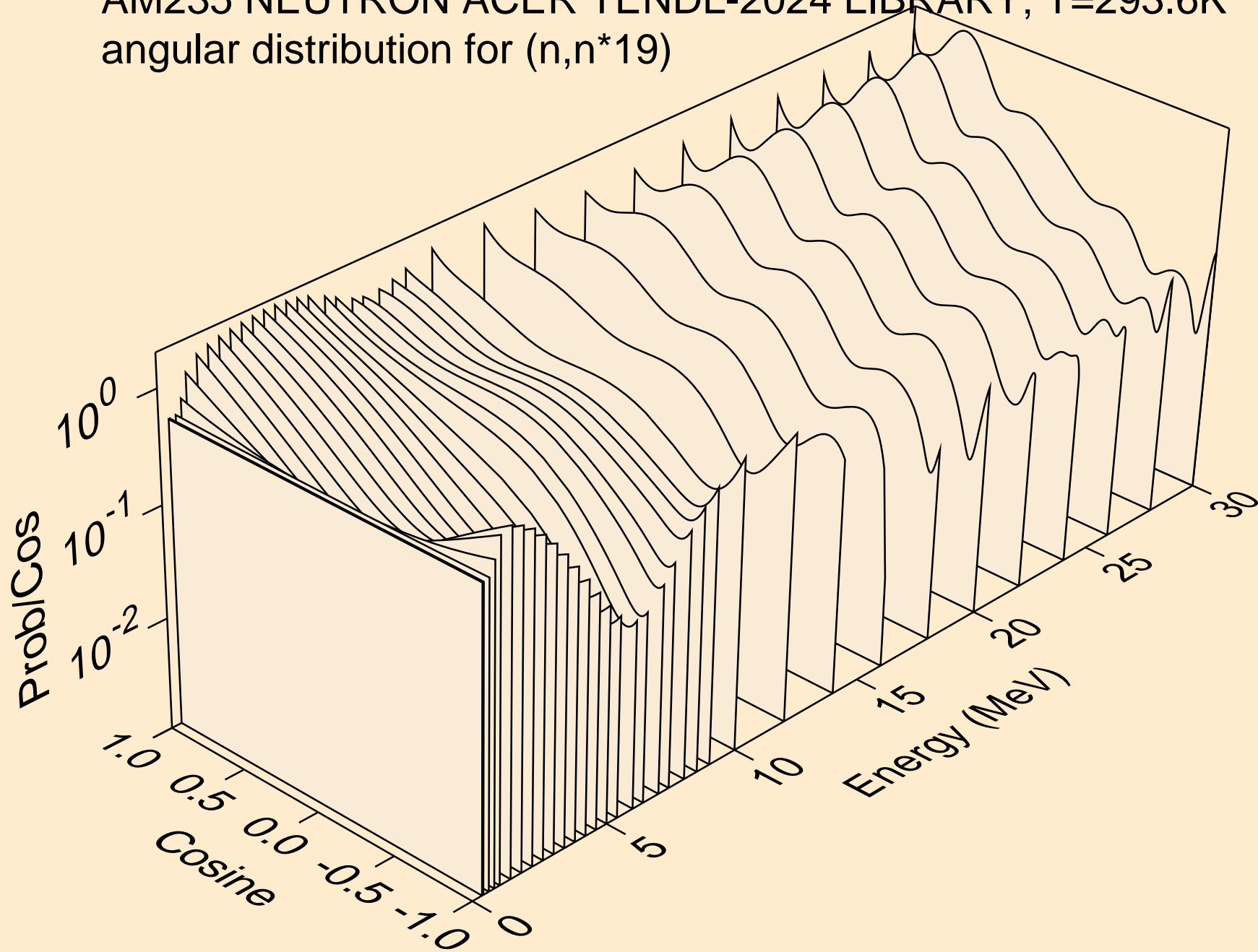

AM235 NEUTRON ACER TENDL-2024 LIBRARY; T=293.6K  
angular distribution for (n,n\*20)

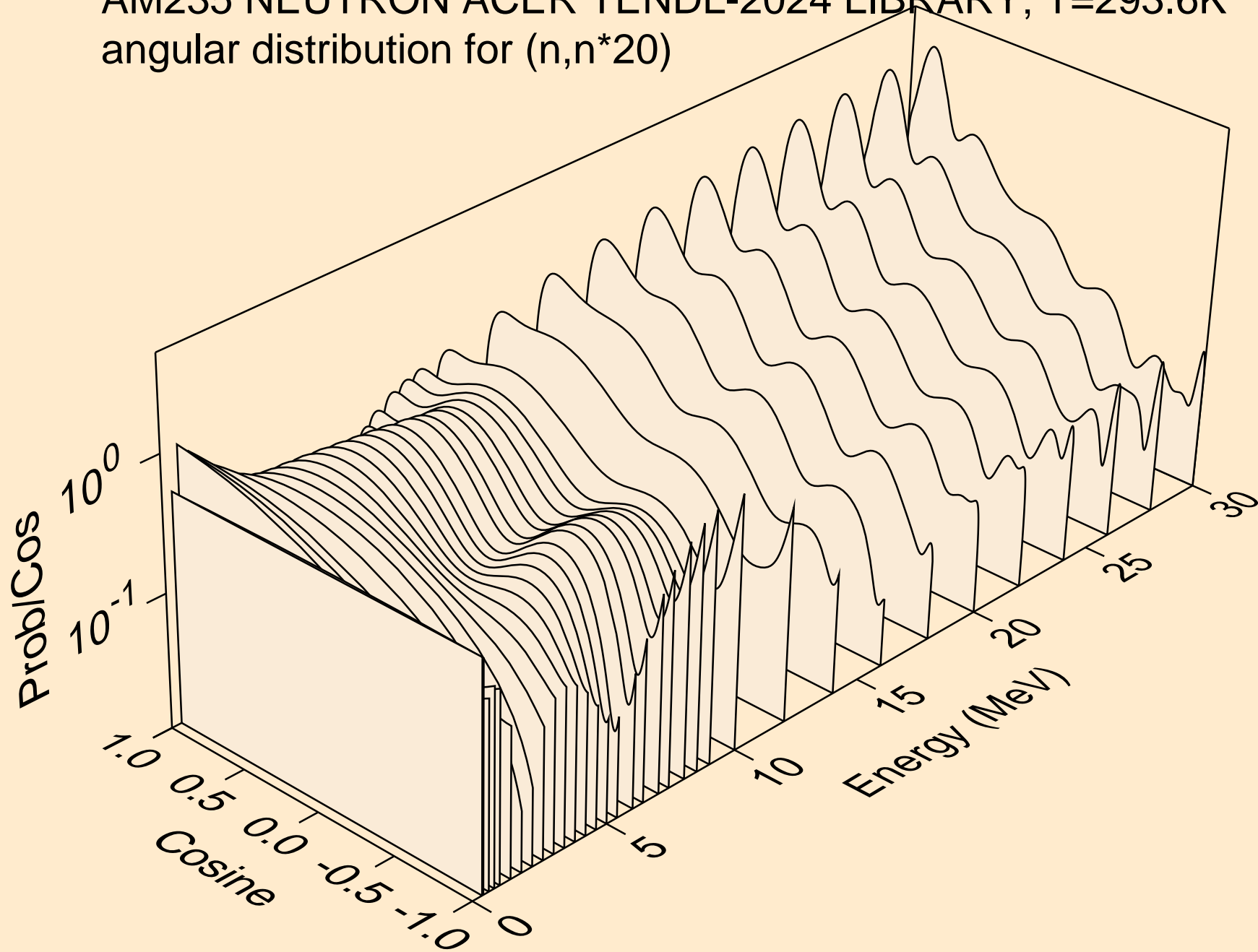

AM235 NEUTRON ACER TENDL-2024 LIBRARY; T=293.6K  
angular distribution for (n,n\*21)

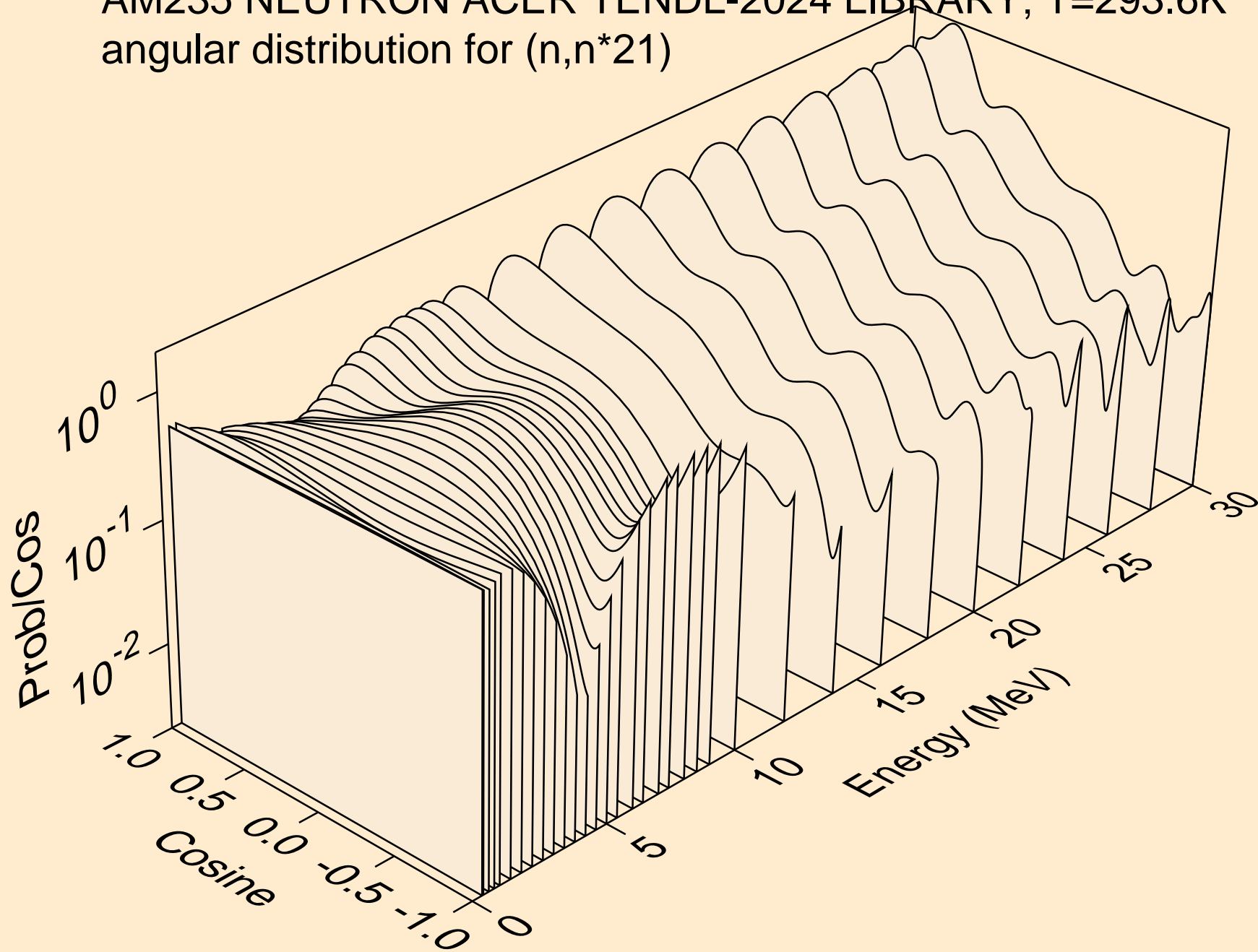

AM235 NEUTRON ACER TENDL-2024 LIBRARY; T=293.6K  
angular distribution for (n,n\*22)

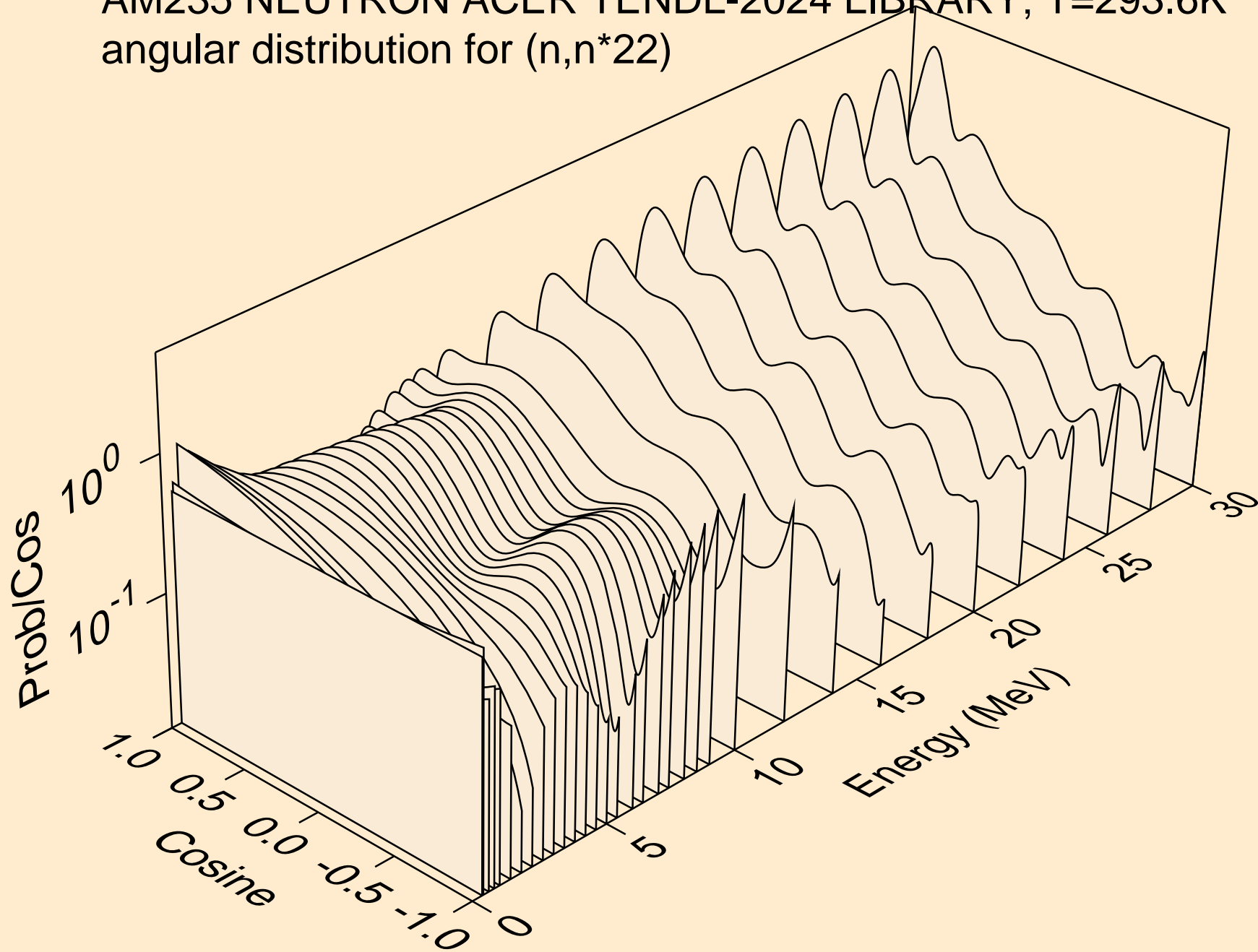

AM235 NEUTRON ACER TENDL-2024 LIBRARY; T=293.6K  
angular distribution for (n,n\*23)

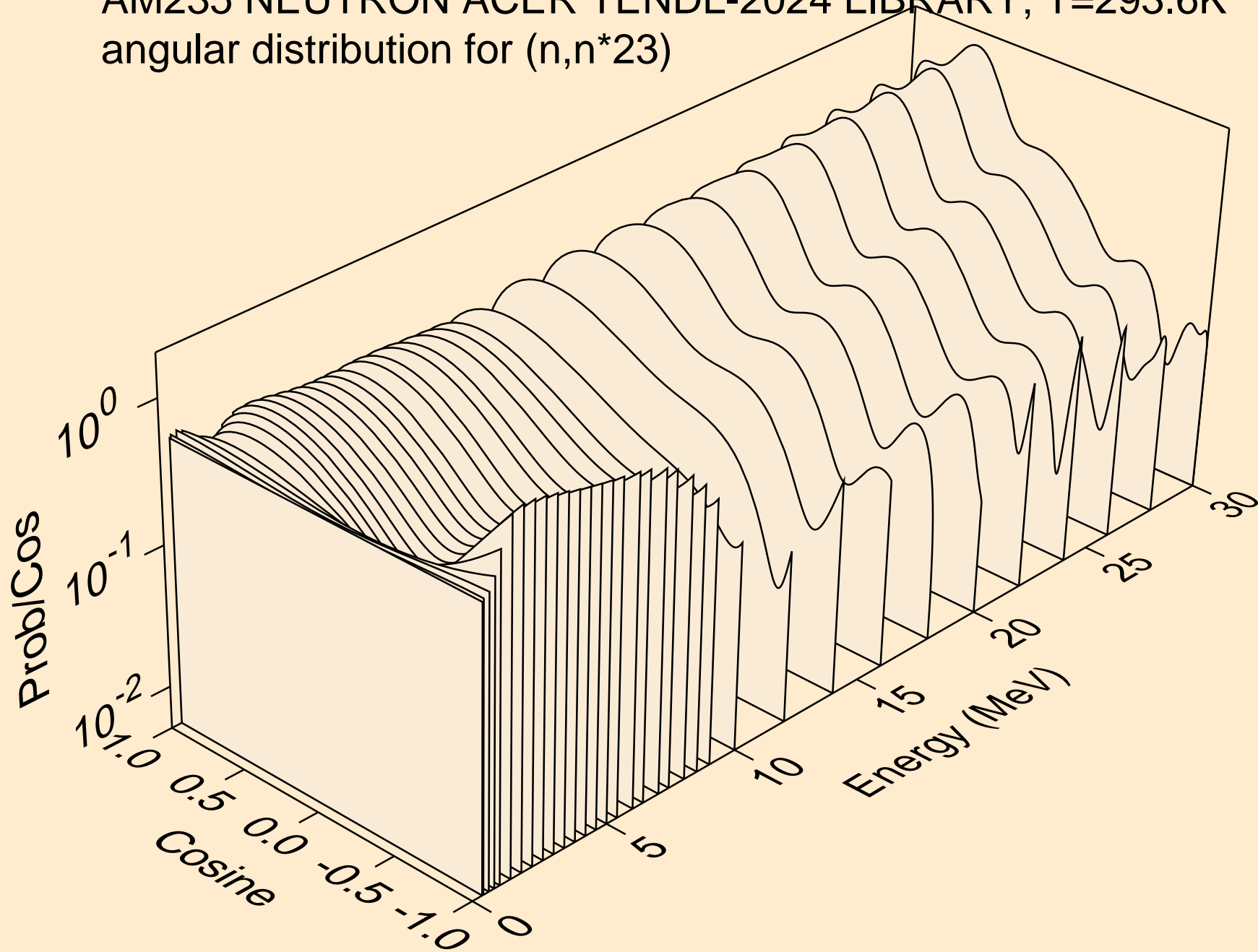

AM235 NEUTRON ACER TENDL-2024 LIBRARY; T=293.6K  
angular distribution for (n,n\*24)

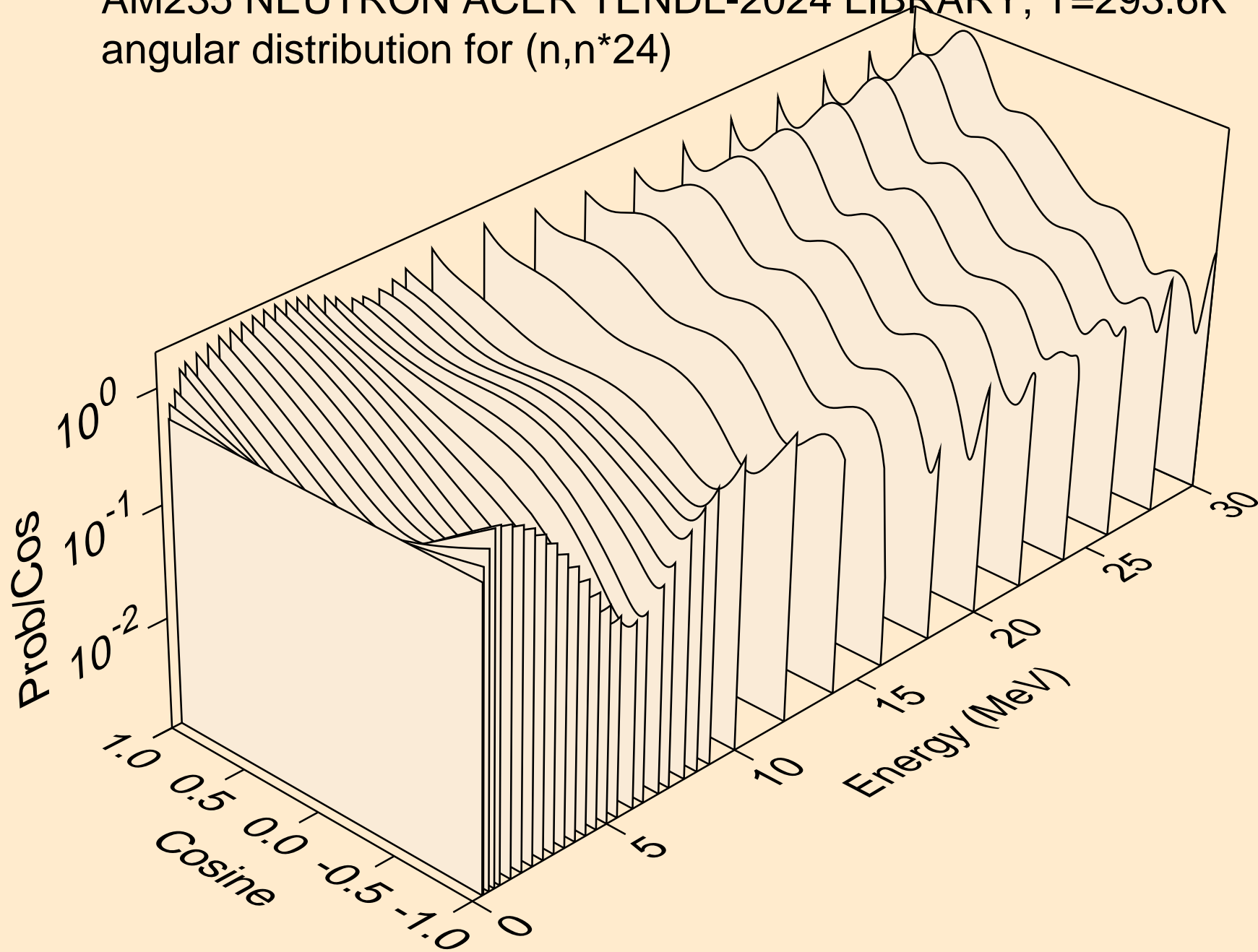

AM235 NEUTRON ACER TENDL-2024 LIBRARY; T=293.6K  
angular distribution for (n,n\*25)

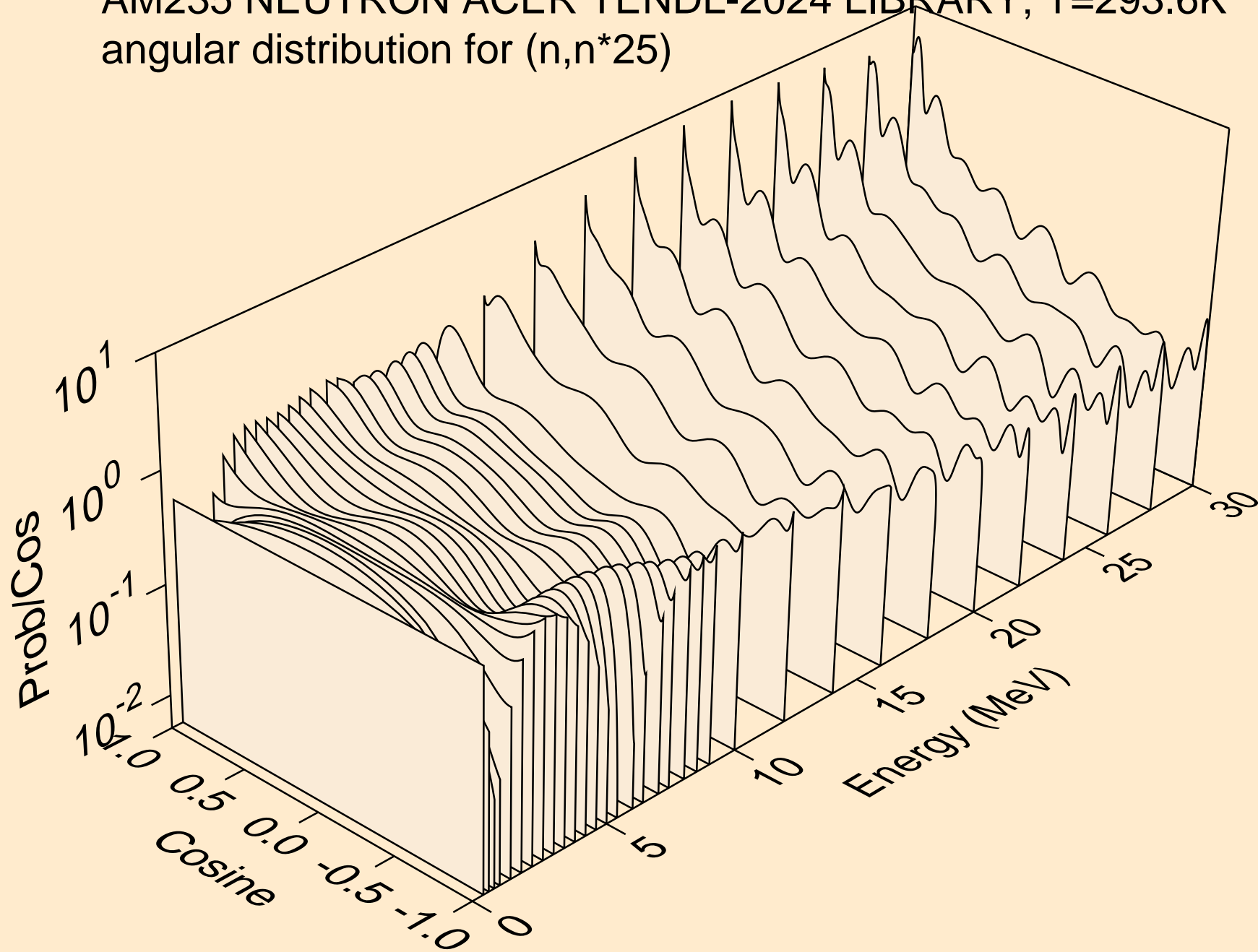

AM235 NEUTRON ACER TENDL-2024 LIBRARY; T=293.6K  
angular distribution for (n,n\*26)

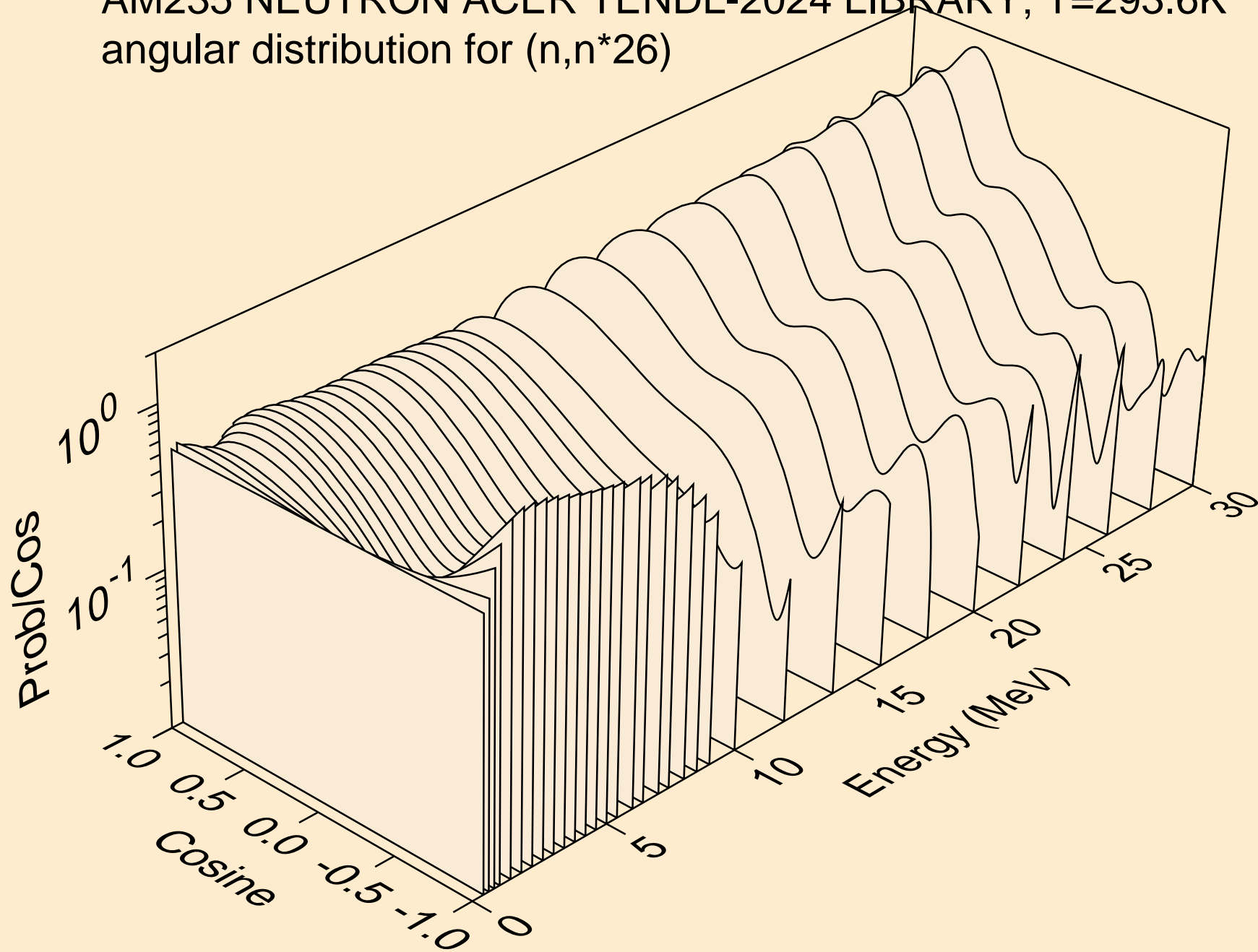

AM235 NEUTRON ACER TENDL-2024 LIBRARY; T=293.6K  
angular distribution for (n,n\*27)

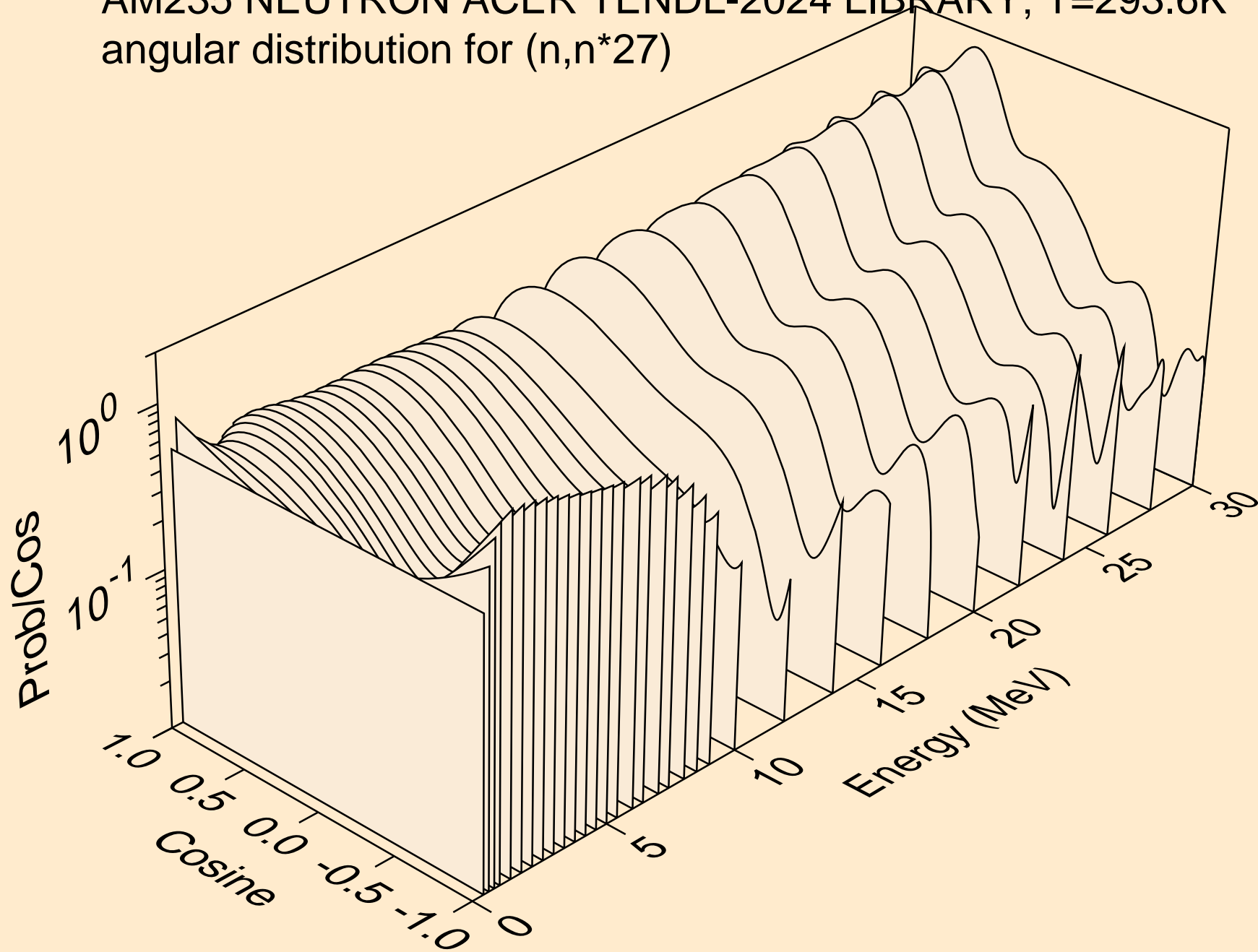

AM235 NEUTRON ACER TENDL-2024 LIBRARY; T=293.6K  
angular distribution for (n,n\*28)

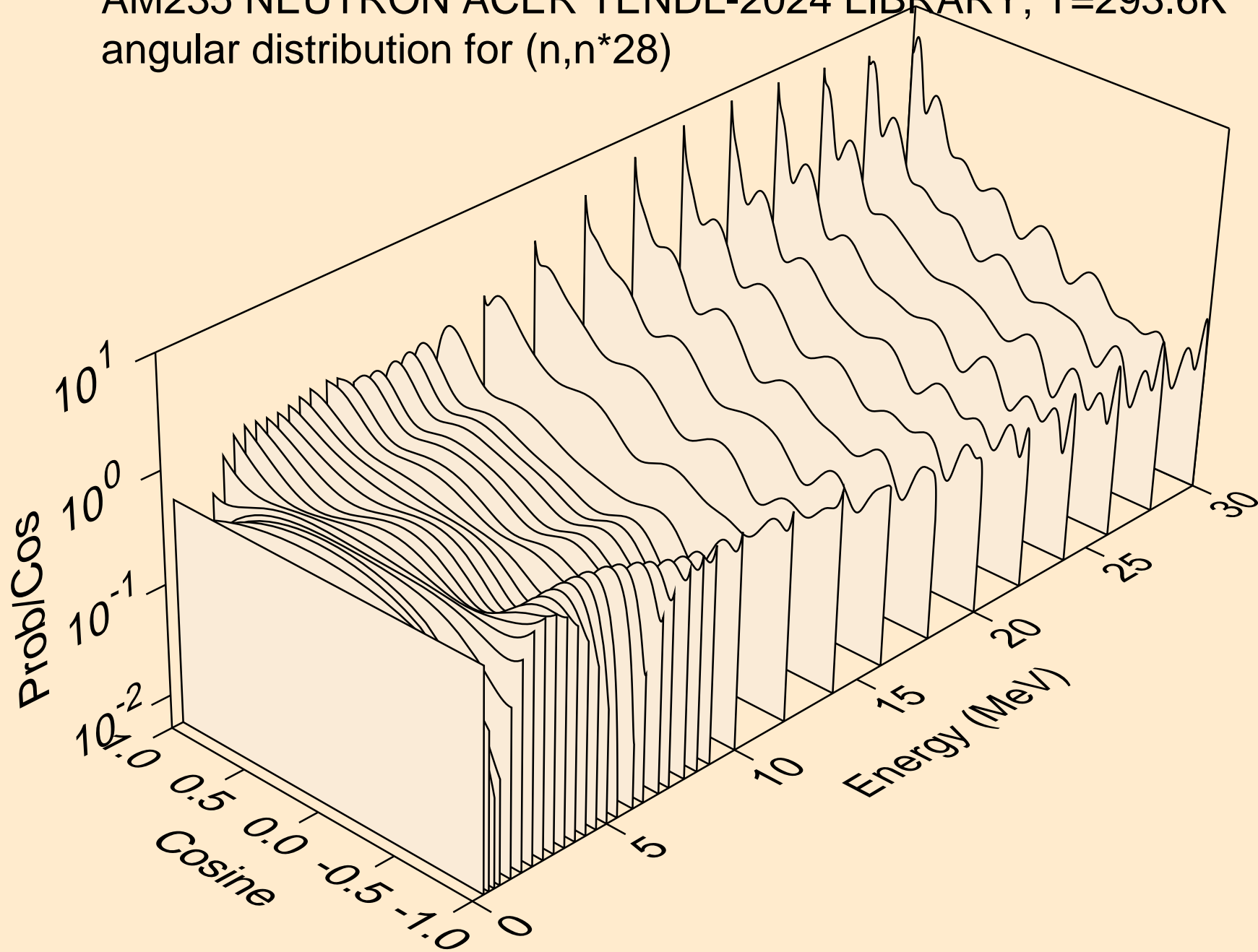

AM235 NEUTRON ACER TENDL-2024 LIBRARY; T=293.6K  
angular distribution for (n,n\*29)

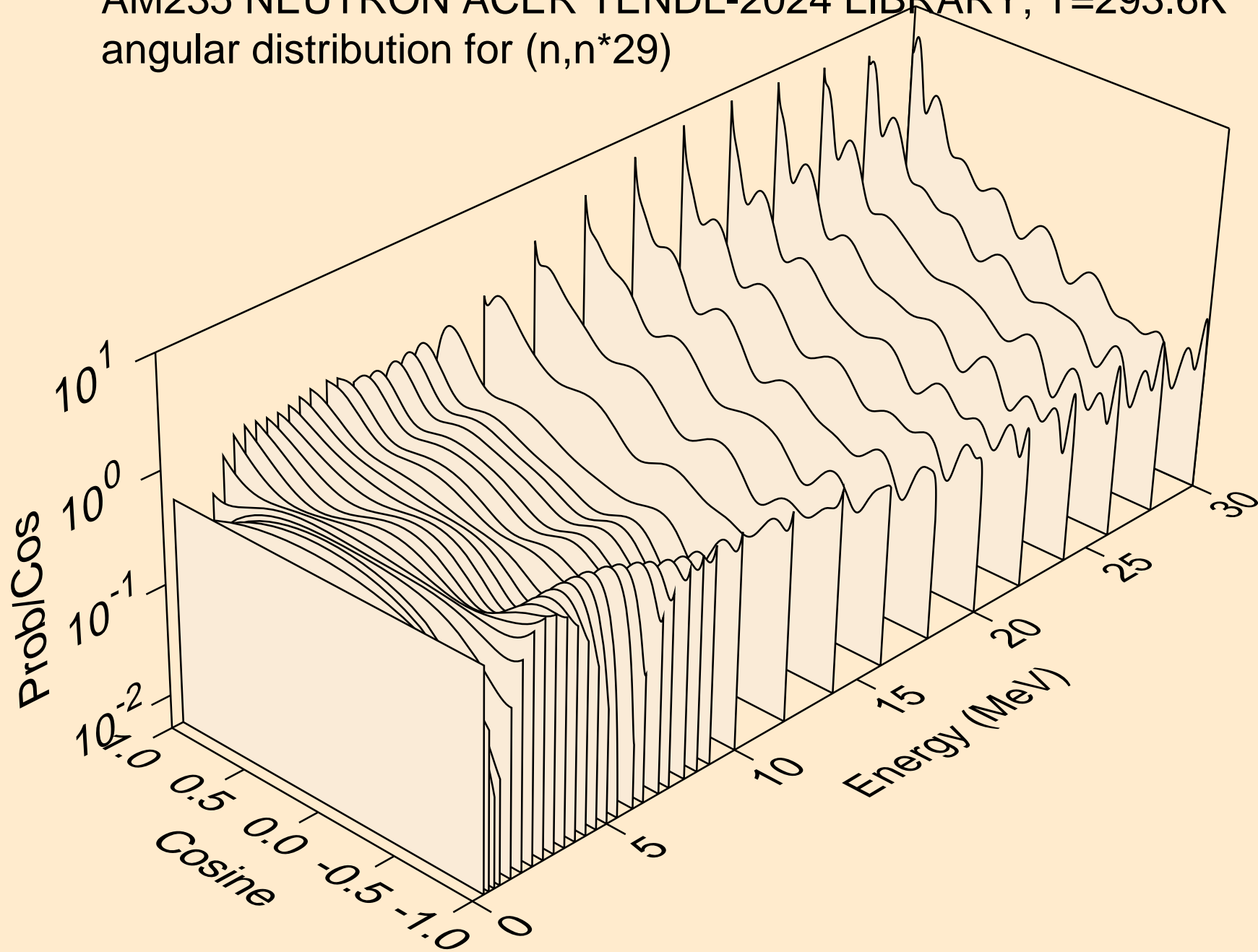

AM235 NEUTRON ACER TENDL-2024 LIBRARY; T=293.6K  
angular distribution for (n,n\*30)

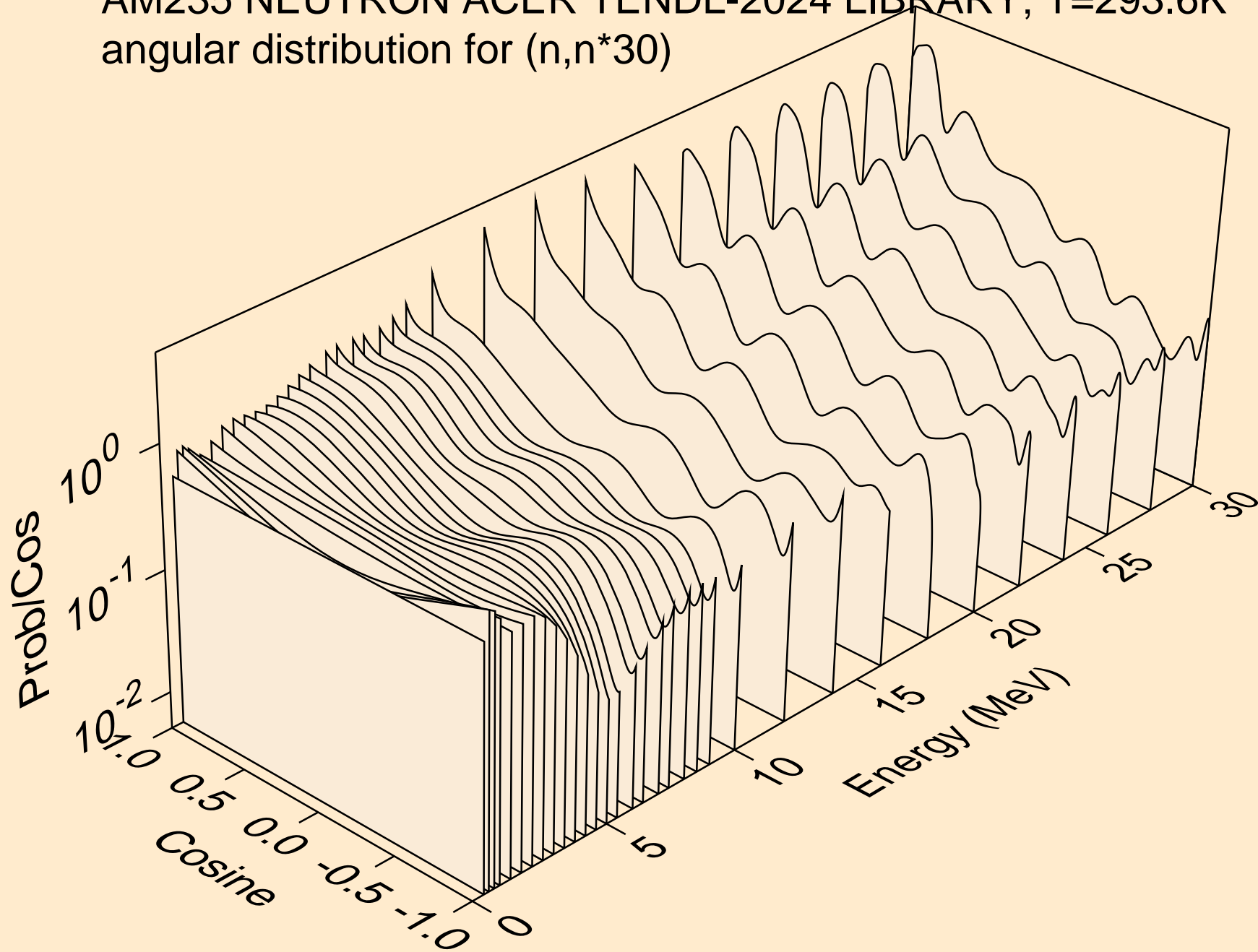

AM235 NEUTRON ACER TENDL-2024 LIBRARY; T=293.6K  
Total fission nubar

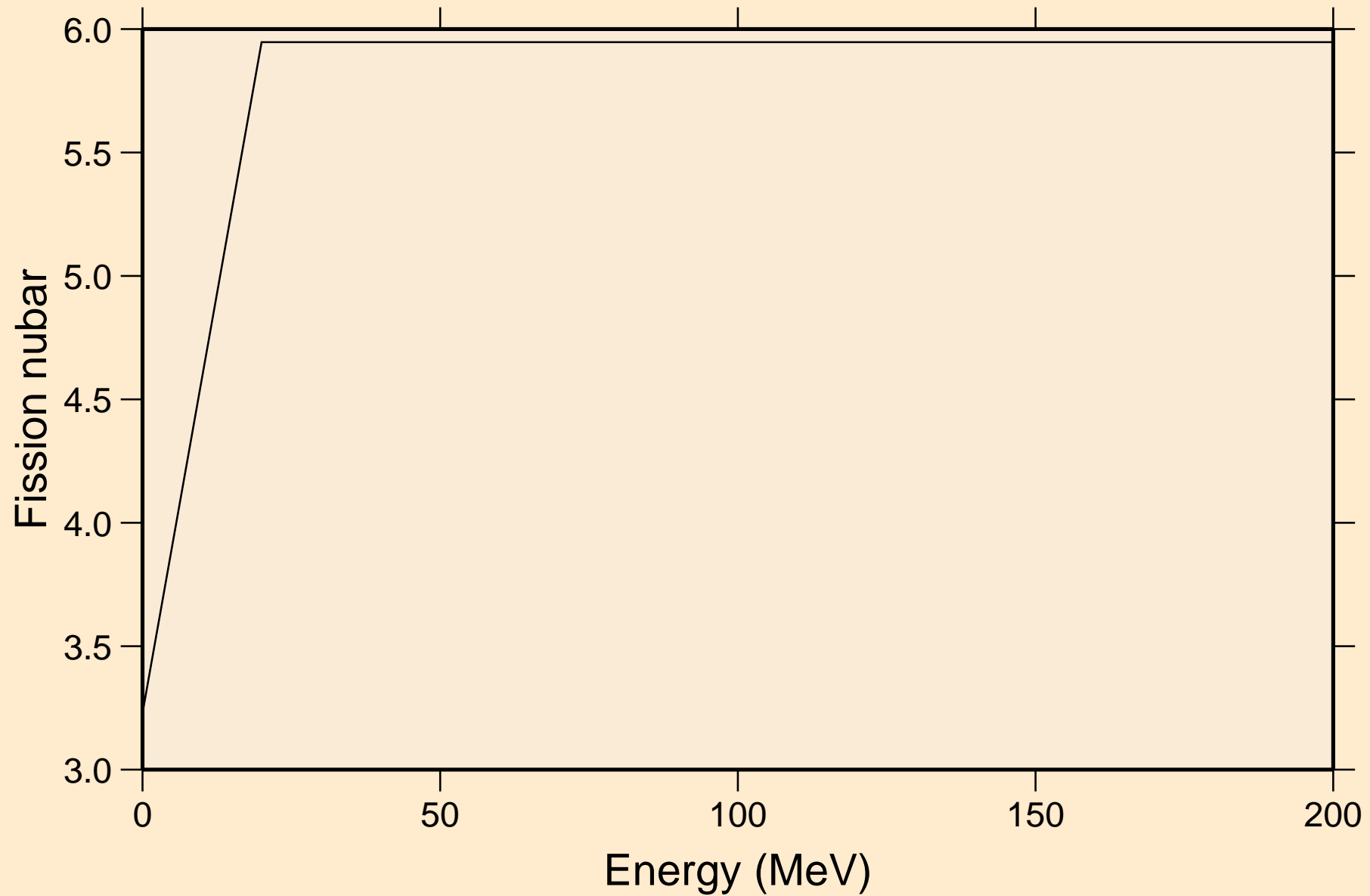

AM235 NEUTRON ACER TENDL-2024 LIBRARY; T=293.6K  
Neutron emission for (n,x)

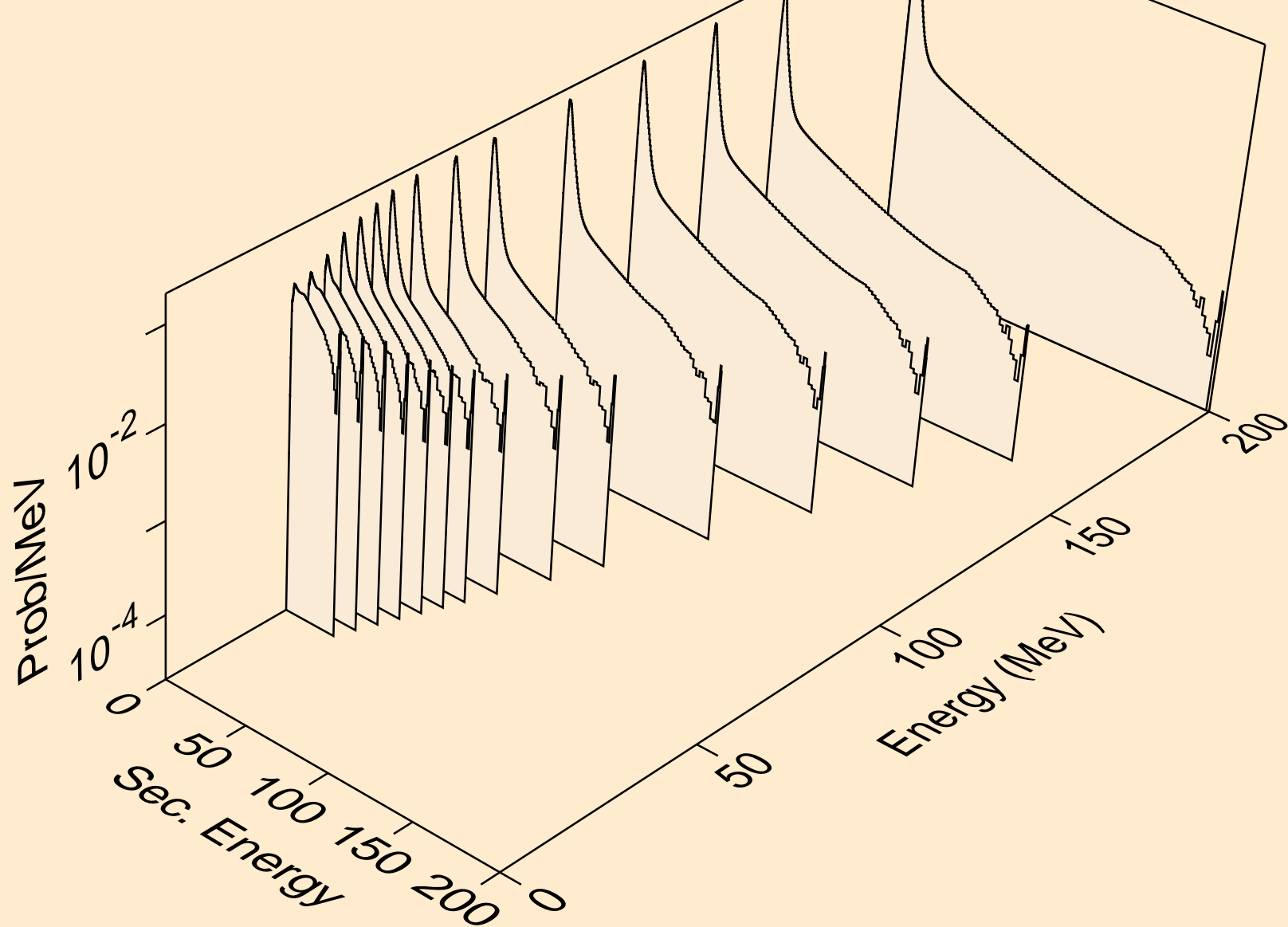

AM235 NEUTRON ACER TENDL-2024 LIBRARY; T=293.6K  
Neutron emission for (n,2nd)

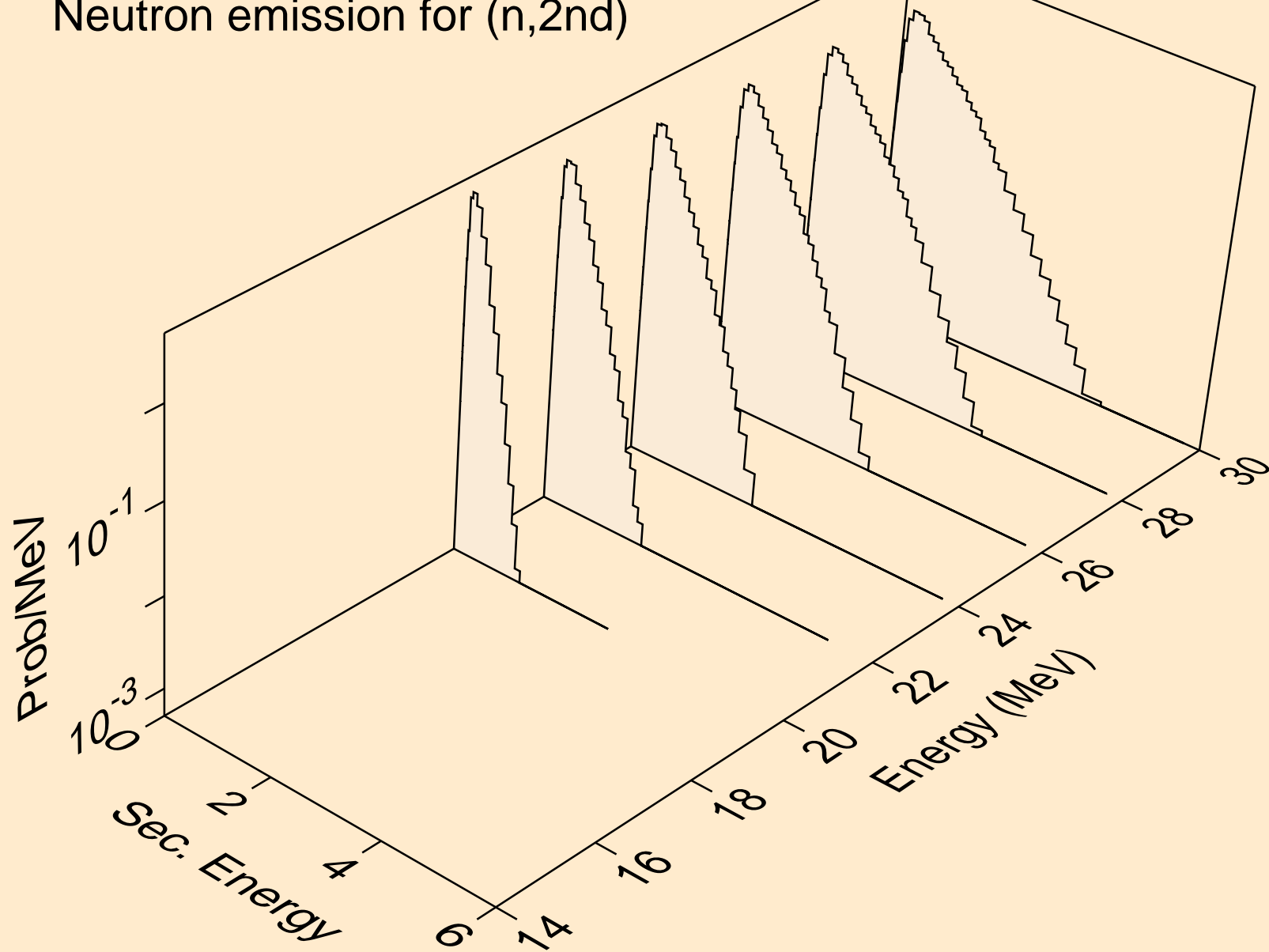

AM235 NEUTRON ACER TENDL-2024 LIBRARY; T=293.6K  
Neutron emission for (n,2n)

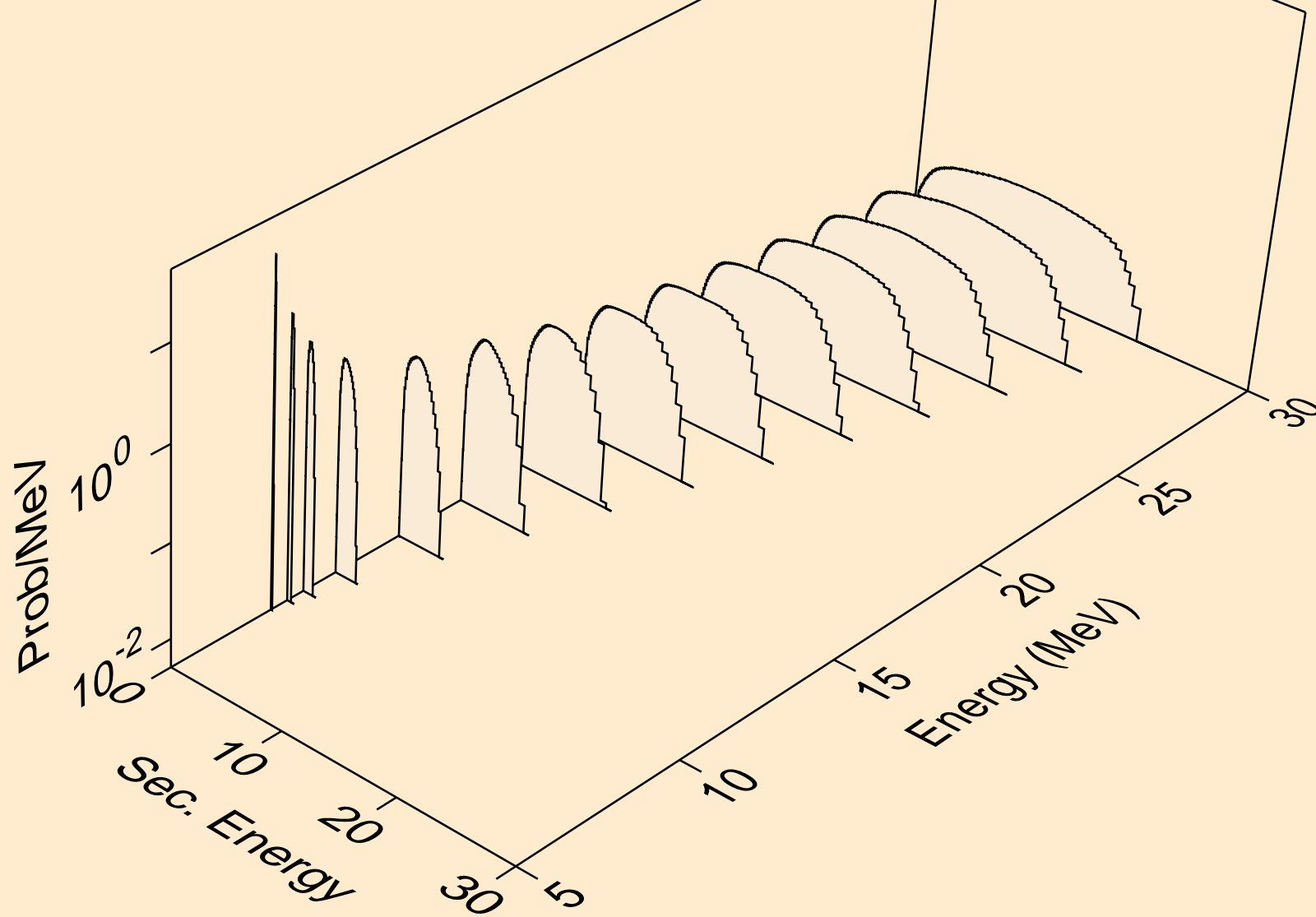

AM235 NEUTRON ACER TENDL-2024 LIBRARY; T=293.6K  
Neutron emission for (n,3n)

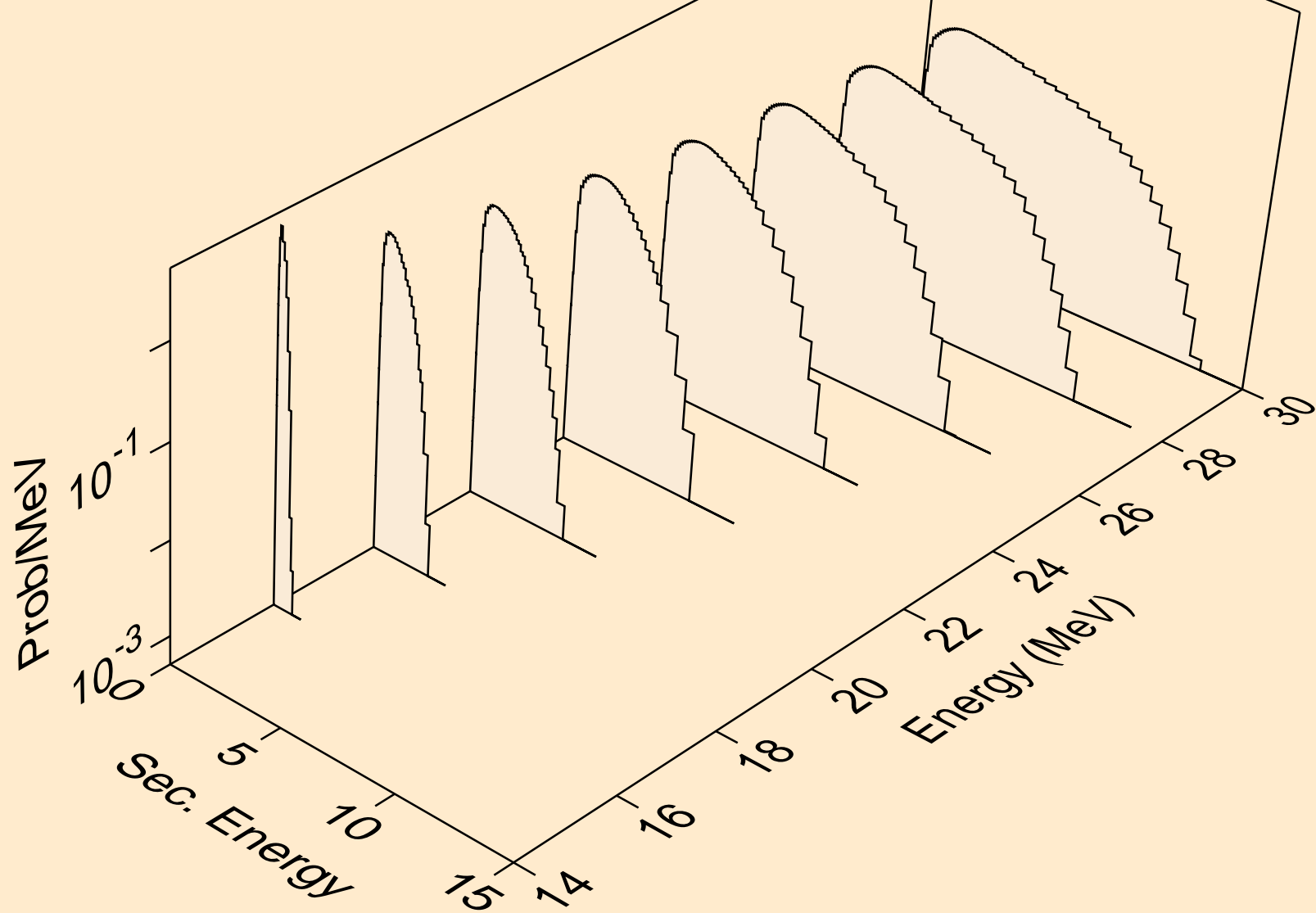

AM235 NEUTRON ACER TENDL-2024 LIBRARY; T=293.6K  
Neutron emission for fission

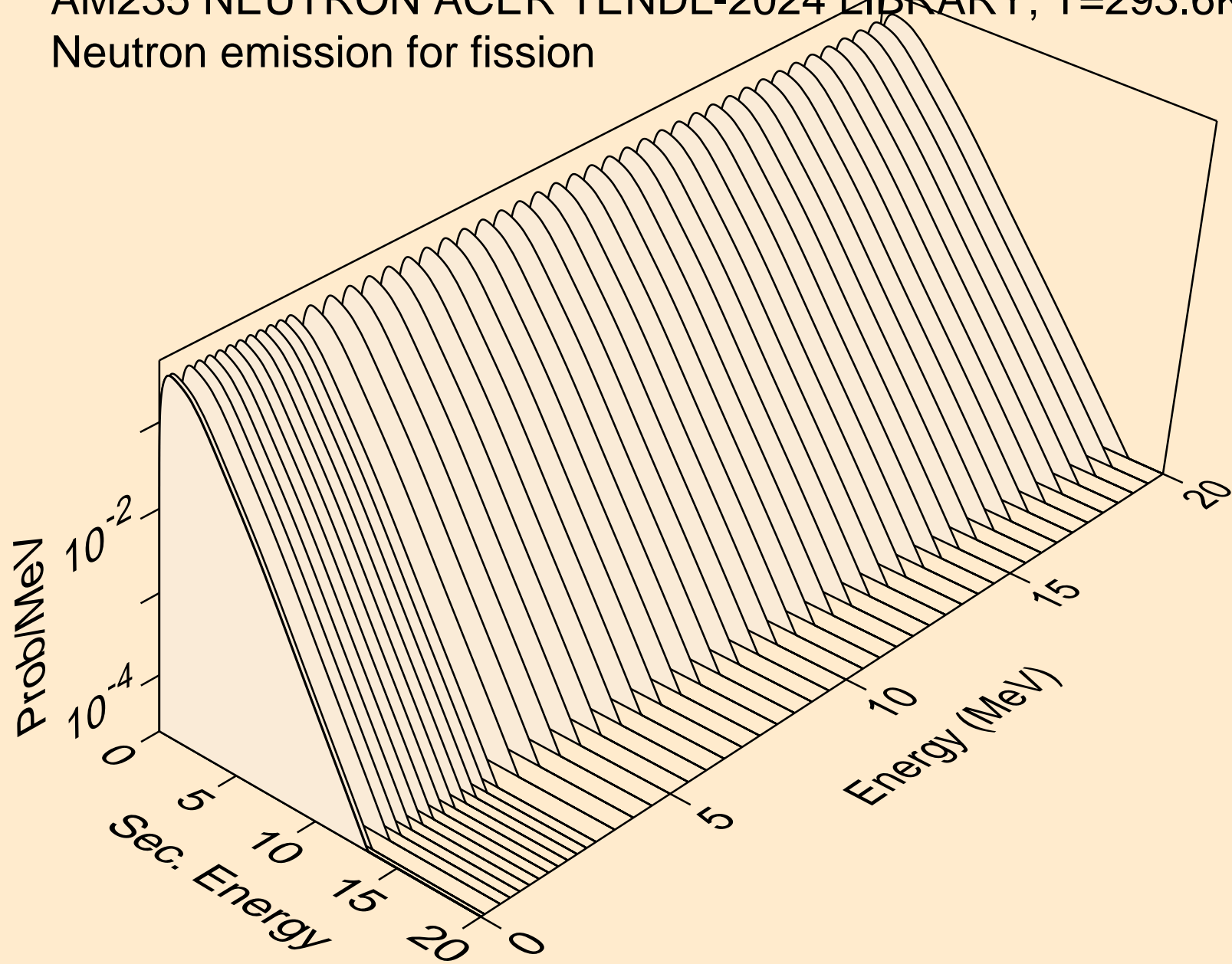

AM235 NEUTRON ACER TENDL-2024 LIBRARY; T=293.6K  
Neutron emission for (n,n\*)a

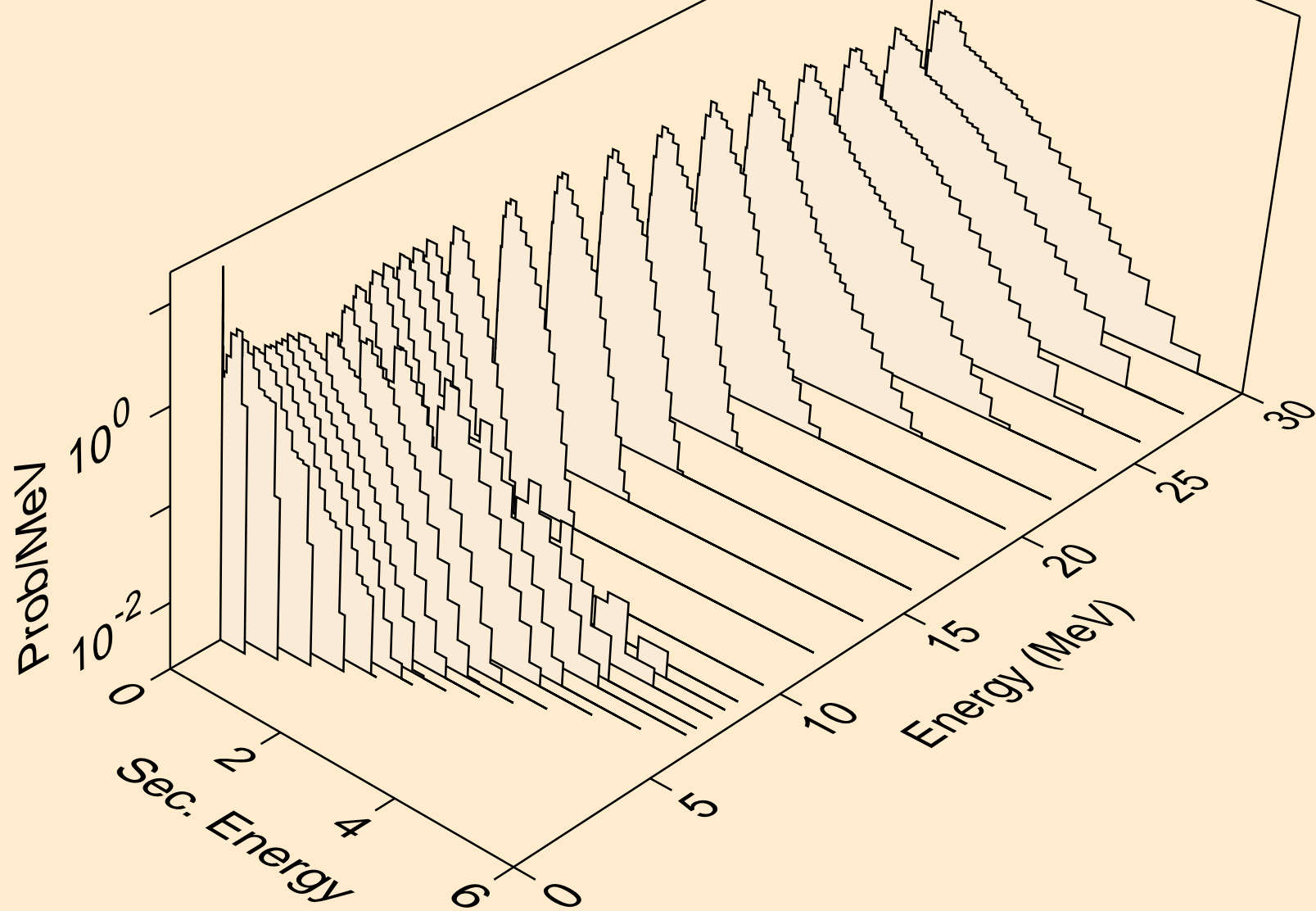

AM235 NEUTRON ACER TENDL-2024 LIBRARY; T=293.6K  
Neutron emission for (n,2n)a

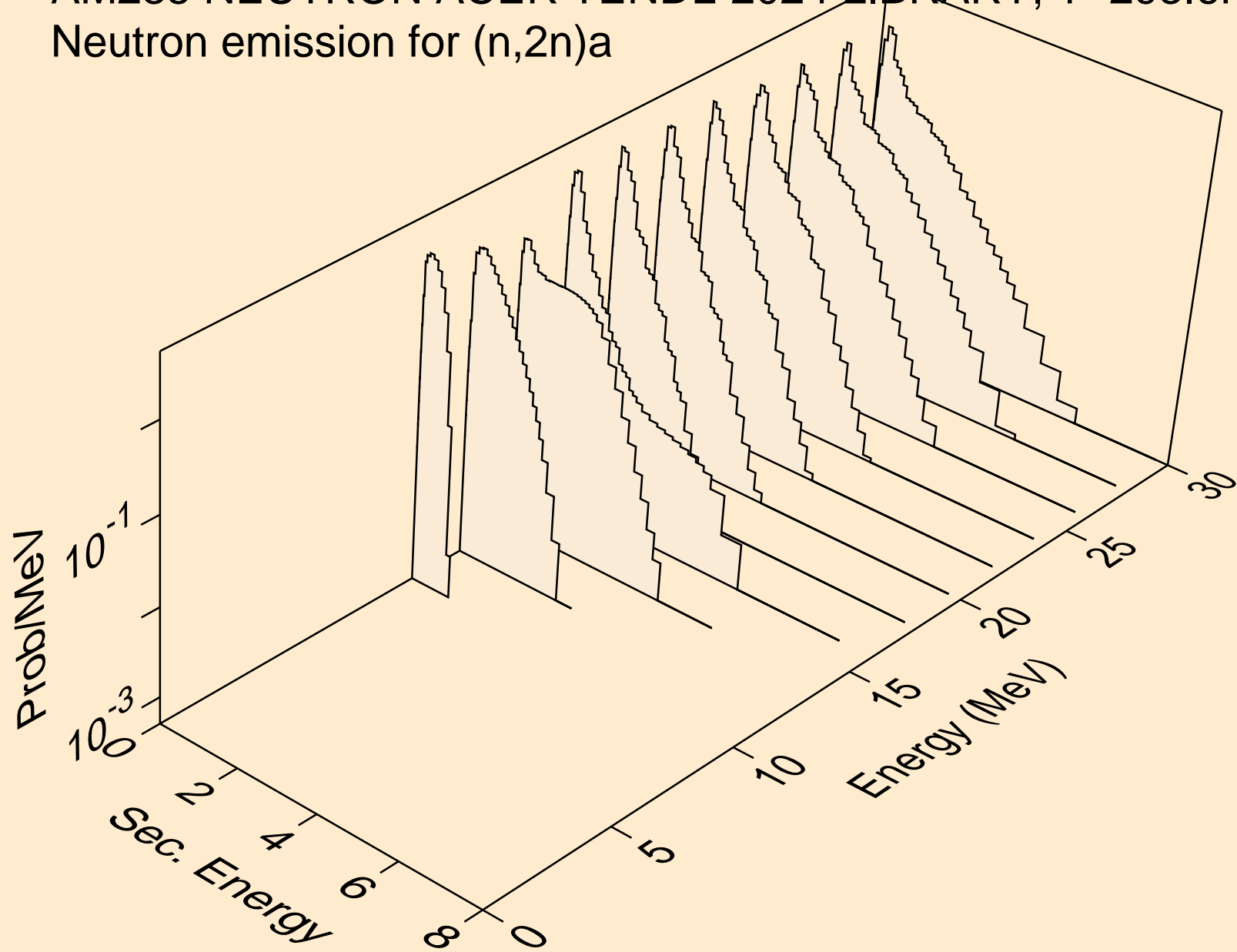

AM235 NEUTRON ACER TENDL-2024 LIBRARY; T=293.6K  
Neutron emission for (n,3n)a

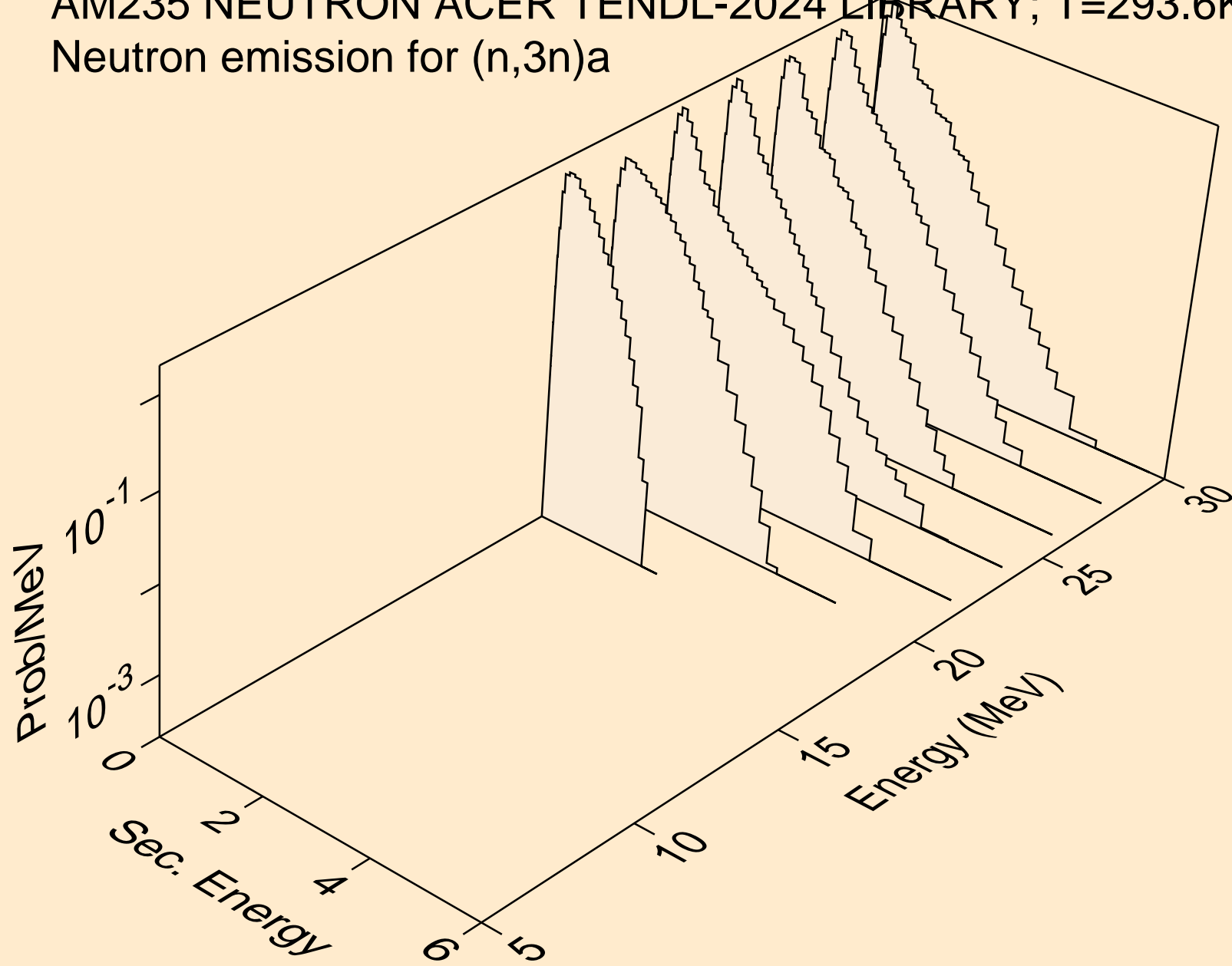

AM235 NEUTRON ACER TENDL-2024 LIBRARY; T=293.6K  
Neutron emission for (n,n\*)p

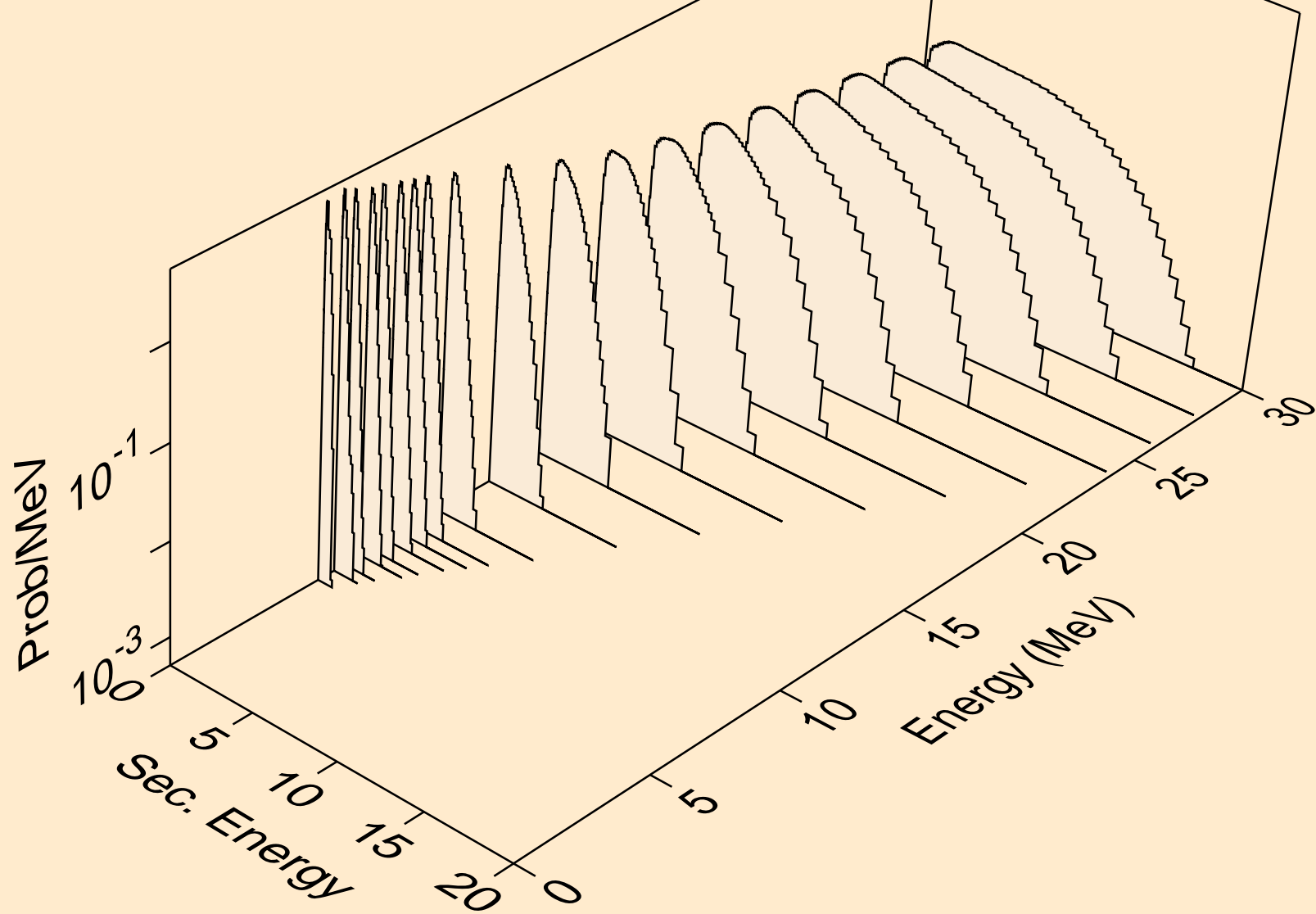

AM235 NEUTRON ACER TENDL-2024 LIBRARY; T=293.6K  
Neutron emission for (n,n\*)2a

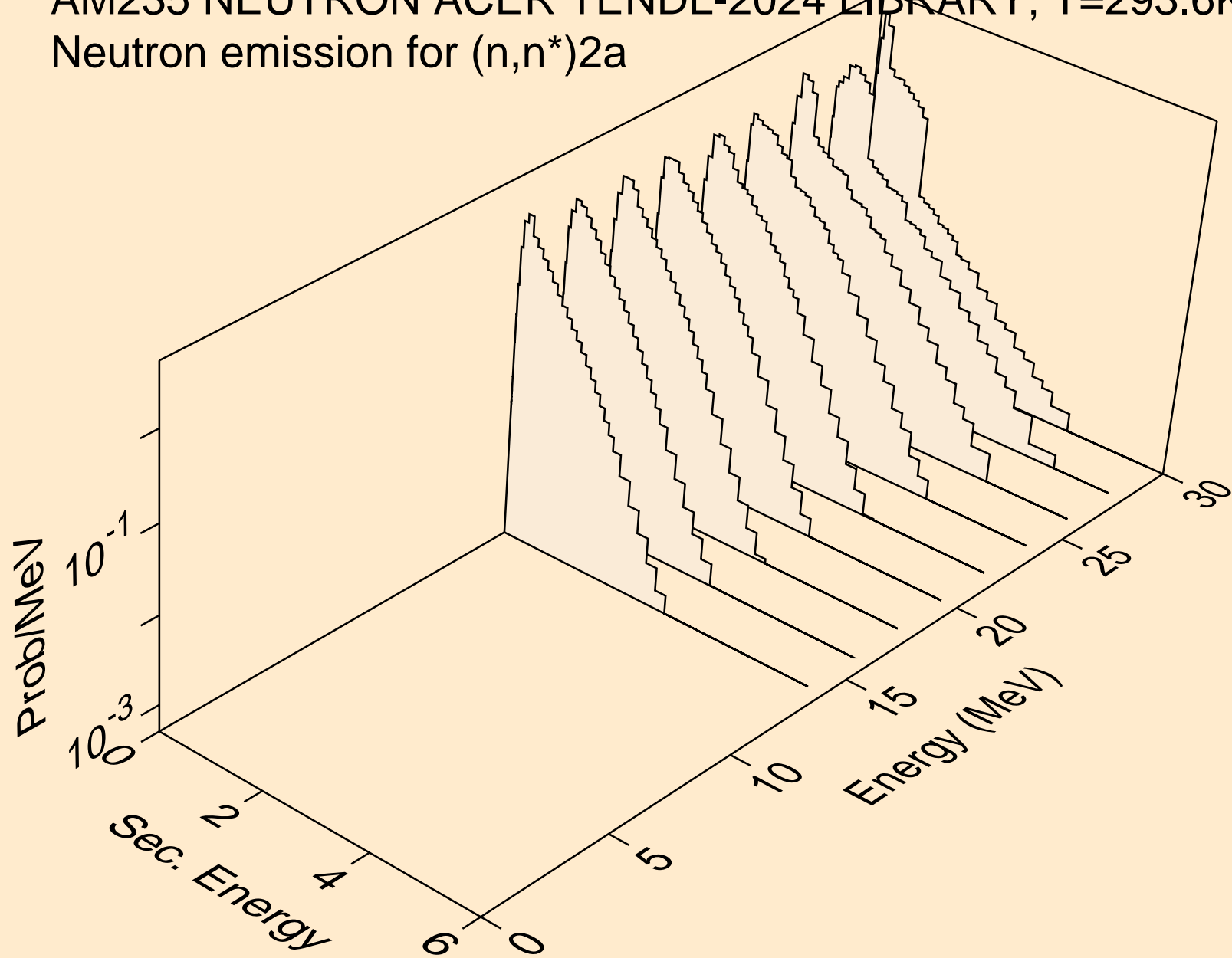

AM235 NEUTRON ACER TENDL-2024 LIBRARY; T=293.6K  
Neutron emission for (n,n\*)d

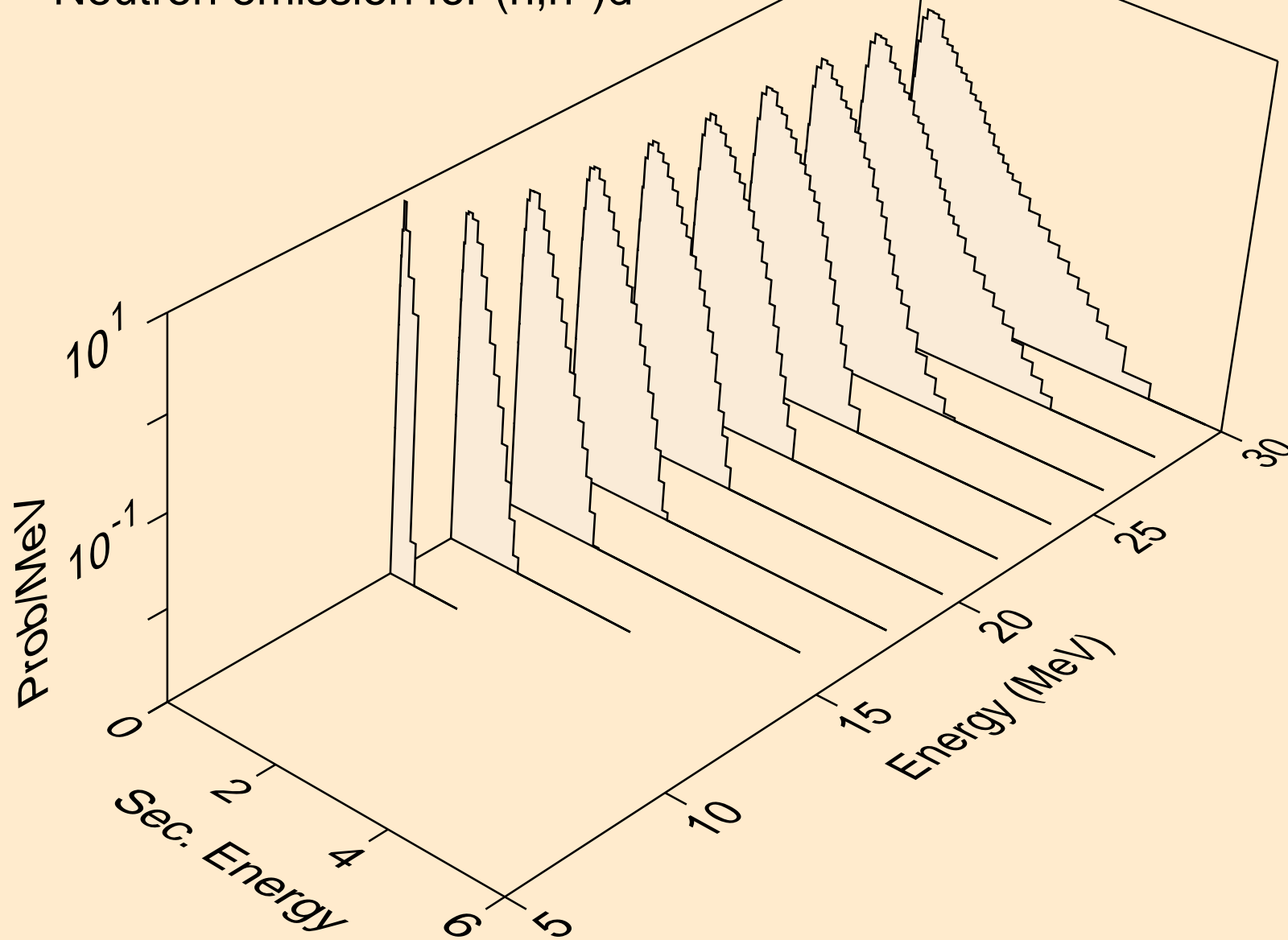

AM235 NEUTRON ACER TENDL-2024 LIBRARY; T=293.6K  
Neutron emission for (n,n\*)t

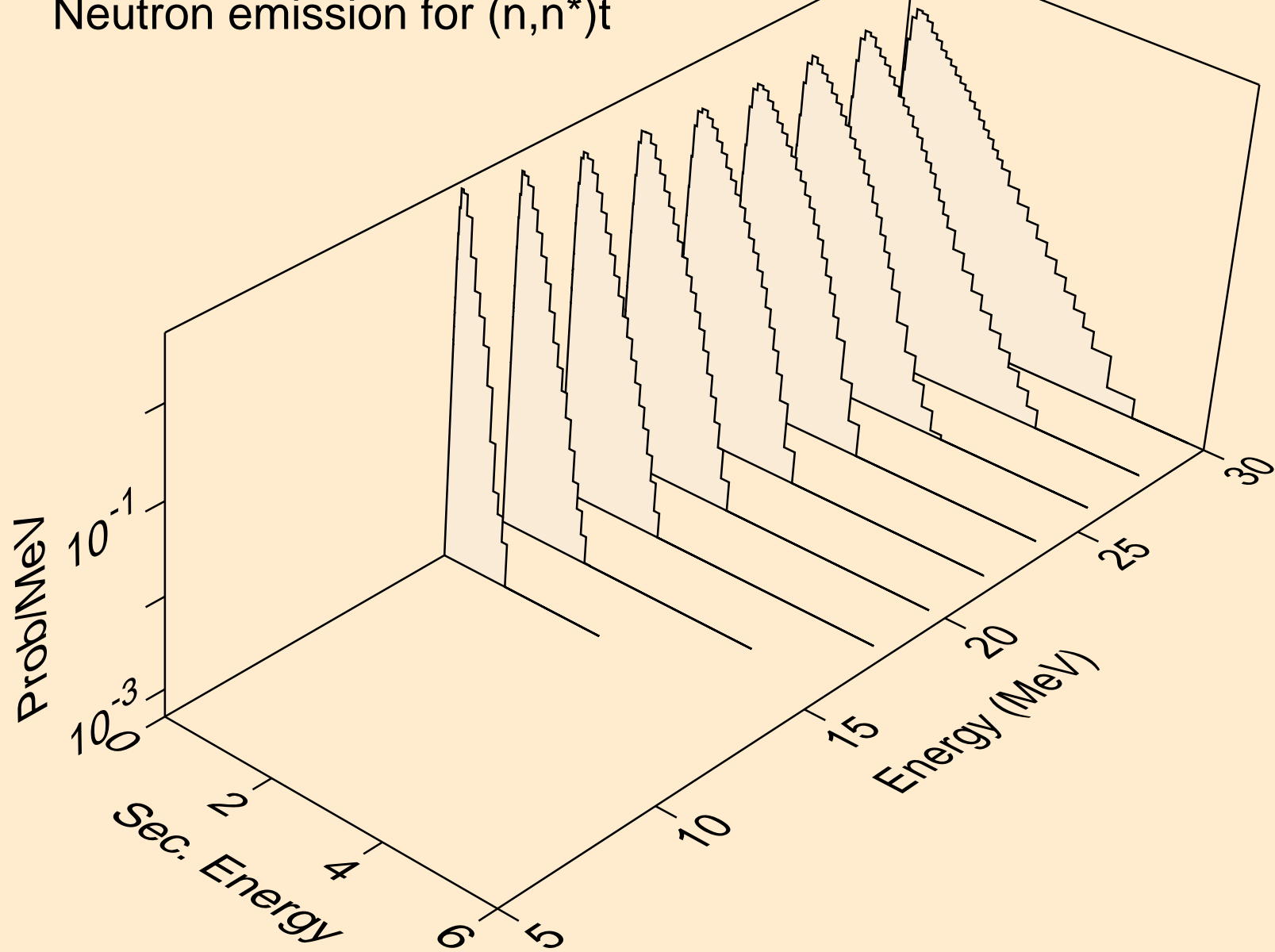

AM235 NEUTRON ACER TENDL-2024 LIBRARY; T=293.6K  
Neutron emission for (n,n\*)he3

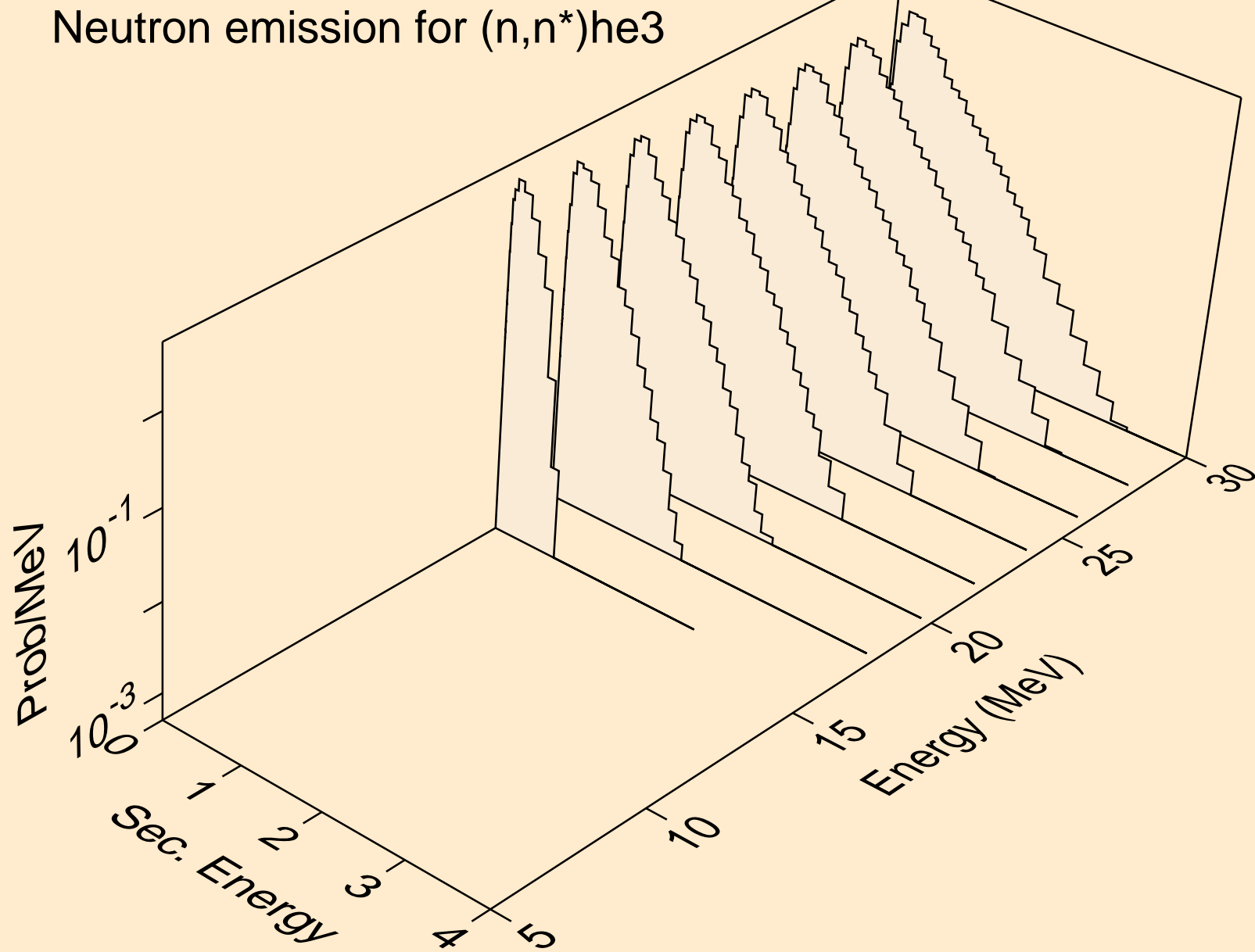

AM235 NEUTRON ACER TENDL-2024 LIBRARY; T=293.6K  
Neutron emission for (n,4n)

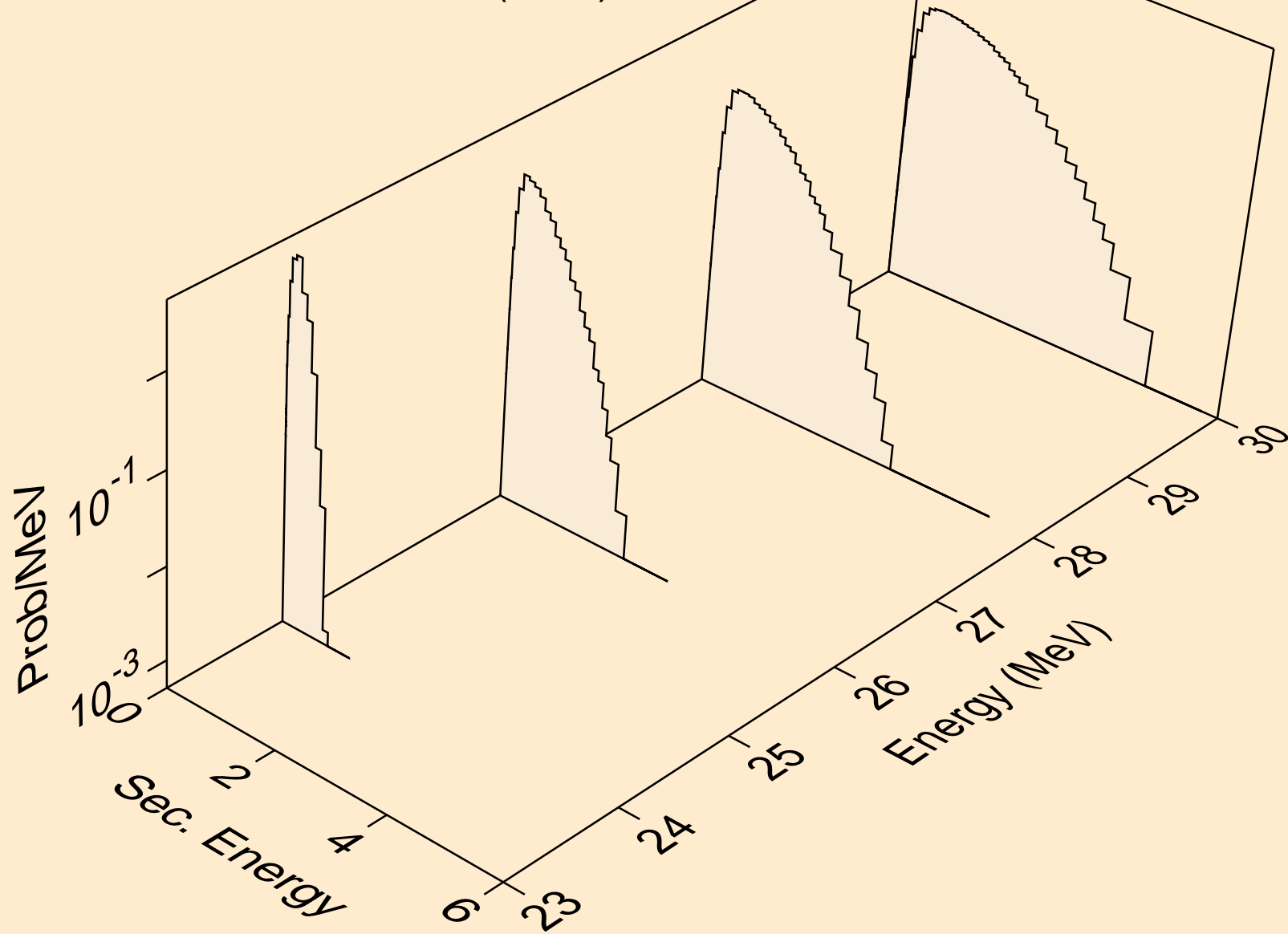

AM235 NEUTRON ACER TENDL-2024 LIBRARY; T=293.6K  
Neutron emission for (n,2np)

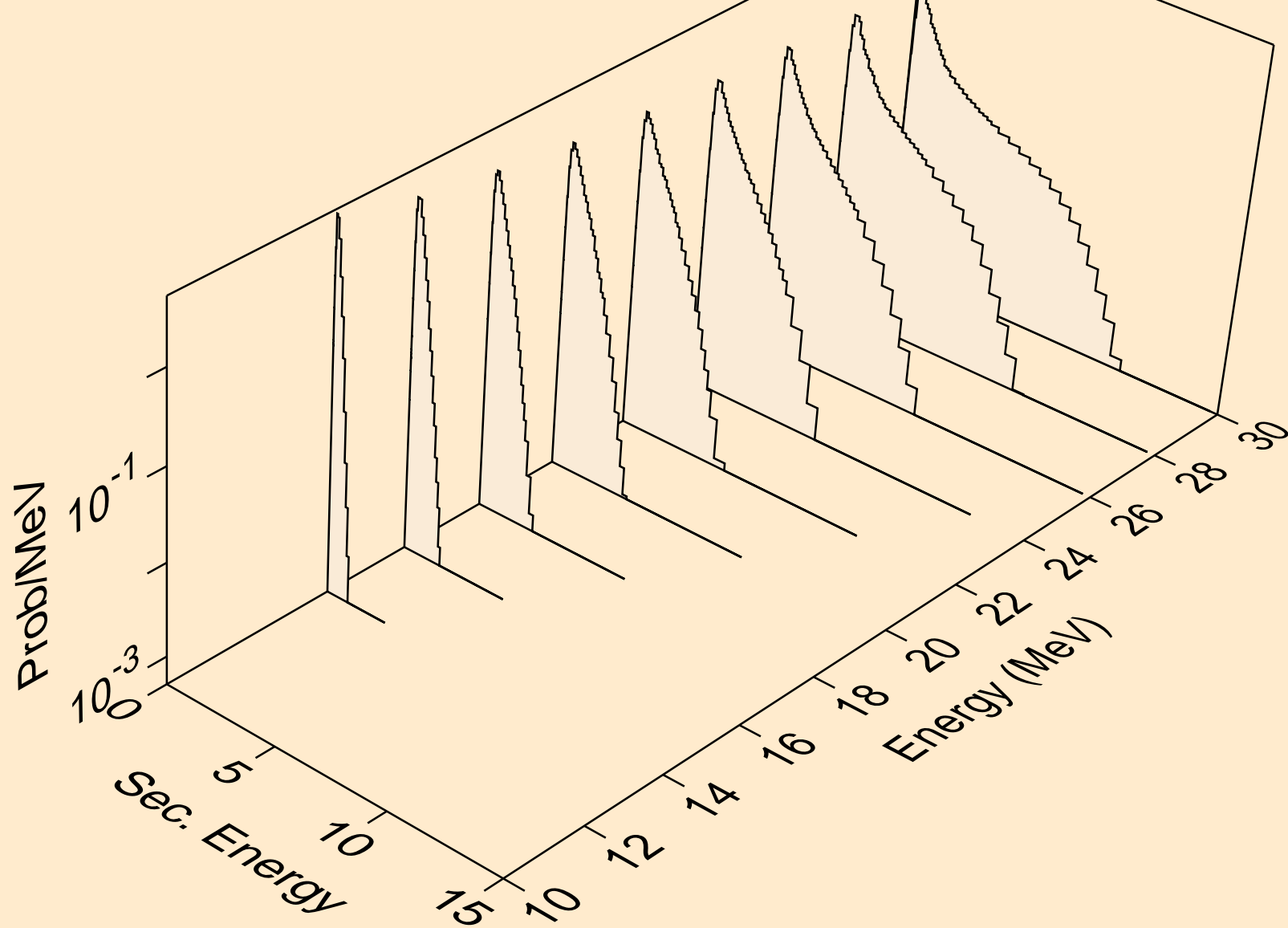

AM235 NEUTRON ACER TENDL-2024 LIBRARY; T=293.6K  
Neutron emission for (n,3np)

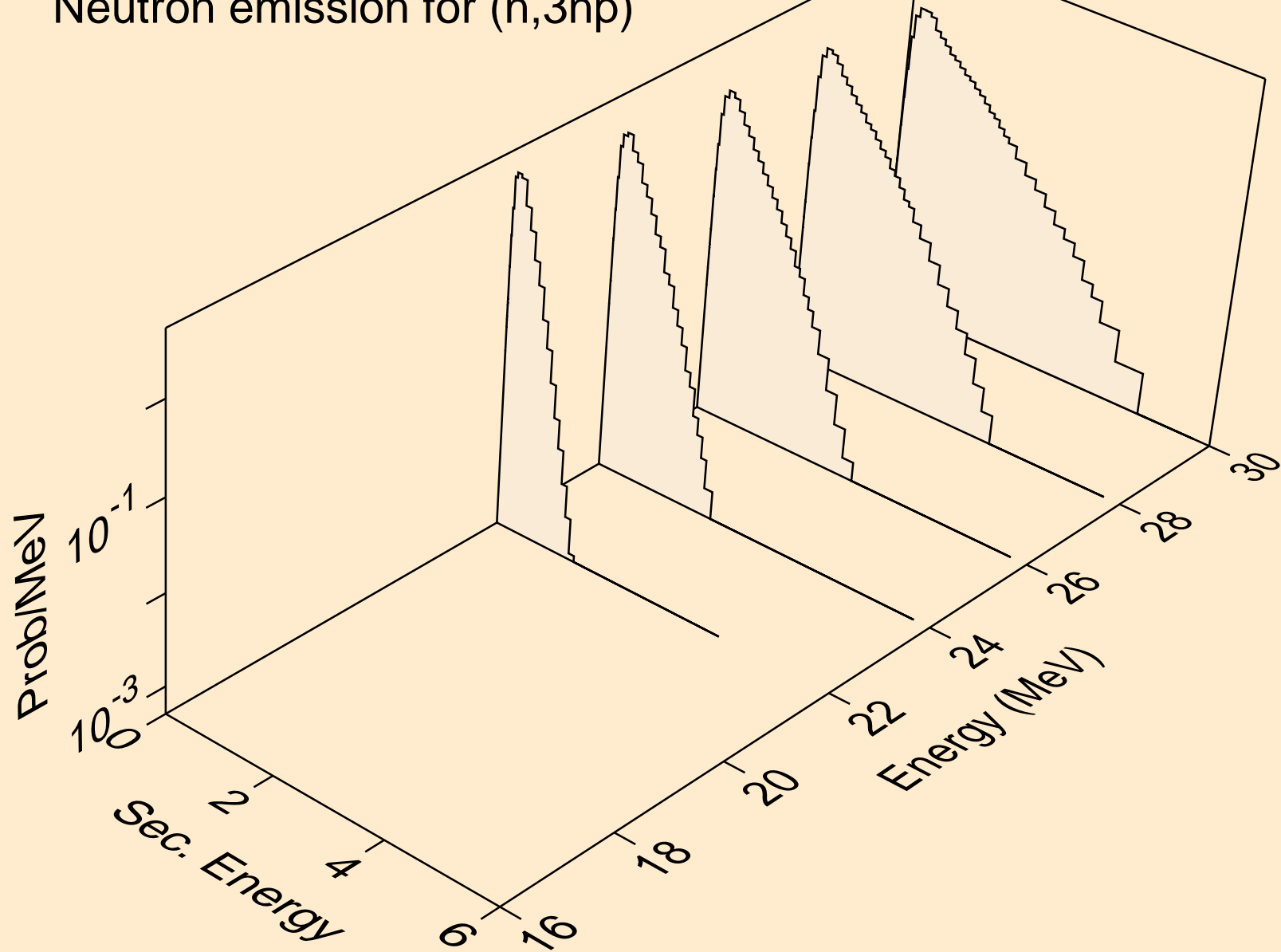

AM235 NEUTRON ACER TENDL-2024 LIBRARY; T=293.6K  
Neutron emission for (n,n2p)

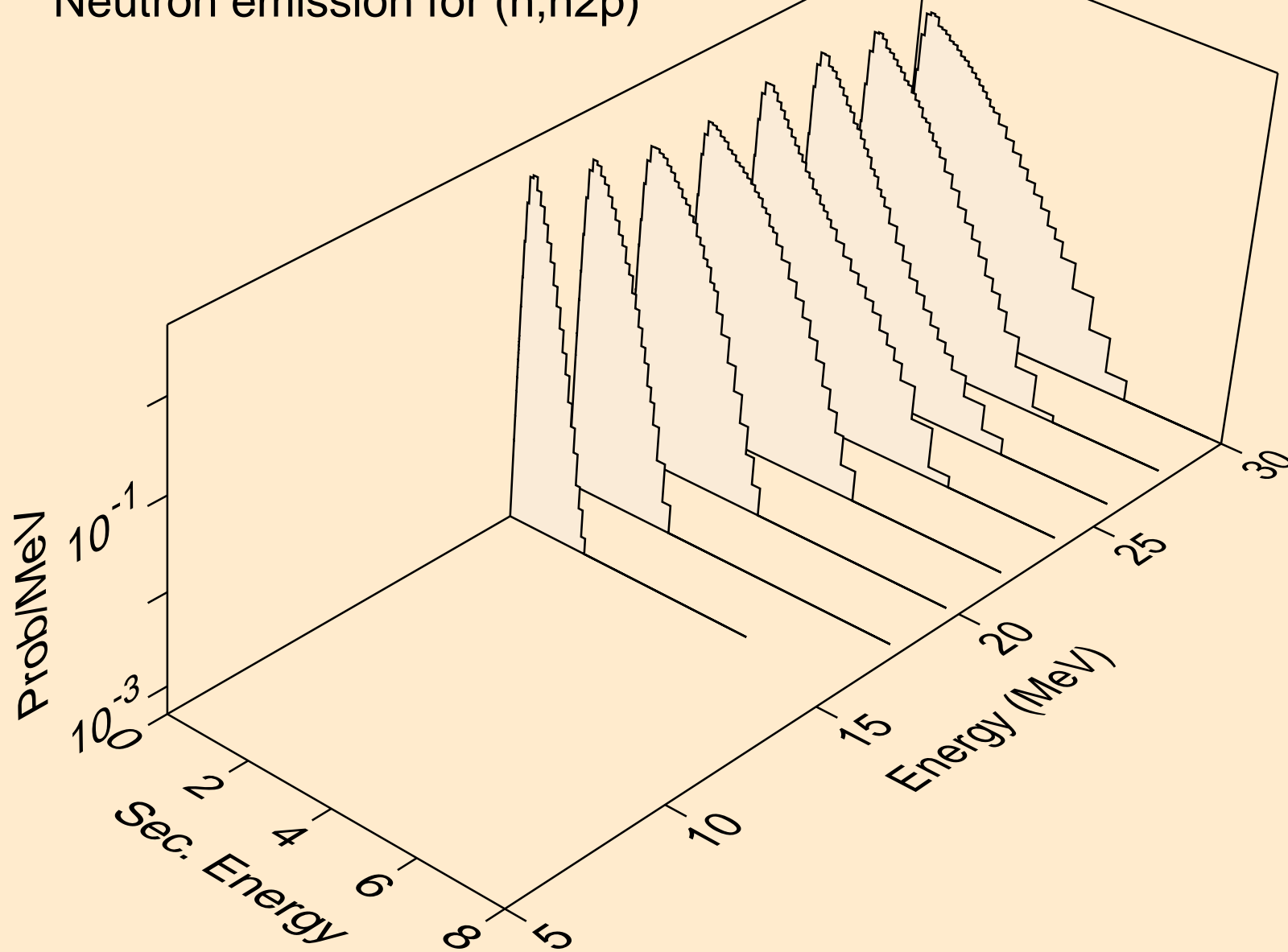

AM235 NEUTRON ACER TENDL-2024 LIBRARY; T=293.6K  
Neutron emission for (n,npa)

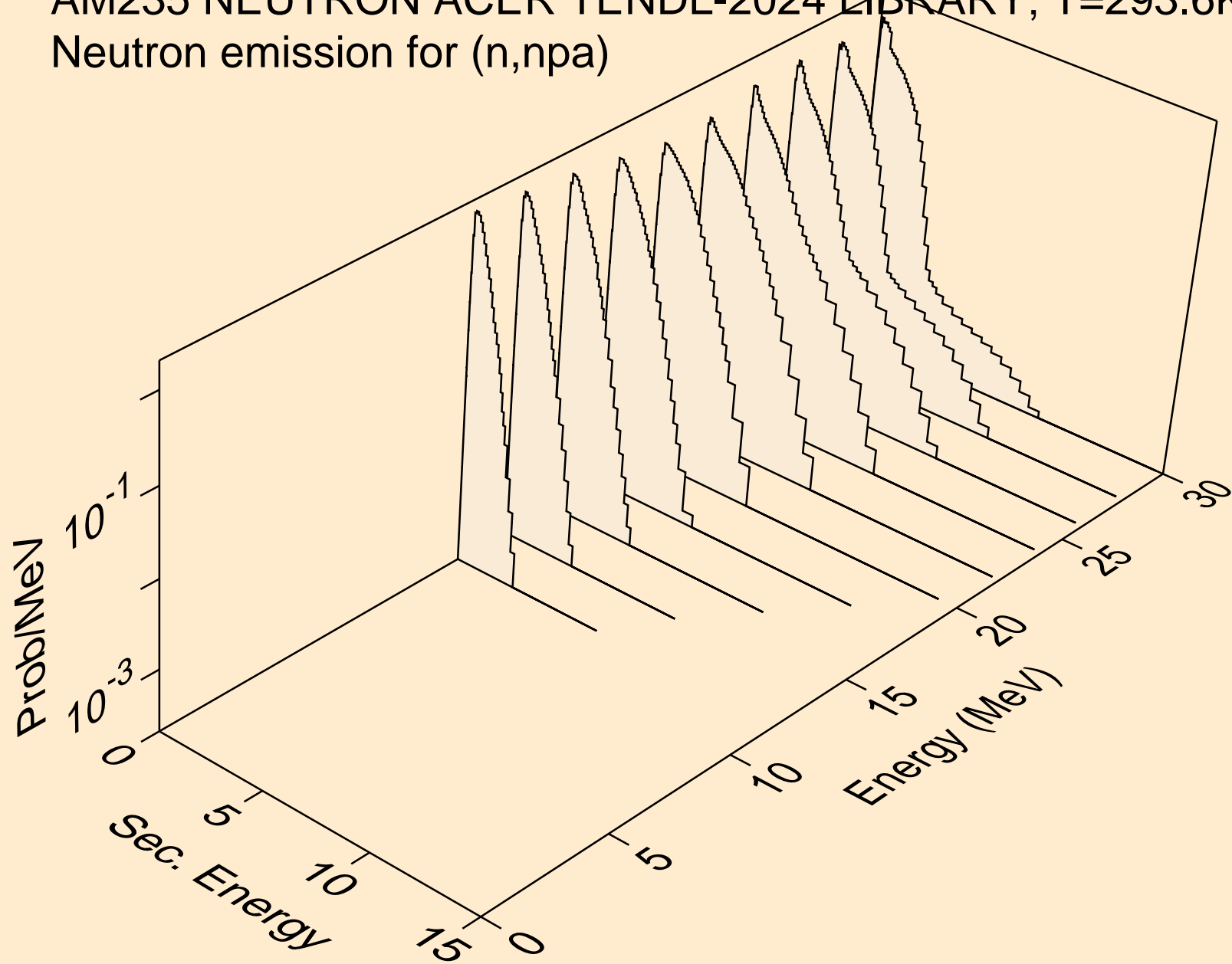

AM235 NEUTRON ACER TENDL-2024 LIBRARY; T=293.6K  
Neutron emission for (n,n\*c)

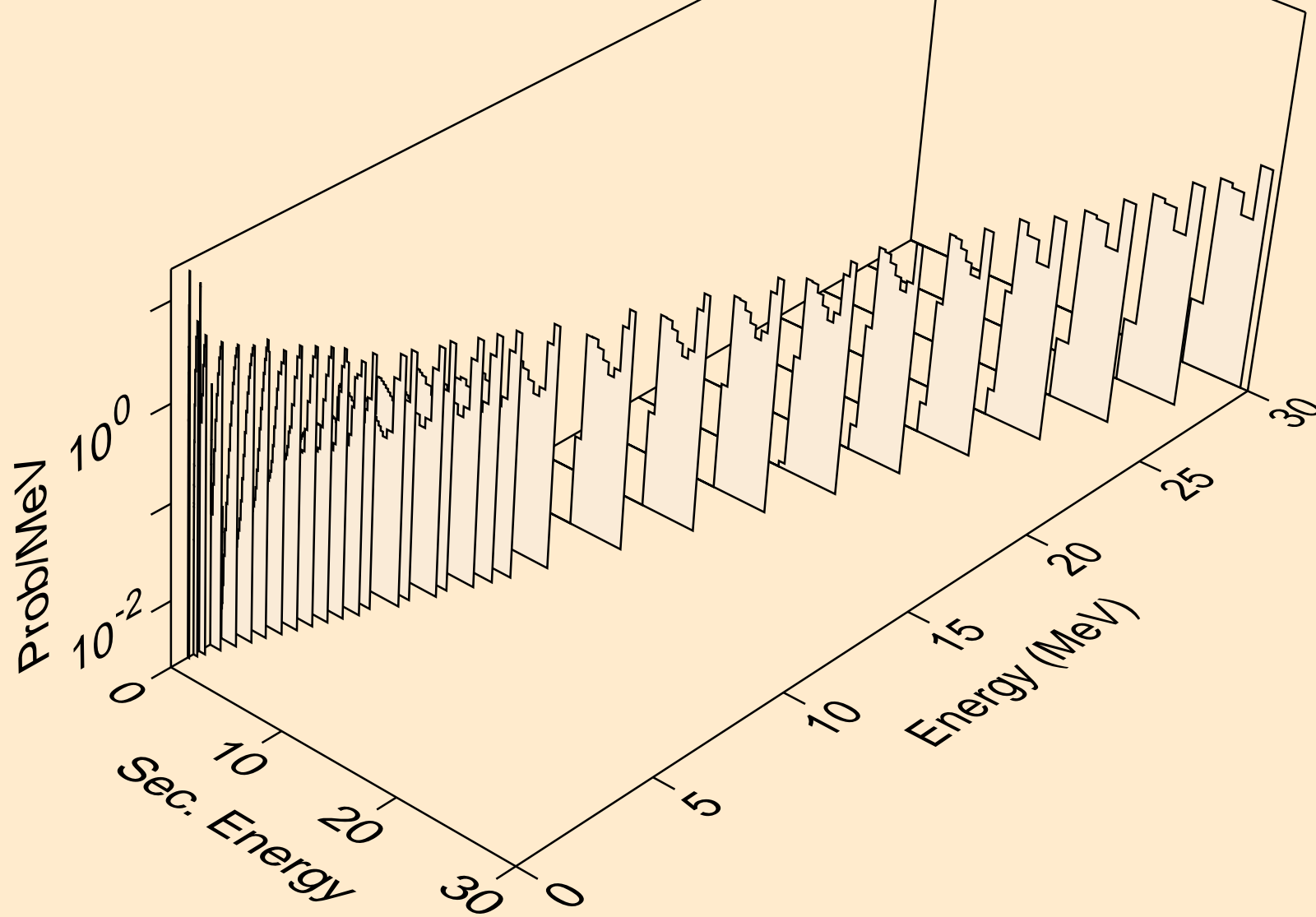

# AM235 NEUTRON ACER TENDL-2024 LIBRARY; T=293.6K

## Delayed nubar

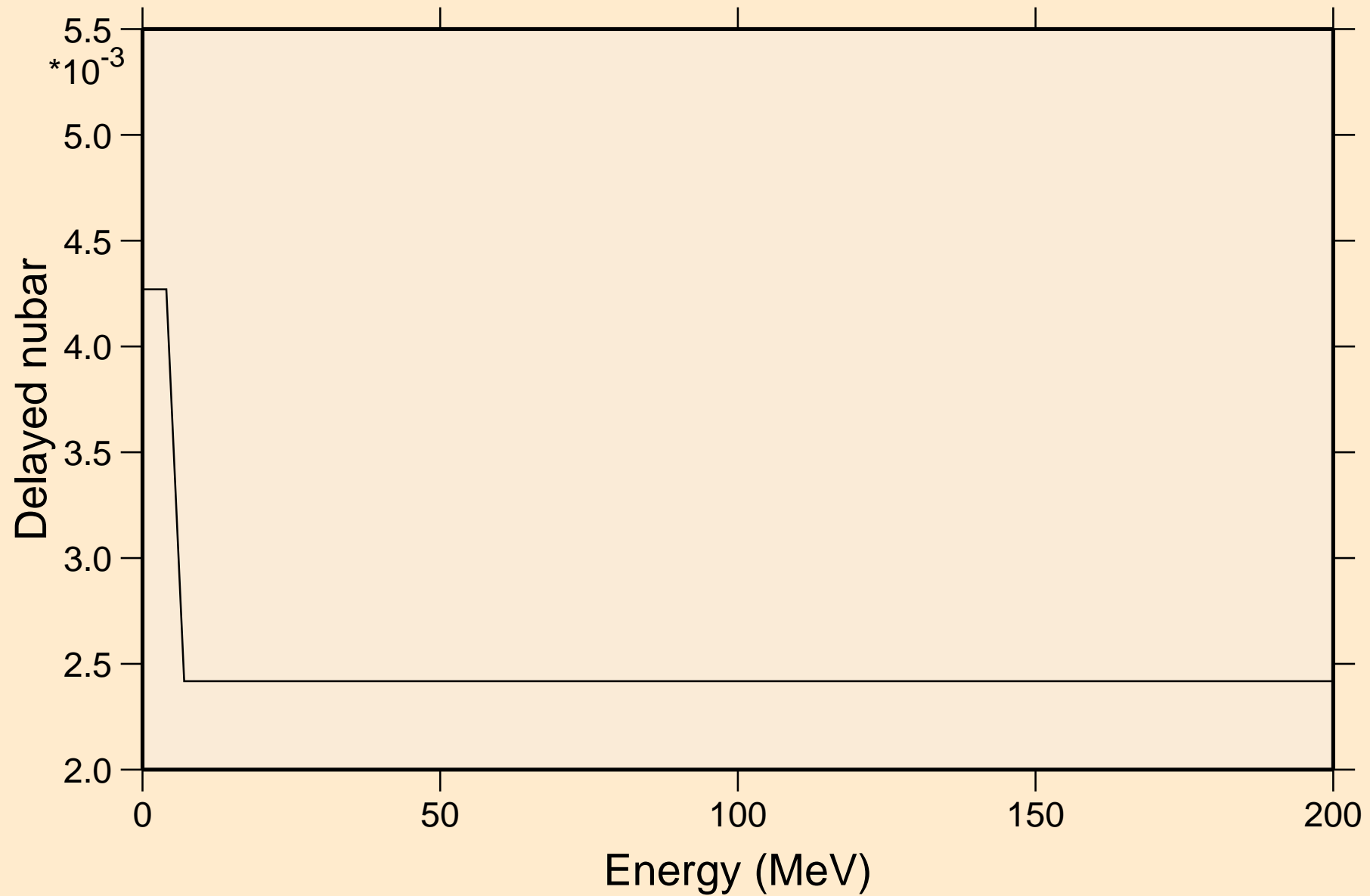

# AM235 NEUTRON ACER TENDL-2024 LIBRARY; T=293.6K

## Delayed neutron spectra

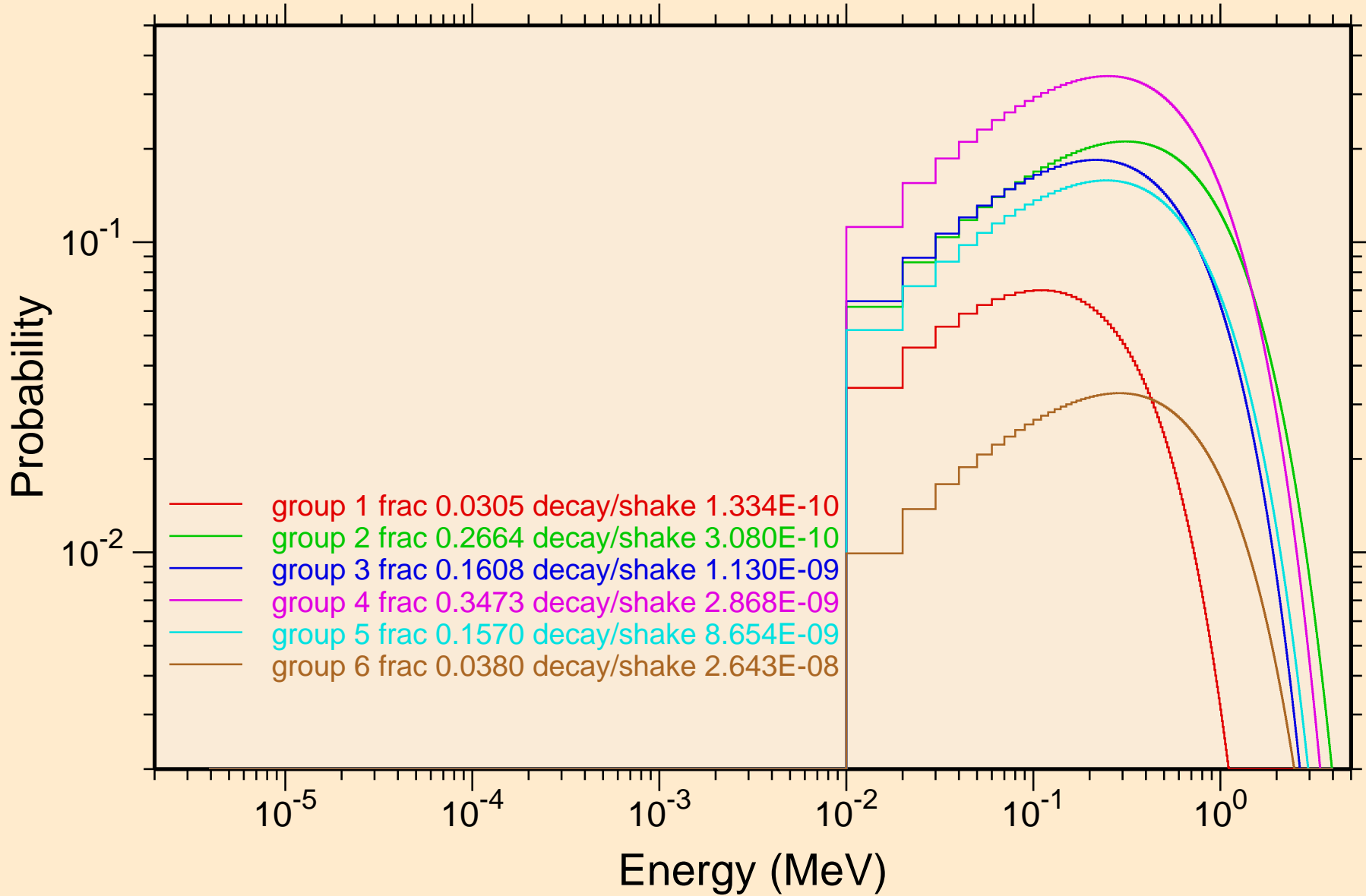

AM235 NEUTRON ACER TENDL-2024 LIBRARY; T=293.6K  
Photon emission for (n,x)

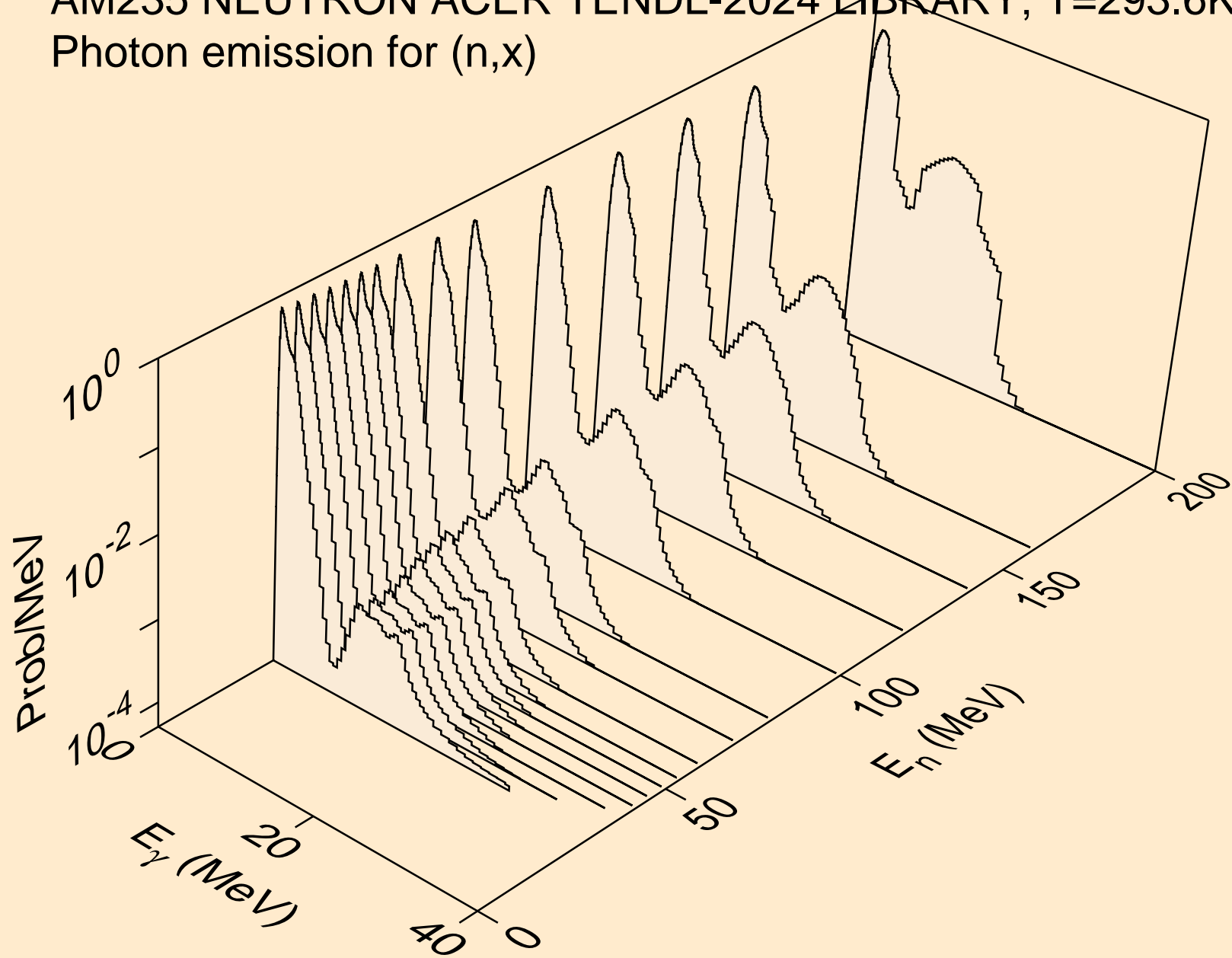

AM235 NEUTRON ACER TENDL-2024 LIBRARY; T=293.6K  
Photon emission for (n,2nd)

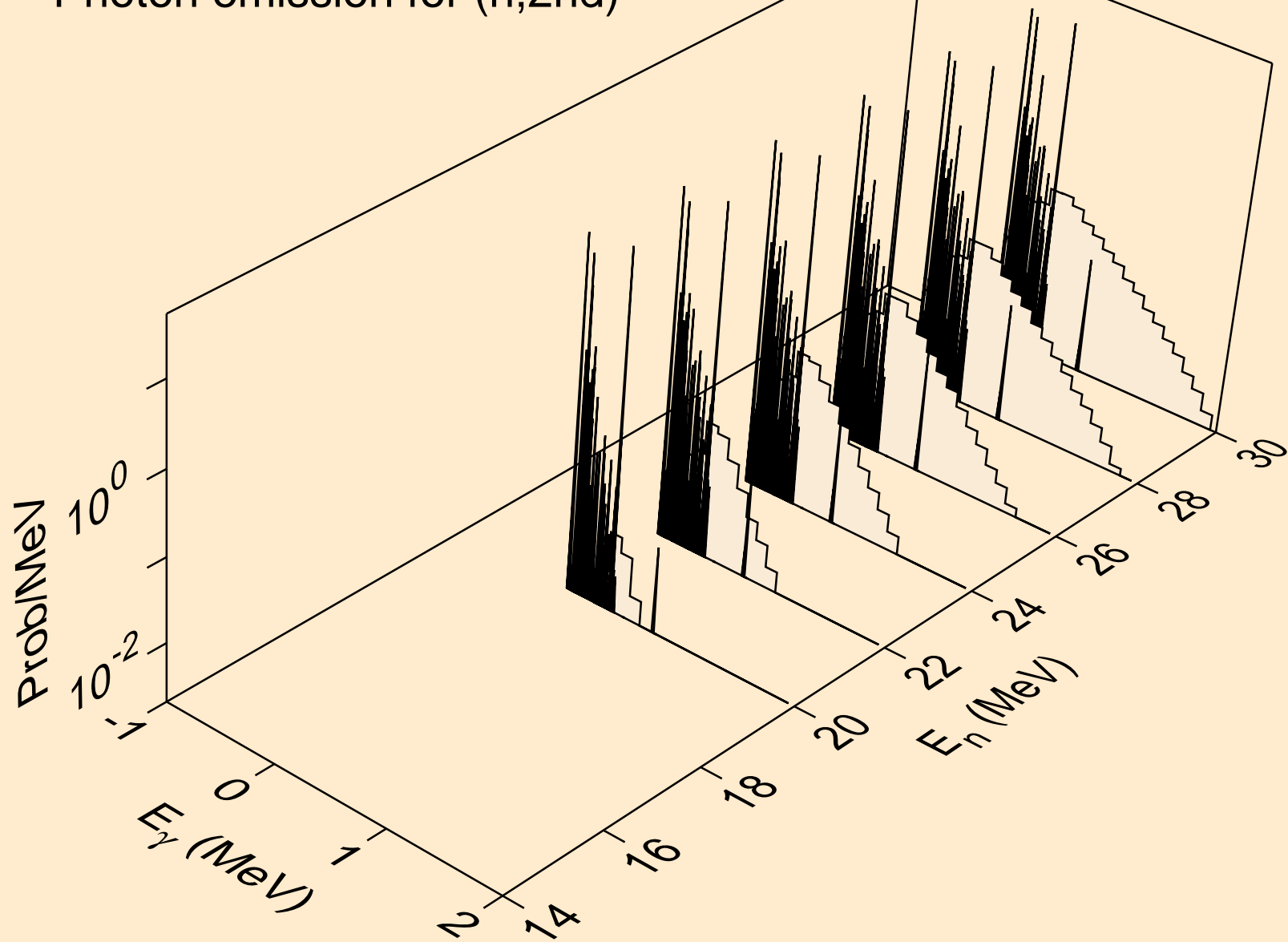

AM235 NEUTRON ACER TENDL-2024 LIBRARY; T=293.6K  
Photon emission for (n,2n)

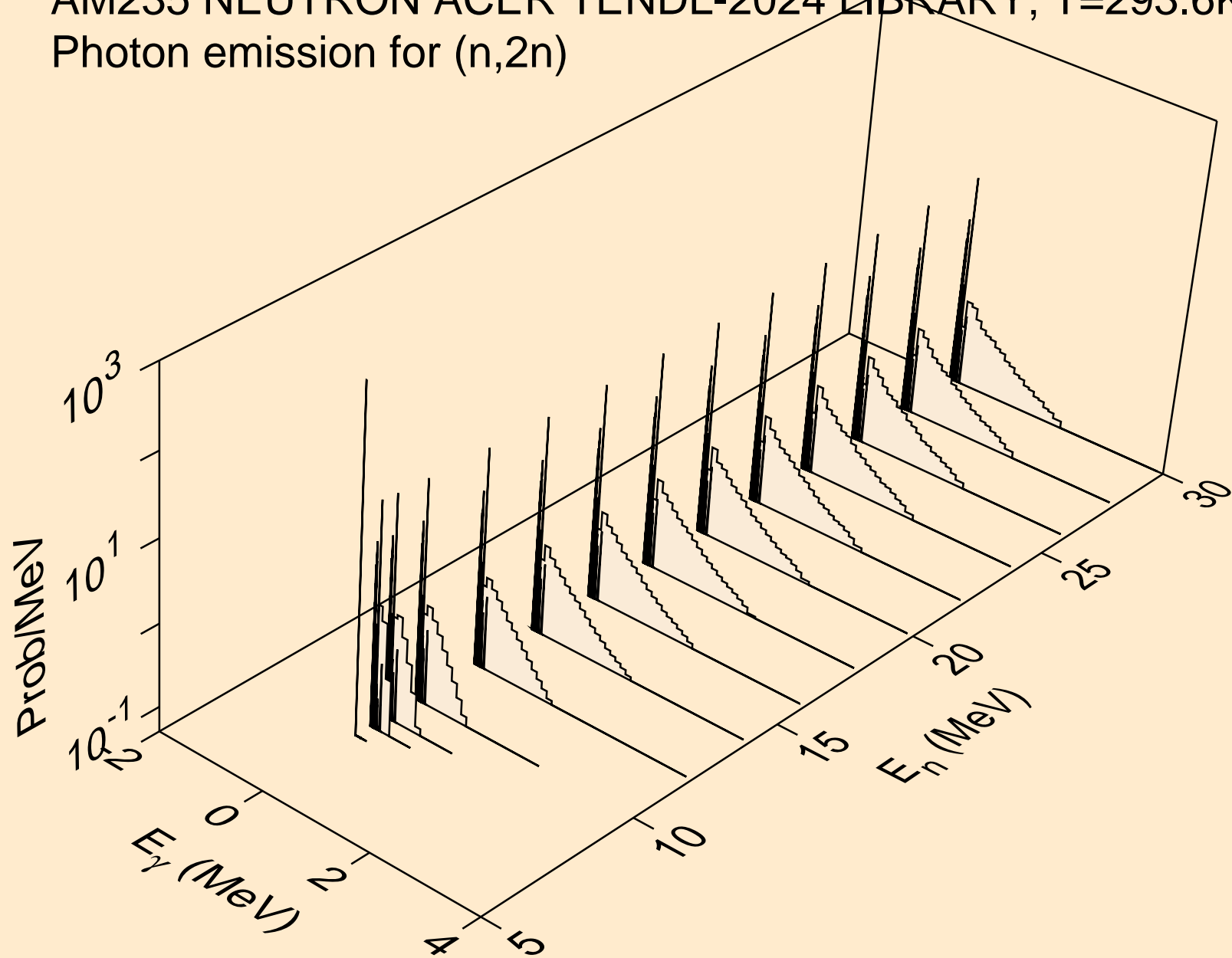

AM235 NEUTRON ACER TENDL-2024 LIBRARY; T=293.6K  
Photon emission for (n,3n)

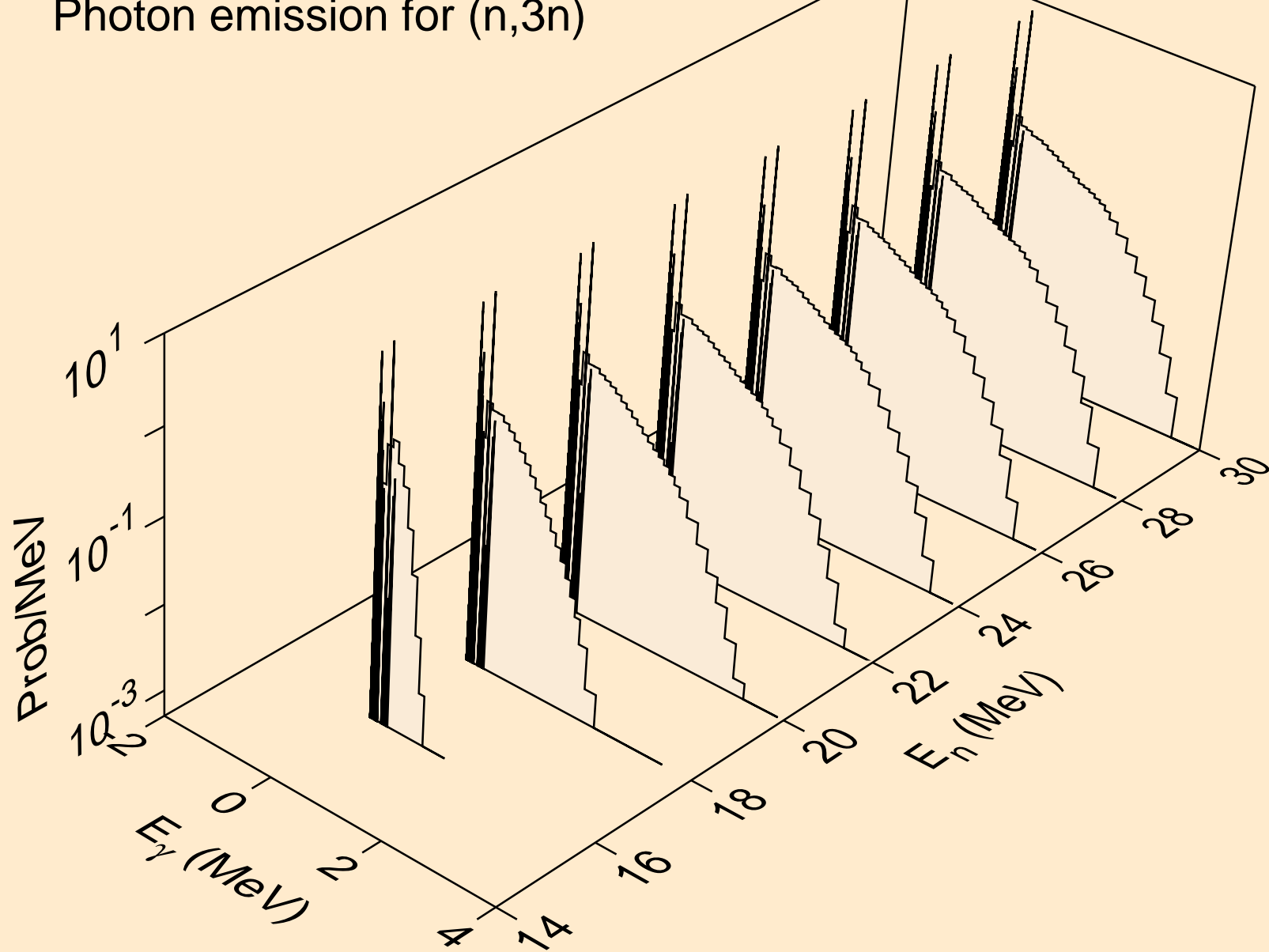

AM235 NEUTRON ACER TENDL-2024 LIBRARY; T=293.6K  
Photon emission for (n,n\*)a

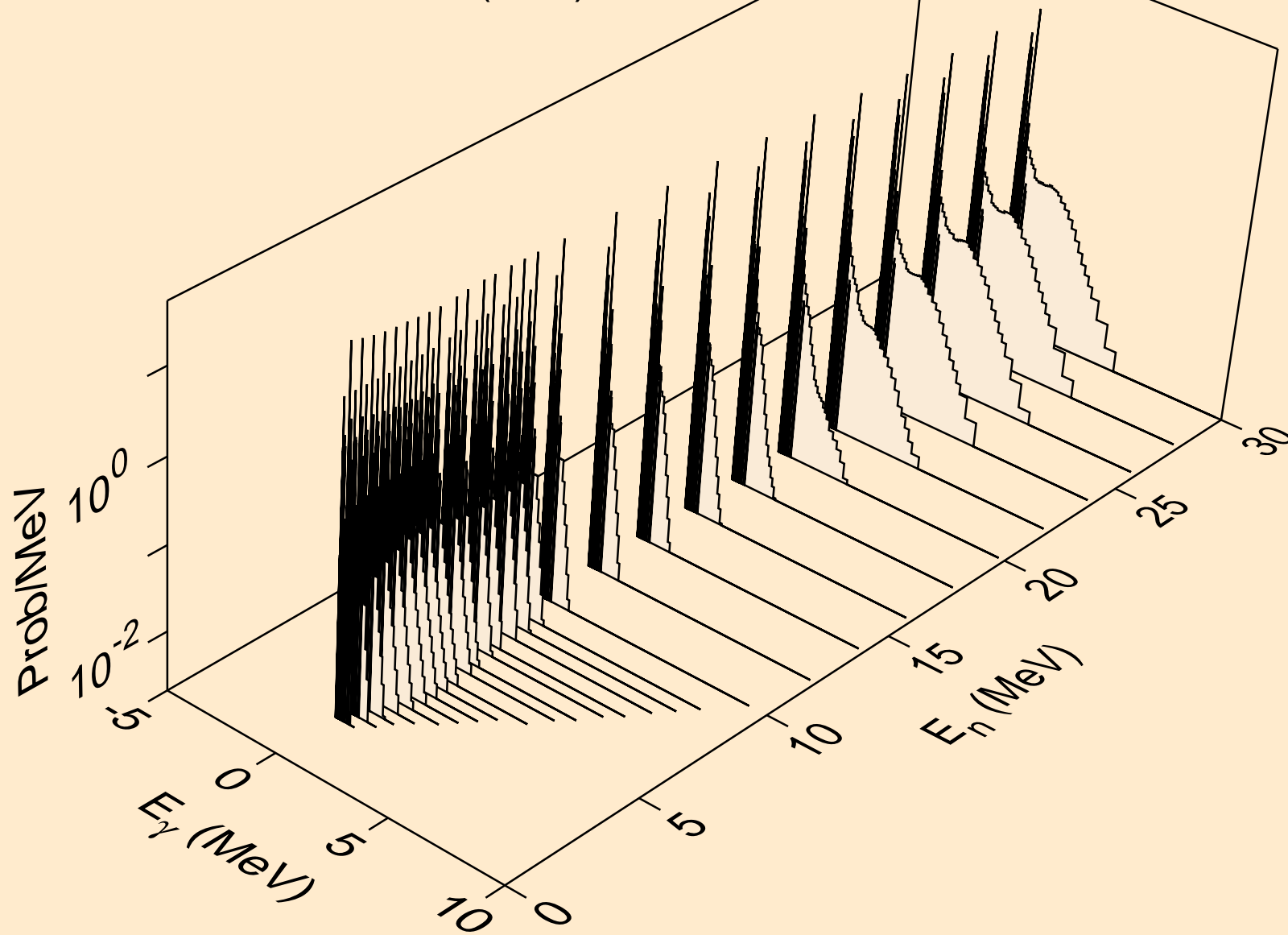

AM235 NEUTRON ACER TENDL-2024 LIBRARY; T=293.6K  
Photon emission for (n,2n)a

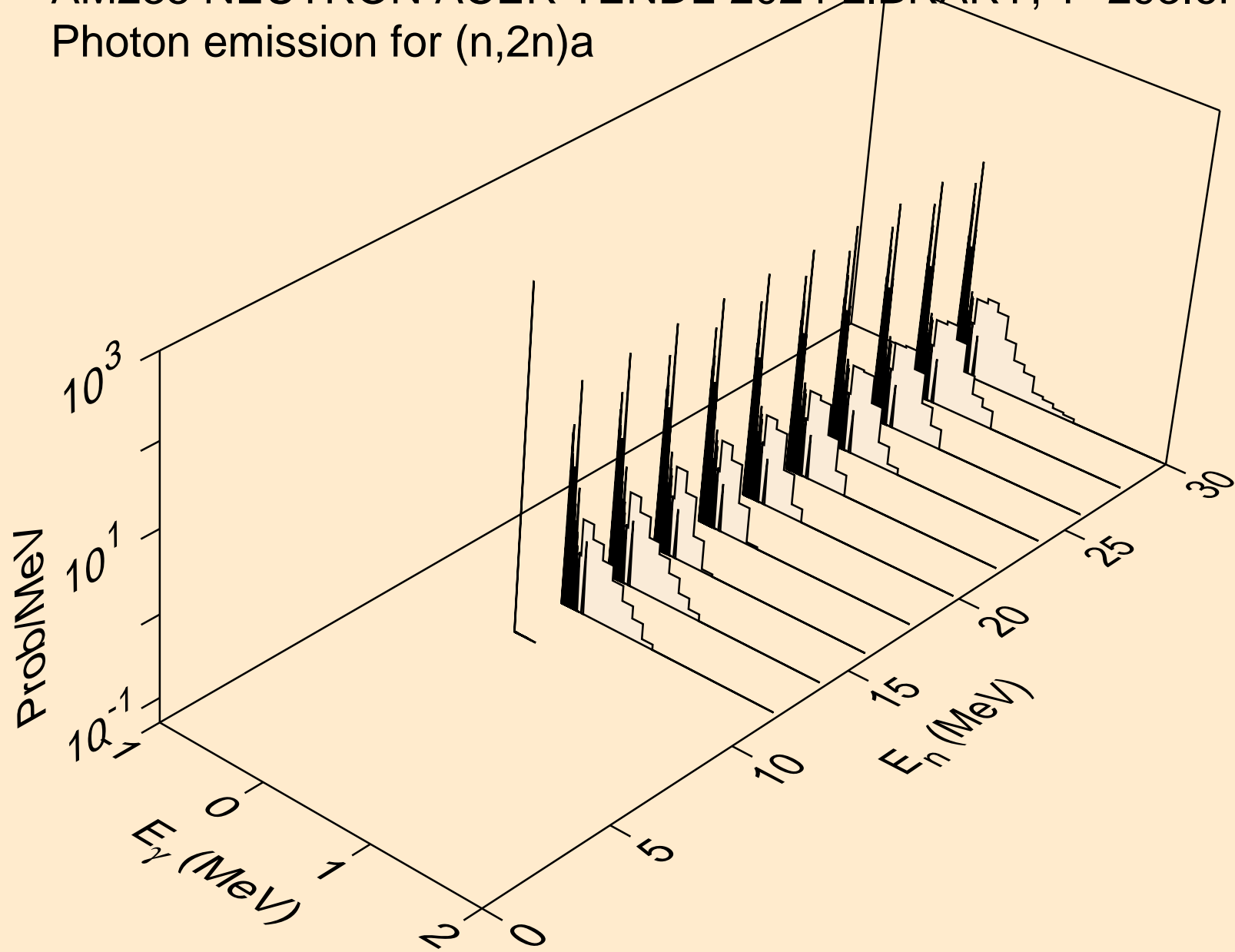

AM235 NEUTRON ACER TENDL-2024 LIBRARY; T=293.6K  
Photon emission for (n,3n)a

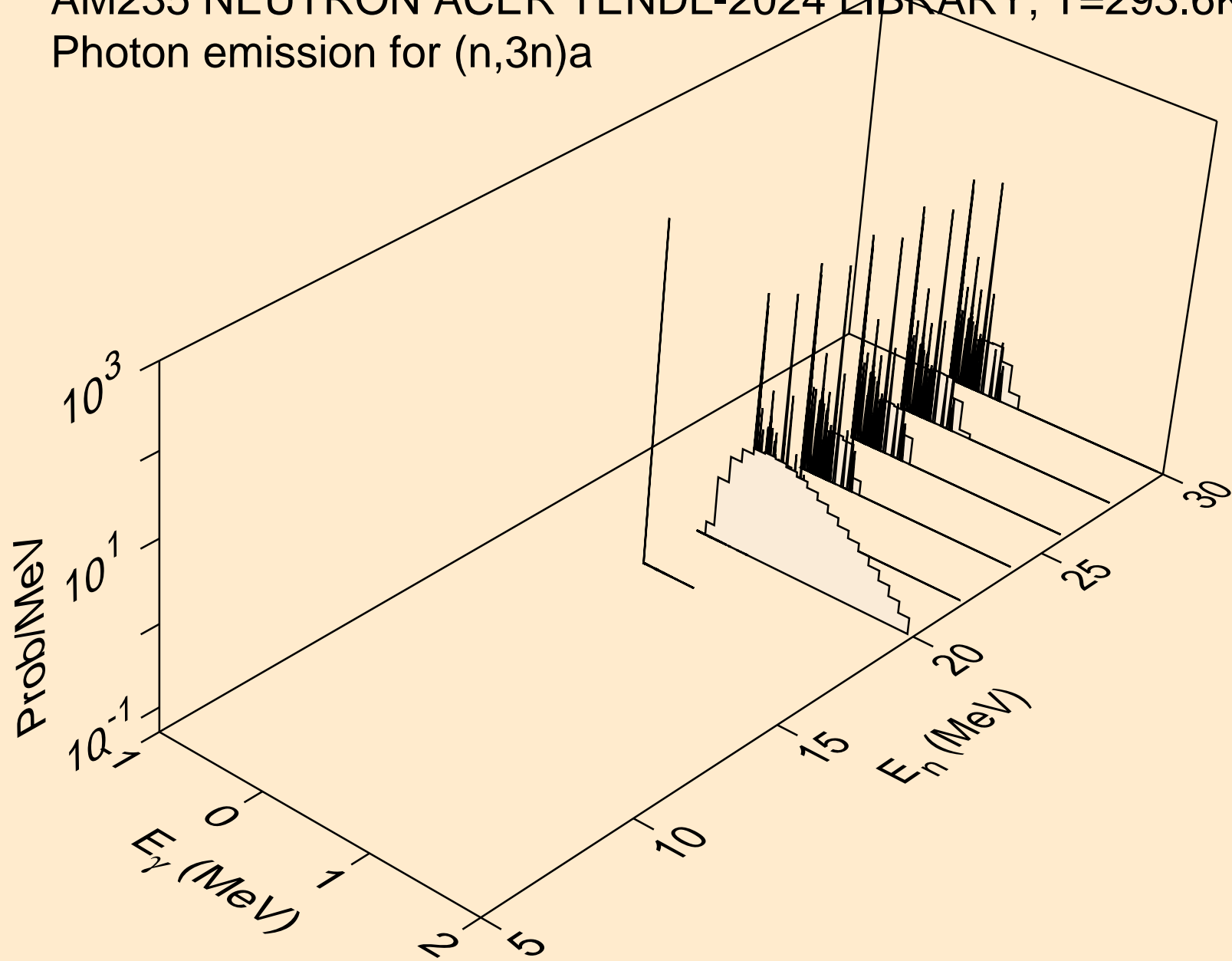

AM235 NEUTRON ACER TENDL-2024 LIBRARY; T=293.6K  
Photon emission for (n,n\*)p

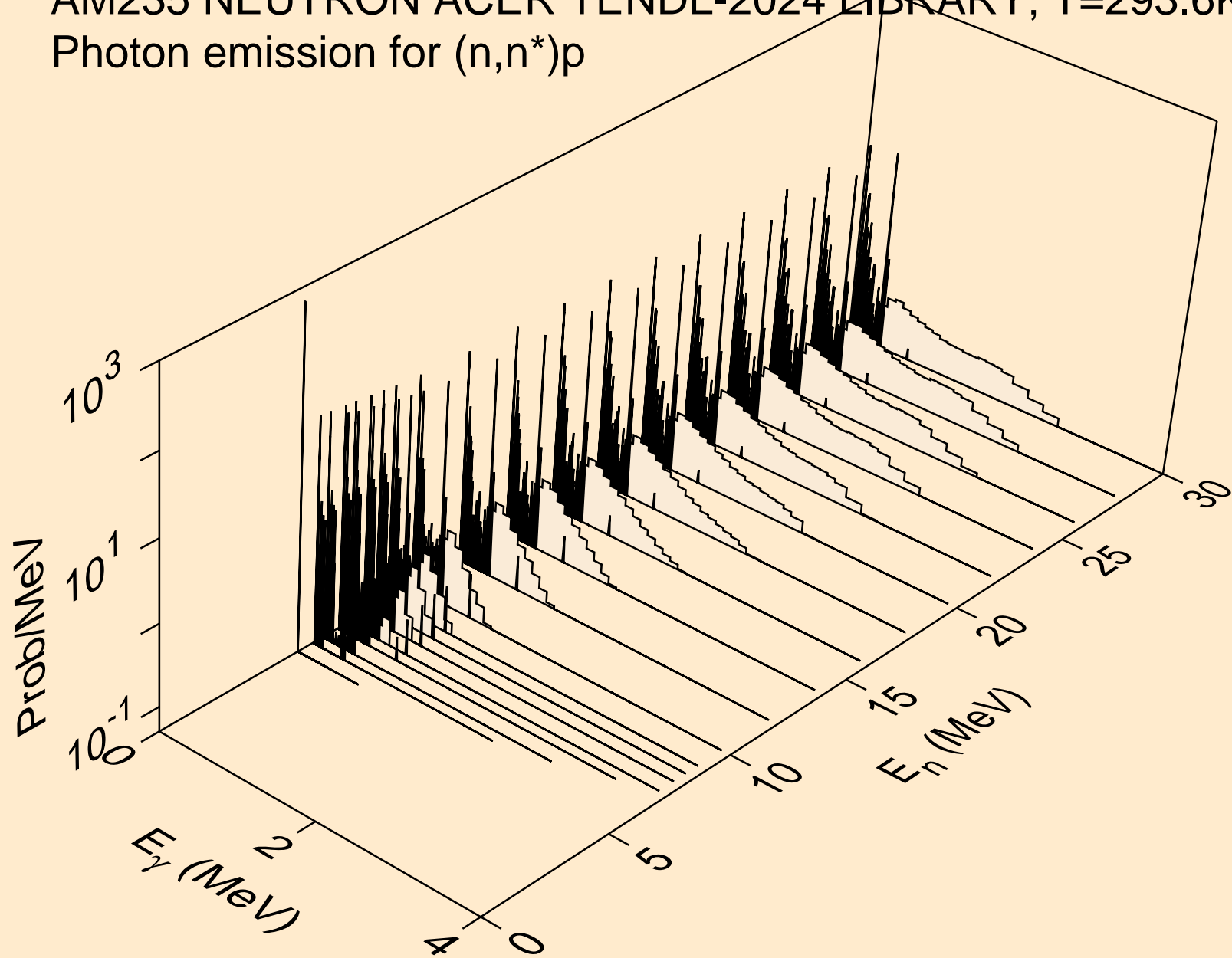

AM235 NEUTRON ACER TENDL-2024 LIBRARY; T=293.6K  
Photon emission for (n,n\*)2a

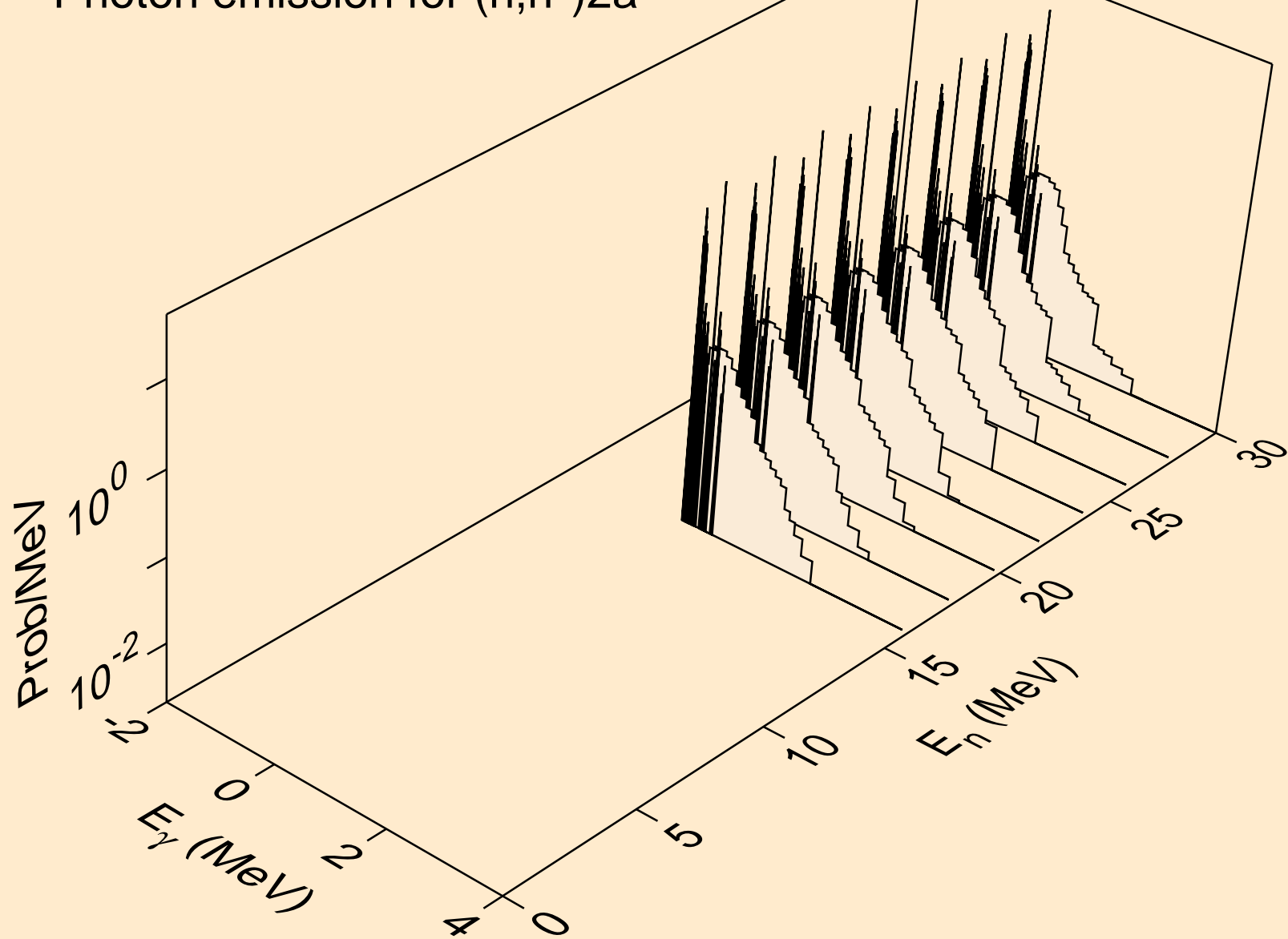

AM235 NEUTRON ACER TENDL-2024 LIBRARY; T=293.6K  
Photon emission for (n,n\*)d

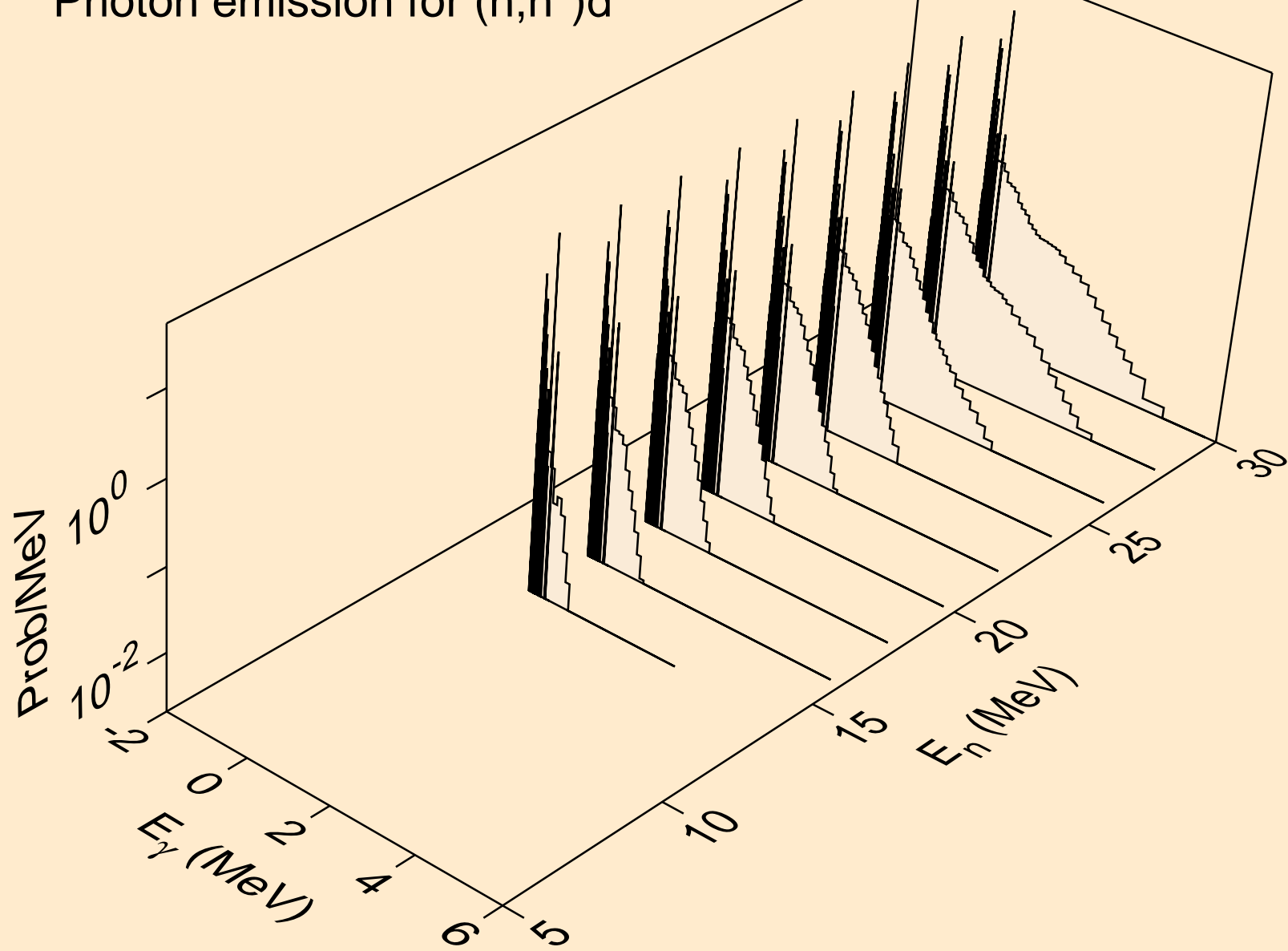

AM235 NEUTRON ACER TENDL-2024 LIBRARY; T=293.6K  
Photon emission for (n,n\*)t

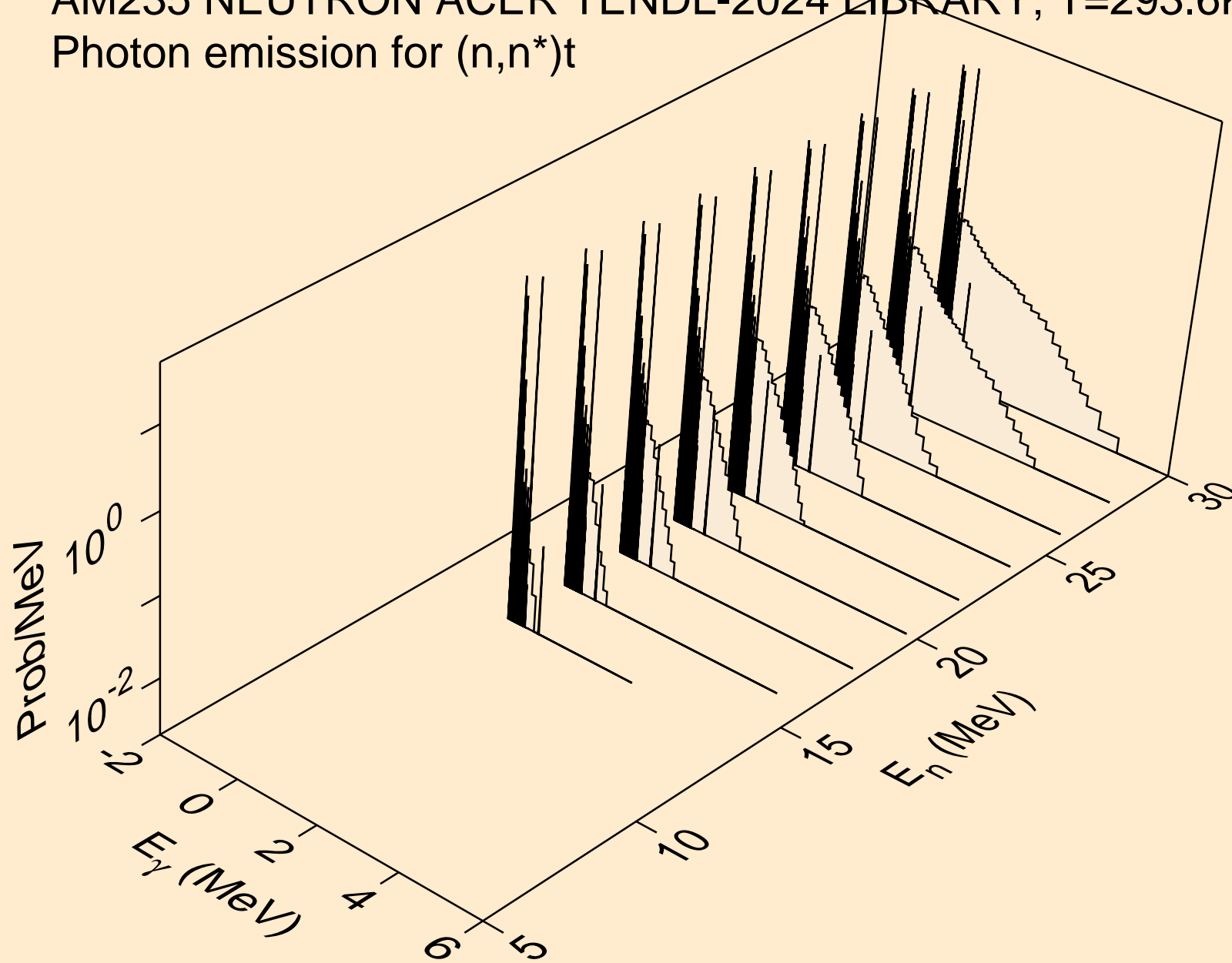

AM235 NEUTRON ACER TENDL-2024 LIBRARY; T=293.6K  
Photon emission for (n,n\*)he3

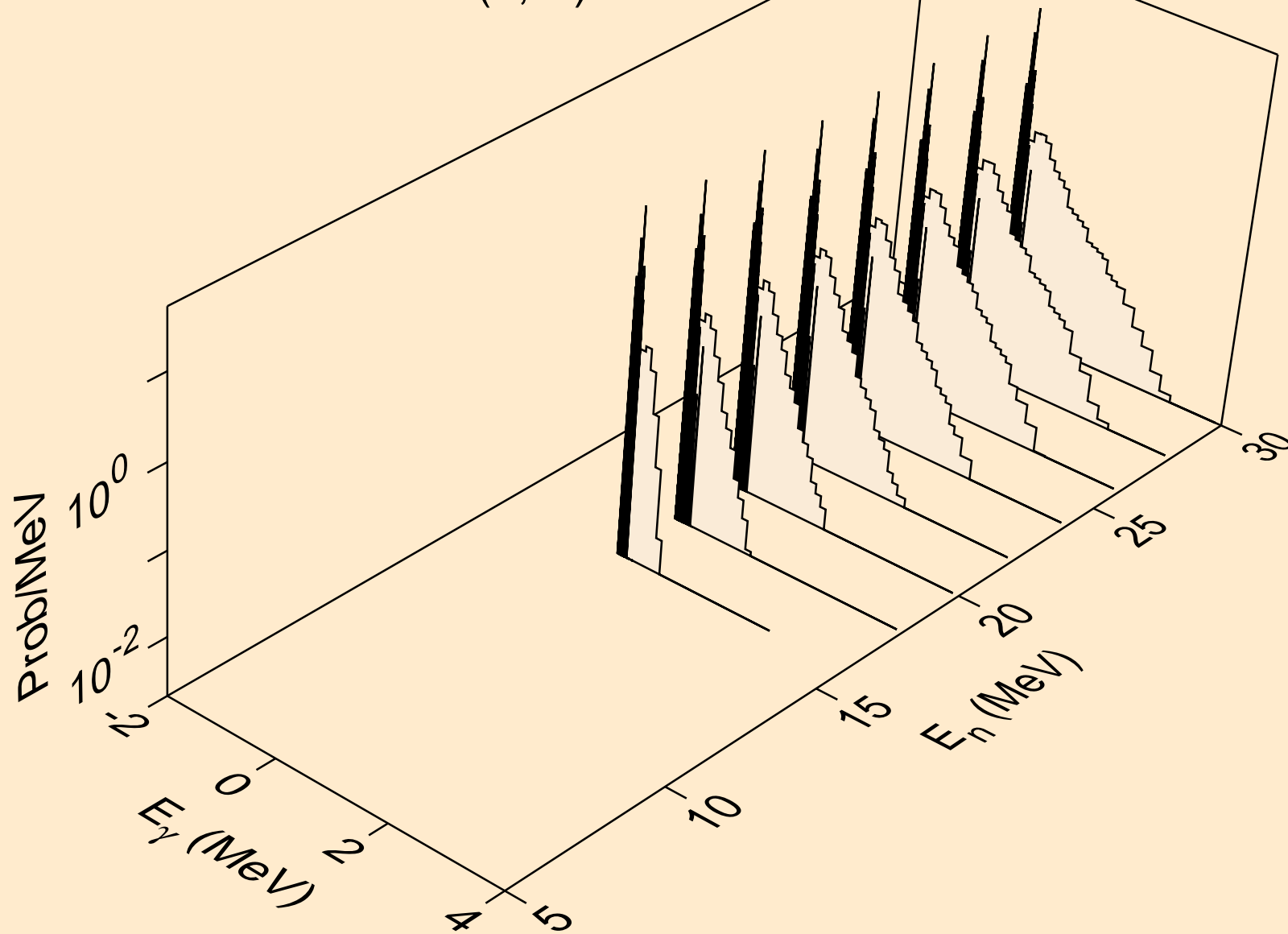

AM235 NEUTRON ACER TENDL-2024 LIBRARY; T=293.6K  
Photon emission for (n,4n)

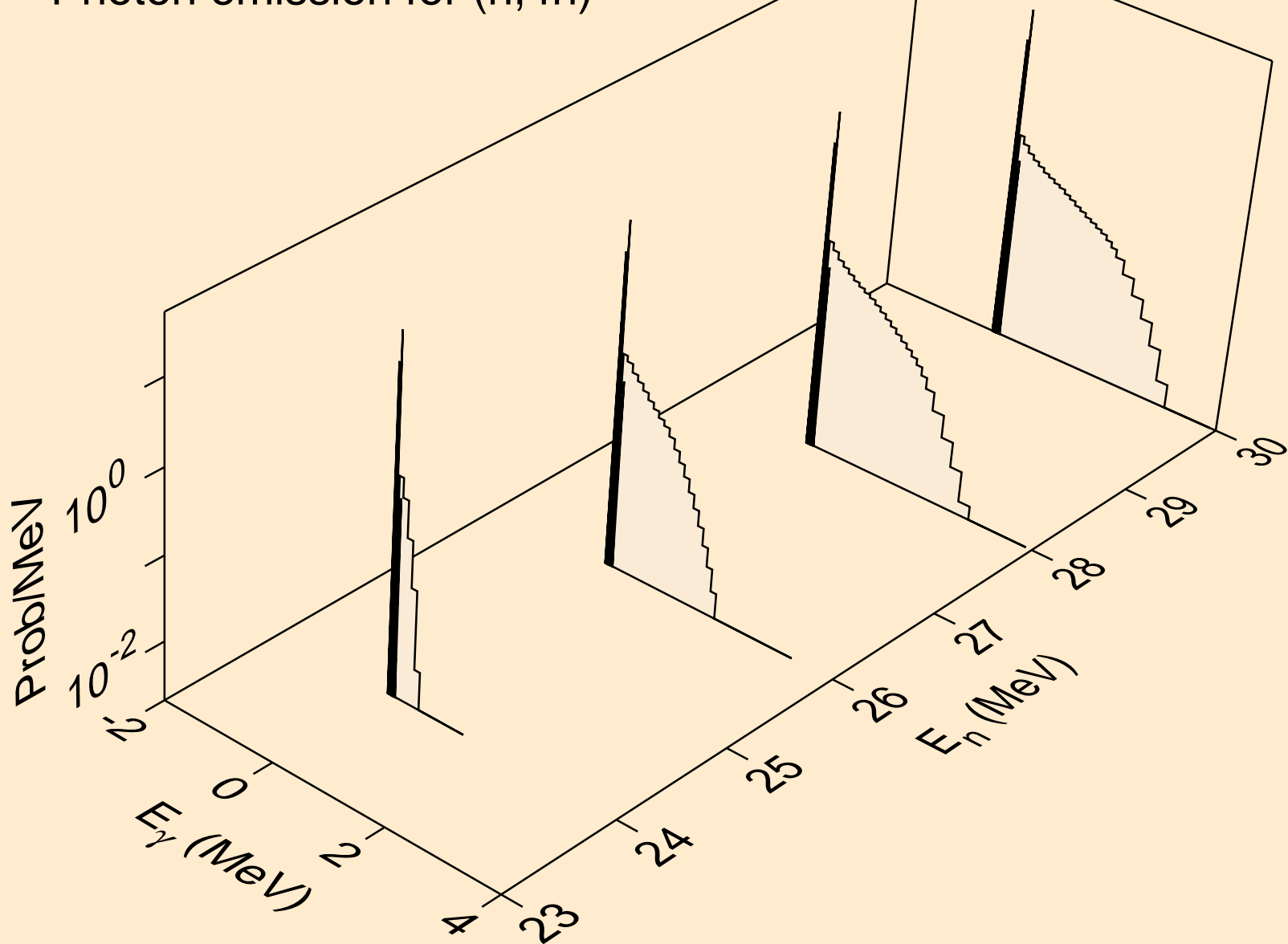

AM235 NEUTRON ACER TENDL-2024 LIBRARY; T=293.6K  
Photon emission for (n,2np)

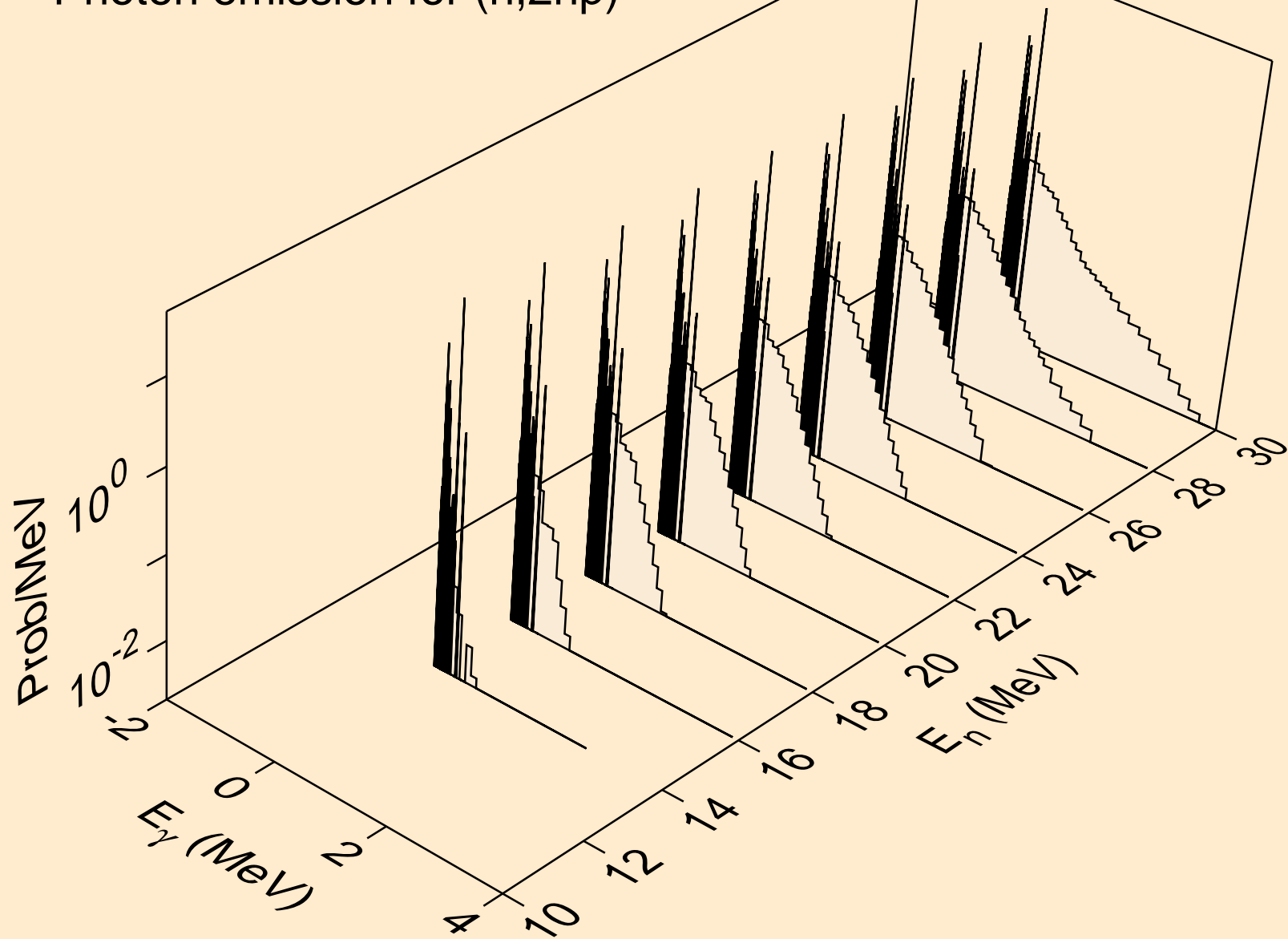

AM235 NEUTRON ACER TENDL-2024 LIBRARY; T=293.6K  
Photon emission for (n,3np)

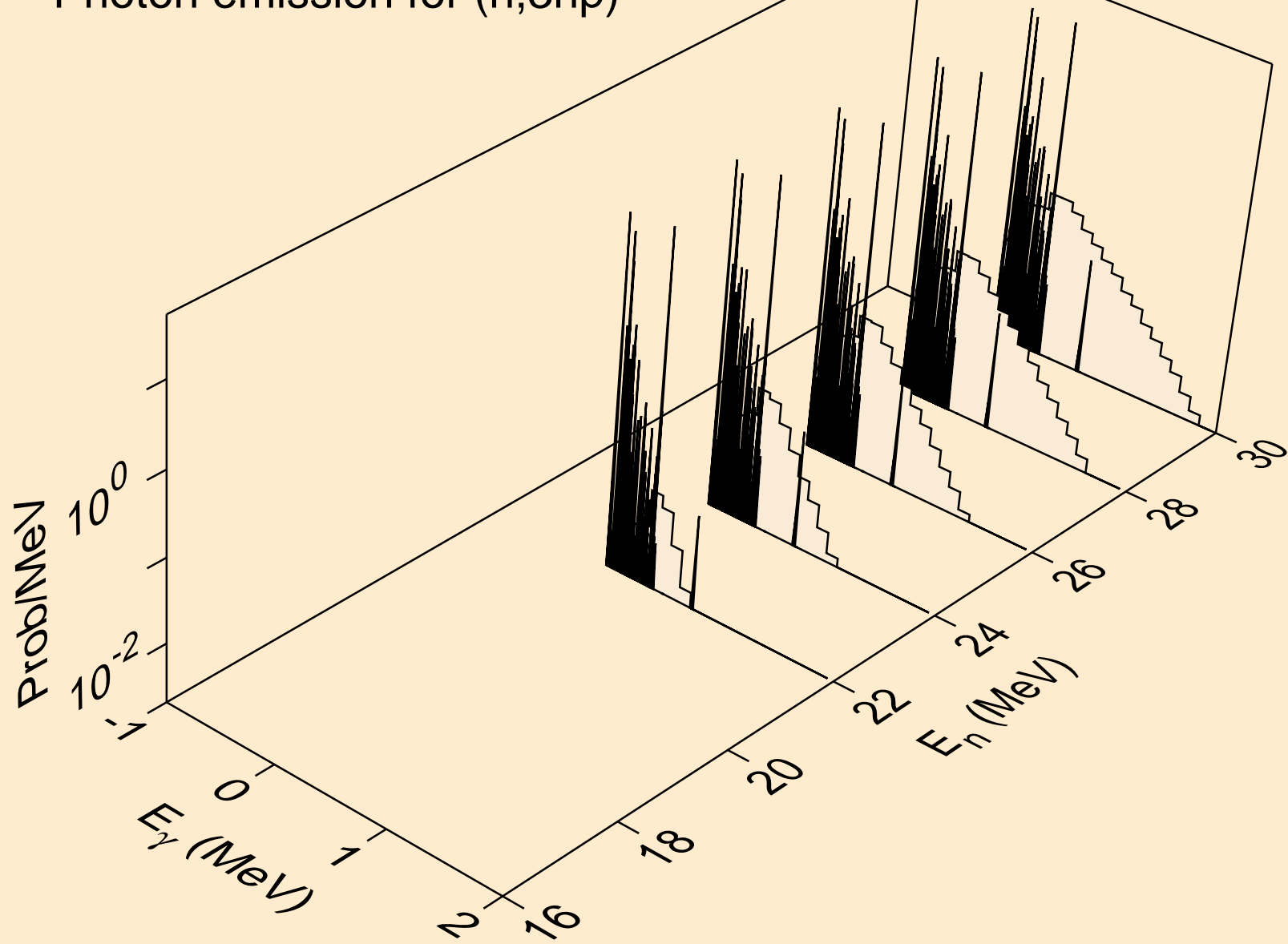

AM235 NEUTRON ACER TENDL-2024 LIBRARY; T=293.6K  
Photon emission for (n,n2p)

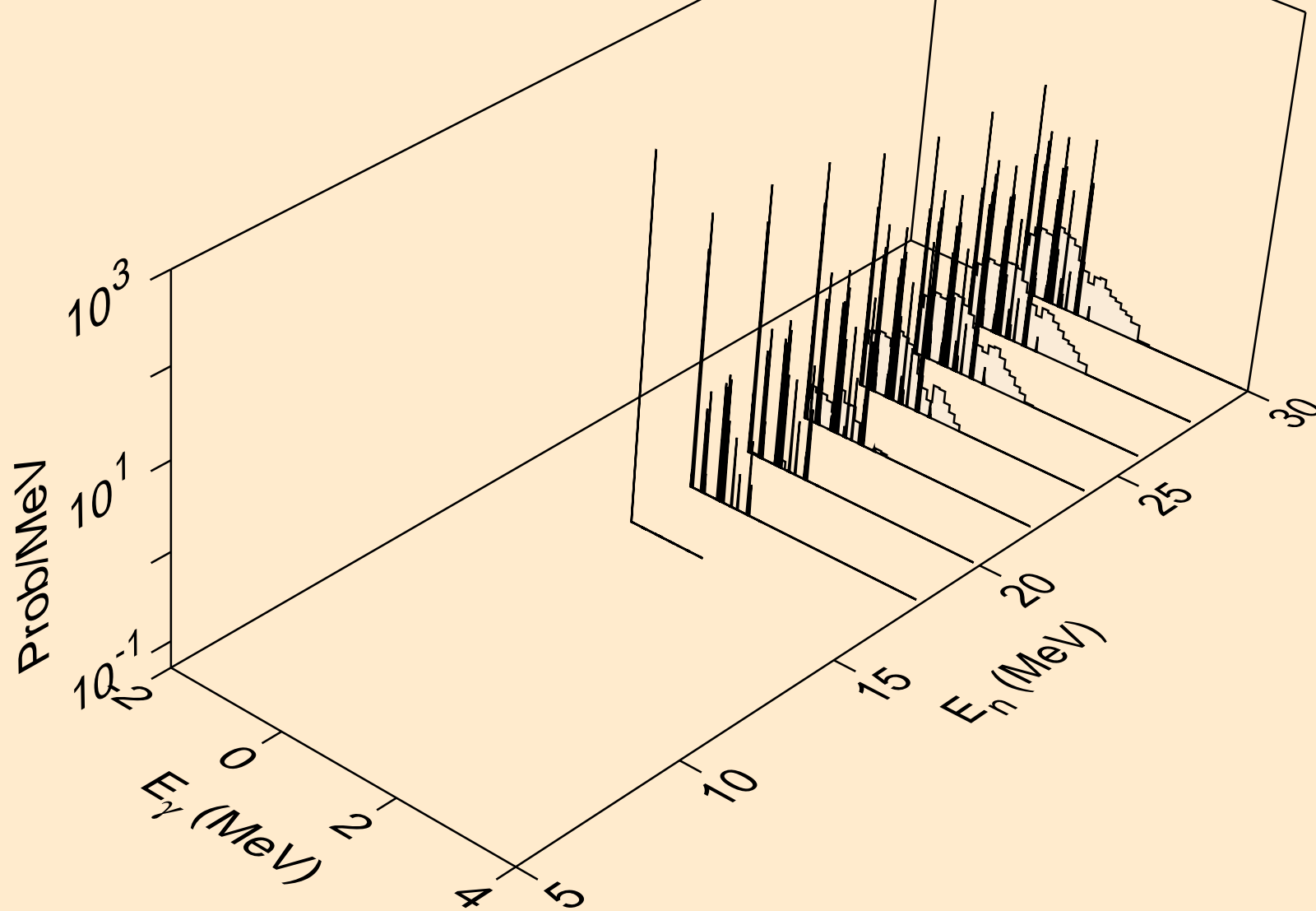

AM235 NEUTRON ACER TENDL-2024 LIBRARY; T=293.6K  
Photon emission for (n,npa)

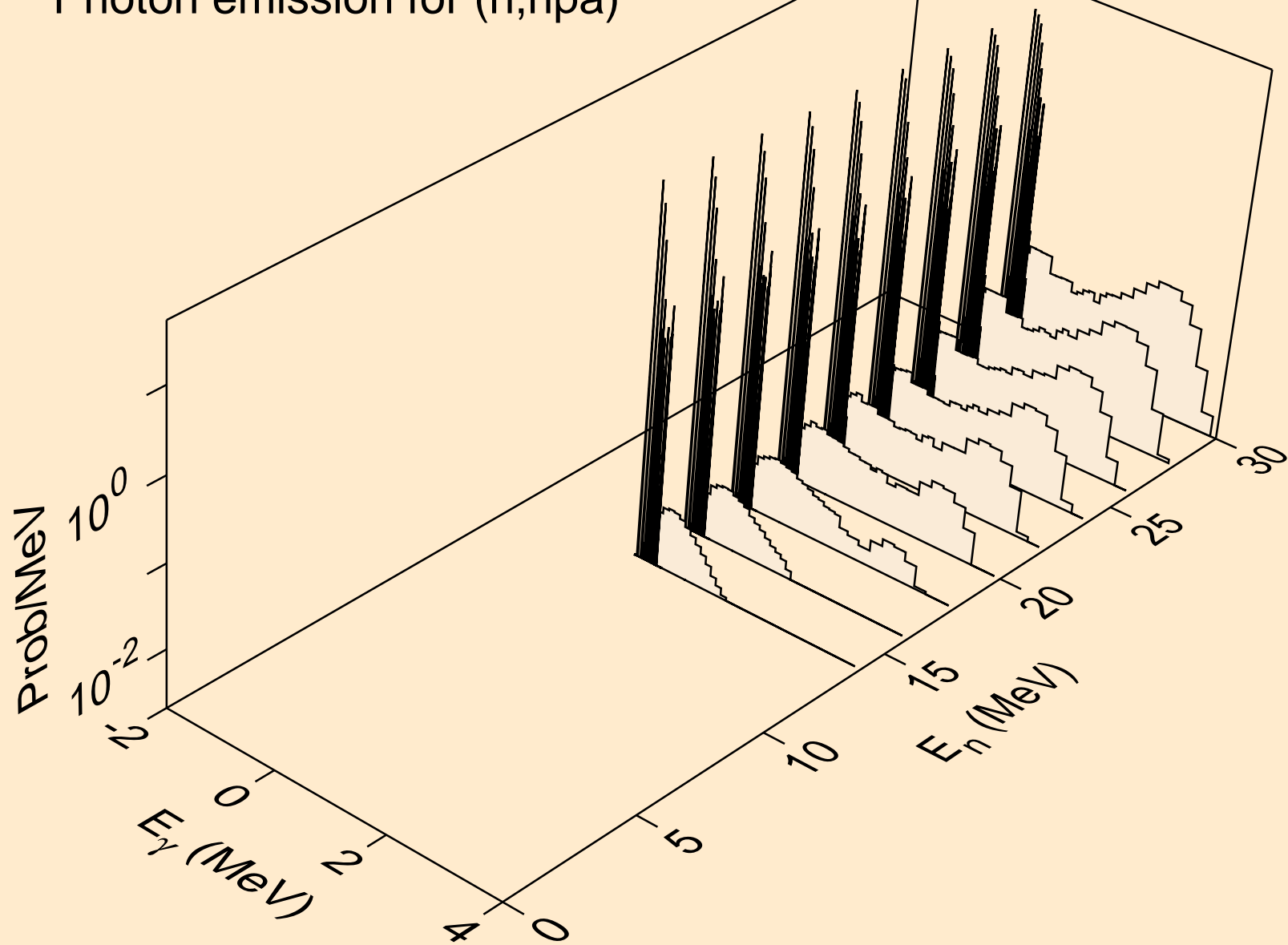

AM235 NEUTRON ACER TENDL-2024 LIBRARY; T=293.6K  
Photon emission for (n,n\*c)

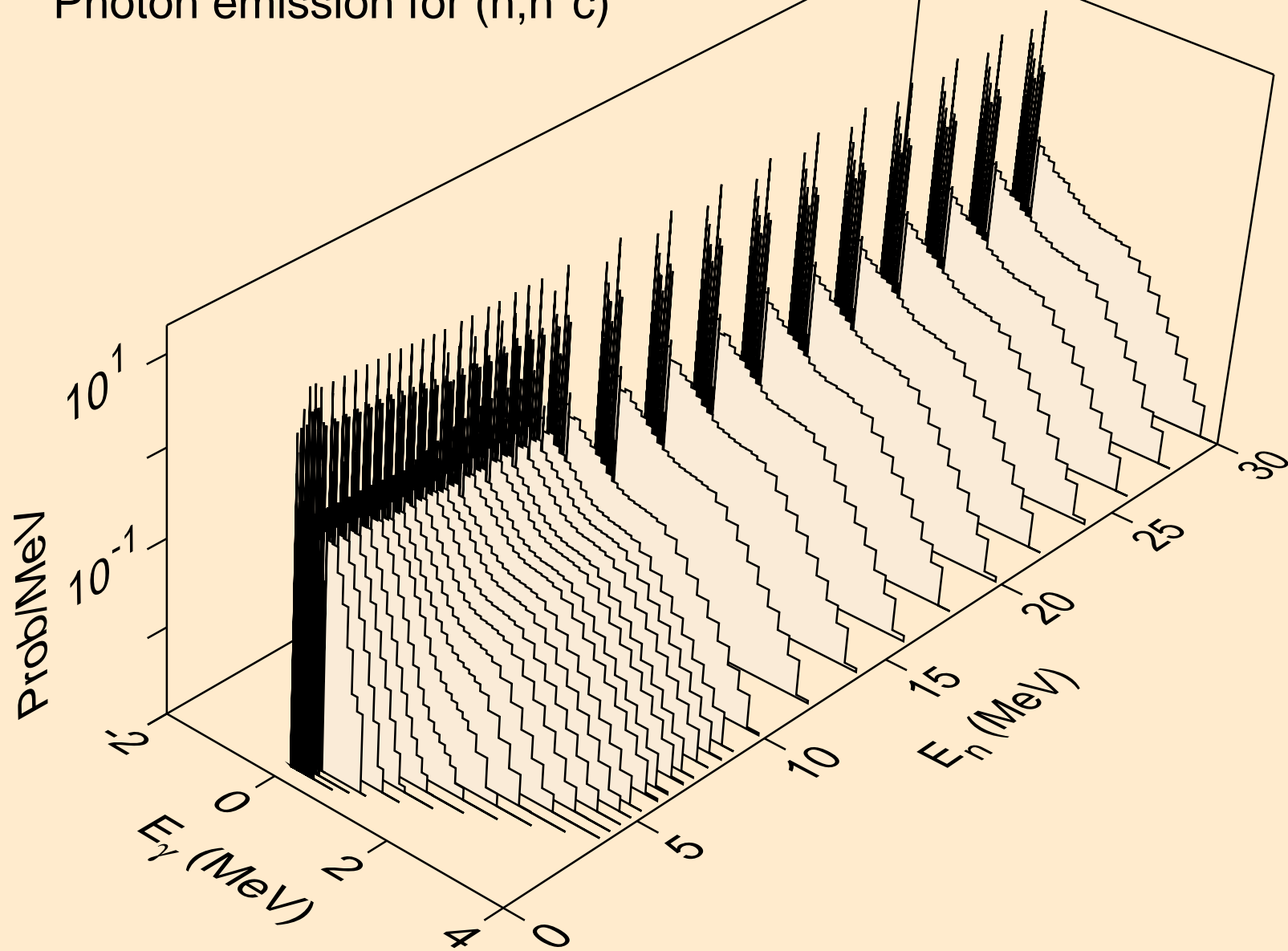

AM235 NEUTRON ACER TENDL-2024 LIBRARY; T=293.6K  
Photon emission for (n,gma)

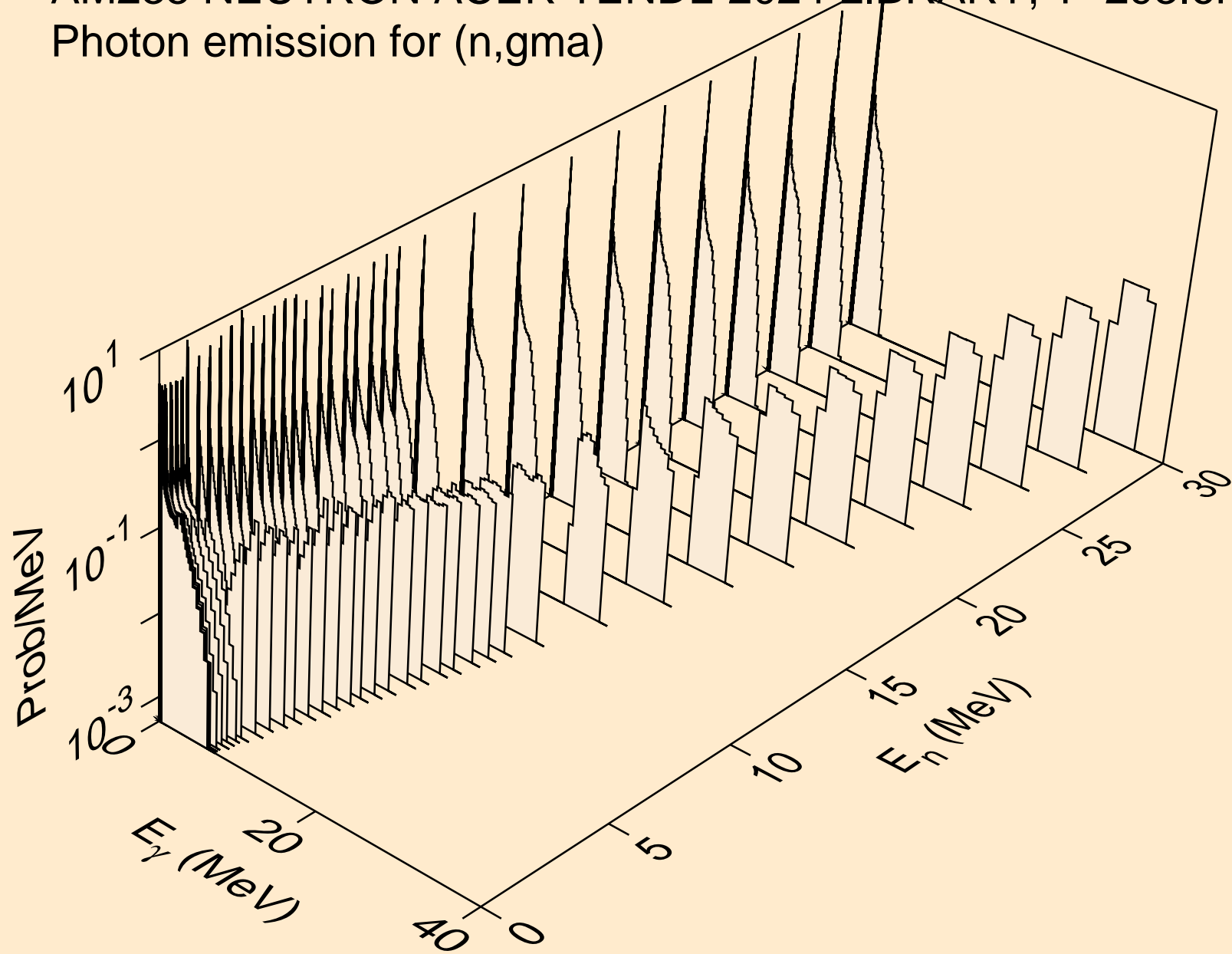

AM235 NEUTRON ACER TENDL-2024 LIBRARY; T=293.6K  
Photon emission for (n,p)

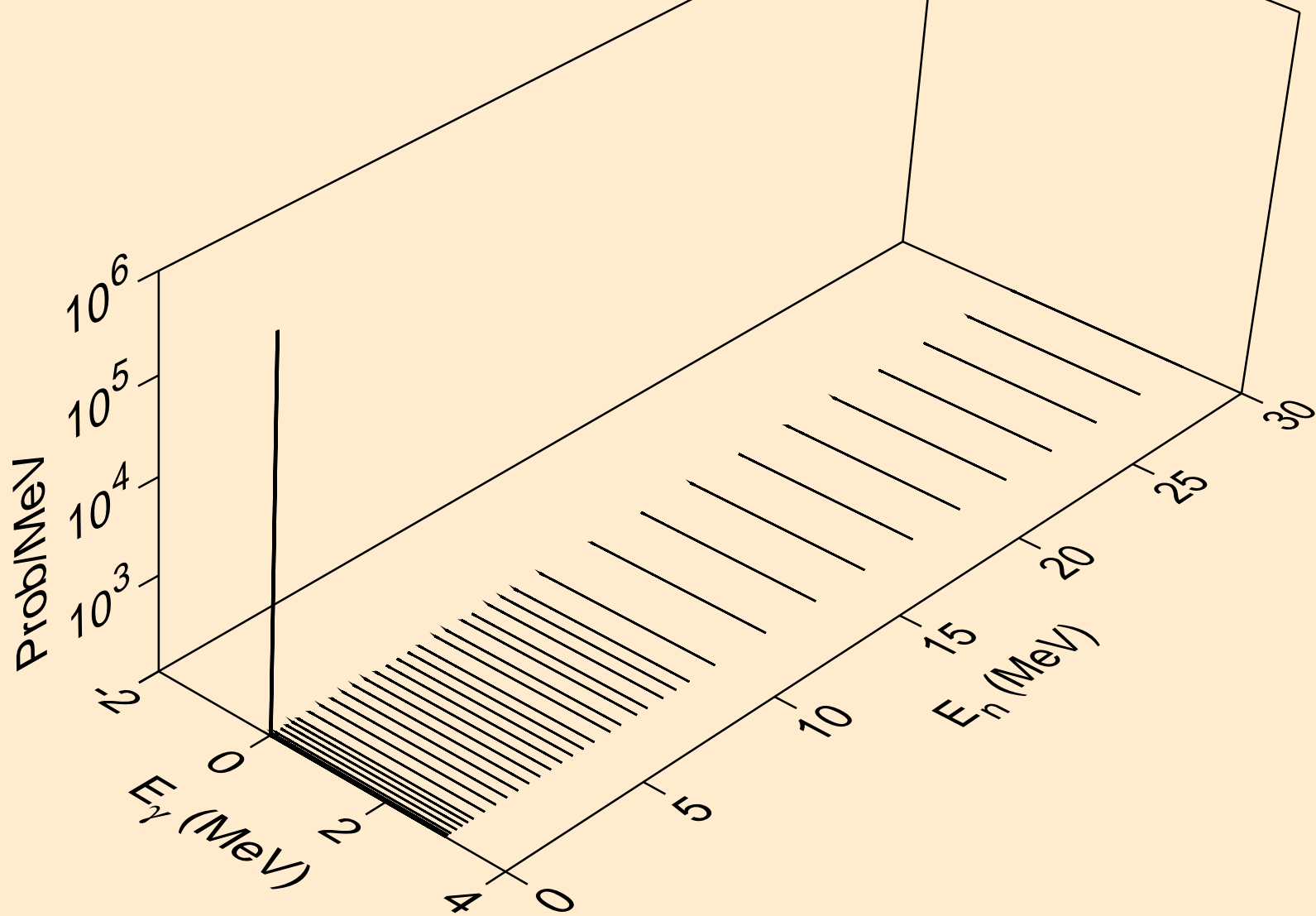

AM235 NEUTRON ACER TENDL-2024 LIBRARY; T=293.6K  
Photon emission for (n,d)

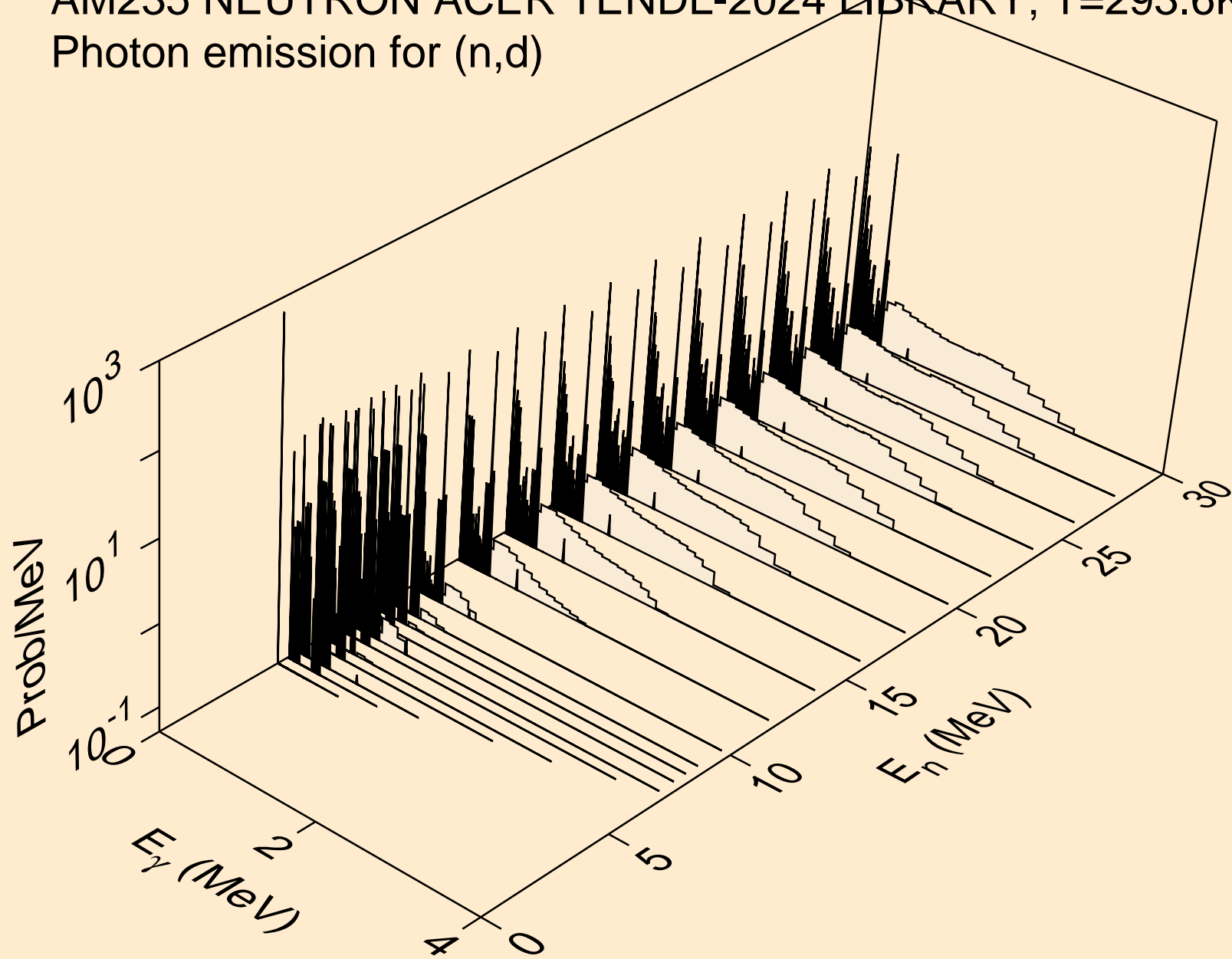

AM235 NEUTRON ACER TENDL-2024 LIBRARY; T=293.6K  
Photon emission for (n,t)

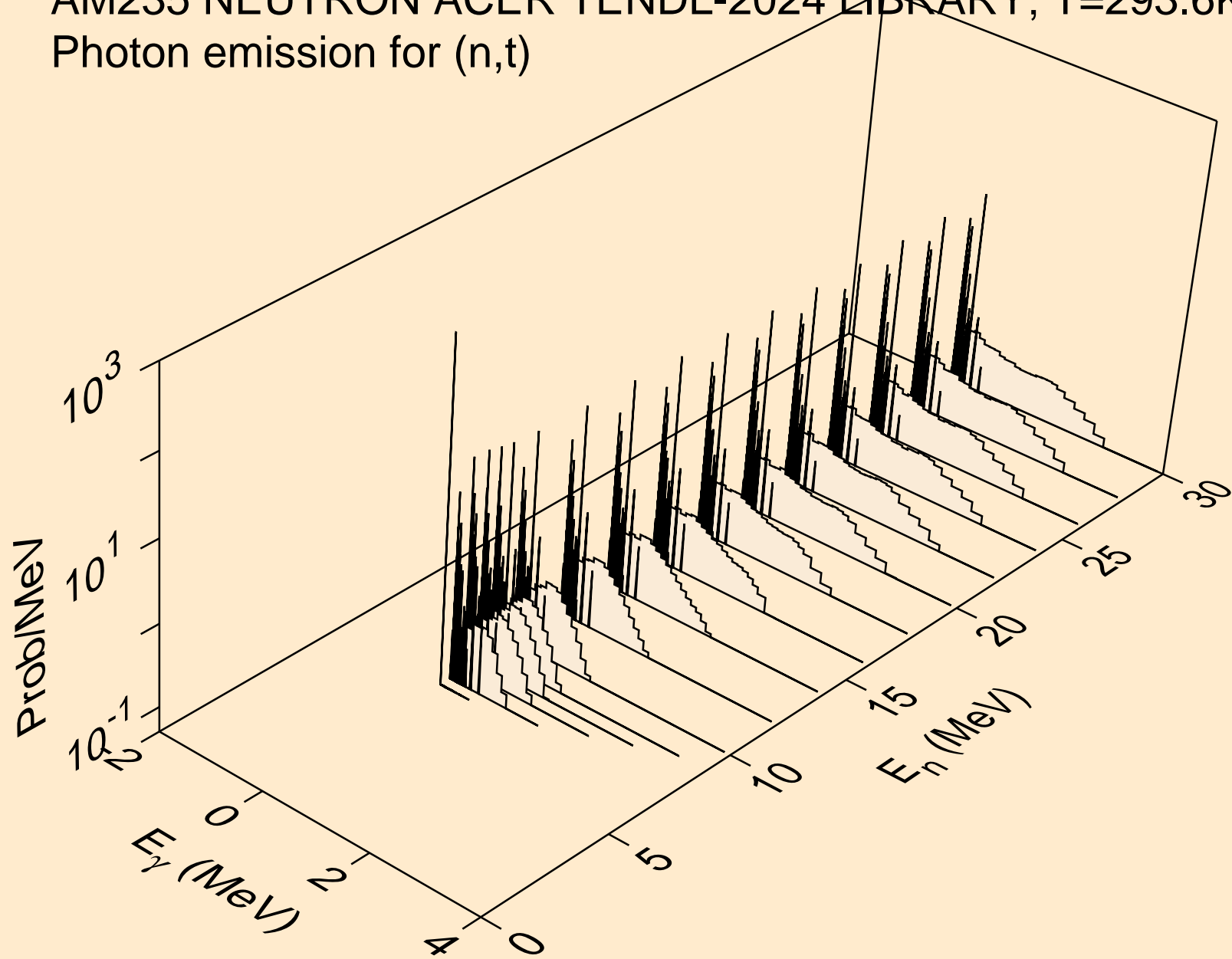

AM235 NEUTRON ACER TENDL-2024 LIBRARY; T=293.6K  
Photon emission for (n,he3)

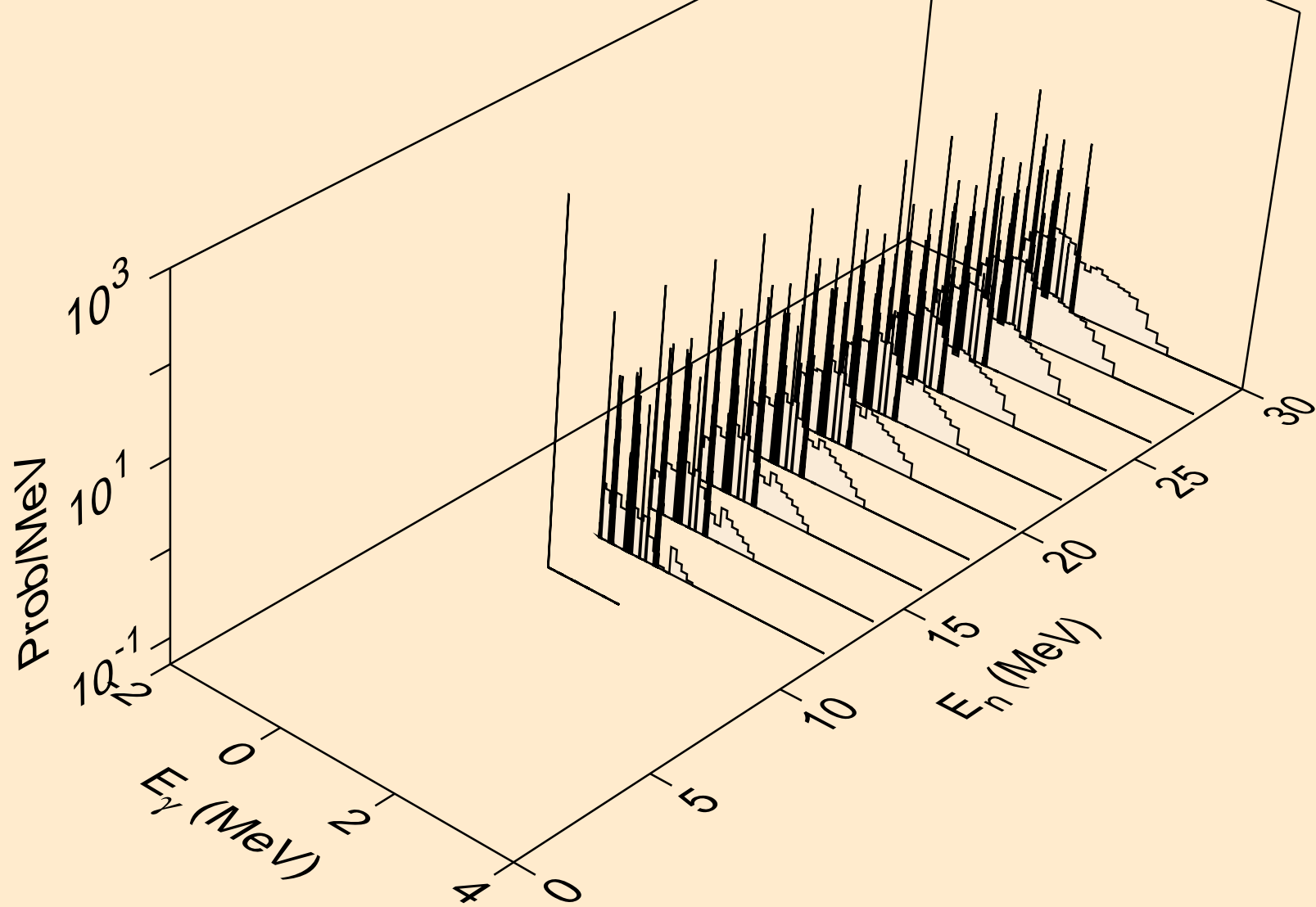

AM235 NEUTRON ACER TENDL-2024 LIBRARY; T=293.6K  
Photon emission for (n,a)

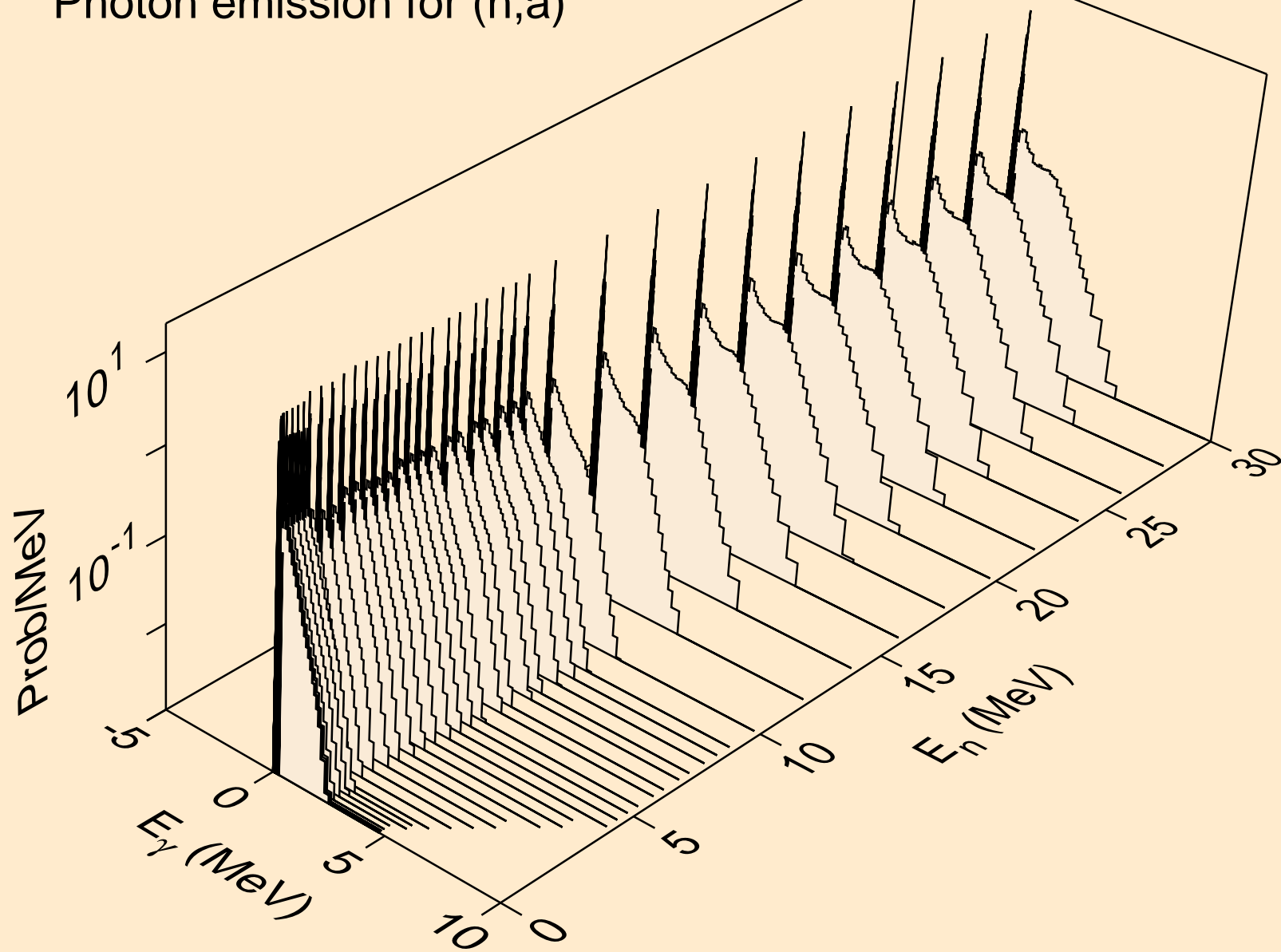

AM235 NEUTRON ACER TENDL-2024 LIBRARY; T=293.6K  
Photon emission for (n,2a)

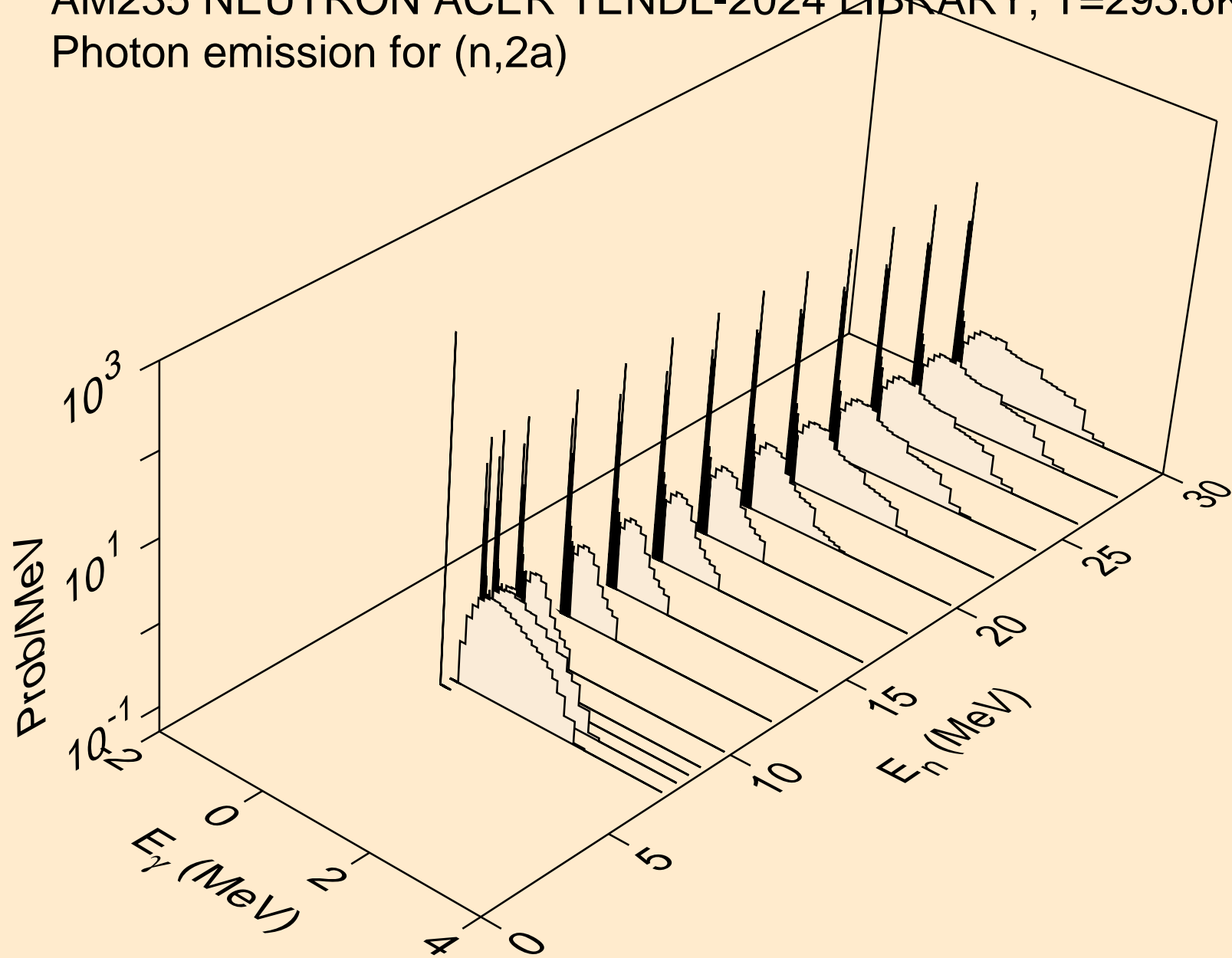

AM235 NEUTRON ACER TENDL-2024 LIBRARY; T=293.6K  
Photon emission for (n,2p)

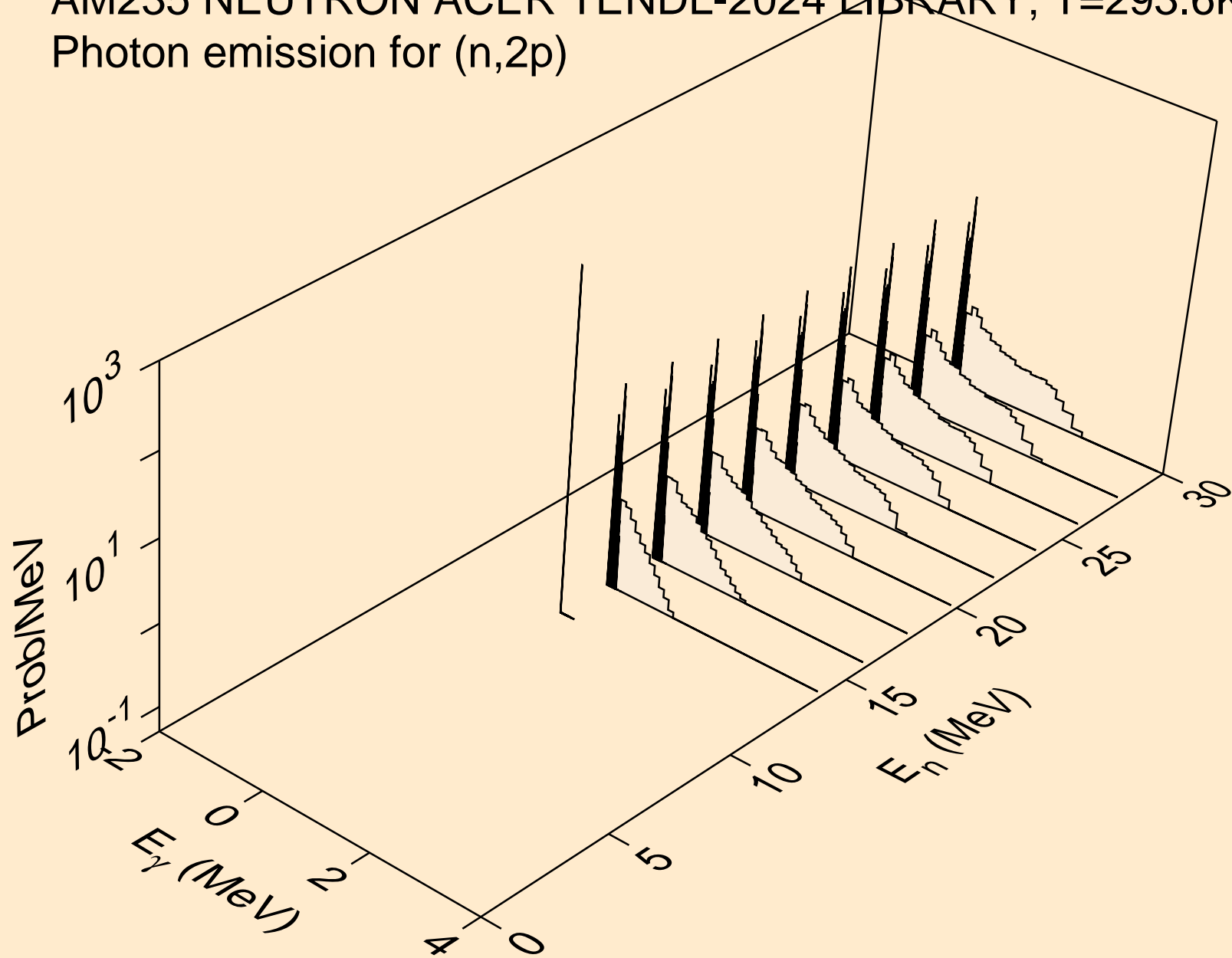

AM235 NEUTRON ACER TENDL-2024 LIBRARY; T=293.6K  
Photon emission for (n,p $\alpha$ )

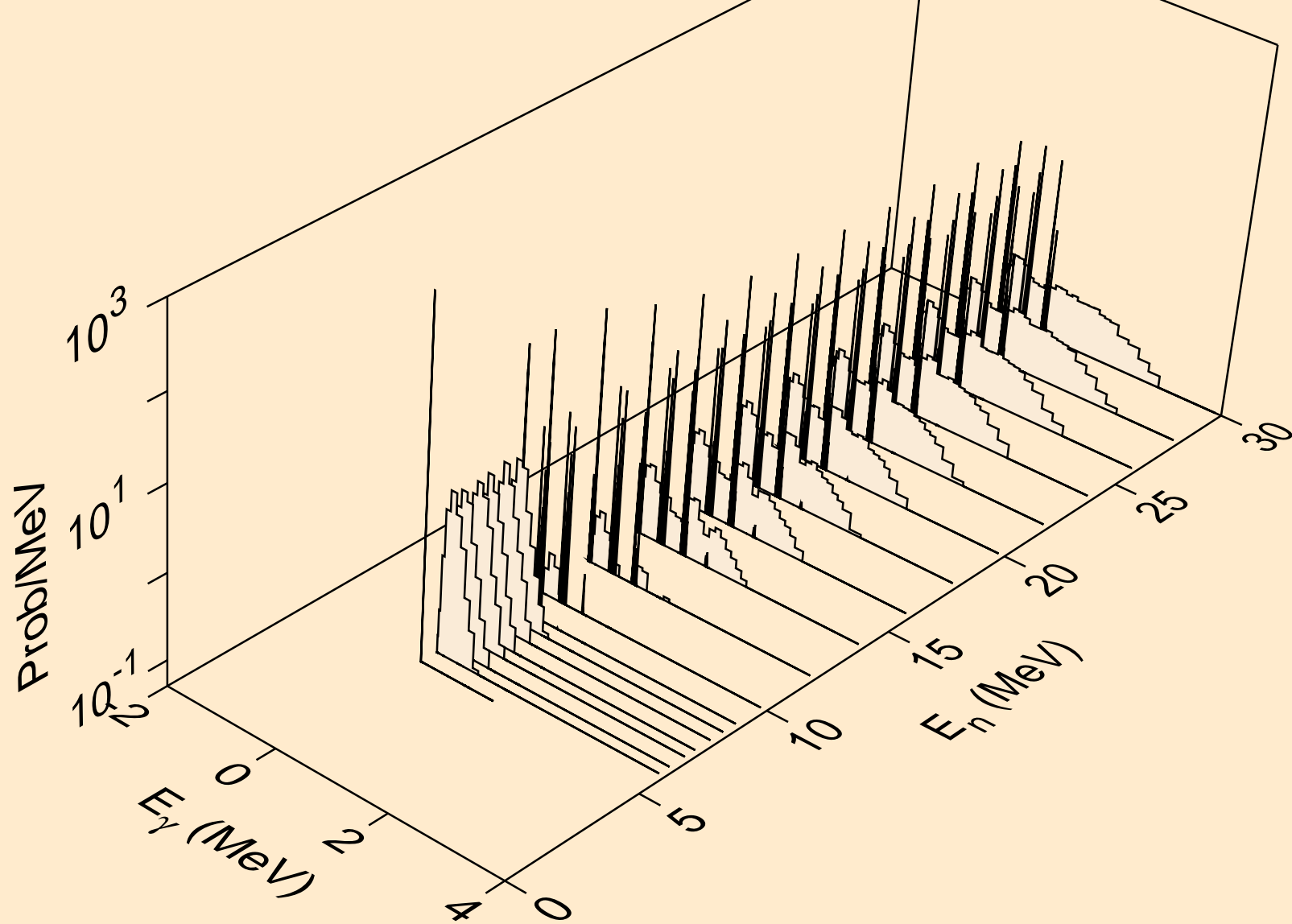

AM235 NEUTRON ACER TENDL-2024 LIBRARY; T=293.6K  
Photon emission for (n,pd)

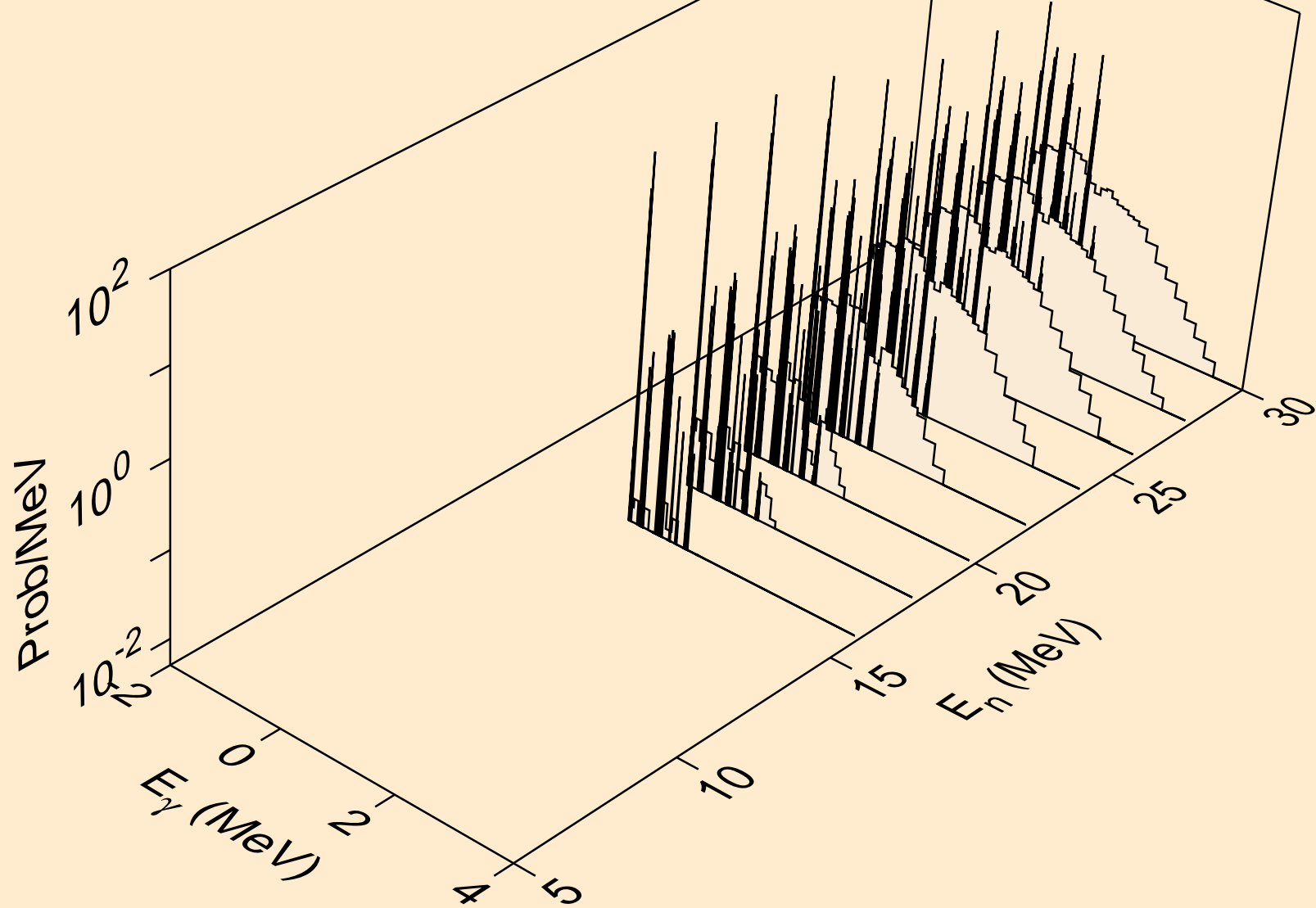

AM235 NEUTRON ACER TENDL-2024 LIBRARY; T=293.6K  
Photon emission for (n,pt)

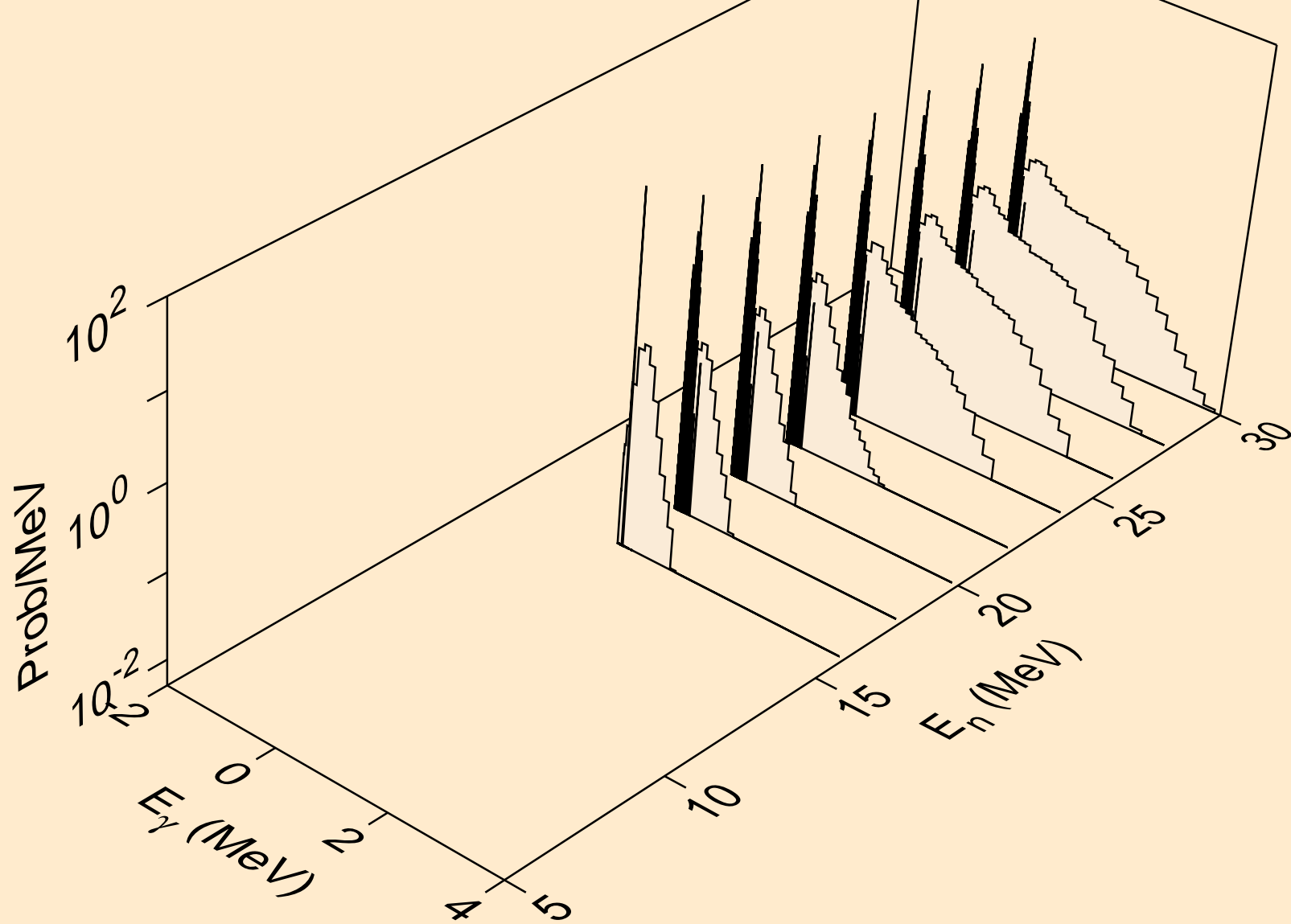

AM235 NEUTRON ACER TENDL-2024 LIBRARY; T=293.6K  
Photon emission for (n,da)

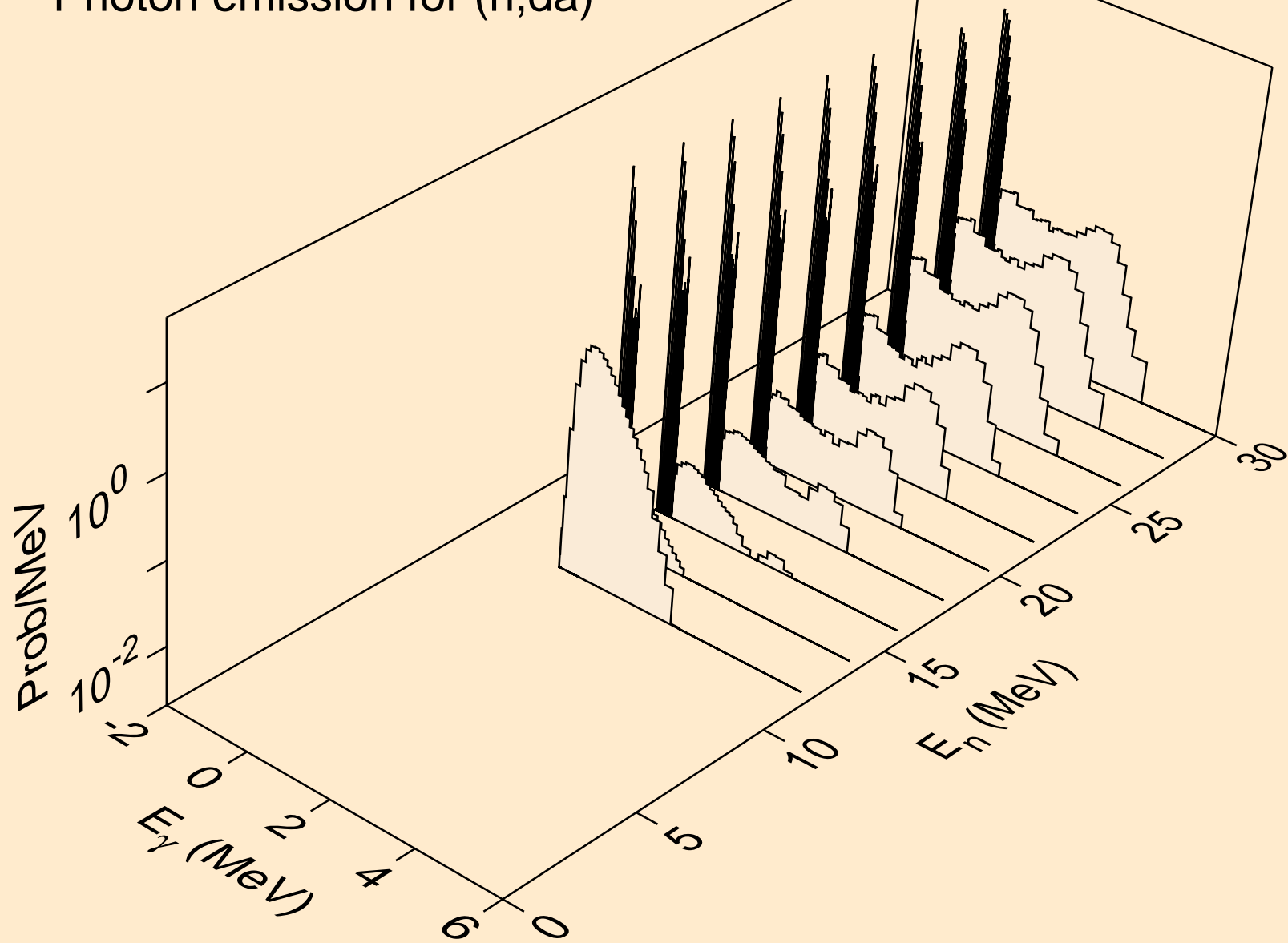

AM235 NEUTRON ACER TENDL-2024 LIBRARY; T=293.6K  
thermal capture photon spectrum

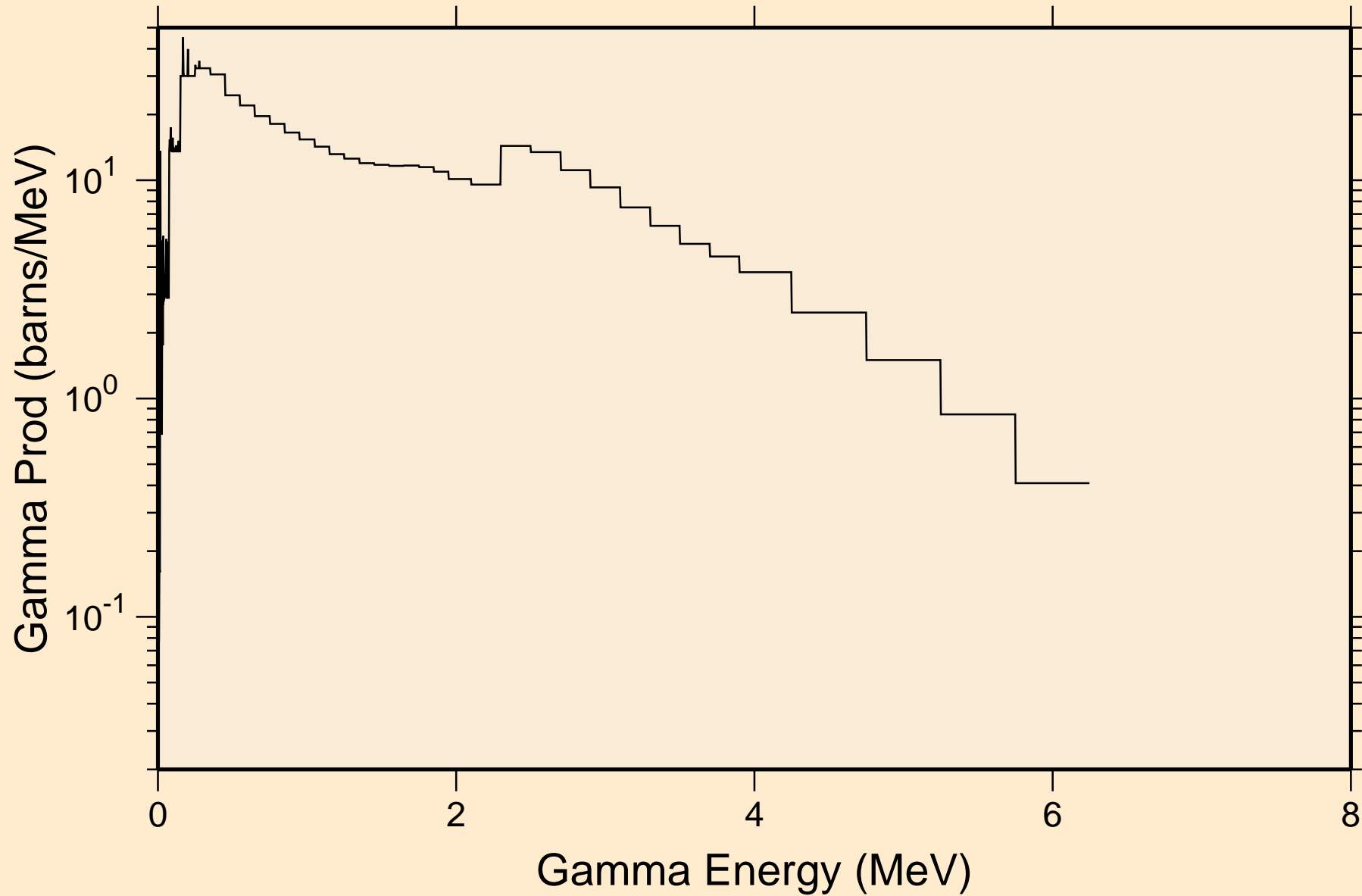

AM235 NEUTRON ACER TENDL-2024 LIBRARY; T=293.6K  
14 MeV photon spectrum

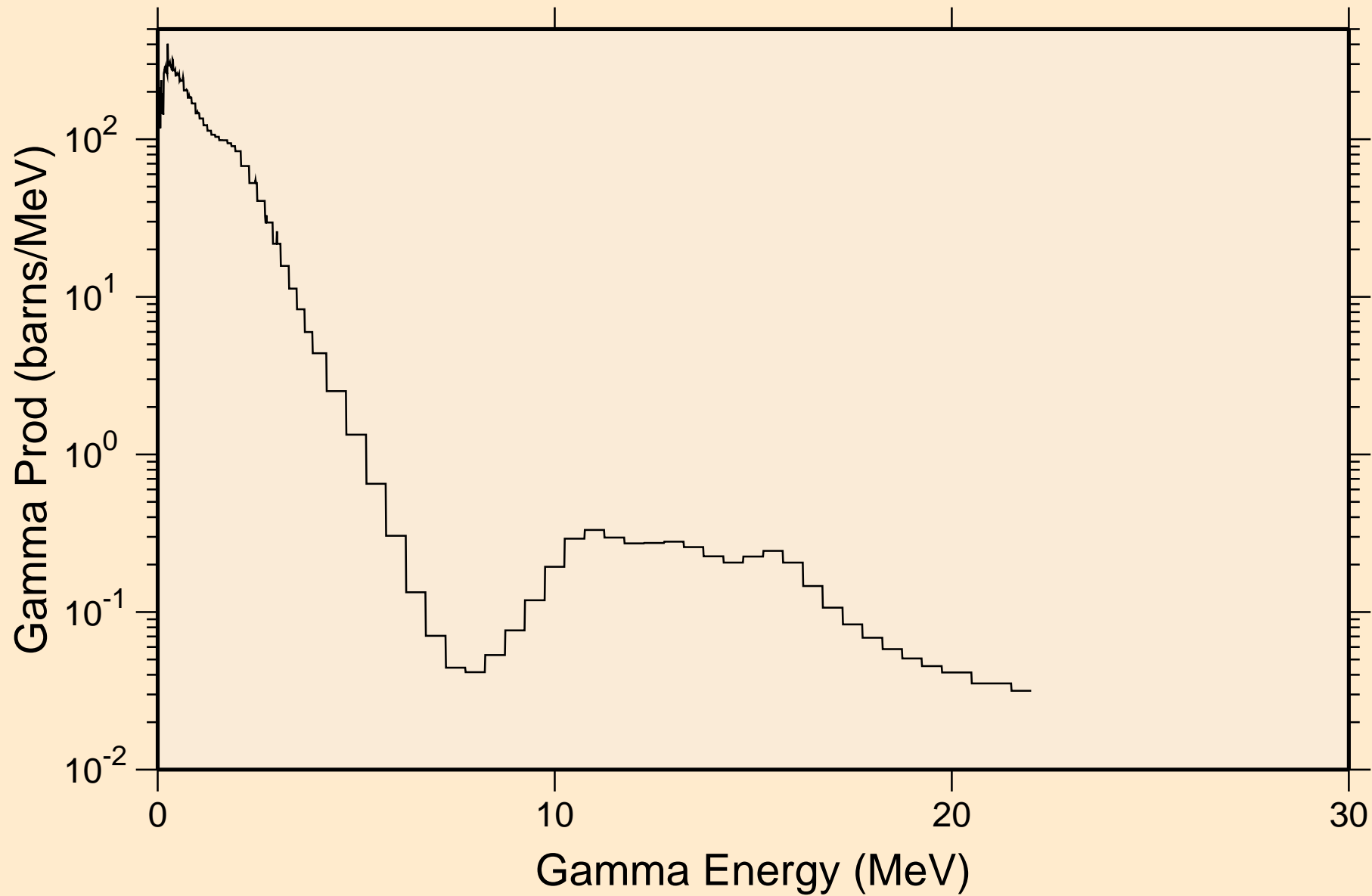

AM235 NEUTRON ACER TENDL-2024 LIBRARY; T=293.6K  
Particle heating contributions

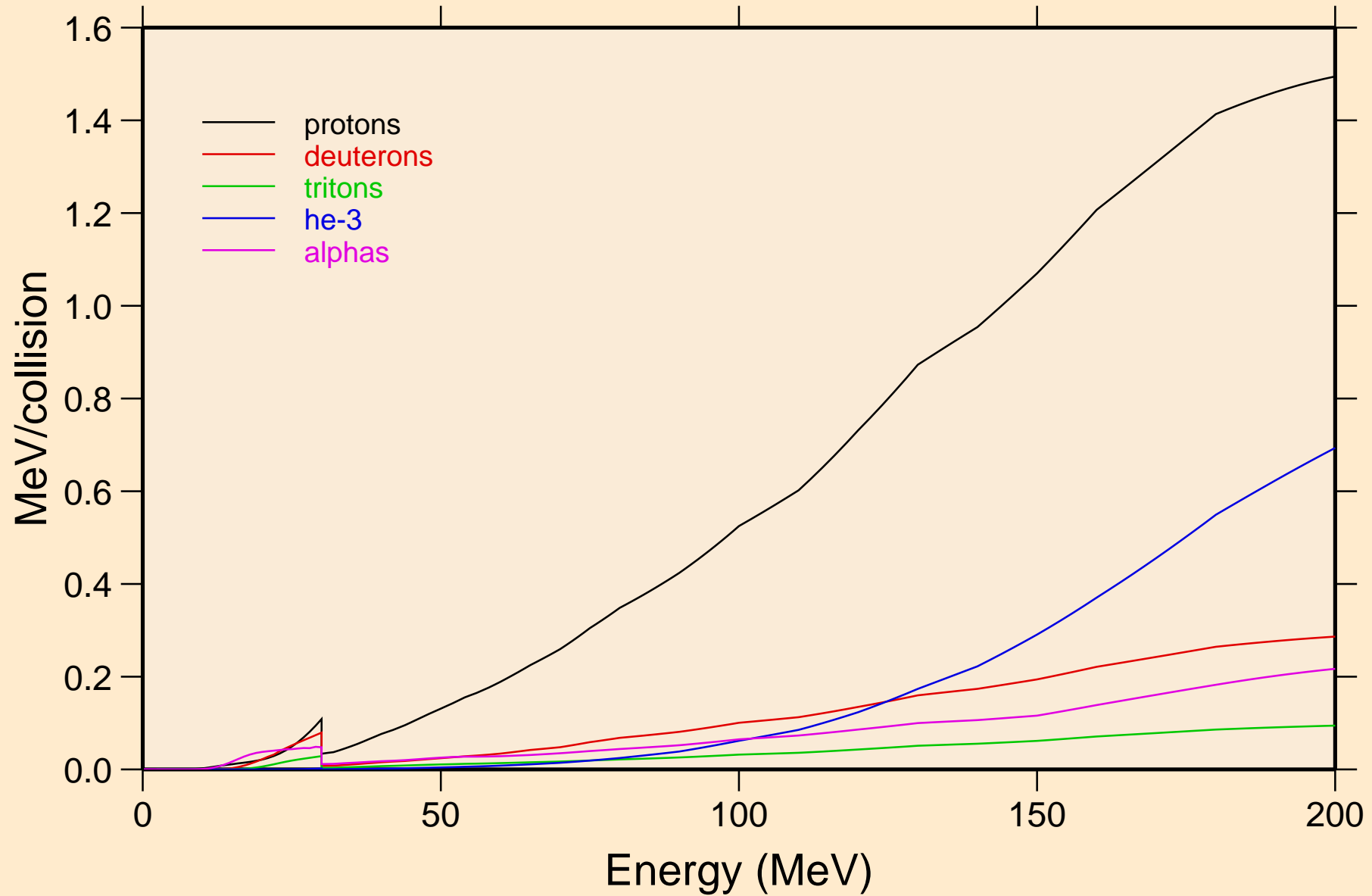

AM235 NEUTRON ACER TENDL-2024 LIBRARY; T=293.6K  
Recoil Heating

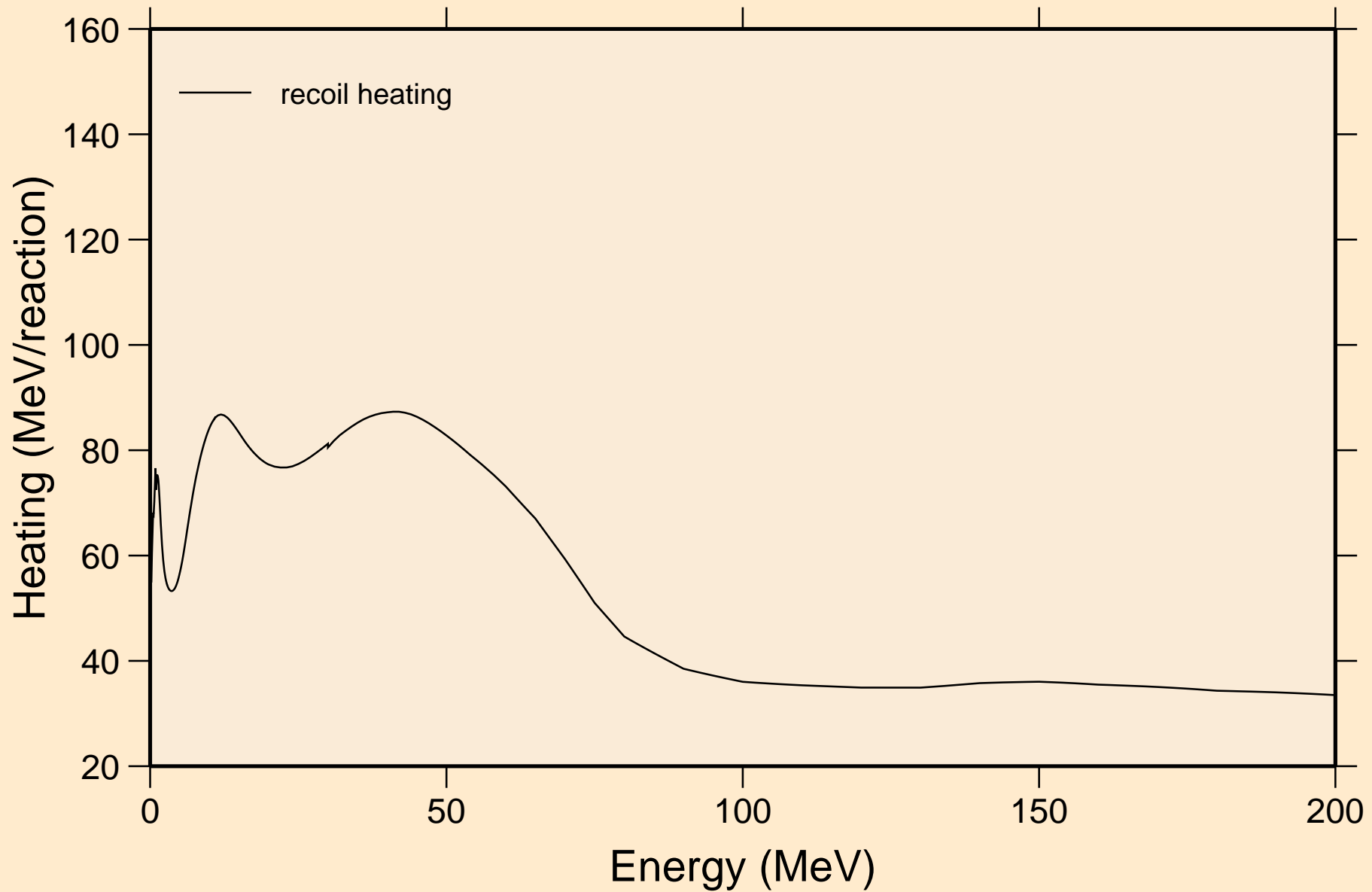

AM235 NEUTRON ACER TENDL-2024 LIBRARY; T=293.6K  
Particle production cross sections

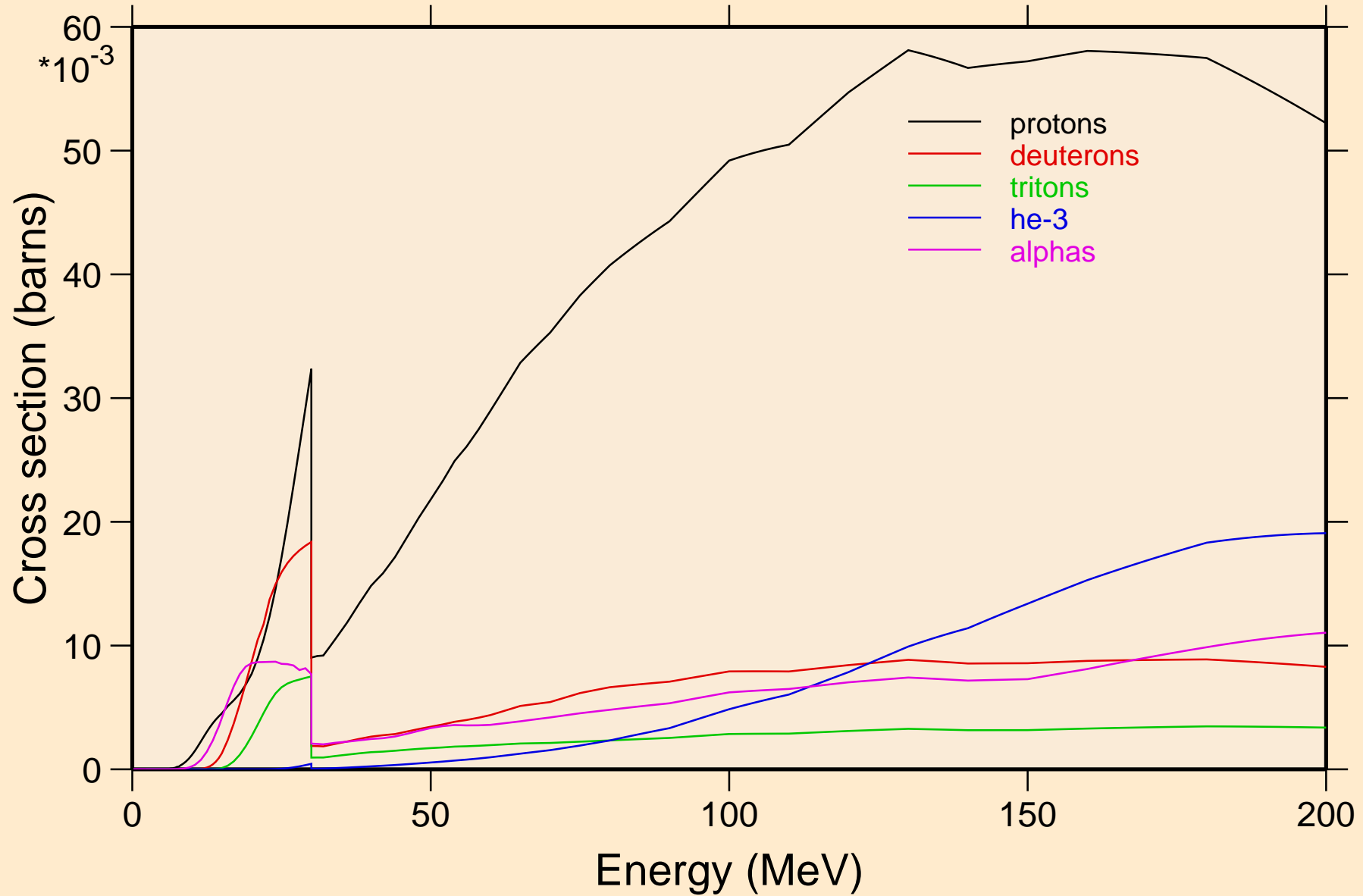

AM235 NEUTRON ACER TENDL-2024 LIBRARY; T=293.6K  
protons from (n,x)

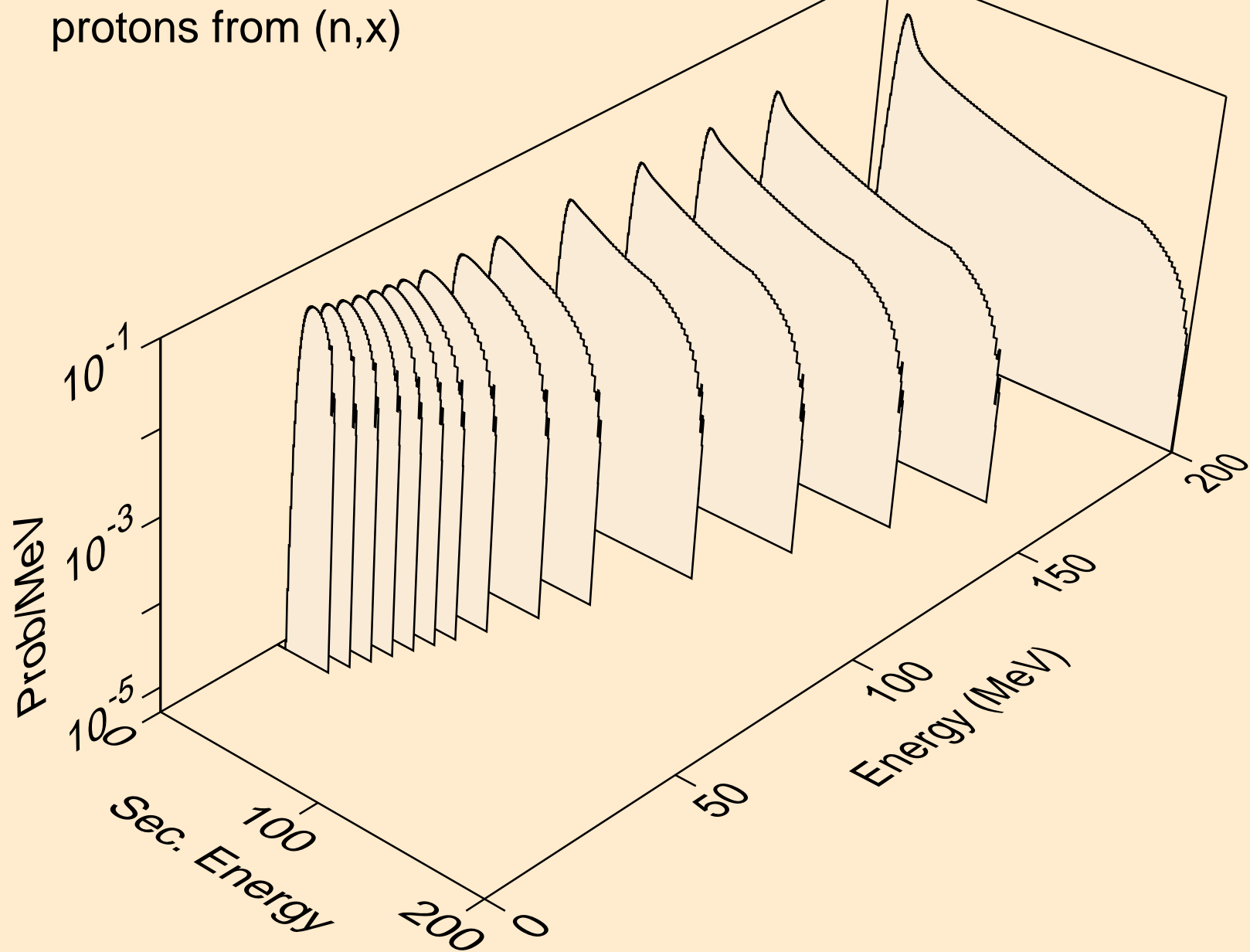

AM235 NEUTRON ACER TENDL-2024 LIBRARY; T=293.6K  
protons from (n,n\*)p

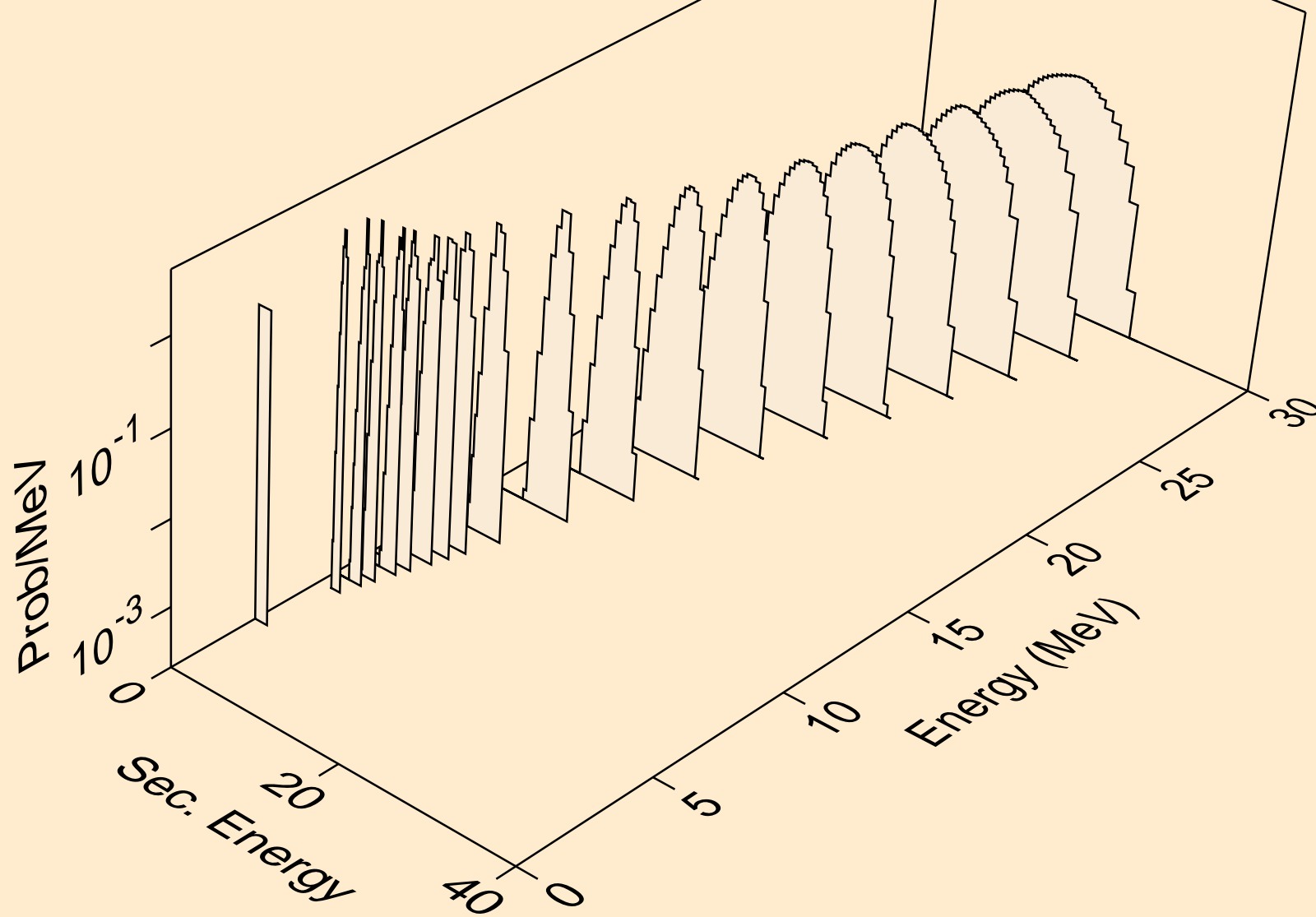

AM235 NEUTRON ACER TENDL-2024 LIBRARY; T=293.6K  
protons from (n,2np)

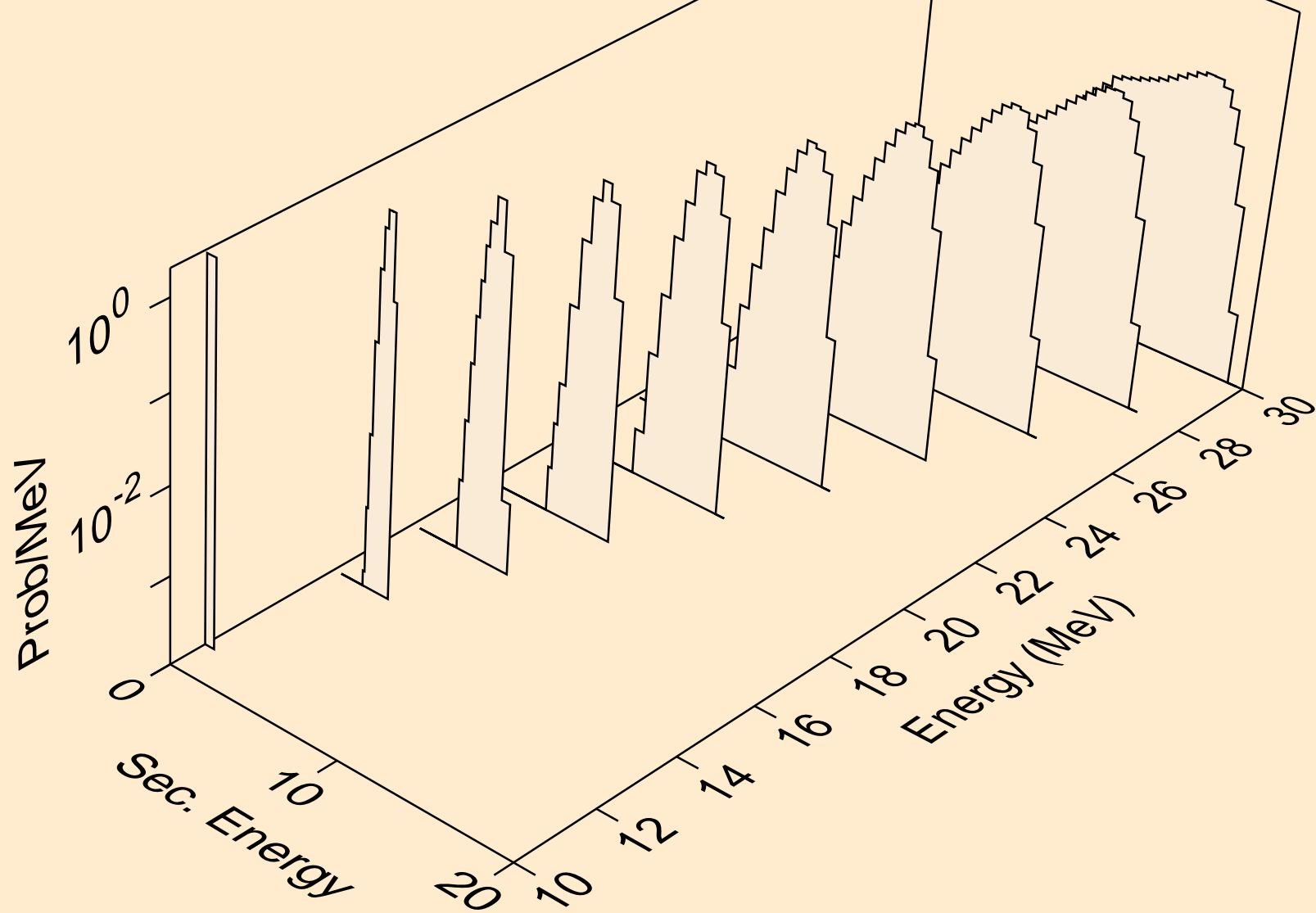

AM235 NEUTRON ACER TENDL-2024 LIBRARY; T=293.6K  
protons from (n,3np)

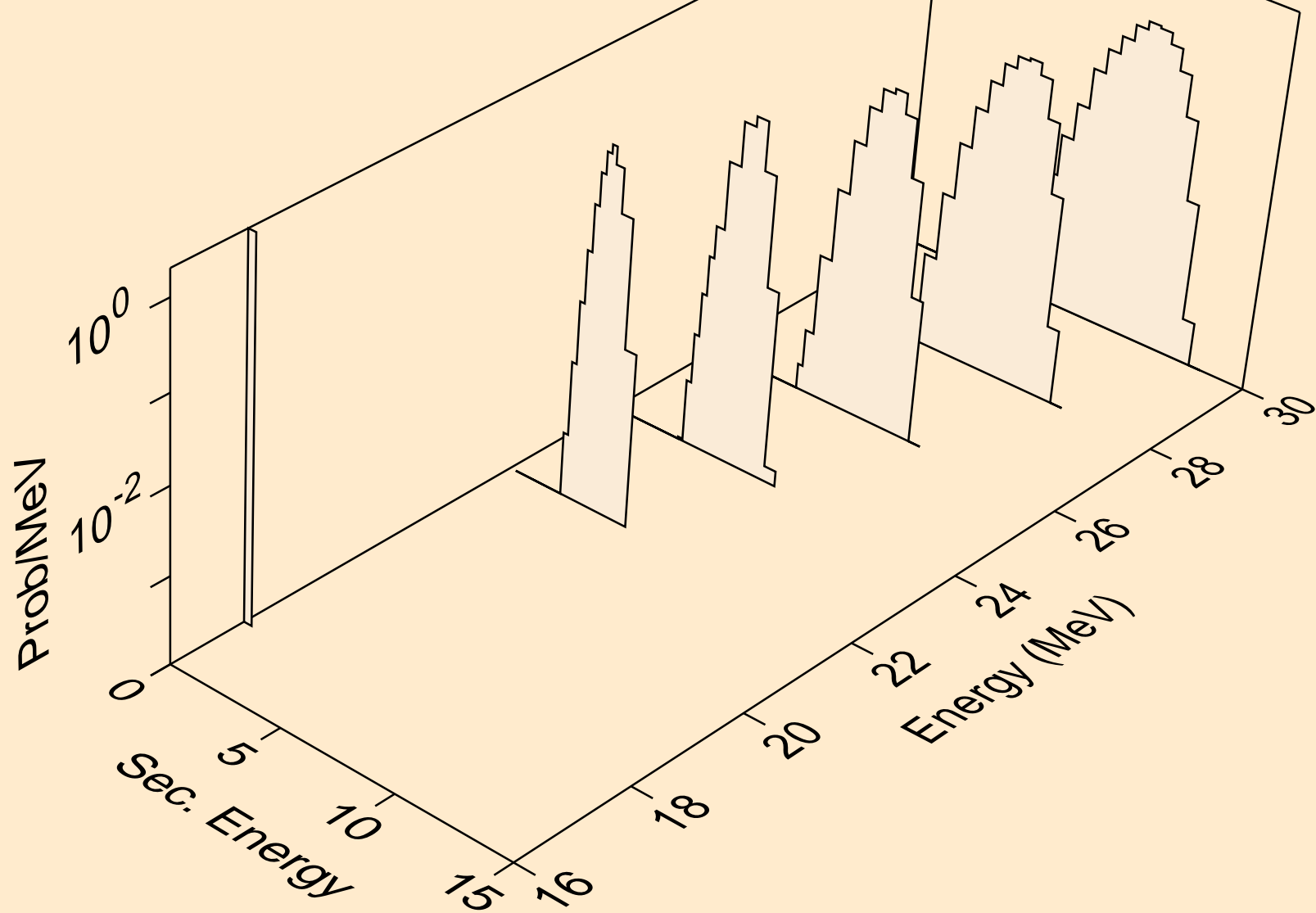

AM235 NEUTRON ACER TENDL-2024 LIBRARY; T=293.6K  
protons from (n,n2p)

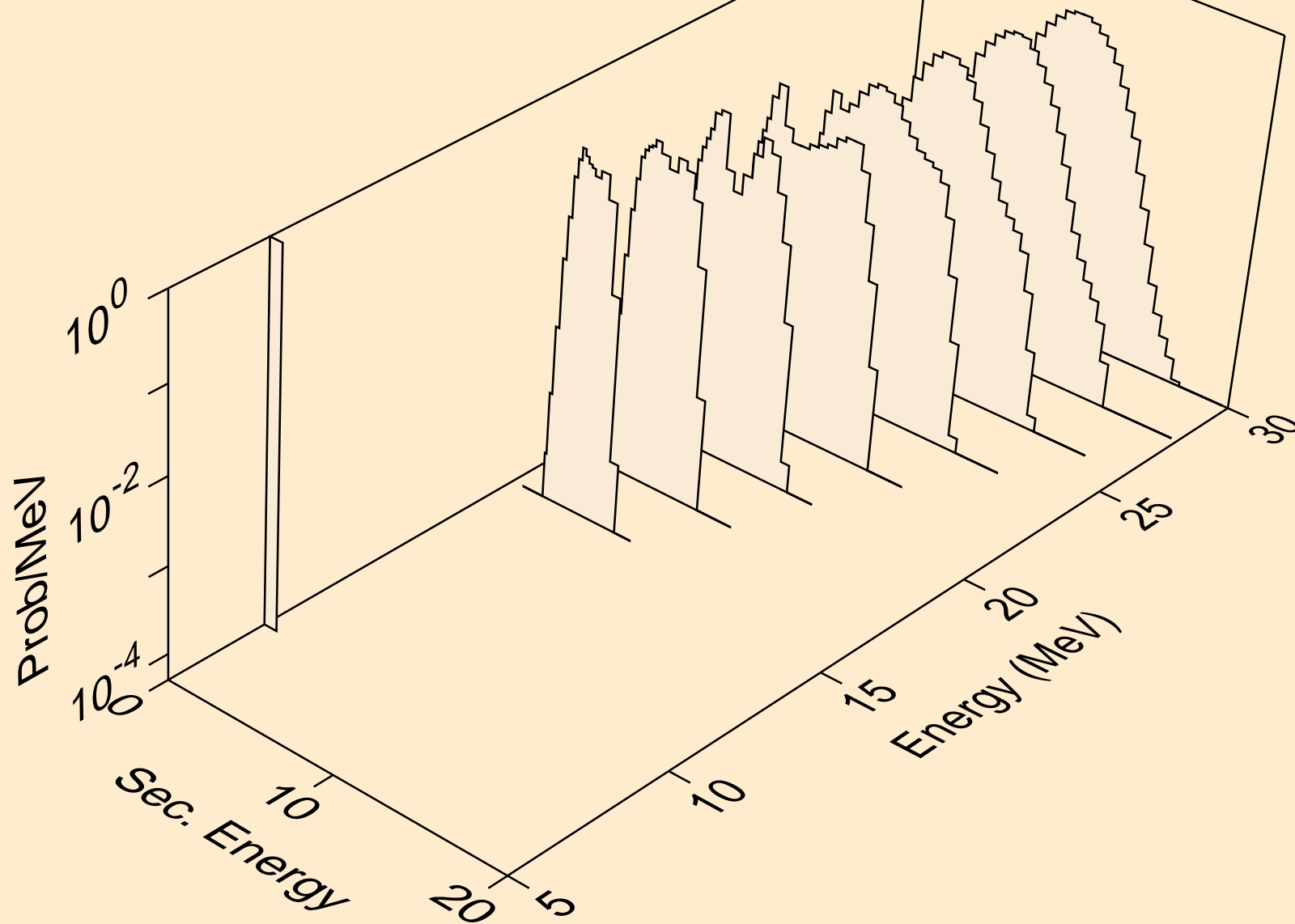

AM235 NEUTRON ACER TENDL-2024 LIBRARY; T=293.6K  
protons from (n,npa)

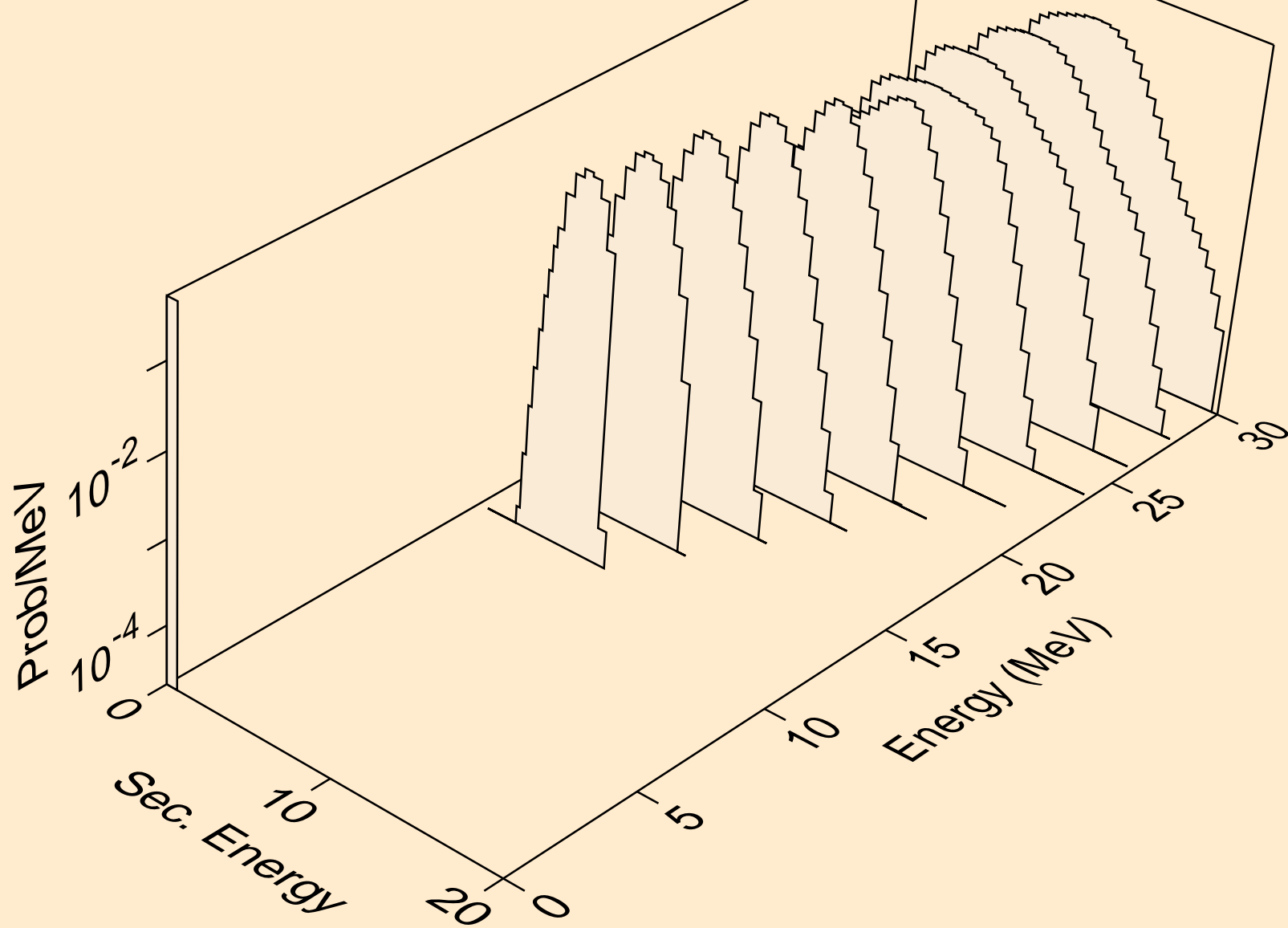

AM235 NEUTRON ACER TENDL-2024 LIBRARY; T=293.6K  
protons from (n,p)

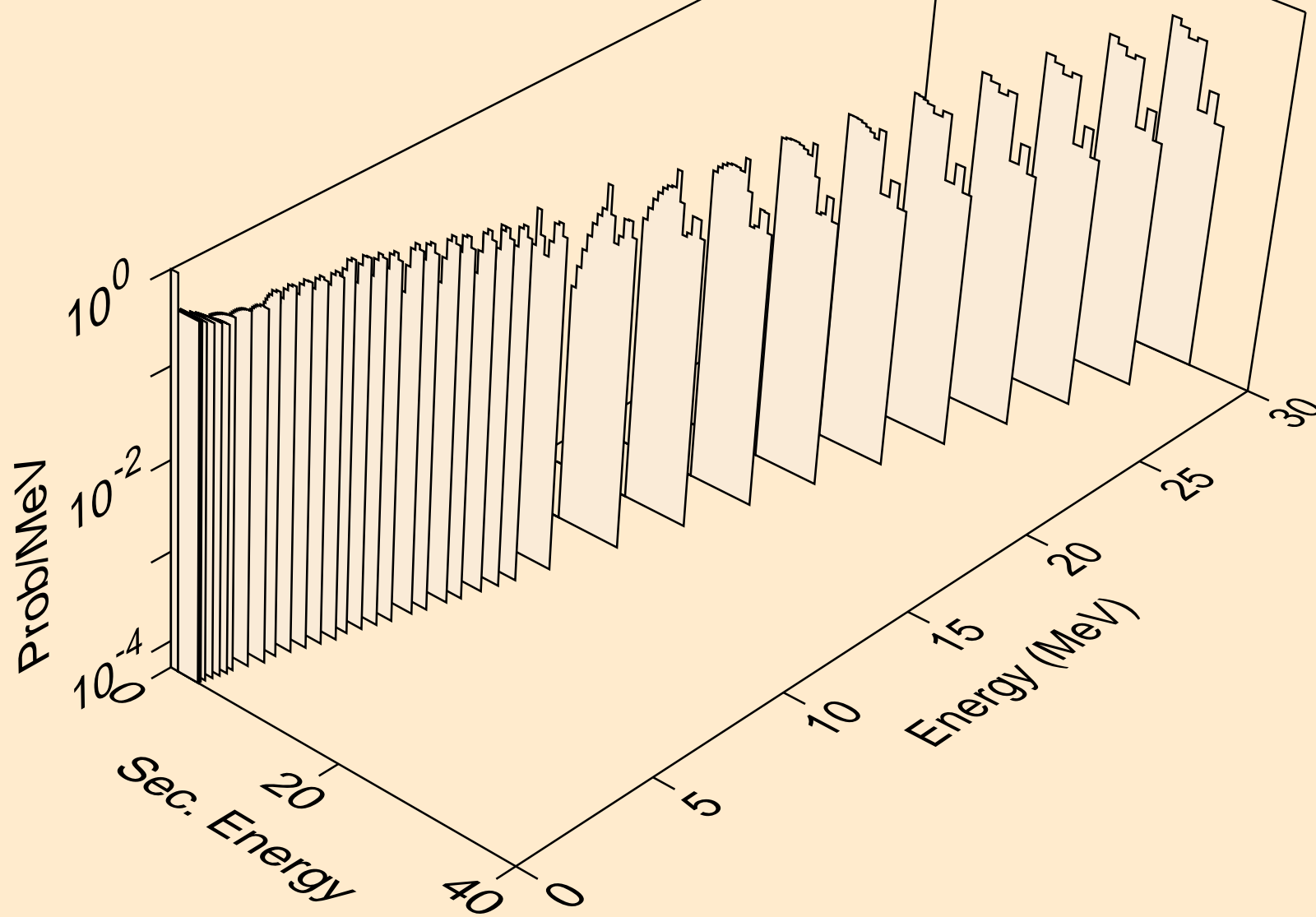

AM235 NEUTRON ACER TENDL-2024 LIBRARY; T=293.6K  
protons from (n,2p)

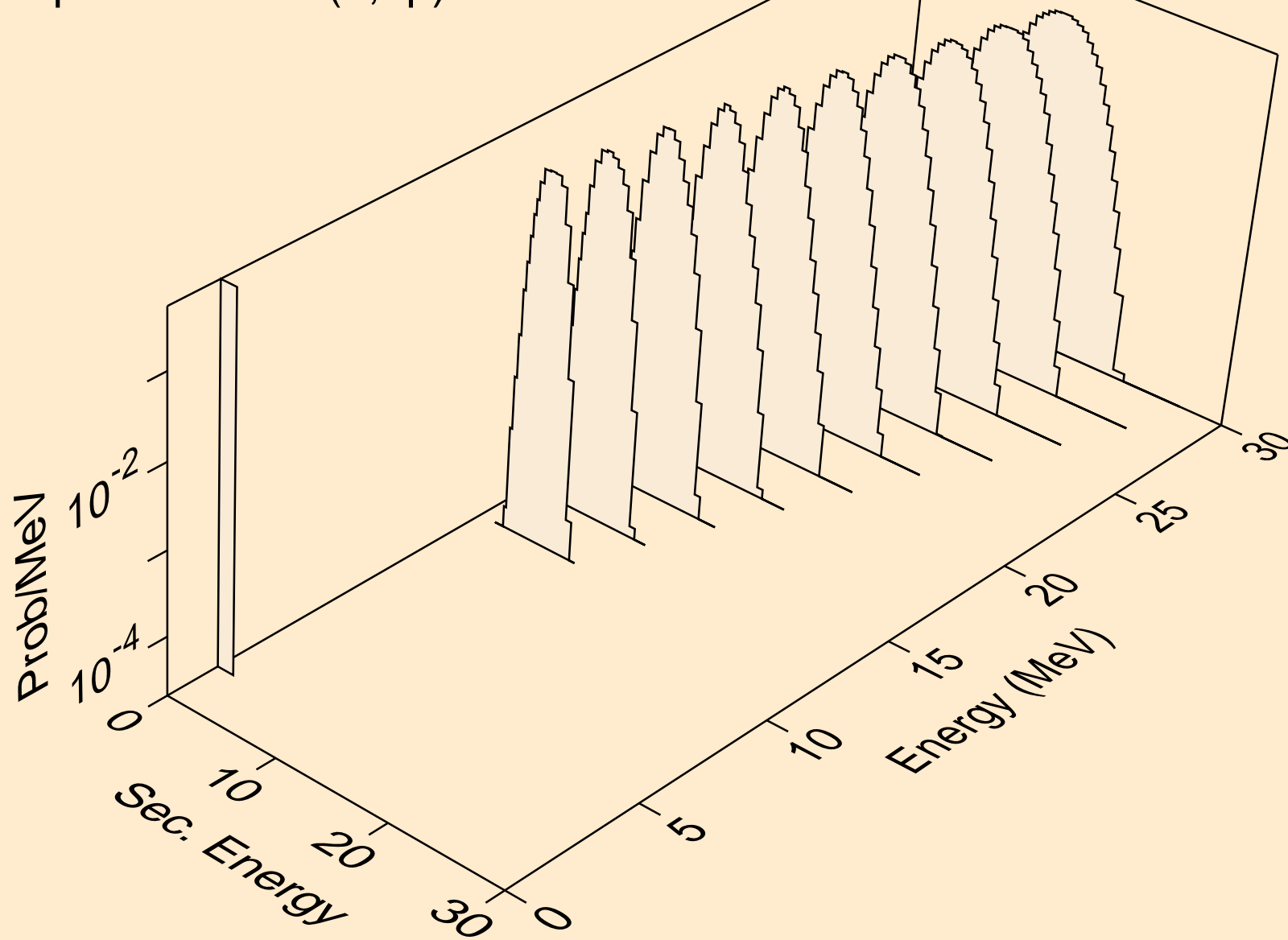

AM235 NEUTRON ACER TENDL-2024 LIBRARY; T=293.6K  
protons from (n,p)

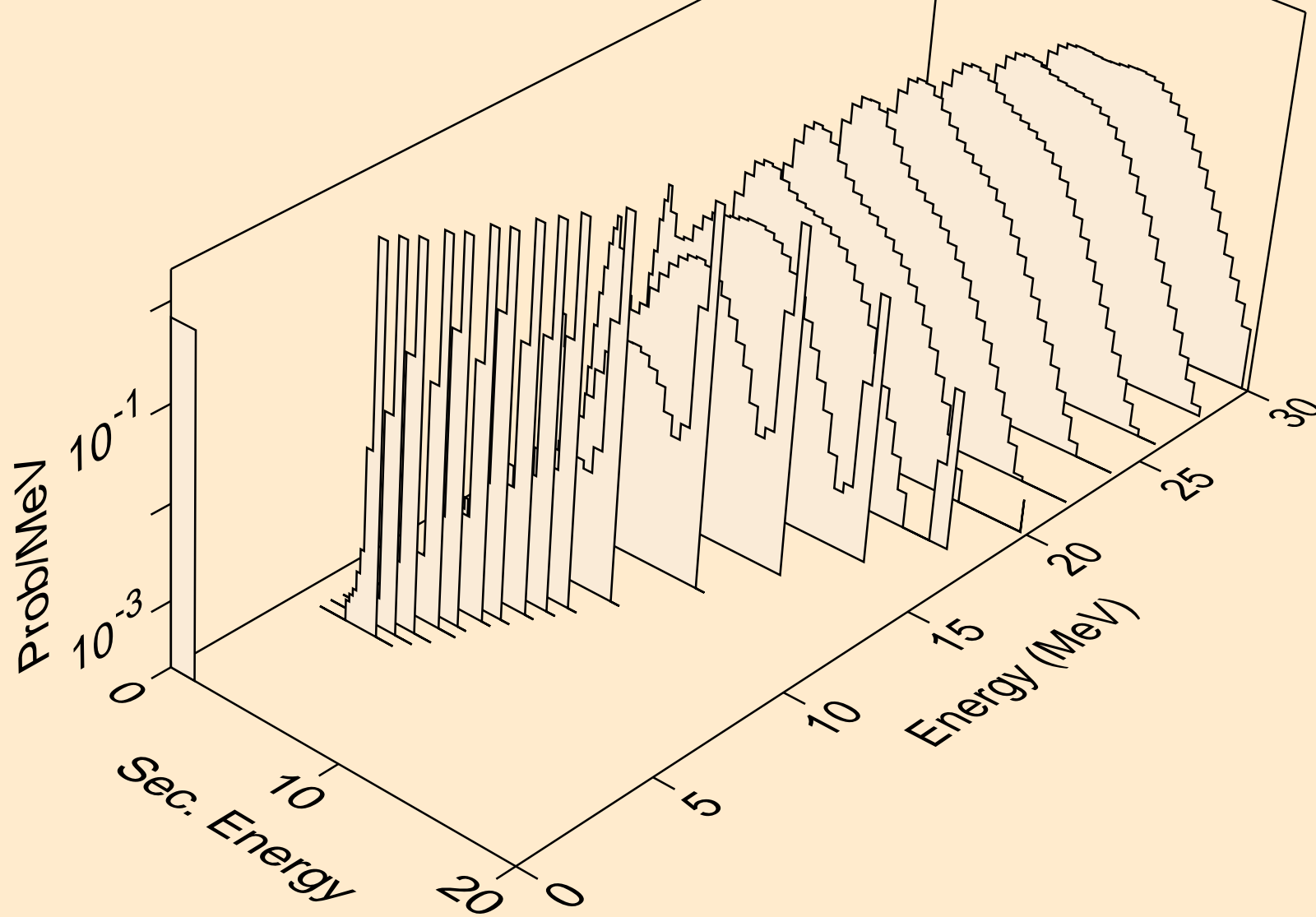

AM235 NEUTRON ACER TENDL-2024 LIBRARY; T=293.6K  
protons from (n,pd)

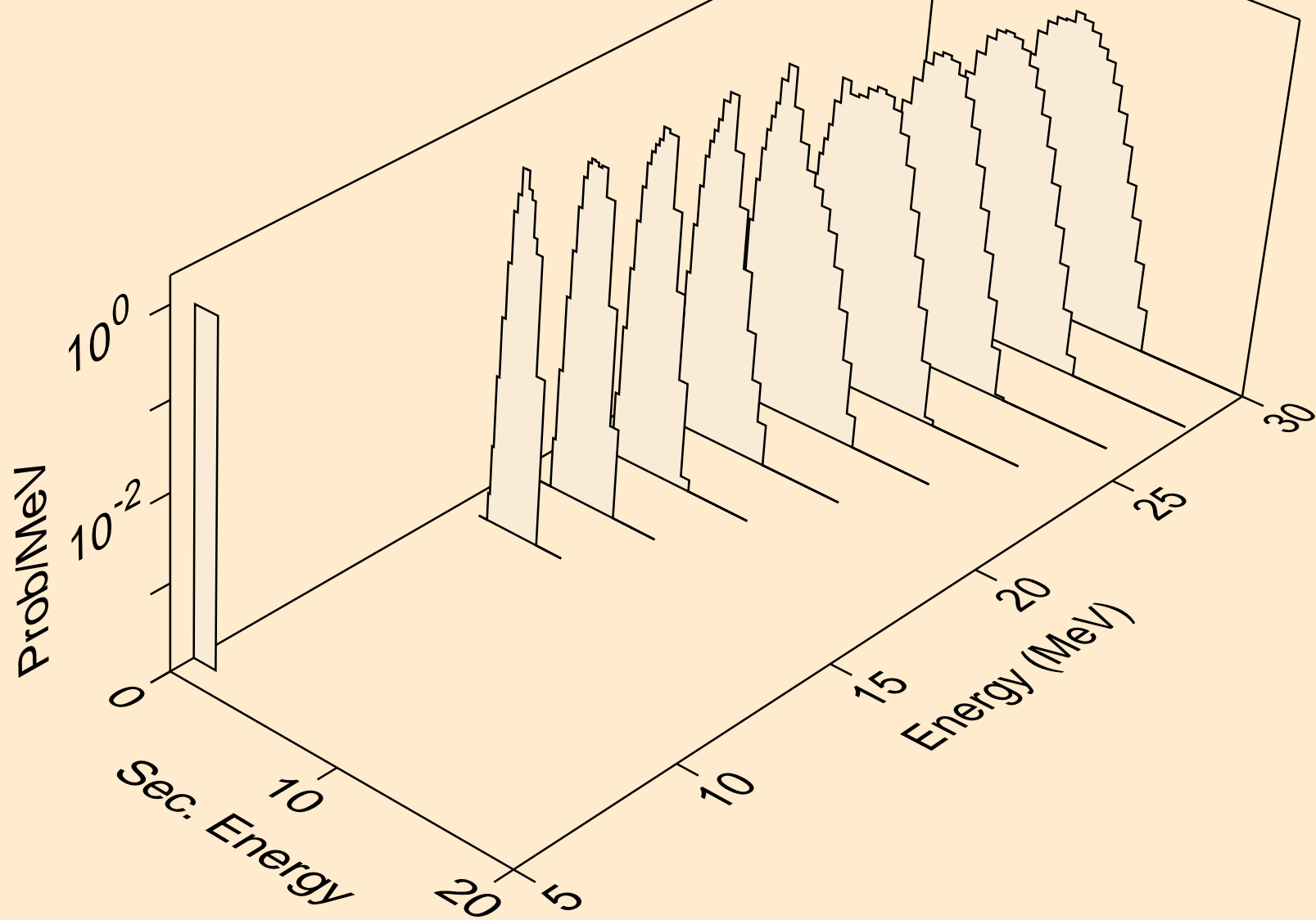

AM235 NEUTRON ACER TENDL-2024 LIBRARY; T=293.6K  
protons from (n,pt)

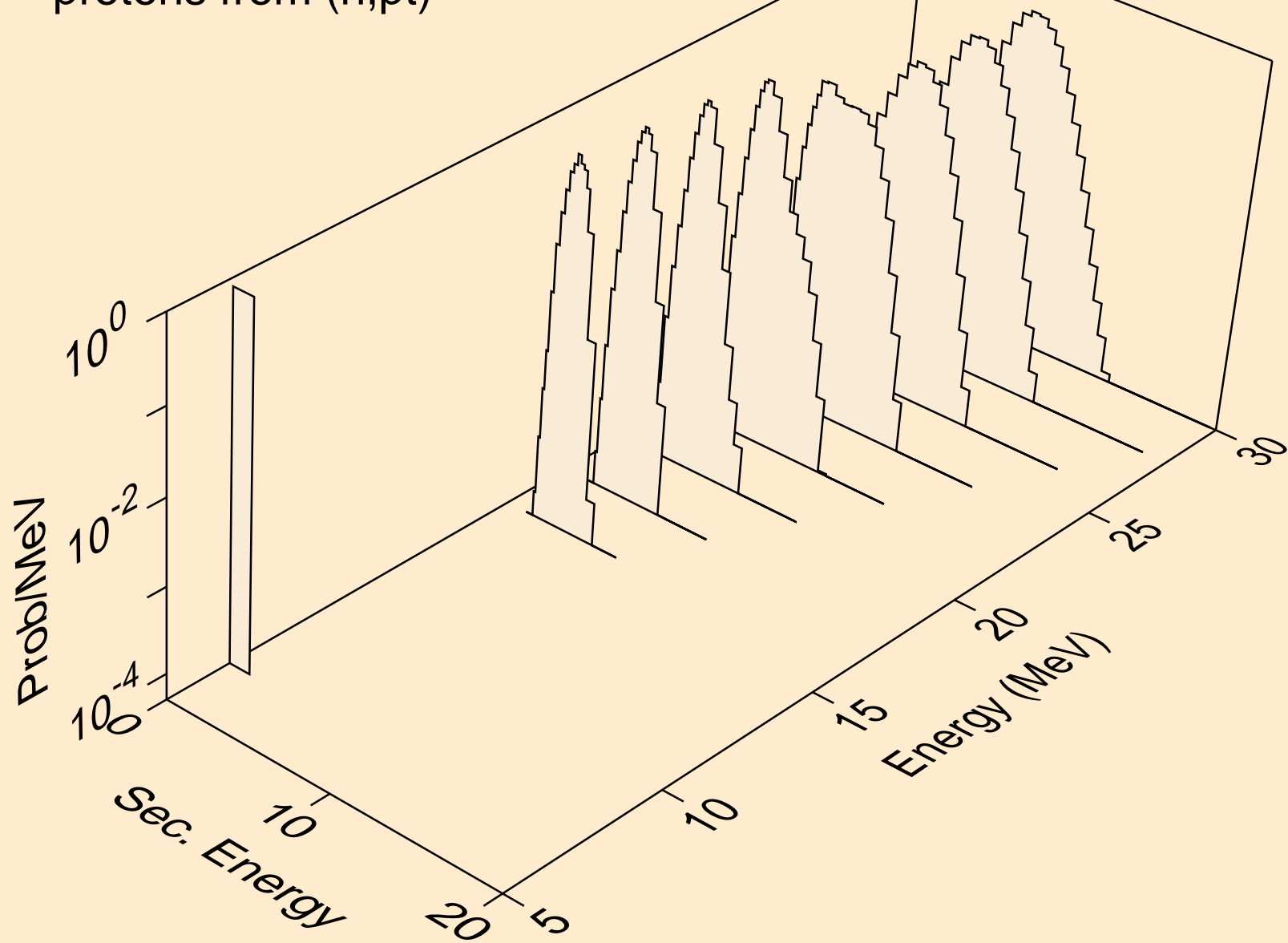

AM235 NEUTRON ACER TENDL-2024 LIBRARY; T=293.6K  
deuterons from (n,x)

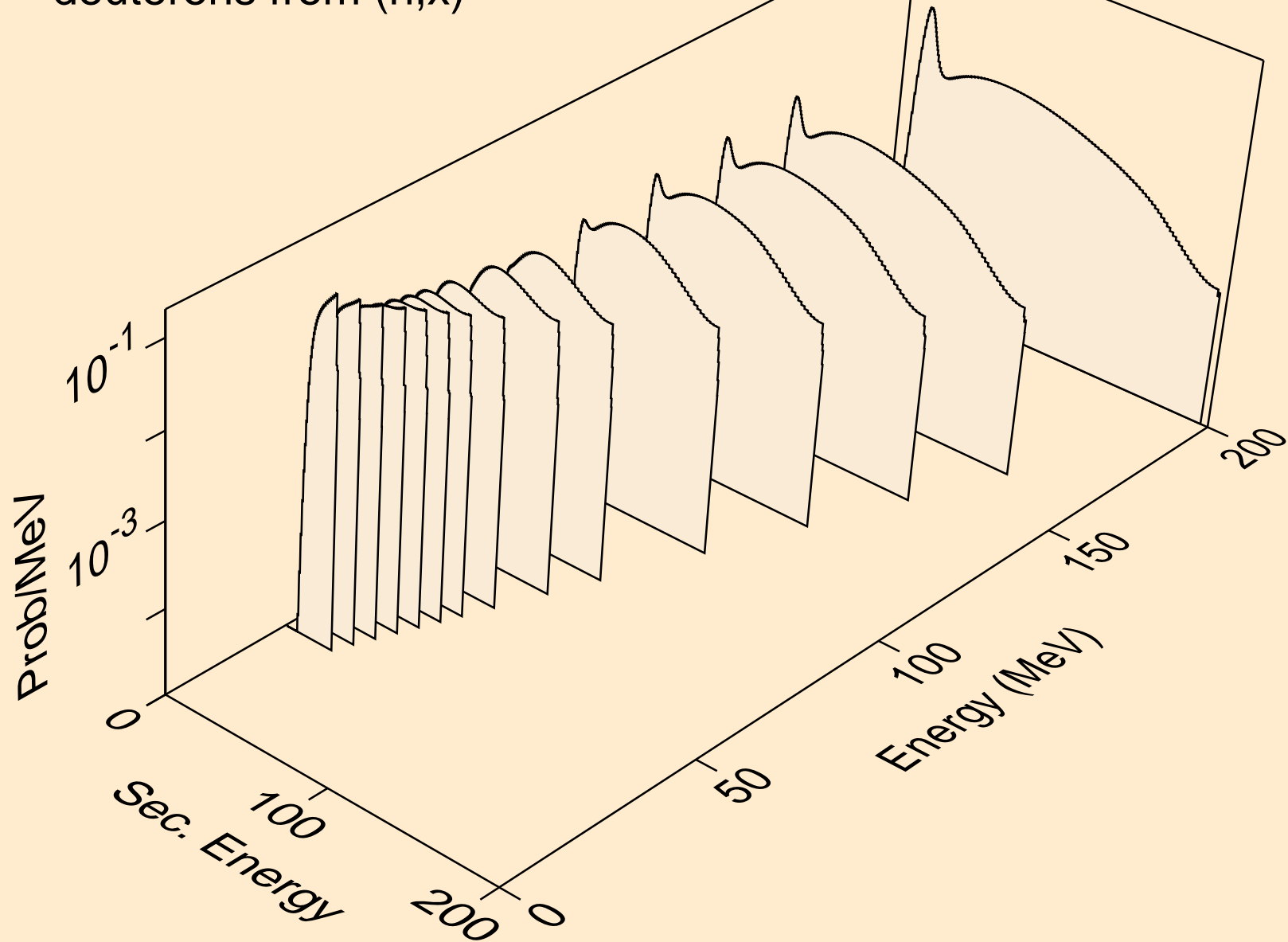

AM235 NEUTRON ACER TENDL-2024 LIBRARY; T=293.6K  
deuterons from (n,2nd)

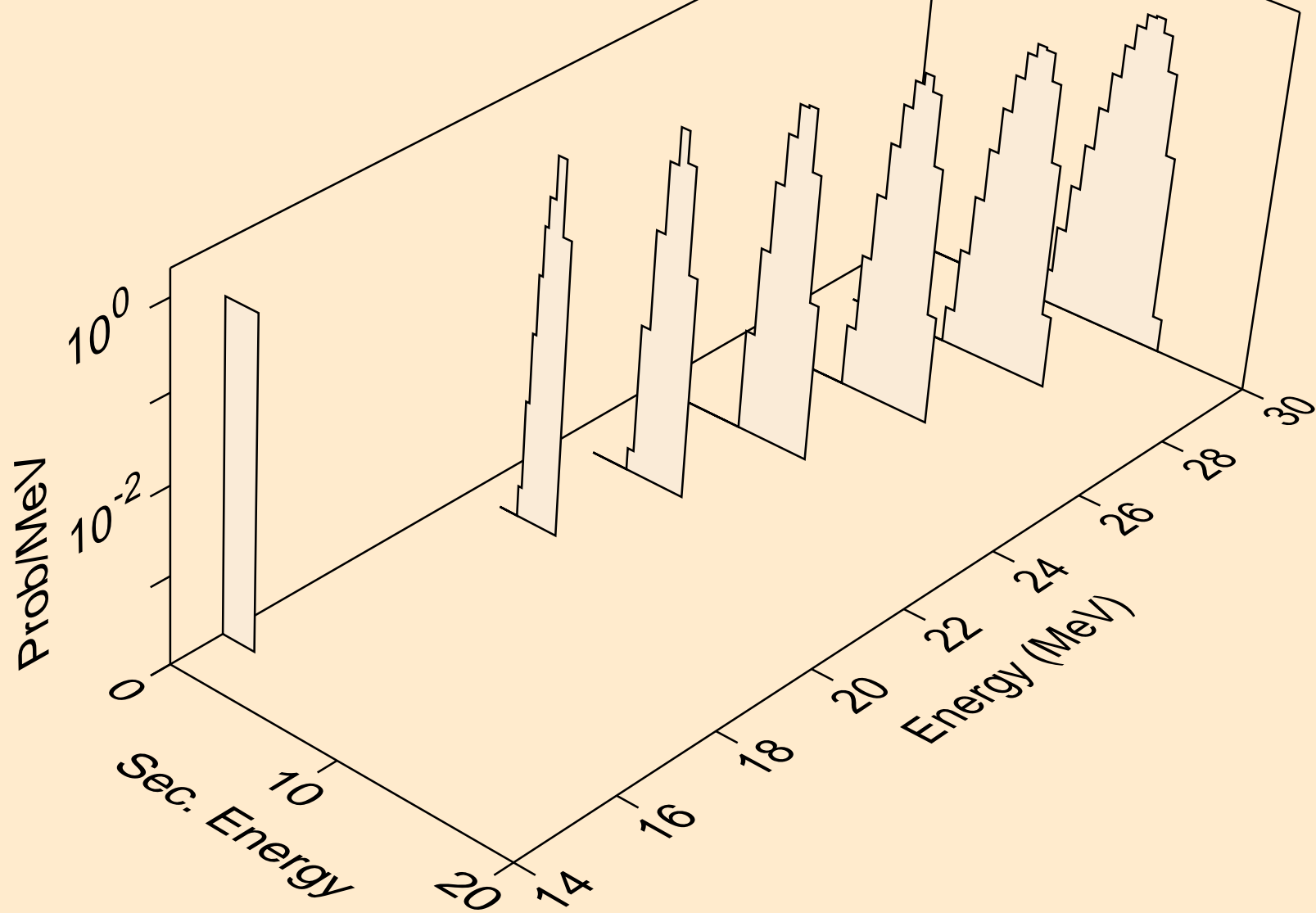

AM235 NEUTRON ACER TENDL-2024 LIBRARY; T=293.6K  
deuterons from (n,n\*)d

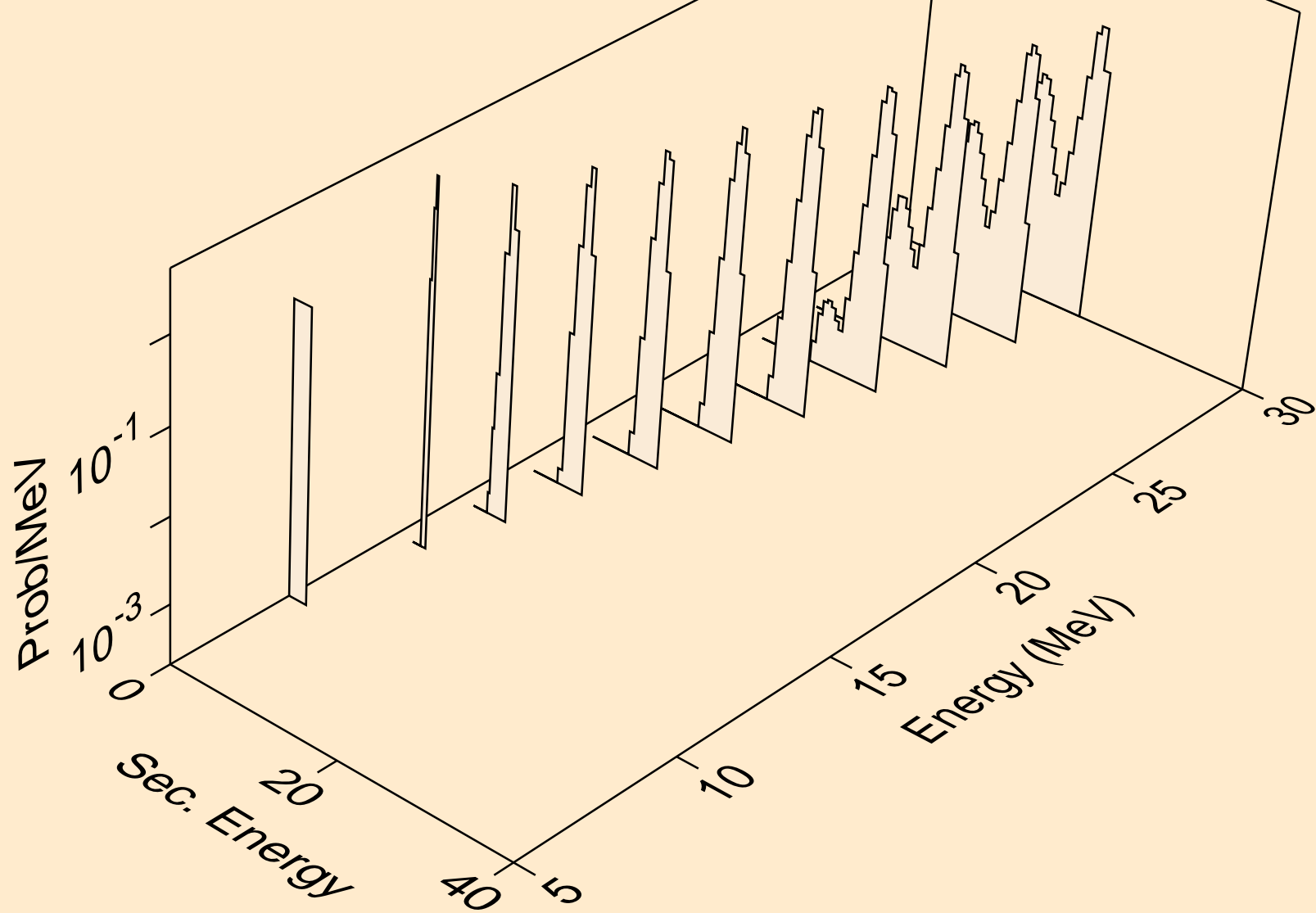

AM235 NEUTRON ACER TENDL-2024 LIBRARY; T=293.6K  
deuterons from (n,d)

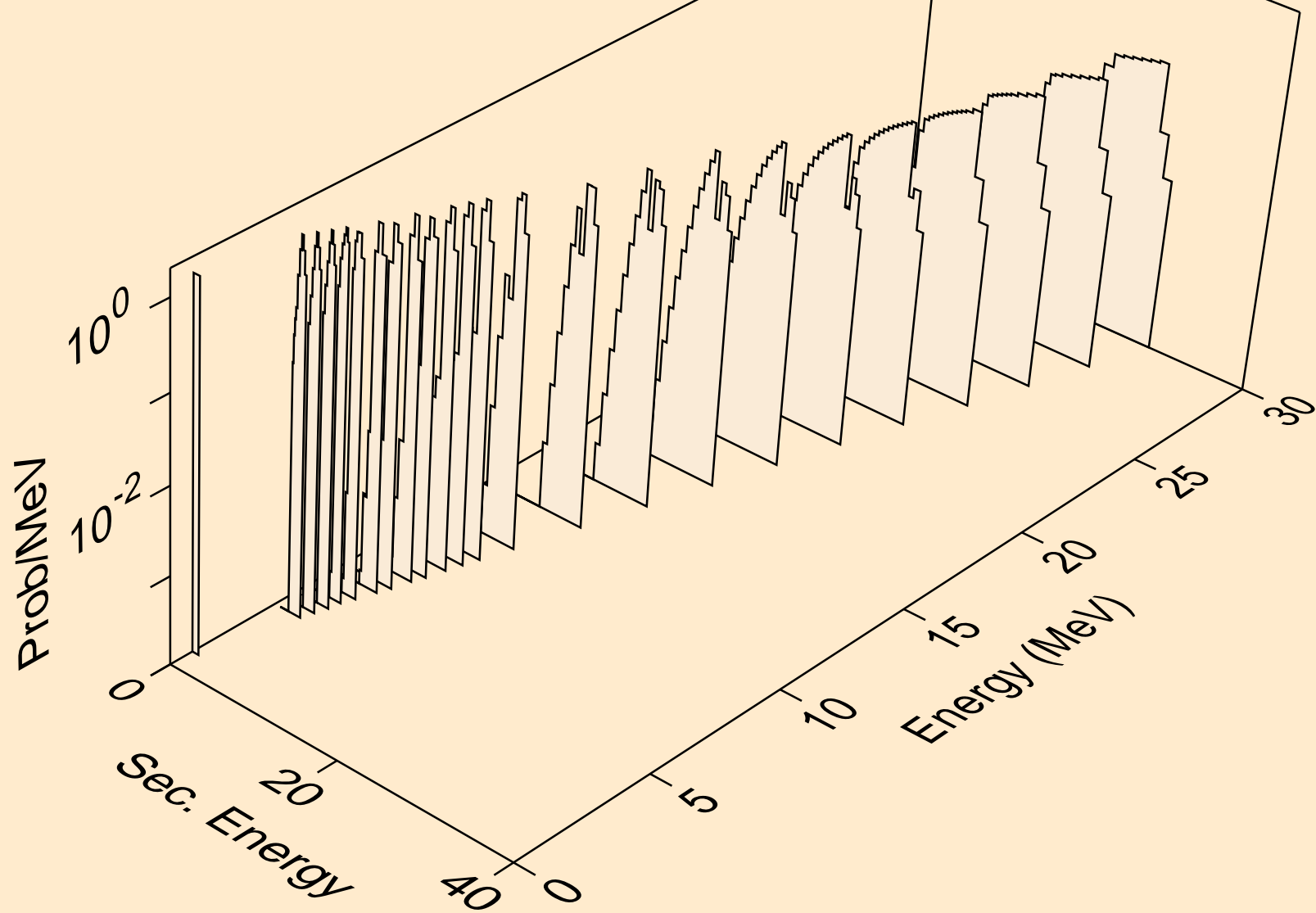

AM235 NEUTRON ACER TENDL-2024 LIBRARY; T=293.6K  
deuterons from (n,pd)

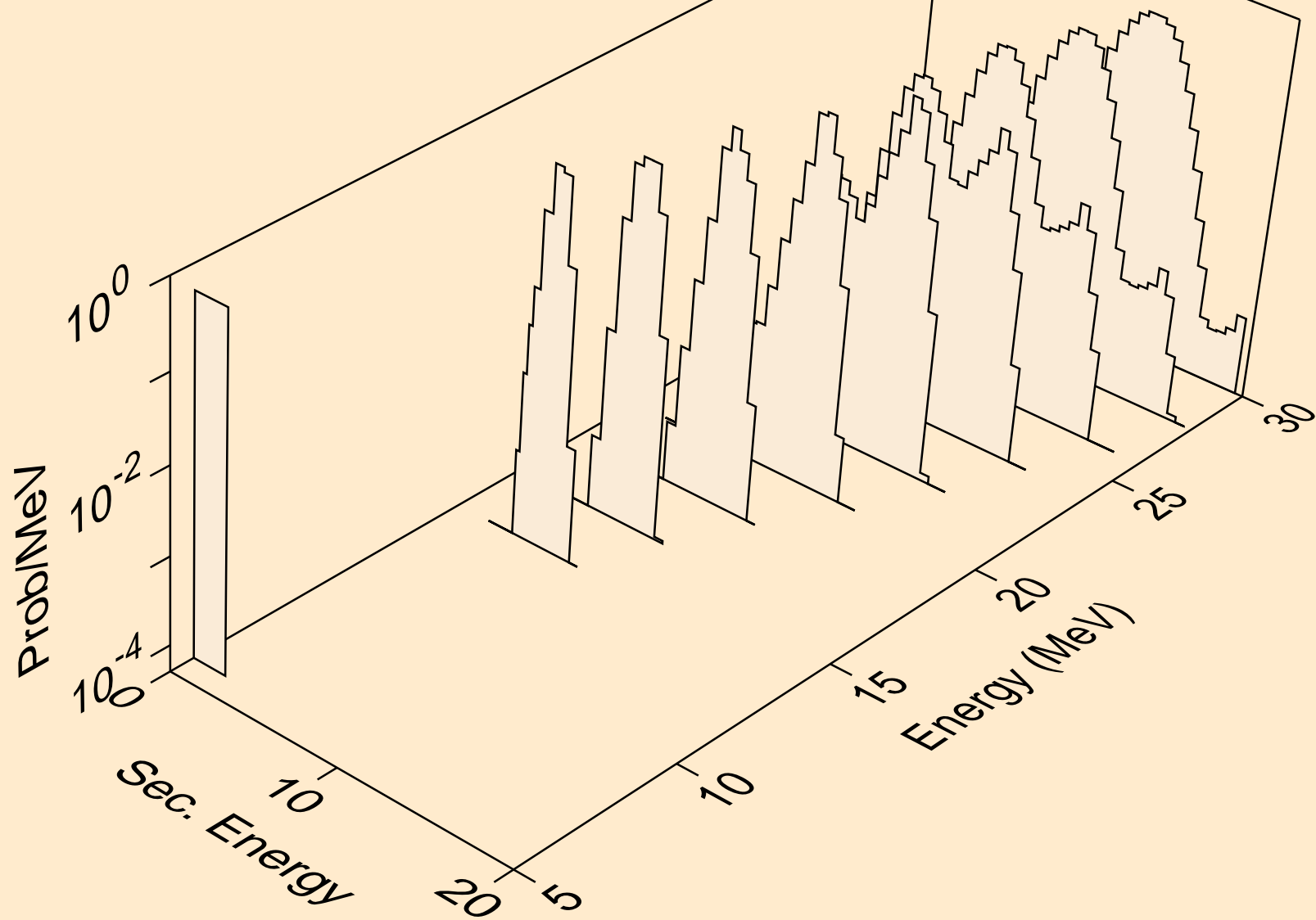

AM235 NEUTRON ACER TENDL-2024 LIBRARY; T=293.6K  
deuterons from (n,da)

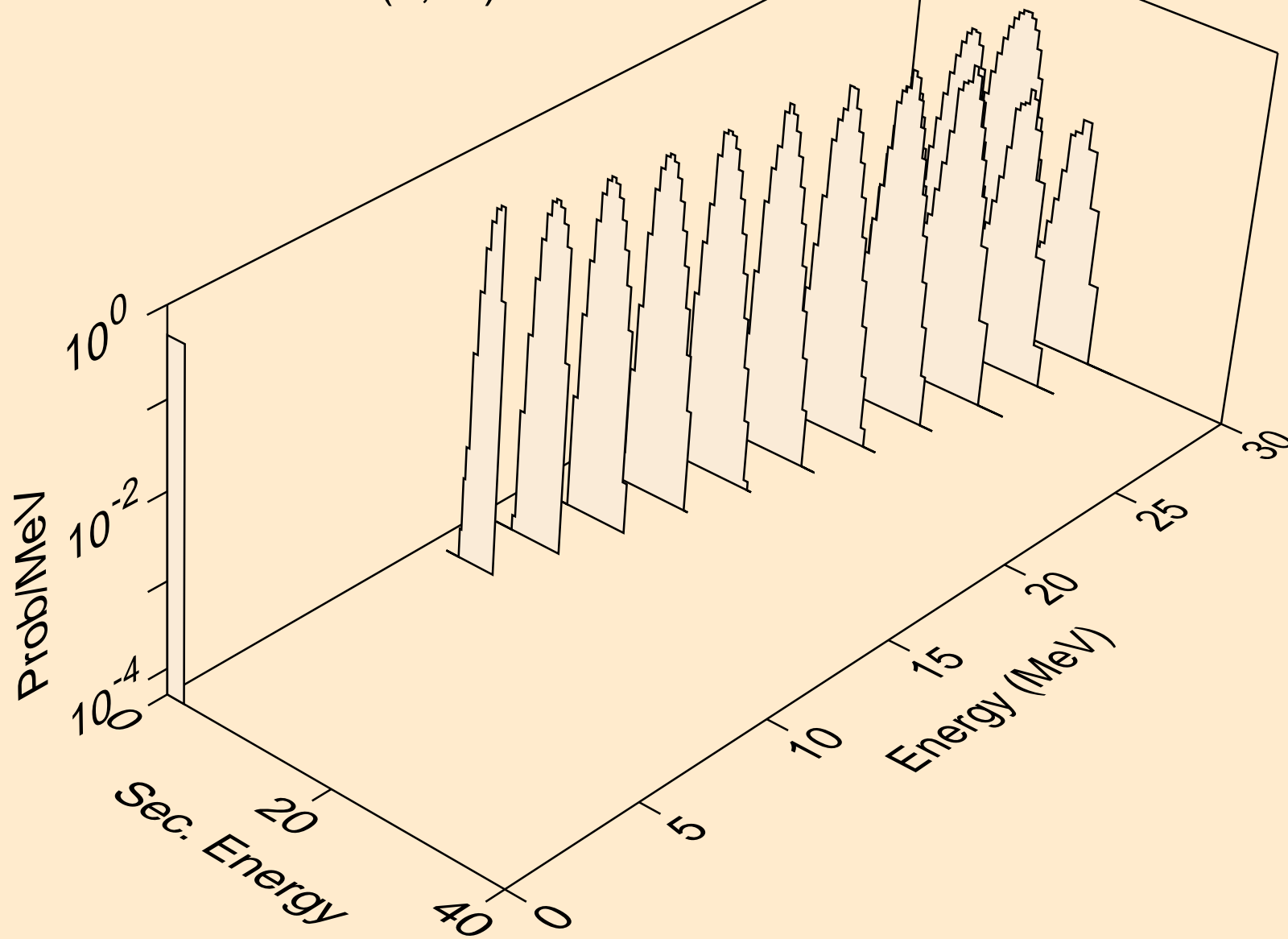

AM235 NEUTRON ACER TENDL-2024 LIBRARY; T=293.6K  
tritons from (n,x)

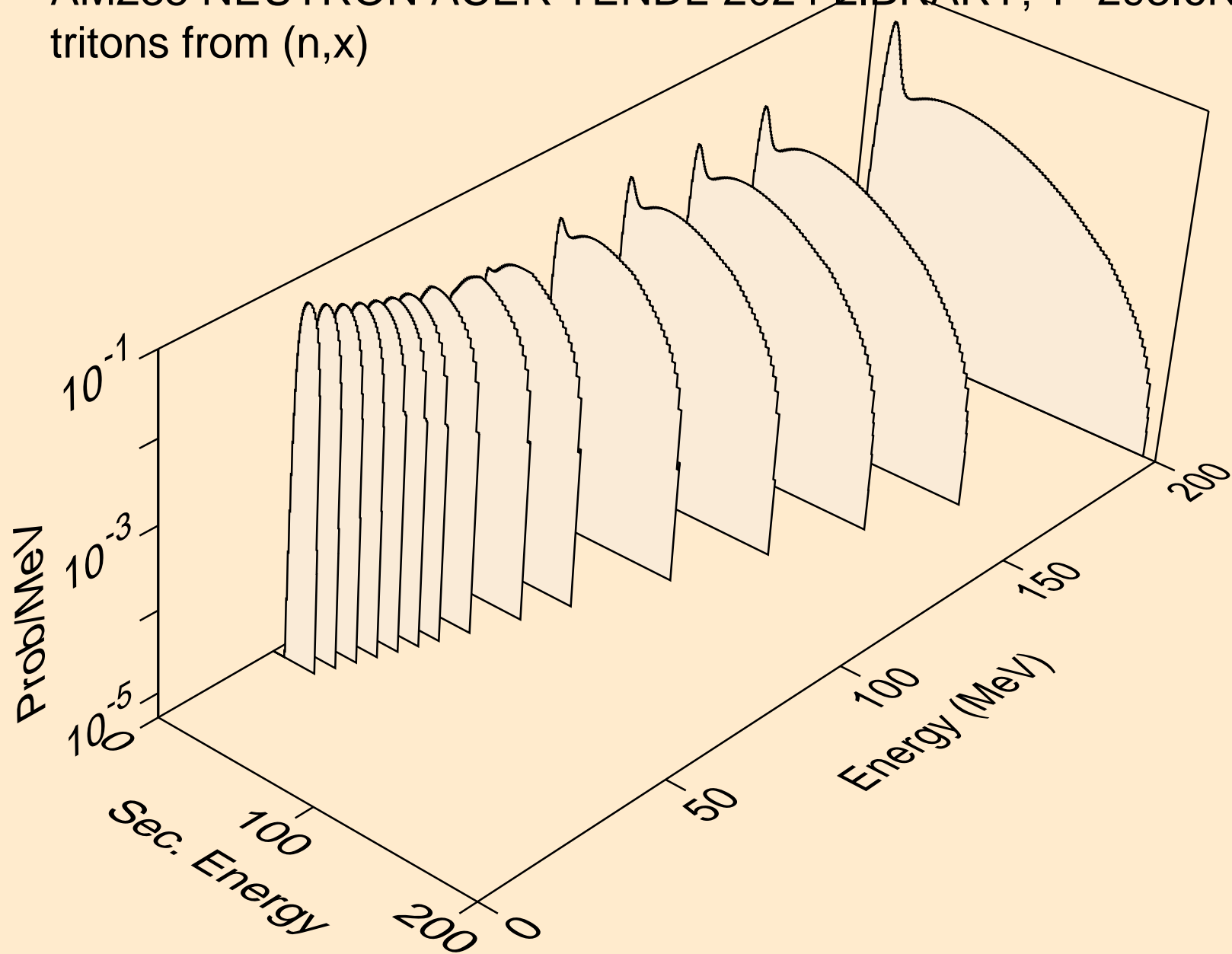

AM235 NEUTRON ACER TENDL-2024 LIBRARY; T=293.6K  
tritons from (n,n\*)t

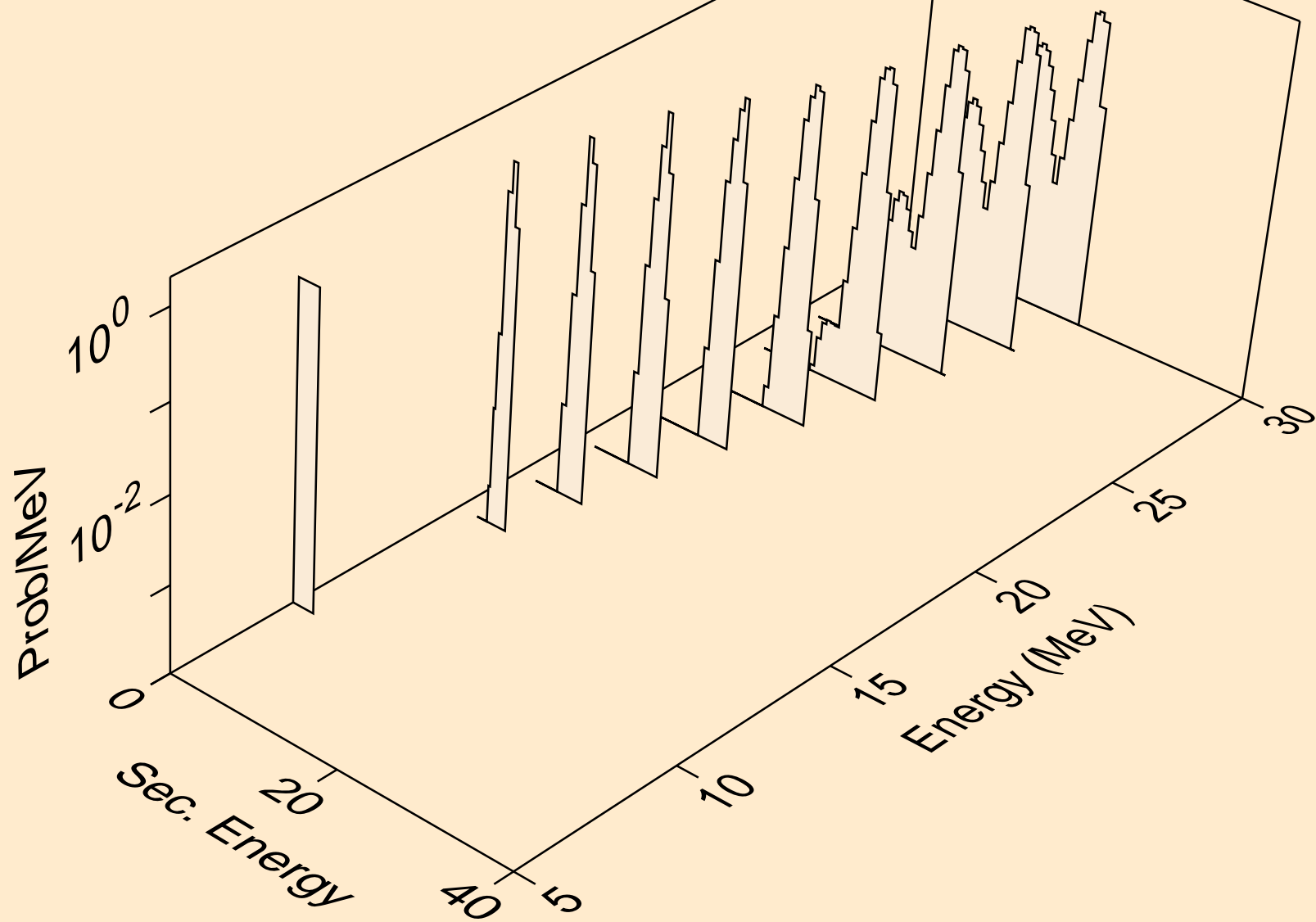

AM235 NEUTRON ACER TENDL-2024 LIBRARY; T=293.6K  
tritons from (n,t)

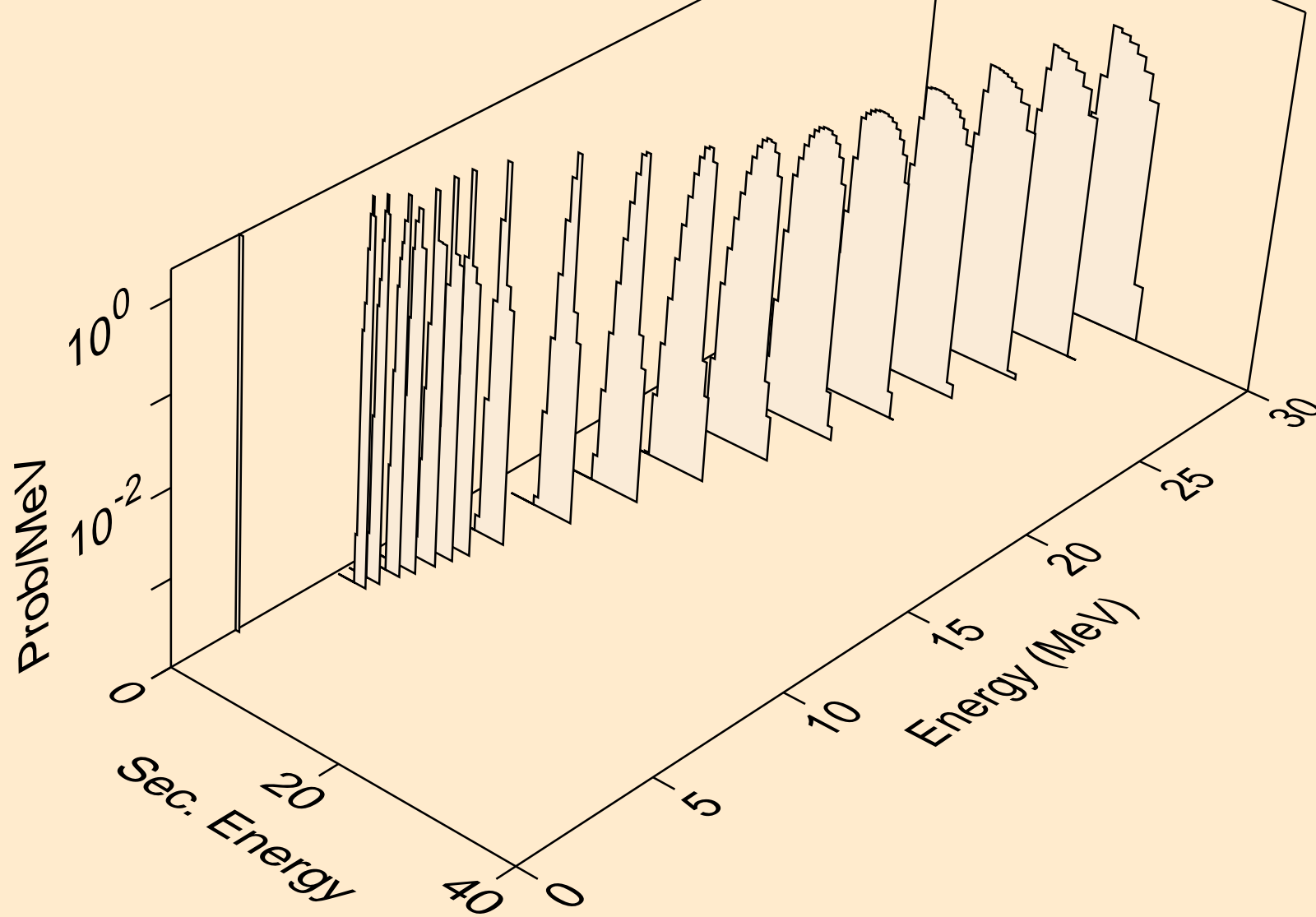

AM235 NEUTRON ACER TENDL-2024 LIBRARY; T=293.6K  
tritons from (n,pt)

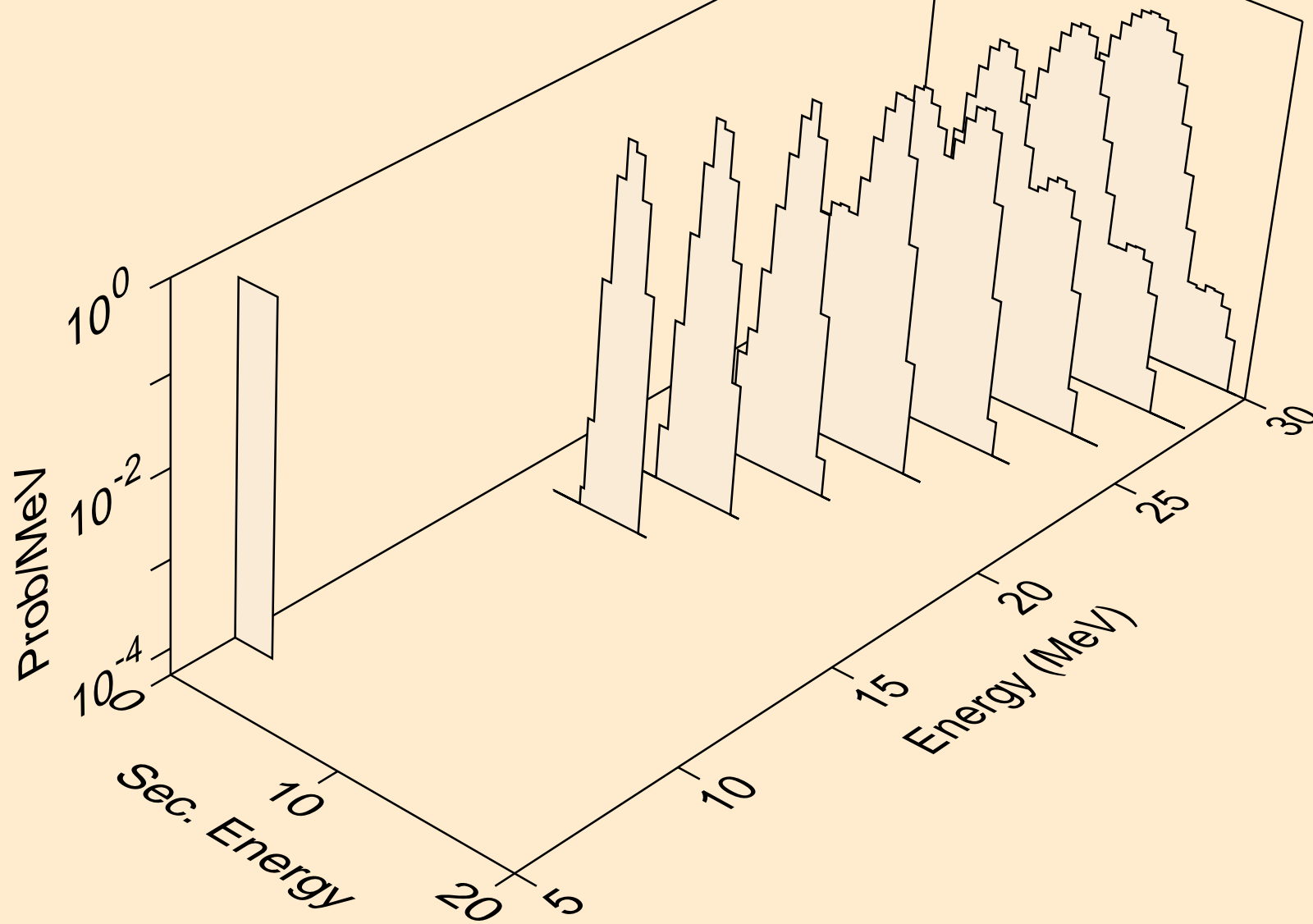

AM235 NEUTRON ACER TENDL-2024 LIBRARY; T=293.6K  
he3s from (n,x)

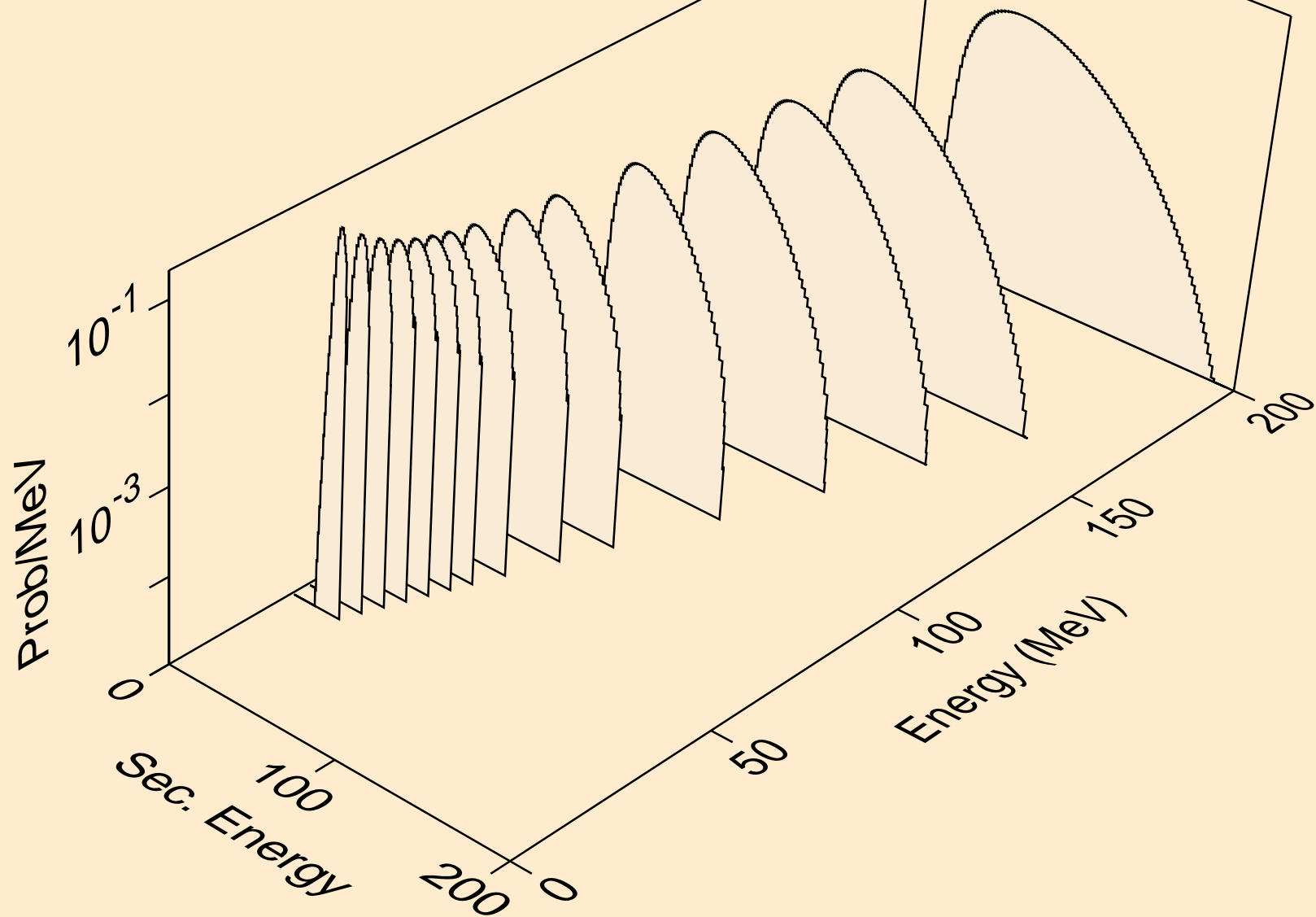

AM235 NEUTRON ACER TENDL-2024 LIBRARY; T=293.6K  
he3s from (n,n\*)he3

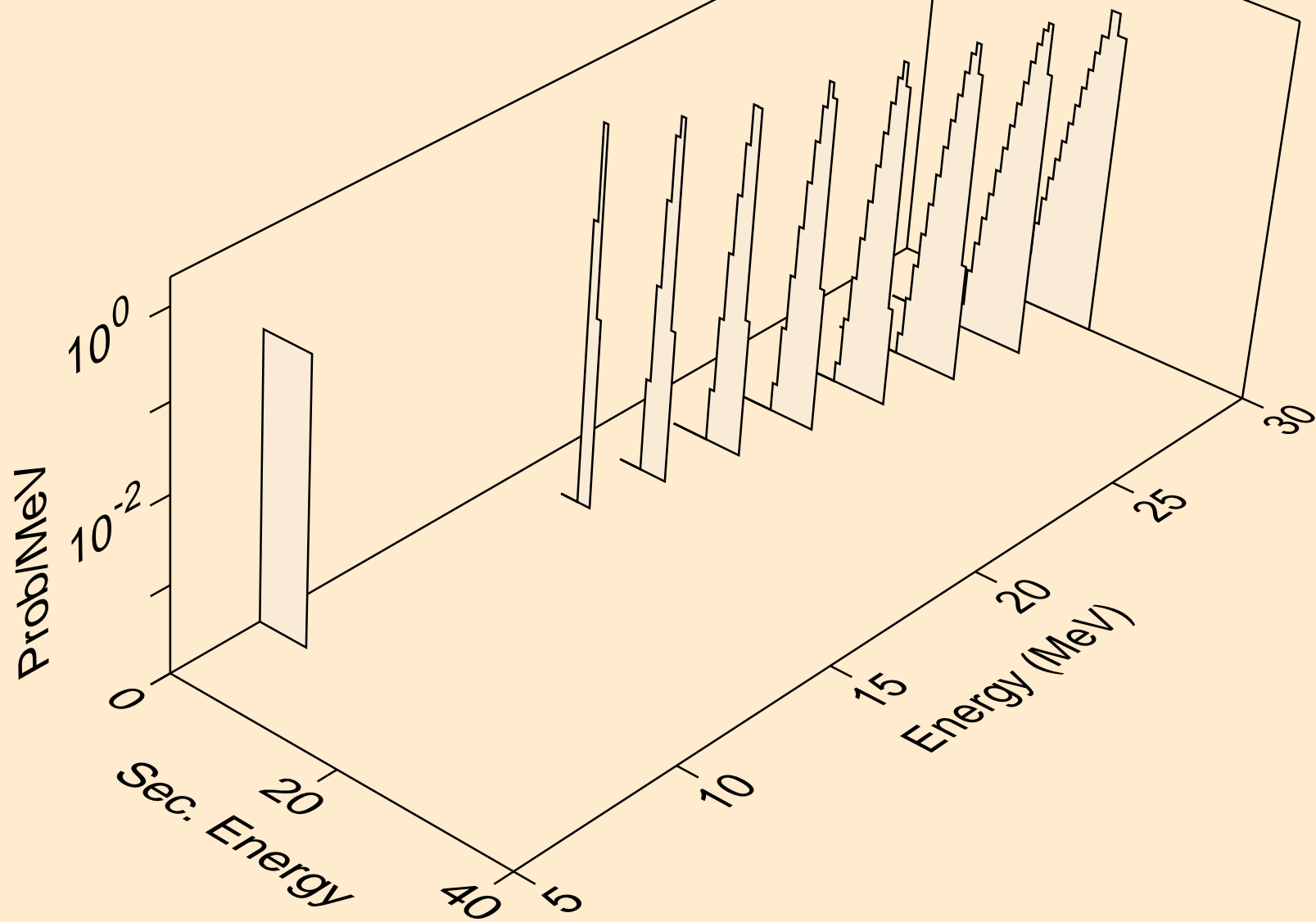

AM235 NEUTRON ACER TENDL-2024 LIBRARY; T=293.6K  
he3s from (n,he3)

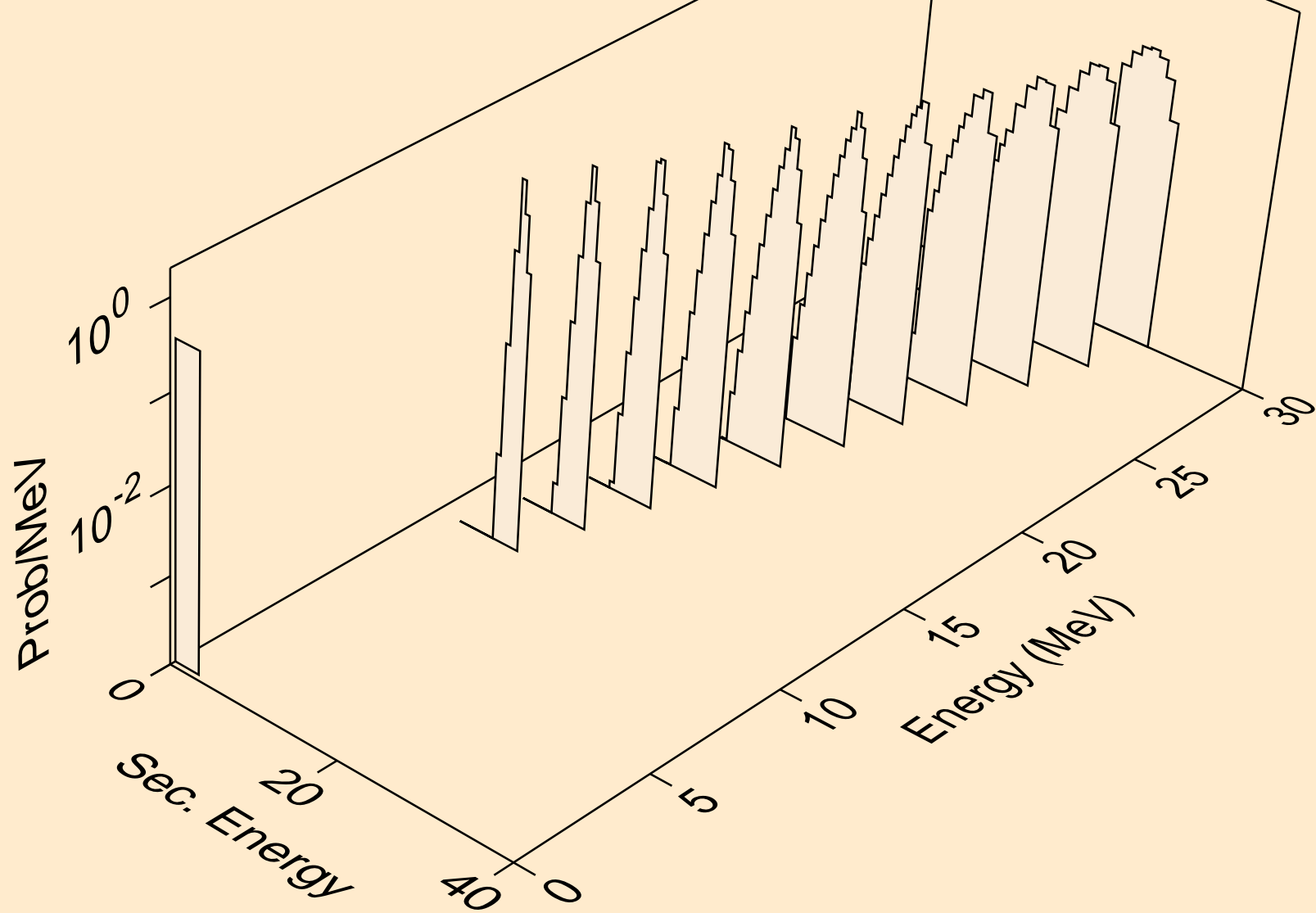

AM235 NEUTRON ACER TENDL-2024 LIBRARY; T=293.6K  
alphas from (n,x)

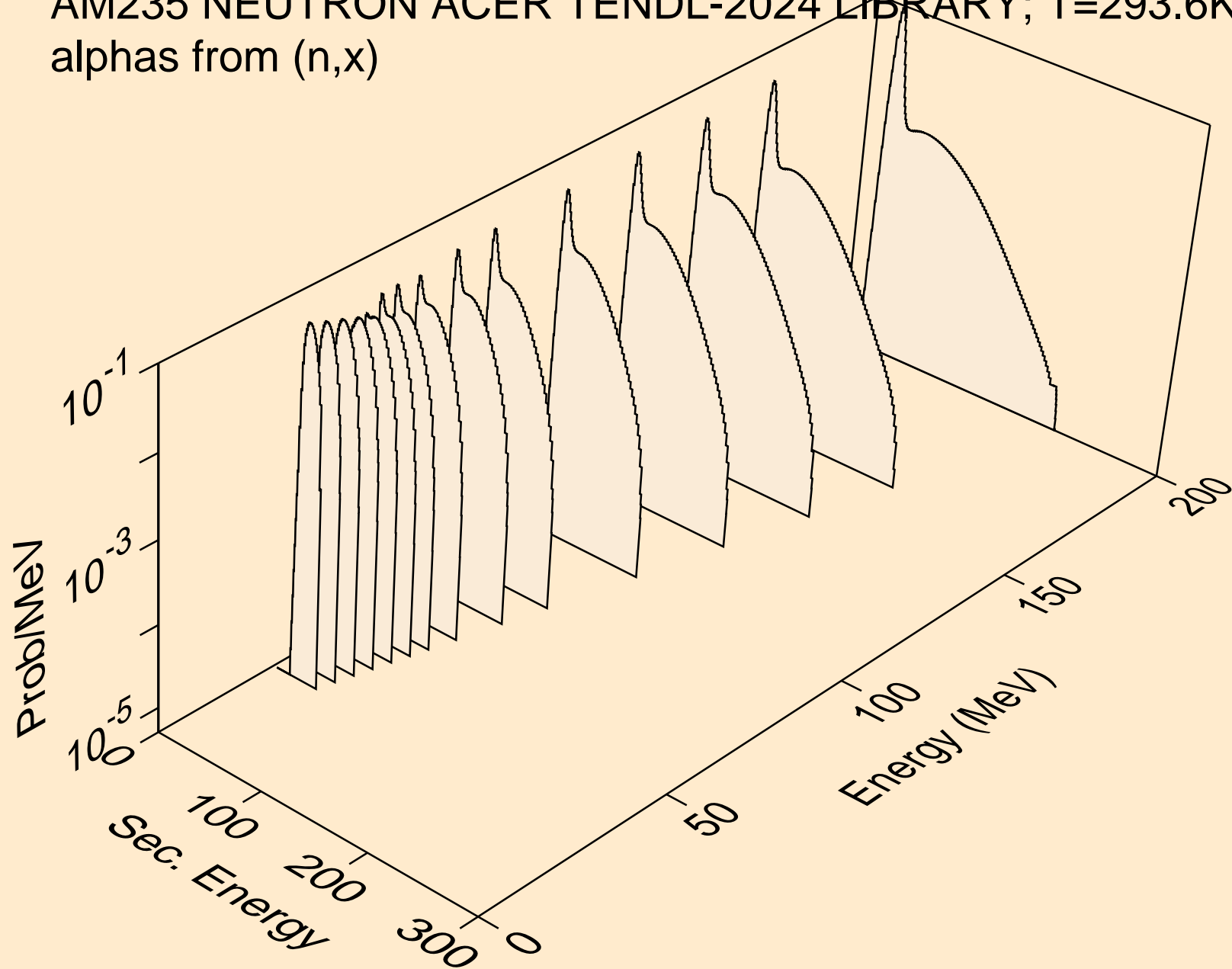

AM235 NEUTRON ACER TENDL-2024 LIBRARY; T=293.6K  
alphas from (n,n\*)a

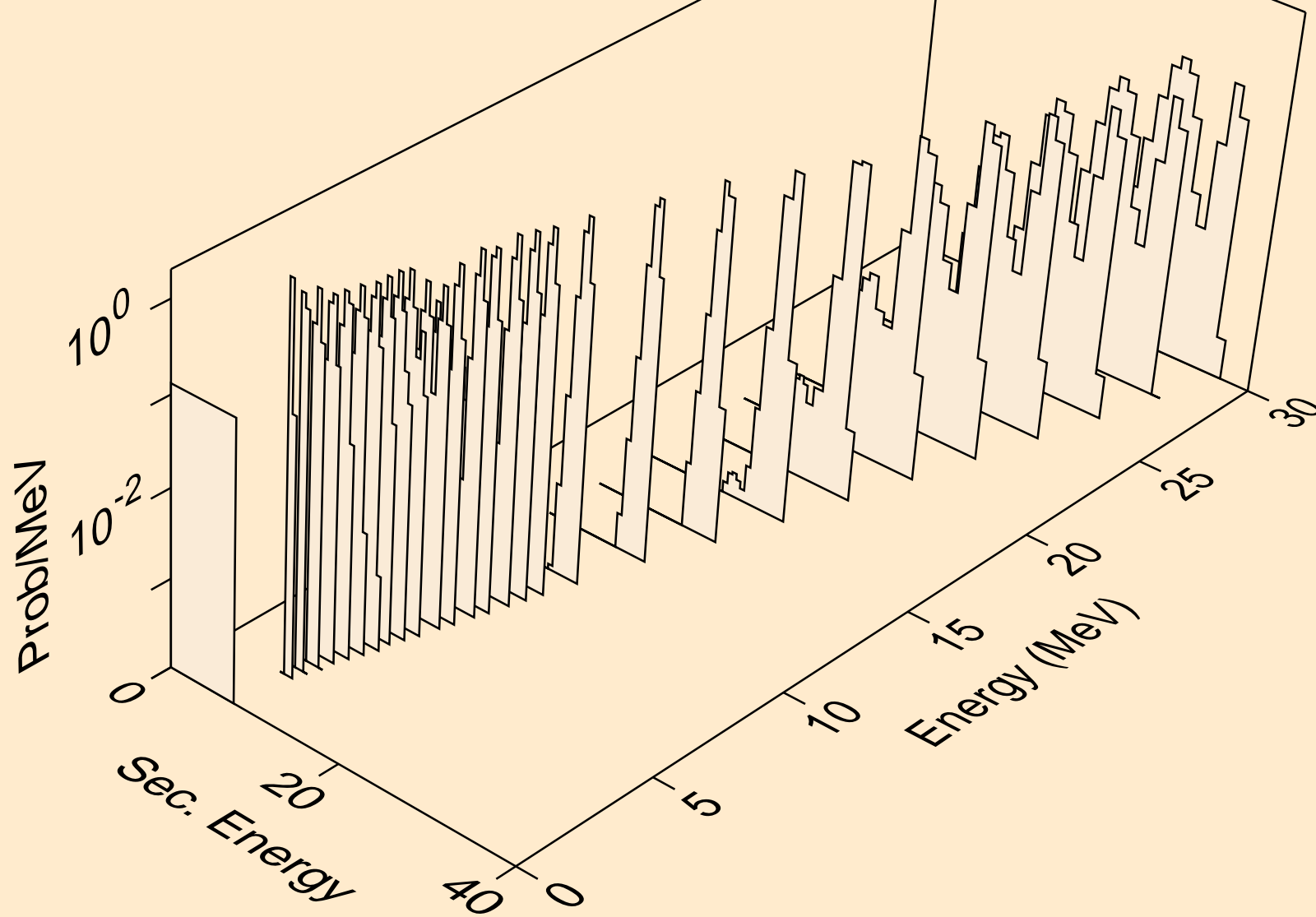

AM235 NEUTRON ACER TENDL-2024 LIBRARY; T=293.6K  
alphas from (n,2n)a

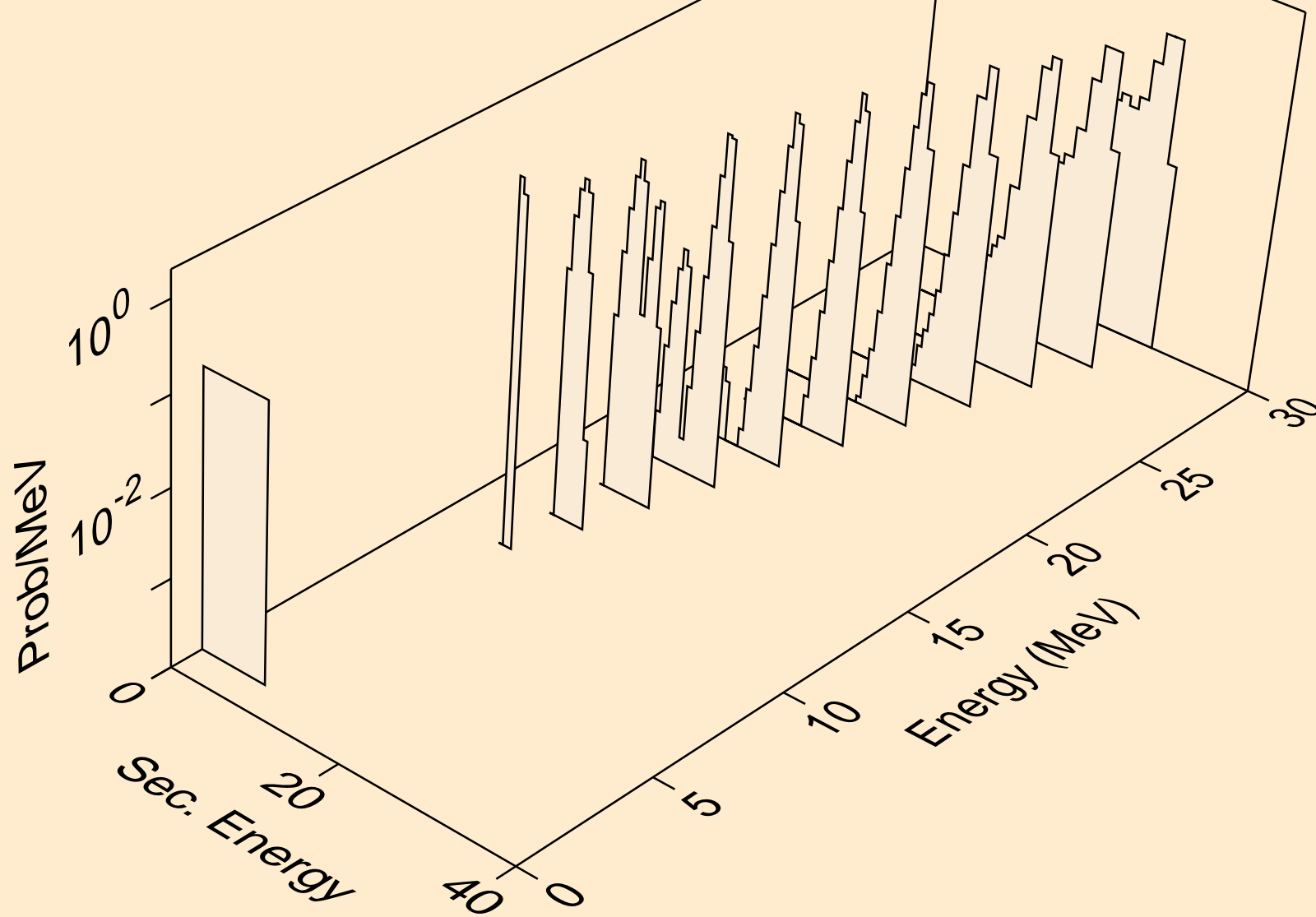

AM235 NEUTRON ACER TENDL-2024 LIBRARY; T=293.6K  
alphas from (n,3n)a

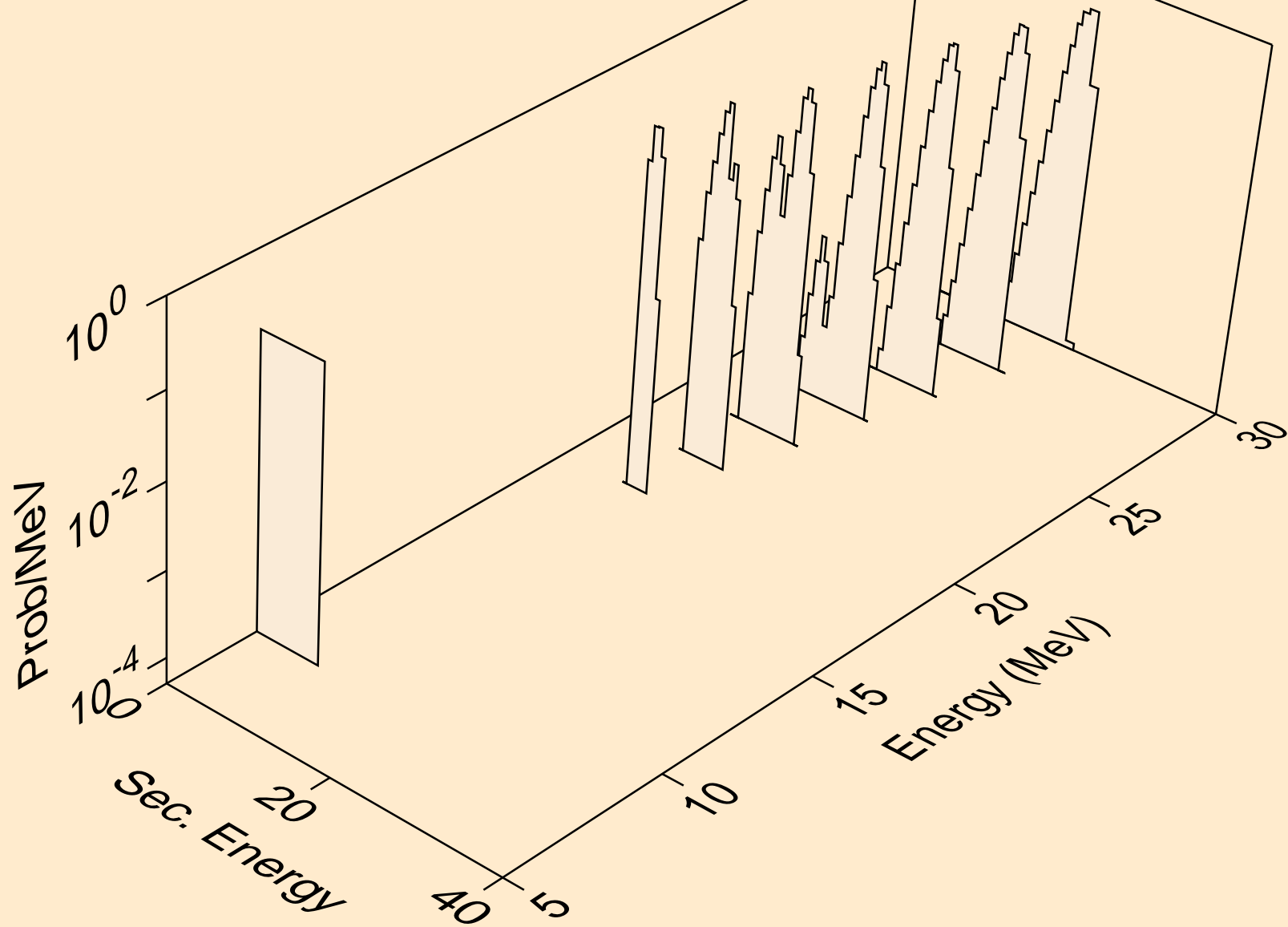

AM235 NEUTRON ACER TENDL-2024 LIBRARY; T=293.6K  
alphas from (n,n\*)2a

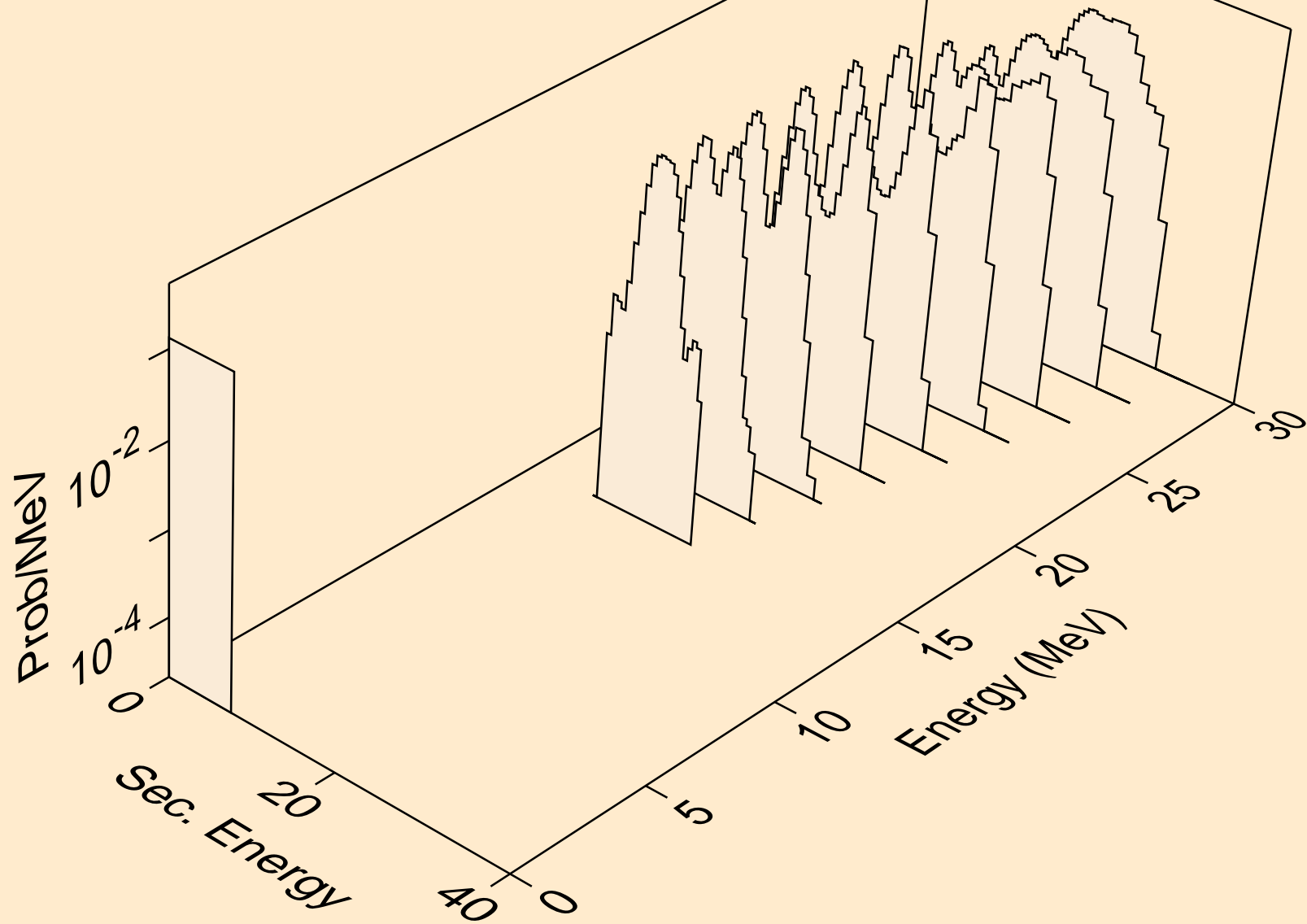

AM235 NEUTRON ACER TENDL-2024 LIBRARY; T=293.6K  
alphas from (n,npa)

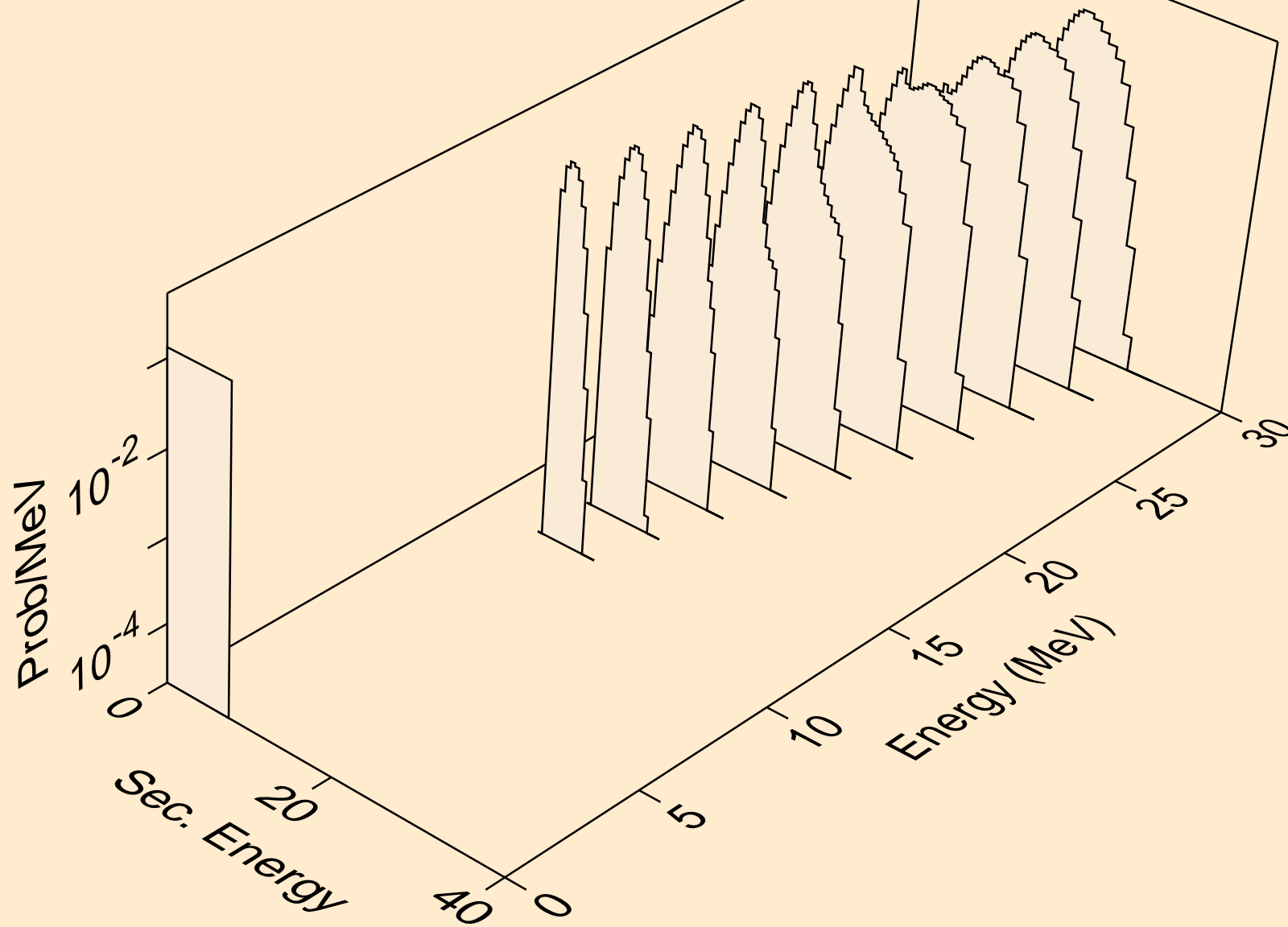

AM235 NEUTRON ACER TENDL-2024 LIBRARY; T=293.6K  
alphas from (n,a)

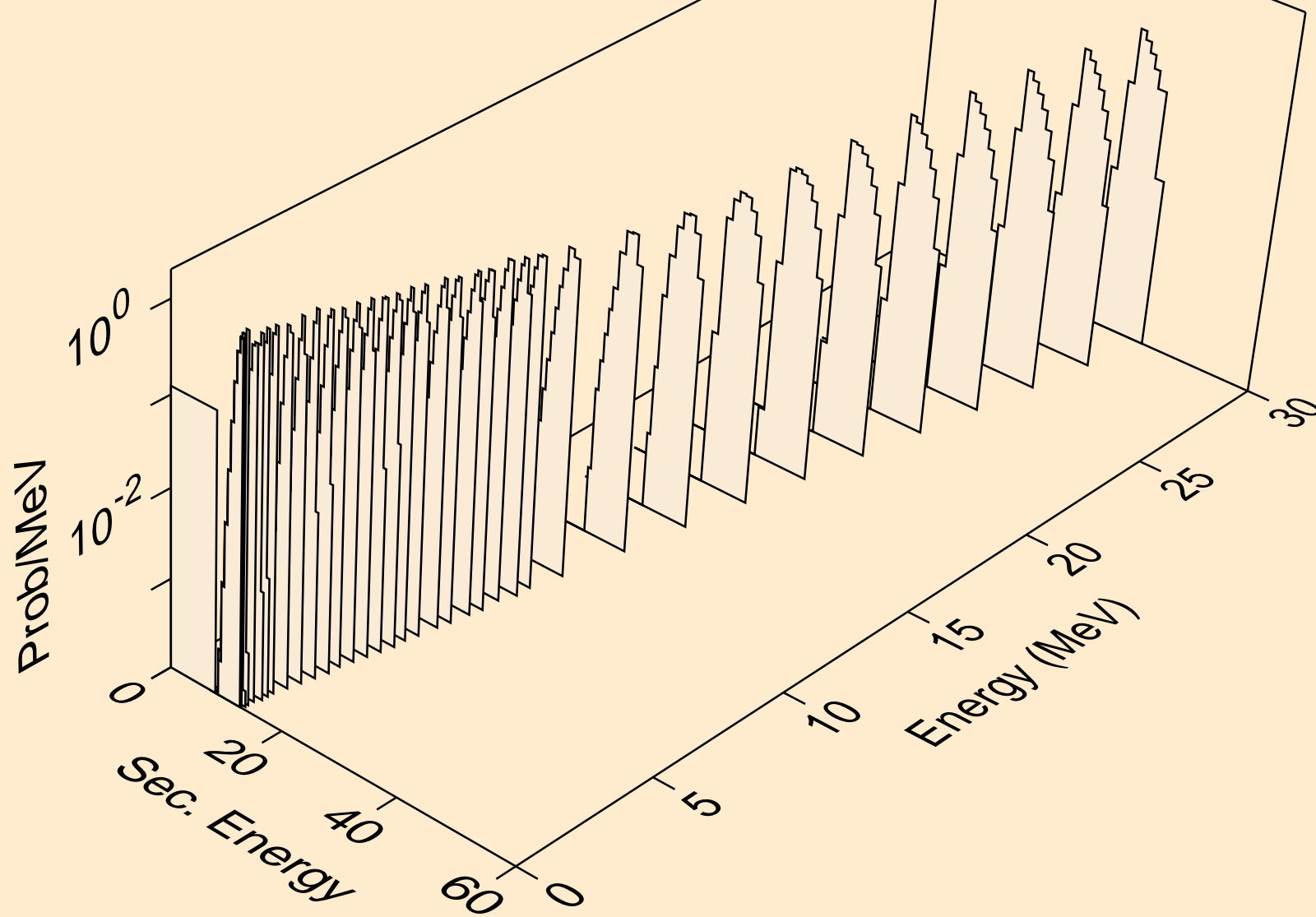

AM235 NEUTRON ACER TENDL-2024 LIBRARY; T=293.6K  
alphas from (n,2a)

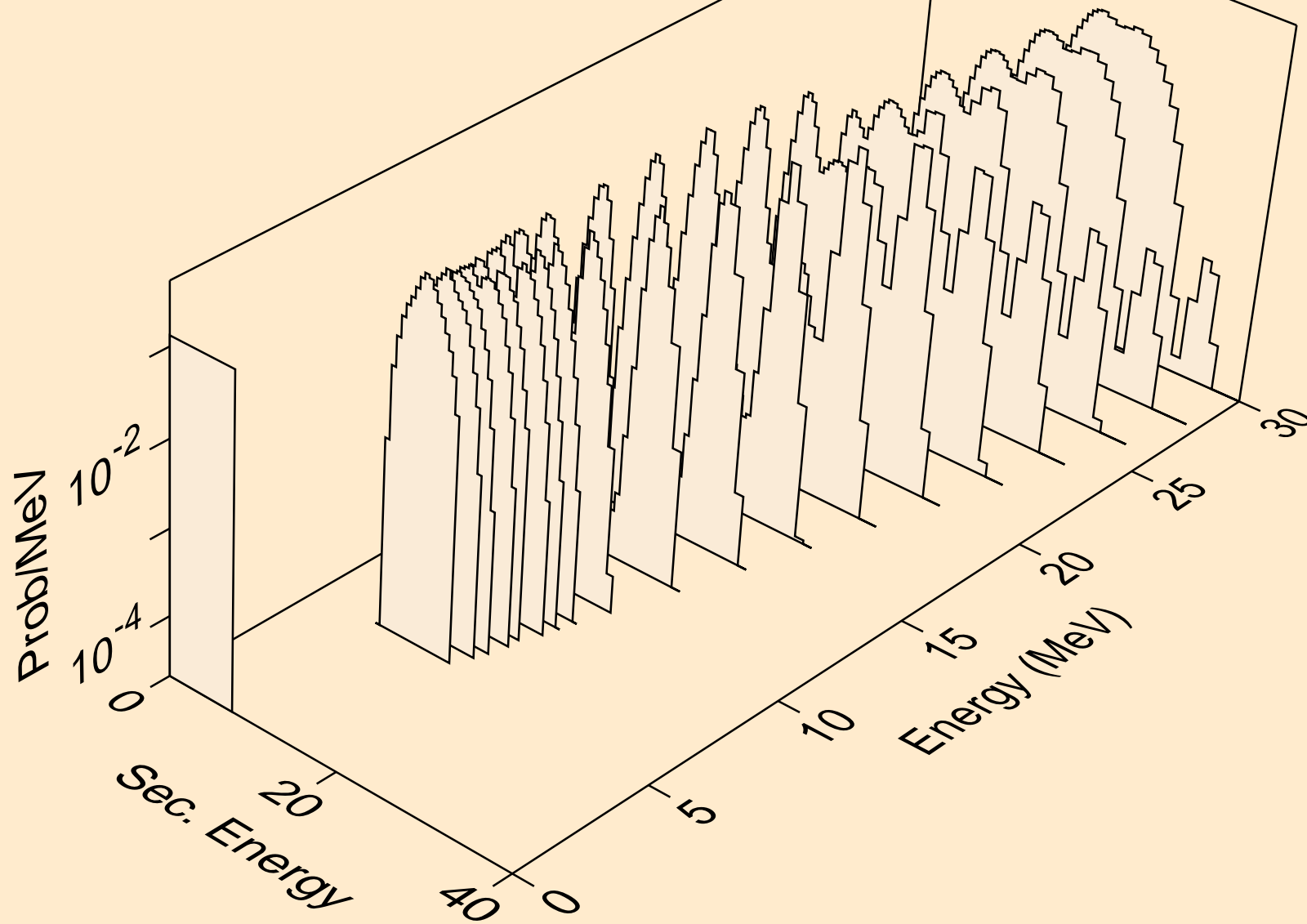

AM235 NEUTRON ACER TENDL-2024 LIBRARY; T=293.6K  
alphas from (n,pa)

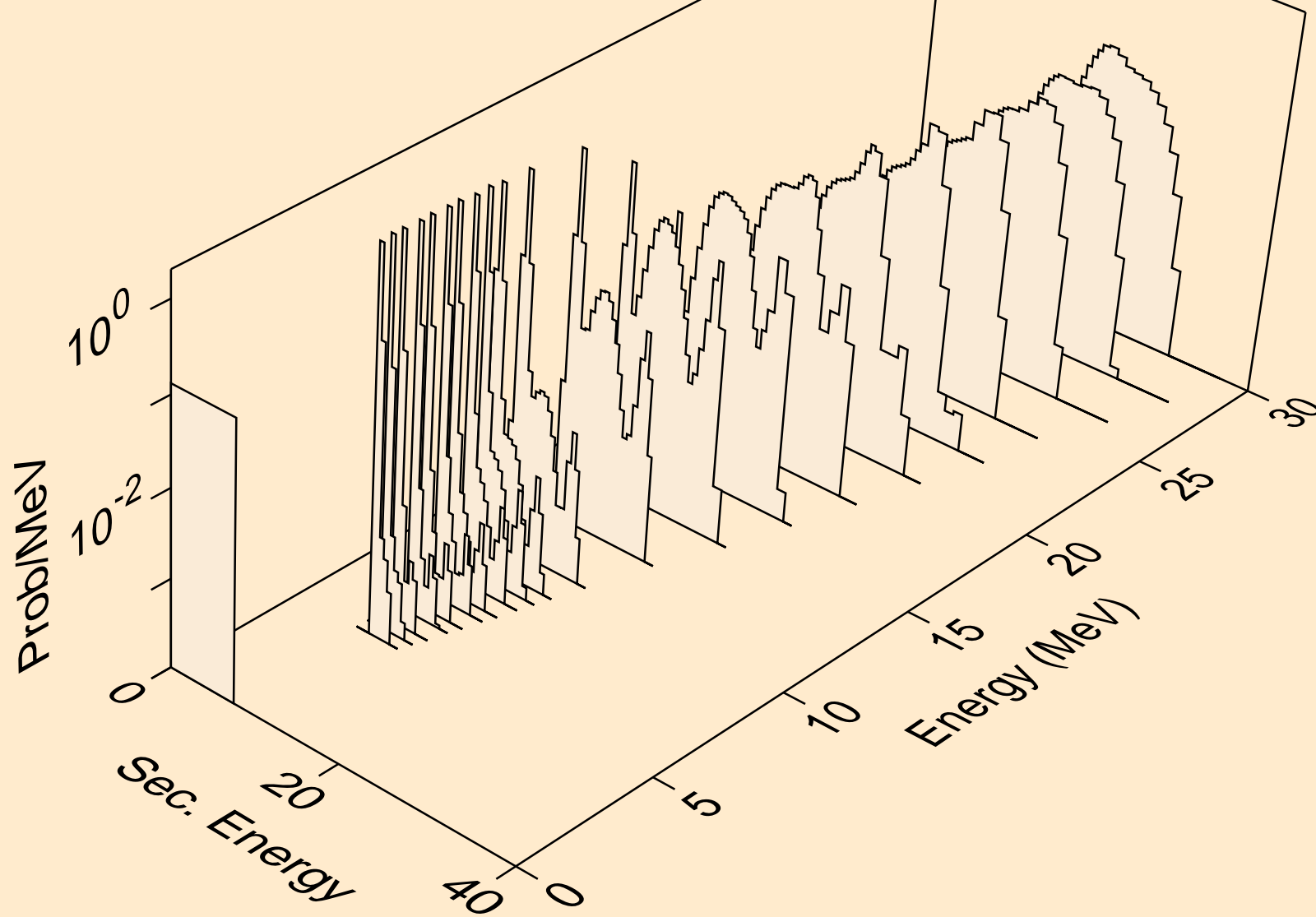

AM235 NEUTRON ACER TENDL-2024 LIBRARY; T=293.6K  
alphas from (n,da)

