

AM249 NEUTRON ACER TENDL-2024 LIBRARY; T=293.6K
Principal cross sections

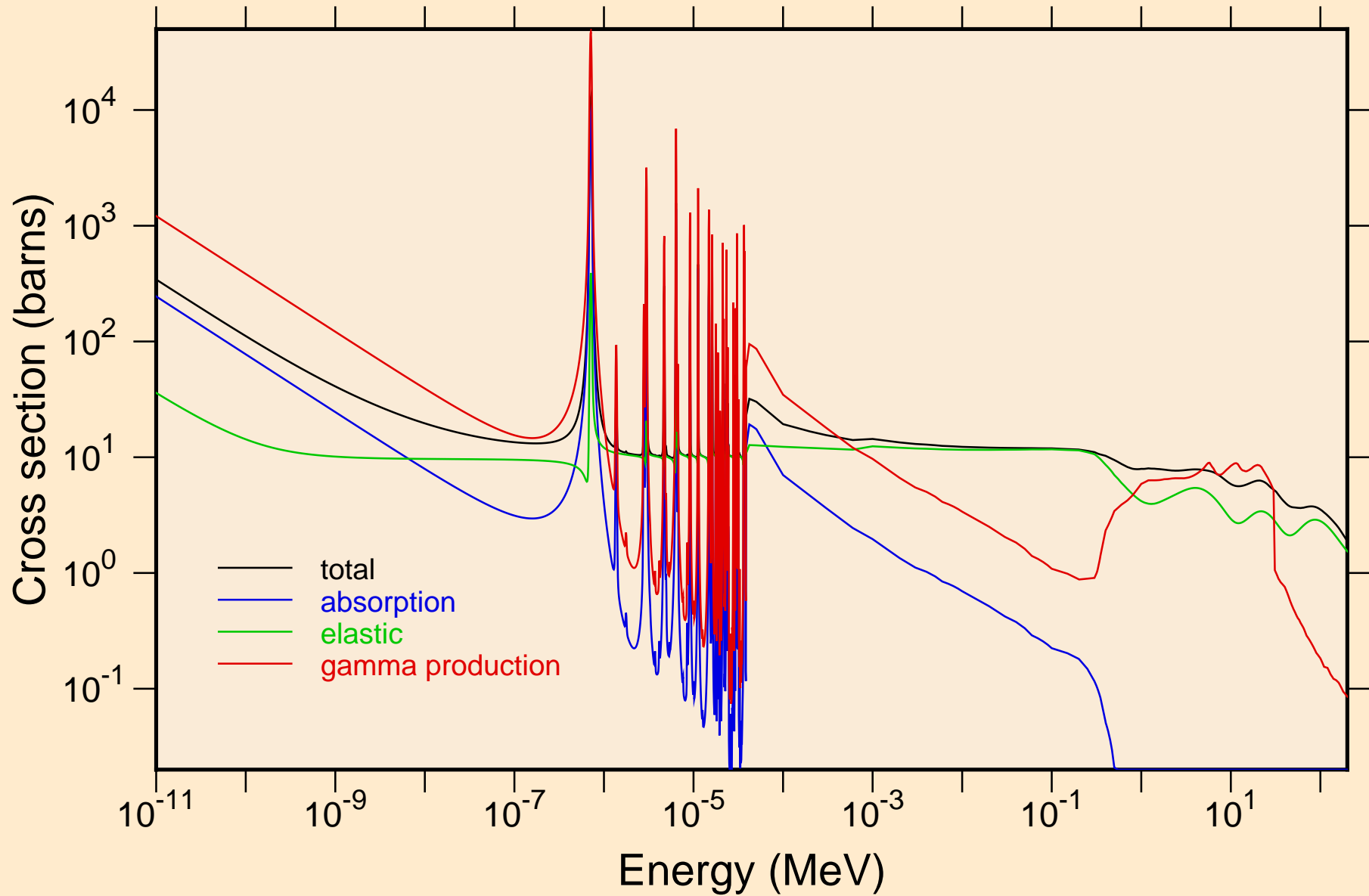

AM249 NEUTRON ACER TENDL-2024 LIBRARY; T=293.6K
resonance total cross section

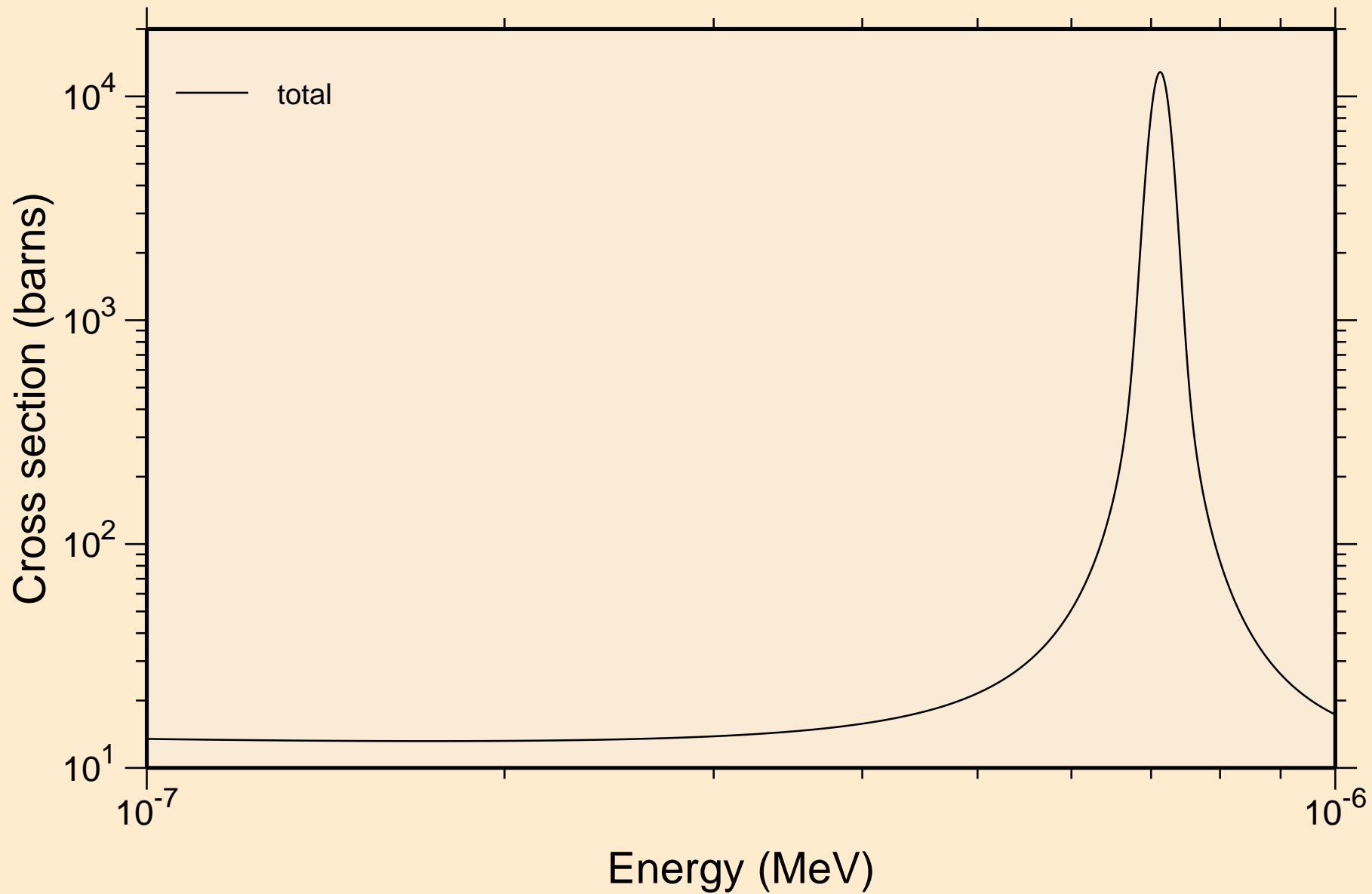

AM249 NEUTRON ACER TENDL-2024 LIBRARY; T=293.6K
resonance total cross section

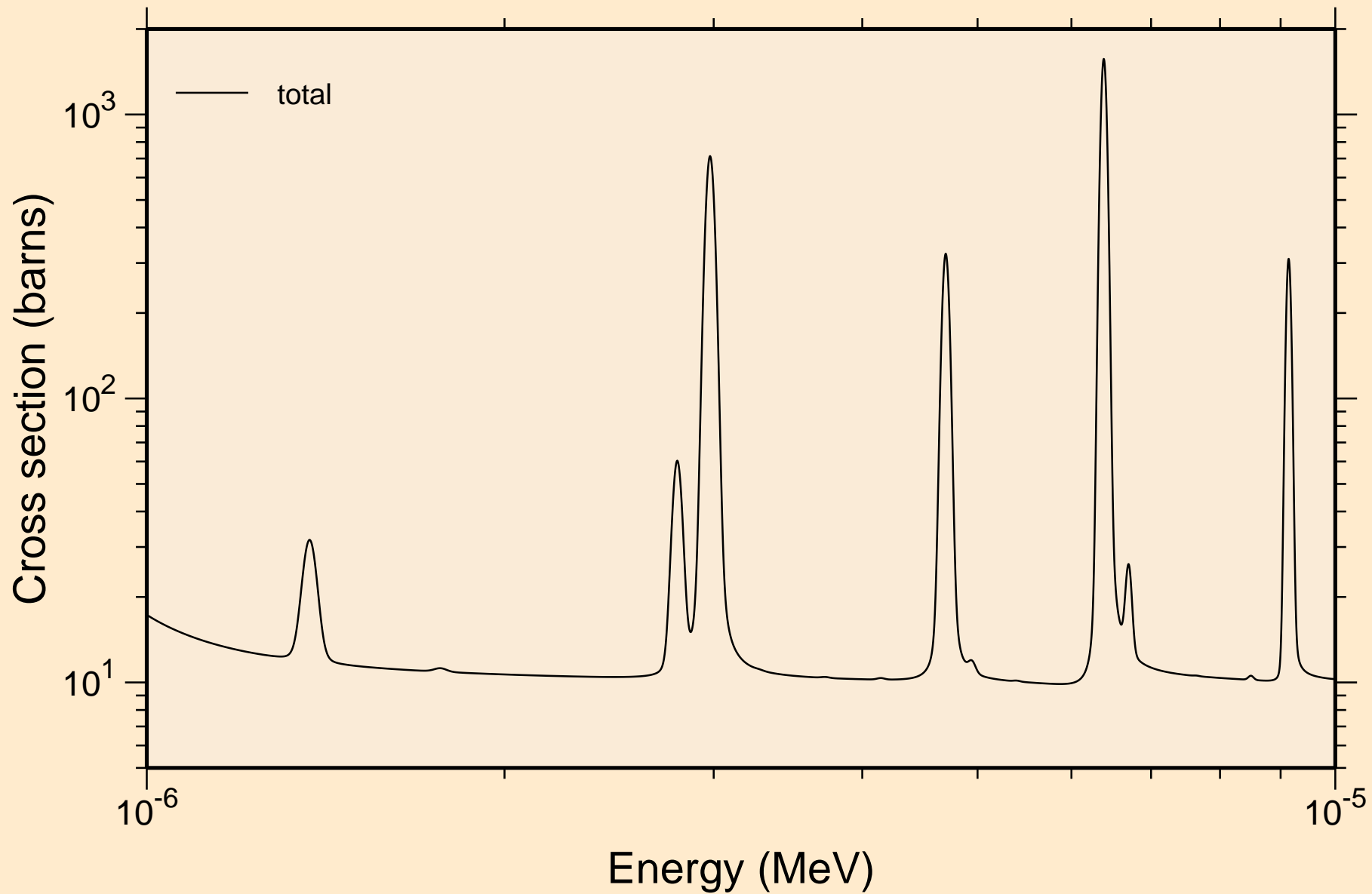

AM249 NEUTRON ACER TENDL-2024 LIBRARY; T=293.6K
resonance total cross section

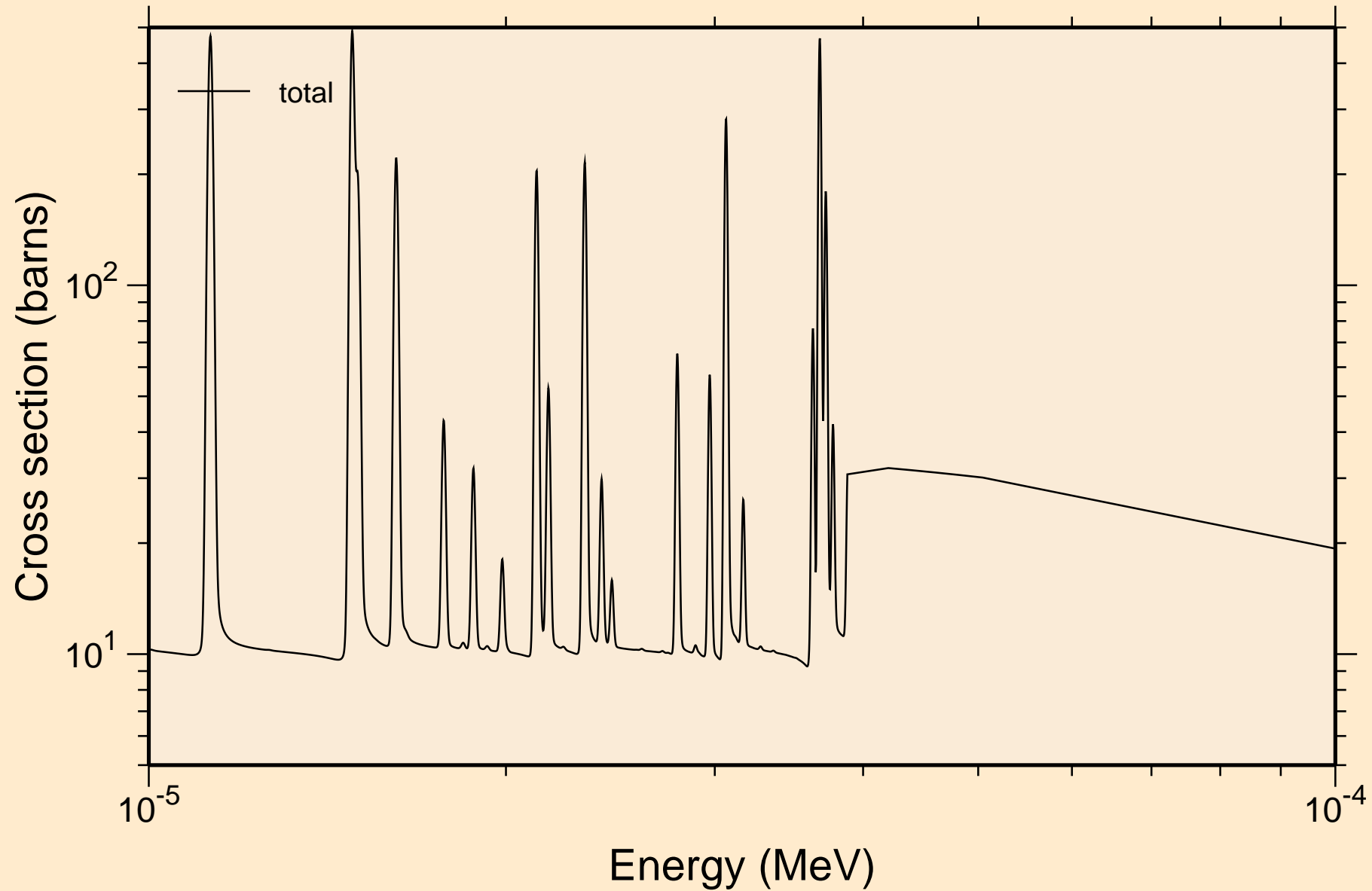

AM249 NEUTRON ACER TENDL-2024 LIBRARY; T=293.6K
resonance total cross section

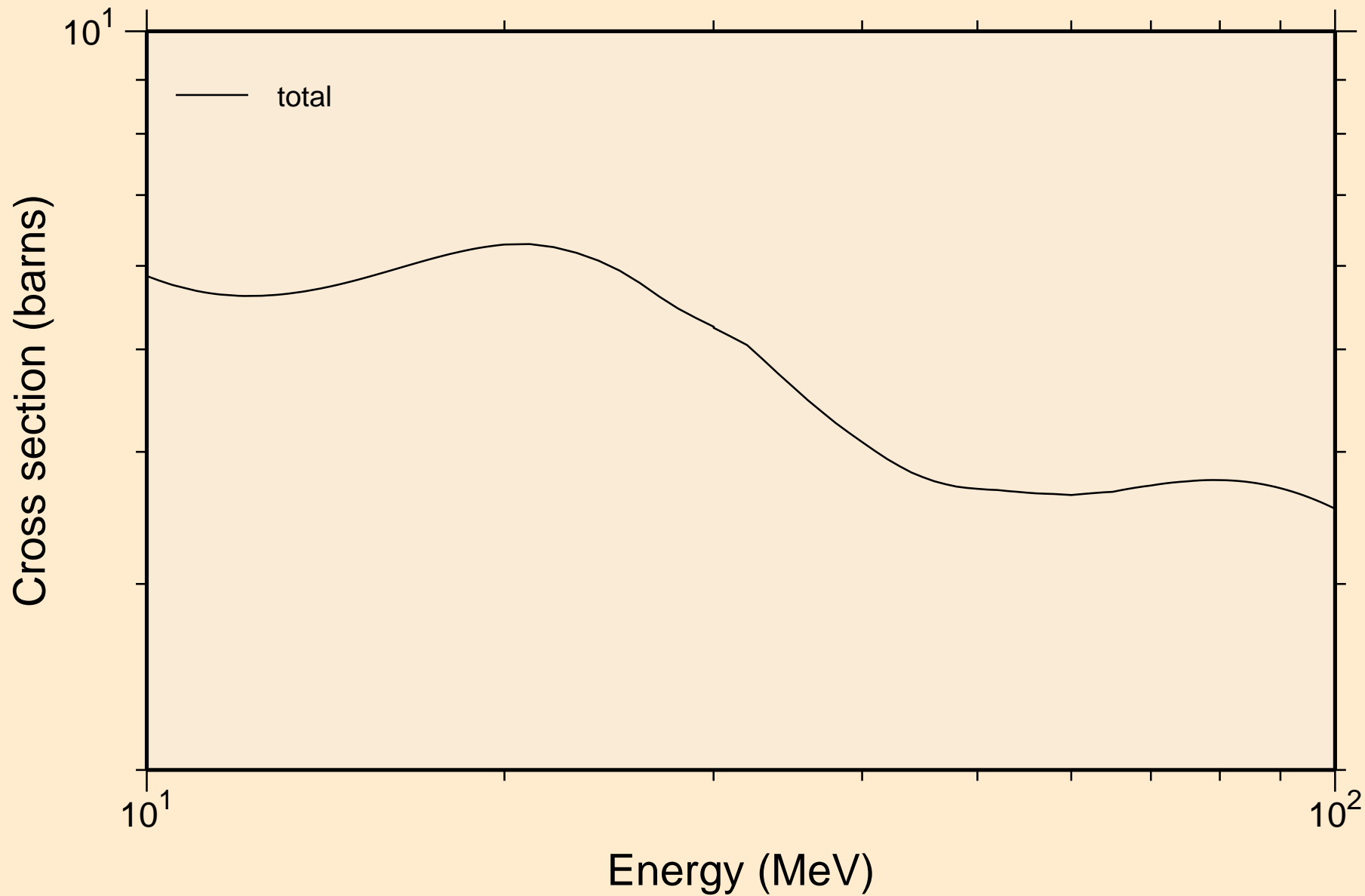

AM249 NEUTRON ACER TENDL-2024 LIBRARY; T=293.6K
resonance absorption cross sections

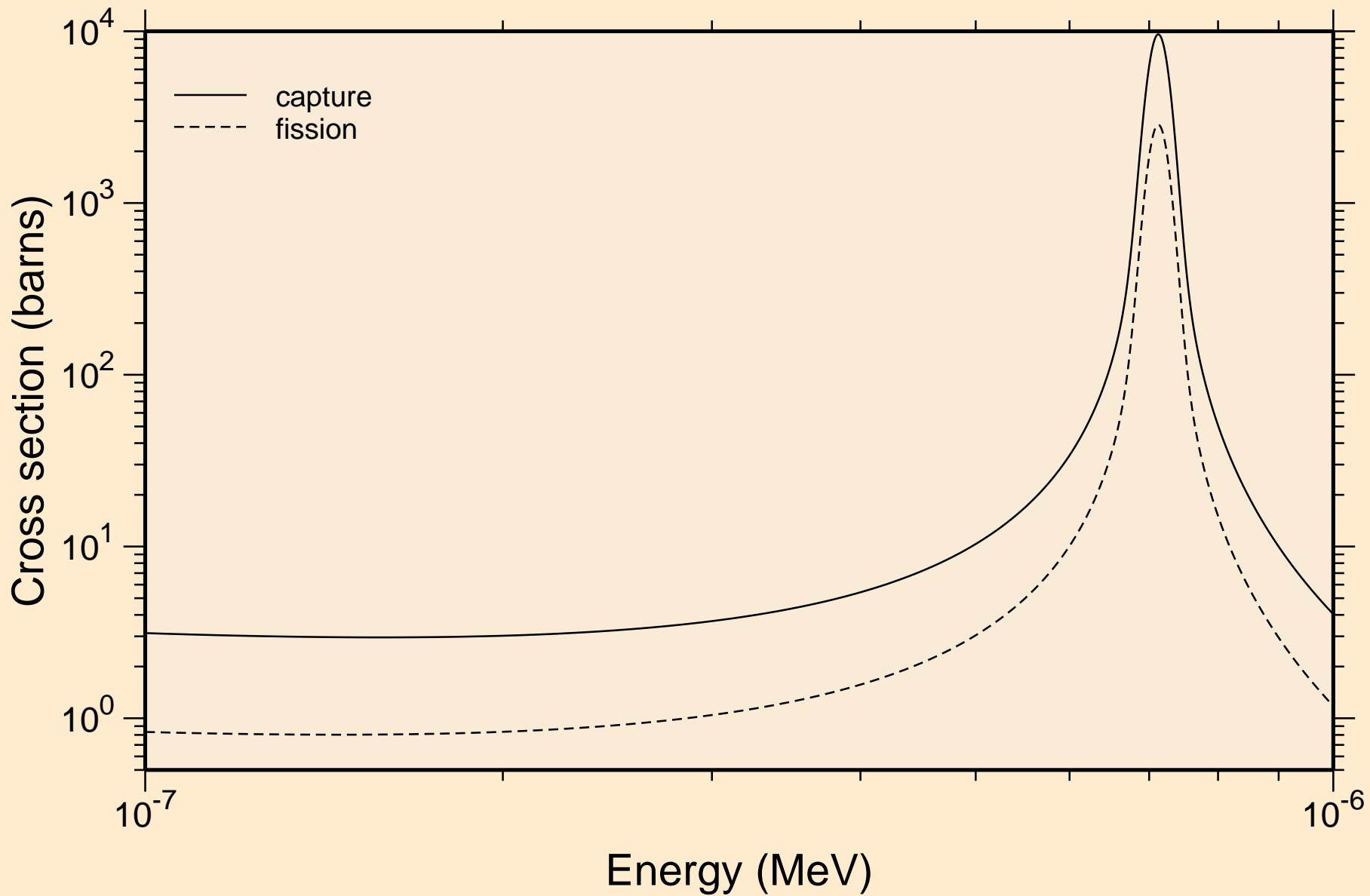

AM249 NEUTRON ACER TENDL-2024 LIBRARY; T=293.6K
resonance absorption cross sections

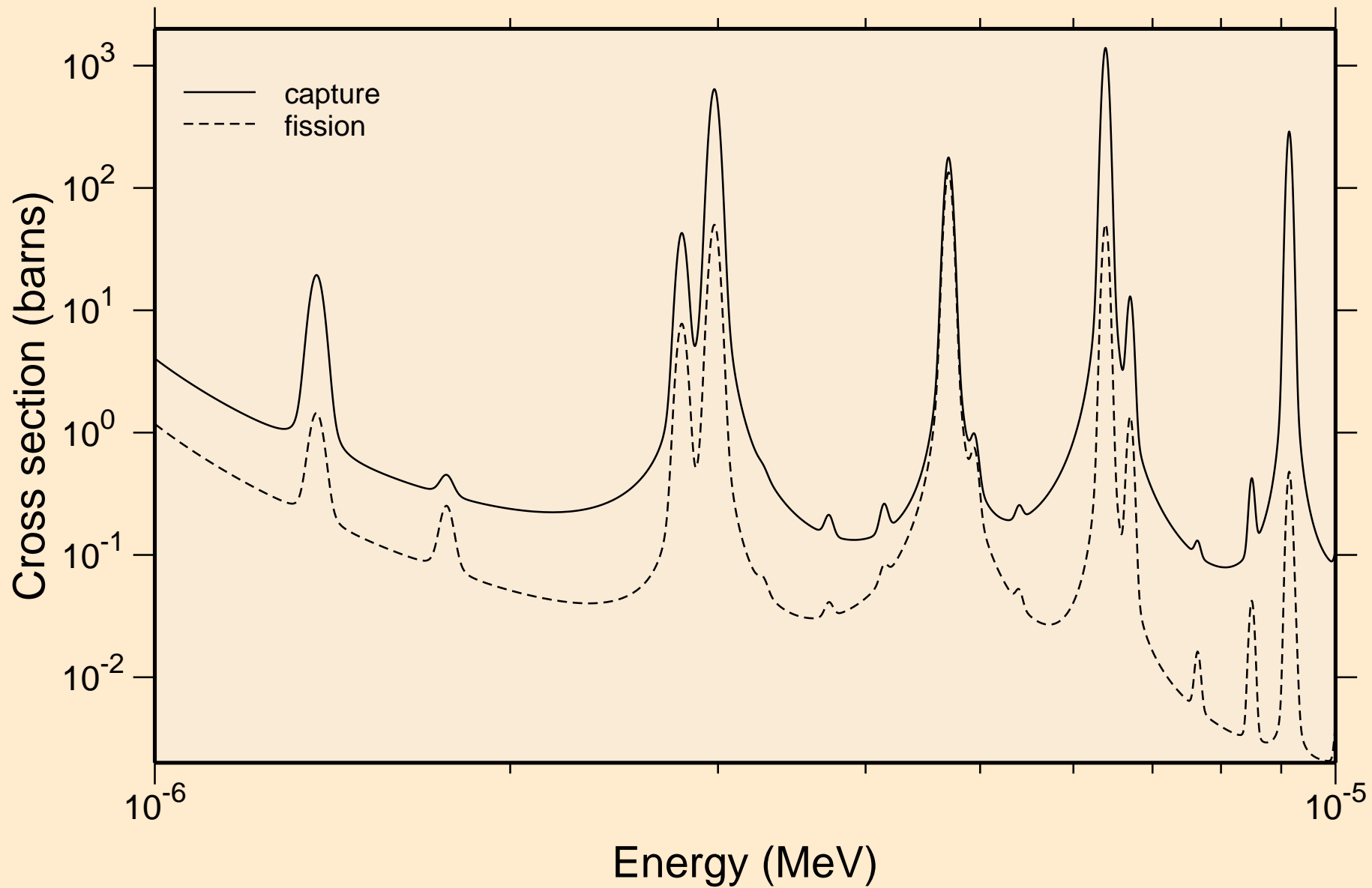

AM249 NEUTRON ACER TENDL-2024 LIBRARY; T=293.6K
resonance absorption cross sections

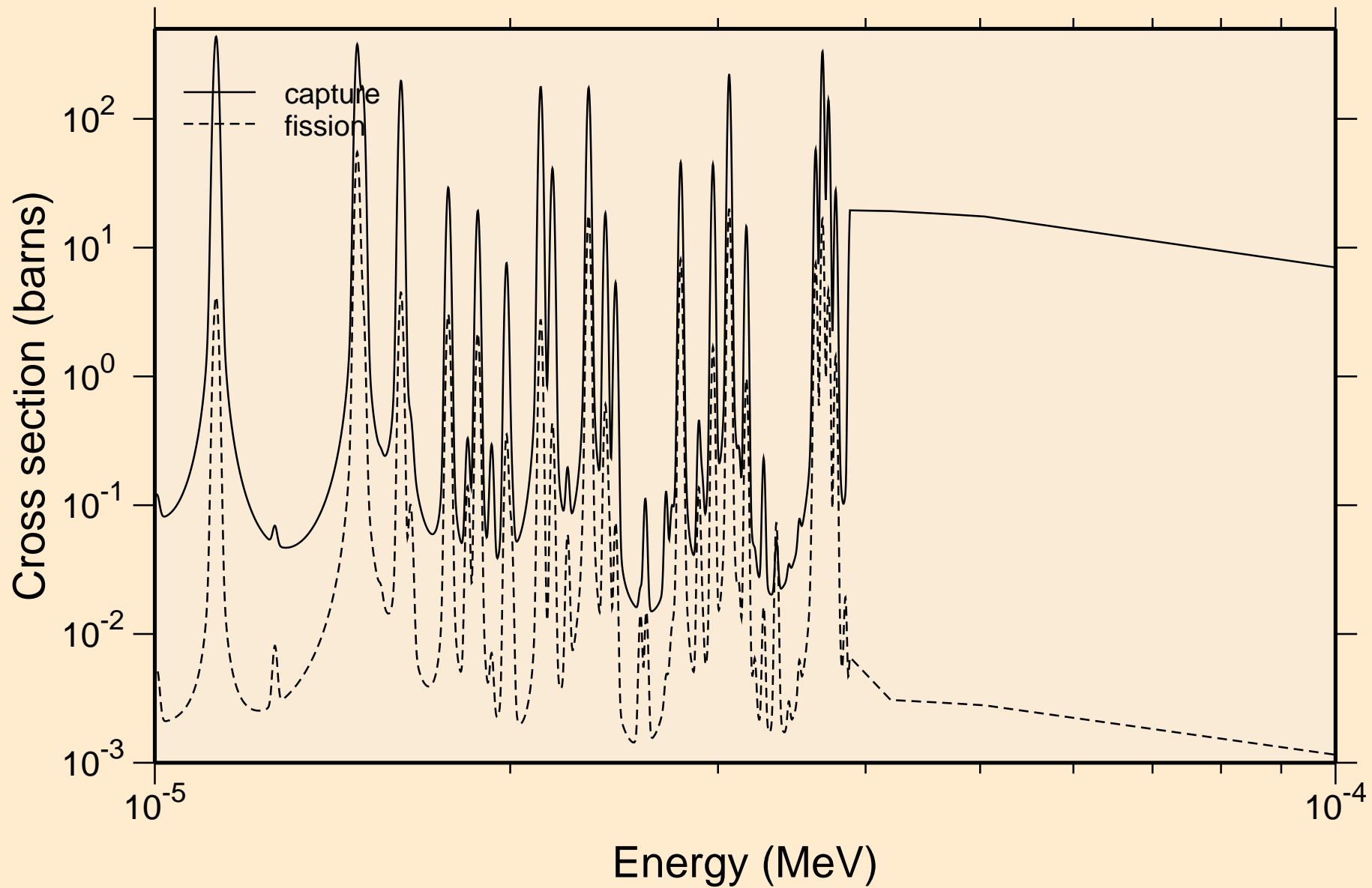

AM249 NEUTRON ACER TENDL-2024 LIBRARY; T=293.6K
resonance absorption cross sections

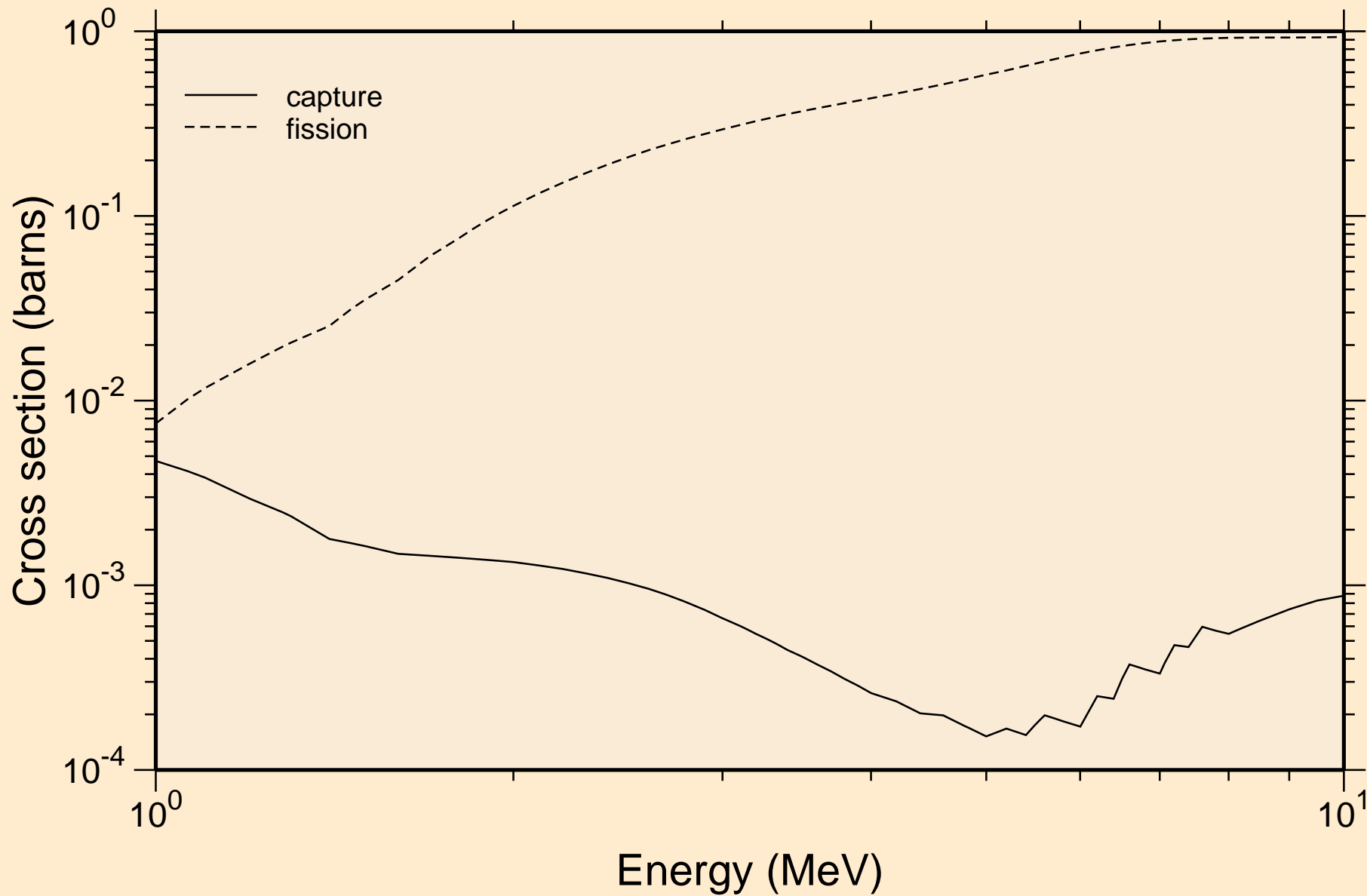

AM249 NEUTRON ACER TENDL-2024 LIBRARY; T=293.6K
Heating

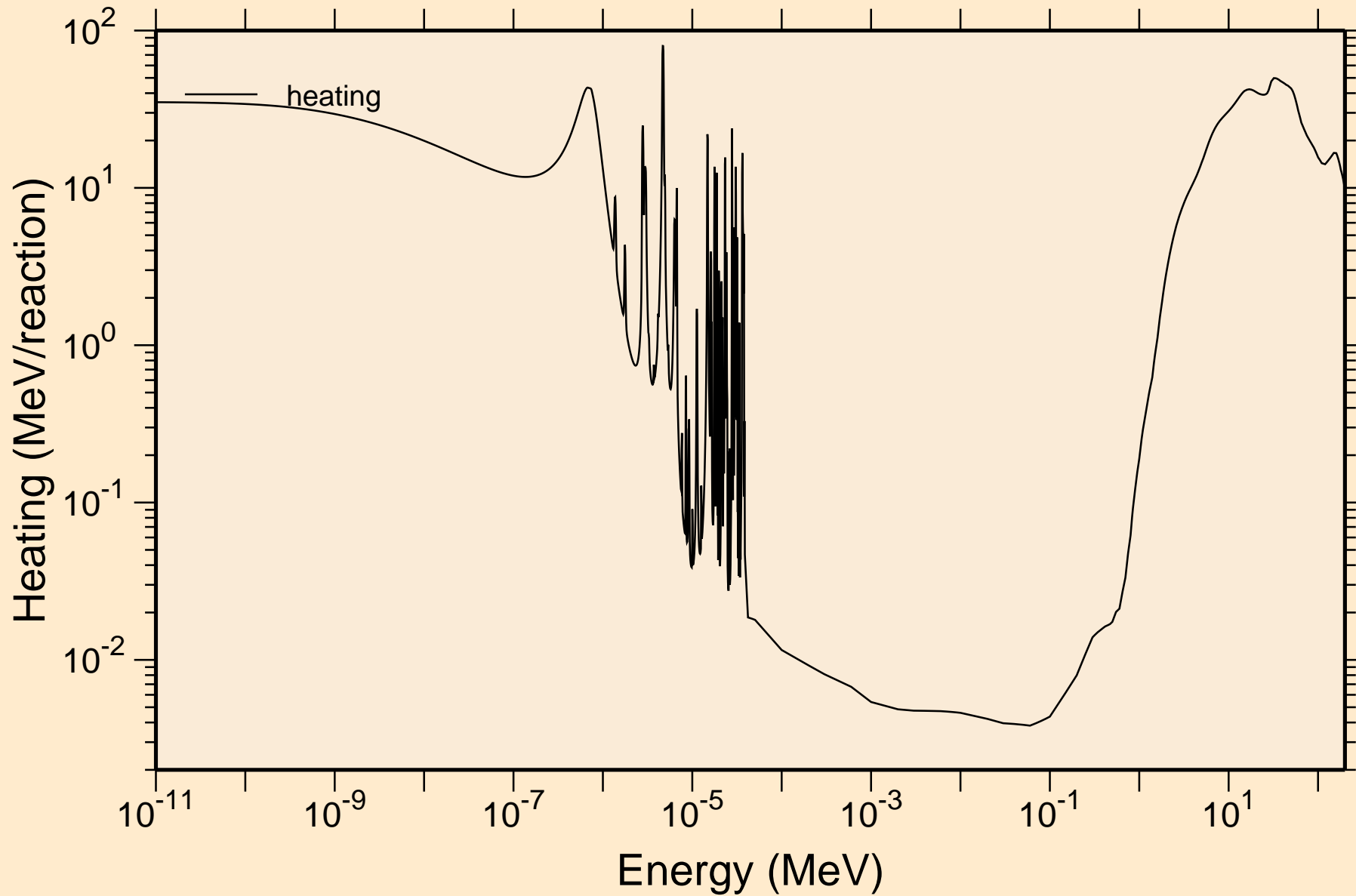

AM249 NEUTRON ACER TENDL-2024 LIBRARY; T=293.6K
Damage

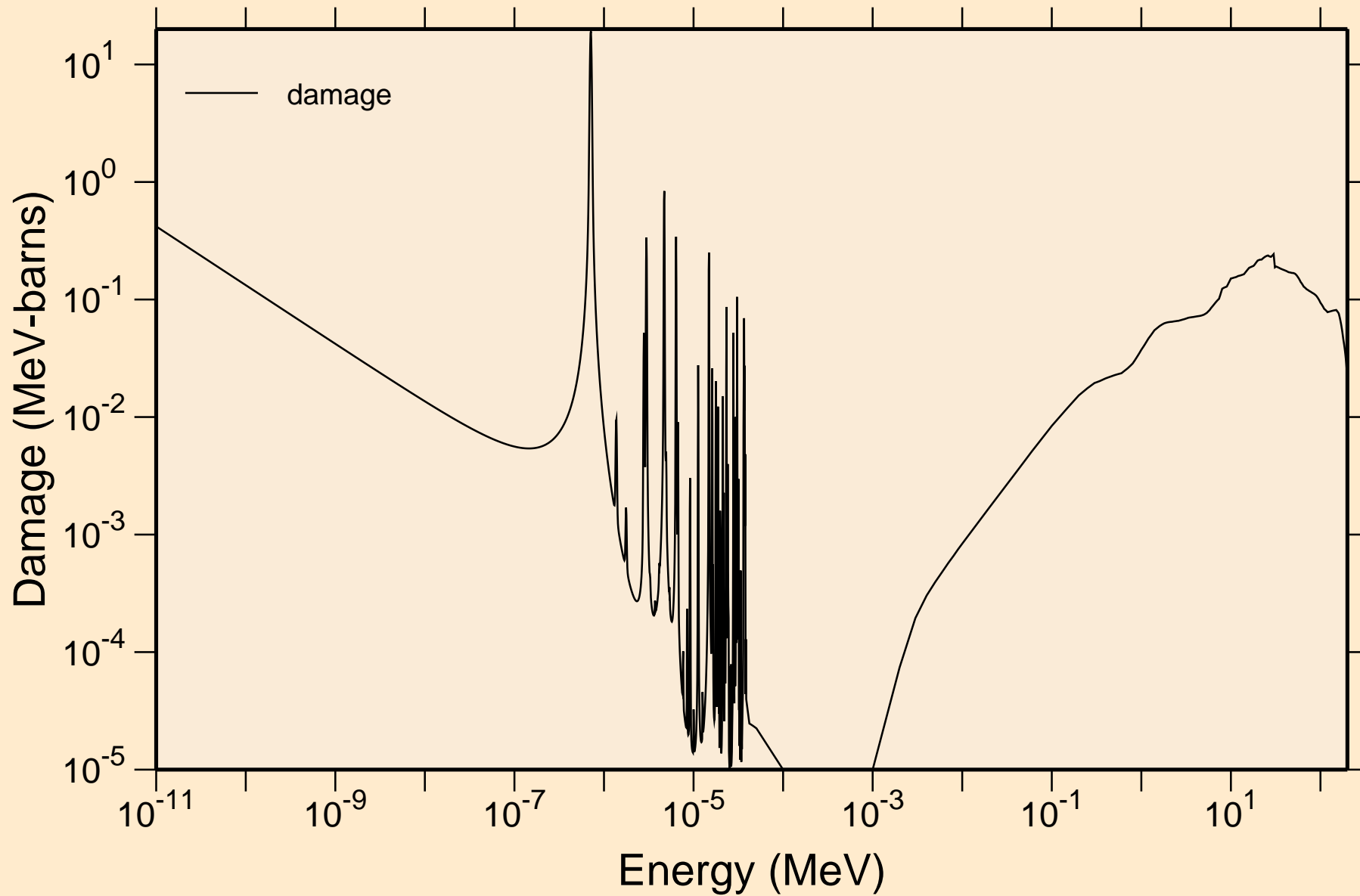

AM249 NEUTRON ACER TENDL-2024 LIBRARY; T=293.6K
Non-threshold reactions

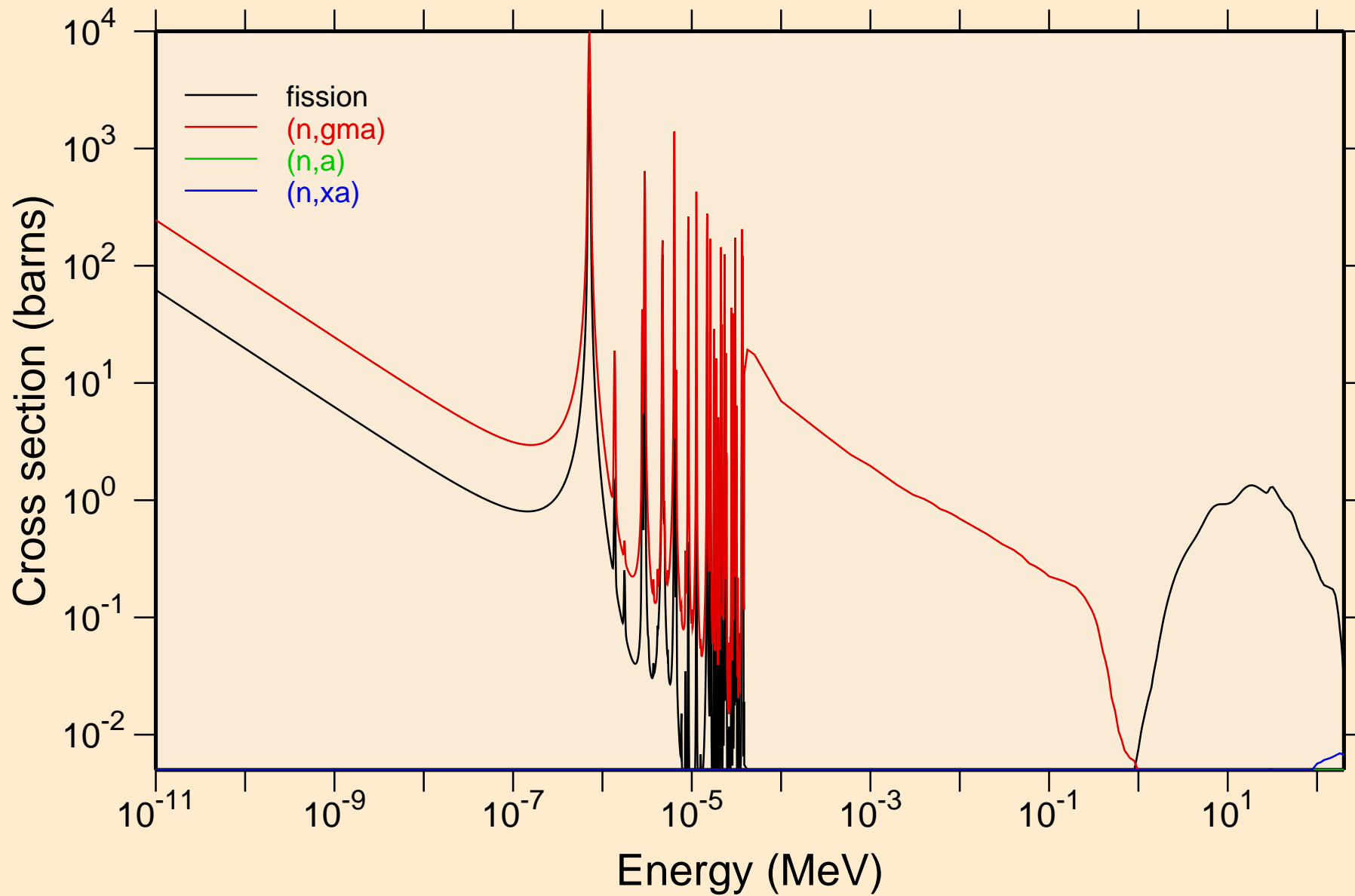

AM249 NEUTRON ACER TENDL-2024 LIBRARY; T=293.6K
Principal cross sections

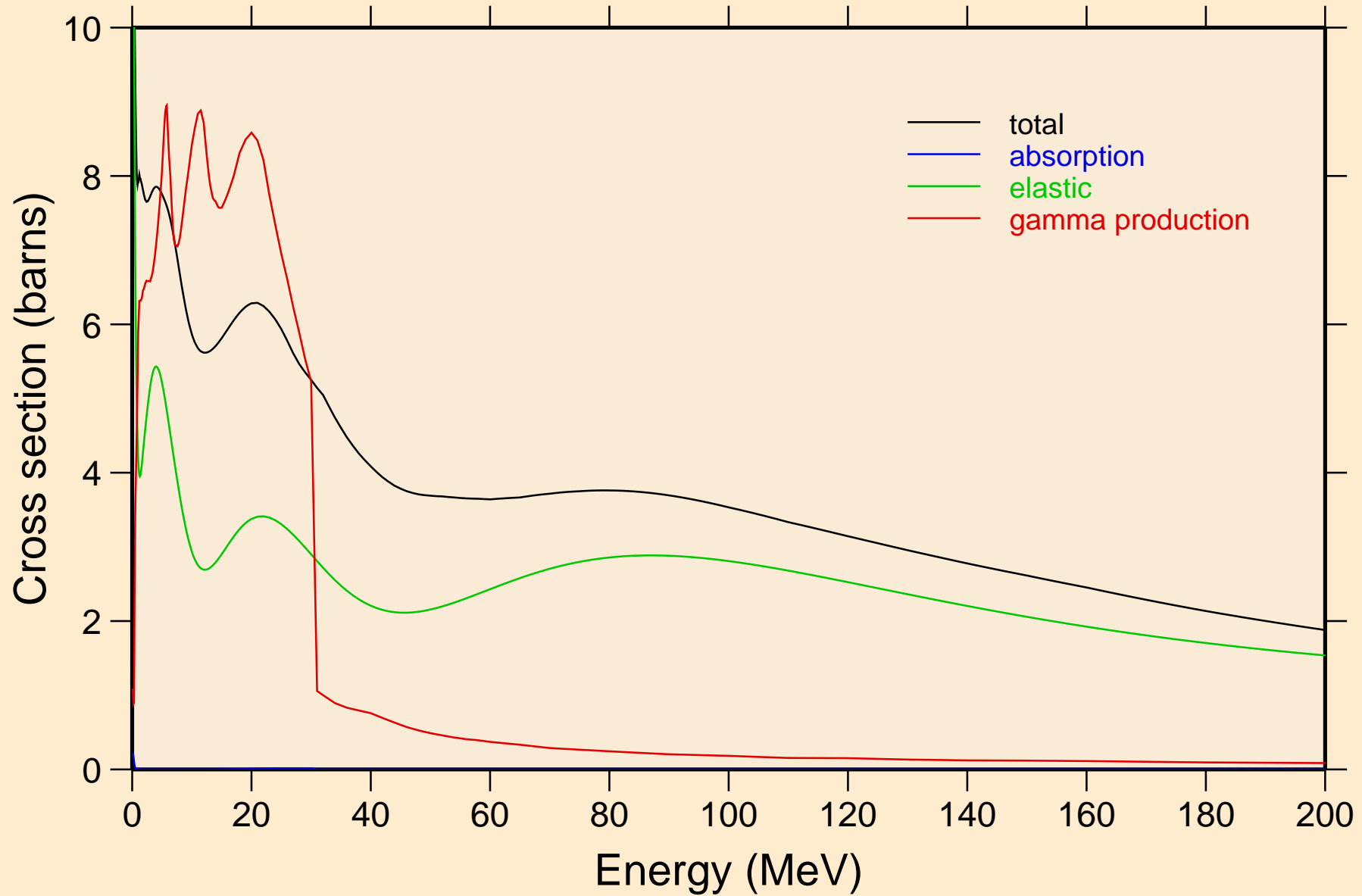

AM249 NEUTRON ACER TENDL-2024 LIBRARY; T=293.6K

Heating

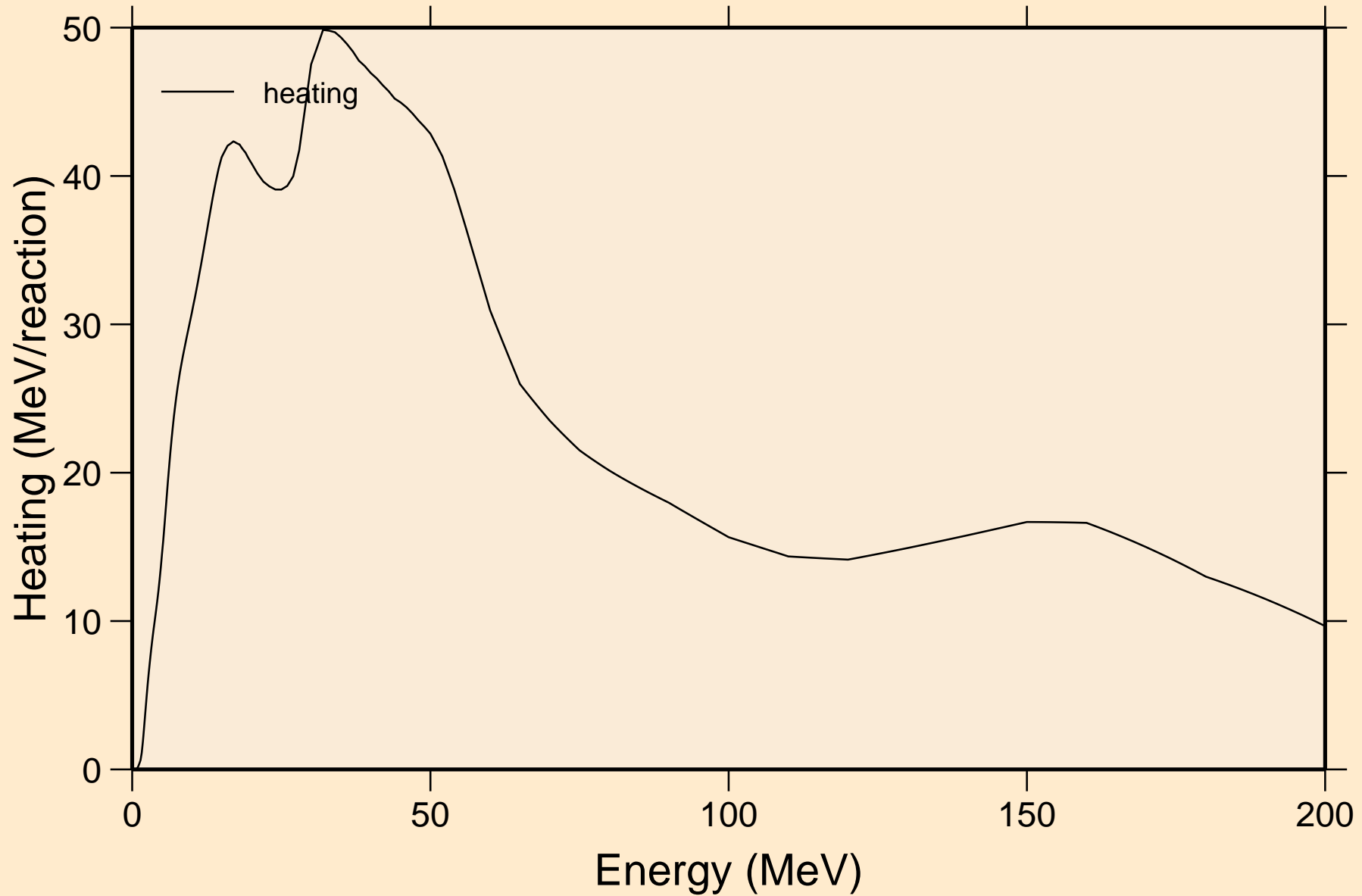

AM249 NEUTRON ACER TENDL-2024 LIBRARY; T=293.6K
Damage

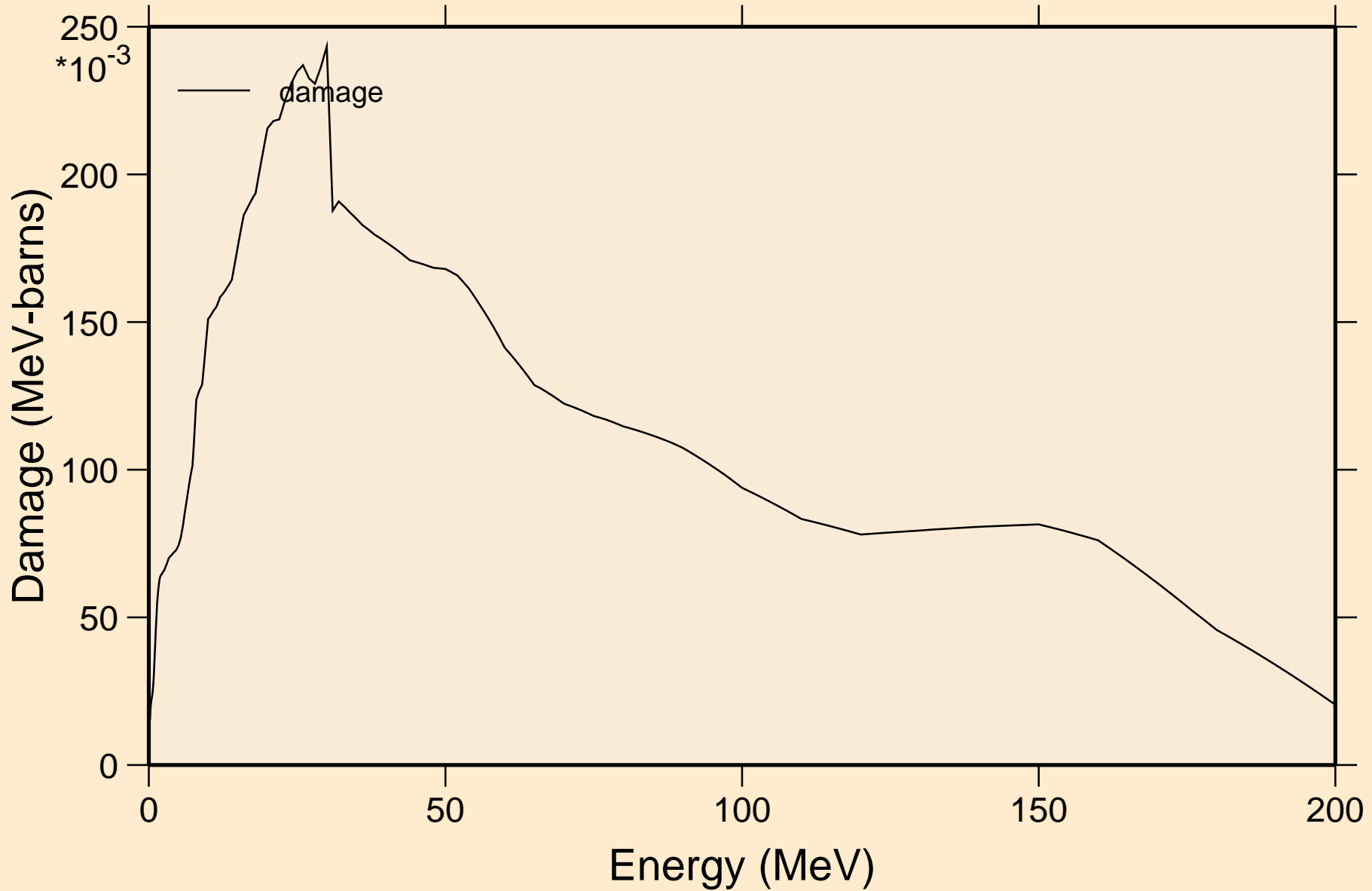

AM249 NEUTRON ACER TENDL-2024 LIBRARY; T=293.6K
Non-threshold reactions

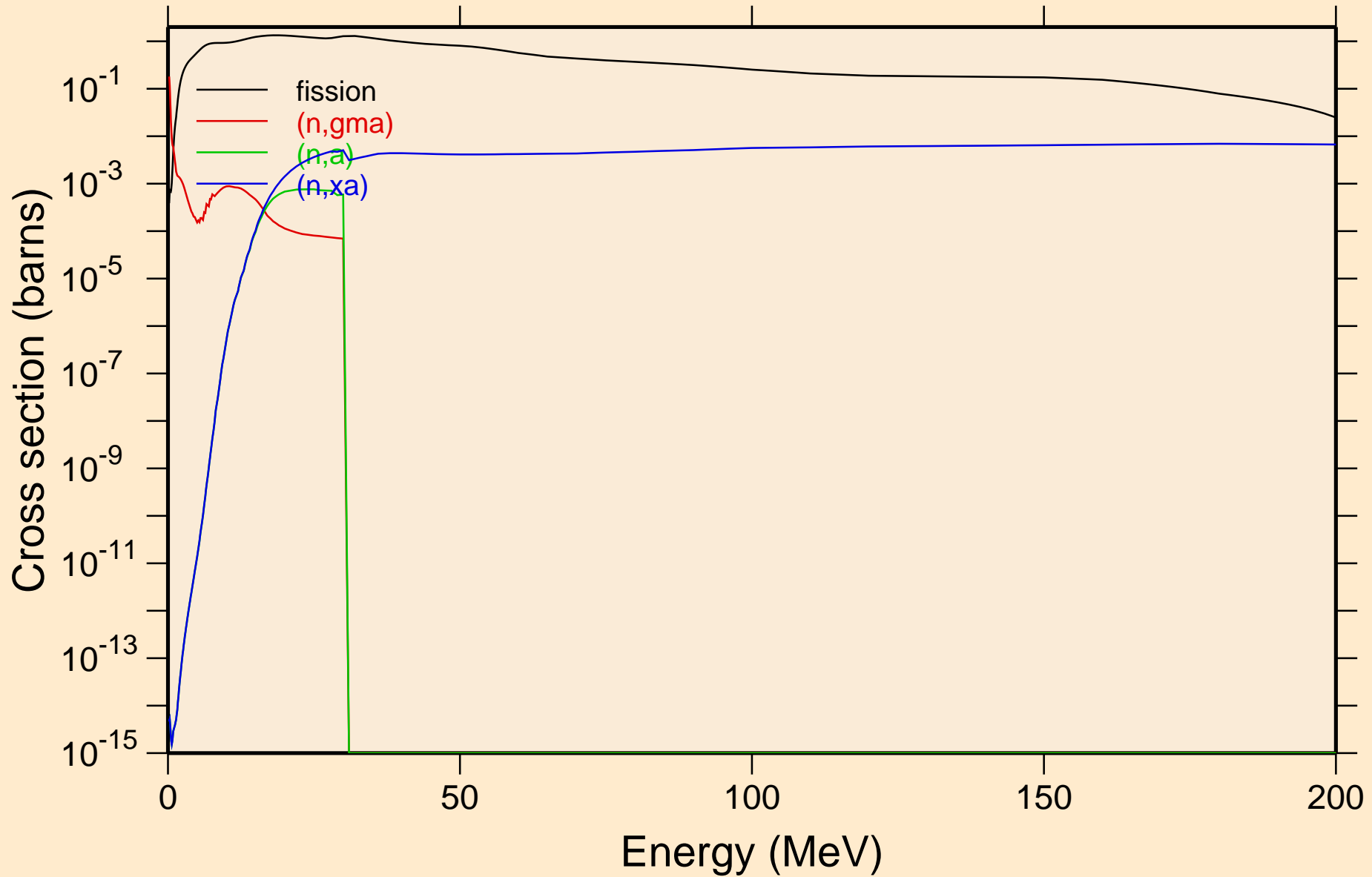

AM249 NEUTRON ACER TENDL-2024 LIBRARY; T=293.6K
Inelastic levels

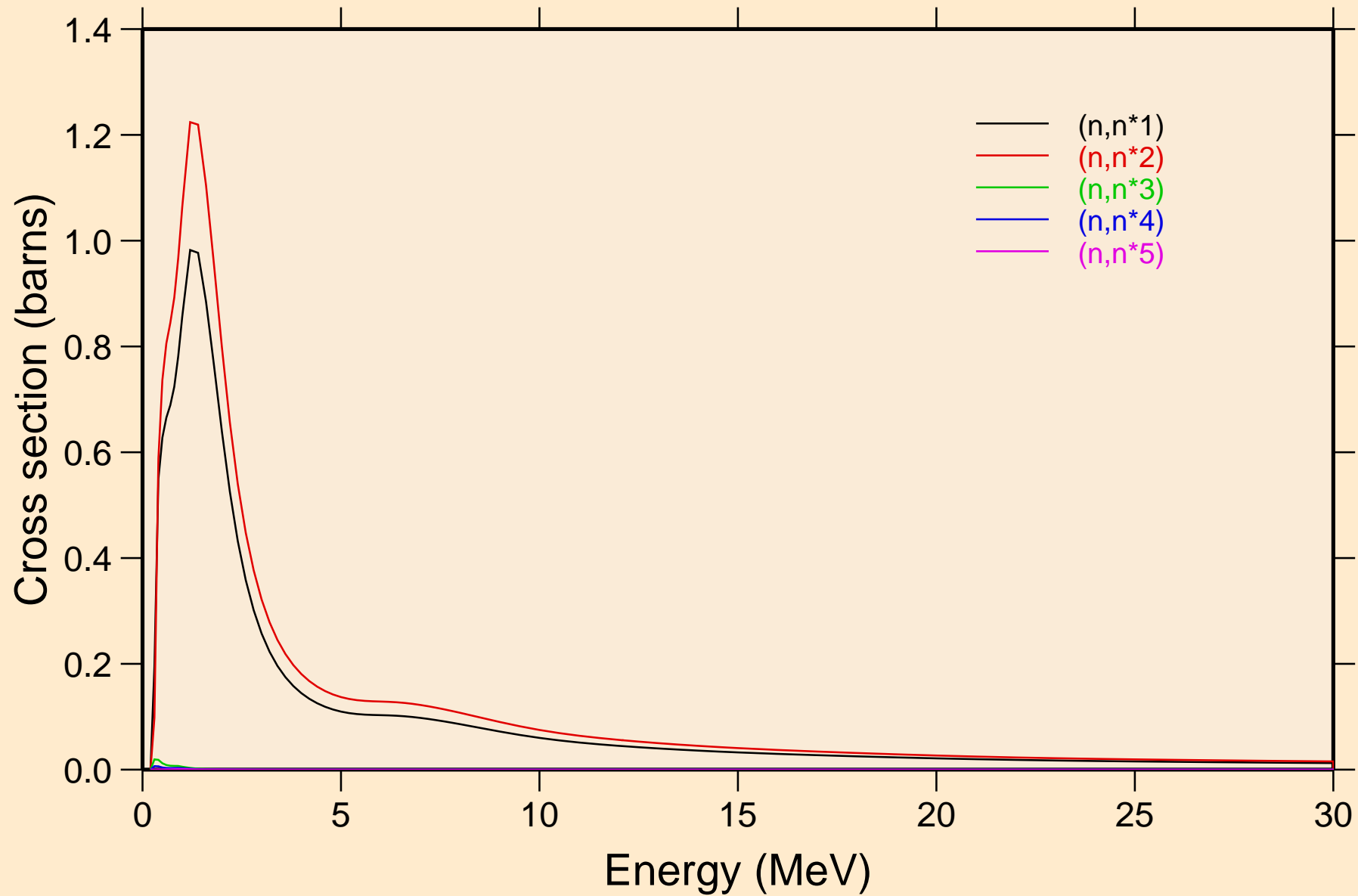

AM249 NEUTRON ACER TENDL-2024 LIBRARY; T=293.6K
Inelastic levels

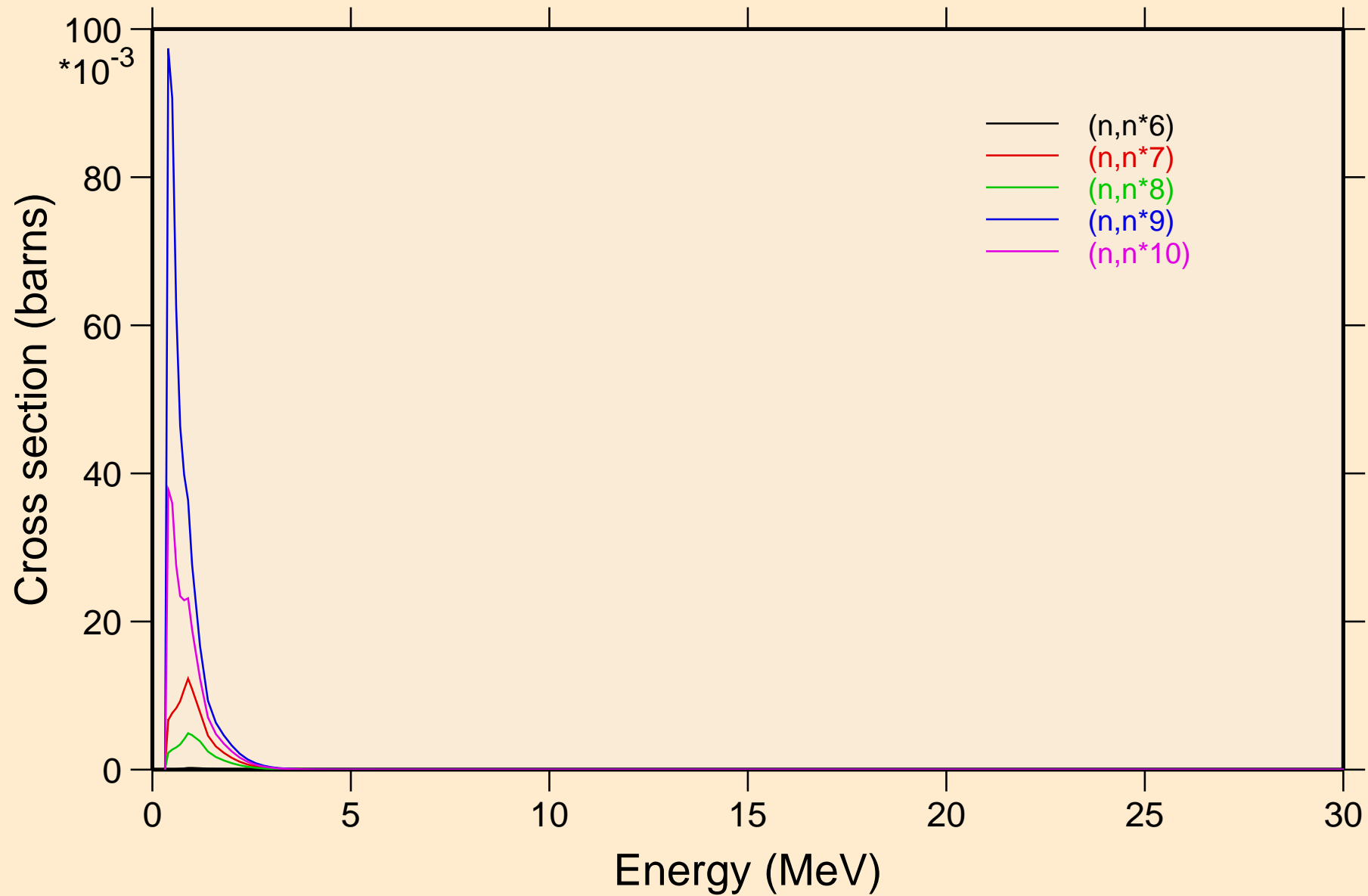

AM249 NEUTRON ACER TENDL-2024 LIBRARY; T=293.6K
Inelastic levels

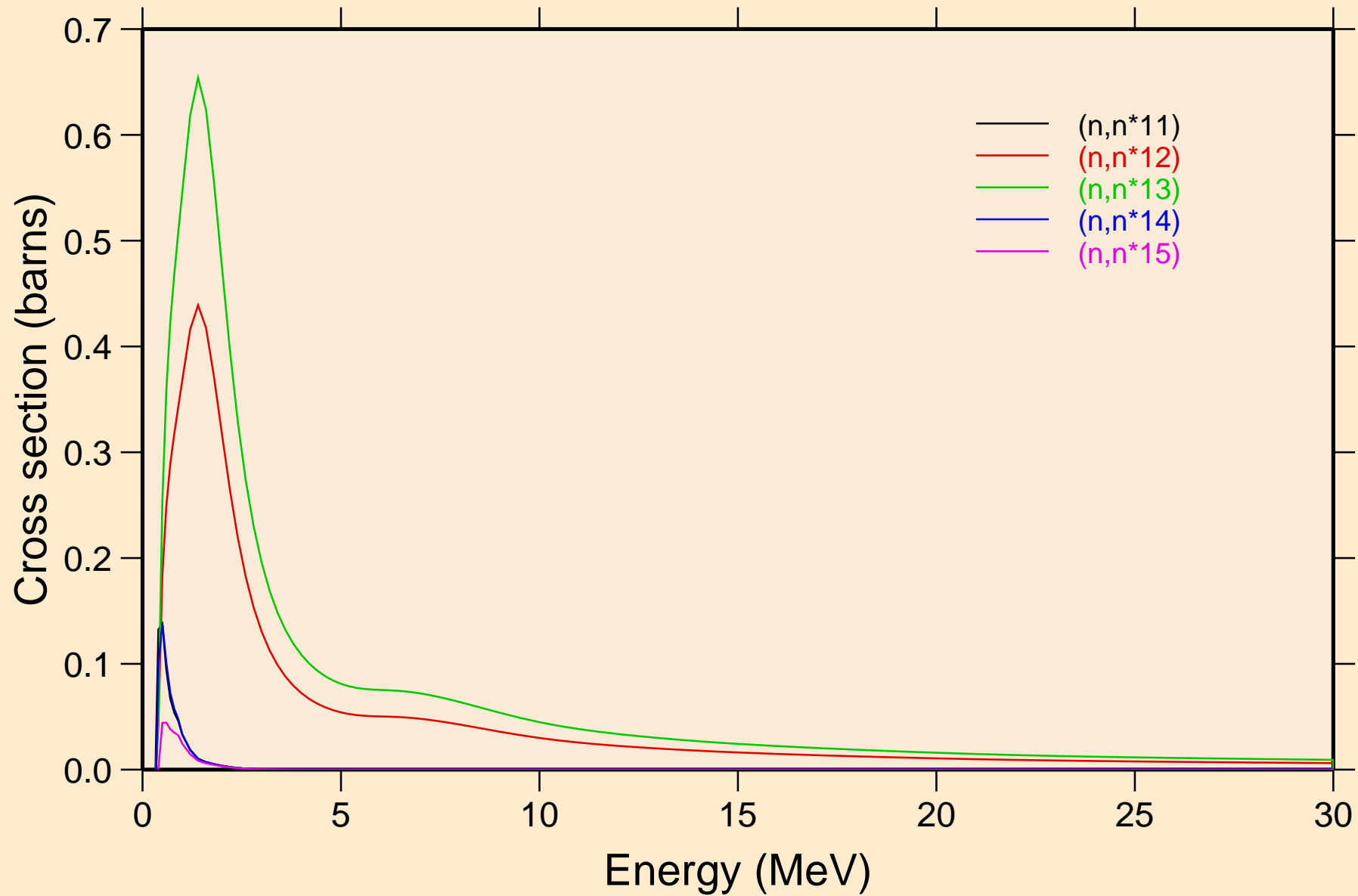

AM249 NEUTRON ACER TENDL-2024 LIBRARY; T=293.6K
Inelastic levels

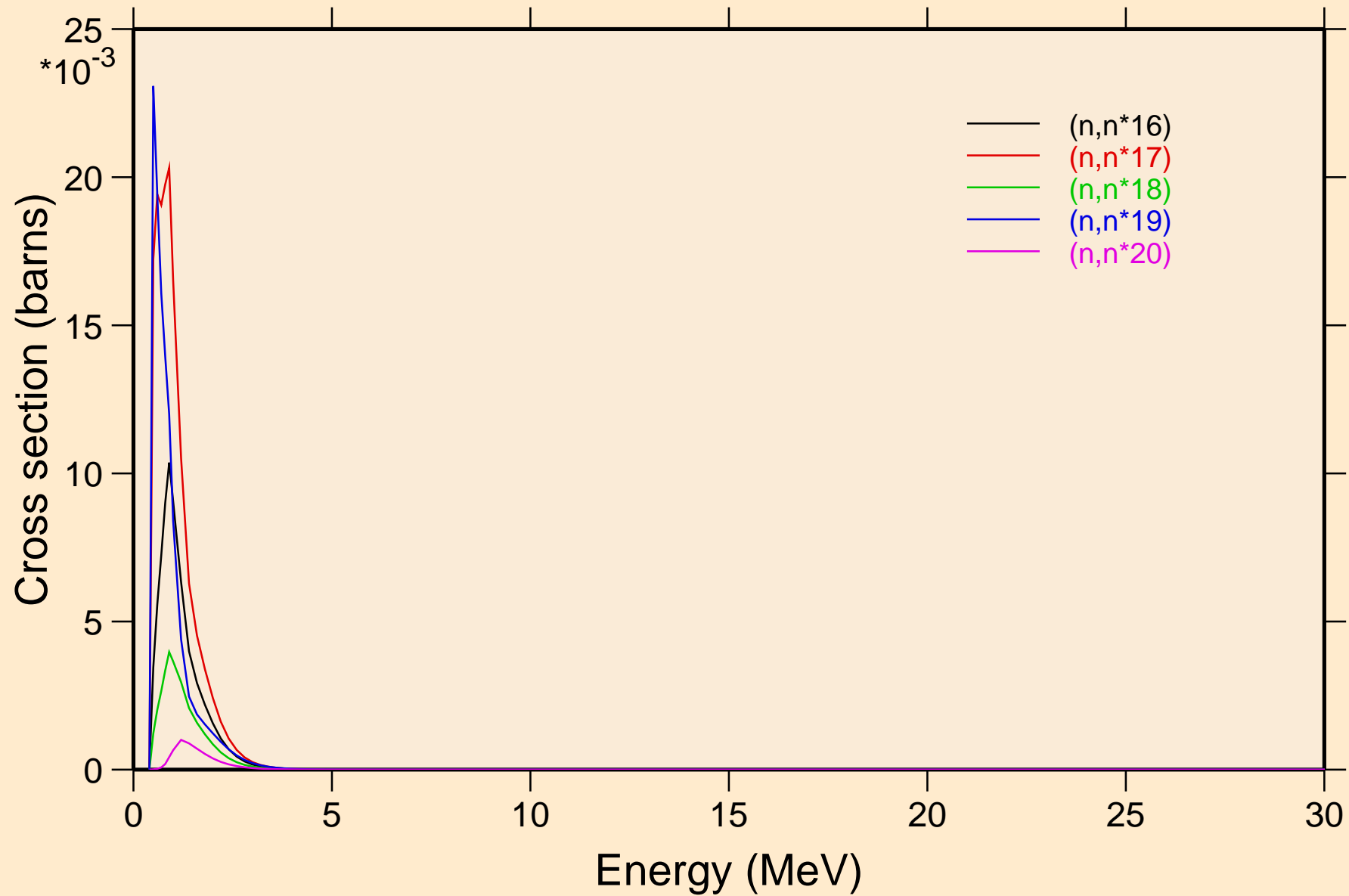

AM249 NEUTRON ACER TENDL-2024 LIBRARY; T=293.6K
Inelastic levels

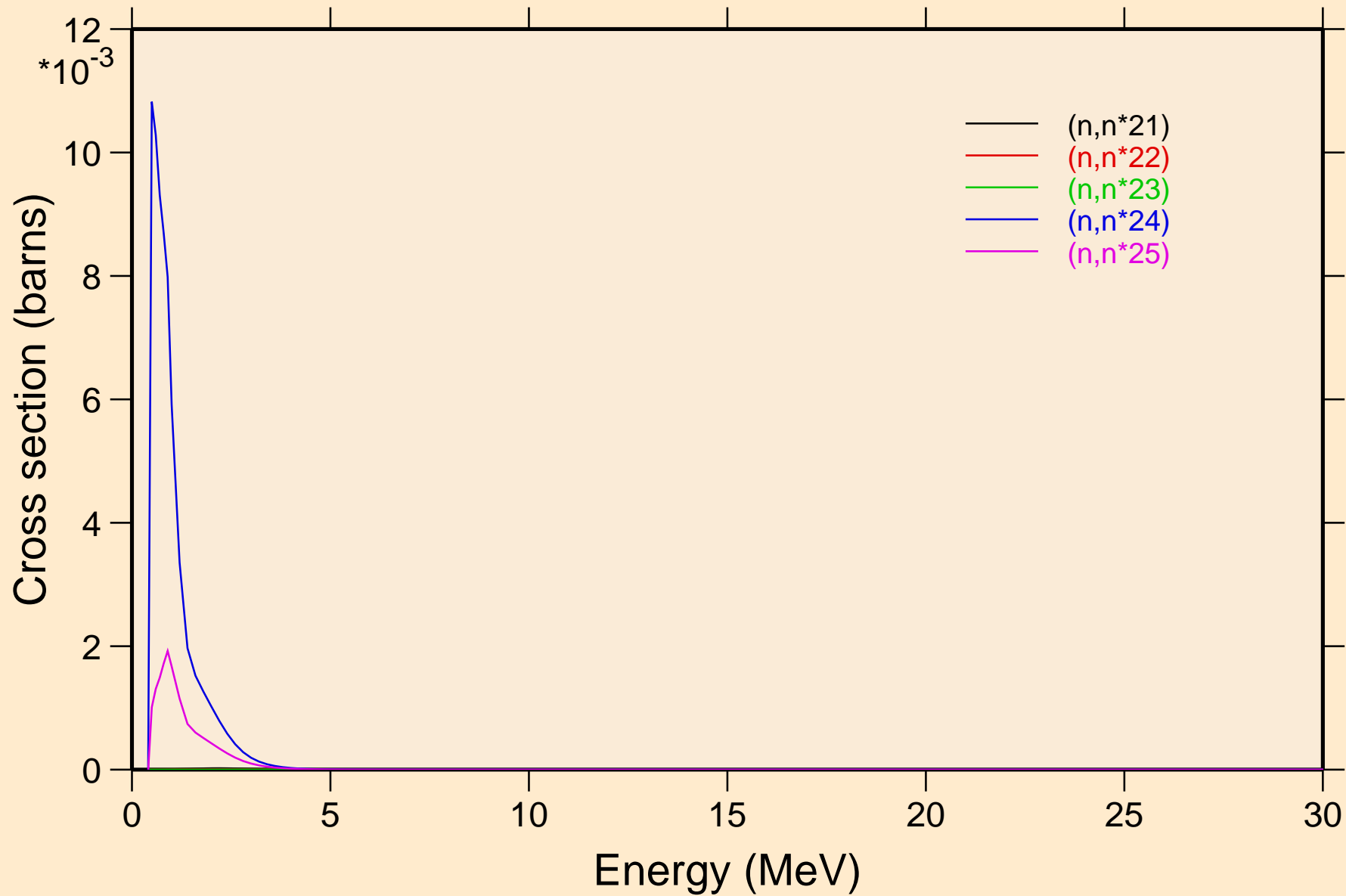

AM249 NEUTRON ACER TENDL-2024 LIBRARY; T=293.6K
Inelastic levels

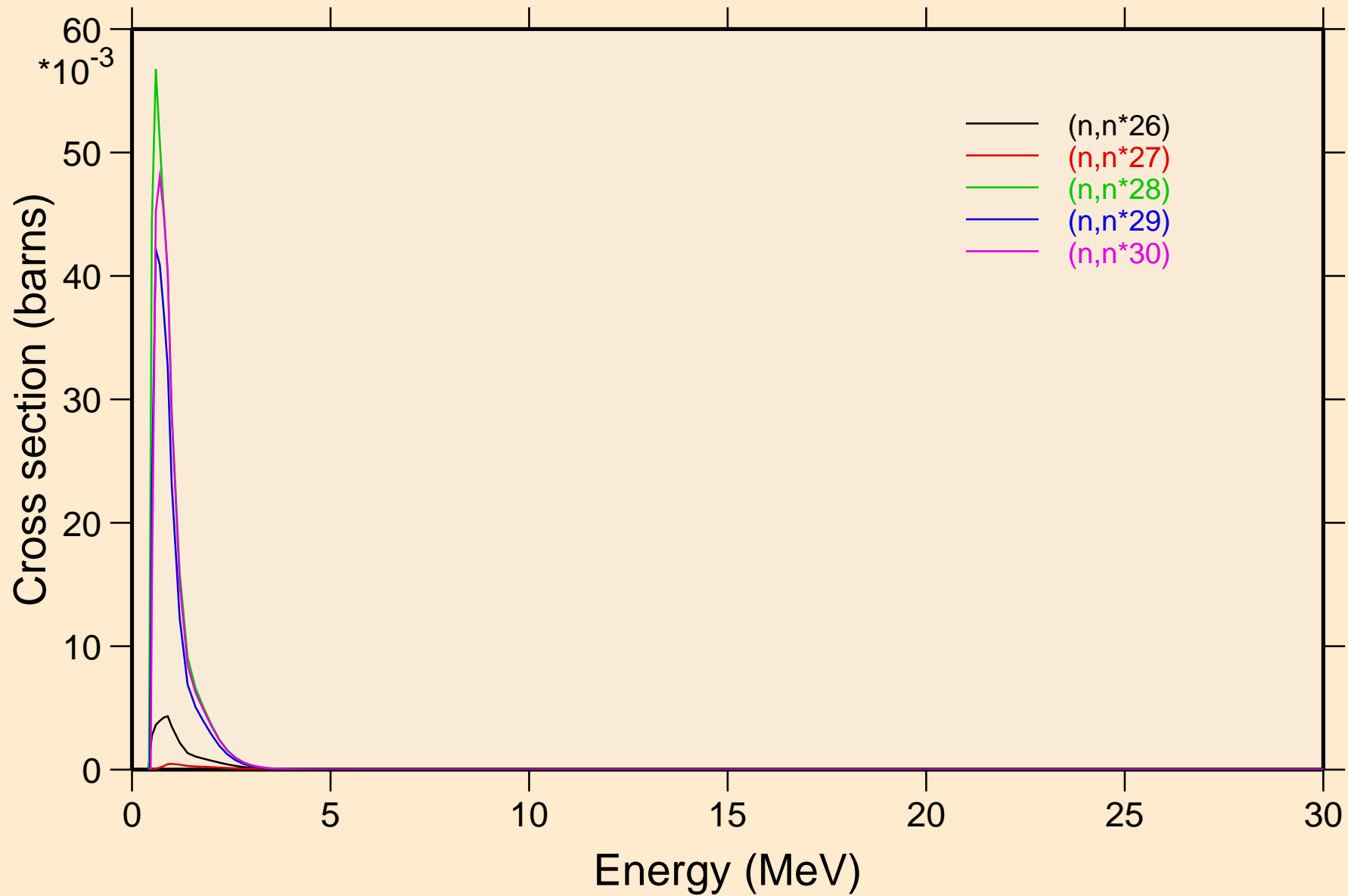

AM249 NEUTRON ACER TENDL-2024 LIBRARY; T=293.6K
Threshold reactions

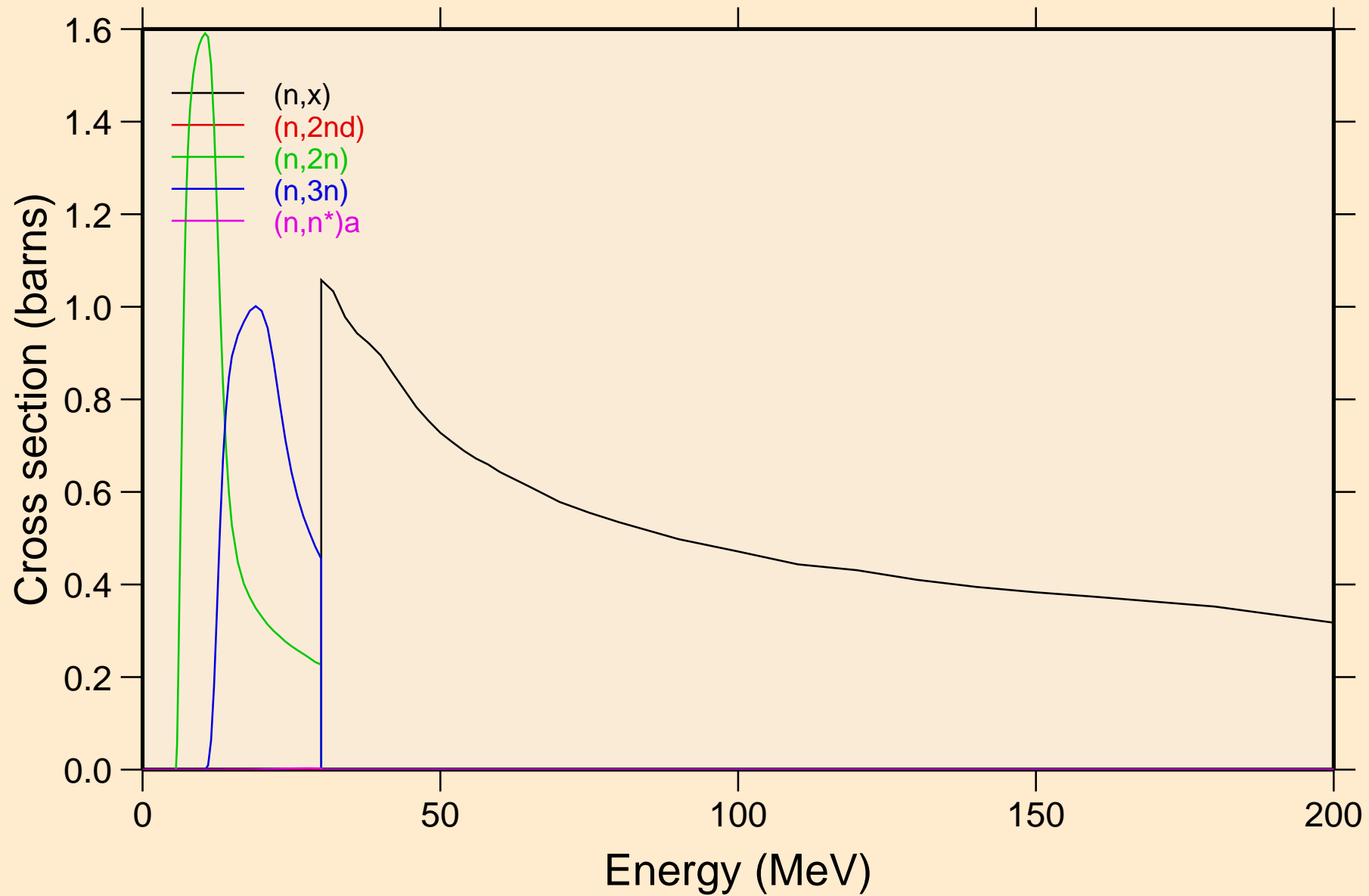

AM249 NEUTRON ACER TENDL-2024 LIBRARY; T=293.6K
Threshold reactions

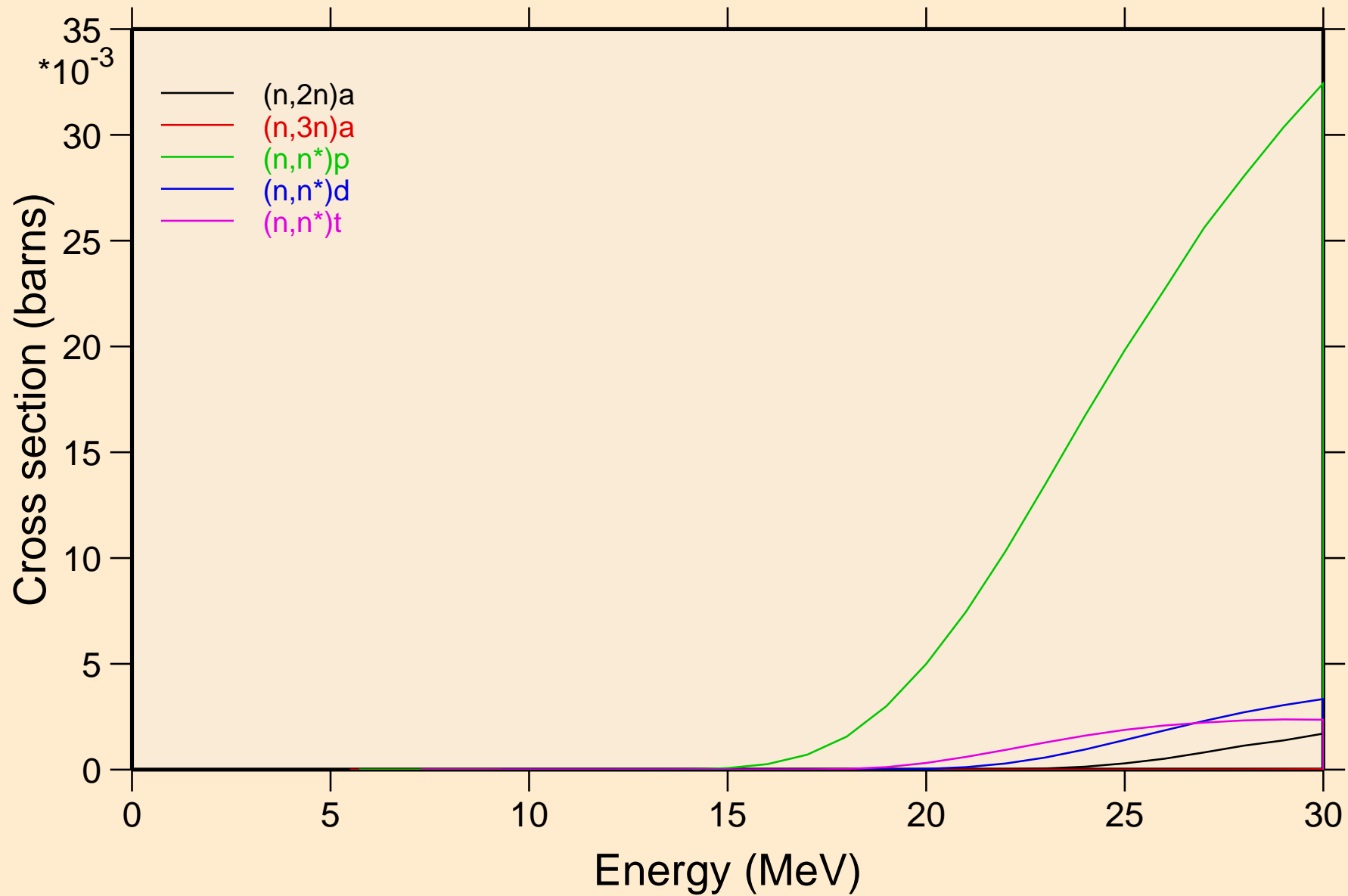

AM249 NEUTRON ACER TENDL-2024 LIBRARY; T=293.6K
Threshold reactions

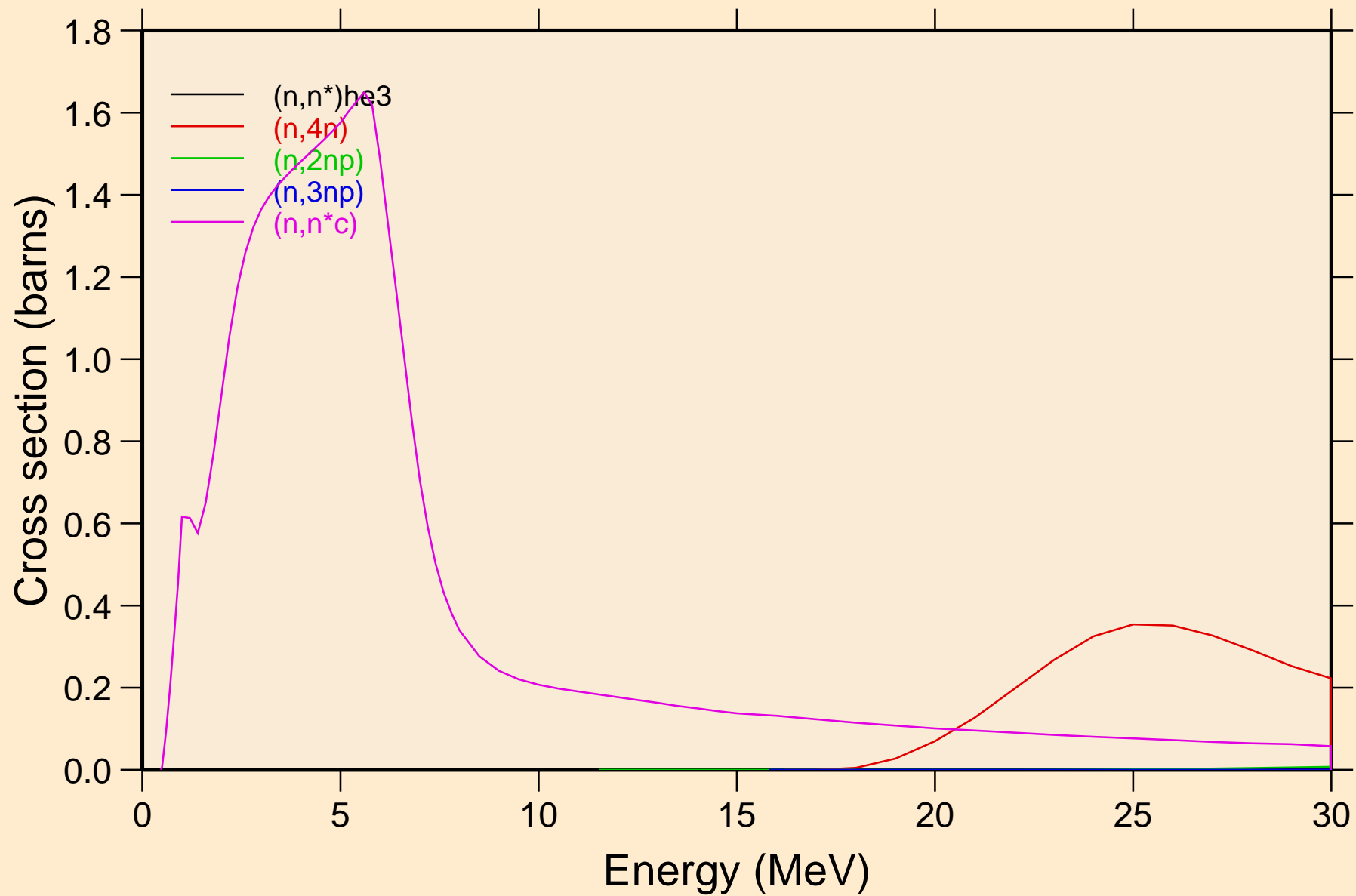

AM249 NEUTRON ACER TENDL-2024 LIBRARY; T=293.6K

Threshold reactions

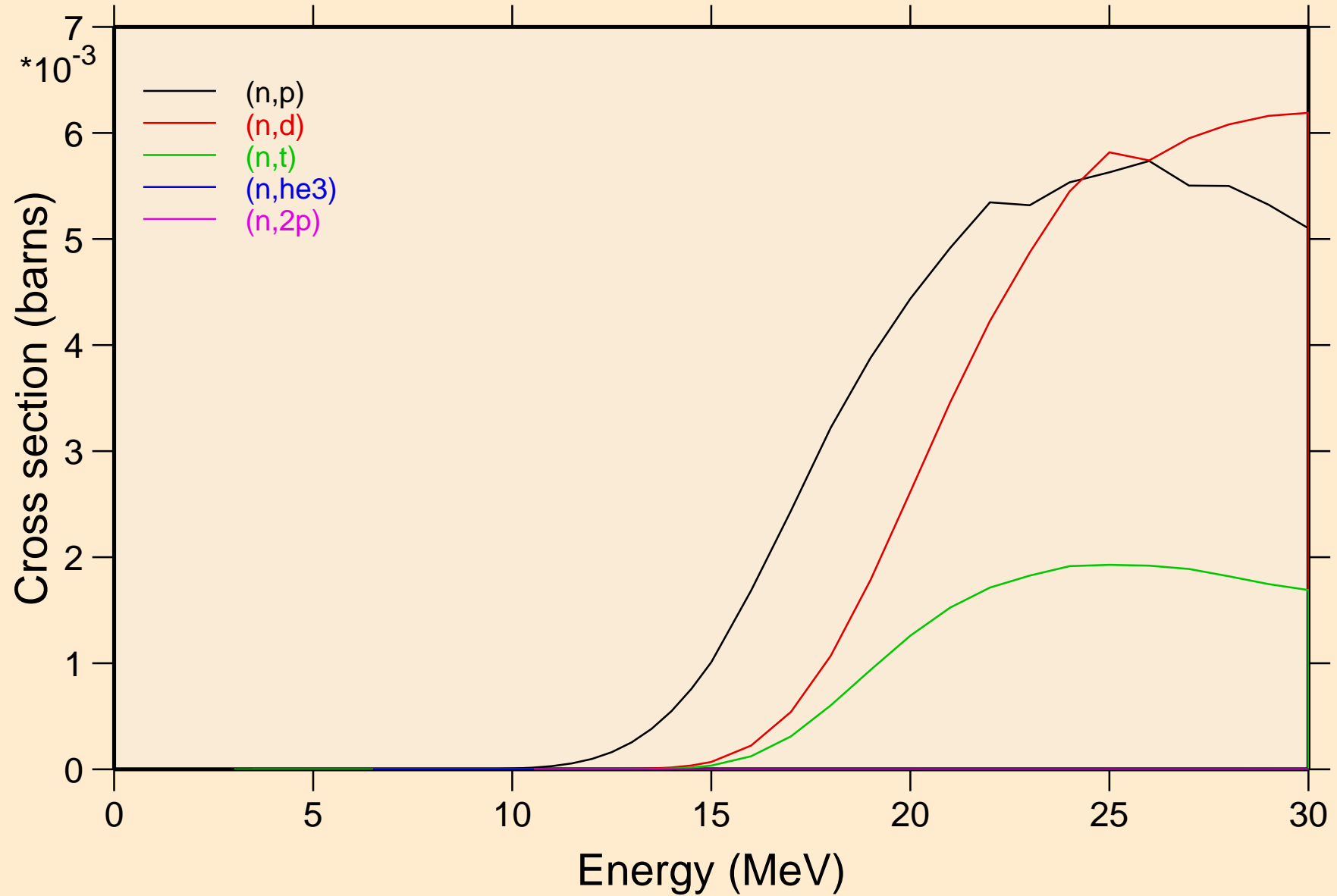

AM249 NEUTRON ACER TENDL-2024 LIBRARY; T=293.6K

Threshold reactions

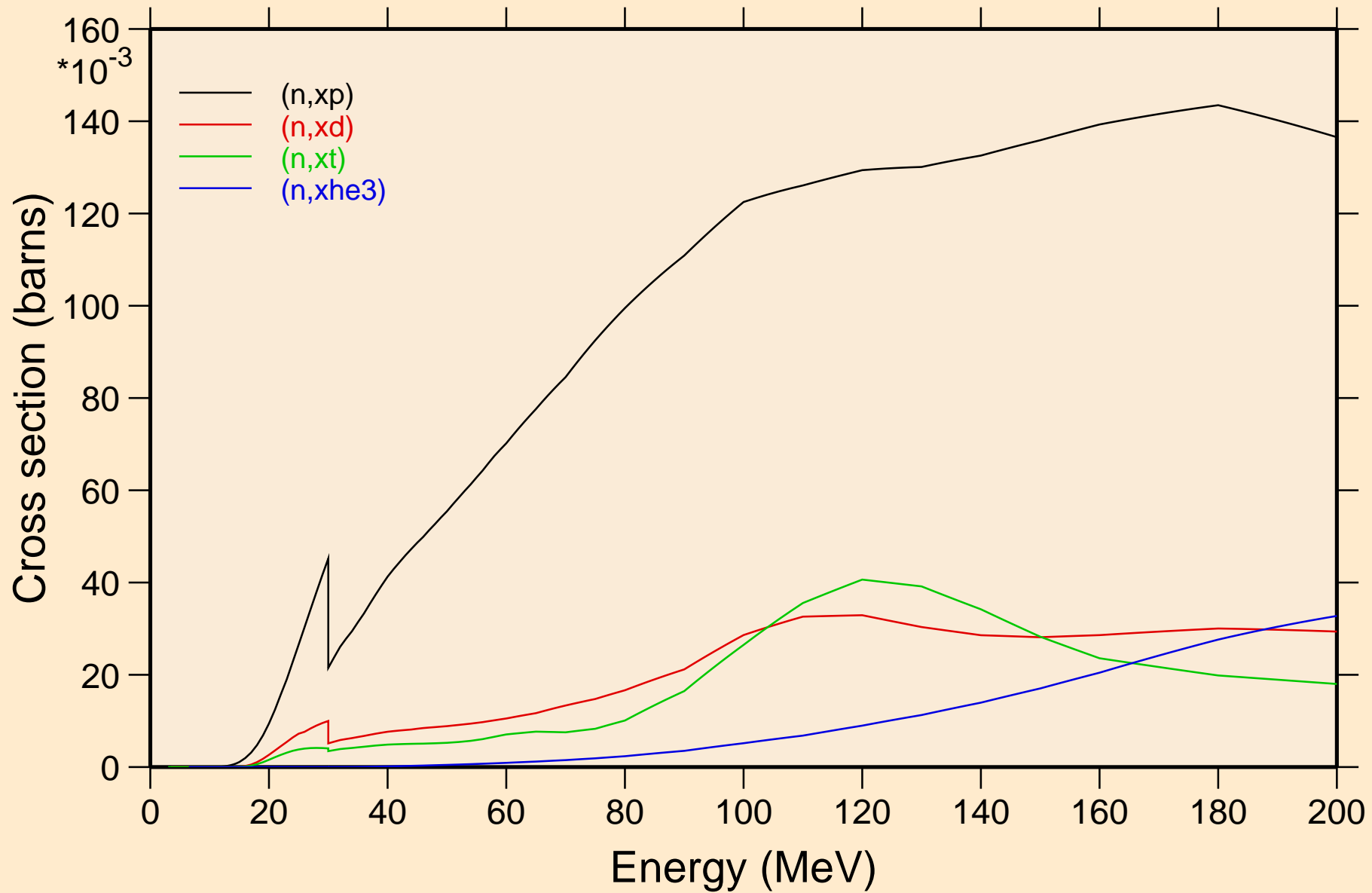

AM249 NEUTRON ACER TENDL-2024 LIBRARY; T=293.6K
angular distribution for elastic

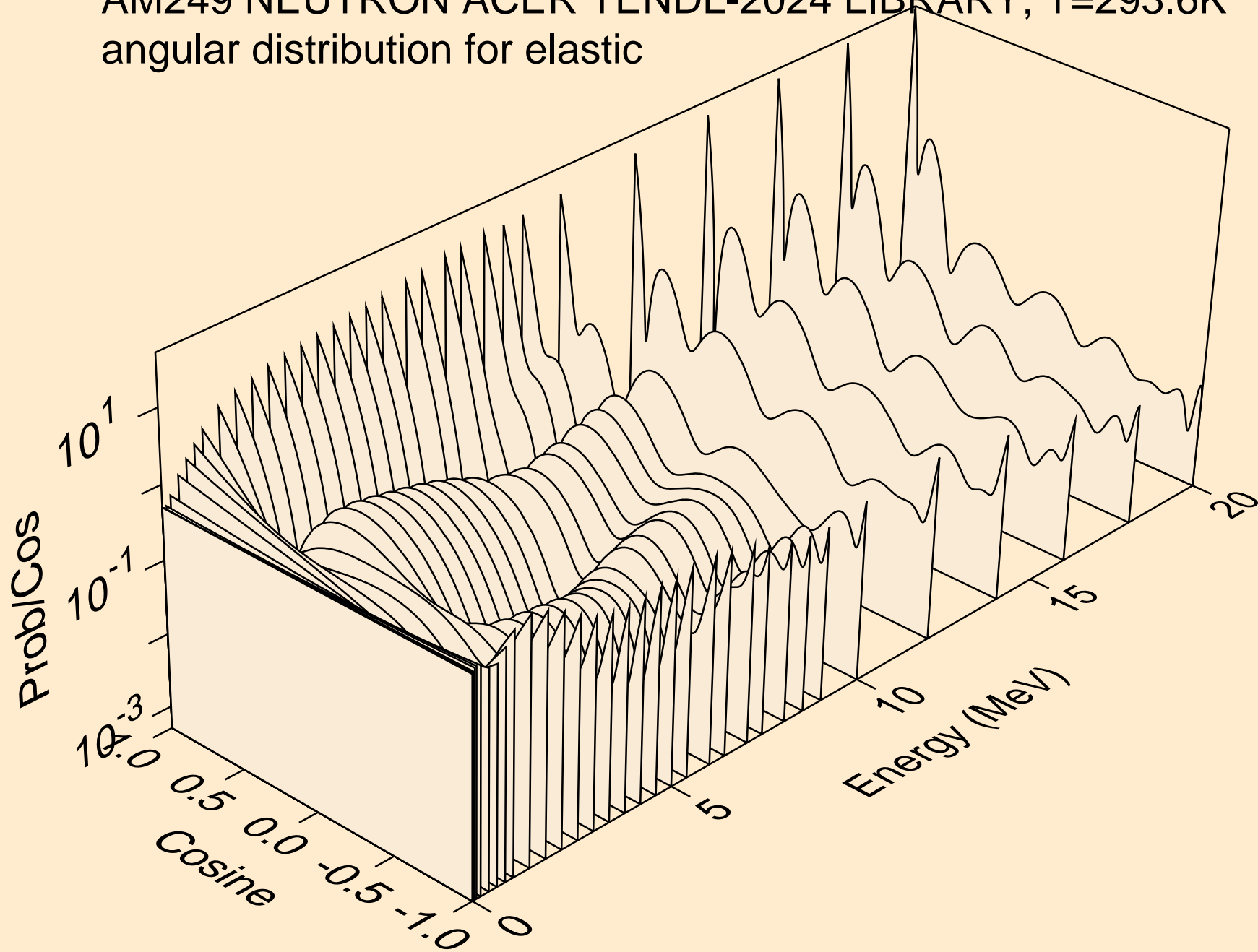

AM249 NEUTRON ACER TENDL-2024 LIBRARY; T=293.6K
angular distribution for elastic

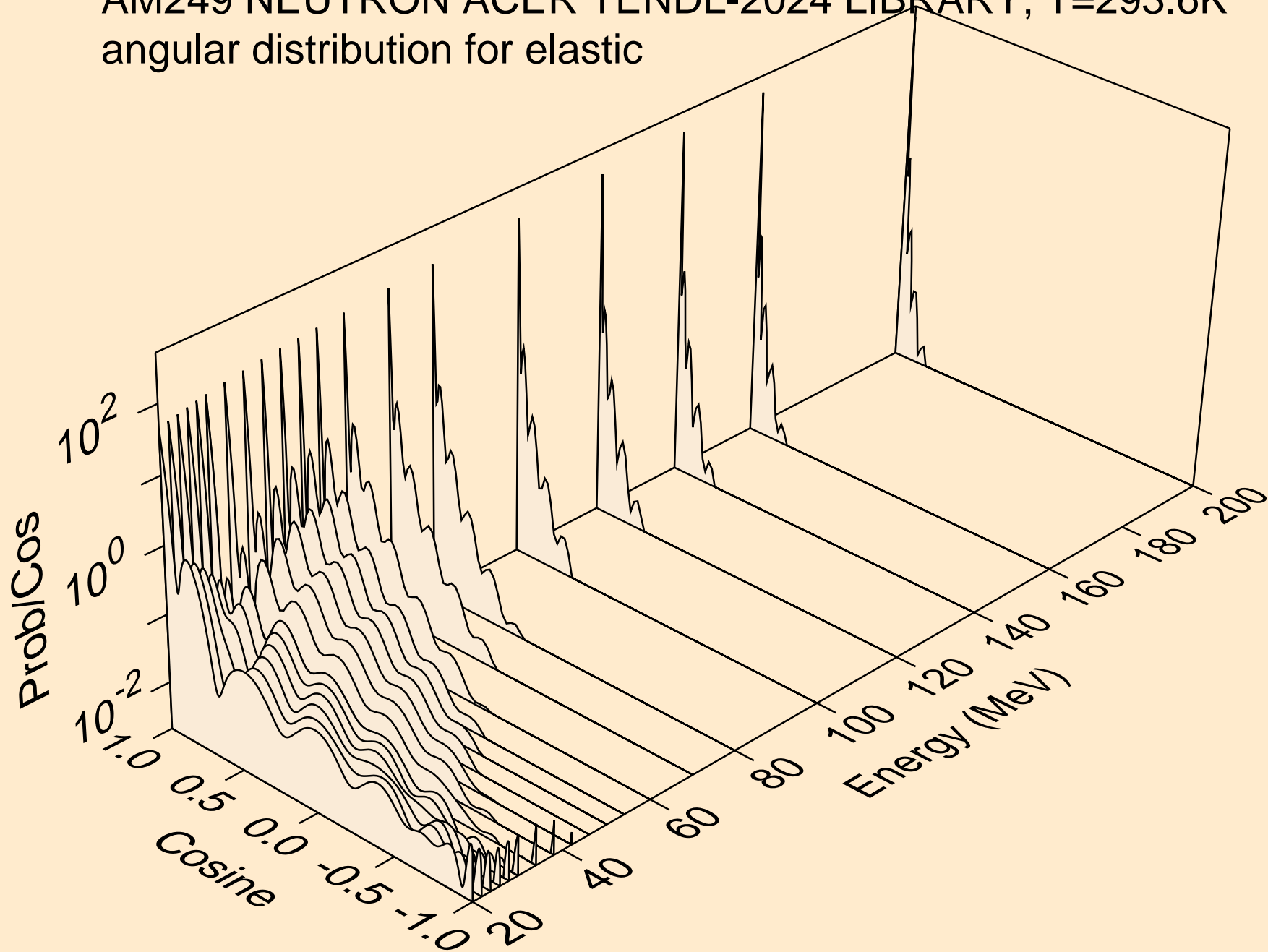

AM249 NEUTRON ACER TENDL-2024 LIBRARY; T=293.6K
angular distribution for (n,n*1)

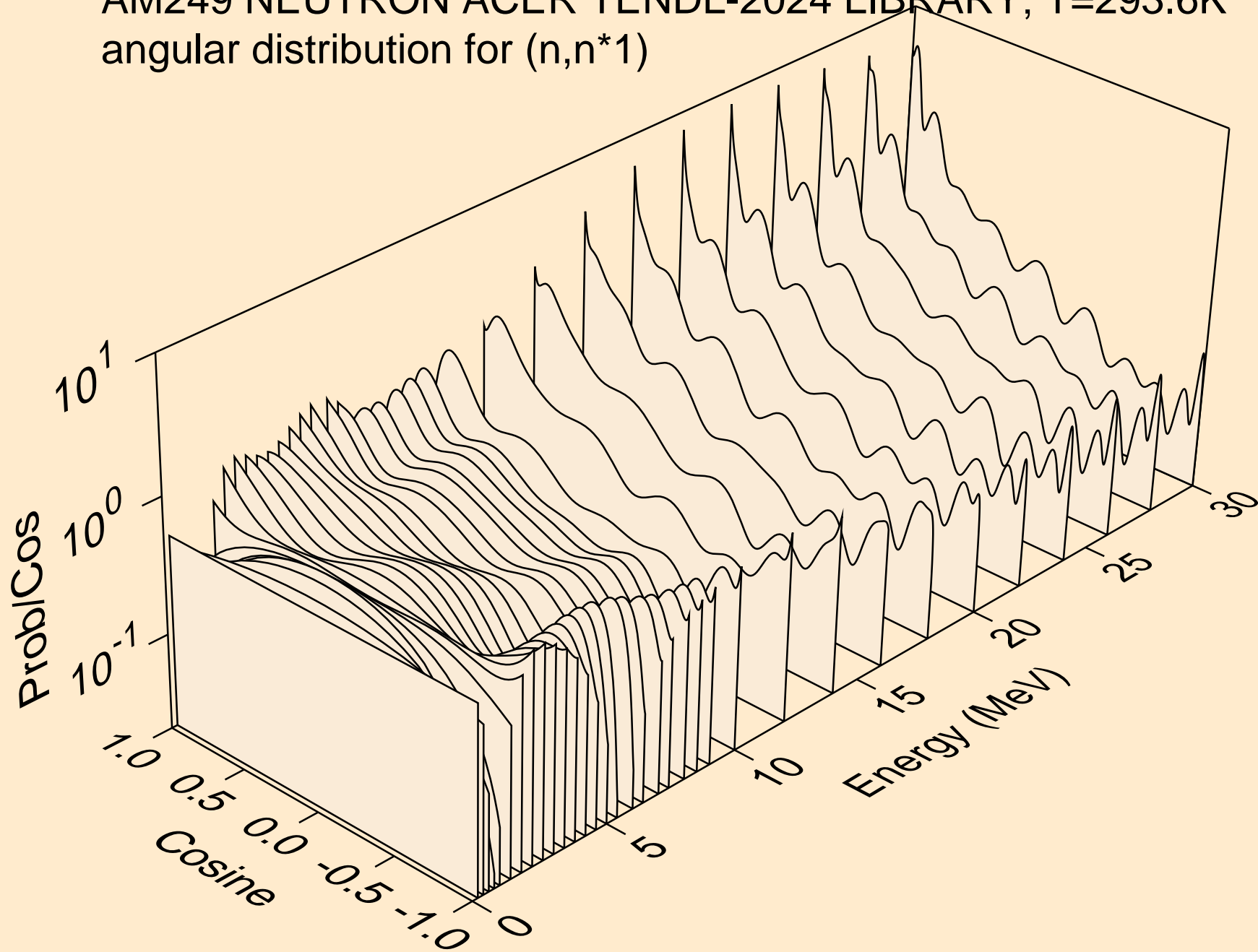

AM249 NEUTRON ACER TENDL-2024 LIBRARY; T=293.6K
angular distribution for (n,n*2)

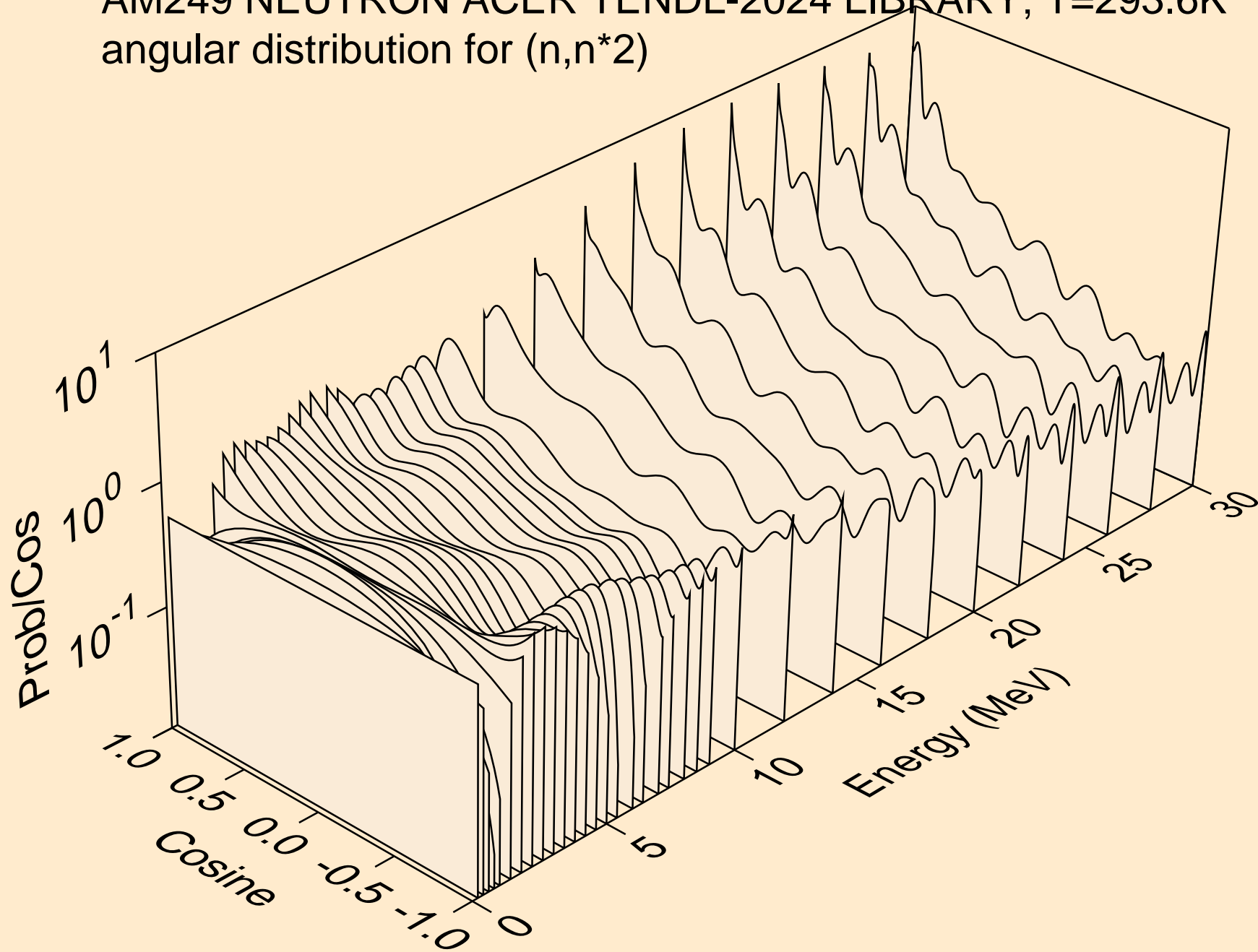

AM249 NEUTRON ACER TENDL-2024 LIBRARY; T=293.6K
angular distribution for (n,n*3)

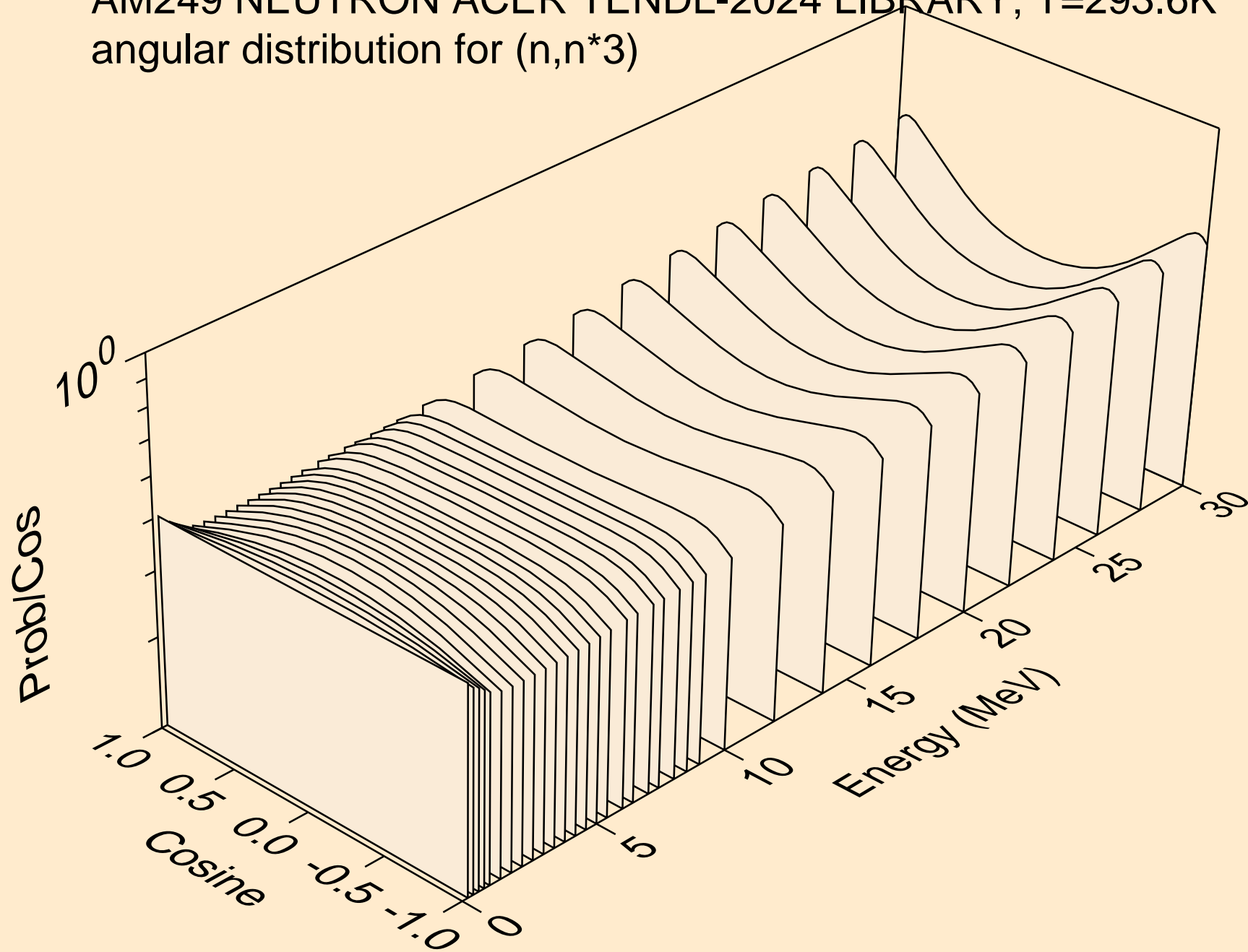

AM249 NEUTRON ACER TENDL-2024 LIBRARY; T=293.6K
angular distribution for (n,n*4)

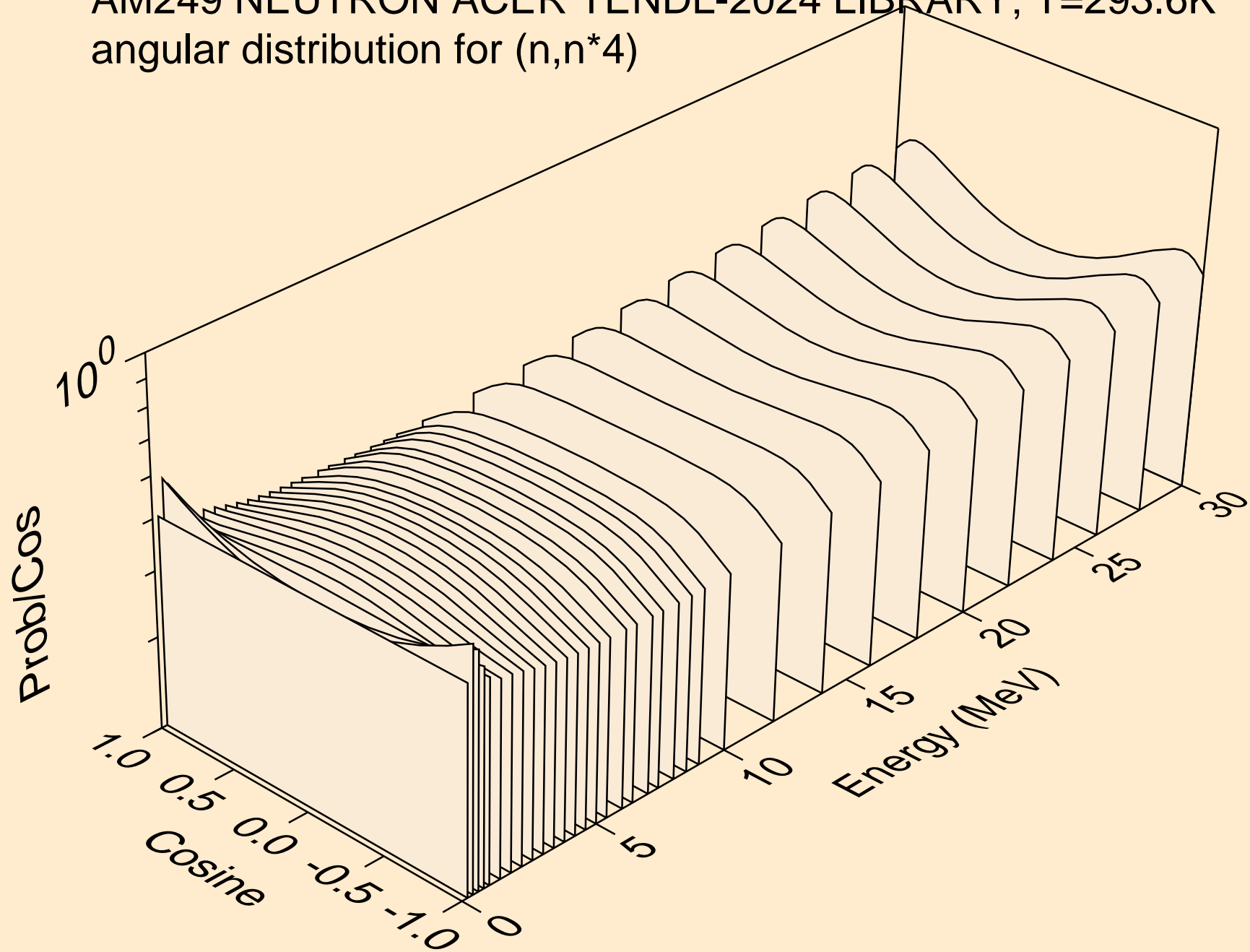

AM249 NEUTRON ACER TENDL-2024 LIBRARY; T=293.6K
angular distribution for (n,n*5)

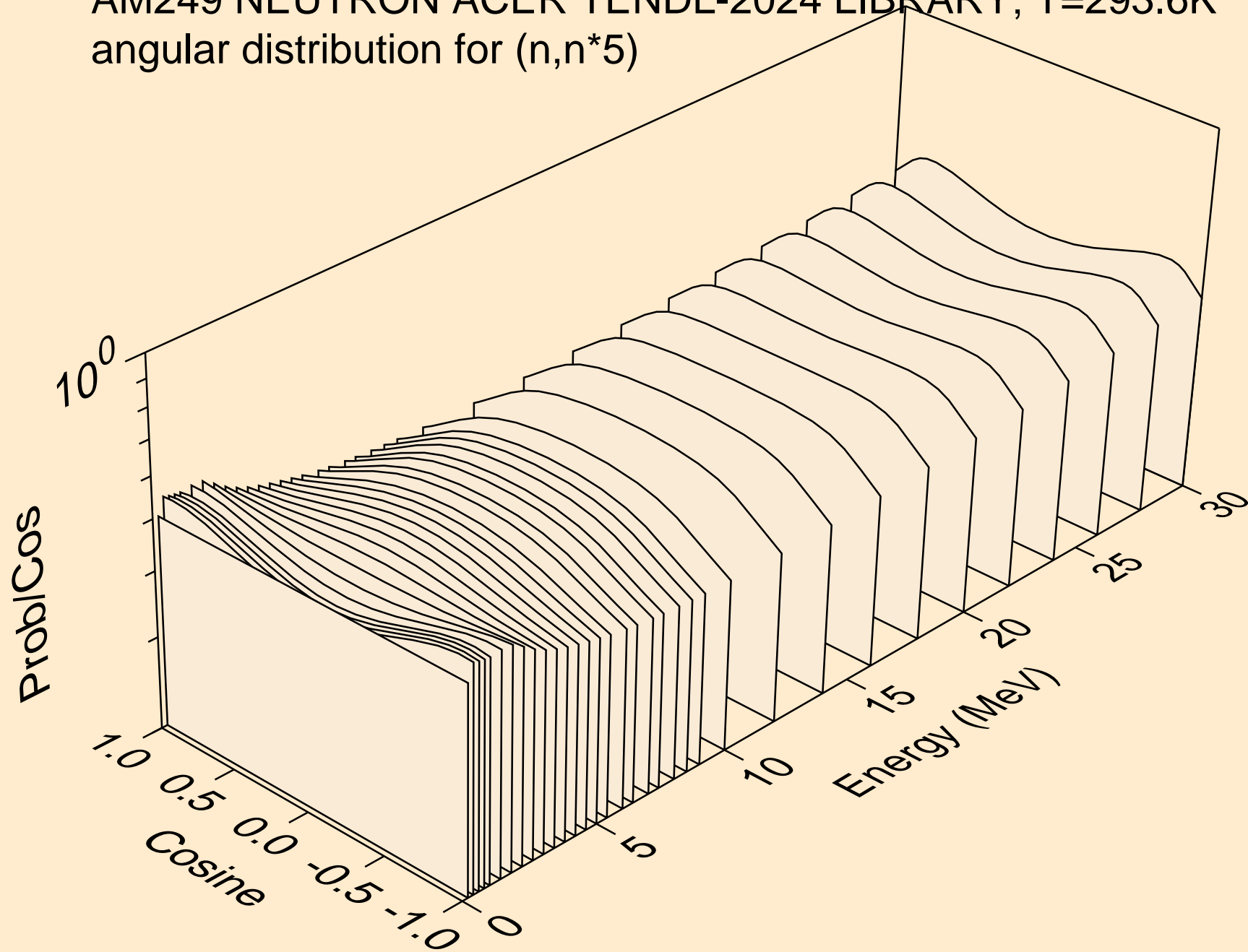

AM249 NEUTRON ACER TENDL-2024 LIBRARY; T=293.6K
angular distribution for (n,n*6)

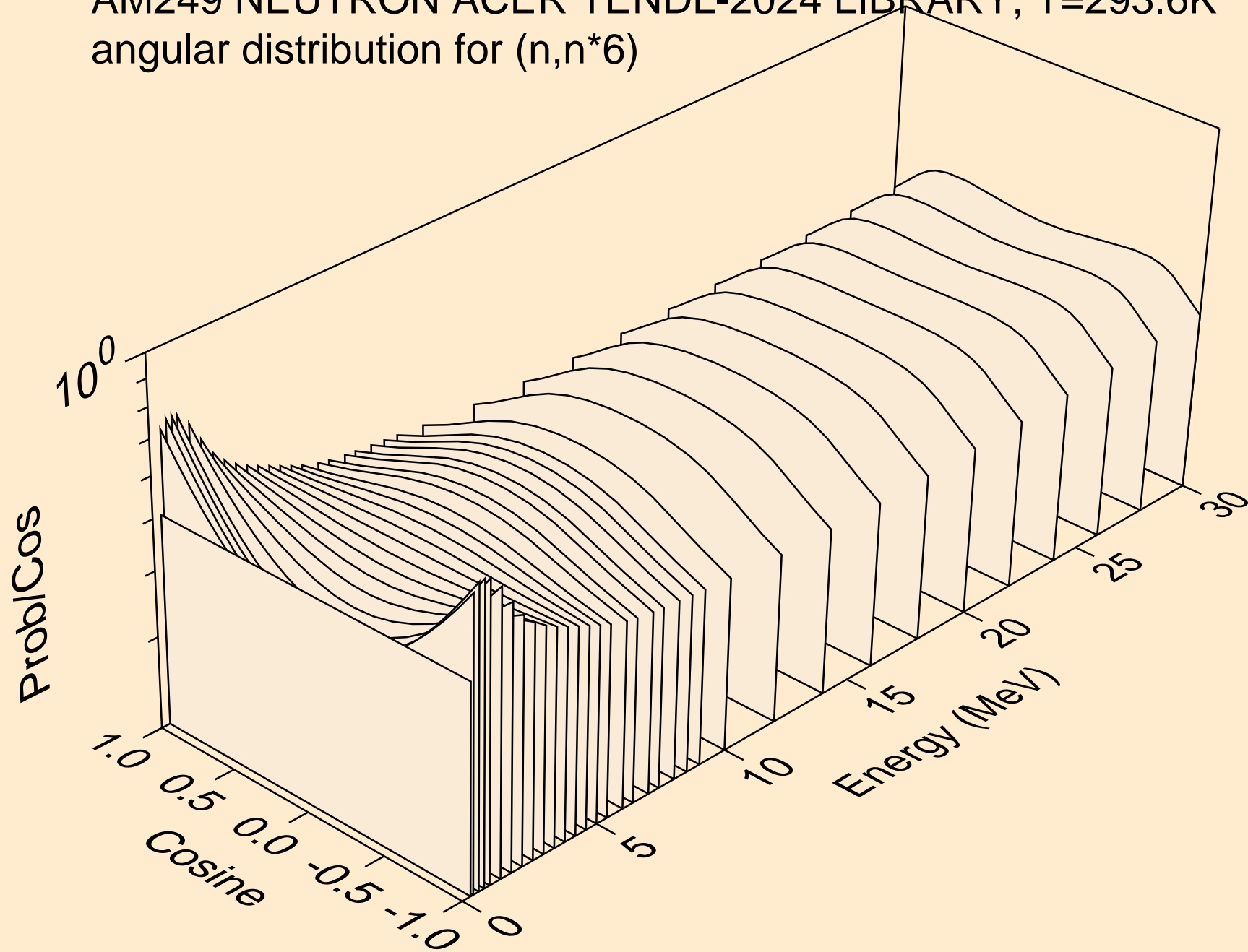

AM249 NEUTRON ACER TENDL-2024 LIBRARY; T=293.6K
angular distribution for (n,n*7)

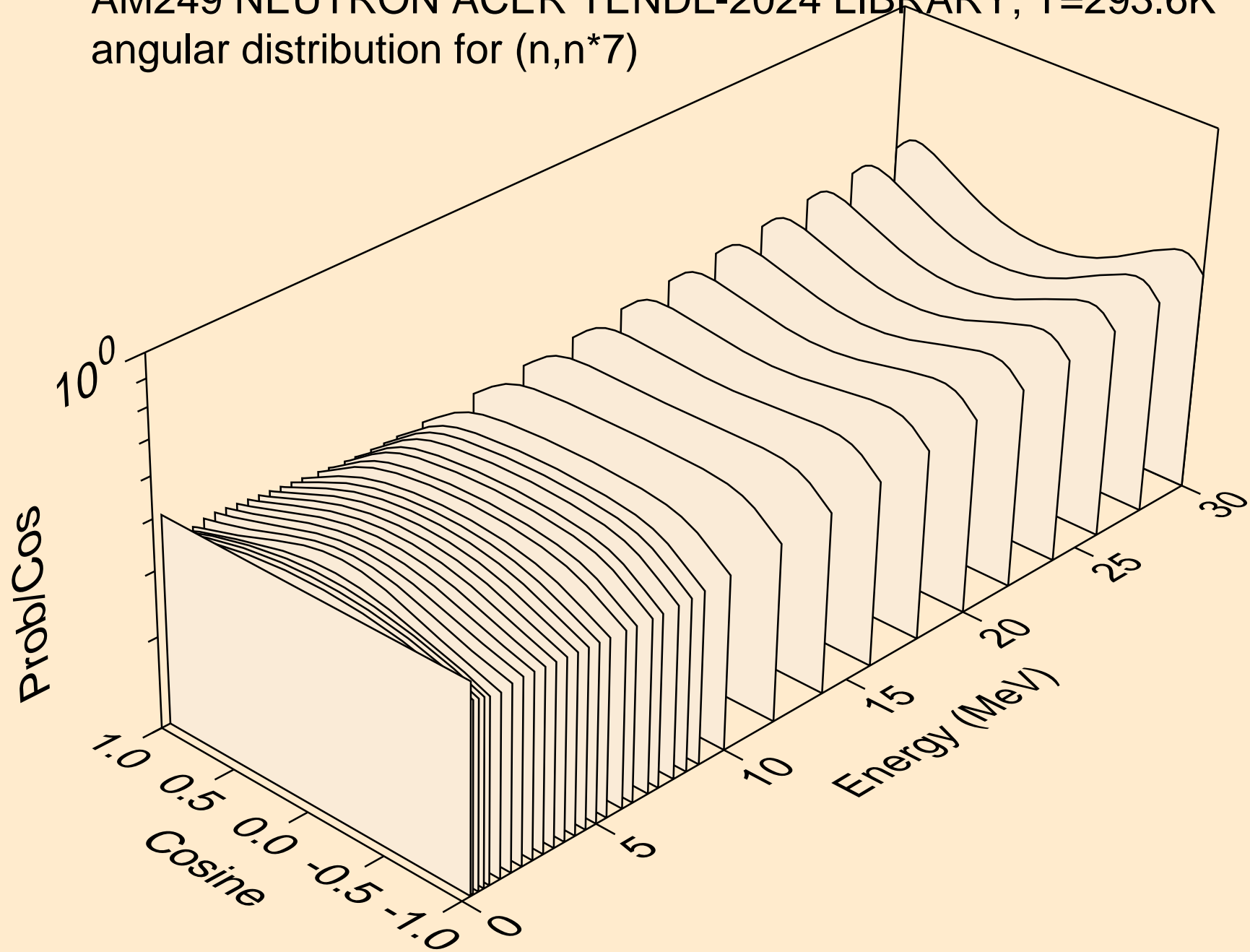

AM249 NEUTRON ACER TENDL-2024 LIBRARY; T=293.6K
angular distribution for (n,n*8)

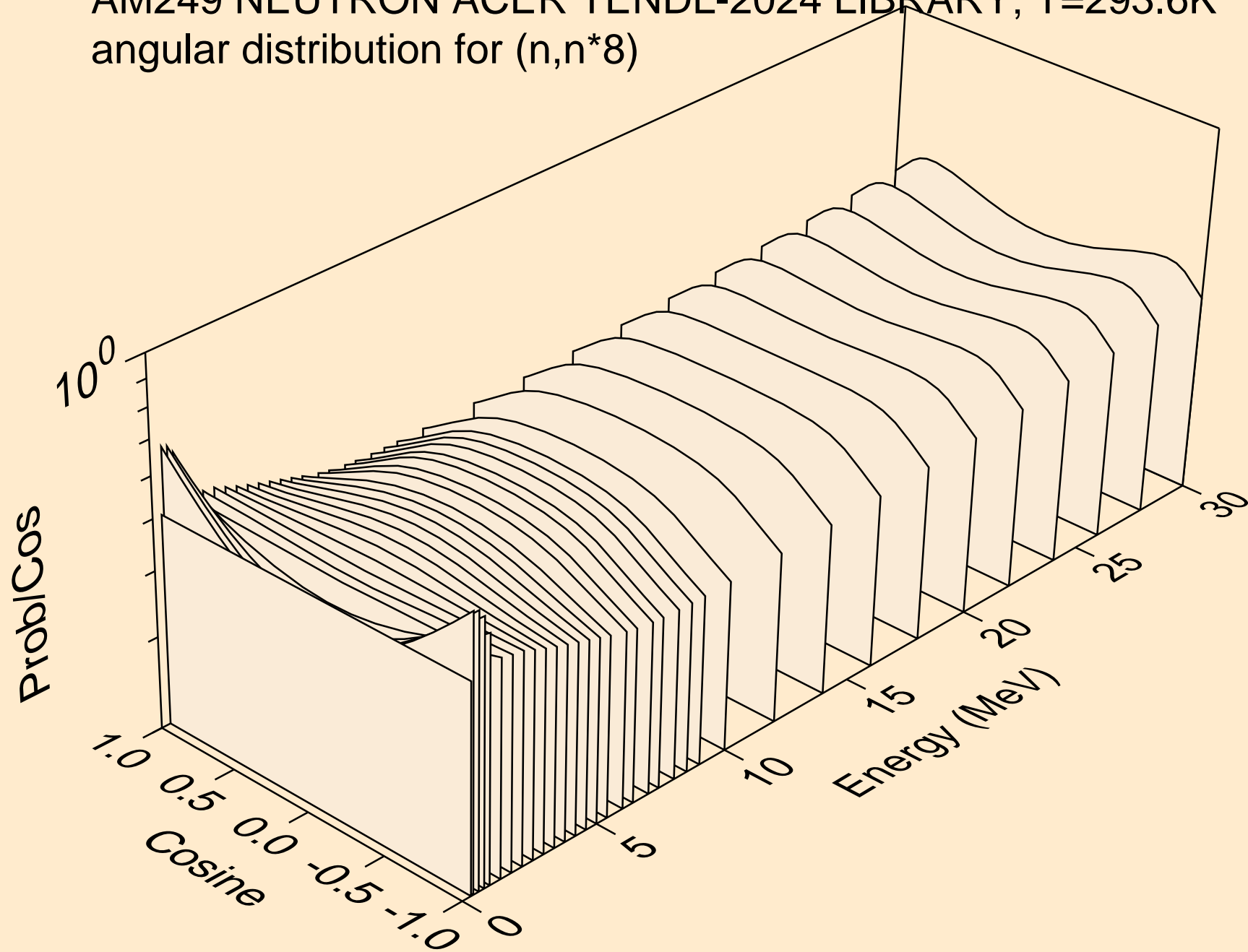

AM249 NEUTRON ACER TENDL-2024 LIBRARY; T=293.6K
angular distribution for (n,n*9)

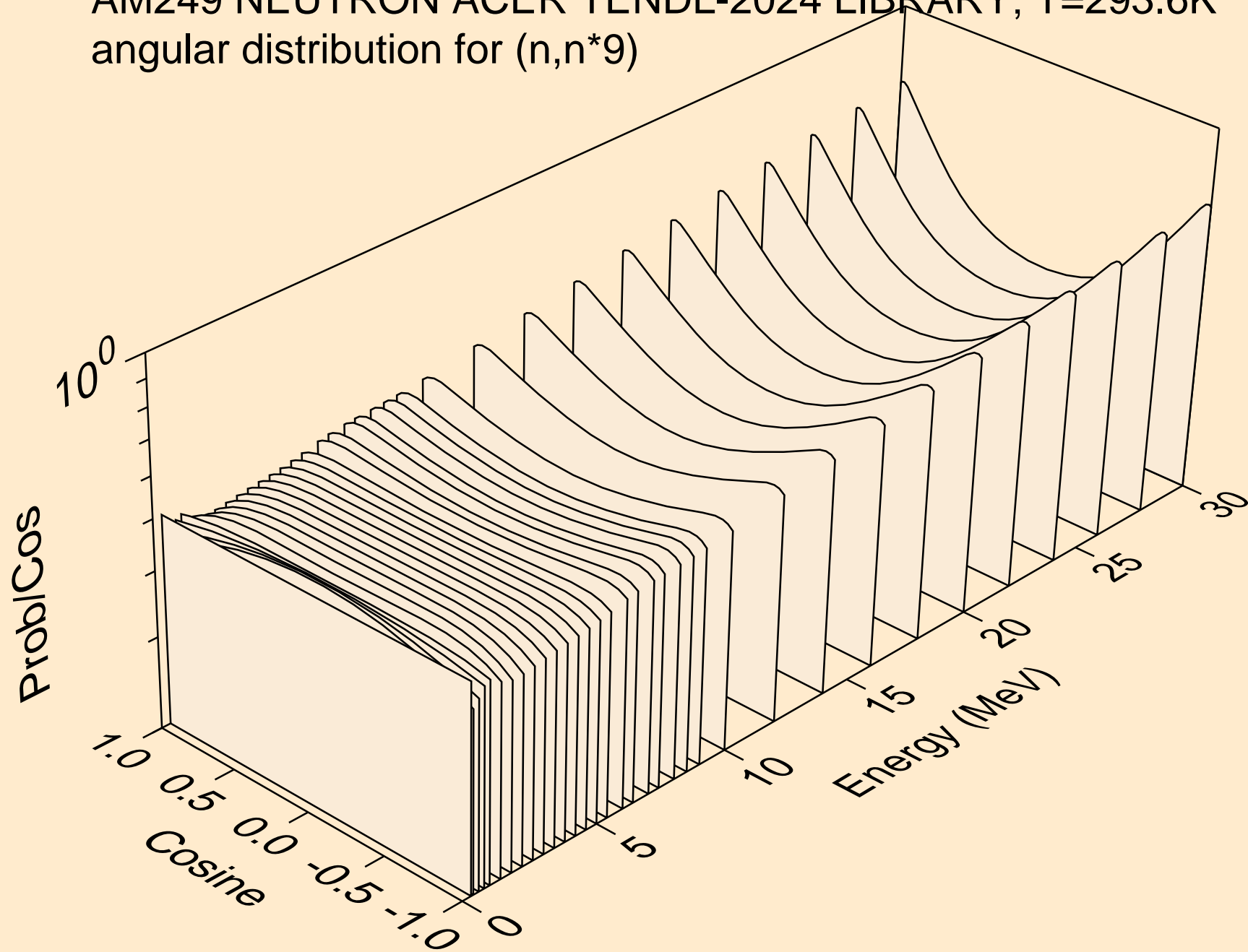

AM249 NEUTRON ACER TENDL-2024 LIBRARY; T=293.6K
angular distribution for (n,n*10)

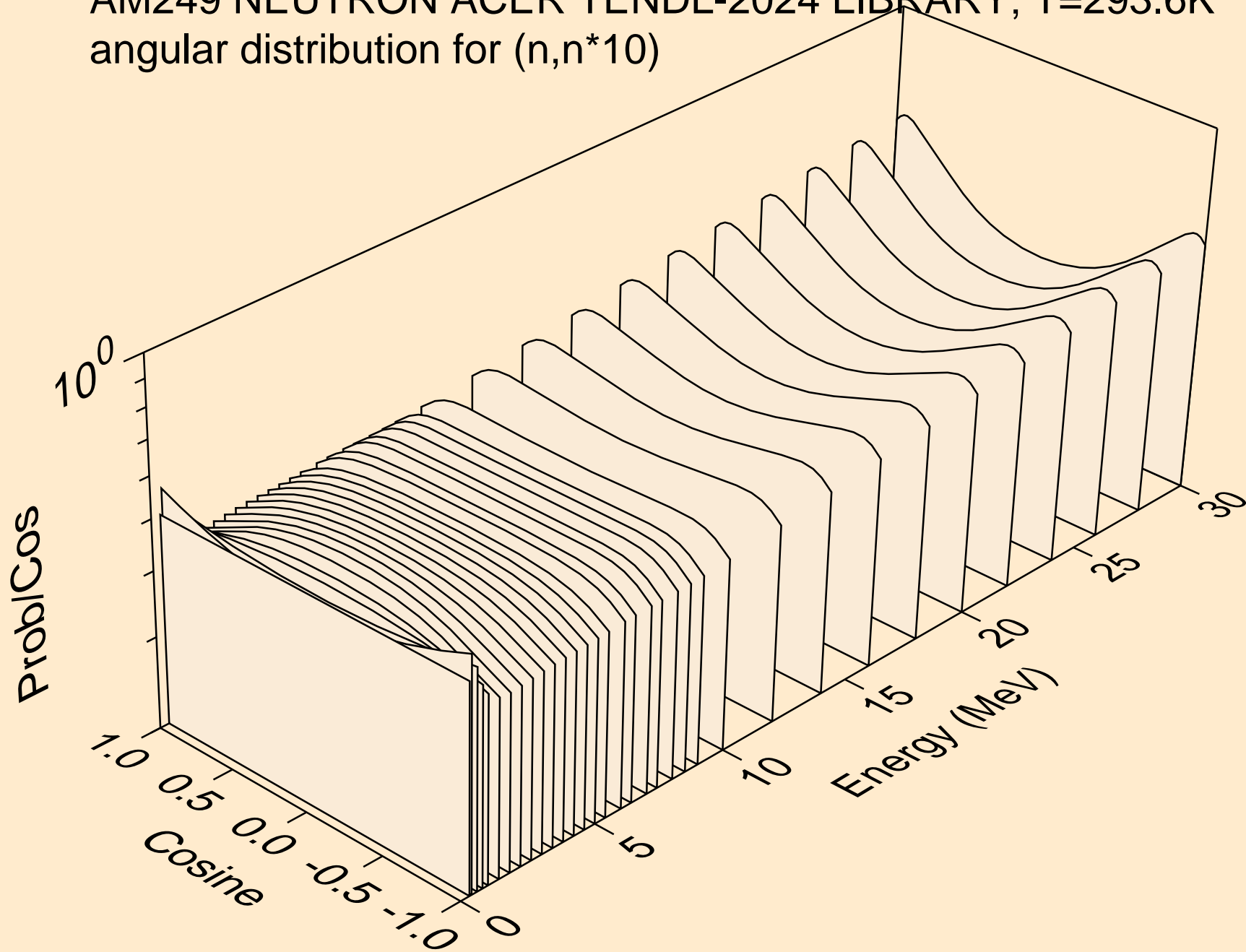

AM249 NEUTRON ACER TENDL-2024 LIBRARY; T=293.6K
angular distribution for (n,n*11)

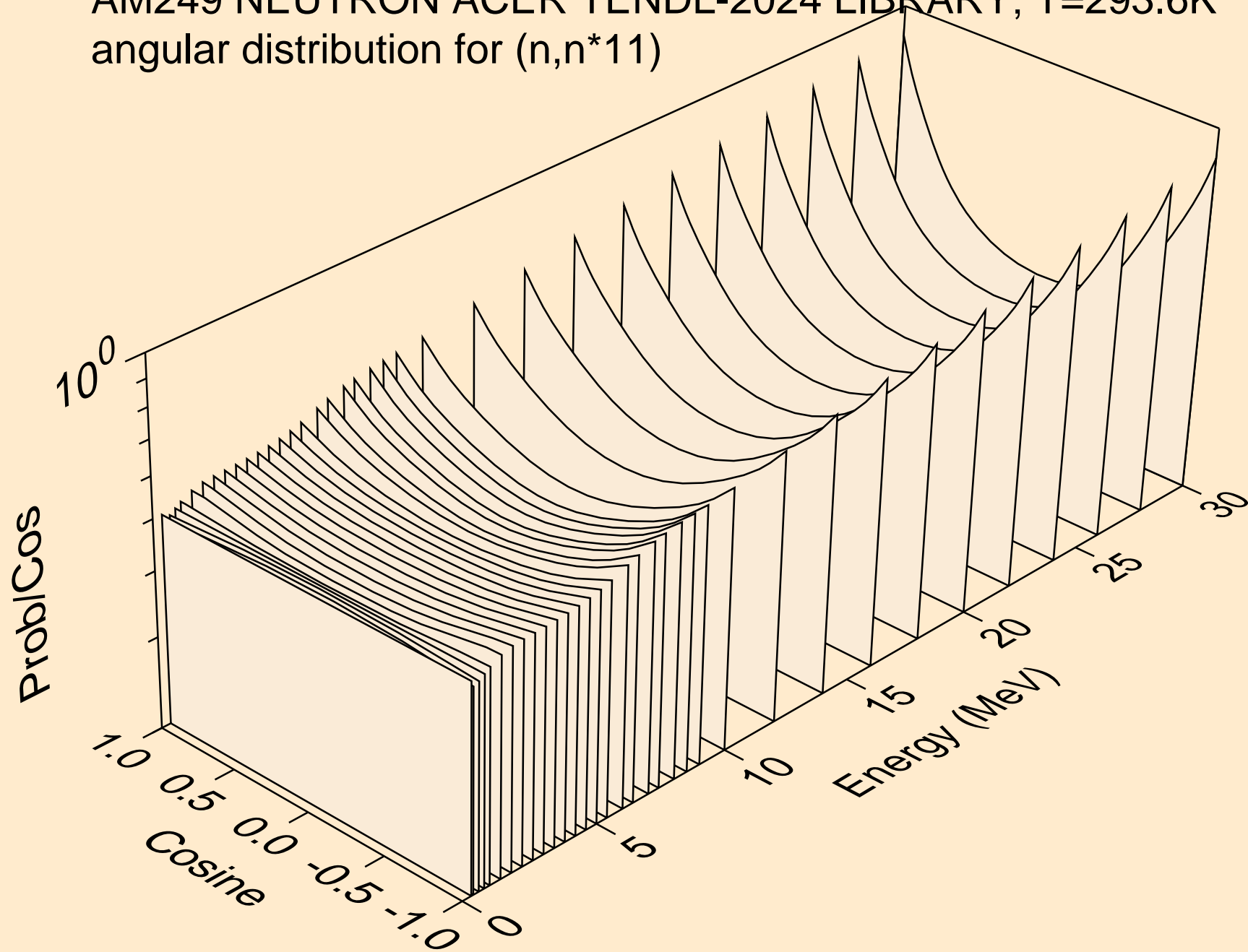

AM249 NEUTRON ACER TENDL-2024 LIBRARY; T=293.6K
angular distribution for (n,n*12)

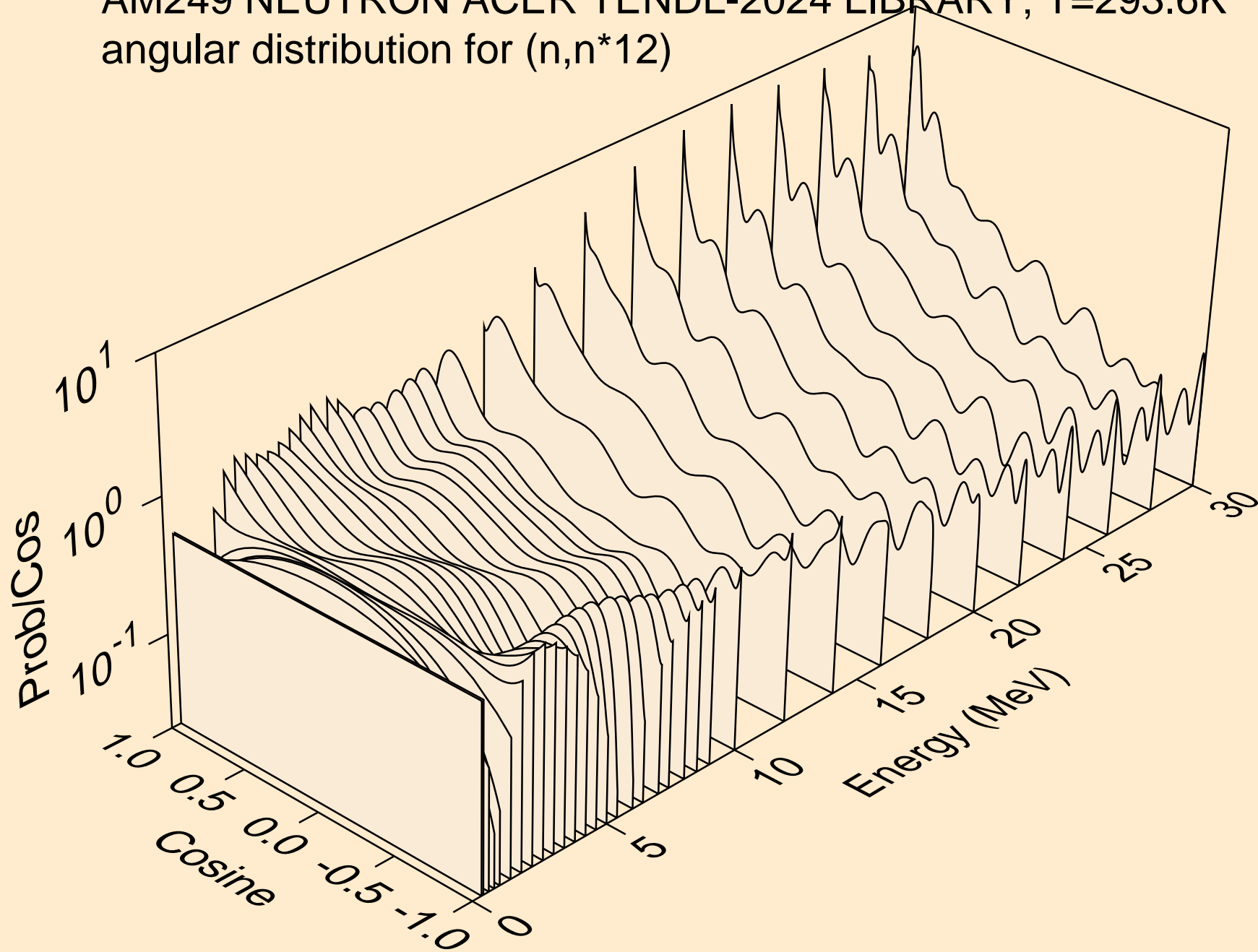

AM249 NEUTRON ACER TENDL-2024 LIBRARY; T=293.6K
angular distribution for (n,n*13)

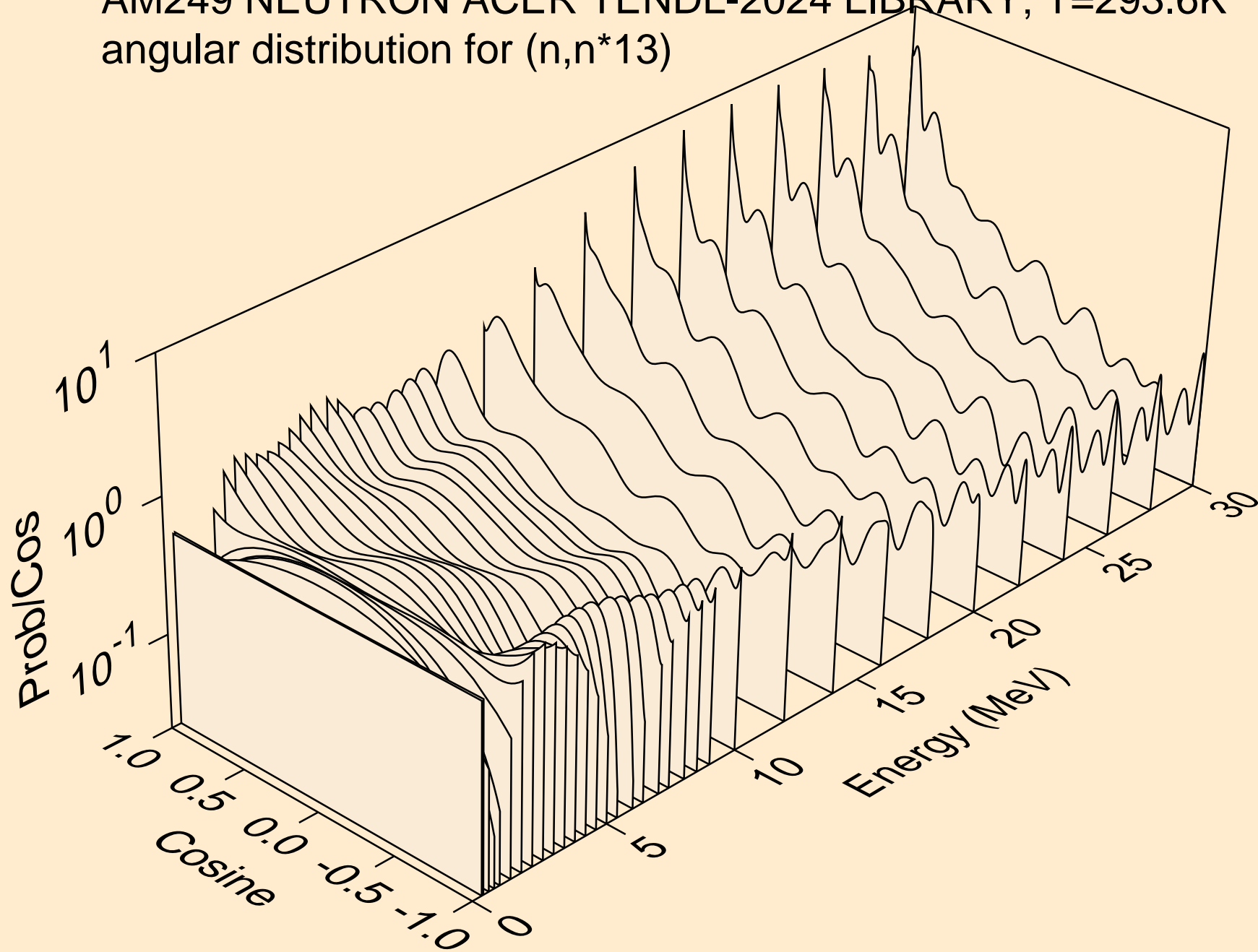

AM249 NEUTRON ACER TENDL-2024 LIBRARY; T=293.6K
angular distribution for (n,n*14)

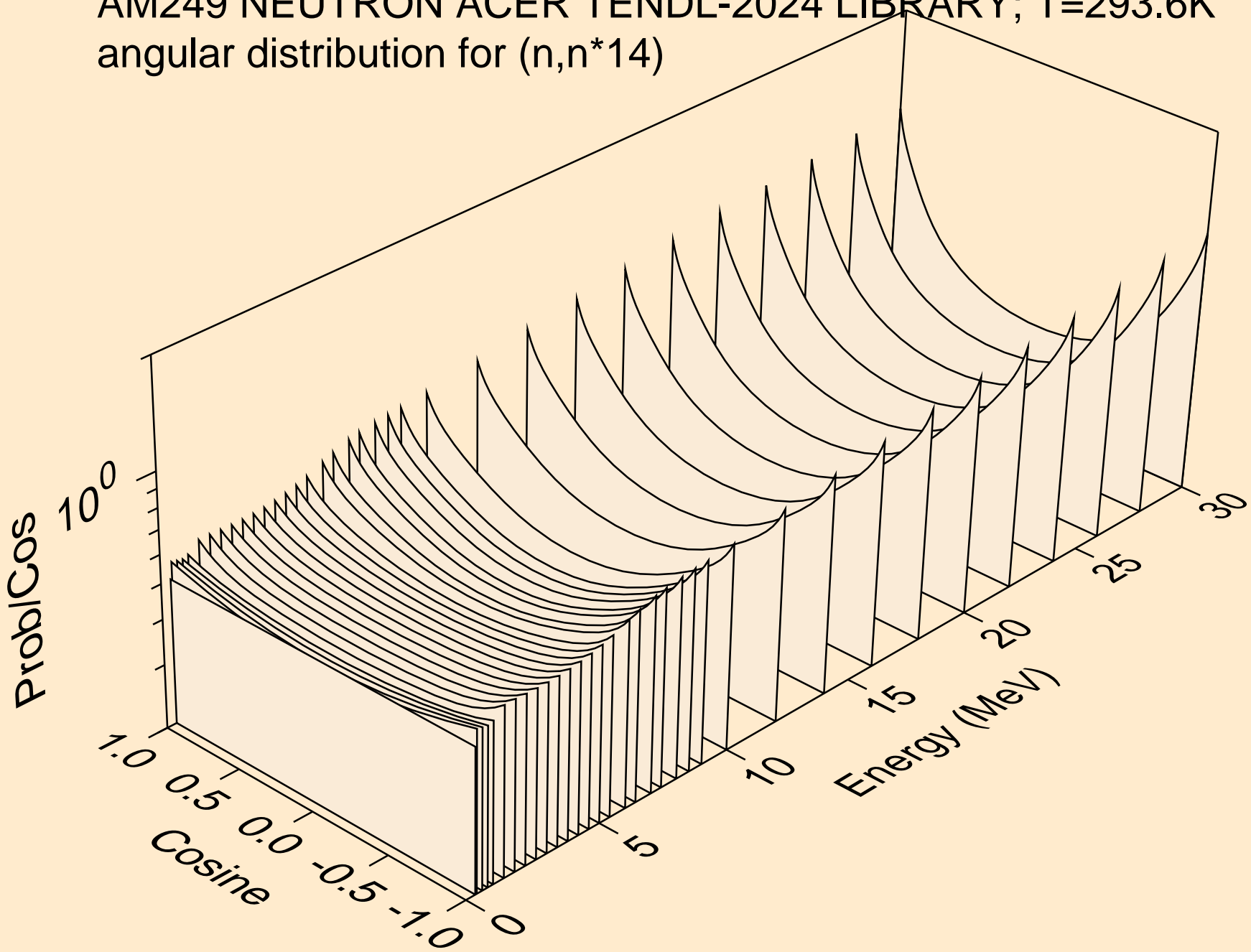

AM249 NEUTRON ACER TENDL-2024 LIBRARY; T=293.6K
angular distribution for (n,n*15)

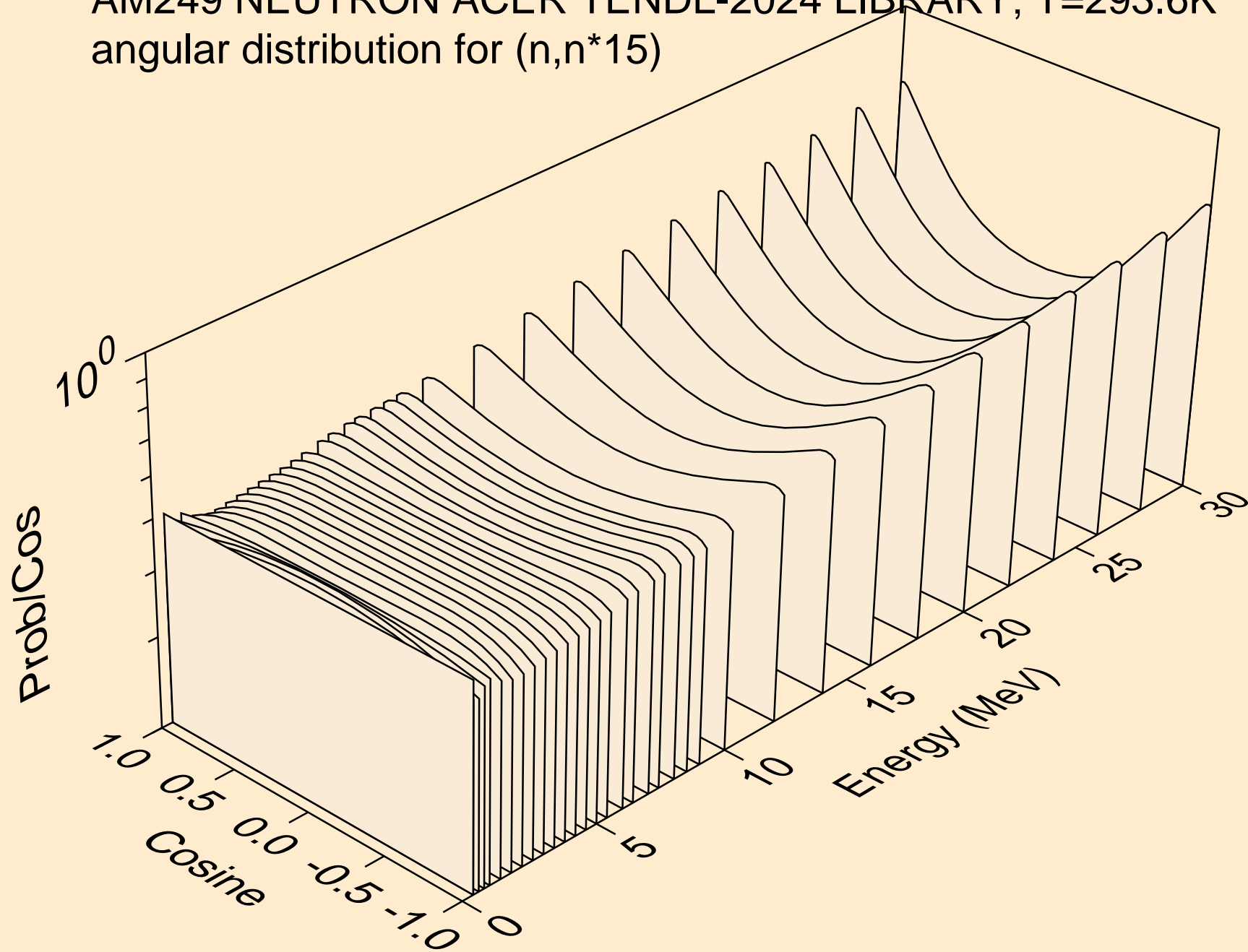

AM249 NEUTRON ACER TENDL-2024 LIBRARY; T=293.6K
angular distribution for (n,n*16)

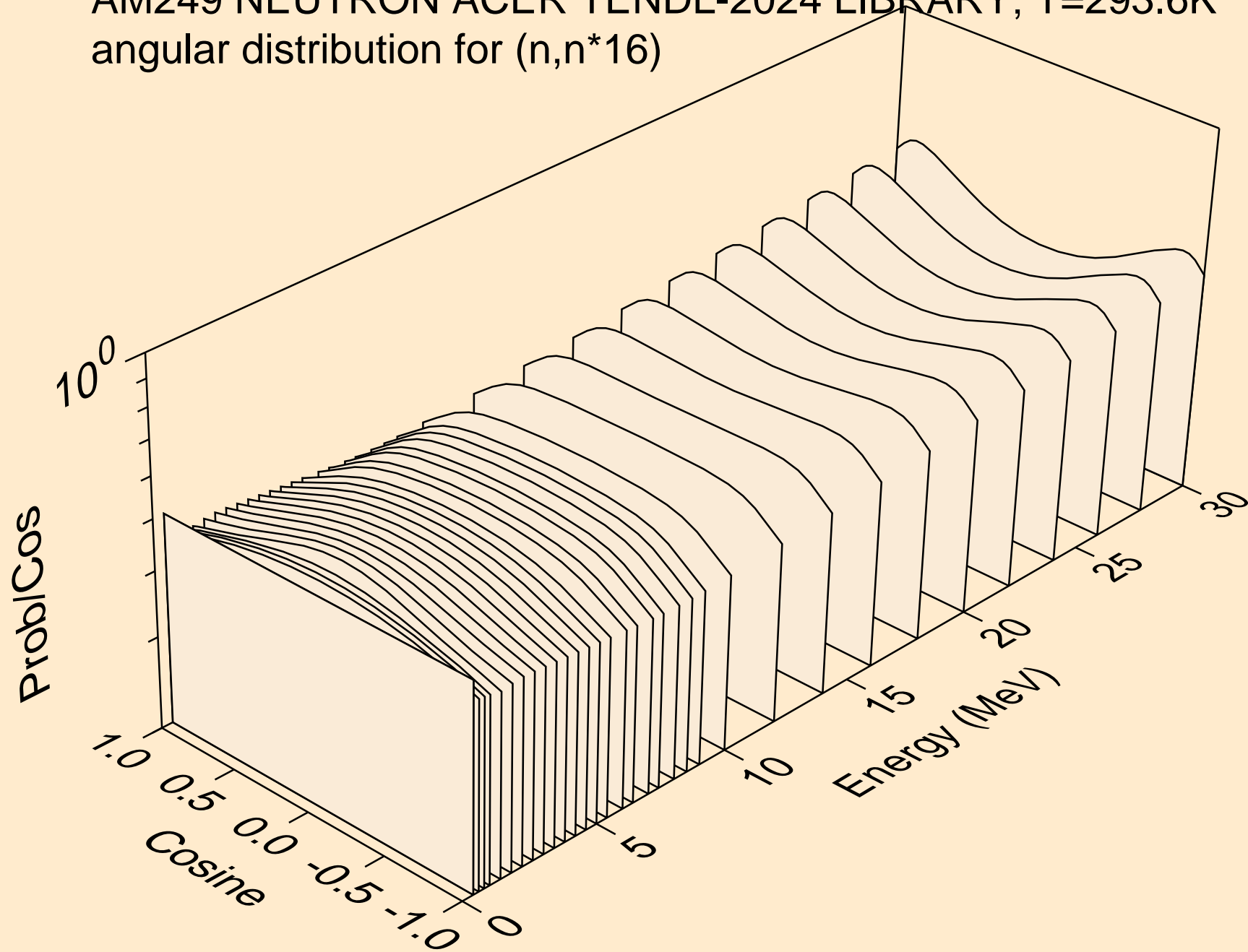

AM249 NEUTRON ACER TENDL-2024 LIBRARY; T=293.6K
angular distribution for (n,n*17)

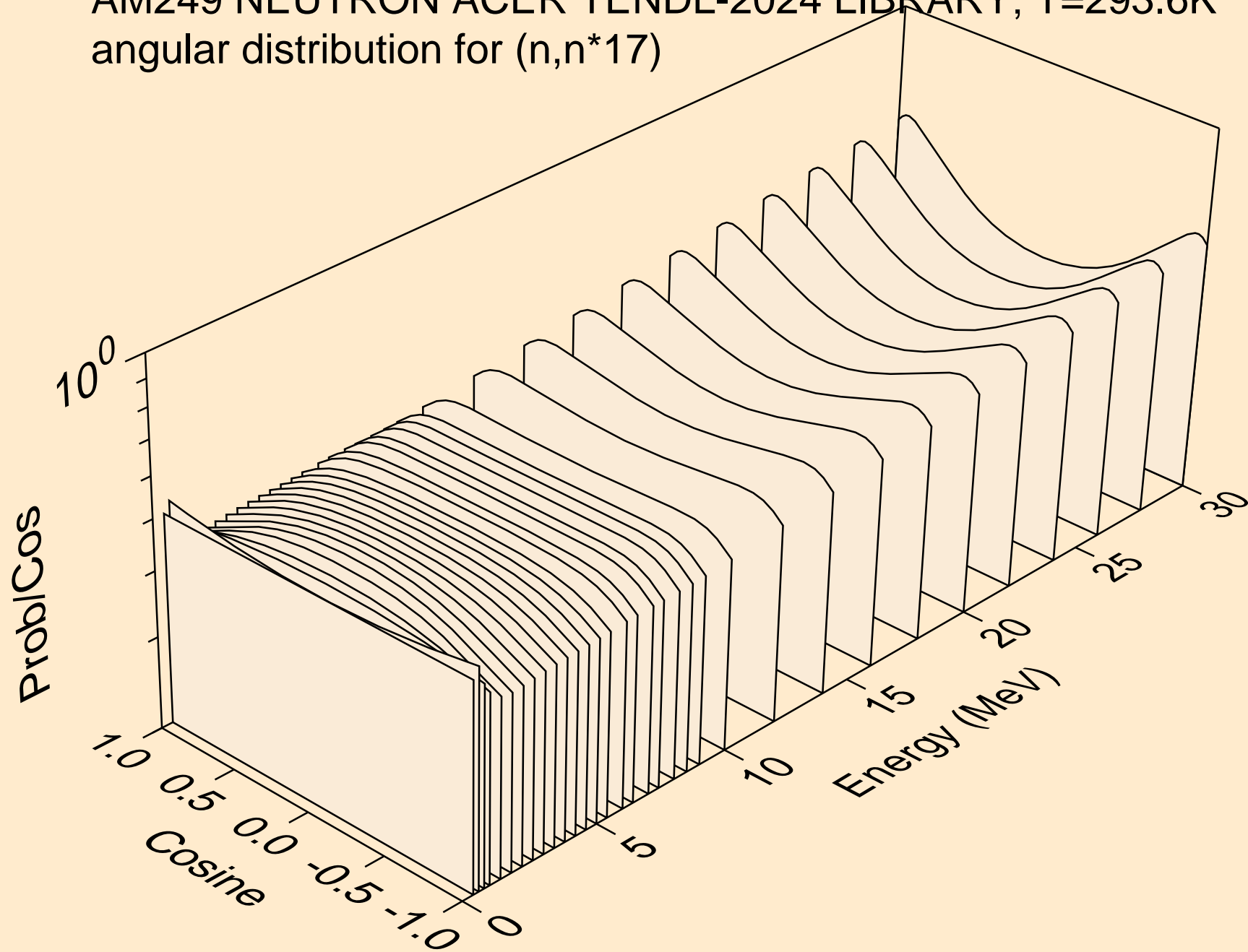

AM249 NEUTRON ACER TENDL-2024 LIBRARY; T=293.6K
angular distribution for (n,n*18)

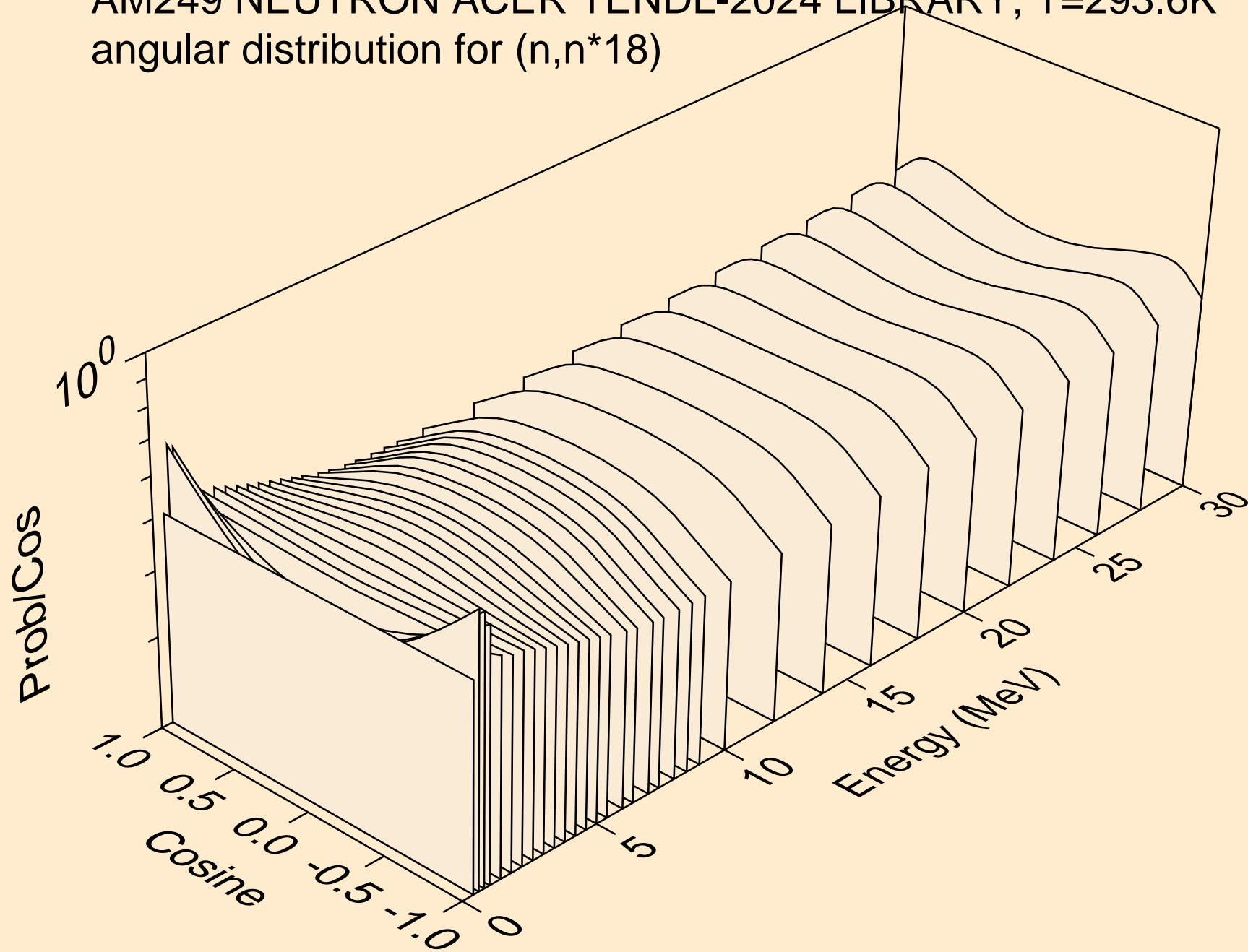

AM249 NEUTRON ACER TENDL-2024 LIBRARY; T=293.6K
angular distribution for (n,n*19)

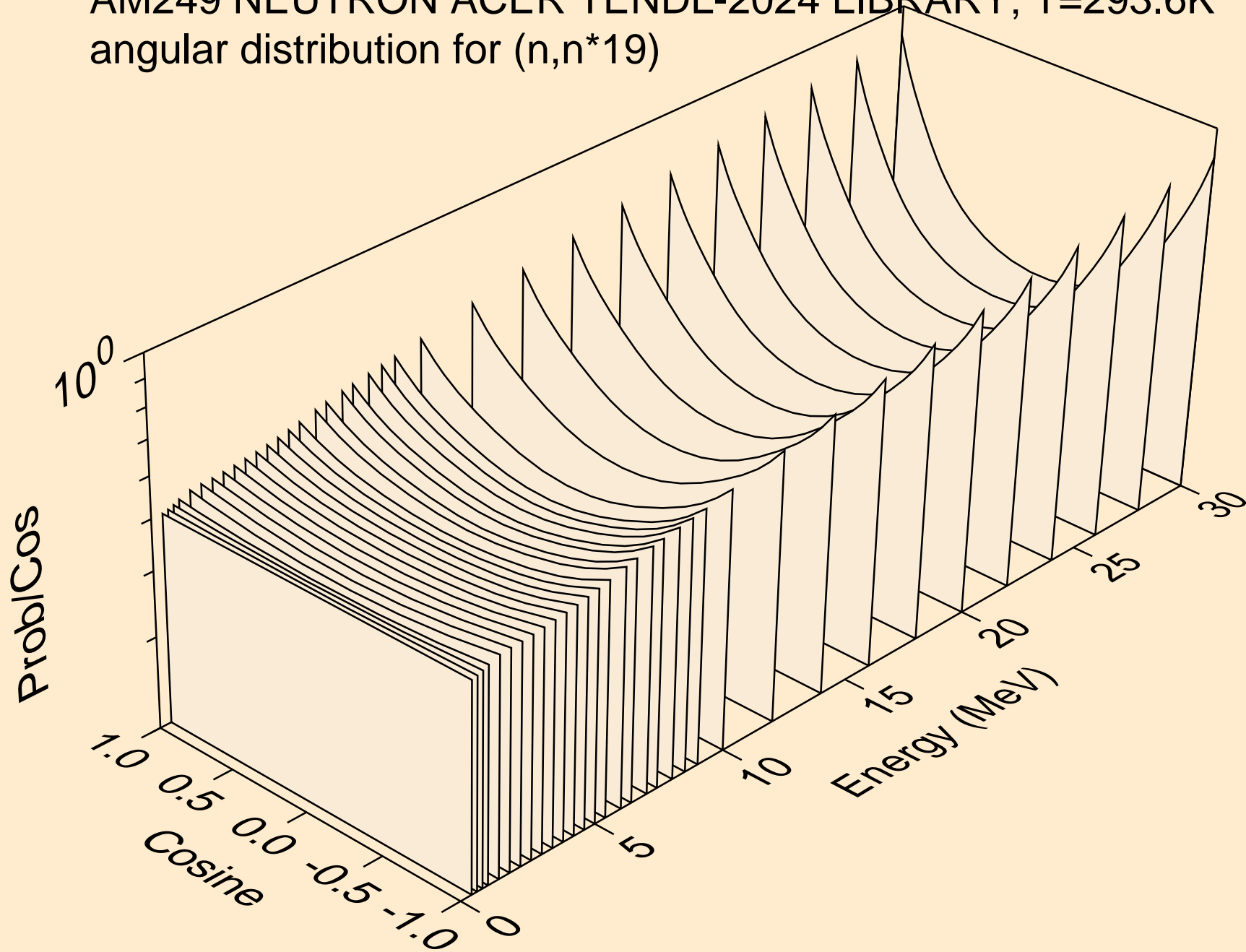

AM249 NEUTRON ACER TENDL-2024 LIBRARY; T=293.6K
angular distribution for (n,n*20)

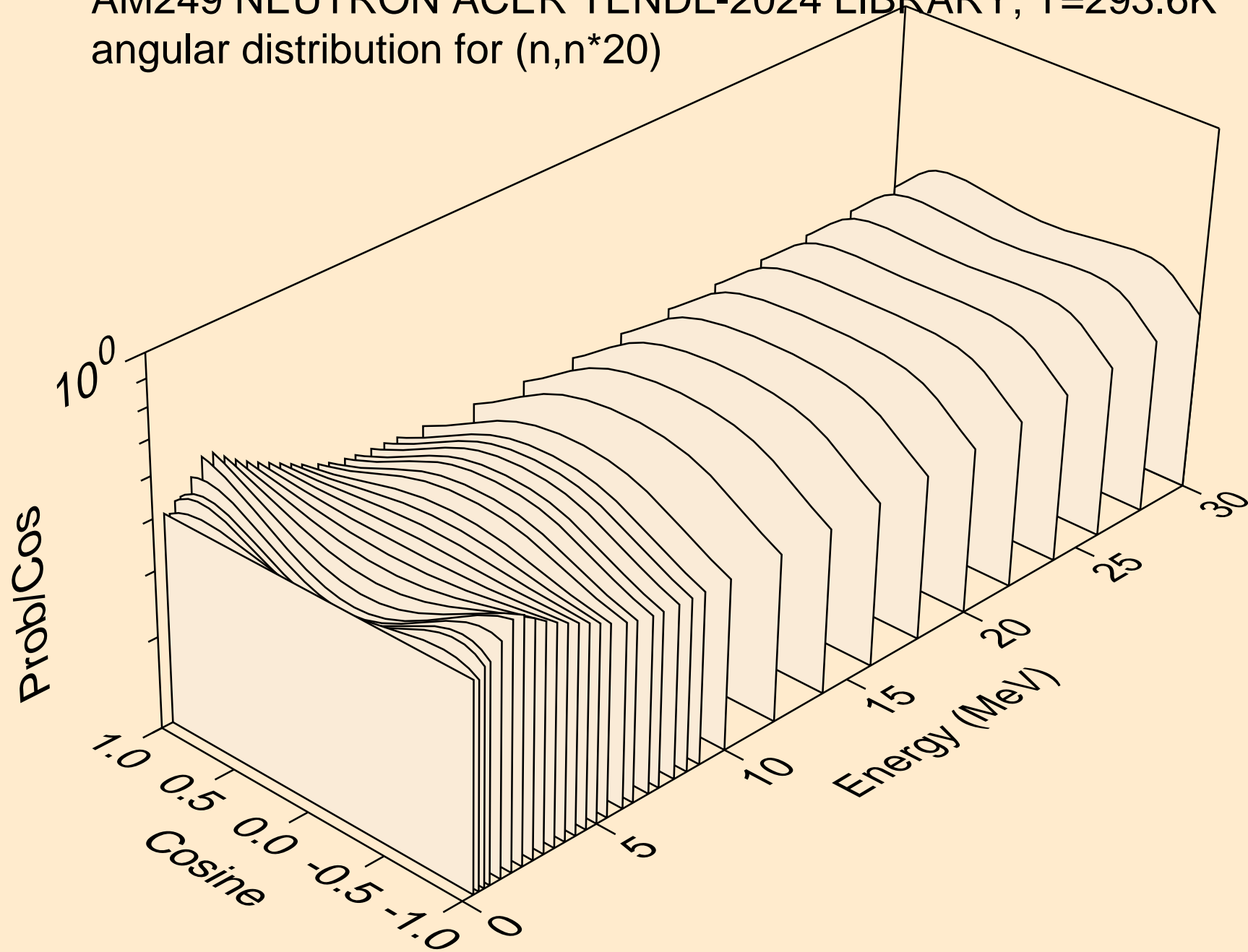

AM249 NEUTRON ACER TENDL-2024 LIBRARY; T=293.6K
angular distribution for (n,n*21)

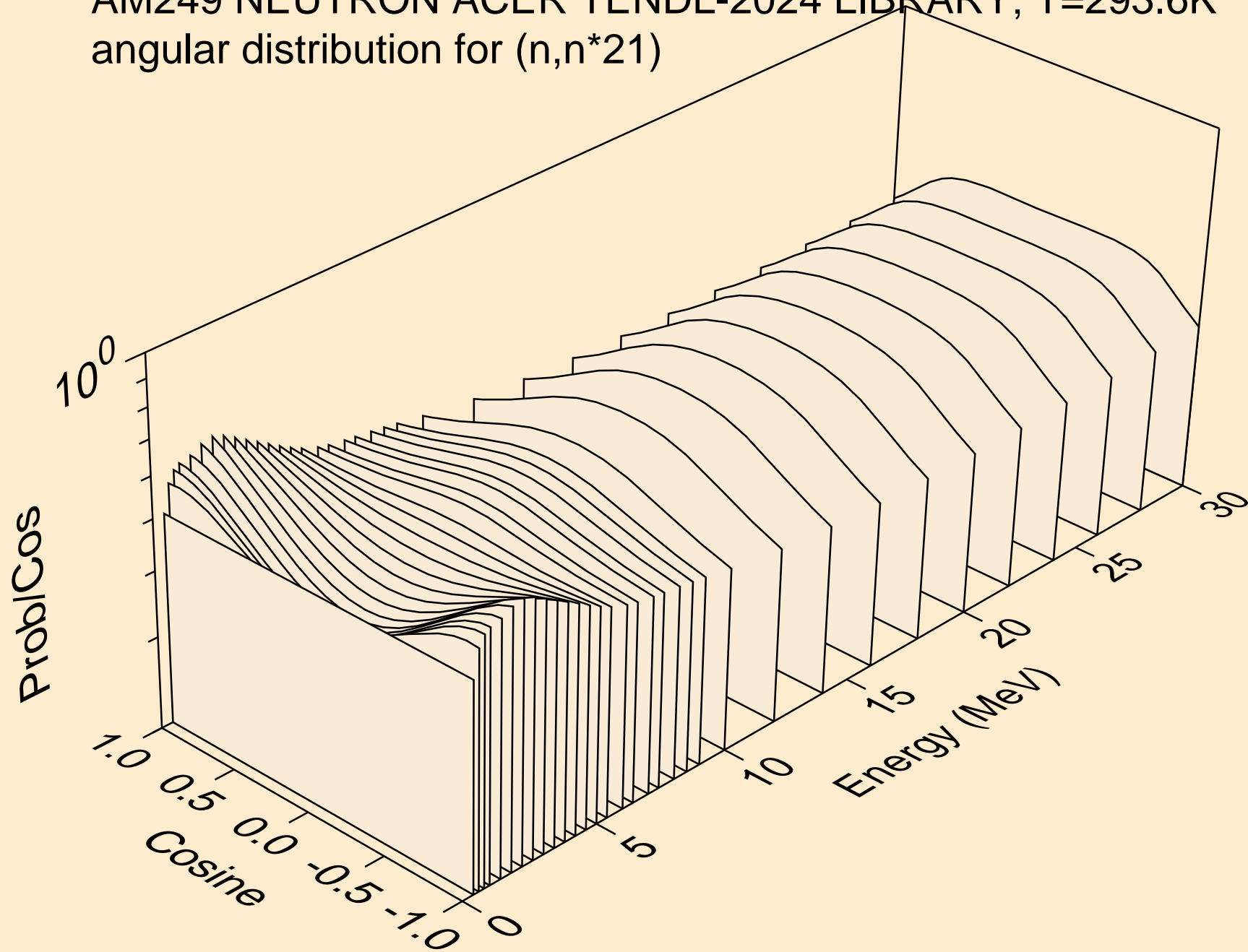

AM249 NEUTRON ACER TENDL-2024 LIBRARY; T=293.6K
angular distribution for (n,n*22)

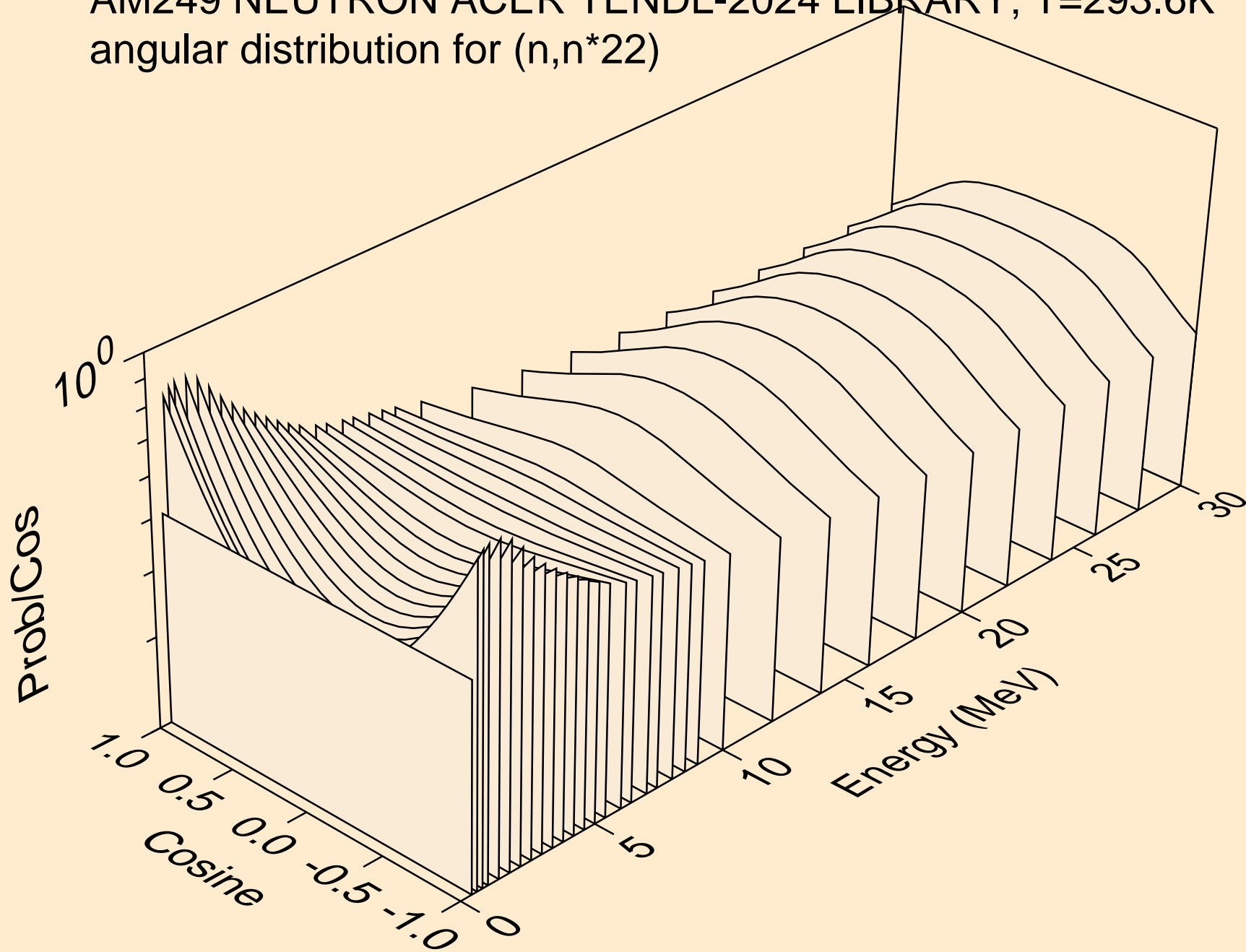

AM249 NEUTRON ACER TENDL-2024 LIBRARY; T=293.6K
angular distribution for (n,n*23)

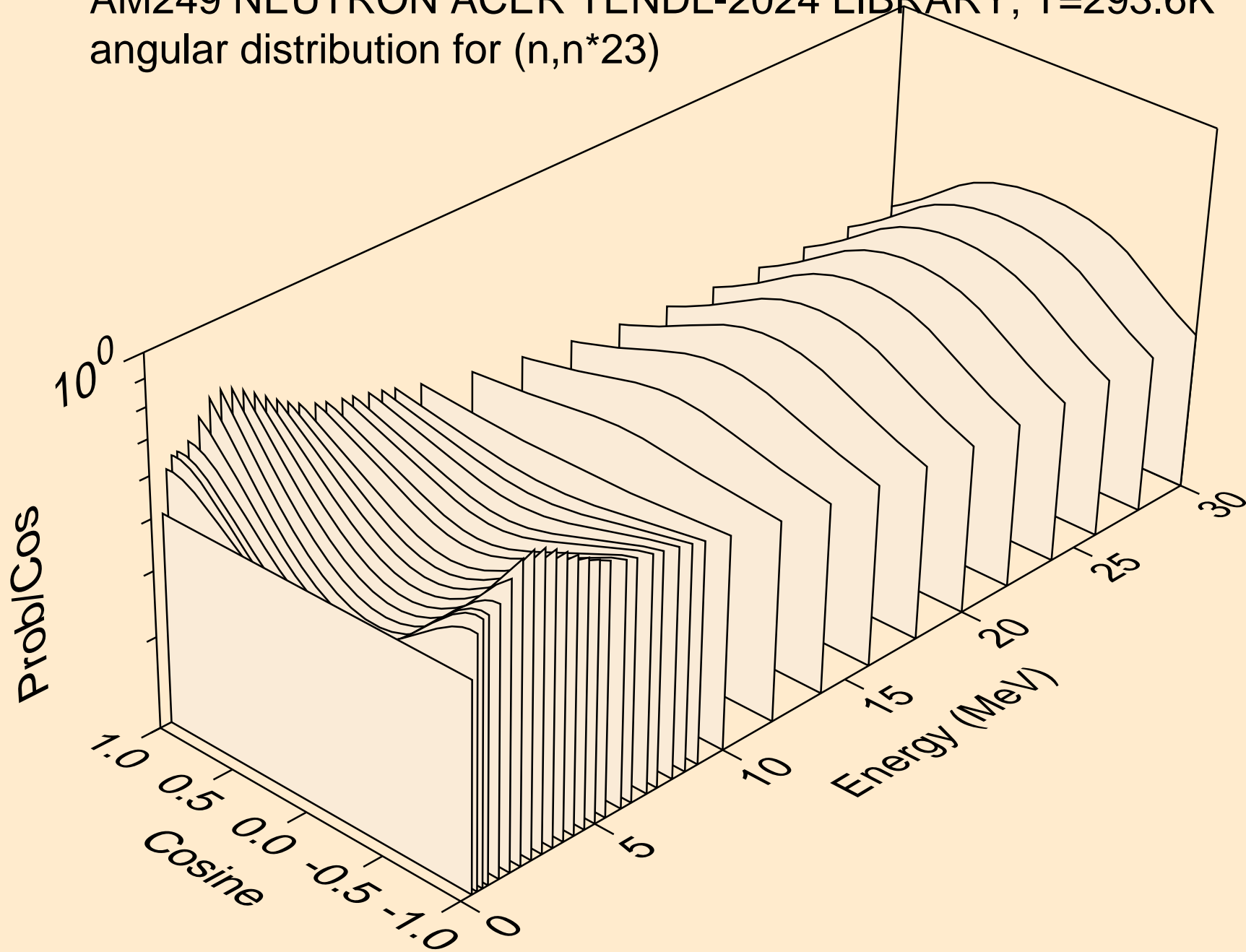

AM249 NEUTRON ACER TENDL-2024 LIBRARY; T=293.6K
angular distribution for (n,n*24)

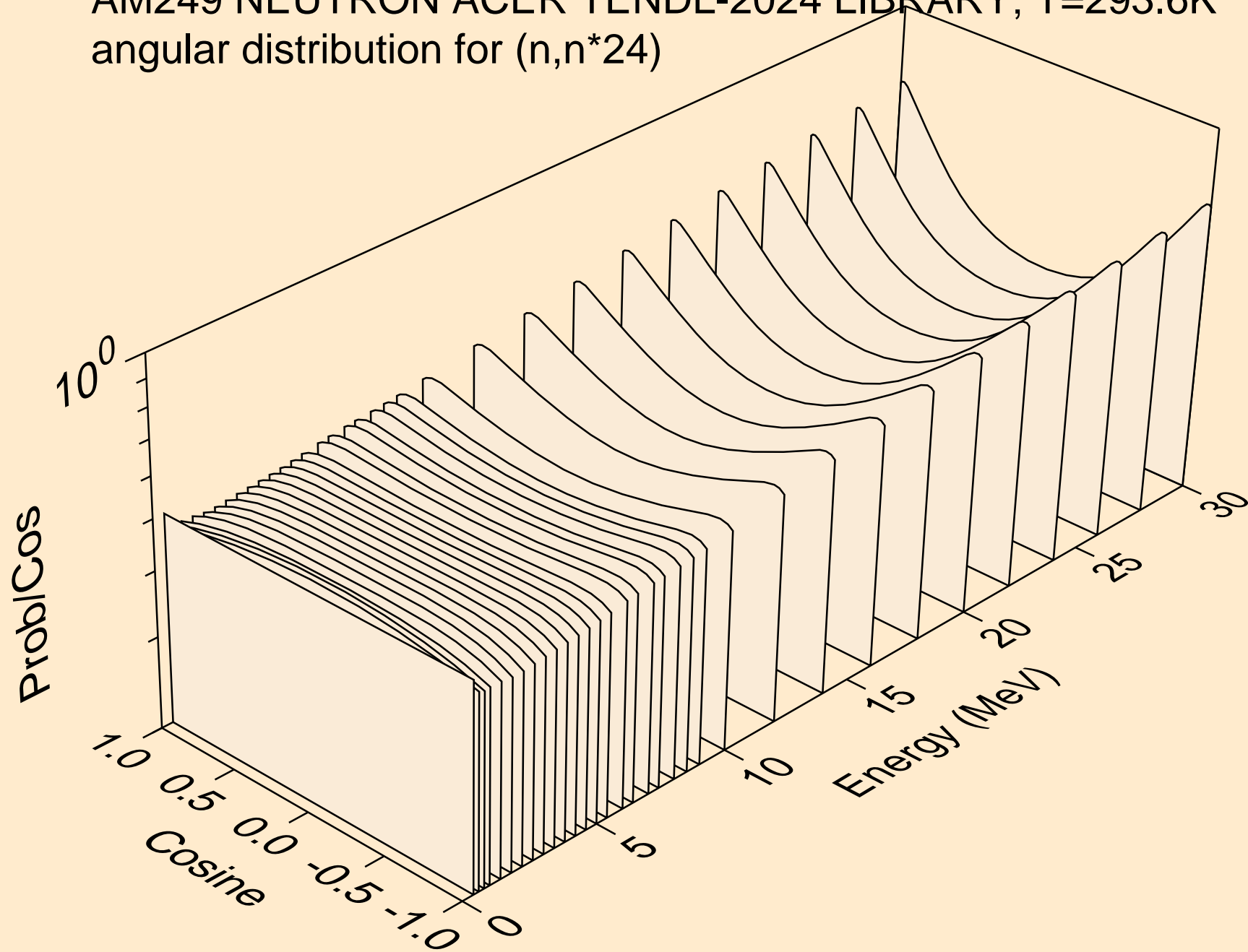

AM249 NEUTRON ACER TENDL-2024 LIBRARY; T=293.6K
angular distribution for (n,n*25)

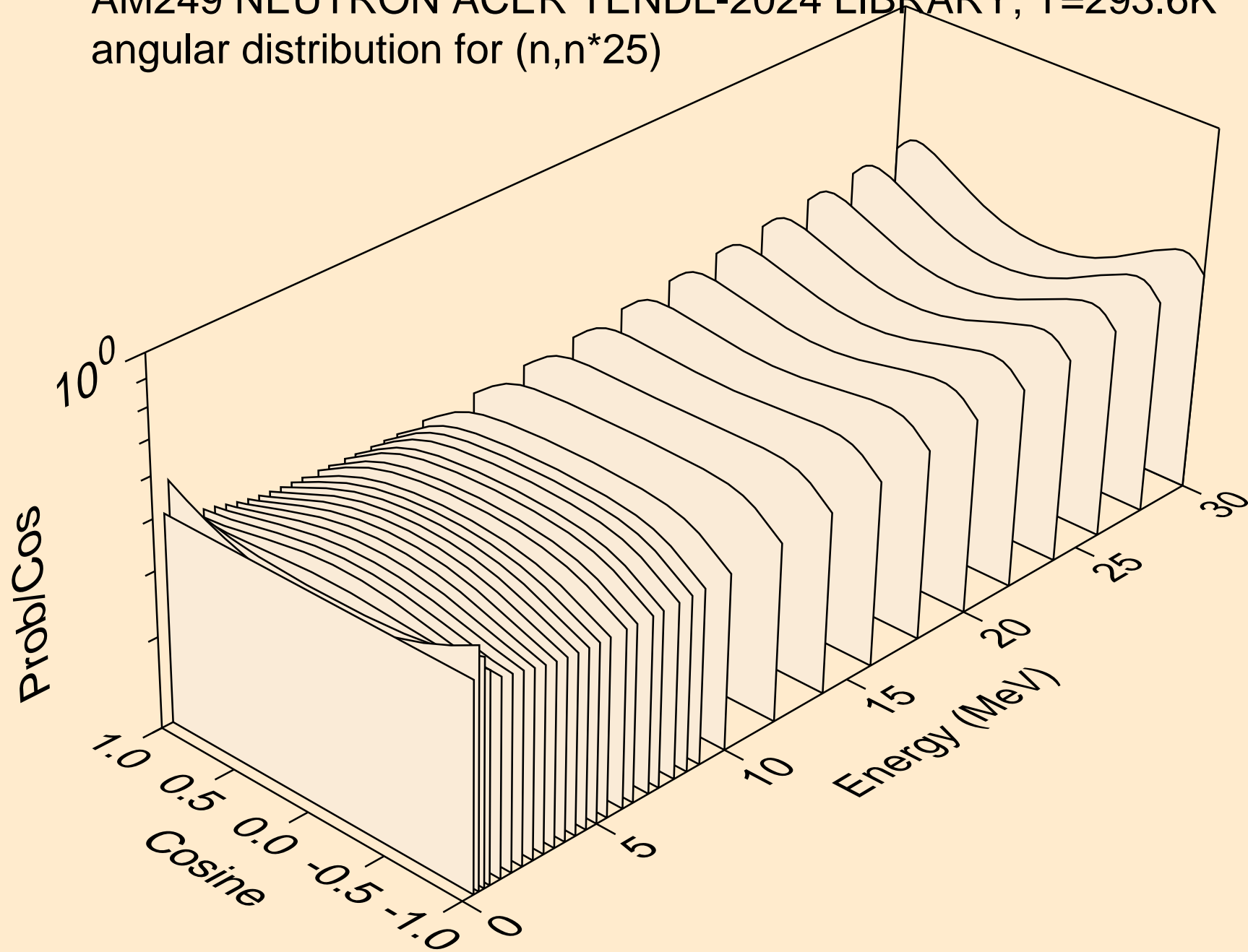

AM249 NEUTRON ACER TENDL-2024 LIBRARY; T=293.6K
angular distribution for (n,n*26)

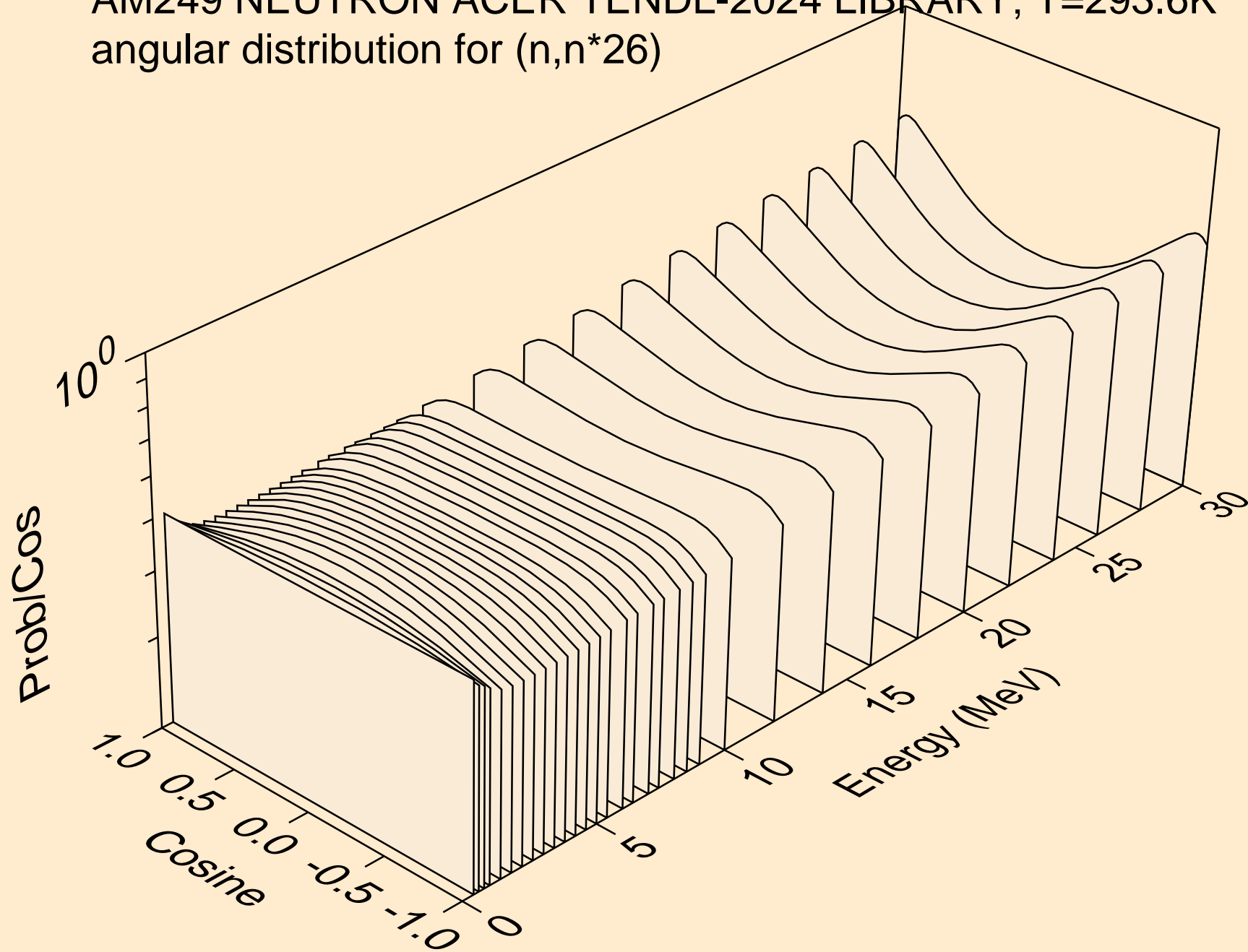

AM249 NEUTRON ACER TENDL-2024 LIBRARY; T=293.6K
angular distribution for (n,n*27)

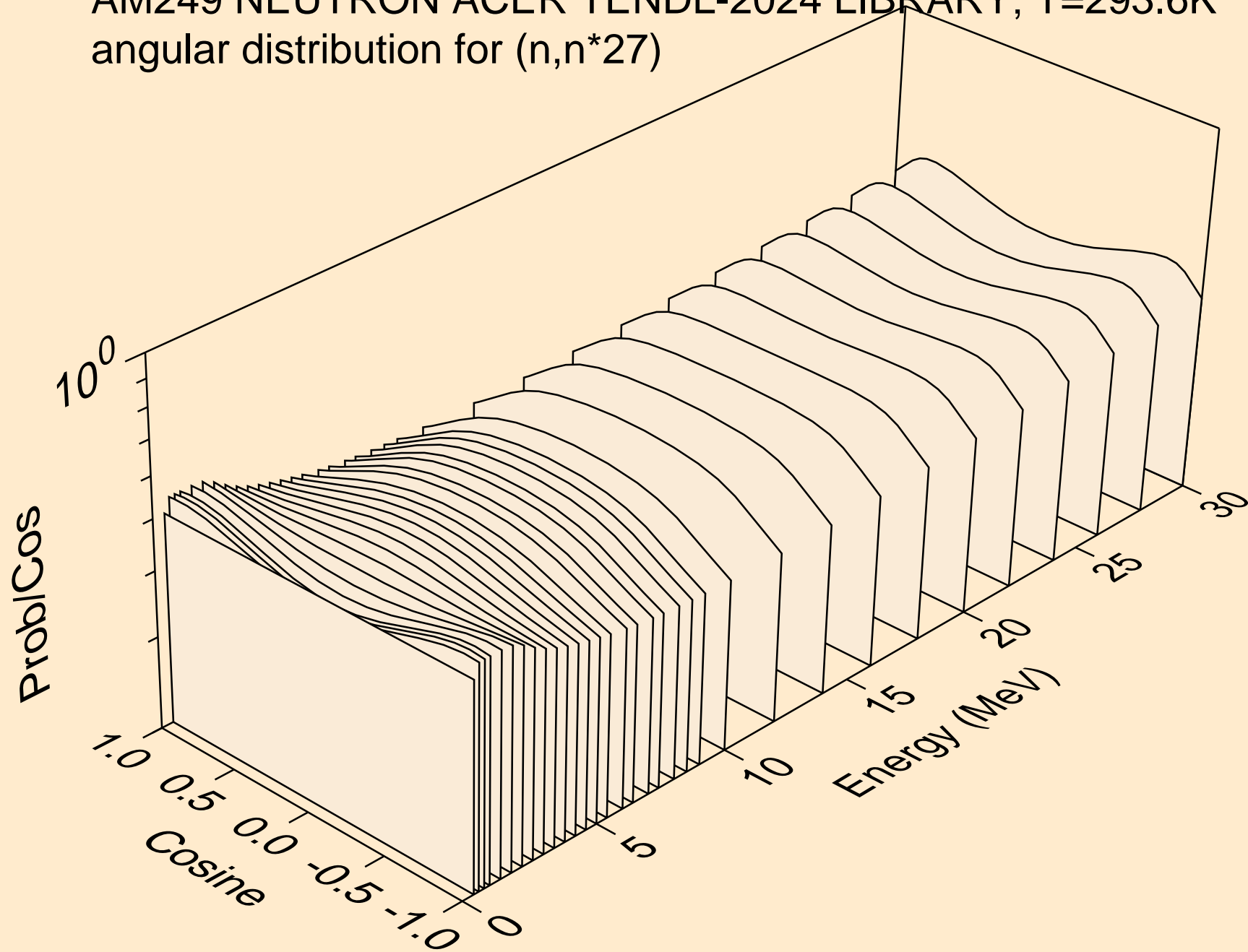

AM249 NEUTRON ACER TENDL-2024 LIBRARY; T=293.6K
angular distribution for (n,n*28)

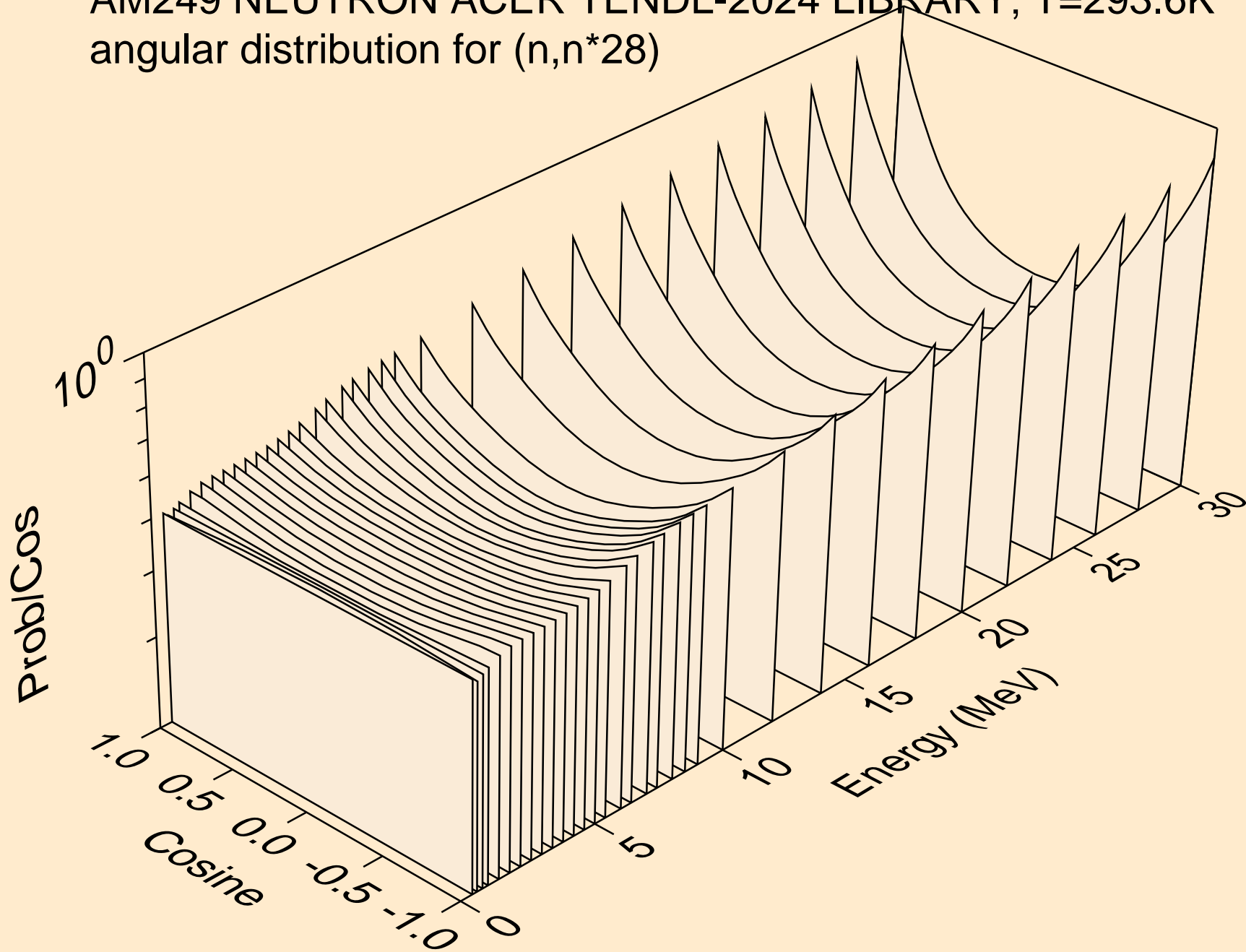

AM249 NEUTRON ACER TENDL-2024 LIBRARY; T=293.6K
angular distribution for (n,n*29)

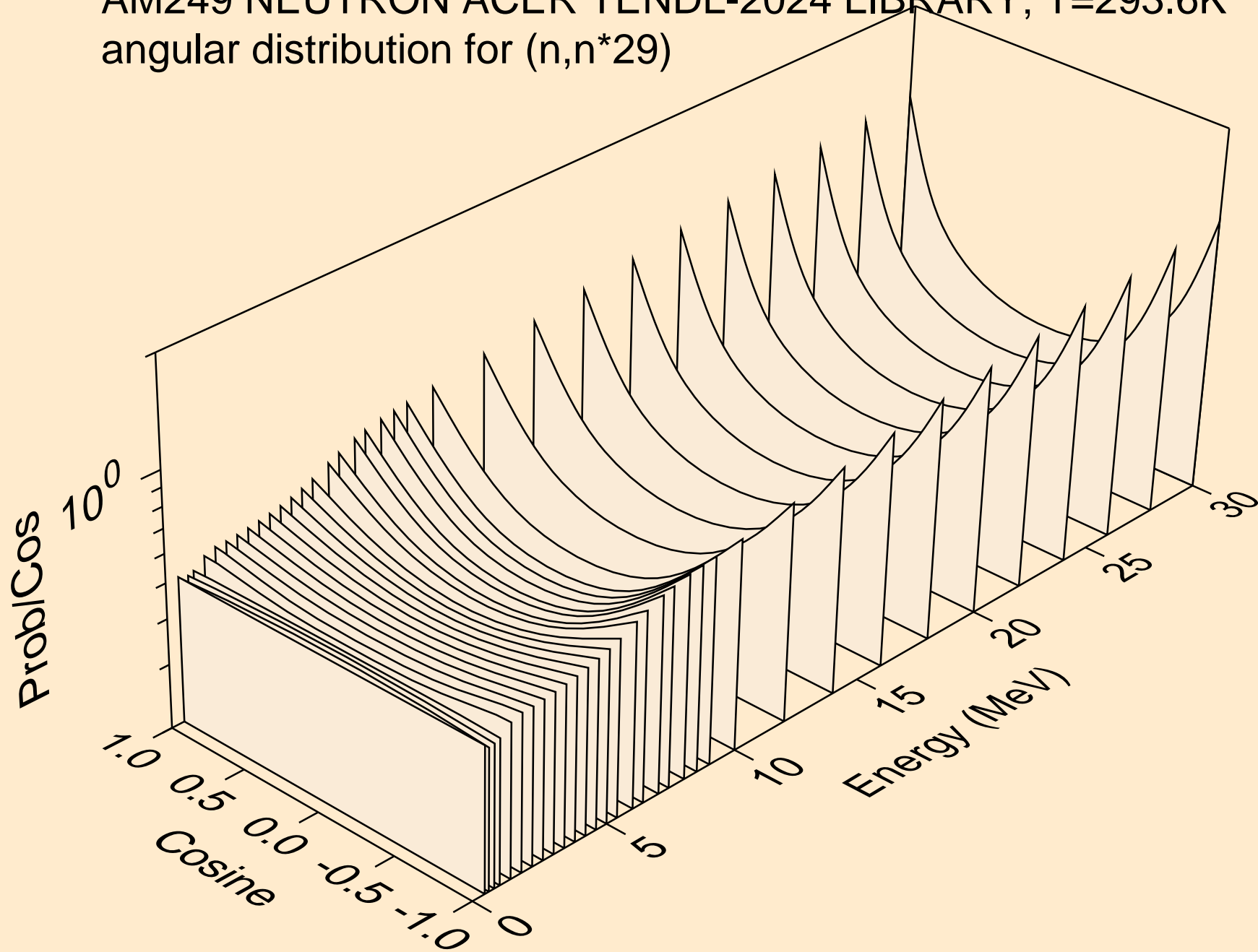

AM249 NEUTRON ACER TENDL-2024 LIBRARY; T=293.6K
angular distribution for (n,n*30)

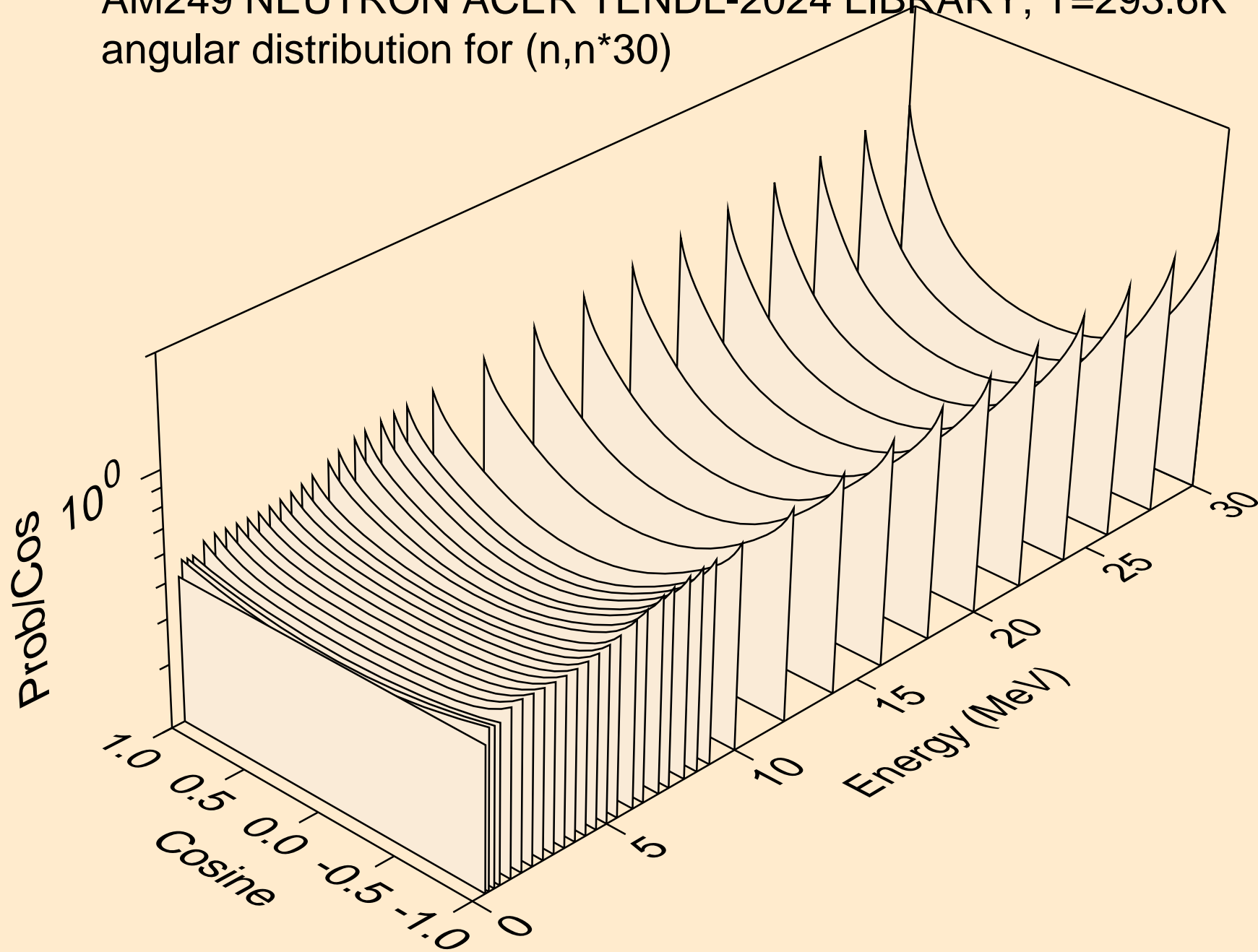

AM249 NEUTRON ACER TENDL-2024 LIBRARY; T=293.6K
Total fission nubar

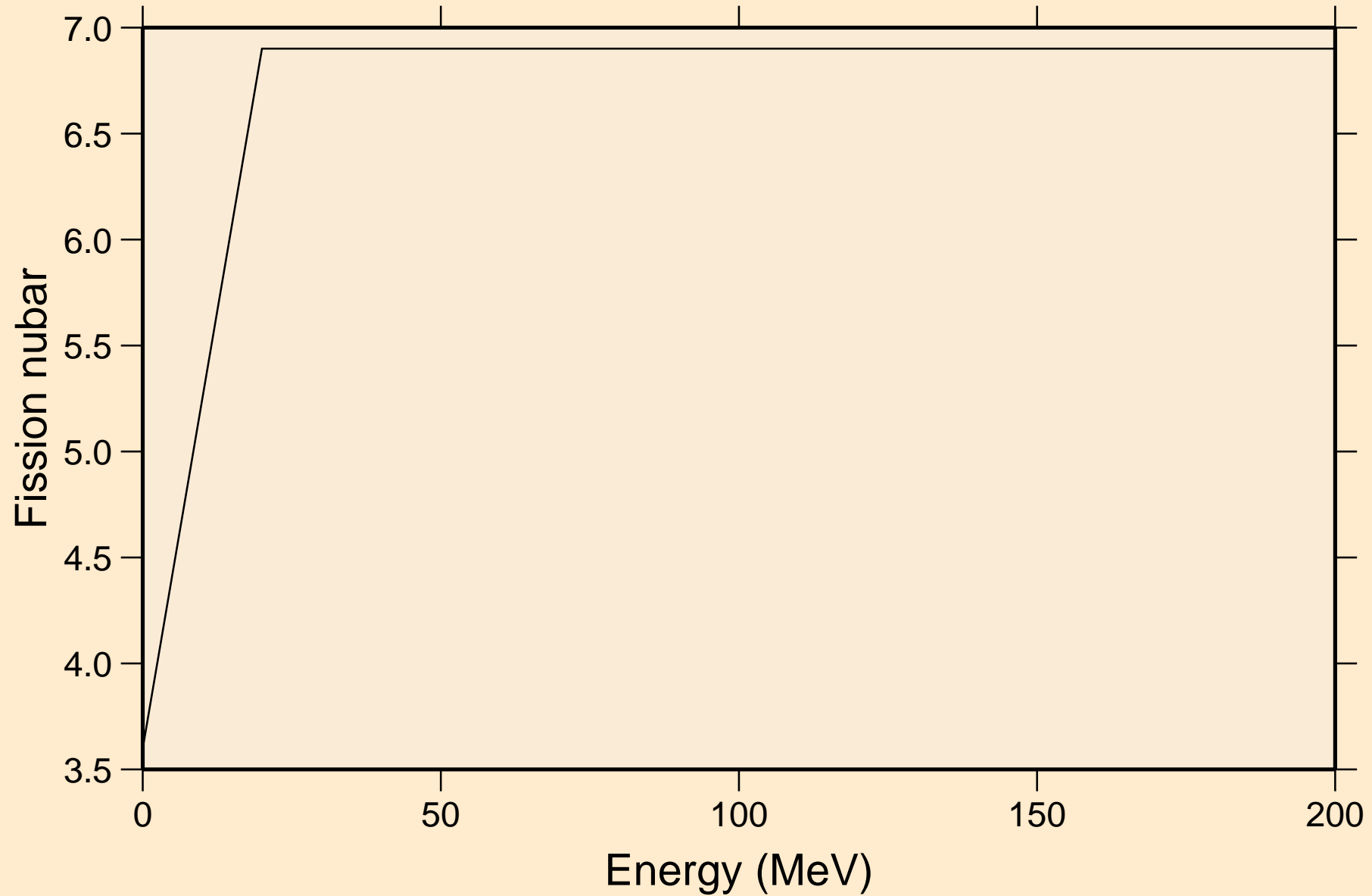

AM249 NEUTRON ACER TENDL-2024 LIBRARY; T=293.6K
Neutron emission for (n,x)

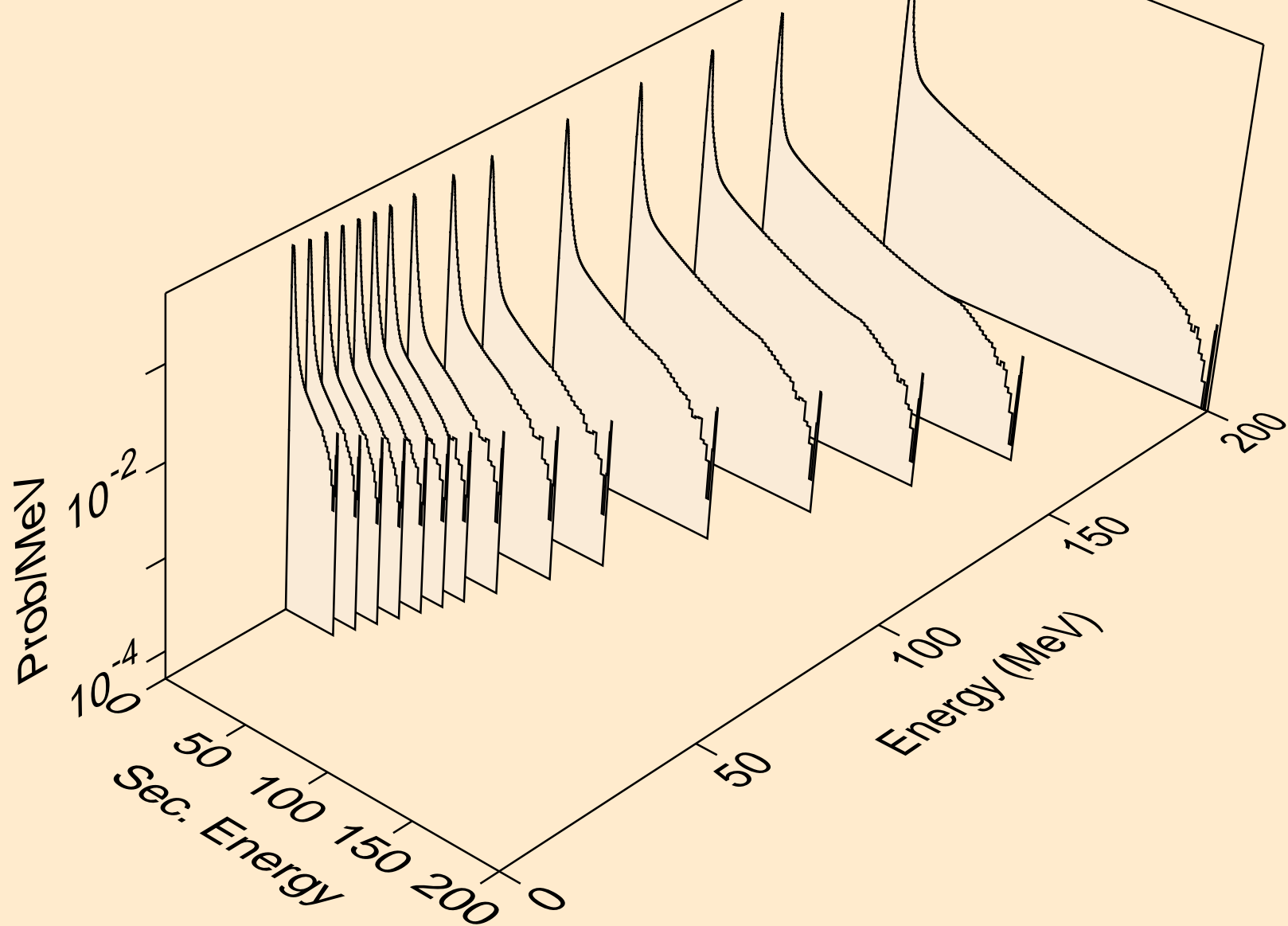

AM249 NEUTRON ACER TENDL-2024 LIBRARY; T=293.6K
Neutron emission for (n,2nd)

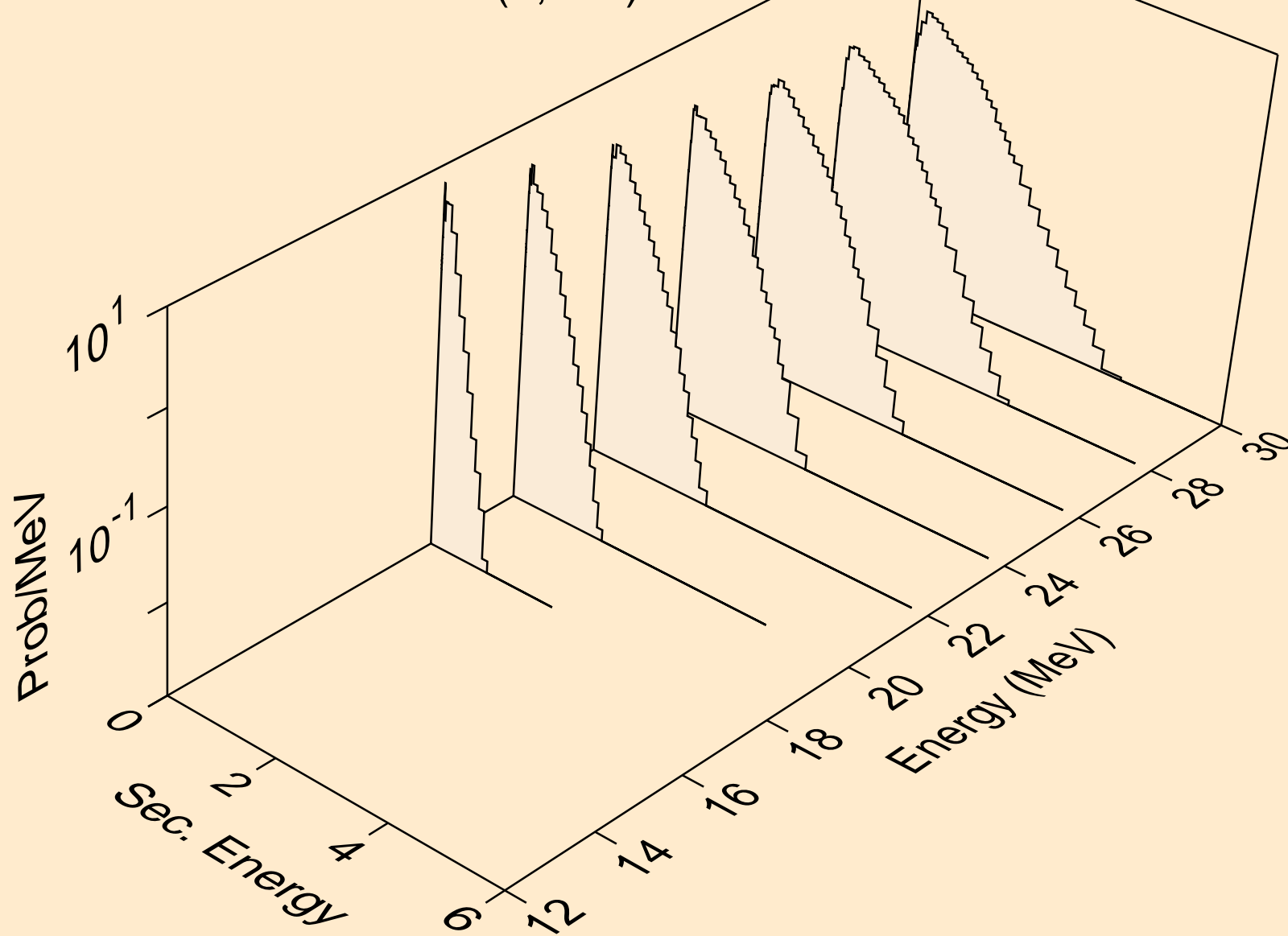

AM249 NEUTRON ACER TENDL-2024 LIBRARY; T=293.6K
Neutron emission for (n,2n)

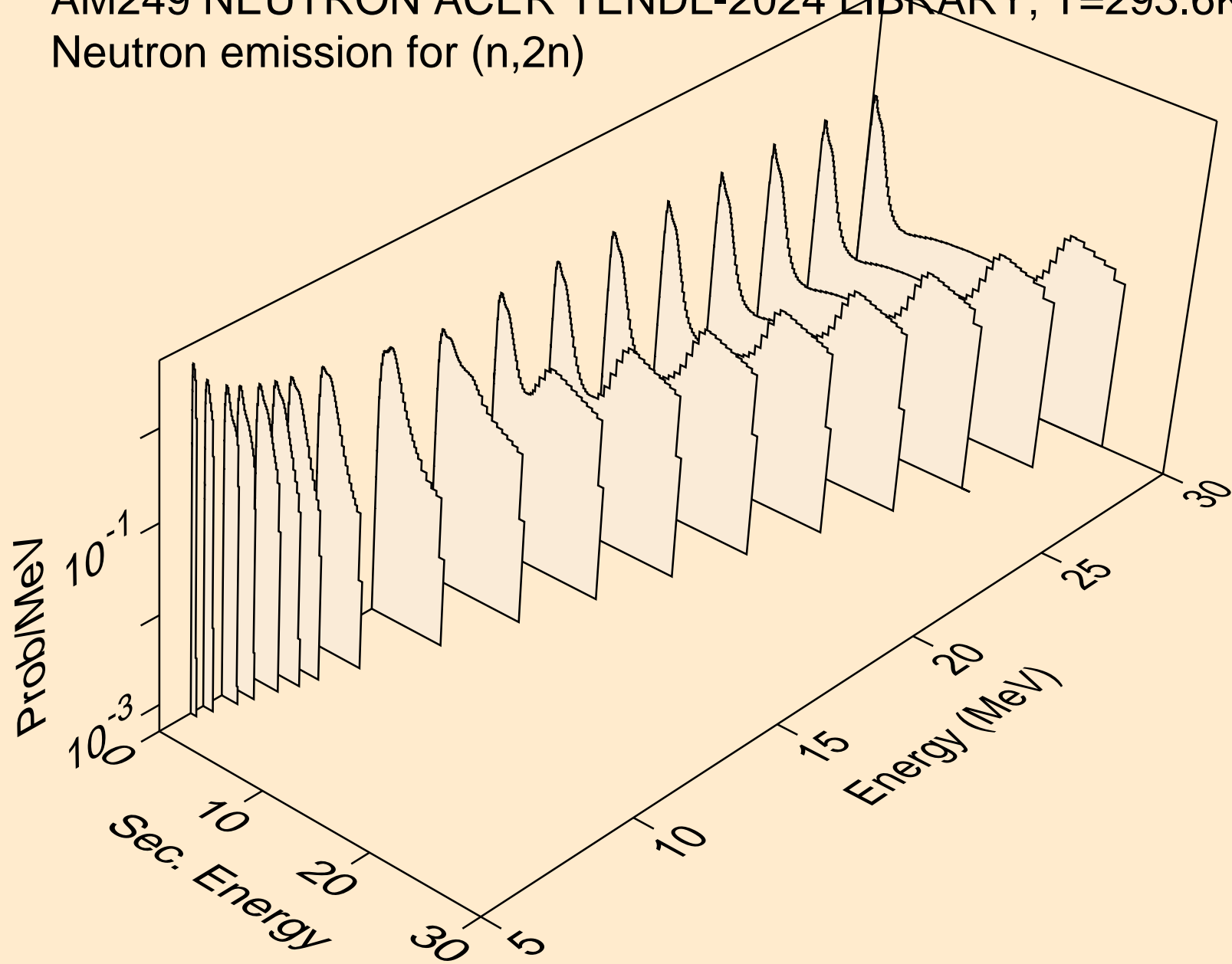

AM249 NEUTRON ACER TENDL-2024 LIBRARY; T=293.6K
Neutron emission for (n,3n)

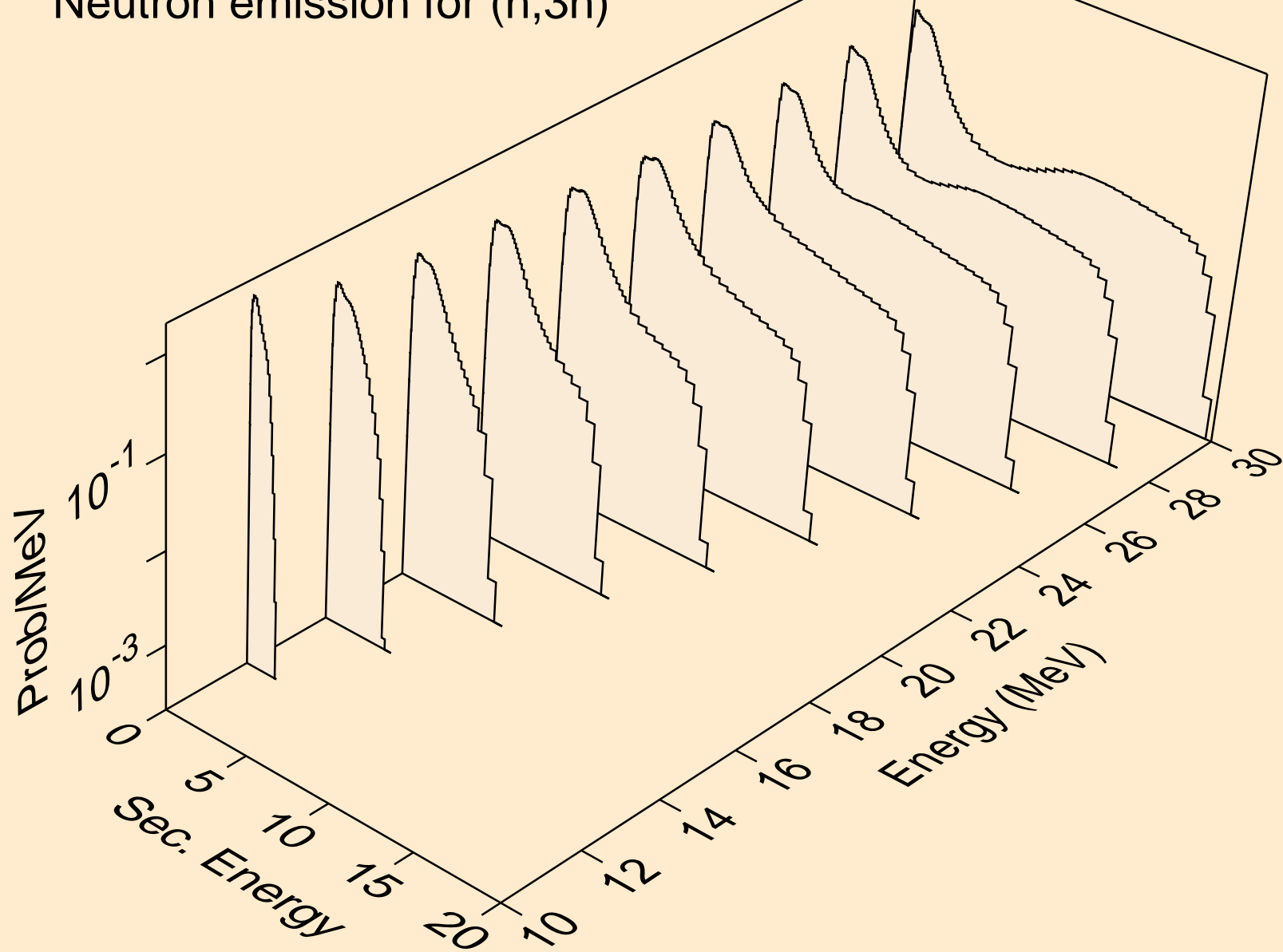

AM249 NEUTRON ACER TENDL-2024 LIBRARY; T=293.6K
Neutron emission for fission

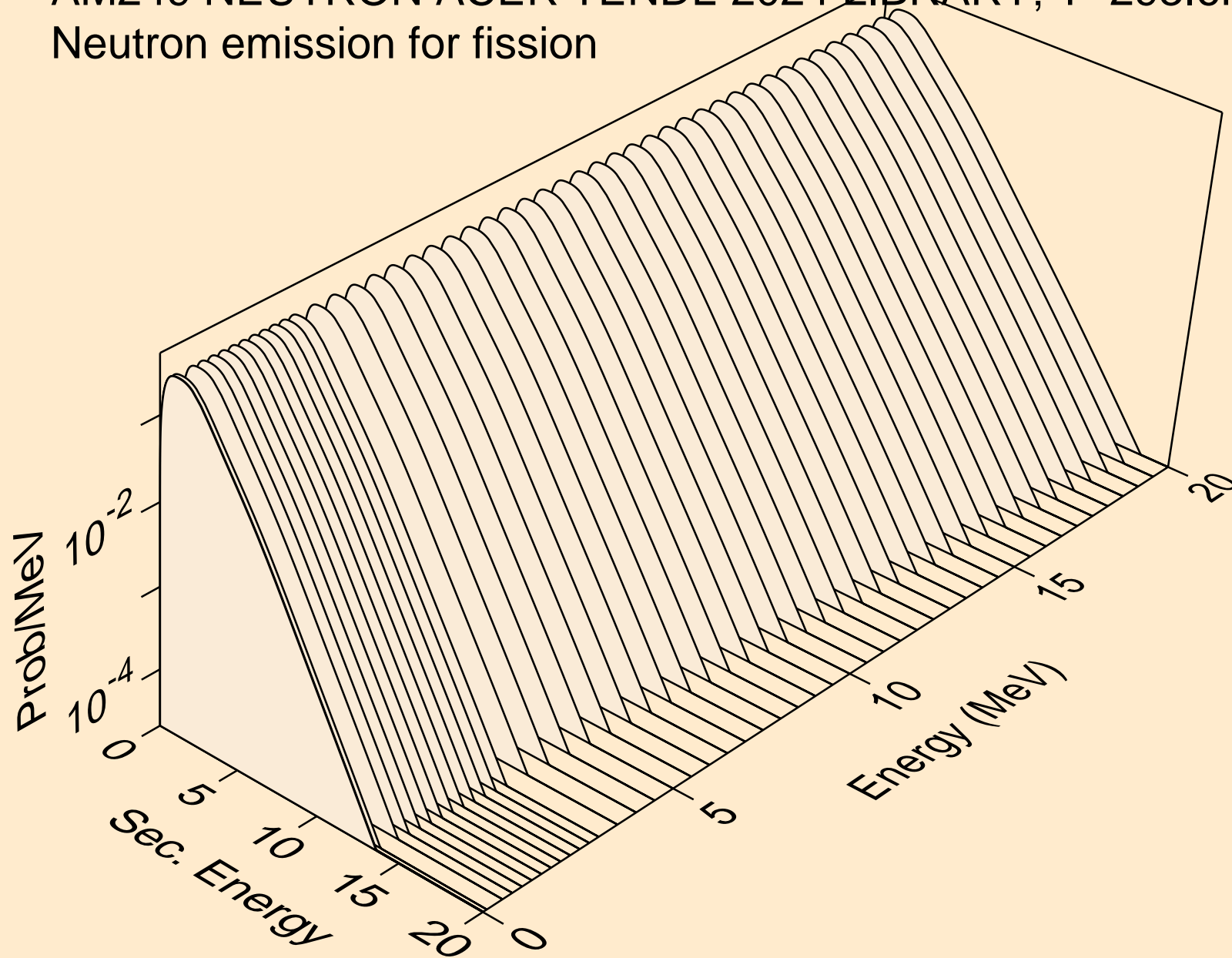

AM249 NEUTRON ACER TENDL-2024 LIBRARY; T=293.6K
Neutron emission for (n,n*)a

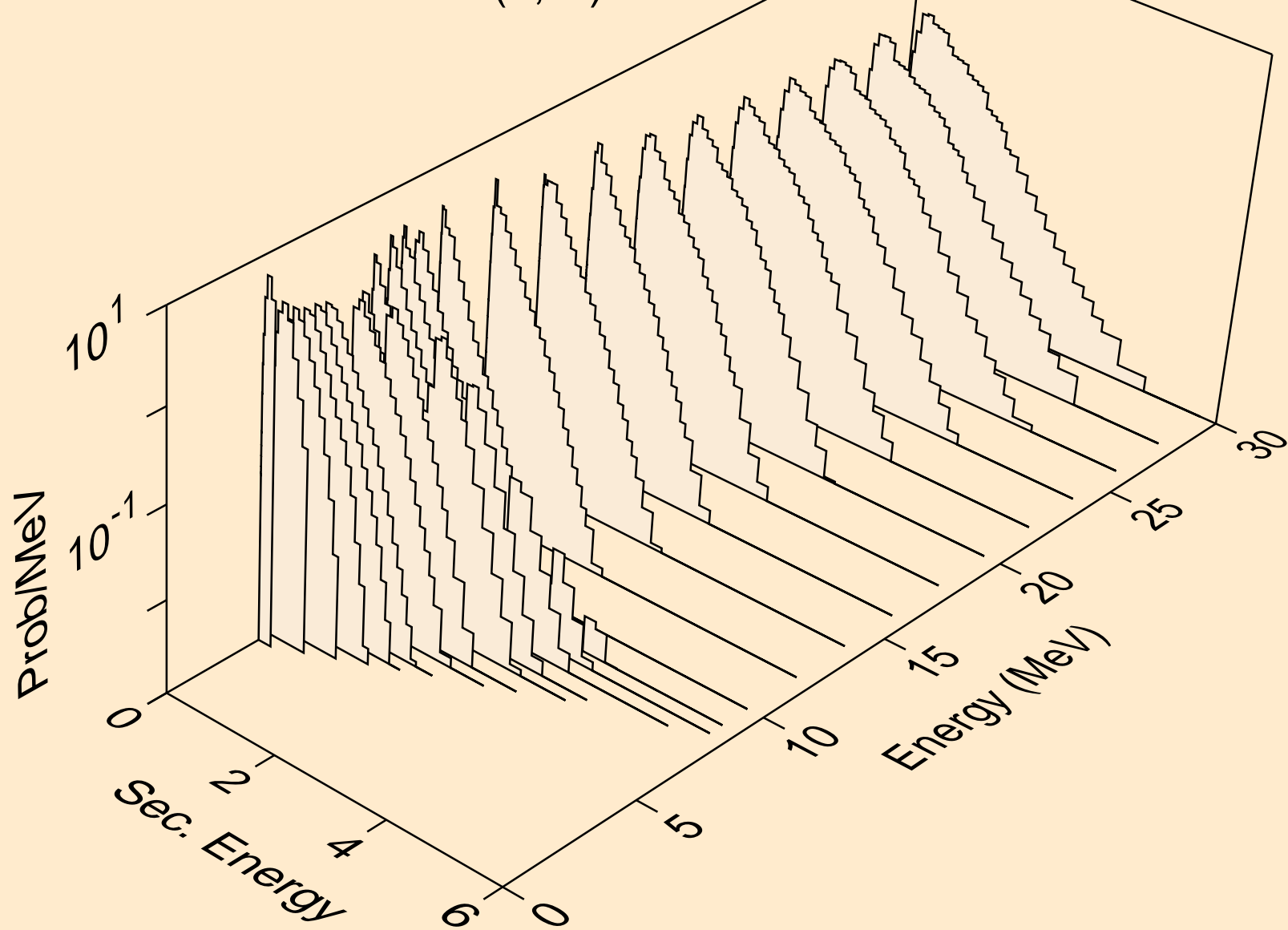

AM249 NEUTRON ACER TENDL-2024 LIBRARY; T=293.6K
Neutron emission for (n,2n)a

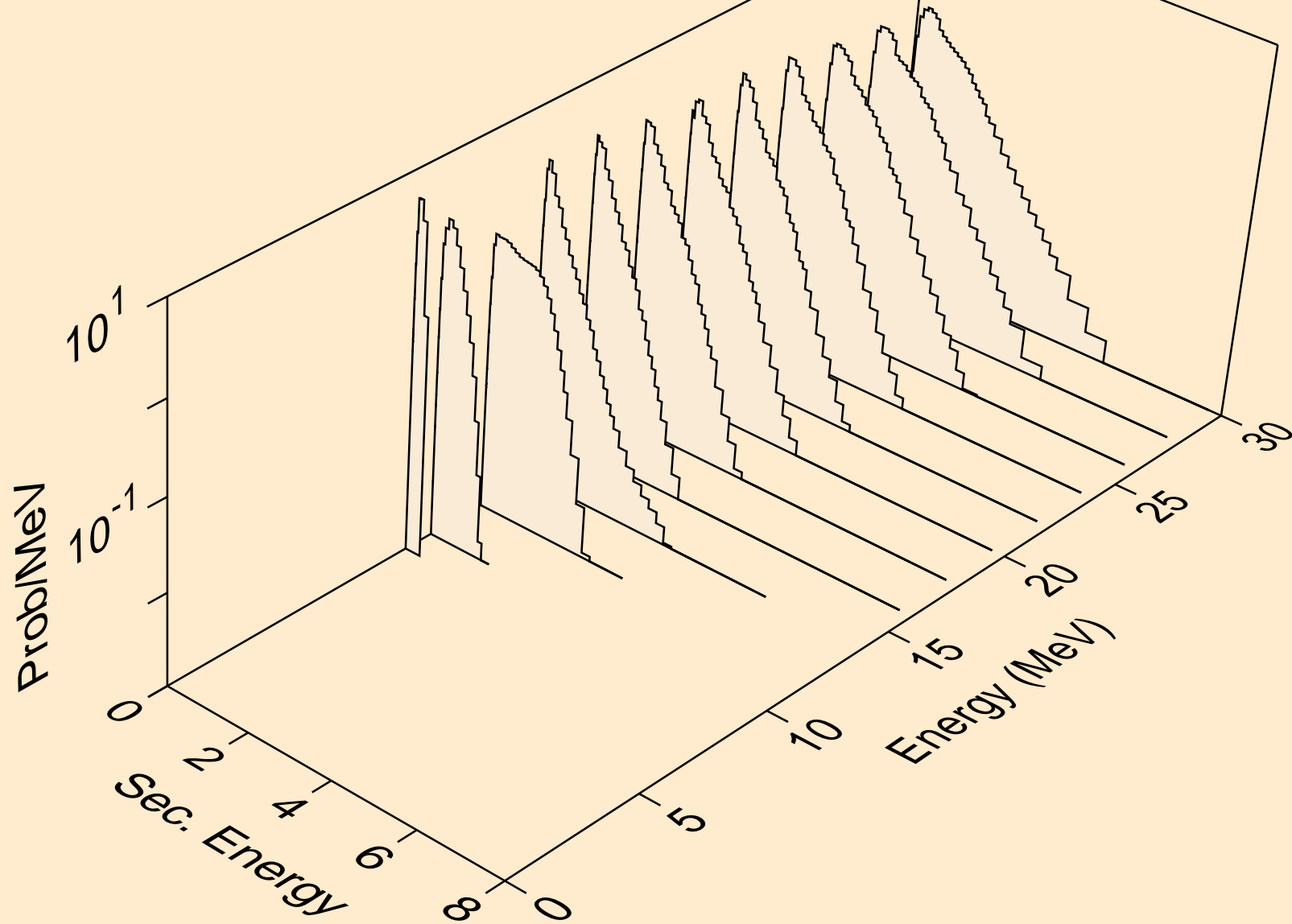

AM249 NEUTRON ACER TENDL-2024 LIBRARY; T=293.6K
Neutron emission for (n,3n)a

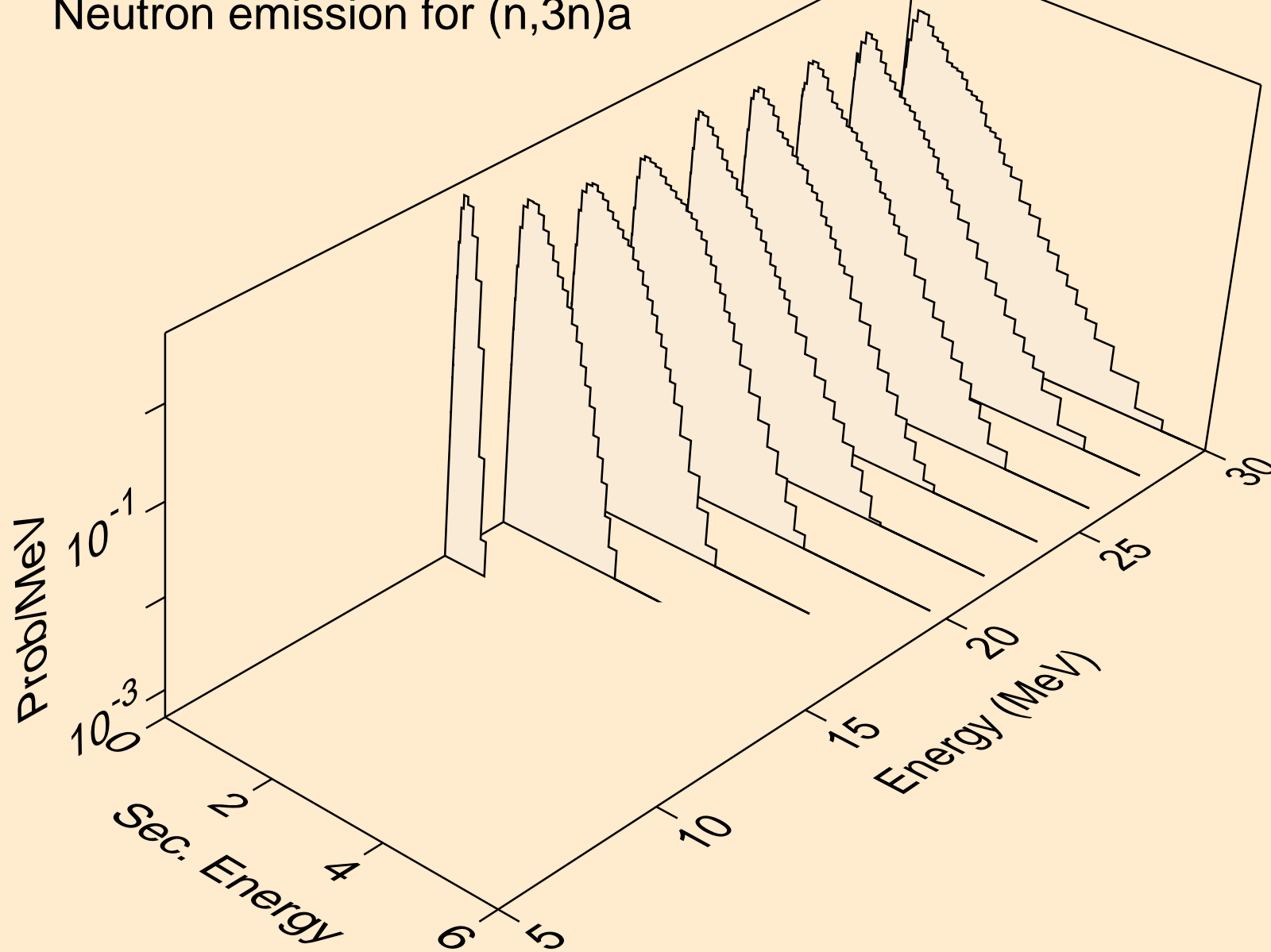

AM249 NEUTRON ACER TENDL-2024 LIBRARY; T=293.6K
Neutron emission for (n,n*)p

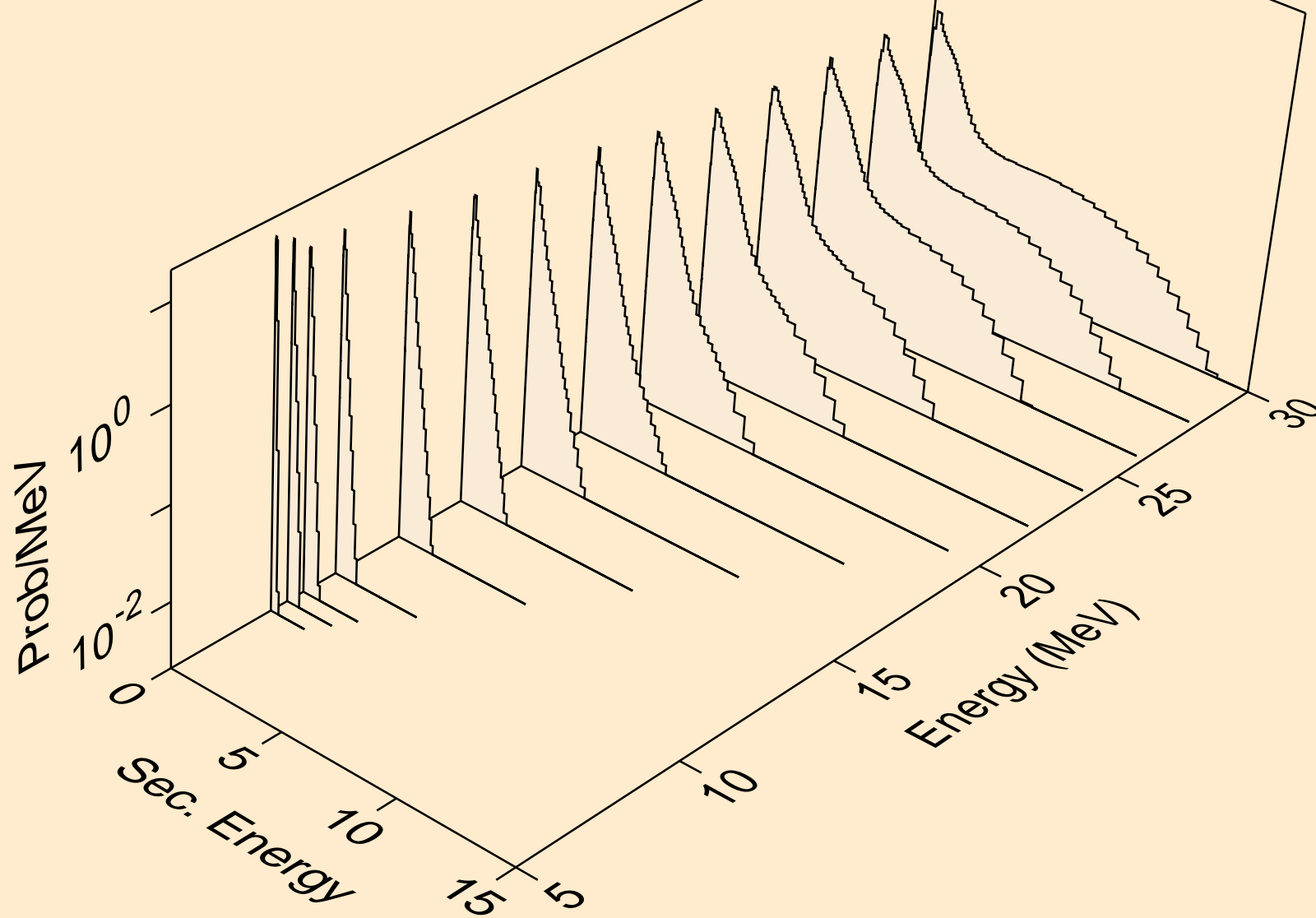

AM249 NEUTRON ACER TENDL-2024 LIBRARY; T=293.6K
Neutron emission for (n,n*)d

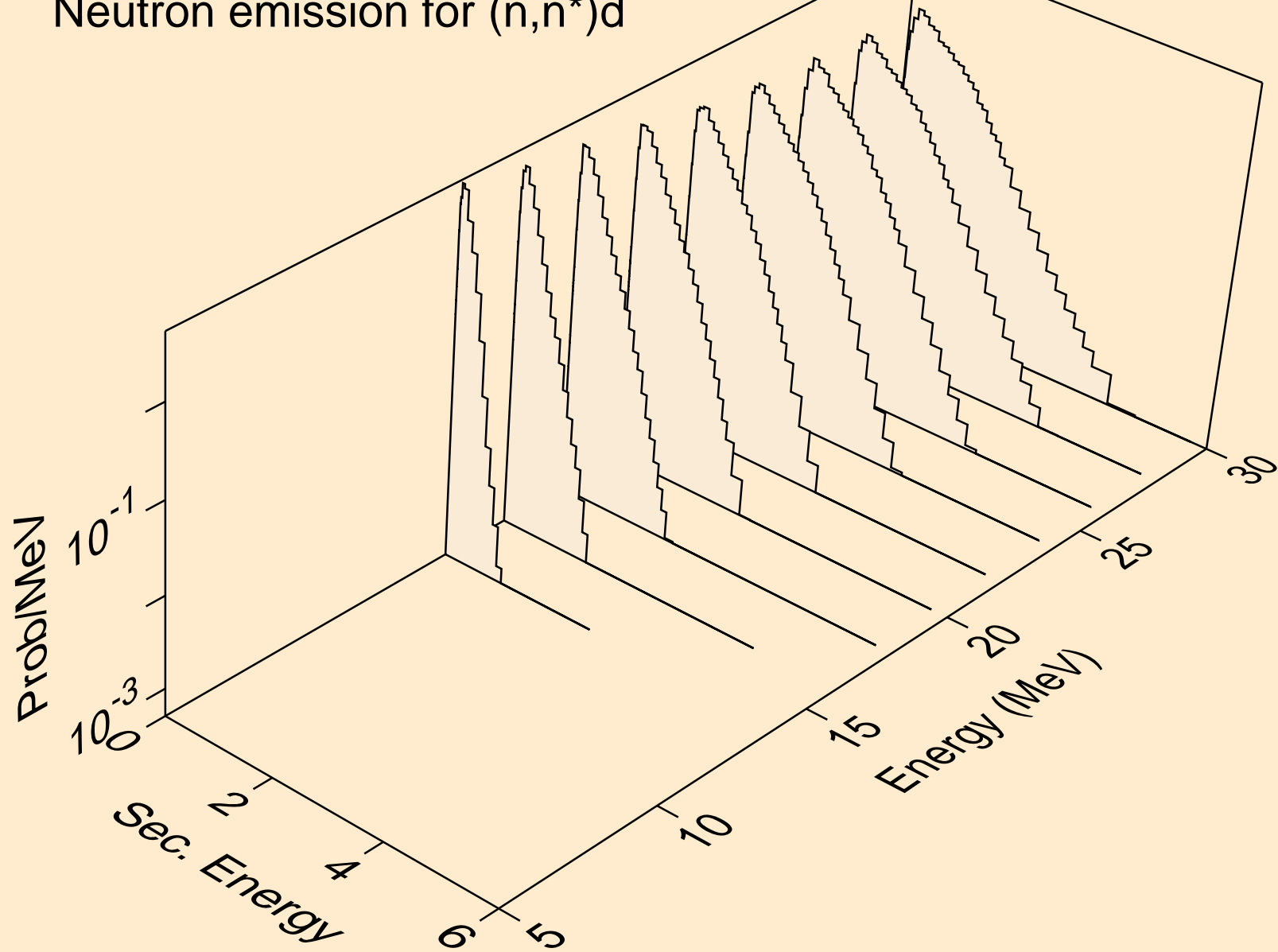

AM249 NEUTRON ACER TENDL-2024 LIBRARY; T=293.6K
Neutron emission for (n,n*)t

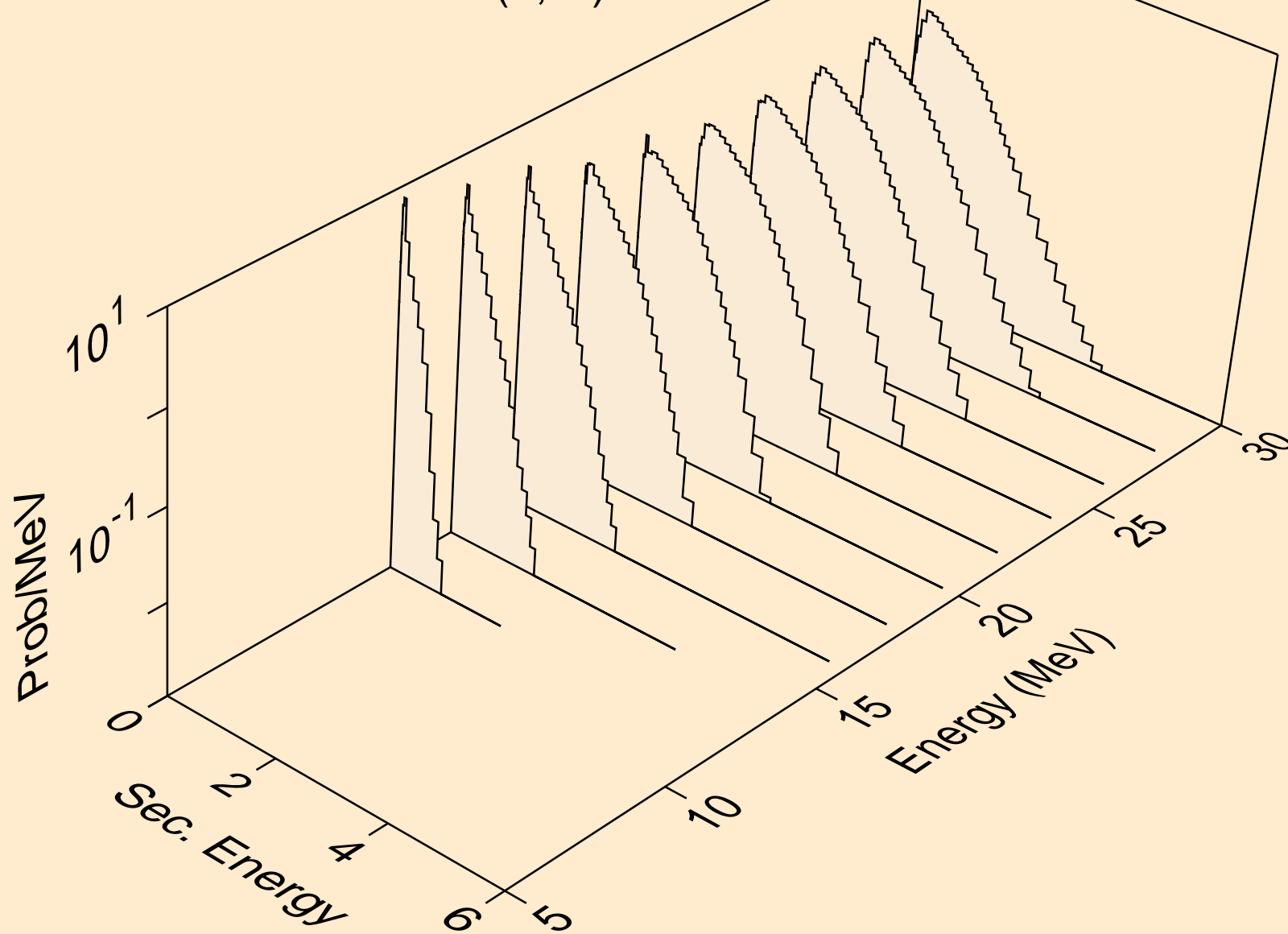

AM249 NEUTRON ACER TENDL-2024 LIBRARY; T=293.6K
Neutron emission for (n,n*)he3

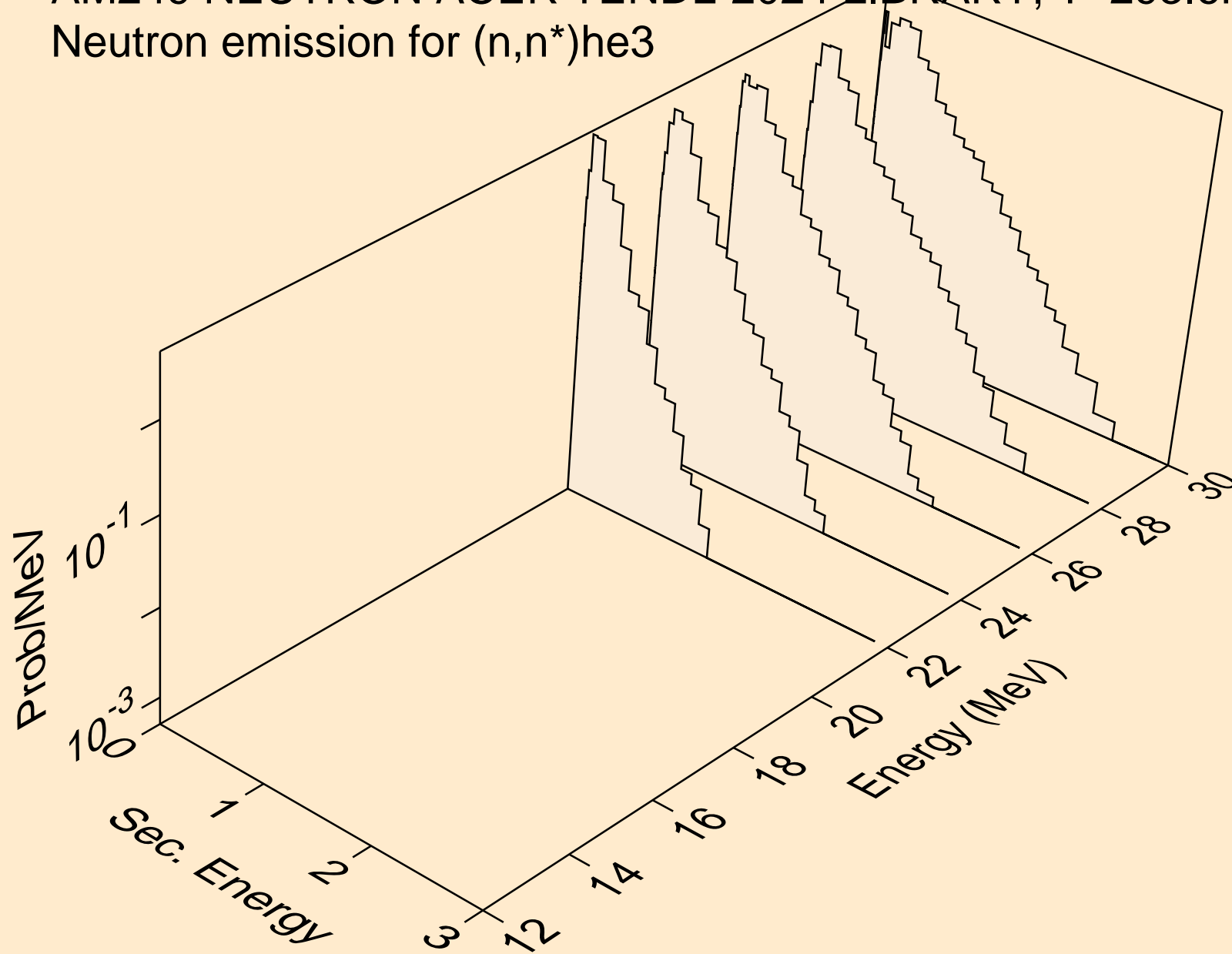

AM249 NEUTRON ACER TENDL-2024 LIBRARY; T=293.6K
Neutron emission for (n,4n)

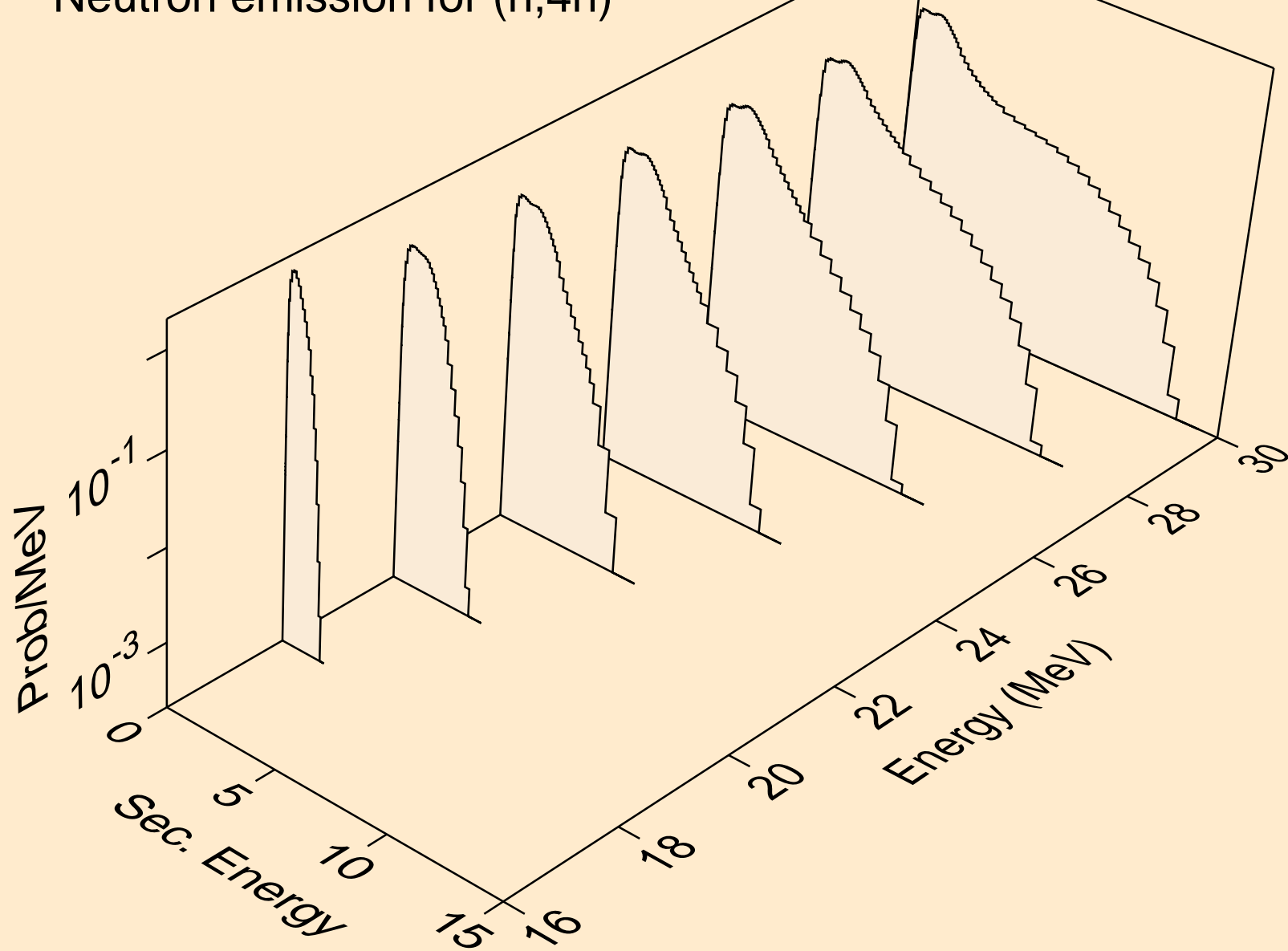

AM249 NEUTRON ACER TENDL-2024 LIBRARY; T=293.6K
Neutron emission for (n,2np)

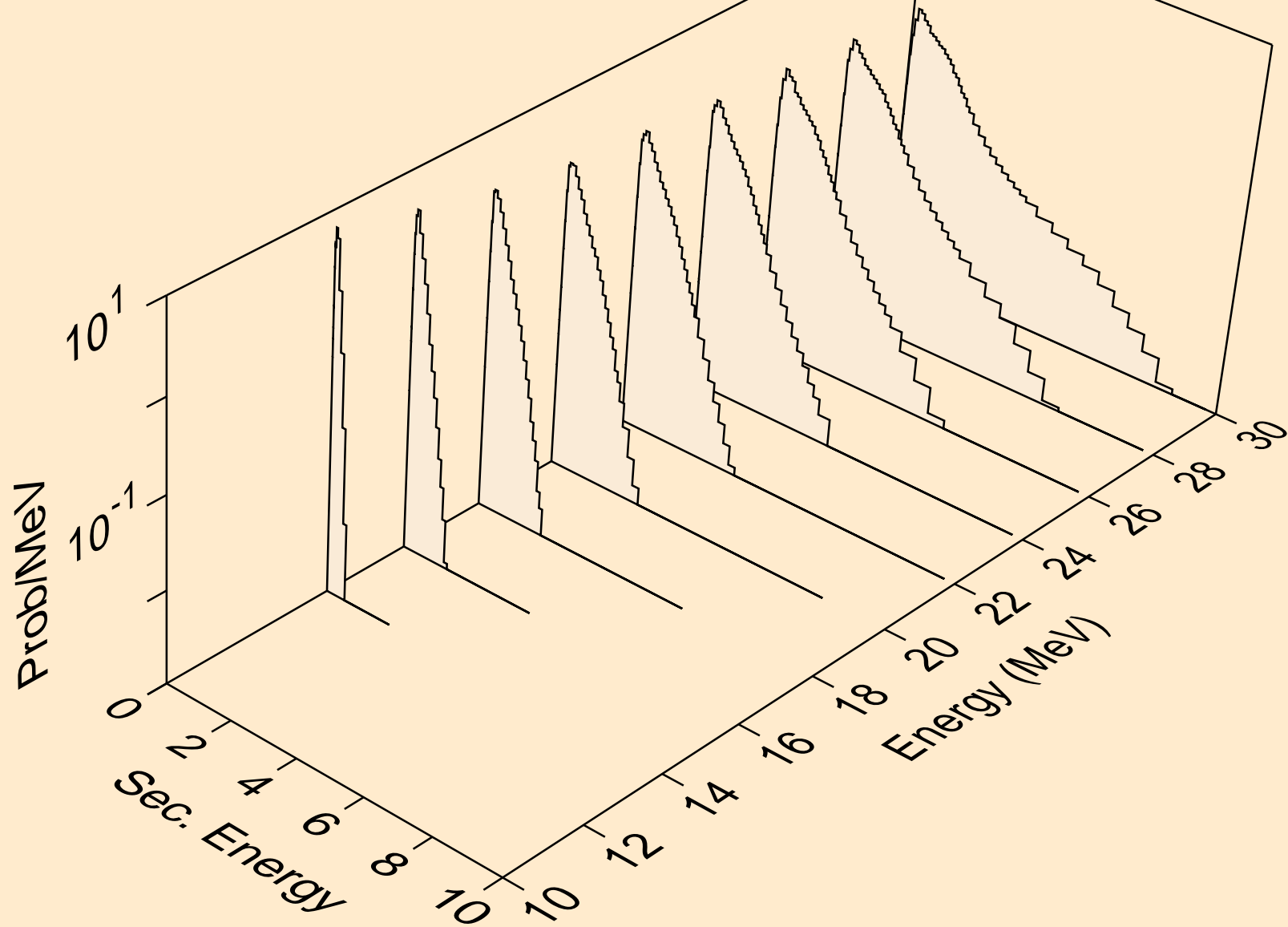

AM249 NEUTRON ACER TENDL-2024 LIBRARY; T=293.6K
Neutron emission for (n,3np)

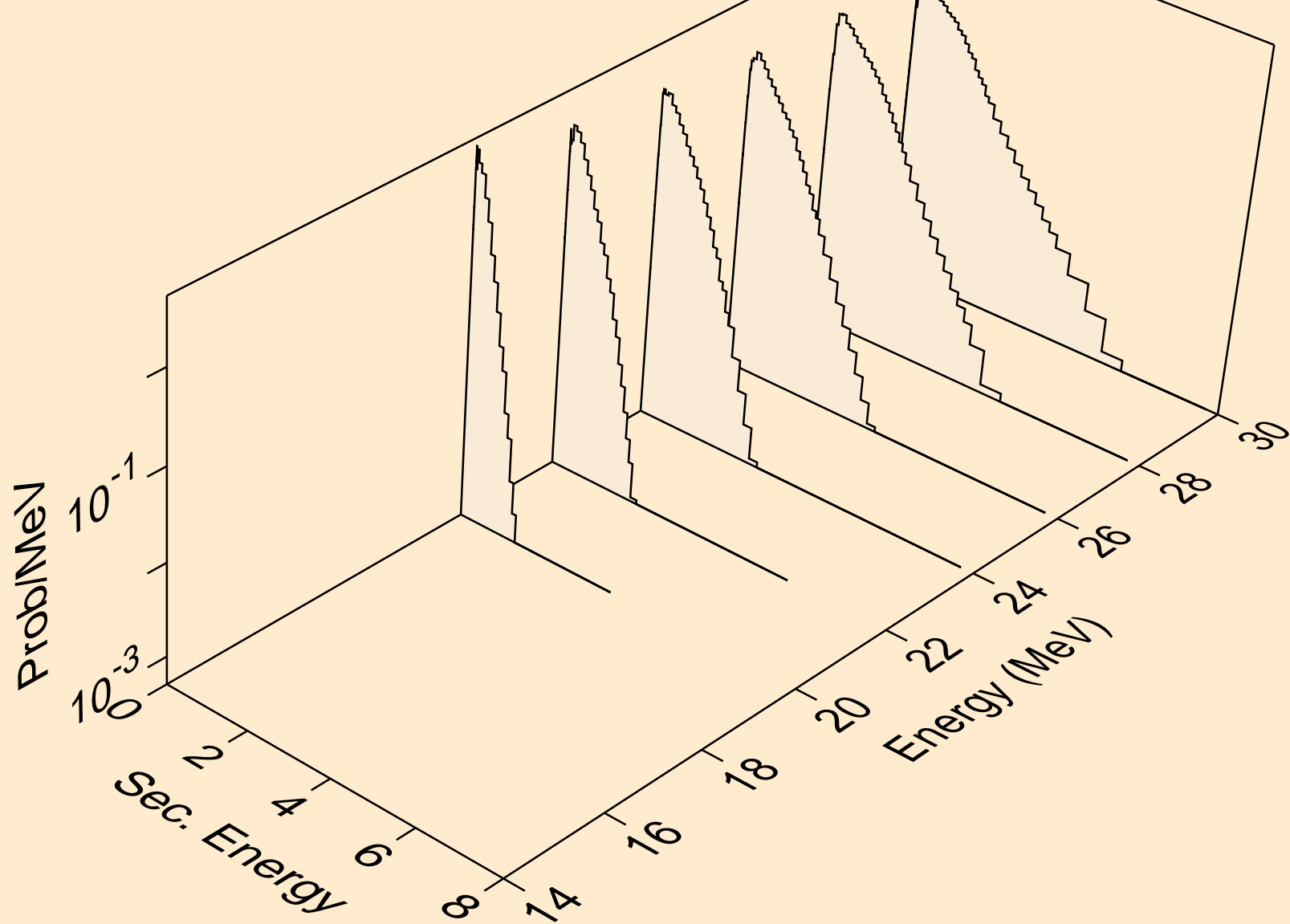

AM249 NEUTRON ACER TENDL-2024 LIBRARY; T=293.6K
Neutron emission for (n,n*c)

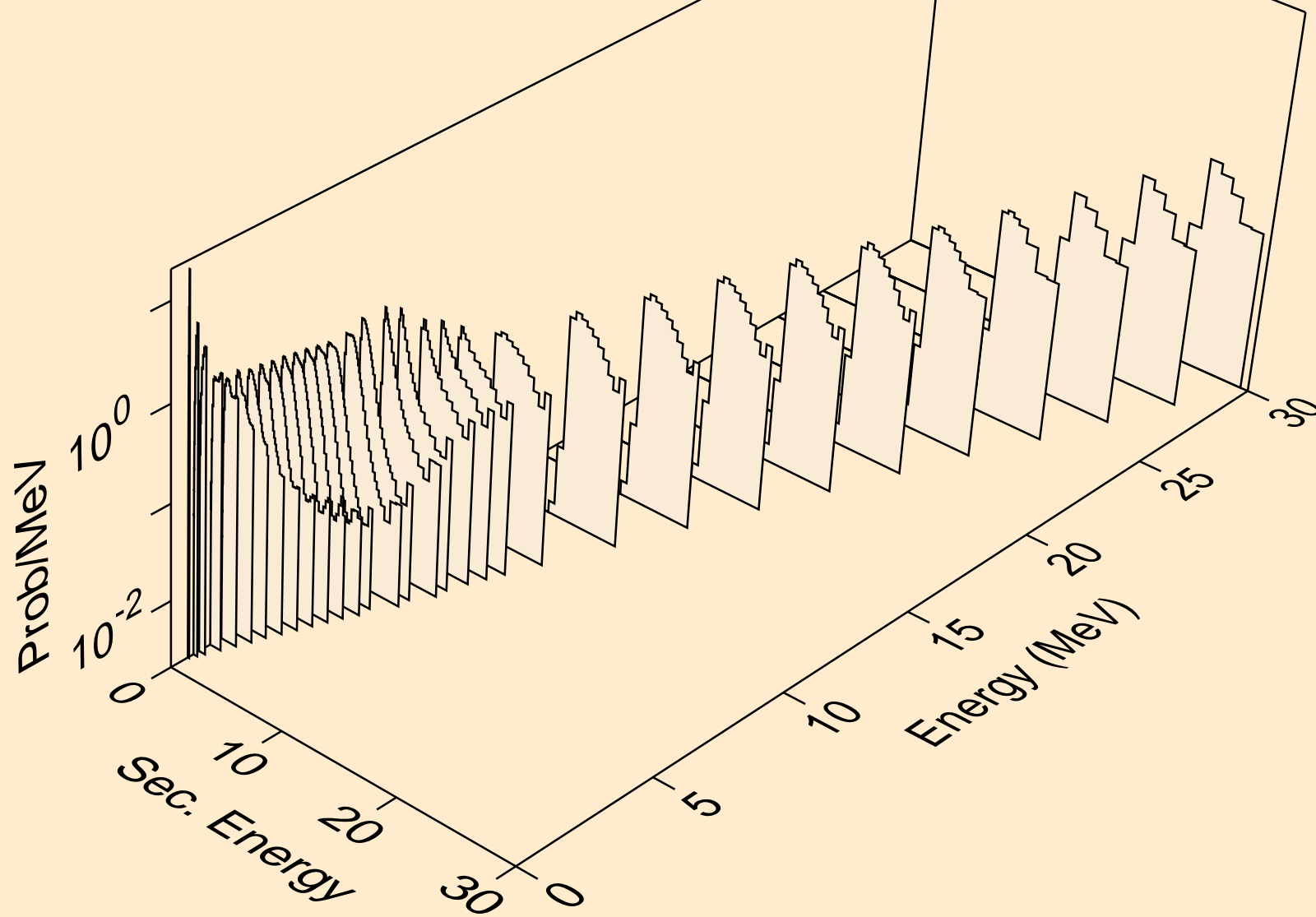

AM249 NEUTRON ACER TENDL-2024 LIBRARY; T=293.6K

Delayed nubar

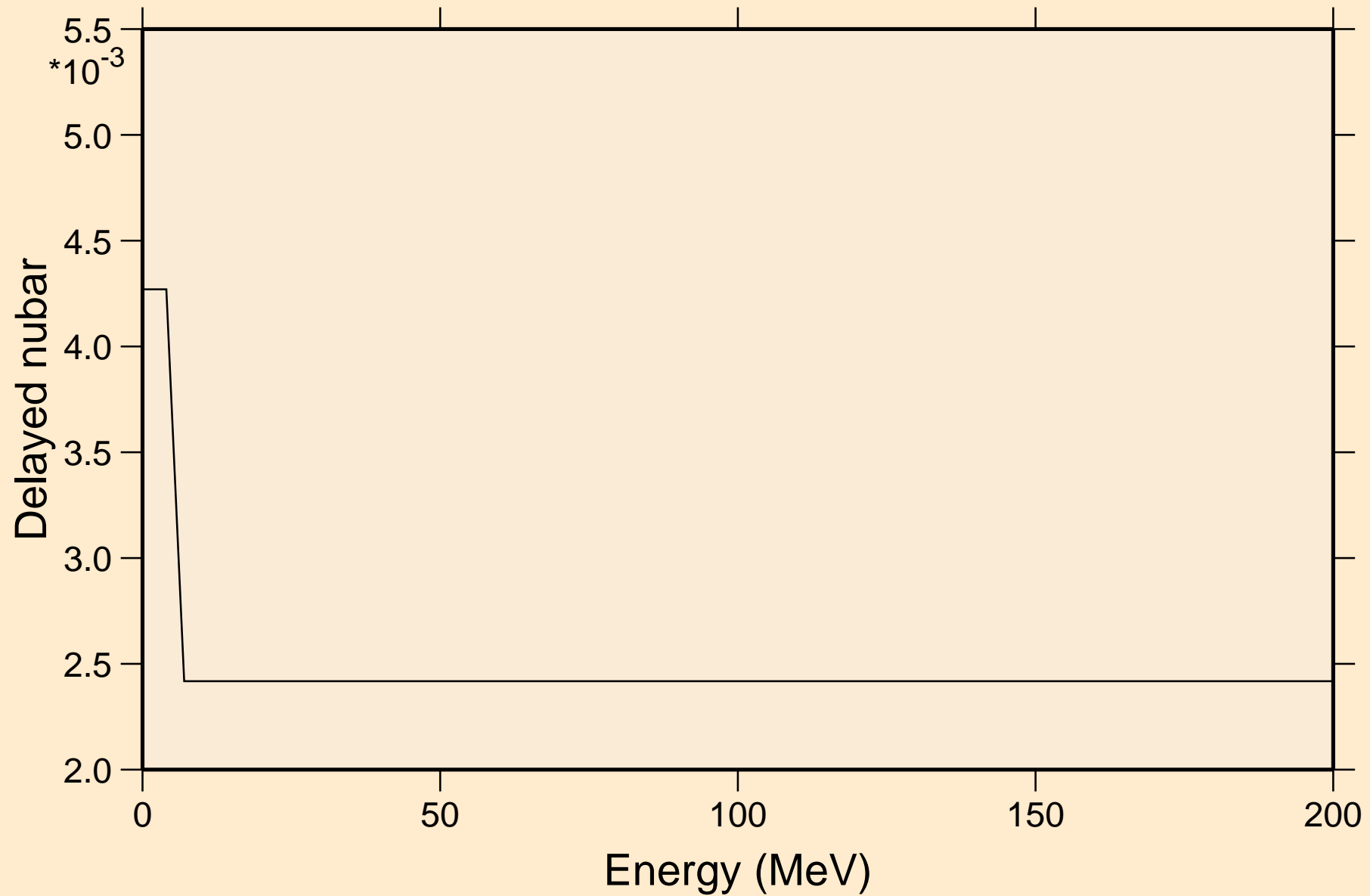

AM249 NEUTRON ACER TENDL-2024 LIBRARY; T=293.6K

Delayed neutron spectra

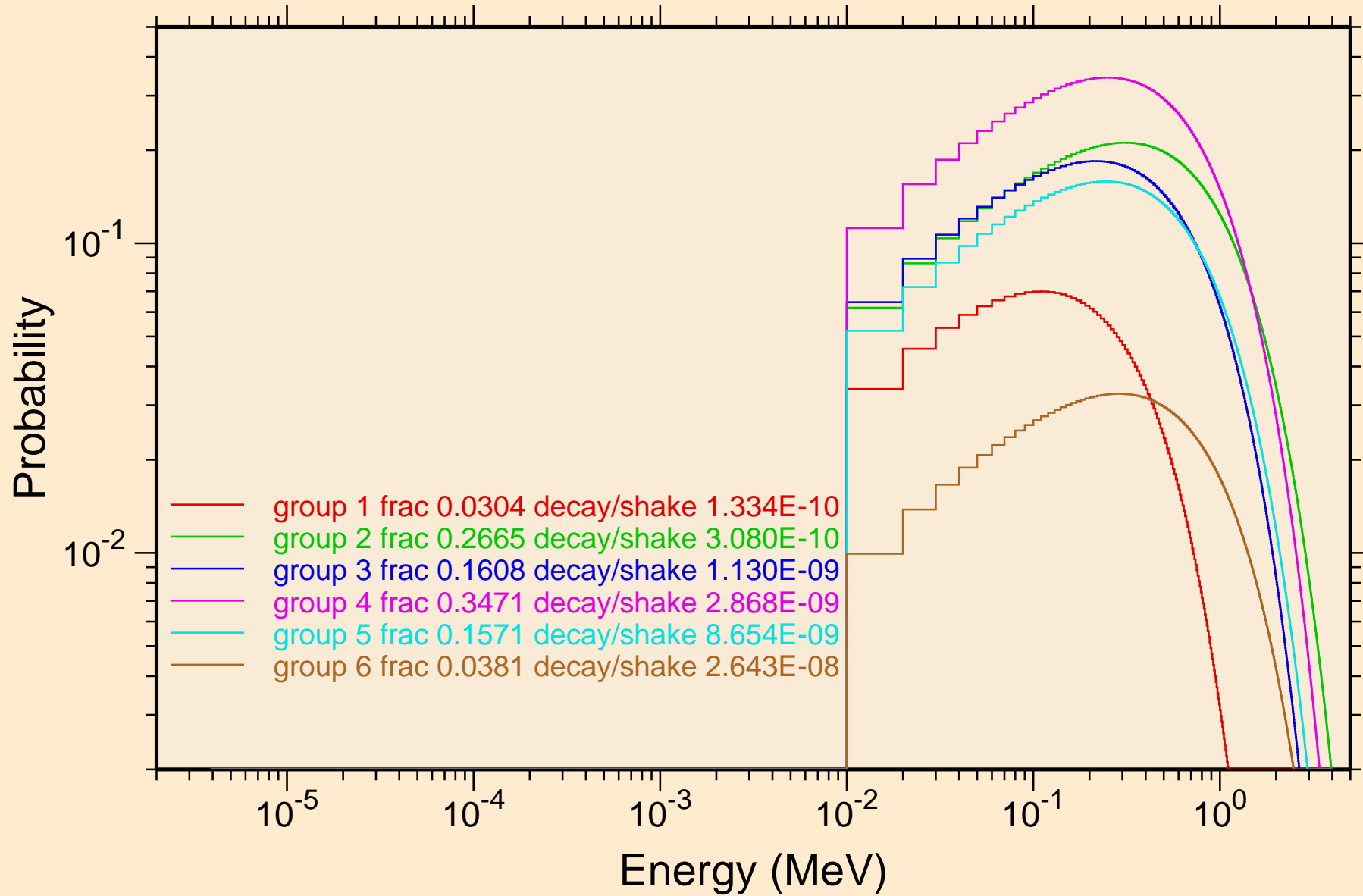

AM249 NEUTRON ACER TENDL-2024 LIBRARY; T=293.6K
Photon emission for (n,x)

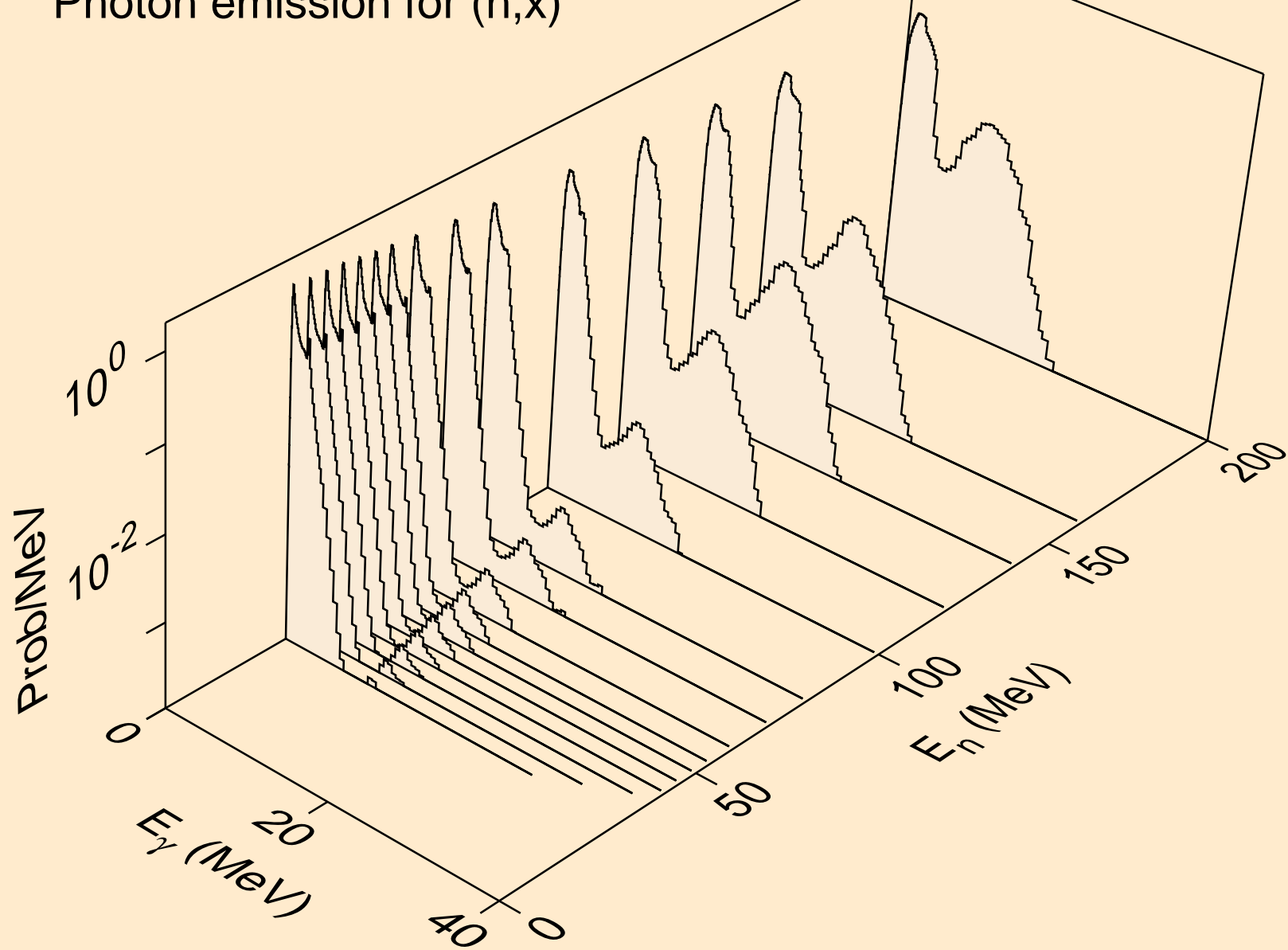

AM249 NEUTRON ACER TENDL-2024 LIBRARY; T=293.6K
Photon emission for (n,2nd)

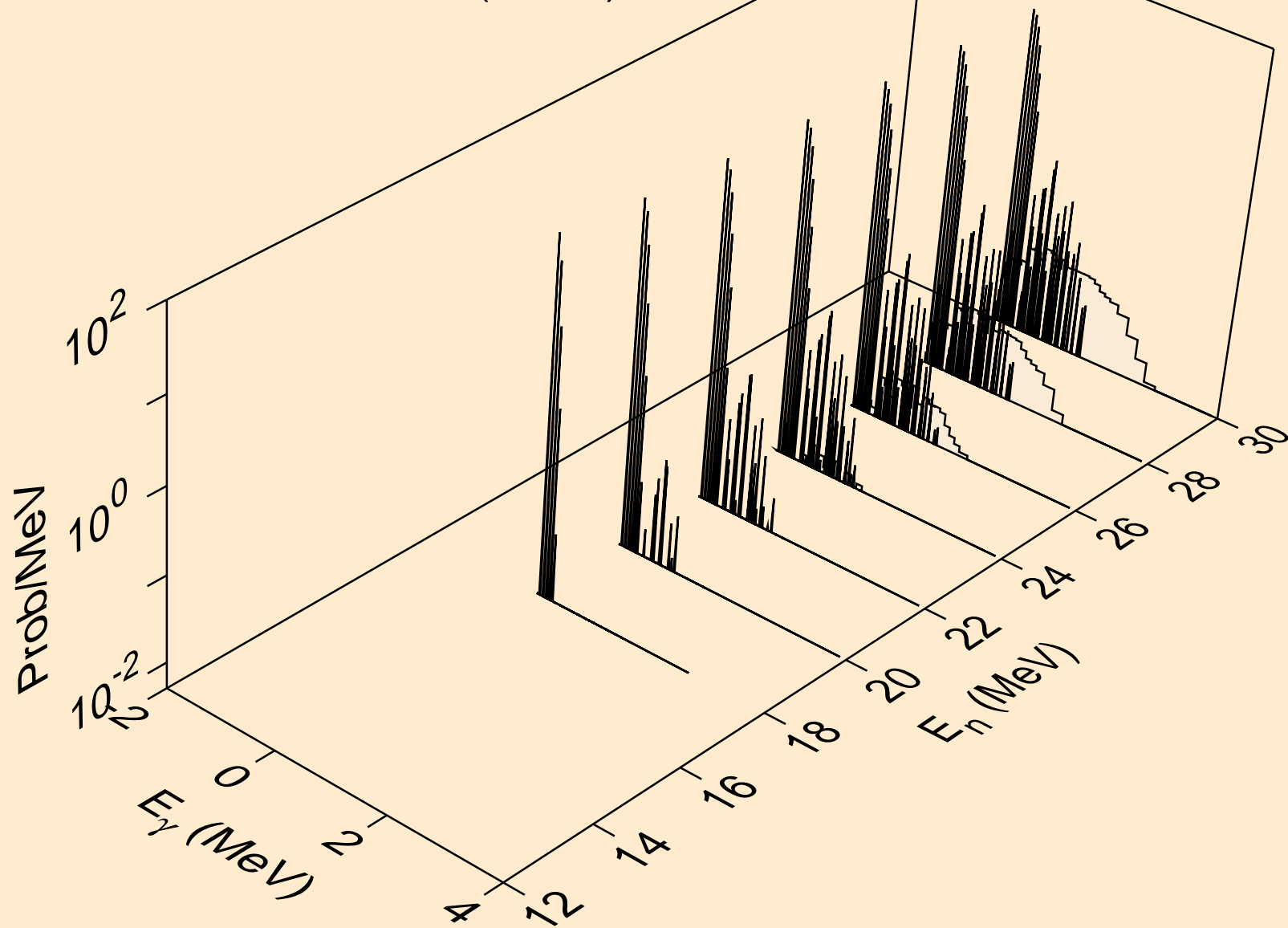

AM249 NEUTRON ACER TENDL-2024 LIBRARY; T=293.6K
Photon emission for (n,2n)

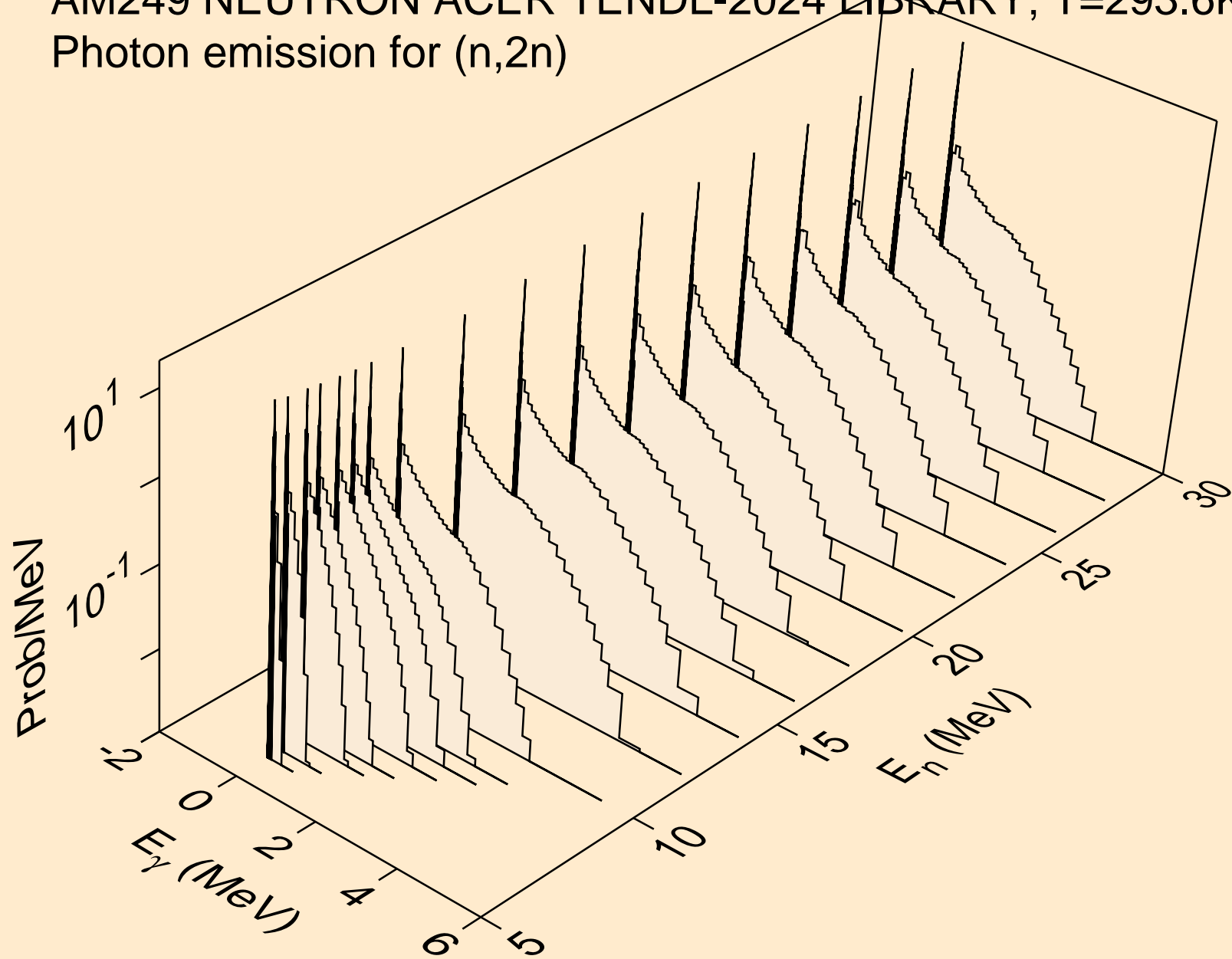

AM249 NEUTRON ACER TENDL-2024 LIBRARY; T=293.6K
Photon emission for (n,3n)

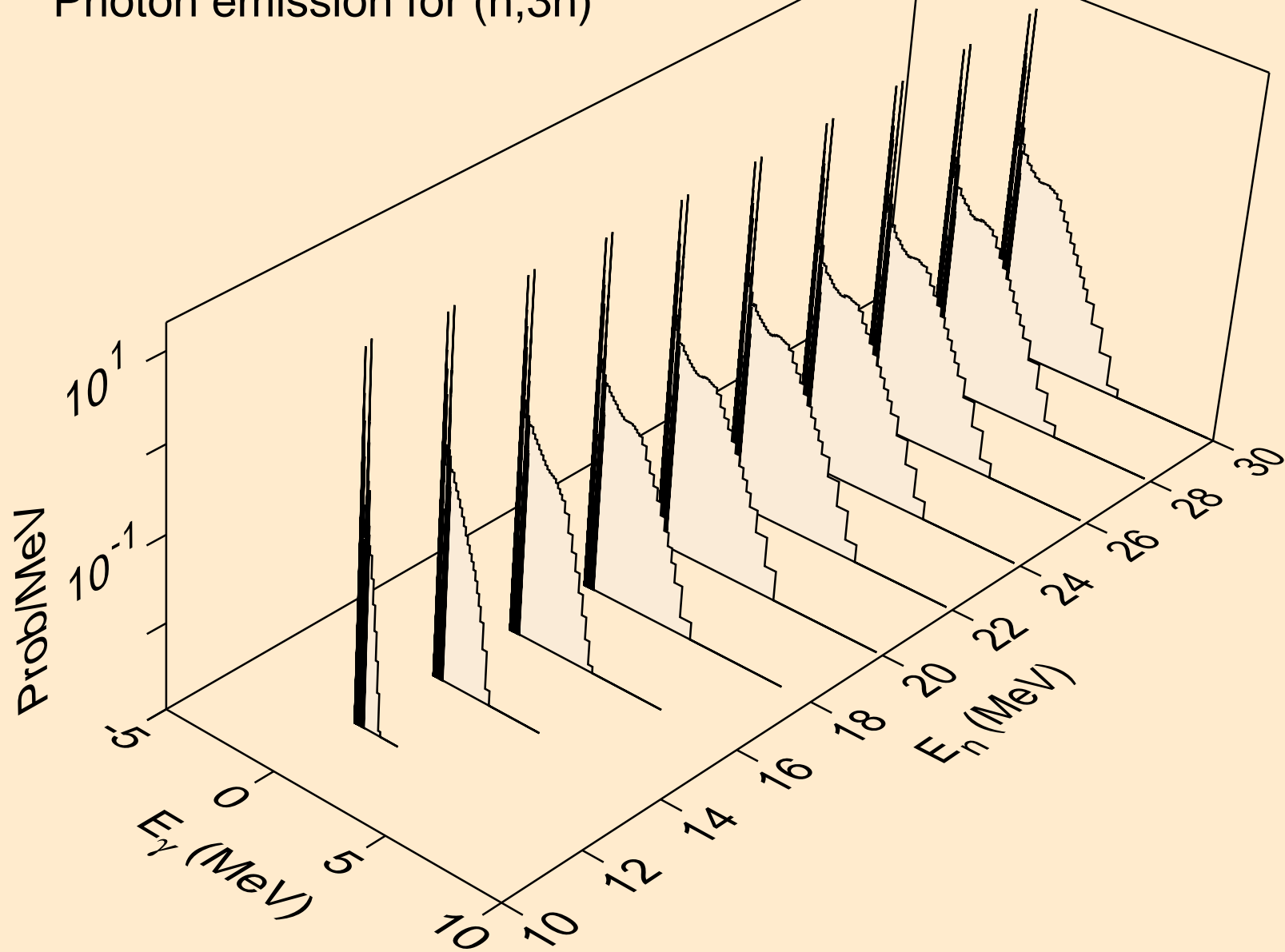

AM249 NEUTRON ACER TENDL-2024 LIBRARY; T=293.6K
Photon emission for (n,n*)a

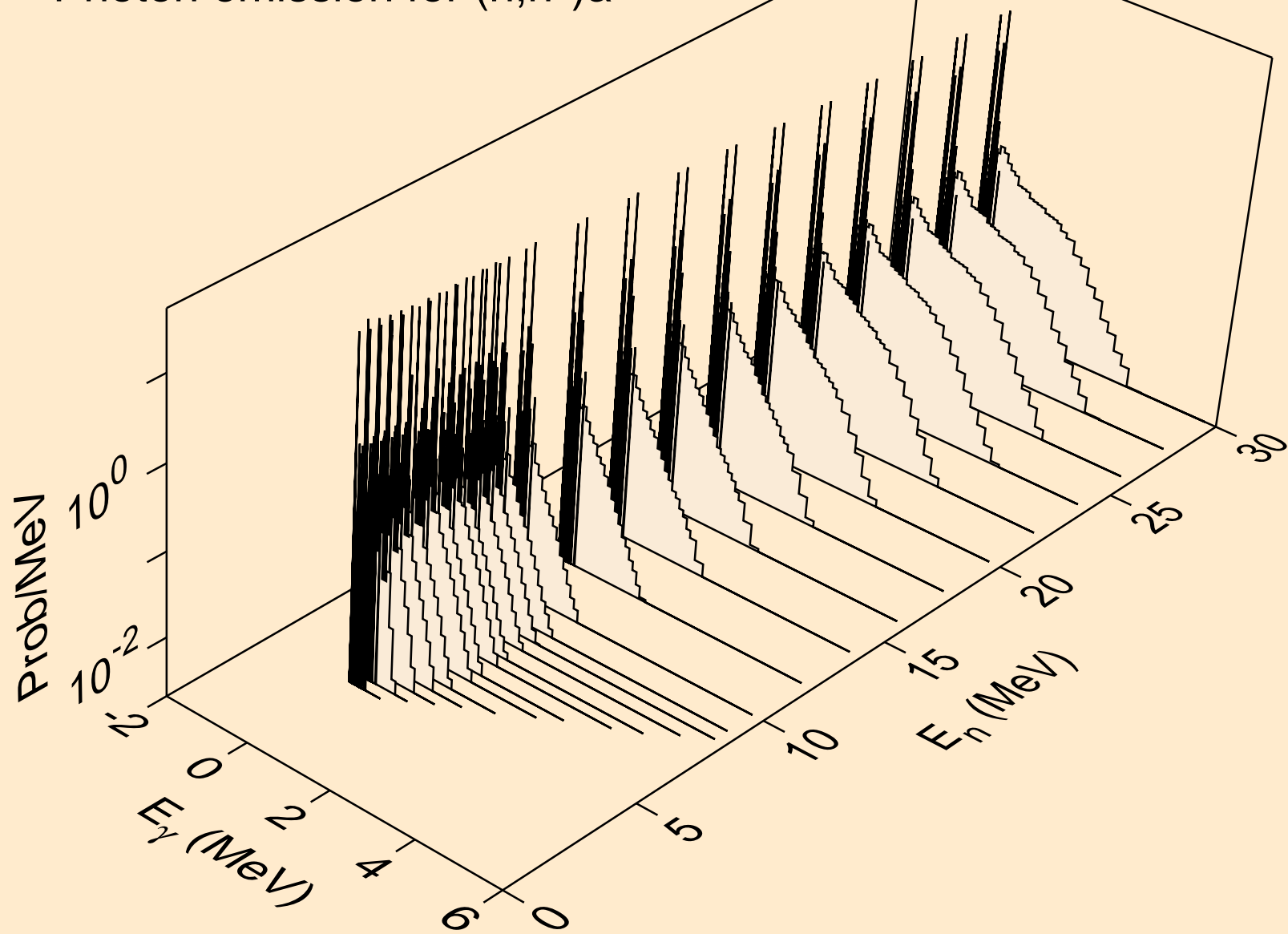

AM249 NEUTRON ACER TENDL-2024 LIBRARY; T=293.6K
Photon emission for (n,2n)a

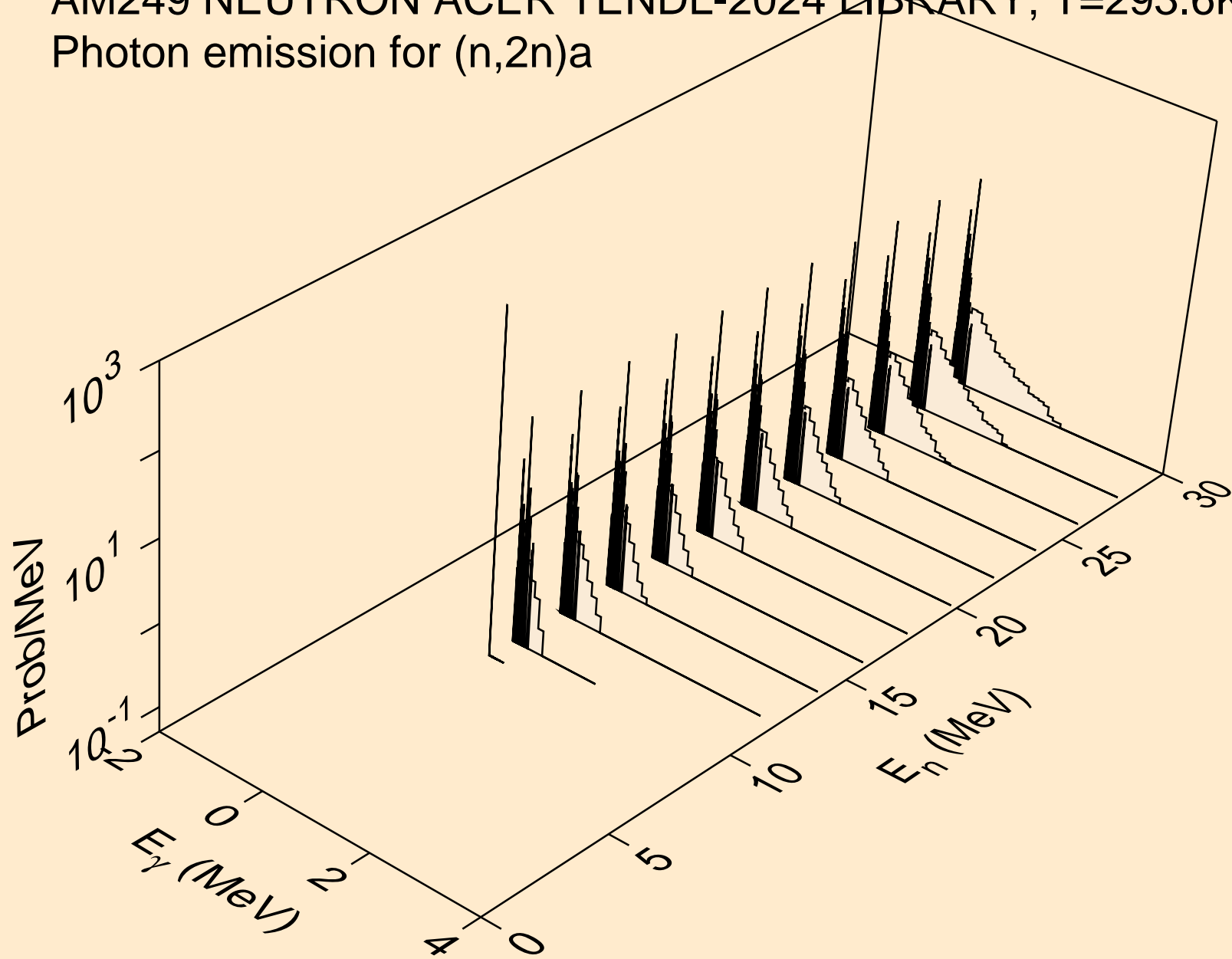

AM249 NEUTRON ACER TENDL-2024 LIBRARY; T=293.6K
Photon emission for (n,3n)a

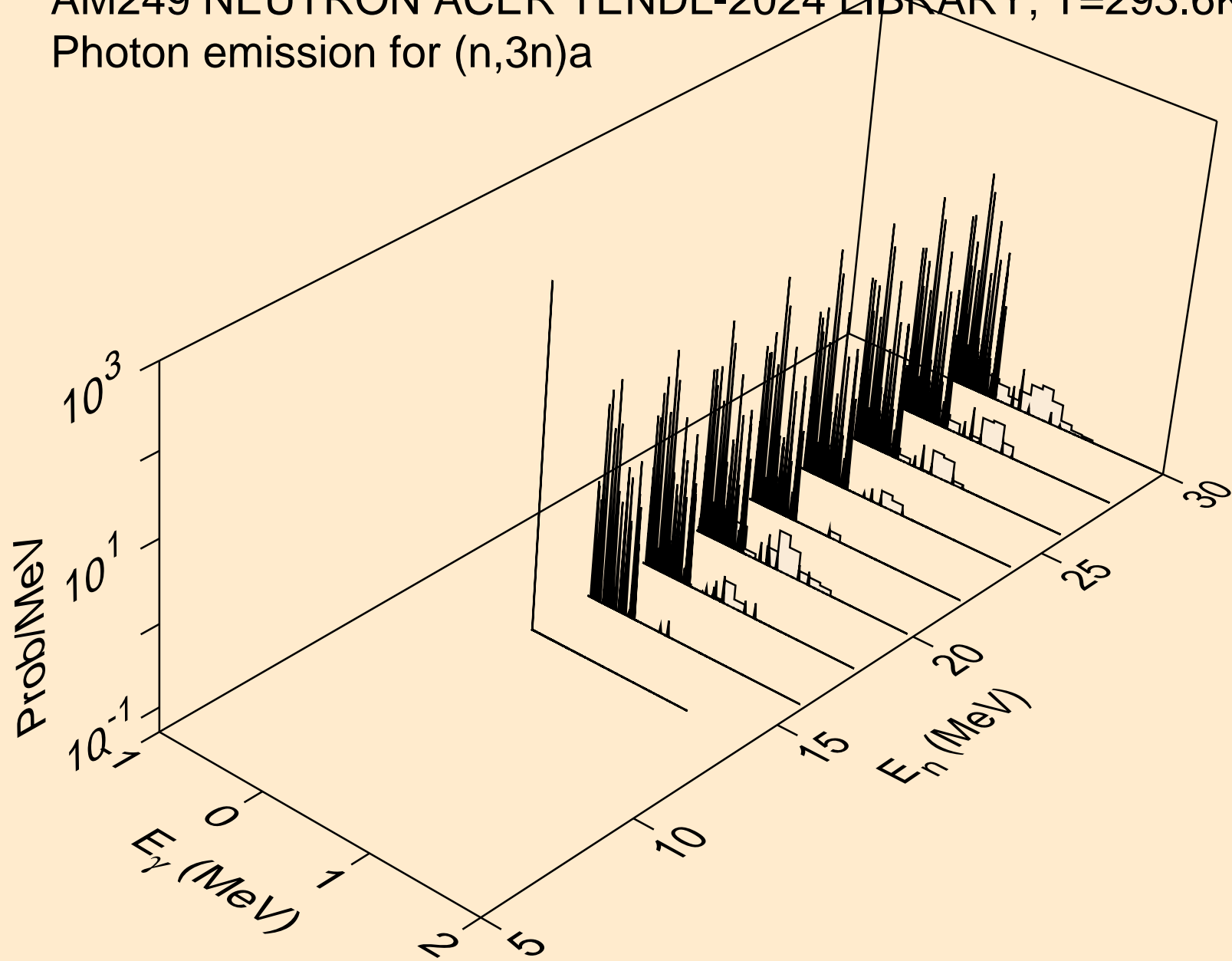

AM249 NEUTRON ACER TENDL-2024 LIBRARY; T=293.6K
Photon emission for (n,n*)p

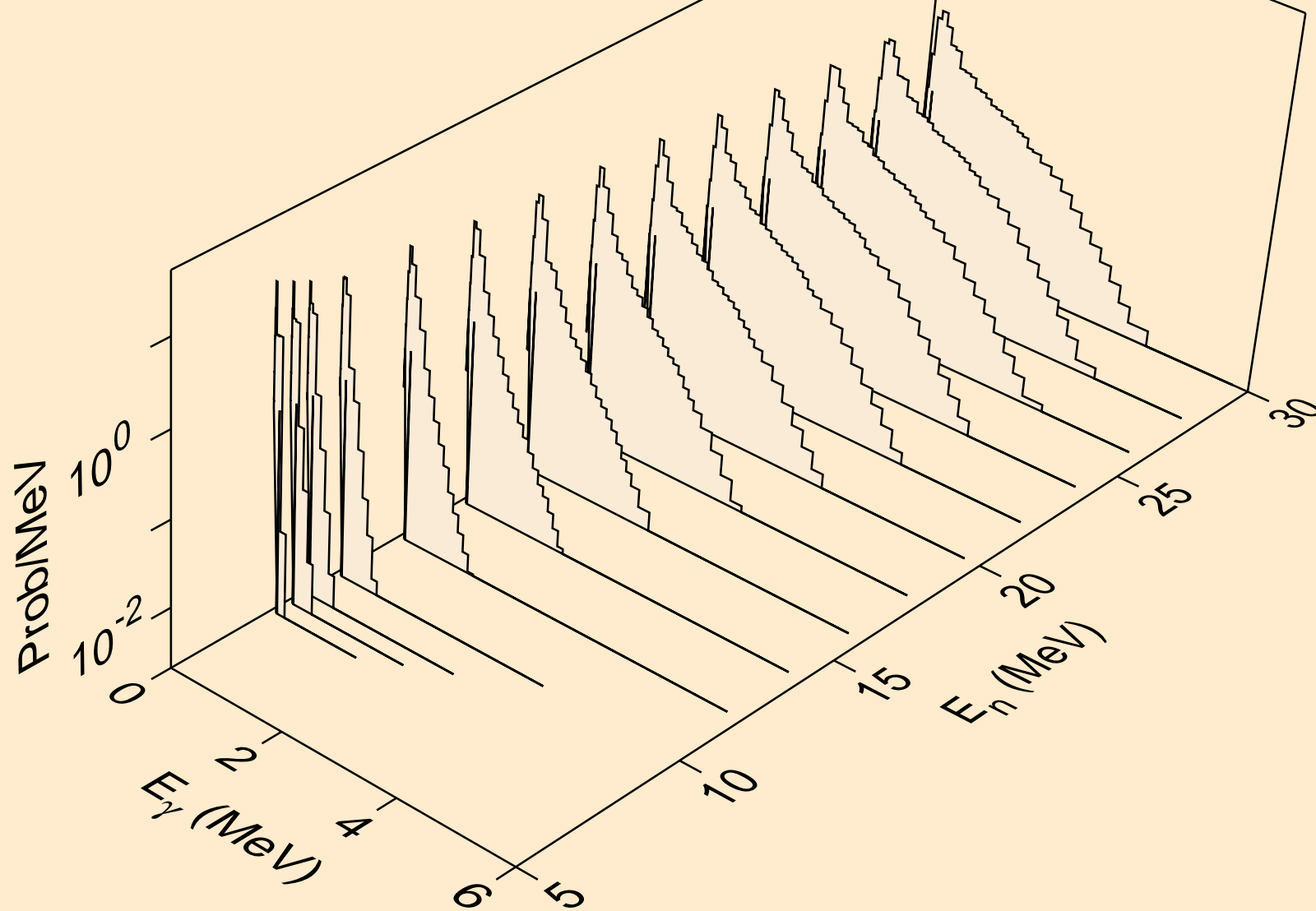

AM249 NEUTRON ACER TENDL-2024 LIBRARY; T=293.6K
Photon emission for (n,n*)d

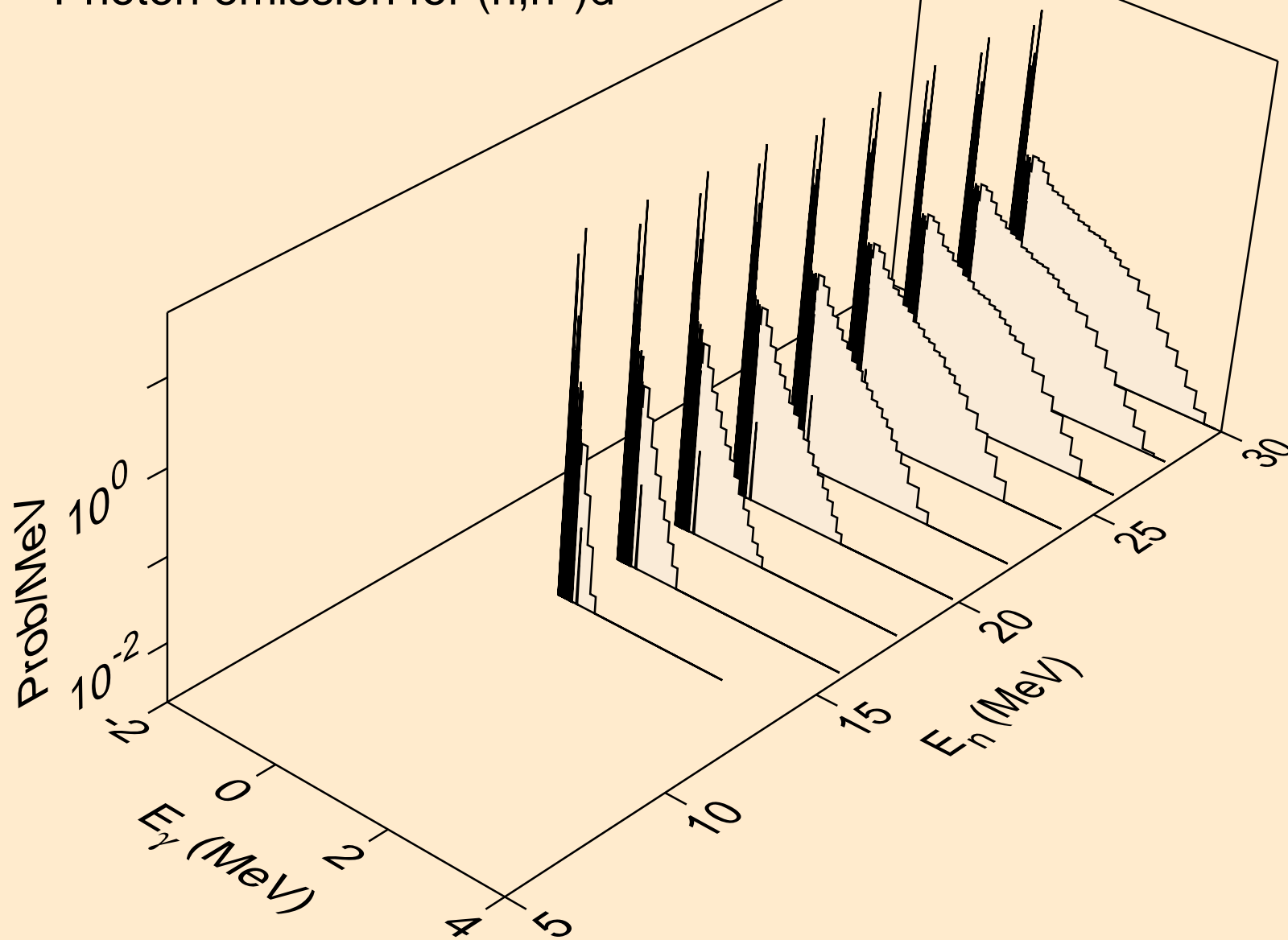

AM249 NEUTRON ACER TENDL-2024 LIBRARY; T=293.6K
Photon emission for (n,n*)t

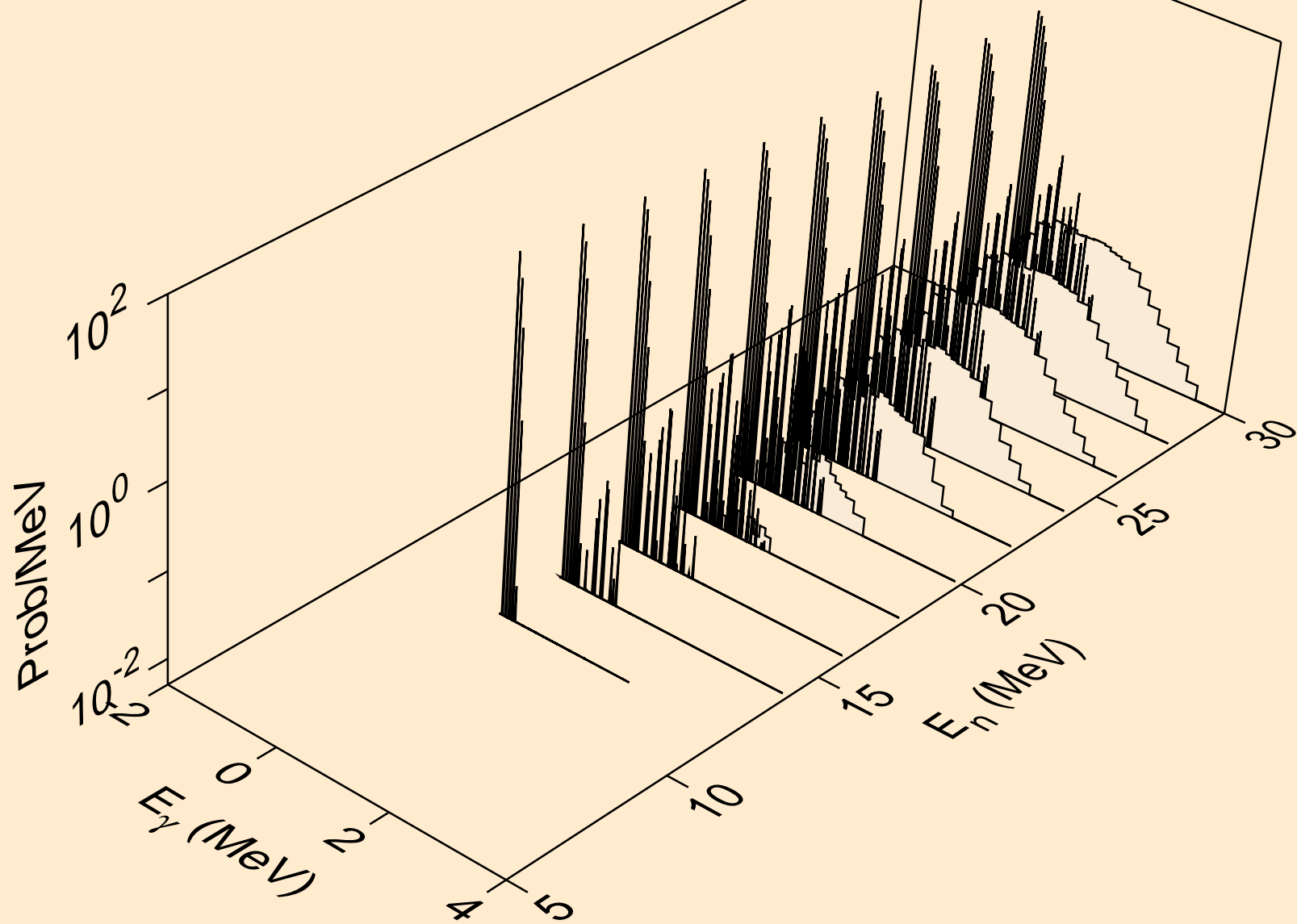

AM249 NEUTRON ACER TENDL-2024 LIBRARY; T=293.6K
Photon emission for (n,n*)he3

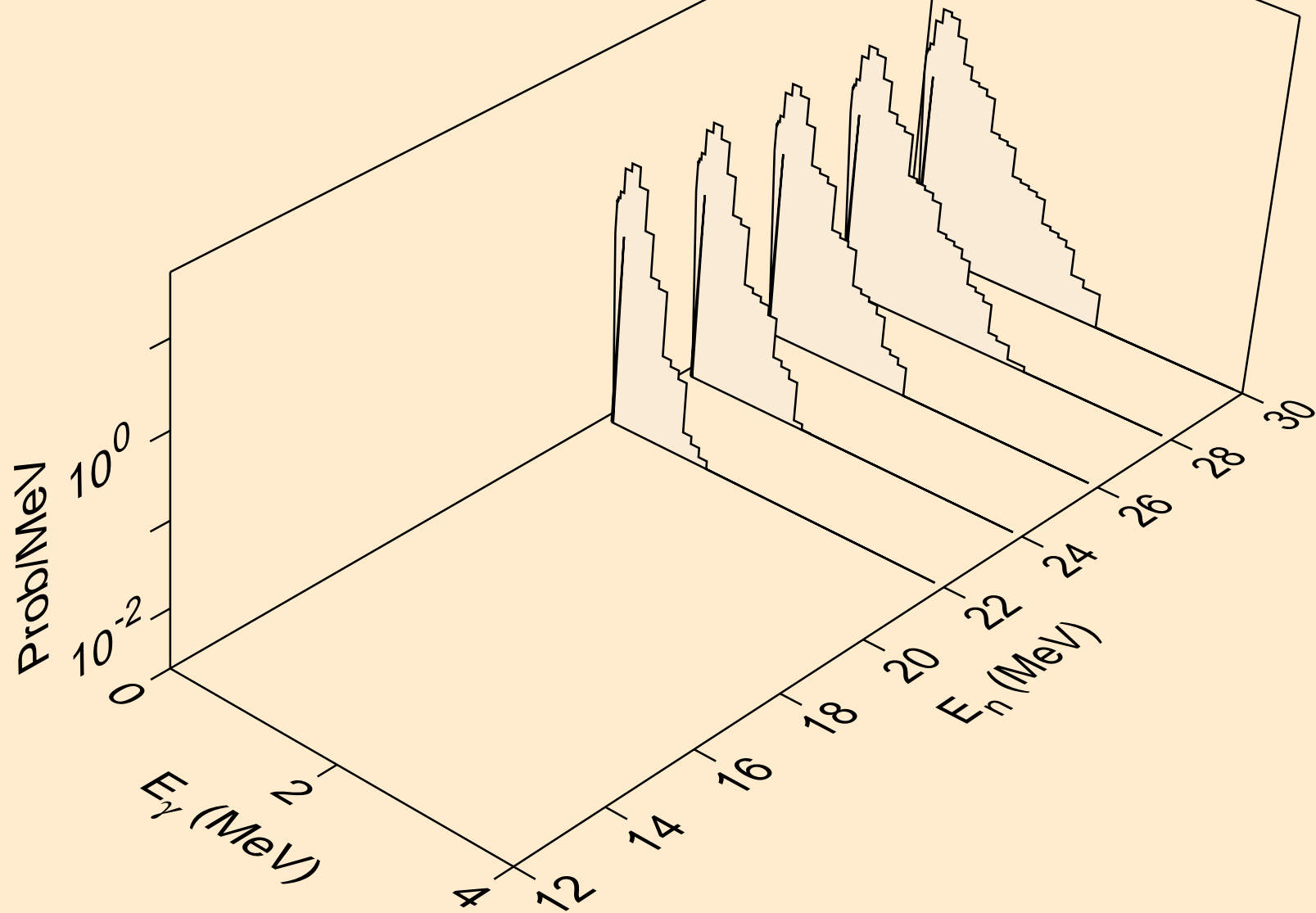

AM249 NEUTRON ACER TENDL-2024 LIBRARY; T=293.6K
Photon emission for (n,4n)

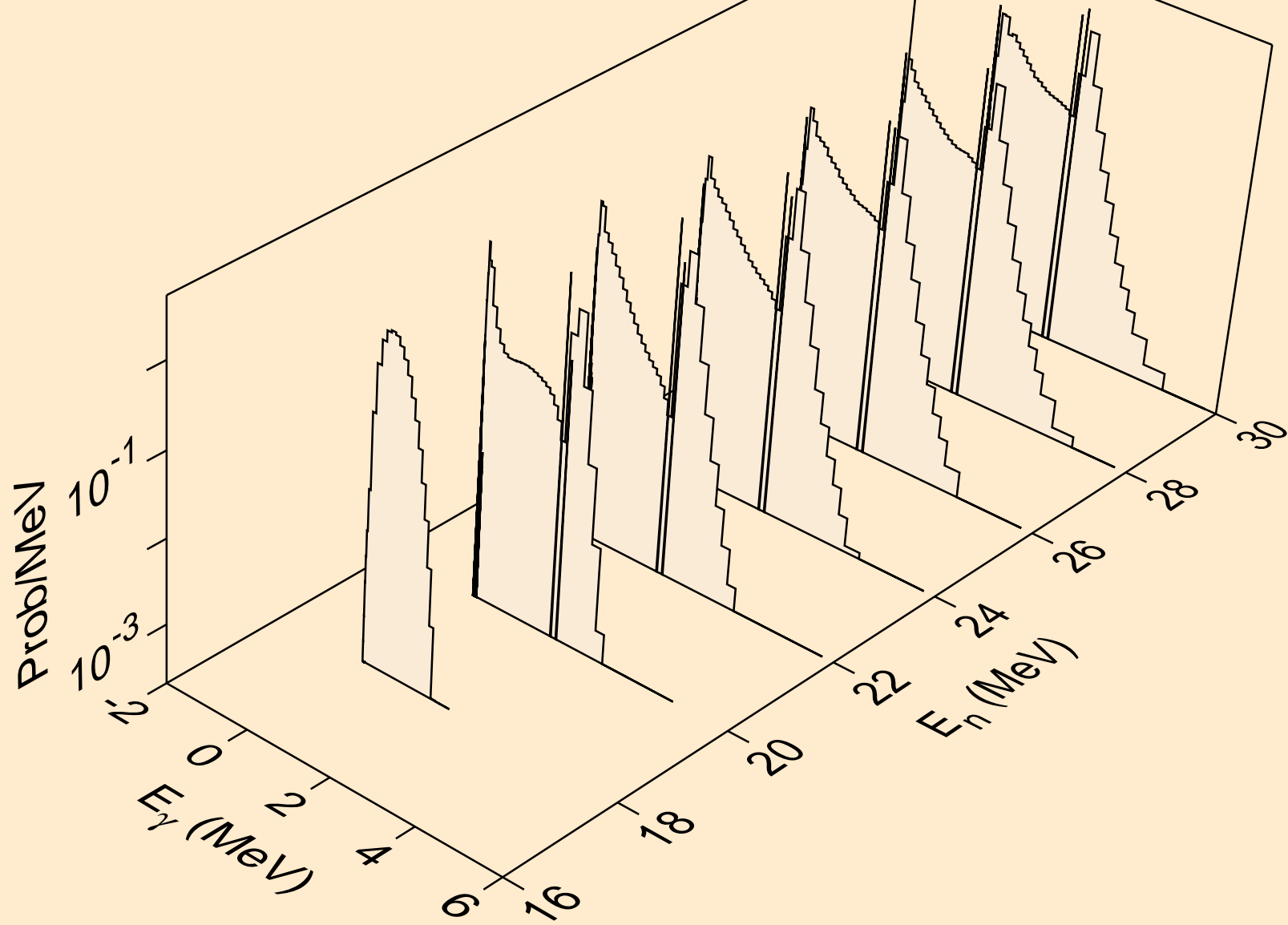

AM249 NEUTRON ACER TENDL-2024 LIBRARY; T=293.6K
Photon emission for (n,2np)

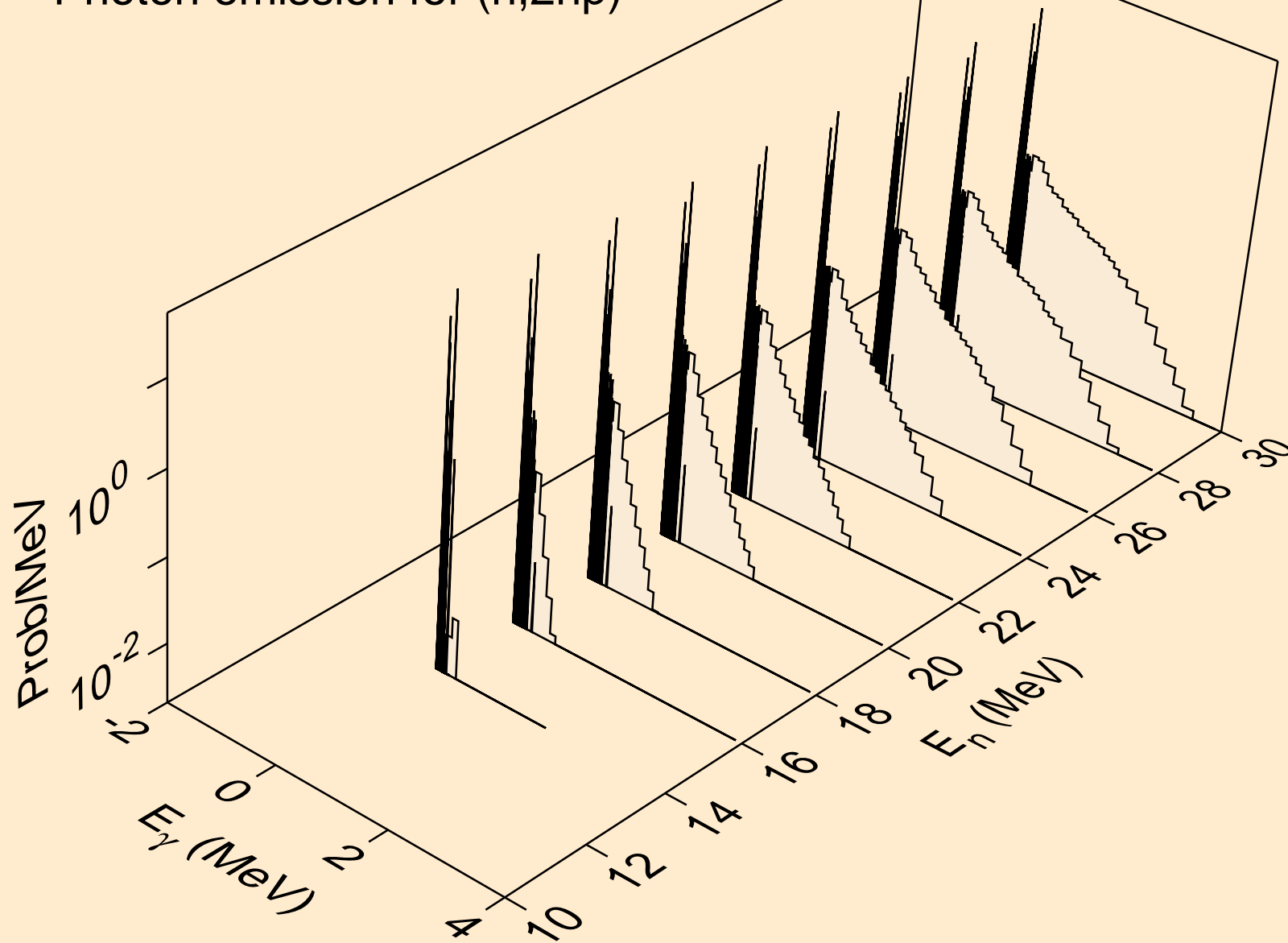

AM249 NEUTRON ACER TENDL-2024 LIBRARY; T=293.6K
Photon emission for (n,3np)

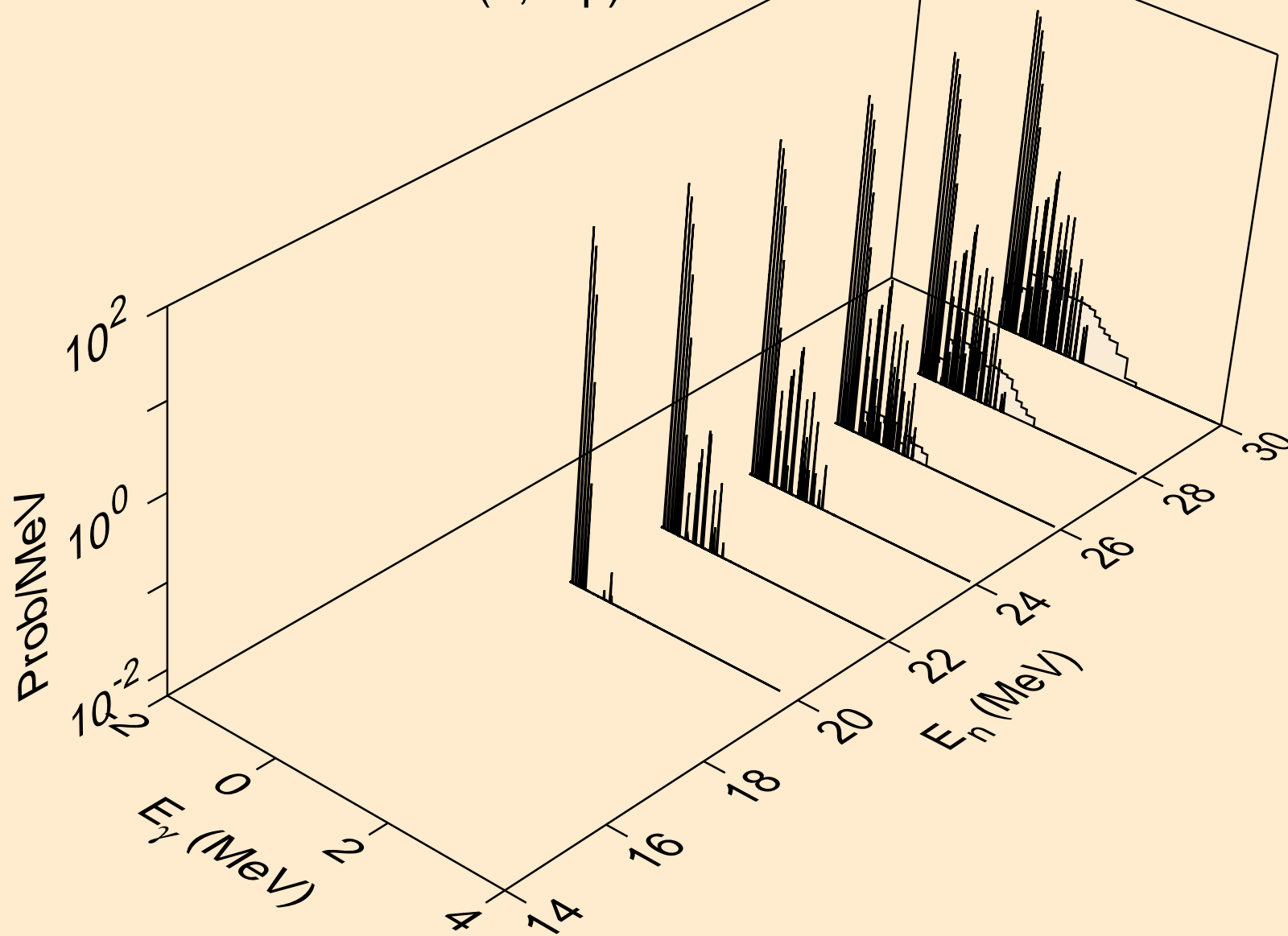

AM249 NEUTRON ACER TENDL-2024 LIBRARY; T=293.6K
Photon emission for (n,n*c)

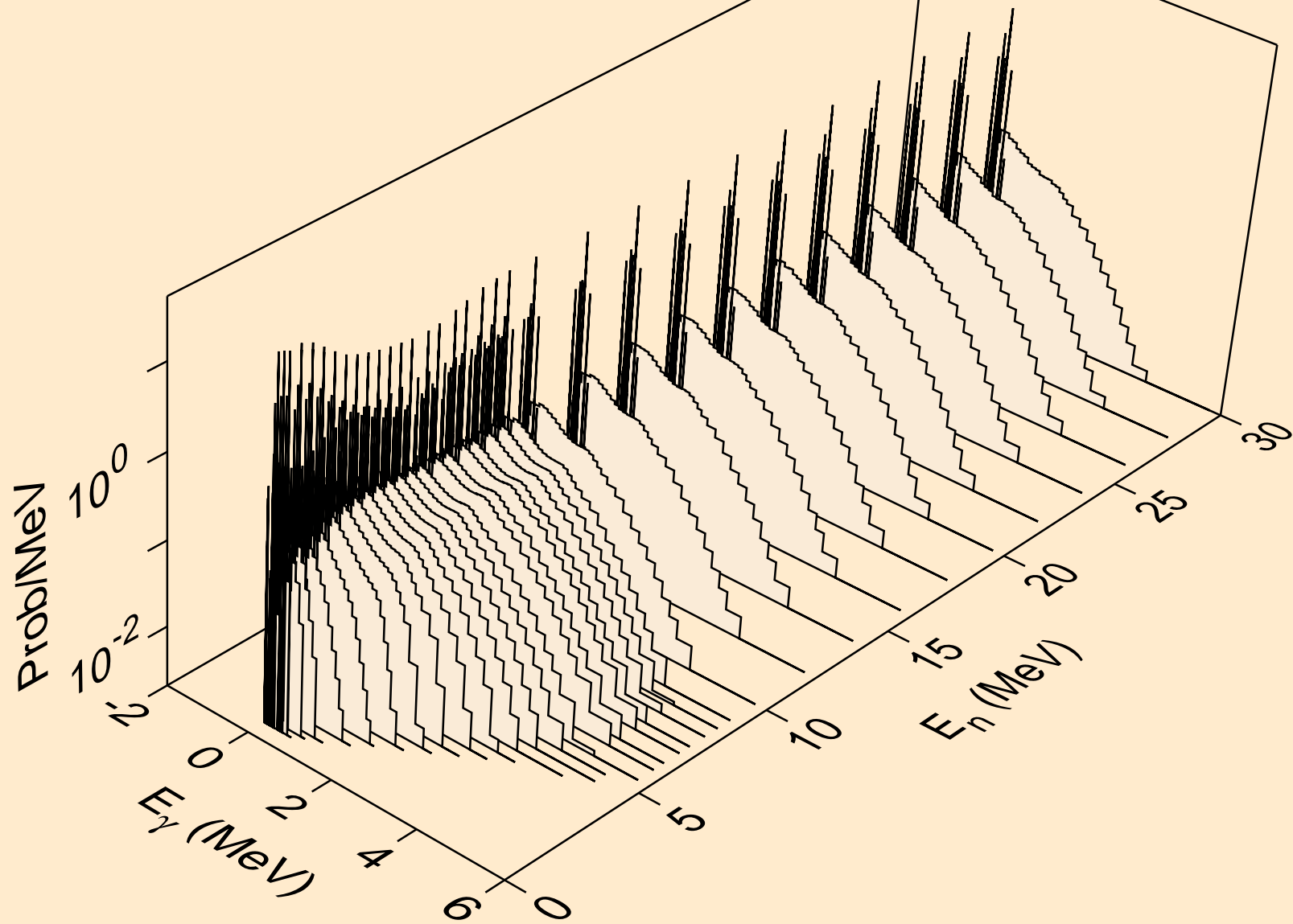

AM249 NEUTRON ACER TENDL-2024 LIBRARY; T=293.6K
Photon emission for (n,gma)

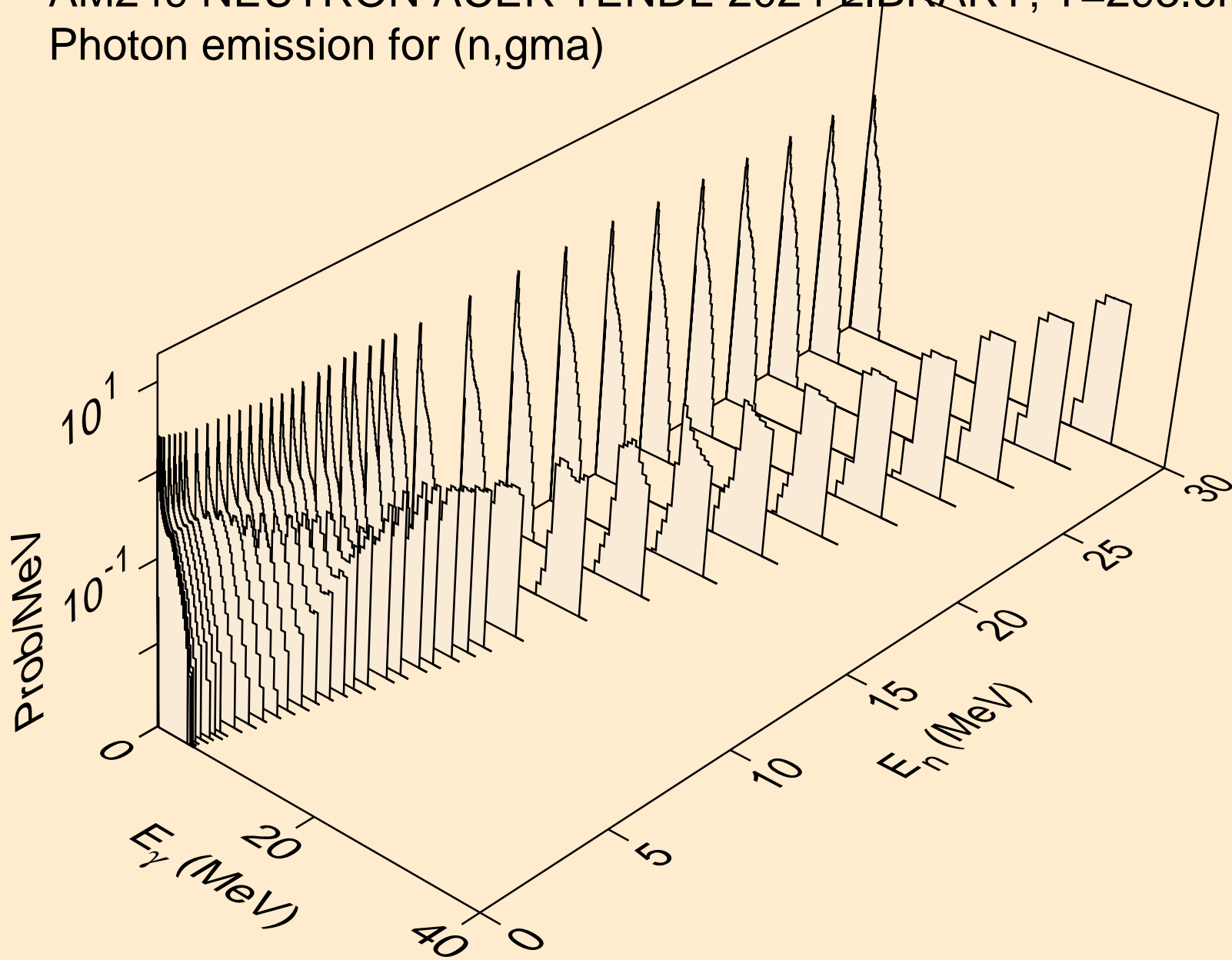

AM249 NEUTRON ACER TENDL-2024 LIBRARY; T=293.6K
Photon emission for (n,p)

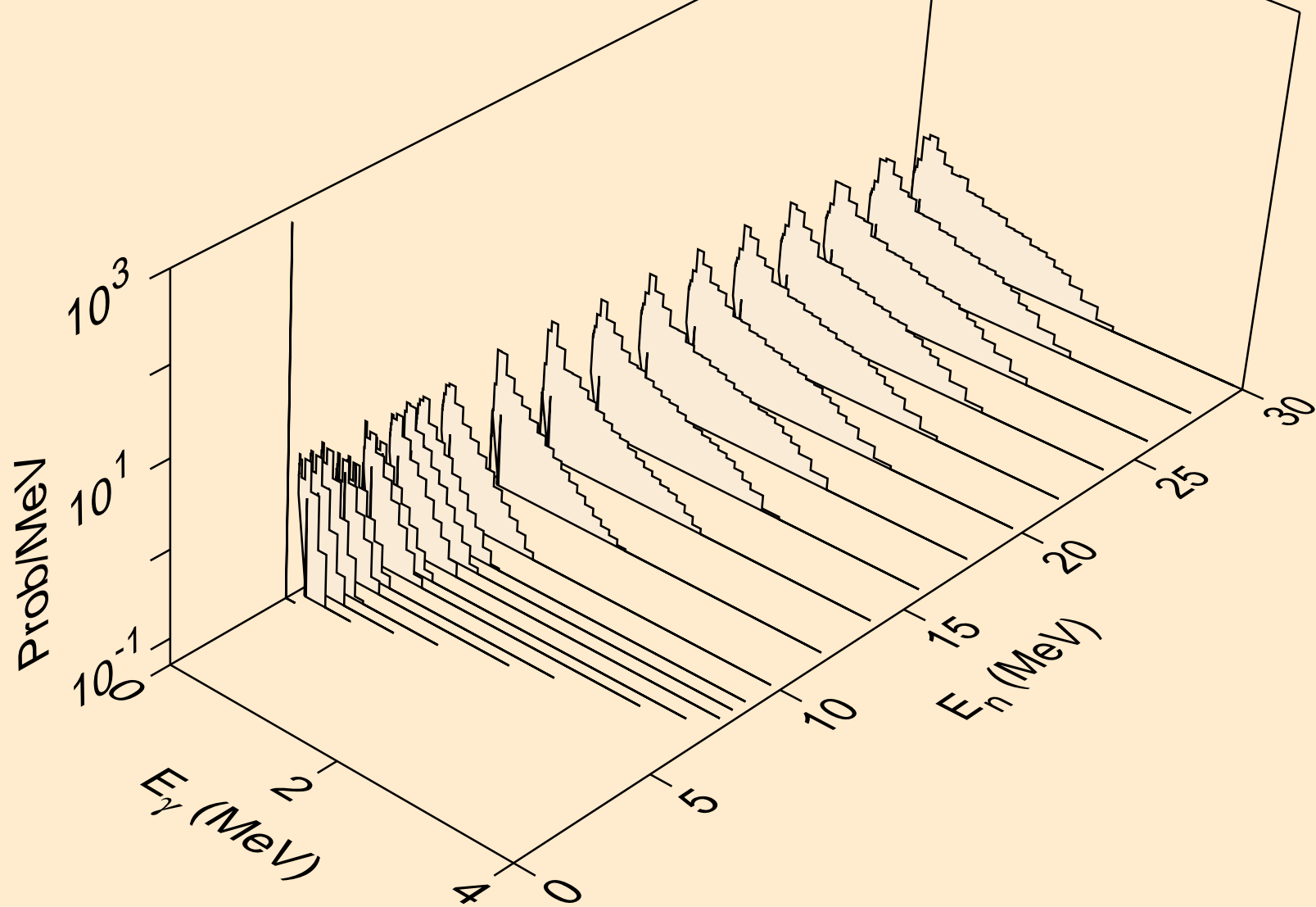

AM249 NEUTRON ACER TENDL-2024 LIBRARY; T=293.6K
Photon emission for (n,d)

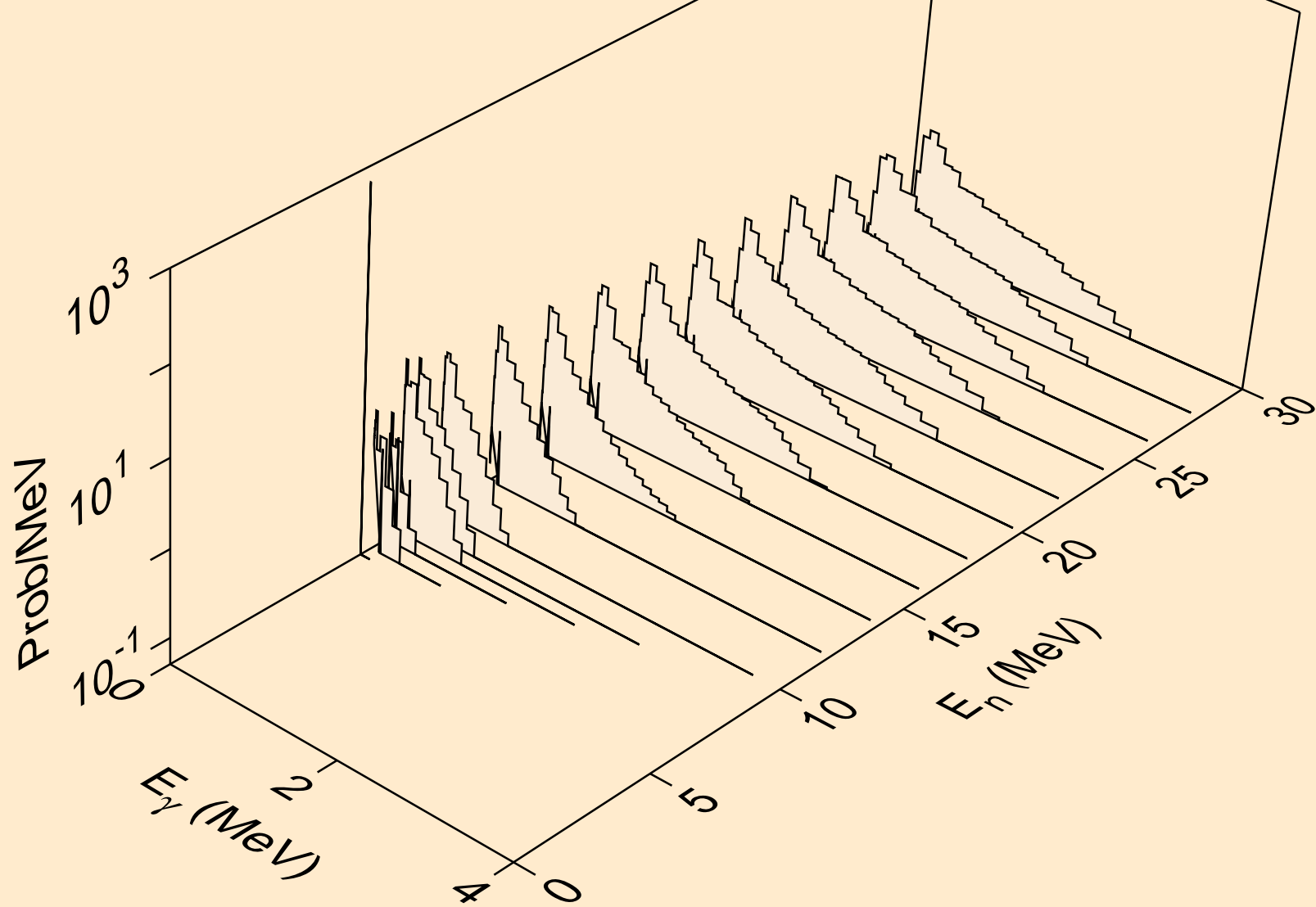

AM249 NEUTRON ACER TENDL-2024 LIBRARY; T=293.6K
Photon emission for (n,t)

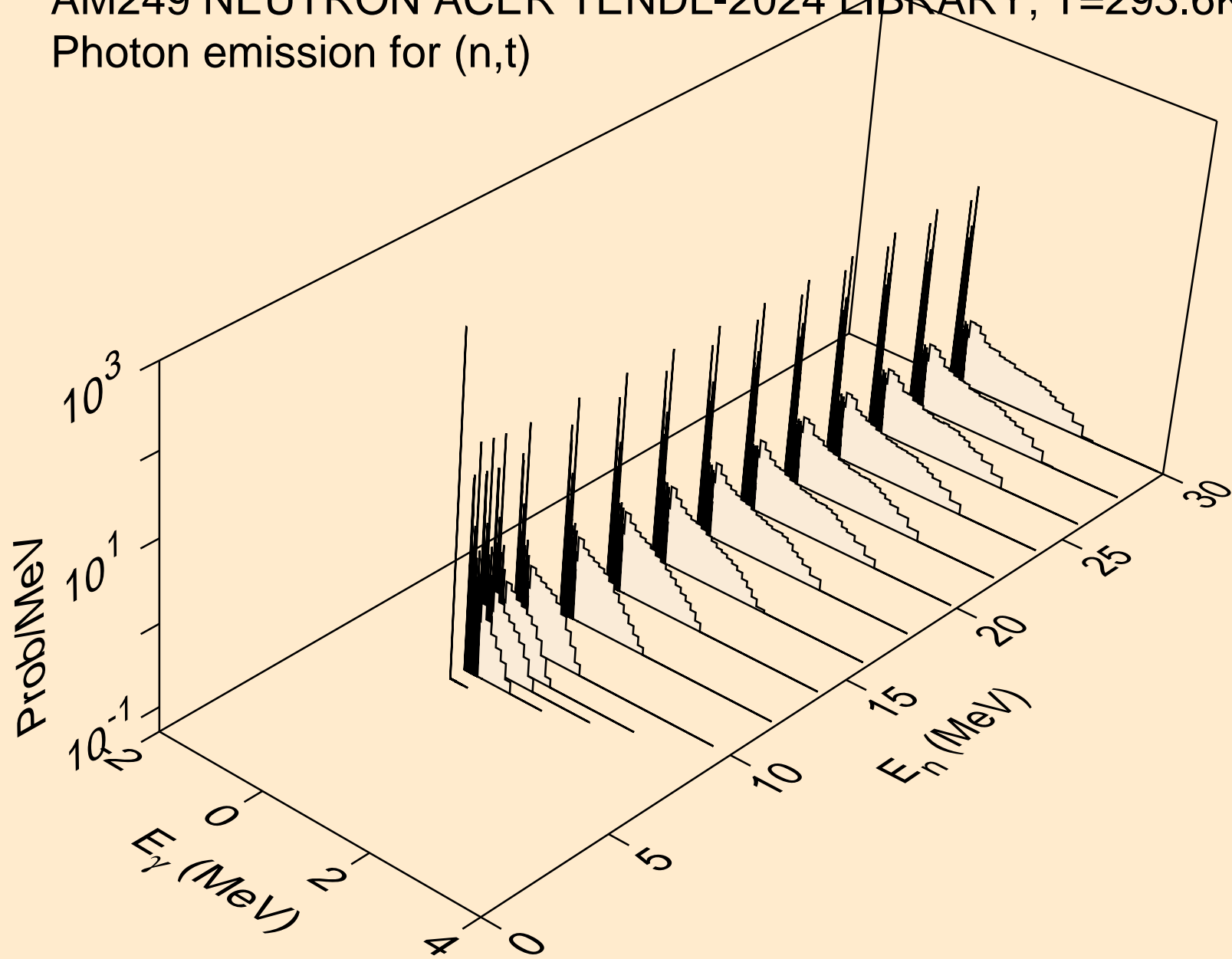

AM249 NEUTRON ACER TENDL-2024 LIBRARY; T=293.6K
Photon emission for (n,he3)

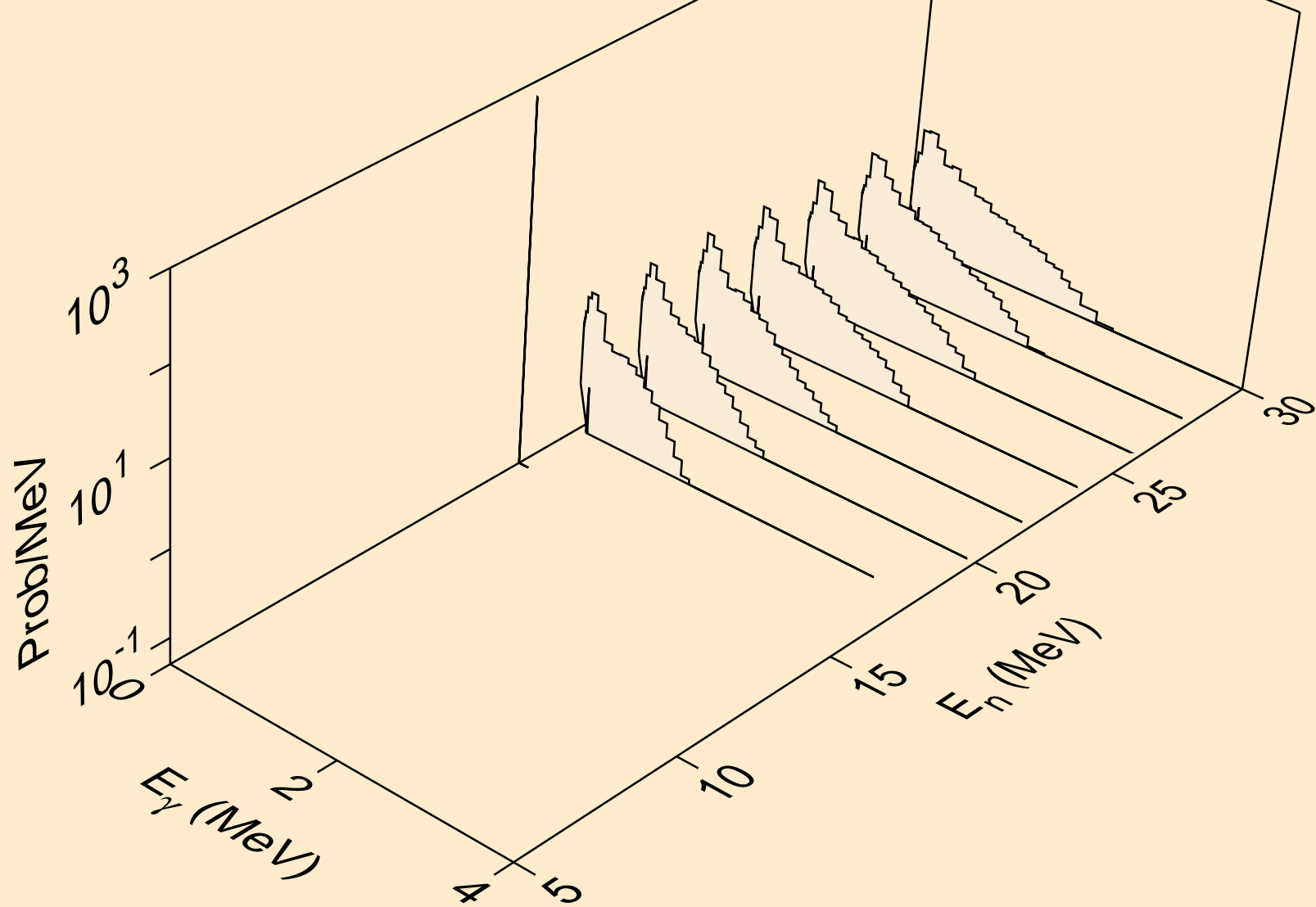

AM249 NEUTRON ACER TENDL-2024 LIBRARY; T=293.6K
Photon emission for (n,a)

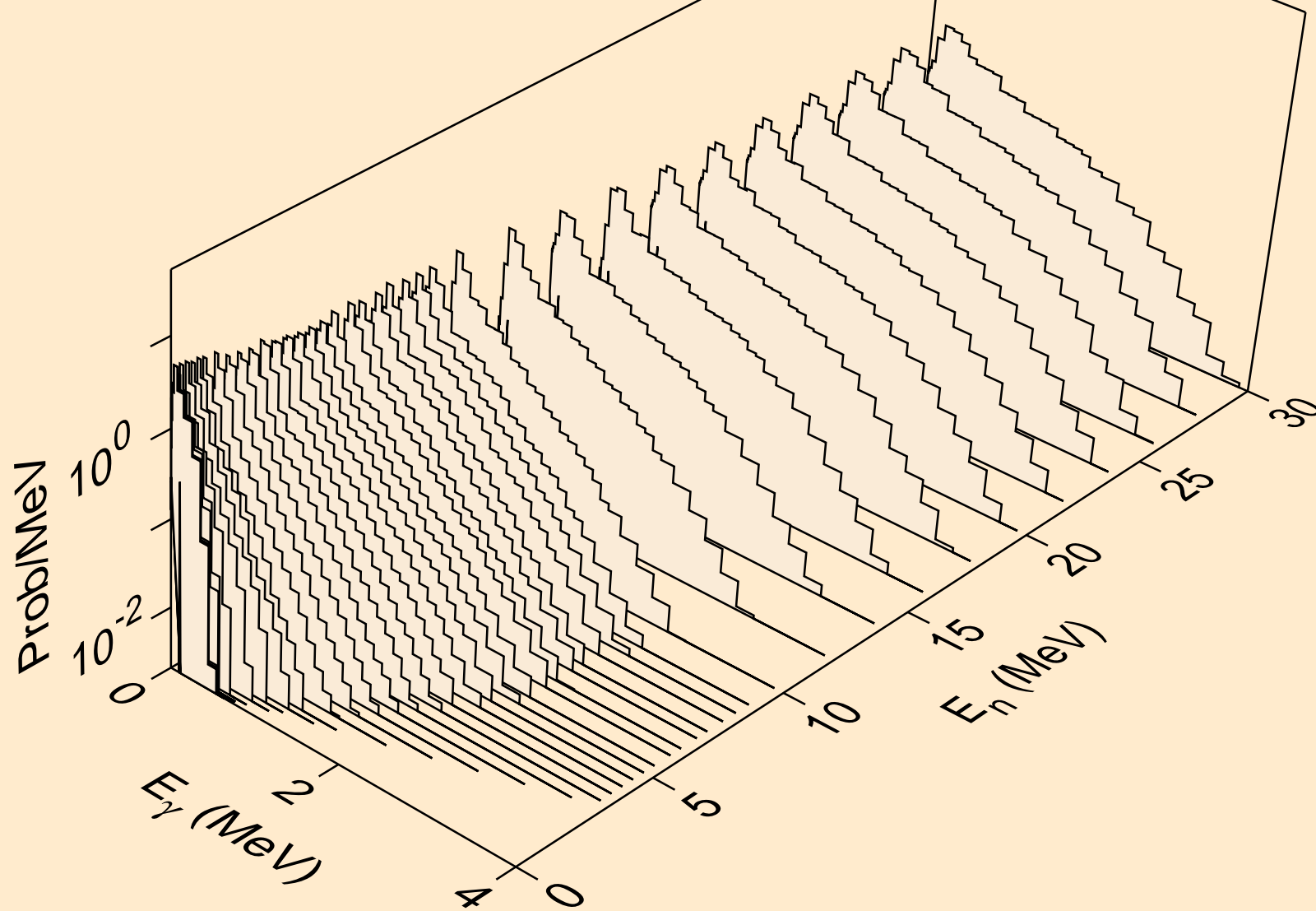

AM249 NEUTRON ACER TENDL-2024 LIBRARY; T=293.6K
Photon emission for (n,2p)

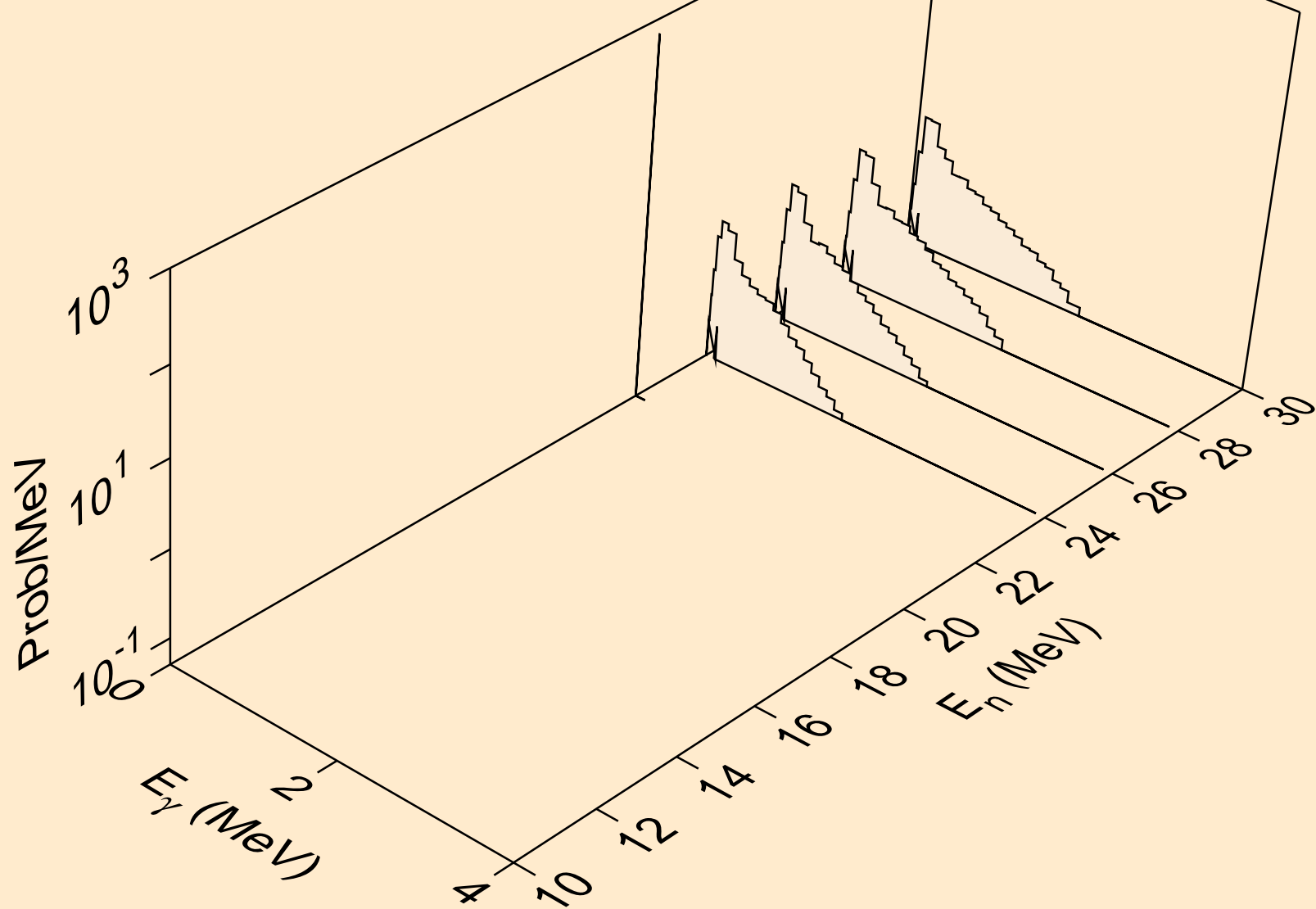

AM249 NEUTRON ACER TENDL-2024 LIBRARY; T=293.6K
thermal capture photon spectrum

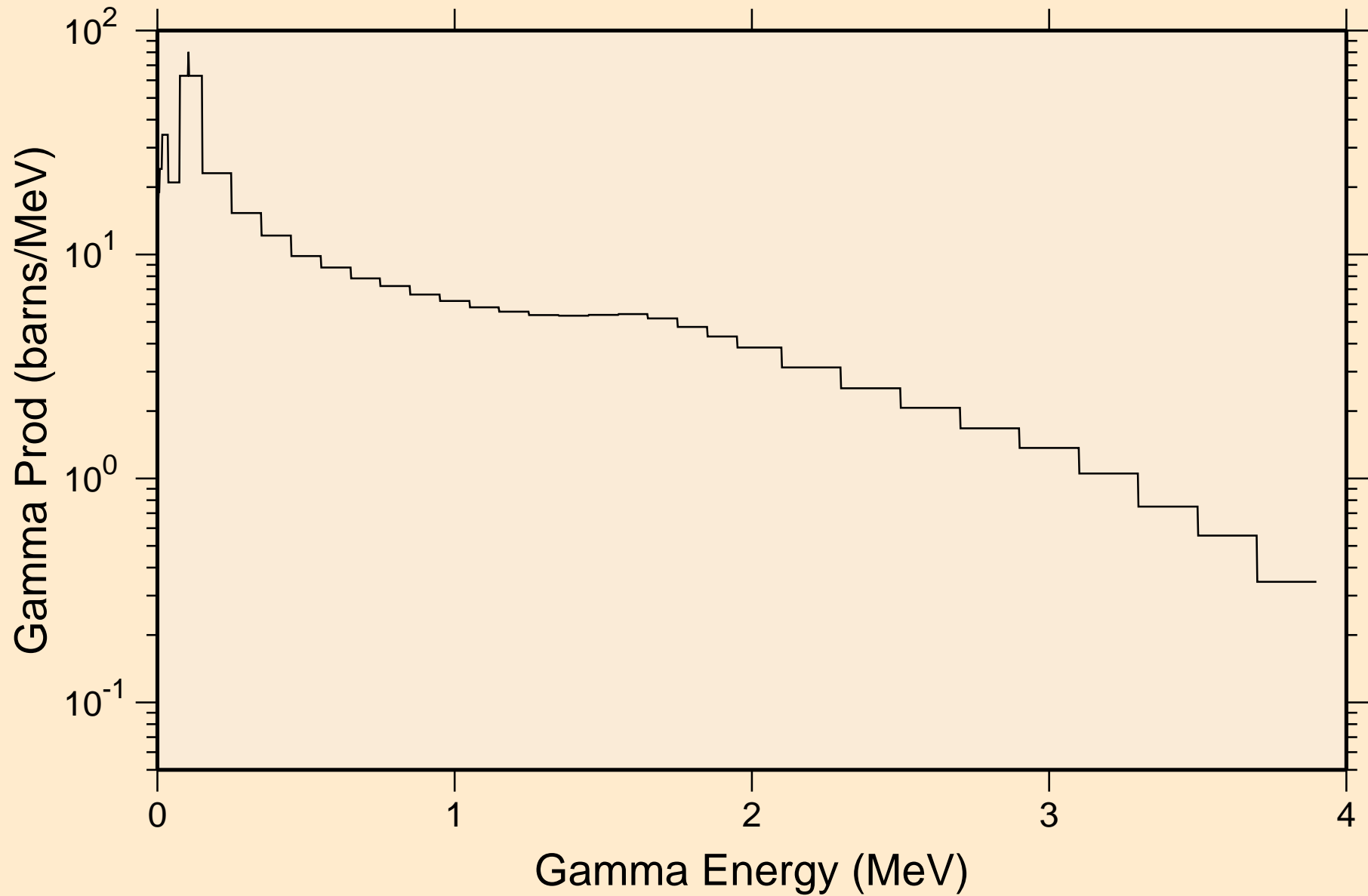

AM249 NEUTRON ACER TENDL-2024 LIBRARY; T=293.6K
14 MeV photon spectrum

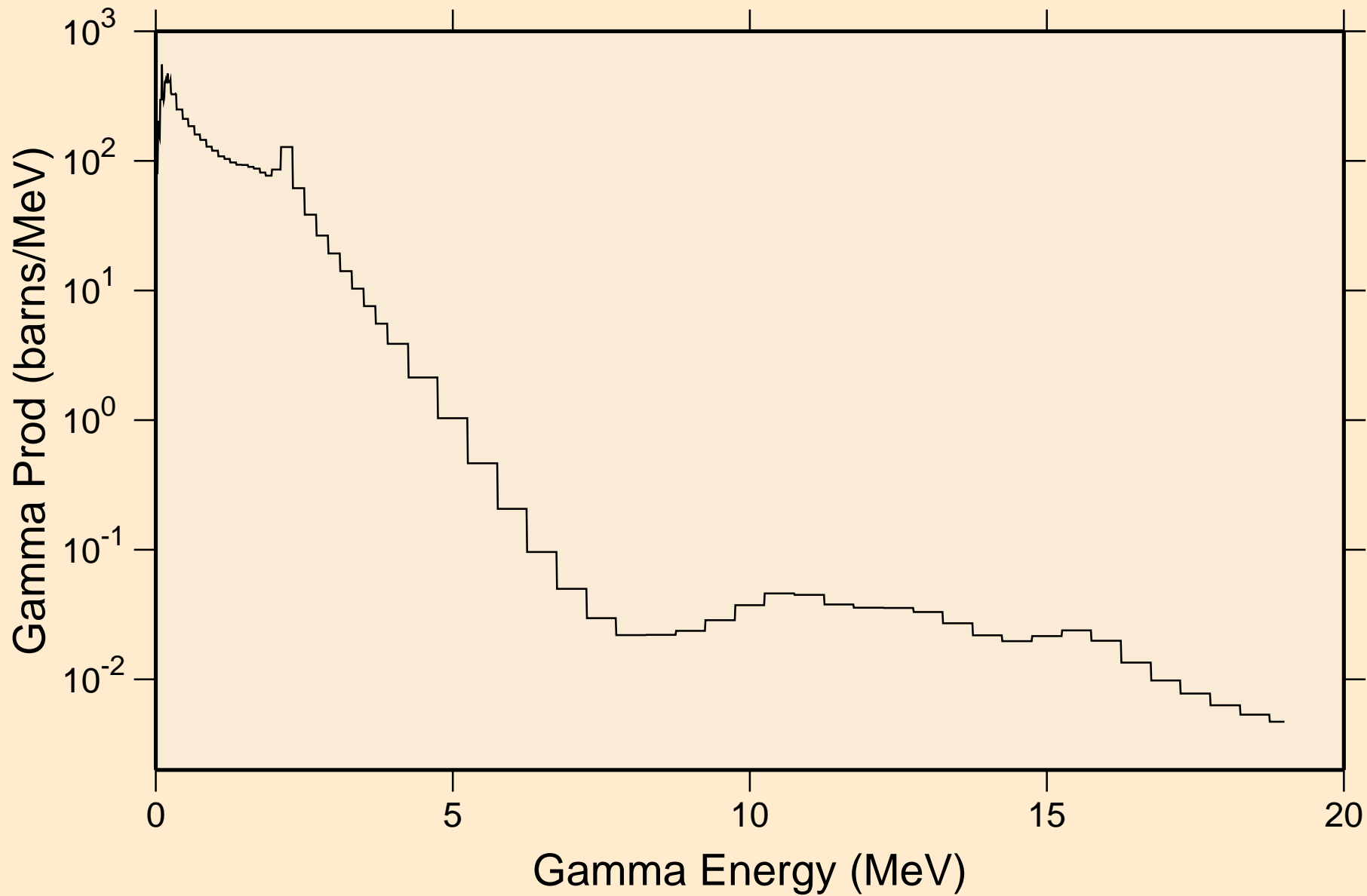

AM249 NEUTRON ACER TENDL-2024 LIBRARY; T=293.6K
Particle heating contributions

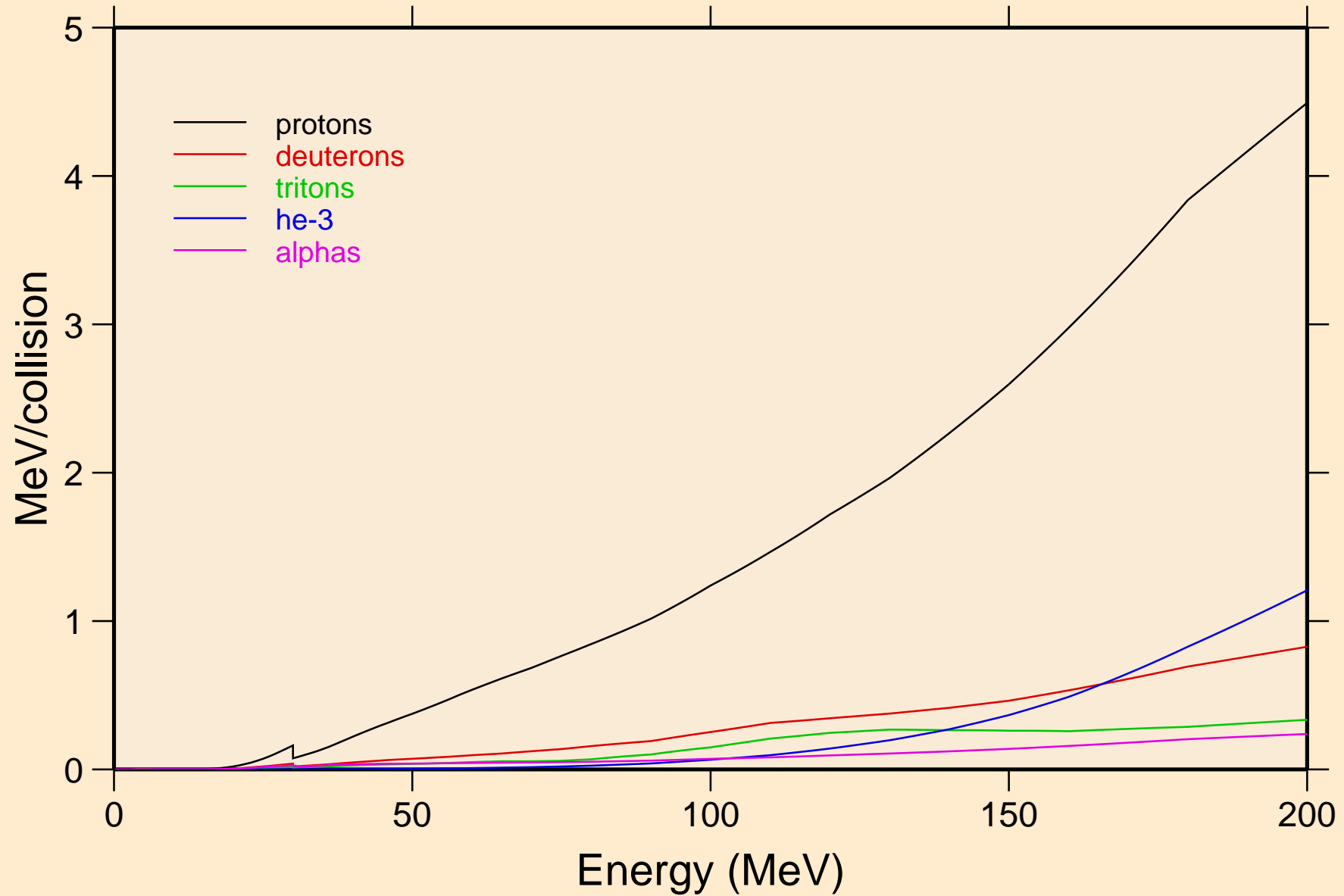

AM249 NEUTRON ACER TENDL-2024 LIBRARY; T=293.6K
Recoil Heating

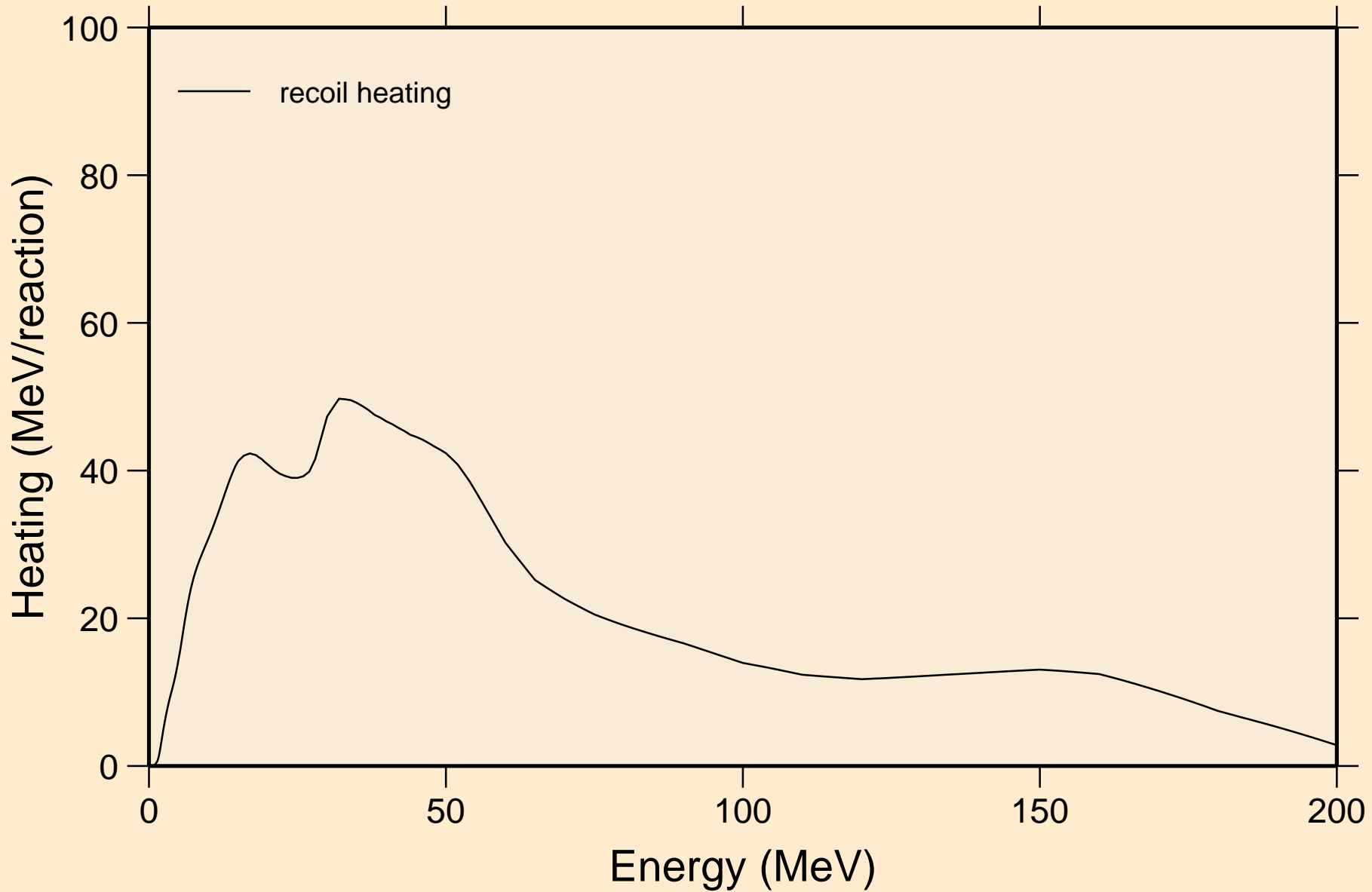

AM249 NEUTRON ACER TENDL-2024 LIBRARY; T=293.6K

Particle production cross sections

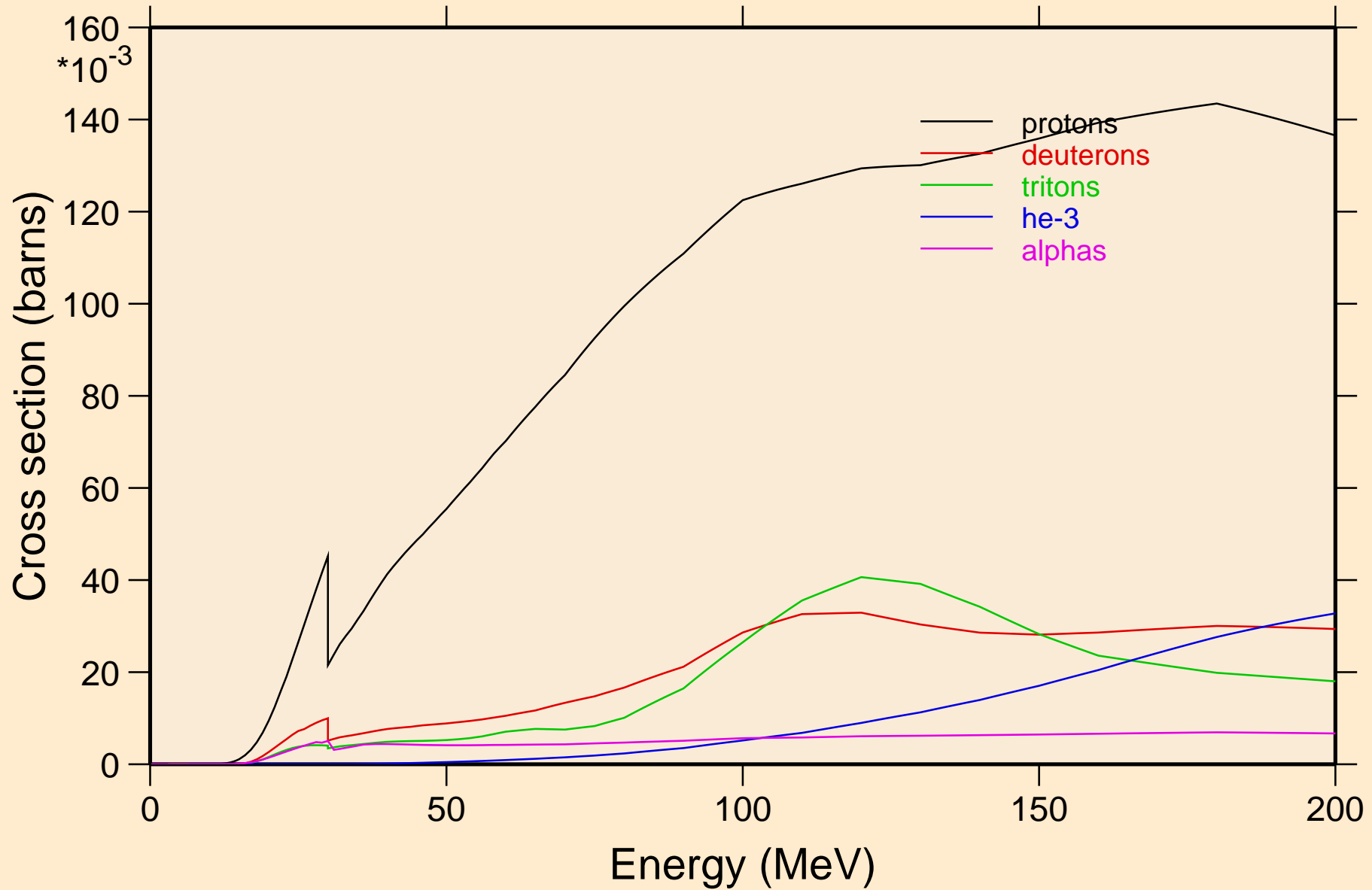

AM249 NEUTRON ACER TENDL-2024 LIBRARY; T=293.6K
protons from (n,x)

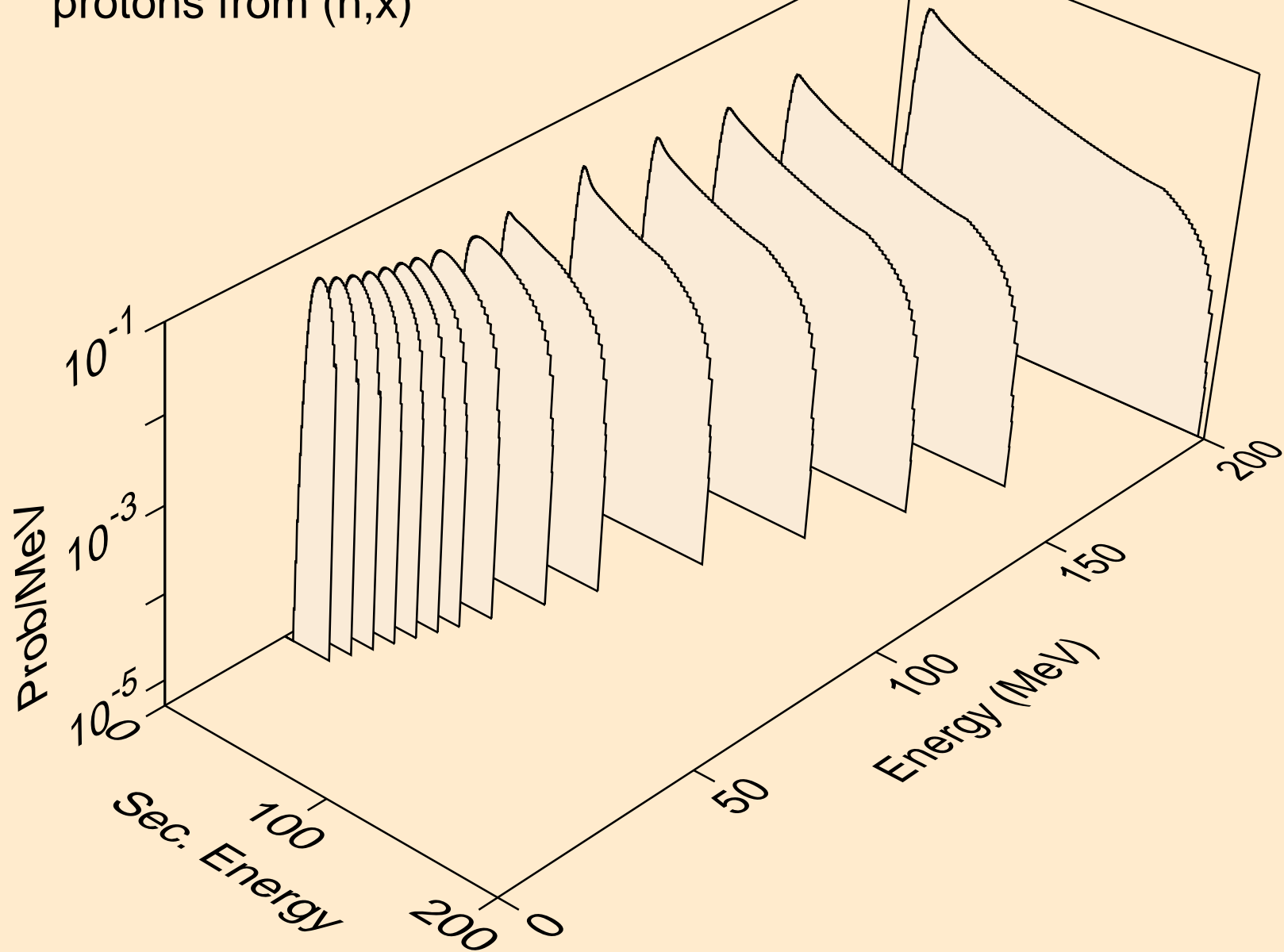

AM249 NEUTRON ACER TENDL-2024 LIBRARY; T=293.6K
protons from (n,n*)p

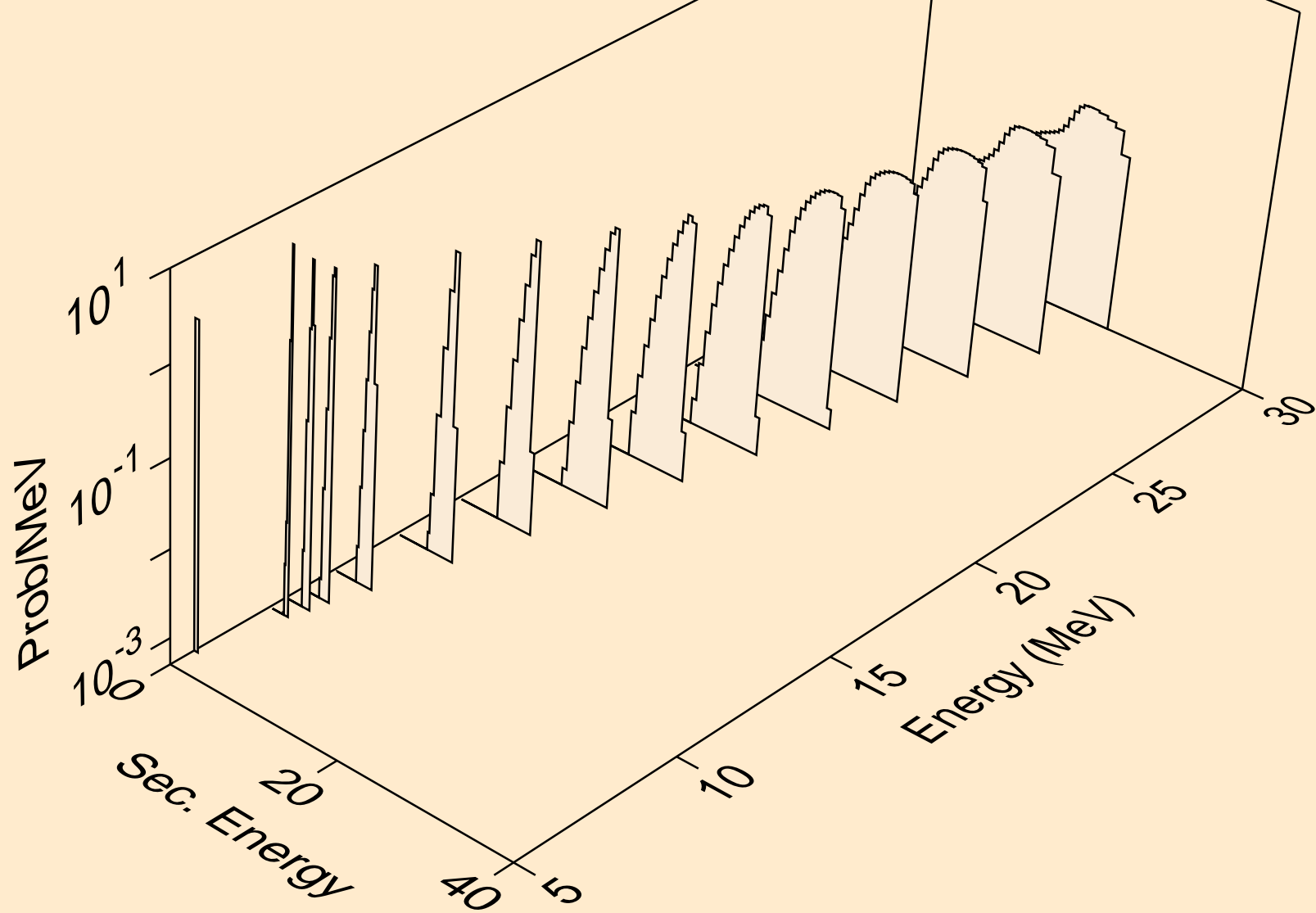

AM249 NEUTRON ACER TENDL-2024 LIBRARY; T=293.6K
protons from (n,2np)

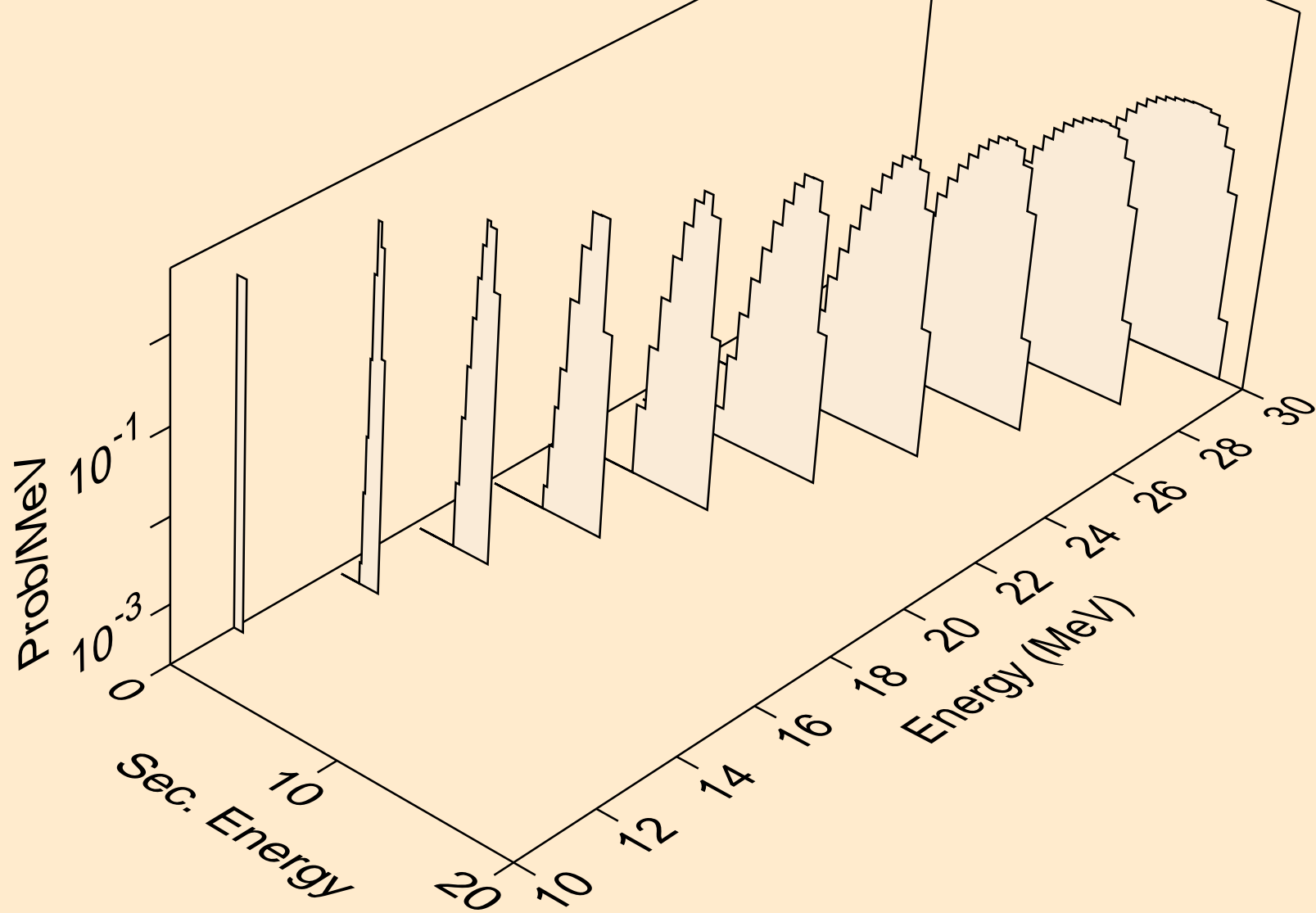

AM249 NEUTRON ACER TENDL-2024 LIBRARY; T=293.6K
protons from (n,3np)

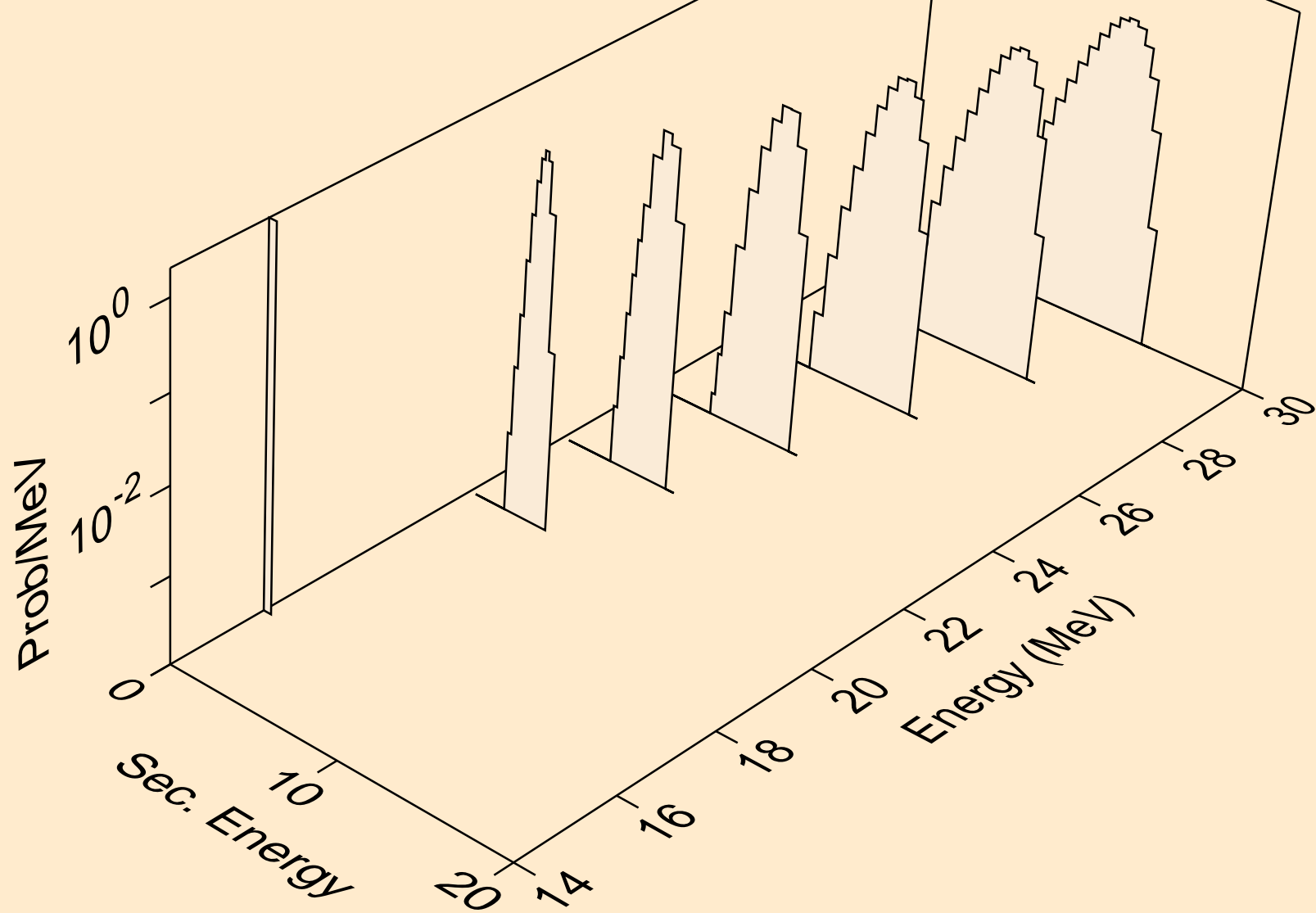

AM249 NEUTRON ACER TENDL-2024 LIBRARY; T=293.6K
protons from (n,p)

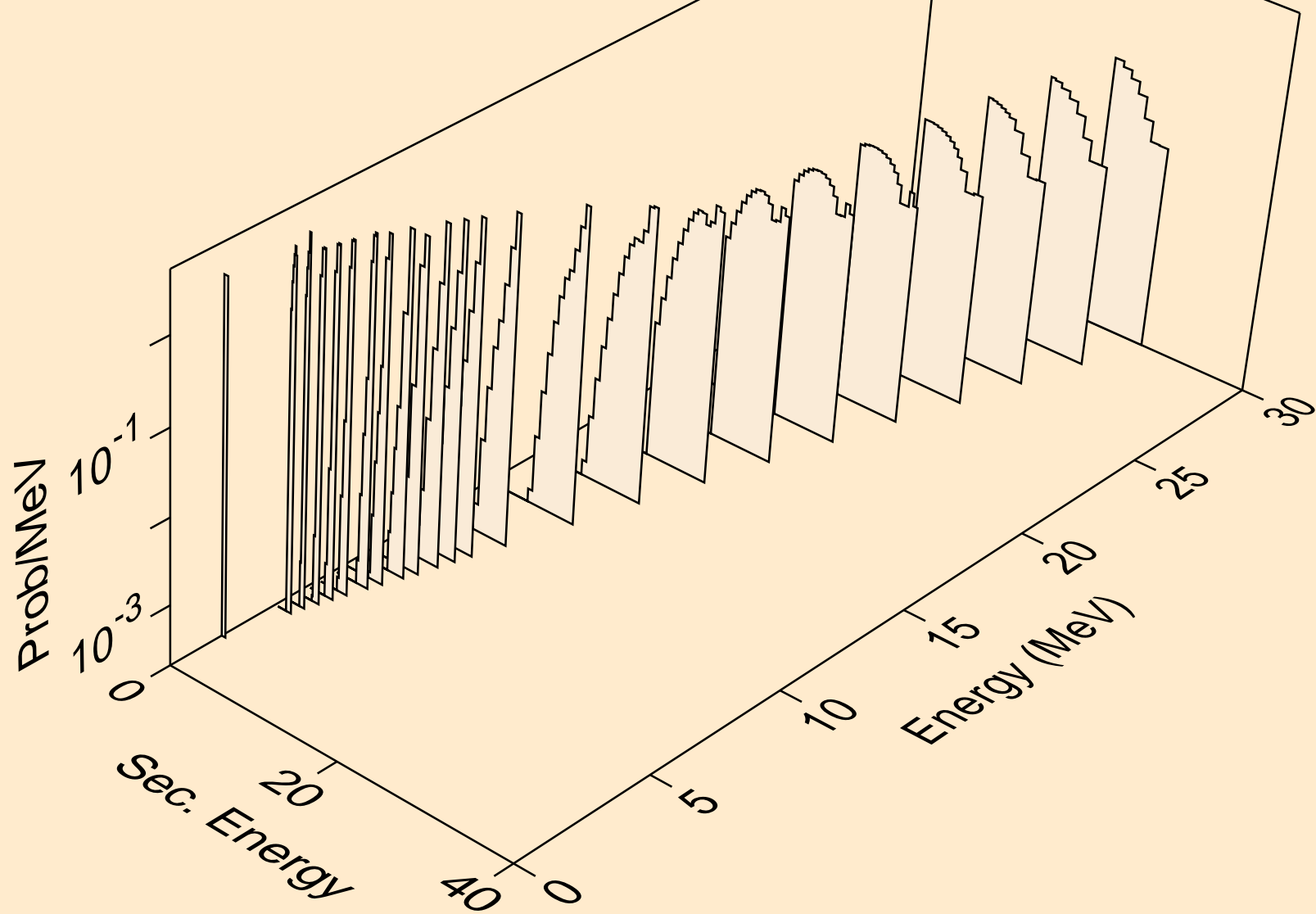

AM249 NEUTRON ACER TENDL-2024 LIBRARY; T=293.6K
protons from (n,2p)

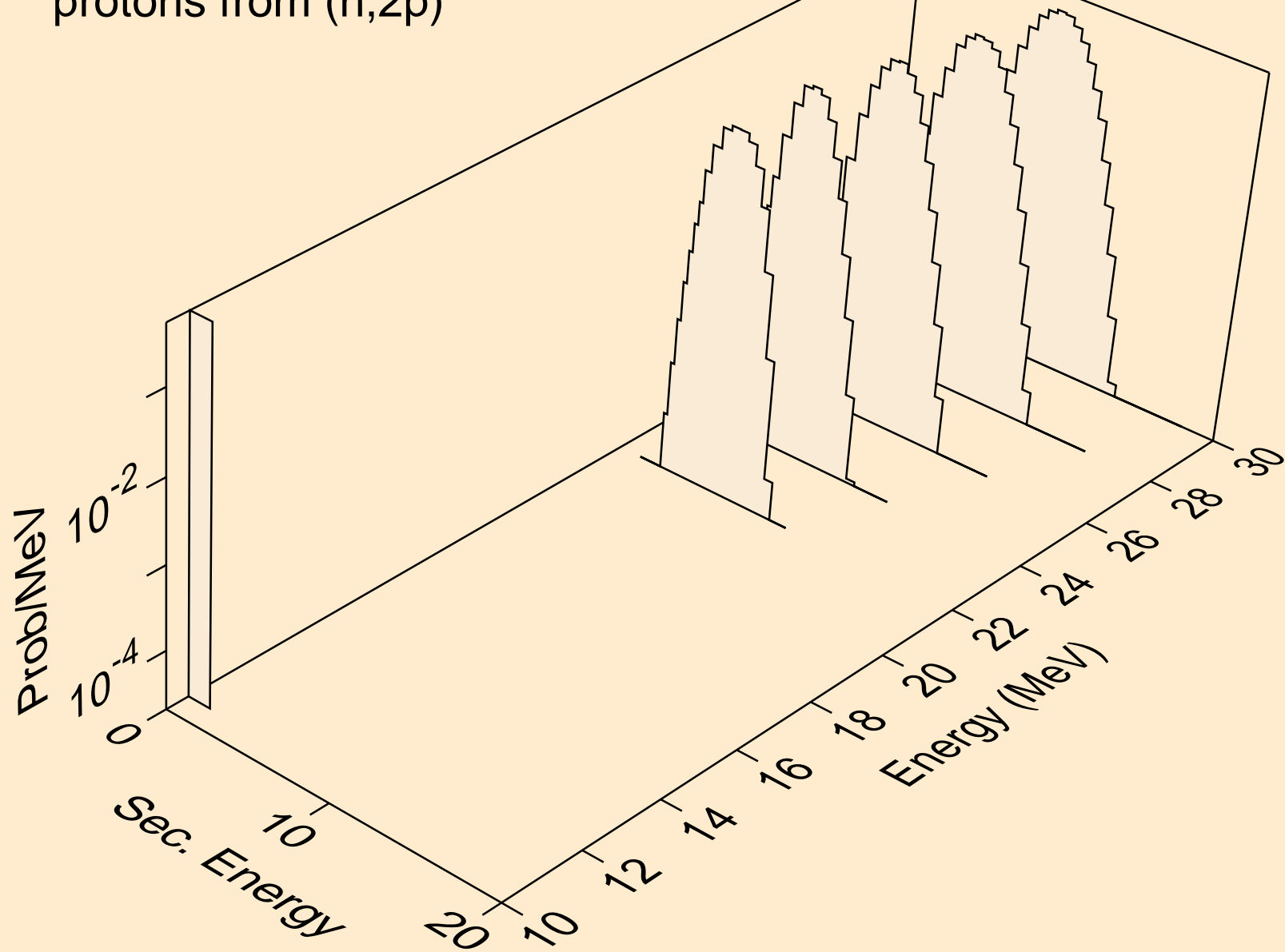

AM249 NEUTRON ACER TENDL-2024 LIBRARY; T=293.6K
deuterons from (n,x)

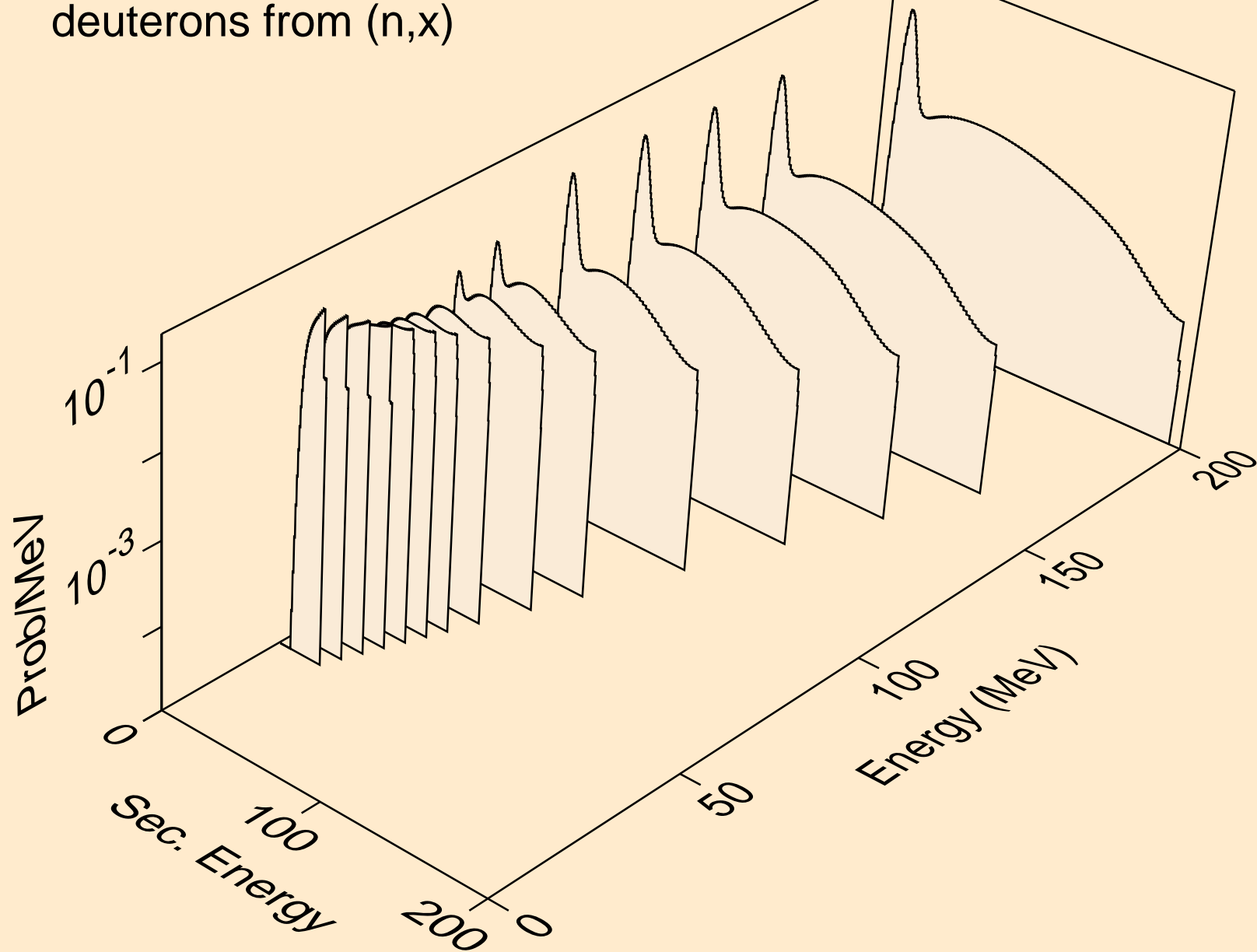

AM249 NEUTRON ACER TENDL-2024 LIBRARY; T=293.6K
deuterons from (n,2nd)

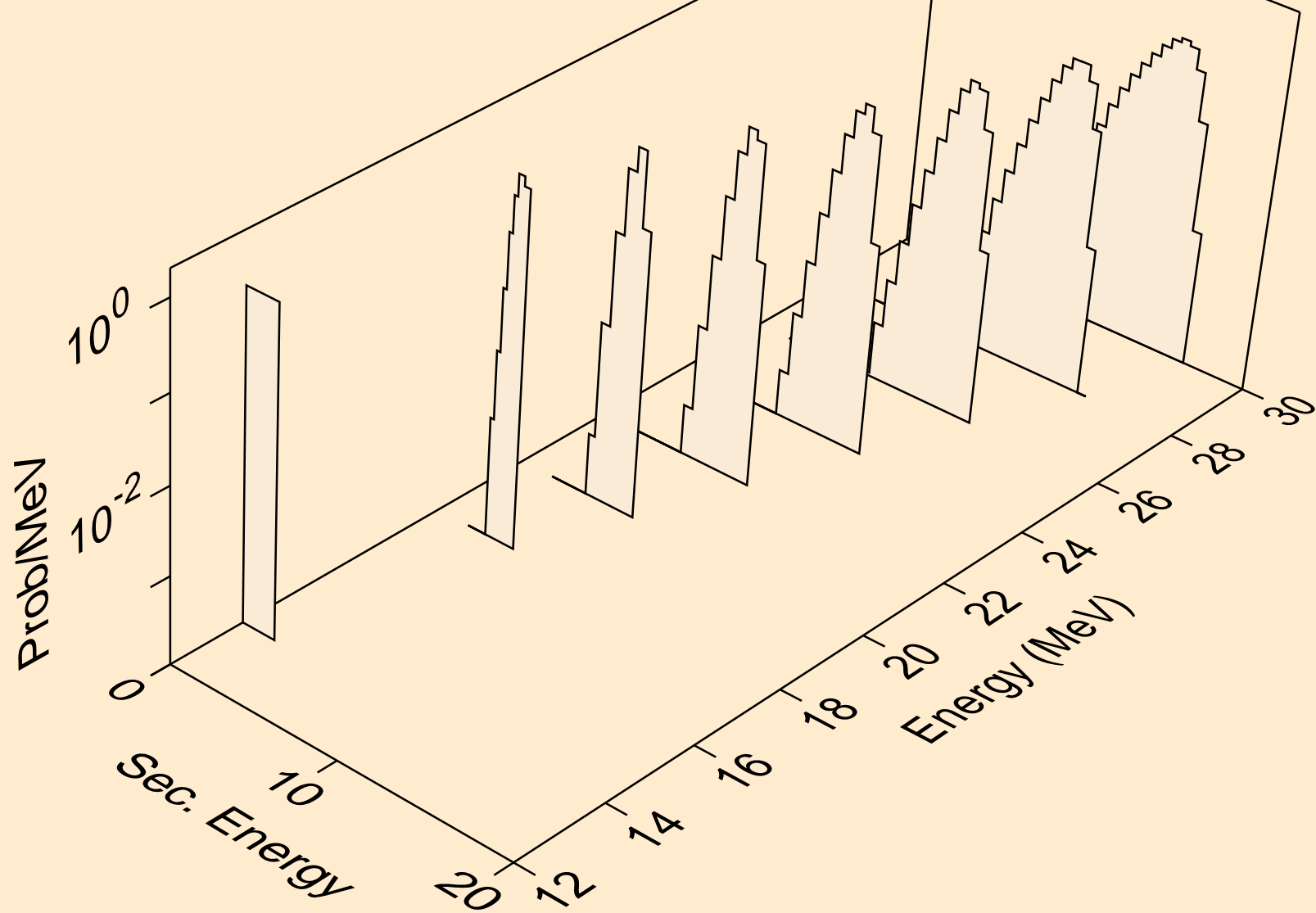

AM249 NEUTRON ACER TENDL-2024 LIBRARY; T=293.6K
deuterons from (n,n*)d

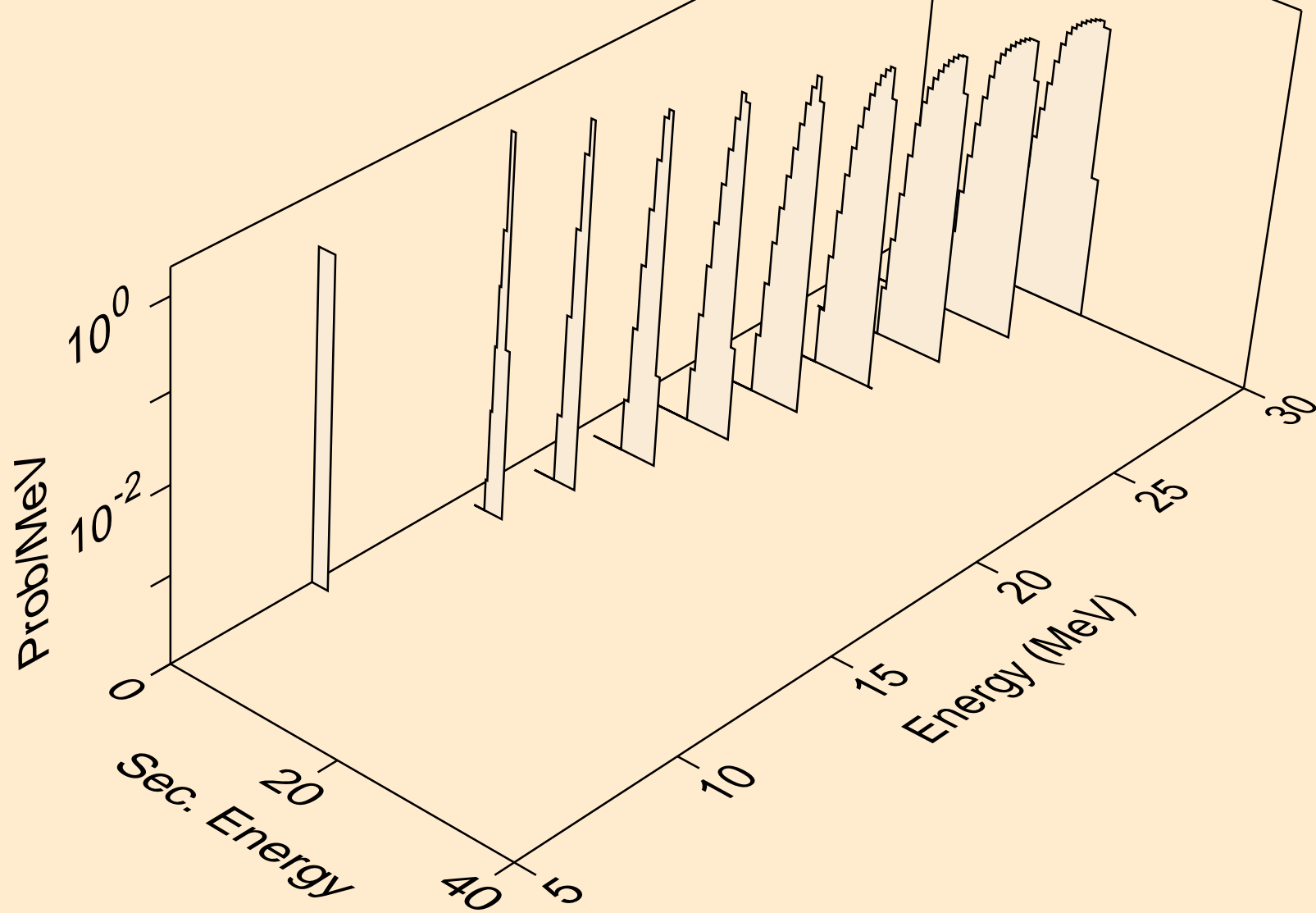

AM249 NEUTRON ACER TENDL-2024 LIBRARY; T=293.6K
deuterons from (n,d)

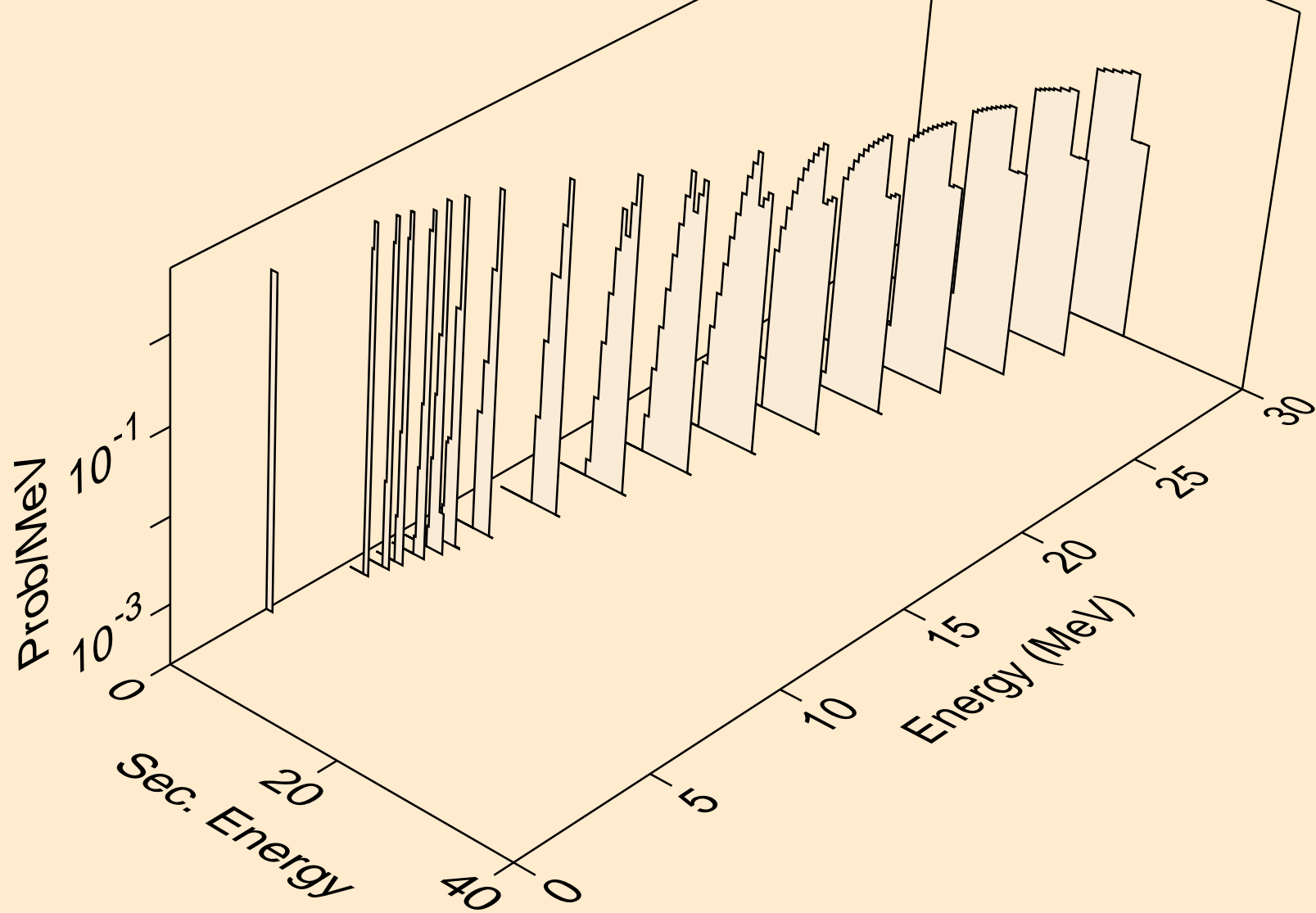

AM249 NEUTRON ACER TENDL-2024 LIBRARY; T=293.6K
tritons from (n,x)

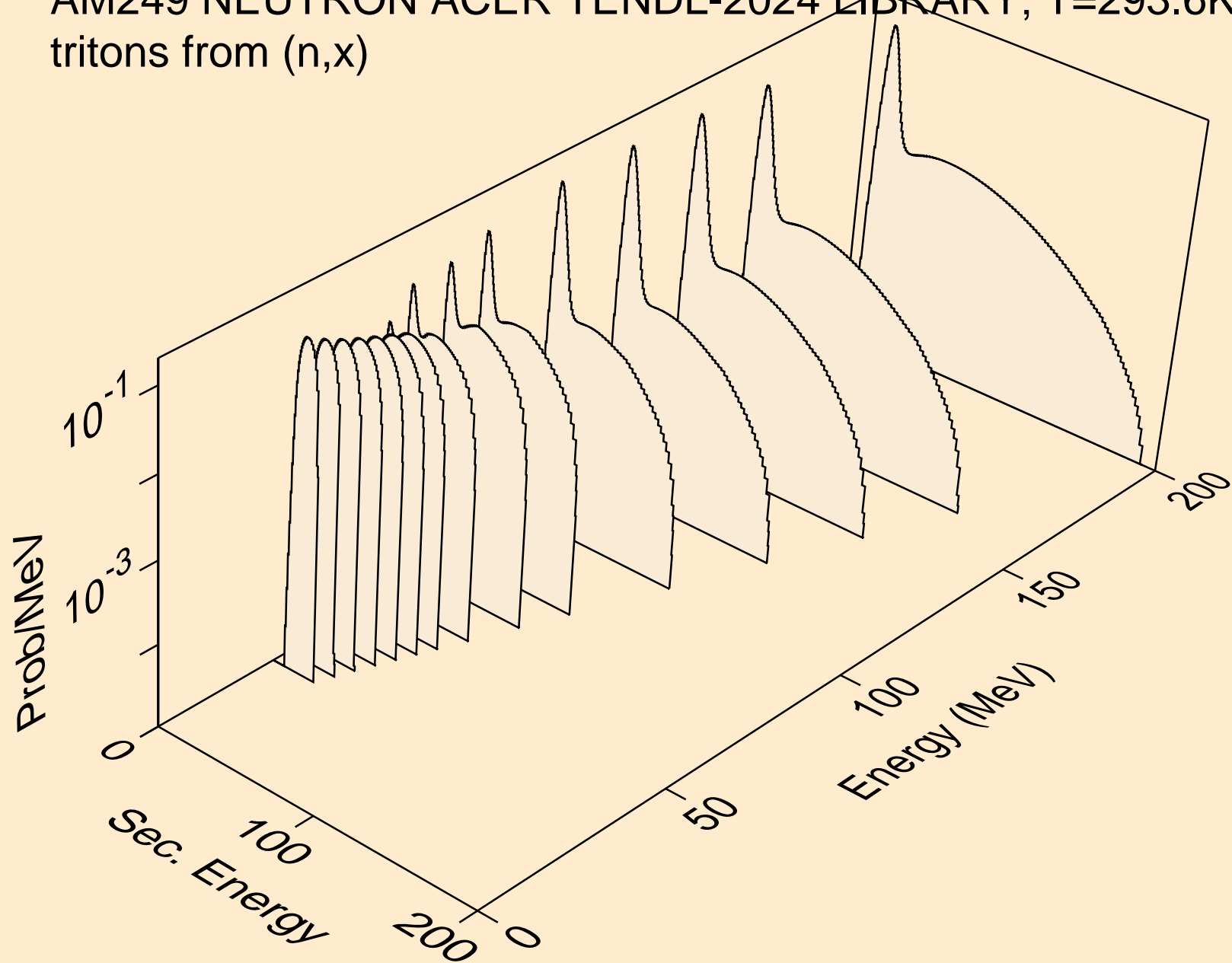

AM249 NEUTRON ACER TENDL-2024 LIBRARY; T=293.6K
tritons from (n,n*)t

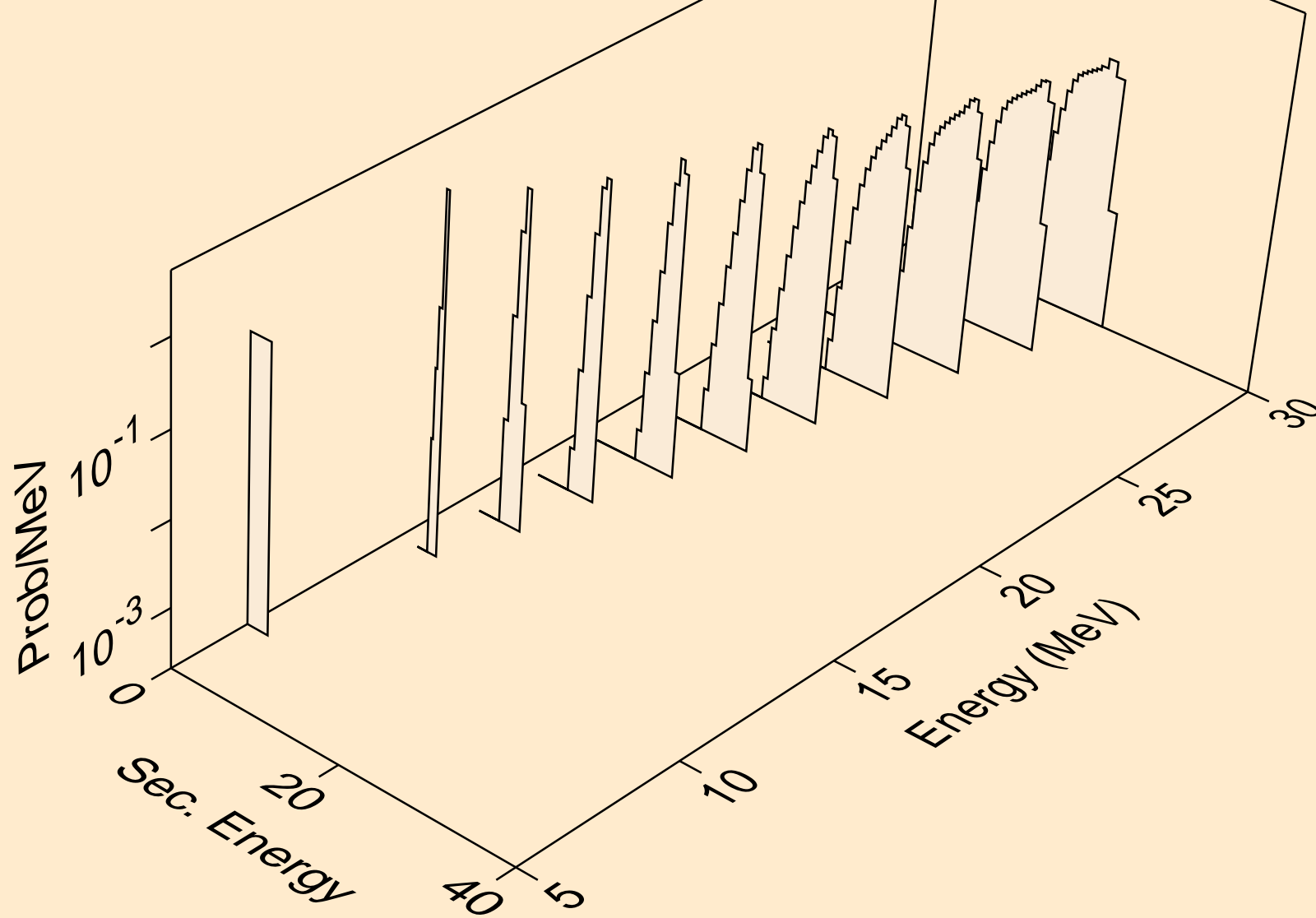

AM249 NEUTRON ACER TENDL-2024 LIBRARY; T=293.6K
tritons from (n,t)

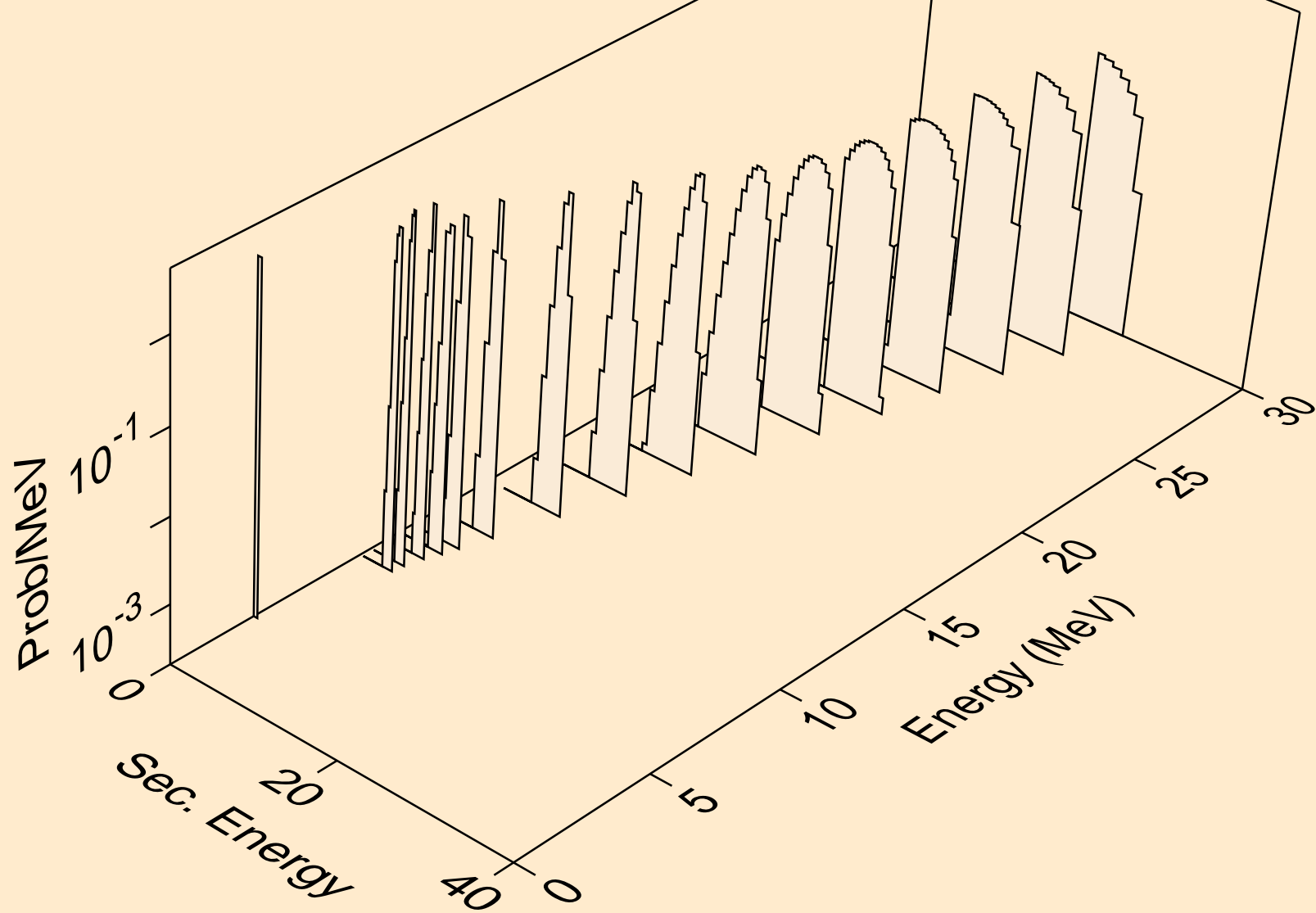

AM249 NEUTRON ACER TENDL-2024 LIBRARY; T=293.6K
he3s from (n,x)

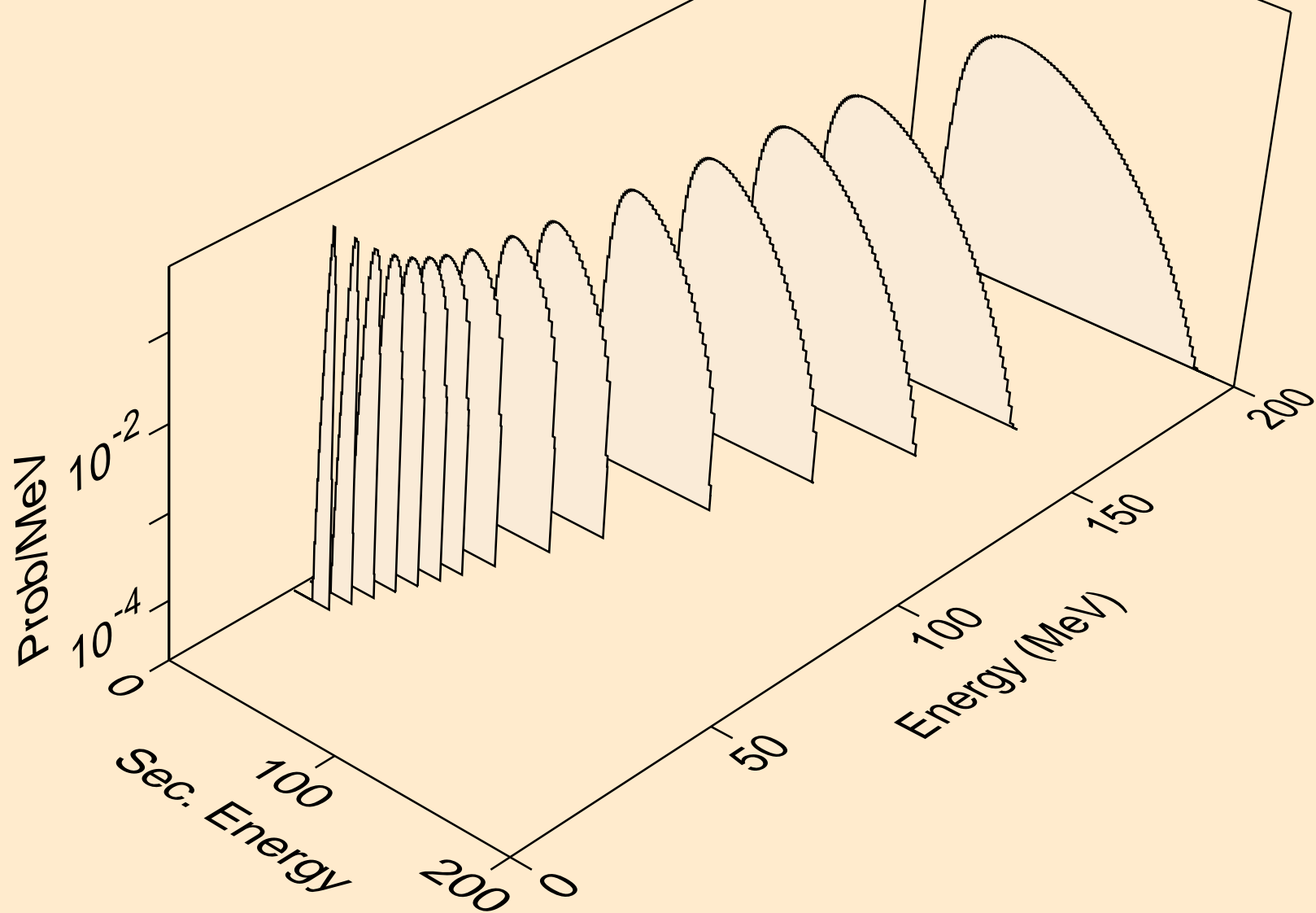

AM249 NEUTRON ACER TENDL-2024 LIBRARY; T=293.6K
he3s from (n,n*)he3

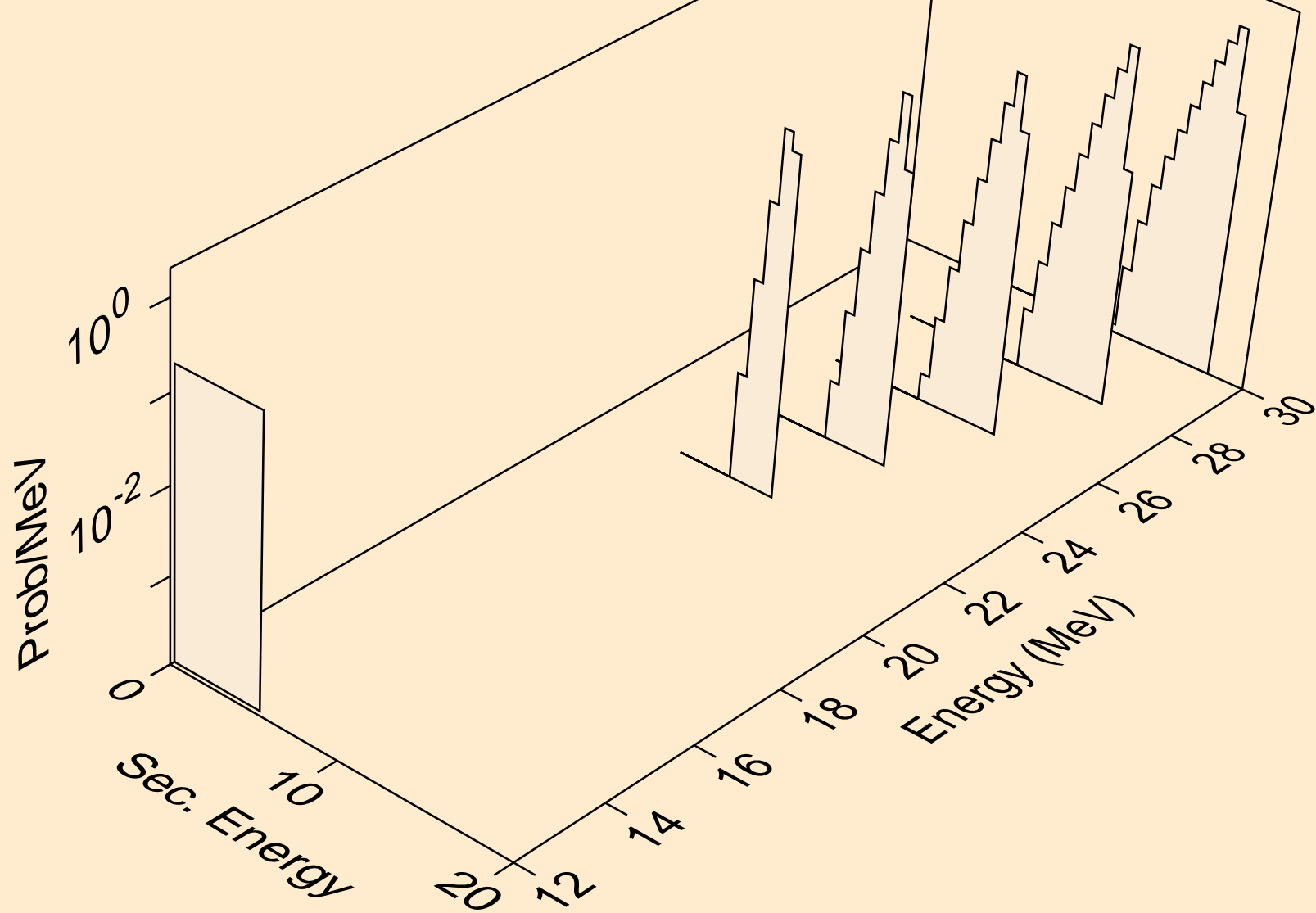

AM249 NEUTRON ACER TENDL-2024 LIBRARY; T=293.6K
he3s from (n,he3)

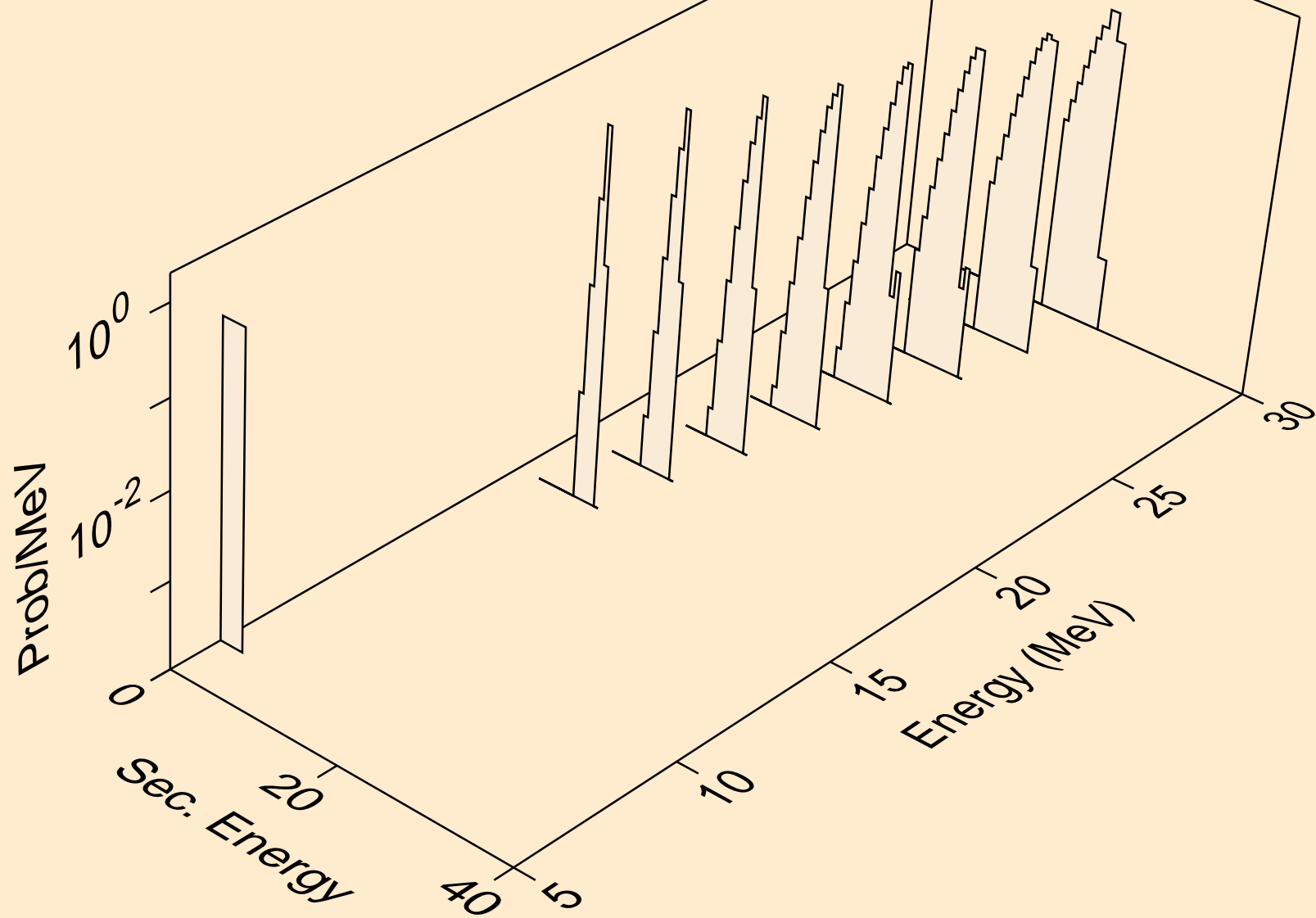

AM249 NEUTRON ACER TENDL-2024 LIBRARY; T=293.6K
alphas from (n,x)

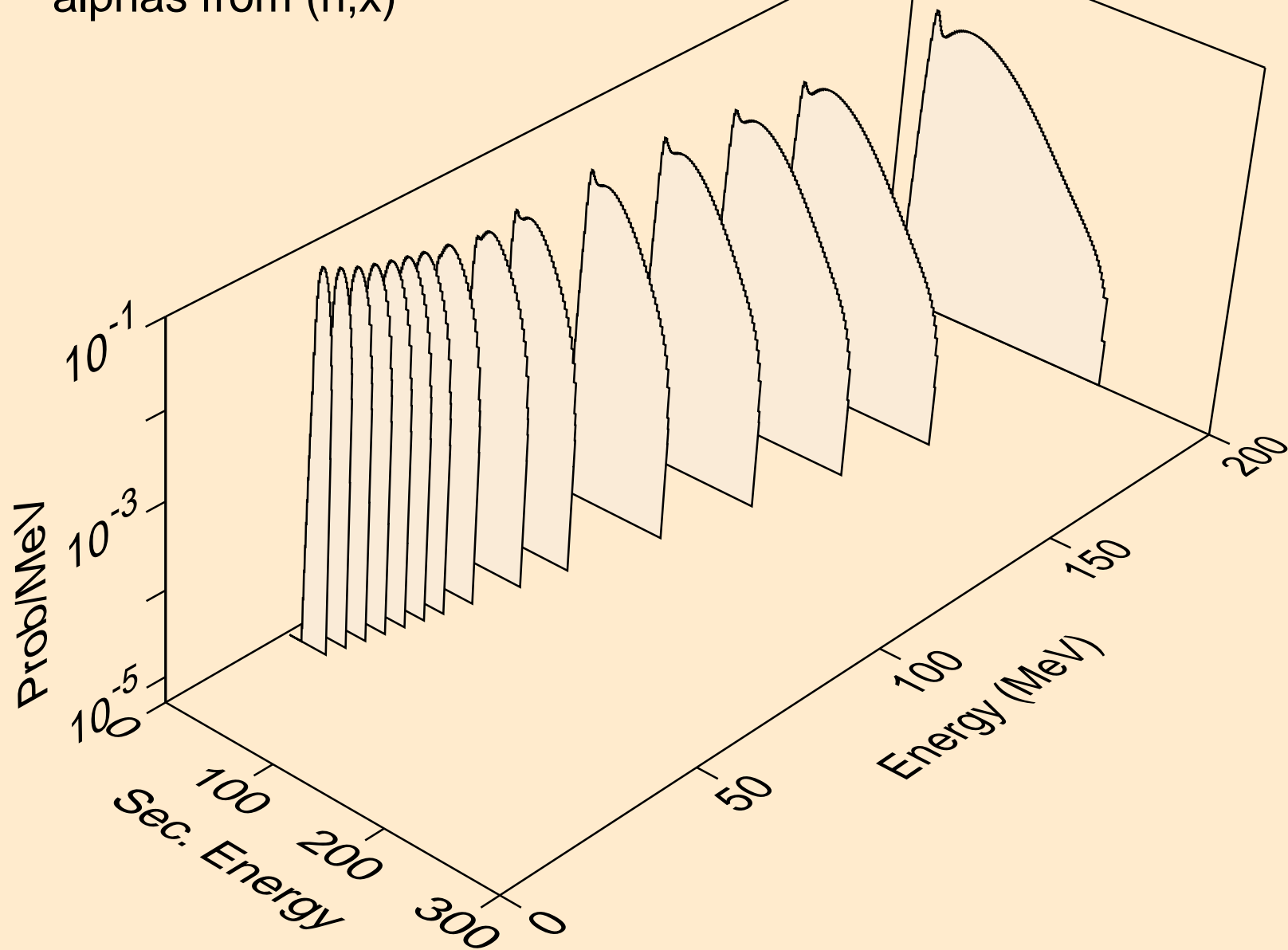

AM249 NEUTRON ACER TENDL-2024 LIBRARY; T=293.6K
alphas from (n,n*)a

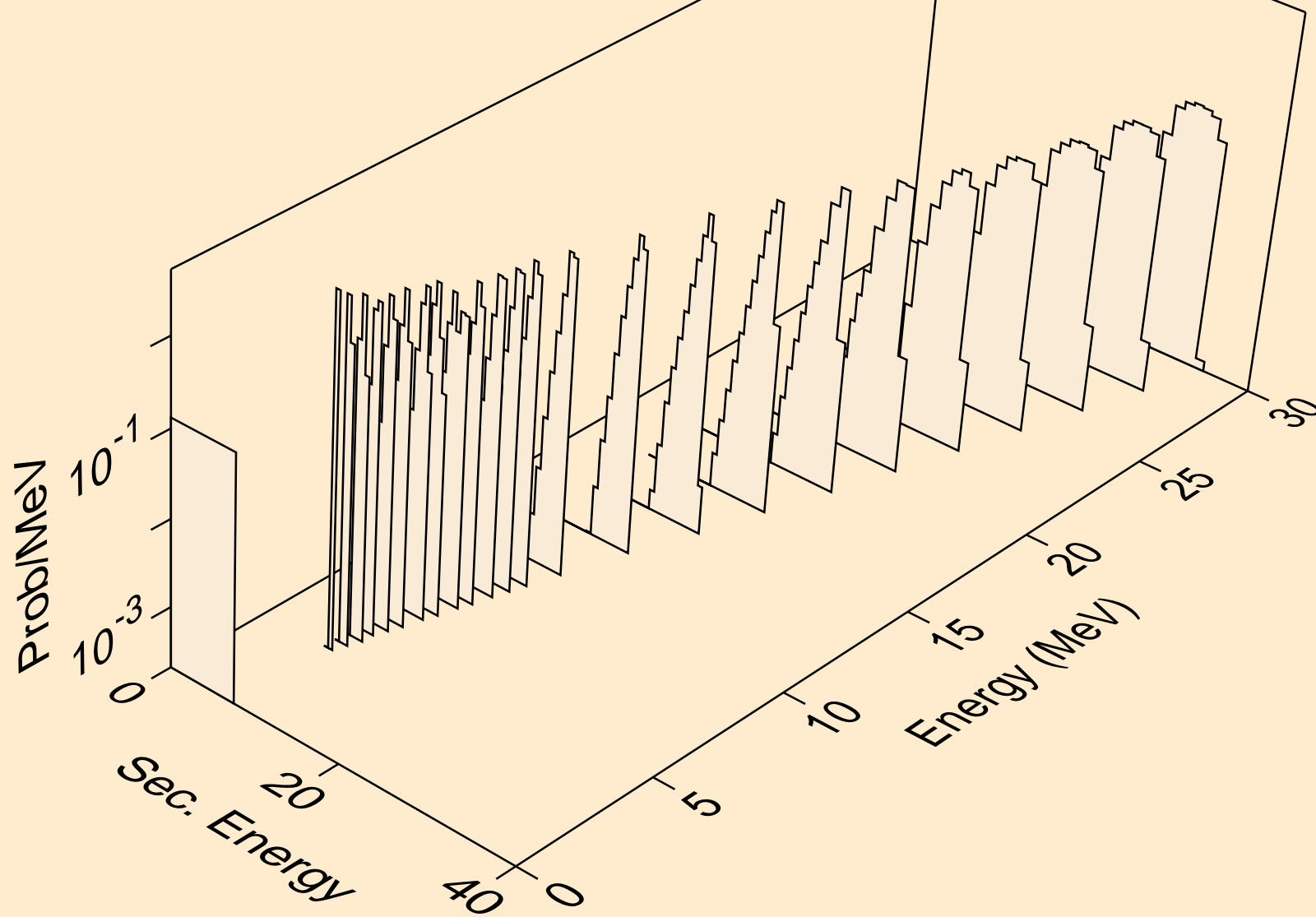

AM249 NEUTRON ACER TENDL-2024 LIBRARY; T=293.6K
alphas from (n,2n)a

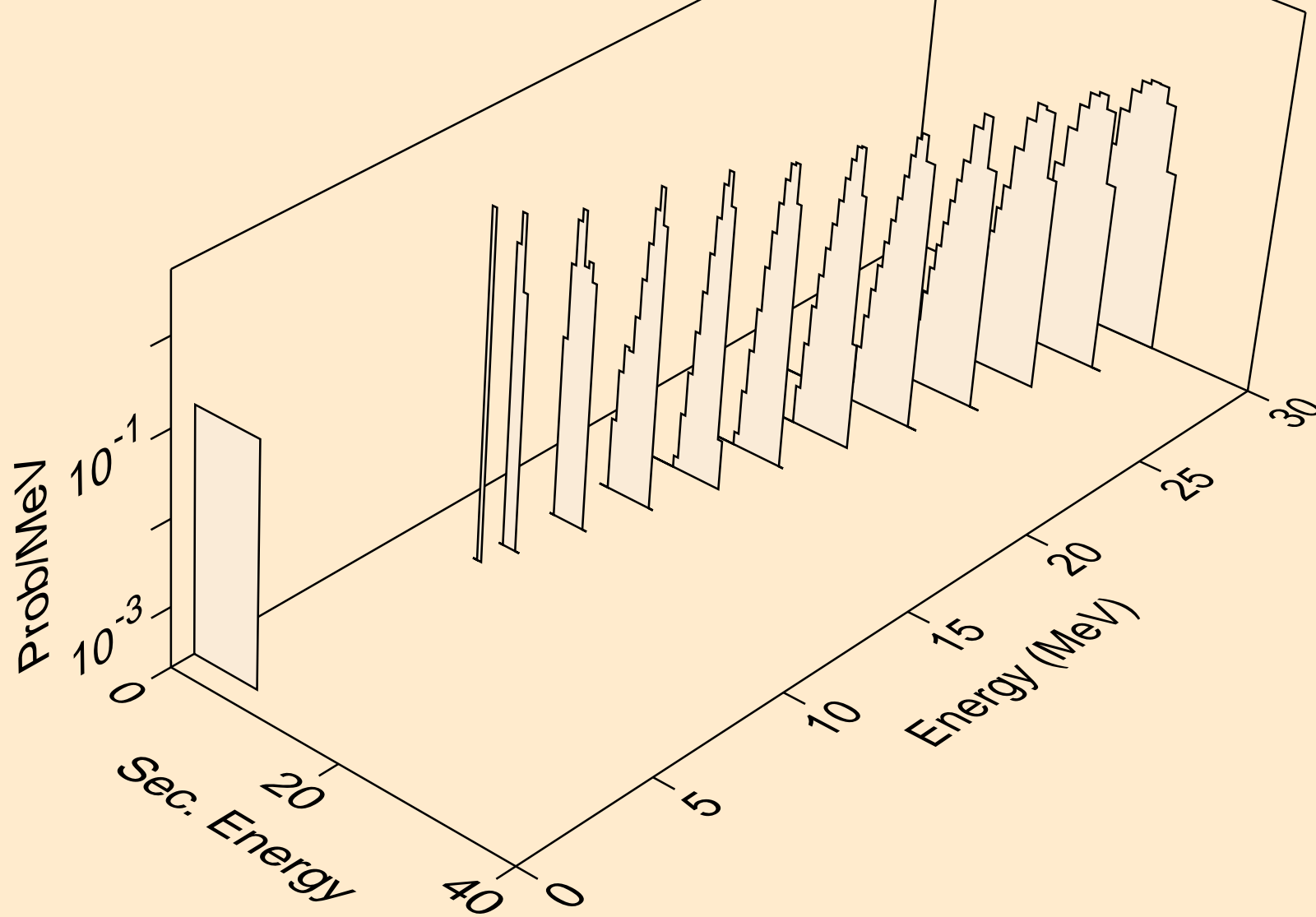

AM249 NEUTRON ACER TENDL-2024 LIBRARY; T=293.6K
alphas from (n,3n)a

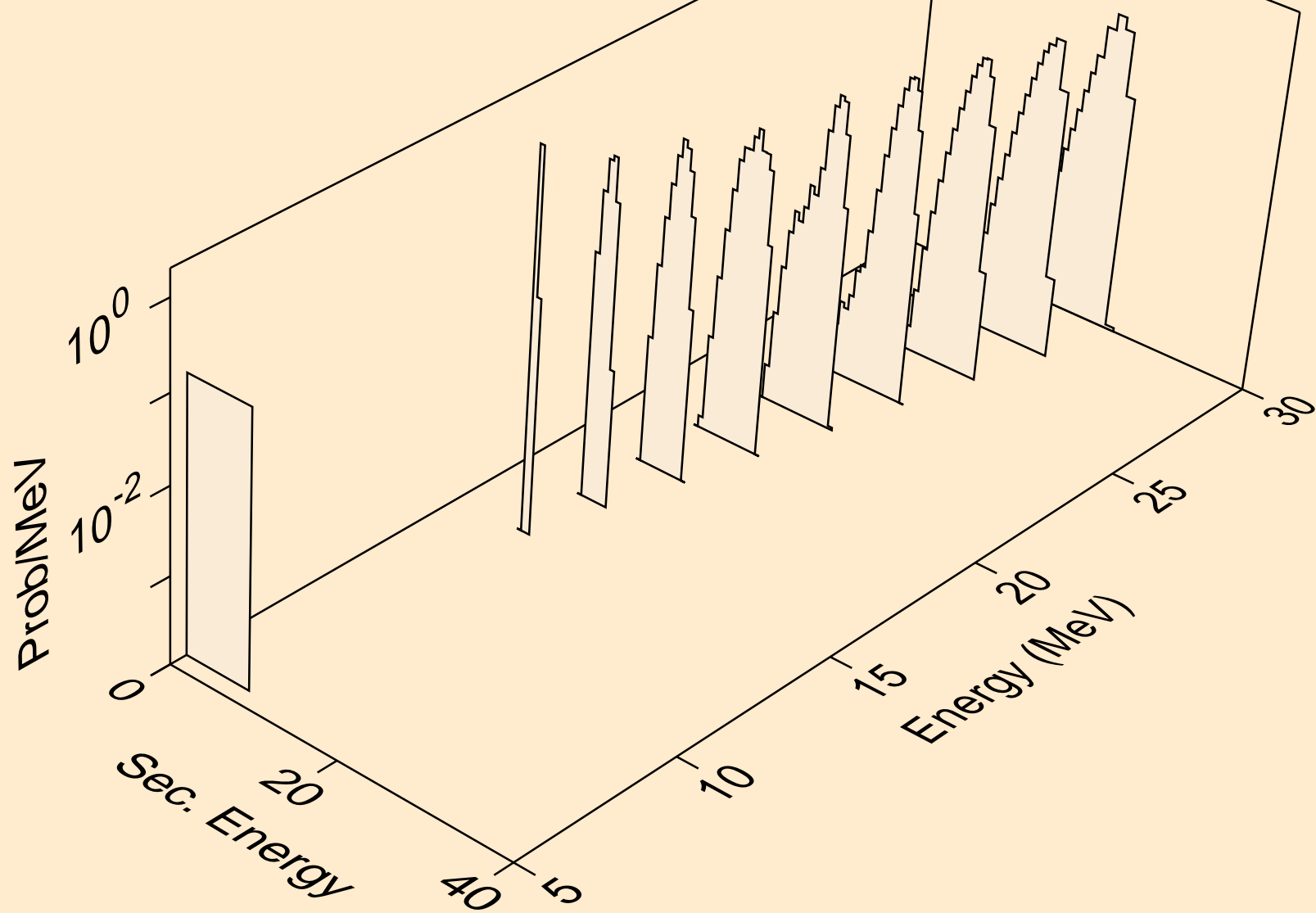

AM249 NEUTRON ACER TENDL-2024 LIBRARY; T=293.6K
alphas from (n,a)

