

AR035 NEUTRON ACER TENDL-2024 LIBRARY; T=293.6K

Principal cross sections

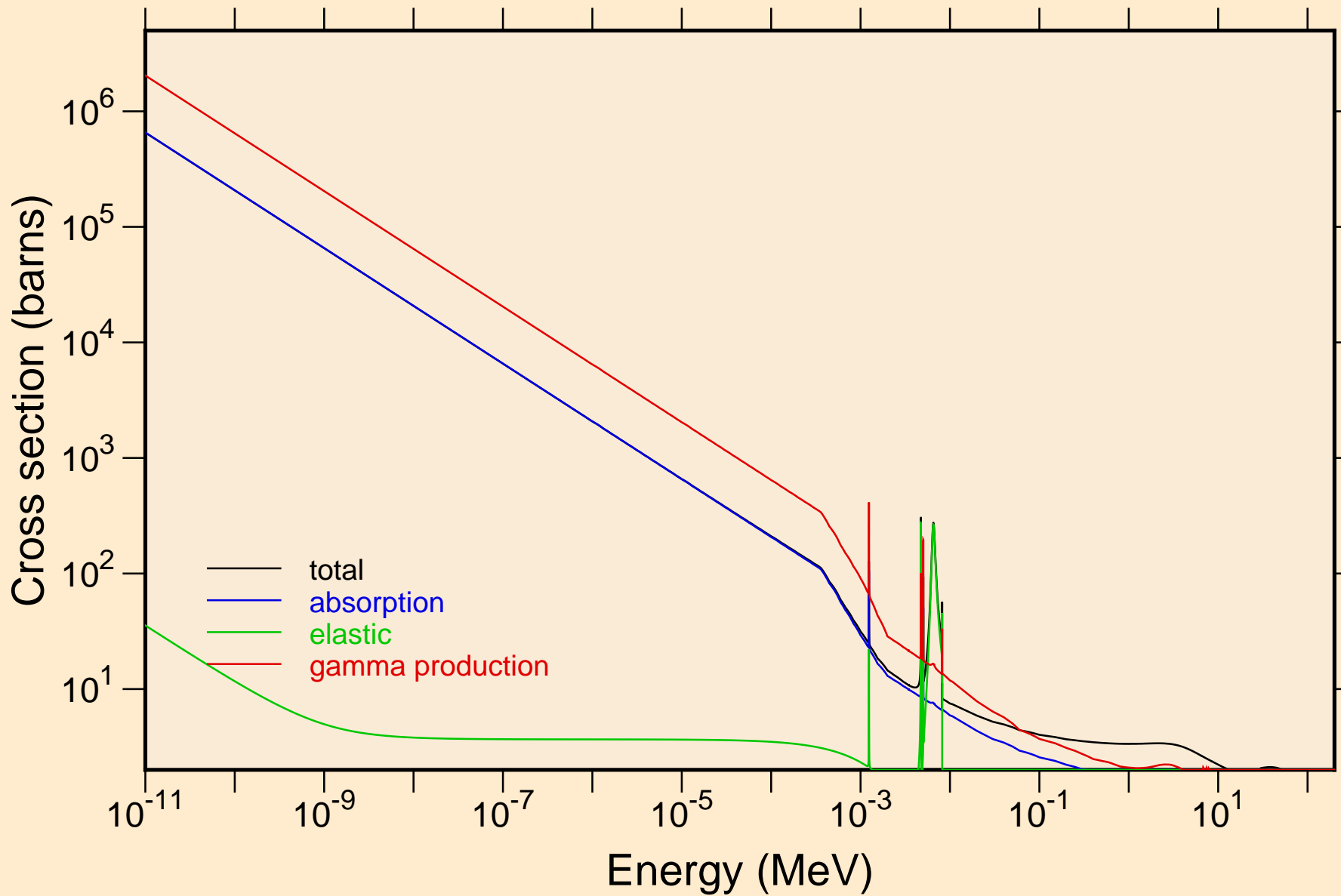

AR035 NEUTRON ACER TENDL-2024 LIBRARY; T=293.6K
resonance total cross section

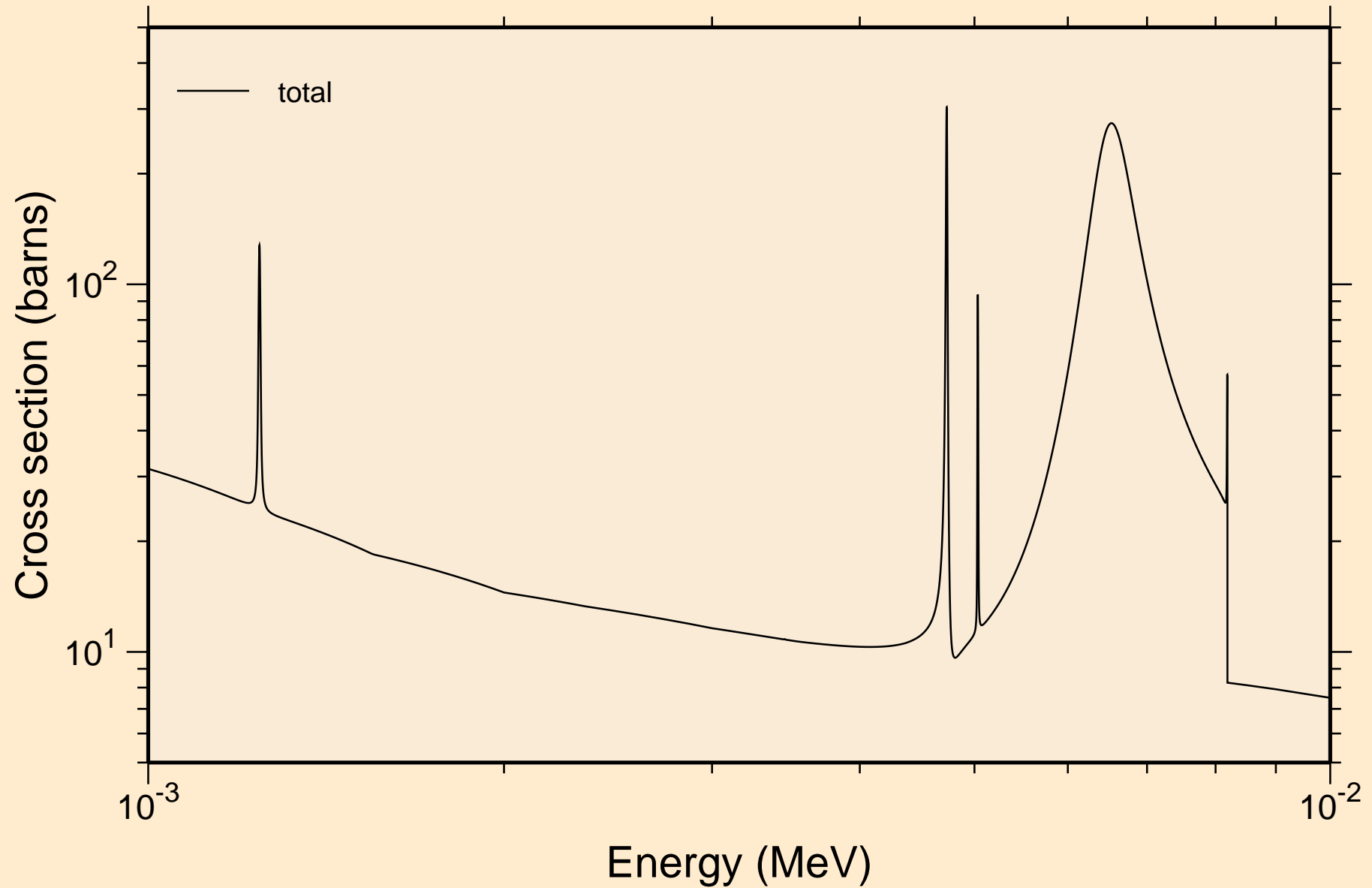

AR035 NEUTRON ACER TENDL-2024 LIBRARY; T=293.6K
resonance total cross section

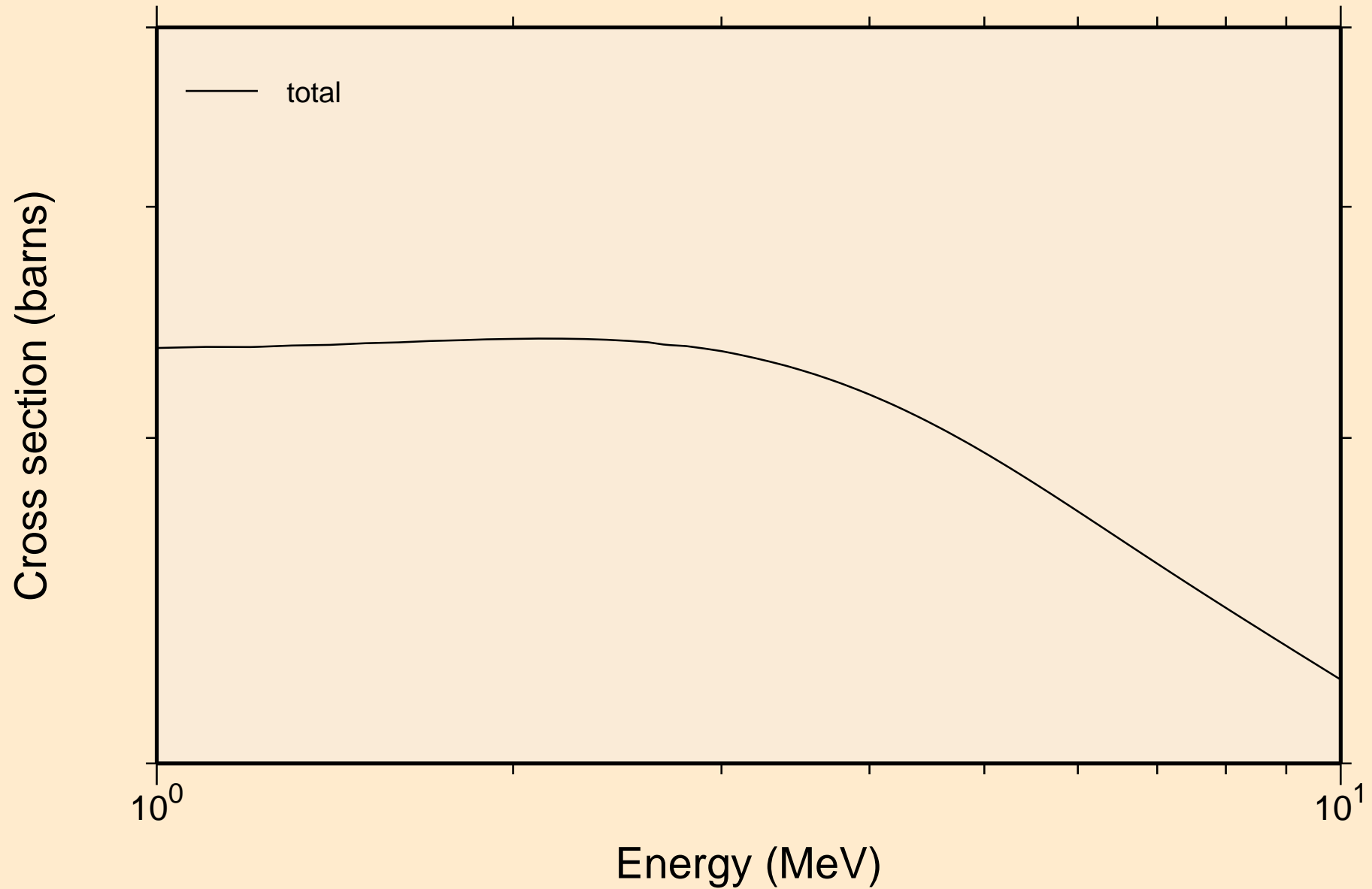

AR035 NEUTRON ACER TENDL-2024 LIBRARY; T=293.6K
resonance absorption cross sections

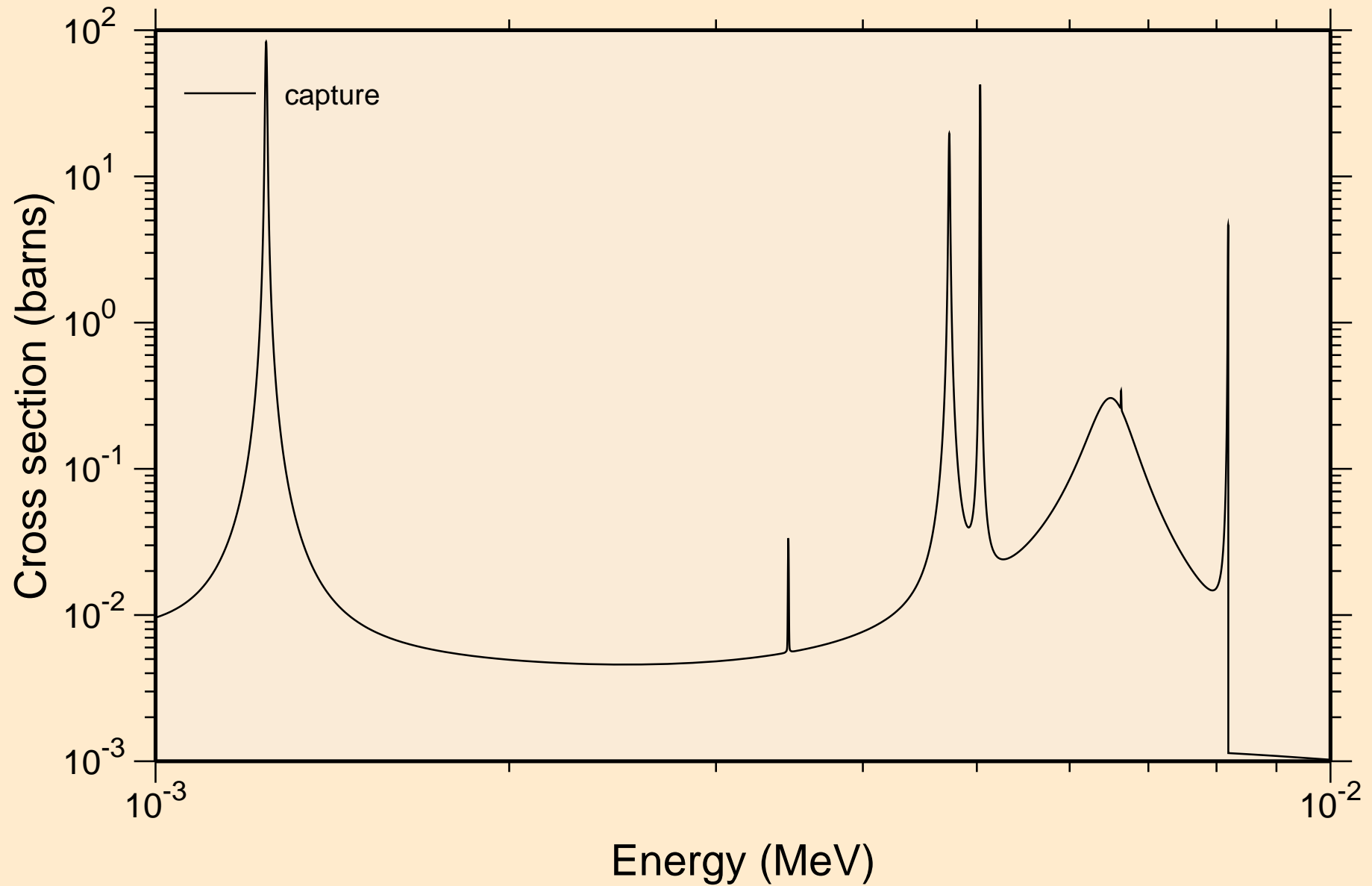

AR035 NEUTRON ACER TENDL-2024 LIBRARY; T=293.6K
resonance absorption cross sections

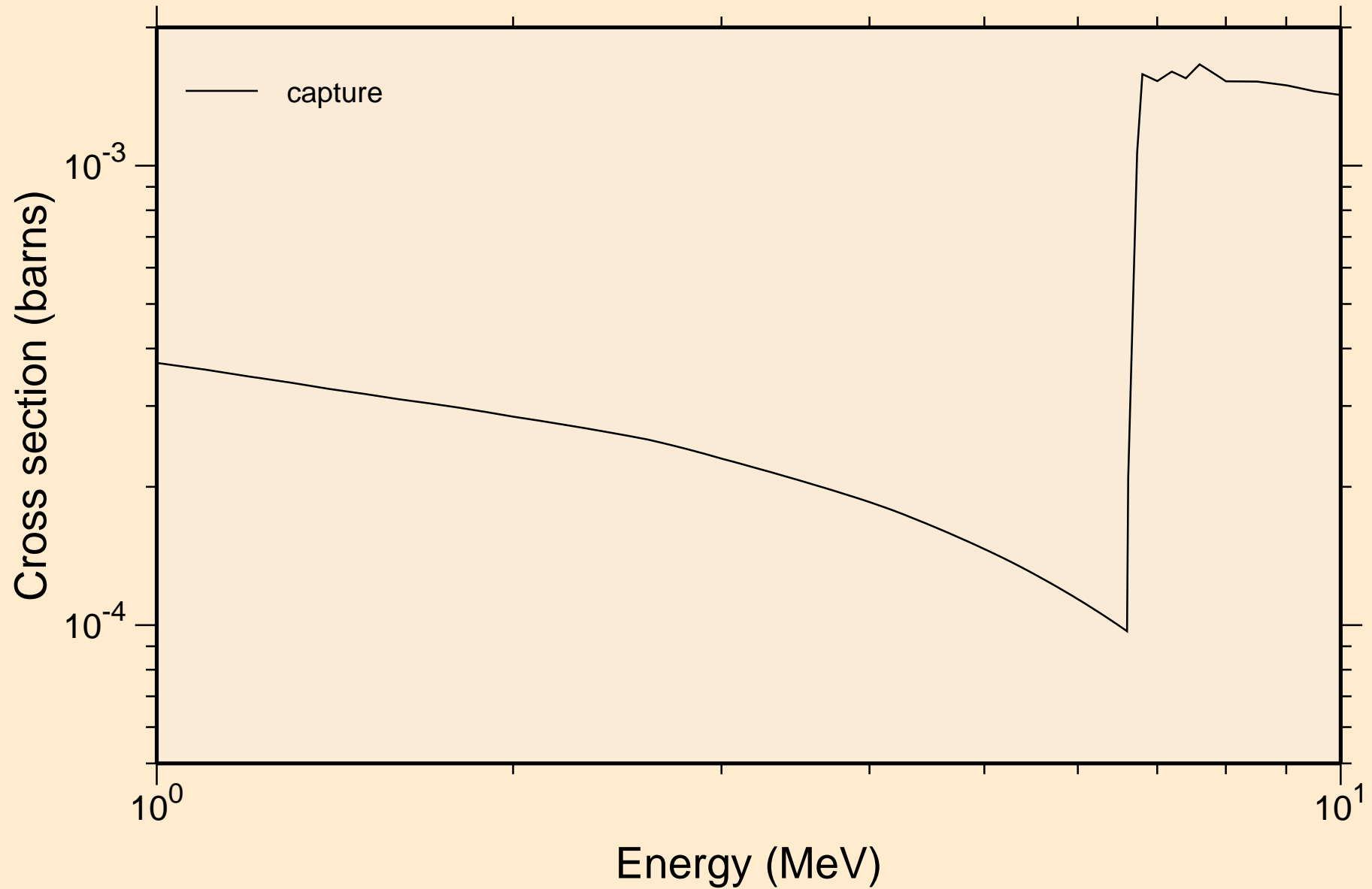

AR035 NEUTRON ACER TENDL-2024 LIBRARY; T=293.6K
Heating

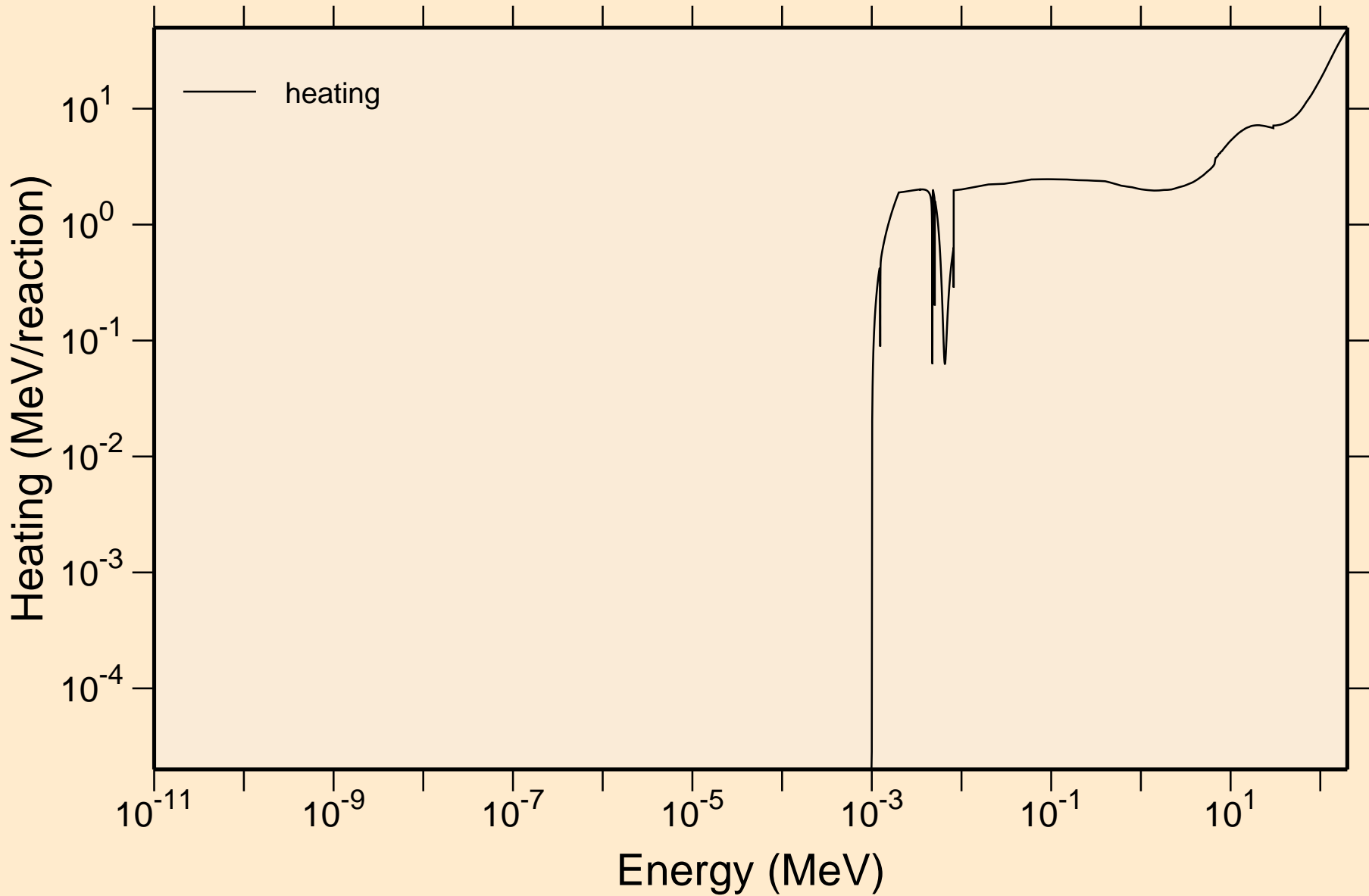

AR035 NEUTRON ACER TENDL-2024 LIBRARY; T=293.6K

Damage

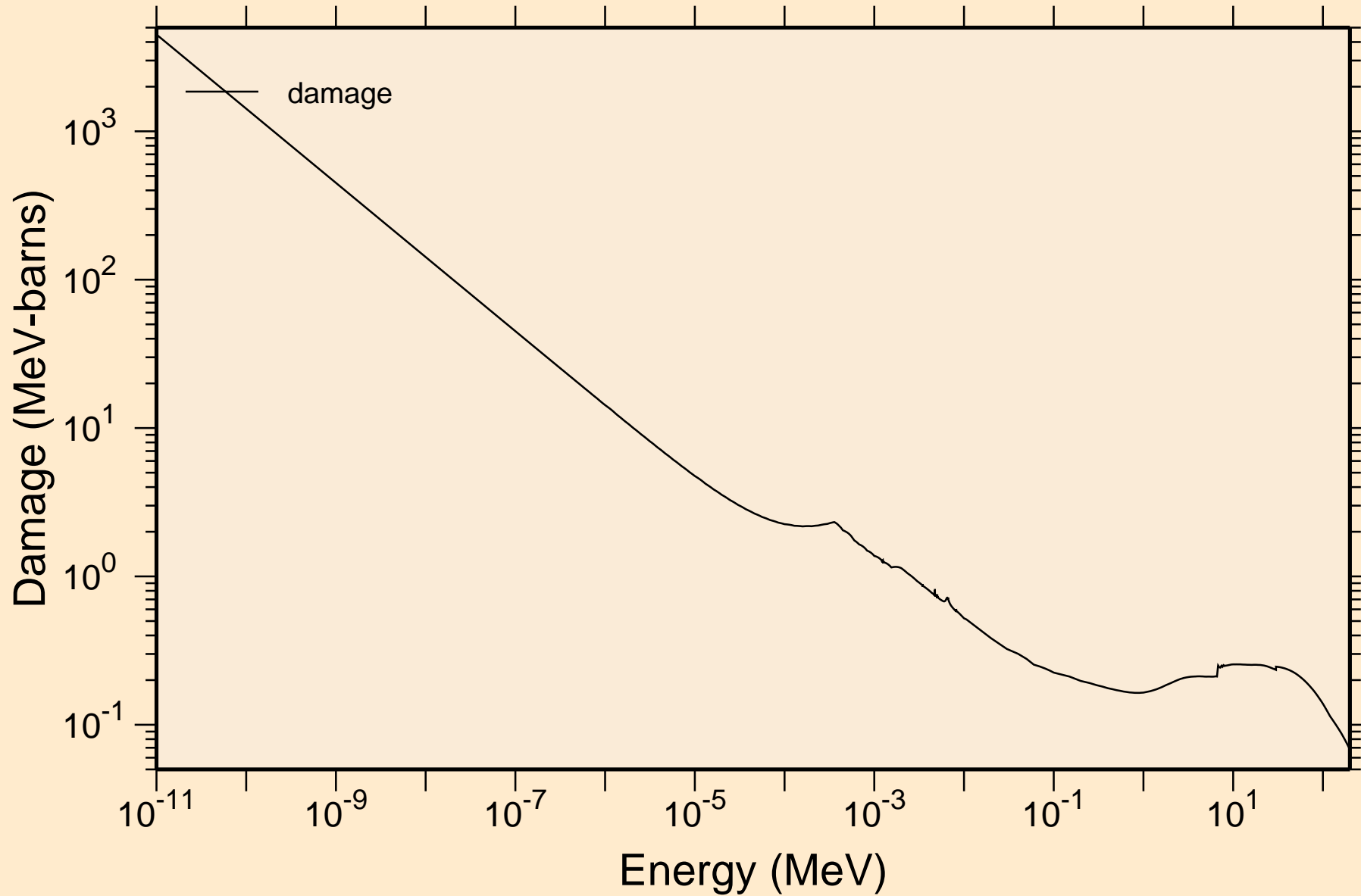

AR035 NEUTRON ACER TENDL-2024 LIBRARY; T=293.6K
Non-threshold reactions

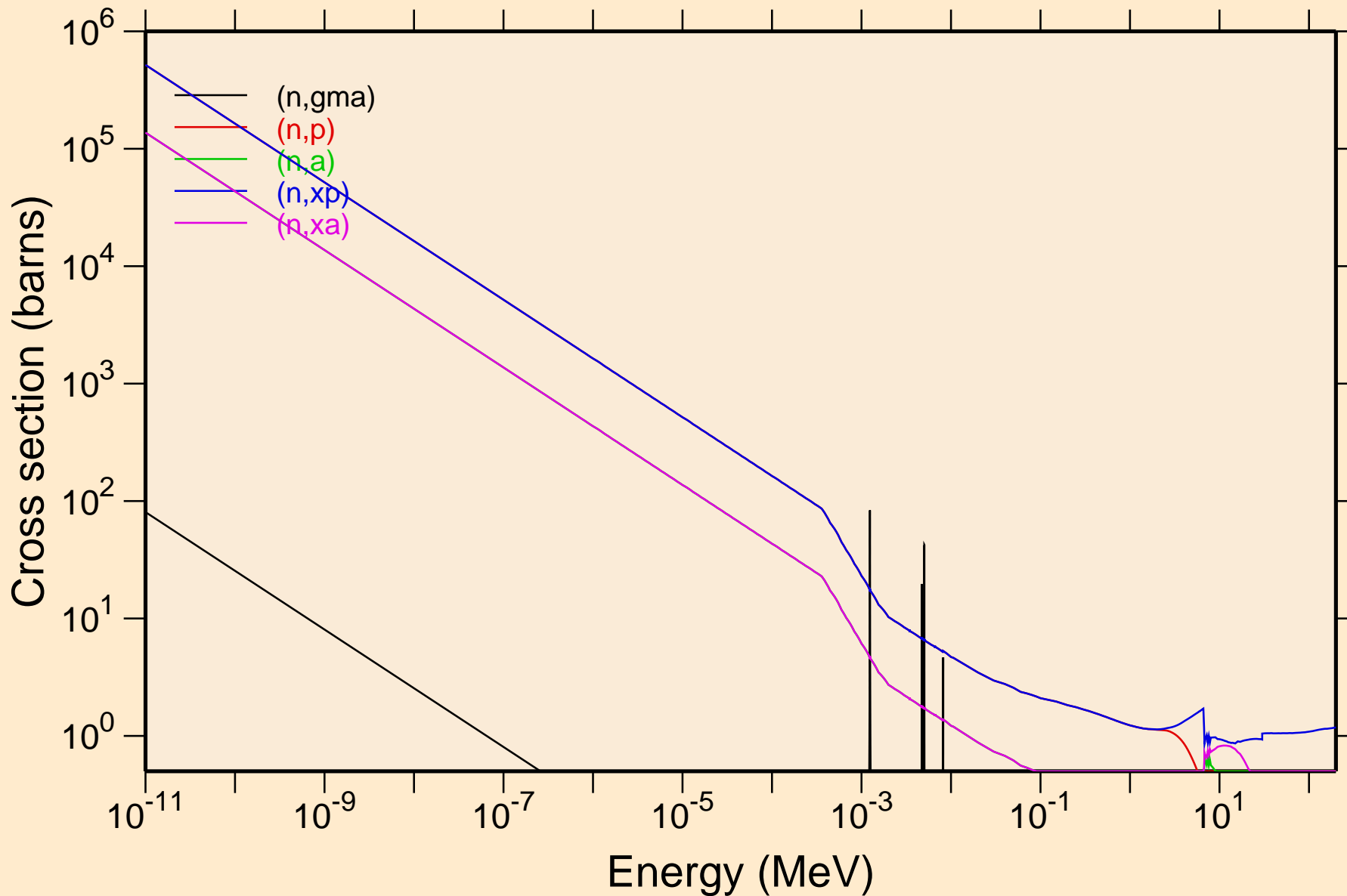

AR035 NEUTRON ACER TENDL-2024 LIBRARY; T=293.6K

Principal cross sections

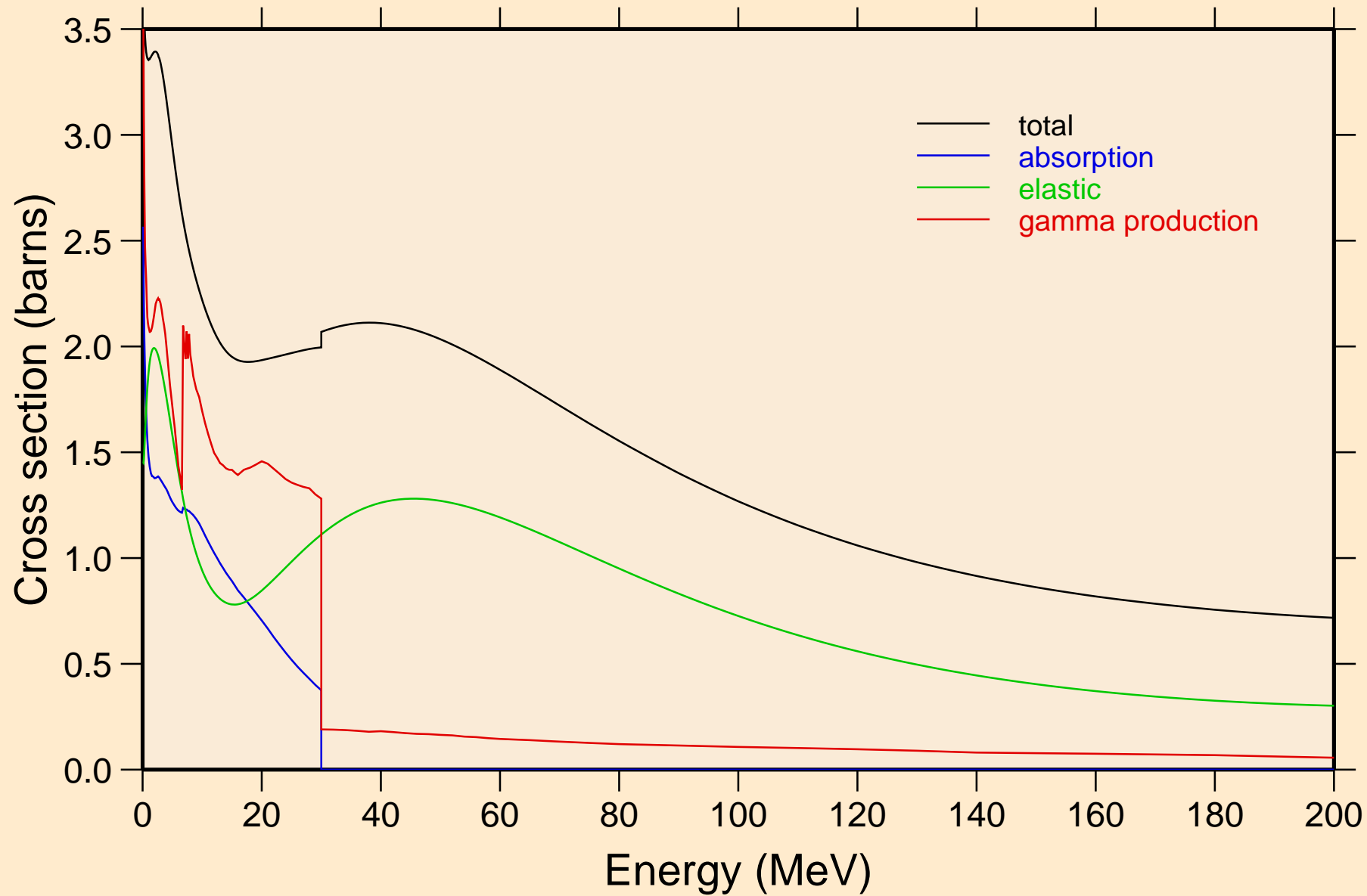

AR035 NEUTRON ACER TENDL-2024 LIBRARY; T=293.6K

Heating

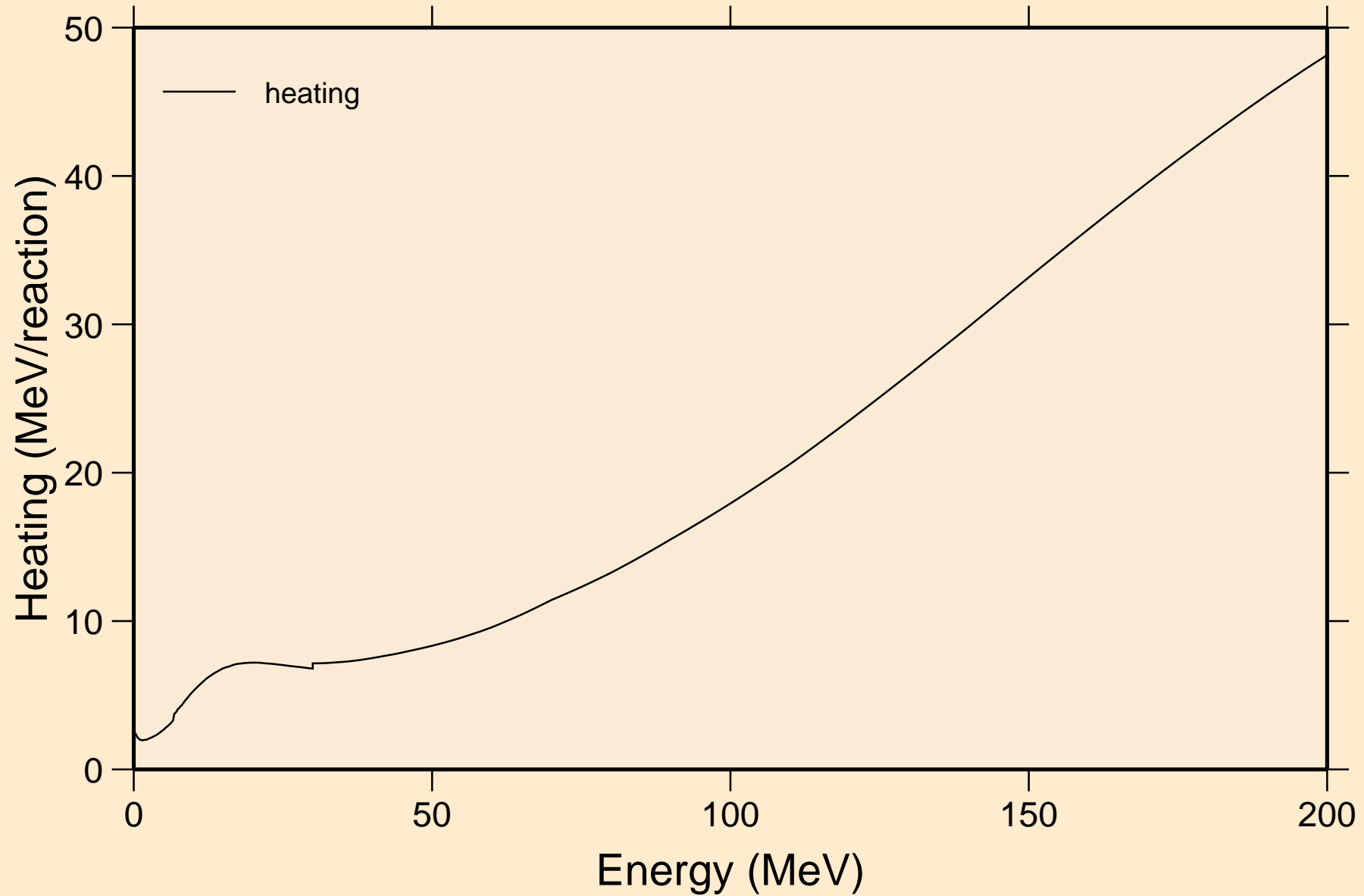

AR035 NEUTRON ACER TENDL-2024 LIBRARY; T=293.6K
Damage

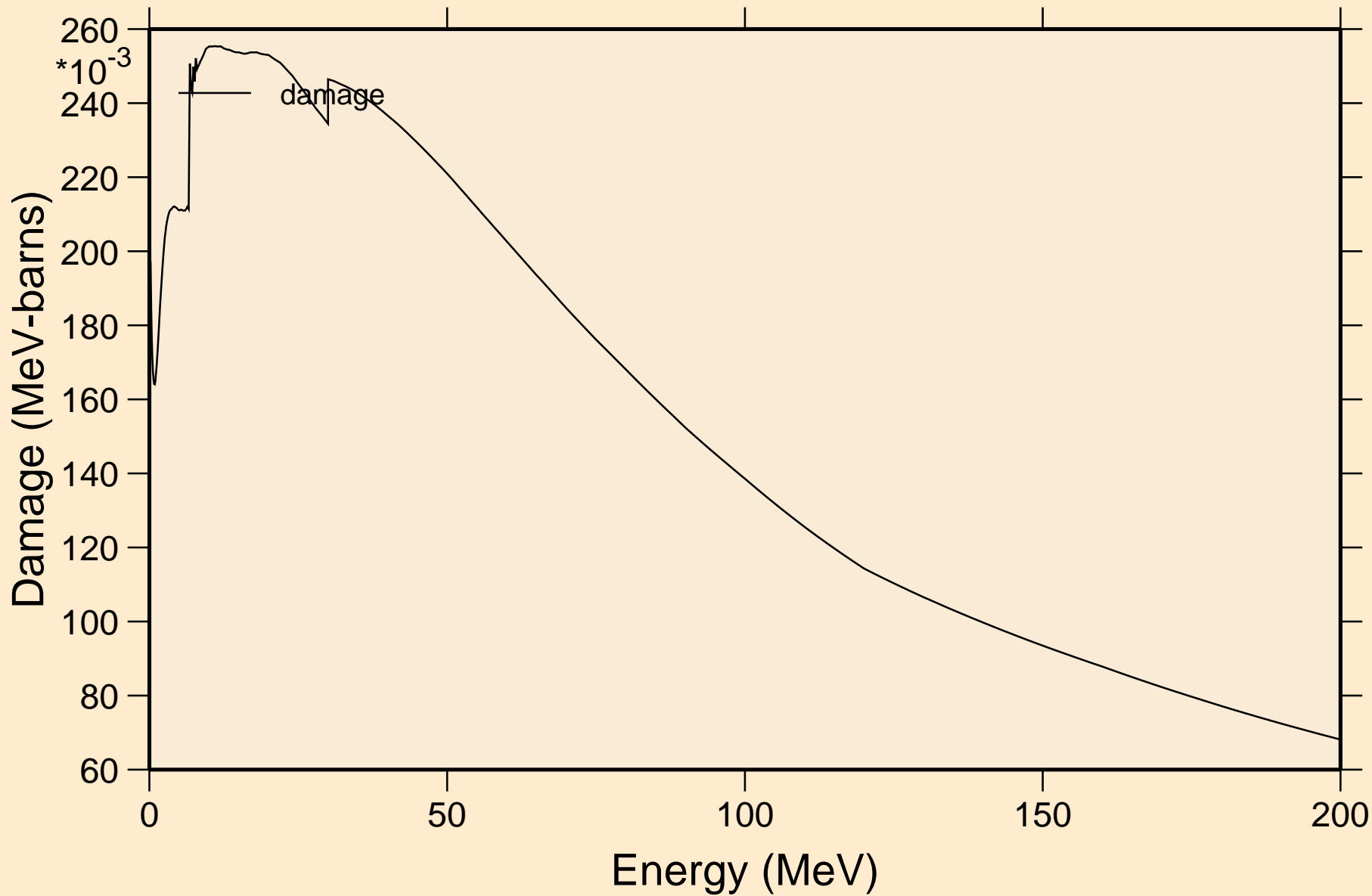

AR035 NEUTRON ACER TENDL-2024 LIBRARY; T=293.6K
Non-threshold reactions

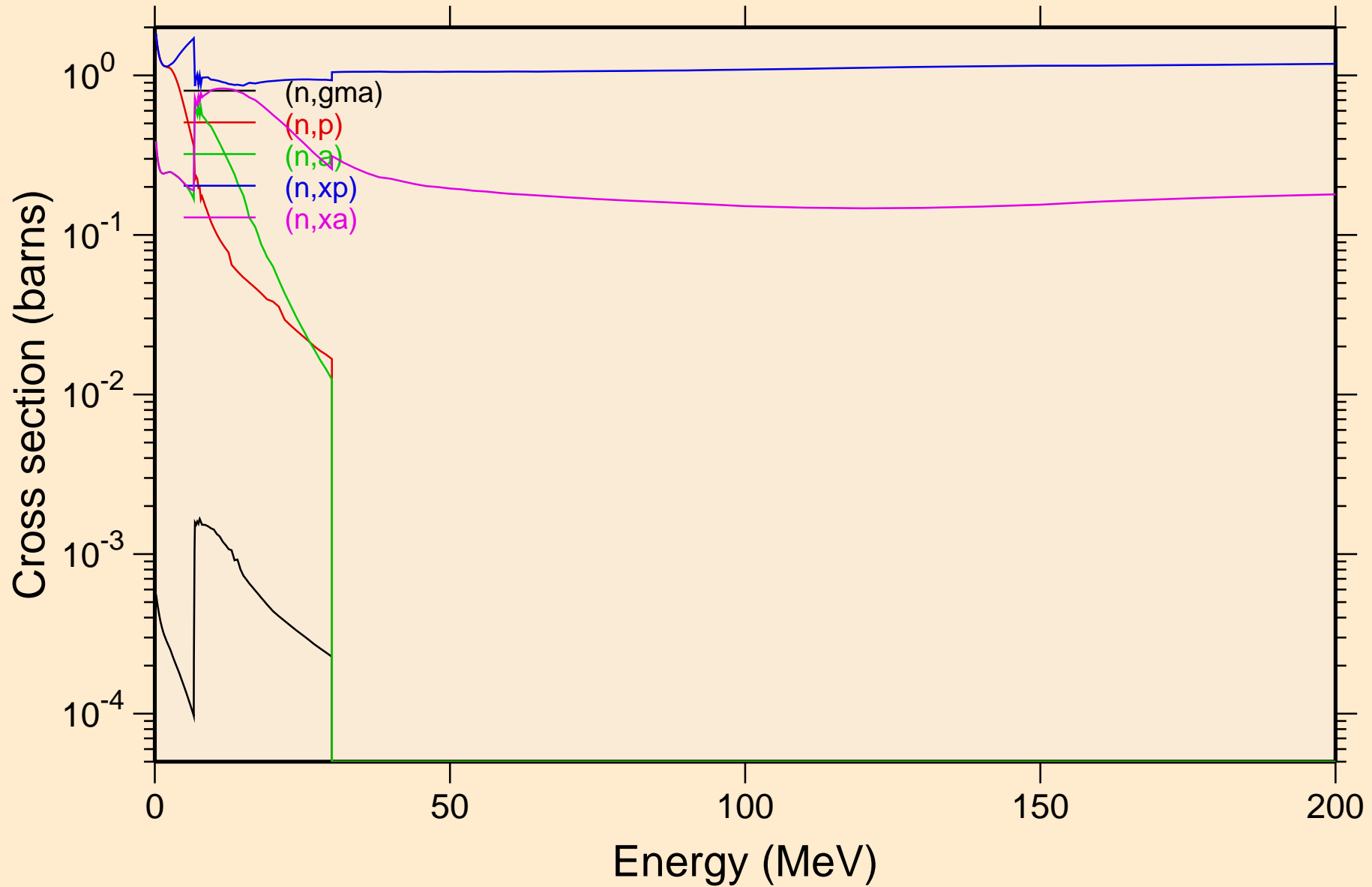

AR035 NEUTRON ACER TENDL-2024 LIBRARY; T=293.6K
Inelastic levels

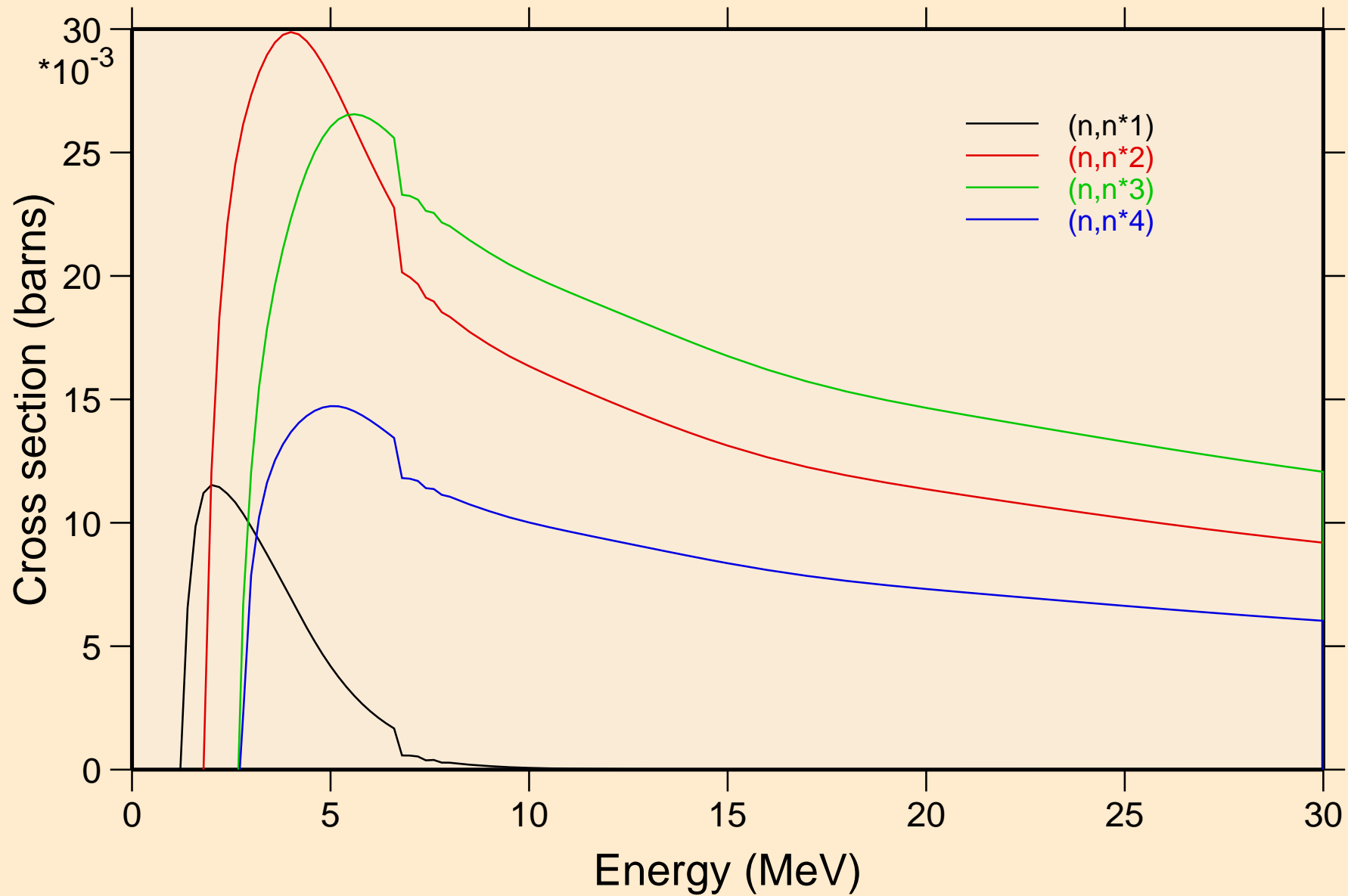

AR035 NEUTRON ACER TENDL-2024 LIBRARY; T=293.6K
Threshold reactions

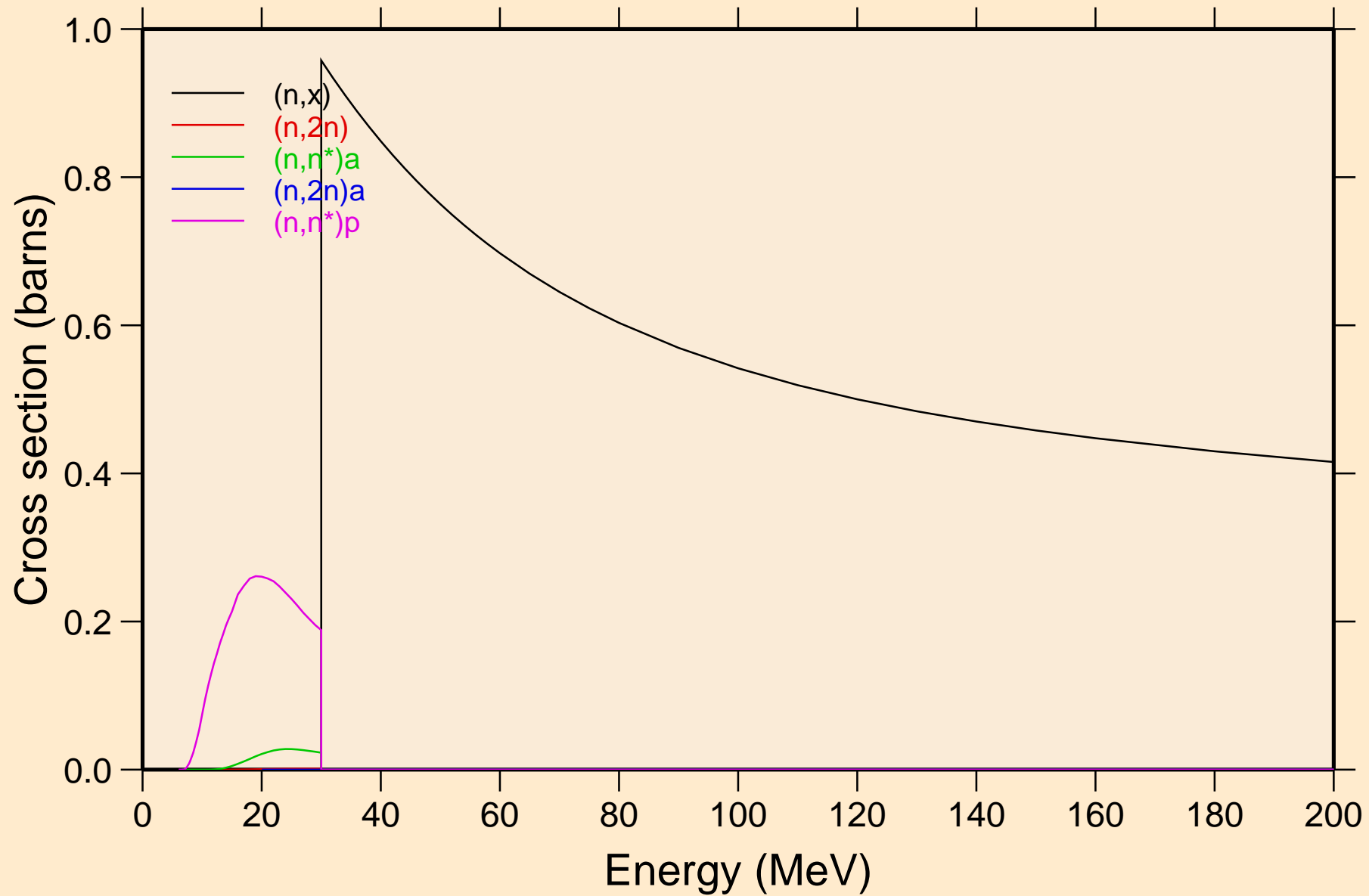

AR035 NEUTRON ACER TENDL-2024 LIBRARY; T=293.6K

Threshold reactions

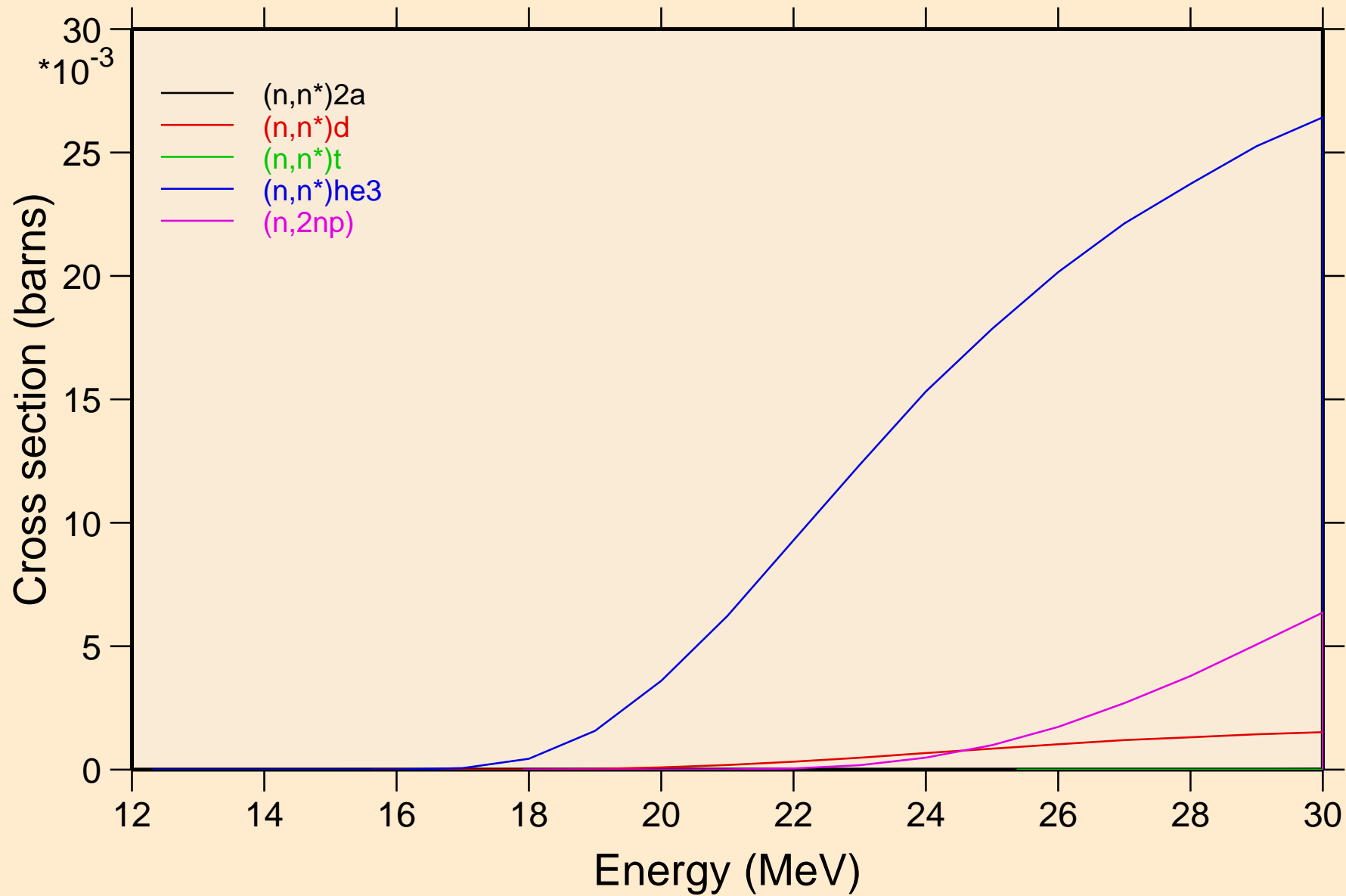

AR035 NEUTRON ACER TENDL-2024 LIBRARY; T=293.6K

Threshold reactions

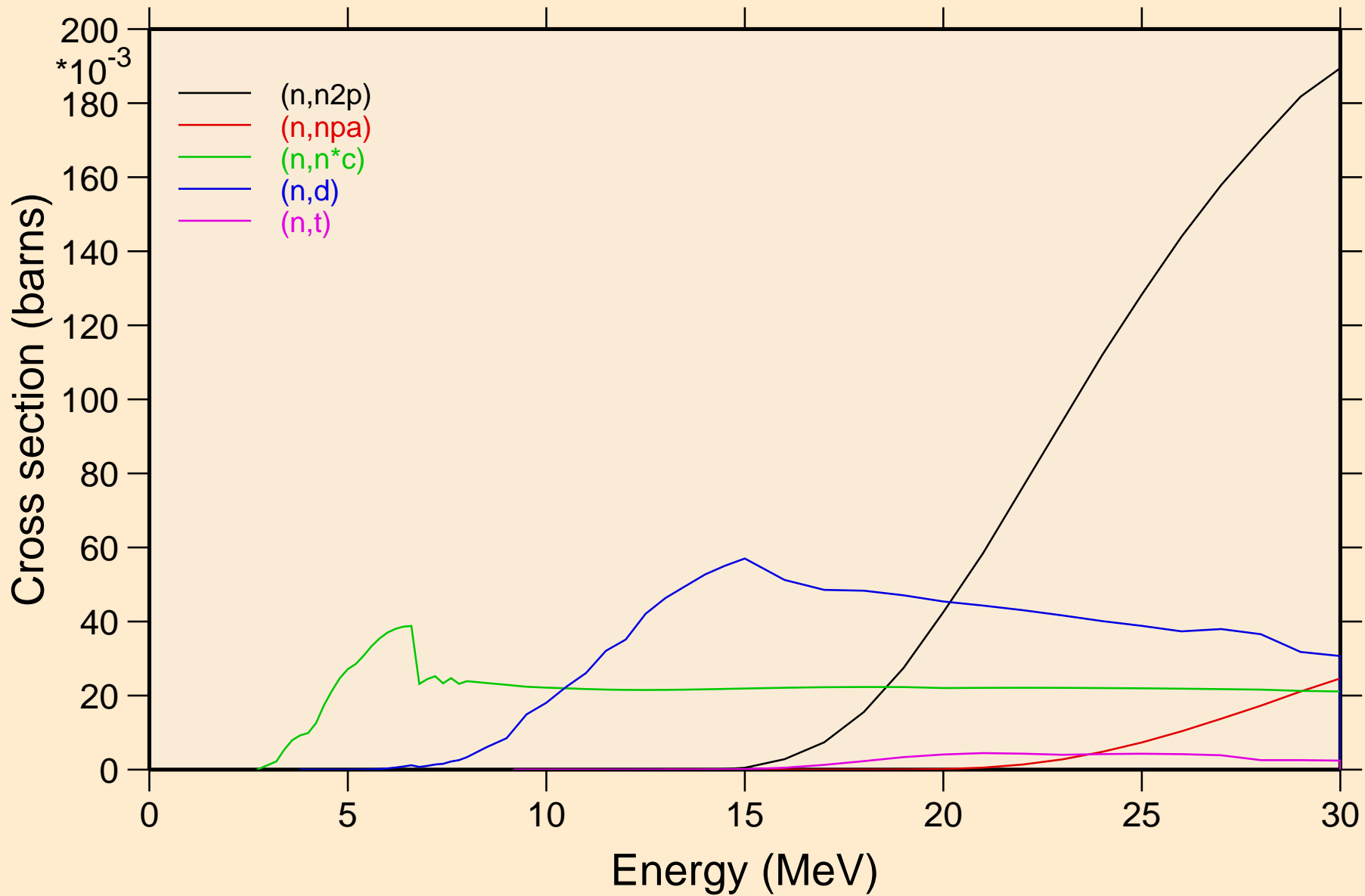

AR035 NEUTRON ACER TENDL-2024 LIBRARY; T=293.6K
Threshold reactions

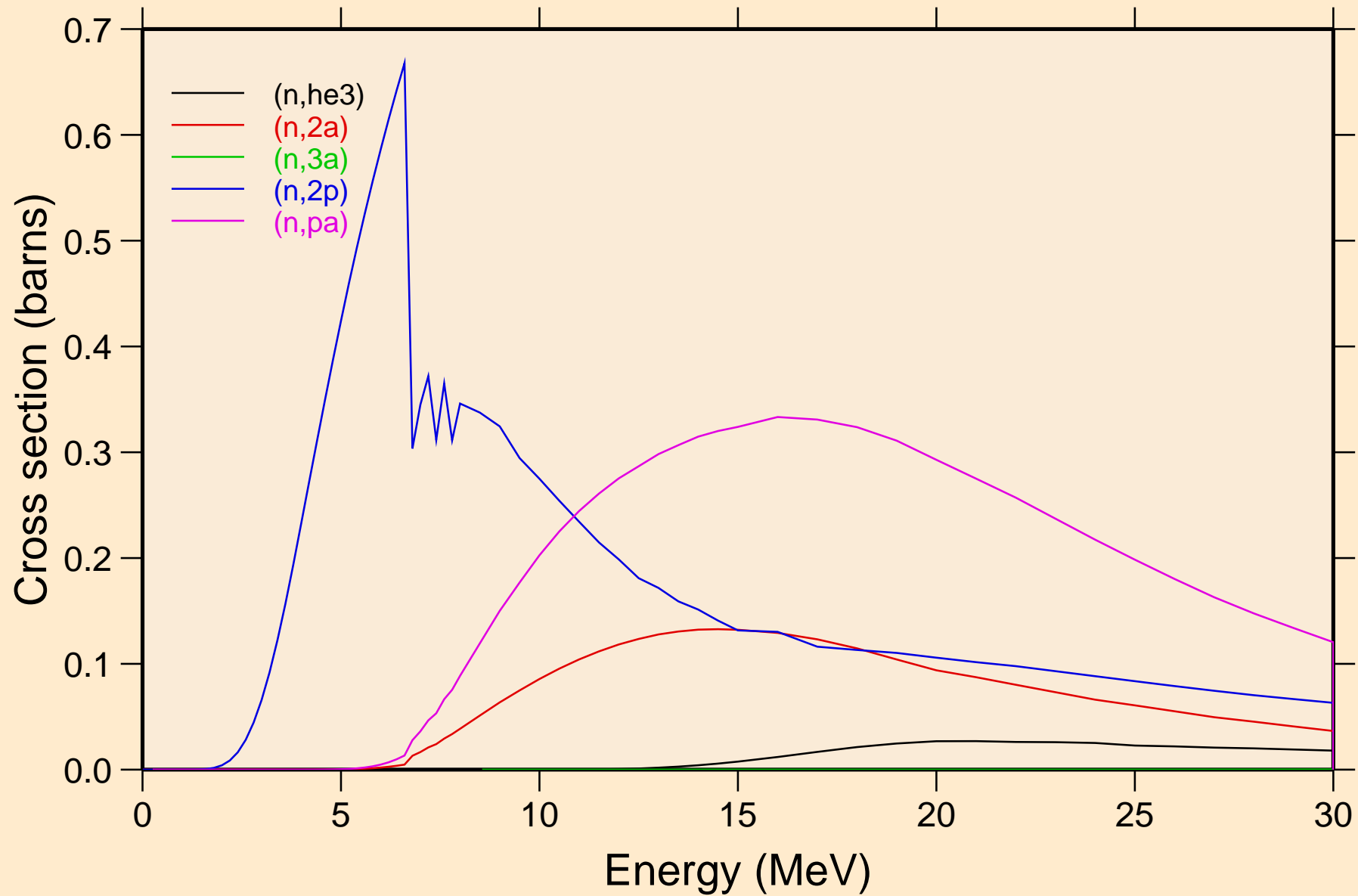

AR035 NEUTRON ACER TENDL-2024 LIBRARY; T=293.6K
Threshold reactions

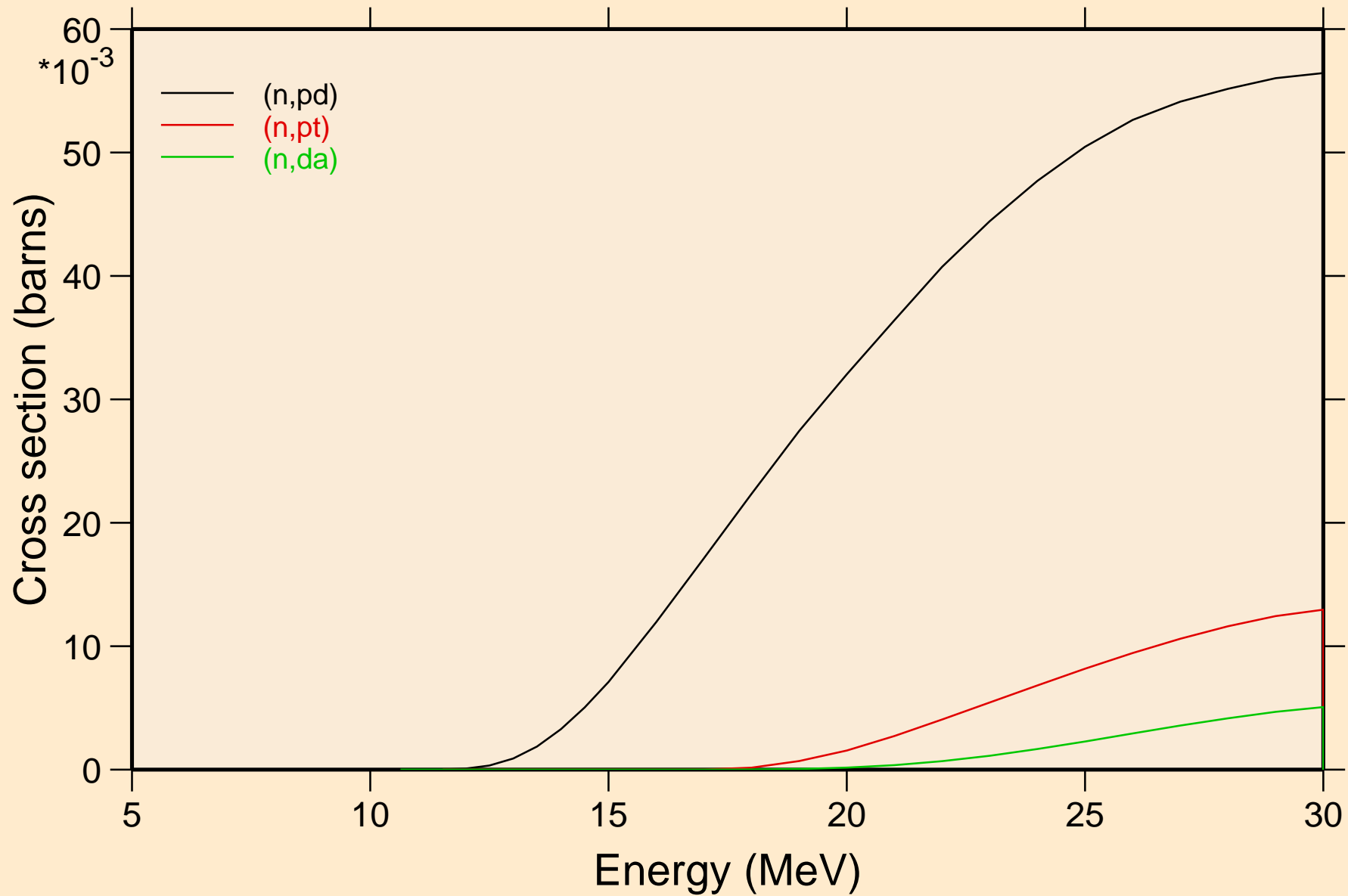

AR035 NEUTRON ACER TENDL-2024 LIBRARY; T=293.6K

Threshold reactions

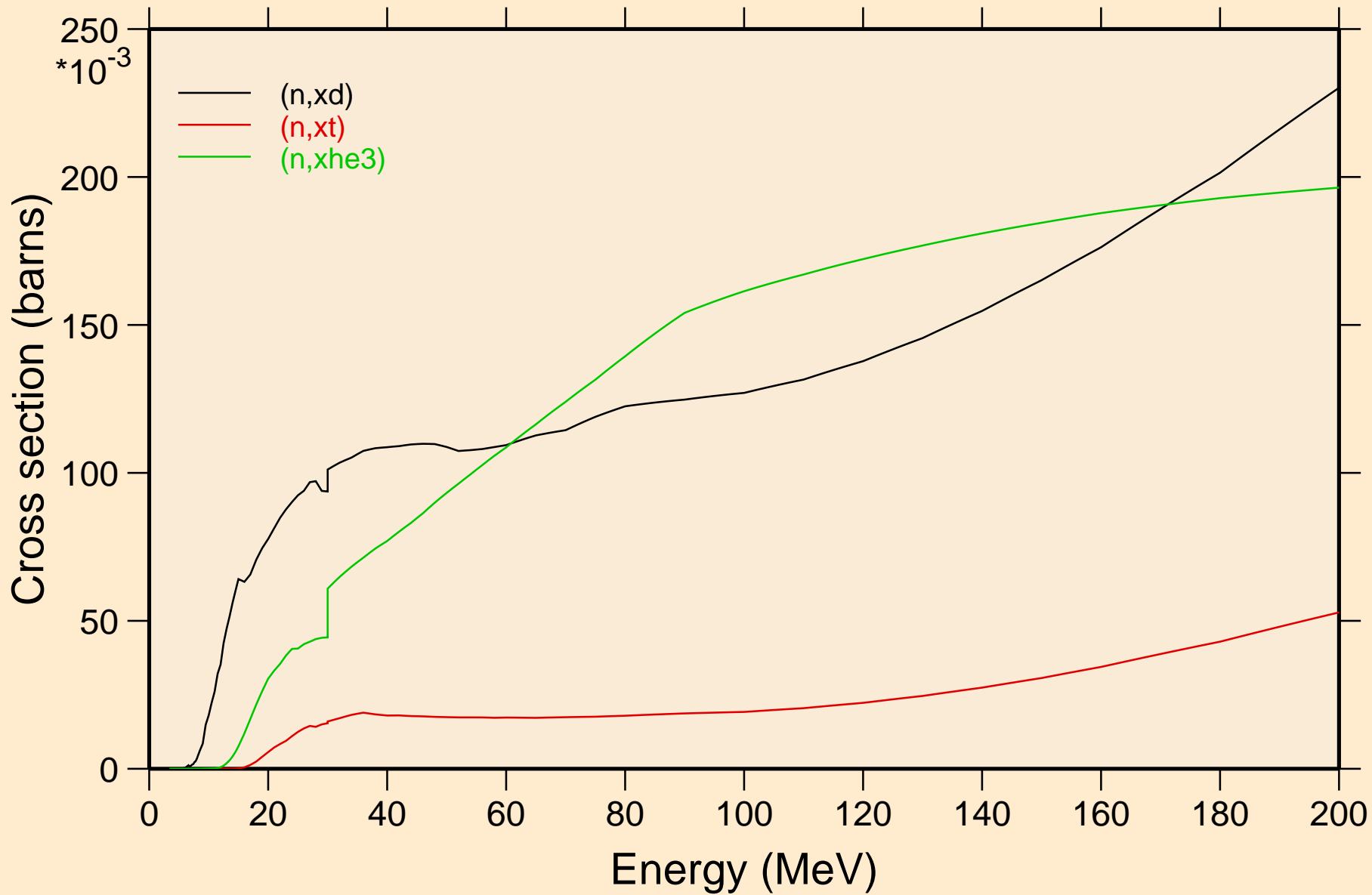

AR035 NEUTRON ACER TENDL-2024 LIBRARY; T=293.6K
angular distribution for elastic

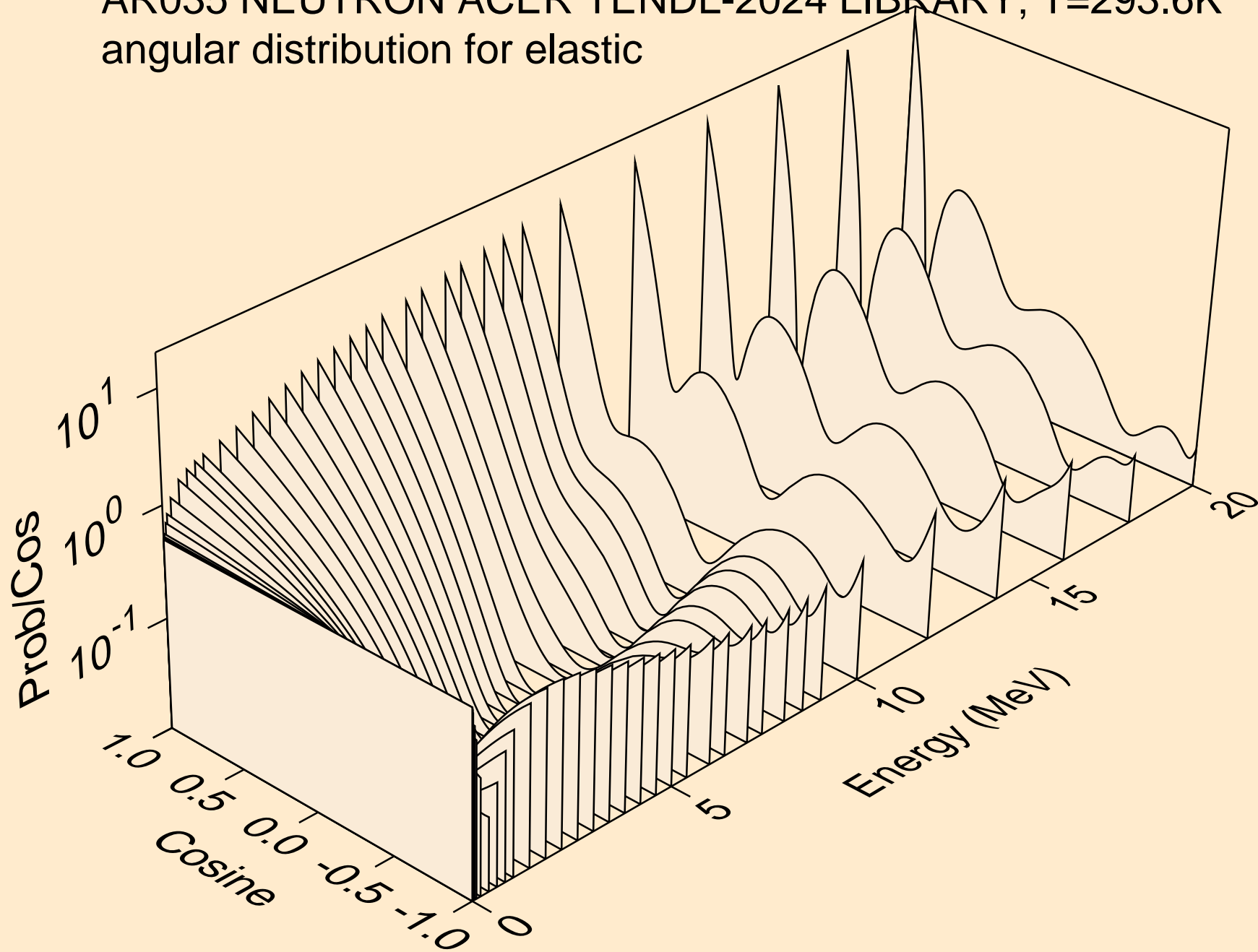

AR035 NEUTRON ACER TENDL-2024 LIBRARY; T=293.6K
angular distribution for elastic

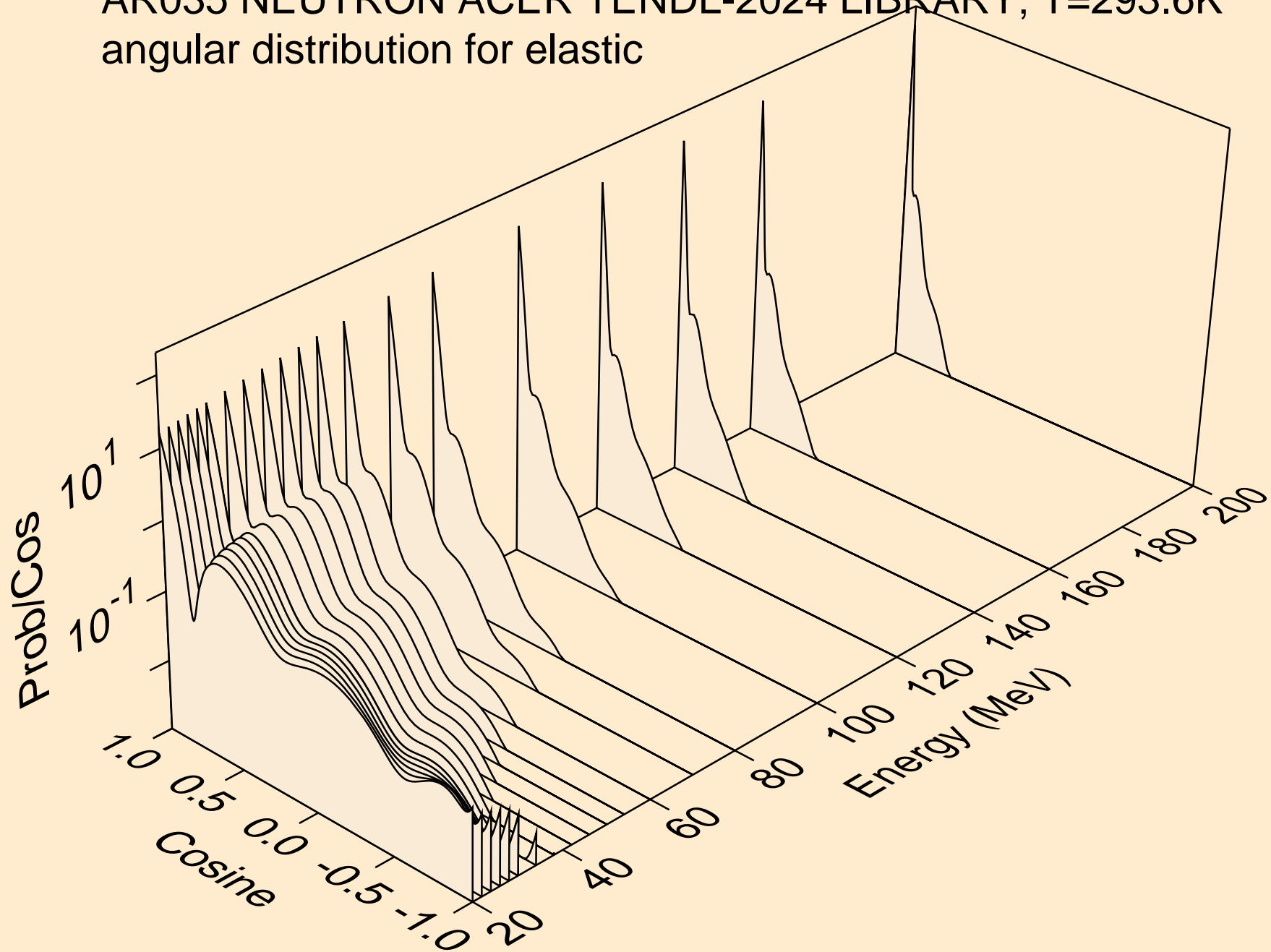

AR035 NEUTRON ACER TENDL-2024 LIBRARY; T=293.6K
angular distribution for (n,n*1)

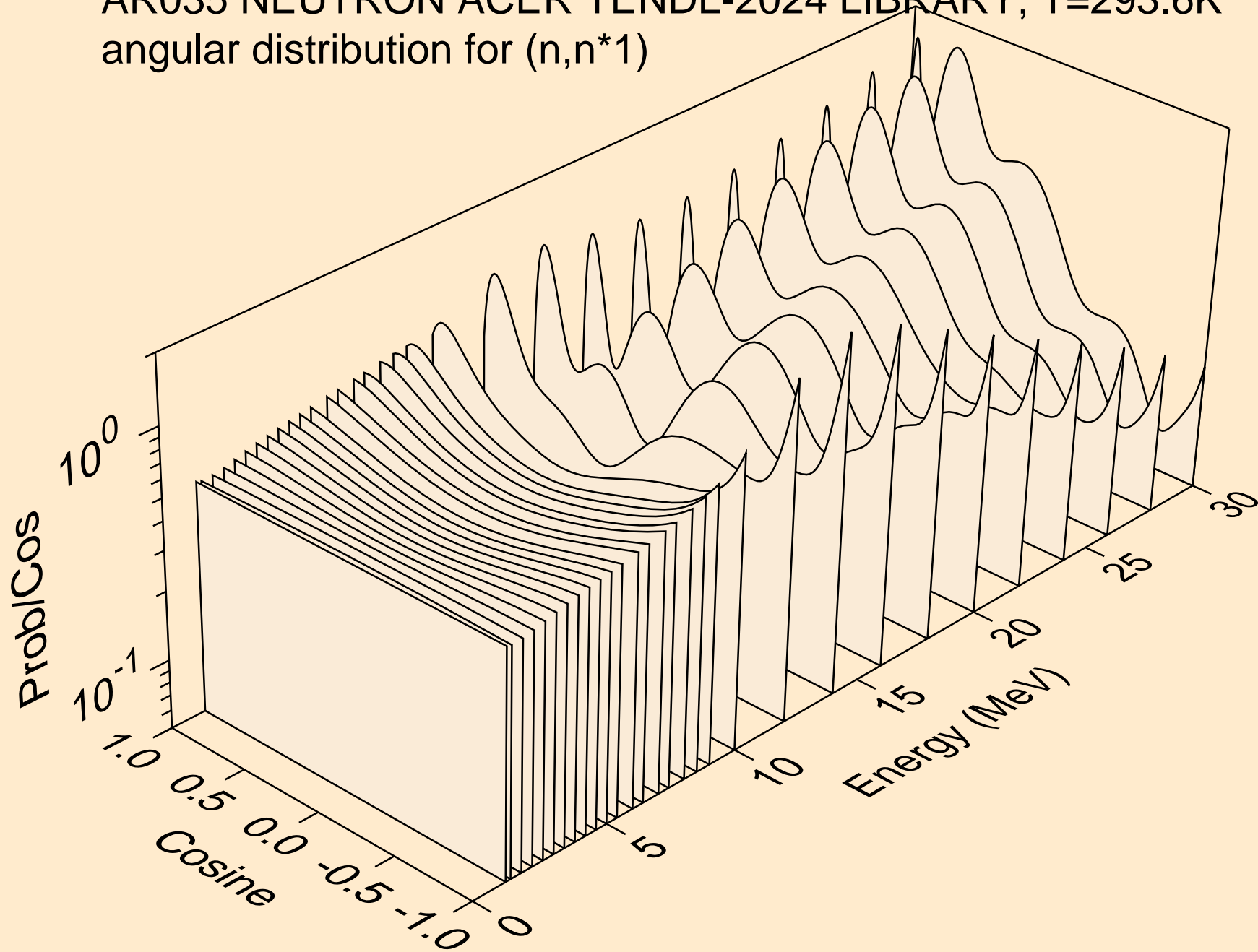

AR035 NEUTRON ACER TENDL-2024 LIBRARY; T=293.6K
angular distribution for (n,n*2)

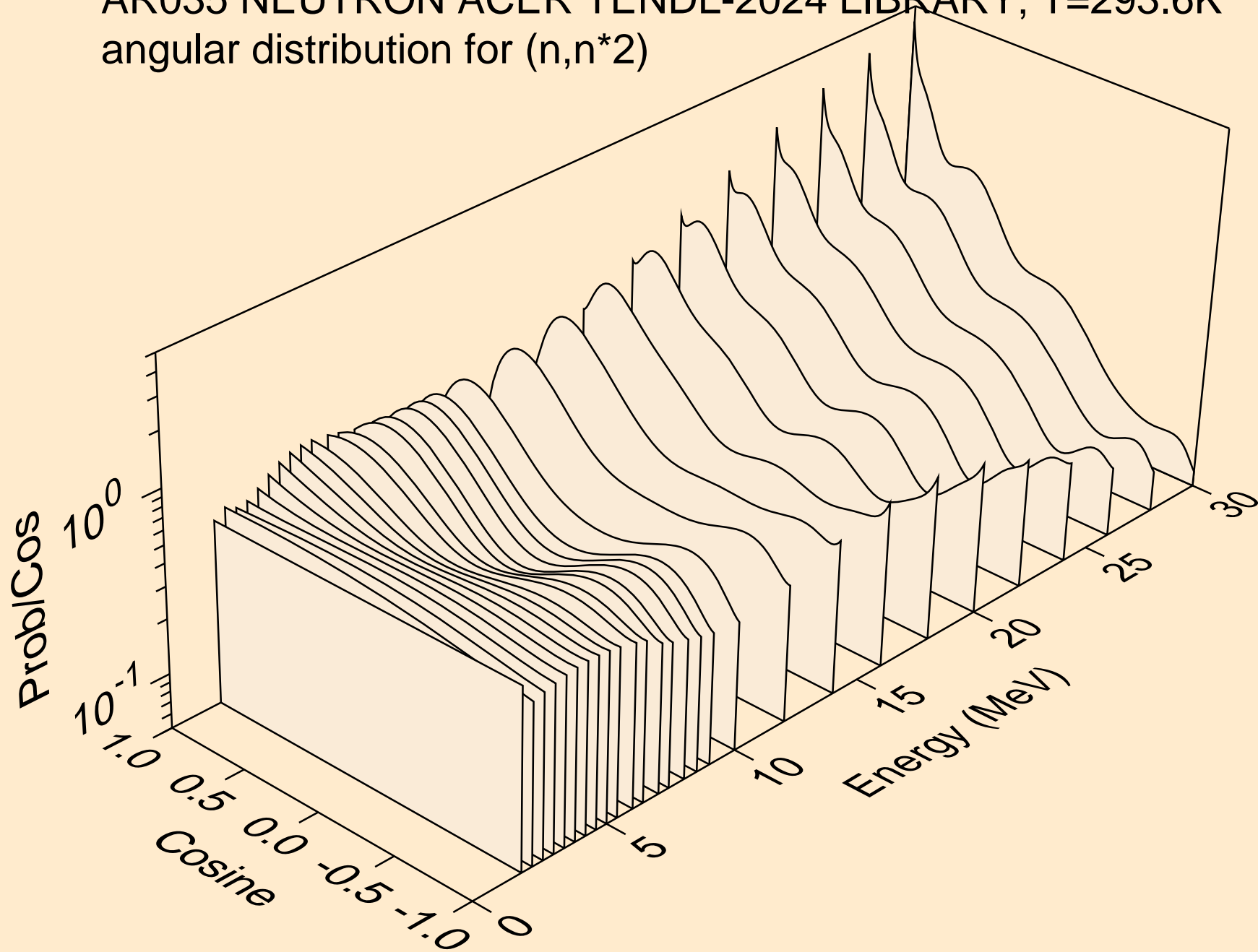

AR035 NEUTRON ACER TENDL-2024 LIBRARY; T=293.6K
angular distribution for (n,n*3)

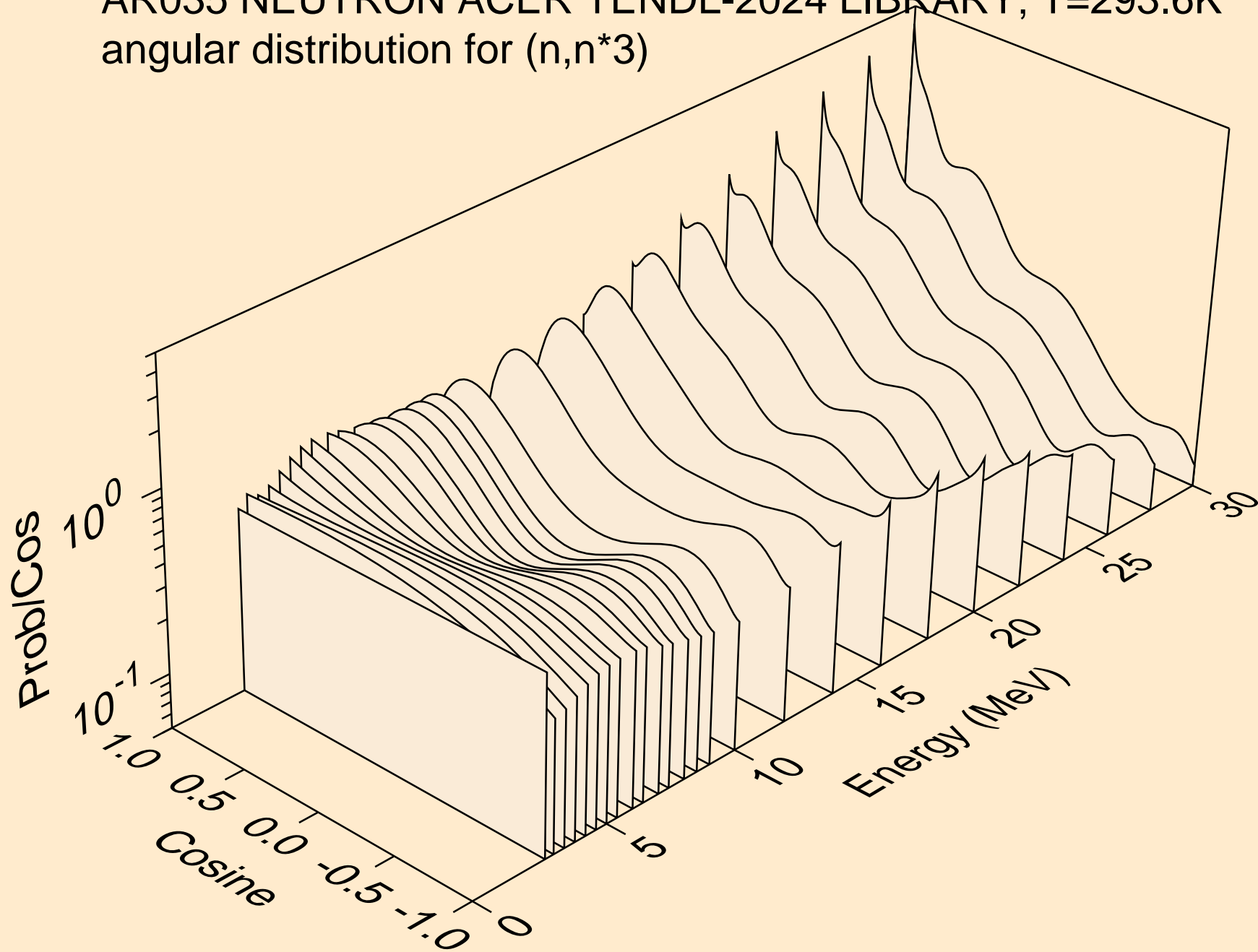

AR035 NEUTRON ACER TENDL-2024 LIBRARY; T=293.6K
angular distribution for (n,n*4)

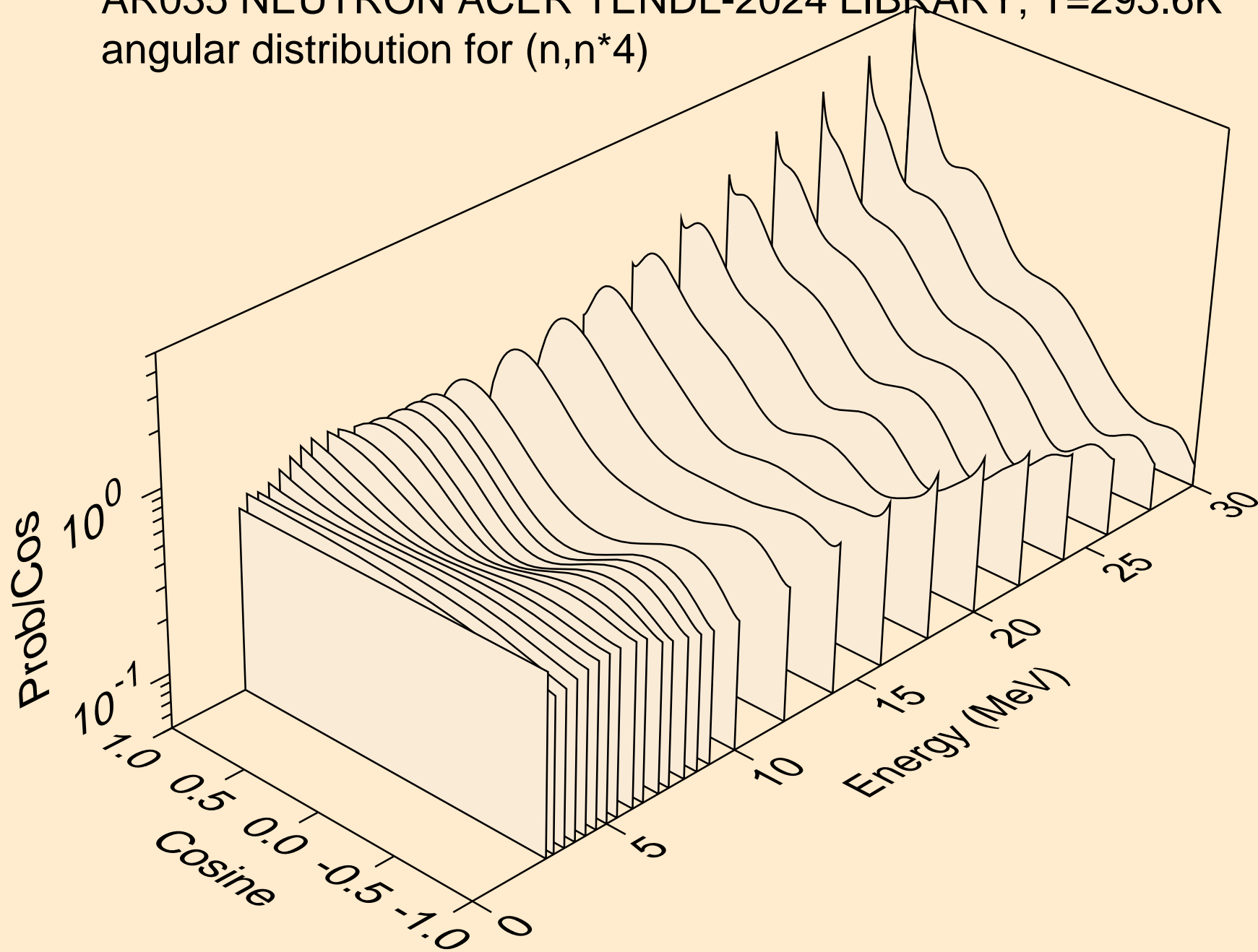

AR035 NEUTRON ACER TENDL-2024 LIBRARY; T=293.6K
Neutron emission for (n,x)

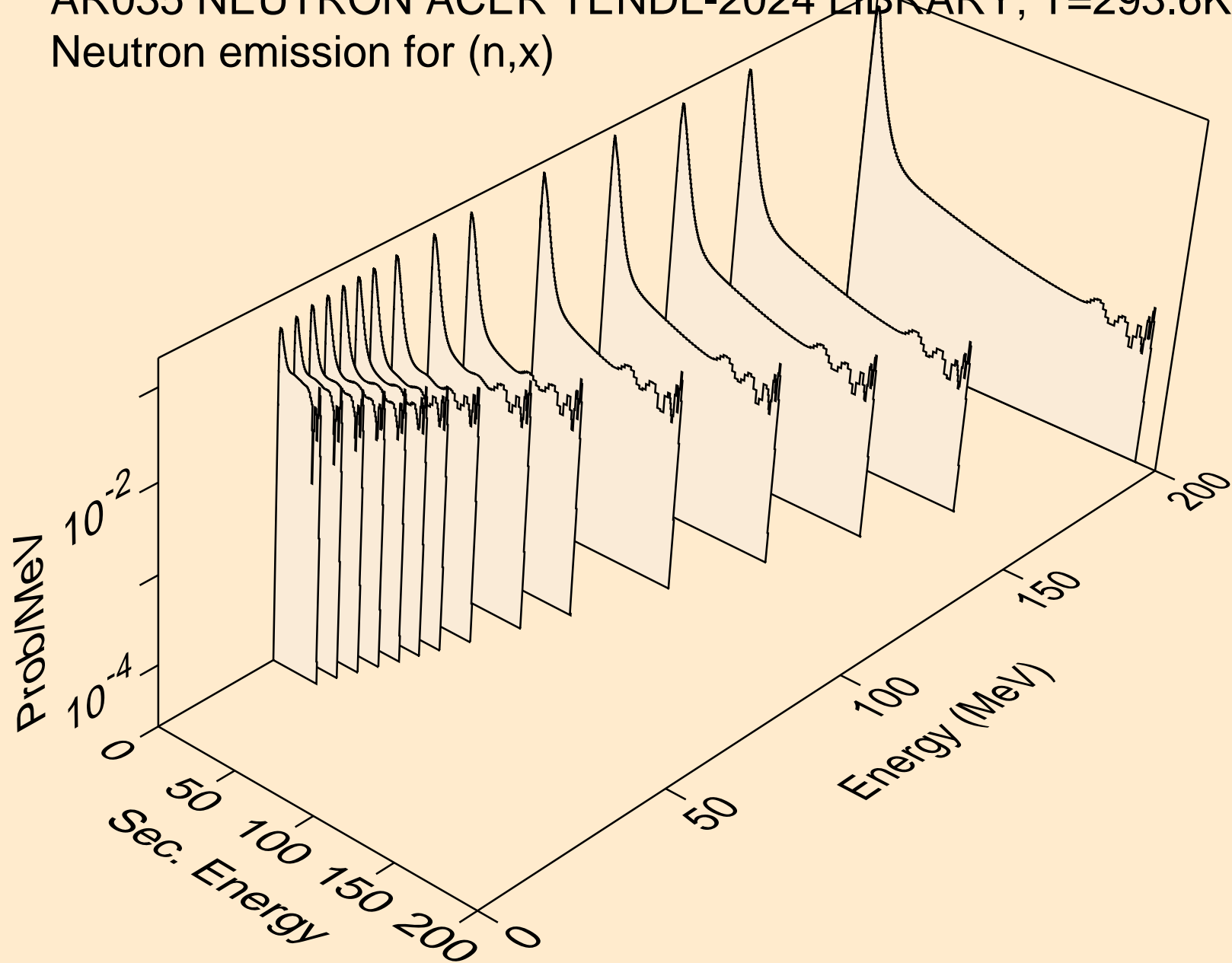

AR035 NEUTRON ACER TENDL-2024 LIBRARY; T=293.6K
Neutron emission for (n,2n)

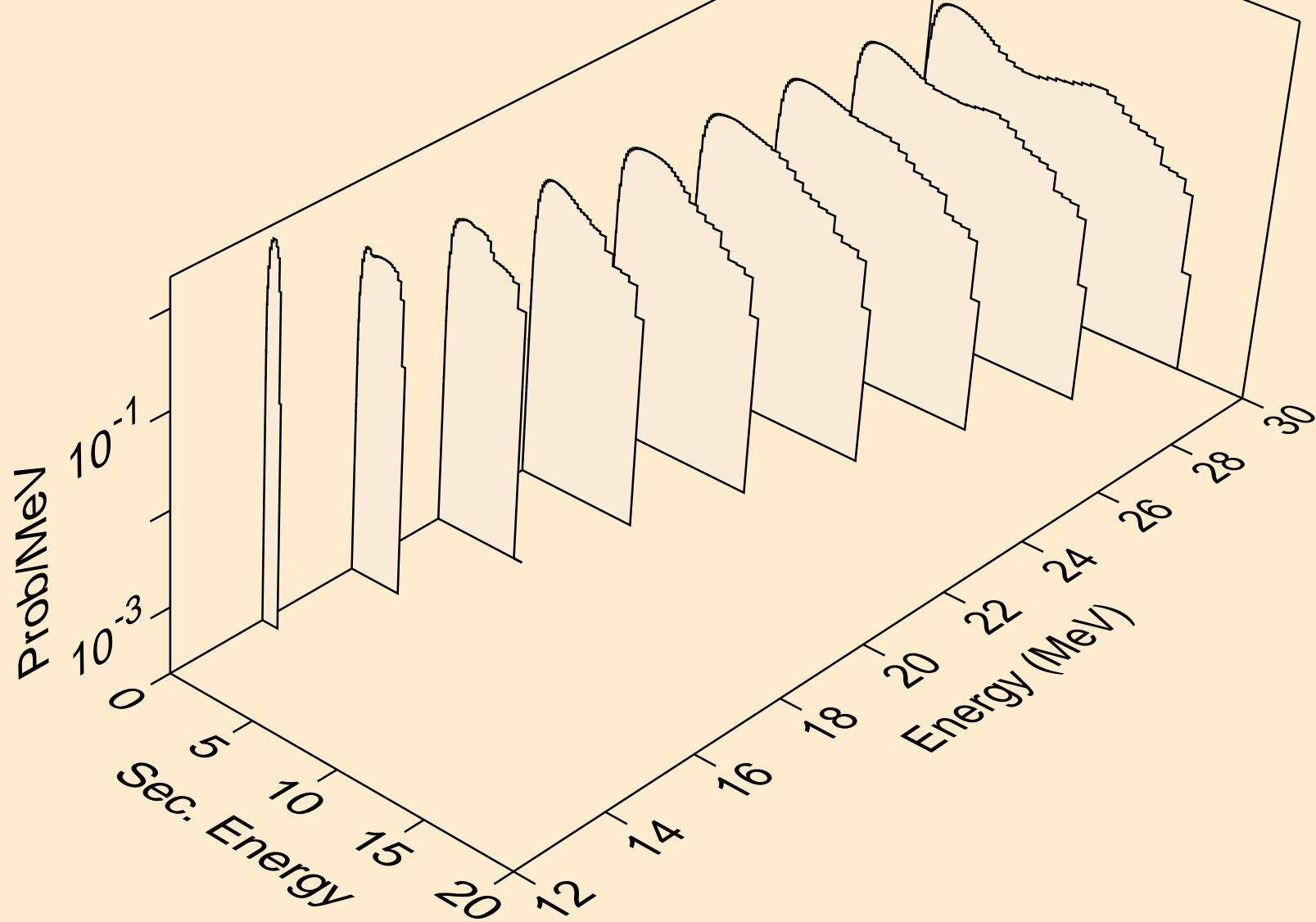

AR035 NEUTRON ACER TENDL-2024 LIBRARY; T=293.6K
Neutron emission for (n,n*)a

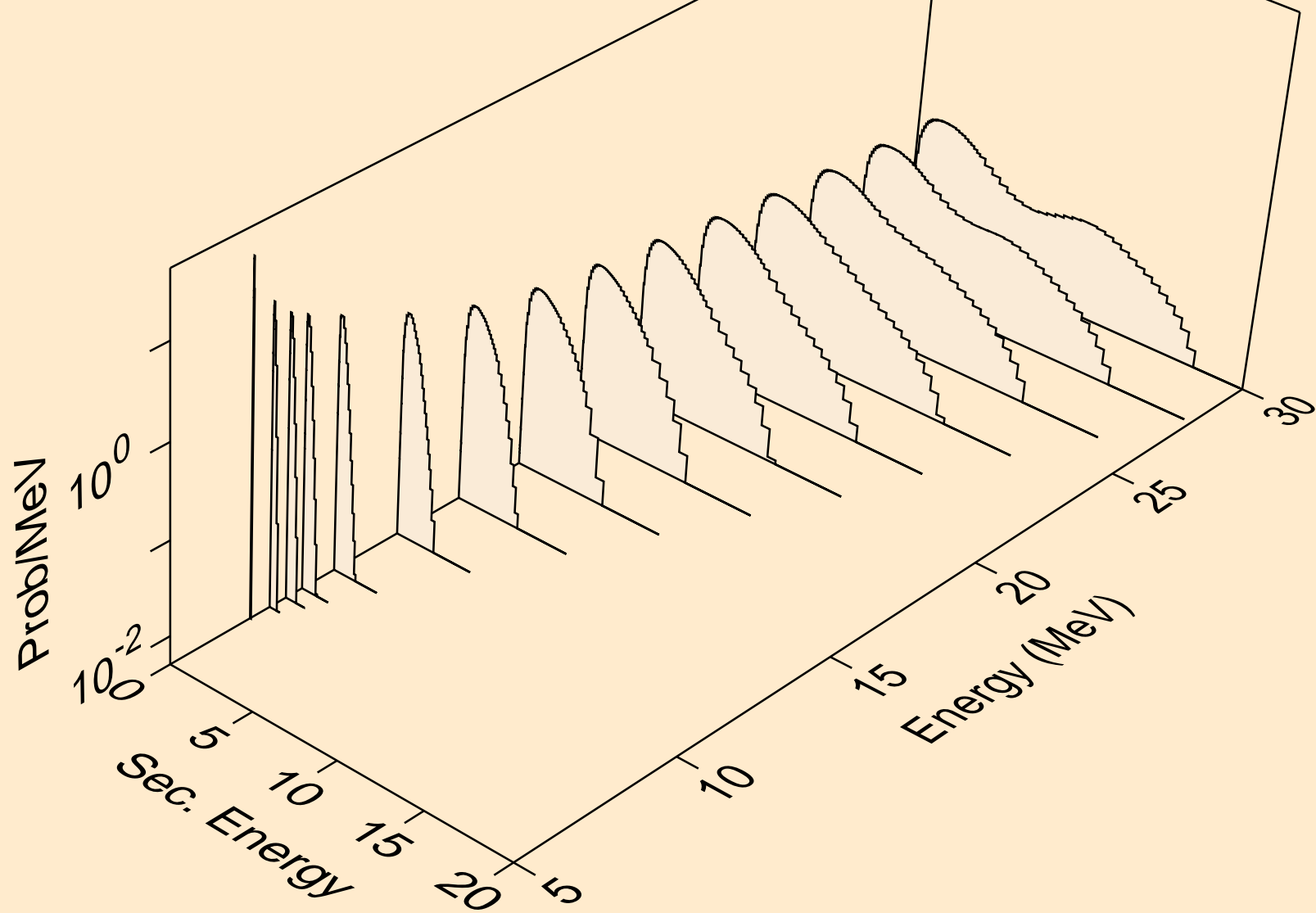

AR035 NEUTRON ACER TENDL-2024 LIBRARY; T=293.6K
Neutron emission for (n,2n)_a

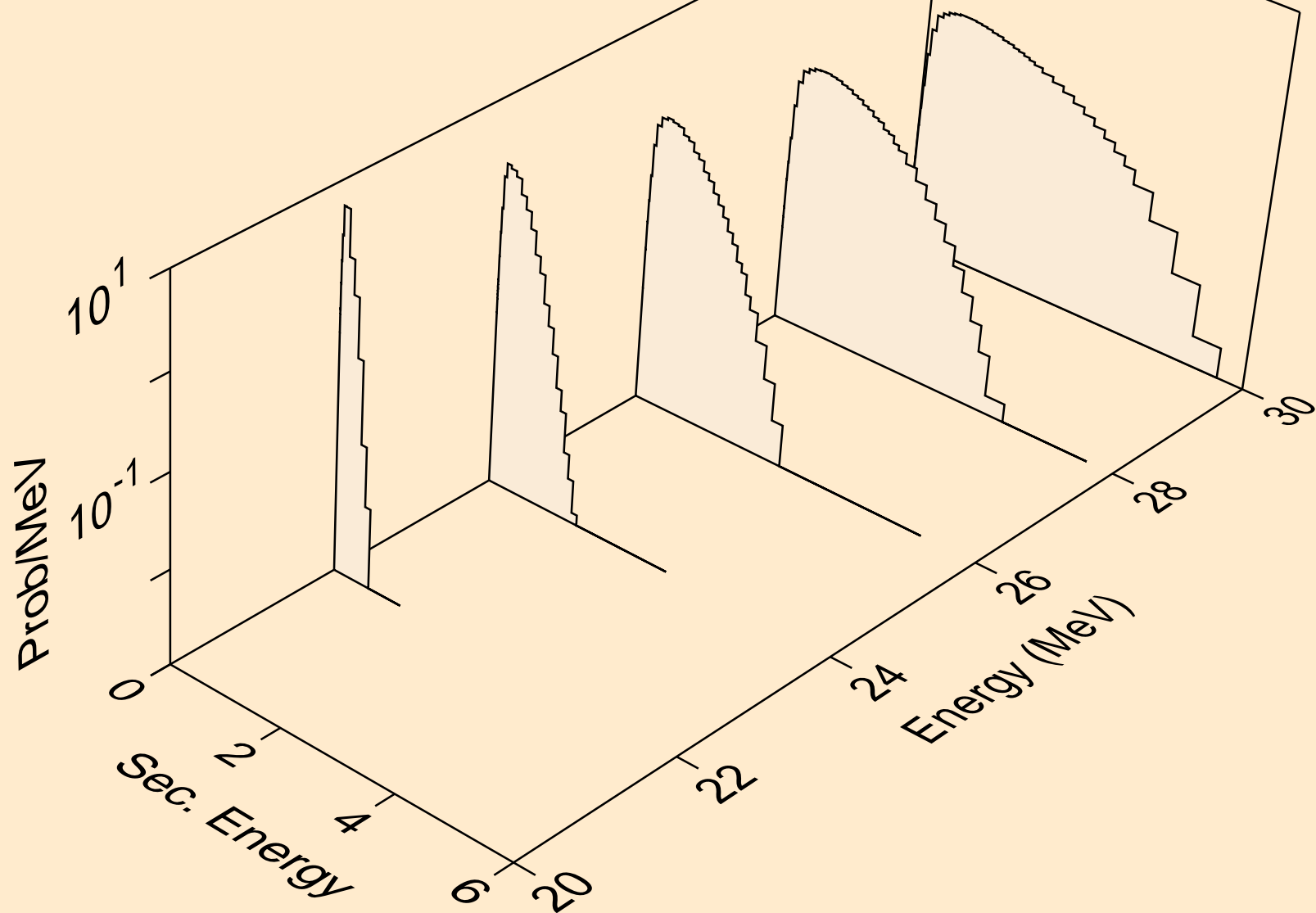

AR035 NEUTRON ACER TENDL-2024 LIBRARY; T=293.6K
Neutron emission for (n,n*)p

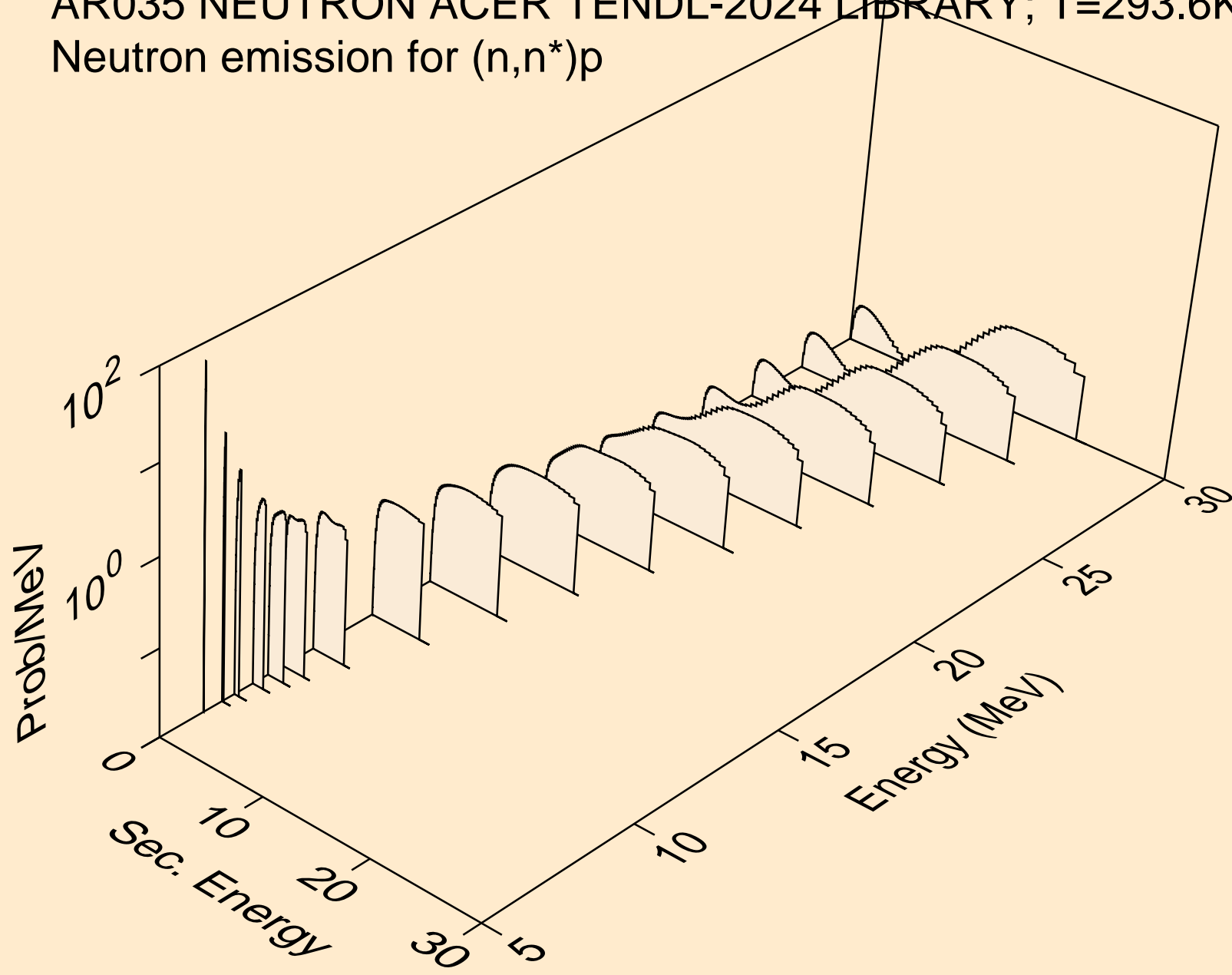

AR035 NEUTRON ACER TENDL-2024 LIBRARY; T=293.6K
Neutron emission for (n,n*)2a

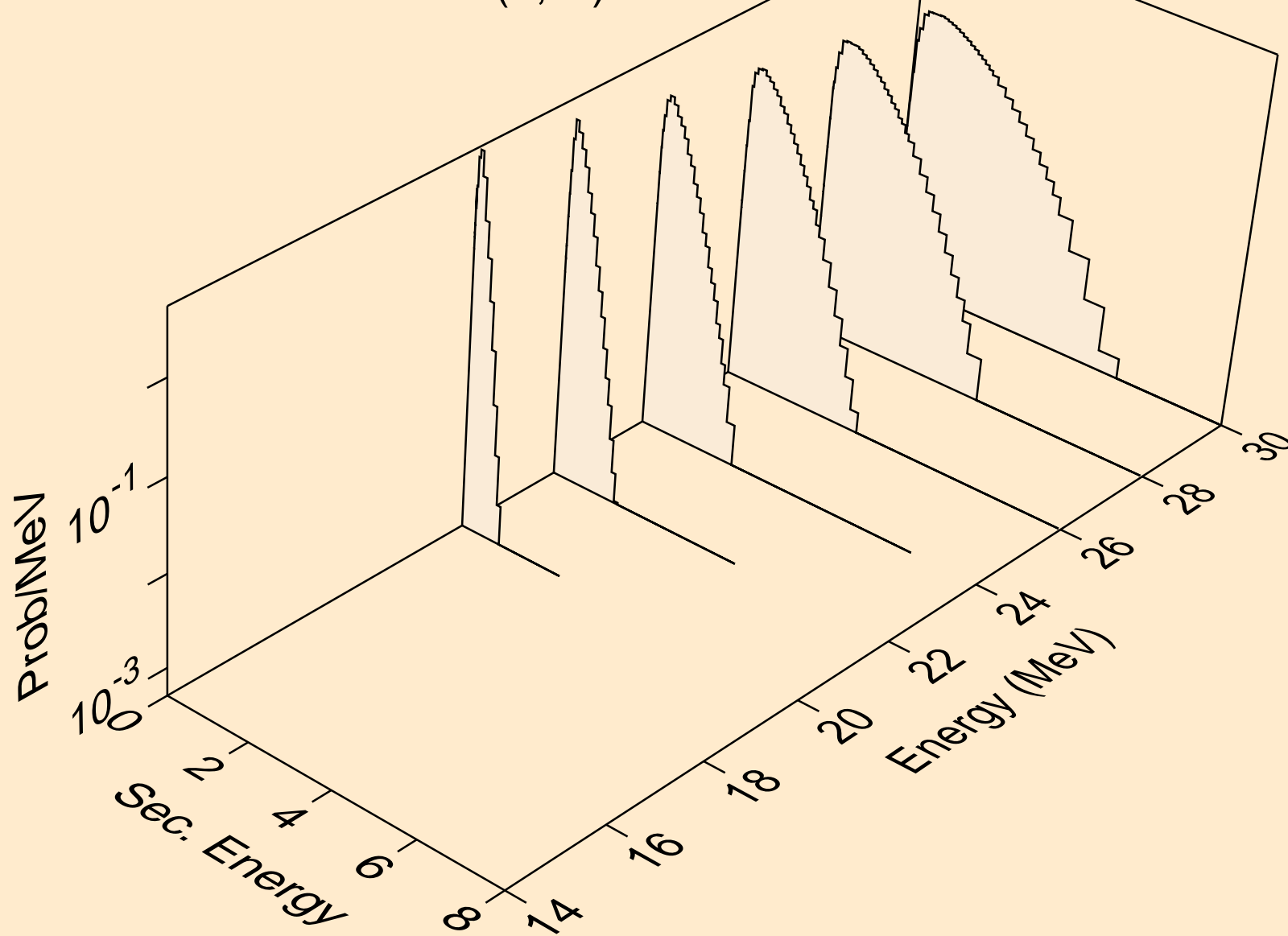

AR035 NEUTRON ACER TENDL-2024 LIBRARY; T=293.6K
Neutron emission for (n,n*)d

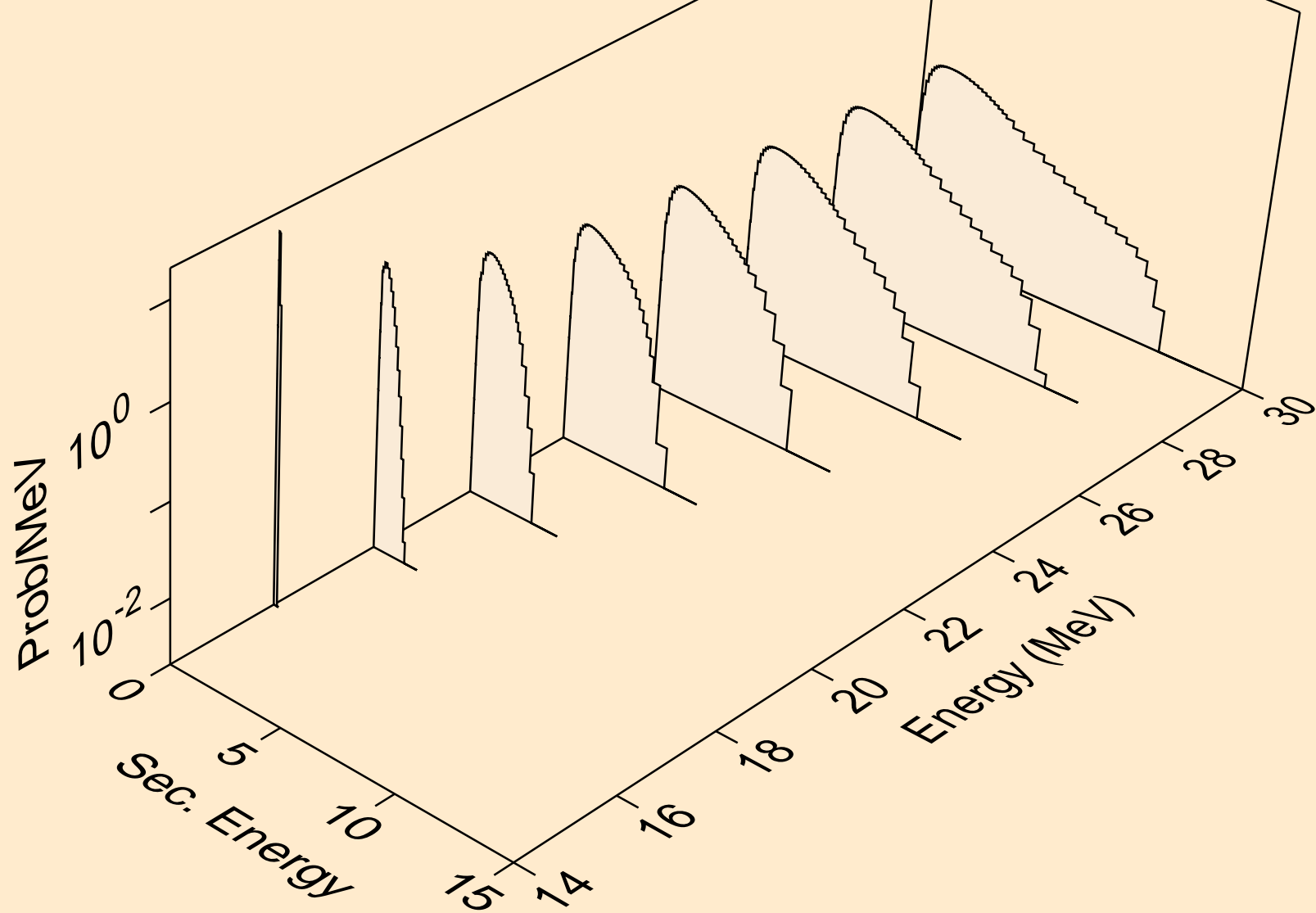

AR035 NEUTRON ACER TENDL-2024 LIBRARY; T=293.6K
Neutron emission for (n,n*)t

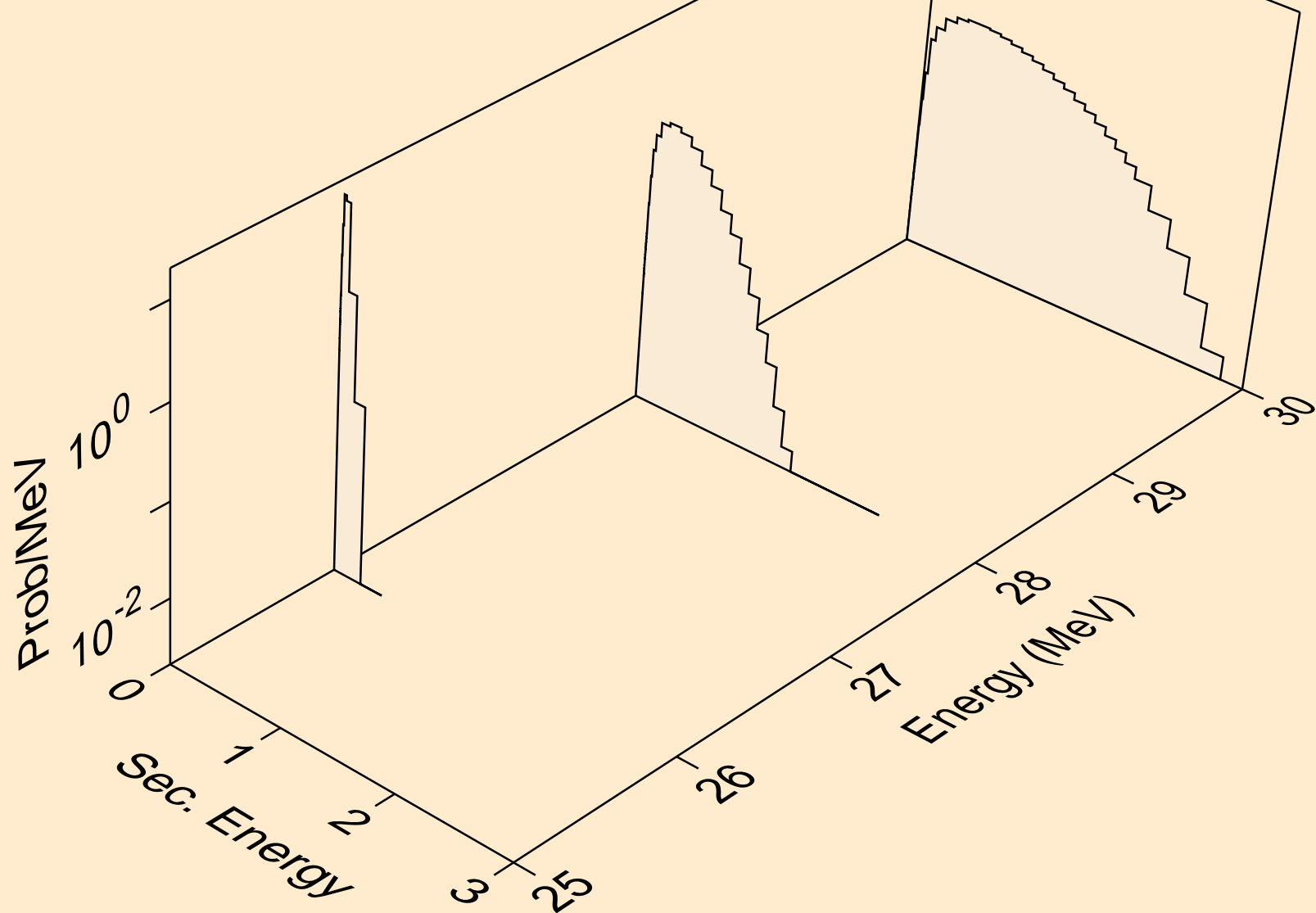

AR035 NEUTRON ACER TENDL-2024 LIBRARY; T=293.6K
Neutron emission for (n,n*)he3

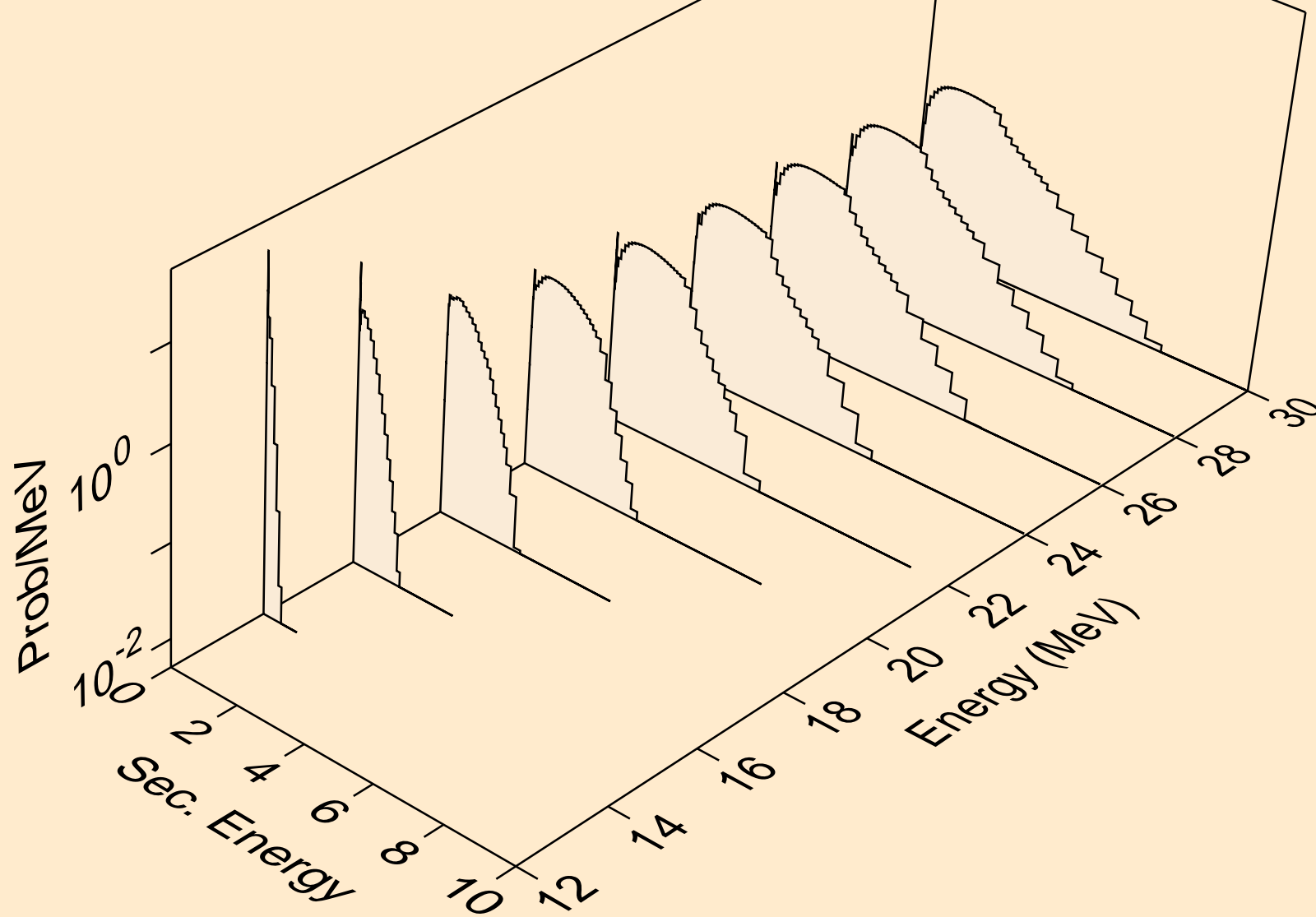

AR035 NEUTRON ACER TENDL-2024 LIBRARY; T=293.6K
Neutron emission for (n,2np)

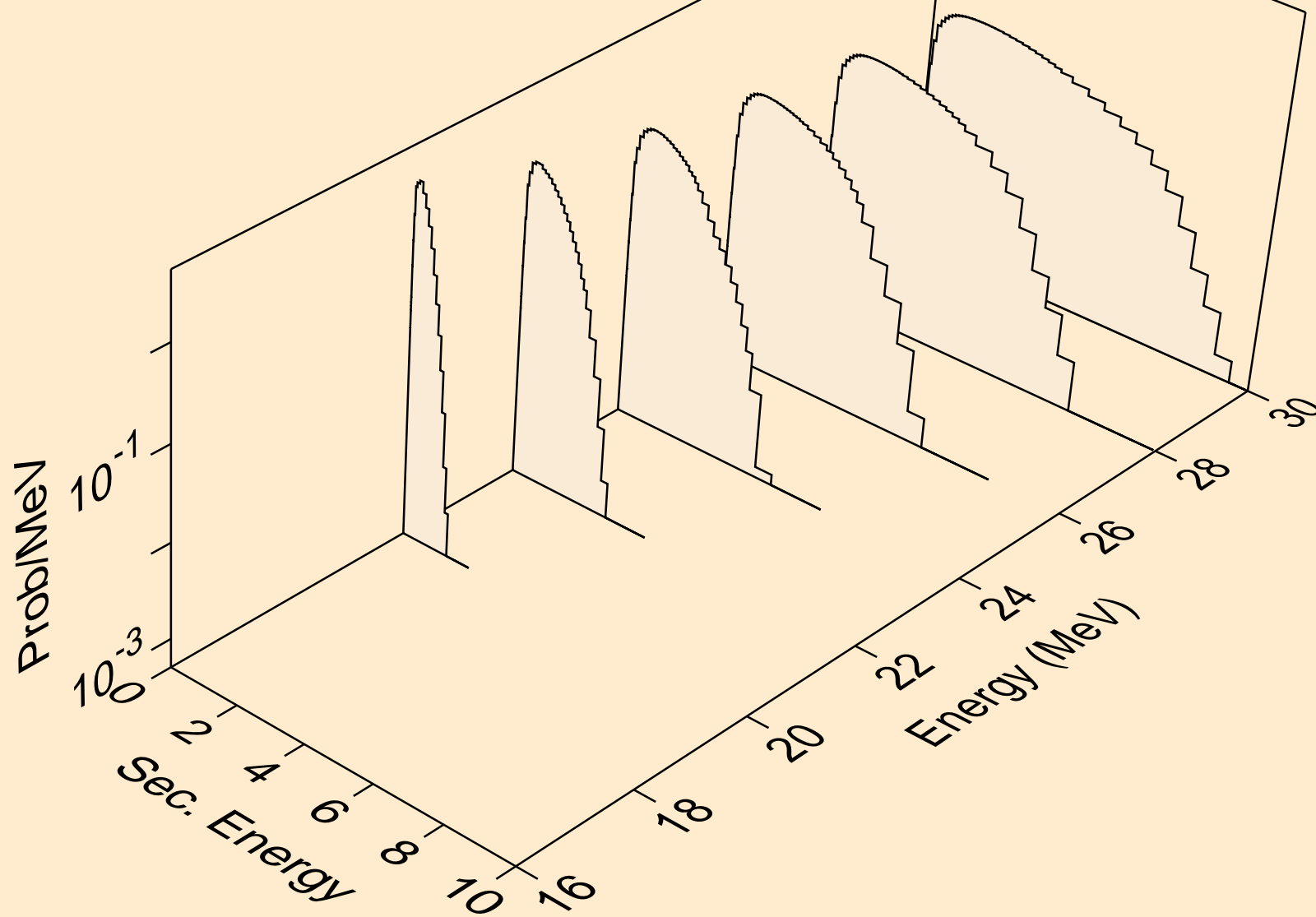

AR035 NEUTRON ACER TENDL-2024 LIBRARY; T=293.6K
Neutron emission for (n,n2p)

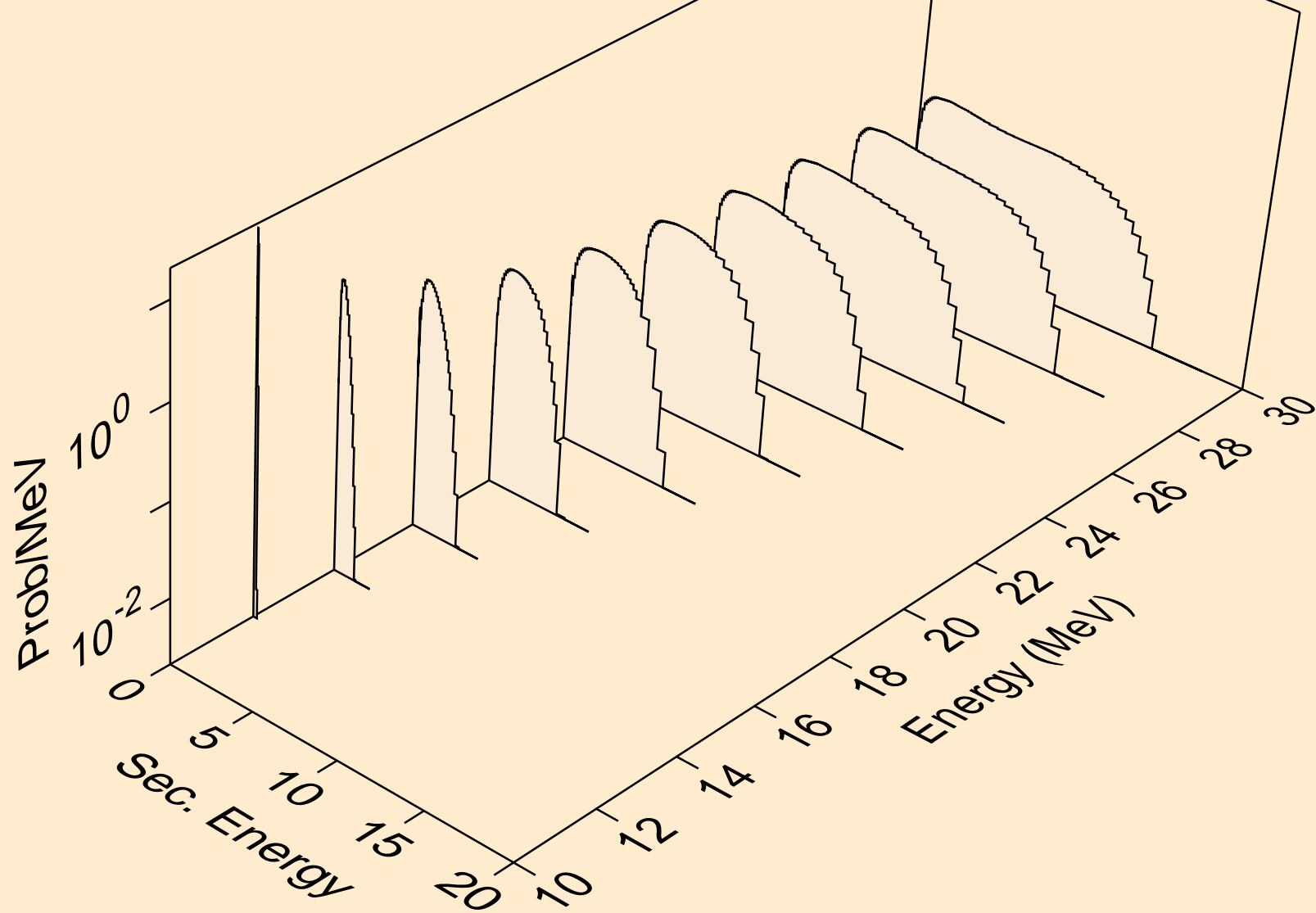

AR035 NEUTRON ACER TENDL-2024 LIBRARY; T=293.6K
Neutron emission for (n,npa)

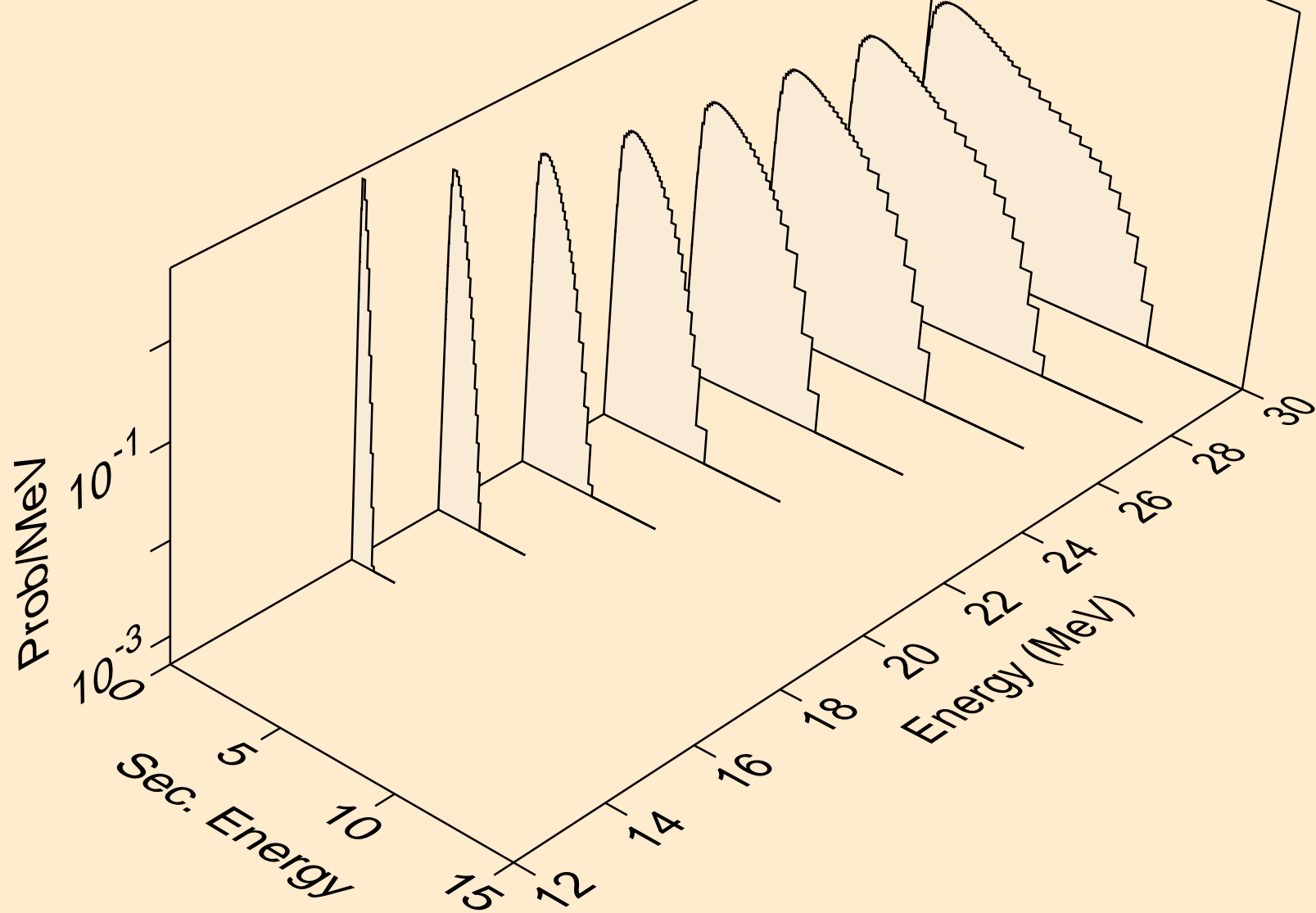

AR035 NEUTRON ACER TENDL-2024 LIBRARY; T=293.6K
Neutron emission for (n,n*c)

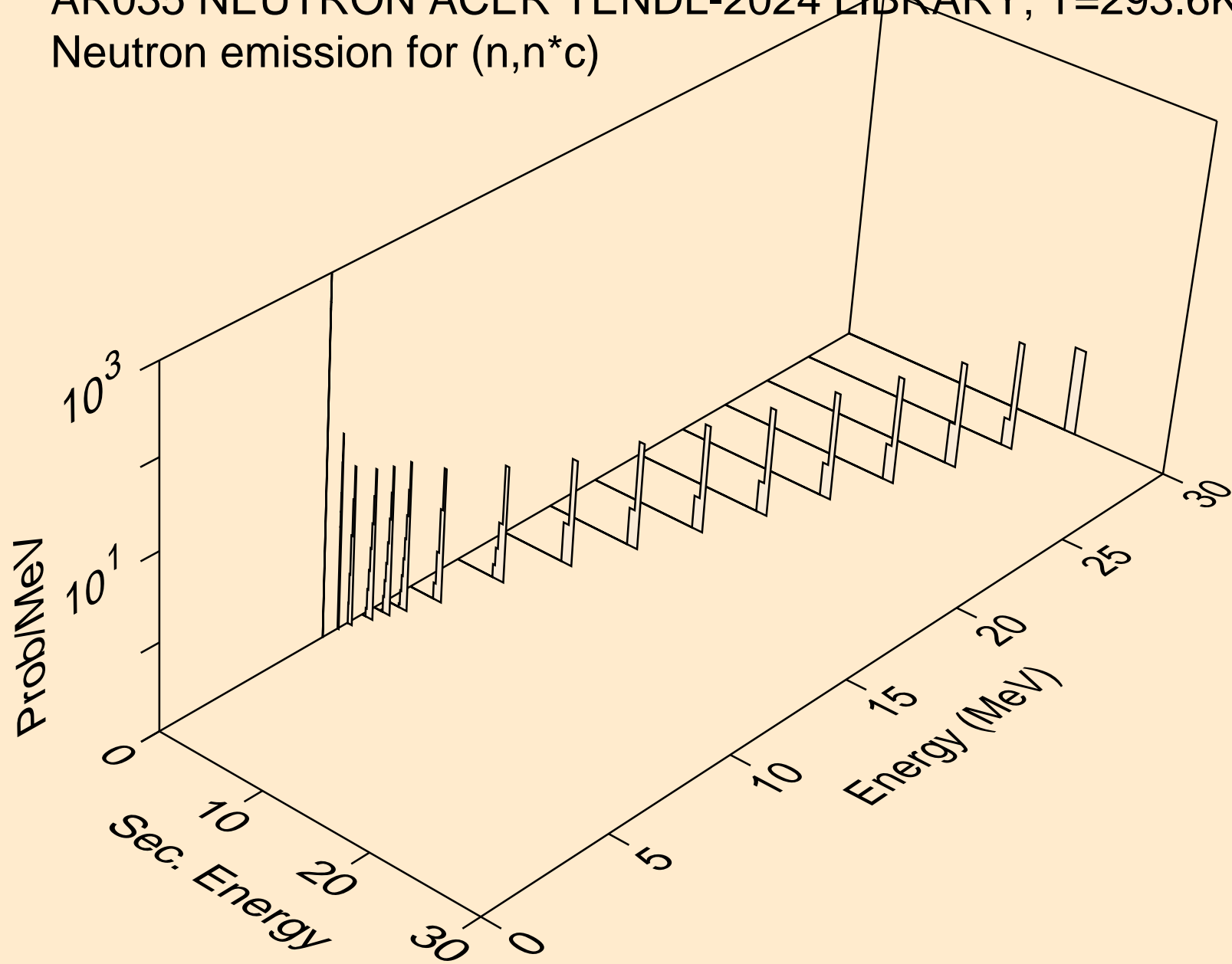

AR035 NEUTRON ACER TENDL-2024 LIBRARY; T=293.6K
Photon emission for (n,x)

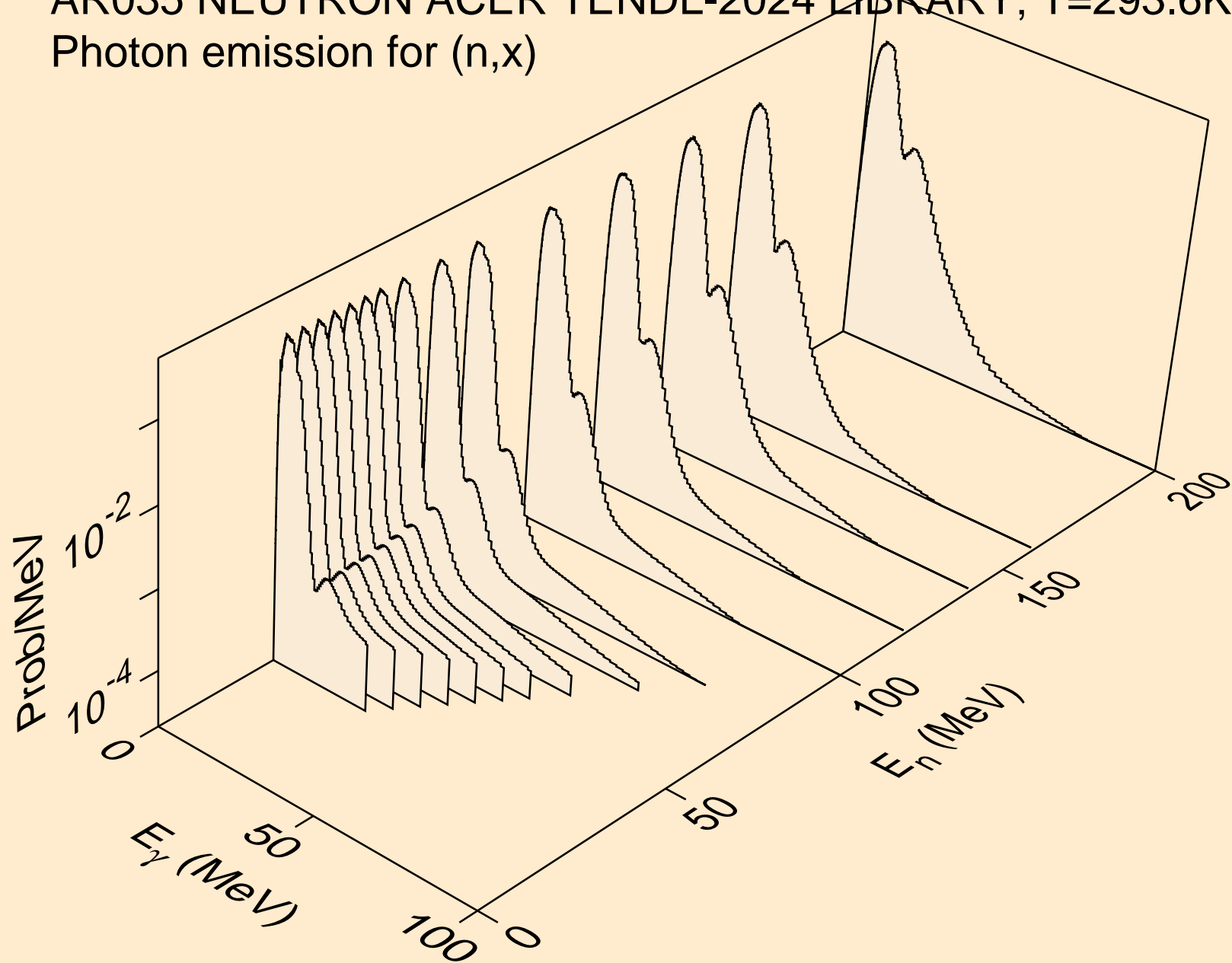

AR035 NEUTRON ACER TENDL-2024 LIBRARY; T=293.6K
Photon emission for (n,2n)

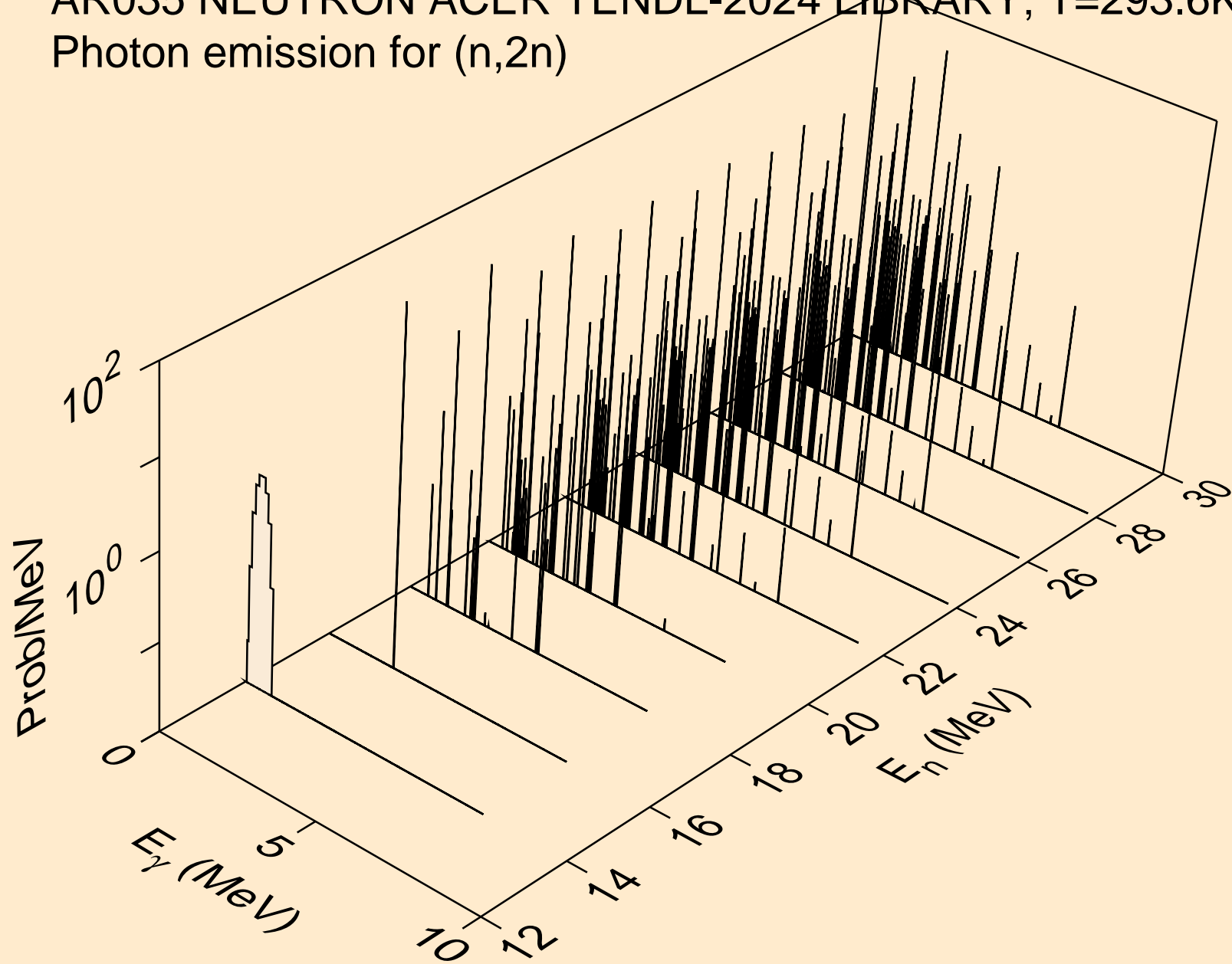

AR035 NEUTRON ACER TENDL-2024 LIBRARY; T=293.6K
Photon emission for (n,n*)a

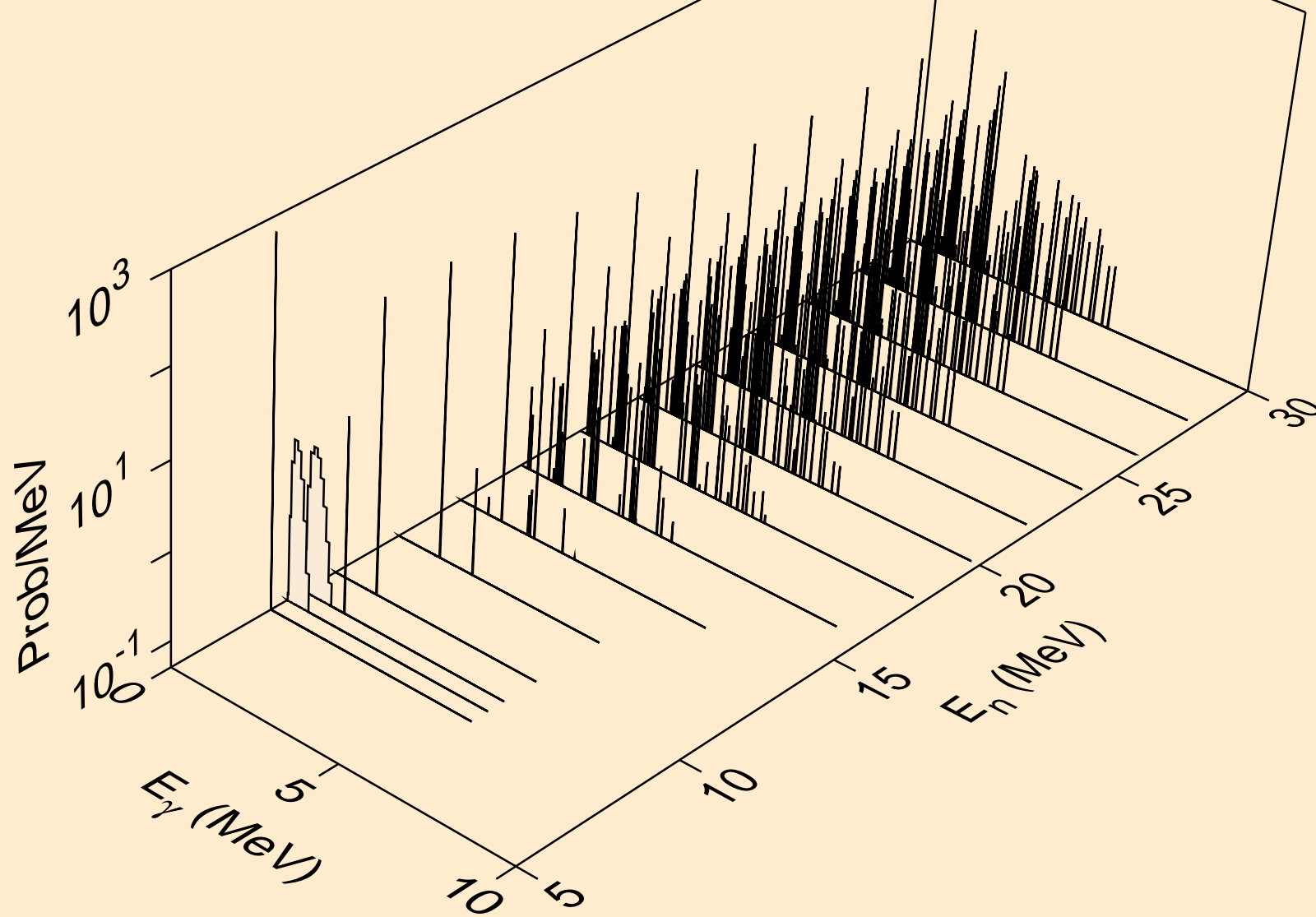

AR035 NEUTRON ACER TENDL-2024 LIBRARY; T=293.6K
Photon emission for (n,2n)a

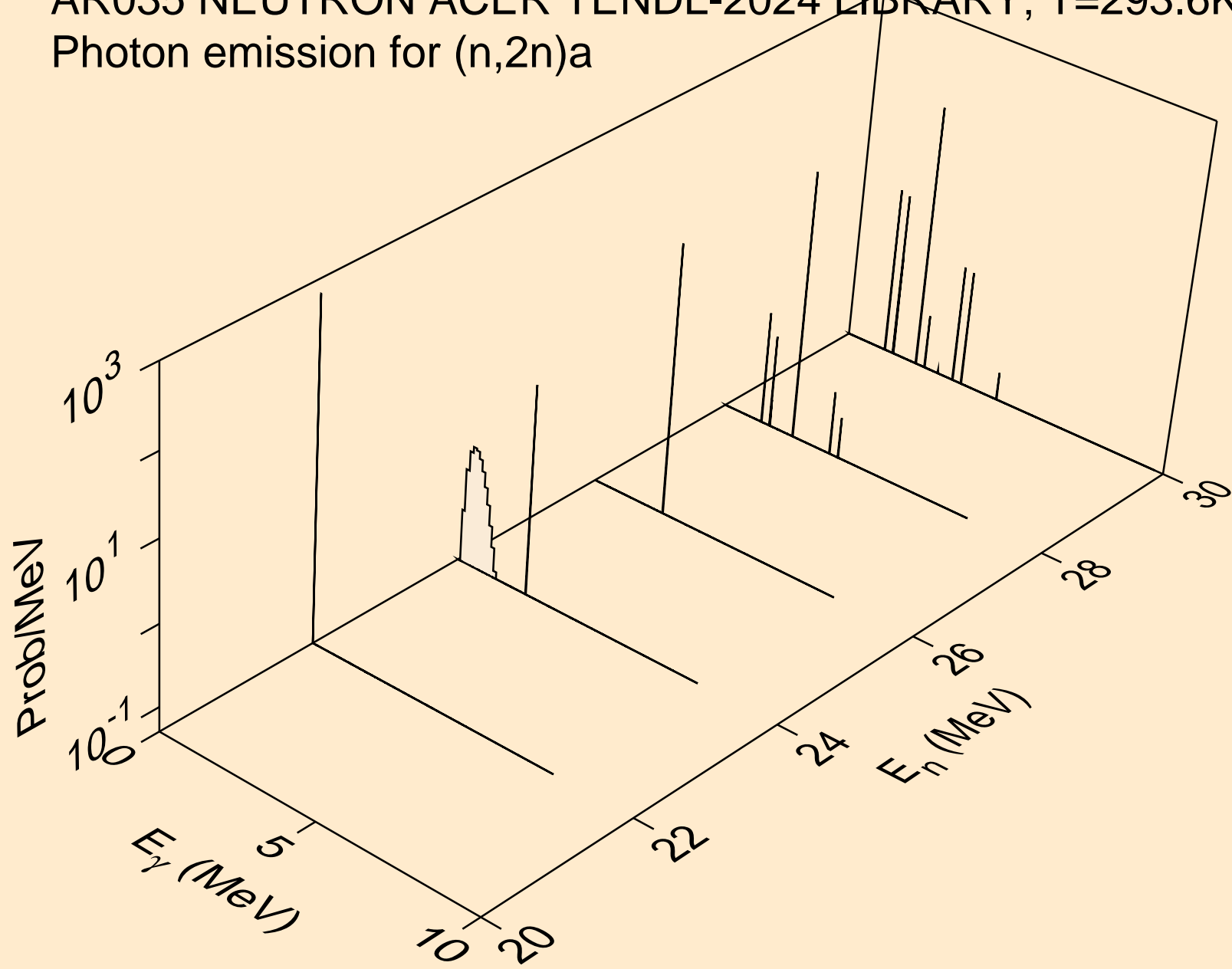

AR035 NEUTRON ACER TENDL-2024 LIBRARY; T=293.6K
Photon emission for (n,n*)p

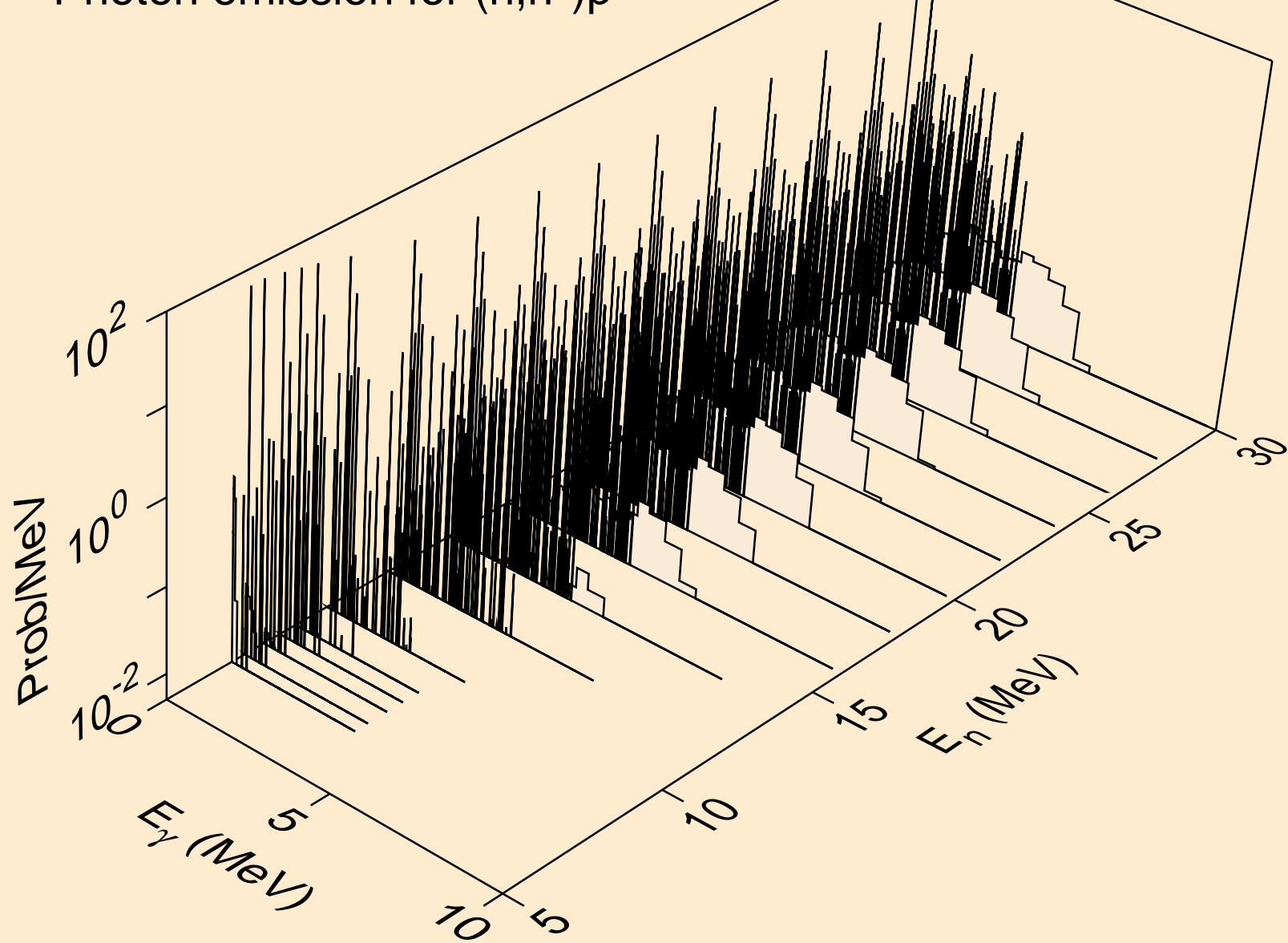

AR035 NEUTRON ACER TENDL-2024 LIBRARY; T=293.6K
Photon emission for (n,n*)2a

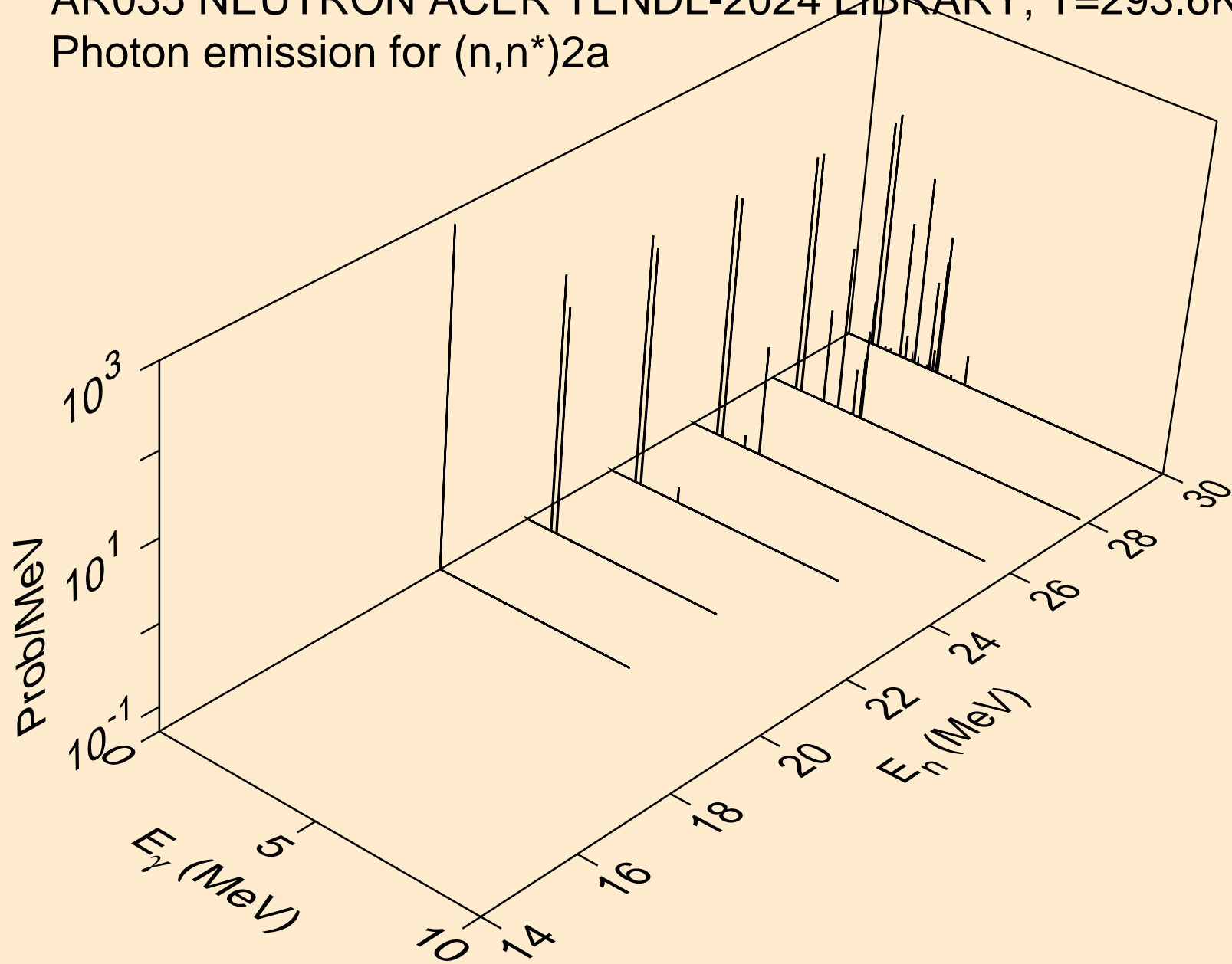

AR035 NEUTRON ACER TENDL-2024 LIBRARY; T=293.6K
Photon emission for (n,n*)d

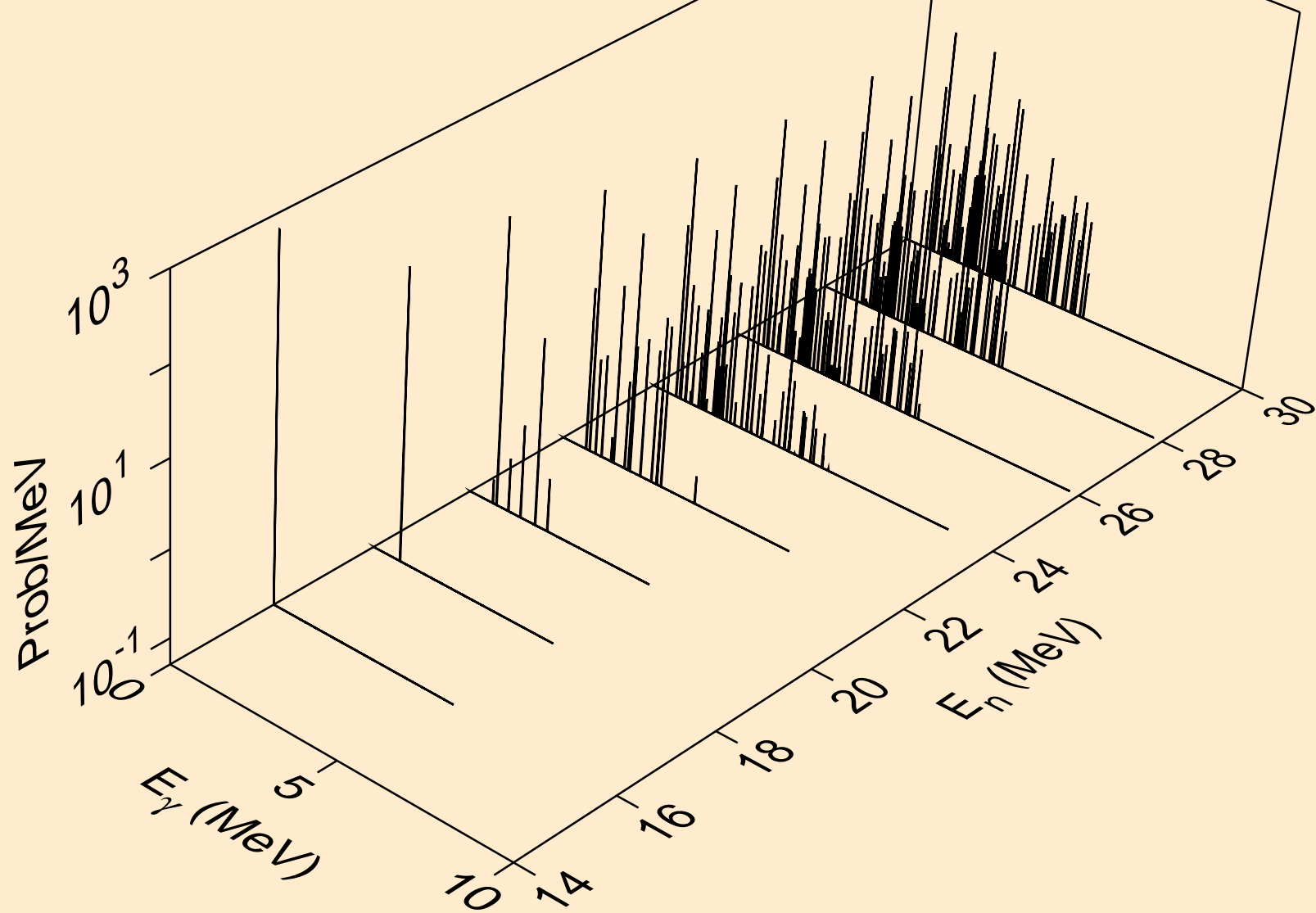

AR035 NEUTRON ACER TENDL-2024 LIBRARY; T=293.6K
Photon emission for (n,n*)t

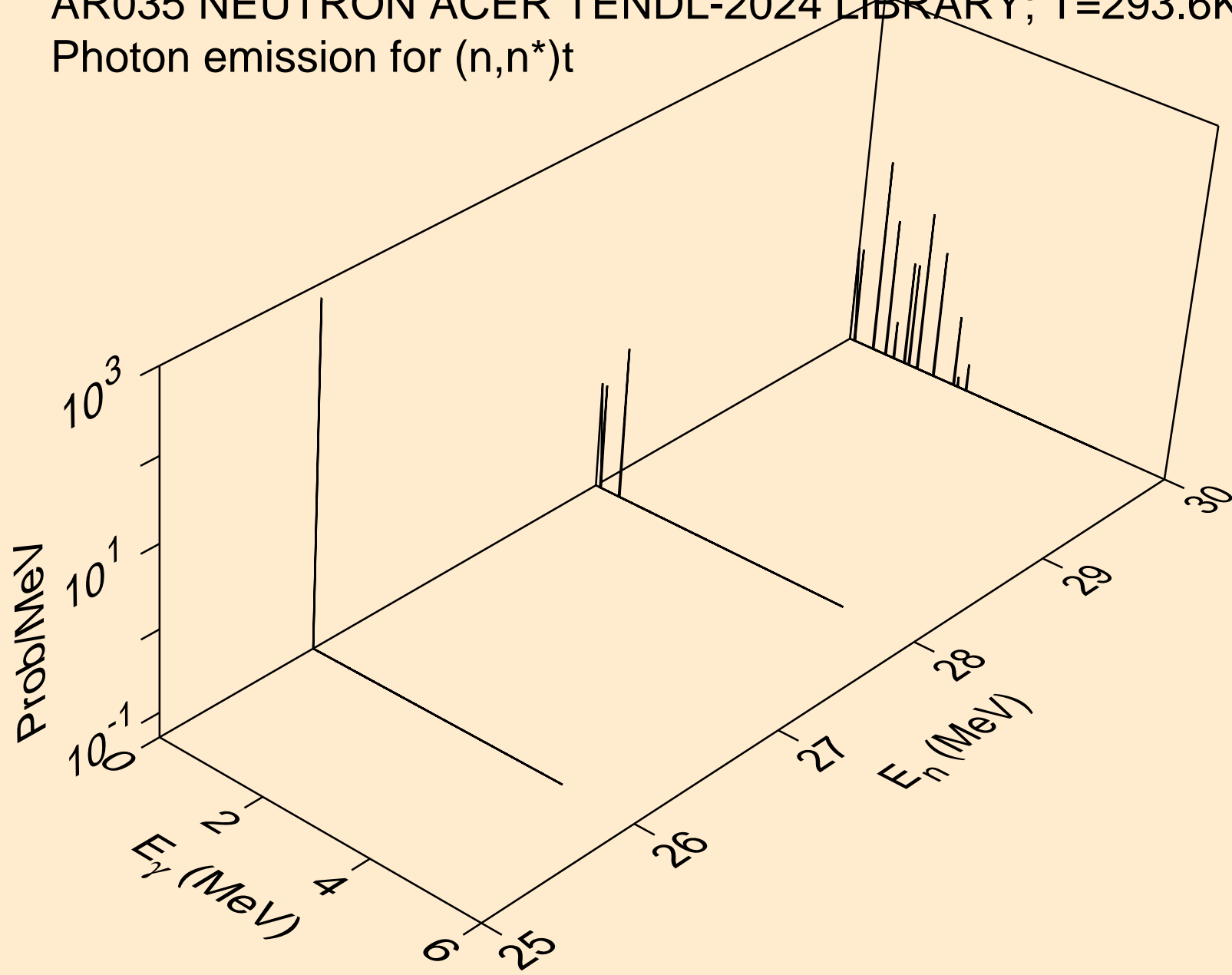

AR035 NEUTRON ACER TENDL-2024 LIBRARY; T=293.6K
Photon emission for (n,n*)he3

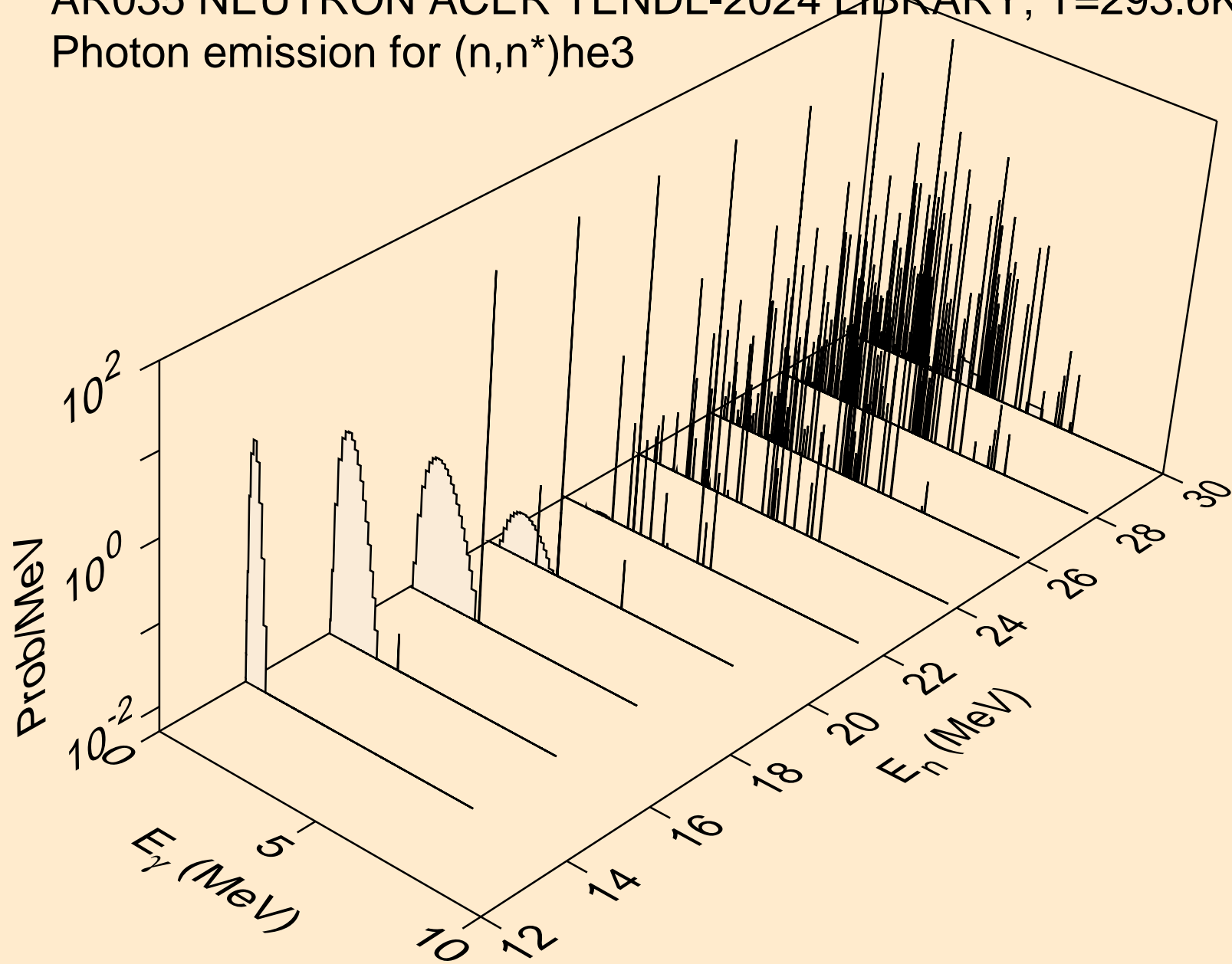

AR035 NEUTRON ACER TENDL-2024 LIBRARY; T=293.6K
Photon emission for (n,2np)

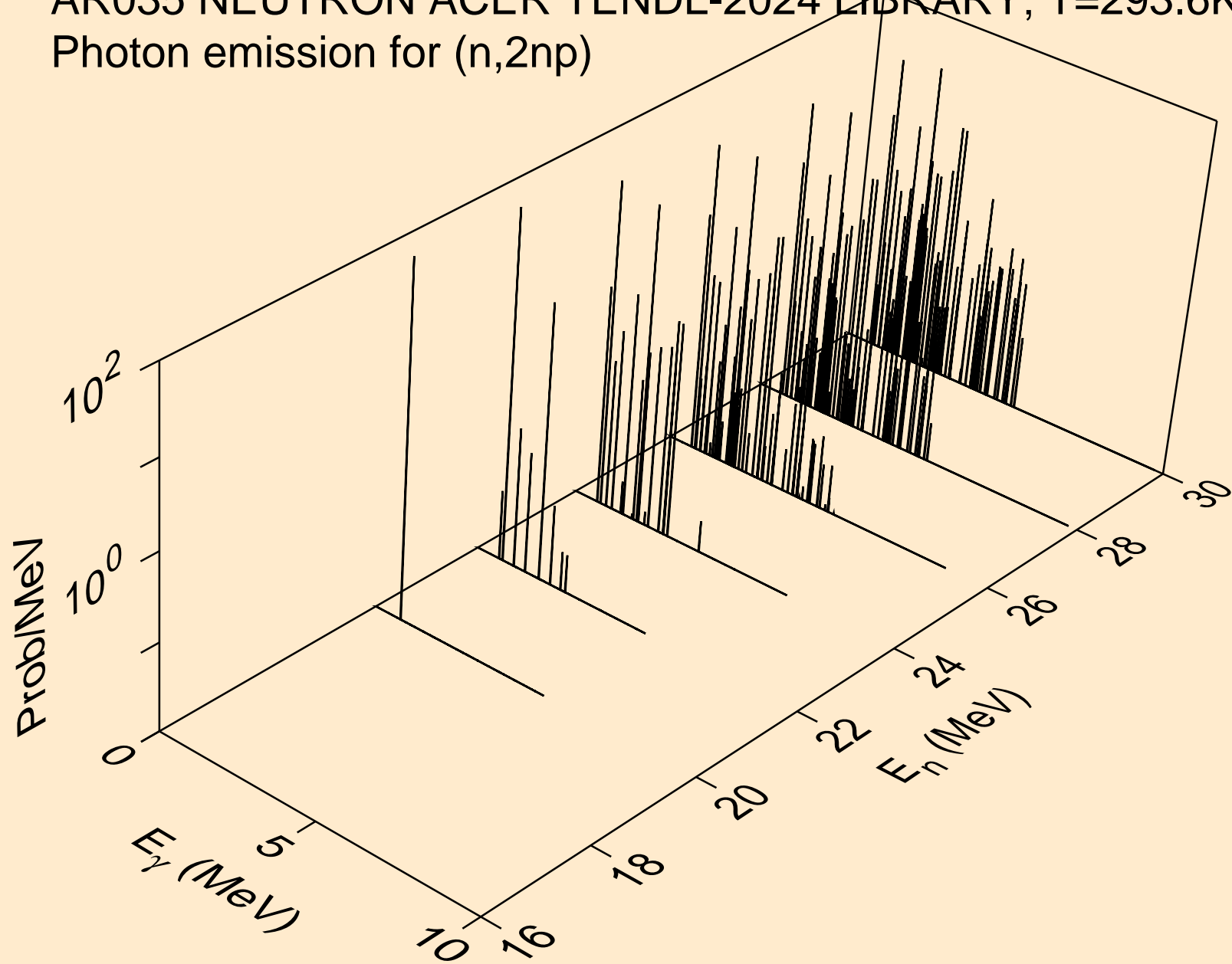

AR035 NEUTRON ACER TENDL-2024 LIBRARY; T=293.6K
Photon emission for (n,n2p)

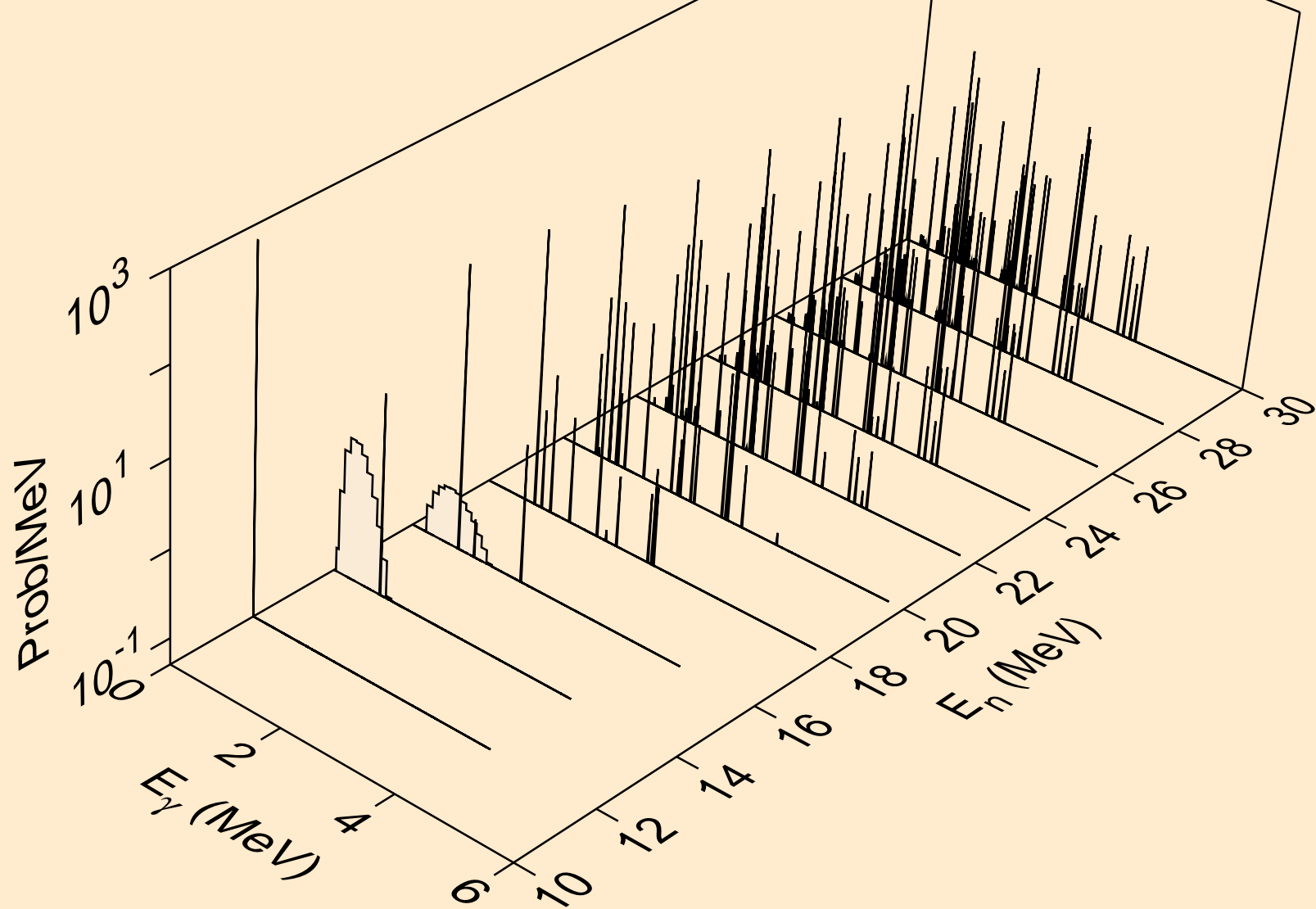

AR035 NEUTRON ACER TENDL-2024 LIBRARY; T=293.6K
Photon emission for (n,npa)

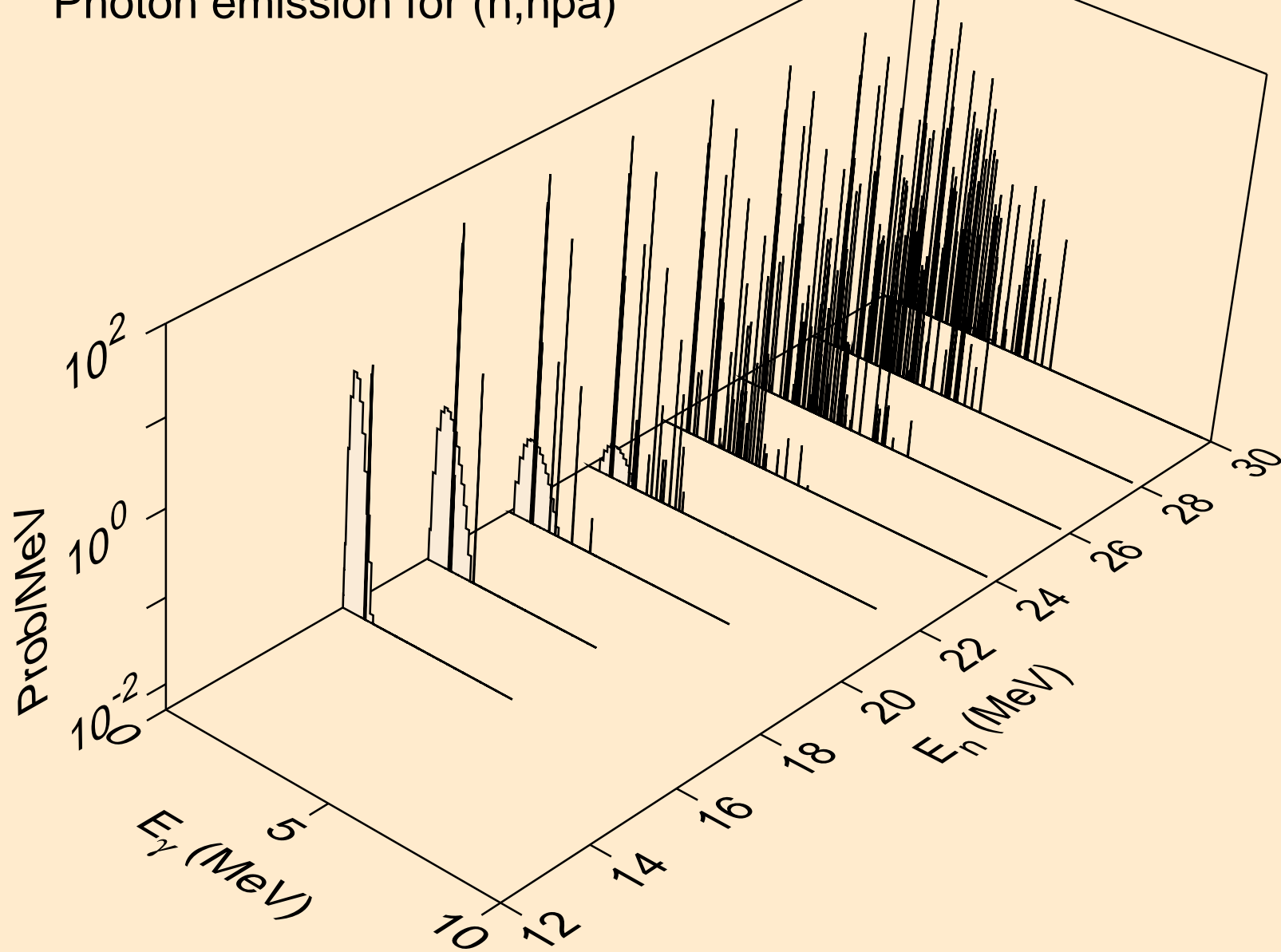

AR035 NEUTRON ACER TENDL-2024 LIBRARY; T=293.6K
Photon emission for (n,n*c)

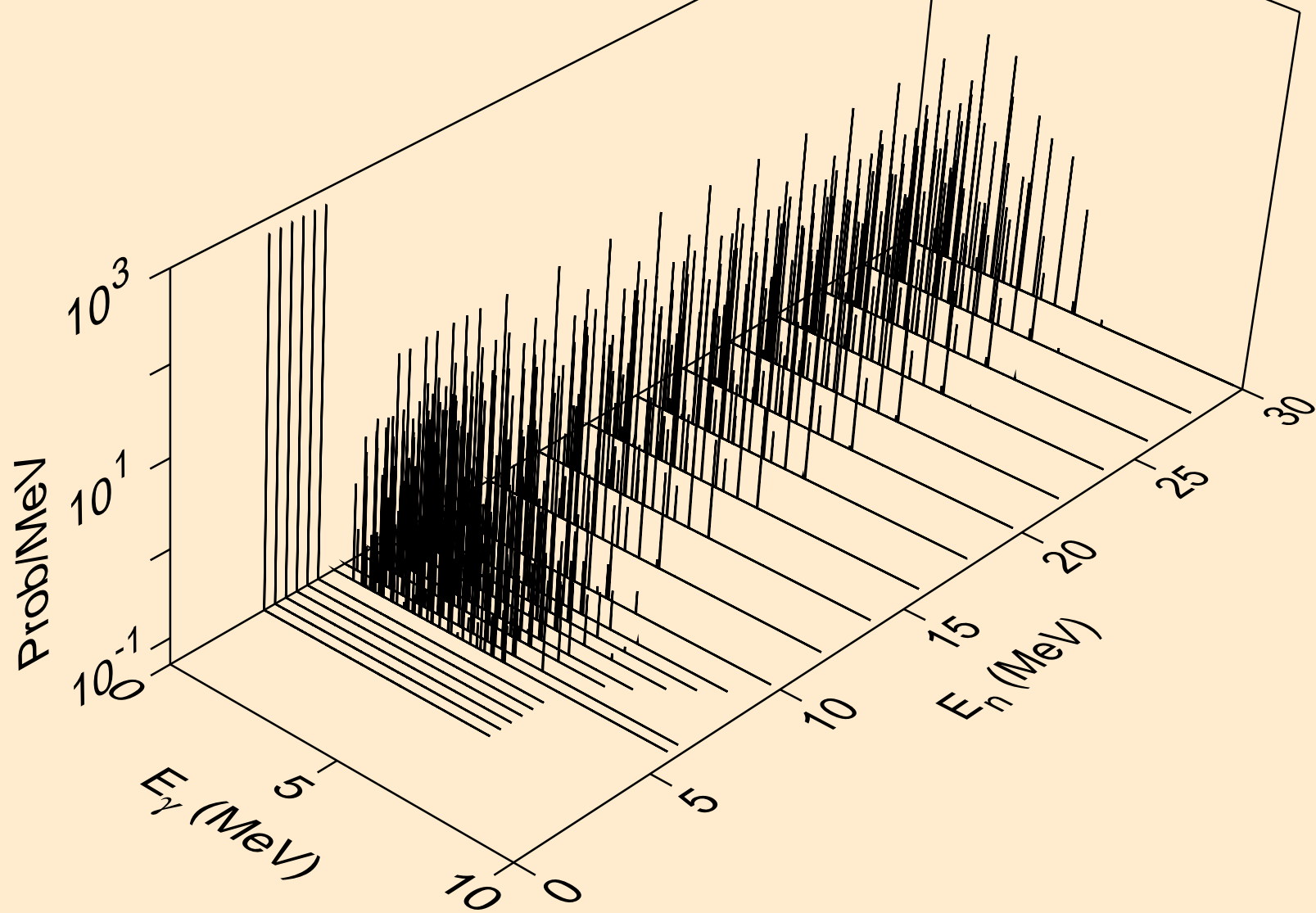

AR035 NEUTRON ACER TENDL-2024 LIBRARY; T=293.6K
Photon emission for (n,gma)

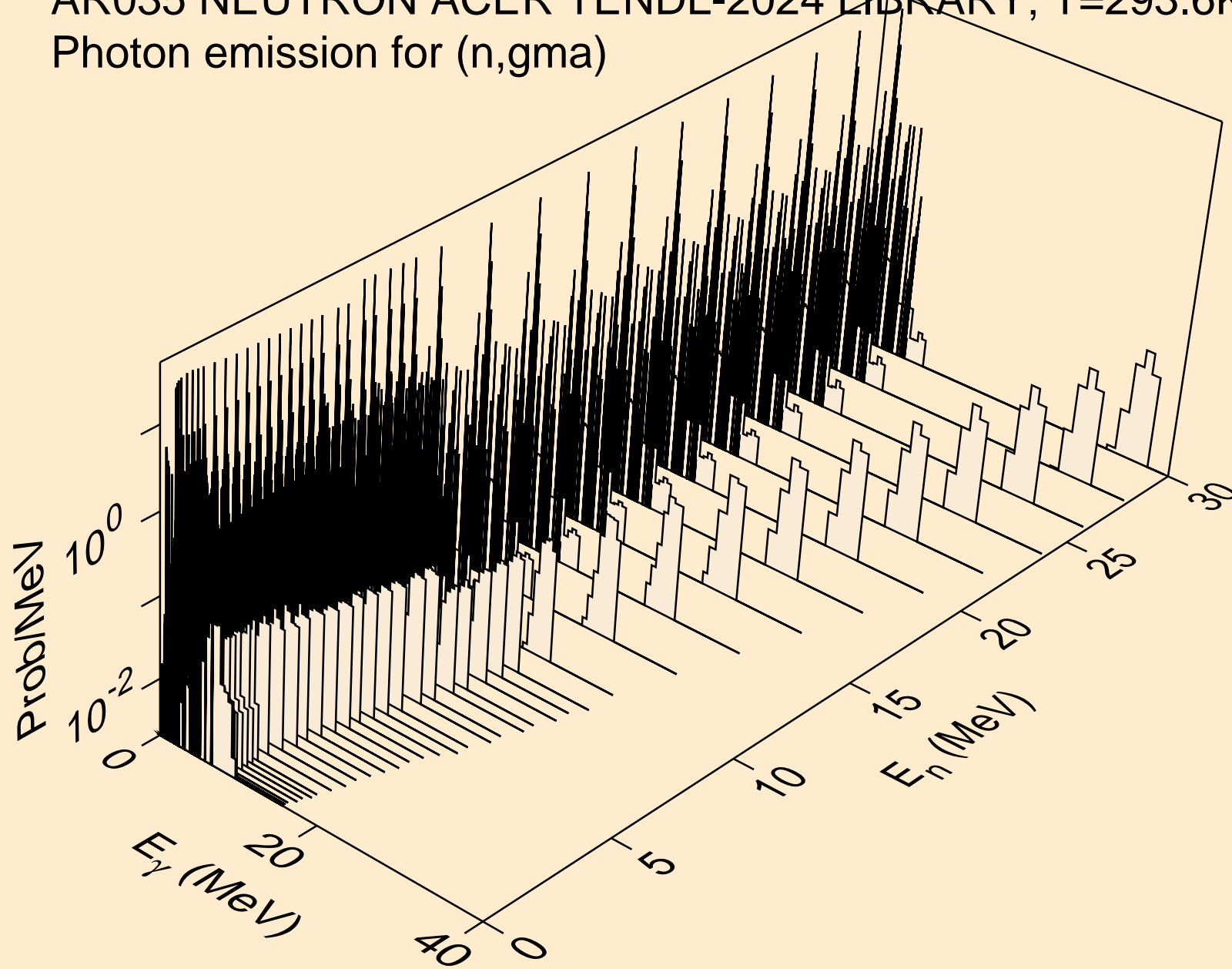

AR035 NEUTRON ACER TENDL-2024 LIBRARY; T=293.6K
Photon emission for (n,p)

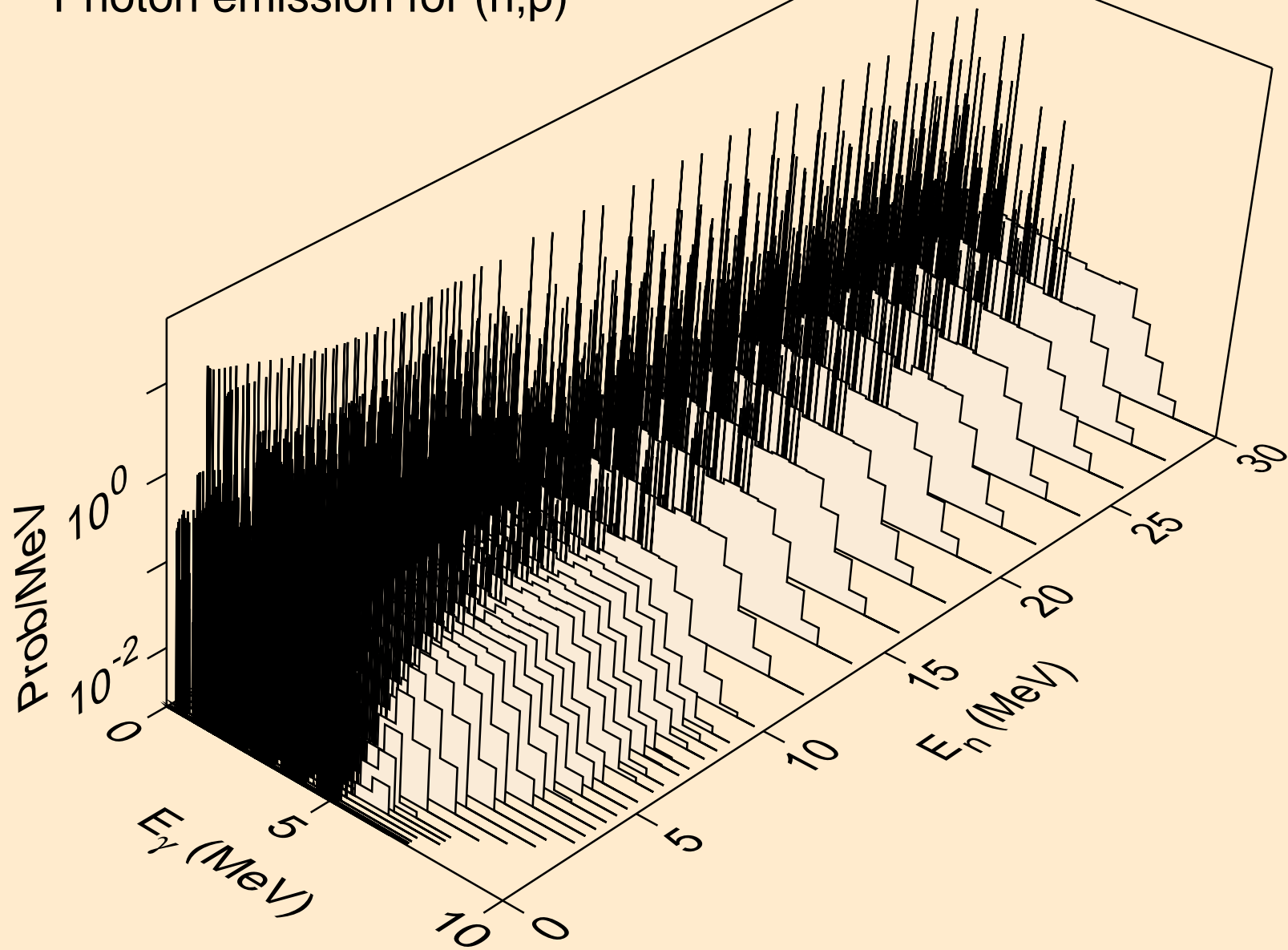

AR035 NEUTRON ACER TENDL-2024 LIBRARY; T=293.6K
Photon emission for (n,d)

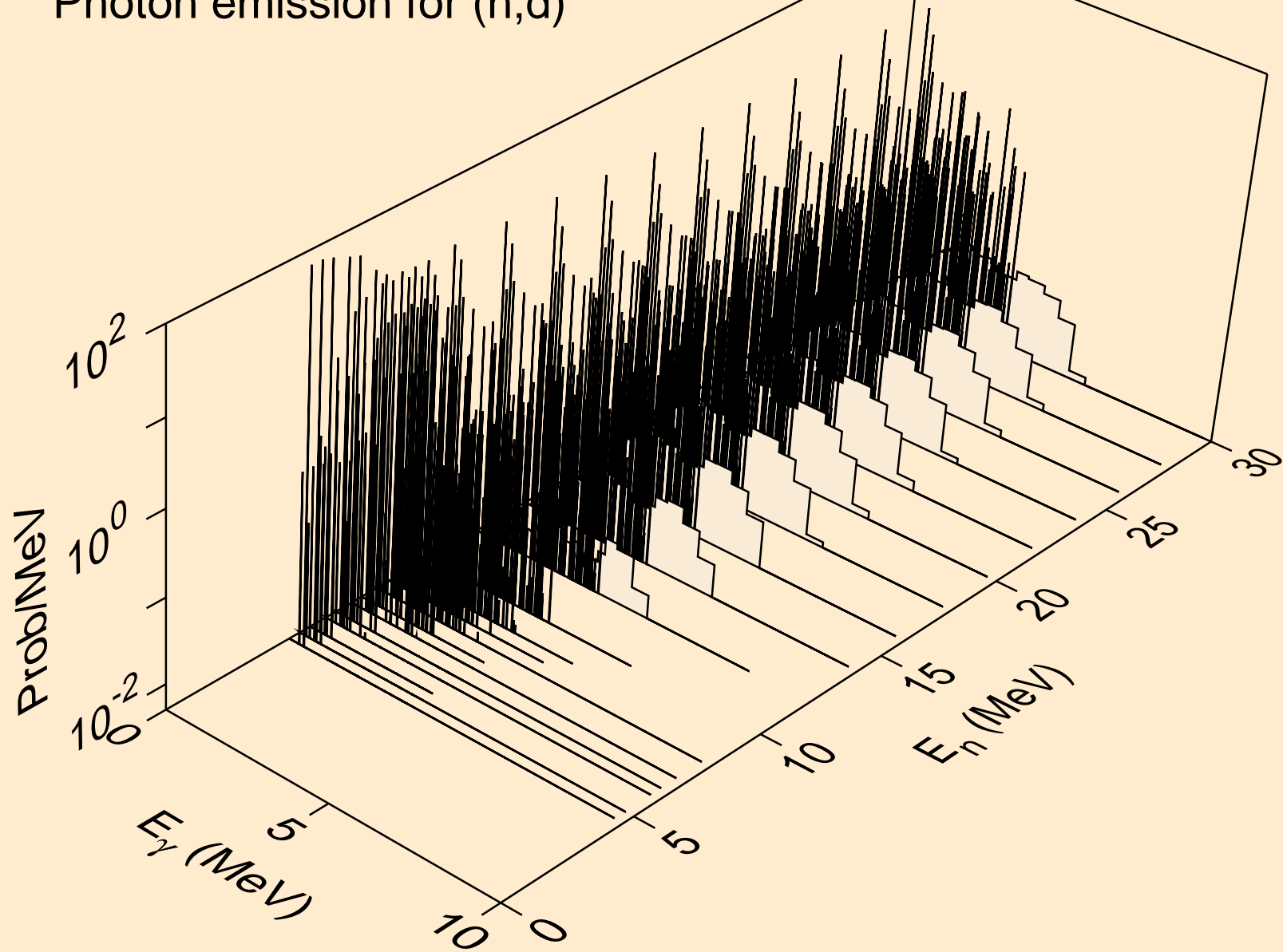

AR035 NEUTRON ACER TENDL-2024 LIBRARY; T=293.6K
Photon emission for (n,t)

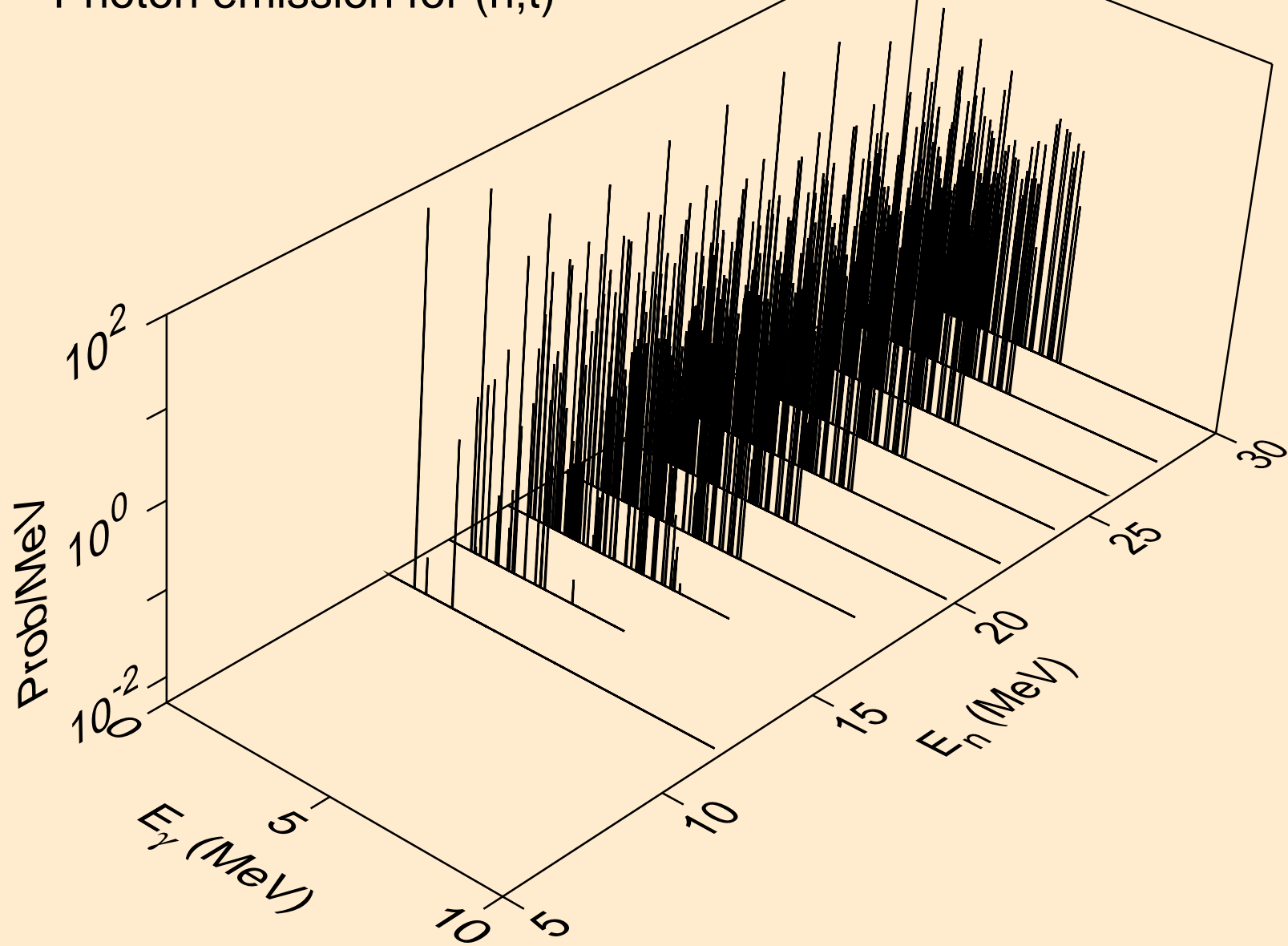

AR035 NEUTRON ACER TENDL-2024 LIBRARY; T=293.6K
Photon emission for (n,he3)

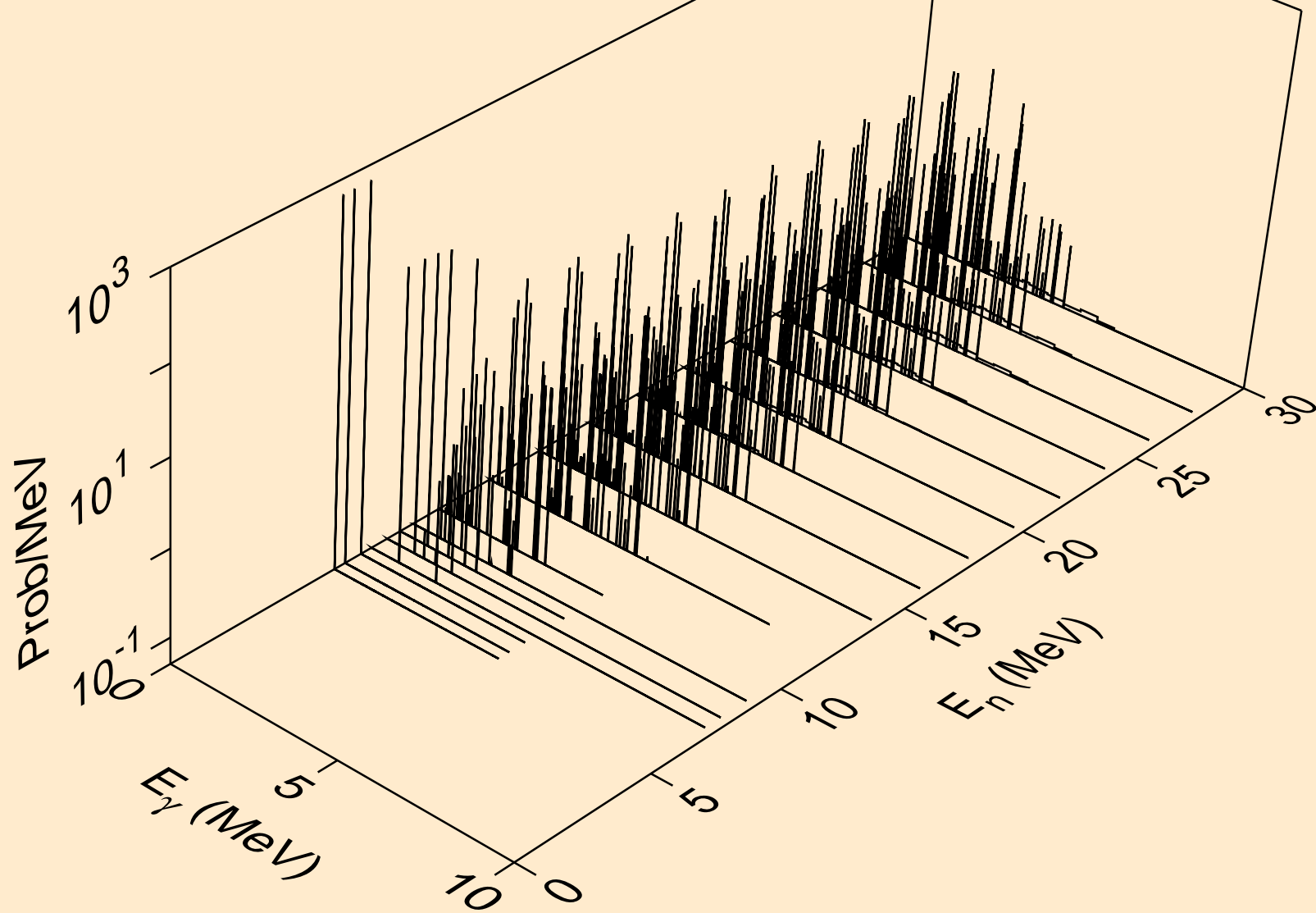

AR035 NEUTRON ACER TENDL-2024 LIBRARY; T=293.6K
Photon emission for (n,a)

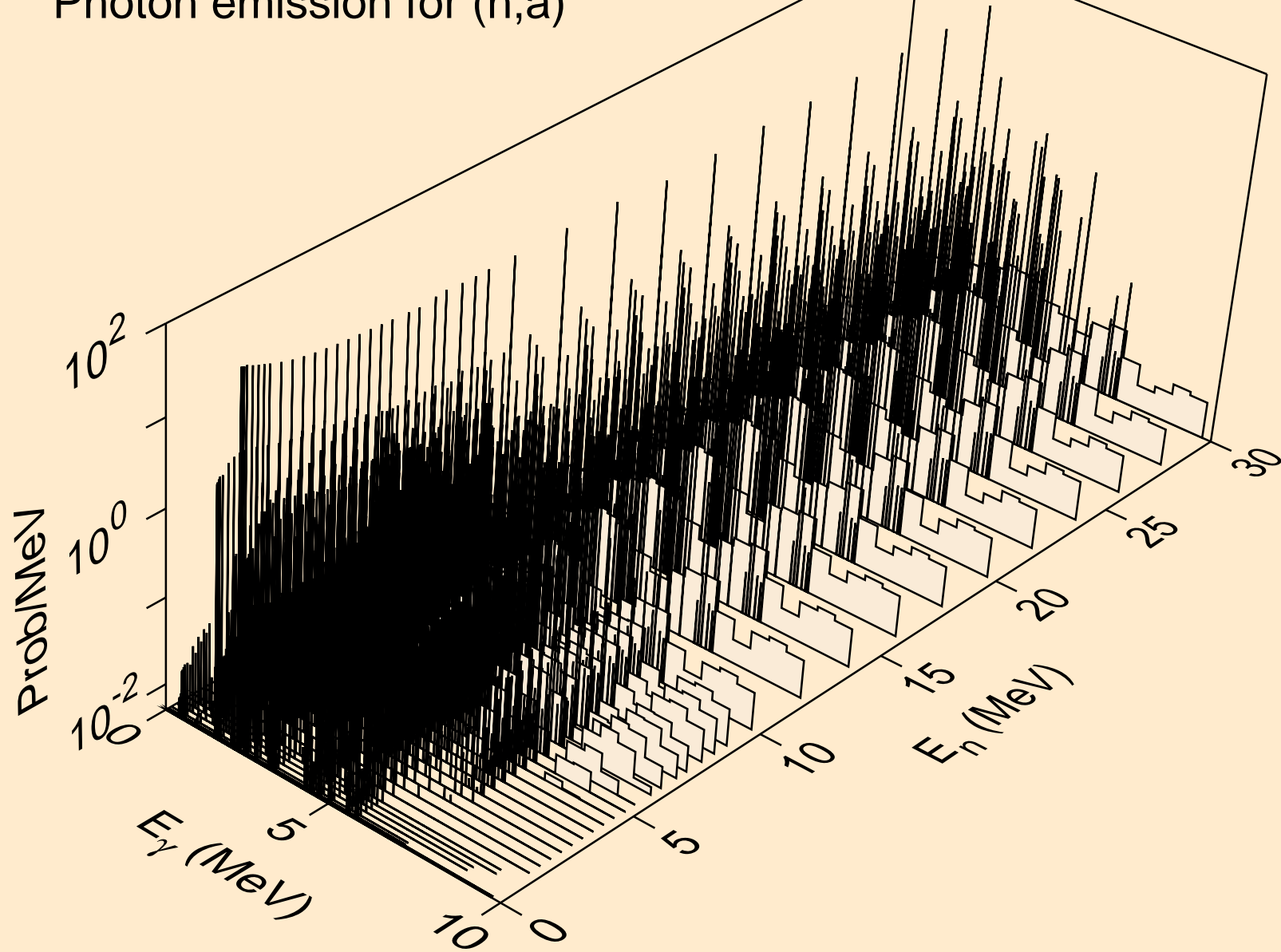

AR035 NEUTRON ACER TENDL-2024 LIBRARY; T=293.6K
Photon emission for (n,2a)

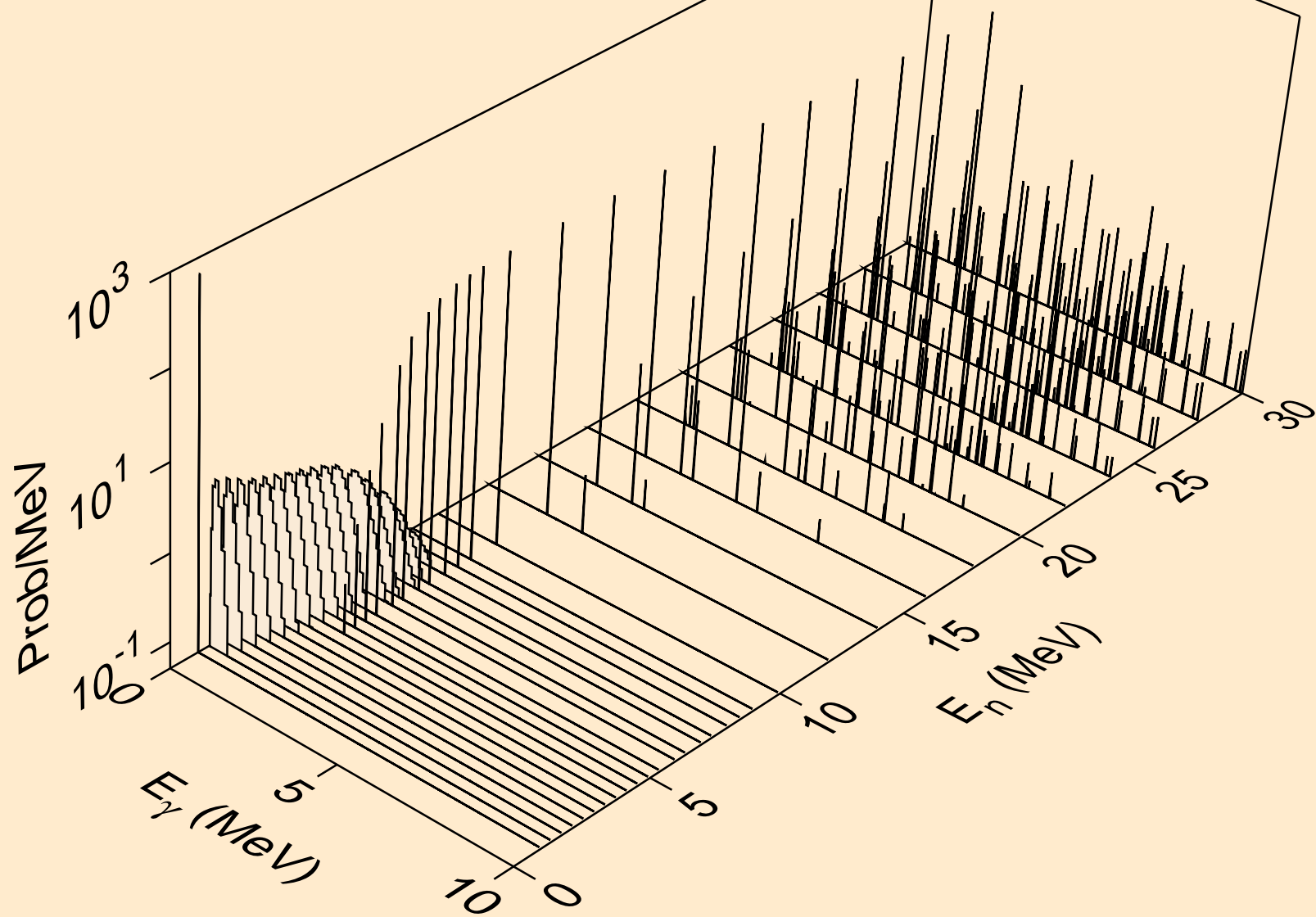

AR035 NEUTRON ACER TENDL-2024 LIBRARY; T=293.6K
Photon emission for (n,3a)

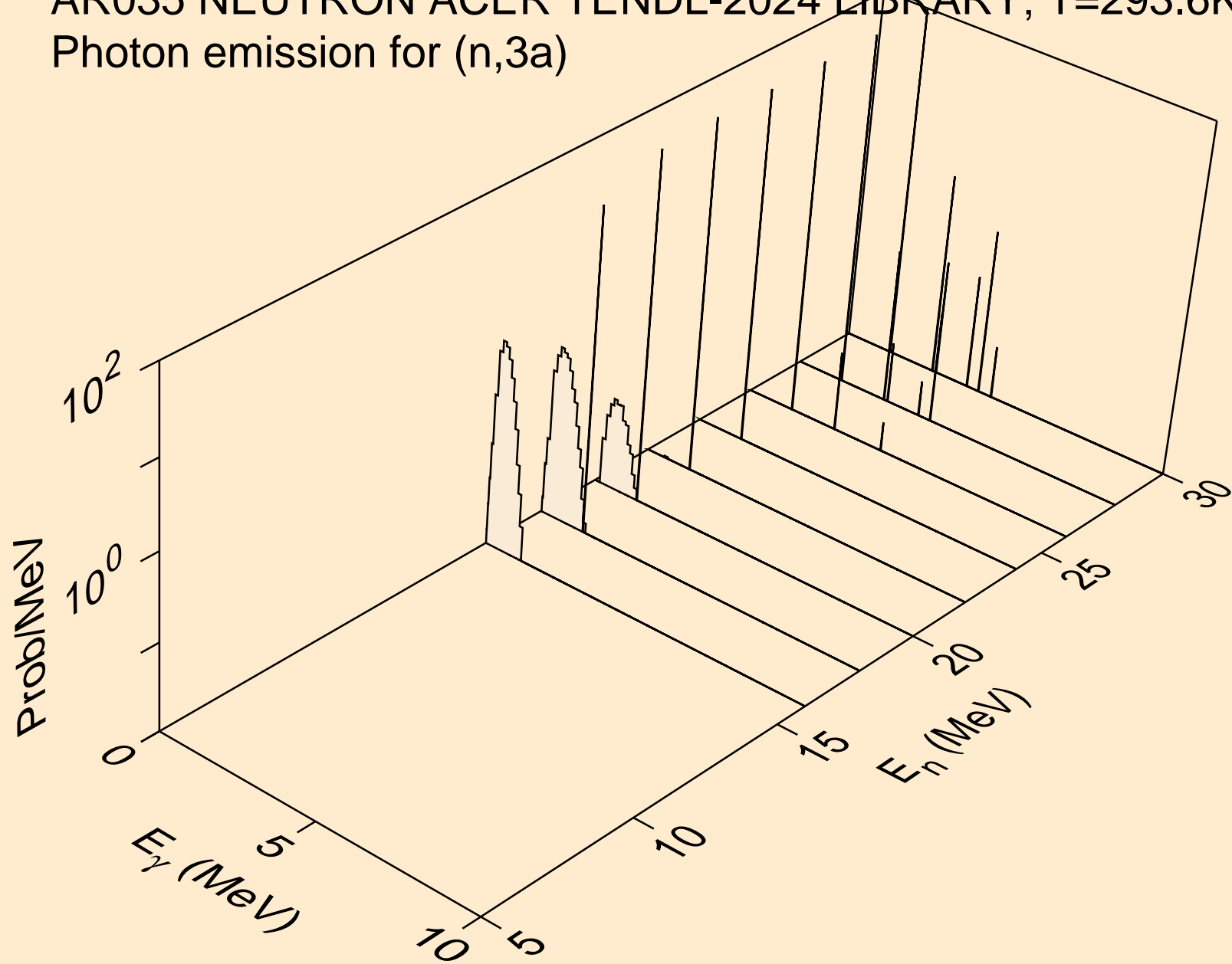

AR035 NEUTRON ACER TENDL-2024 LIBRARY; T=293.6K
Photon emission for (n,2p)

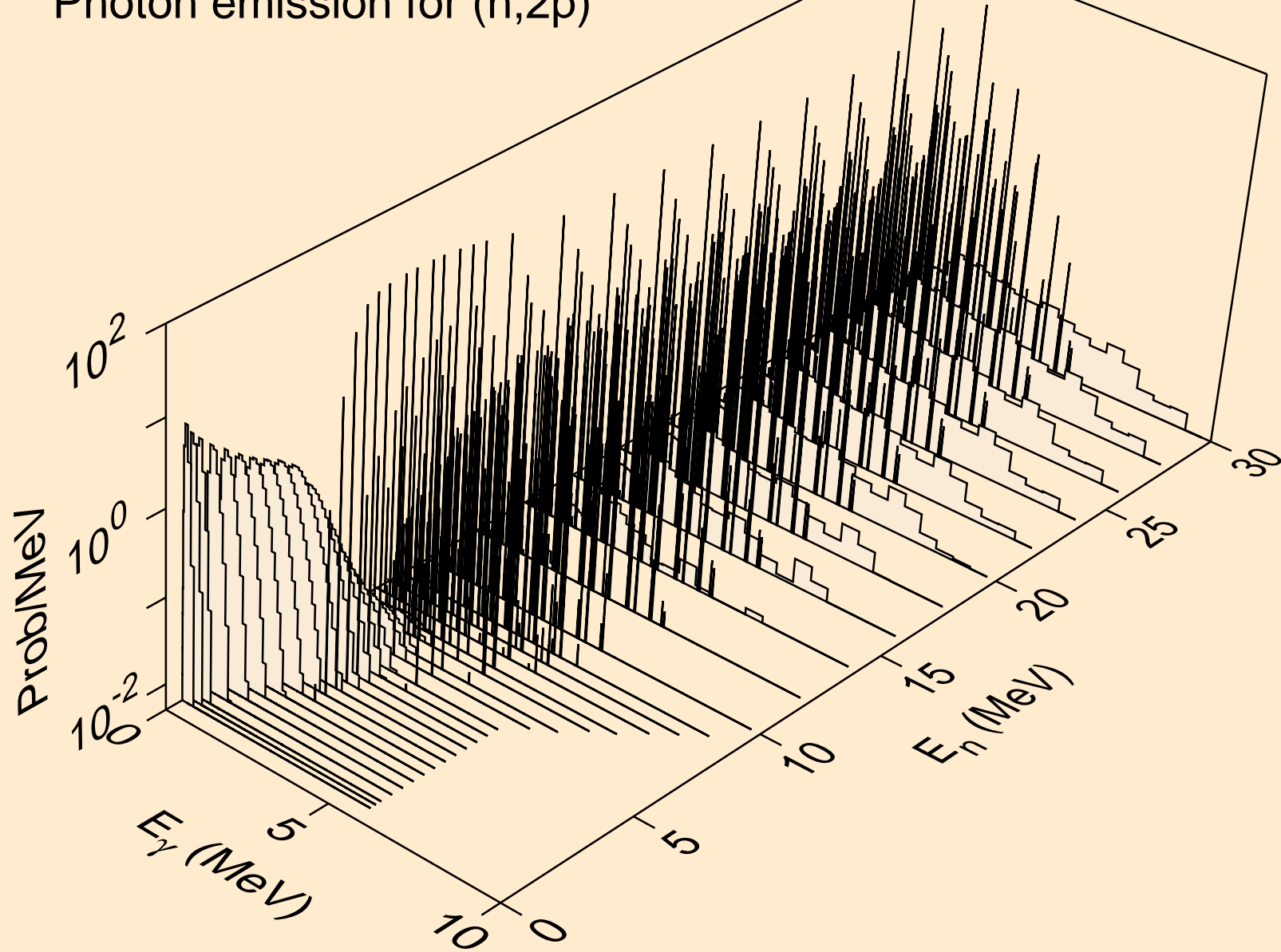

AR035 NEUTRON ACER TENDL-2024 LIBRARY; T=293.6K
Photon emission for (n,p α)

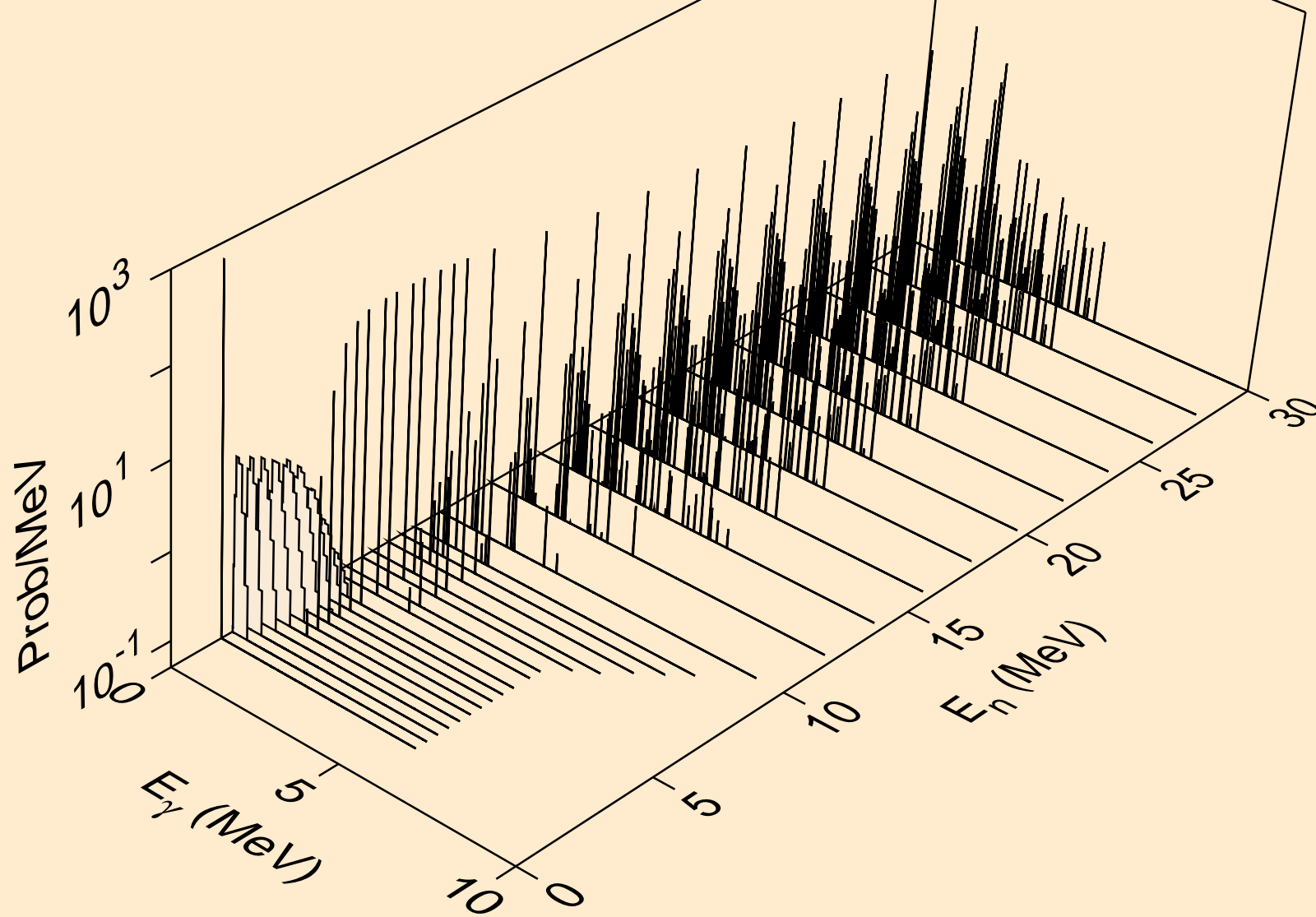

AR035 NEUTRON ACER TENDL-2024 LIBRARY; T=293.6K
Photon emission for (n,pd)

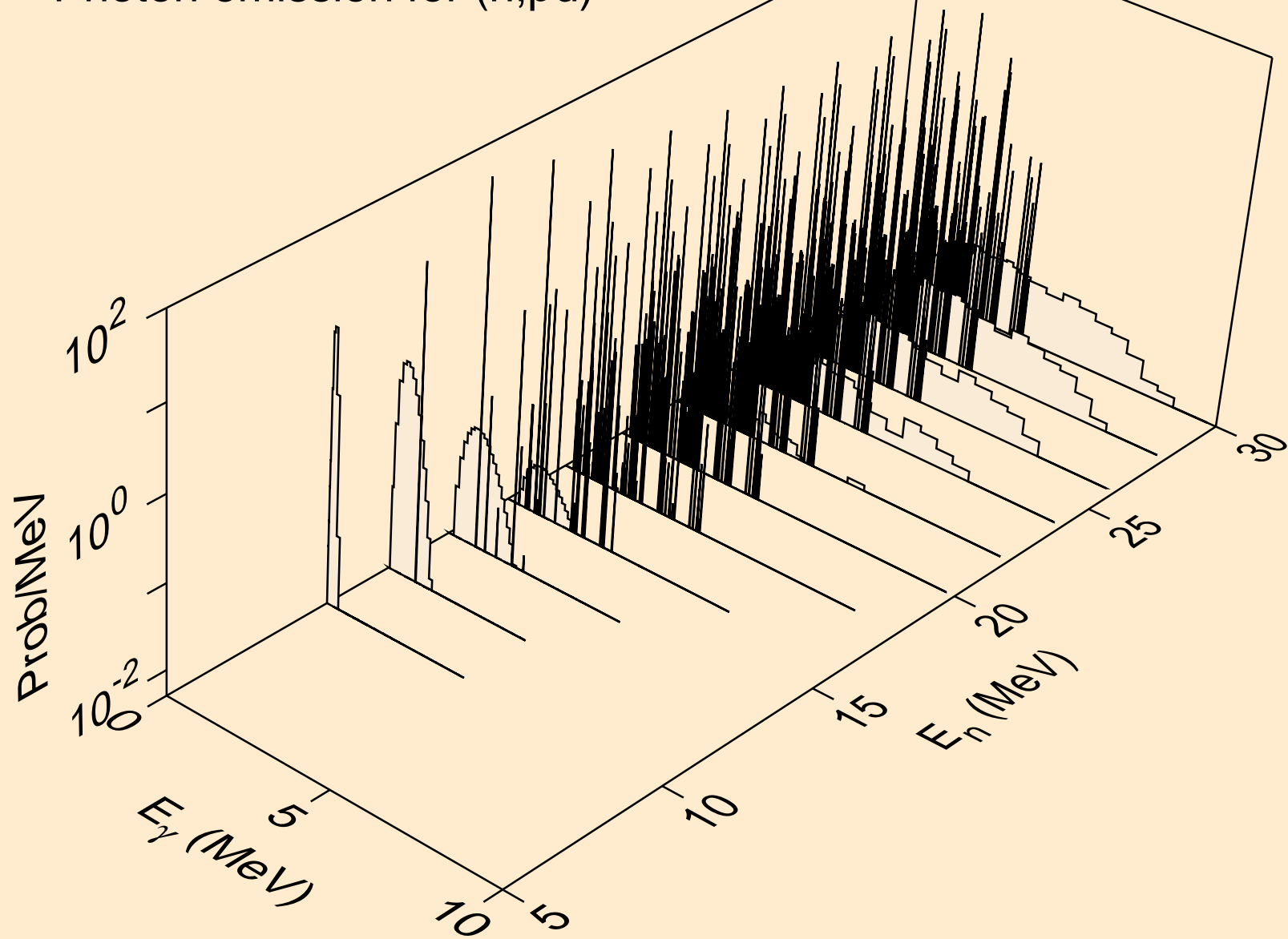

AR035 NEUTRON ACER TENDL-2024 LIBRARY; T=293.6K
Photon emission for (n,pt)

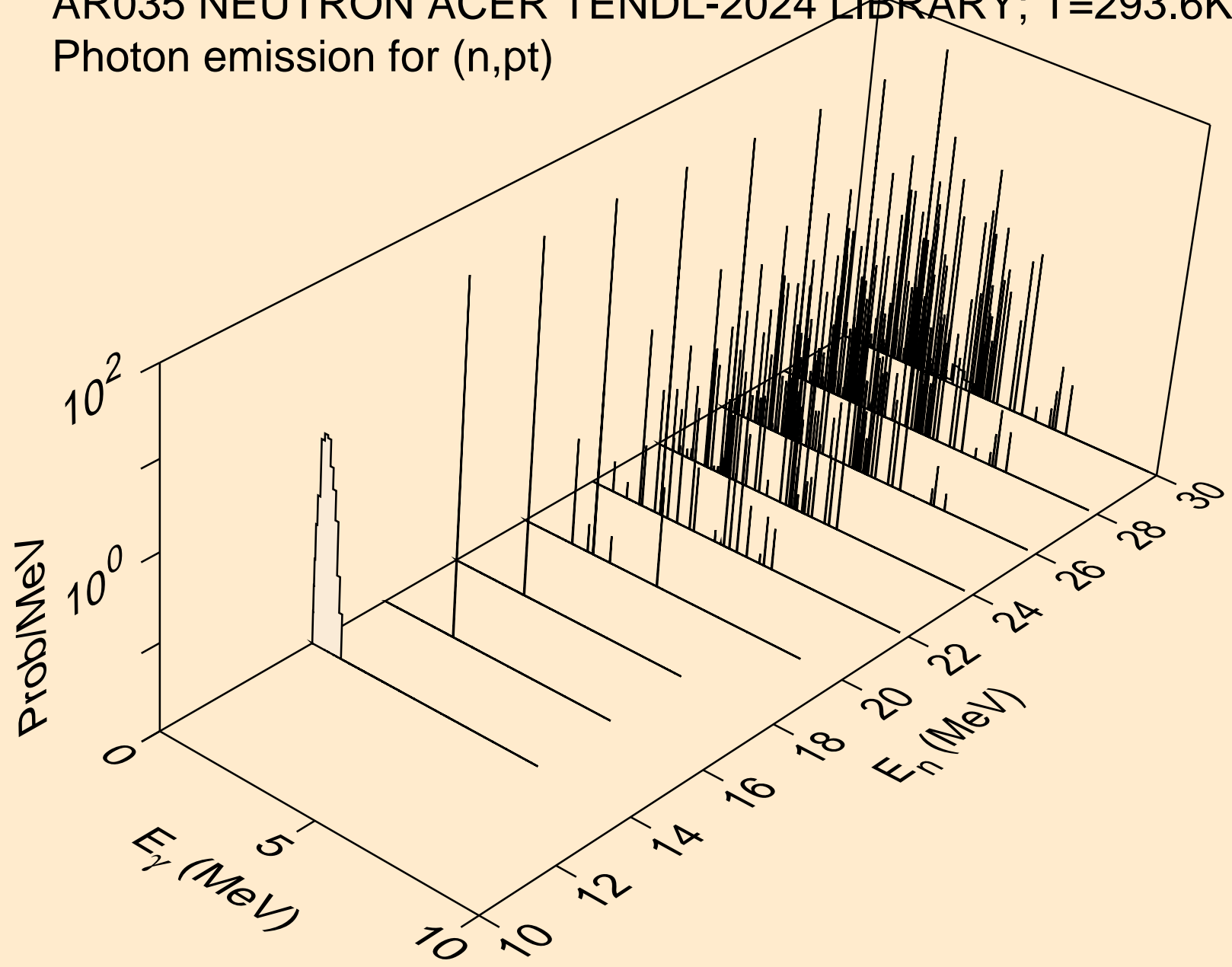

AR035 NEUTRON ACER TENDL-2024 LIBRARY; T=293.6K
Photon emission for (n,da)

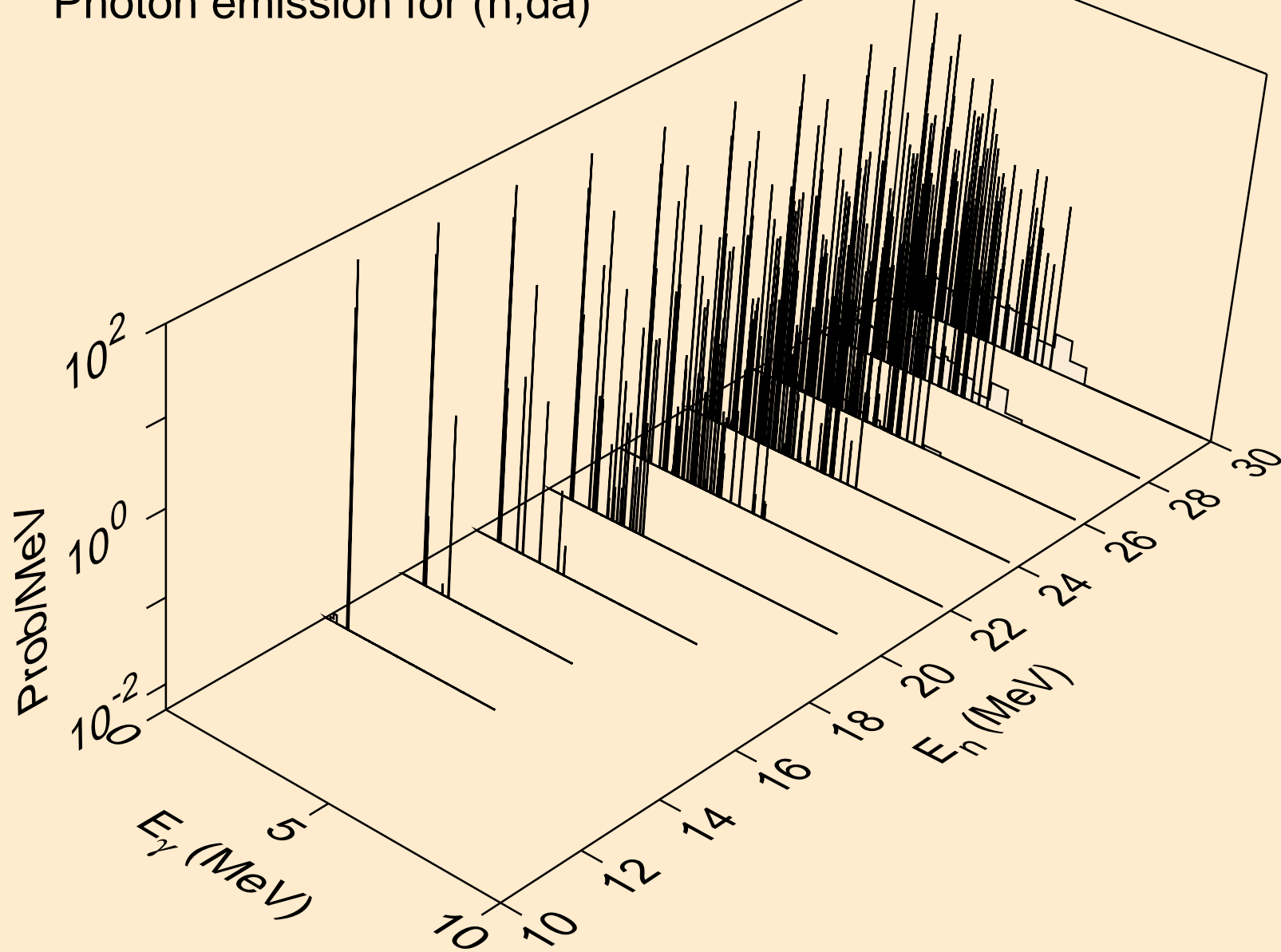

AR035 NEUTRON ACER TENDL-2024 LIBRARY; T=293.6K
thermal capture photon spectrum

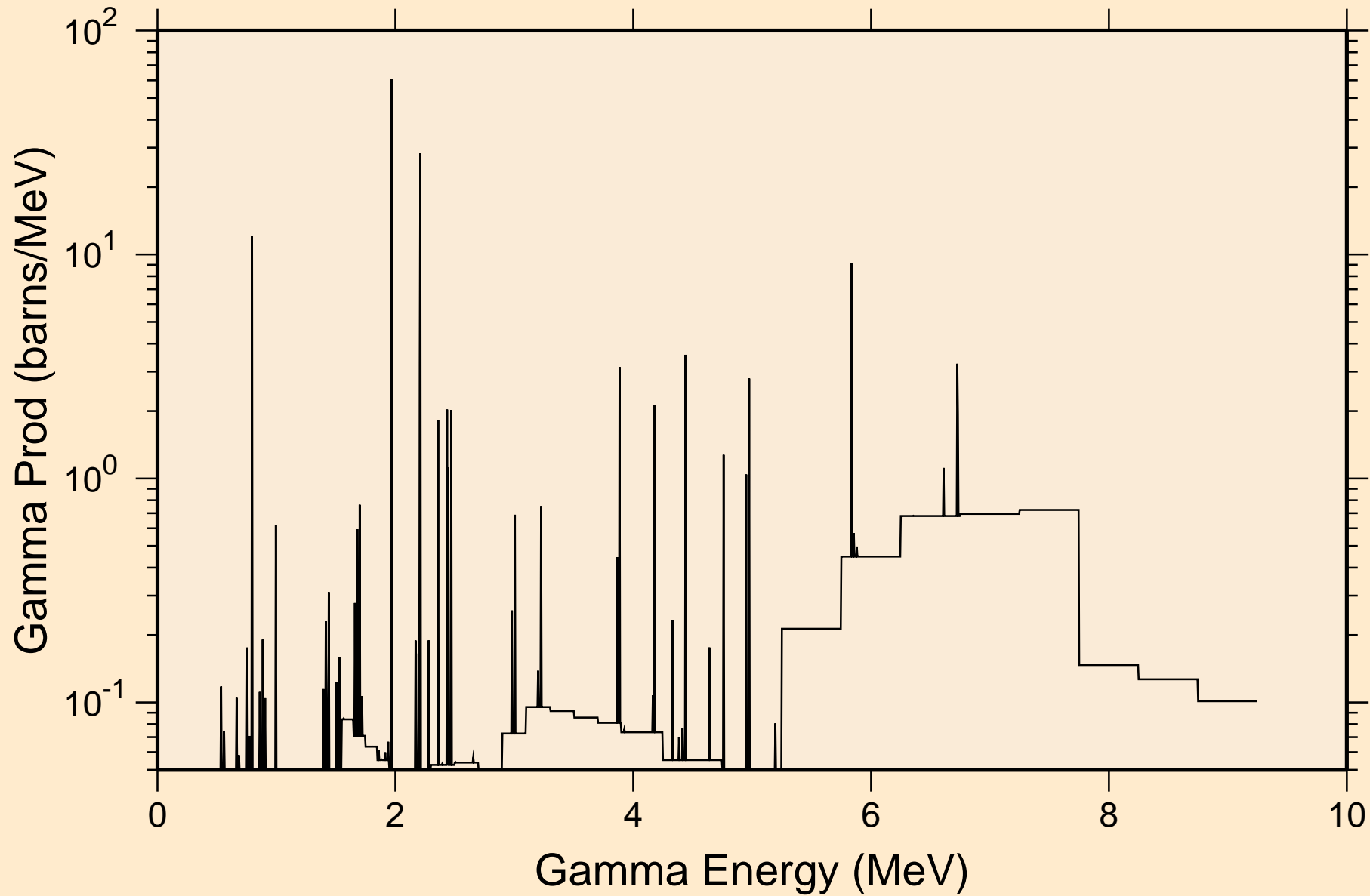

AR035 NEUTRON ACER TENDL-2024 LIBRARY; T=293.6K
14 MeV photon spectrum

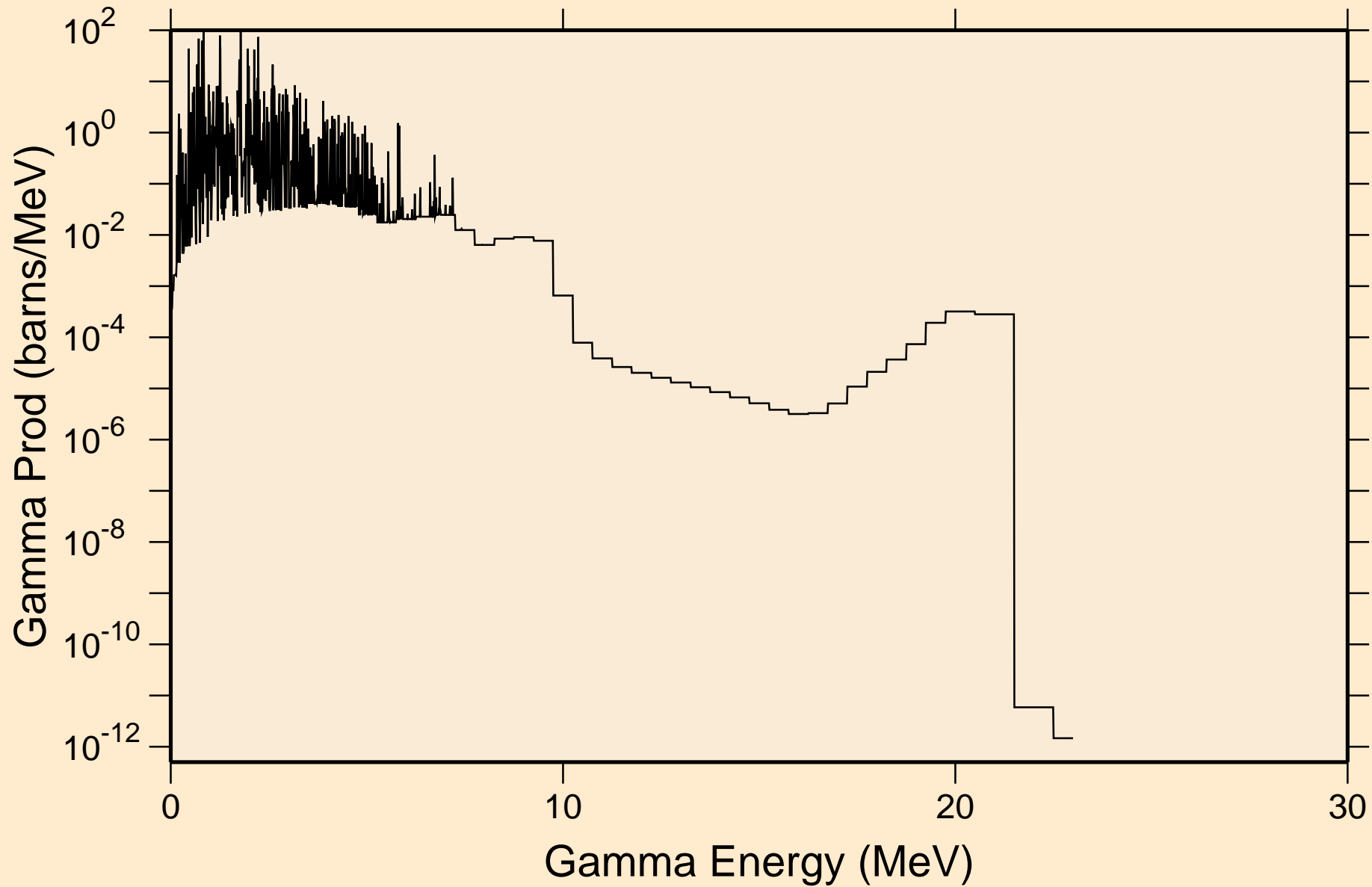

AR035 NEUTRON ACER TENDL-2024 LIBRARY; T=293.6K

Particle heating contributions

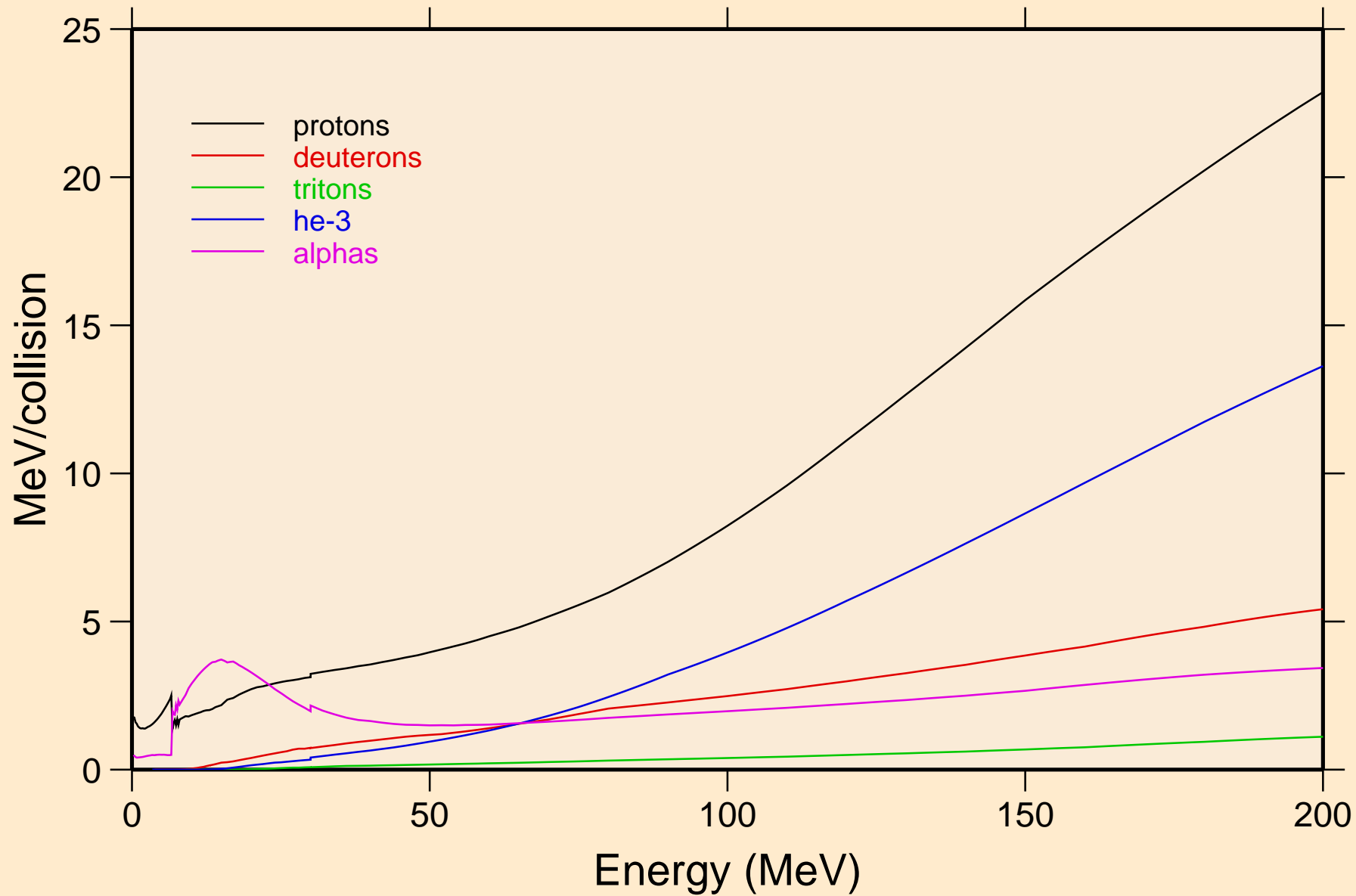

AR035 NEUTRON ACER TENDL-2024 LIBRARY; T=293.6K
Recoil Heating

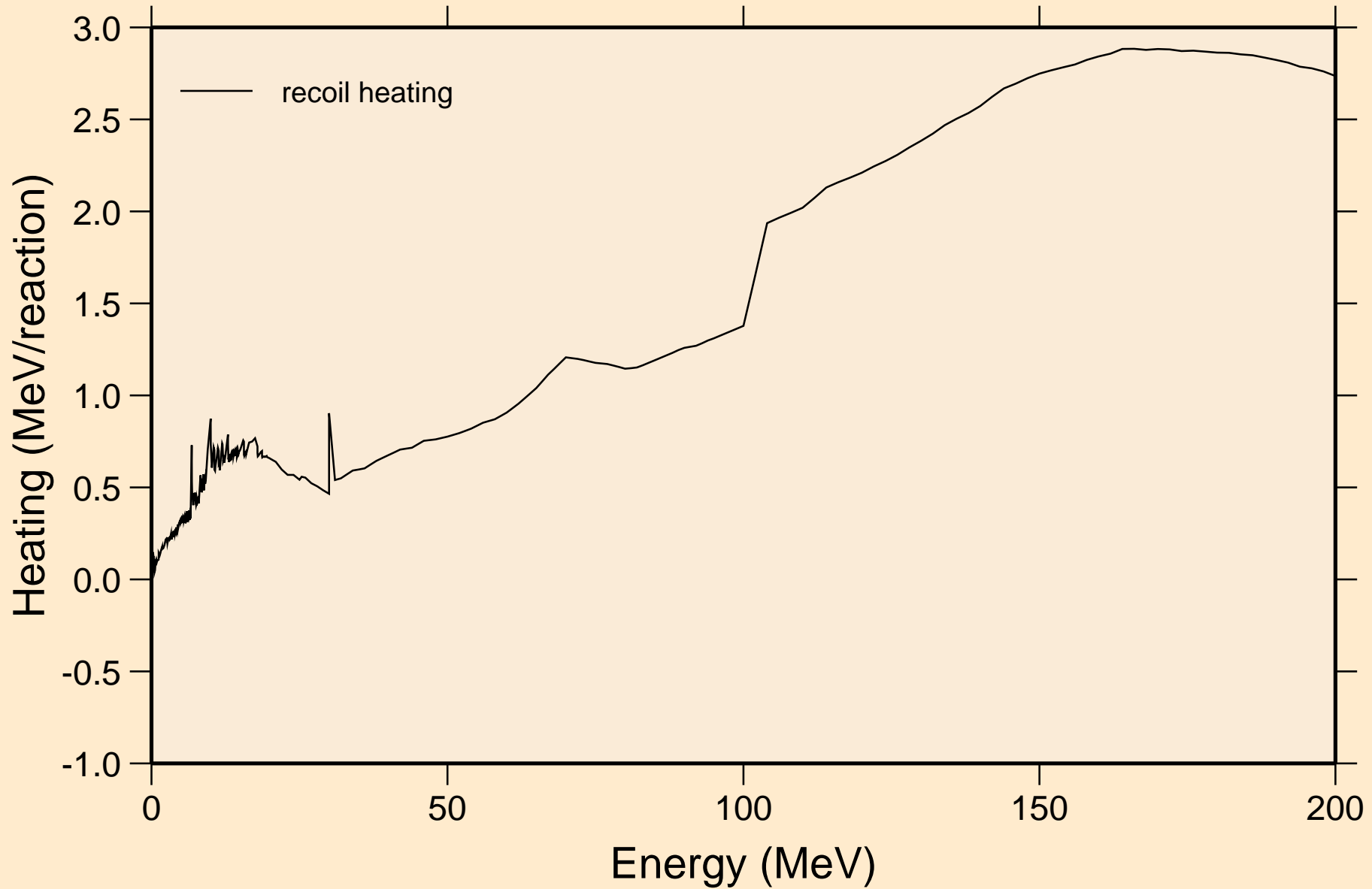

AR035 NEUTRON ACER TENDL-2024 LIBRARY; T=293.6K

Particle production cross sections

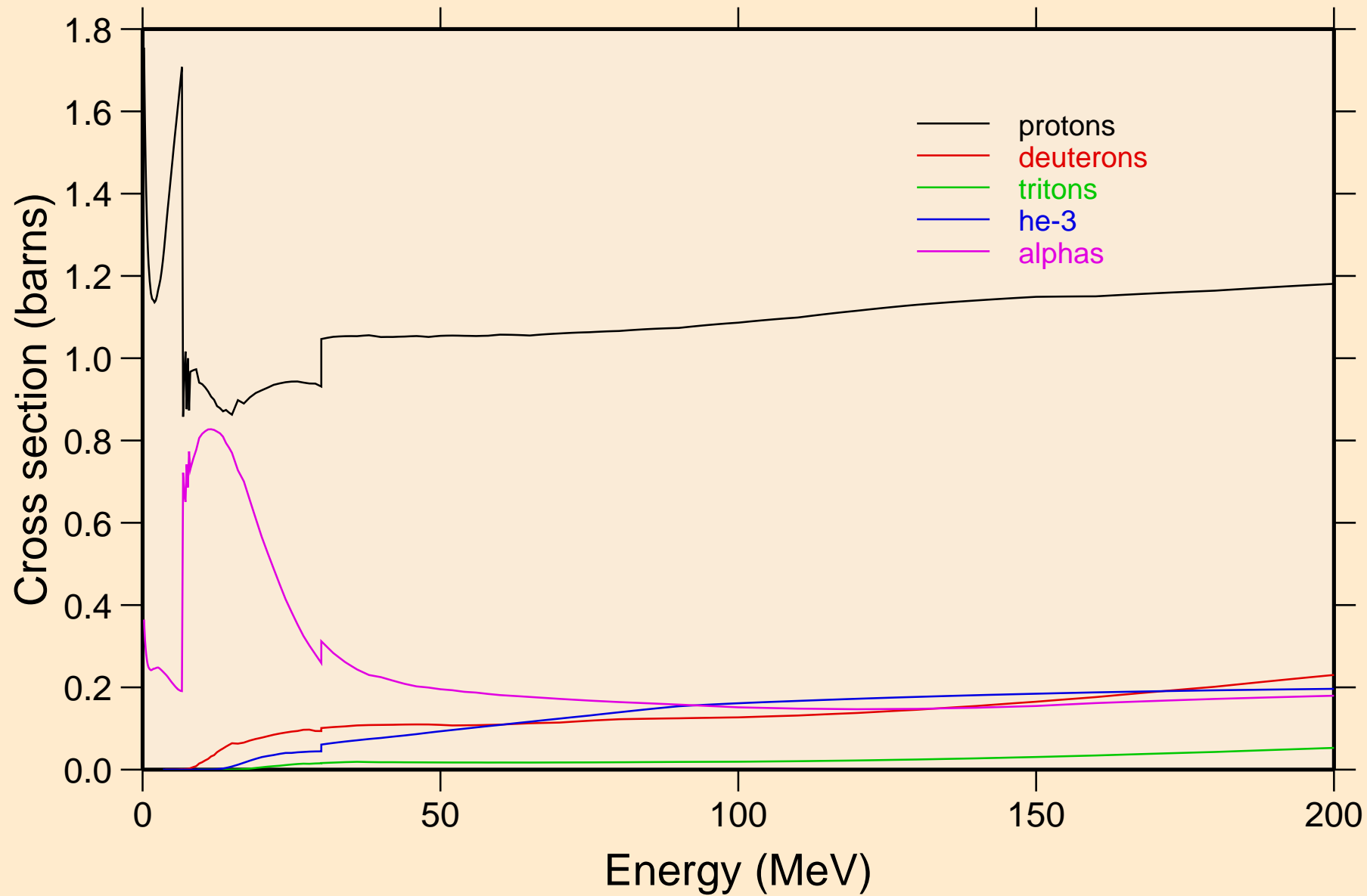

AR035 NEUTRON ACER TENDL-2024 LIBRARY; T=293.6K
protons from (n,x)

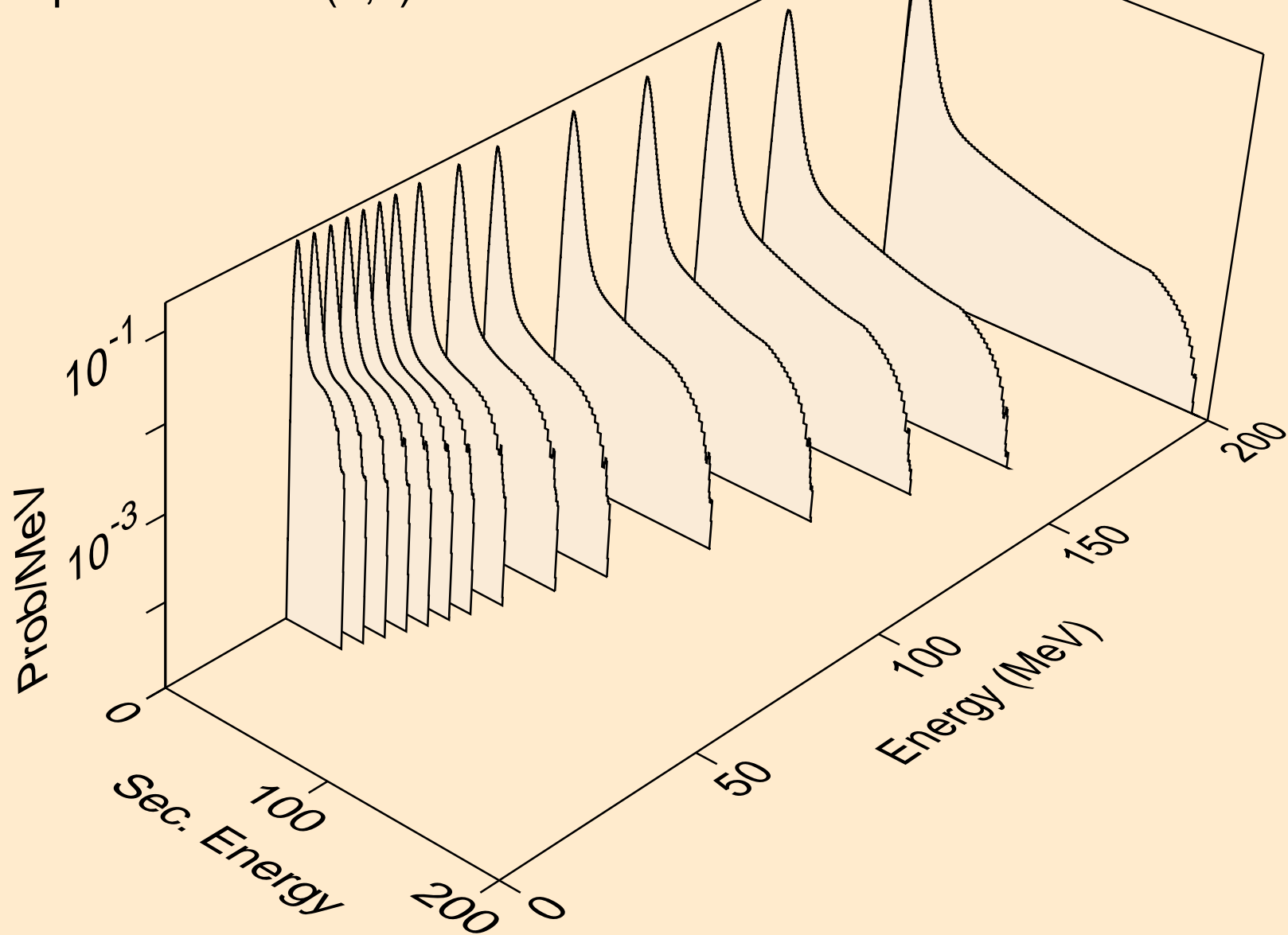

AR035 NEUTRON ACER TENDL-2024 LIBRARY; T=293.6K
protons from (n,n*)p

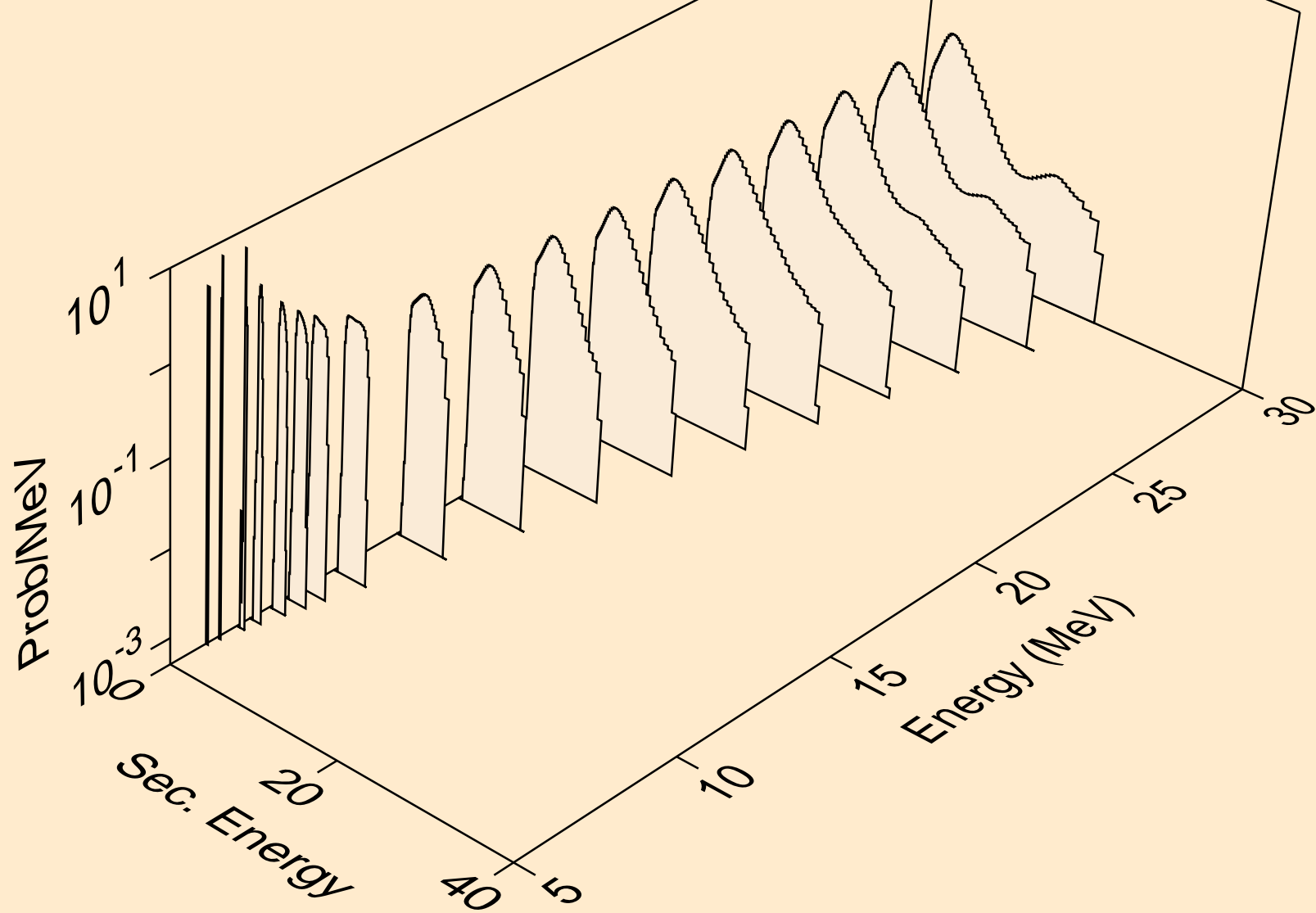

AR035 NEUTRON ACER TENDL-2024 LIBRARY; T=293.6K
protons from (n,2np)

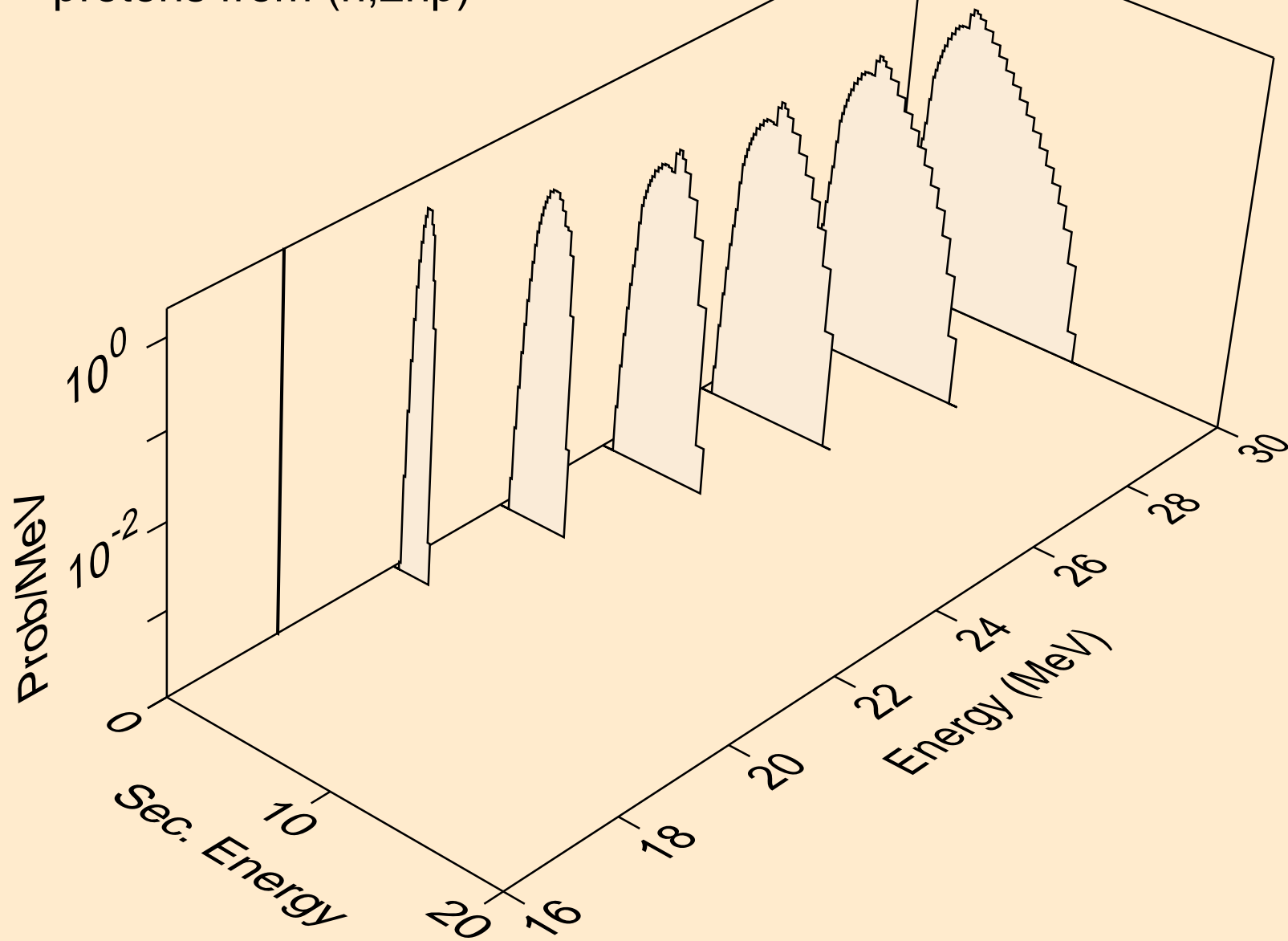

AR035 NEUTRON ACER TENDL-2024 LIBRARY; T=293.6K
protons from (n,n2p)

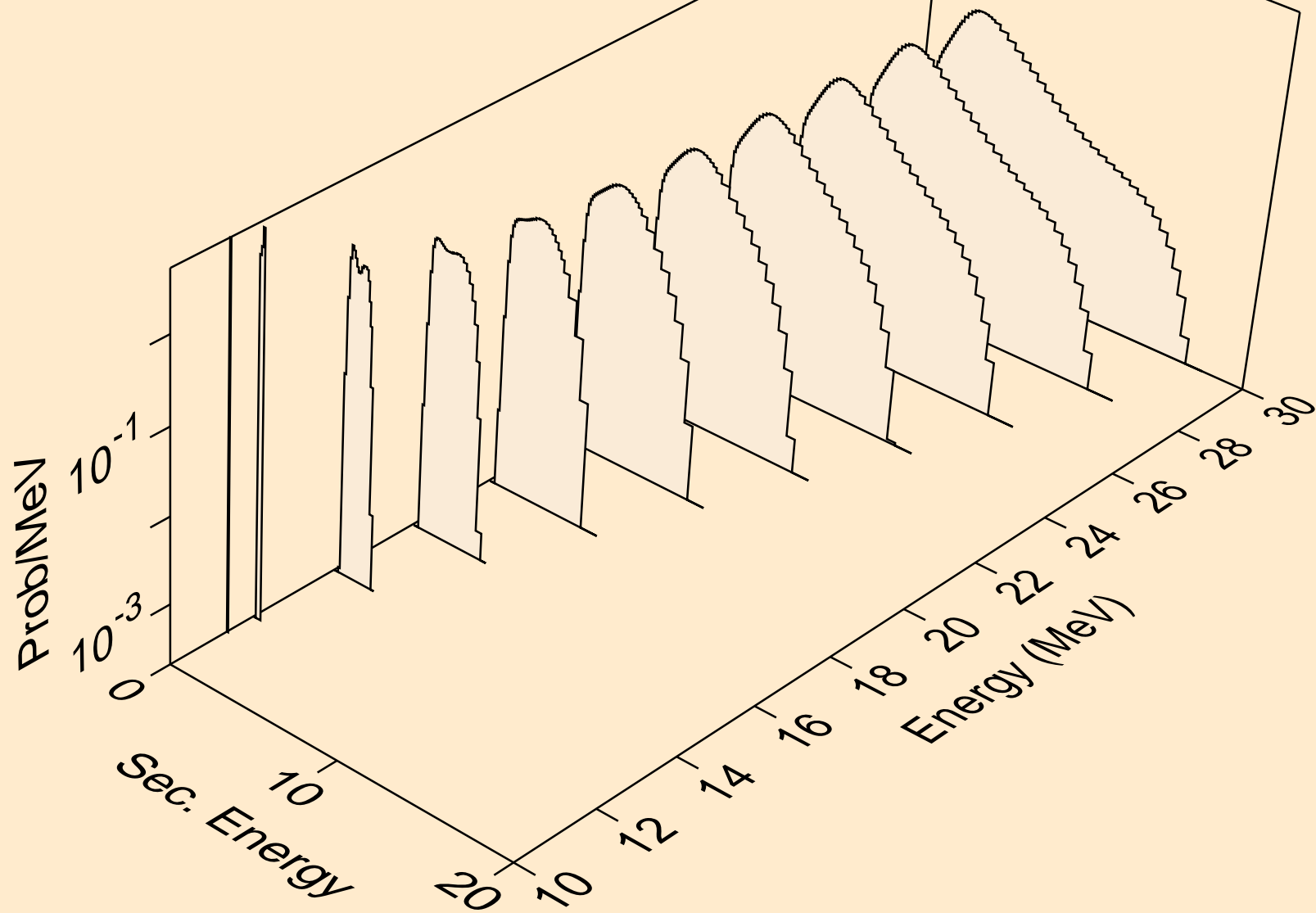

AR035 NEUTRON ACER TENDL-2024 LIBRARY; T=293.6K
protons from (n,npa)

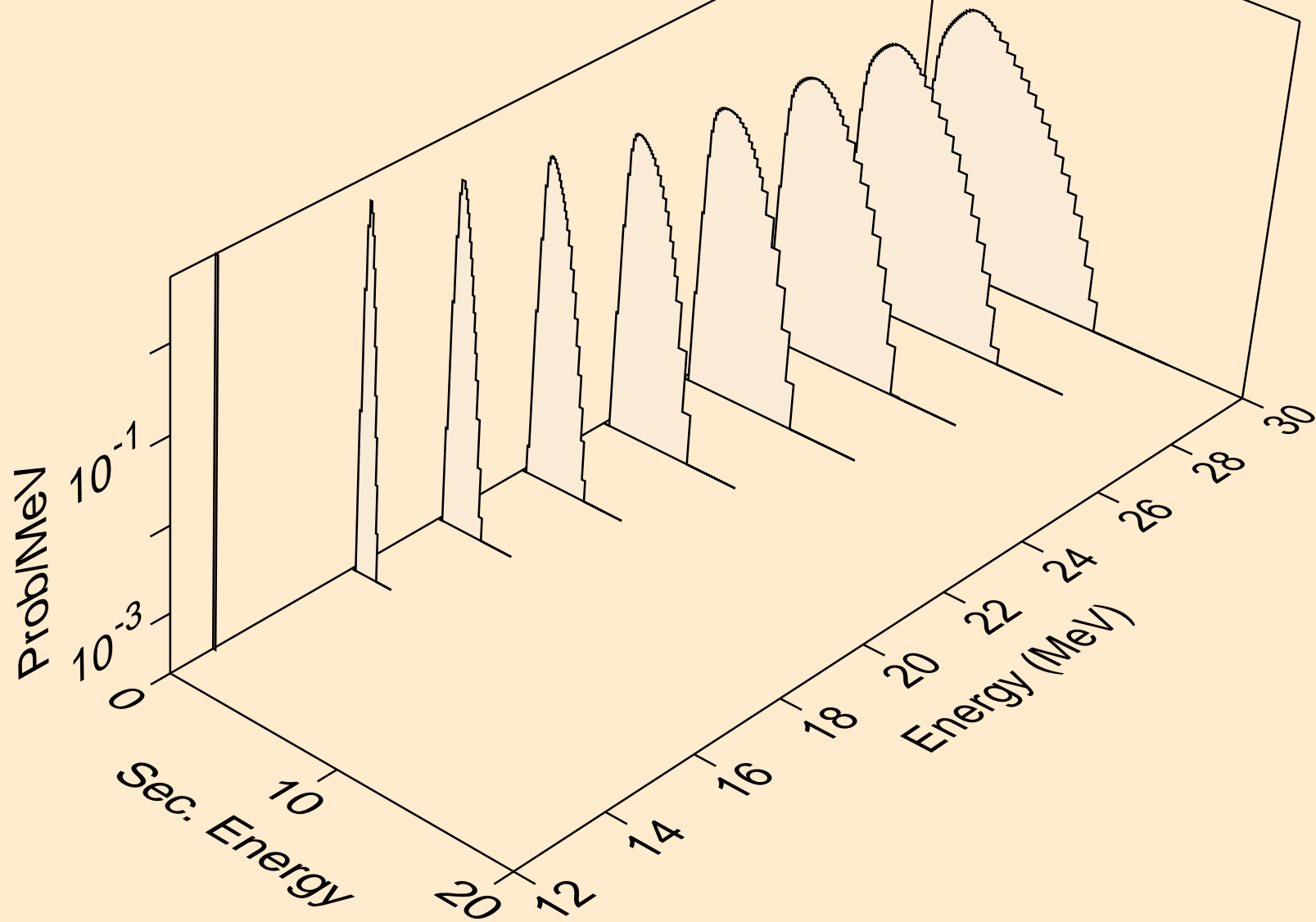

AR035 NEUTRON ACER TENDL-2024 LIBRARY; T=293.6K
protons from (n,p)

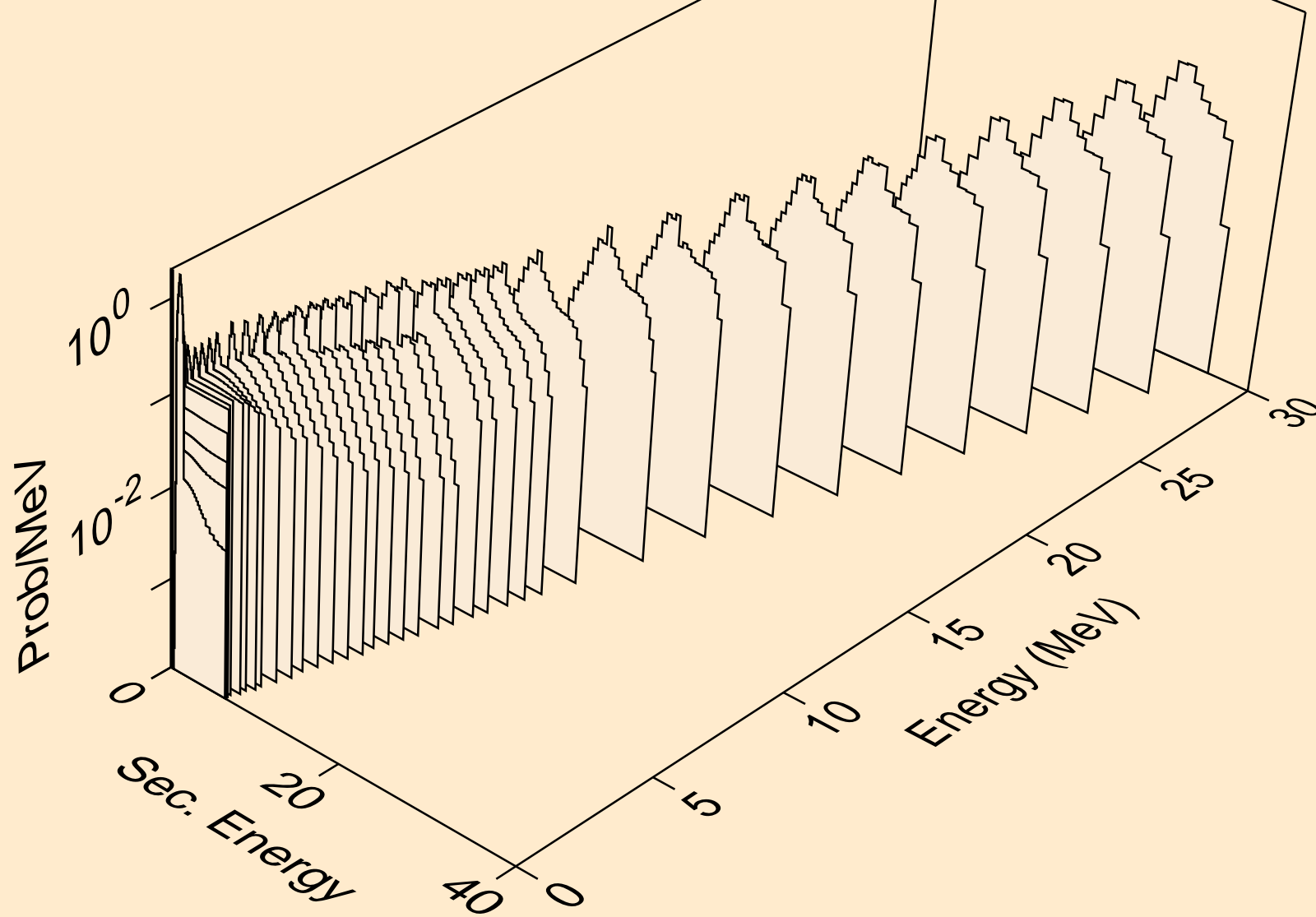

AR035 NEUTRON ACER TENDL-2024 LIBRARY; T=293.6K
protons from (n,2p)

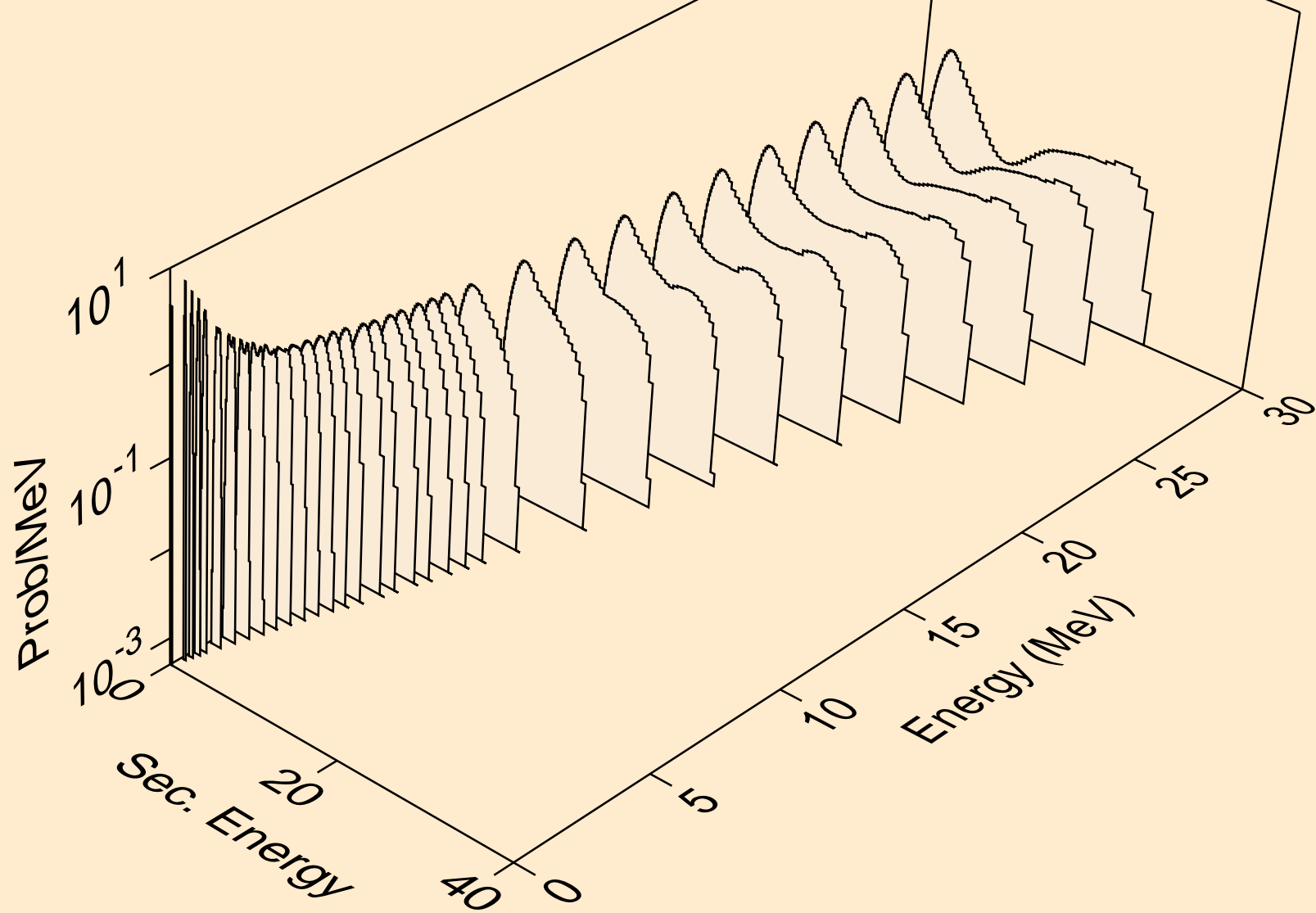

AR035 NEUTRON ACER TENDL-2024 LIBRARY; T=293.6K
protons from (n,p)

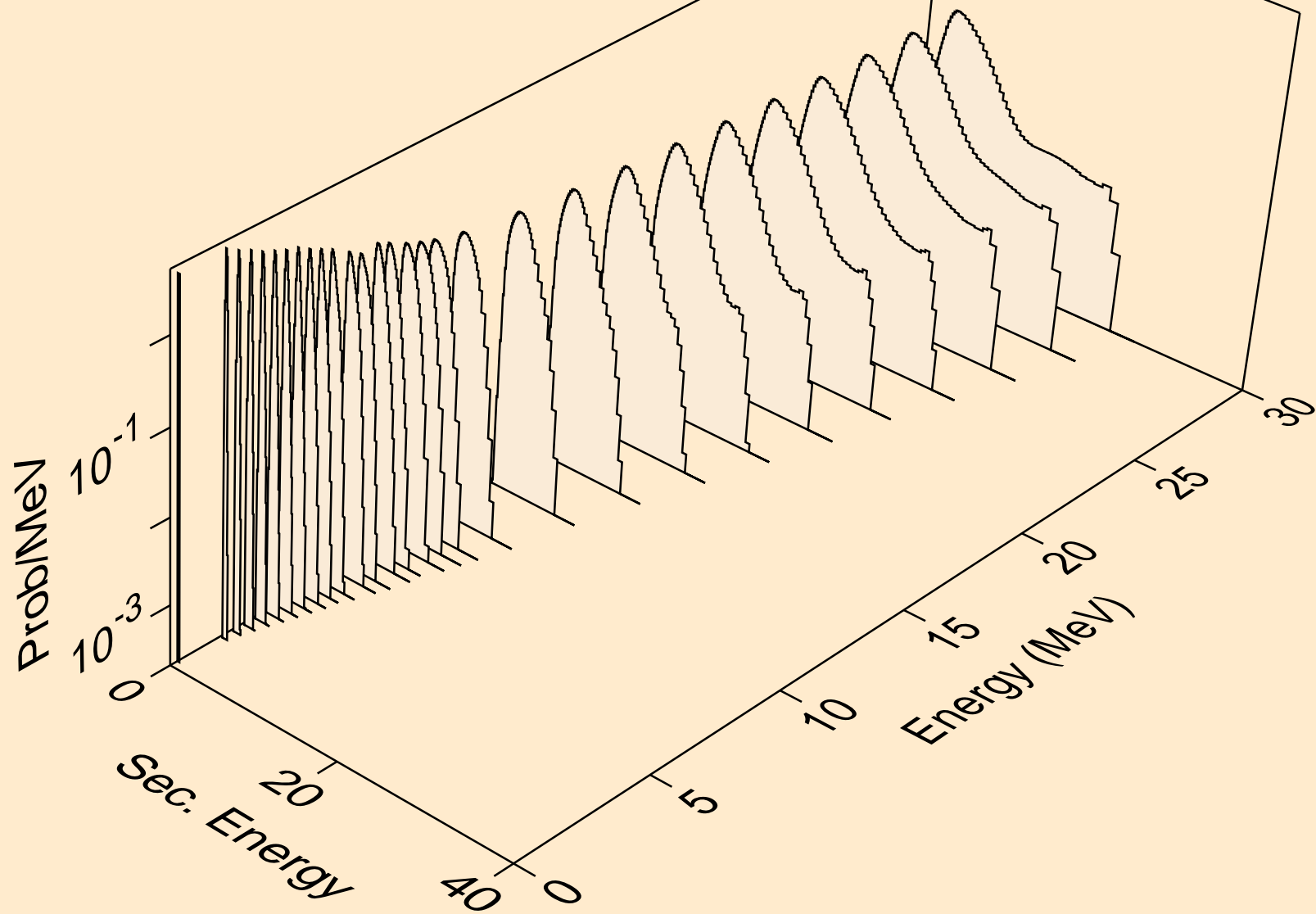

AR035 NEUTRON ACER TENDL-2024 LIBRARY; T=293.6K
protons from (n,pd)

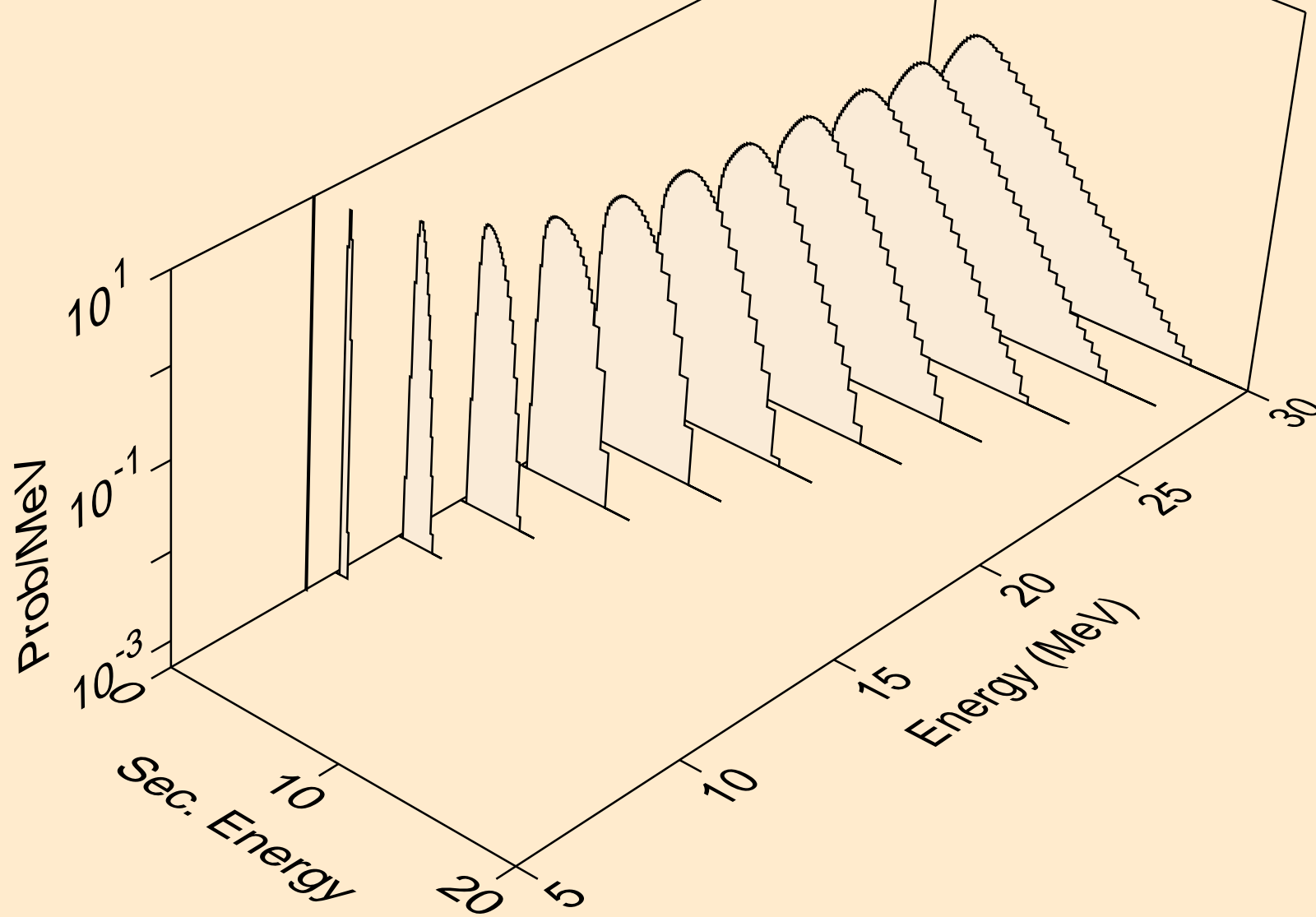

AR035 NEUTRON ACER TENDL-2024 LIBRARY; T=293.6K
protons from (n,pt)

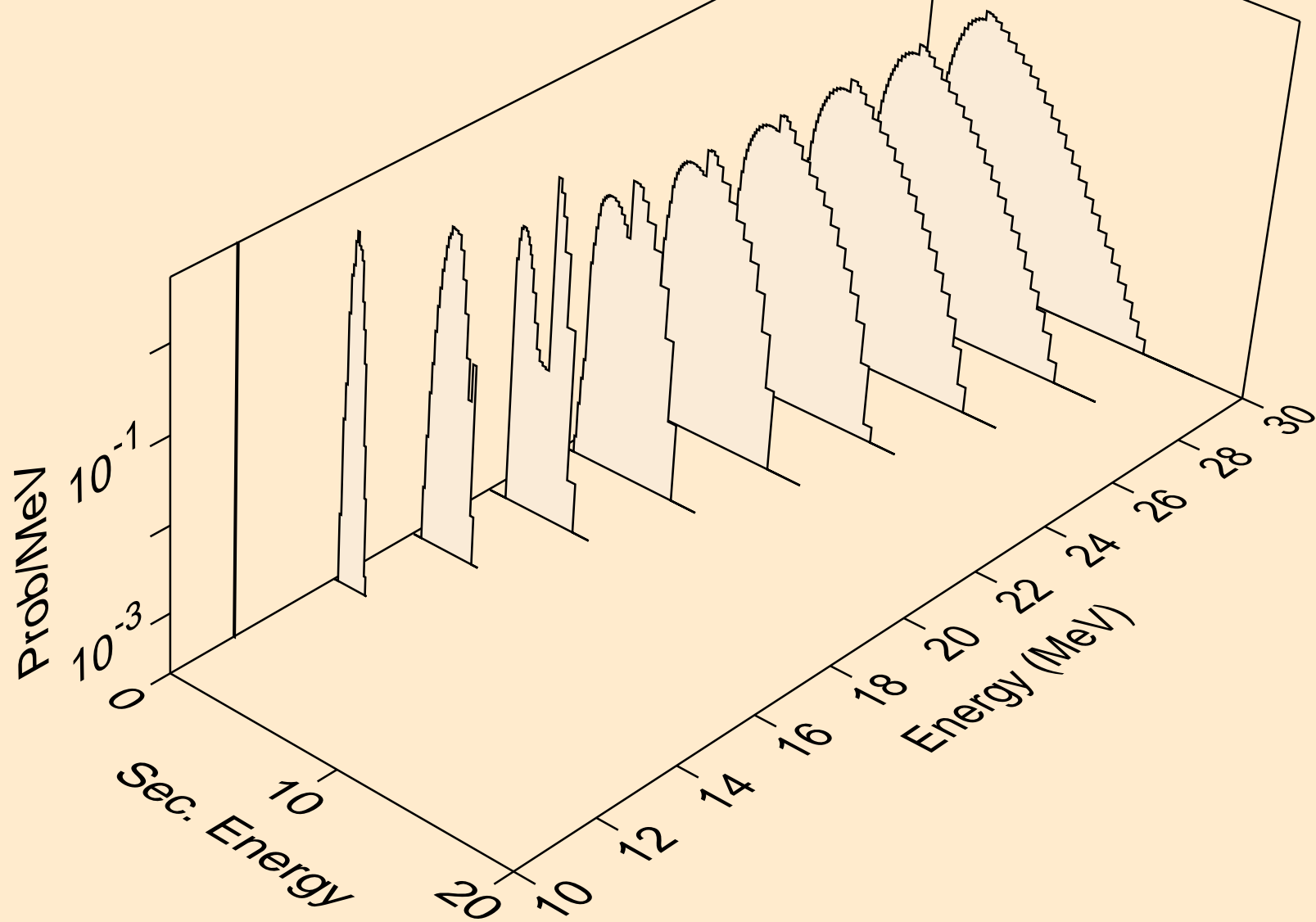

AR035 NEUTRON ACER TENDL-2024 LIBRARY; T=293.6K
deuterons from (n,x)

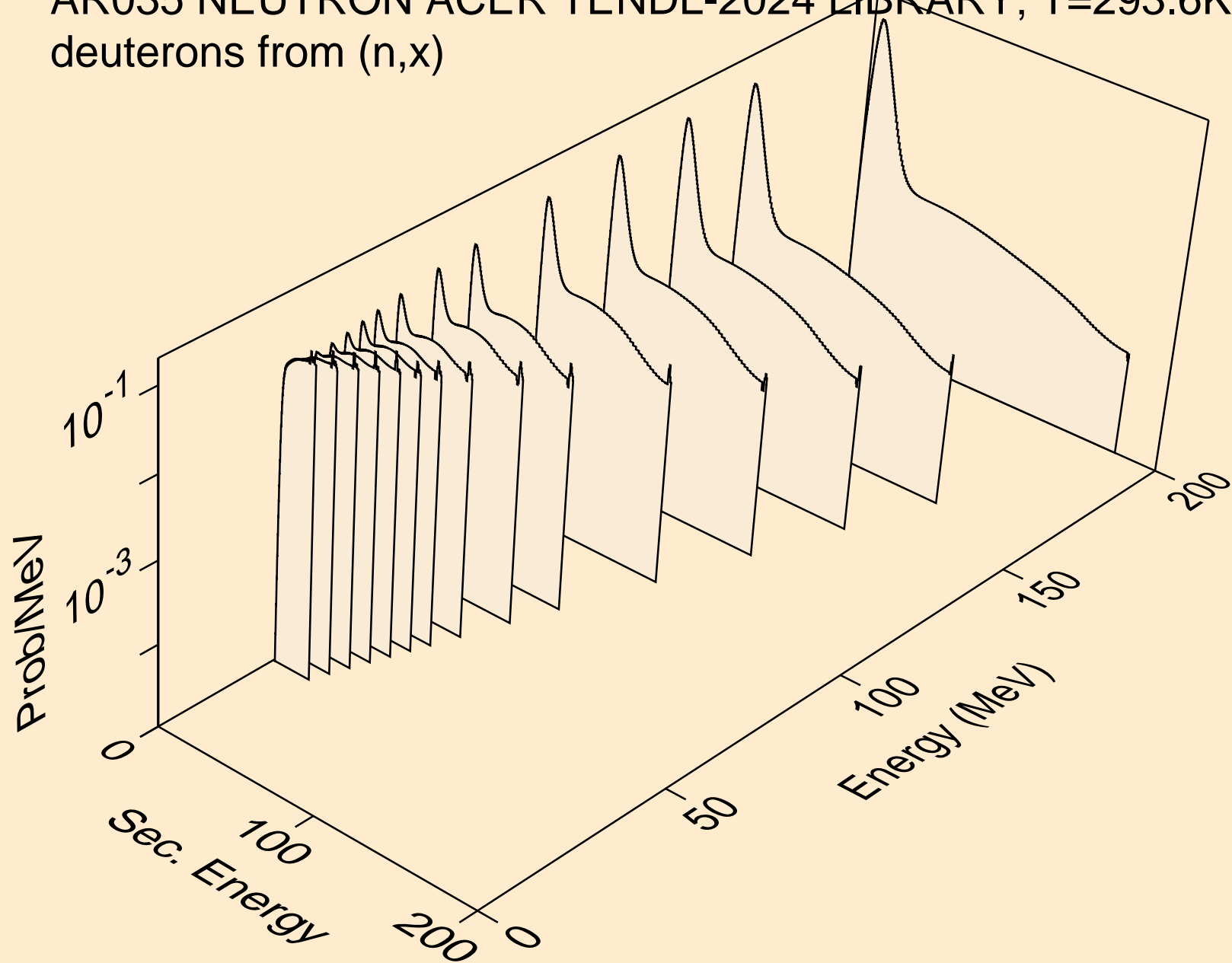

AR035 NEUTRON ACER TENDL-2024 LIBRARY; T=293.6K
deuterons from (n,n*)d

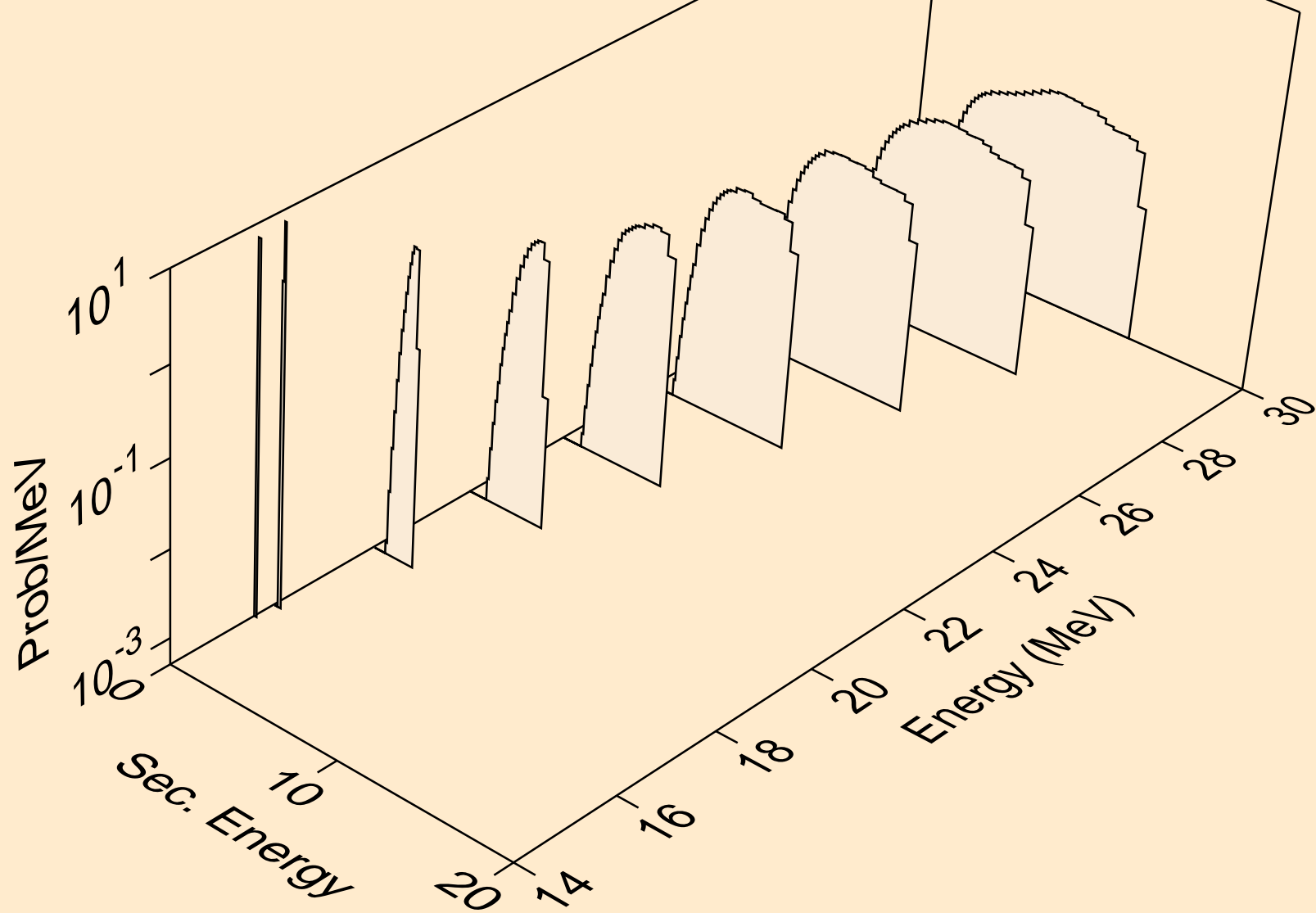

AR035 NEUTRON ACER TENDL-2024 LIBRARY; T=293.6K
deuterons from (n,d)

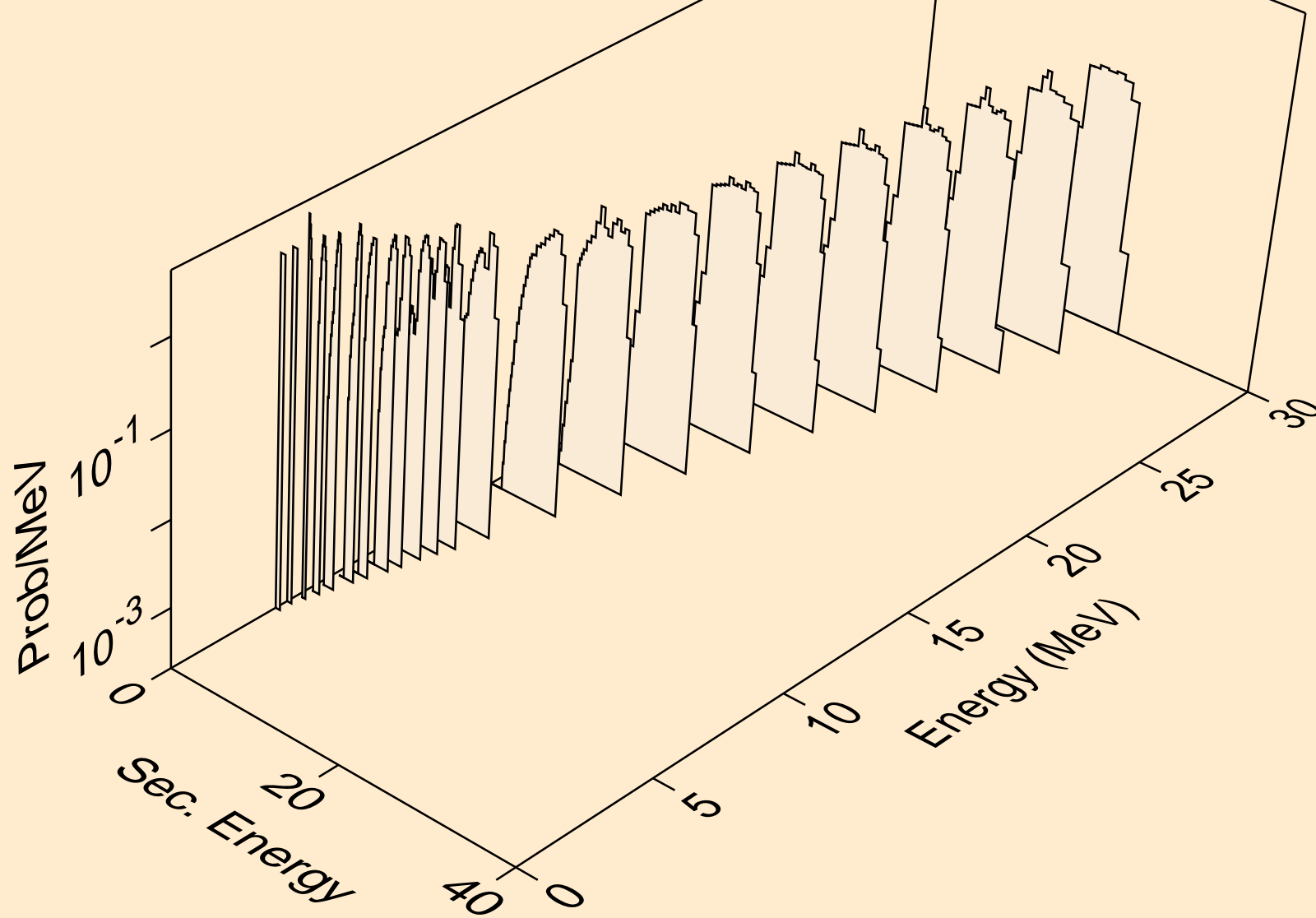

AR035 NEUTRON ACER TENDL-2024 LIBRARY; T=293.6K
deuterons from (n,pd)

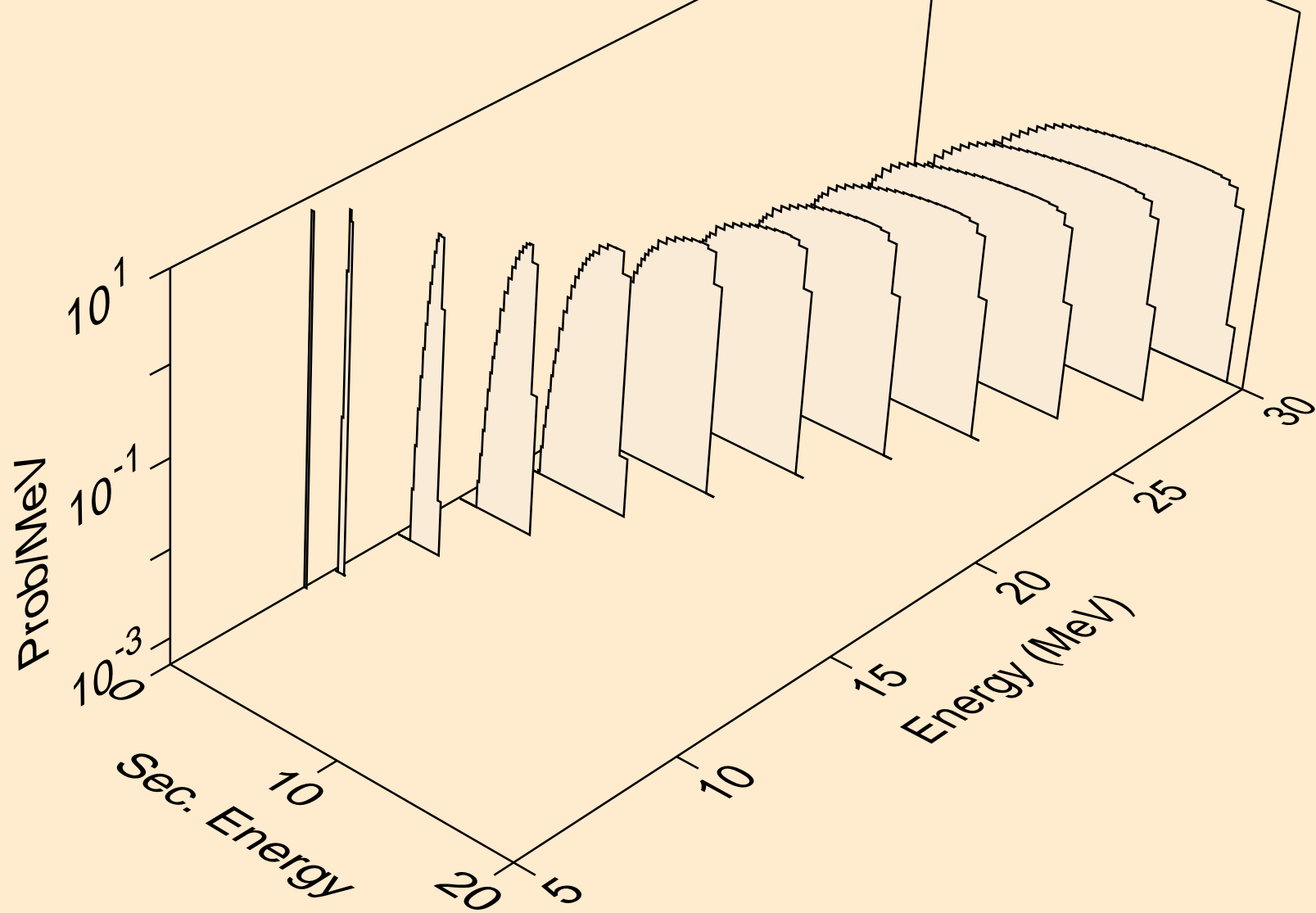

AR035 NEUTRON ACER TENDL-2024 LIBRARY; T=293.6K
deuterons from (n,da)

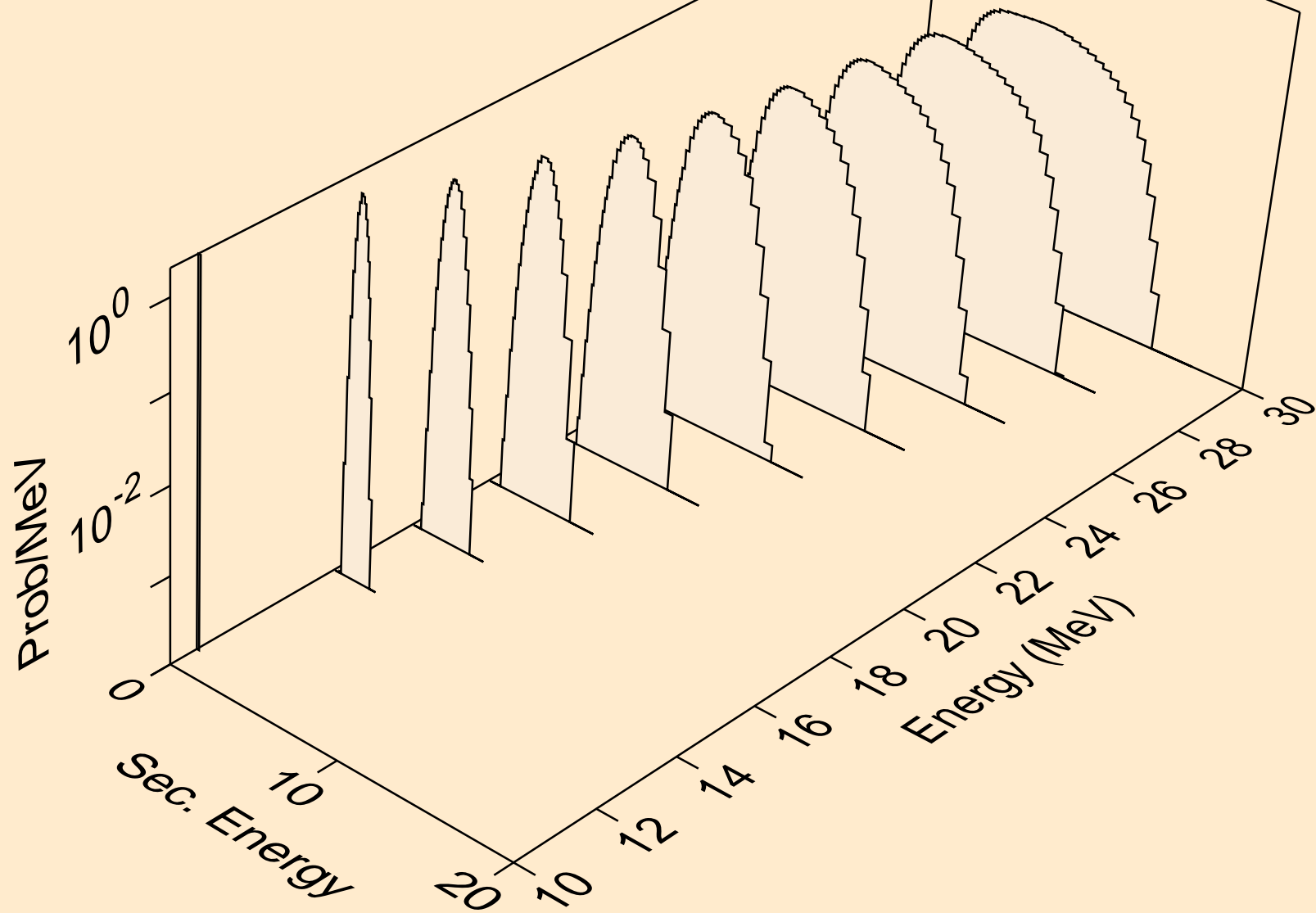

AR035 NEUTRON ACER TENDL-2024 LIBRARY; T=293.6K
tritons from (n,x)

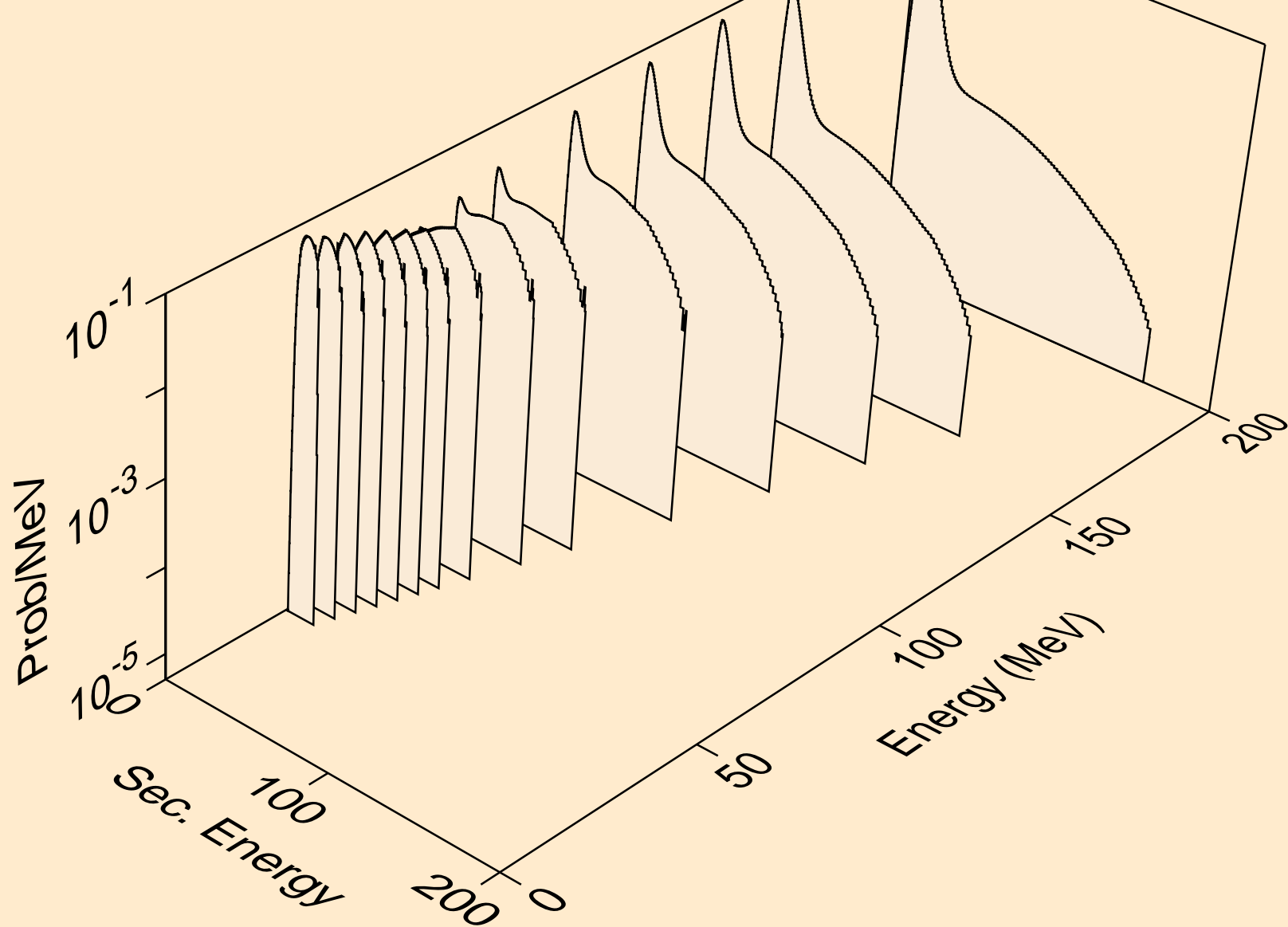

AR035 NEUTRON ACER TENDL-2024 LIBRARY; T=293.6K
tritons from (n,n*)t

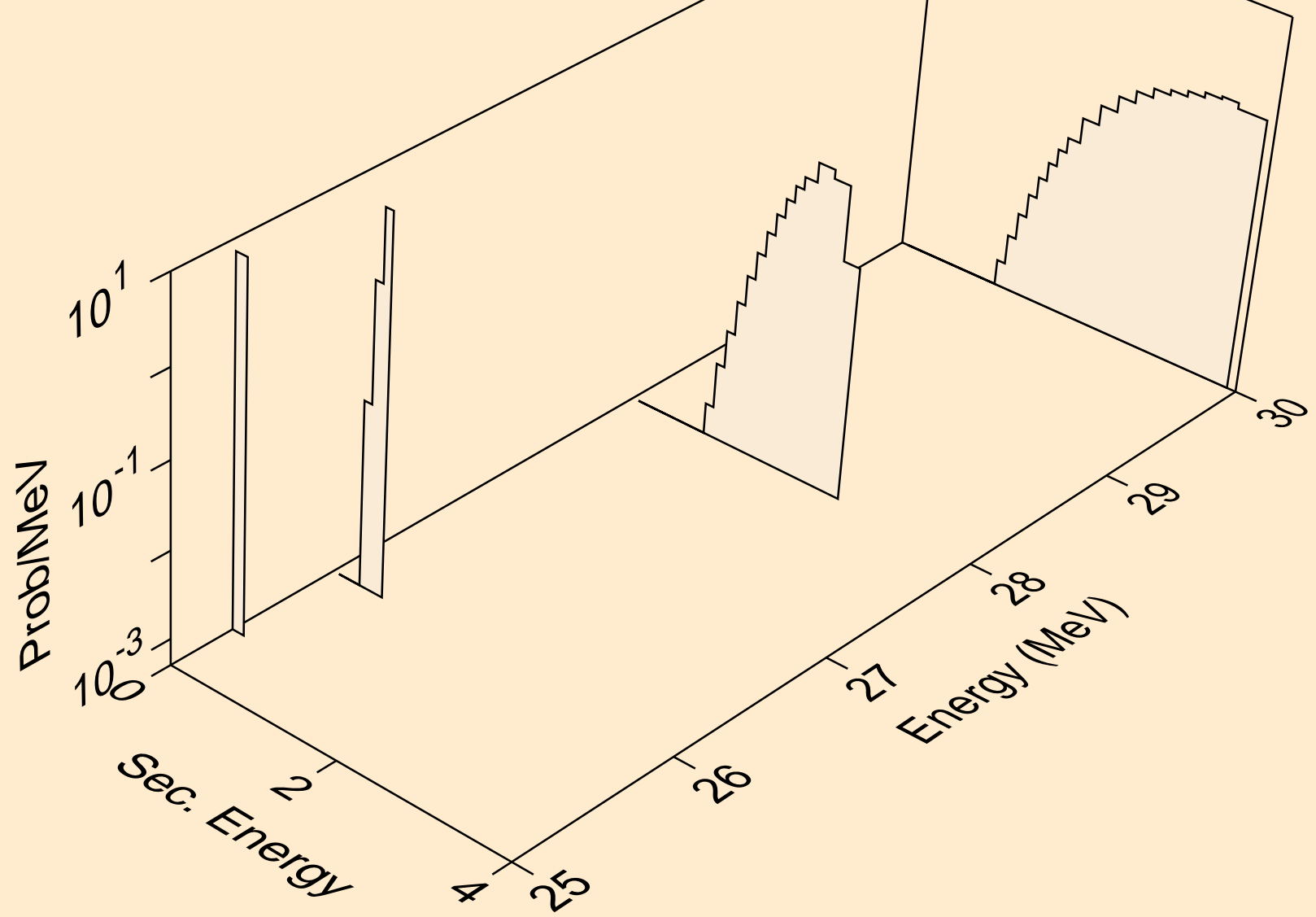

AR035 NEUTRON ACER TENDL-2024 LIBRARY; T=293.6K
tritons from (n,t)

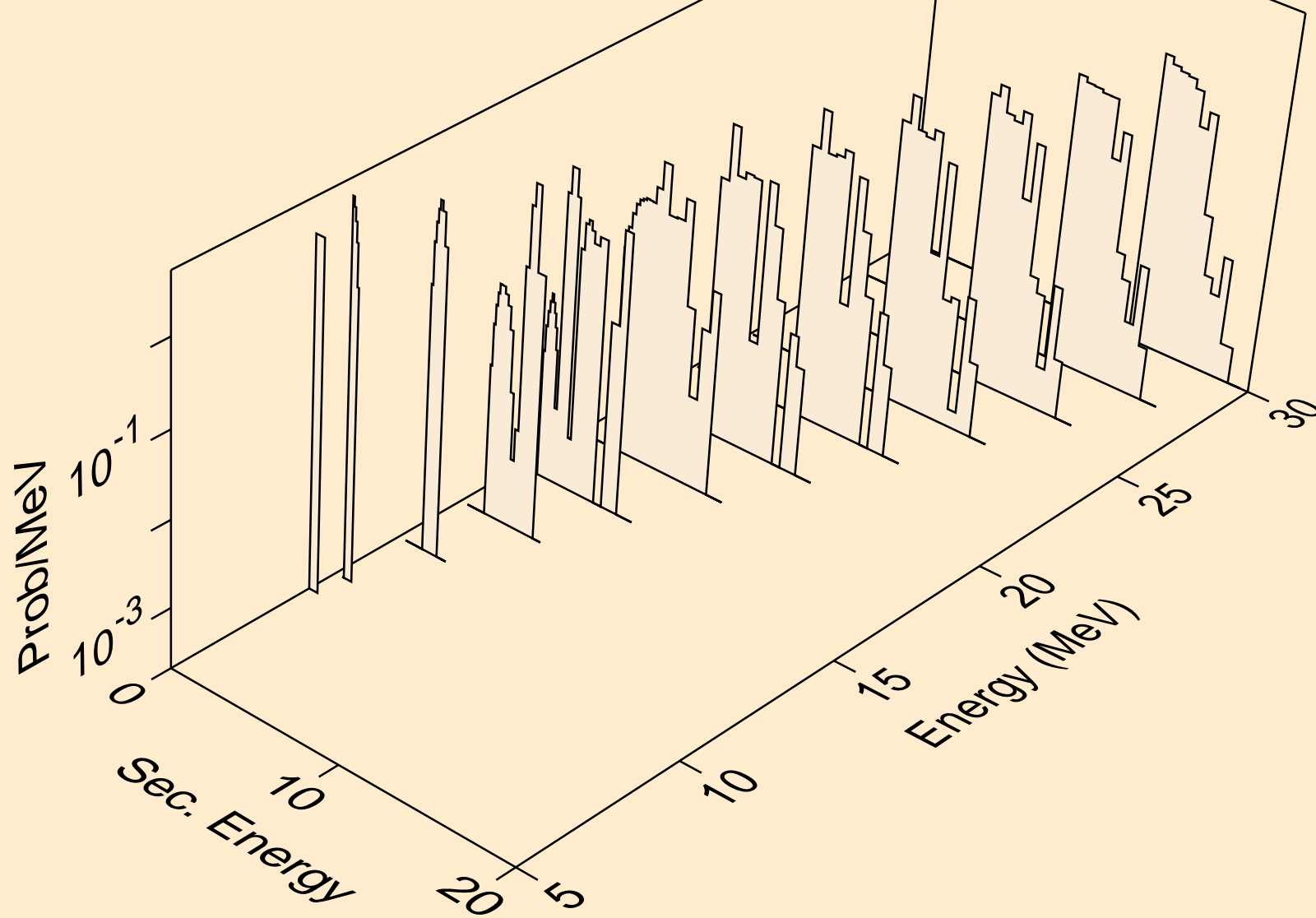

AR035 NEUTRON ACER TENDL-2024 LIBRARY; T=293.6K
tritons from (n,pt)

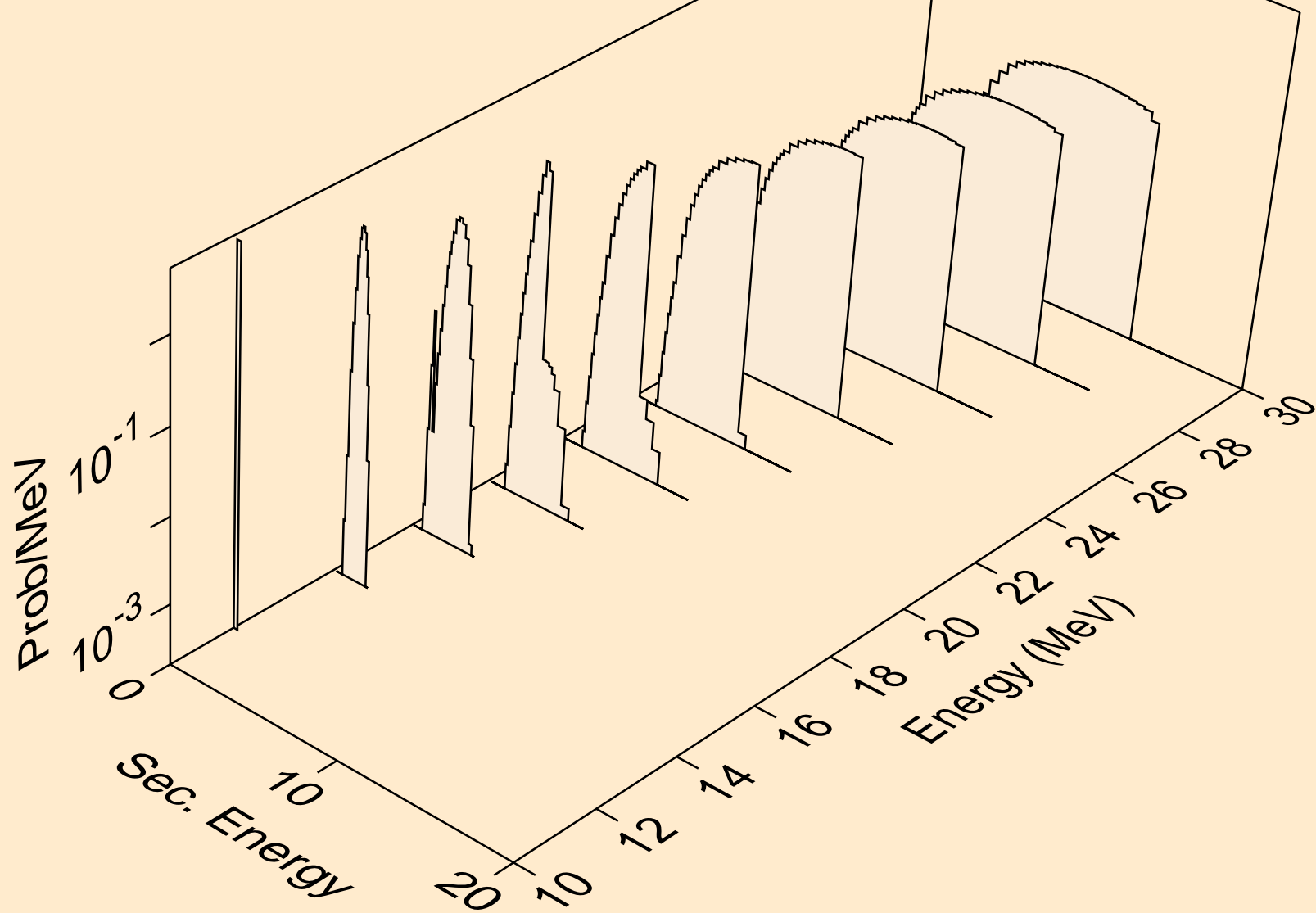

AR035 NEUTRON ACER TENDL-2024 LIBRARY; T=293.6K
he3s from (n,x)

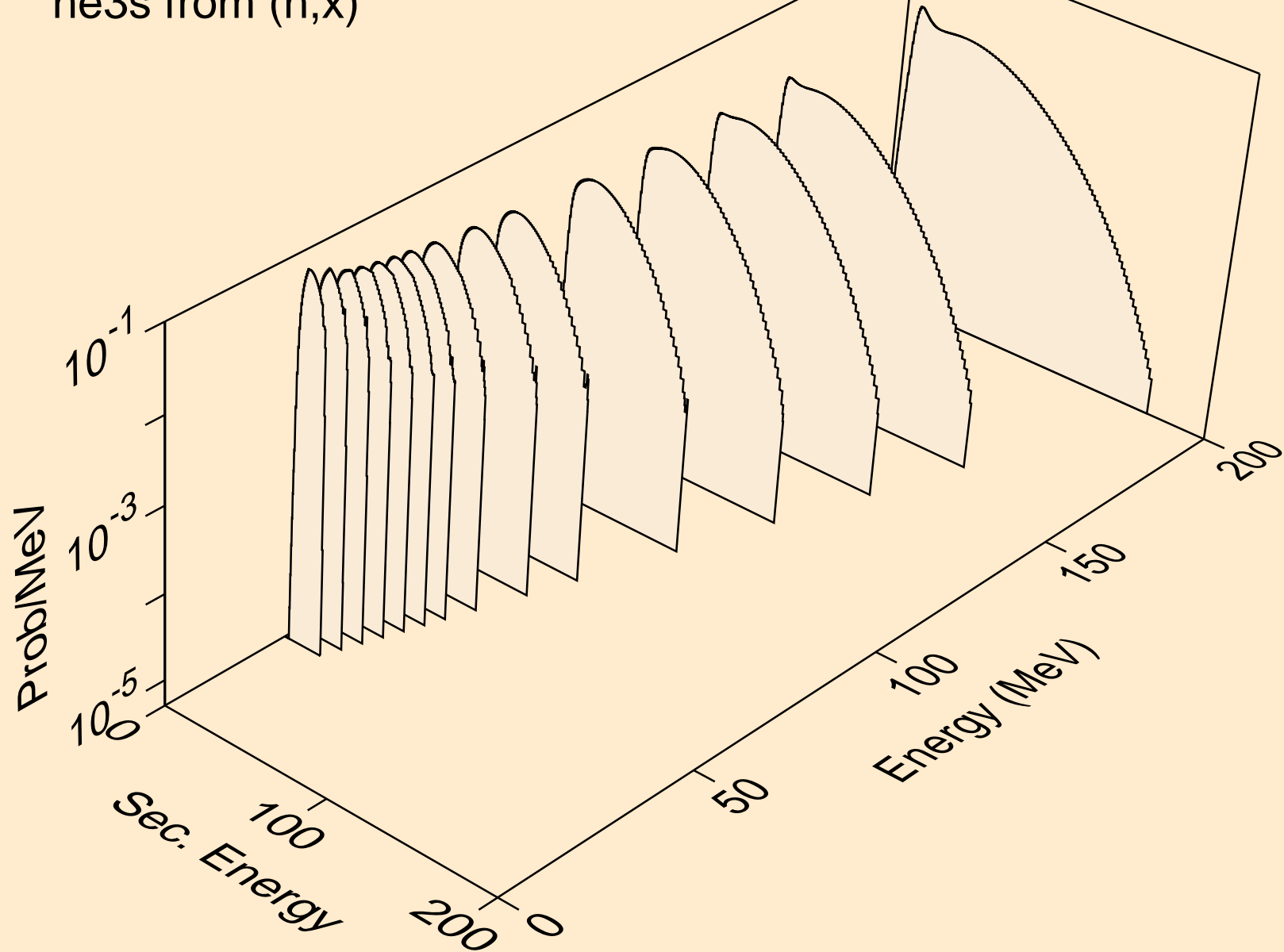

AR035 NEUTRON ACER TENDL-2024 LIBRARY; T=293.6K
he3s from (n,n*)he3

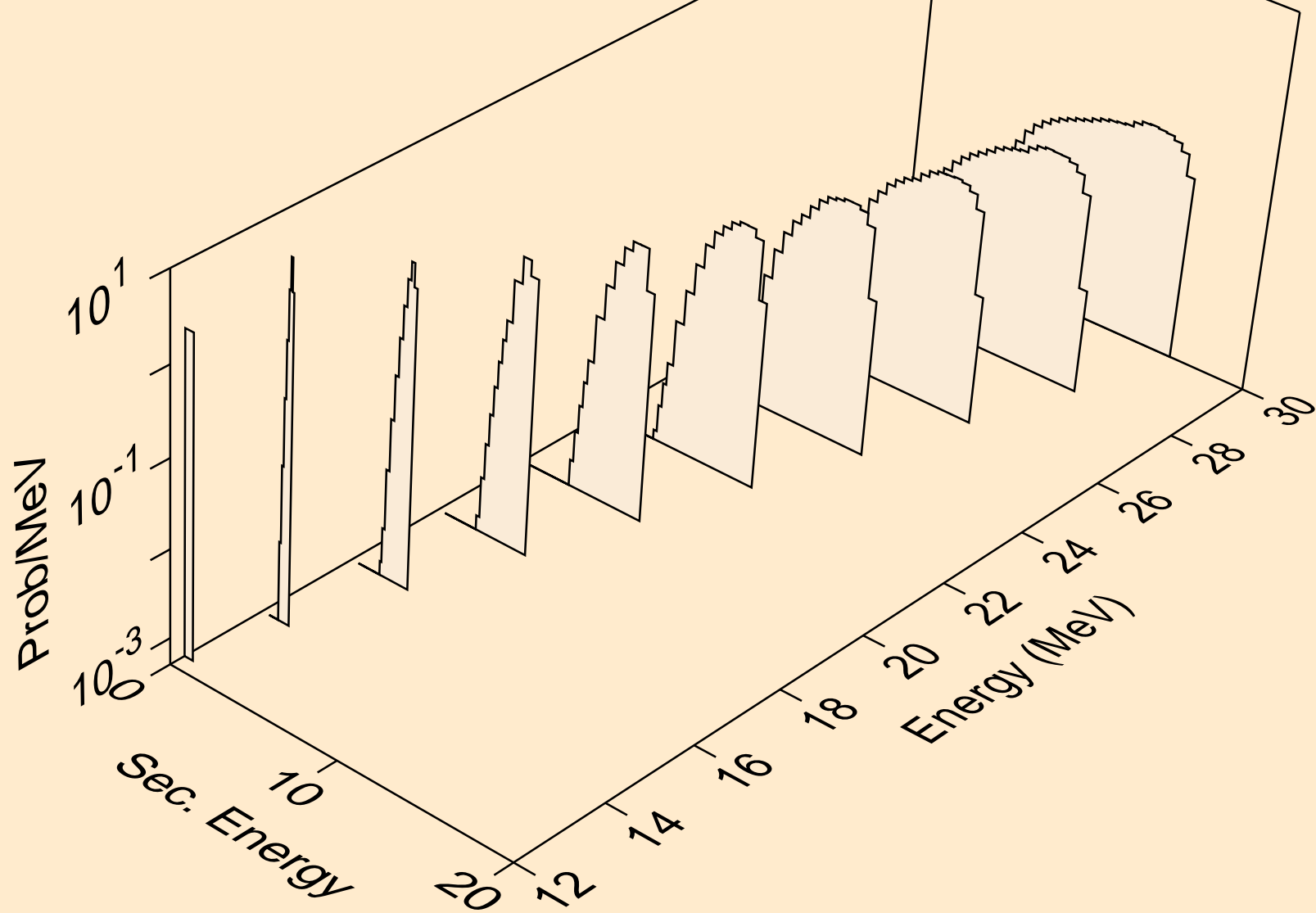

AR035 NEUTRON ACER TENDL-2024 LIBRARY; T=293.6K
he3s from (n,he3)

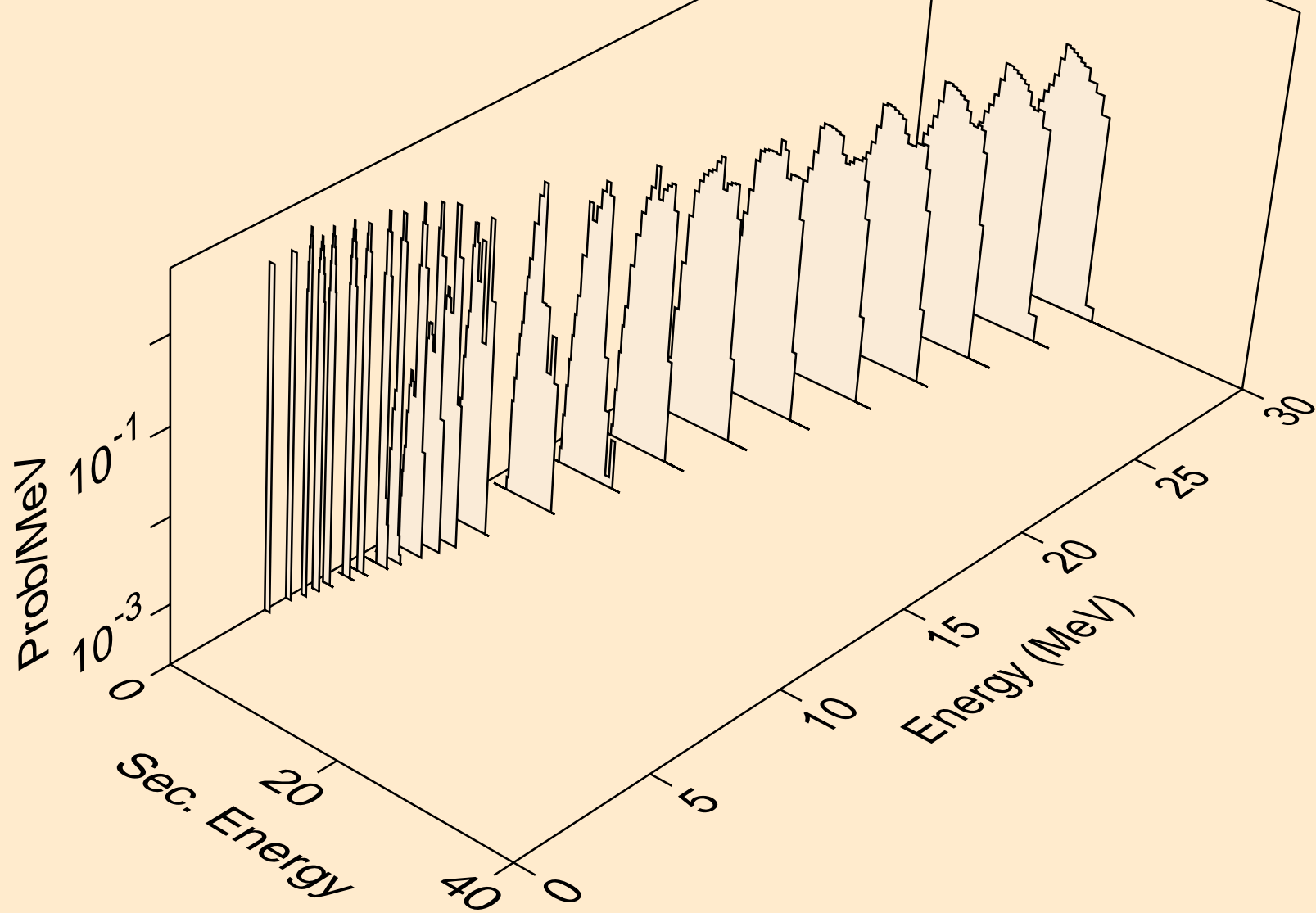

AR035 NEUTRON ACER TENDL-2024 LIBRARY; T=293.6K
alphas from (n,x)

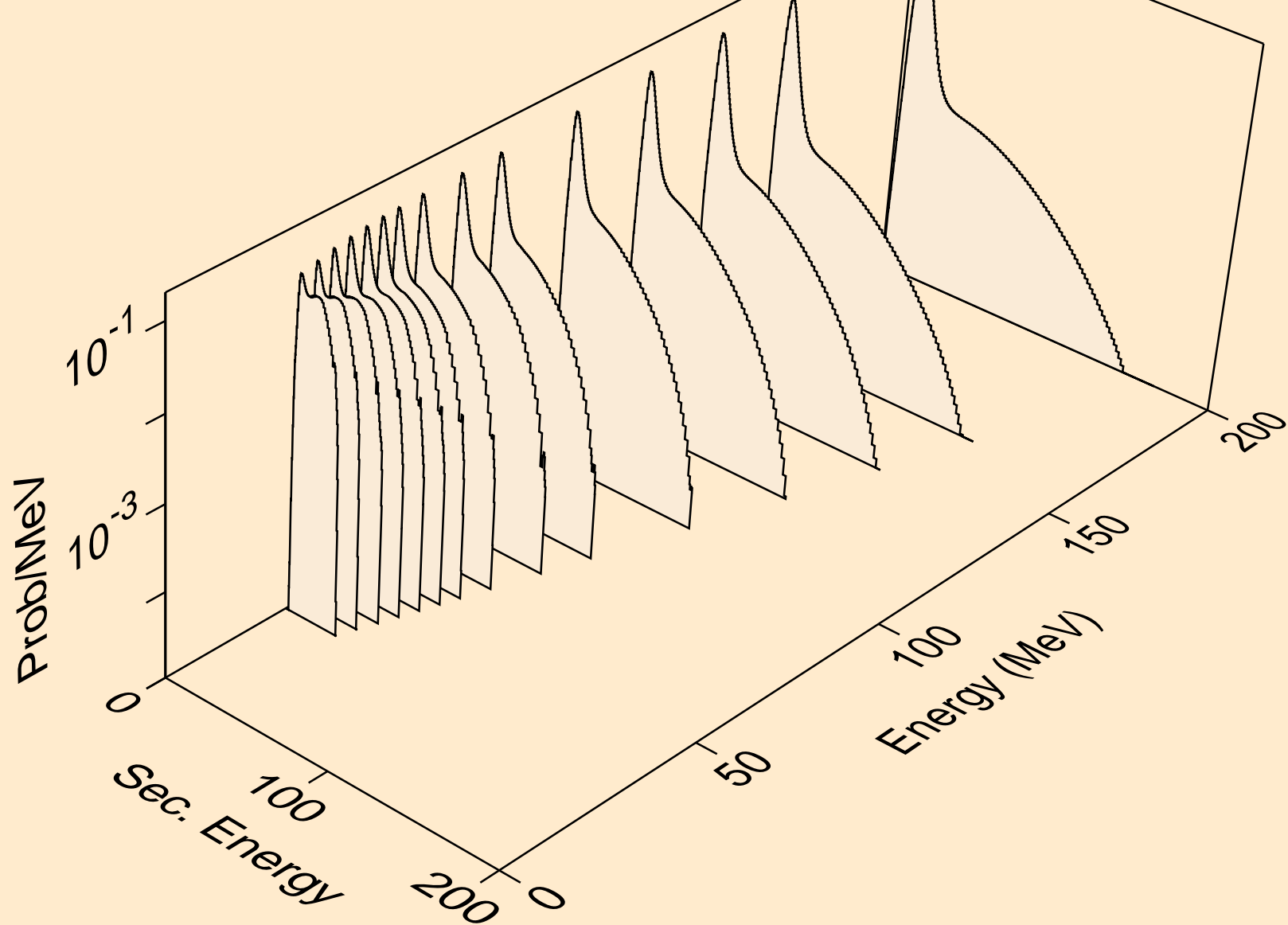

AR035 NEUTRON ACER TENDL-2024 LIBRARY; T=293.6K
alphas from (n,n*)a

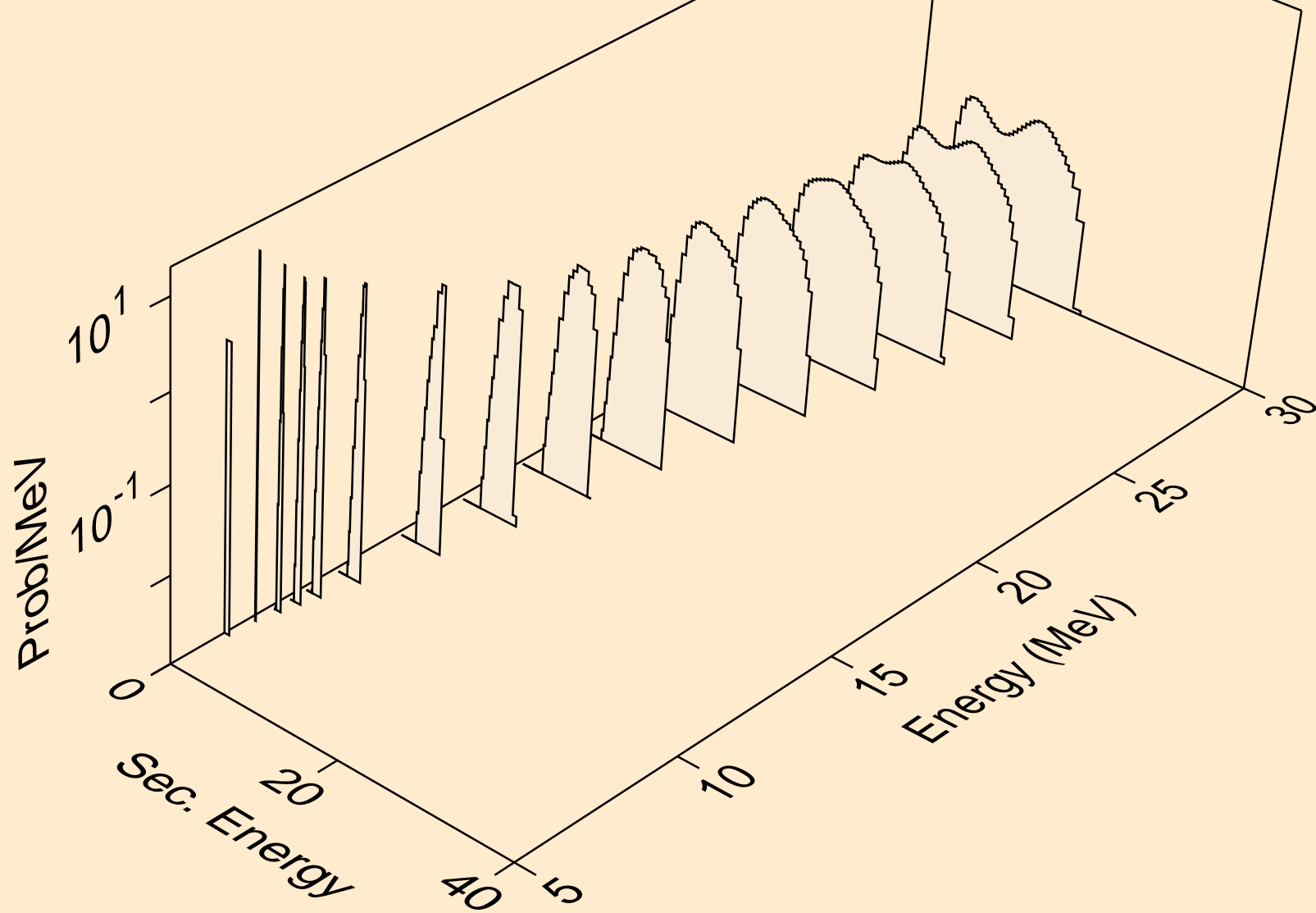

AR035 NEUTRON ACER TENDL-2024 LIBRARY; T=293.6K
alphas from (n,2n)a

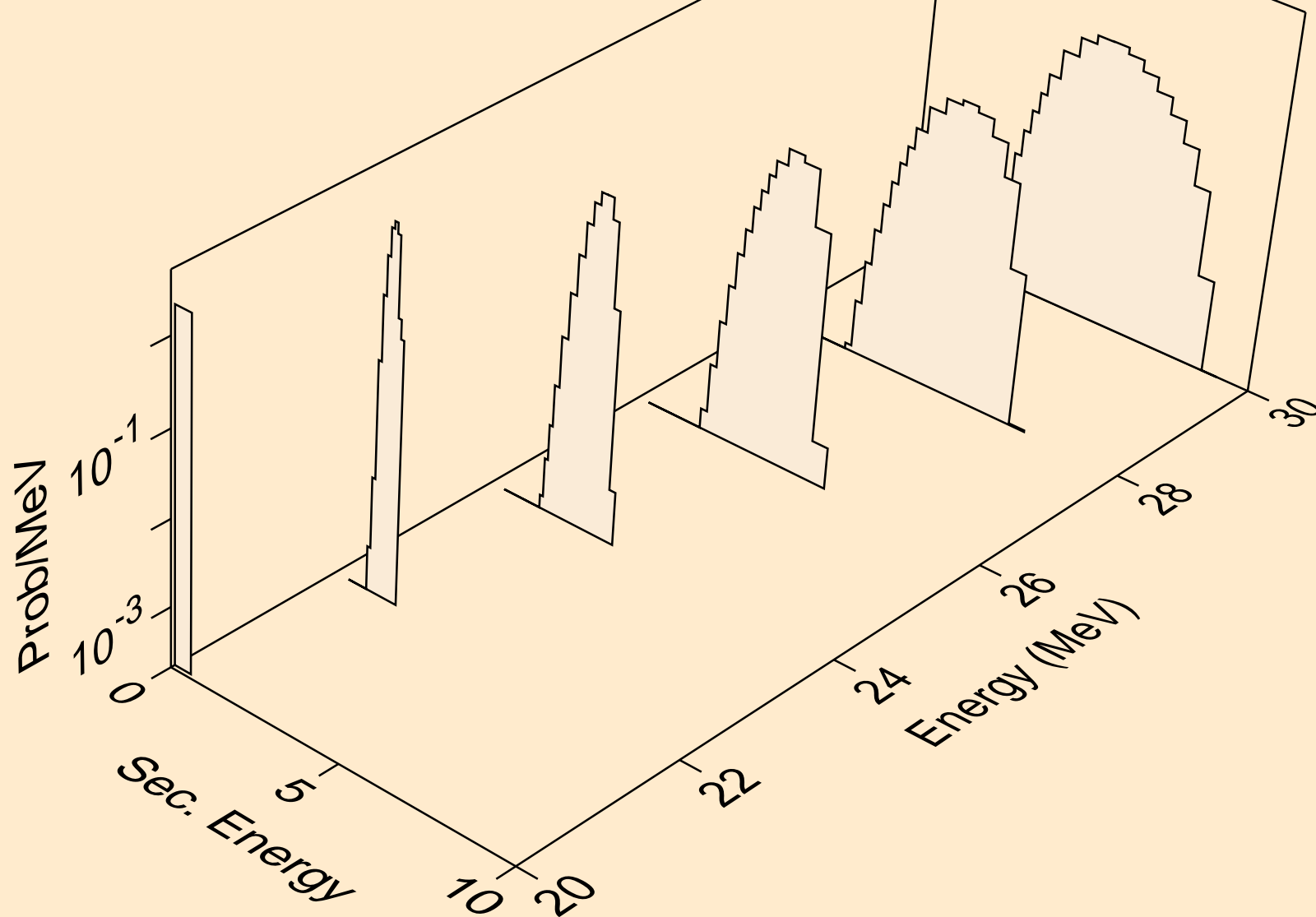

AR035 NEUTRON ACER TENDL-2024 LIBRARY; T=293.6K
alphas from (n,n*)2a

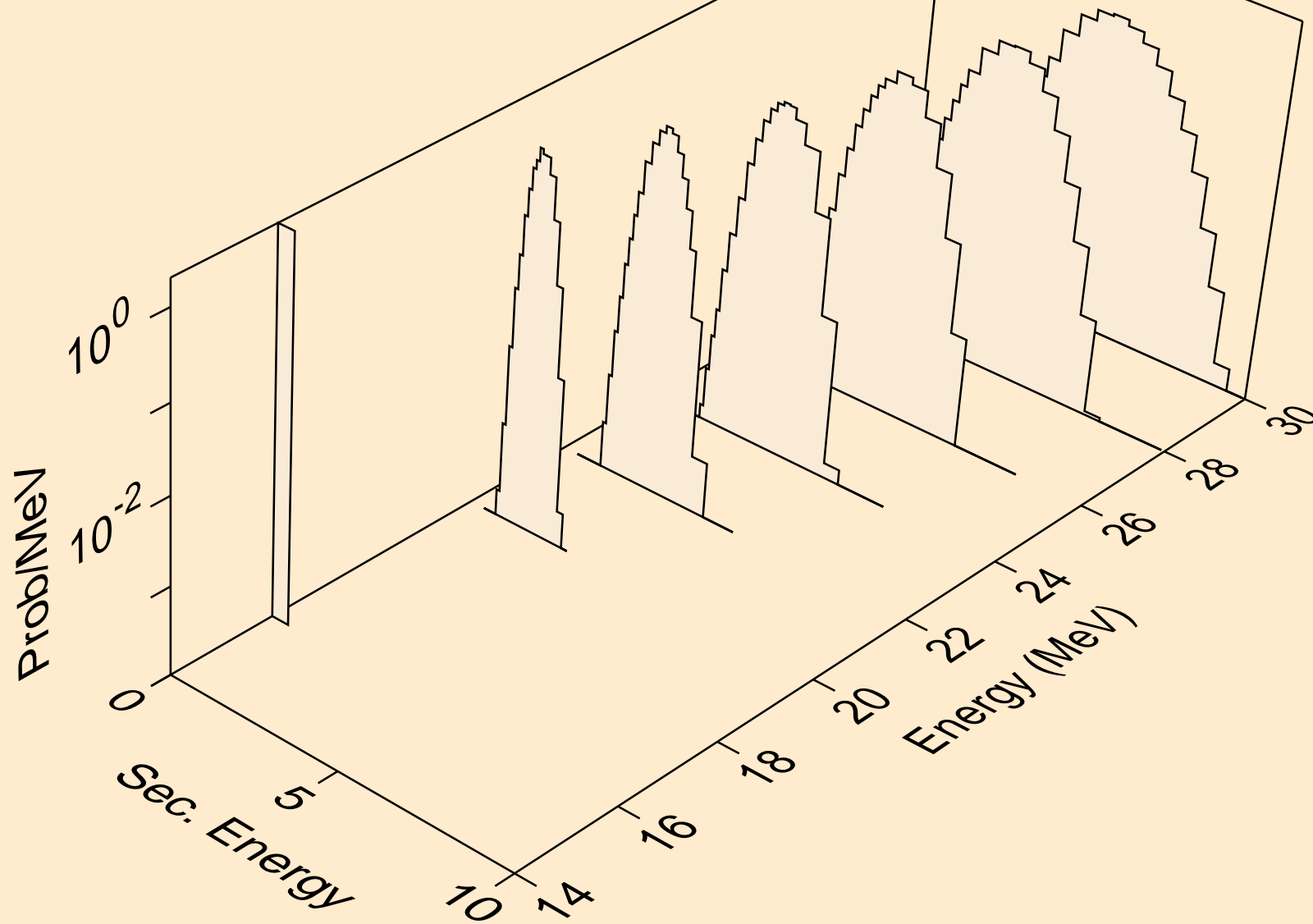

AR035 NEUTRON ACER TENDL-2024 LIBRARY; T=293.6K
alphas from (n,npa)

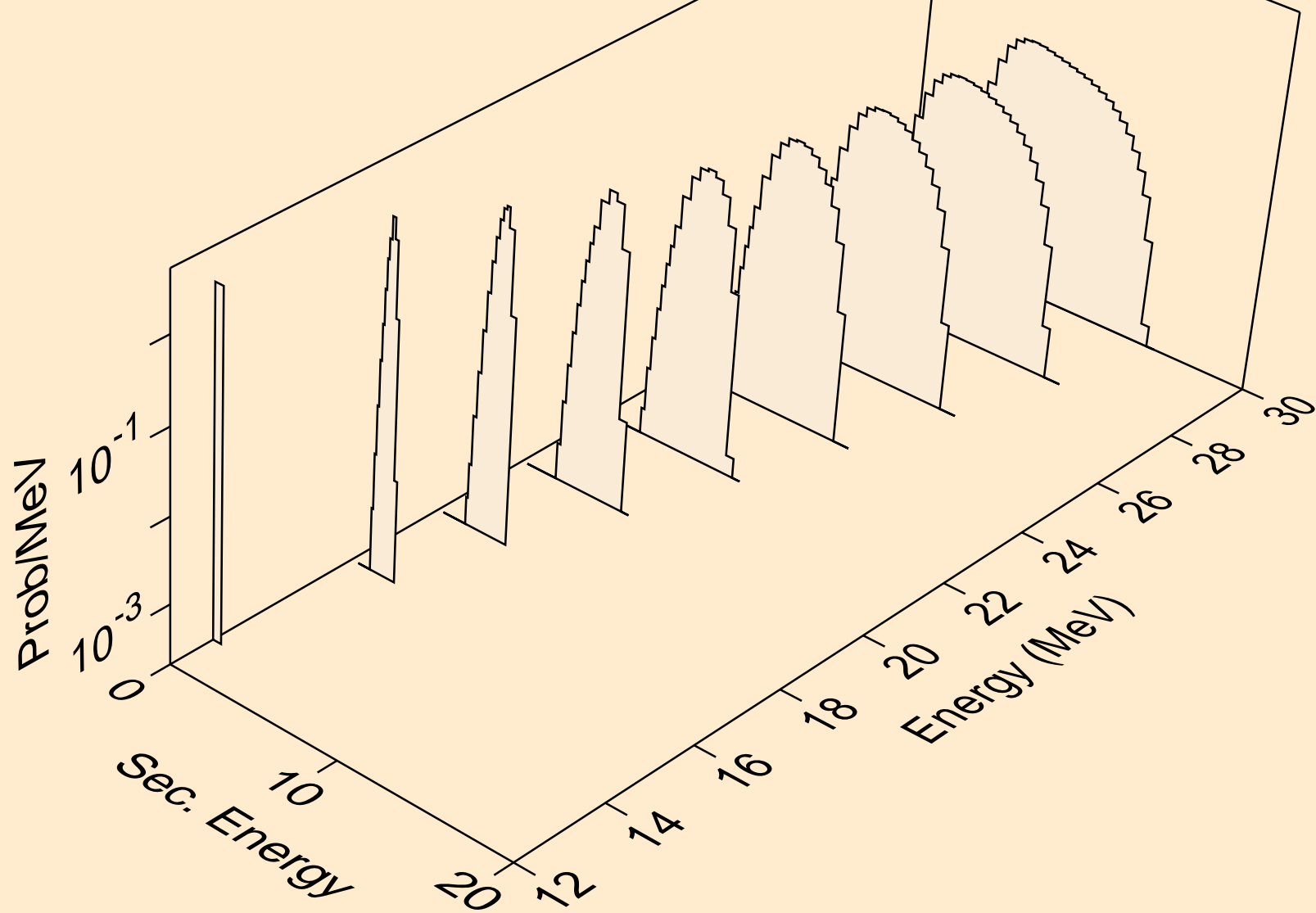

AR035 NEUTRON ACER TENDL-2024 LIBRARY; T=293.6K
alphas from (n,a)

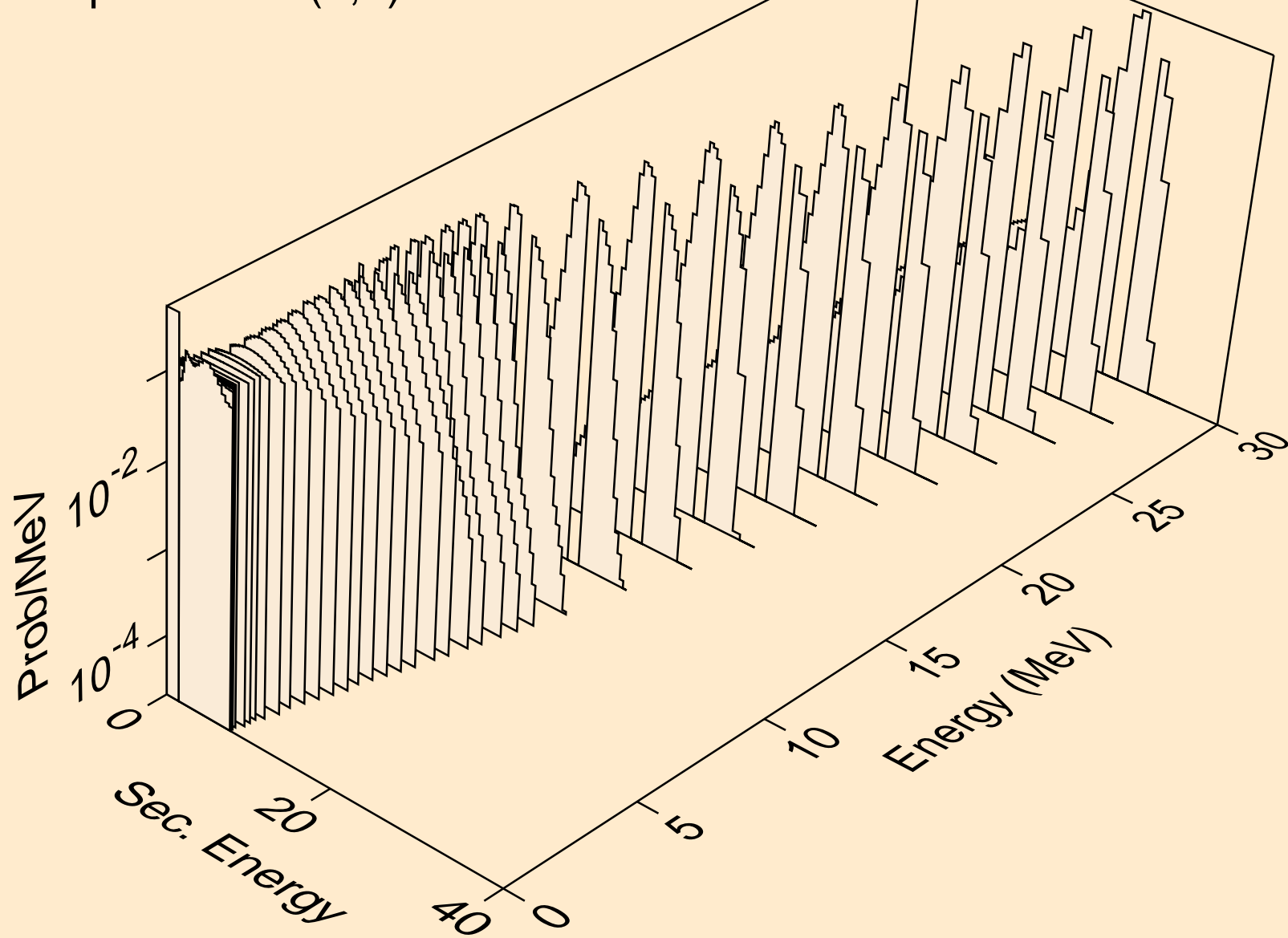

AR035 NEUTRON ACER TENDL-2024 LIBRARY; T=293.6K
alphas from (n,2a)

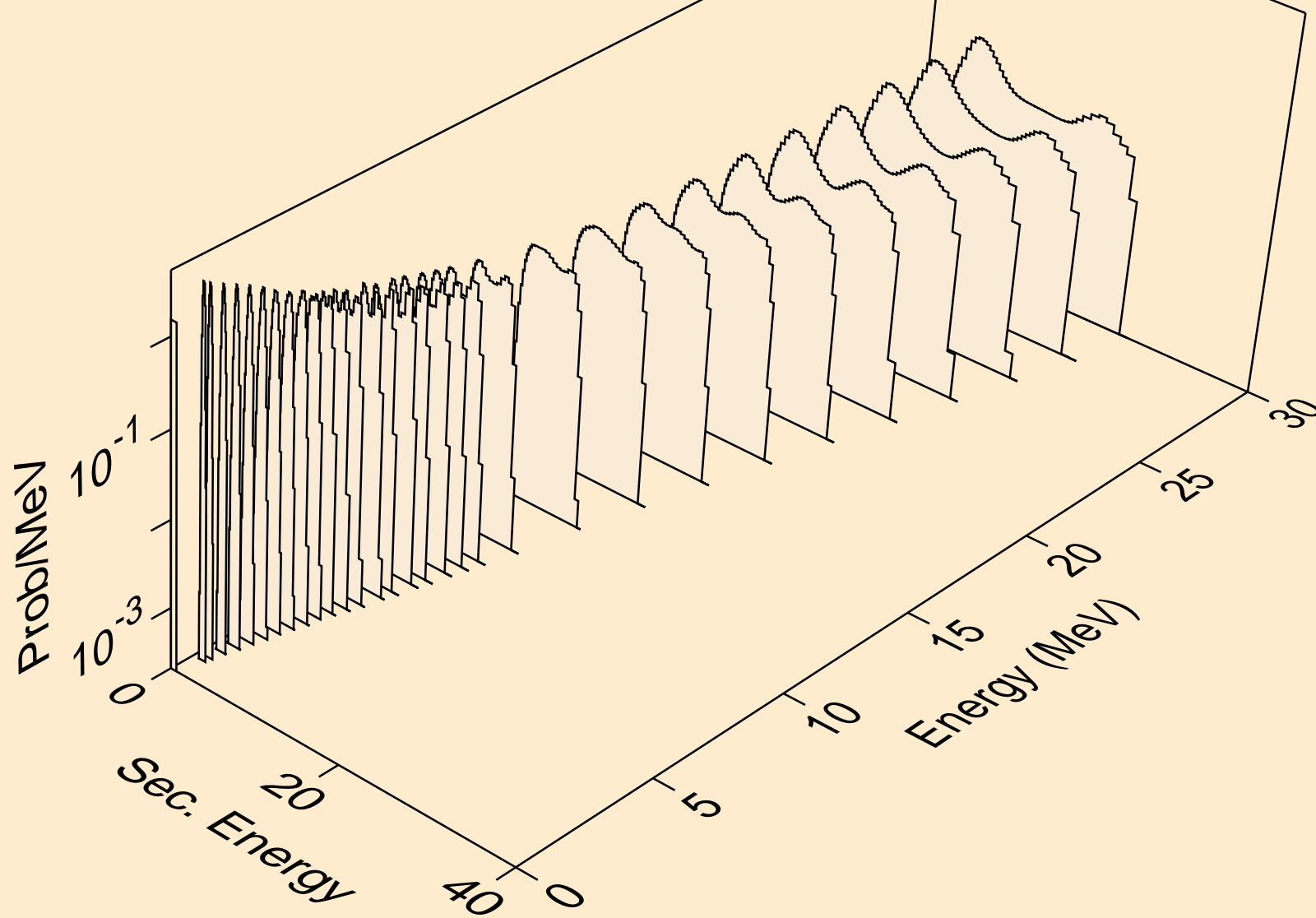

AR035 NEUTRON ACER TENDL-2024 LIBRARY; T=293.6K
alphas from (n,3a)

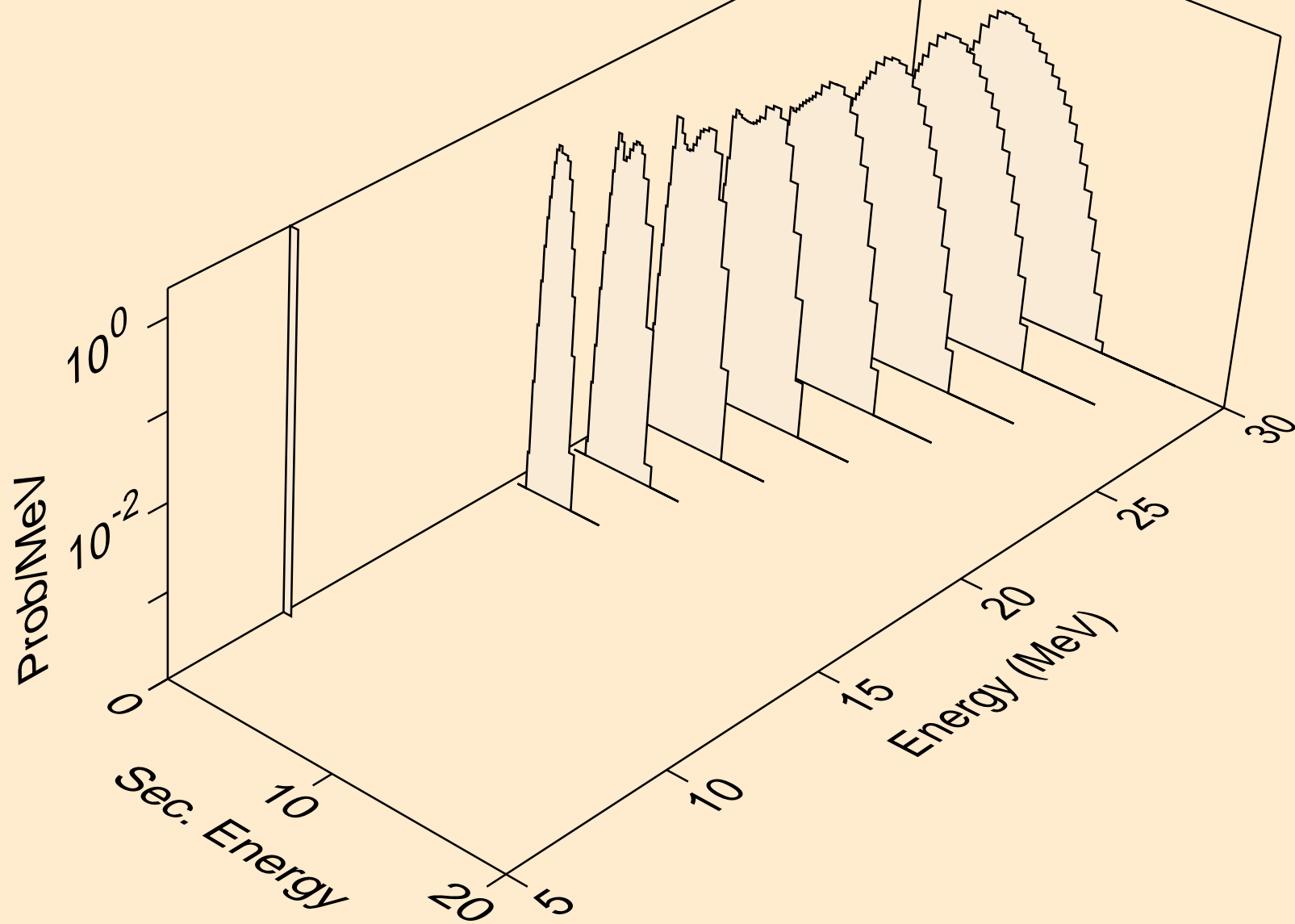

AR035 NEUTRON ACER TENDL-2024 LIBRARY; T=293.6K
alphas from (n,pa)

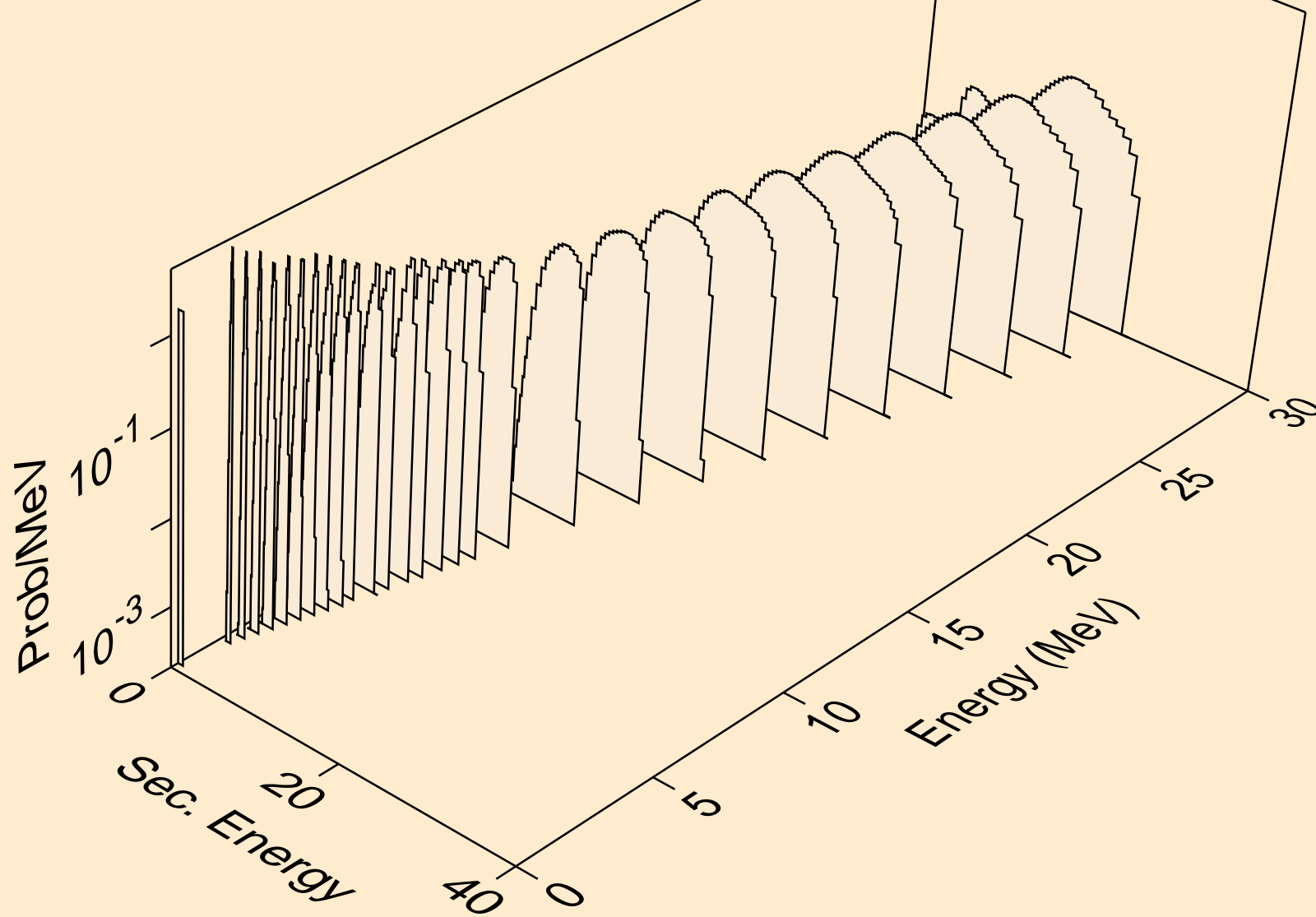

AR035 NEUTRON ACER TENDL-2024 LIBRARY; T=293.6K
alphas from (n,da)

